

TC088M NEUTRON ACER TENDL-2019 LIBRARY; T=293.16K  
Principal cross sections

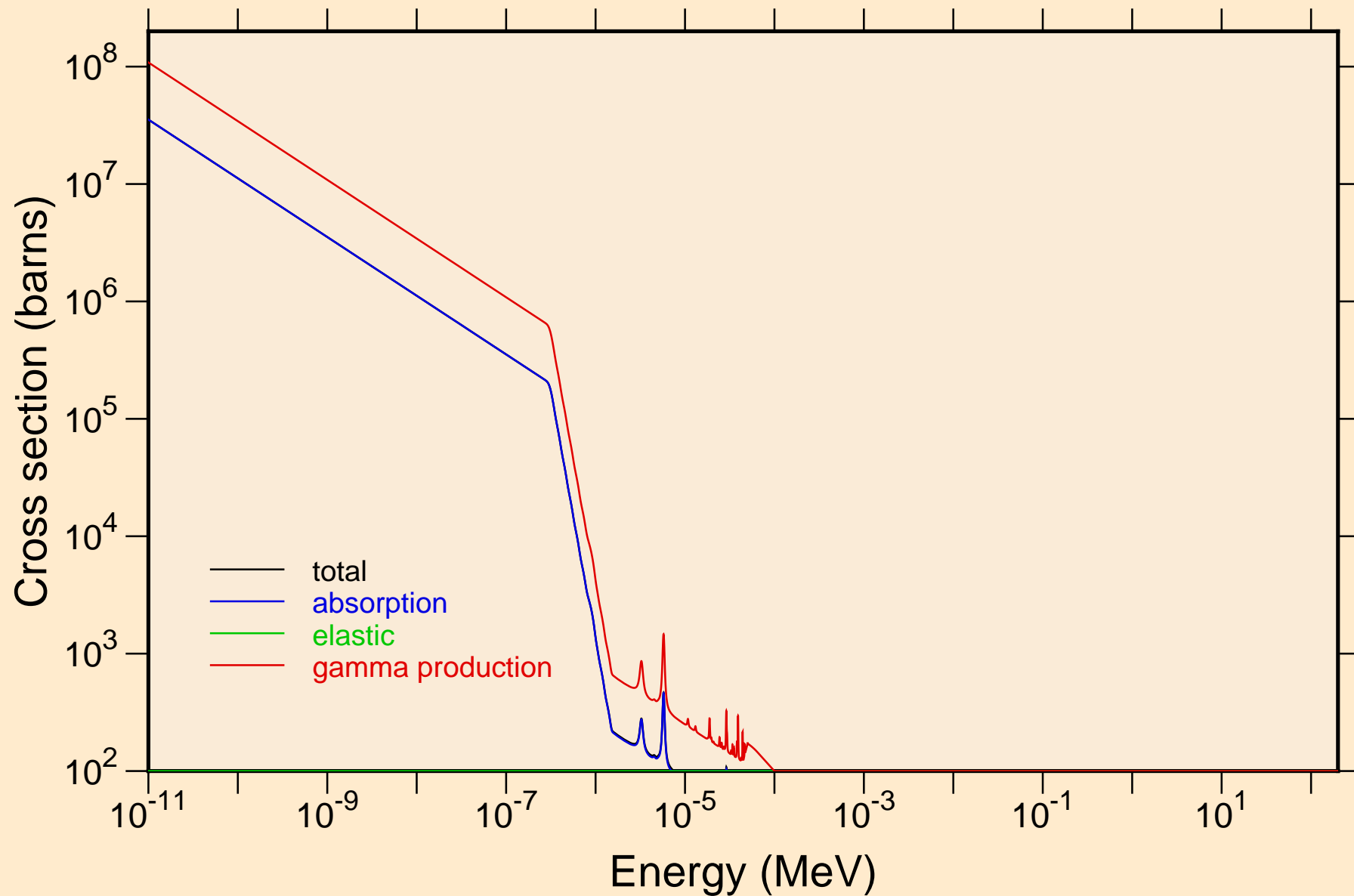

TC088M NEUTRON ACER TENDL-2019 LIBRARY; T=293.16K  
resonance total cross section

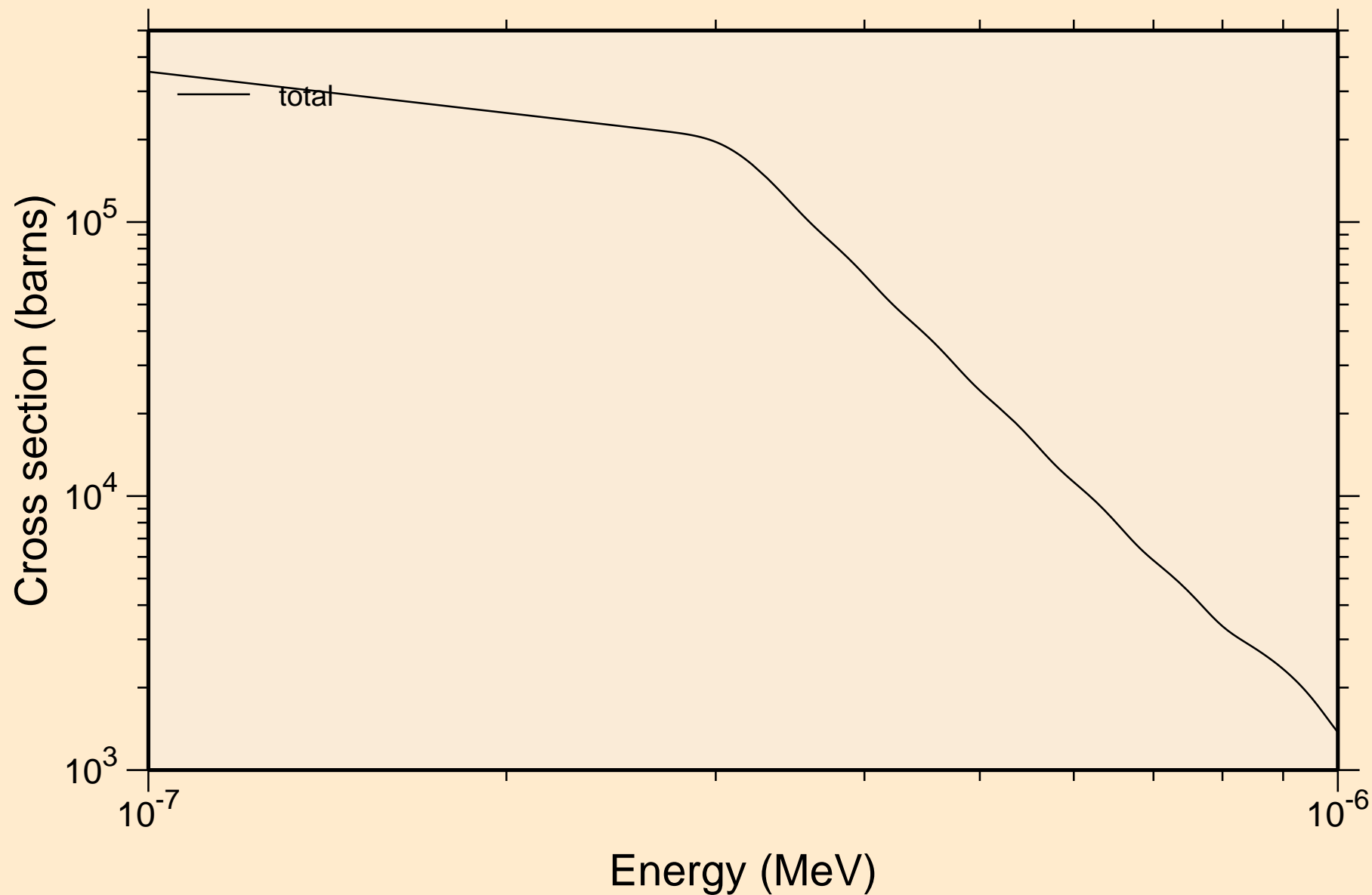

TC088M NEUTRON ACER TENDL-2019 LIBRARY; T=293.16K  
resonance total cross section

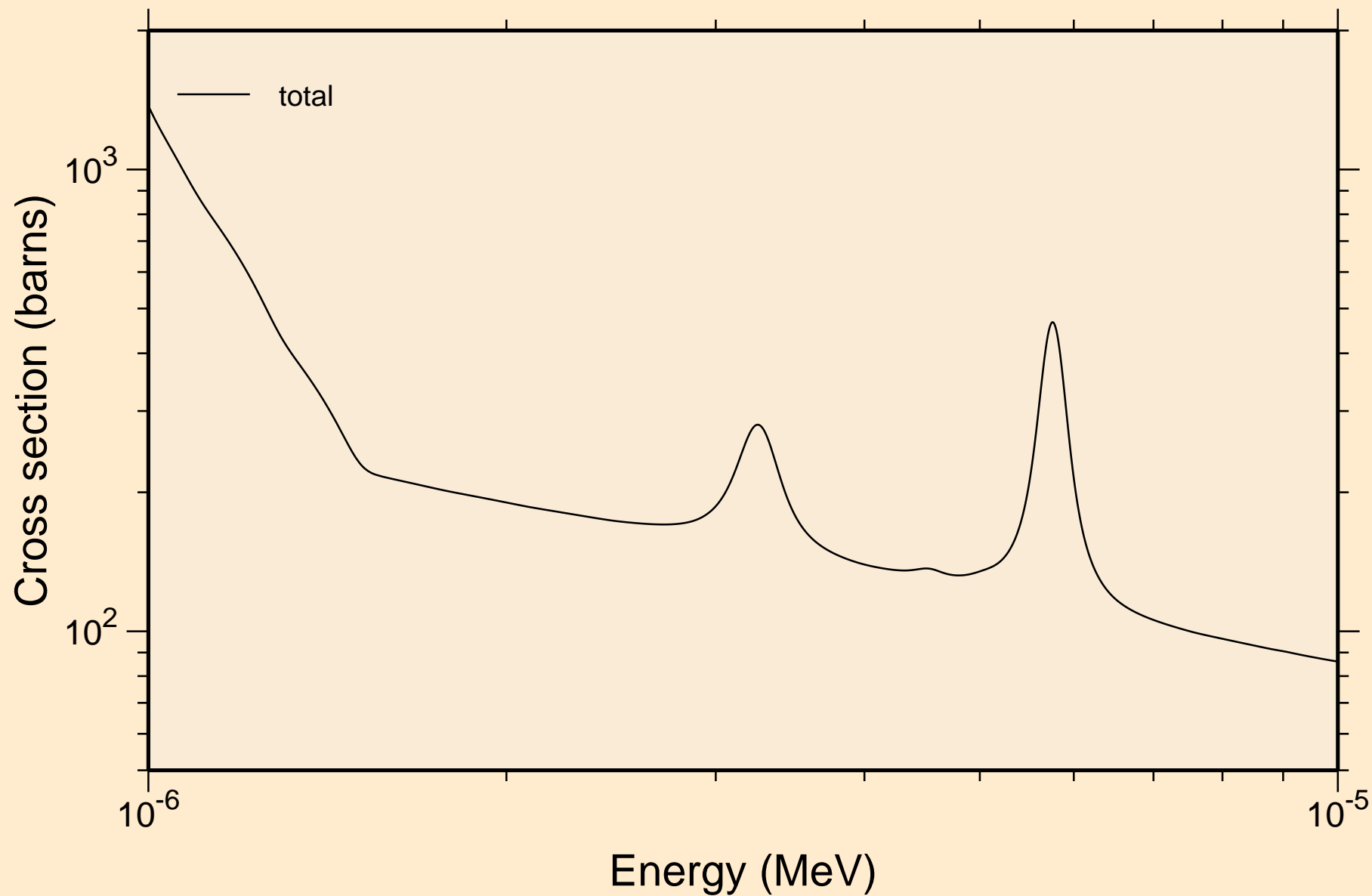

TC088M NEUTRON ACER TENDL-2019 LIBRARY; T=293.16K  
resonance total cross section

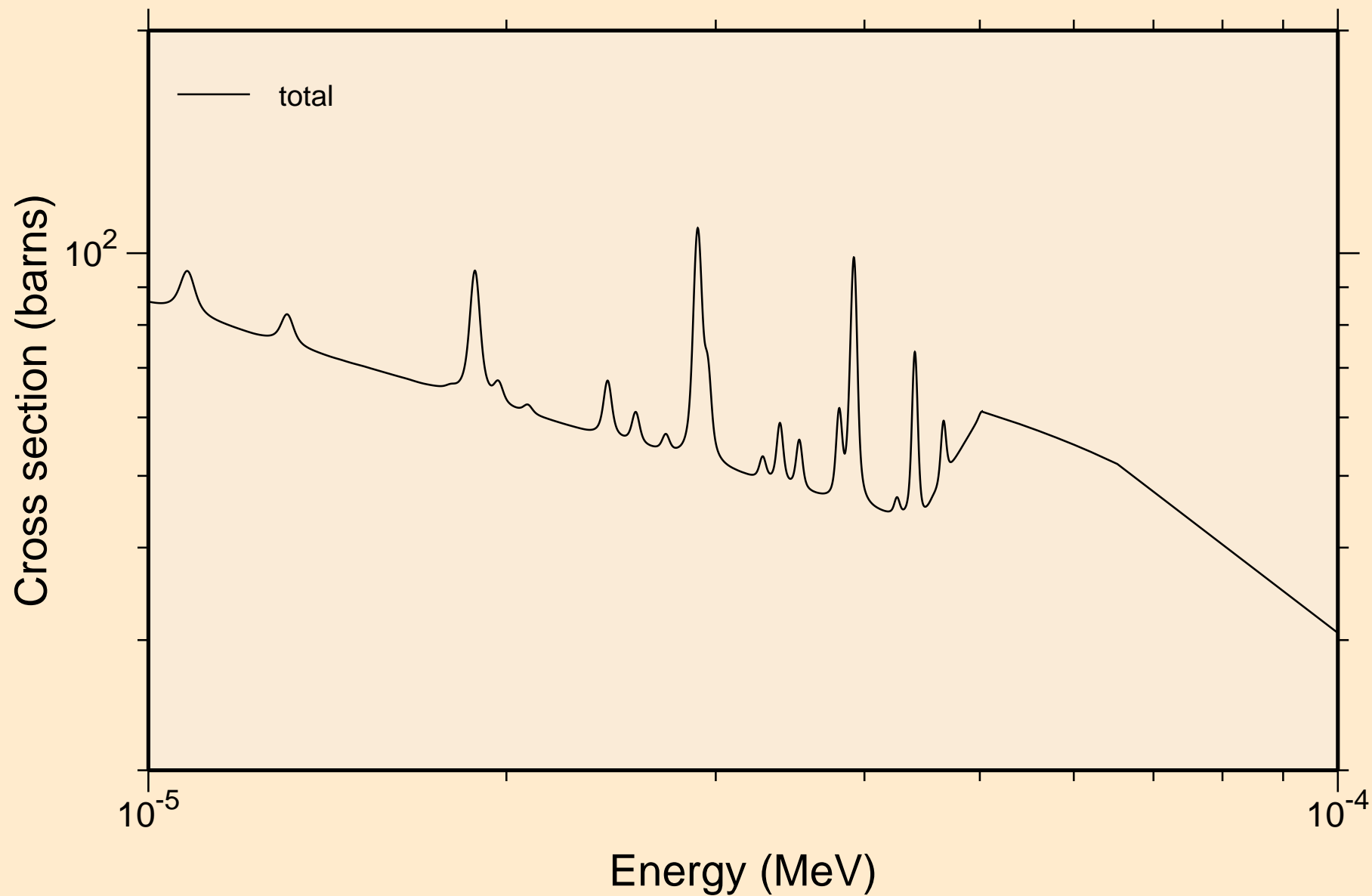

T̄C088M NEUTRON ACER TENDL-2019 LIBRARY; T=293.16K  
resonance total cross section

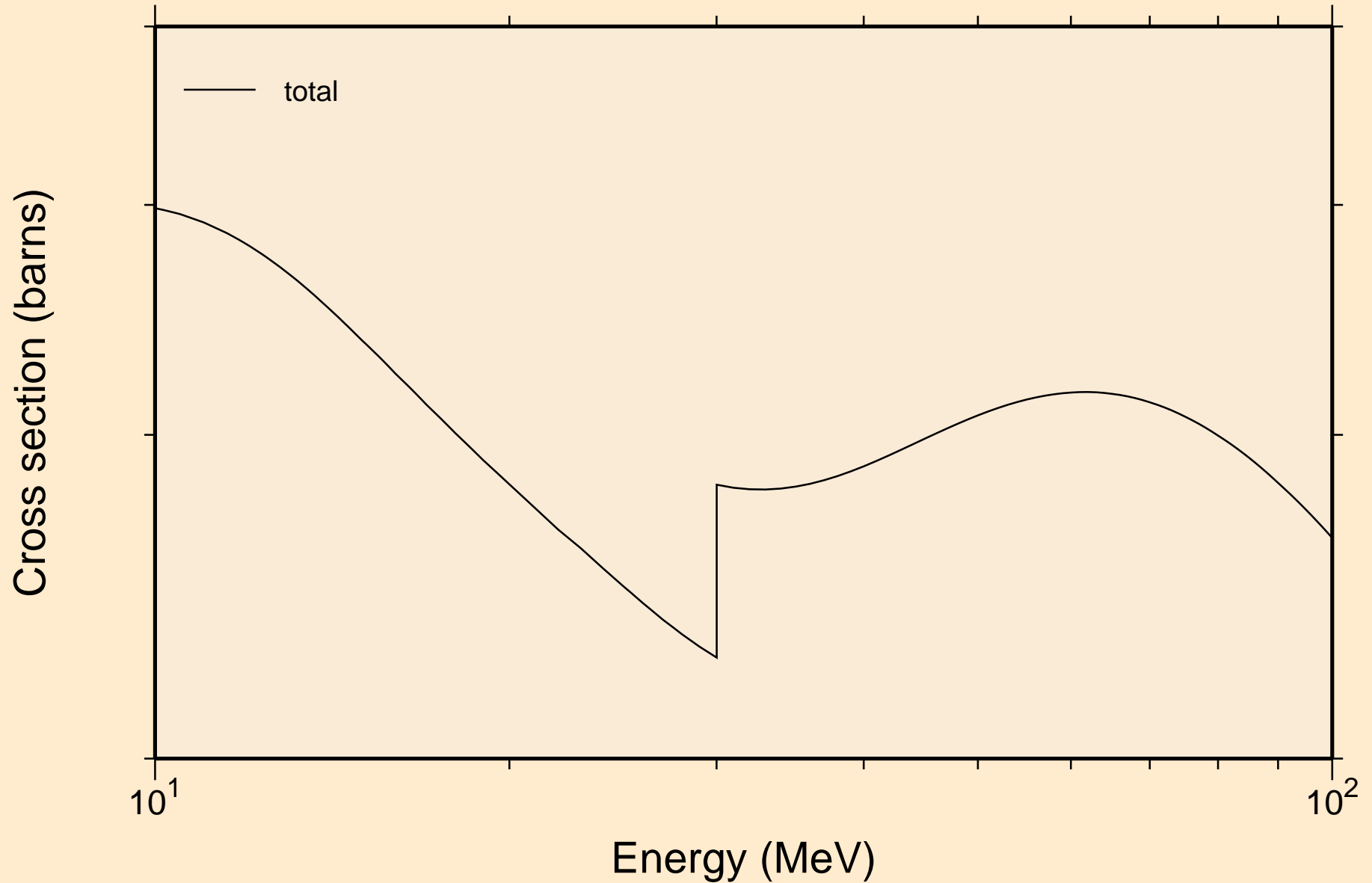

TC088M NEUTRON ACER TENDL-2019 LIBRARY; T=293.16K  
resonance absorption cross sections

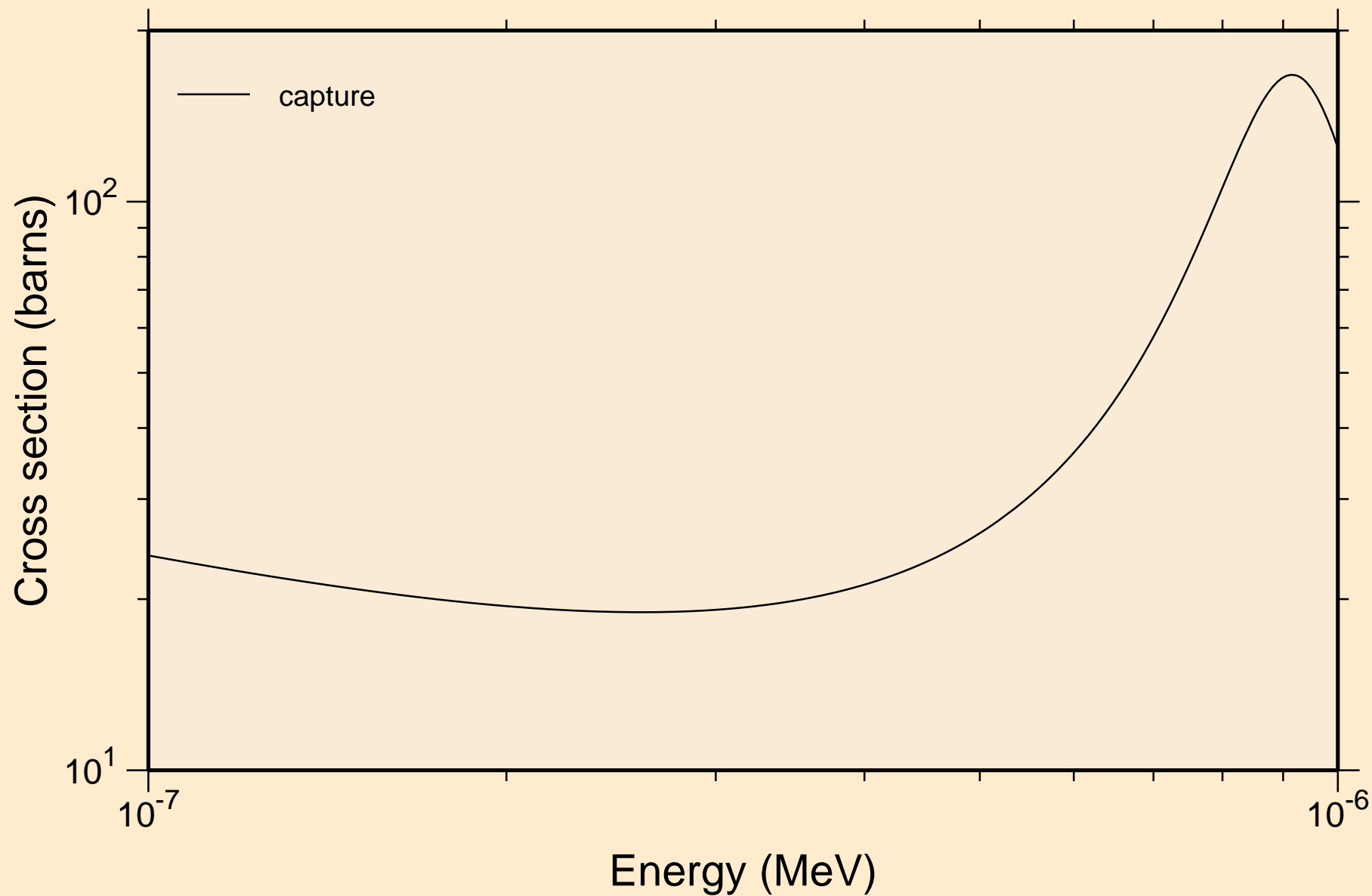

TC088M NEUTRON ACER TENDL-2019 LIBRARY; T=293.16K  
resonance absorption cross sections

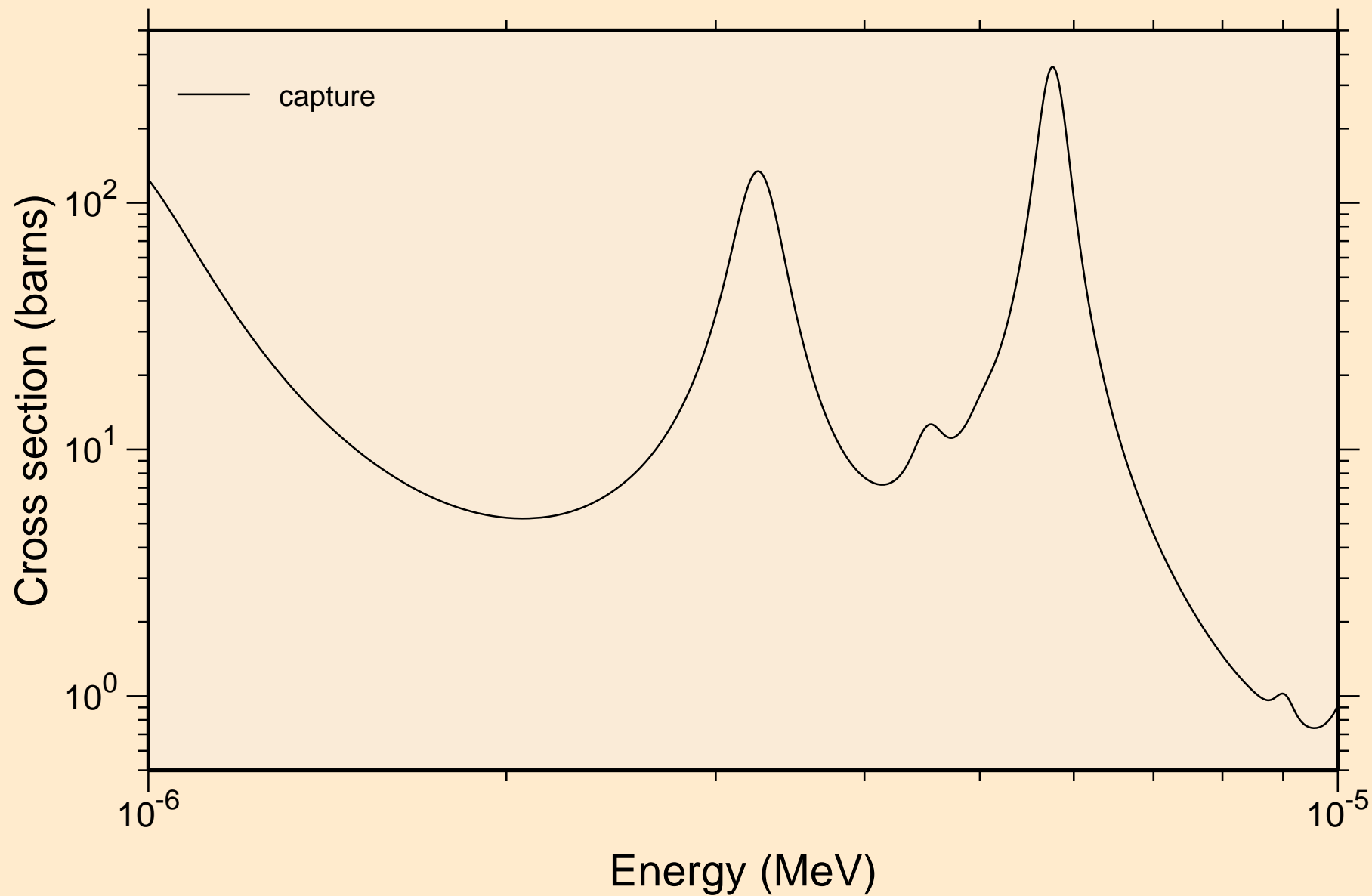

TC088M NEUTRON ACER TENDL-2019 LIBRARY; T=293.16K  
resonance absorption cross sections

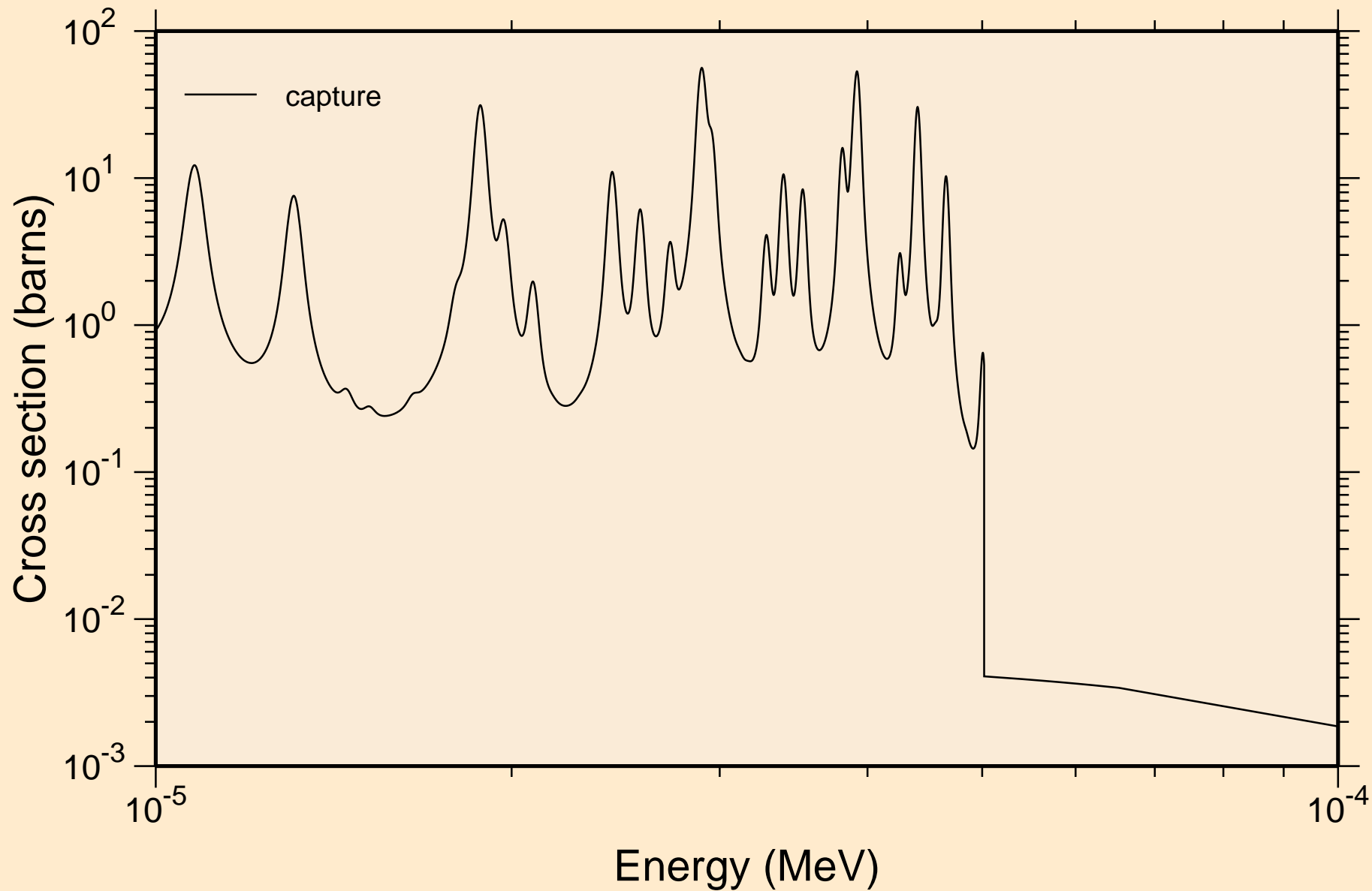



TC088M NEUTRON ACER TENDL-2019 LIBRARY; T=293.16K  
resonance absorption cross sections

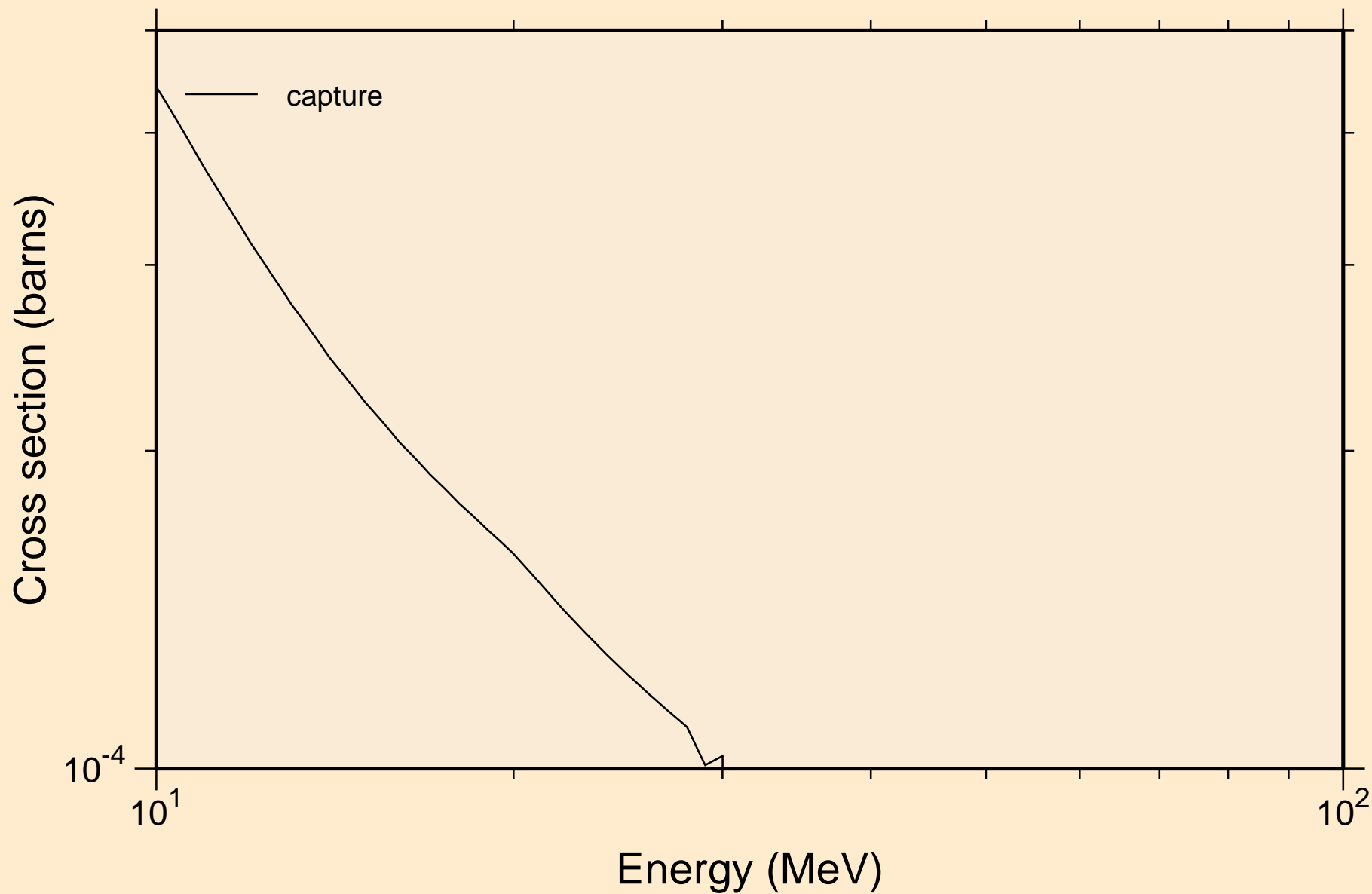

TC088M NEUTRON ACER TENDL-2019 LIBRARY; T=293.16K  
Heating

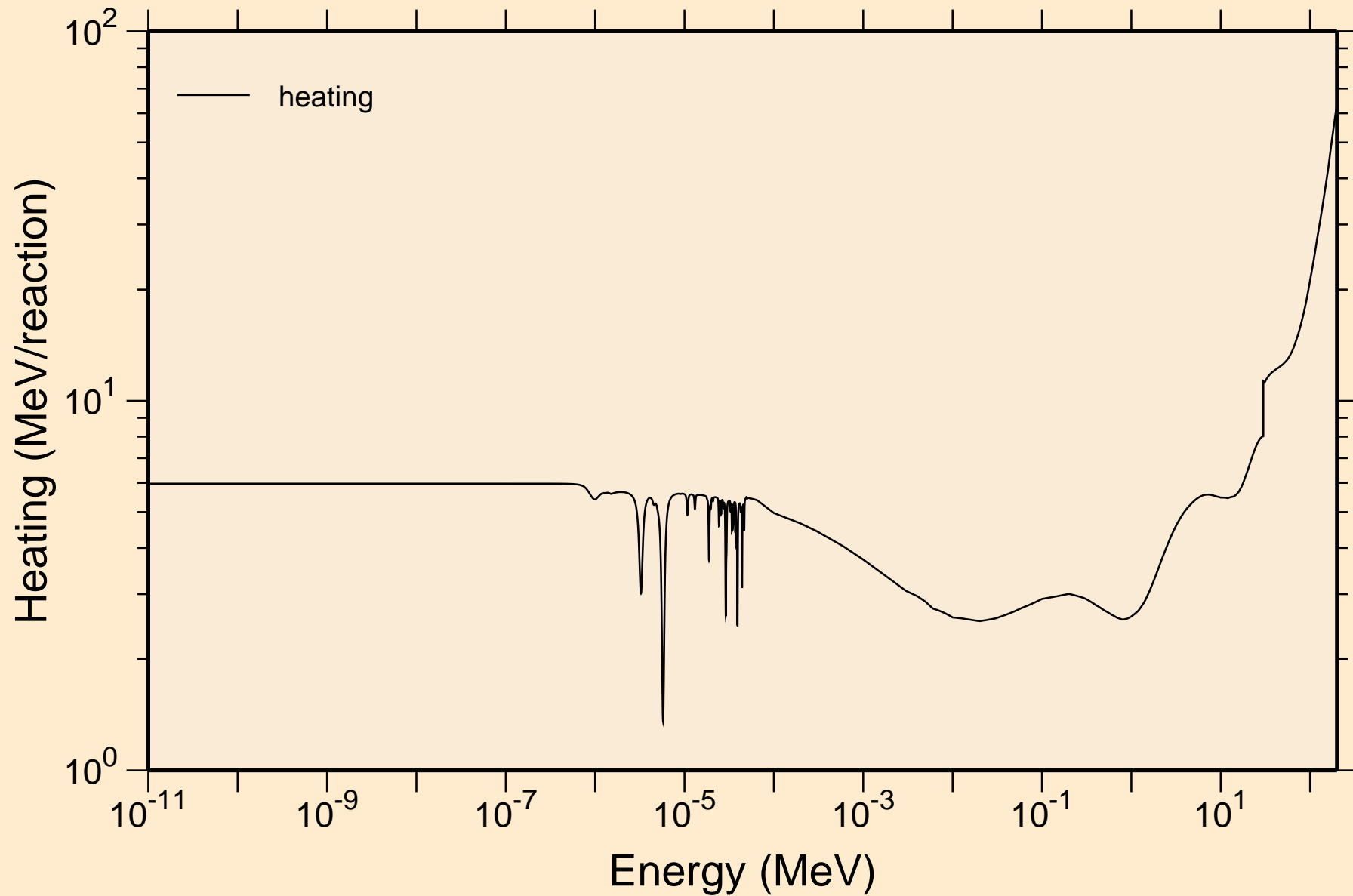

TC088M NEUTRON ACER TENDL-2019 LIBRARY; T=293.16K  
Damage

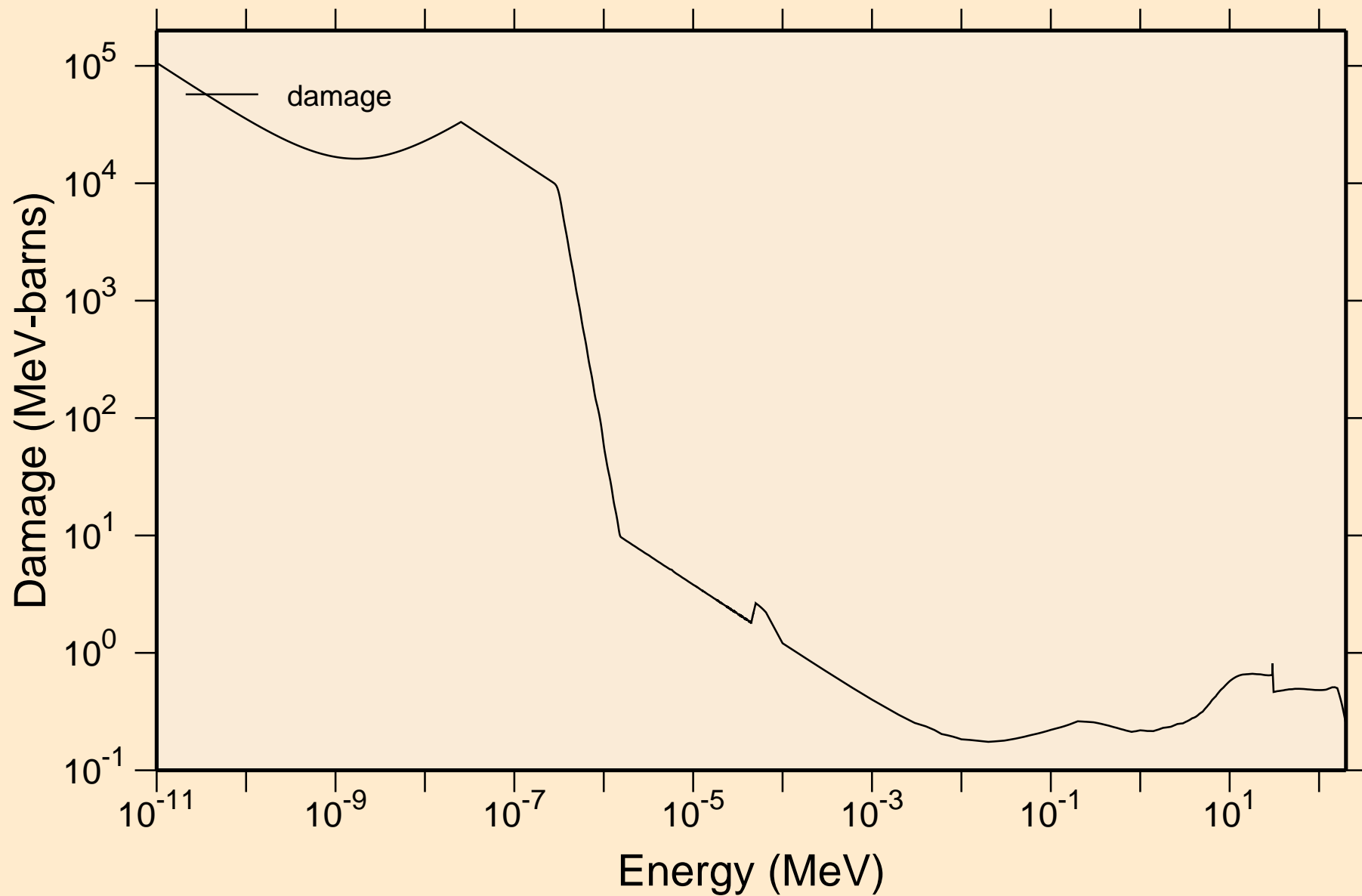

TC088M NEUTRON ACER TENDL-2019 LIBRARY; T=293.16K  
Non-threshold reactions

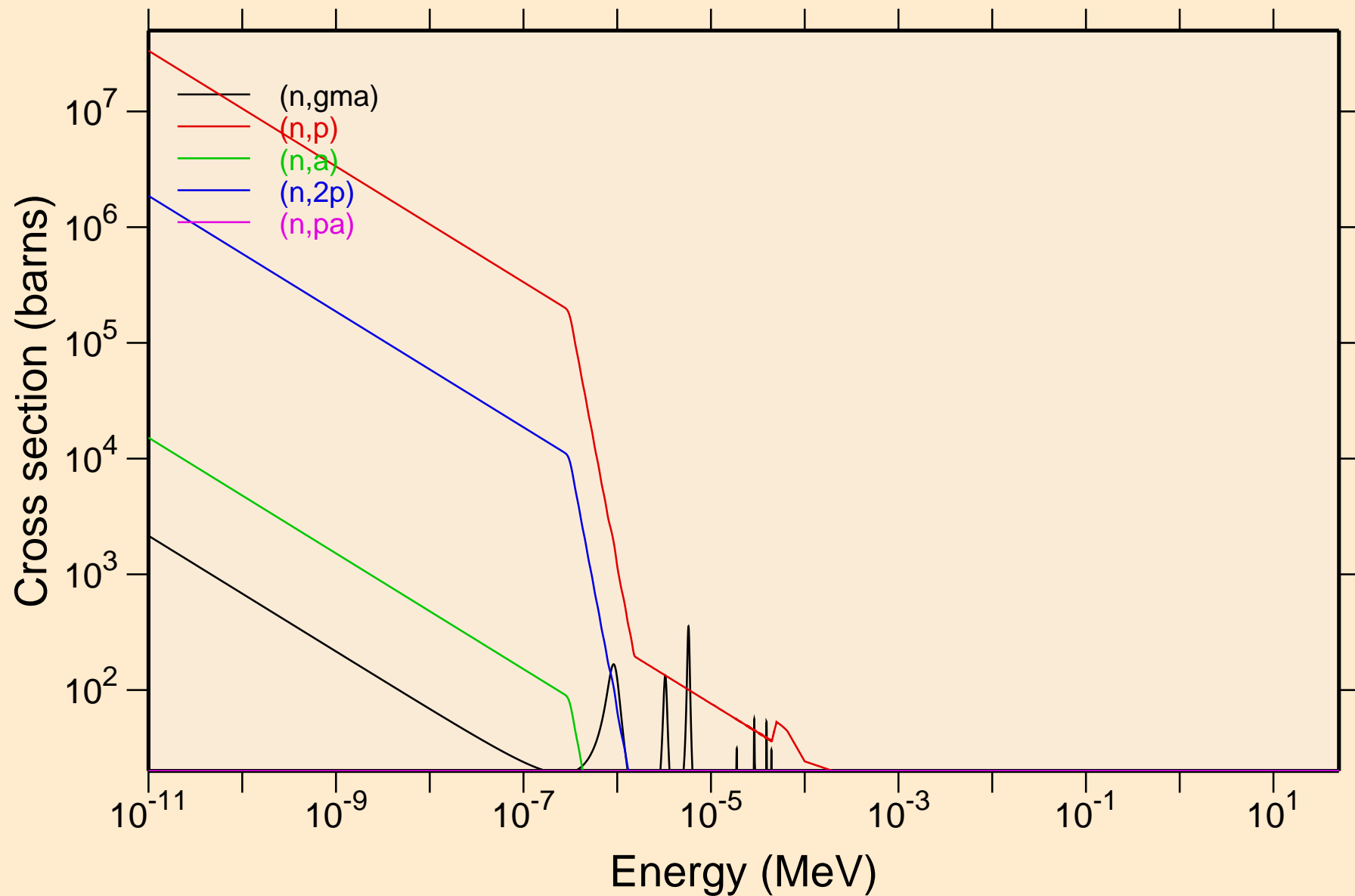

TC088M NEUTRON ACER TENDL-2019 LIBRARY; T=293.16K  
Non-threshold reactions

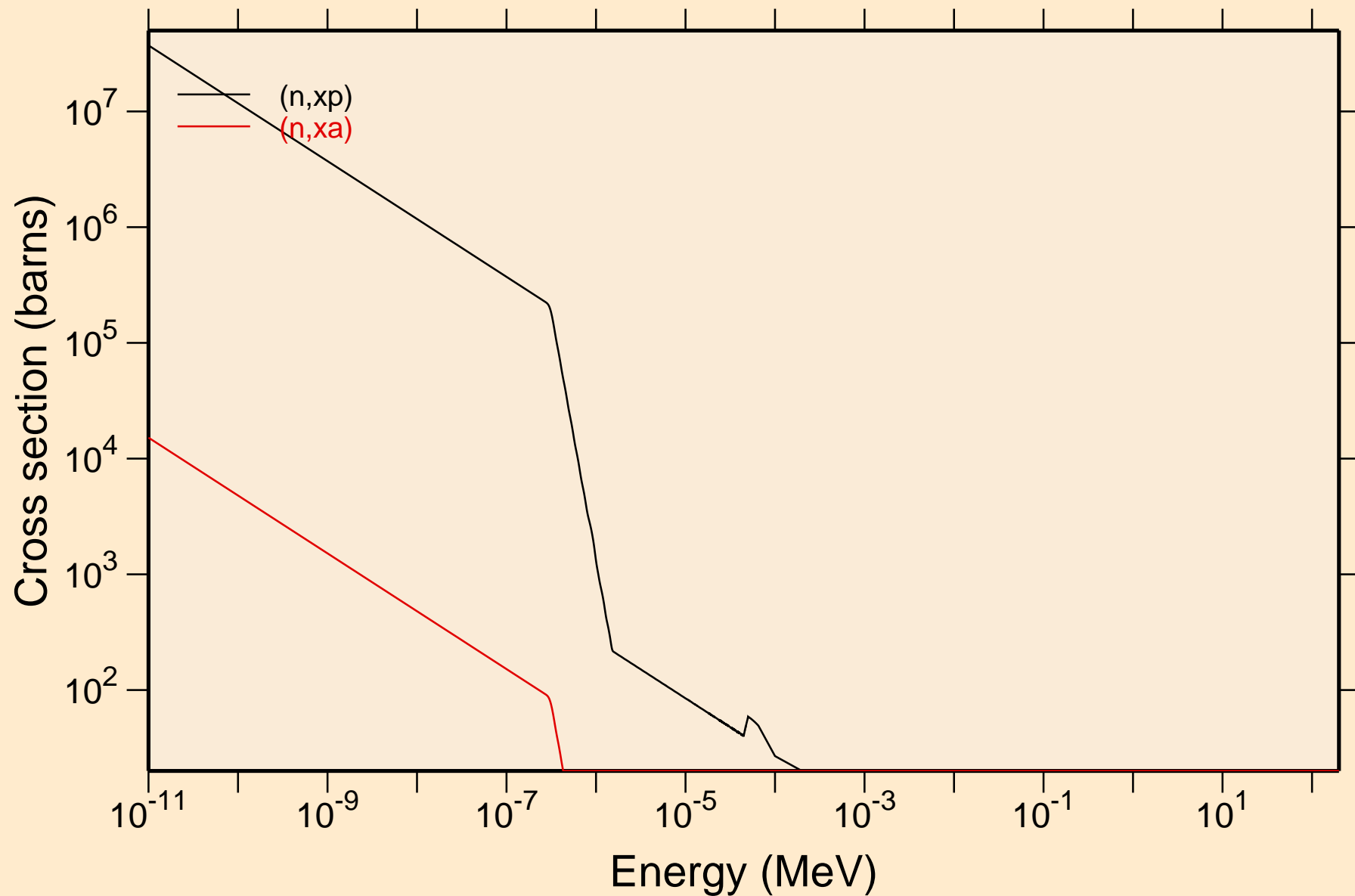

TC088M NEUTRON ACER TENDL-2019 LIBRARY; T=293.16K  
Principal cross sections

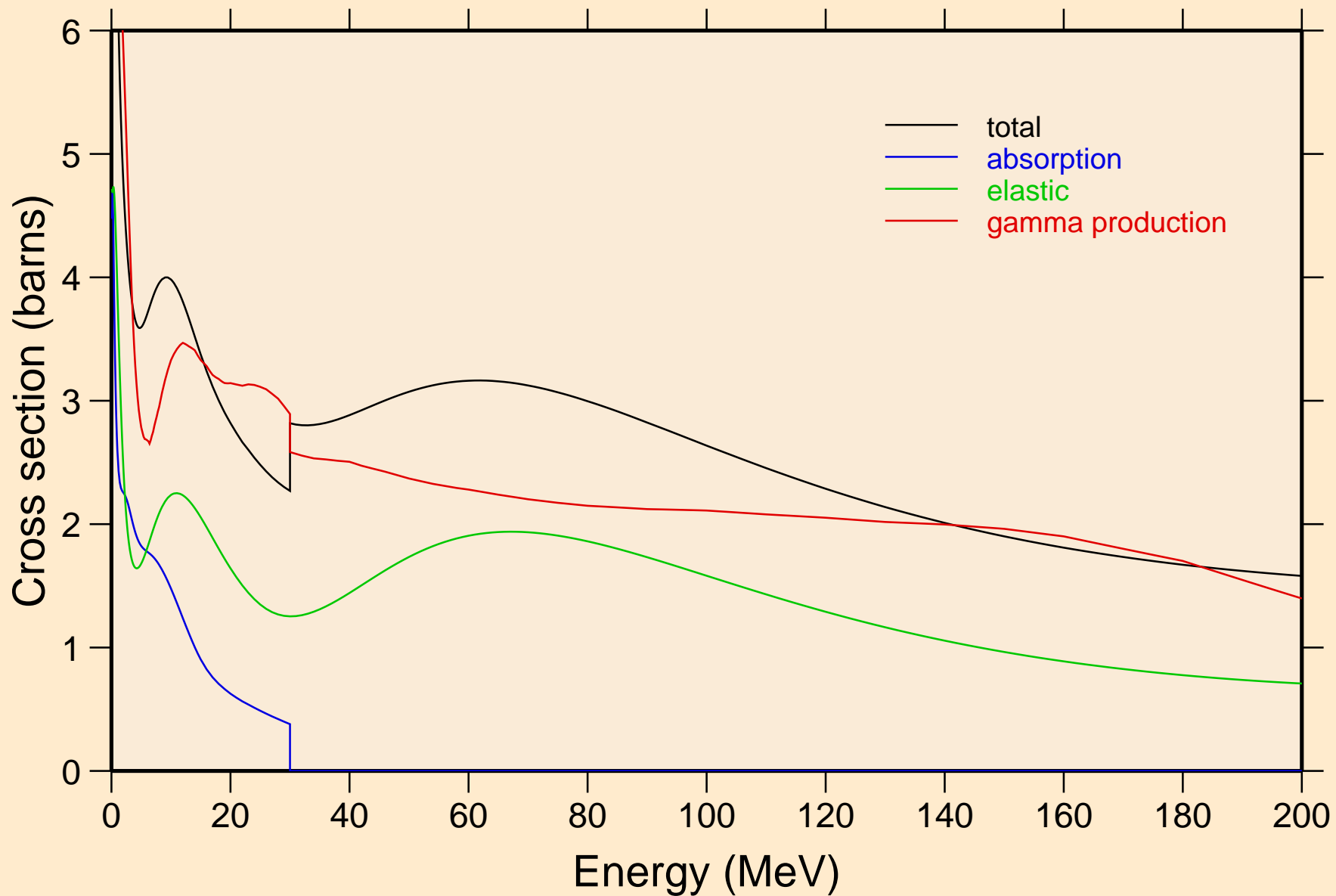

TC088M NEUTRON ACER TENDL-2019 LIBRARY; T=293.16K  
Heating

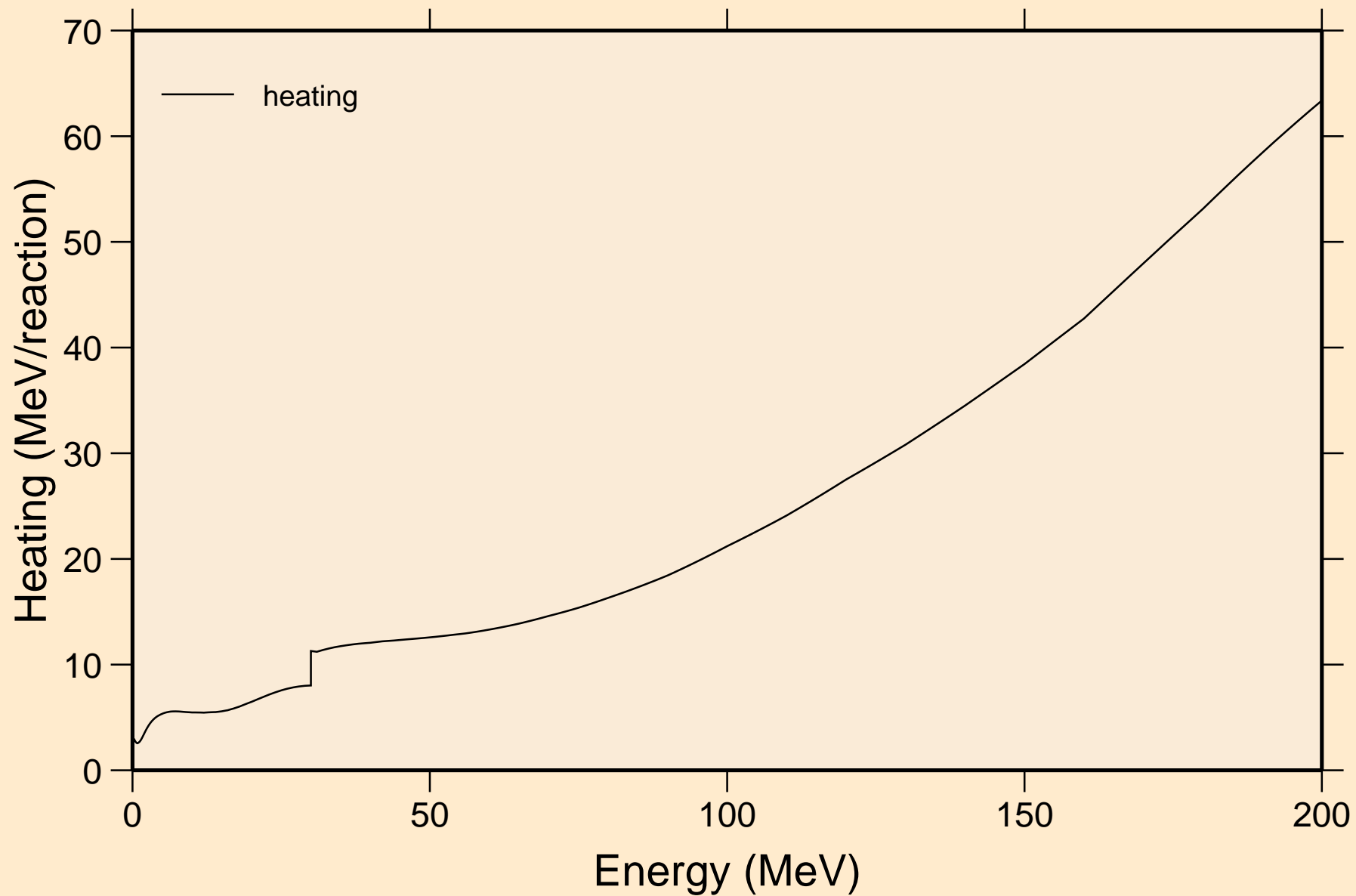

TC088M NEUTRON ACER TENDL-2019 LIBRARY; T=293.16K  
Damage

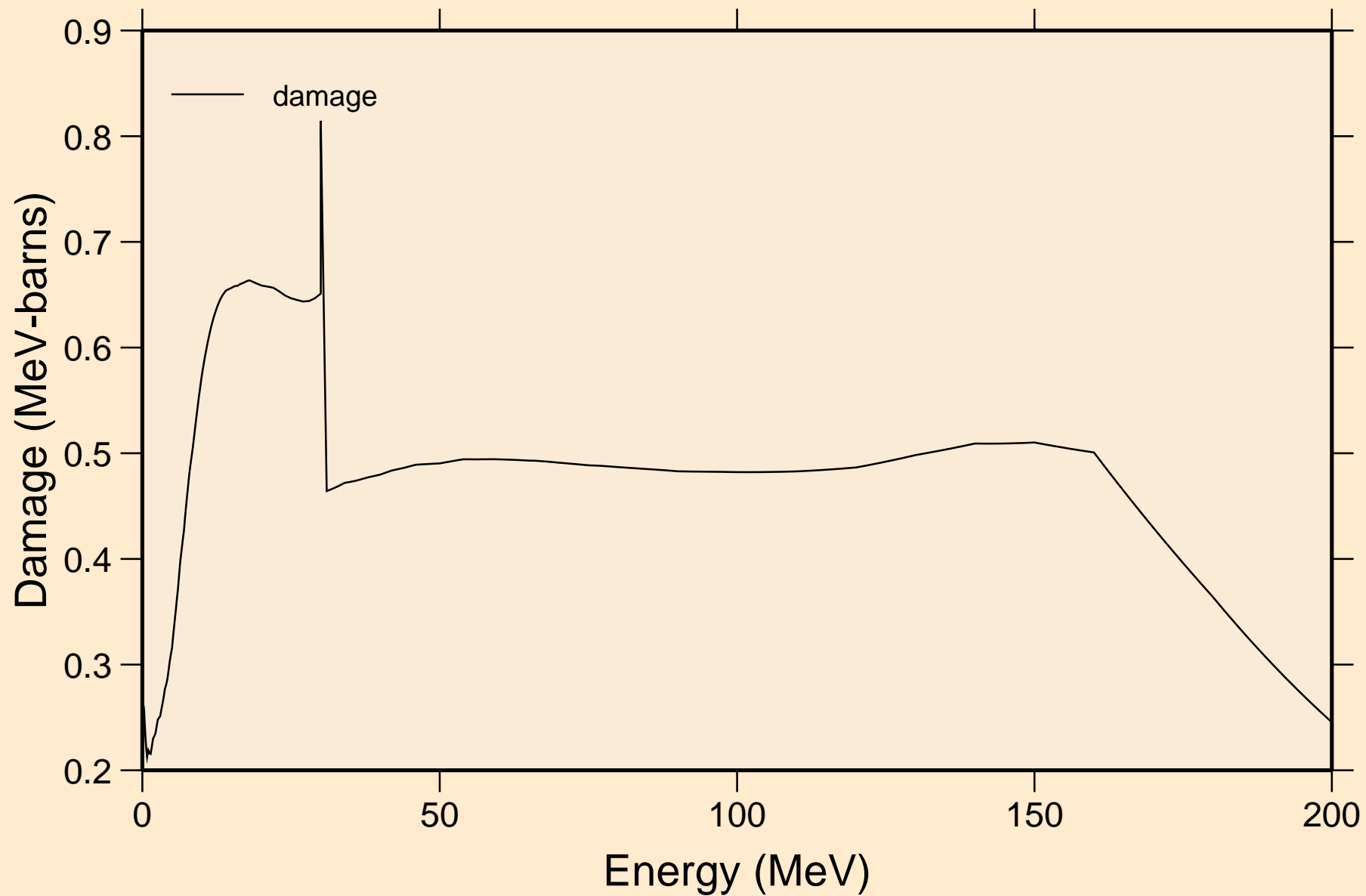



TC088M NEUTRON ACER TENDL-2019 LIBRARY; T=293.16K  
Non-threshold reactions

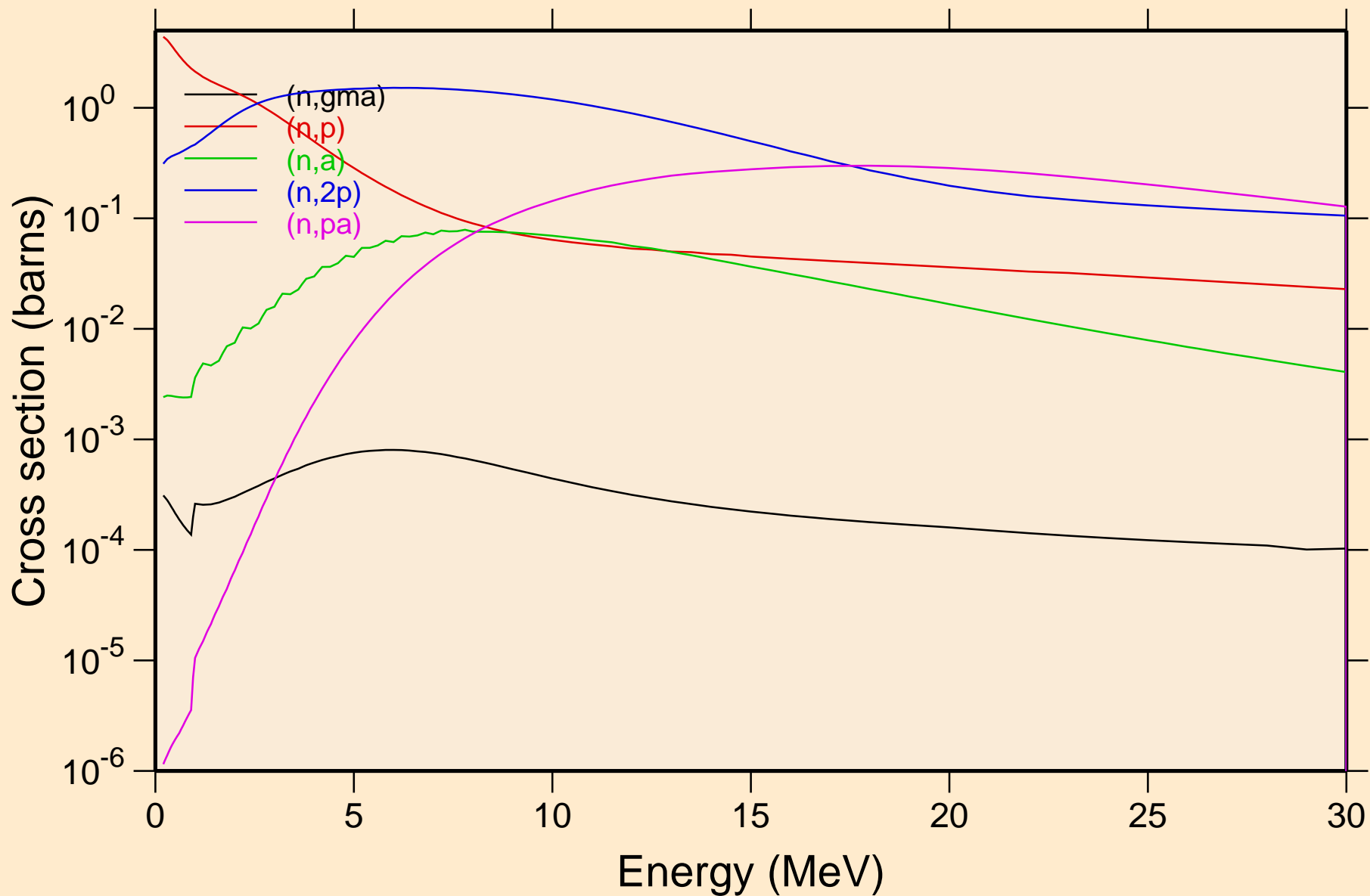

TC088M NEUTRON ACER TENDL-2019 LIBRARY; T=293.16K  
Non-threshold reactions

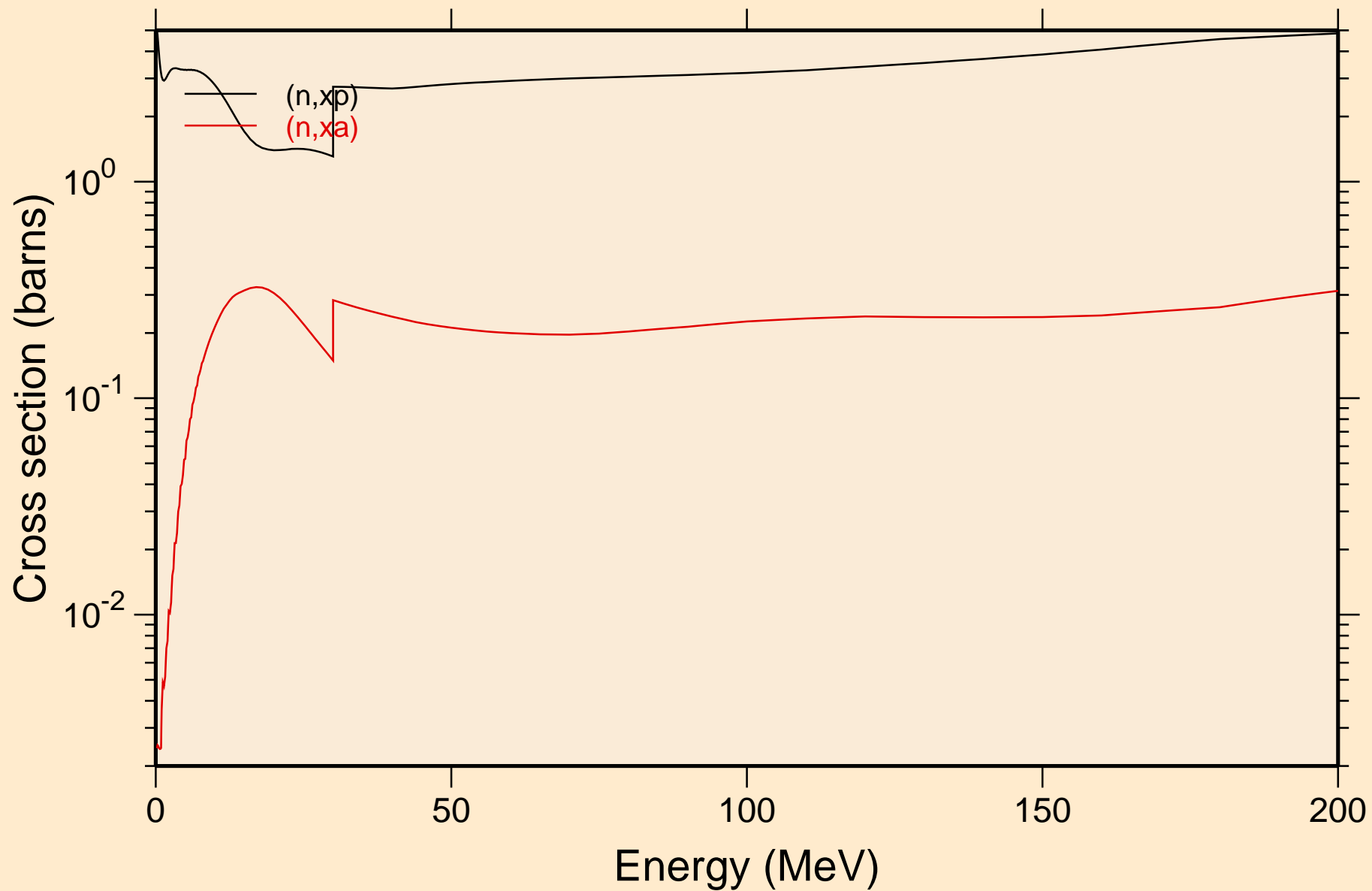

TC088M NEUTRON ACER TENDL-2019 LIBRARY; T=293.16K  
Inelastic levels

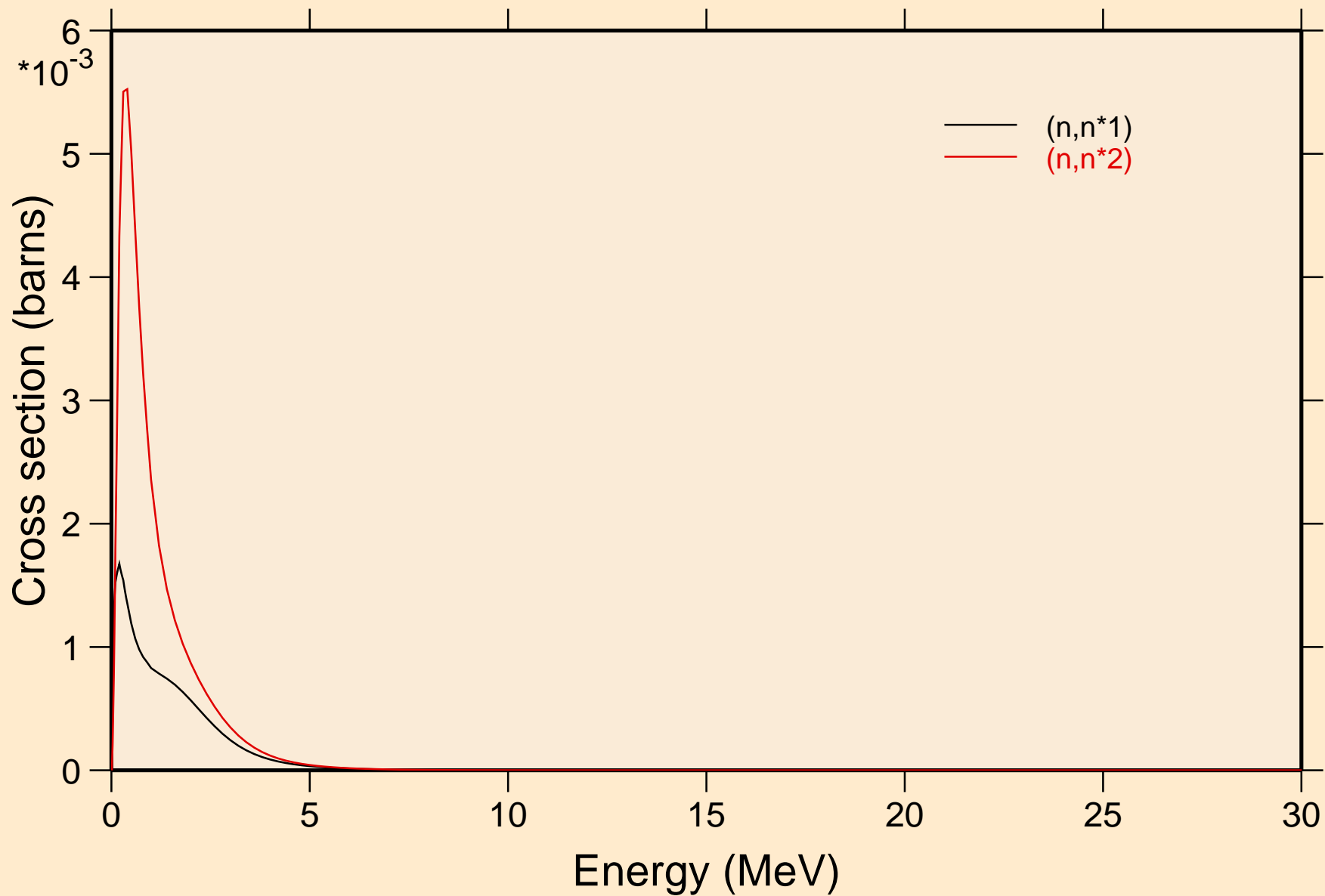

TC088M NEUTRON ACER TENDL-2019 LIBRARY; T=293.16K  
Threshold reactions

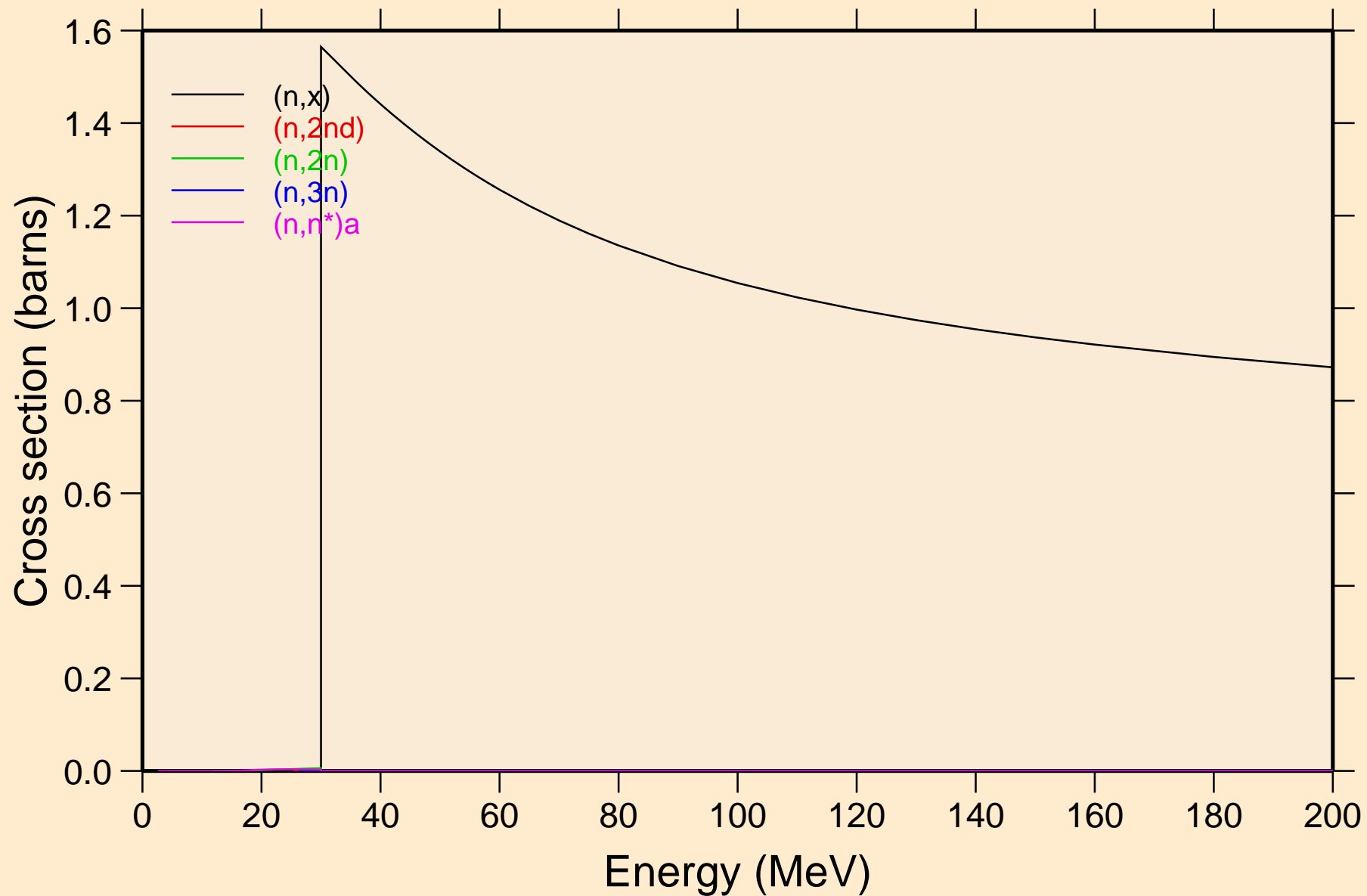

TC088M NEUTRON ACER TENDL-2019 LIBRARY; T=293.16K  
Threshold reactions

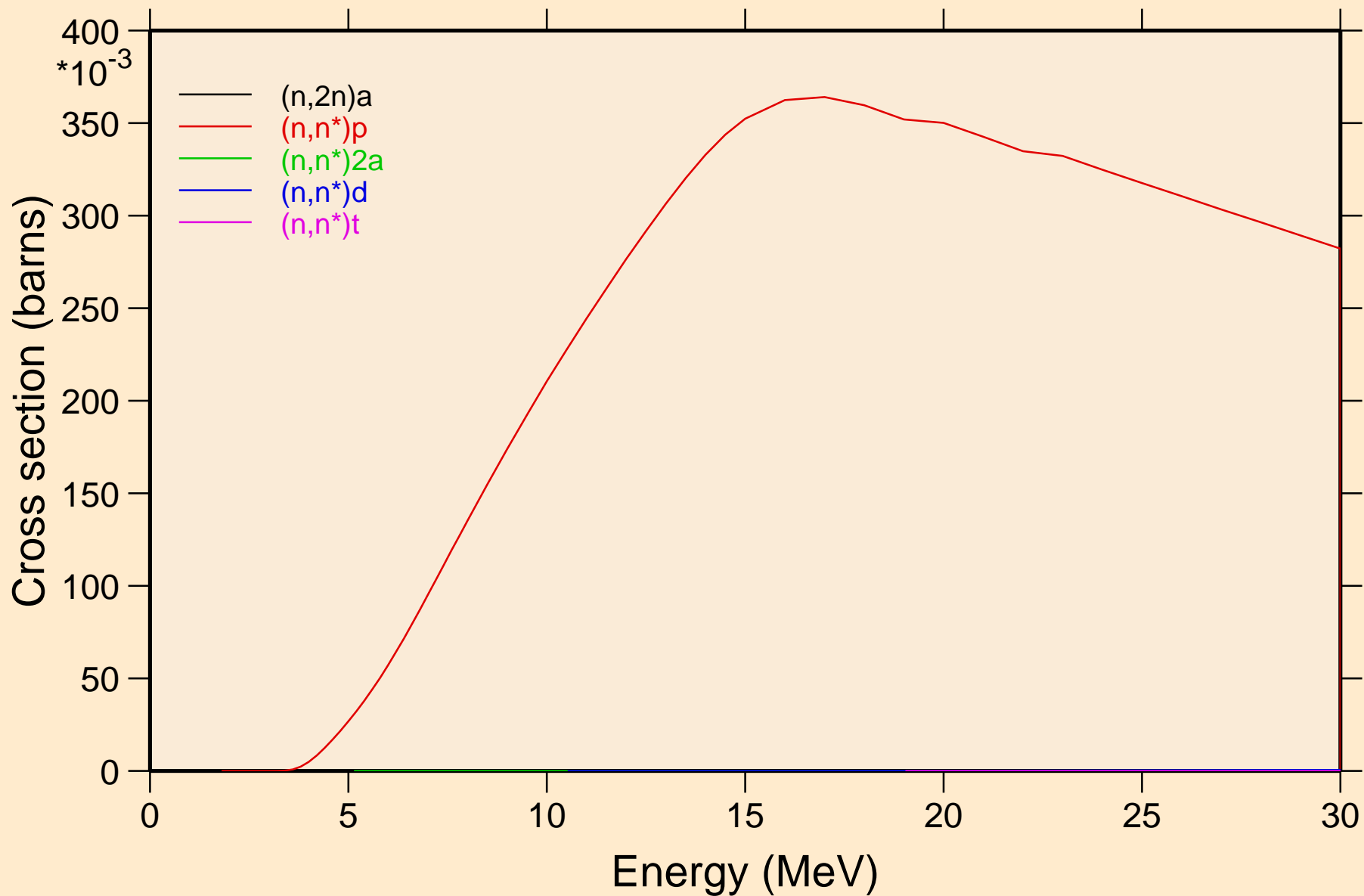

TC088M NEUTRON ACER TENDL-2019 LIBRARY; T=293.16K  
Threshold reactions

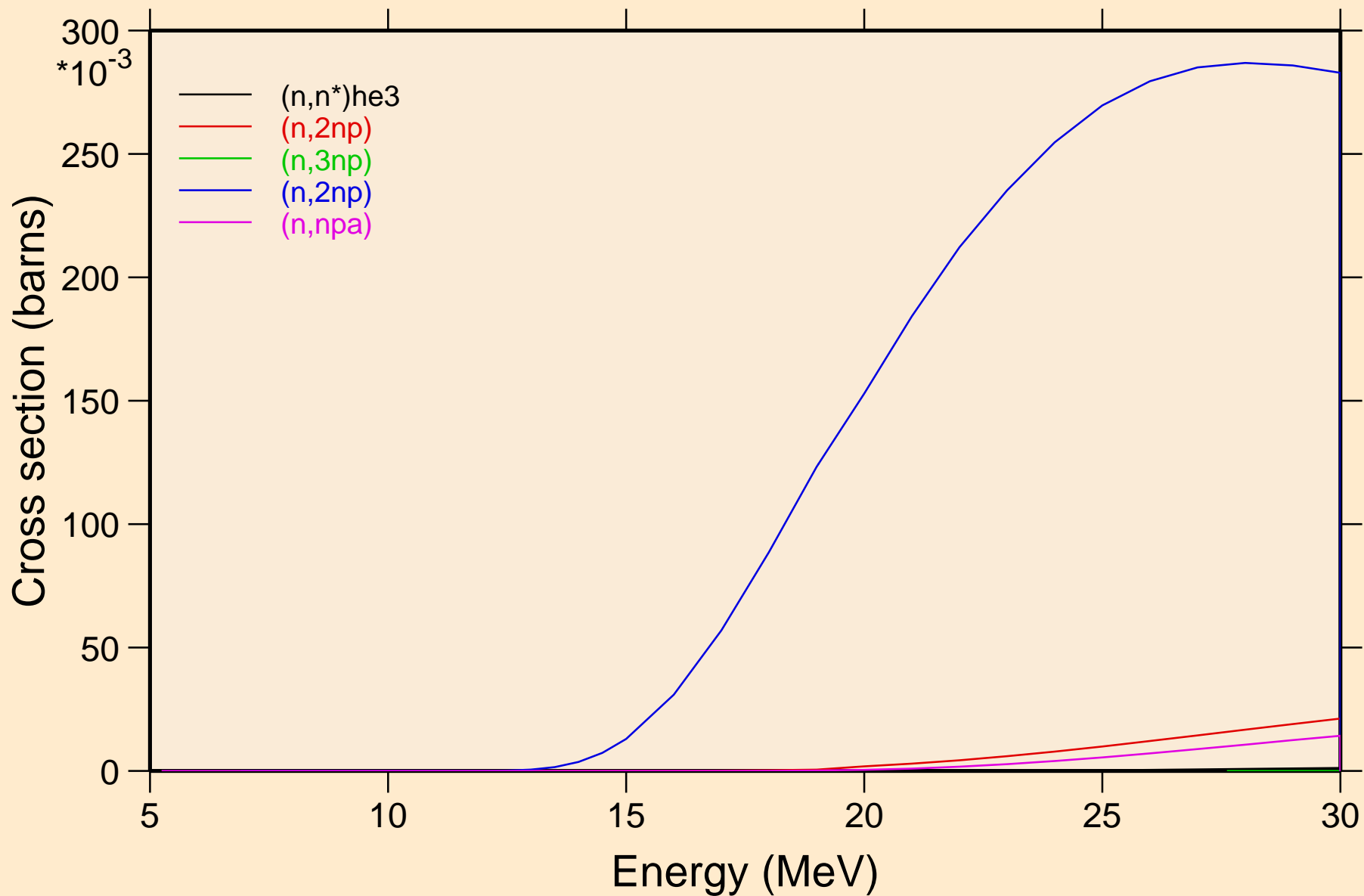

TC088M NEUTRON ACER TENDL-2019 LIBRARY; T=293.16K  
Threshold reactions

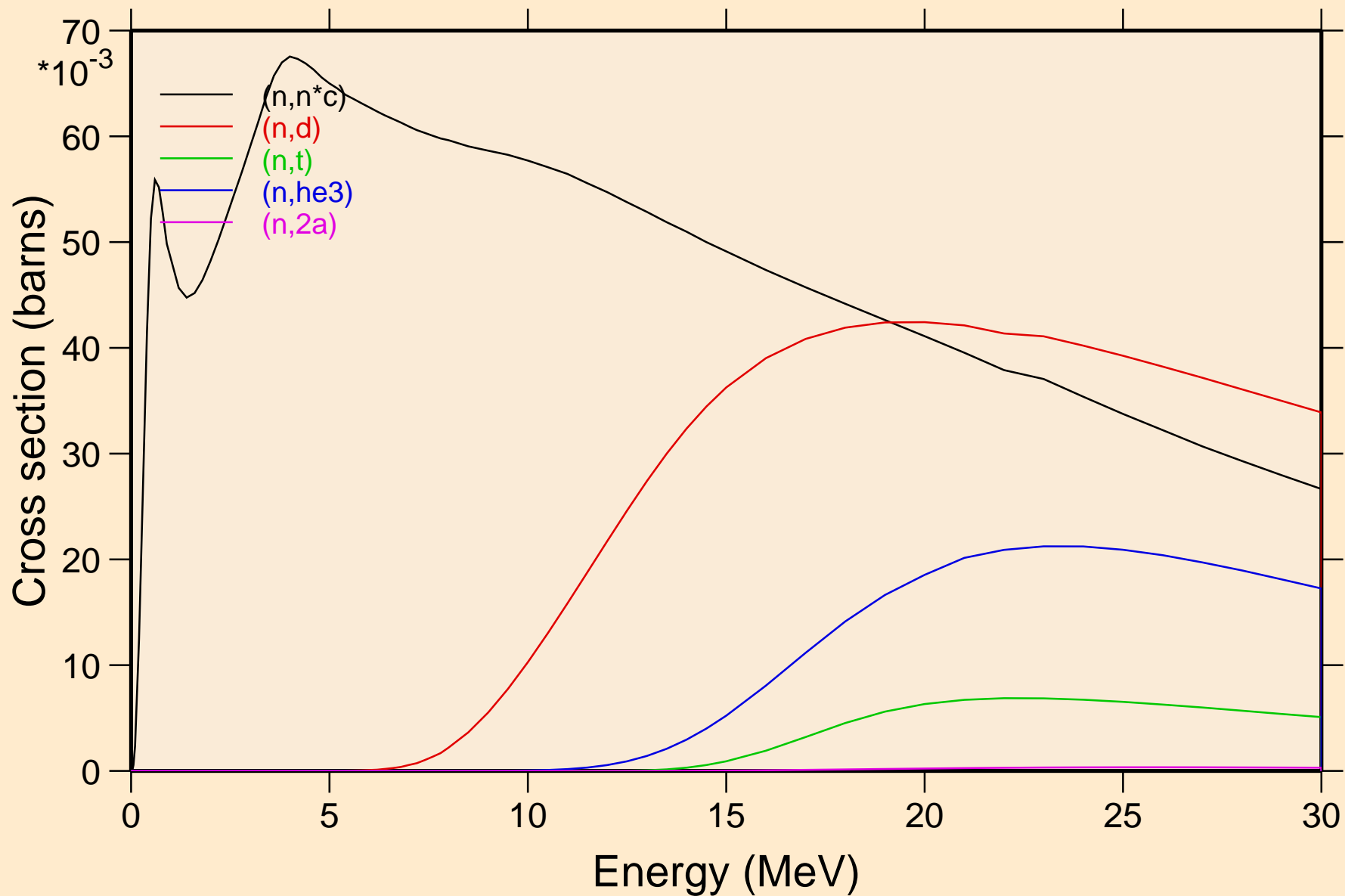

TC088M NEUTRON ACER TENDL-2019 LIBRARY; T=293.16K  
Threshold reactions

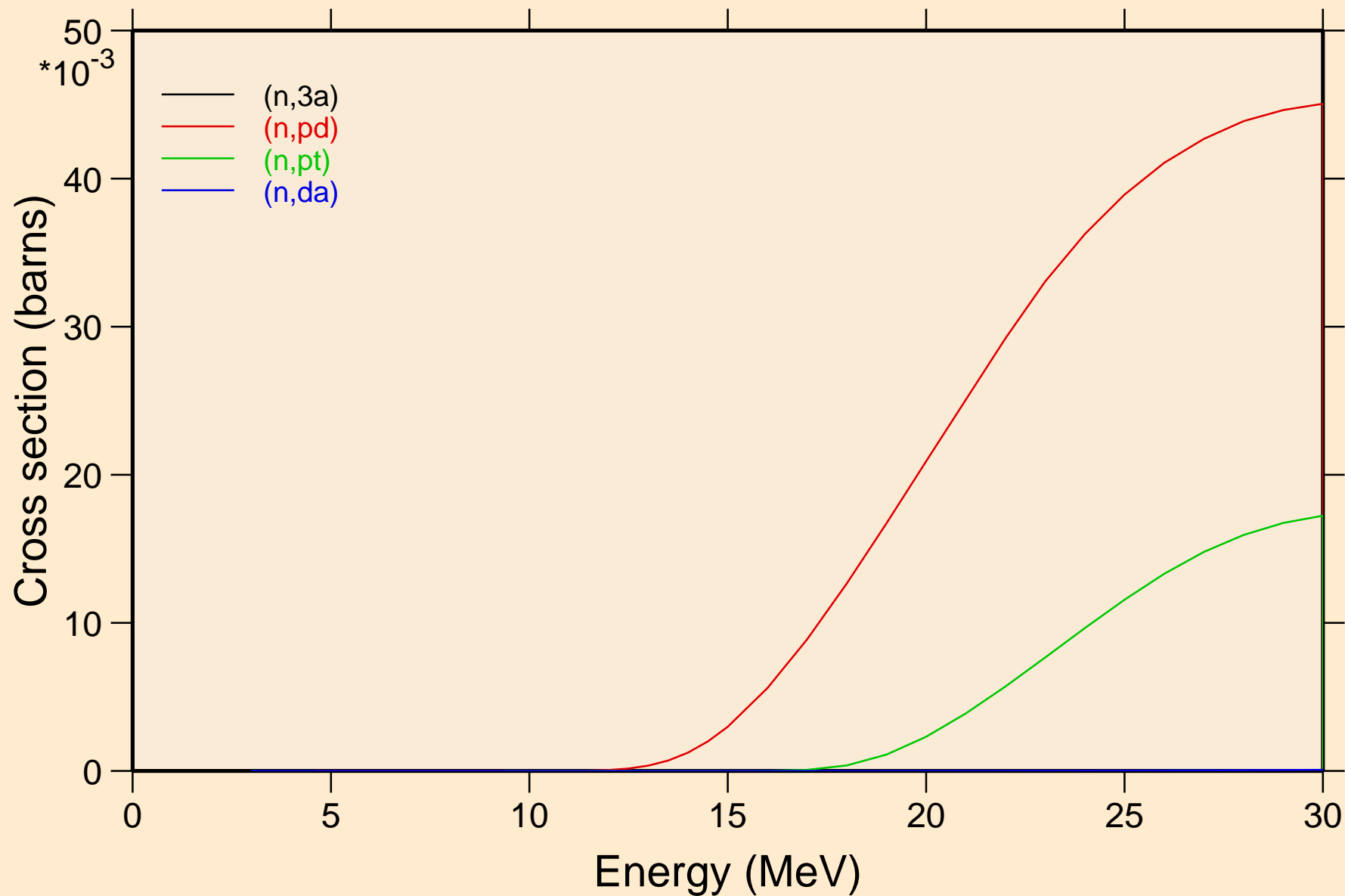



TC088M NEUTRON ACER TENDL-2019 LIBRARY; T=293.16K  
Threshold reactions

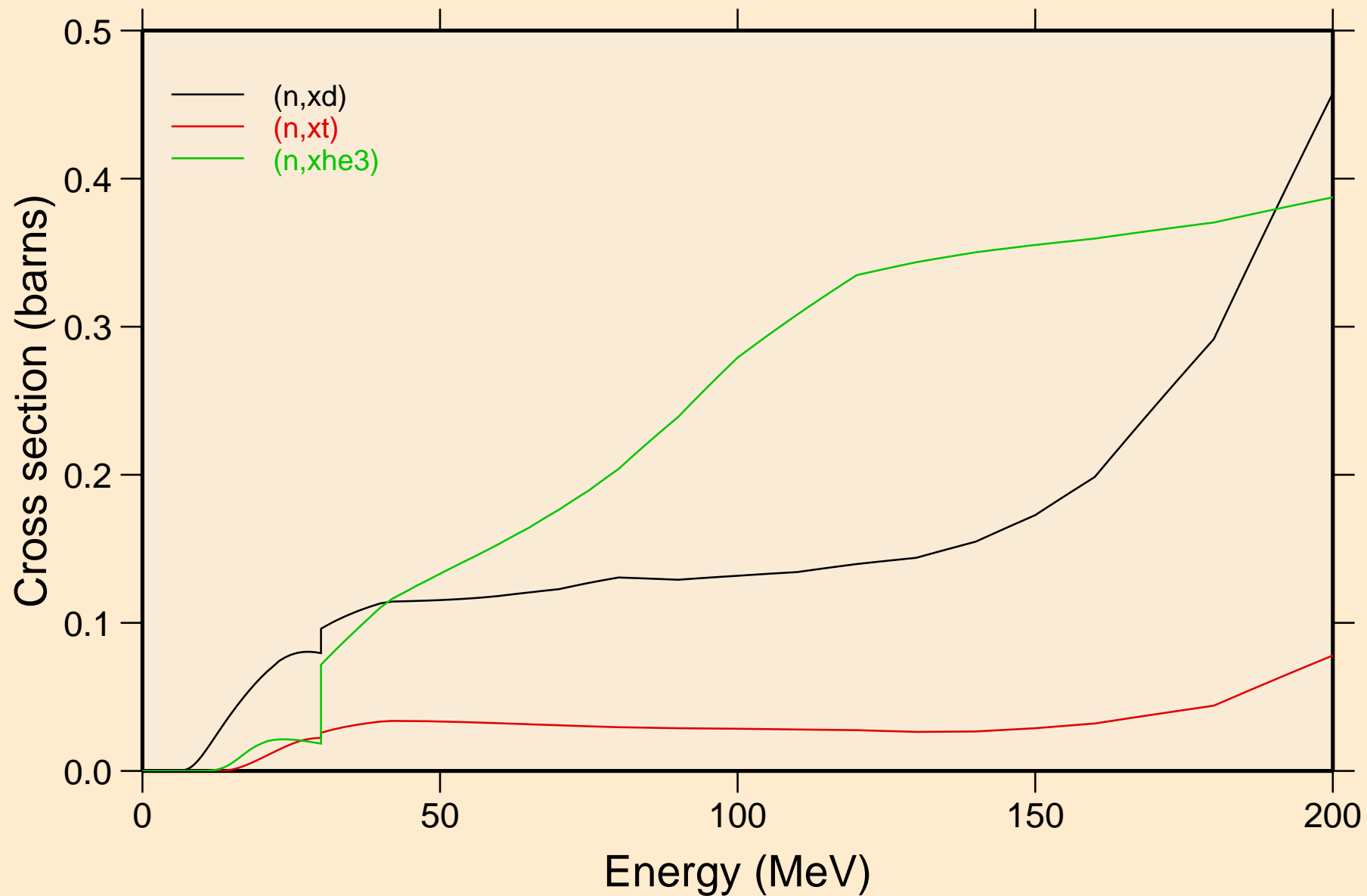

TC088M NEUTRON ACER TENDL-2019 LIBRARY; T=293.16K  
angular distribution for elastic

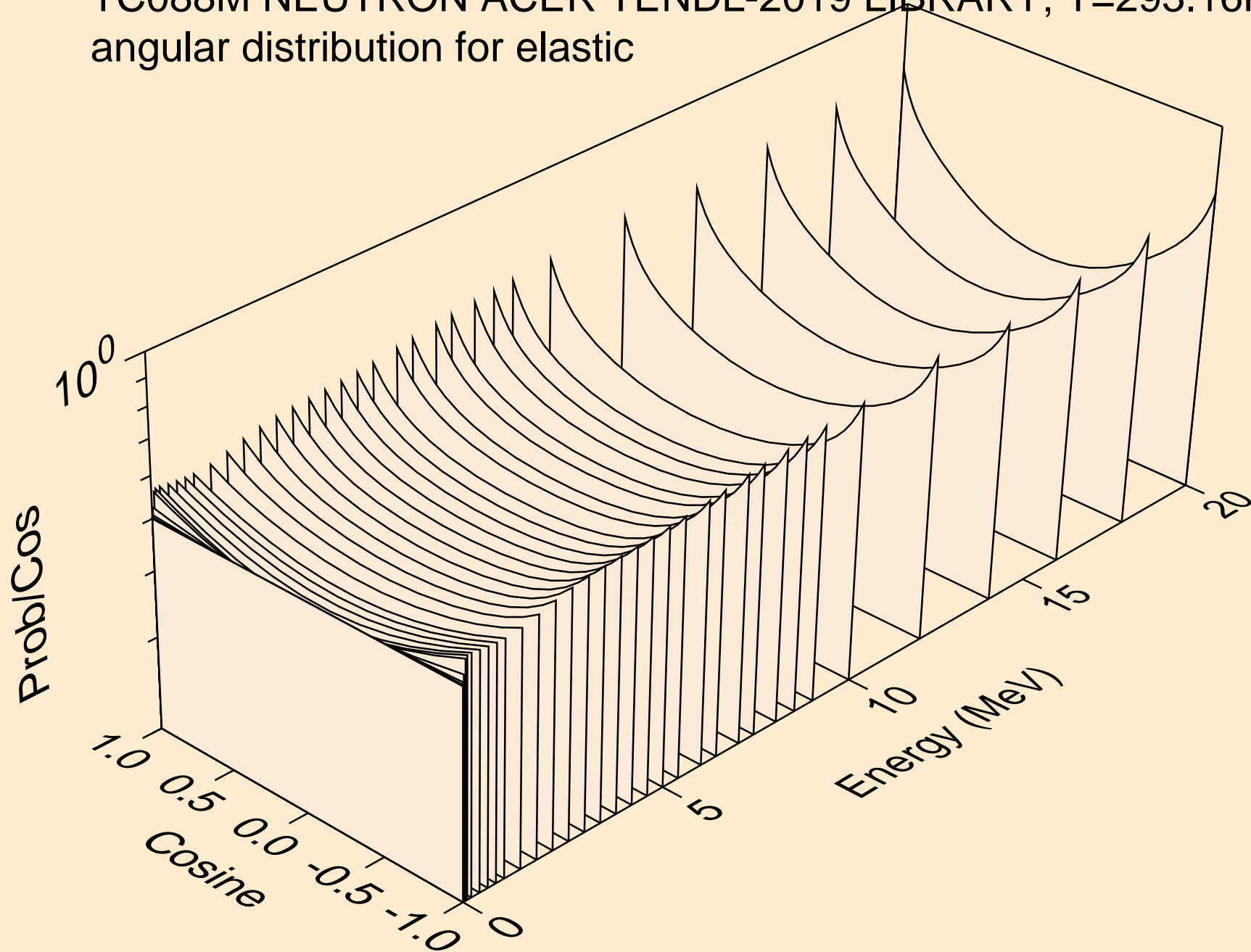

TC088M NEUTRON ACER TENDL-2019 LIBRARY; T=293.16K  
angular distribution for elastic

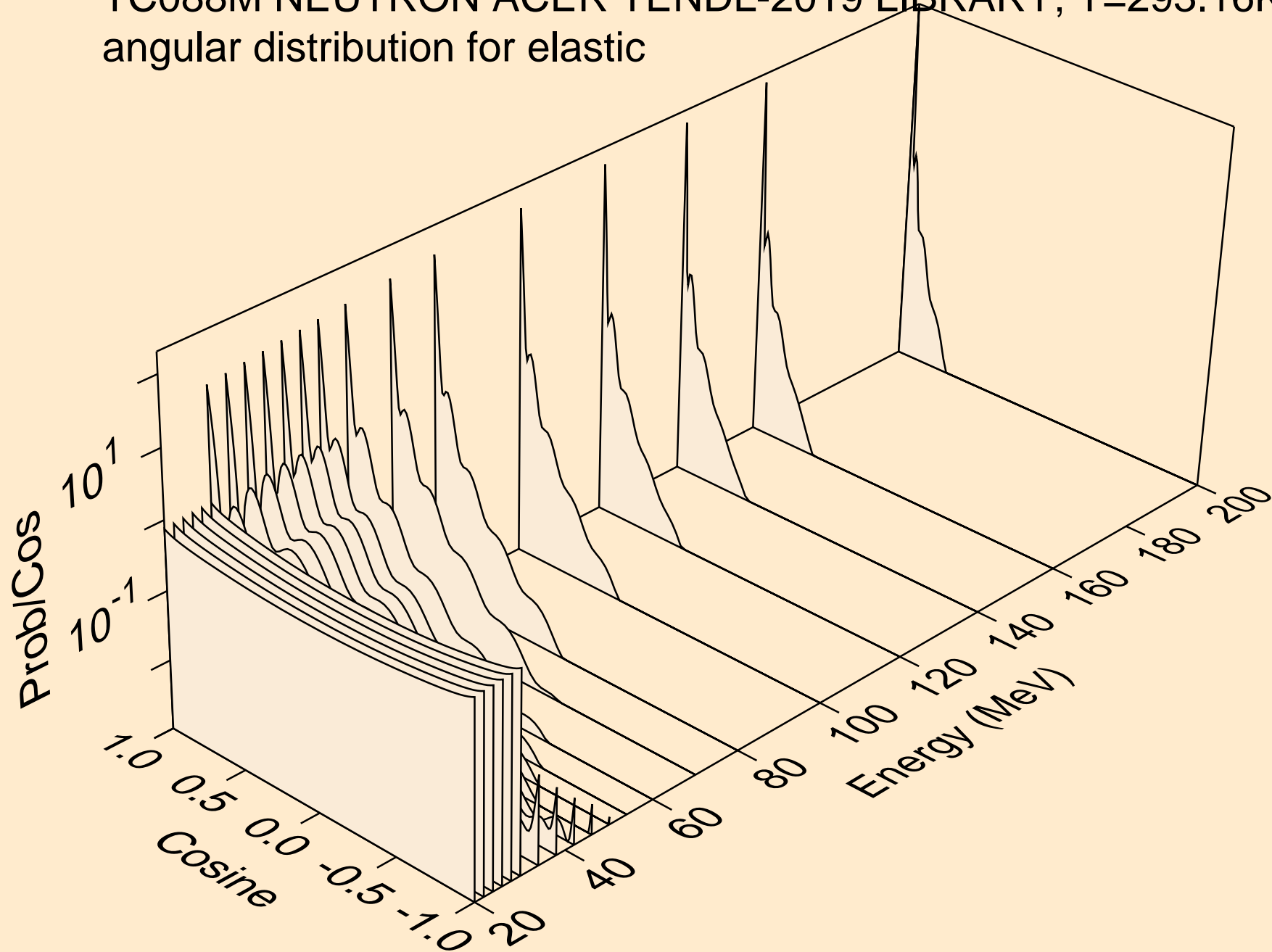

TC088M NEUTRON ACER TENDL-2019 LIBRARY; T=293.16K  
angular distribution for (n,n\*1)

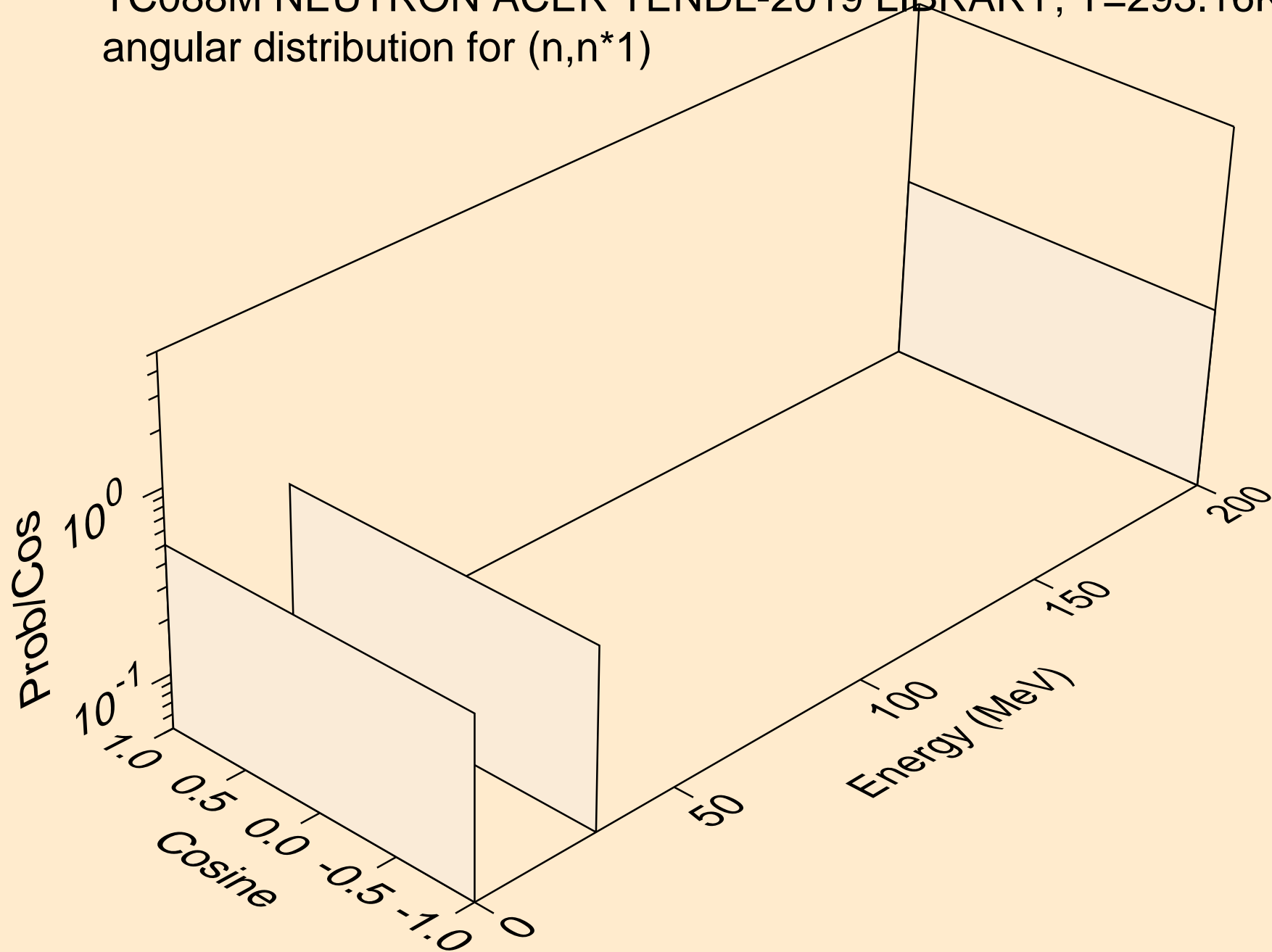

TC088M NEUTRON ACER TENDL-2019 LIBRARY; T=293.16K  
angular distribution for (n,n\*2)

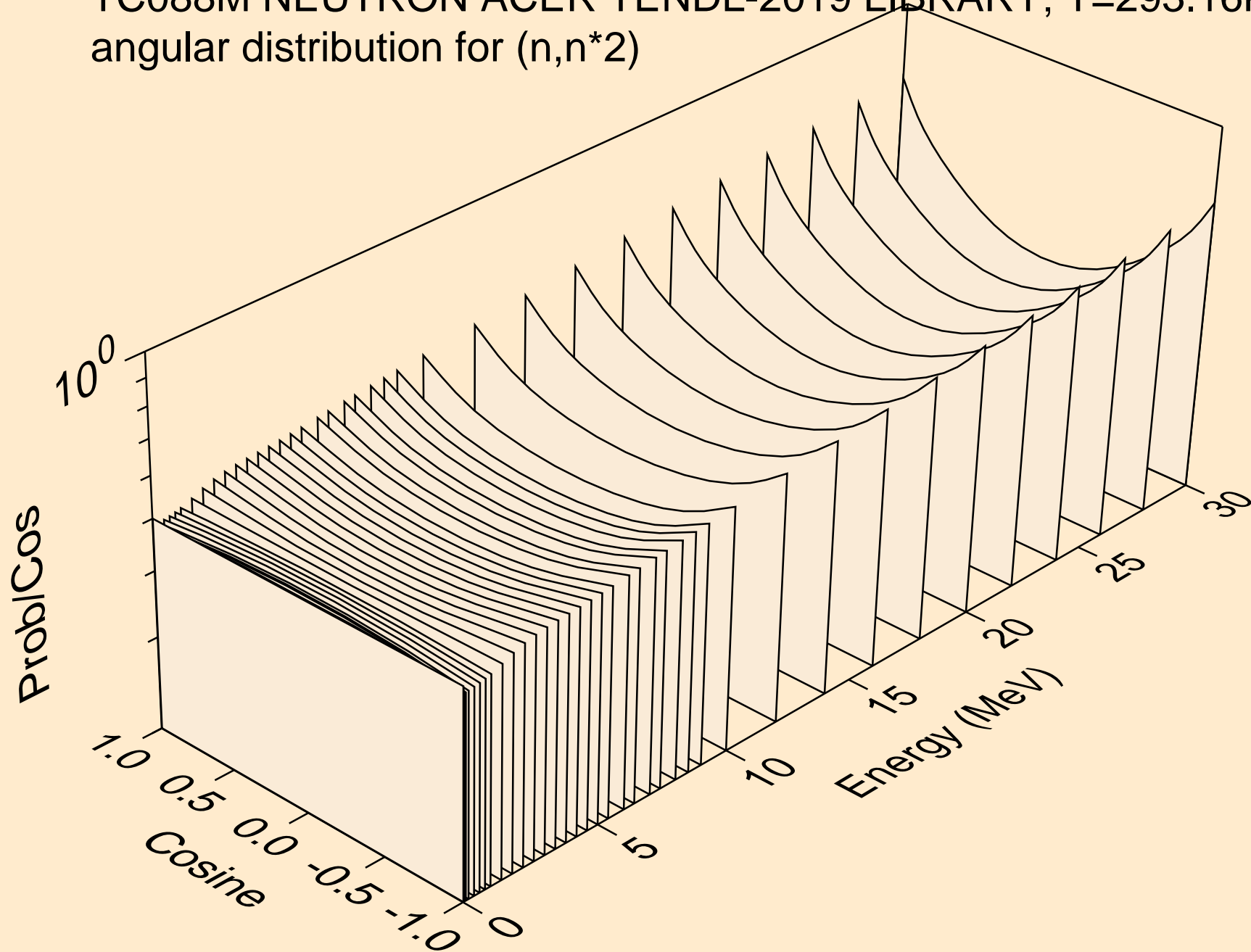

TC088M NEUTRON ACER TENDL-2019 LIBRARY; T=293.16K  
Neutron emission for (n,x)

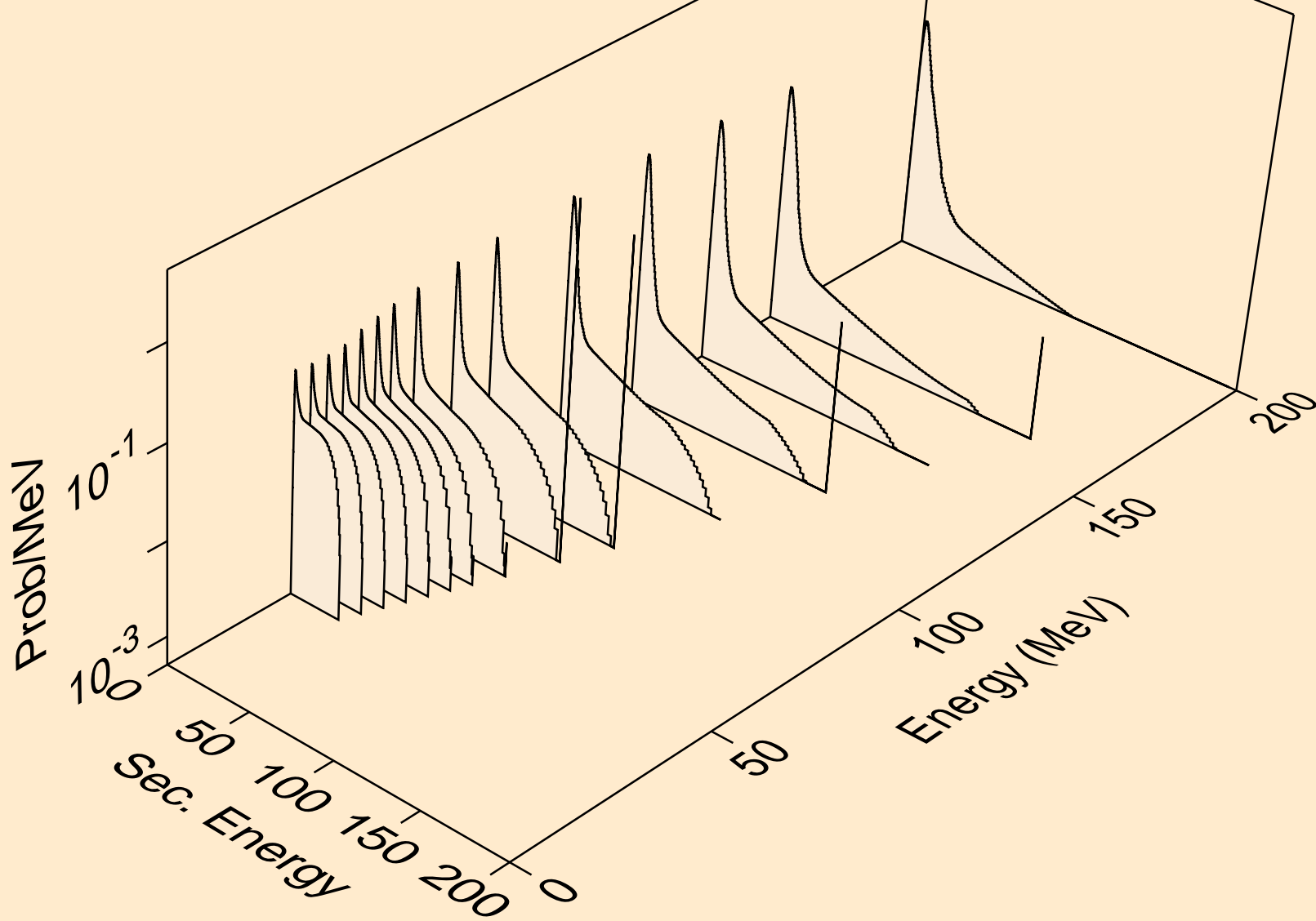

TC088M NEUTRON ACER TENDL-2019 LIBRARY; T=293.16K  
Neutron emission for (n,2nd)

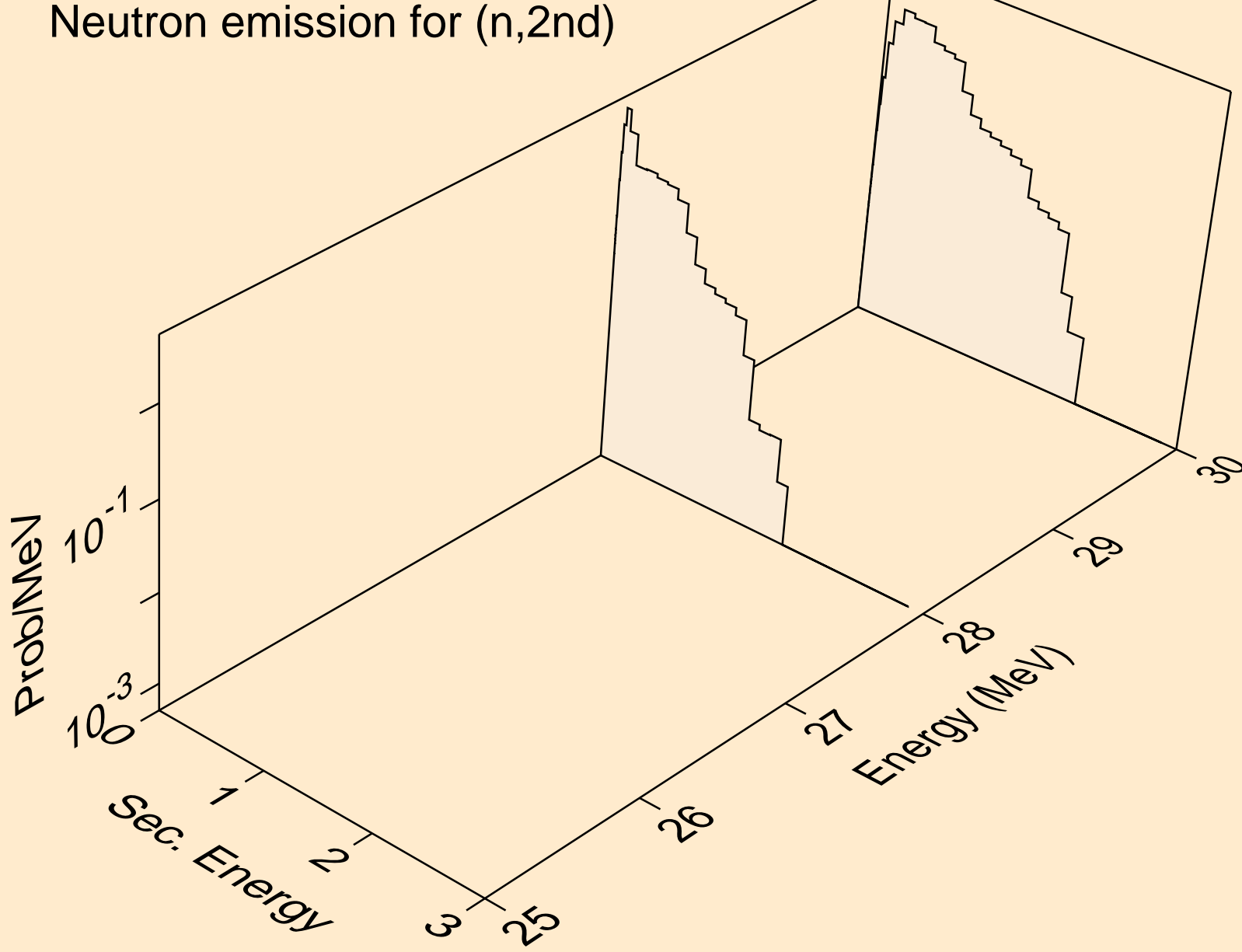

TC088M NEUTRON ACER TENDL-2019 LIBRARY; T=293.16K  
Neutron emission for (n,2n)

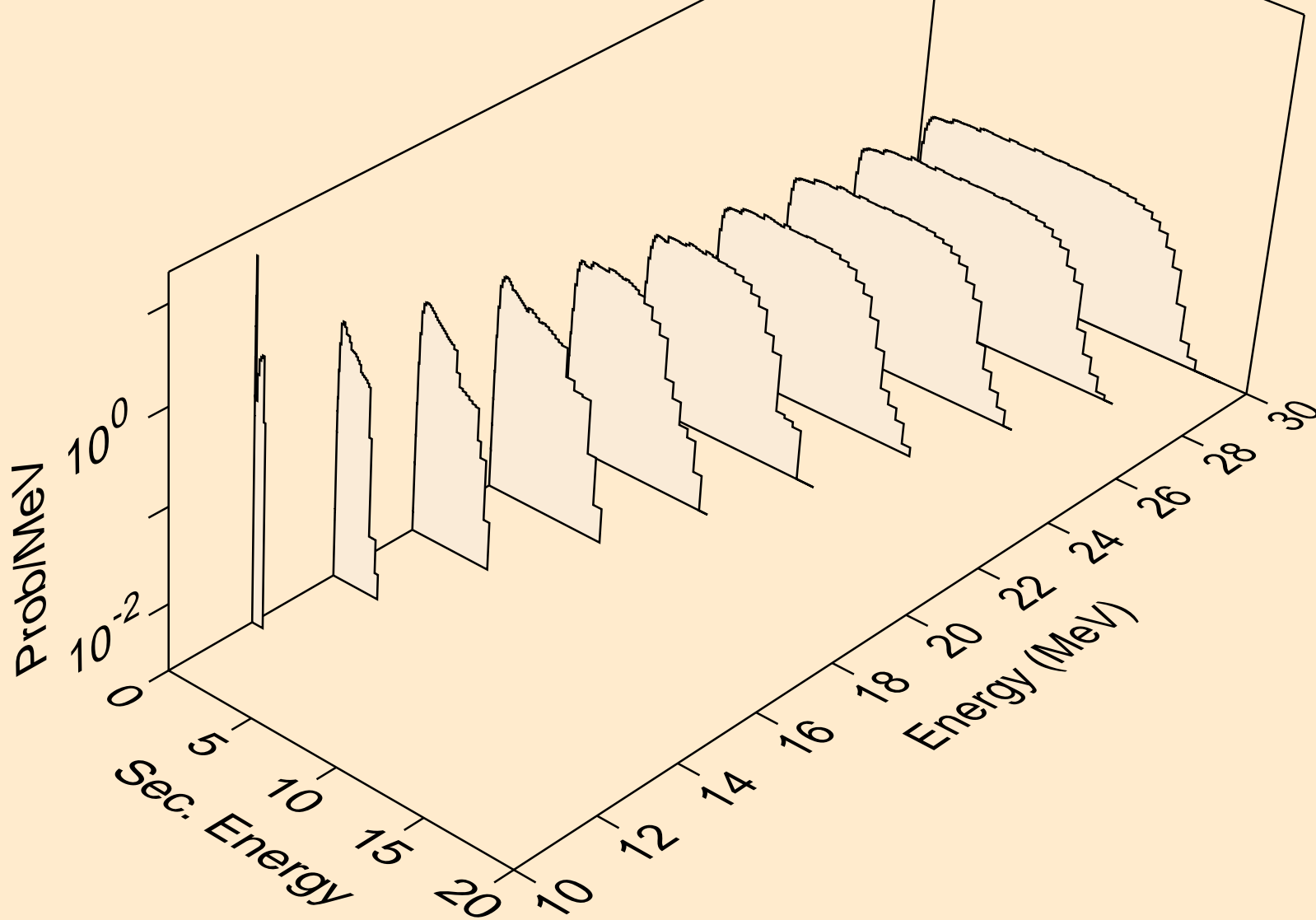



TC088M NEUTRON ACER TENDL-2019 LIBRARY; T=293.16K  
Neutron emission for (n,3n)

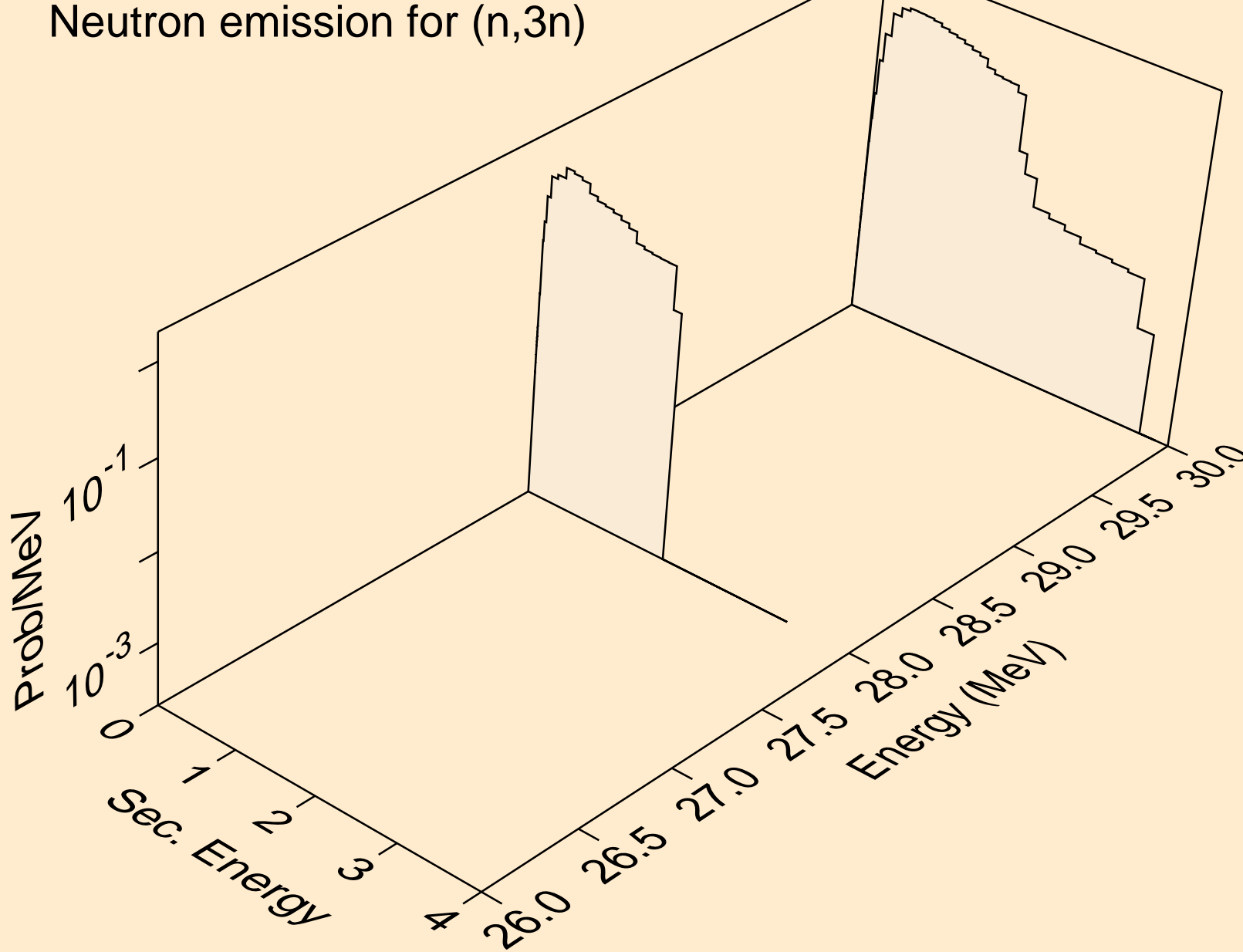

TC088M NEUTRON ACER TENDL-2019 LIBRARY; T=293.16K  
Neutron emission for (n,n\*)a

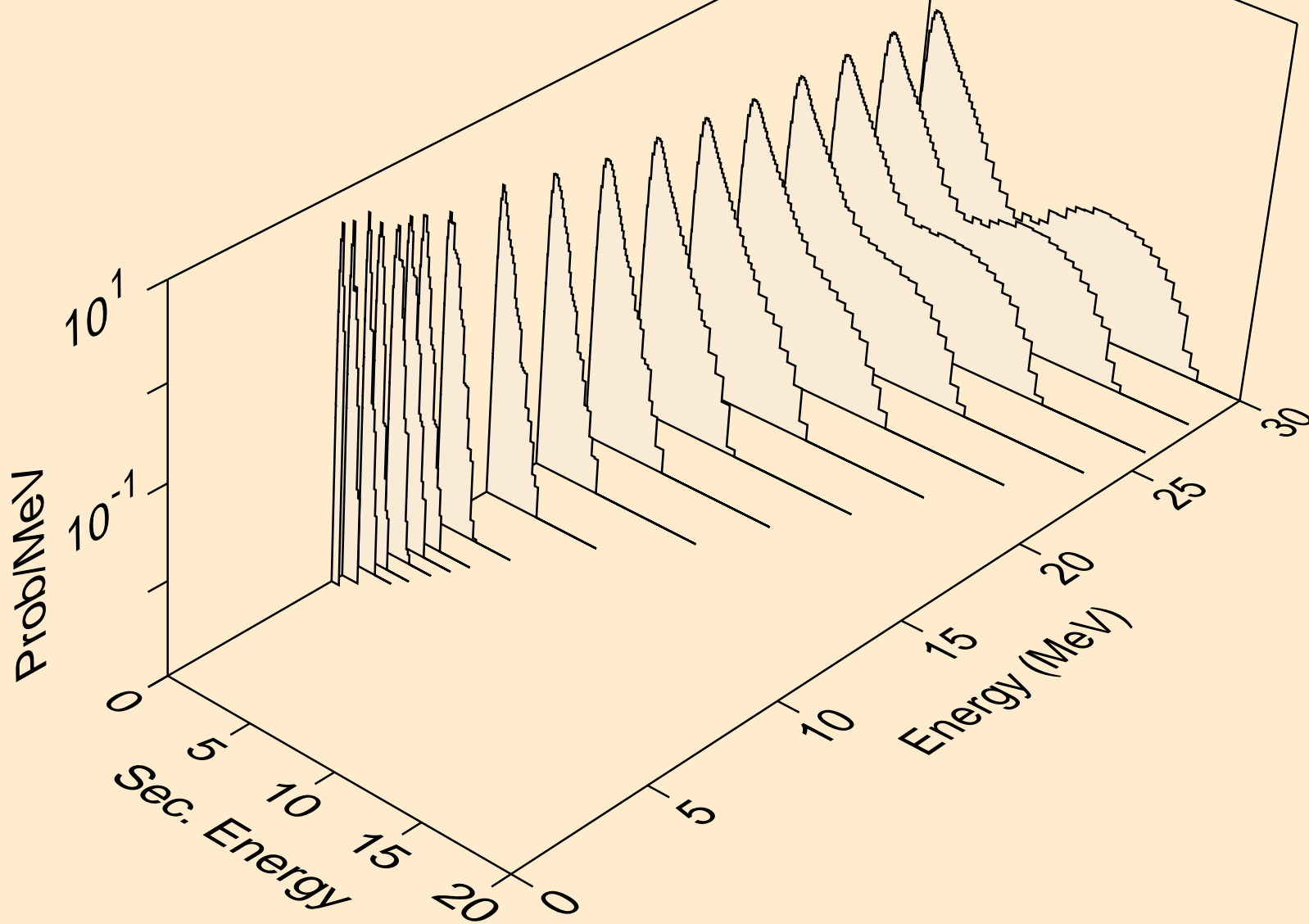

TC088M NEUTRON ACER TENDL-2019 LIBRARY; T=293.16K  
Neutron emission for (n,2n)a

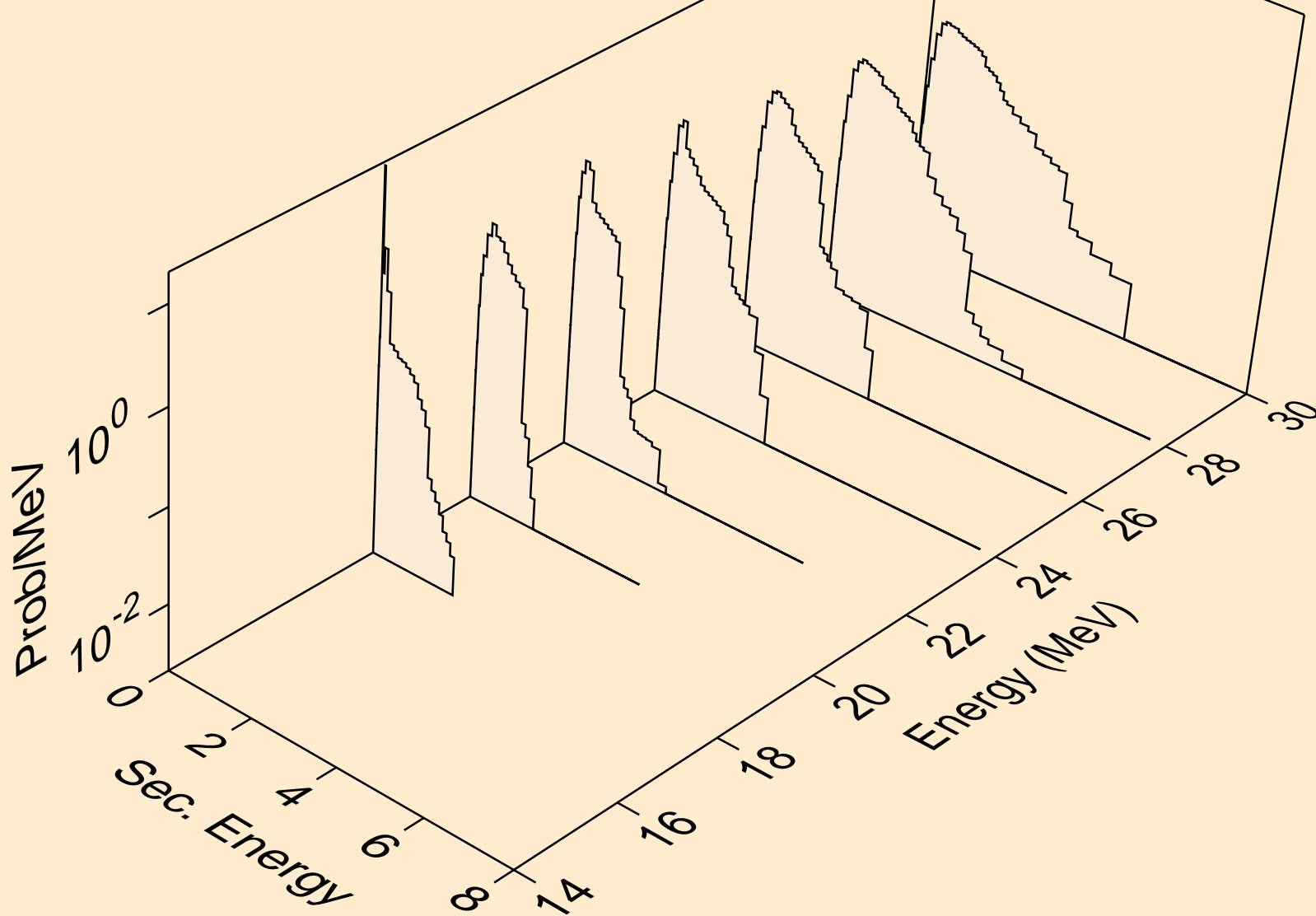

TC088M NEUTRON ACER TENDL-2019 LIBRARY; T=293.16K  
Neutron emission for (n,n\*)p

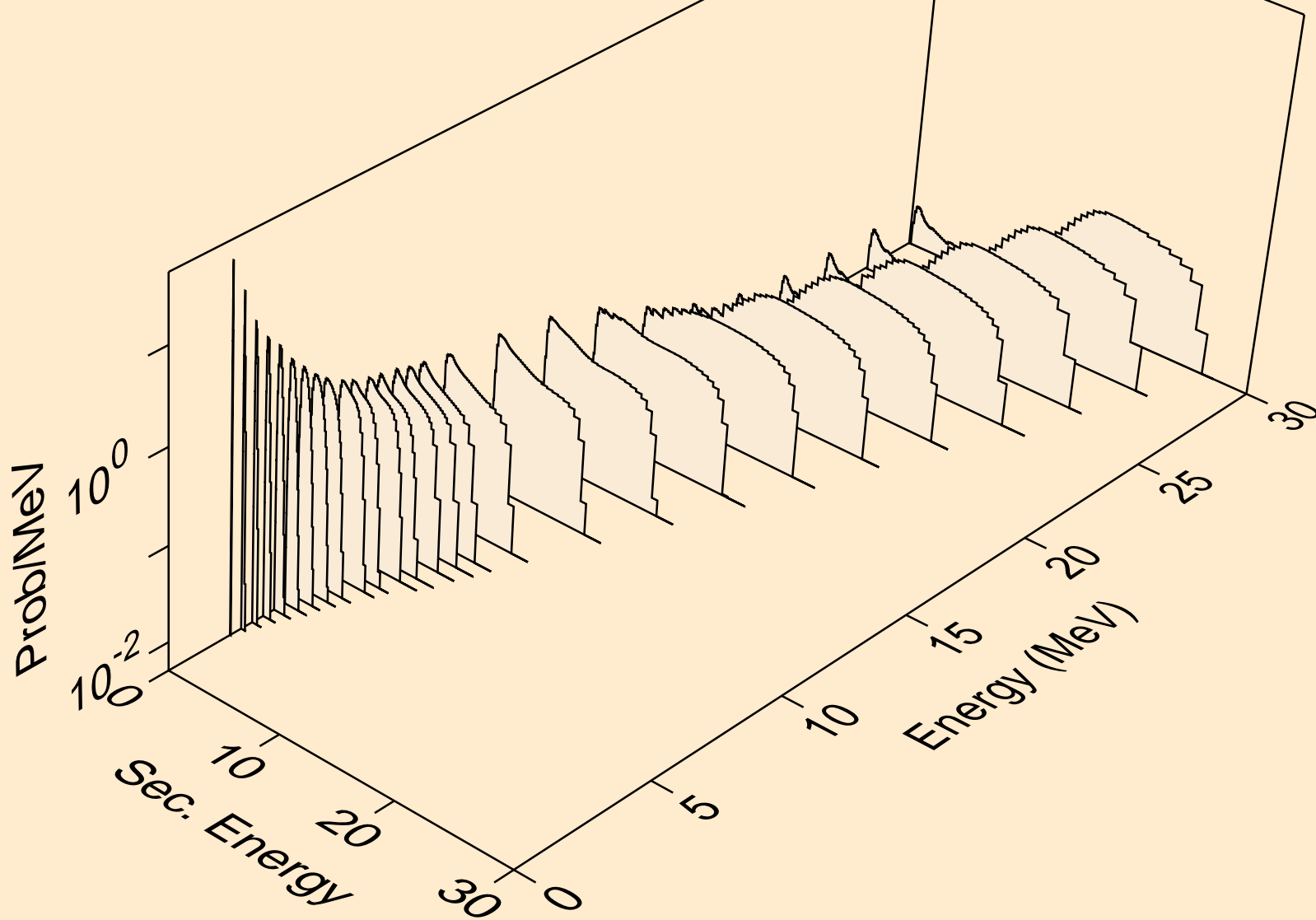

TC088M NEUTRON ACER TENDL-2019 LIBRARY; T=293.16K  
Neutron emission for (n,n\*)2a

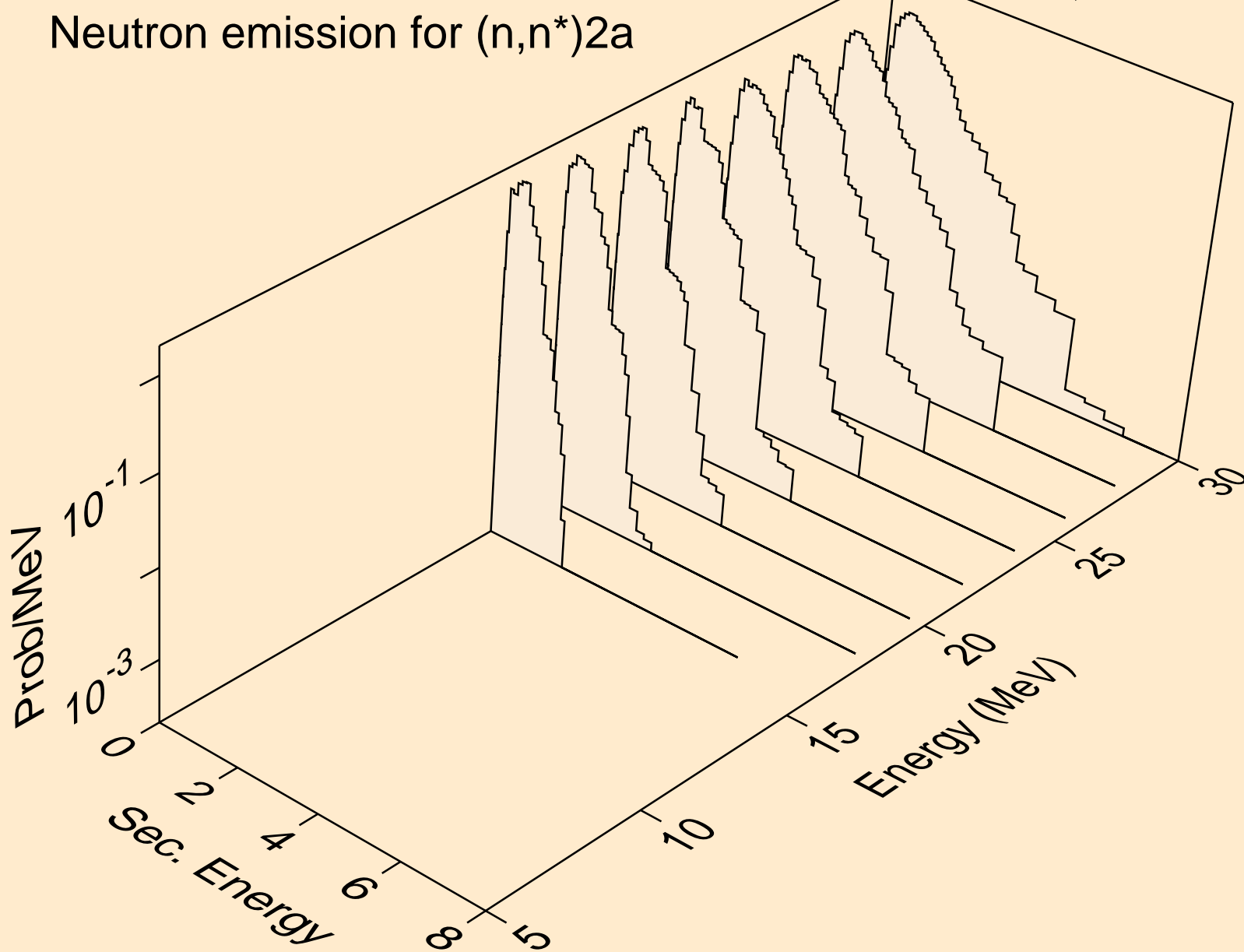

TC088M NEUTRON ACER TENDL-2019 LIBRARY; T=293.16K  
Neutron emission for (n,n\*)d

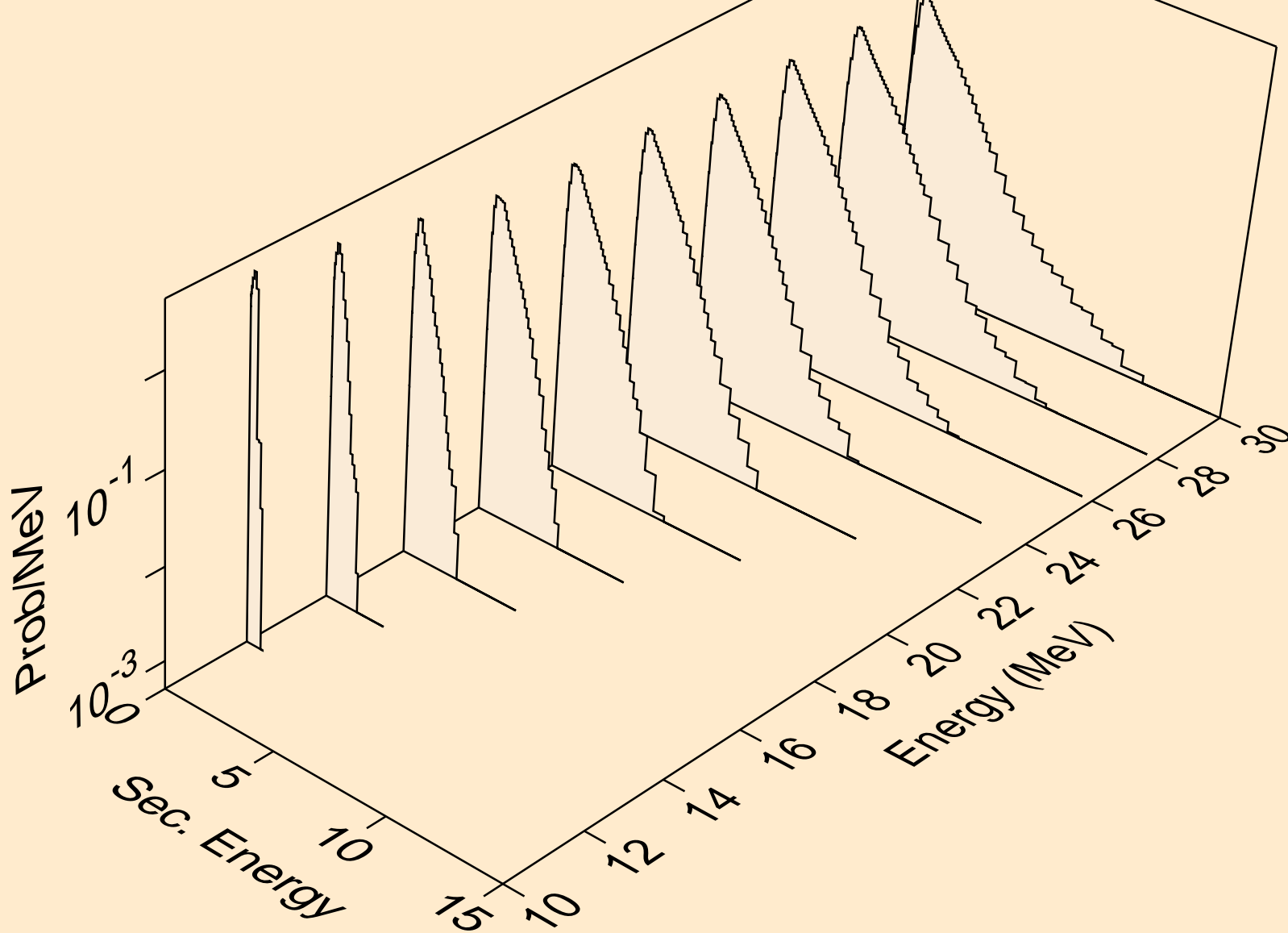

TC088M NEUTRON ACER TENDL-2019 LIBRARY; T=293.16K  
Neutron emission for (n,n\*)t

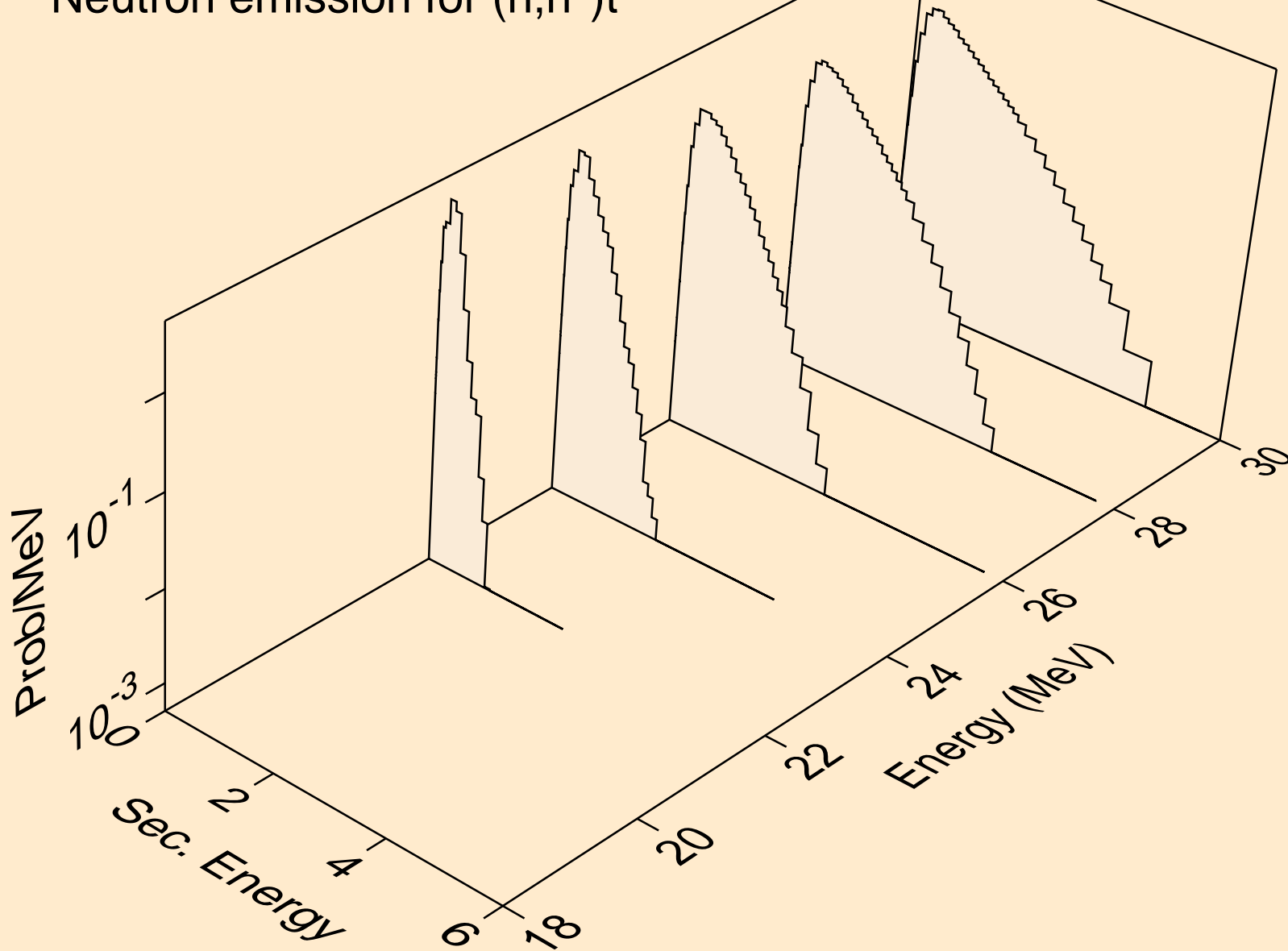

TC088M NEUTRON ACER TENDL-2019 LIBRARY; T=293.16K  
Neutron emission for (n,n\*)he3

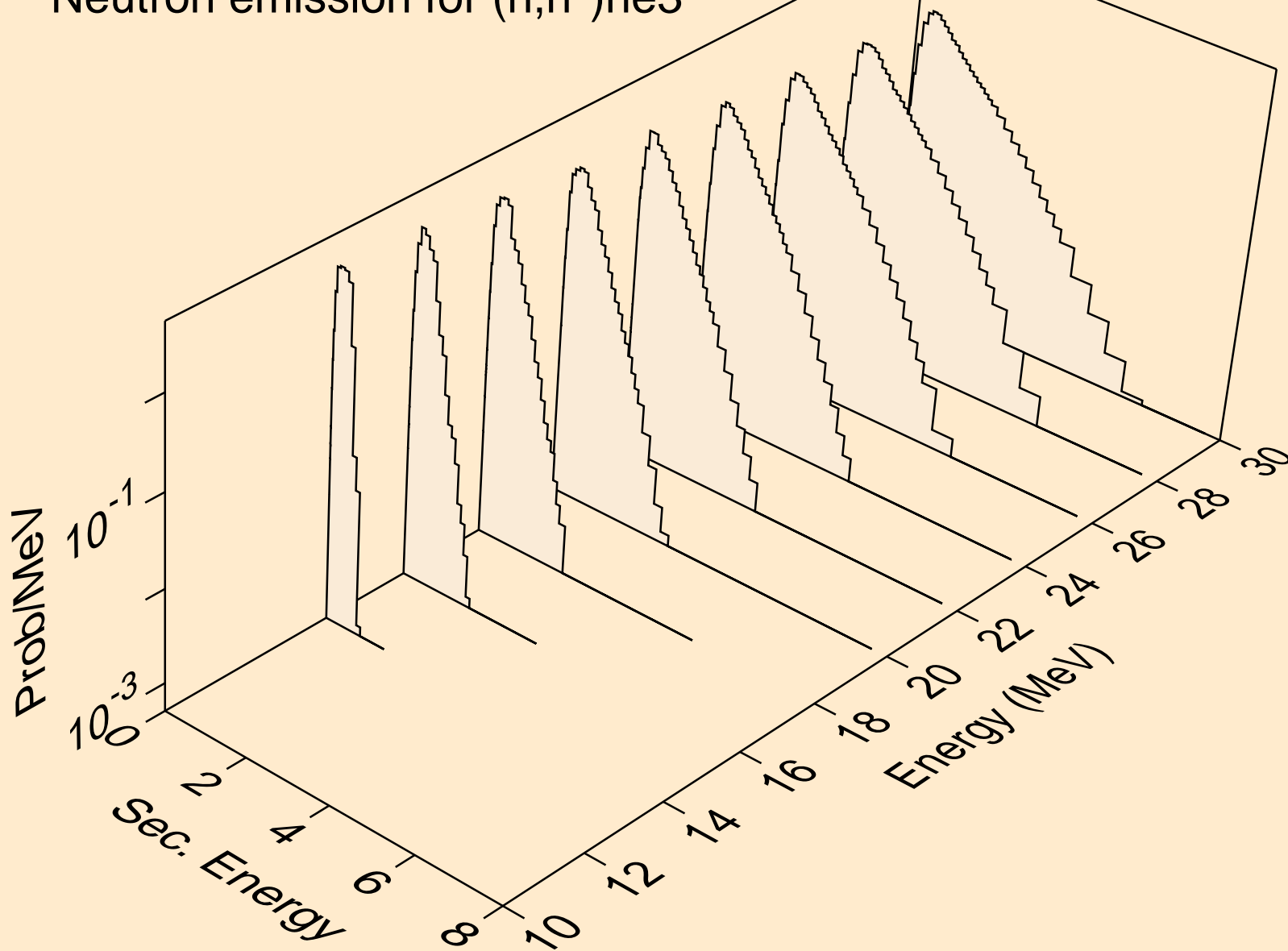



TC088M NEUTRON ACER TENDL-2019 LIBRARY; T=293.16K  
Neutron emission for (n,2np)

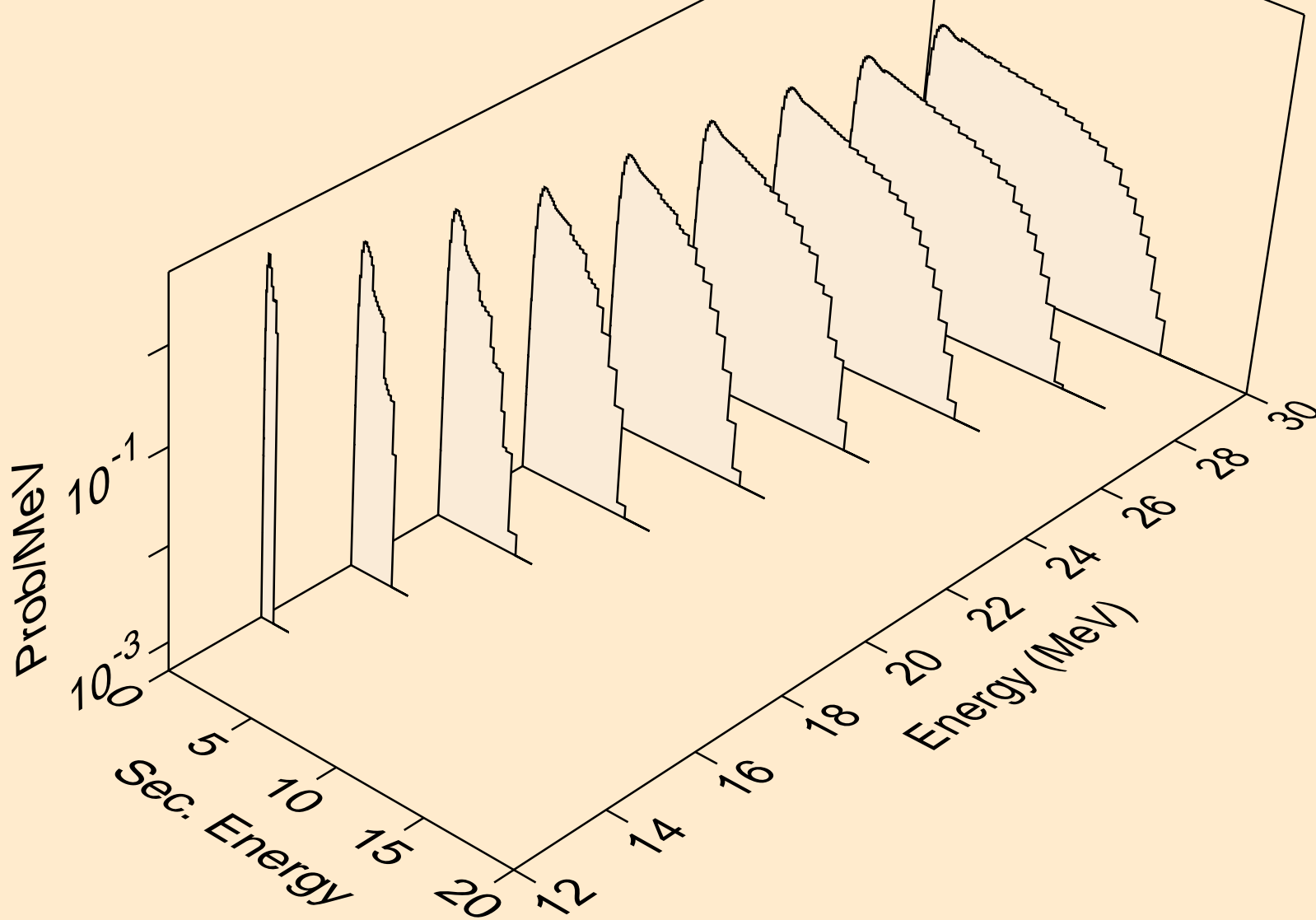

TC088M NEUTRON ACER TENDL-2019 LIBRARY; T=293.16K  
Neutron emission for (n,3np)

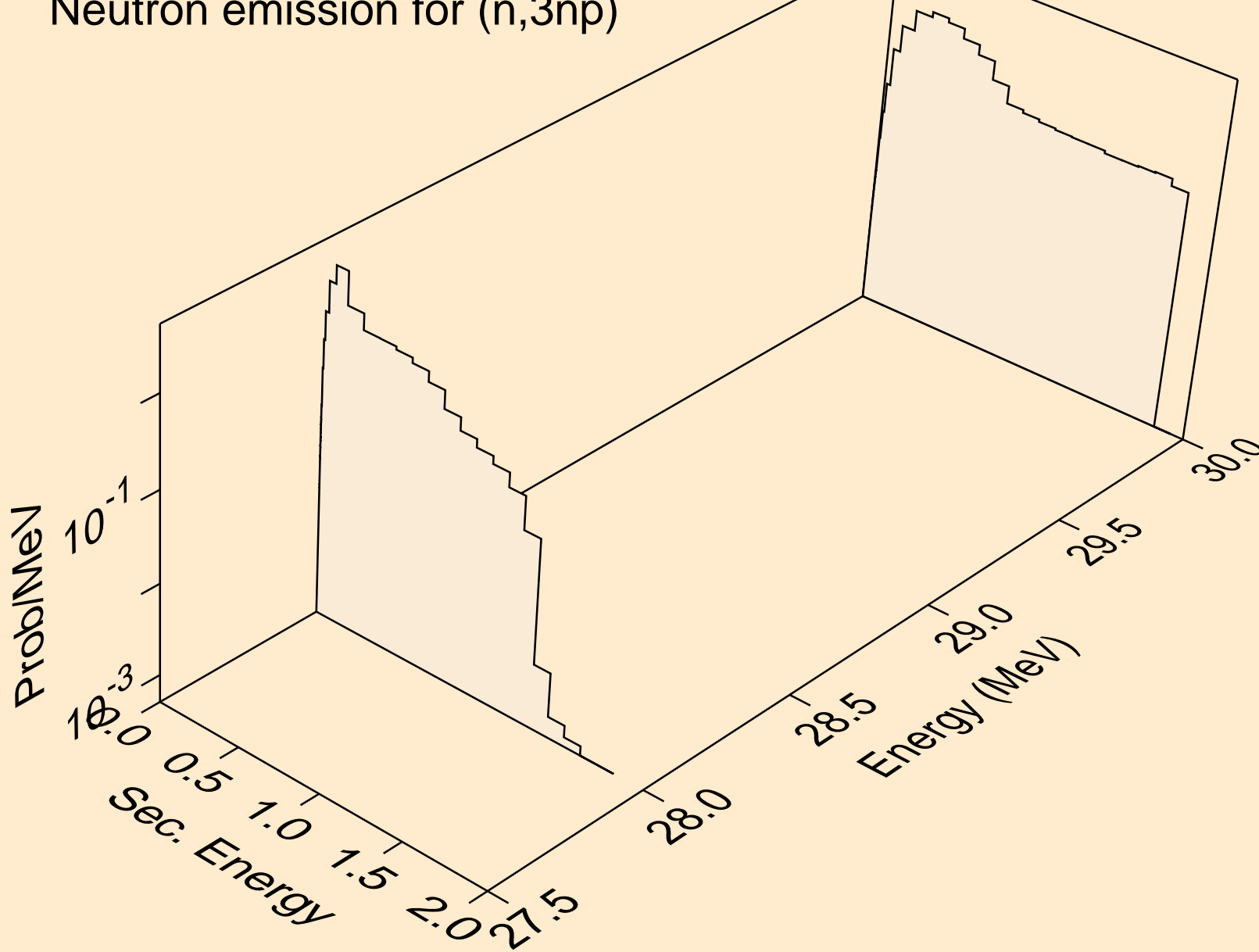

TC088M NEUTRON ACER TENDL-2019 LIBRARY; T=293.16K  
Neutron emission for (n,2np)

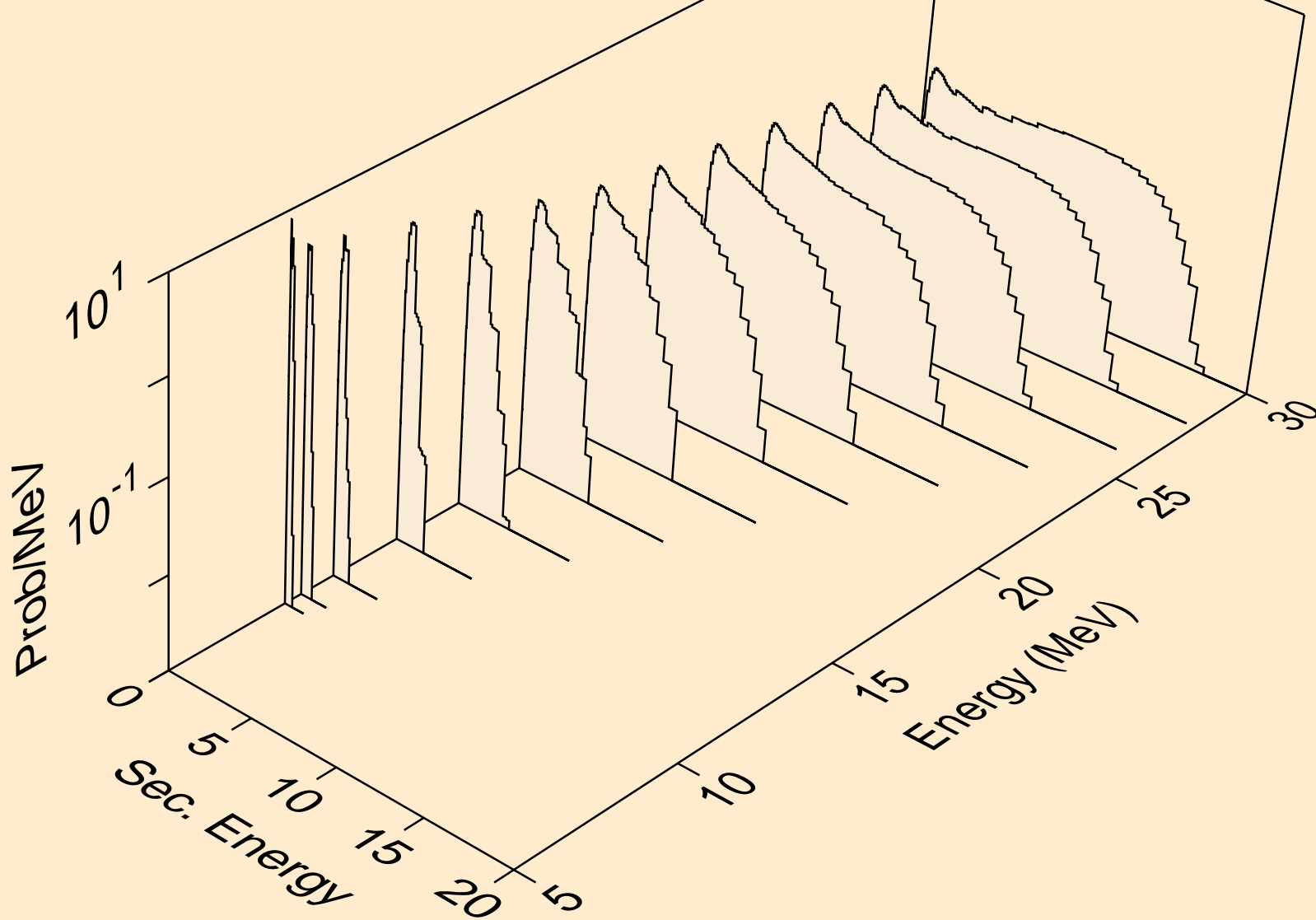

TC088M NEUTRON ACER TENDL-2019 LIBRARY; T=293.16K  
Neutron emission for (n,npa)

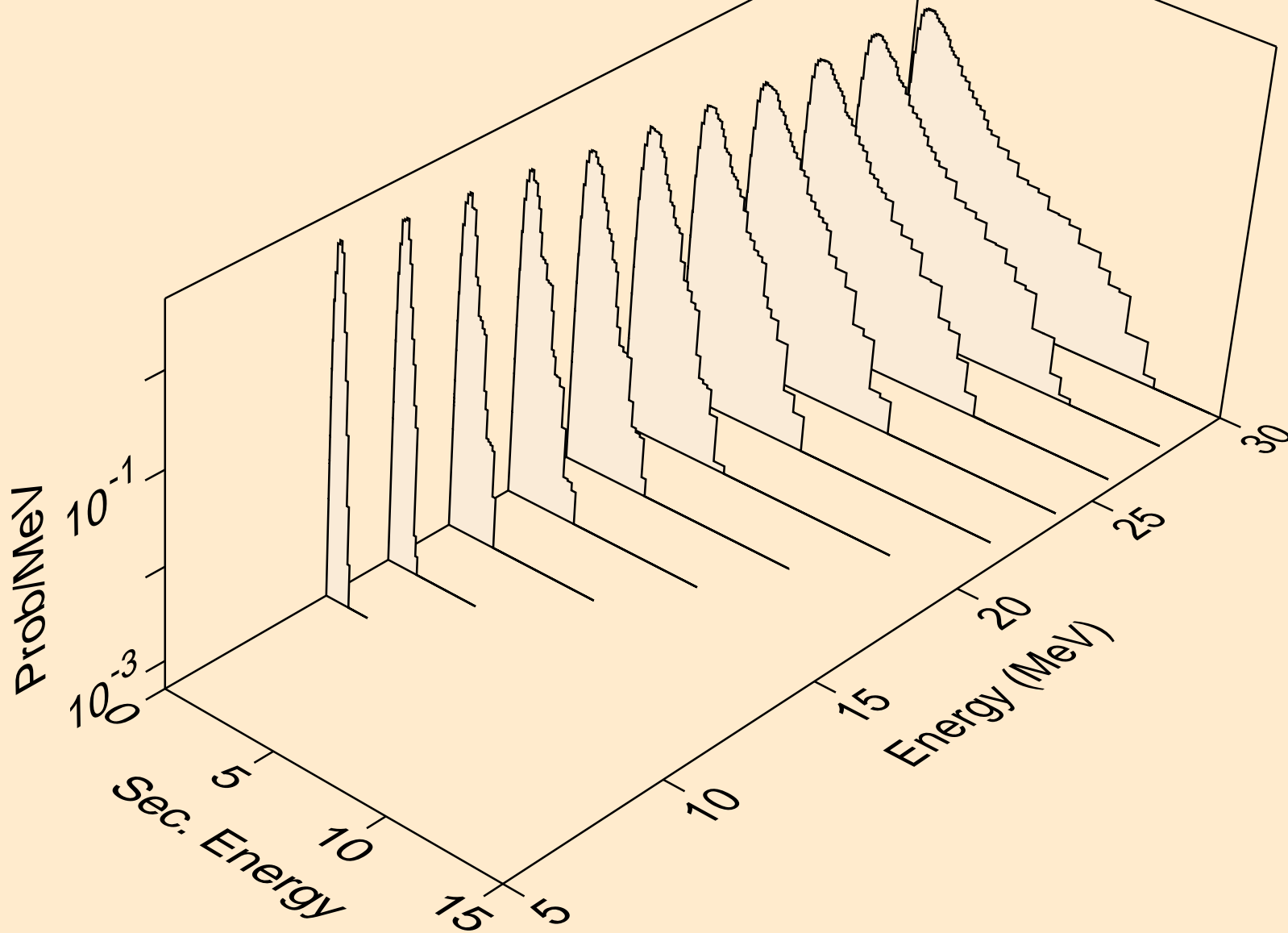

TC088M NEUTRON ACER TENDL-2019 LIBRARY; T=293.16K  
Neutron emission for (n,n\*c)

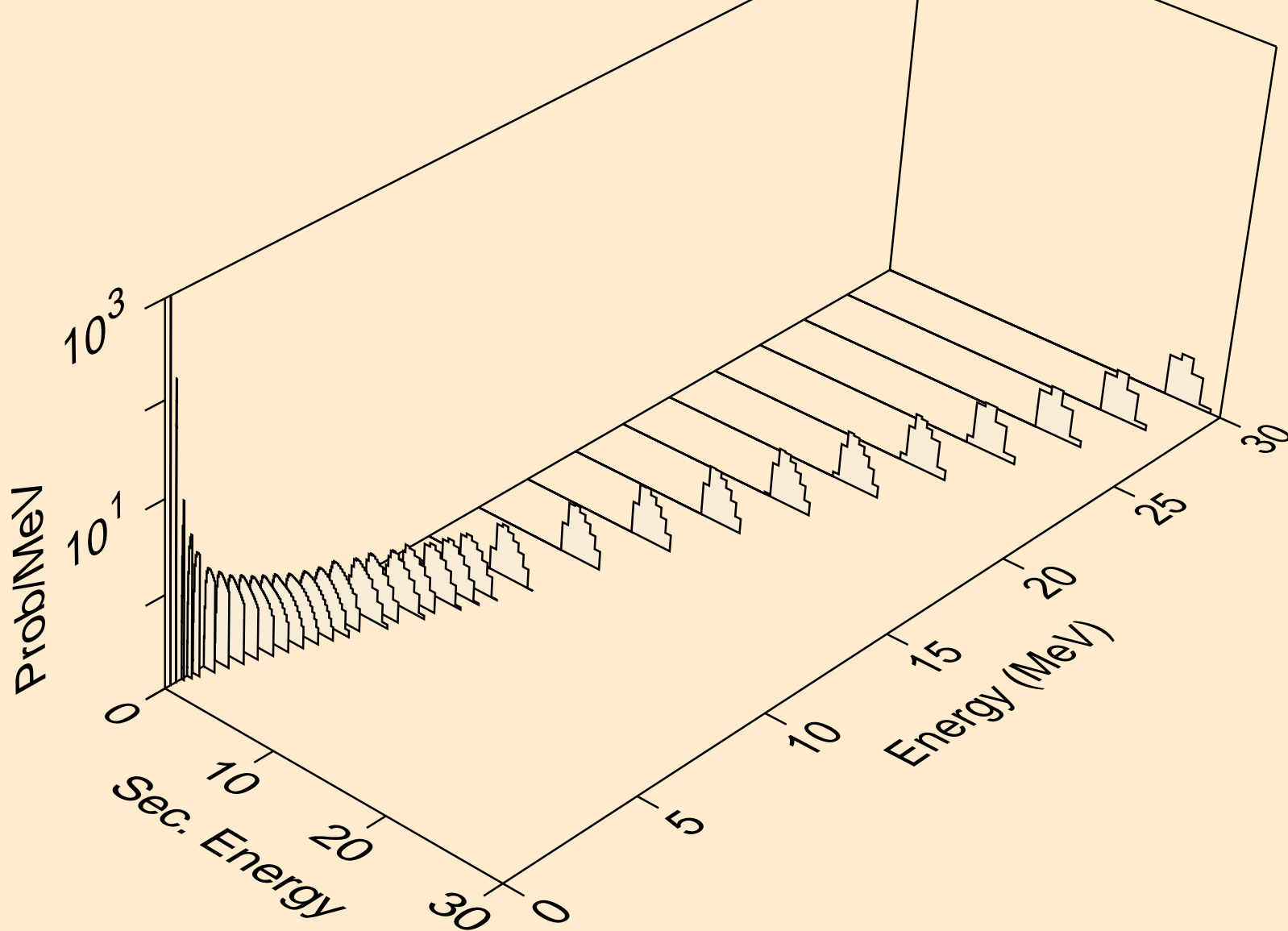

TC088M NEUTRON ACER TENDL-2019 LIBRARY; T=293.16K  
Photon emission for (n,x)

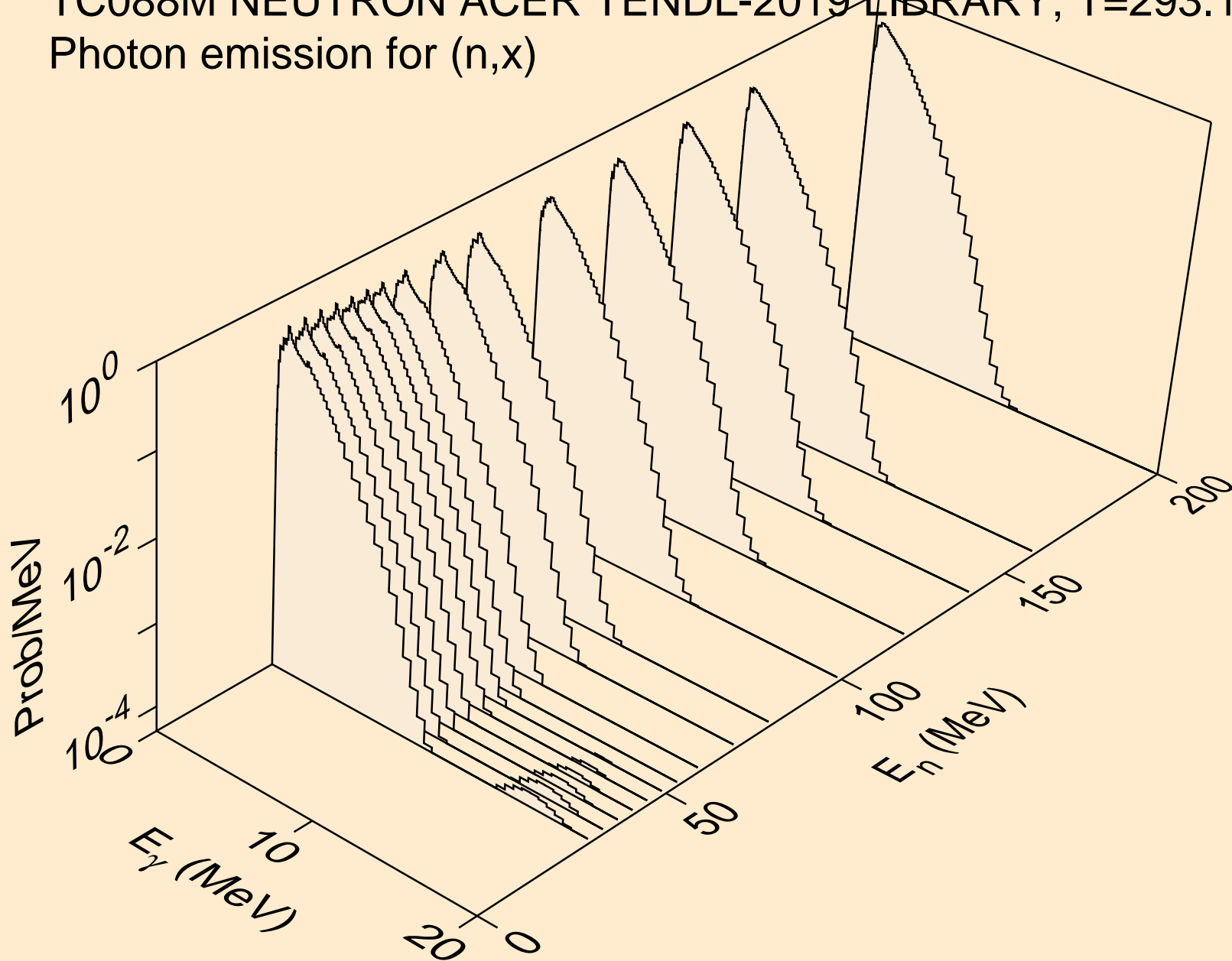

TC088M NEUTRON ACER TENDL-2019 LIBRARY; T=293.16K  
Photon emission for (n,2nd)

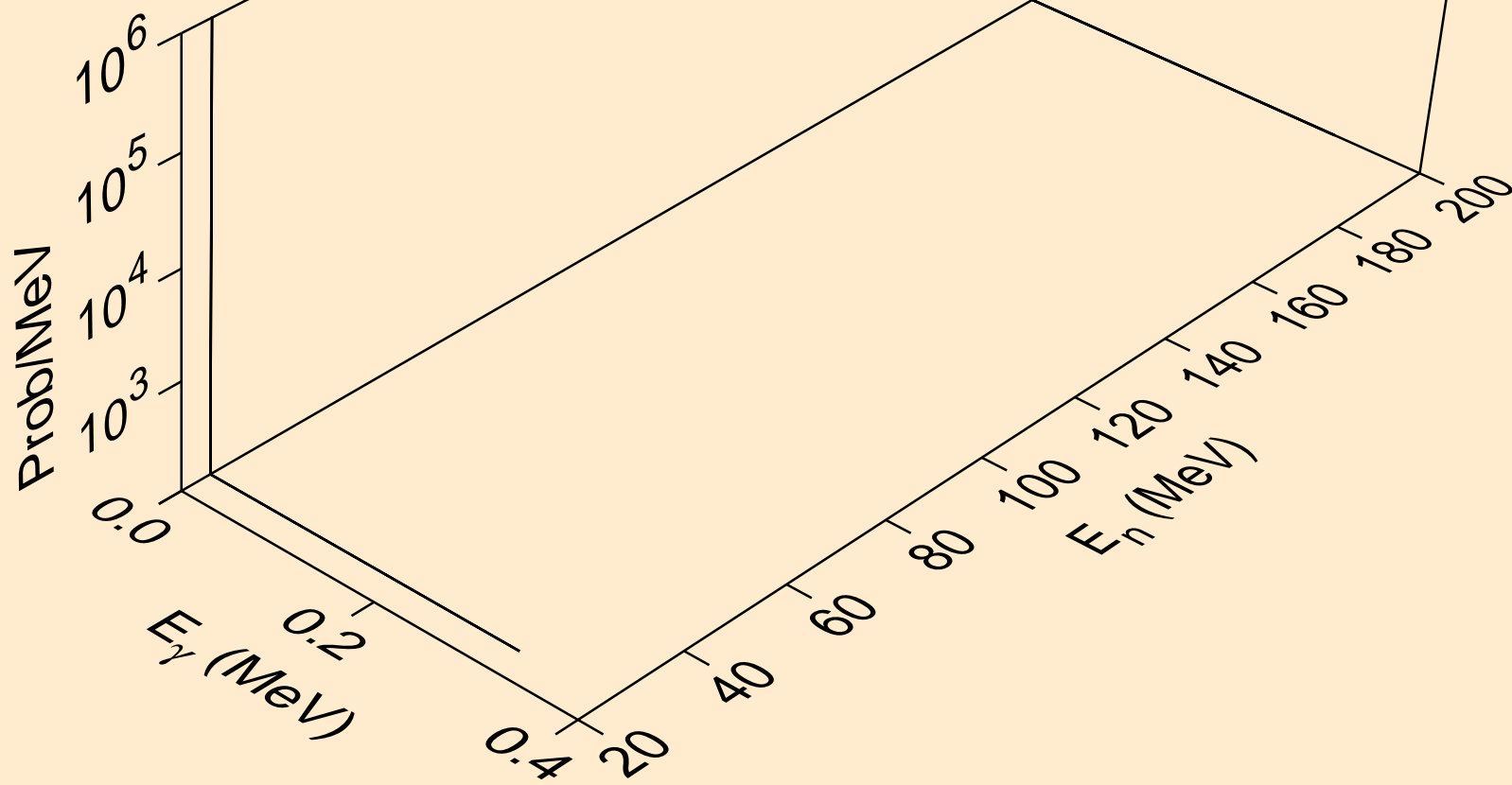

TC088M NEUTRON ACER TENDL-2019 LIBRARY; T=293.16K  
Photon emission for (n,2n)

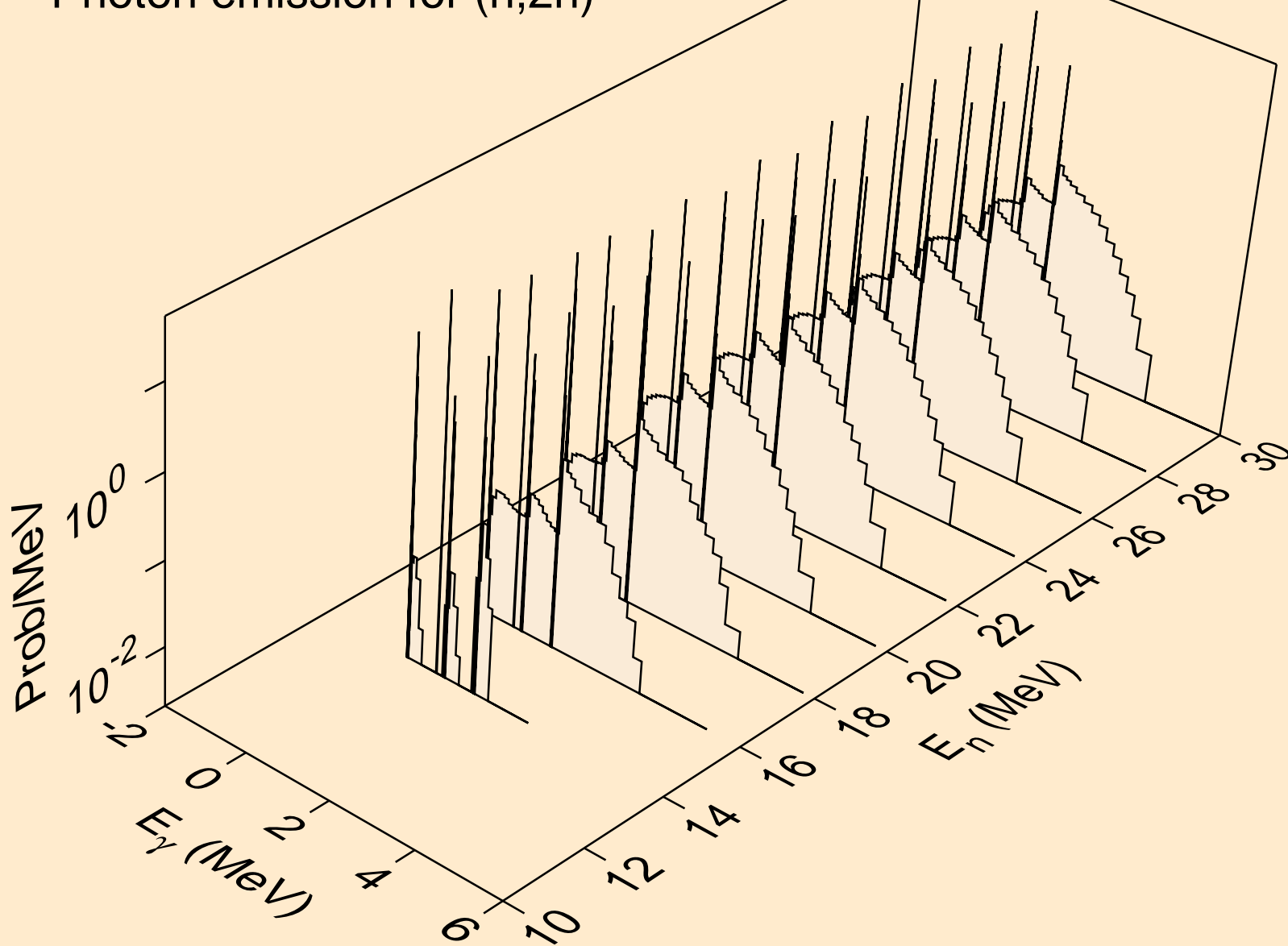



TC088M NEUTRON ACER TENDL-2019 LIBRARY; T=293.16K  
Photon emission for (n,3n)

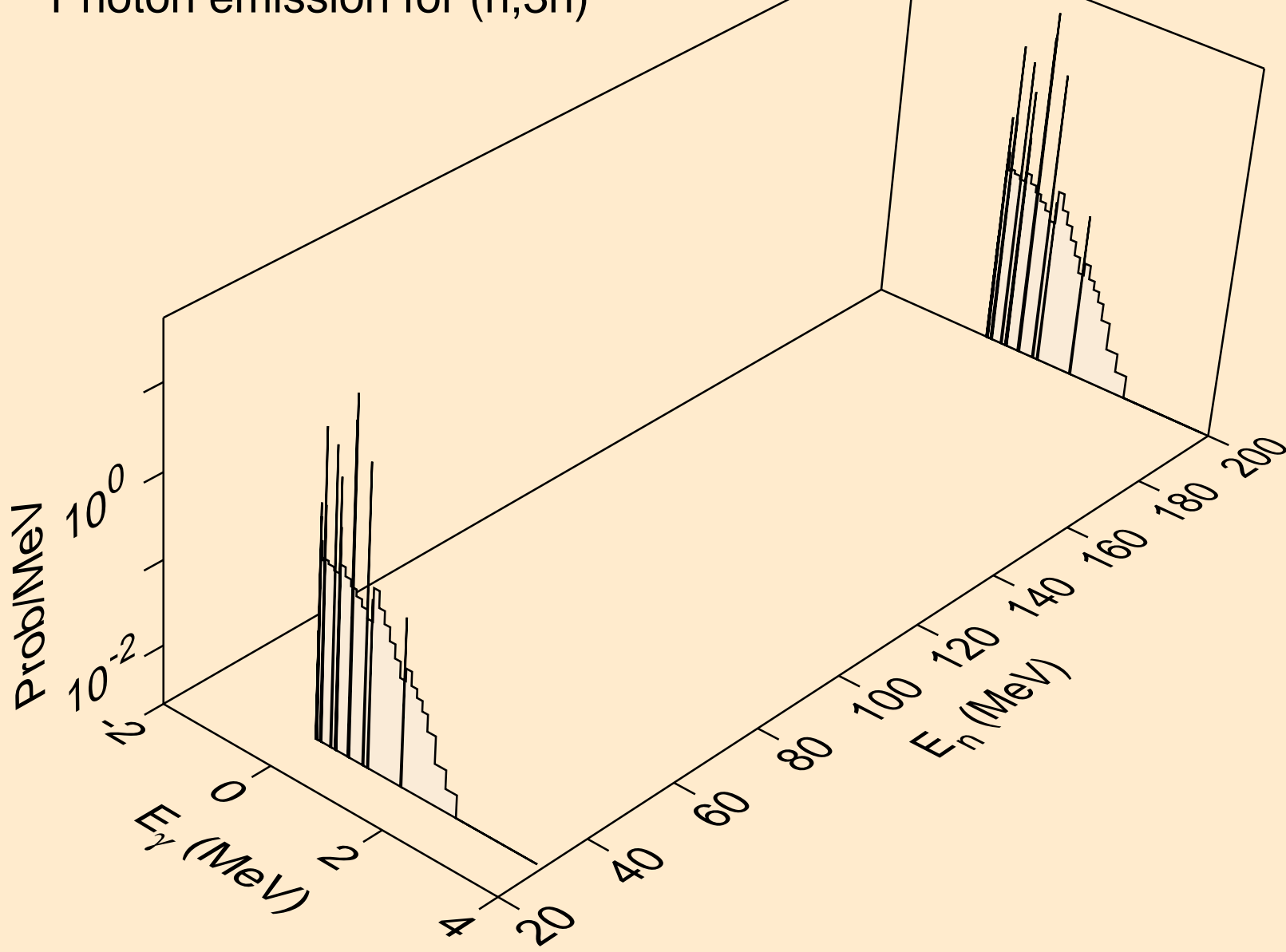

TC088M NEUTRON ACER TENDL-2019 LIBRARY; T=293.16K  
Photon emission for (n,n\*)a

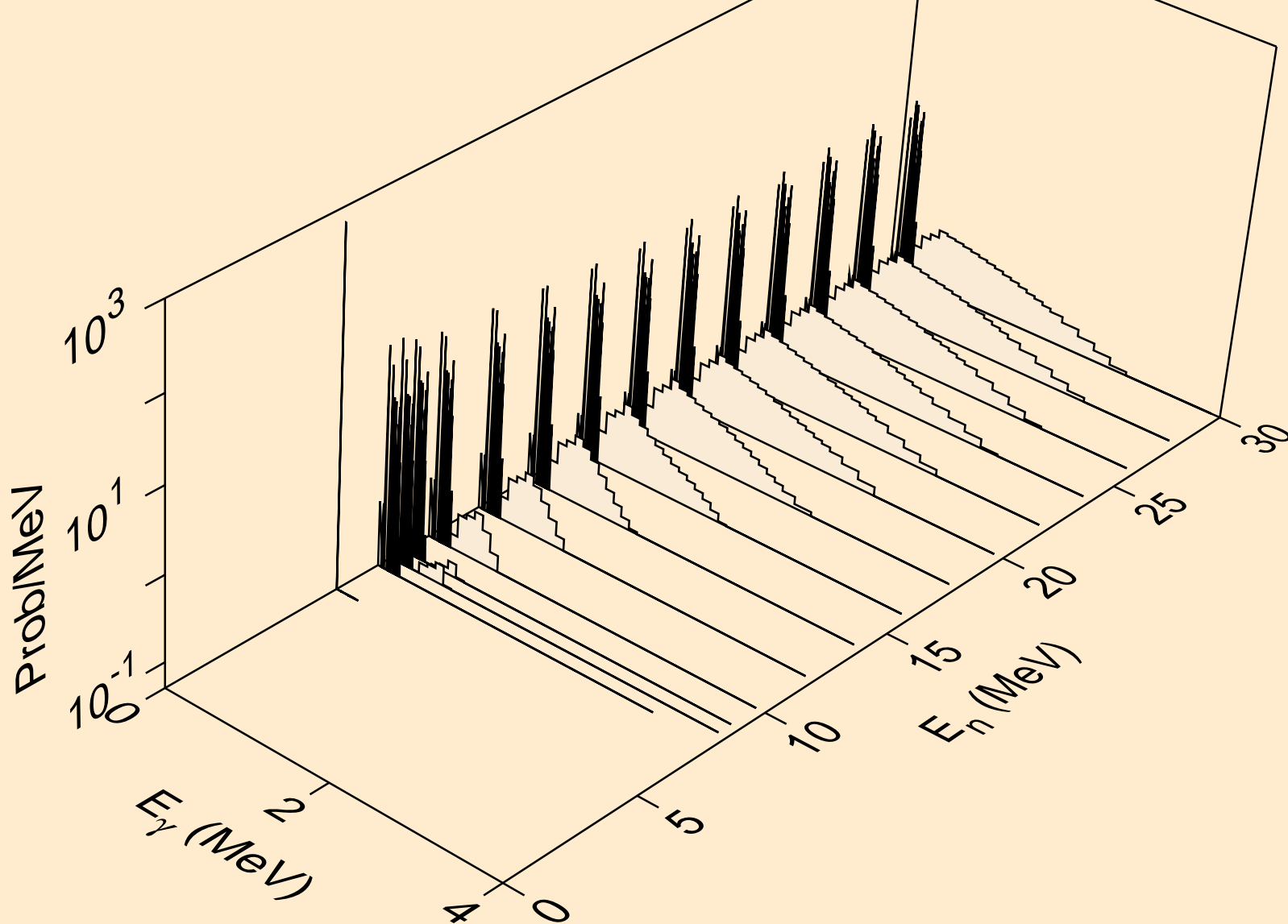

TC088M NEUTRON ACER TENDL-2019 LIBRARY; T=293.16K  
Photon emission for (n,2n)a

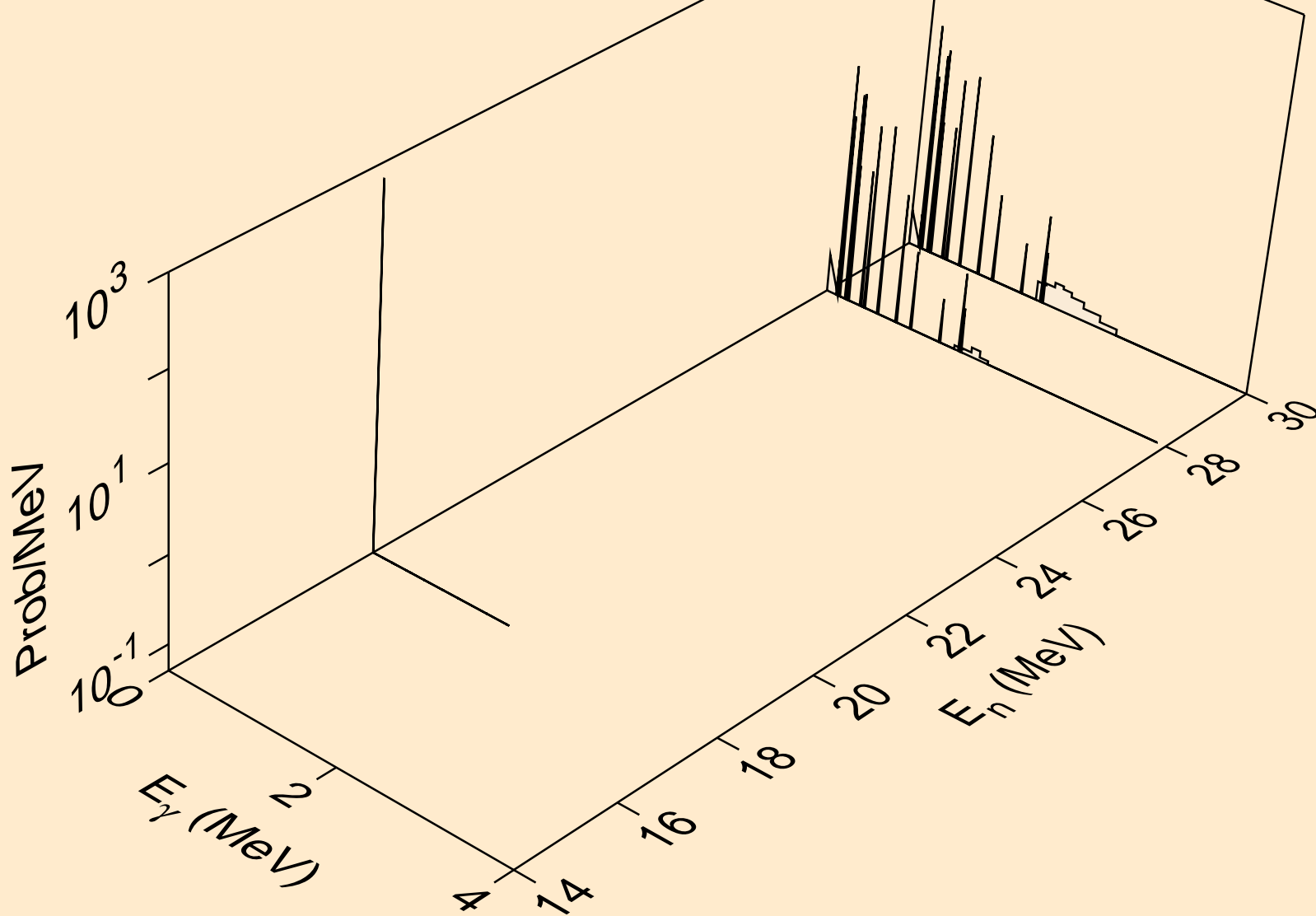

TC088M NEUTRON ACER TENDL-2019 LIBRARY; T=293.16K  
Photon emission for (n,n\*)p

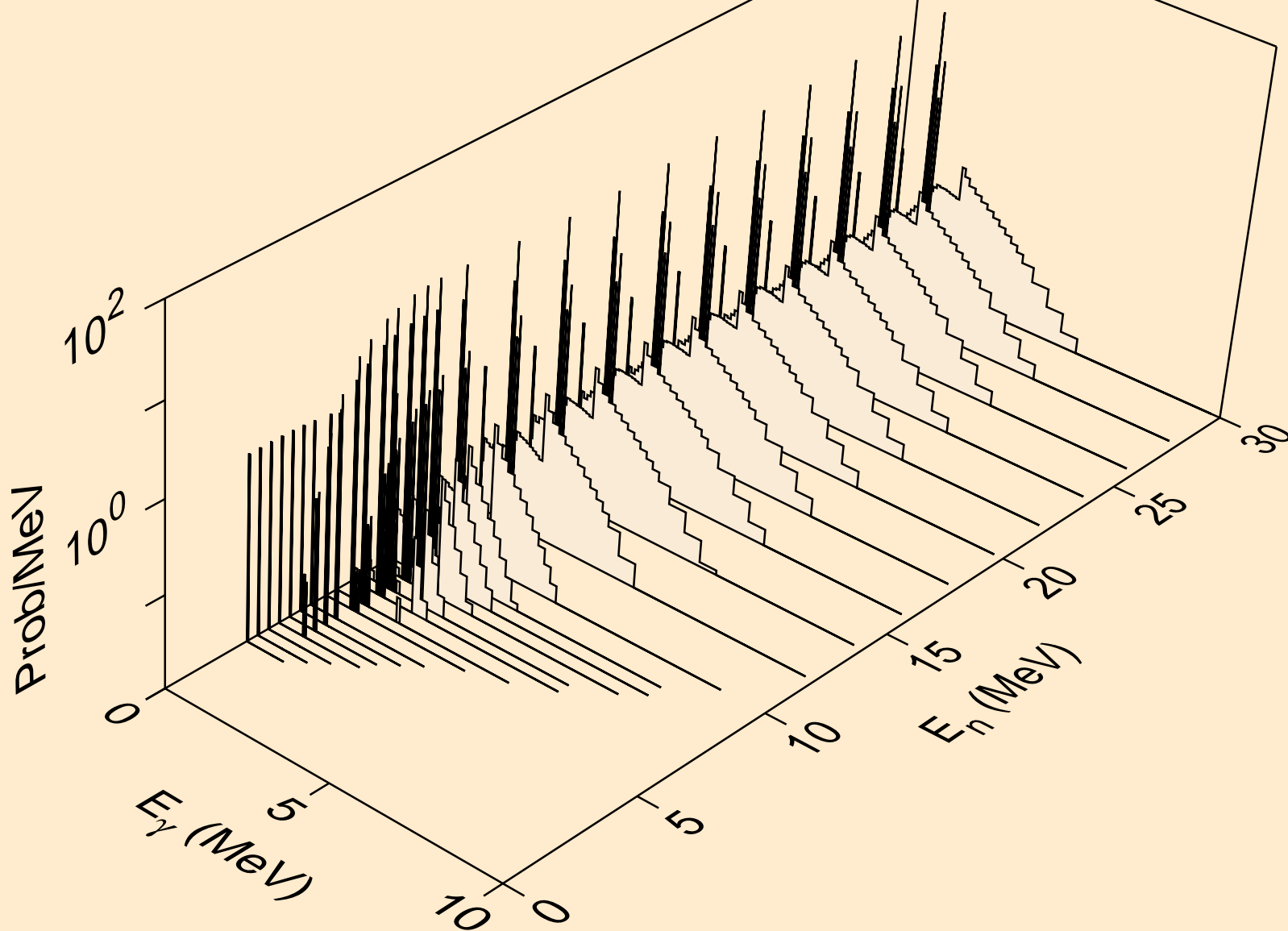

TC088M NEUTRON ACER TENDL-2019 LIBRARY; T=293.16K  
Photon emission for (n,n\*)2a

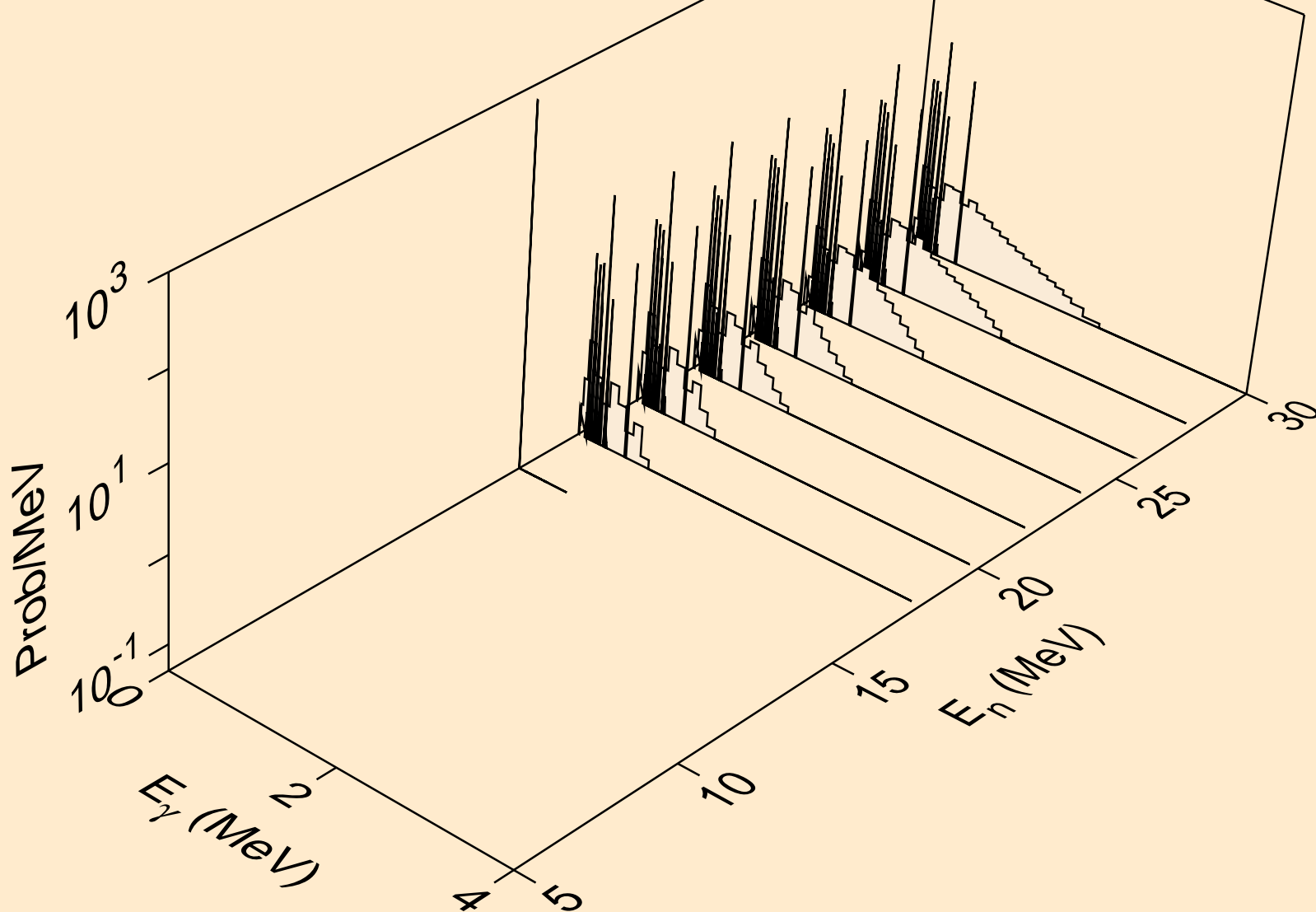

TC088M NEUTRON ACER TENDL-2019 LIBRARY; T=293.16K  
Photon emission for (n,n\*)d

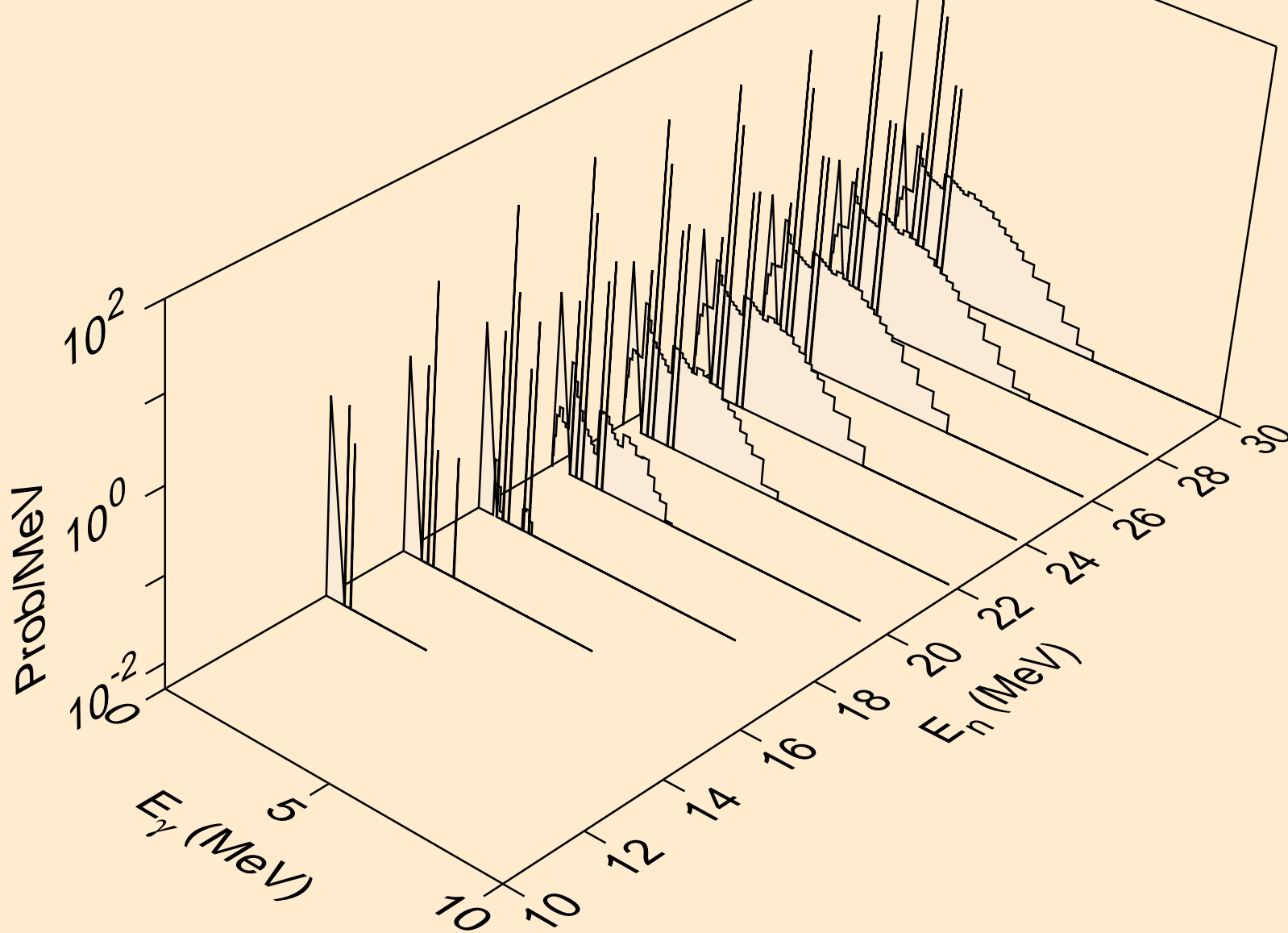

TC088M NEUTRON ACER TENDL-2019 LIBRARY; T=293.16K  
Photon emission for (n,n\*)t

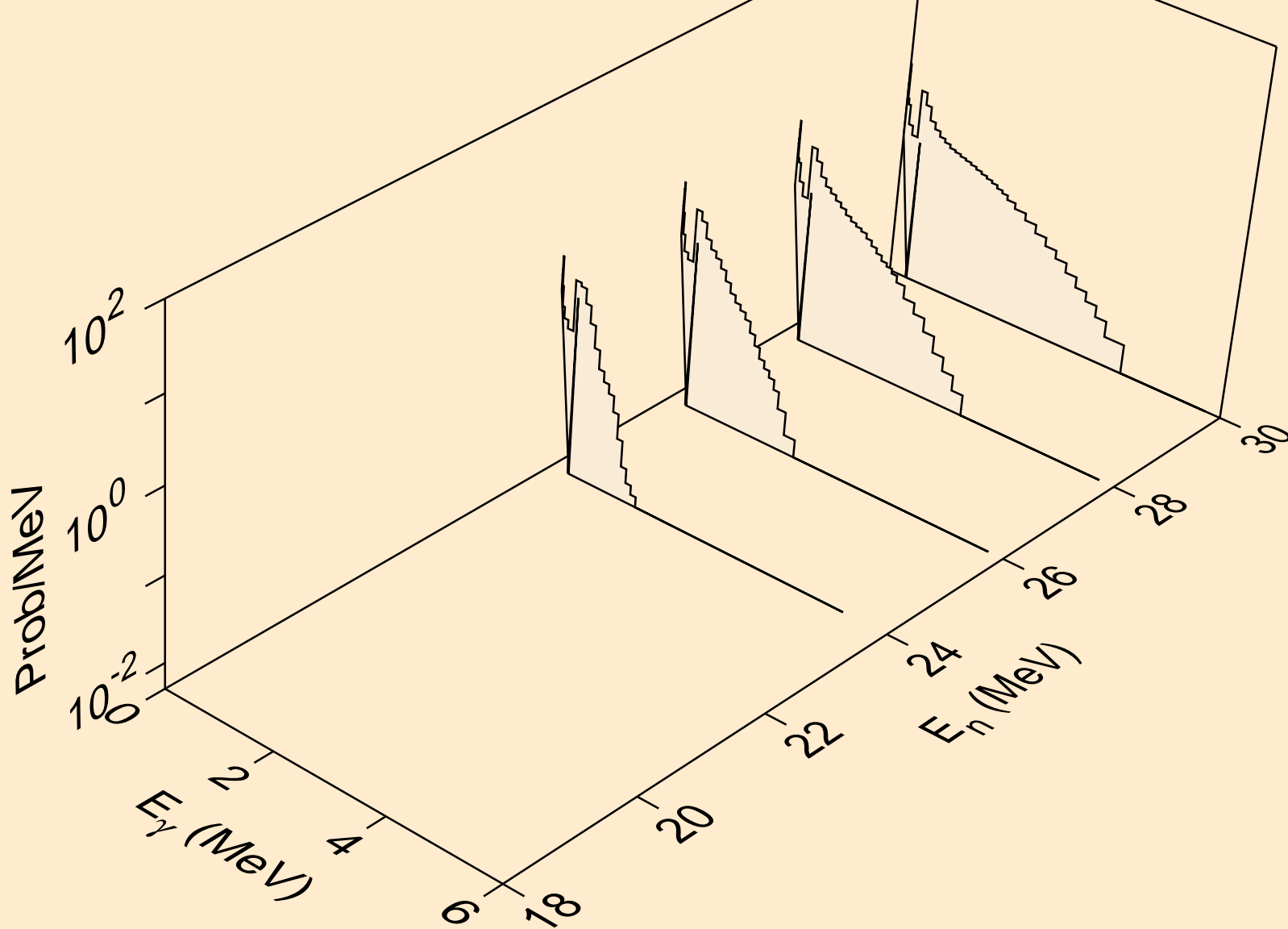

TC088M NEUTRON ACER TENDL-2019 LIBRARY; T=293.16K  
Photon emission for (n,n\*)he3

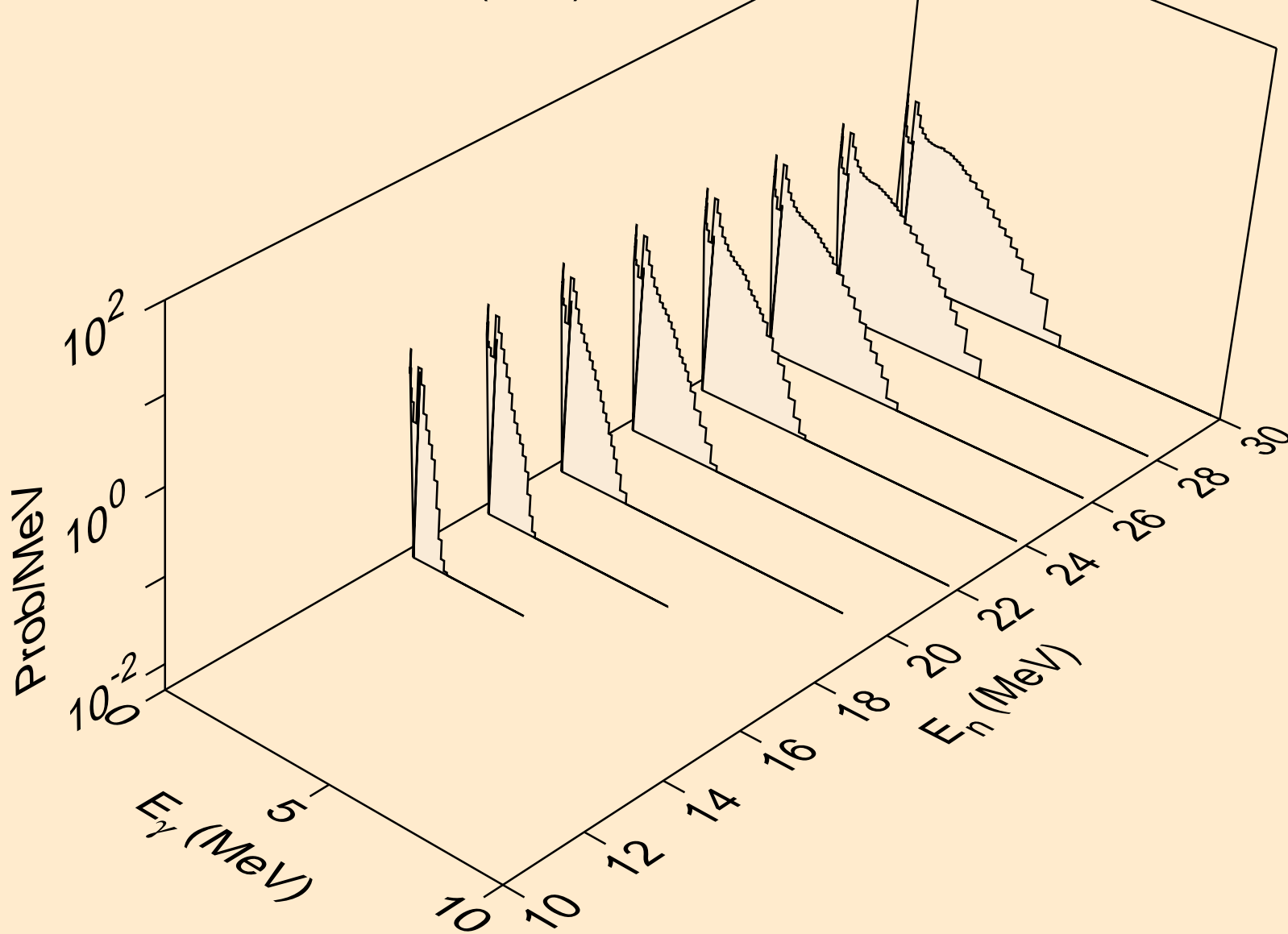



TC088M NEUTRON ACER TENDL-2019 LIBRARY; T=293.16K  
Photon emission for (n,2np)

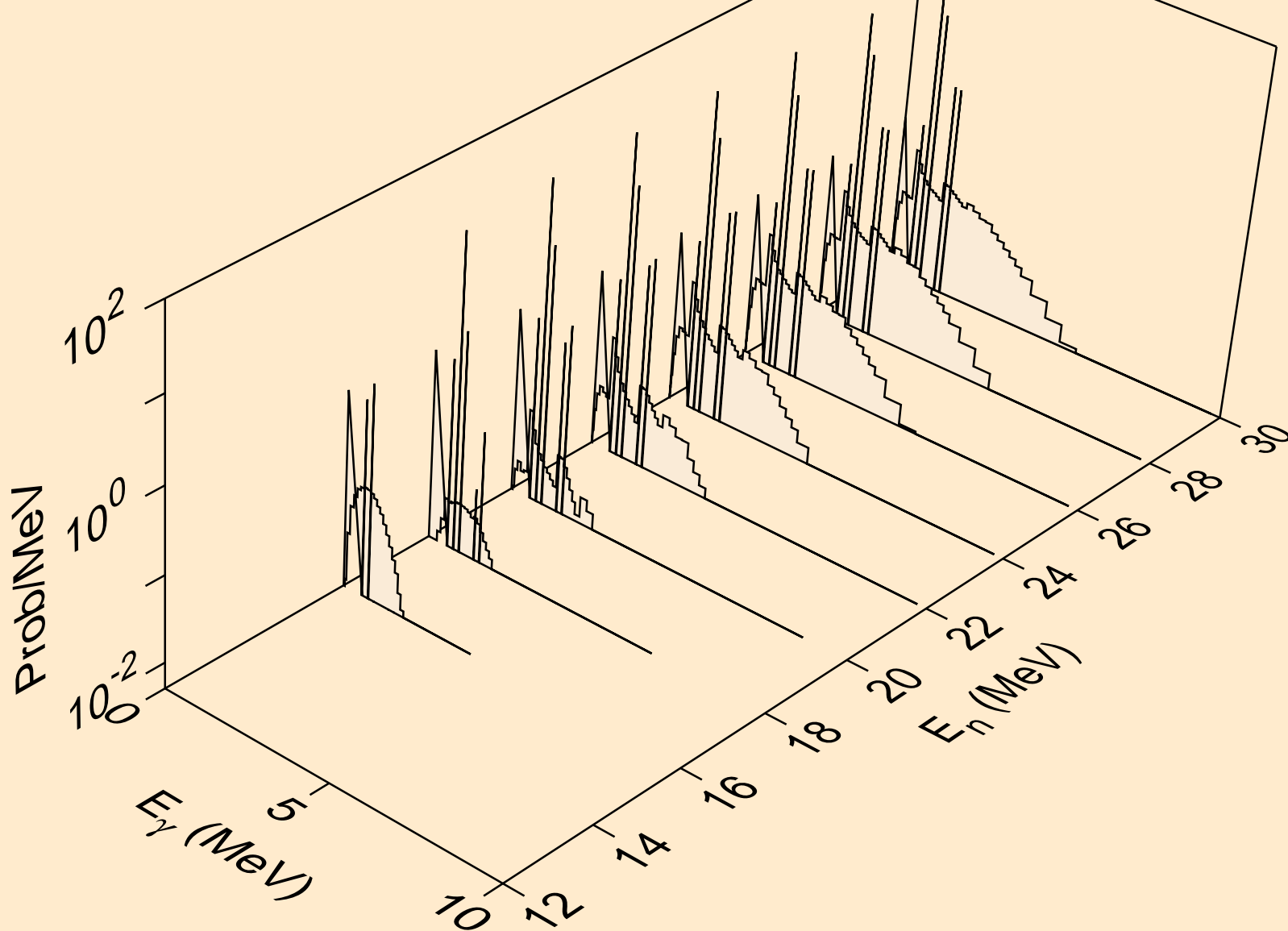

TC088M NEUTRON ACER TENDL-2019 LIBRARY; T=293.16K  
Photon emission for (n,3np)

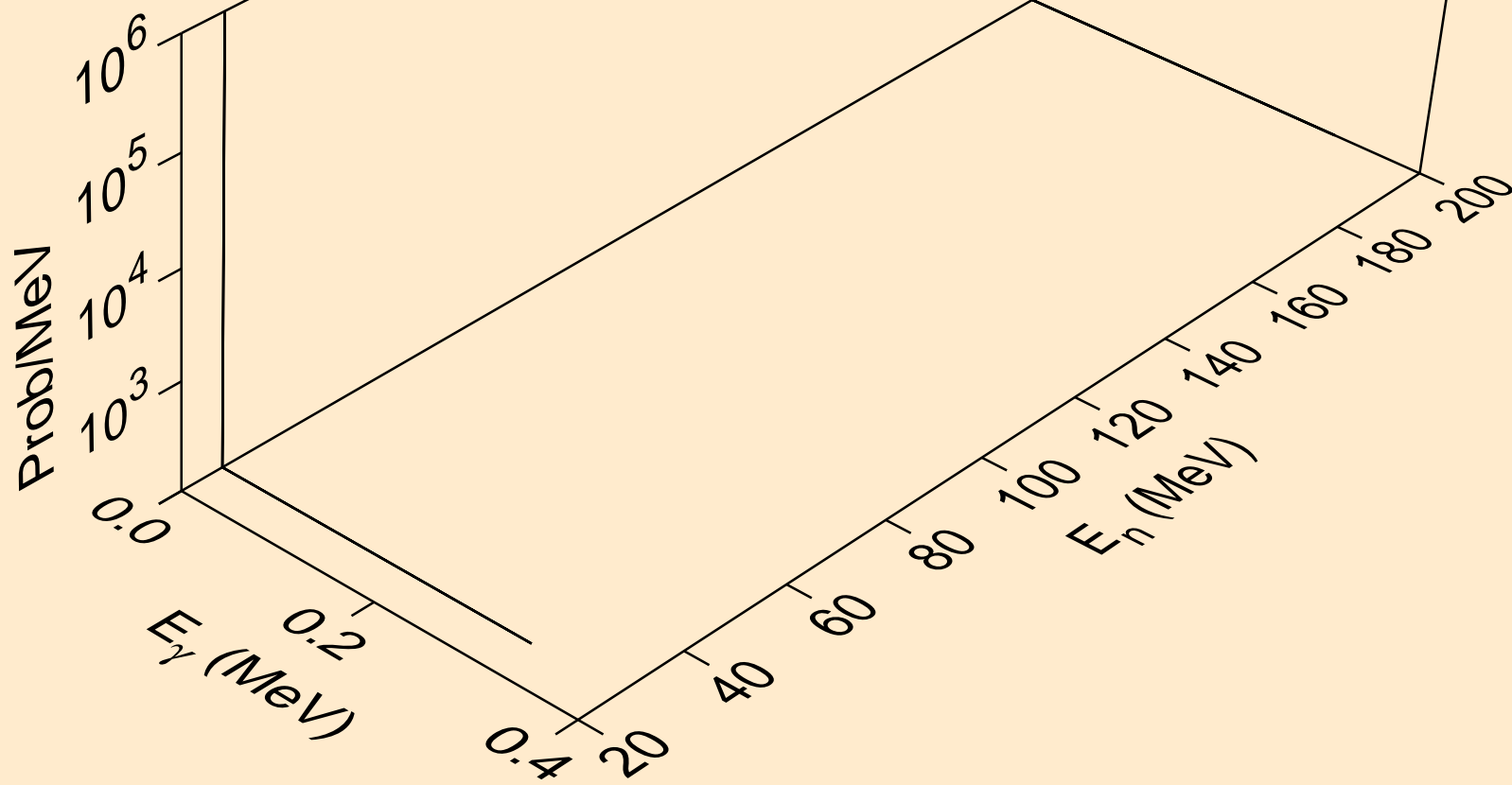

TC088M NEUTRON ACER TENDL-2019 LIBRARY; T=293.16K  
Photon emission for (n,2np)

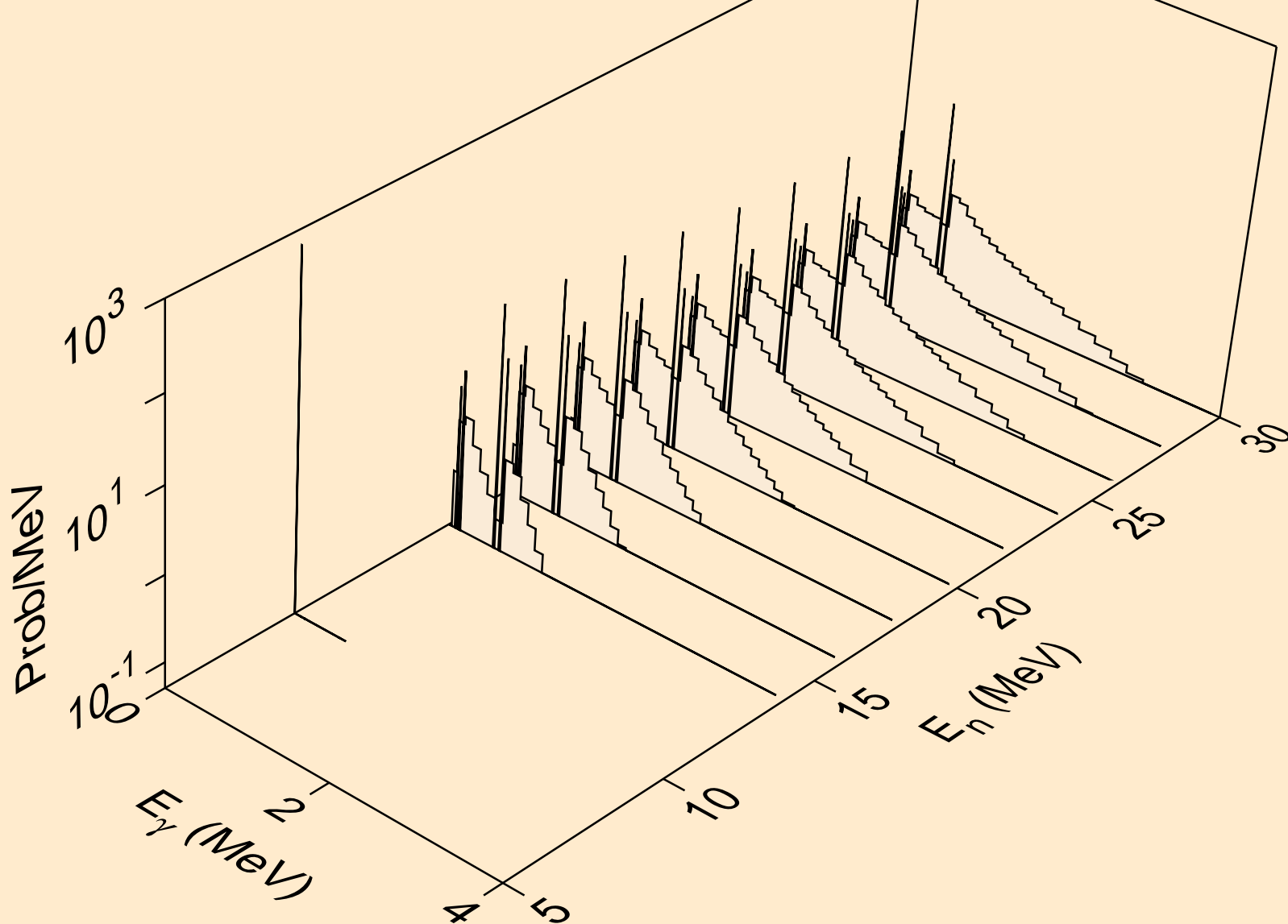

TC088M NEUTRON ACER TENDL-2019 LIBRARY; T=293.16K  
Photon emission for (n,npa)

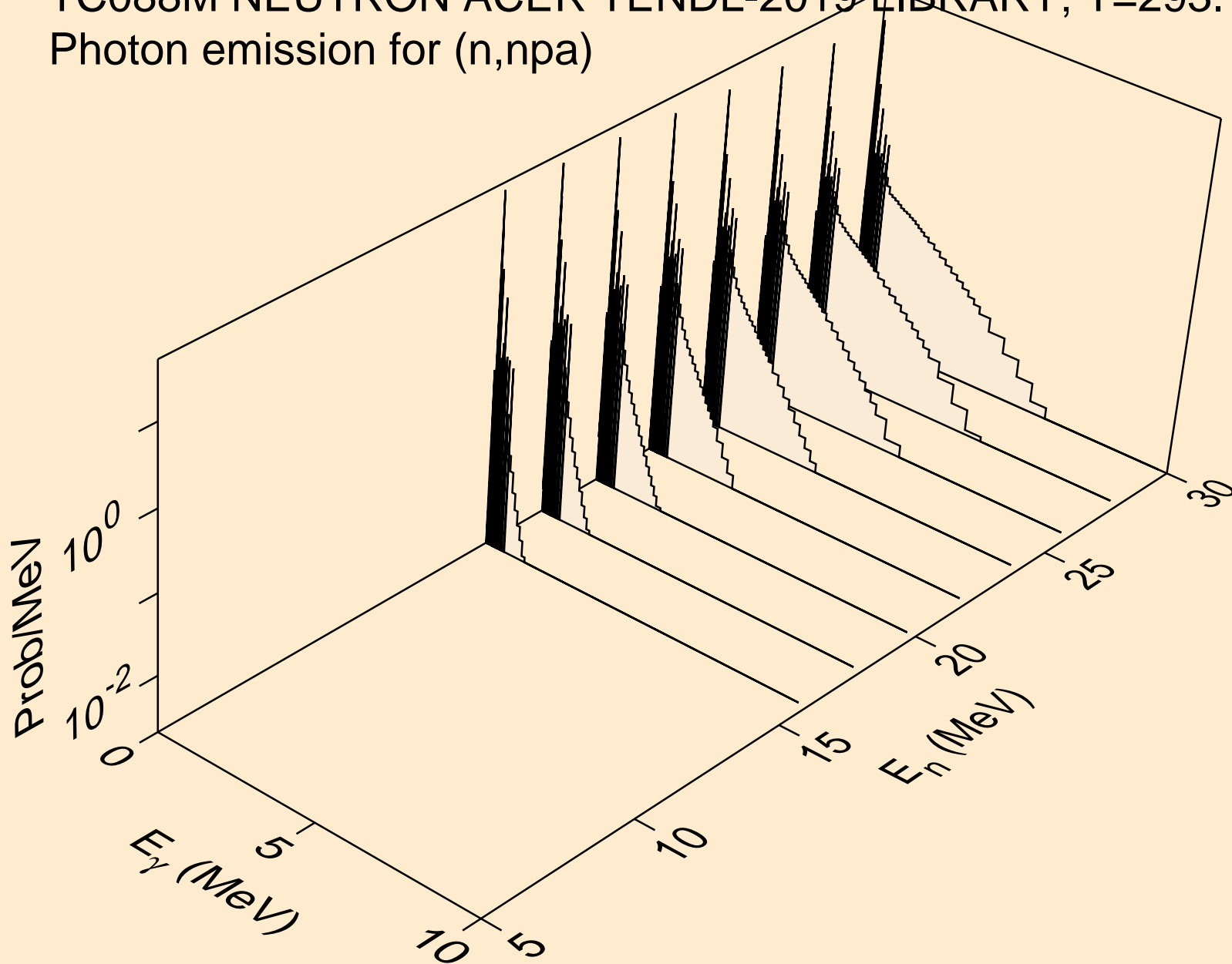

TC088M NEUTRON ACER TENDL-2019 LIBRARY; T=293.16K  
Photon emission for (n,n\*2)

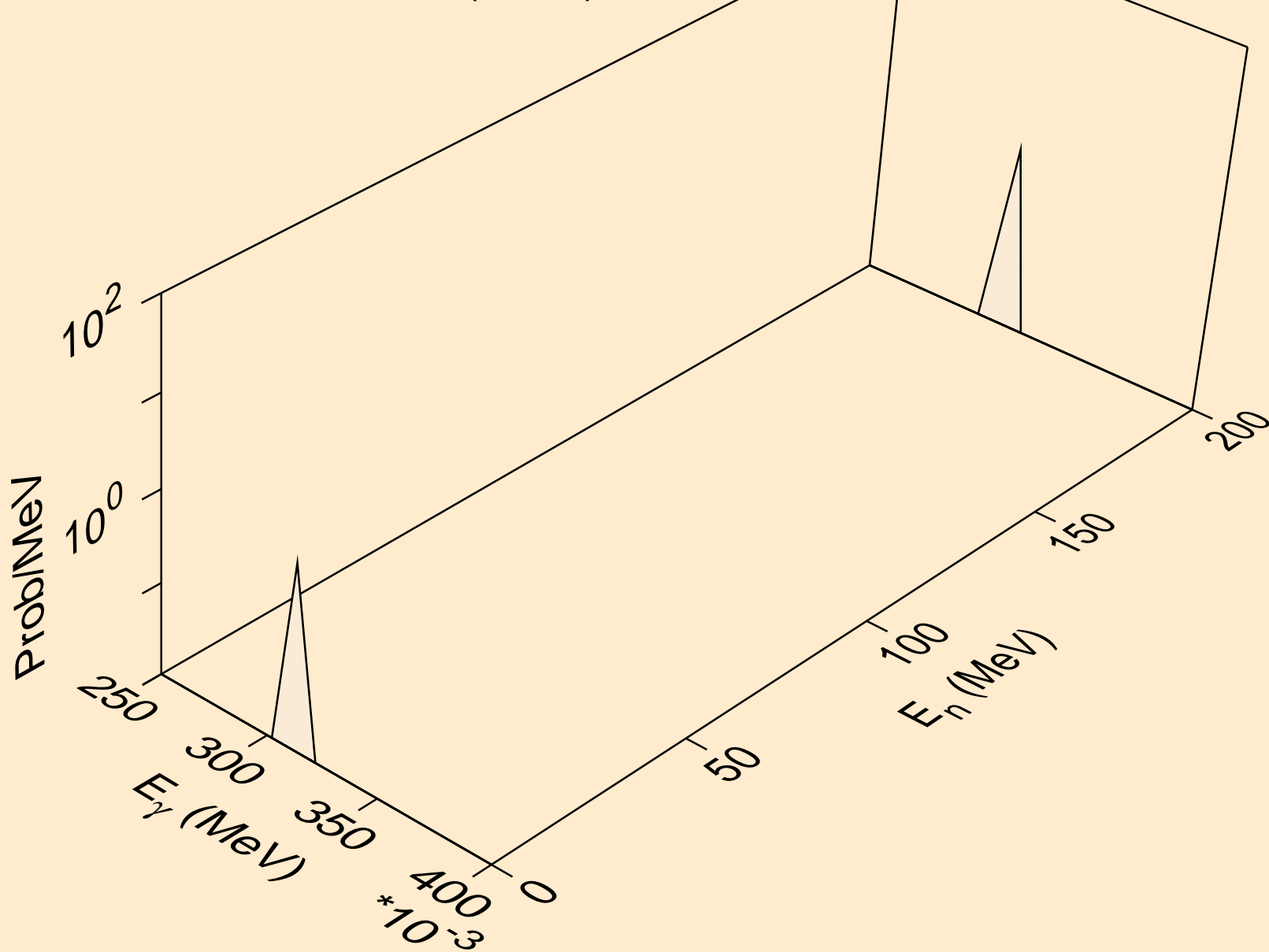

TC088M NEUTRON ACER TENDL-2019 LIBRARY; T=293.16K  
Photon emission for (n,n\*c)

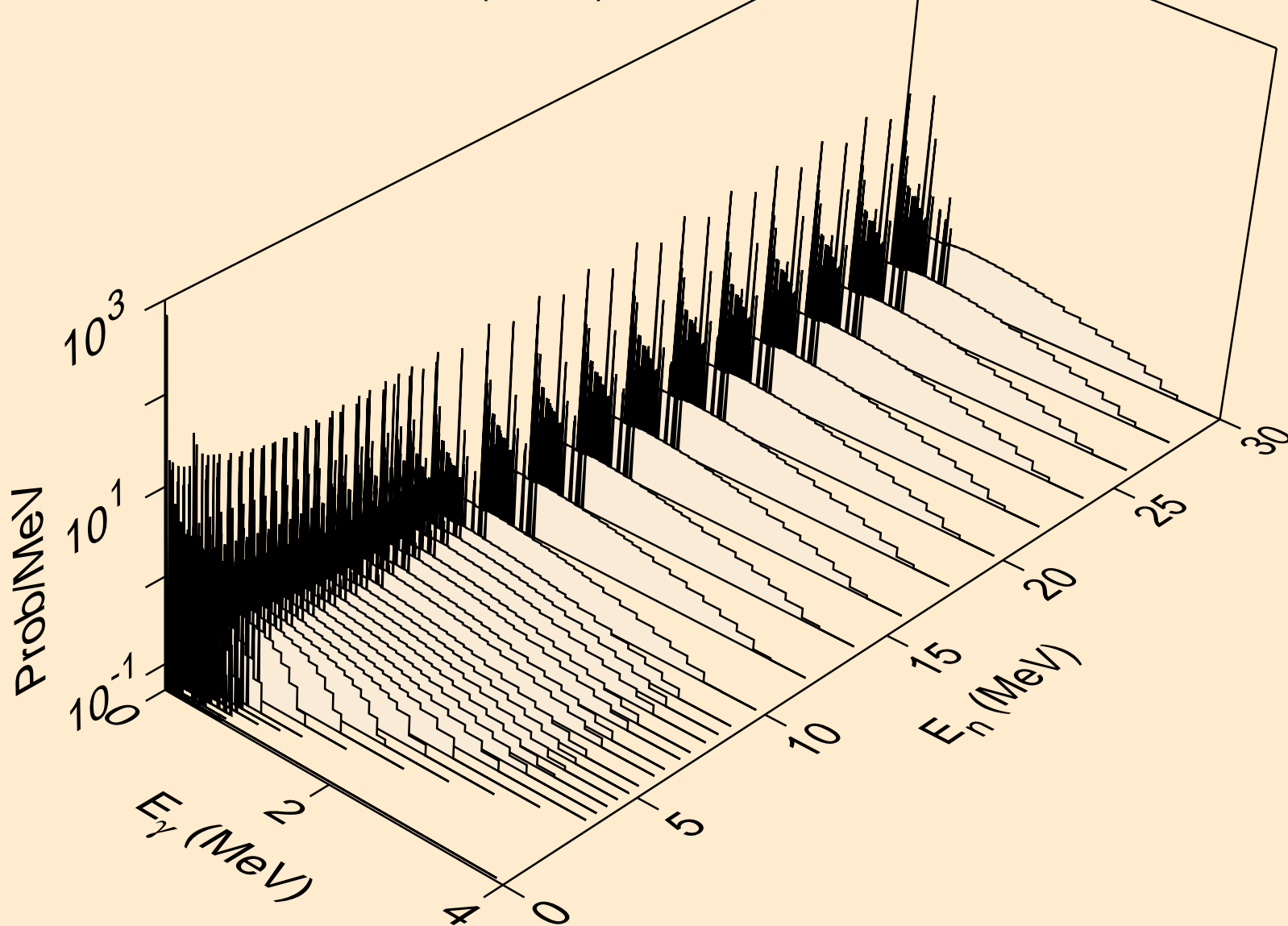

TC088M NEUTRON ACER TENDL-2019 LIBRARY; T=293.16K  
Photon emission for (n,gma)

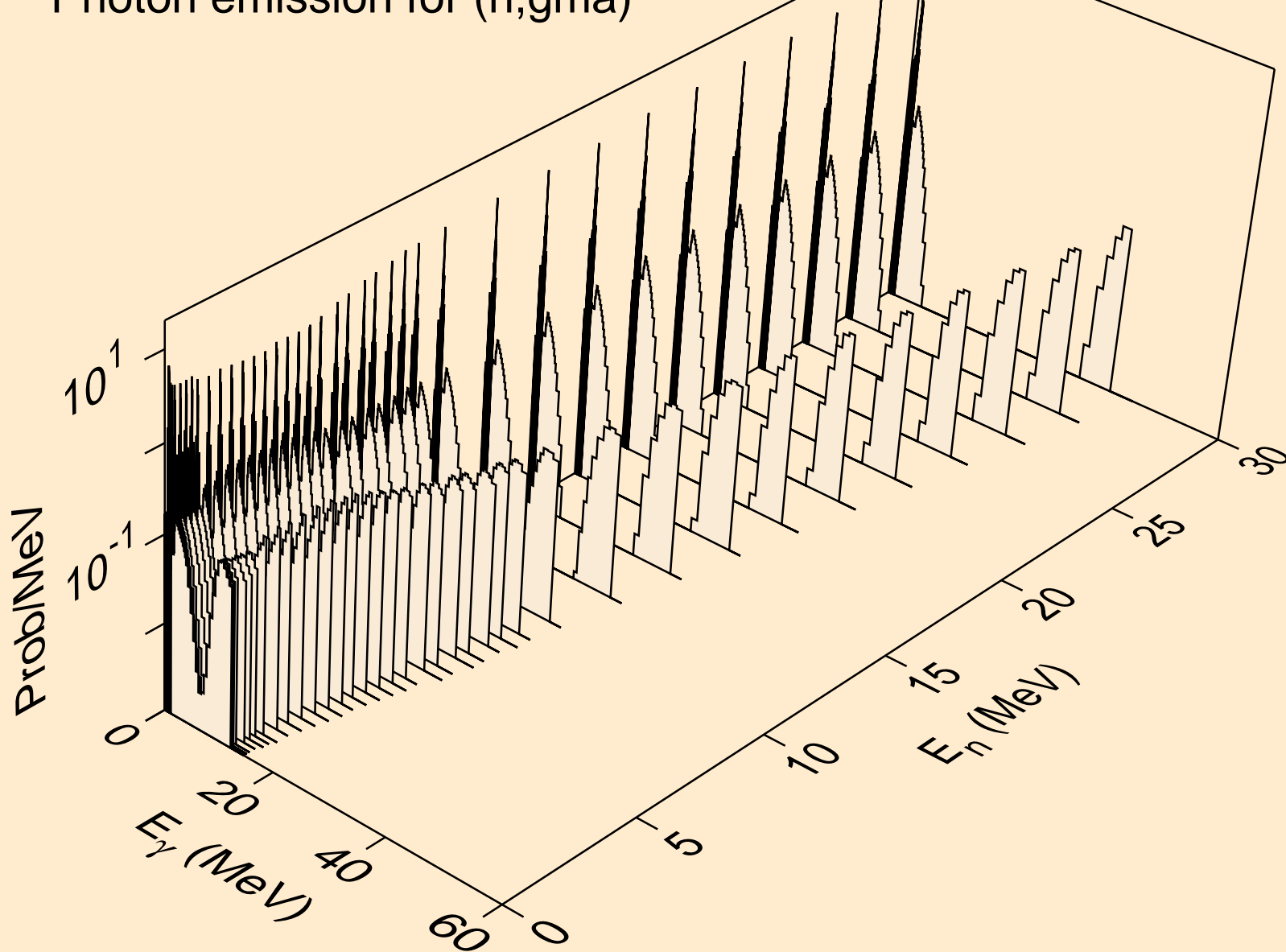

TC088M NEUTRON ACER TENDL-2019 LIBRARY; T=293.16K  
Photon emission for (n,p)

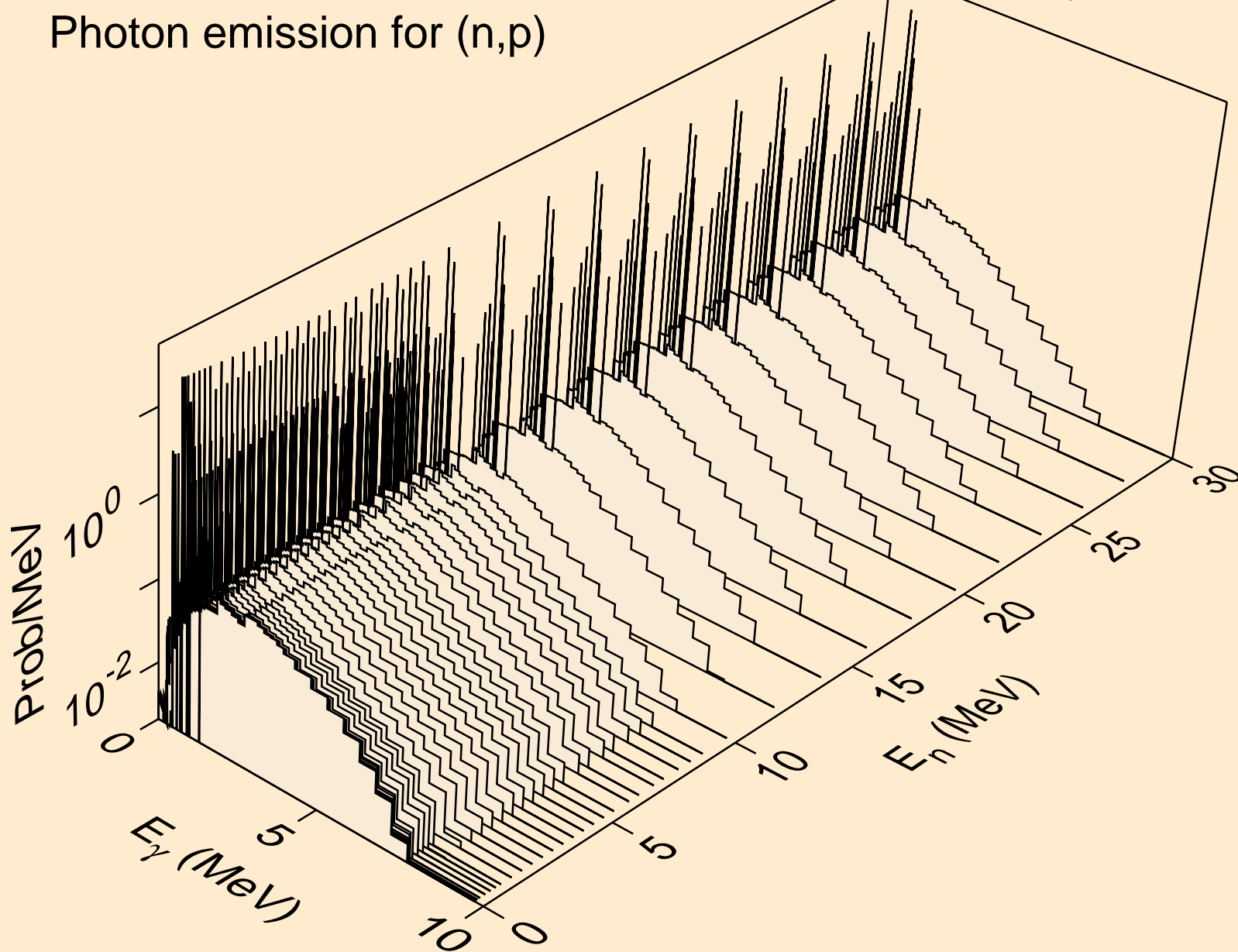



TC088M NEUTRON ACER TENDL-2019 LIBRARY; T=293.16K  
Photon emission for (n,d)

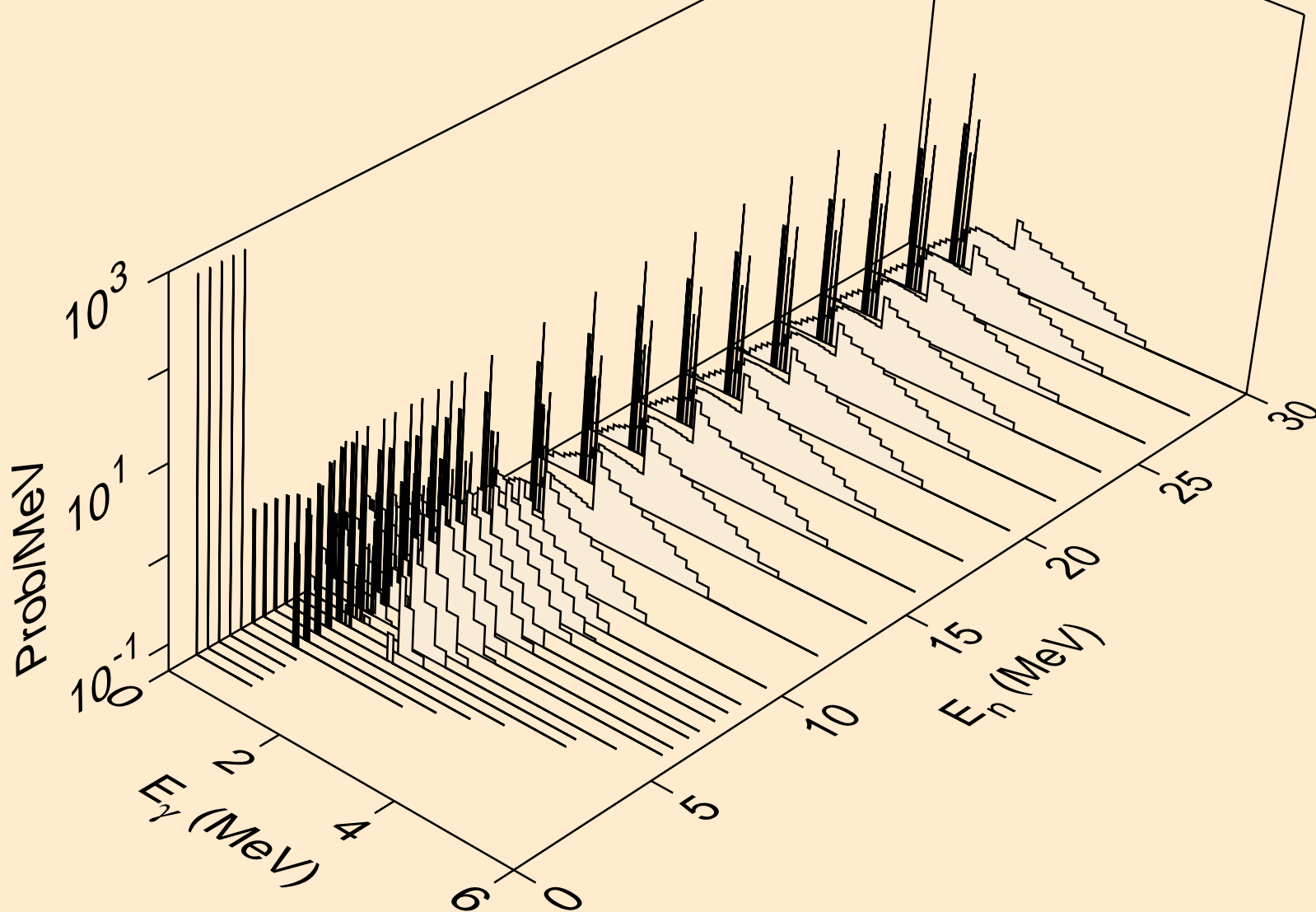

TC088M NEUTRON ACER TENDL-2019 LIBRARY; T=293.16K  
Photon emission for (n,t)

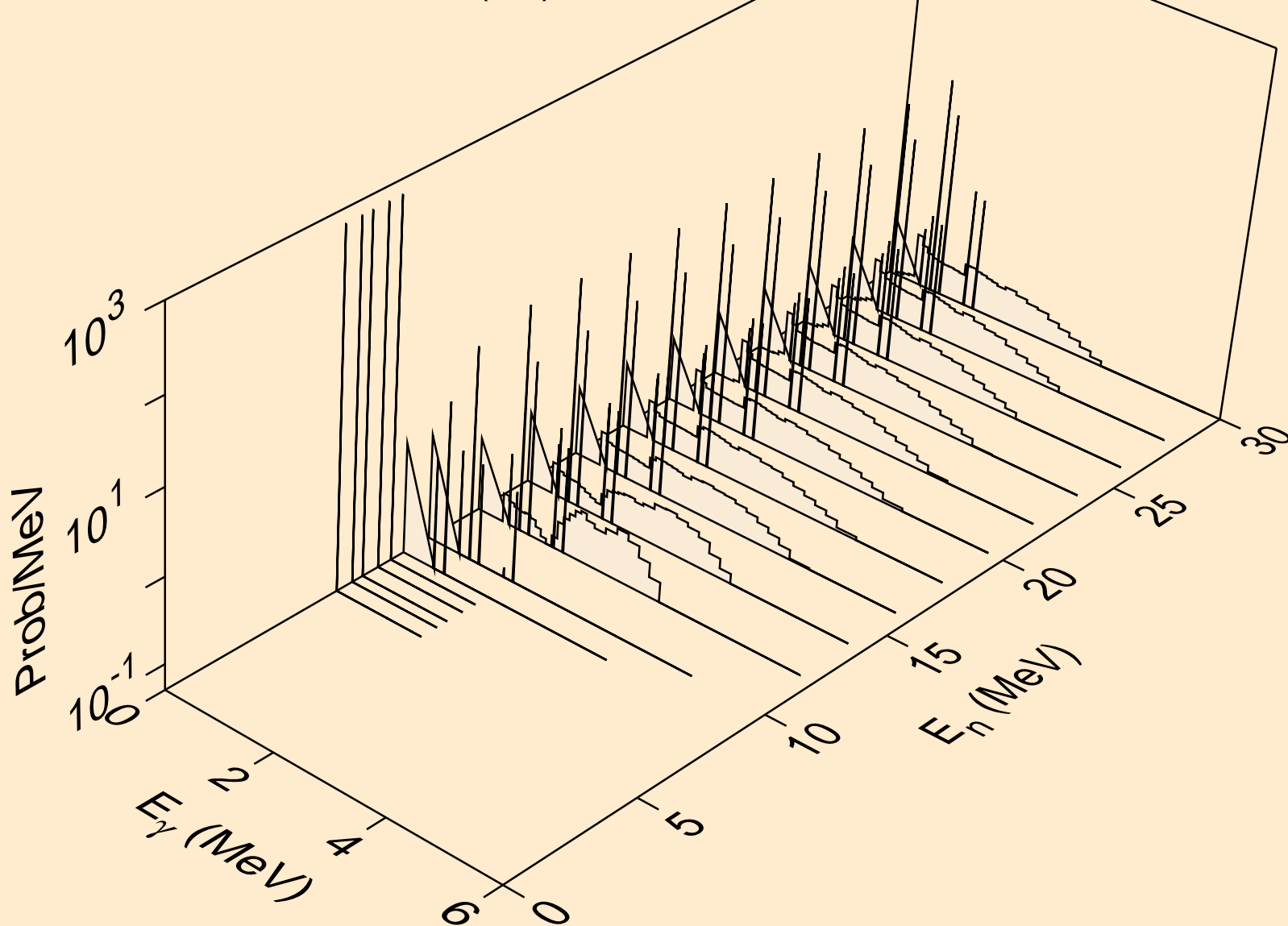

TC088M NEUTRON ACER TENDL-2019 LIBRARY; T=293.16K  
Photon emission for (n,he3)

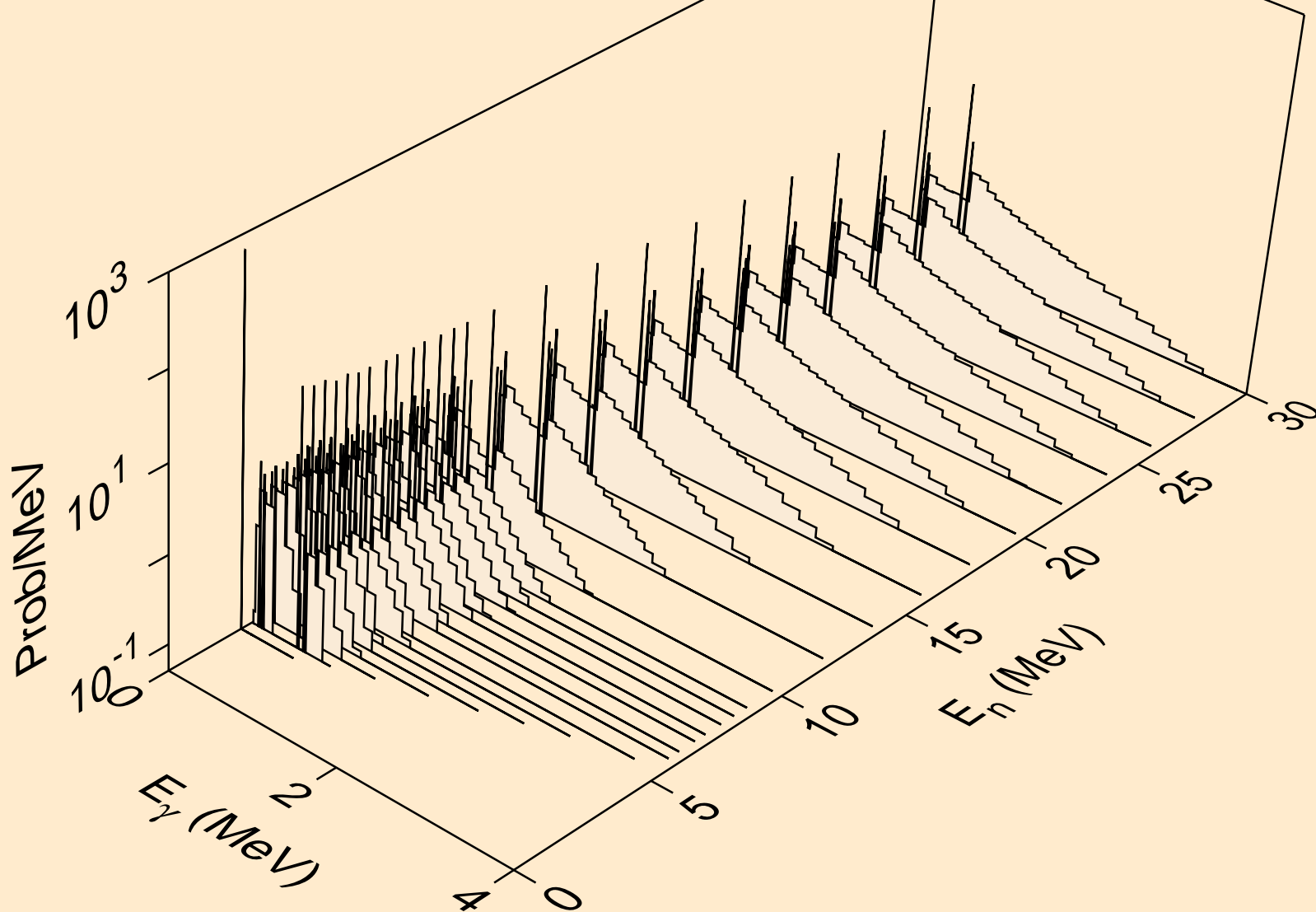

TC088M NEUTRON ACER TENDL-2019 LIBRARY; T=293.16K  
Photon emission for (n,a)

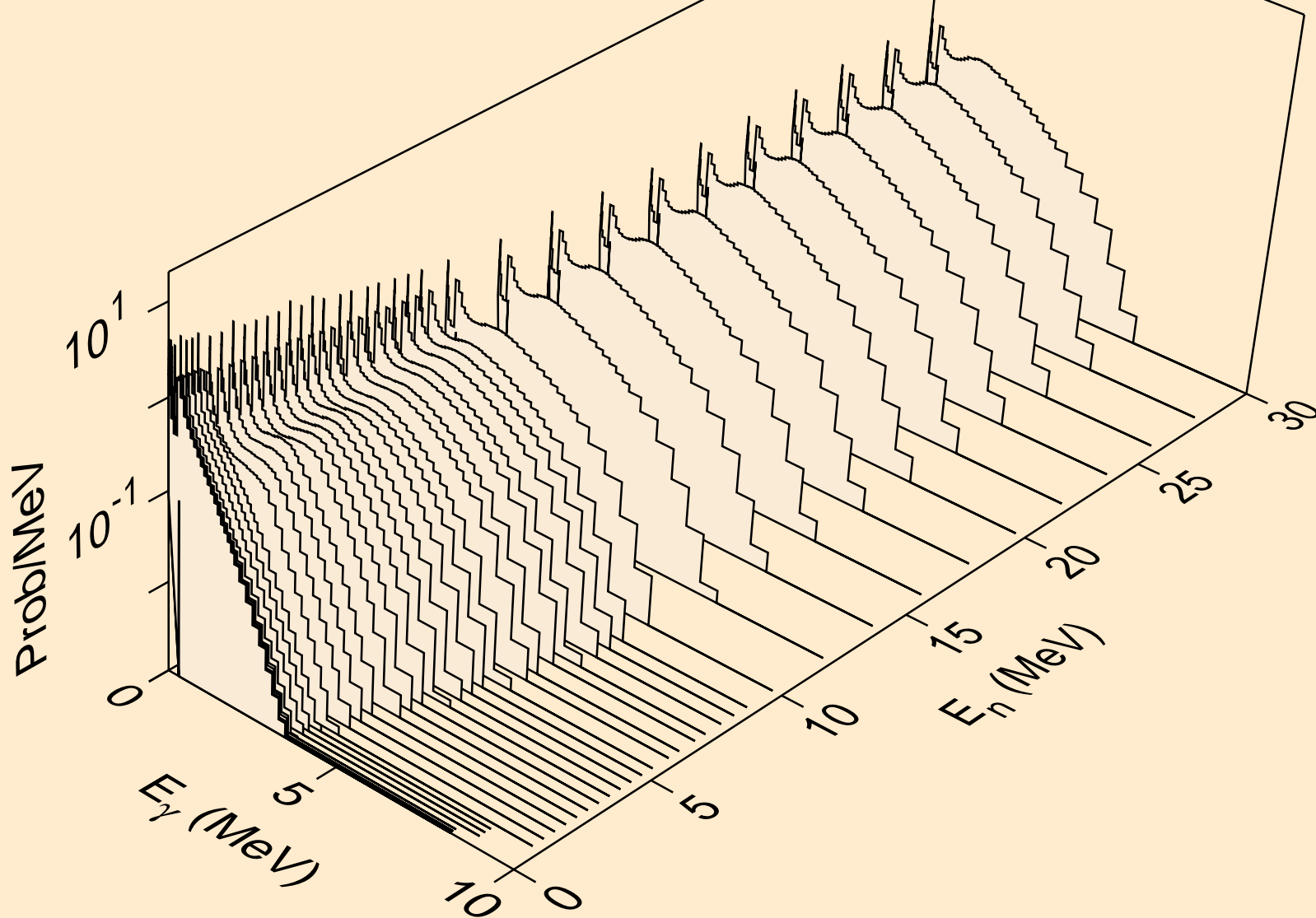

TC088M NEUTRON ACER TENDL-2019 LIBRARY; T=293.16K  
Photon emission for (n,2a)

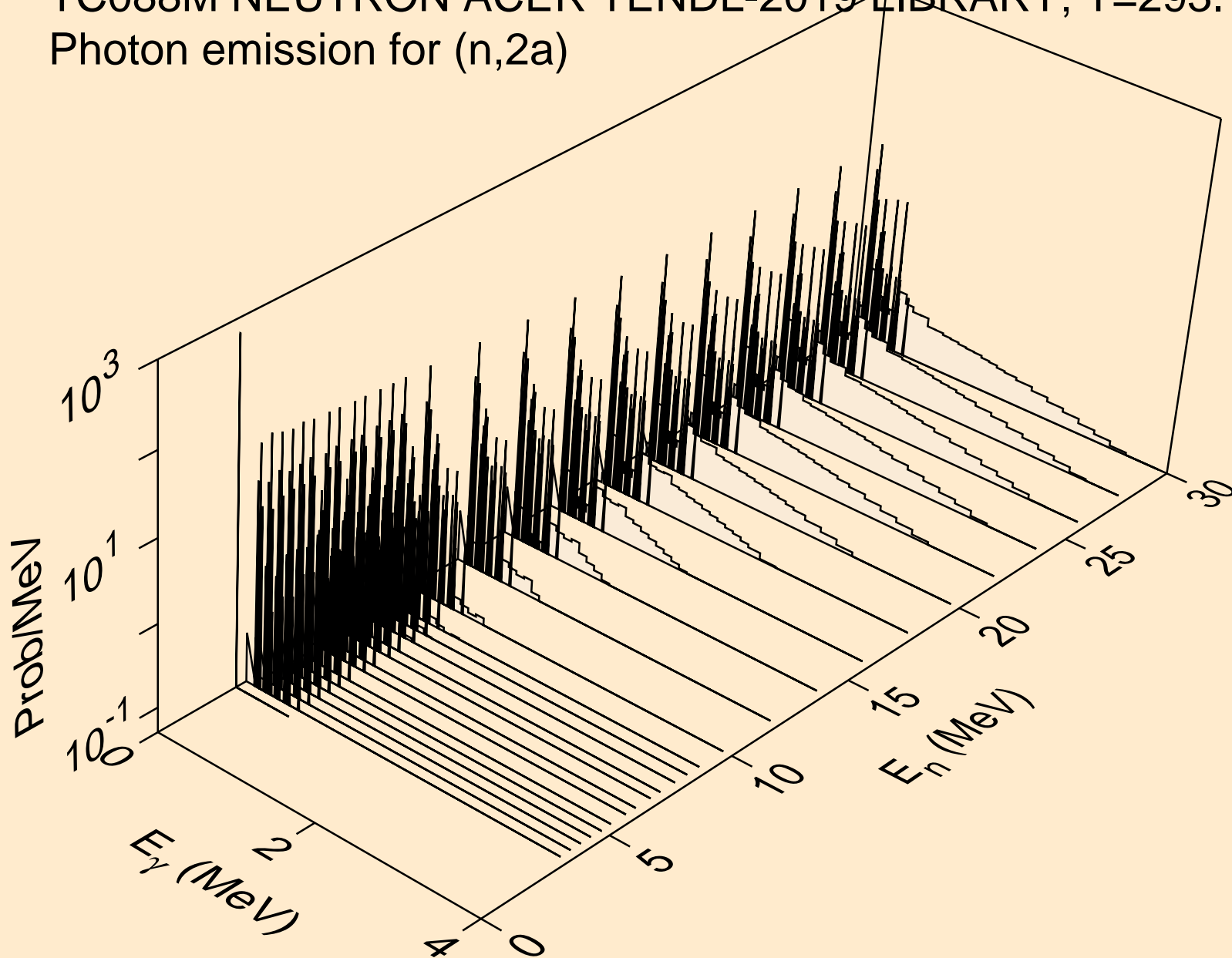

TC088M NEUTRON ACER TENDL-2019 LIBRARY; T=293.16K  
Photon emission for (n,3a)

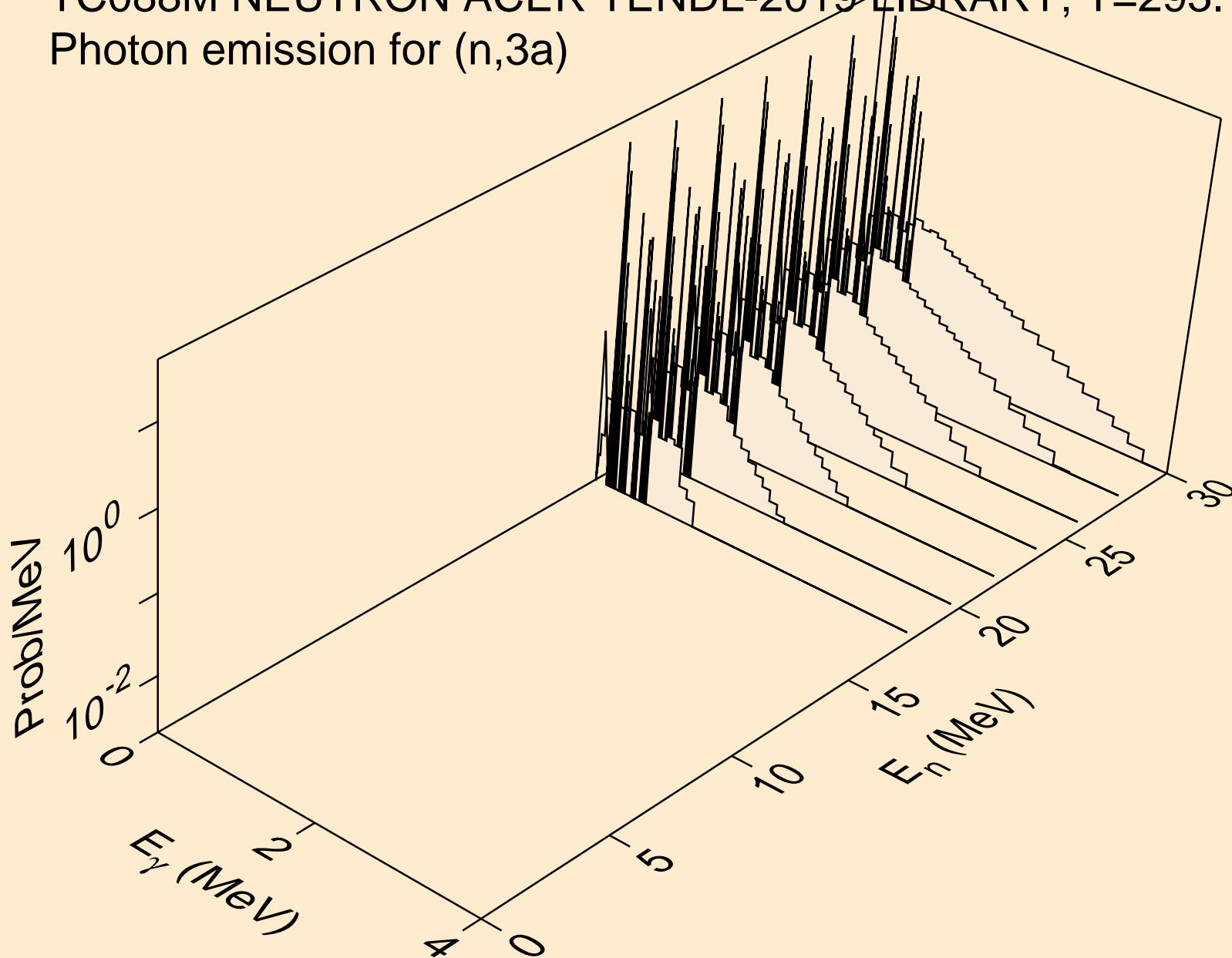

TC088M NEUTRON ACER TENDL-2019 LIBRARY; T=293.16K  
Photon emission for (n,2p)

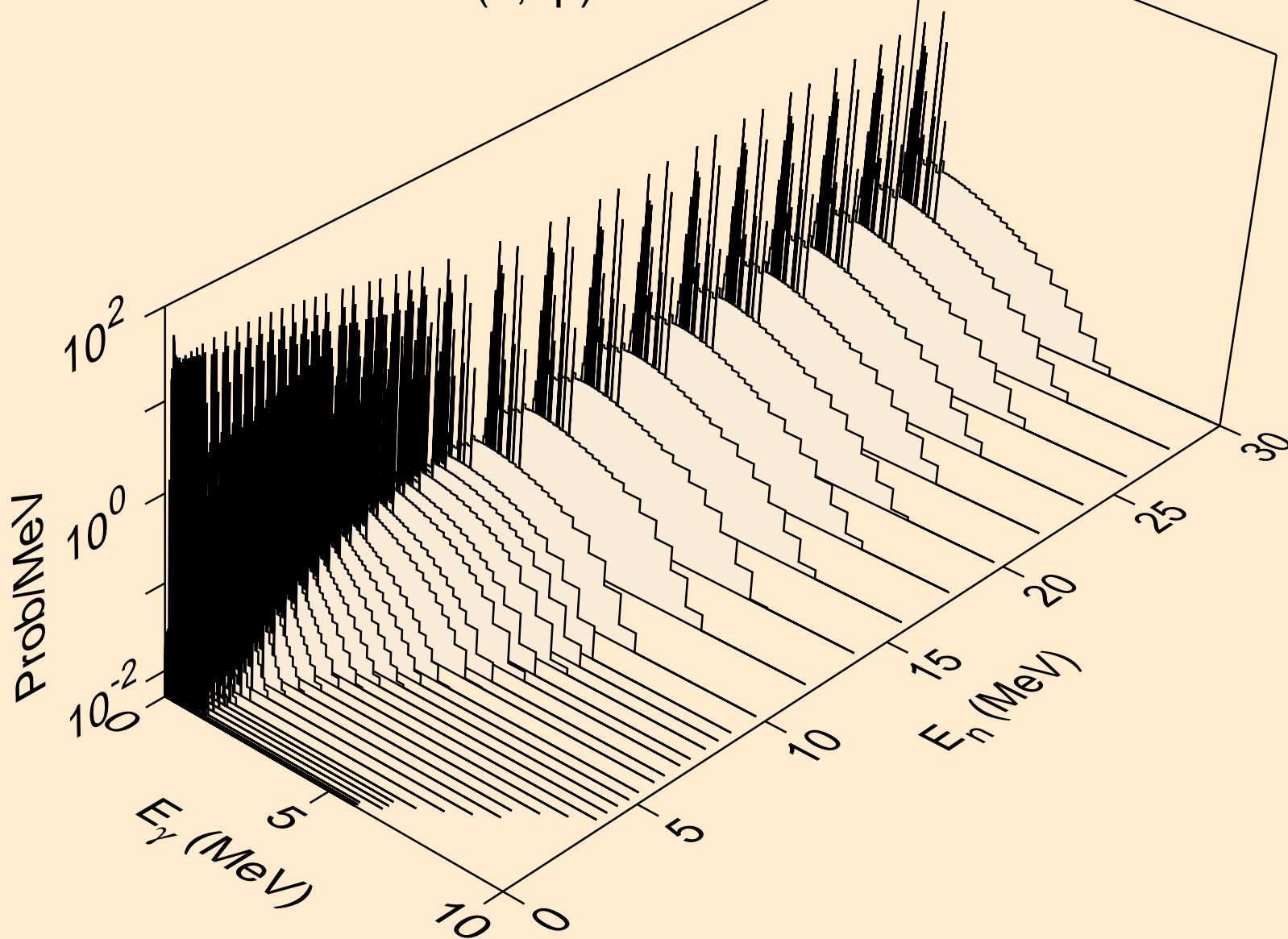

TC088M NEUTRON ACER TENDL-2019 LIBRARY; T=293.16K  
Photon emission for (n,p $\alpha$ )

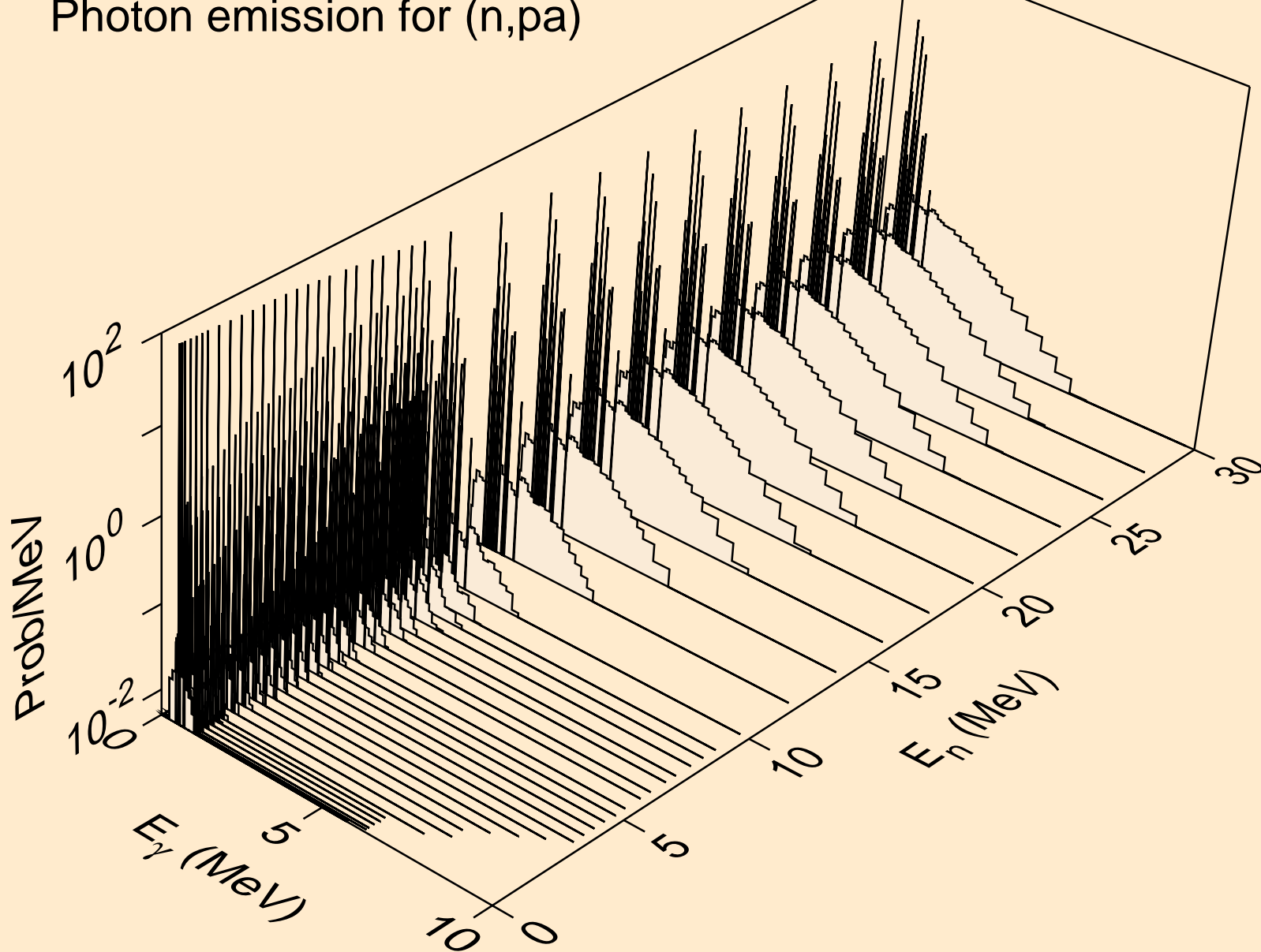



TC088M NEUTRON ACER TENDL-2019 LIBRARY; T=293.16K  
Photon emission for (n,pd)

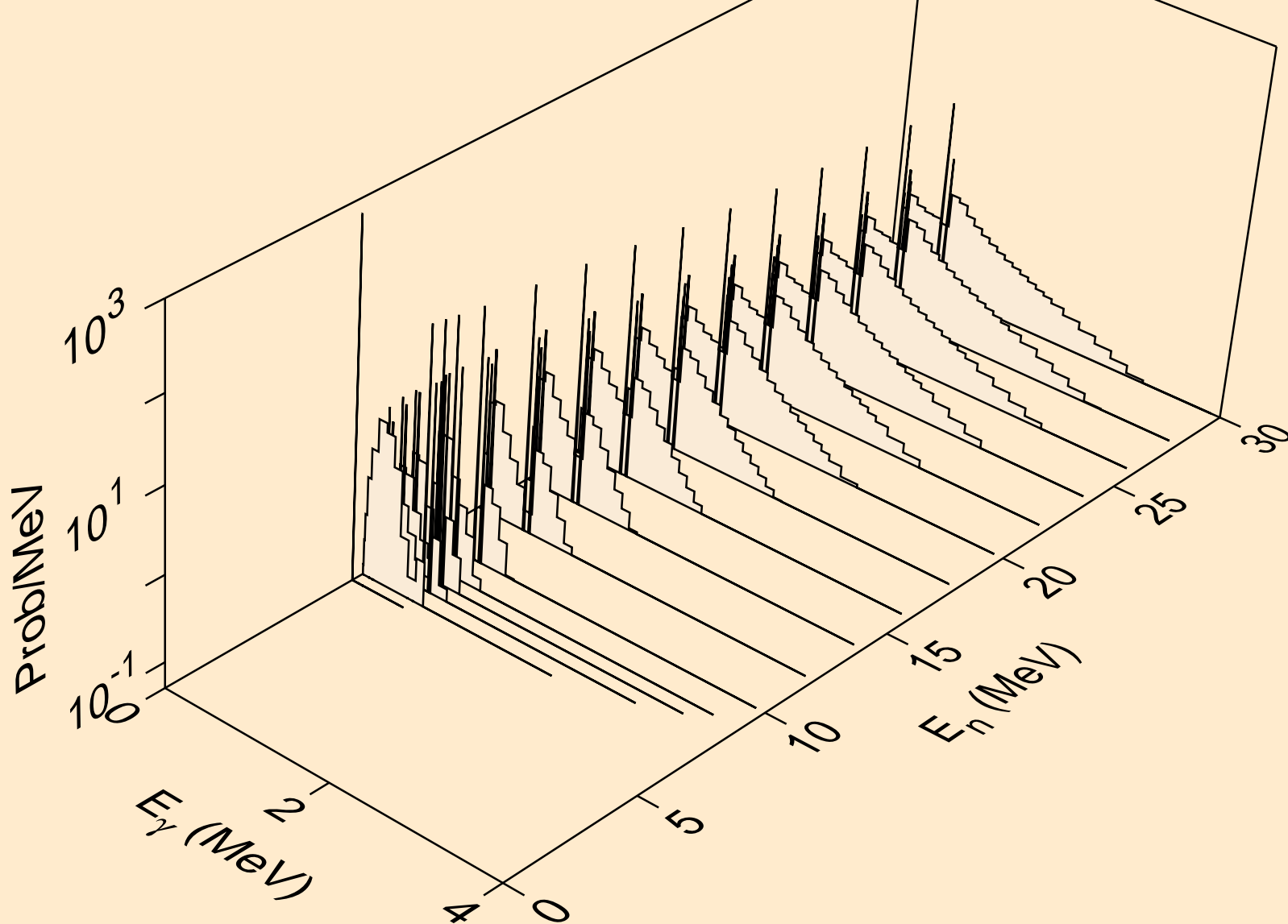

TC088M NEUTRON ACER TENDL-2019 LIBRARY; T=293.16K  
Photon emission for (n,pt)

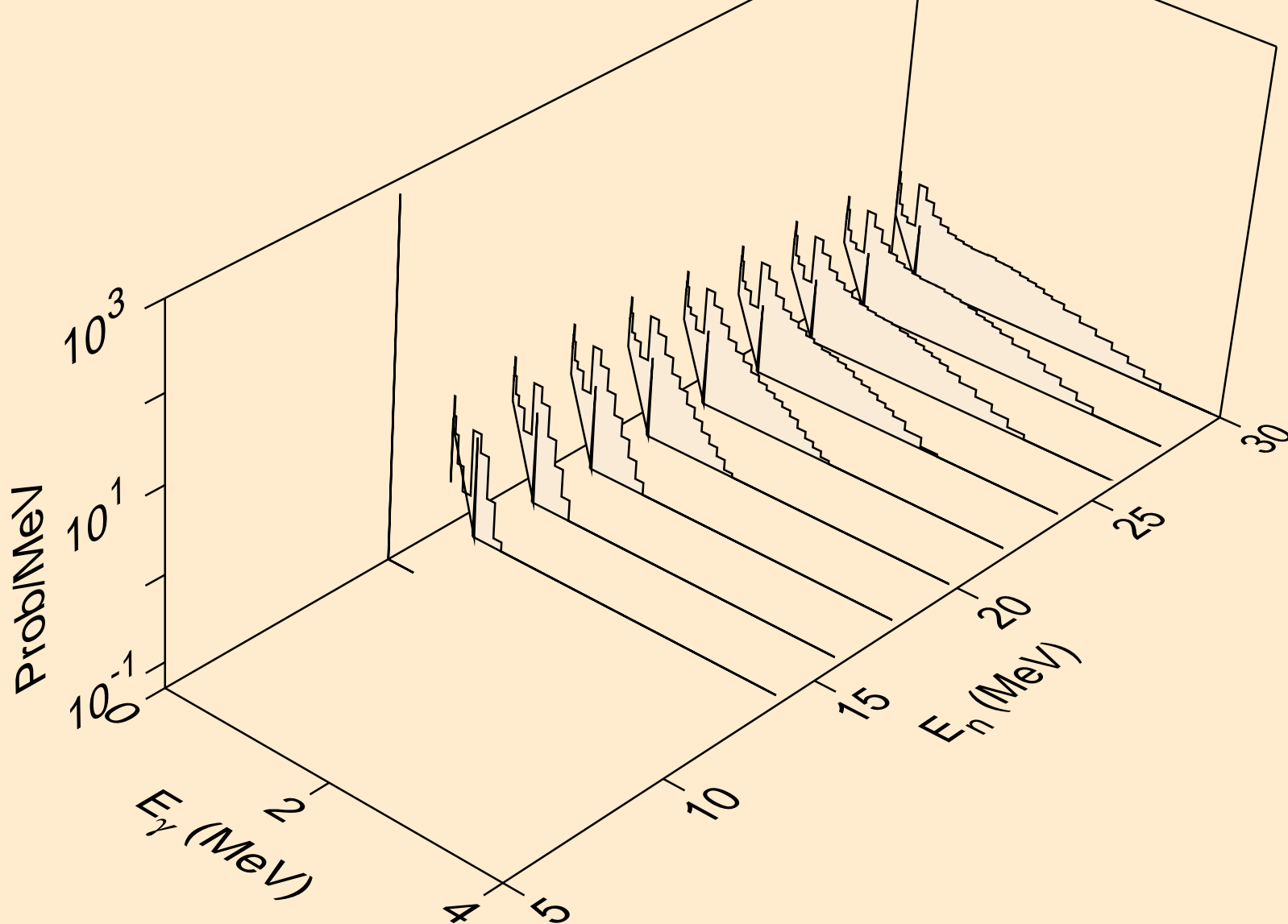

TC088M NEUTRON ACER TENDL-2019 LIBRARY; T=293.16K  
Photon emission for (n,da)

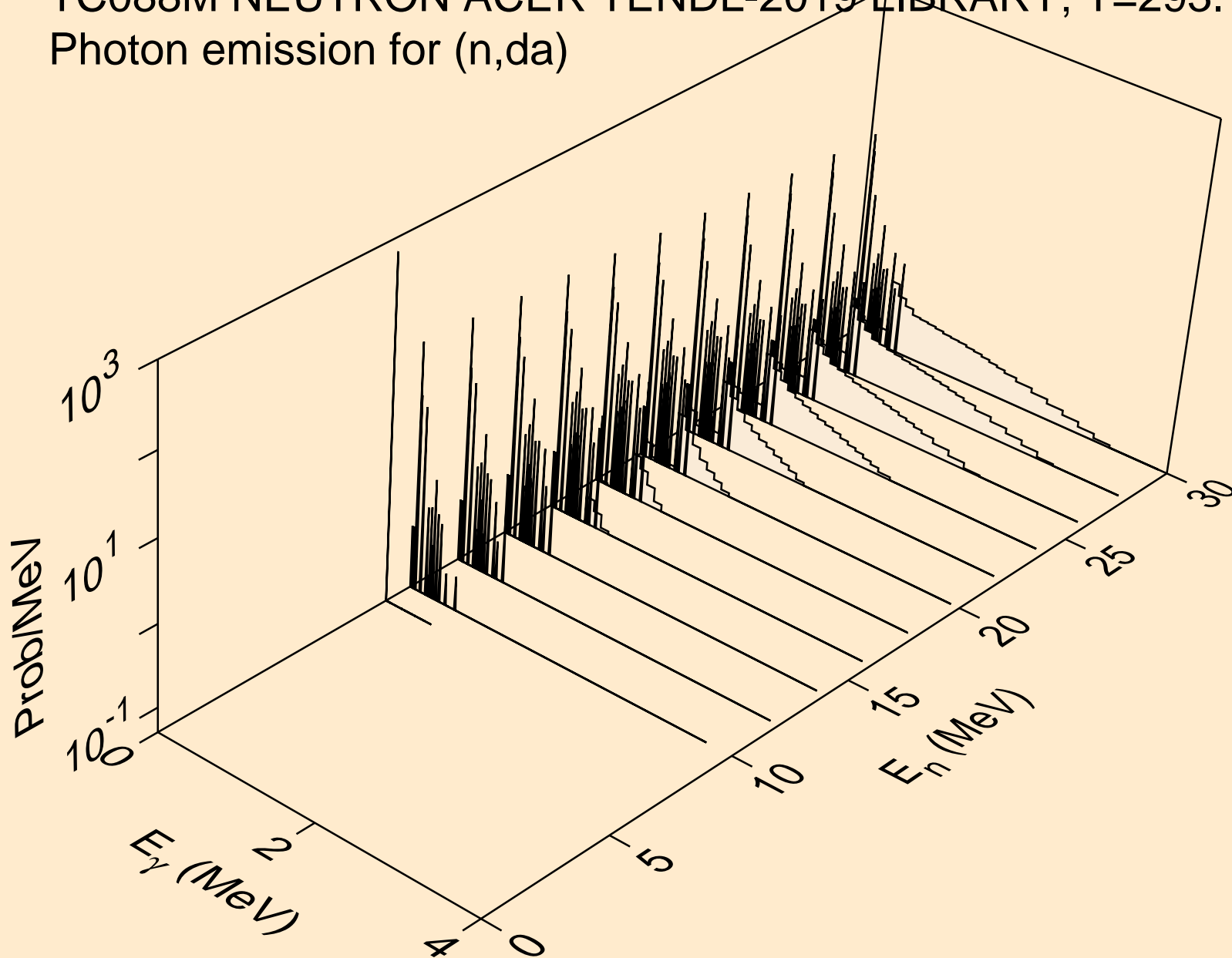

TC088M NEUTRON ACER TENDL-2019 LIBRARY; T=293.16K  
thermal capture photon spectrum

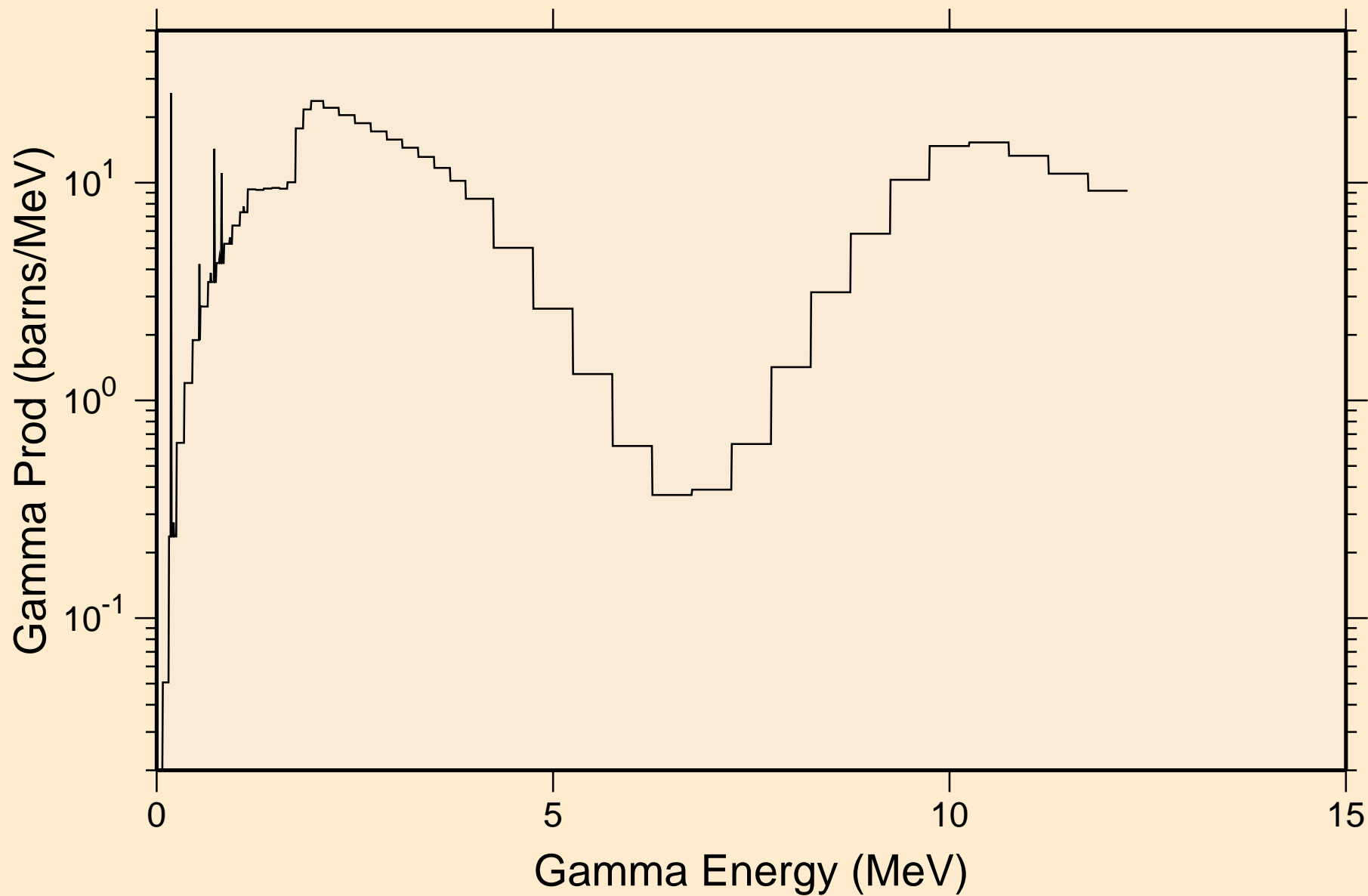

TC088M NEUTRON ACER TENDL-2019 LIBRARY; T=293.16K  
14 MeV photon spectrum

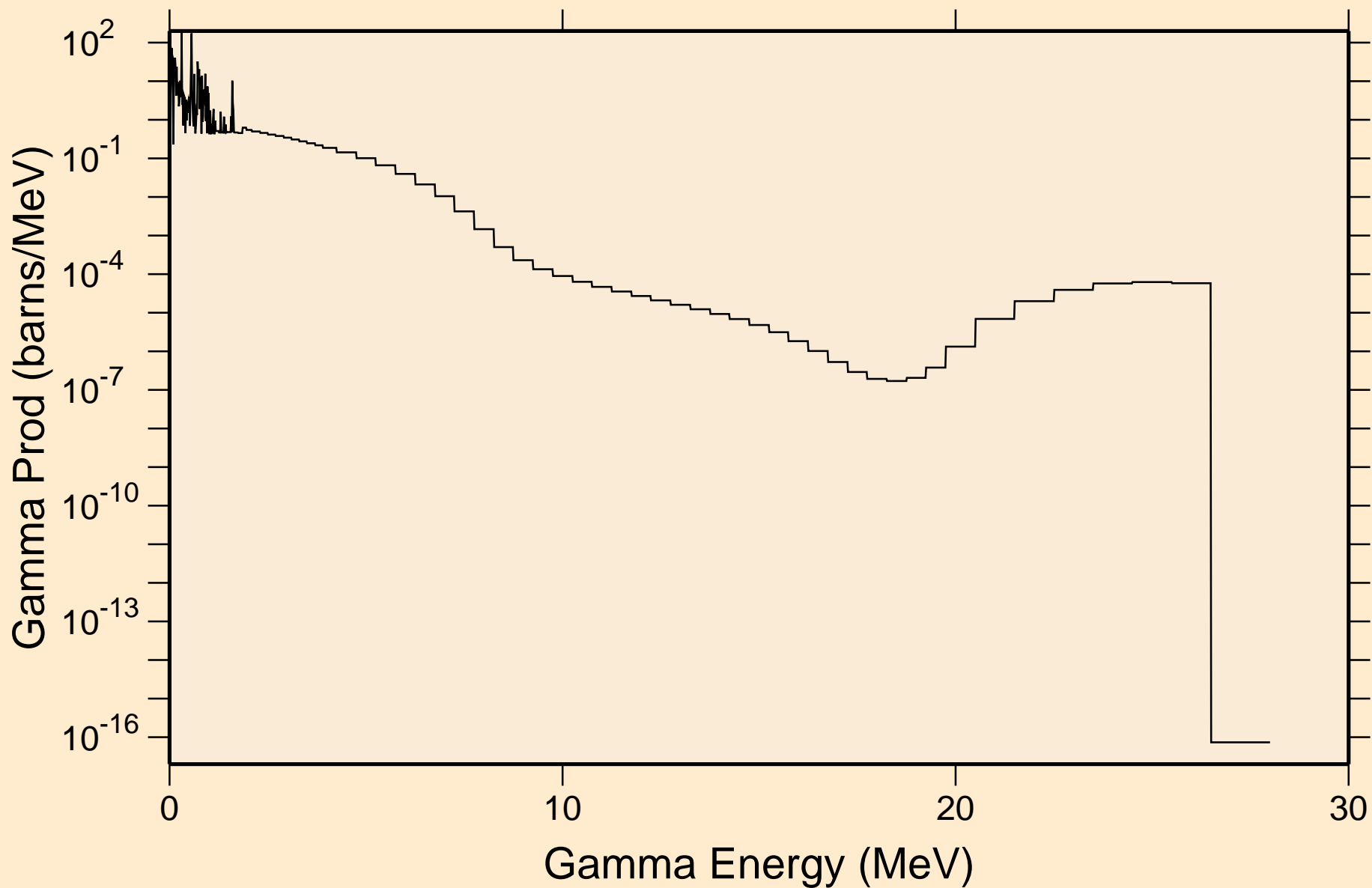

TC088M NEUTRON ACER TENDL-2019 LIBRARY; T=293.16K  
Particle heating contributions

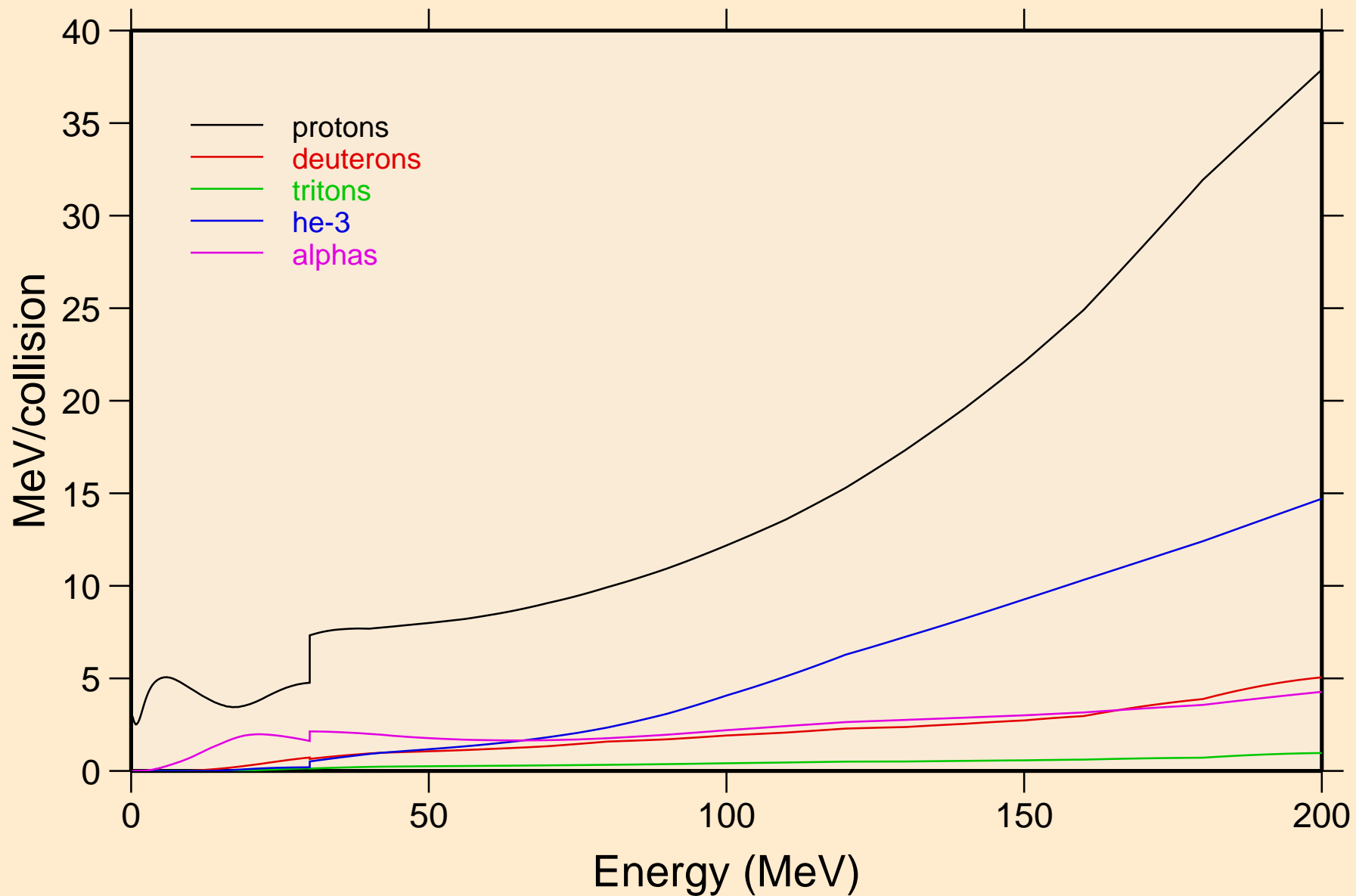

TC088M NEUTRON ACER TENDL-2019 LIBRARY; T=293.16K  
Recoil Heating

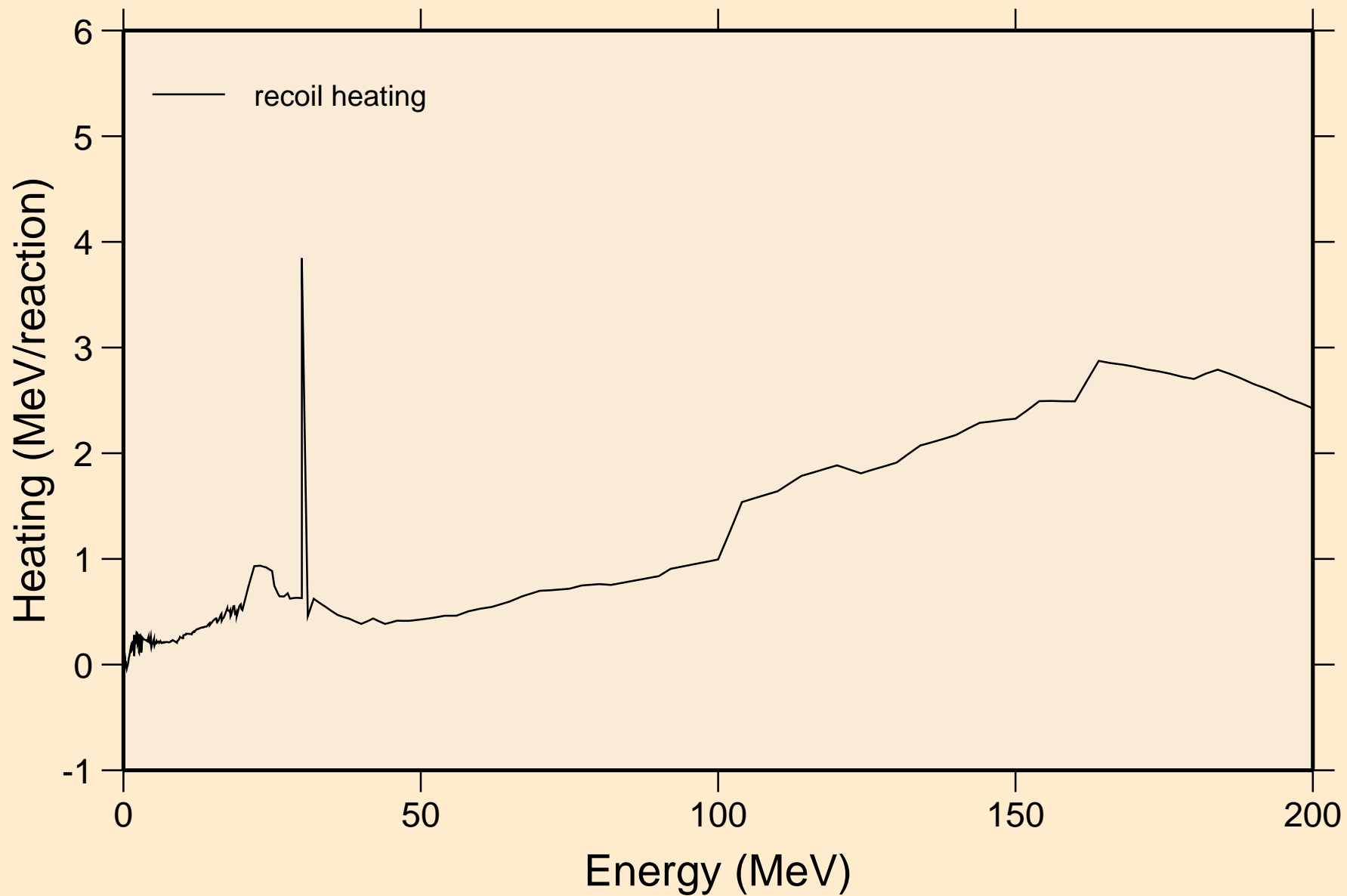

TC088M NEUTRON ACER TENDL-2019 LIBRARY; T=293.16K  
Particle production cross sections

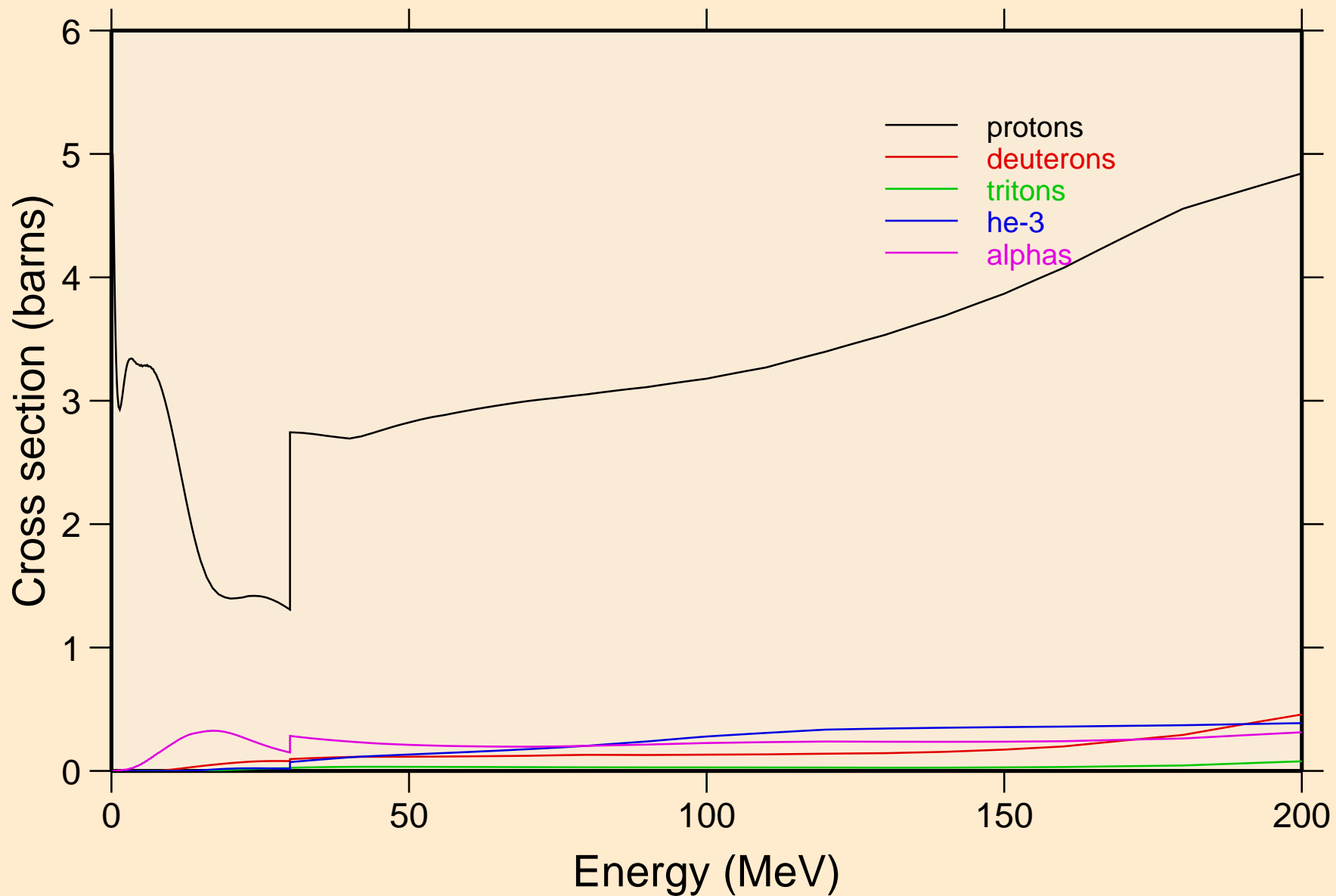



TC088M NEUTRON ACER TENDL-2019 LIBRARY; T=293.16K  
protons from (n,x)

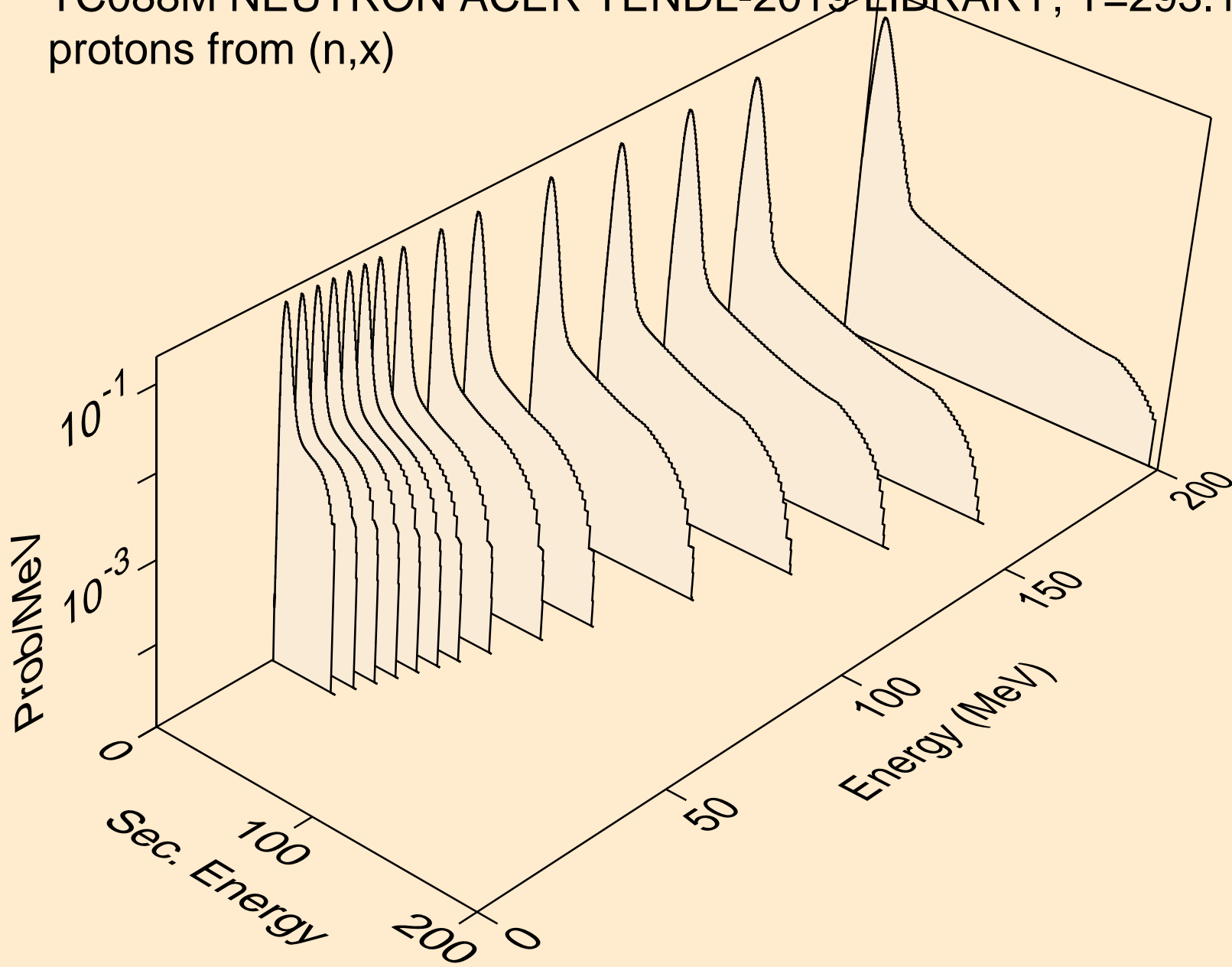

TC088M NEUTRON ACER TENDL-2019 LIBRARY; T=293.16K  
protons from (n,n\*)p

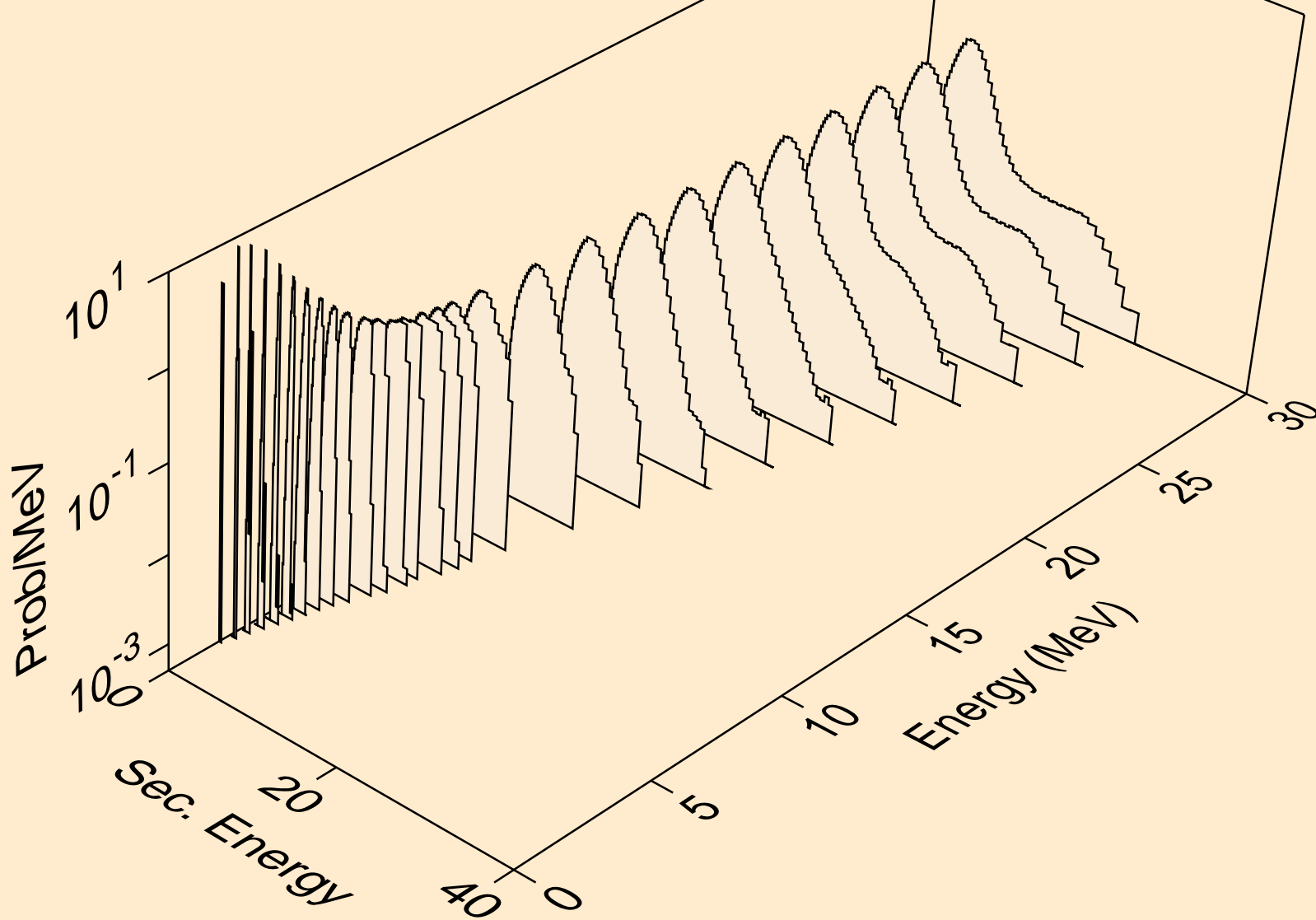

TC088M NEUTRON ACER TENDL-2019 LIBRARY; T=293.16K  
protons from (n,2np)

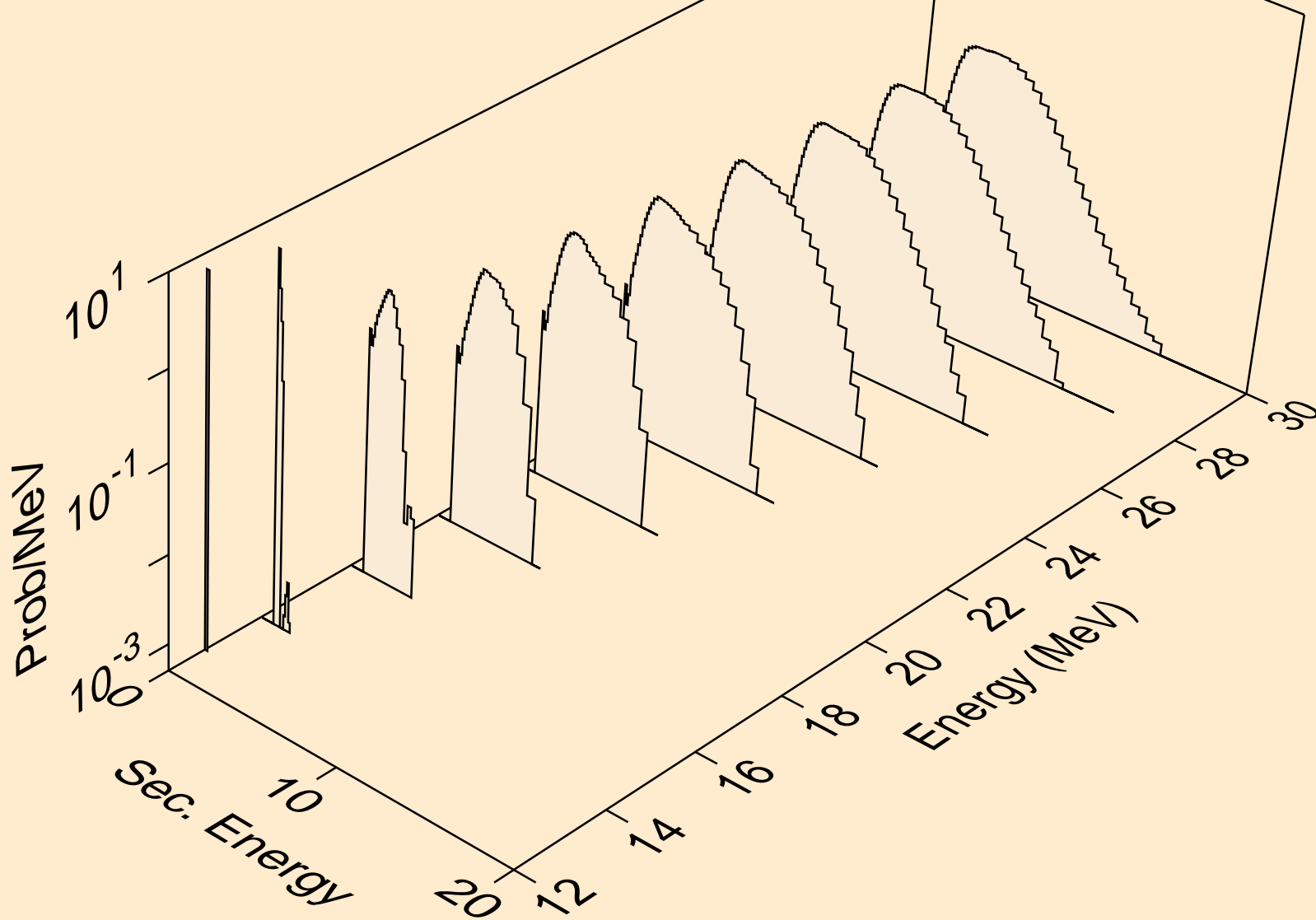

TC088M NEUTRON ACER TENDL-2019 LIBRARY; T=293.16K  
protons from (n,3np)

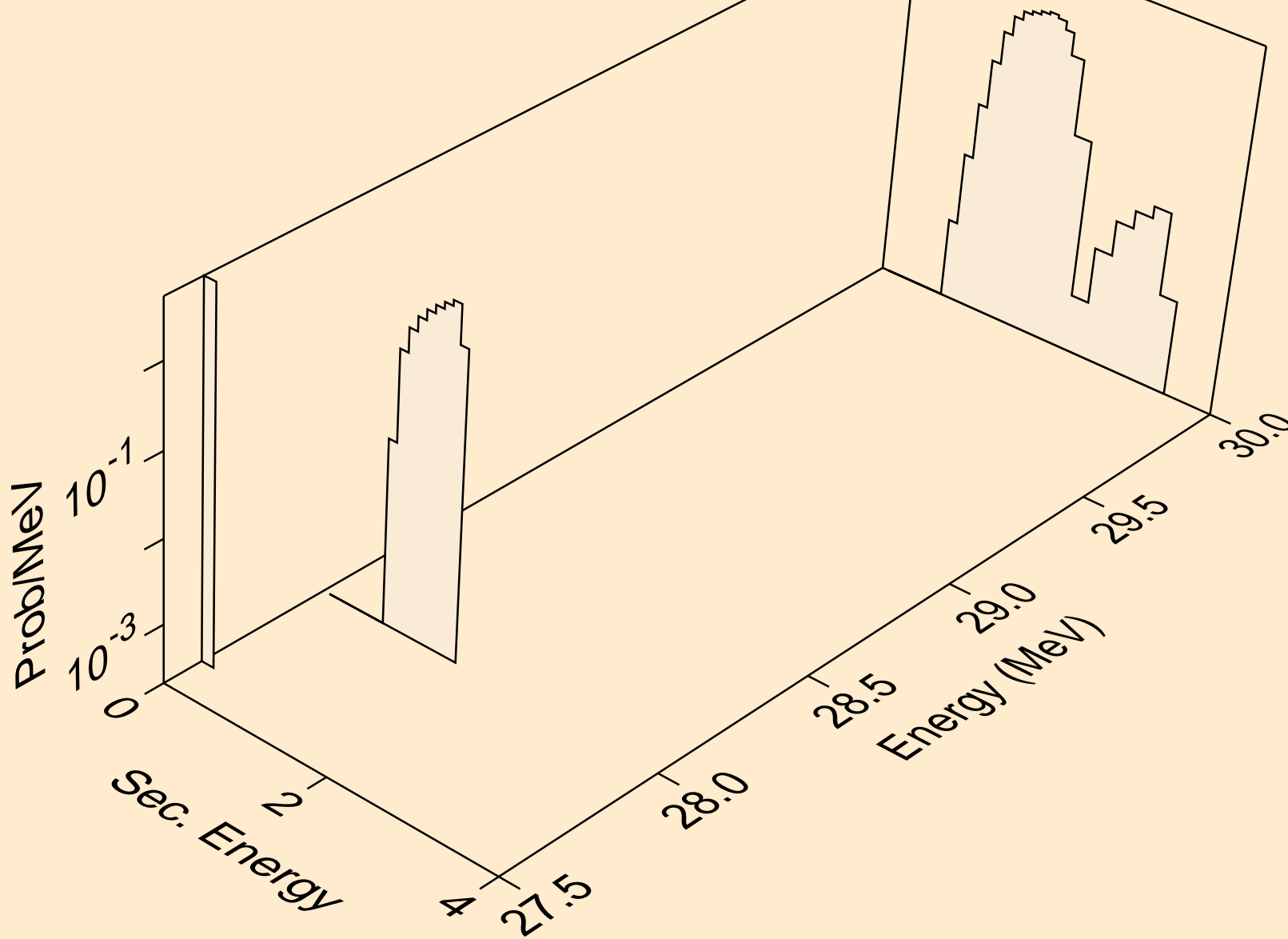

TC088M NEUTRON ACER TENDL-2019 LIBRARY; T=293.16K  
protons from (n,2np)

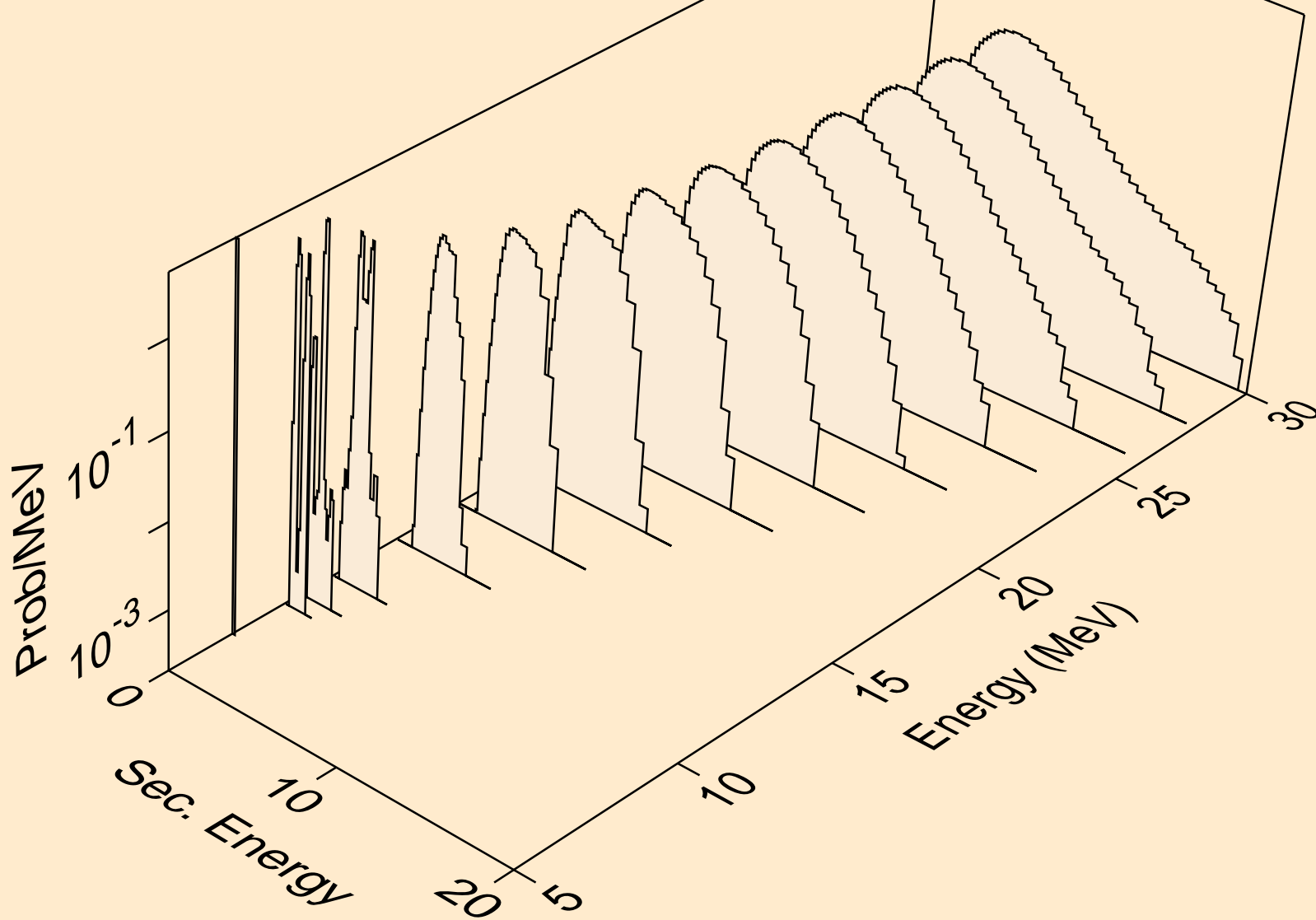

TC088M NEUTRON ACER TENDL-2019 LIBRARY; T=293.16K  
protons from (n,npa)

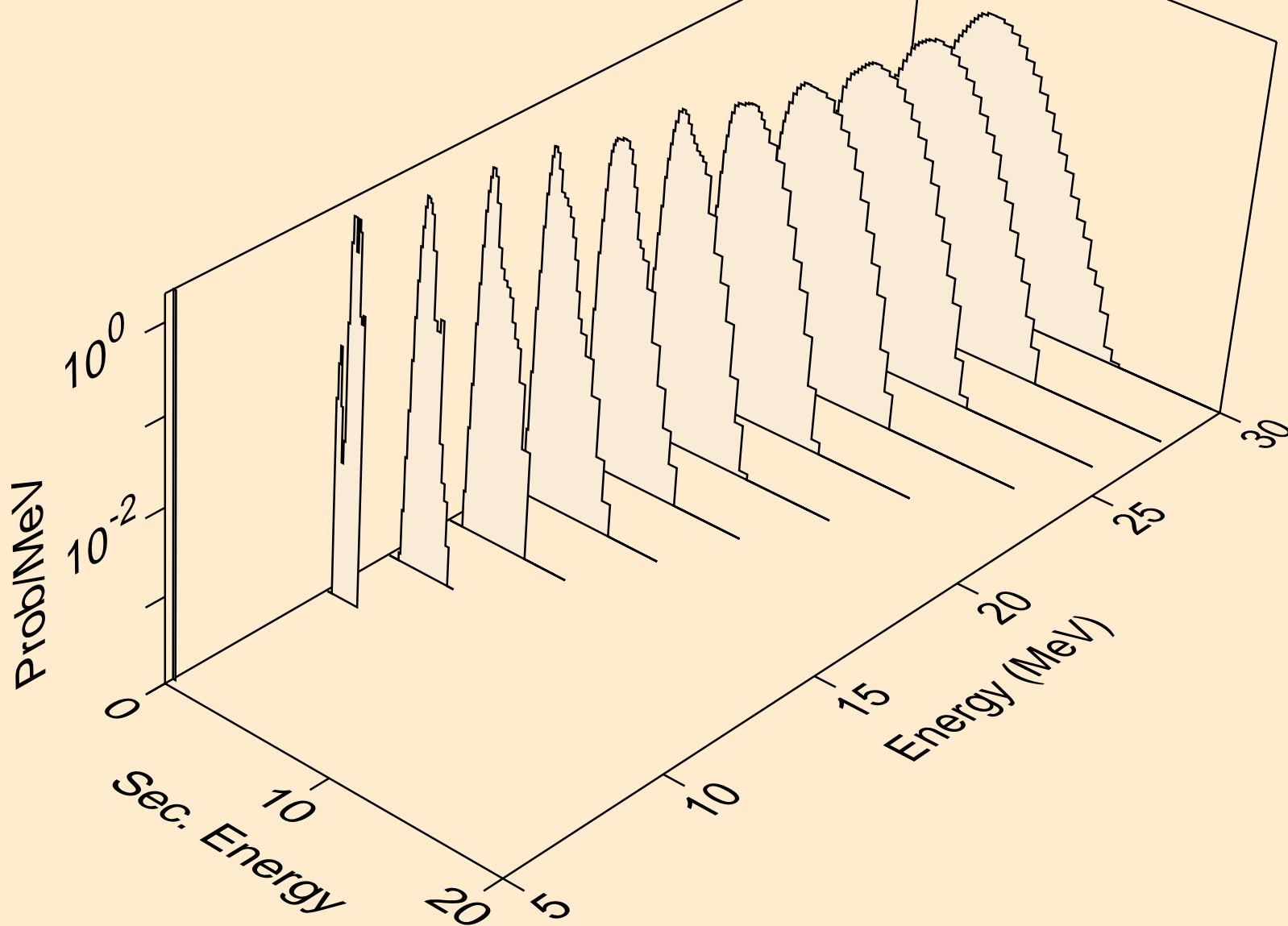

TC088M NEUTRON ACER TENDL-2019 LIBRARY; T=293.16K  
protons from (n,p)

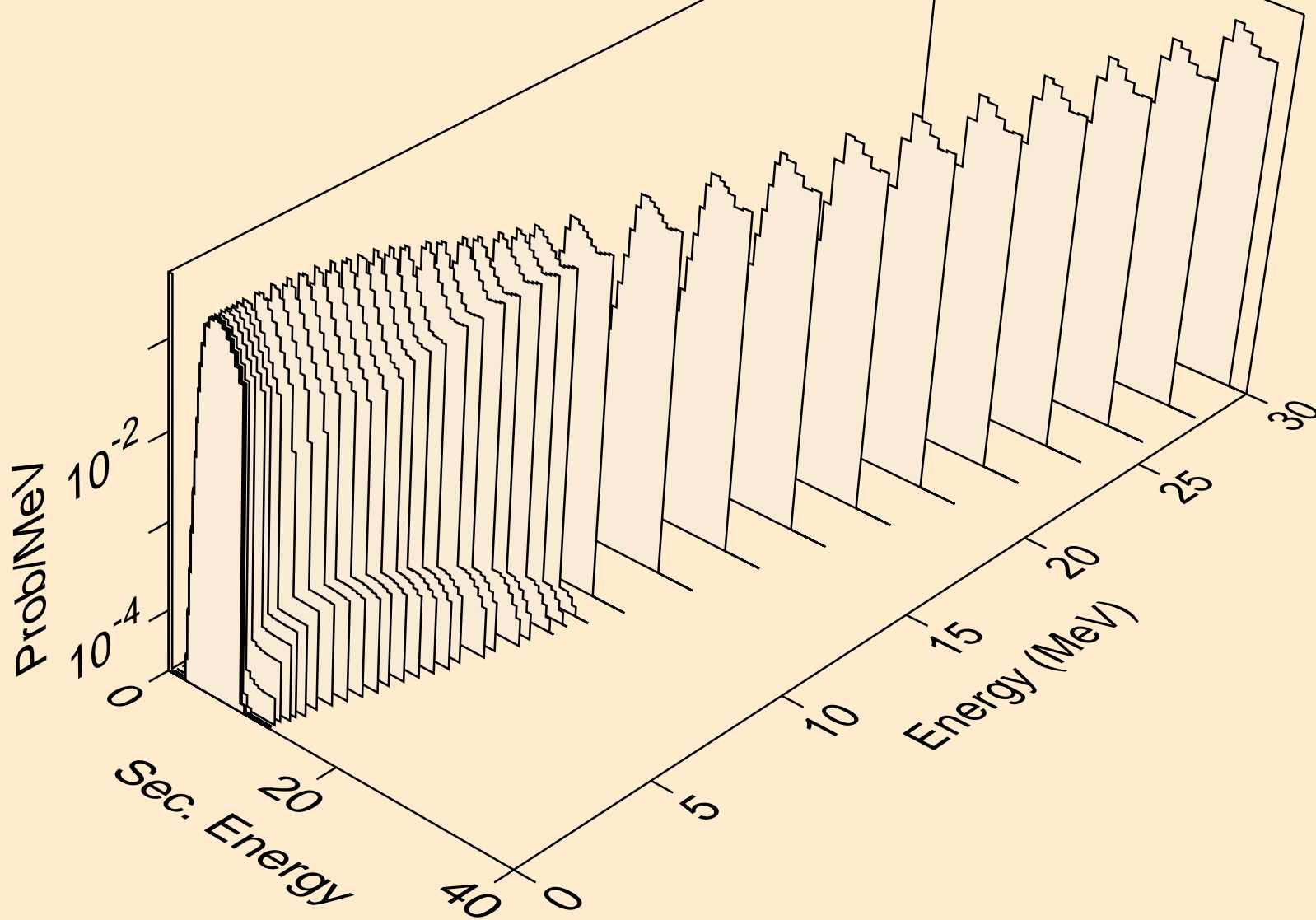

TC088M NEUTRON ACER TENDL-2019 LIBRARY; T=293.16K  
protons from (n,2p)

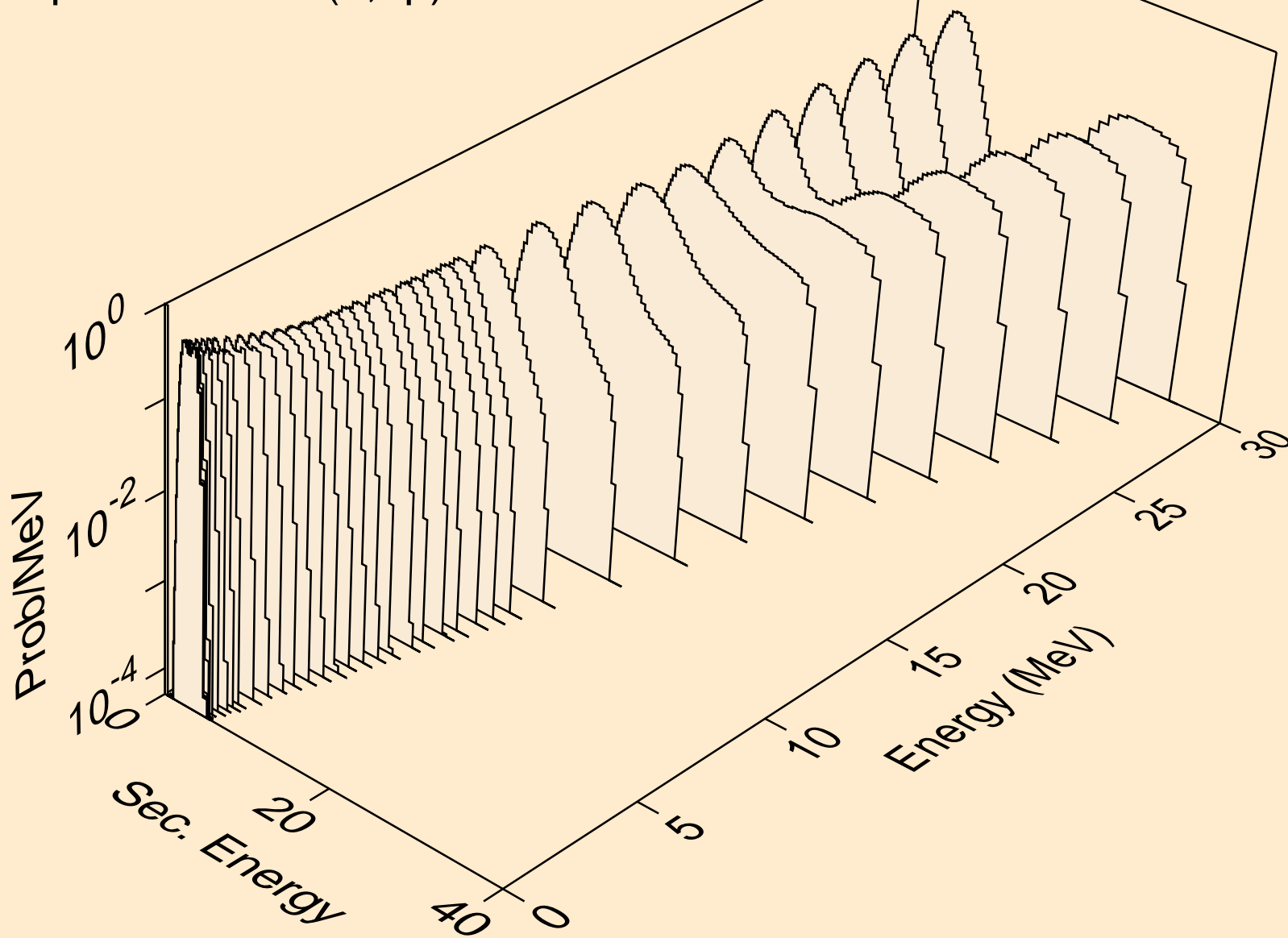



TC088M NEUTRON ACER TENDL-2019 LIBRARY; T=293.16K  
protons from (n,p)

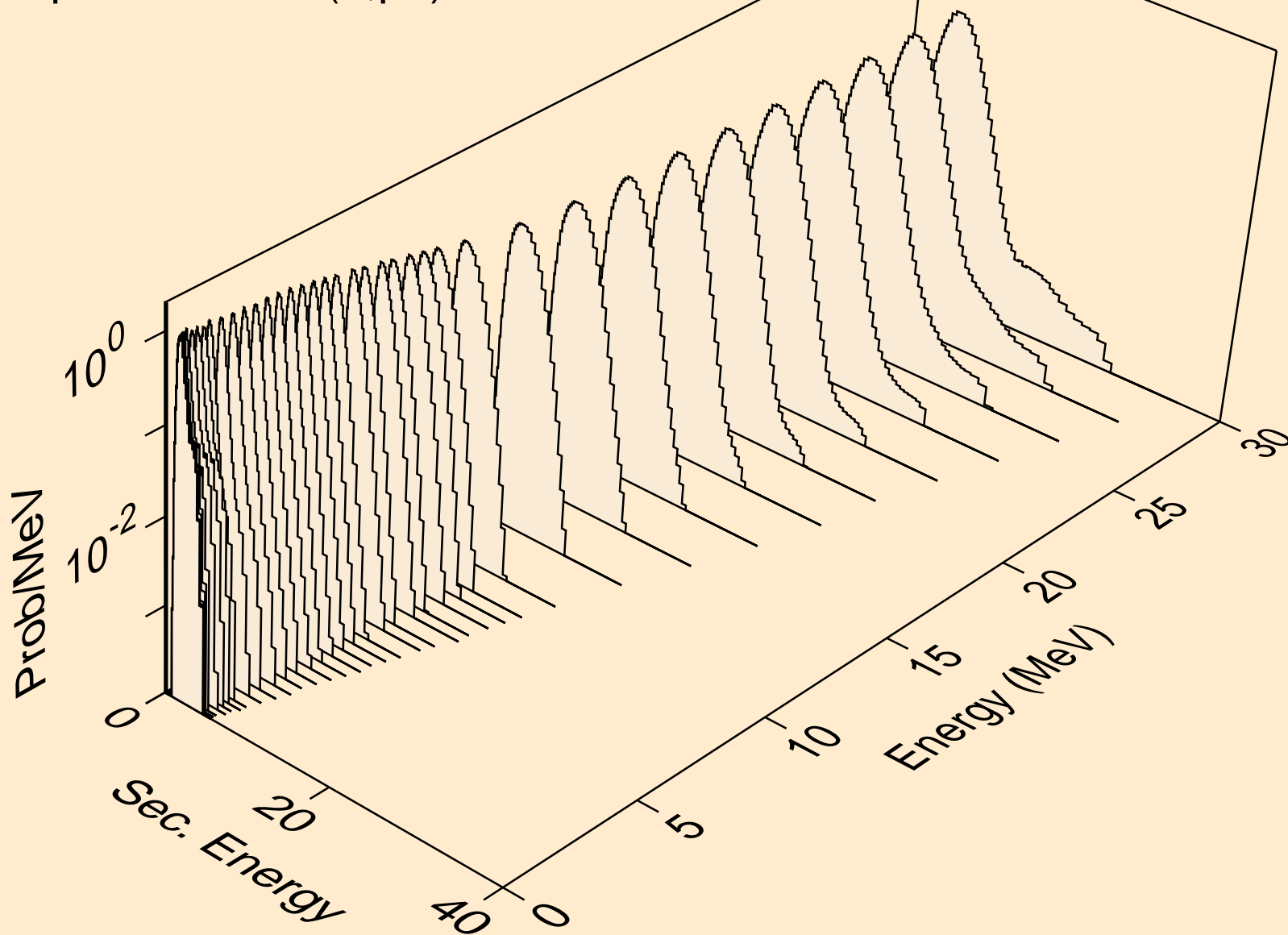

TC088M NEUTRON ACER TENDL-2019 LIBRARY; T=293.16K  
protons from (n,pd)

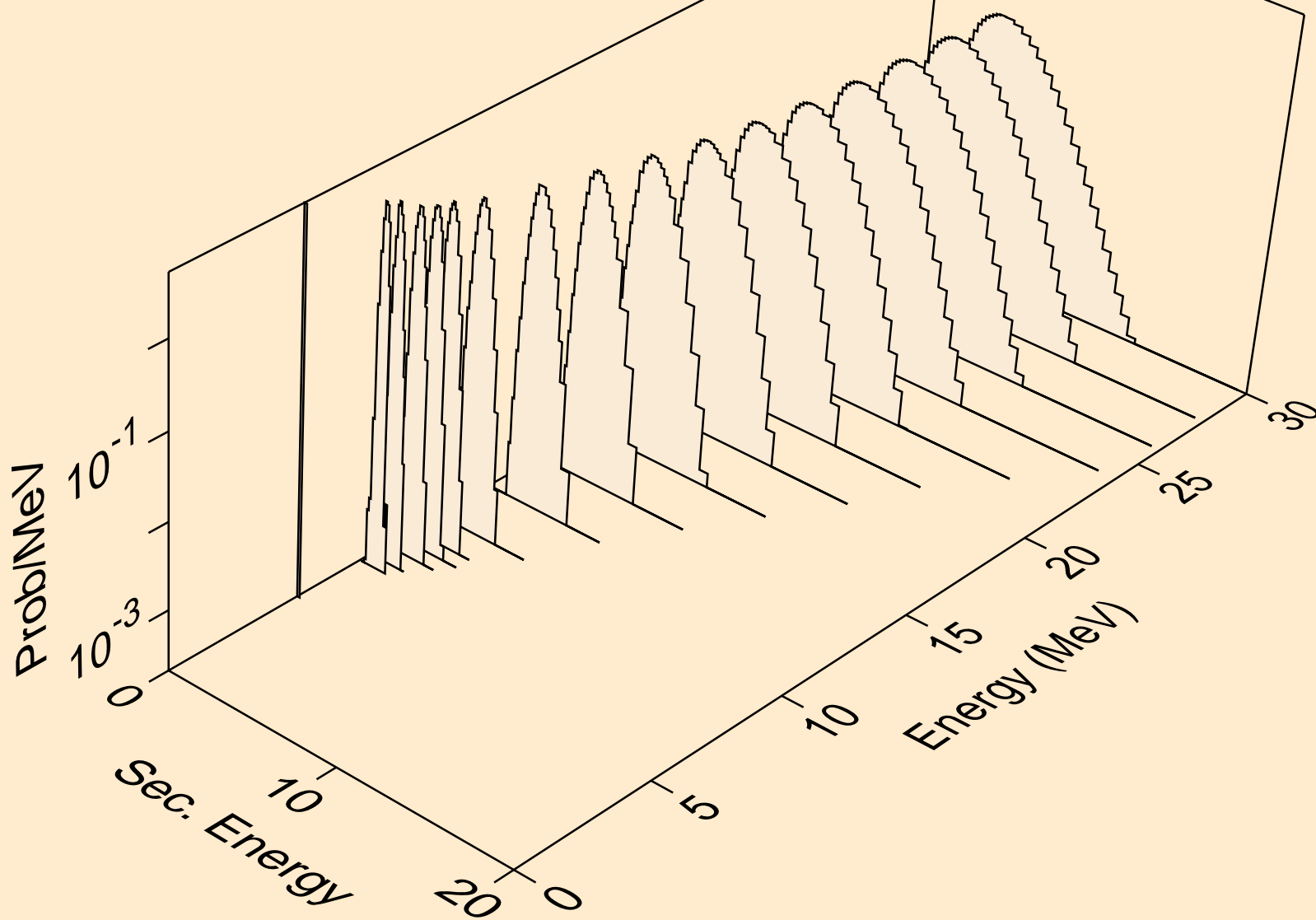

TC088M NEUTRON ACER TENDL-2019 LIBRARY; T=293.16K  
protons from (n,pt)

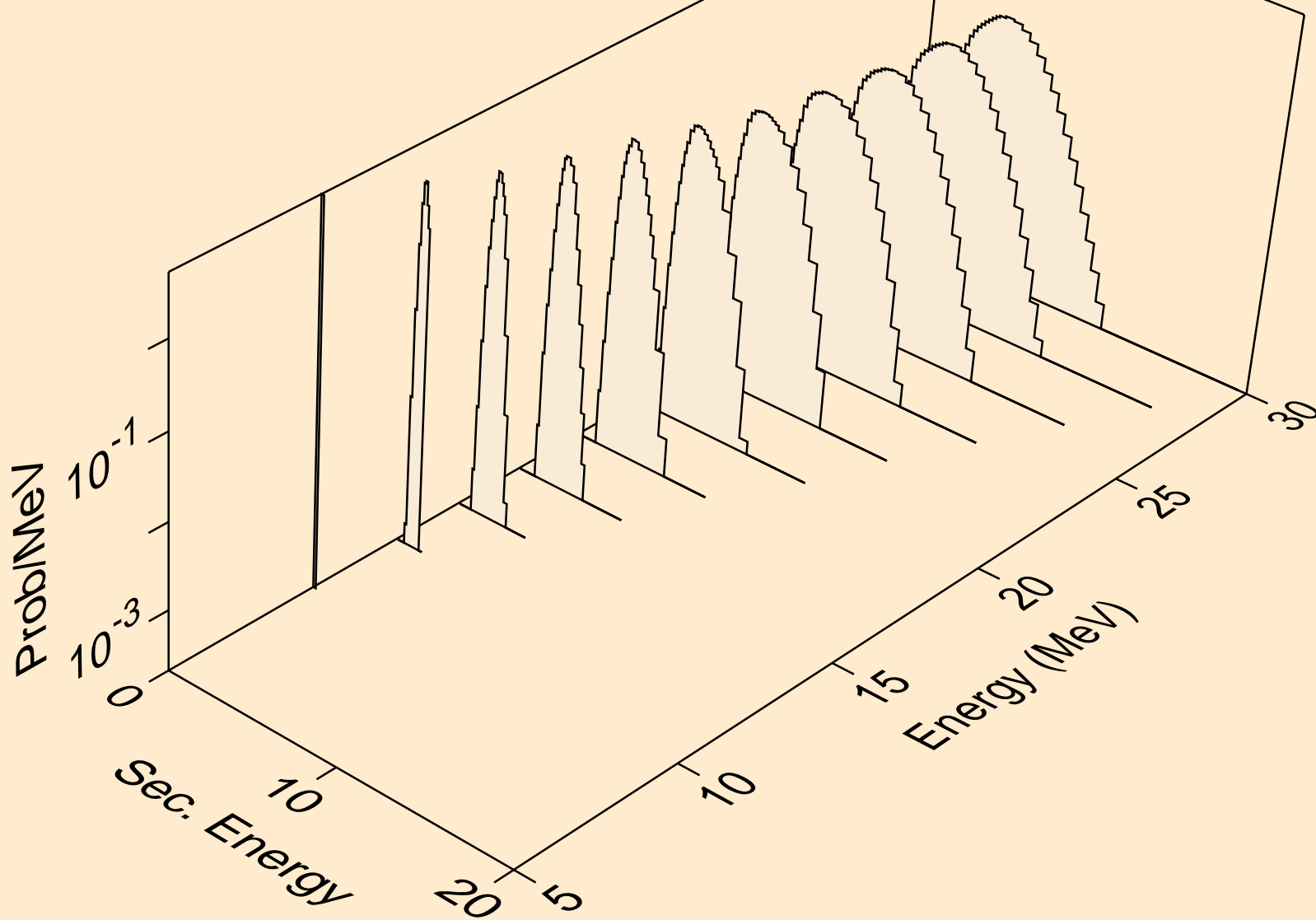

TC088M NEUTRON ACER TENDL-2019 LIBRARY; T=293.16K  
deuterons from (n,x)

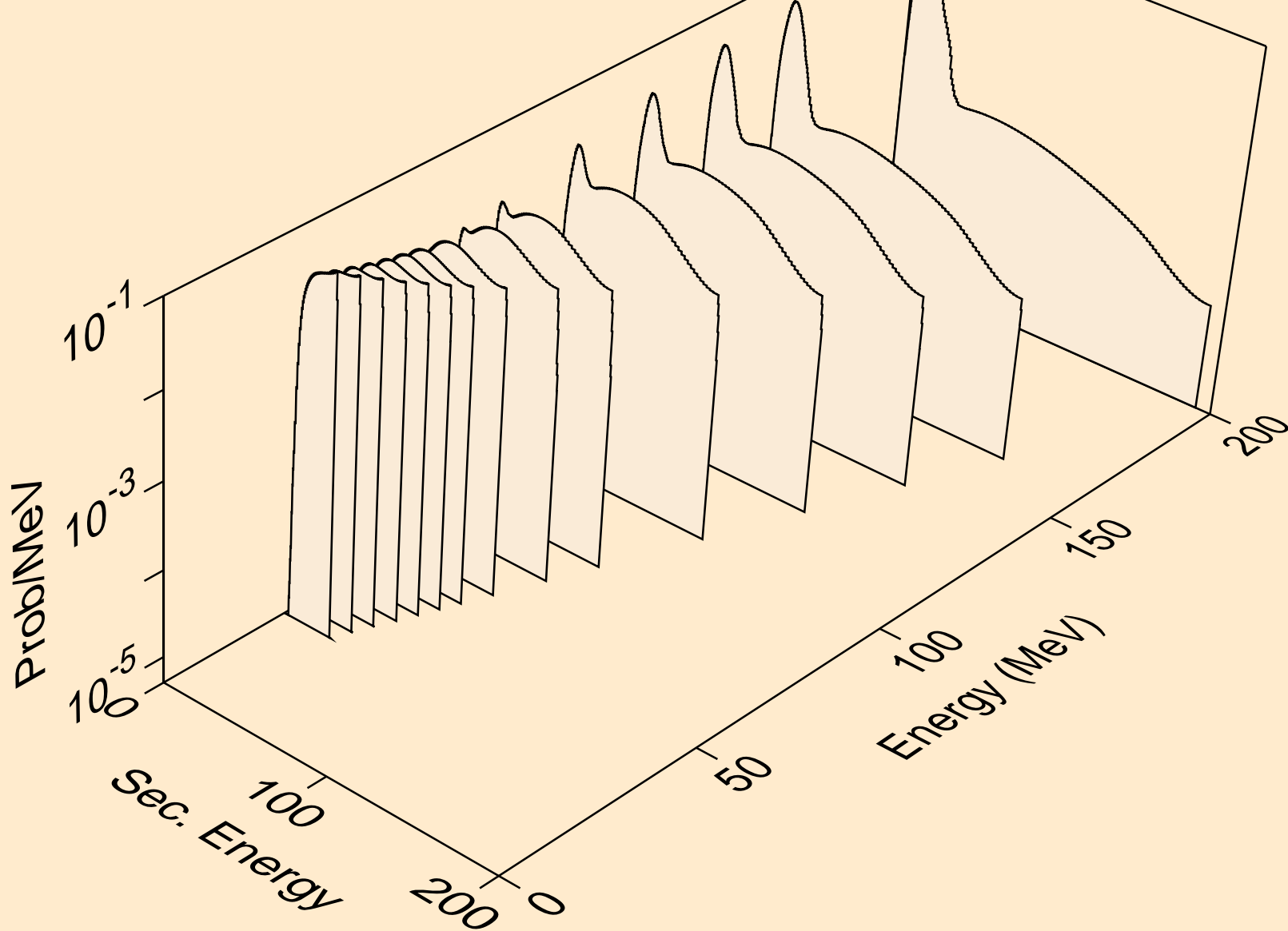

TC088M NEUTRON ACER TENDL-2019 LIBRARY; T=293.16K  
deuterons from (n,2nd)

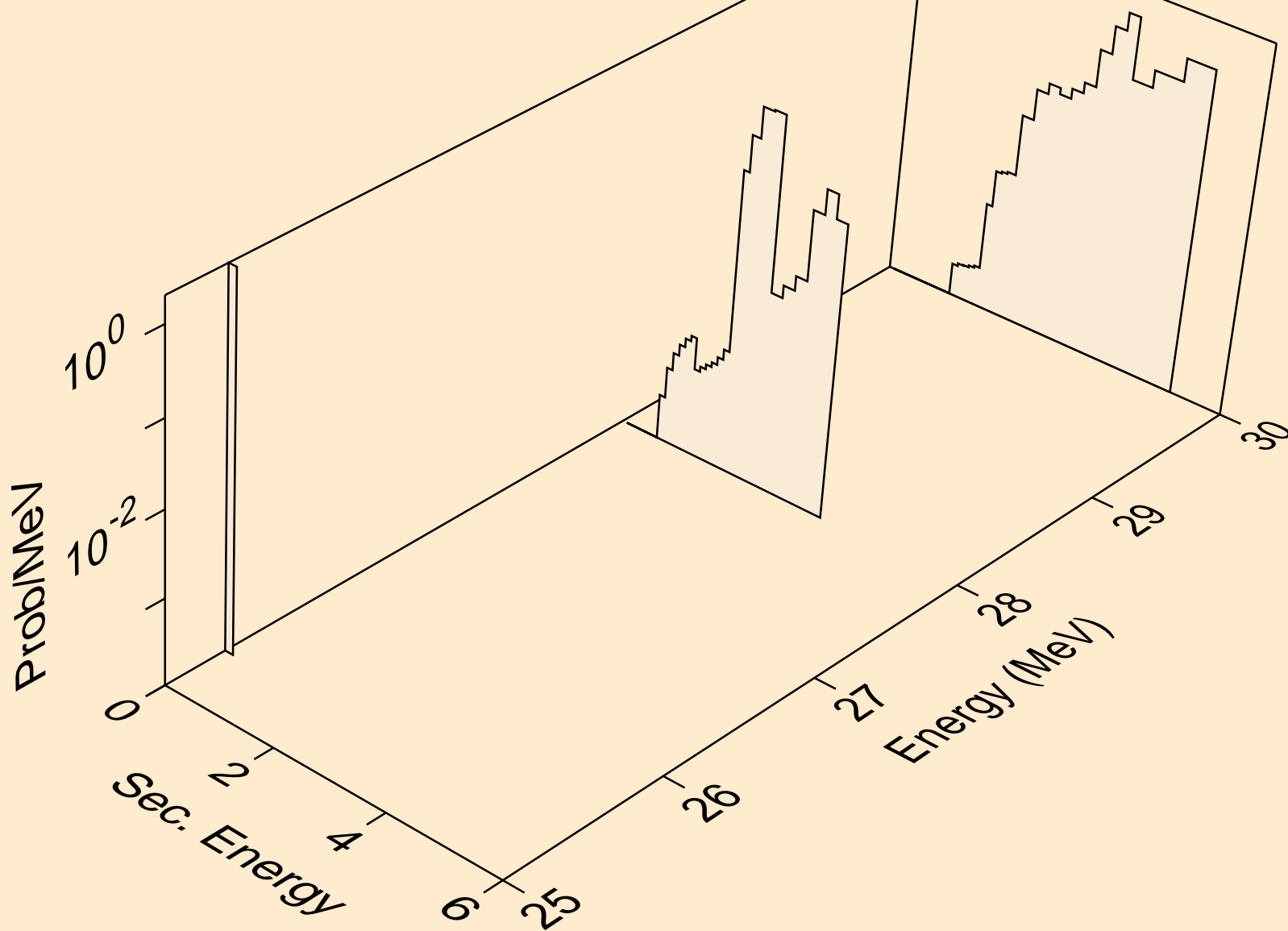

TC088M NEUTRON ACER TENDL-2019 LIBRARY; T=293.16K  
deuterons from (n,n\*)d

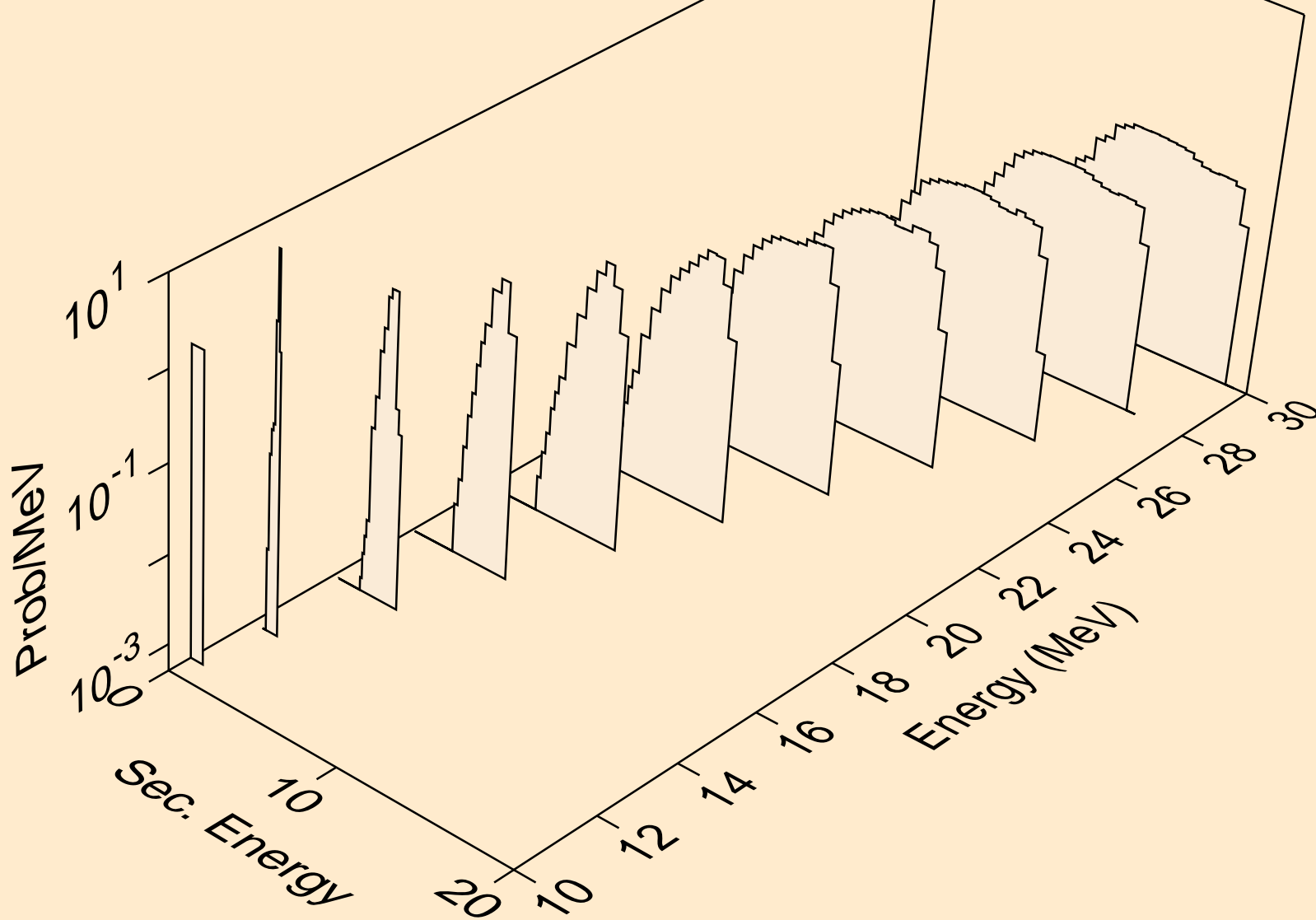

TC088M NEUTRON ACER TENDL-2019 LIBRARY; T=293.16K  
deuterons from (n,d)

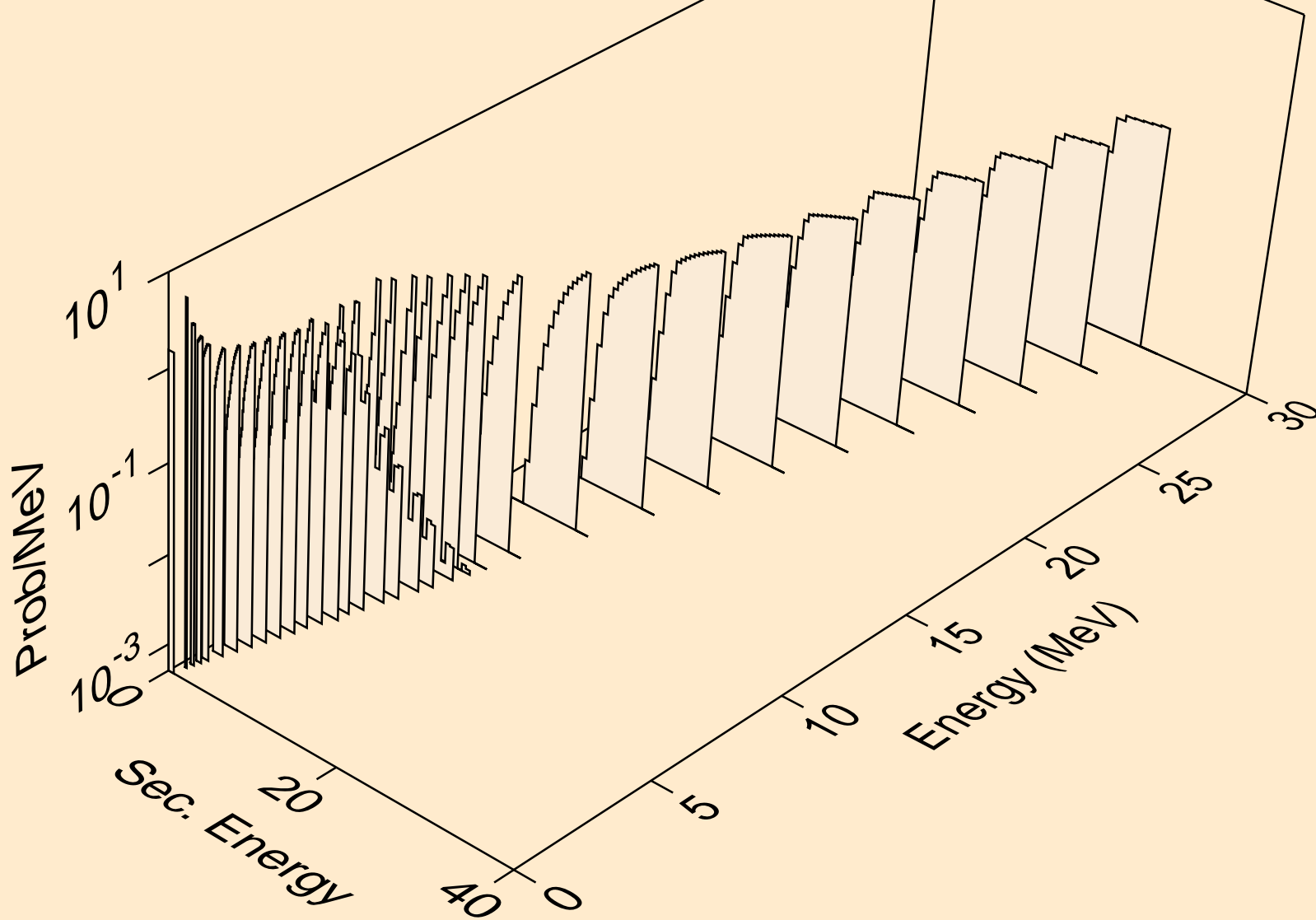

TC088M NEUTRON ACER TENDL-2019 LIBRARY; T=293.16K  
deuterons from (n,pd)

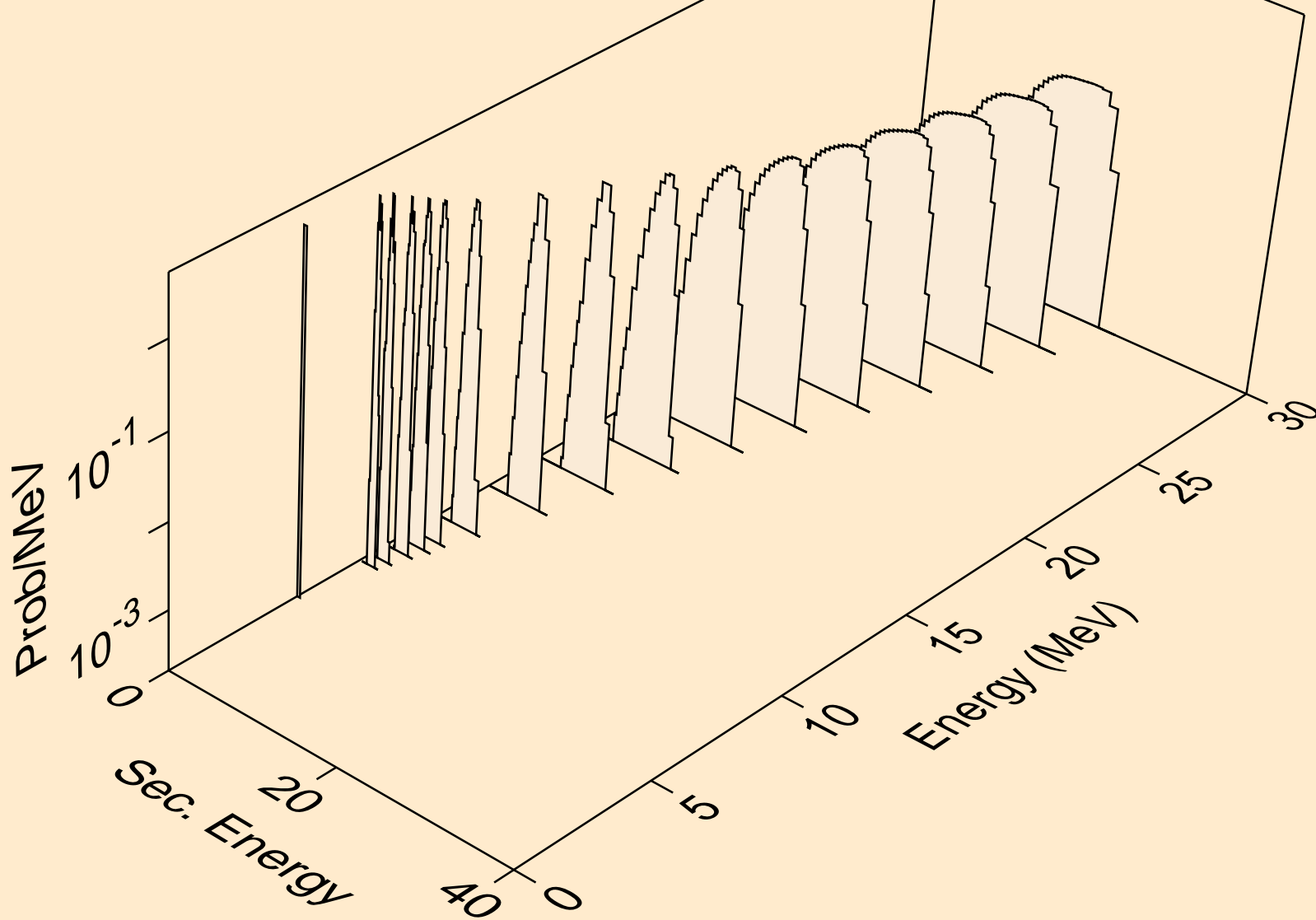



TC088M NEUTRON ACER TENDL-2019 LIBRARY; T=293.16K  
deuterons from (n,da)

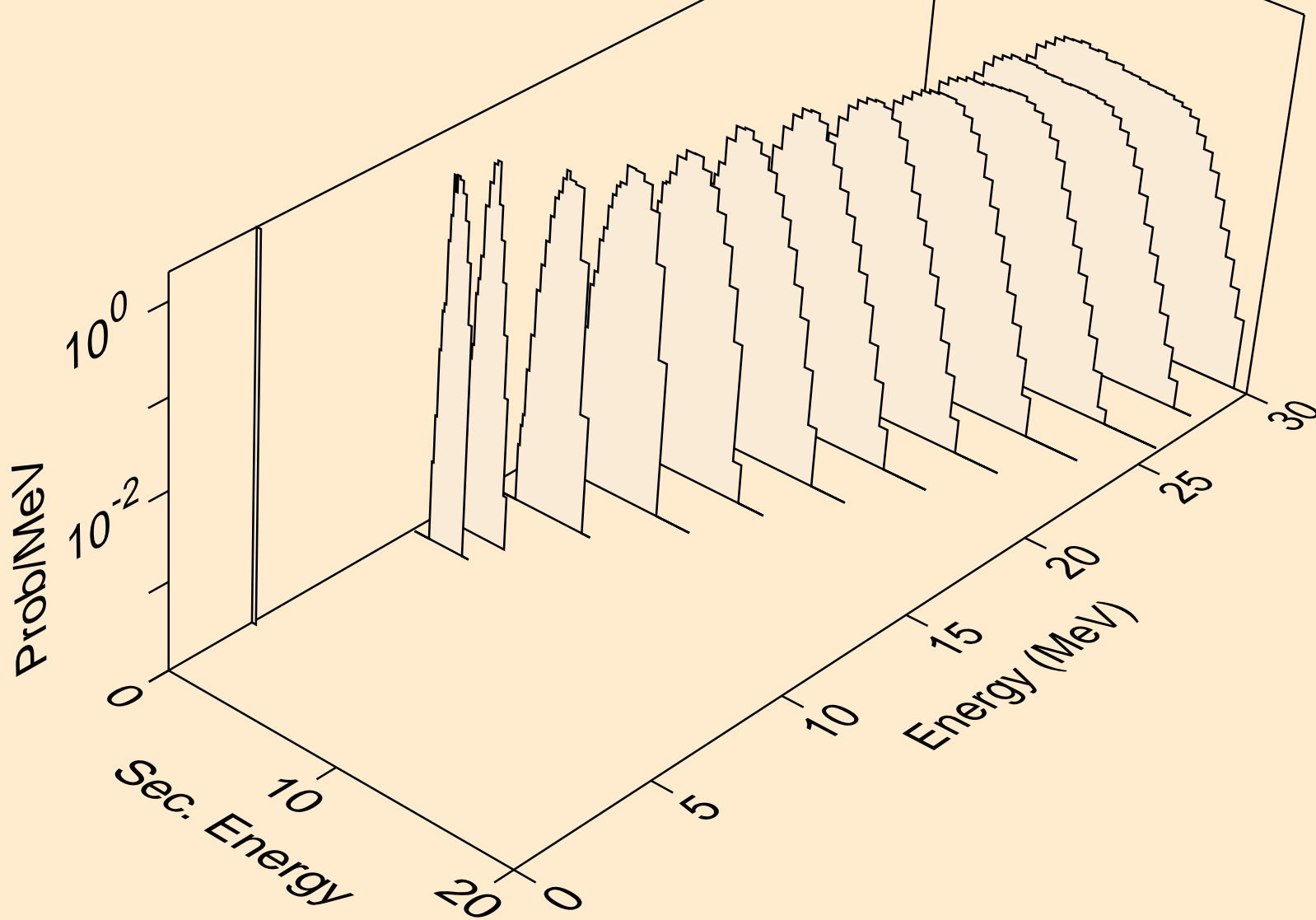

TC088M NEUTRON ACER TENDL-2019 LIBRARY; T=293.16K  
tritons from (n,x)

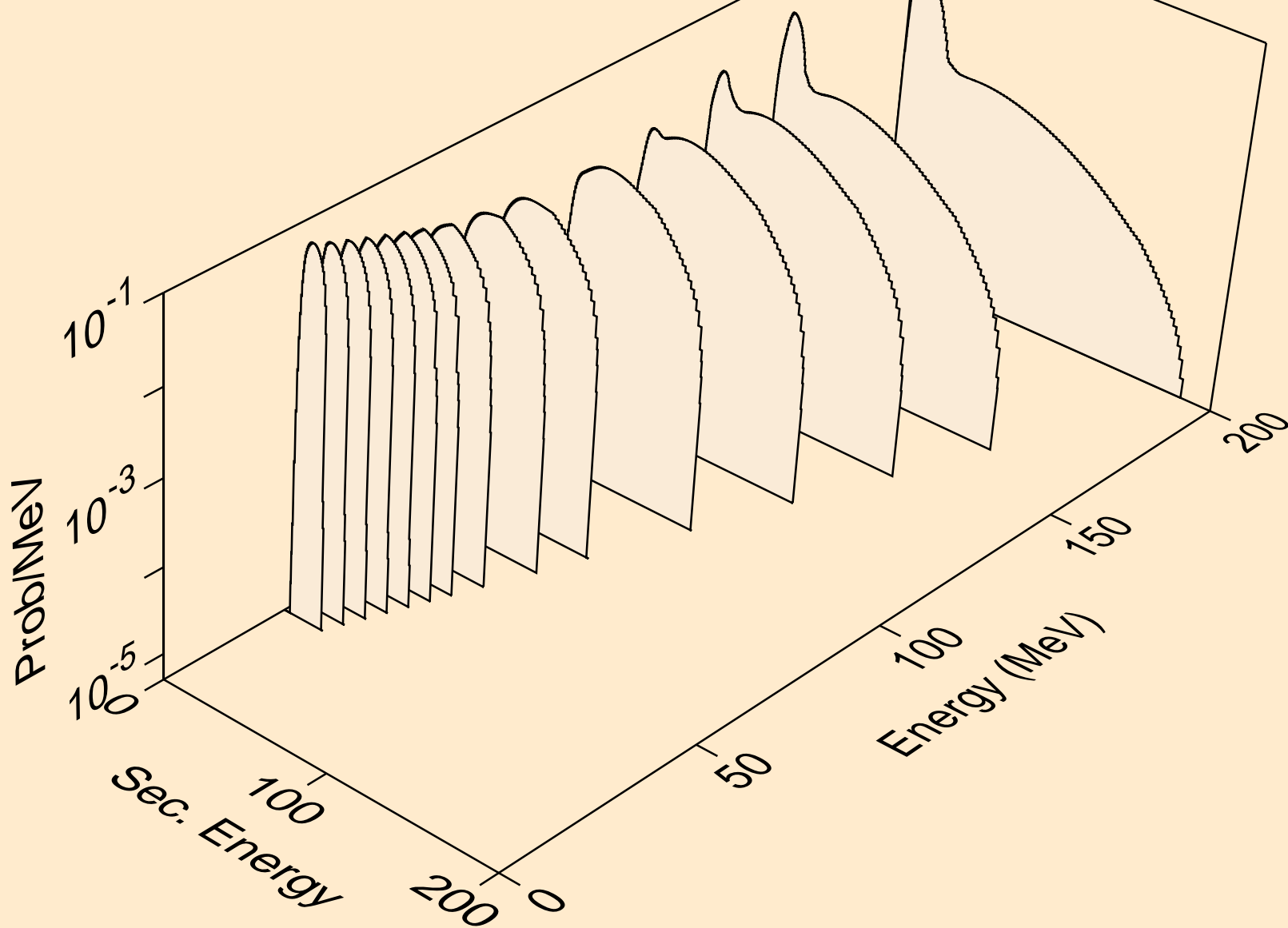

TC088M NEUTRON ACER TENDL-2019 LIBRARY; T=293.16K  
tritons from (n,n\*)t

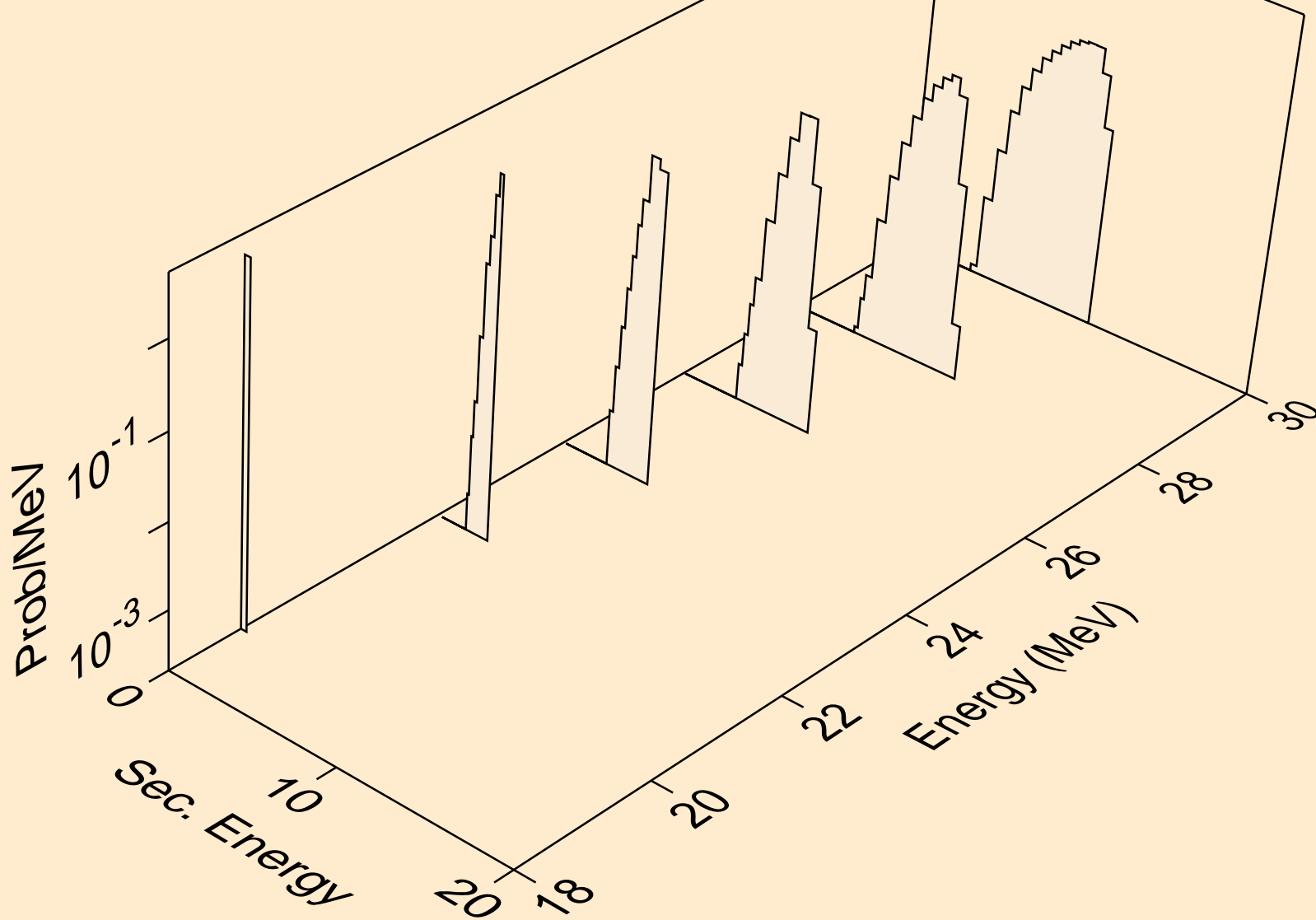

TC088M NEUTRON ACER TENDL-2019 LIBRARY; T=293.16K  
tritons from (n,t)

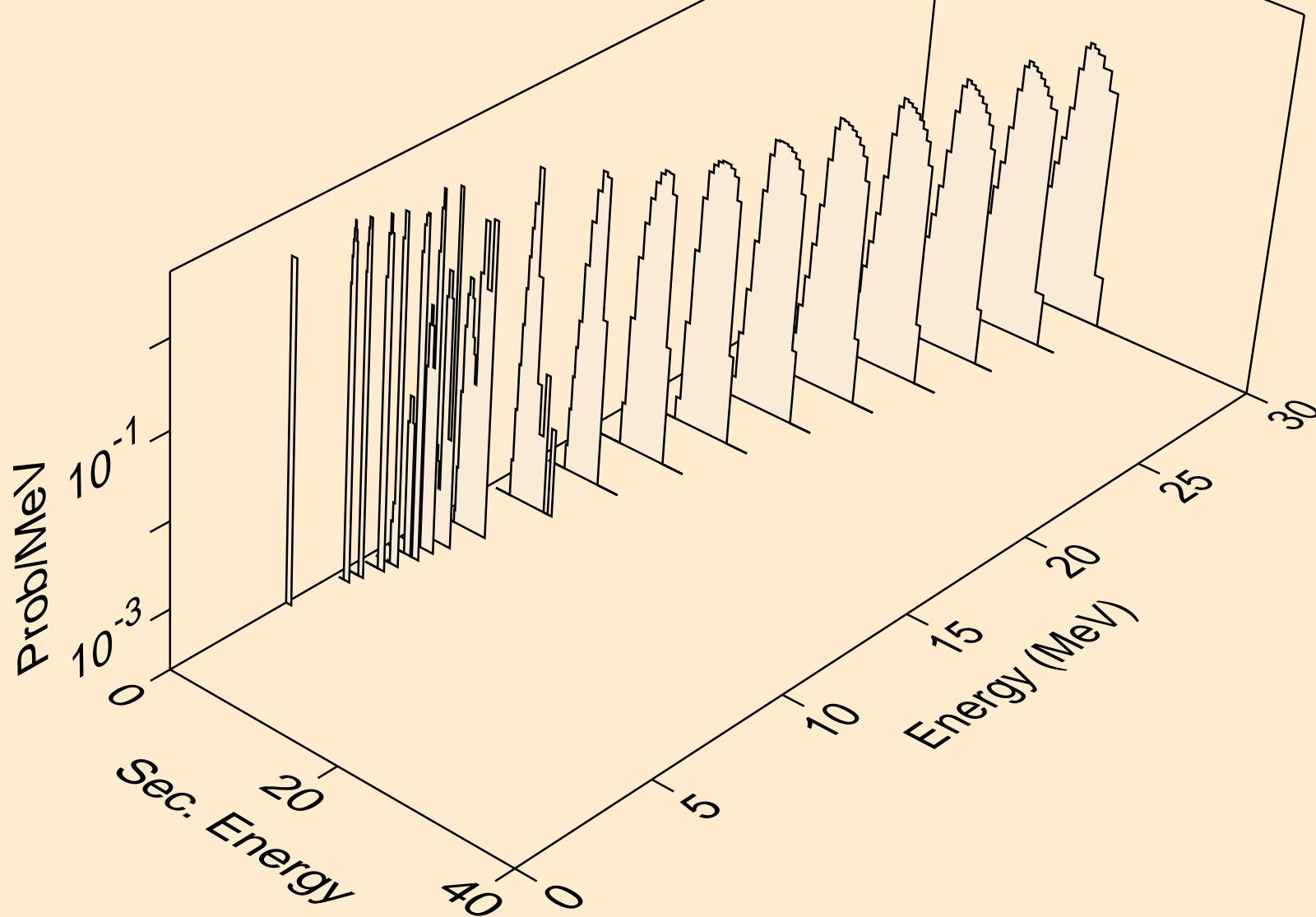

TC088M NEUTRON ACER TENDL-2019 LIBRARY; T=293.16K  
tritons from (n,pt)

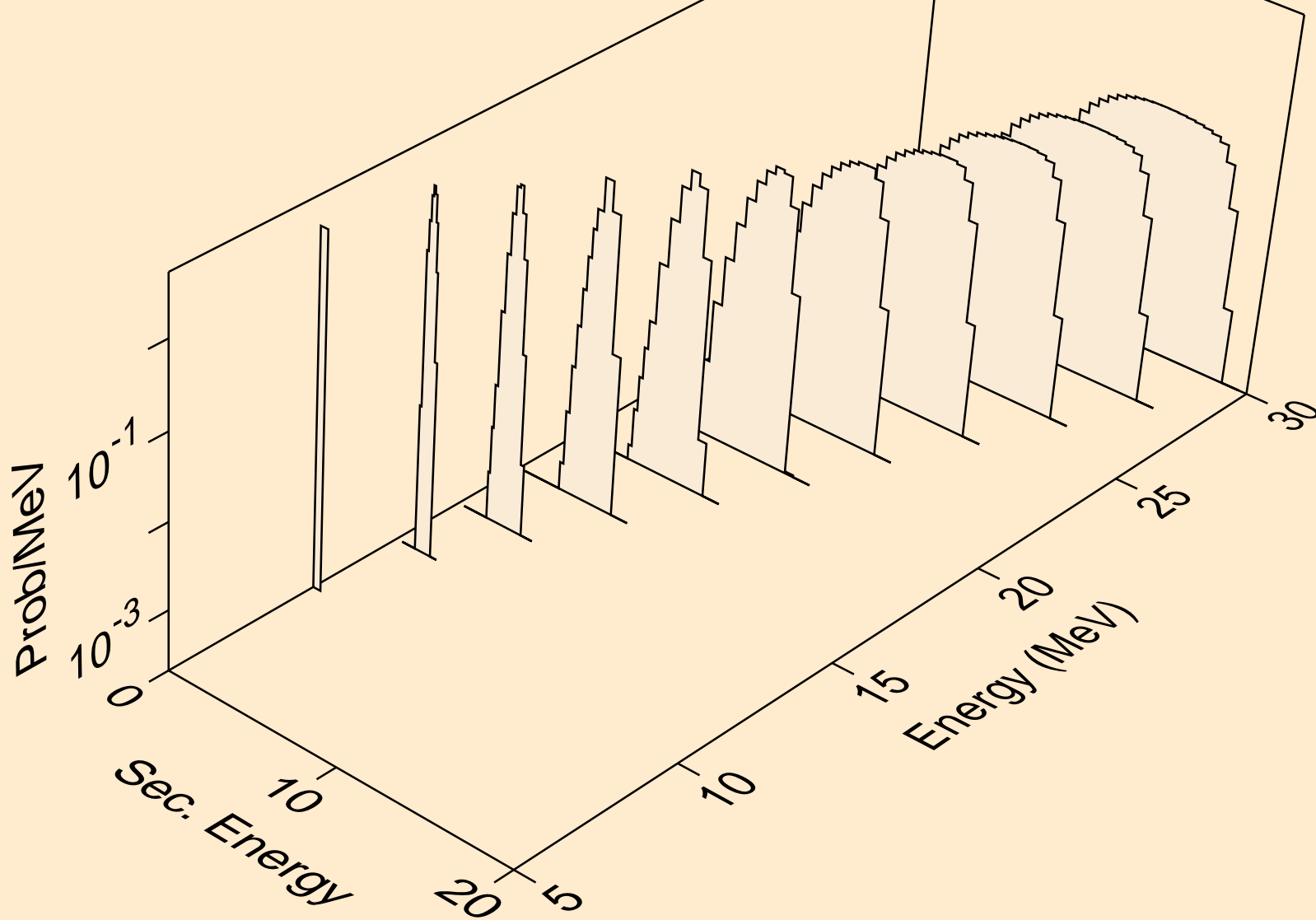

TC088M NEUTRON ACER TENDL-2019 LIBRARY; T=293.16K  
he3s from (n,x)

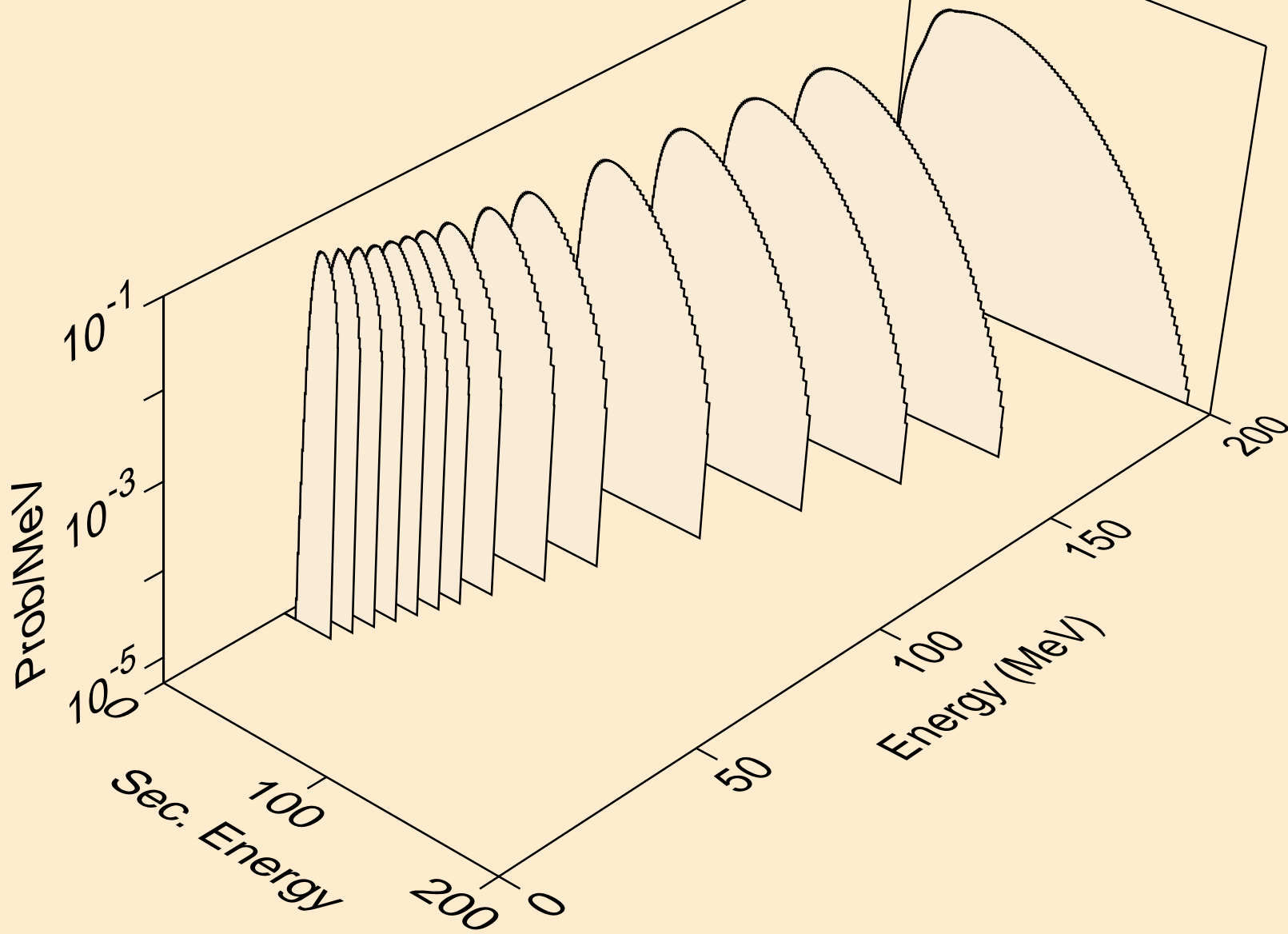

TC088M NEUTRON ACER TENDL-2019 LIBRARY; T=293.16K  
he3s from (n,n\*)he3

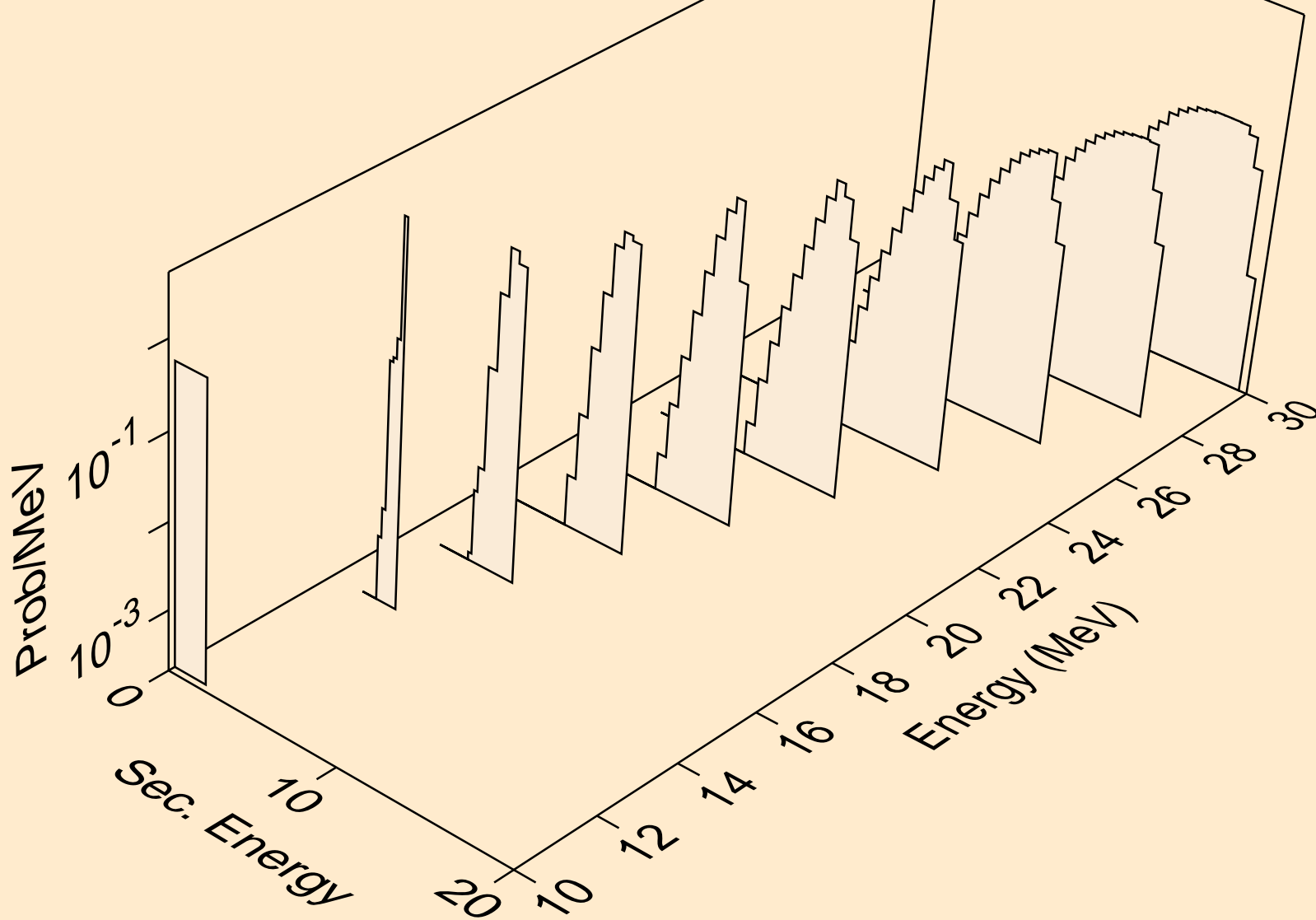

TC088M NEUTRON ACER TENDL-2019 LIBRARY; T=293.16K  
he3s from (n,he3)

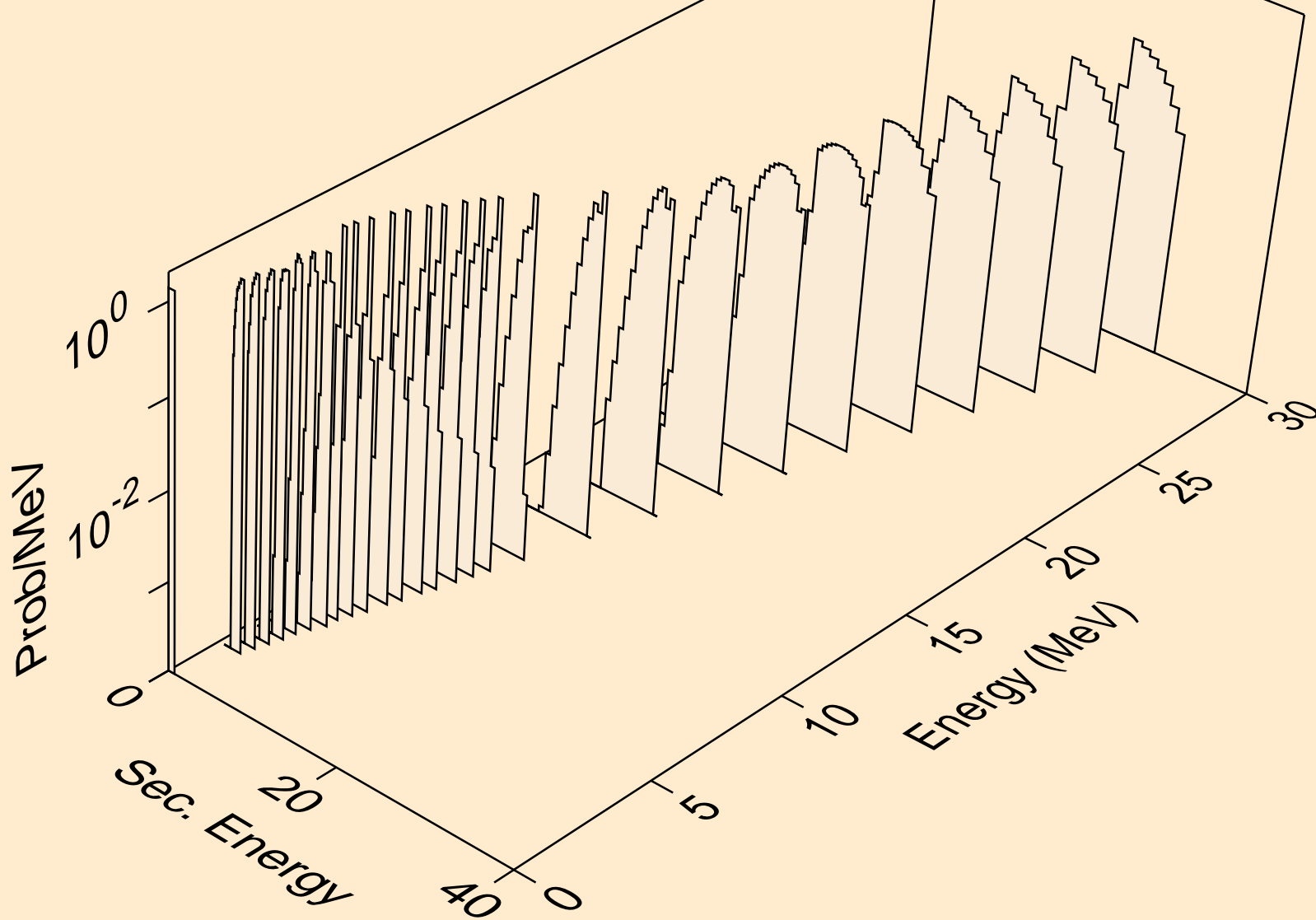



TC088M NEUTRON ACER TENDL-2019 LIBRARY; T=293.16K  
alphas from (n,x)

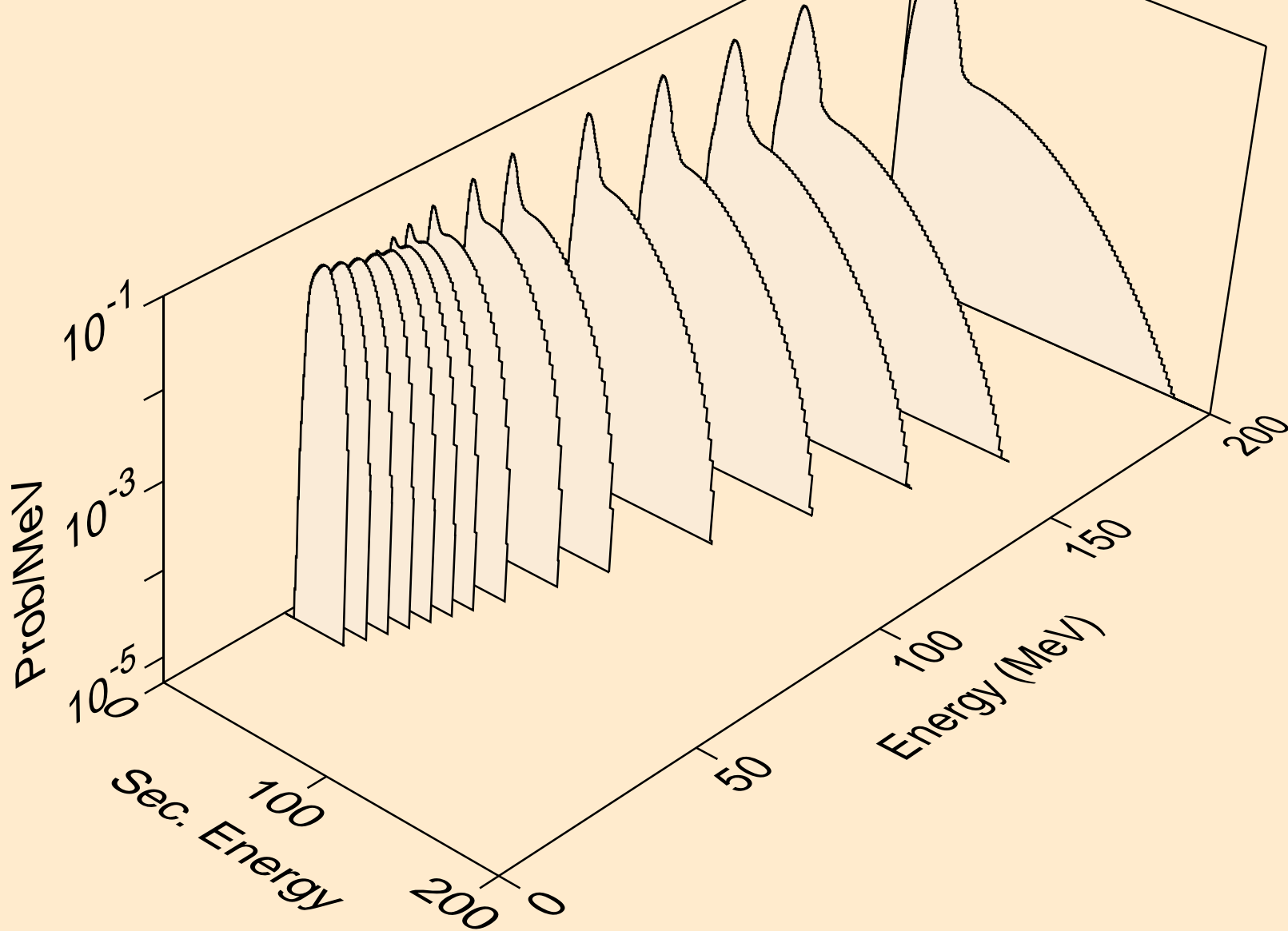

TC088M NEUTRON ACER TENDL-2019 LIBRARY; T=293.16K  
alphas from (n,n\*)a

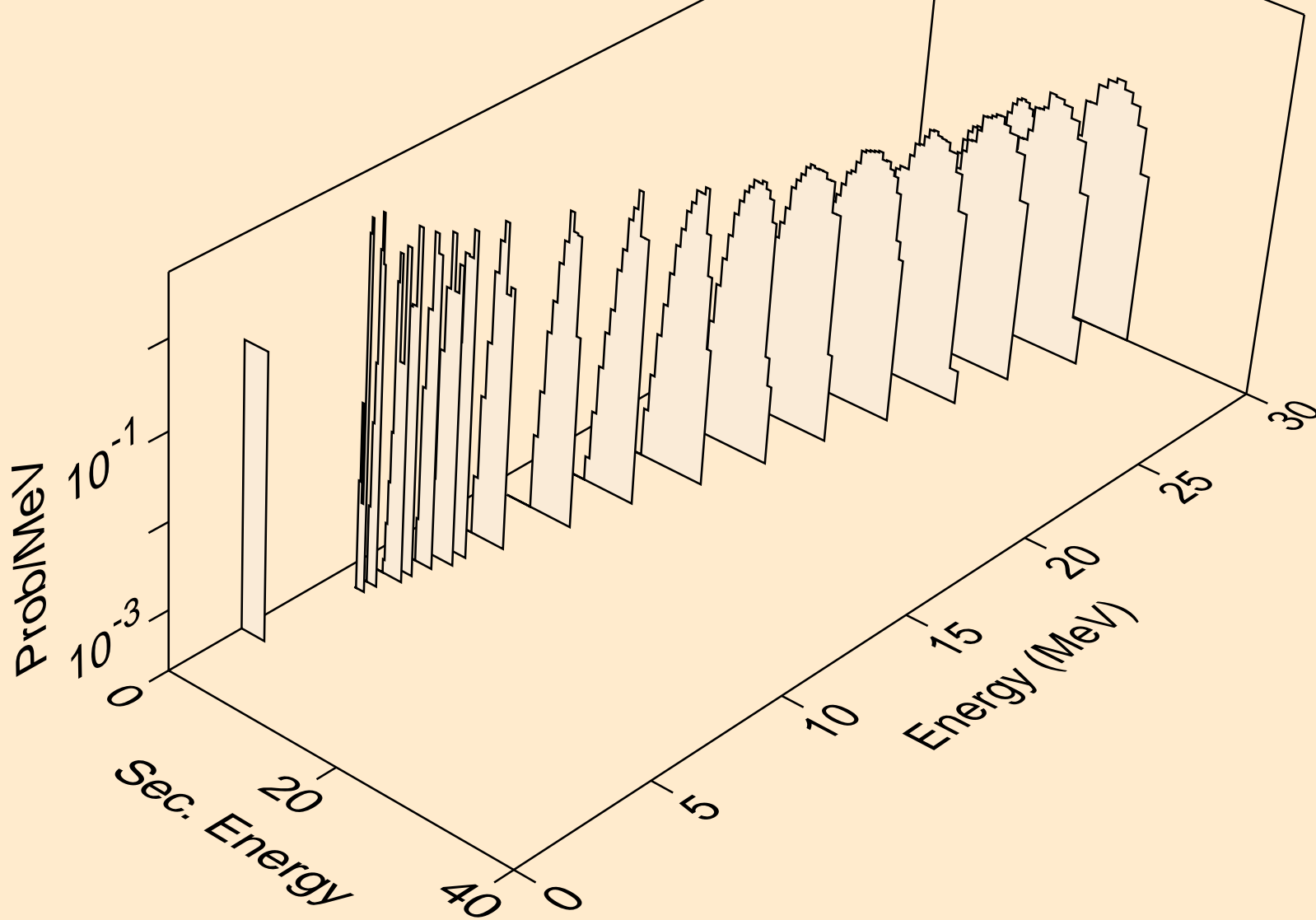

TC088M NEUTRON ACER TENDL-2019 LIBRARY; T=293.16K  
alphas from (n,2n)a

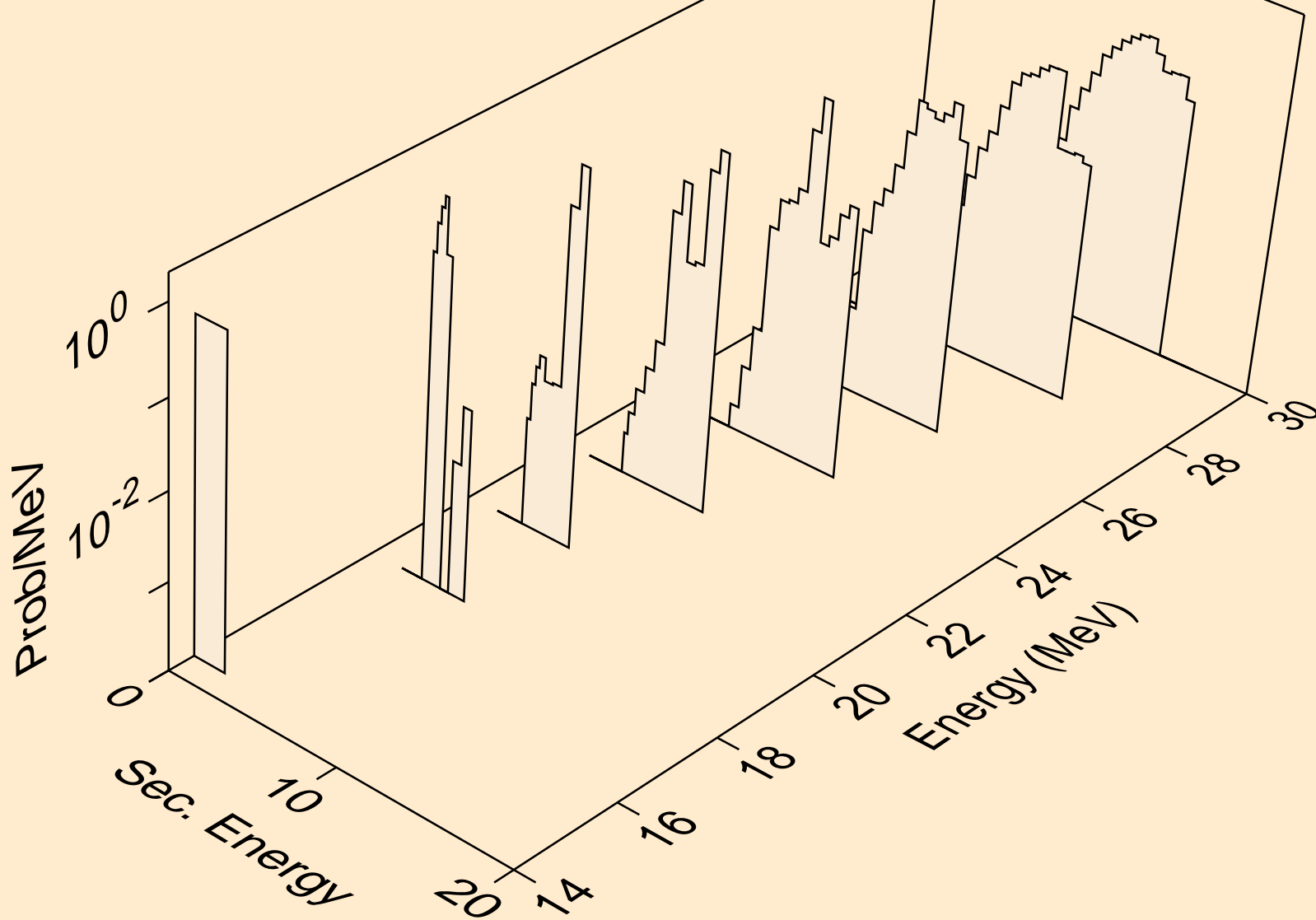

TC088M NEUTRON ACER TENDL-2019 LIBRARY; T=293.16K  
alphas from (n,n\*)2a

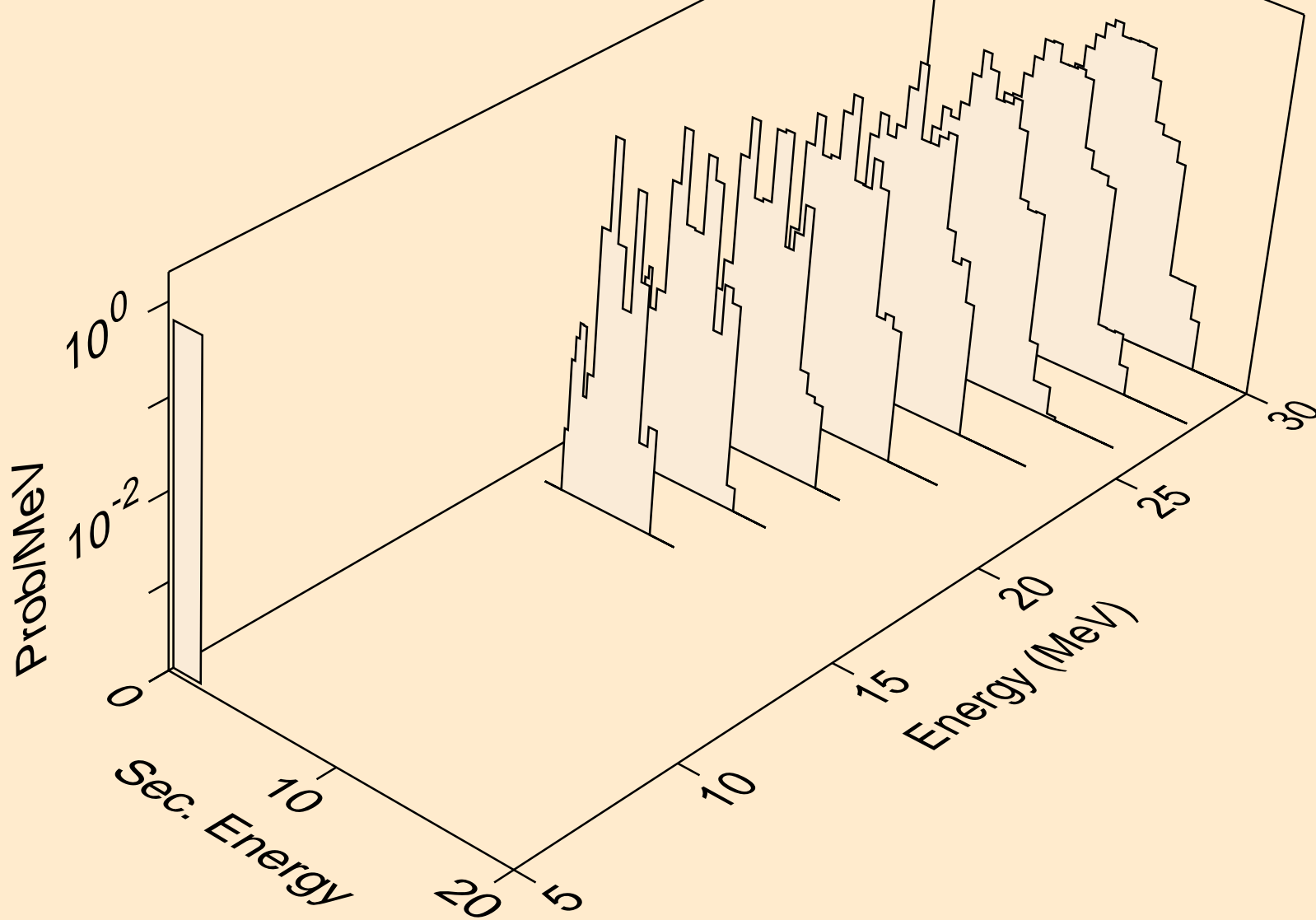

TC088M NEUTRON ACER TENDL-2019 LIBRARY; T=293.16K  
alphas from (n,npa)

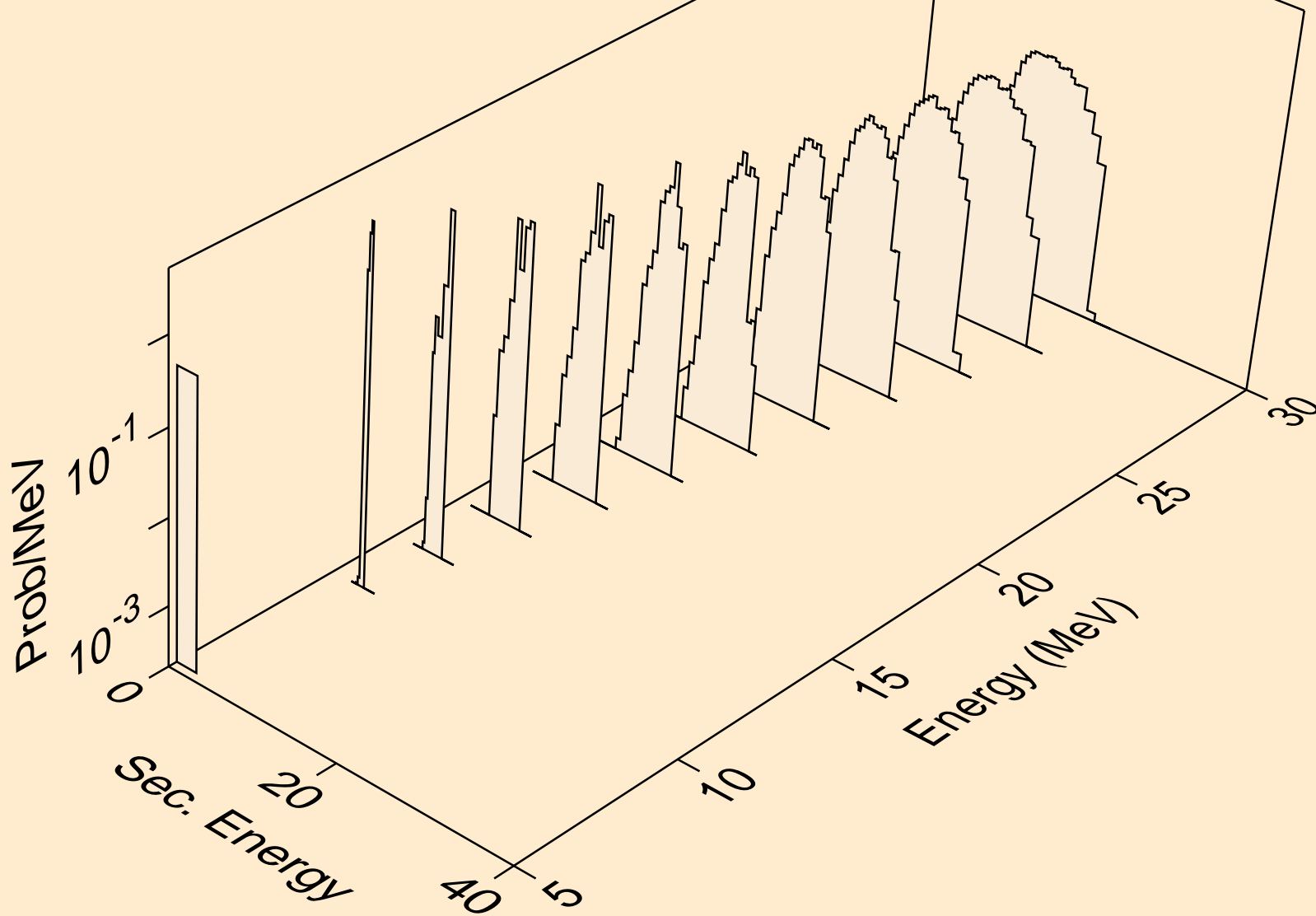

TC088M NEUTRON ACER TENDL-2019 LIBRARY; T=293.16K  
alphas from (n,a)

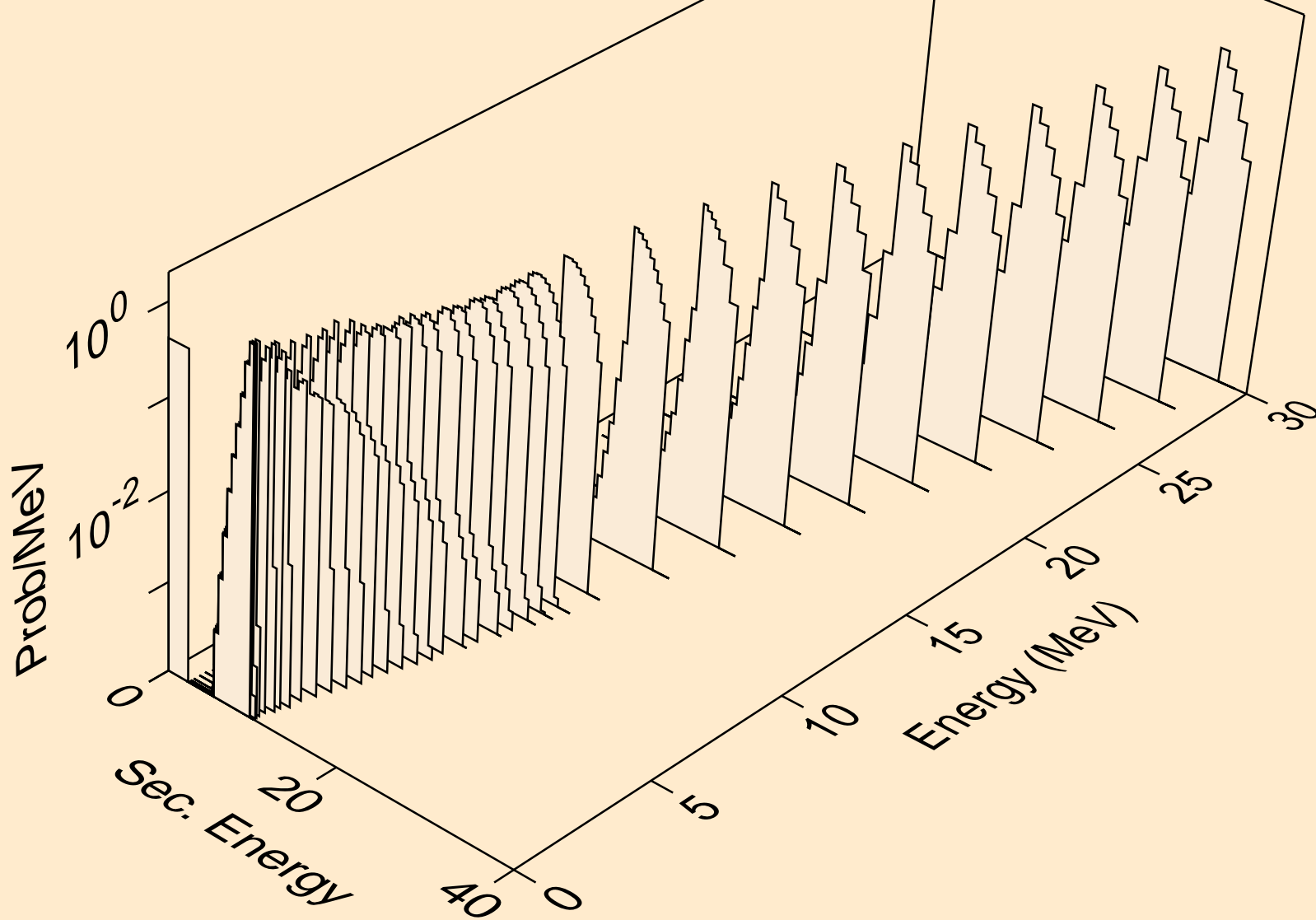

TC088M NEUTRON ACER TENDL-2019 LIBRARY; T=293.16K  
alphas from (n,2a)

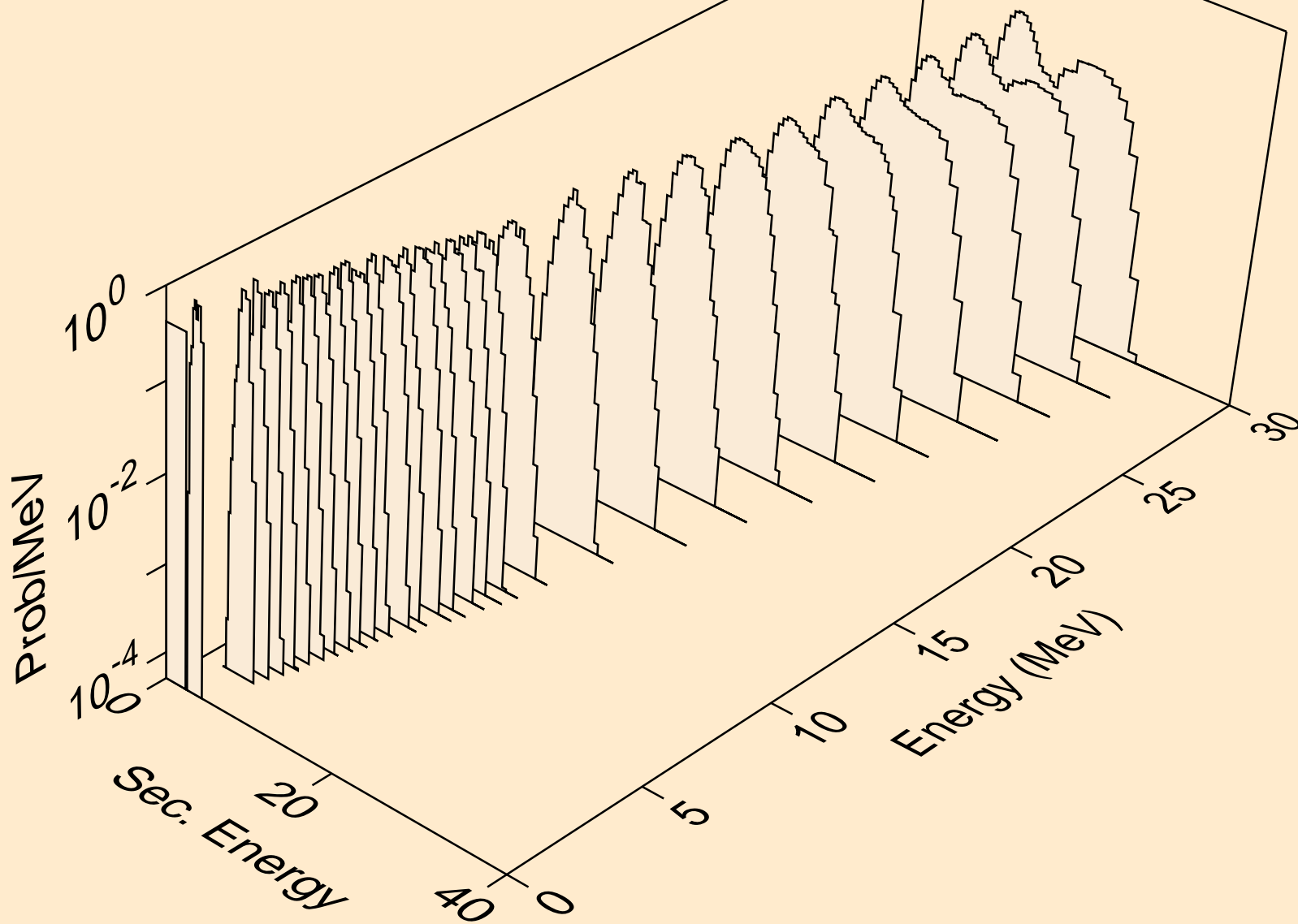

TC088M NEUTRON ACER TENDL-2019 LIBRARY; T=293.16K  
alphas from (n,3a)

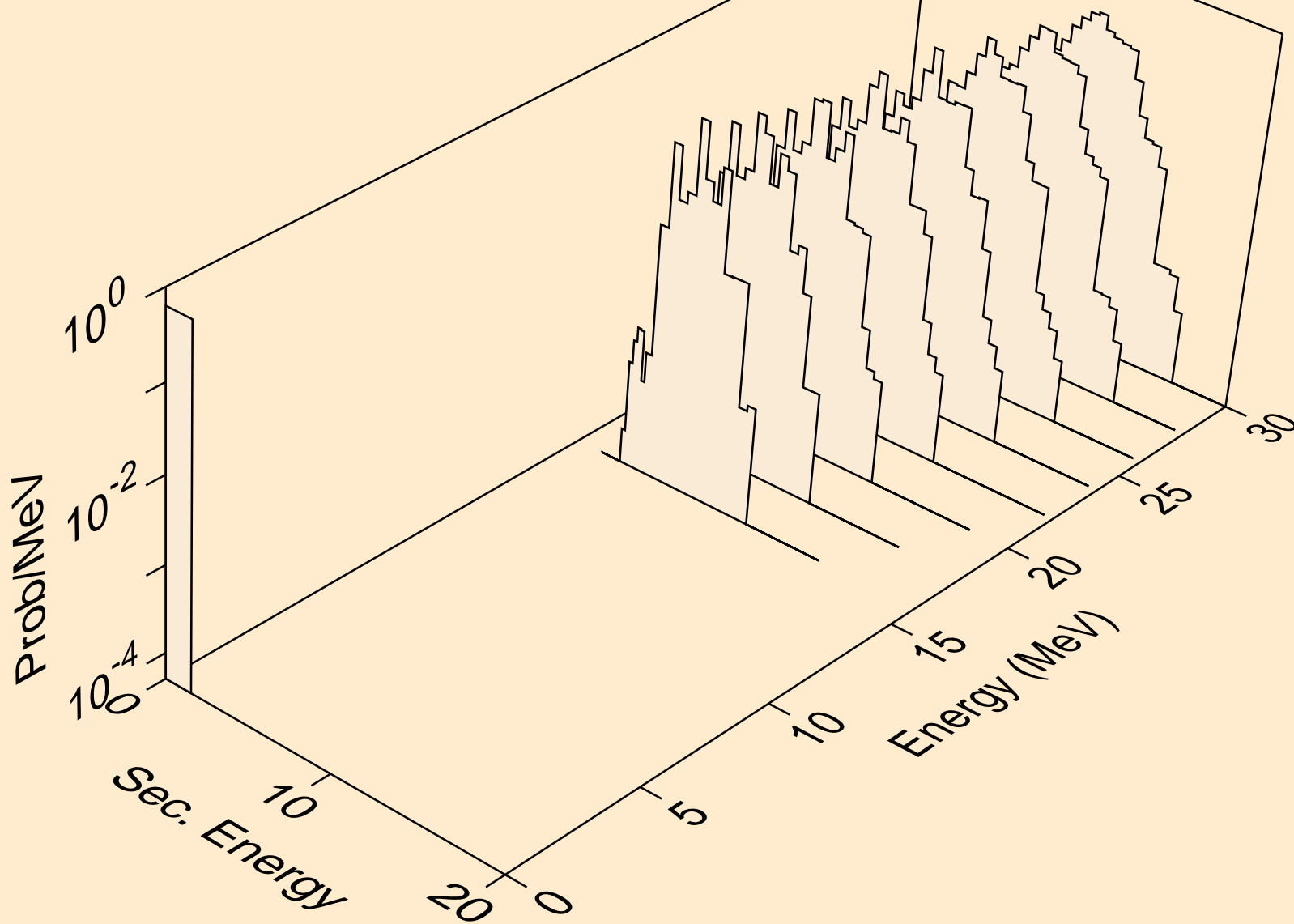



TC088M NEUTRON ACER TENDL-2019 LIBRARY; T=293.16K  
alphas from (n,pa)

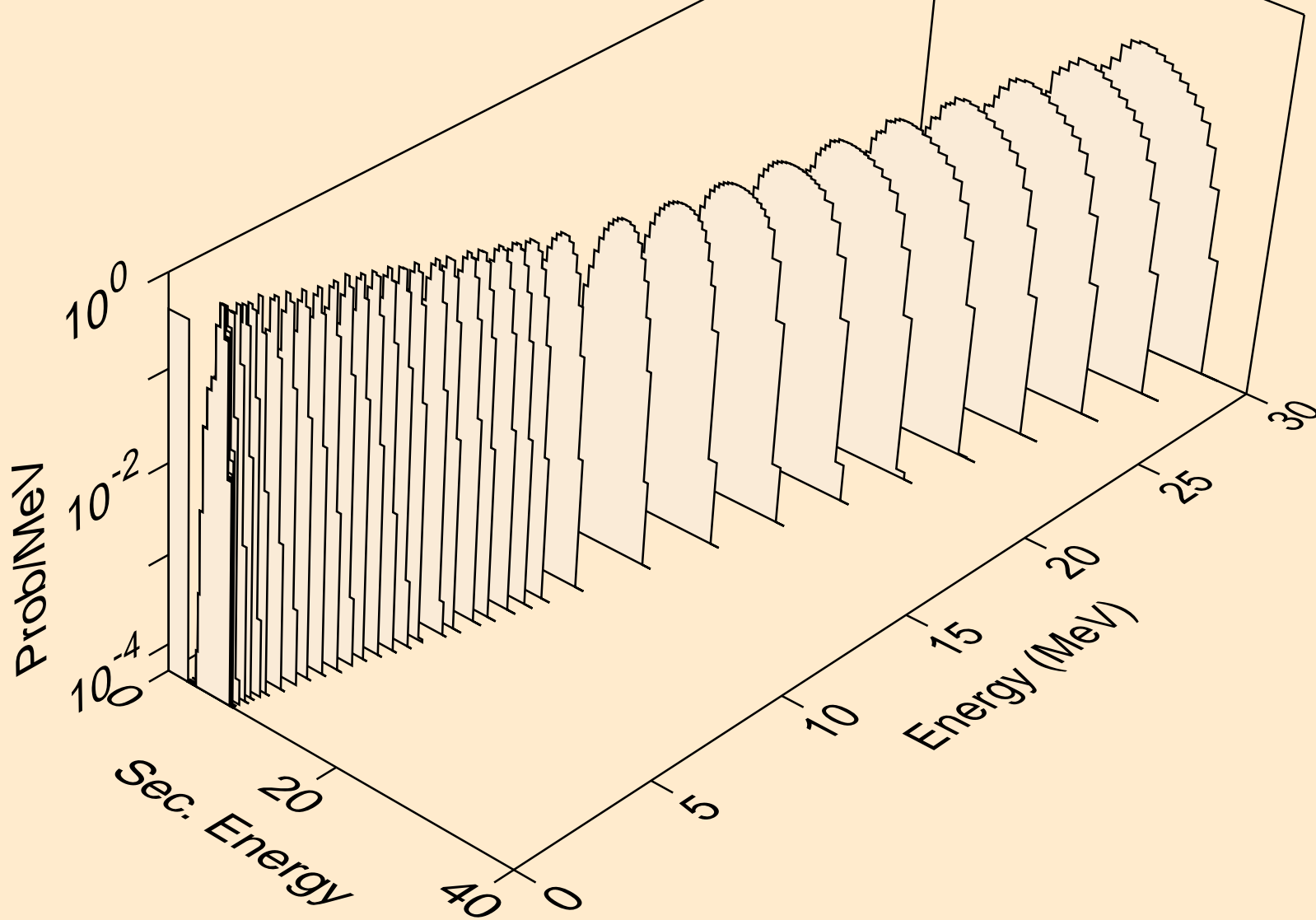

TC088M NEUTRON ACER TENDL-2019 LIBRARY; T=293.16K  
alphas from (n,da)

