

TC090N NEUTRON ACER TENDL-2019 LIBRARY; T=293.16K
Principal cross sections

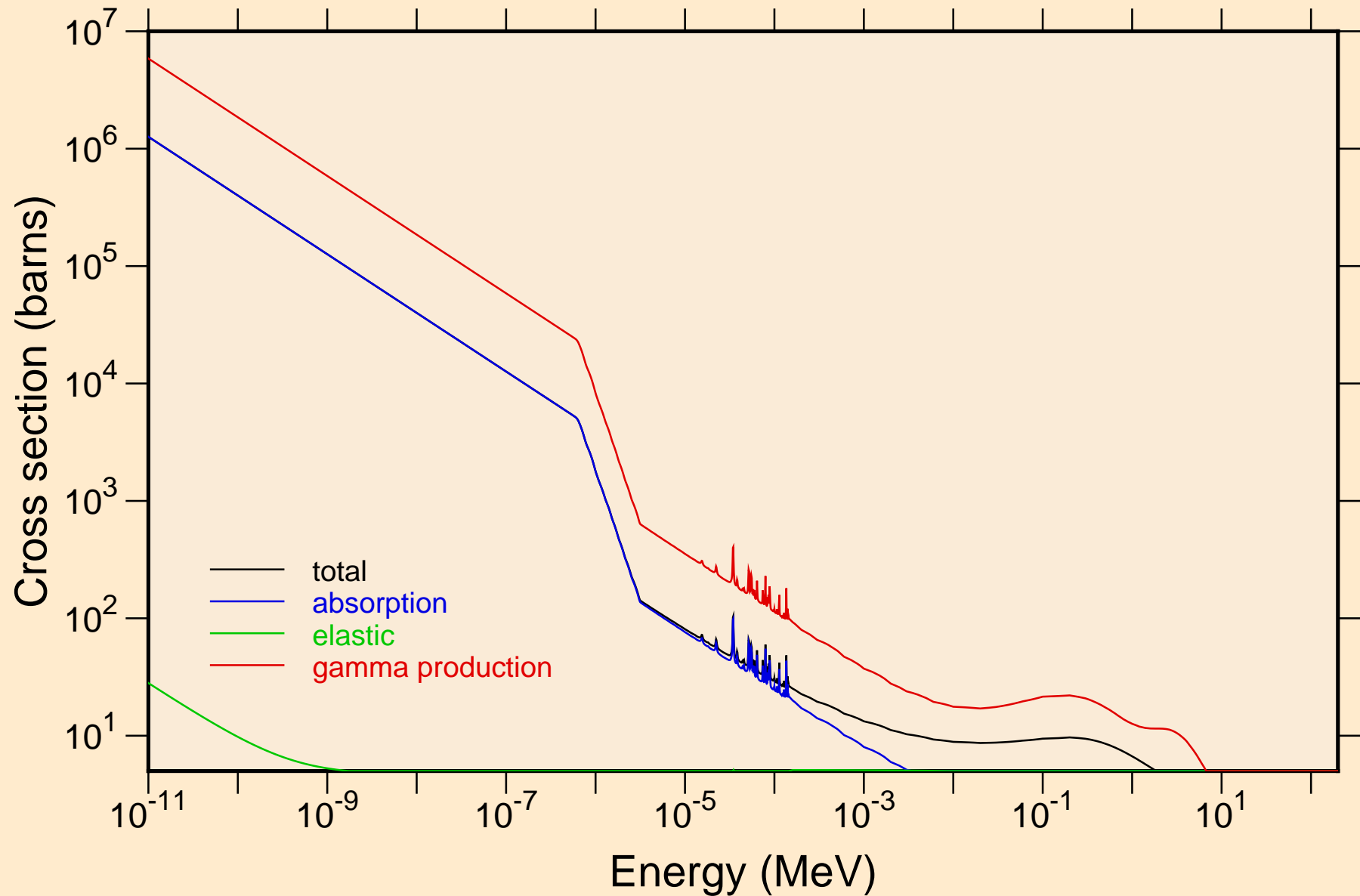

TC090N NEUTRON ACER TENDL-2019 LIBRARY; T=293.16K
resonance total cross section

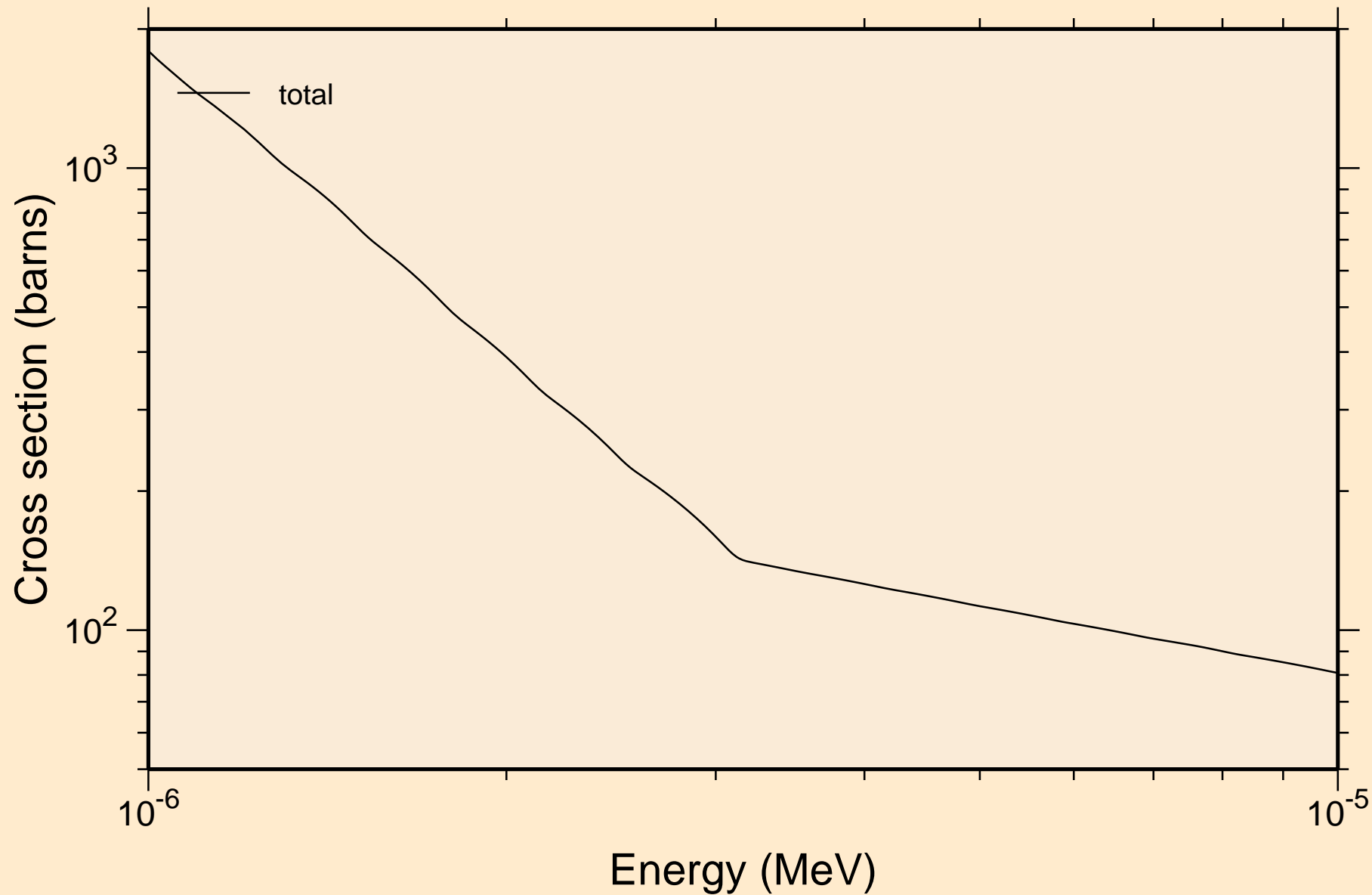

TC090N NEUTRON ACER TENDL-2019 LIBRARY; T=293.16K
resonance total cross section

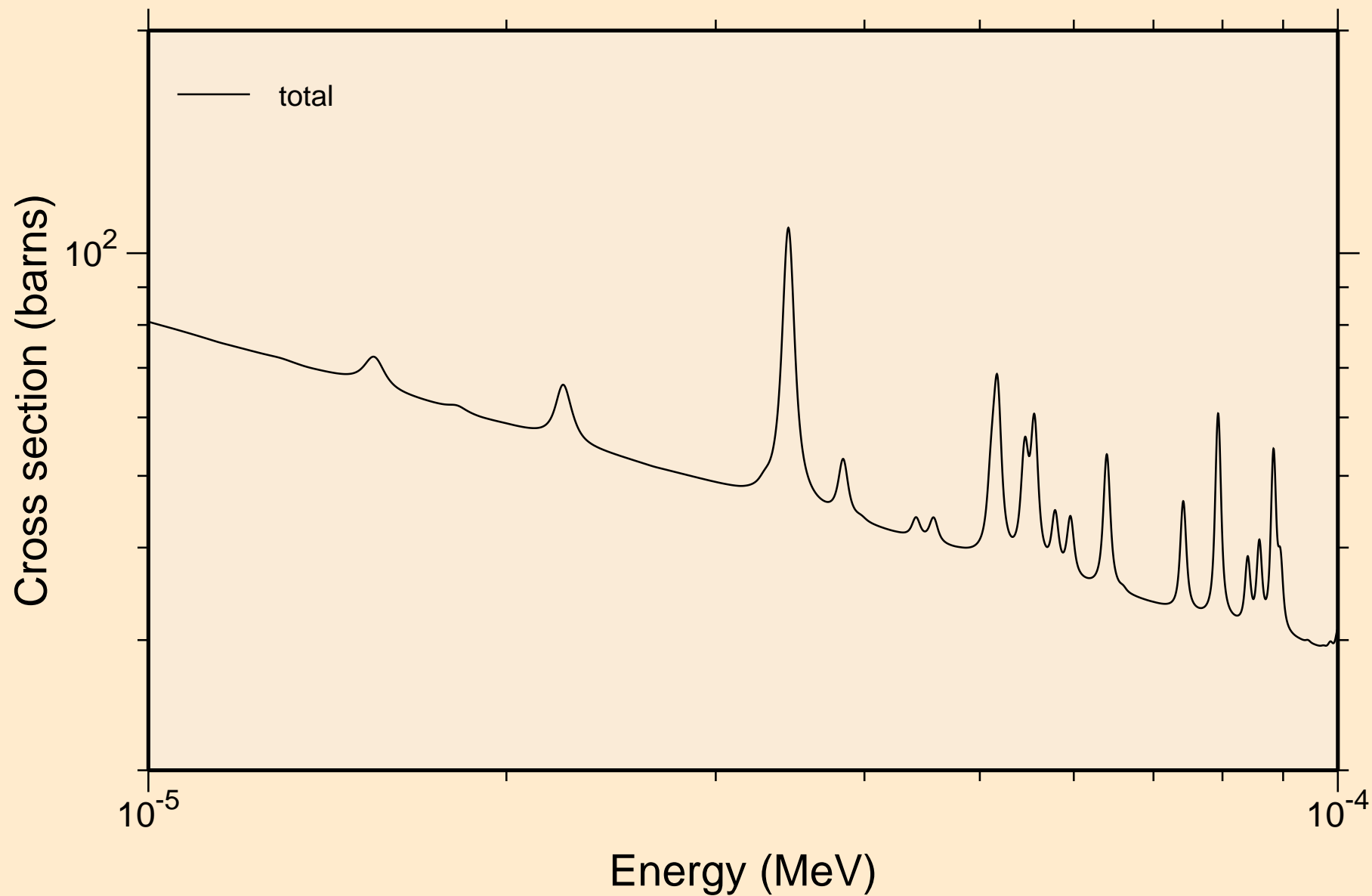

TC090N NEUTRON ACER TENDL-2019 LIBRARY; T=293.16K
resonance total cross section

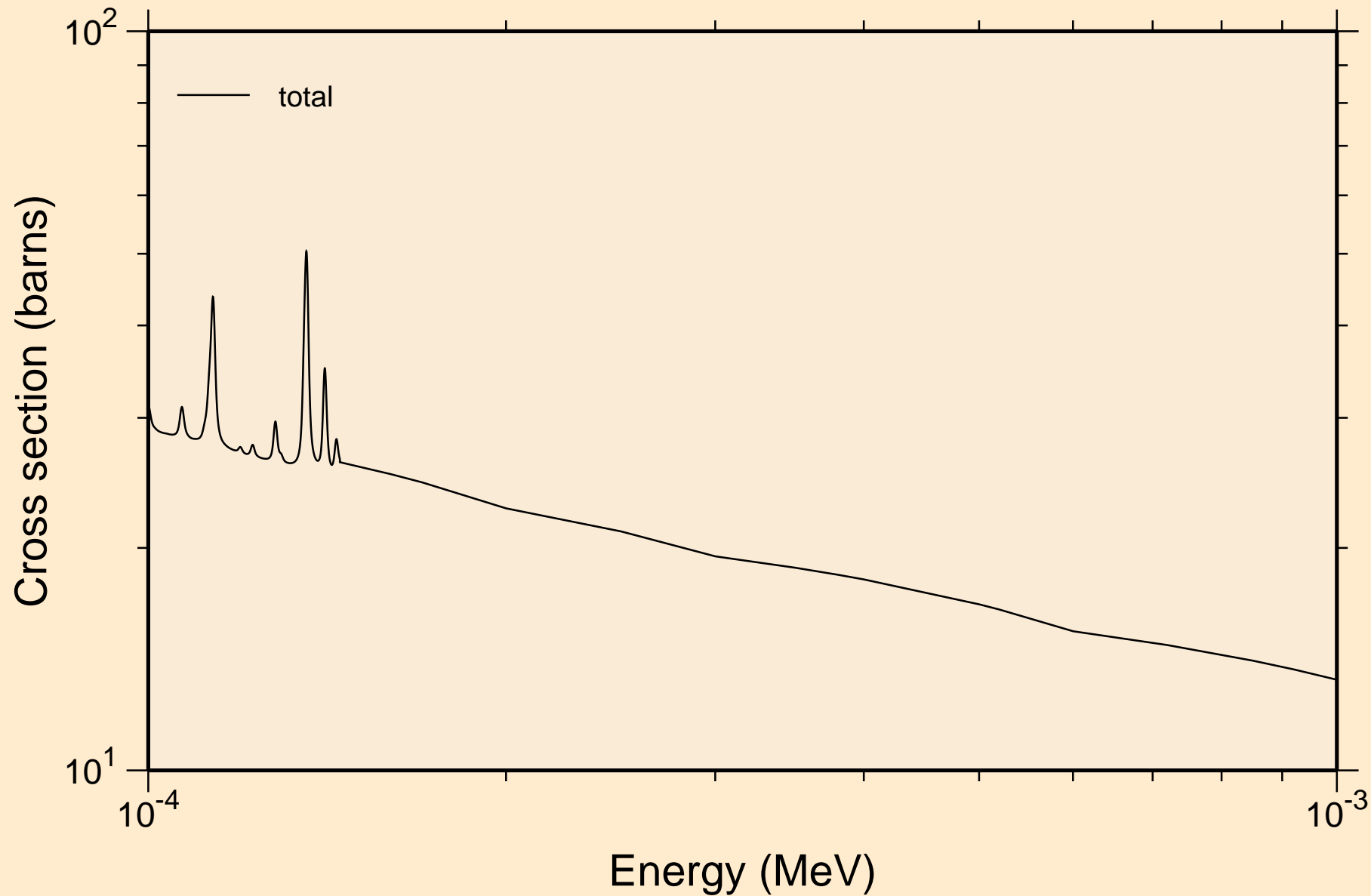

T̄C090N NEUTRON ACER TENDL-2019 LIBRARY; T=293.16K
resonance total cross section

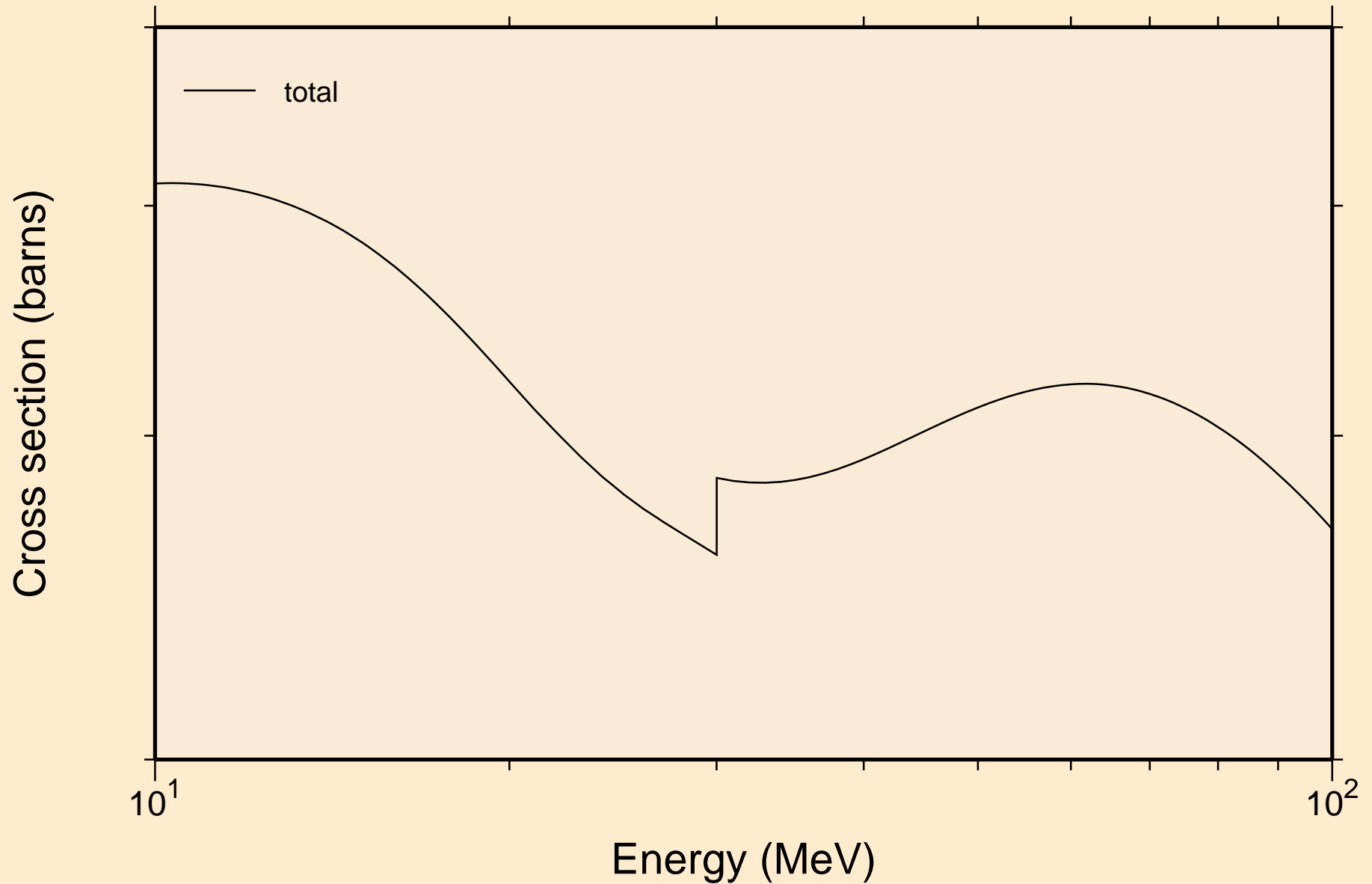

TC090N NEUTRON ACER TENDL-2019 LIBRARY; T=293.16K
resonance absorption cross sections

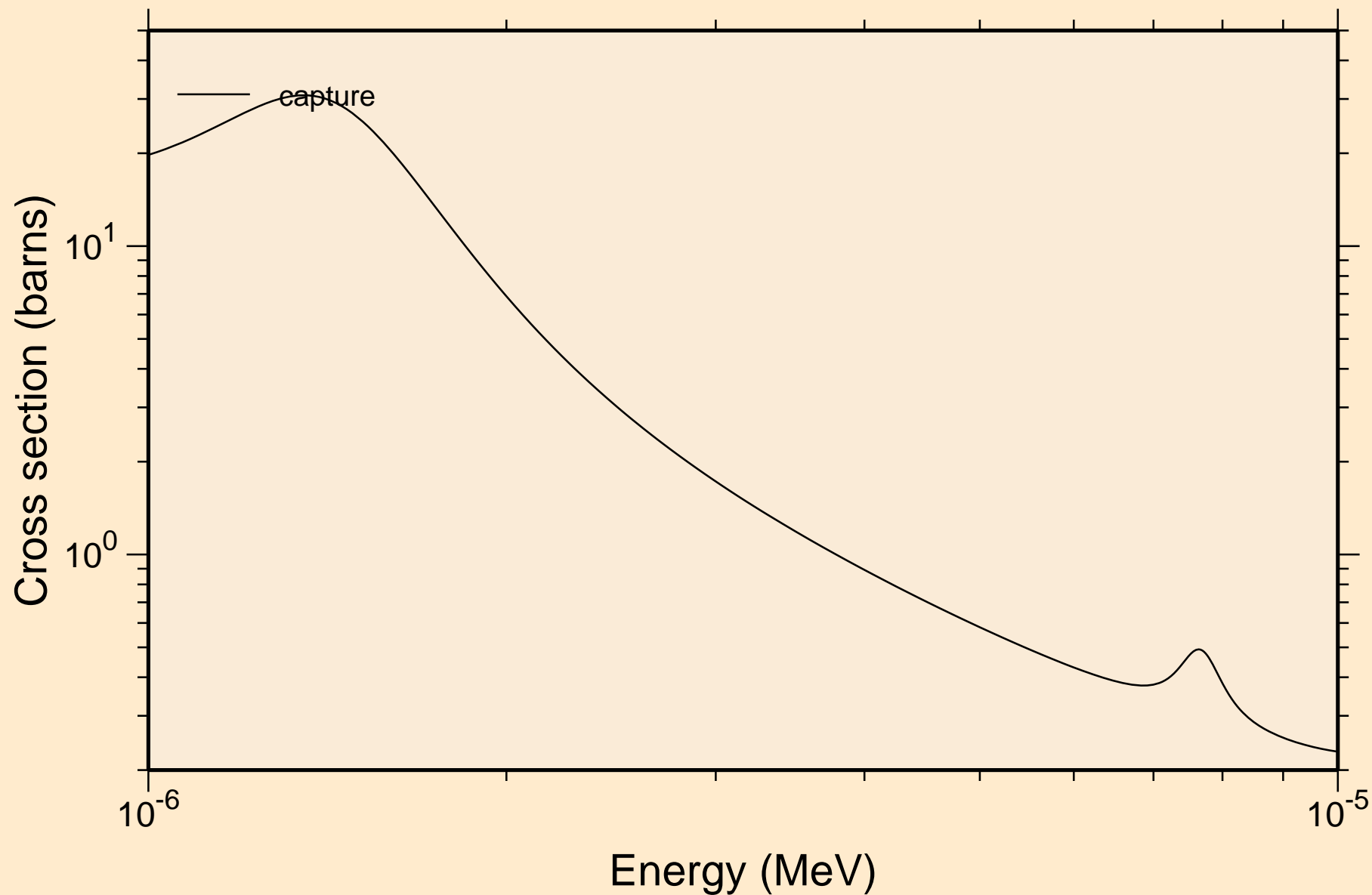

TC090N NEUTRON ACER TENDL-2019 LIBRARY; T=293.16K
resonance absorption cross sections

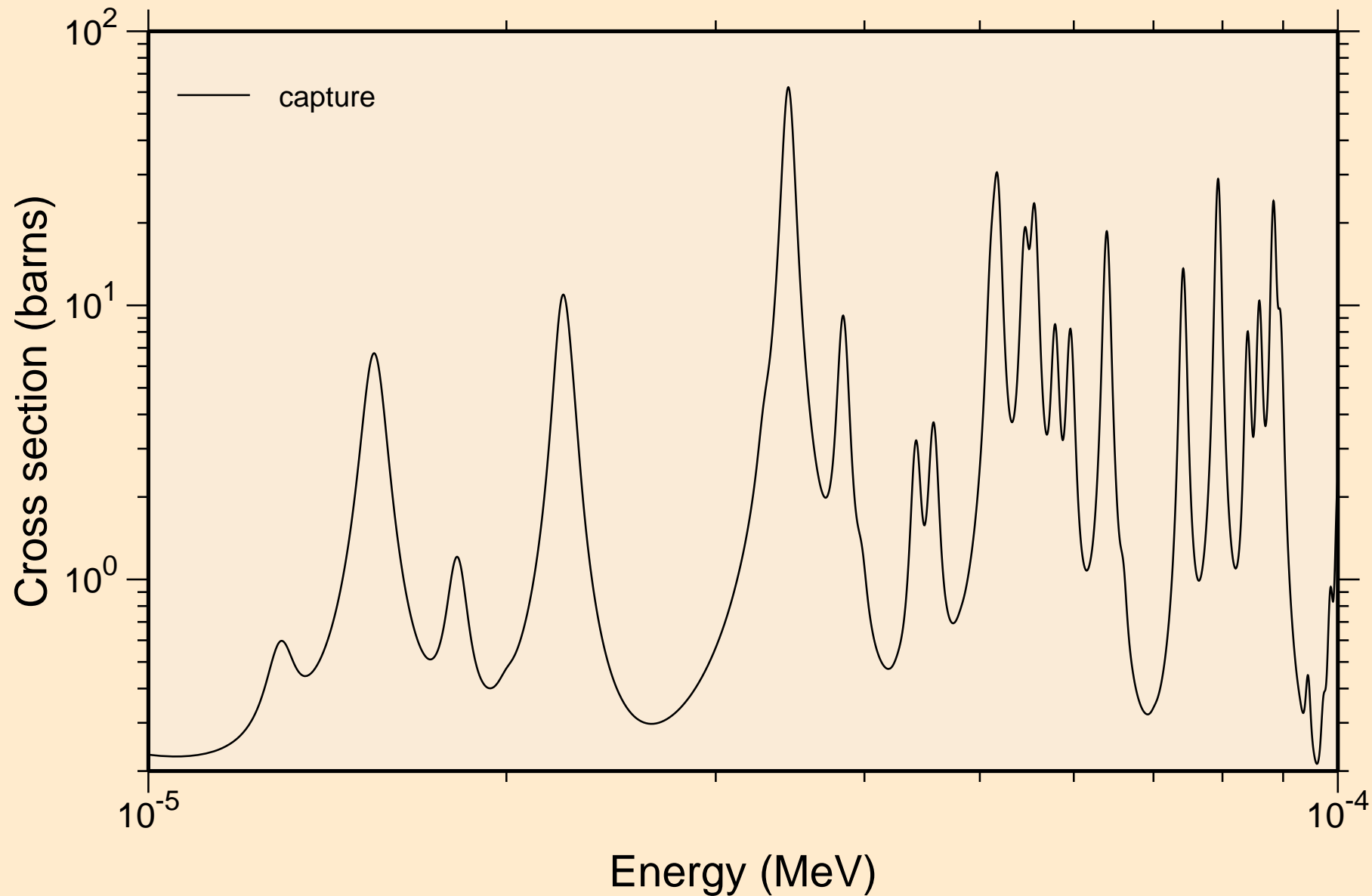

TC090N NEUTRON ACER TENDL-2019 LIBRARY; T=293.16K
resonance absorption cross sections

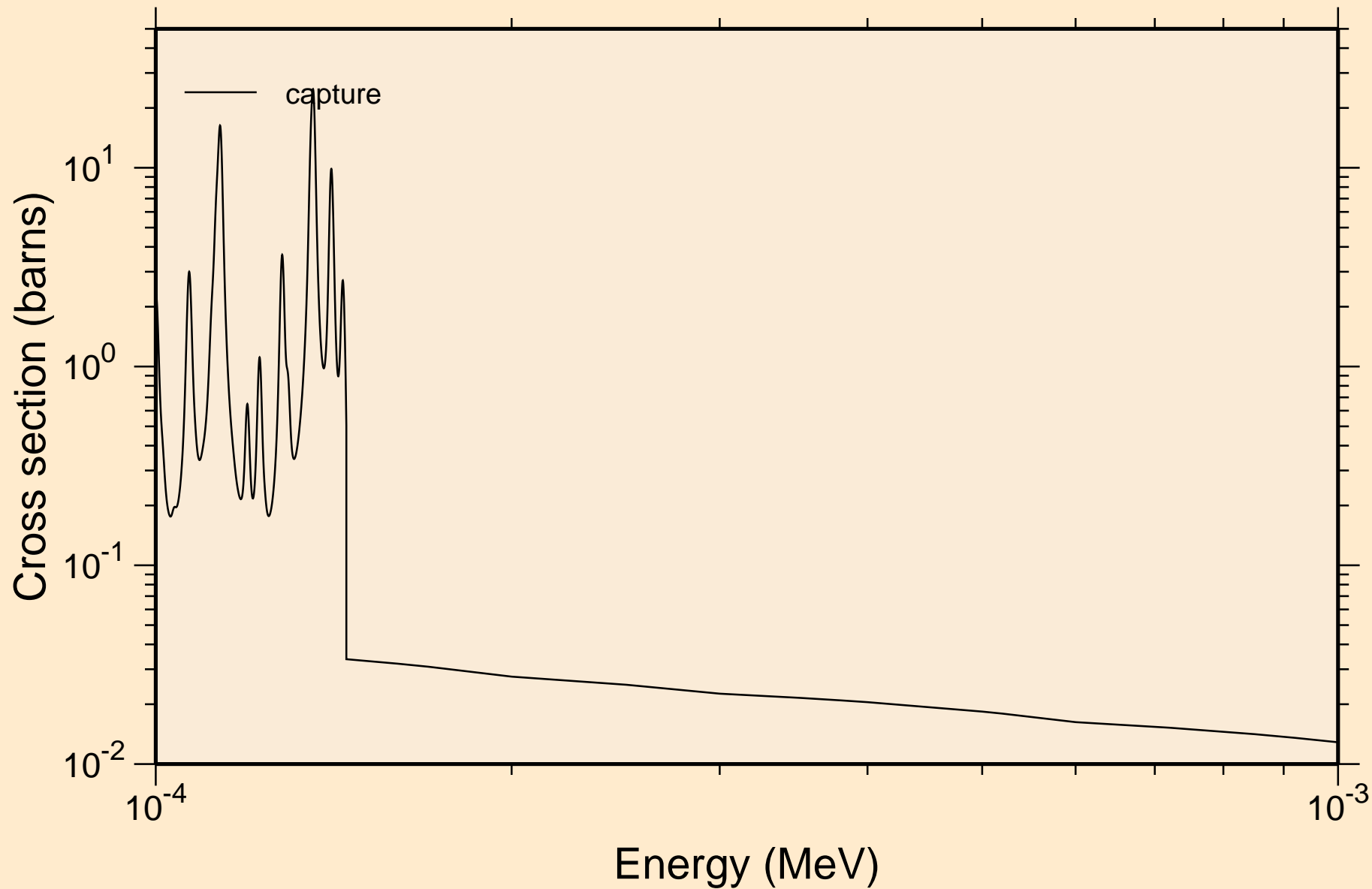

TC090N NEUTRON ACER TENDL-2019 LIBRARY; T=293.16K
resonance absorption cross sections

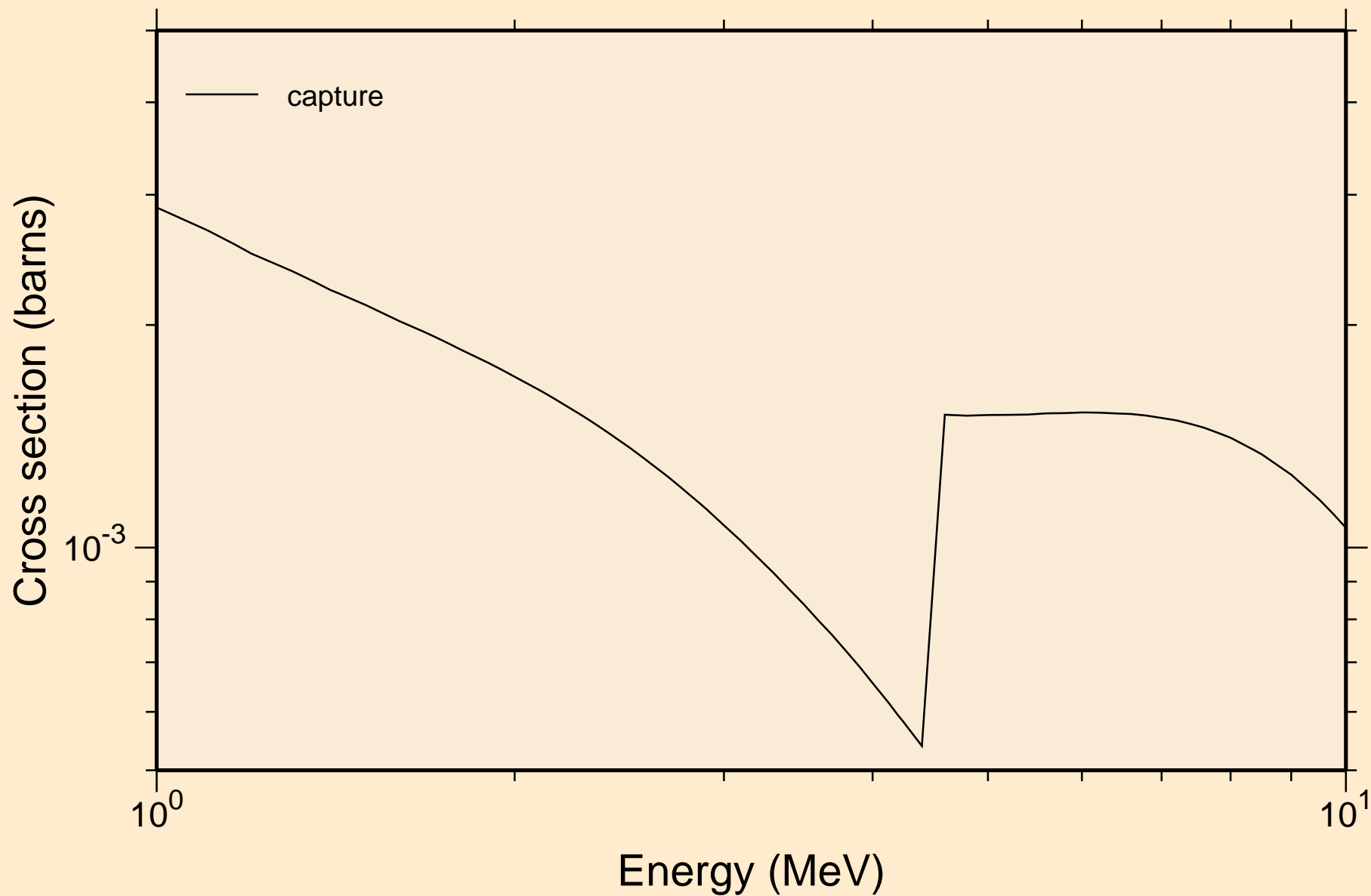

TC090N NEUTRON ACER TENDL-2019 LIBRARY; T=293.16K
Heating

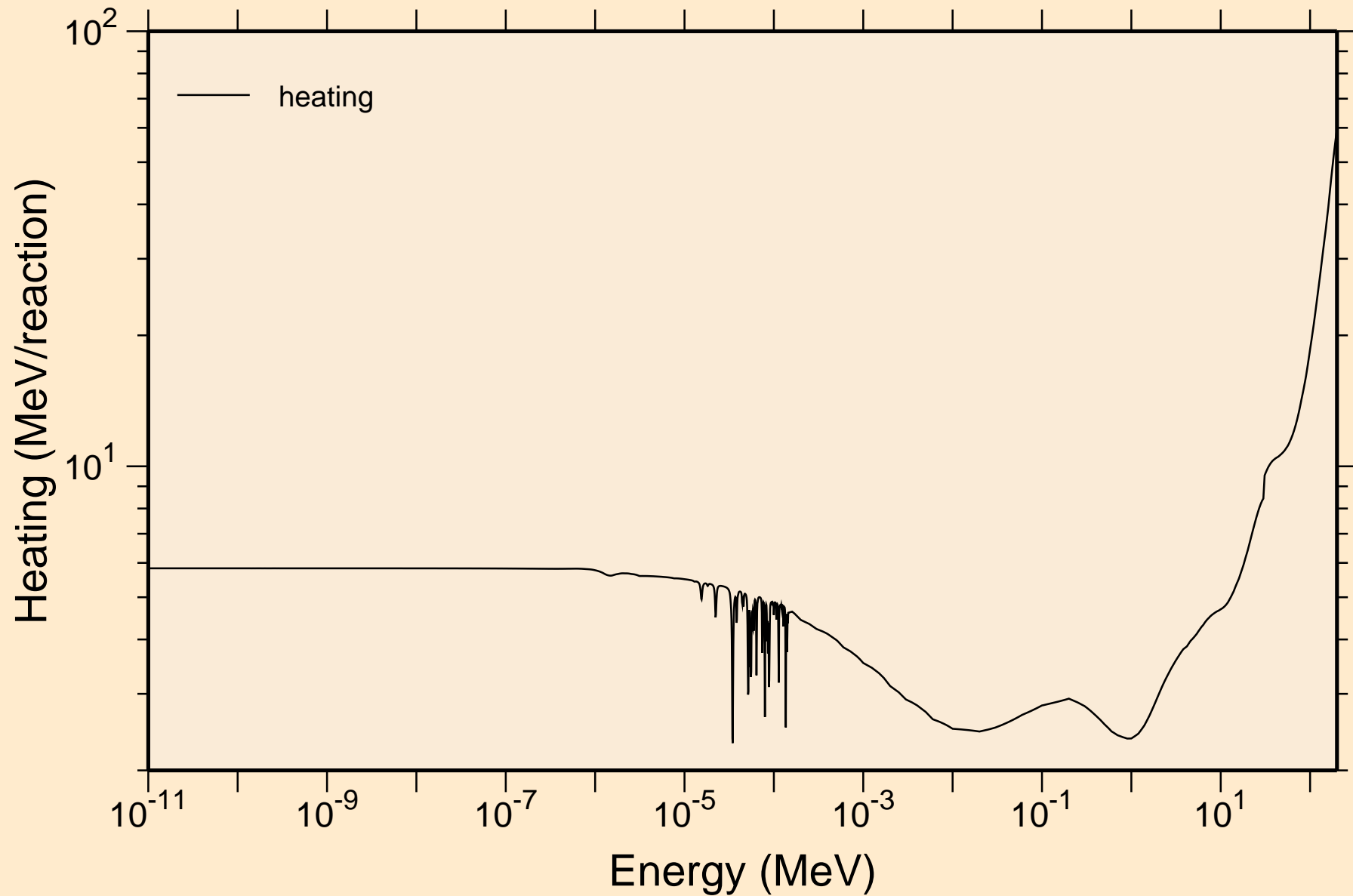

TC090N NEUTRON ACER TENDL-2019 LIBRARY; T=293.16K
Damage

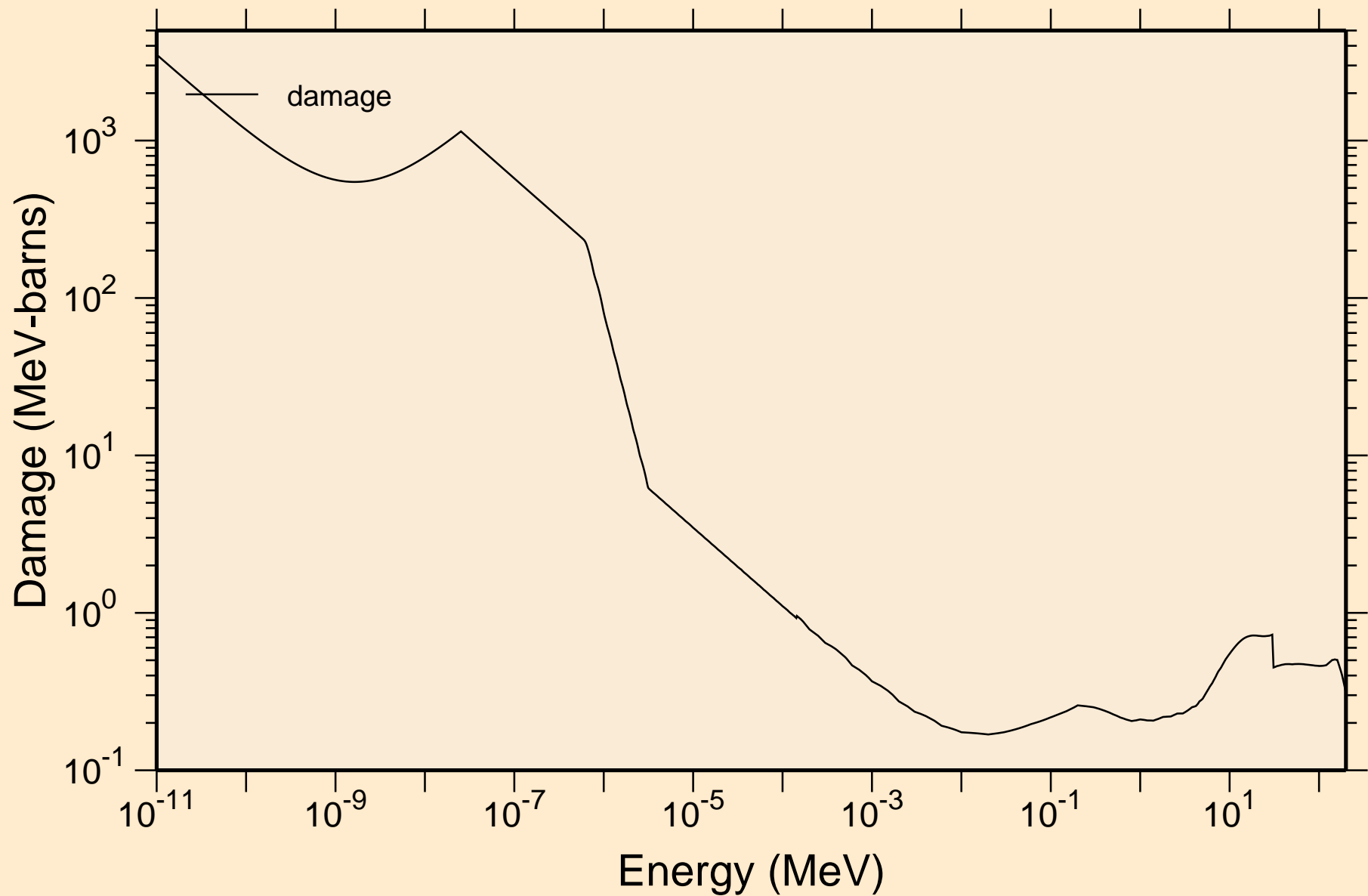

TC090N NEUTRON ACER TENDL-2019 LIBRARY; T=293.16K
Non-threshold reactions

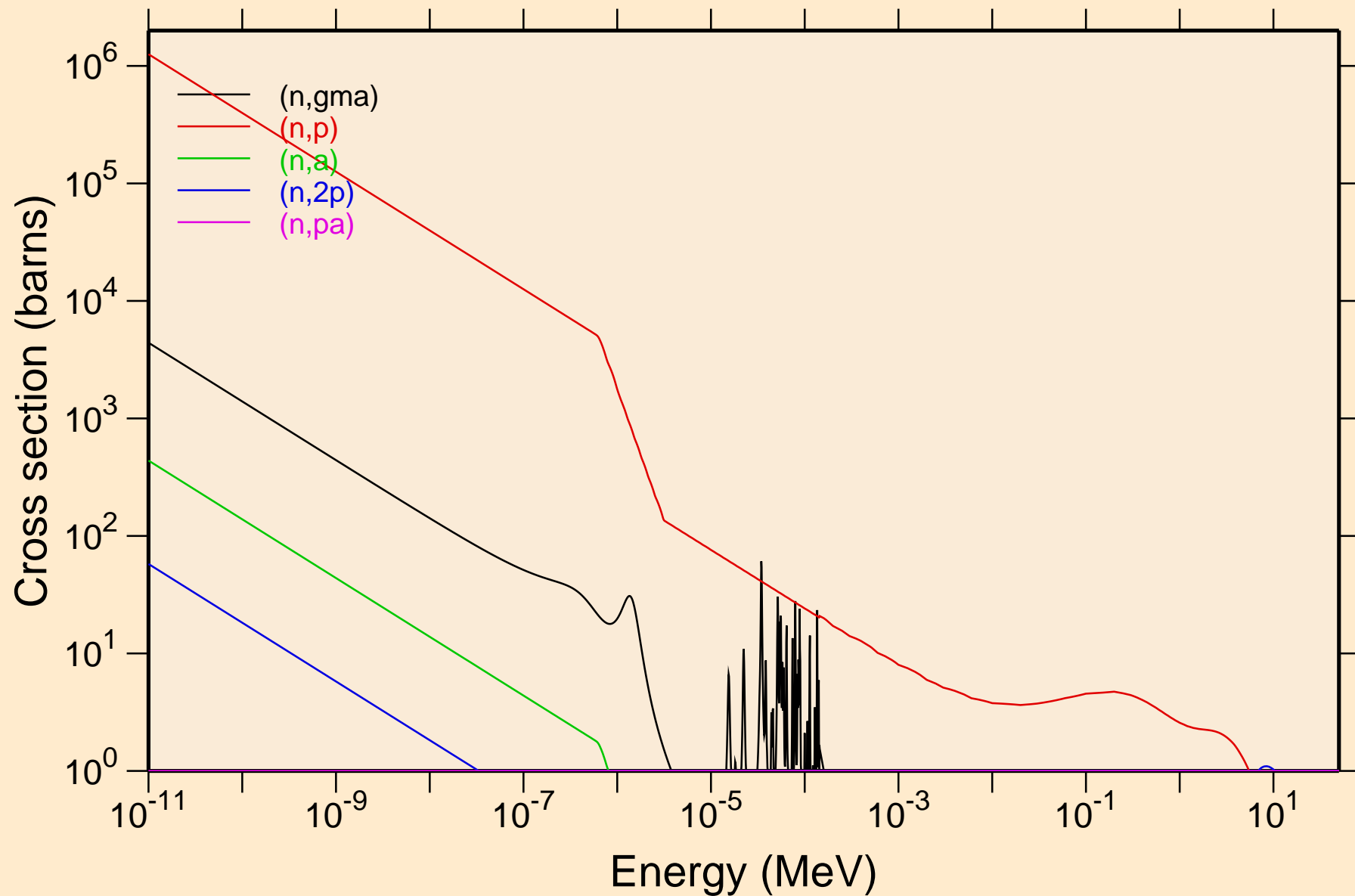

TC090N NEUTRON ACER TENDL-2019 LIBRARY; T=293.16K
Non-threshold reactions

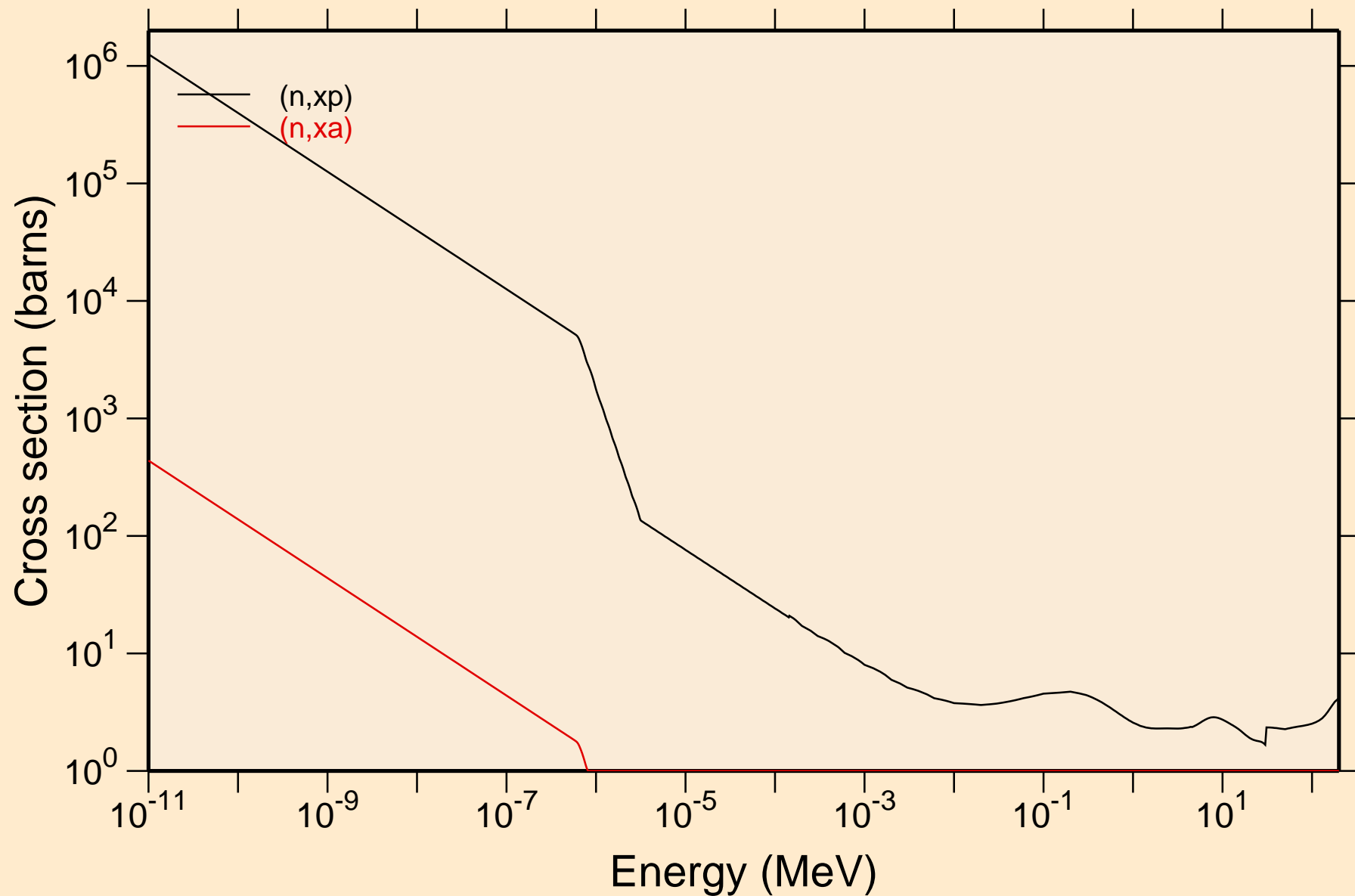

TC090N NEUTRON ACER TENDL-2019 LIBRARY; T=293.16K
Principal cross sections

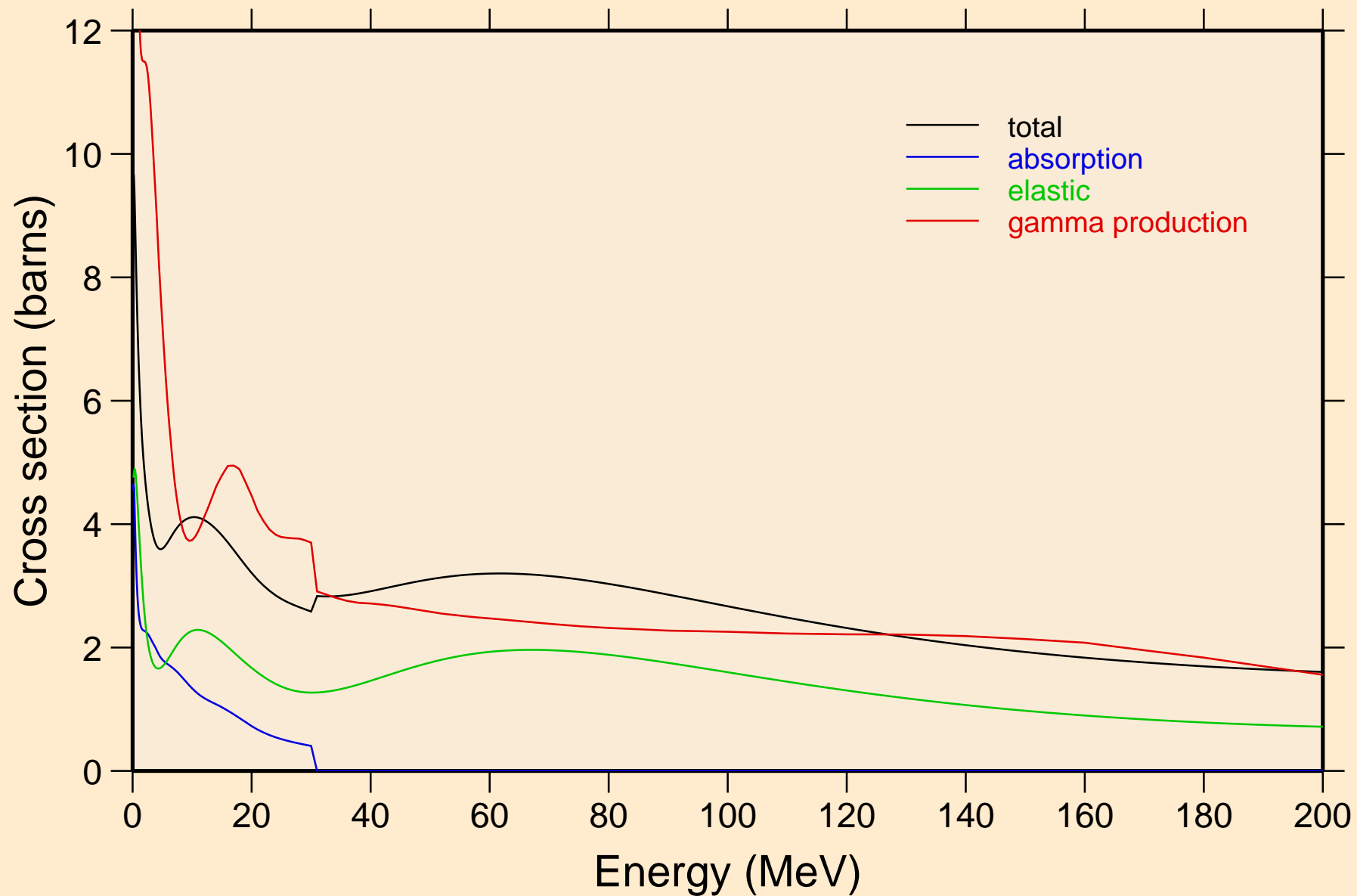

TC090N NEUTRON ACER TENDL-2019 LIBRARY; T=293.16K
Heating

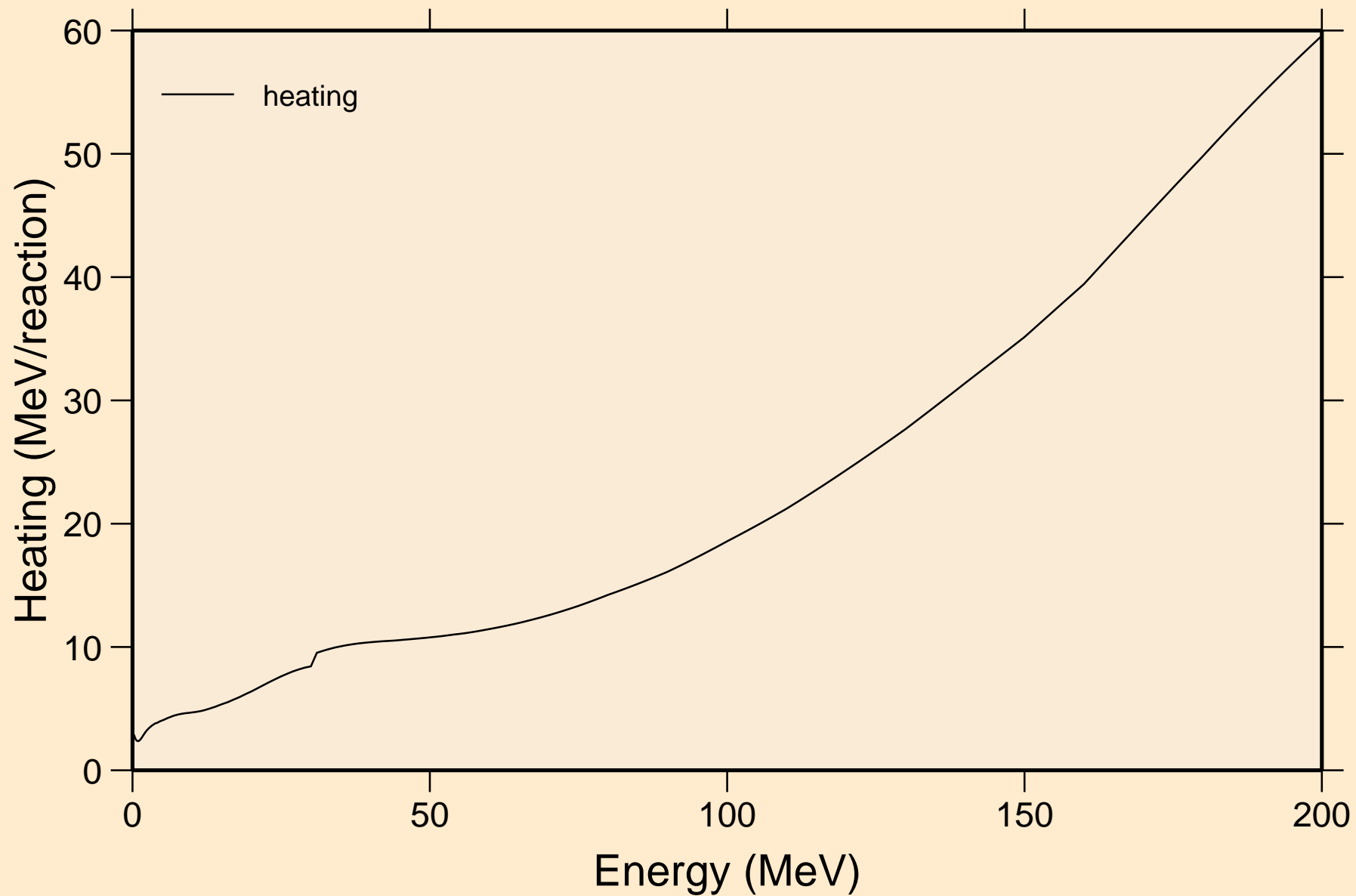

TC090N NEUTRON ACER TENDL-2019 LIBRARY; T=293.16K
Damage

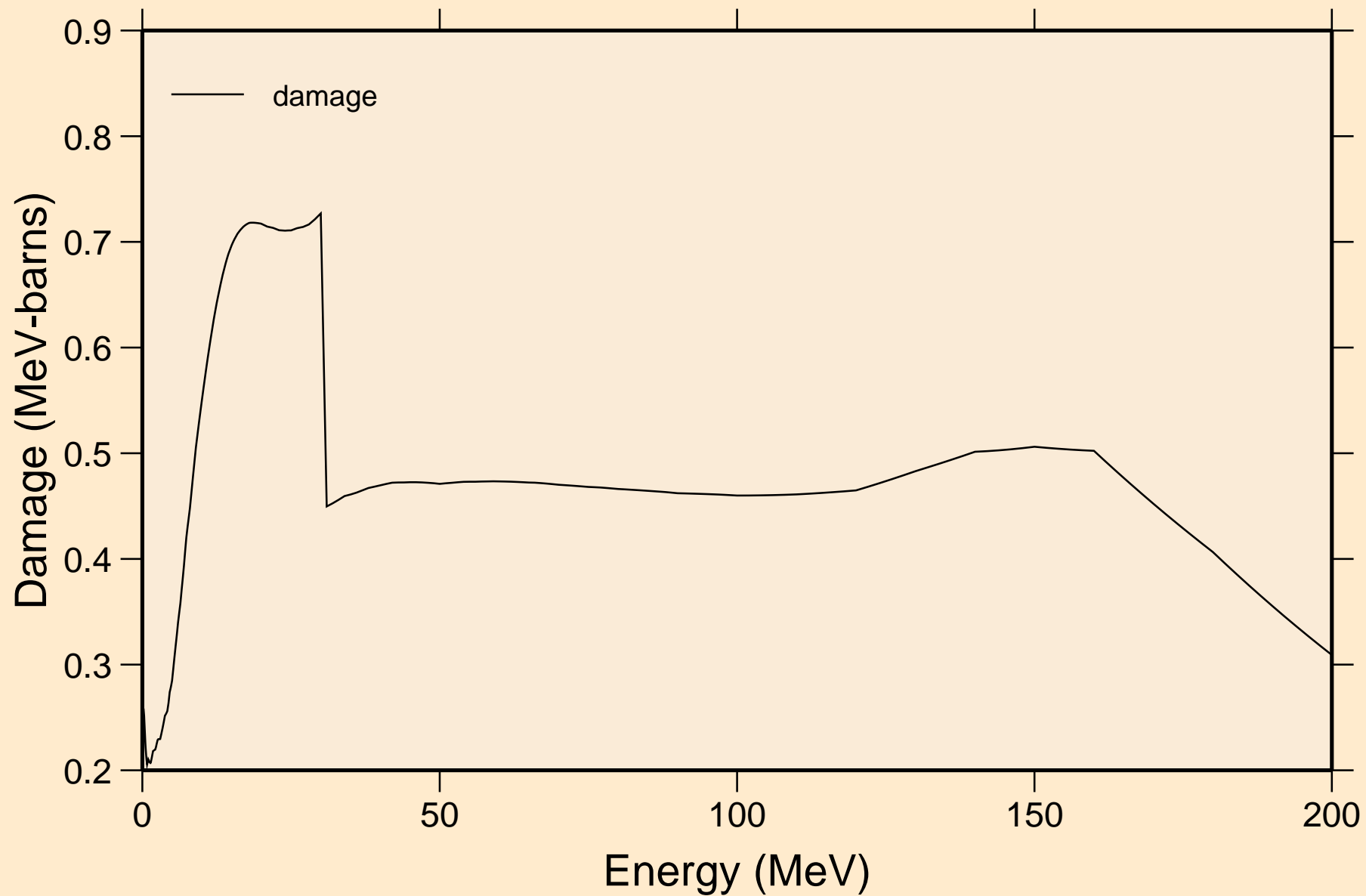

TC090N NEUTRON ACER TENDL-2019 LIBRARY; T=293.16K
Non-threshold reactions

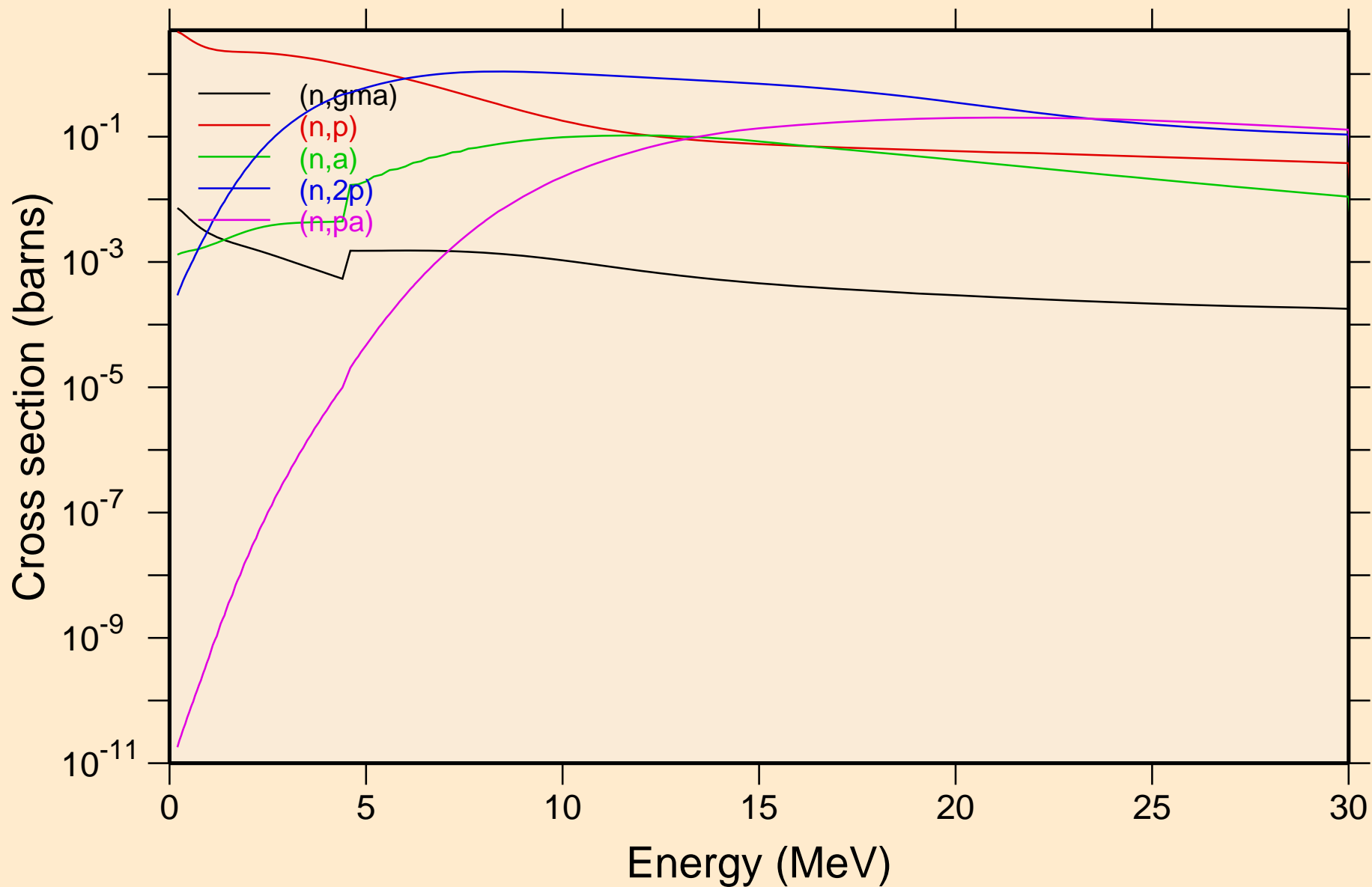

TC090N NEUTRON ACER TENDL-2019 LIBRARY; T=293.16K
Non-threshold reactions

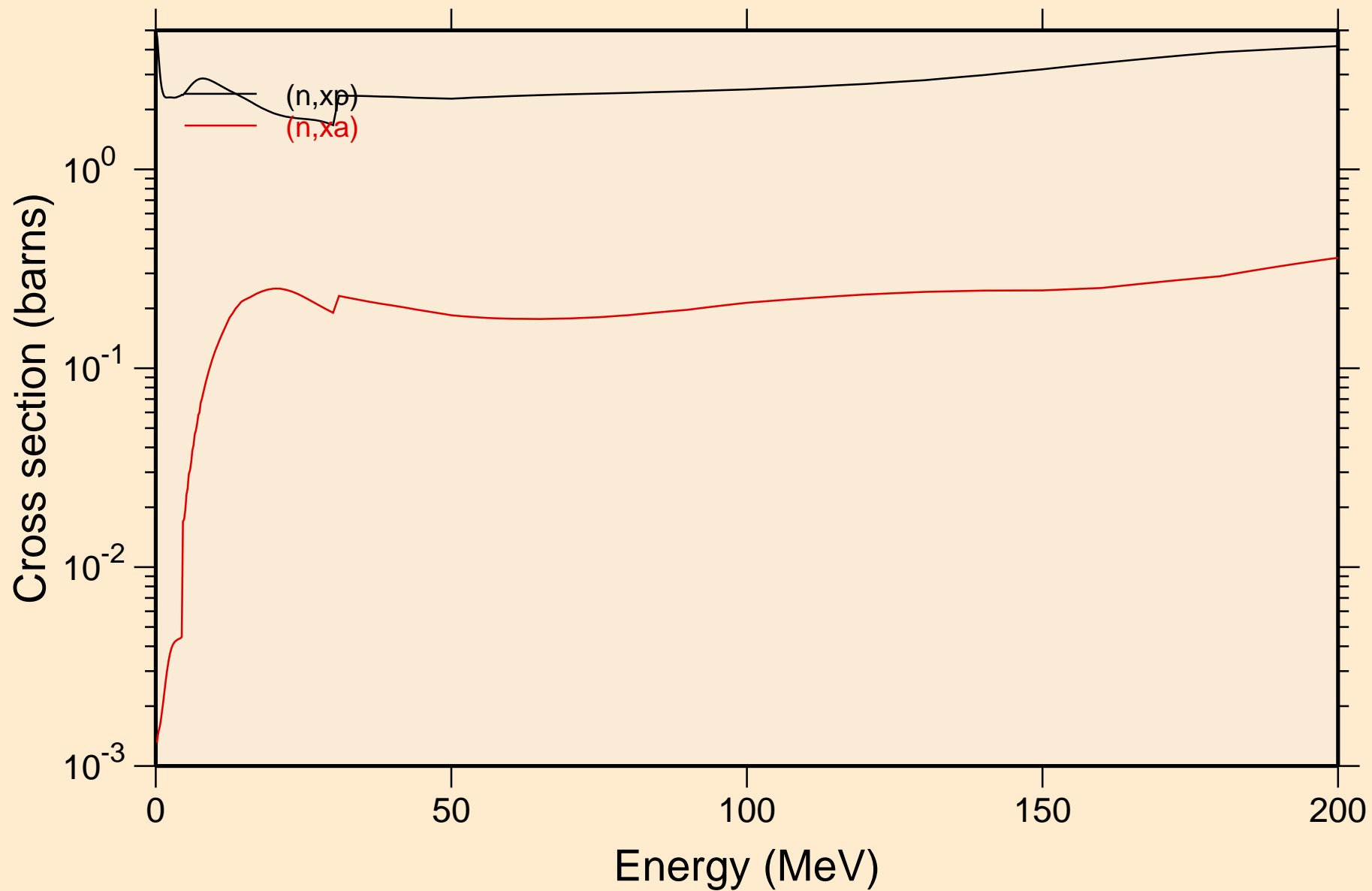

TC090N NEUTRON ACER TENDL-2019 LIBRARY; T=293.16K
Inelastic levels

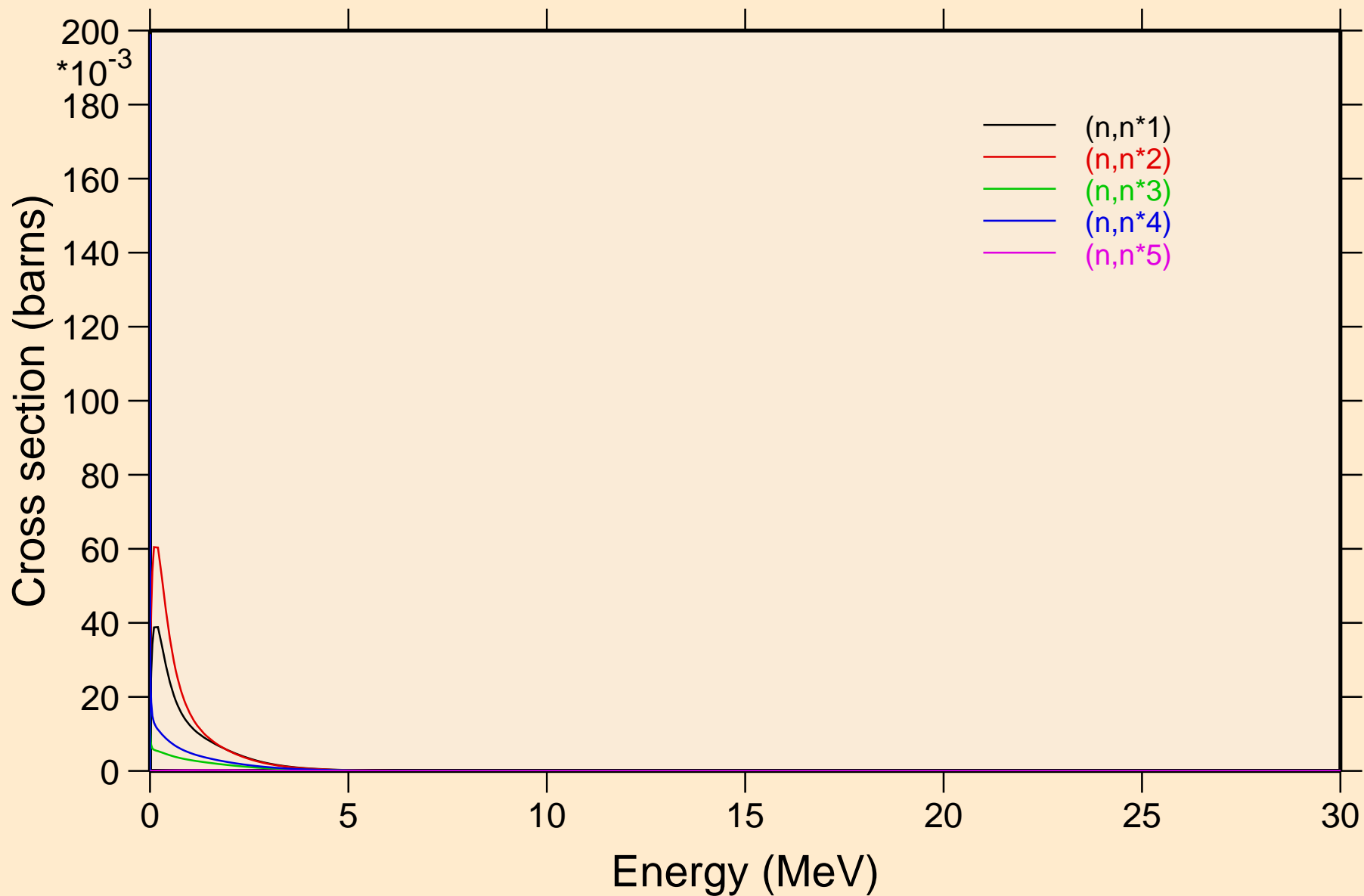

TC090N NEUTRON ACER TENDL-2019 LIBRARY; T=293.16K
Inelastic levels

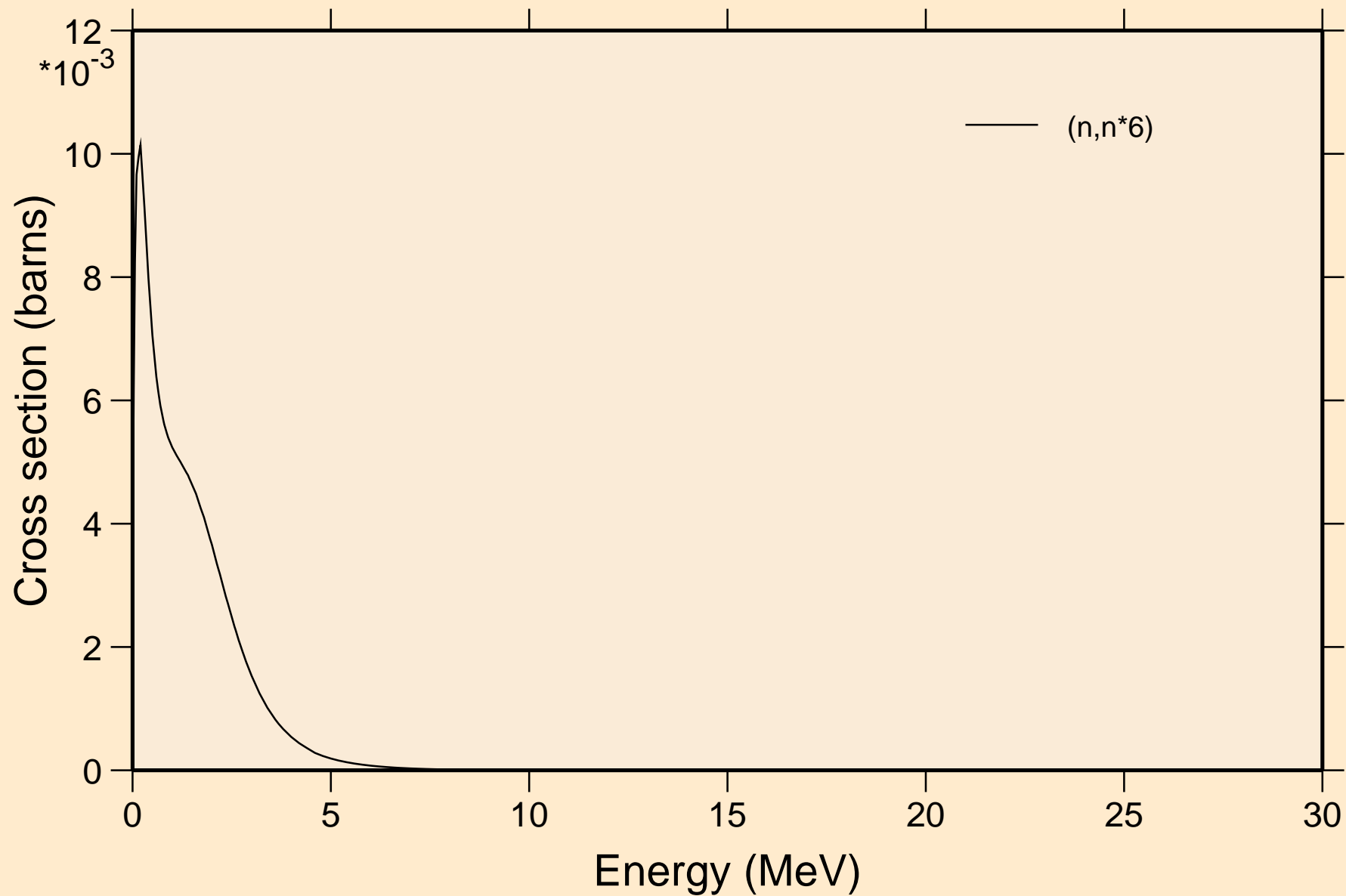

TC090N NEUTRON ACER TENDL-2019 LIBRARY; T=293.16K
Threshold reactions

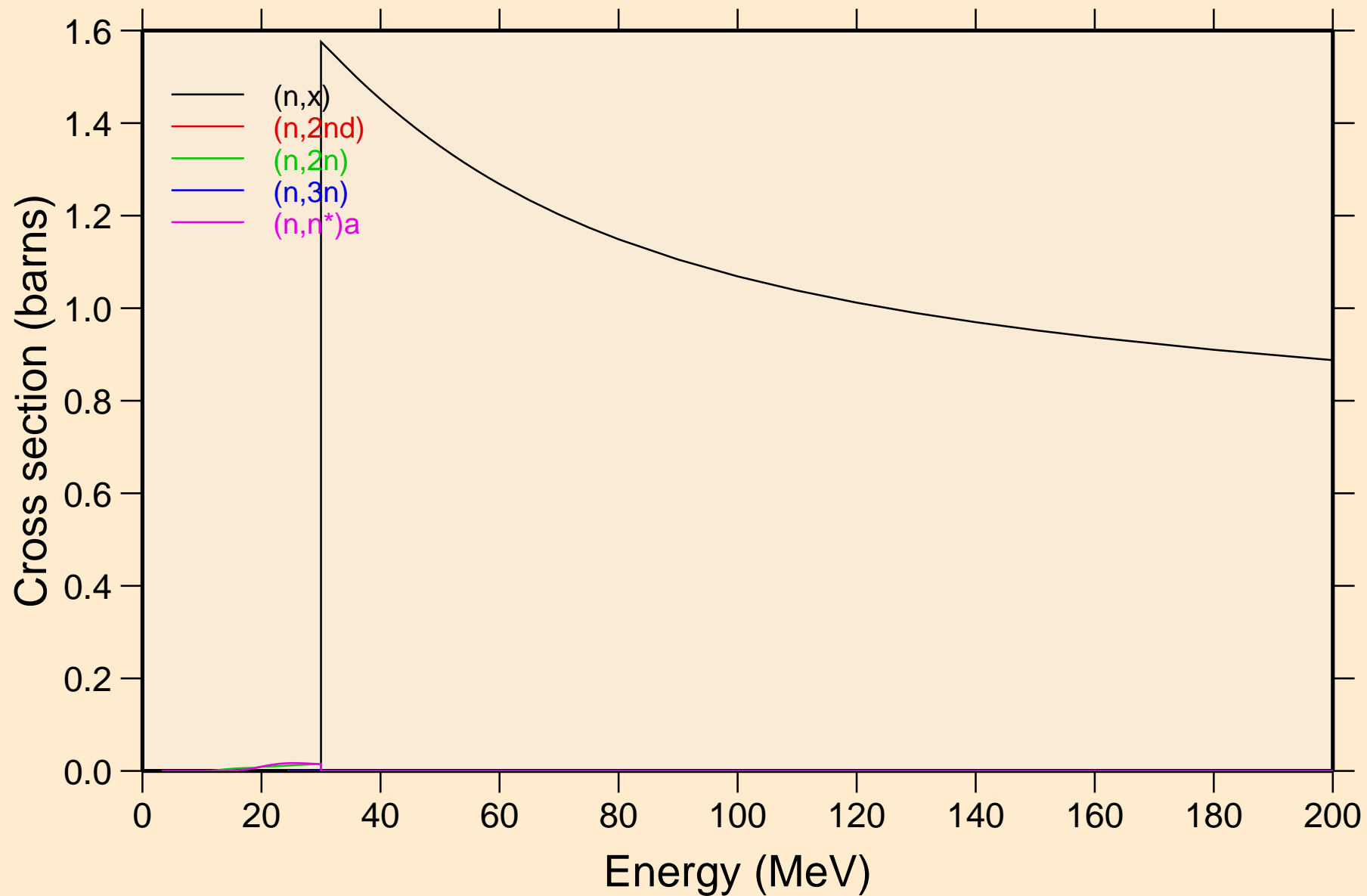

TC090N NEUTRON ACER TENDL-2019 LIBRARY; T=293.16K
Threshold reactions

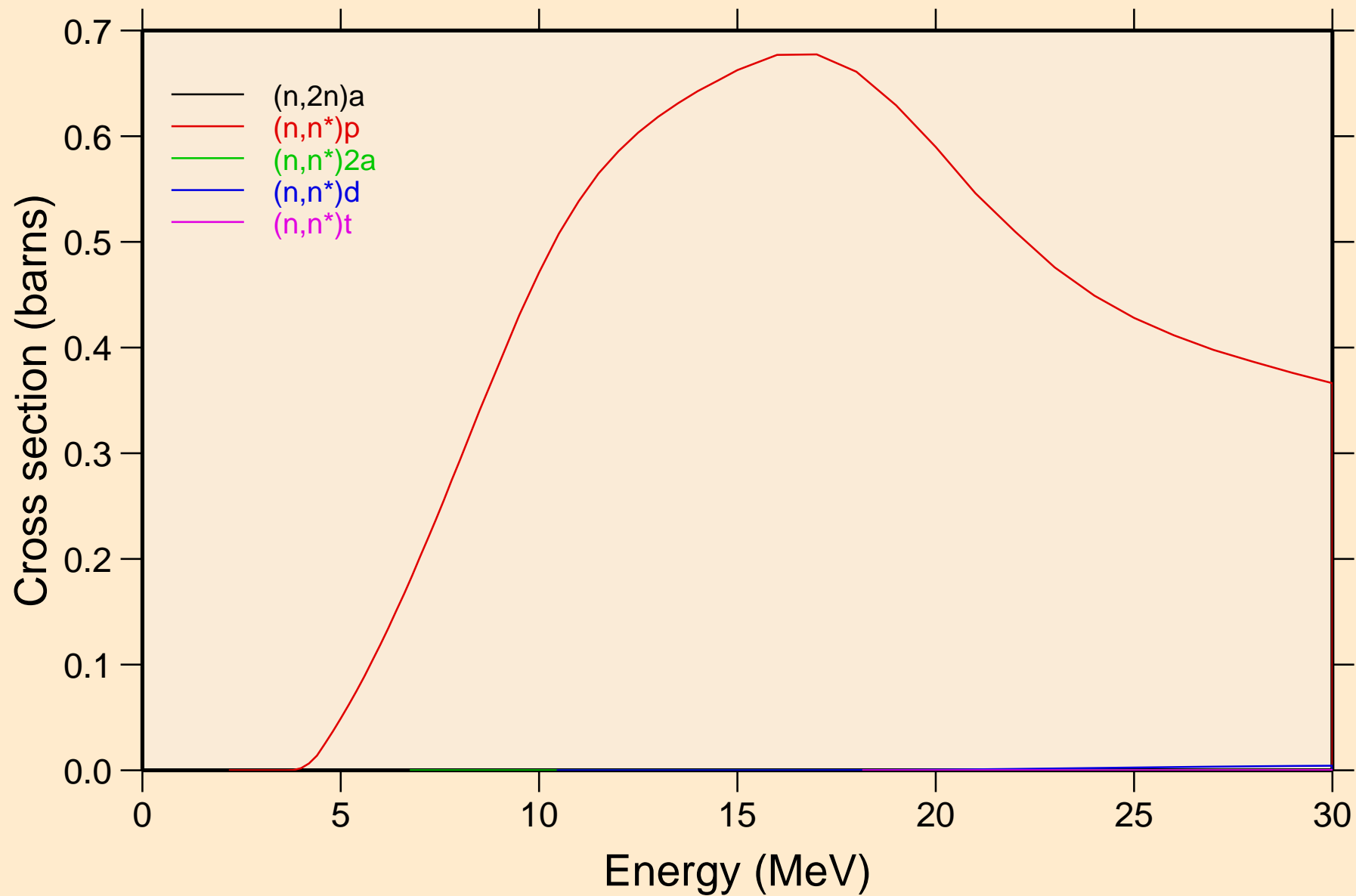

TC090N NEUTRON ACER TENDL-2019 LIBRARY; T=293.16K
Threshold reactions

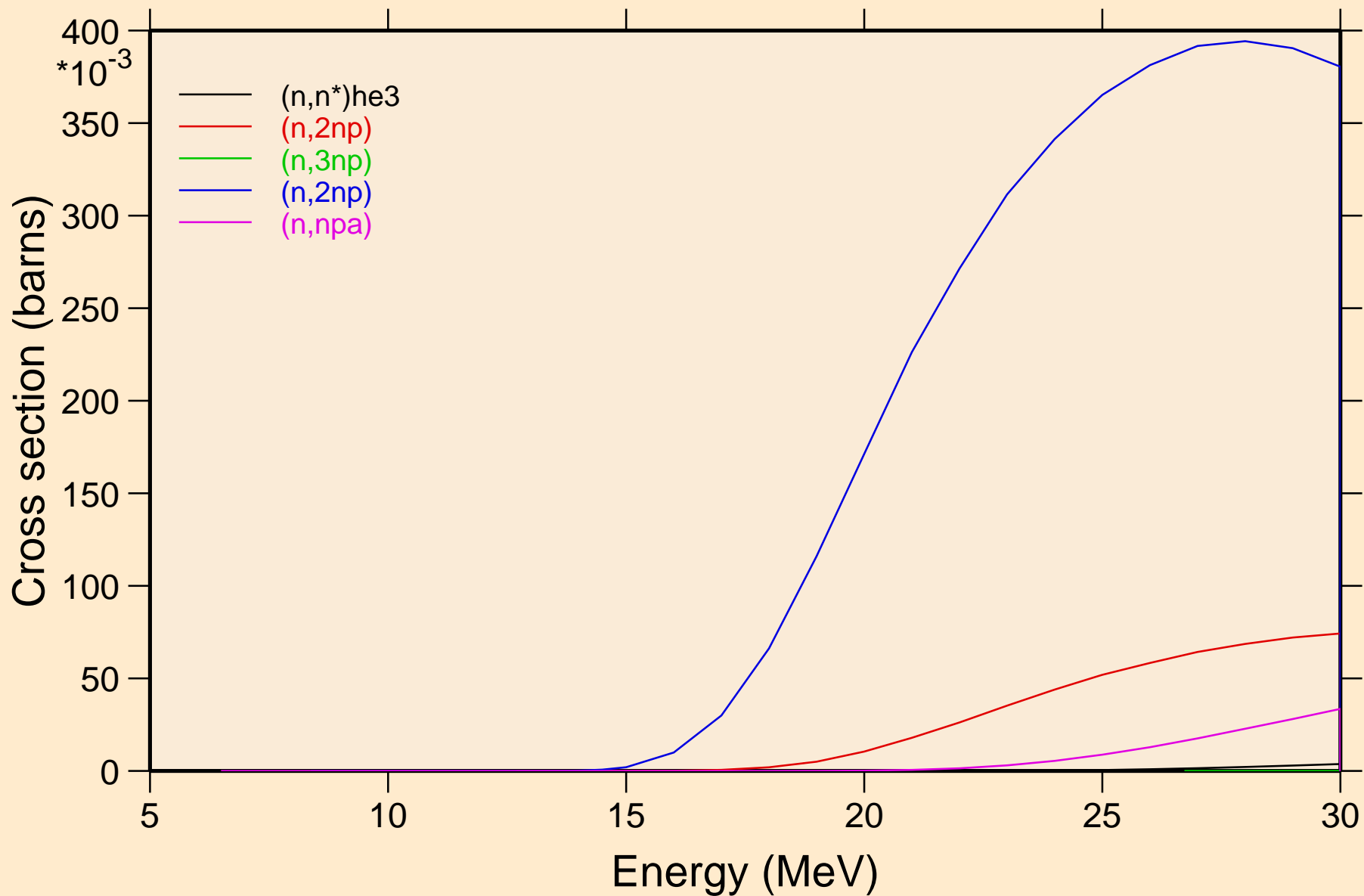

TC090N NEUTRON ACER TENDL-2019 LIBRARY; T=293.16K
Threshold reactions

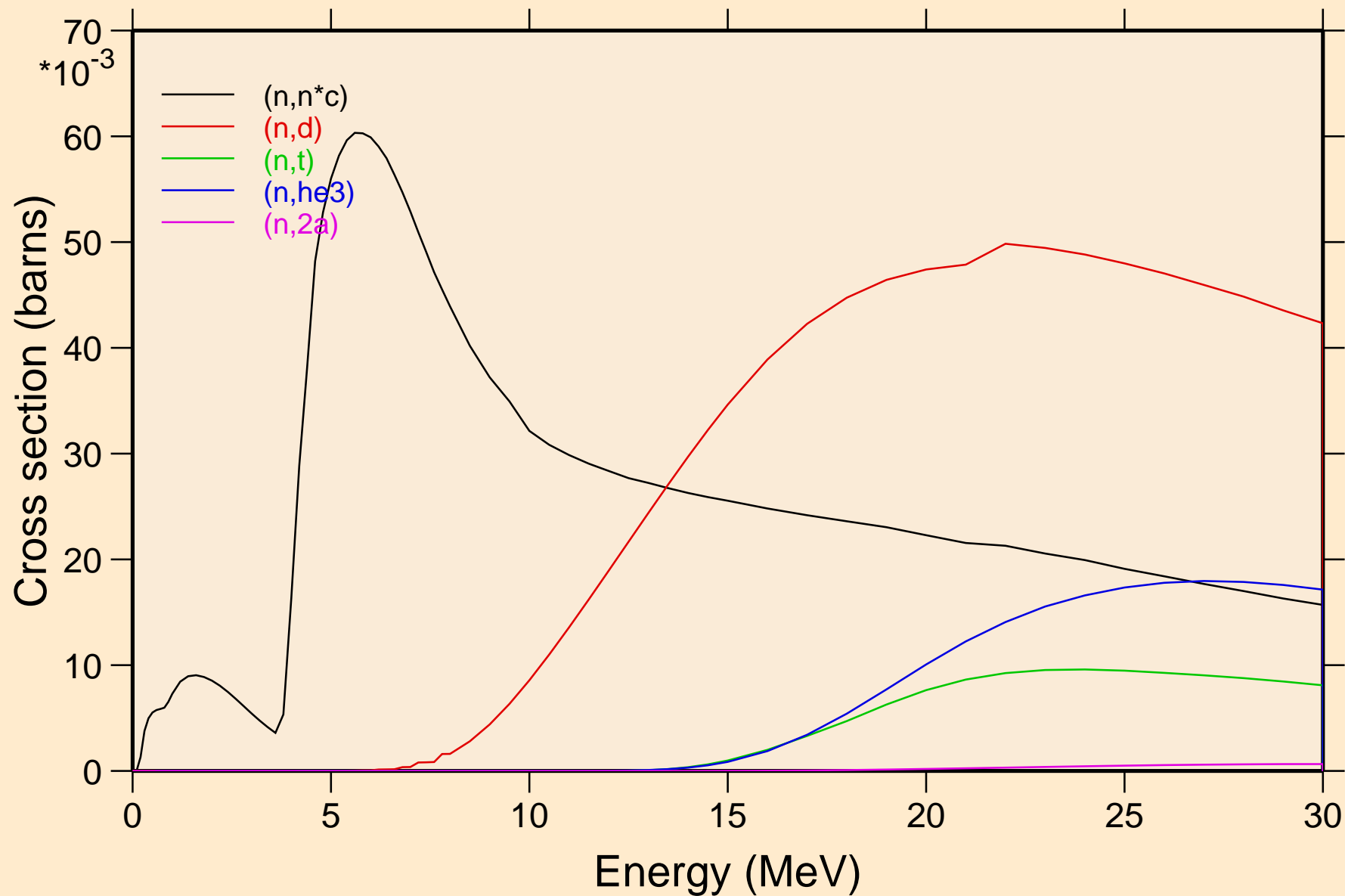

TC090N NEUTRON ACER TENDL-2019 LIBRARY; T=293.16K
Threshold reactions

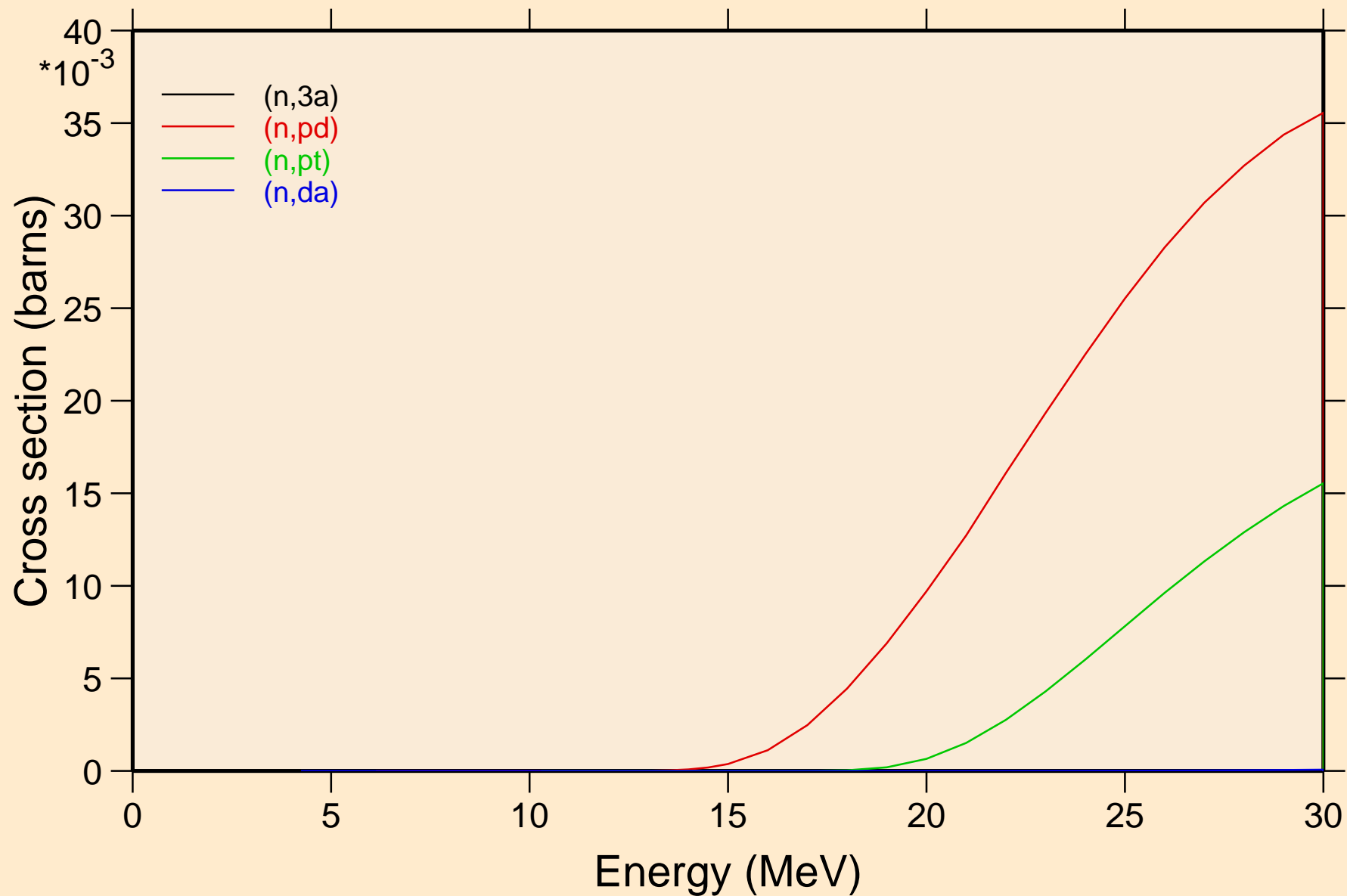

TC090N NEUTRON ACER TENDL-2019 LIBRARY; T=293.16K
Threshold reactions

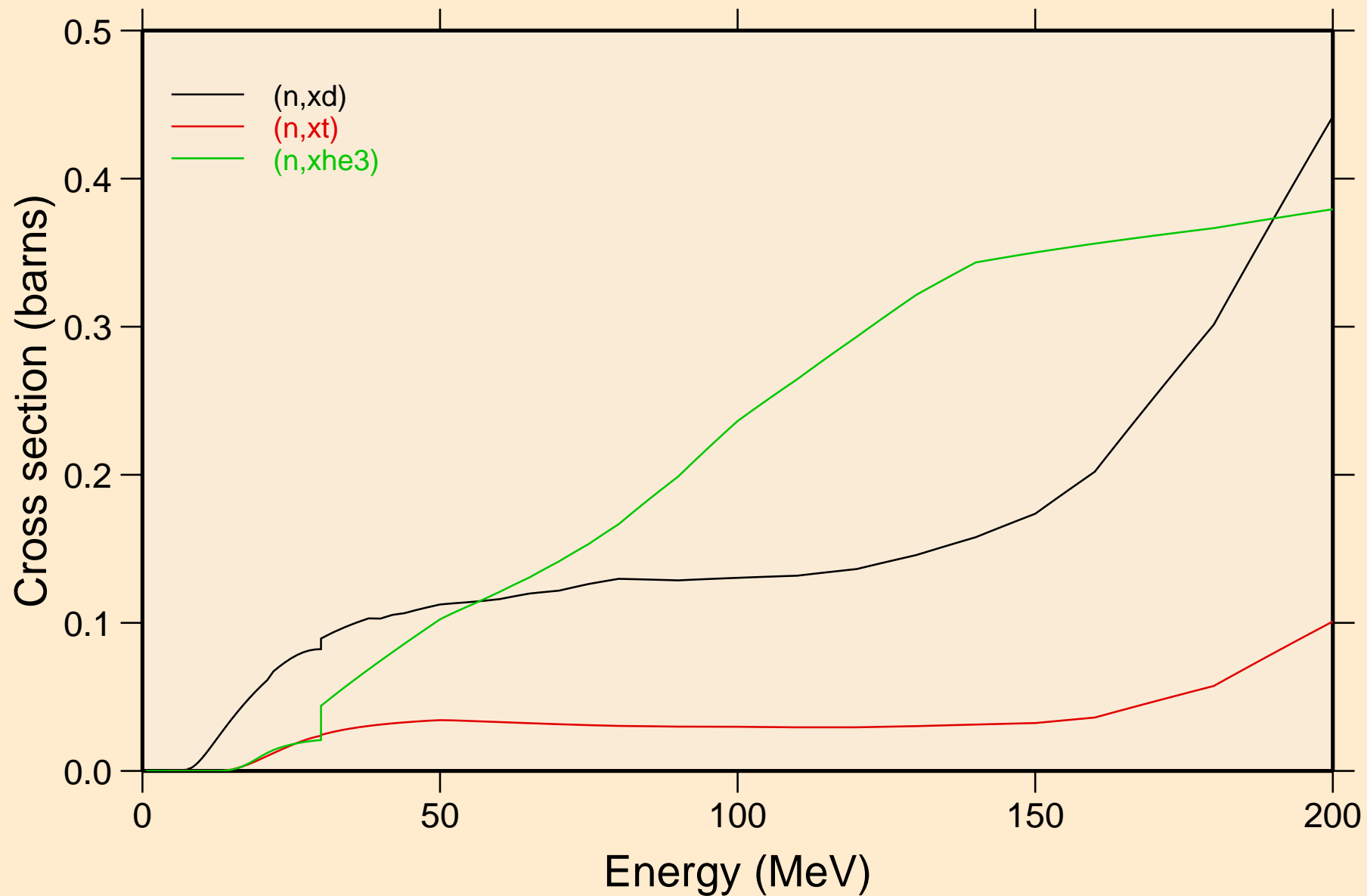

TC090N NEUTRON ACER TENDL-2019 LIBRARY; T=293.16K
angular distribution for elastic

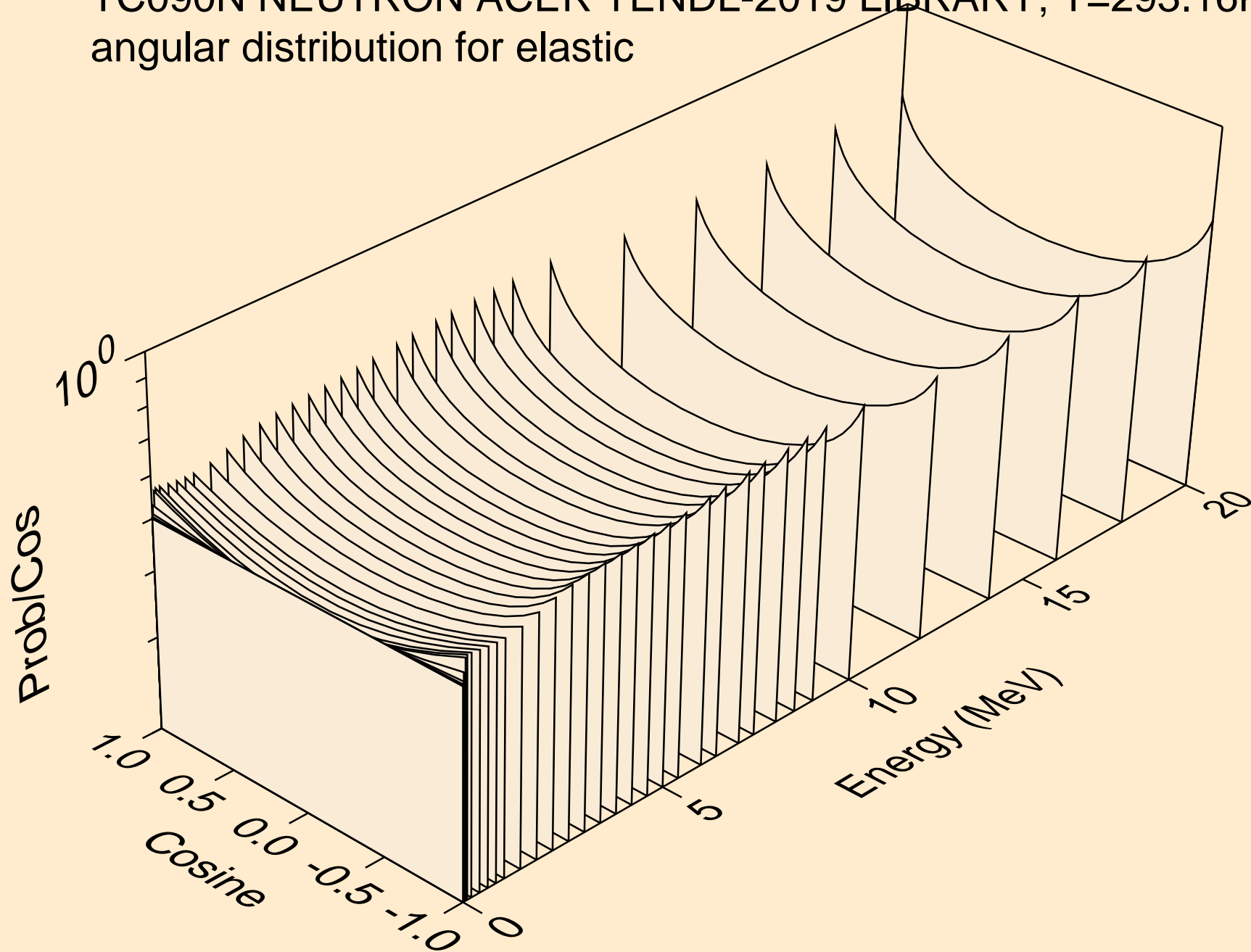

TC090N NEUTRON ACER TENDL-2019 LIBRARY; T=293.16K
angular distribution for elastic

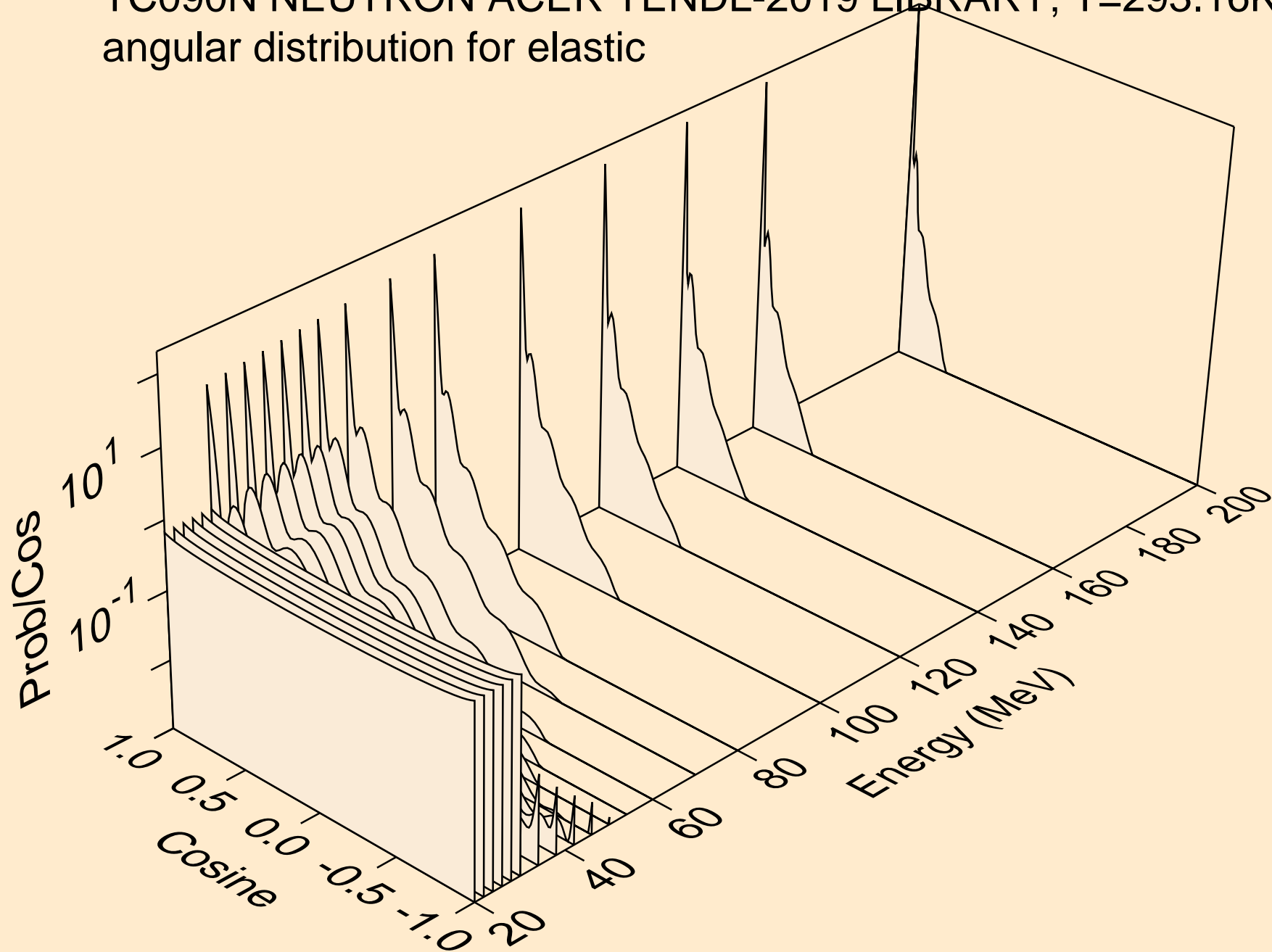

TC090N NEUTRON ACER TENDL-2019 LIBRARY; T=293.16K
angular distribution for (n,n*1)

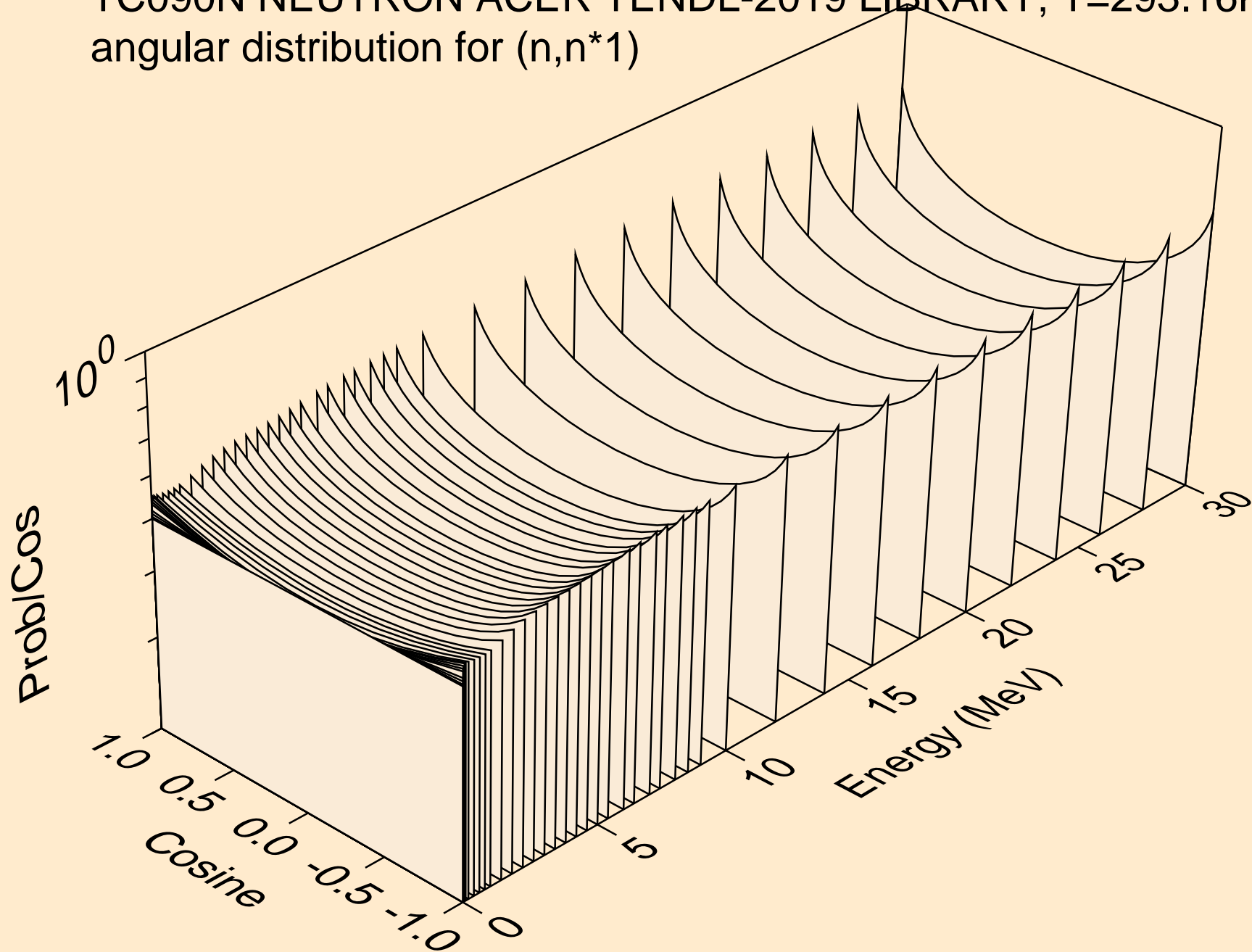

TC090N NEUTRON ACER TENDL-2019 LIBRARY; T=293.16K
angular distribution for (n,n*2)

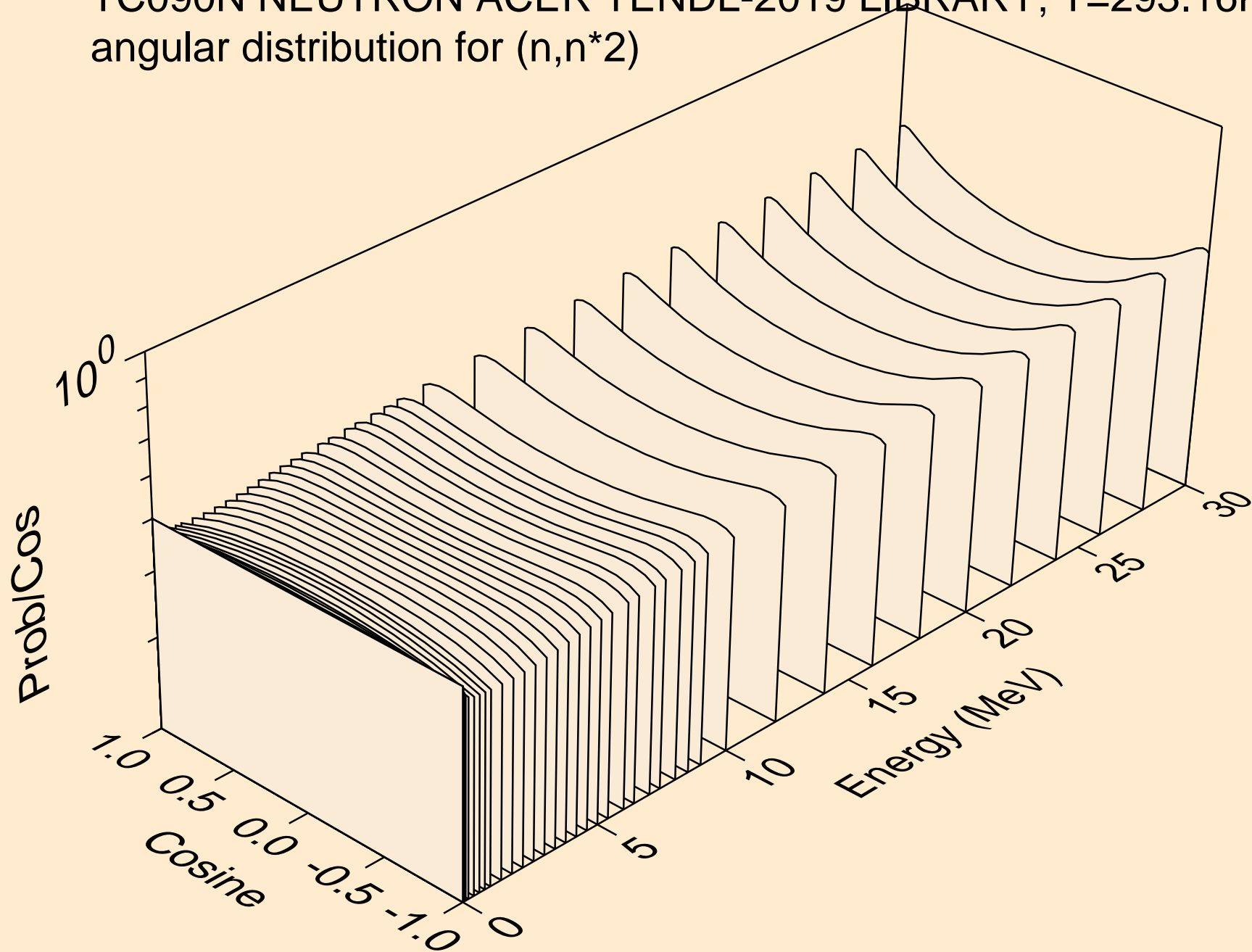

TC090N NEUTRON ACER TENDL-2019 LIBRARY; T=293.16K
angular distribution for (n,n*3)

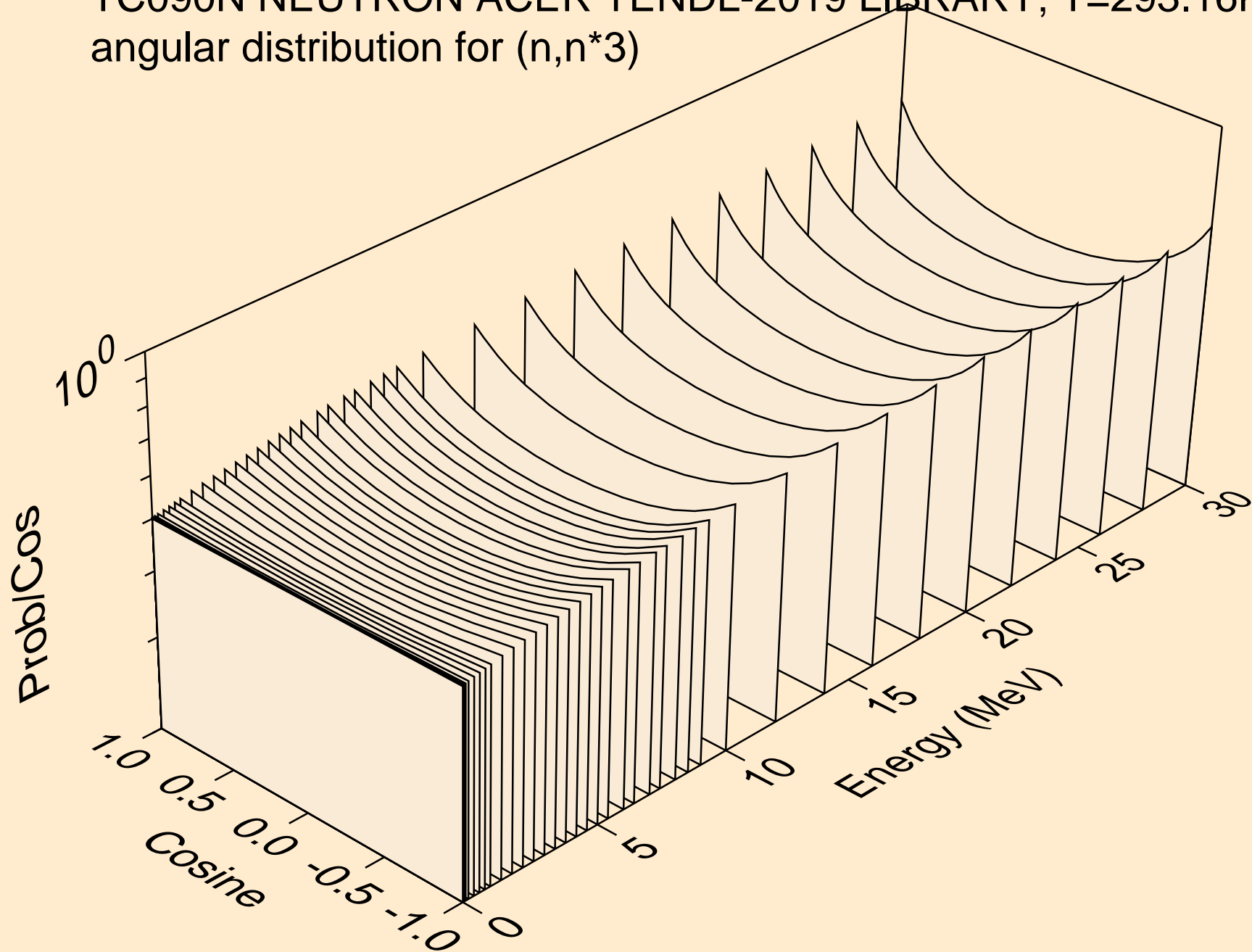

TC090N NEUTRON ACER TENDL-2019 LIBRARY; T=293.16K
angular distribution for (n,n*4)

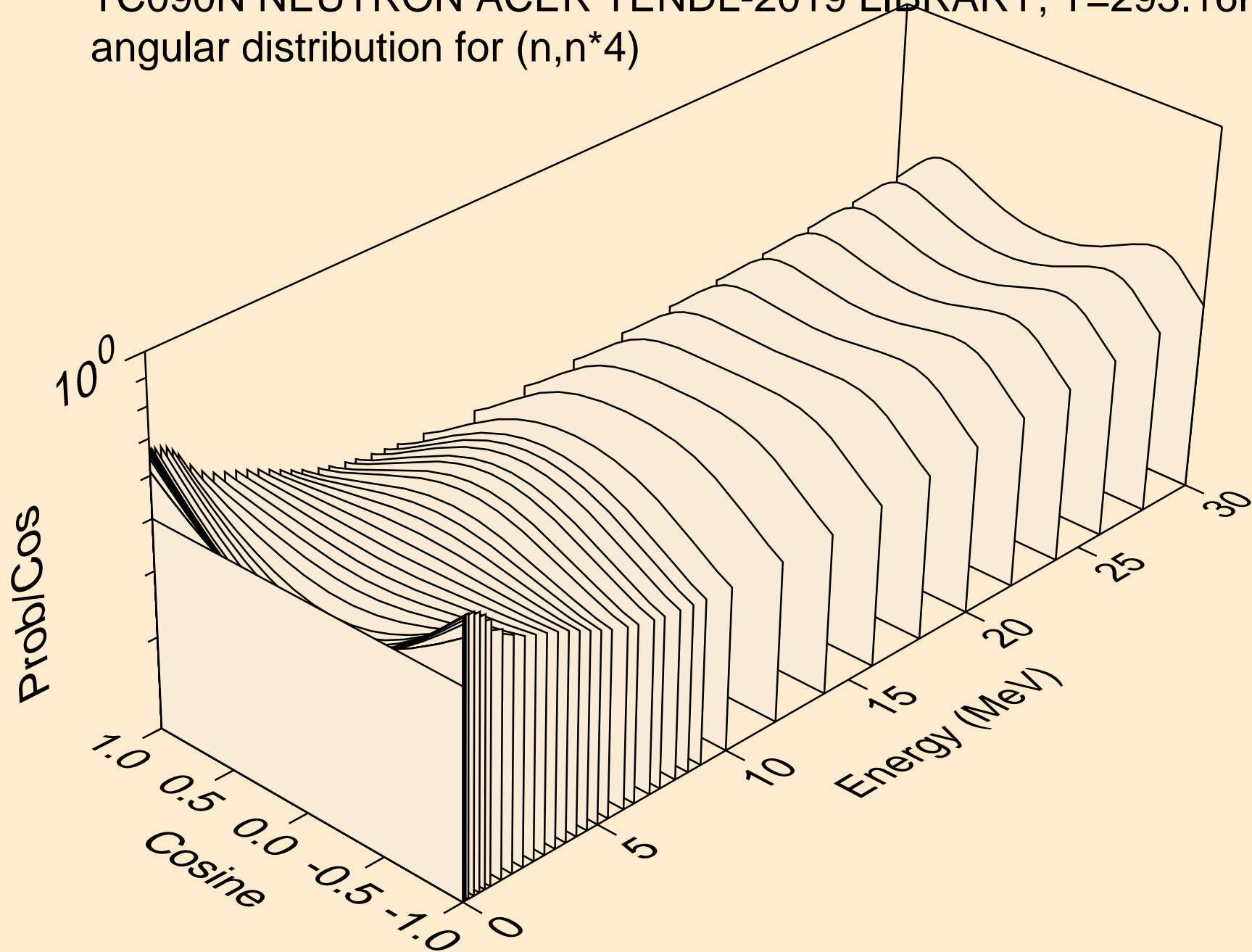

TC090N NEUTRON ACER TENDL-2019 LIBRARY; T=293.16K
angular distribution for (n,n*5)

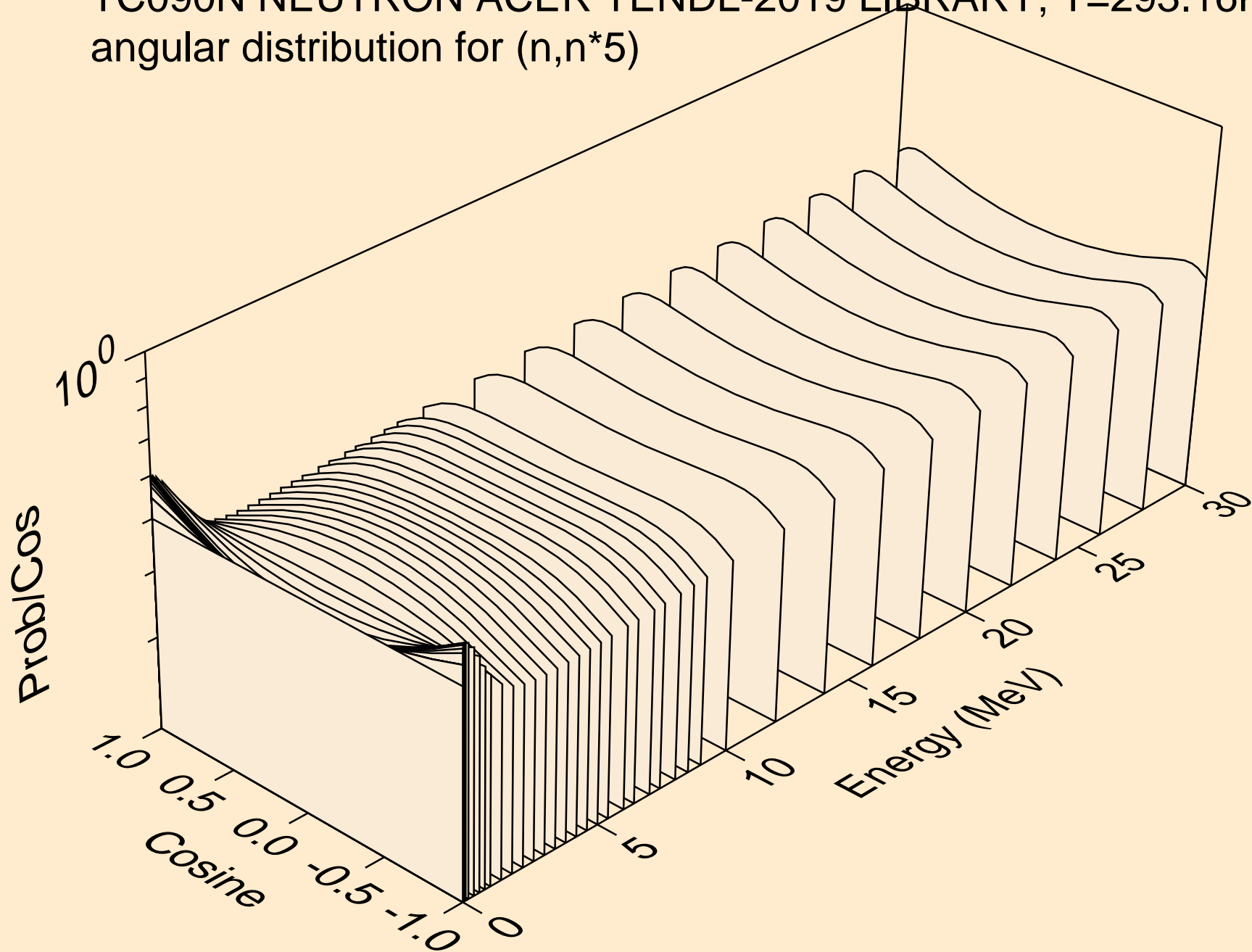

TC090N NEUTRON ACER TENDL-2019 LIBRARY; T=293.16K
angular distribution for (n,n*6)

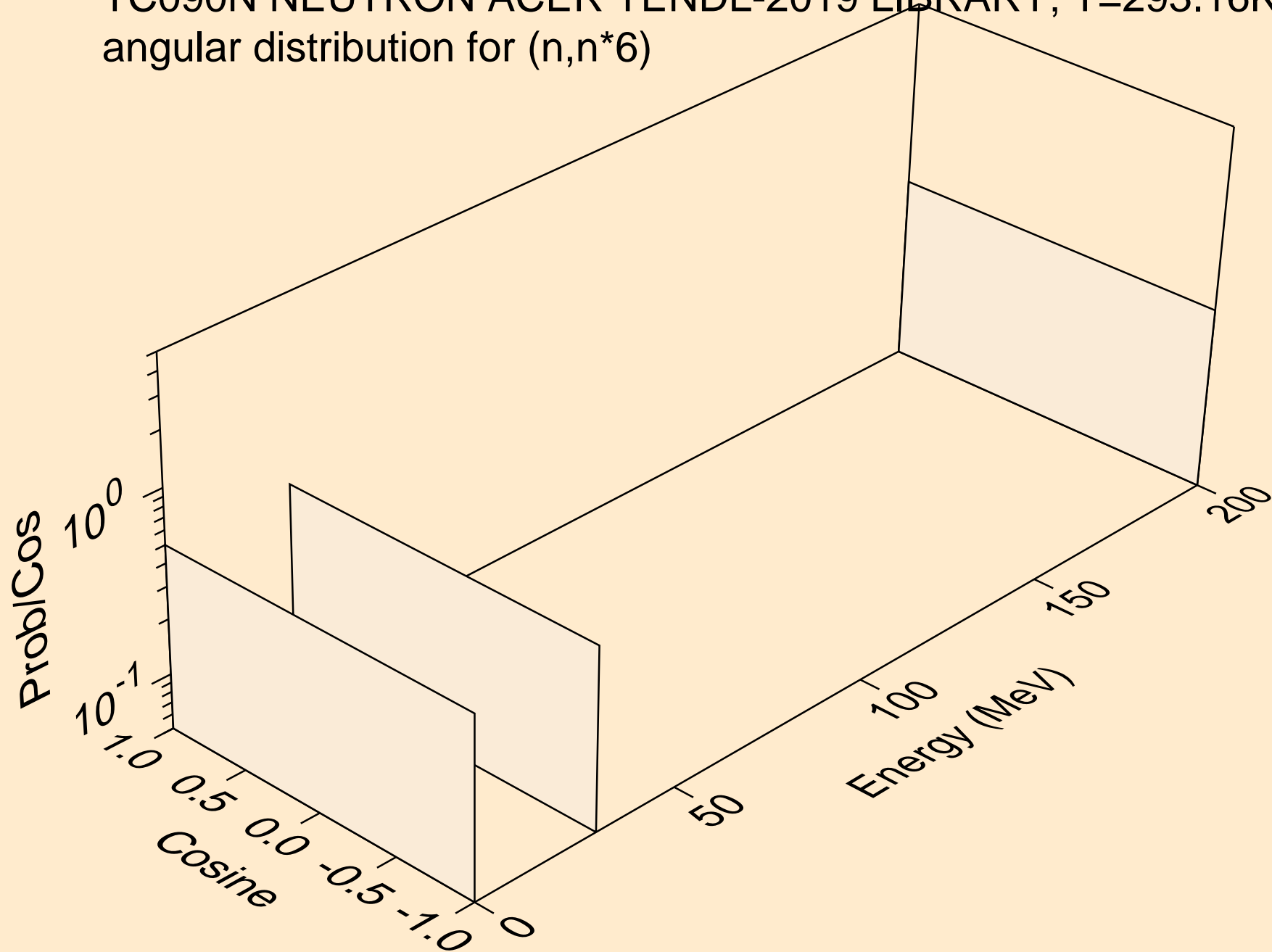

TC090N NEUTRON ACER TENDL-2019 LIBRARY; T=293.16K
Neutron emission for (n,x)

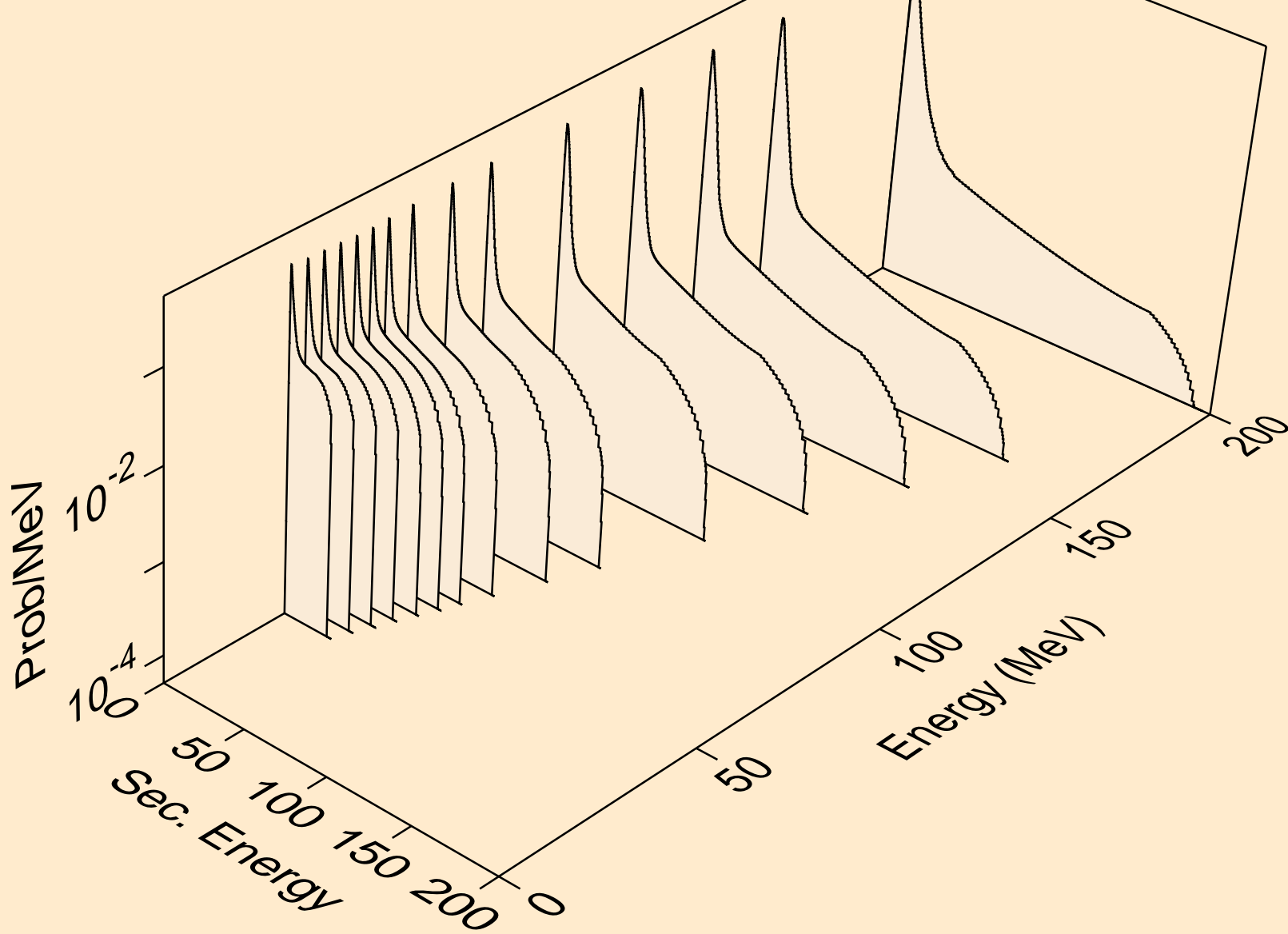

TC090N NEUTRON ACER TENDL-2019 LIBRARY; T=293.16K
Neutron emission for (n,2nd)

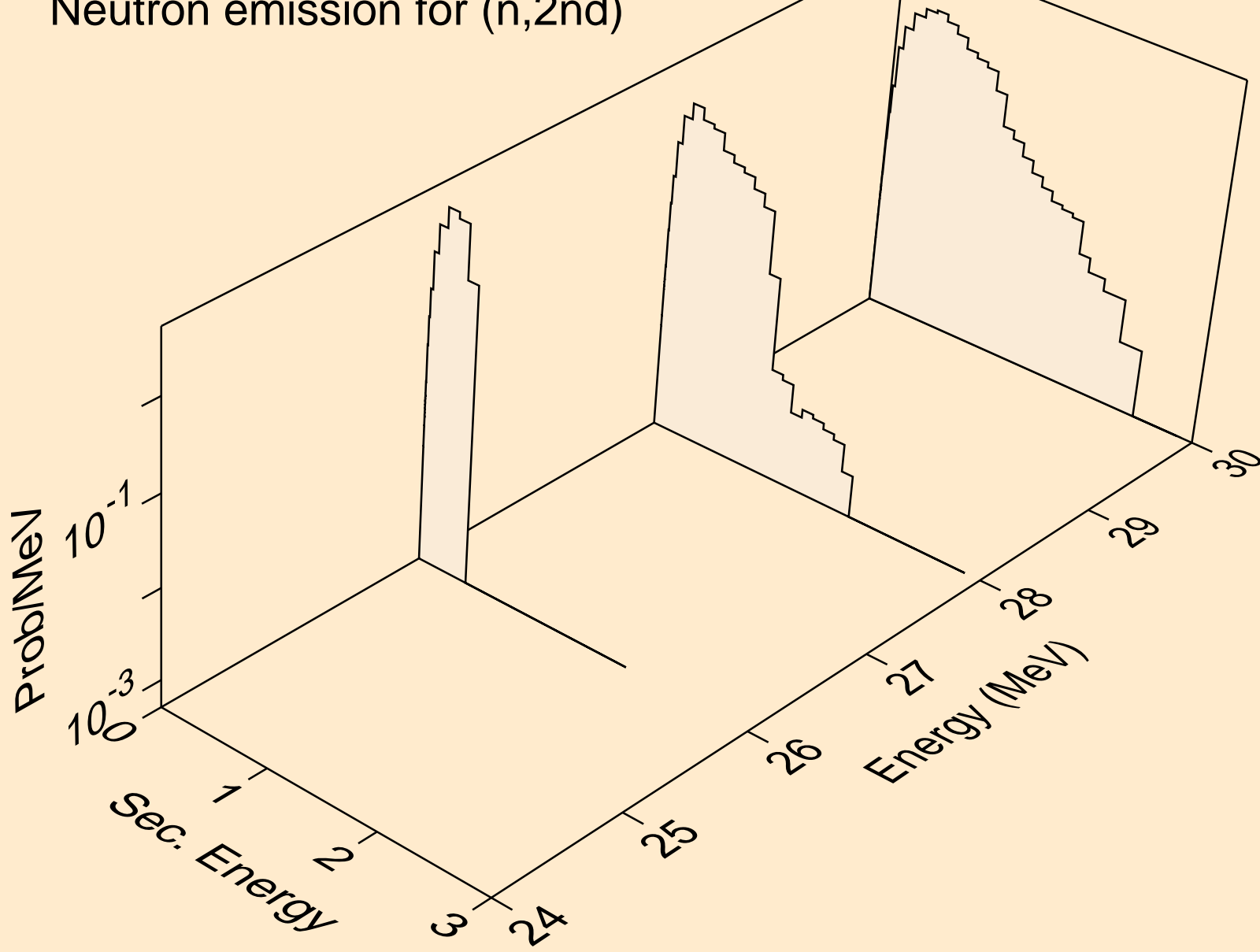

TC090N NEUTRON ACER TENDL-2019 LIBRARY; T=293.16K
Neutron emission for (n,2n)

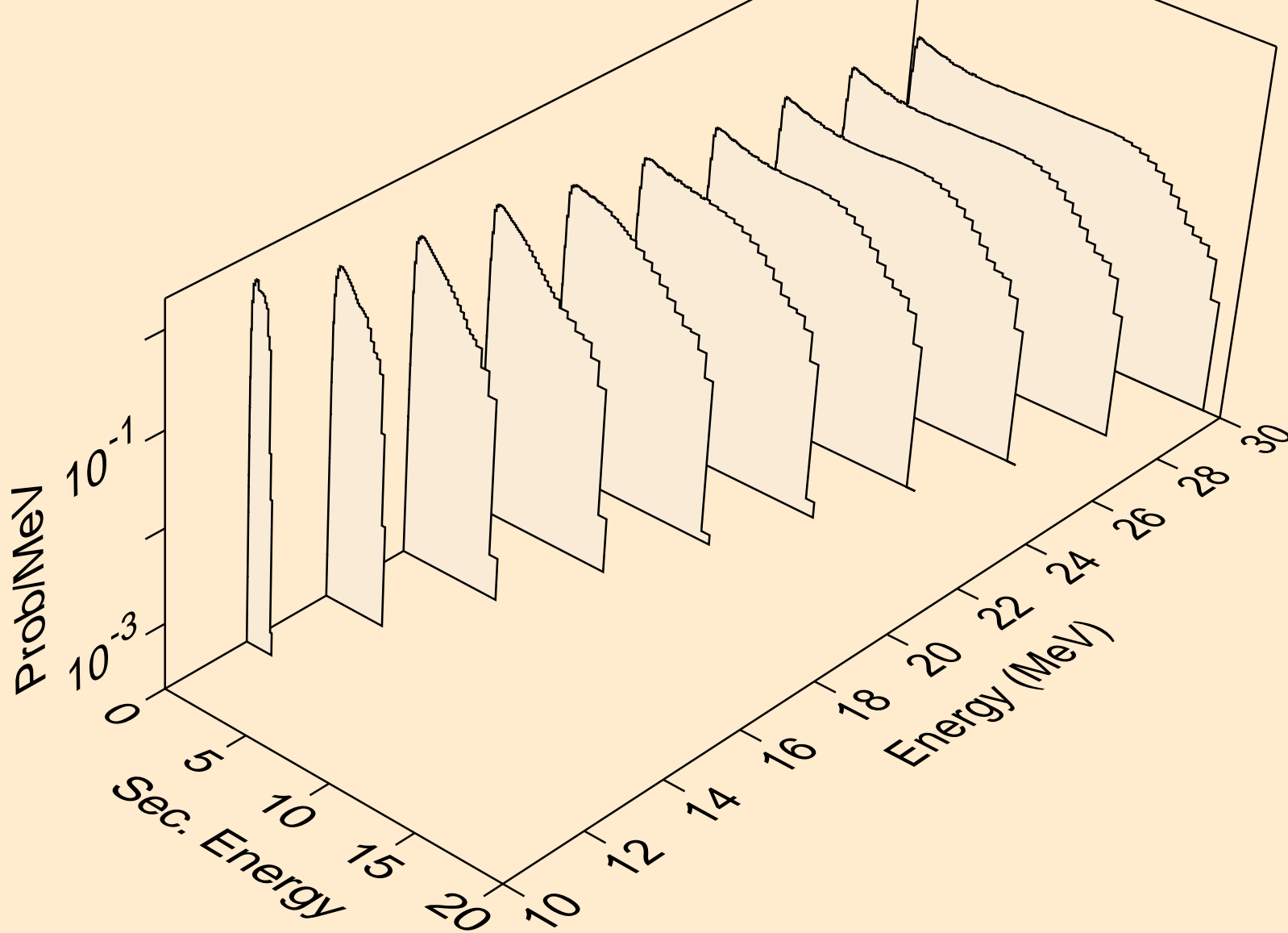

TC090N NEUTRON ACER TENDL-2019 LIBRARY; T=293.16K
Neutron emission for (n,3n)

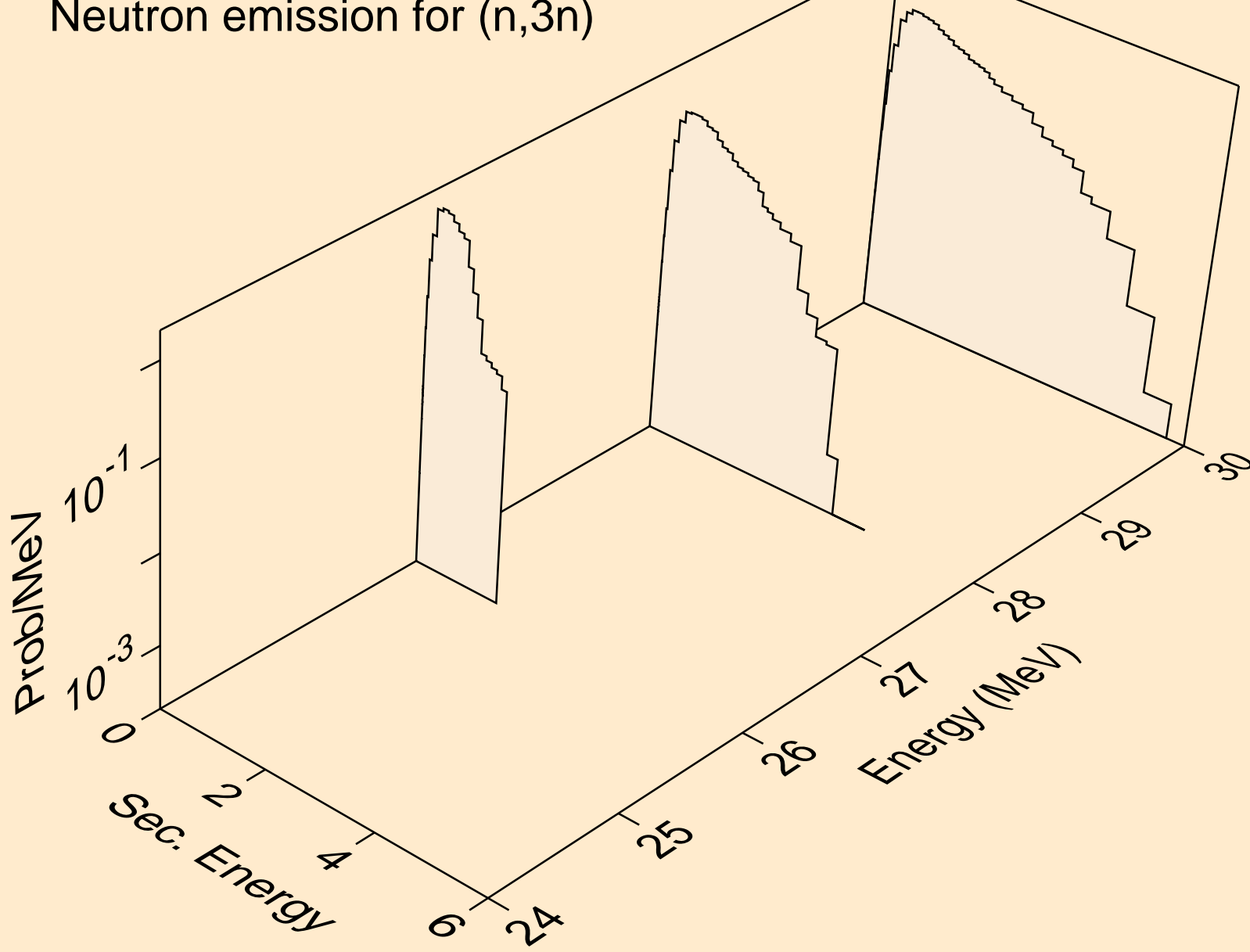

TC090N NEUTRON ACER TENDL-2019 LIBRARY; T=293.16K
Neutron emission for (n,n*)a

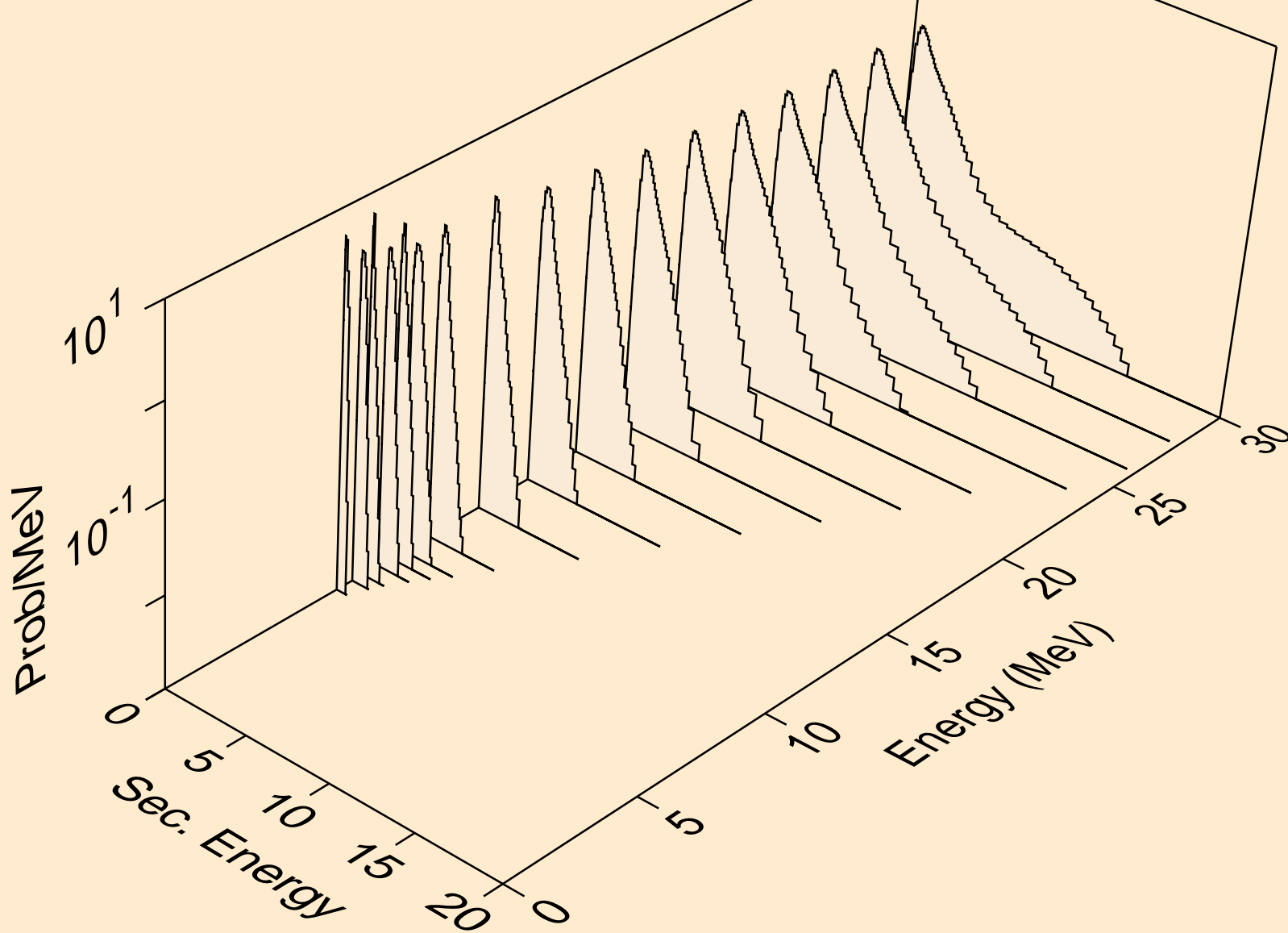

TC090N NEUTRON ACER TENDL-2019 LIBRARY; T=293.16K
Neutron emission for (n,2n)a

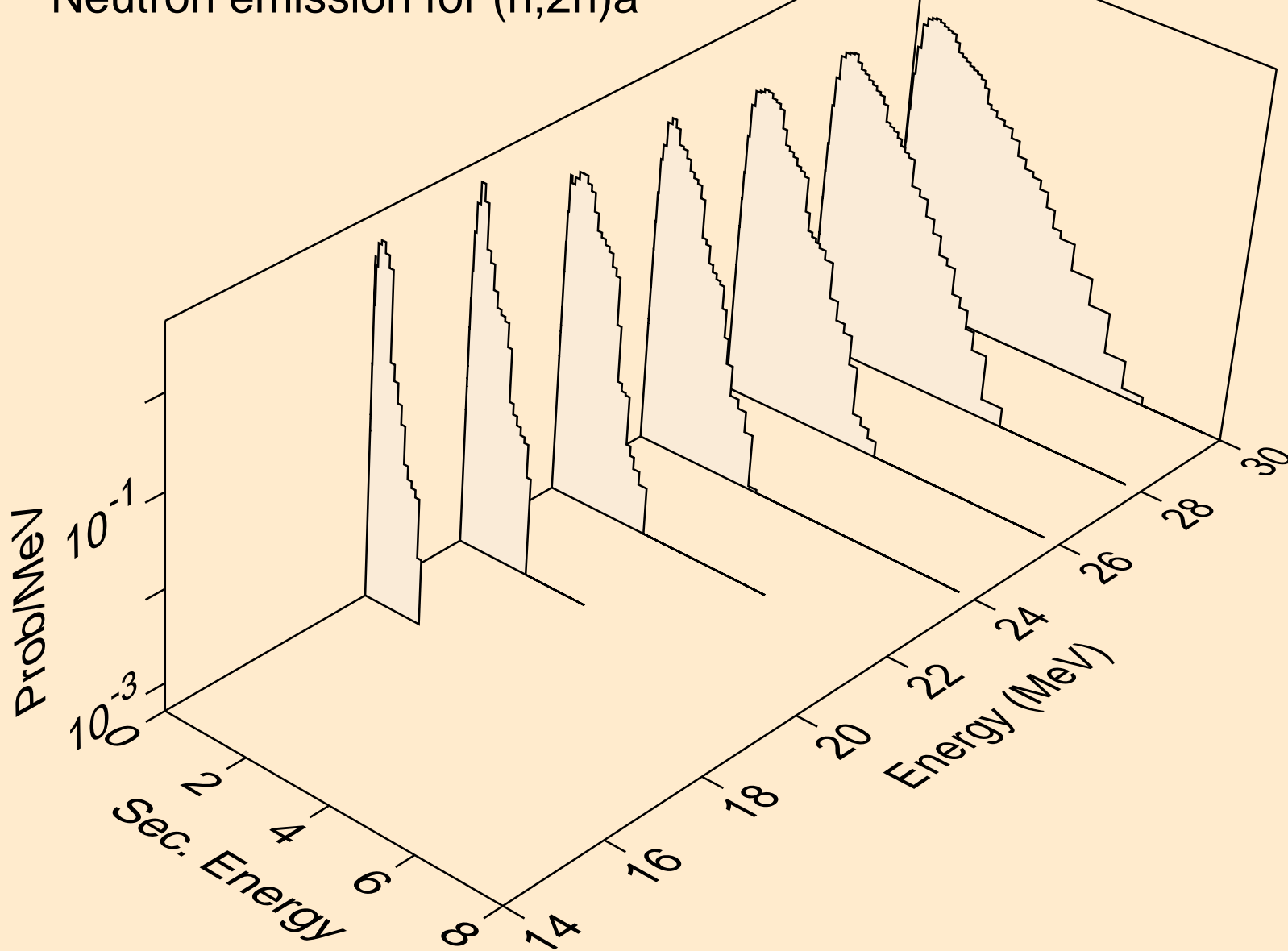

TC090N NEUTRON ACER TENDL-2019 LIBRARY; T=293.16K
Neutron emission for (n,n*)p

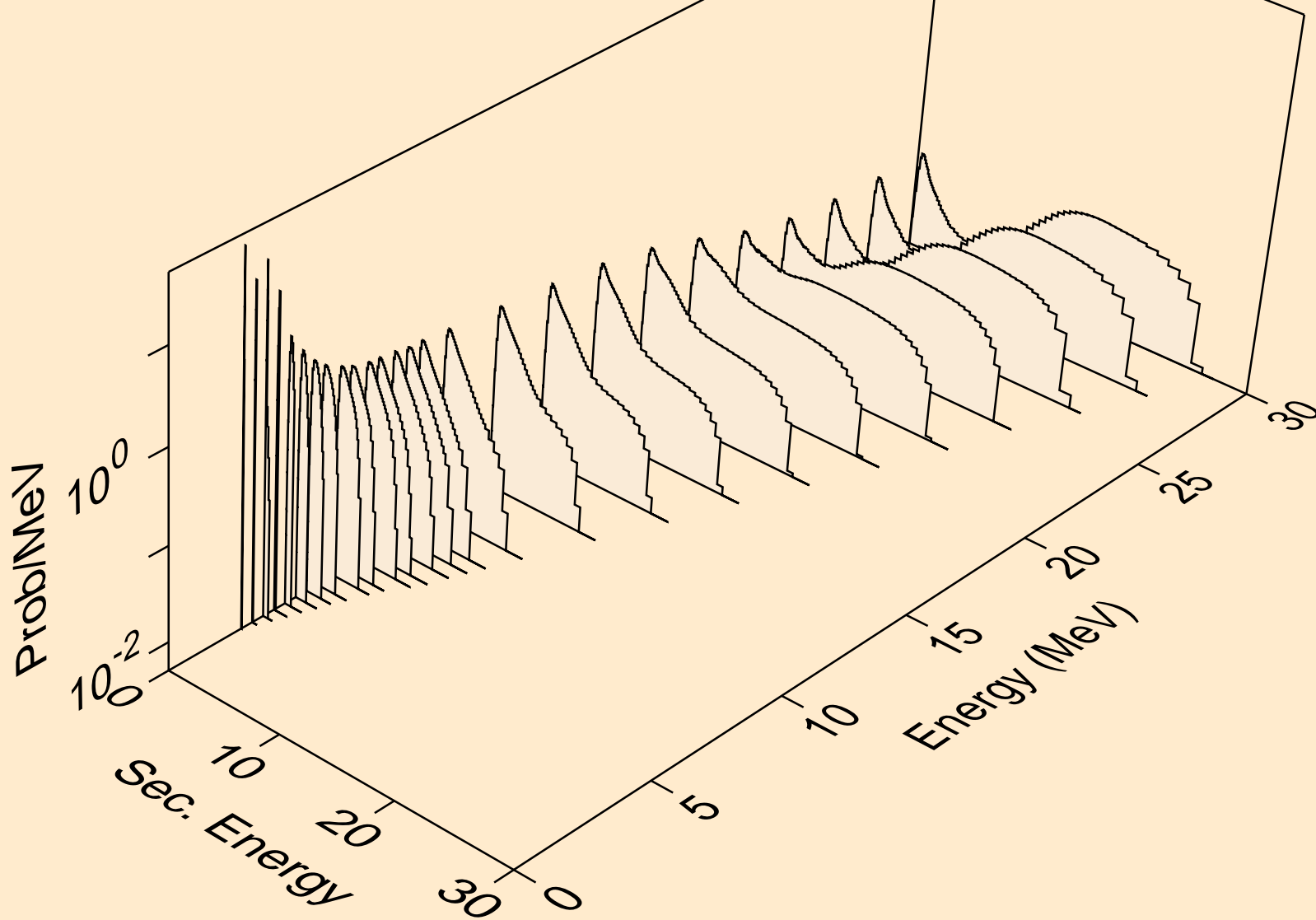

TC090N NEUTRON ACER TENDL-2019 LIBRARY; T=293.16K
Neutron emission for (n,n*)2a

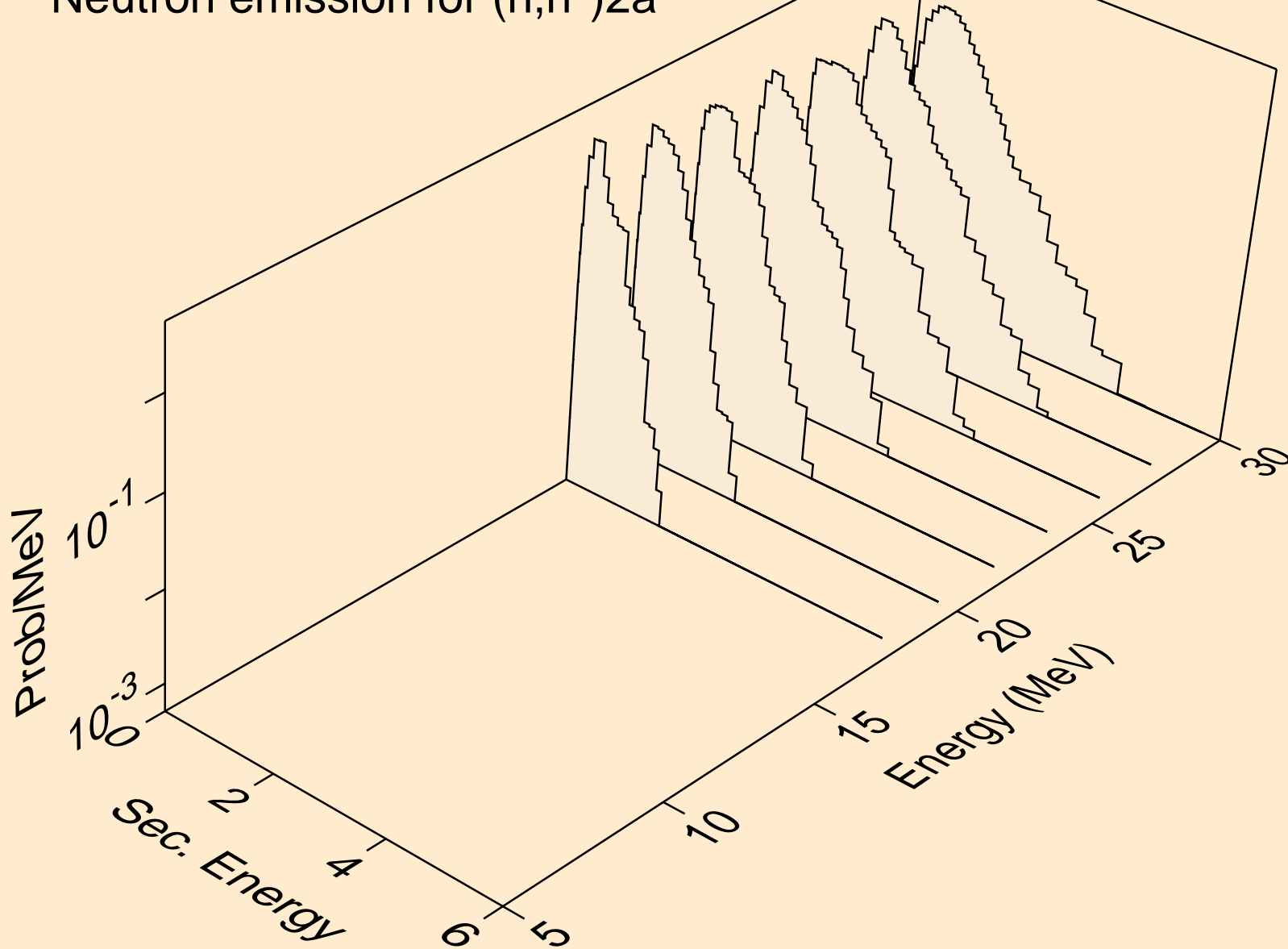

TC090N NEUTRON ACER TENDL-2019 LIBRARY; T=293.16K
Neutron emission for (n,n*)d

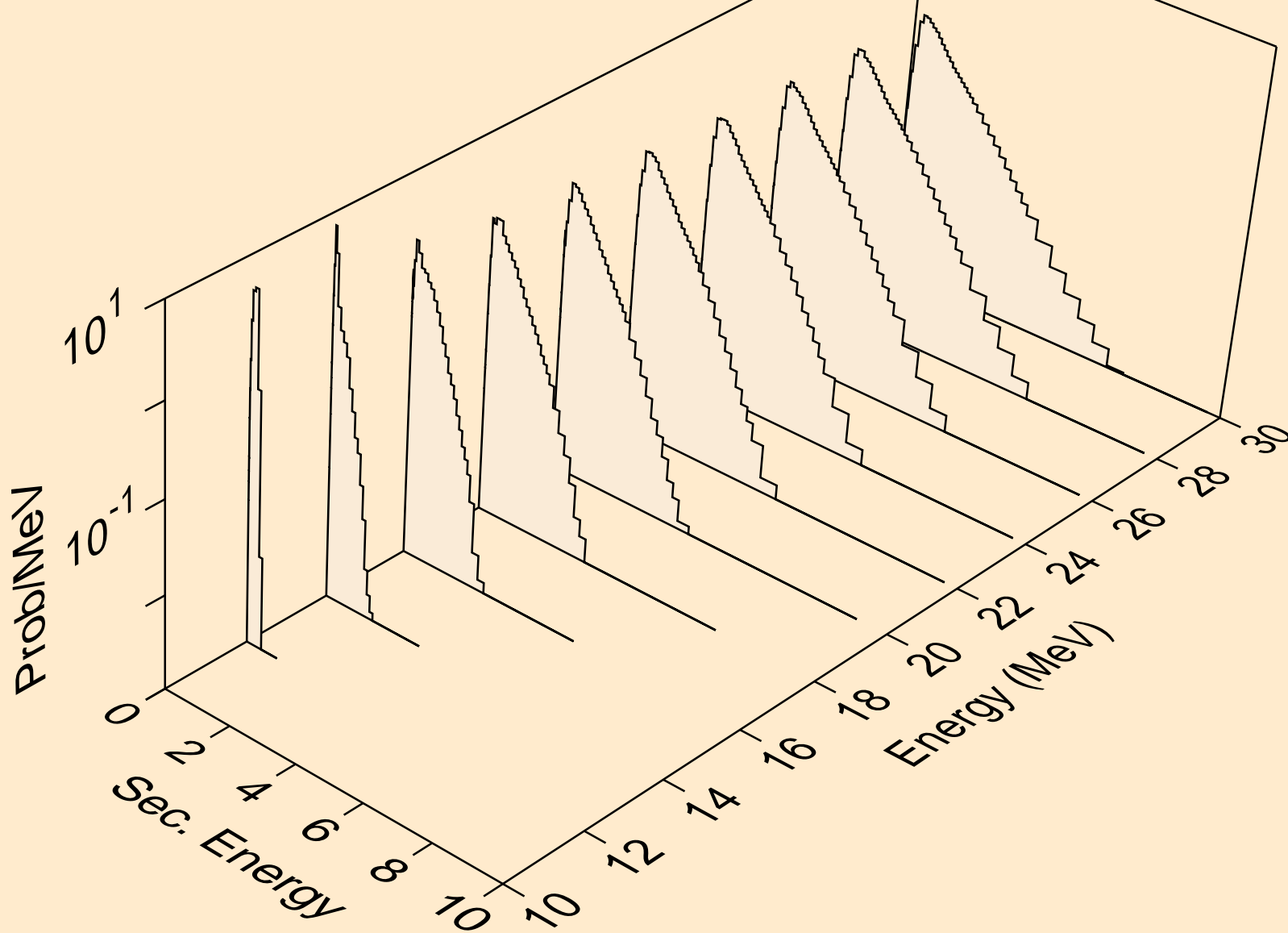

TC090N NEUTRON ACER TENDL-2019 LIBRARY; T=293.16K
Neutron emission for (n,n*)t

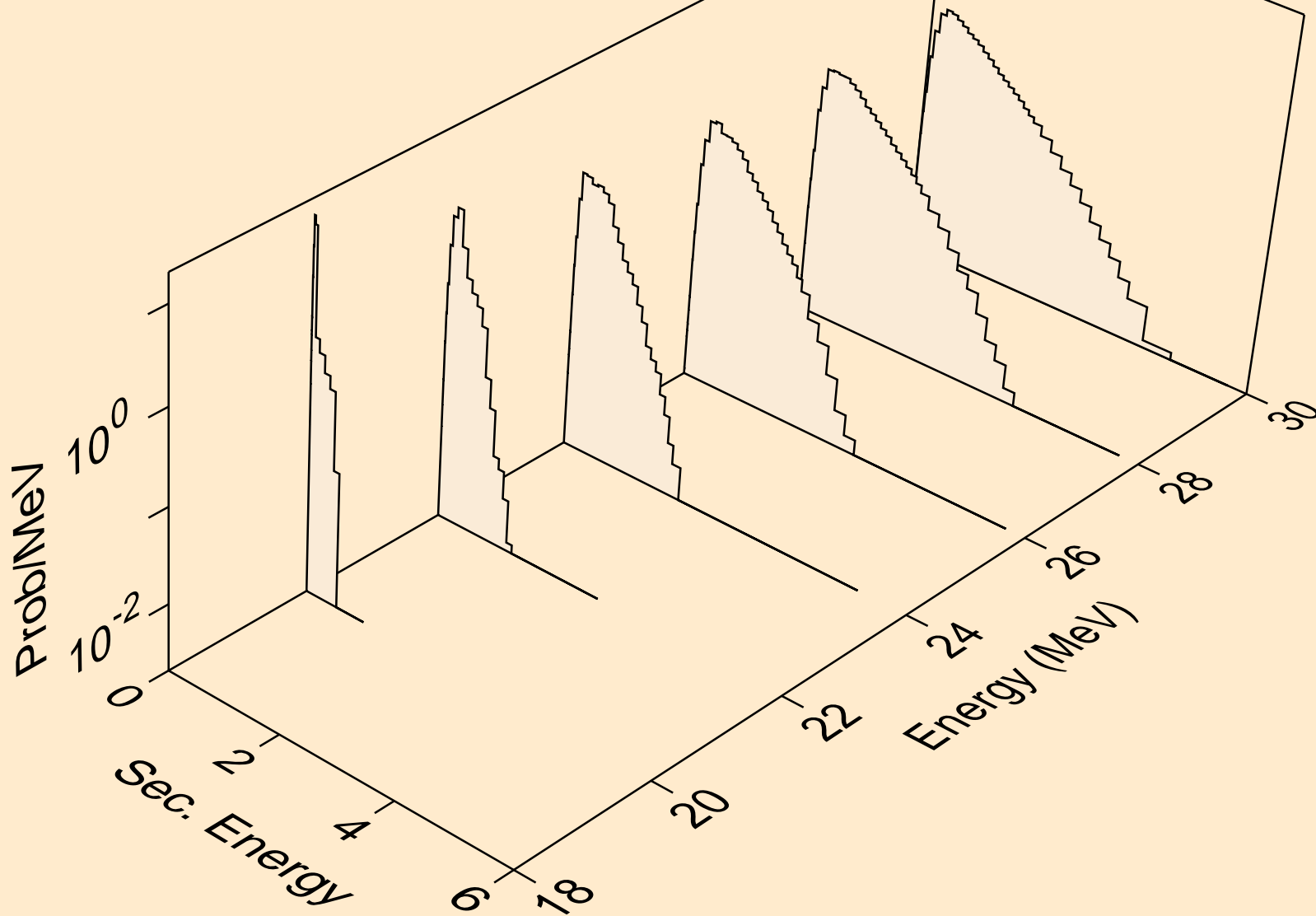

TC090N NEUTRON ACER TENDL-2019 LIBRARY; T=293.16K
Neutron emission for (n,n*)he3

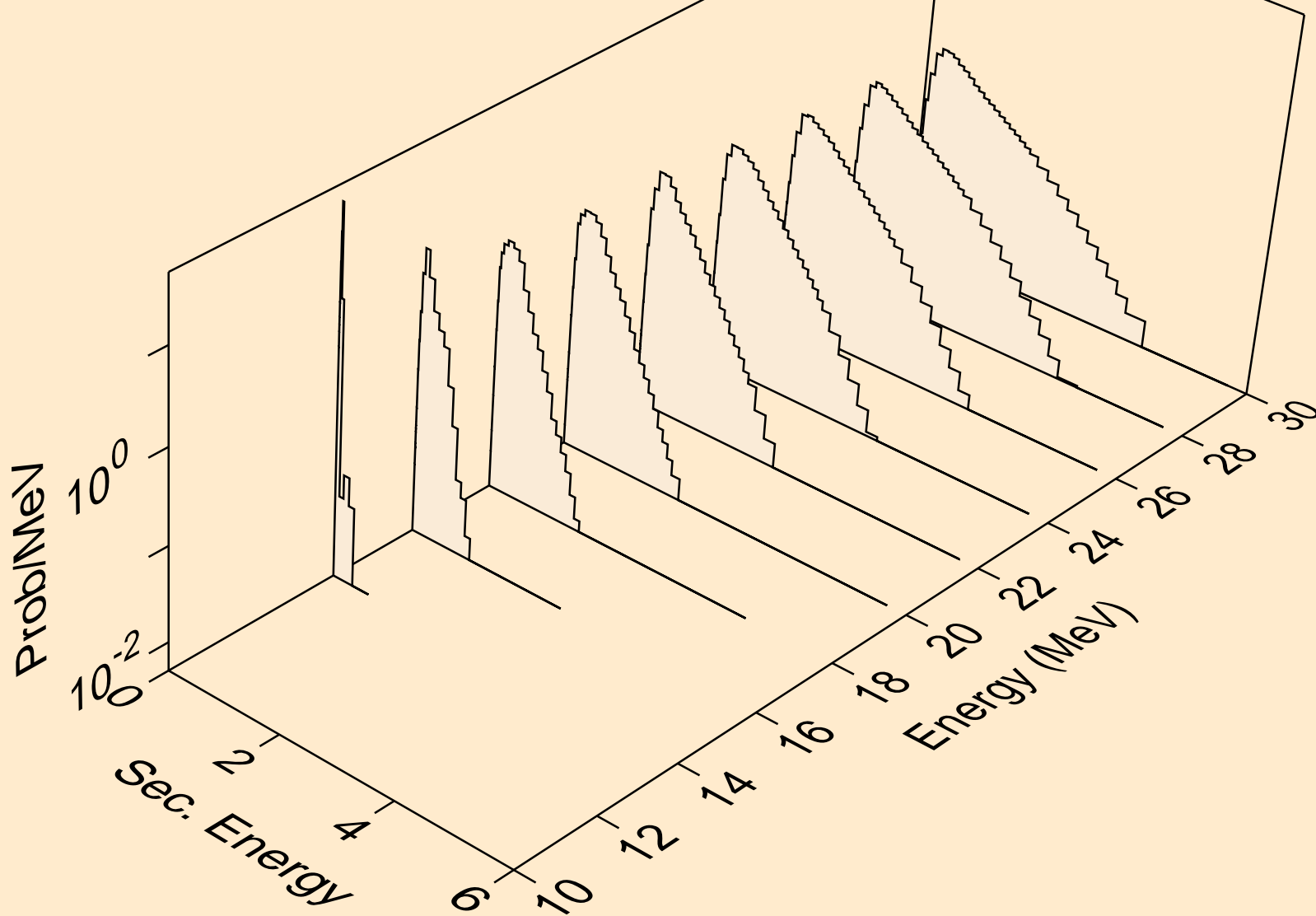

TC090N NEUTRON ACER TENDL-2019 LIBRARY; T=293.16K
Neutron emission for (n,2np)

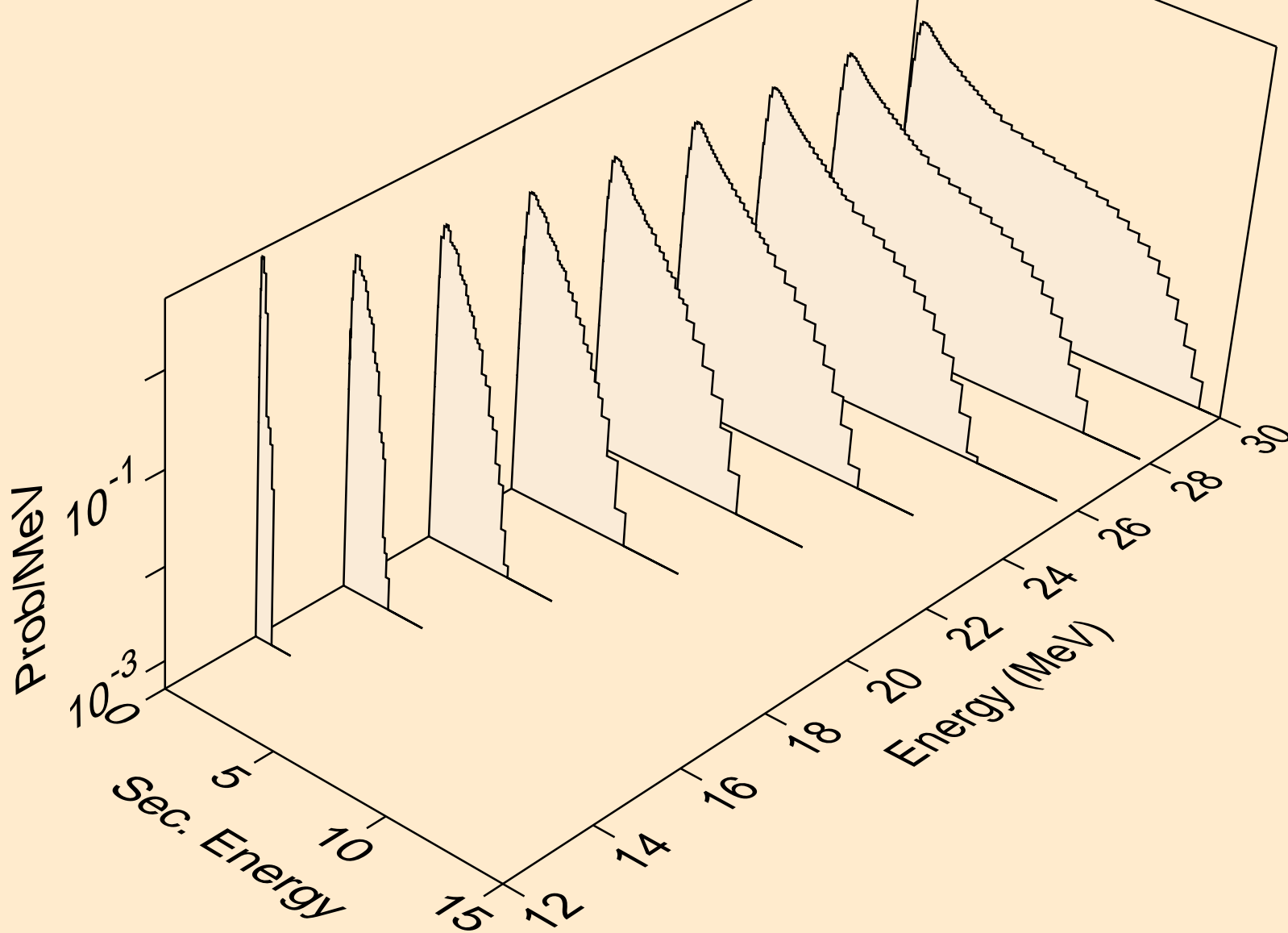

TC090N NEUTRON ACER TENDL-2019 LIBRARY; T=293.16K
Neutron emission for (n,3np)

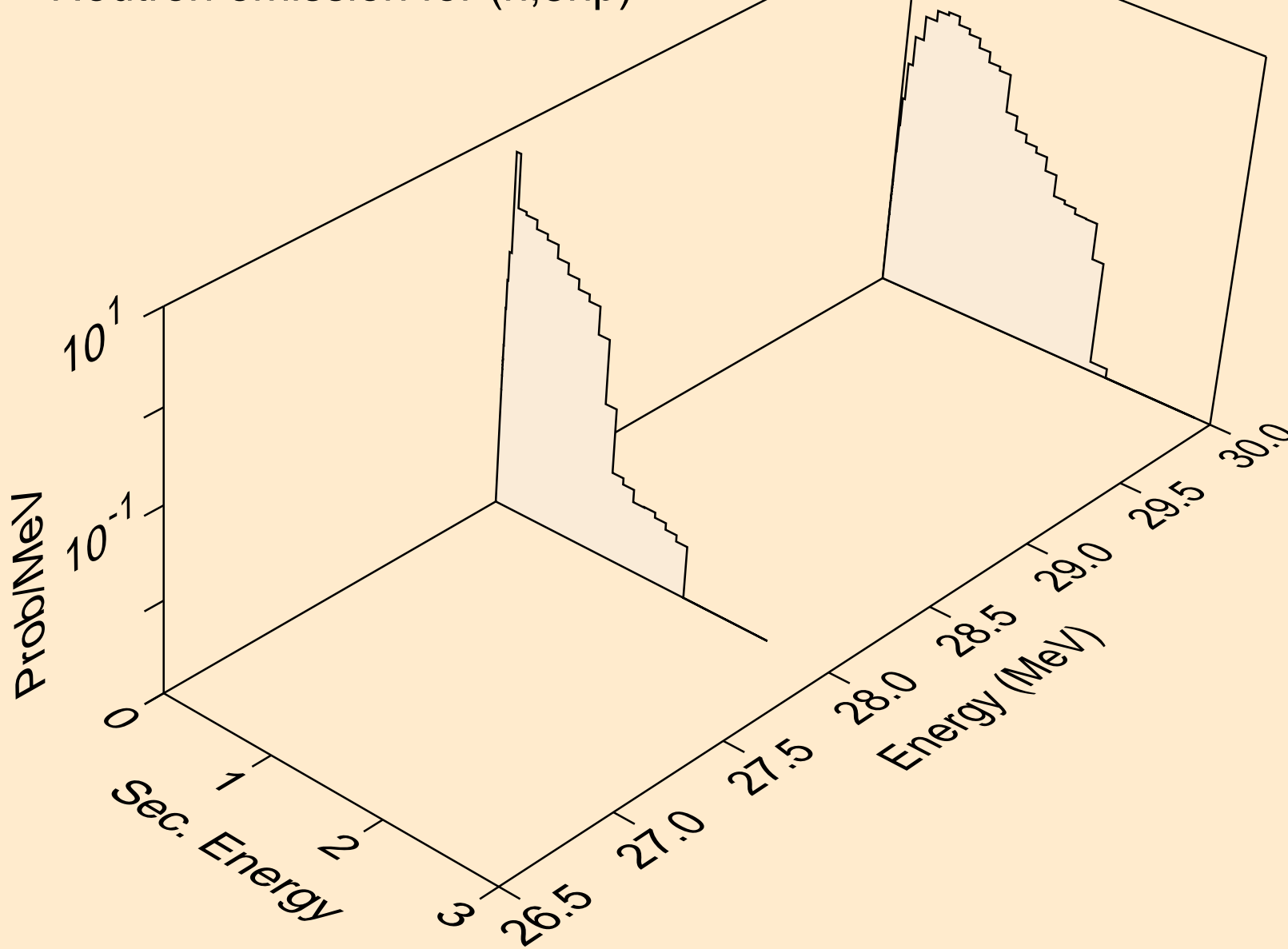

TC090N NEUTRON ACER TENDL-2019 LIBRARY; T=293.16K
Neutron emission for (n,2np)

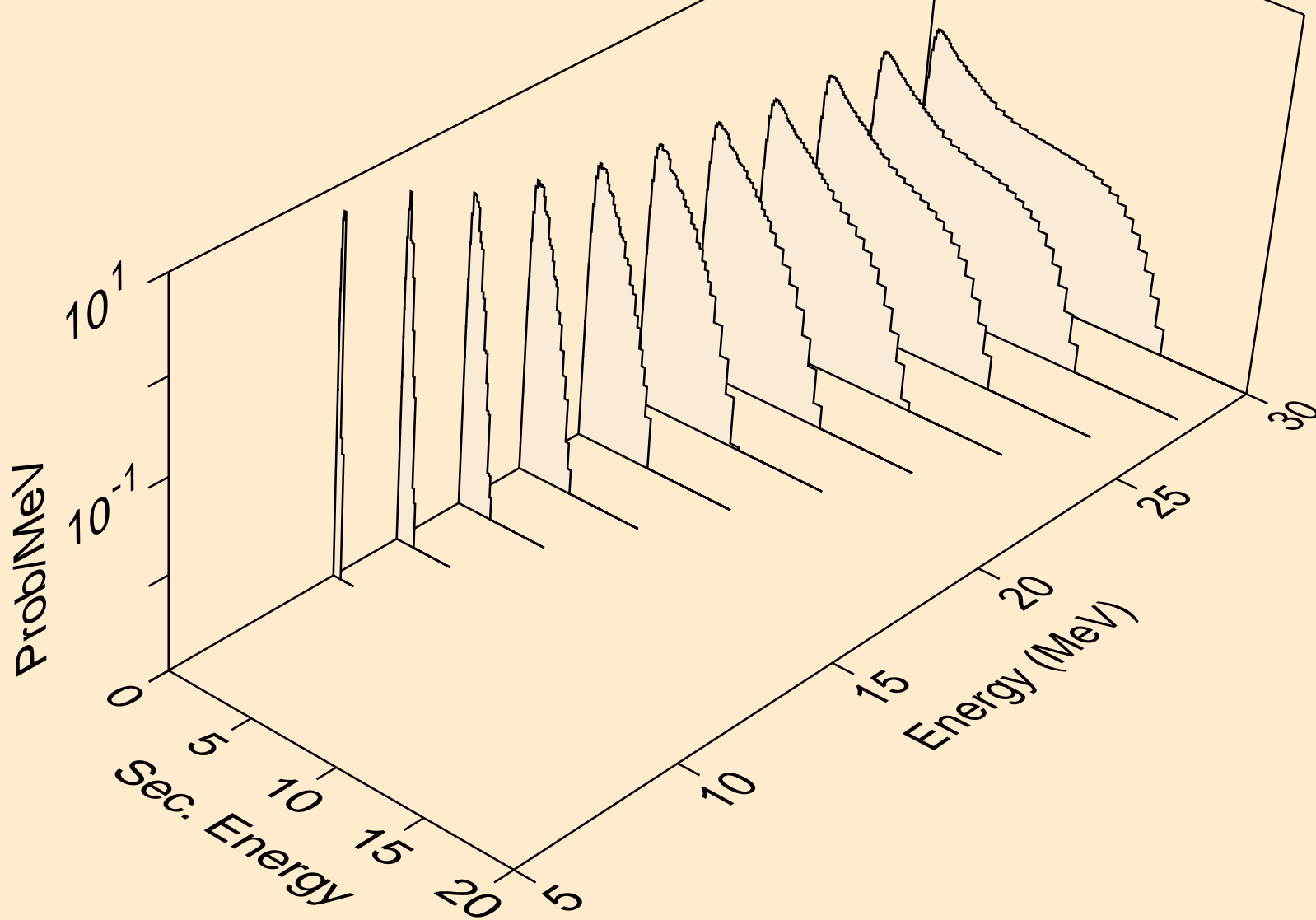

TC090N NEUTRON ACER TENDL-2019 LIBRARY; T=293.16K
Neutron emission for (n,npa)

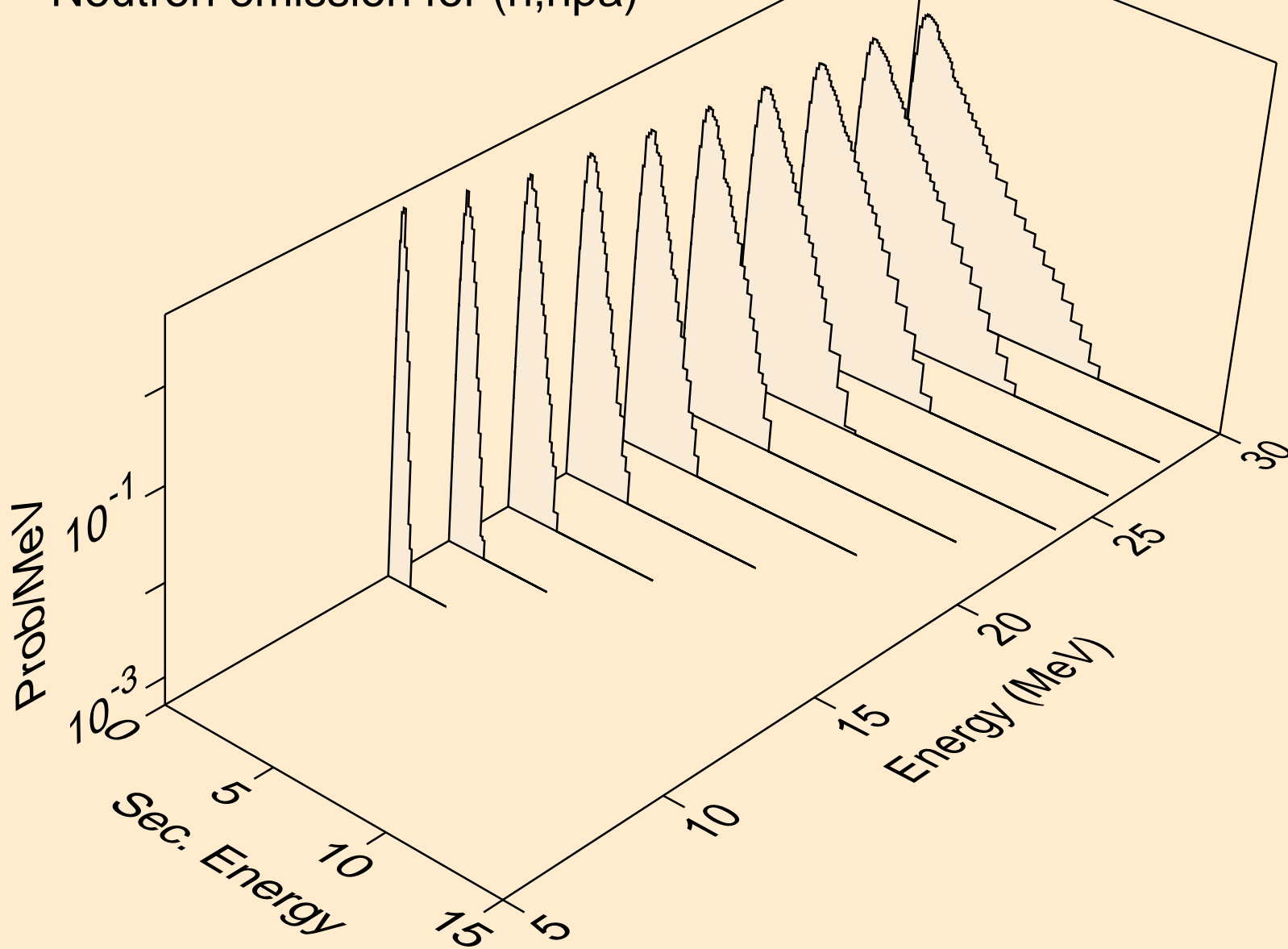

TC090N NEUTRON ACER TENDL-2019 LIBRARY; T=293.16K
Neutron emission for (n,n*c)

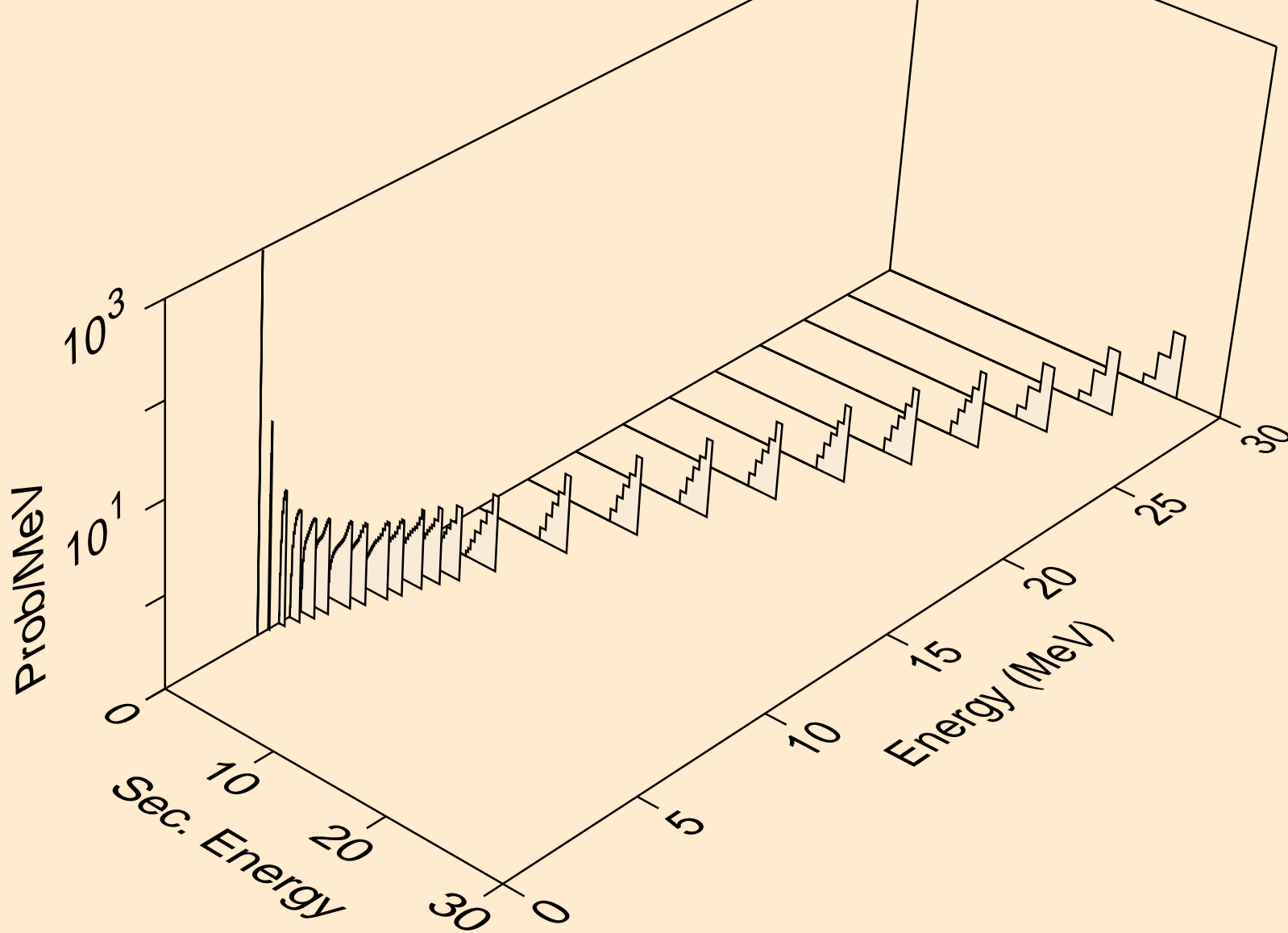

TC090N NEUTRON ACER TENDL-2019 LIBRARY; T=293.16K
Photon emission for (n,x)

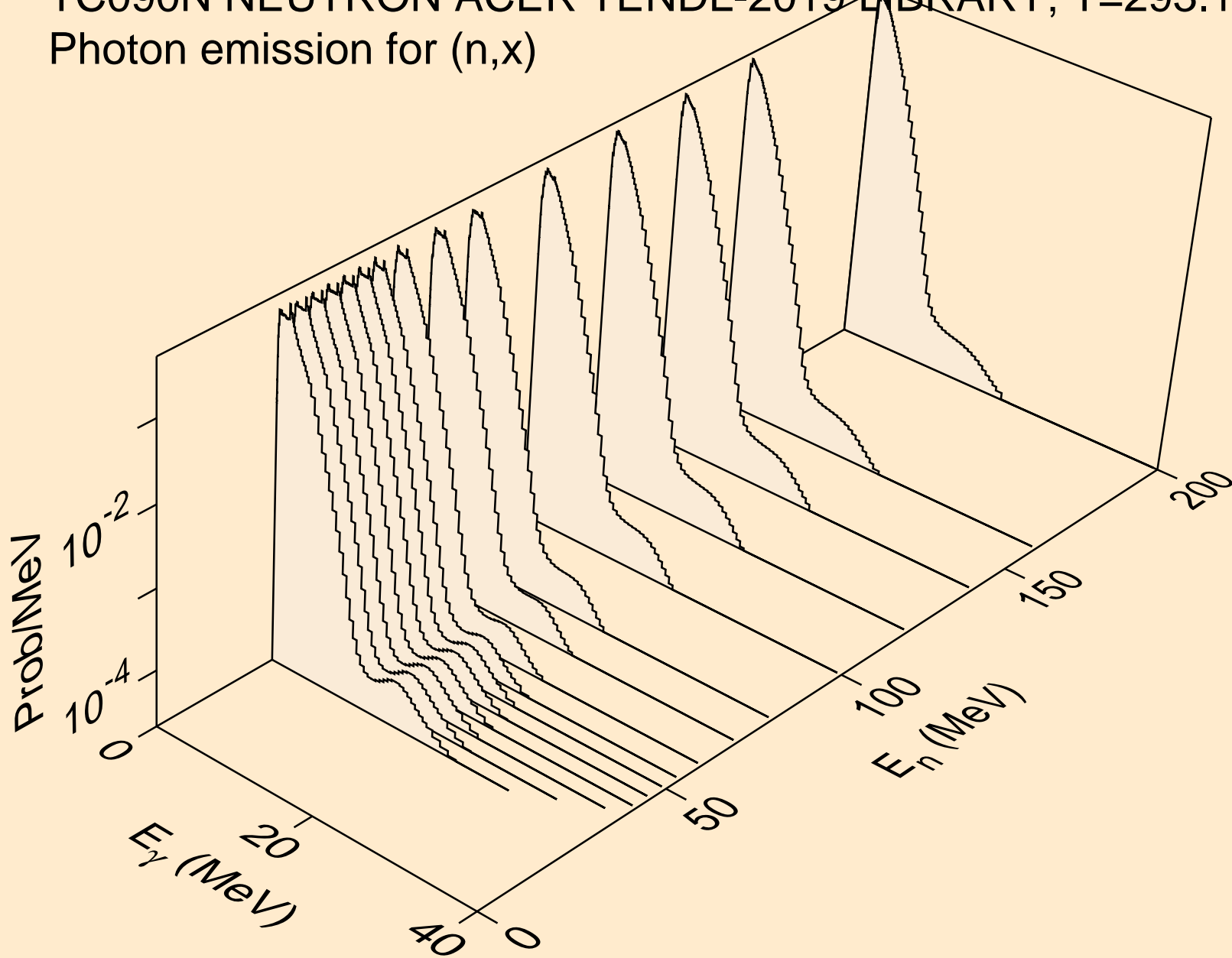

TC090N NEUTRON ACER TENDL-2019 LIBRARY; T=293.16K
Photon emission for (n,2nd)

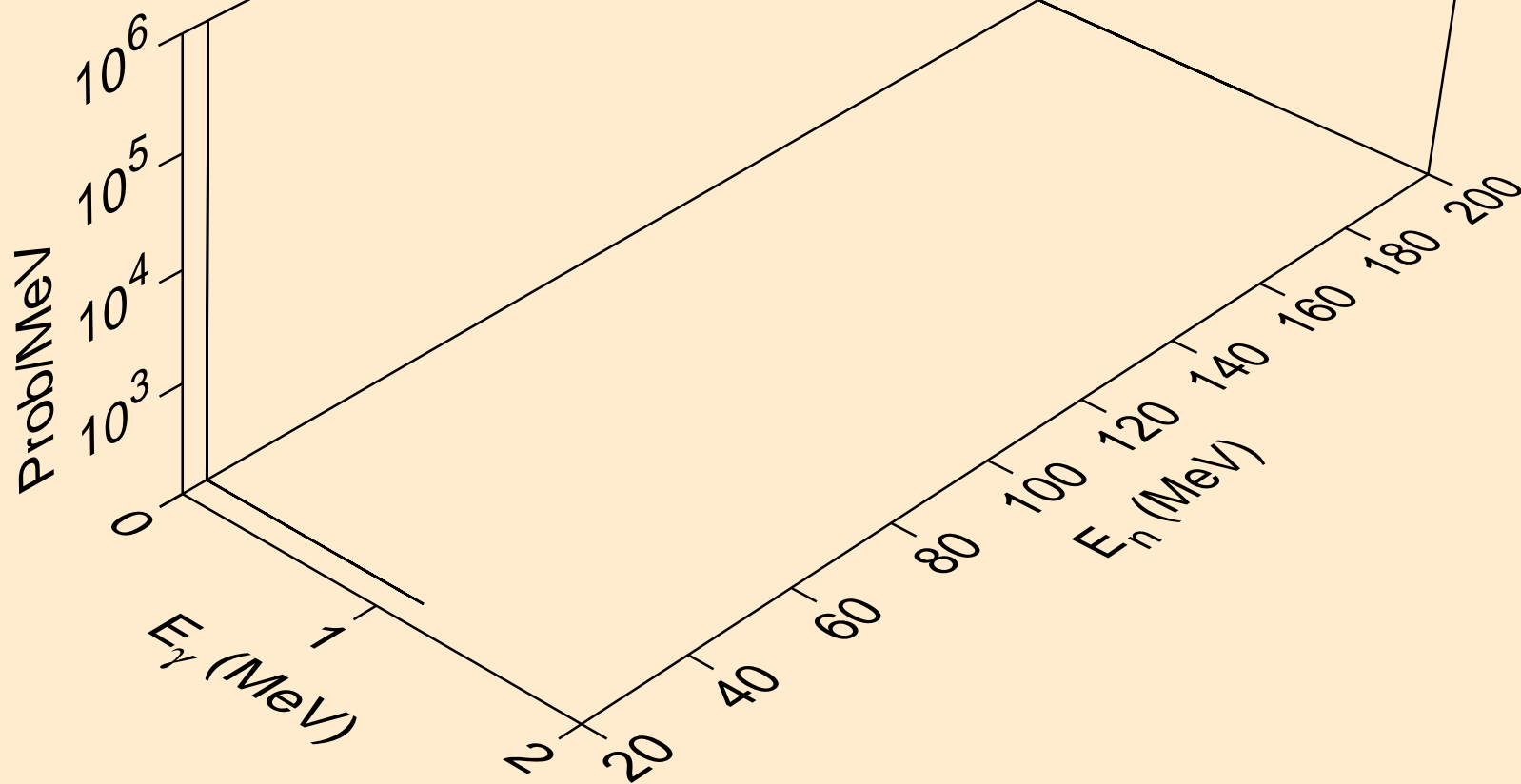

TC090N NEUTRON ACER TENDL-2019 LIBRARY; T=293.16K
Photon emission for (n,2n)

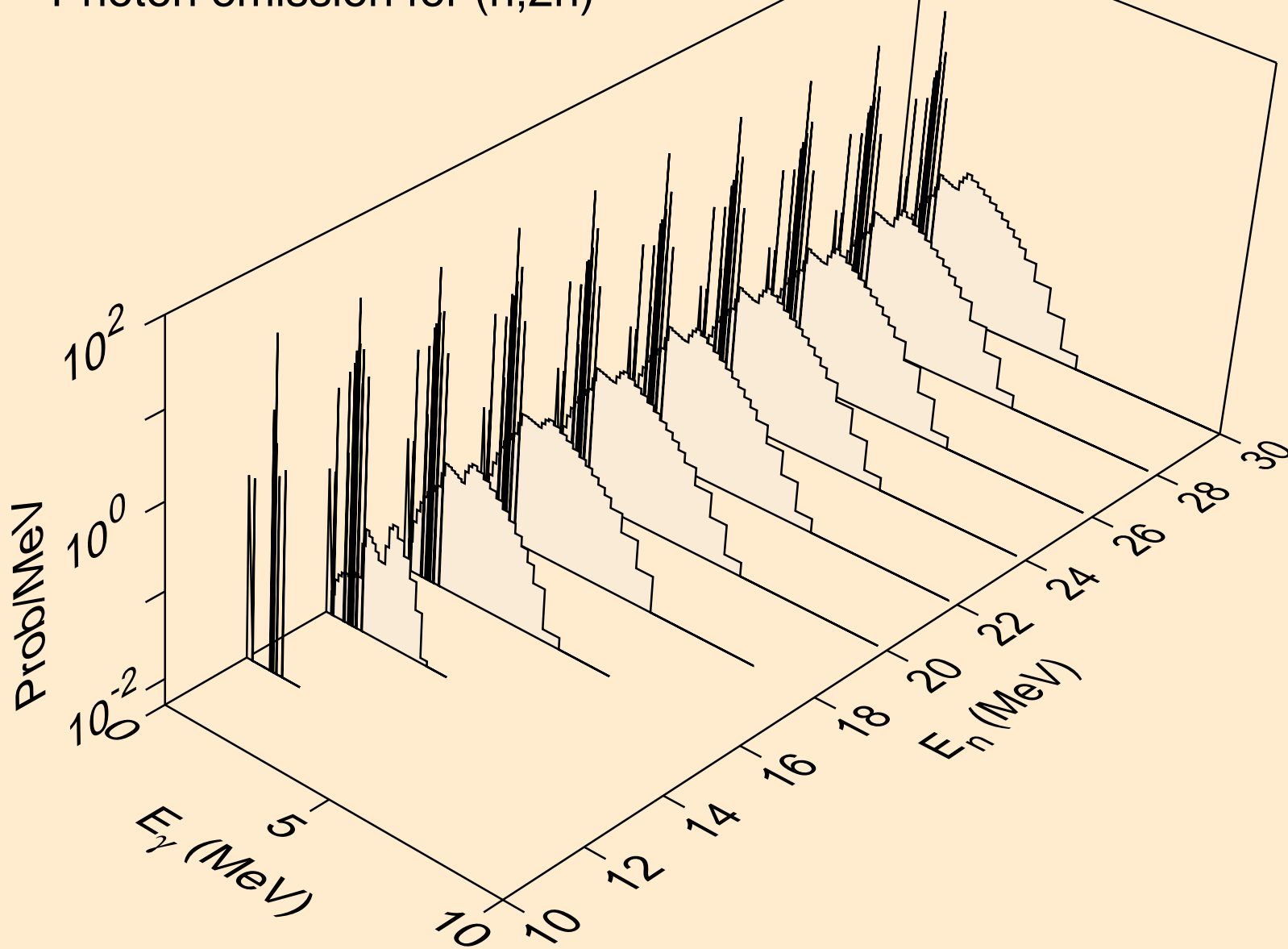

TC090N NEUTRON ACER TENDL-2019 LIBRARY; T=293.16K
Photon emission for (n,3n)

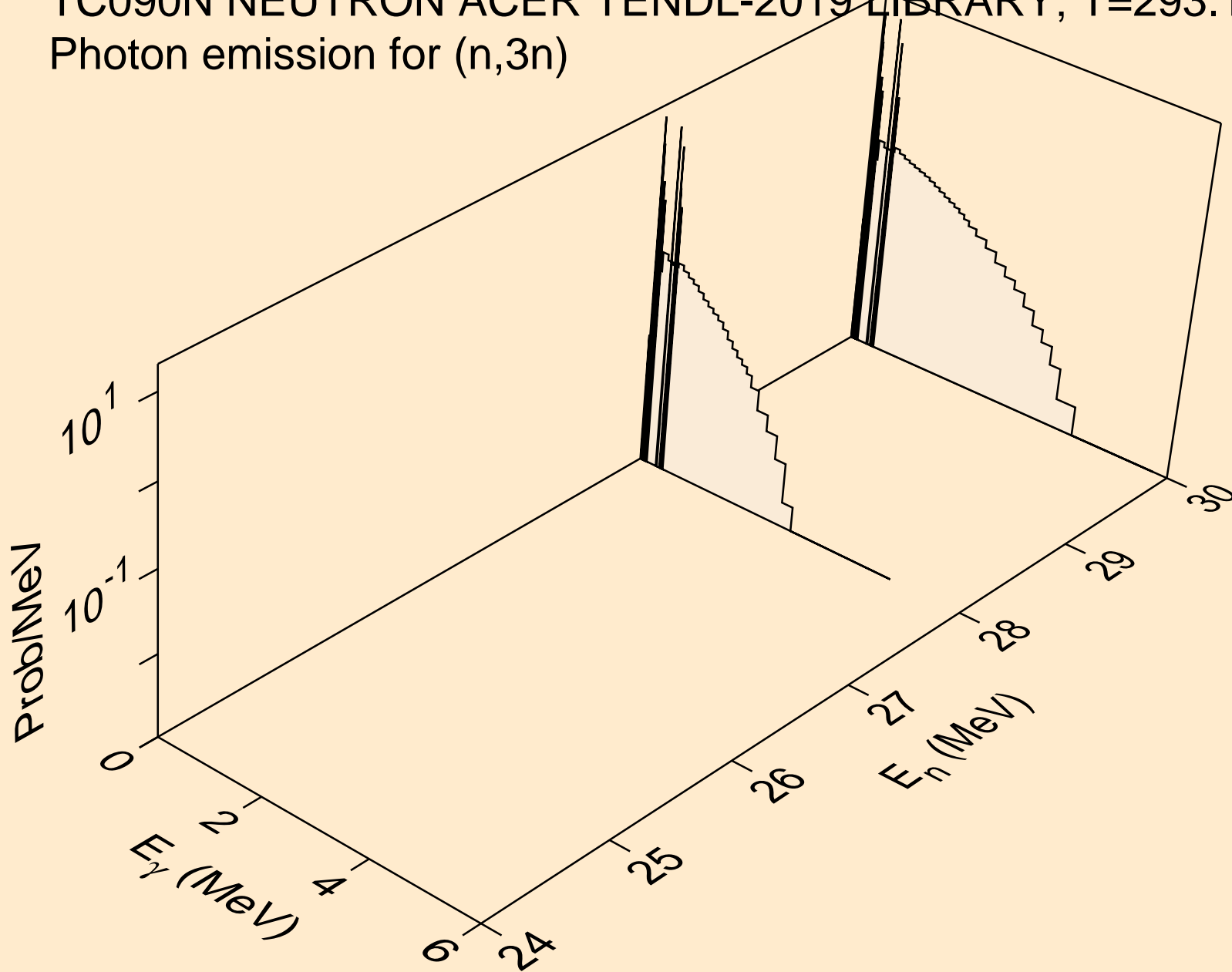

TC090N NEUTRON ACER TENDL-2019 LIBRARY; T=293.16K
Photon emission for (n,n*)a

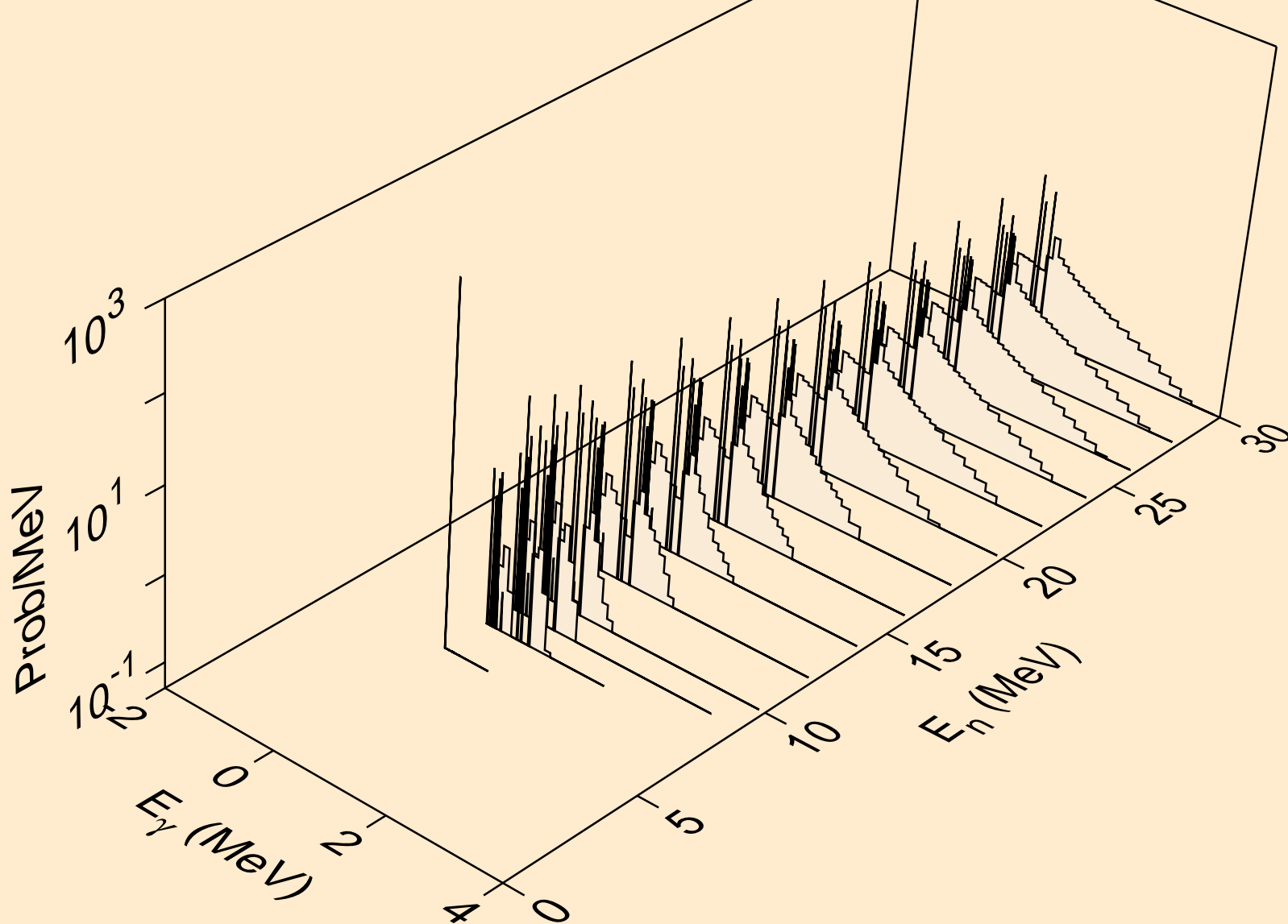

TC090N NEUTRON ACER TENDL-2019 LIBRARY; T=293.16K
Photon emission for (n,2n)a

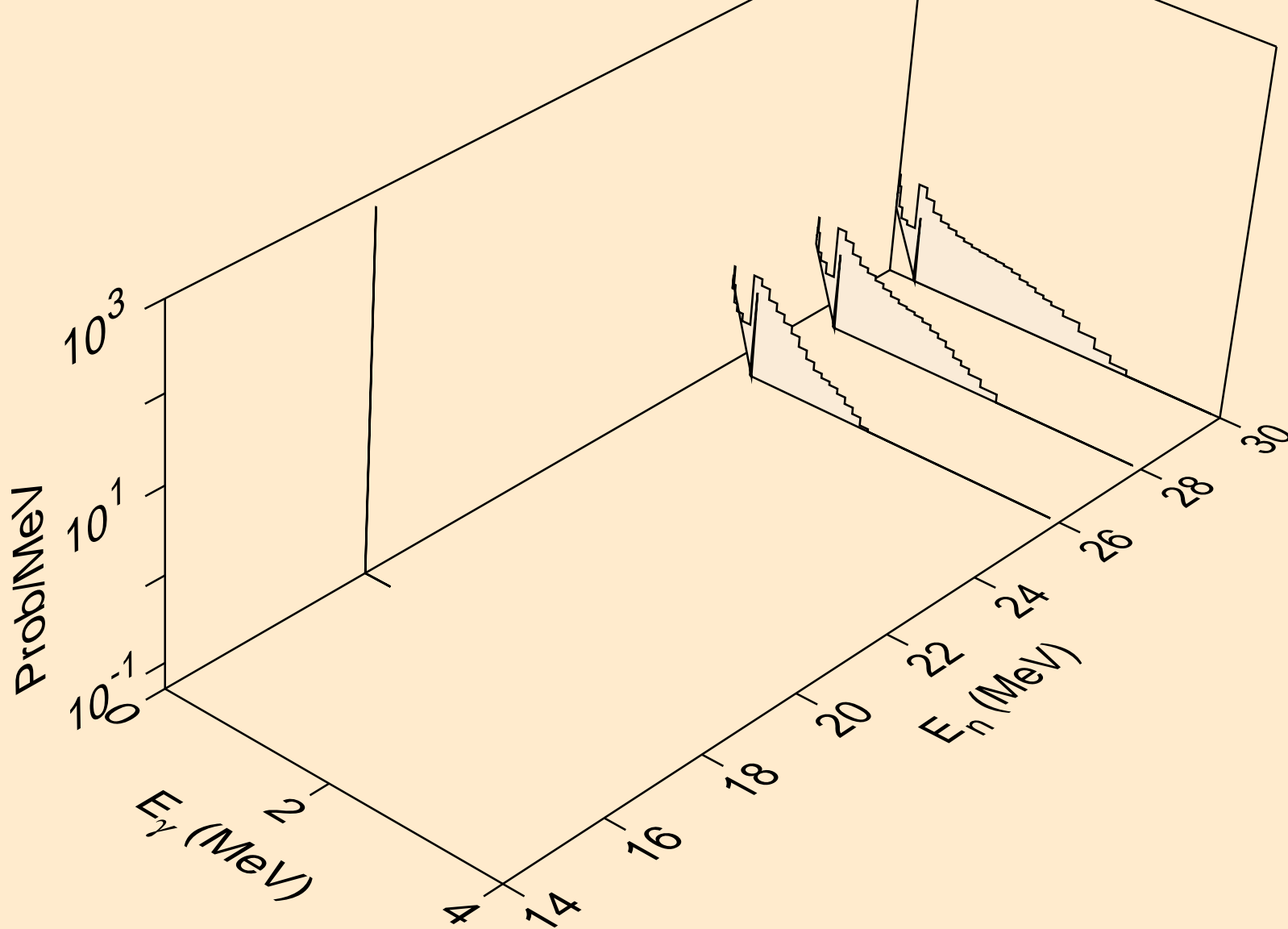

TC090N NEUTRON ACER TENDL-2019 LIBRARY; T=293.16K
Photon emission for (n,n*)p

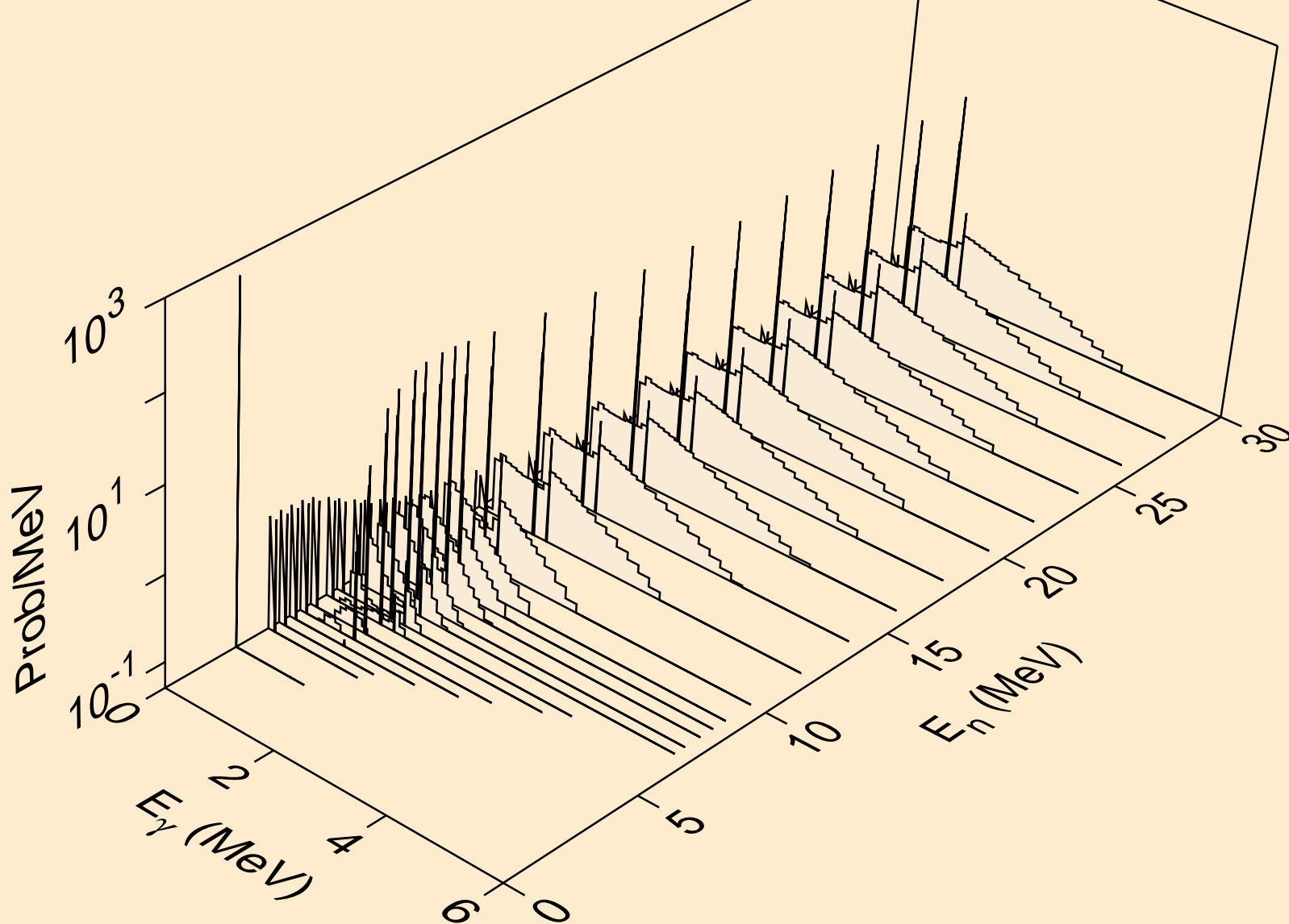

TC090N NEUTRON ACER TENDL-2019 LIBRARY; T=293.16K
Photon emission for (n,n*)2a

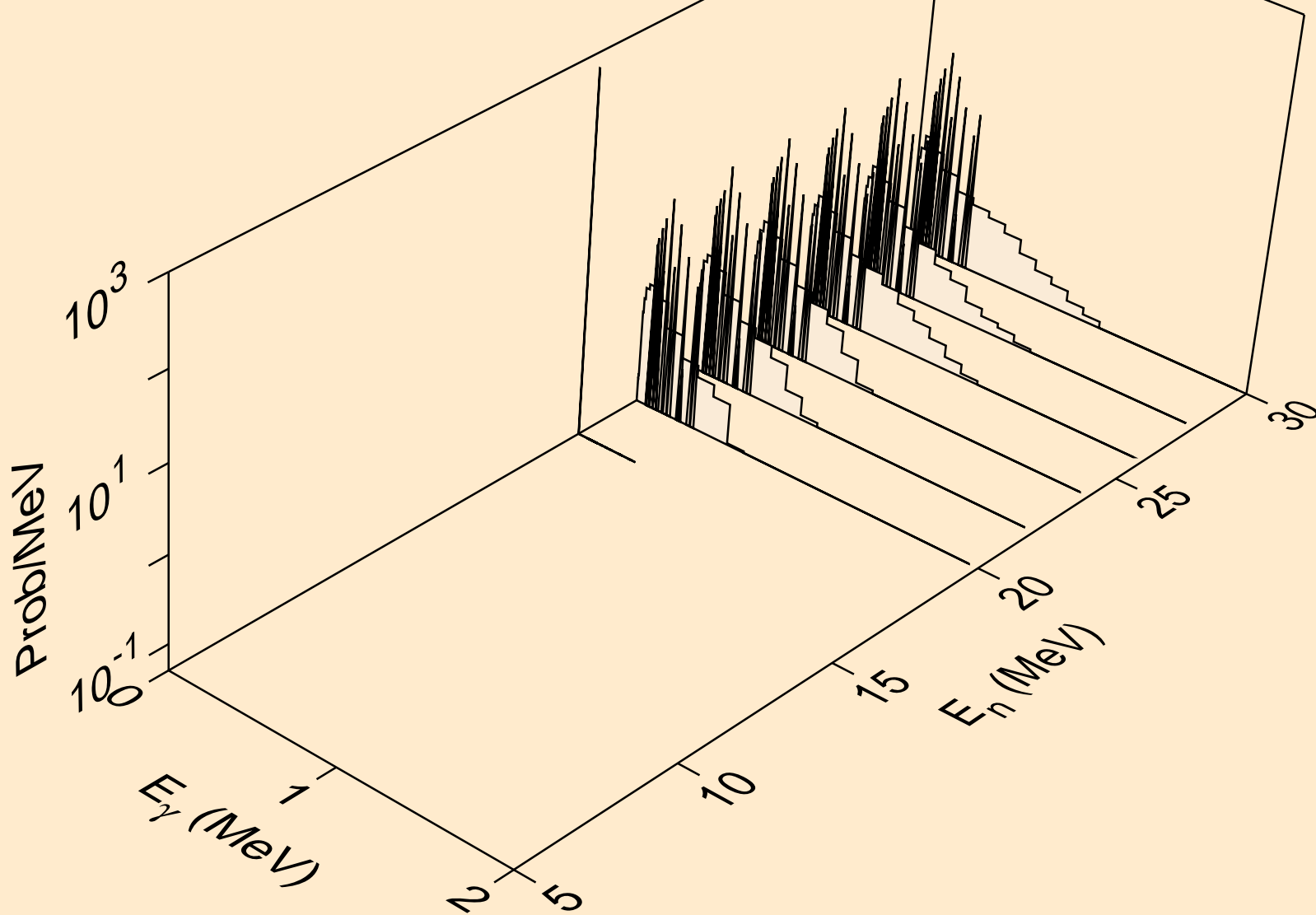

TC090N NEUTRON ACER TENDL-2019 LIBRARY; T=293.16K
Photon emission for (n,n*)d

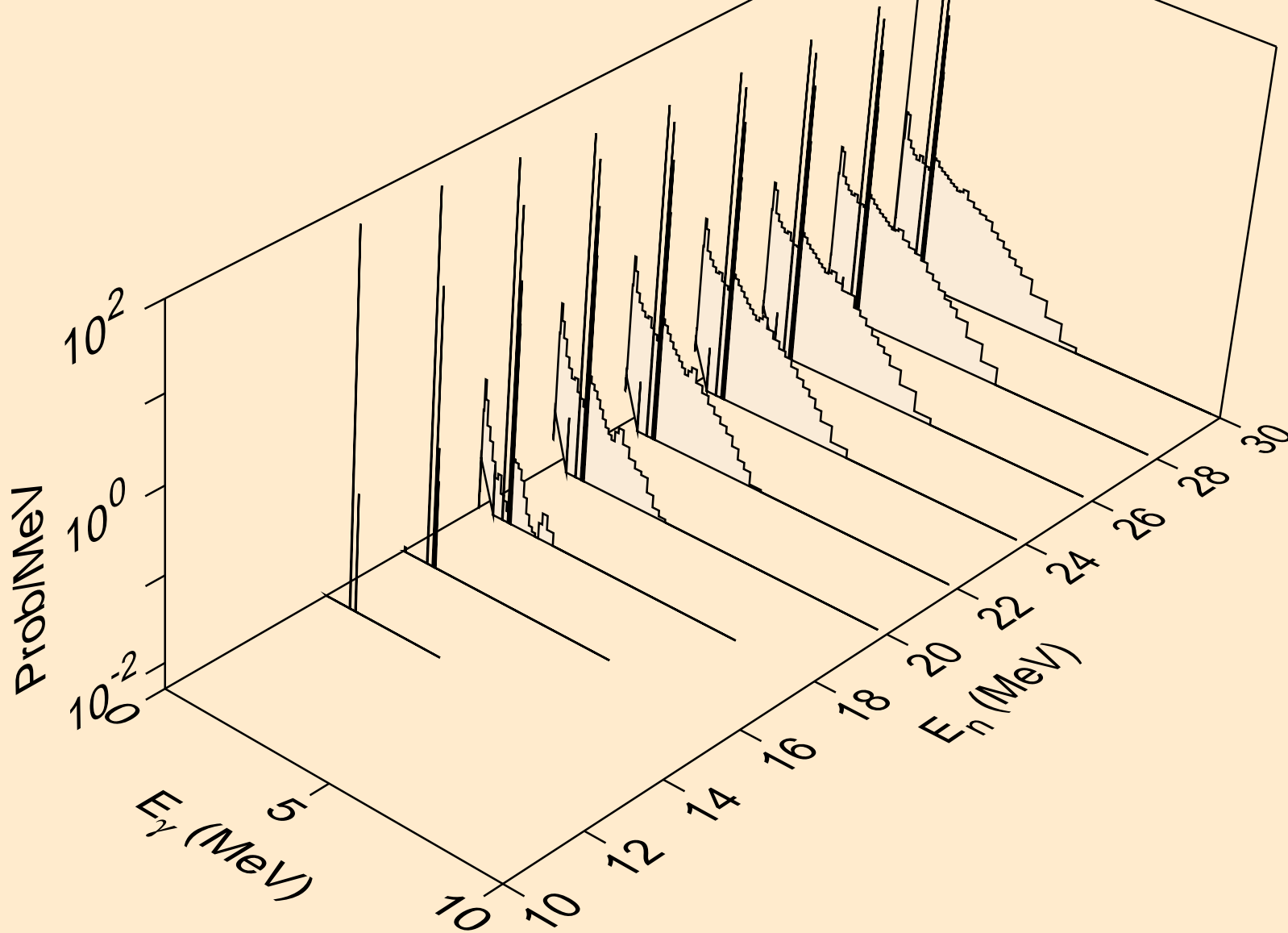

TC090N NEUTRON ACER TENDL-2019 LIBRARY; T=293.16K
Photon emission for (n,n*)t

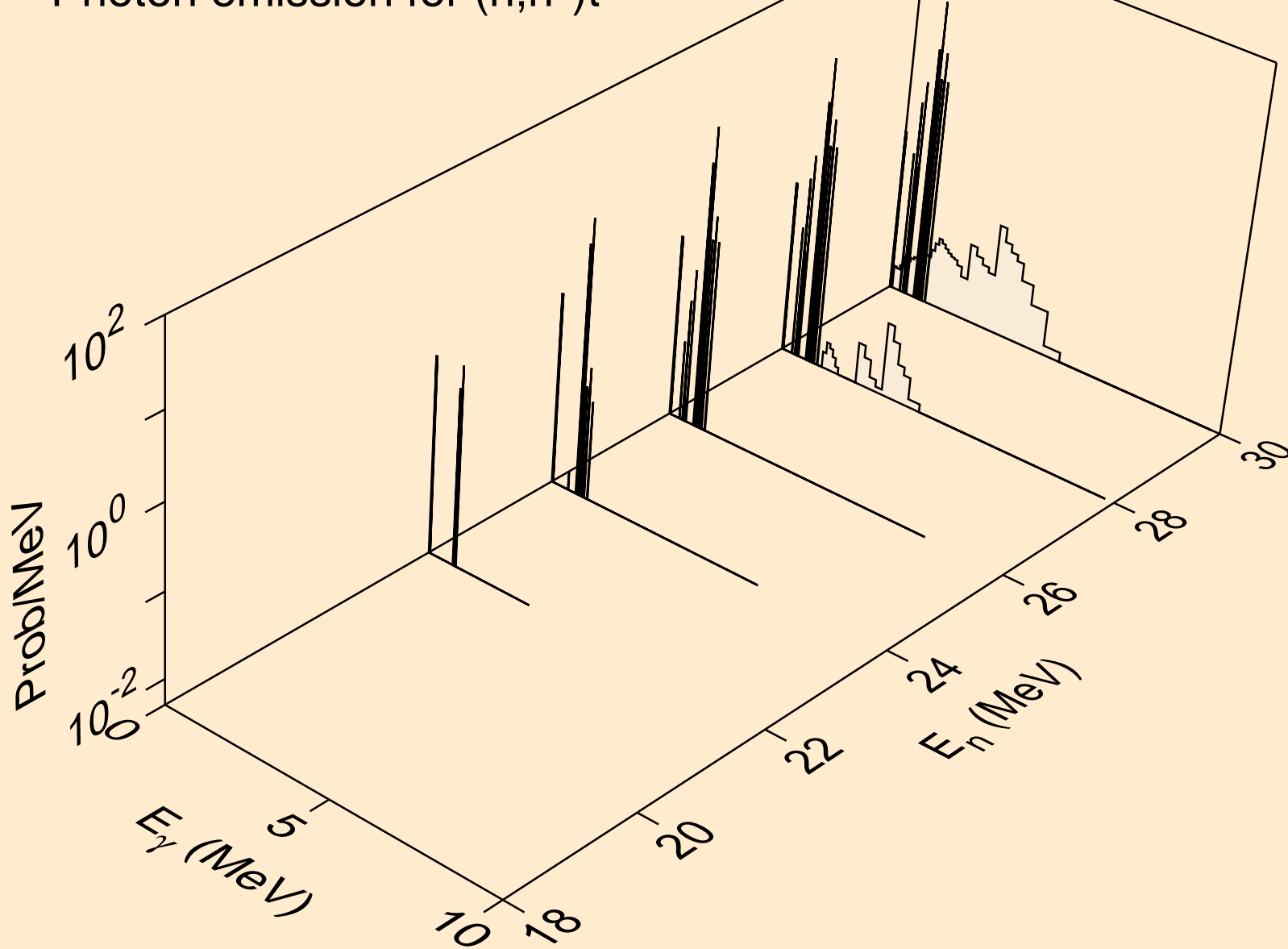

TC090N NEUTRON ACER TENDL-2019 LIBRARY; T=293.16K
Photon emission for (n,n*)he3

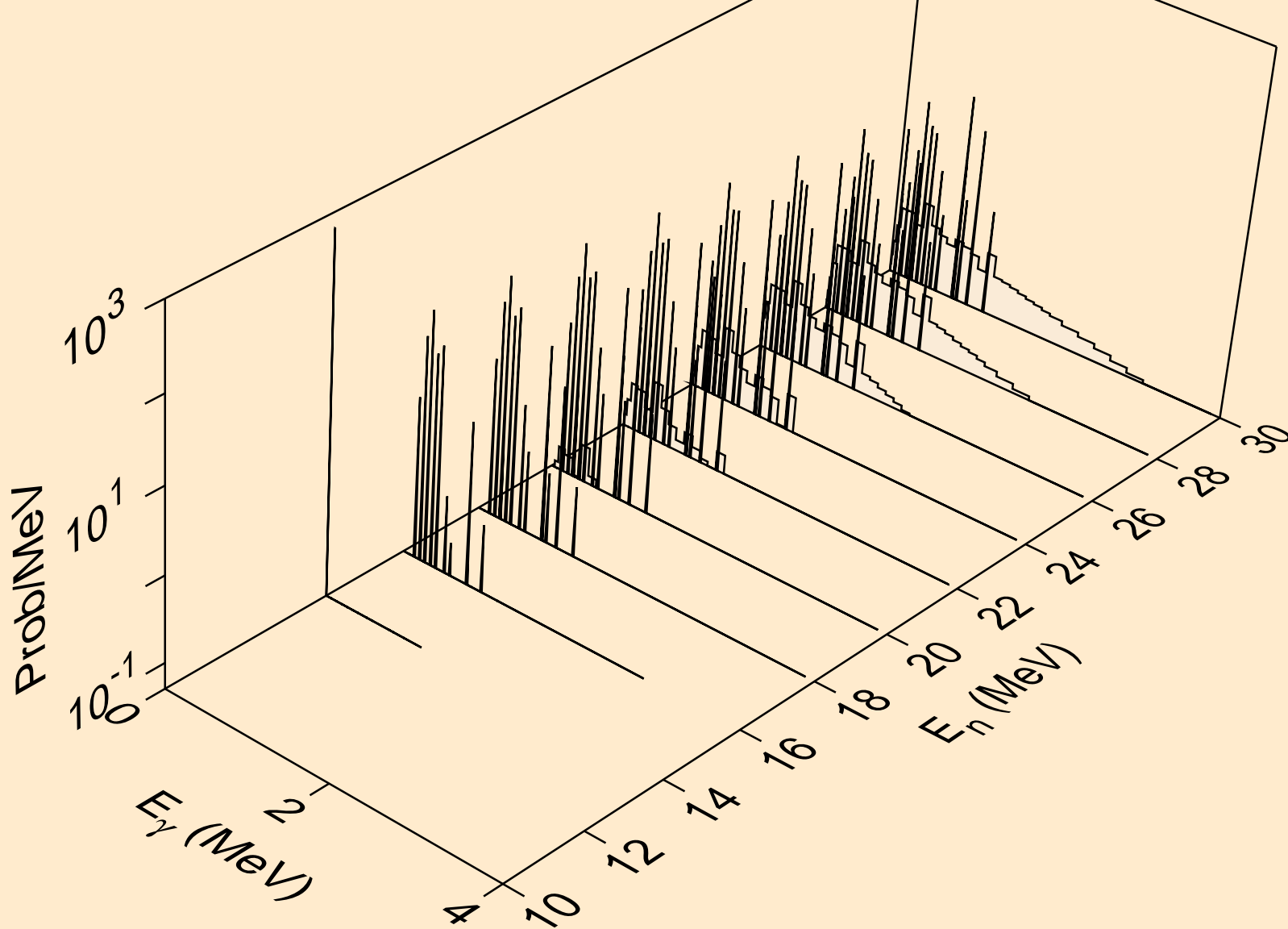

TC090N NEUTRON ACER TENDL-2019 LIBRARY; T=293.16K
Photon emission for (n,2np)

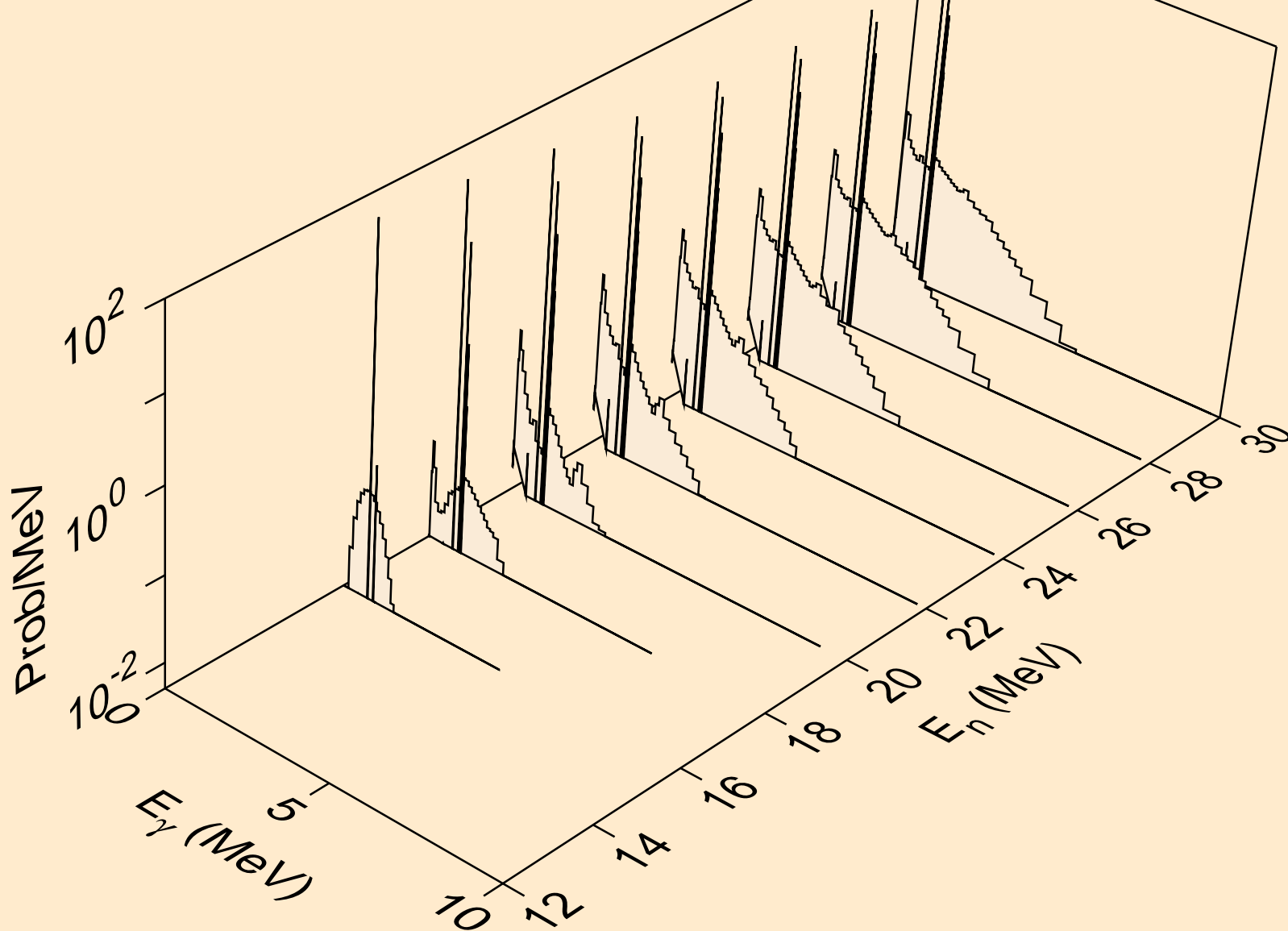

TC090N NEUTRON ACER TENDL-2019 LIBRARY; T=293.16K
Photon emission for (n,3np)

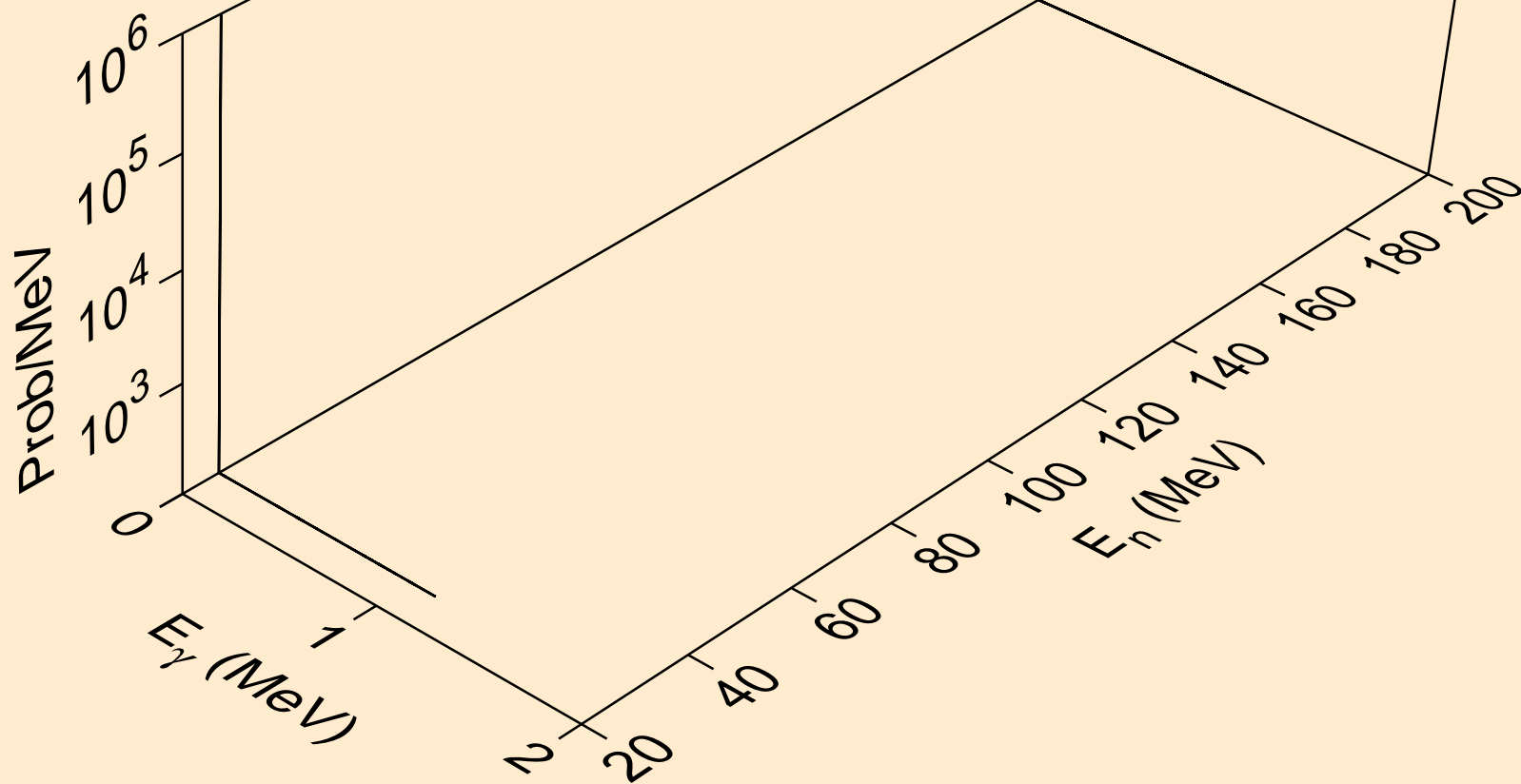

TC090N NEUTRON ACER TENDL-2019 LIBRARY; T=293.16K
Photon emission for (n,2np)

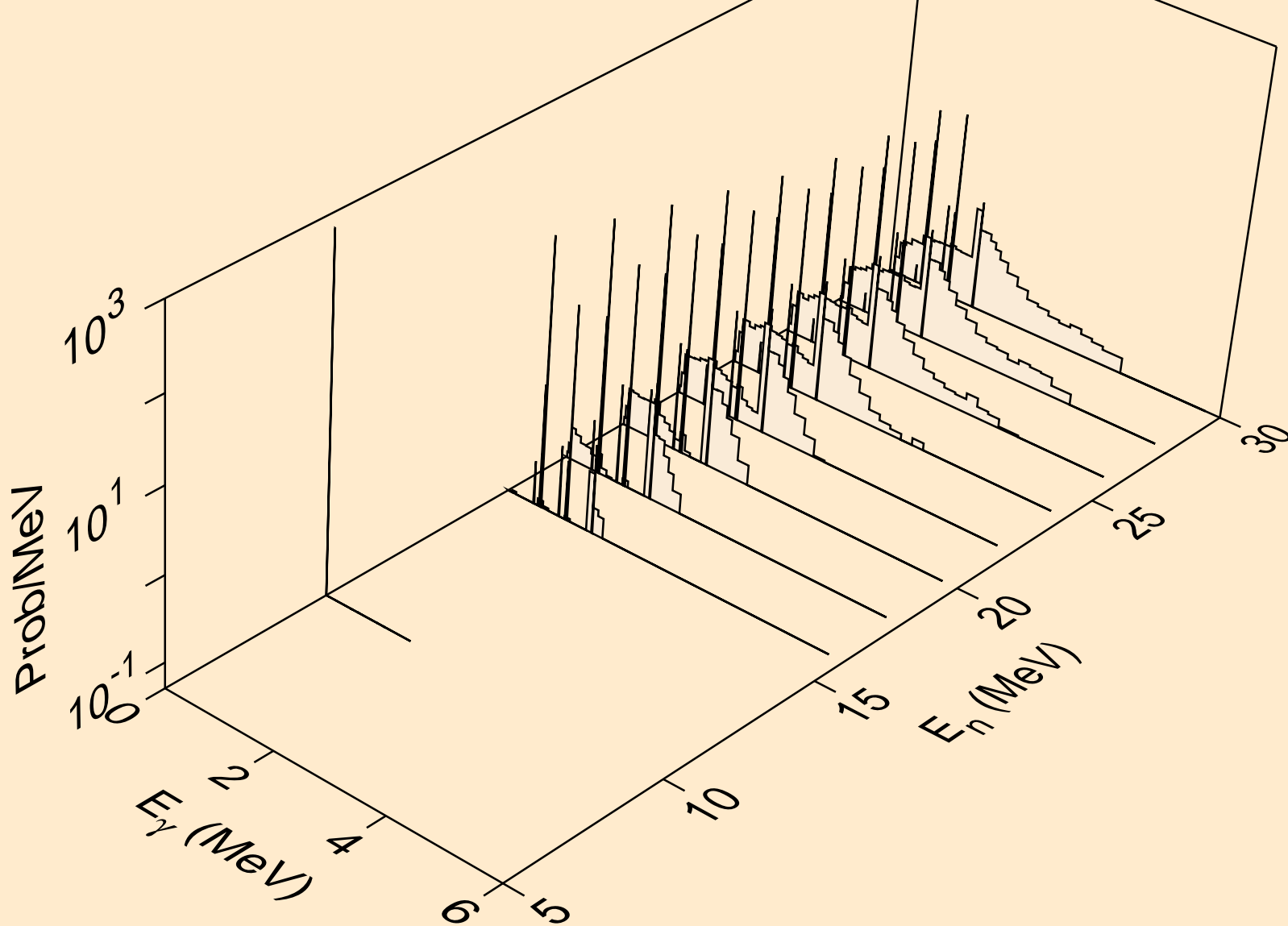

TC090N NEUTRON ACER TENDL-2019 LIBRARY; T=293.16K
Photon emission for (n,npa)

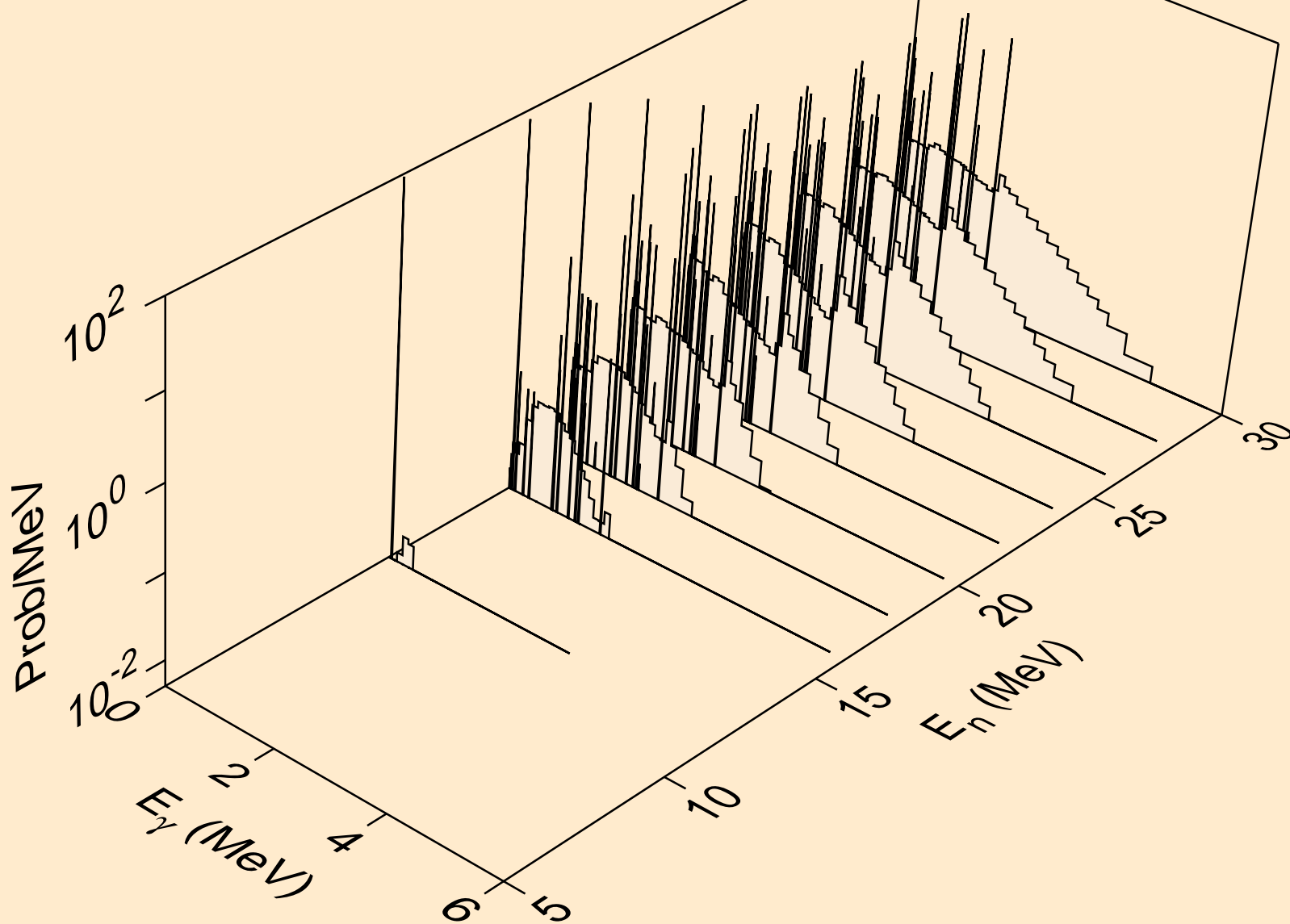

TC090N NEUTRON ACER TENDL-2019 LIBRARY; T=293.16K
Photon emission for (n,n*1)

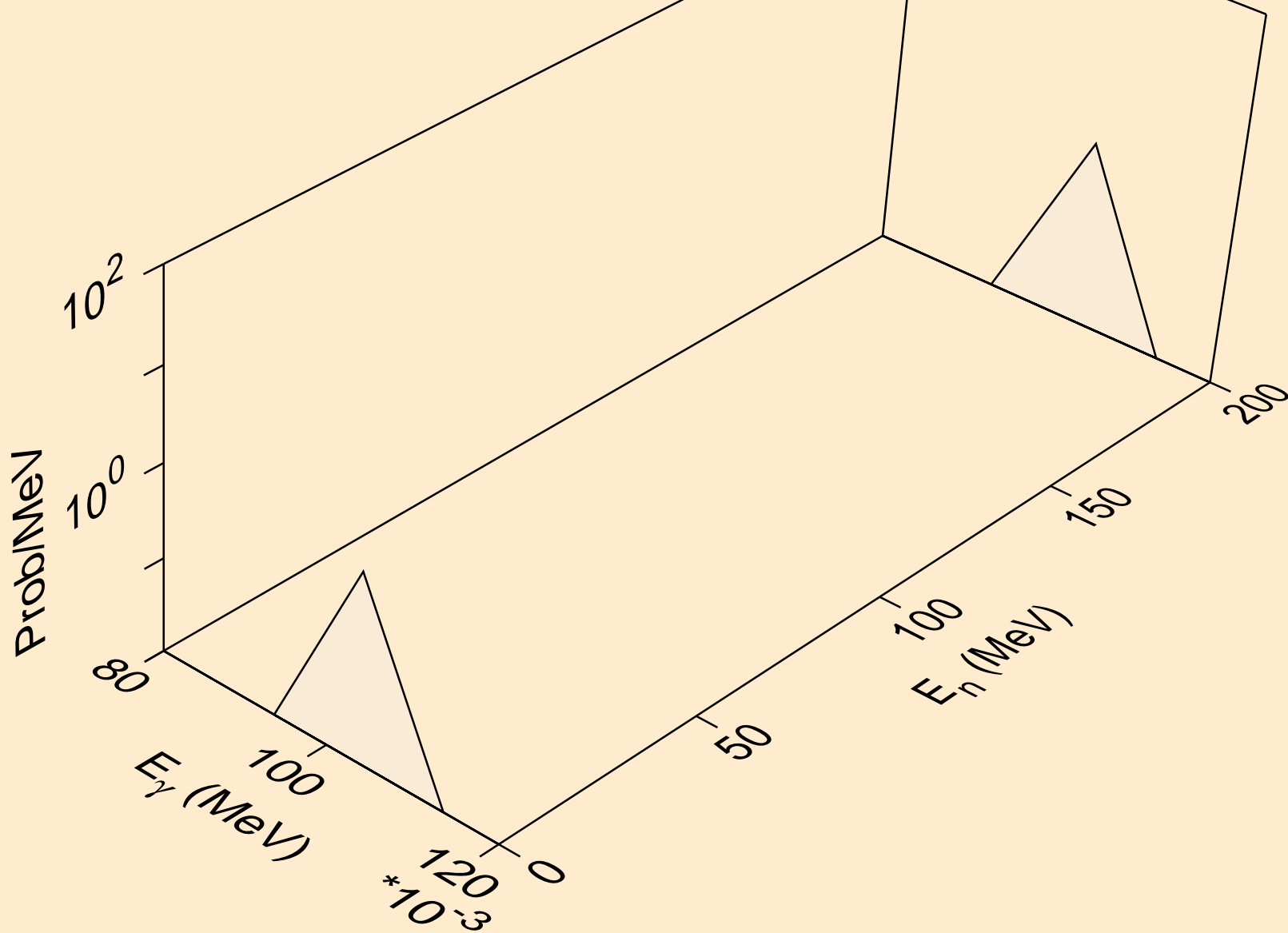

TC090N NEUTRON ACER TENDL-2019 LIBRARY; T=293.16K
Photon emission for (n,n*2)

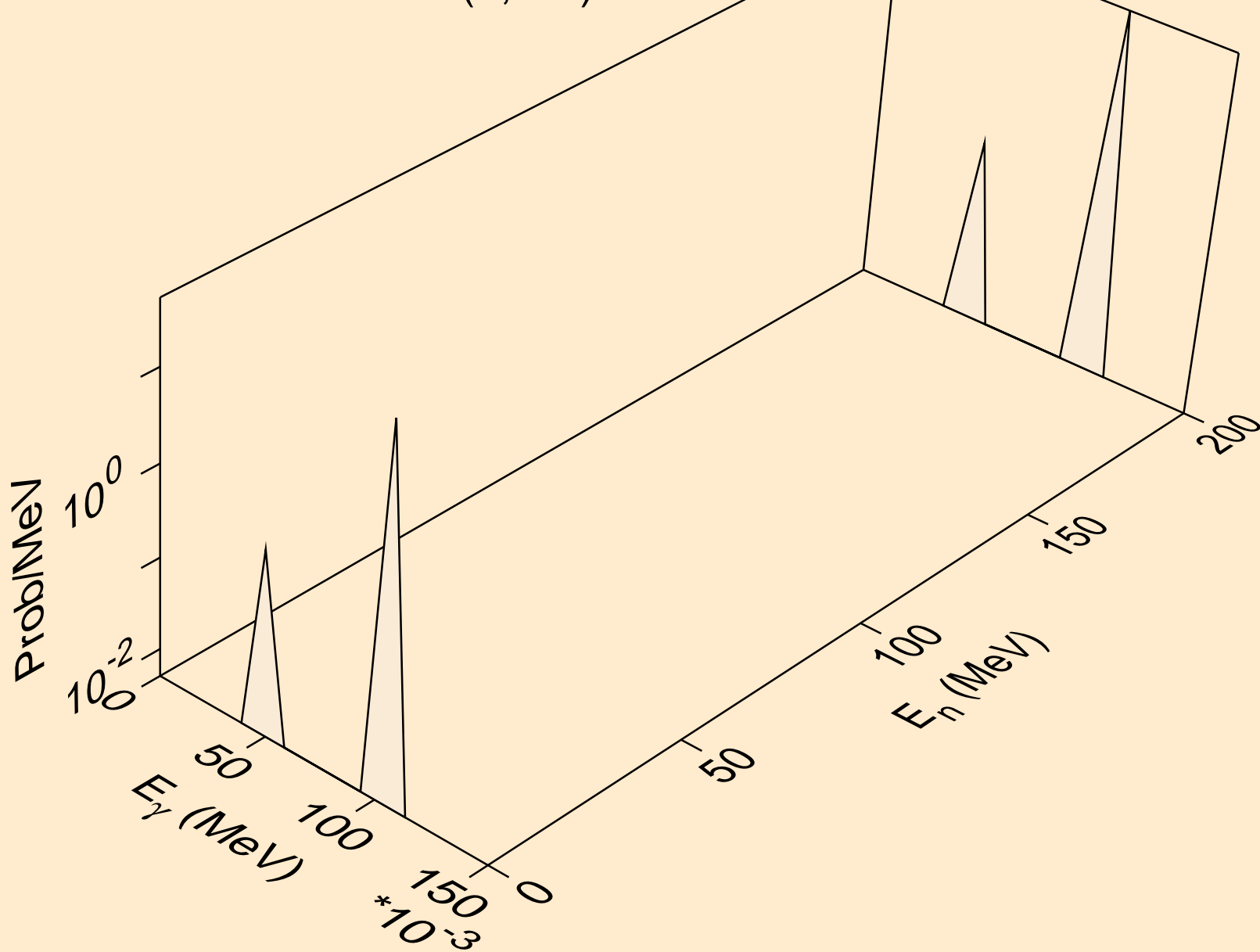

TC090N NEUTRON ACER TENDL-2019 LIBRARY; T=293.16K
Photon emission for (n,n*3)

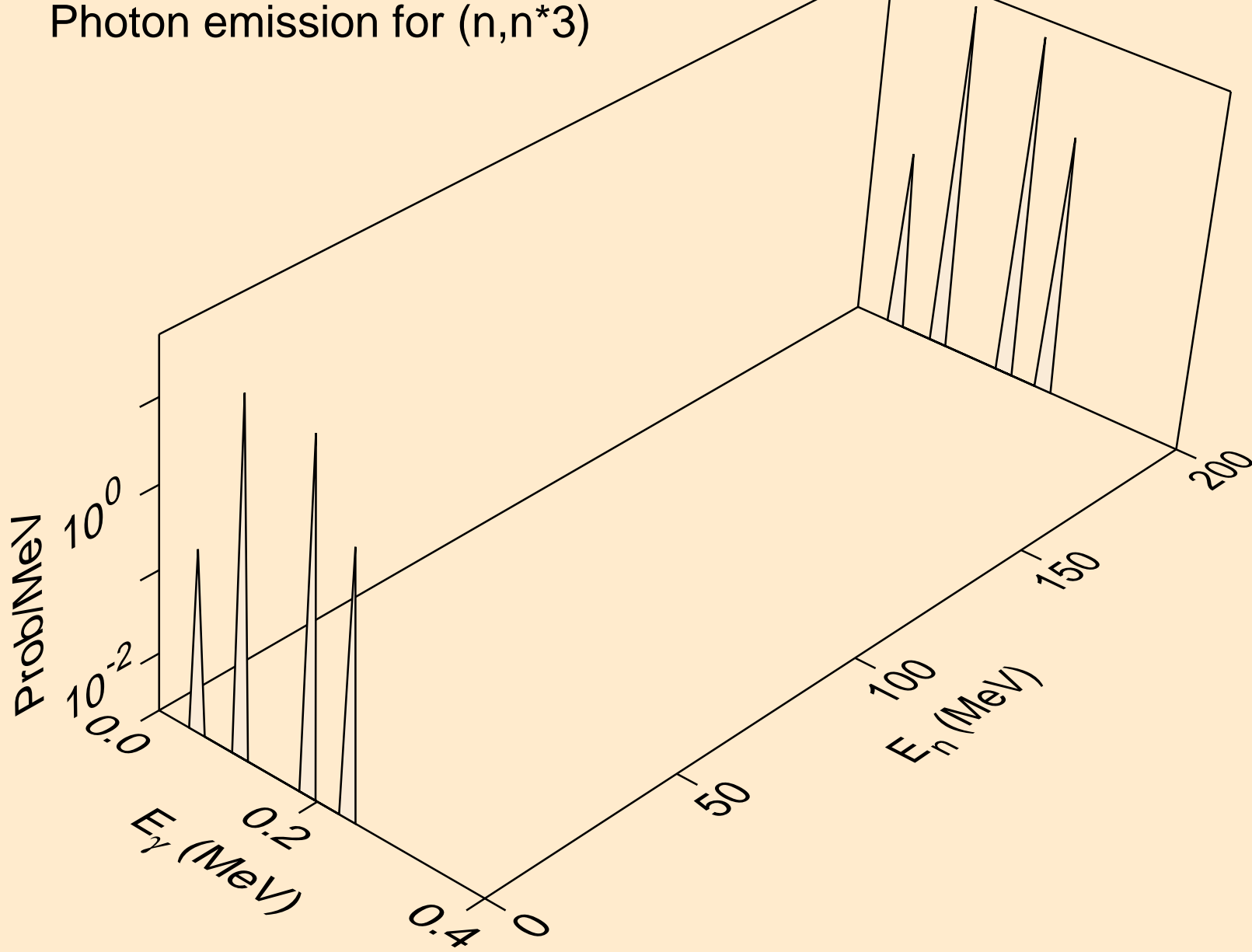

TC090N NEUTRON ACER TENDL-2019 LIBRARY; T=293.16K
Photon emission for (n,n*5)

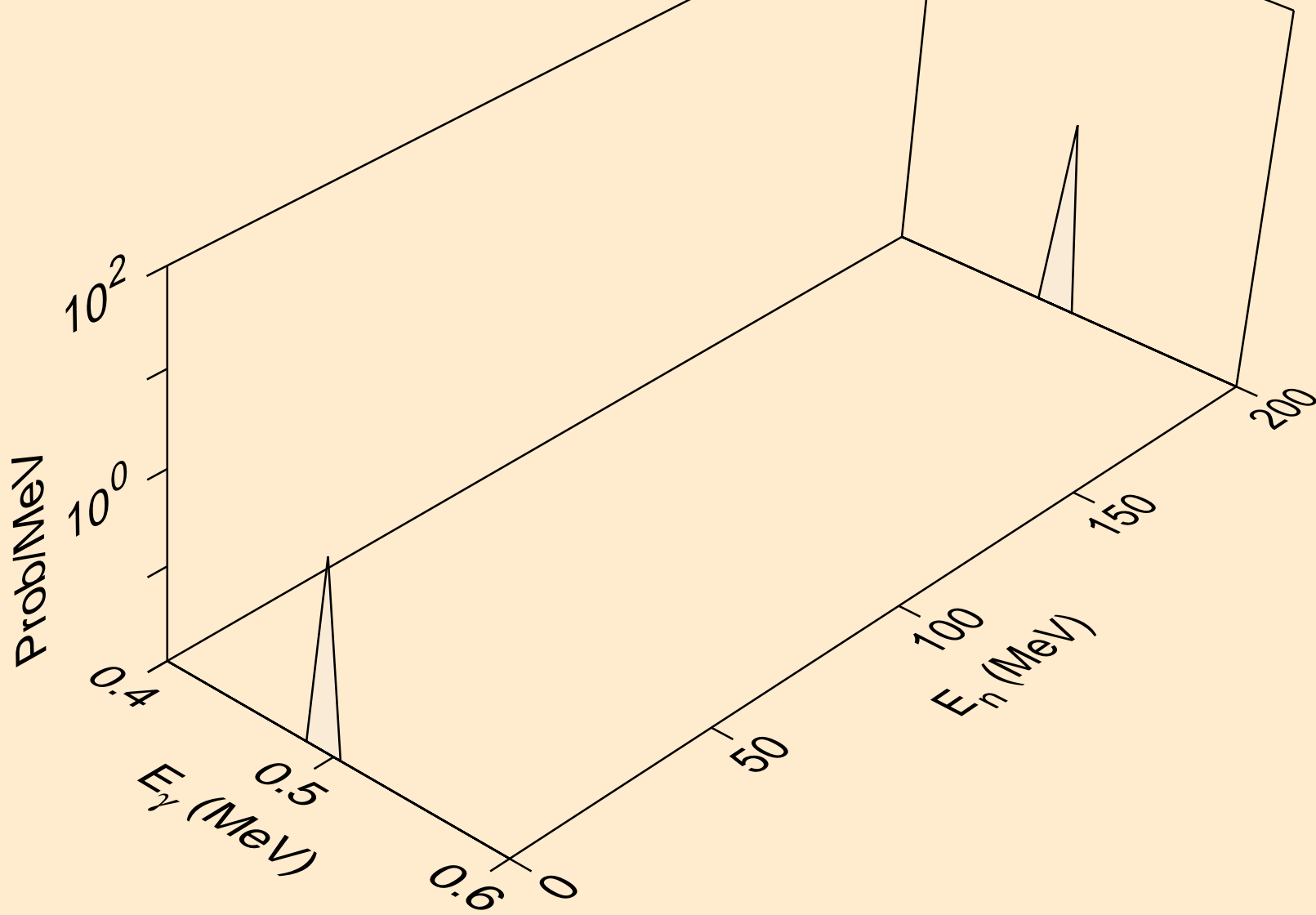

TC090N NEUTRON ACER TENDL-2019 LIBRARY; T=293.16K
Photon emission for (n,n*c)

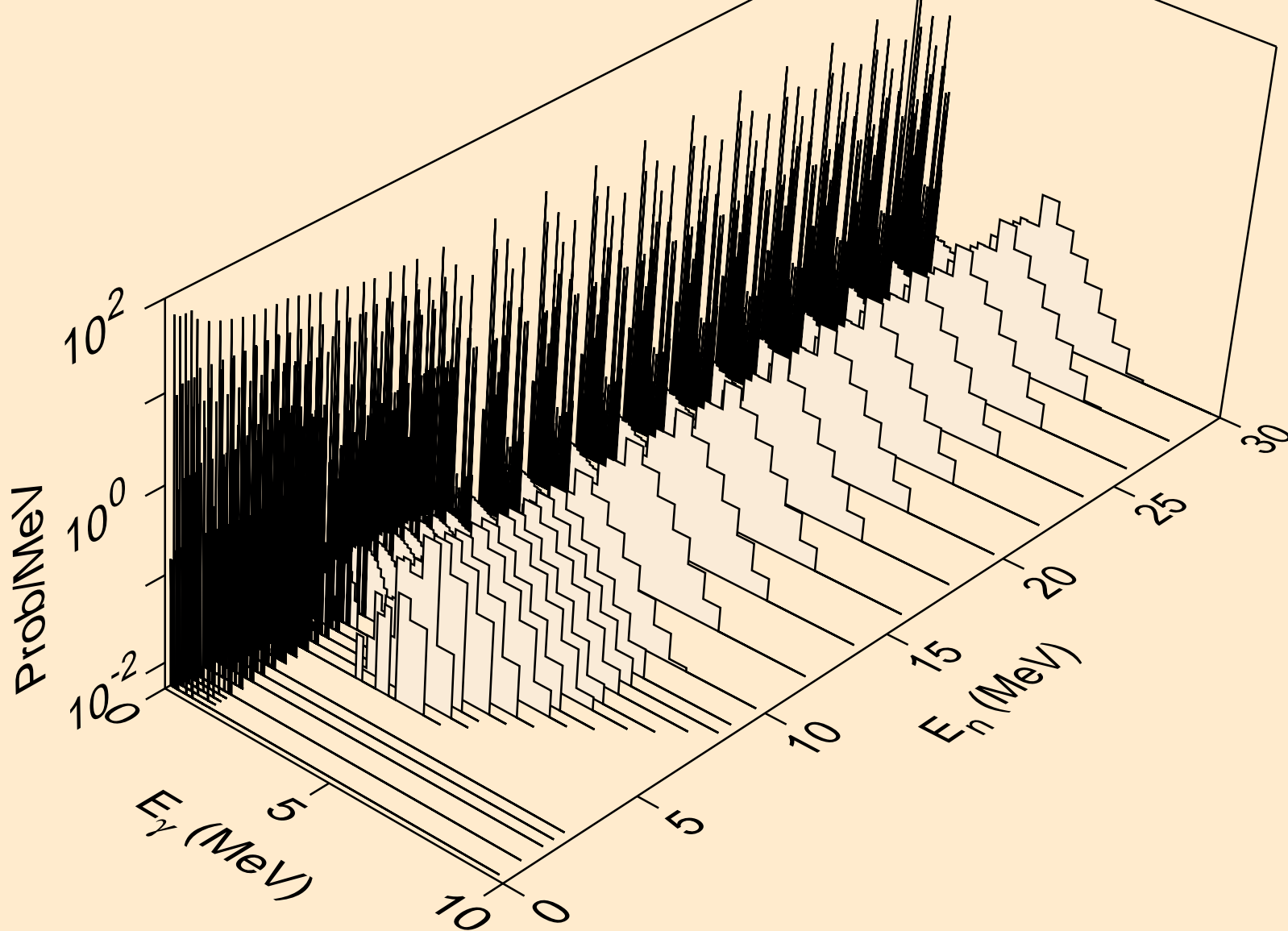

TC090N NEUTRON ACER TENDL-2019 LIBRARY; T=293.16K
Photon emission for (n,gma)

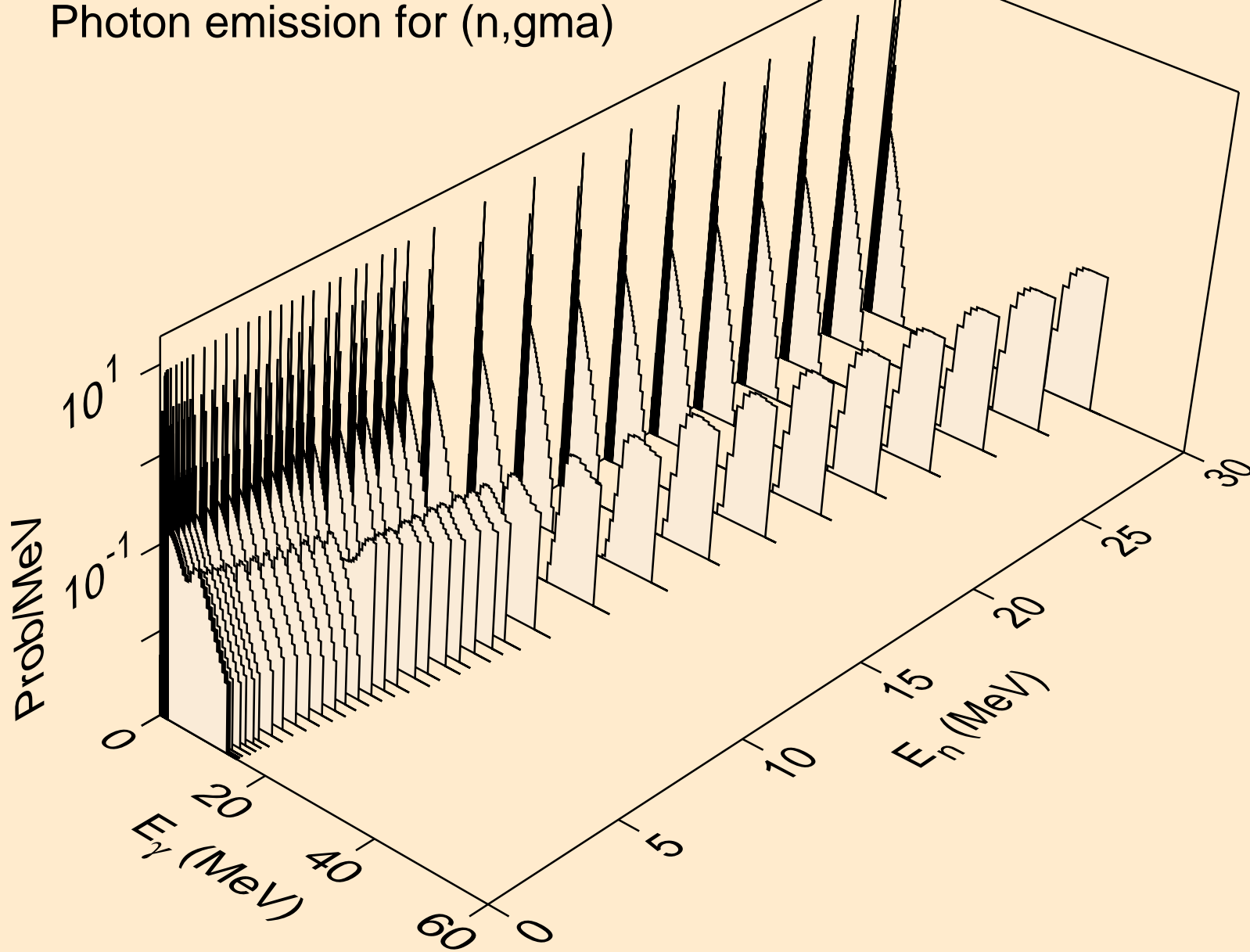

TC090N NEUTRON ACER TENDL-2019 LIBRARY; T=293.16K
Photon emission for (n,p)

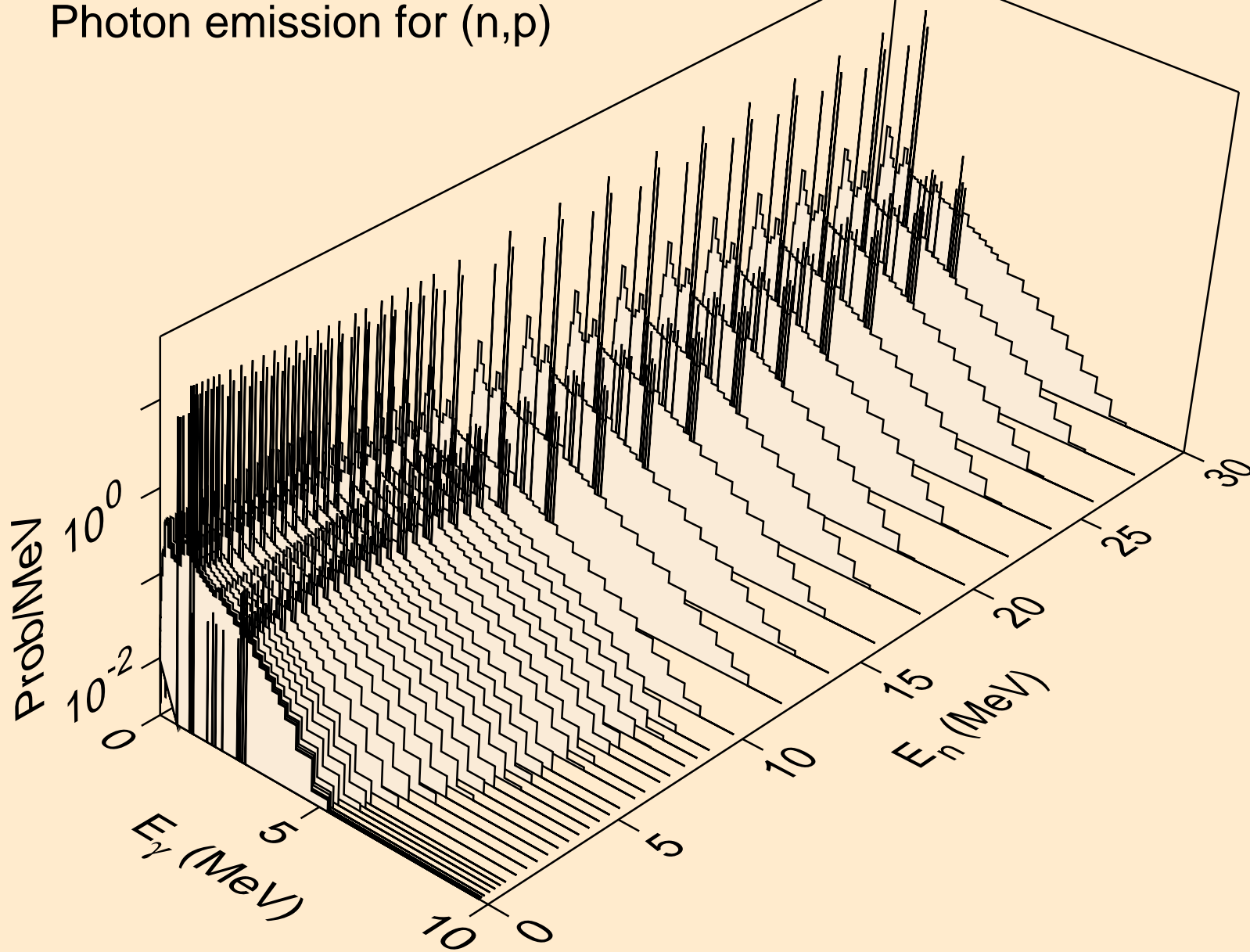

TC090N NEUTRON ACER TENDL-2019 LIBRARY; T=293.16K
Photon emission for (n,d)

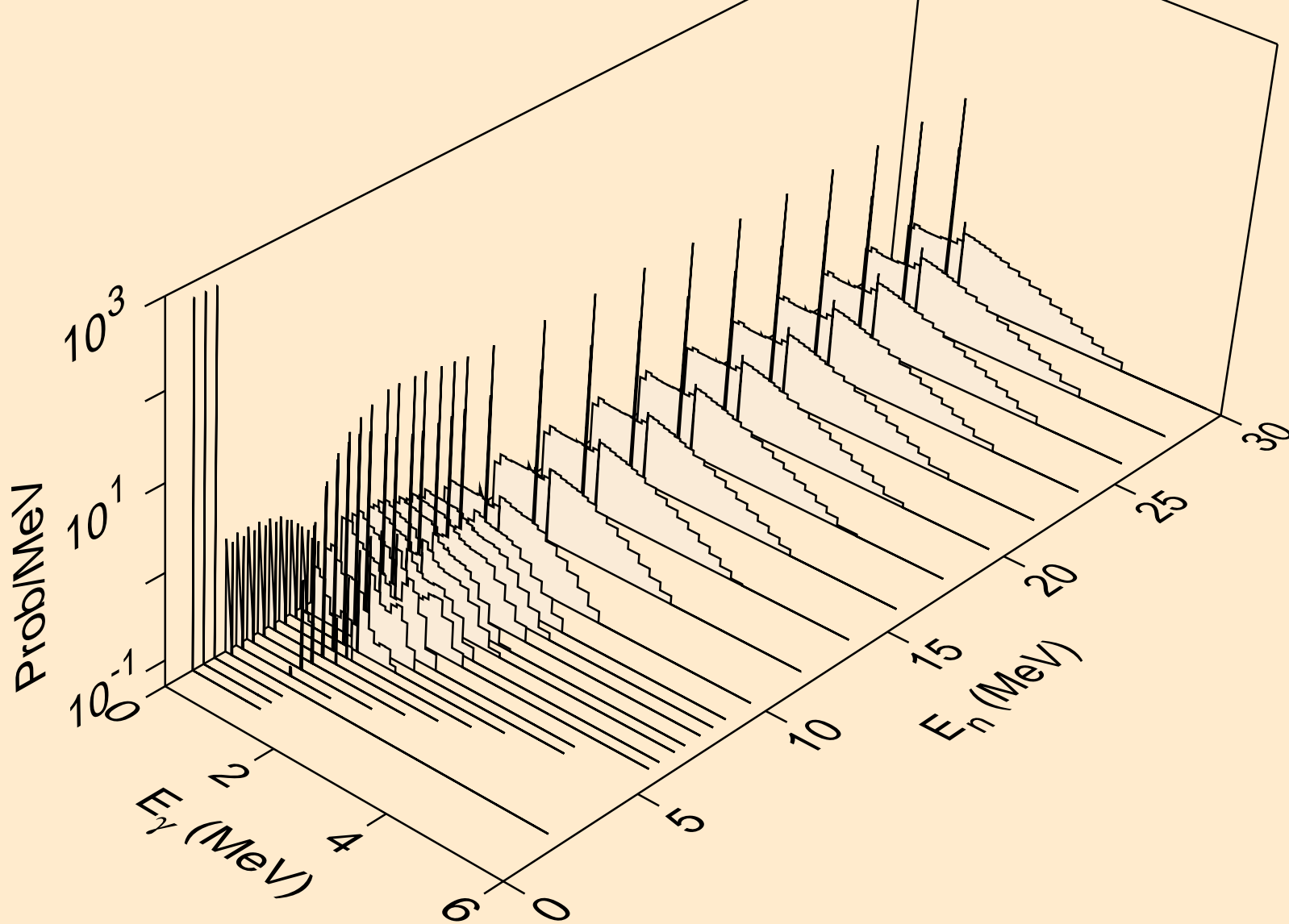

TC090N NEUTRON ACER TENDL-2019 LIBRARY; T=293.16K
Photon emission for (n,t)

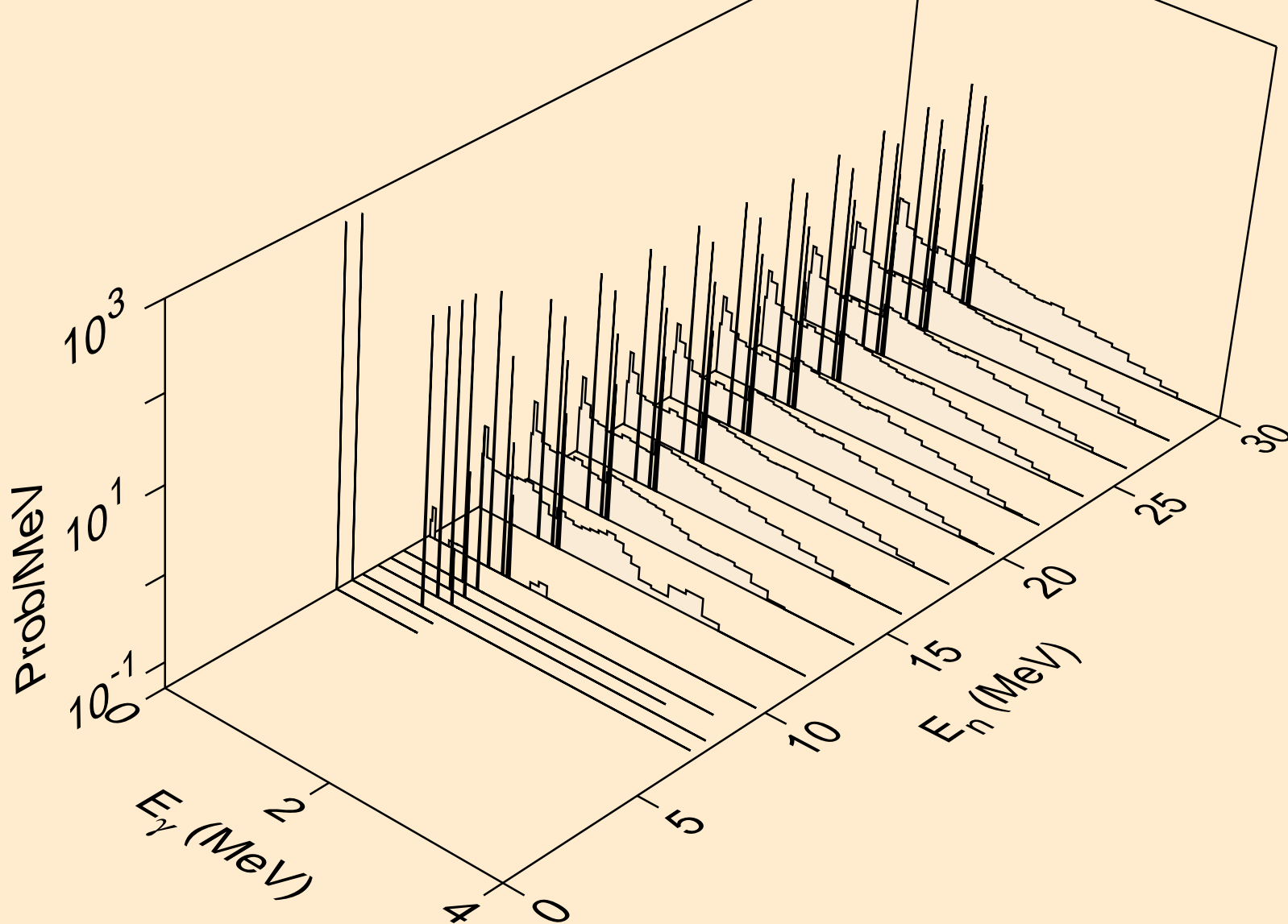

TC090N NEUTRON ACER TENDL-2019 LIBRARY; T=293.16K
Photon emission for (n,he3)

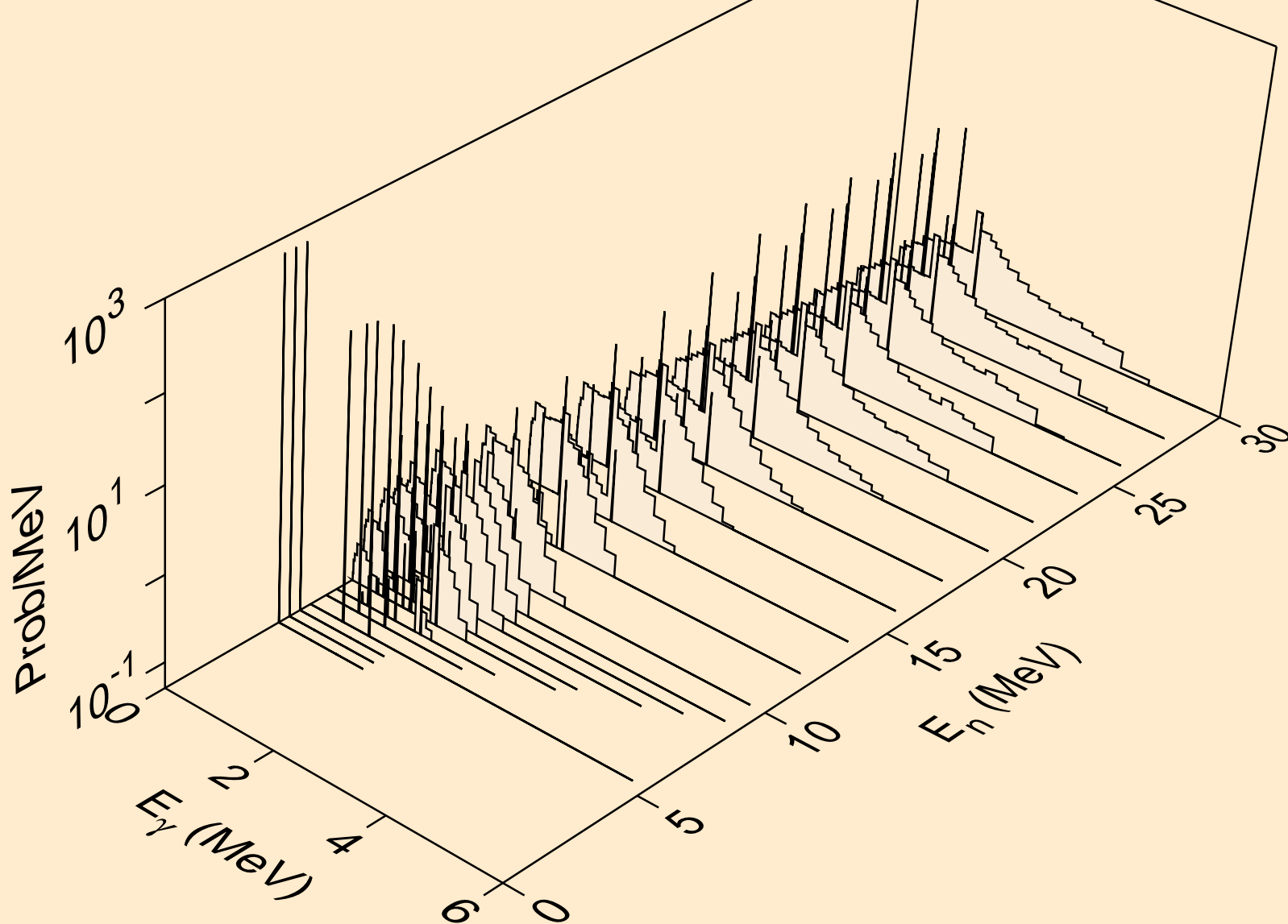

TC090N NEUTRON ACER TENDL-2019 LIBRARY; T=293.16K
Photon emission for (n,a)

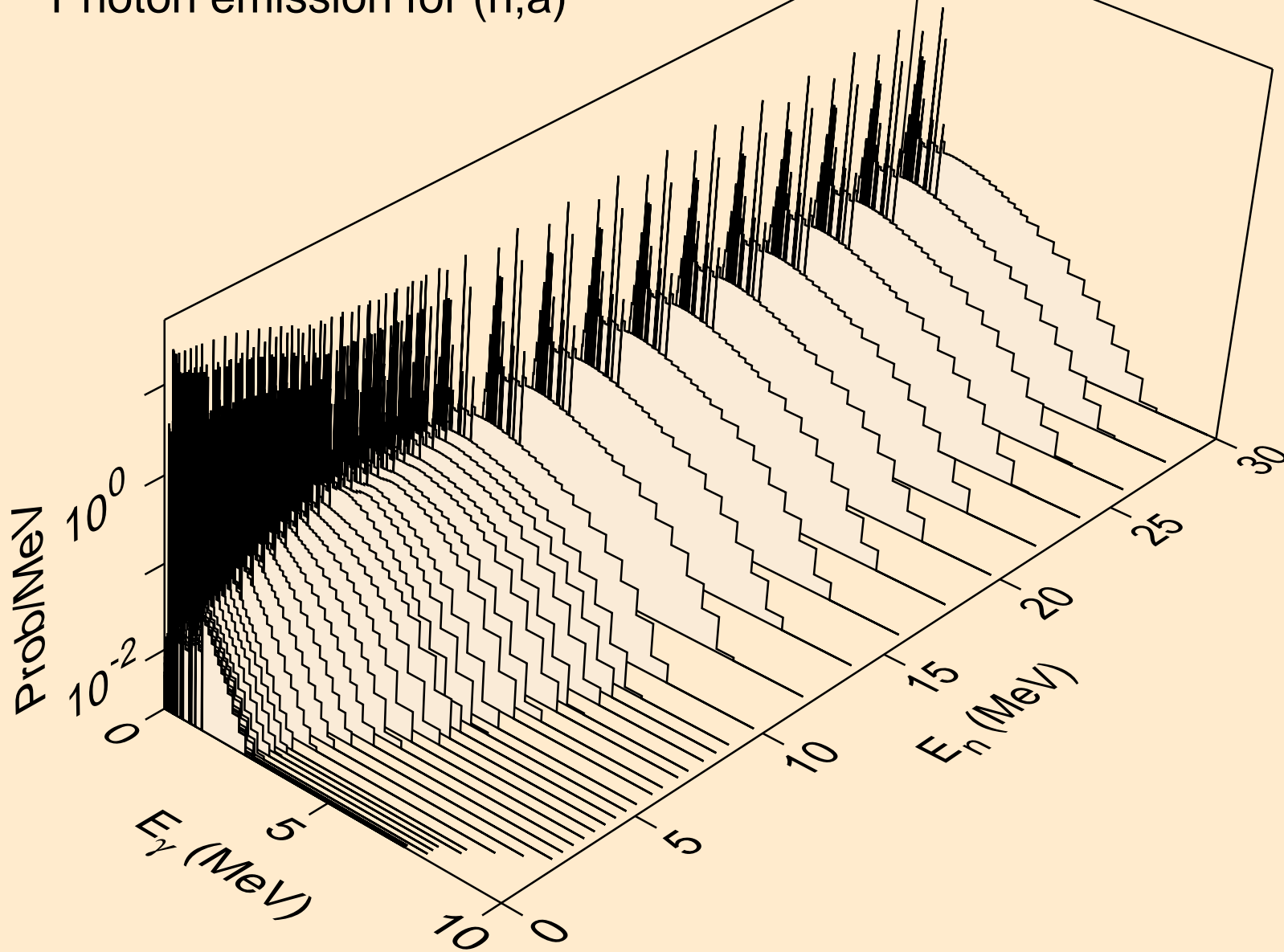

TC090N NEUTRON ACER TENDL-2019 LIBRARY; T=293.16K
Photon emission for (n,2a)

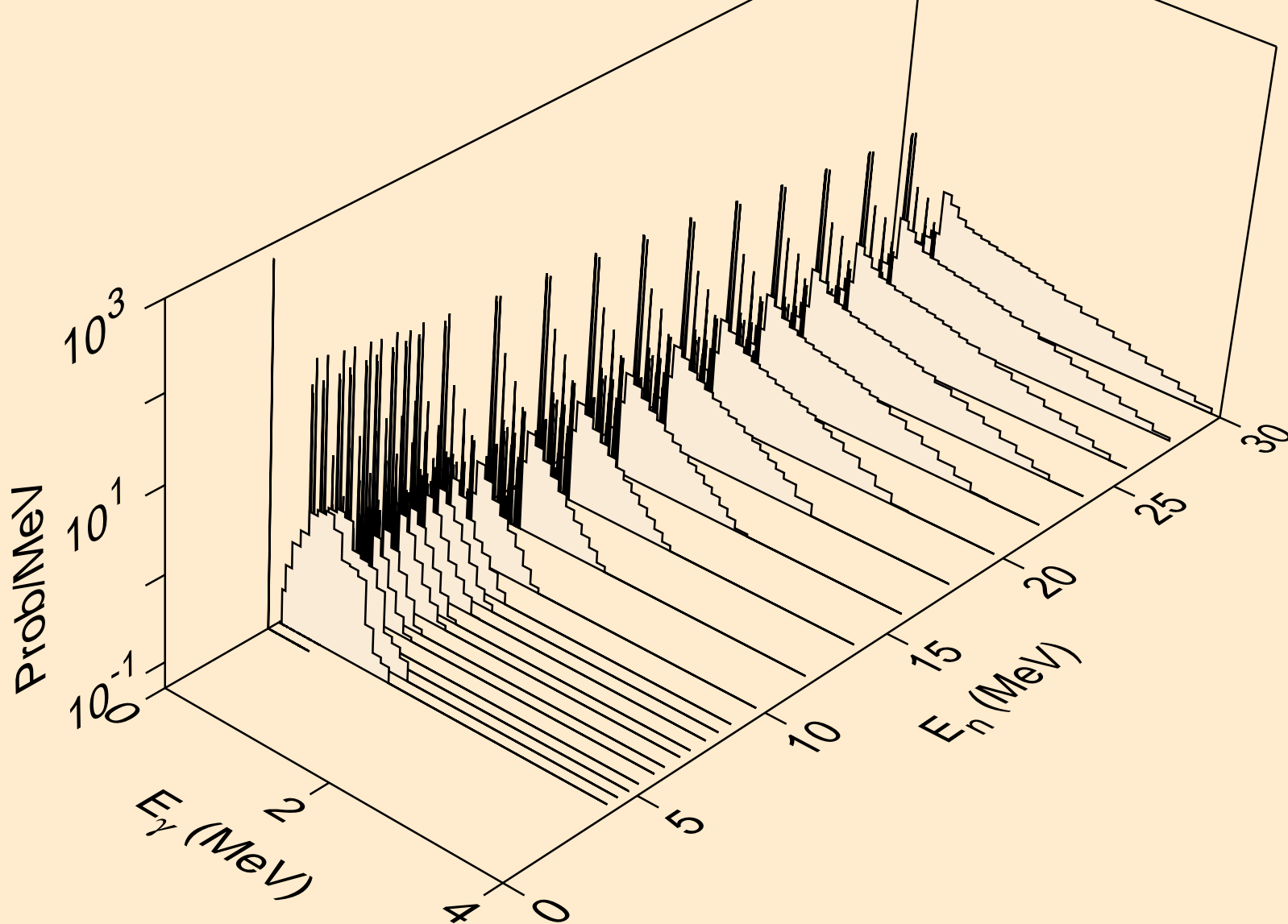

TC090N NEUTRON ACER TENDL-2019 LIBRARY; T=293.16K
Photon emission for (n,3a)

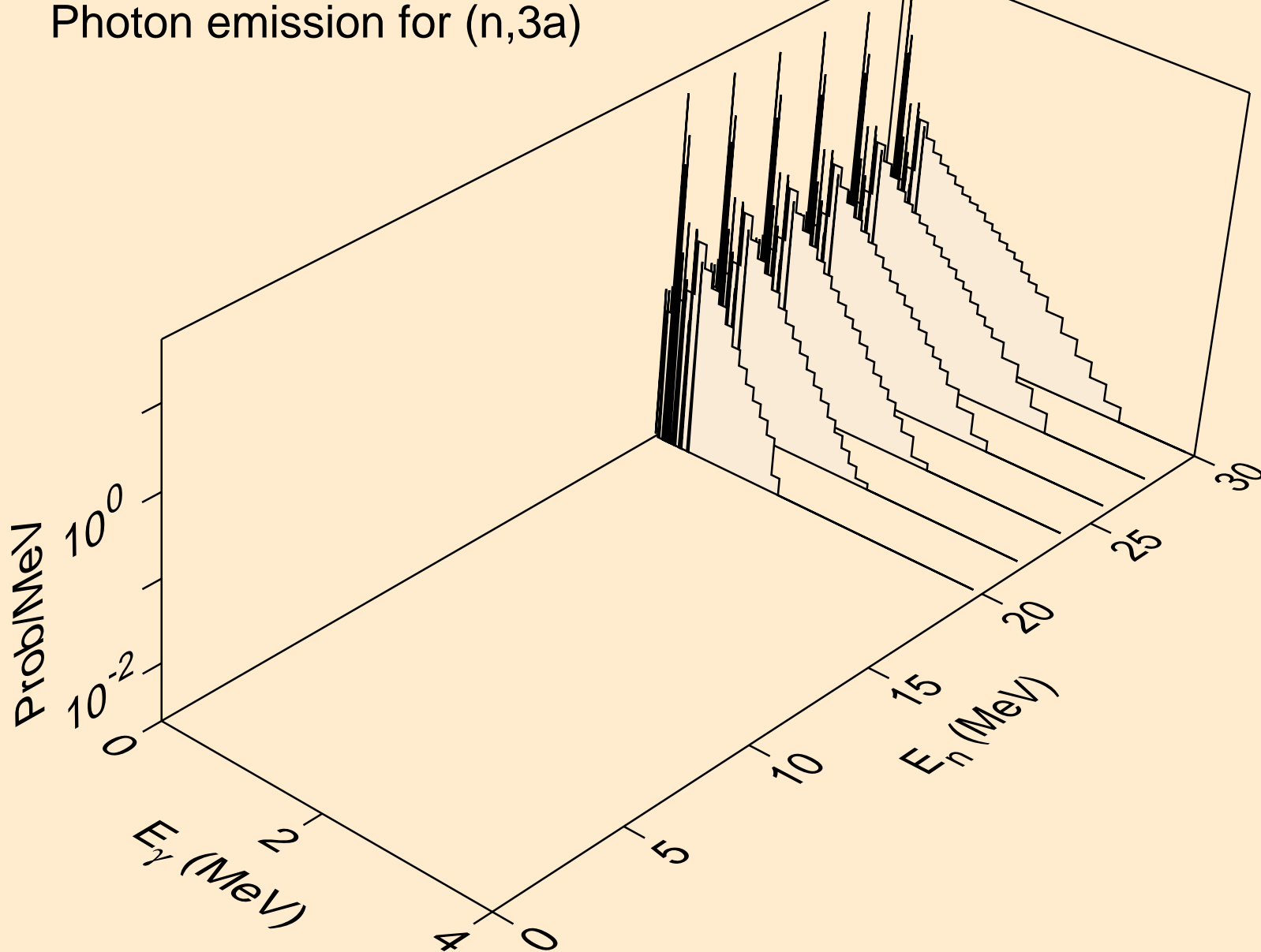

TC090N NEUTRON ACER TENDL-2019 LIBRARY; T=293.16K
Photon emission for (n,2p)

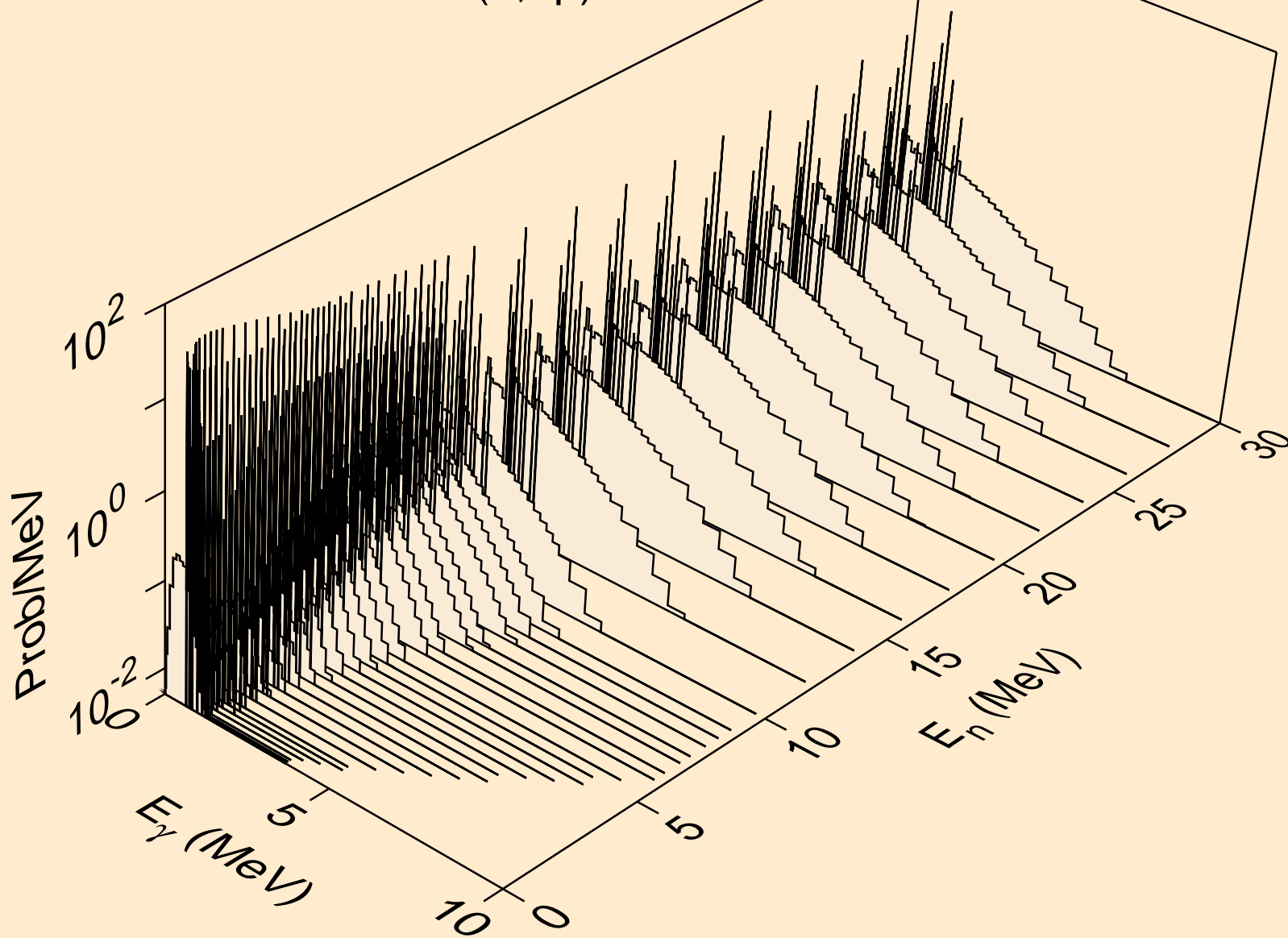

TC090N NEUTRON ACER TENDL-2019 LIBRARY; T=293.16K
Photon emission for (n,p α)

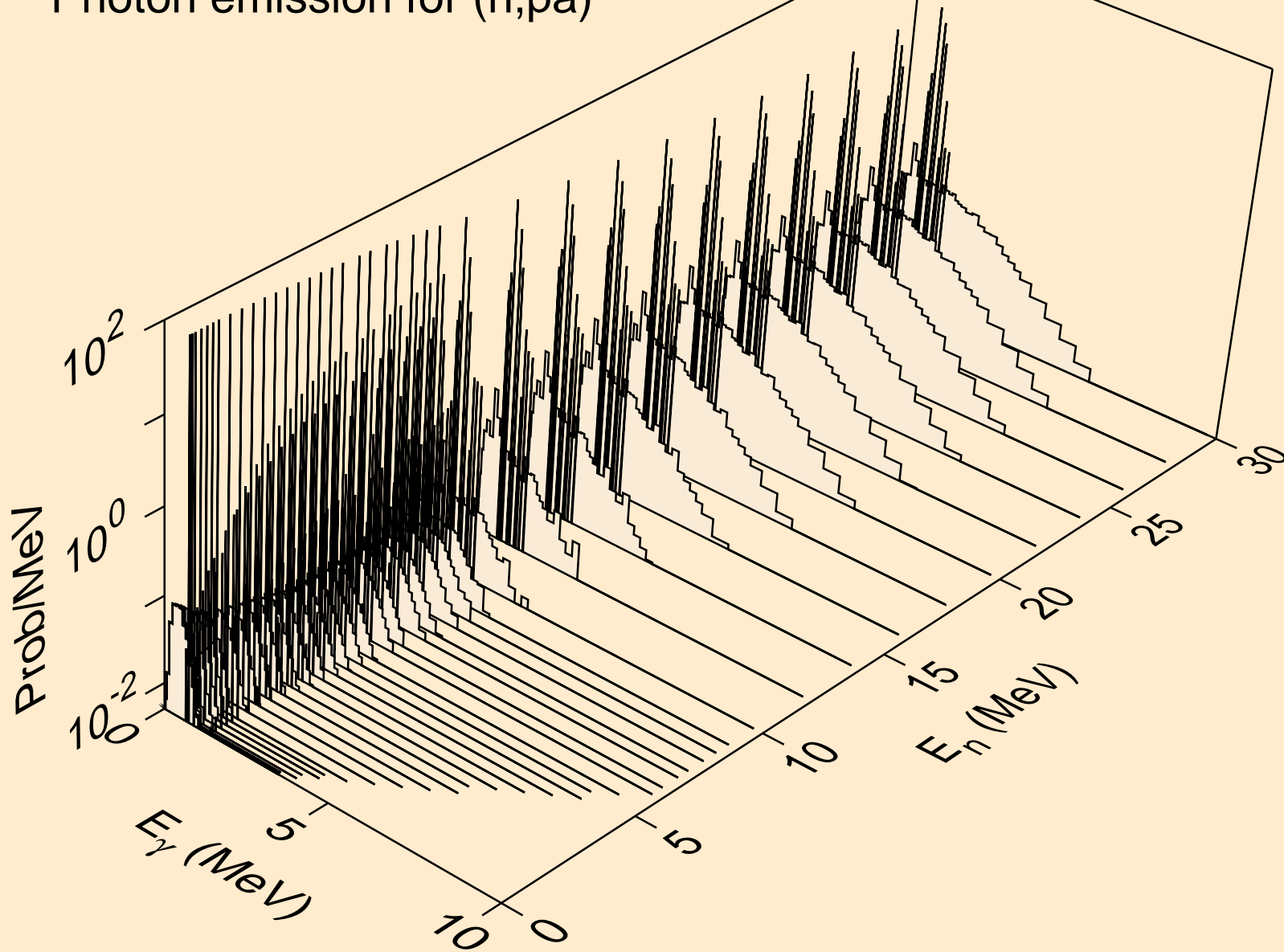

TC090N NEUTRON ACER TENDL-2019 LIBRARY; T=293.16K
Photon emission for (n,pd)

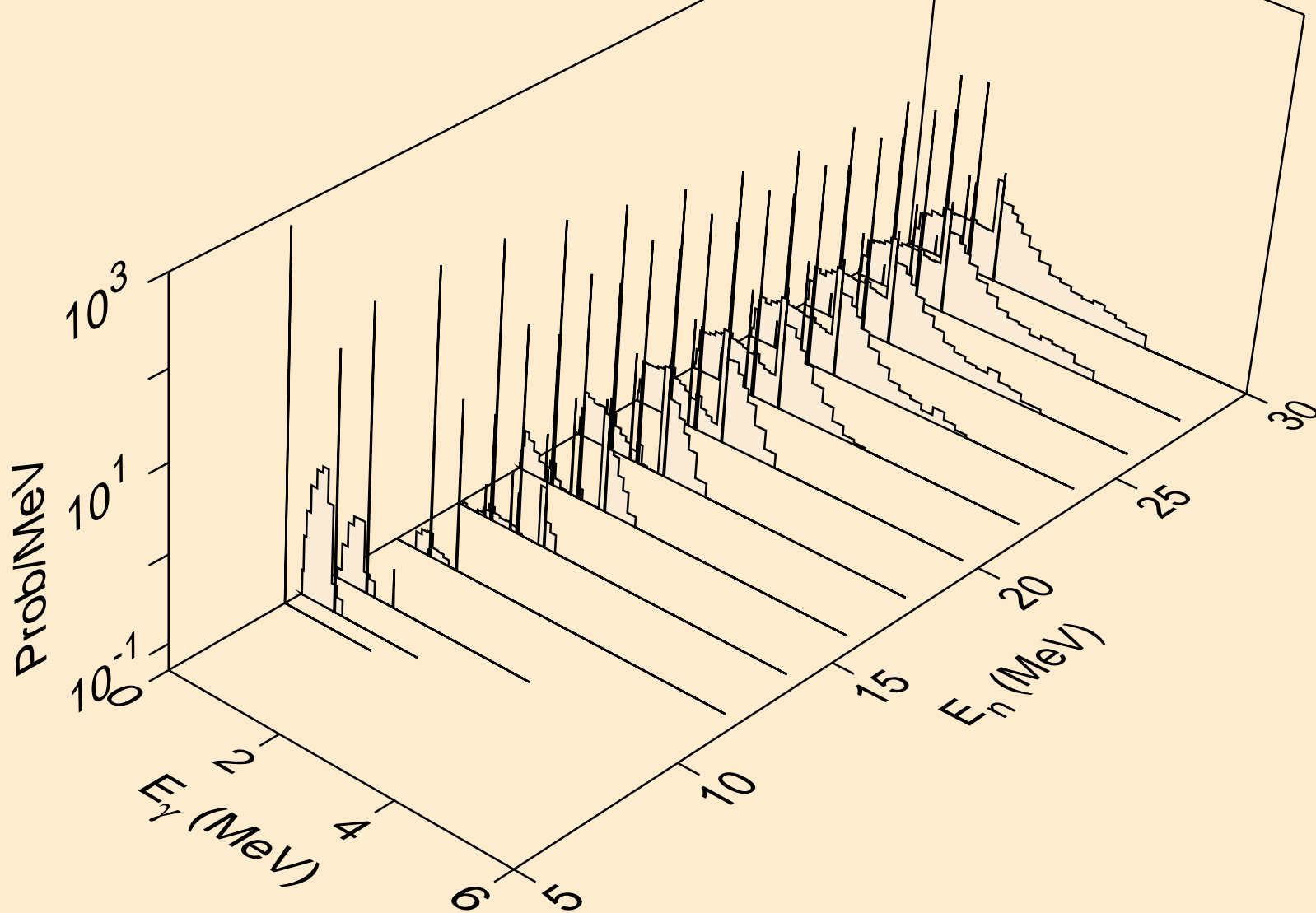

TC090N NEUTRON ACER TENDL-2019 LIBRARY; T=293.16K
Photon emission for (n,pt)

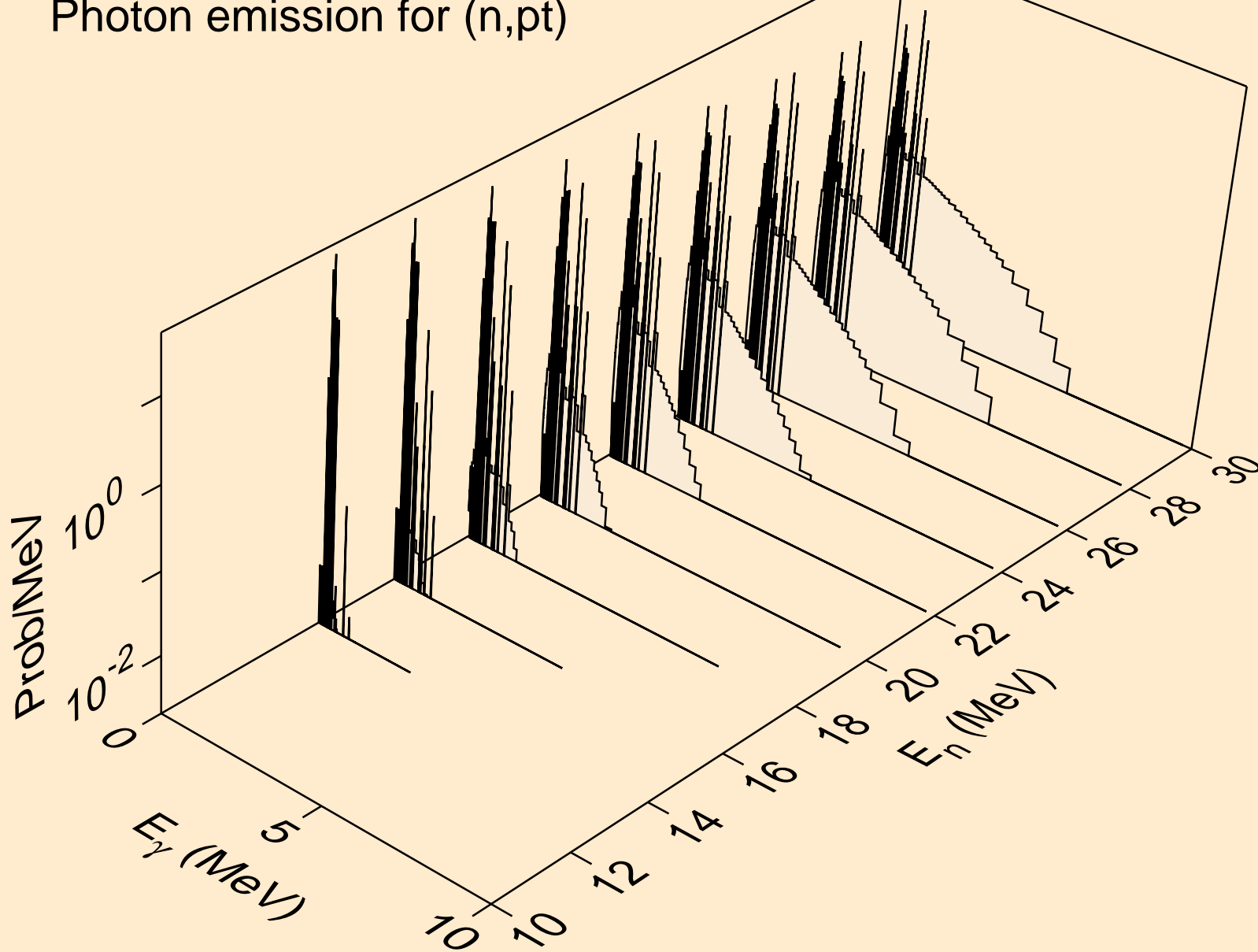

TC090N NEUTRON ACER TENDL-2019 LIBRARY; T=293.16K
Photon emission for (n,da)

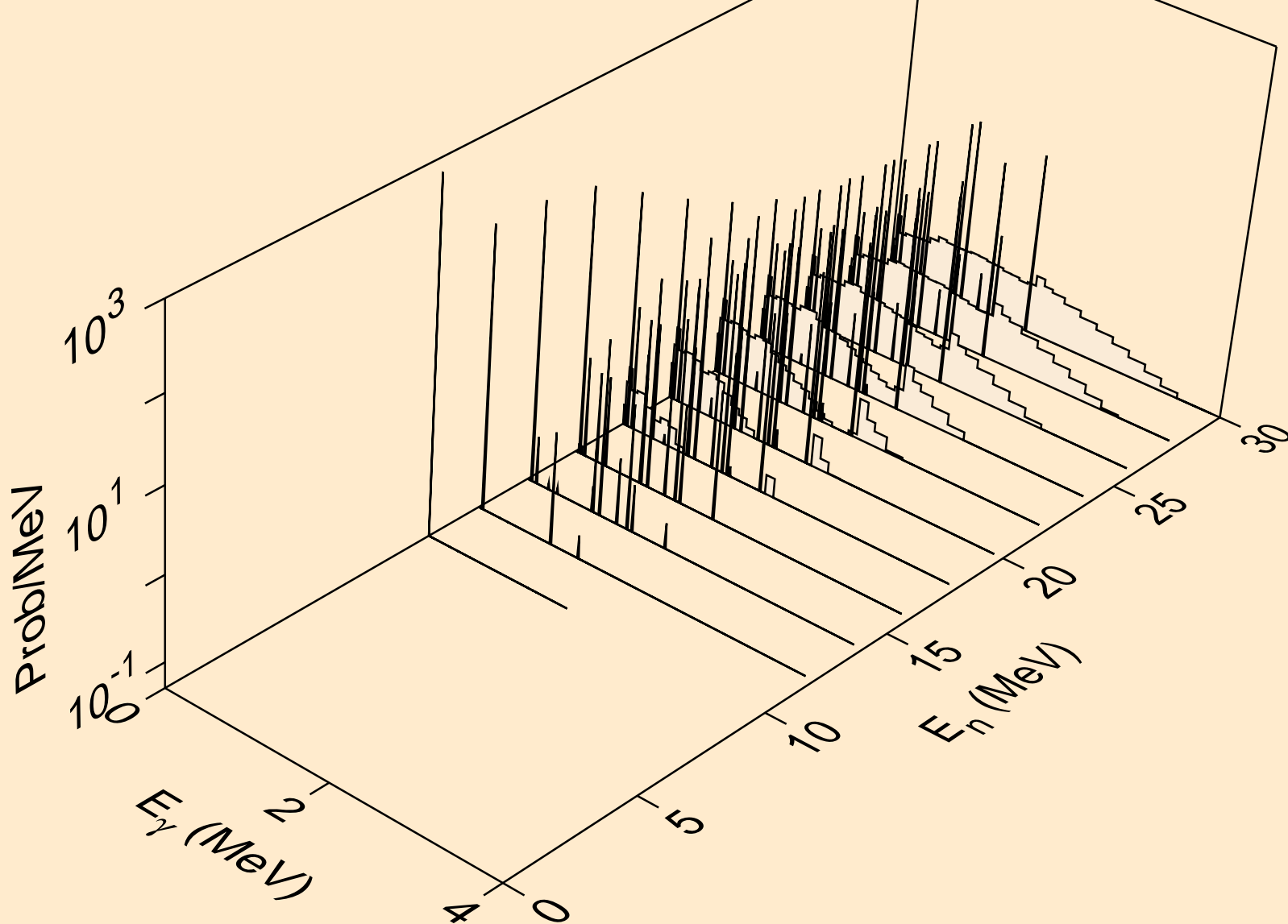

TC090N NEUTRON ACER TENDL-2019 LIBRARY; T=293.16K
thermal capture photon spectrum

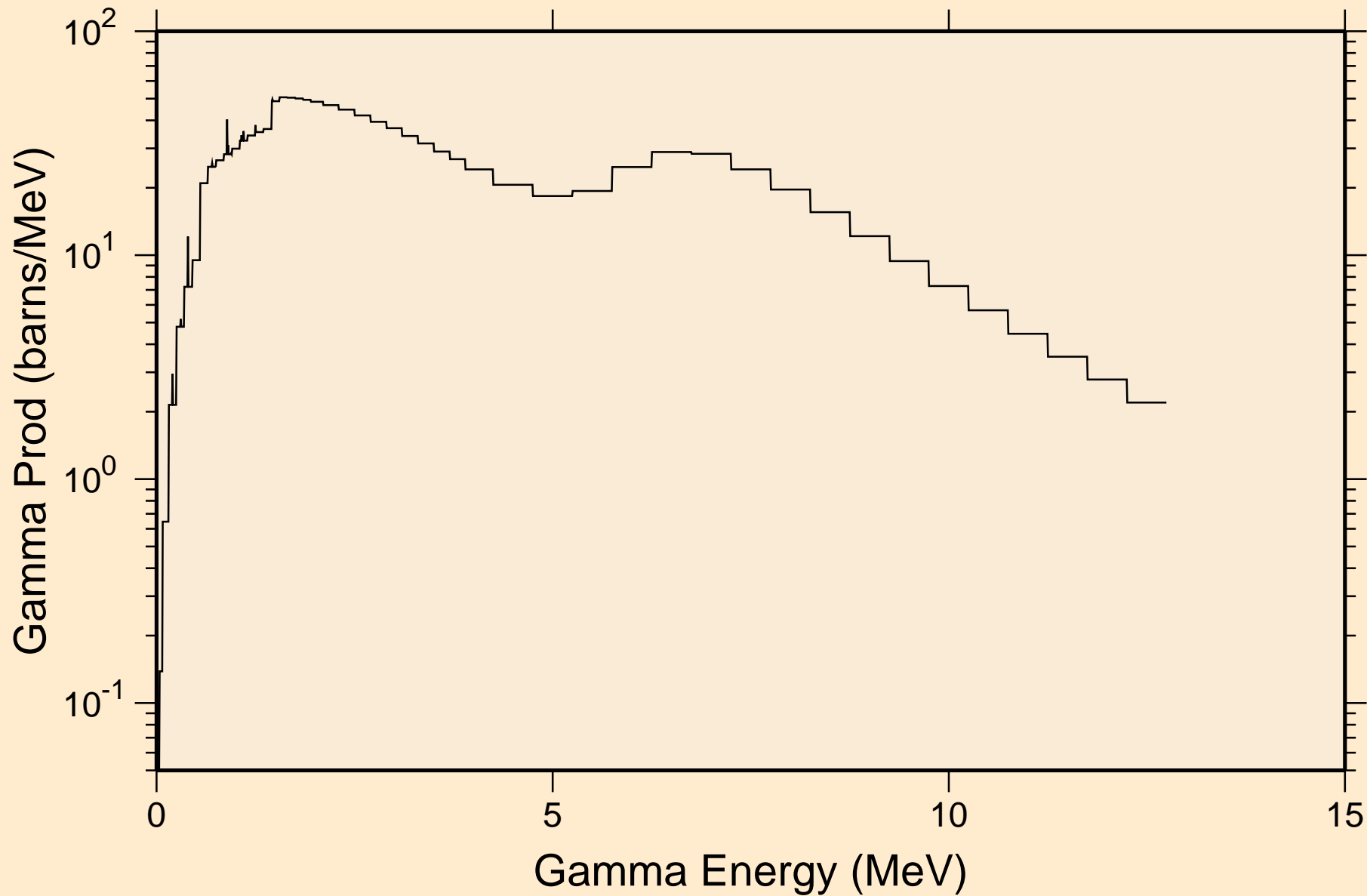

TC090N NEUTRON ACER TENDL-2019 LIBRARY; T=293.16K
14 MeV photon spectrum

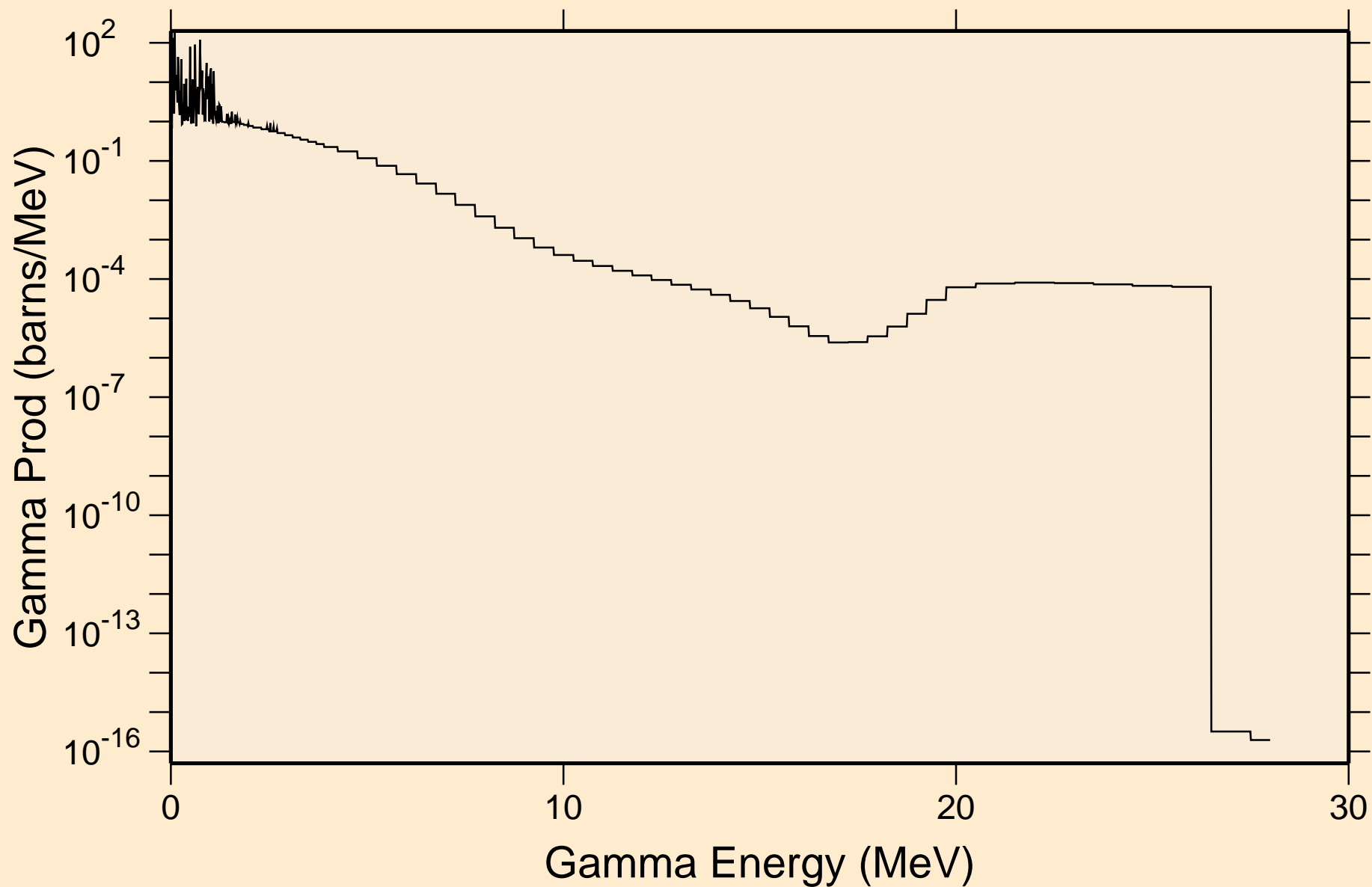

TC090N NEUTRON ACER TENDL-2019 LIBRARY; T=293.16K
Particle heating contributions

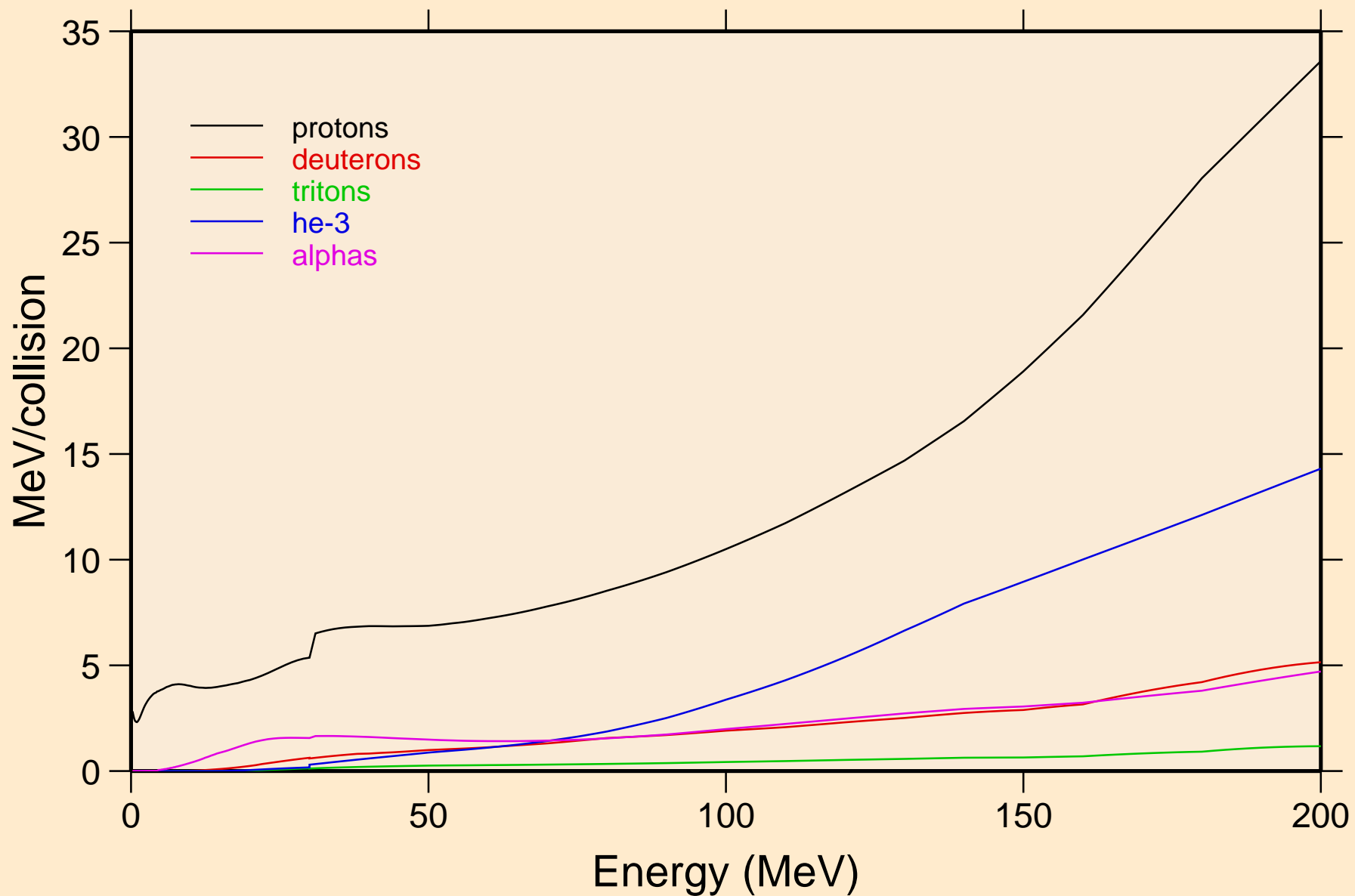

TC090N NEUTRON ACER TENDL-2019 LIBRARY; T=293.16K
Recoil Heating

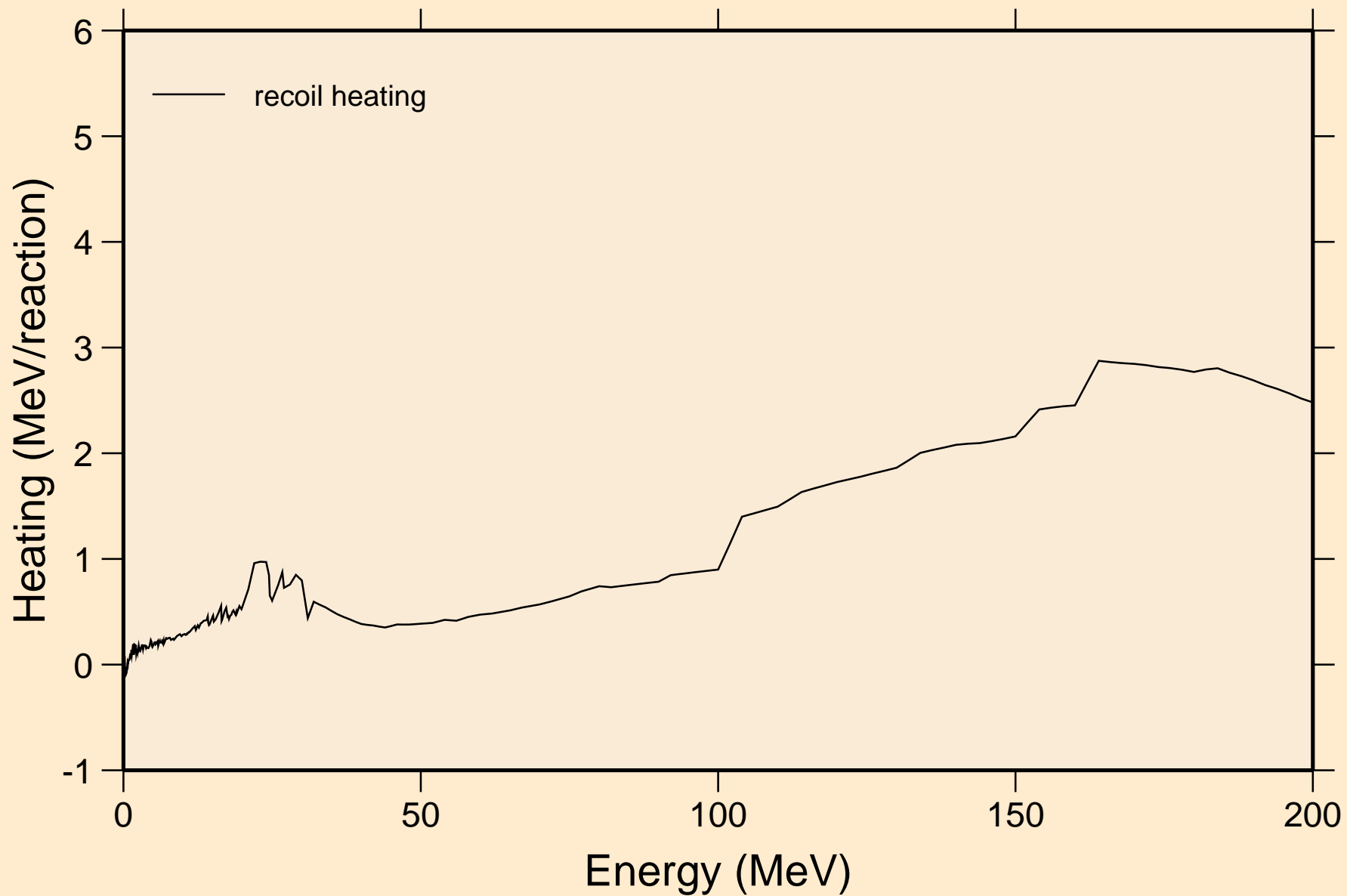

TC090N NEUTRON ACER TENDL-2019 LIBRARY; T=293.16K
Particle production cross sections

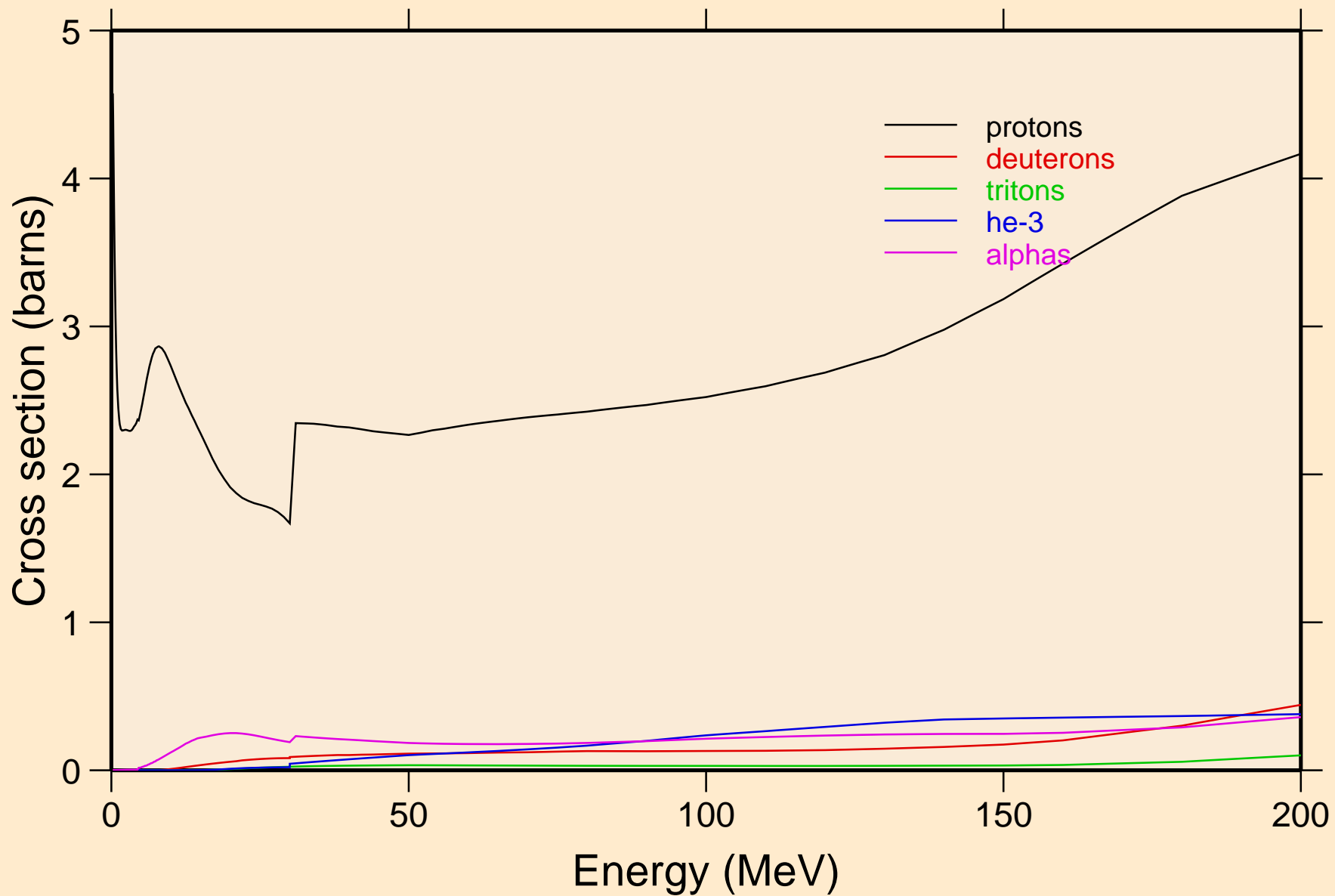

TC090N NEUTRON ACER TENDL-2019 LIBRARY; T=293.16K
protons from (n,x)

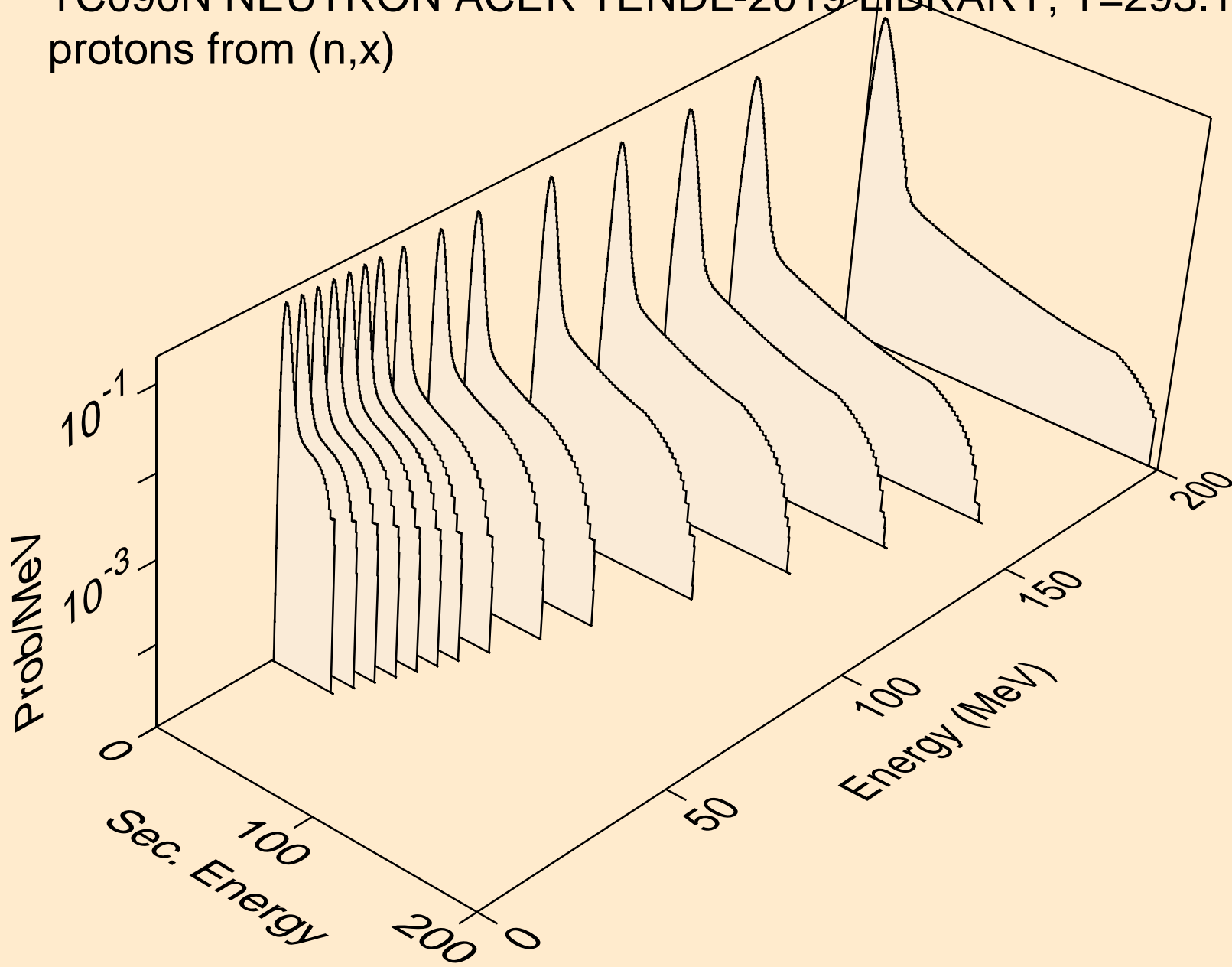

TC090N NEUTRON ACER TENDL-2019 LIBRARY; T=293.16K
protons from (n,n*)p

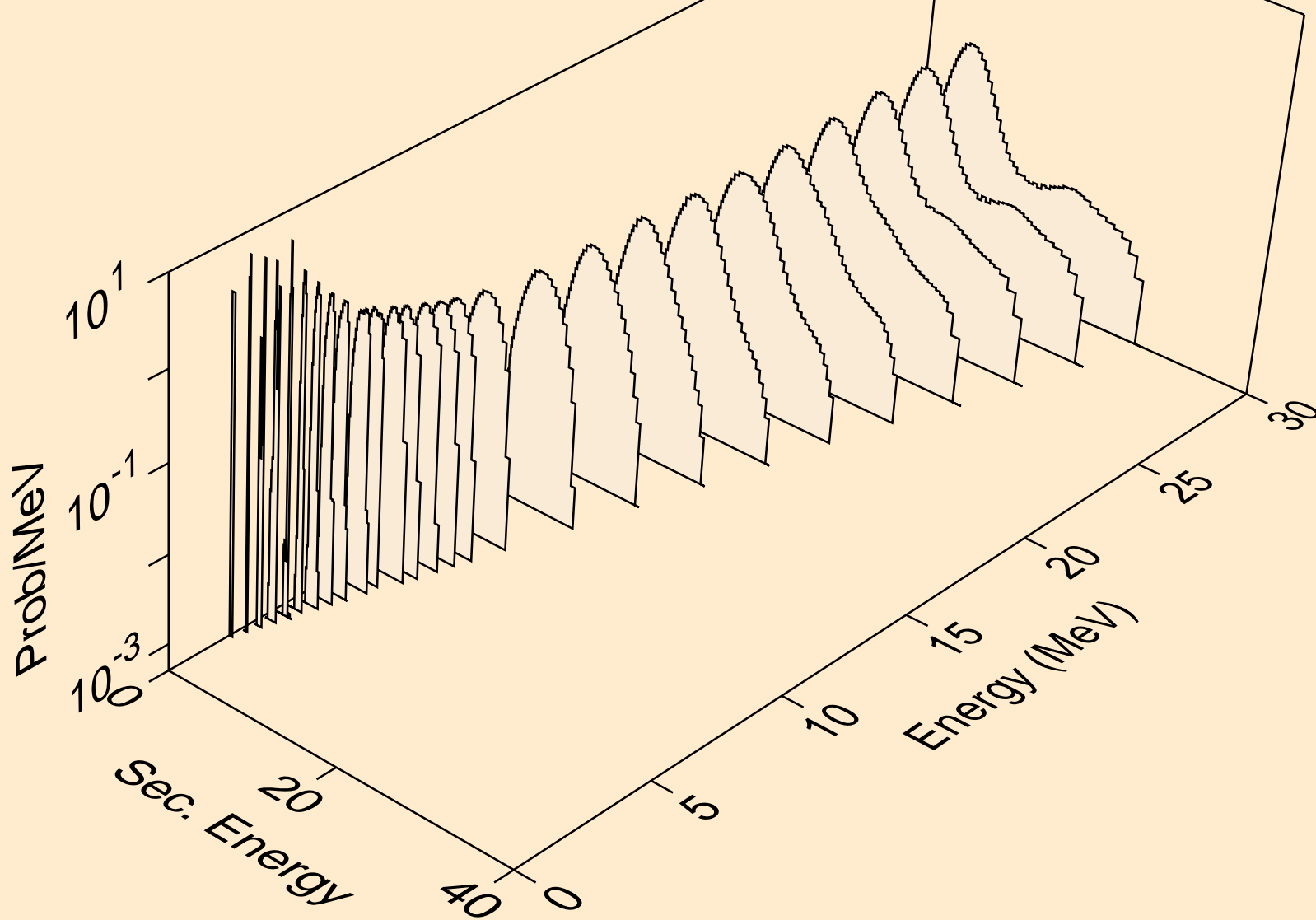

TC090N NEUTRON ACER TENDL-2019 LIBRARY; T=293.16K
protons from (n,2np)

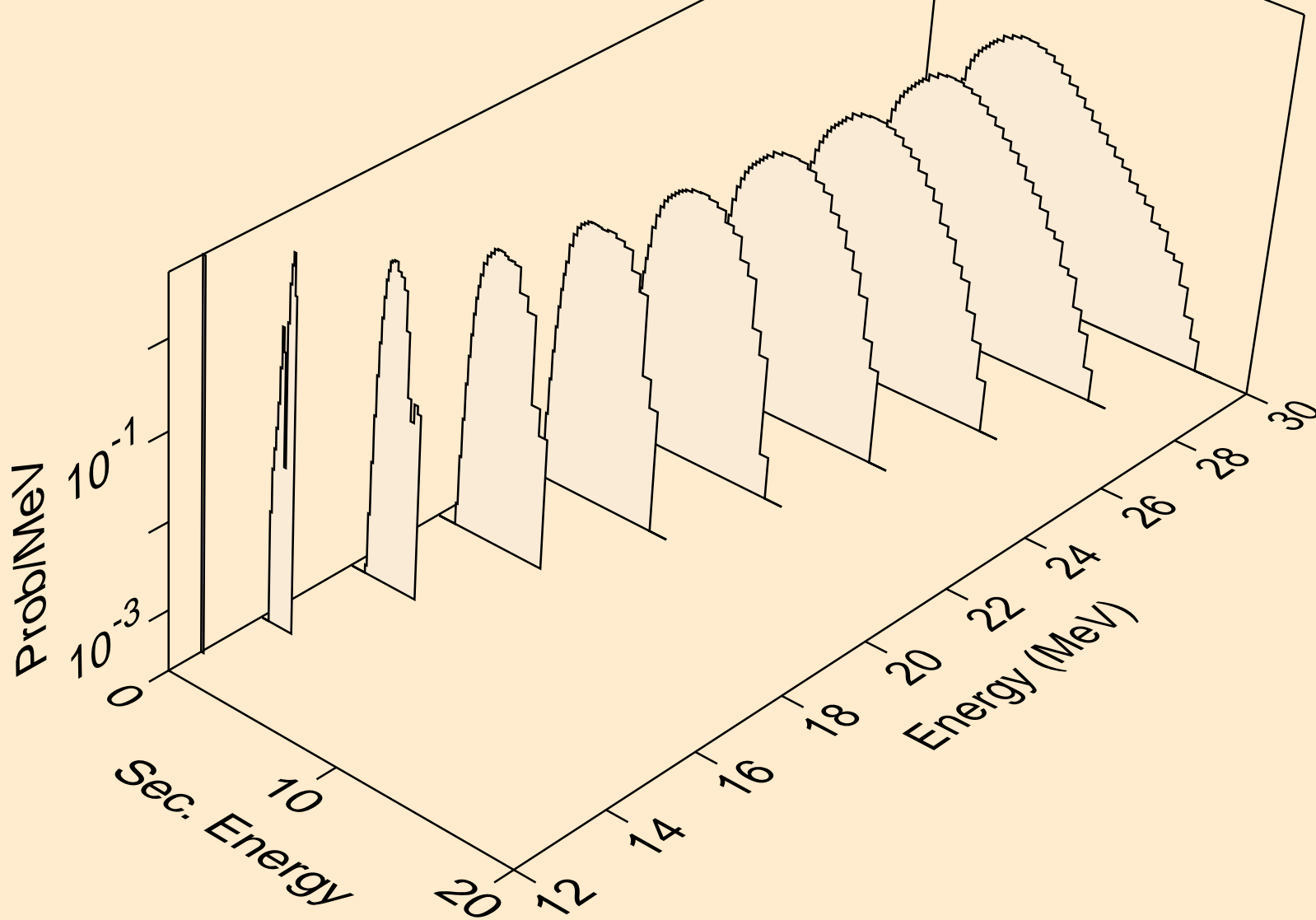

TC090N NEUTRON ACER TENDL-2019 LIBRARY; T=293.16K
protons from (n,3np)

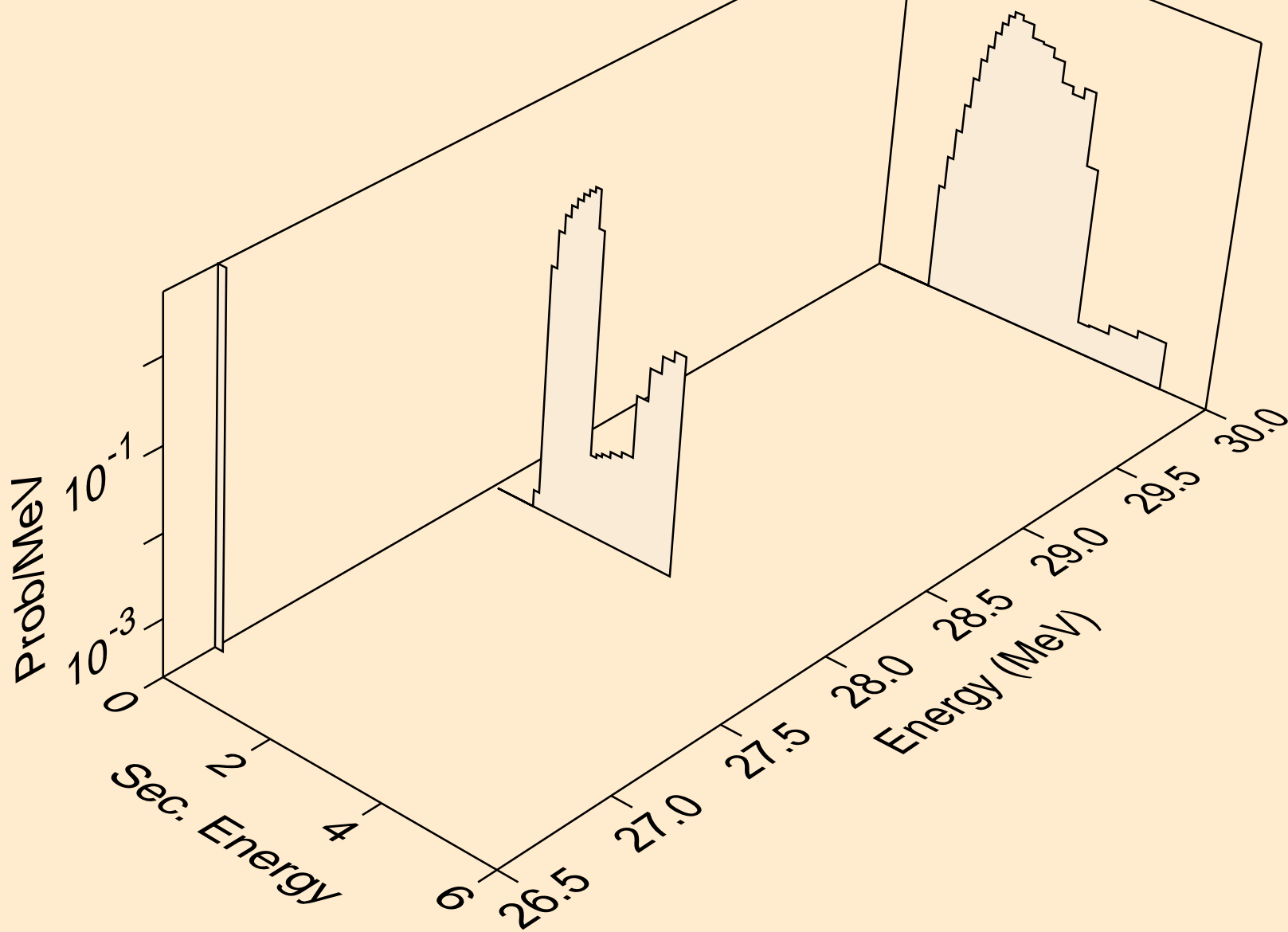

TC090N NEUTRON ACER TENDL-2019 LIBRARY; T=293.16K
protons from (n,2np)

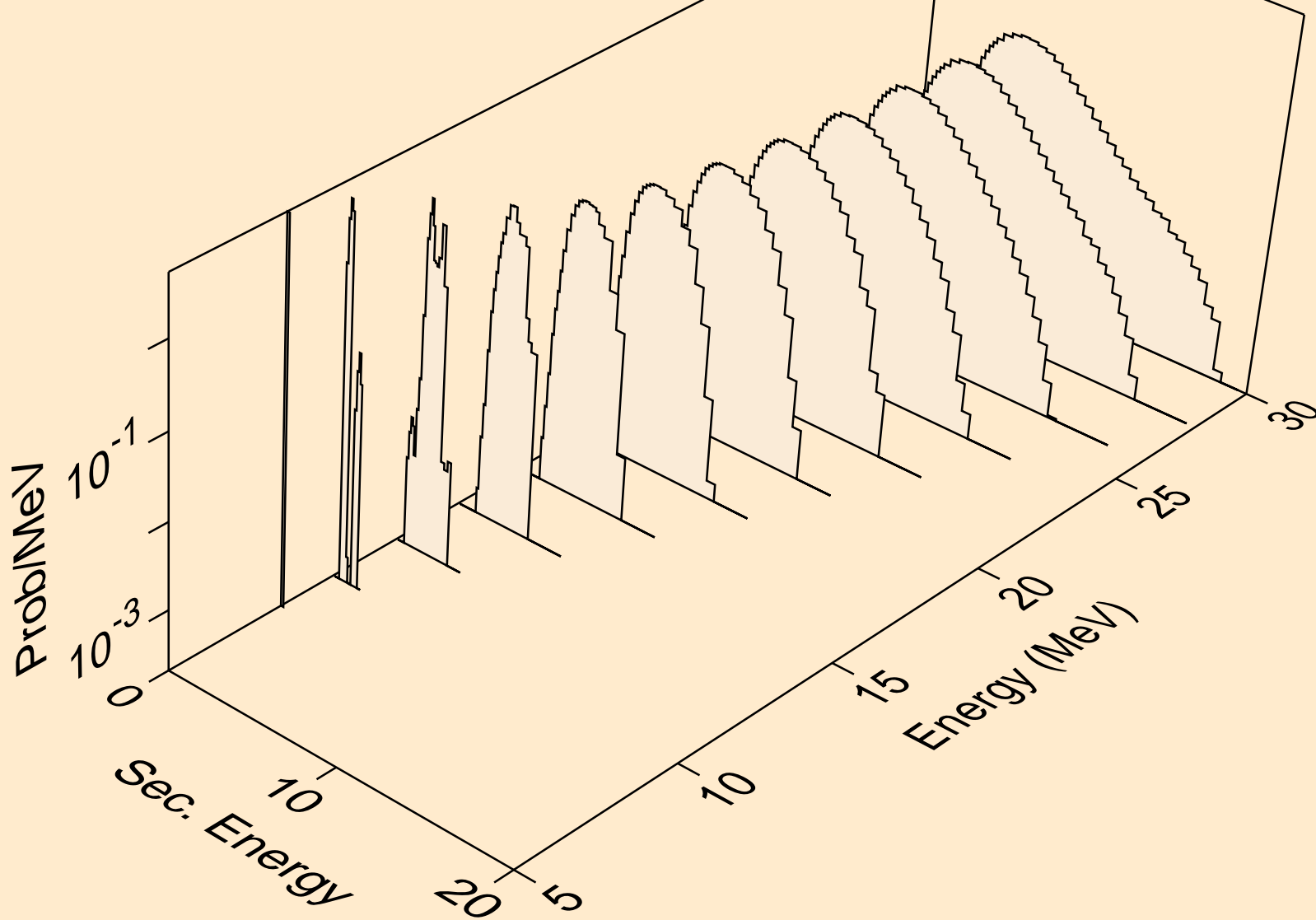

TC090N NEUTRON ACER TENDL-2019 LIBRARY; T=293.16K
protons from (n,npa)

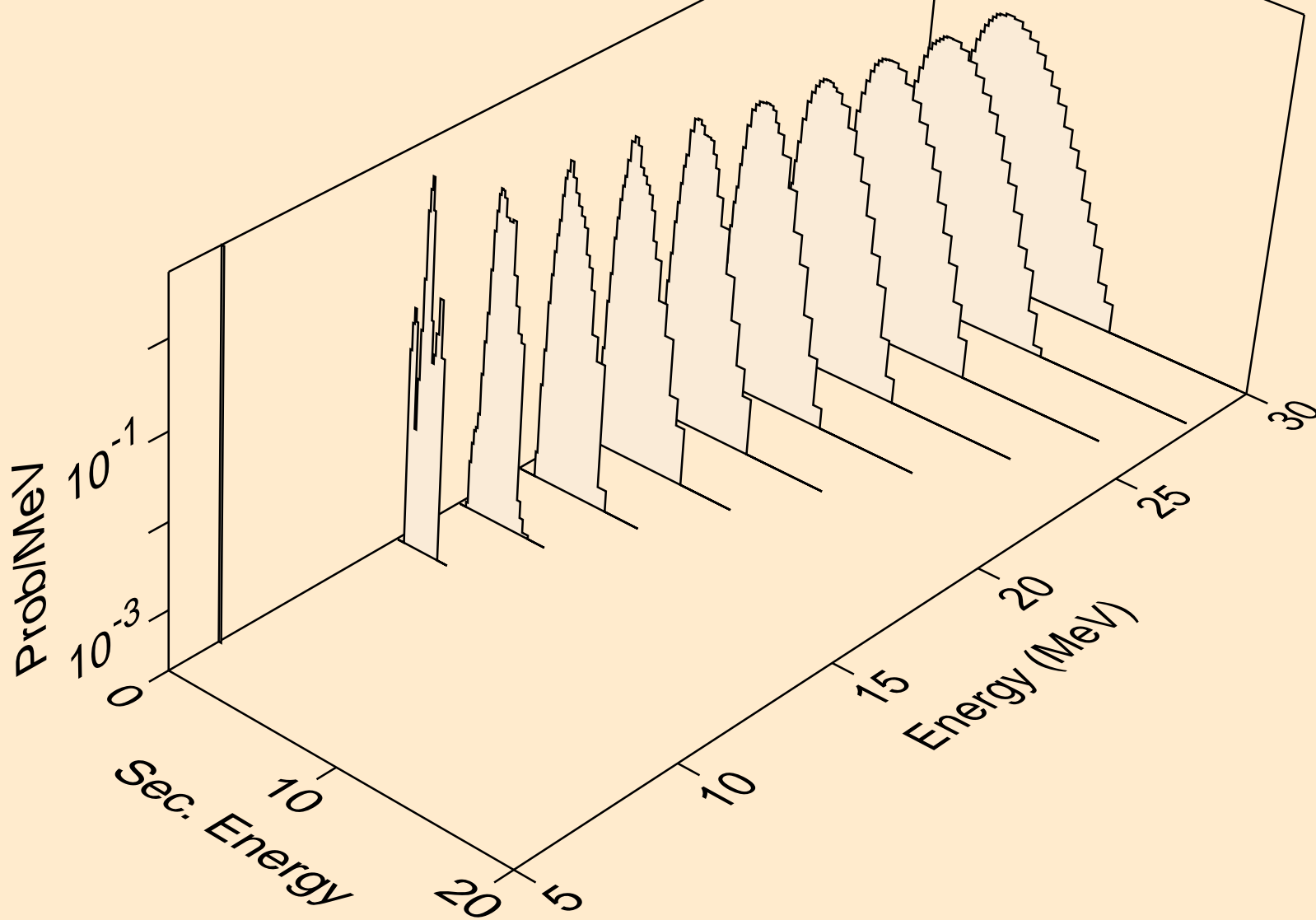

TC090N NEUTRON ACER TENDL-2019 LIBRARY; T=293.16K
protons from (n,p)

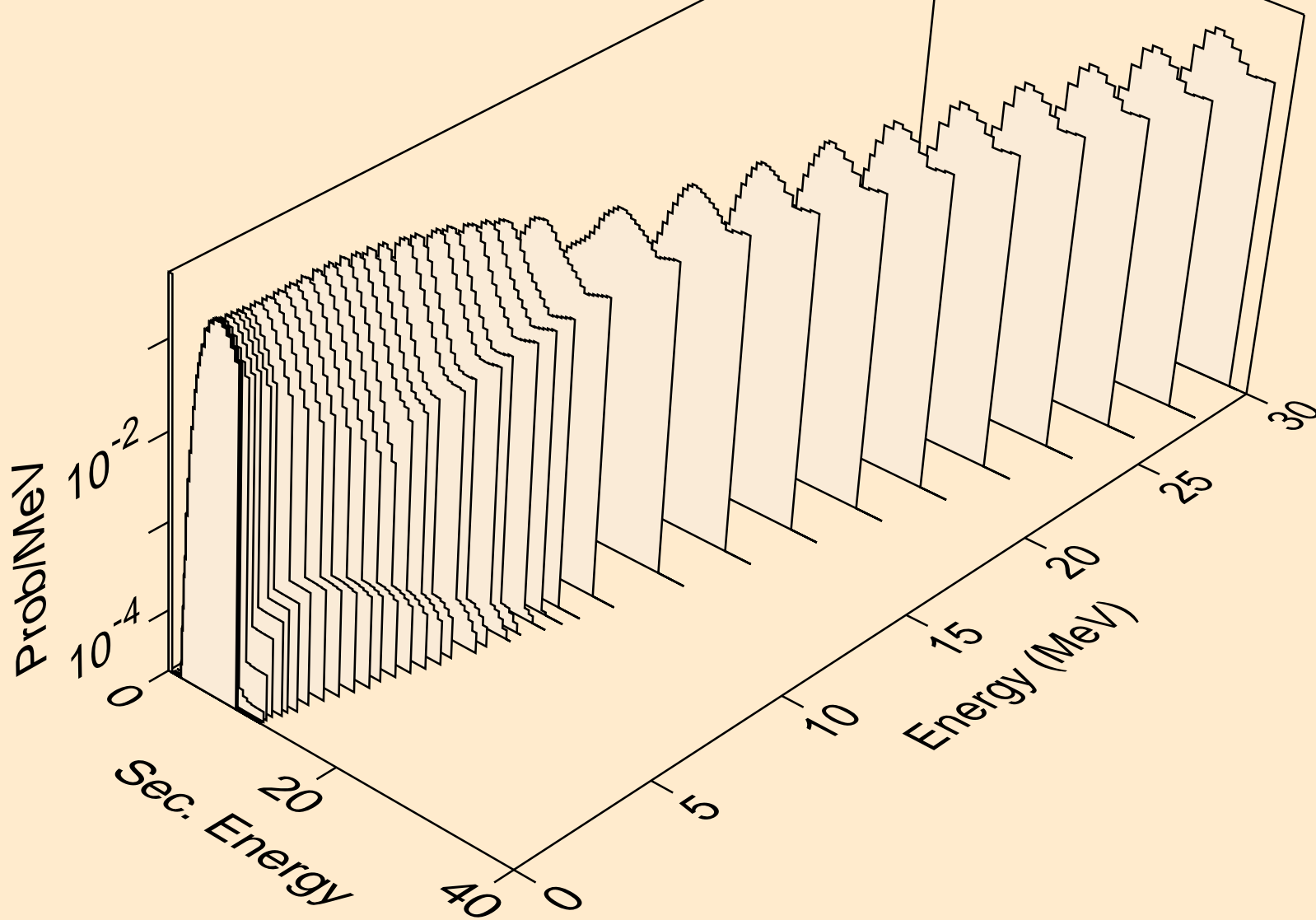

TC090N NEUTRON ACER TENDL-2019 LIBRARY; T=293.16K
protons from (n,2p)

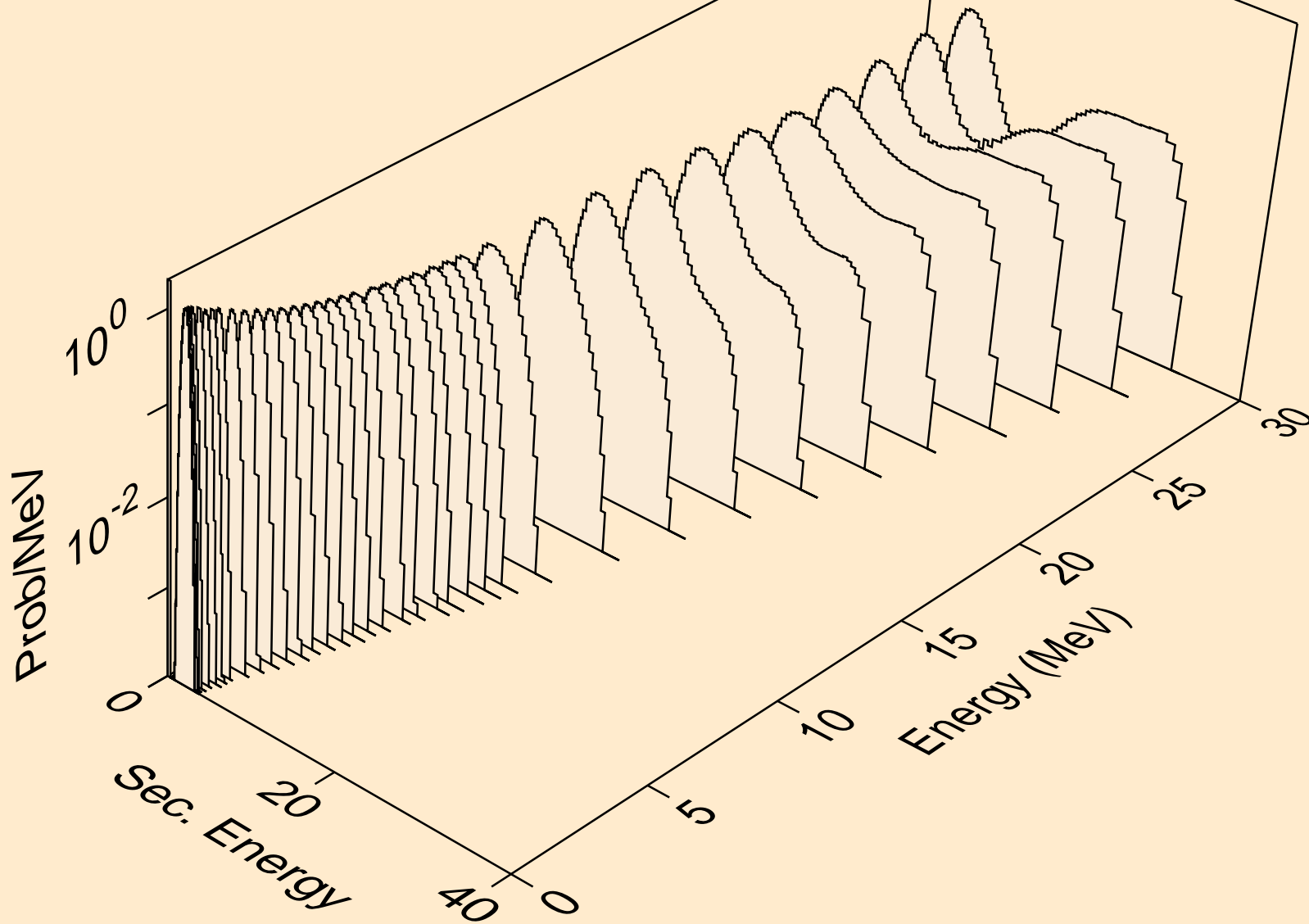

TC090N NEUTRON ACER TENDL-2019 LIBRARY; T=293.16K
protons from (n,p)

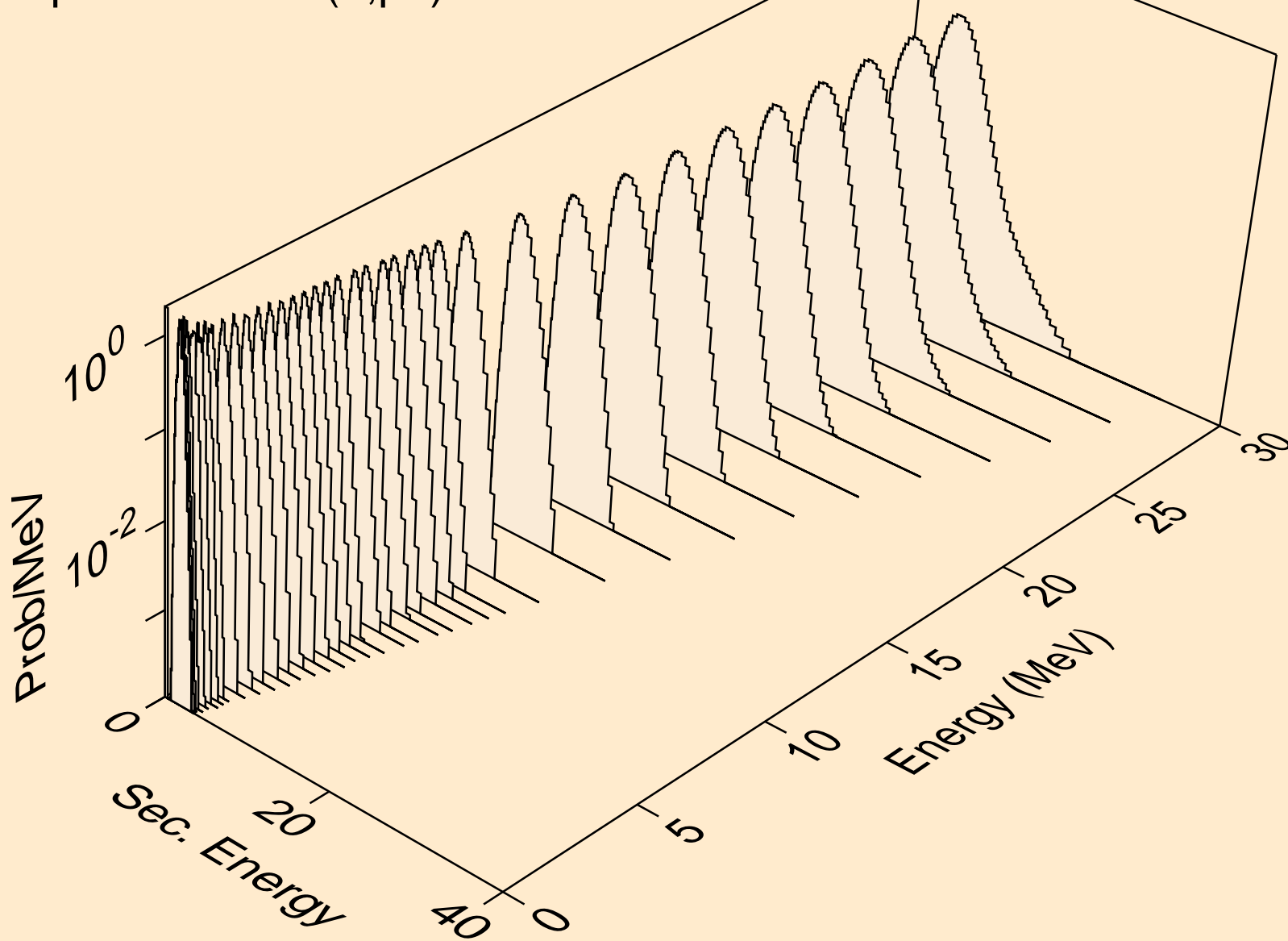

TC090N NEUTRON ACER TENDL-2019 LIBRARY; T=293.16K
protons from (n,pd)

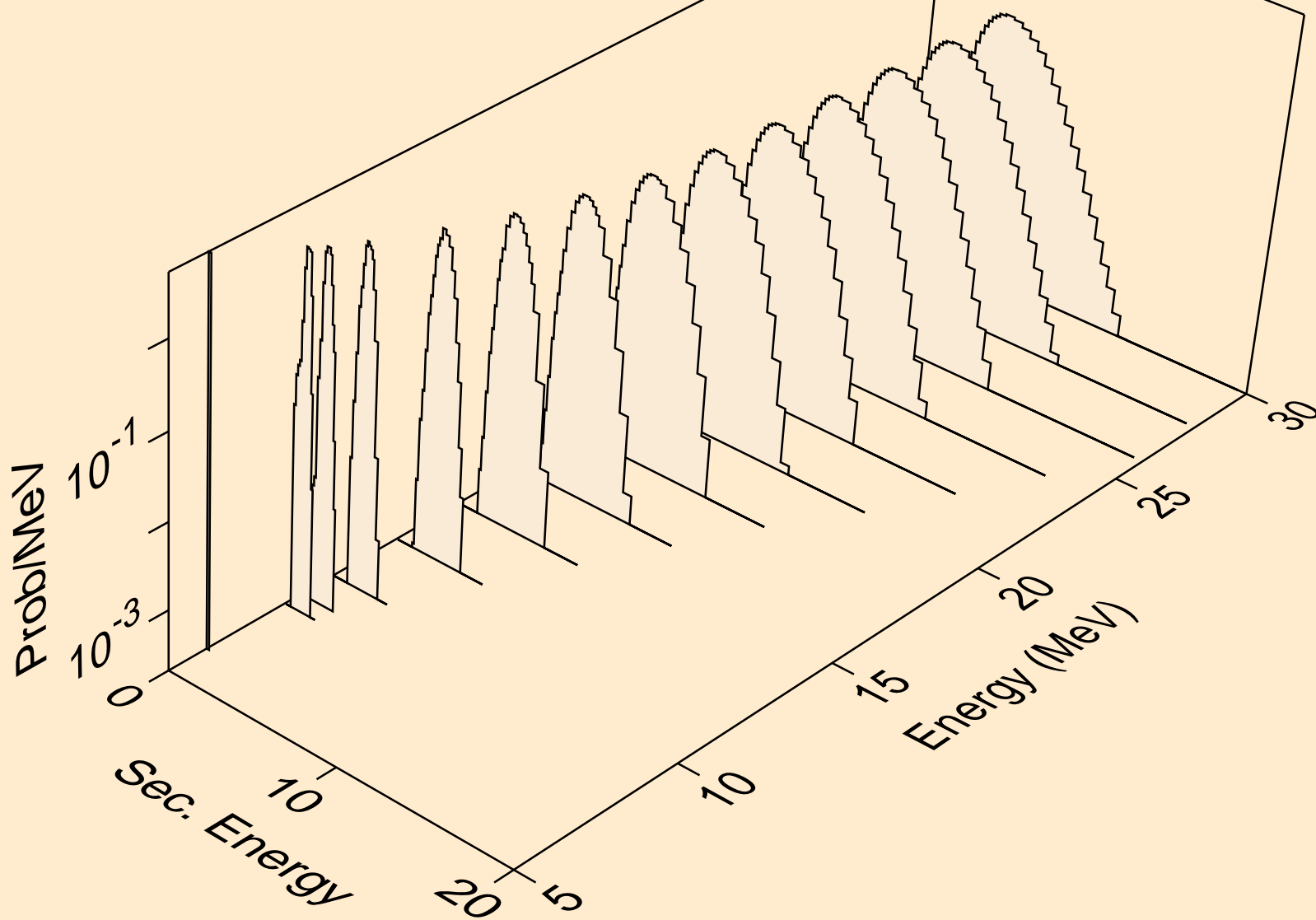

TC090N NEUTRON ACER TENDL-2019 LIBRARY; T=293.16K
protons from (n,pt)

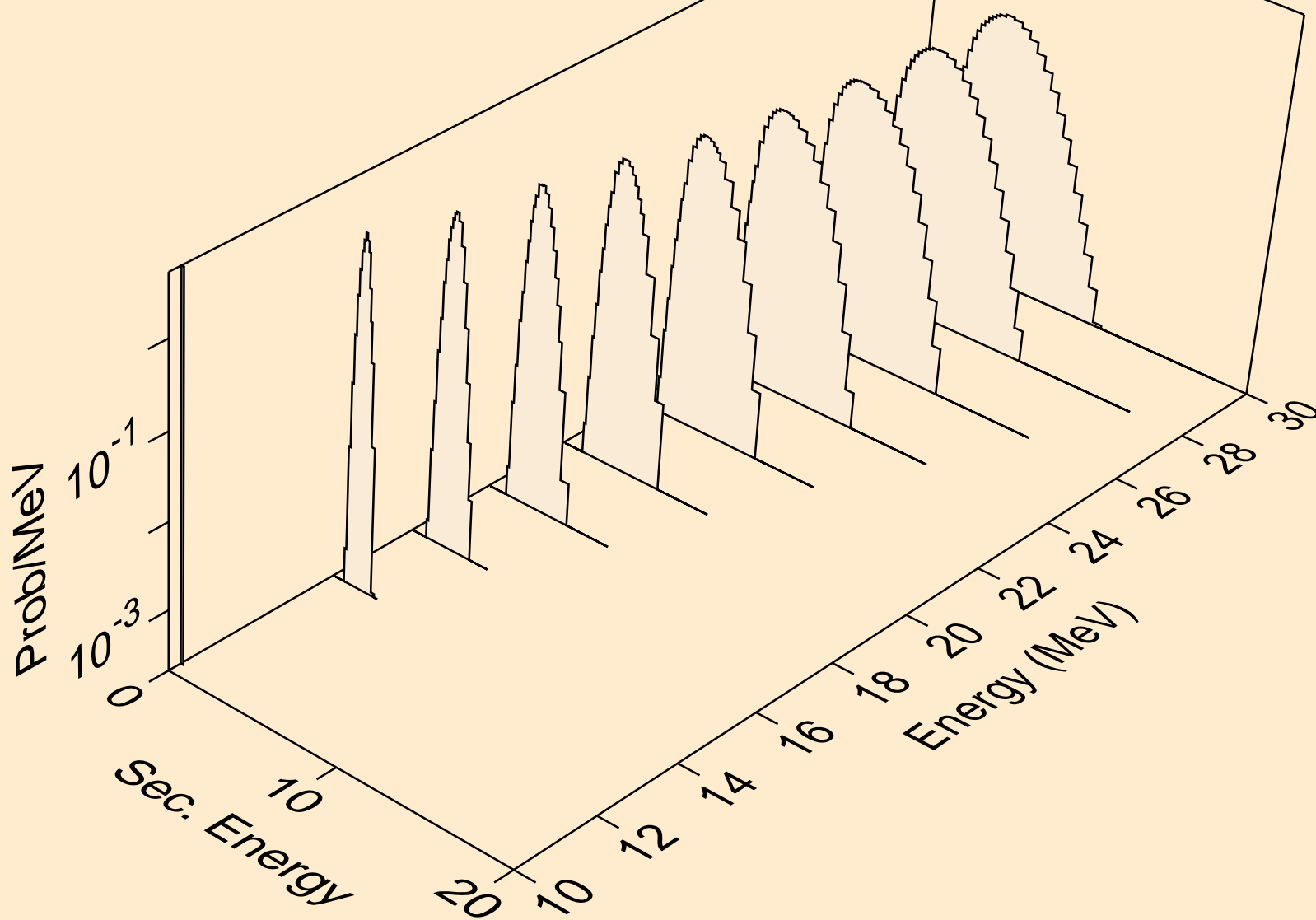

TC090N NEUTRON ACER TENDL-2019 LIBRARY; T=293.16K
deuterons from (n,x)

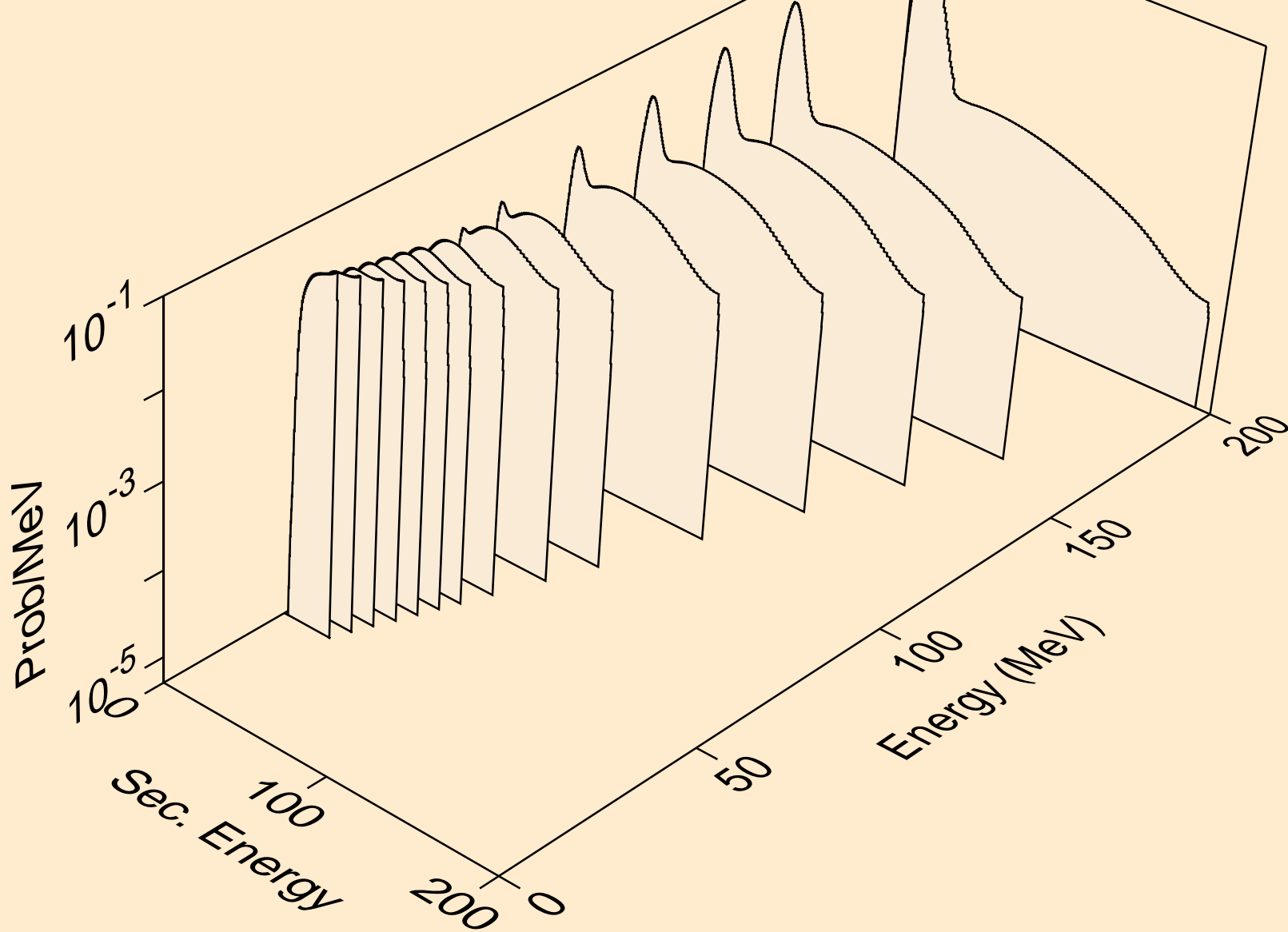

TC090N NEUTRON ACER TENDL-2019 LIBRARY; T=293.16K
deuterons from (n,2nd)

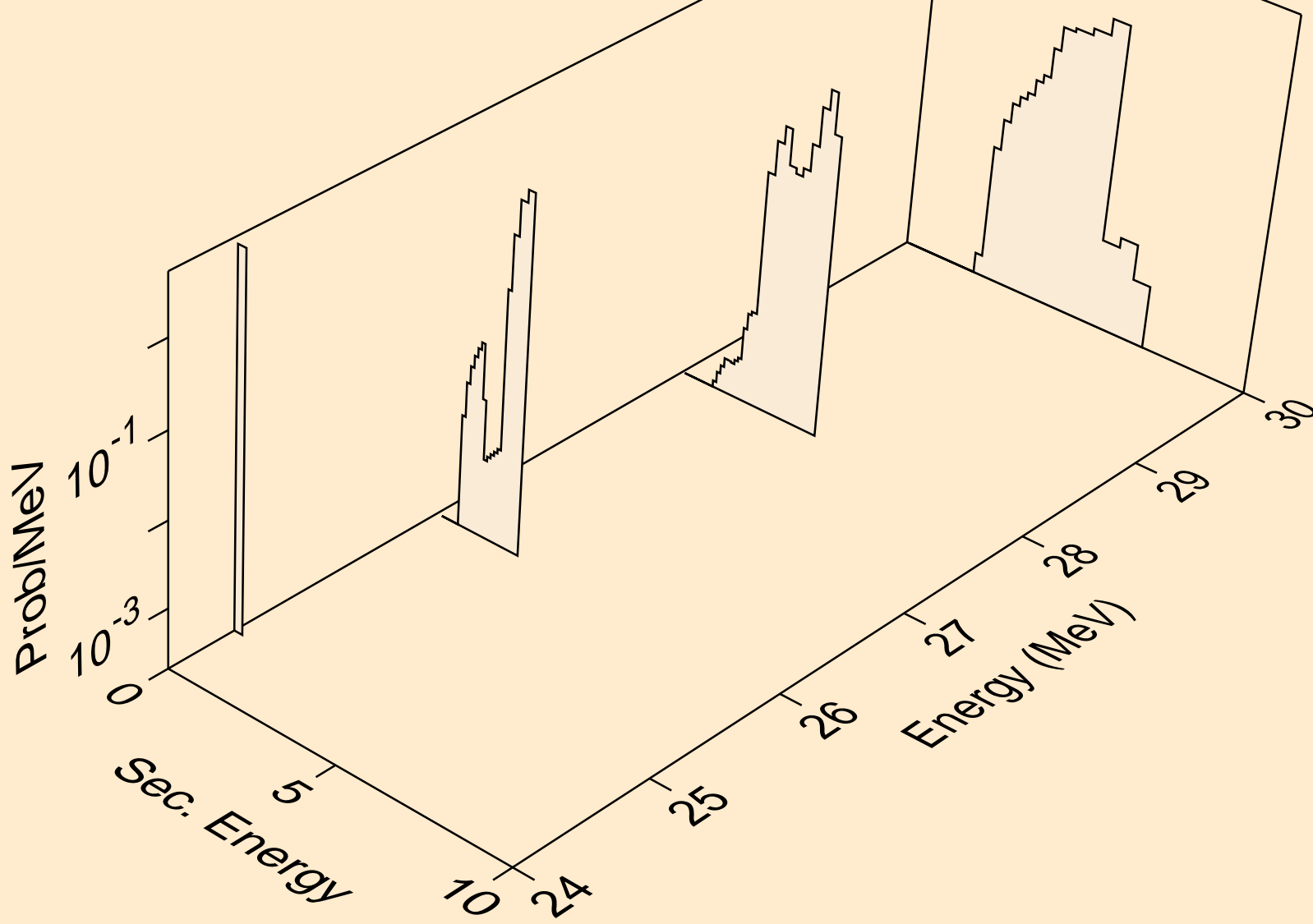

TC090N NEUTRON ACER TENDL-2019 LIBRARY; T=293.16K
deuterons from (n,n*)d

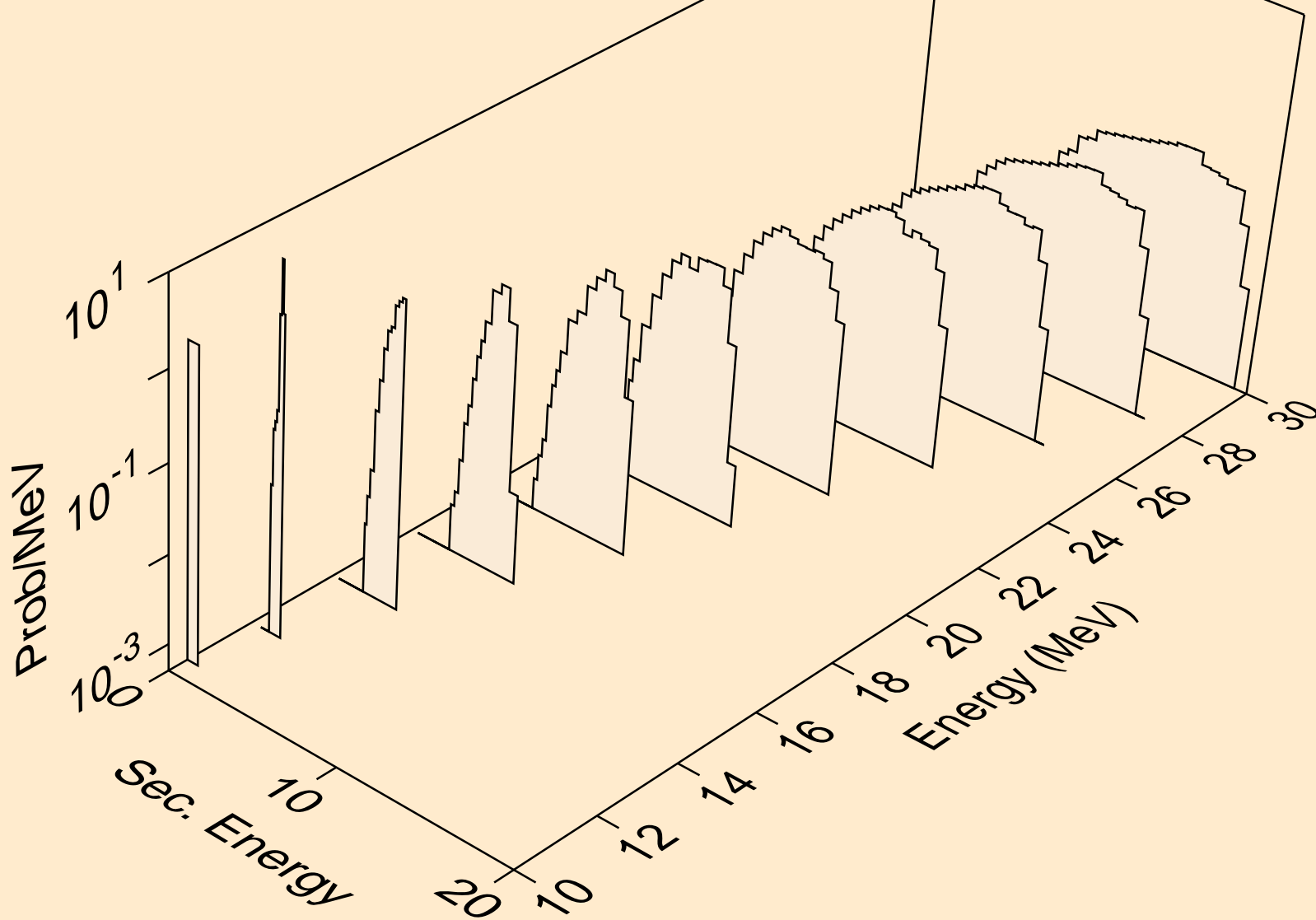

TC090N NEUTRON ACER TENDL-2019 LIBRARY; T=293.16K
deuterons from (n,d)

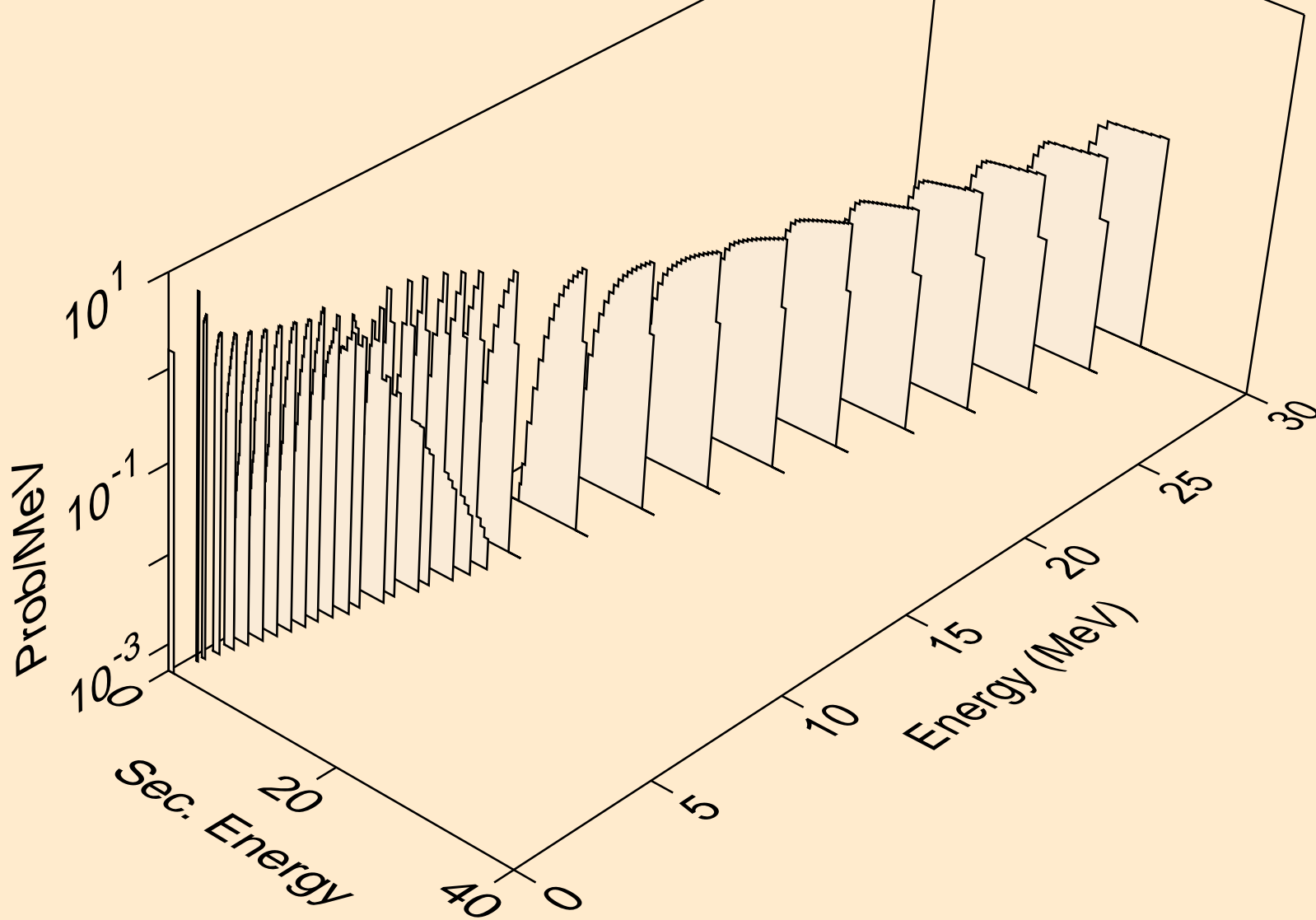

TC090N NEUTRON ACER TENDL-2019 LIBRARY; T=293.16K
deuterons from (n,pd)

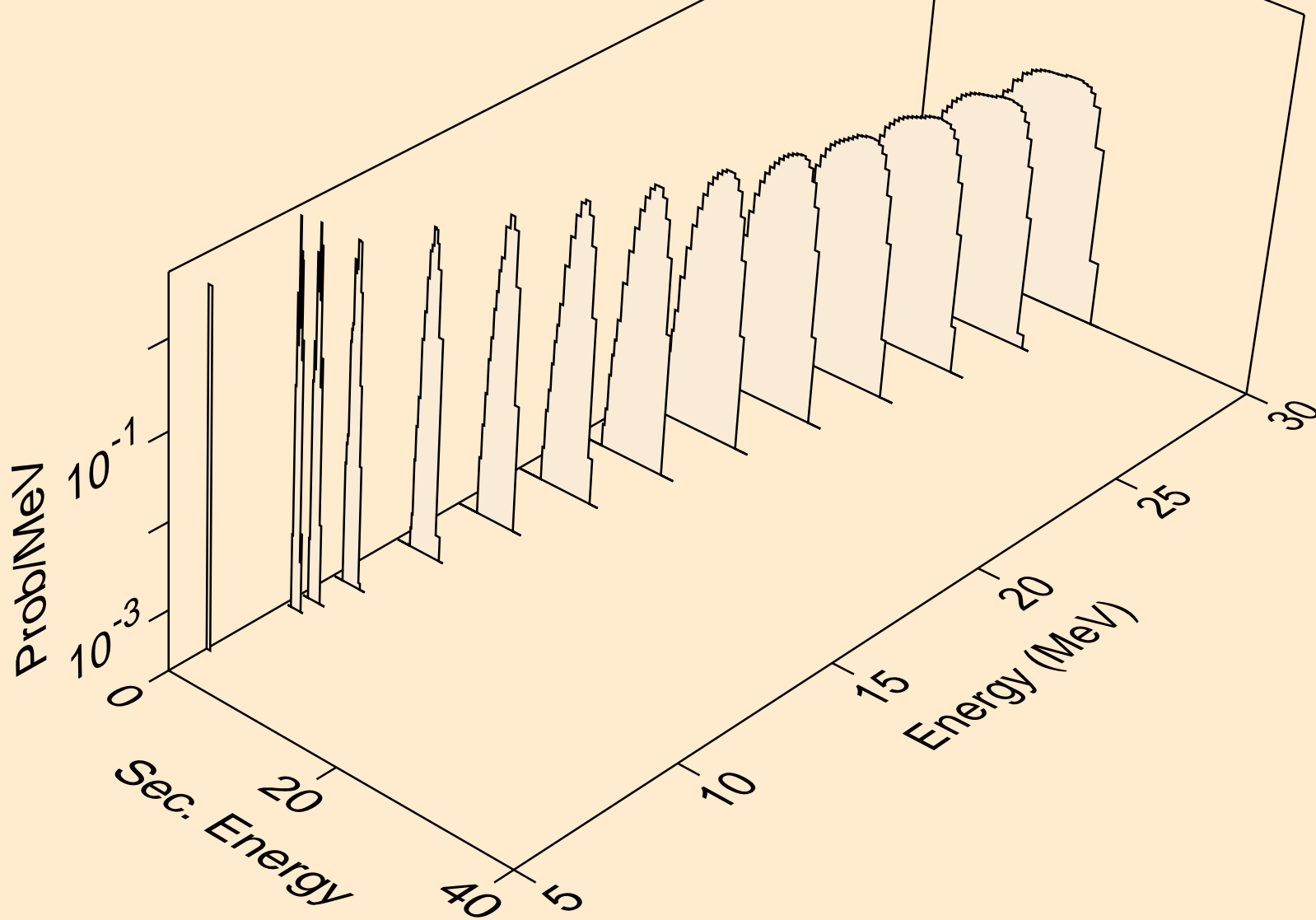

TC090N NEUTRON ACER TENDL-2019 LIBRARY; T=293.16K
deuterons from (n,da)

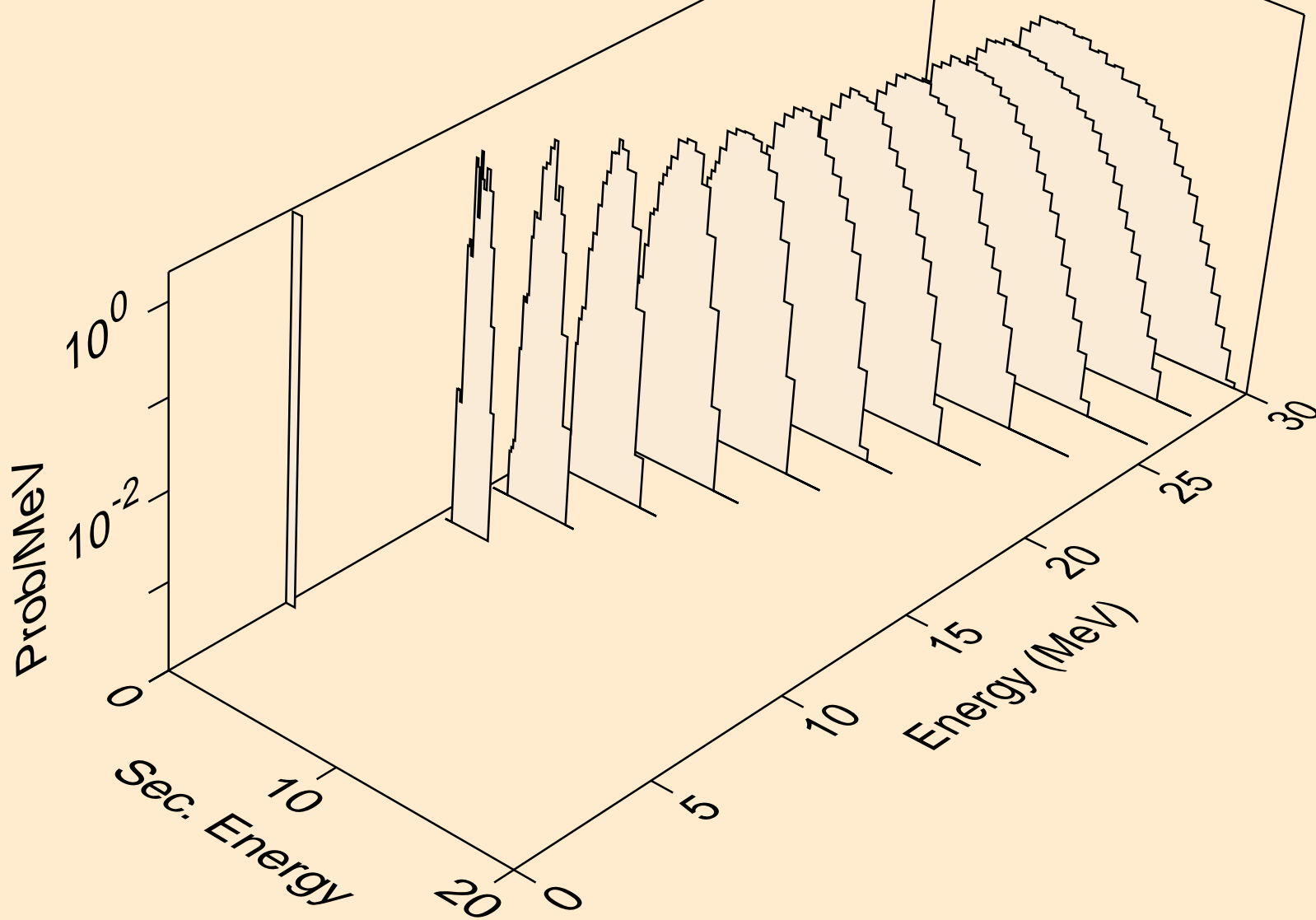

TC090N NEUTRON ACER TENDL-2019 LIBRARY; T=293.16K
tritons from (n,x)

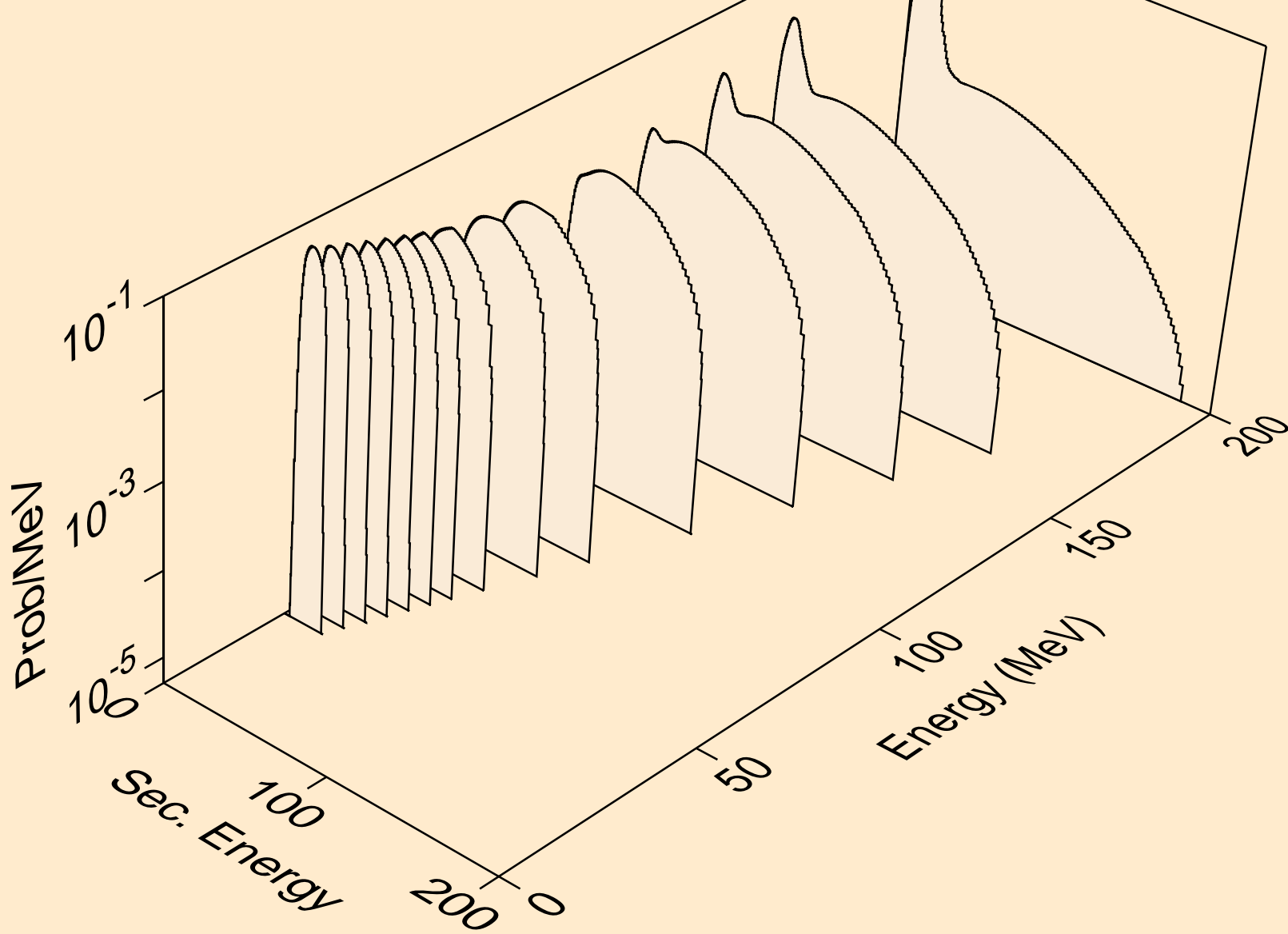

TC090N NEUTRON ACER TENDL-2019 LIBRARY; T=293.16K
tritons from (n,n*)t

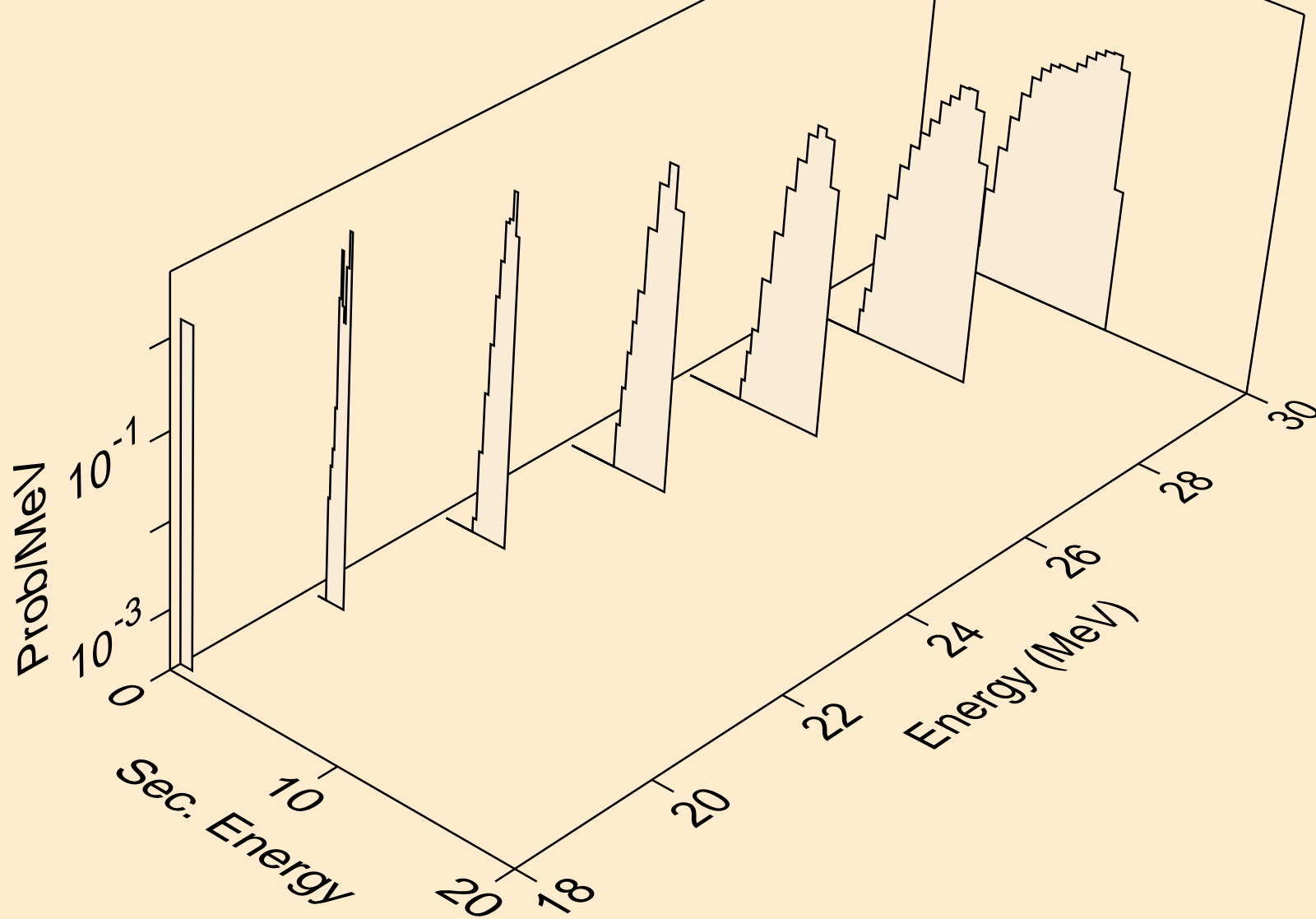

TC090N NEUTRON ACER TENDL-2019 LIBRARY; T=293.16K
tritons from (n,t)

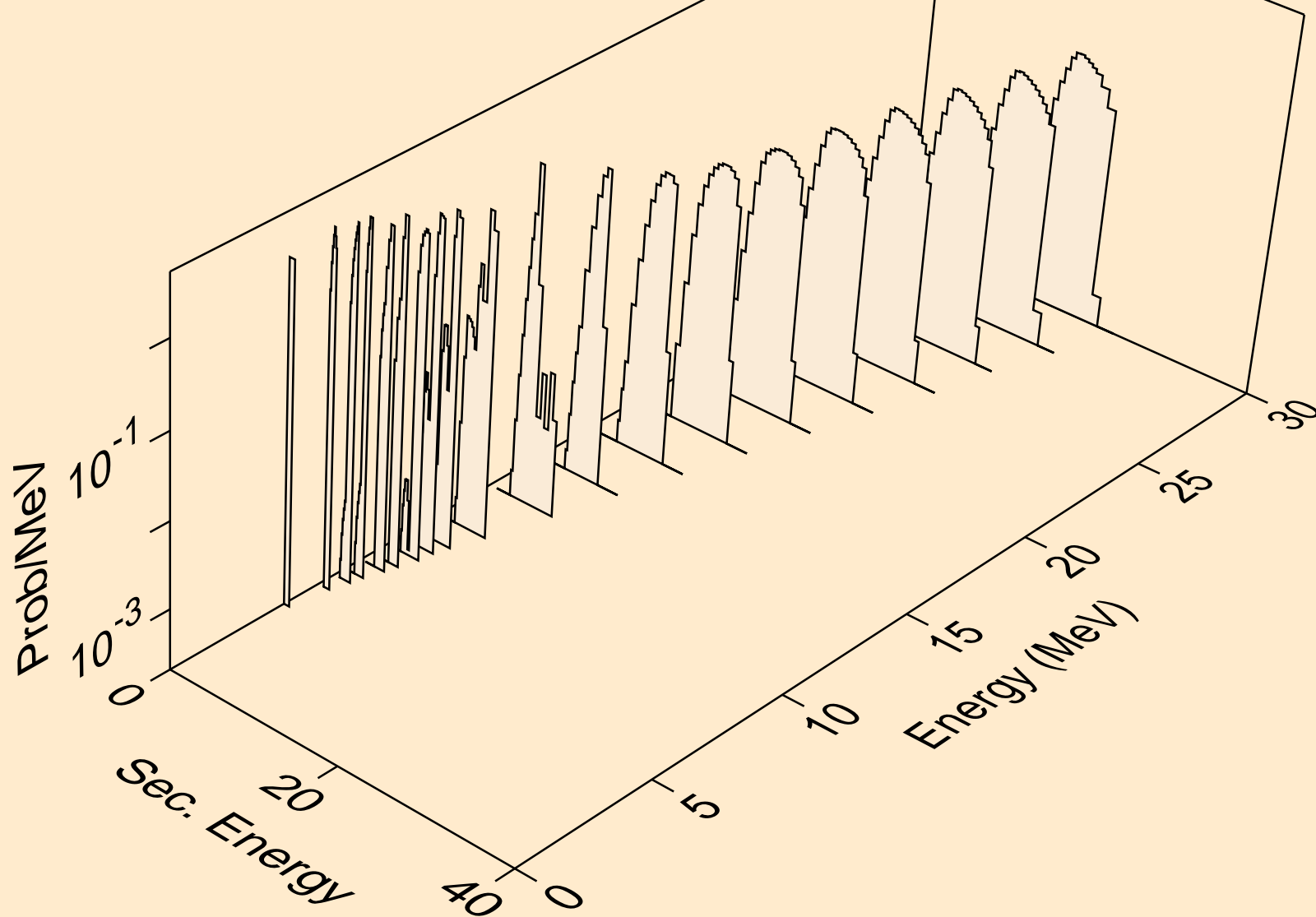

TC090N NEUTRON ACER TENDL-2019 LIBRARY; T=293.16K
tritons from (n,pt)

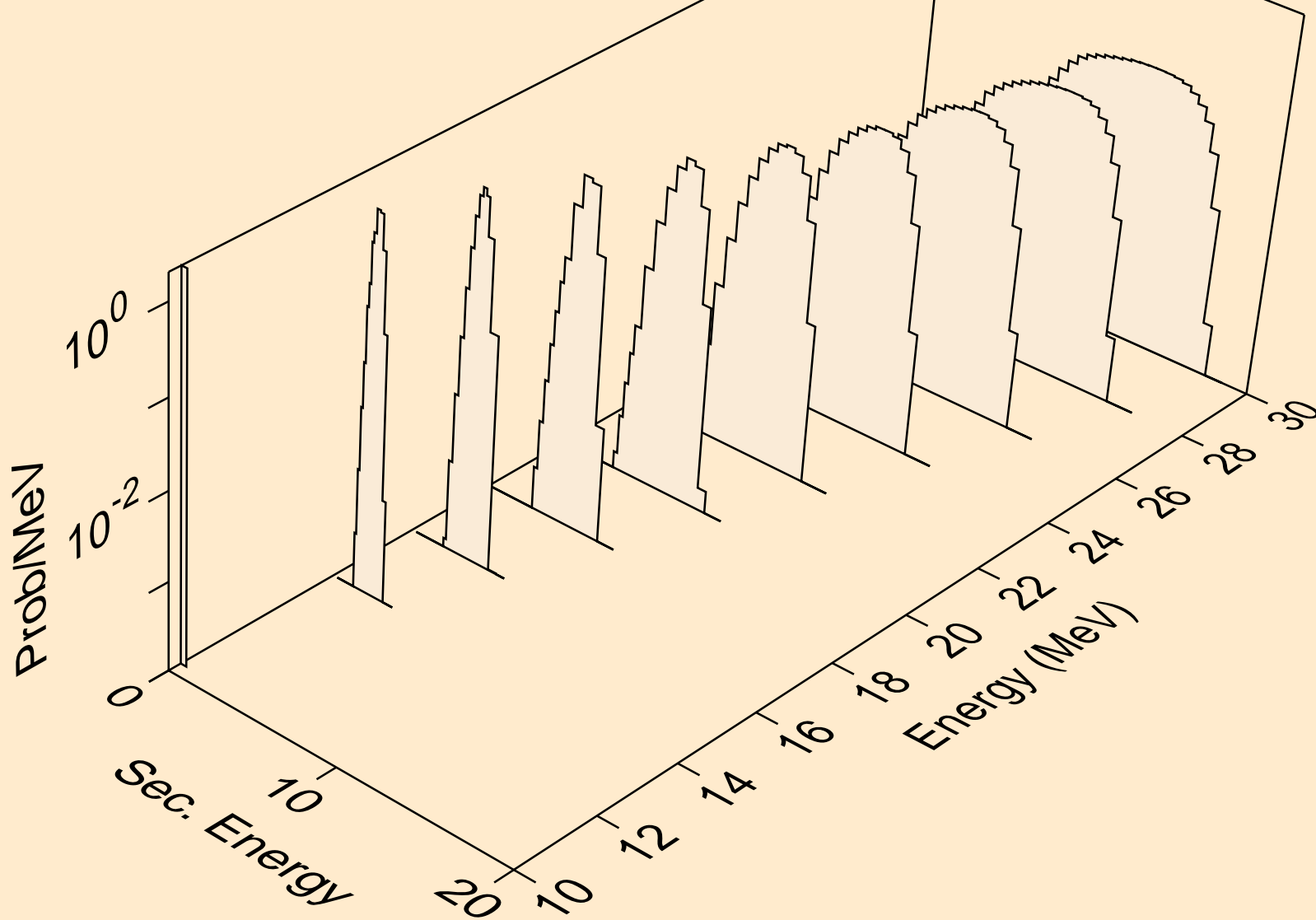

TC090N NEUTRON ACER TENDL-2019 LIBRARY; T=293.16K
he3s from (n,x)

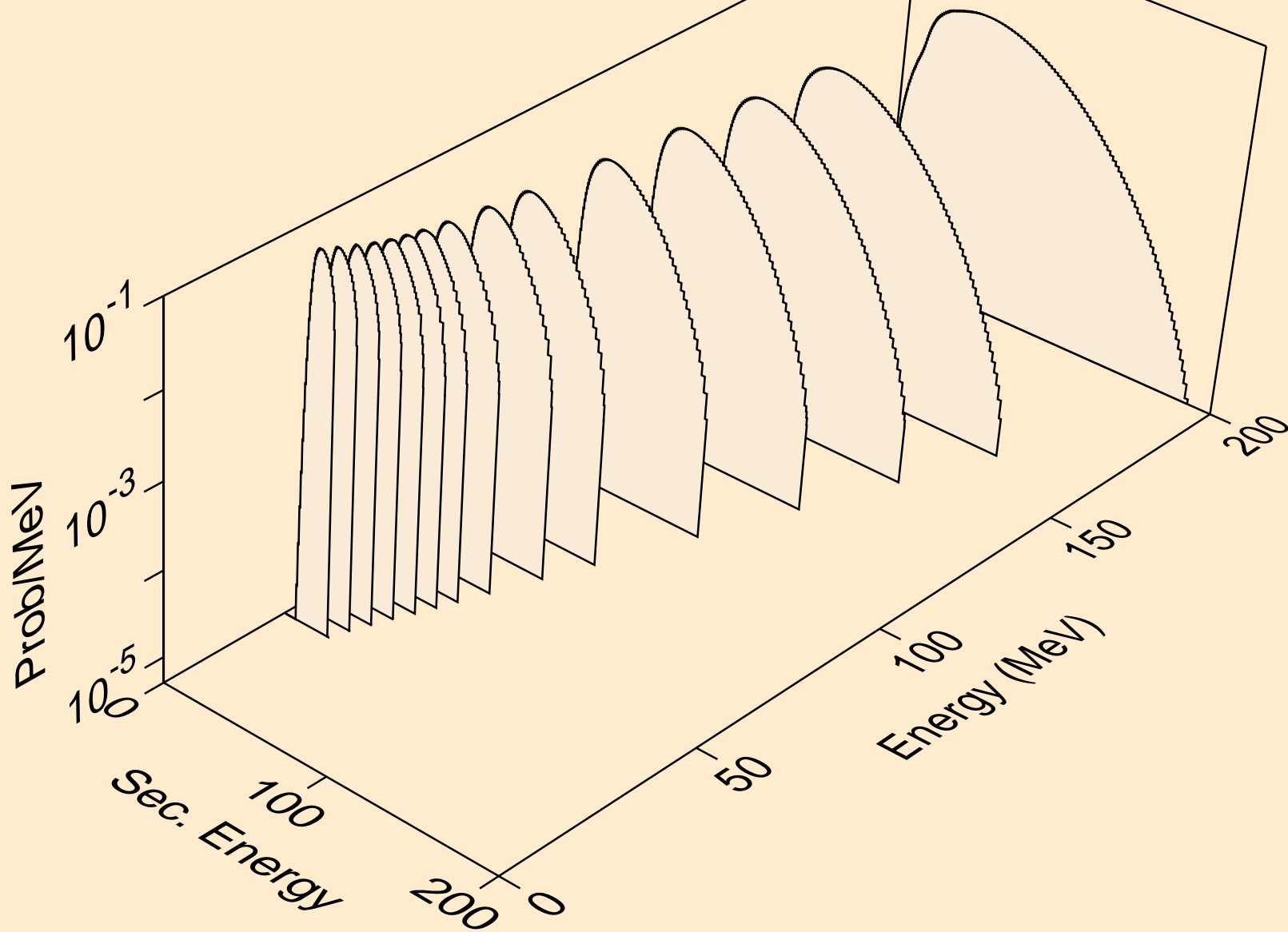

TC090N NEUTRON ACER TENDL-2019 LIBRARY; T=293.16K
he3s from (n,n*)he3

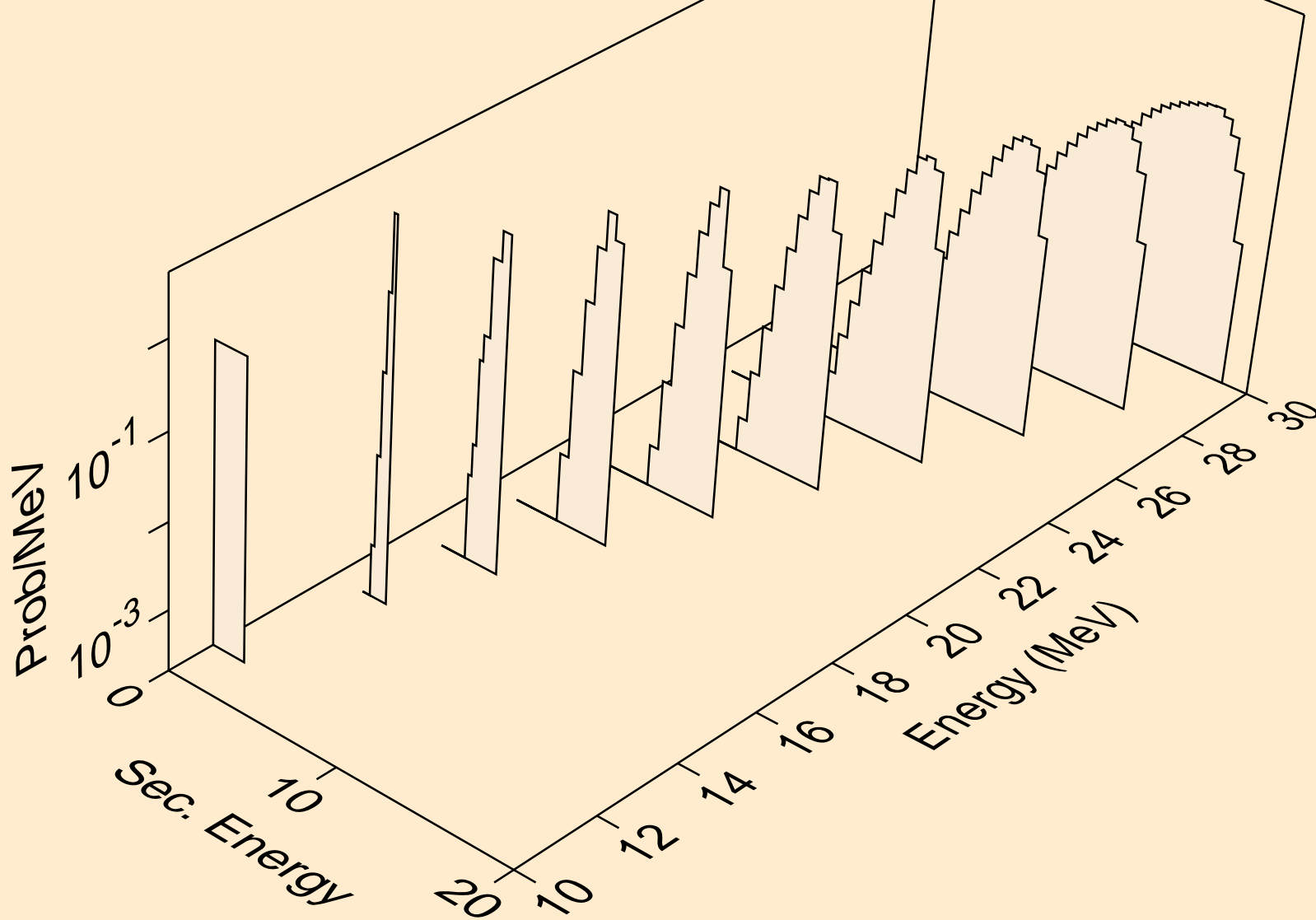

TC090N NEUTRON ACER TENDL-2019 LIBRARY; T=293.16K
he3s from (n,he3)

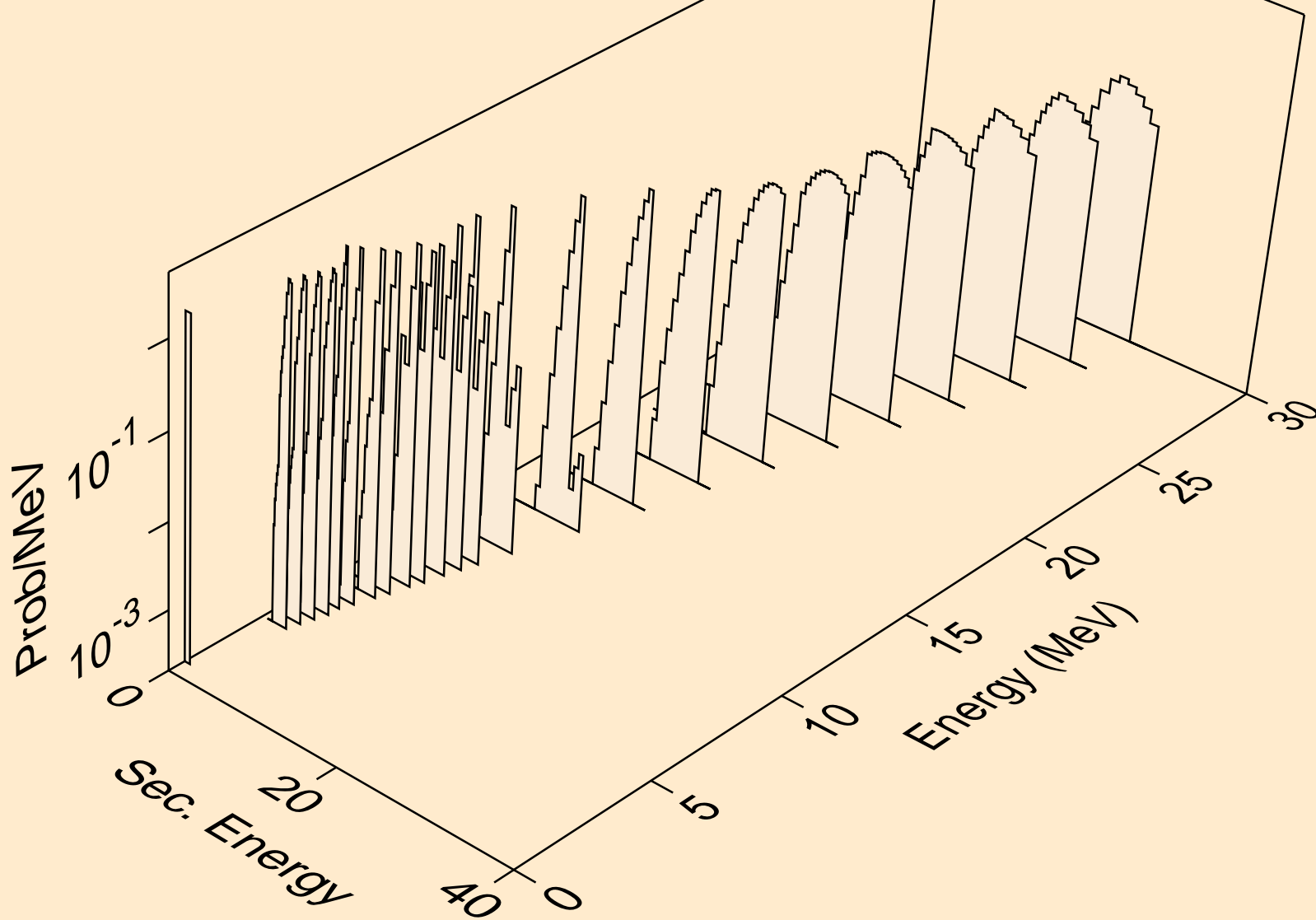

TC090N NEUTRON ACER TENDL-2019 LIBRARY; T=293.16K
alphas from (n,x)

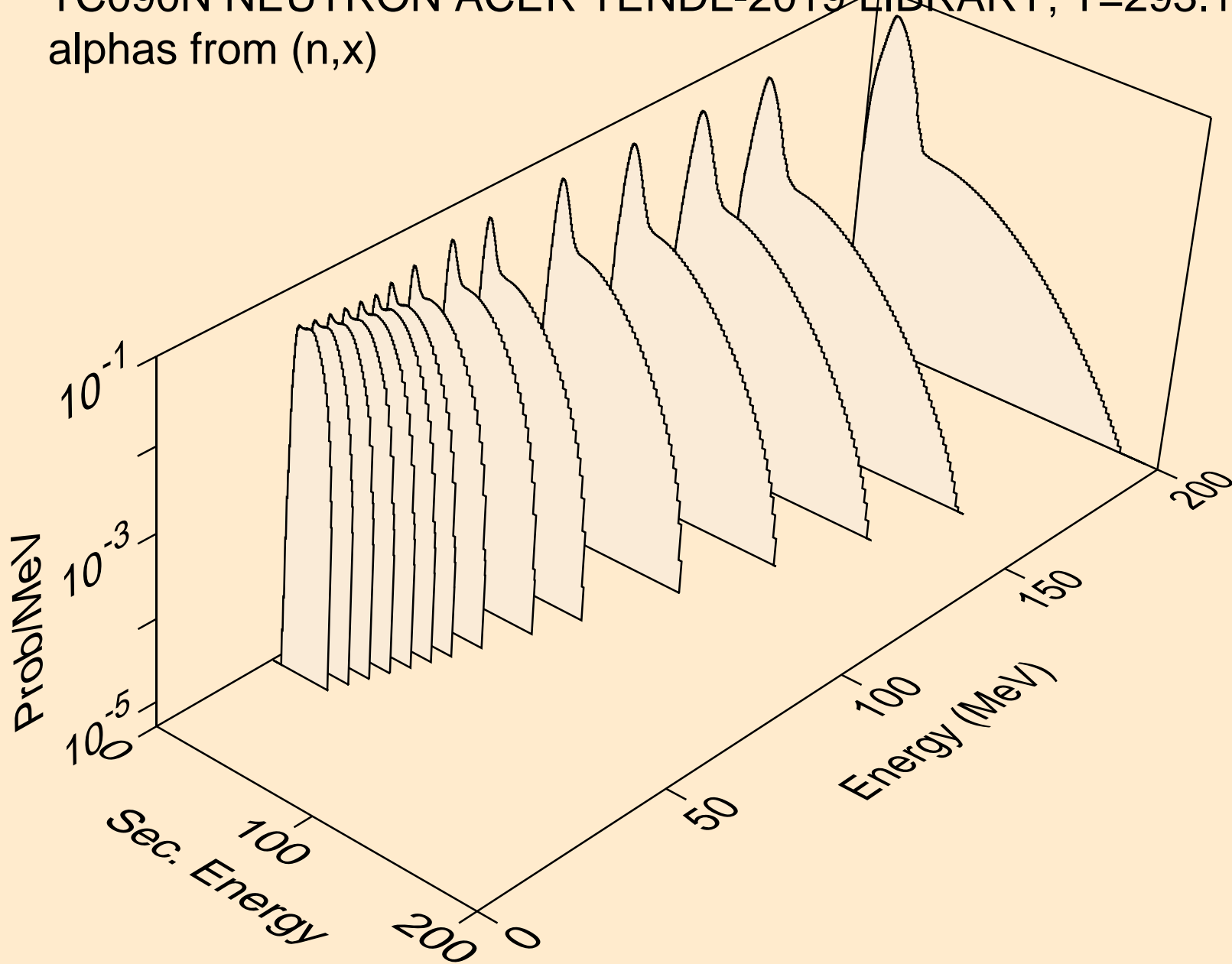

TC090N NEUTRON ACER TENDL-2019 LIBRARY; T=293.16K
alphas from (n,n*)a

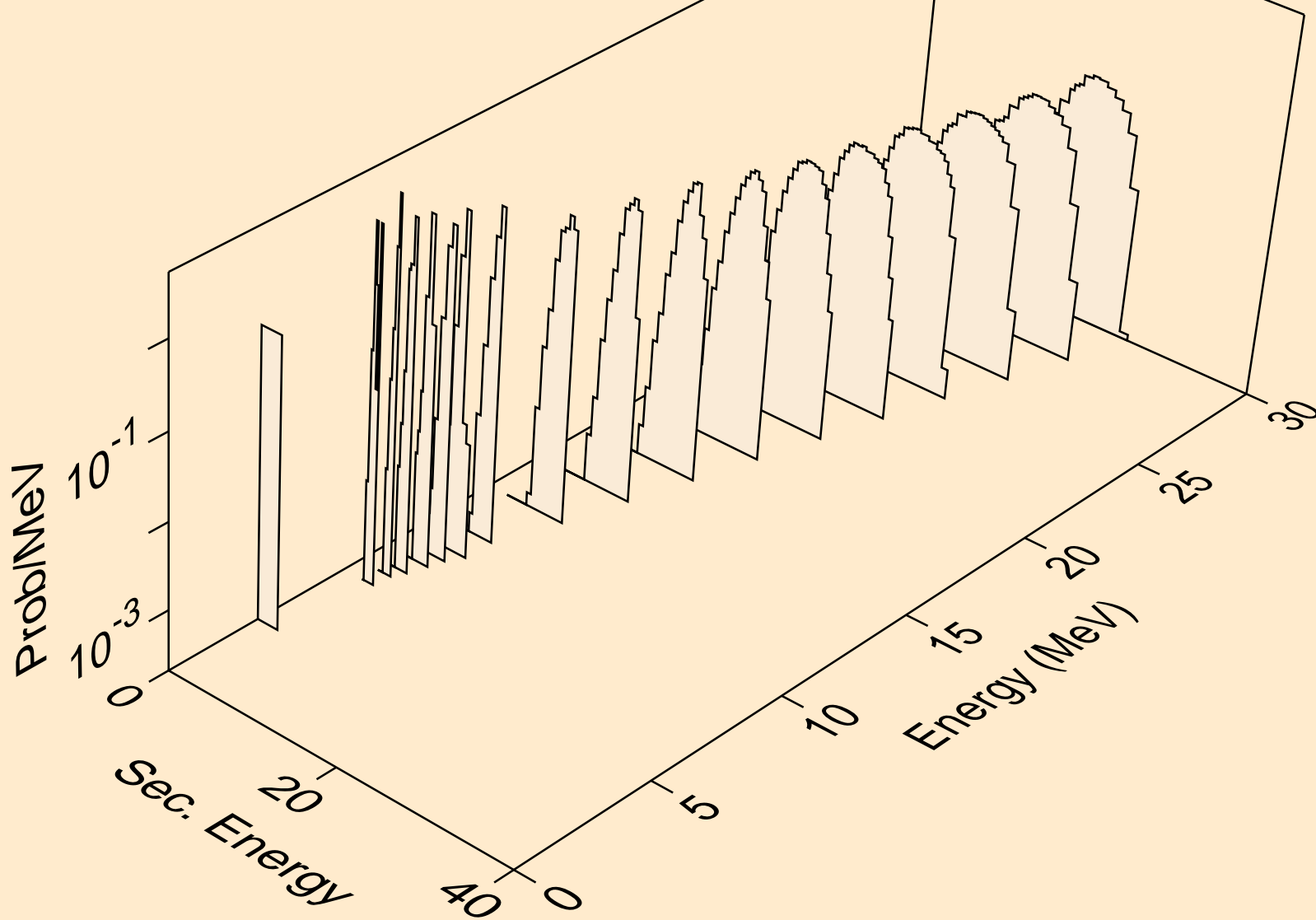

TC090N NEUTRON ACER TENDL-2019 LIBRARY; T=293.16K
alphas from (n,2n)a

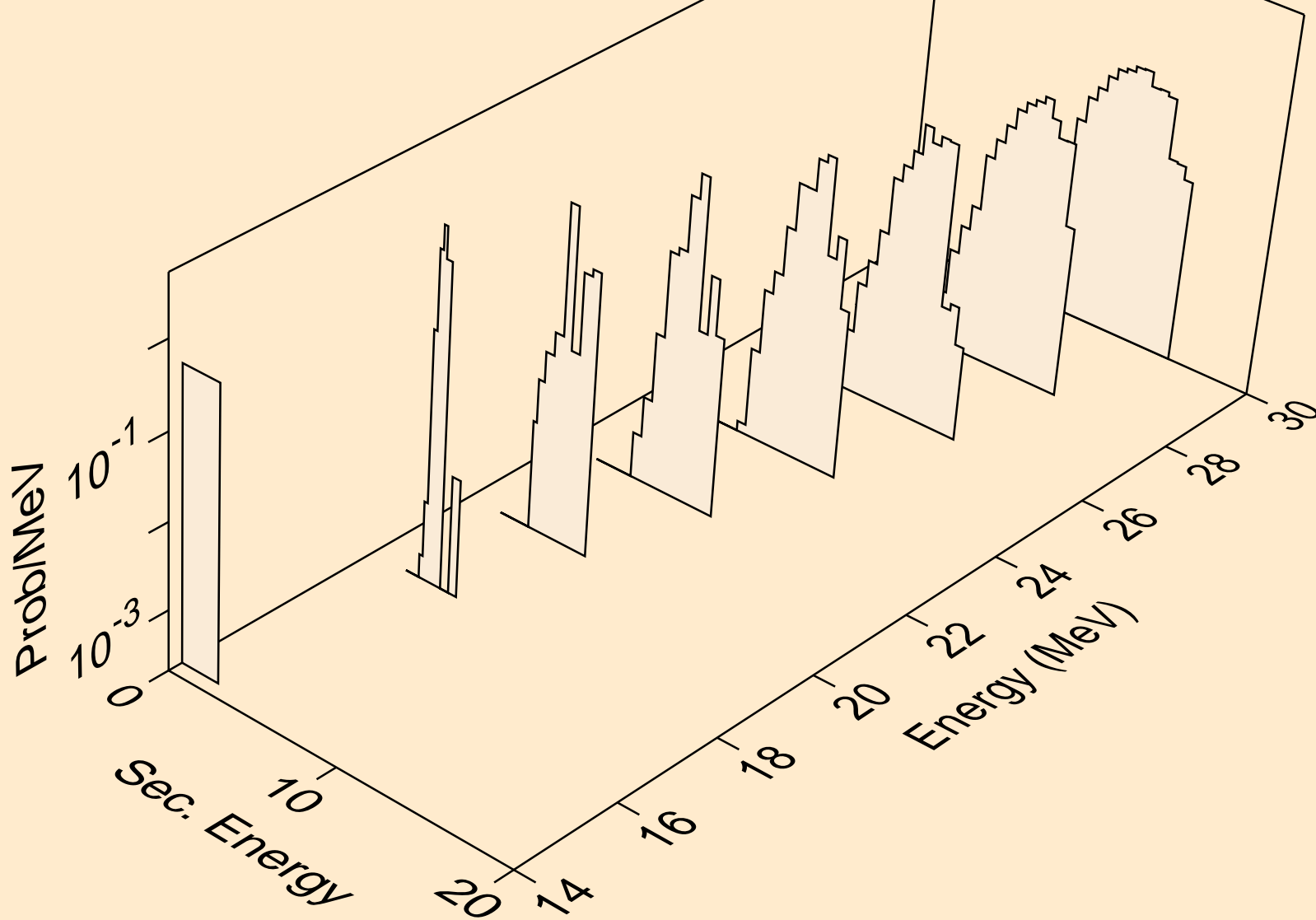

TC090N NEUTRON ACER TENDL-2019 LIBRARY; T=293.16K
alphas from (n,n*)2a

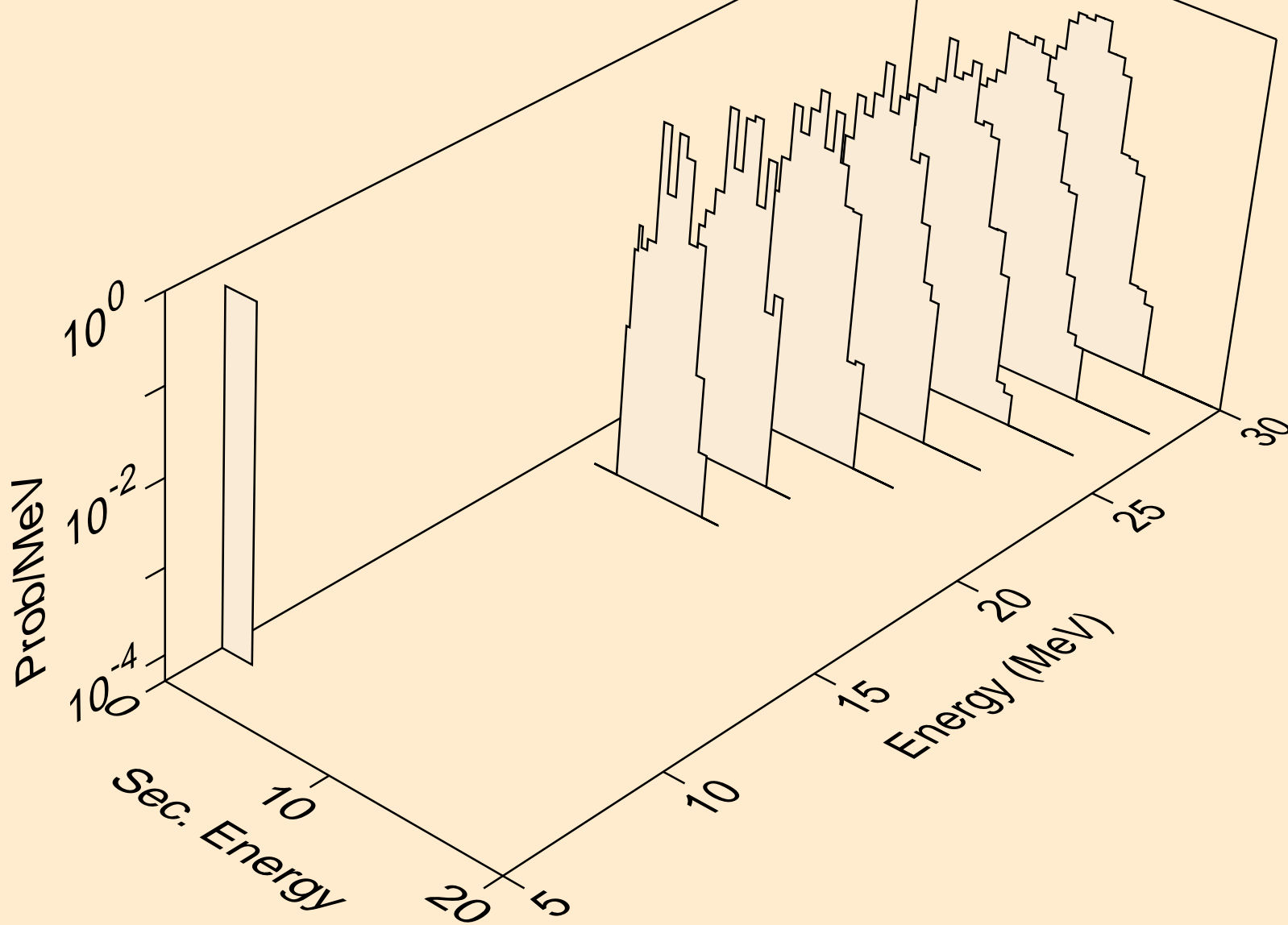

TC090N NEUTRON ACER TENDL-2019 LIBRARY; T=293.16K
alphas from (n,npa)

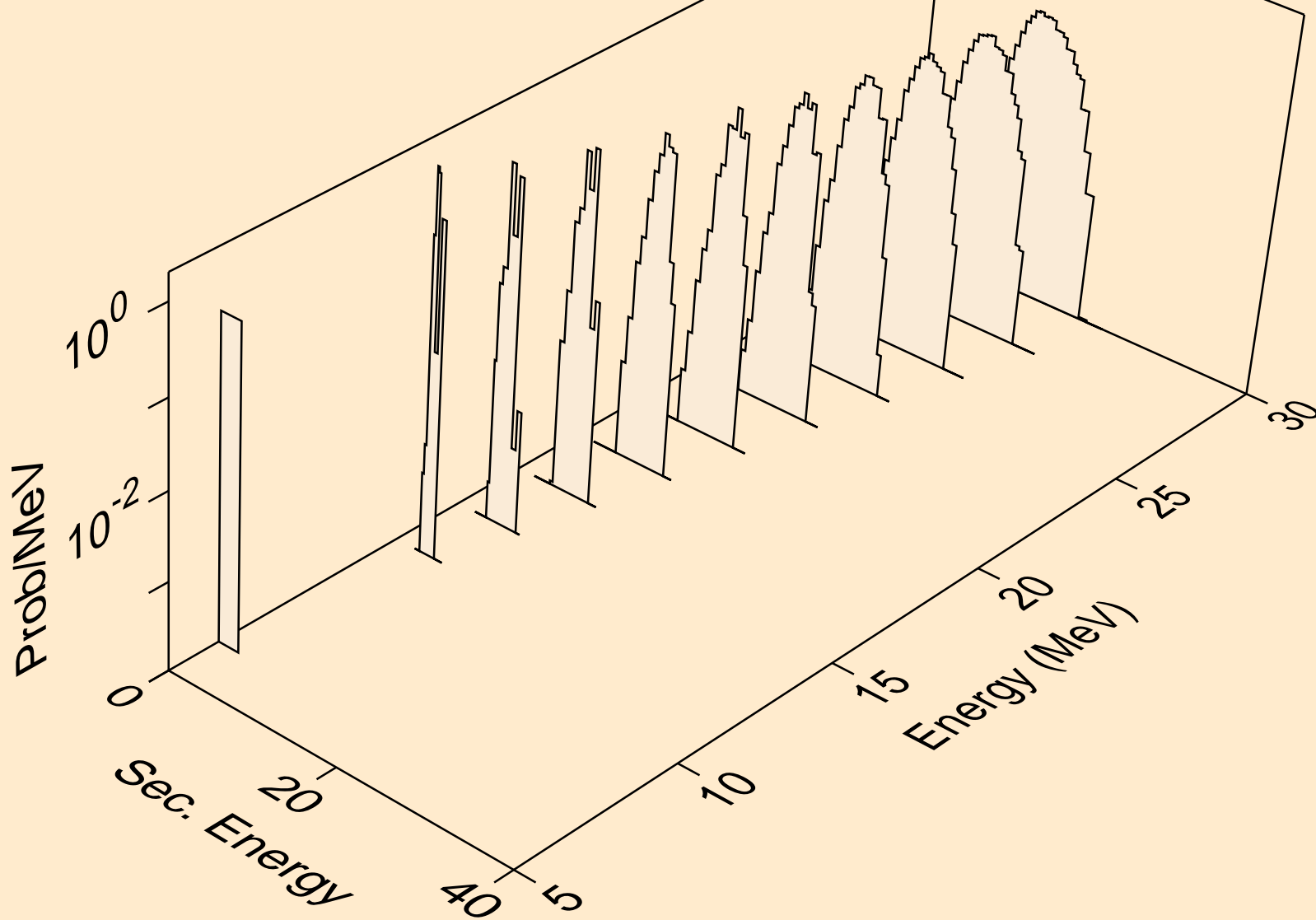

TC090N NEUTRON ACER TENDL-2019 LIBRARY; T=293.16K
alphas from (n,a)

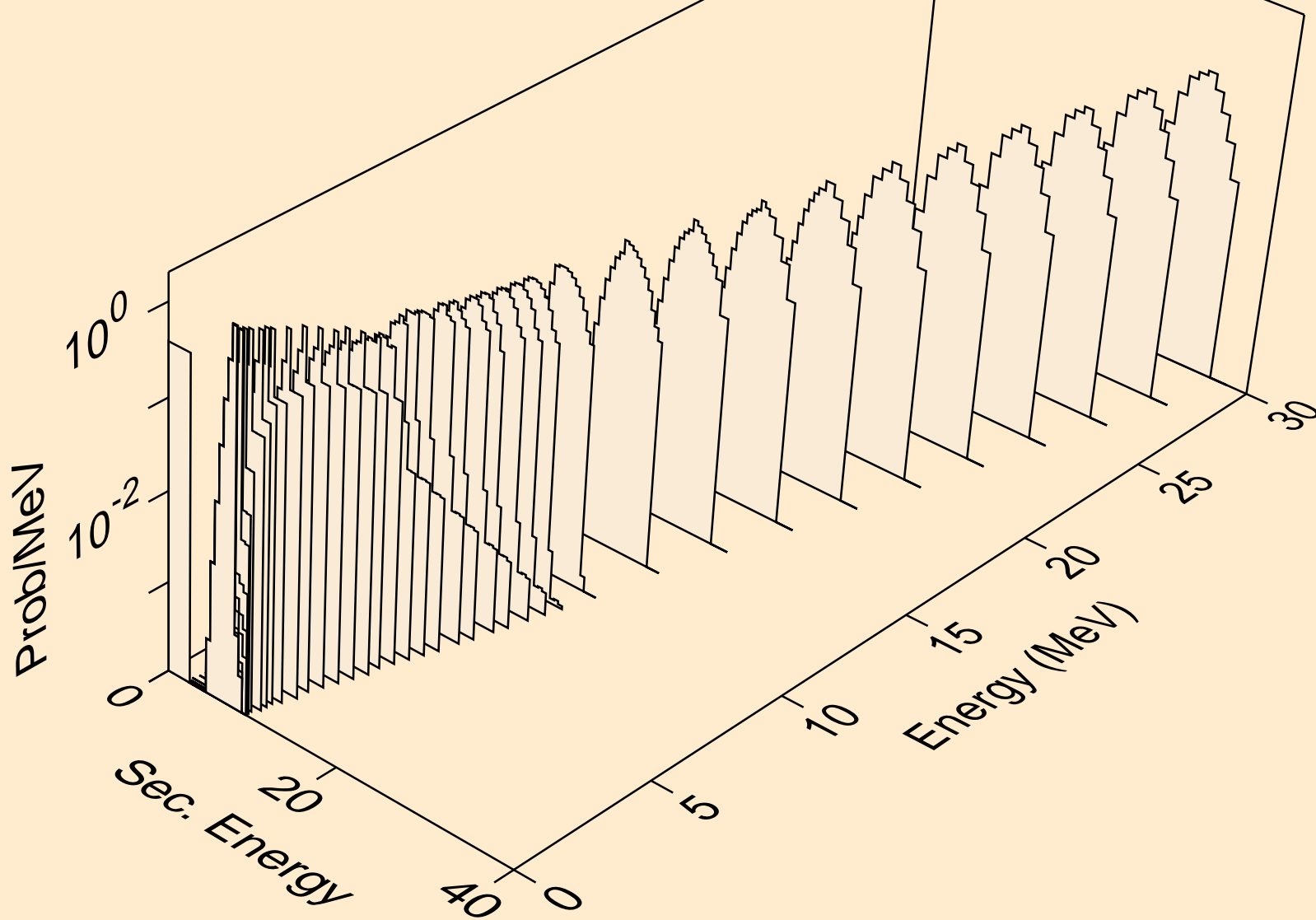

TC090N NEUTRON ACER TENDL-2019 LIBRARY; T=293.16K
alphas from (n,2a)

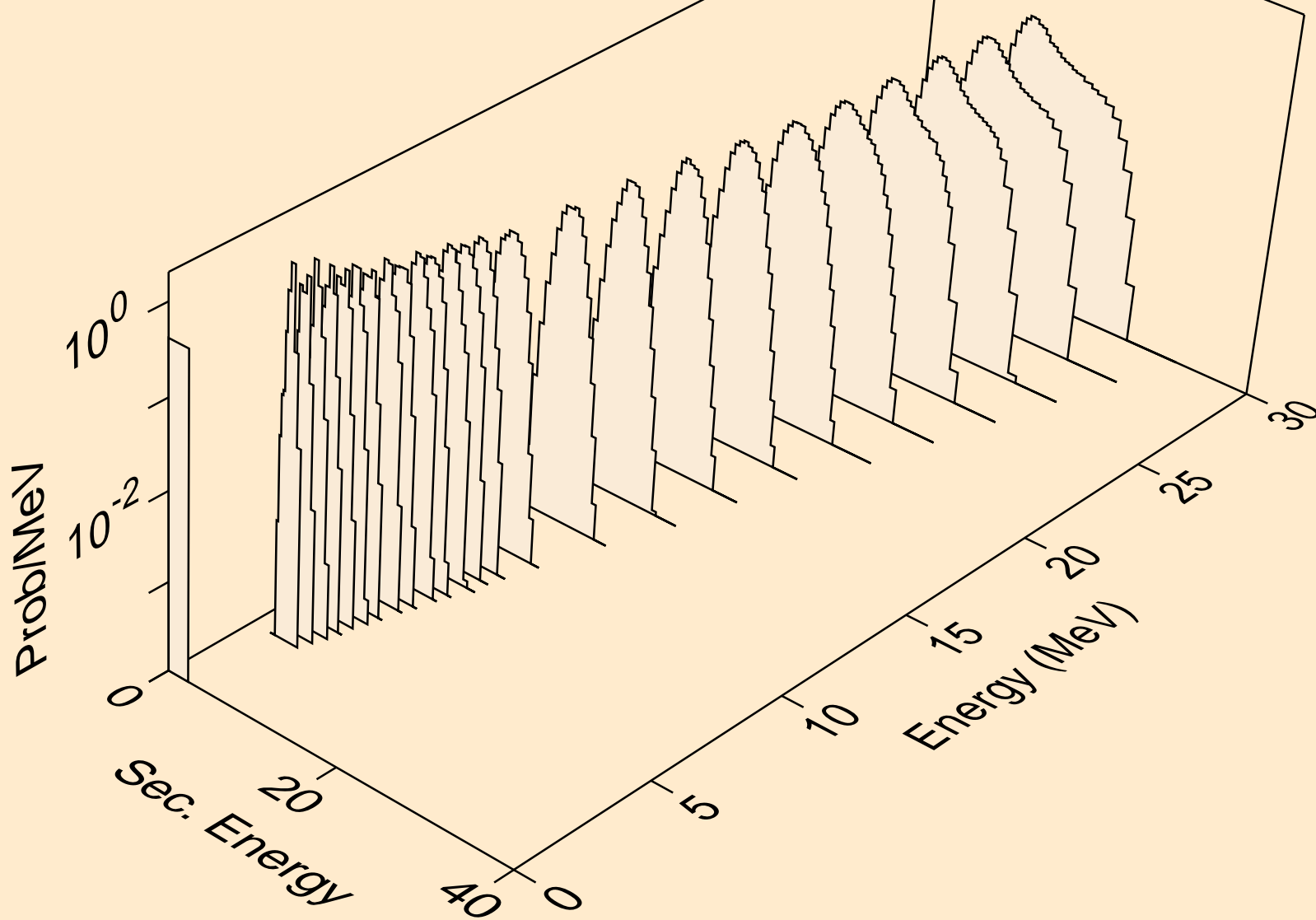

TC090N NEUTRON ACER TENDL-2019 LIBRARY; T=293.16K
alphas from (n,3a)

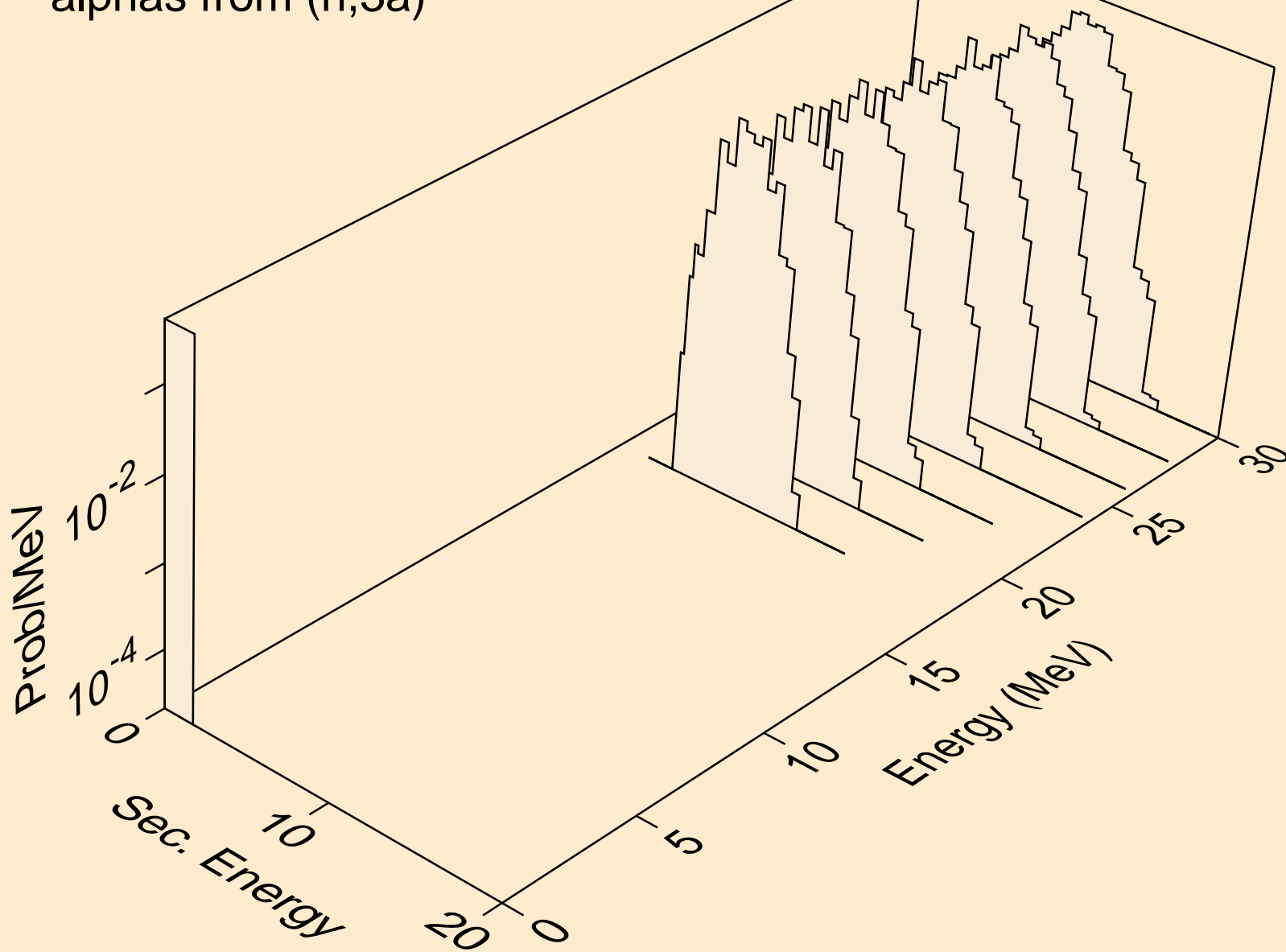

TC090N NEUTRON ACER TENDL-2019 LIBRARY; T=293.16K
alphas from (n,pa)

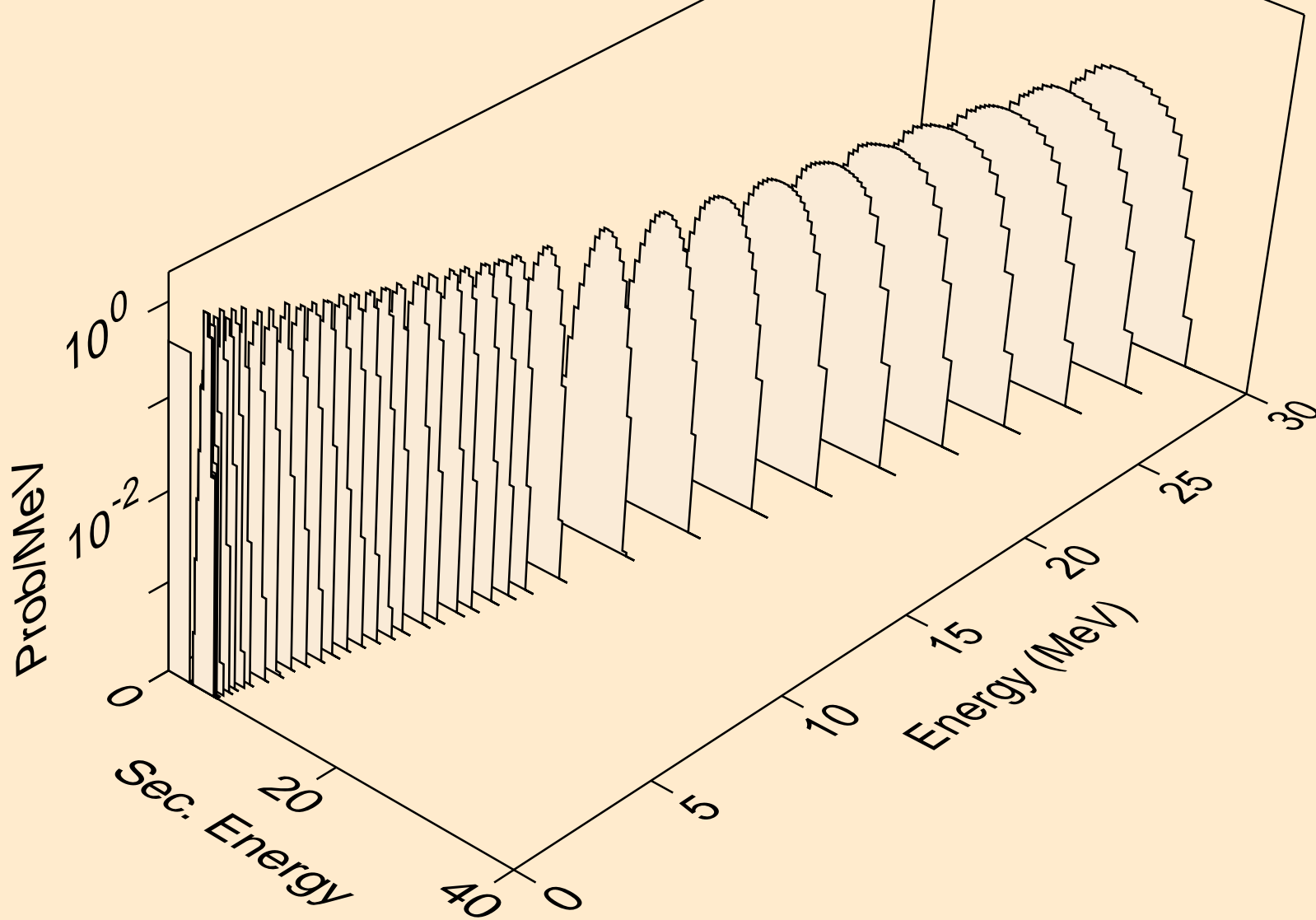

TC090N NEUTRON ACER TENDL-2019 LIBRARY; T=293.16K
alphas from (n,da)

