

TC091 NEUTRON ACER TENDL-2019 LIBRARY; T=293.16K
Principal cross sections

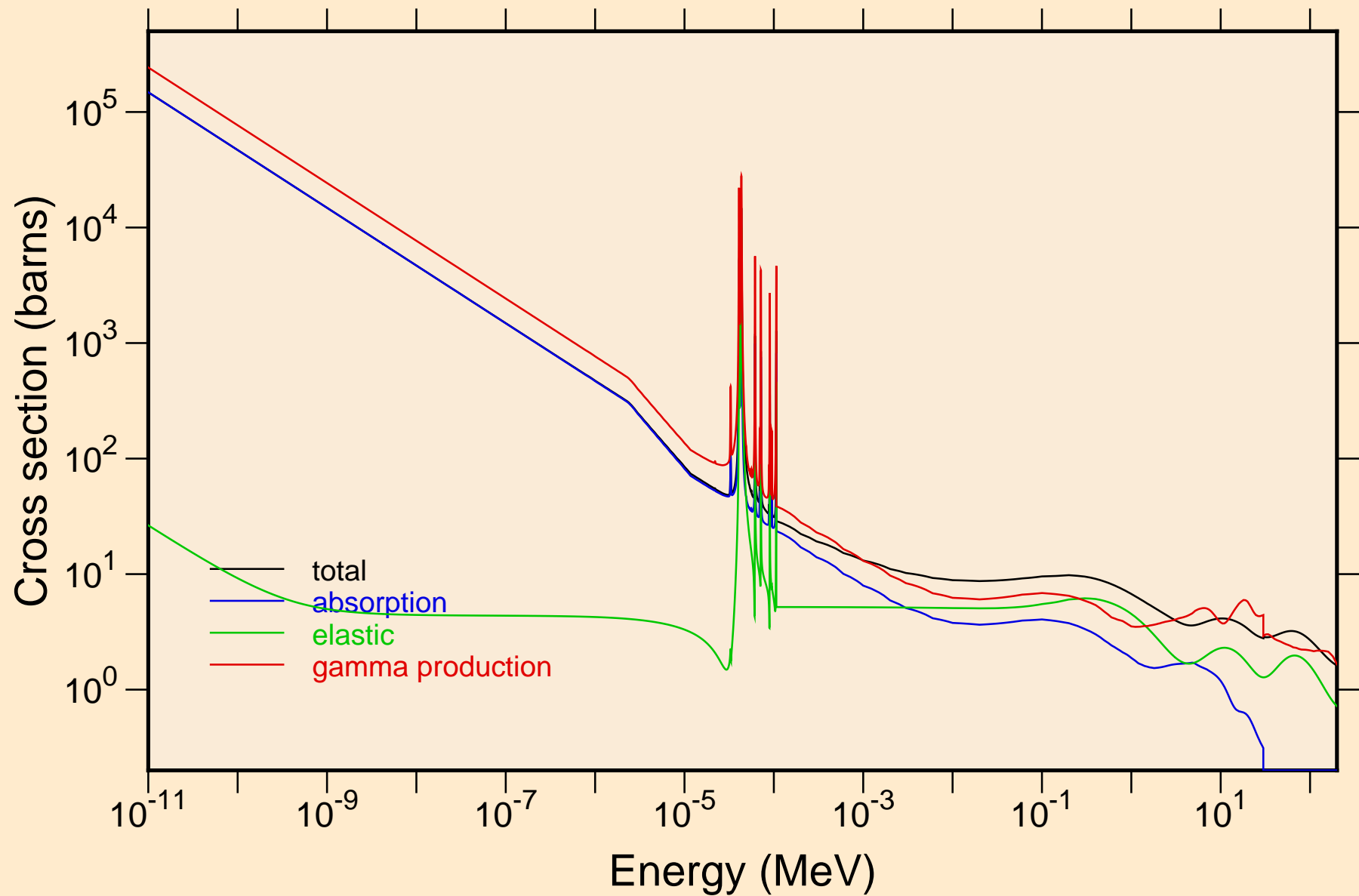

TC091 NEUTRON ACER TENDL-2019 LIBRARY; T=293.16K
resonance total cross section

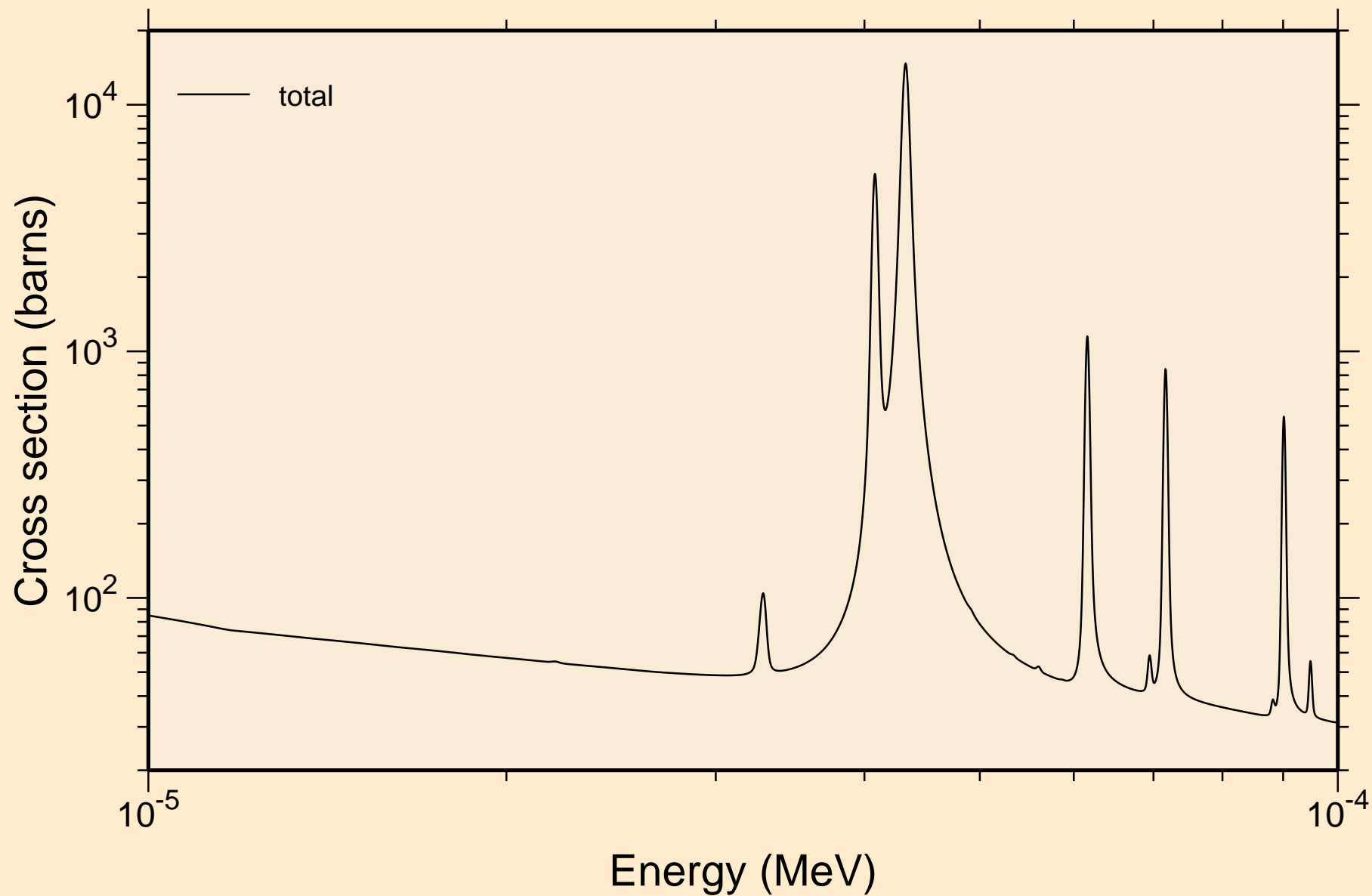

TC091 NEUTRON ACER TENDL-2019 LIBRARY; T=293.16K
resonance total cross section

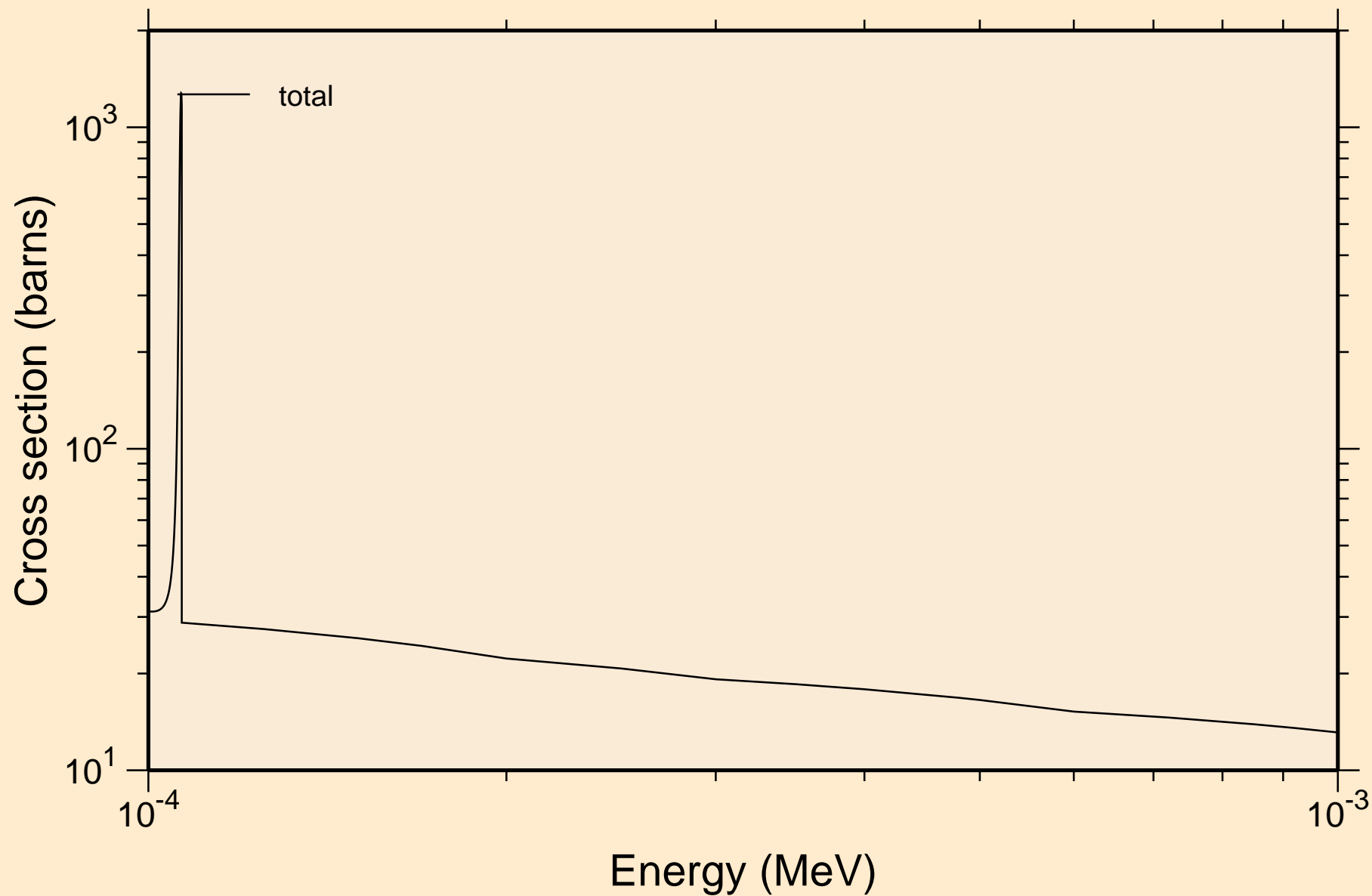

T̄C091 NEUTRON ACER TENDL-2019 LIBRARY; T=293.16K
resonance total cross section

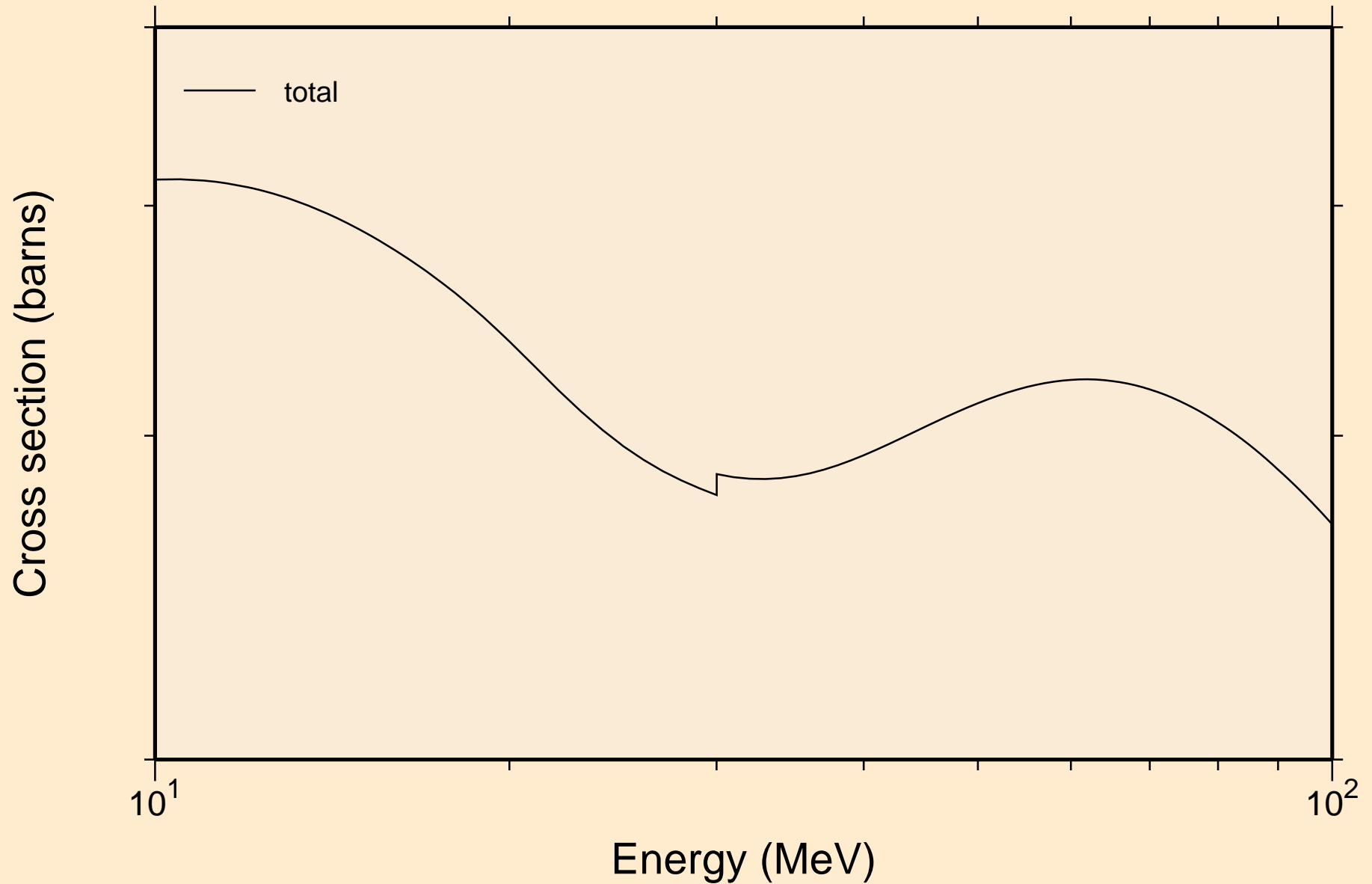

TC091 NEUTRON ACER TENDL-2019 LIBRARY; T=293.16K
resonance absorption cross sections

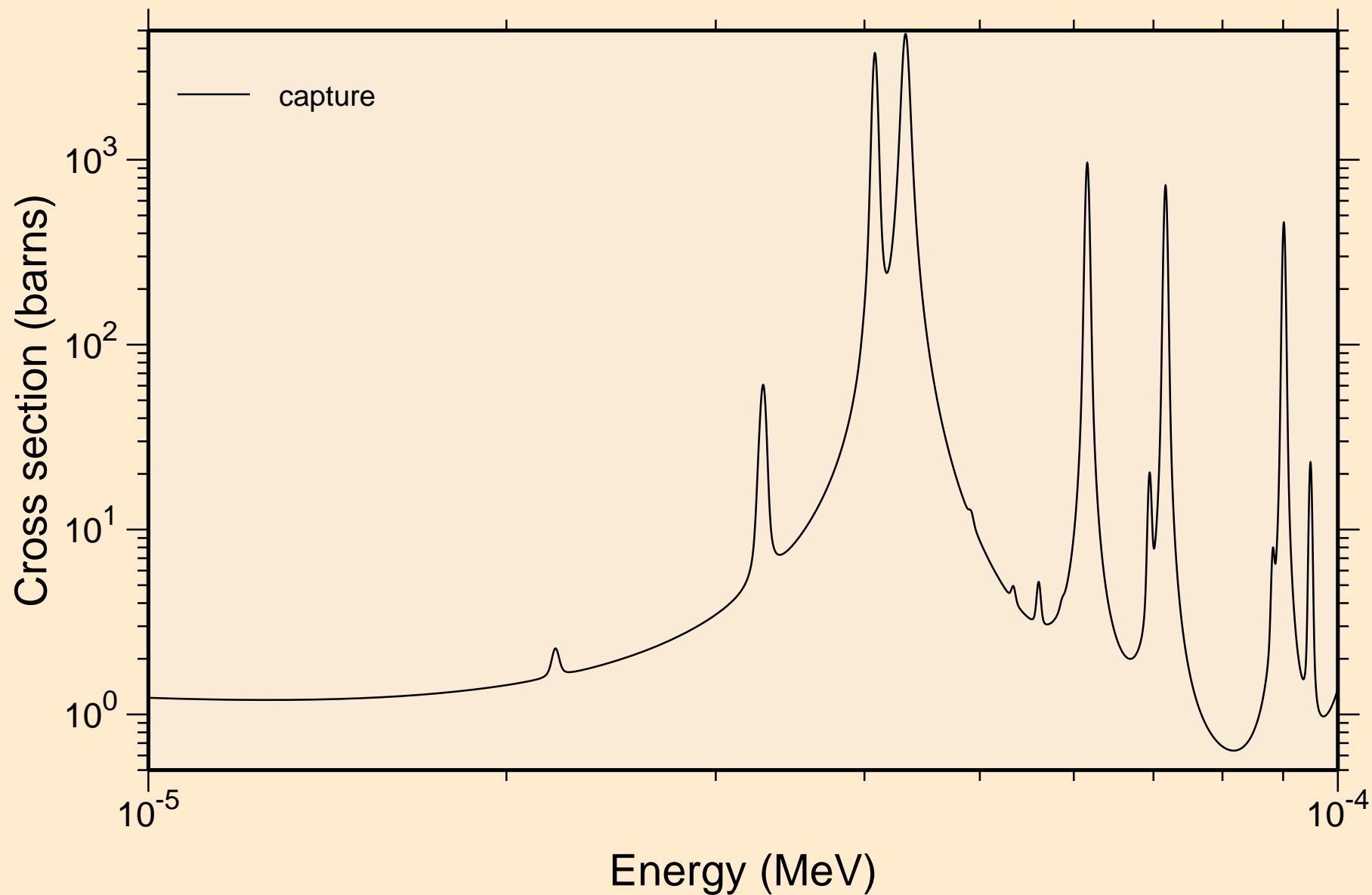

TC091 NEUTRON ACER TENDL-2019 LIBRARY; T=293.16K
resonance absorption cross sections

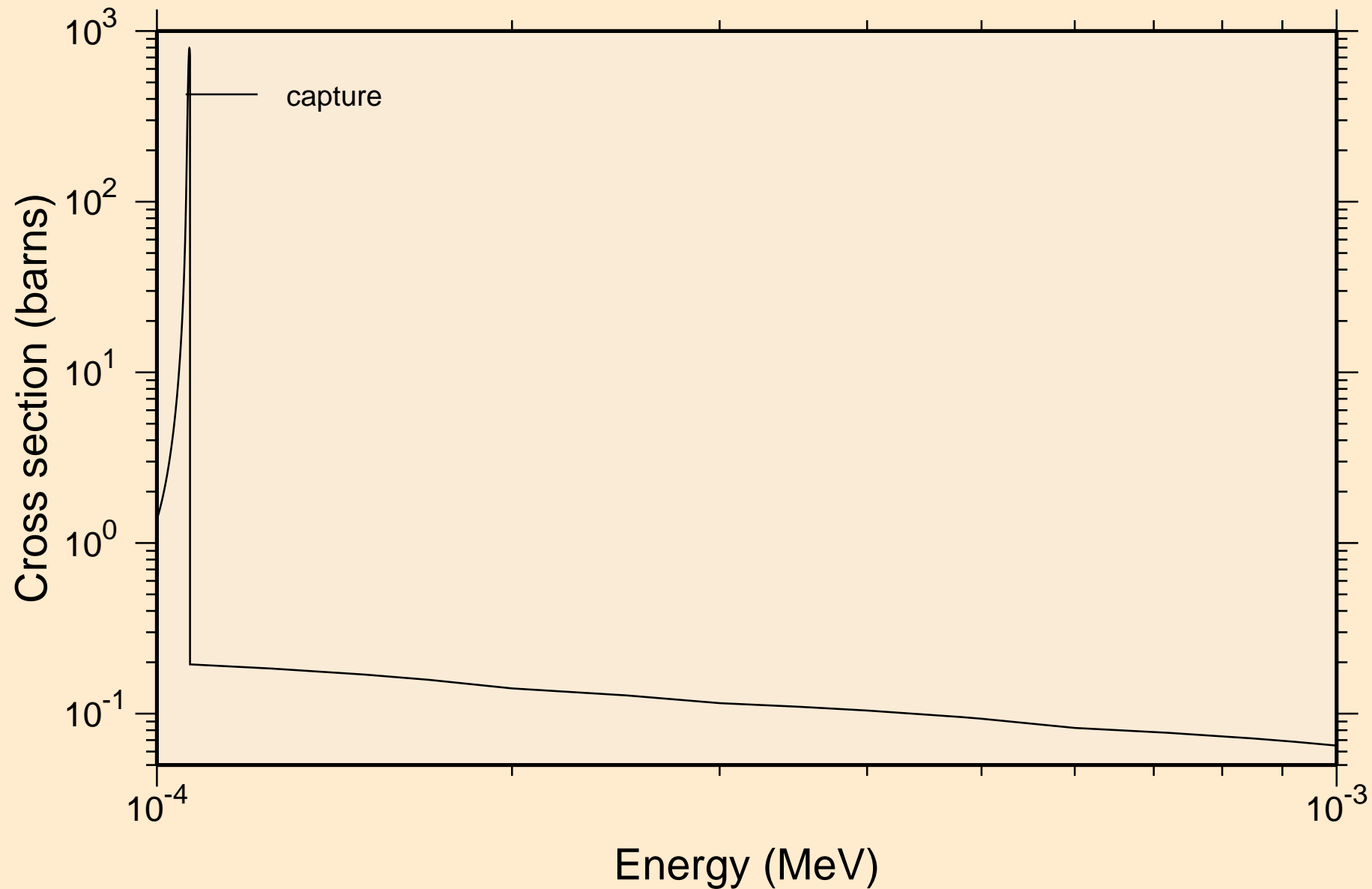

TC091 NEUTRON ACER TENDL-2019 LIBRARY; T=293.16K
resonance absorption cross sections

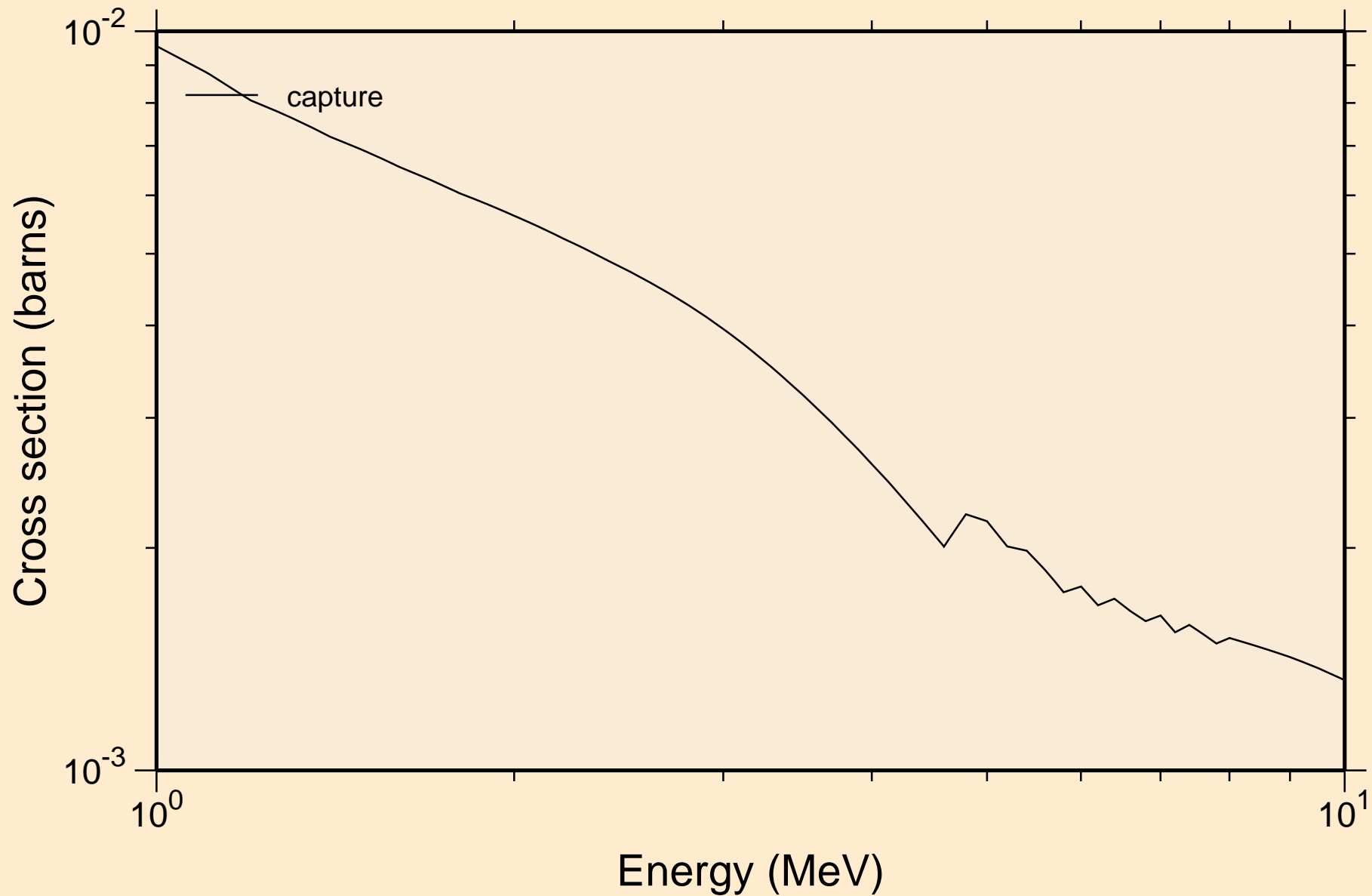

TC091 NEUTRON ACER TENDL-2019 LIBRARY; T=293.16K
Heating

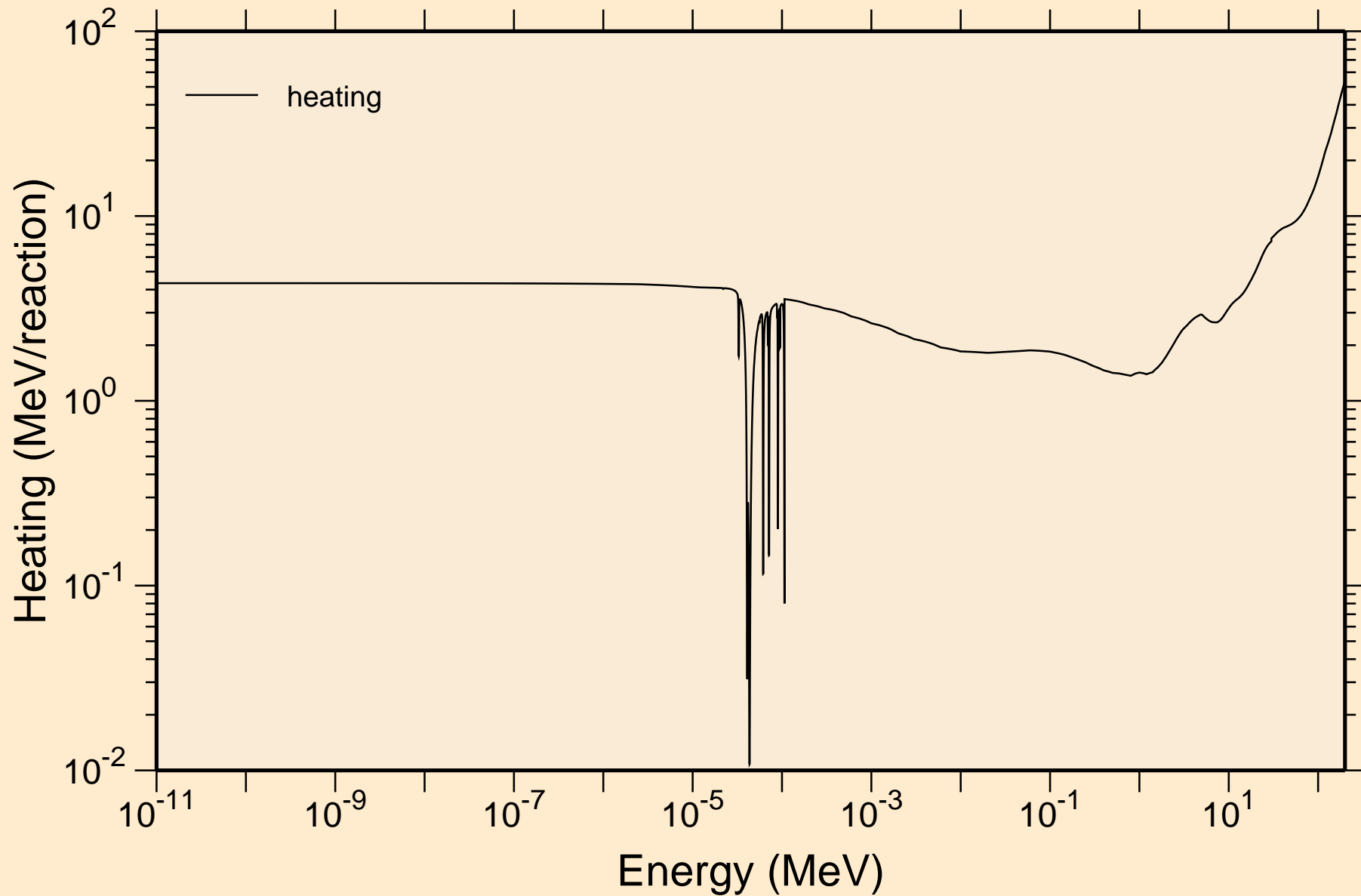

TC091 NEUTRON ACER TENDL-2019 LIBRARY; T=293.16K
Damage

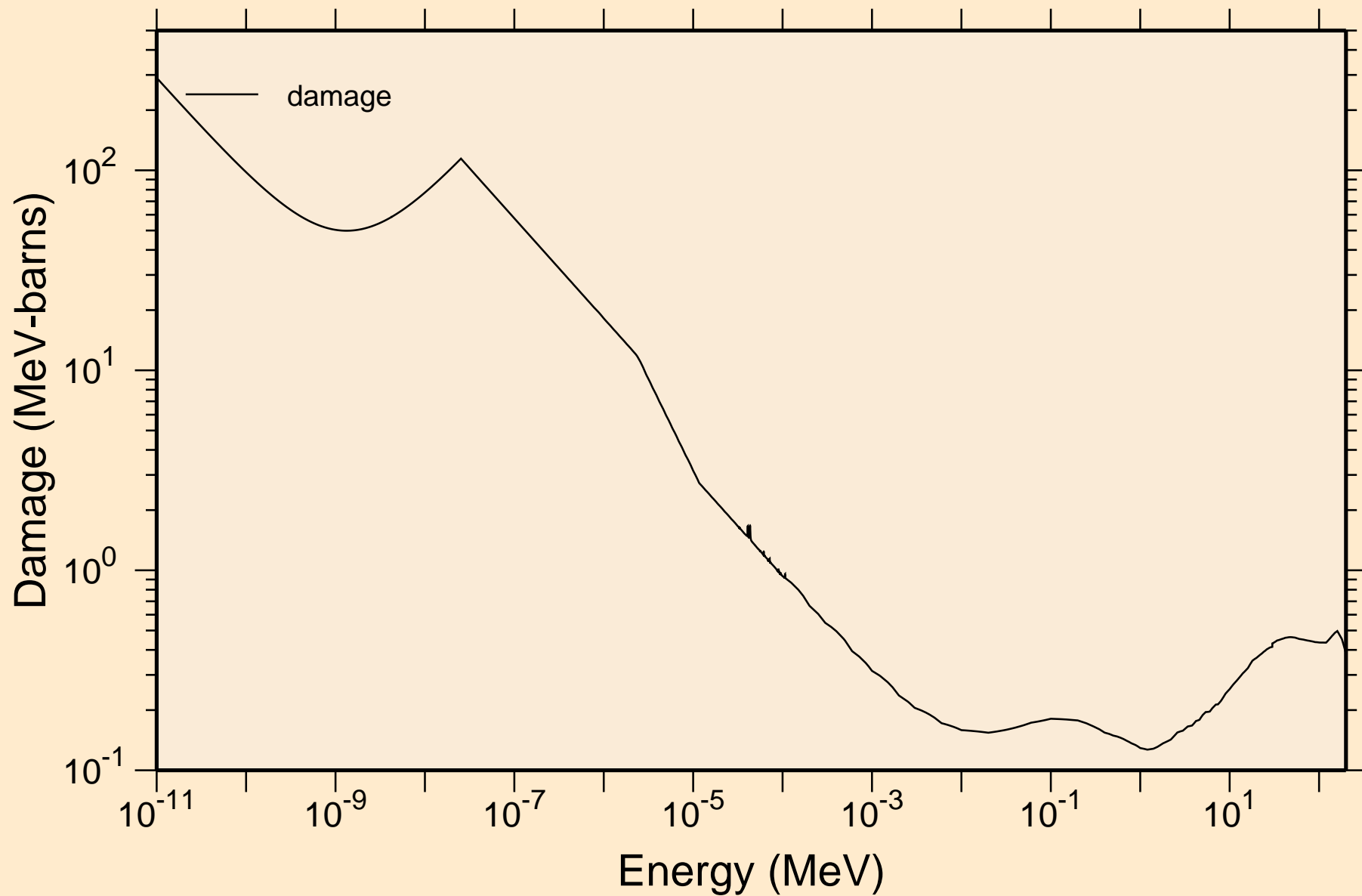

TC091 NEUTRON ACER TENDL-2019 LIBRARY; T=293.16K
Non-threshold reactions

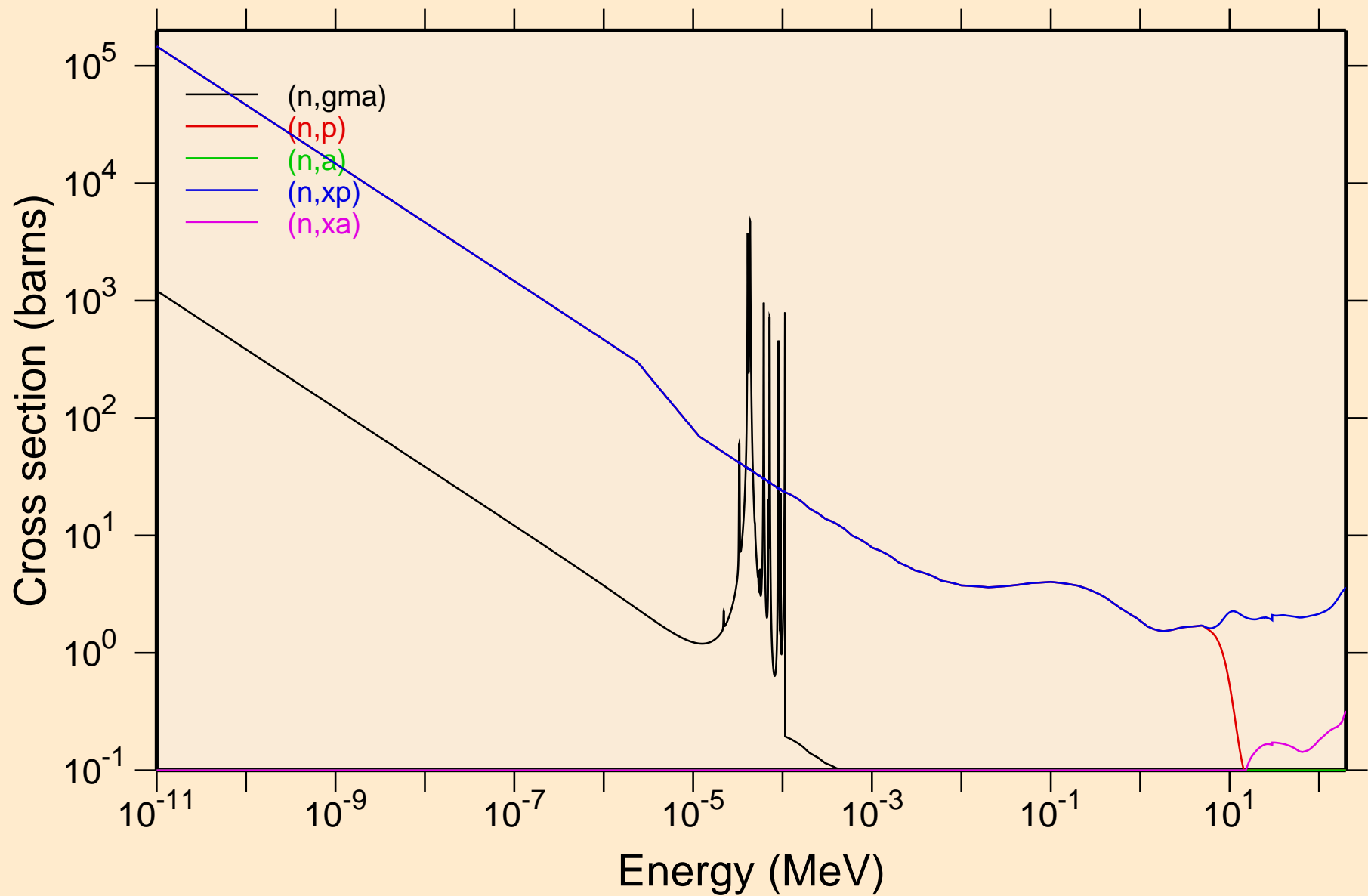

TC091 NEUTRON ACER TENDL-2019 LIBRARY; T=293.16K
Principal cross sections

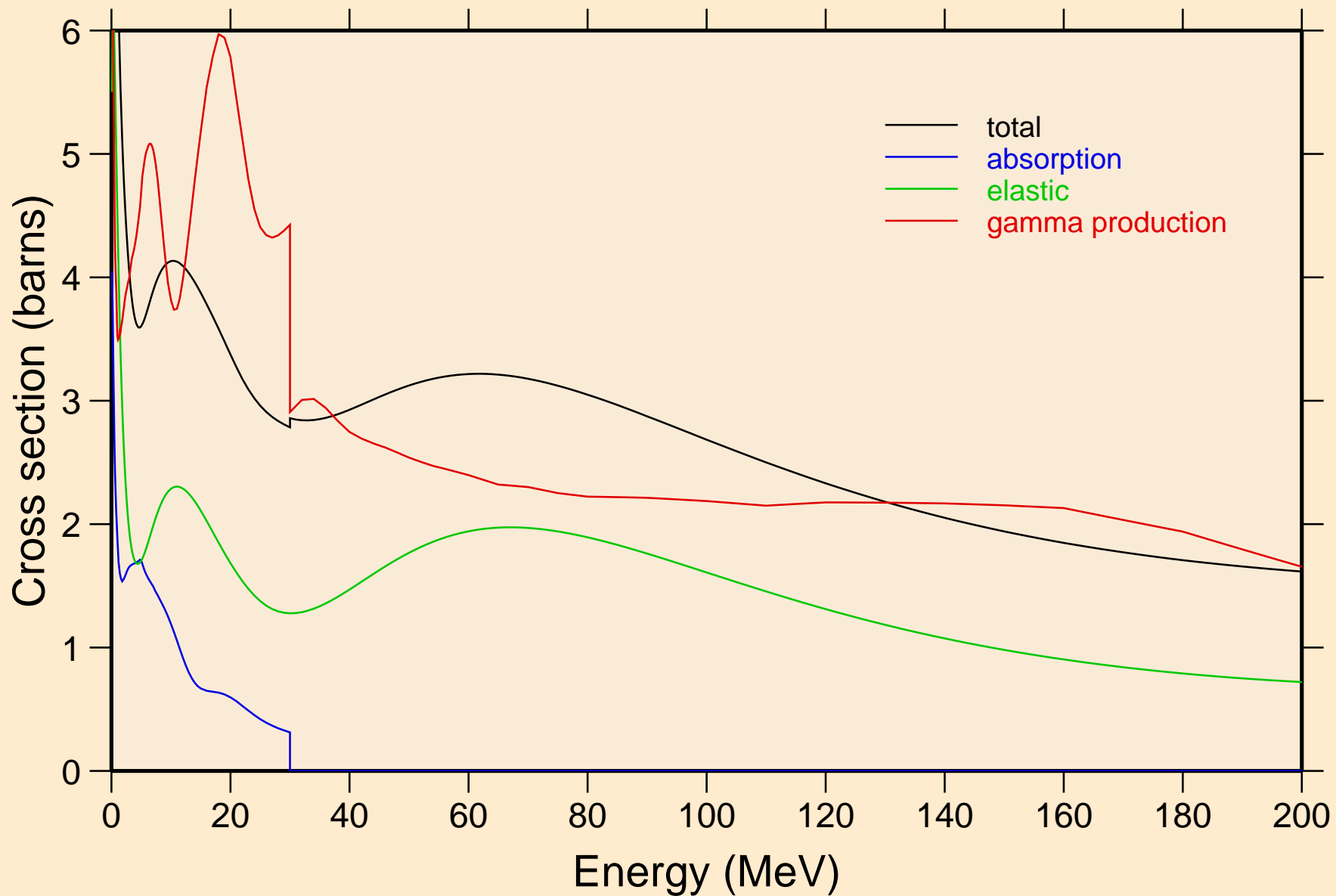

TC091 NEUTRON ACER TENDL-2019 LIBRARY; T=293.16K
Heating

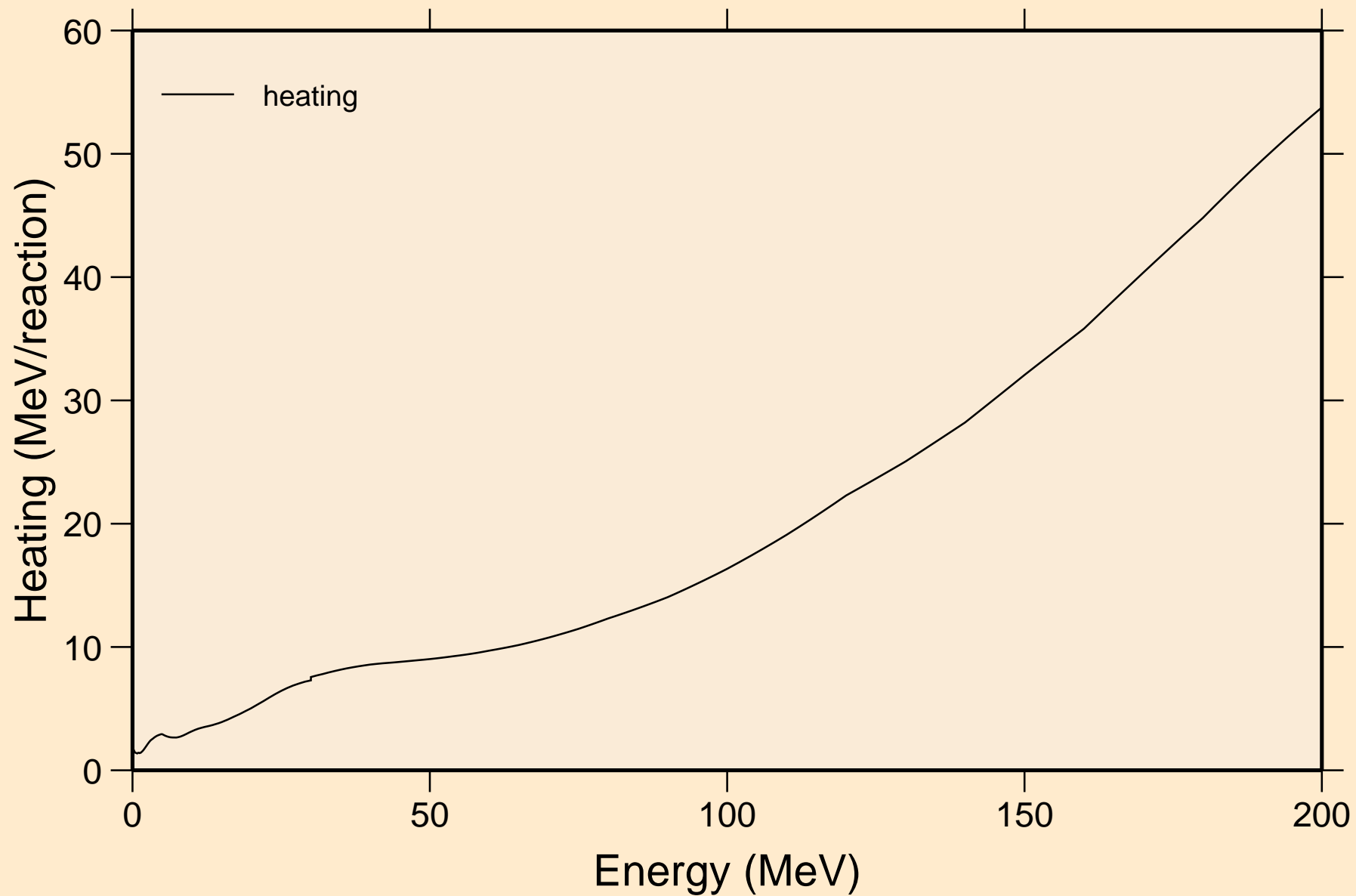

TC091 NEUTRON ACER TENDL-2019 LIBRARY; T=293.16K
Damage

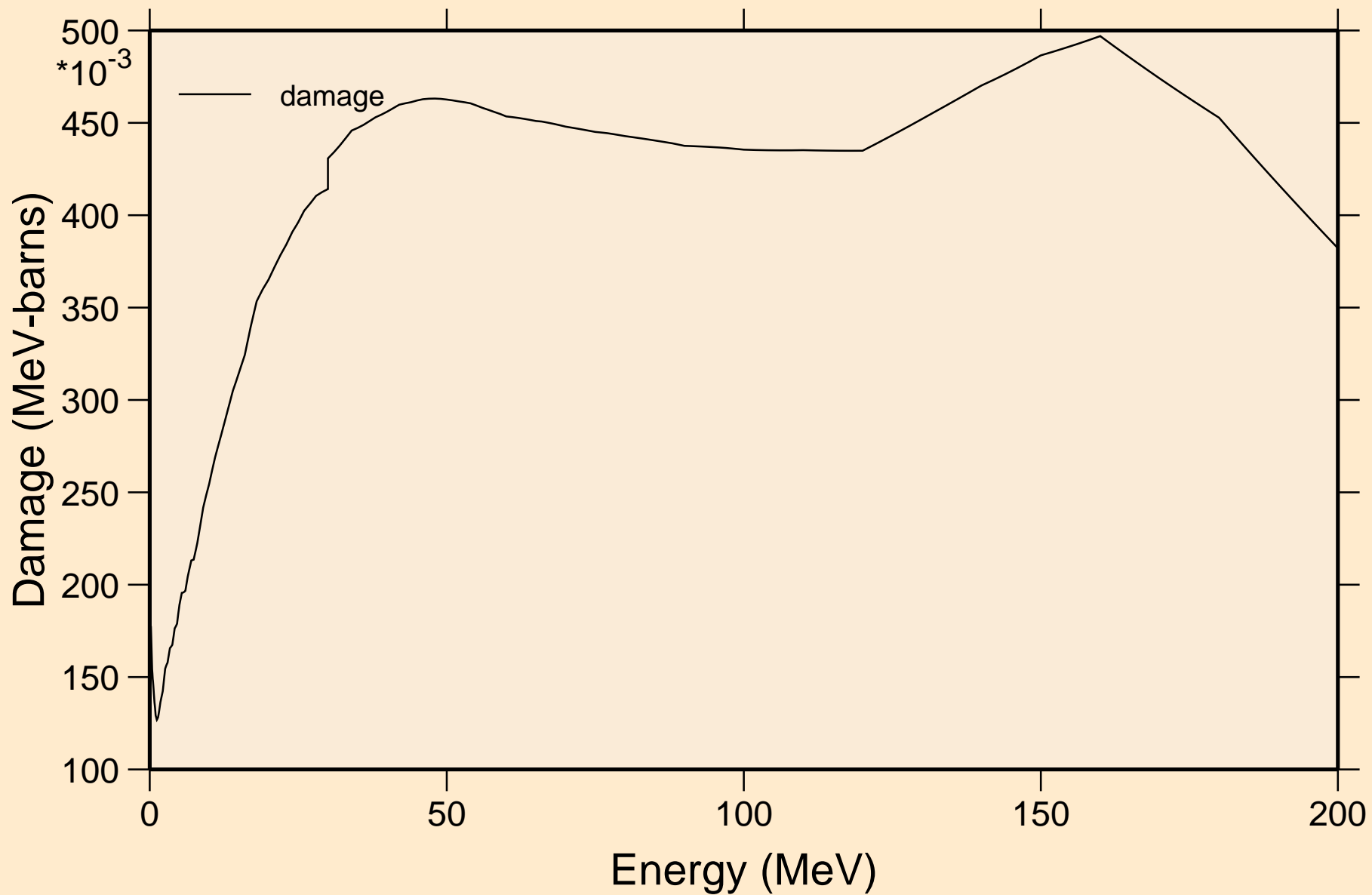

TC091 NEUTRON ACER TENDL-2019 LIBRARY; T=293.16K
Non-threshold reactions

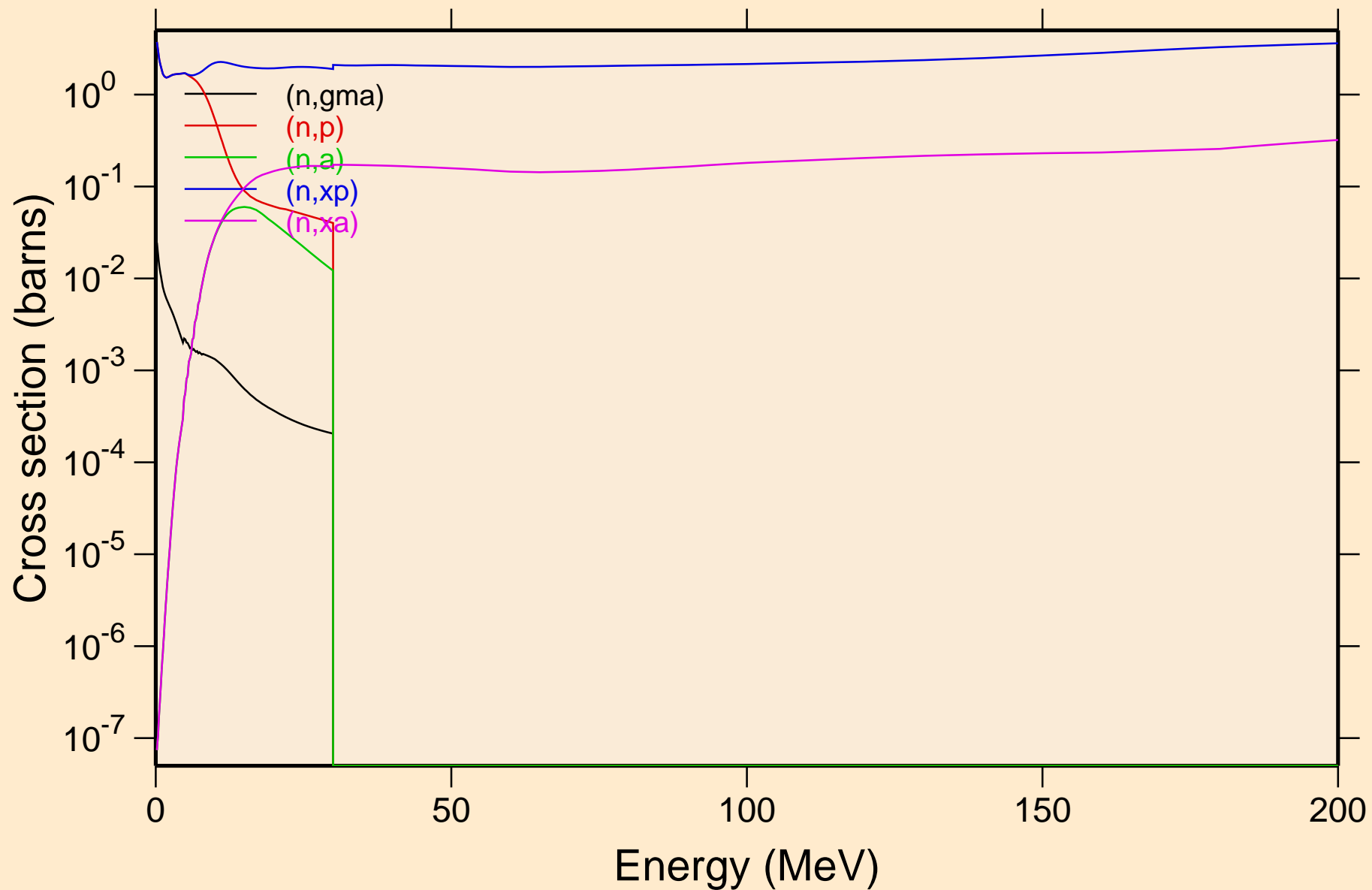

TC091 NEUTRON ACER TENDL-2019 LIBRARY; T=293.16K
Inelastic levels

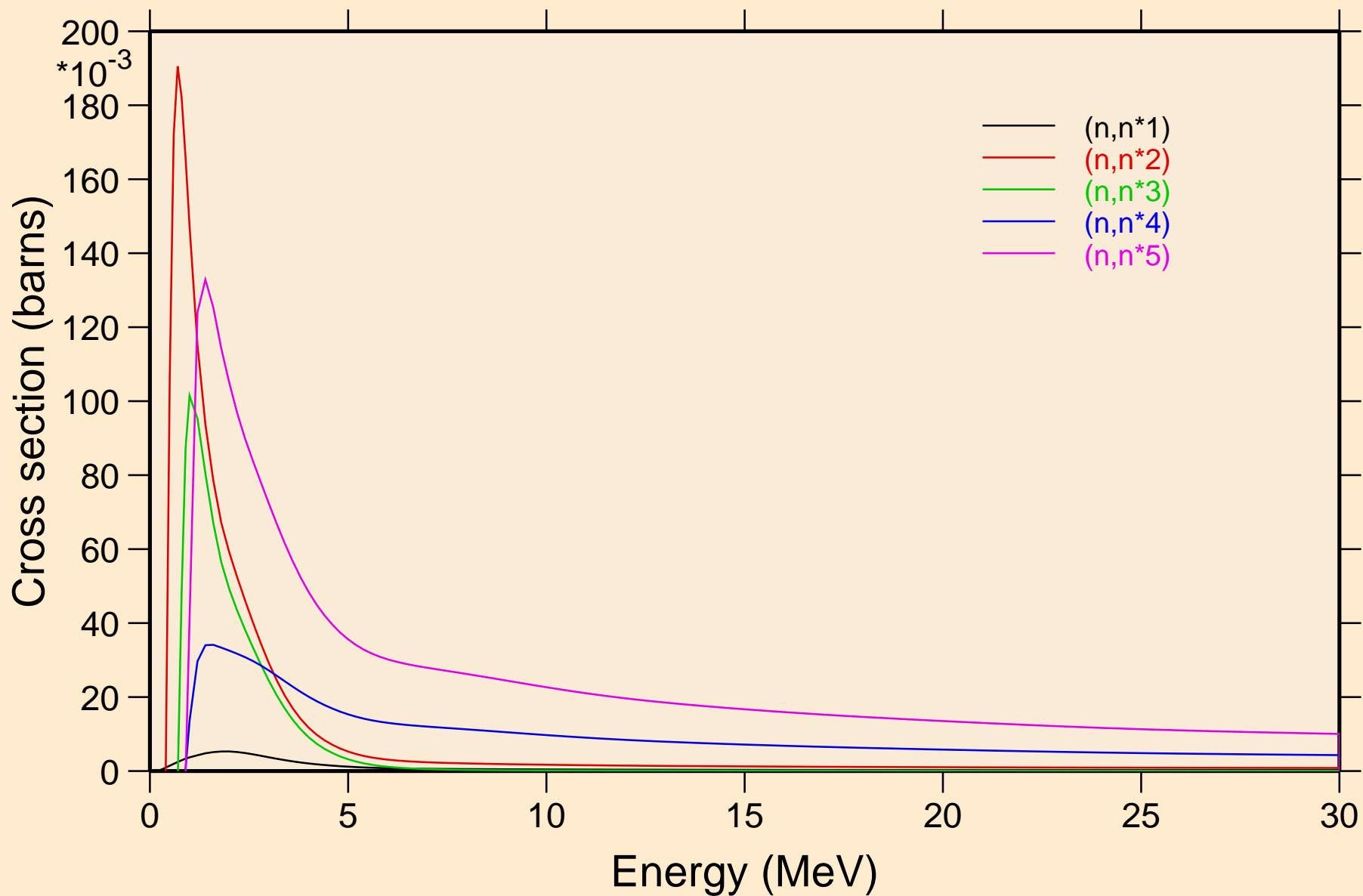

TC091 NEUTRON ACER TENDL-2019 LIBRARY; T=293.16K
Inelastic levels

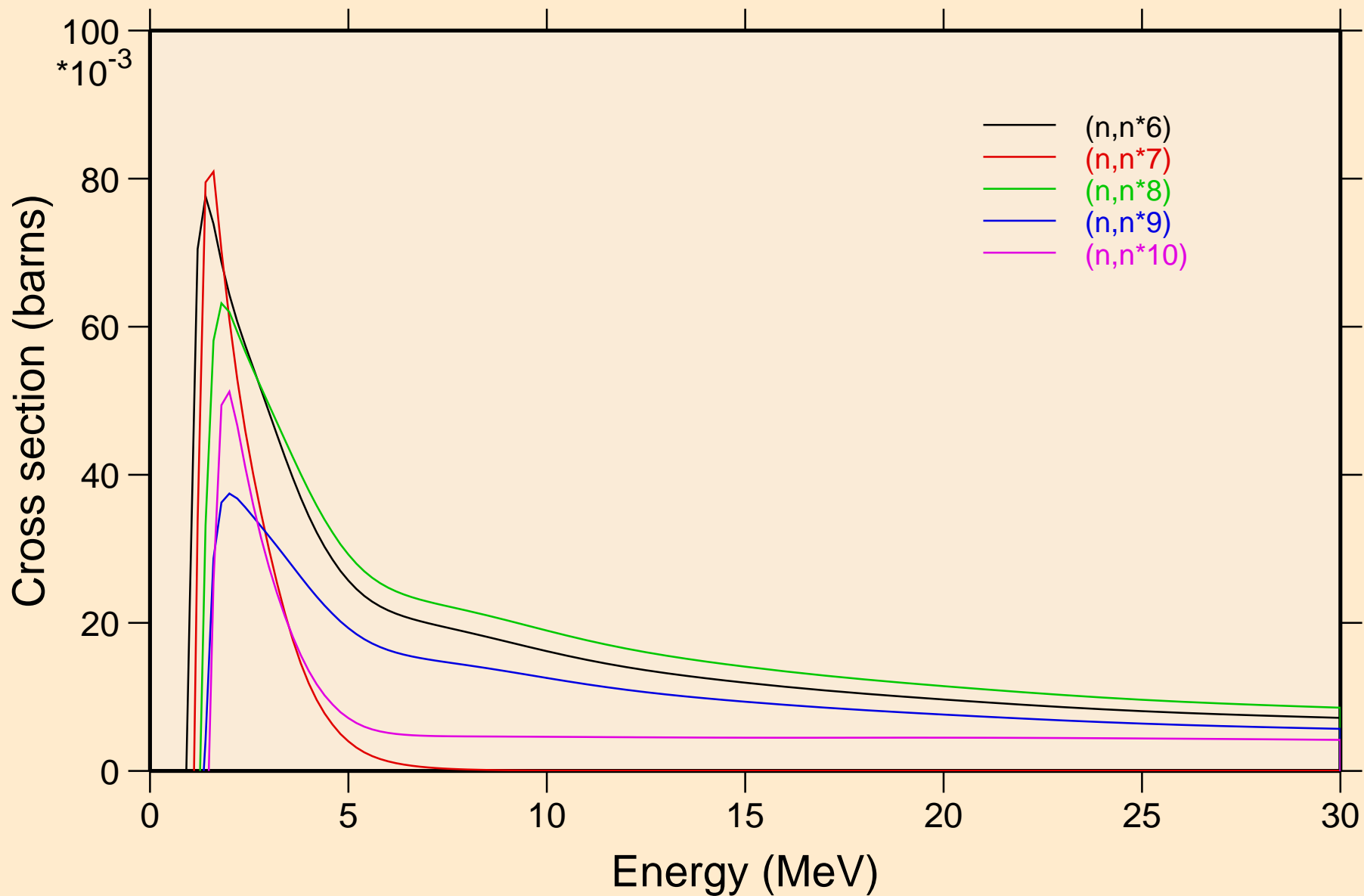

TC091 NEUTRON ACER TENDL-2019 LIBRARY; T=293.16K
Inelastic levels

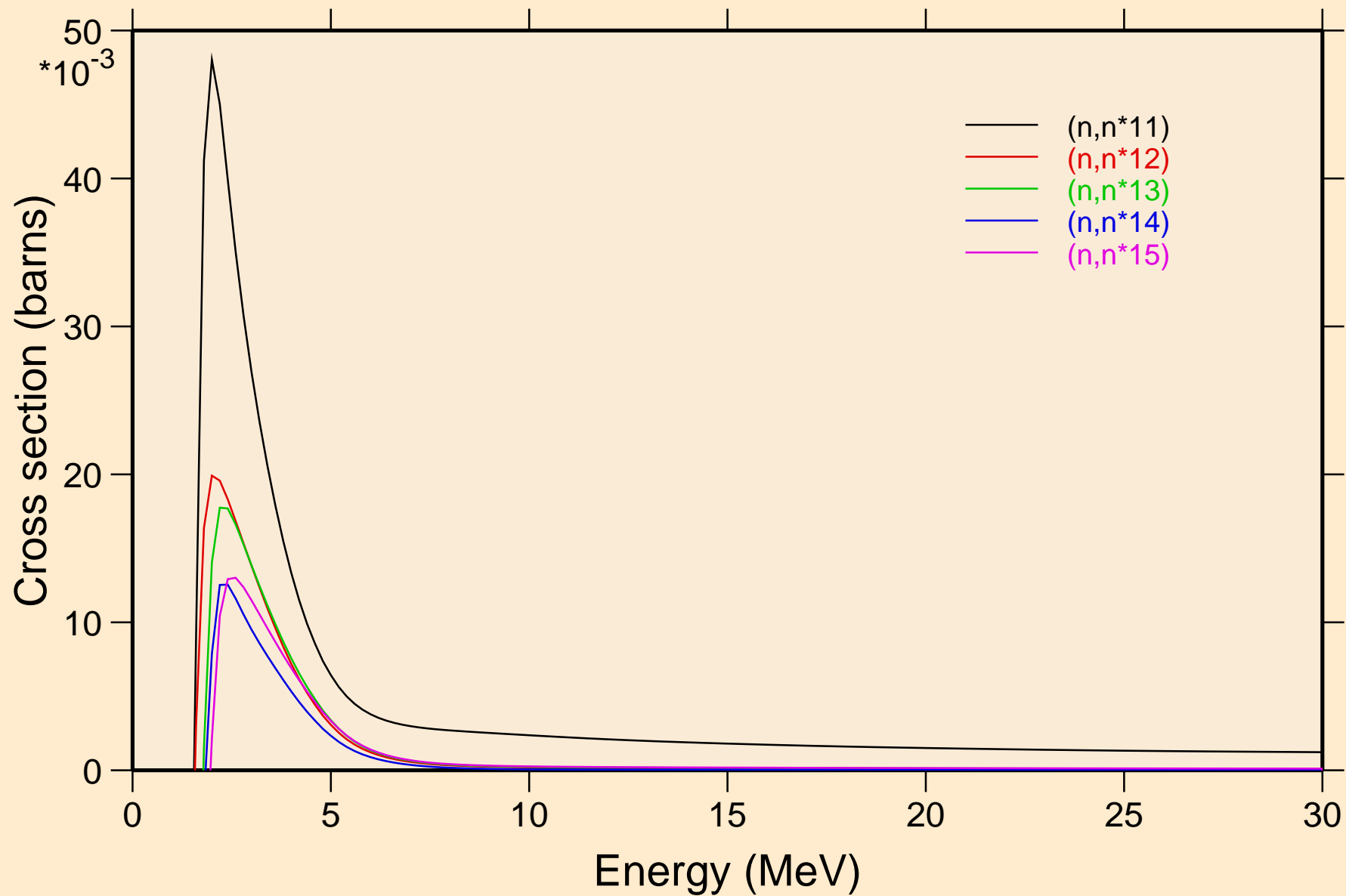

TC091 NEUTRON ACER TENDL-2019 LIBRARY; T=293.16K
Inelastic levels

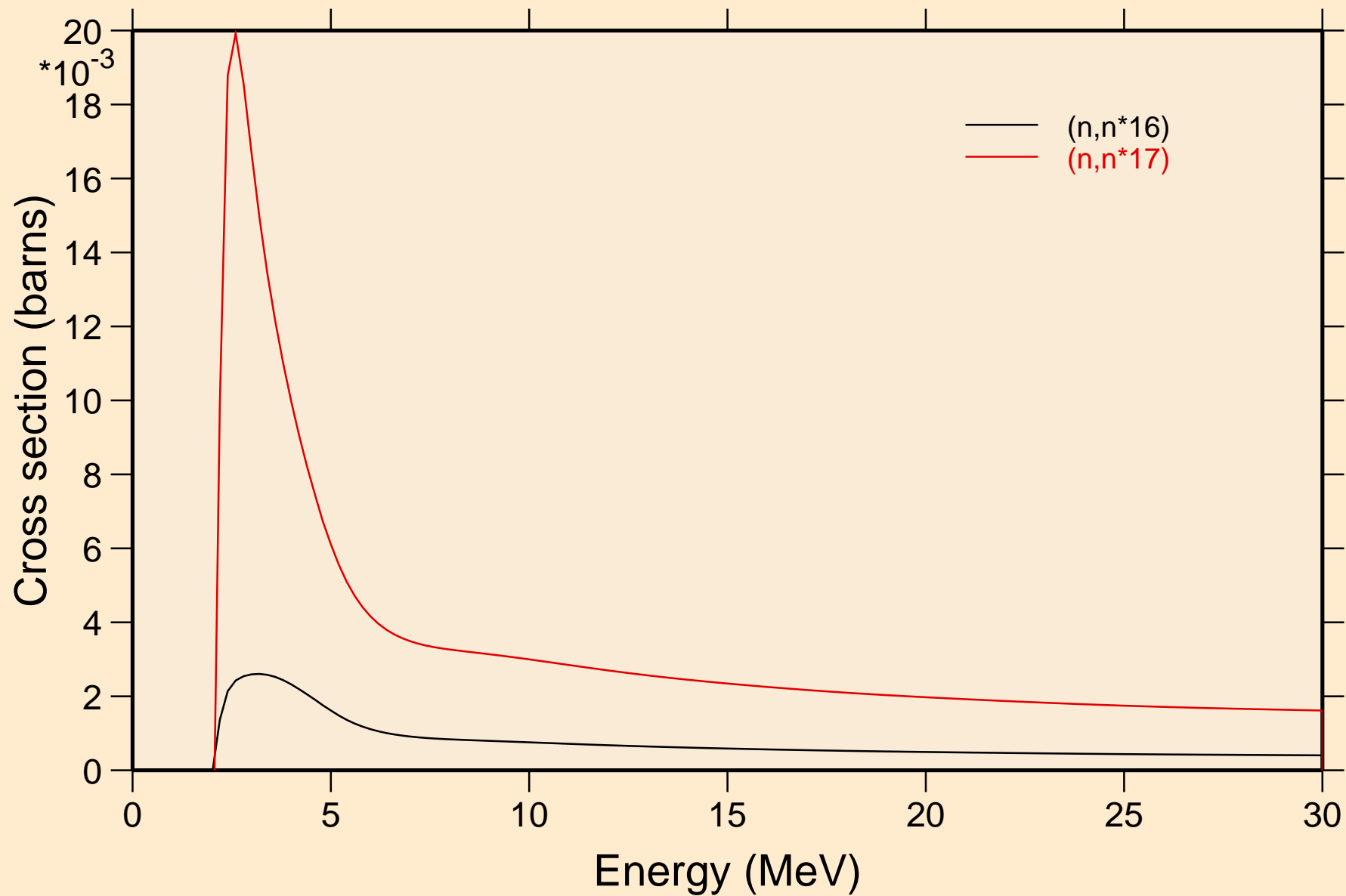

TC091 NEUTRON ACER TENDL-2019 LIBRARY; T=293.16K
Threshold reactions

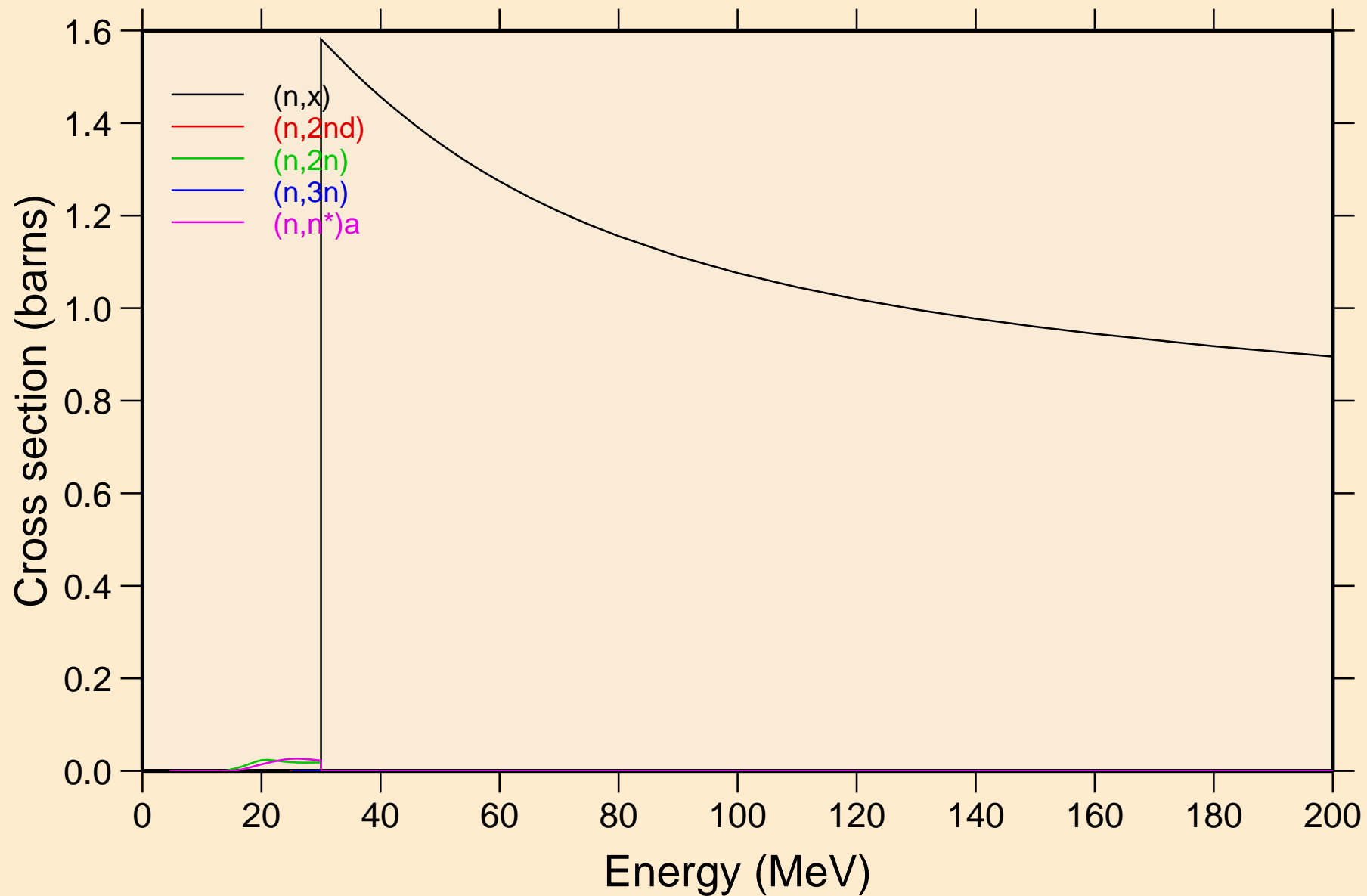

TC091 NEUTRON ACER TENDL-2019 LIBRARY; T=293.16K
Threshold reactions

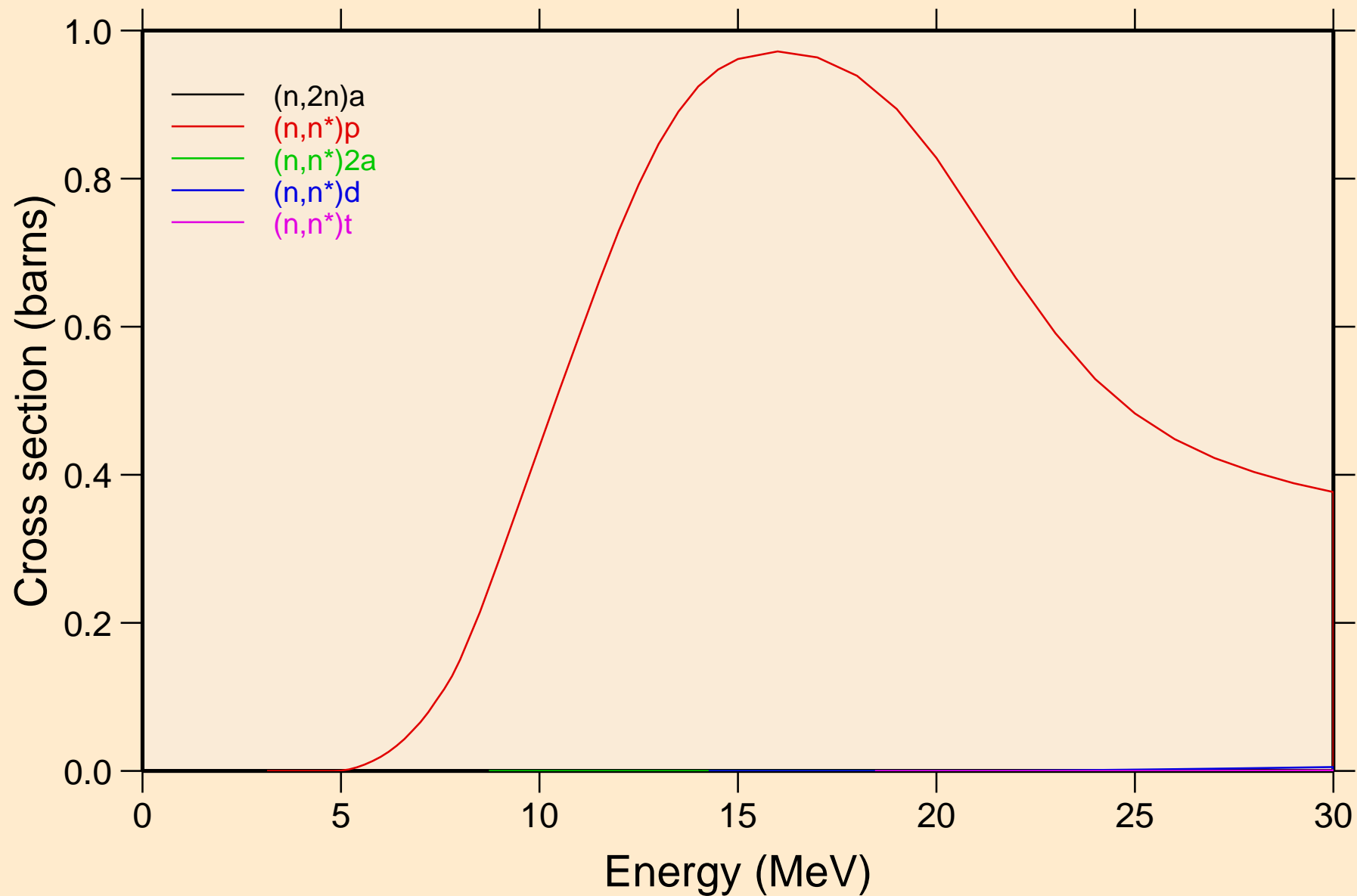

TC091 NEUTRON ACER TENDL-2019 LIBRARY; T=293.16K
Threshold reactions

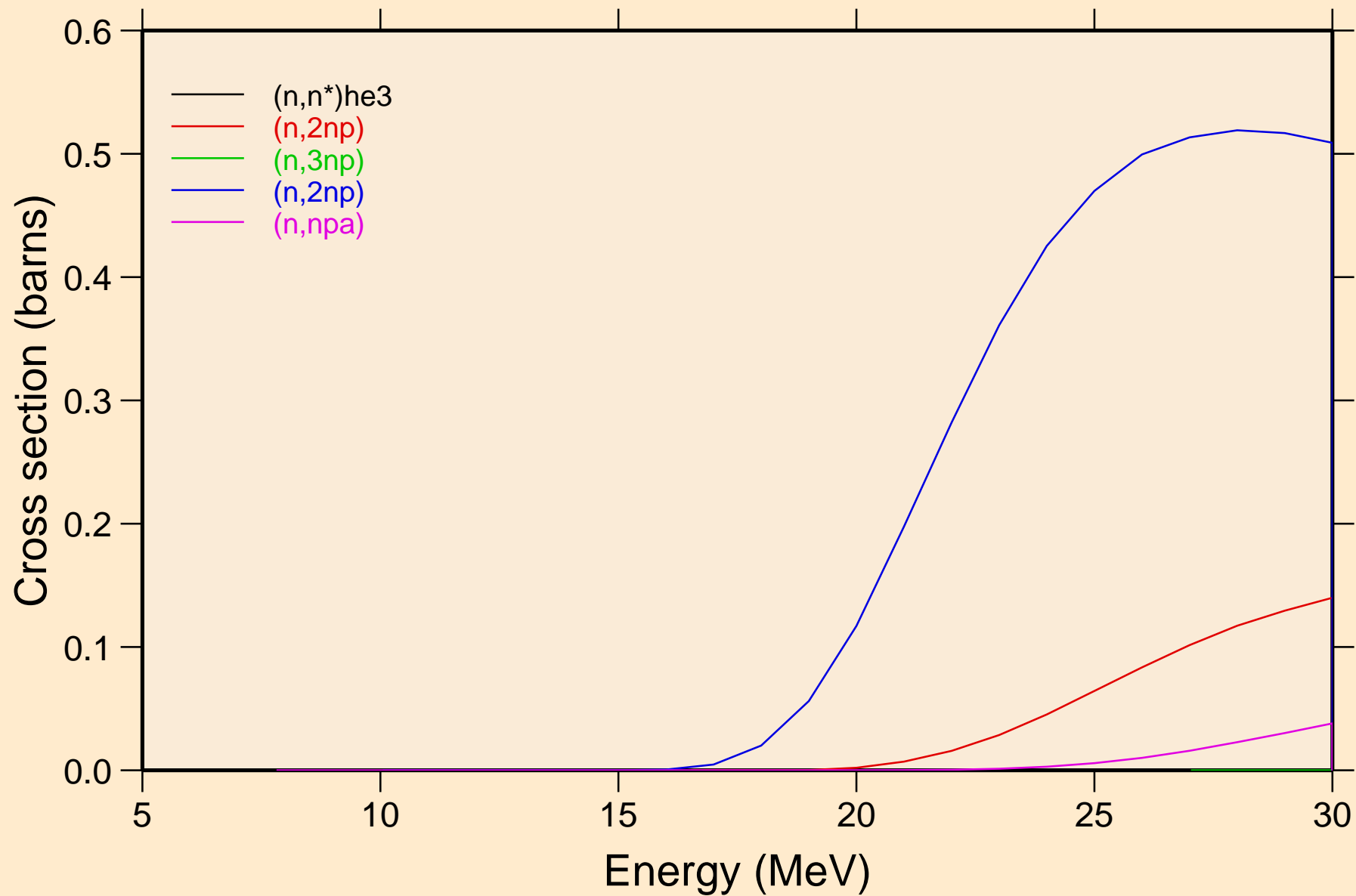

TC091 NEUTRON ACER TENDL-2019 LIBRARY; T=293.16K
Threshold reactions

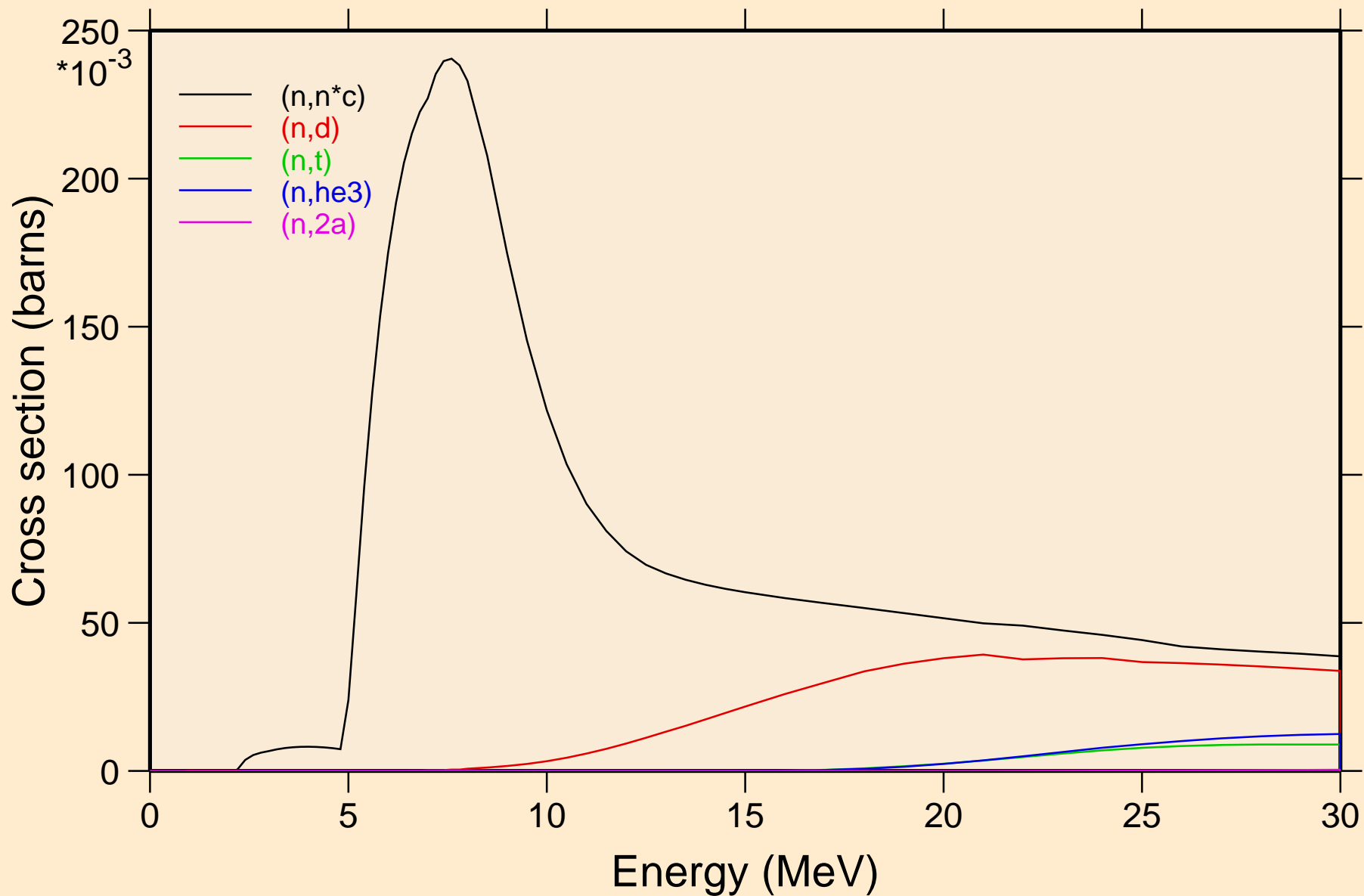

TC091 NEUTRON ACER TENDL-2019 LIBRARY; T=293.16K
Threshold reactions

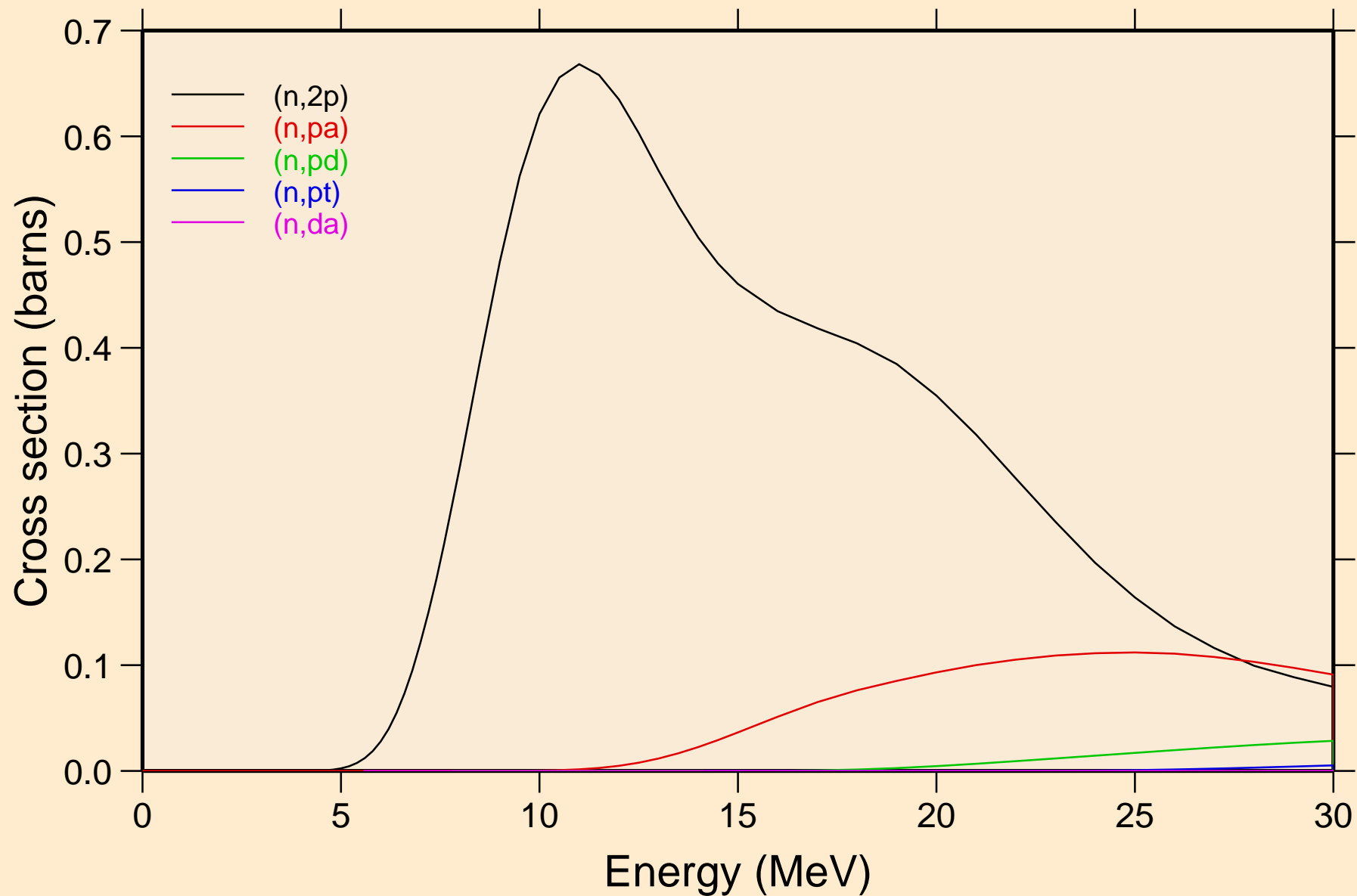

TC091 NEUTRON ACER TENDL-2019 LIBRARY; T=293.16K
Threshold reactions

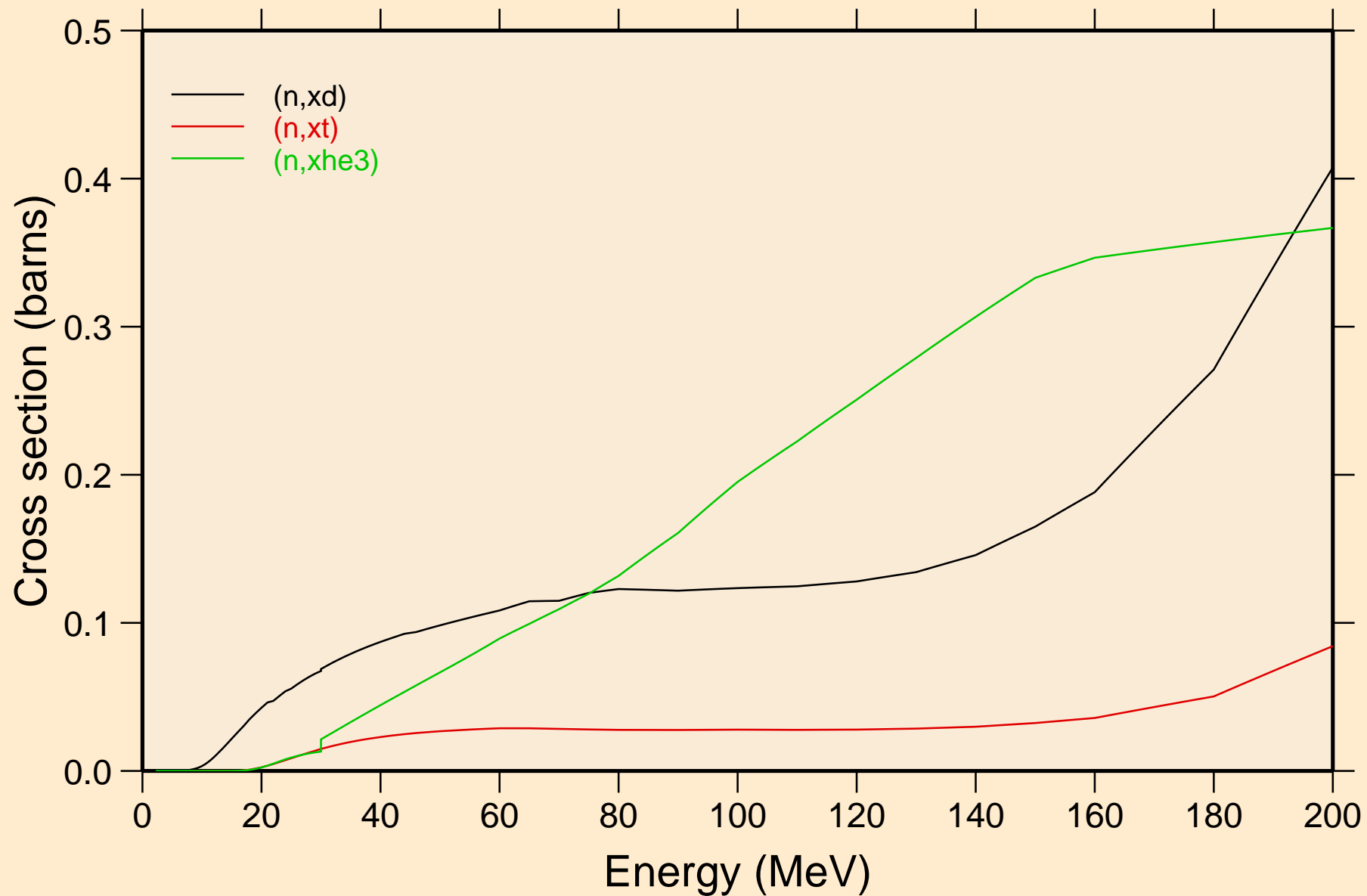

TC091 NEUTRON ACER TENDL-2019 LIBRARY; T=293.16K
angular distribution for elastic

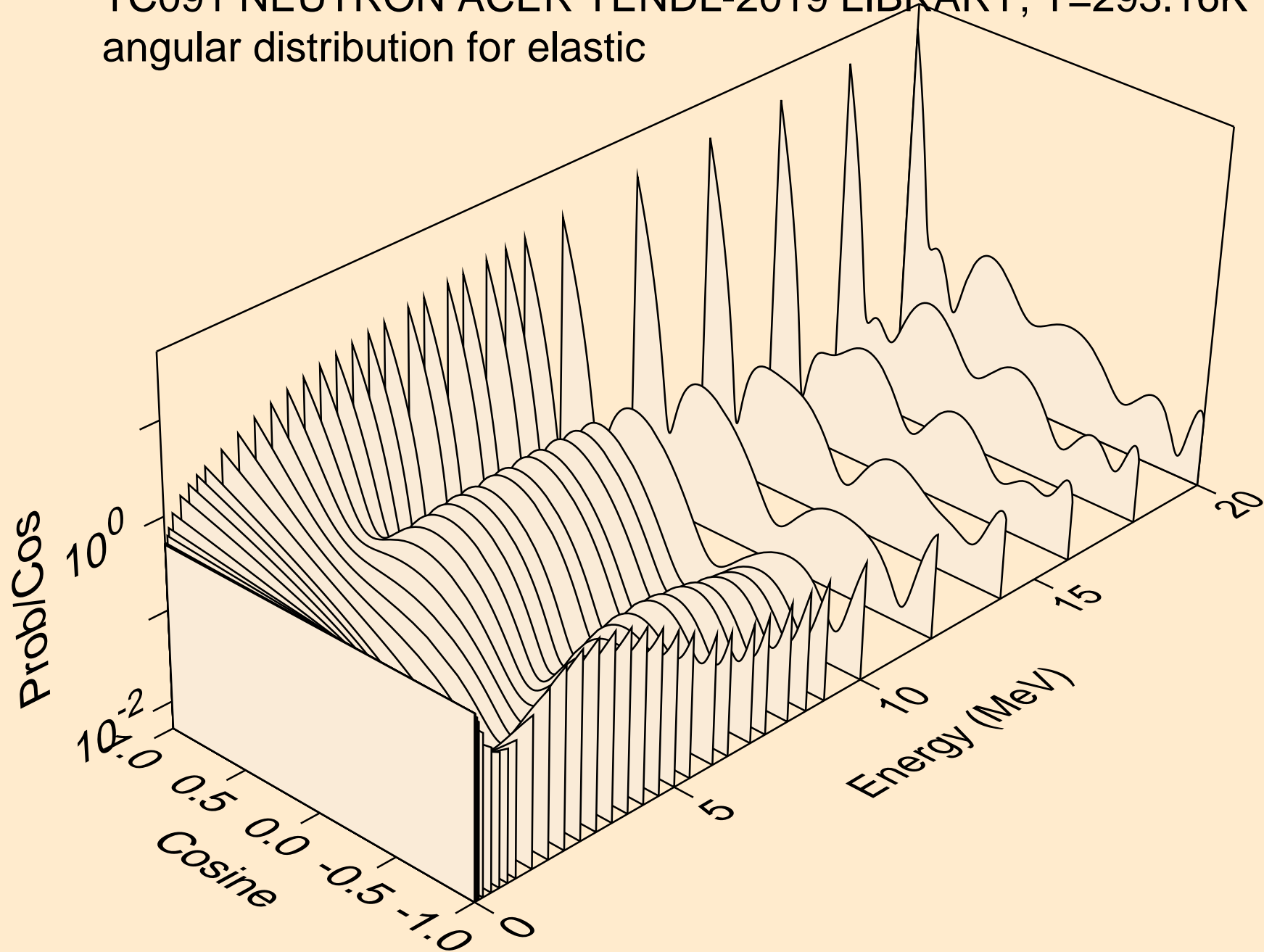

TC091 NEUTRON ACER TENDL-2019 LIBRARY; T=293.16K
angular distribution for elastic

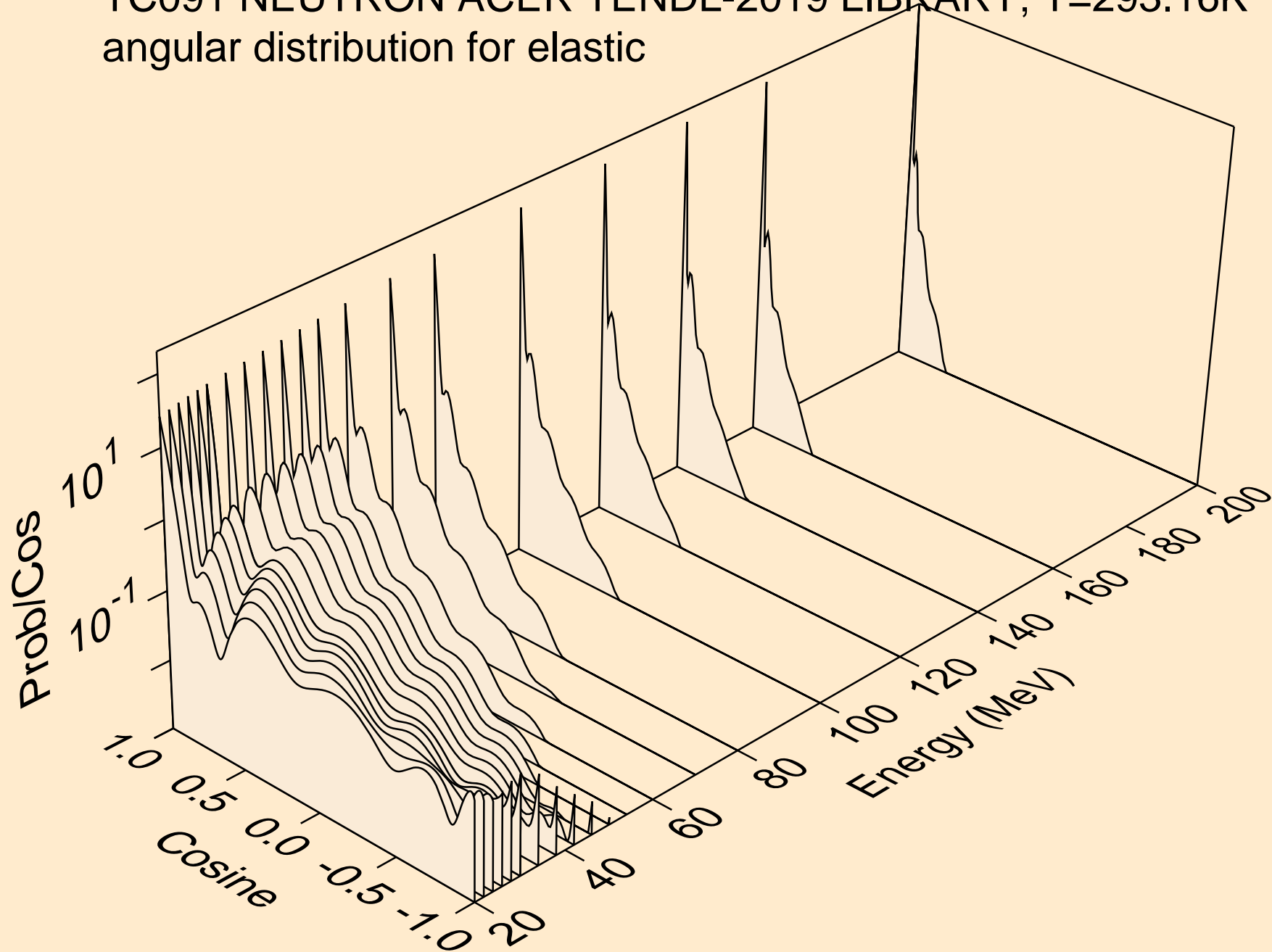

TC091 NEUTRON ACER TENDL-2019 LIBRARY; T=293.16K
angular distribution for (n,n*1)

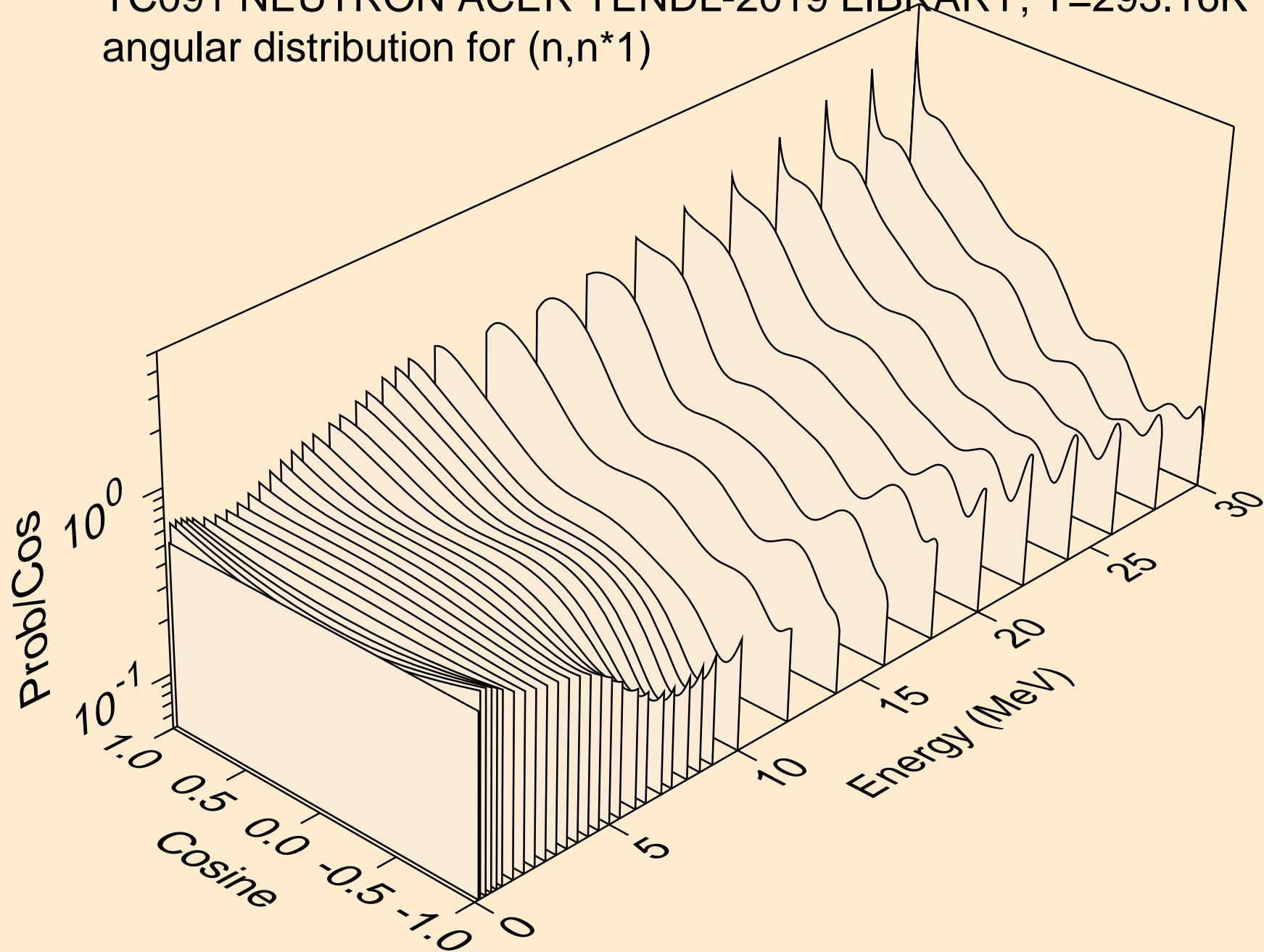

TC091 NEUTRON ACER TENDL-2019 LIBRARY; T=293.16K
angular distribution for (n,n*2)

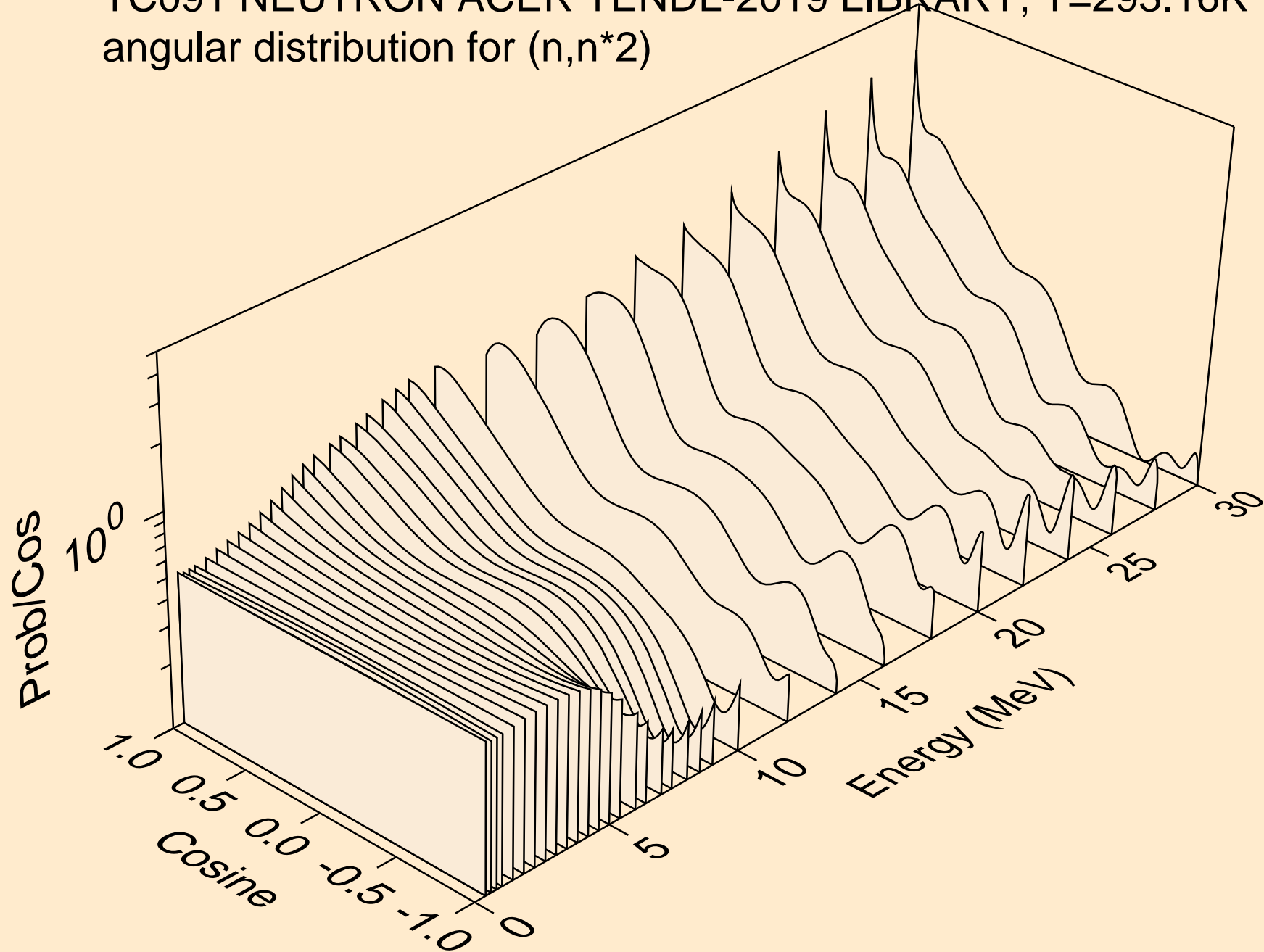

TC091 NEUTRON ACER TENDL-2019 LIBRARY; T=293.16K
angular distribution for (n,n*3)

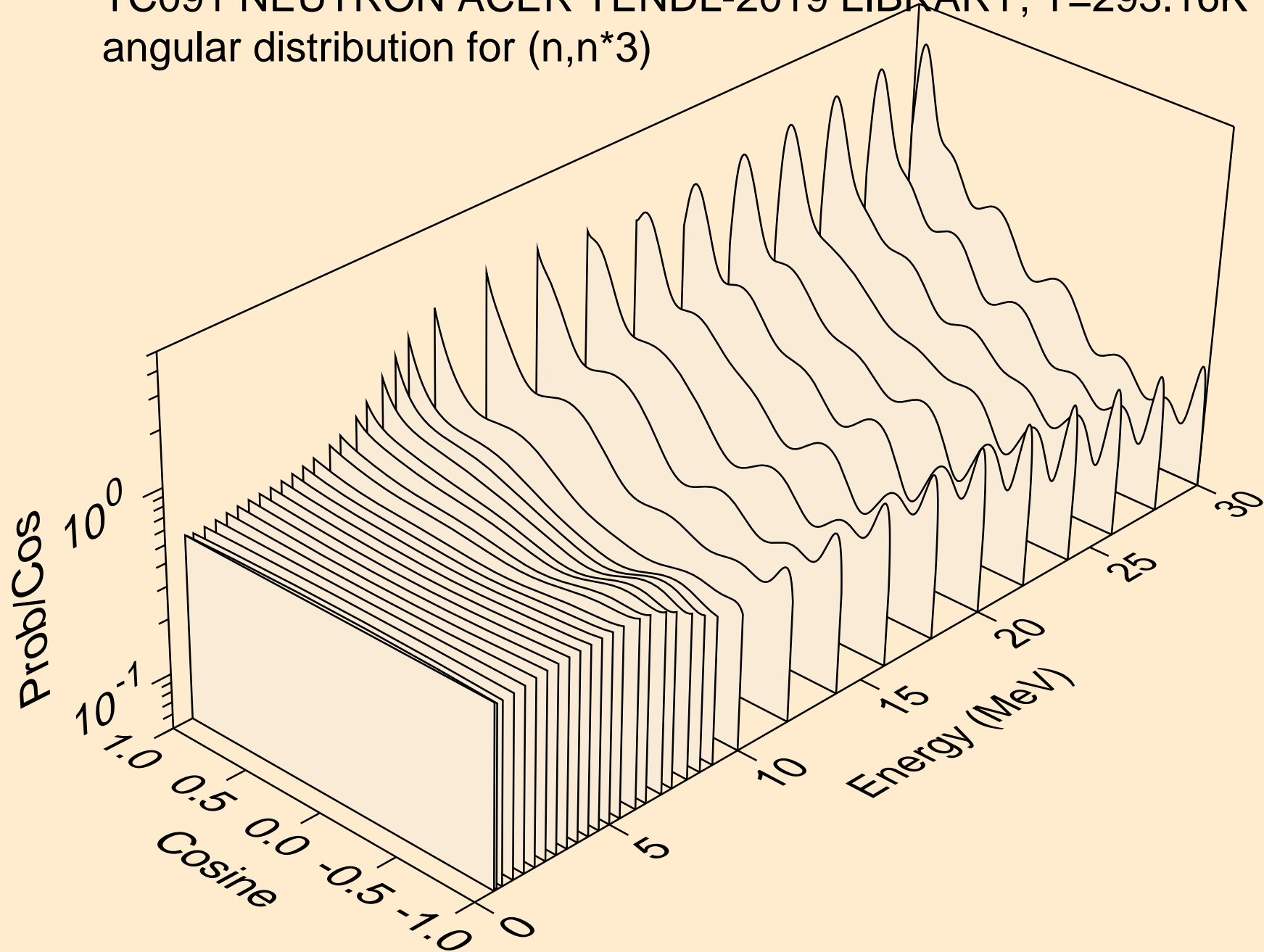

TC091 NEUTRON ACER TENDL-2019 LIBRARY; T=293.16K
angular distribution for (n,n*4)

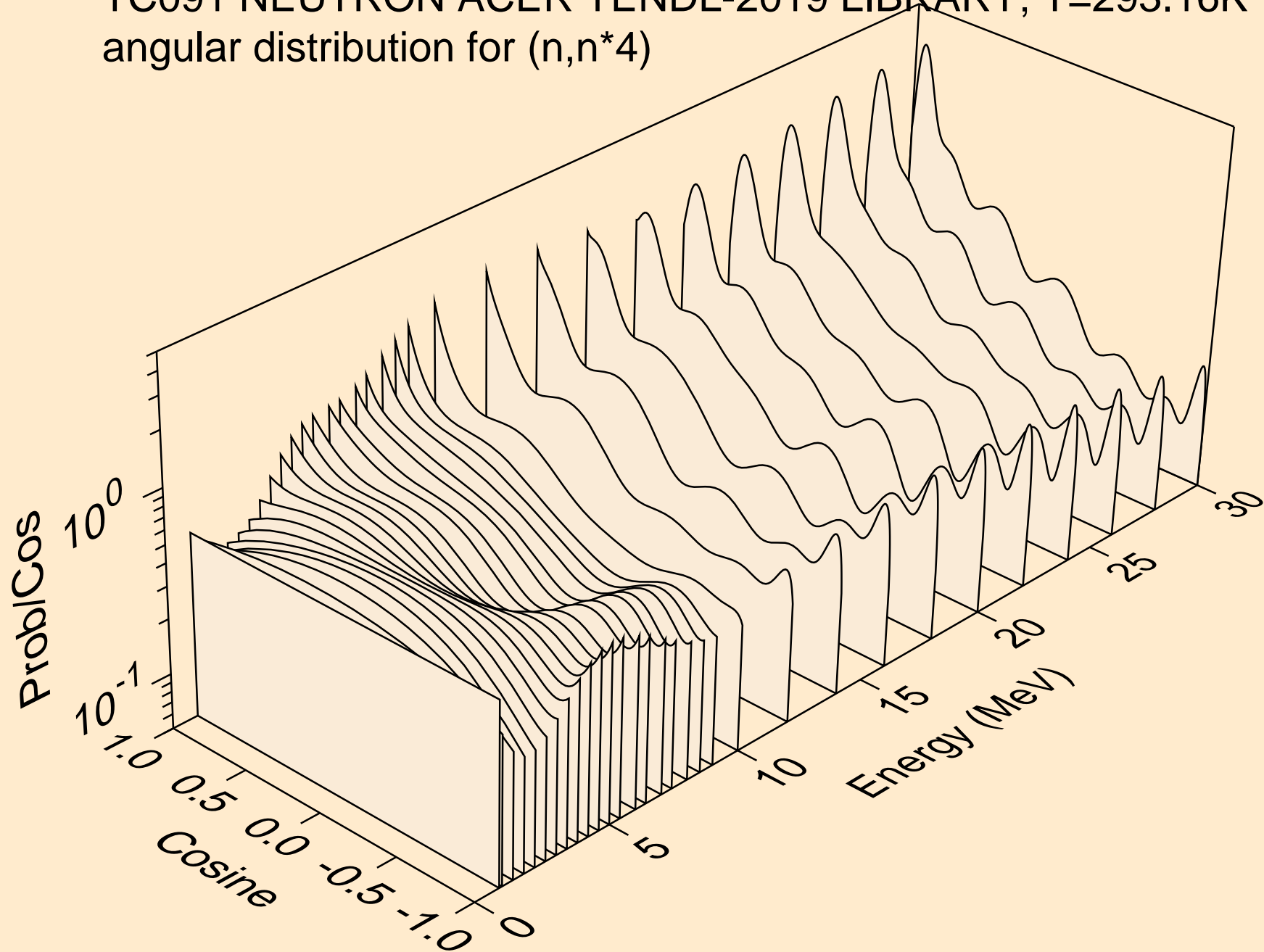

TC091 NEUTRON ACER TENDL-2019 LIBRARY; T=293.16K
angular distribution for (n,n*5)

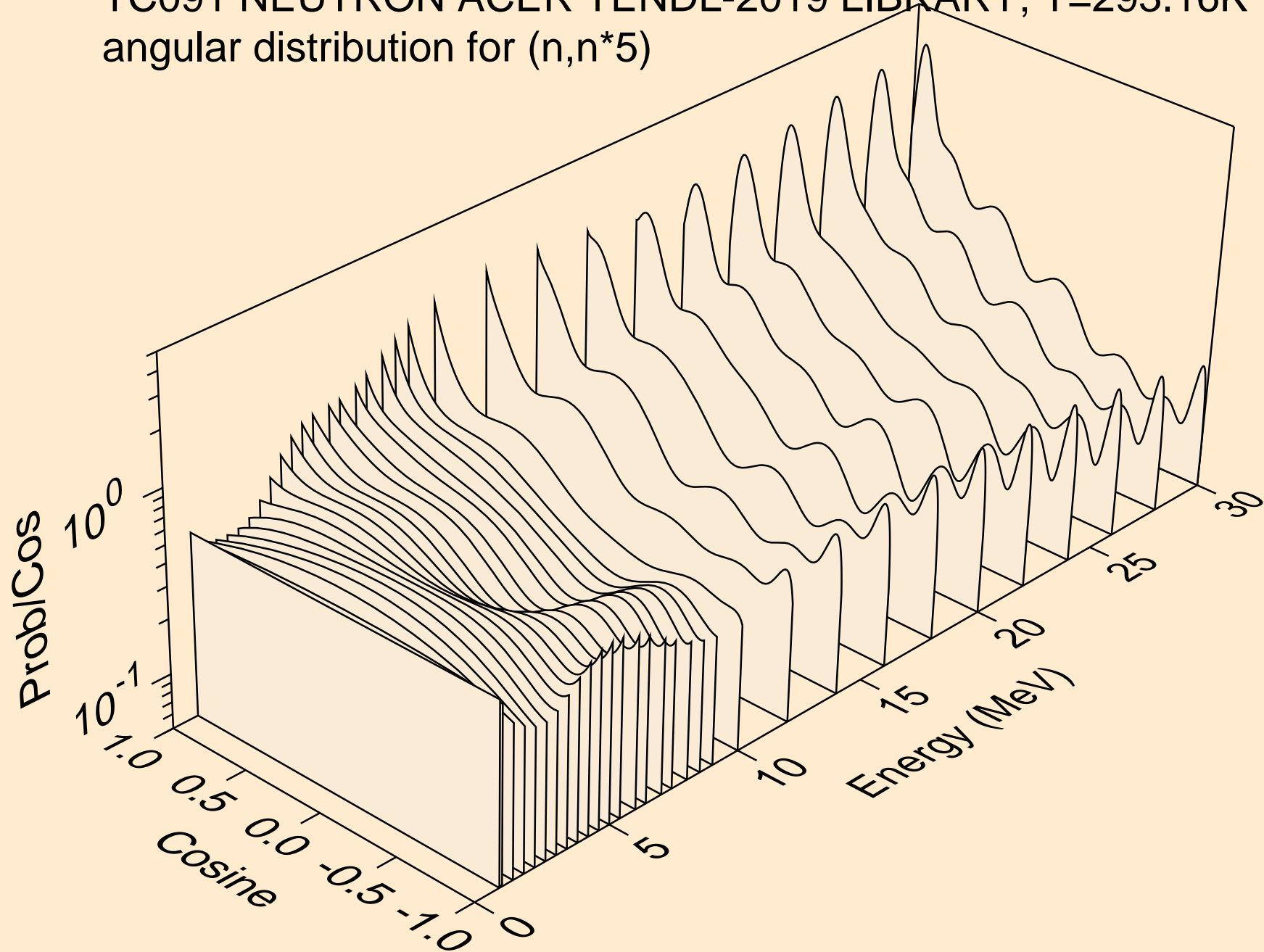

TC091 NEUTRON ACER TENDL-2019 LIBRARY; T=293.16K
angular distribution for (n,n*6)

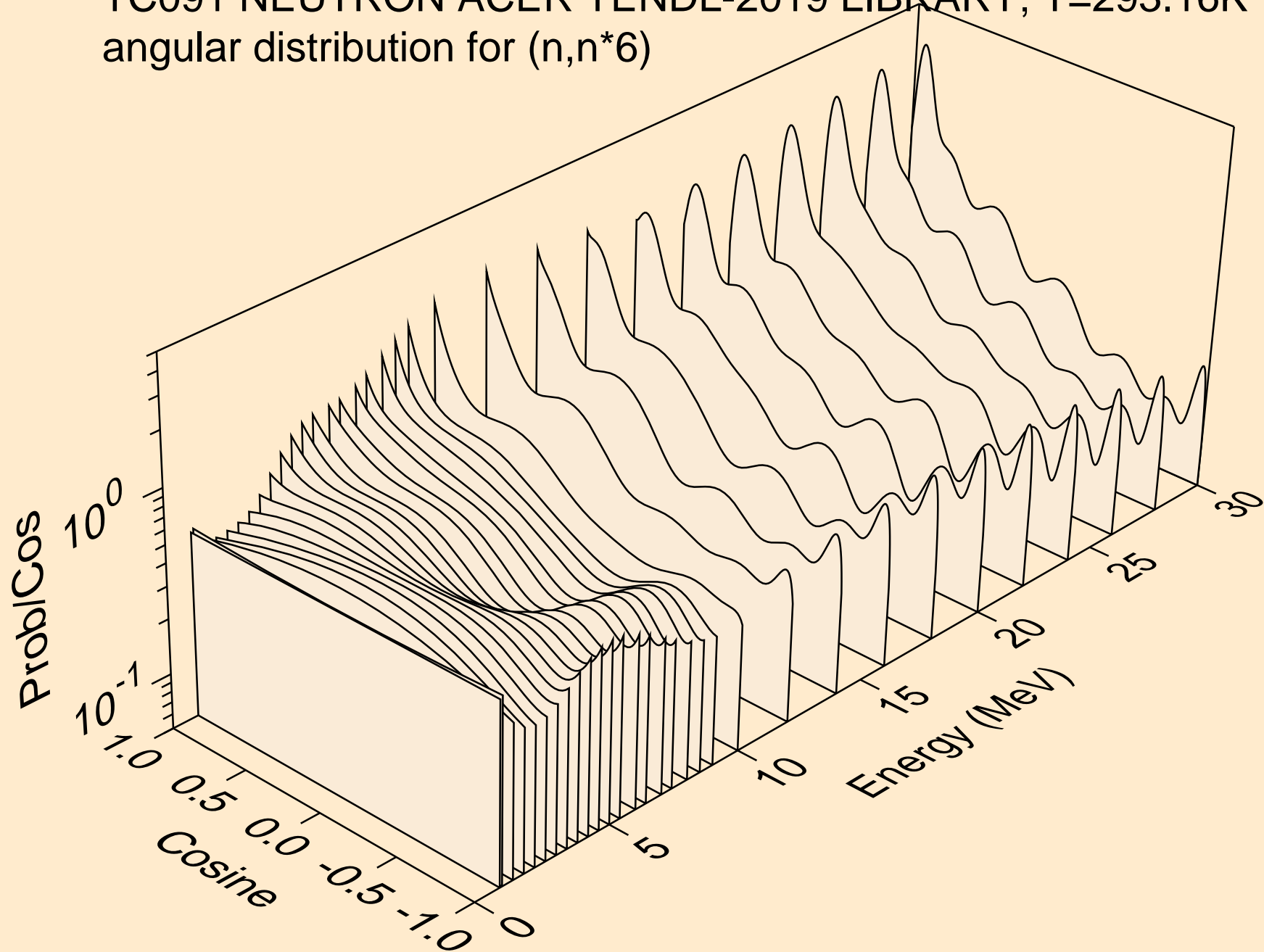

TC091 NEUTRON ACER TENDL-2019 LIBRARY; T=293.16K
angular distribution for (n,n*7)

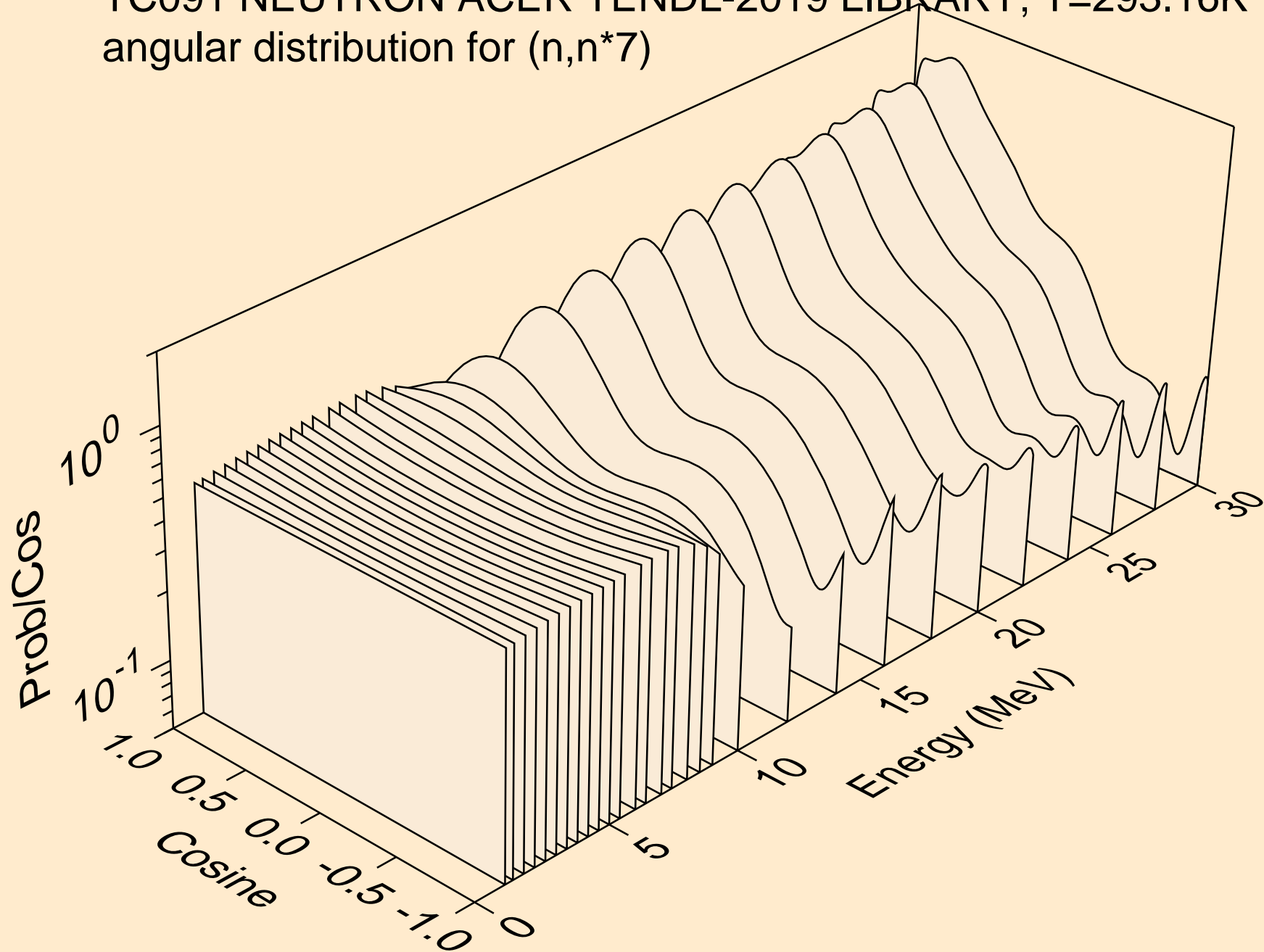

TC091 NEUTRON ACER TENDL-2019 LIBRARY; T=293.16K
angular distribution for (n,n*8)

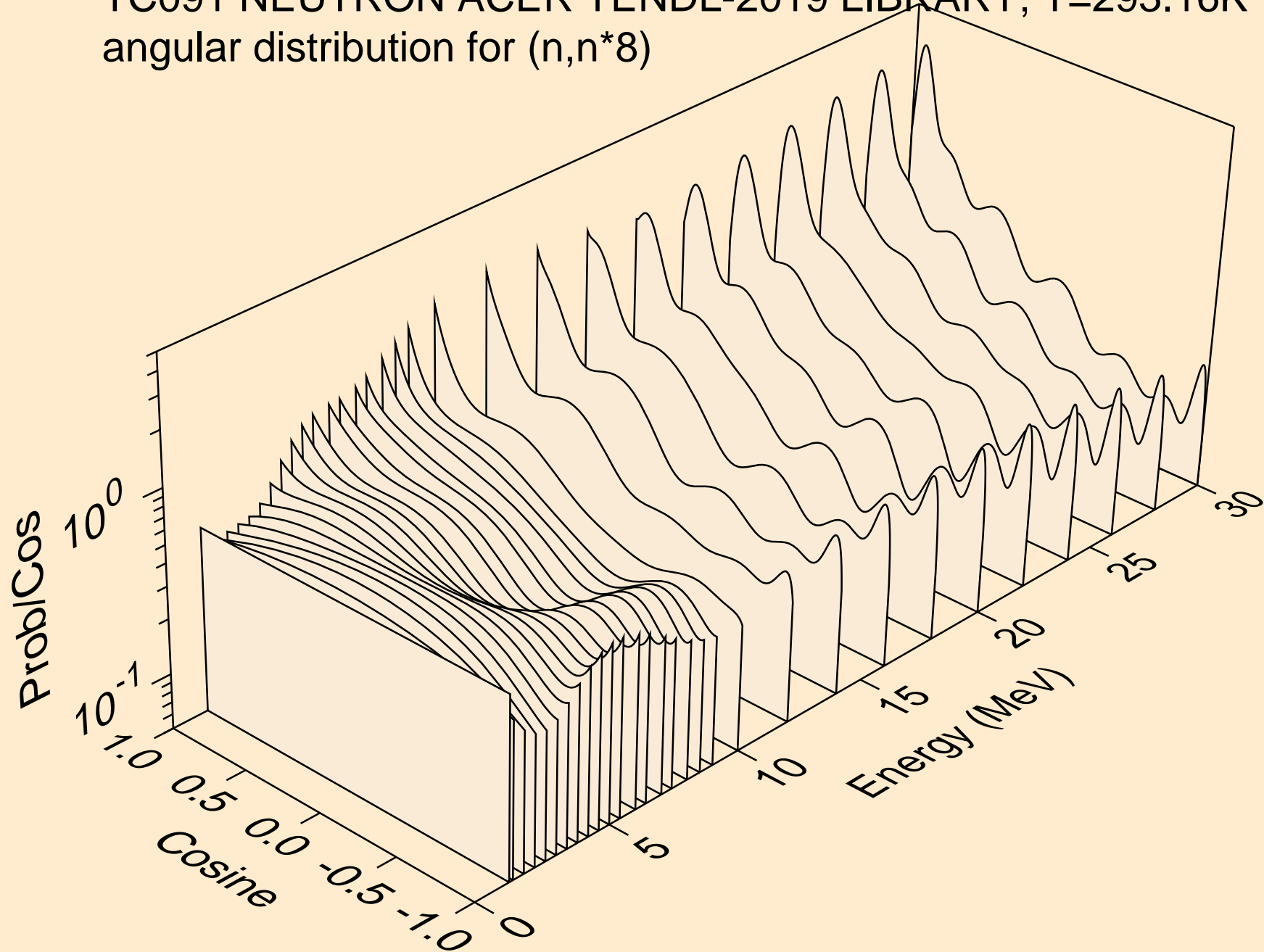

TC091 NEUTRON ACER TENDL-2019 LIBRARY; T=293.16K
angular distribution for (n,n*9)

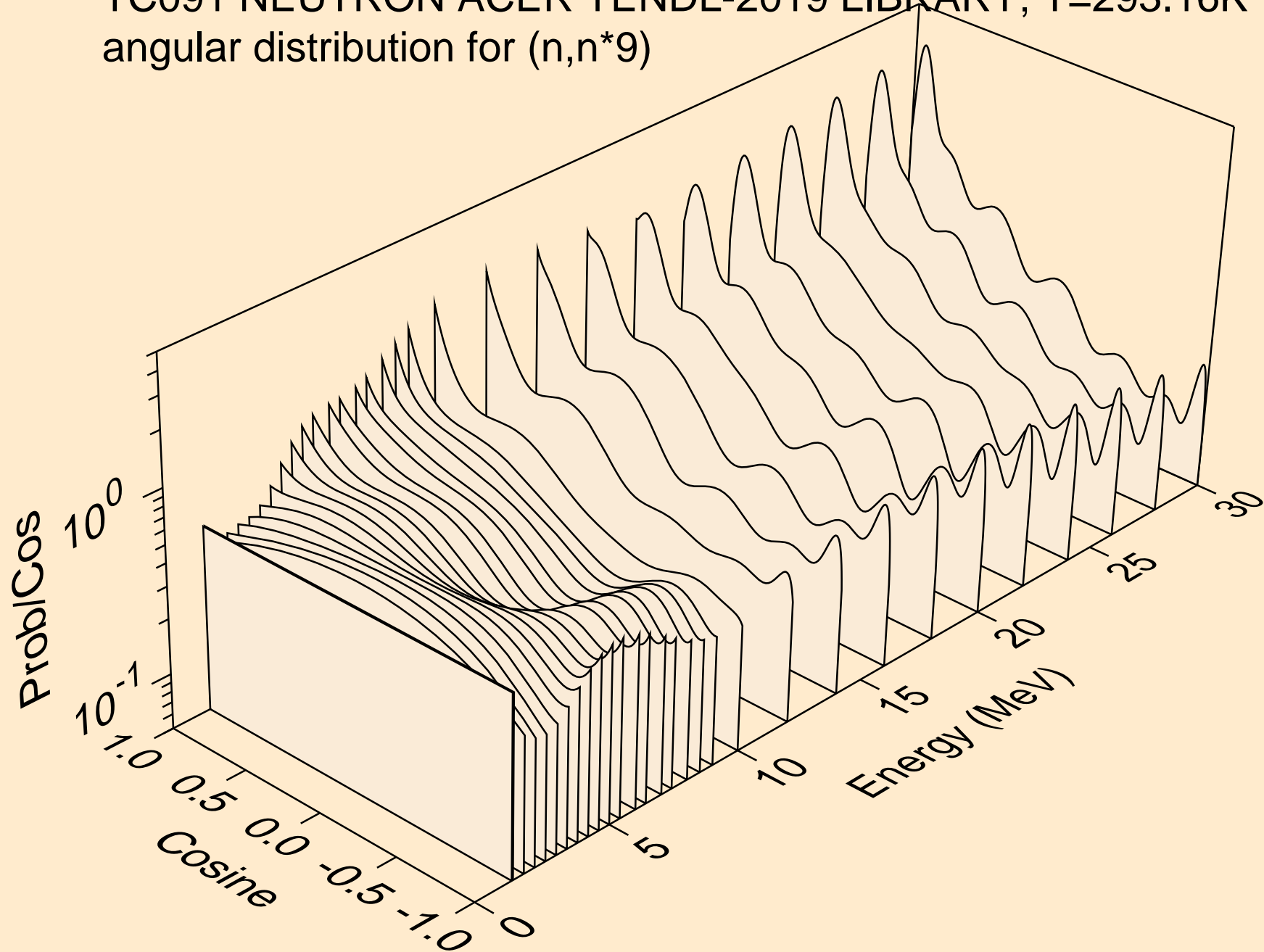

TC091 NEUTRON ACER TENDL-2019 LIBRARY; T=293.16K
angular distribution for (n,n*10)

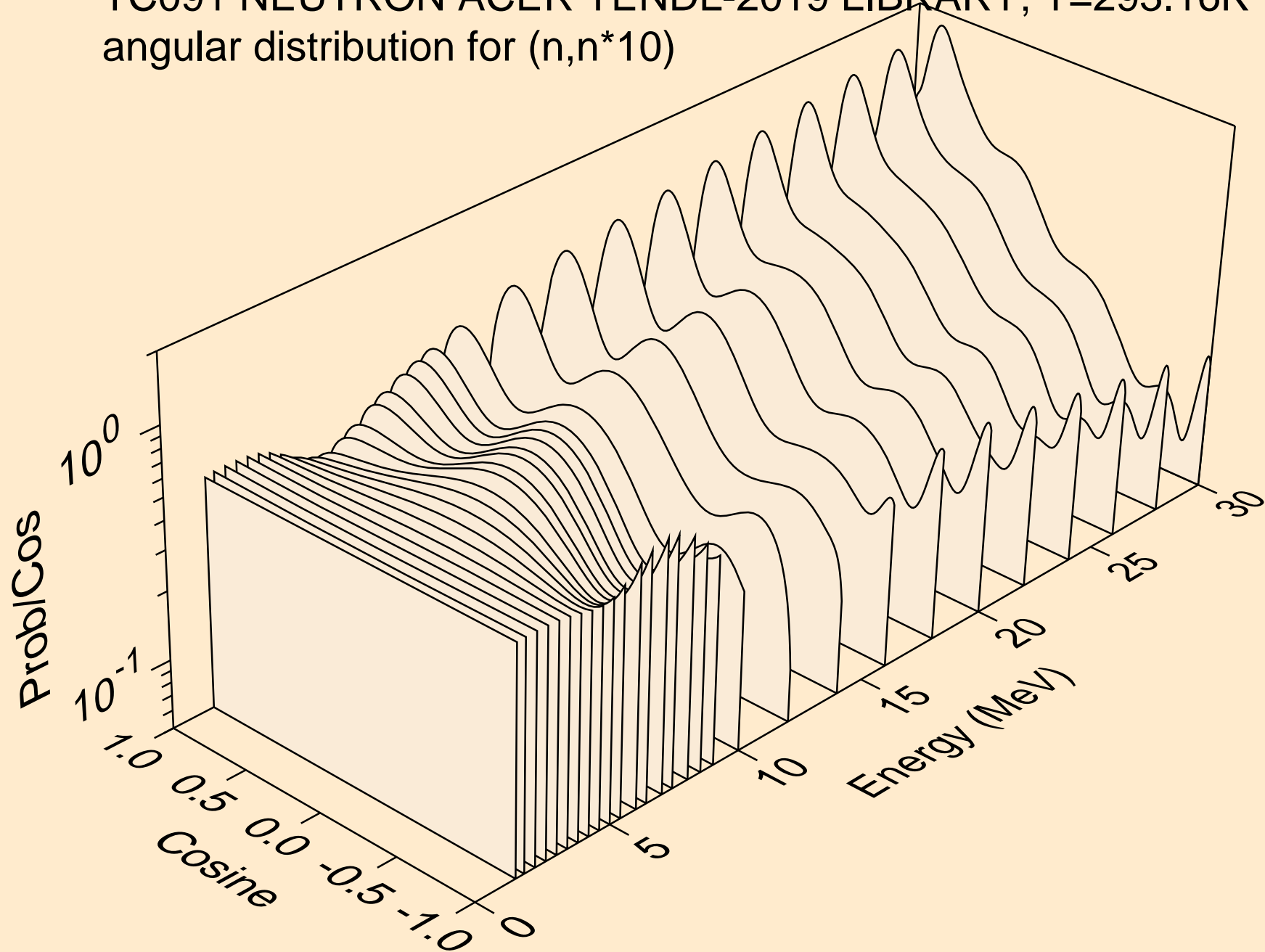

TC091 NEUTRON ACER TENDL-2019 LIBRARY; T=293.16K
angular distribution for (n,n*11)

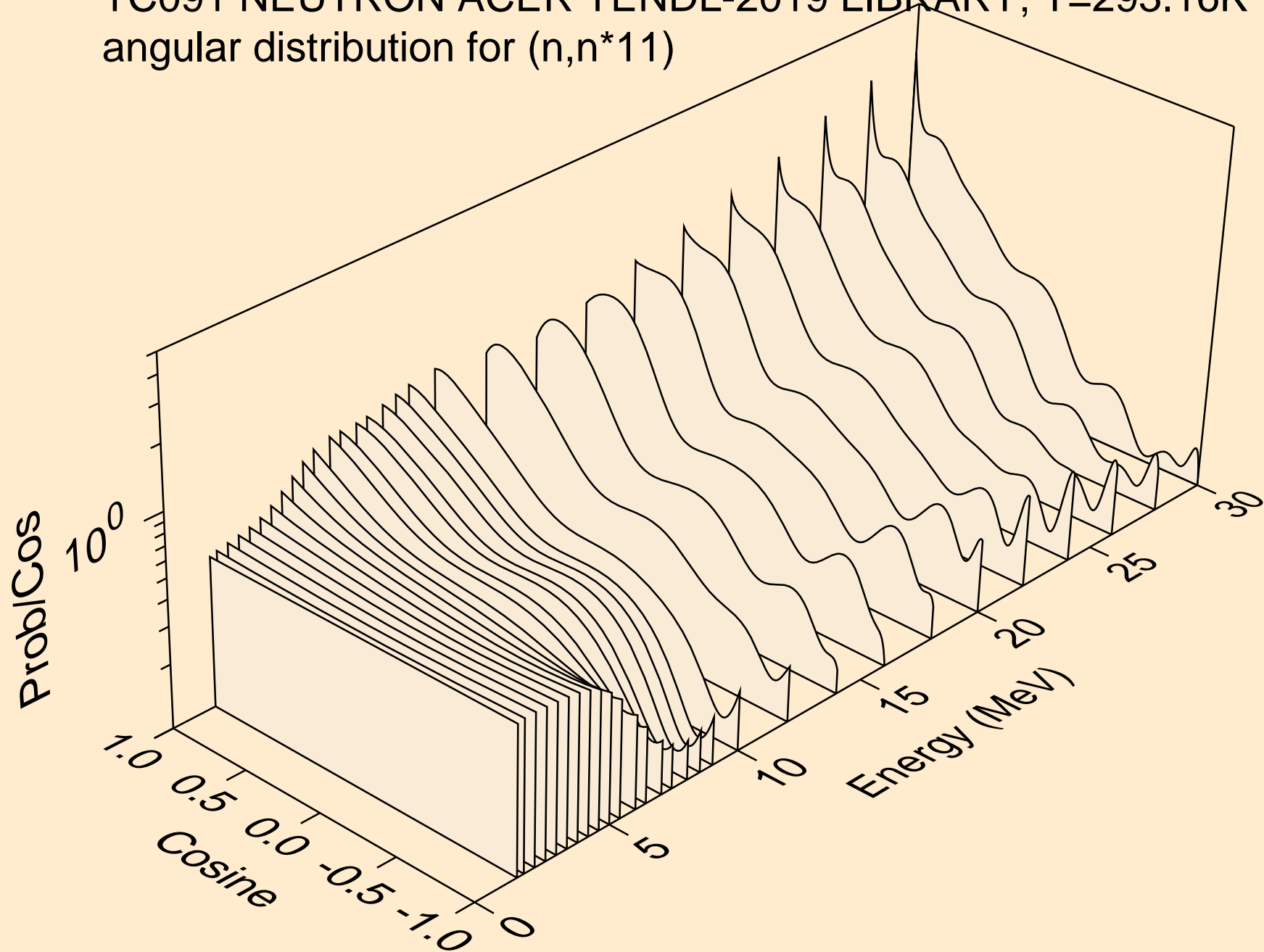

TC091 NEUTRON ACER TENDL-2019 LIBRARY; T=293.16K
angular distribution for (n,n*12)

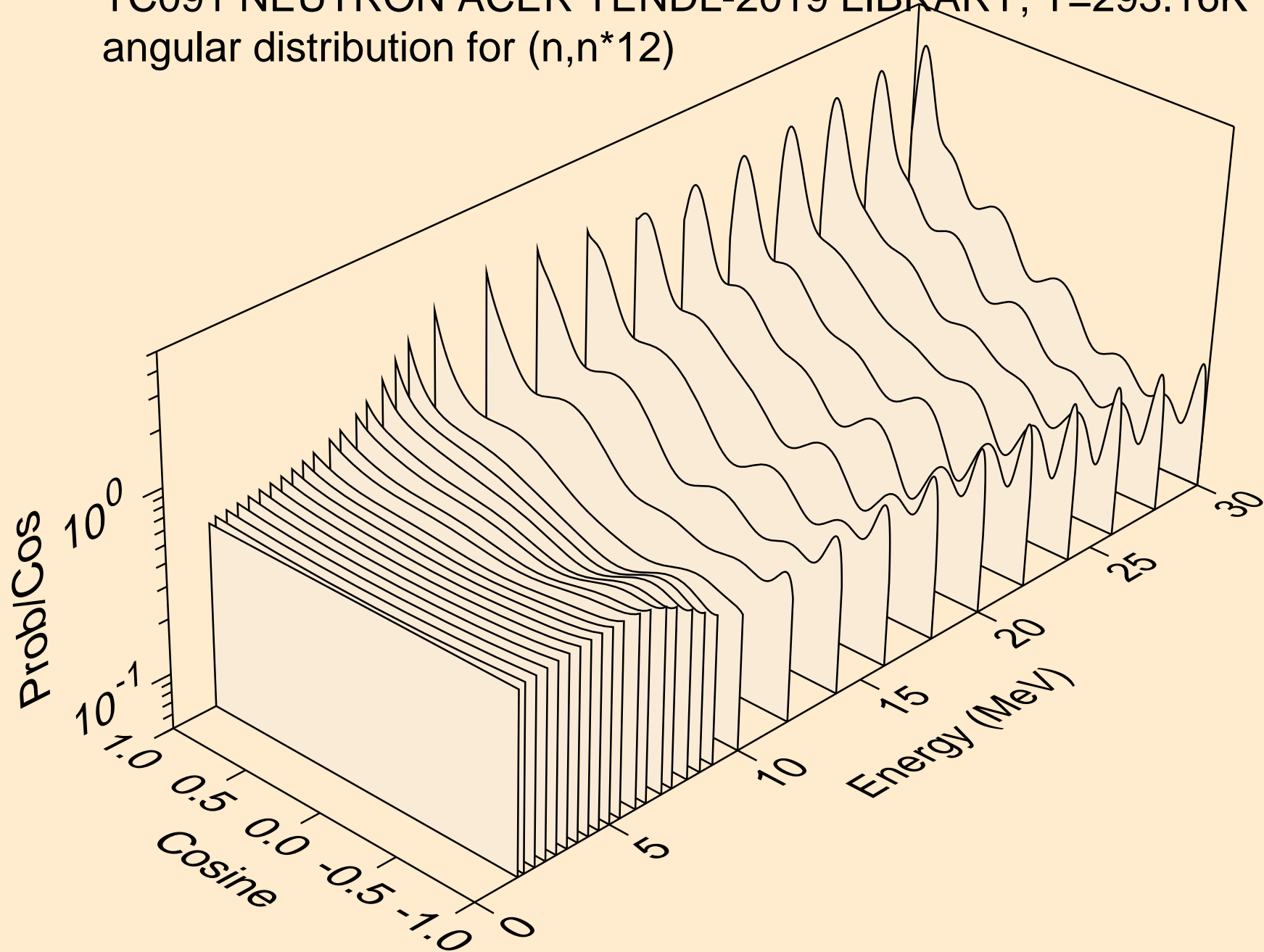

TC091 NEUTRON ACER TENDL-2019 LIBRARY; T=293.16K
angular distribution for (n,n*13)

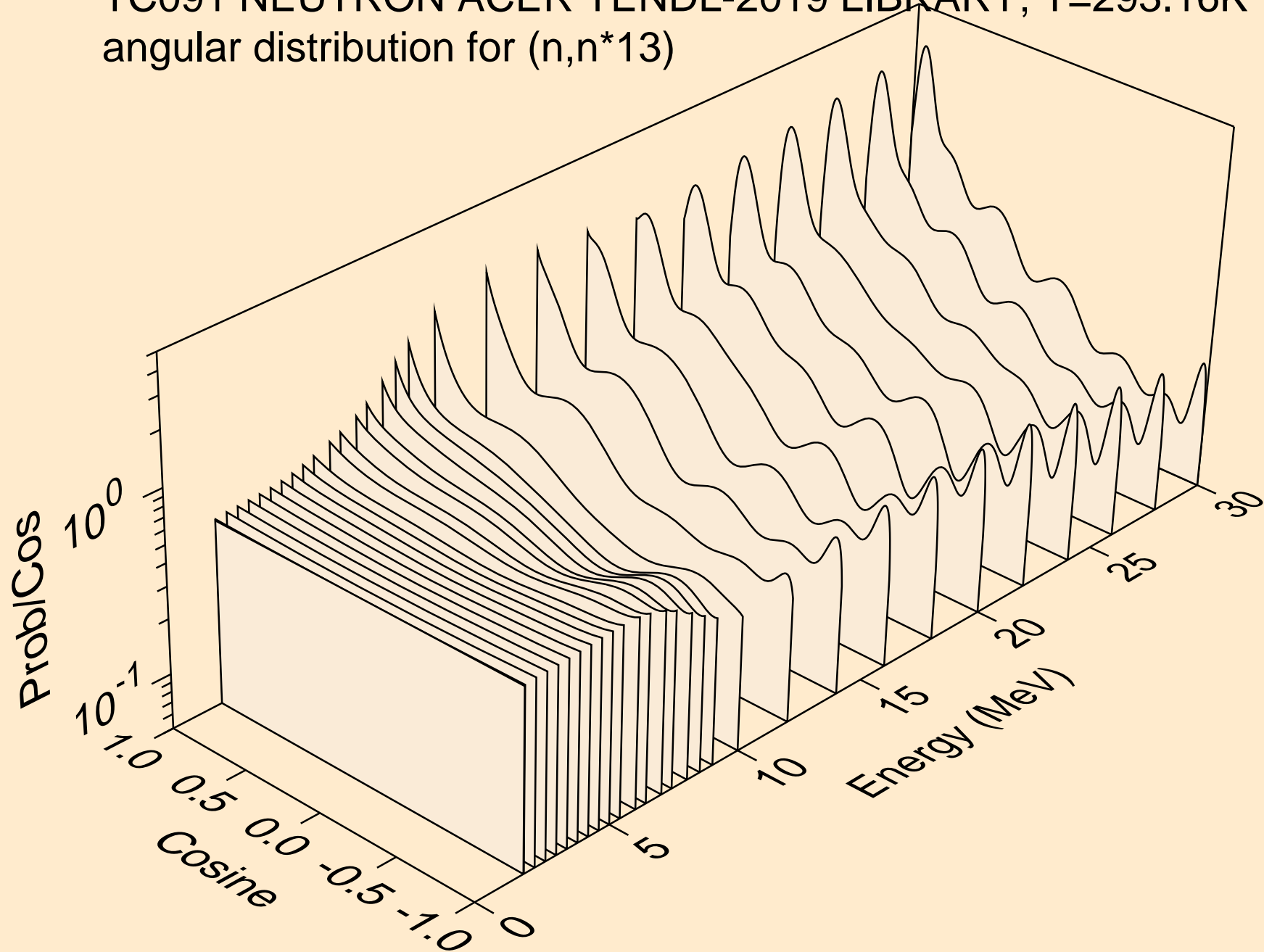

TC091 NEUTRON ACER TENDL-2019 LIBRARY; T=293.16K
angular distribution for (n,n*14)

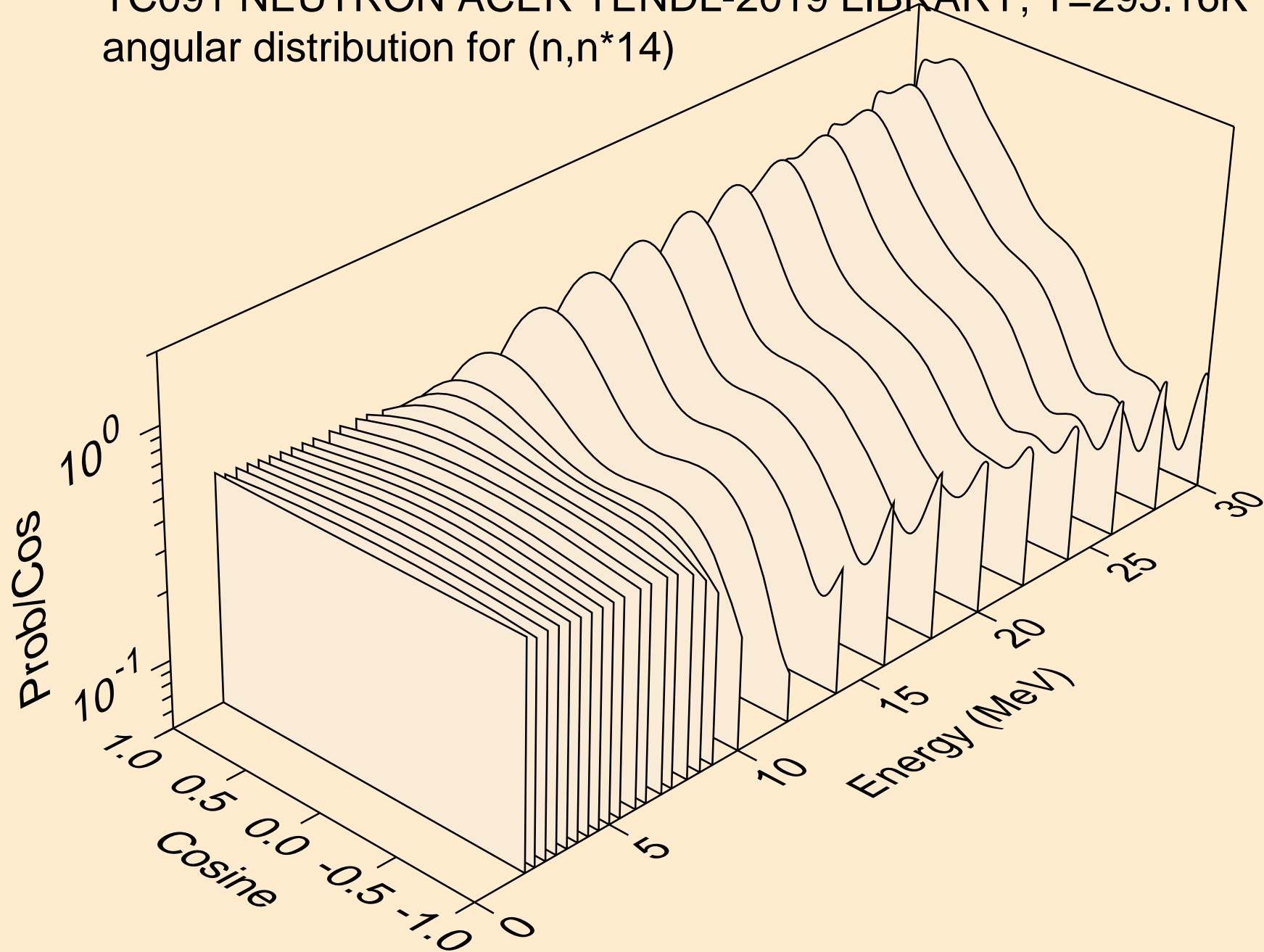

TC091 NEUTRON ACER TENDL-2019 LIBRARY; T=293.16K
angular distribution for (n,n*15)

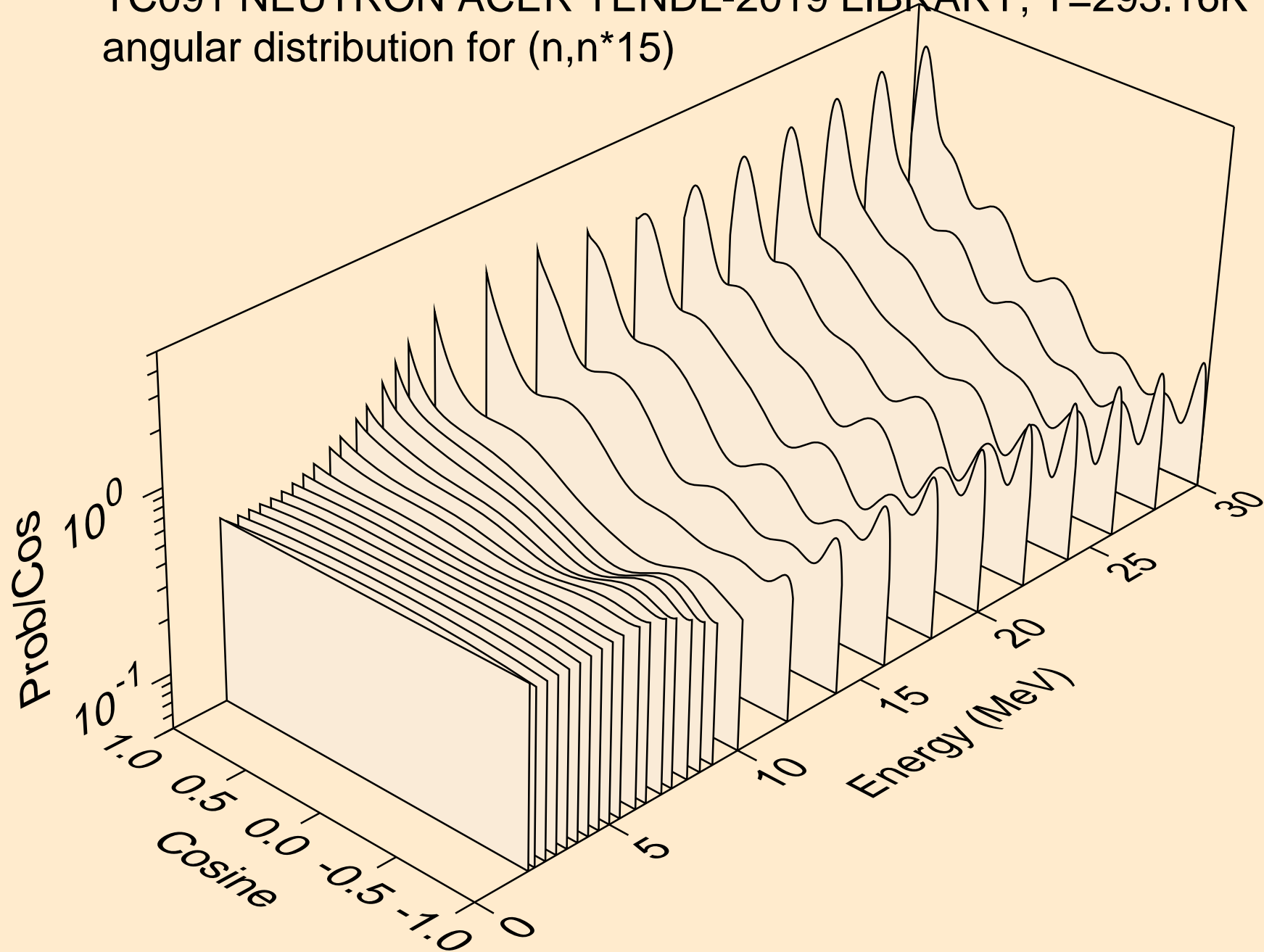

TC091 NEUTRON ACER TENDL-2019 LIBRARY; T=293.16K
angular distribution for (n,n*16)

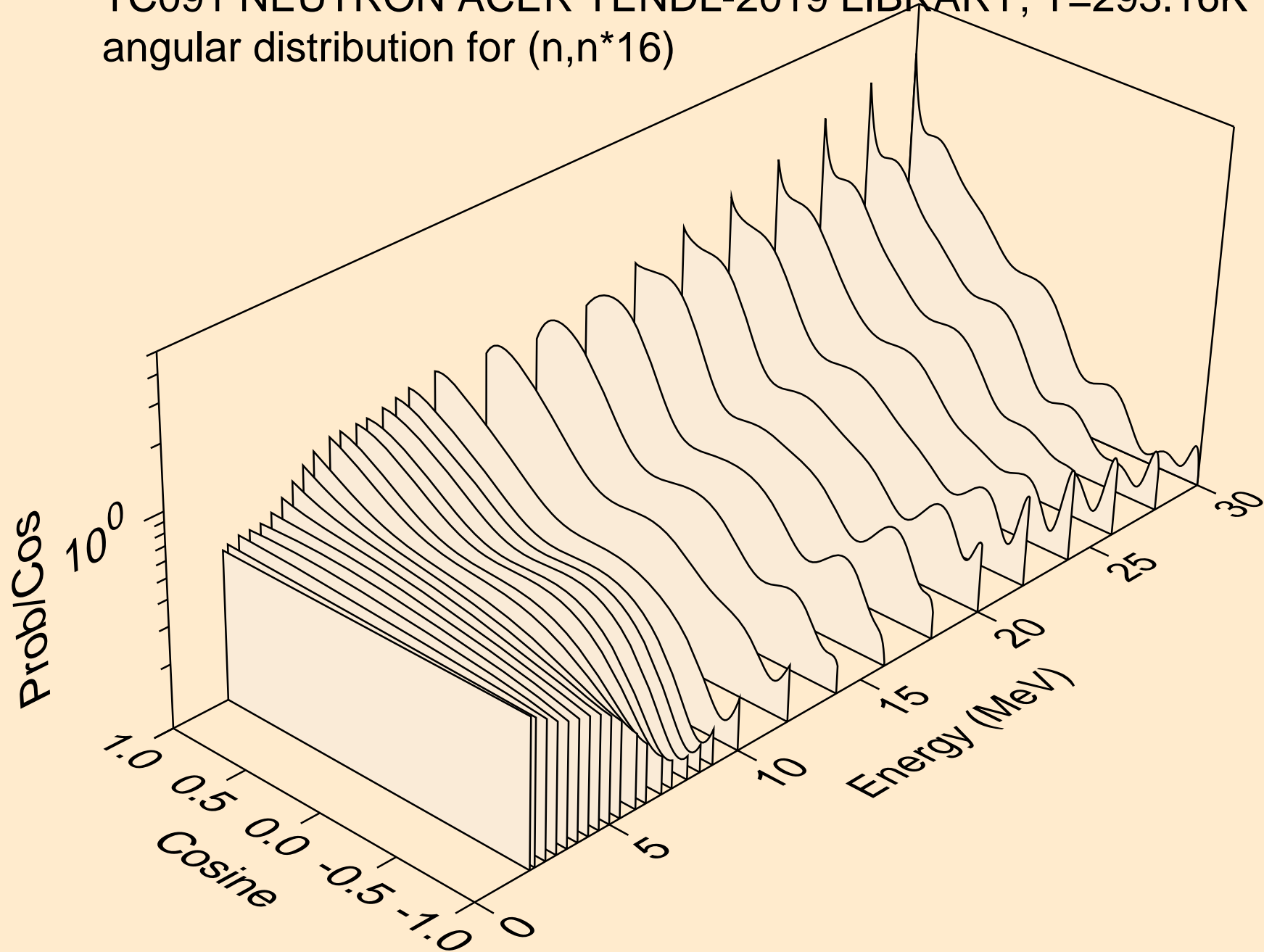

TC091 NEUTRON ACER TENDL-2019 LIBRARY; T=293.16K
angular distribution for (n,n*17)

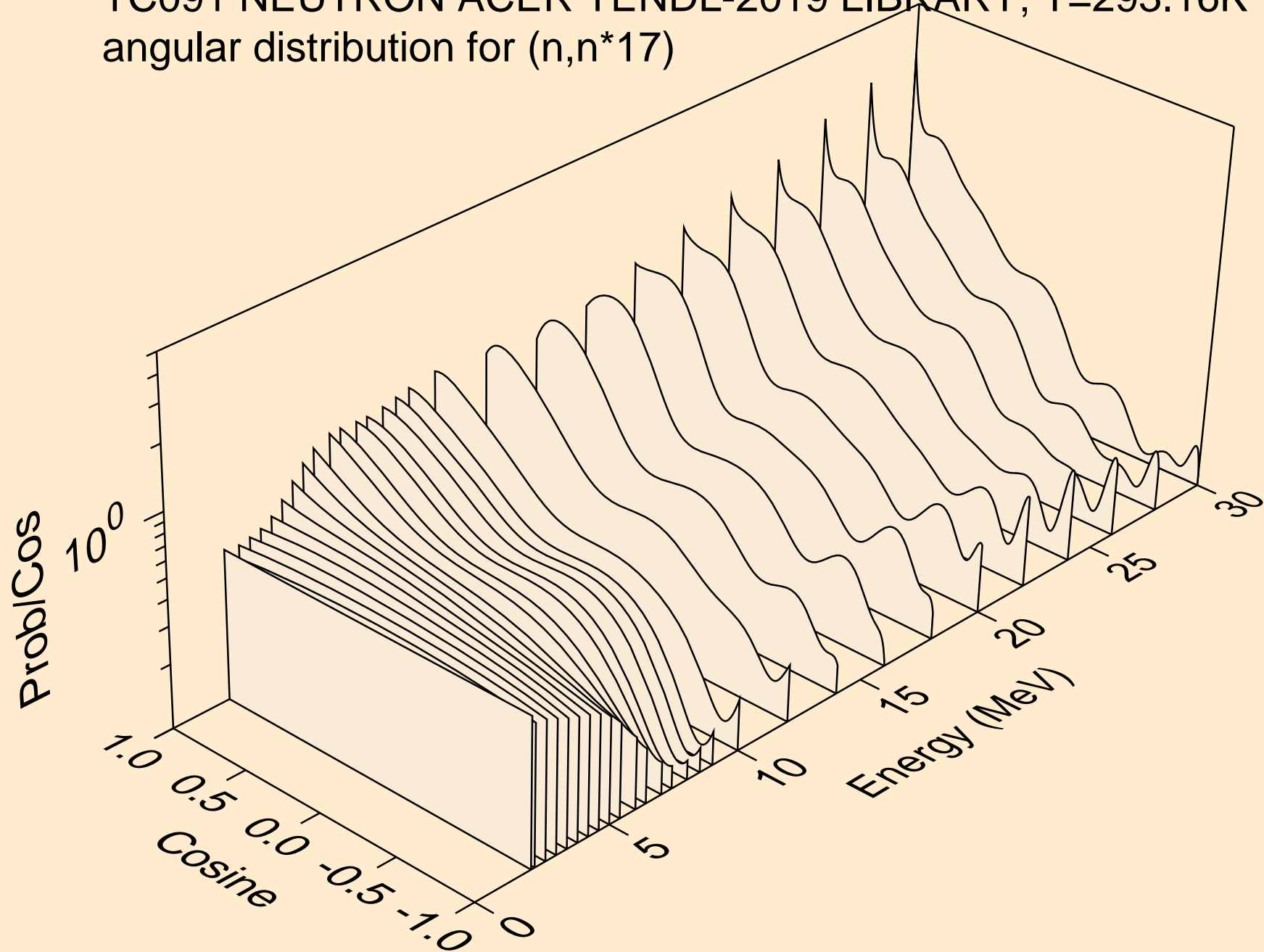

TC091 NEUTRON ACER TENDL-2019 LIBRARY; T=293.16K
Neutron emission for (n,x)

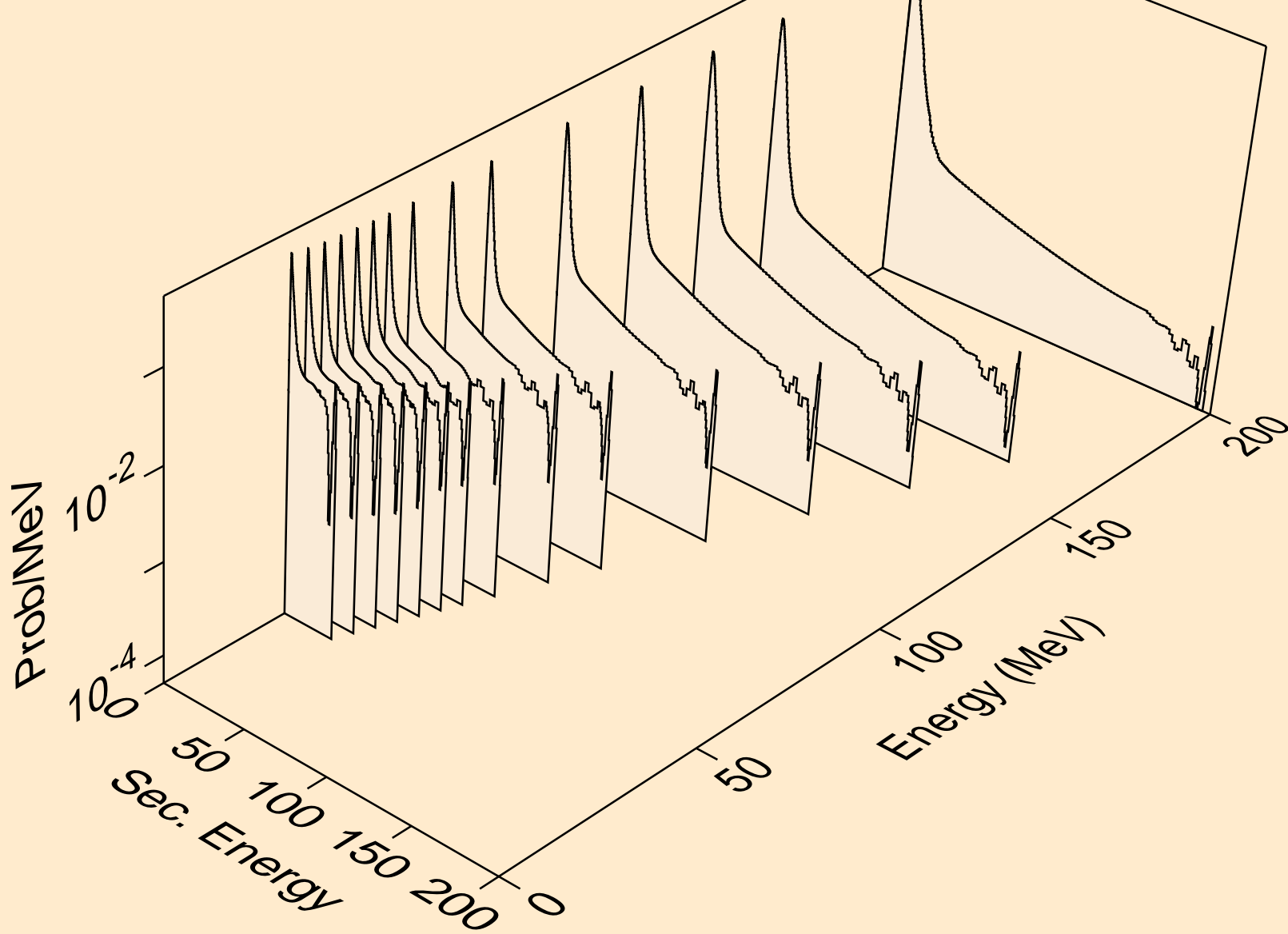

TC091 NEUTRON ACER TENDL-2019 LIBRARY; T=293.16K
Neutron emission for (n,2nd)

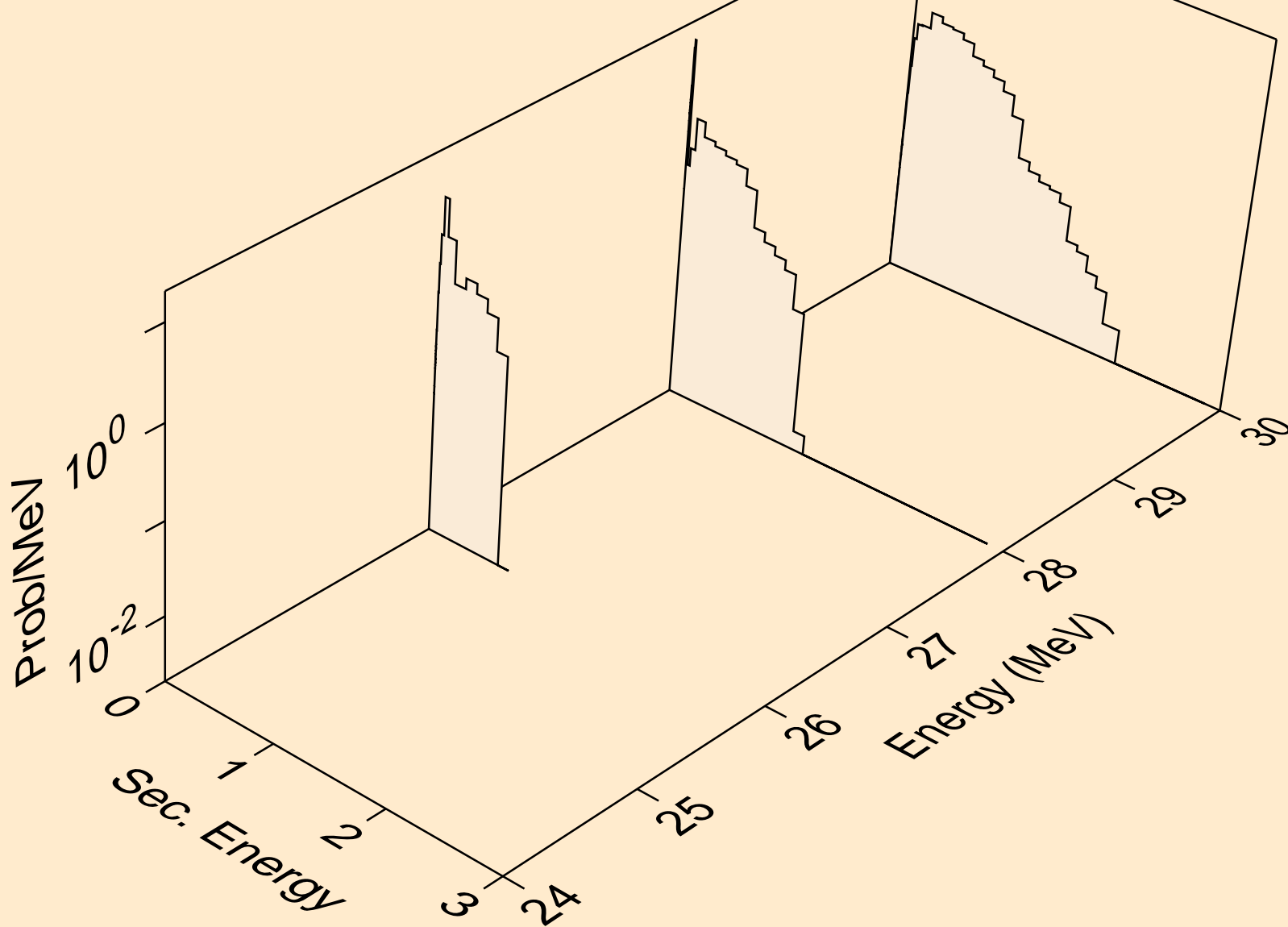

TC091 NEUTRON ACER TENDL-2019 LIBRARY; T=293.16K
Neutron emission for (n,2n)

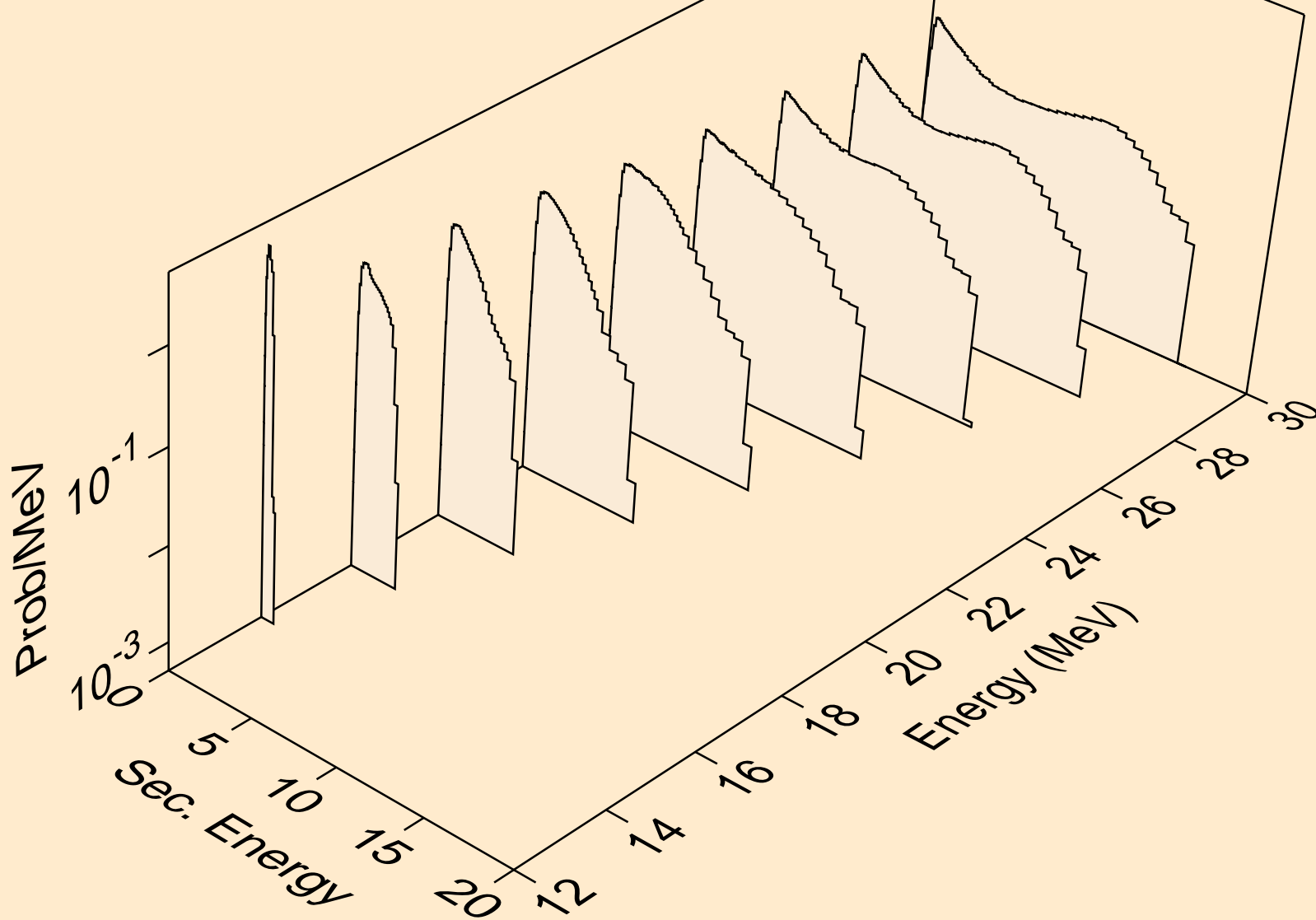

TC091 NEUTRON ACER TENDL-2019 LIBRARY; T=293.16K
Neutron emission for (n,3n)

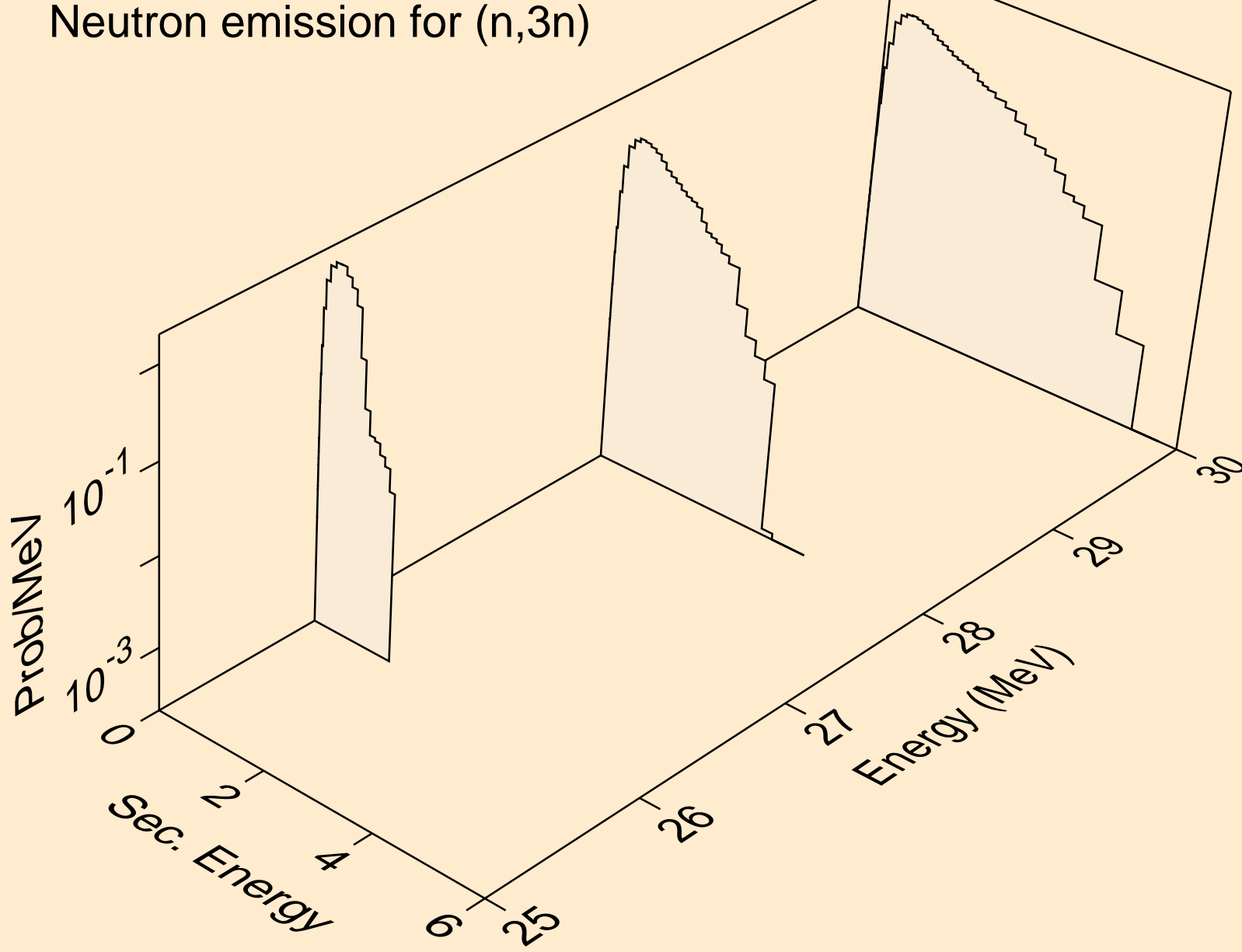

TC091 NEUTRON ACER TENDL-2019 LIBRARY; T=293.16K
Neutron emission for (n,n*)a

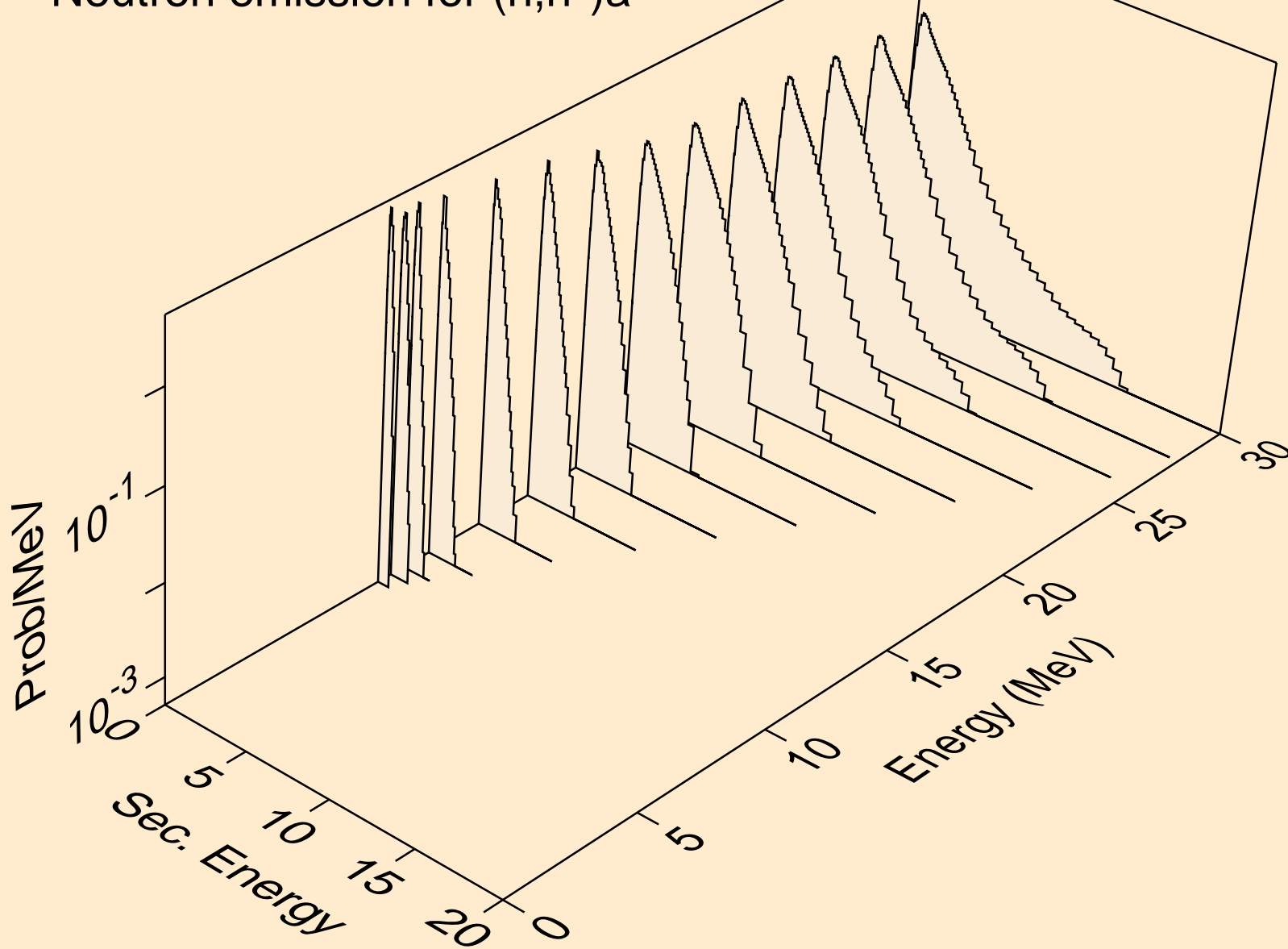

TC091 NEUTRON ACER TENDL-2019 LIBRARY; T=293.16K
Neutron emission for (n,2n)a

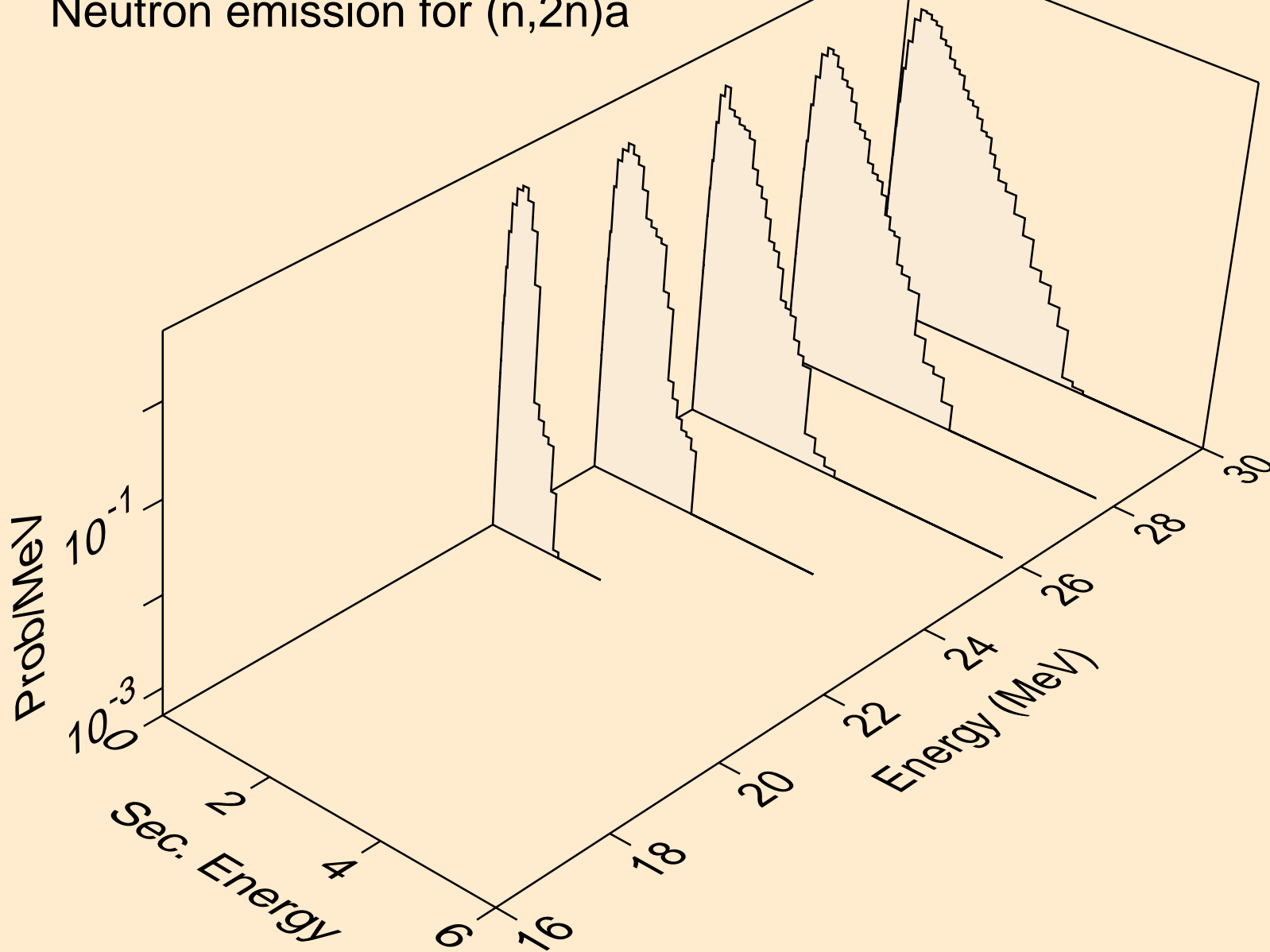

TC091 NEUTRON ACER TENDL-2019 LIBRARY; T=293.16K
Neutron emission for (n,n*)p

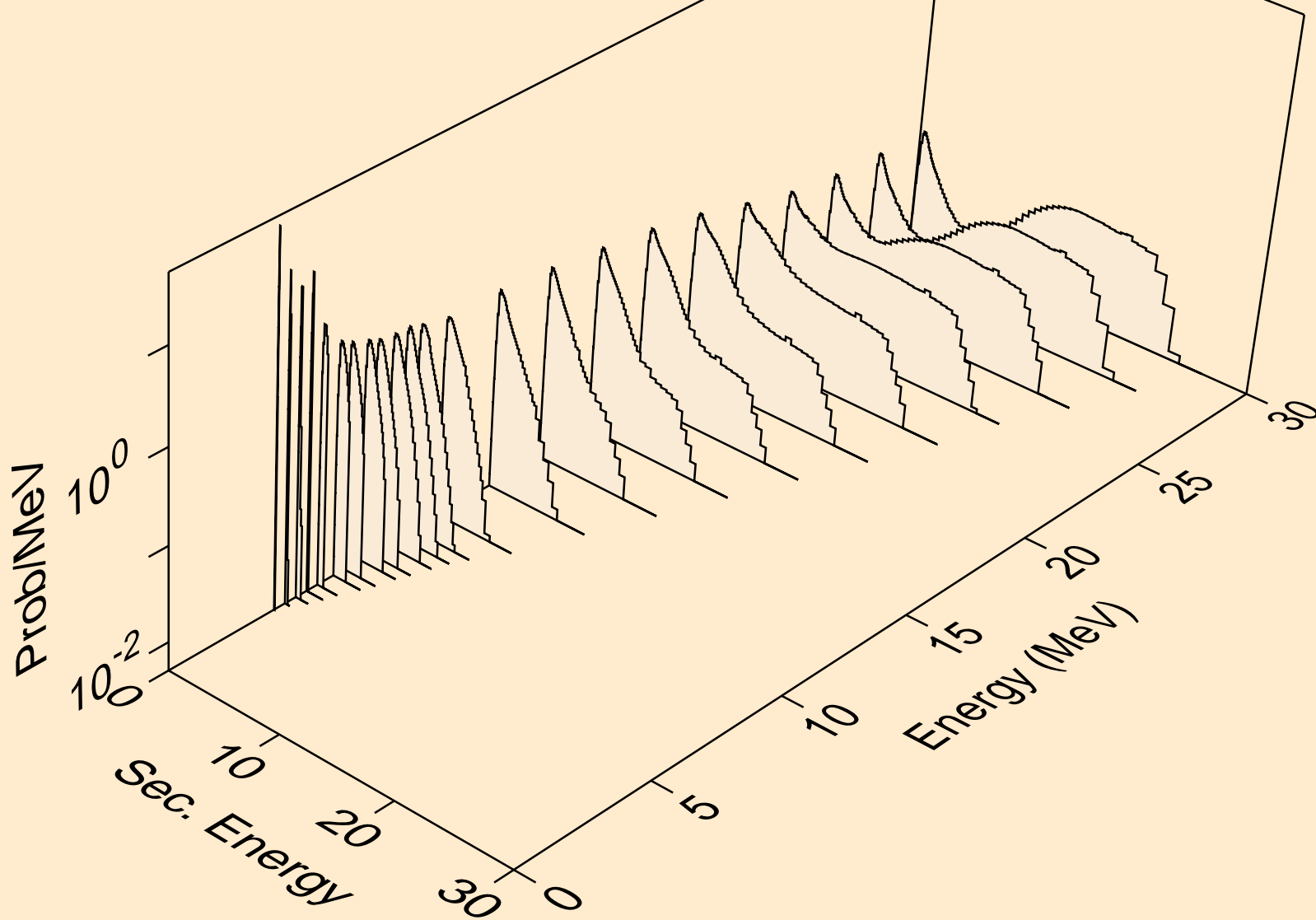

TC091 NEUTRON ACER TENDL-2019 LIBRARY; T=293.16K
Neutron emission for (n,n*)2a

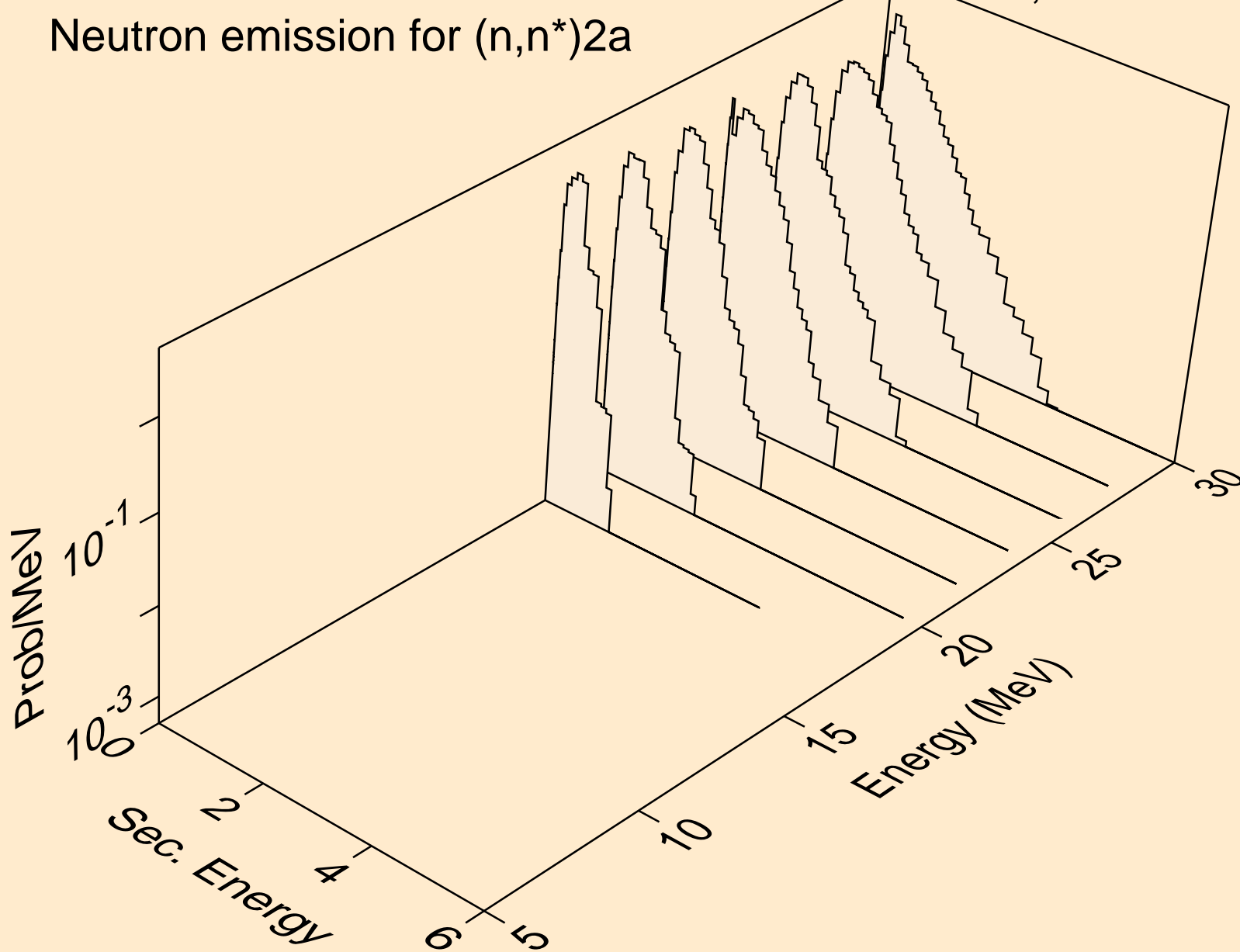

TC091 NEUTRON ACER TENDL-2019 LIBRARY; T=293.16K
Neutron emission for (n,n*)d

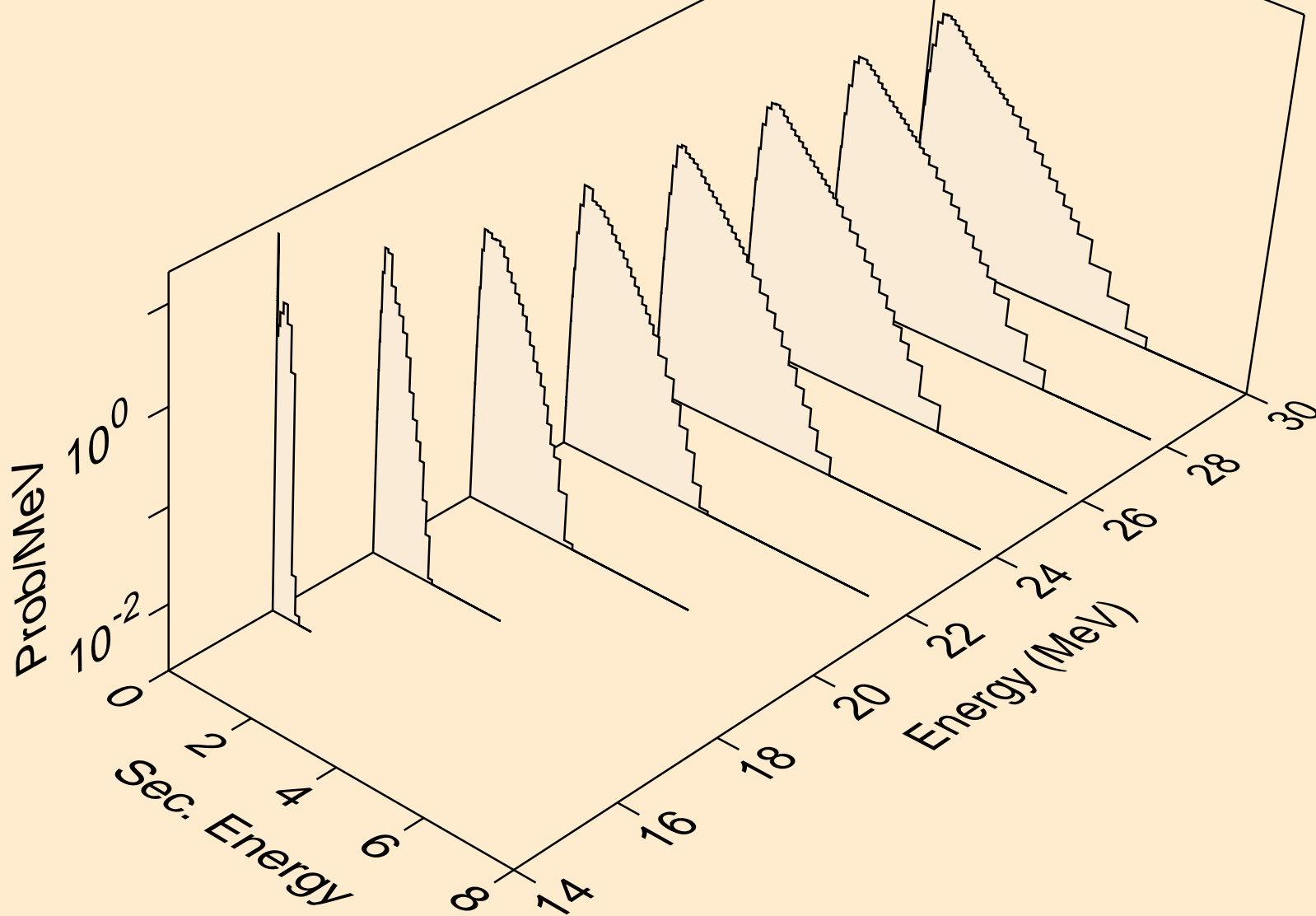

TC091 NEUTRON ACER TENDL-2019 LIBRARY; T=293.16K
Neutron emission for (n,n*)t

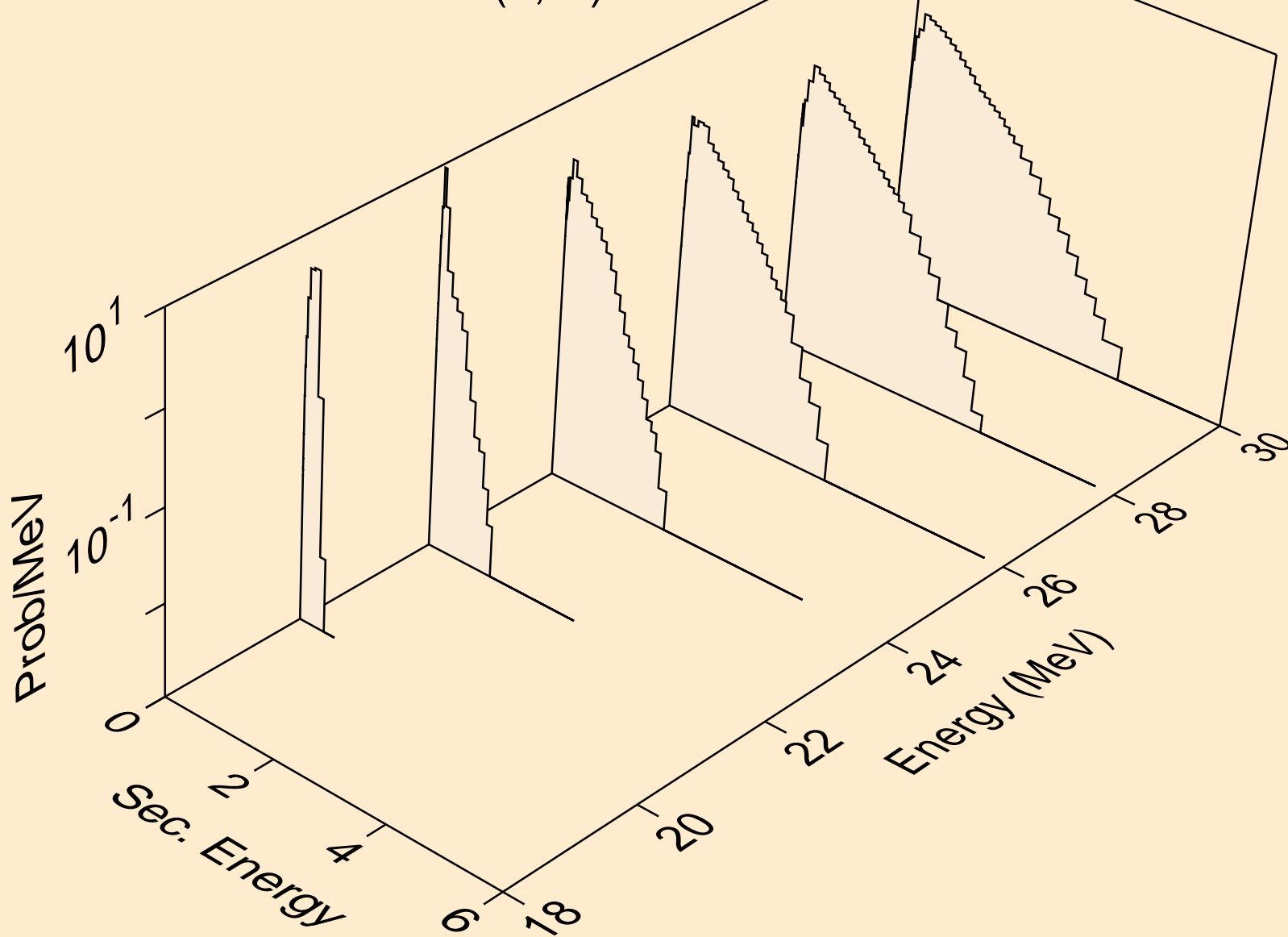

TC091 NEUTRON ACER TENDL-2019 LIBRARY; T=293.16K
Neutron emission for (n,n*)he3

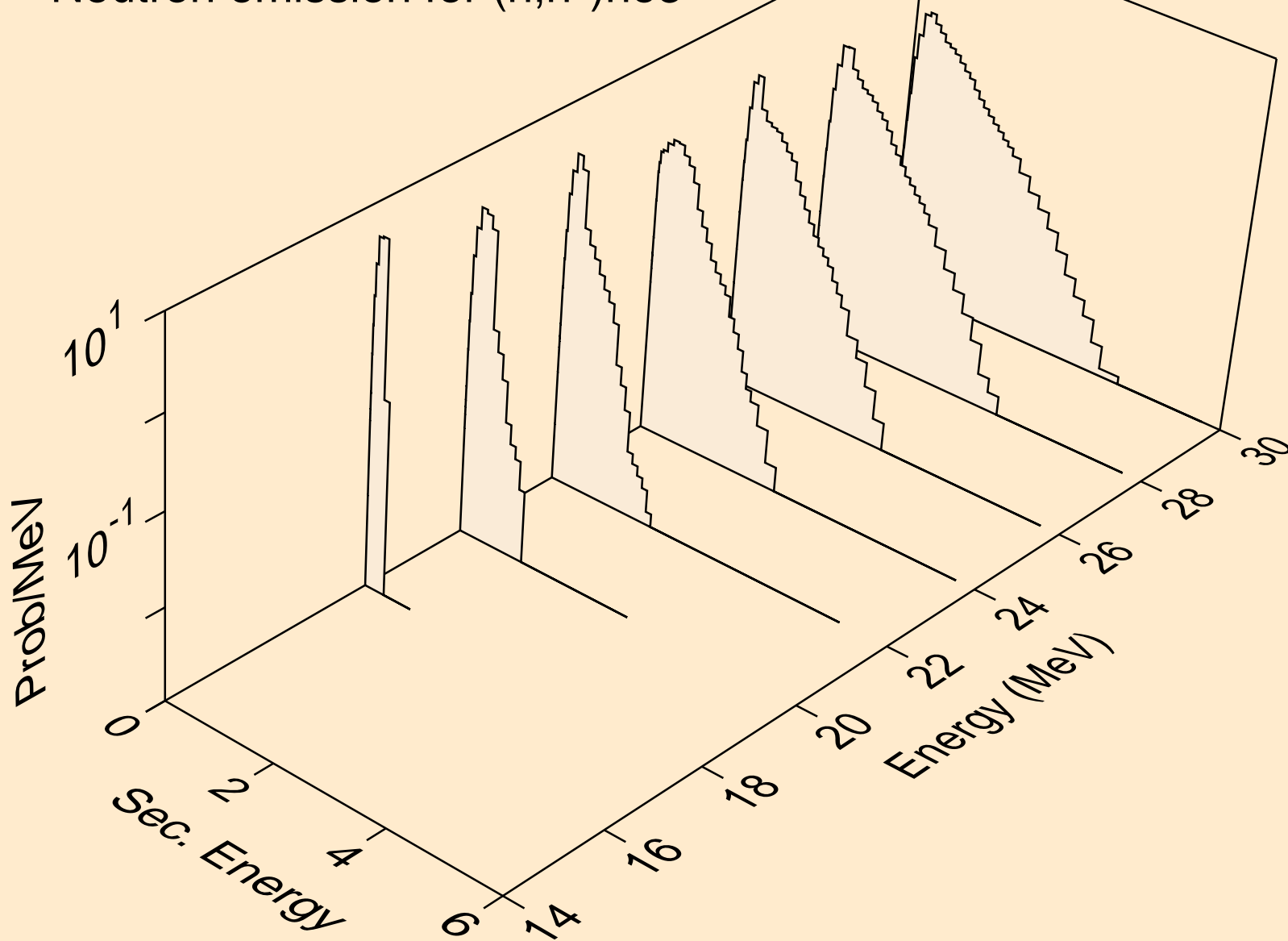

TC091 NEUTRON ACER TENDL-2019 LIBRARY; T=293.16K
Neutron emission for (n,2np)

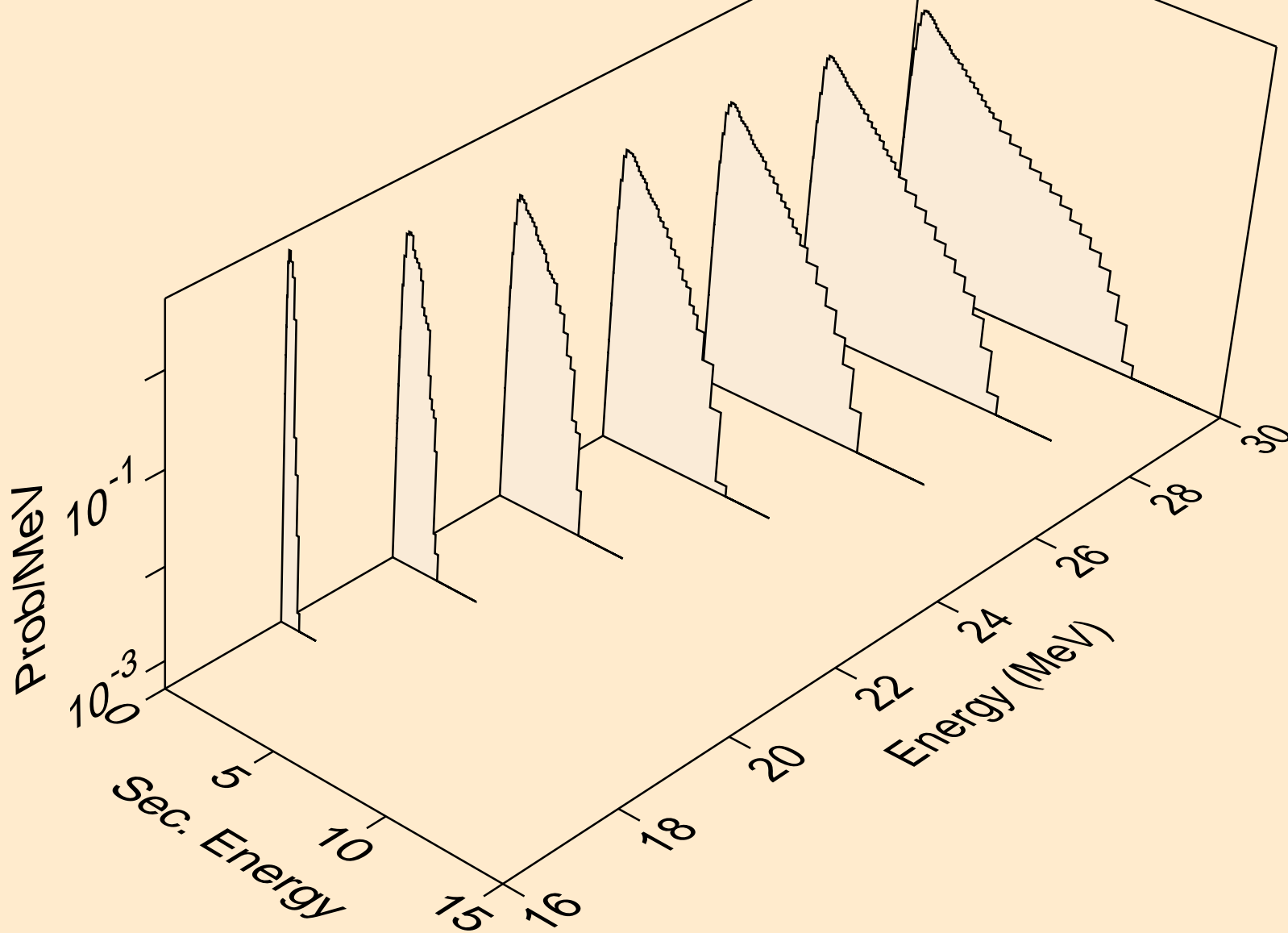

TC091 NEUTRON ACER TENDL-2019 LIBRARY; T=293.16K
Neutron emission for (n,3np)

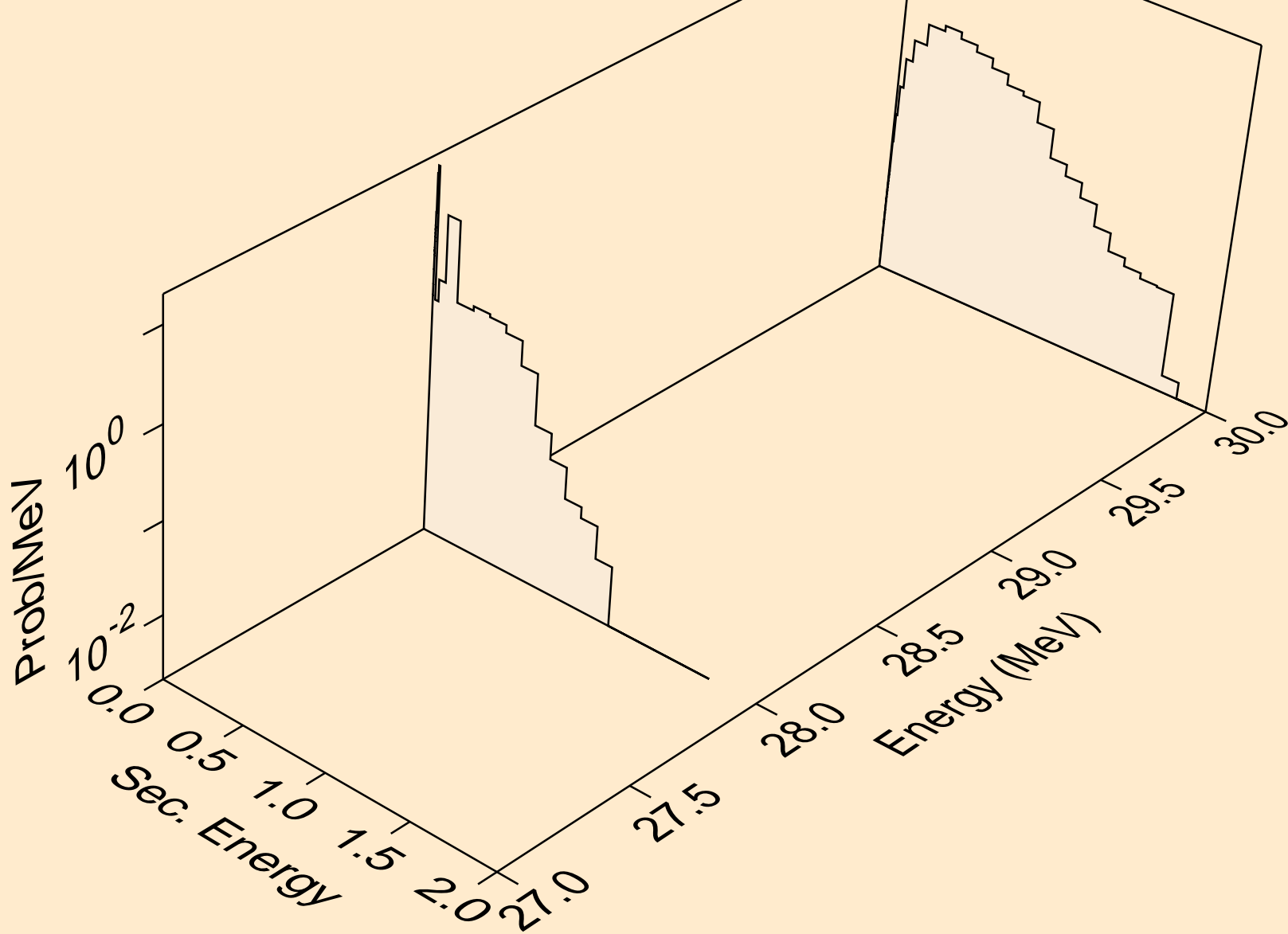

TC091 NEUTRON ACER TENDL-2019 LIBRARY; T=293.16K
Neutron emission for (n,2np)

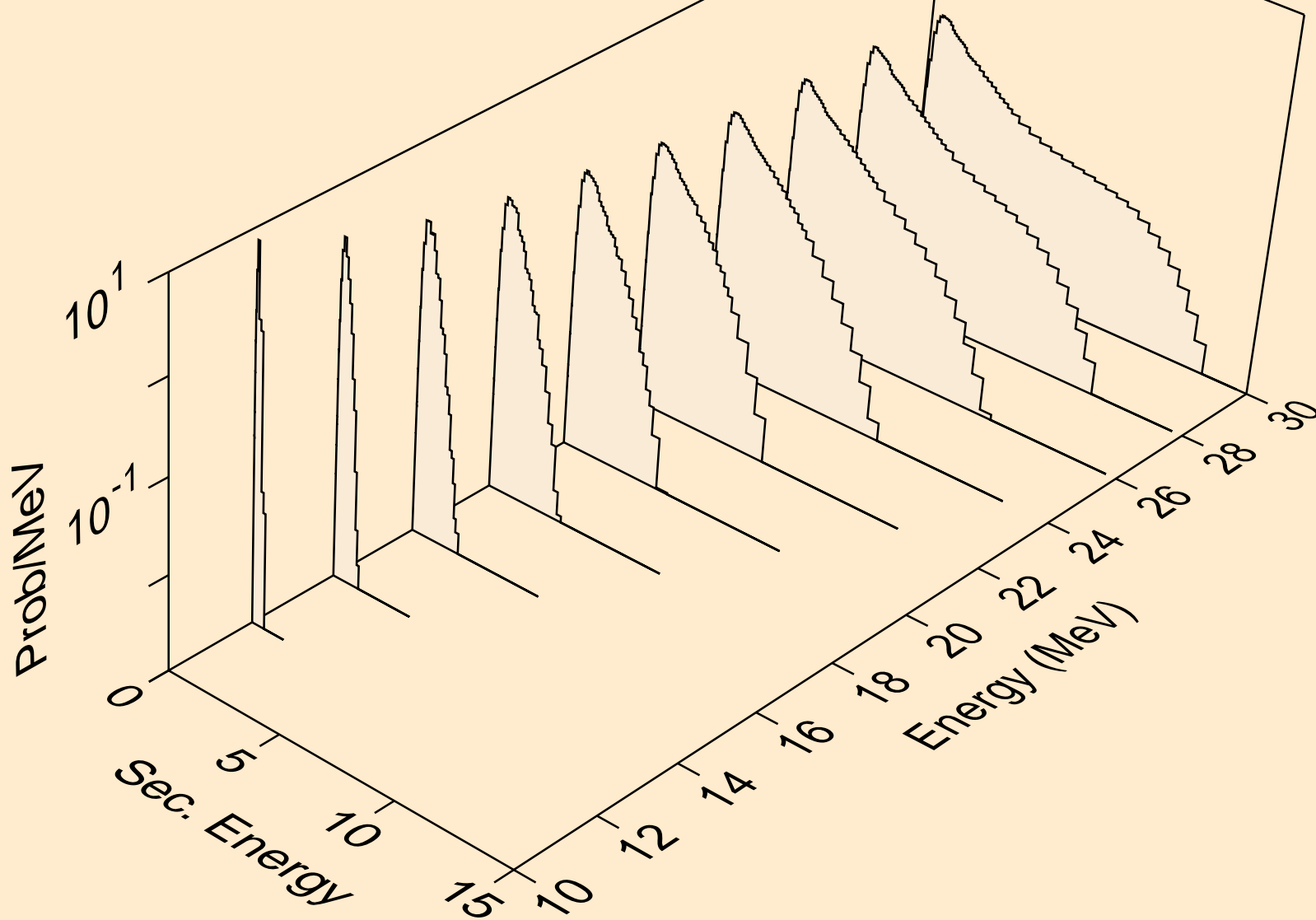

TC091 NEUTRON ACER TENDL-2019 LIBRARY; T=293.16K
Neutron emission for (n,npa)

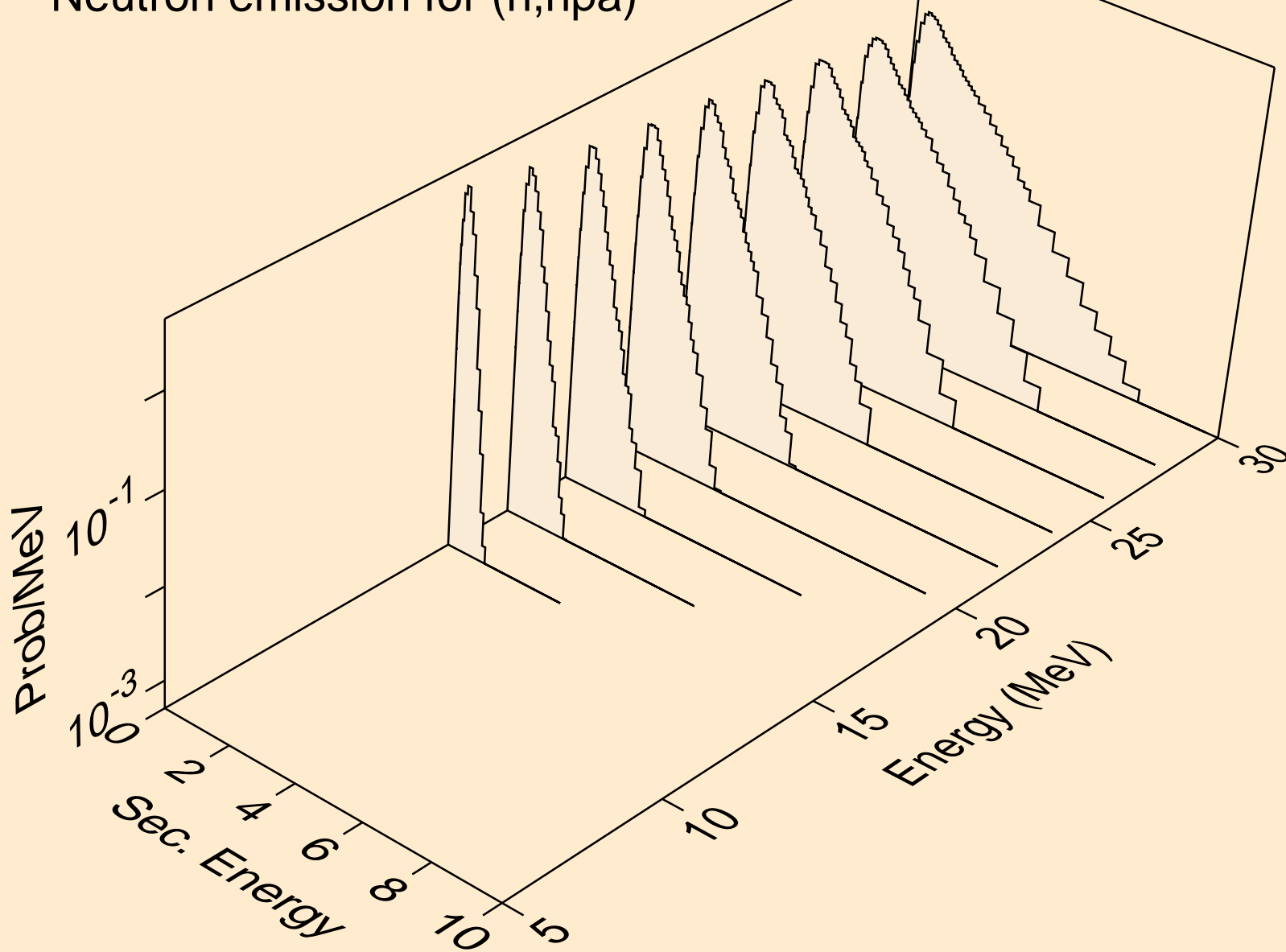

TC091 NEUTRON ACER TENDL-2019 LIBRARY; T=293.16K
Neutron emission for (n,n*c)

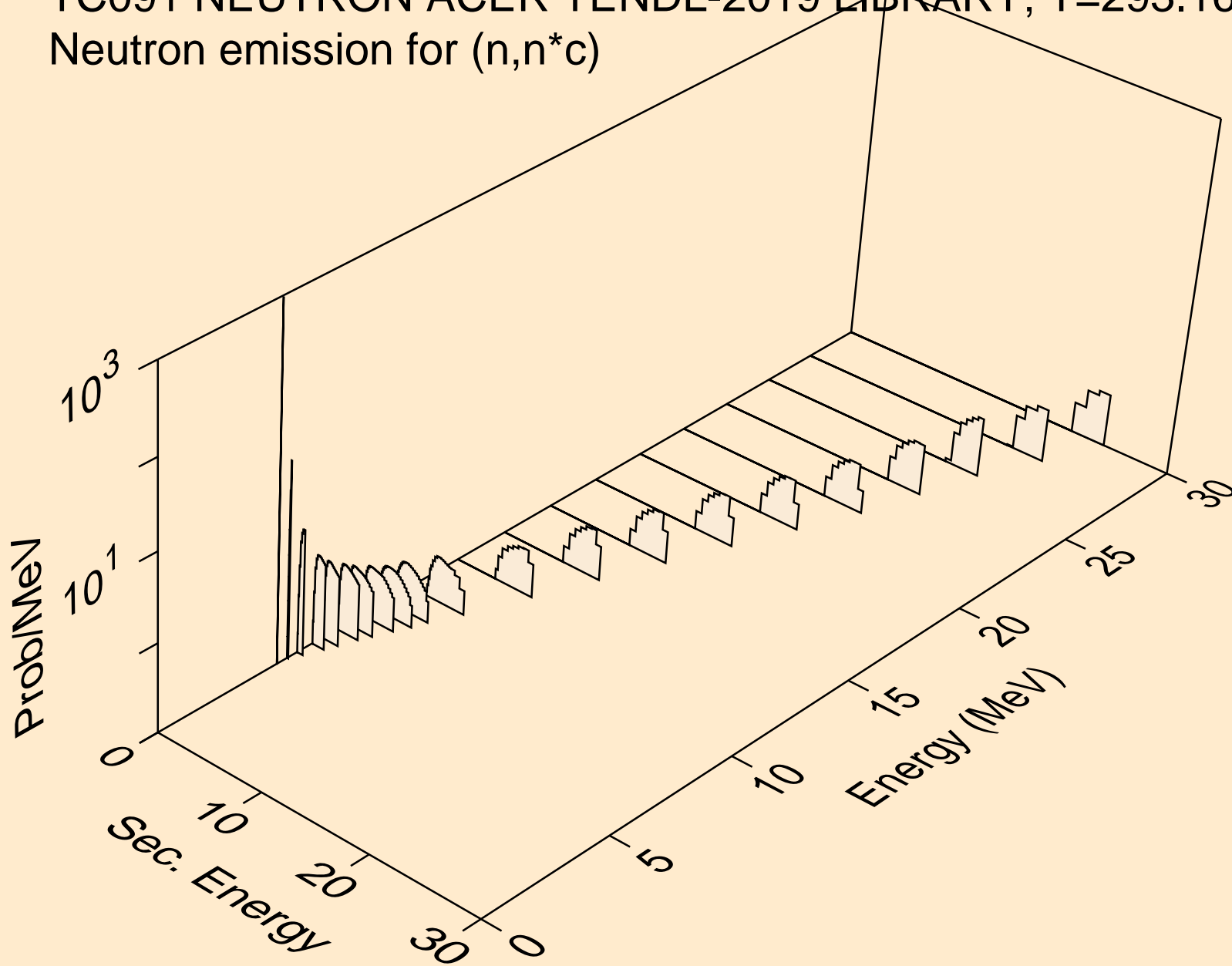

TC091 NEUTRON ACER TENDL-2019 LIBRARY; T=293.16K
Photon emission for (n,x)

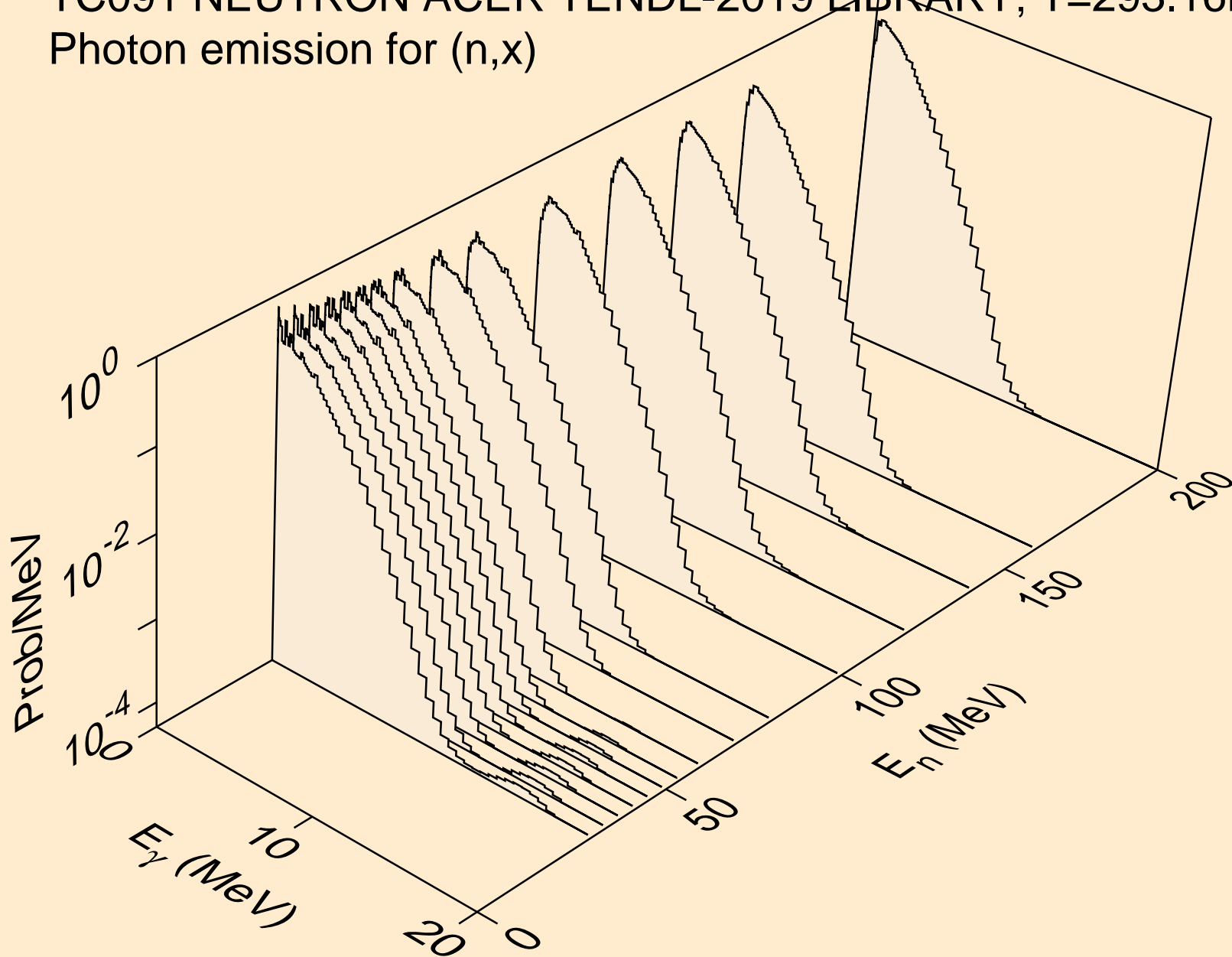

TC091 NEUTRON ACER TENDL-2019 LIBRARY; T=293.16K
Photon emission for (n,2nd)

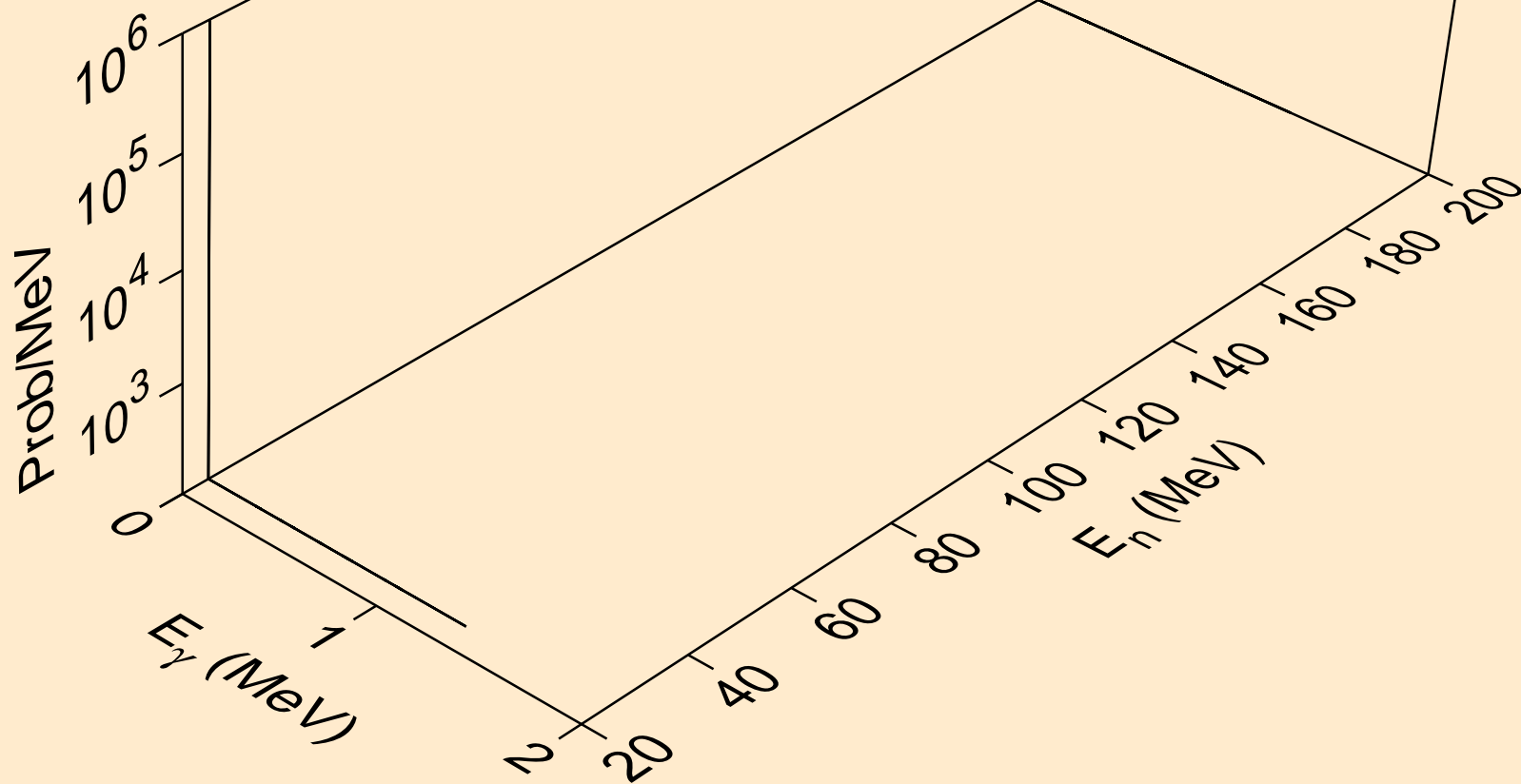

TC091 NEUTRON ACER TENDL-2019 LIBRARY; T=293.16K
Photon emission for (n,2n)

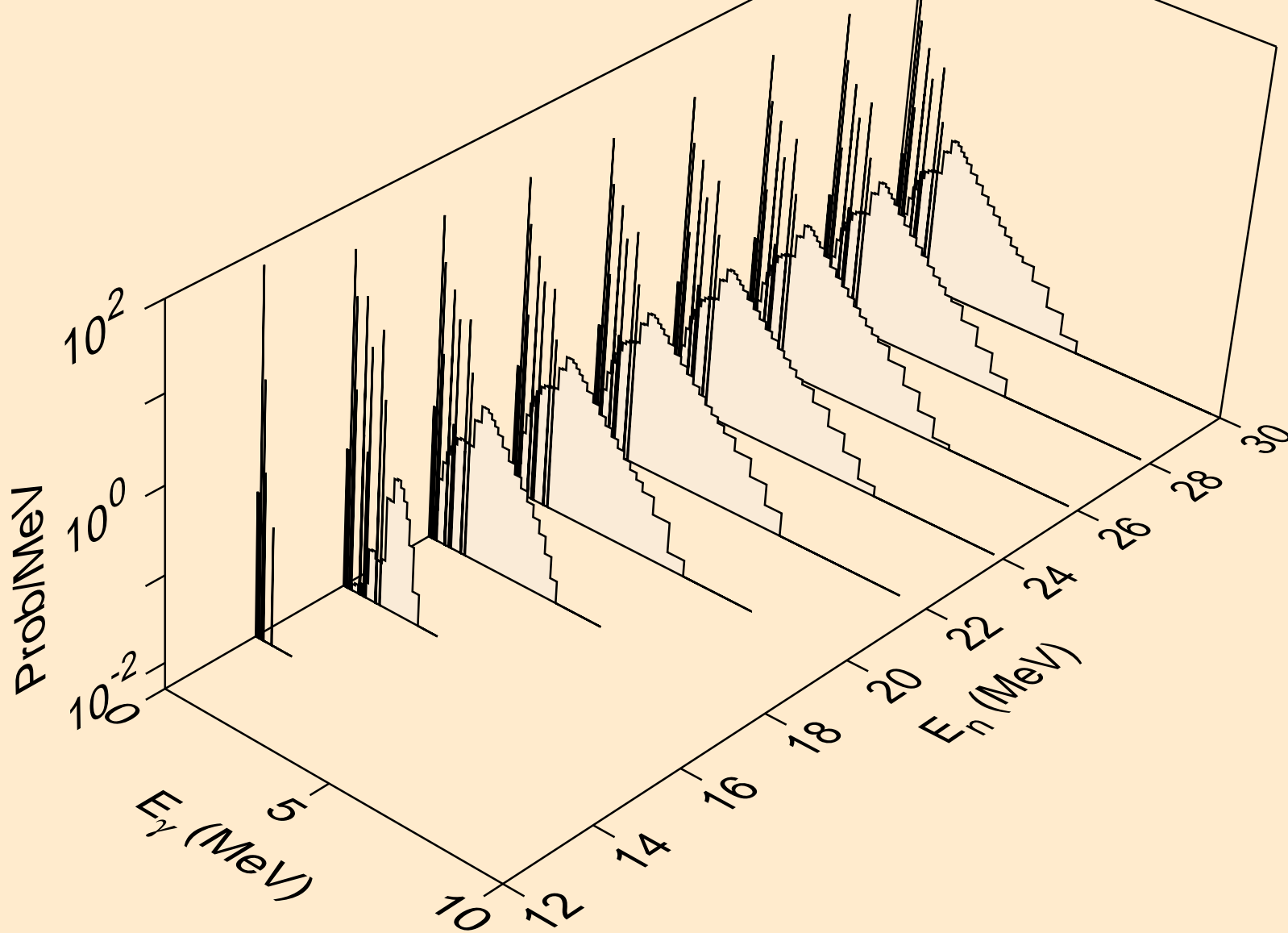

TC091 NEUTRON ACER TENDL-2019 LIBRARY; T=293.16K
Photon emission for (n,3n)

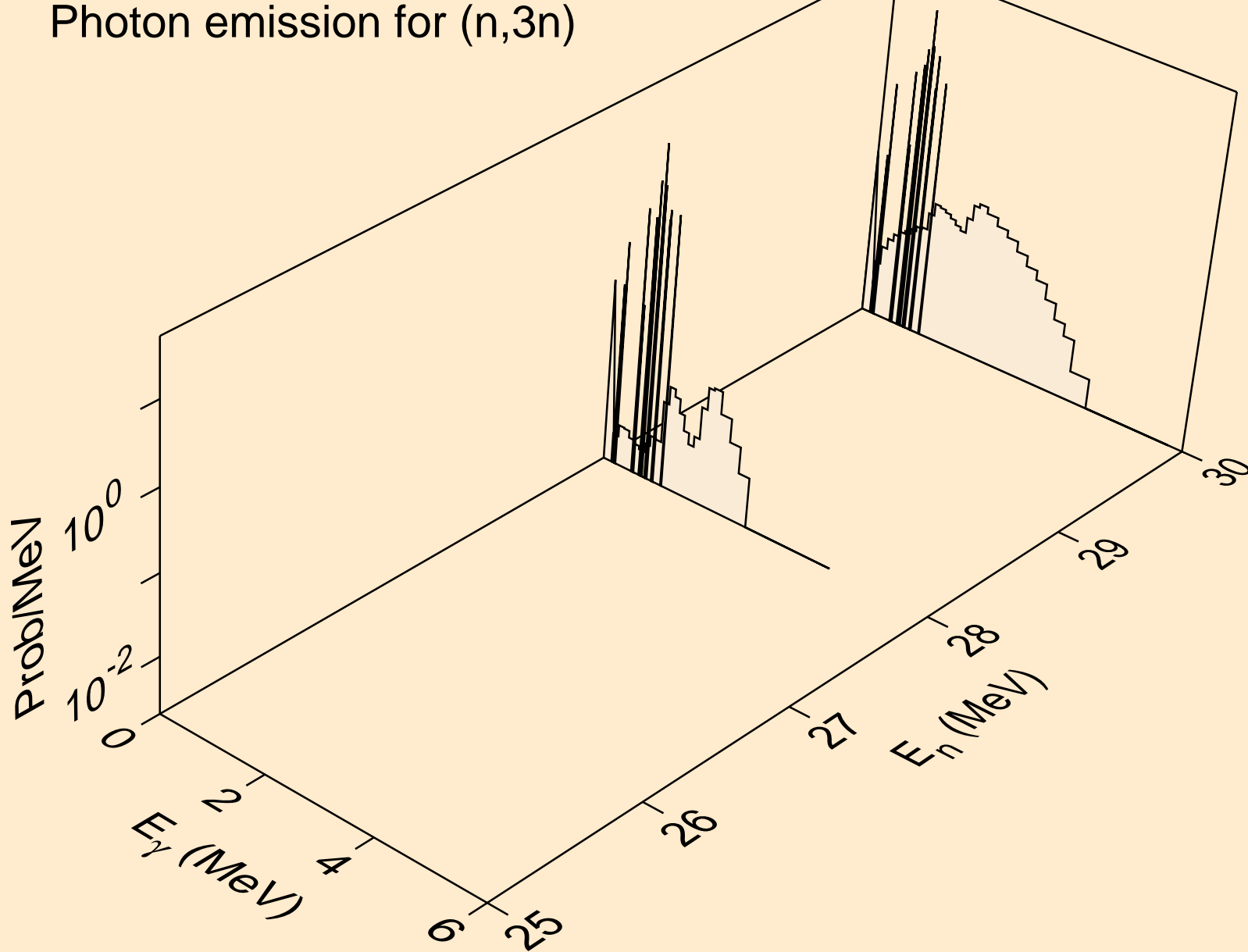

TC091 NEUTRON ACER TENDL-2019 LIBRARY; T=293.16K
Photon emission for (n,n*)a

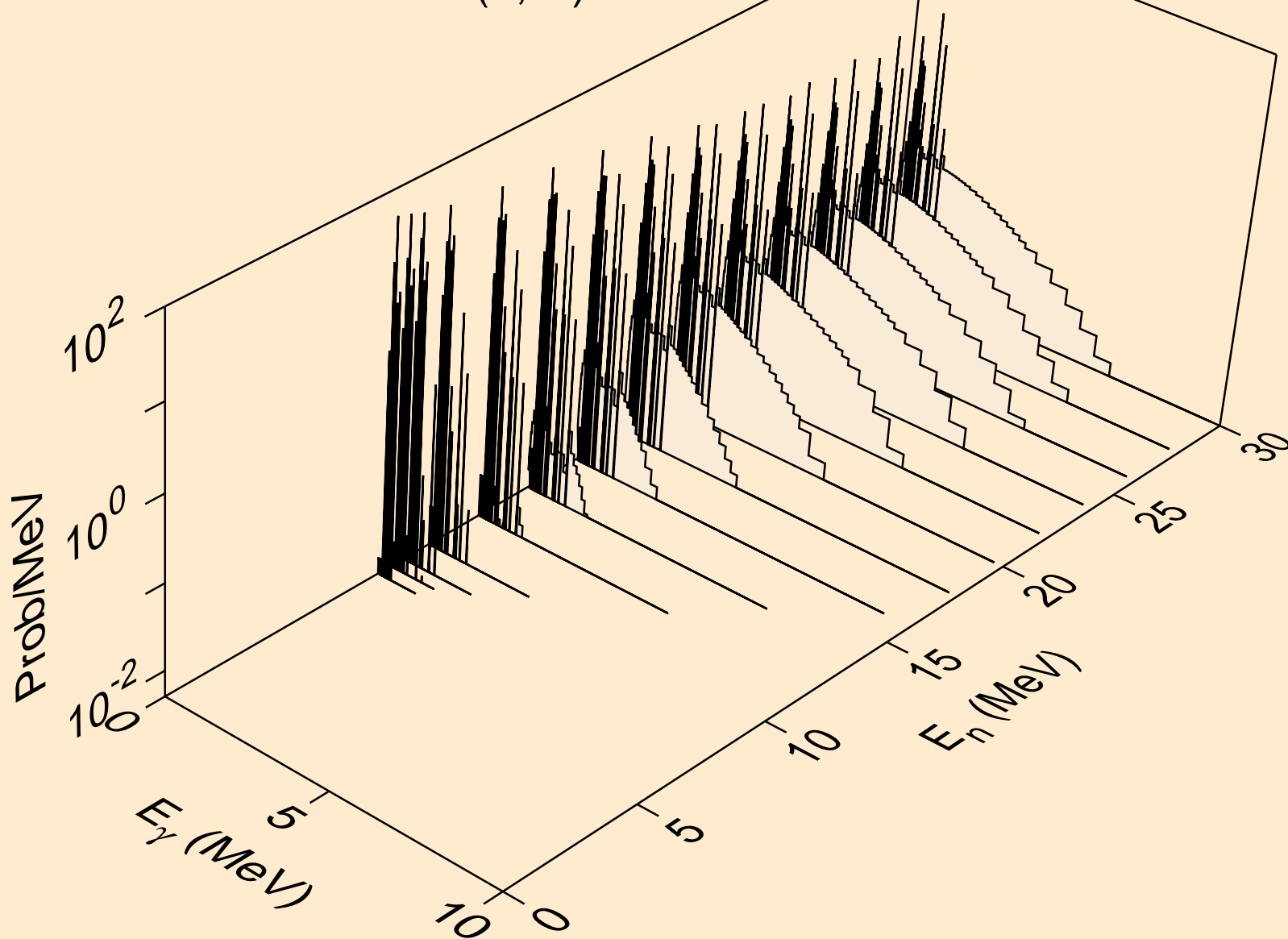

TC091 NEUTRON ACER TENDL-2019 LIBRARY; T=293.16K
Photon emission for (n,2n)a

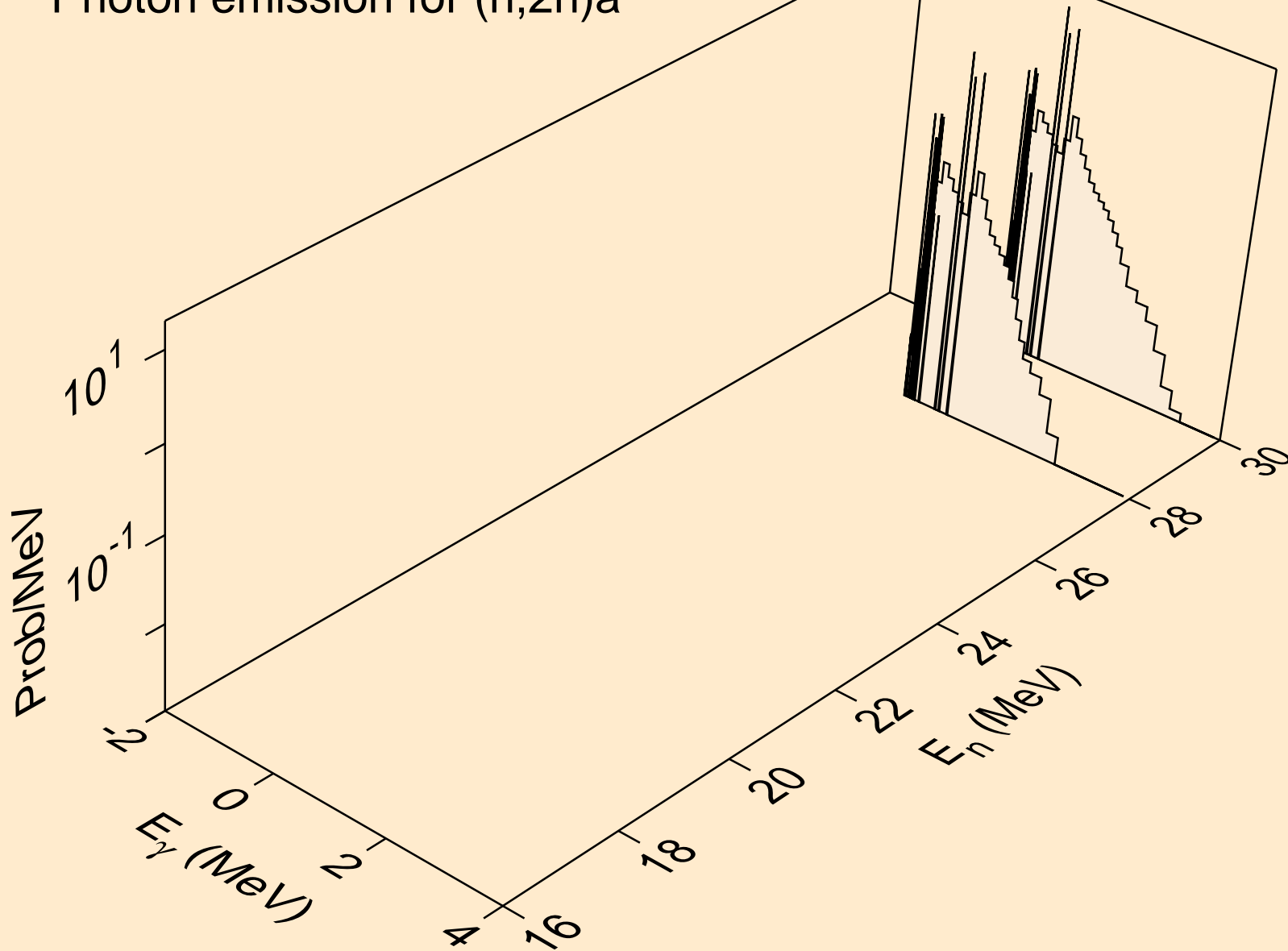

TC091 NEUTRON ACER TENDL-2019 LIBRARY; T=293.16K
Photon emission for (n,n*)p

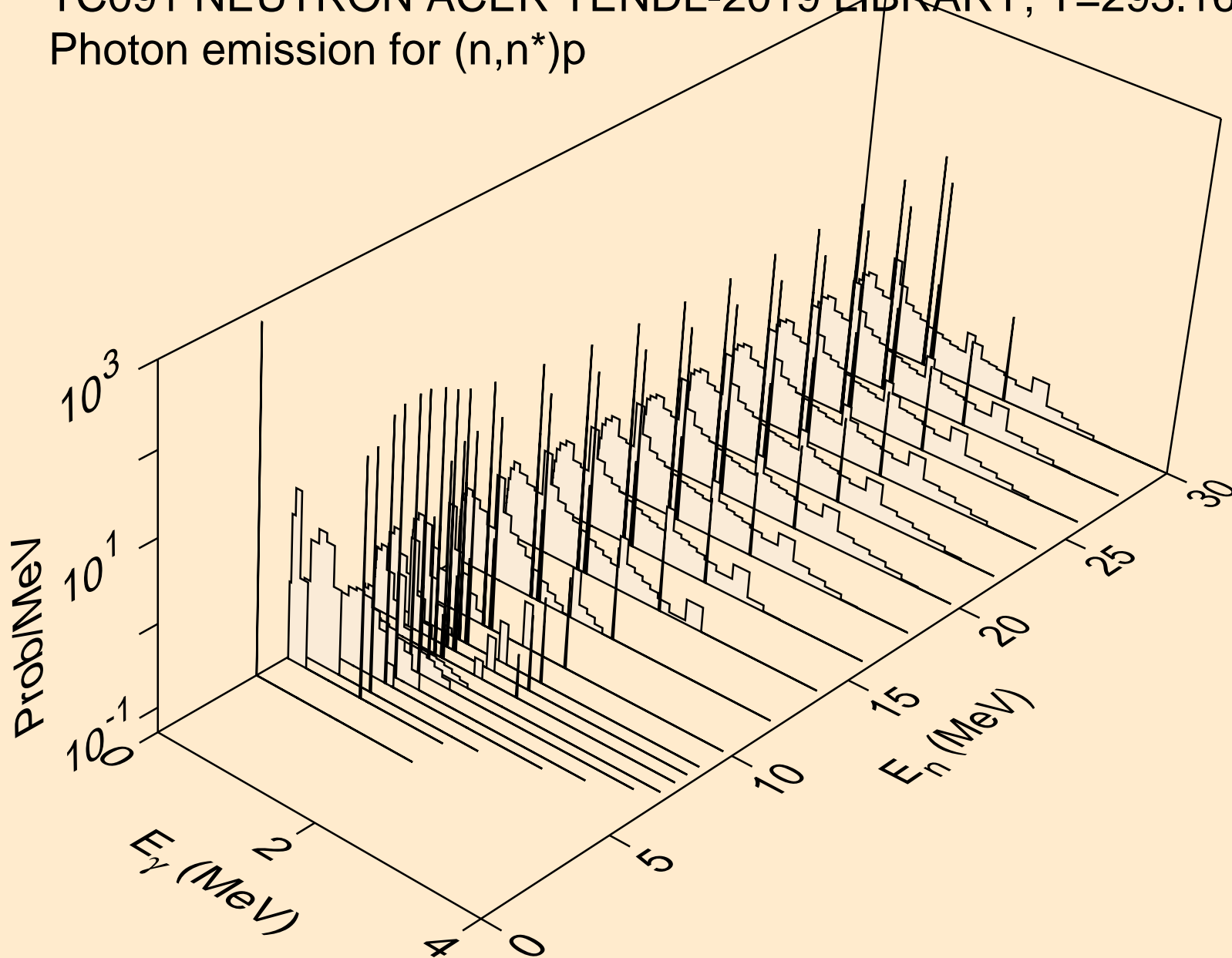

TC091 NEUTRON ACER TENDL-2019 LIBRARY; T=293.16K
Photon emission for (n,n*)2a

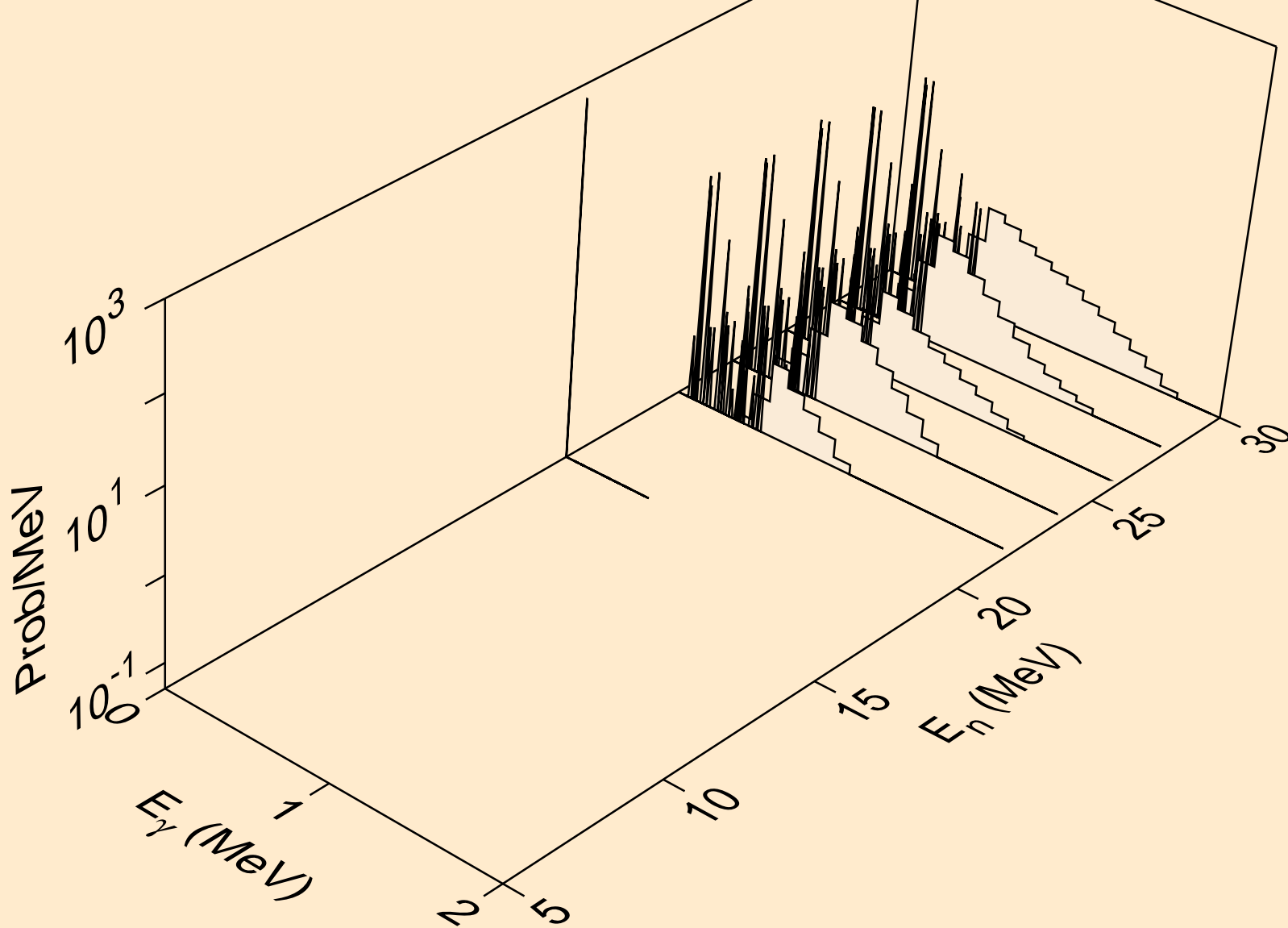

TC091 NEUTRON ACER TENDL-2019 LIBRARY; T=293.16K
Photon emission for (n,n*)d

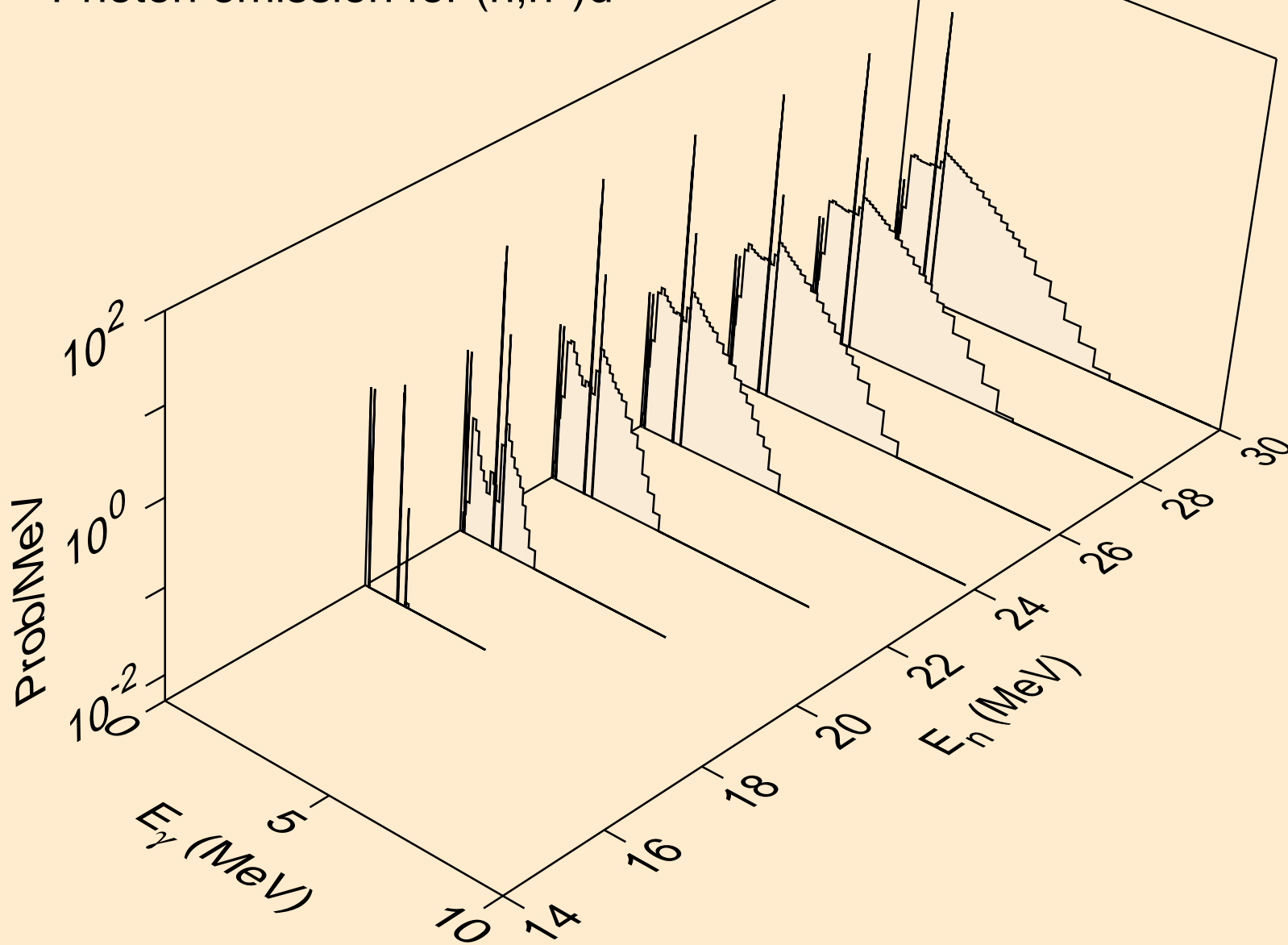

TC091 NEUTRON ACER TENDL-2019 LIBRARY; T=293.16K
Photon emission for (n,n*)t

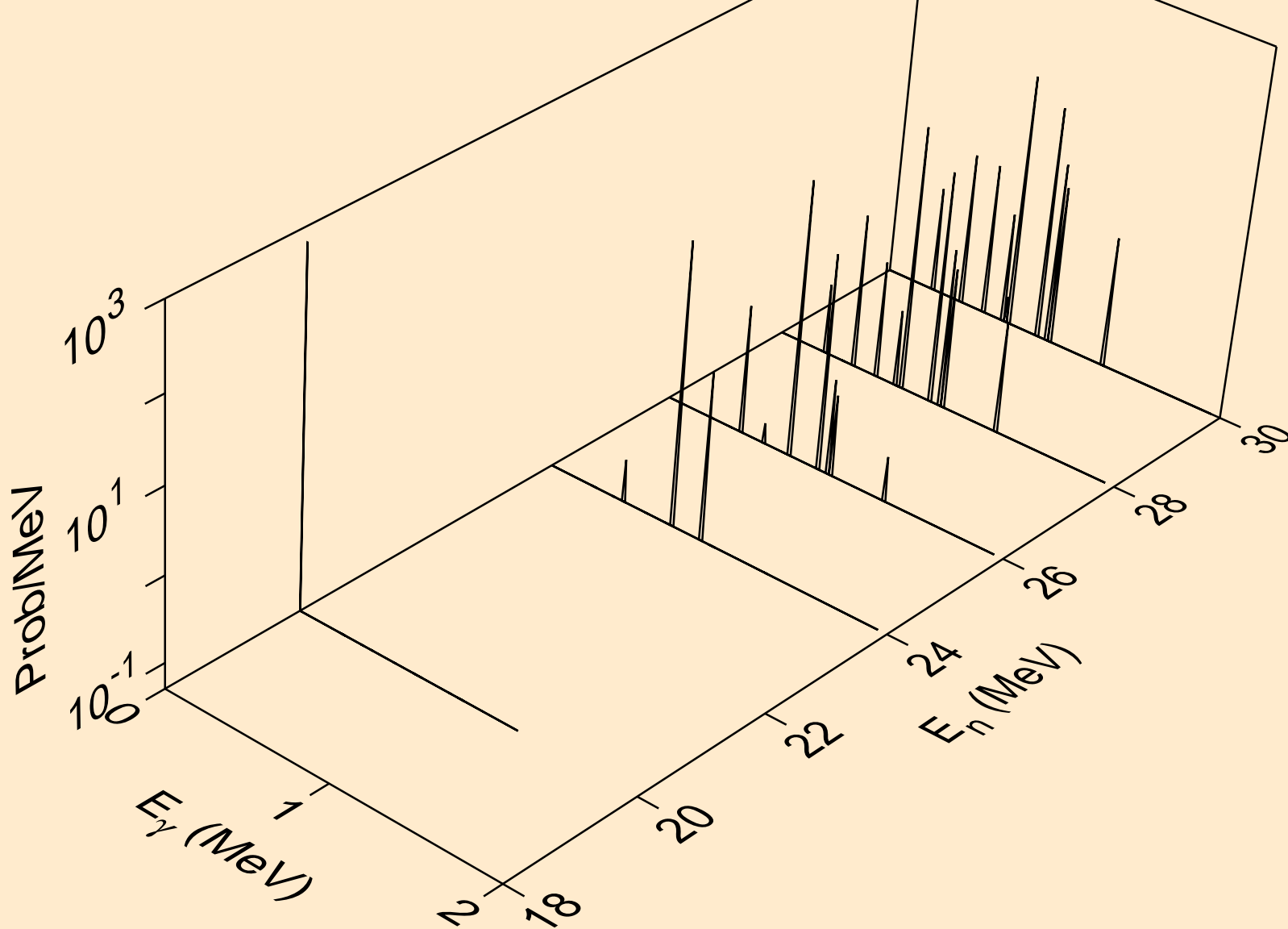

TC091 NEUTRON ACER TENDL-2019 LIBRARY; T=293.16K
Photon emission for (n,n*)he3

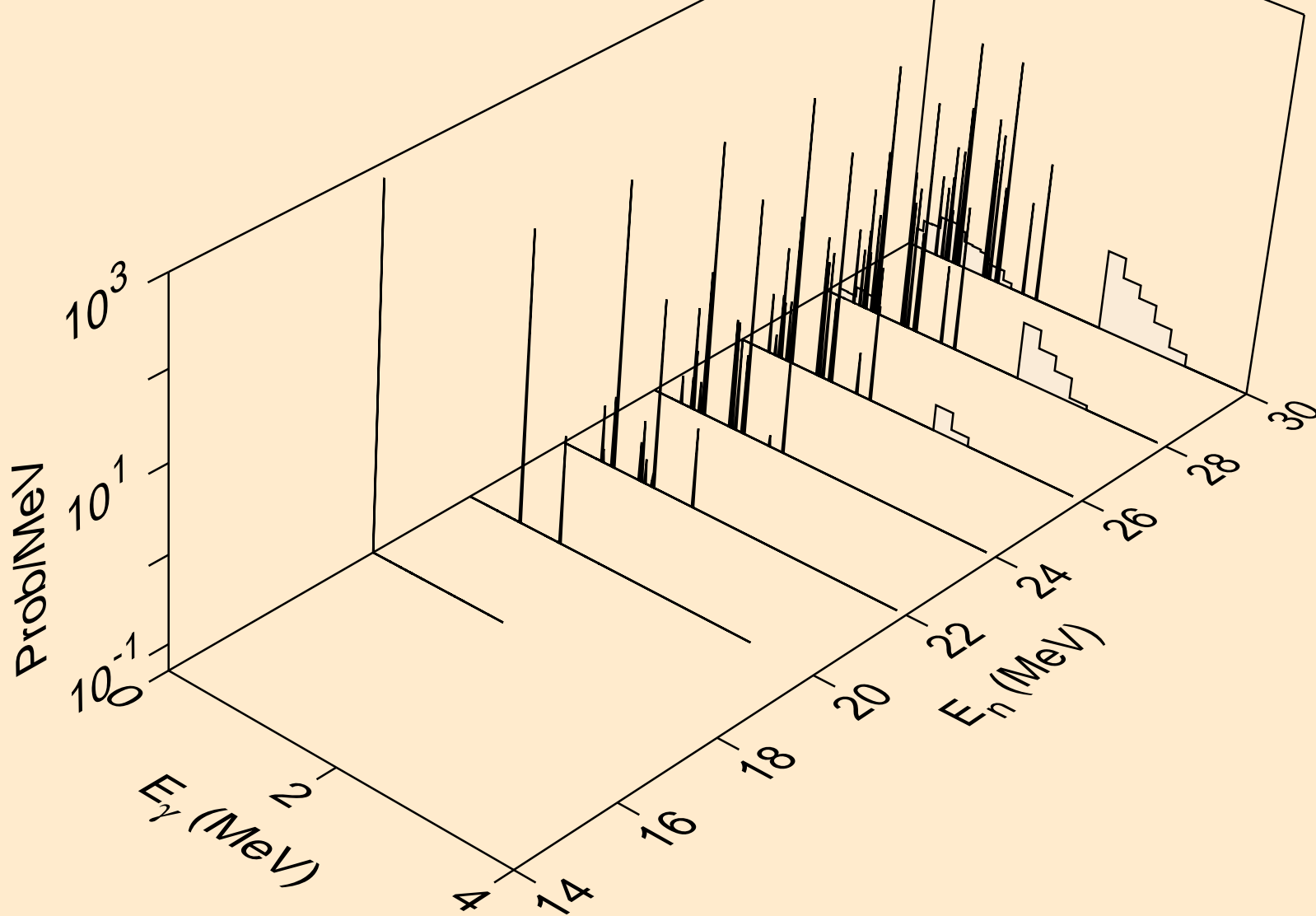

TC091 NEUTRON ACER TENDL-2019 LIBRARY; T=293.16K
Photon emission for (n,2np)

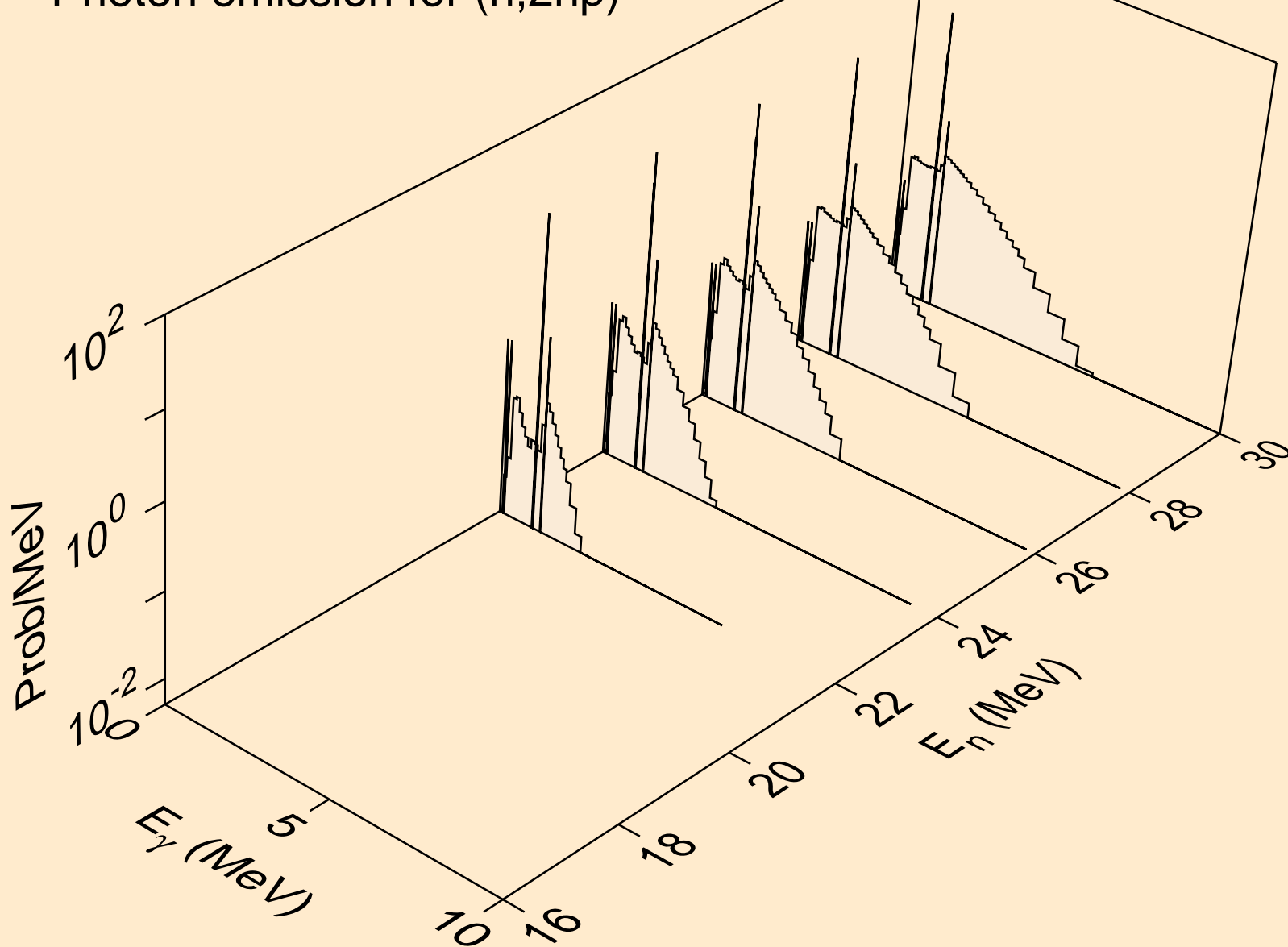

TC091 NEUTRON ACER TENDL-2019 LIBRARY; T=293.16K
Photon emission for (n,3np)

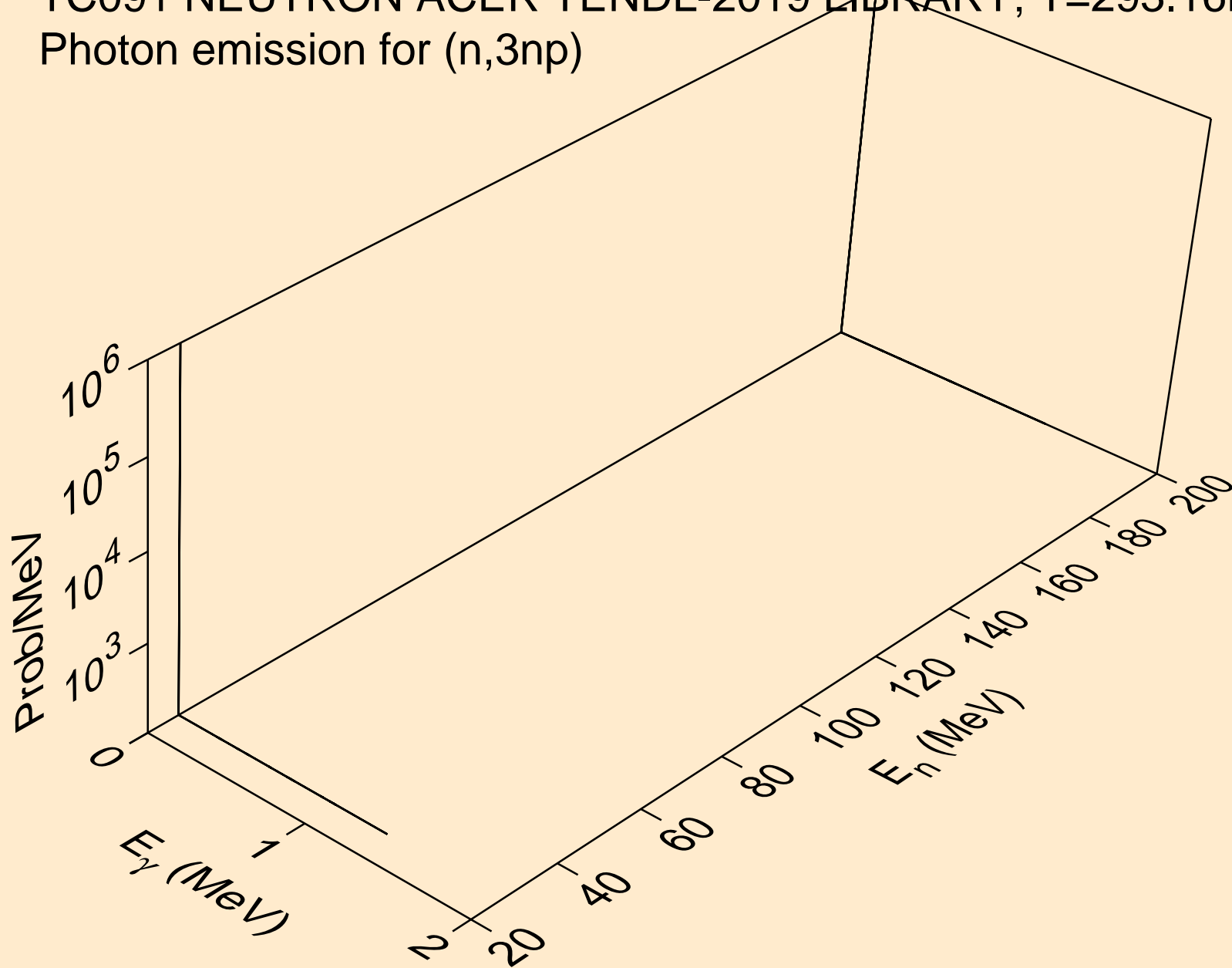

TC091 NEUTRON ACER TENDL-2019 LIBRARY; T=293.16K
Photon emission for (n,2np)

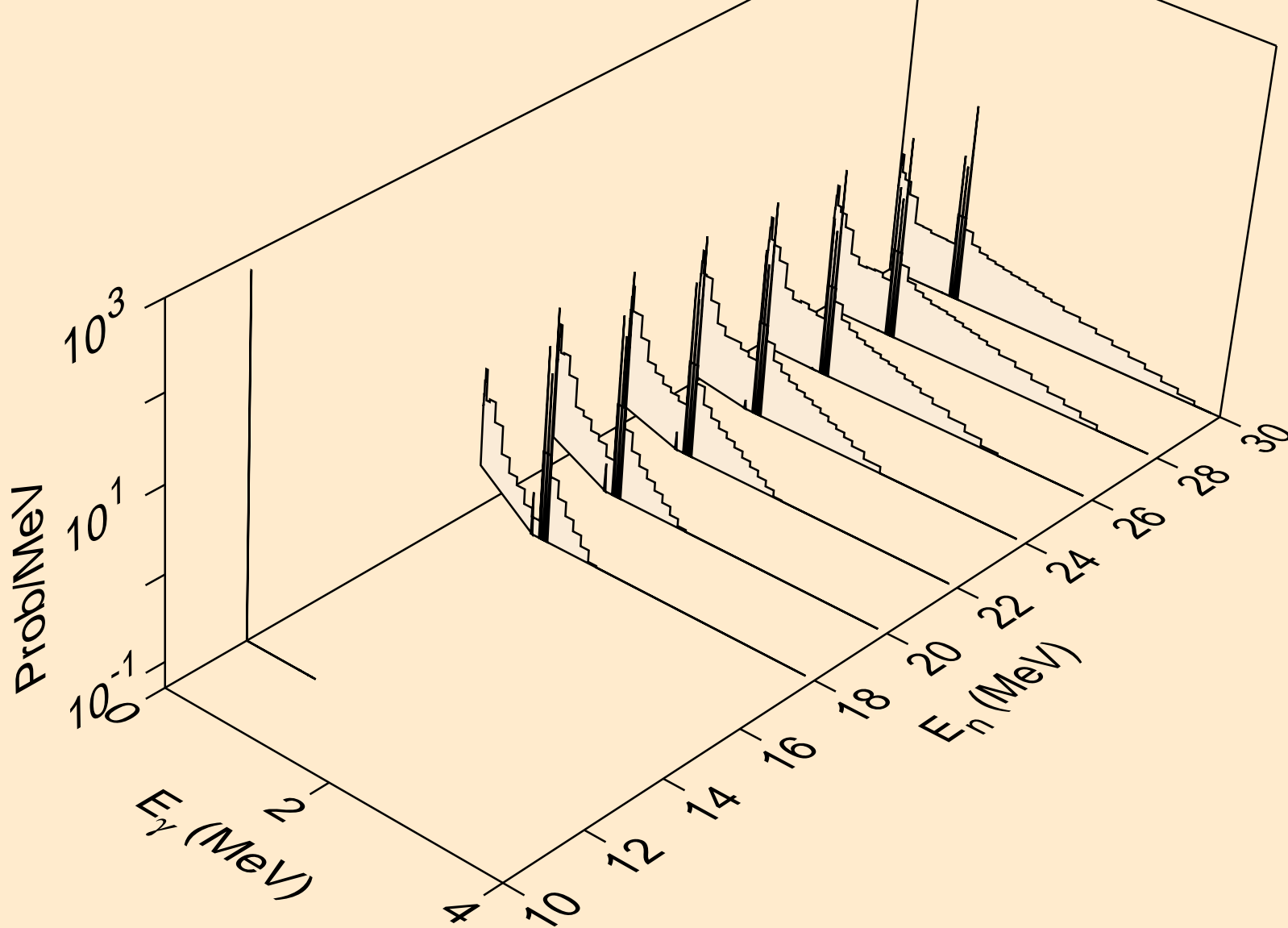

TC091 NEUTRON ACER TENDL-2019 LIBRARY; T=293.16K
Photon emission for (n,npa)

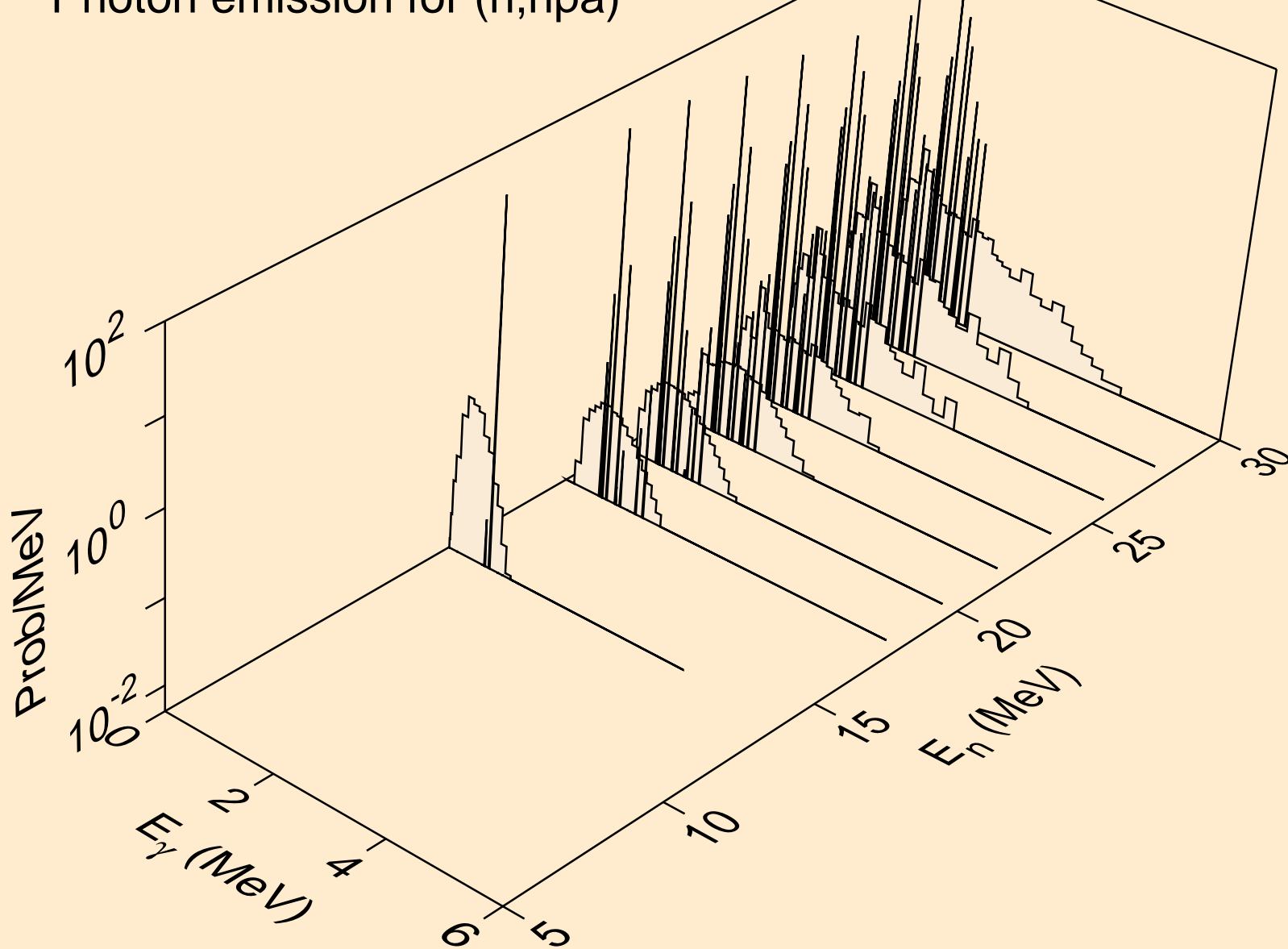

TC091 NEUTRON ACER TENDL-2019 LIBRARY; T=293.16K
Photon emission for (n,n*c)

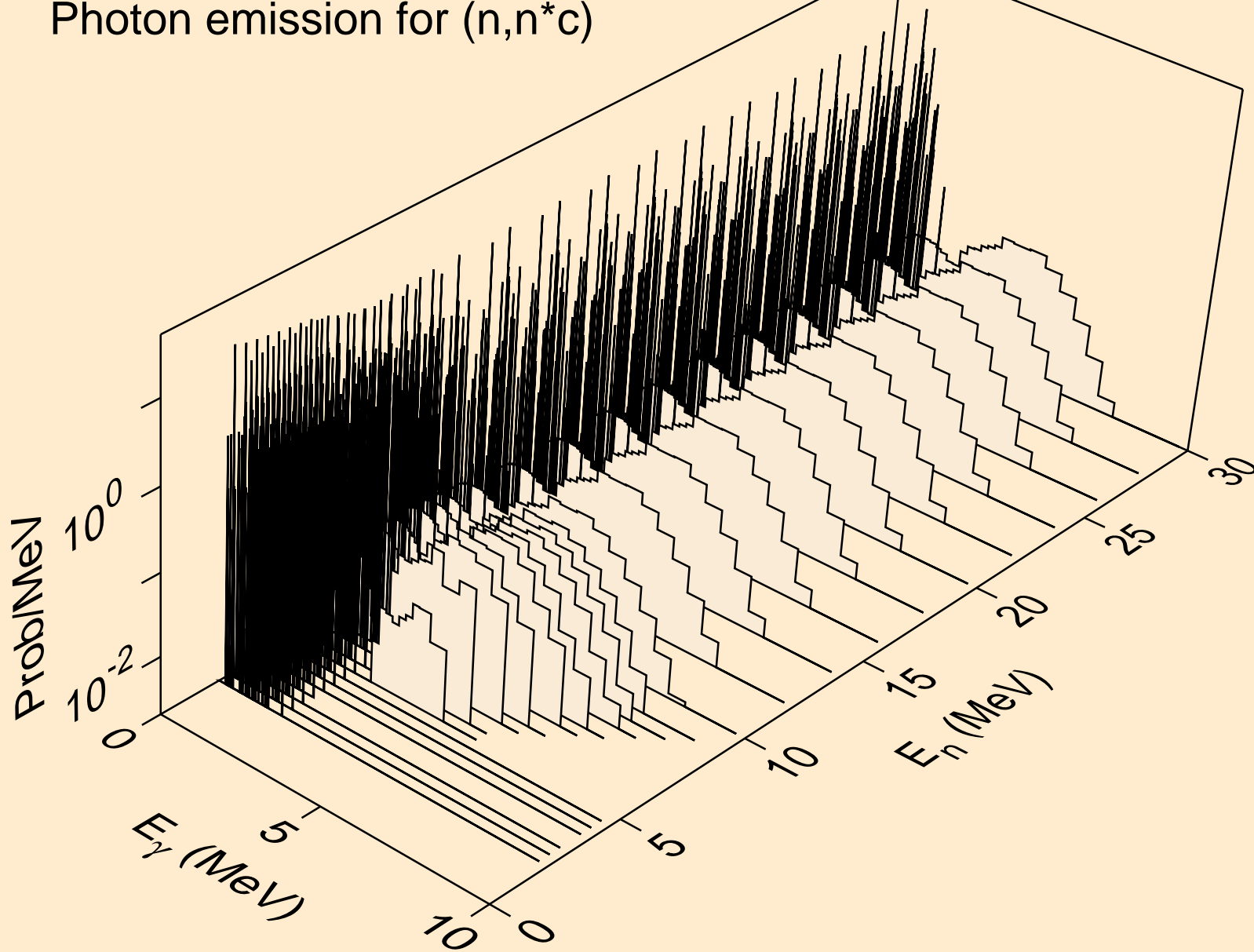

TC091 NEUTRON ACER TENDL-2019 LIBRARY; T=293.16K
Photon emission for (n,gma)

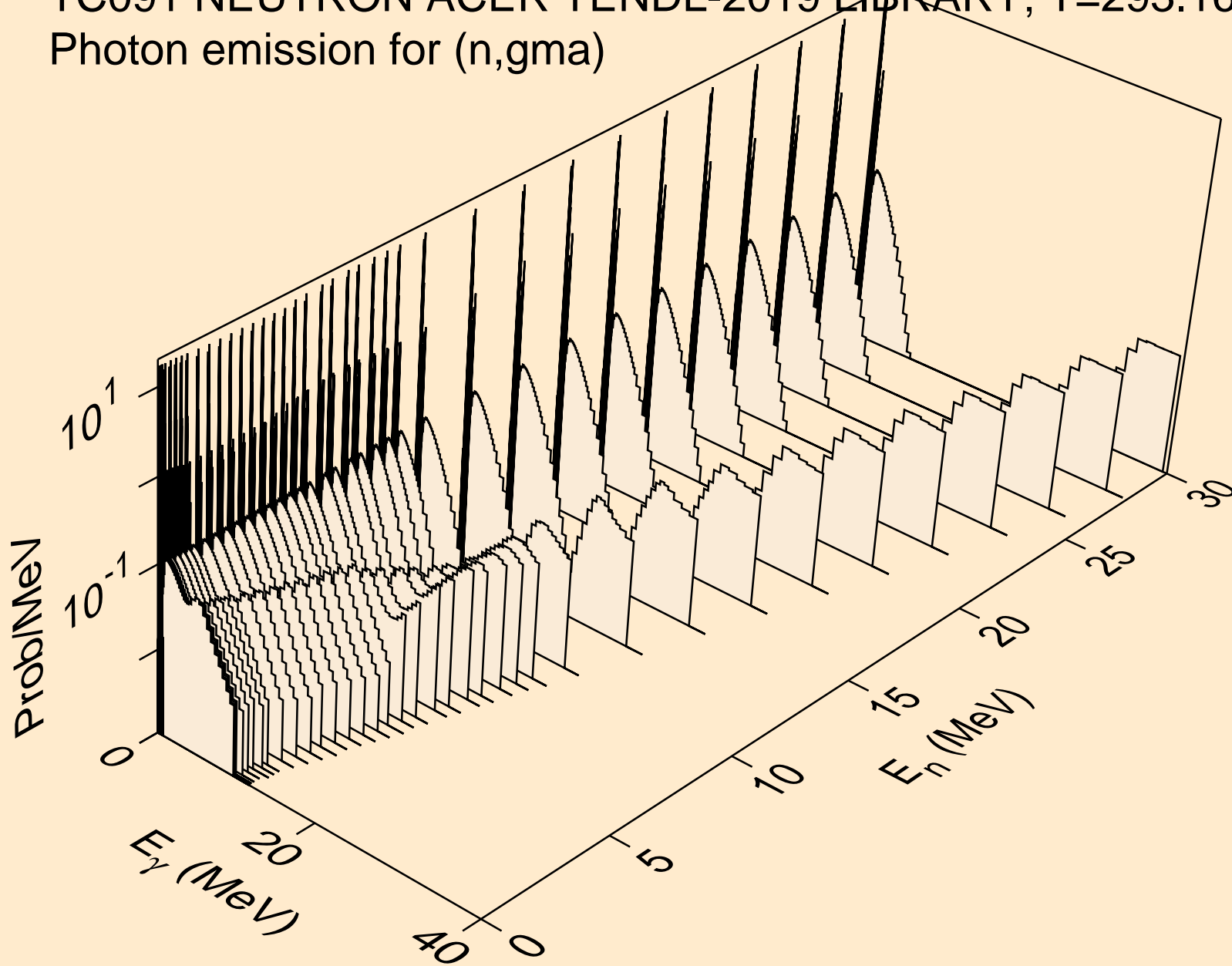

TC091 NEUTRON ACER TENDL-2019 LIBRARY; T=293.16K
Photon emission for (n,p)

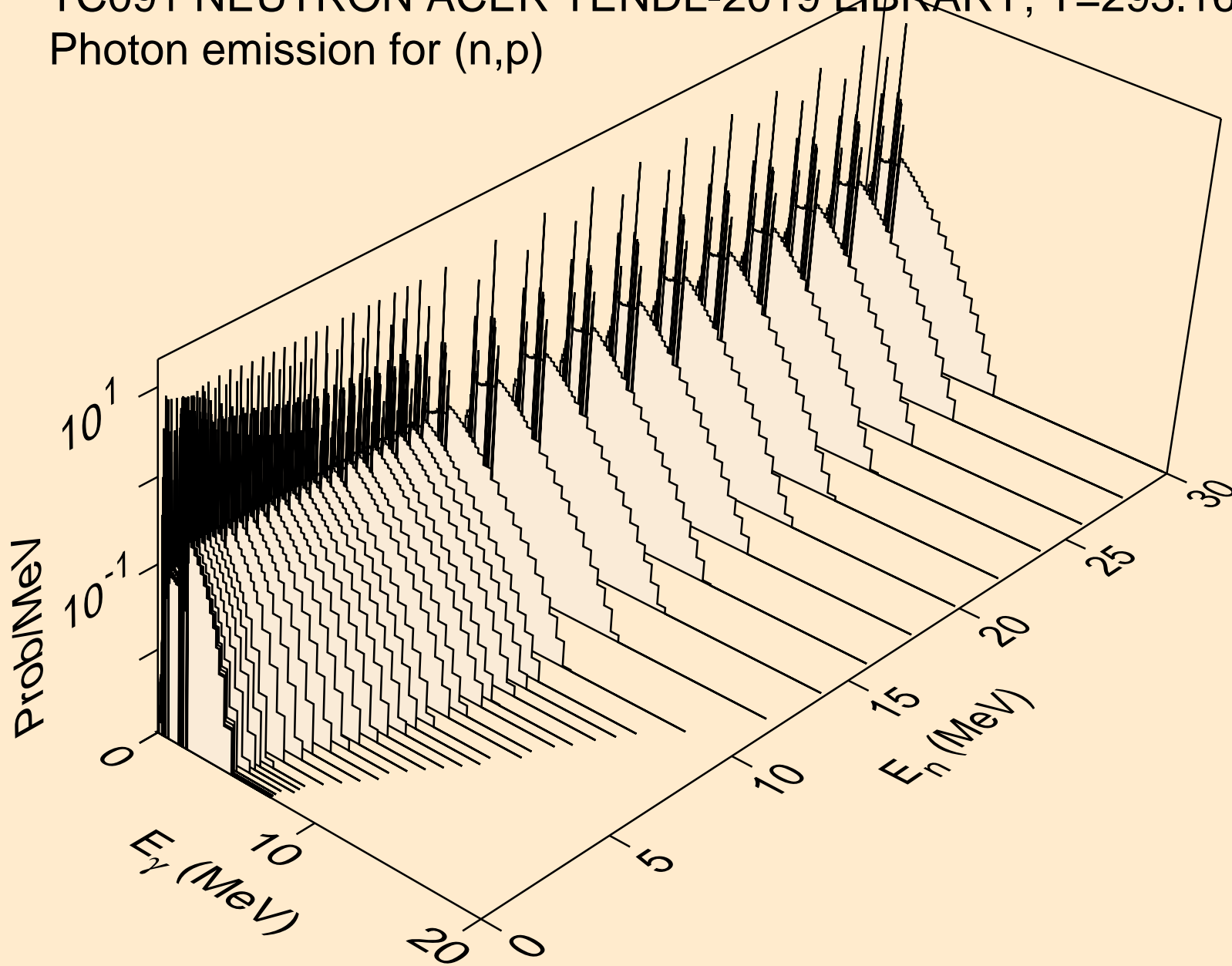

TC091 NEUTRON ACER TENDL-2019 LIBRARY; T=293.16K
Photon emission for (n,d)

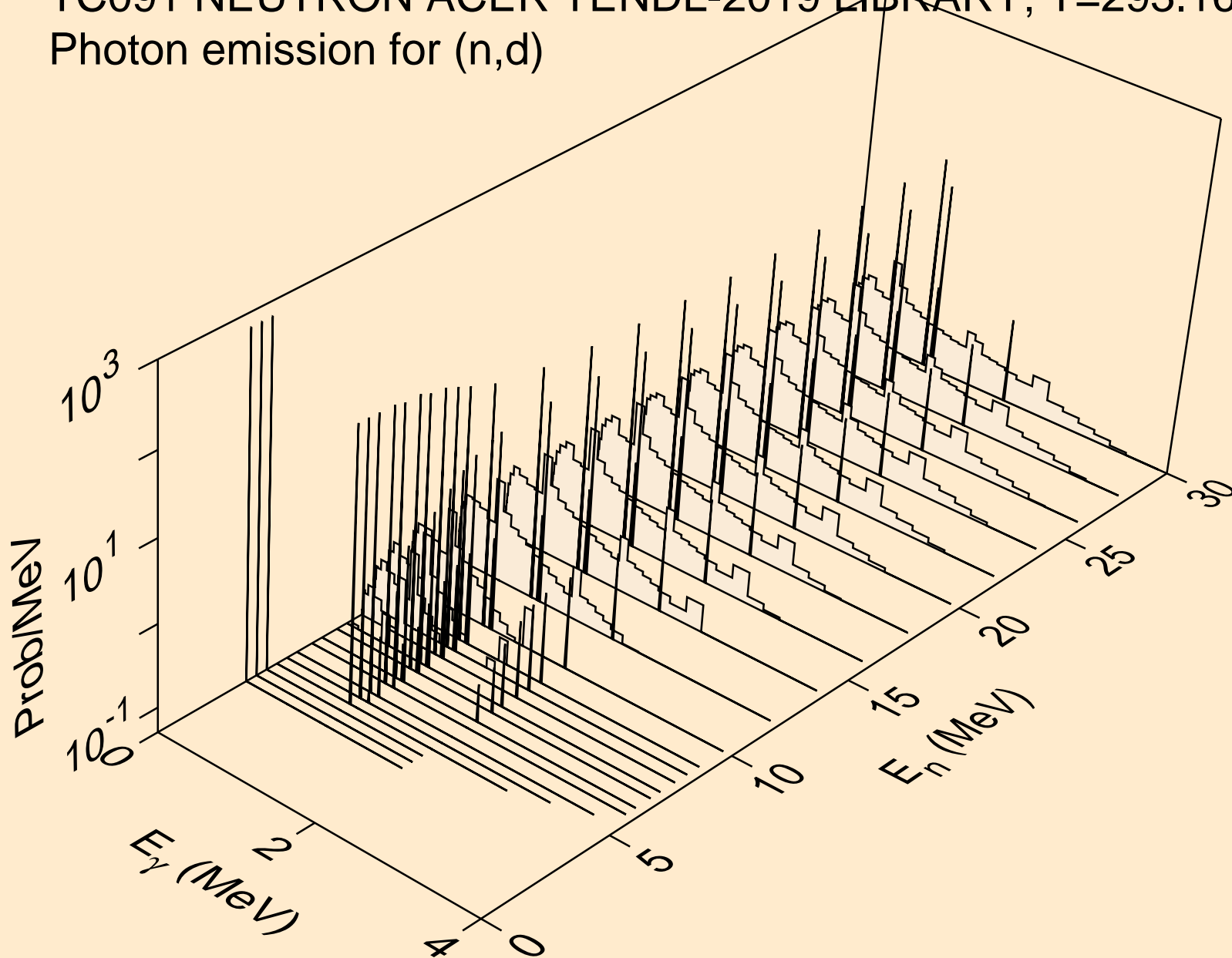

TC091 NEUTRON ACER TENDL-2019 LIBRARY; T=293.16K
Photon emission for (n,t)

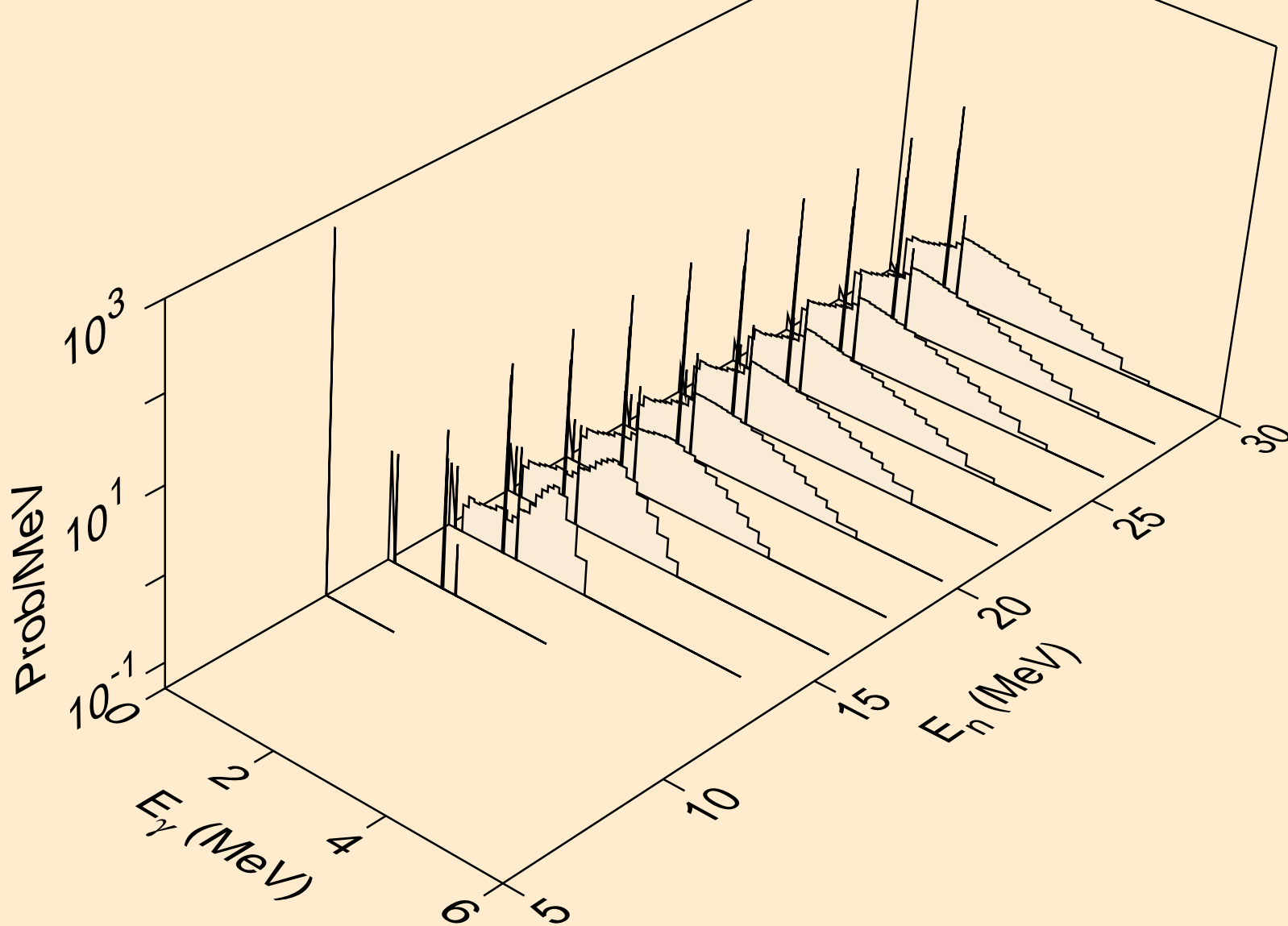

TC091 NEUTRON ACER TENDL-2019 LIBRARY; T=293.16K
Photon emission for (n,he3)

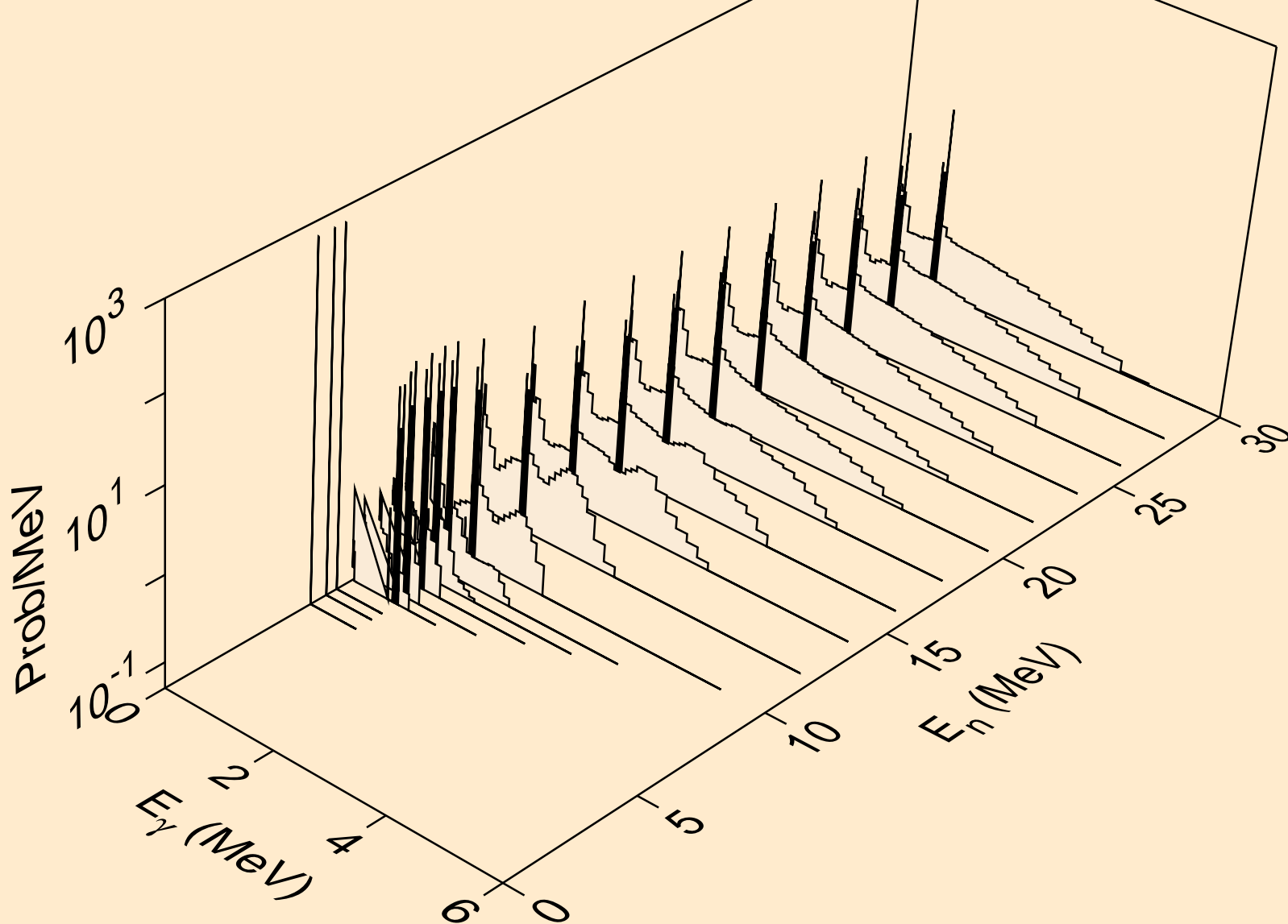

TC091 NEUTRON ACER TENDL-2019 LIBRARY; T=293.16K
Photon emission for (n,a)

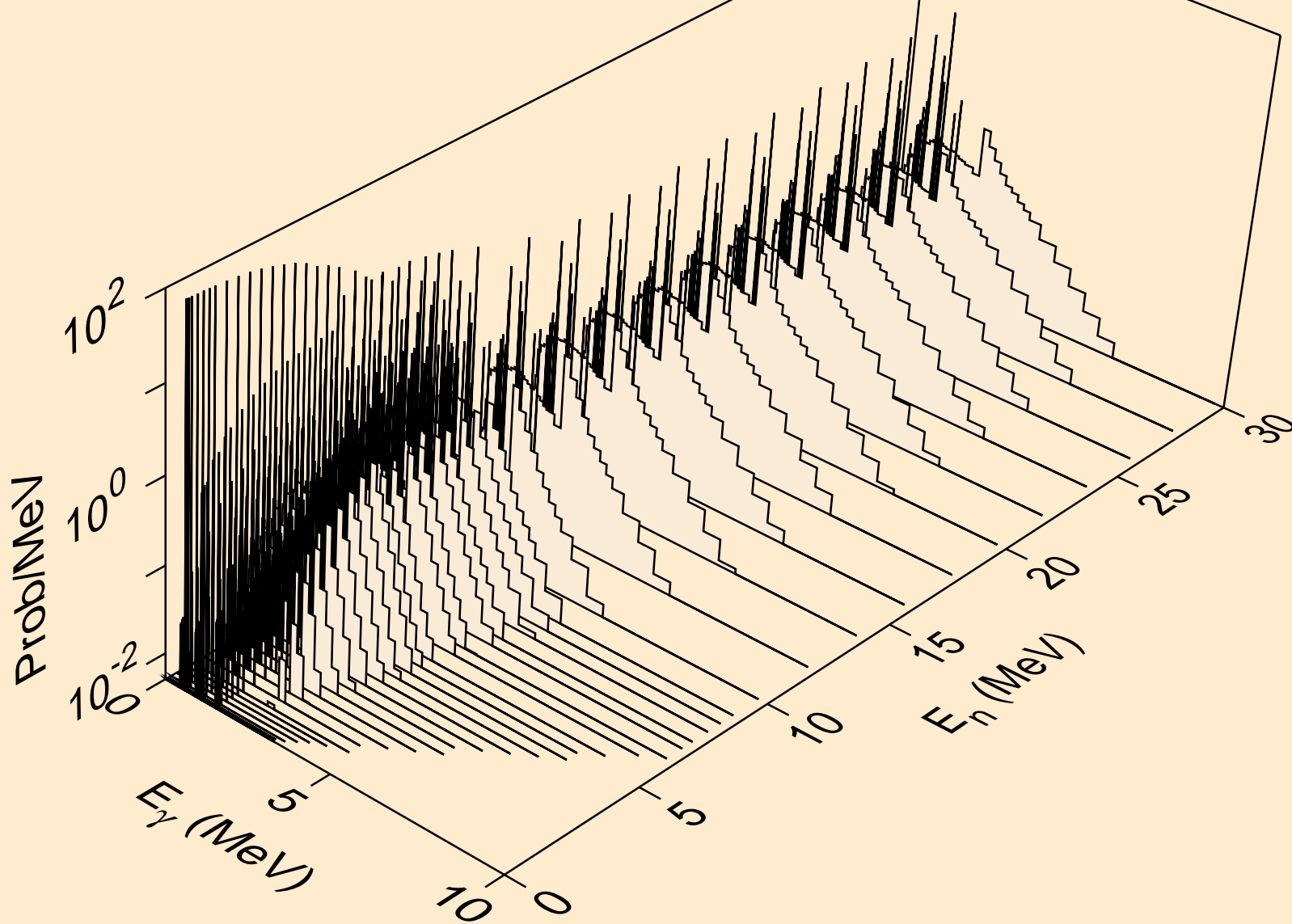

TC091 NEUTRON ACER TENDL-2019 LIBRARY; T=293.16K
Photon emission for (n,2a)

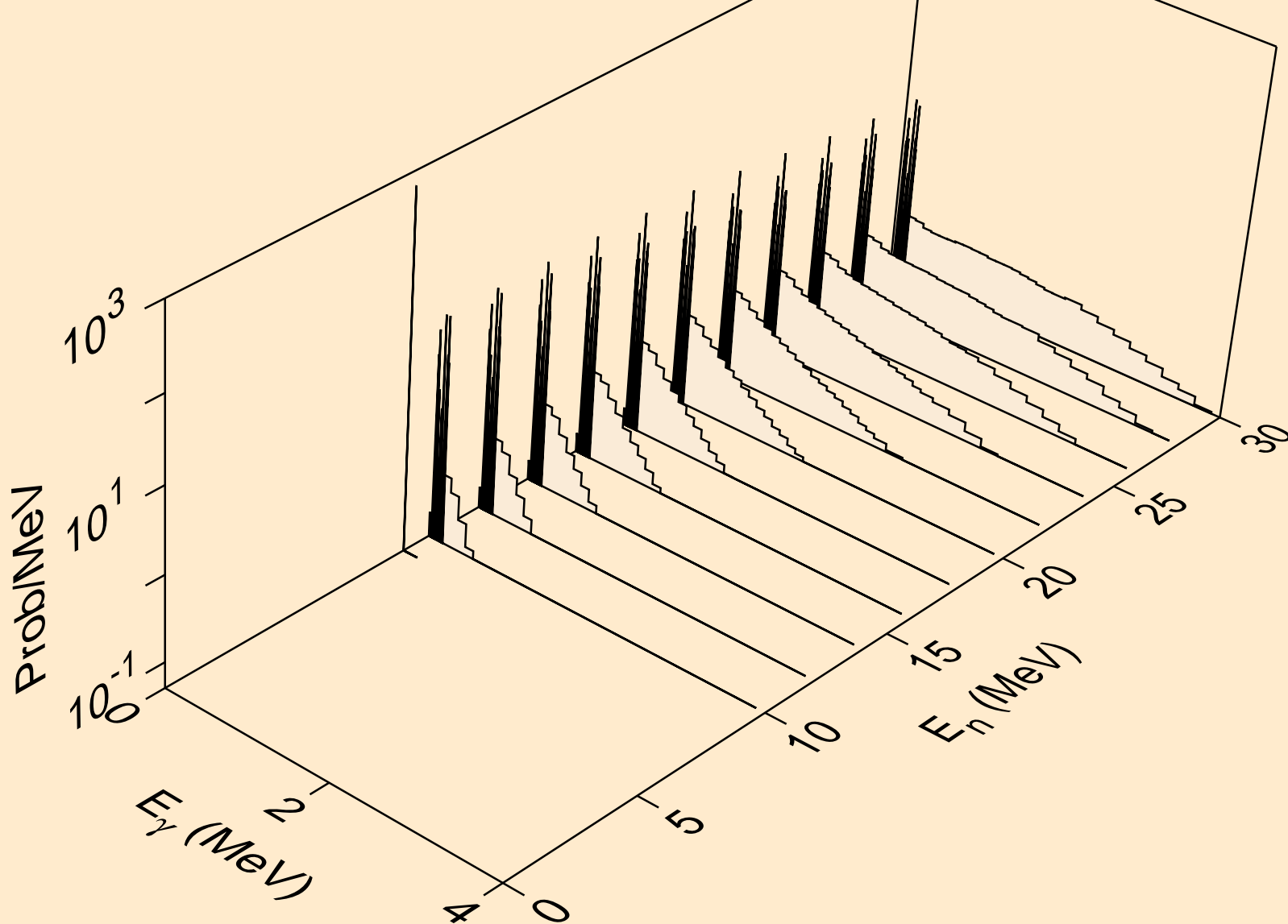

TC091 NEUTRON ACER TENDL-2019 LIBRARY; T=293.16K
Photon emission for (n,2p)

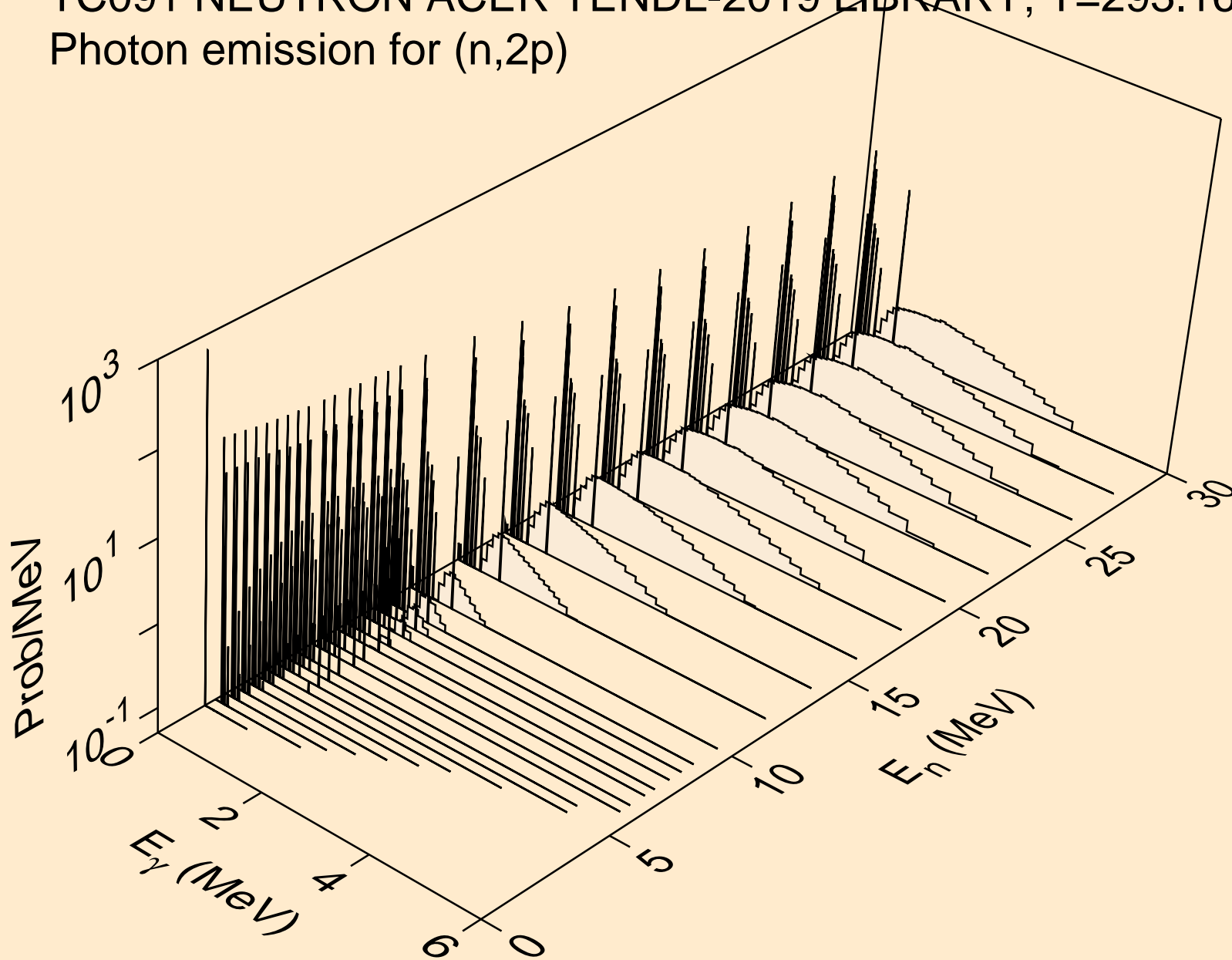

TC091 NEUTRON ACER TENDL-2019 LIBRARY; T=293.16K
Photon emission for (n,p α)

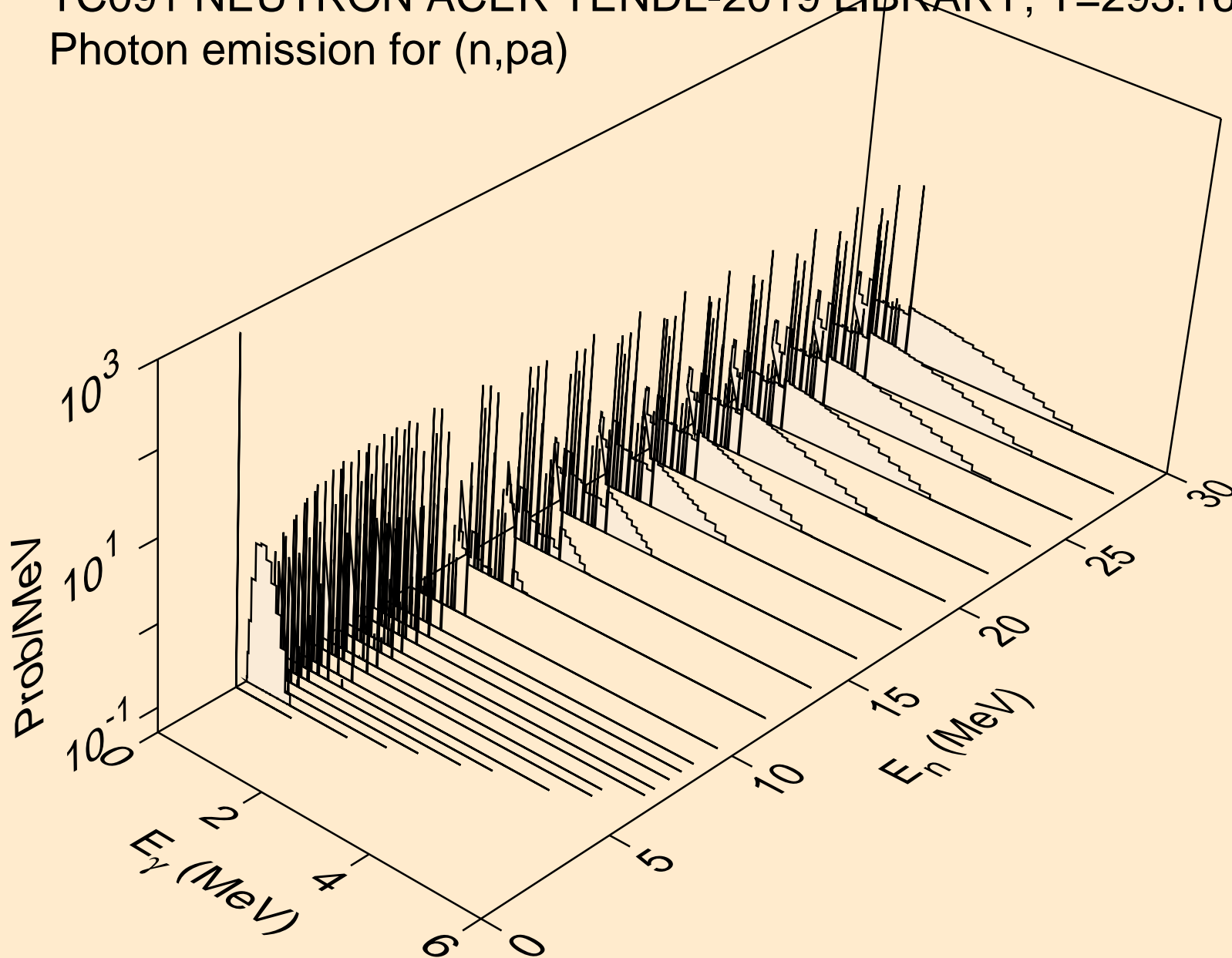

TC091 NEUTRON ACER TENDL-2019 LIBRARY; T=293.16K
Photon emission for (n,pd)

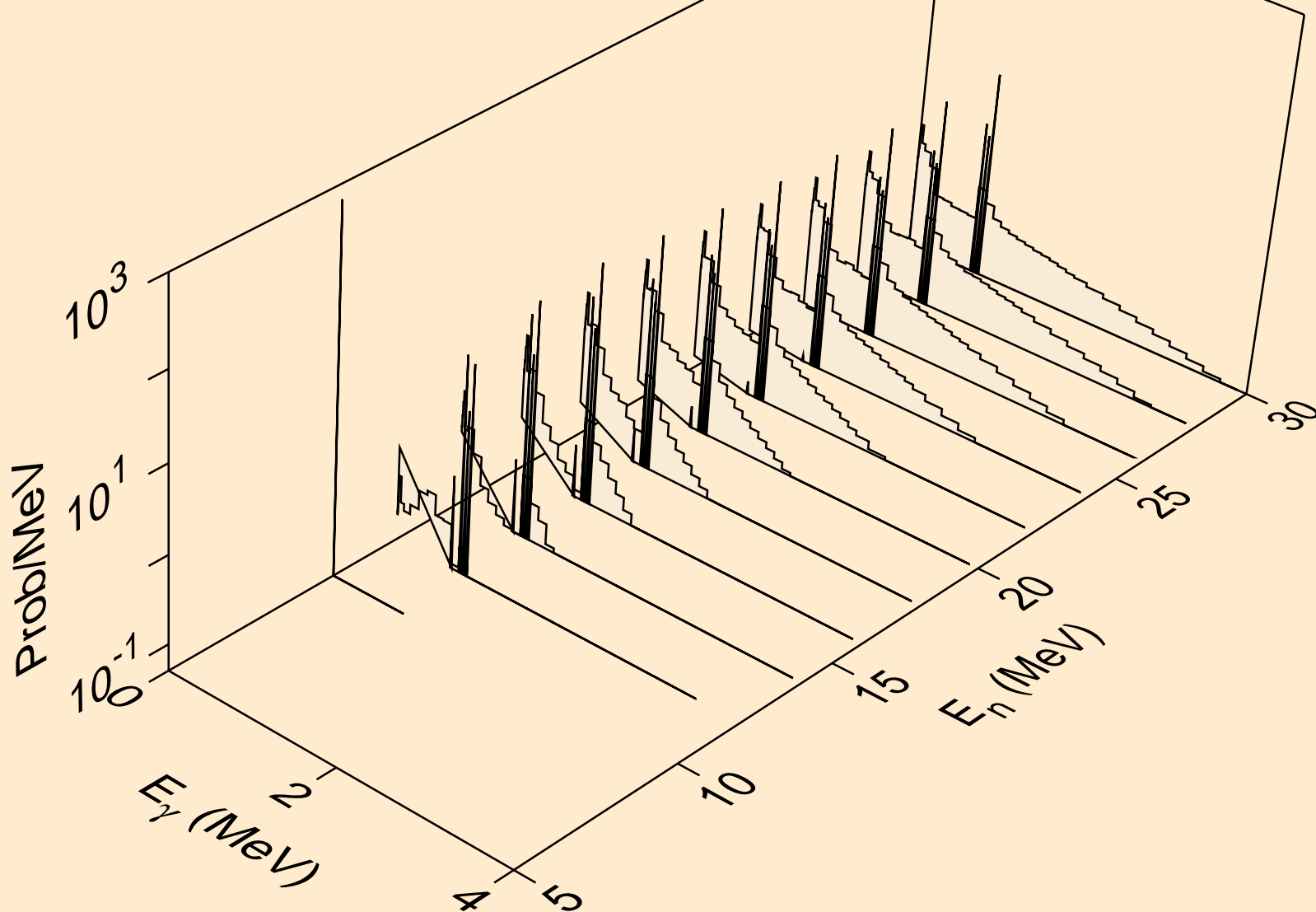

TC091 NEUTRON ACER TENDL-2019 LIBRARY; T=293.16K
Photon emission for (n,pt)

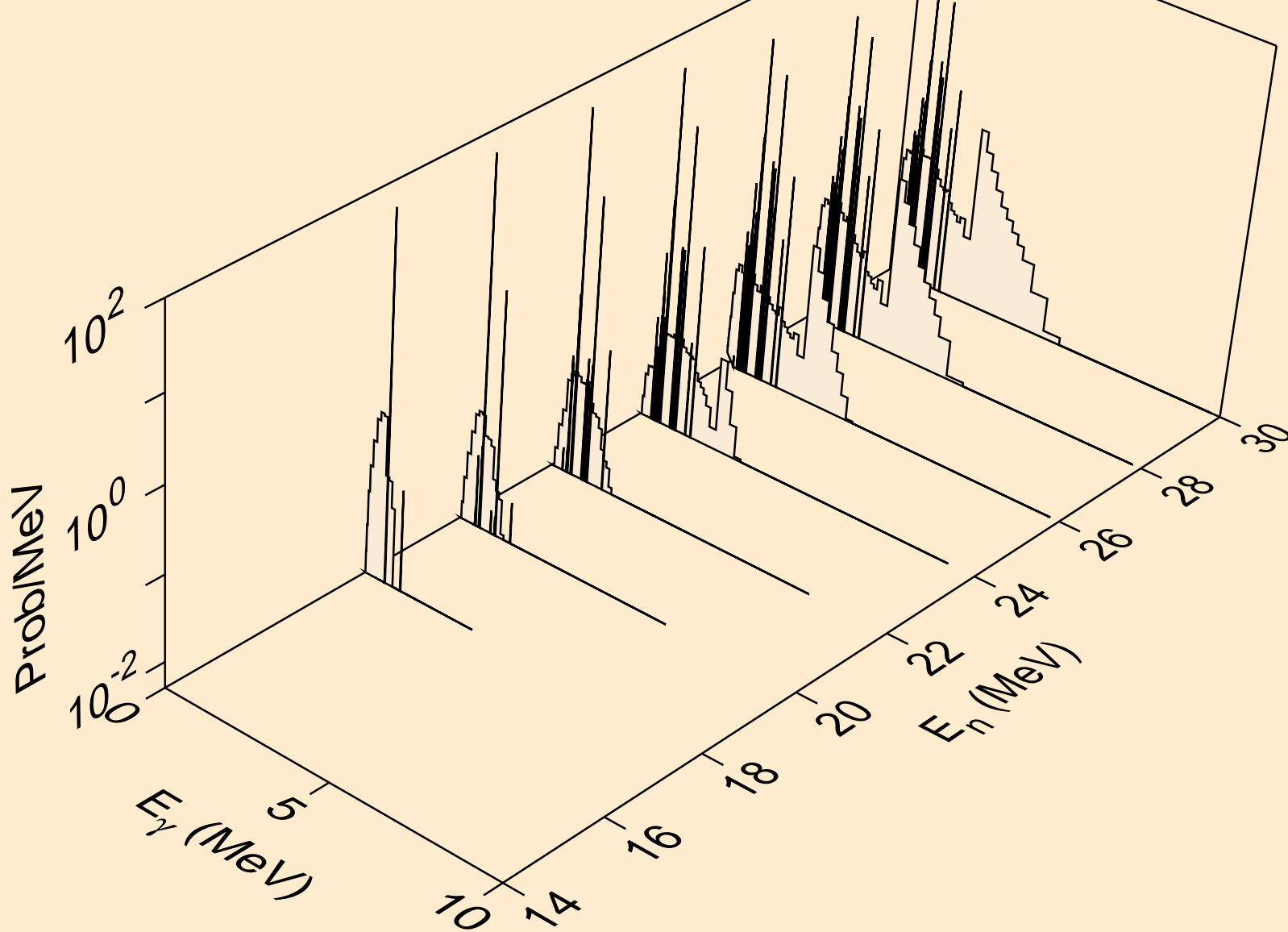

TC091 NEUTRON ACER TENDL-2019 LIBRARY; T=293.16K
Photon emission for (n,da)

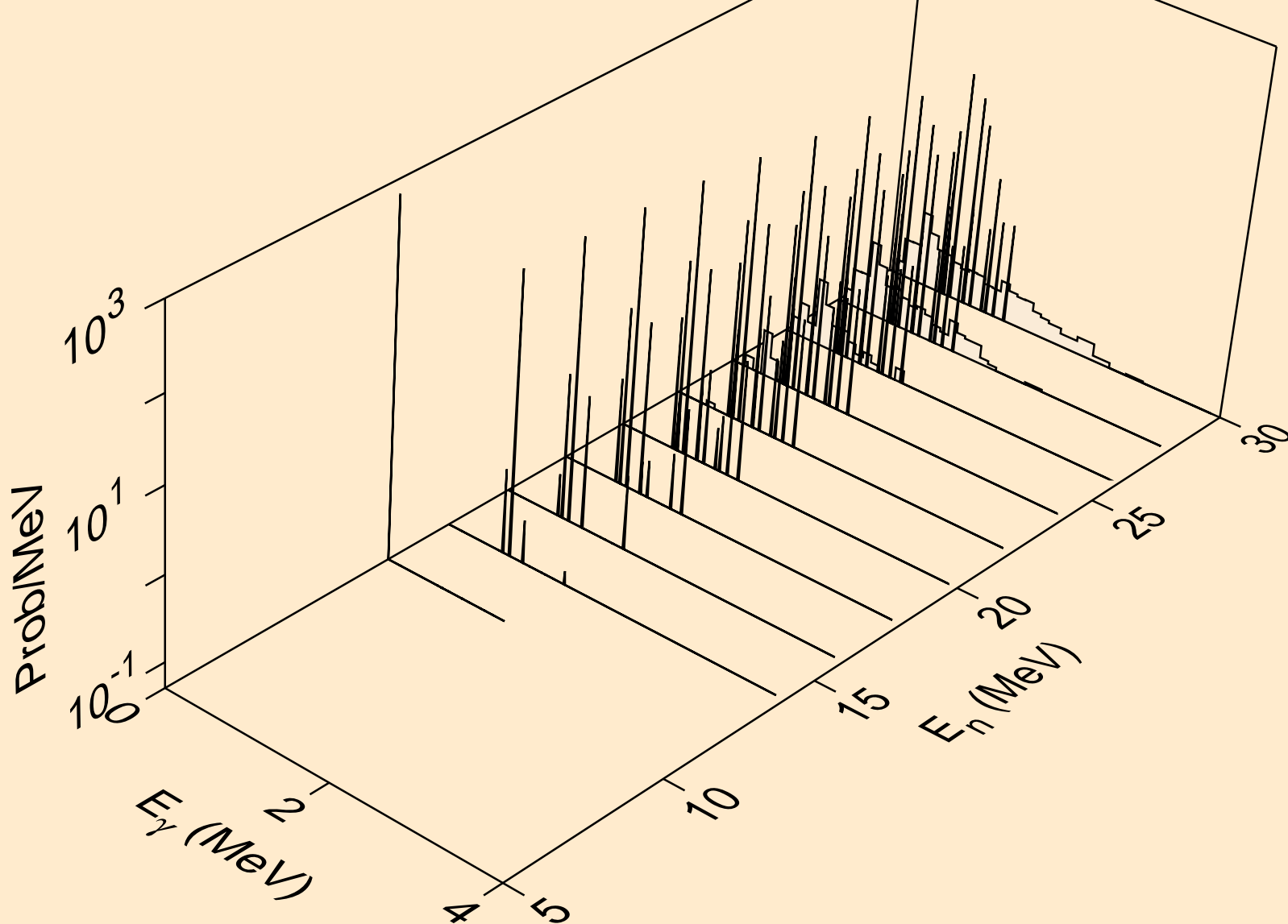

TC091 NEUTRON ACER TENDL-2019 LIBRARY; T=293.16K
thermal capture photon spectrum

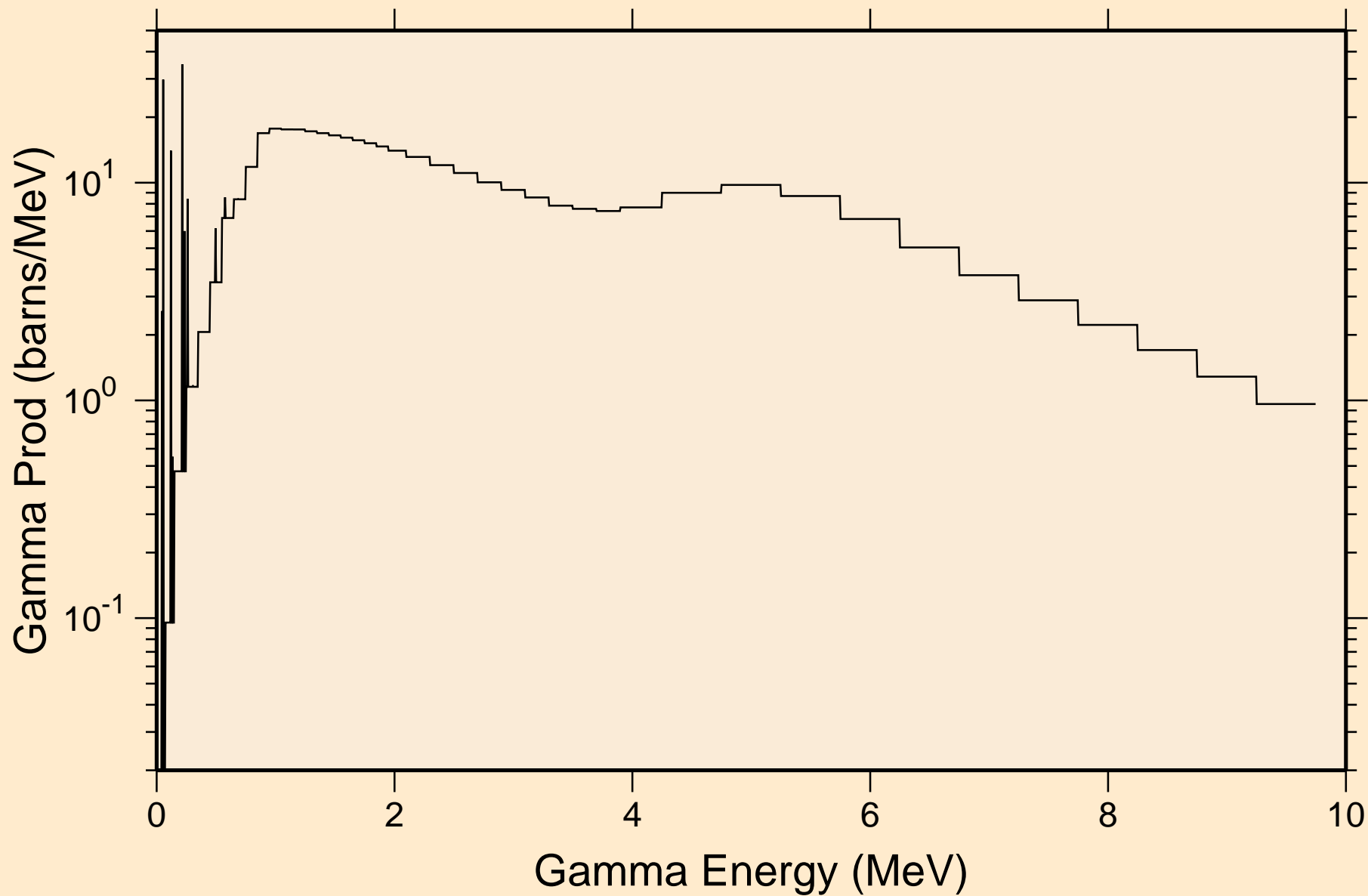

TC091 NEUTRON ACER TENDL-2019 LIBRARY; T=293.16K
14 MeV photon spectrum

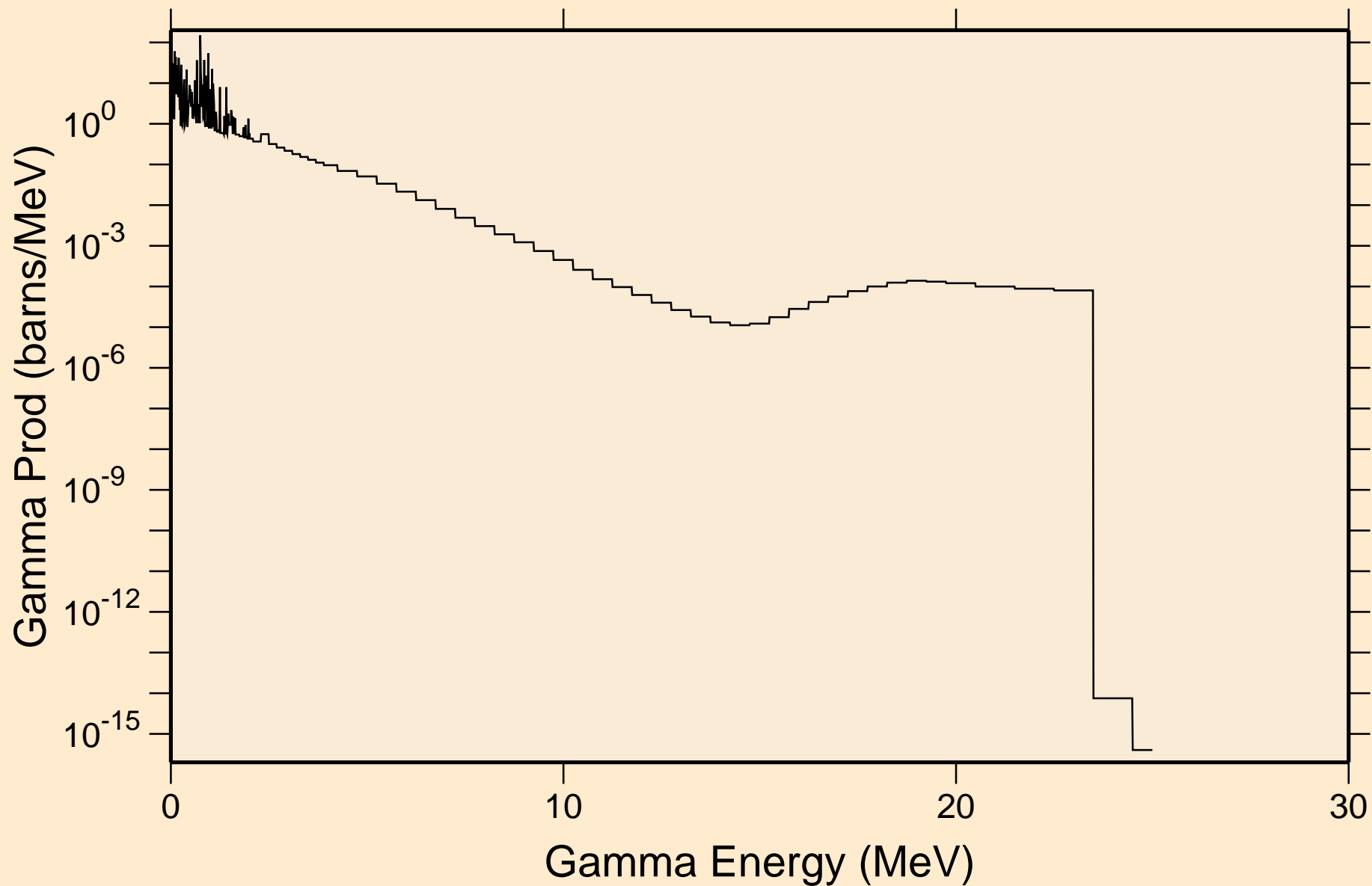

TC091 NEUTRON ACER TENDL-2019 LIBRARY; T=293.16K

Particle heating contributions

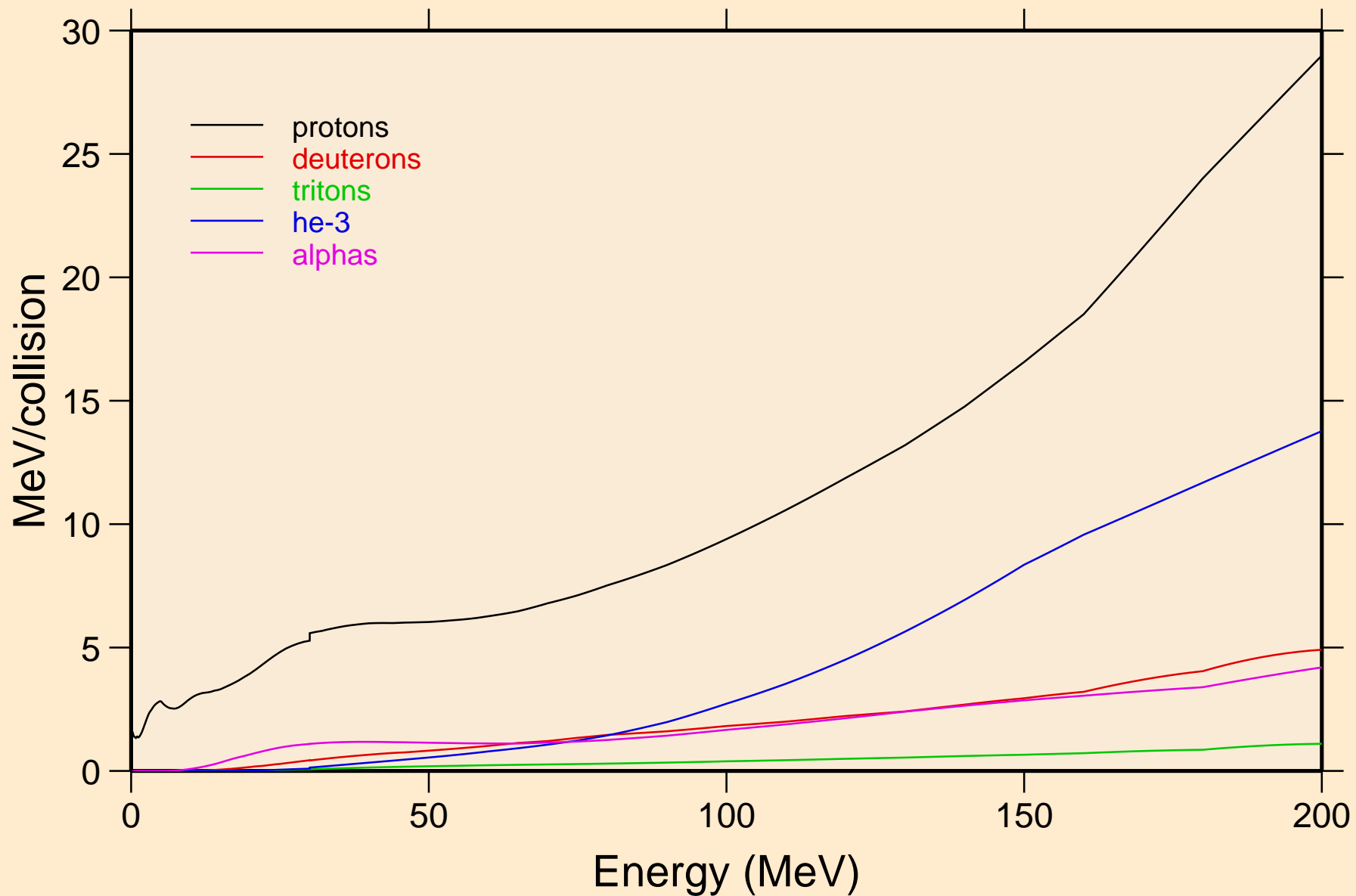

TC091 NEUTRON ACER TENDL-2019 LIBRARY; T=293.16K
Recoil Heating

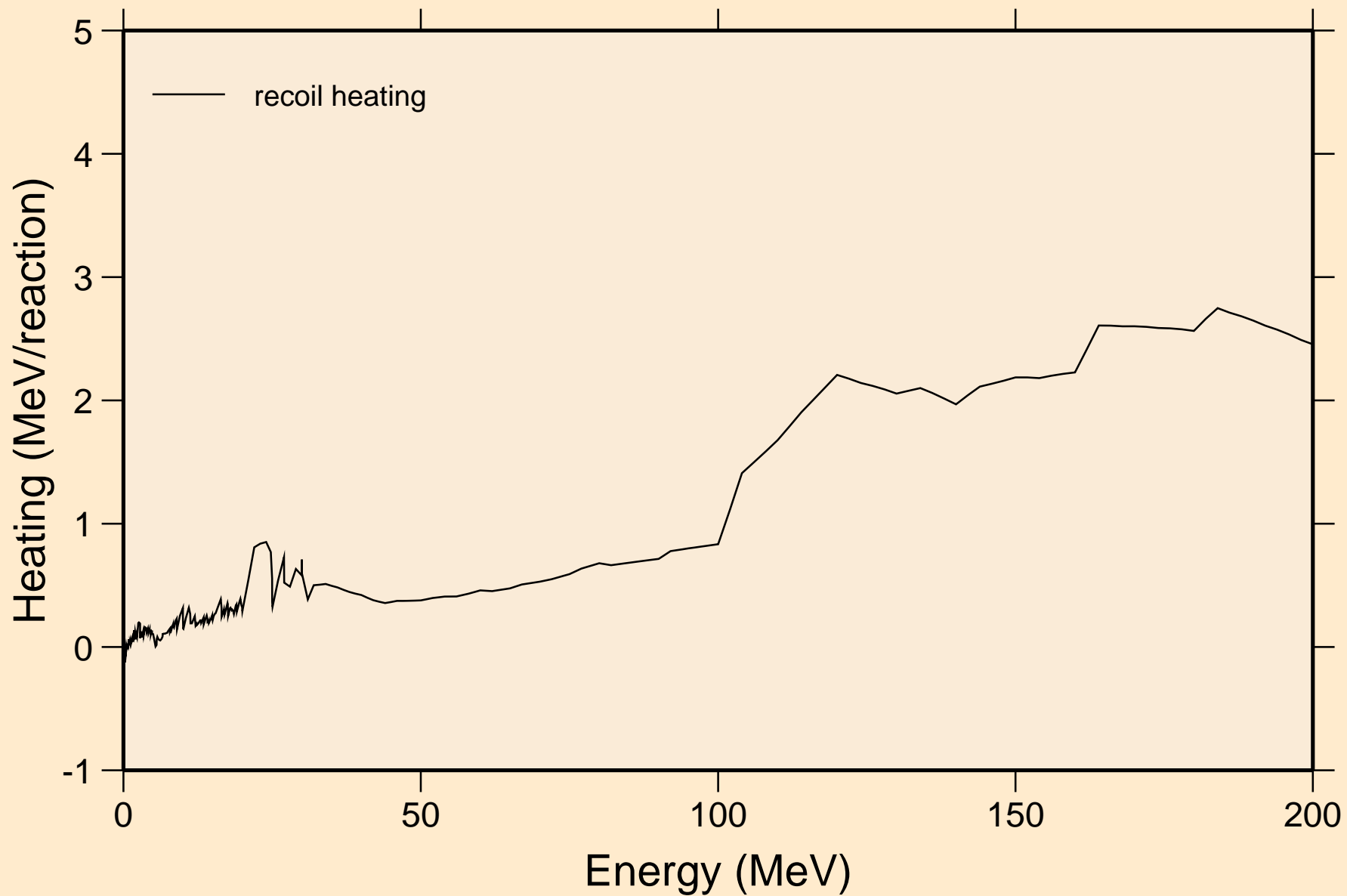

TC091 NEUTRON ACER TENDL-2019 LIBRARY; T=293.16K
Particle production cross sections

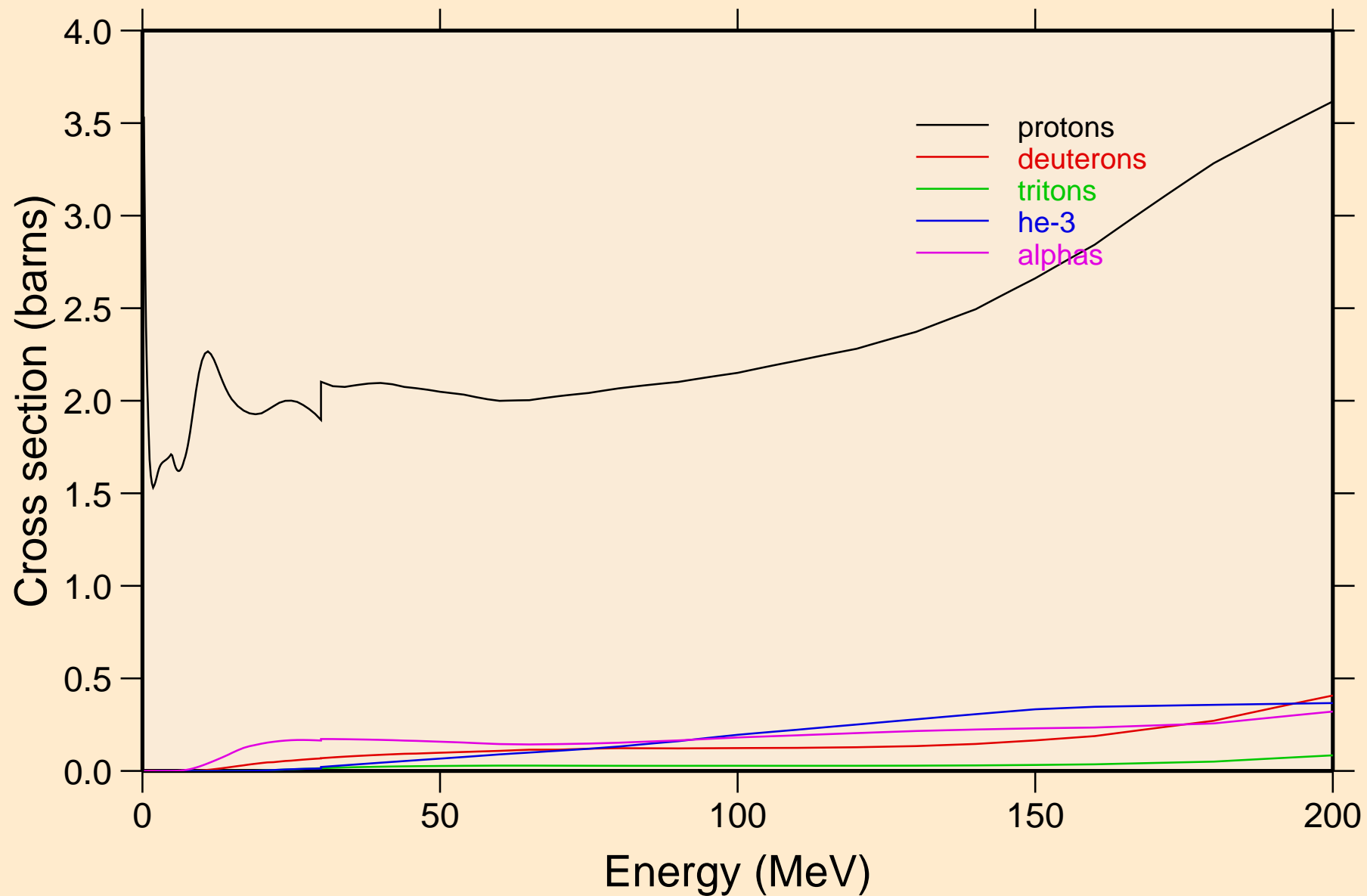

TC091 NEUTRON ACER TENDL-2019 LIBRARY; T=293.16K
protons from (n,x)

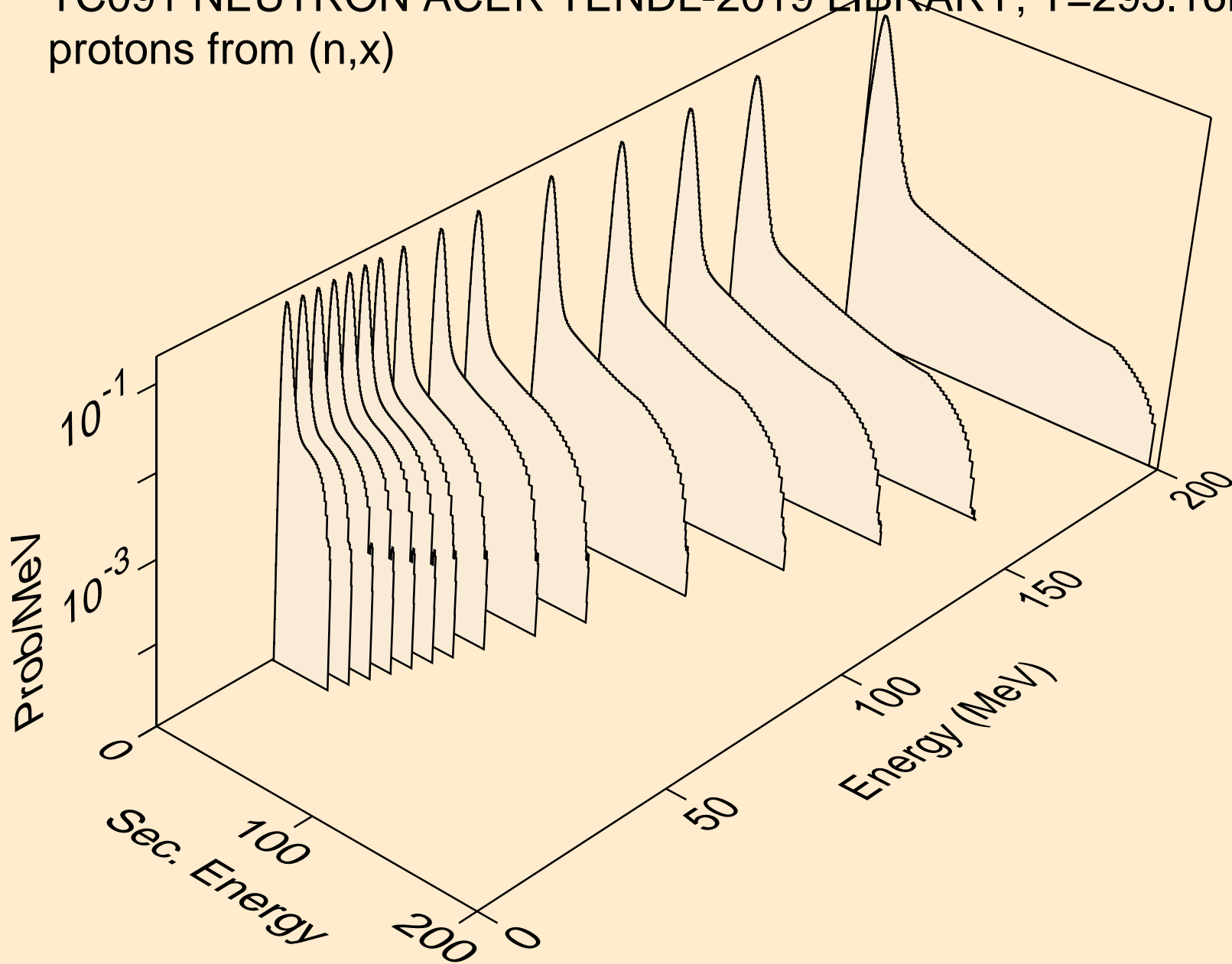

TC091 NEUTRON ACER TENDL-2019 LIBRARY; T=293.16K
protons from (n,n*)p

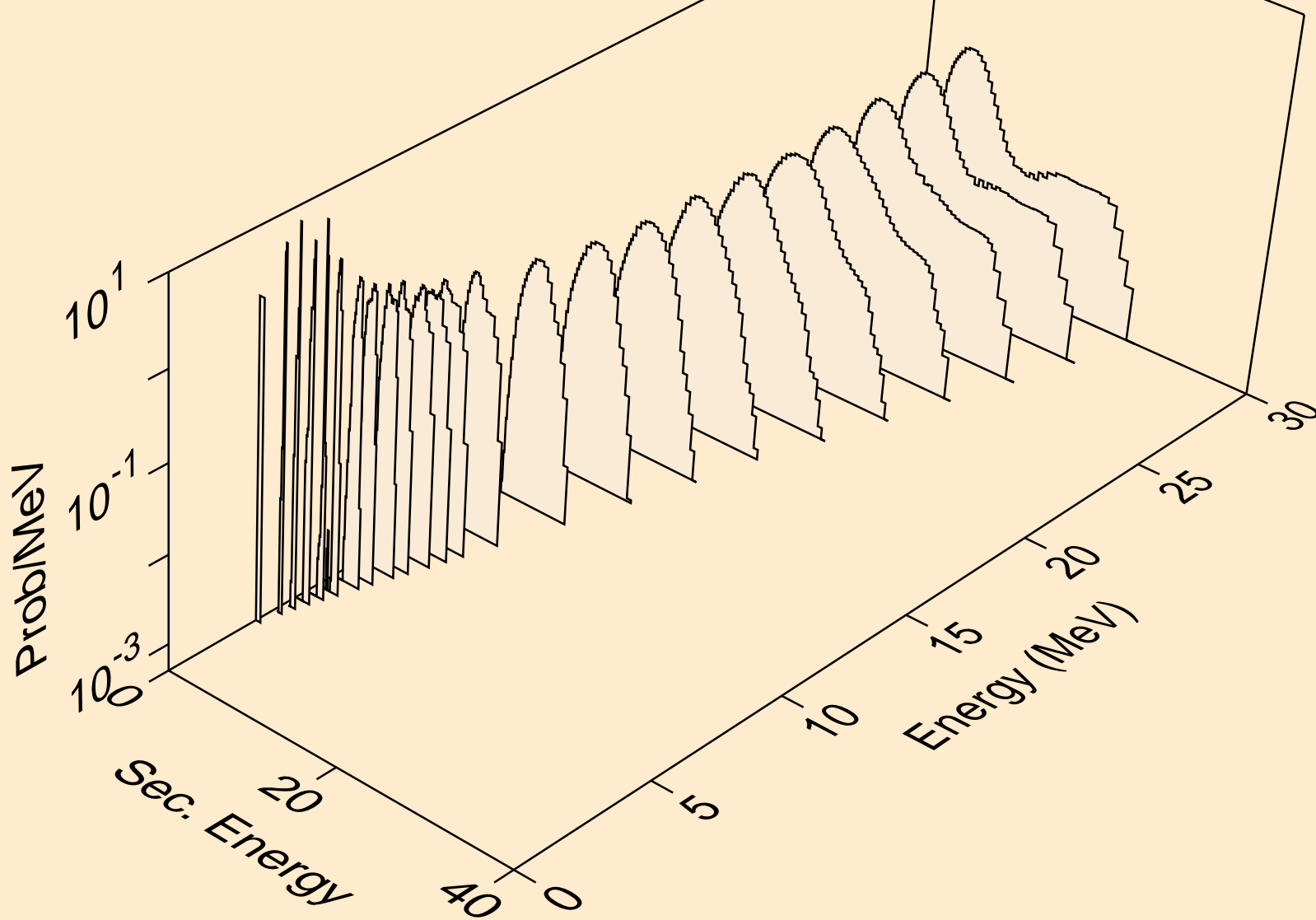

TC091 NEUTRON ACER TENDL-2019 LIBRARY; T=293.16K
protons from (n,2np)

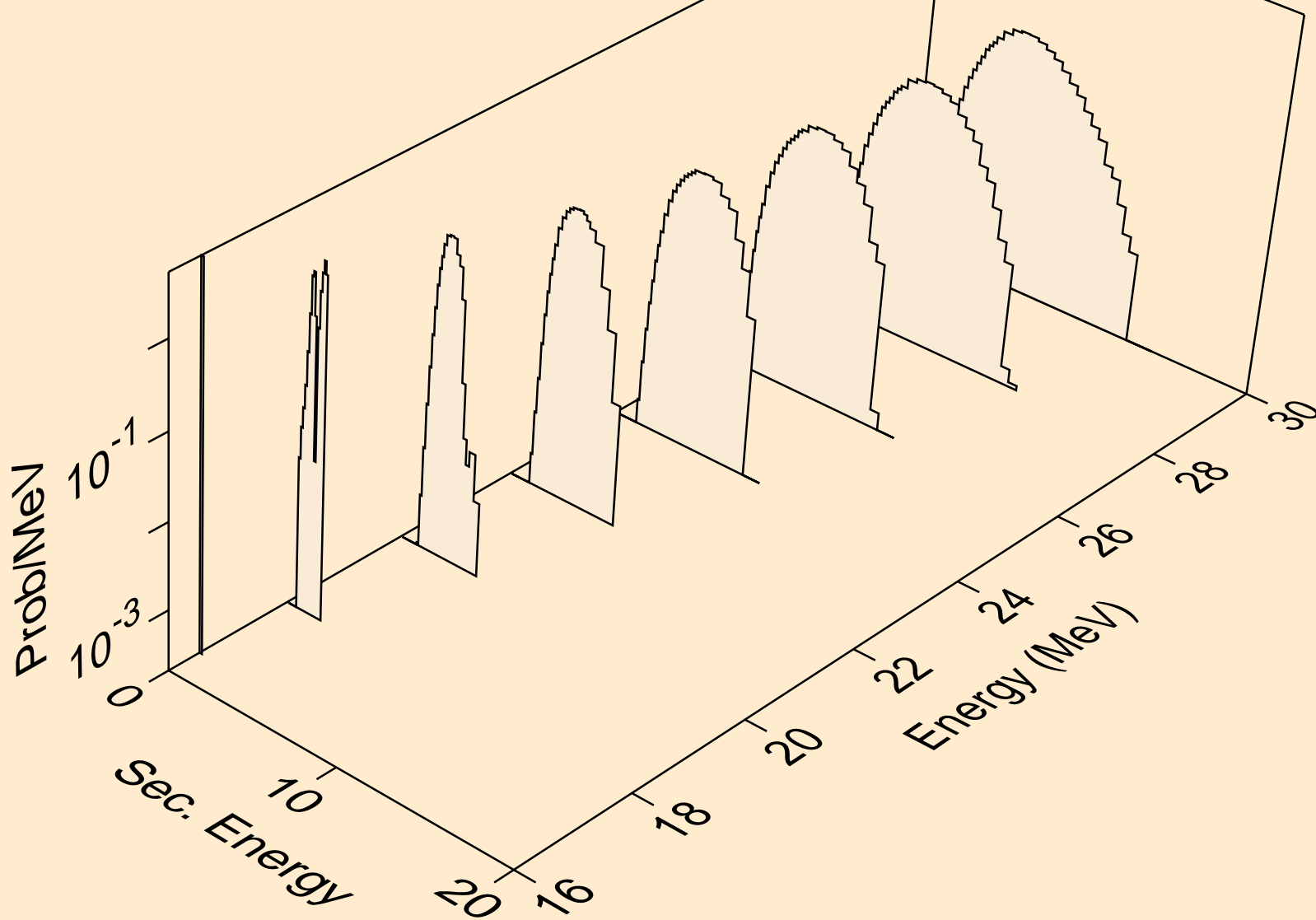

TC091 NEUTRON ACER TENDL-2019 LIBRARY; T=293.16K
protons from (n,3np)

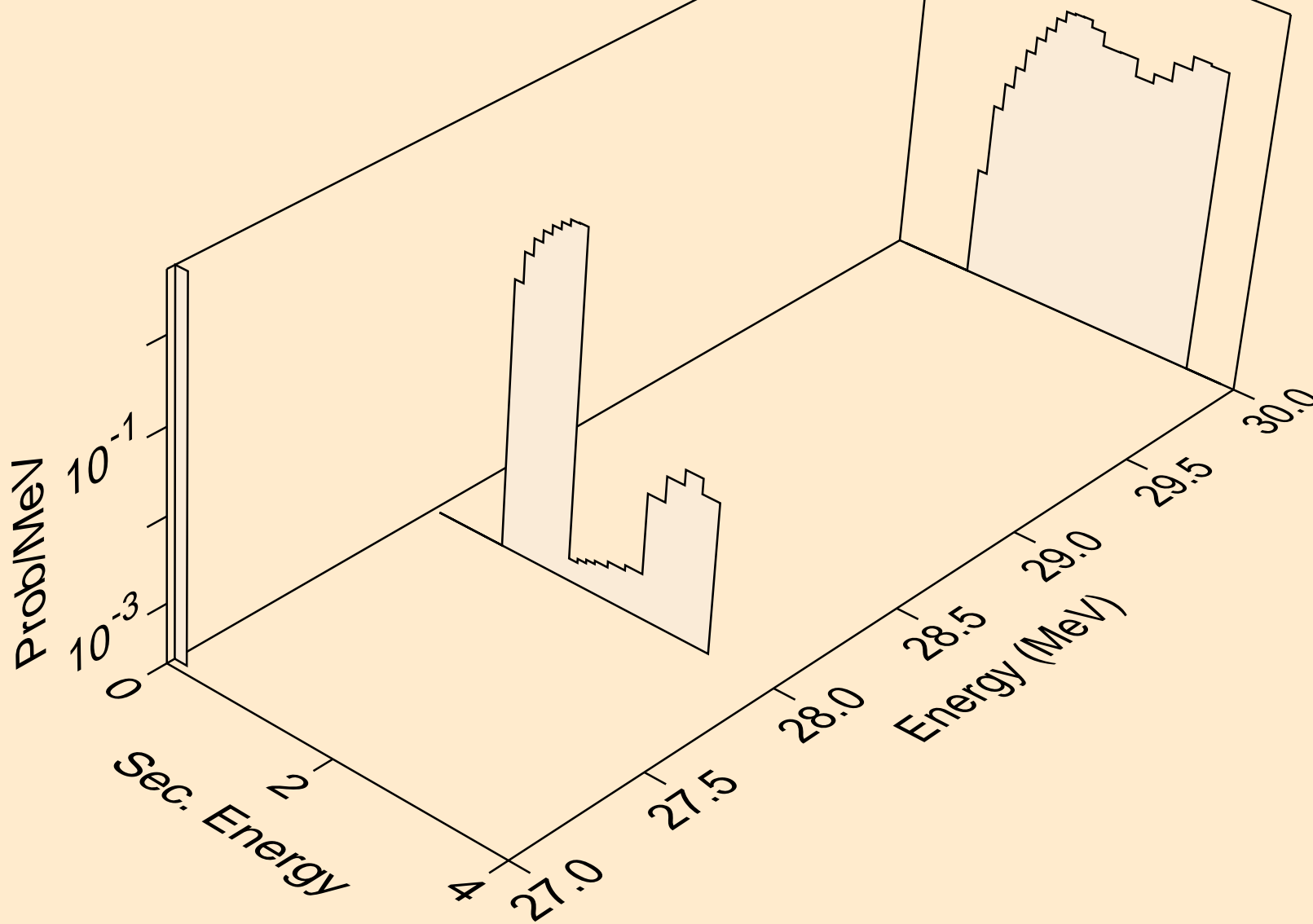

TC091 NEUTRON ACER TENDL-2019 LIBRARY; T=293.16K
protons from (n,2np)

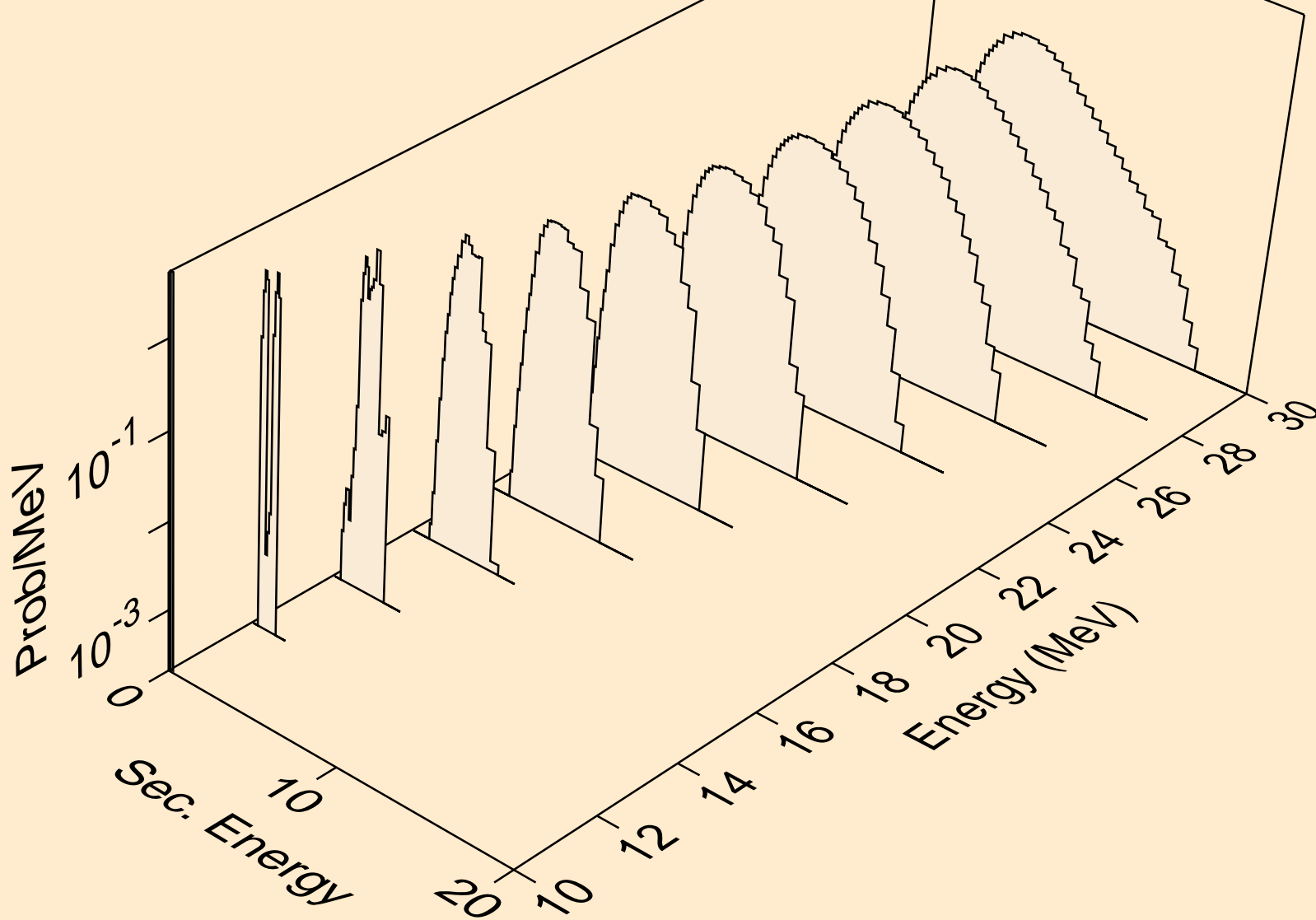

TC091 NEUTRON ACER TENDL-2019 LIBRARY; T=293.16K
protons from (n,npa)

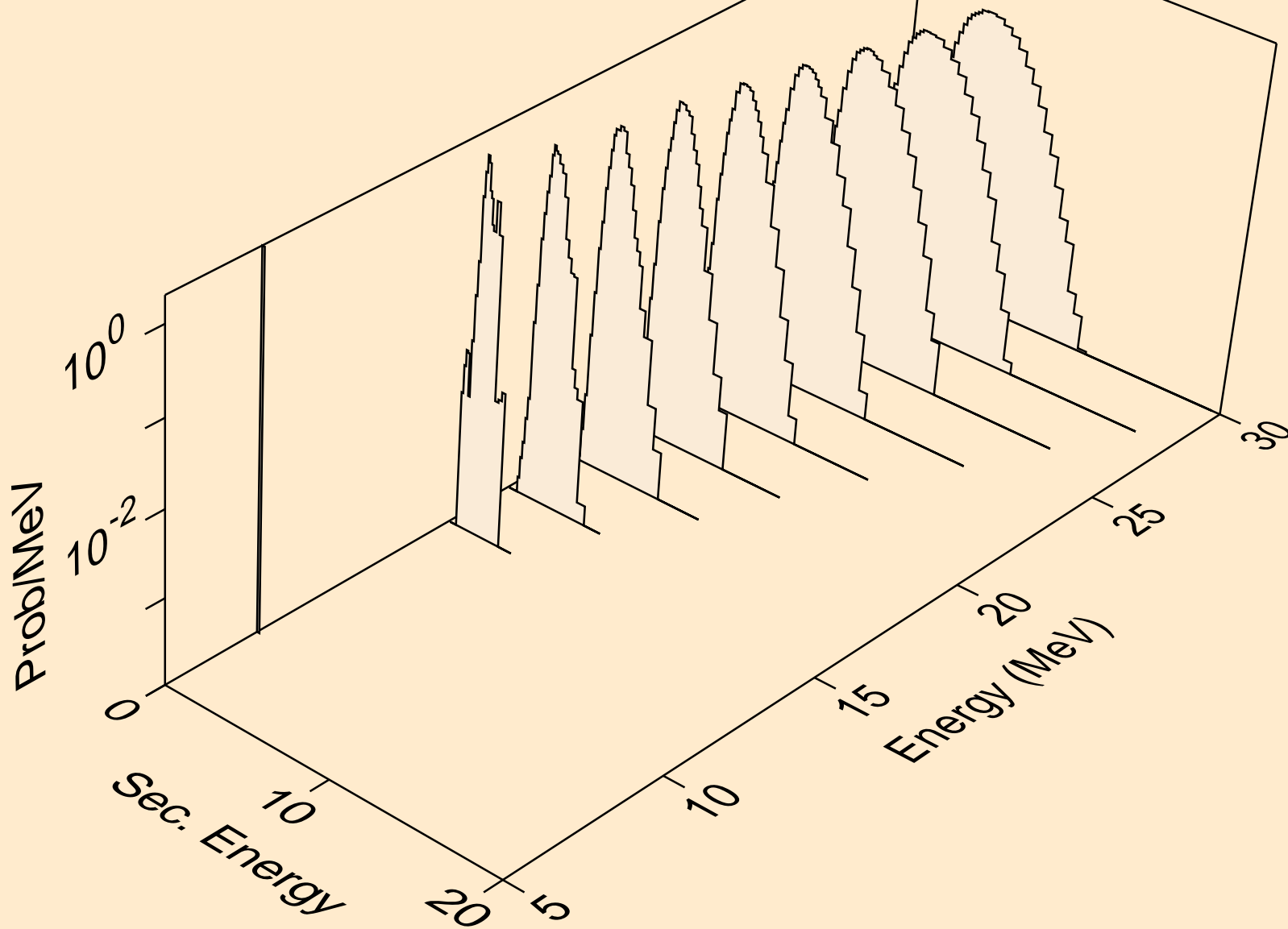

TC091 NEUTRON ACER TENDL-2019 LIBRARY; T=293.16K
protons from (n,p)

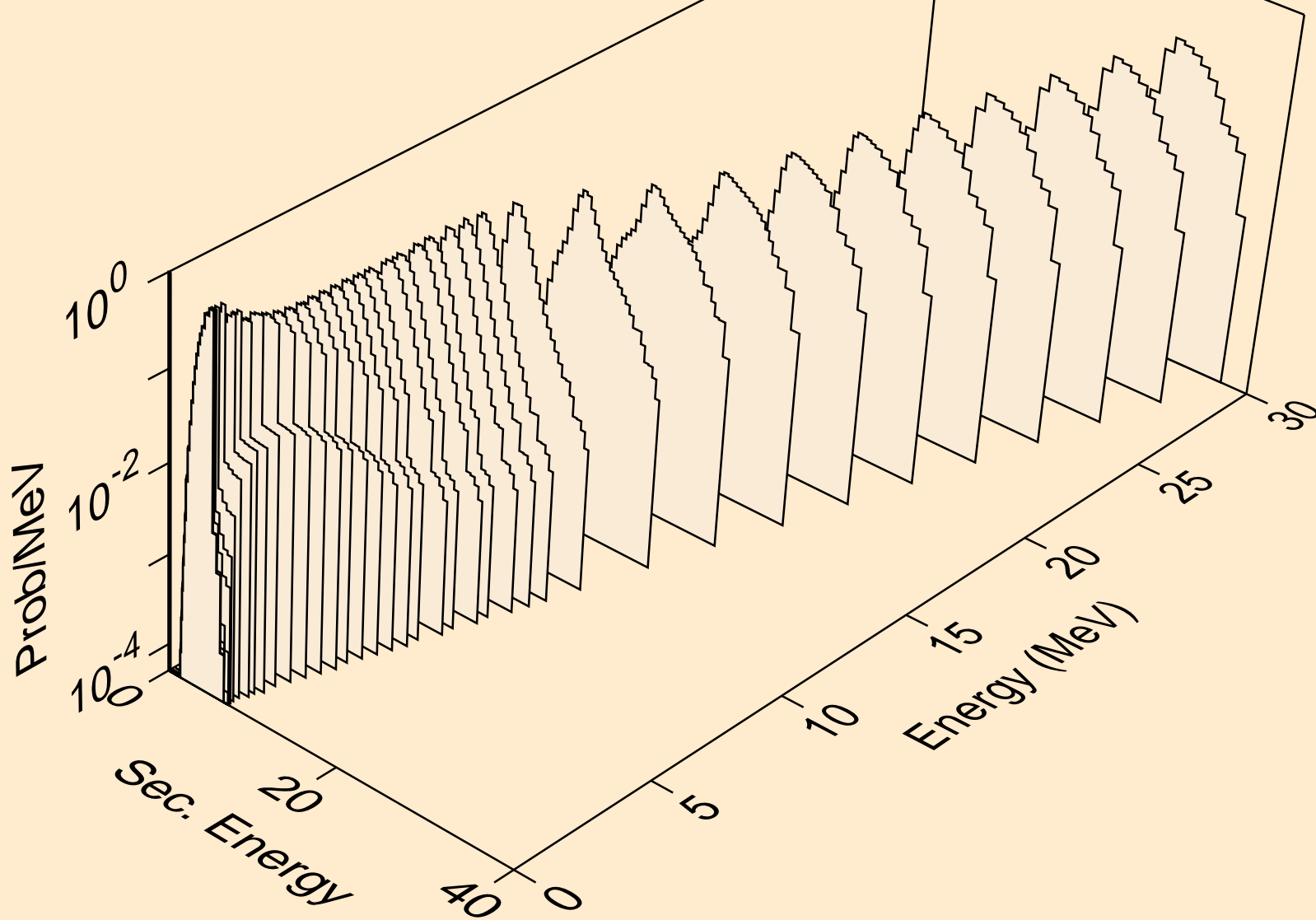

TC091 NEUTRON ACER TENDL-2019 LIBRARY; T=293.16K
protons from (n,2p)

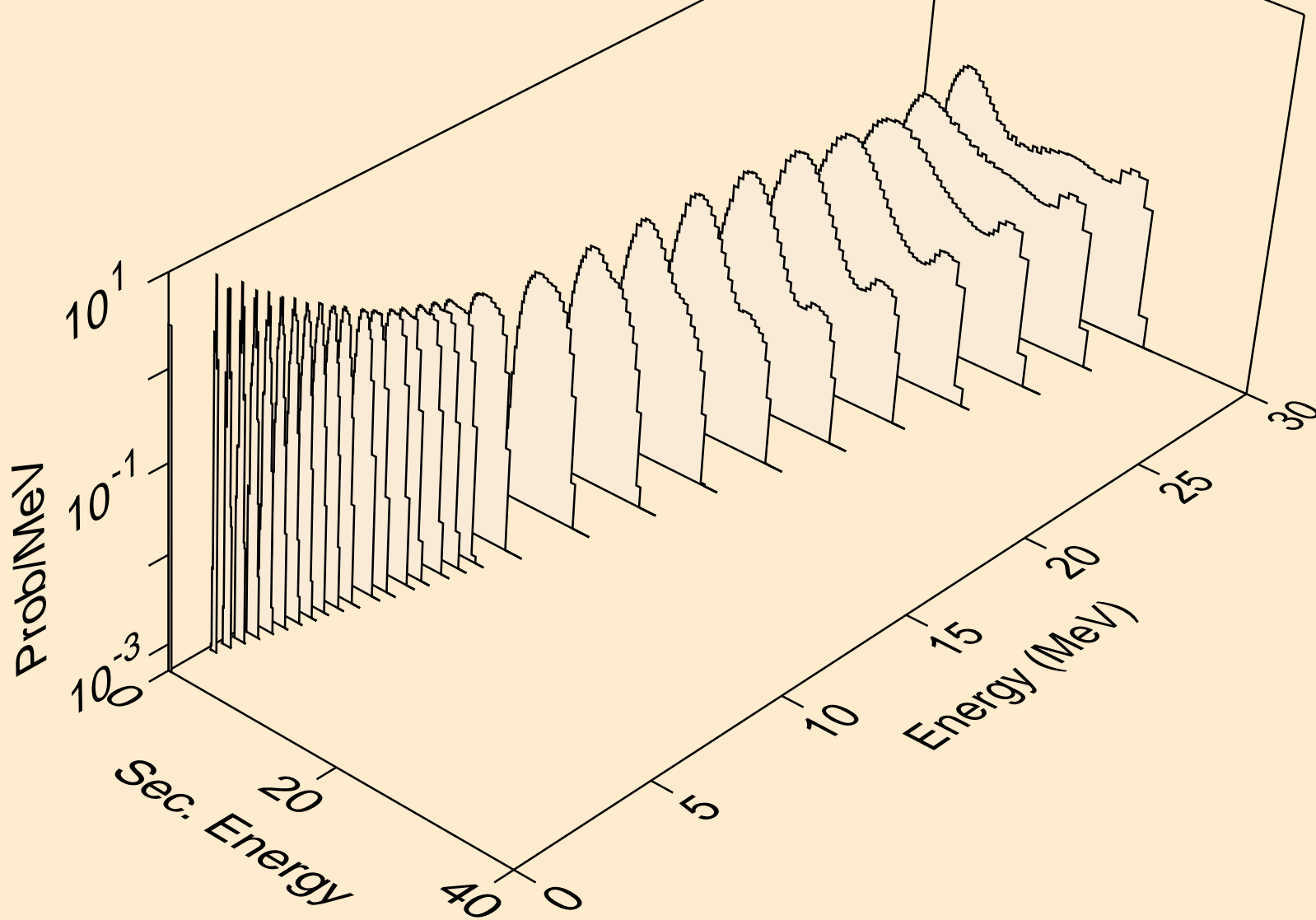

TC091 NEUTRON ACER TENDL-2019 LIBRARY; T=293.16K
protons from (n,p)

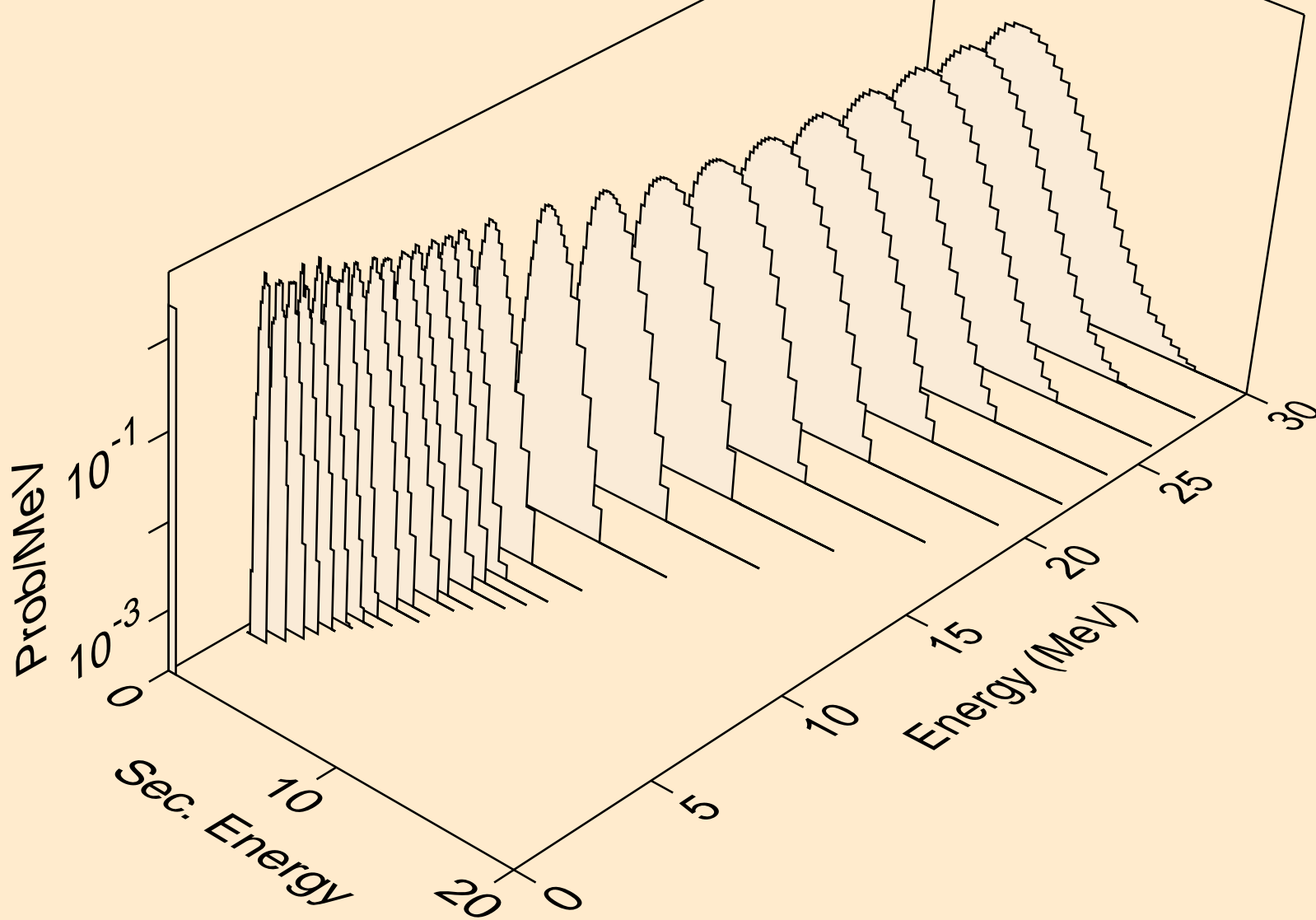

TC091 NEUTRON ACER TENDL-2019 LIBRARY; T=293.16K
protons from (n,pd)

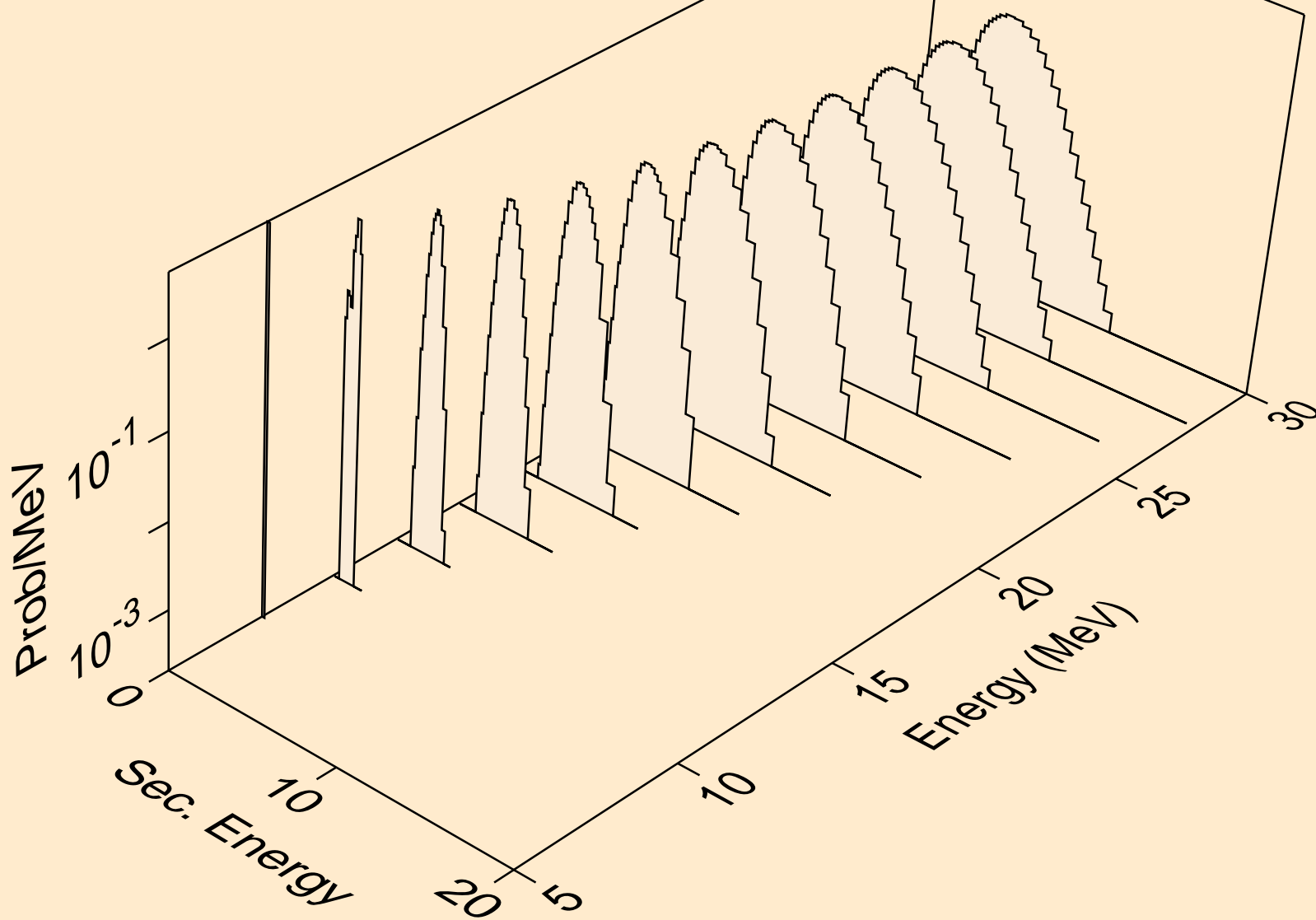

TC091 NEUTRON ACER TENDL-2019 LIBRARY; T=293.16K
protons from (n,pt)

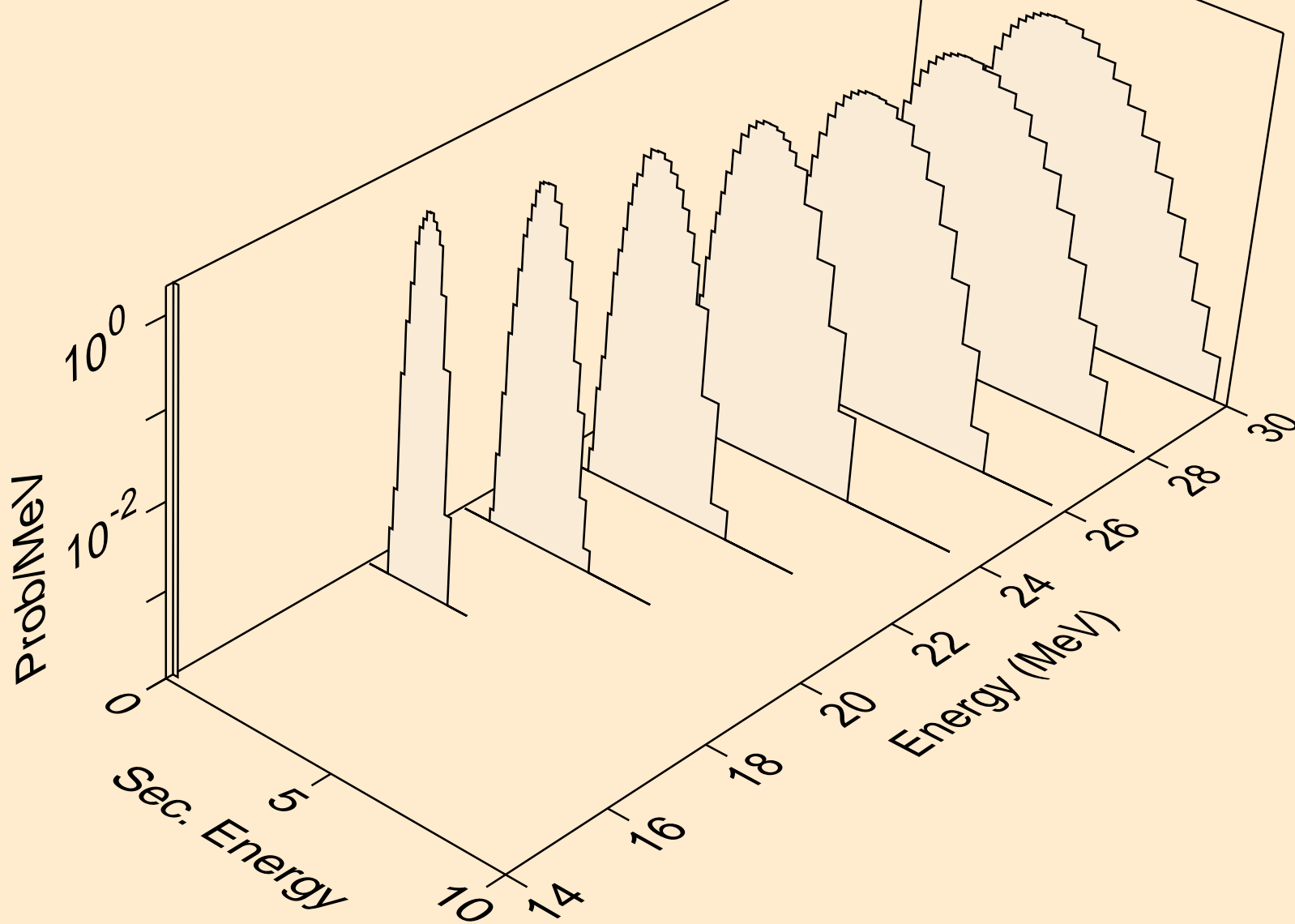

TC091 NEUTRON ACER TENDL-2019 LIBRARY; T=293.16K
deuterons from (n,x)

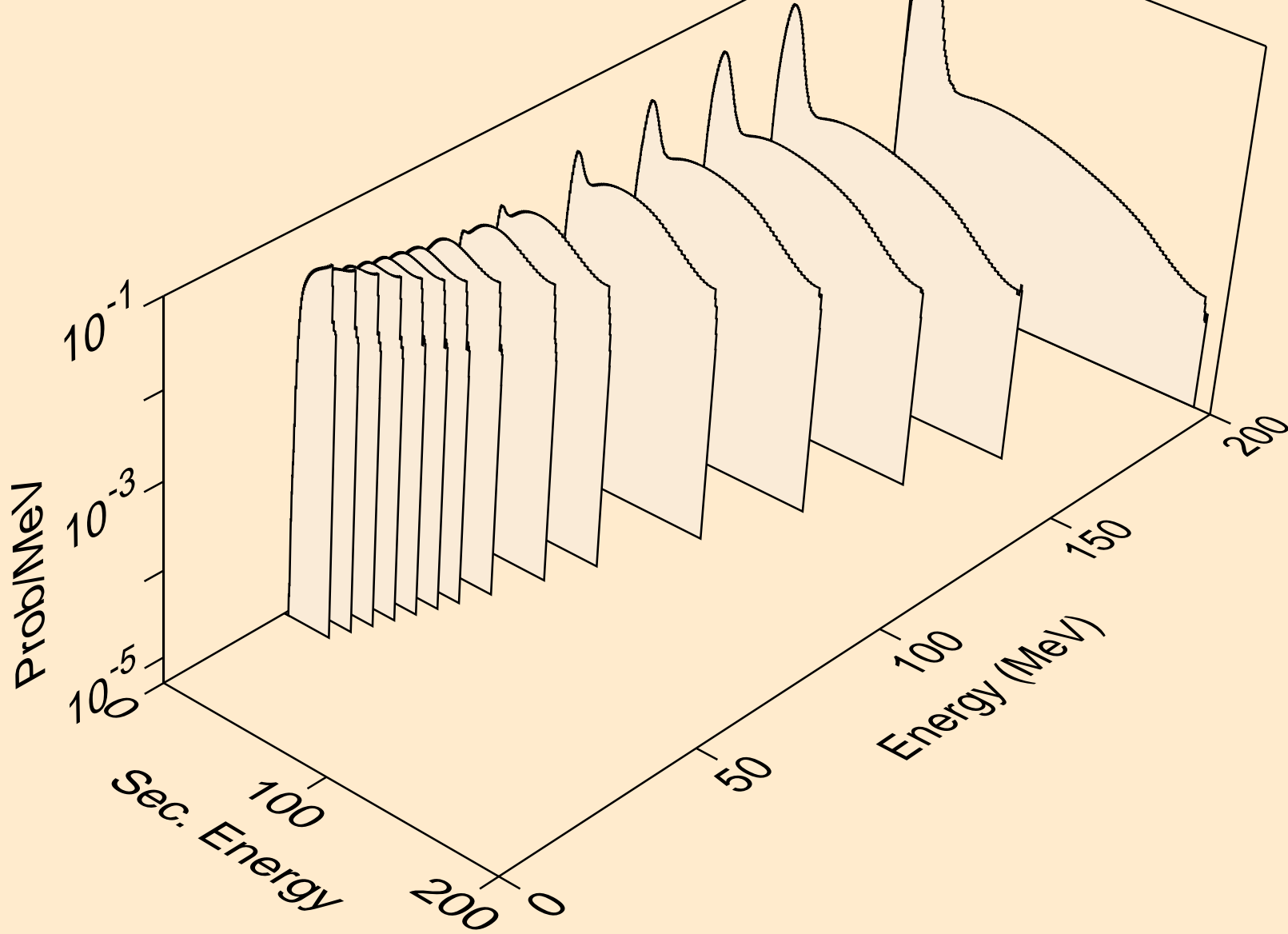

TC091 NEUTRON ACER TENDL-2019 LIBRARY; T=293.16K
deuterons from (n,2nd)

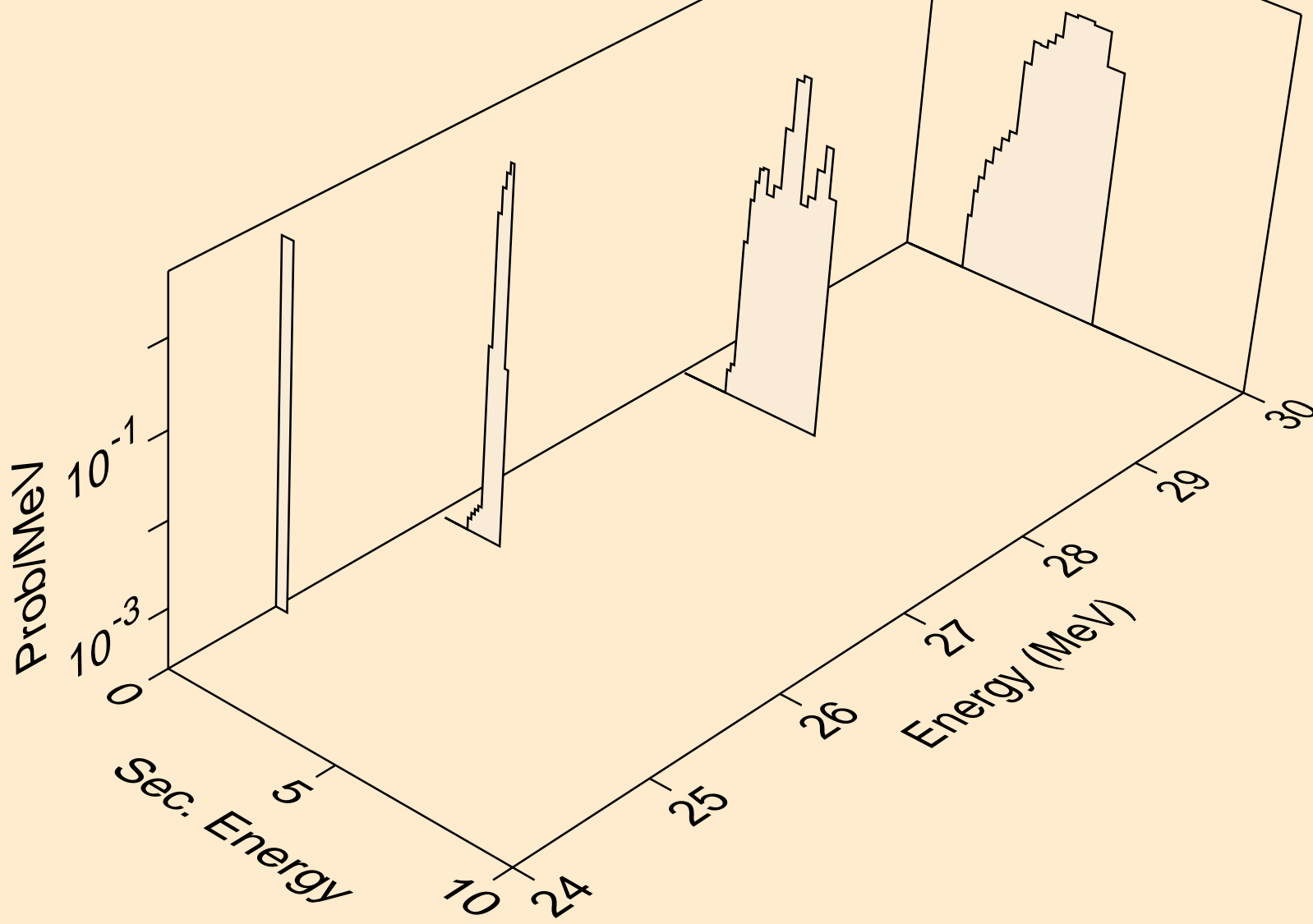

TC091 NEUTRON ACER TENDL-2019 LIBRARY; T=293.16K
deuterons from (n,n*)d

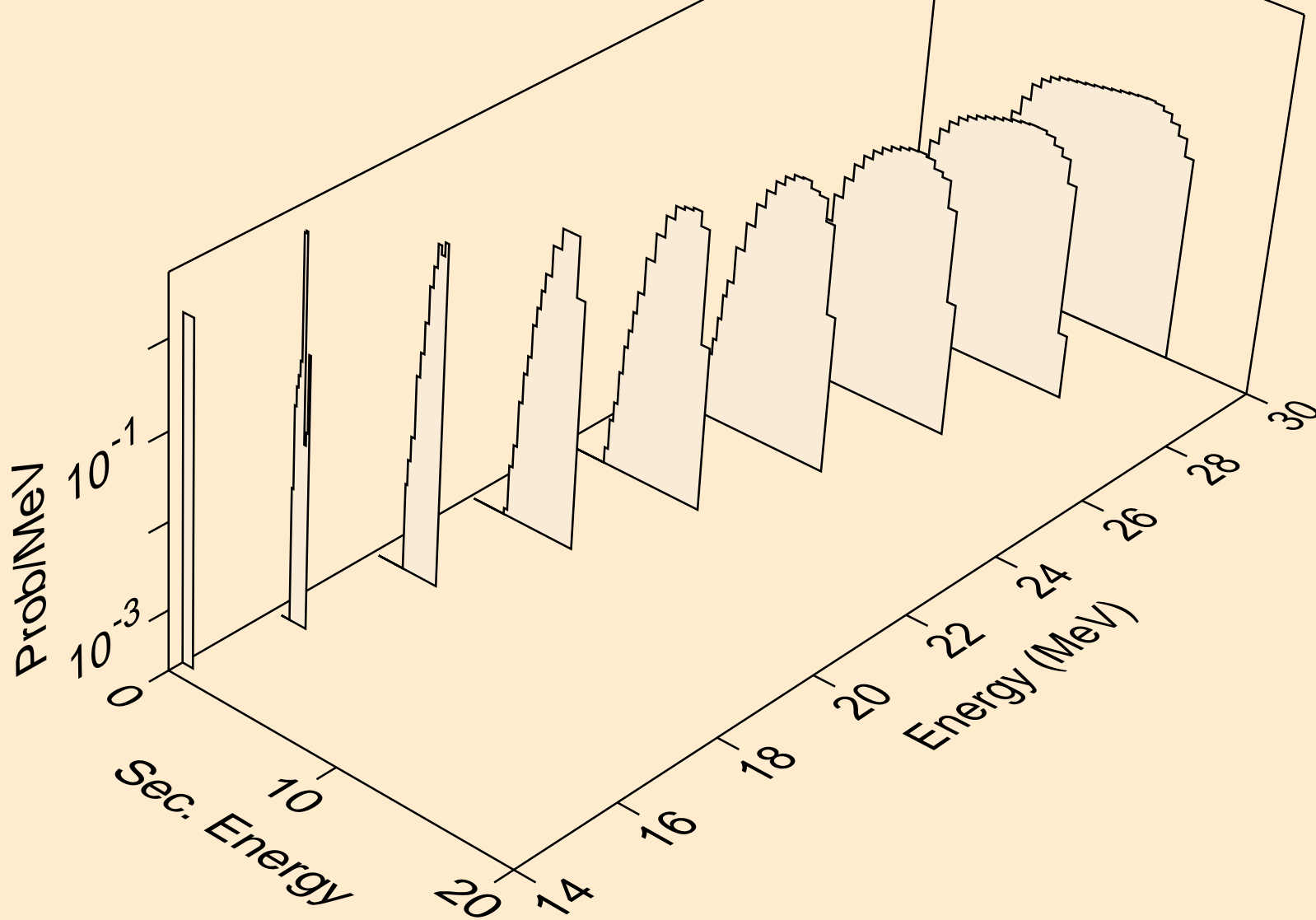

TC091 NEUTRON ACER TENDL-2019 LIBRARY; T=293.16K
deuterons from (n,d)

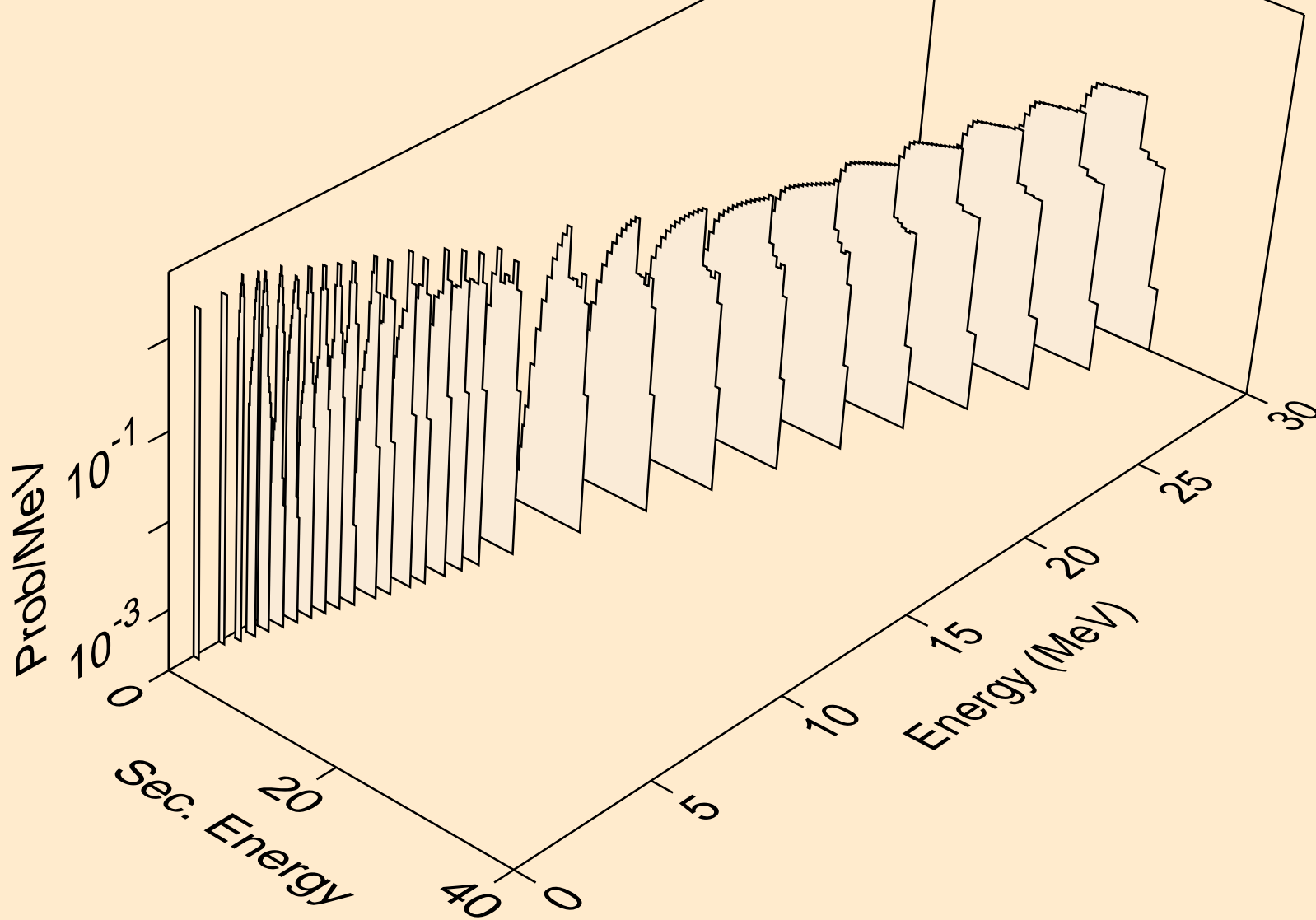

TC091 NEUTRON ACER TENDL-2019 LIBRARY; T=293.16K
deuterons from (n,pd)

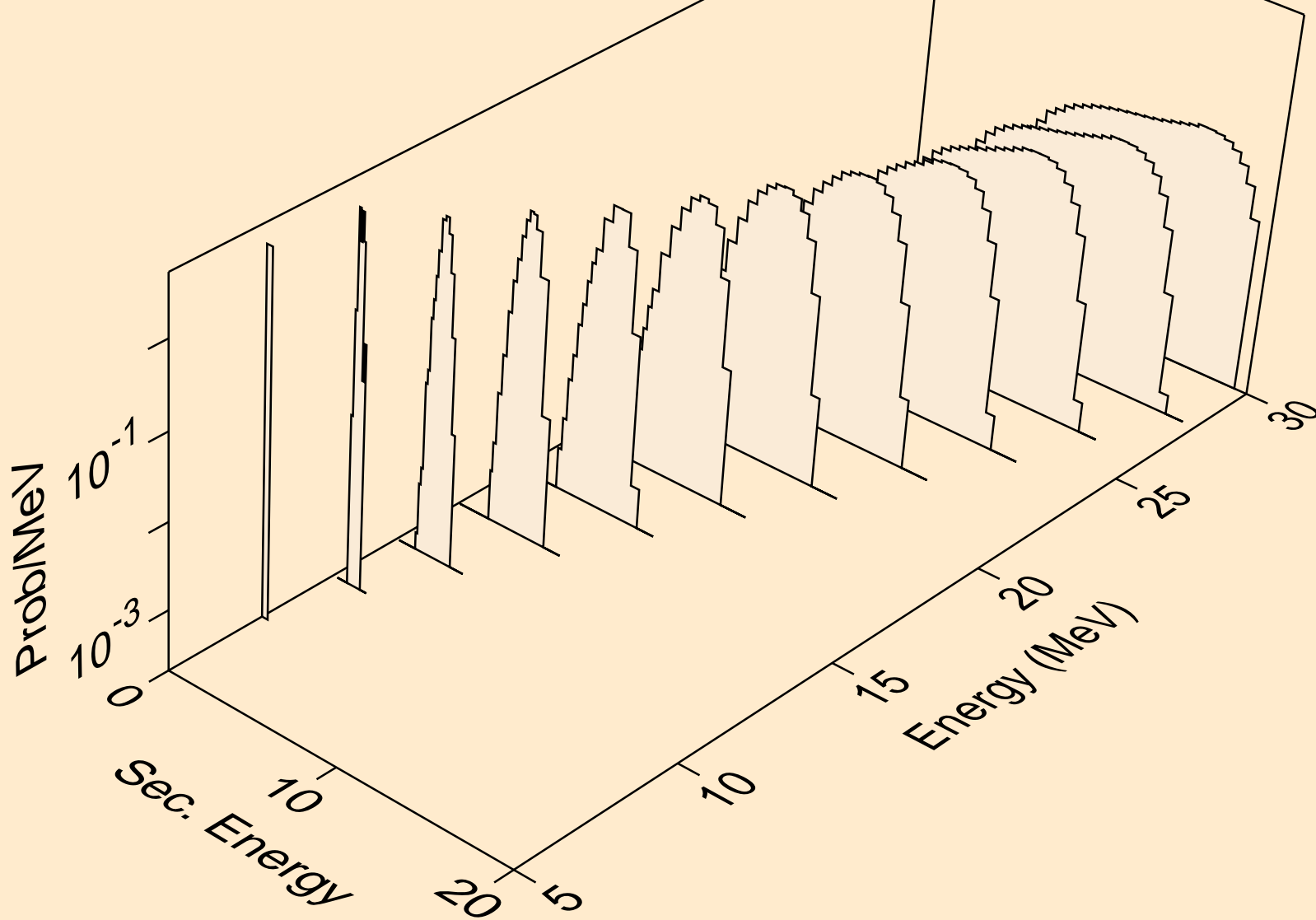

TC091 NEUTRON ACER TENDL-2019 LIBRARY; T=293.16K
deuterons from (n,da)

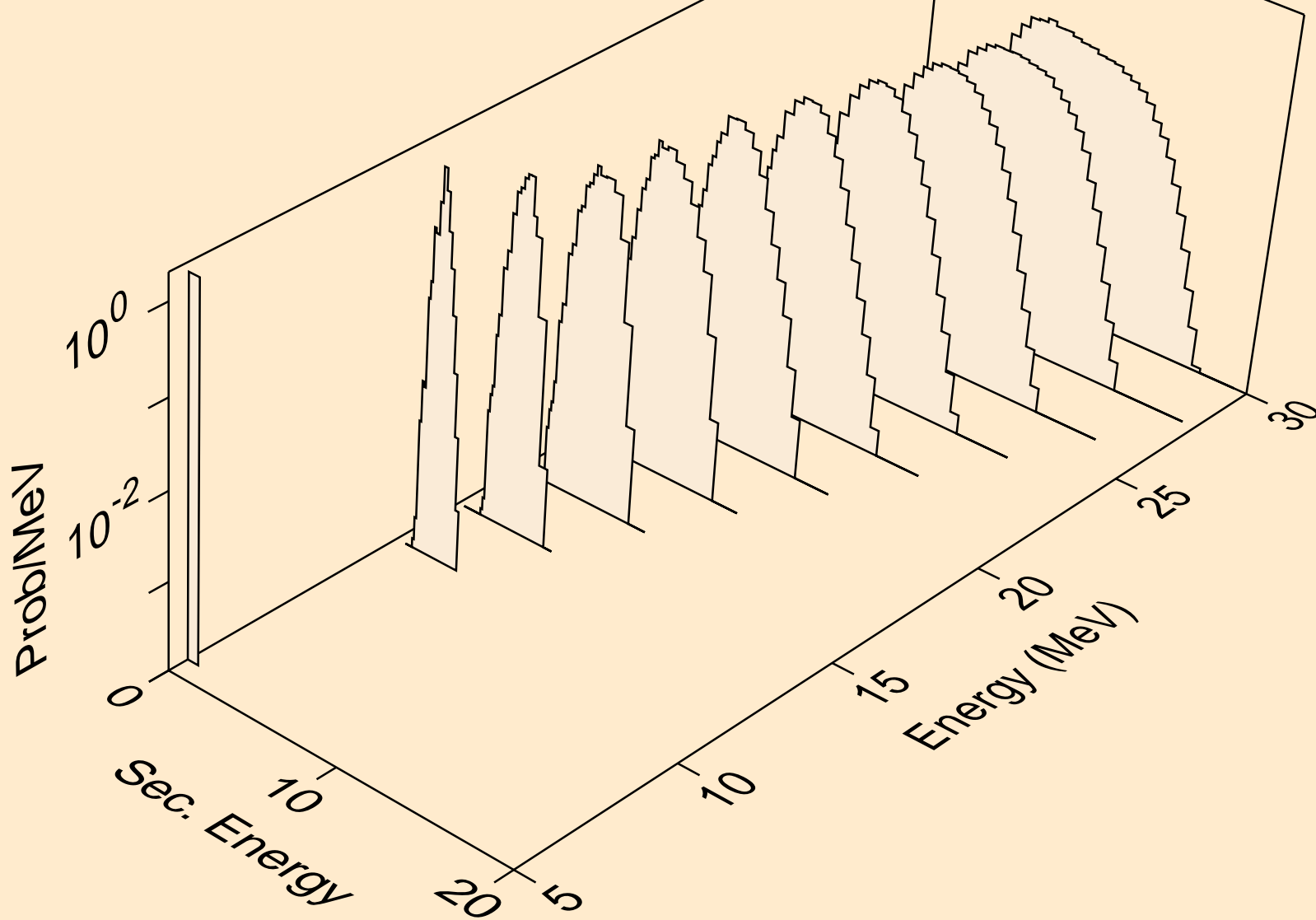

TC091 NEUTRON ACER TENDL-2019 LIBRARY; T=293.16K
tritons from (n,x)

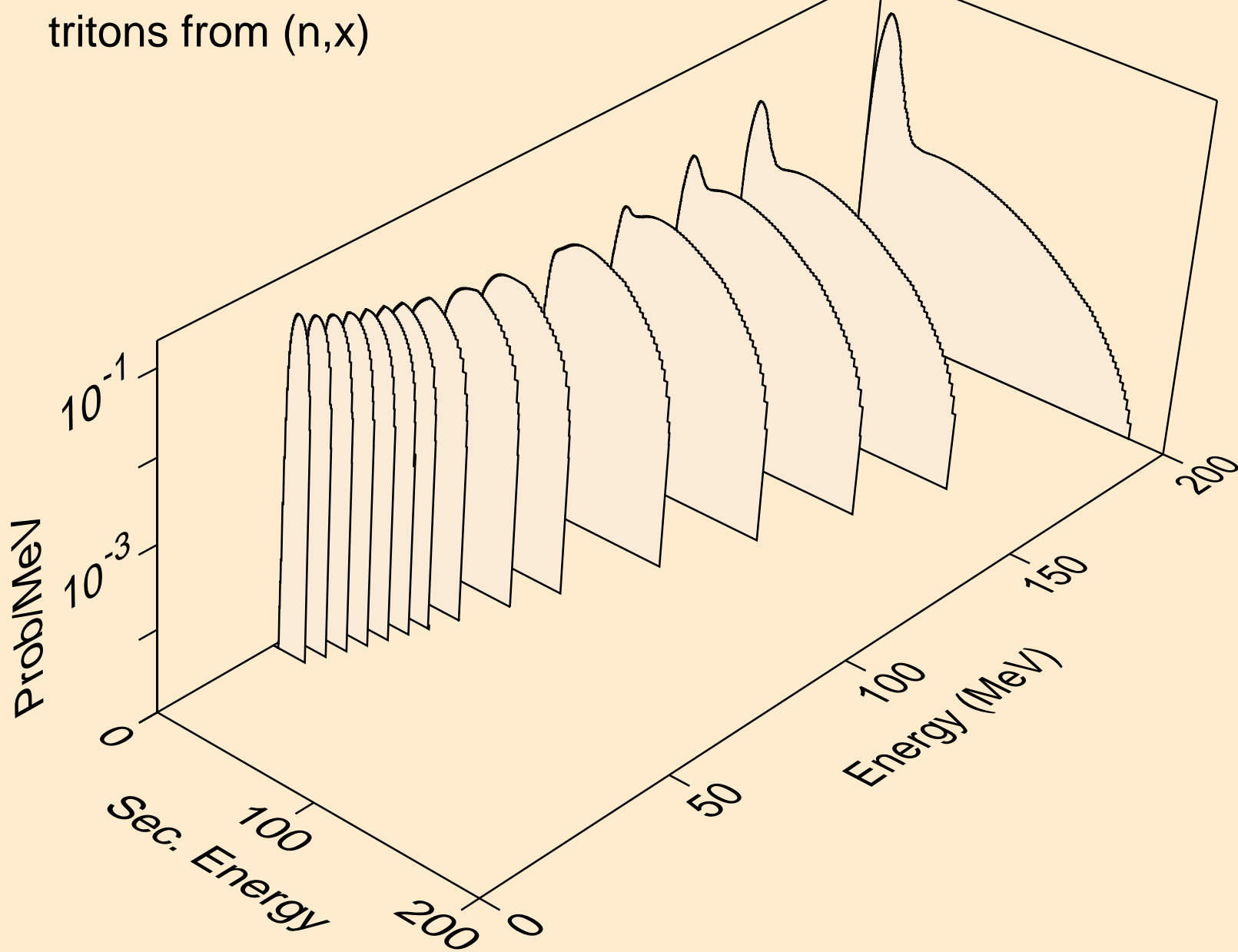

TC091 NEUTRON ACER TENDL-2019 LIBRARY; T=293.16K
tritons from (n,n*)t

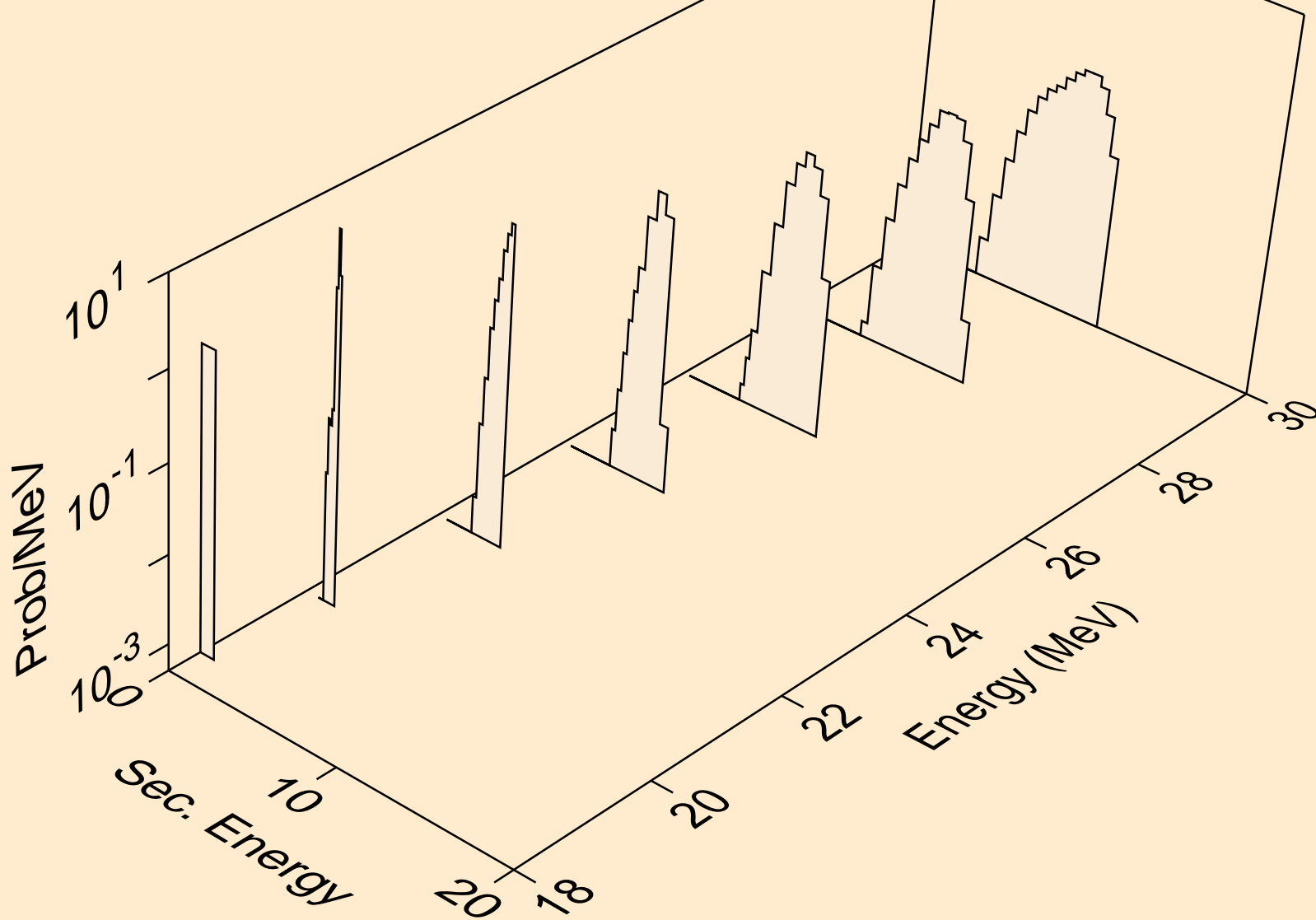

TC091 NEUTRON ACER TENDL-2019 LIBRARY; T=293.16K
tritons from (n,t)

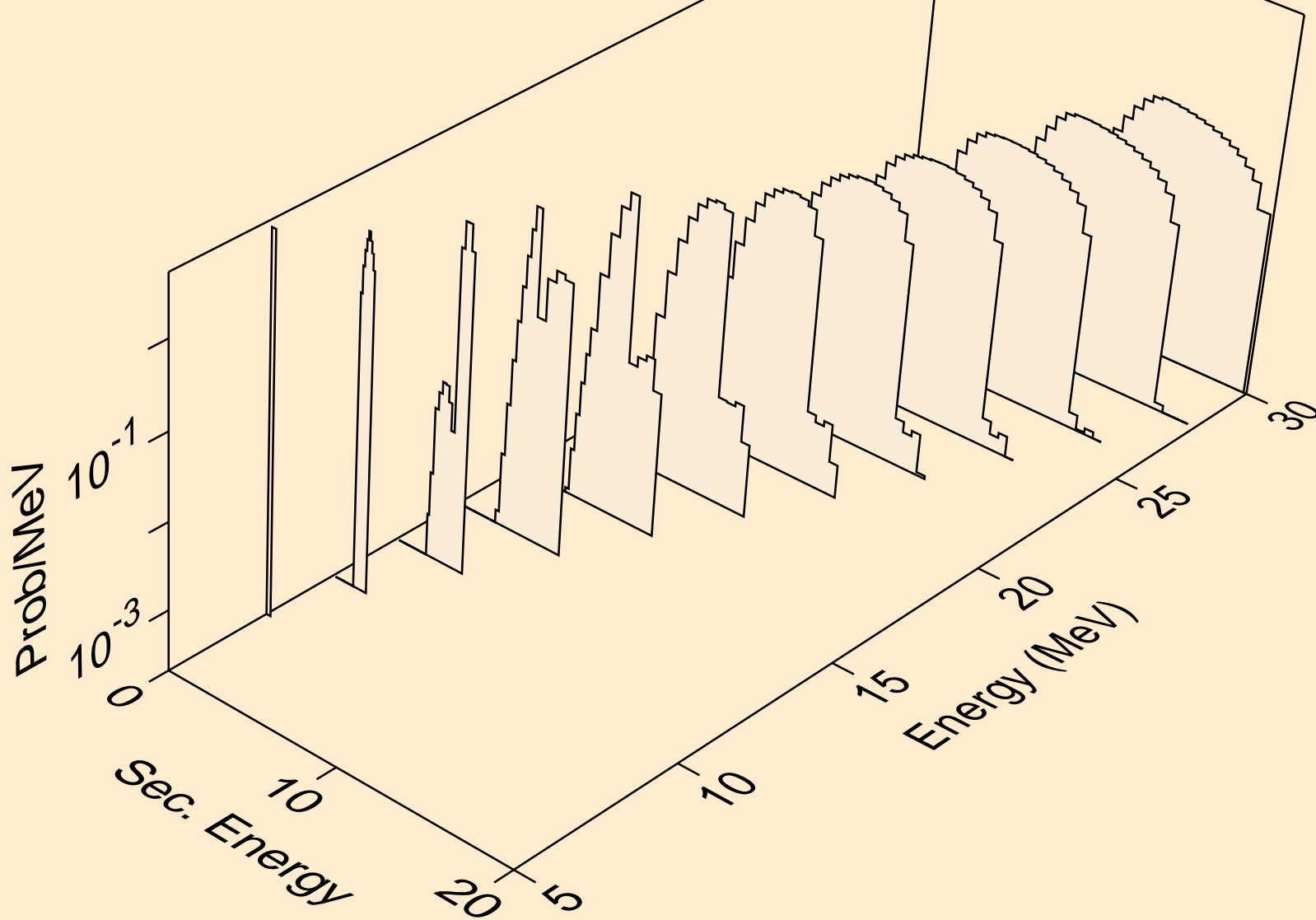

TC091 NEUTRON ACER TENDL-2019 LIBRARY; T=293.16K
tritons from (n,pt)

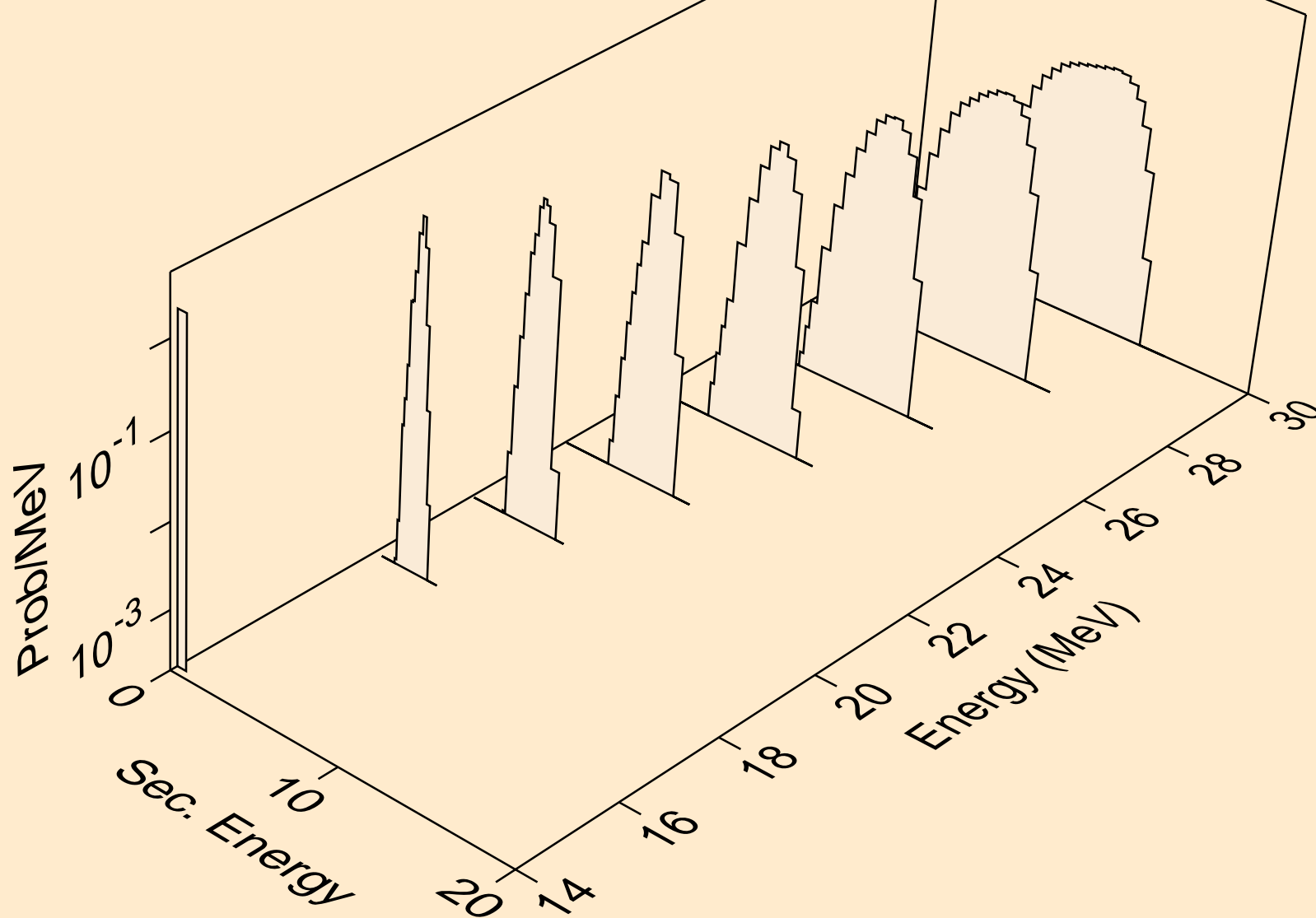

TC091 NEUTRON ACER TENDL-2019 LIBRARY; T=293.16K
he3s from (n,x)

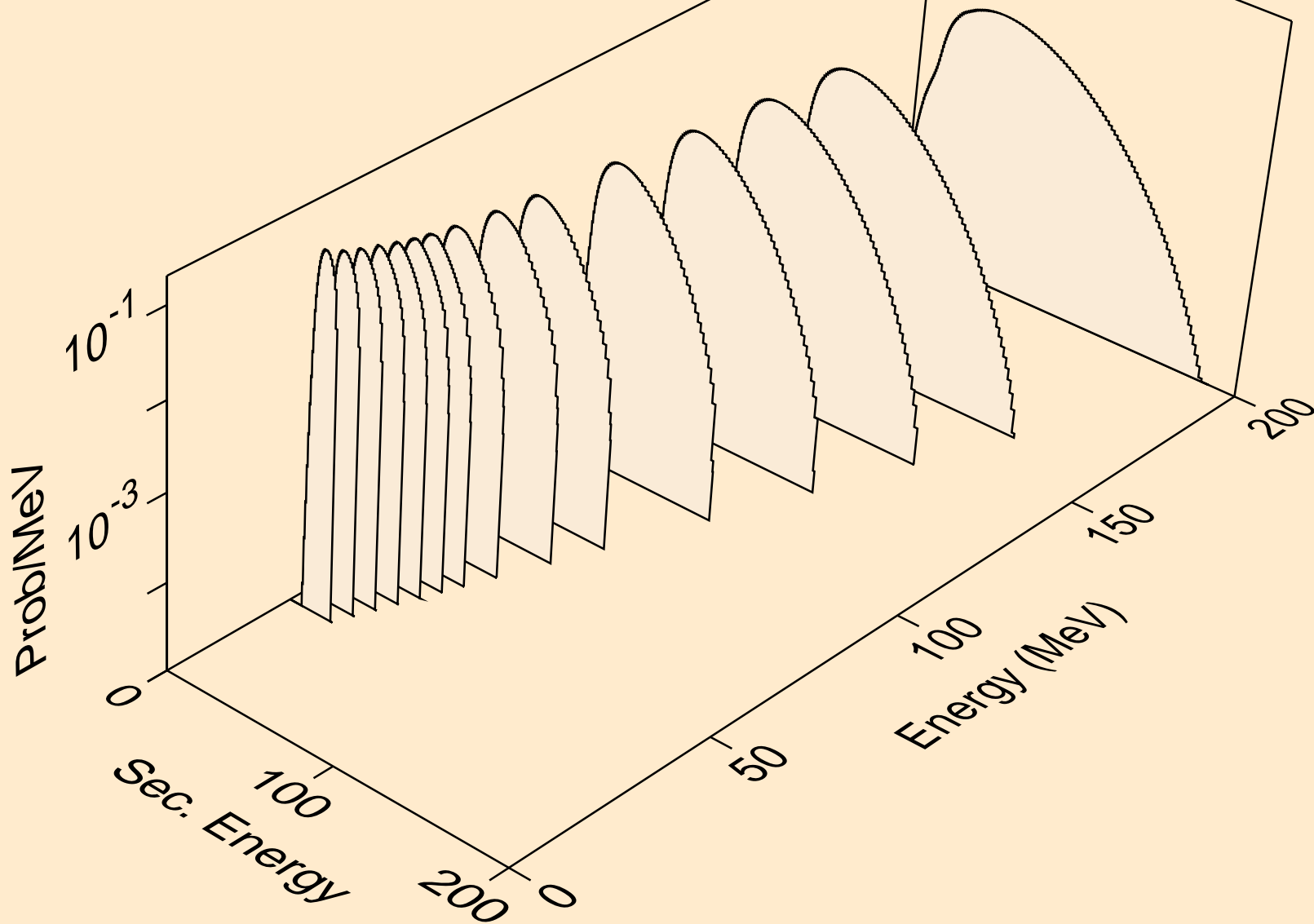

TC091 NEUTRON ACER TENDL-2019 LIBRARY; T=293.16K
he3s from (n,n*)he3

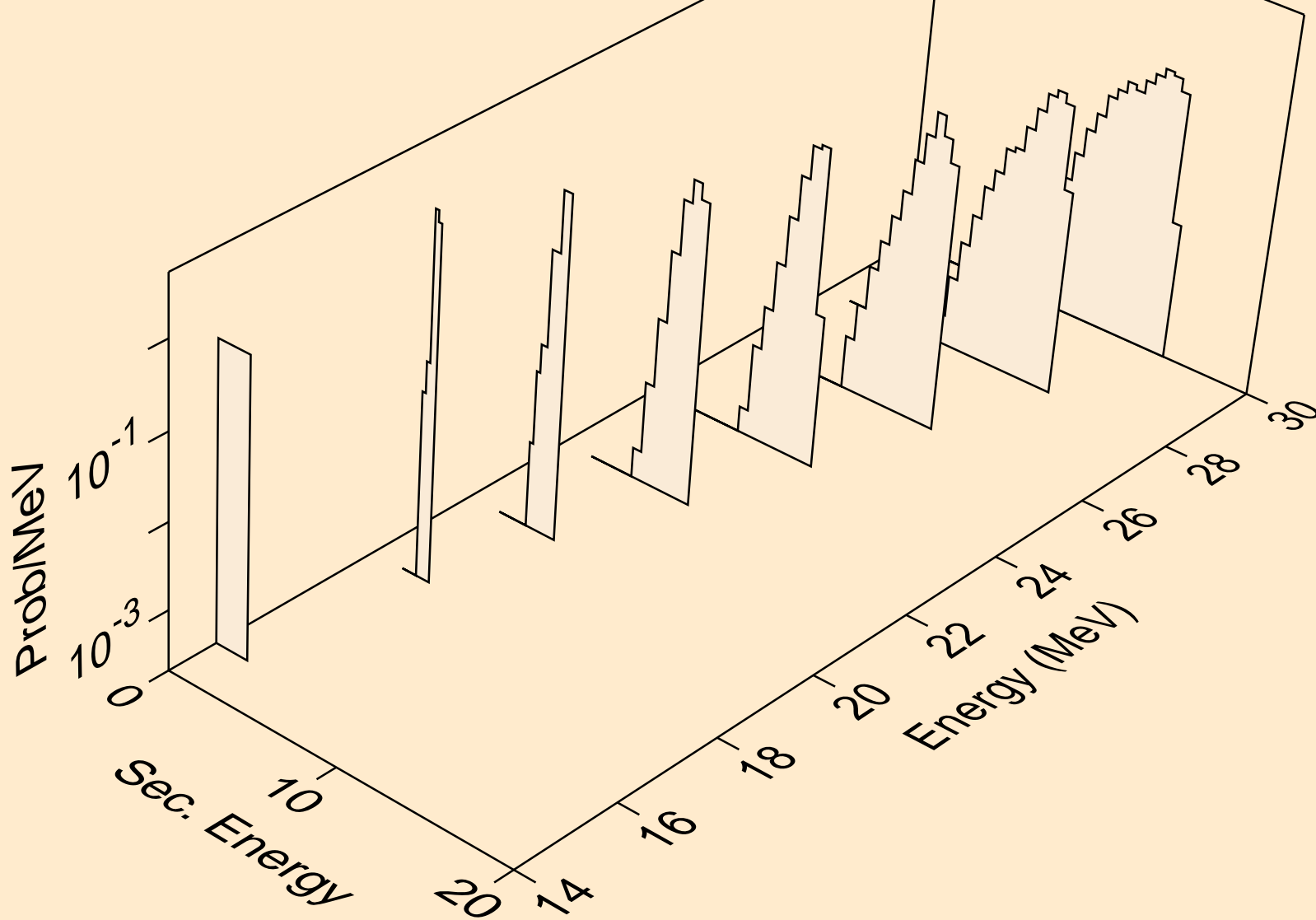

TC091 NEUTRON ACER TENDL-2019 LIBRARY; T=293.16K
he3s from (n,he3)

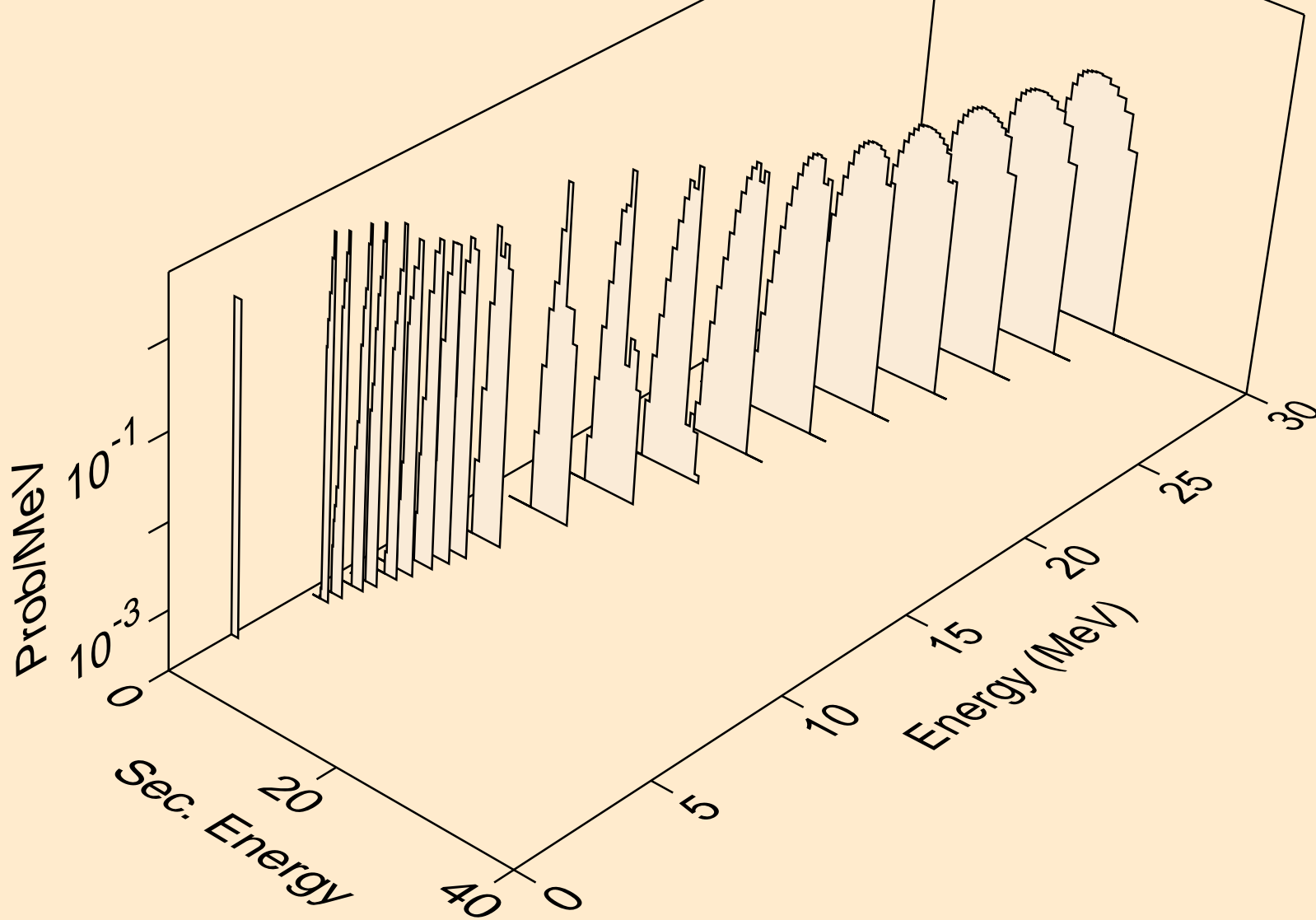

TC091 NEUTRON ACER TENDL-2019 LIBRARY; T=293.16K
alphas from (n,x)

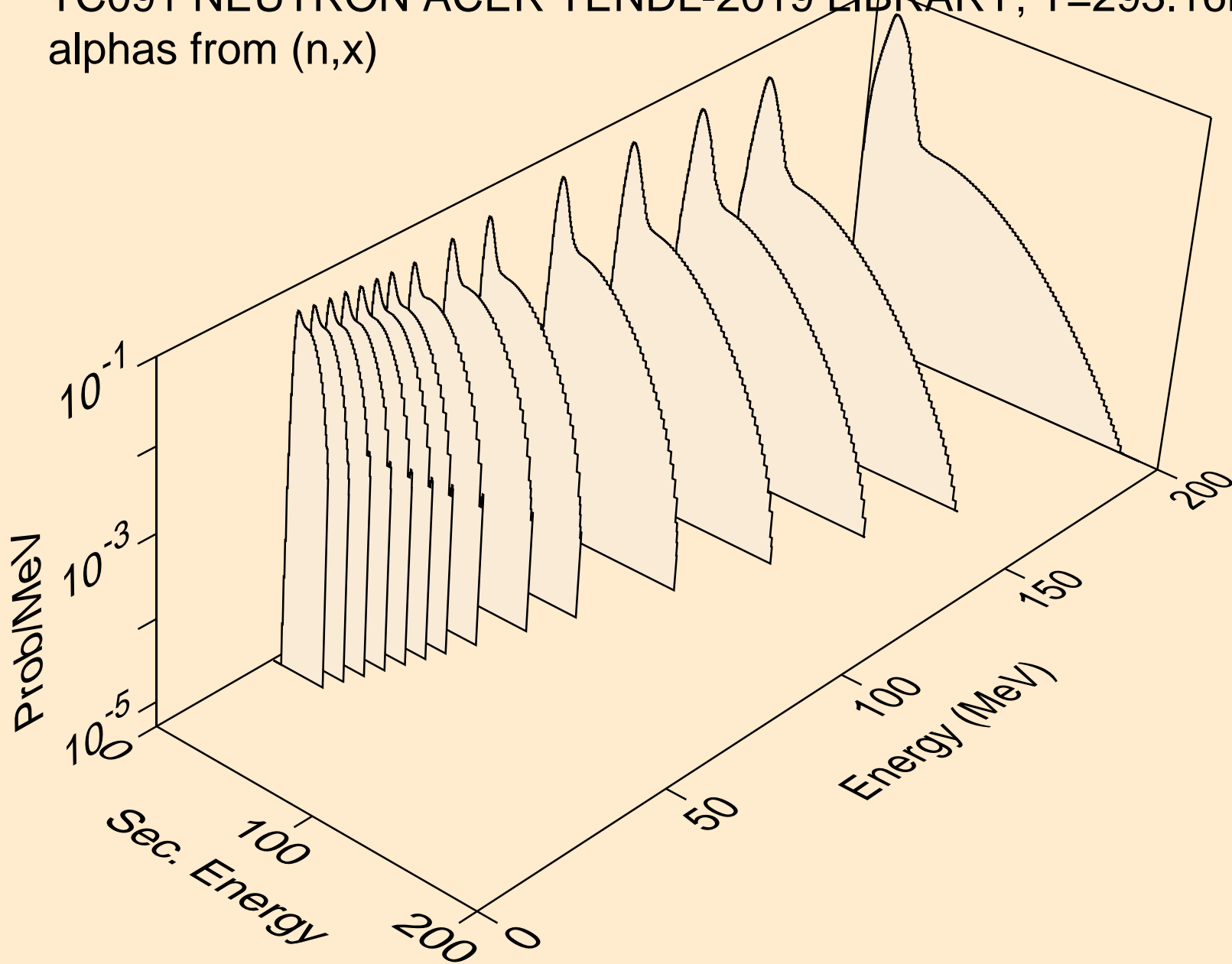

TC091 NEUTRON ACER TENDL-2019 LIBRARY; T=293.16K
alphas from (n,n*)a

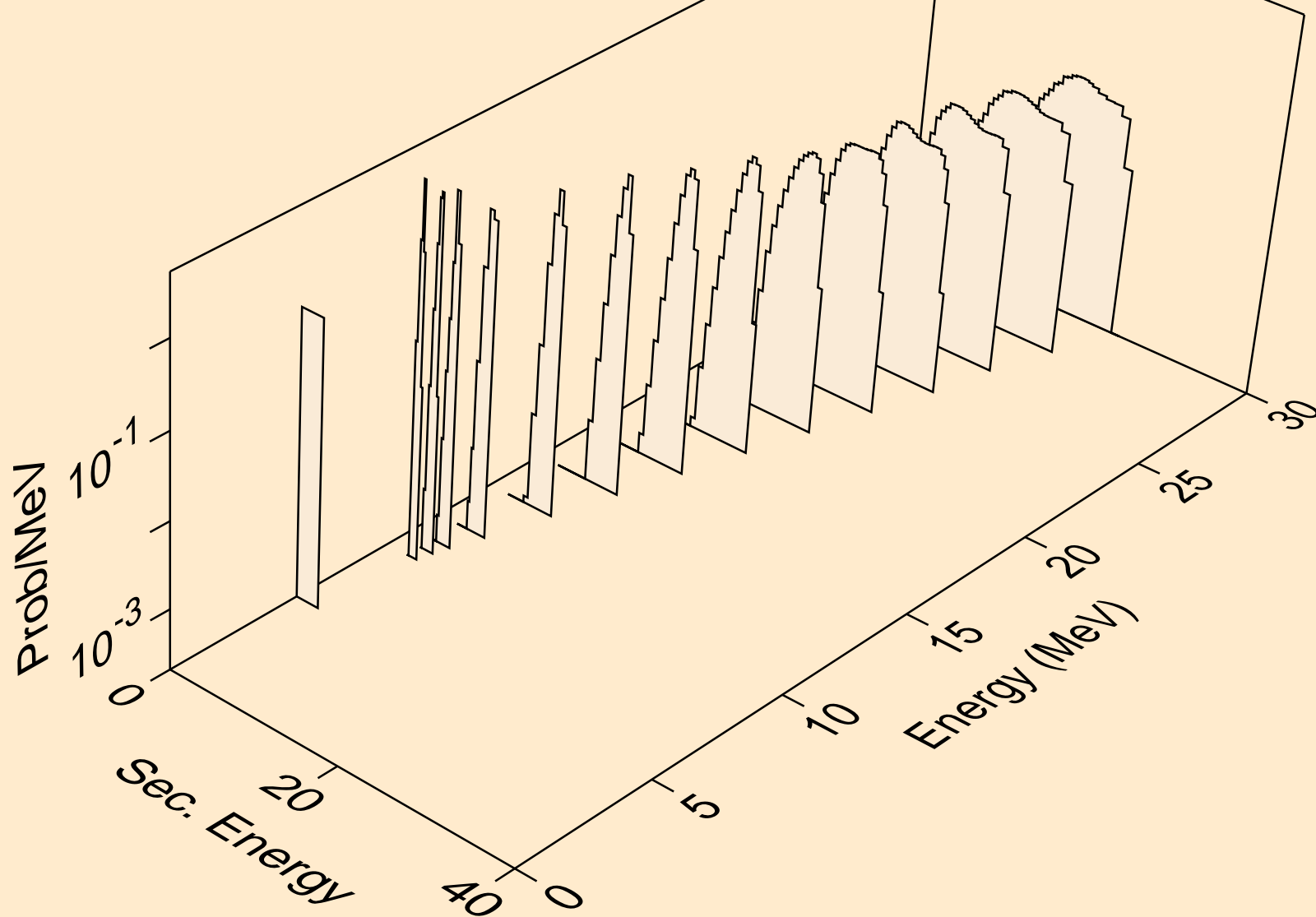

TC091 NEUTRON ACER TENDL-2019 LIBRARY; T=293.16K
alphas from (n,2n)a

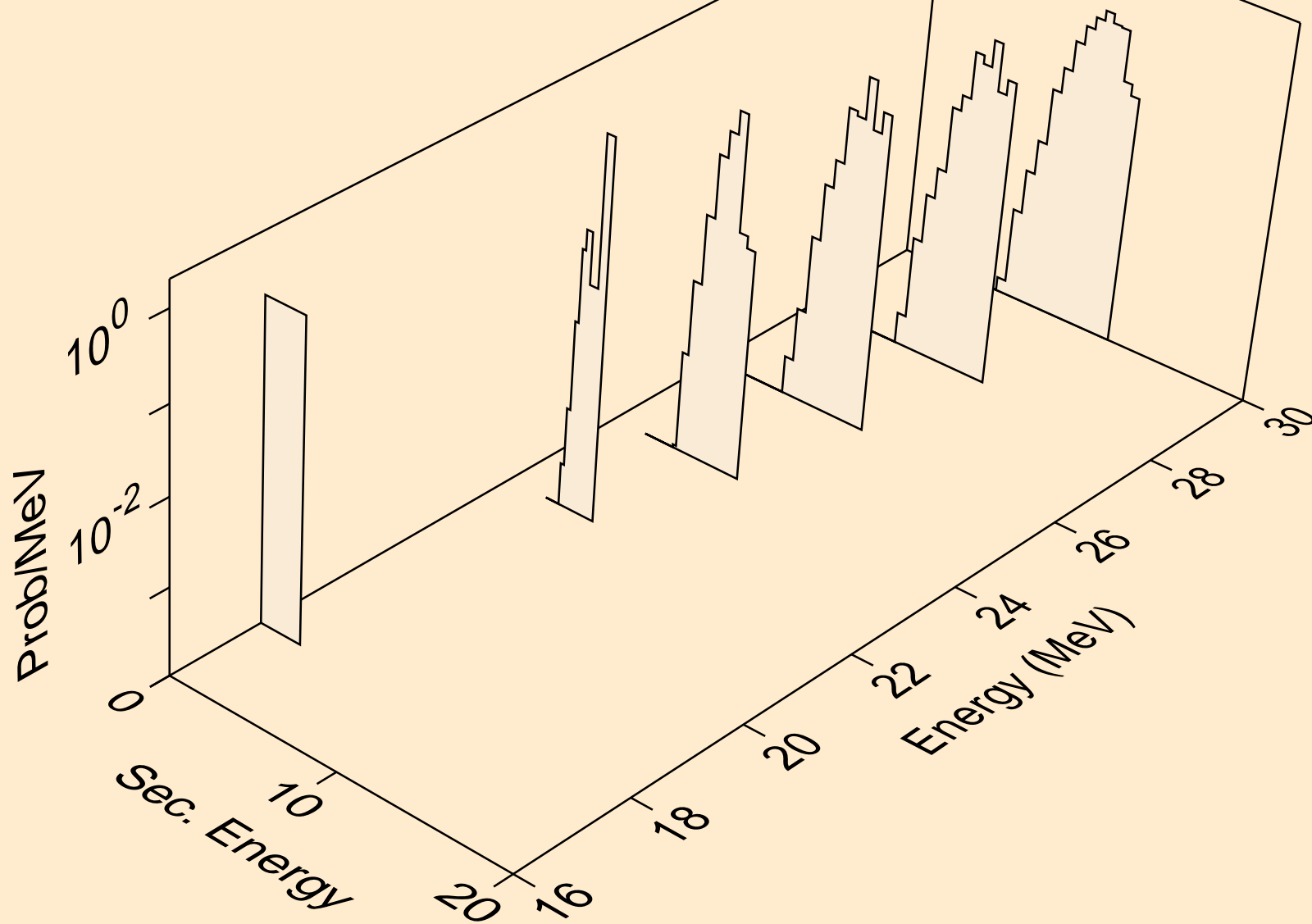

TC091 NEUTRON ACER TENDL-2019 LIBRARY; T=293.16K
alphas from (n,n*)2a

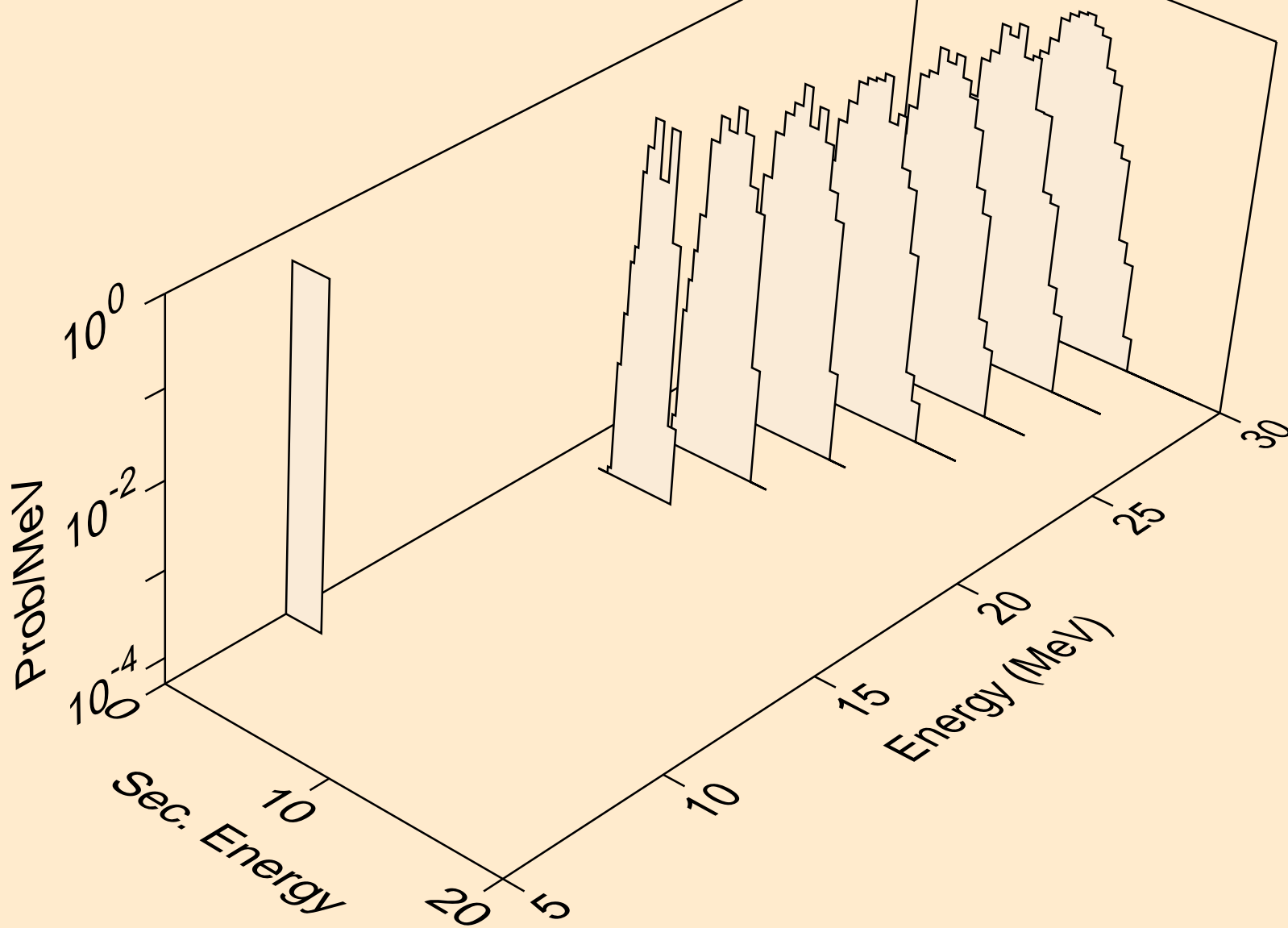

TC091 NEUTRON ACER TENDL-2019 LIBRARY; T=293.16K
alphas from (n,npa)

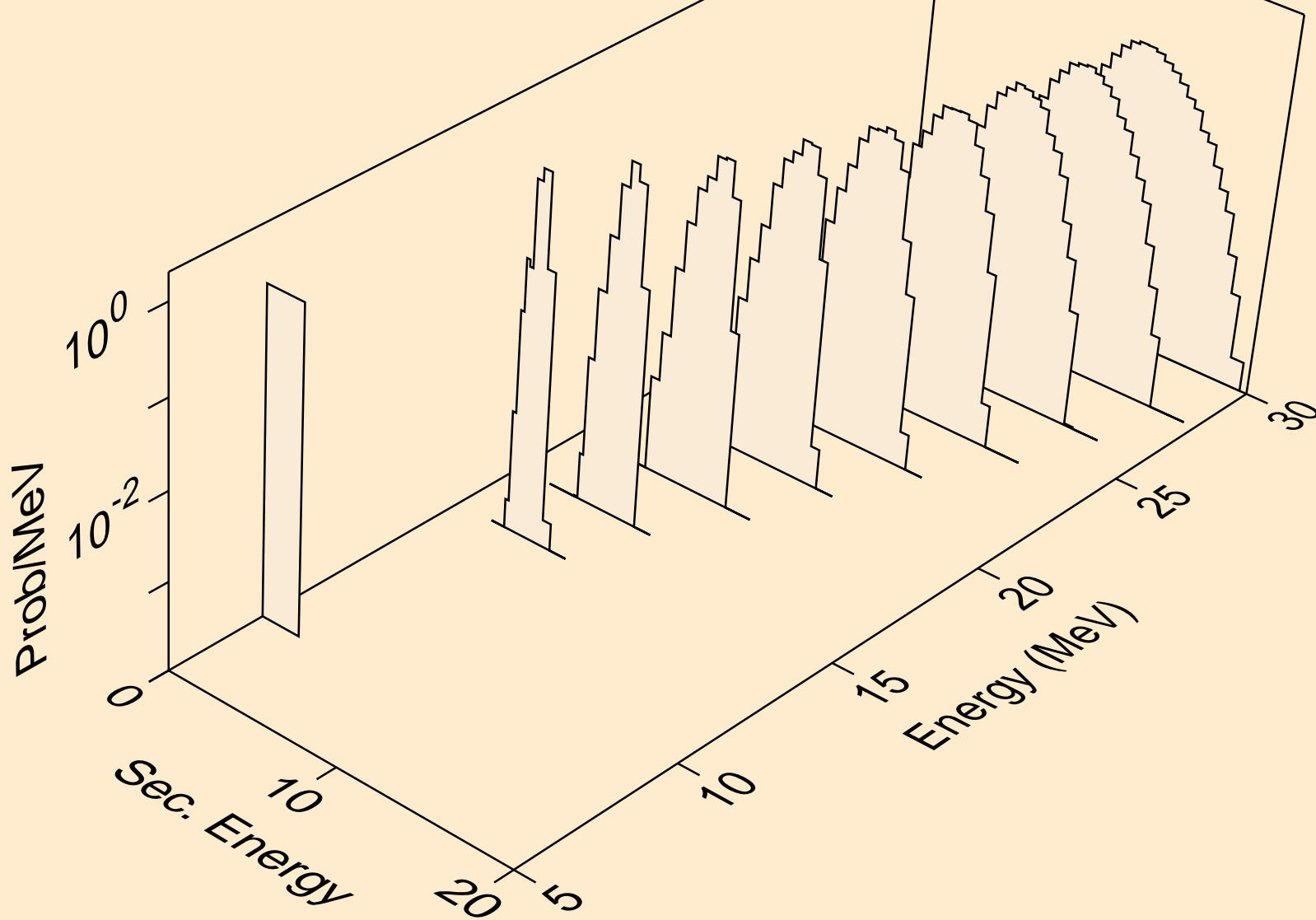

TC091 NEUTRON ACER TENDL-2019 LIBRARY; T=293.16K
alphas from (n,a)

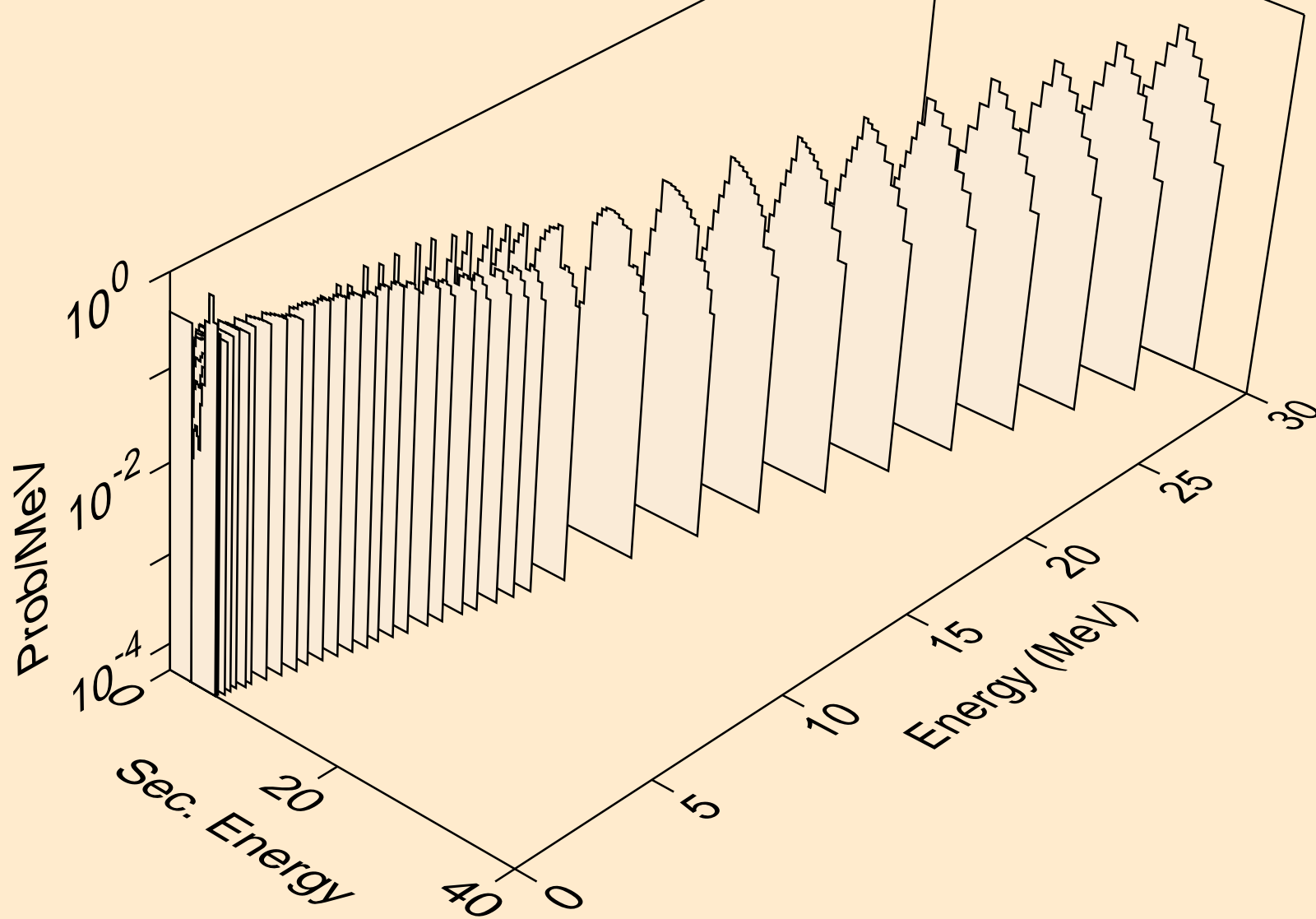

TC091 NEUTRON ACER TENDL-2019 LIBRARY; T=293.16K
alphas from (n,2a)

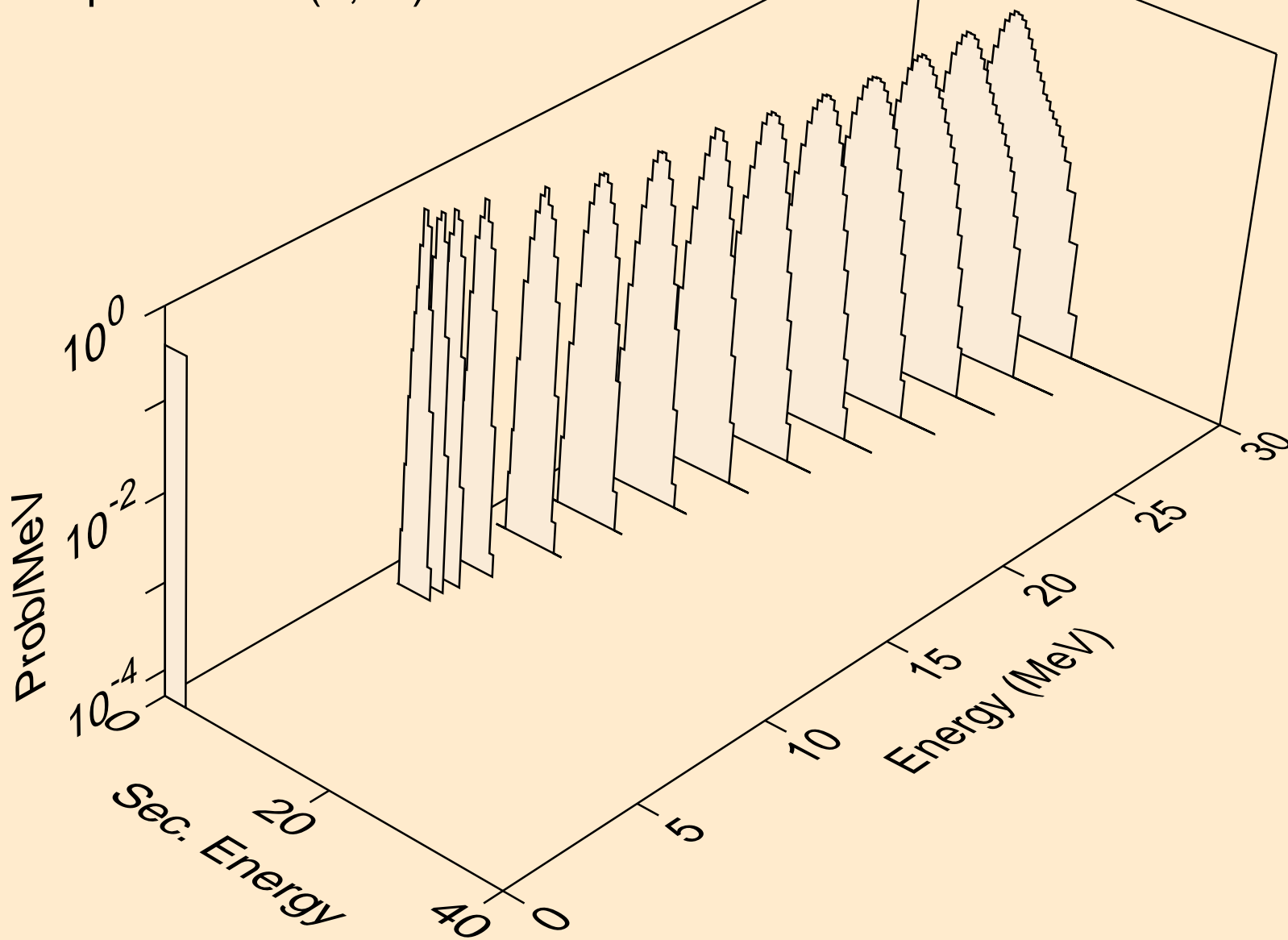

TC091 NEUTRON ACER TENDL-2019 LIBRARY; T=293.16K
alphas from (n,pa)

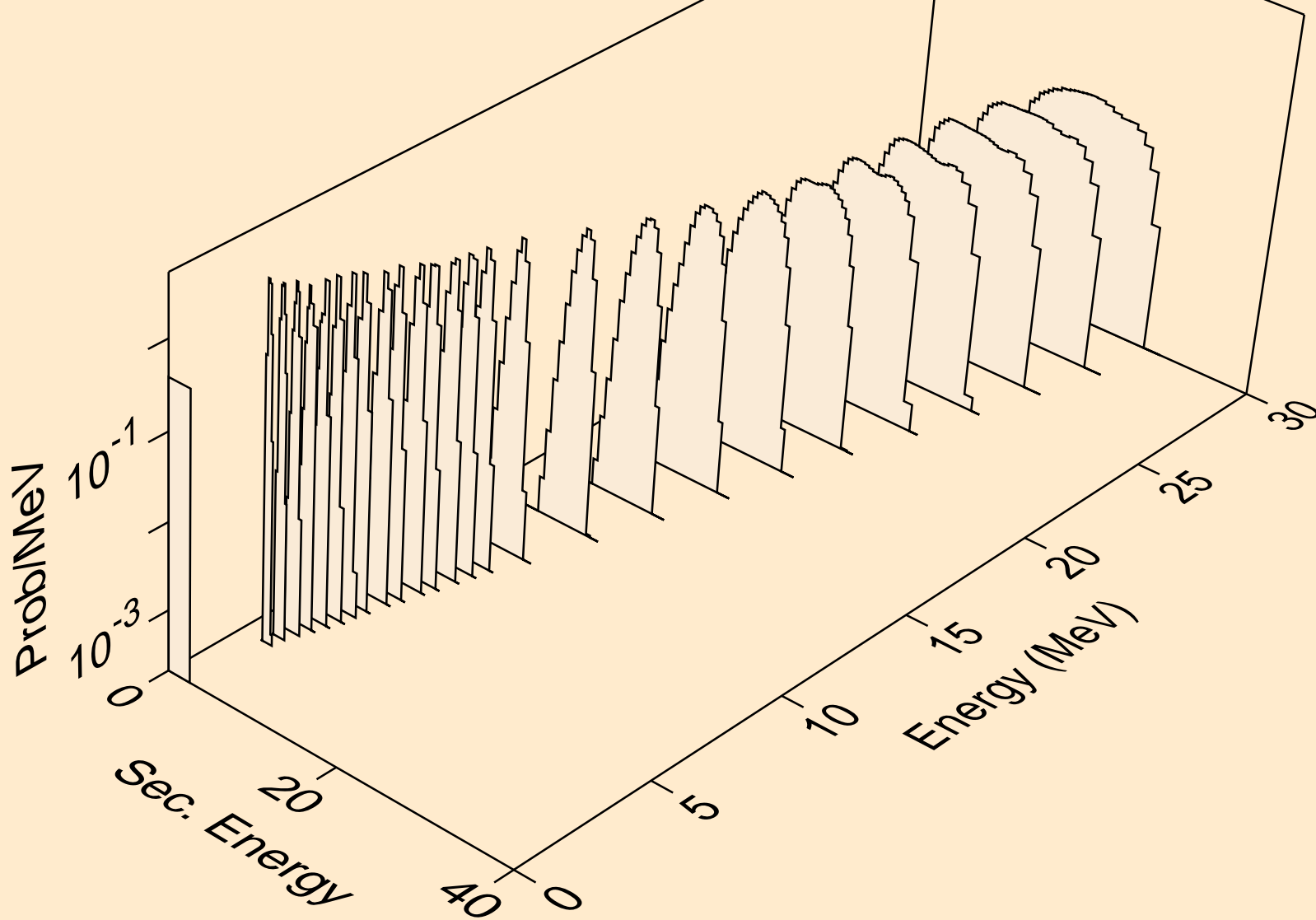

TC091 NEUTRON ACER TENDL-2019 LIBRARY; T=293.16K
alphas from (n,da)

