

TC094M NEUTRON ACER TENDL-2019 LIBRARY; T=293.16K  
Principal cross sections

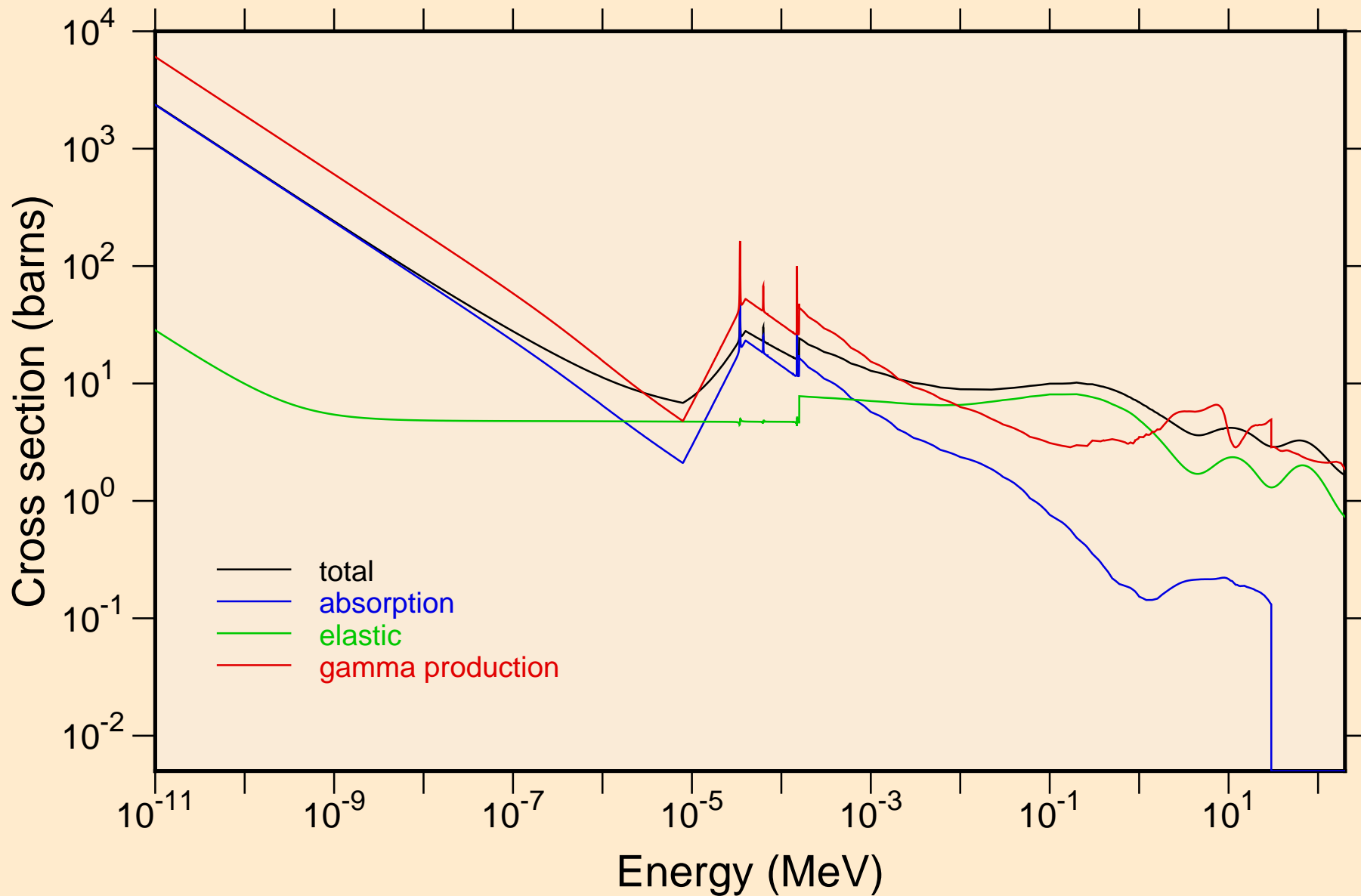

TC094M NEUTRON ACER TENDL-2019 LIBRARY; T=293.16K  
resonance total cross section

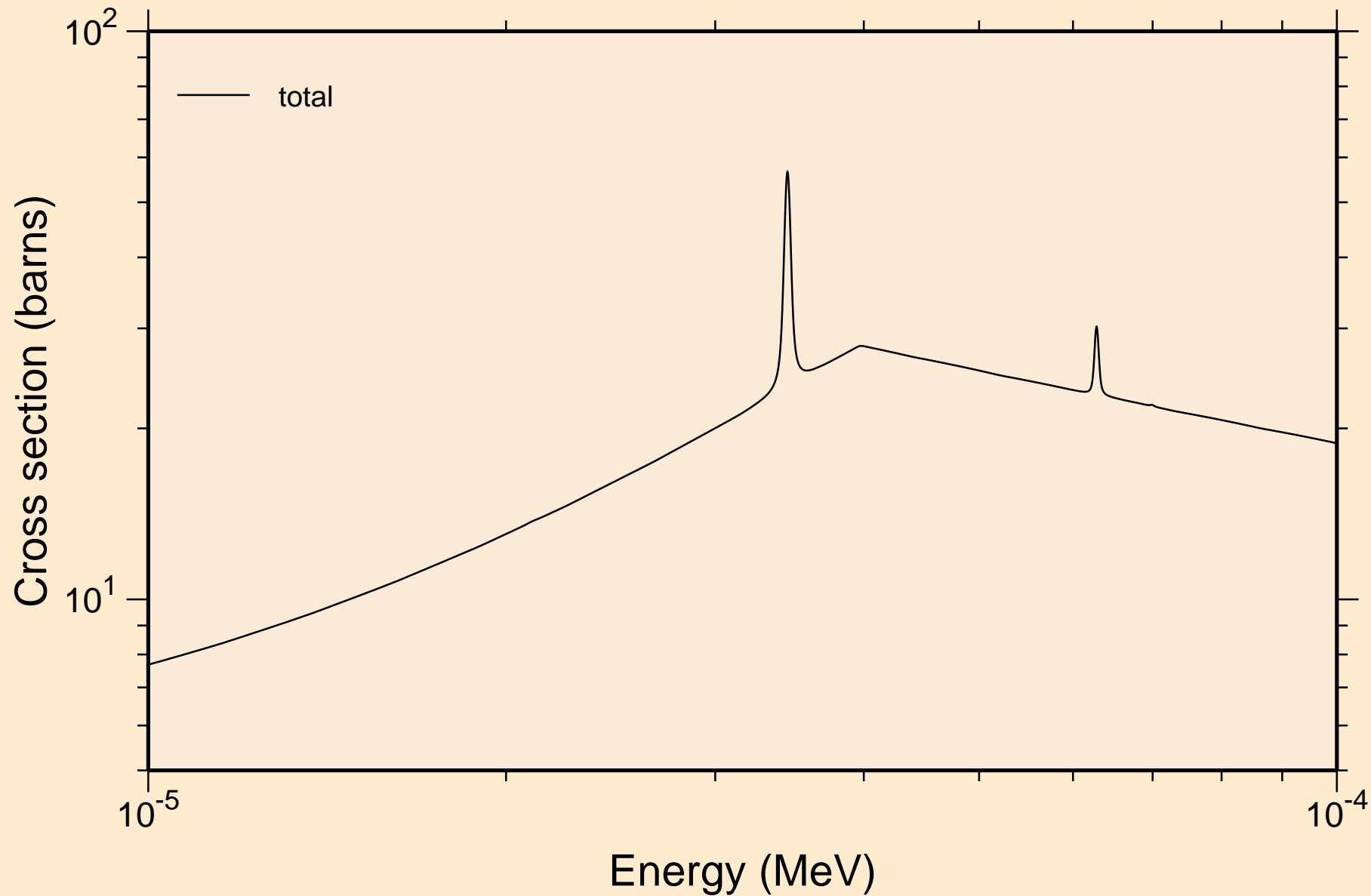

TC094M NEUTRON ACER TENDL-2019 LIBRARY; T=293.16K  
resonance total cross section

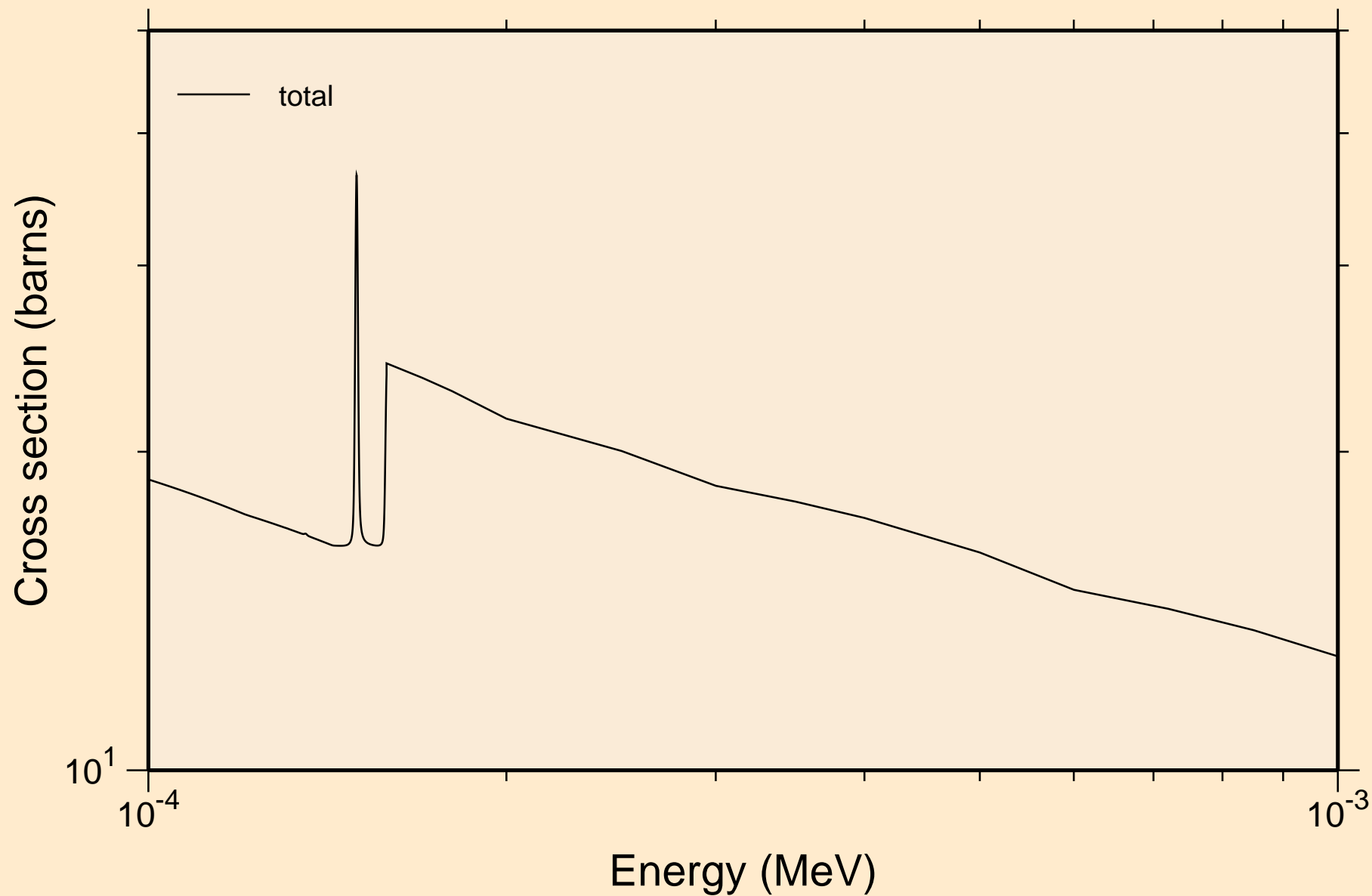

T̄C094M NEUTRON ACER TENDL-2019 LIBRARY; T=293.16K  
resonance total cross section

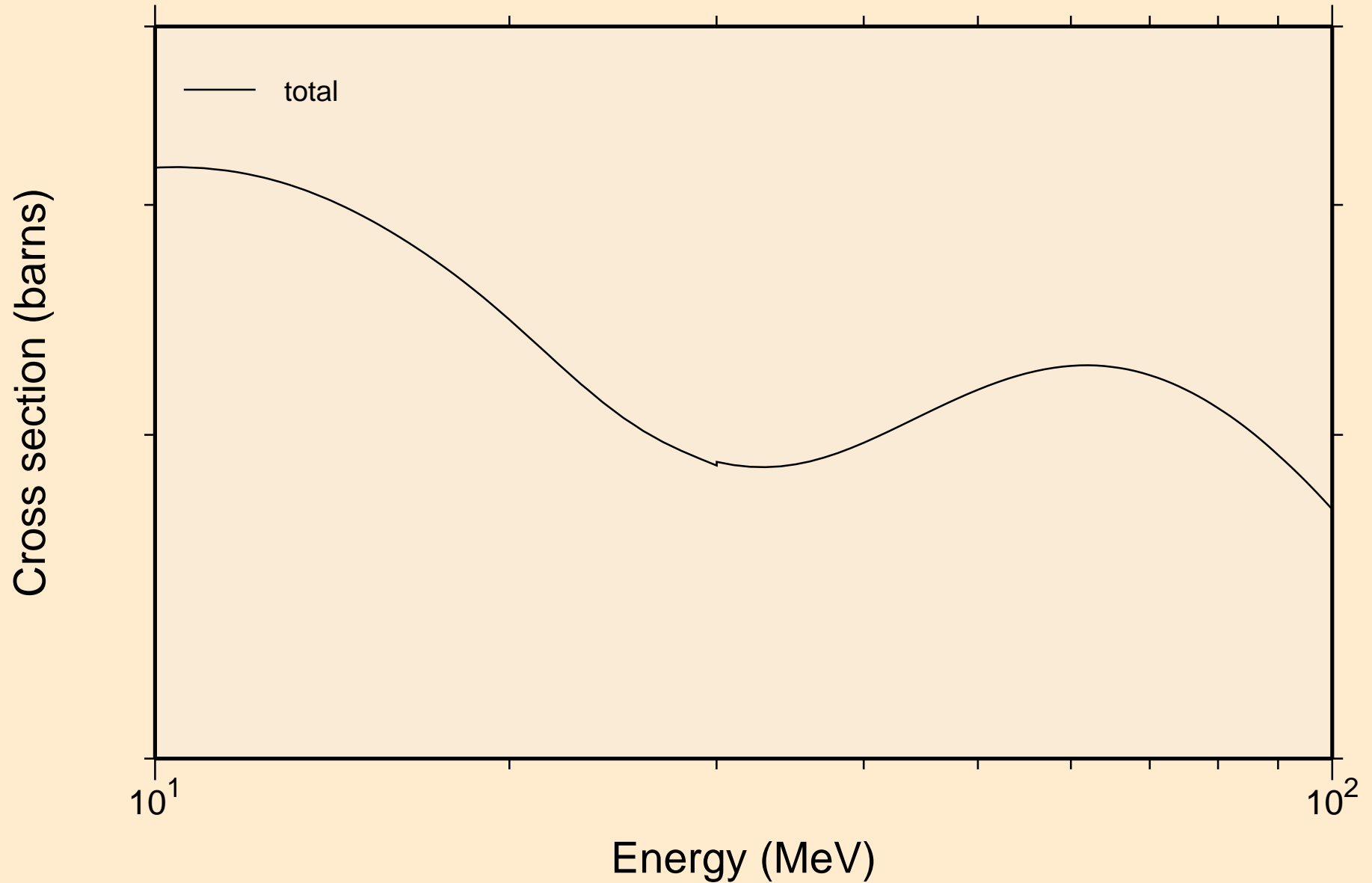

TC094M NEUTRON ACER TENDL-2019 LIBRARY; T=293.16K  
resonance absorption cross sections

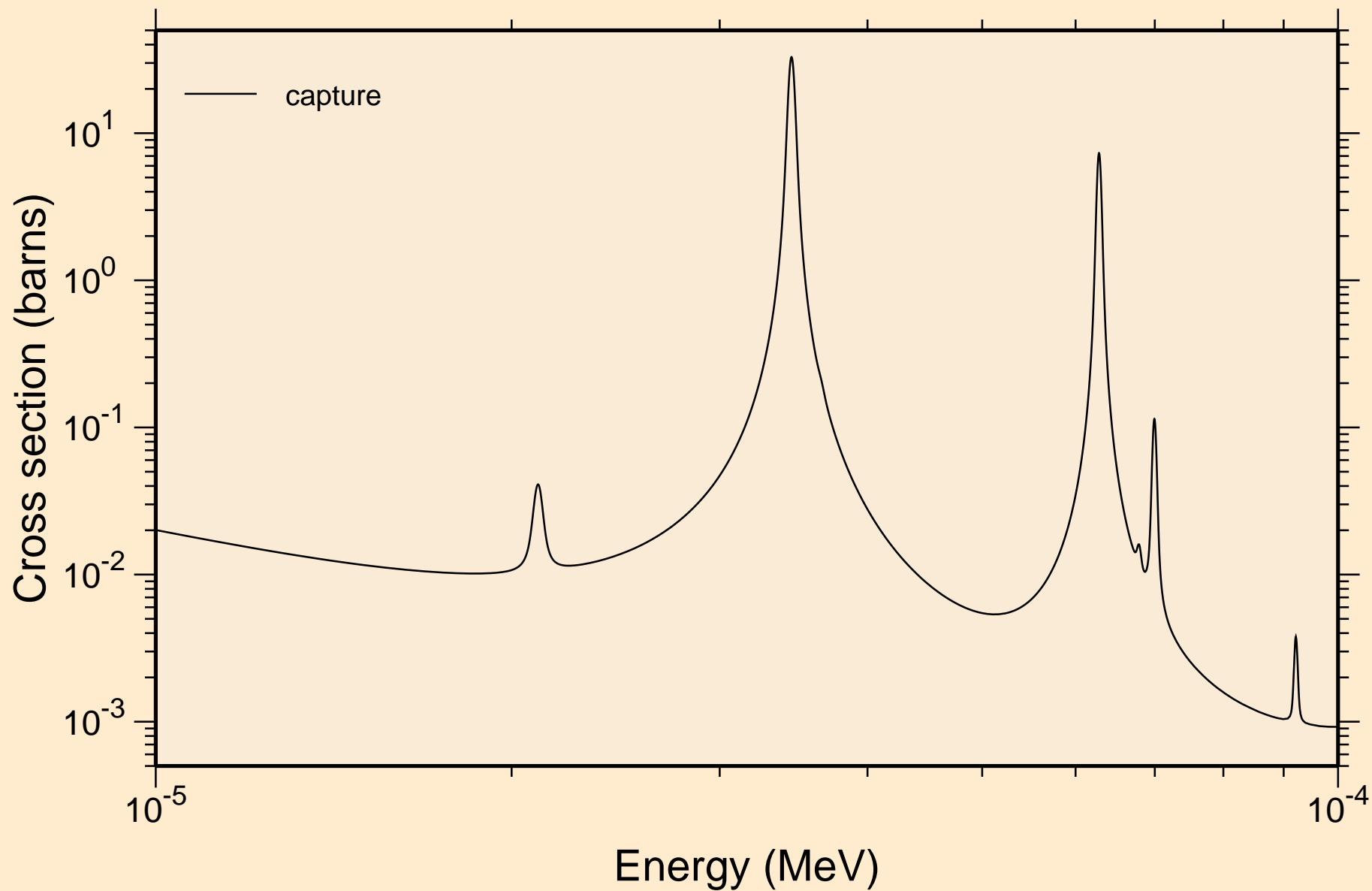

TC094M NEUTRON ACER TENDL-2019 LIBRARY; T=293.16K  
resonance absorption cross sections

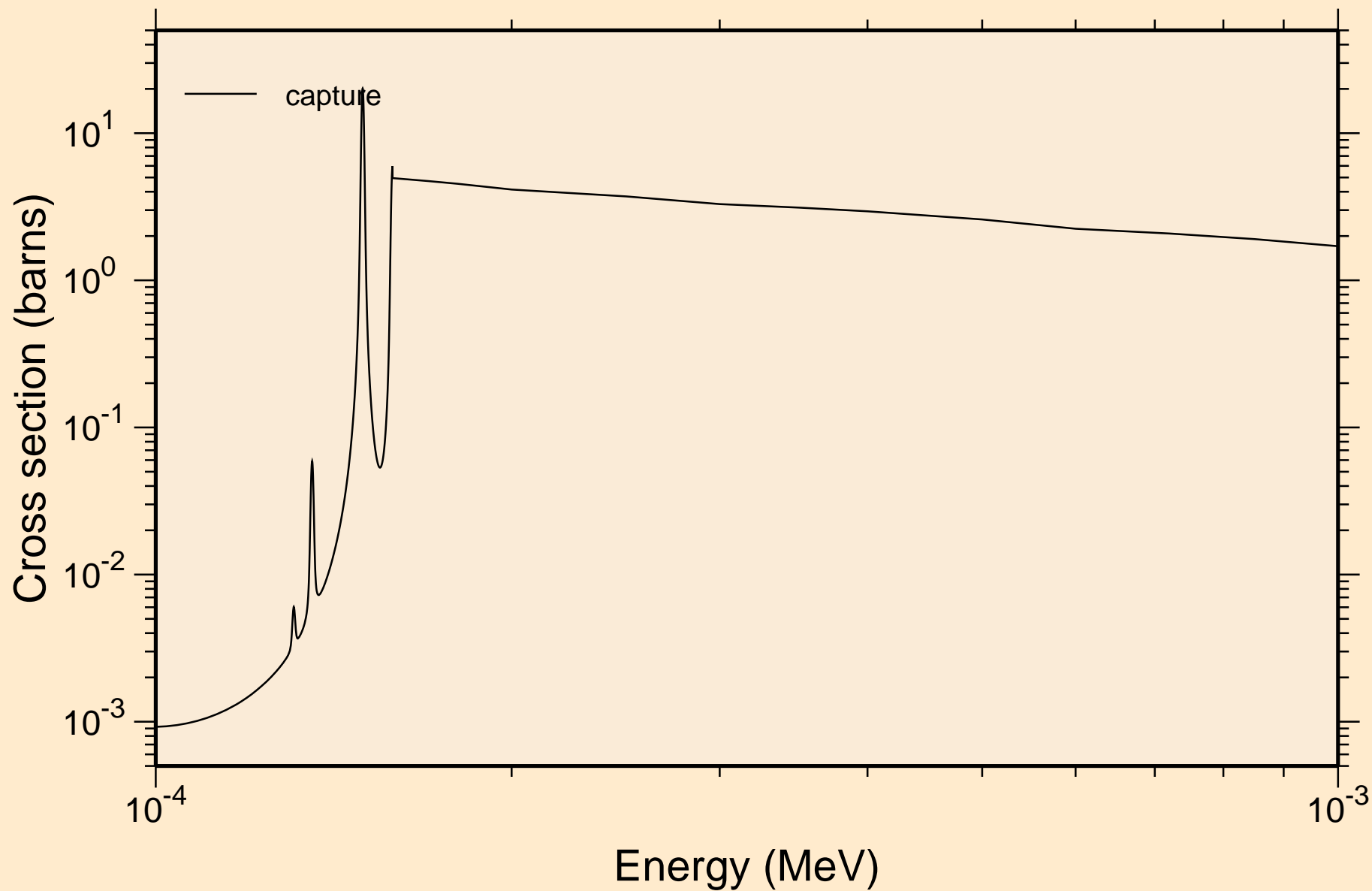

TC094M NEUTRON ACER TENDL-2019 LIBRARY; T=293.16K  
resonance absorption cross sections

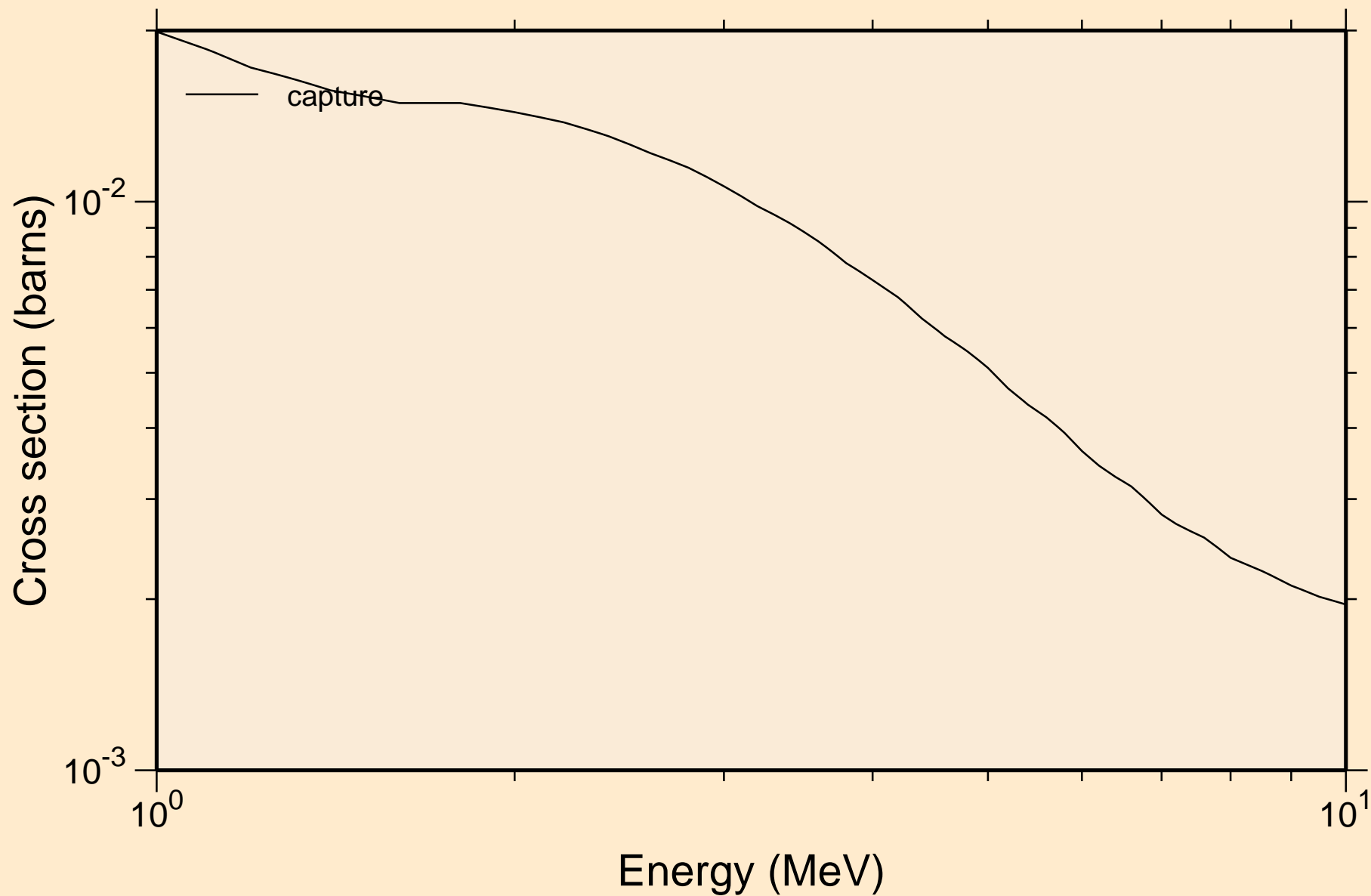

TC094M NEUTRON ACER TENDL-2019 LIBRARY; T=293.16K  
Heating

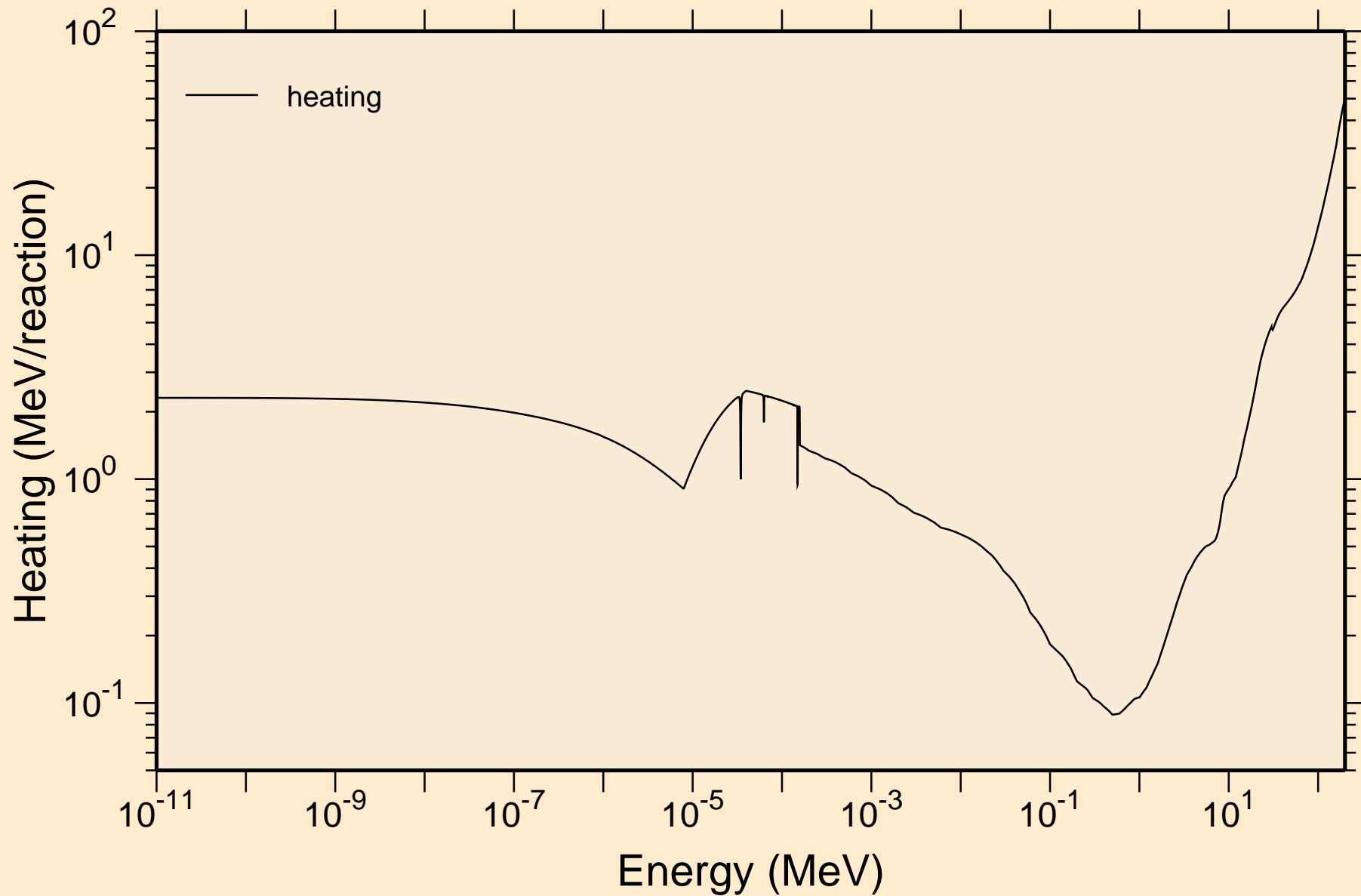



TC094M NEUTRON ACER TENDL-2019 LIBRARY; T=293.16K  
Damage

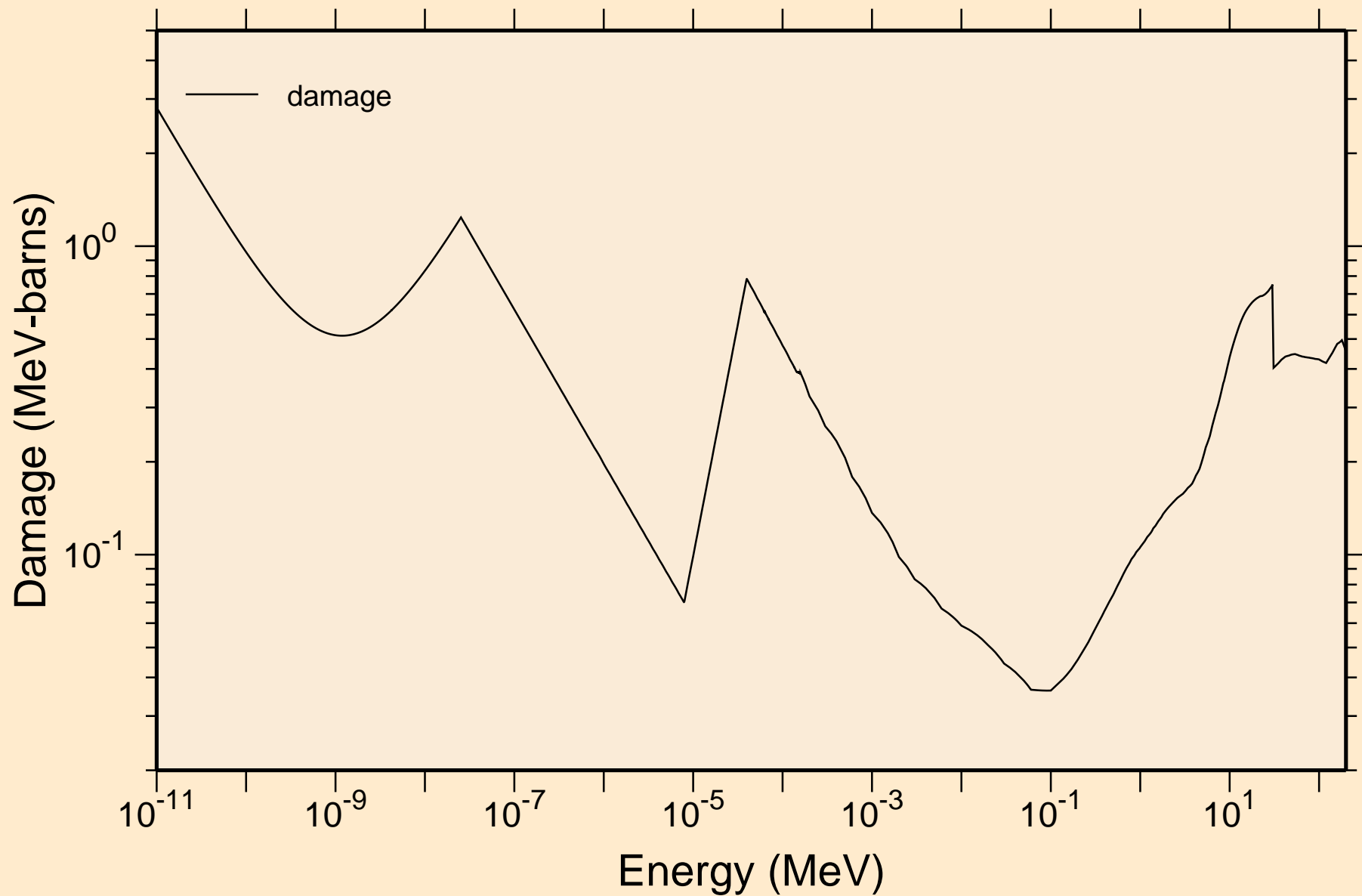

TC094M NEUTRON ACER TENDL-2019 LIBRARY; T=293.16K  
Non-threshold reactions

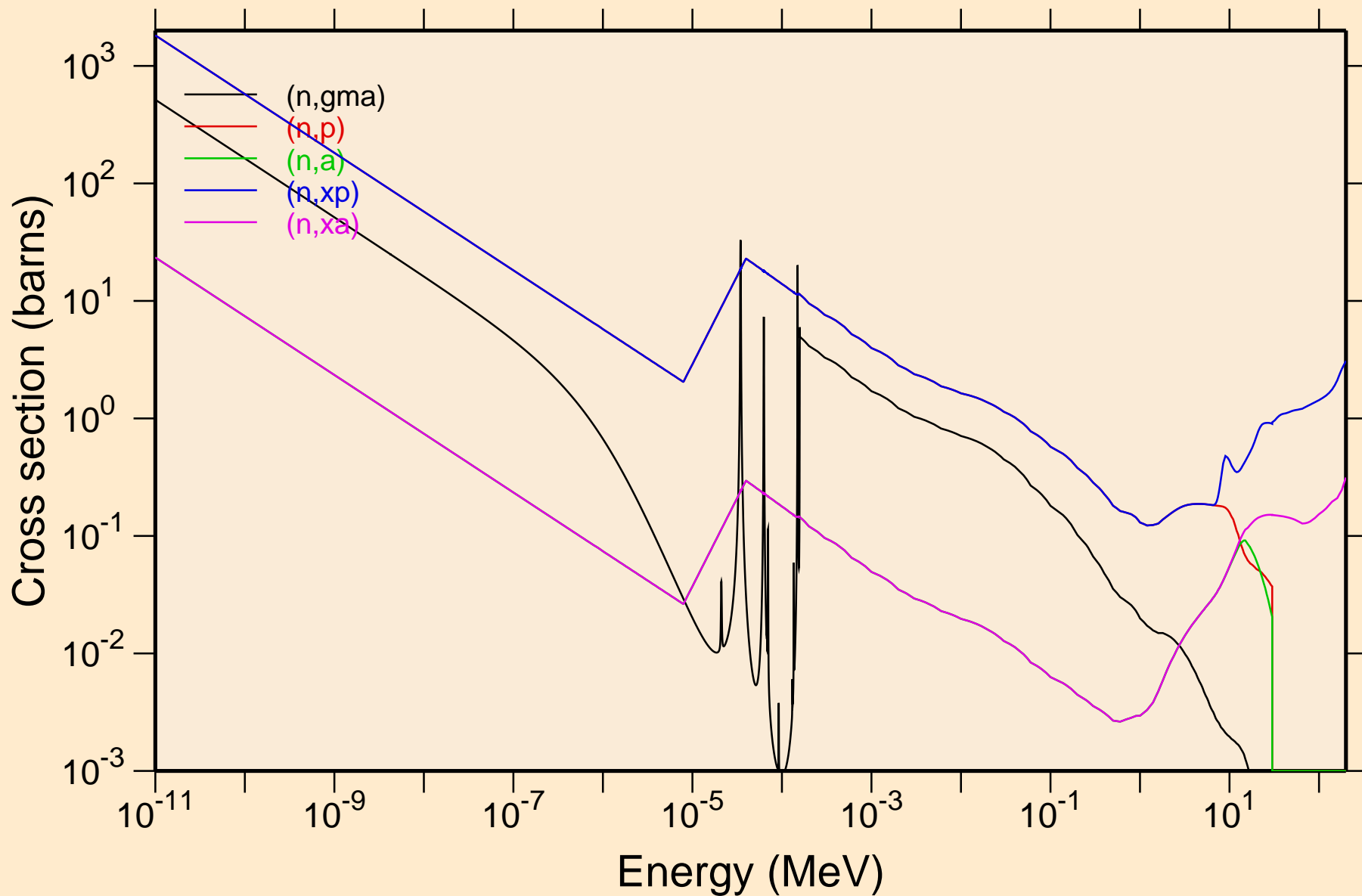

TC094M NEUTRON ACER TENDL-2019 LIBRARY; T=293.16K  
Principal cross sections

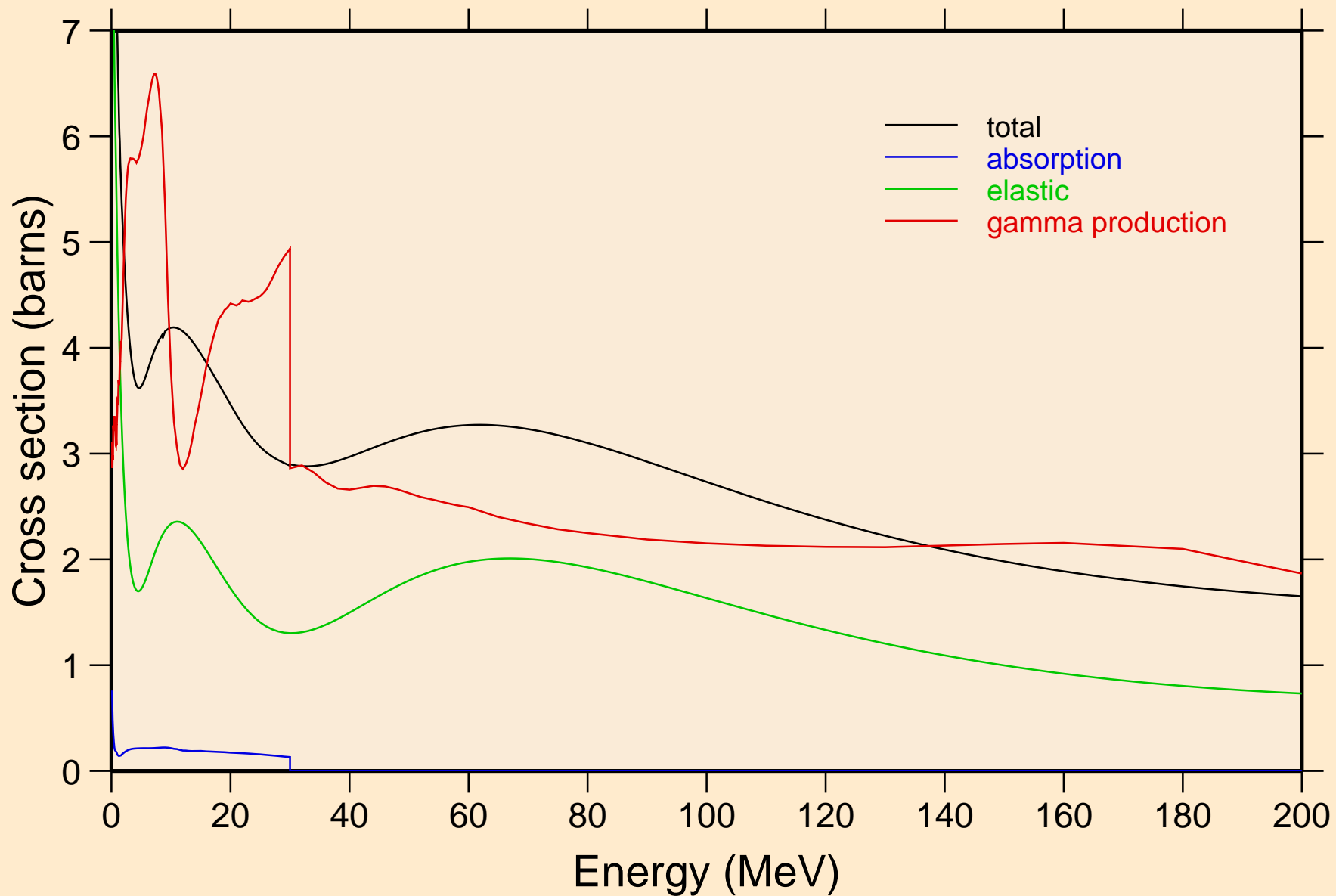

TC094M NEUTRON ACER TENDL-2019 LIBRARY; T=293.16K  
Heating

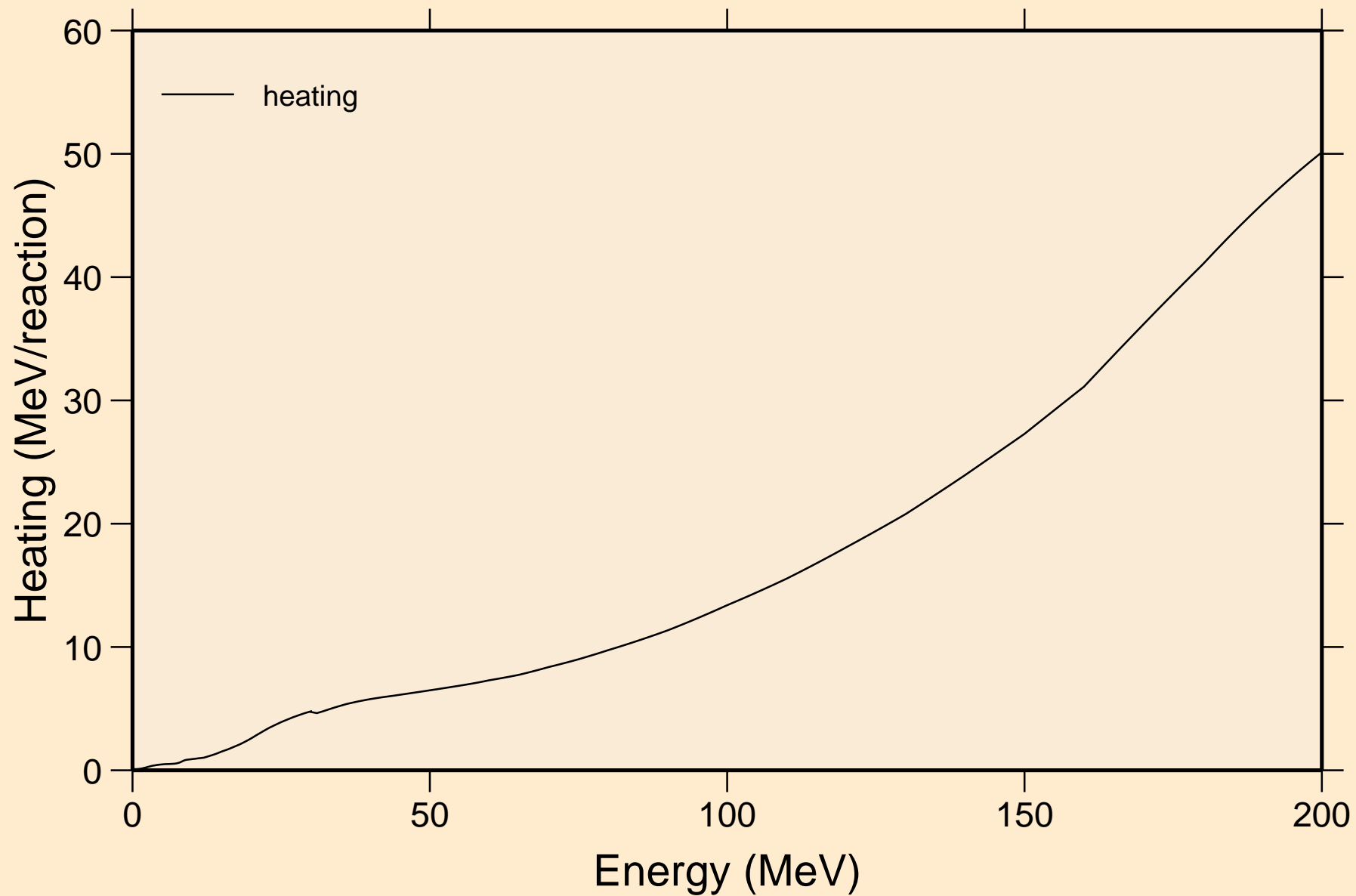

TC094M NEUTRON ACER TENDL-2019 LIBRARY; T=293.16K  
Damage

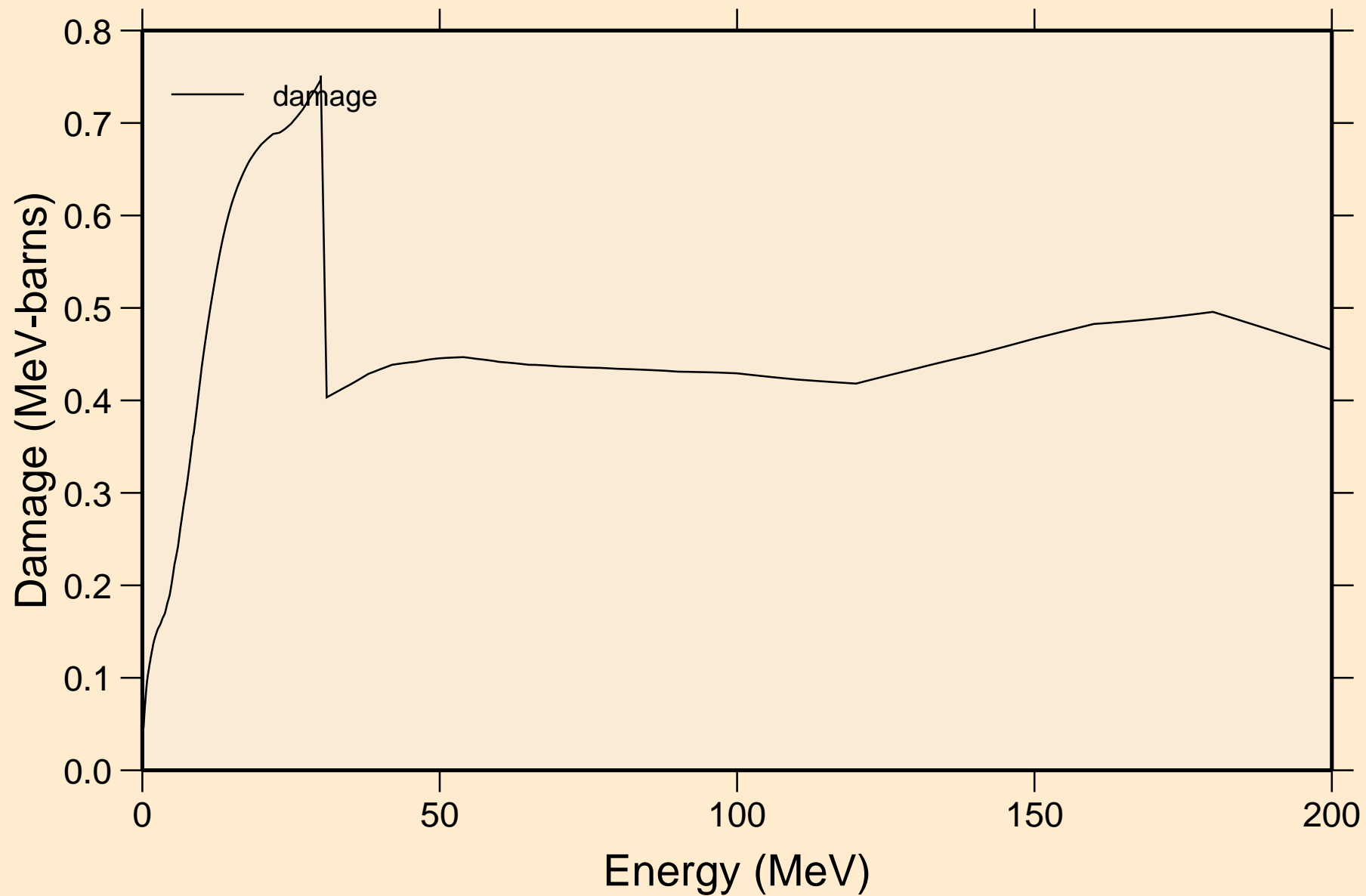

TC094M NEUTRON ACER TENDL-2019 LIBRARY; T=293.16K  
Non-threshold reactions

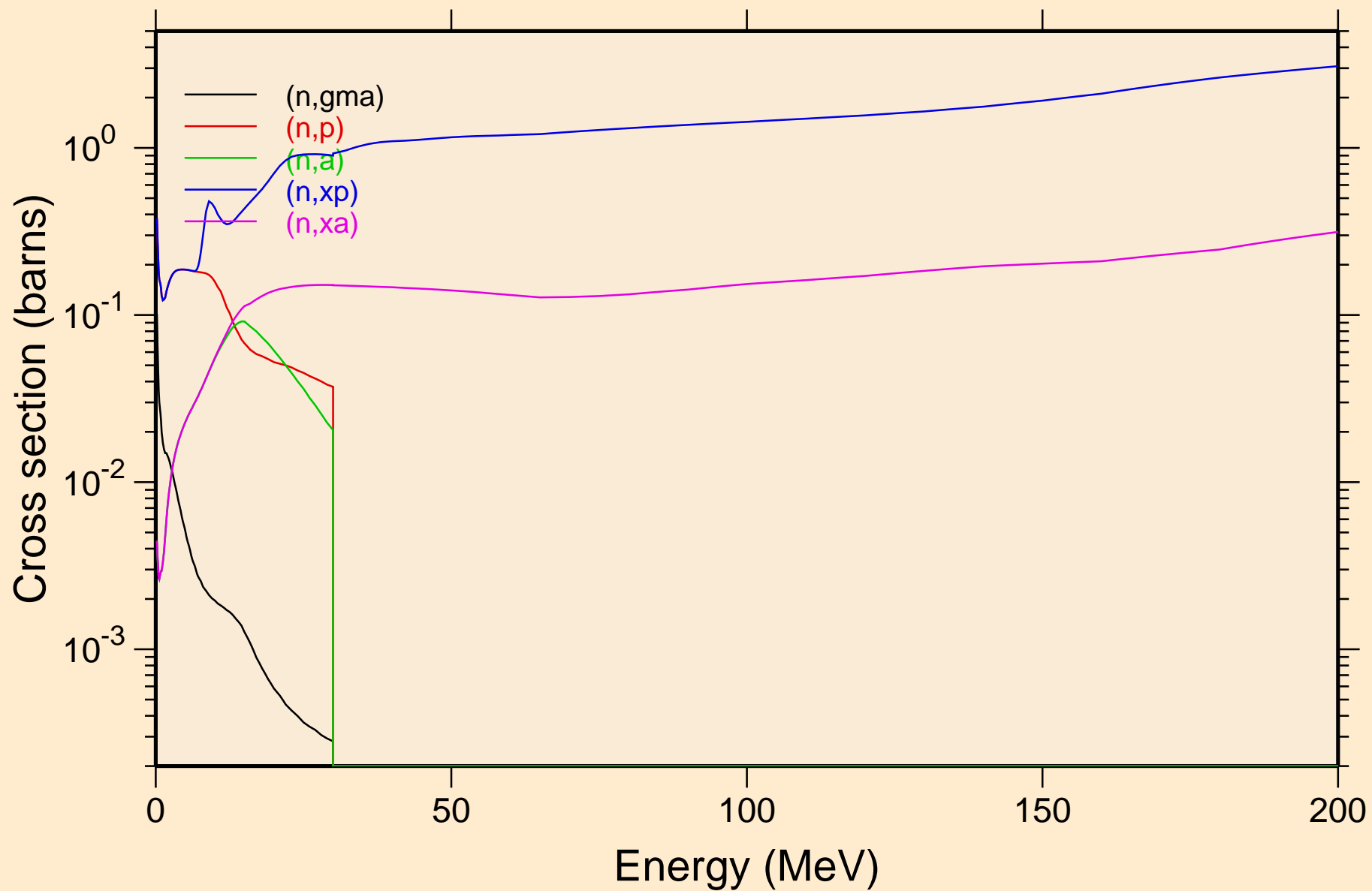

TC094M NEUTRON ACER TENDL-2019 LIBRARY; T=293.16K  
Inelastic levels

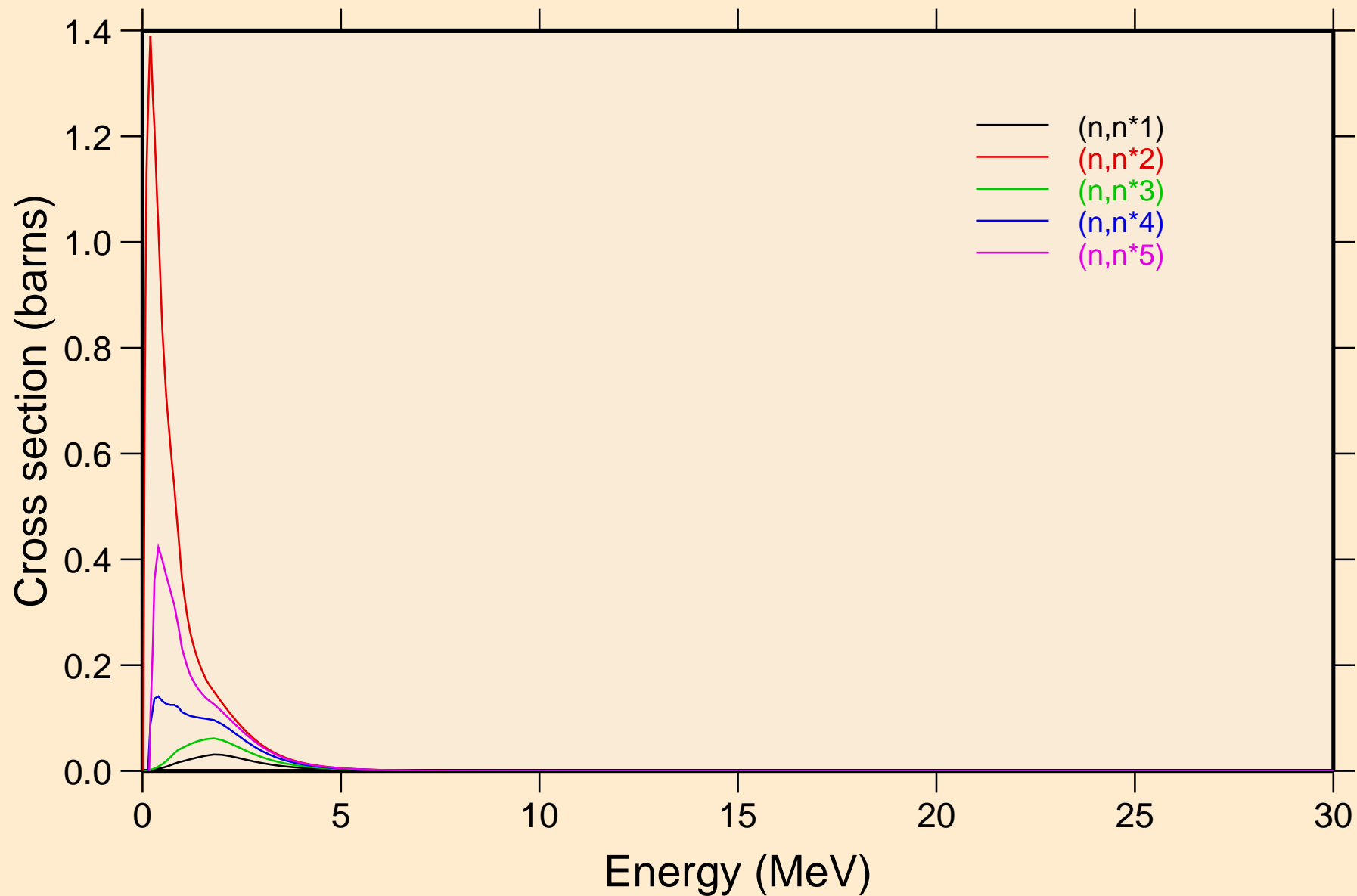

TC094M NEUTRON ACER TENDL-2019 LIBRARY; T=293.16K  
Inelastic levels

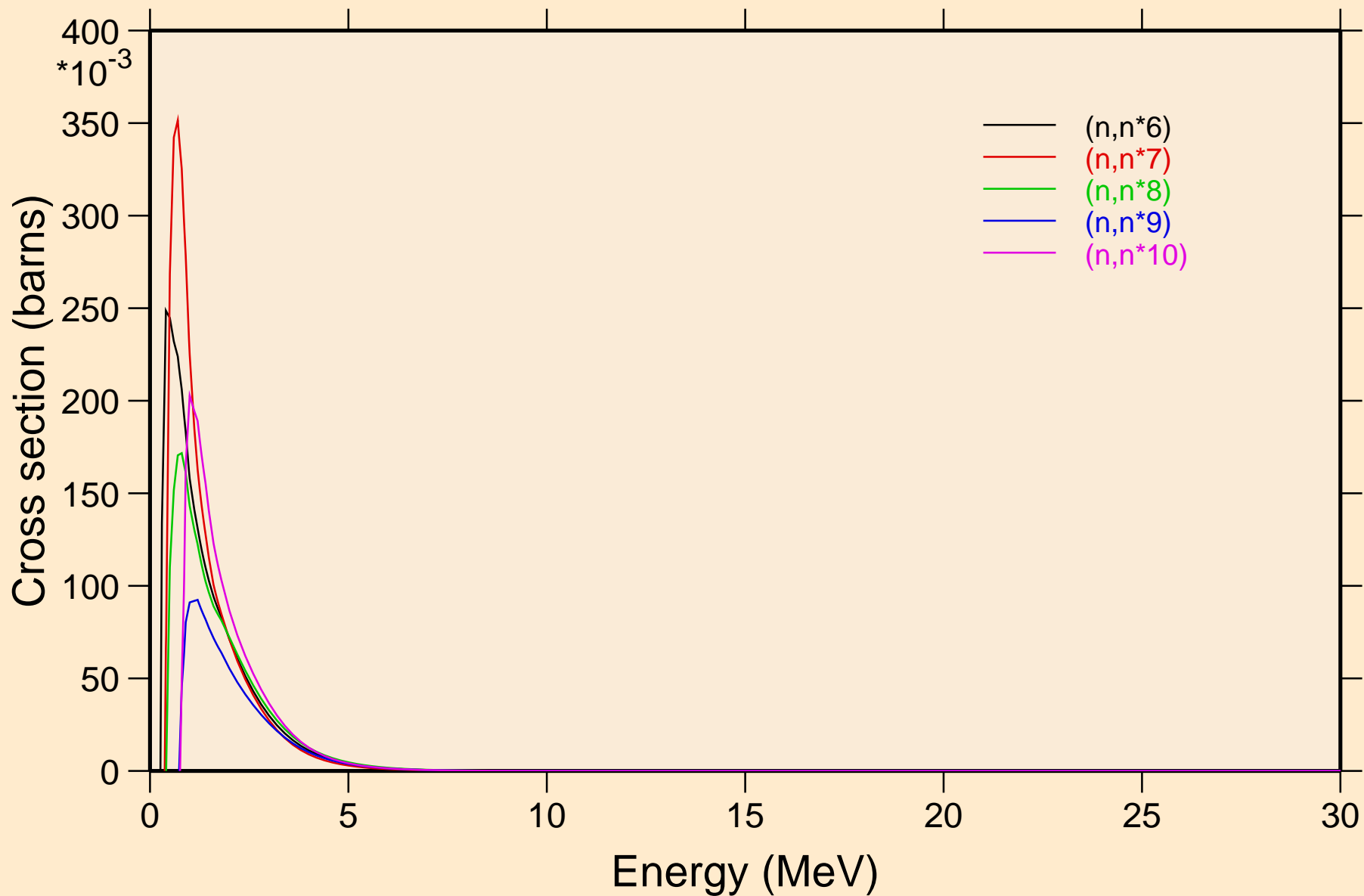



TC094M NEUTRON ACER TENDL-2019 LIBRARY; T=293.16K  
Inelastic levels

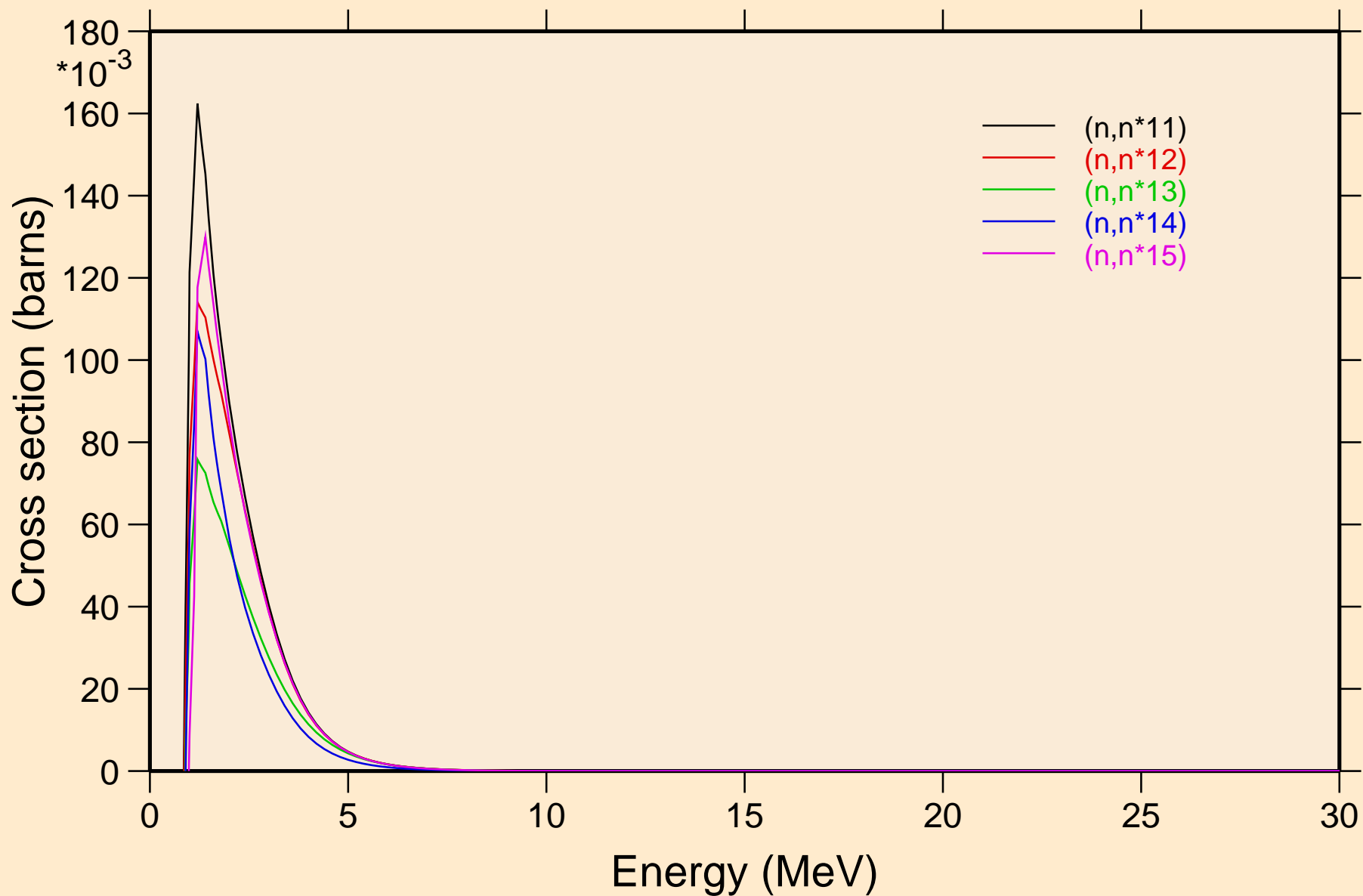

TC094M NEUTRON ACER TENDL-2019 LIBRARY; T=293.16K  
Inelastic levels

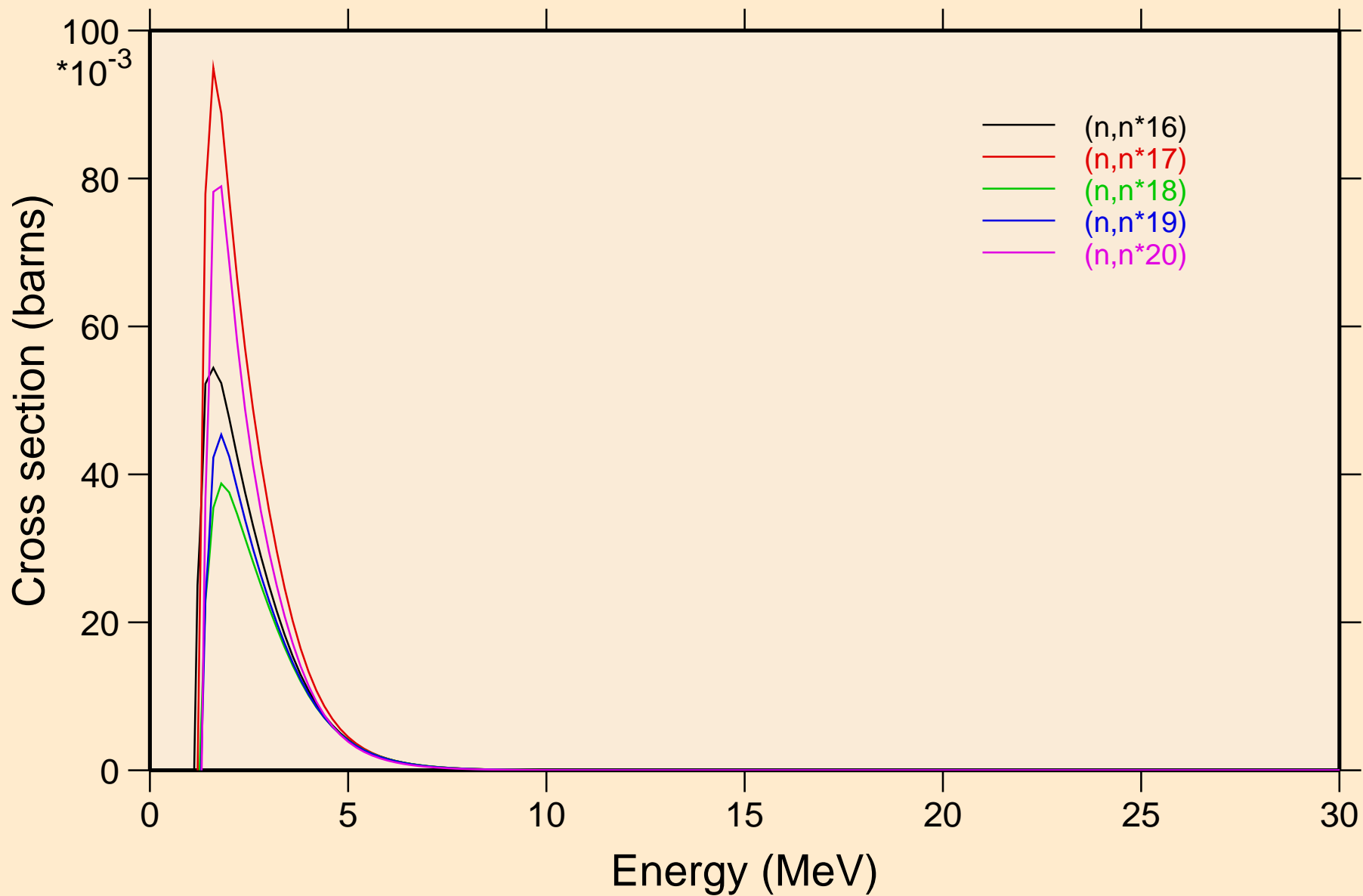

TC094M NEUTRON ACER TENDL-2019 LIBRARY; T=293.16K  
Inelastic levels

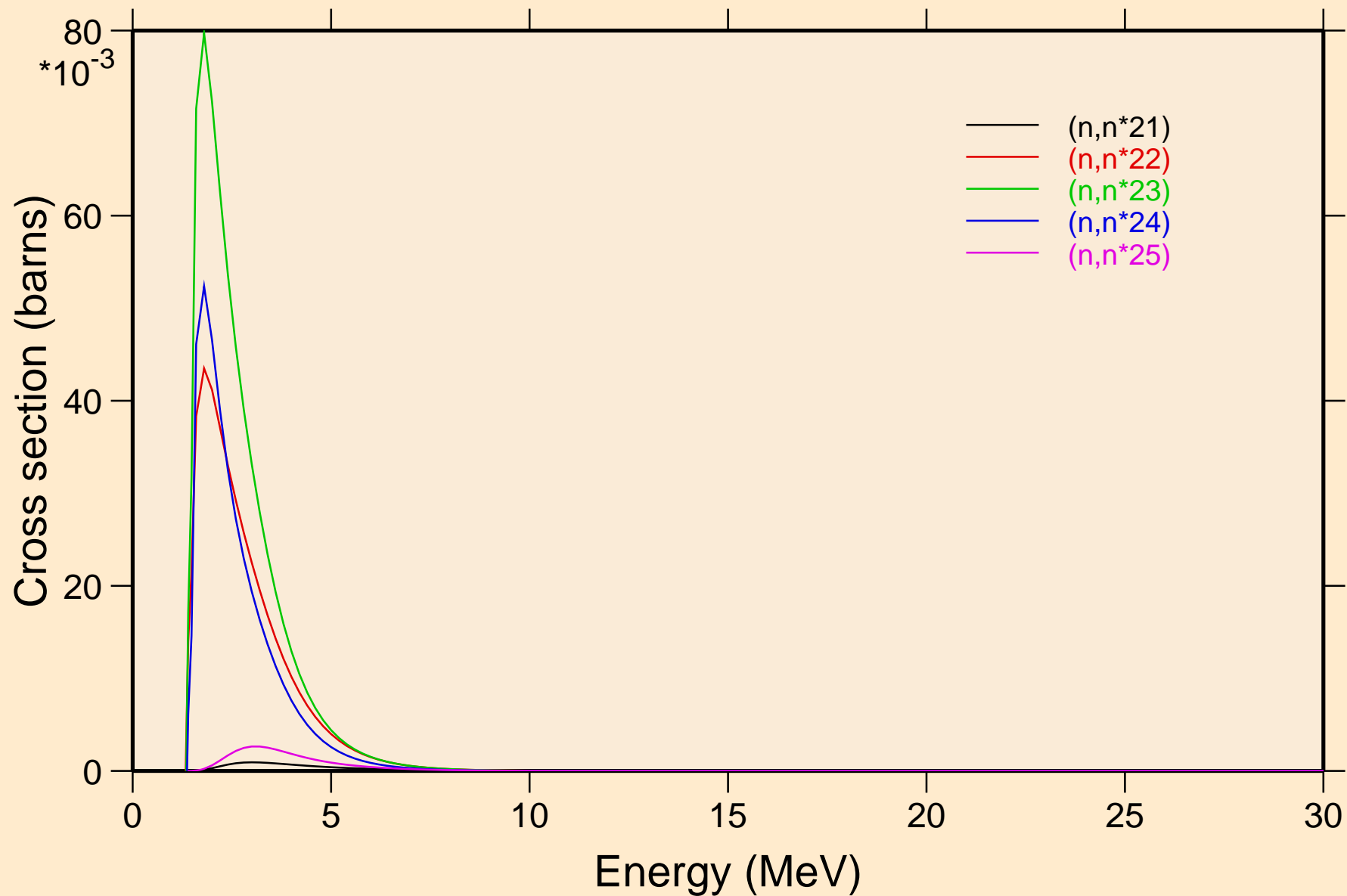

TC094M NEUTRON ACER TENDL-2019 LIBRARY; T=293.16K  
Inelastic levels

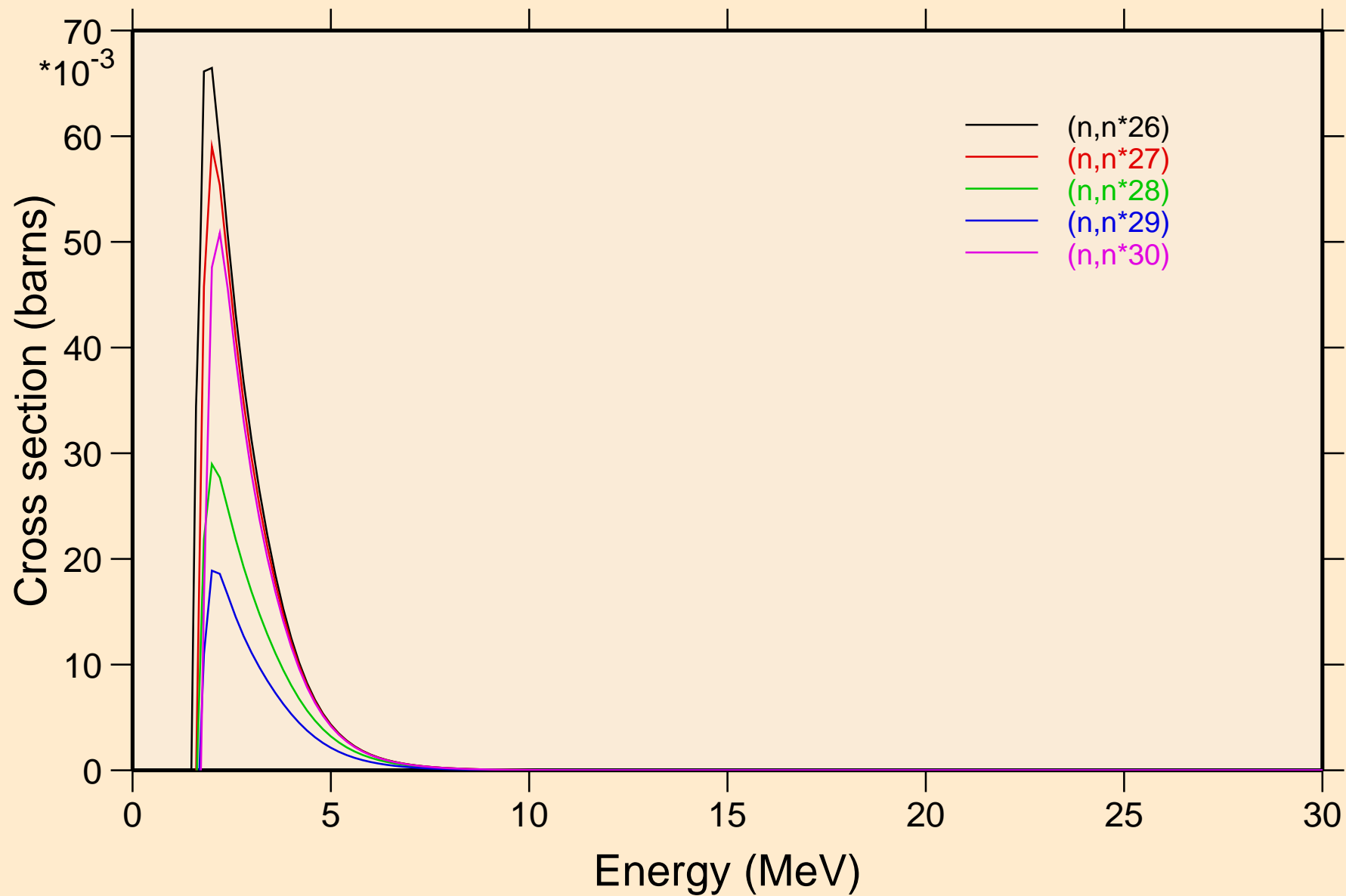

TC094M NEUTRON ACER TENDL-2019 LIBRARY; T=293.16K  
Threshold reactions

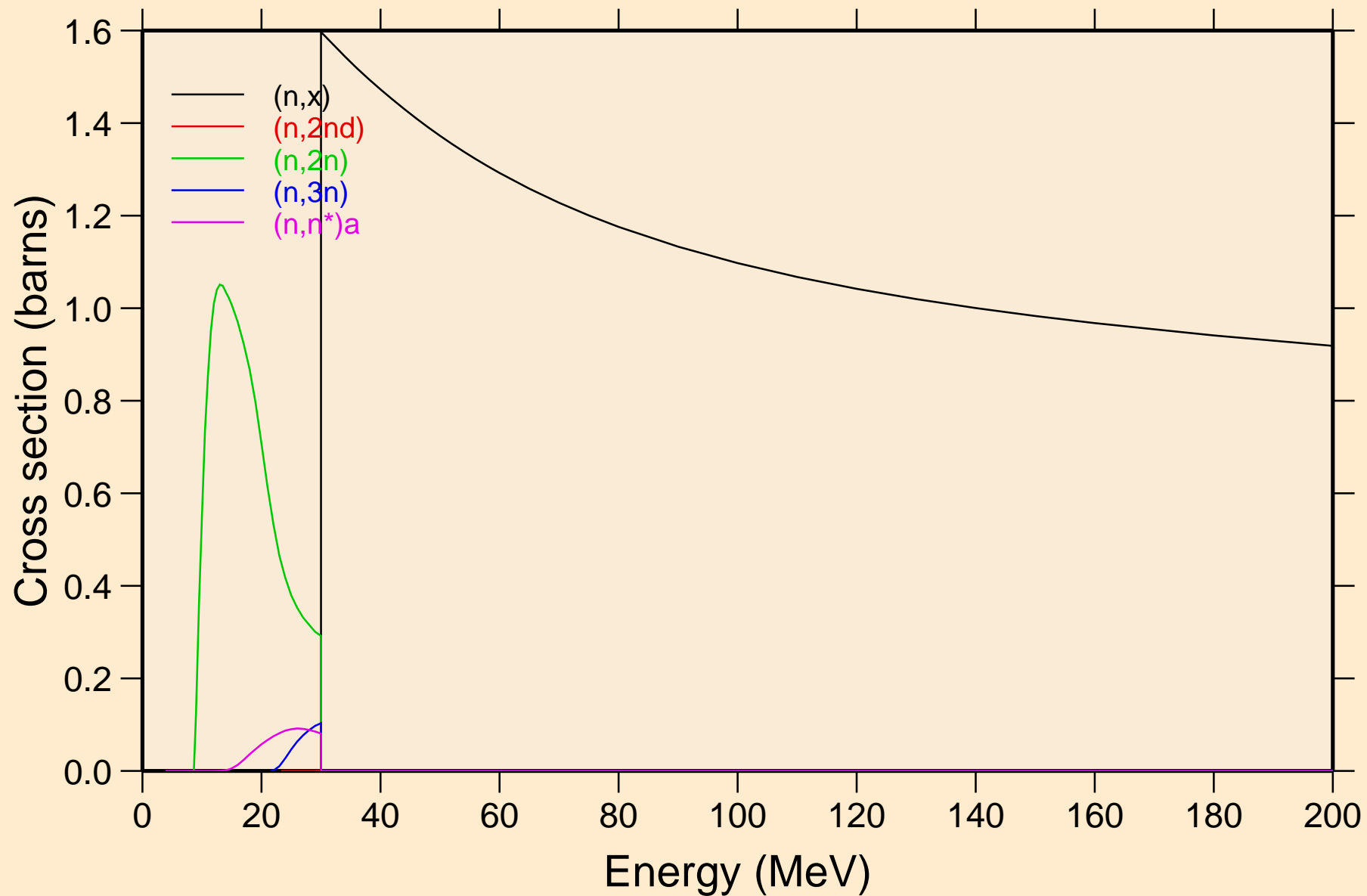

TC094M NEUTRON ACER TENDL-2019 LIBRARY; T=293.16K  
Threshold reactions

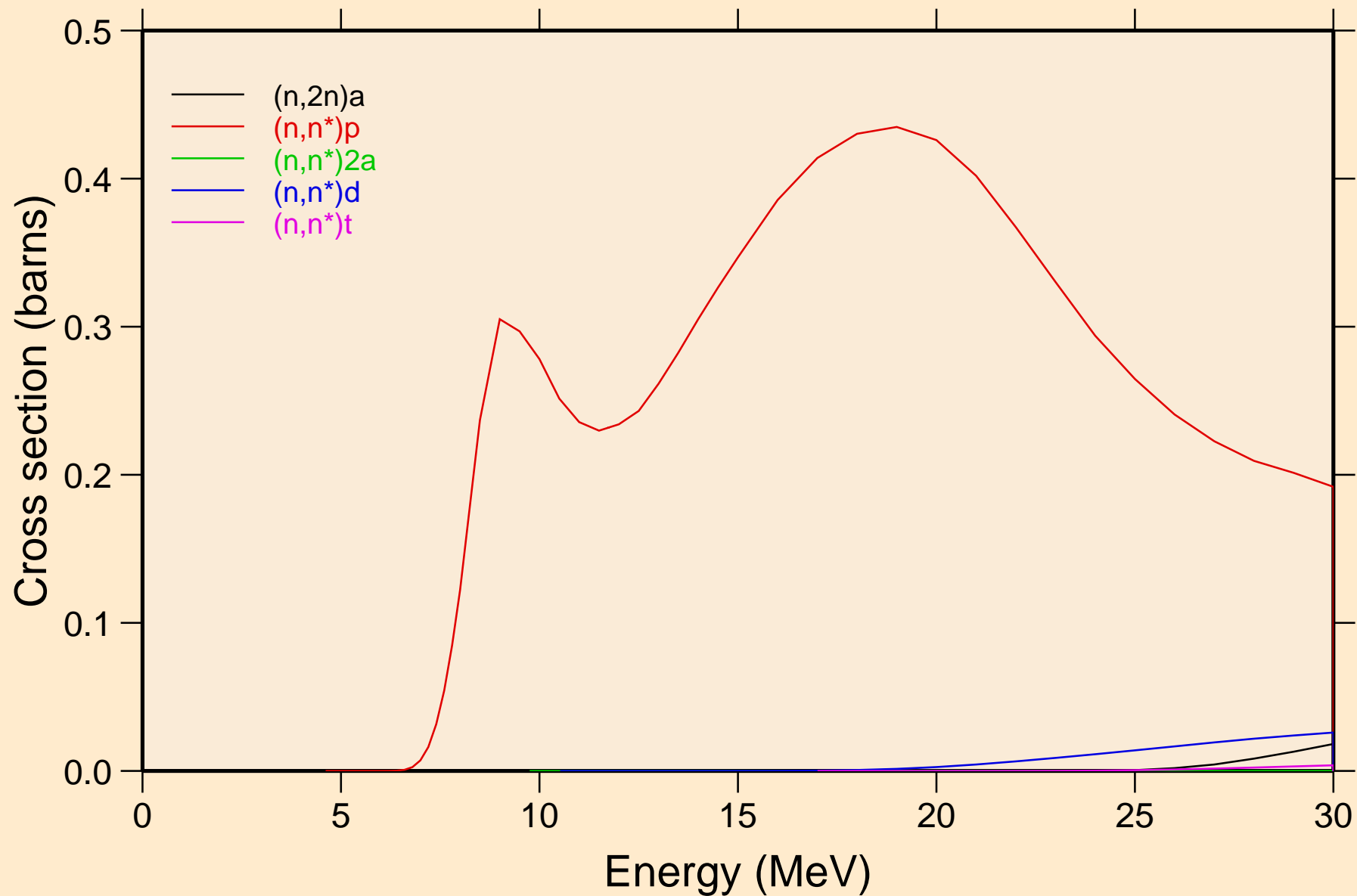

TC094M NEUTRON ACER TENDL-2019 LIBRARY; T=293.16K  
Threshold reactions

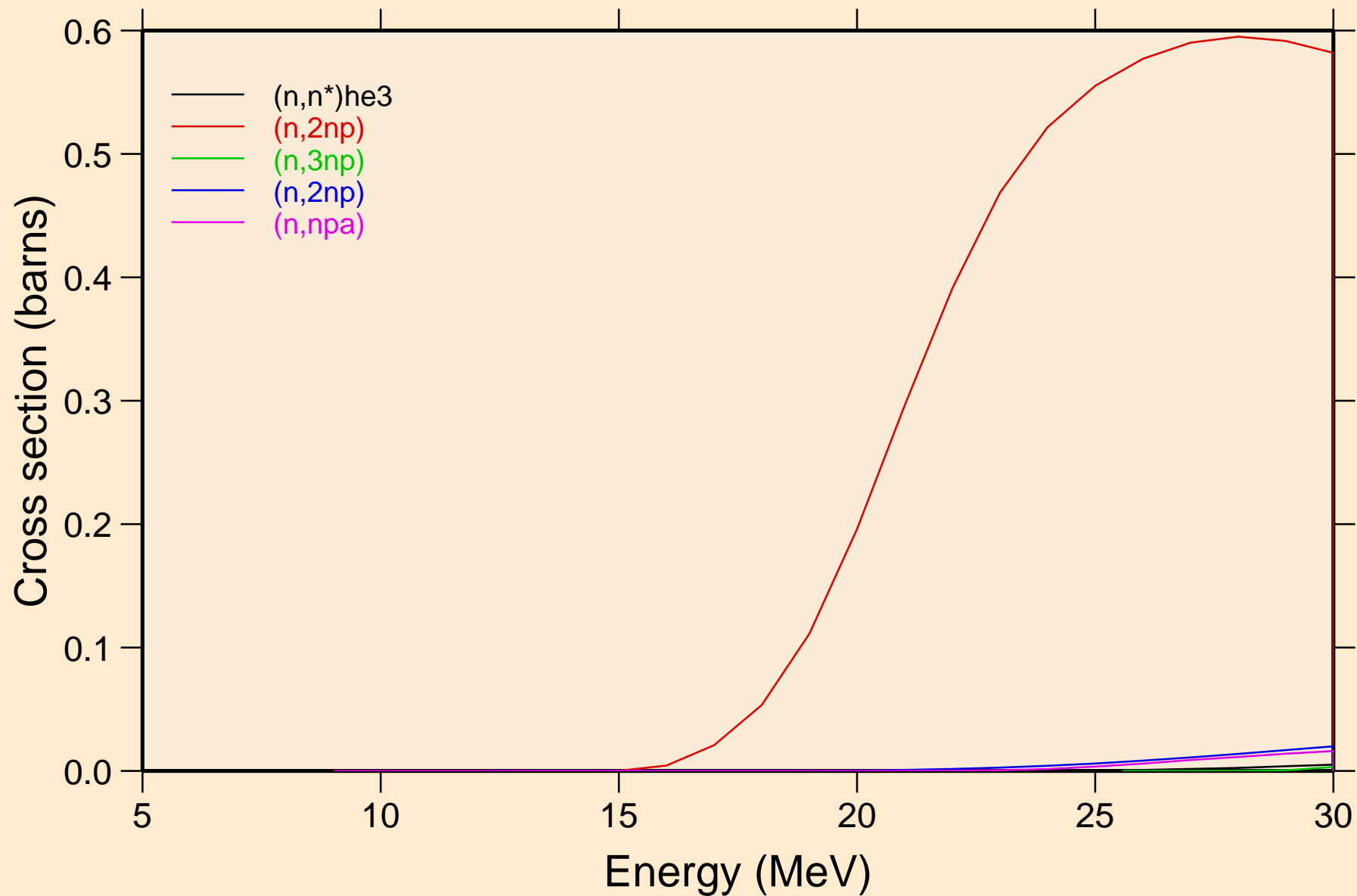

TC094M NEUTRON ACER TENDL-2019 LIBRARY; T=293.16K  
Threshold reactions

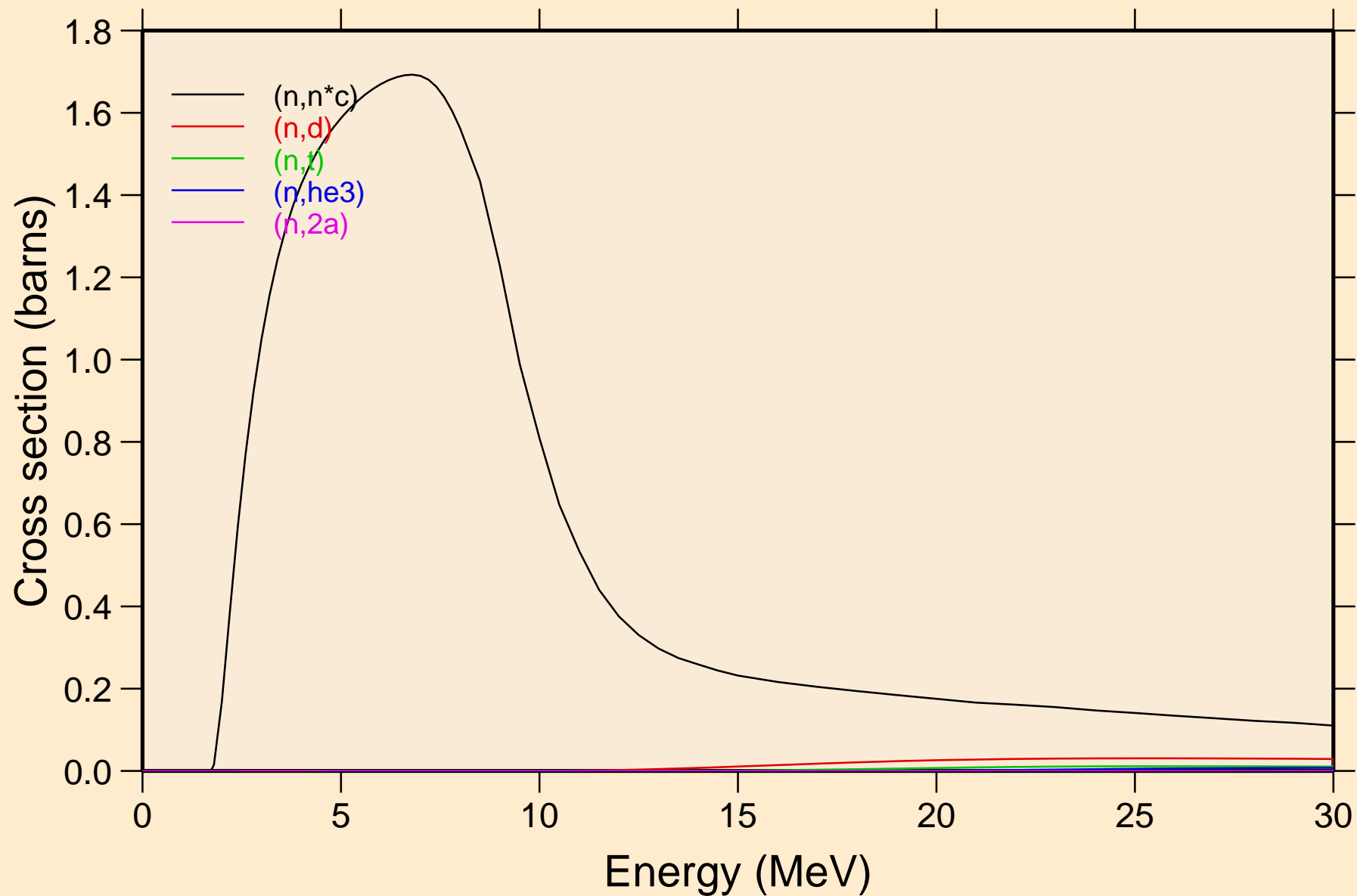



TC094M NEUTRON ACER TENDL-2019 LIBRARY; T=293.16K  
Threshold reactions

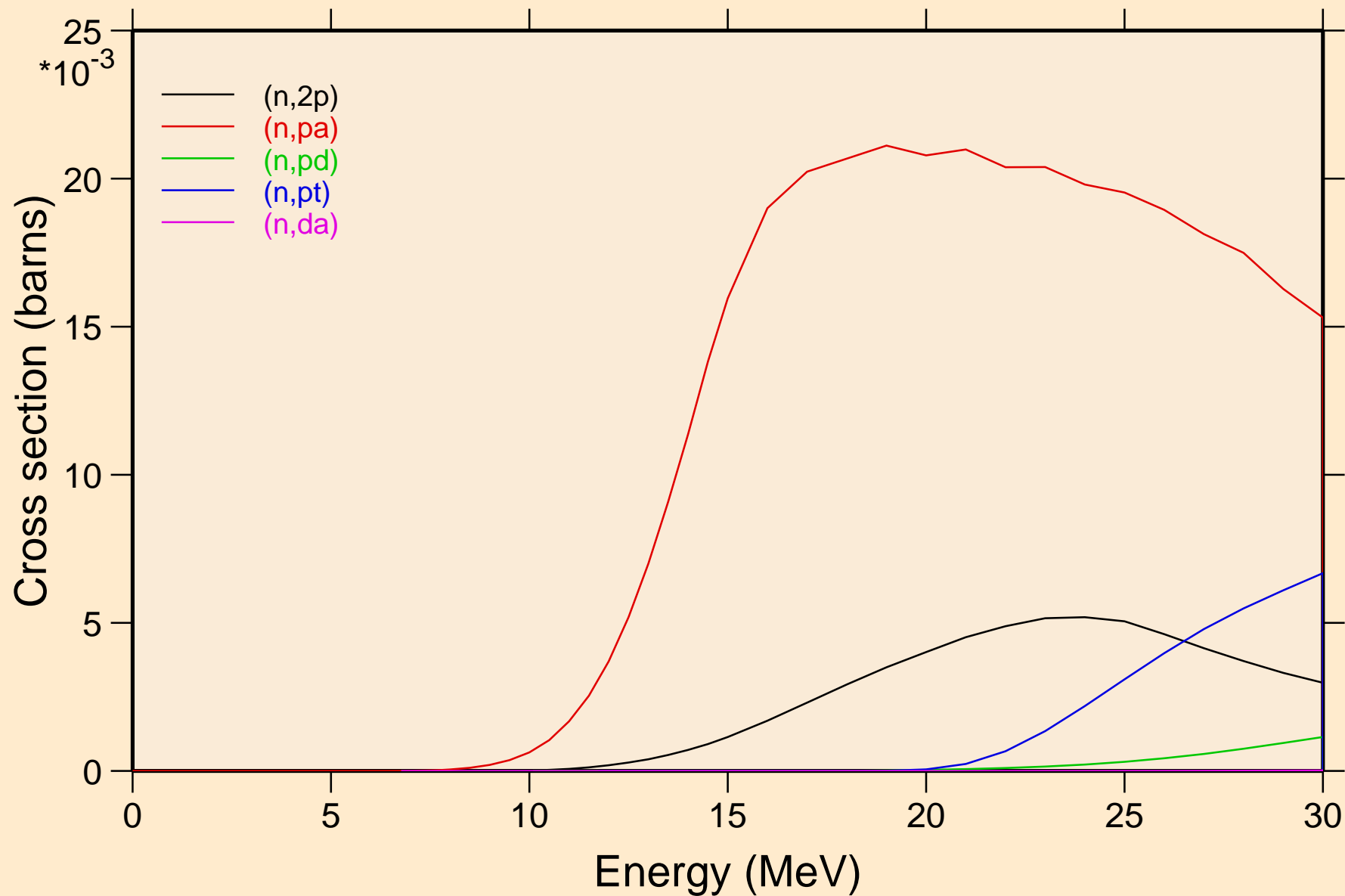

TC094M NEUTRON ACER TENDL-2019 LIBRARY; T=293.16K  
Threshold reactions

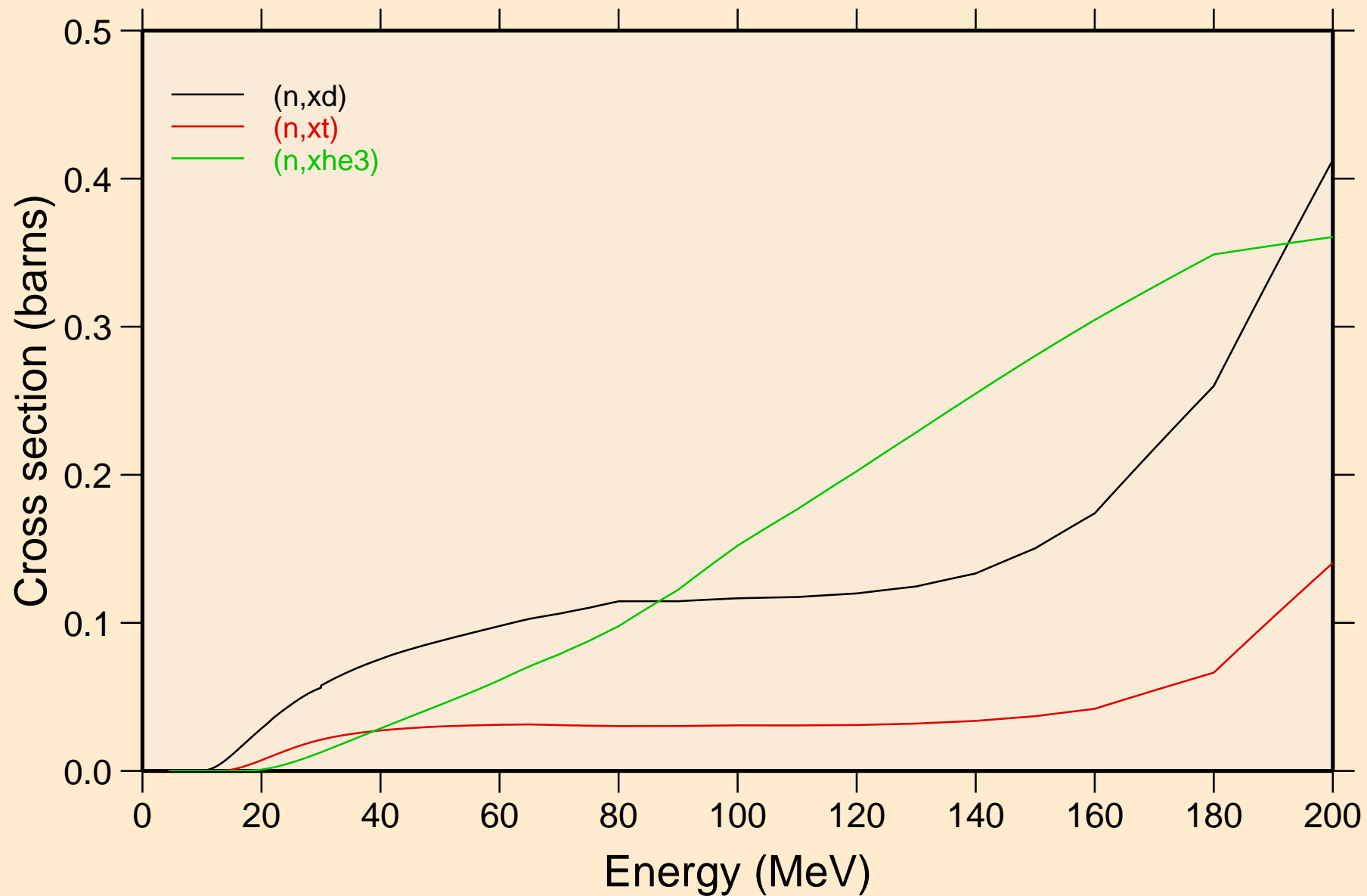

TC094M NEUTRON ACER TENDL-2019 LIBRARY; T=293.16K  
angular distribution for elastic

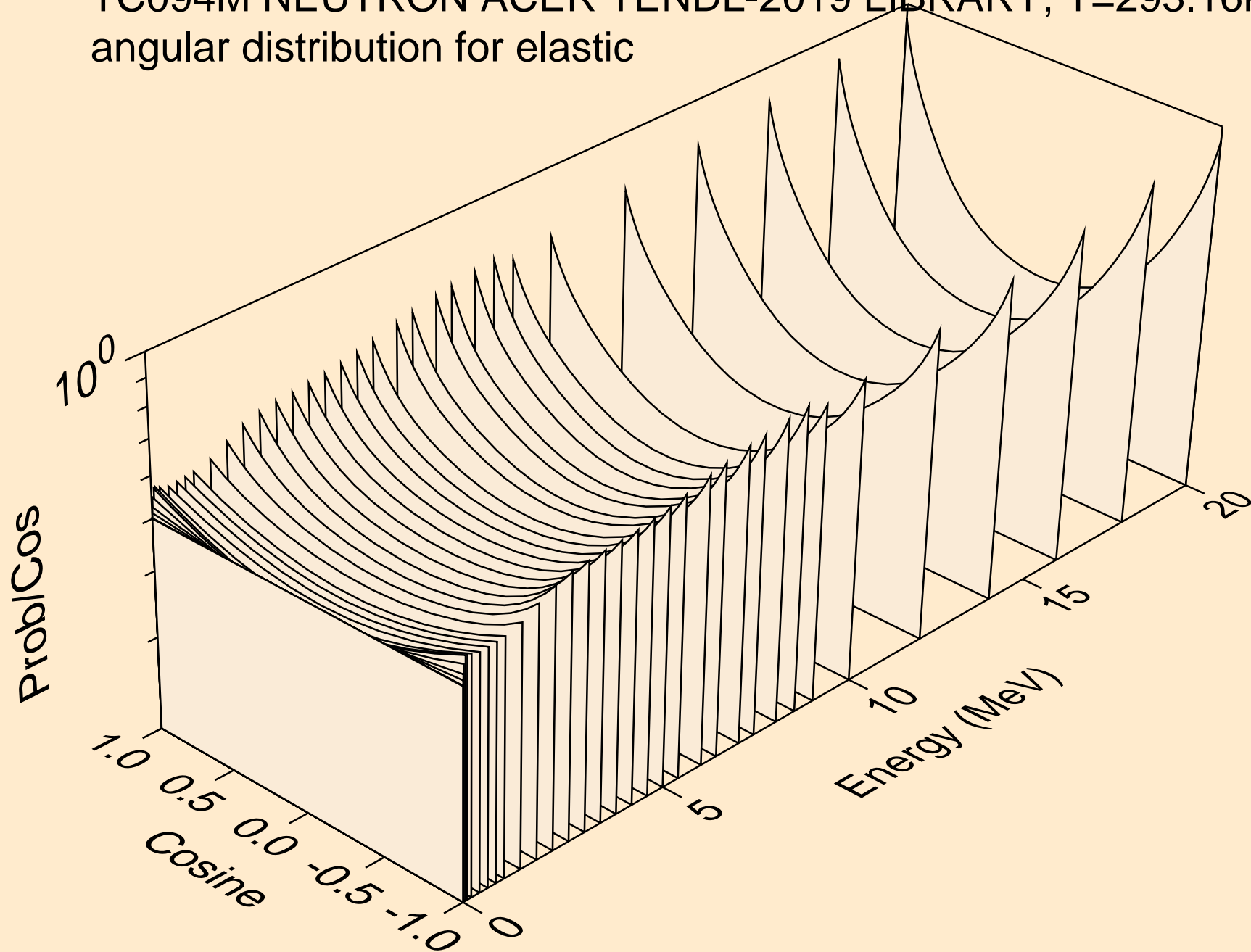

TC094M NEUTRON ACER TENDL-2019 LIBRARY; T=293.16K  
angular distribution for elastic

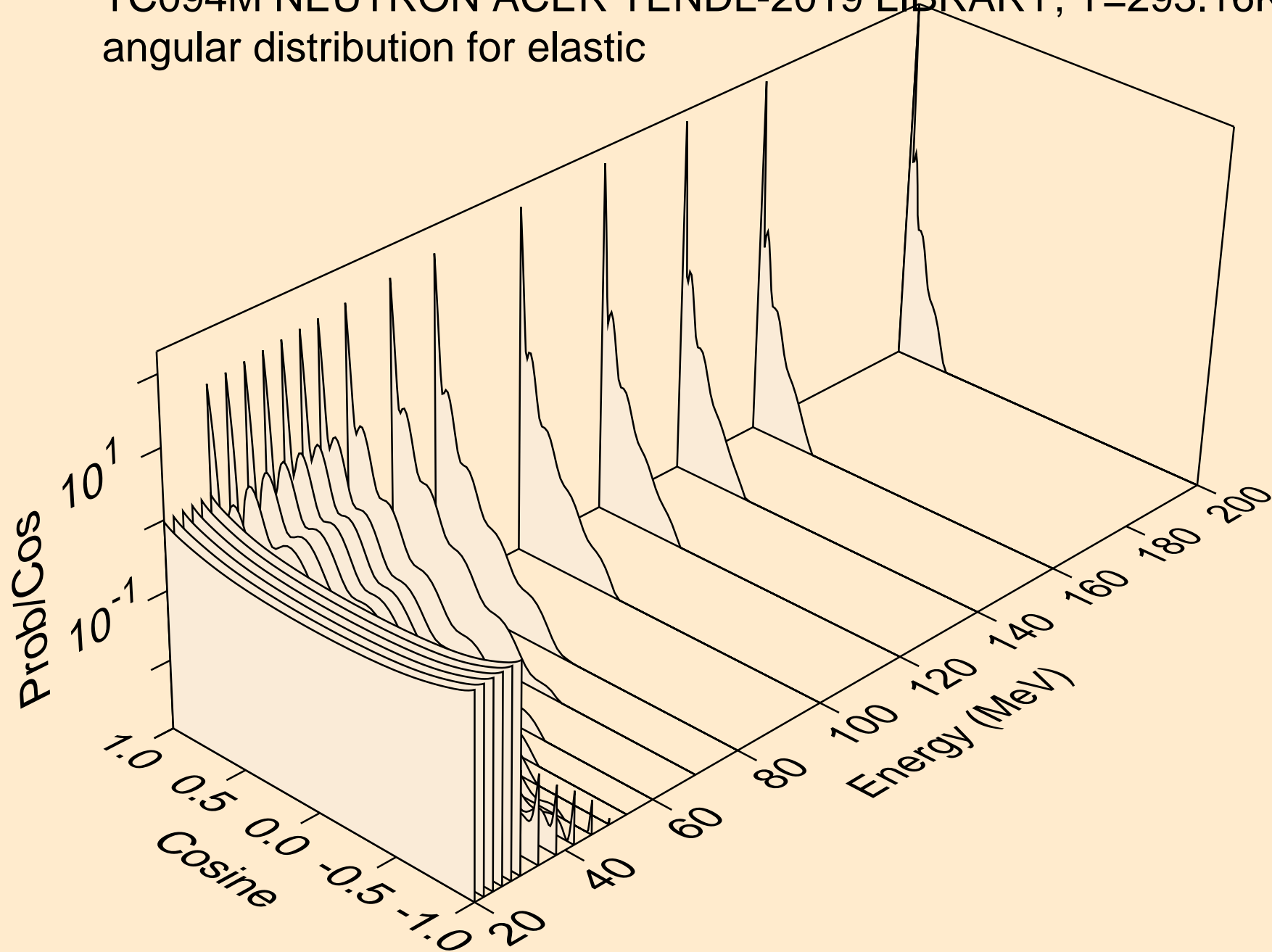

TC094M NEUTRON ACER TENDL-2019 LIBRARY; T=293.16K  
angular distribution for (n,n\*1)

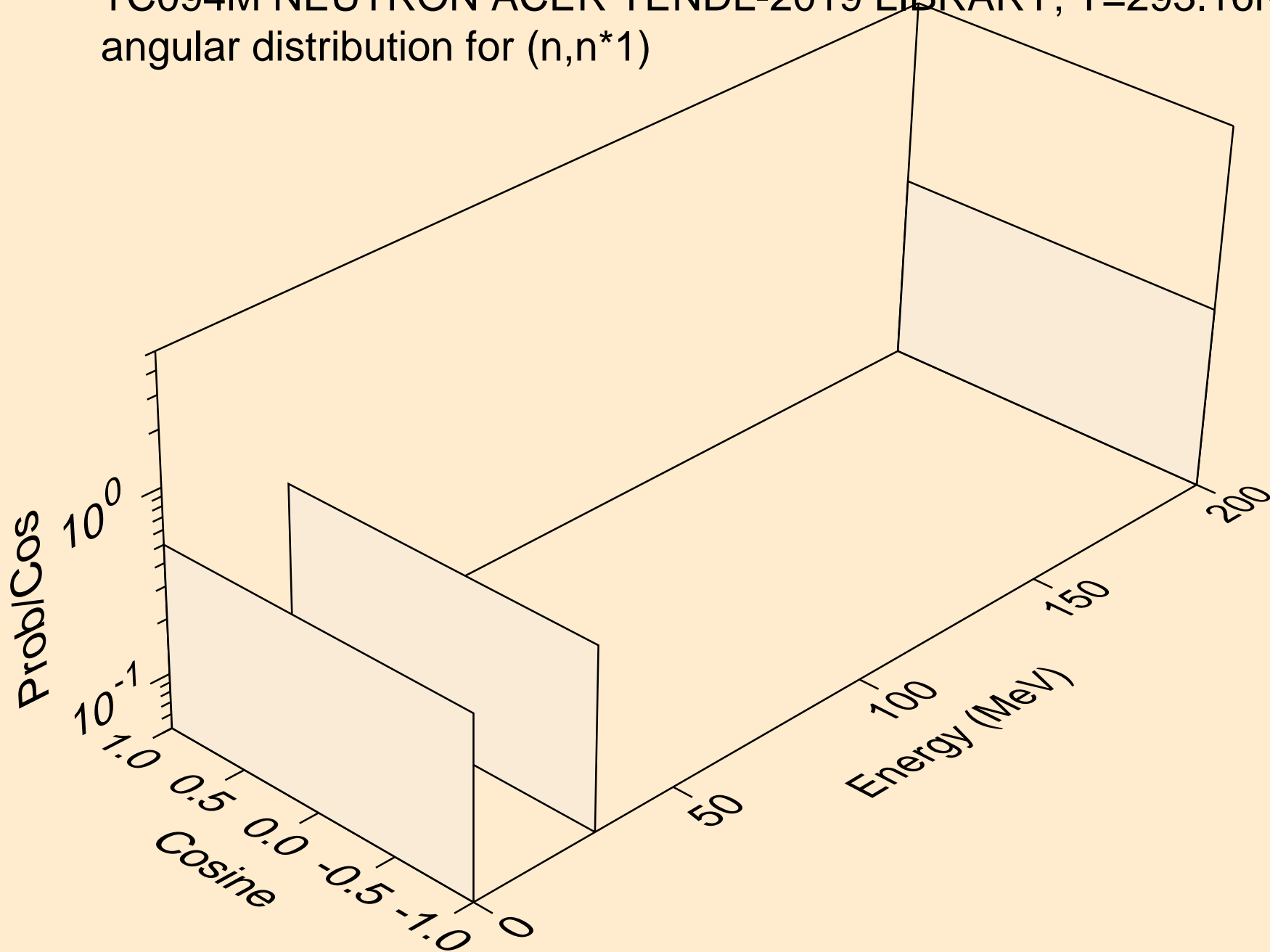

TC094M NEUTRON ACER TENDL-2019 LIBRARY; T=293.16K  
angular distribution for (n,n\*2)

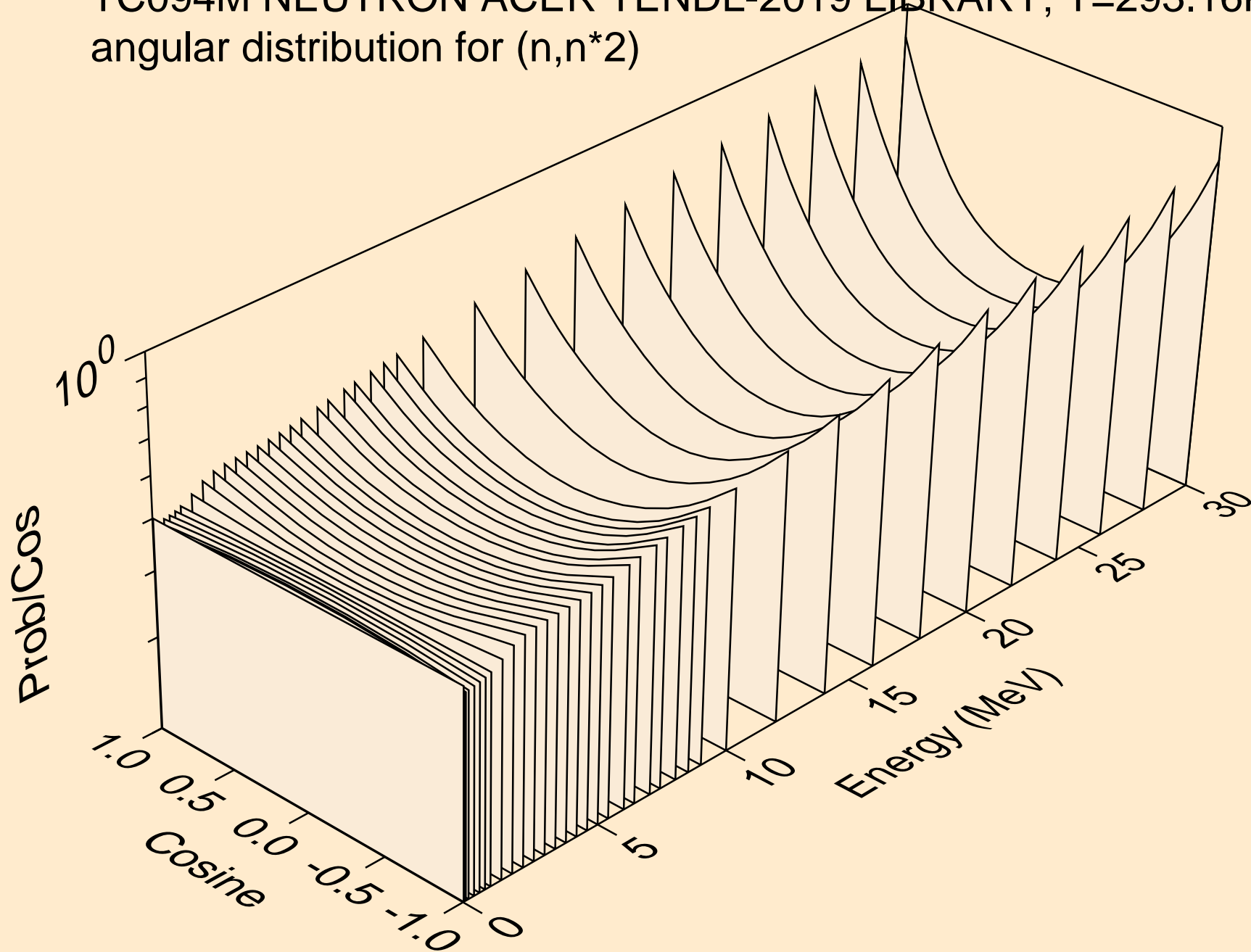

TC094M NEUTRON ACER TENDL-2019 LIBRARY; T=293.16K  
angular distribution for (n,n\*3)

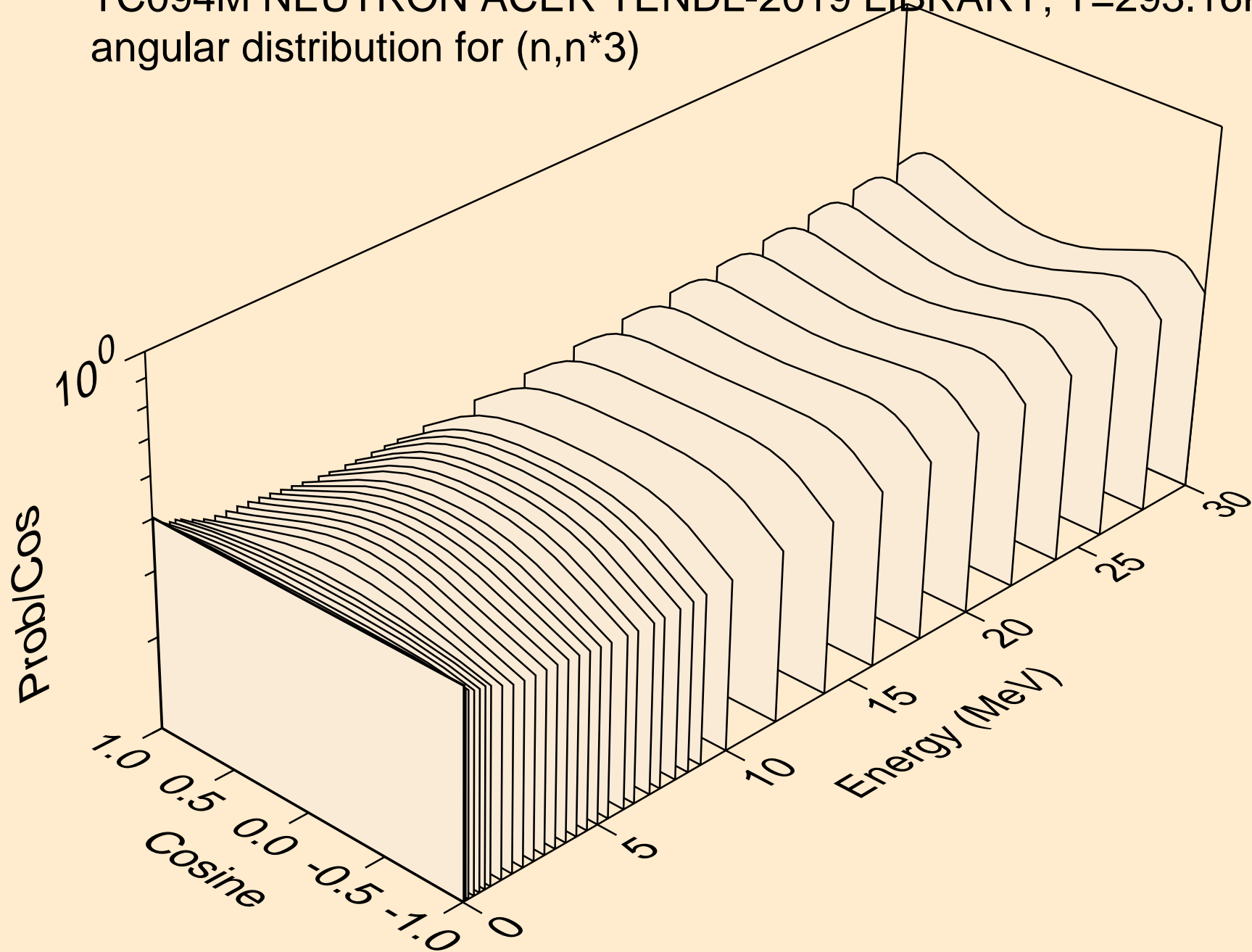

TC094M NEUTRON ACER TENDL-2019 LIBRARY; T=293.16K  
angular distribution for (n,n\*4)

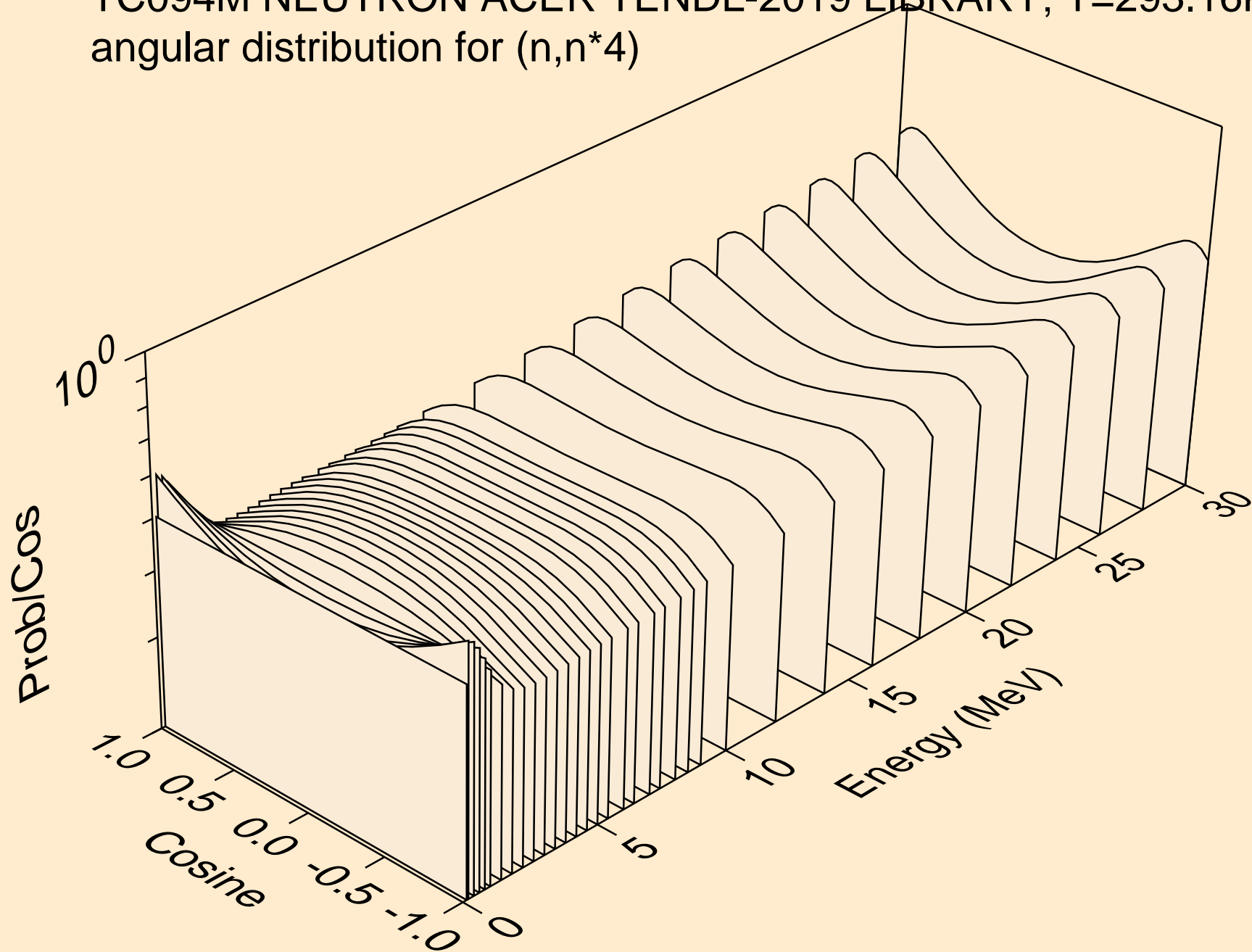



TC094M NEUTRON ACER TENDL-2019 LIBRARY; T=293.16K  
angular distribution for (n,n\*5)

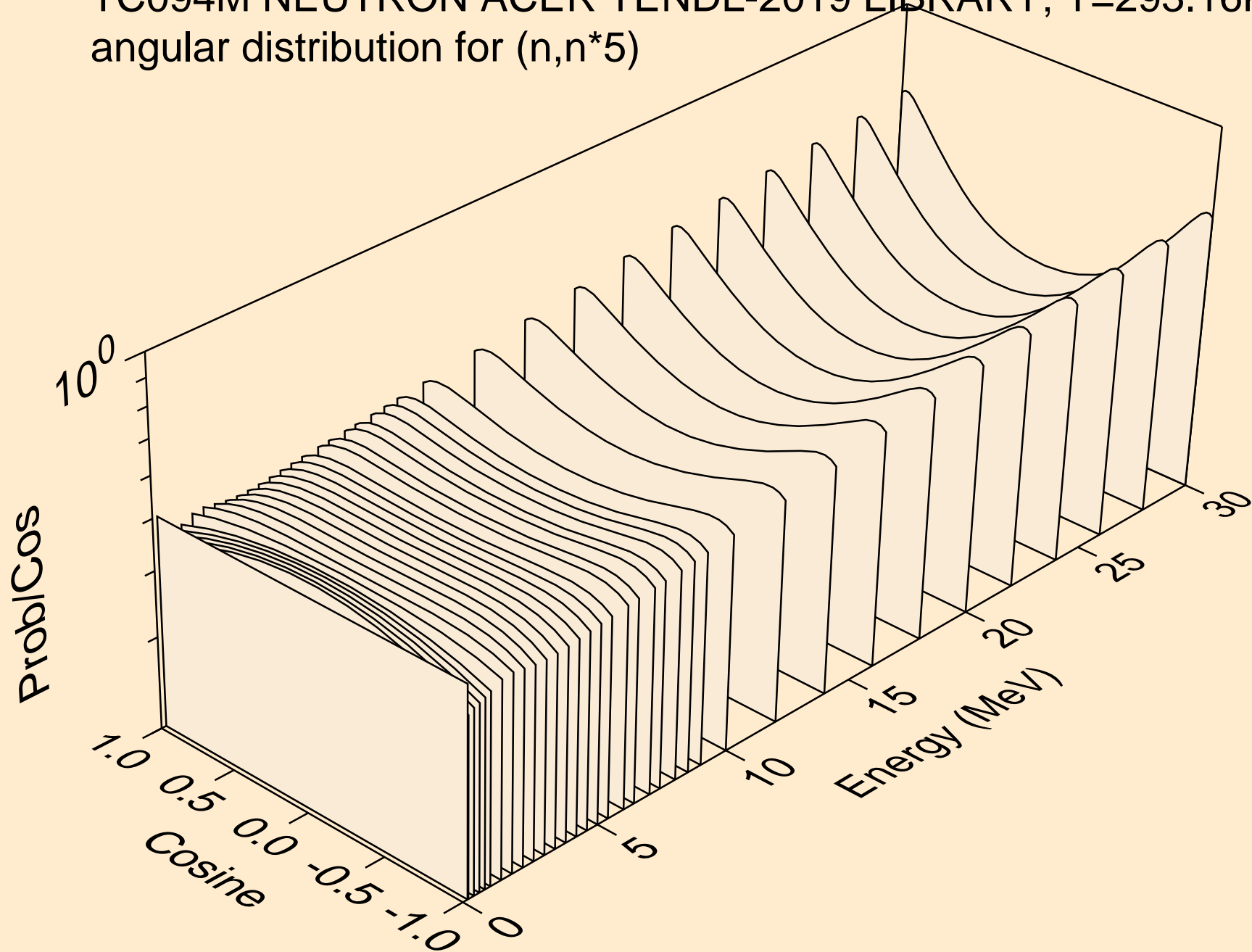

TC094M NEUTRON ACER TENDL-2019 LIBRARY; T=293.16K  
angular distribution for (n,n\*6)

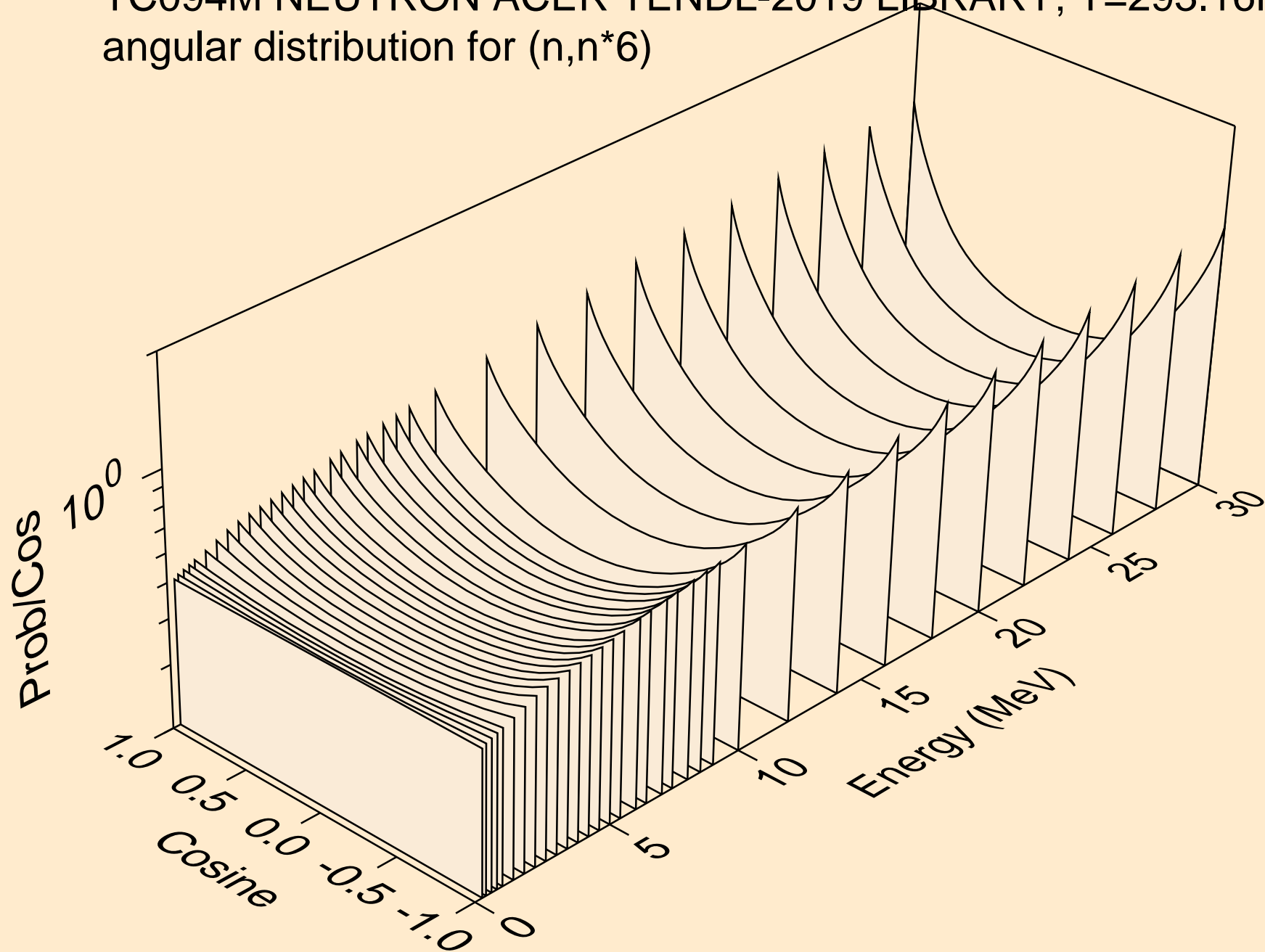

TC094M NEUTRON ACER TENDL-2019 LIBRARY; T=293.16K  
angular distribution for (n,n\*7)

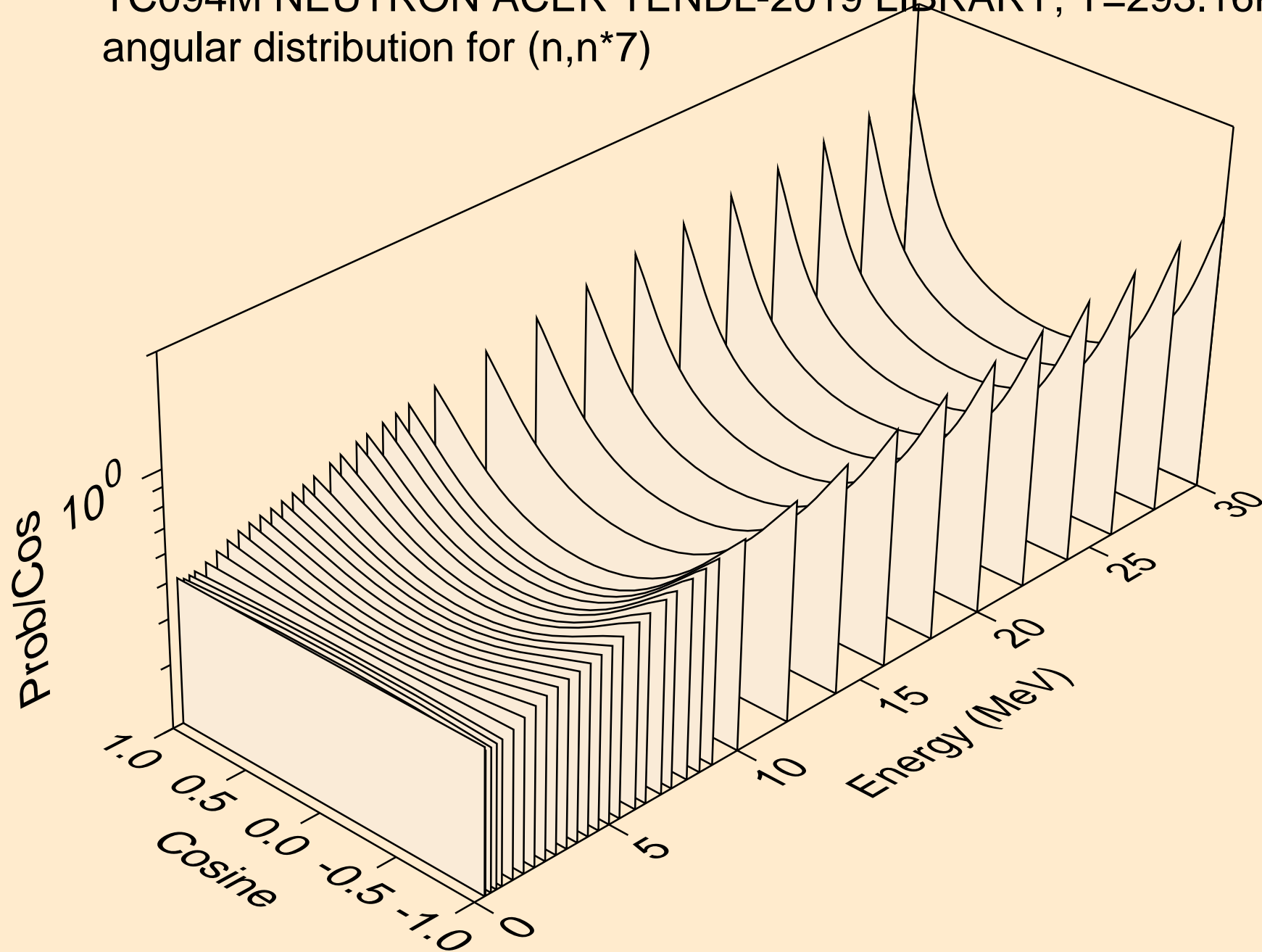

TC094M NEUTRON ACER TENDL-2019 LIBRARY; T=293.16K  
angular distribution for (n,n\*8)

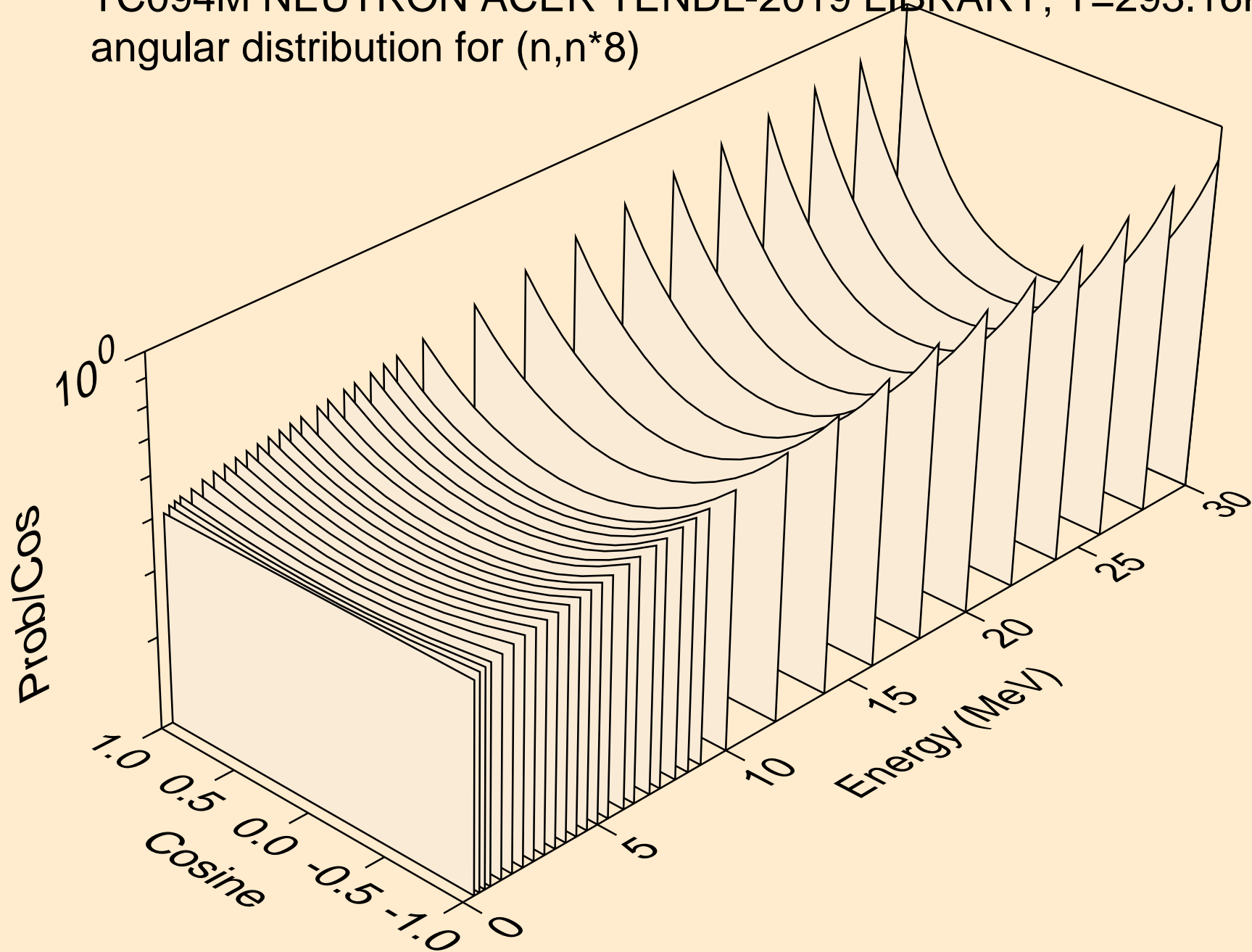

TC094M NEUTRON ACER TENDL-2019 LIBRARY; T=293.16K  
angular distribution for (n,n\*9)

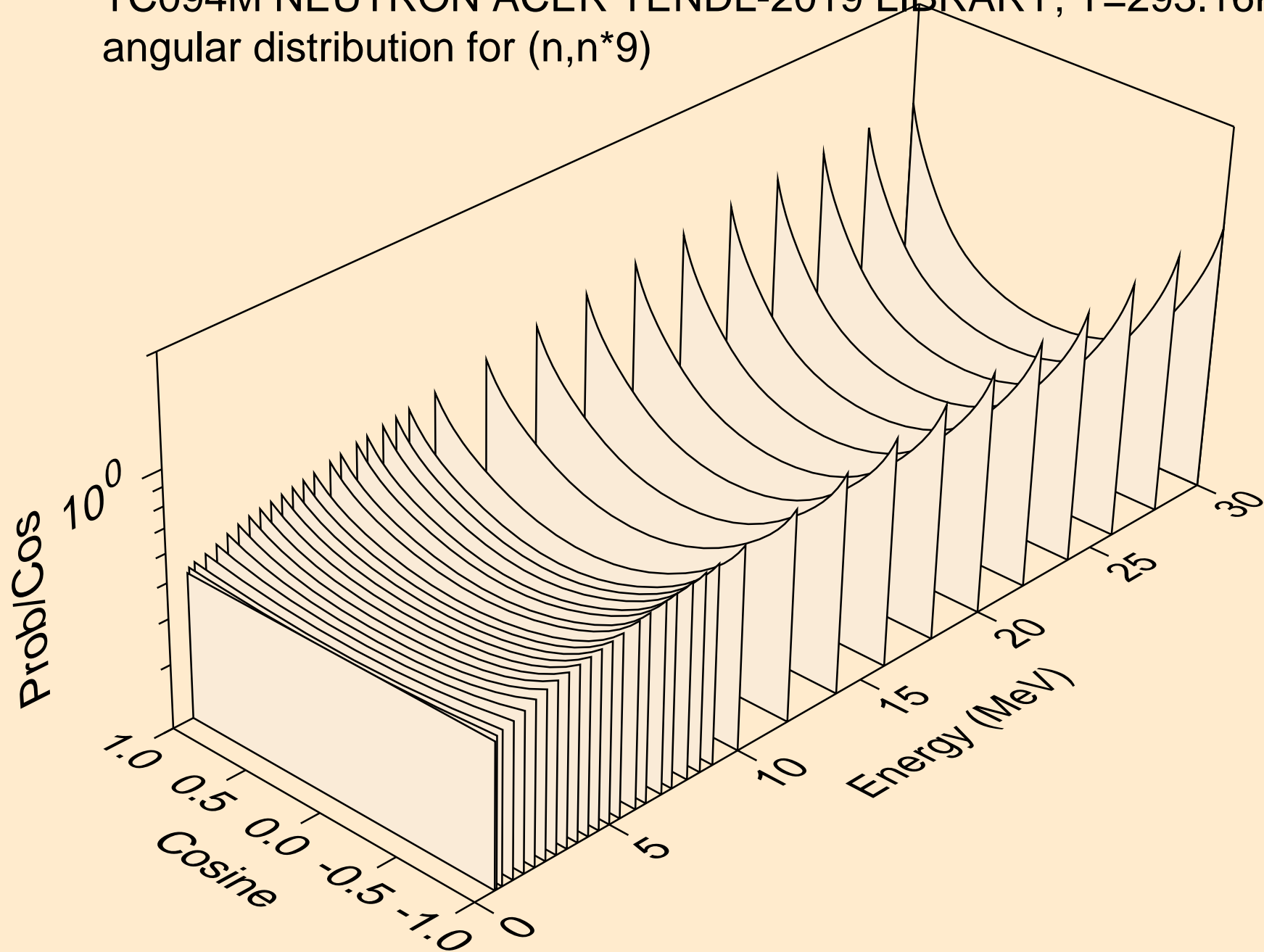

TC094M NEUTRON ACER TENDL-2019 LIBRARY; T=293.16K  
angular distribution for (n,n\*10)

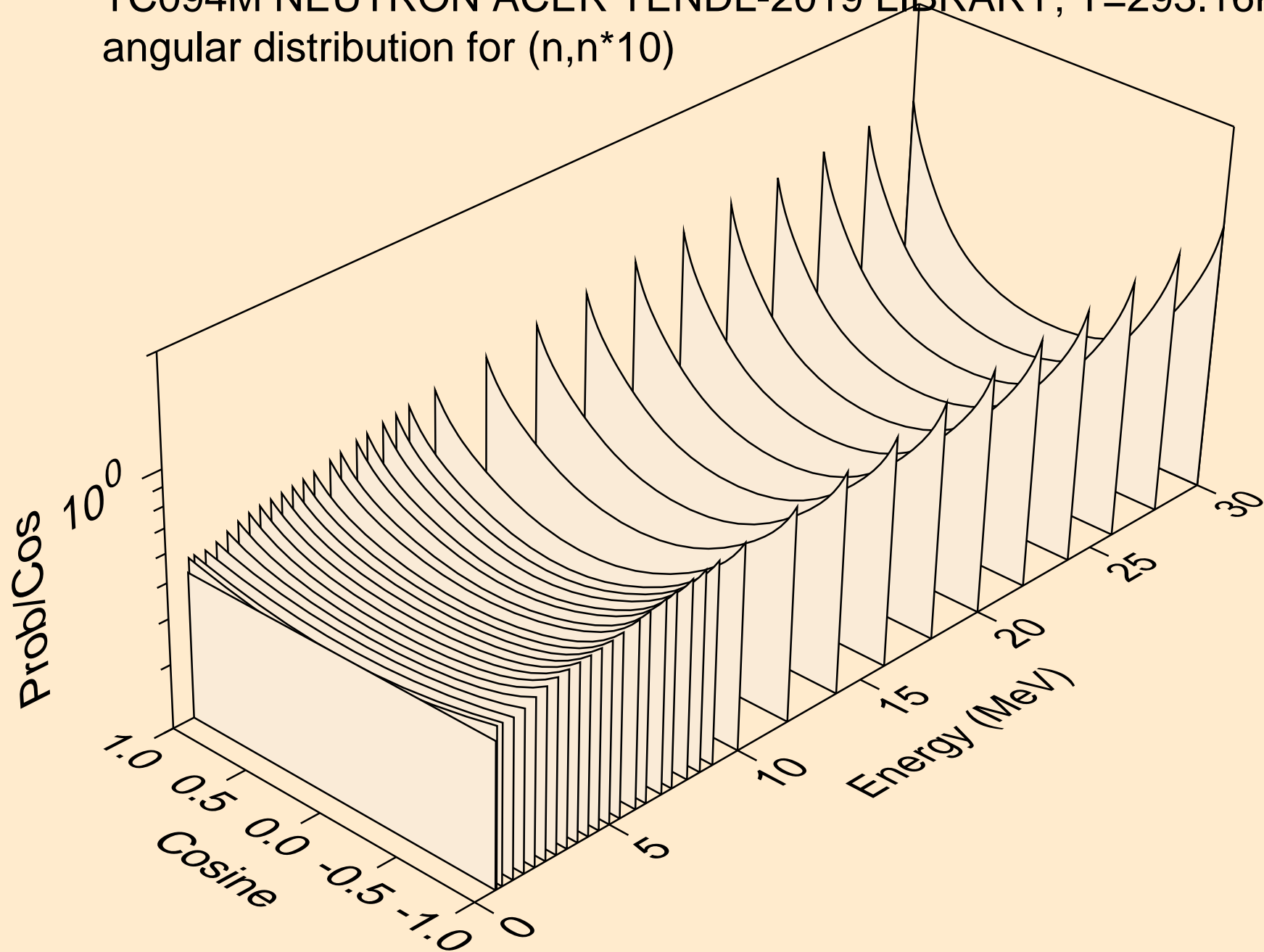

TC094M NEUTRON ACER TENDL-2019 LIBRARY; T=293.16K  
angular distribution for (n,n\*11)

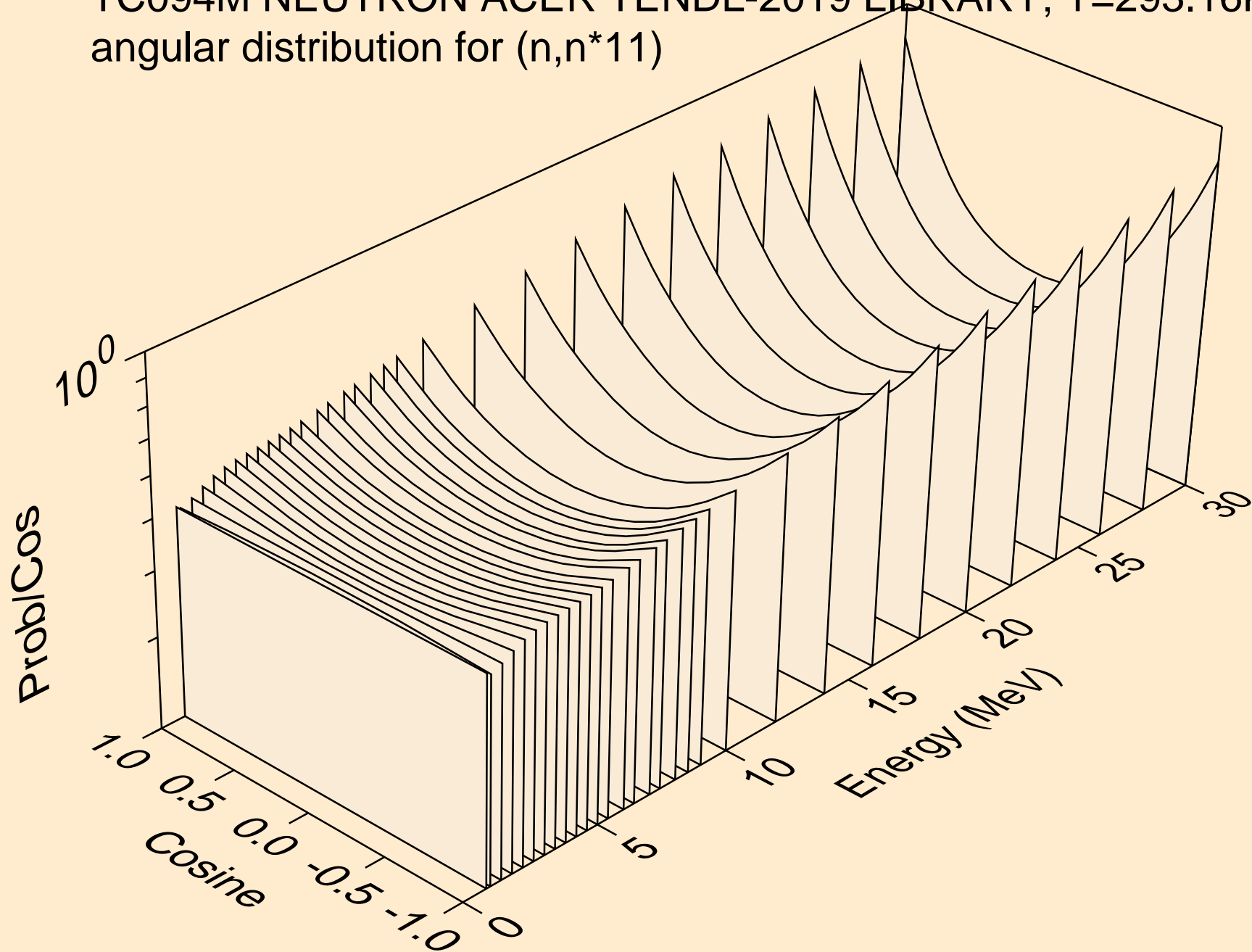

TC094M NEUTRON ACER TENDL-2019 LIBRARY; T=293.16K  
angular distribution for (n,n\*12)

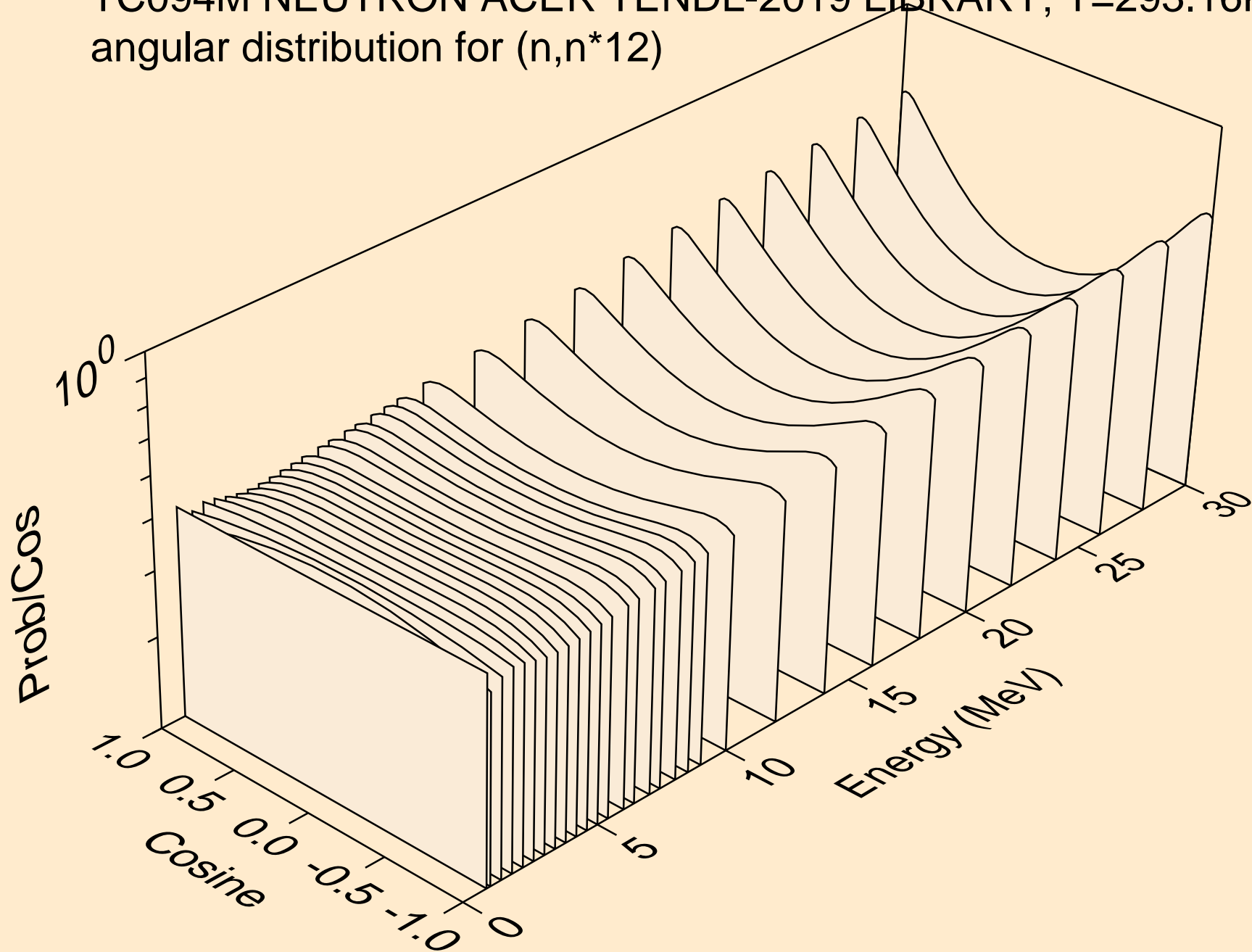



TC094M NEUTRON ACER TENDL-2019 LIBRARY; T=293.16K  
angular distribution for (n,n\*13)

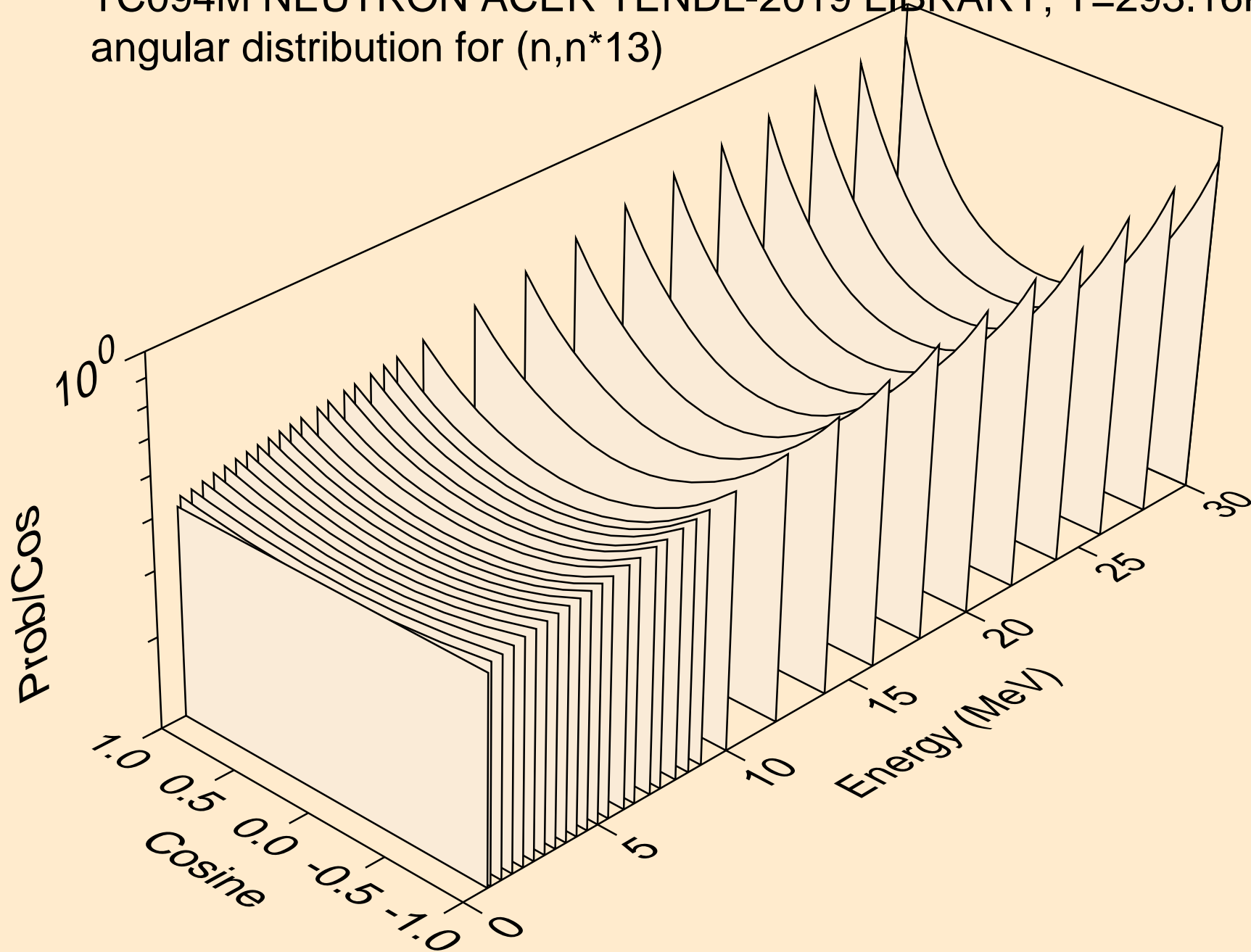

TC094M NEUTRON ACER TENDL-2019 LIBRARY; T=293.16K  
angular distribution for (n,n\*14)

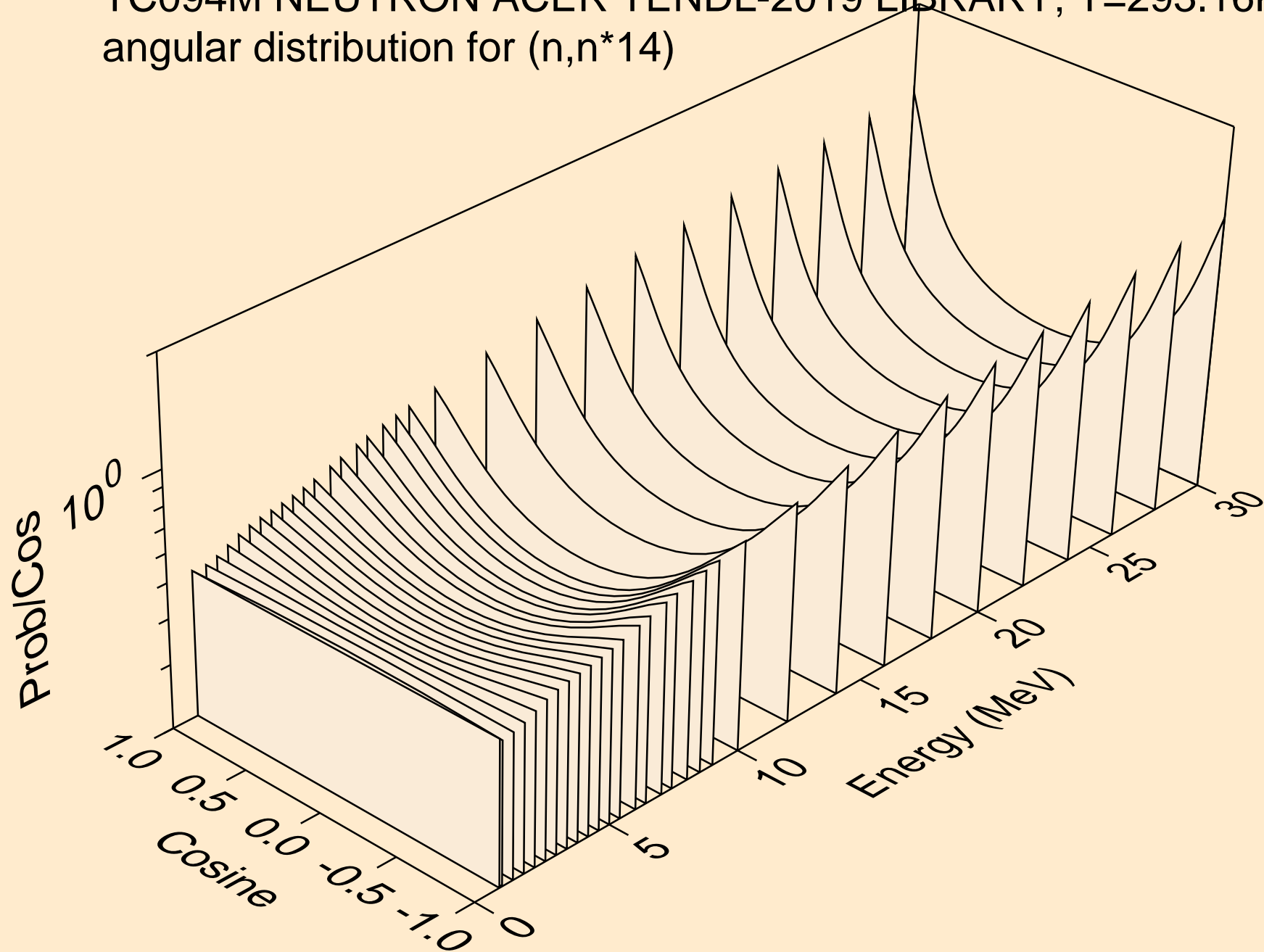

TC094M NEUTRON ACER TENDL-2019 LIBRARY; T=293.16K  
angular distribution for (n,n\*15)

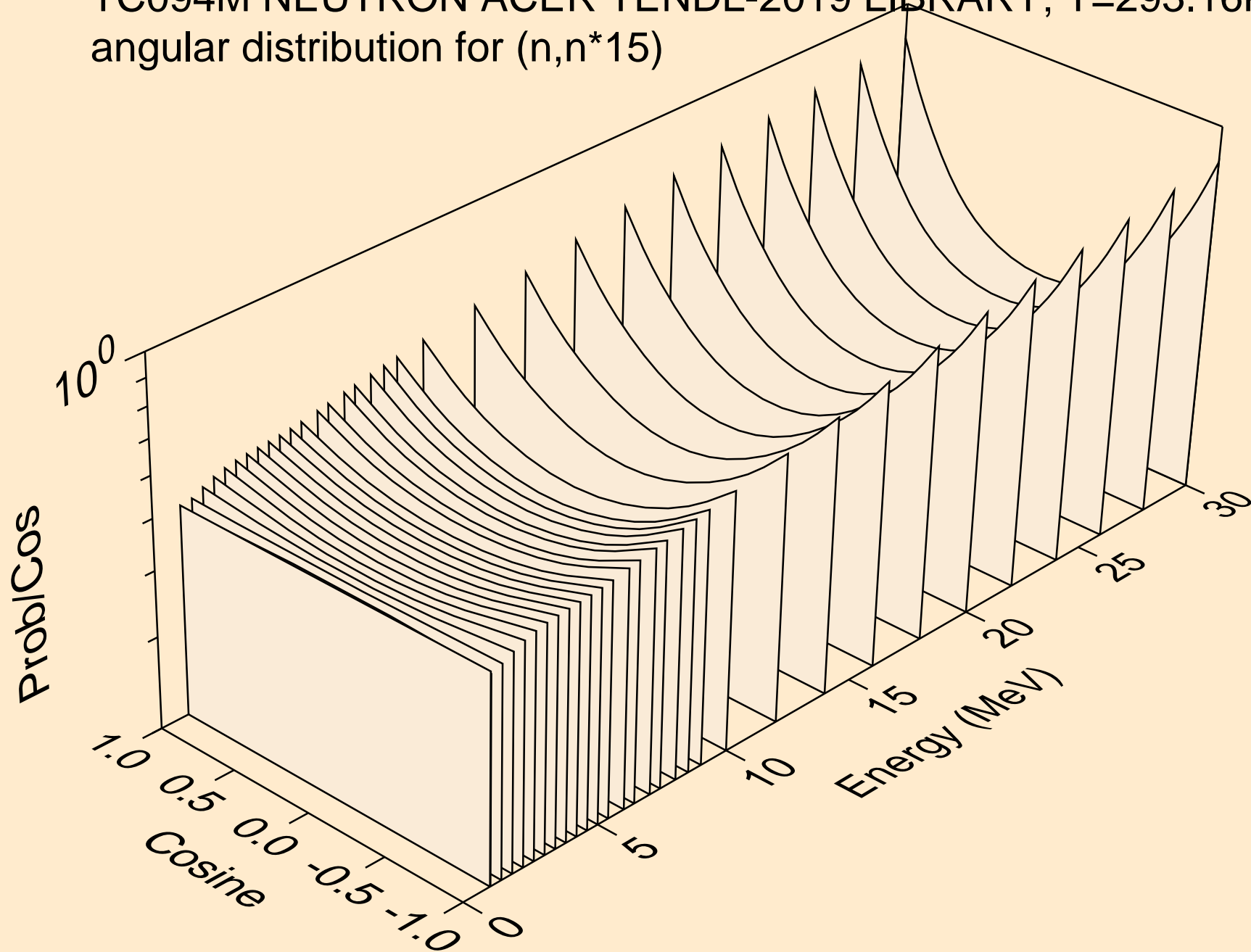

TC094M NEUTRON ACER TENDL-2019 LIBRARY; T=293.16K  
angular distribution for (n,n\*16)

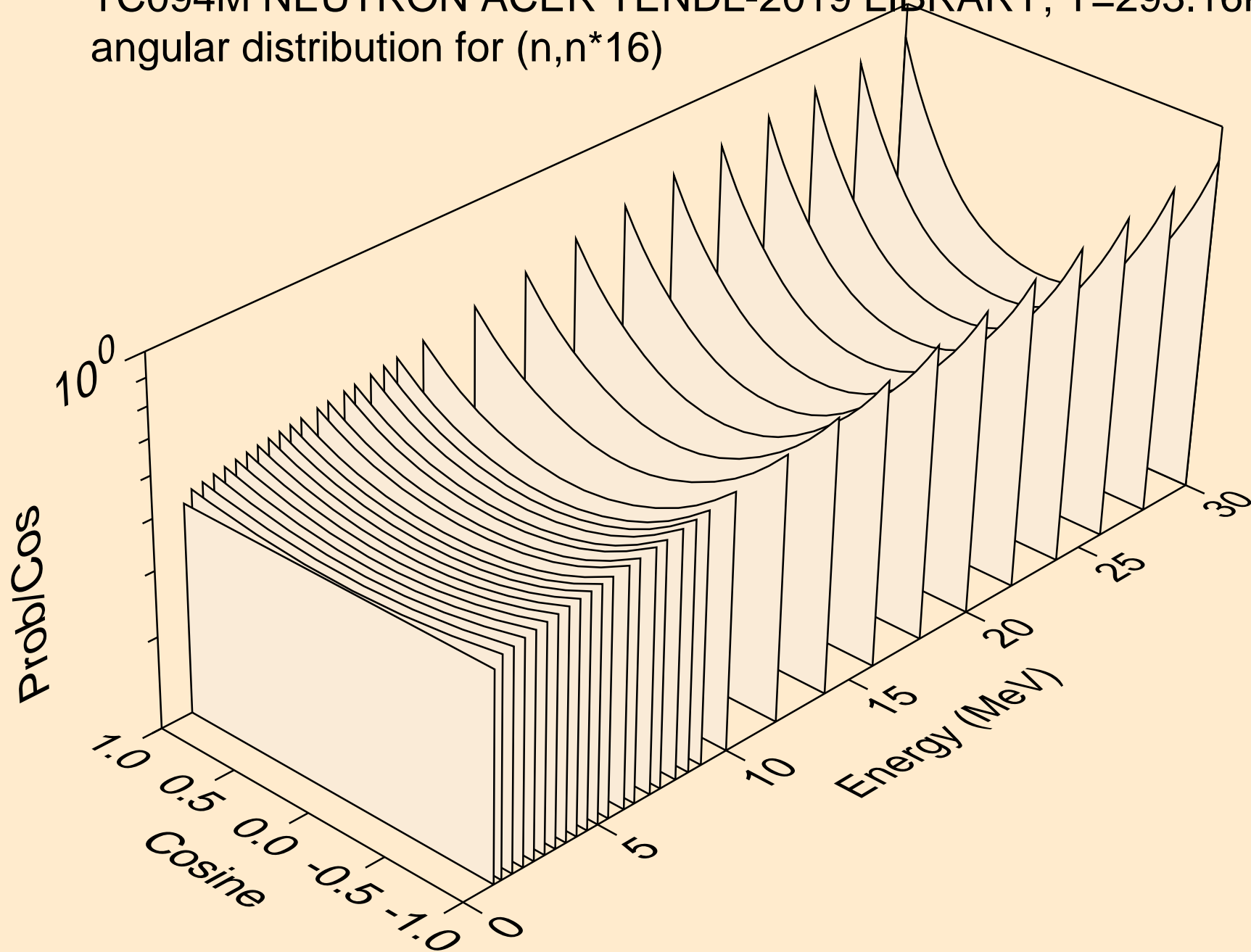

TC094M NEUTRON ACER TENDL-2019 LIBRARY; T=293.16K  
angular distribution for (n,n\*17)

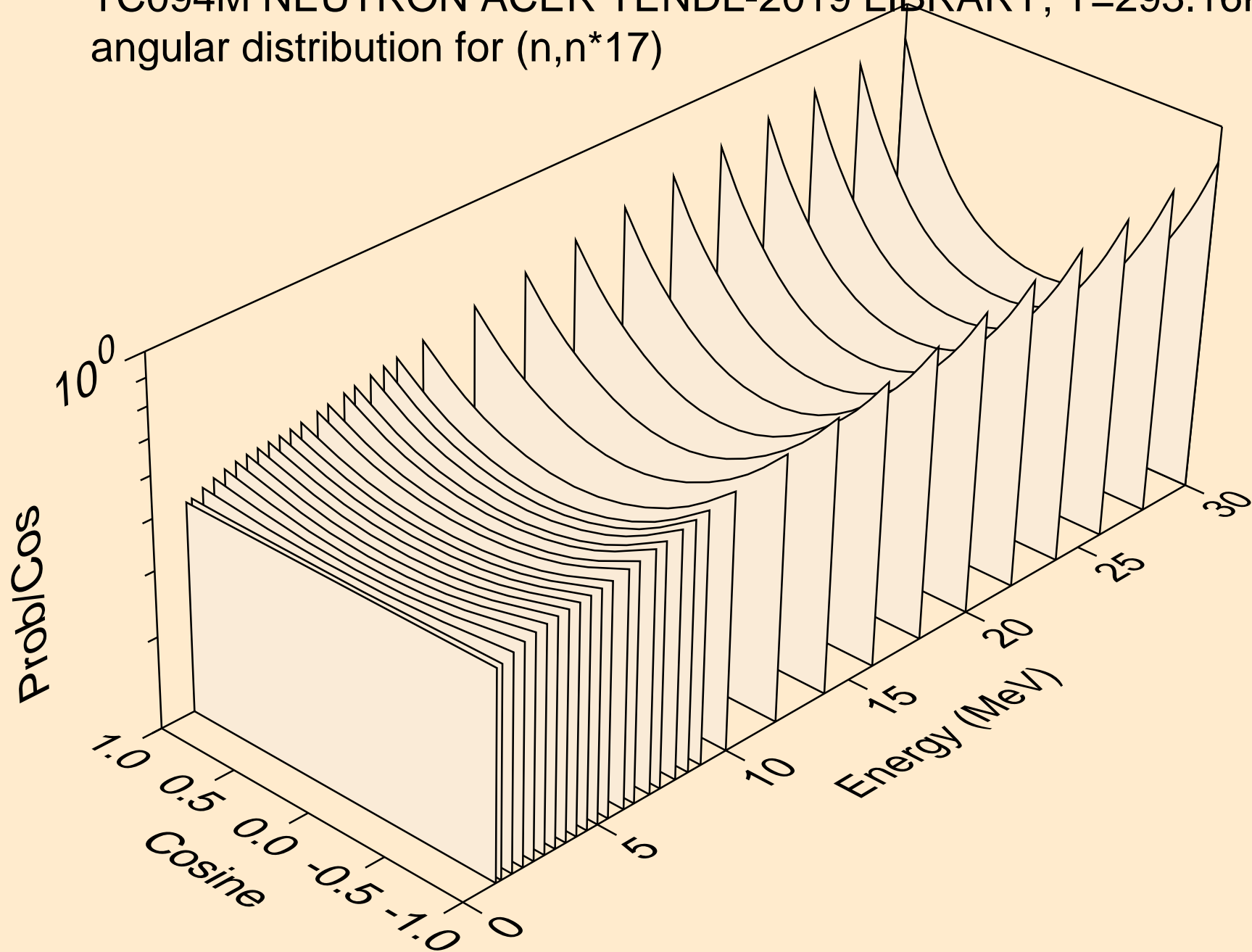

TC094M NEUTRON ACER TENDL-2019 LIBRARY; T=293.16K  
angular distribution for (n,n\*18)

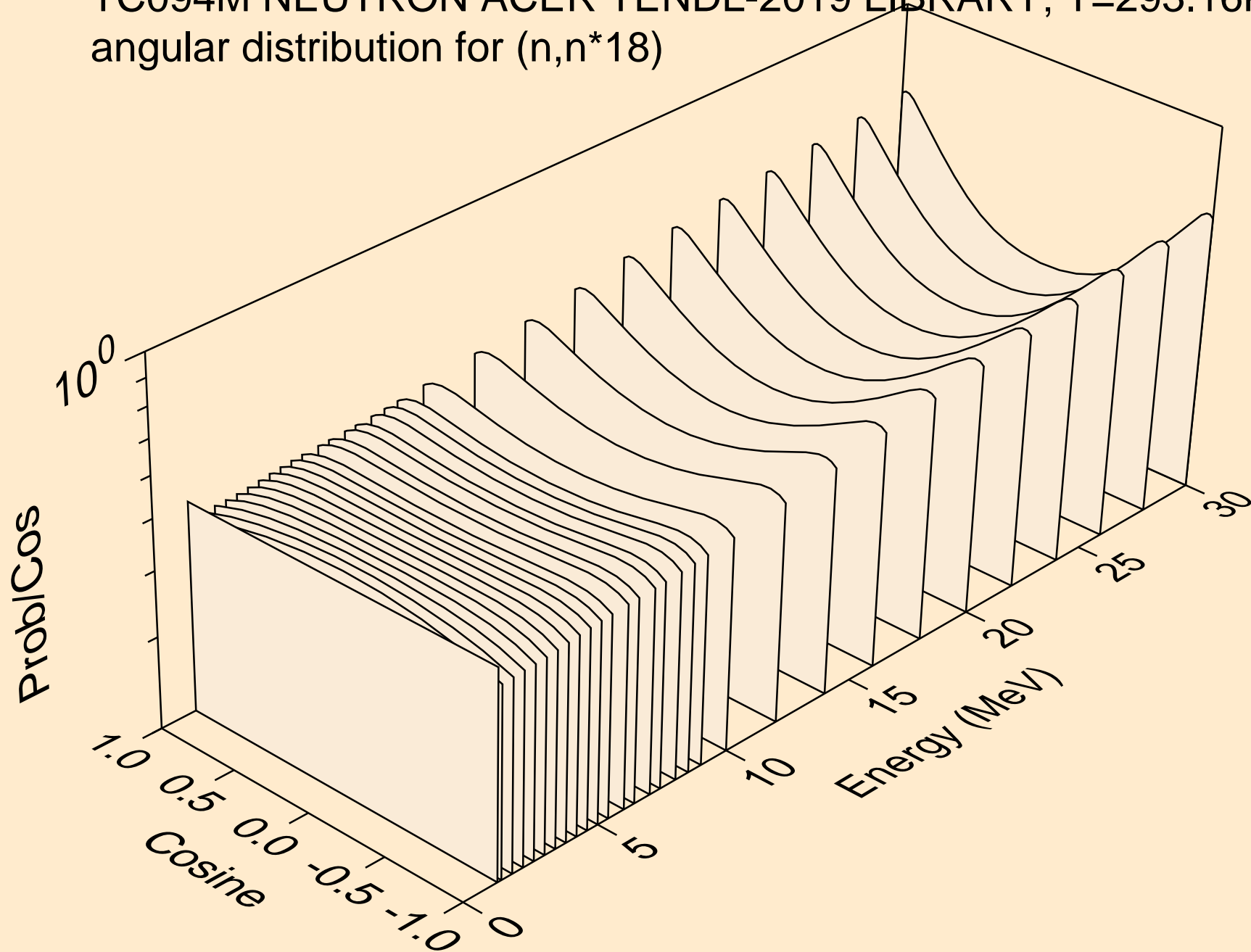

TC094M NEUTRON ACER TENDL-2019 LIBRARY; T=293.16K  
angular distribution for (n,n\*19)

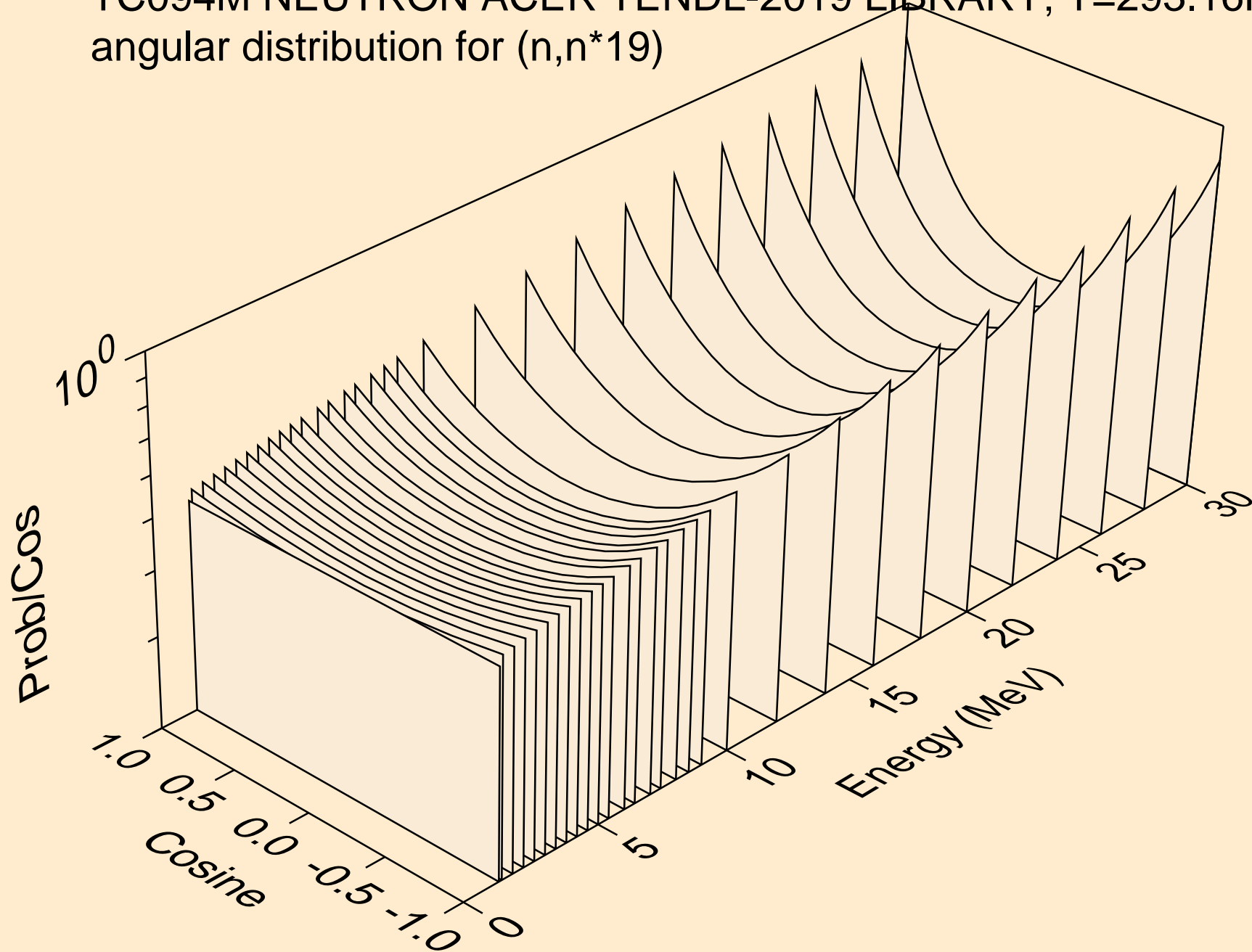

TC094M NEUTRON ACER TENDL-2019 LIBRARY; T=293.16K  
angular distribution for (n,n\*20)

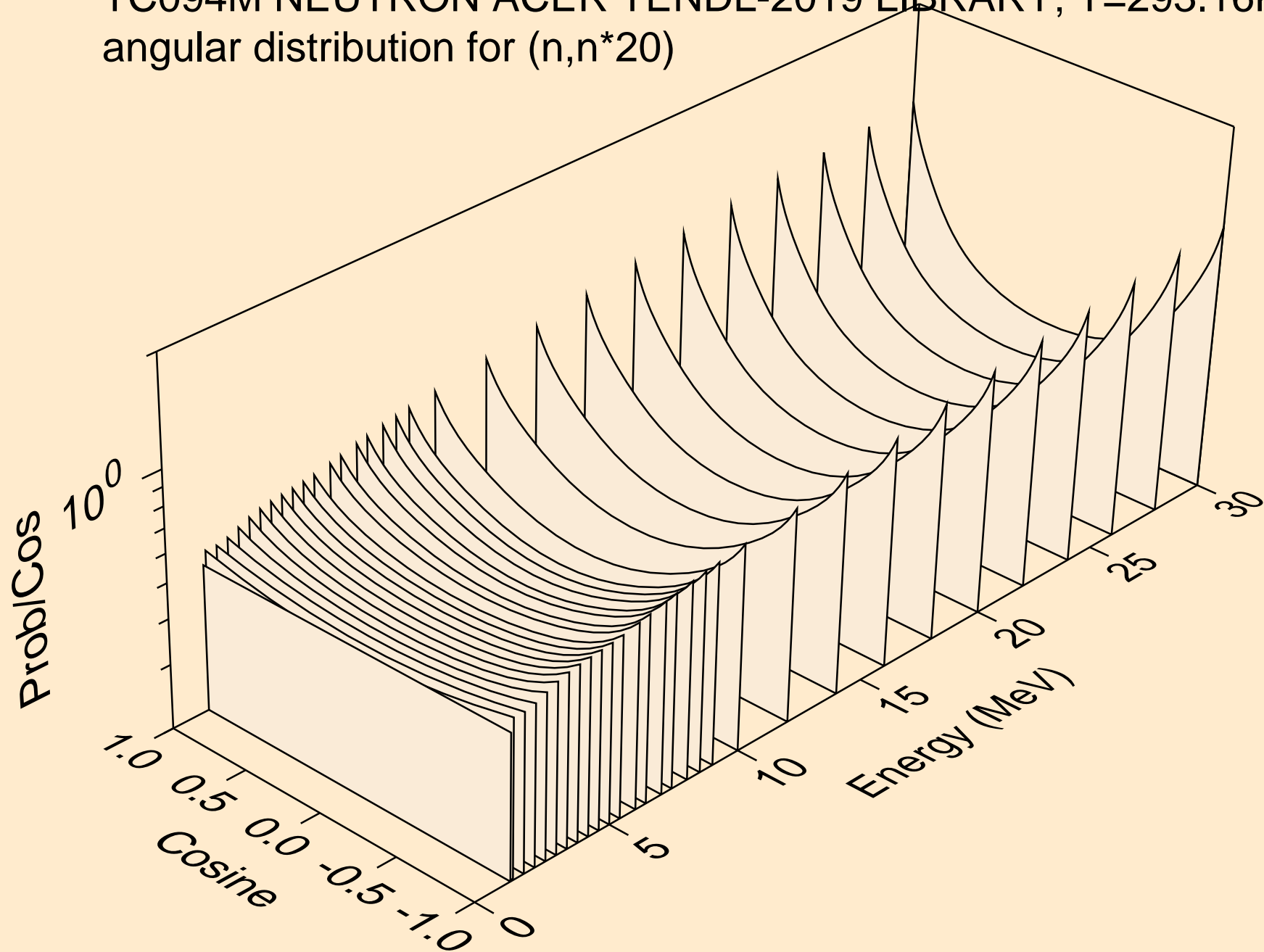



TC094M NEUTRON ACER TENDL-2019 LIBRARY; T=293.16K  
angular distribution for (n,n\*21)

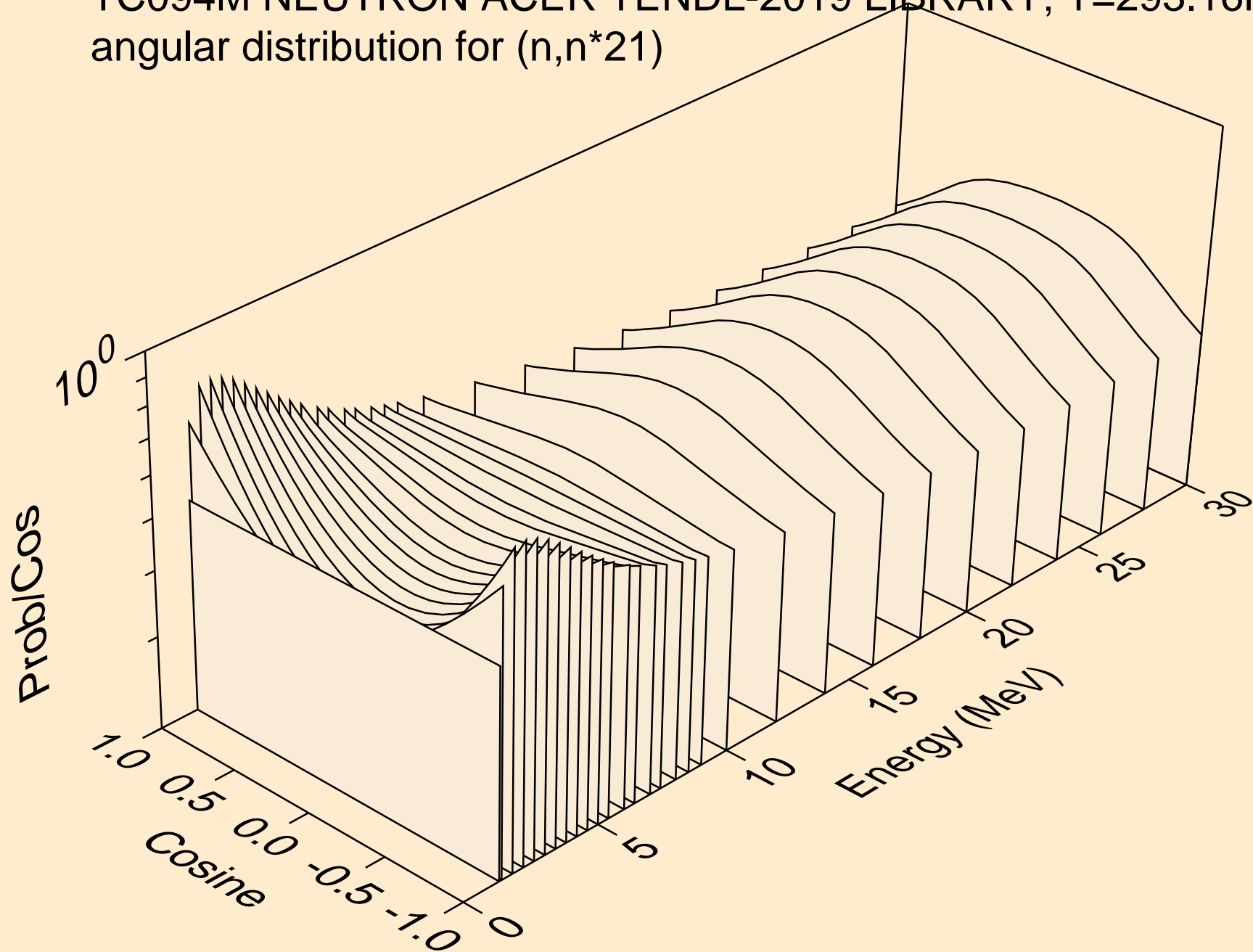

TC094M NEUTRON ACER TENDL-2019 LIBRARY; T=293.16K  
angular distribution for (n,n\*22)

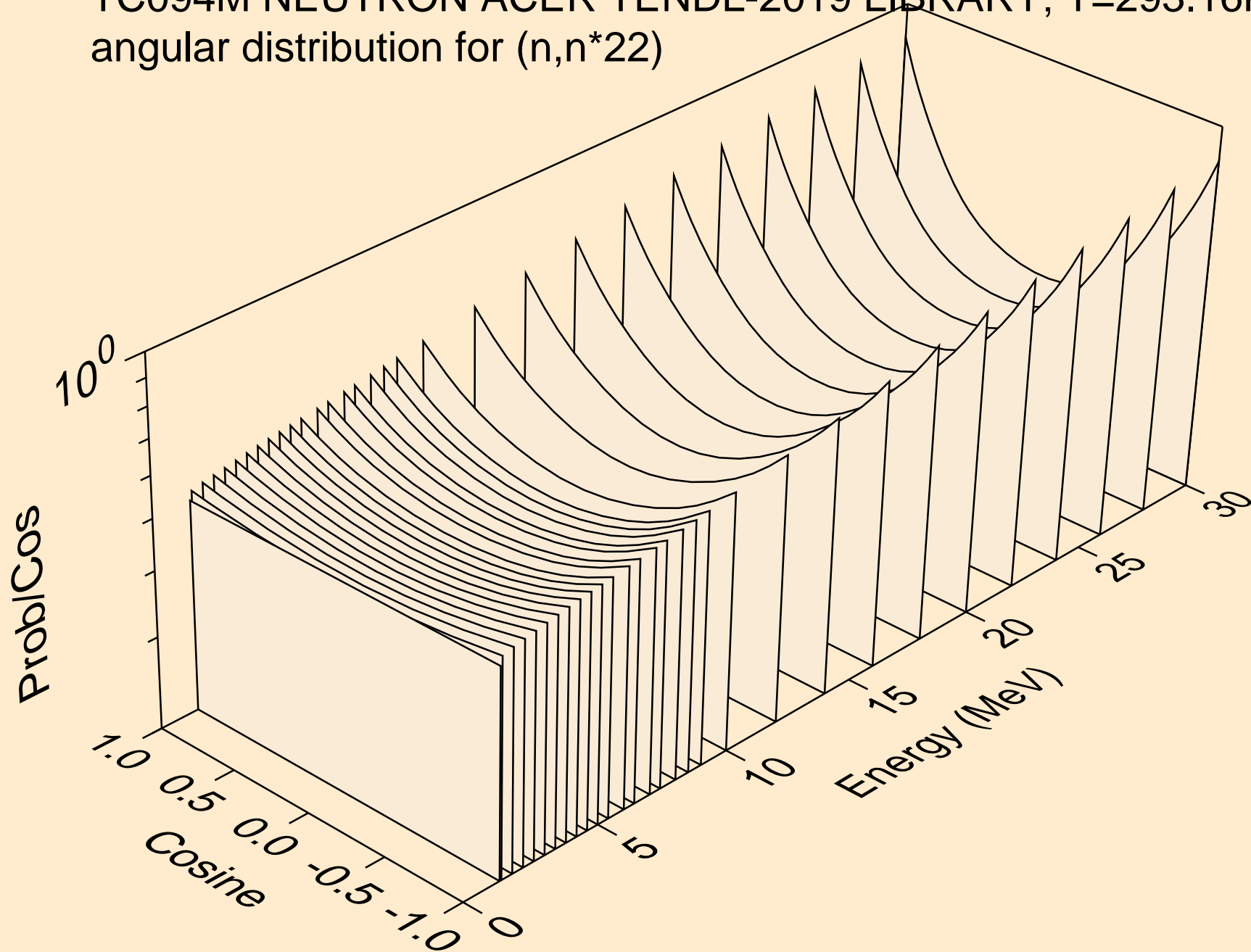

TC094M NEUTRON ACER TENDL-2019 LIBRARY; T=293.16K  
angular distribution for (n,n\*23)

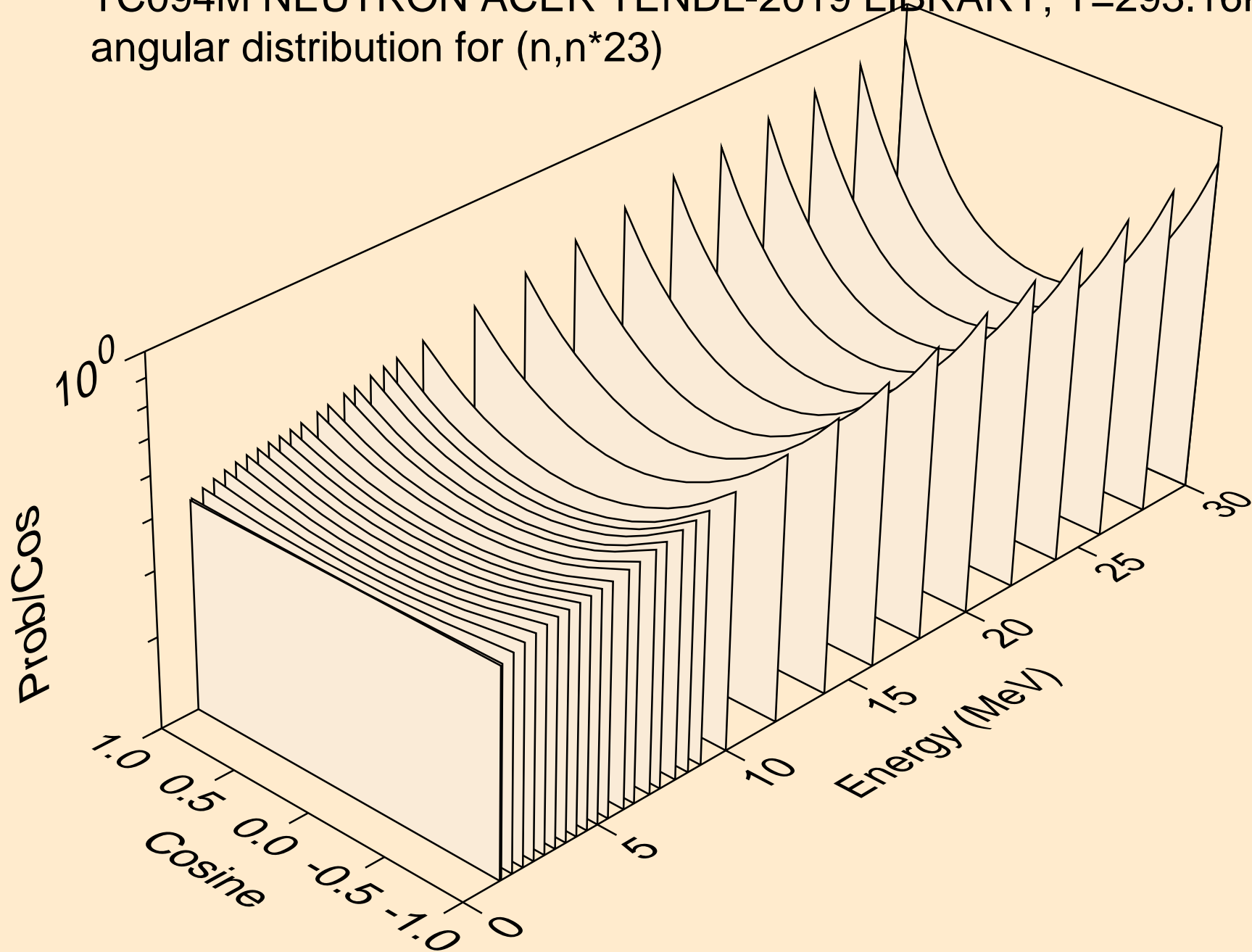

TC094M NEUTRON ACER TENDL-2019 LIBRARY; T=293.16K  
angular distribution for (n,n\*24)

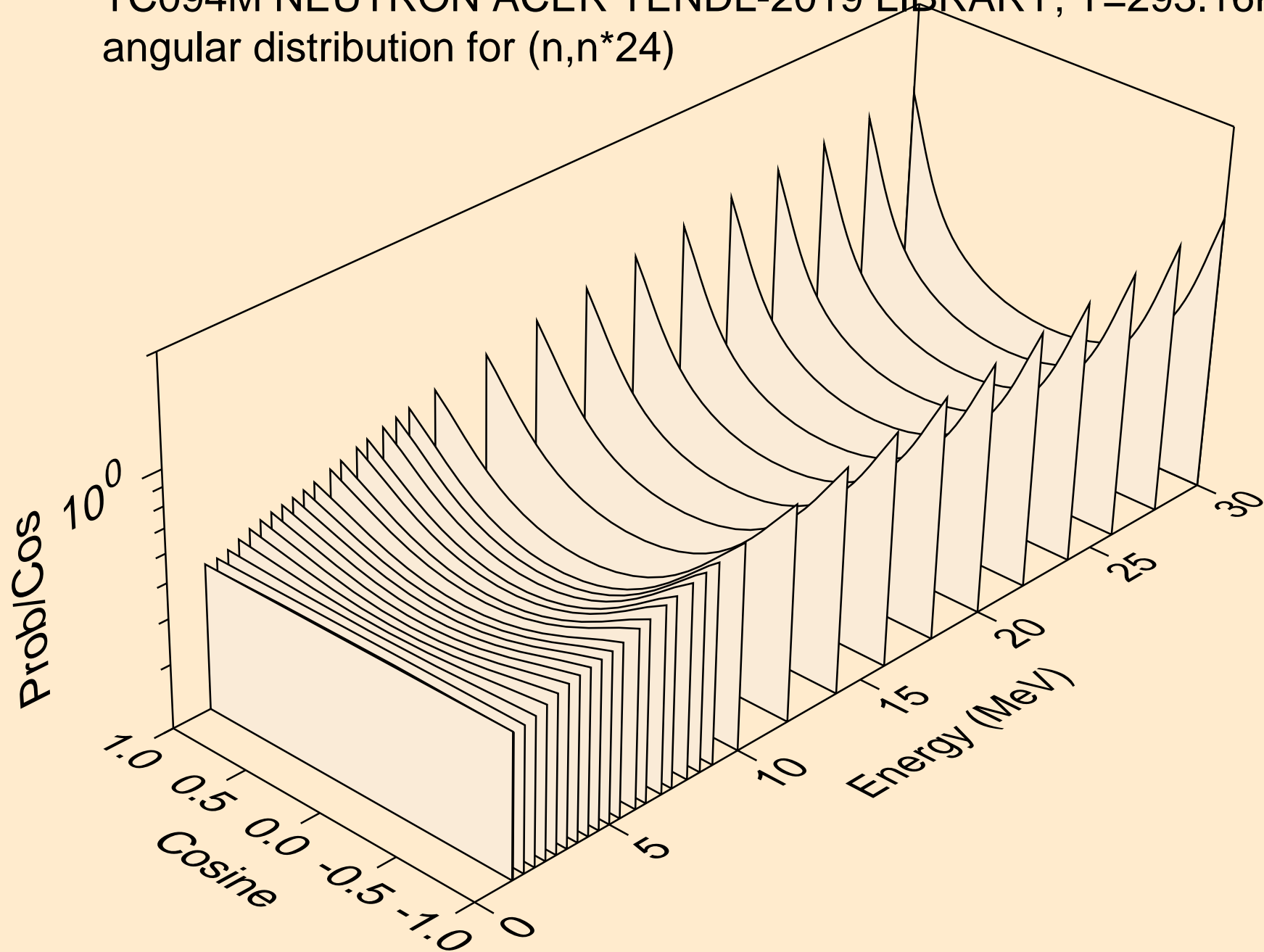

TC094M NEUTRON ACER TENDL-2019 LIBRARY; T=293.16K  
angular distribution for (n,n\*25)

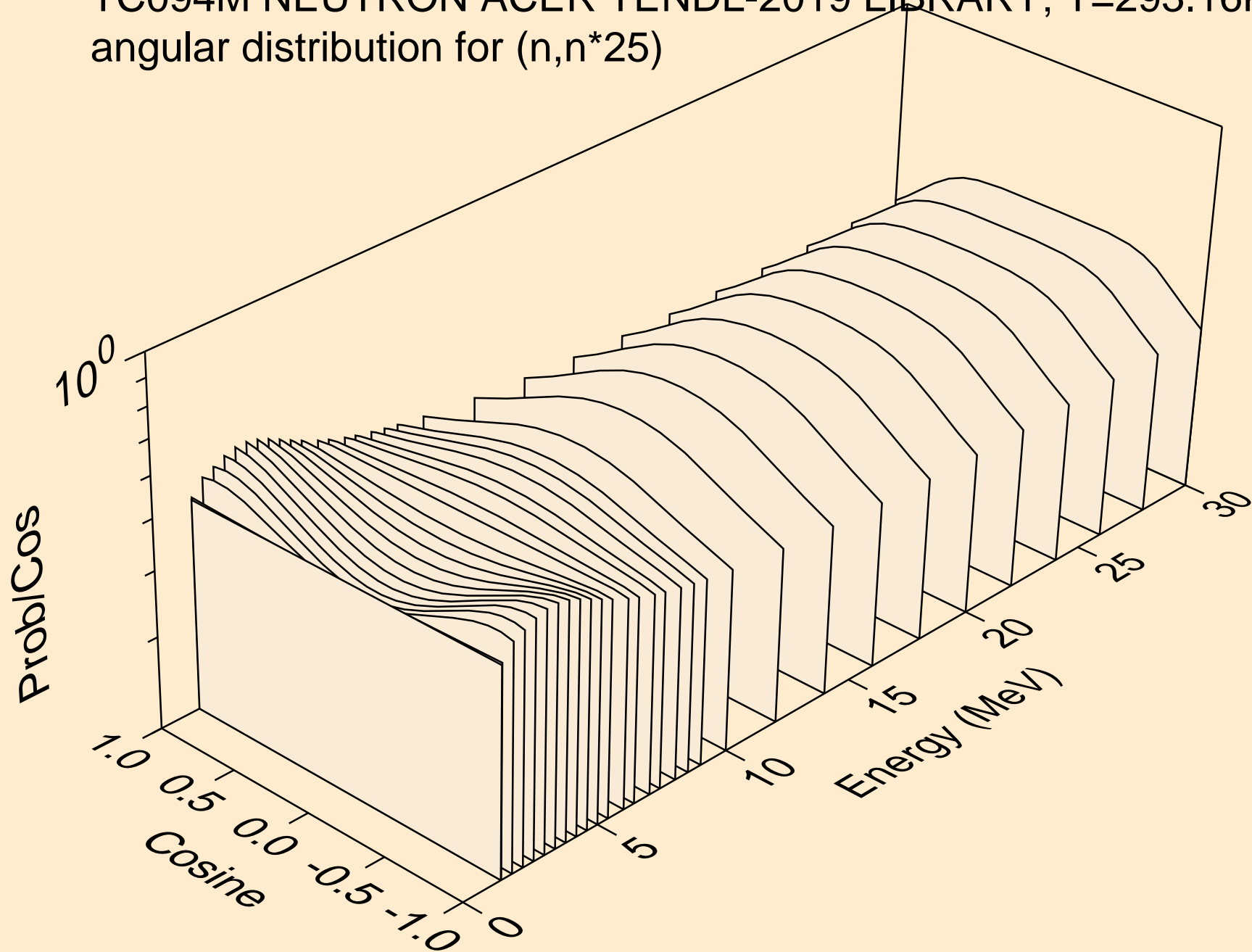

TC094M NEUTRON ACER TENDL-2019 LIBRARY; T=293.16K  
angular distribution for (n,n\*26)

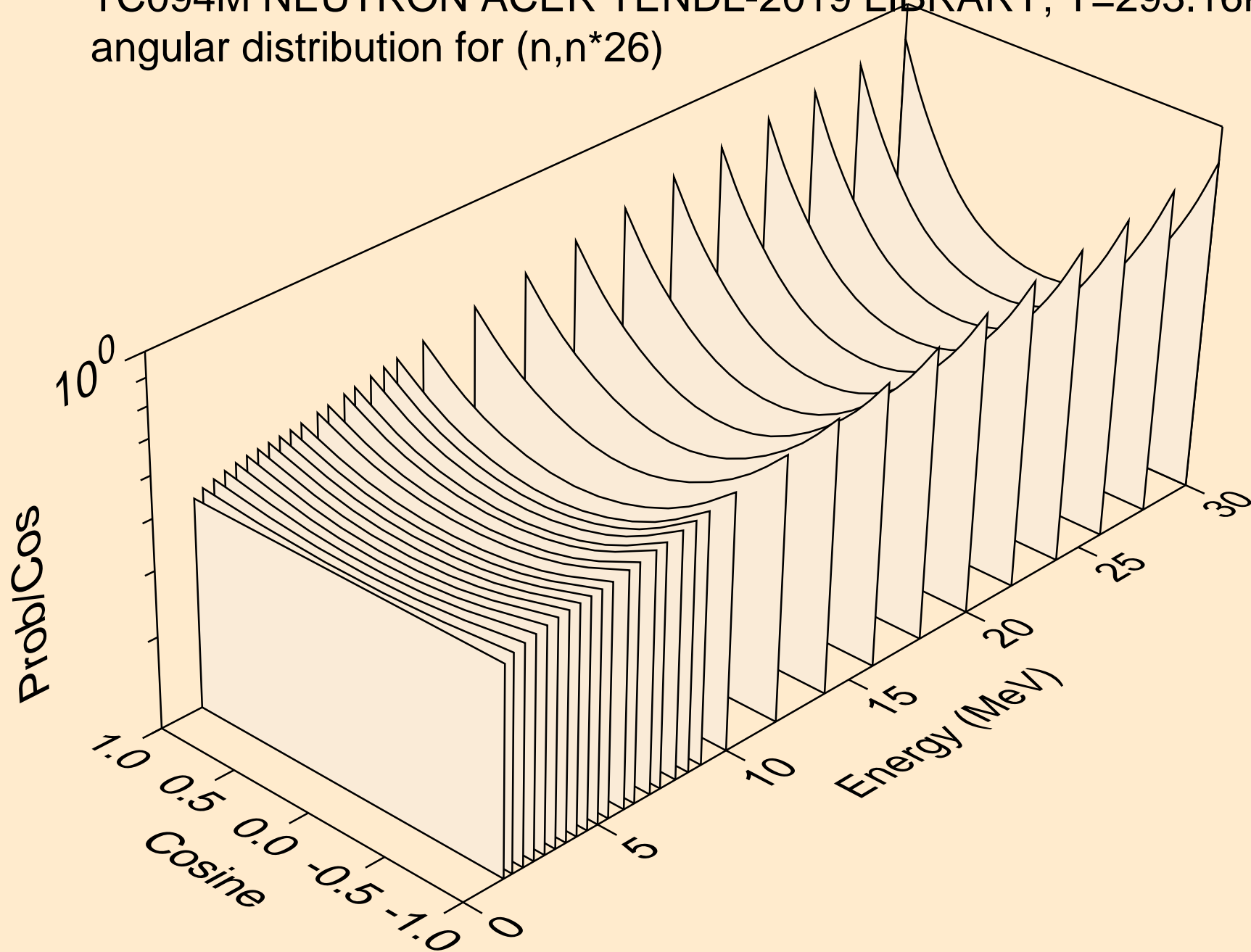

TC094M NEUTRON ACER TENDL-2019 LIBRARY; T=293.16K  
angular distribution for (n,n\*27)

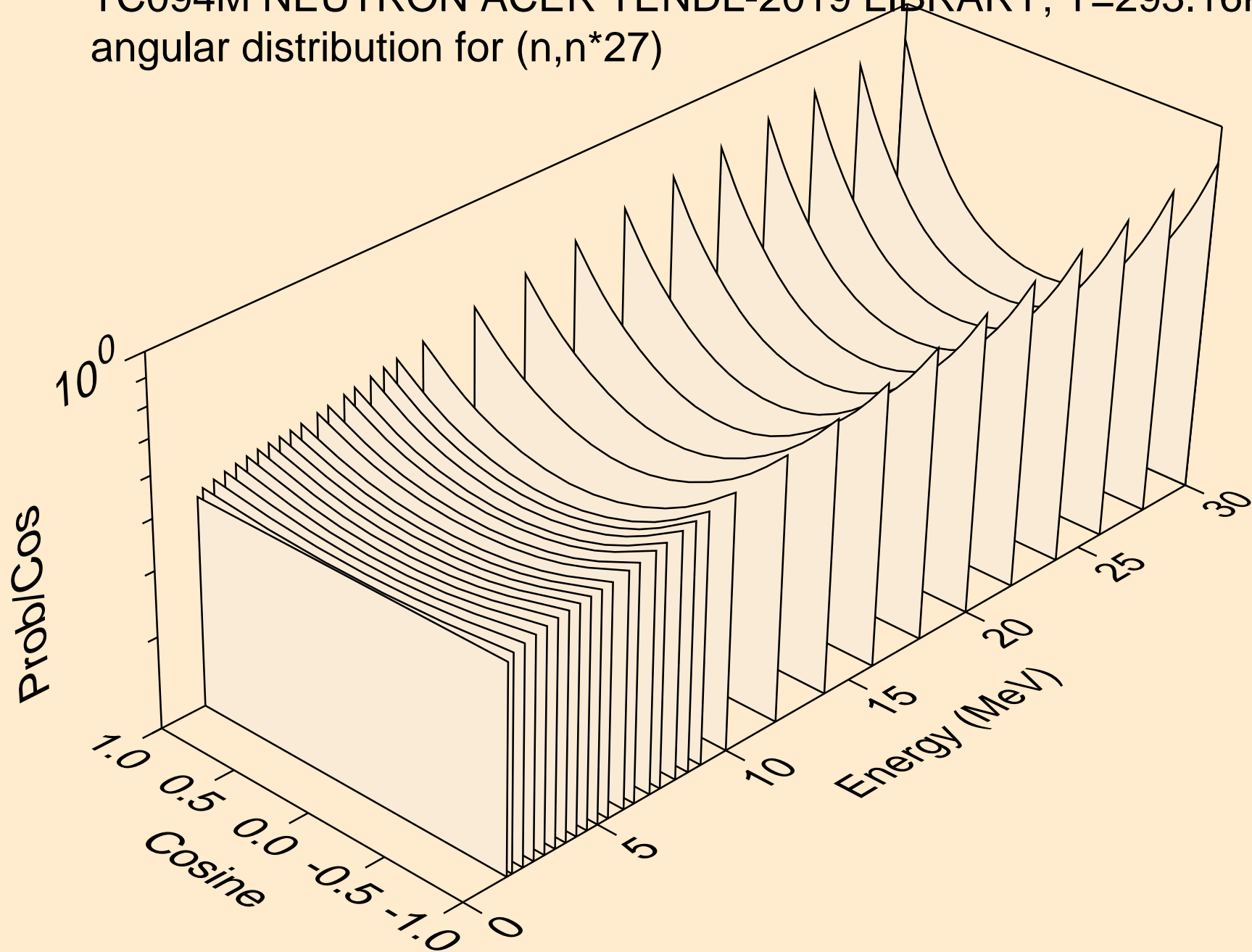

TC094M NEUTRON ACER TENDL-2019 LIBRARY; T=293.16K  
angular distribution for (n,n\*28)

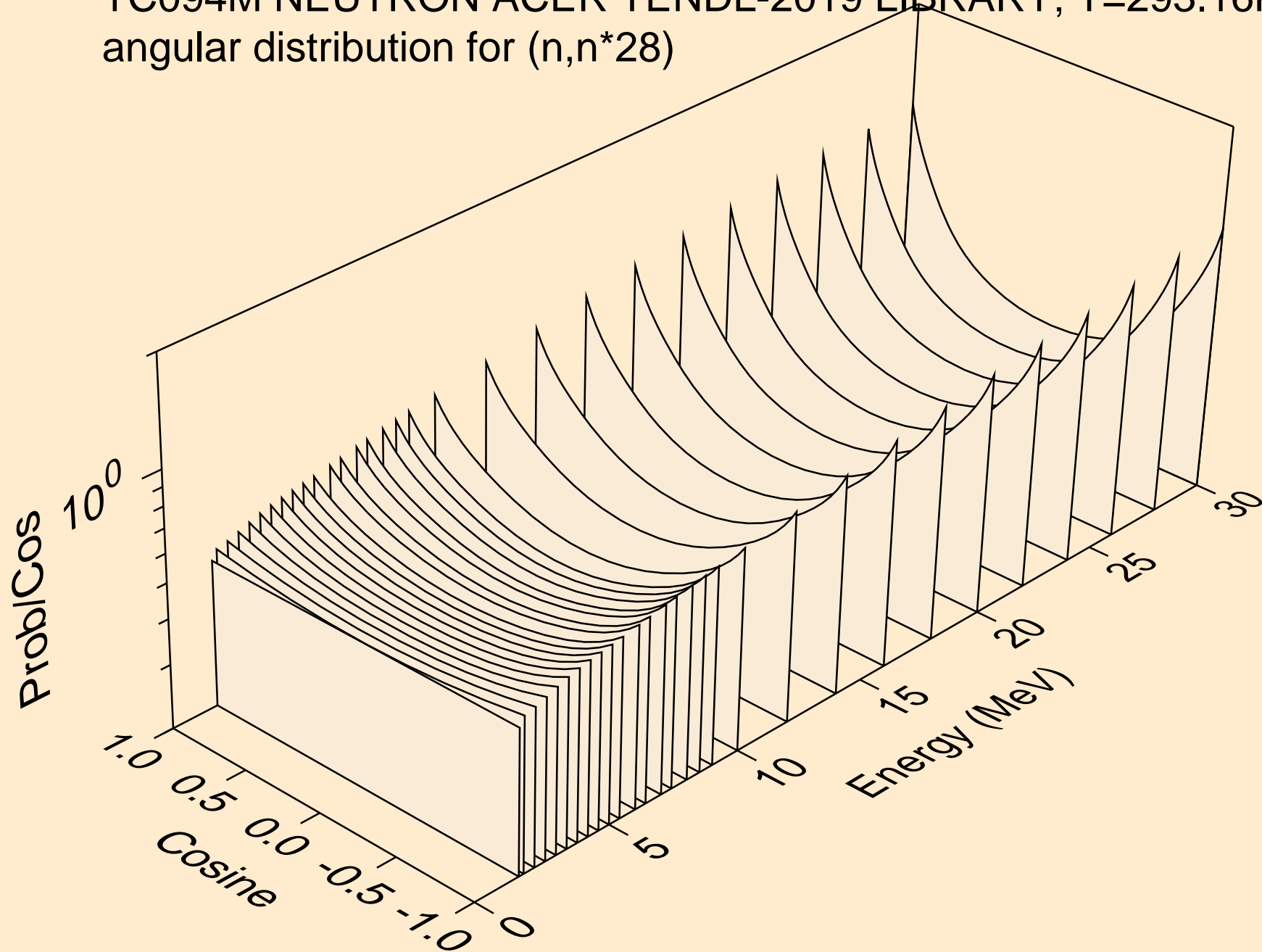



TC094M NEUTRON ACER TENDL-2019 LIBRARY; T=293.16K  
angular distribution for (n,n\*29)

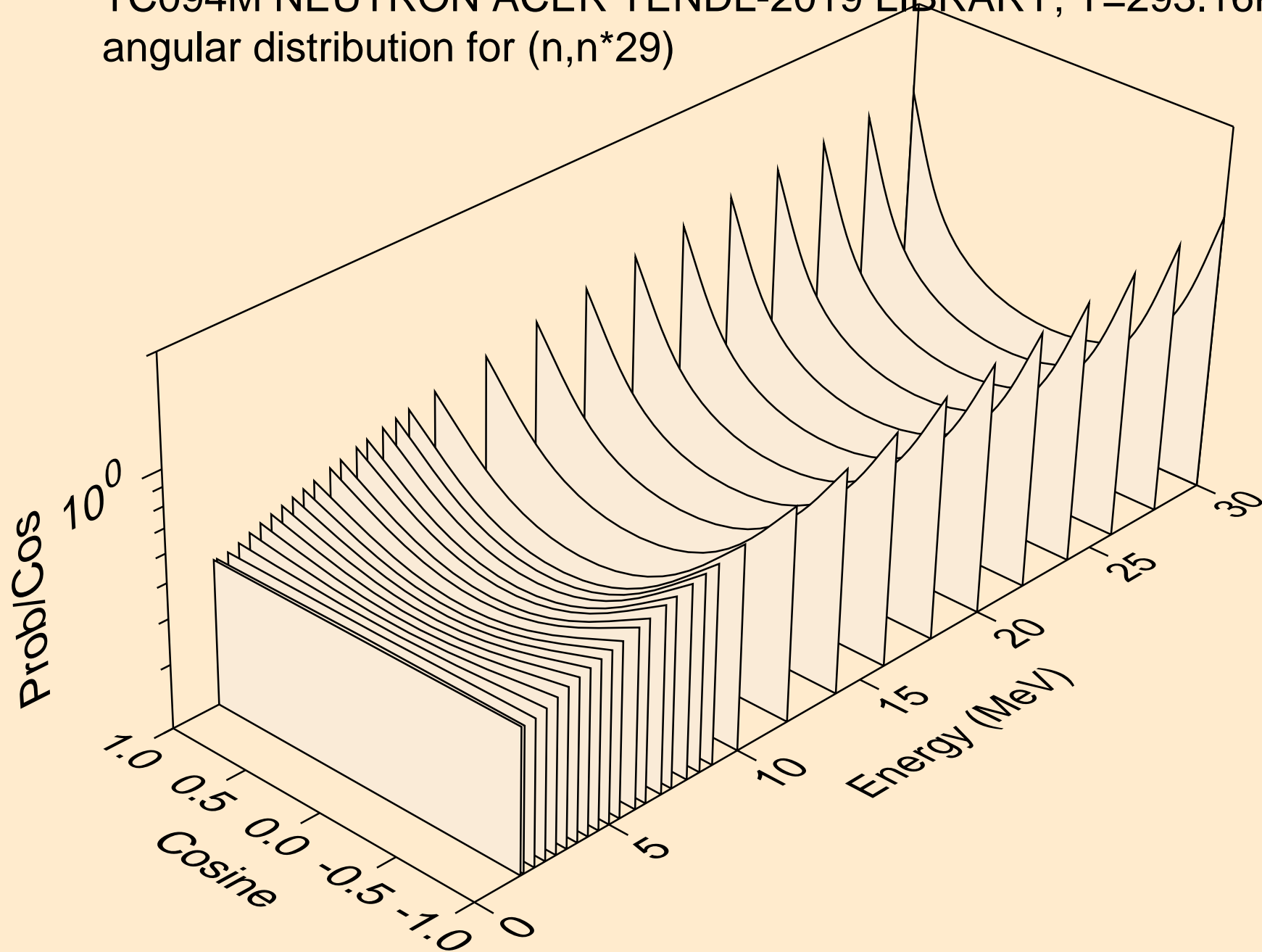

TC094M NEUTRON ACER TENDL-2019 LIBRARY; T=293.16K  
angular distribution for (n,n\*30)

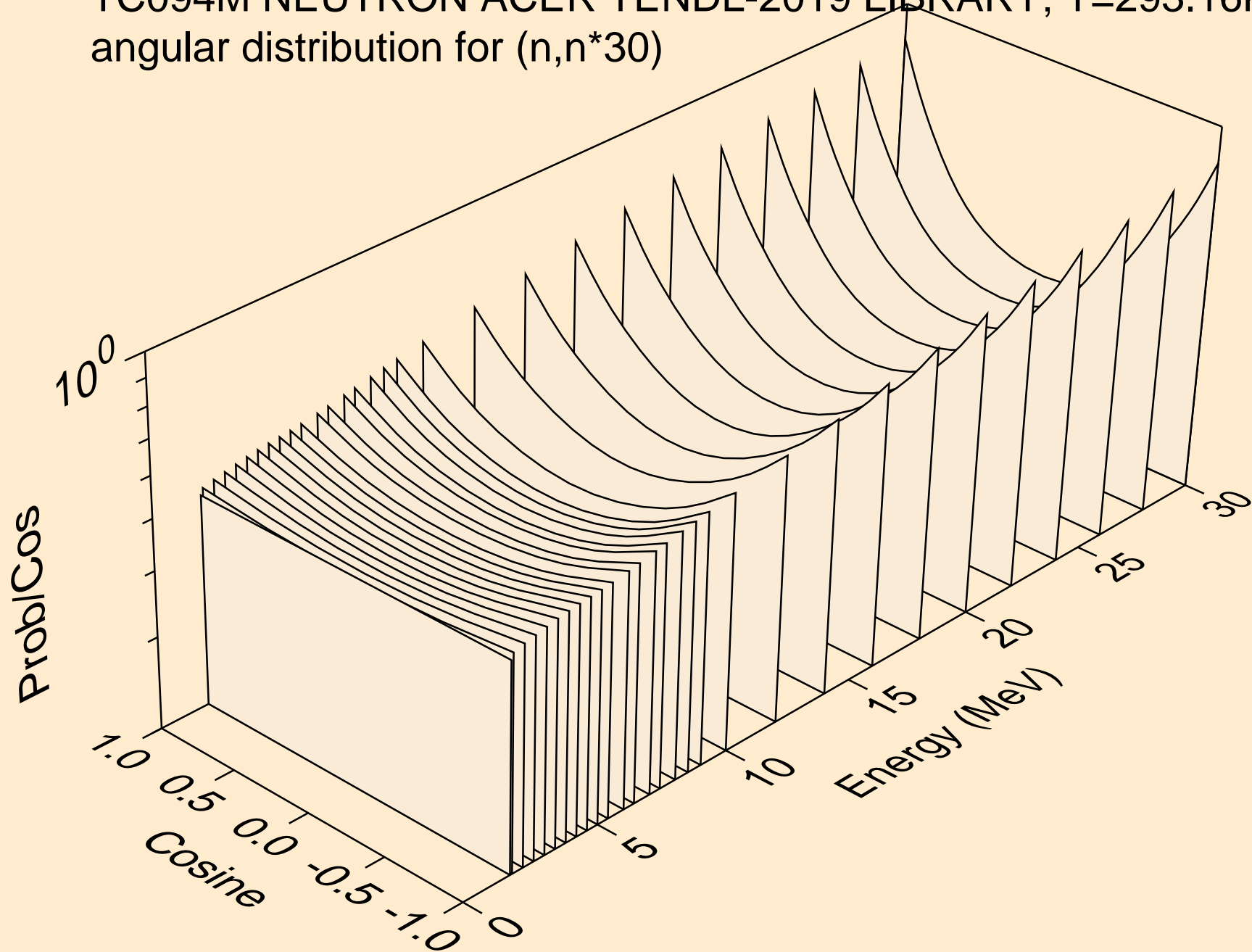

TC094M NEUTRON ACER TENDL-2019 LIBRARY; T=293.16K  
Neutron emission for (n,x)

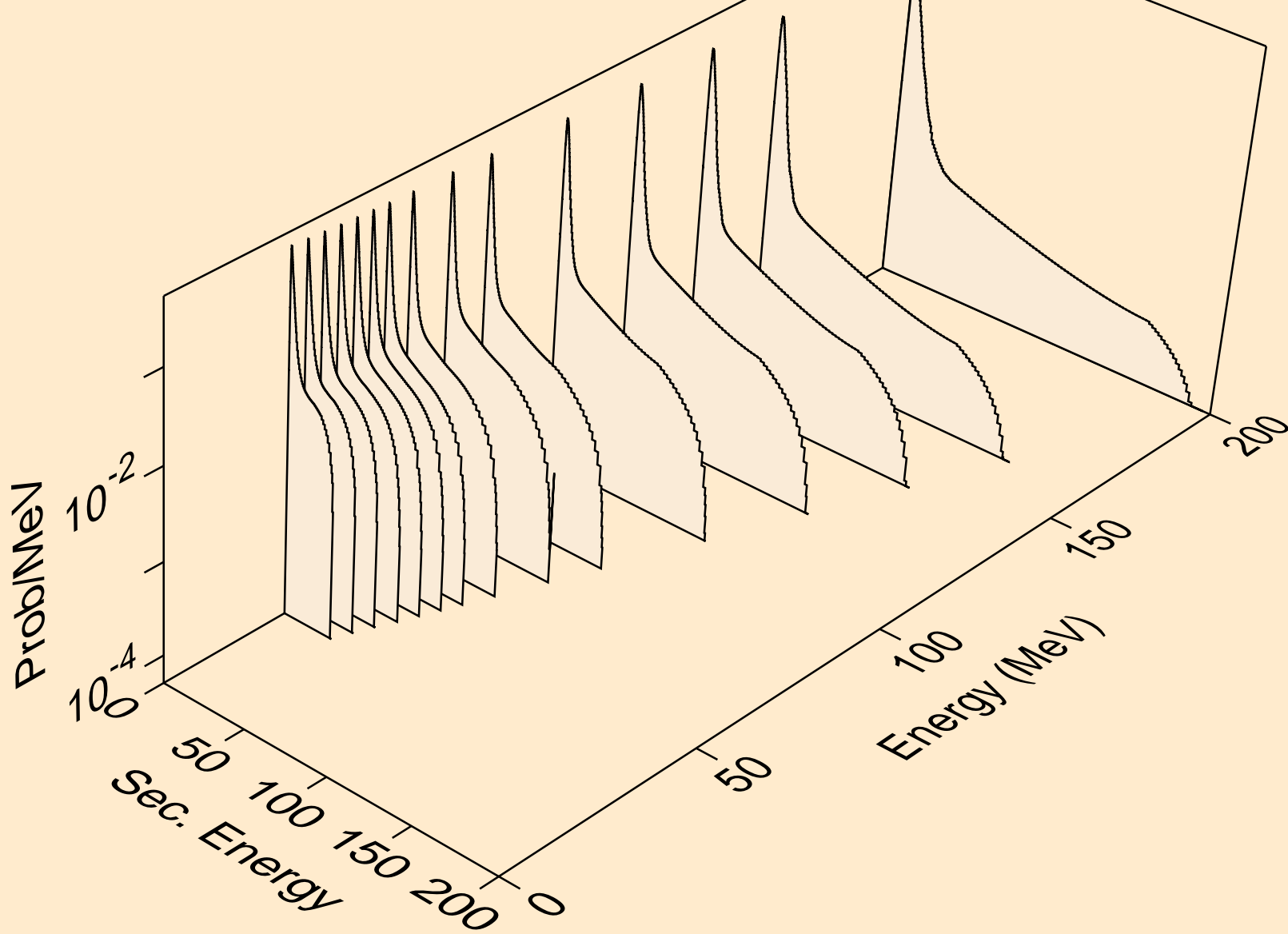

TC094M NEUTRON ACER TENDL-2019 LIBRARY; T=293.16K  
Neutron emission for (n,2nd)

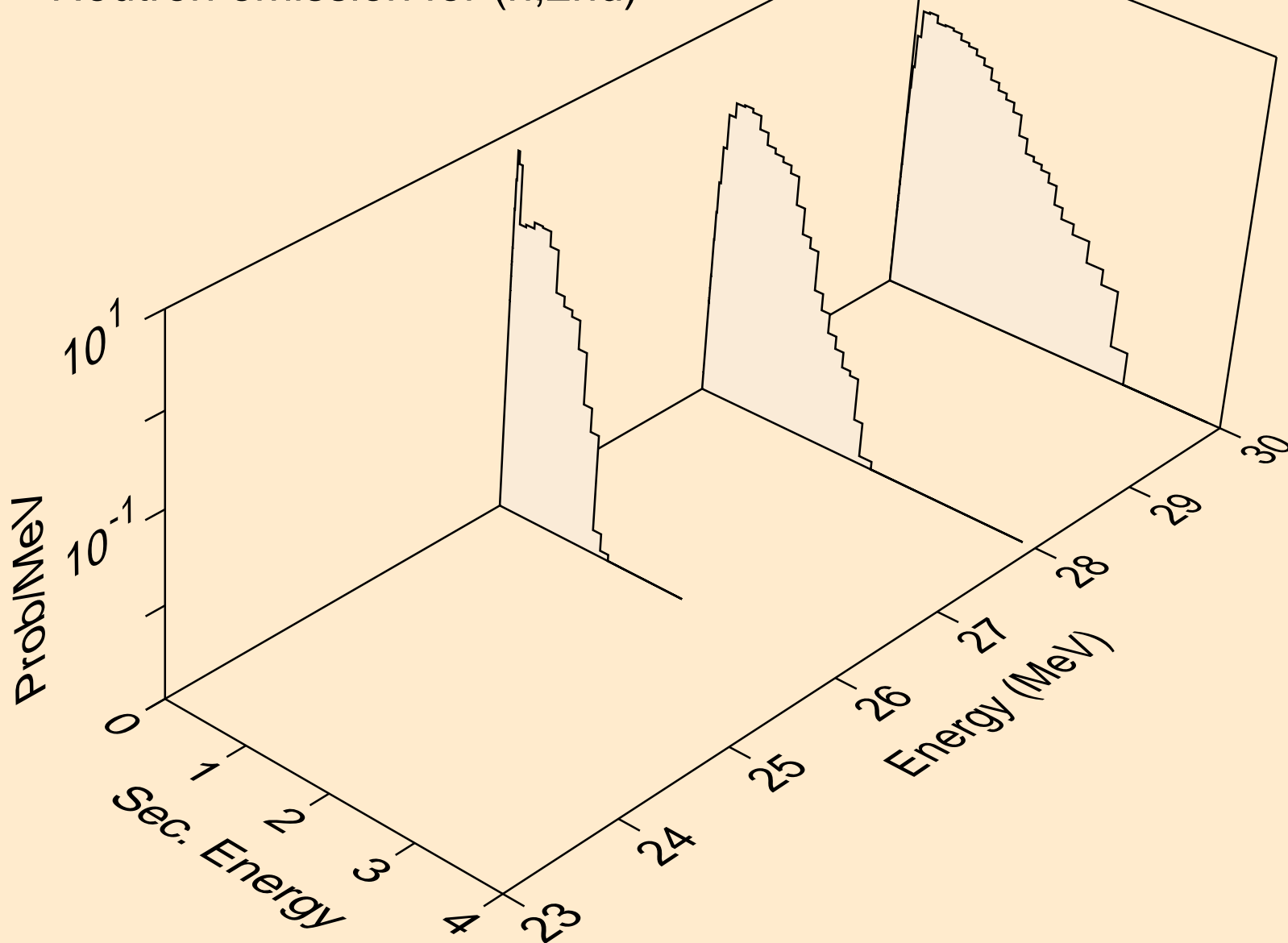

TC094M NEUTRON ACER TENDL-2019 LIBRARY; T=293.16K  
Neutron emission for (n,2n)

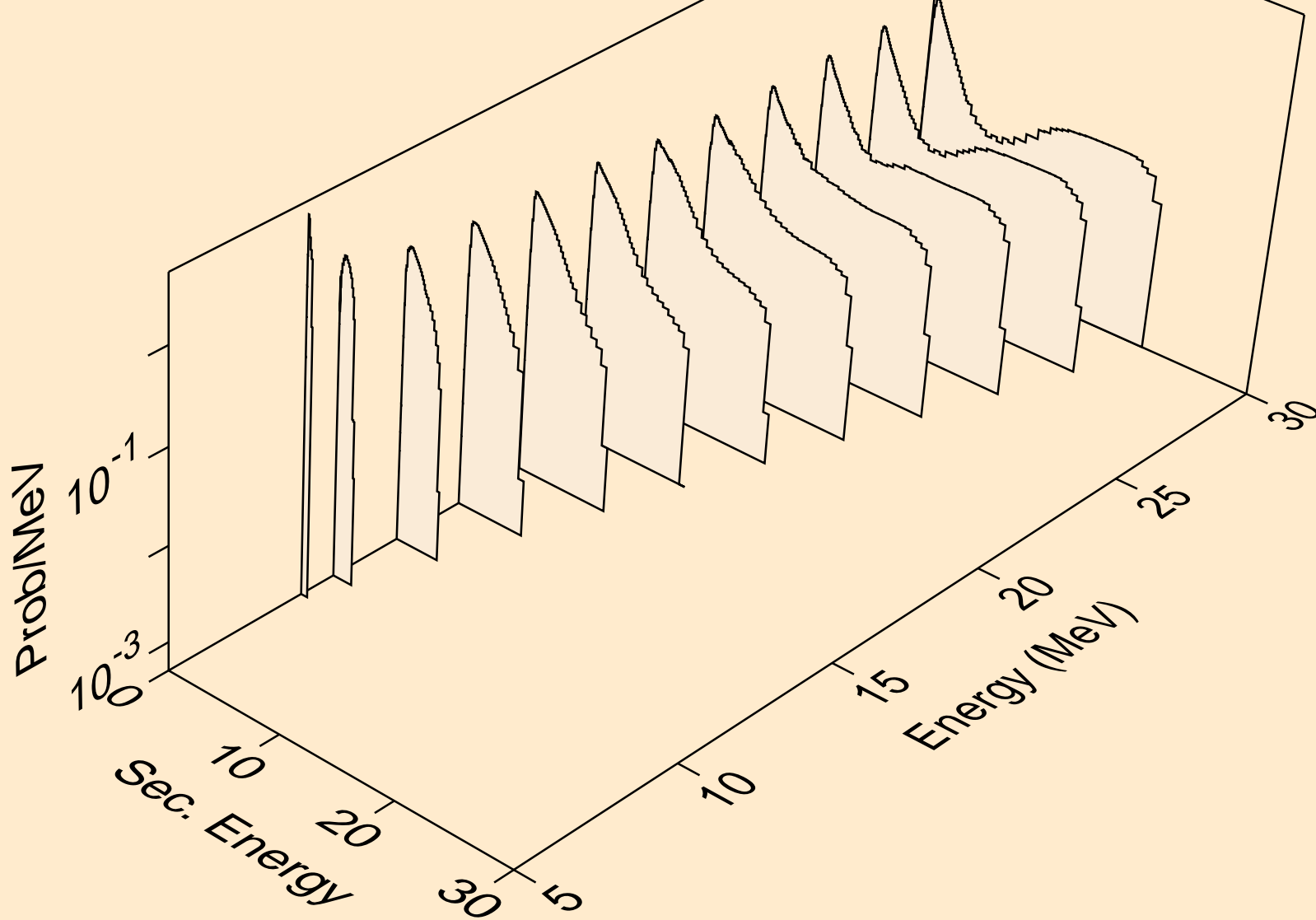

TC094M NEUTRON ACER TENDL-2019 LIBRARY; T=293.16K  
Neutron emission for (n,3n)

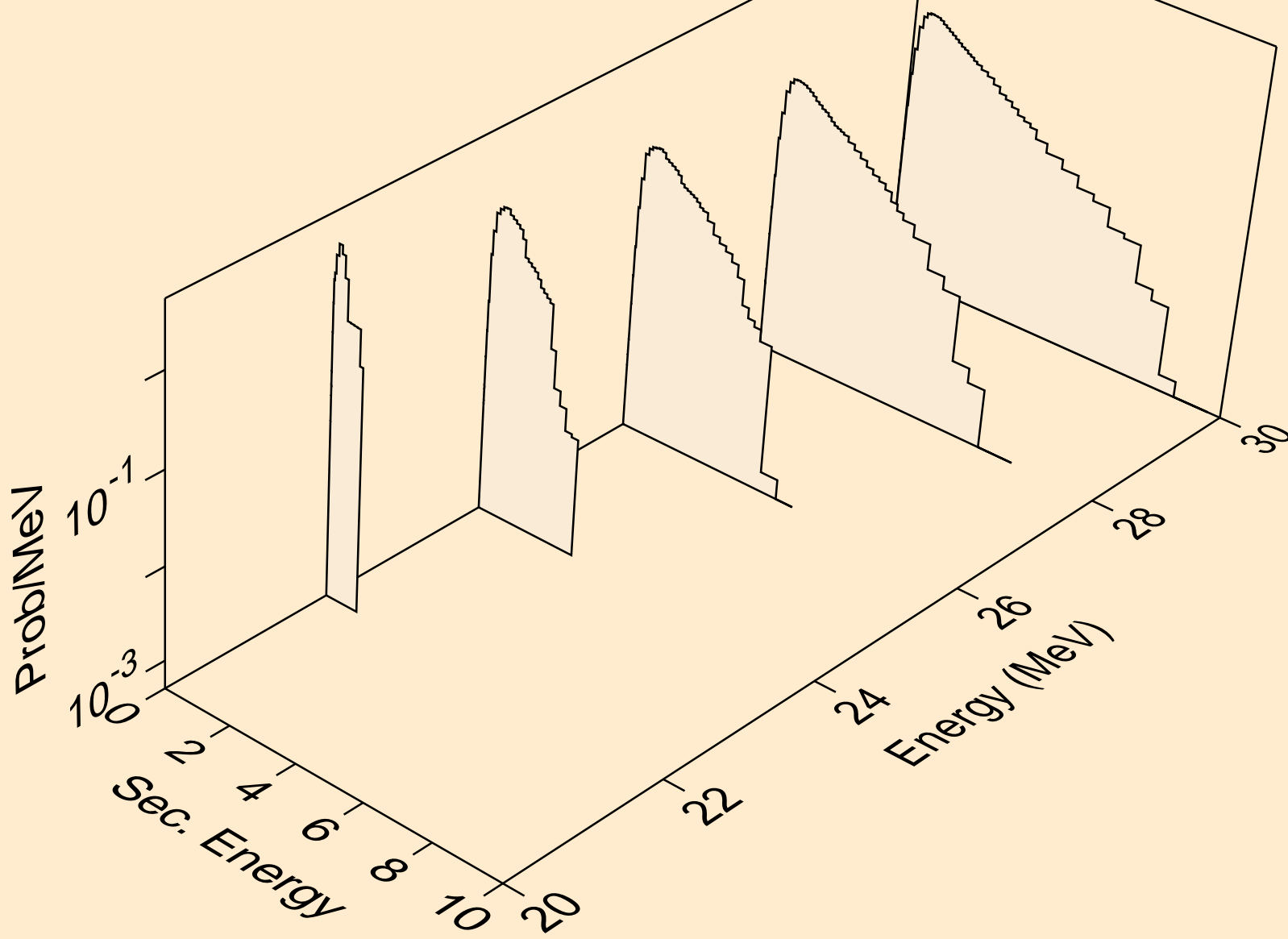

TC094M NEUTRON ACER TENDL-2019 LIBRARY; T=293.16K  
Neutron emission for (n,n\*)a

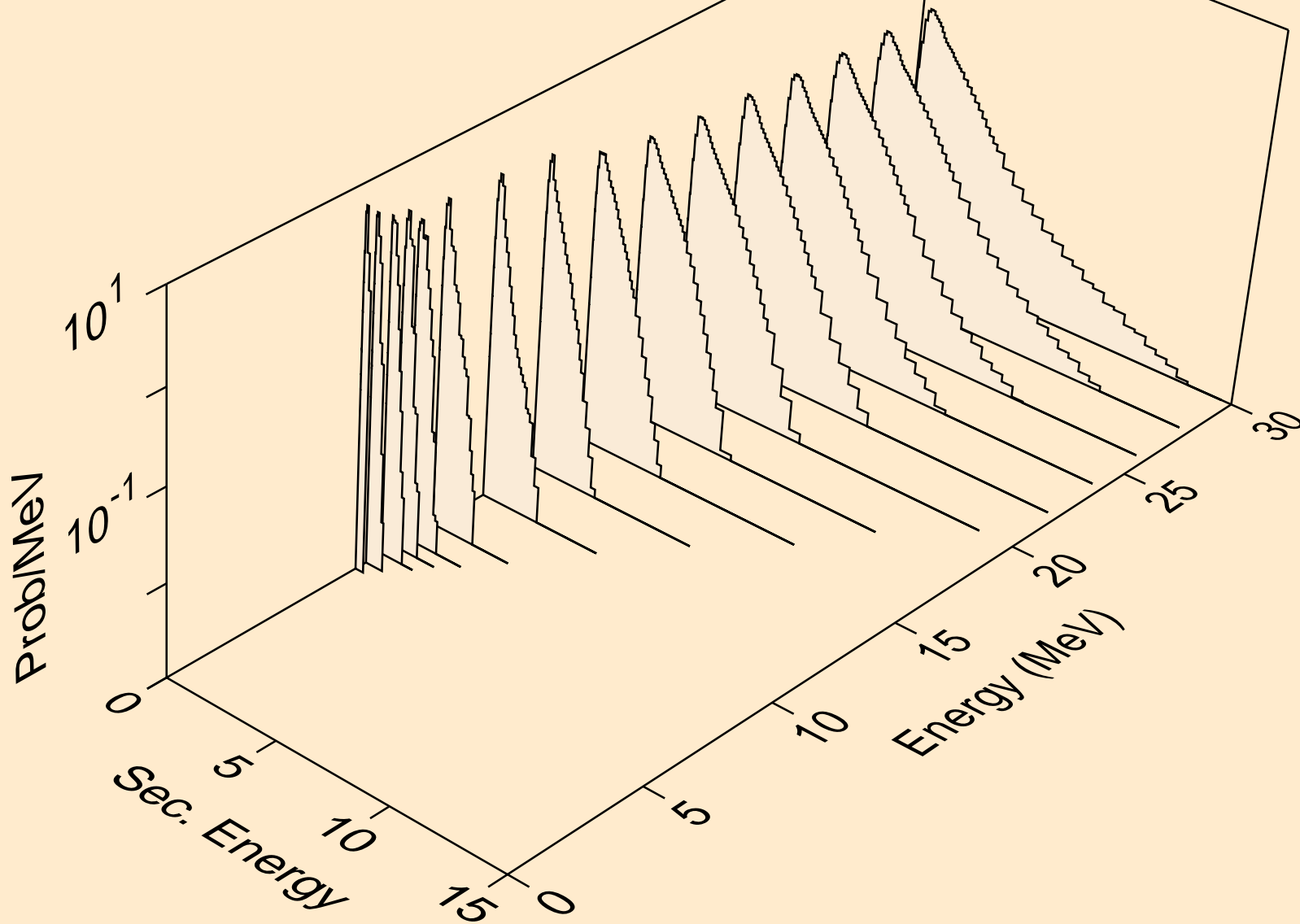

TC094M NEUTRON ACER TENDL-2019 LIBRARY; T=293.16K  
Neutron emission for (n,2n)a

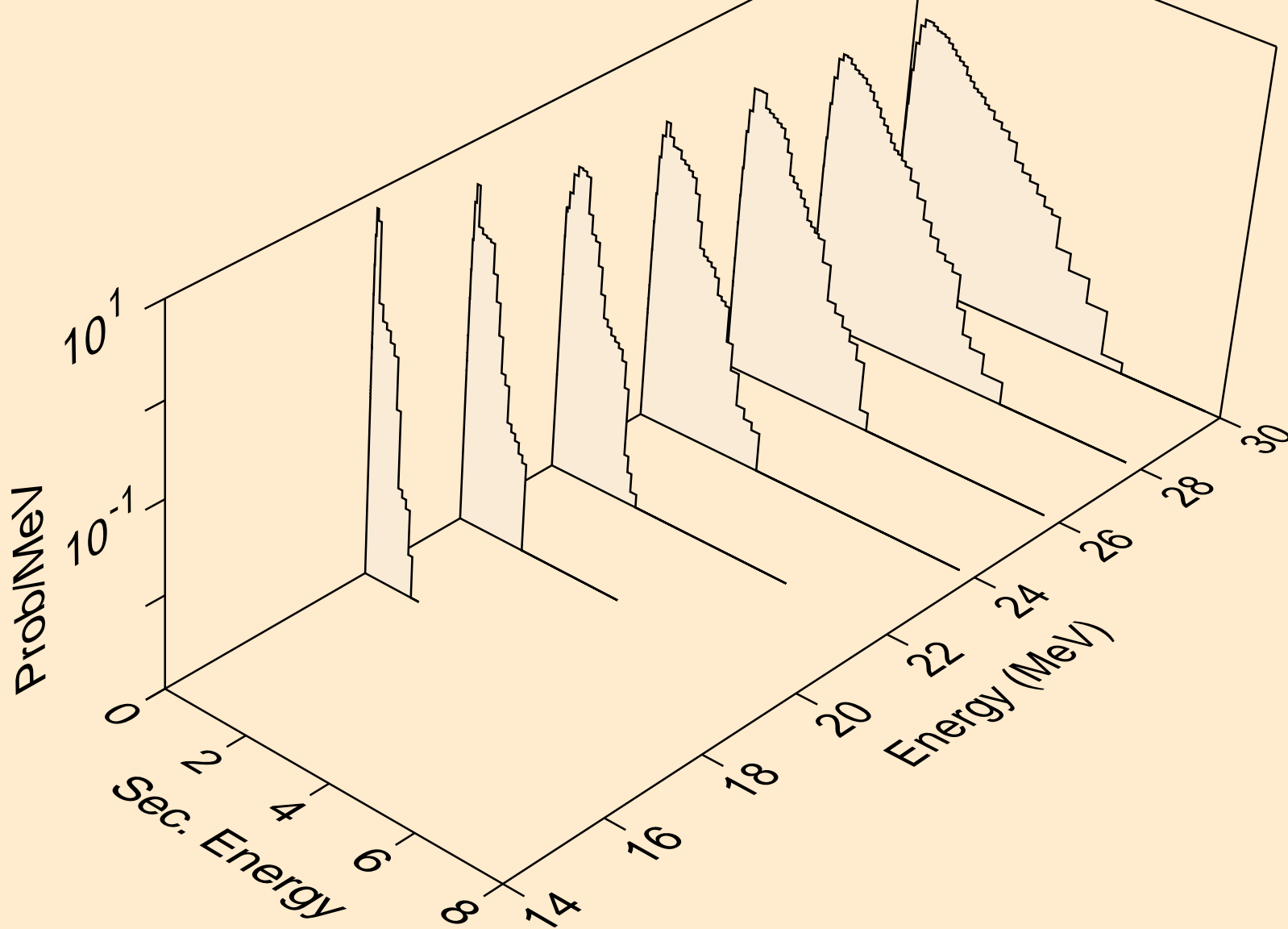



TC094M NEUTRON ACER TENDL-2019 LIBRARY; T=293.16K  
Neutron emission for (n,n\*)p

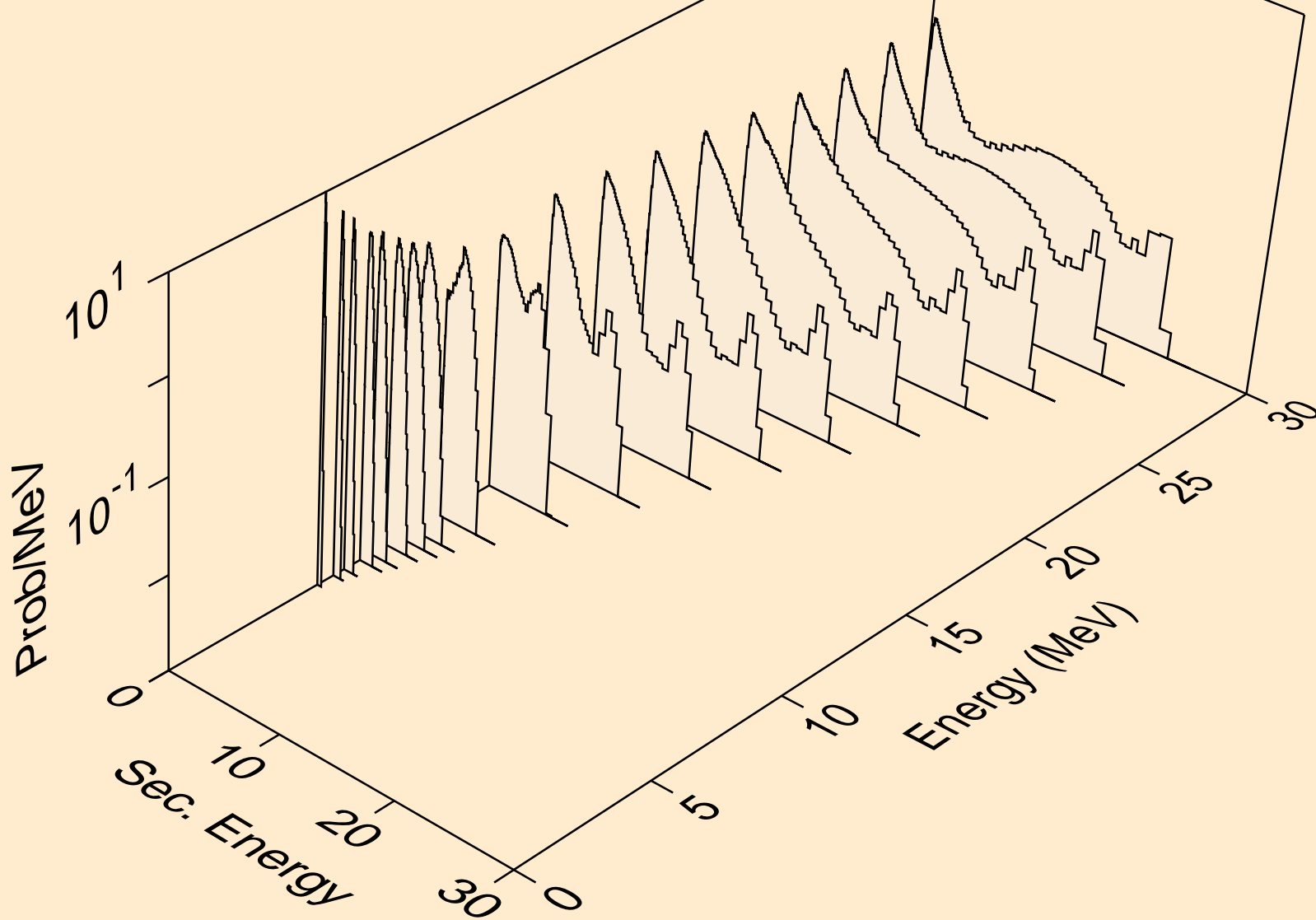

TC094M NEUTRON ACER TENDL-2019 LIBRARY; T=293.16K  
Neutron emission for (n,n\*)2a

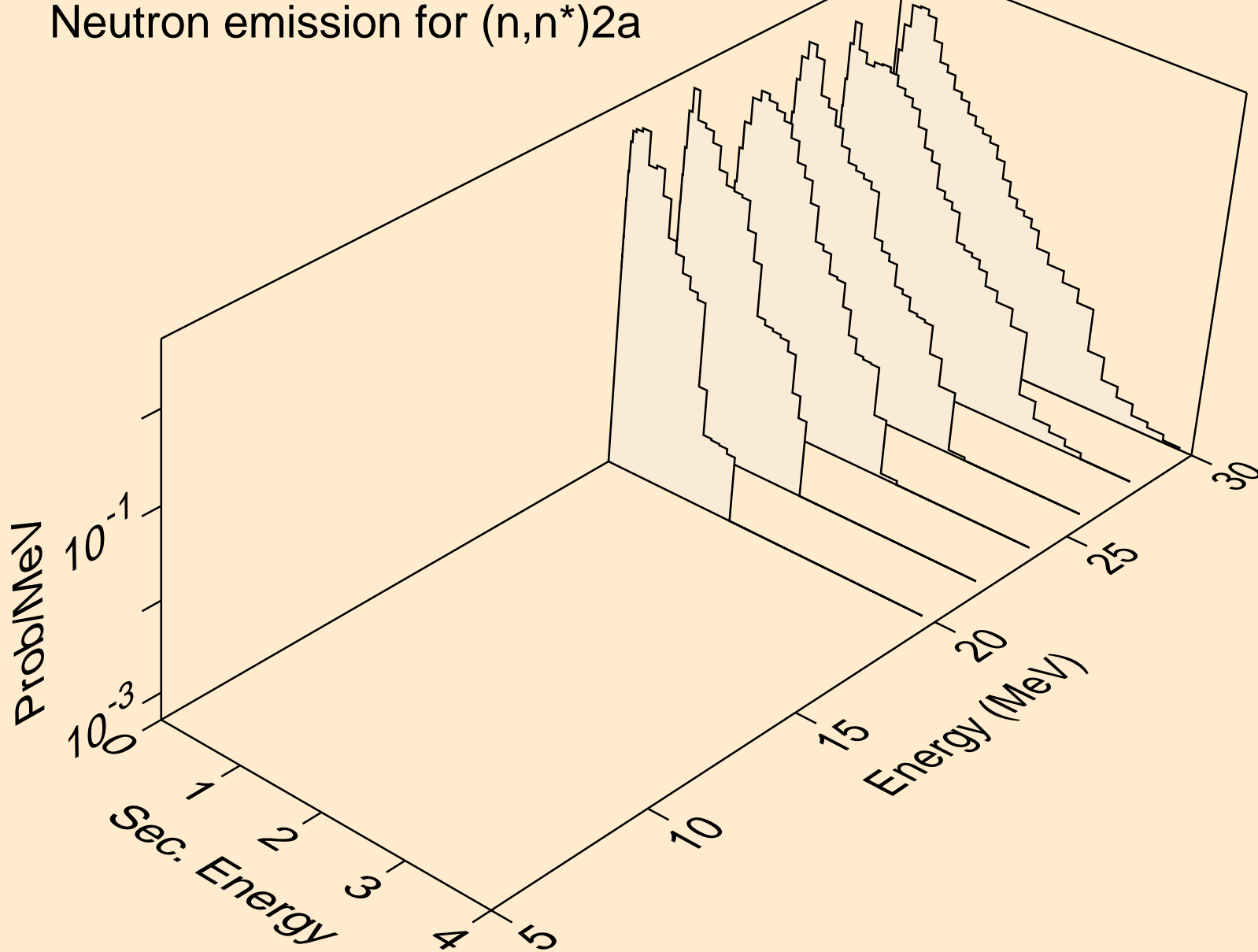

TC094M NEUTRON ACER TENDL-2019 LIBRARY; T=293.16K  
Neutron emission for (n,n\*)d

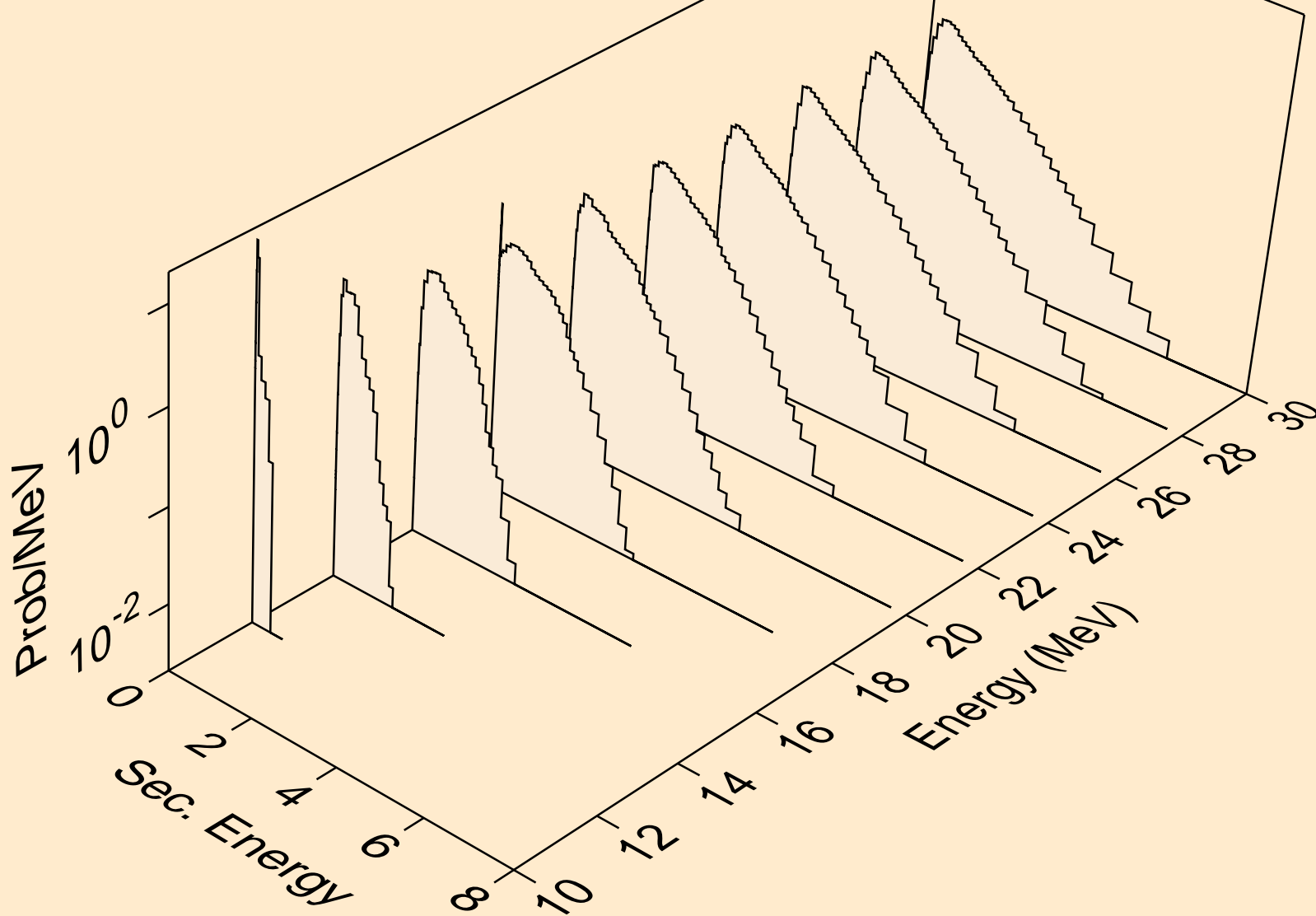

TC094M NEUTRON ACER TENDL-2019 LIBRARY; T=293.16K  
Neutron emission for (n,n\*)t

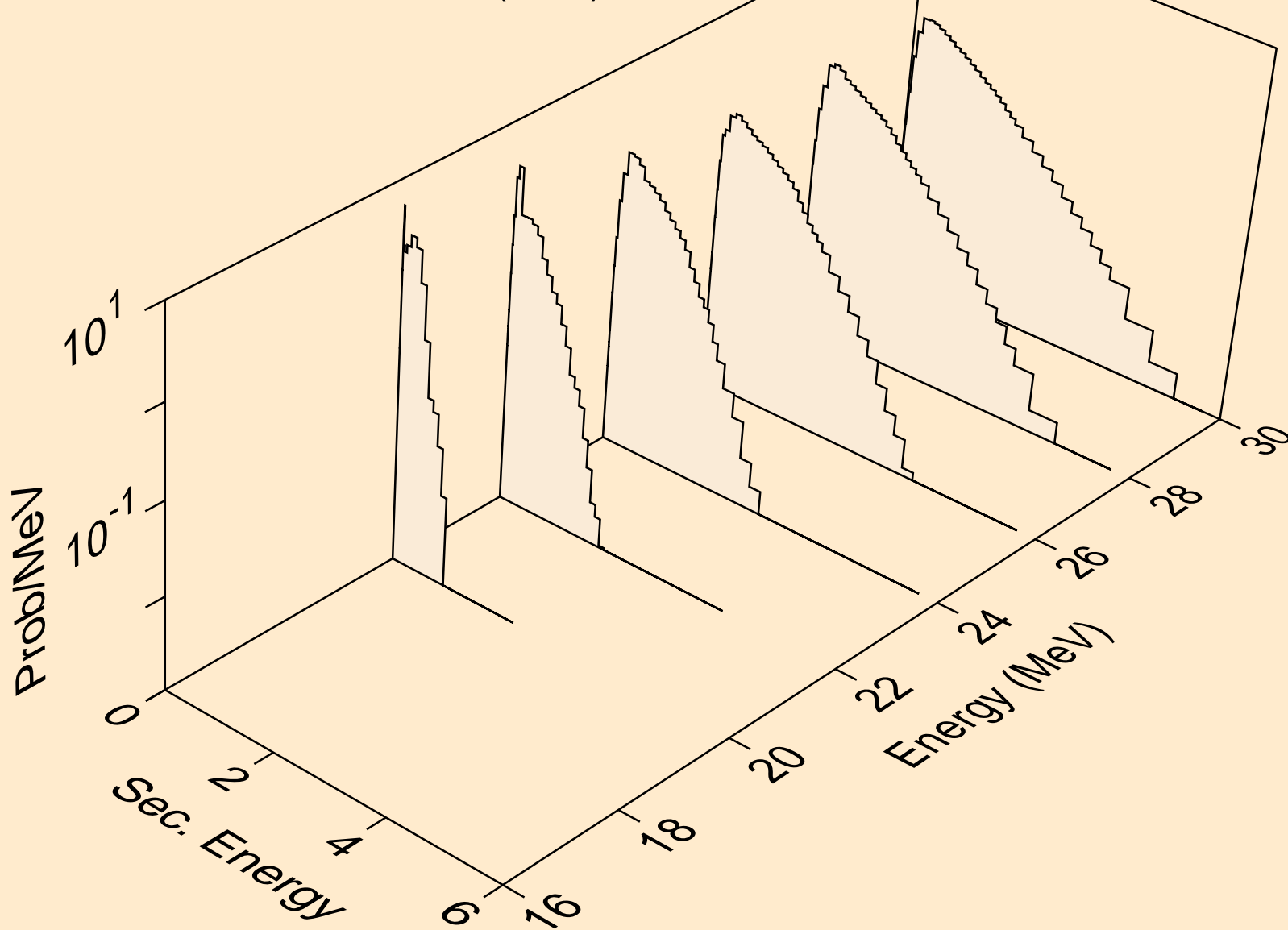

TC094M NEUTRON ACER TENDL-2019 LIBRARY; T=293.16K  
Neutron emission for (n,n\*)he3

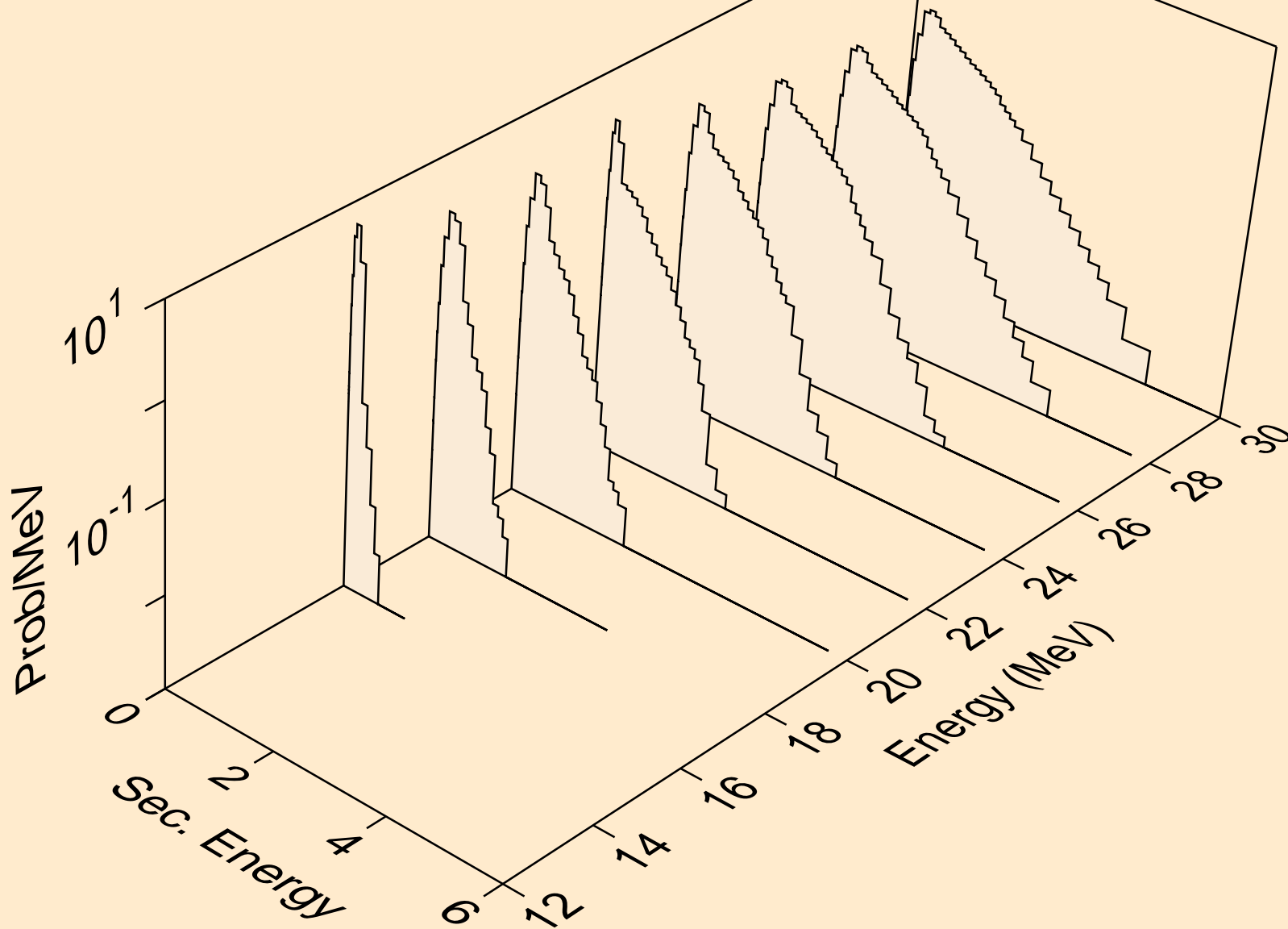

TC094M NEUTRON ACER TENDL-2019 LIBRARY; T=293.16K  
Neutron emission for (n,2np)

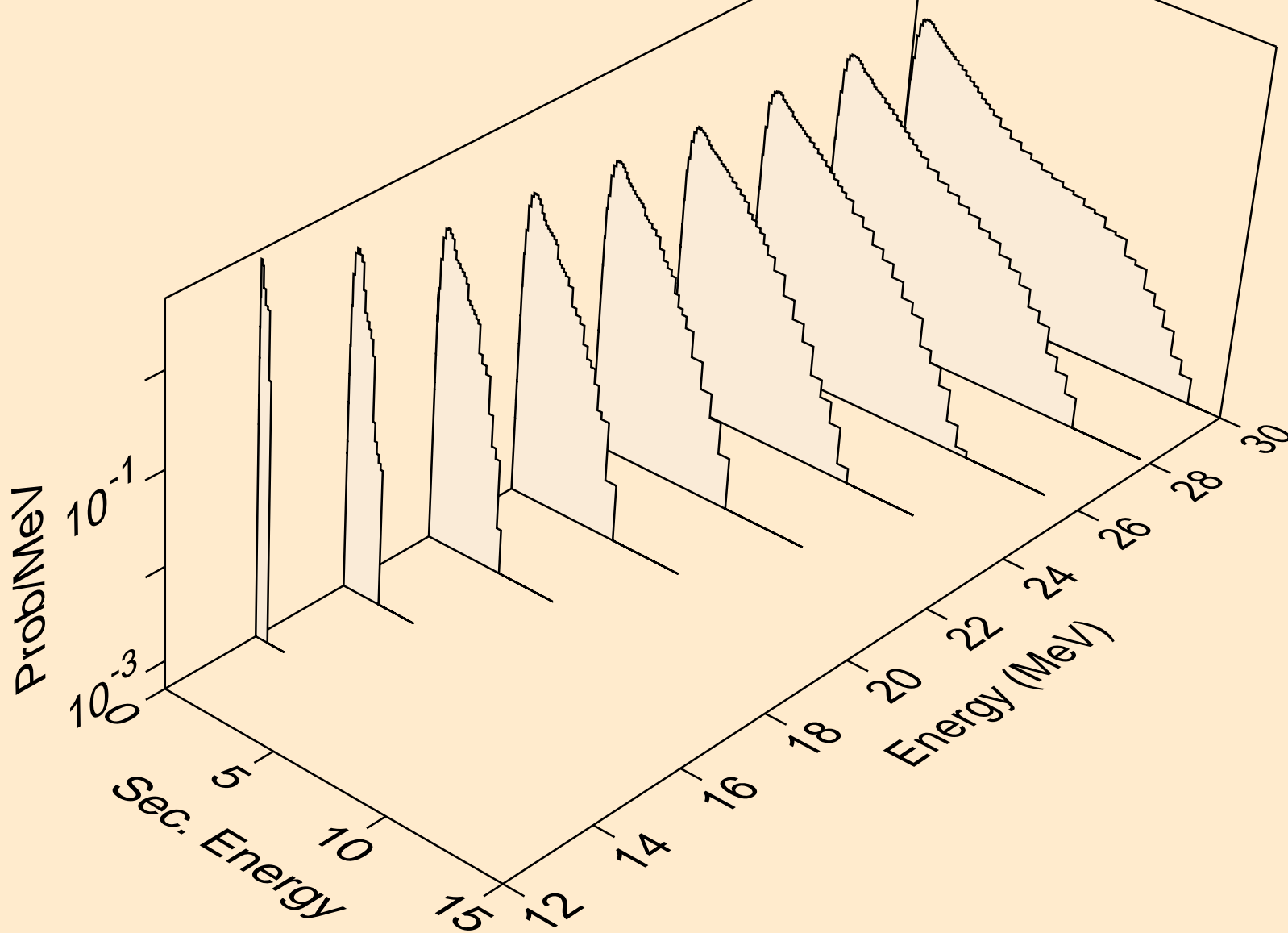

TC094M NEUTRON ACER TENDL-2019 LIBRARY; T=293.16K  
Neutron emission for (n,3np)

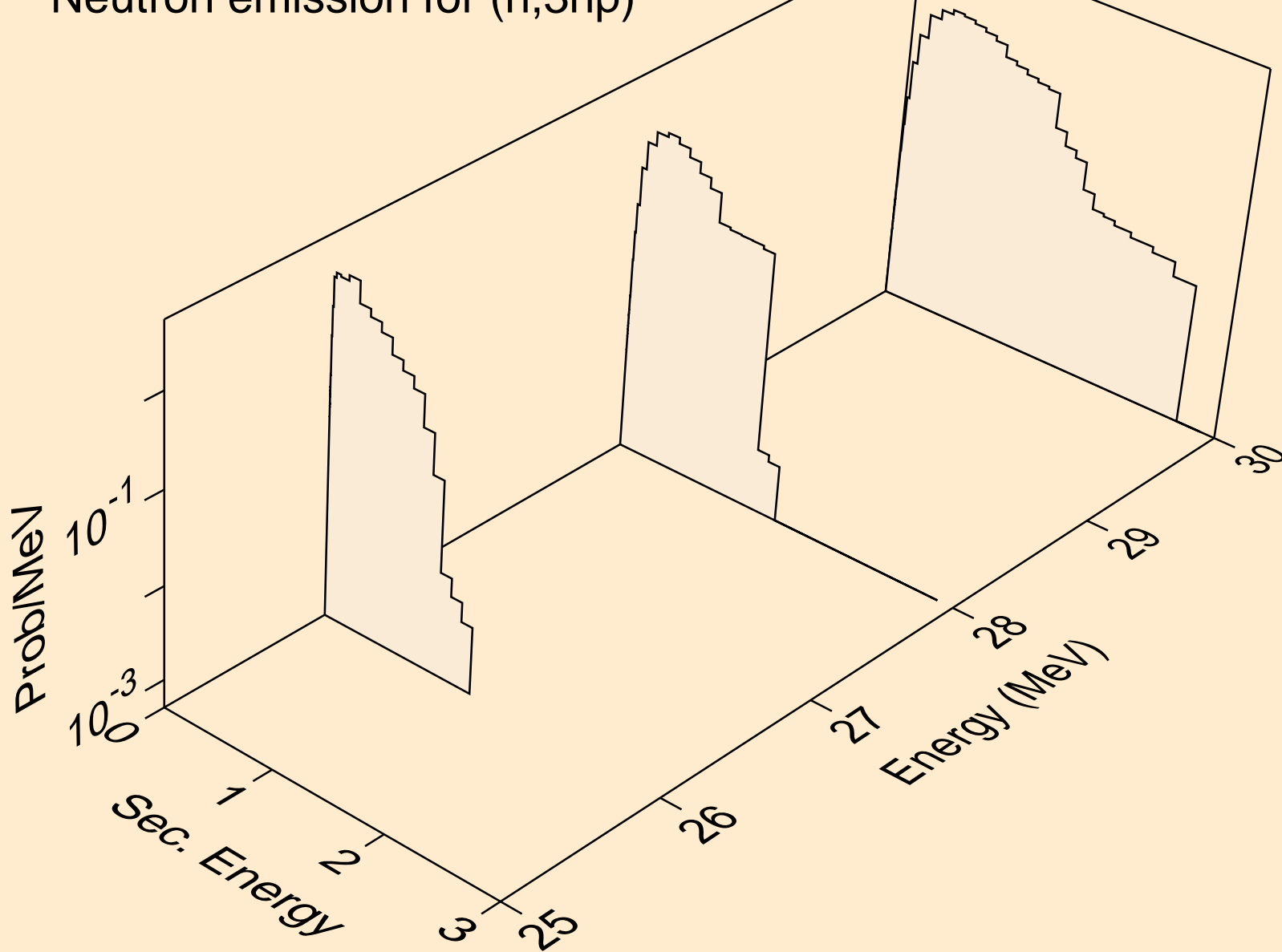

TC094M NEUTRON ACER TENDL-2019 LIBRARY; T=293.16K  
Neutron emission for (n,2np)

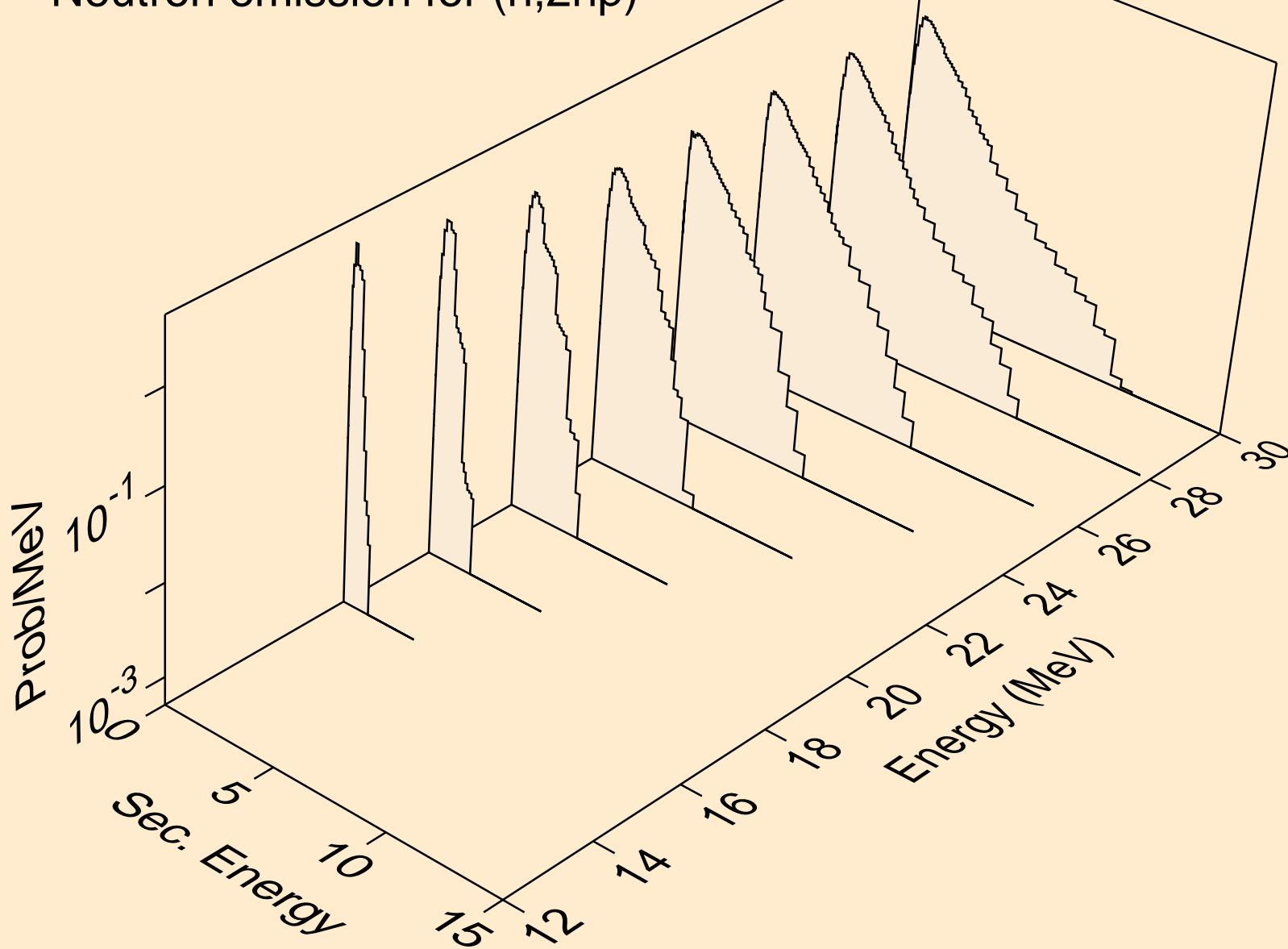



TC094M NEUTRON ACER TENDL-2019 LIBRARY; T=293.16K  
Neutron emission for (n,npa)

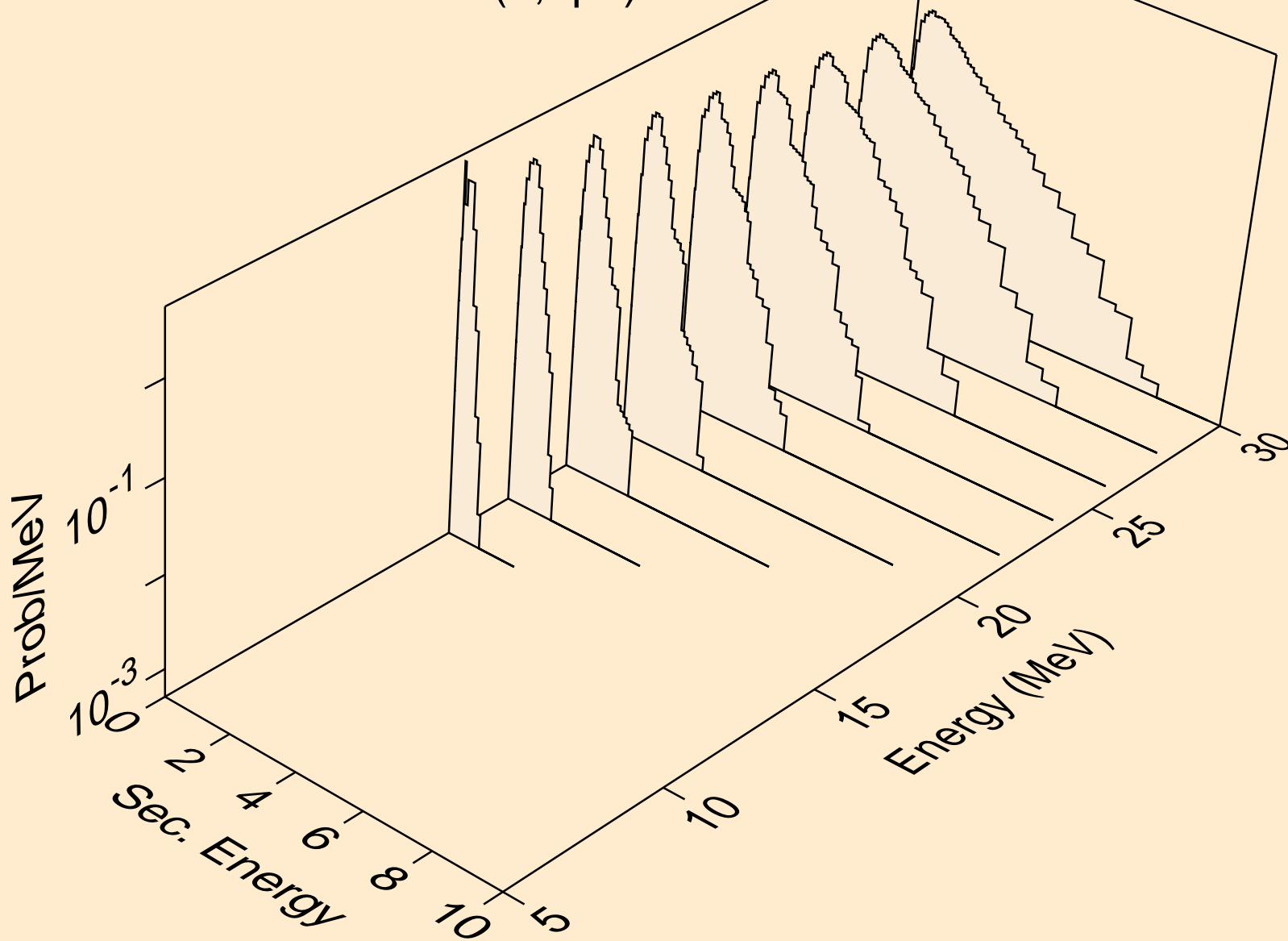

TC094M NEUTRON ACER TENDL-2019 LIBRARY; T=293.16K  
Neutron emission for (n,n\*c)

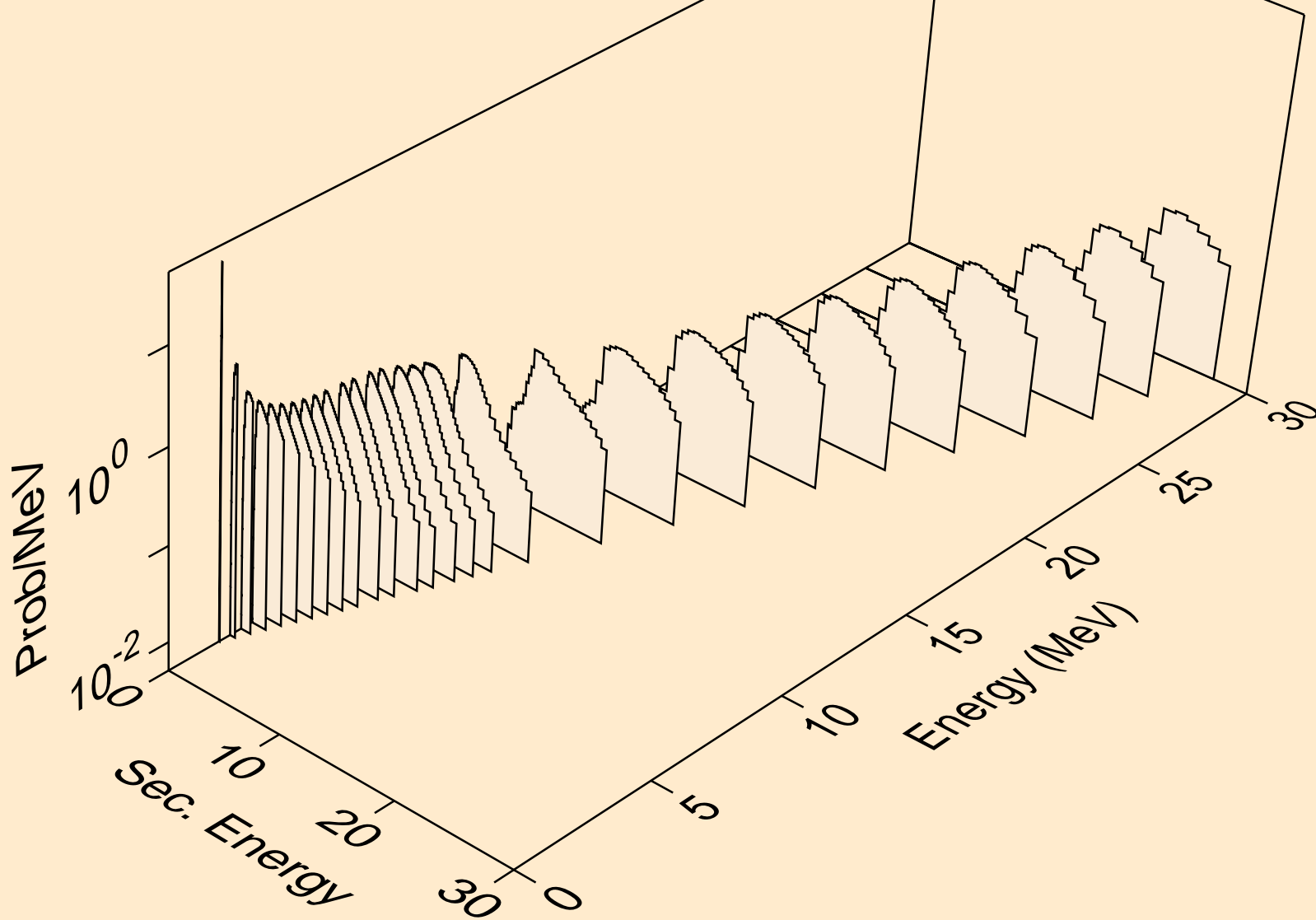

TC094M NEUTRON ACER TENDL-2019 LIBRARY; T=293.16K  
Photon emission for (n,x)

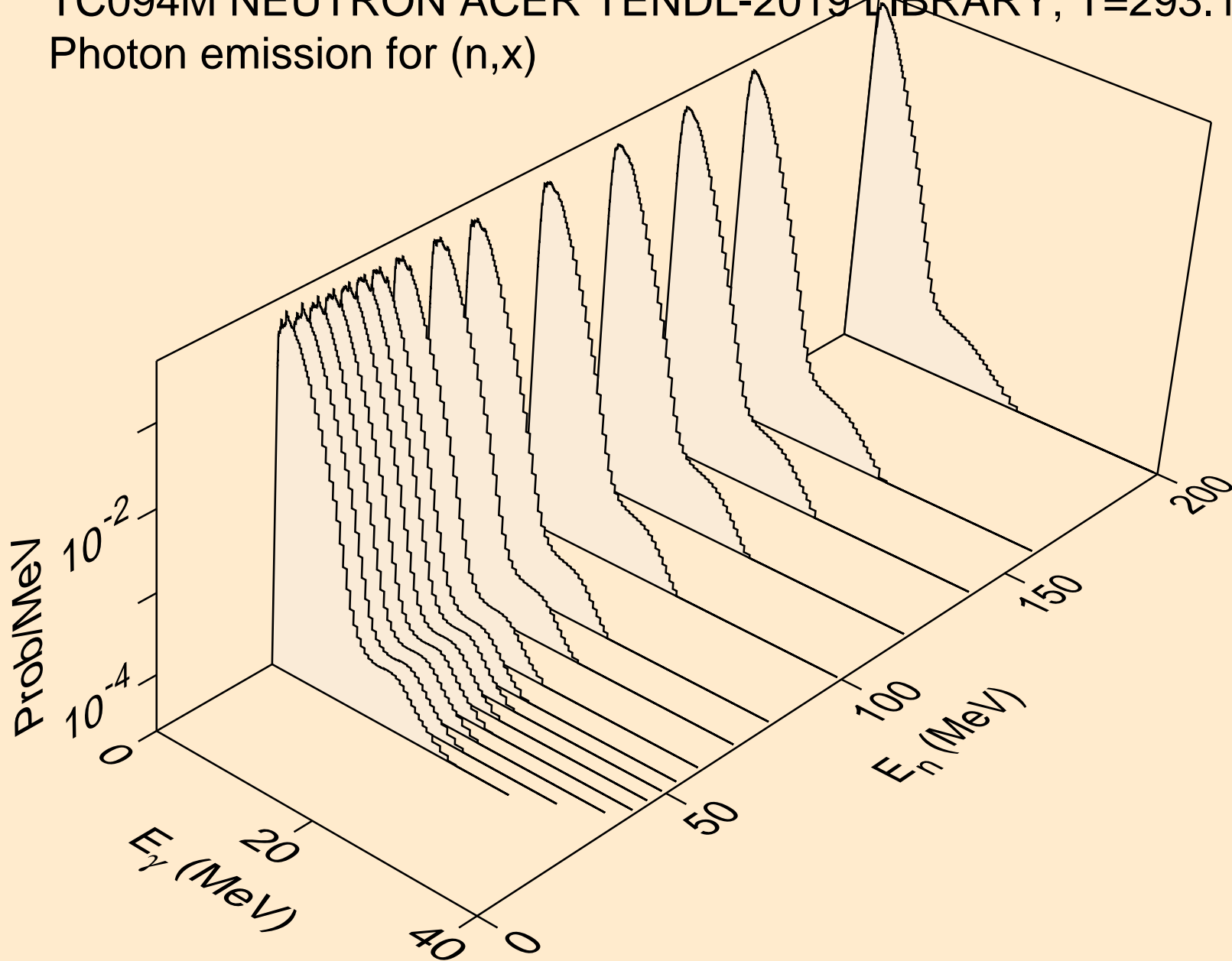

TC094M NEUTRON ACER TENDL-2019 LIBRARY; T=293.16K  
Photon emission for (n,2nd)

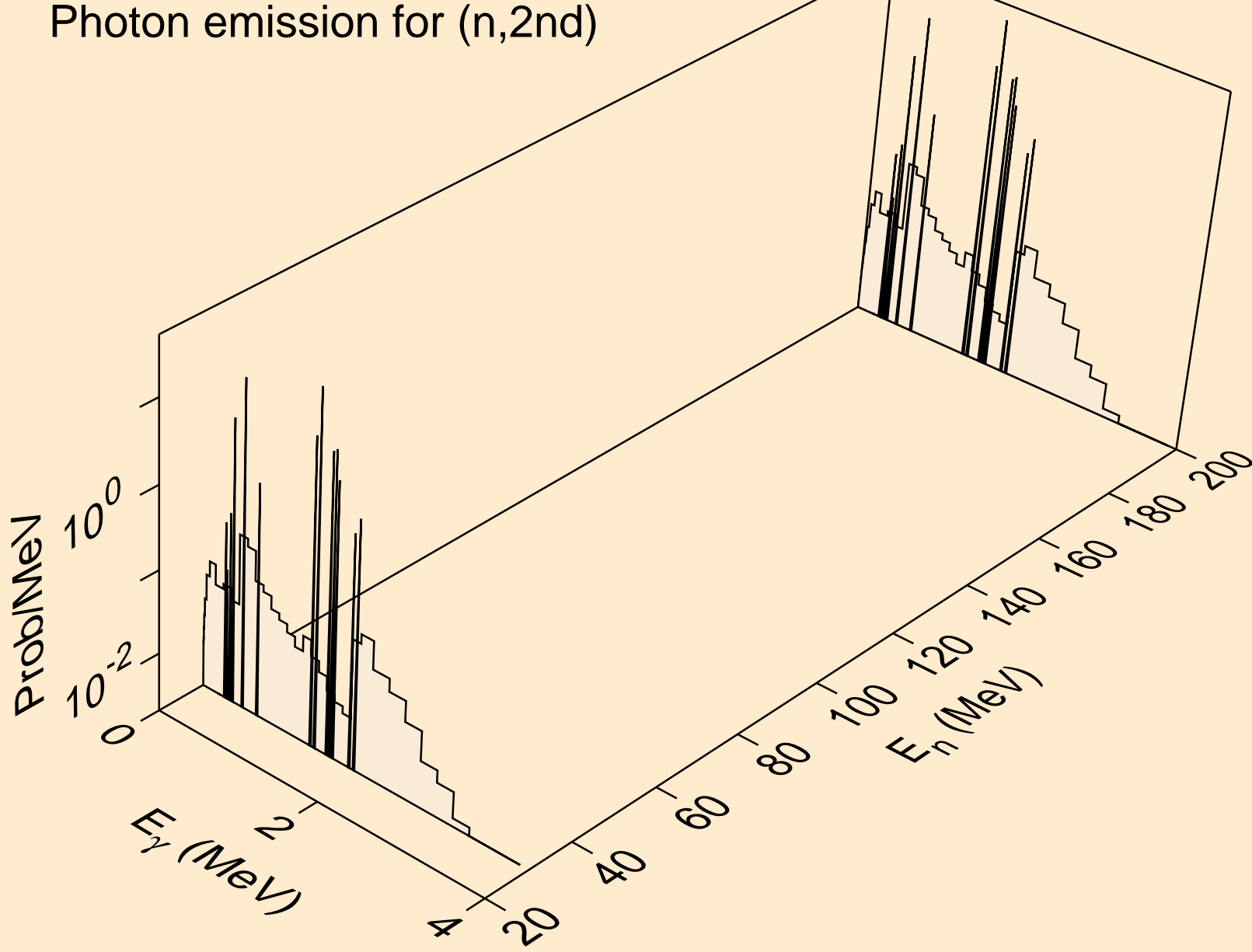

TC094M NEUTRON ACER TENDL-2019 LIBRARY; T=293.16K  
Photon emission for (n,2n)

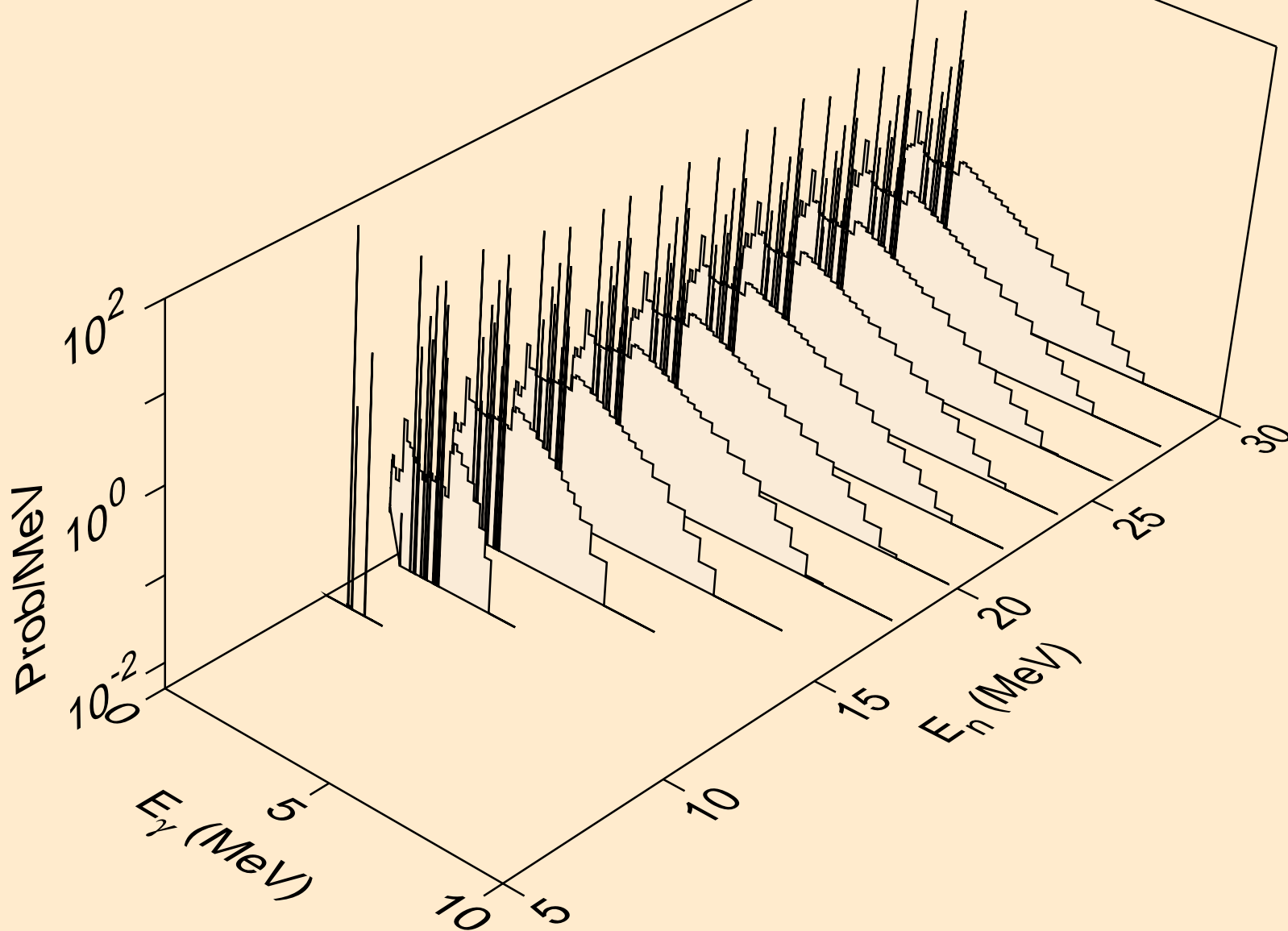

TC094M NEUTRON ACER TENDL-2019 LIBRARY; T=293.16K  
Photon emission for (n,3n)

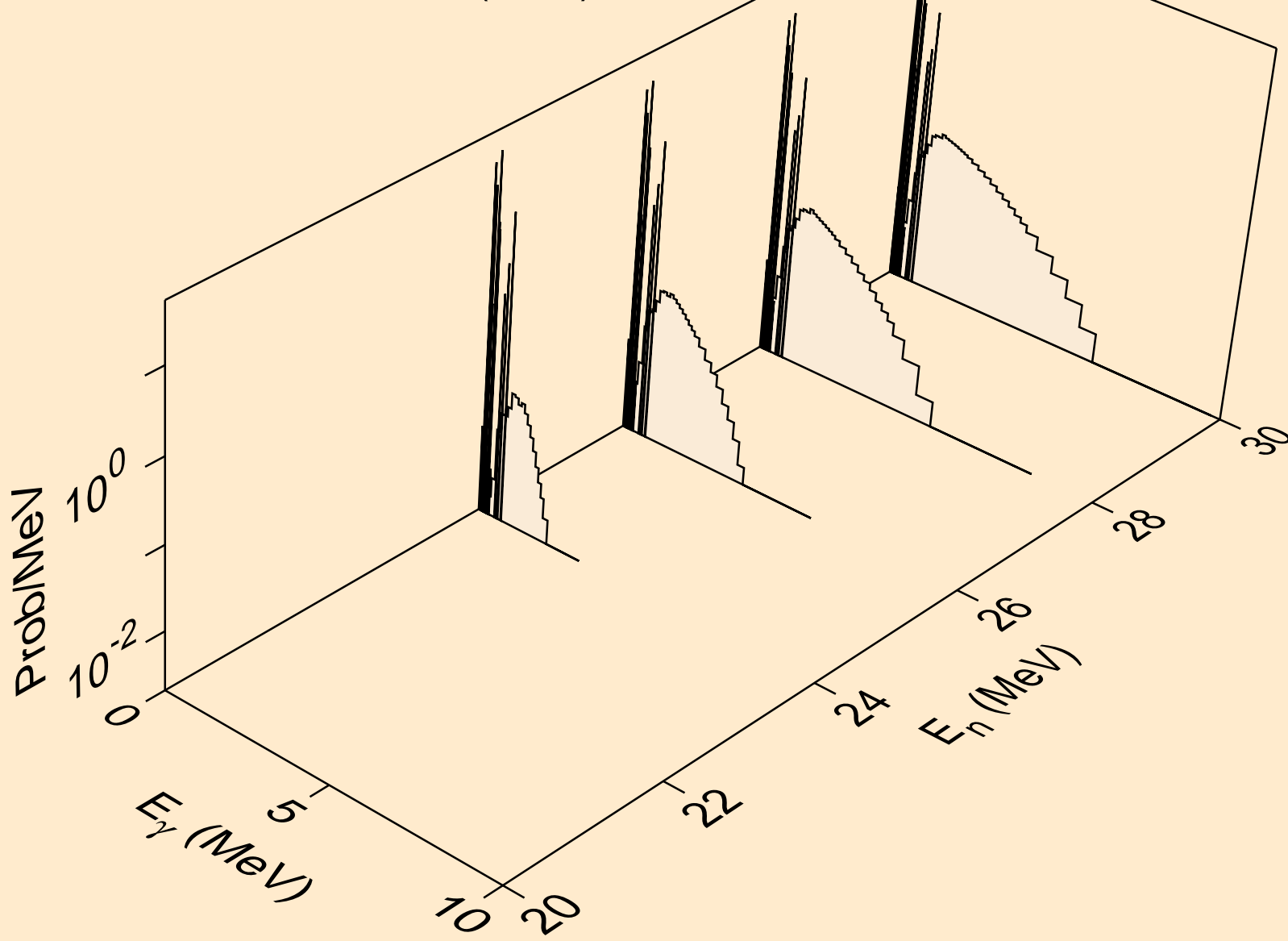

TC094M NEUTRON ACER TENDL-2019 LIBRARY; T=293.16K  
Photon emission for (n,n\*)a

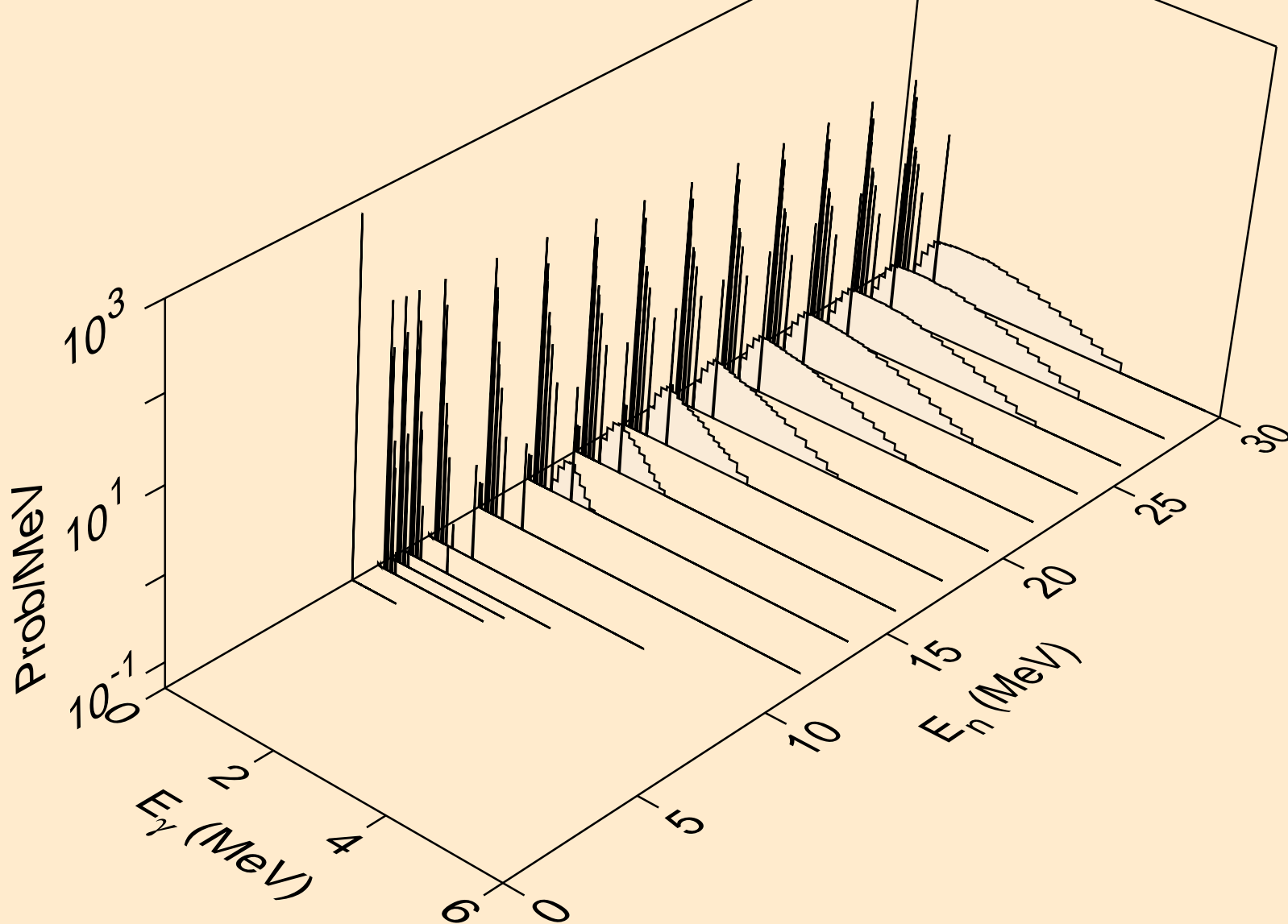

TC094M NEUTRON ACER TENDL-2019 LIBRARY; T=293.16K  
Photon emission for (n,2n)a

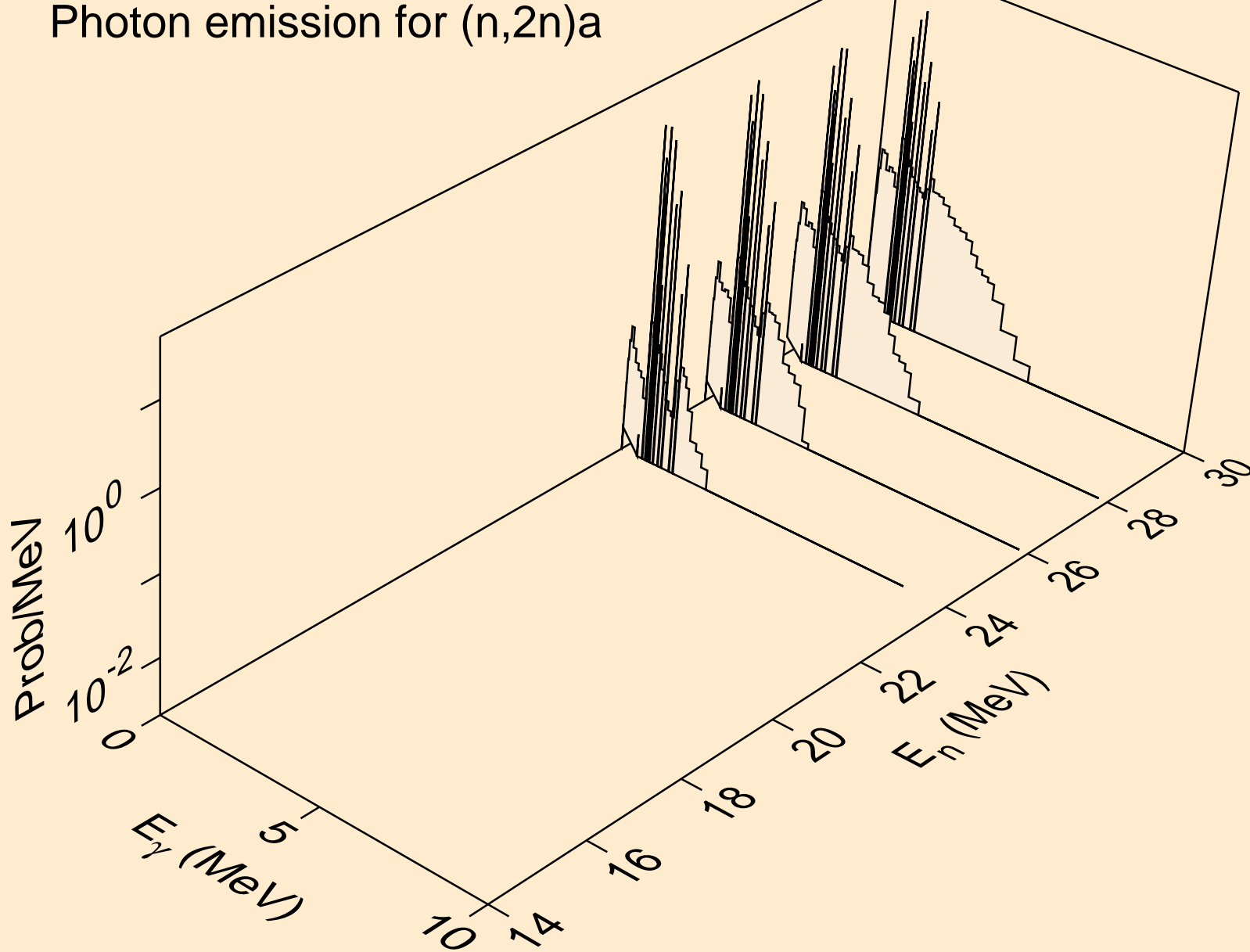



TC094M NEUTRON ACER TENDL-2019 LIBRARY; T=293.16K  
Photon emission for (n,n\*)p

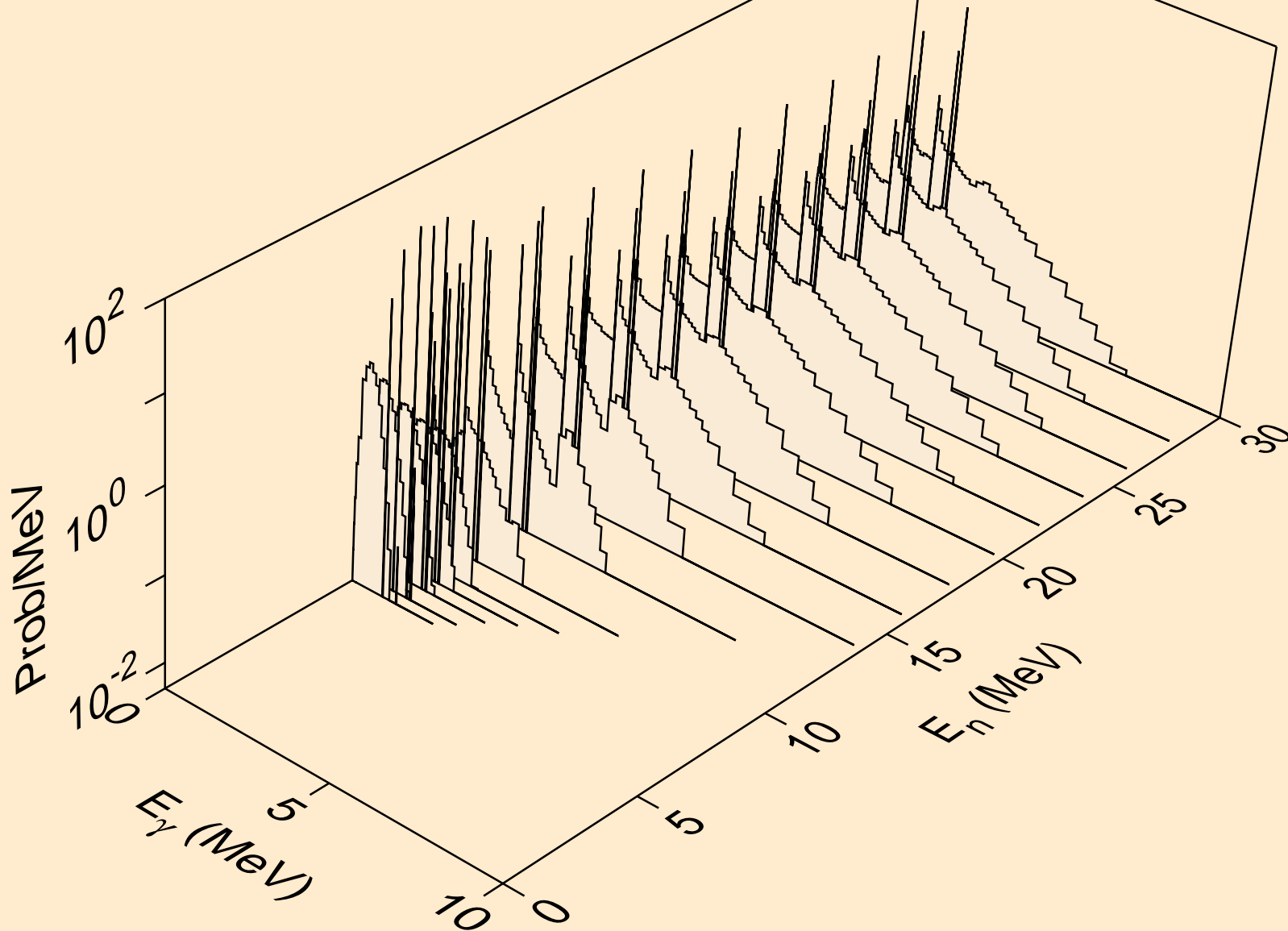

TC094M NEUTRON ACER TENDL-2019 LIBRARY; T=293.16K  
Photon emission for (n,n\*)2a

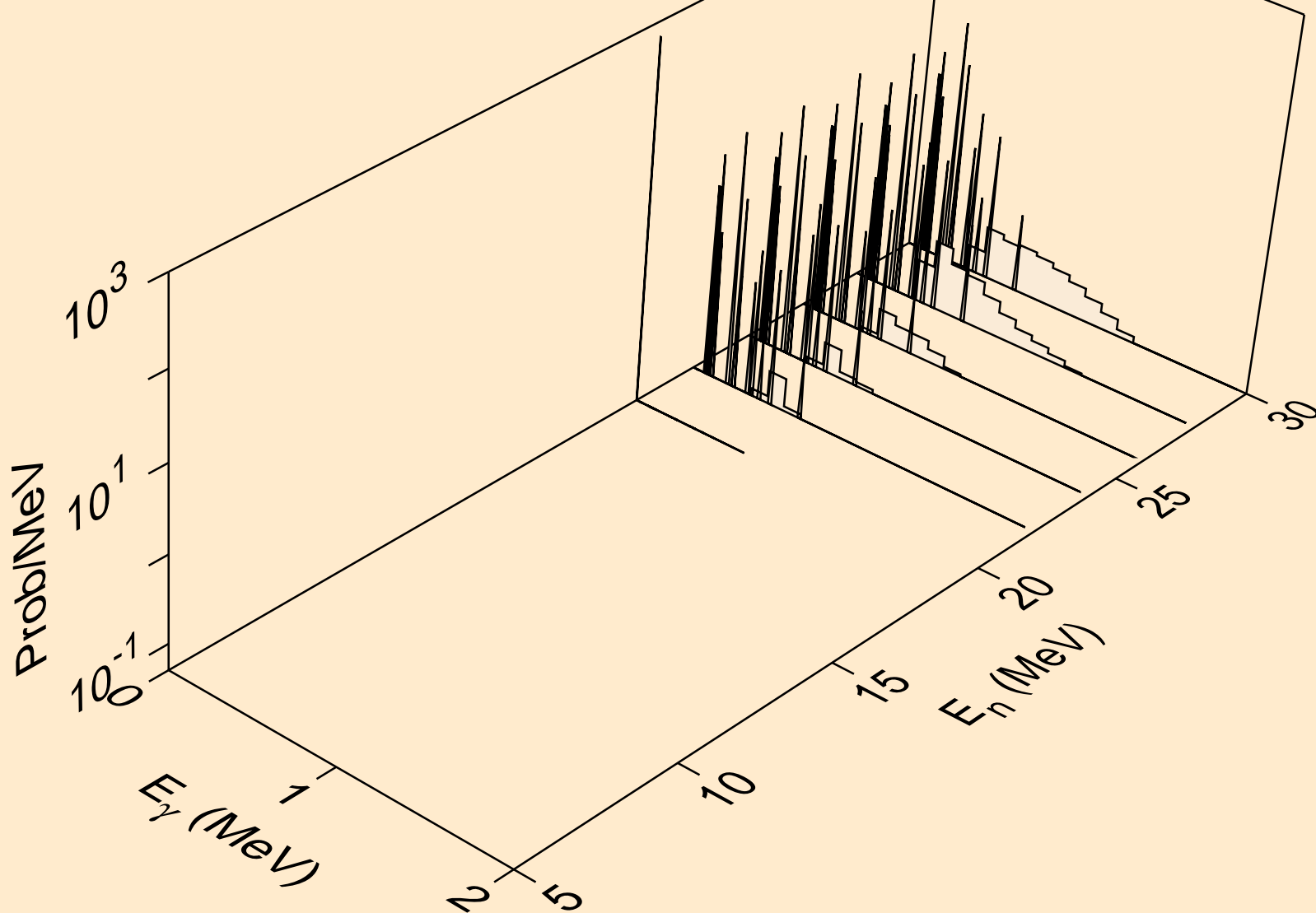

TC094M NEUTRON ACER TENDL-2019 LIBRARY; T=293.16K  
Photon emission for (n,n\*)d

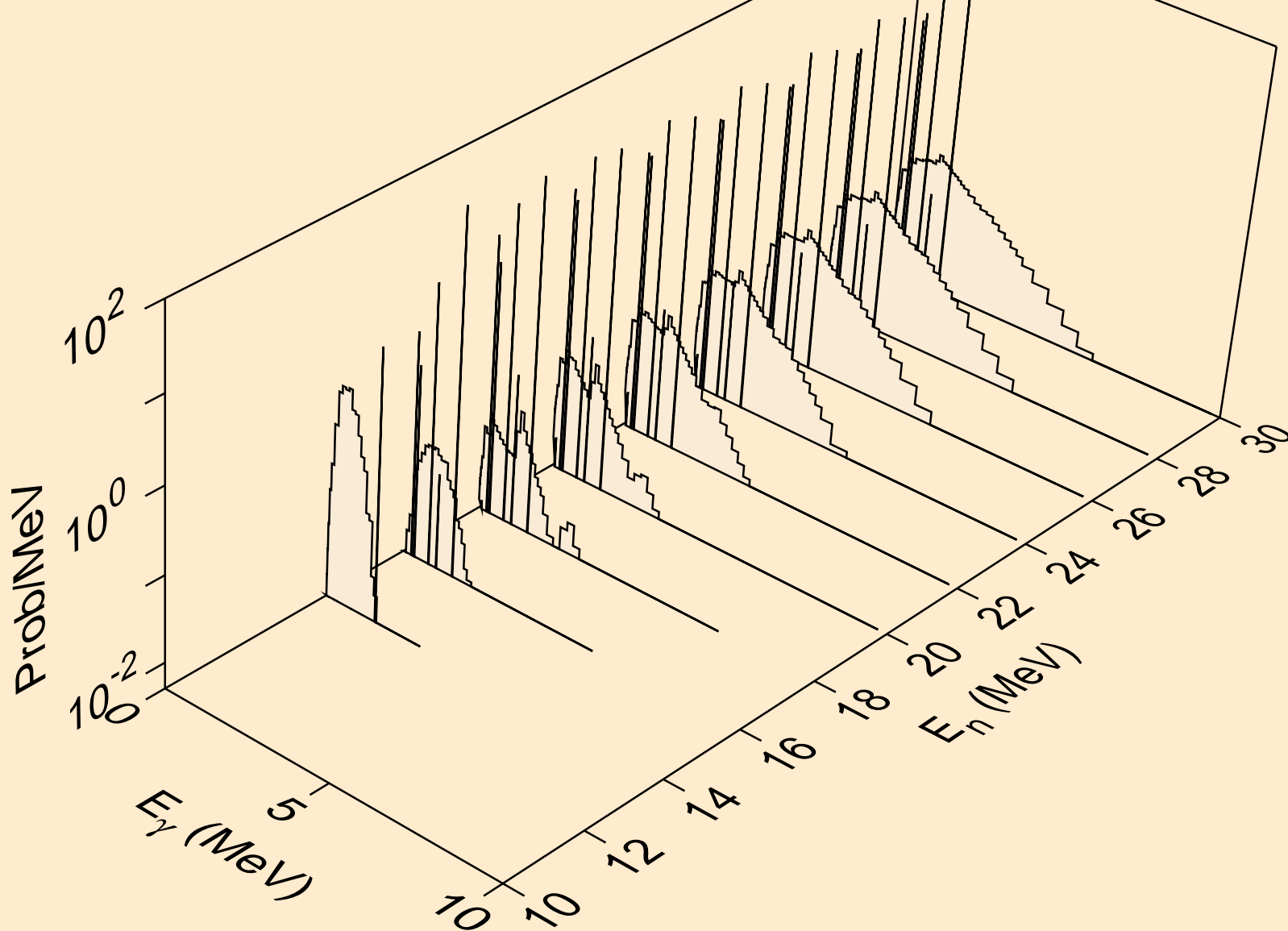

TC094M NEUTRON ACER TENDL-2019 LIBRARY; T=293.16K  
Photon emission for (n,n\*)t

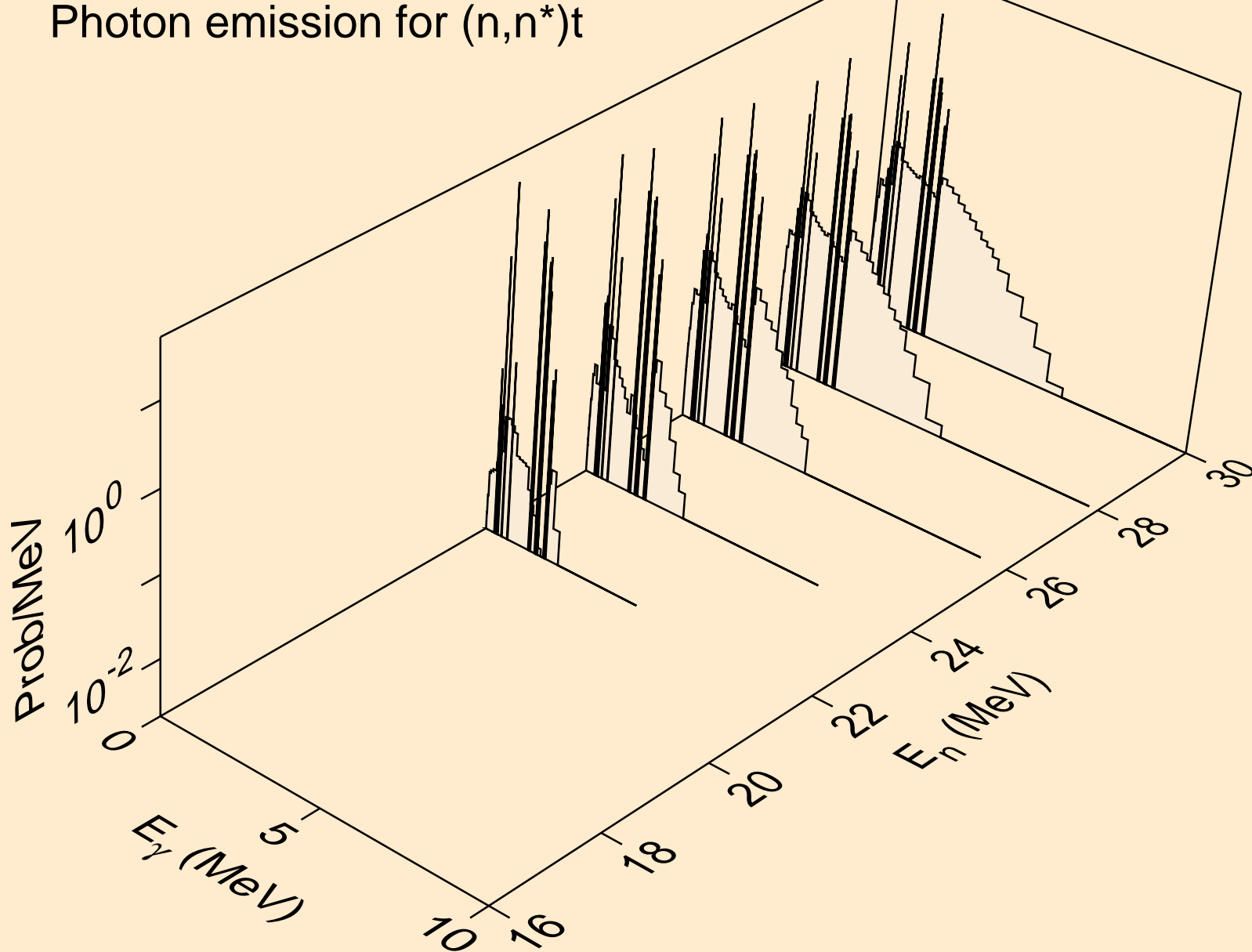

TC094M NEUTRON ACER TENDL-2019 LIBRARY; T=293.16K  
Photon emission for (n,n\*)he3

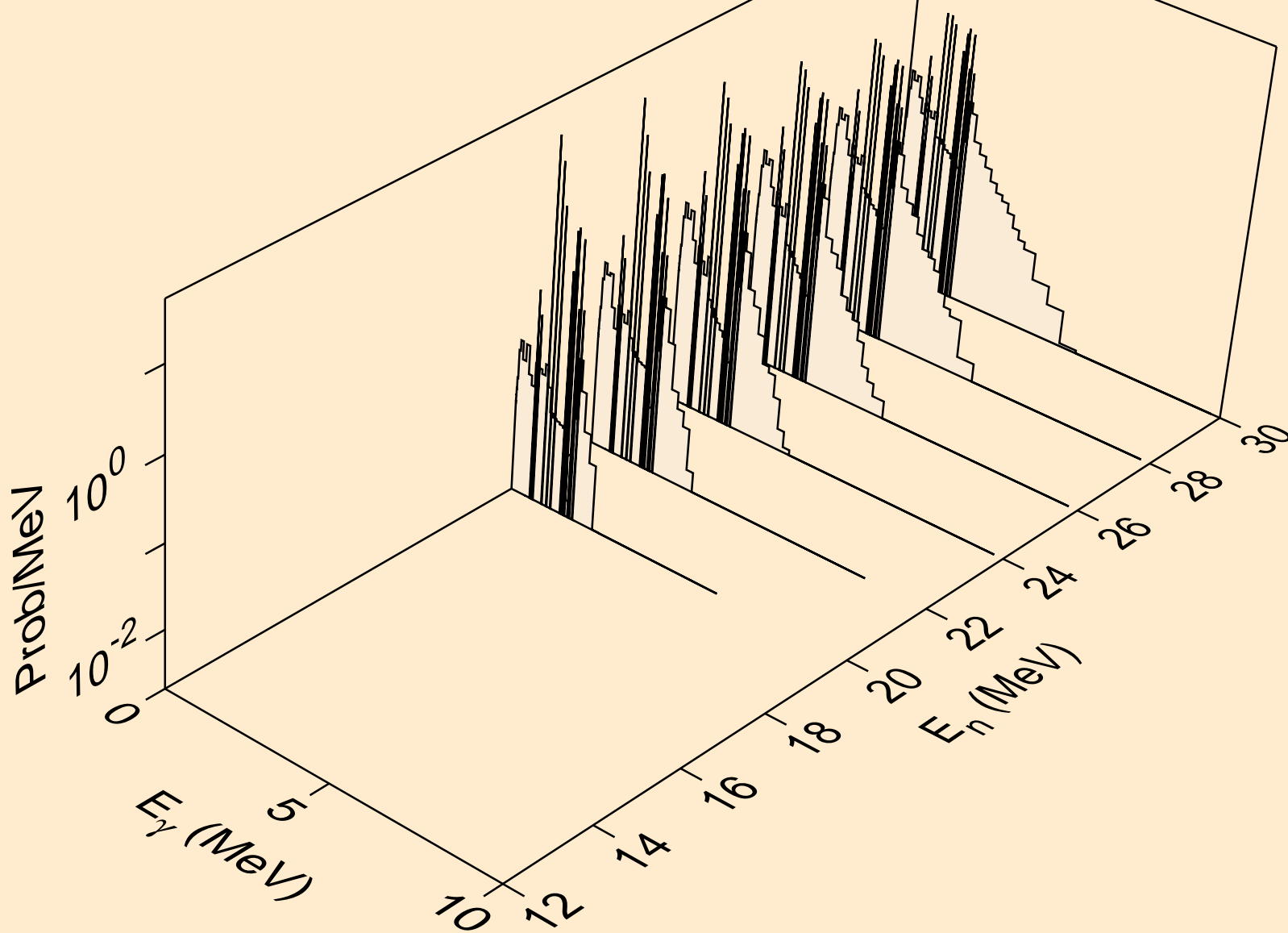

TC094M NEUTRON ACER TENDL-2019 LIBRARY; T=293.16K  
Photon emission for (n,2np)

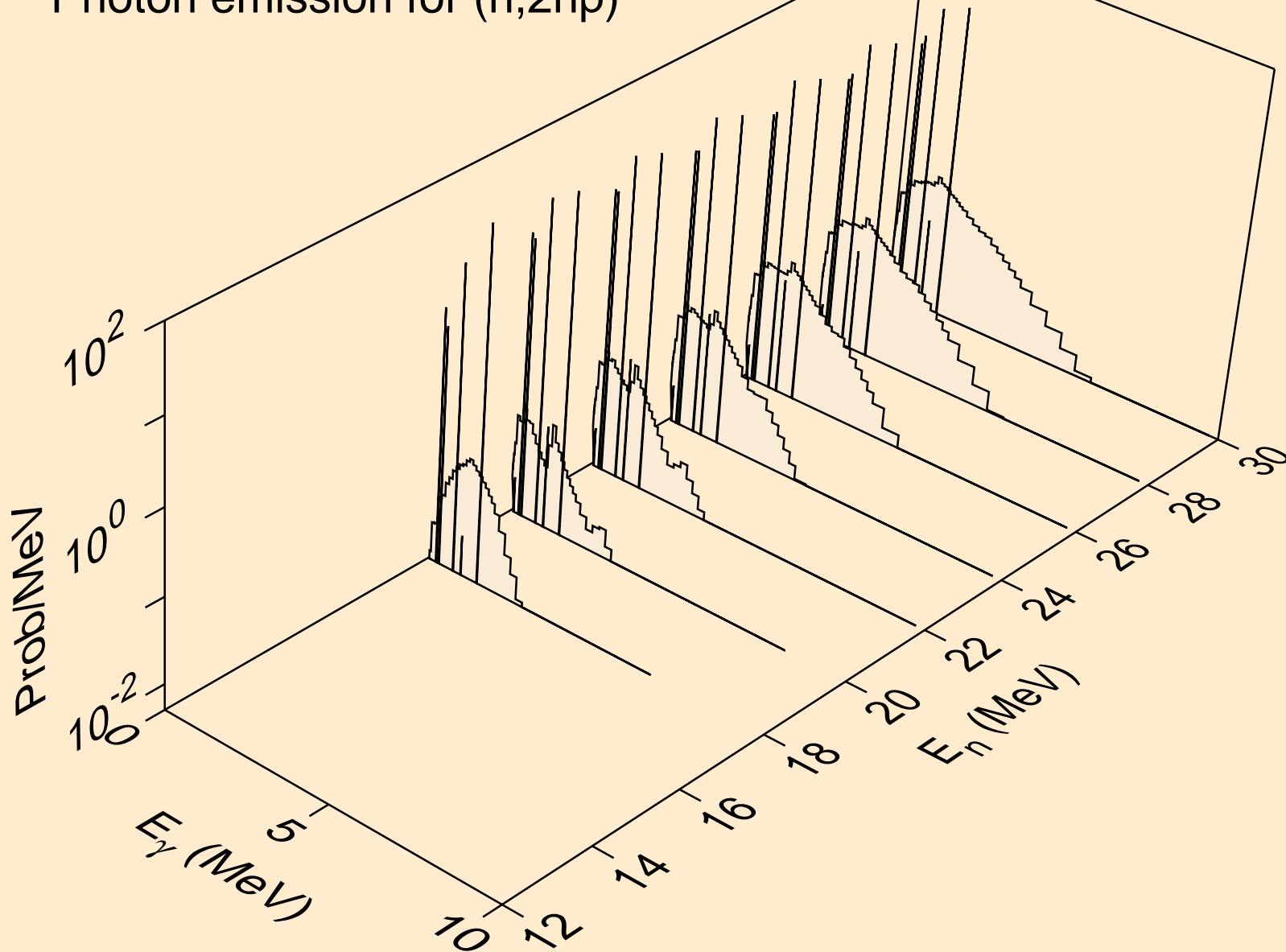

TC094M NEUTRON ACER TENDL-2019 LIBRARY; T=293.16K  
Photon emission for (n,3np)

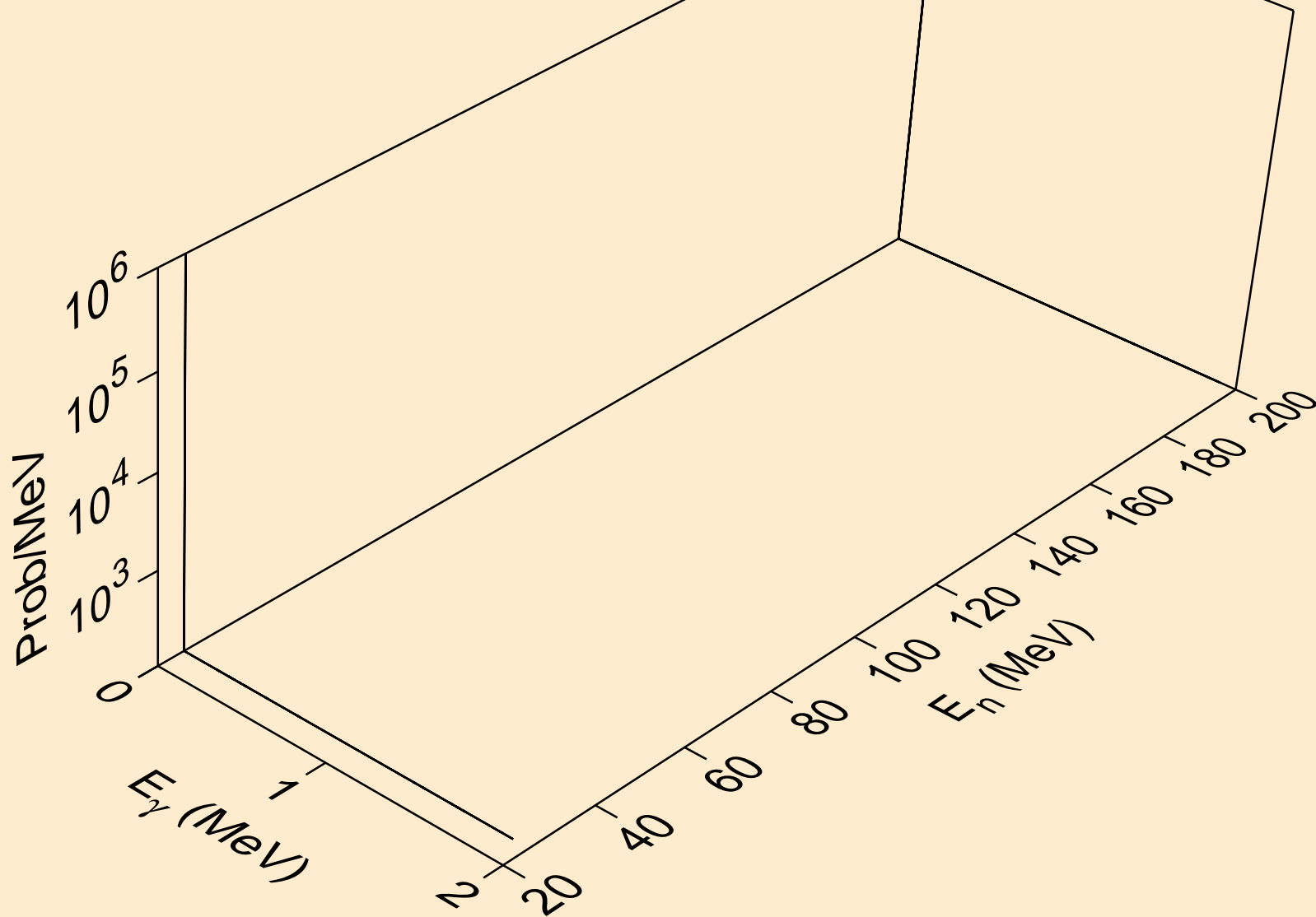

TC094M NEUTRON ACER TENDL-2019 LIBRARY; T=293.16K  
Photon emission for (n,2np)

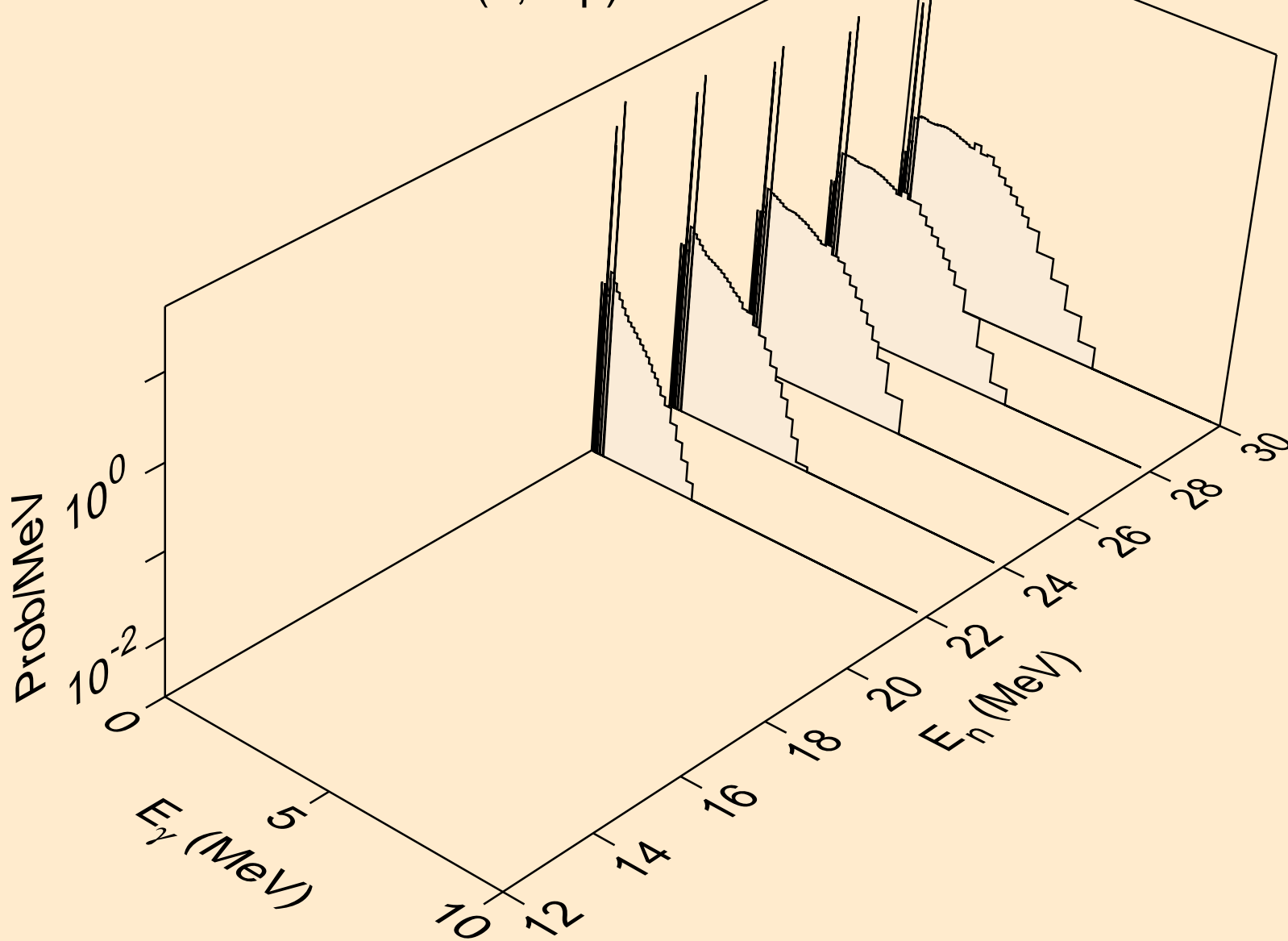



TC094M NEUTRON ACER TENDL-2019 LIBRARY; T=293.16K  
Photon emission for (n,npa)

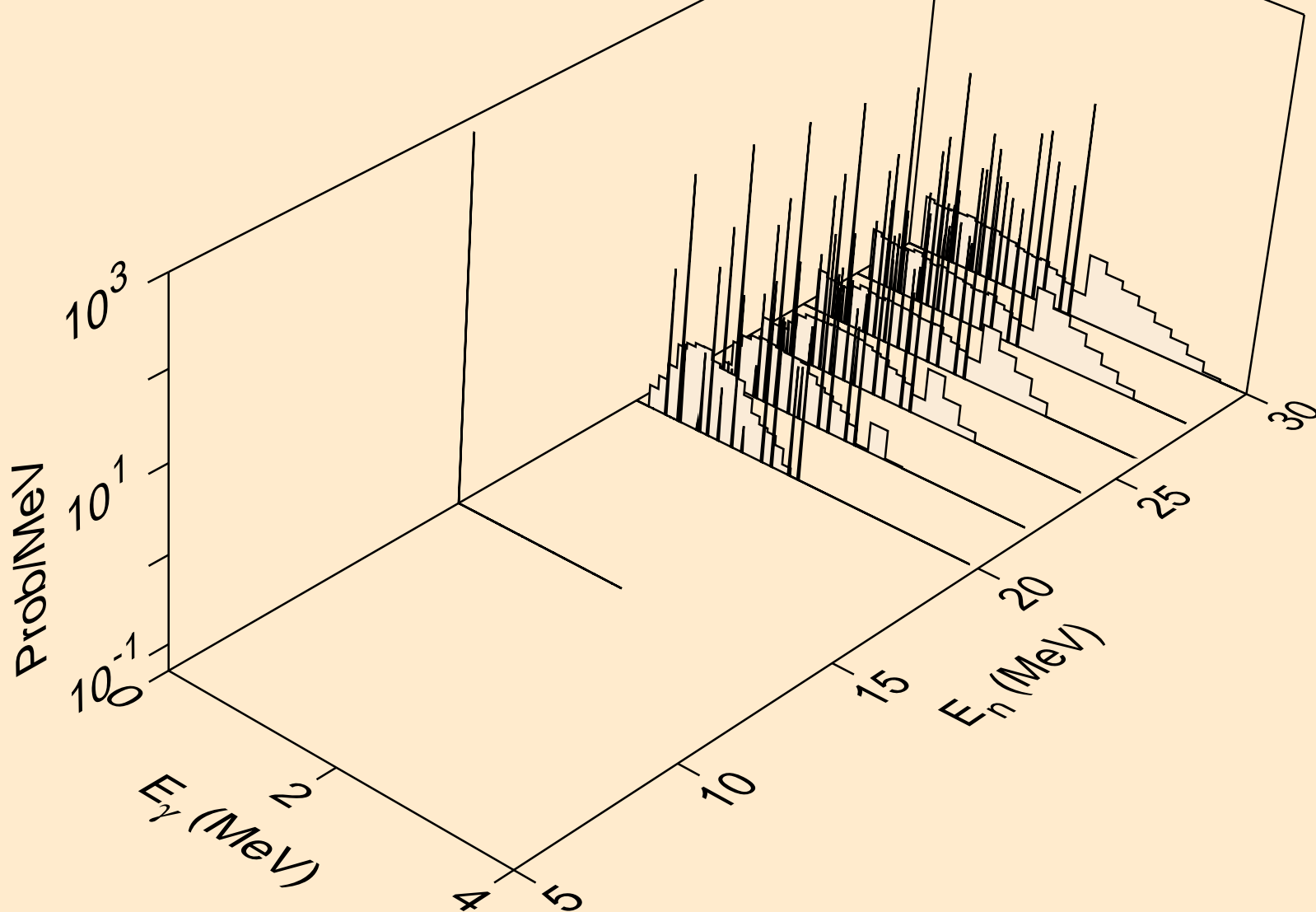

TC094M NEUTRON ACER TENDL-2019 LIBRARY; T=293.16K  
Photon emission for (n,n\*2)

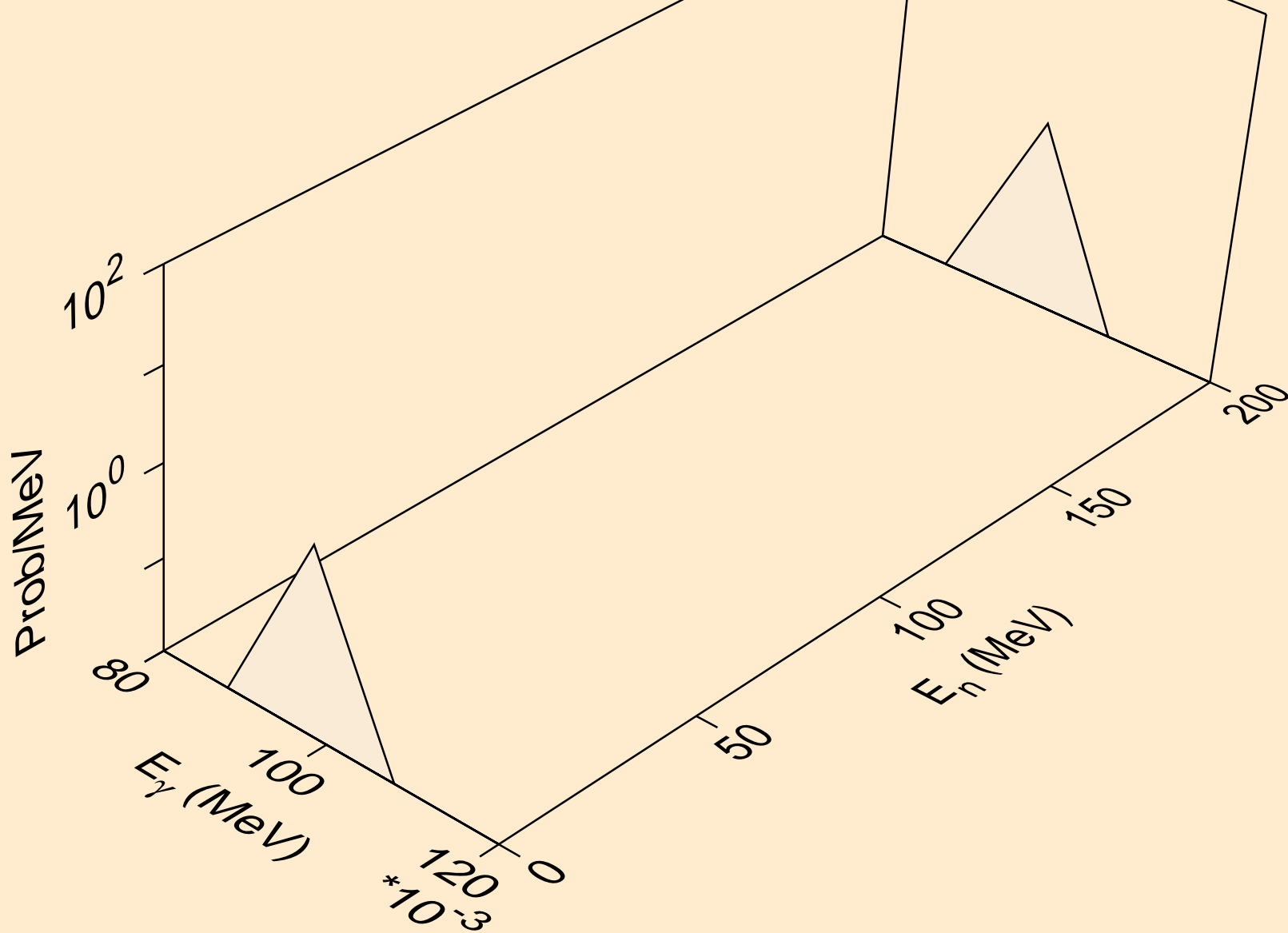

TC094M NEUTRON ACER TENDL-2019 LIBRARY; T=293.16K  
Photon emission for (n,n\*3)

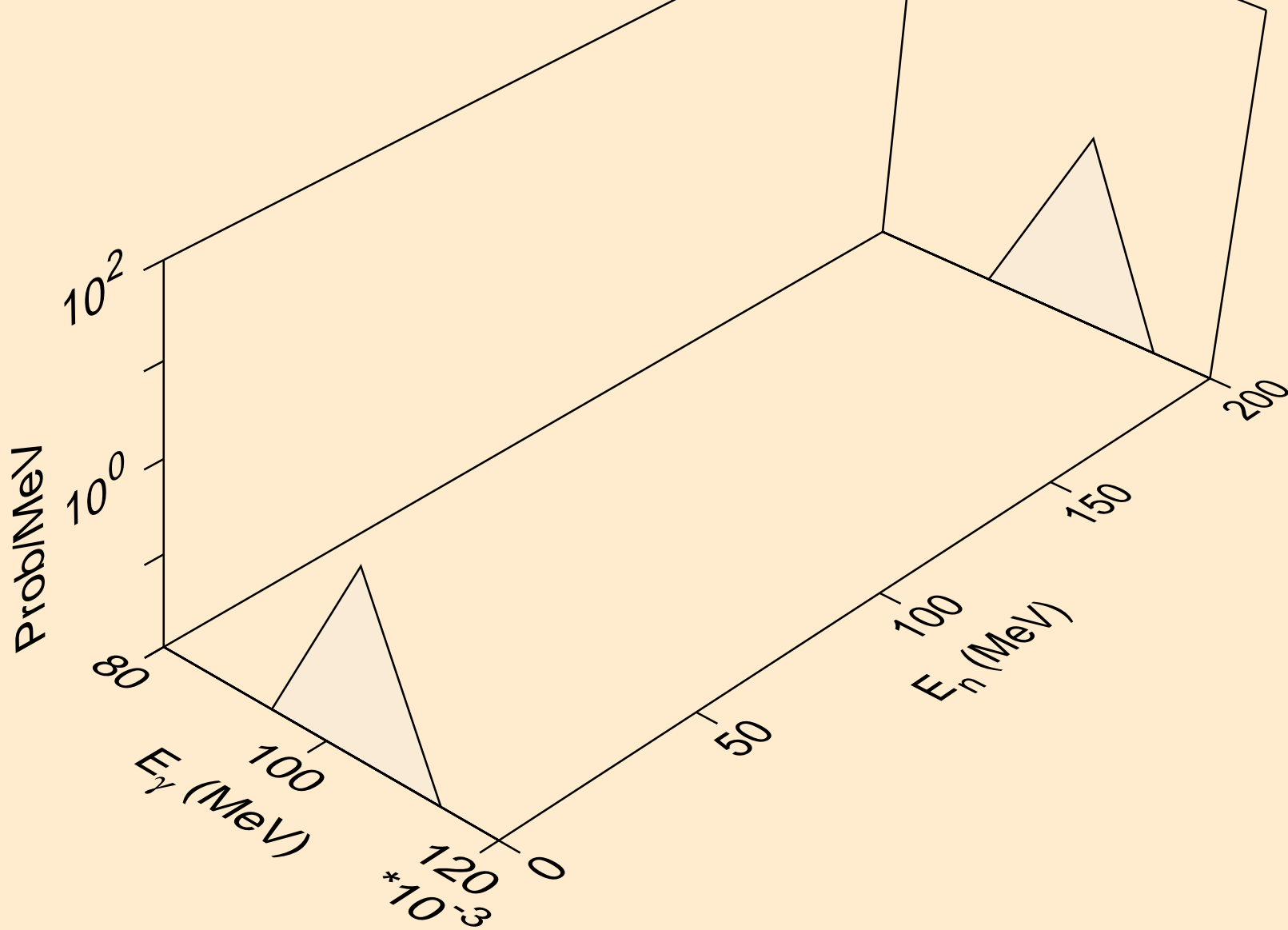

TC094M NEUTRON ACER TENDL-2019 LIBRARY; T=293.16K  
Photon emission for (n,n\*4)

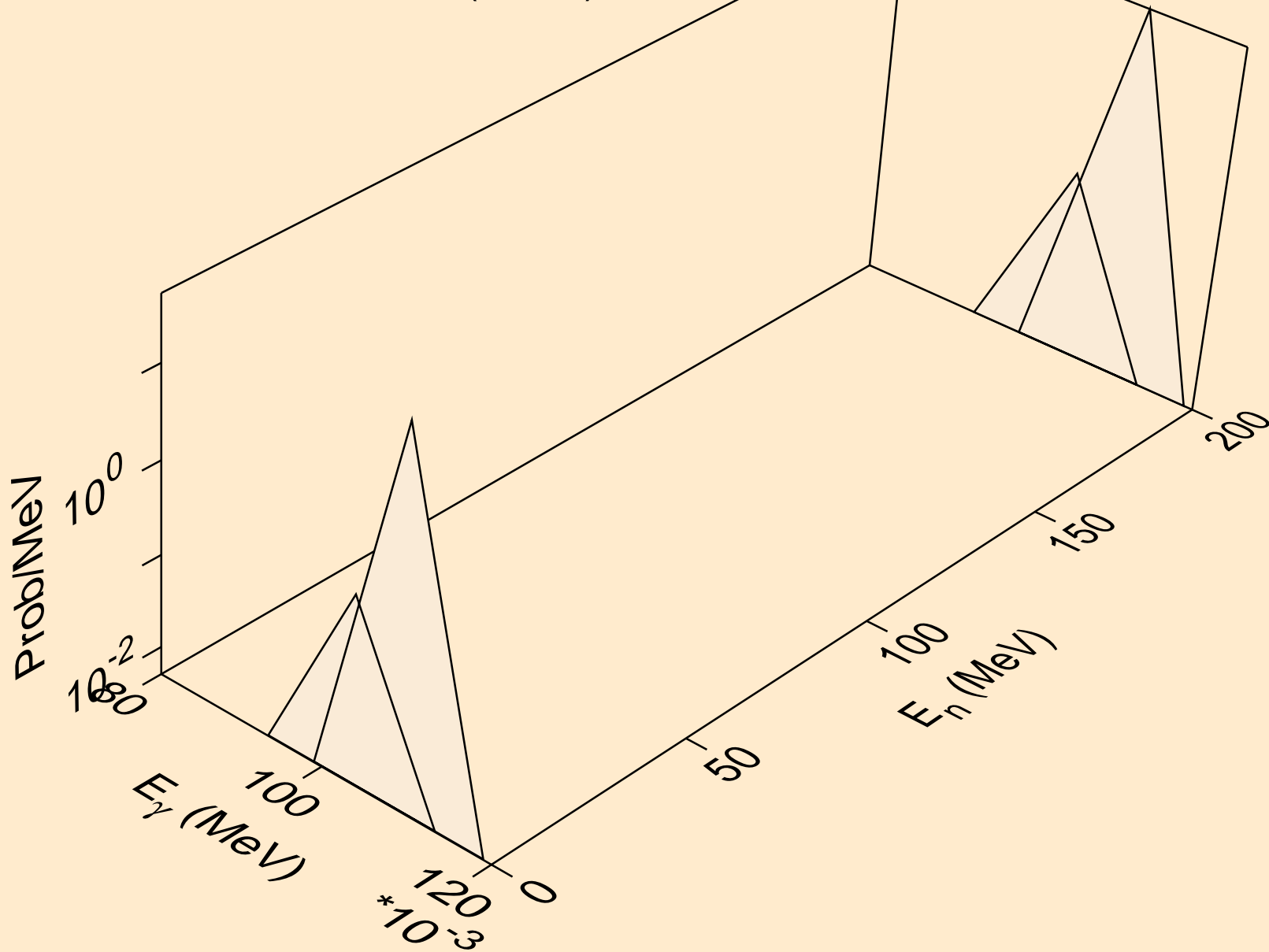

TC094M NEUTRON ACER TENDL-2019 LIBRARY; T=293.16K  
Photon emission for (n,n\*5)

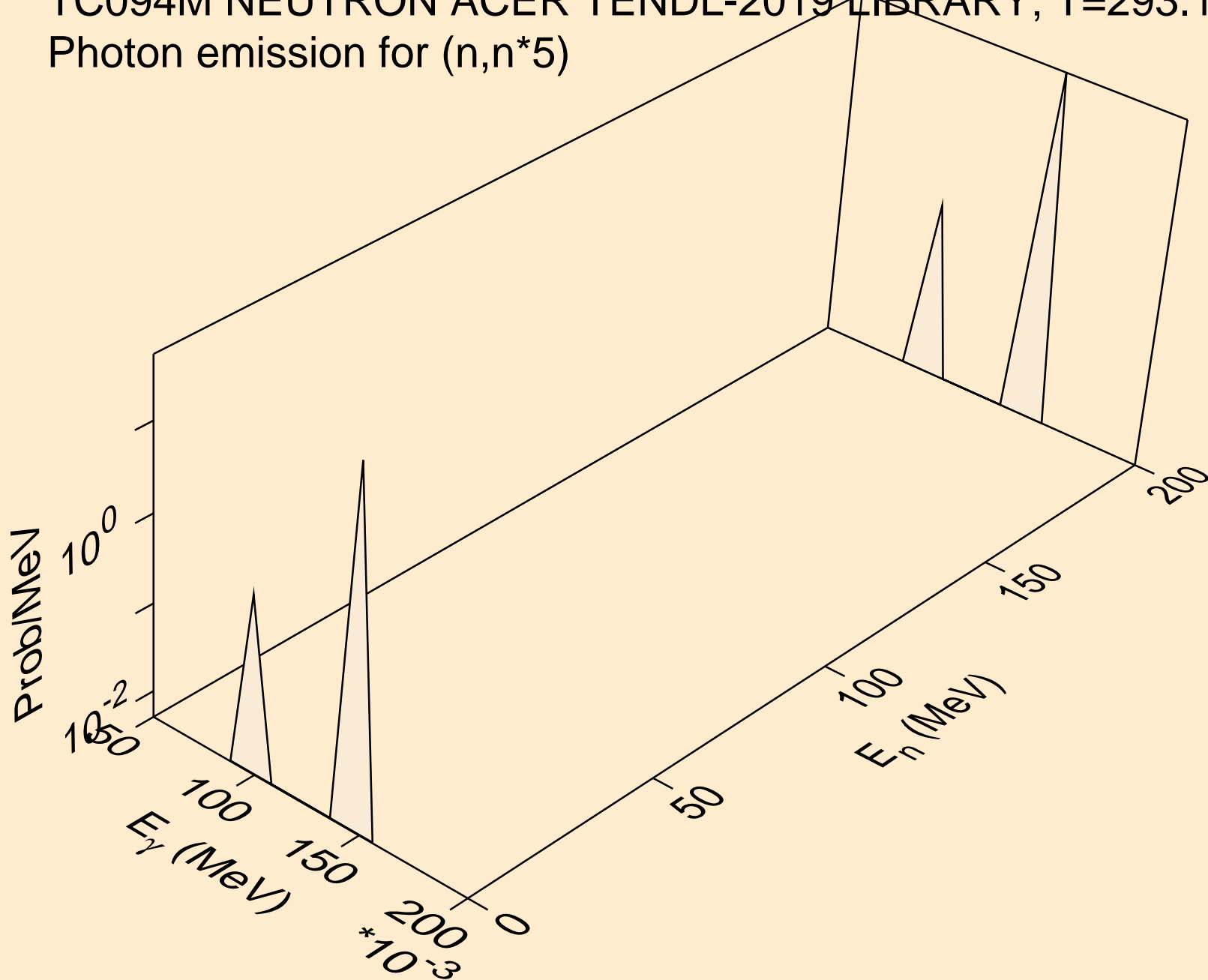

TC094M NEUTRON ACER TENDL-2019 LIBRARY; T=293.16K  
Photon emission for (n,n\*6)

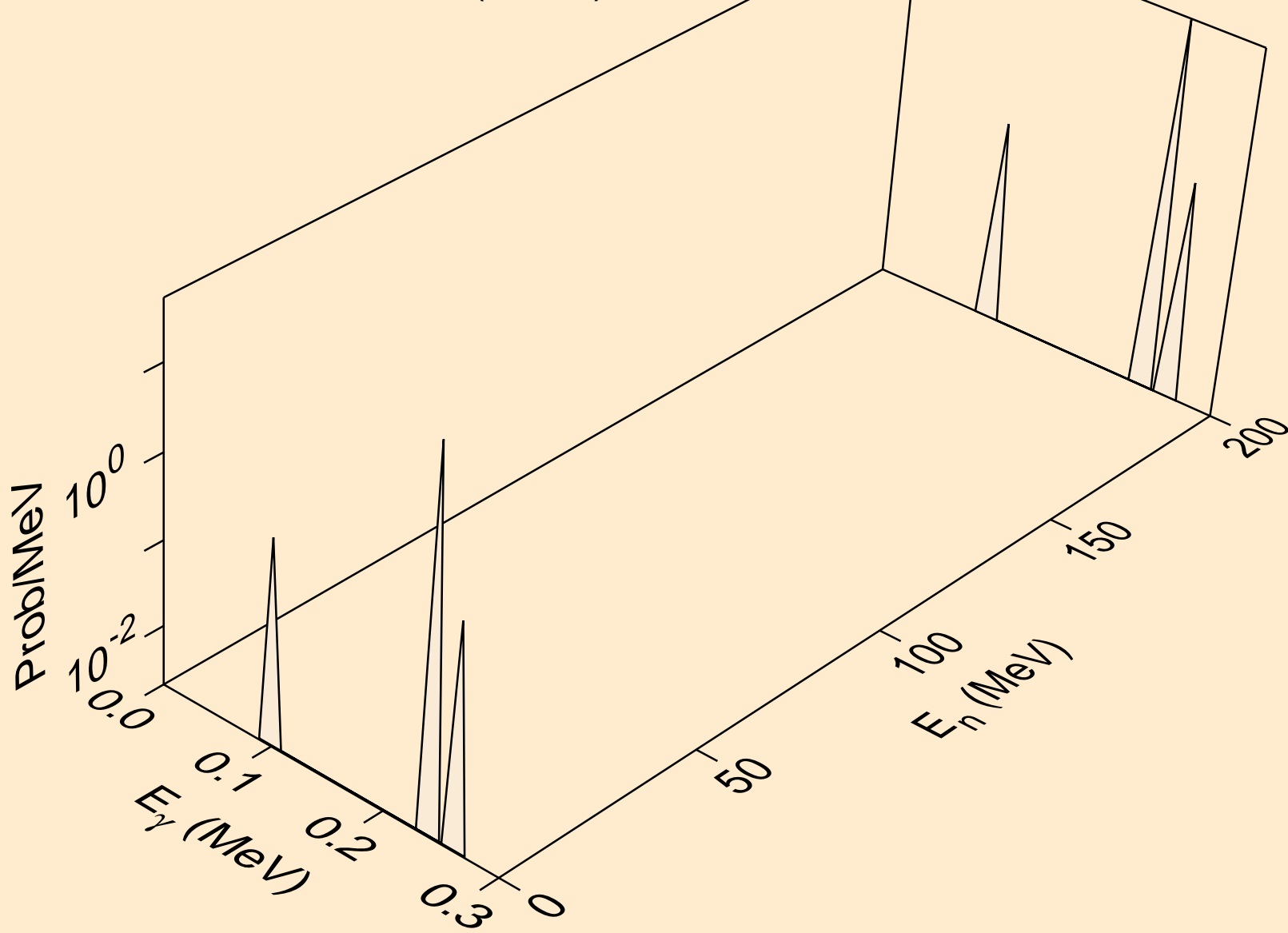

TC094M NEUTRON ACER TENDL-2019 LIBRARY; T=293.16K  
Photon emission for (n,n\*7)

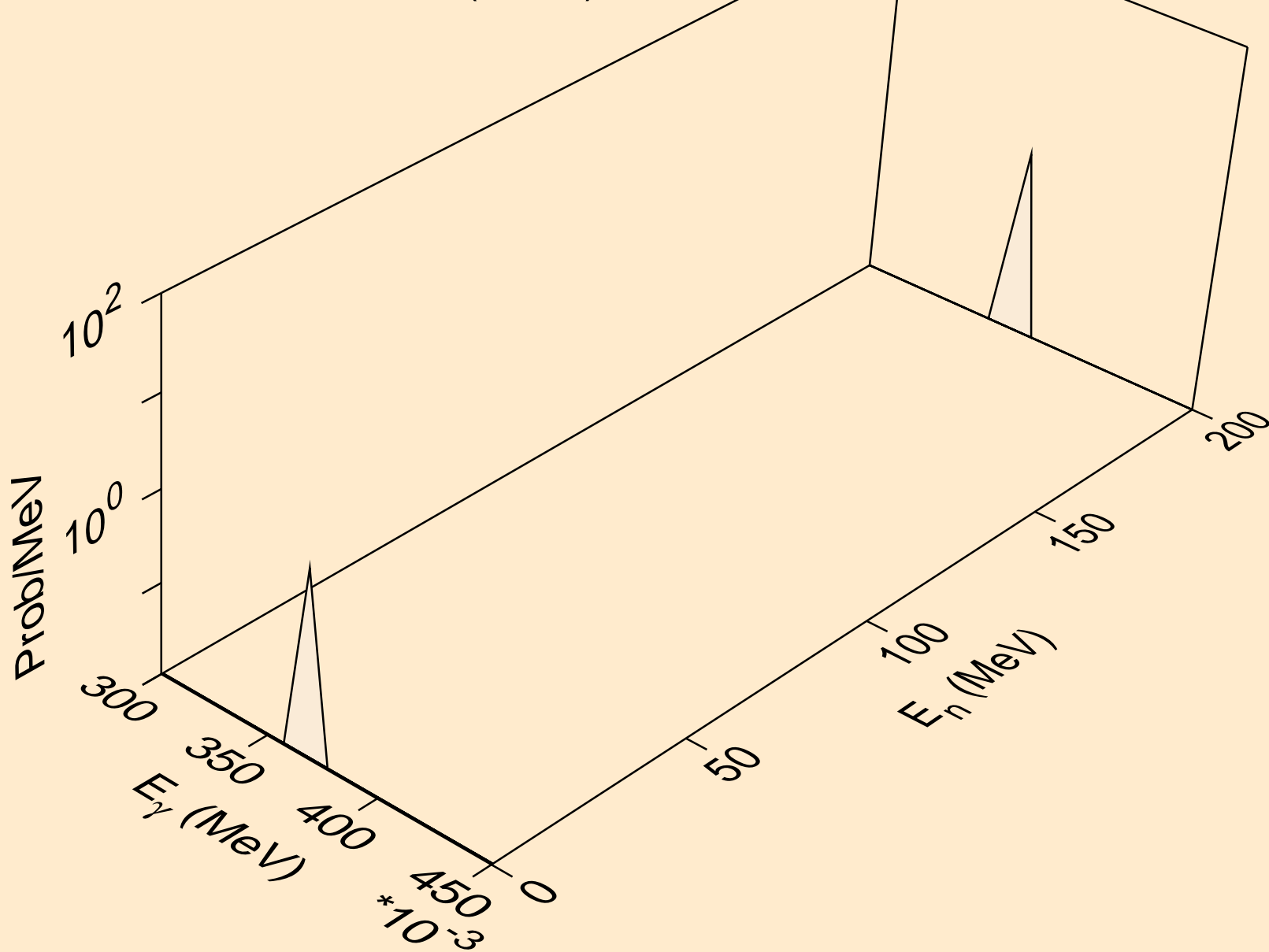

TC094M NEUTRON ACER TENDL-2019 LIBRARY; T=293.16K  
Photon emission for (n,n\*8)

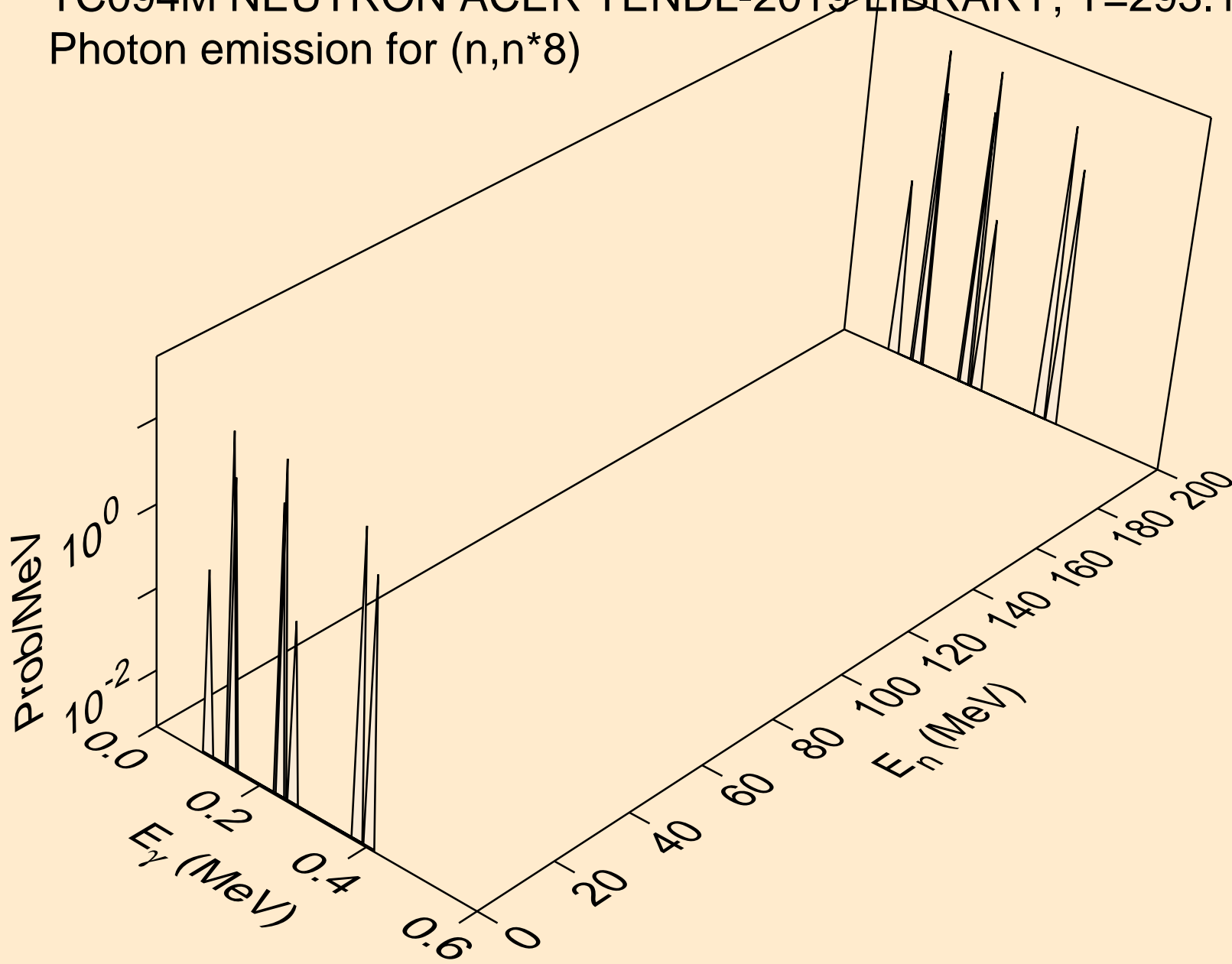



TC094M NEUTRON ACER TENDL-2019 LIBRARY; T=293.16K  
Photon emission for (n,n\*9)

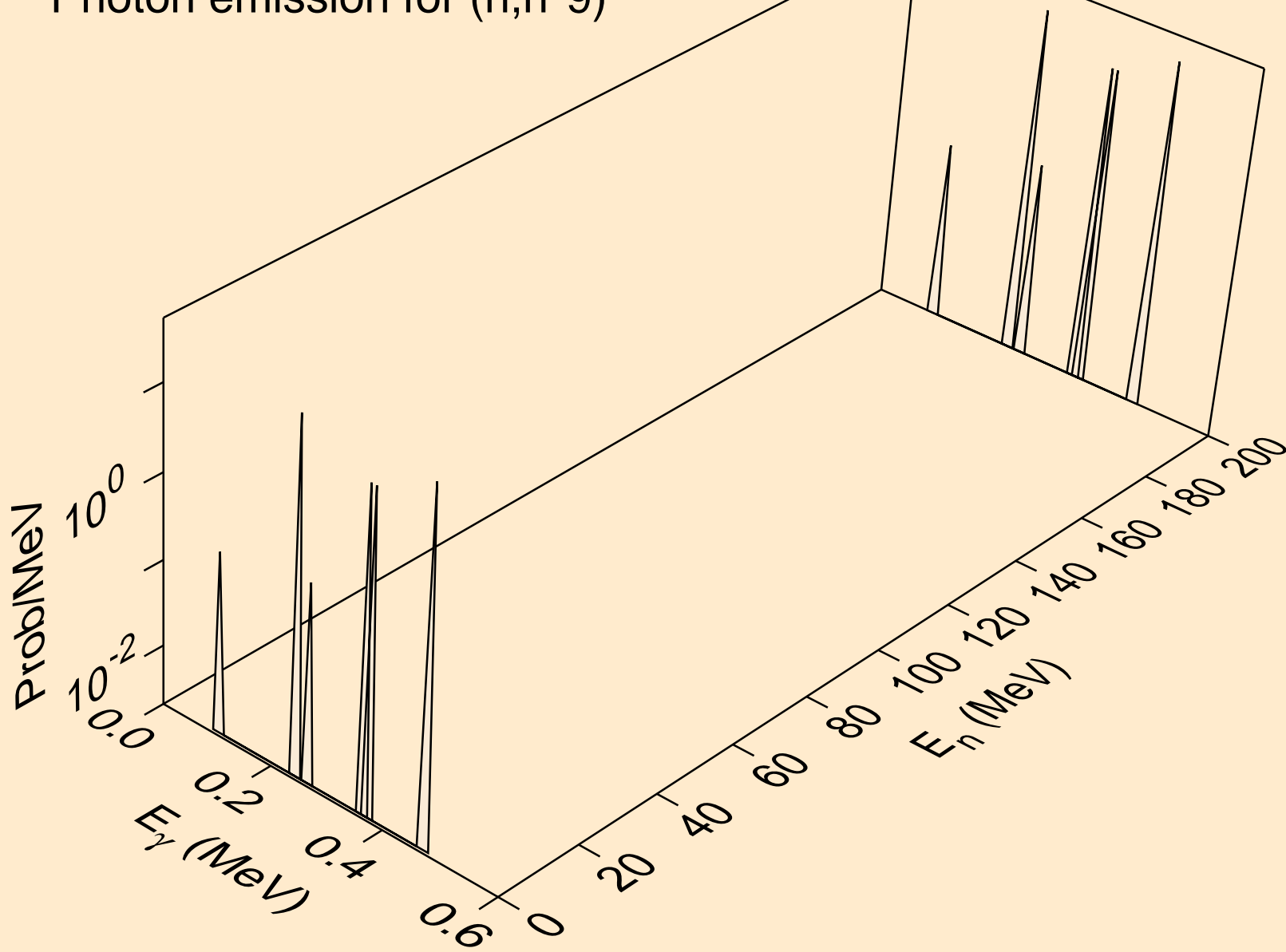

TC094M NEUTRON ACER TENDL-2019 LIBRARY; T=293.16K  
Photon emission for (n,n\*10)

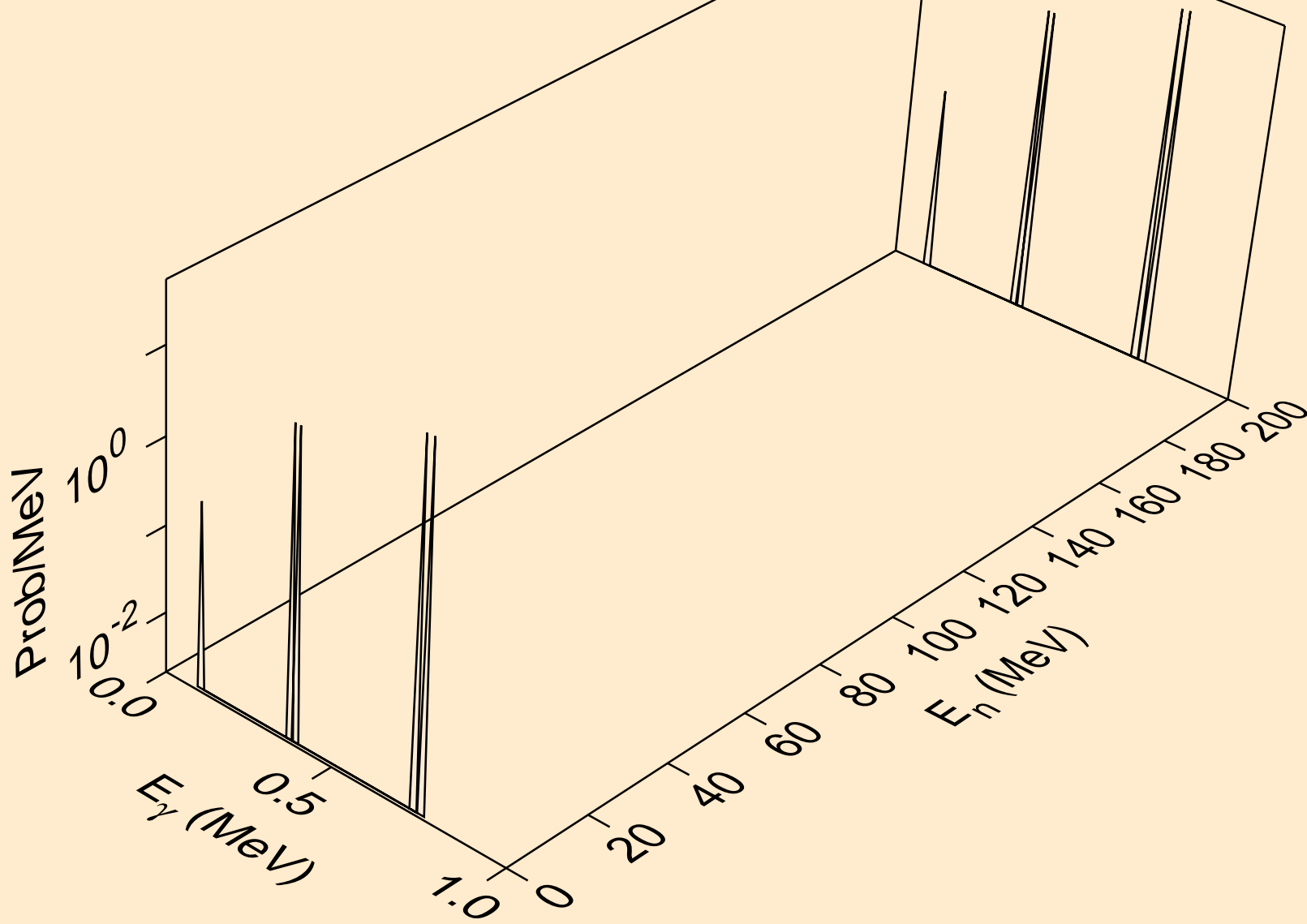

TC094M NEUTRON ACER TENDL-2019 LIBRARY; T=293.16K  
Photon emission for (n,n\*11)

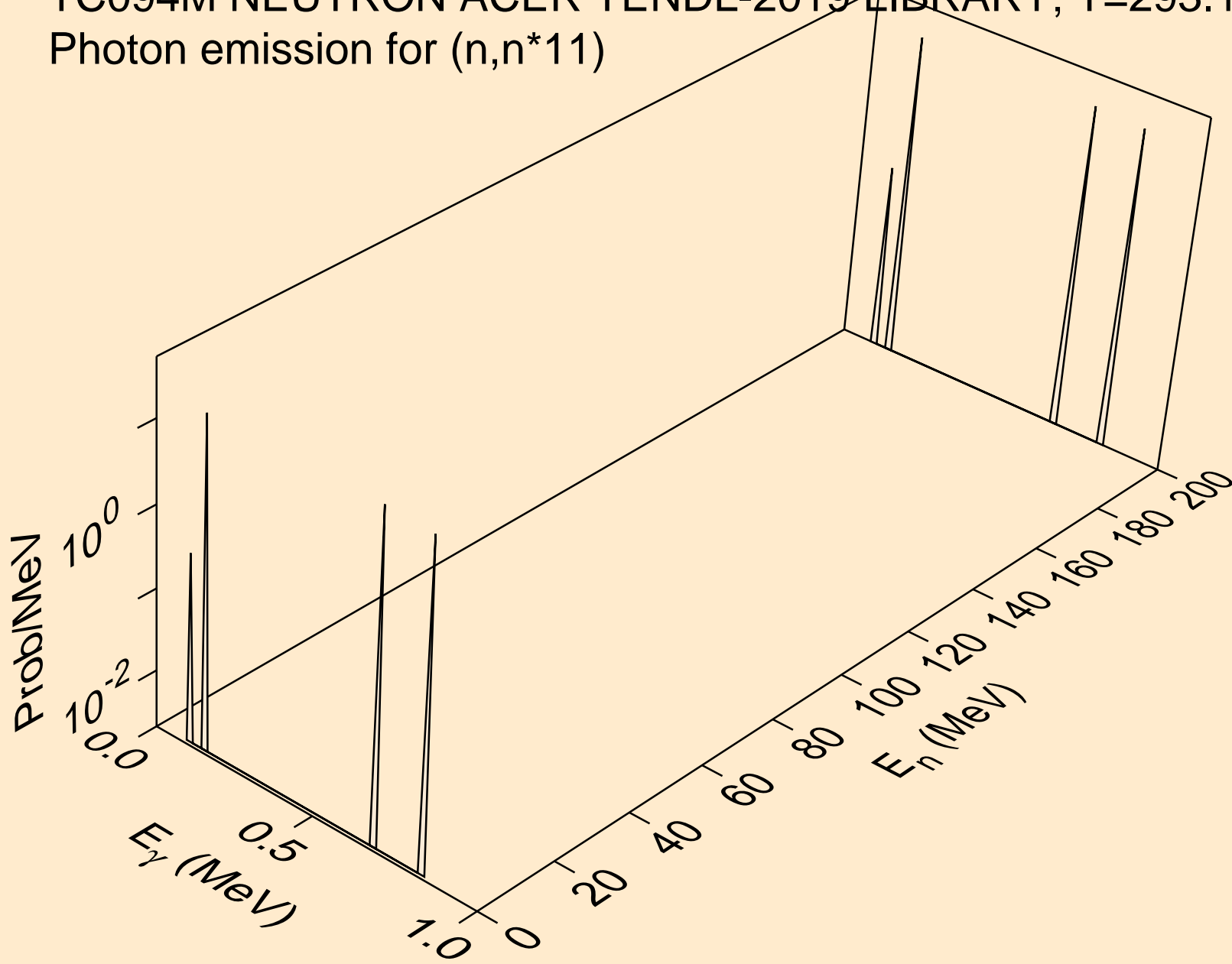

TC094M NEUTRON ACER TENDL-2019 LIBRARY; T=293.16K  
Photon emission for (n,n\*12)

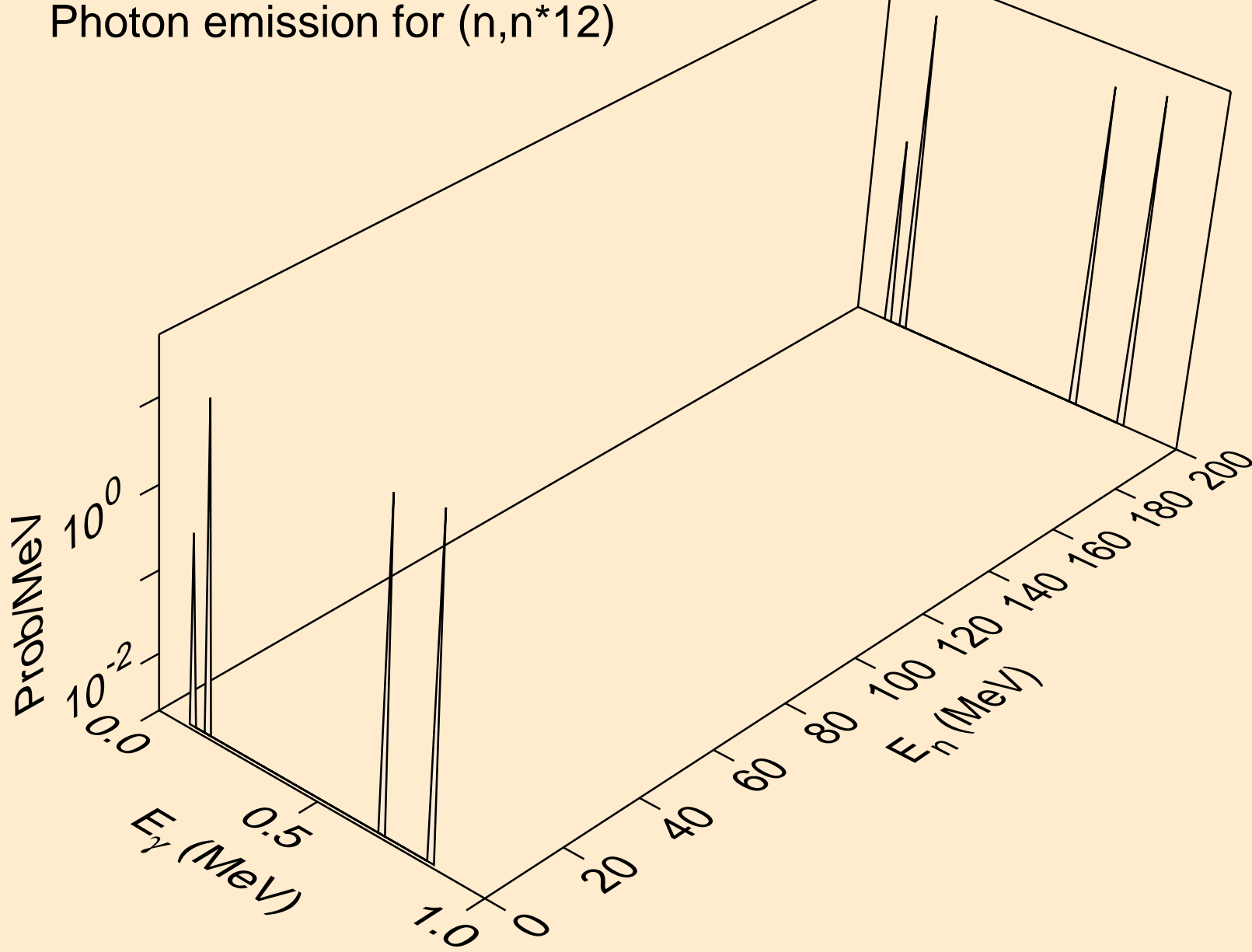

TC094M NEUTRON ACER TENDL-2019 LIBRARY; T=293.16K  
Photon emission for (n,n\*13)

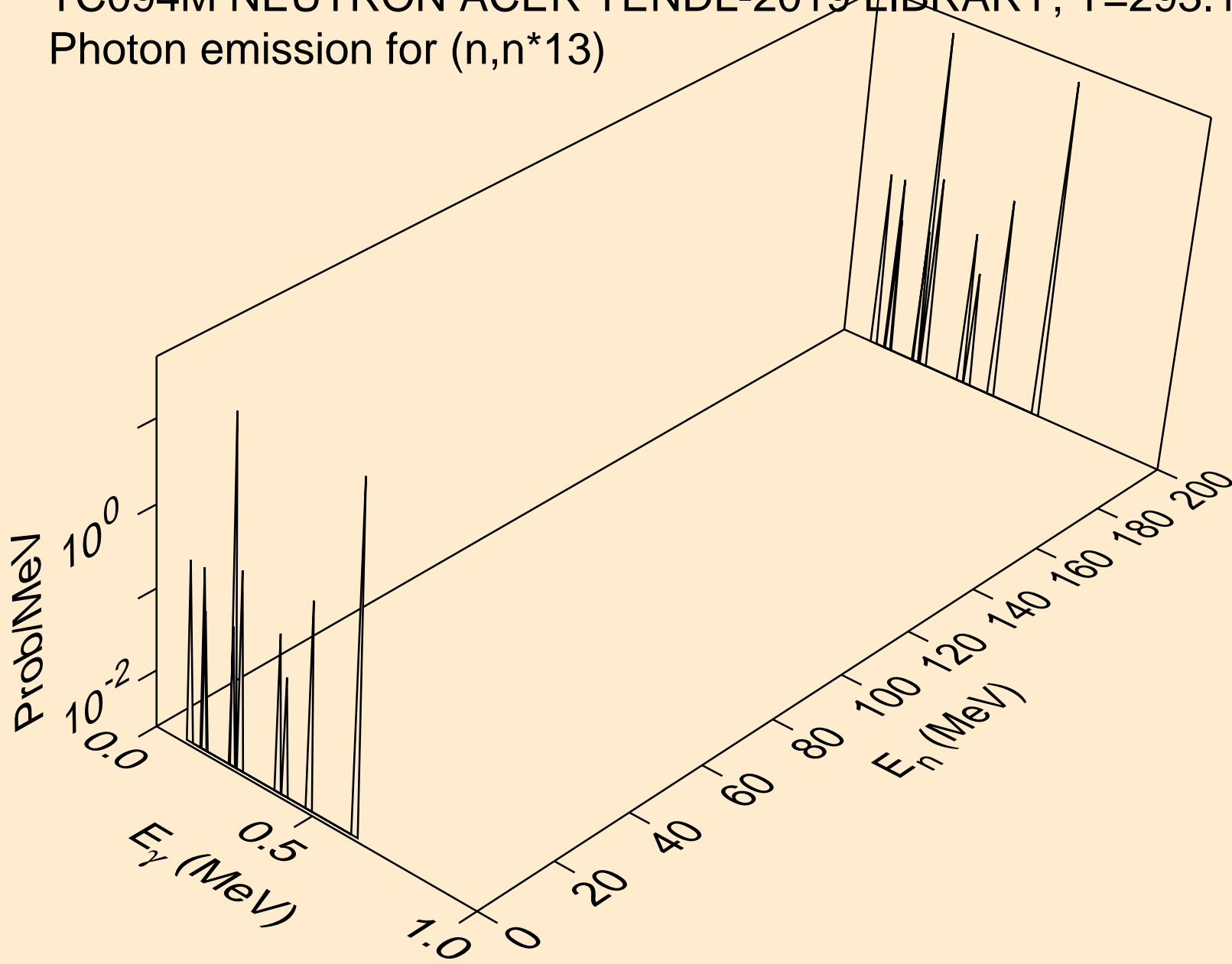

TC094M NEUTRON ACER TENDL-2019 LIBRARY; T=293.16K  
Photon emission for (n,n\*14)

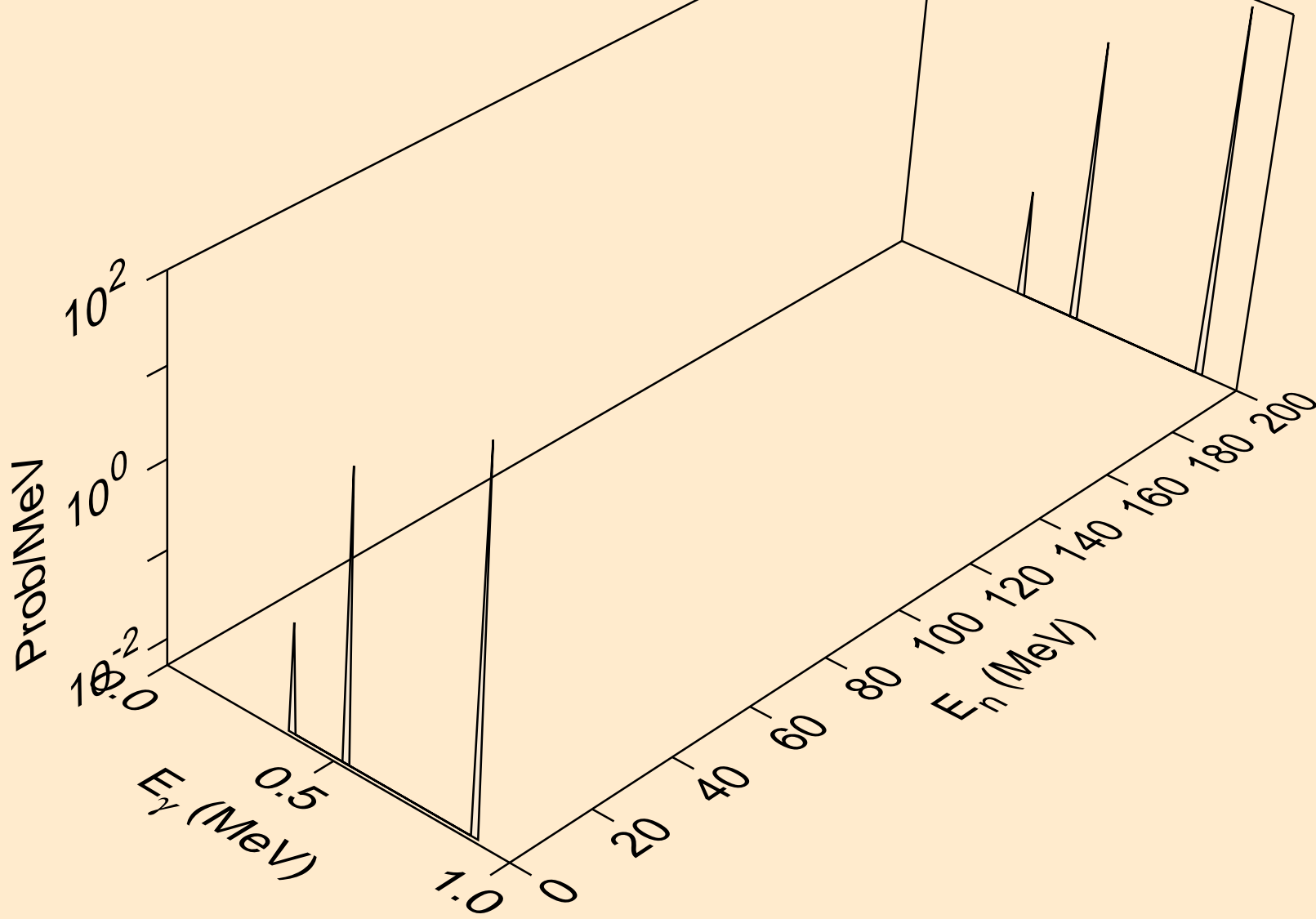

TC094M NEUTRON ACER TENDL-2019 LIBRARY; T=293.16K  
Photon emission for (n,n\*15)

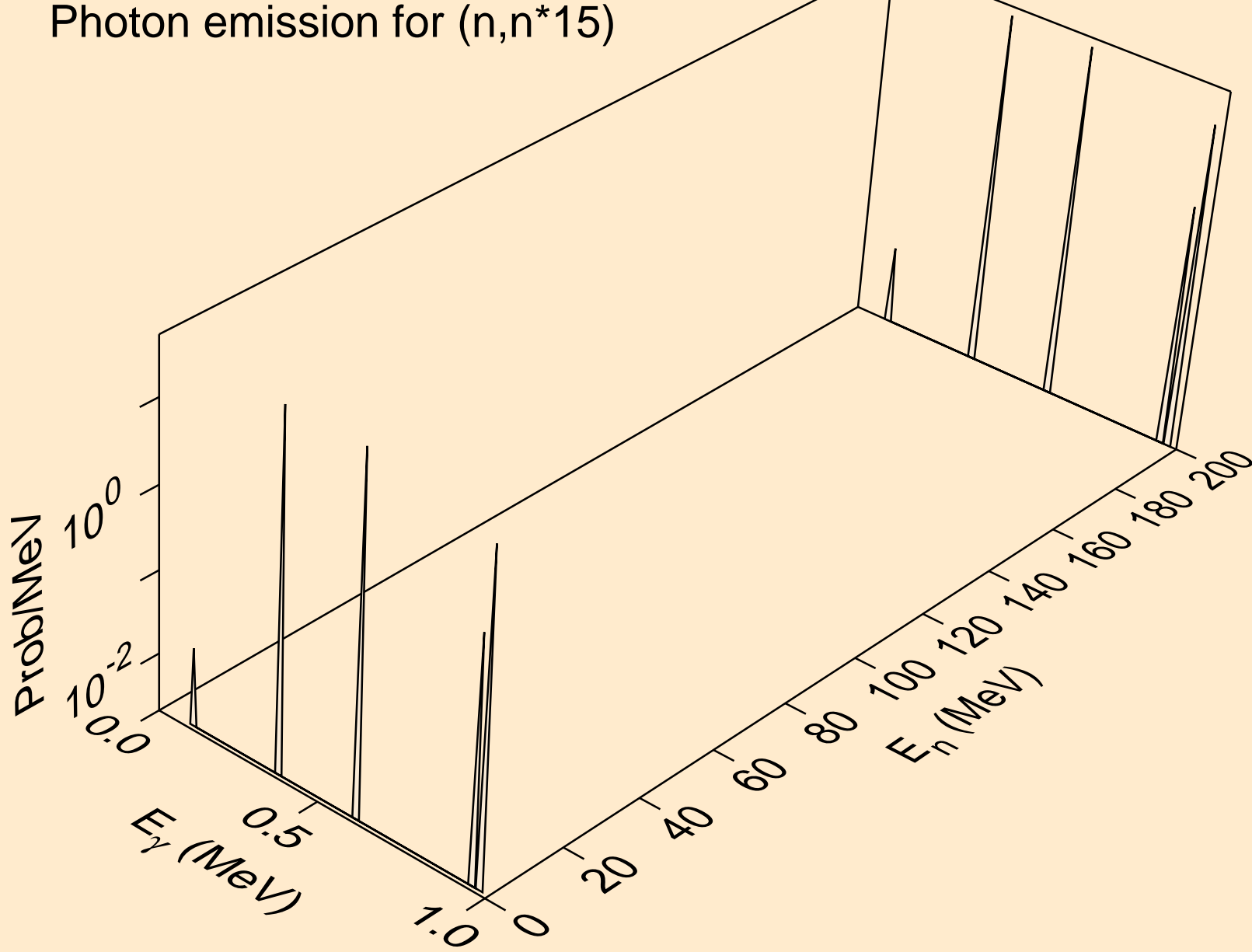

TC094M NEUTRON ACER TENDL-2019 LIBRARY; T=293.16K  
Photon emission for (n,n\*16)

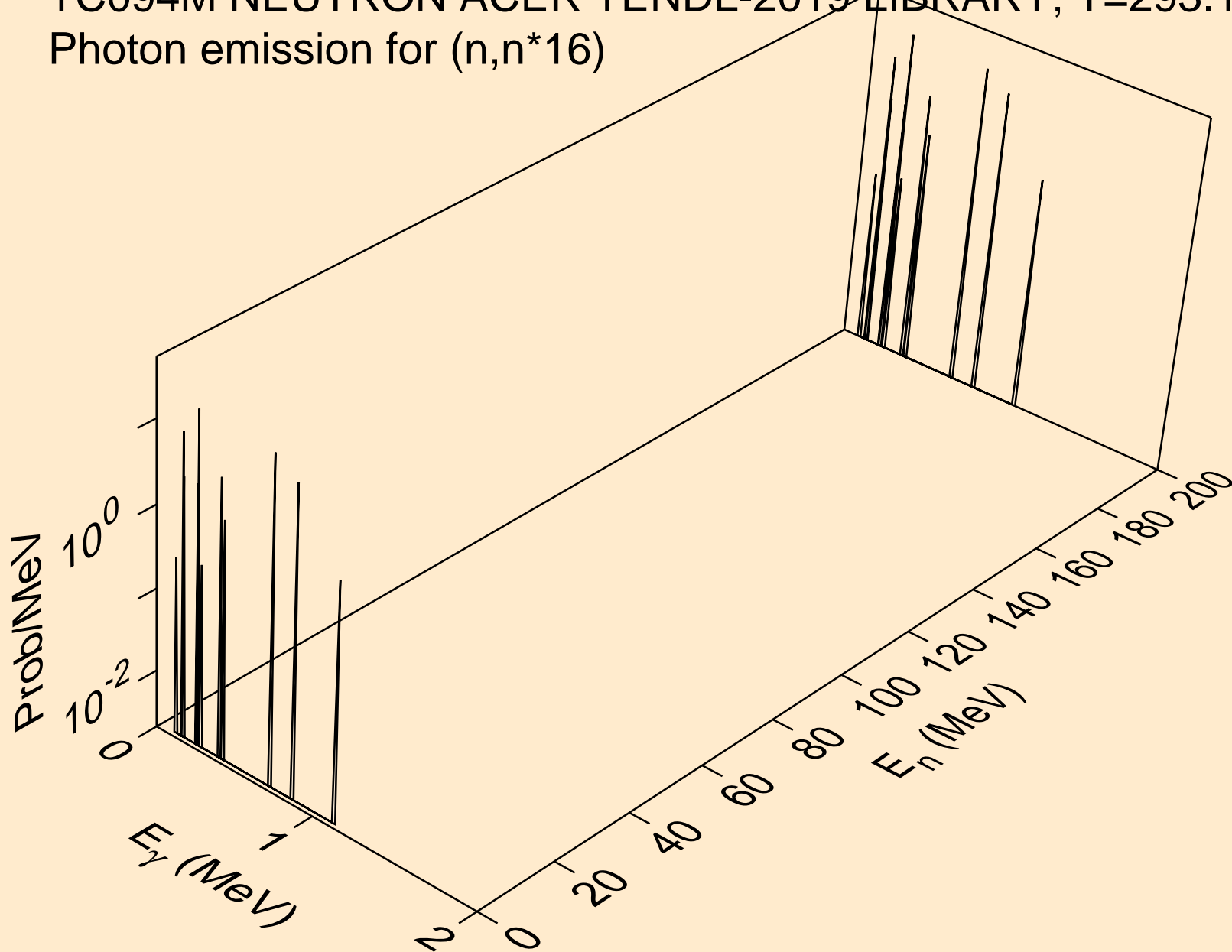



TC094M NEUTRON ACER TENDL-2019 LIBRARY; T=293.16K  
Photon emission for (n,n\*17)

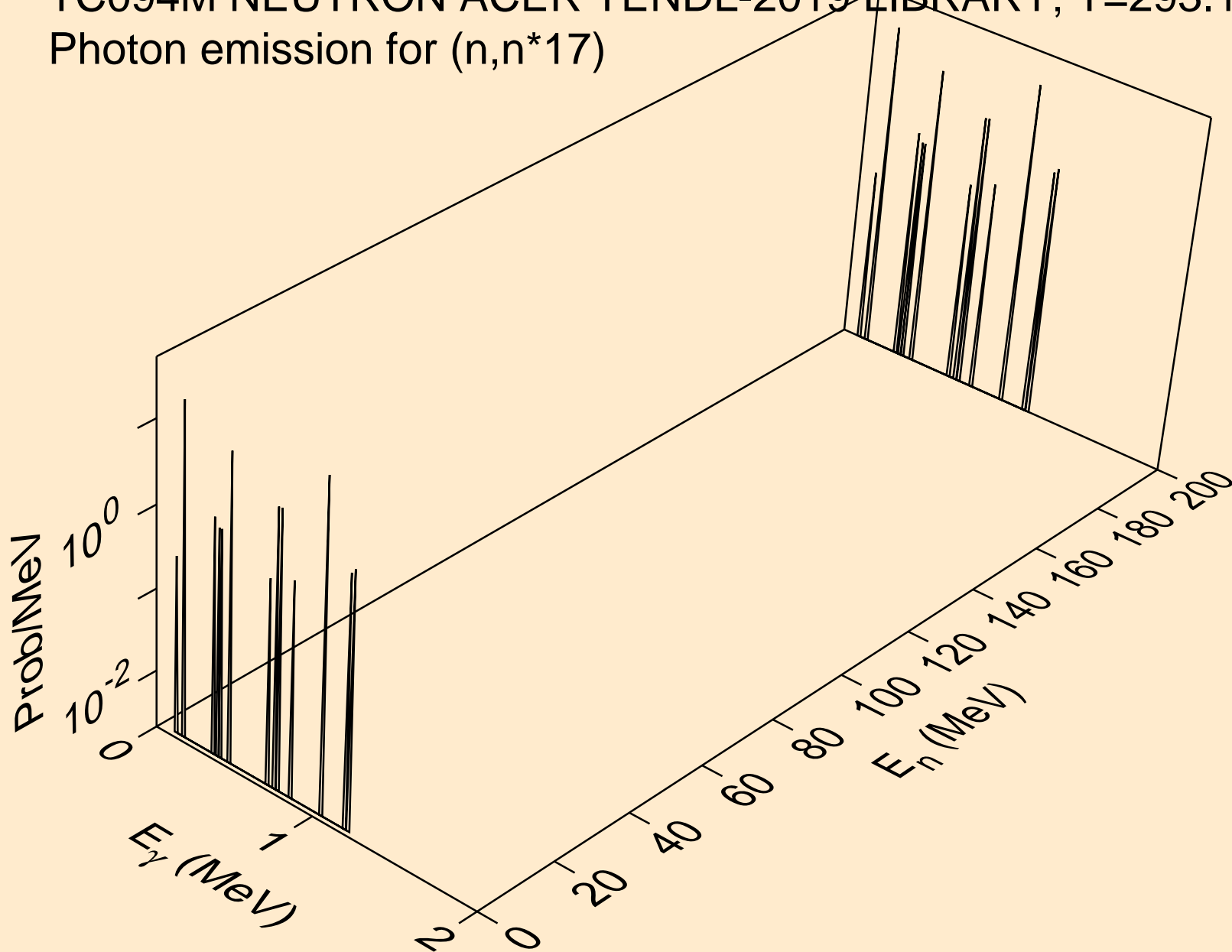

TC094M NEUTRON ACER TENDL-2019 LIBRARY; T=293.16K  
Photon emission for (n,n\*18)

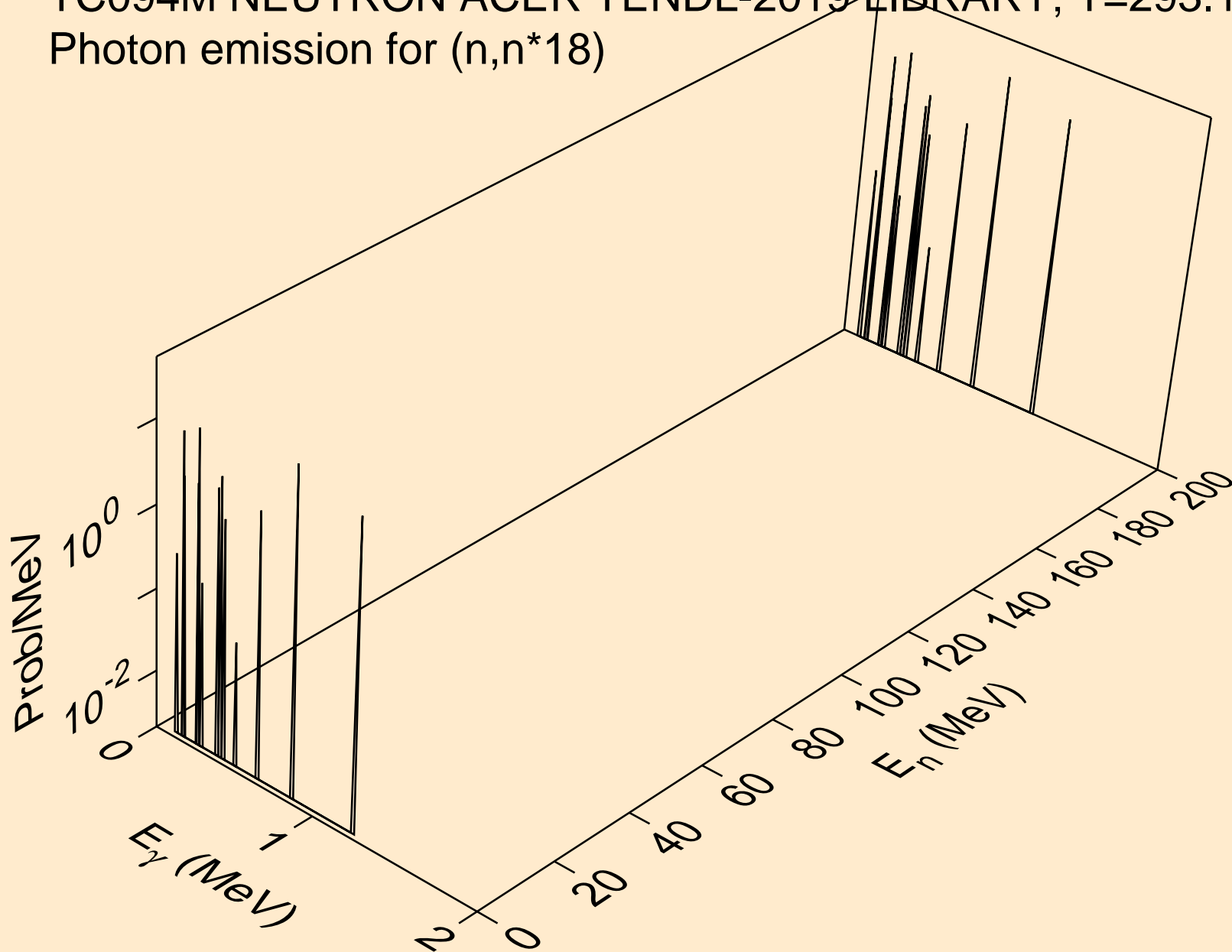

TC094M NEUTRON ACER TENDL-2019 LIBRARY; T=293.16K  
Photon emission for (n,n\*19)

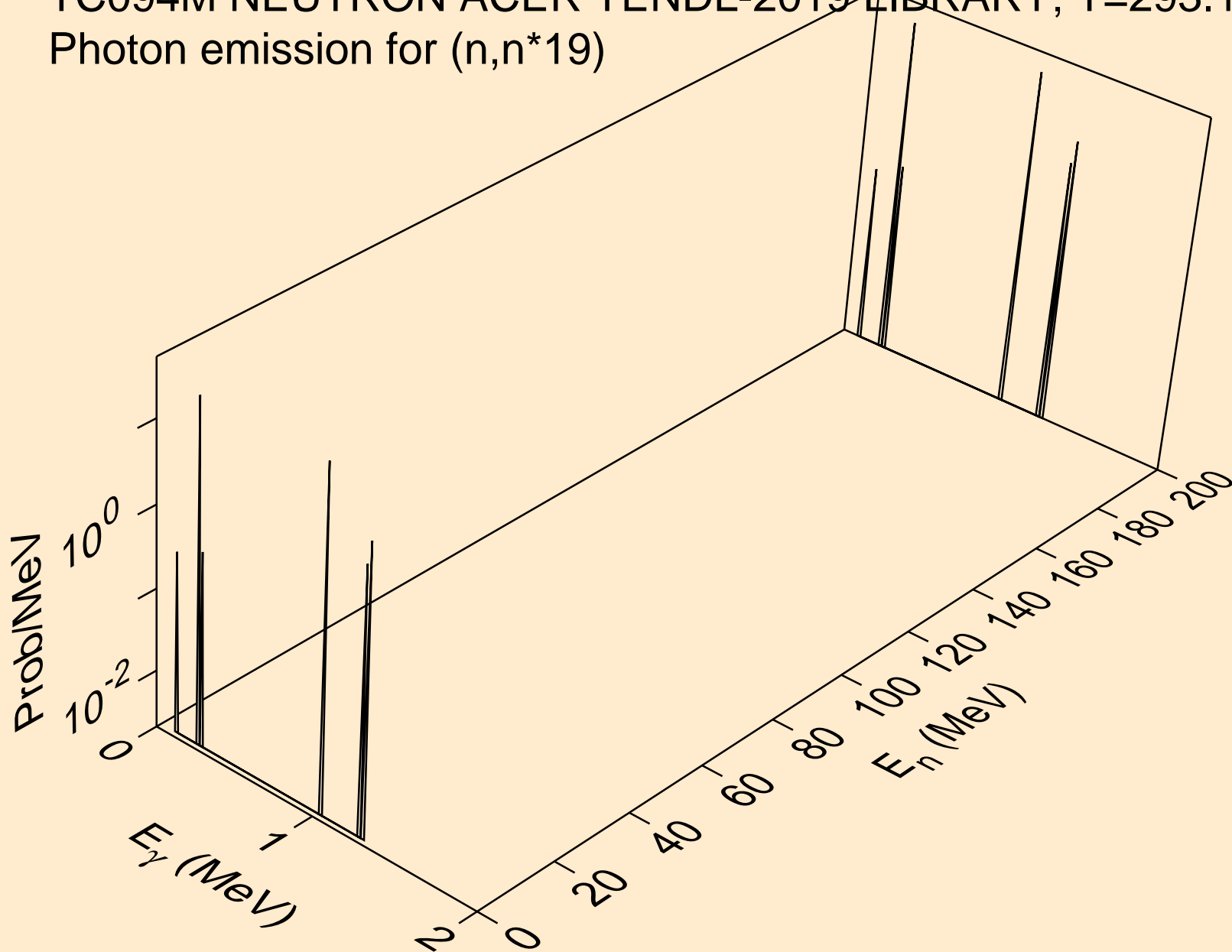

TC094M NEUTRON ACER TENDL-2019 LIBRARY; T=293.16K  
Photon emission for (n,n\*20)

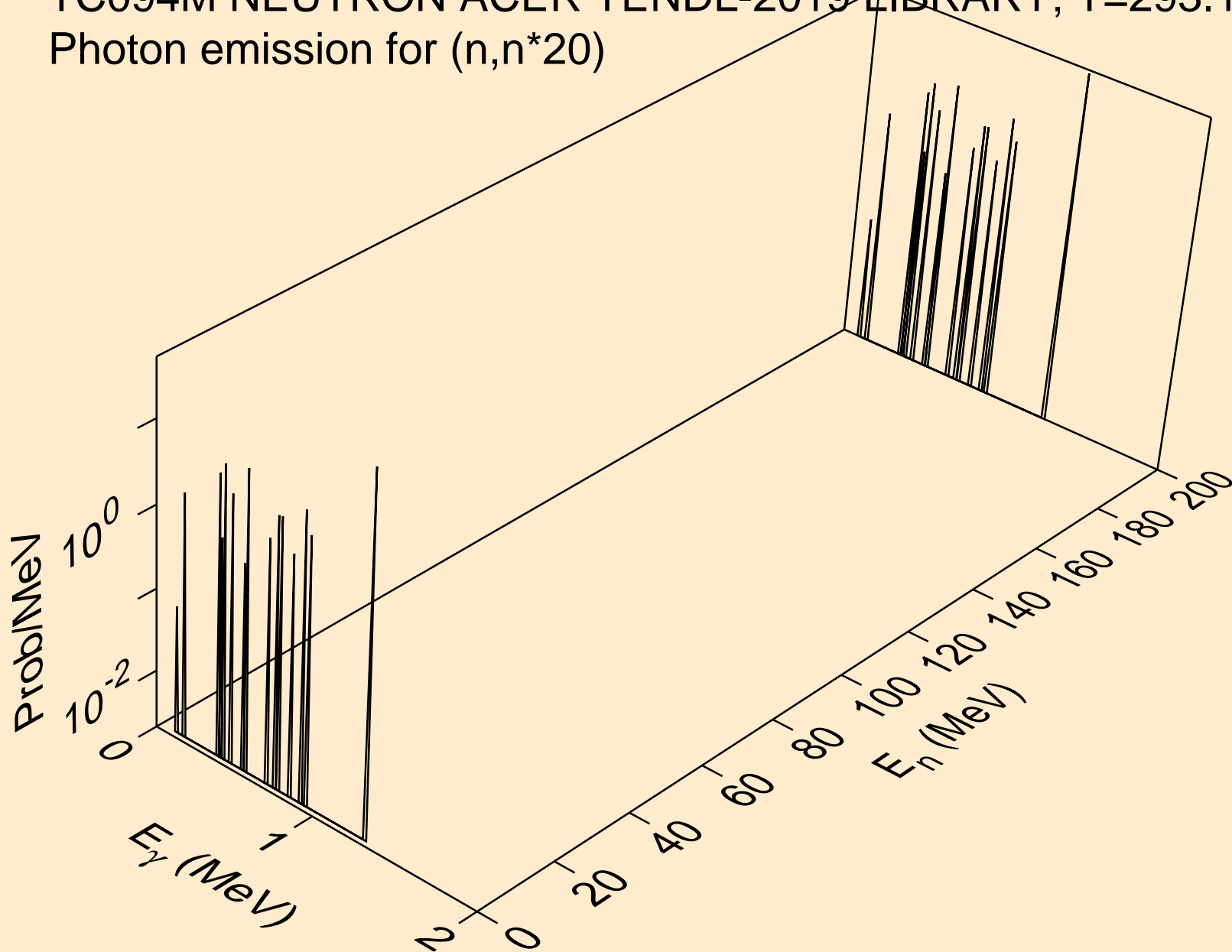

TC094M NEUTRON ACER TENDL-2019 LIBRARY; T=293.16K  
Photon emission for (n,n\*21)

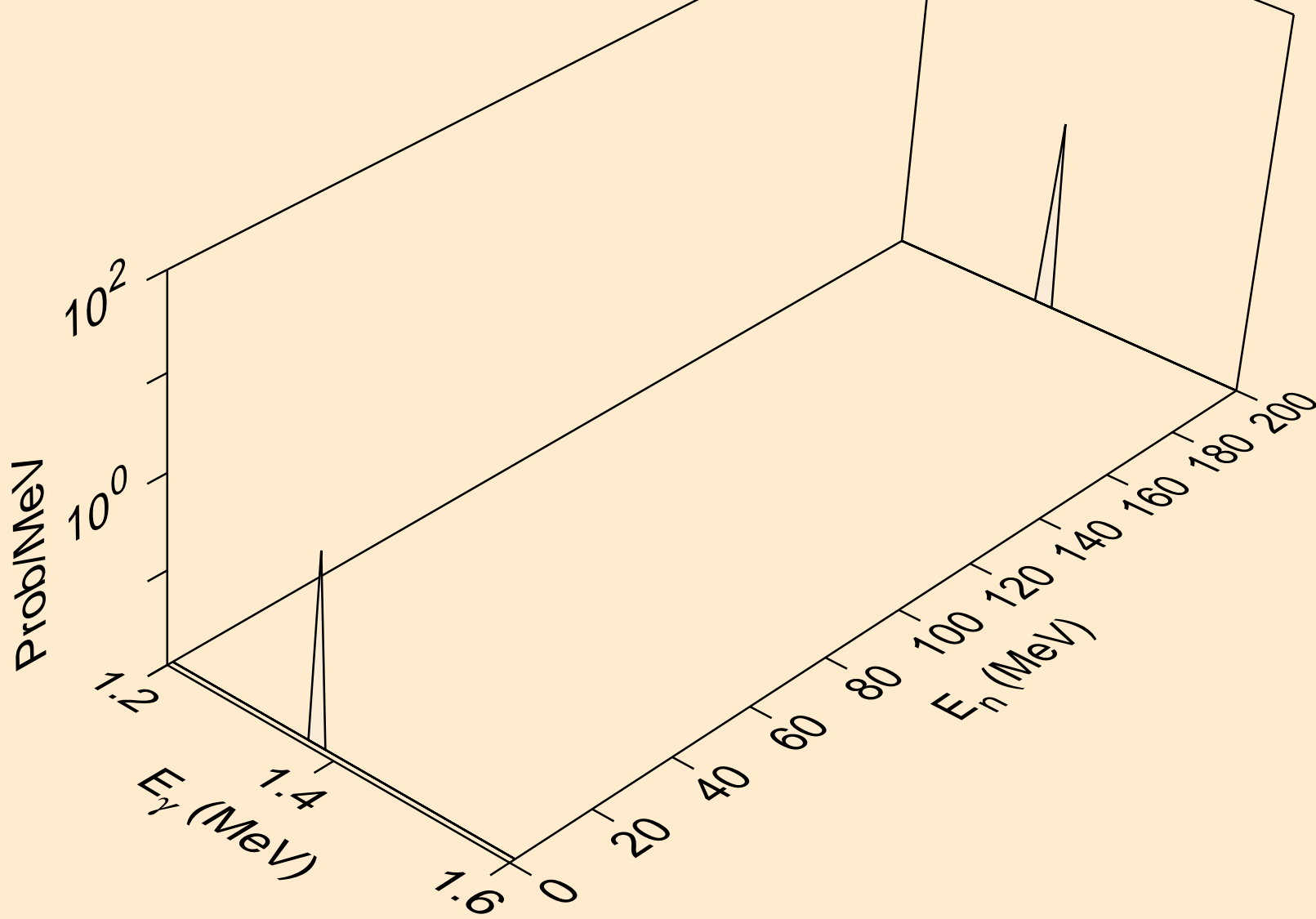

TC094M NEUTRON ACER TENDL-2019 LIBRARY; T=293.16K  
Photon emission for (n,n\*22)

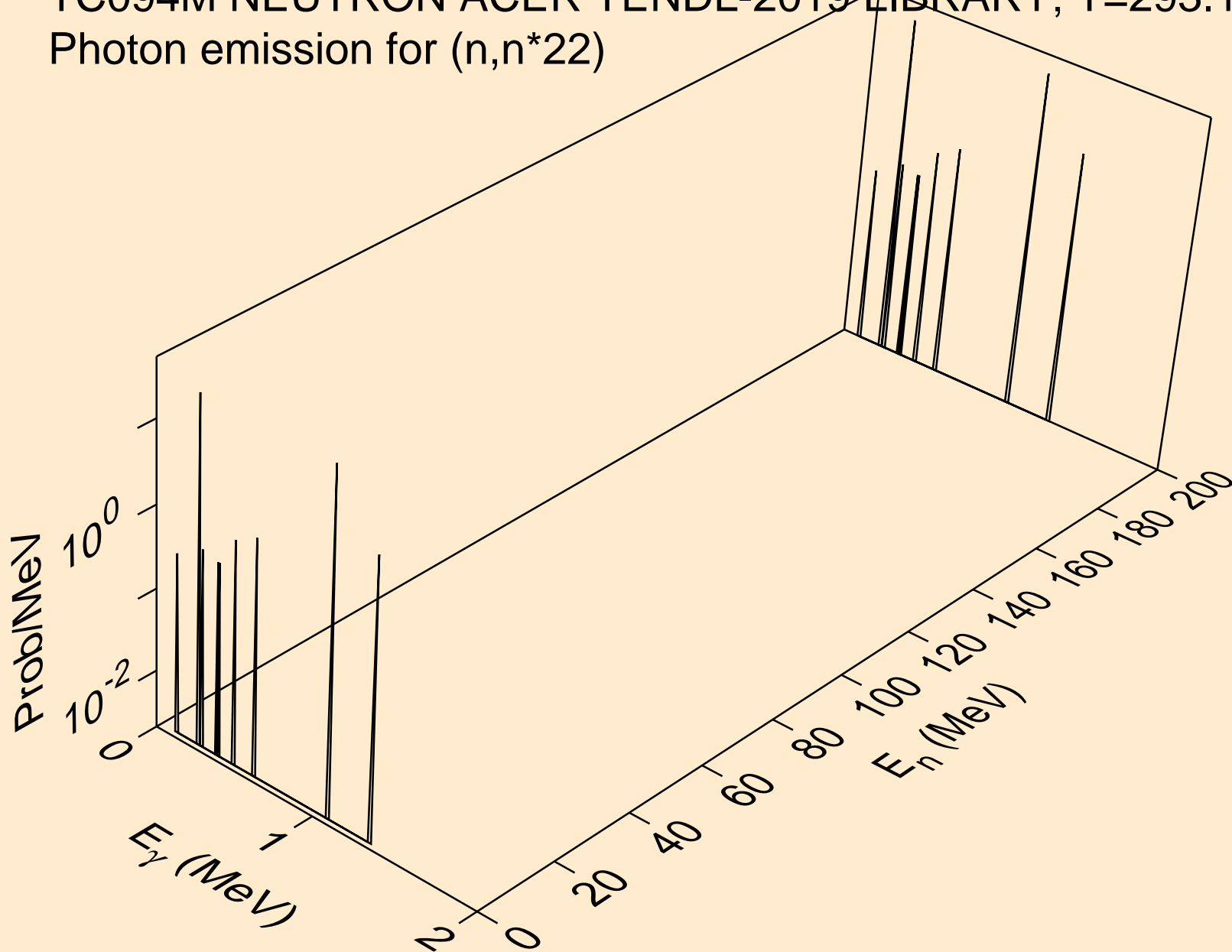

TC094M NEUTRON ACER TENDL-2019 LIBRARY; T=293.16K  
Photon emission for (n,n\*23)

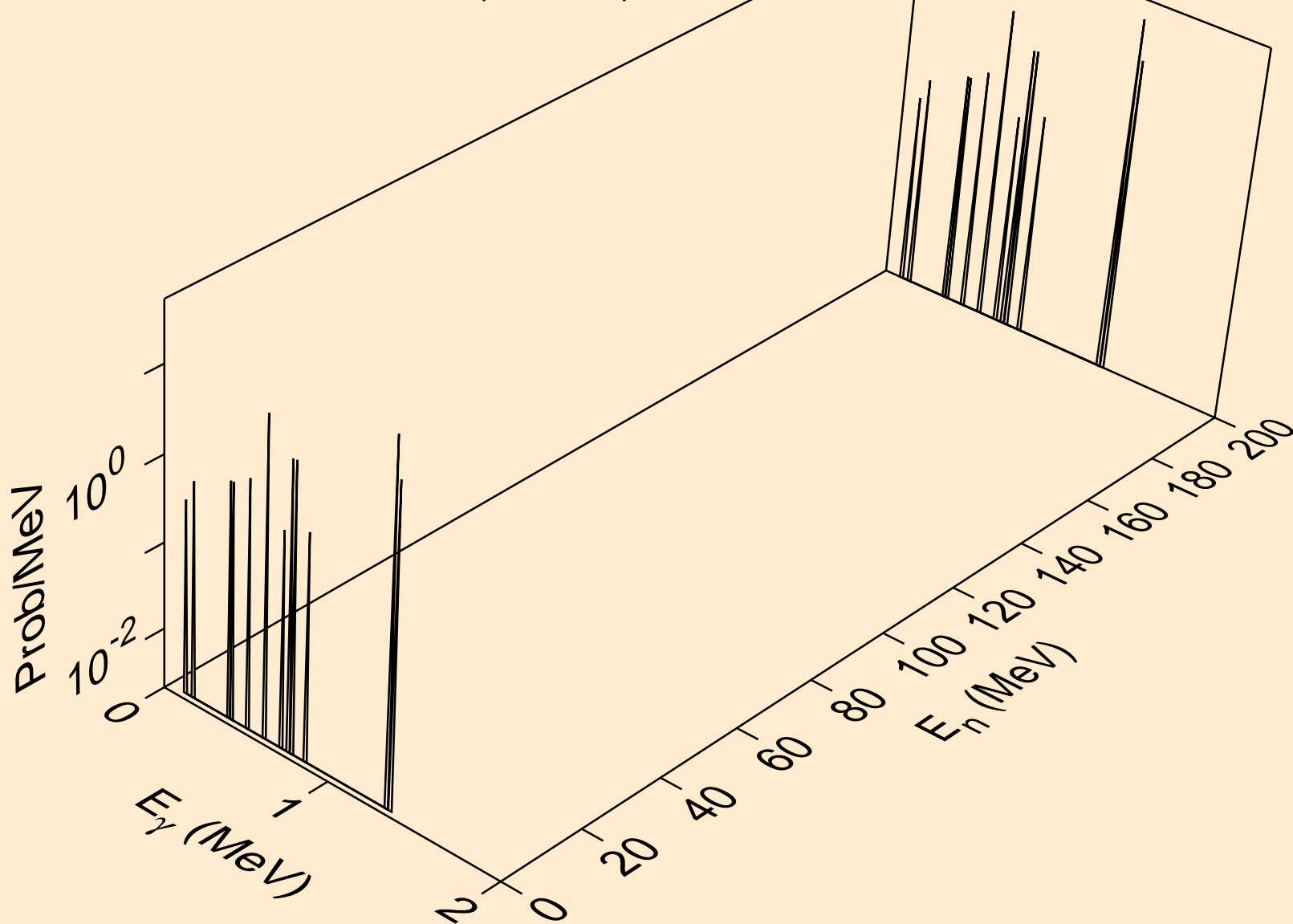

TC094M NEUTRON ACER TENDL-2019 LIBRARY; T=293.16K  
Photon emission for (n,n\*24)

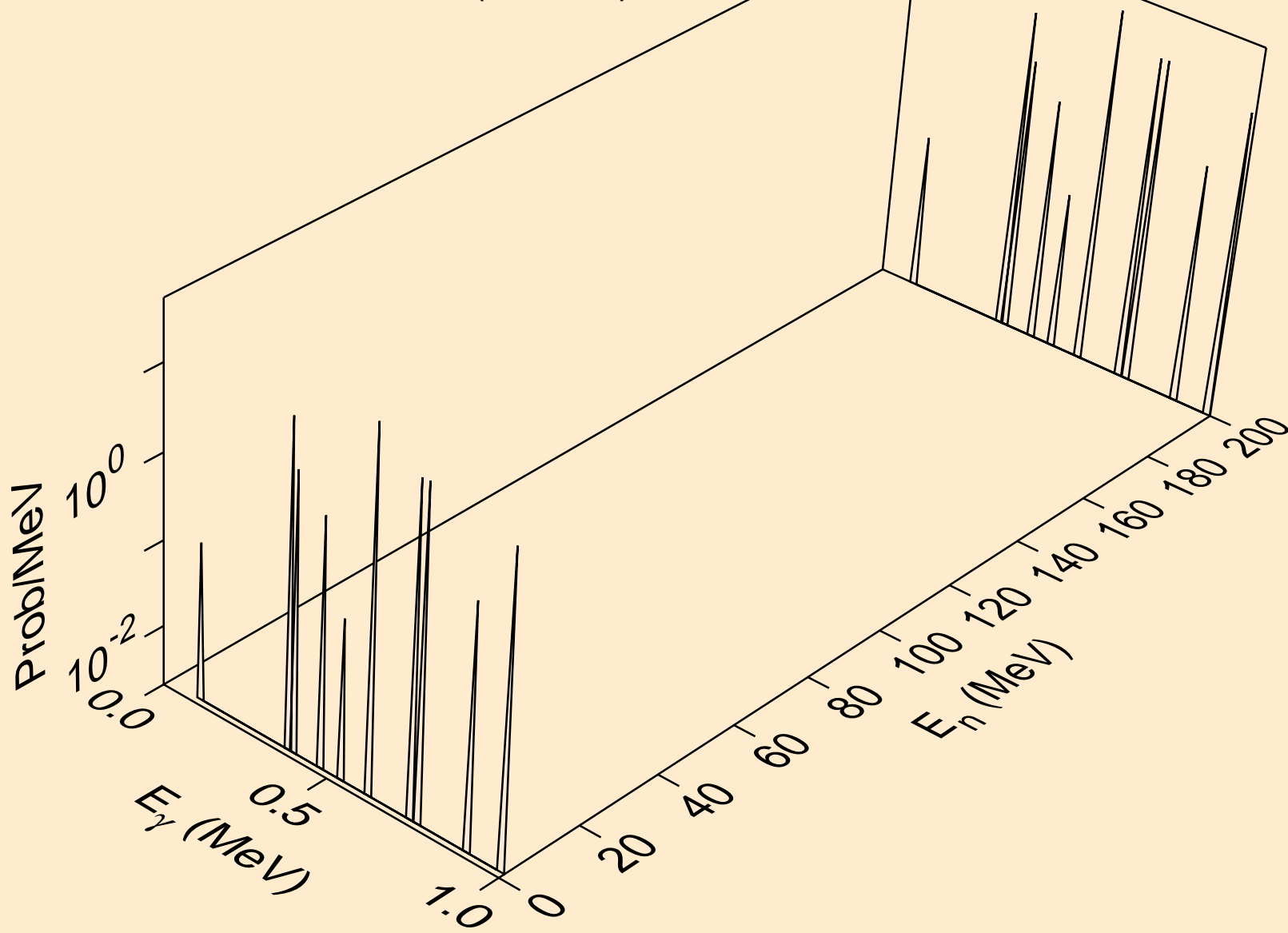



TC094M NEUTRON ACER TENDL-2019 LIBRARY; T=293.16K  
Photon emission for (n,n\*25)

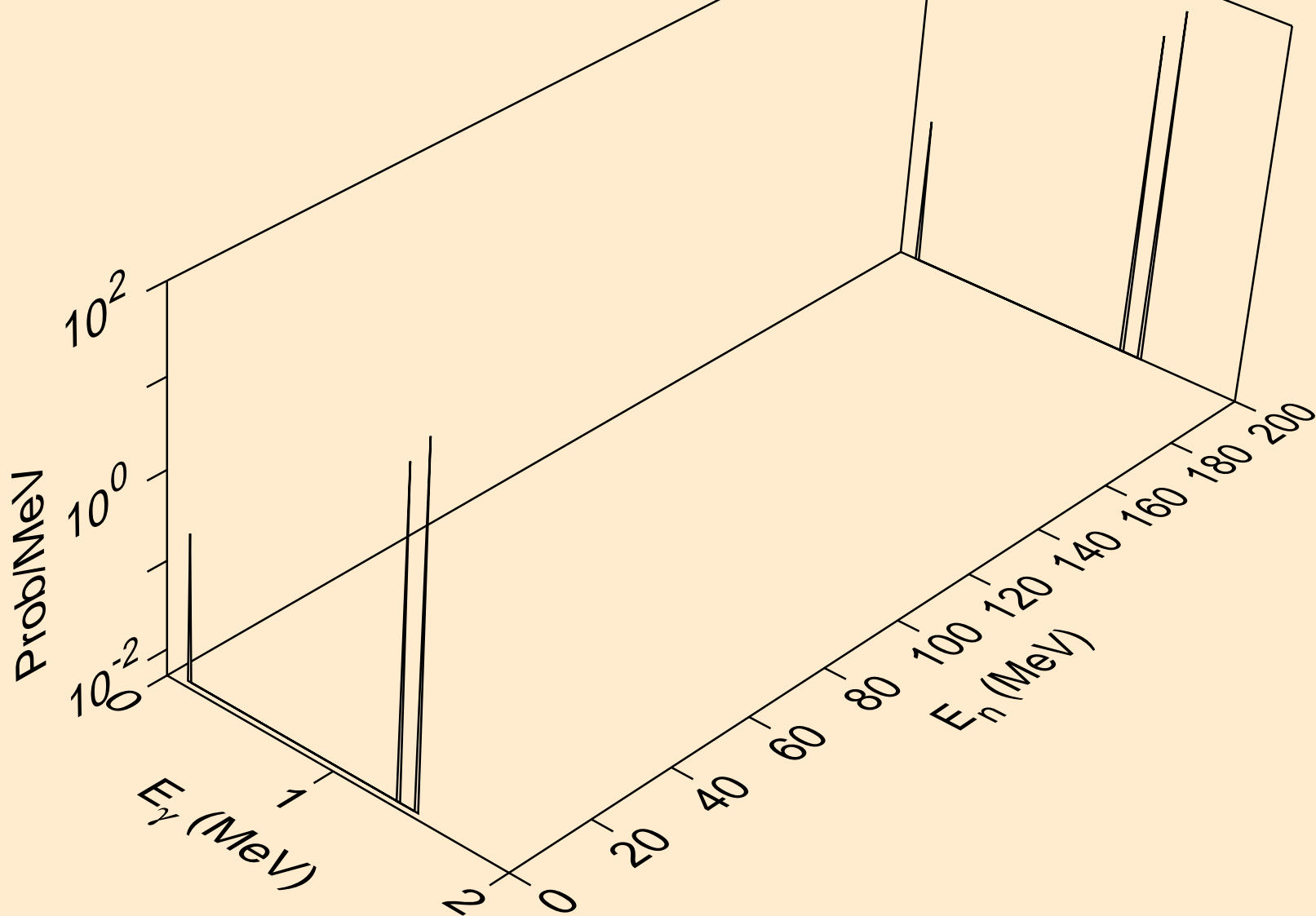

TC094M NEUTRON ACER TENDL-2019 LIBRARY; T=293.16K  
Photon emission for (n,n\*26)

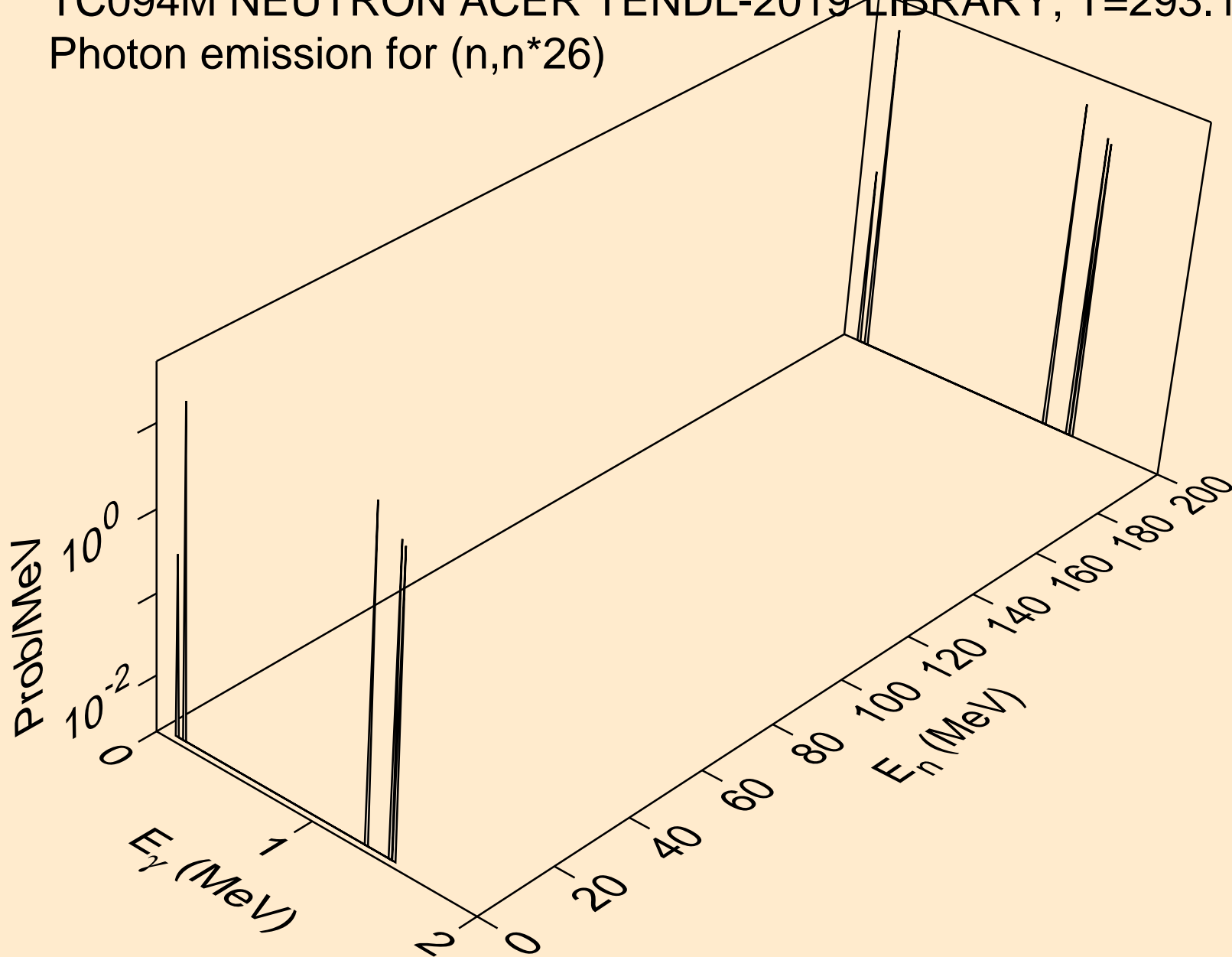

TC094M NEUTRON ACER TENDL-2019 LIBRARY; T=293.16K  
Photon emission for (n,n\*27)

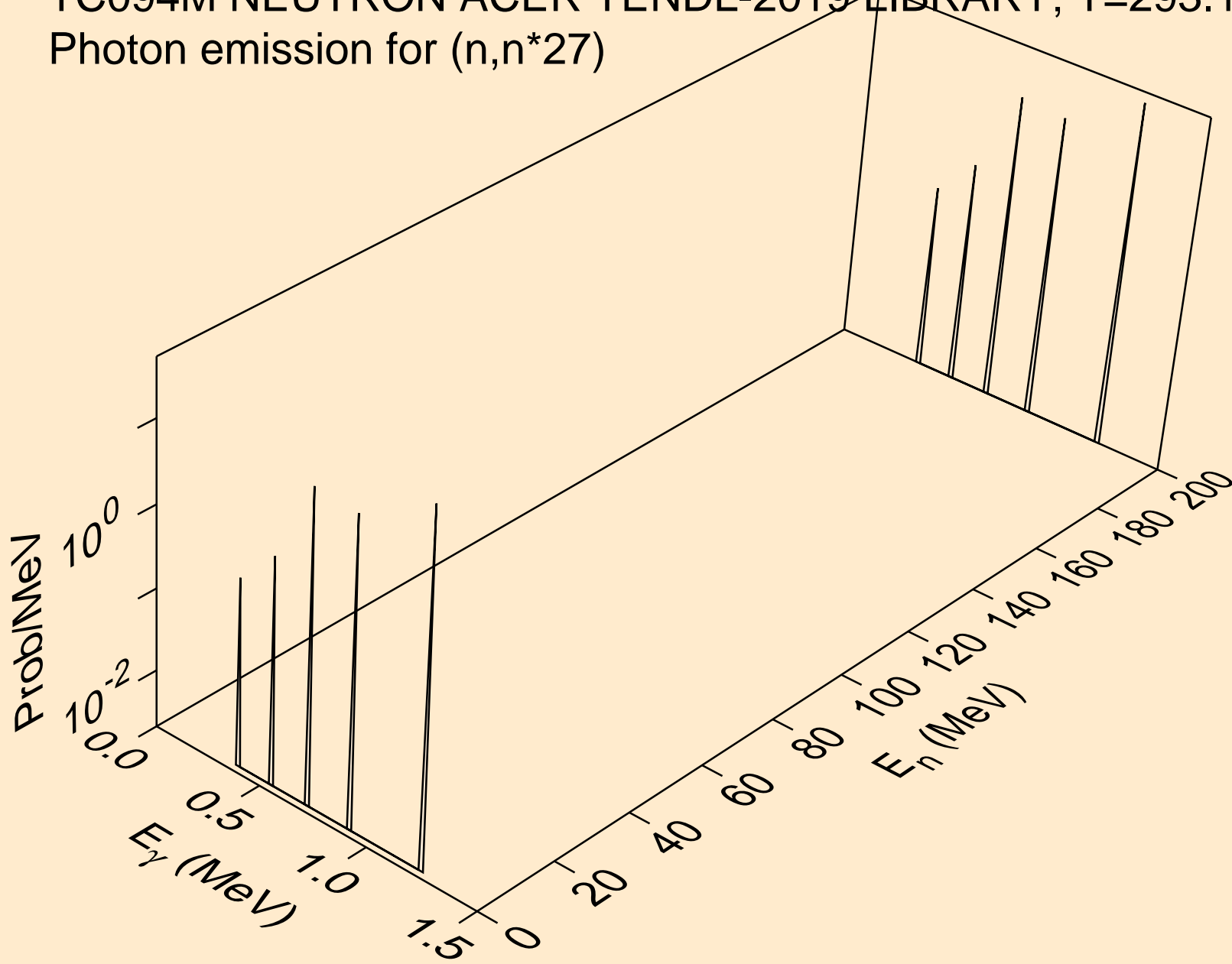

TC094M NEUTRON ACER TENDL-2019 LIBRARY; T=293.16K  
Photon emission for (n,n\*28)

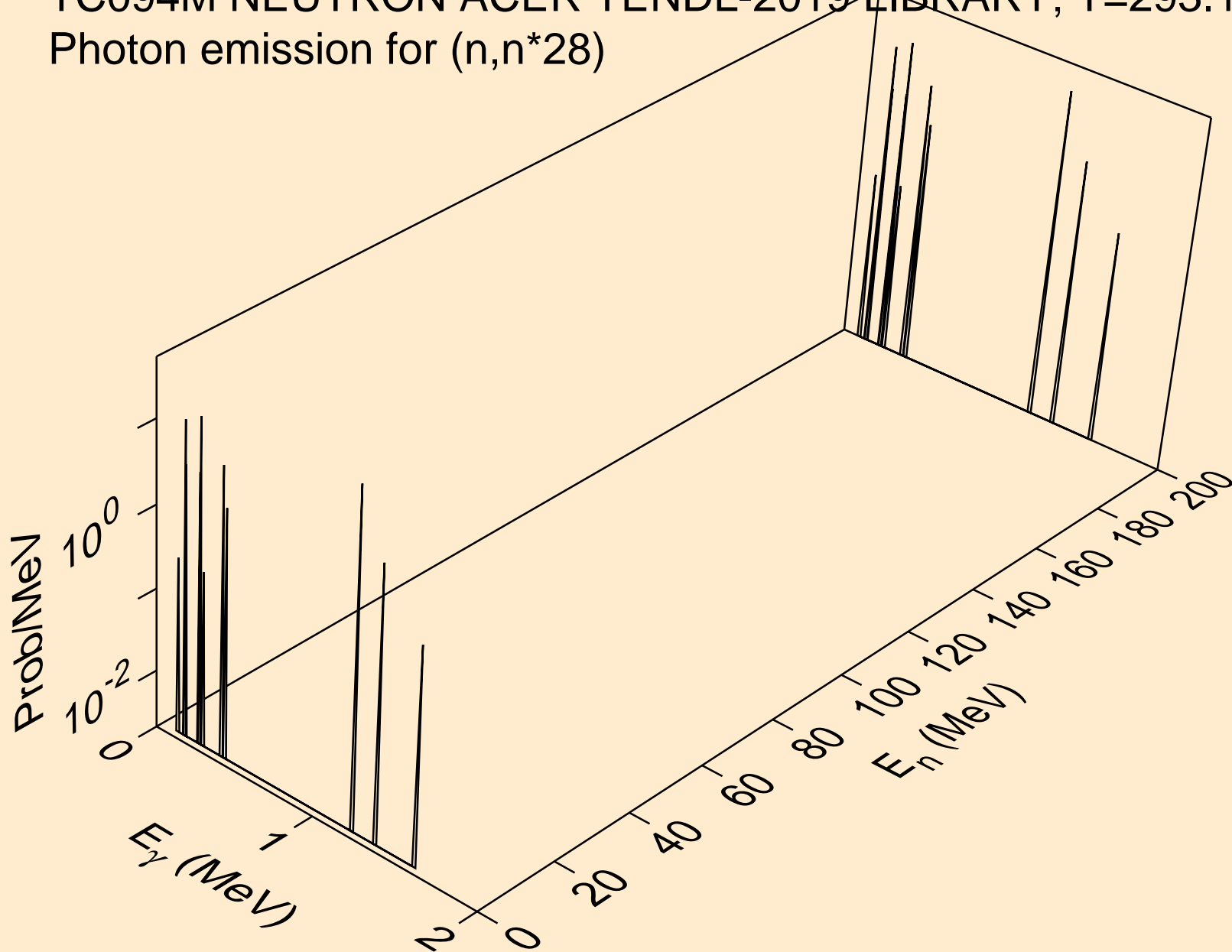

TC094M NEUTRON ACER TENDL-2019 LIBRARY; T=293.16K  
Photon emission for (n,n\*29)

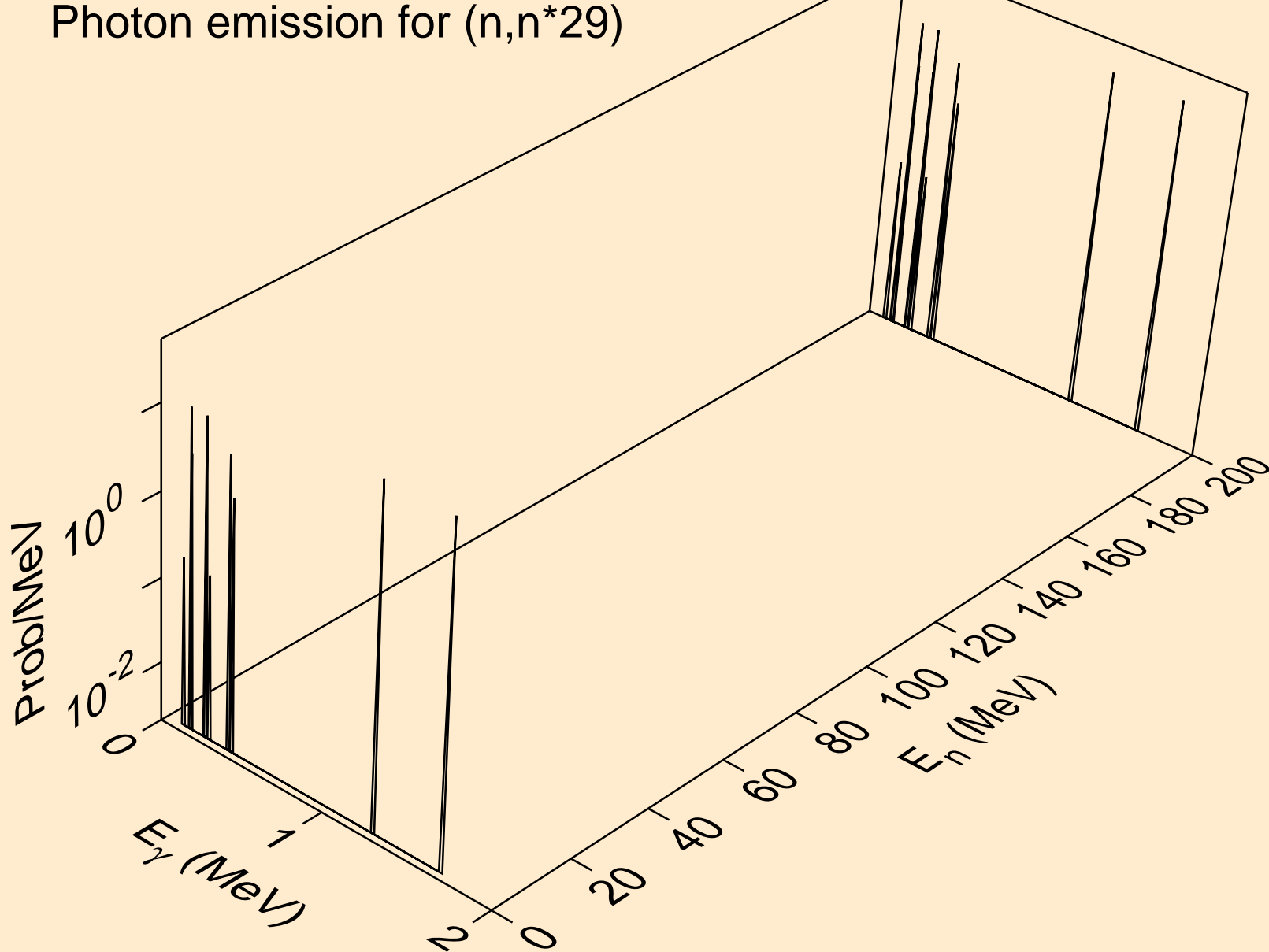

TC094M NEUTRON ACER TENDL-2019 LIBRARY; T=293.16K  
Photon emission for (n,n\*30)

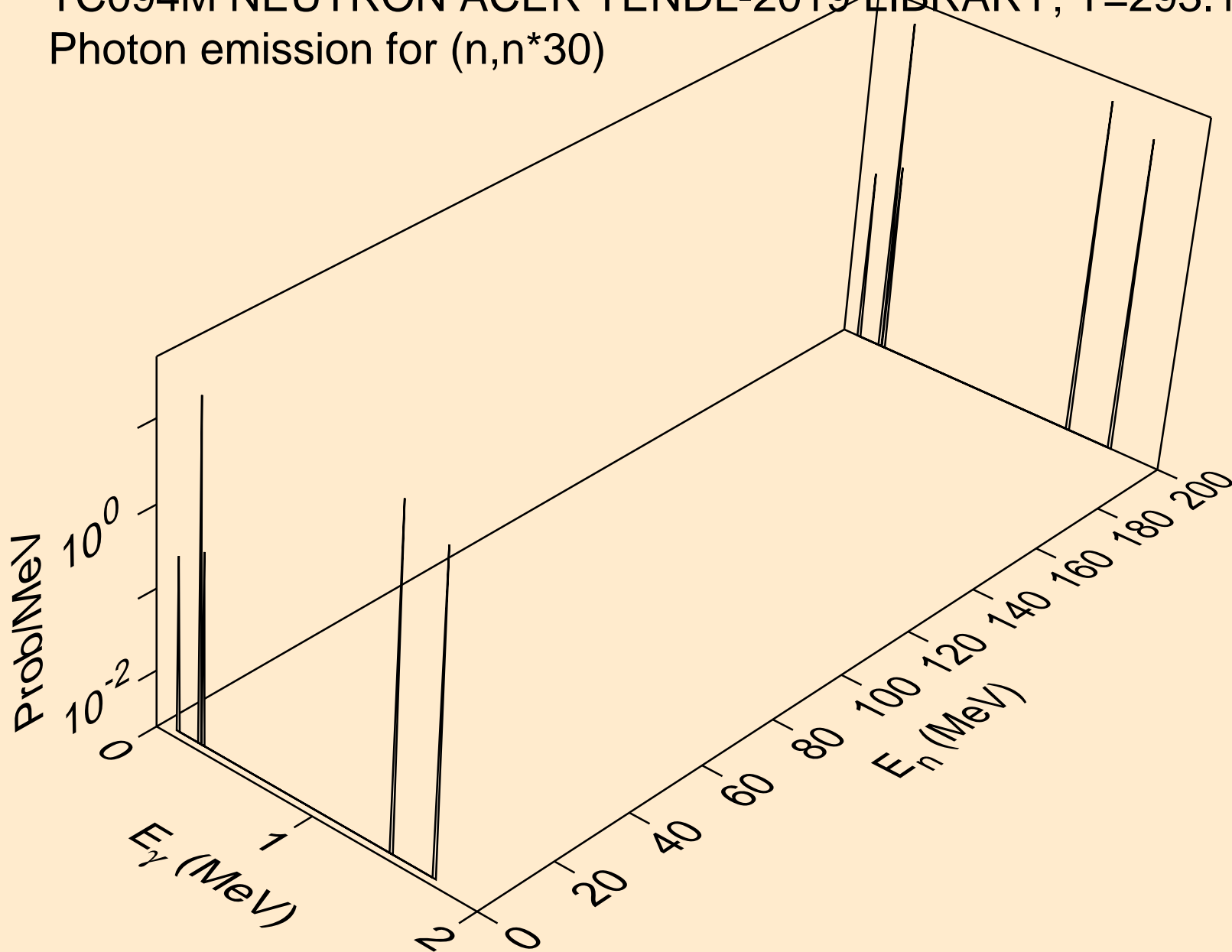

TC094M NEUTRON ACER TENDL-2019 LIBRARY; T=293.16K  
Photon emission for (n,n\*c)

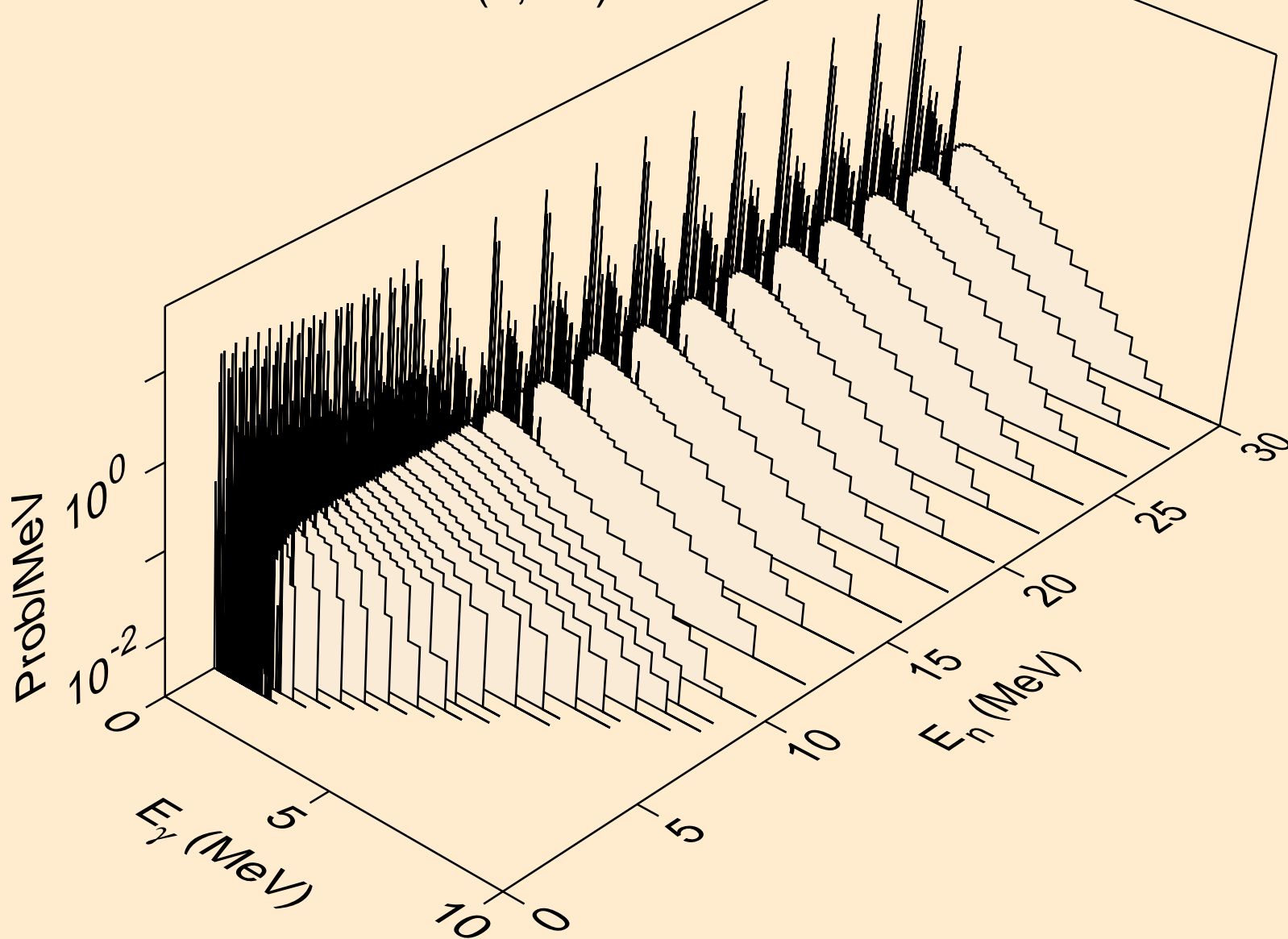

TC094M NEUTRON ACER TENDL-2019 LIBRARY; T=293.16K  
Photon emission for (n,gma)

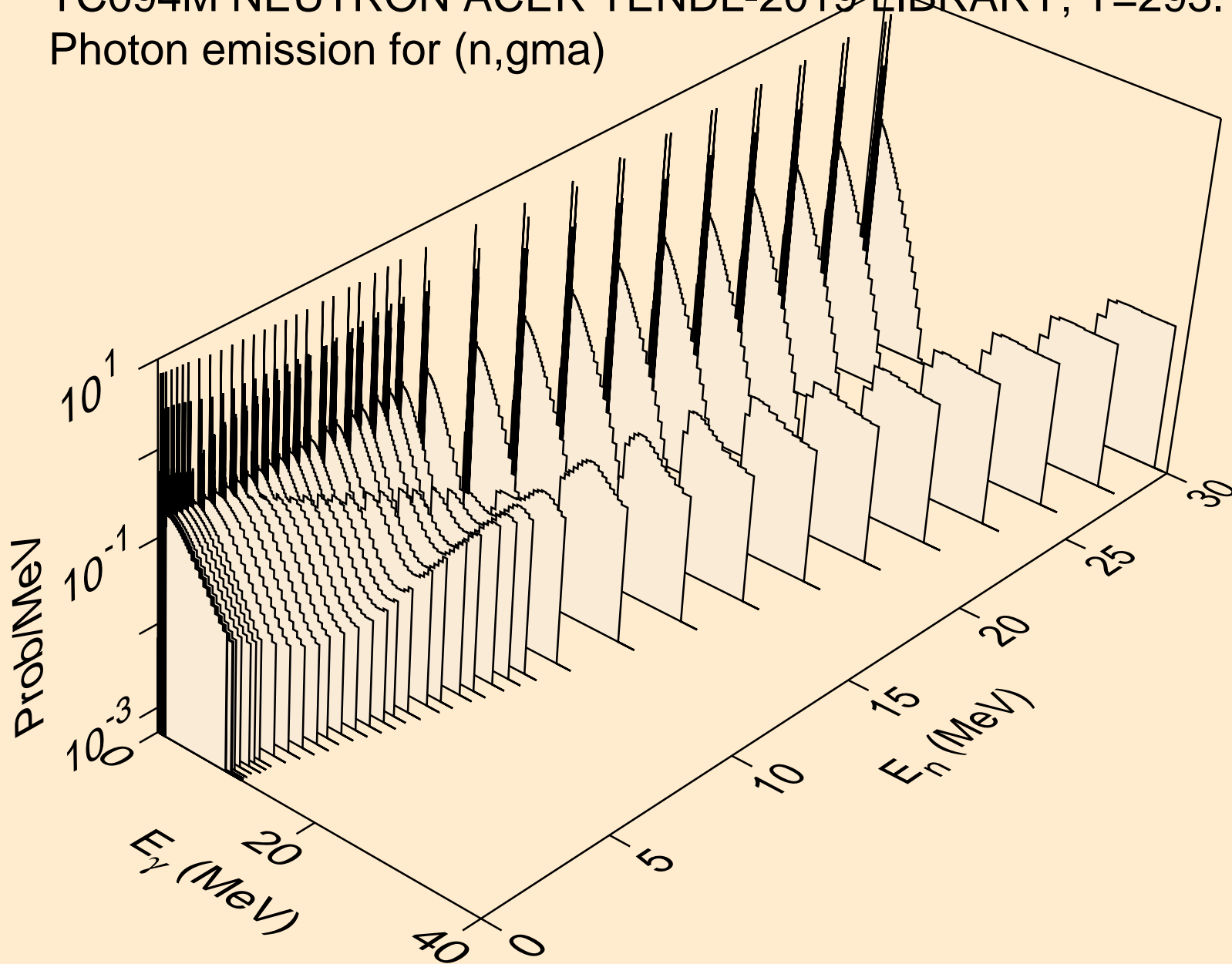



TC094M NEUTRON ACER TENDL-2019 LIBRARY; T=293.16K  
Photon emission for (n,p)

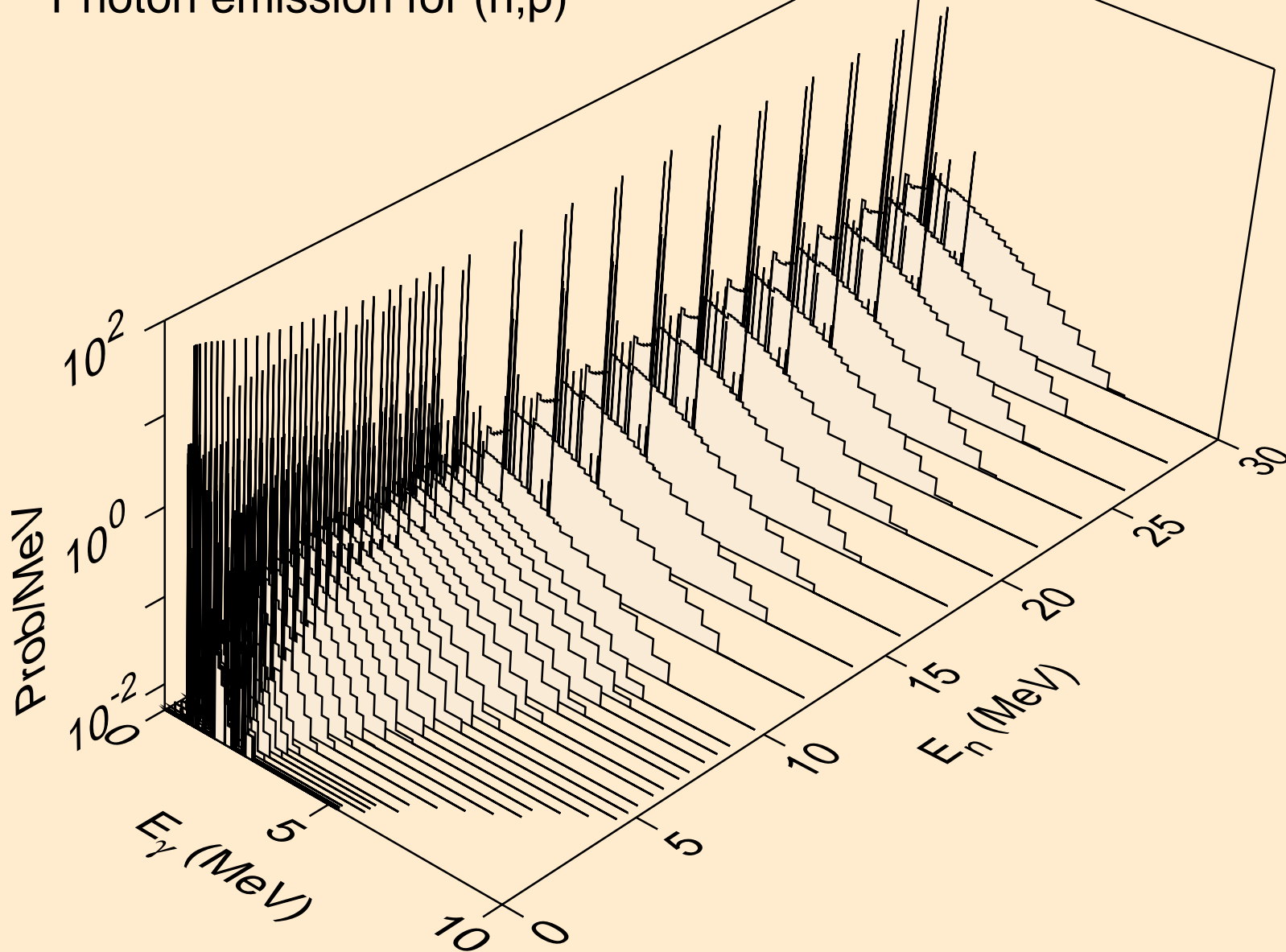

TC094M NEUTRON ACER TENDL-2019 LIBRARY; T=293.16K  
Photon emission for (n,d)

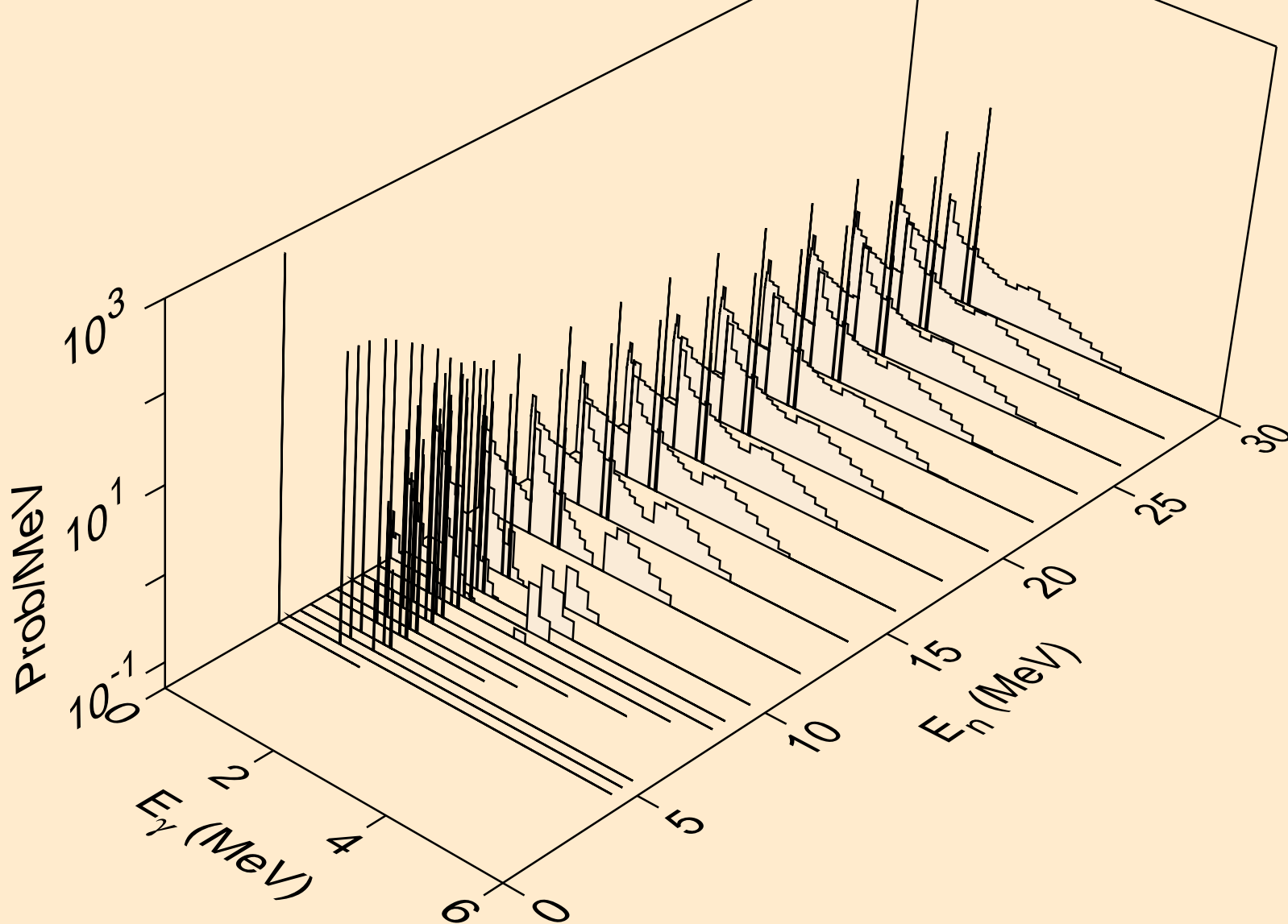

TC094M NEUTRON ACER TENDL-2019 LIBRARY; T=293.16K  
Photon emission for (n,t)

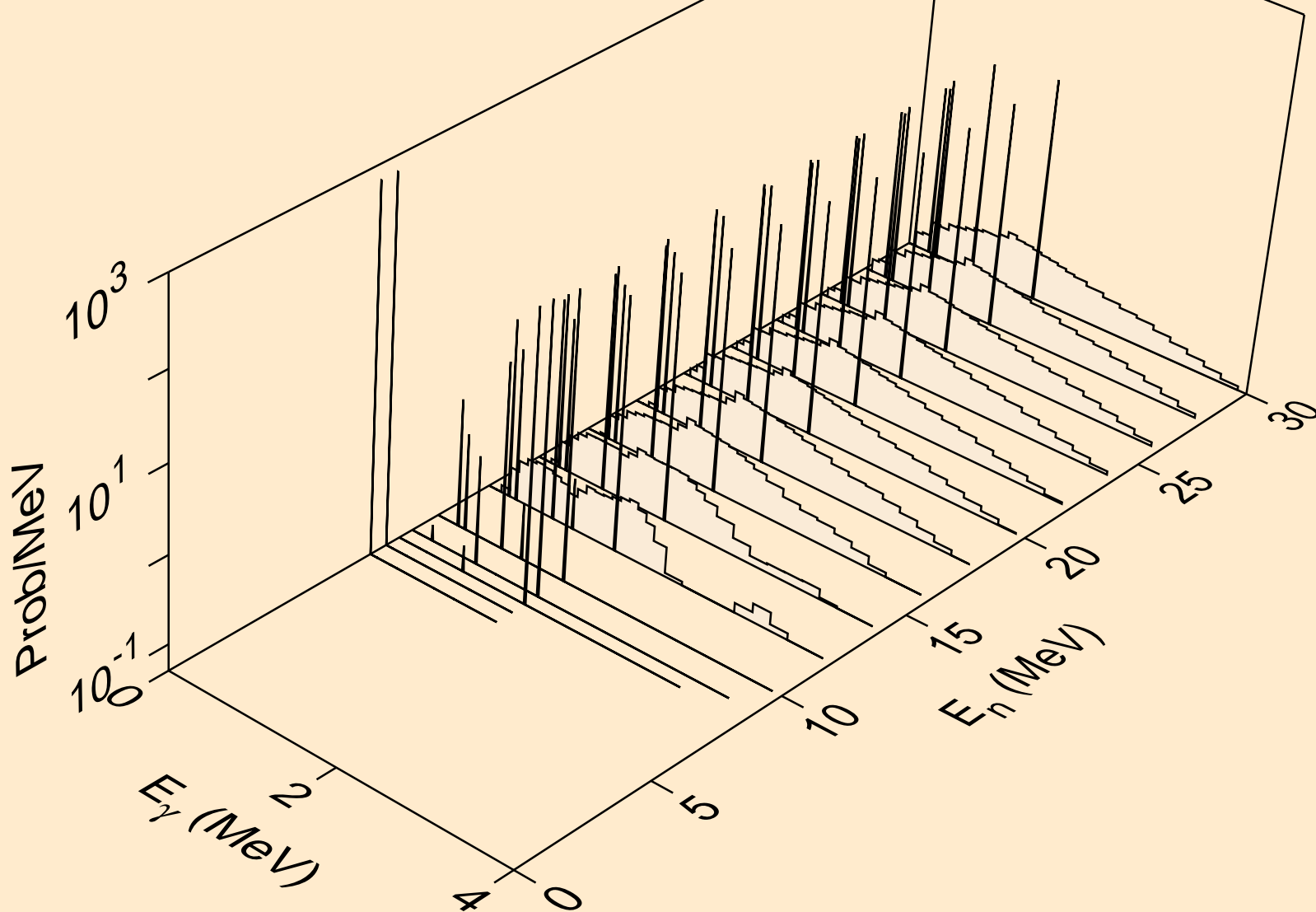

TC094M NEUTRON ACER TENDL-2019 LIBRARY; T=293.16K  
Photon emission for (n,he3)

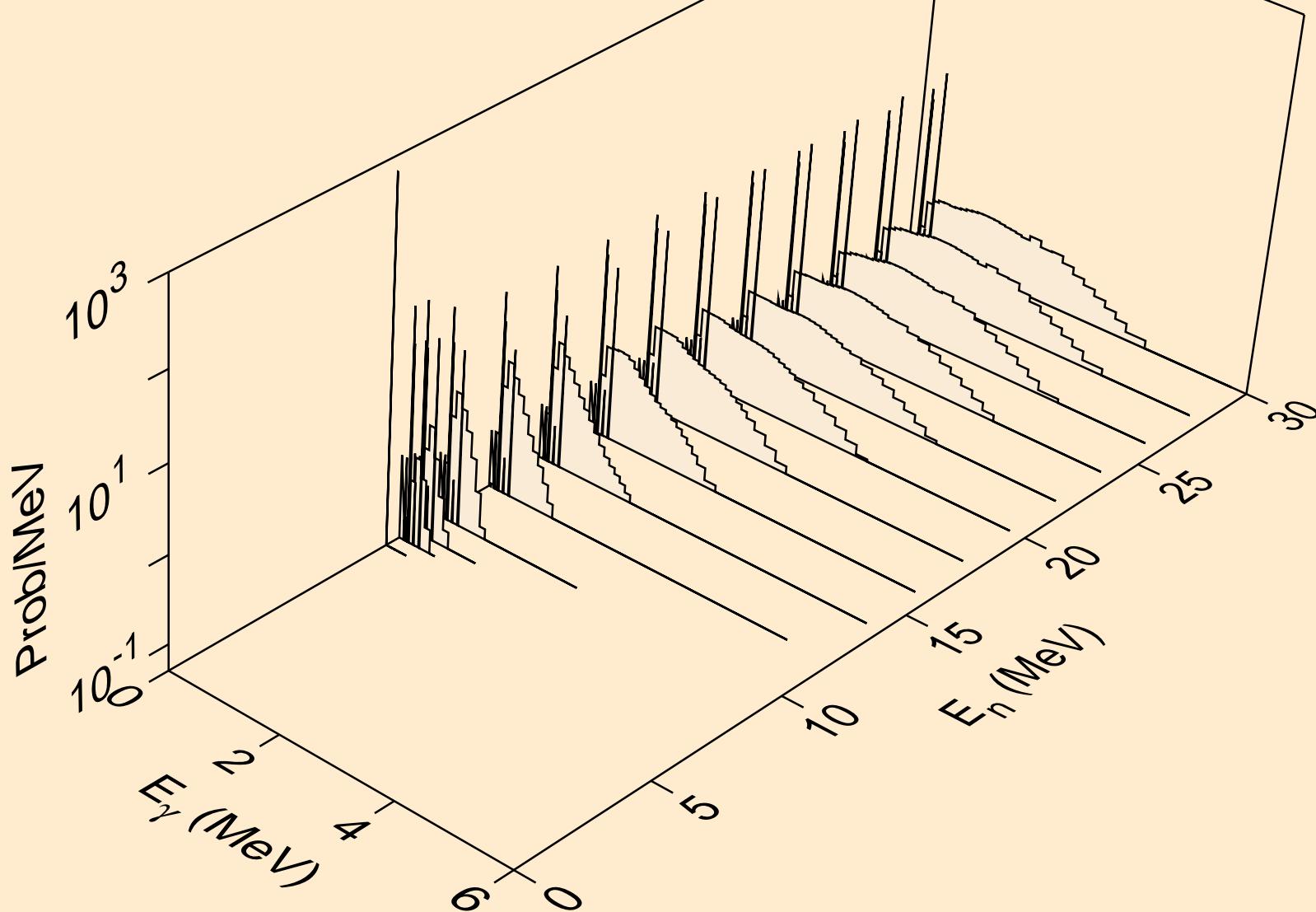

TC094M NEUTRON ACER TENDL-2019 LIBRARY; T=293.16K  
Photon emission for (n,a)

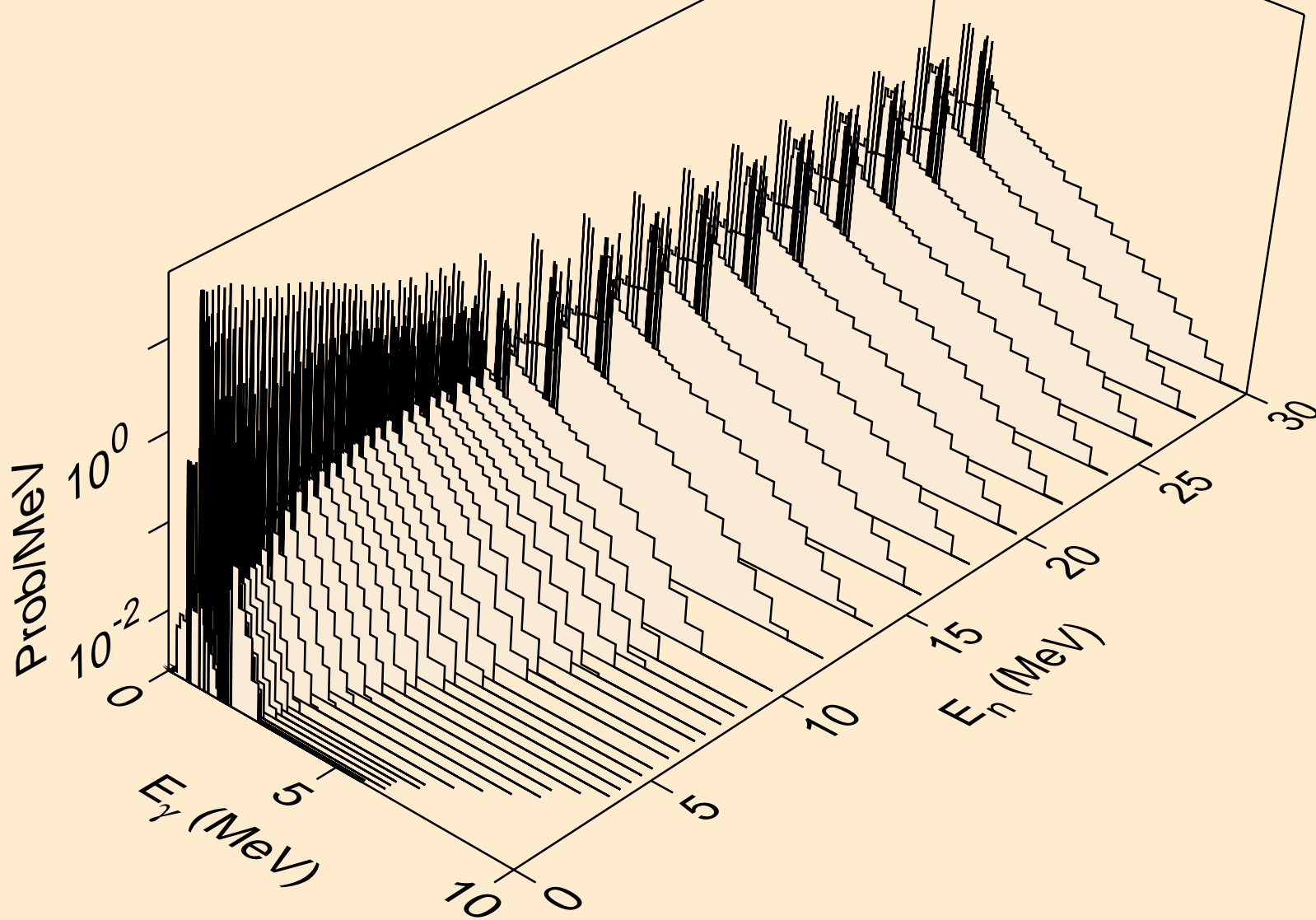

TC094M NEUTRON ACER TENDL-2019 LIBRARY; T=293.16K  
Photon emission for (n,2a)

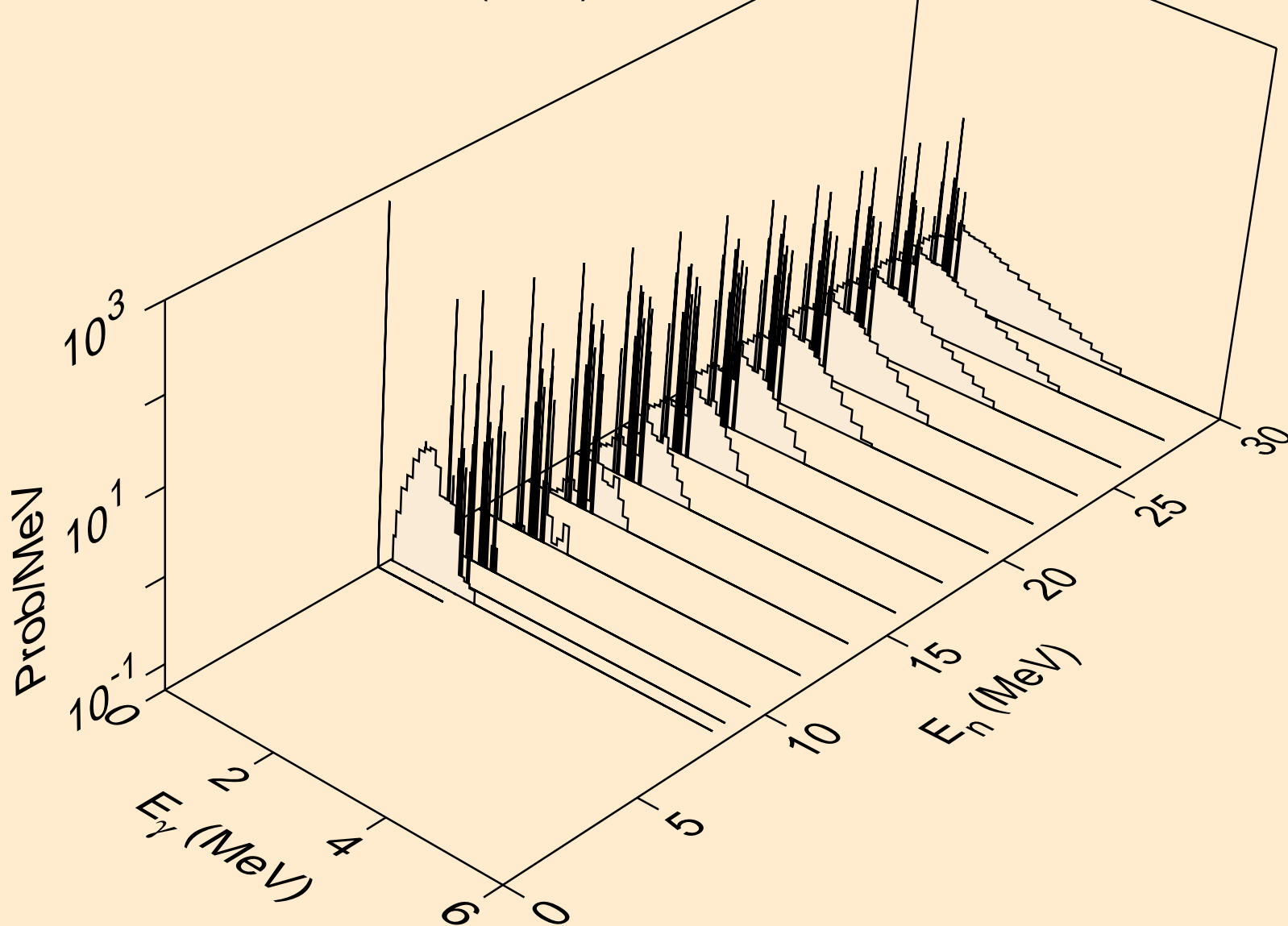

TC094M NEUTRON ACER TENDL-2019 LIBRARY; T=293.16K  
Photon emission for (n,2p)

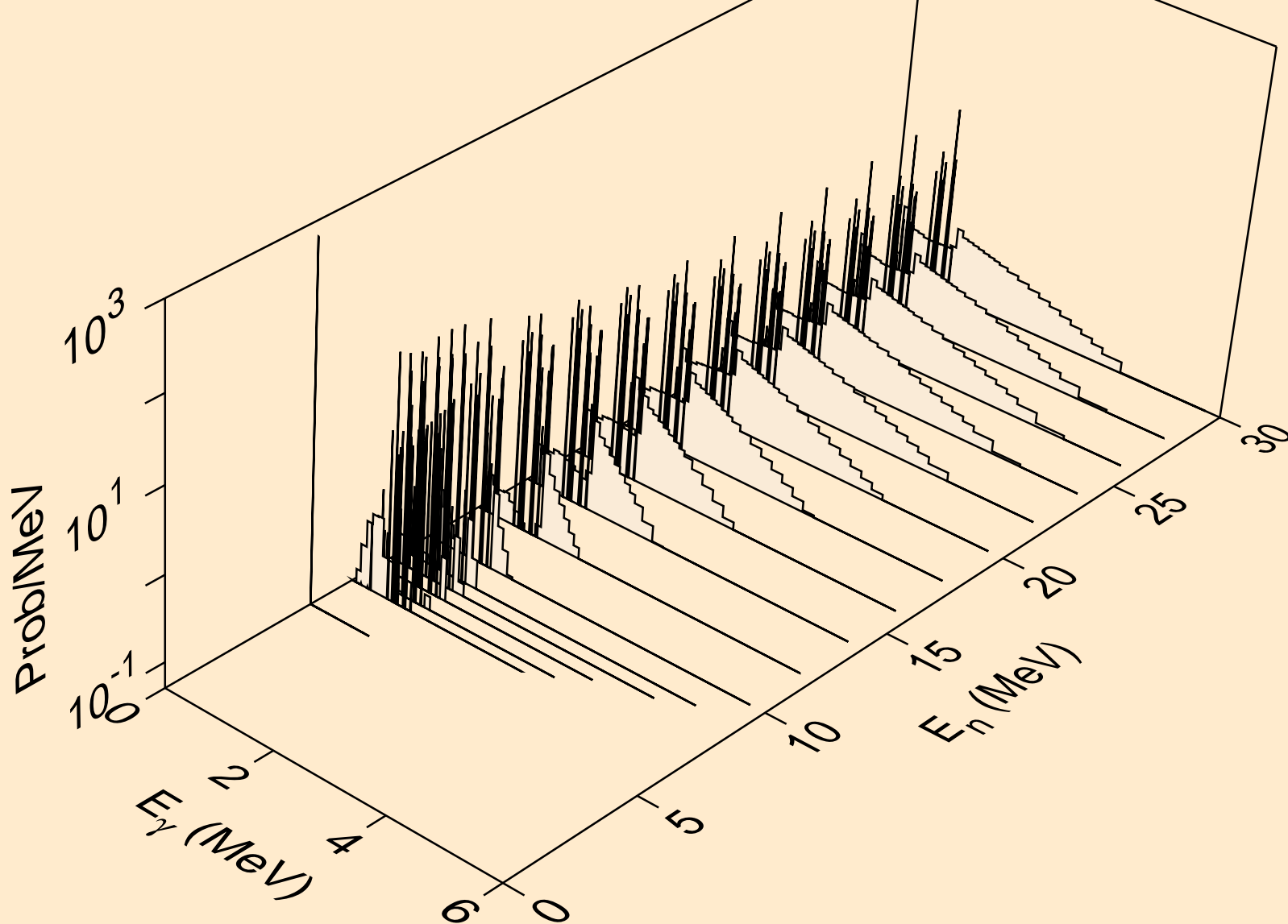

TC094M NEUTRON ACER TENDL-2019 LIBRARY; T=293.16K  
Photon emission for (n,p $\alpha$ )

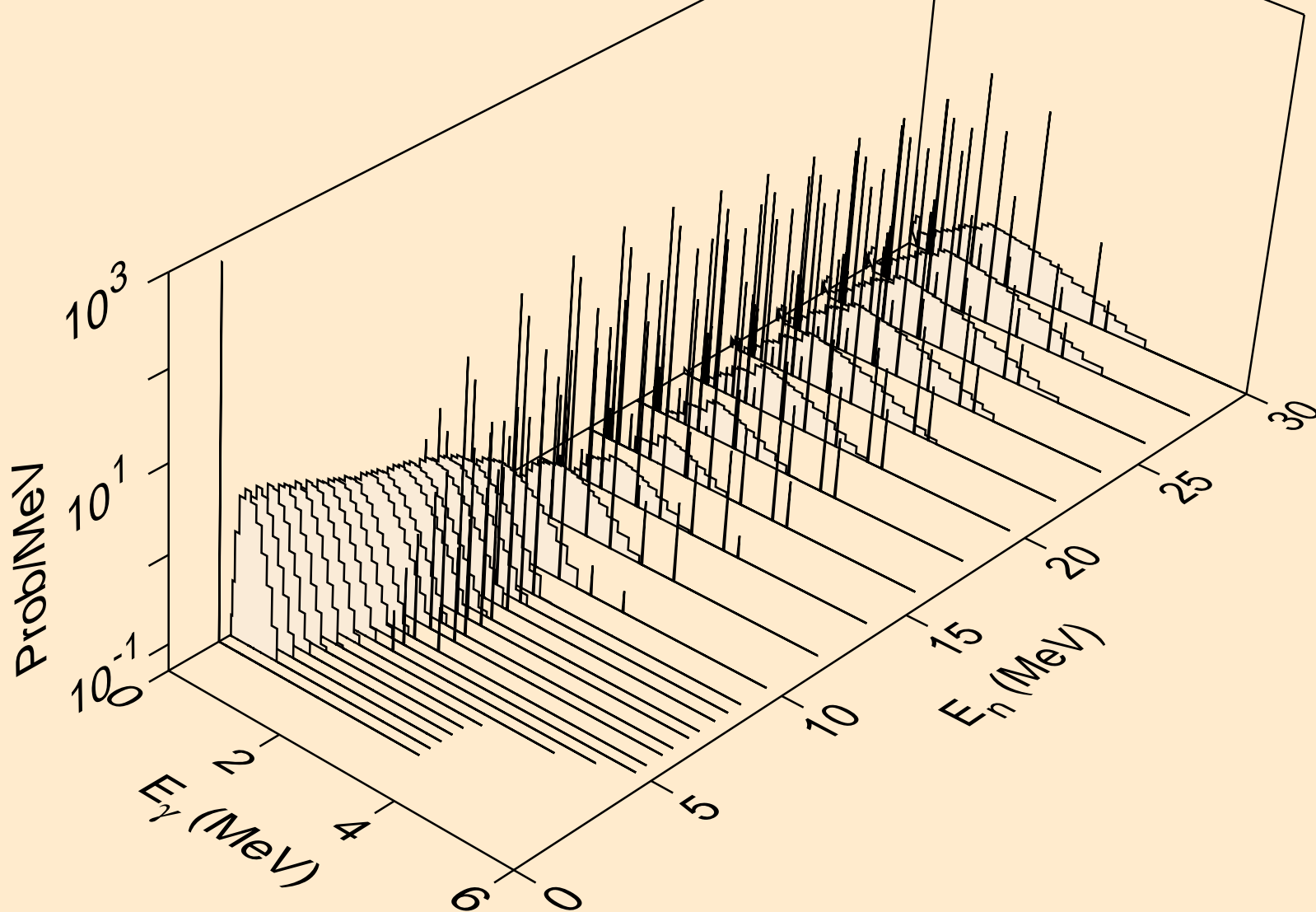



TC094M NEUTRON ACER TENDL-2019 LIBRARY; T=293.16K  
Photon emission for (n,pd)

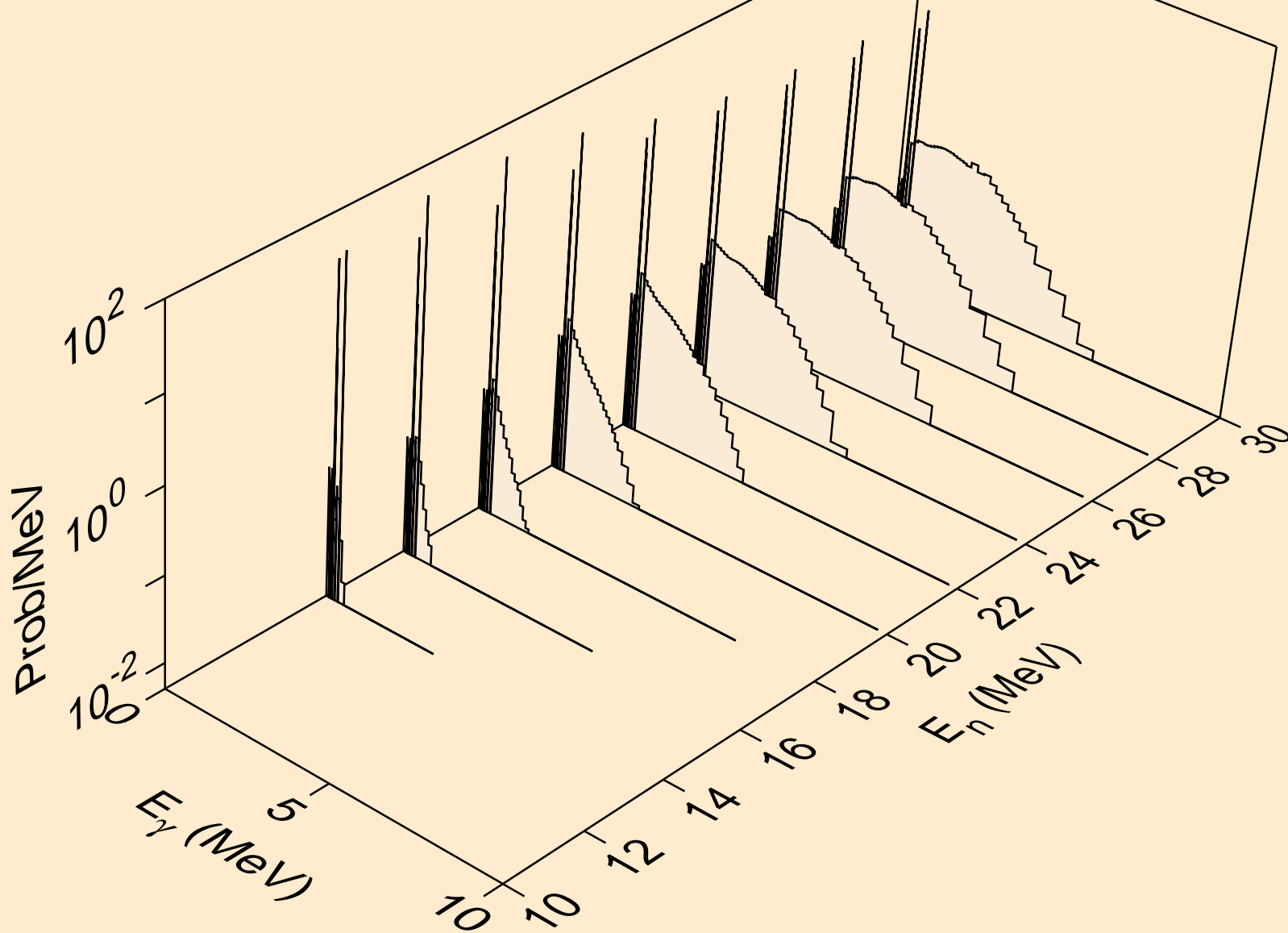

TC094M NEUTRON ACER TENDL-2019 LIBRARY; T=293.16K  
Photon emission for (n,pt)

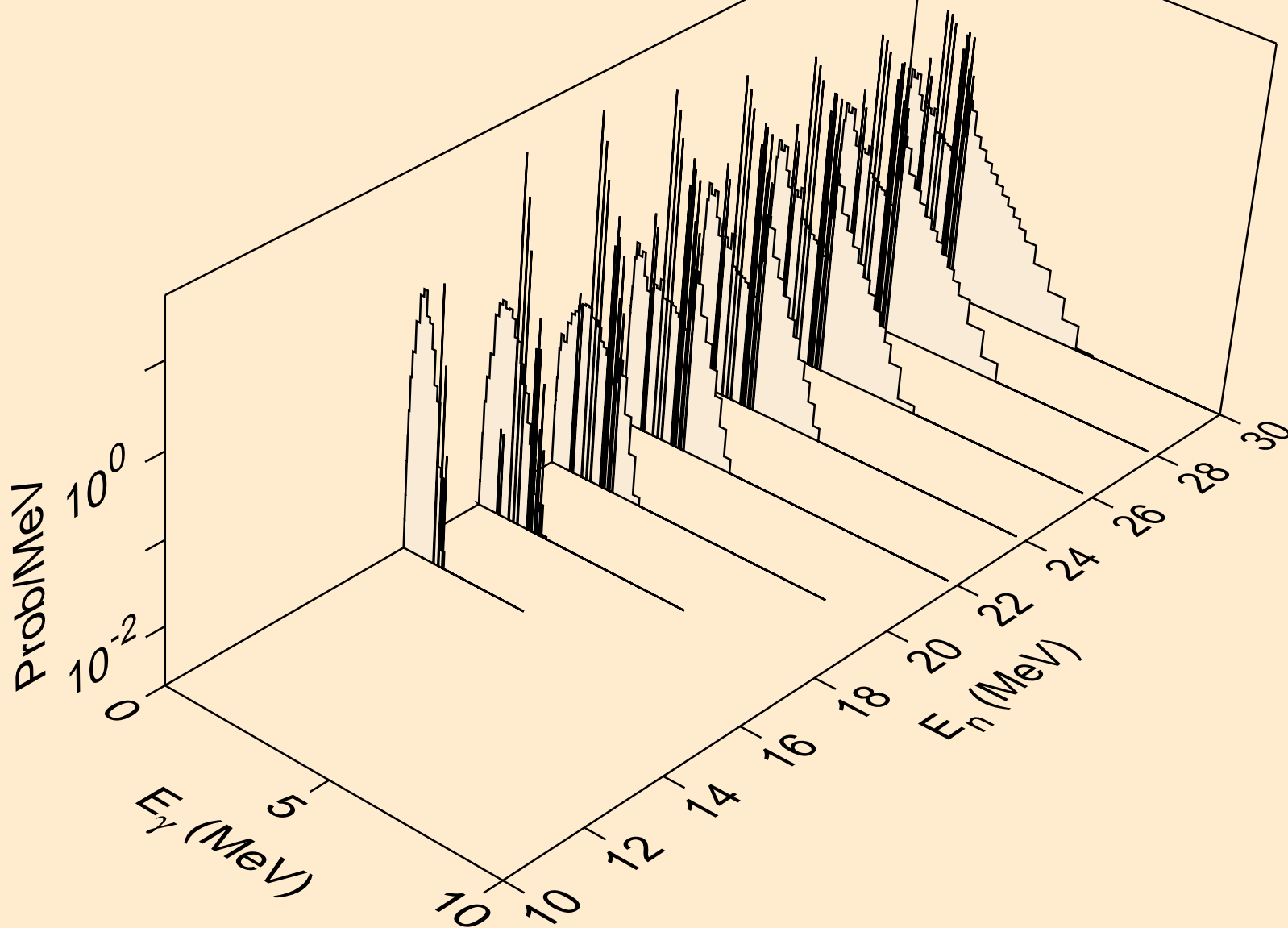

TC094M NEUTRON ACER TENDL-2019 LIBRARY; T=293.16K  
Photon emission for (n,da)

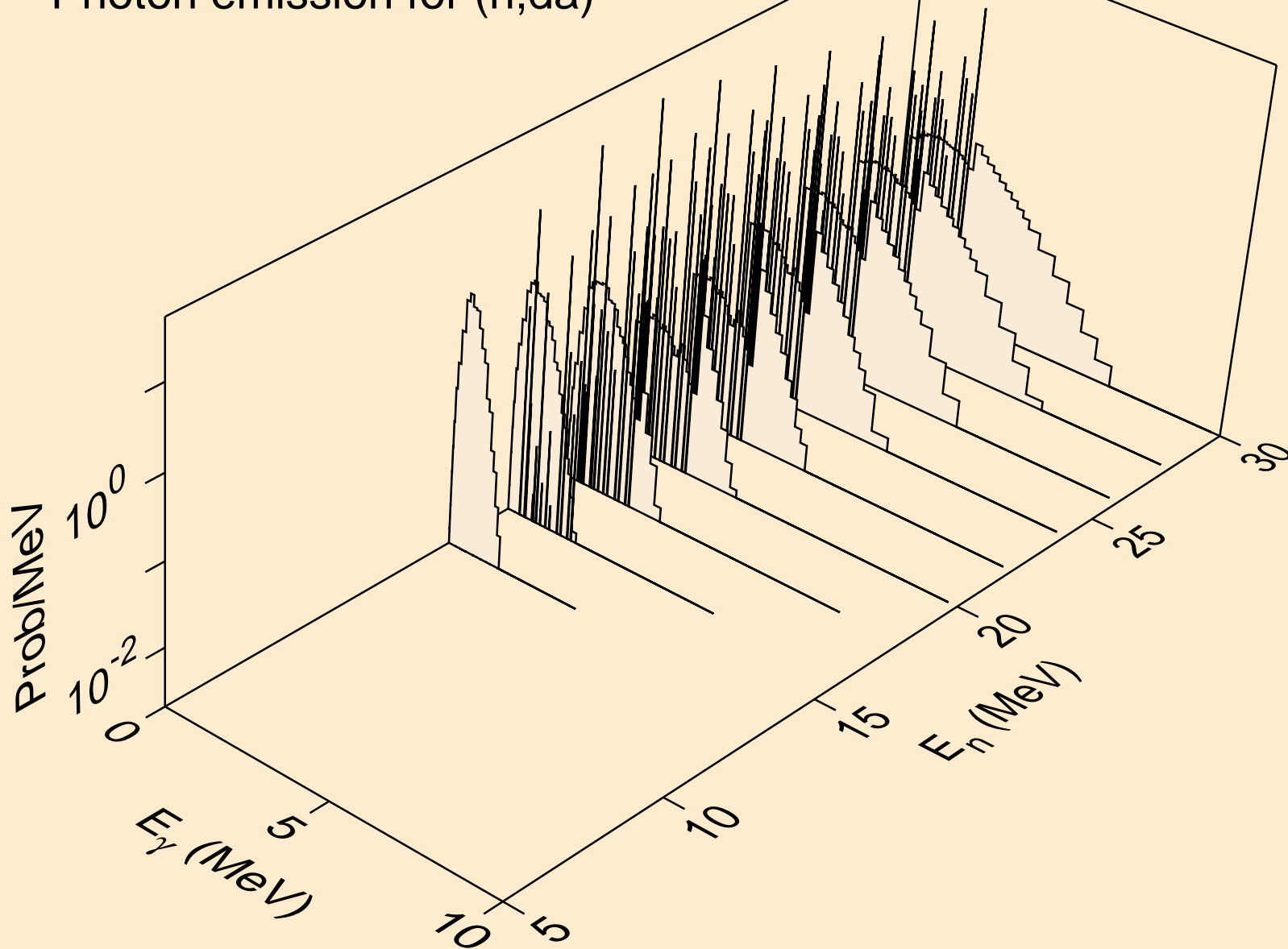

TC094M NEUTRON ACER TENDL-2019 LIBRARY; T=293.16K  
thermal capture photon spectrum

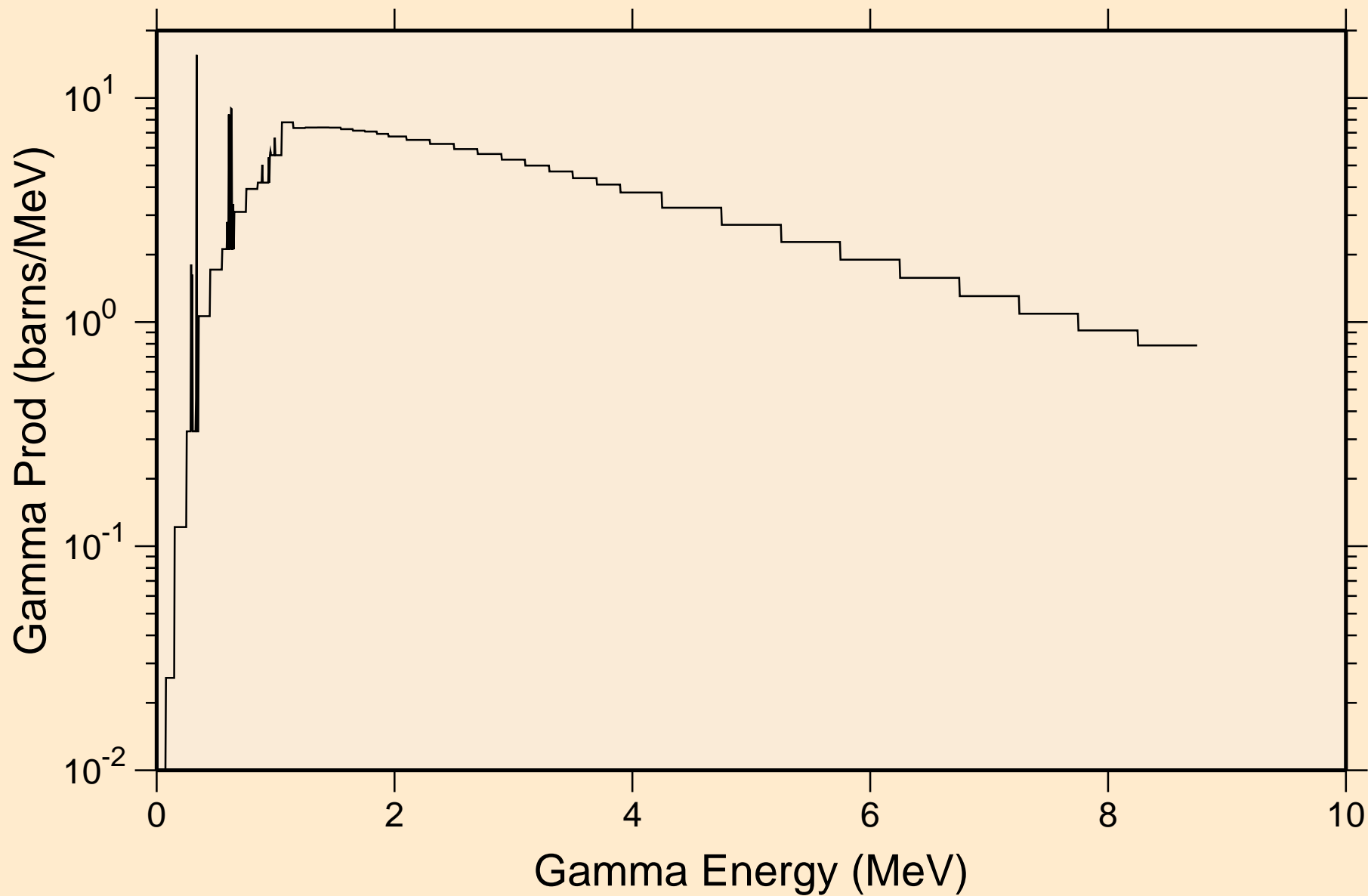

TC094M NEUTRON ACER TENDL-2019 LIBRARY; T=293.16K  
14 MeV photon spectrum

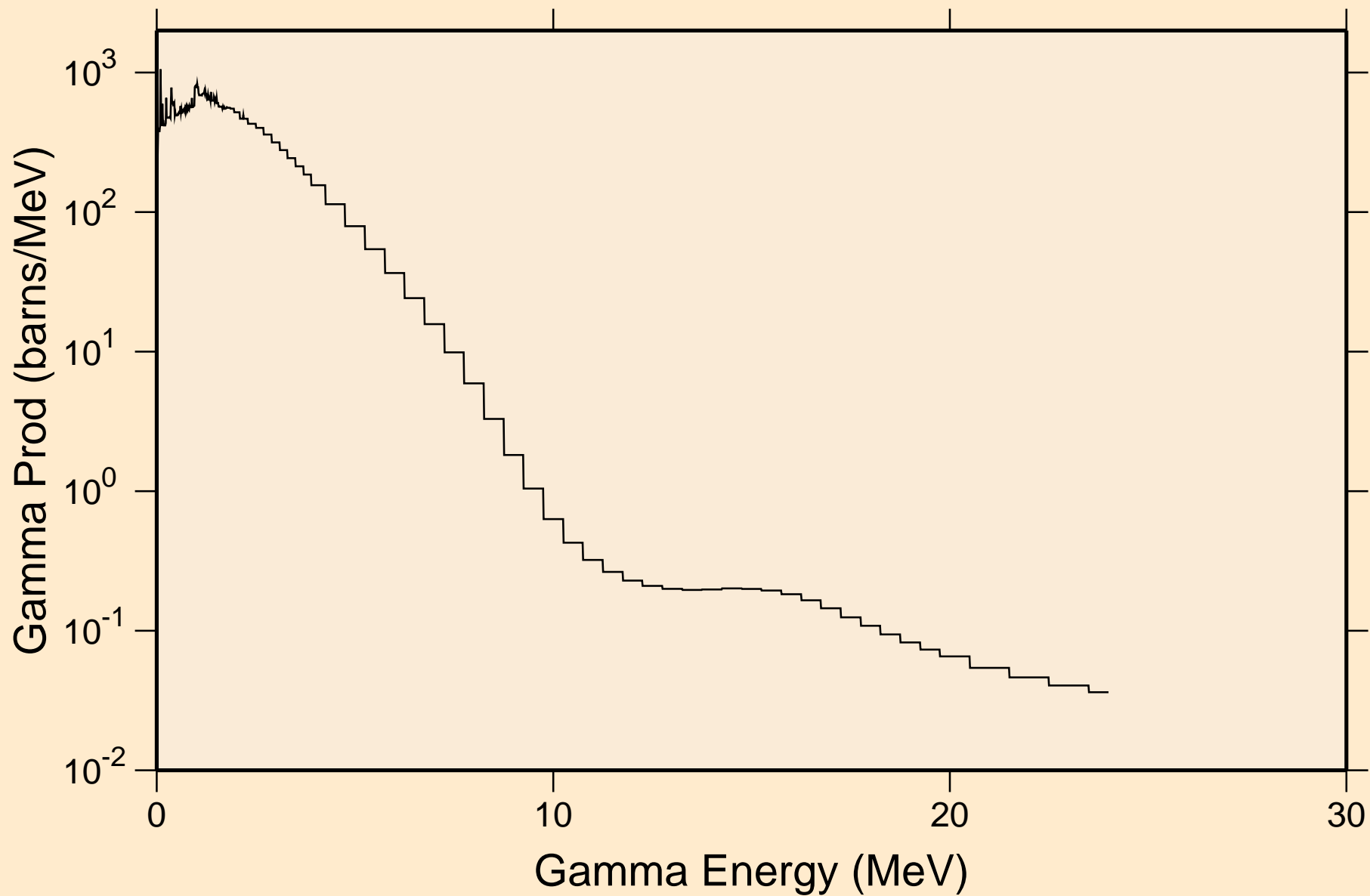

# TC094M NEUTRON ACER TENDL-2019 LIBRARY; T=293.16K

## Particle heating contributions

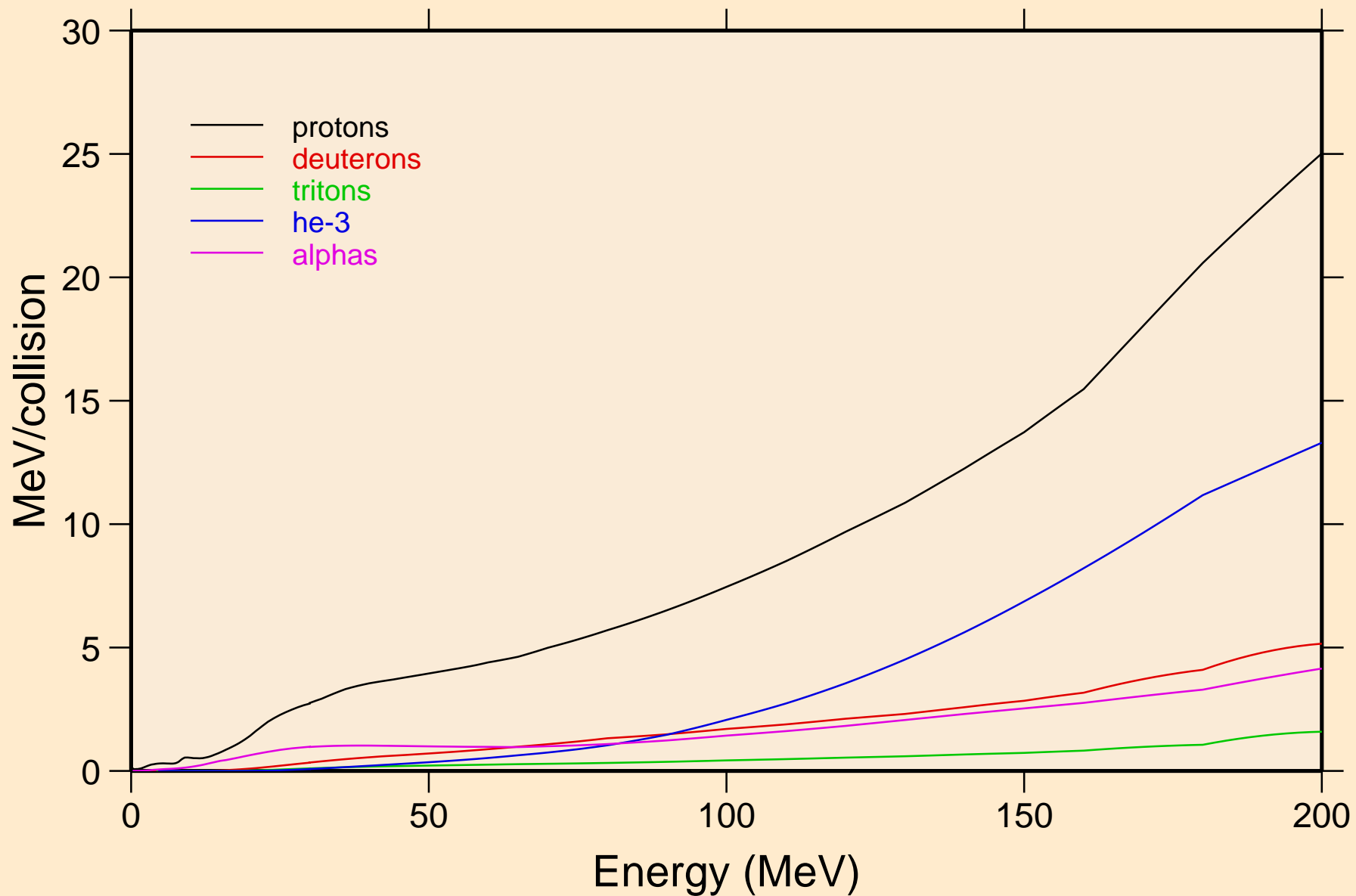

TC094M NEUTRON ACER TENDL-2019 LIBRARY; T=293.16K  
Recoil Heating

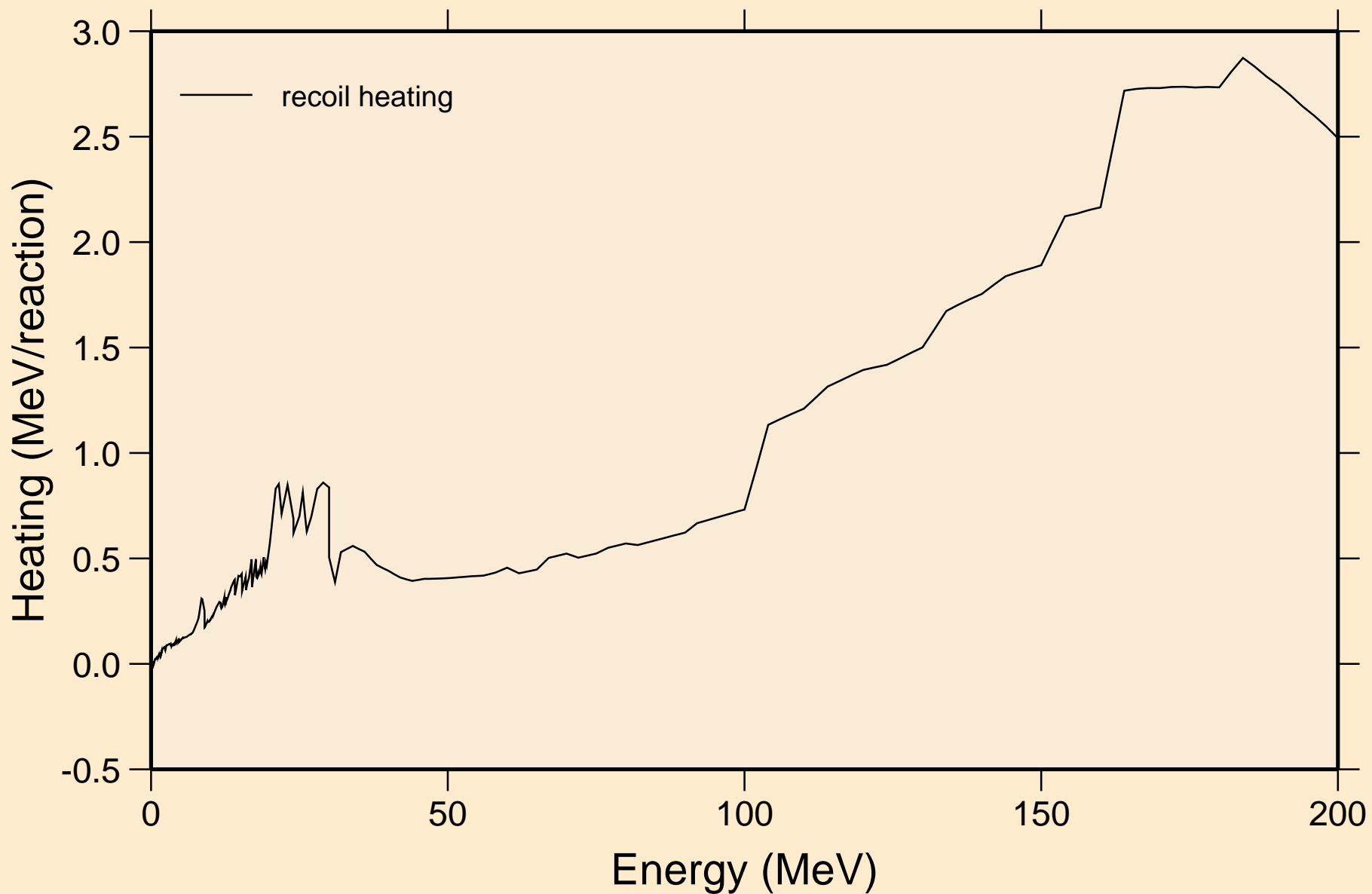

TC094M NEUTRON ACER TENDL-2019 LIBRARY; T=293.16K  
Particle production cross sections

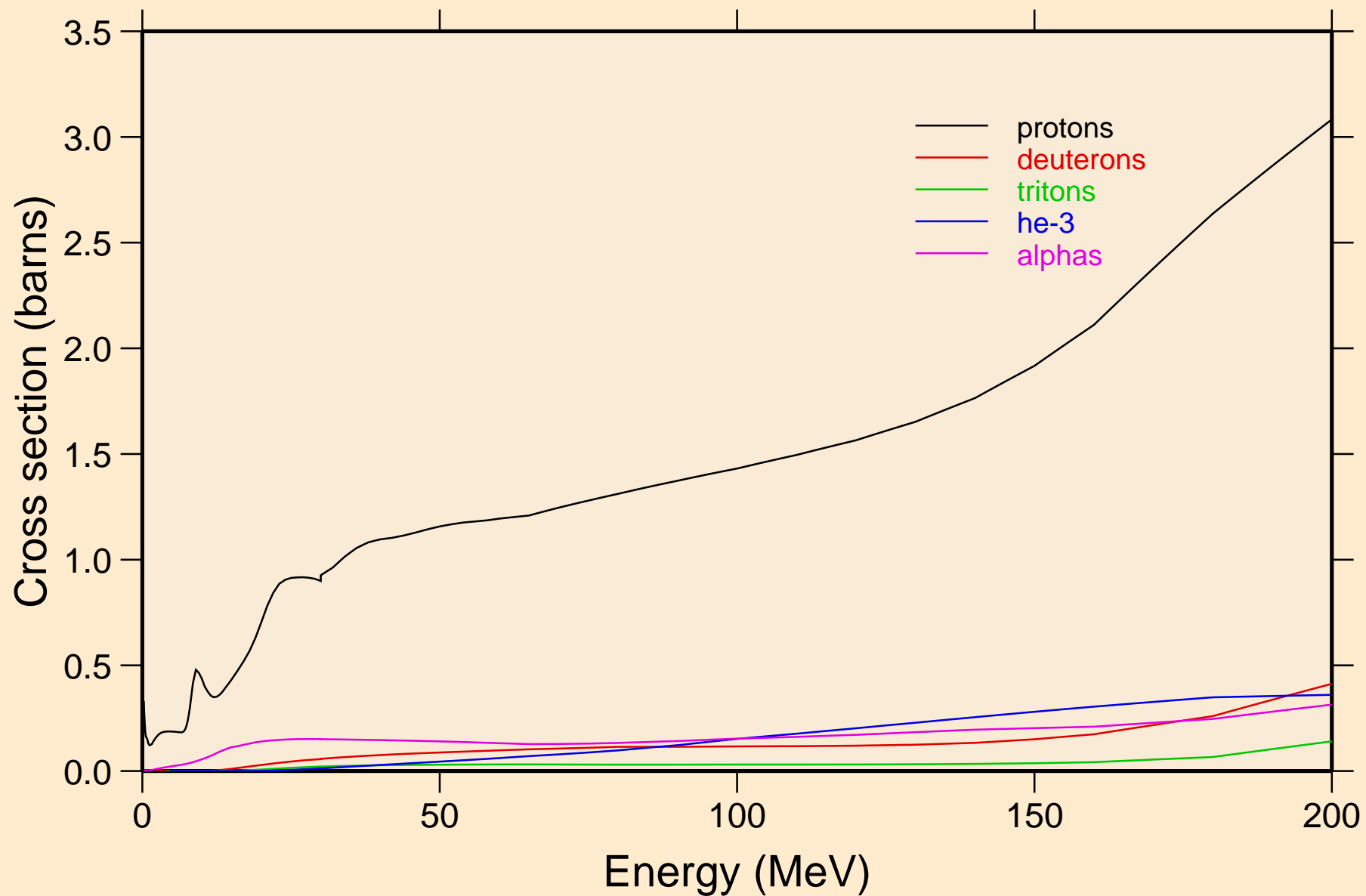



TC094M NEUTRON ACER TENDL-2019 LIBRARY; T=293.16K  
protons from (n,x)

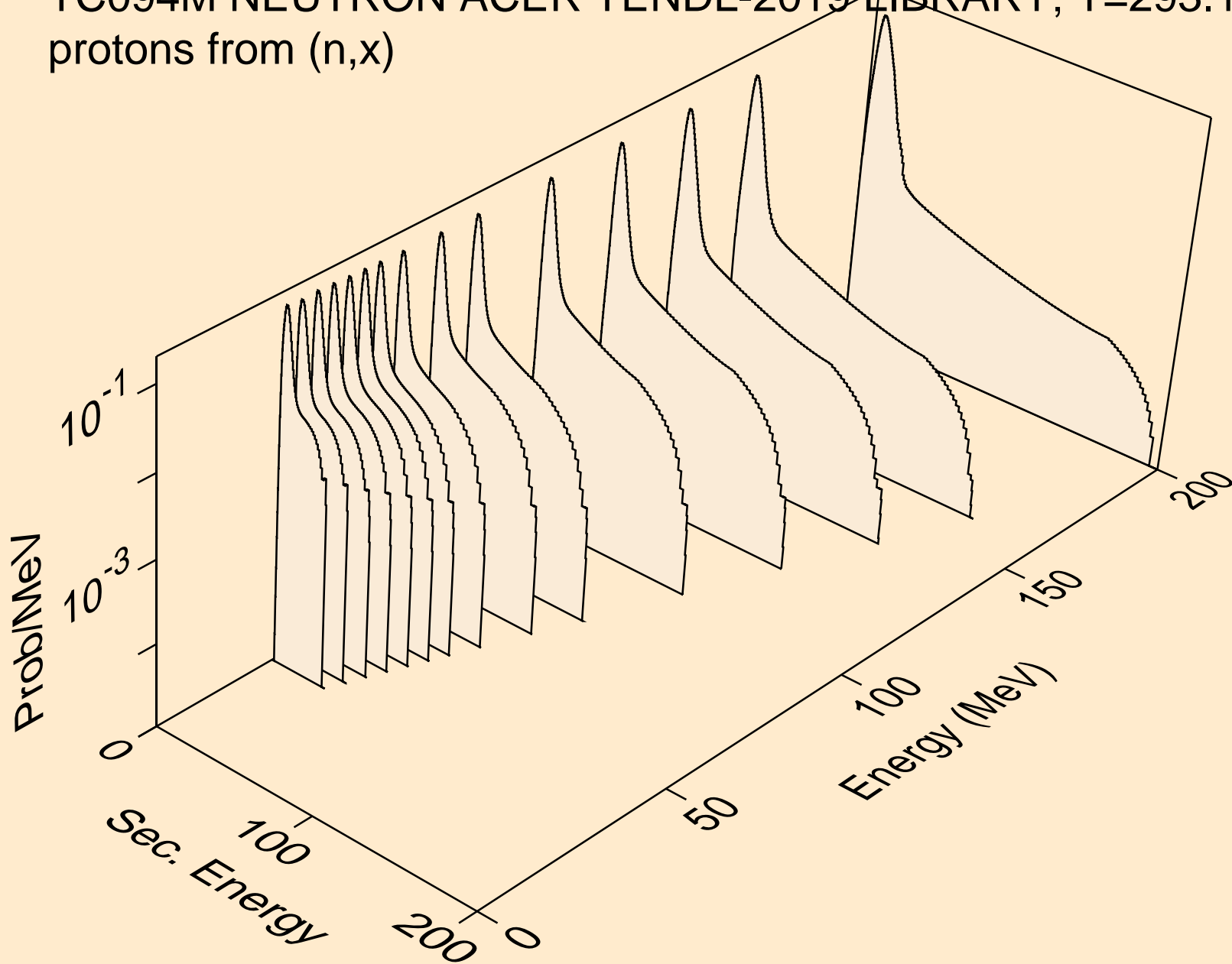

TC094M NEUTRON ACER TENDL-2019 LIBRARY; T=293.16K  
protons from (n,n\*)p

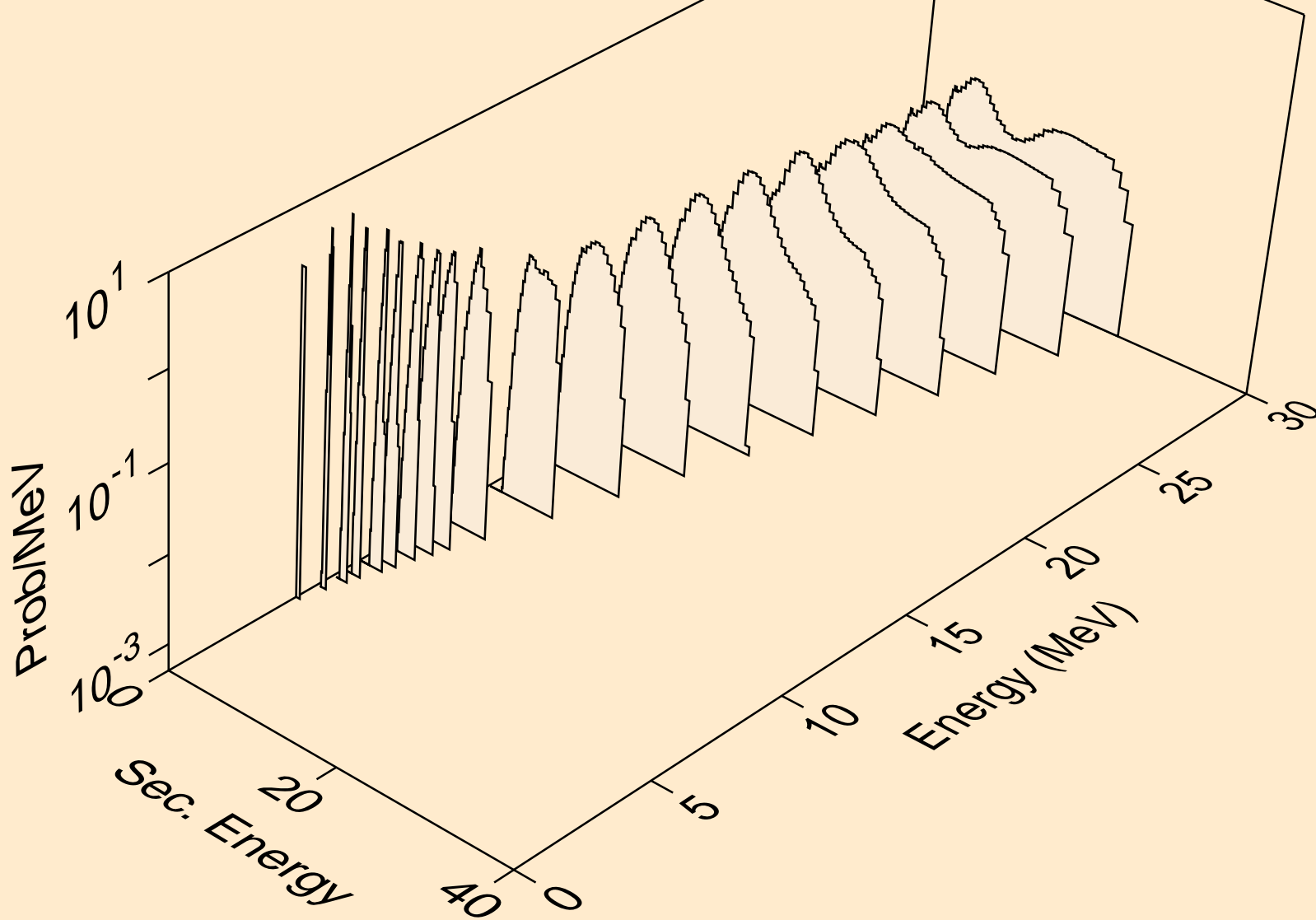

TC094M NEUTRON ACER TENDL-2019 LIBRARY; T=293.16K  
protons from (n,2np)

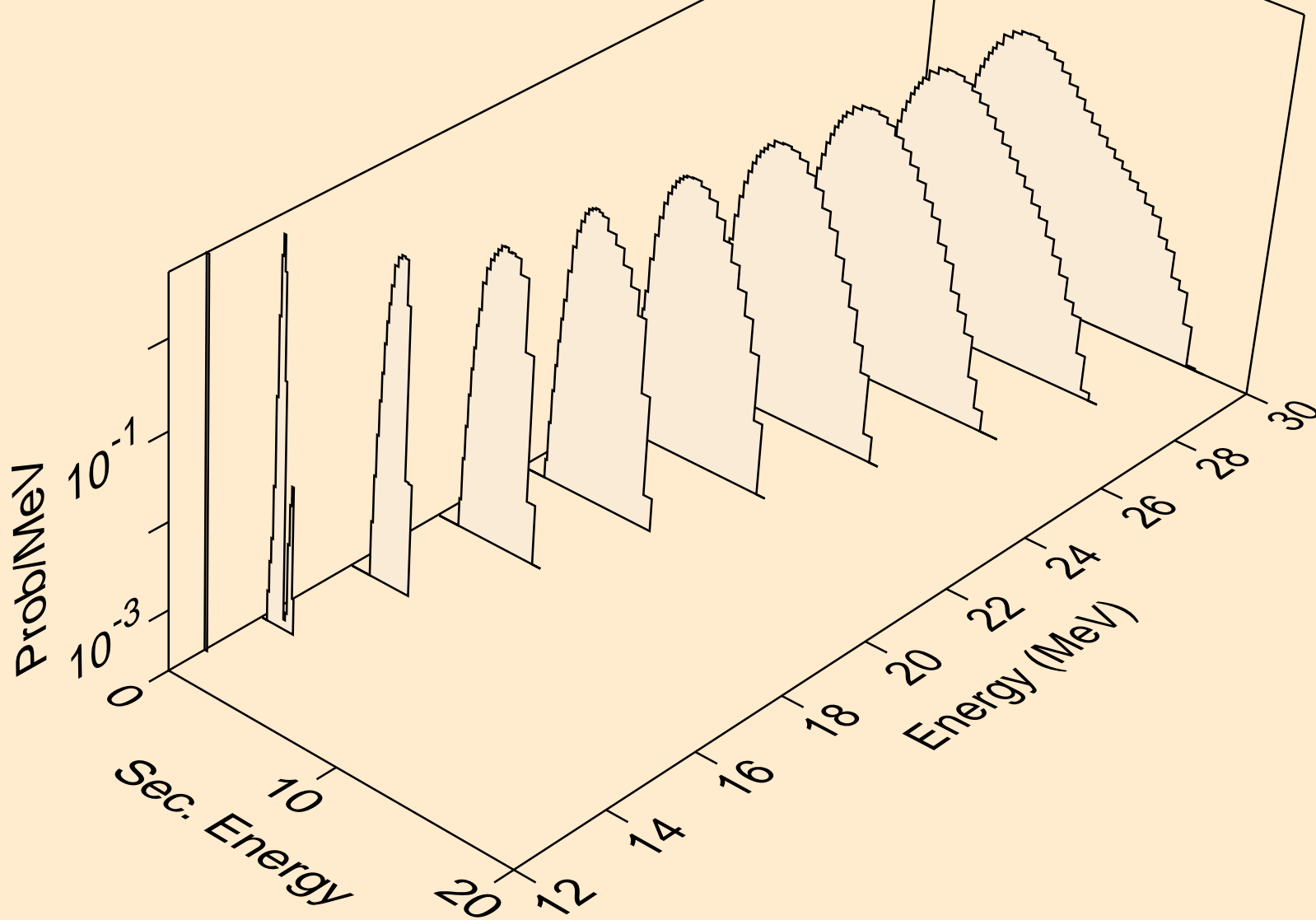

TC094M NEUTRON ACER TENDL-2019 LIBRARY; T=293.16K  
protons from (n,3np)

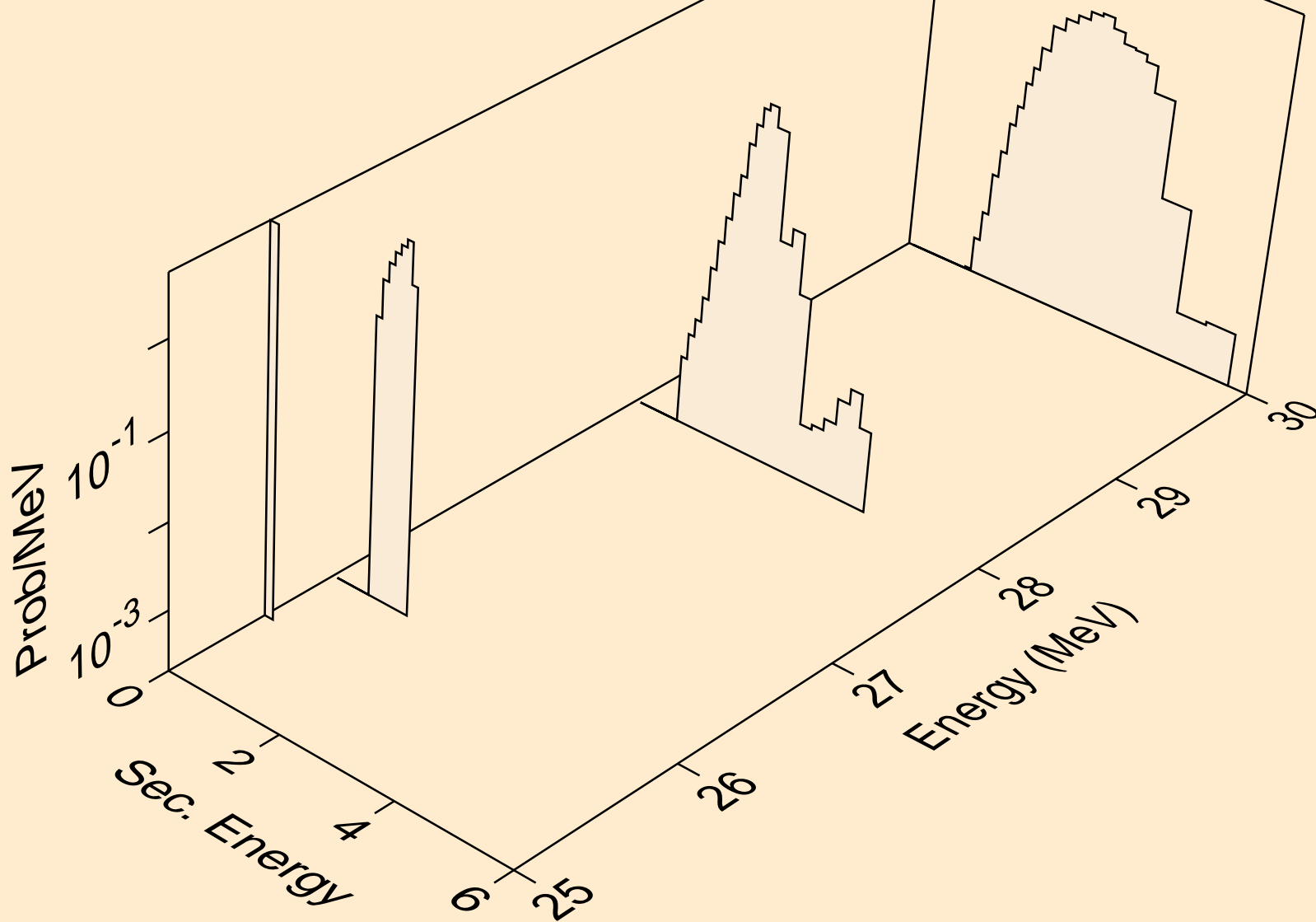

TC094M NEUTRON ACER TENDL-2019 LIBRARY; T=293.16K  
protons from (n,2np)

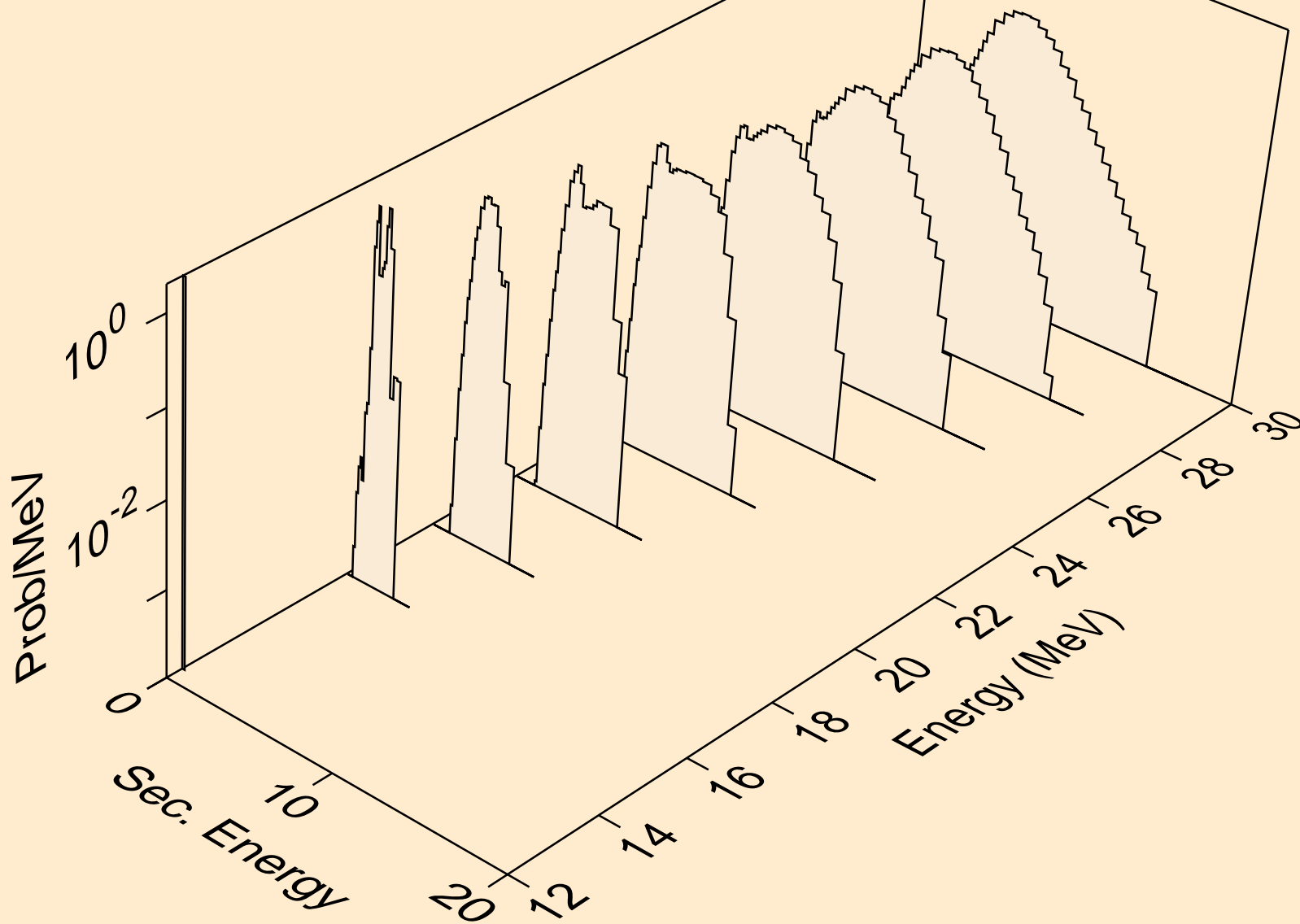

TC094M NEUTRON ACER TENDL-2019 LIBRARY; T=293.16K  
protons from (n,npa)

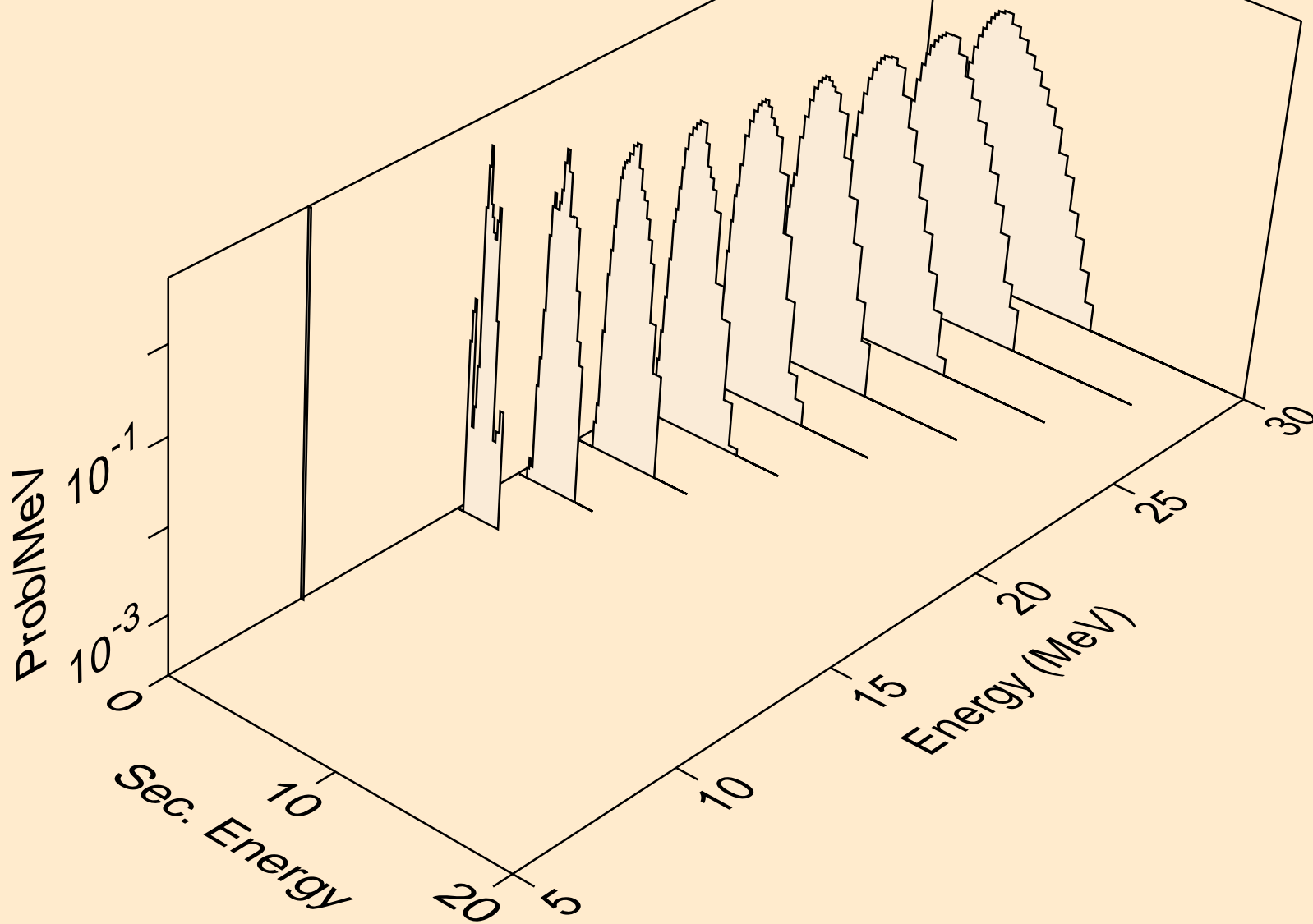

TC094M NEUTRON ACER TENDL-2019 LIBRARY; T=293.16K  
protons from (n,p)

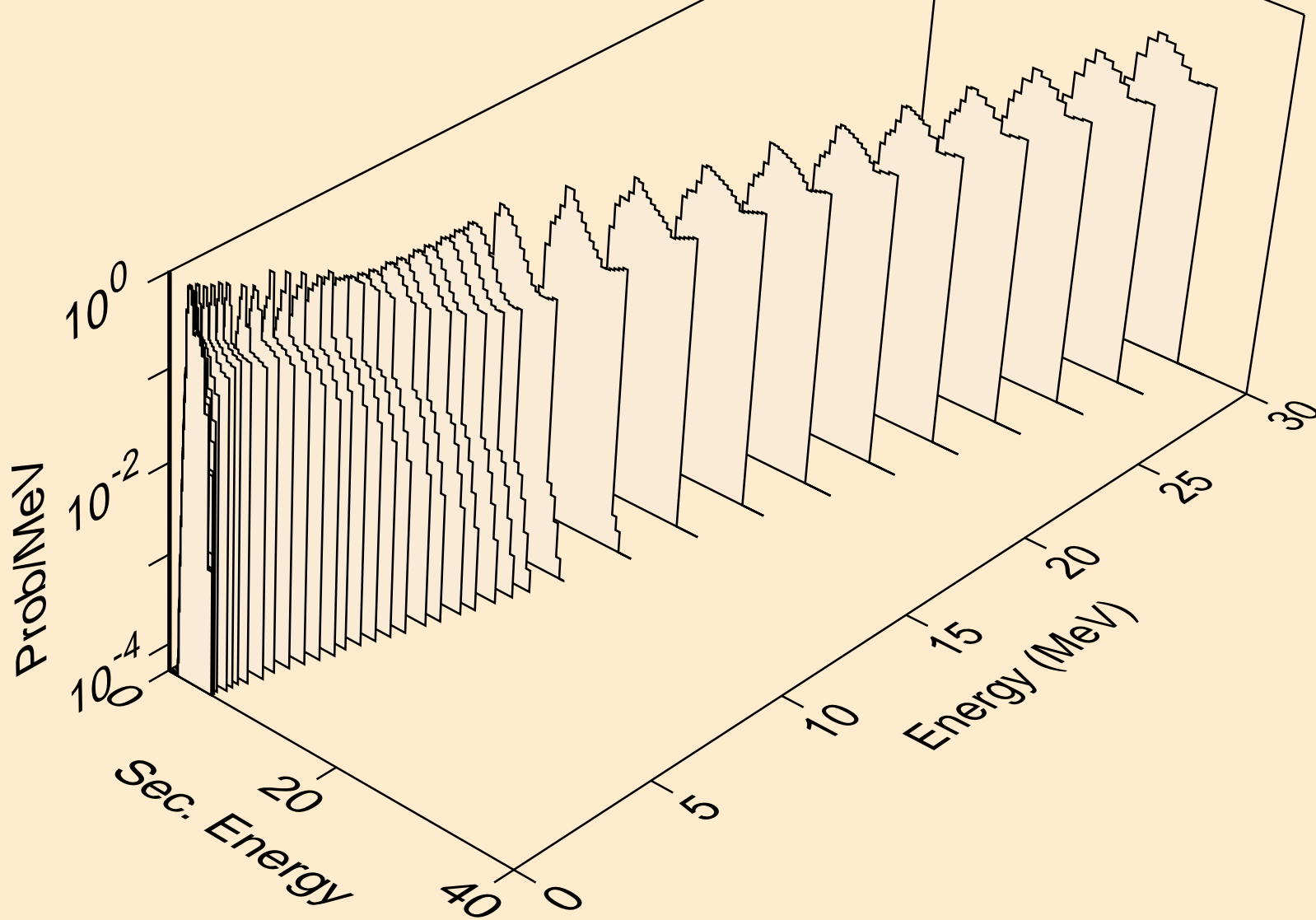

TC094M NEUTRON ACER TENDL-2019 LIBRARY; T=293.16K  
protons from (n,2p)

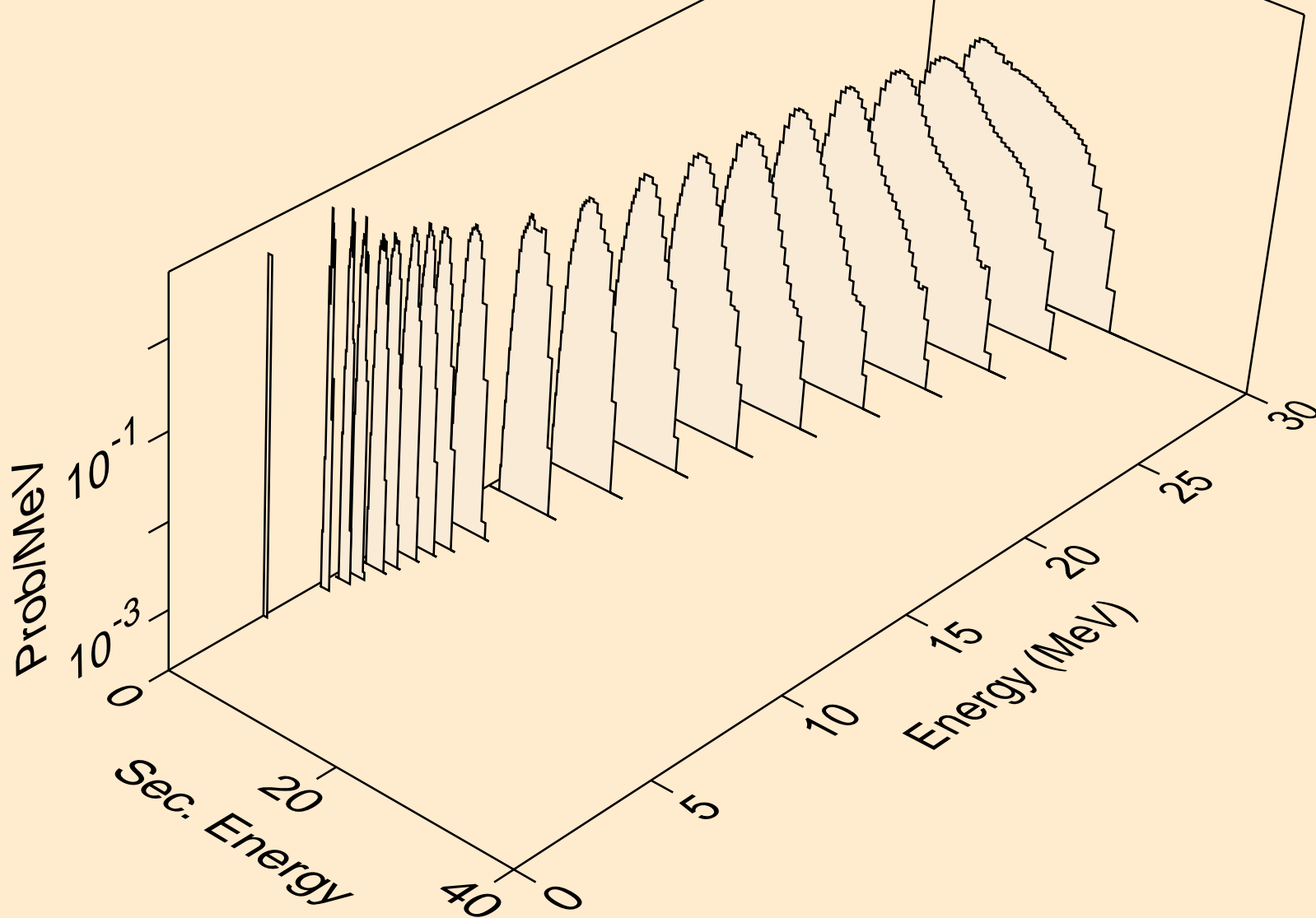



TC094M NEUTRON ACER TENDL-2019 LIBRARY; T=293.16K  
protons from (n,p)

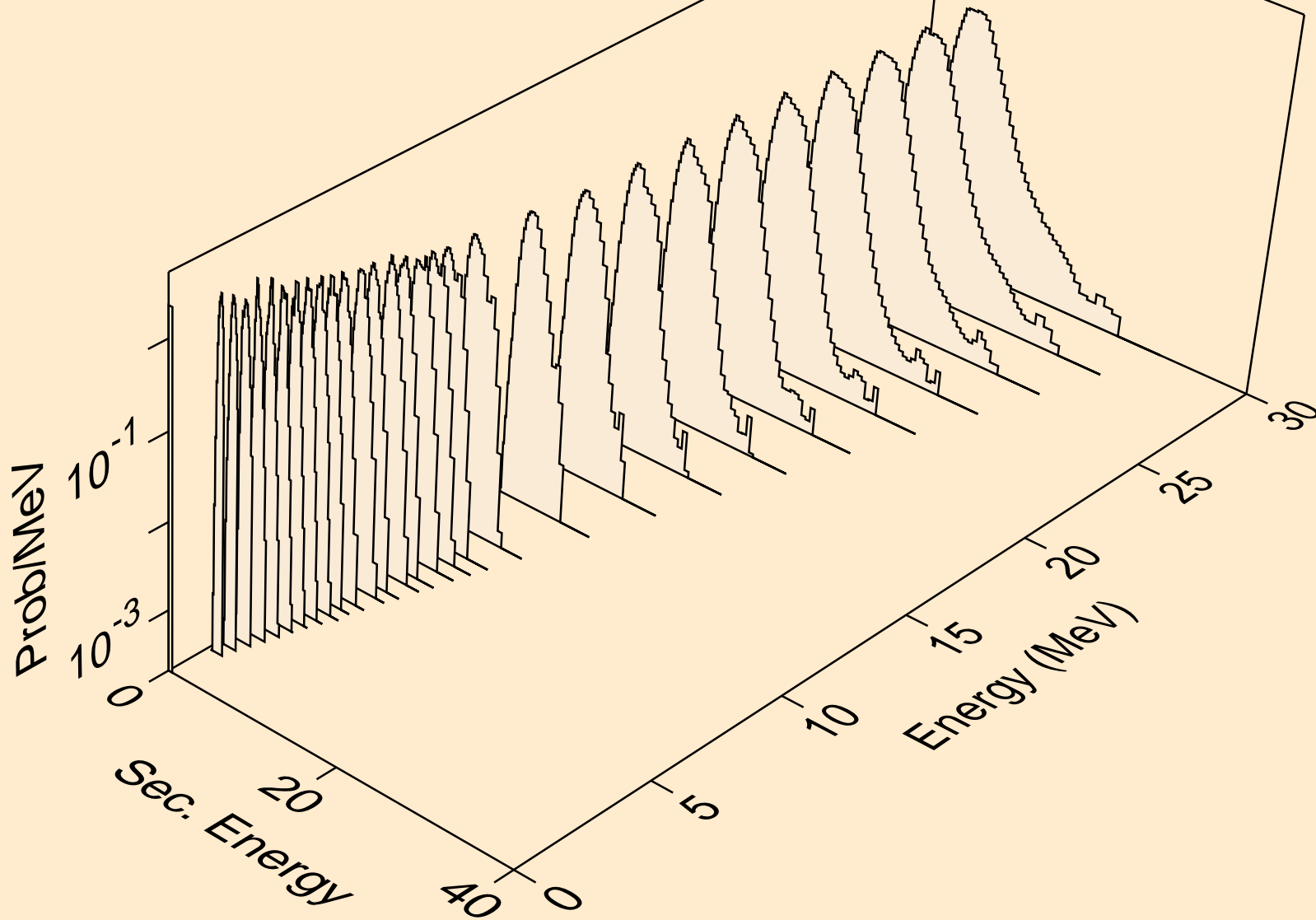

TC094M NEUTRON ACER TENDL-2019 LIBRARY; T=293.16K  
protons from (n,pd)

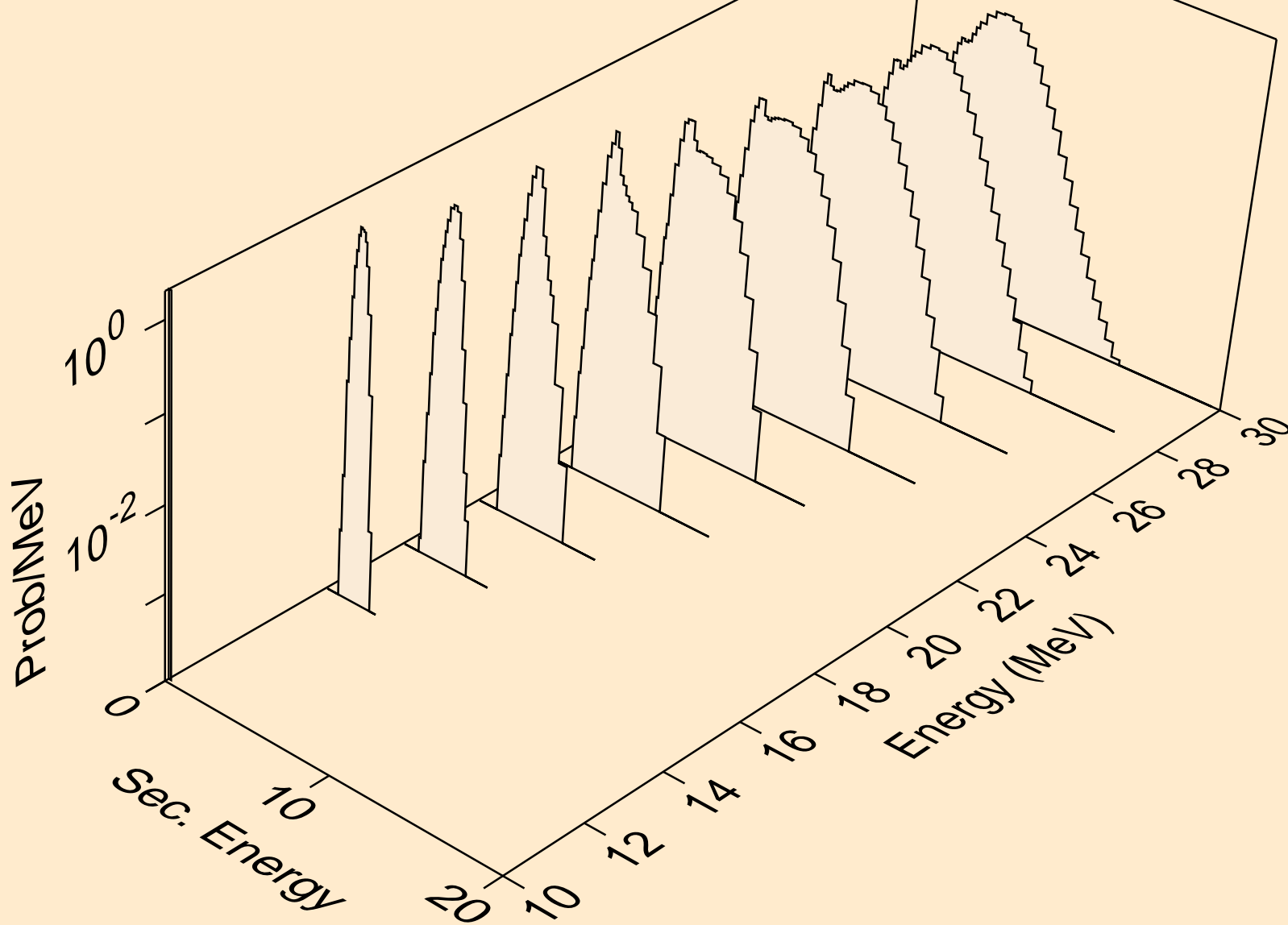

TC094M NEUTRON ACER TENDL-2019 LIBRARY; T=293.16K  
protons from (n,pt)

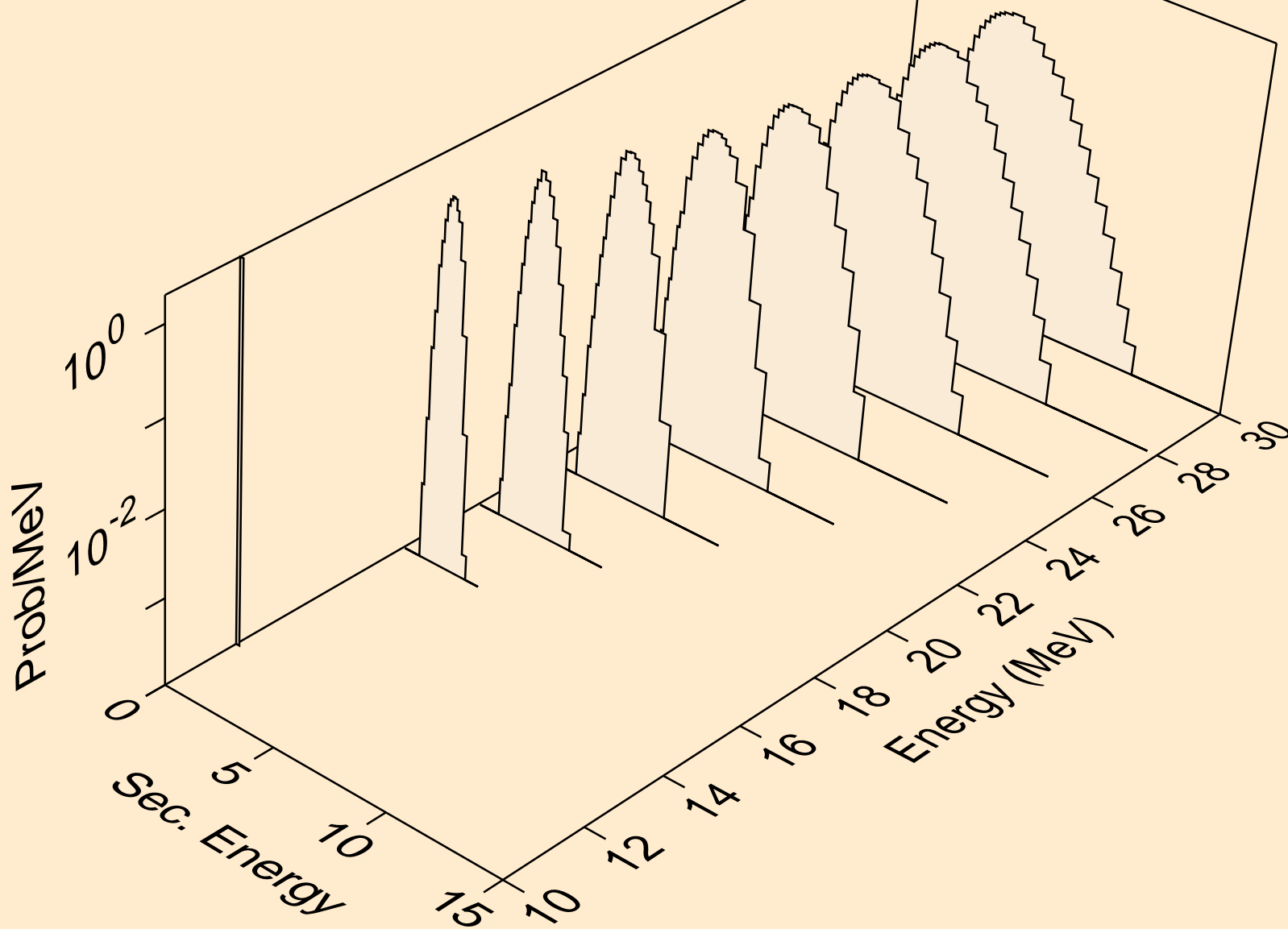

TC094M NEUTRON ACER TENDL-2019 LIBRARY; T=293.16K  
deuterons from (n,x)

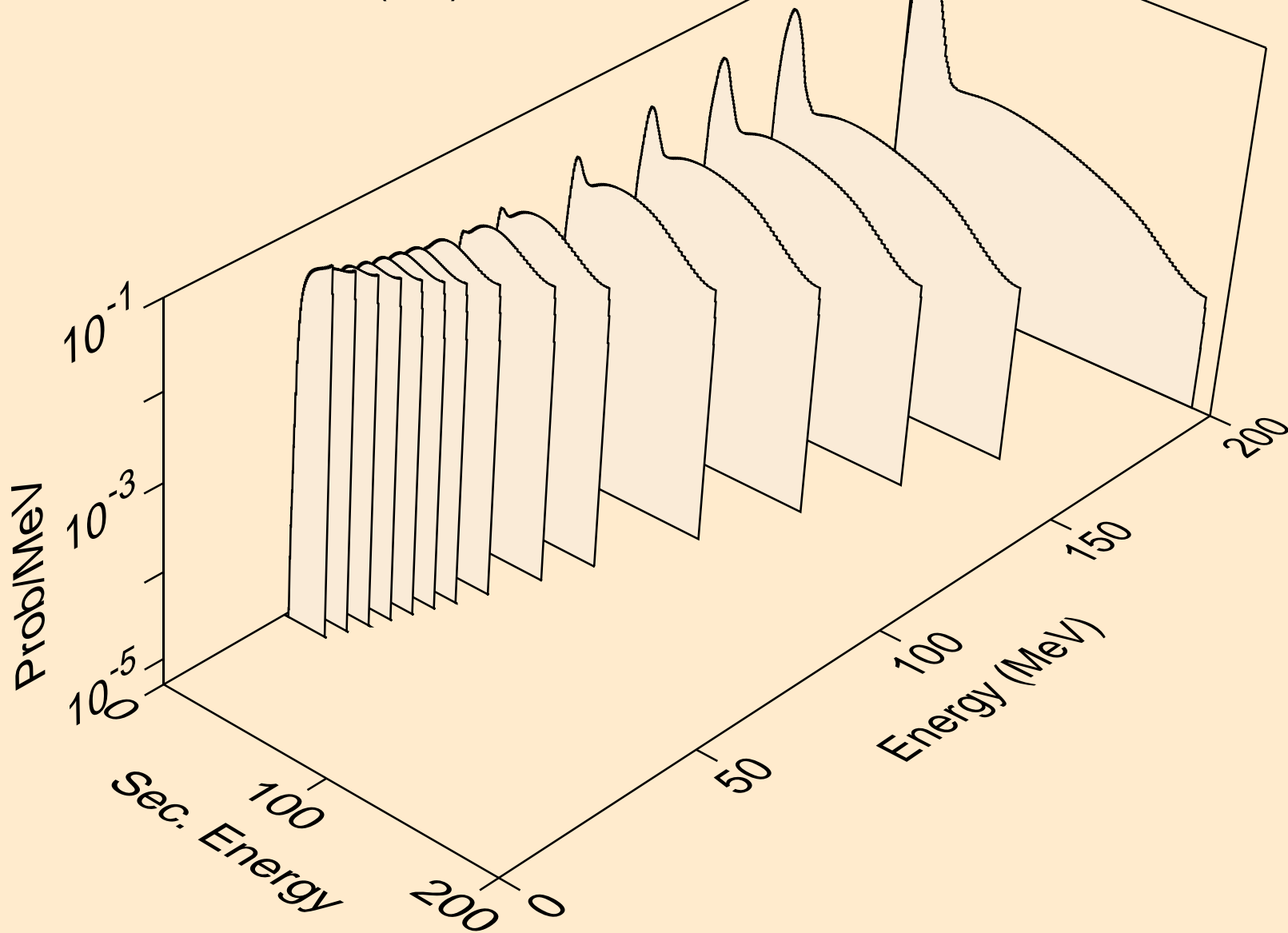

TC094M NEUTRON ACER TENDL-2019 LIBRARY; T=293.16K  
deuterons from (n,2nd)

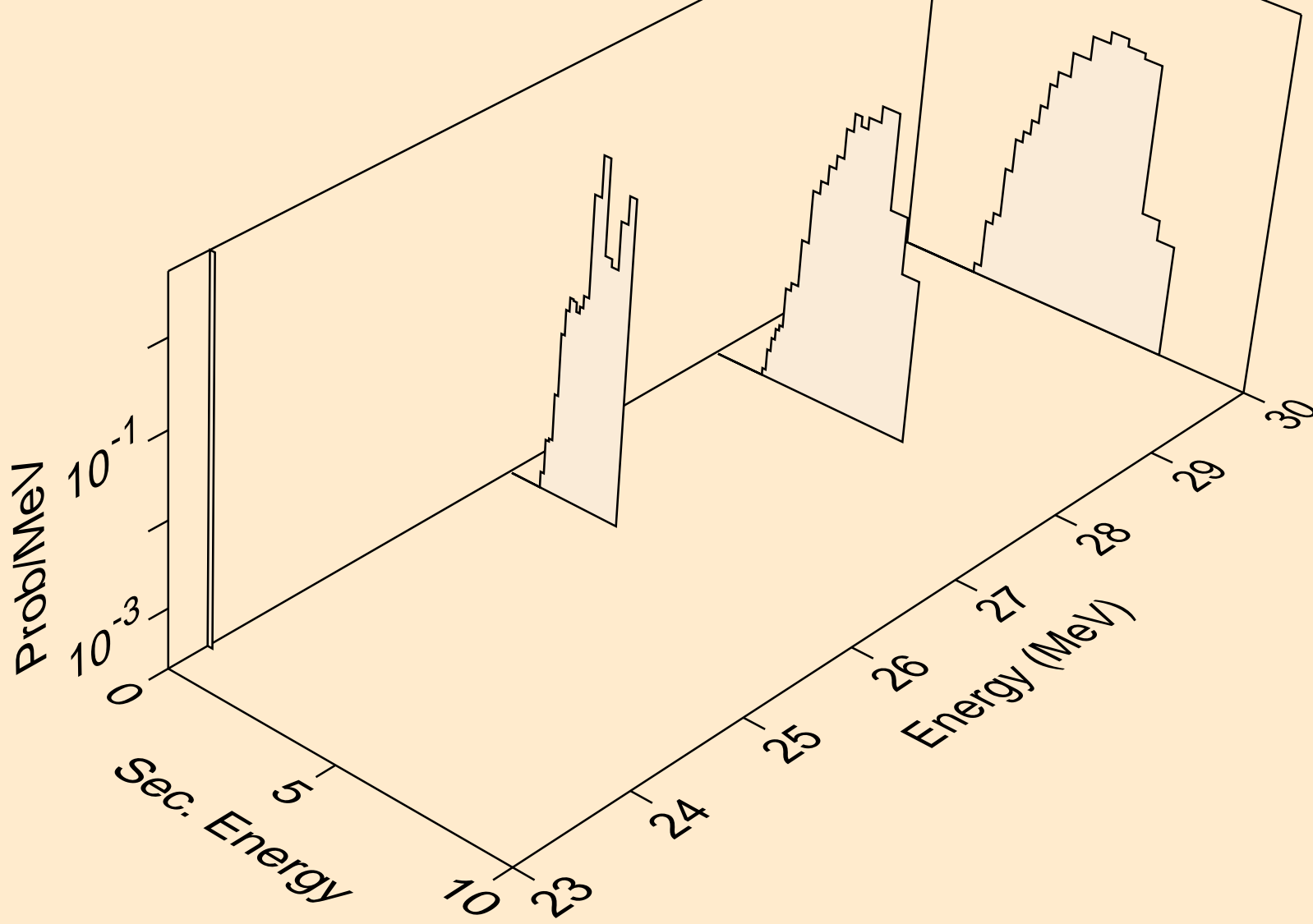

TC094M NEUTRON ACER TENDL-2019 LIBRARY; T=293.16K  
deuterons from (n,n\*)d

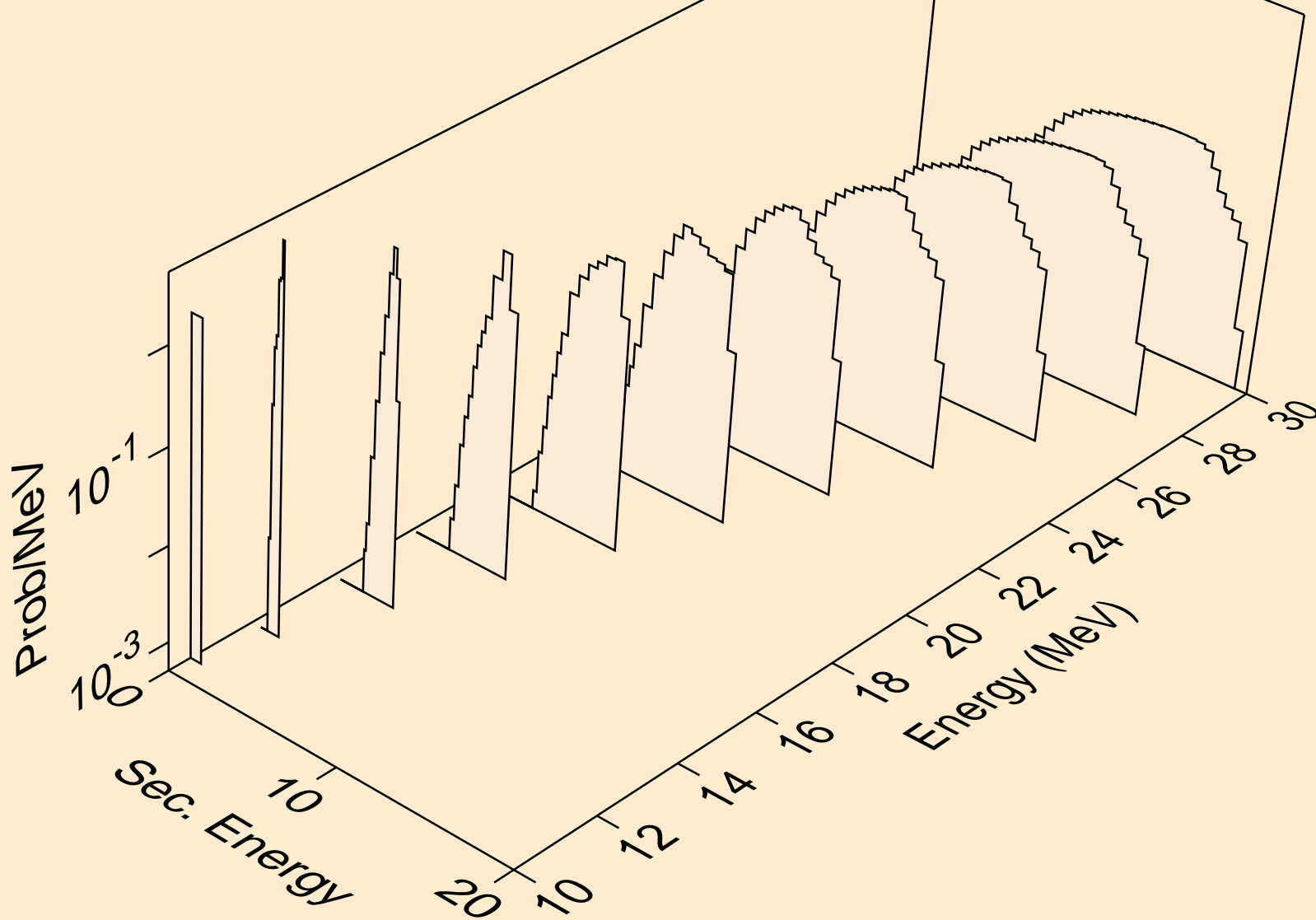

TC094M NEUTRON ACER TENDL-2019 LIBRARY; T=293.16K  
deuterons from (n,d)

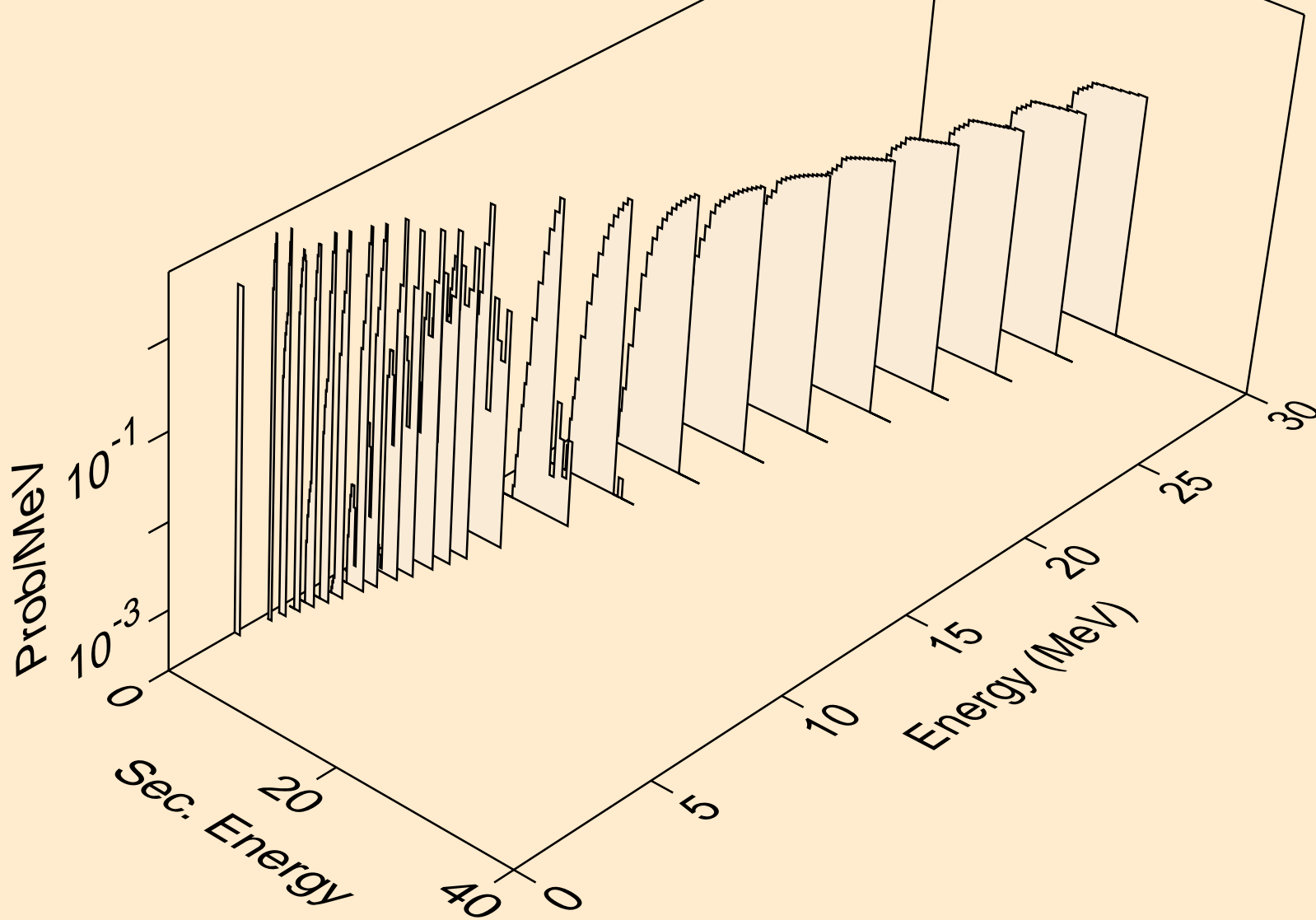

TC094M NEUTRON ACER TENDL-2019 LIBRARY; T=293.16K  
deuterons from (n,pd)

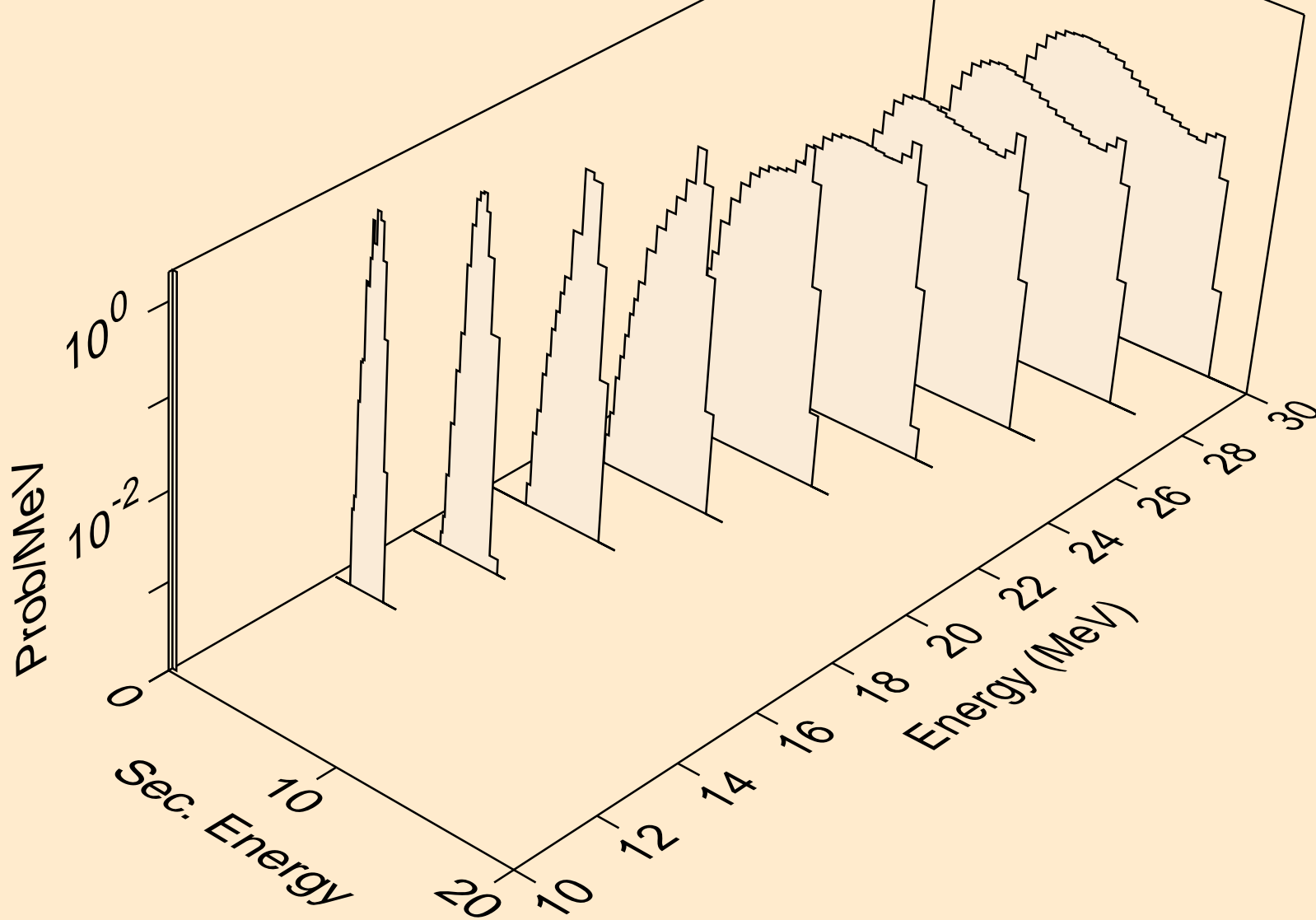



TC094M NEUTRON ACER TENDL-2019 LIBRARY; T=293.16K  
deuterons from (n,da)

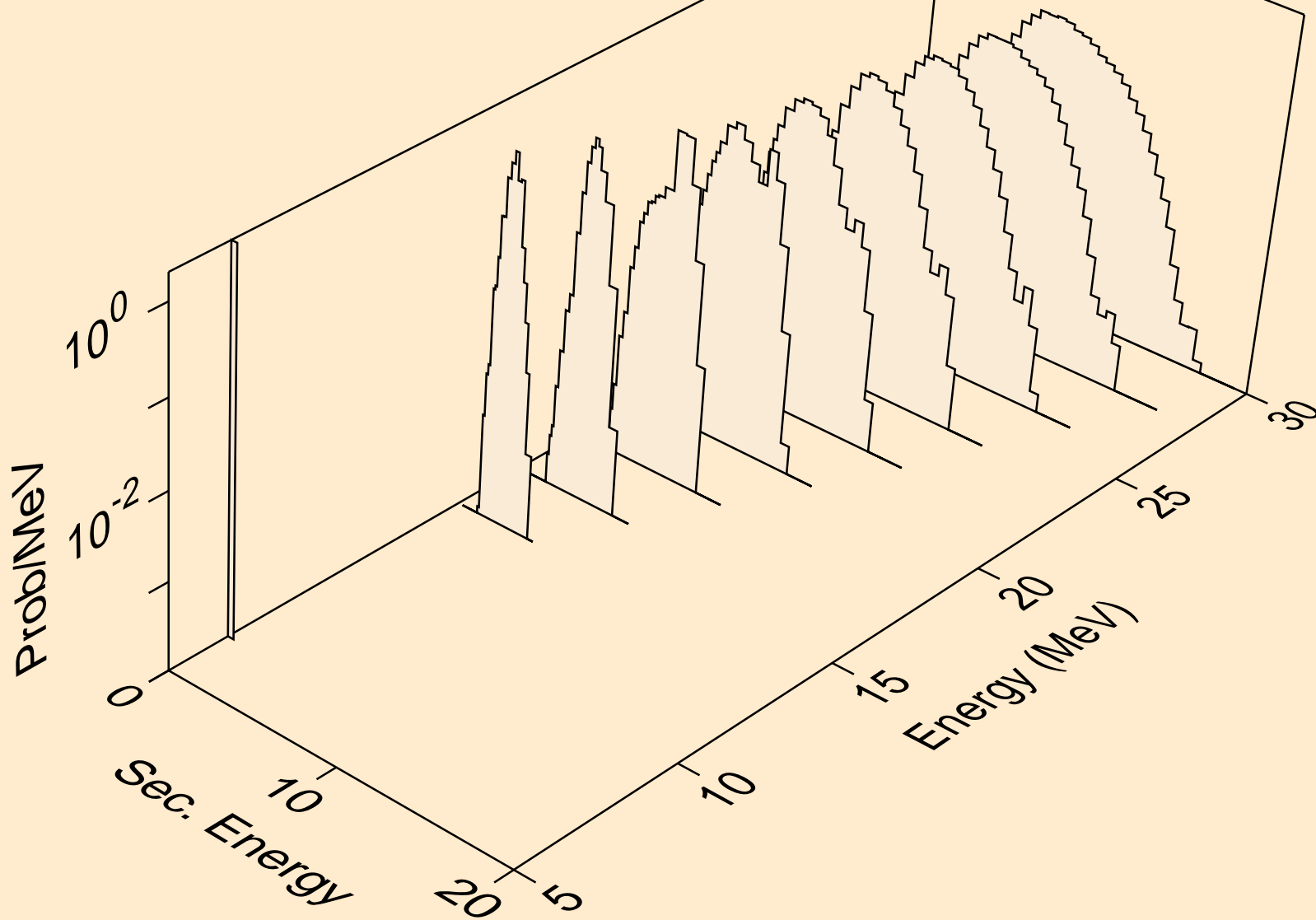

TC094M NEUTRON ACER TENDL-2019 LIBRARY; T=293.16K  
tritons from (n,x)

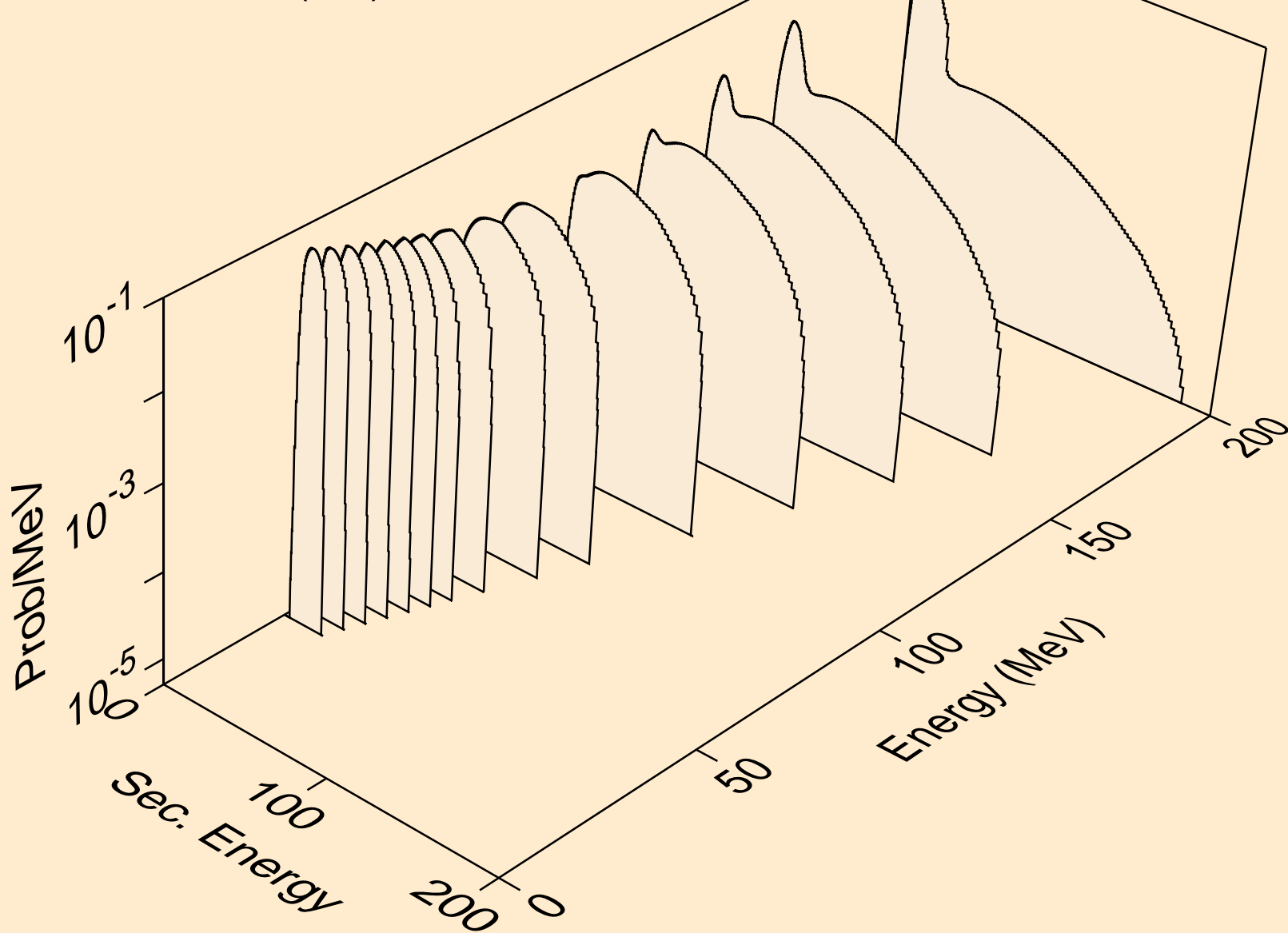

TC094M NEUTRON ACER TENDL-2019 LIBRARY; T=293.16K  
tritons from (n,n\*)t

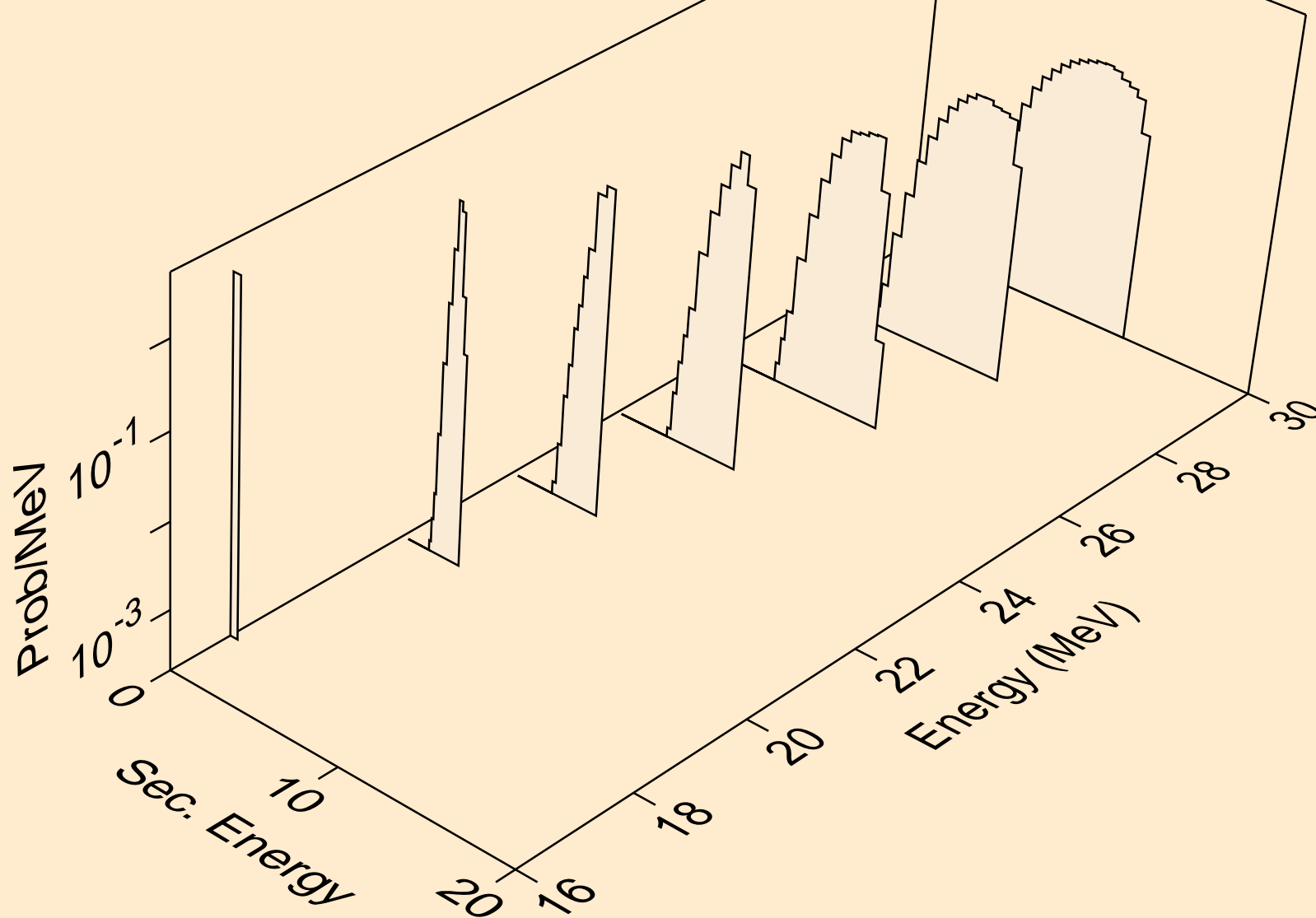

TC094M NEUTRON ACER TENDL-2019 LIBRARY; T=293.16K  
tritons from (n,t)

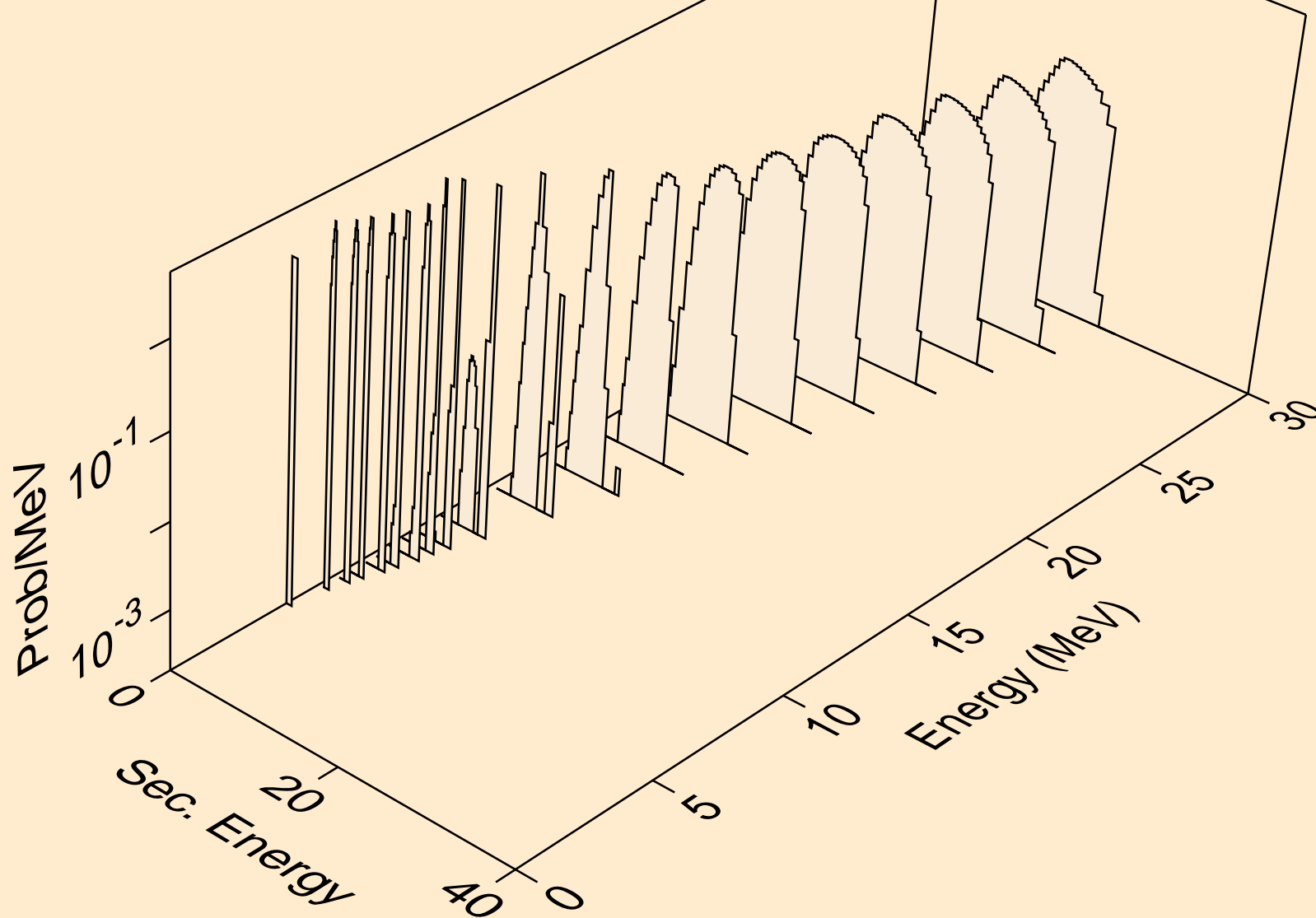

TC094M NEUTRON ACER TENDL-2019 LIBRARY; T=293.16K  
tritons from (n,pt)

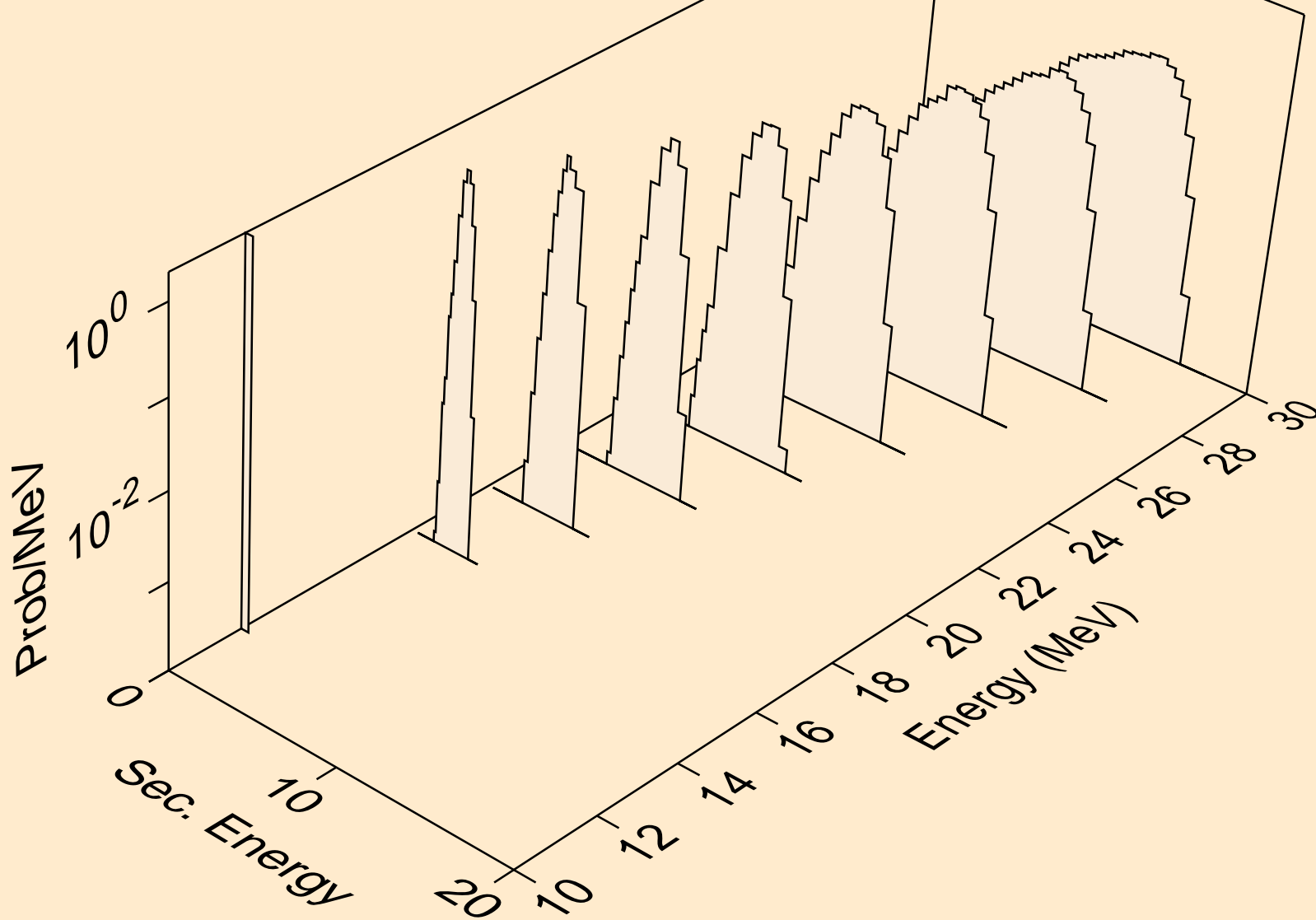

TC094M NEUTRON ACER TENDL-2019 LIBRARY; T=293.16K  
he3s from (n,x)

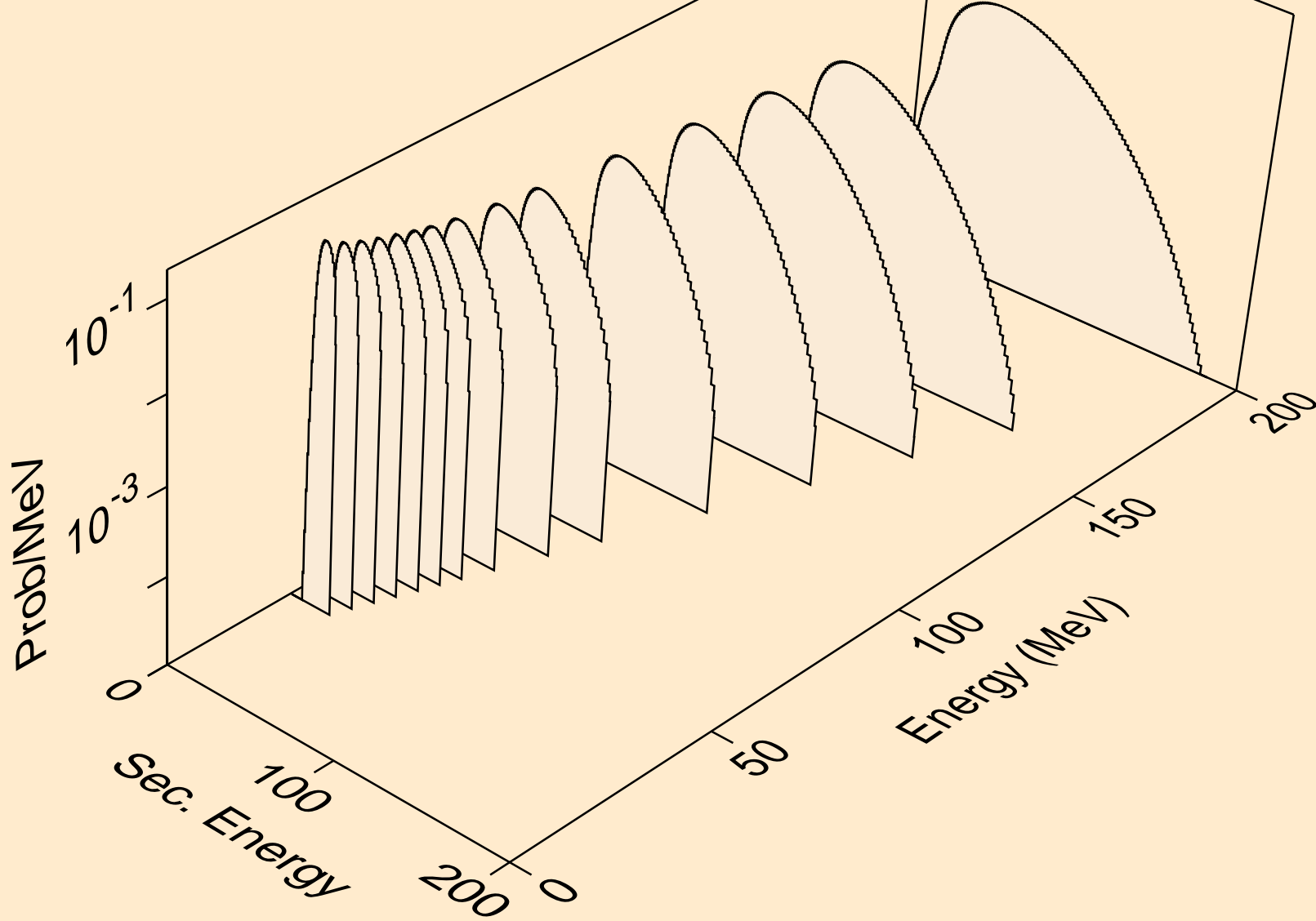

TC094M NEUTRON ACER TENDL-2019 LIBRARY; T=293.16K  
he3s from (n,n\*)he3

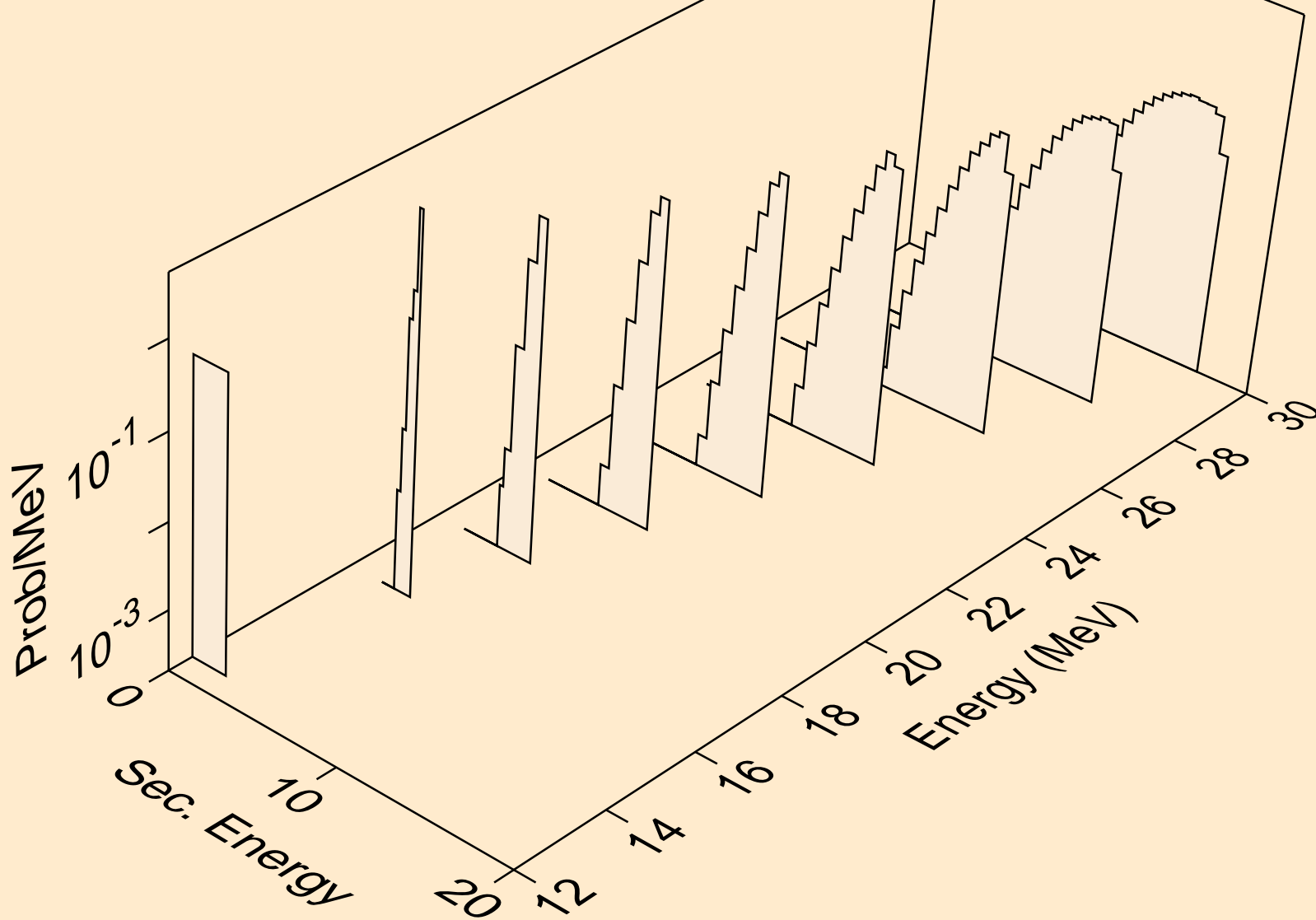

TC094M NEUTRON ACER TENDL-2019 LIBRARY; T=293.16K  
he3s from (n,he3)

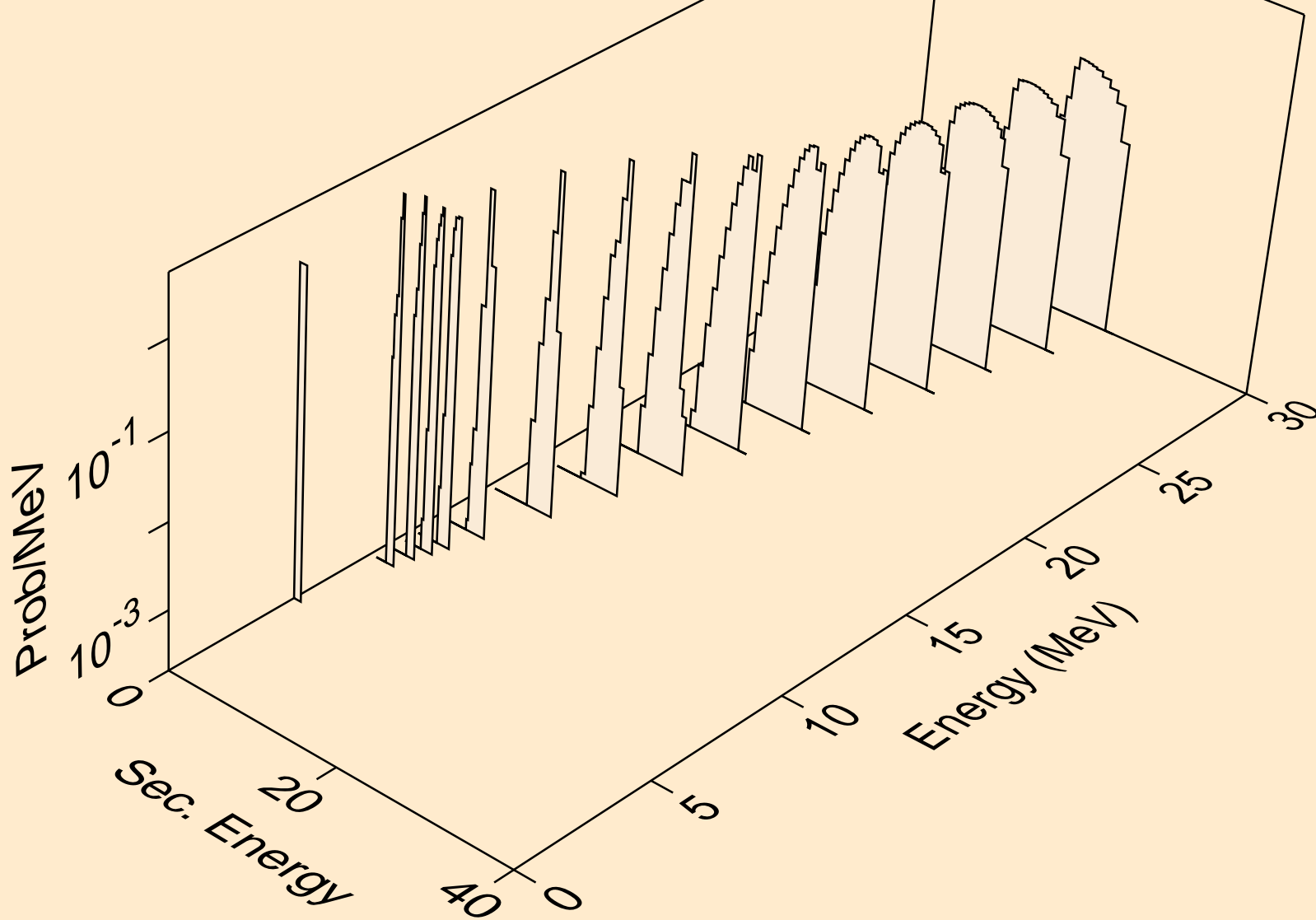



TC094M NEUTRON ACER TENDL-2019 LIBRARY; T=293.16K  
alphas from (n,x)

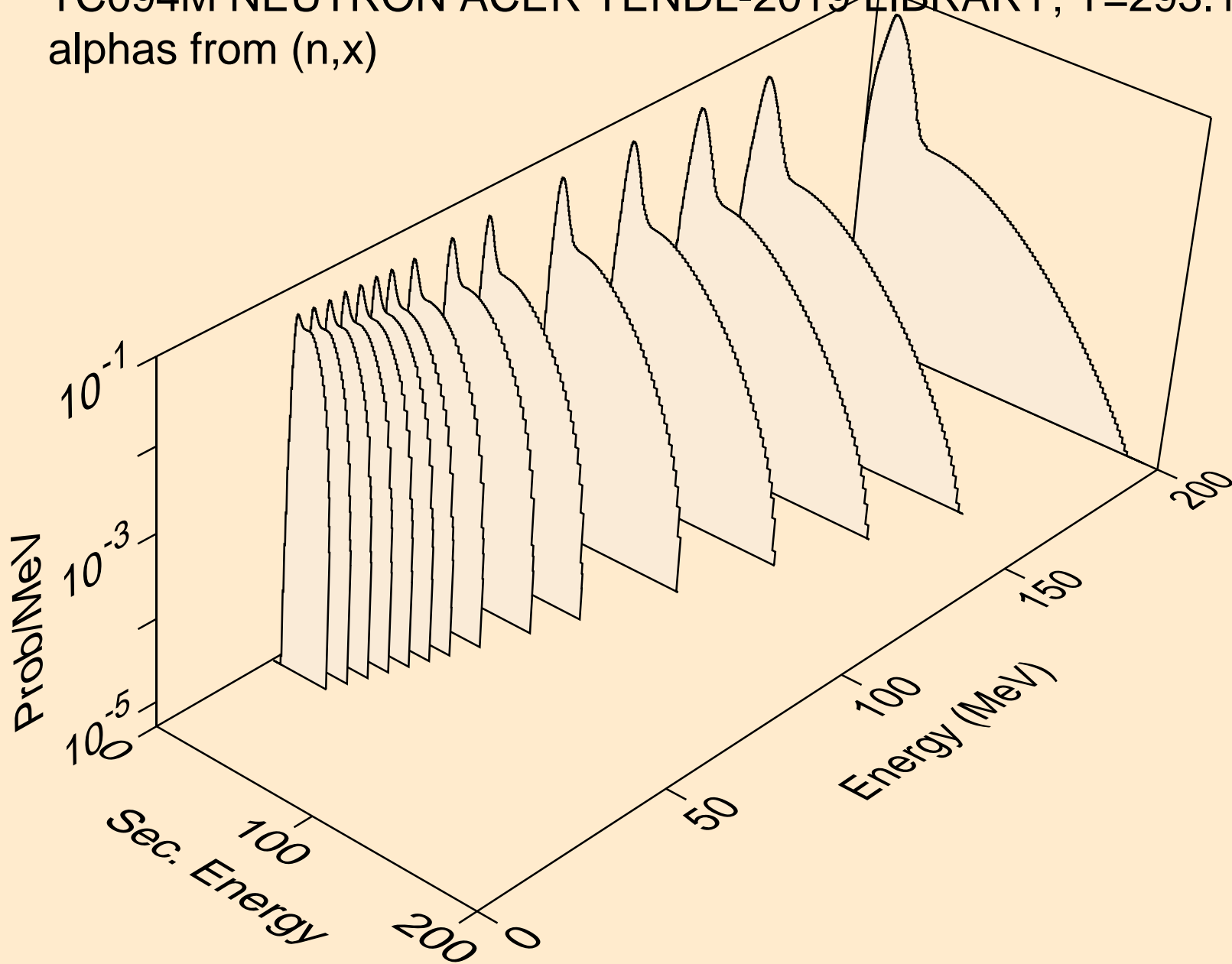

TC094M NEUTRON ACER TENDL-2019 LIBRARY; T=293.16K  
alphas from (n,n\*)a

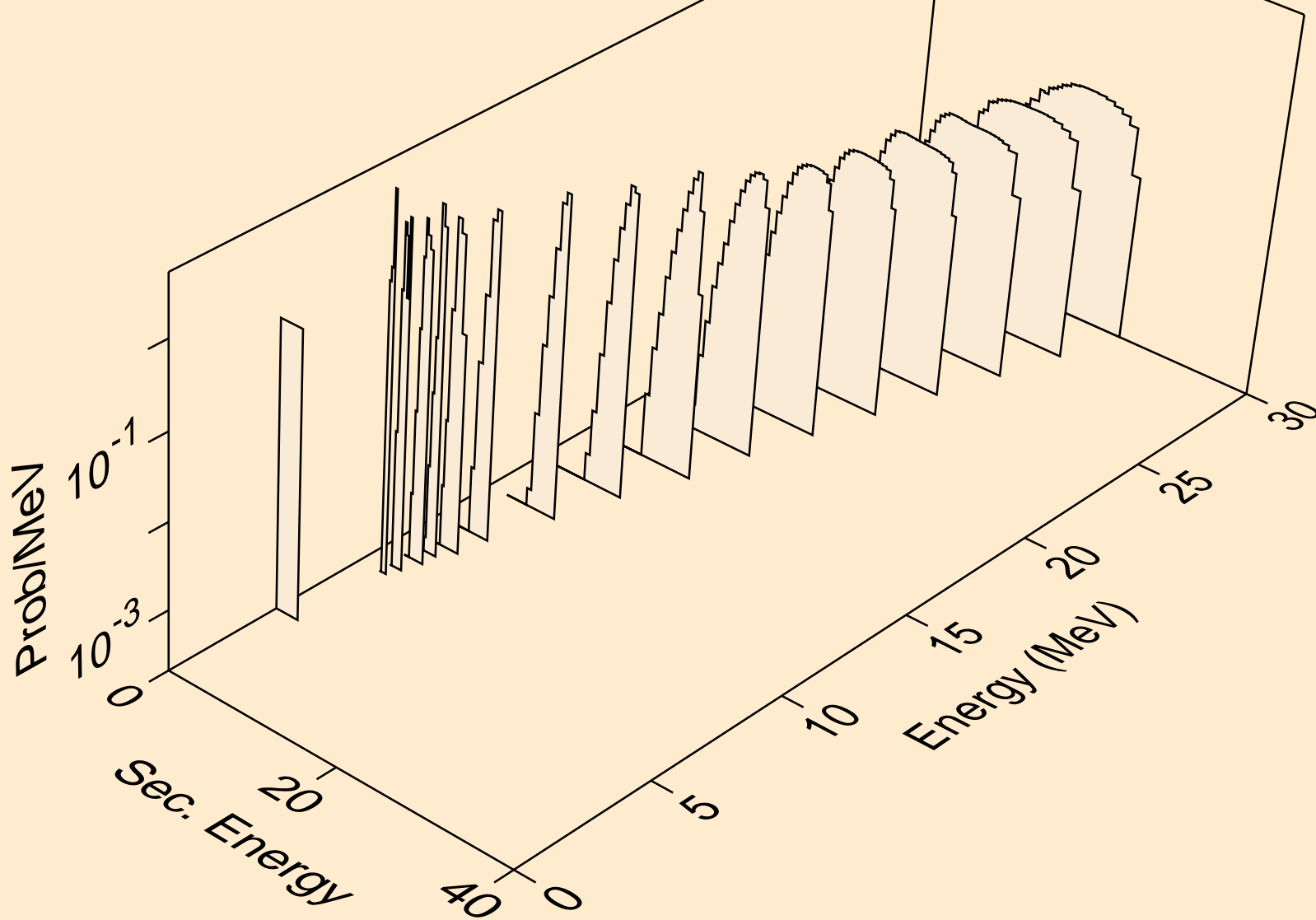

TC094M NEUTRON ACER TENDL-2019 LIBRARY; T=293.16K  
alphas from (n,2n)a

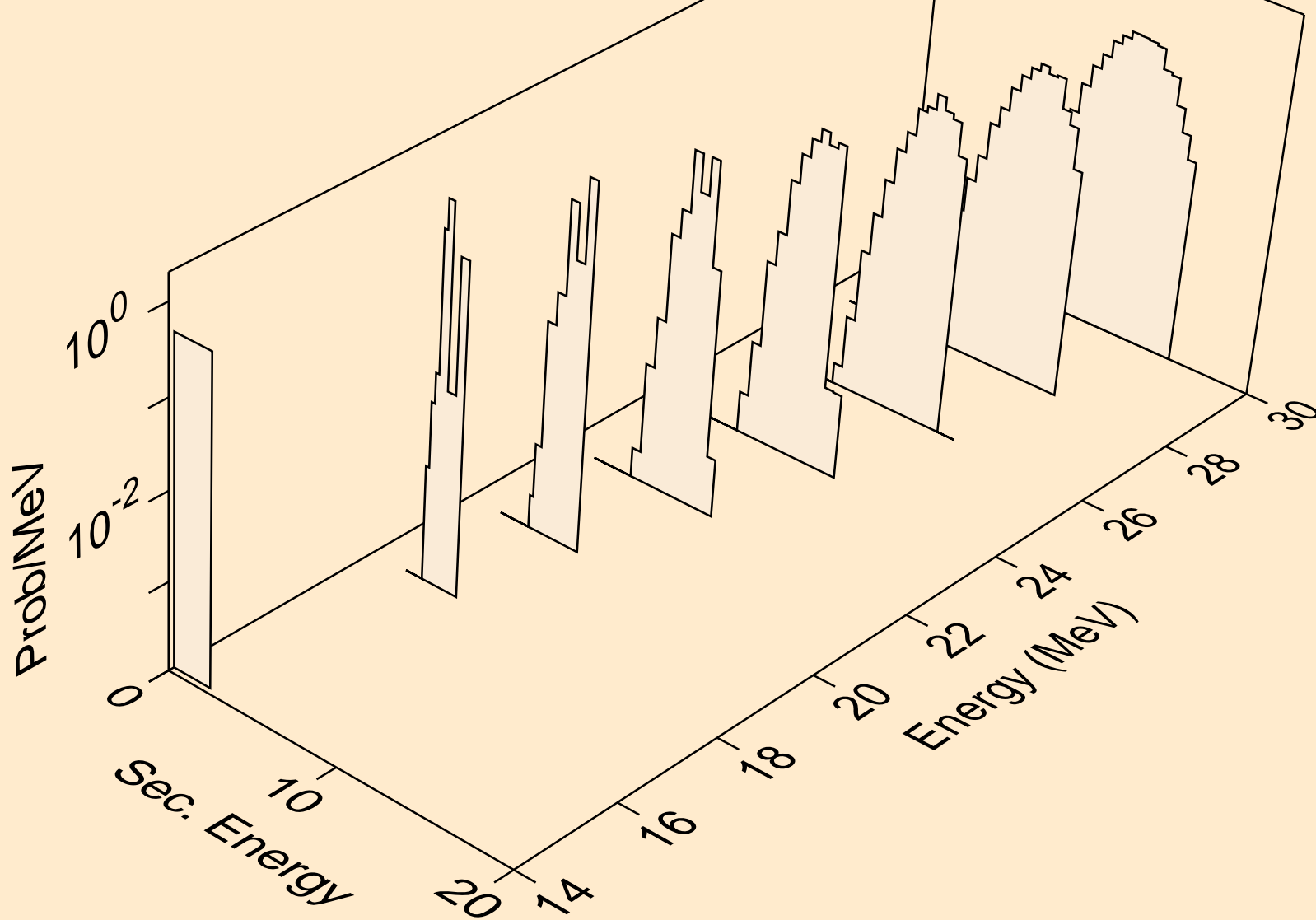

TC094M NEUTRON ACER TENDL-2019 LIBRARY; T=293.16K  
alphas from (n,n\*)2a

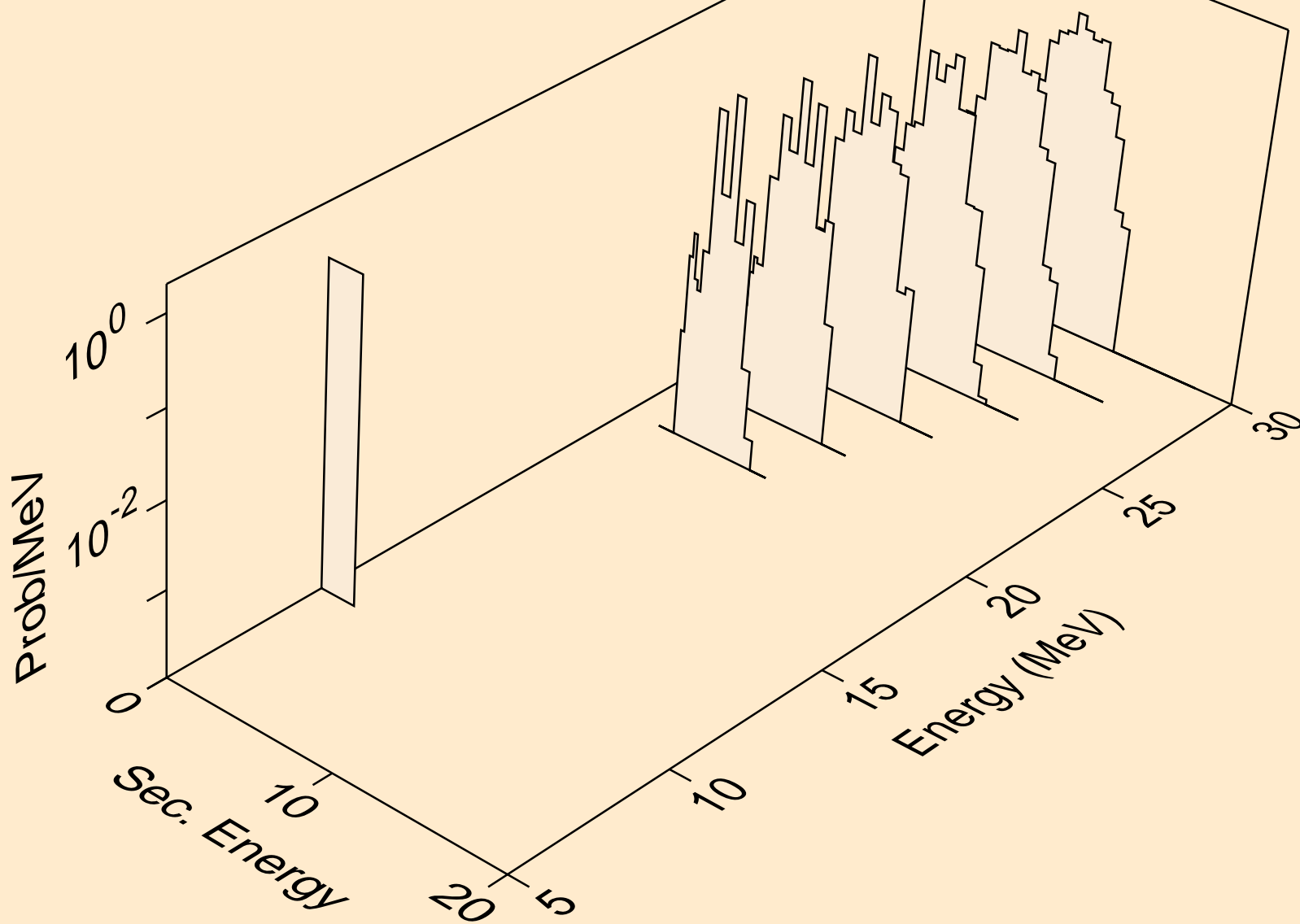

TC094M NEUTRON ACER TENDL-2019 LIBRARY; T=293.16K  
alphas from (n,npa)

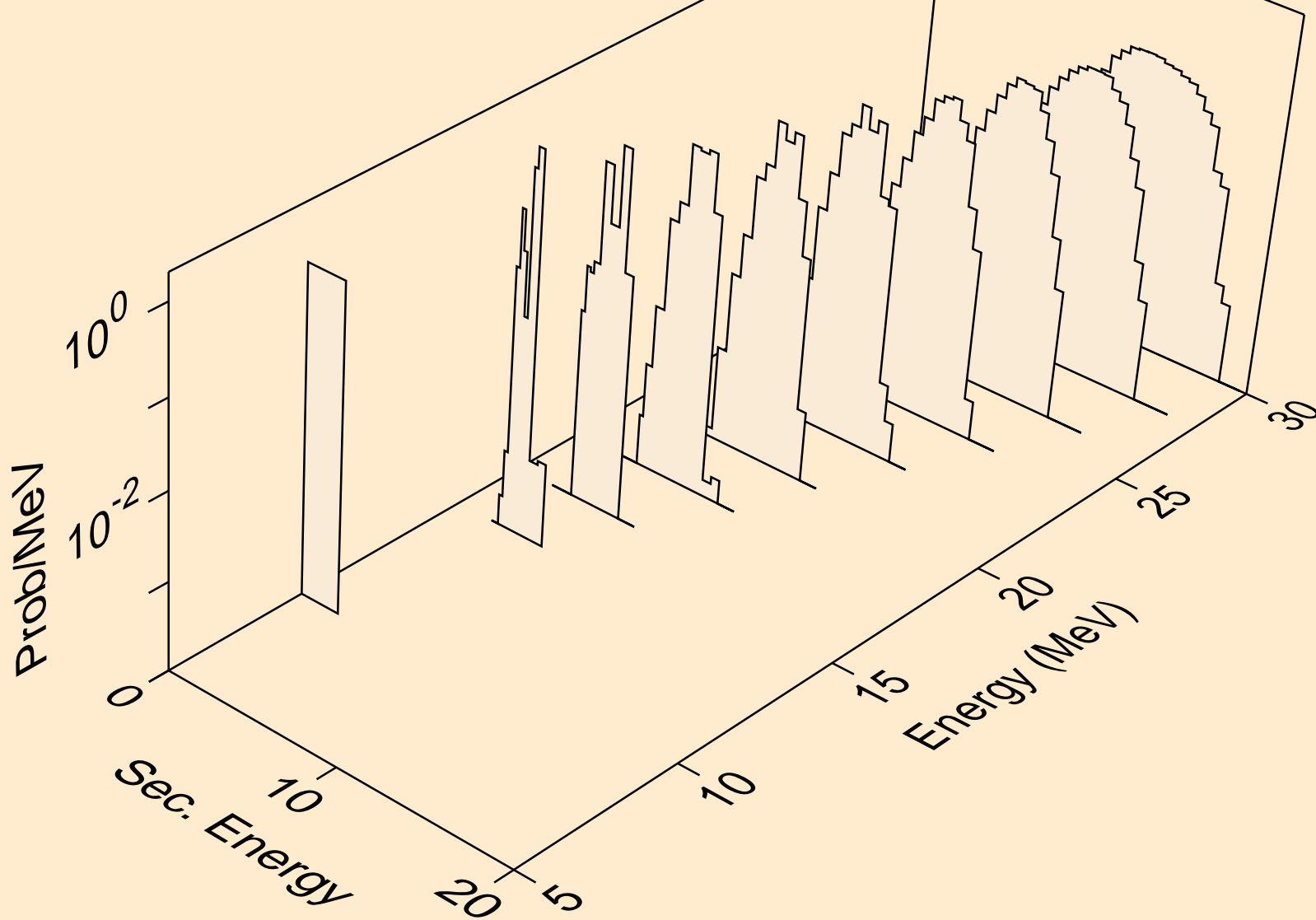

TC094M NEUTRON ACER TENDL-2019 LIBRARY; T=293.16K  
alphas from (n,a)

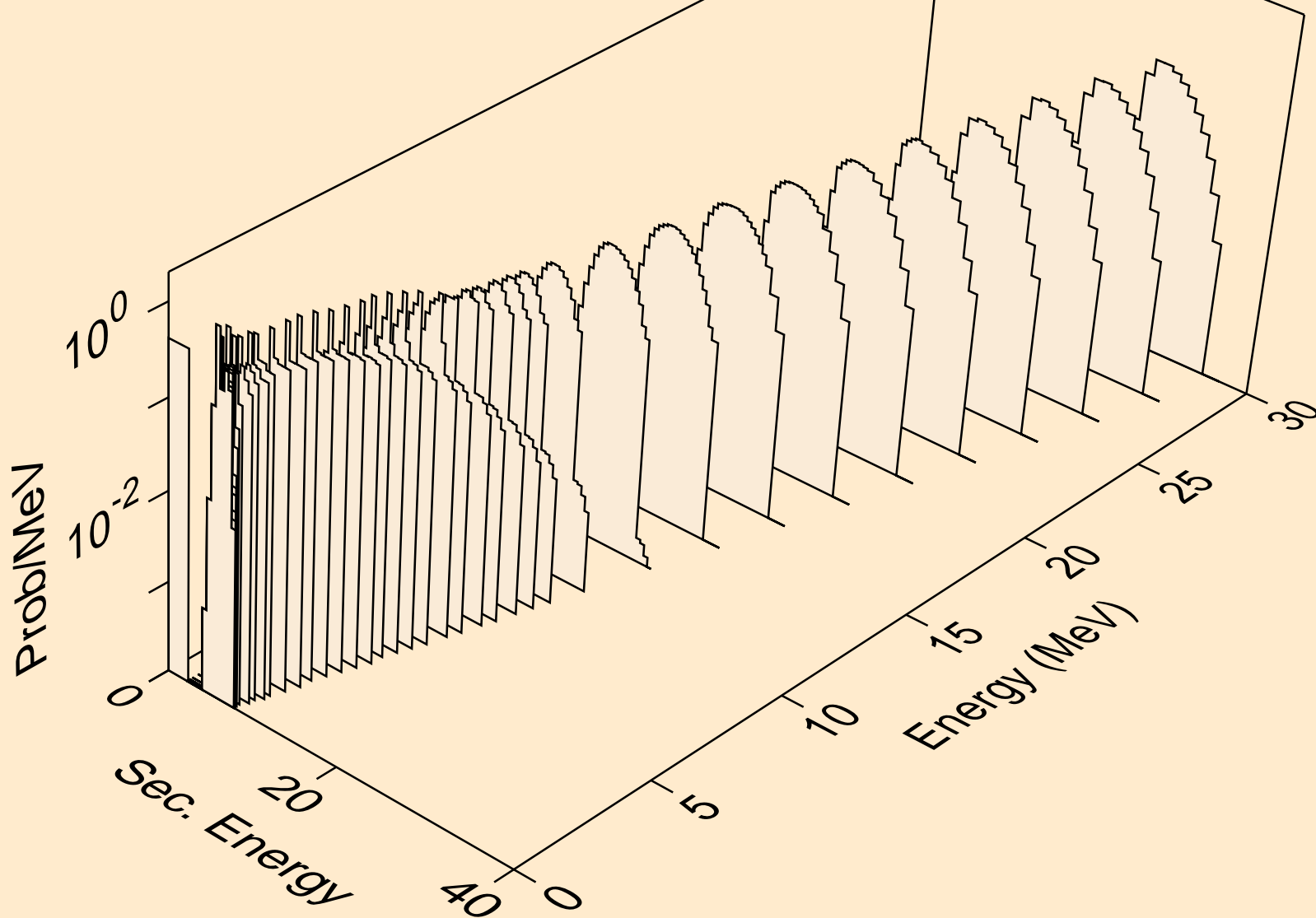

TC094M NEUTRON ACER TENDL-2019 LIBRARY; T=293.16K  
alphas from (n,2a)

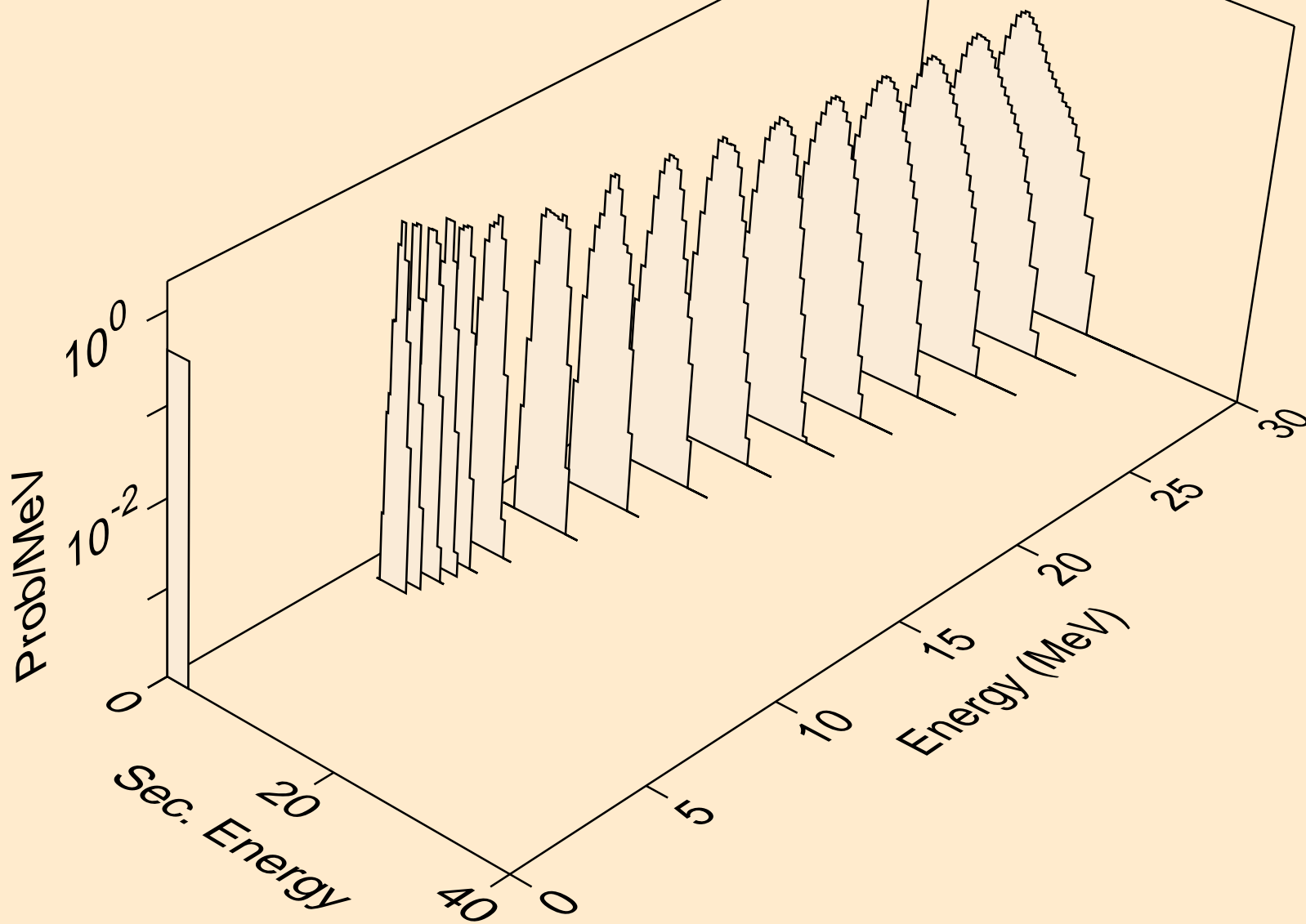

TC094M NEUTRON ACER TENDL-2019 LIBRARY; T=293.16K  
alphas from (n,pa)

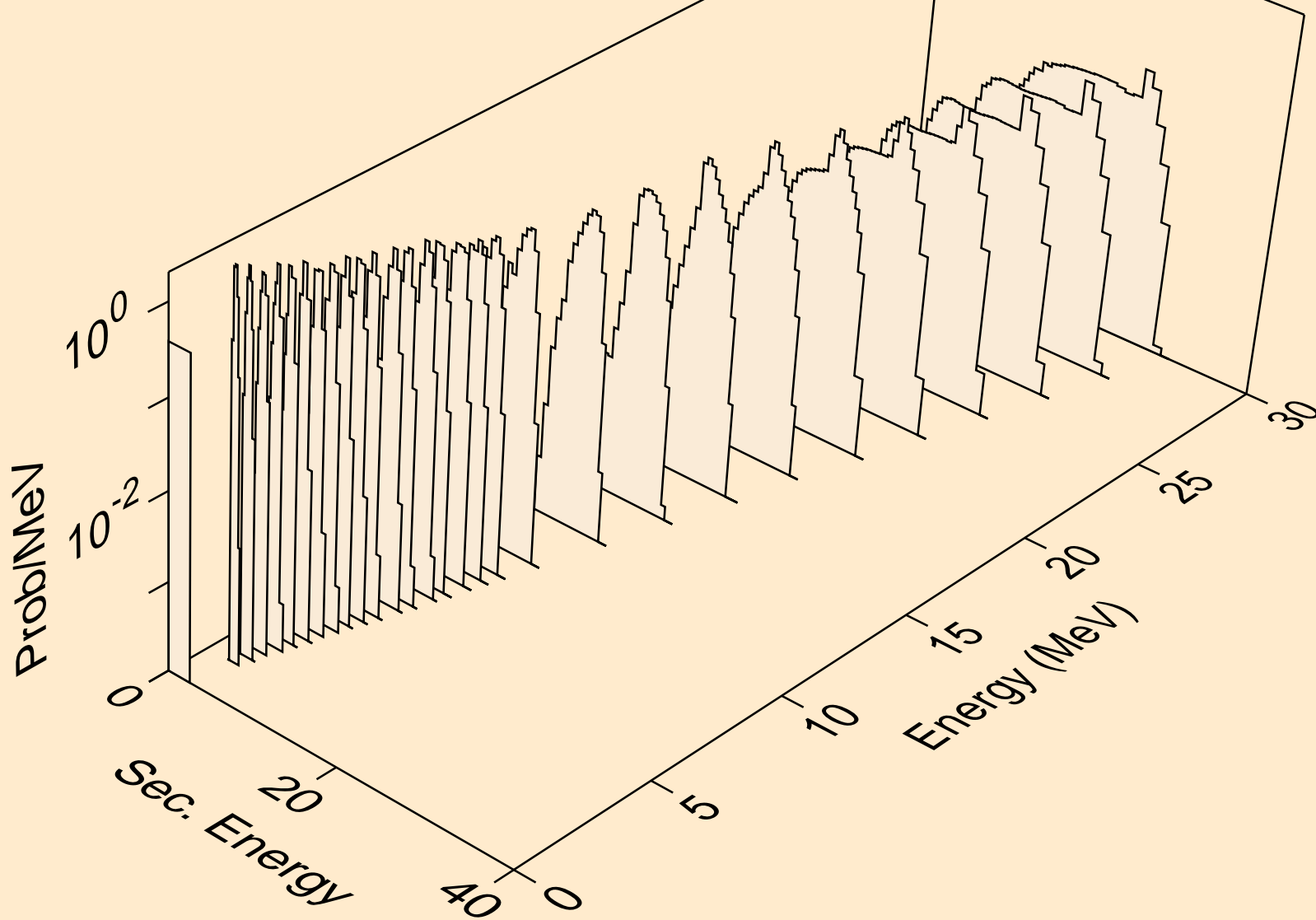



TC094M NEUTRON ACER TENDL-2019 LIBRARY; T=293.16K  
alphas from (n,da)

