

TC096M NEUTRON ACER TENDL-2019 LIBRARY; T=293.16K
Principal cross sections

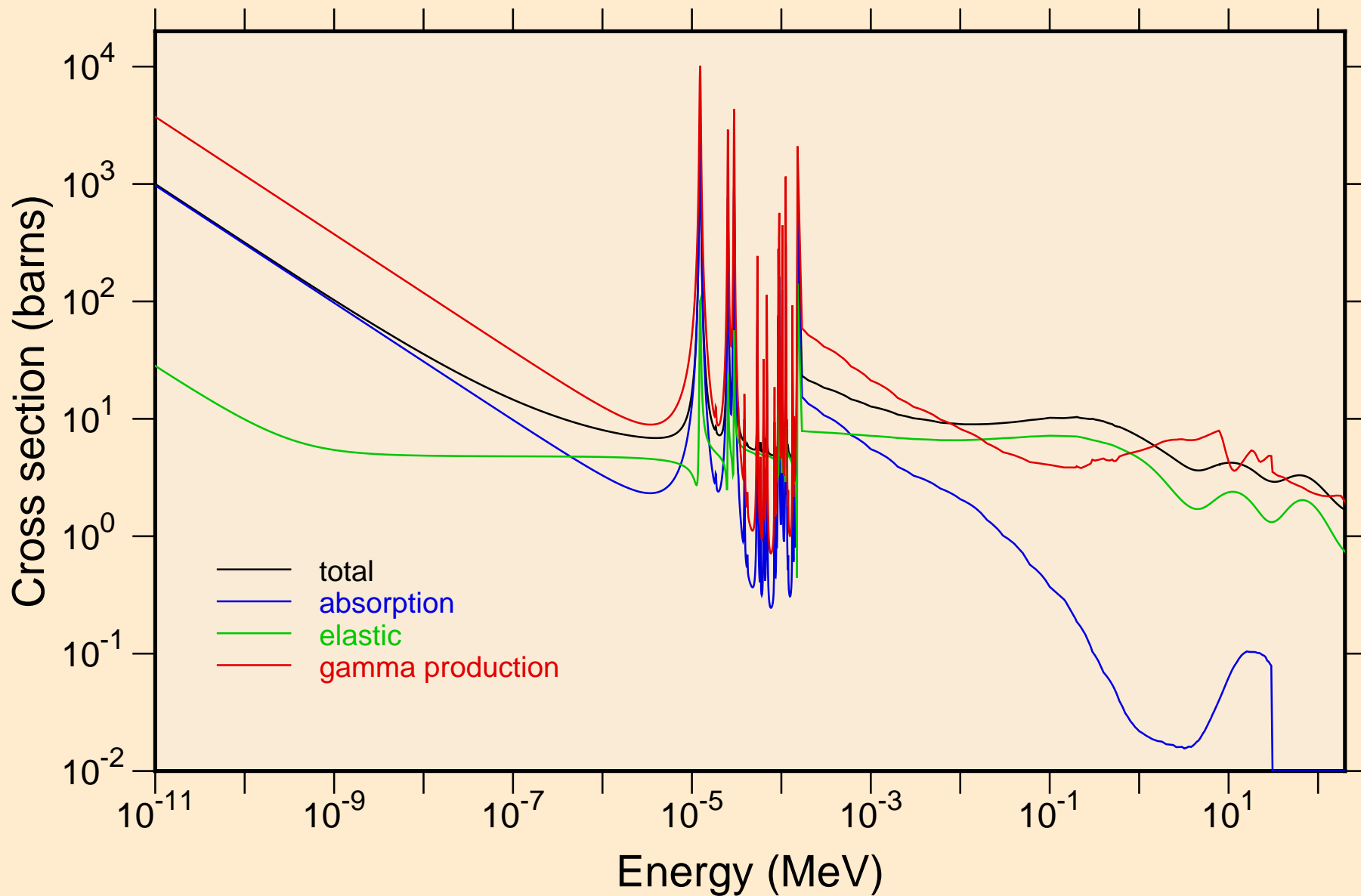

TC096M NEUTRON ACER TENDL-2019 LIBRARY; T=293.16K
resonance total cross section

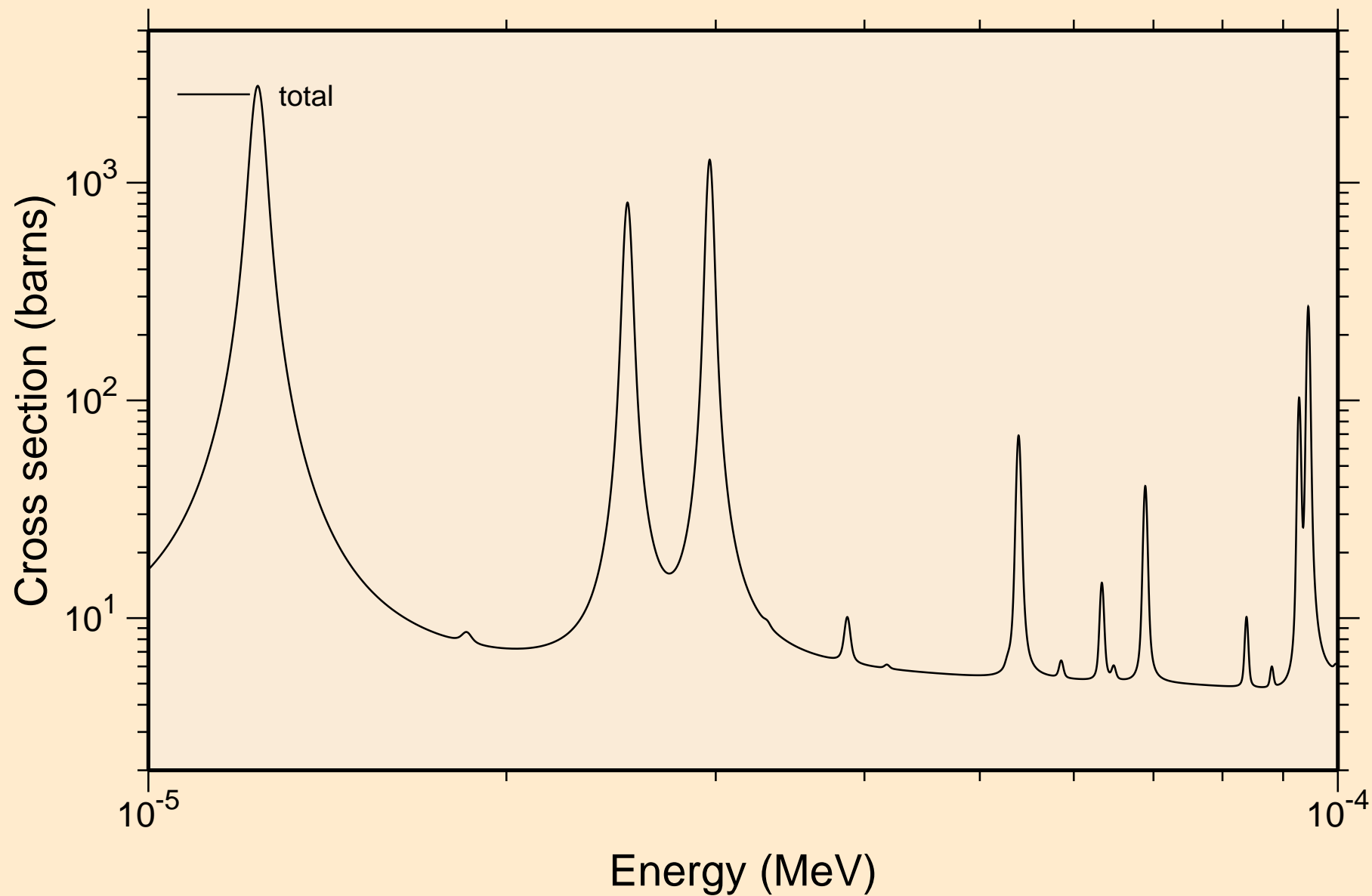

TC096M NEUTRON ACER TENDL-2019 LIBRARY; T=293.16K
resonance total cross section

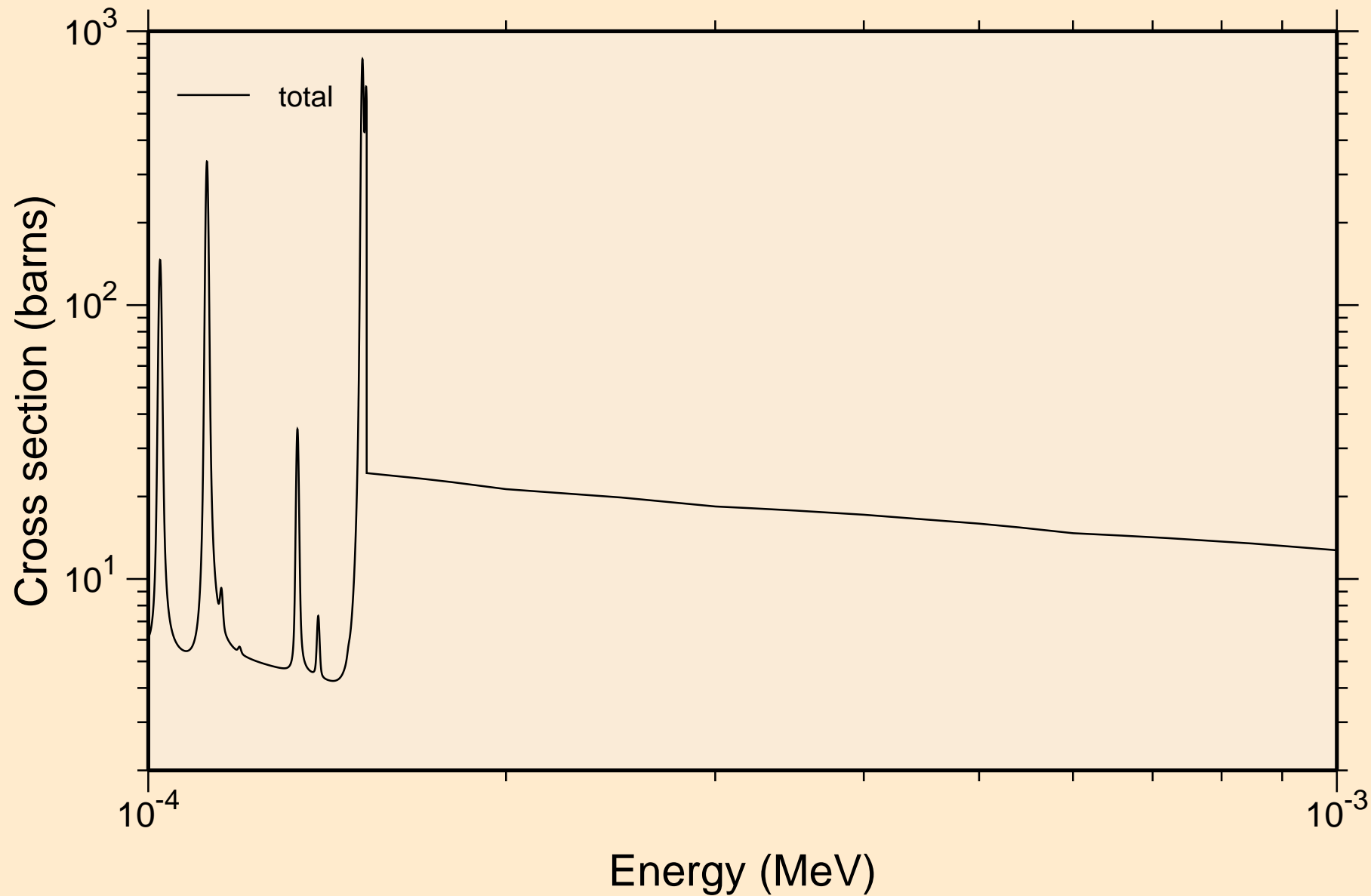

T̄C096M NEUTRON ACER TENDL-2019 LIBRARY; T=293.16K
resonance total cross section

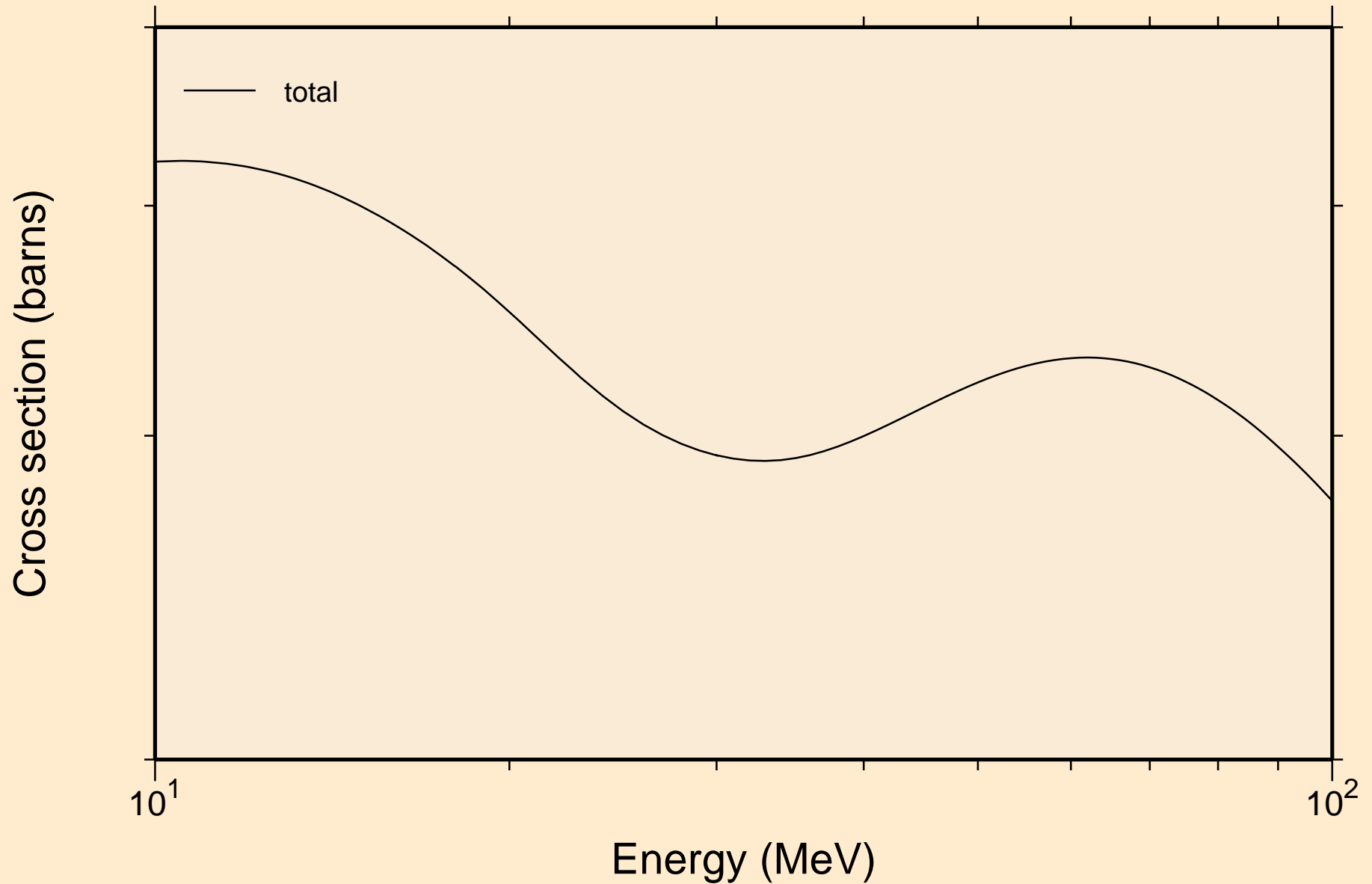

TC096M NEUTRON ACER TENDL-2019 LIBRARY; T=293.16K
resonance absorption cross sections

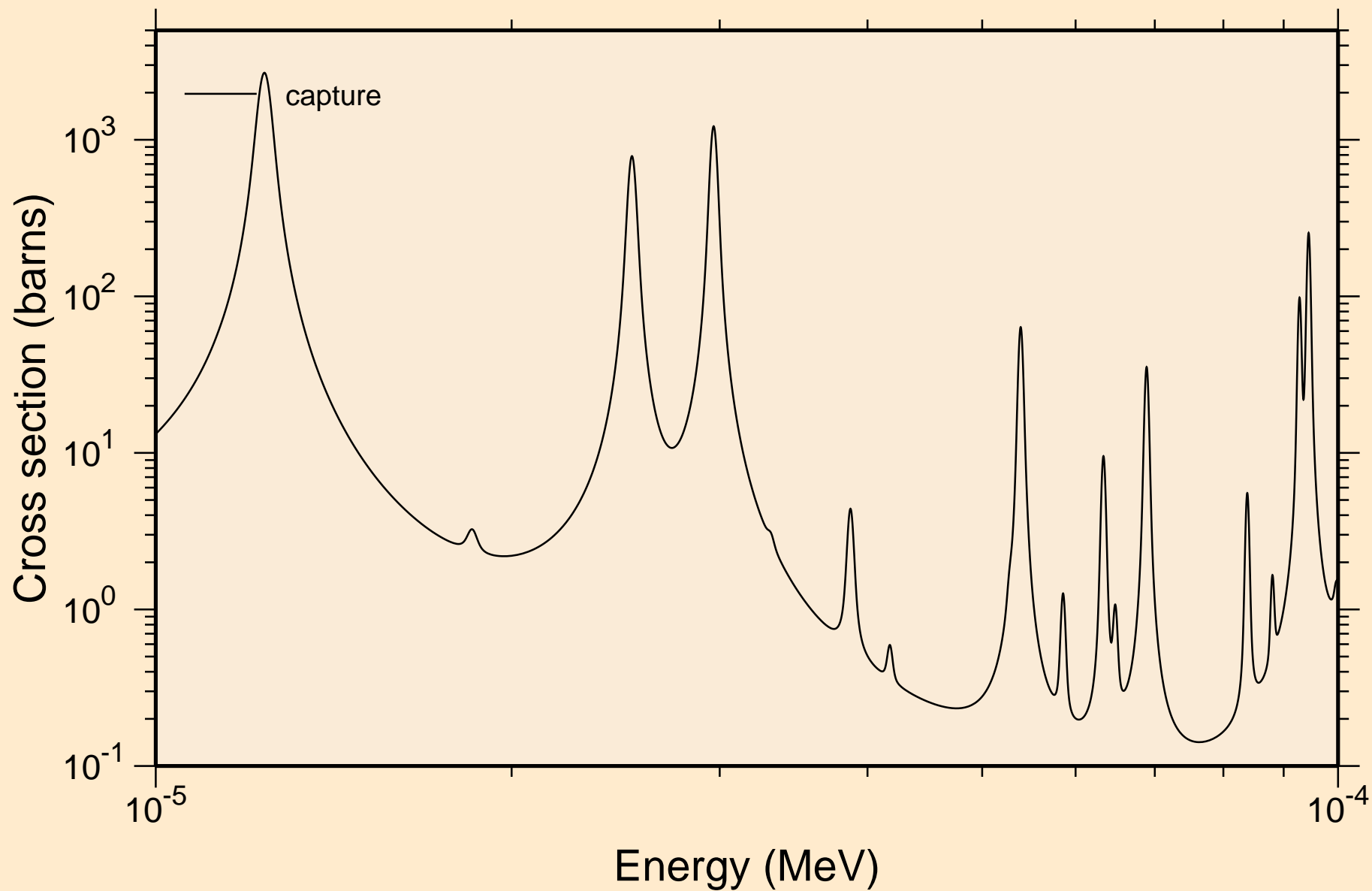

TC096M NEUTRON ACER TENDL-2019 LIBRARY; T=293.16K
resonance absorption cross sections

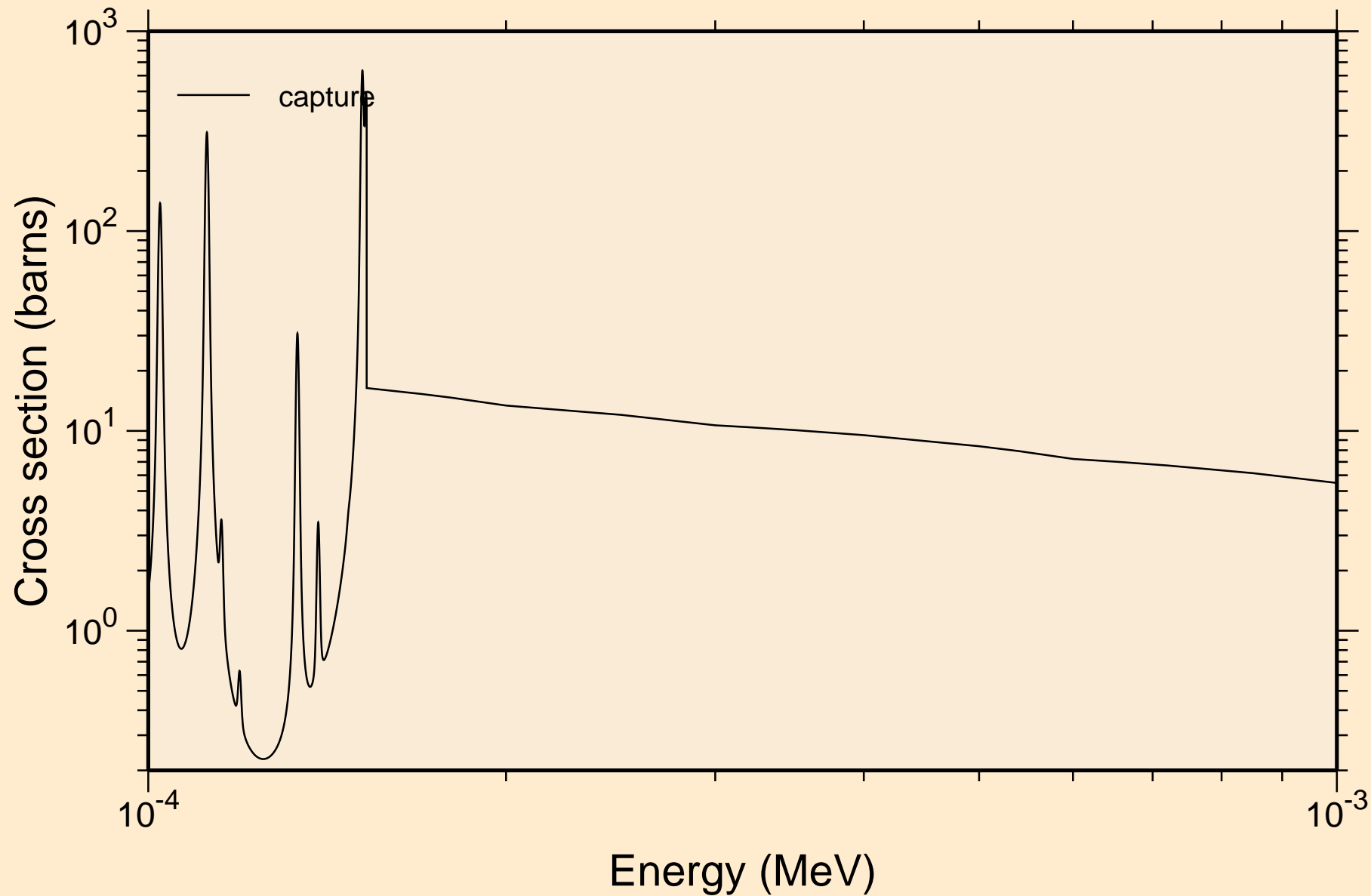

TC096M NEUTRON ACER TENDL-2019 LIBRARY; T=293.16K
resonance absorption cross sections

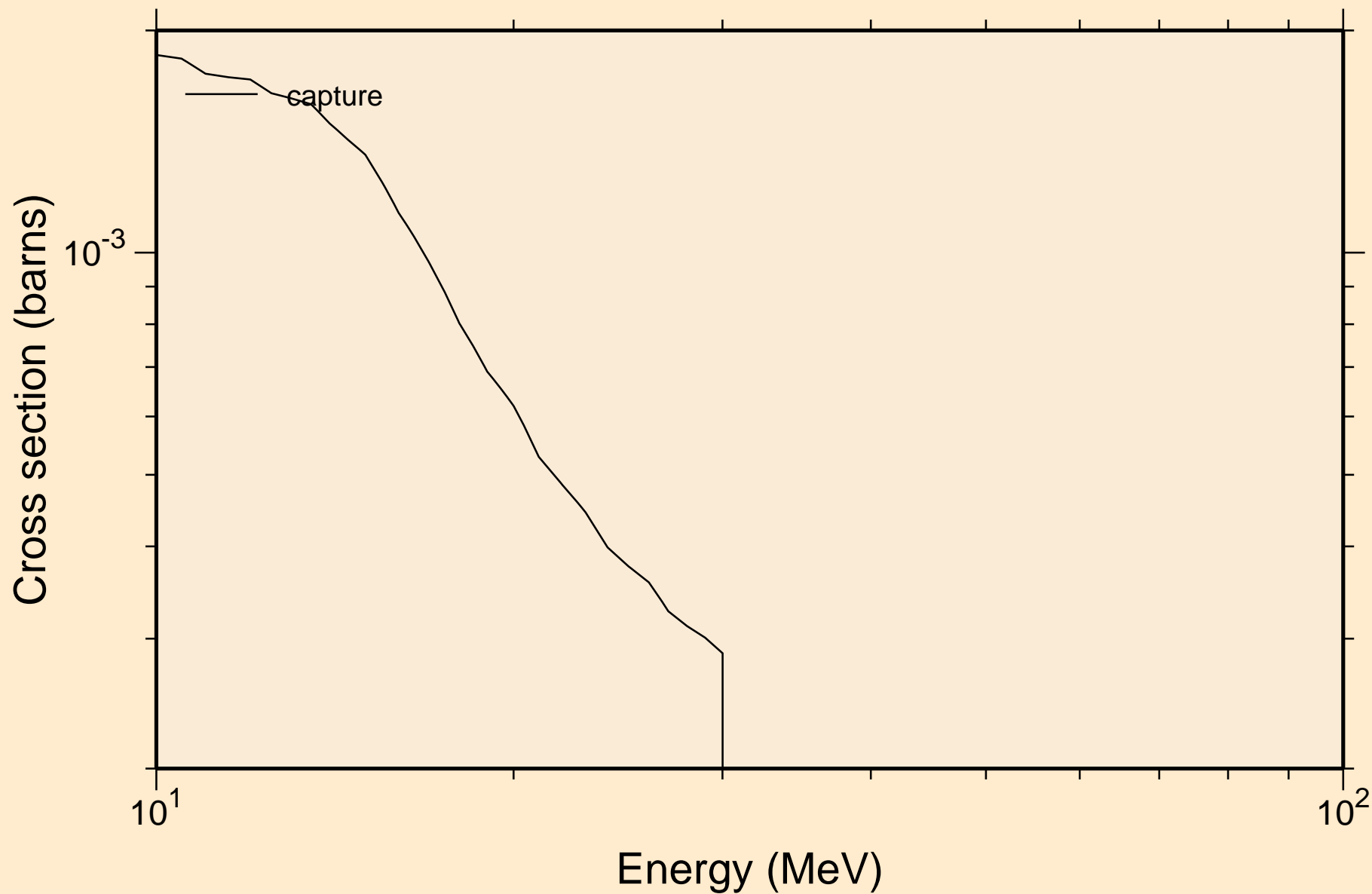

TC096M NEUTRON ACER TENDL-2019 LIBRARY; T=293.16K
Heating

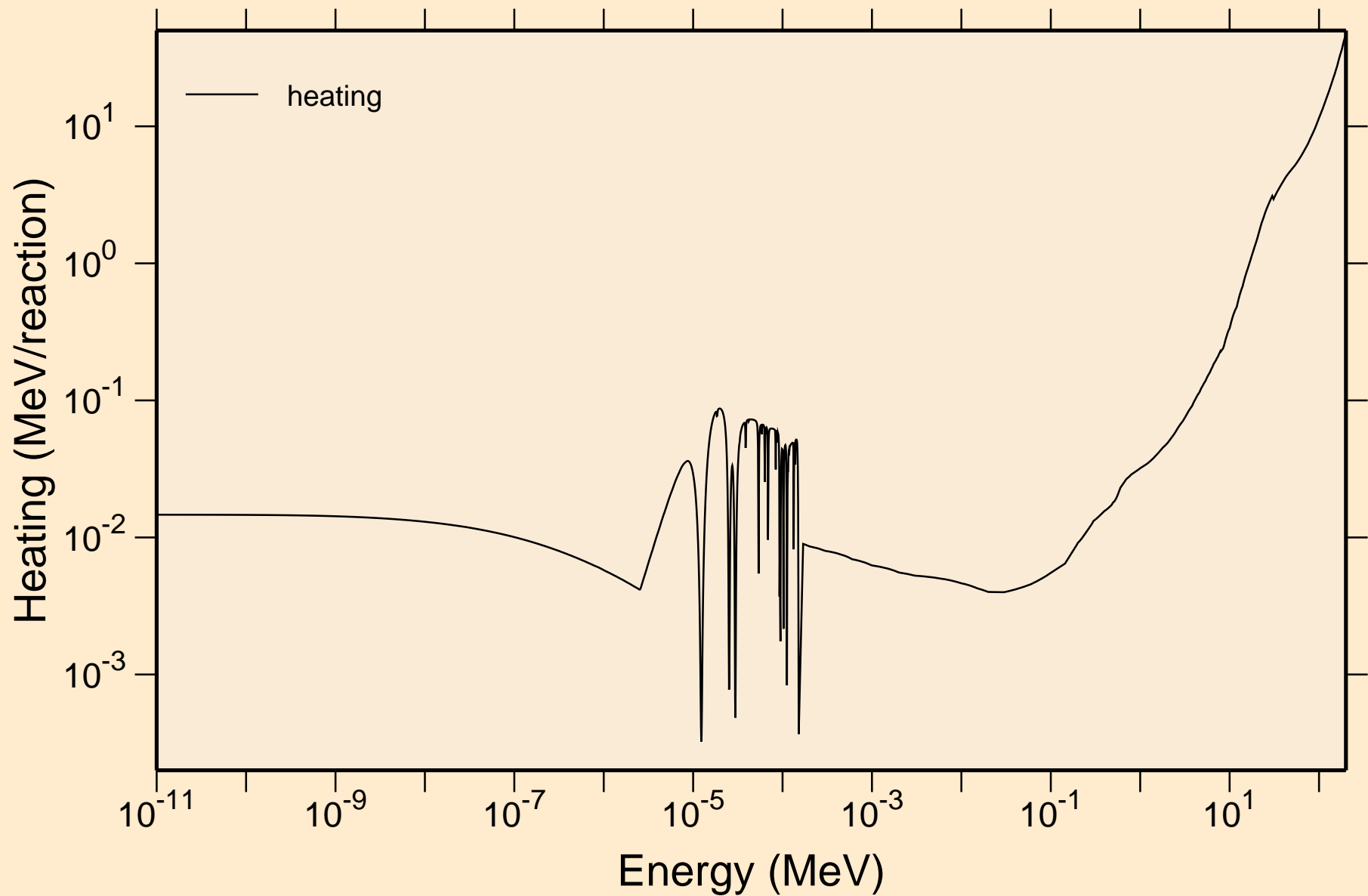

TC096M NEUTRON ACER TENDL-2019 LIBRARY; T=293.16K
Damage

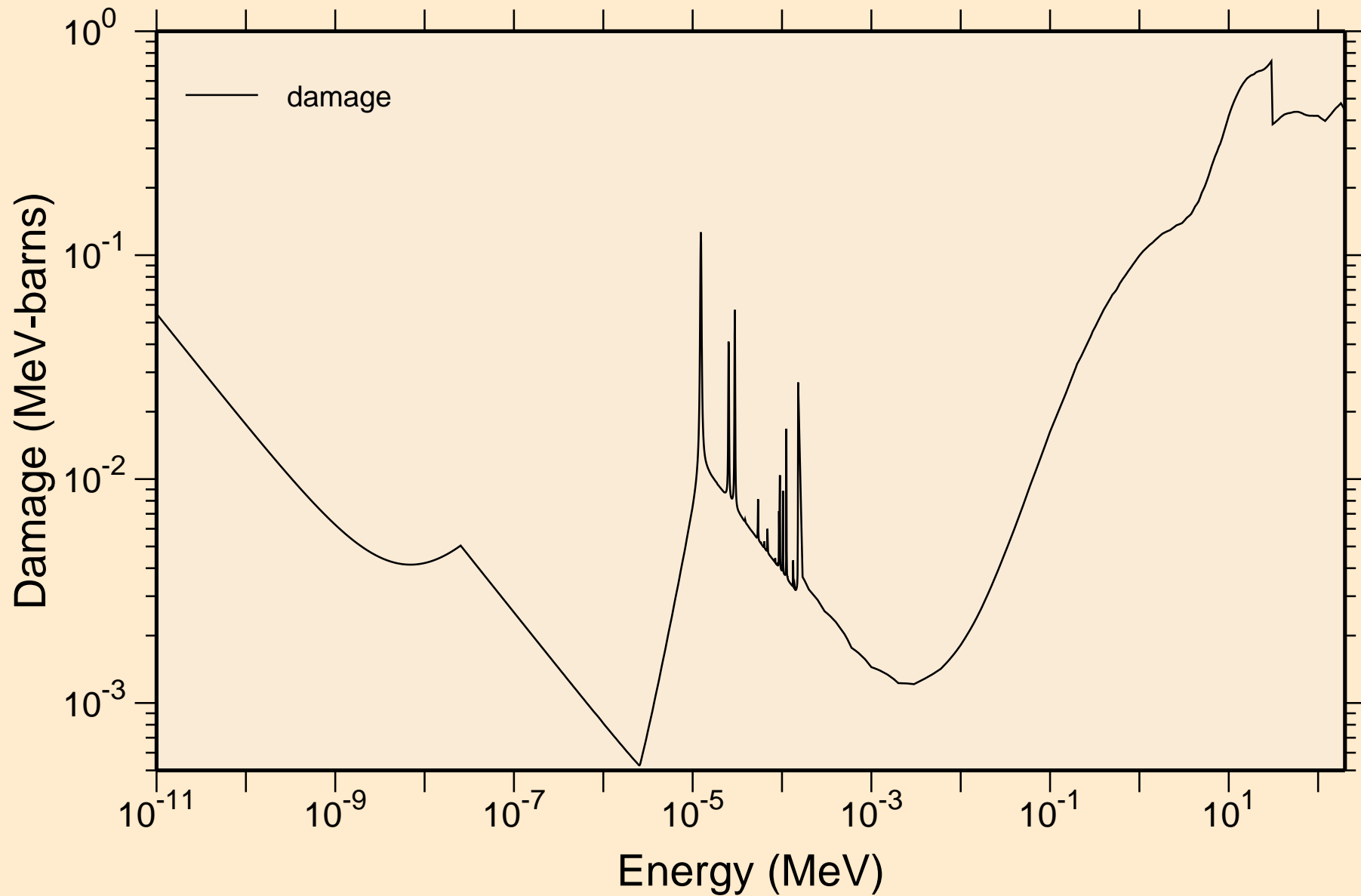

TC096M NEUTRON ACER TENDL-2019 LIBRARY; T=293.16K
Non-threshold reactions

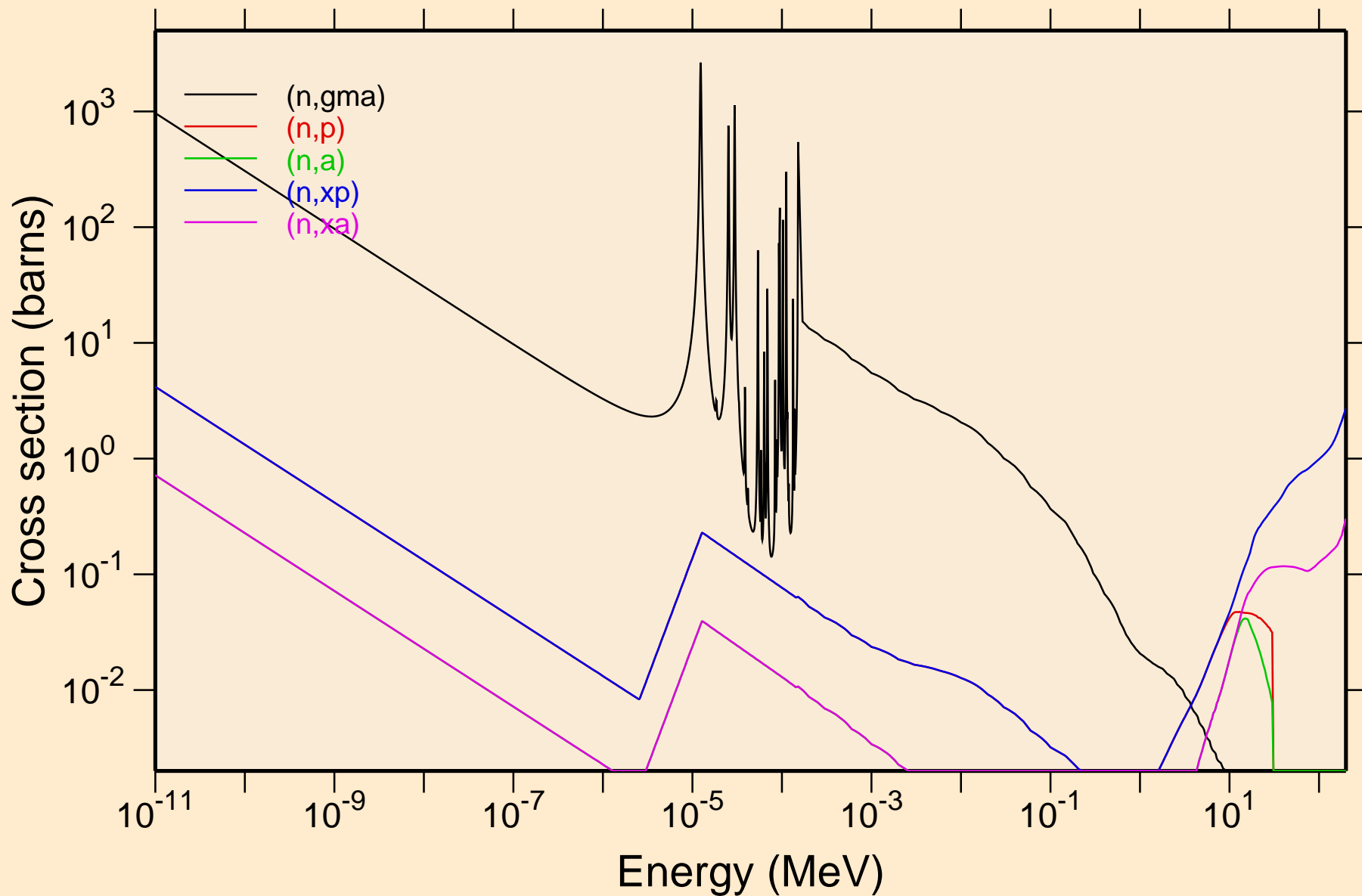

TC096M NEUTRON ACER TENDL-2019 LIBRARY; T=293.16K
Principal cross sections

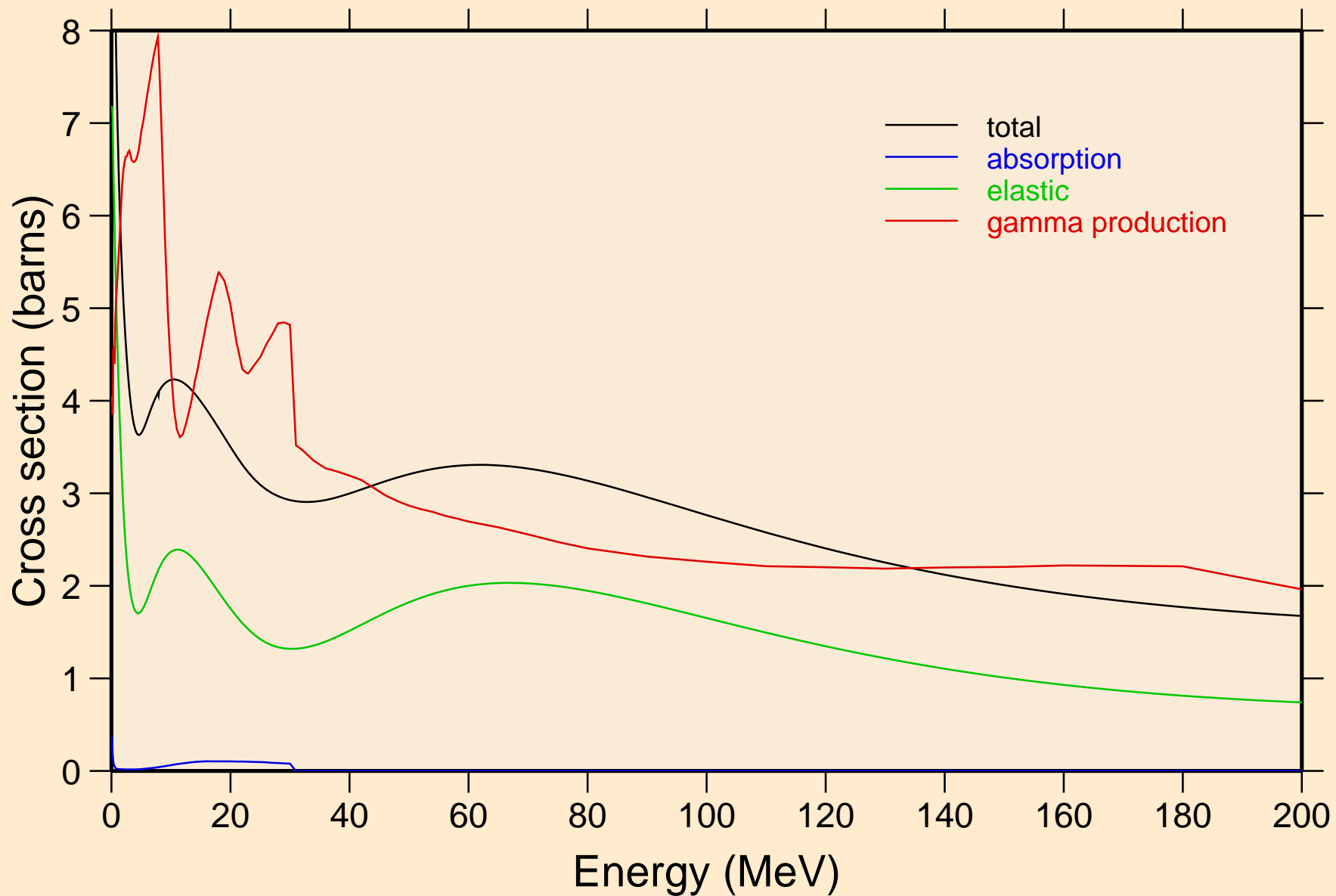

TC096M NEUTRON ACER TENDL-2019 LIBRARY; T=293.16K
Heating

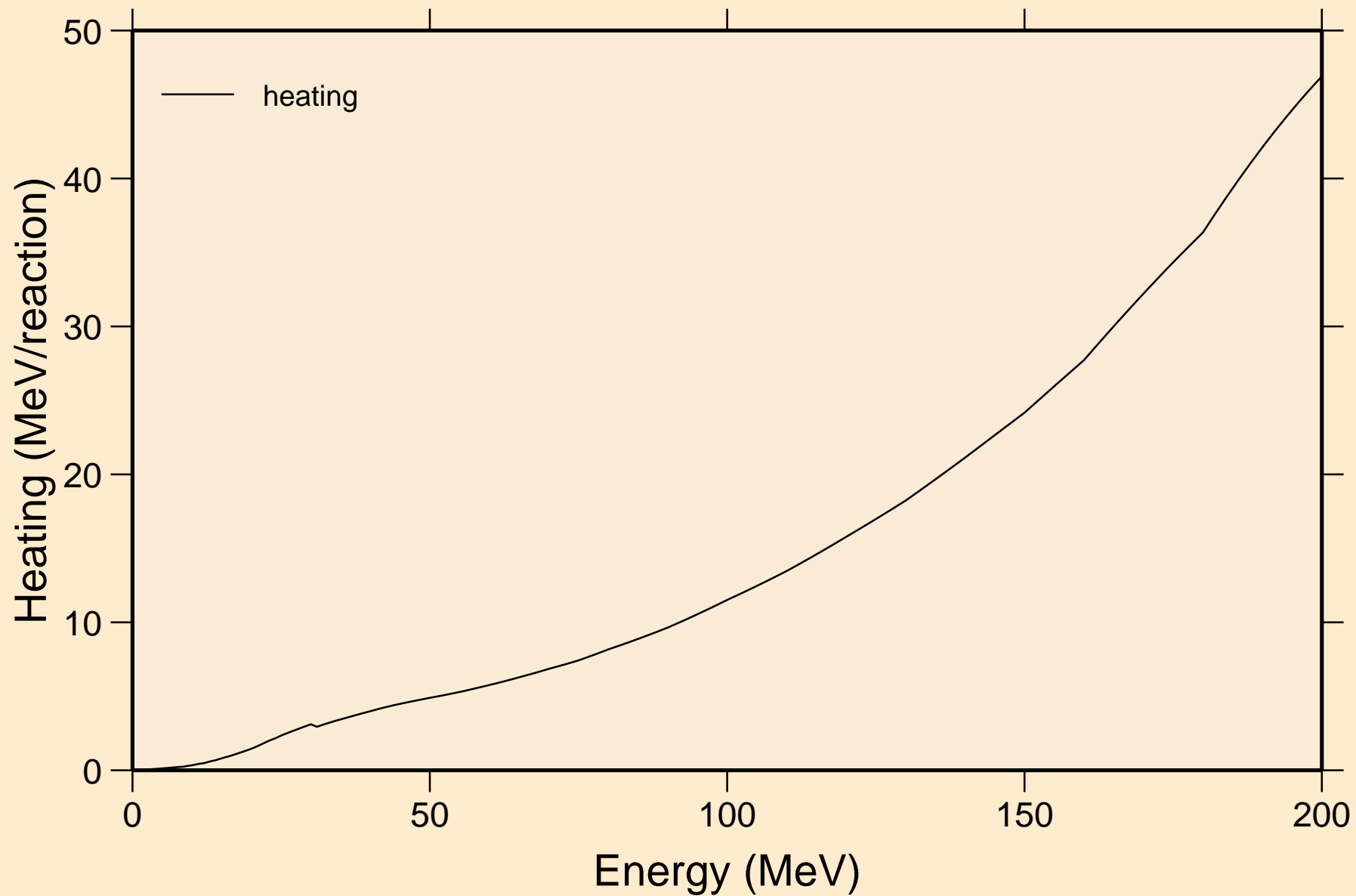

TC096M NEUTRON ACER TENDL-2019 LIBRARY; T=293.16K
Damage

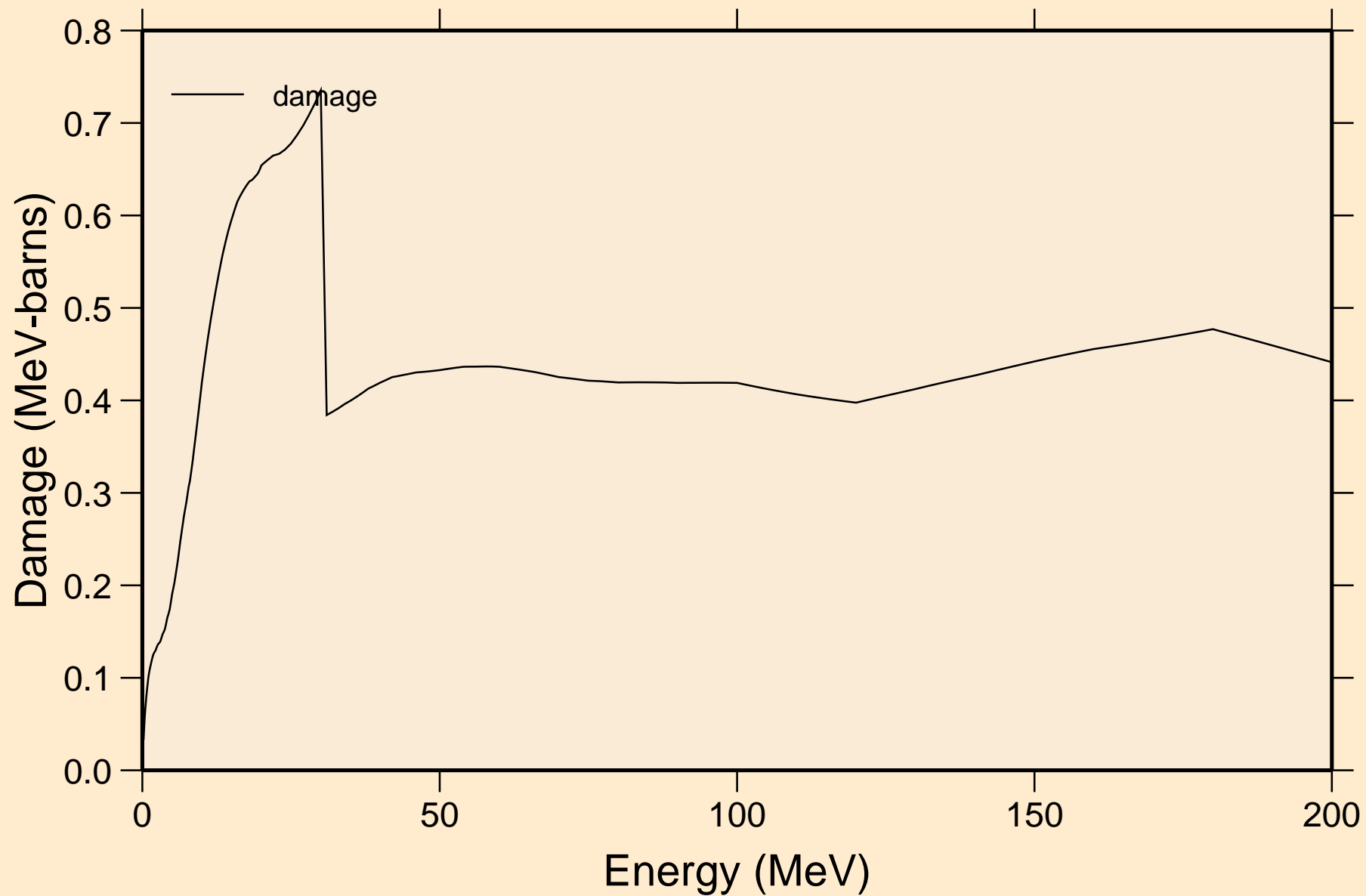

TC096M NEUTRON ACER TENDL-2019 LIBRARY; T=293.16K
Non-threshold reactions

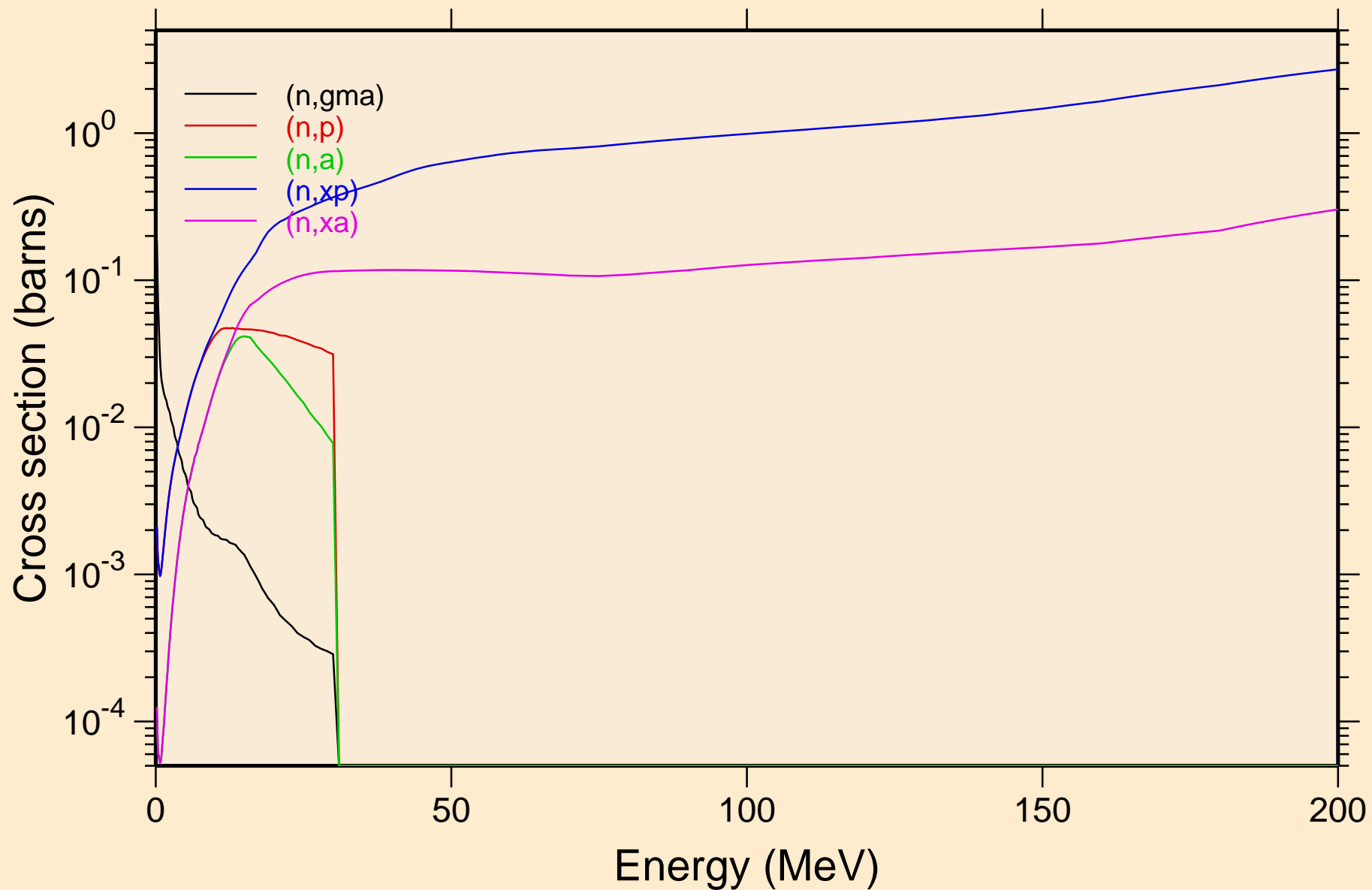

TC096M NEUTRON ACER TENDL-2019 LIBRARY; T=293.16K
Inelastic levels

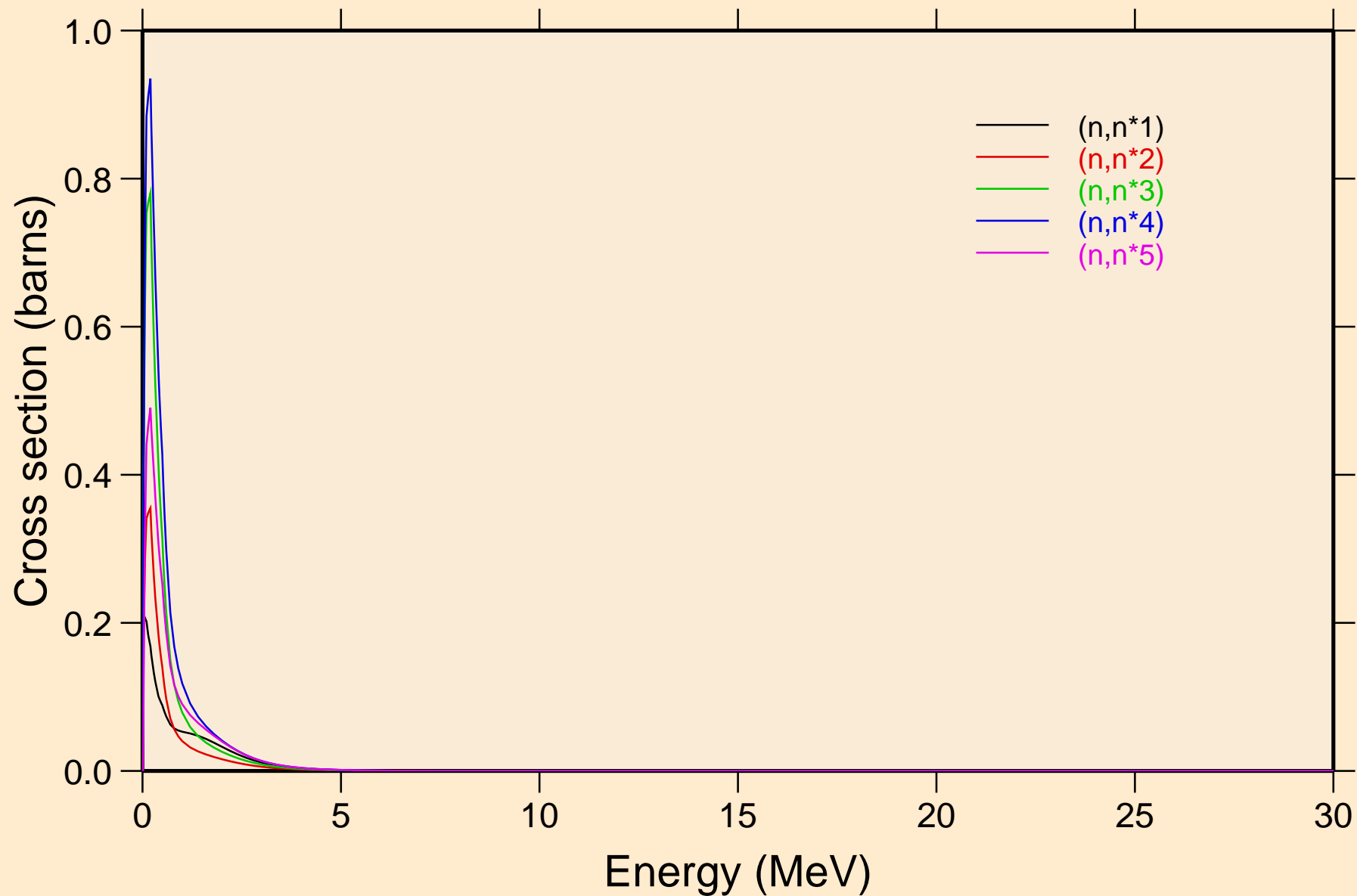

TC096M NEUTRON ACER TENDL-2019 LIBRARY; T=293.16K
Inelastic levels

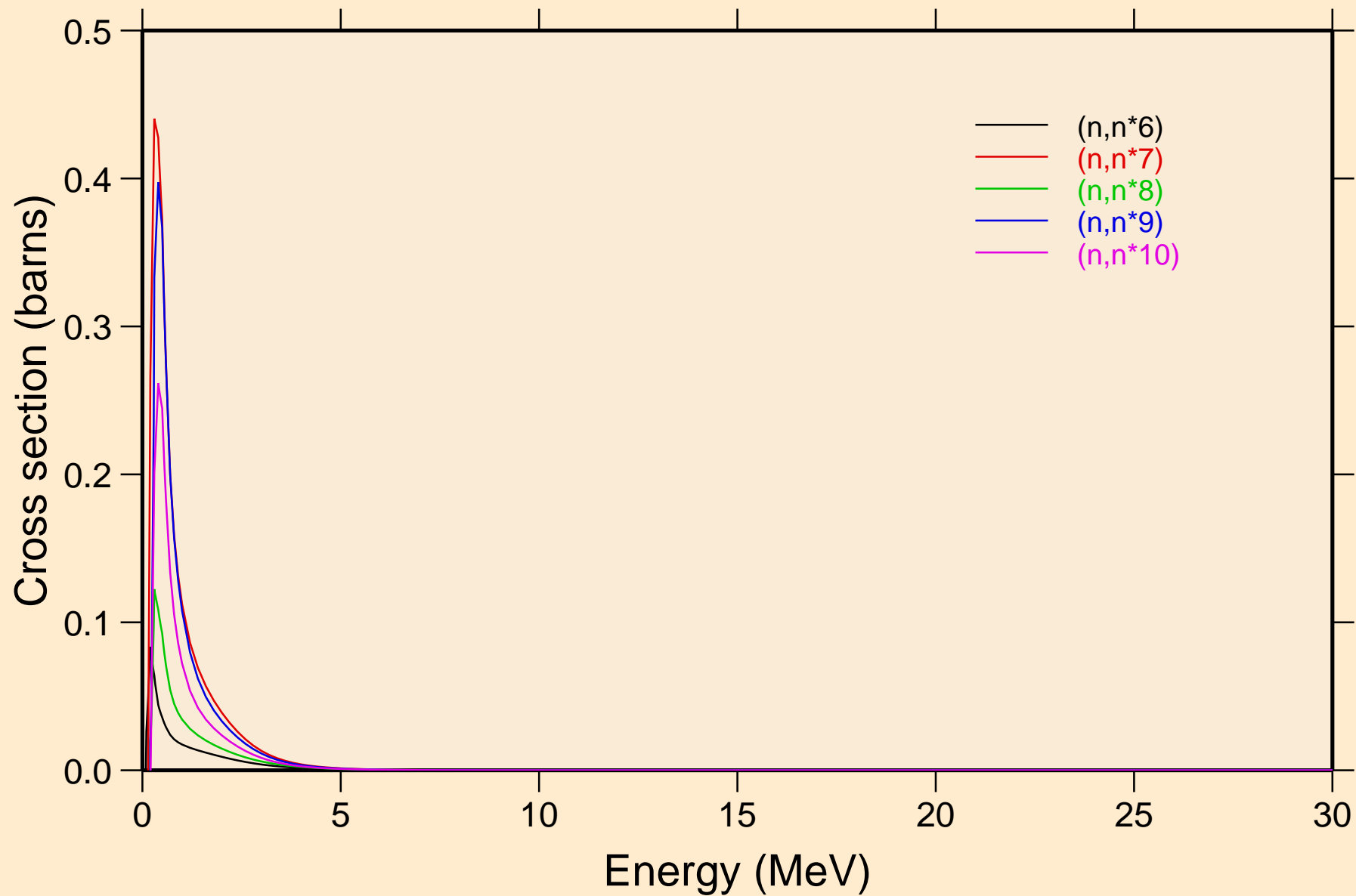

TC096M NEUTRON ACER TENDL-2019 LIBRARY; T=293.16K
Inelastic levels

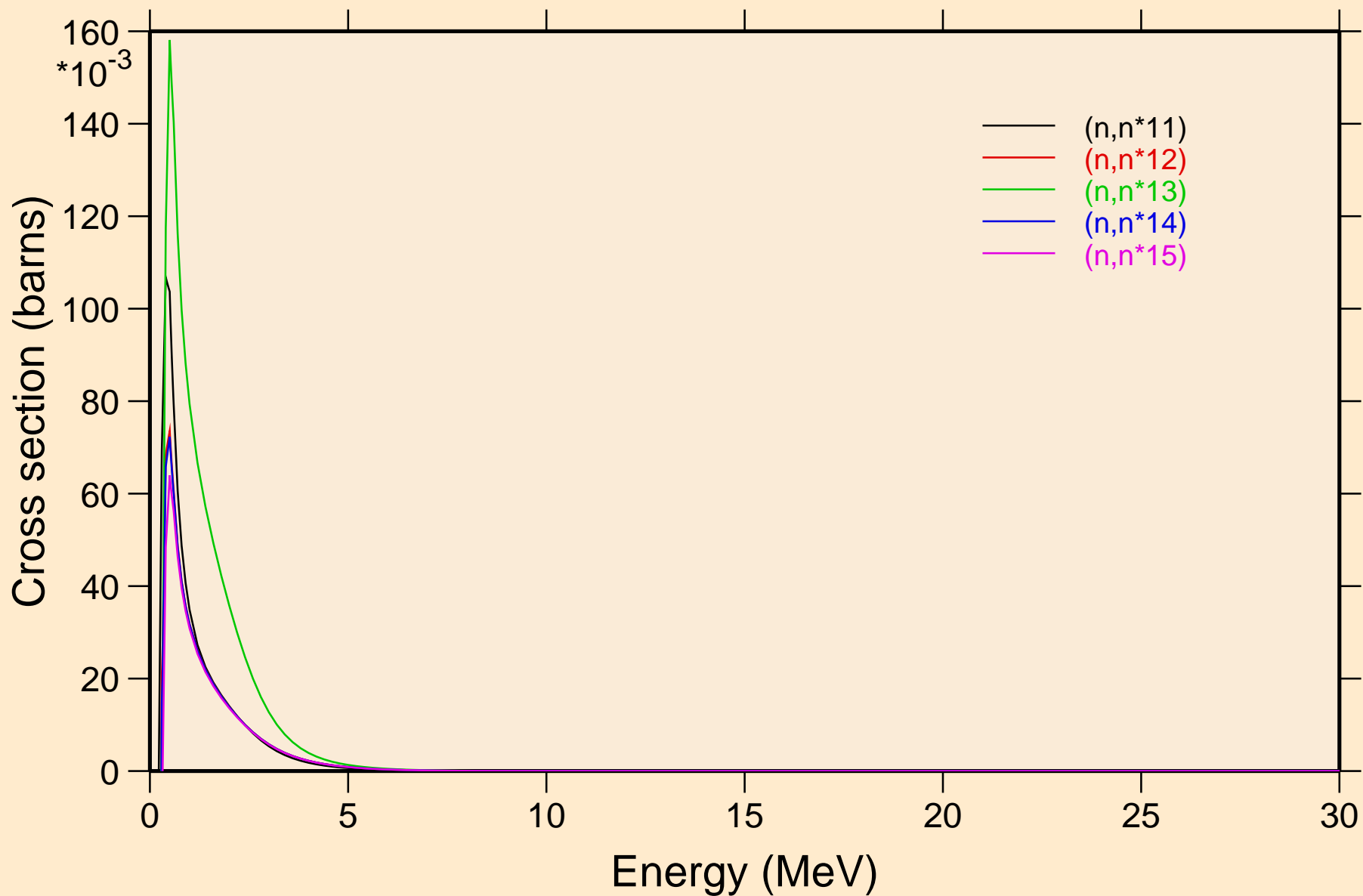

TC096M NEUTRON ACER TENDL-2019 LIBRARY; T=293.16K
Inelastic levels

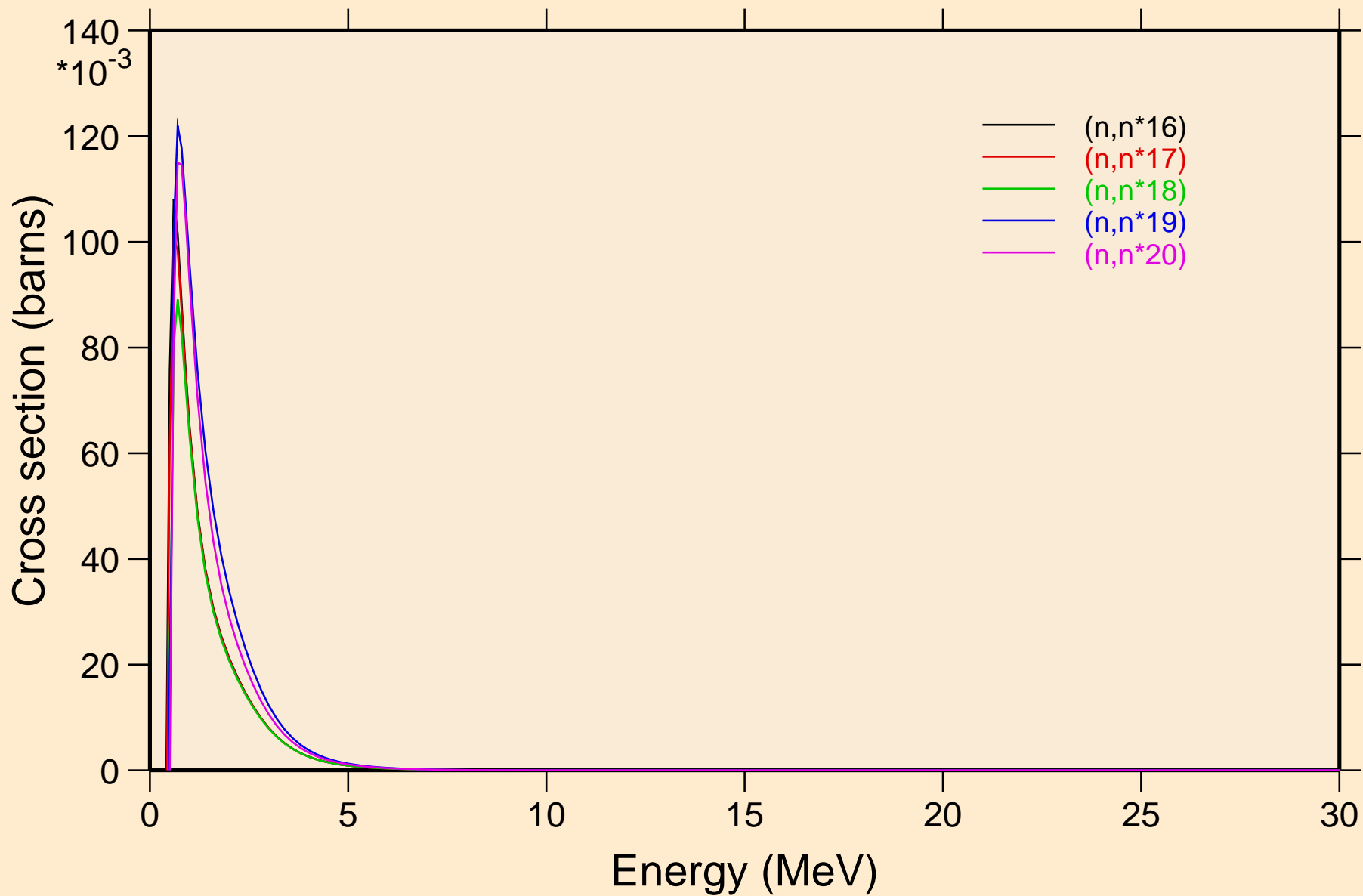

TC096M NEUTRON ACER TENDL-2019 LIBRARY; T=293.16K
Inelastic levels

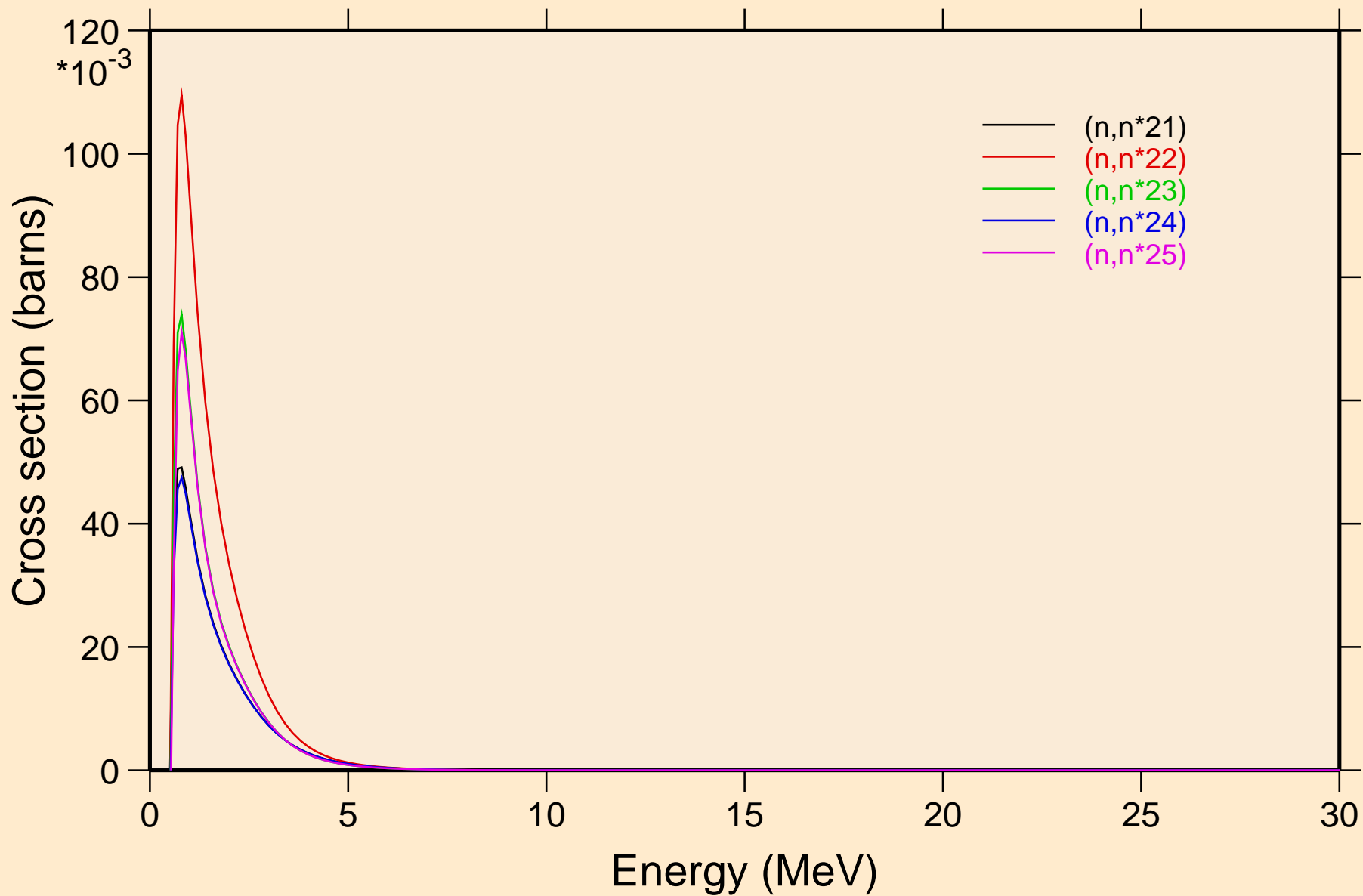

TC096M NEUTRON ACER TENDL-2019 LIBRARY; T=293.16K
Inelastic levels

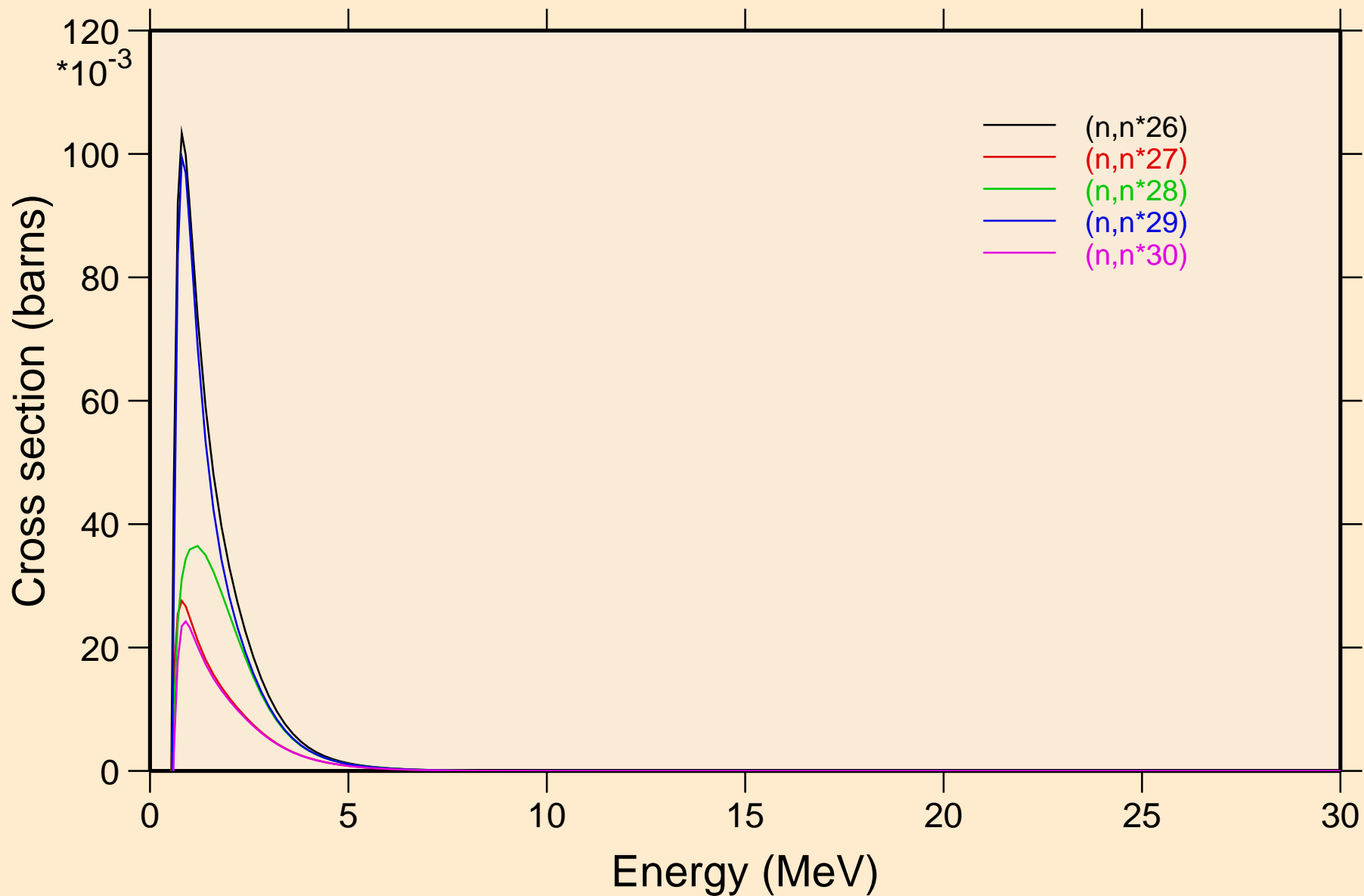

TC096M NEUTRON ACER TENDL-2019 LIBRARY; T=293.16K
Threshold reactions

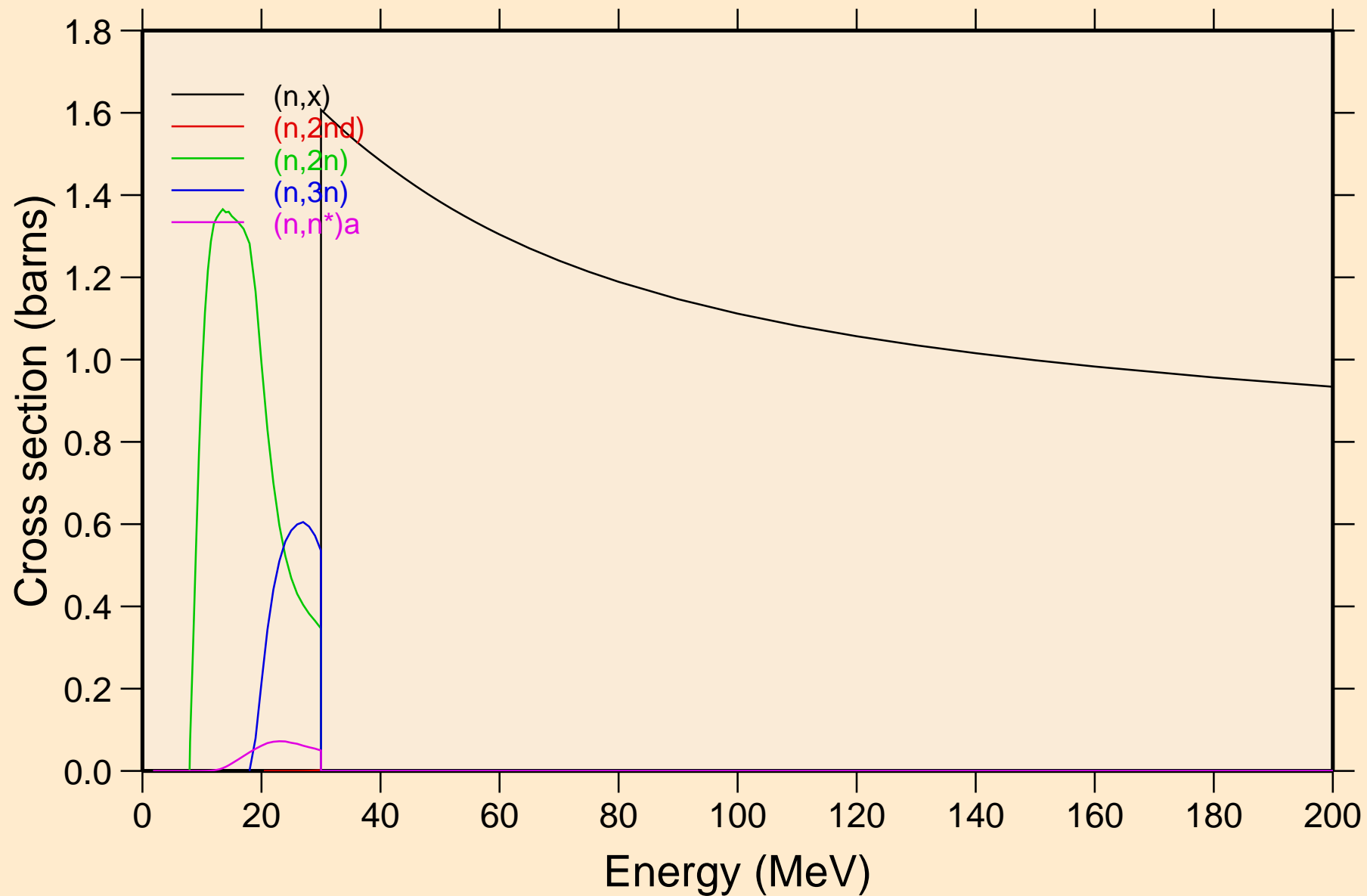

TC096M NEUTRON ACER TENDL-2019 LIBRARY; T=293.16K
Threshold reactions

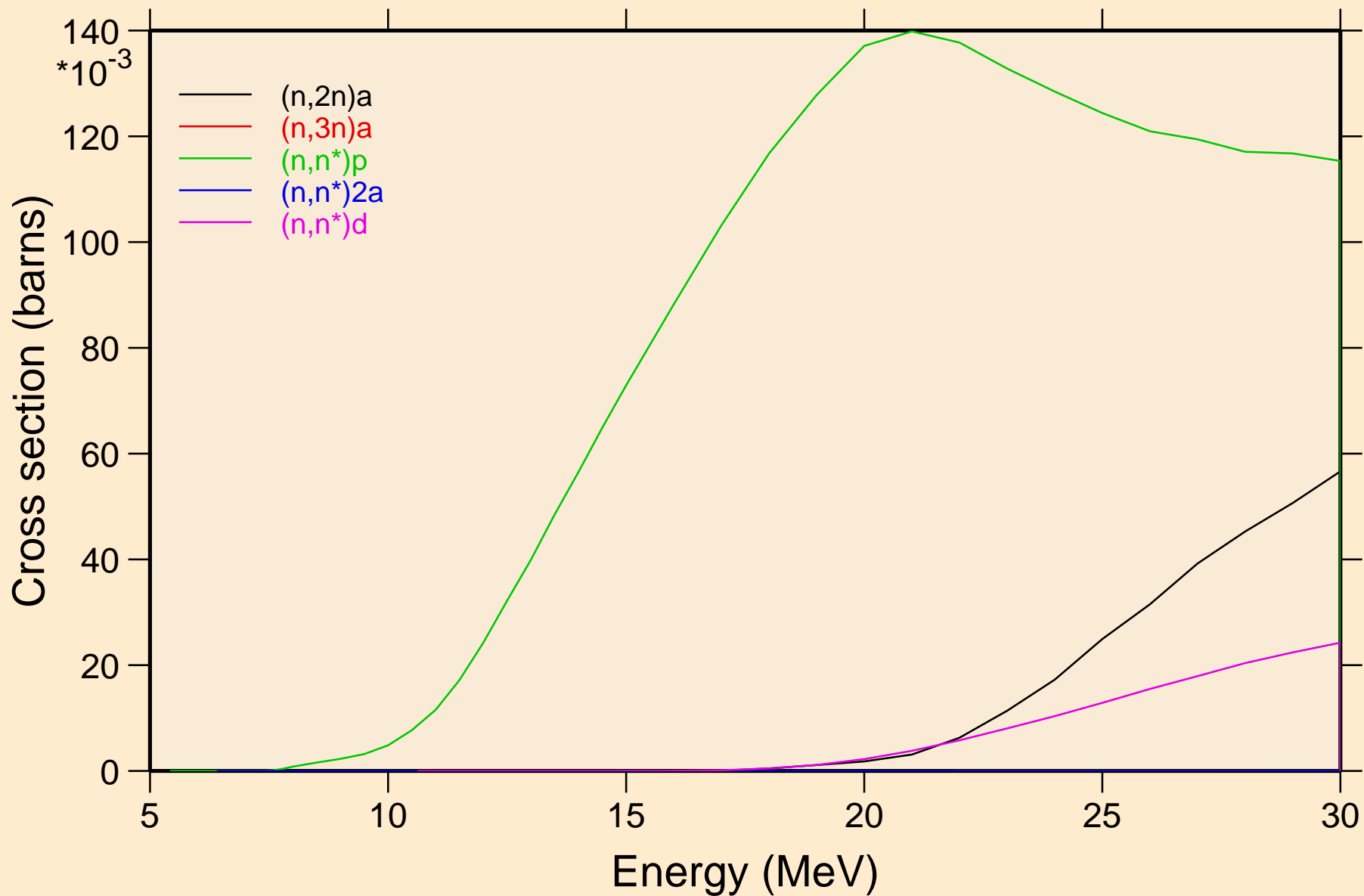

TC096M NEUTRON ACER TENDL-2019 LIBRARY; T=293.16K
Threshold reactions

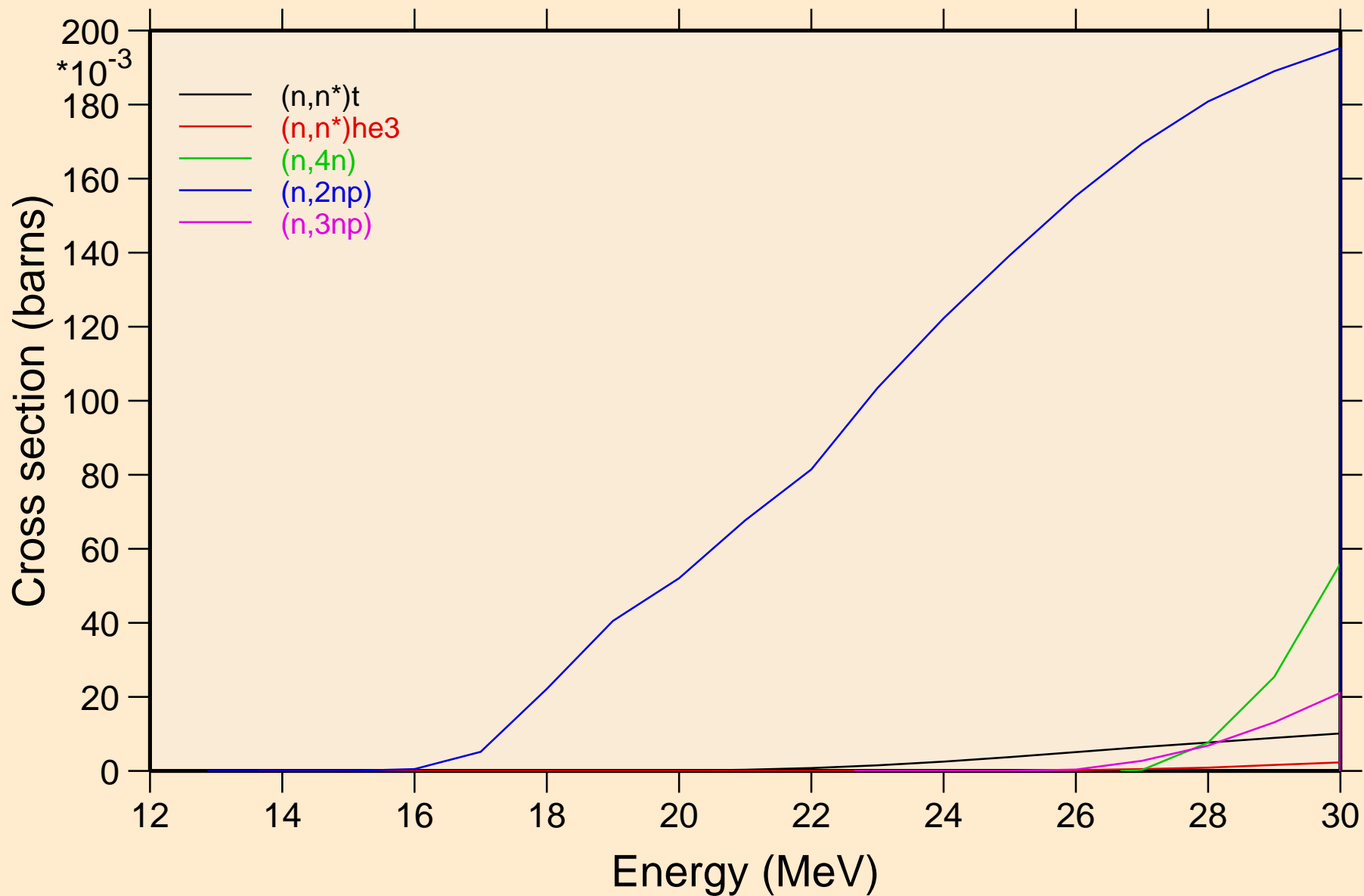

TC096M NEUTRON ACER TENDL-2019 LIBRARY; T=293.16K
Threshold reactions

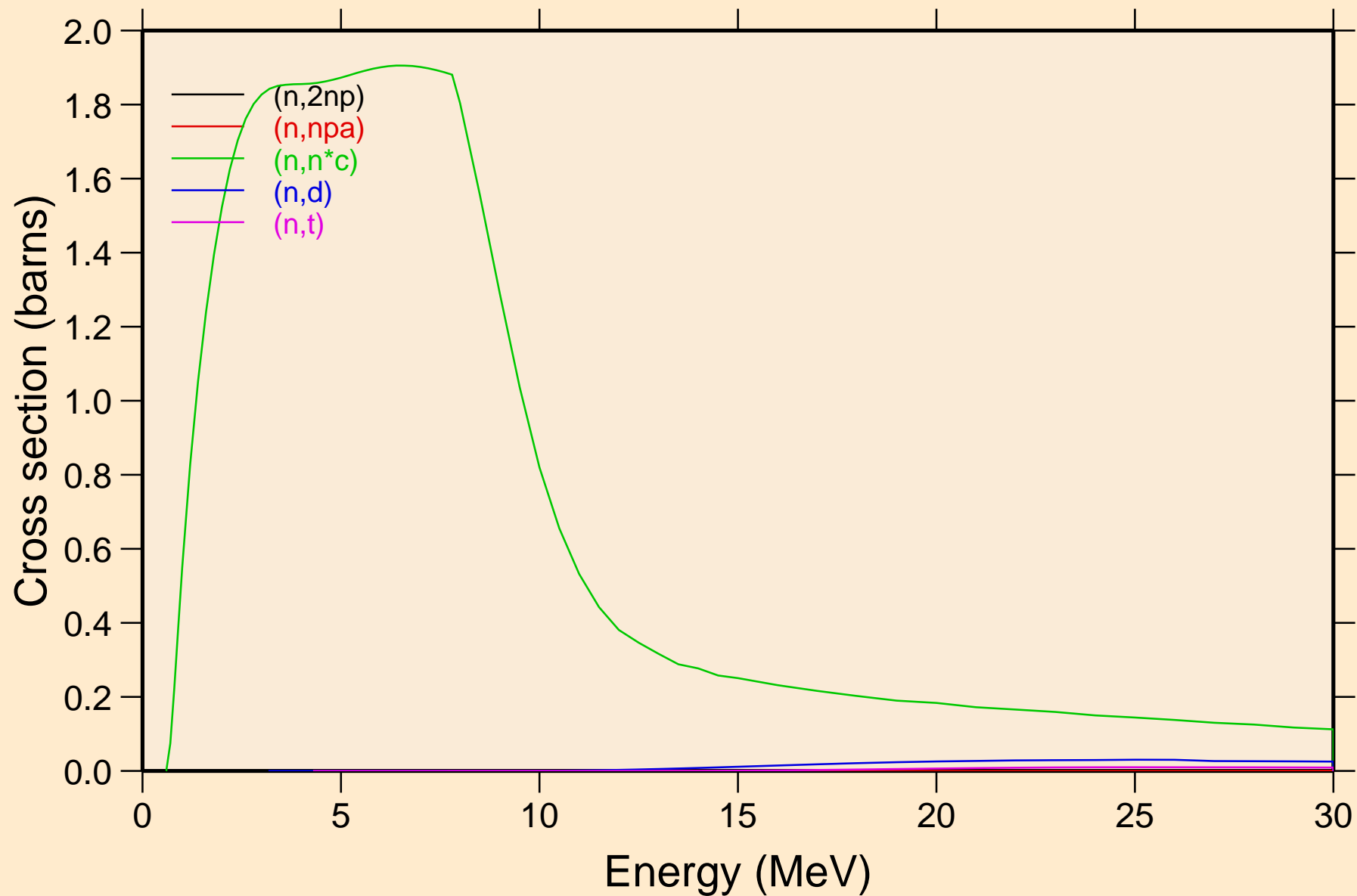

TC096M NEUTRON ACER TENDL-2019 LIBRARY; T=293.16K
Threshold reactions

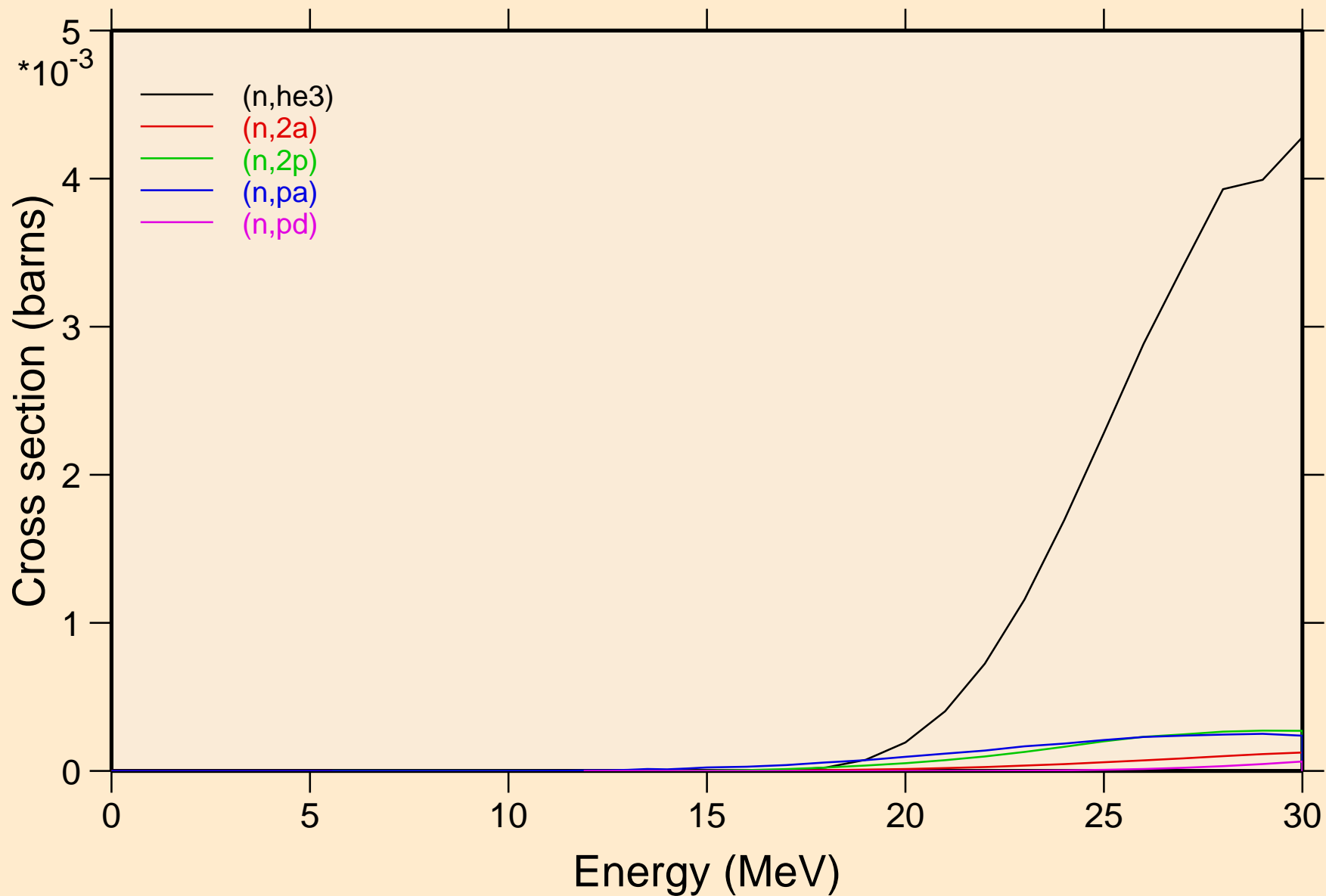

TC096M NEUTRON ACER TENDL-2019 LIBRARY; T=293.16K
Threshold reactions

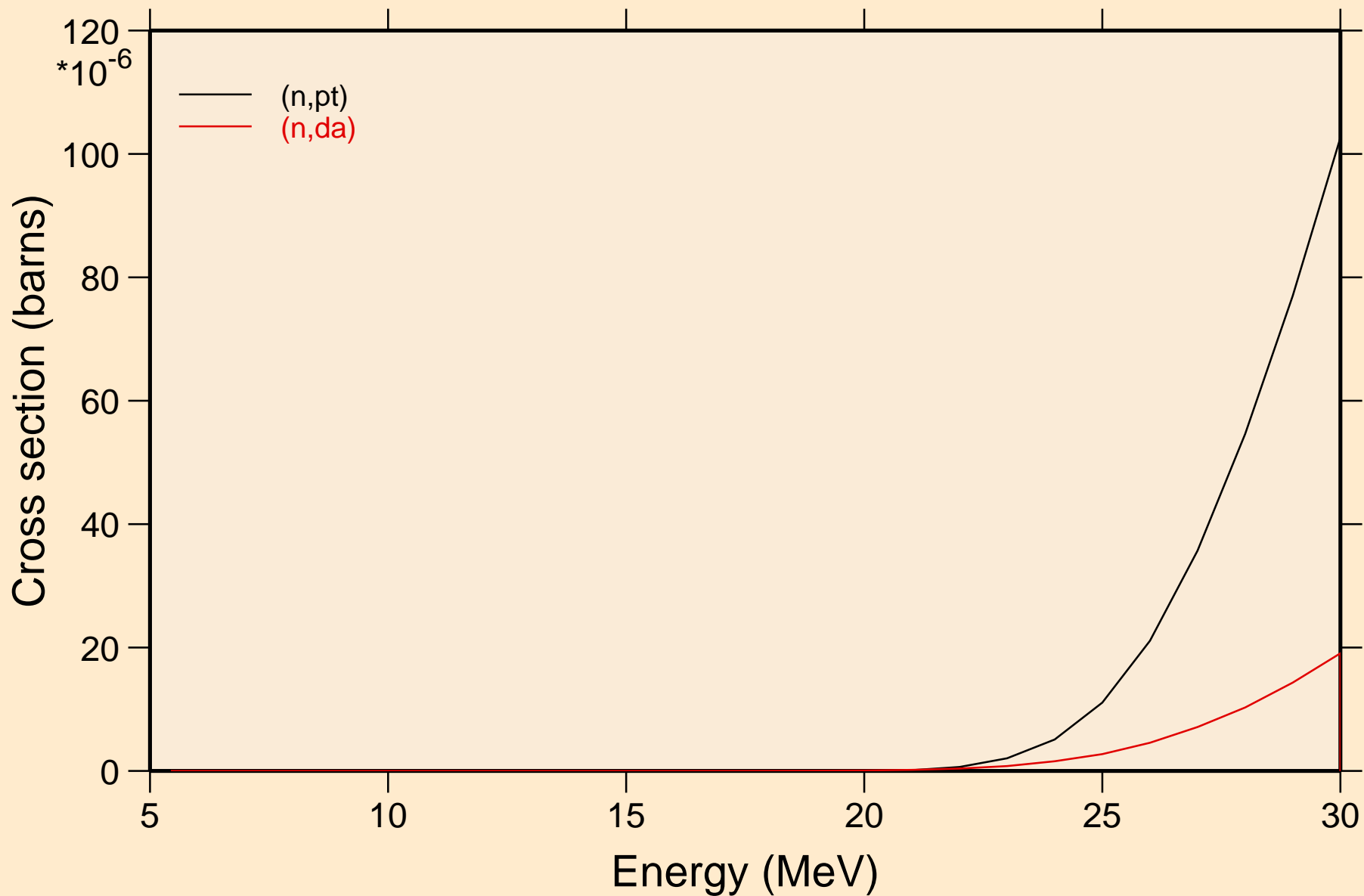

TC096M NEUTRON ACER TENDL-2019 LIBRARY; T=293.16K
Threshold reactions

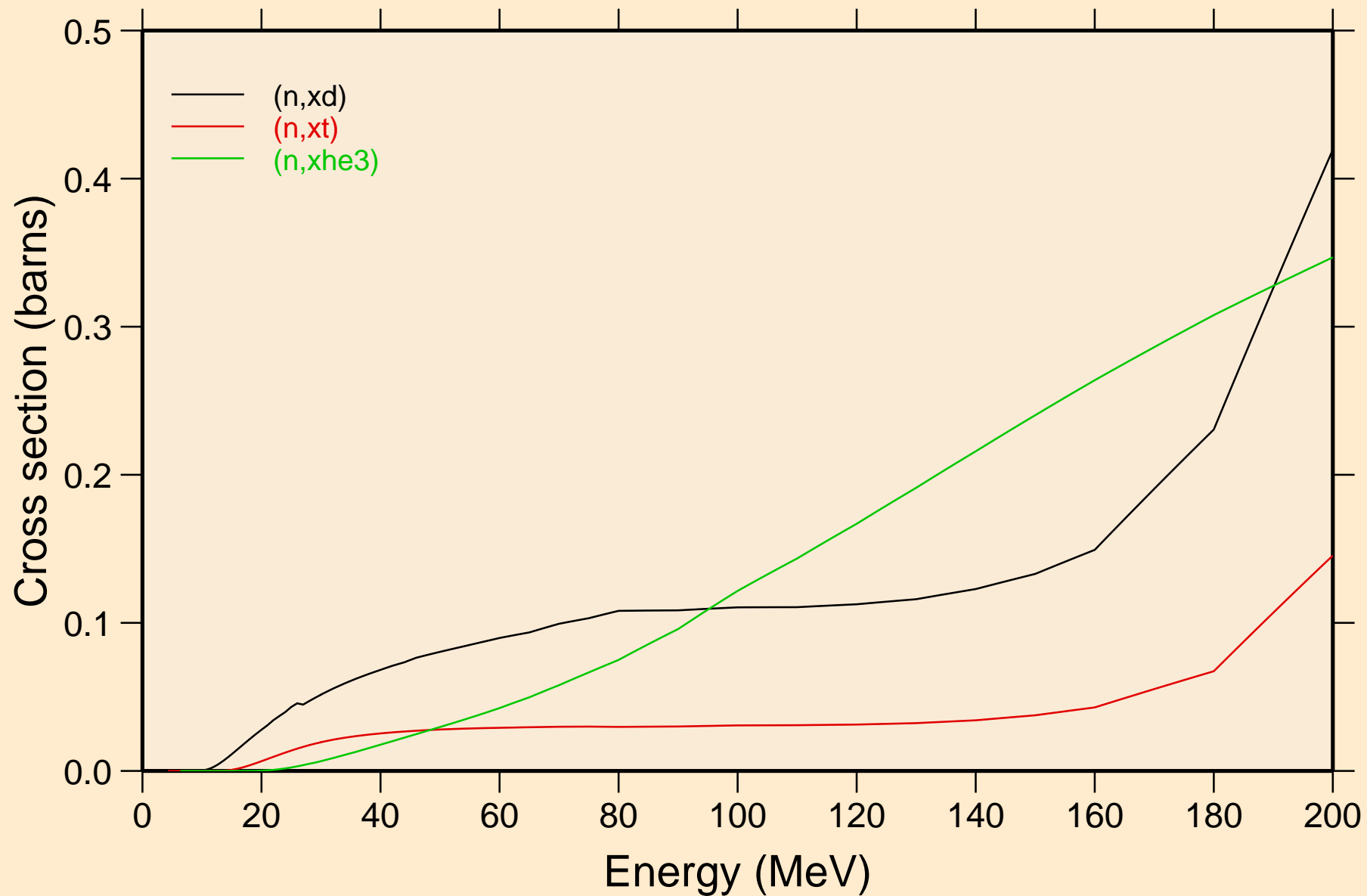

TC096M NEUTRON ACER TENDL-2019 LIBRARY; T=293.16K
angular distribution for elastic

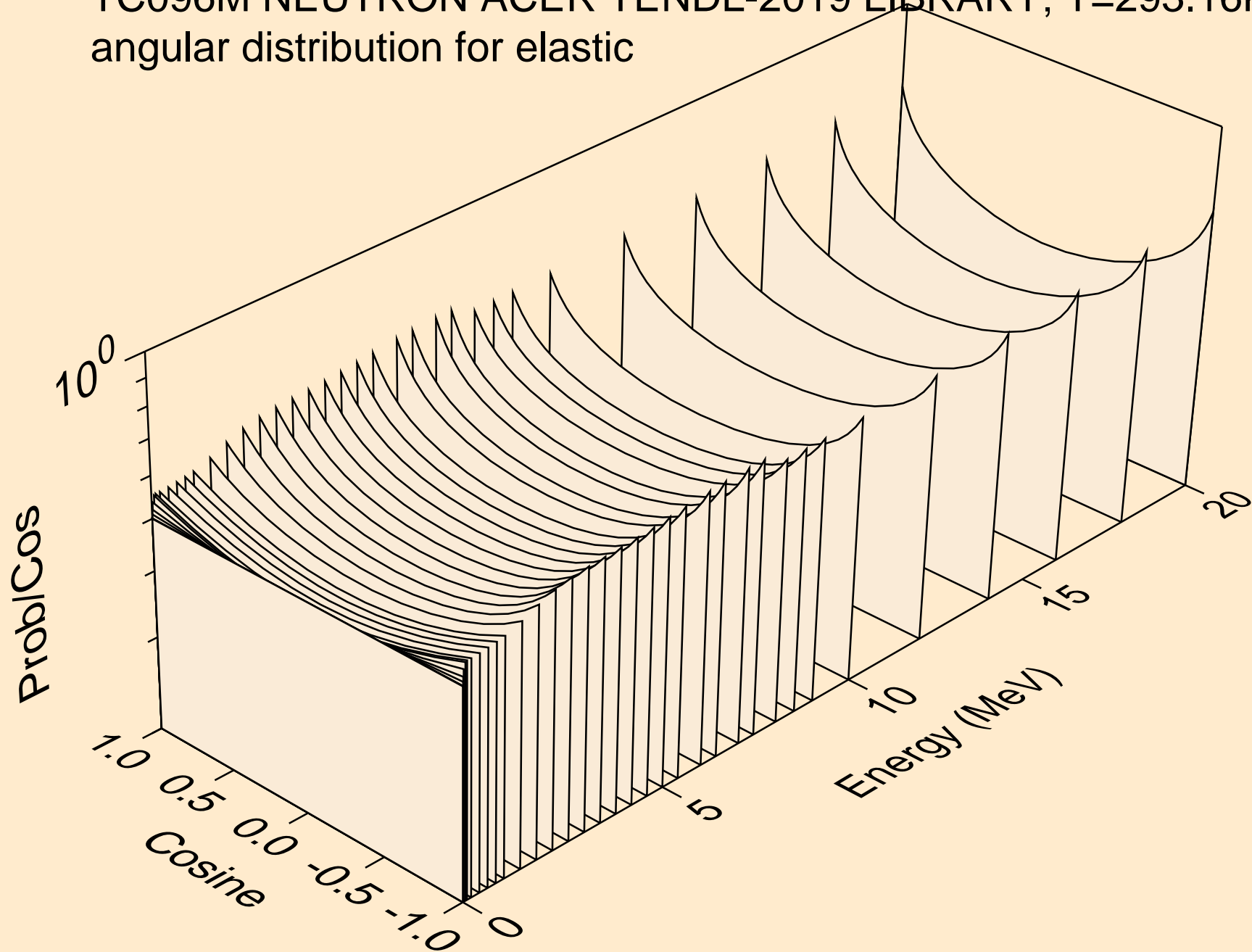

TC096M NEUTRON ACER TENDL-2019 LIBRARY; T=293.16K
angular distribution for elastic

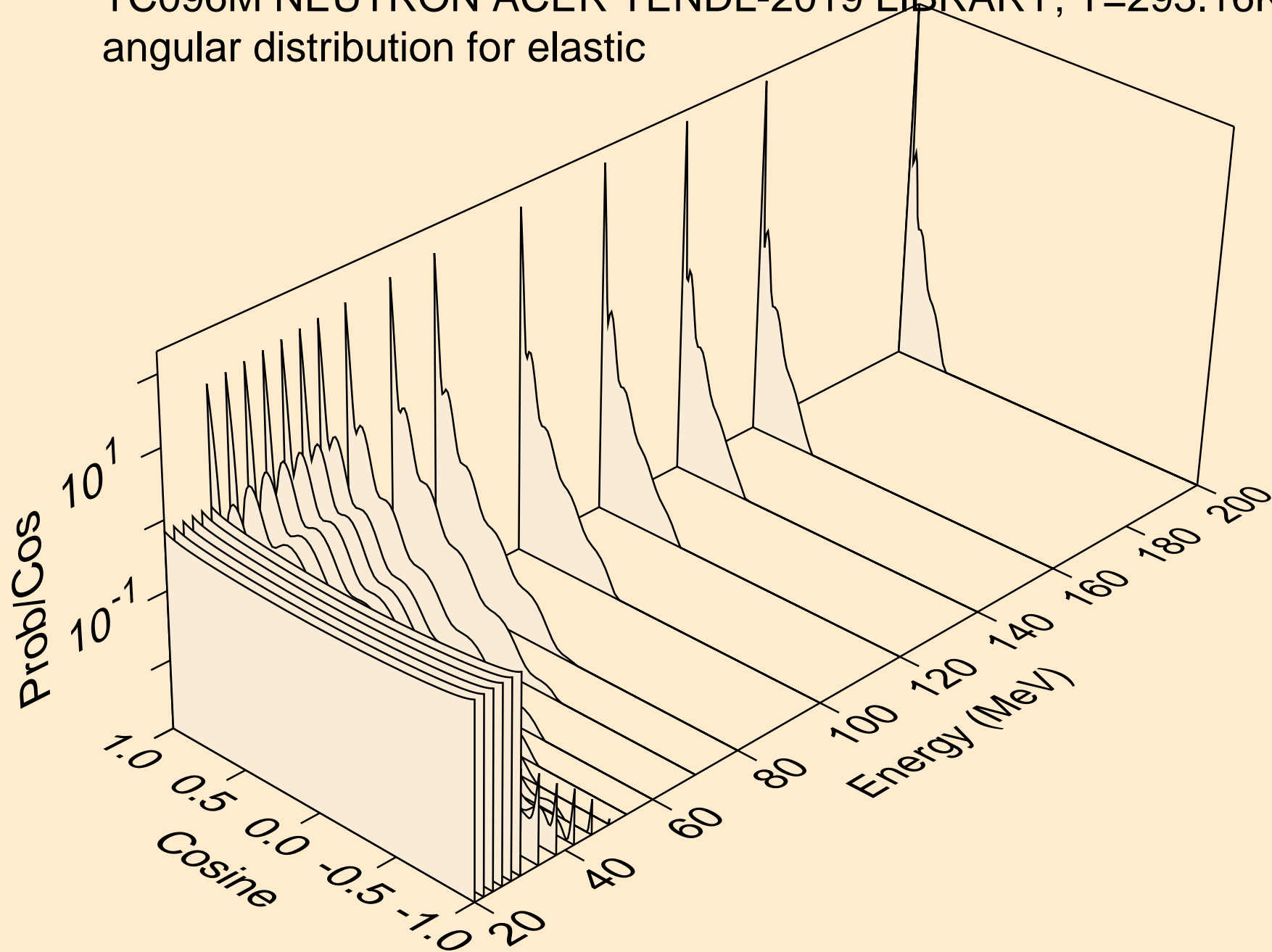

TC096M NEUTRON ACER TENDL-2019 LIBRARY; T=293.16K
angular distribution for (n,n*1)

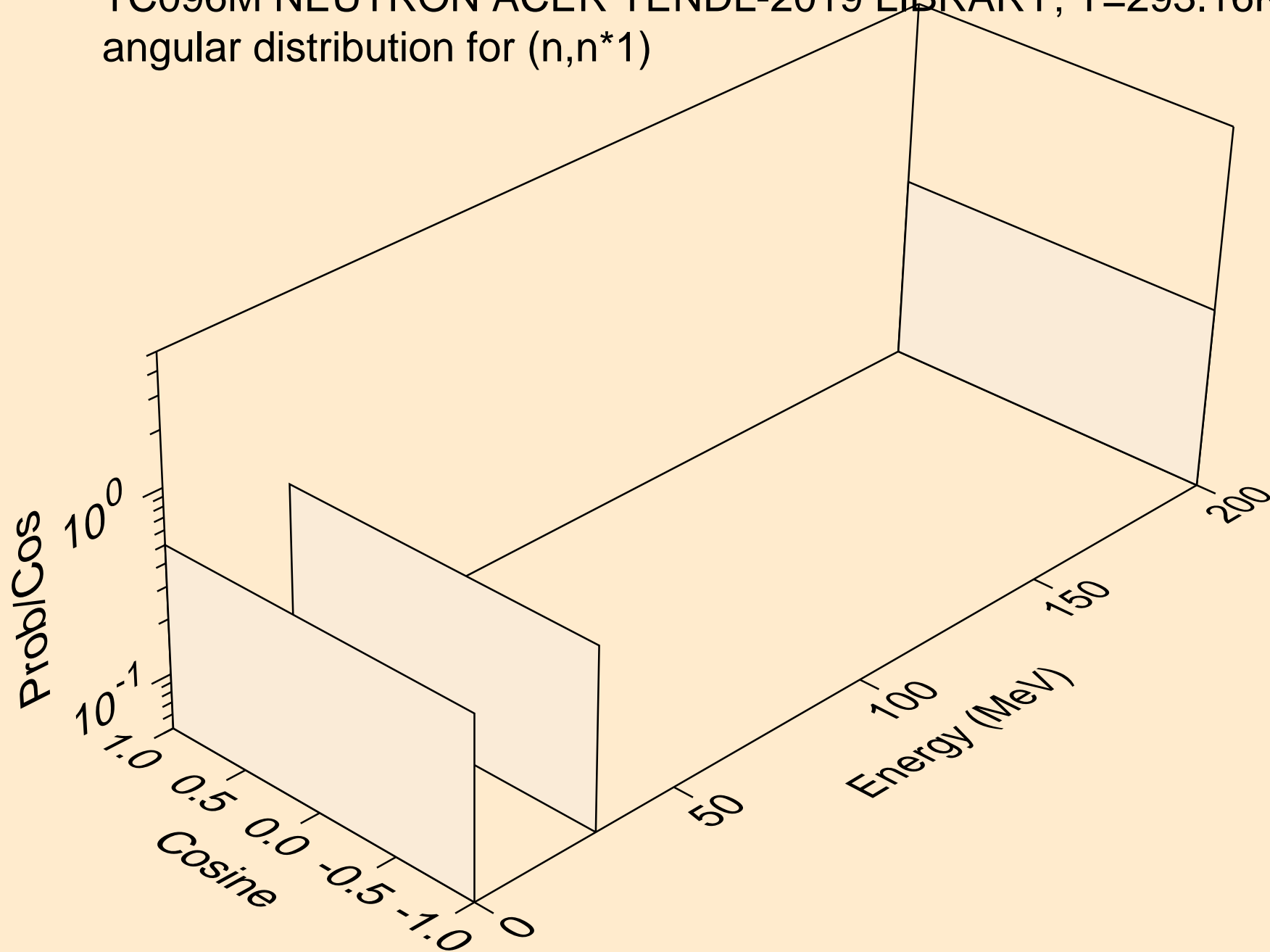

TC096M NEUTRON ACER TENDL-2019 LIBRARY; T=293.16K
angular distribution for (n,n*2)

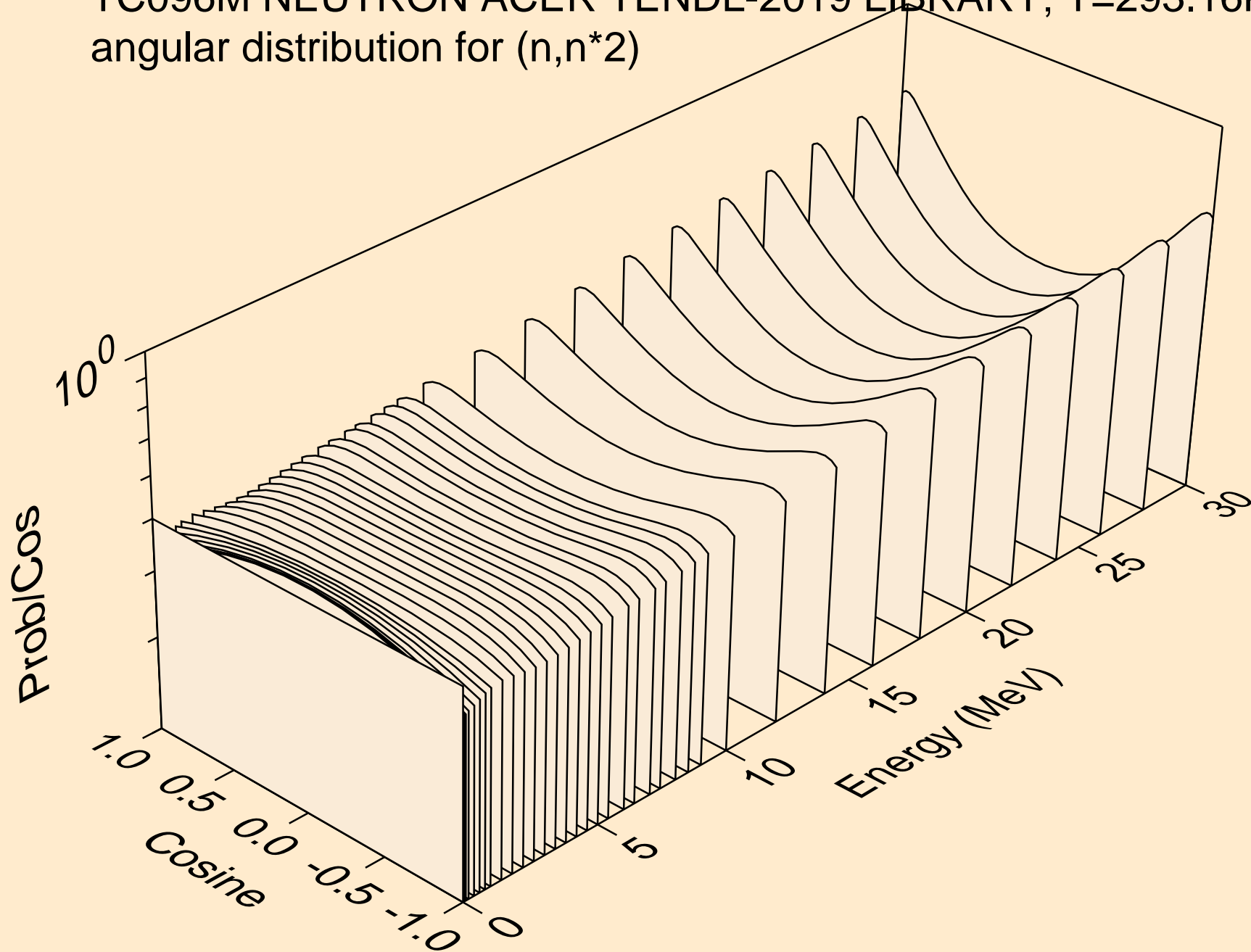

TC096M NEUTRON ACER TENDL-2019 LIBRARY; T=293.16K
angular distribution for (n,n*3)

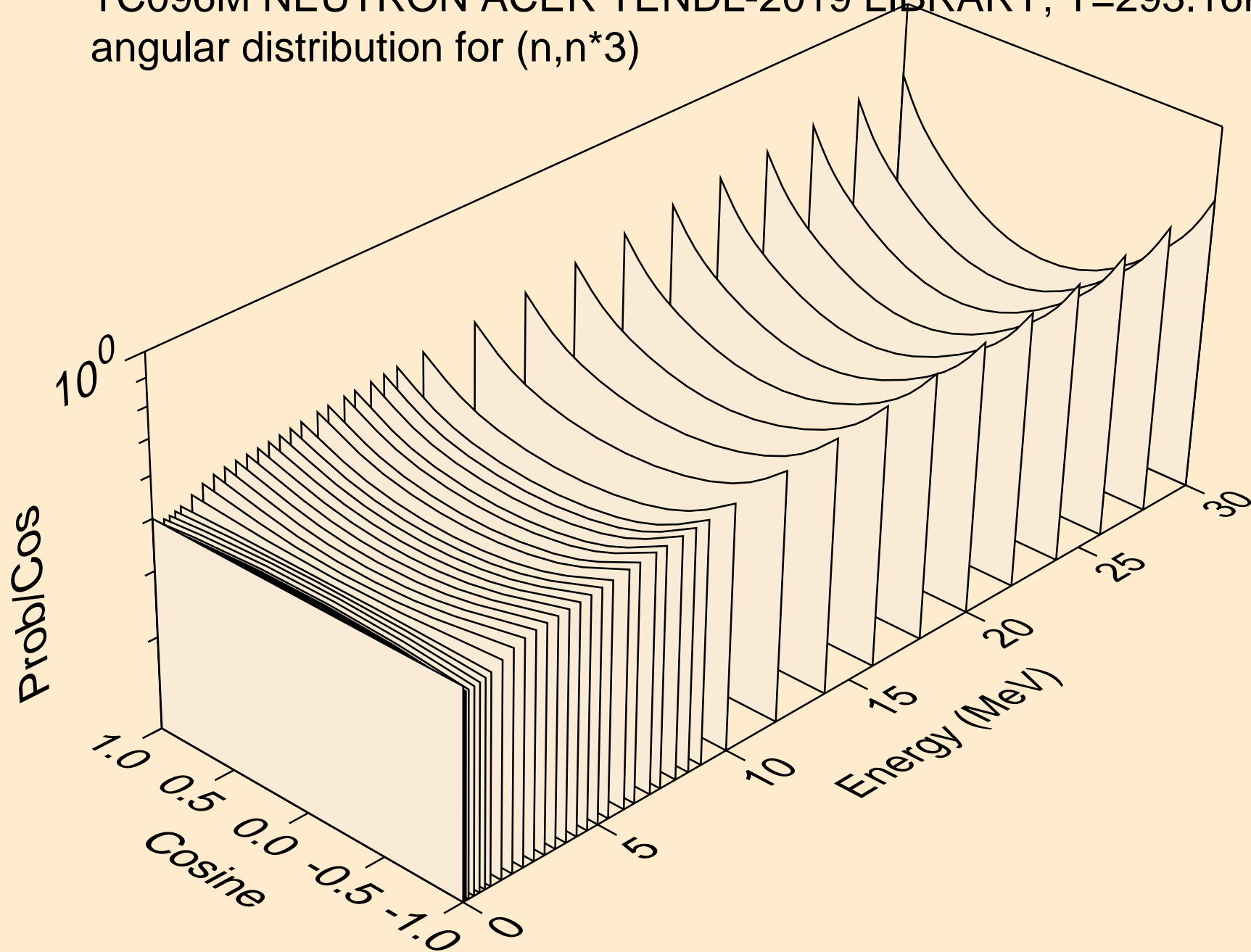

TC096M NEUTRON ACER TENDL-2019 LIBRARY; T=293.16K
angular distribution for (n,n*4)

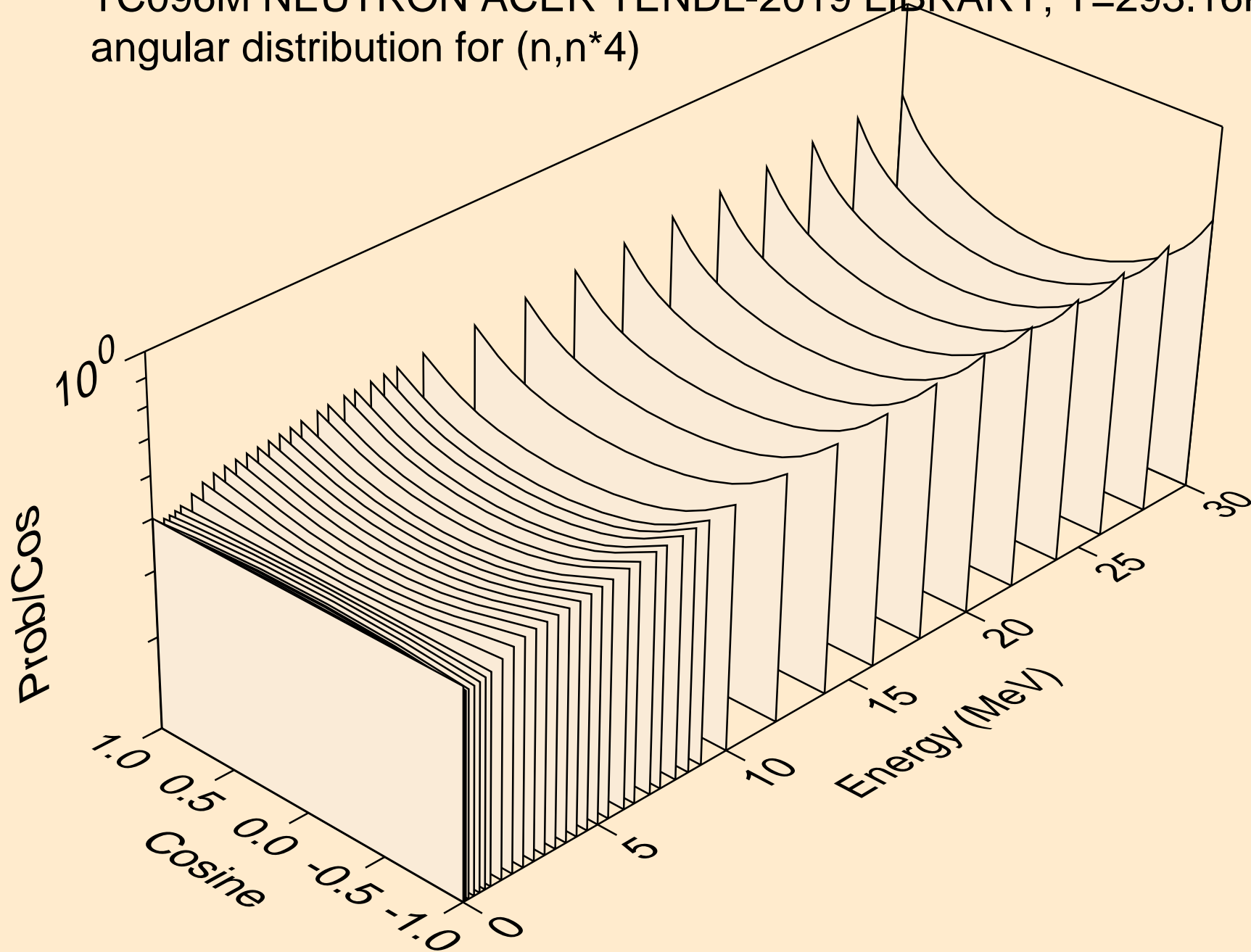

TC096M NEUTRON ACER TENDL-2019 LIBRARY; T=293.16K
angular distribution for (n,n*5)

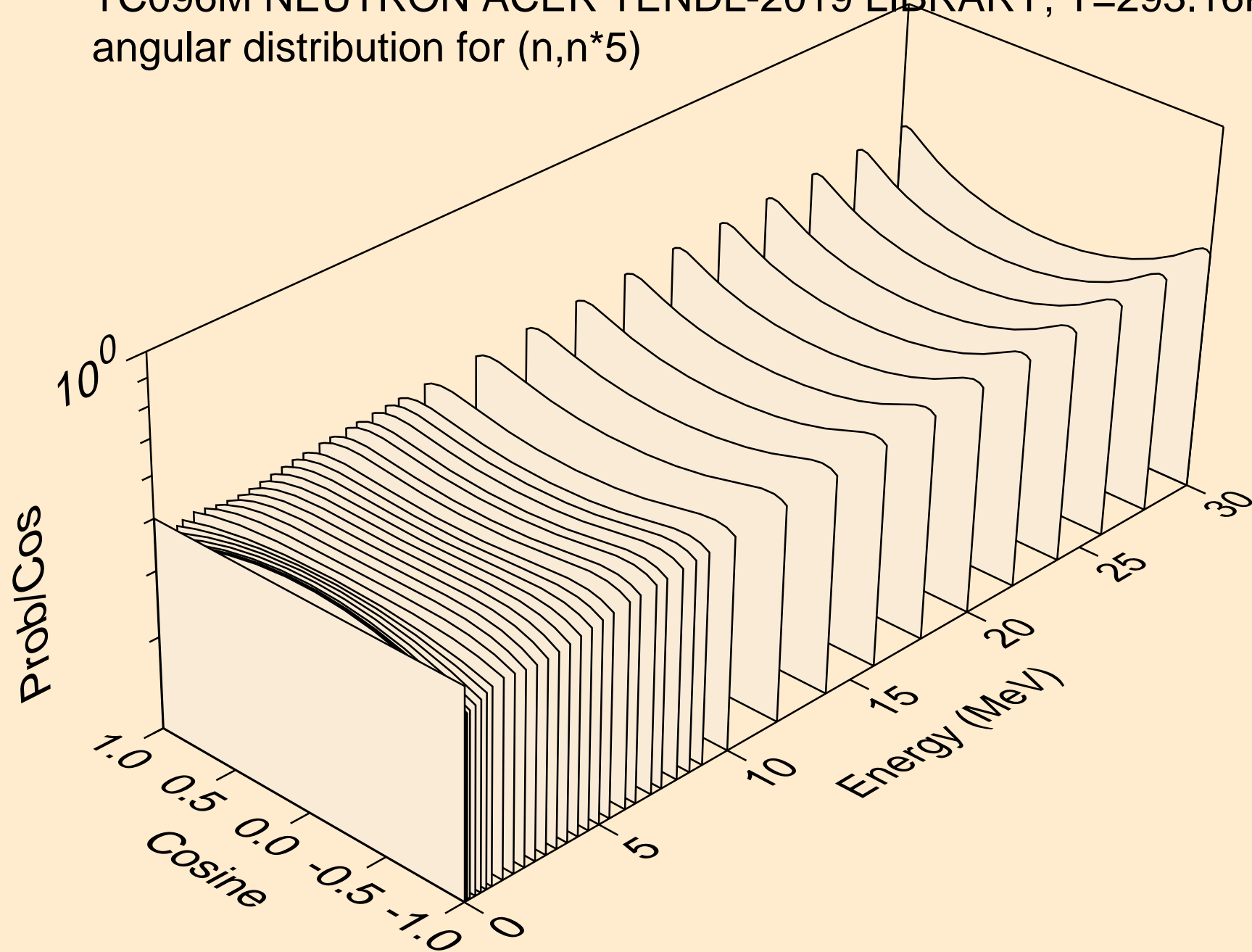

TC096M NEUTRON ACER TENDL-2019 LIBRARY; T=293.16K
angular distribution for (n,n*6)

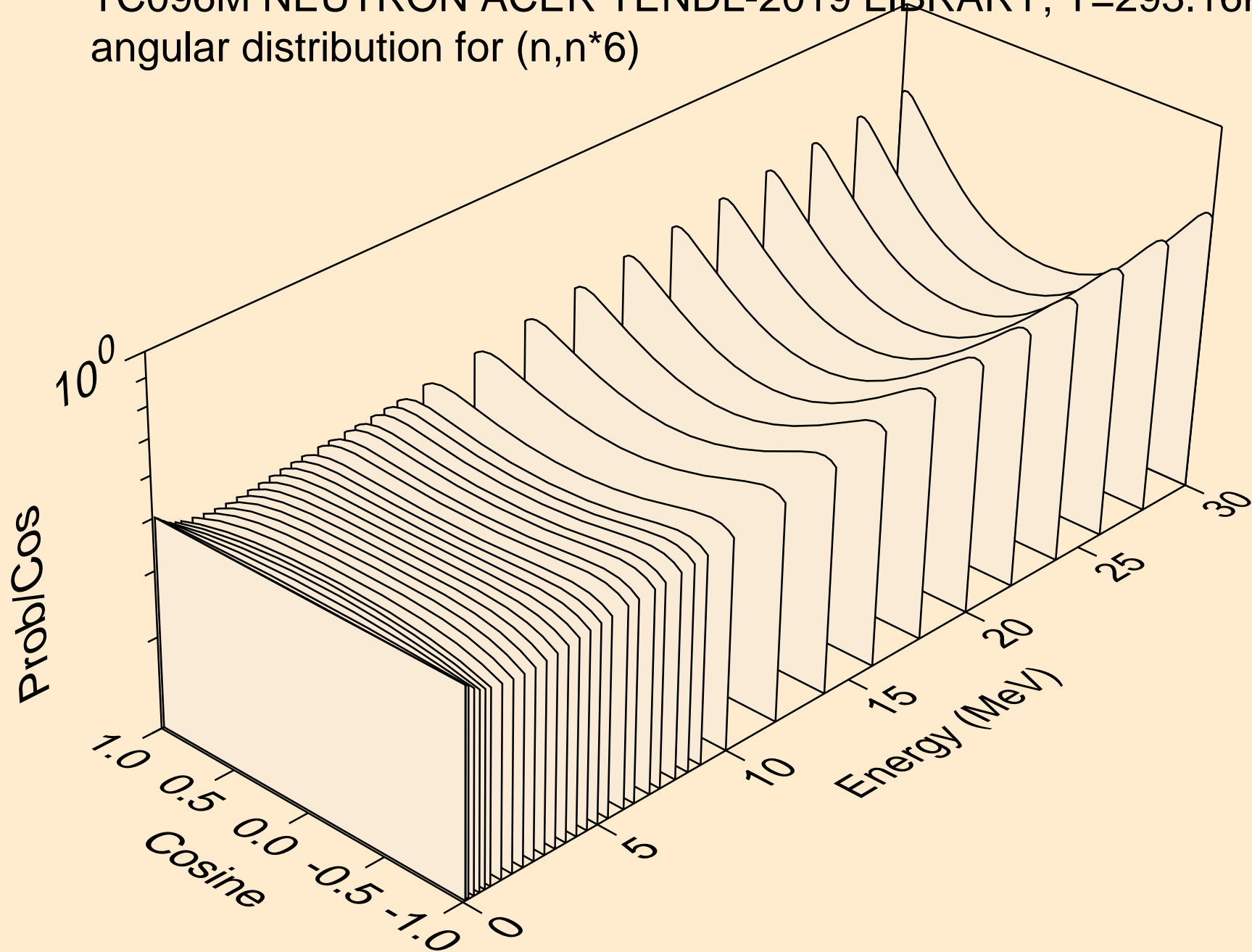

TC096M NEUTRON ACER TENDL-2019 LIBRARY; T=293.16K
angular distribution for (n,n*7)

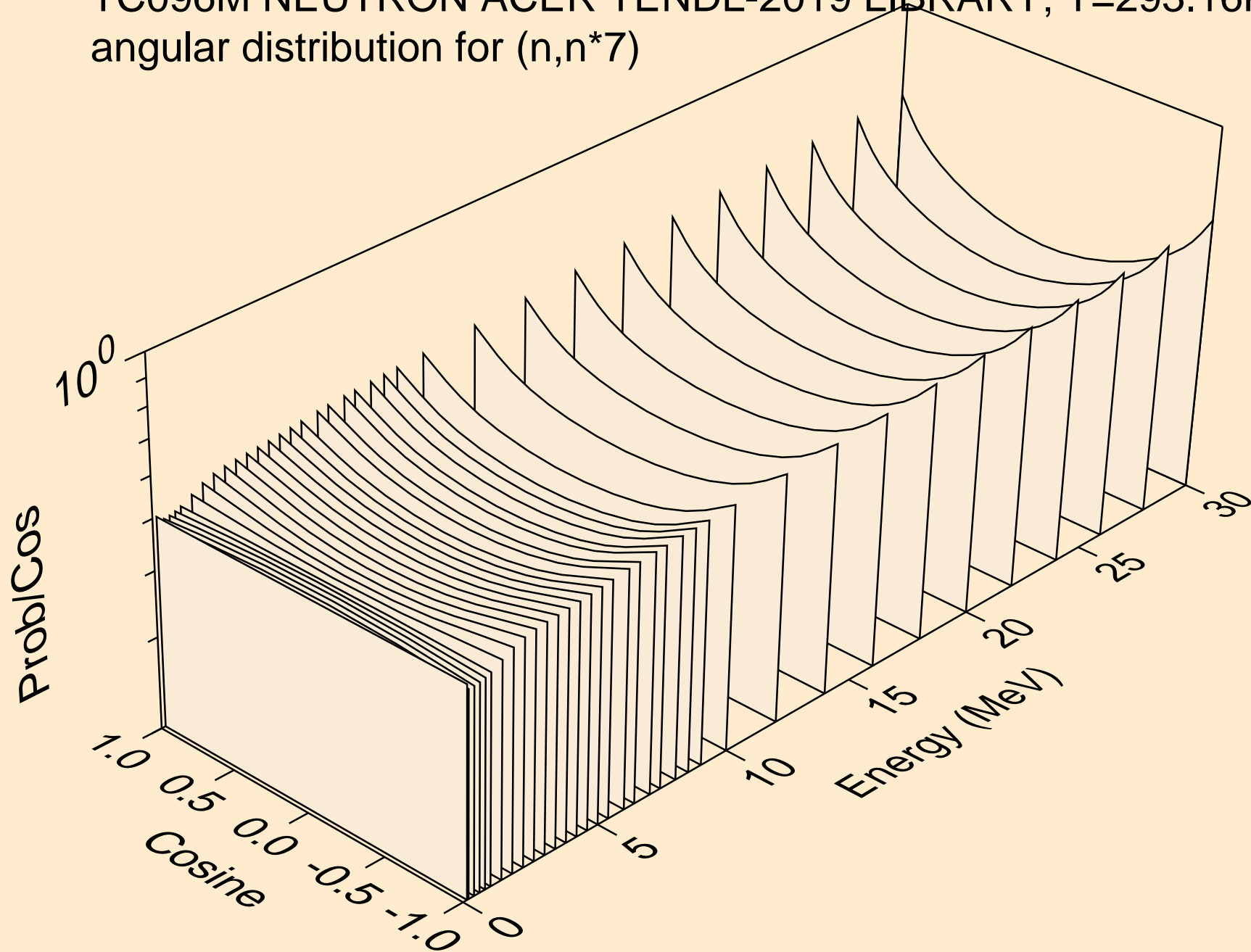

TC096M NEUTRON ACER TENDL-2019 LIBRARY; T=293.16K
angular distribution for (n,n*8)

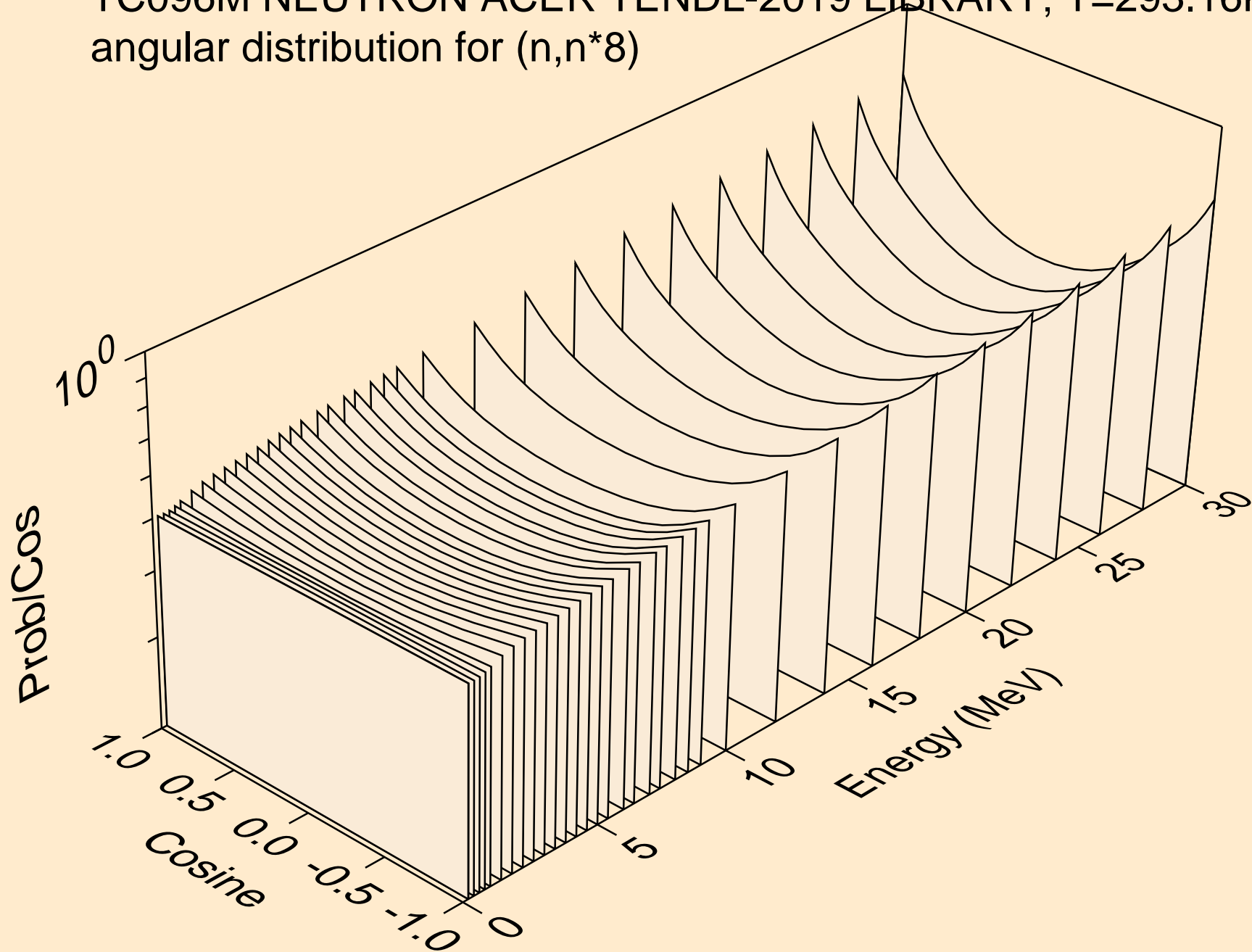

TC096M NEUTRON ACER TENDL-2019 LIBRARY; T=293.16K
angular distribution for (n,n*9)

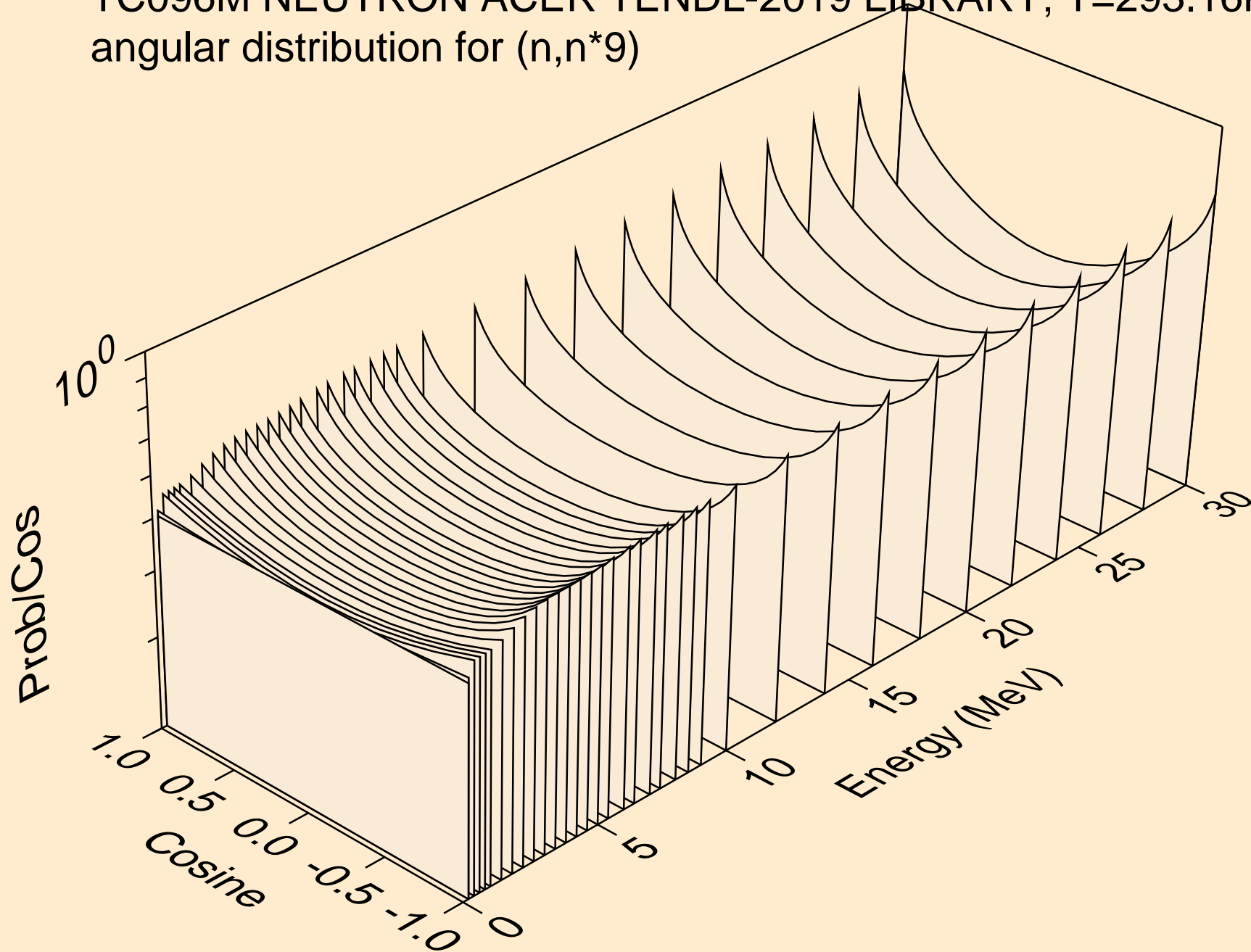

TC096M NEUTRON ACER TENDL-2019 LIBRARY; T=293.16K
angular distribution for (n,n*10)

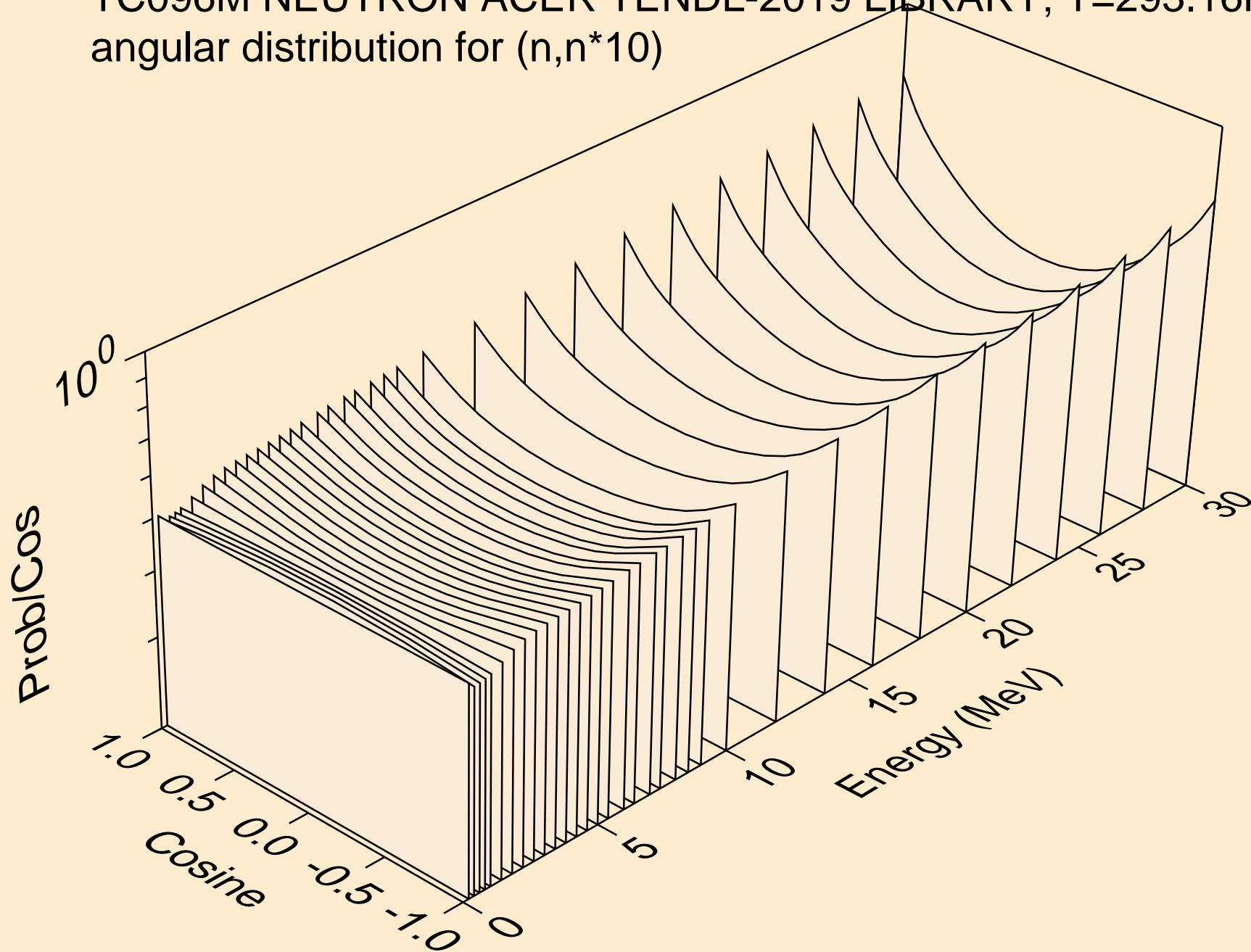

TC096M NEUTRON ACER TENDL-2019 LIBRARY; T=293.16K
angular distribution for (n,n*11)

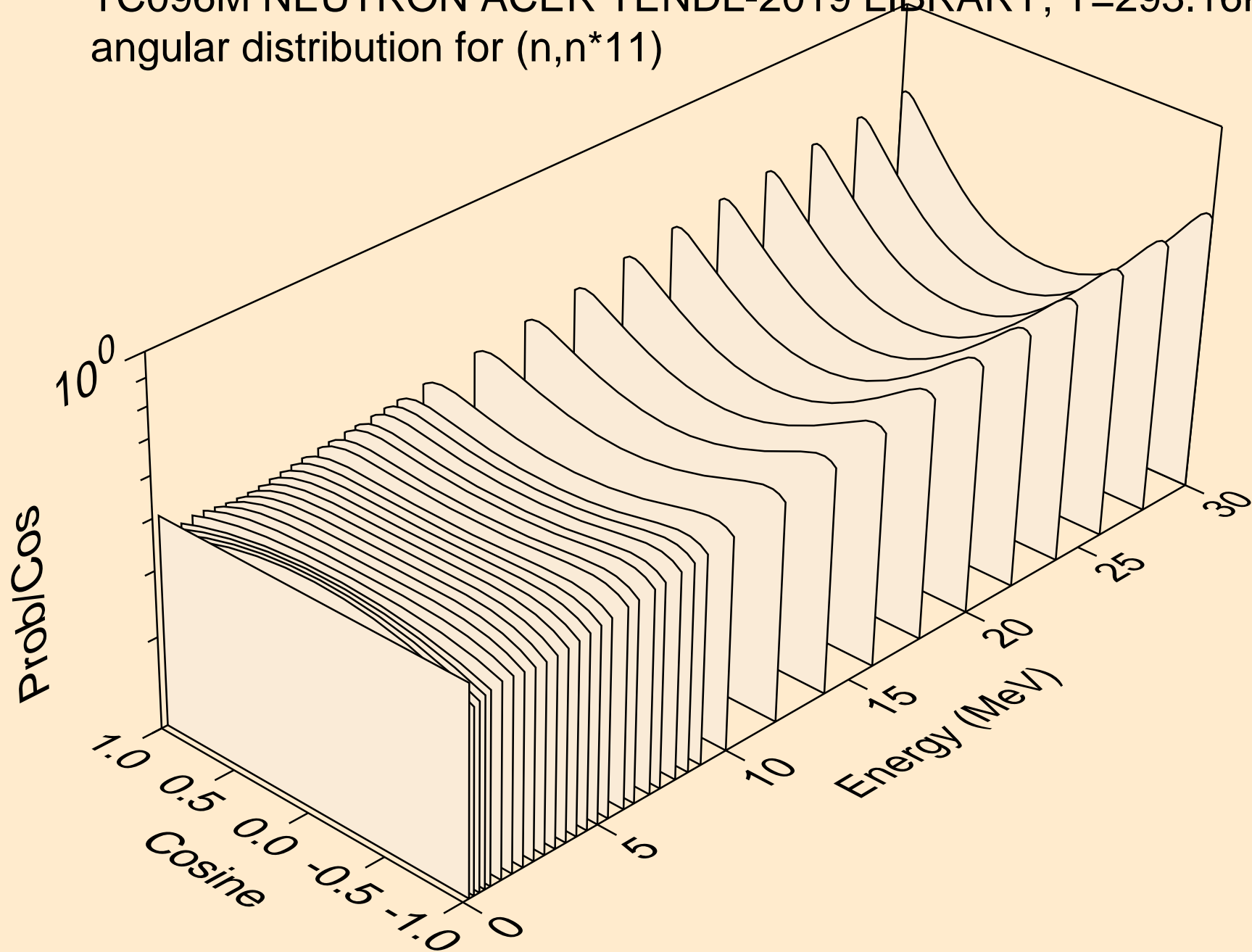

TC096M NEUTRON ACER TENDL-2019 LIBRARY; T=293.16K
angular distribution for (n,n*12)

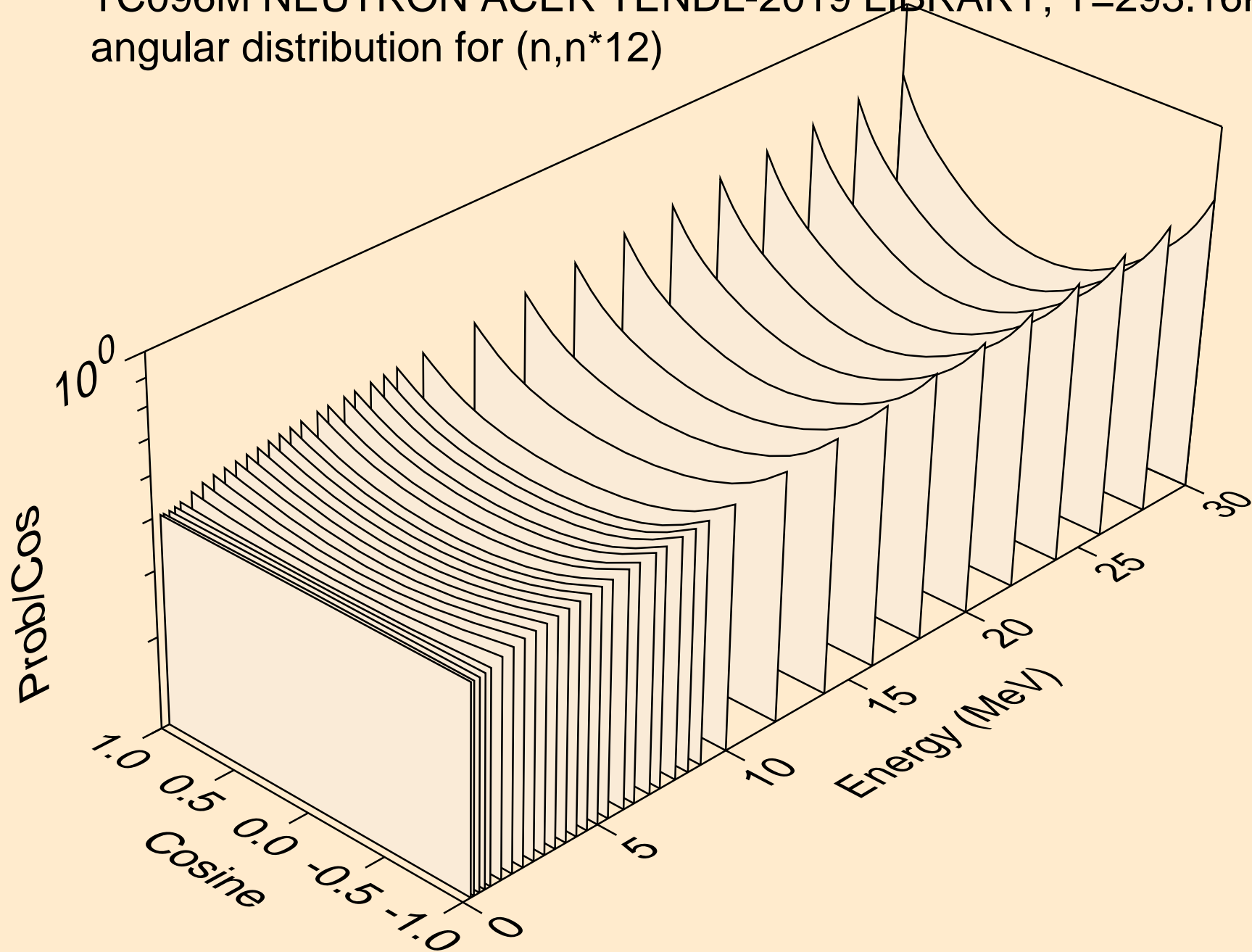

TC096M NEUTRON ACER TENDL-2019 LIBRARY; T=293.16K
angular distribution for (n,n*13)

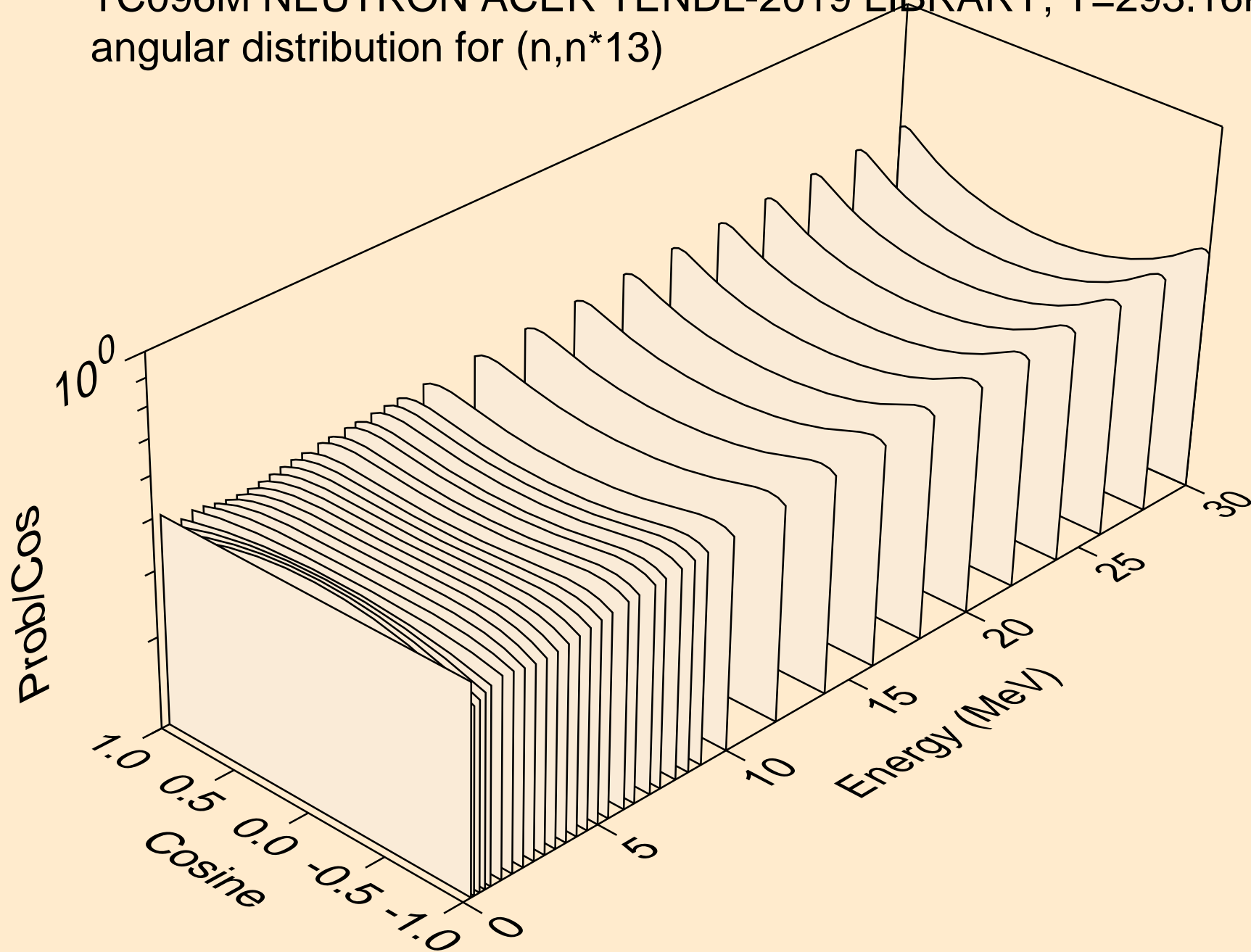

TC096M NEUTRON ACER TENDL-2019 LIBRARY; T=293.16K
angular distribution for (n,n*14)

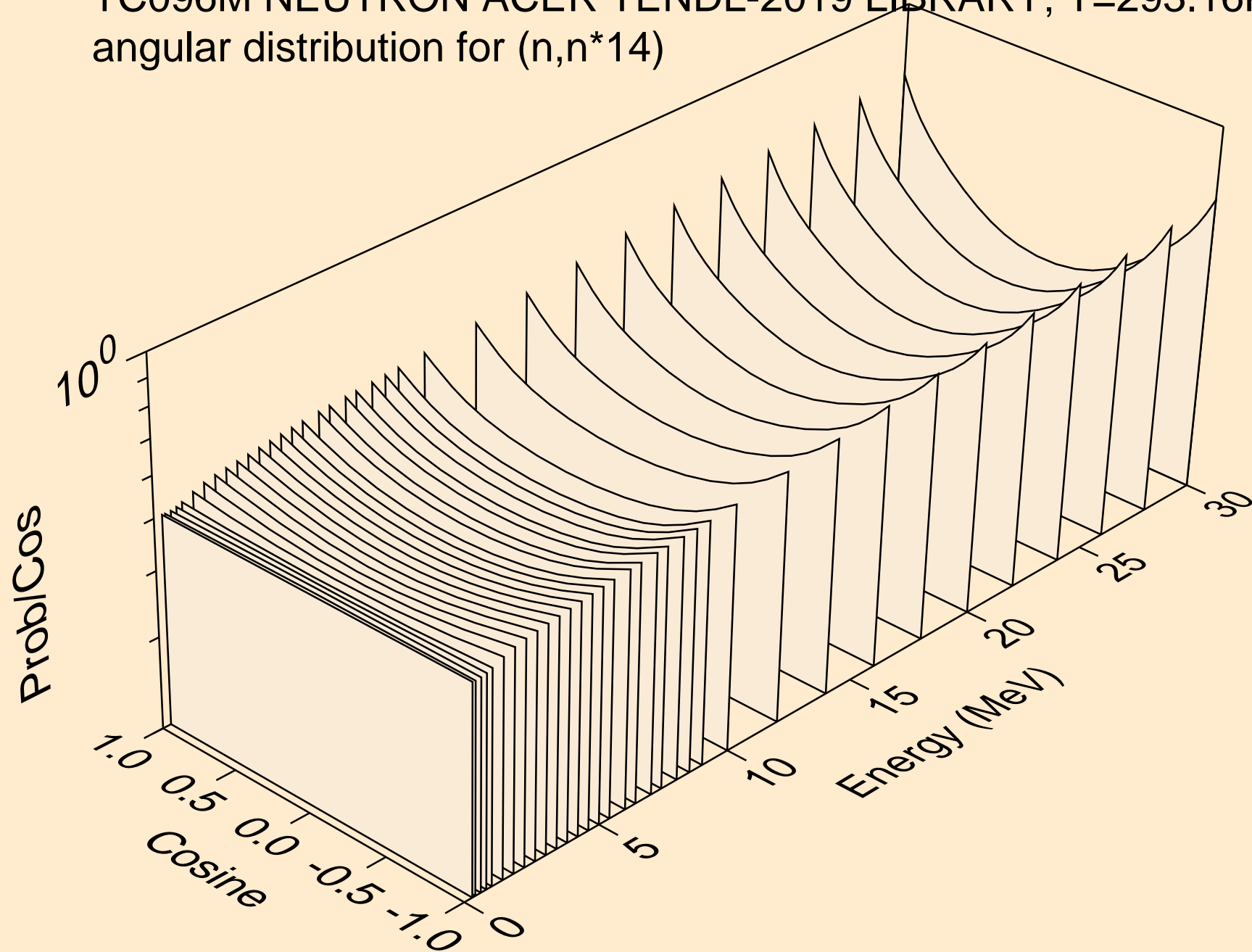

TC096M NEUTRON ACER TENDL-2019 LIBRARY; T=293.16K
angular distribution for (n,n*15)

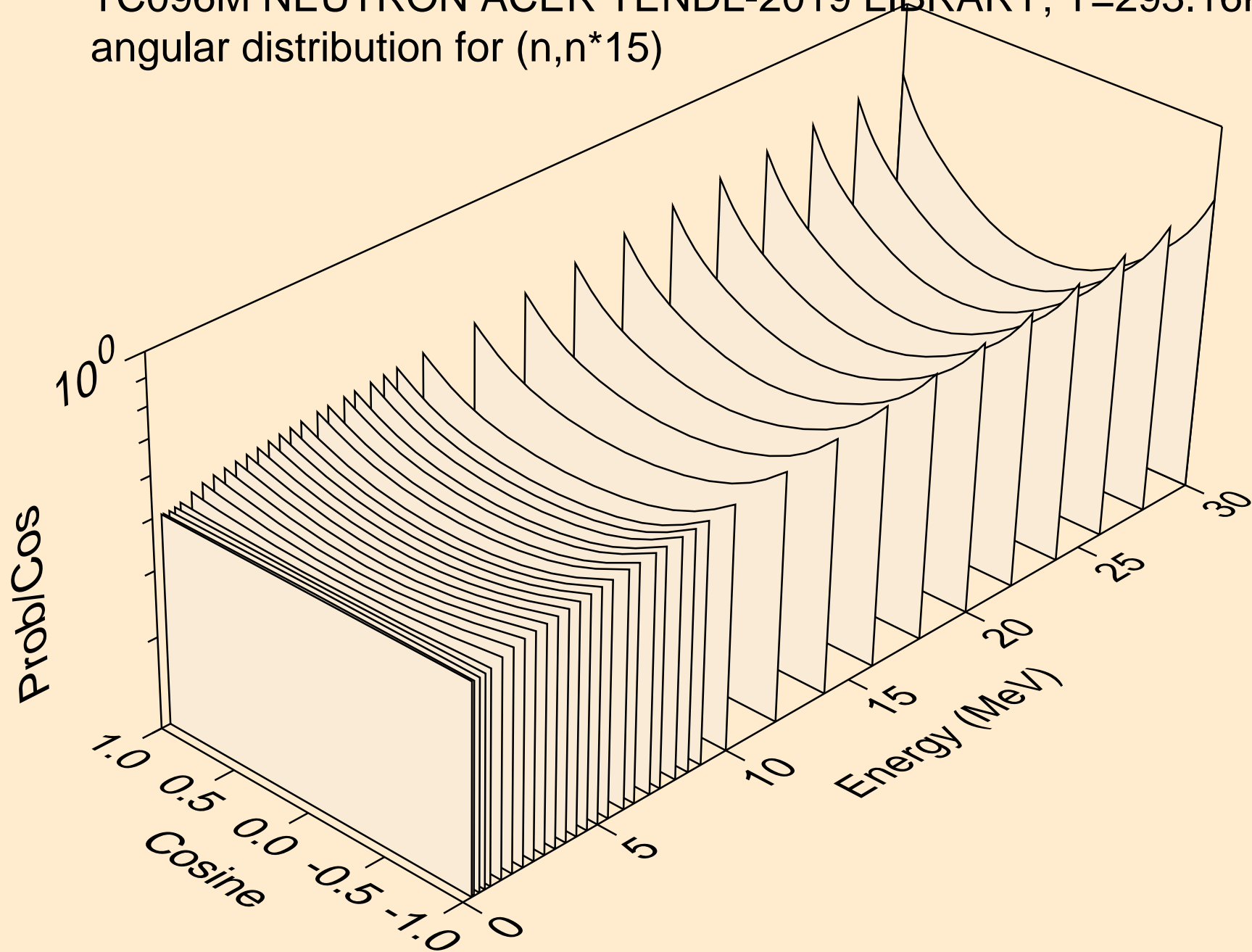

TC096M NEUTRON ACER TENDL-2019 LIBRARY; T=293.16K
angular distribution for (n,n*16)

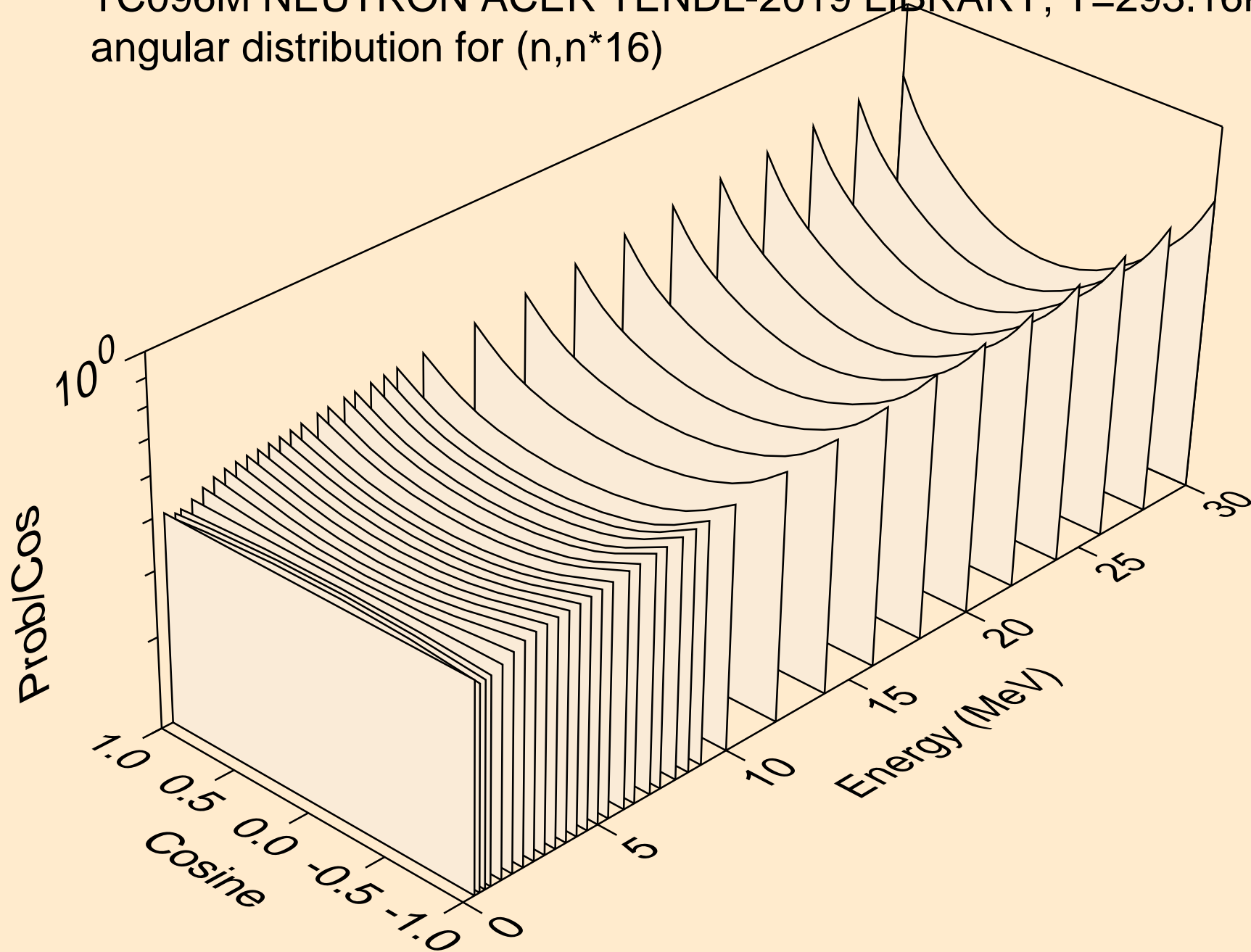

TC096M NEUTRON ACER TENDL-2019 LIBRARY; T=293.16K
angular distribution for (n,n*17)

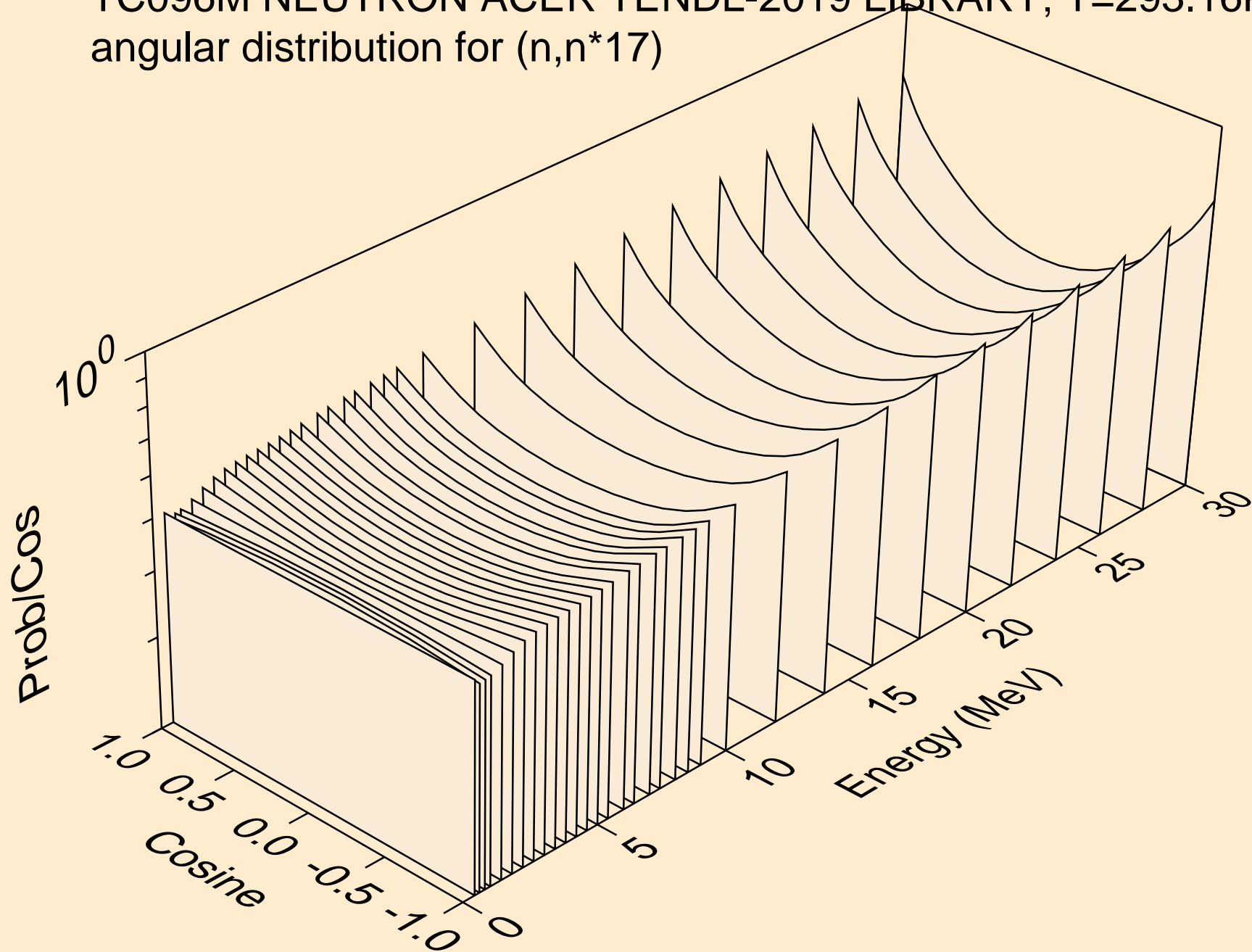

TC096M NEUTRON ACER TENDL-2019 LIBRARY; T=293.16K
angular distribution for (n,n*18)

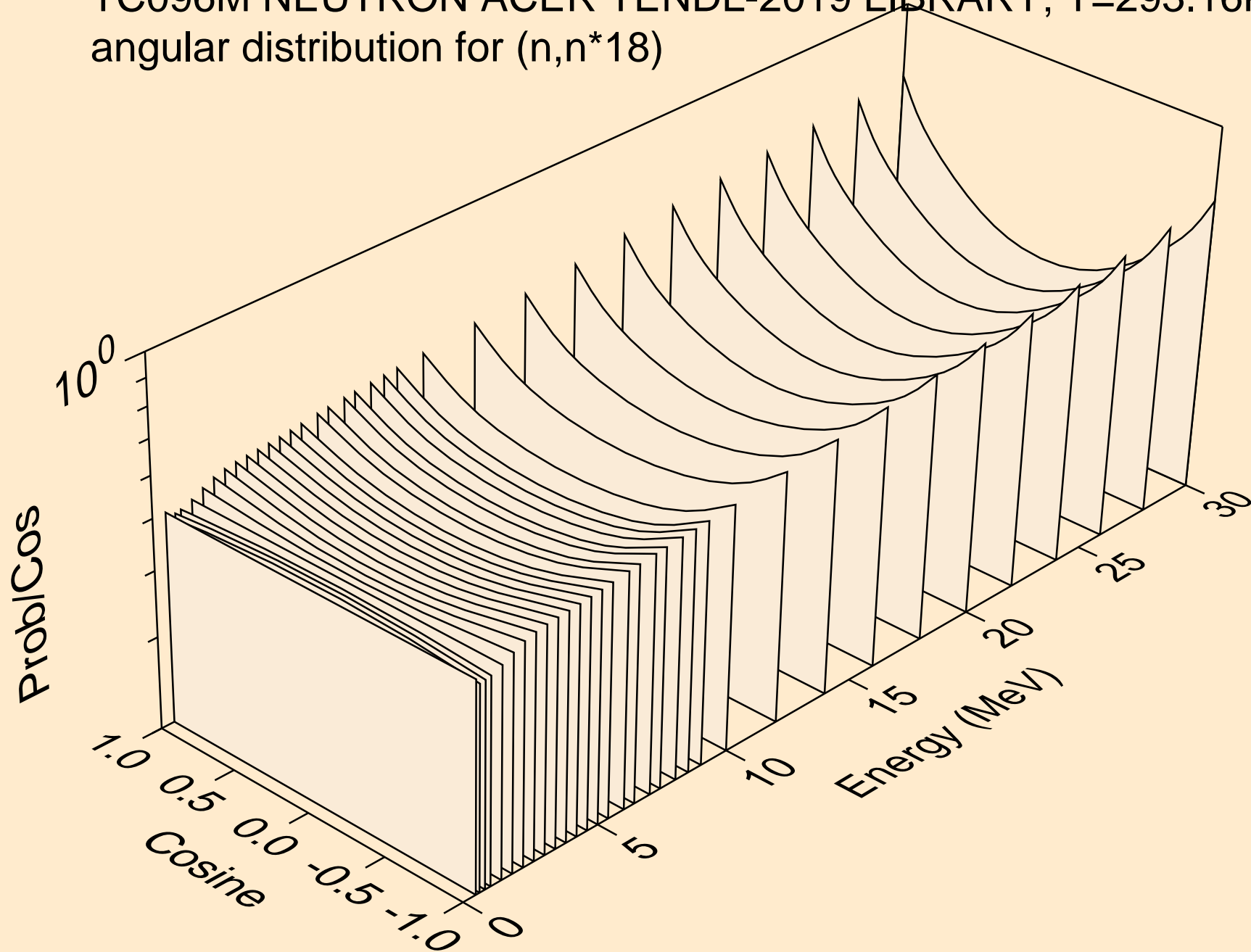

TC096M NEUTRON ACER TENDL-2019 LIBRARY; T=293.16K
angular distribution for (n,n*19)

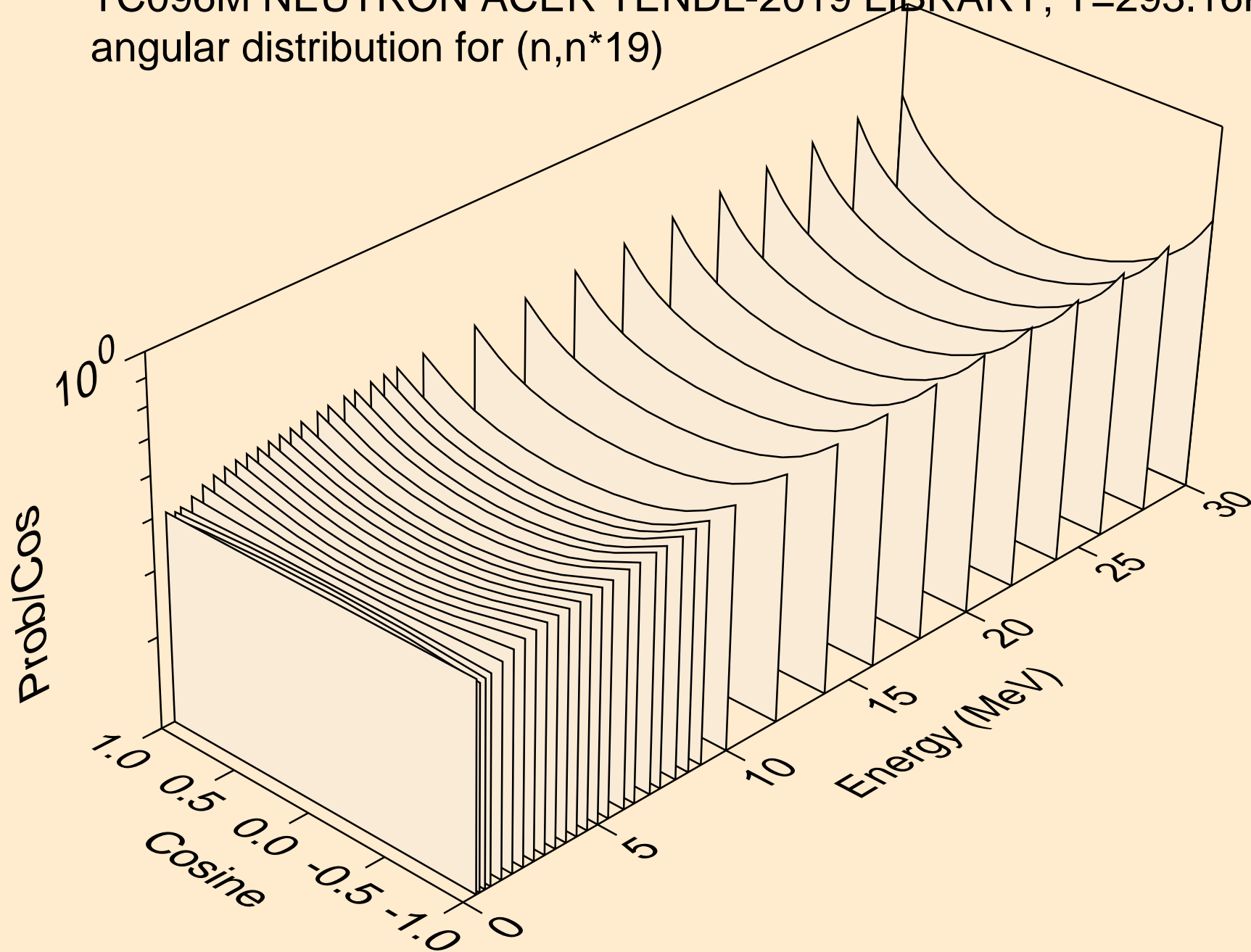

TC096M NEUTRON ACER TENDL-2019 LIBRARY; T=293.16K
angular distribution for (n,n*20)

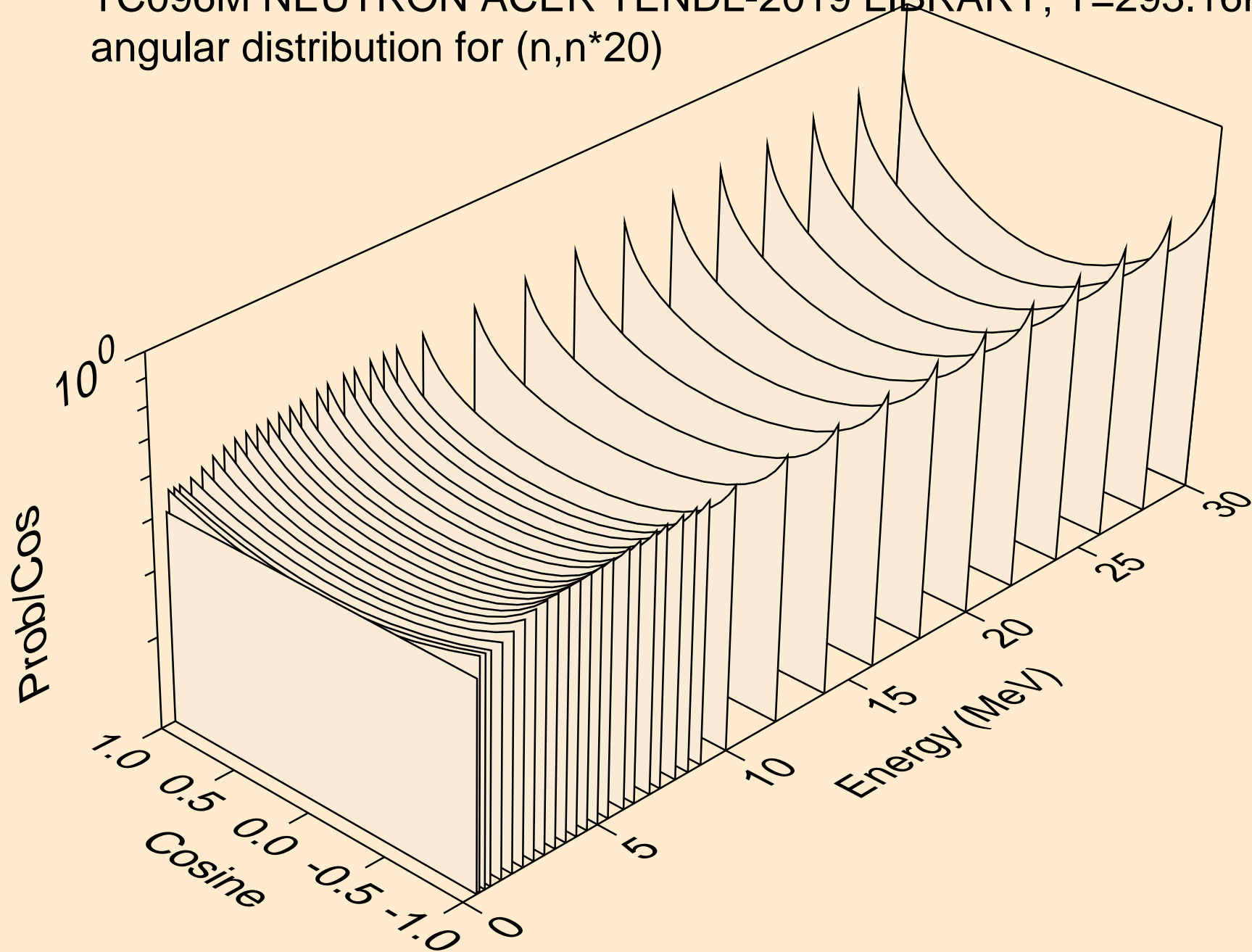

TC096M NEUTRON ACER TENDL-2019 LIBRARY; T=293.16K
angular distribution for (n,n*21)

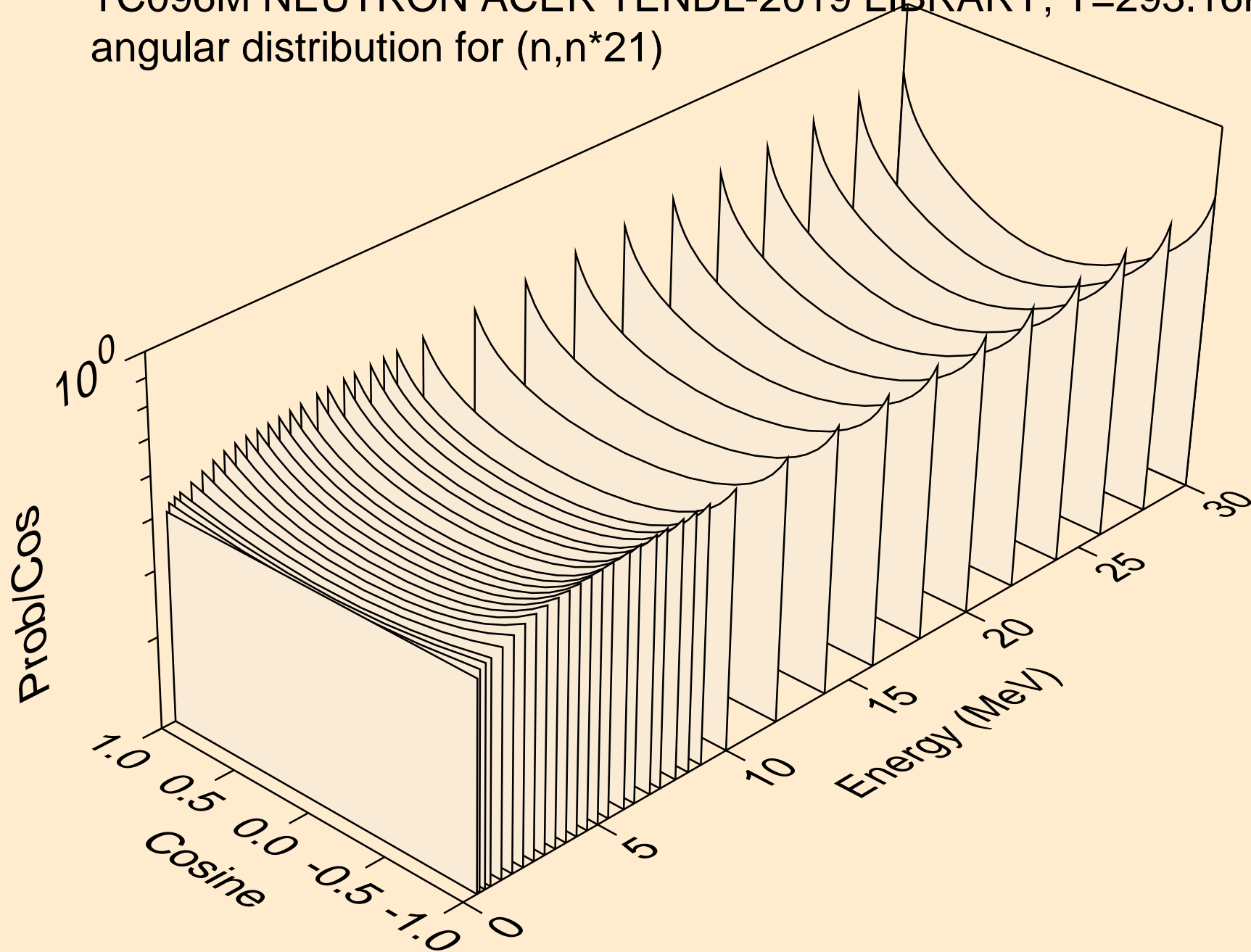

TC096M NEUTRON ACER TENDL-2019 LIBRARY; T=293.16K
angular distribution for (n,n*22)

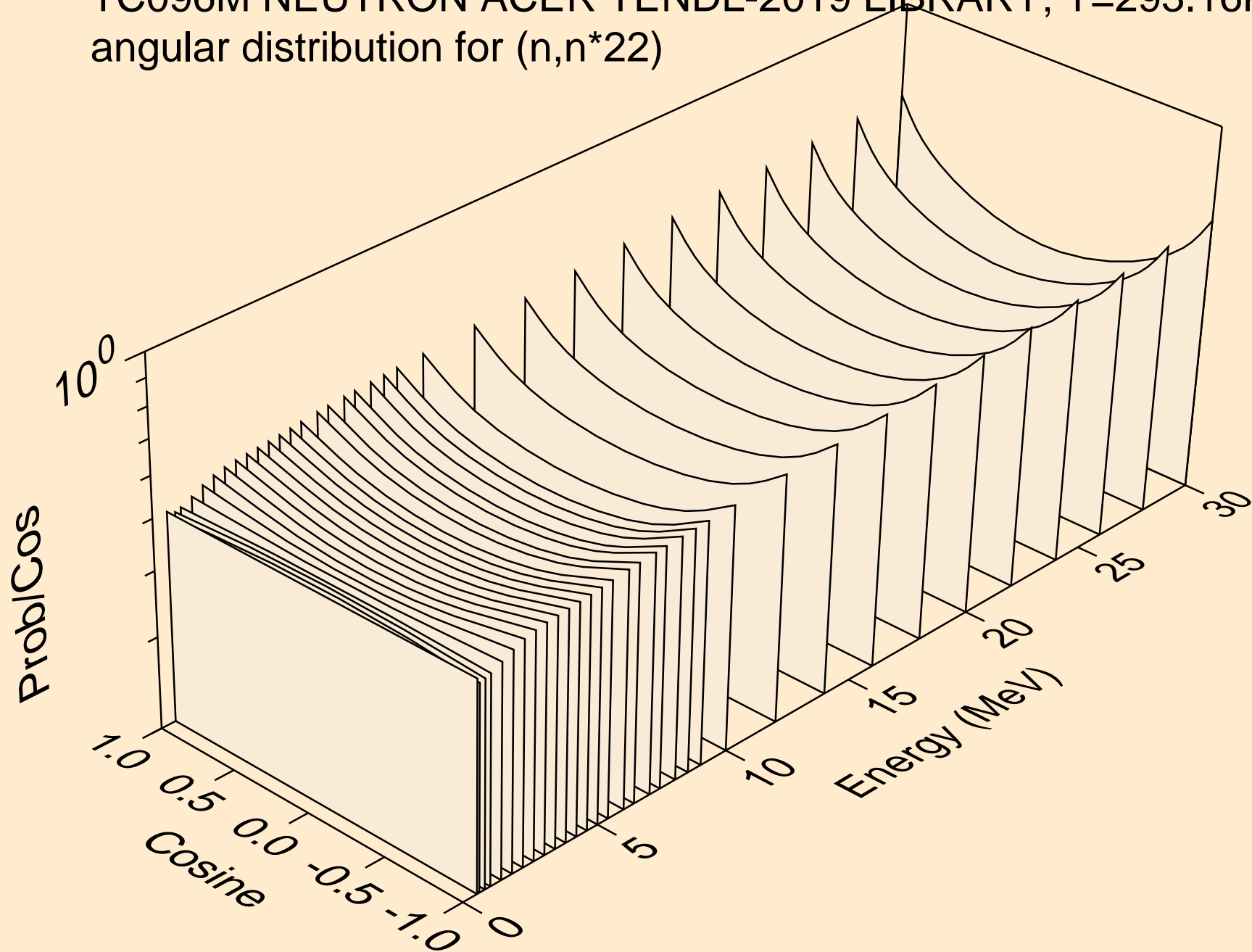

TC096M NEUTRON ACER TENDL-2019 LIBRARY; T=293.16K
angular distribution for (n,n*23)

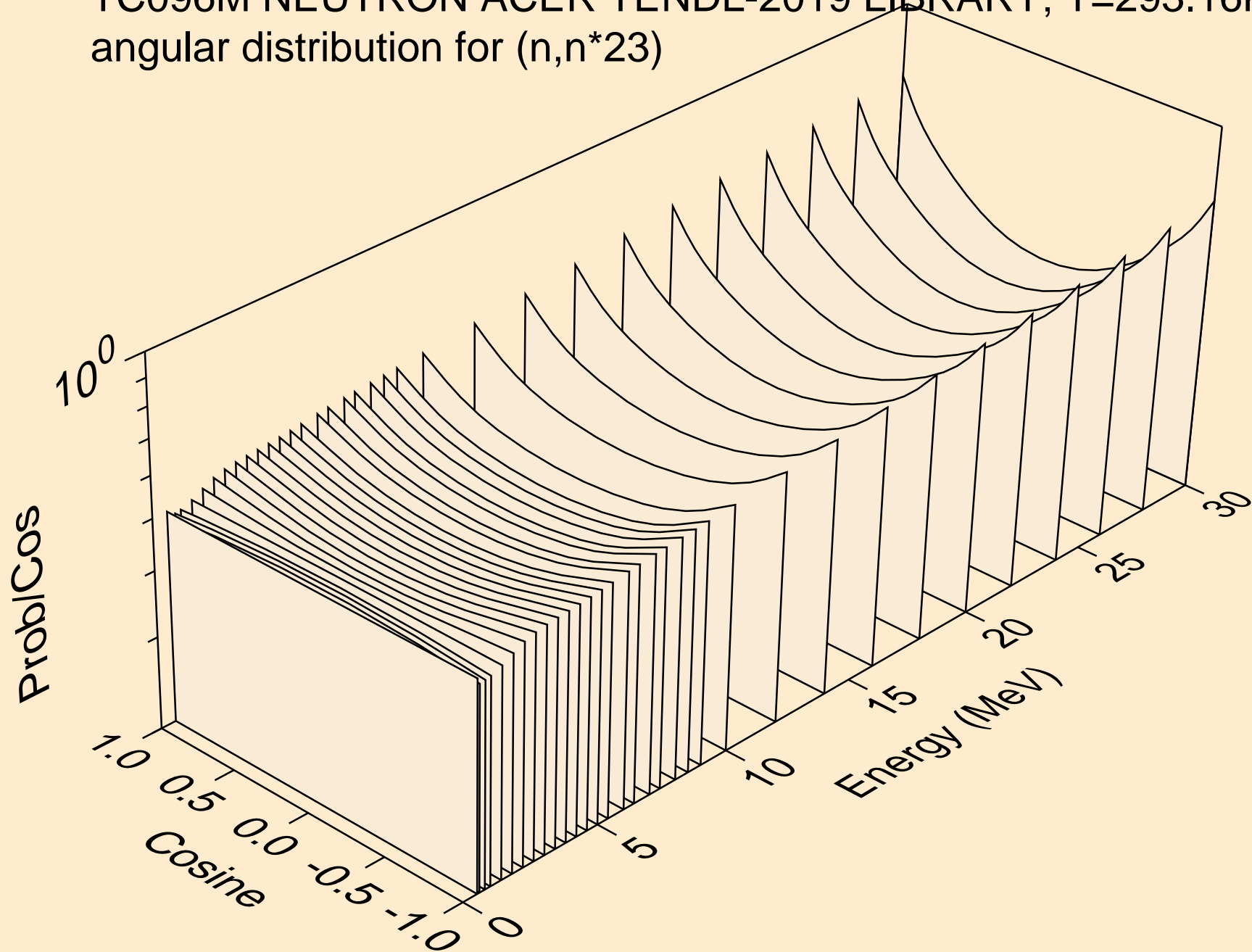

TC096M NEUTRON ACER TENDL-2019 LIBRARY; T=293.16K
angular distribution for (n,n*24)

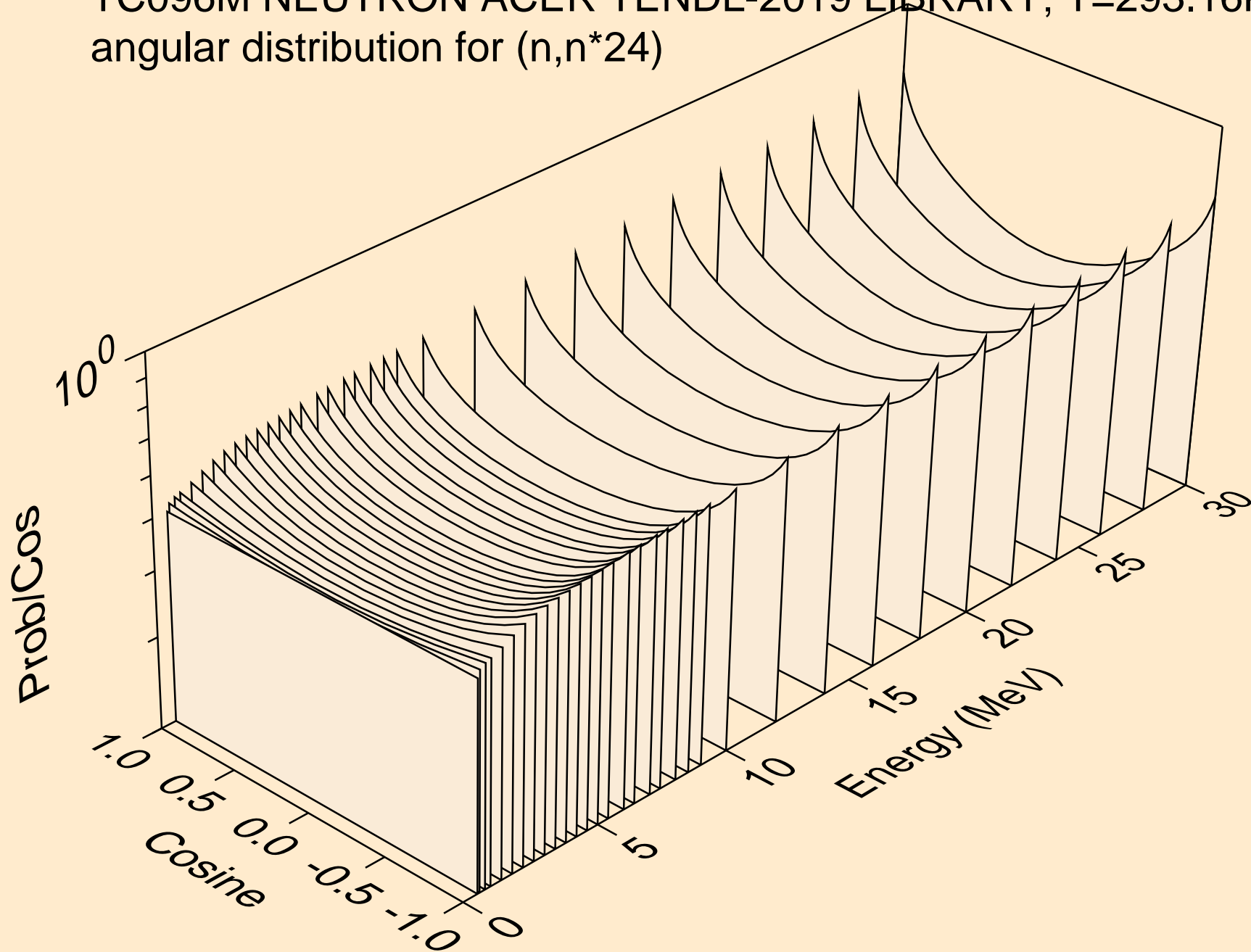

TC096M NEUTRON ACER TENDL-2019 LIBRARY; T=293.16K
angular distribution for (n,n*25)

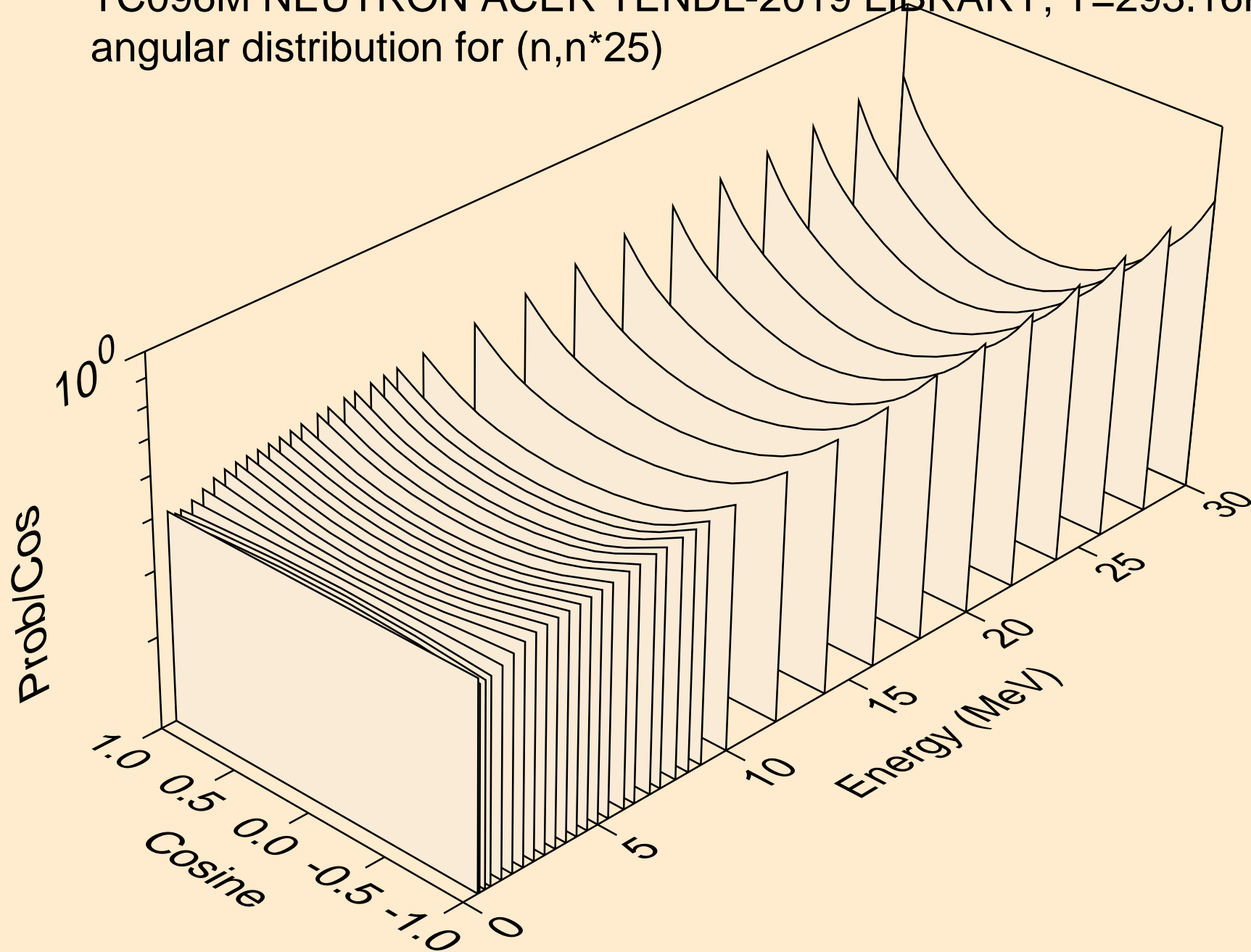

TC096M NEUTRON ACER TENDL-2019 LIBRARY; T=293.16K
angular distribution for (n,n*26)

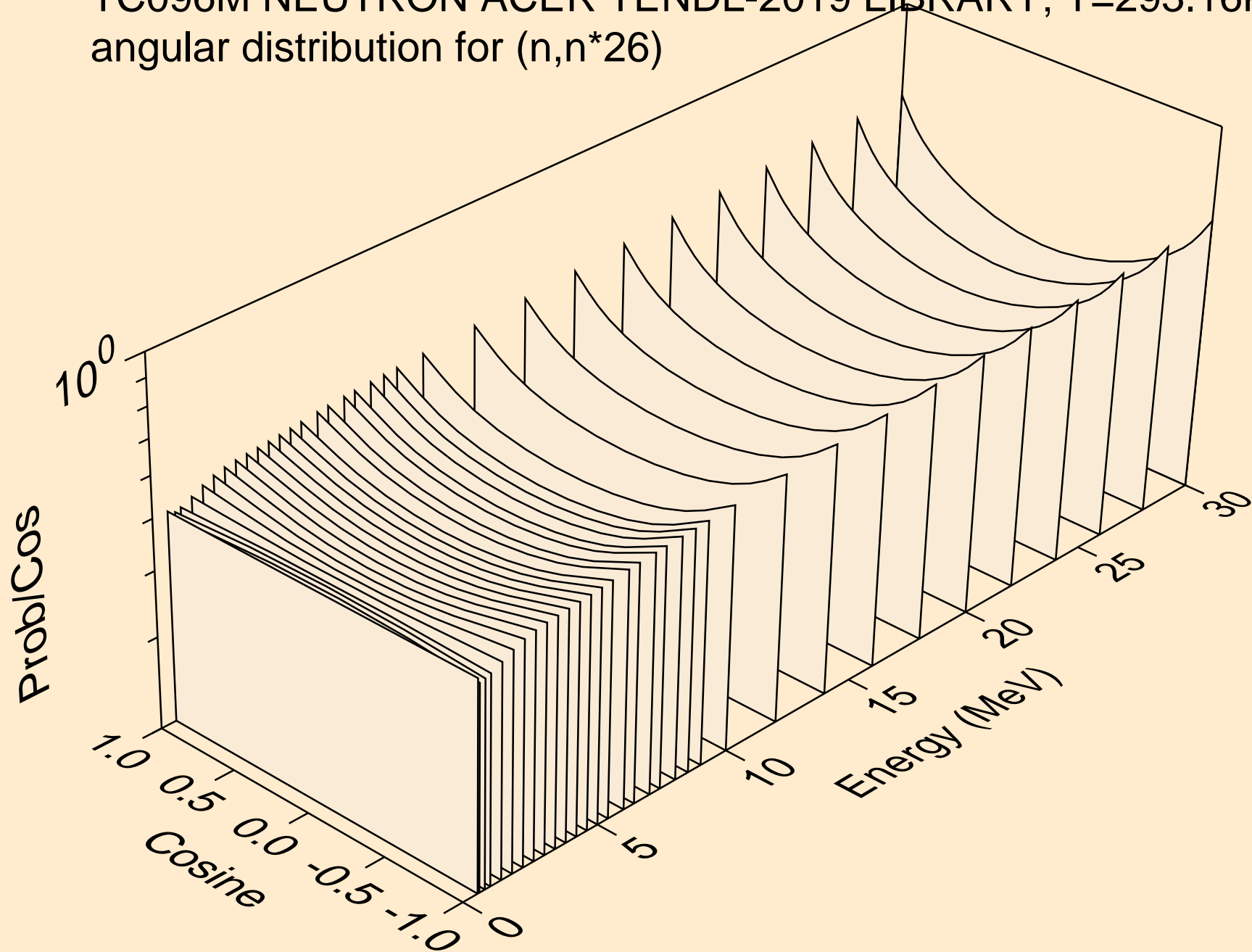

TC096M NEUTRON ACER TENDL-2019 LIBRARY; T=293.16K
angular distribution for (n,n*27)

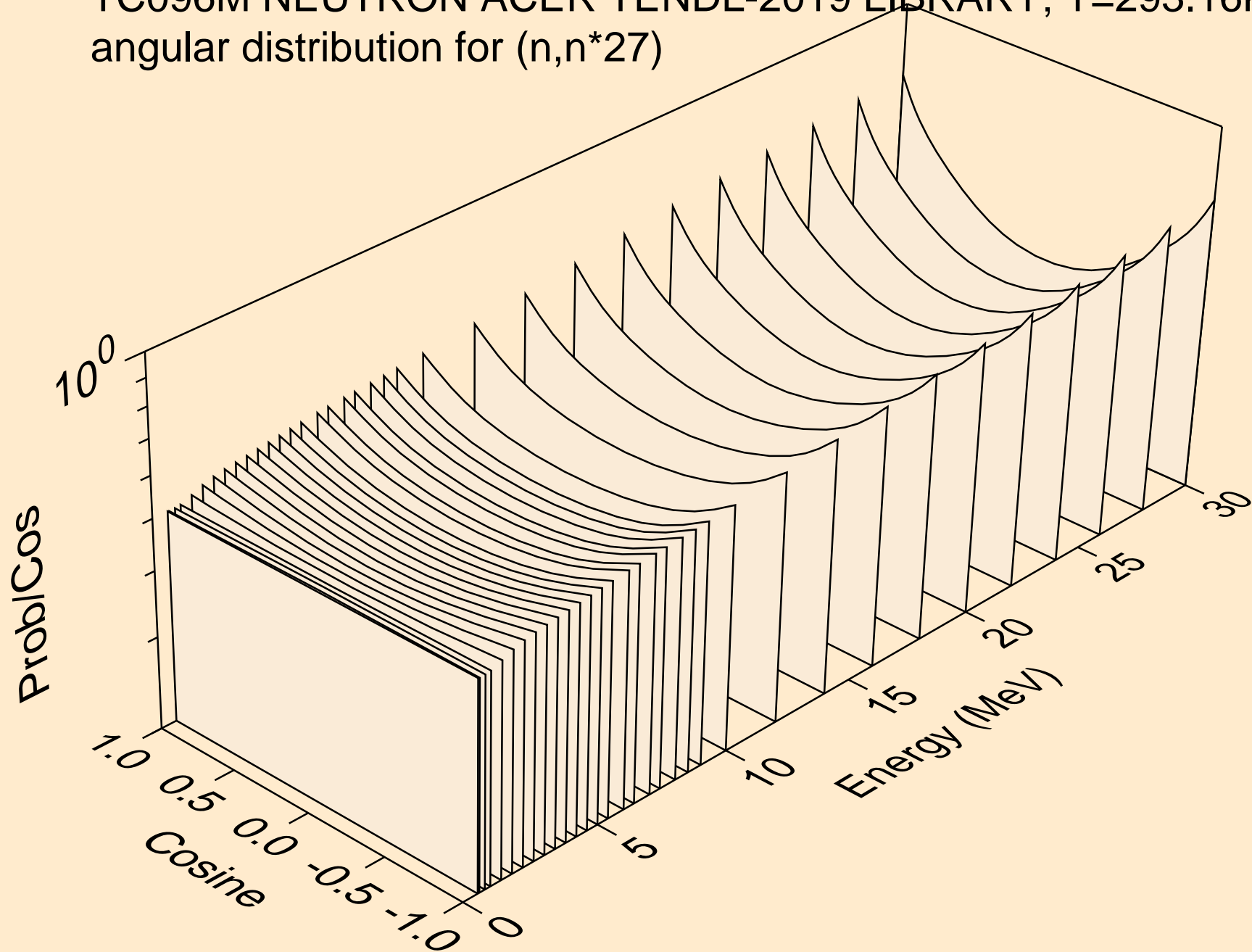

TC096M NEUTRON ACER TENDL-2019 LIBRARY; T=293.16K
angular distribution for (n,n*28)

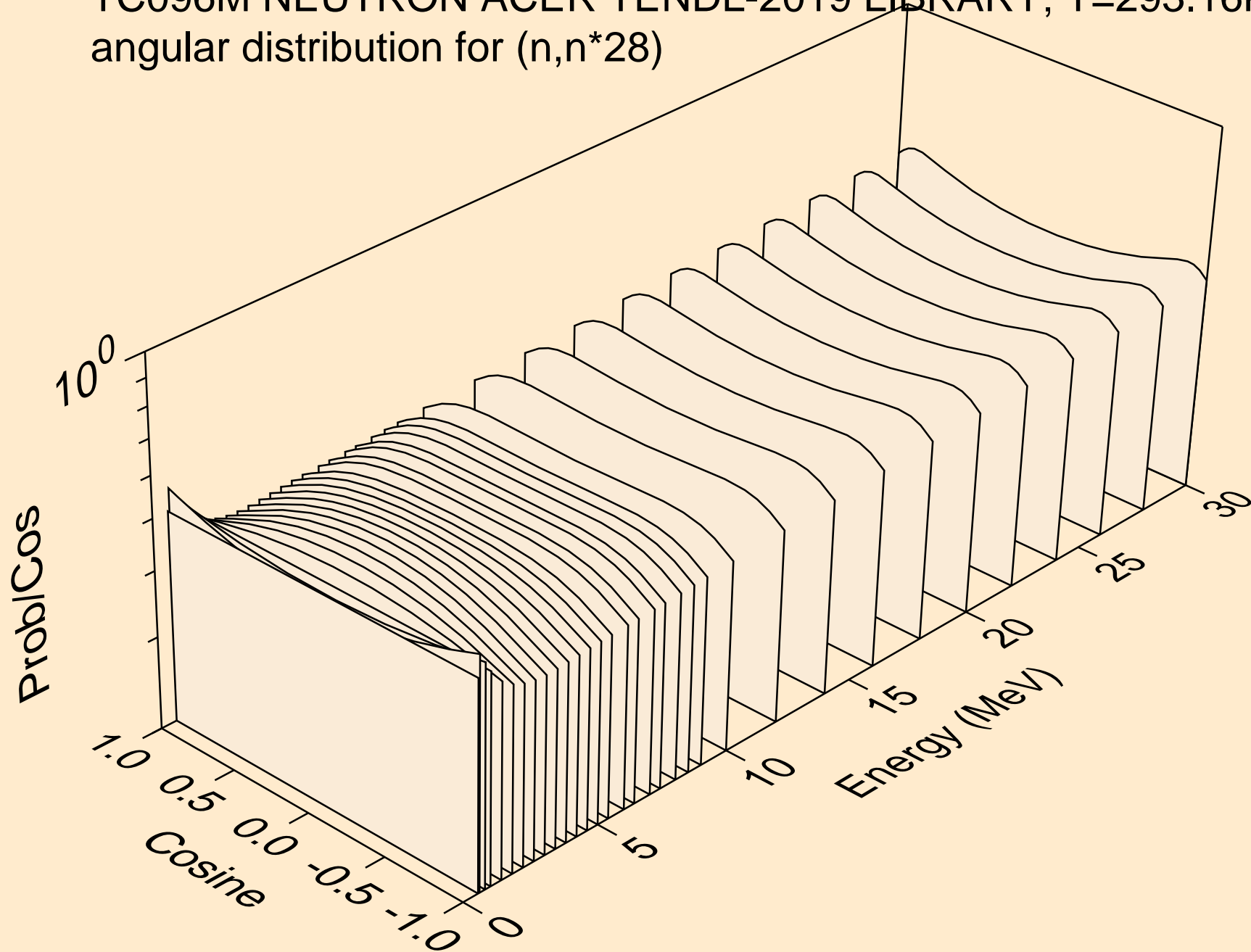

TC096M NEUTRON ACER TENDL-2019 LIBRARY; T=293.16K
angular distribution for (n,n*29)

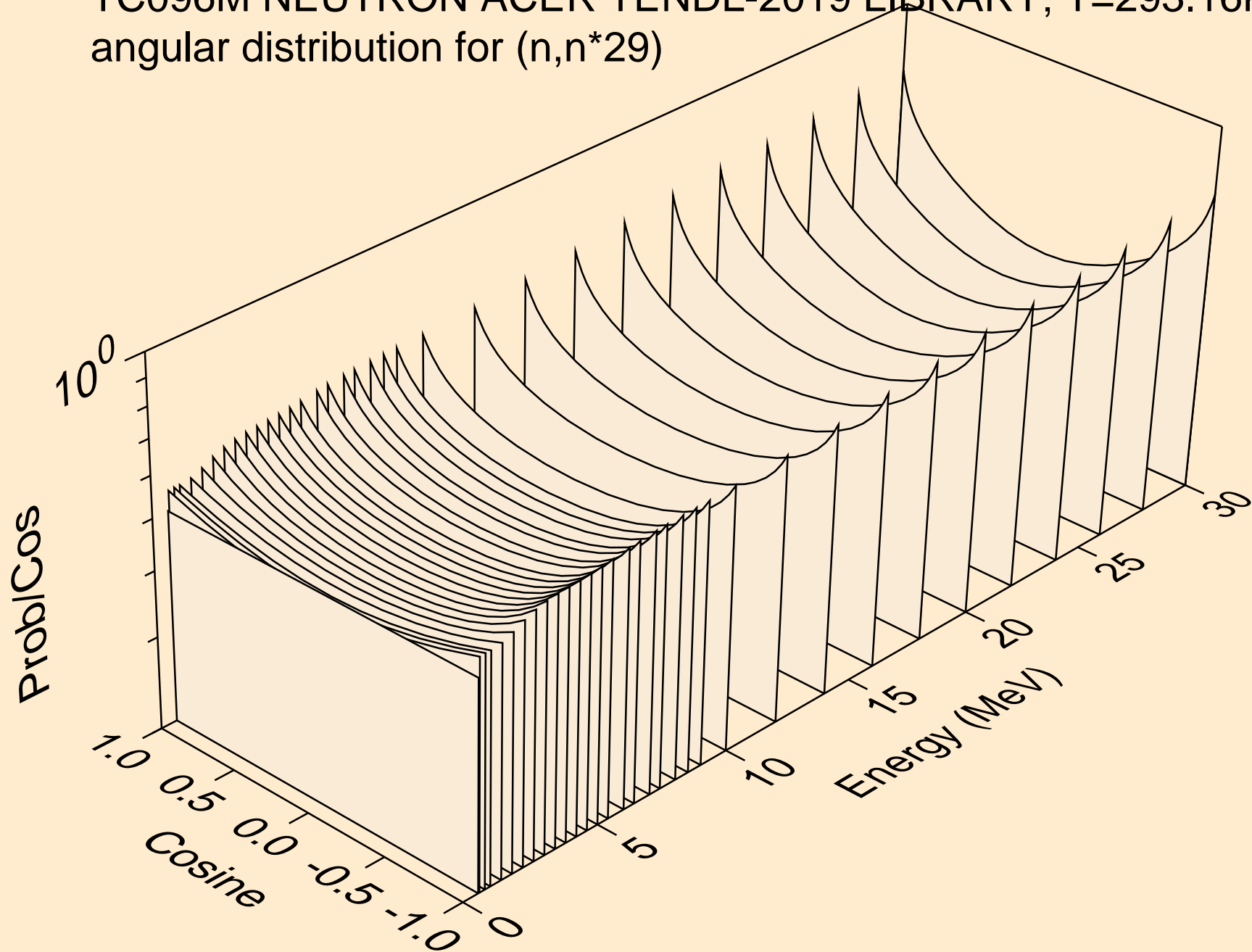

TC096M NEUTRON ACER TENDL-2019 LIBRARY; T=293.16K
angular distribution for (n,n*30)

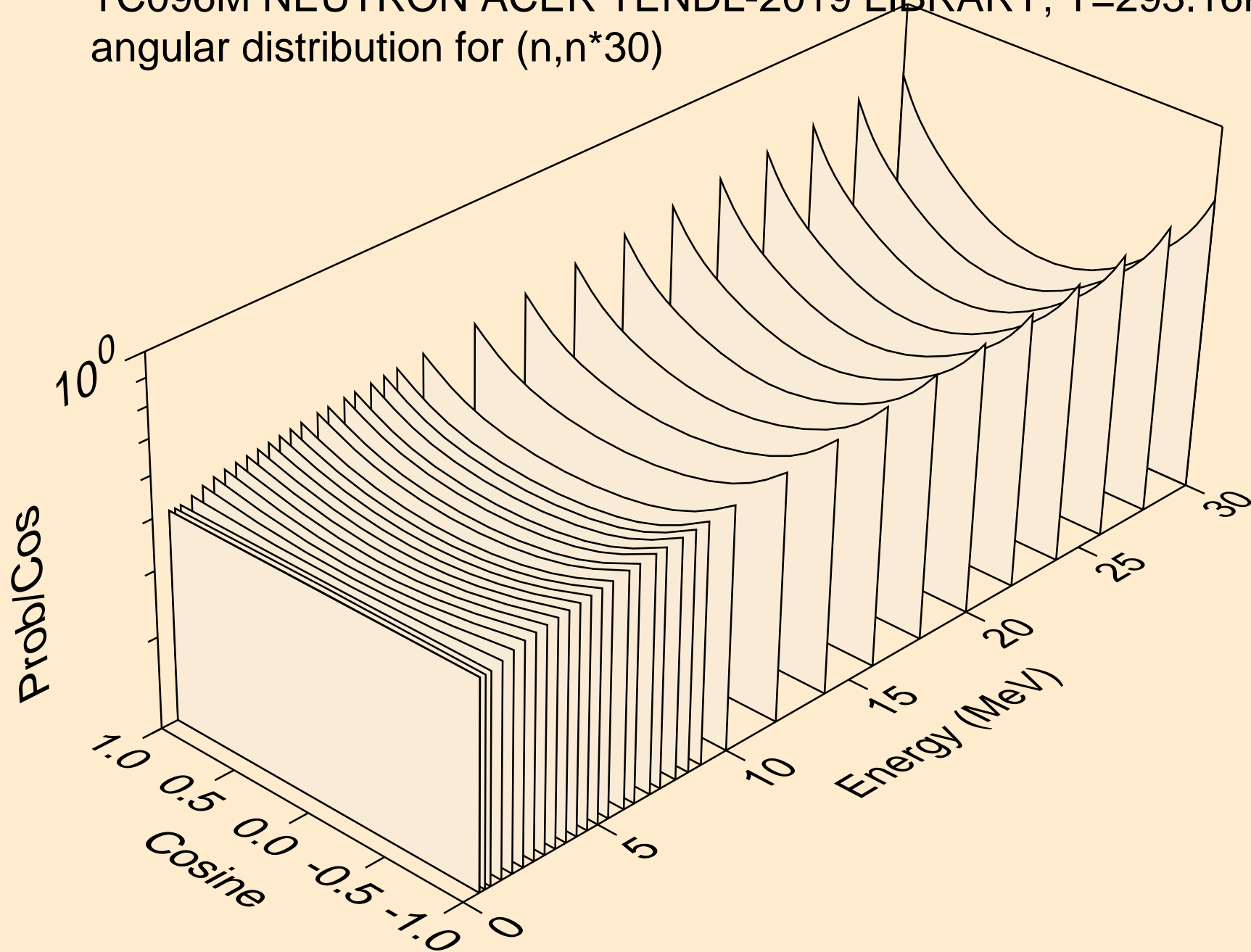

TC096M NEUTRON ACER TENDL-2019 LIBRARY; T=293.16K
Neutron emission for (n,x)

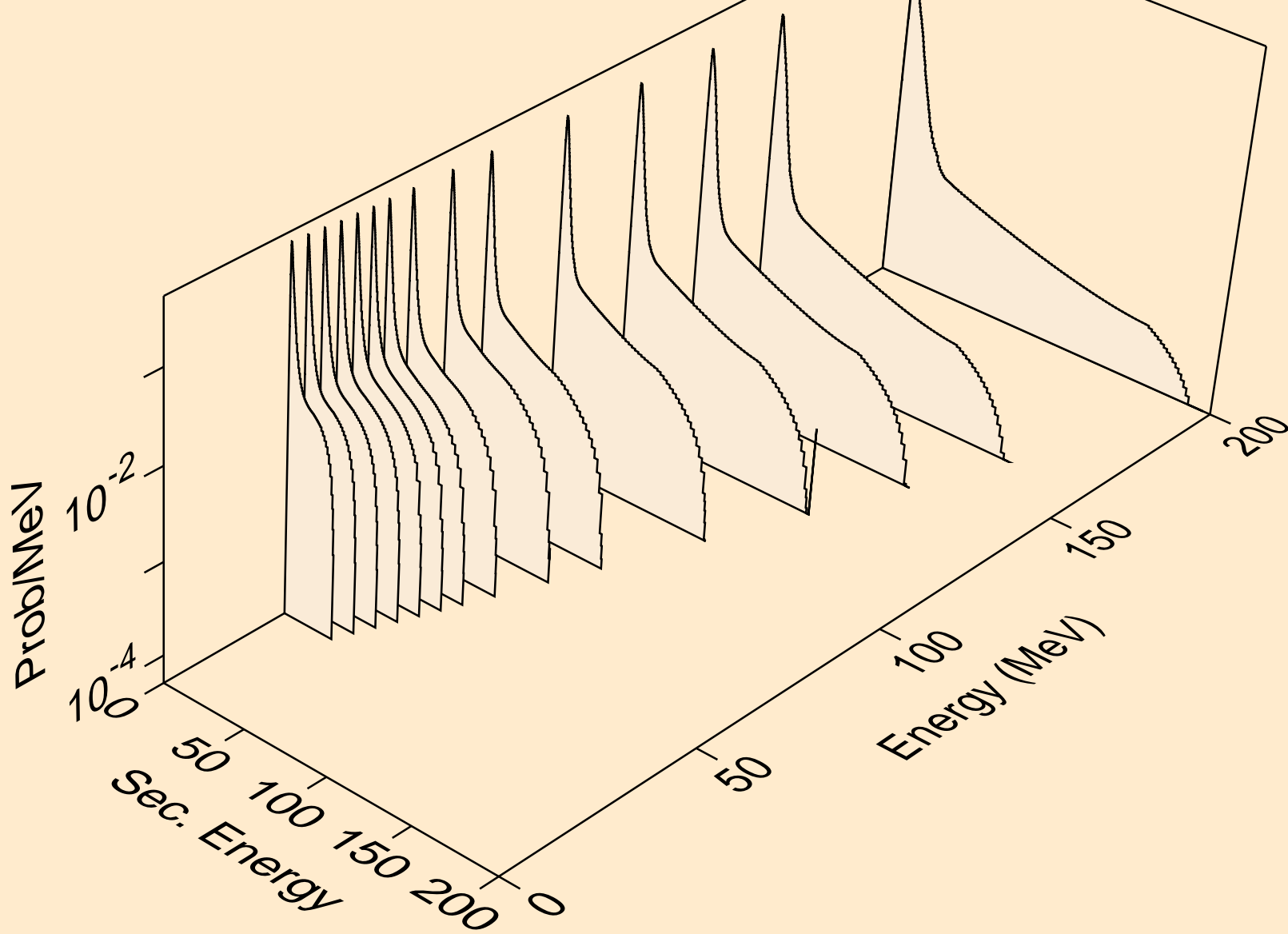

TC096M NEUTRON ACER TENDL-2019 LIBRARY; T=293.16K
Neutron emission for (n,2nd)

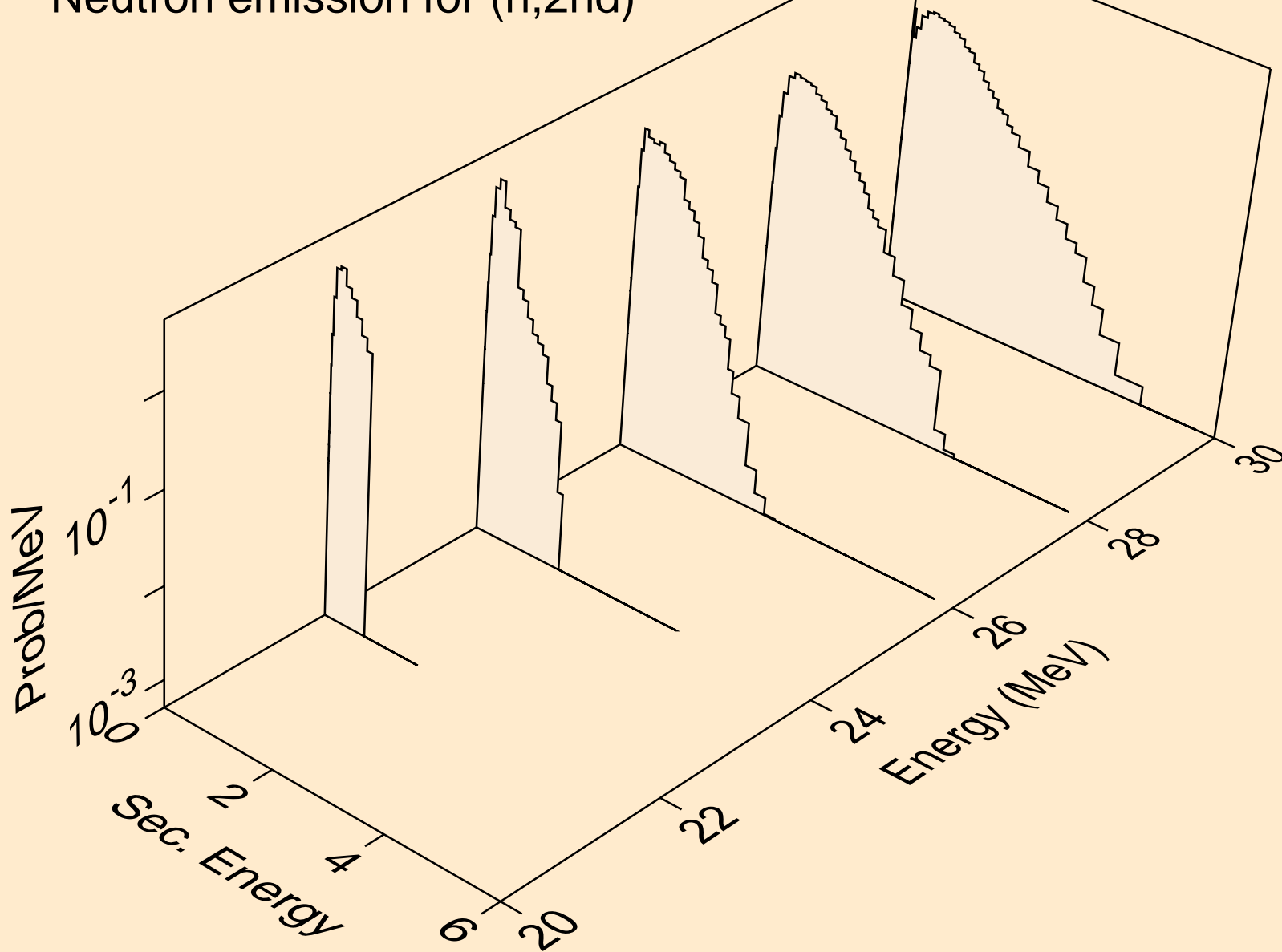

TC096M NEUTRON ACER TENDL-2019 LIBRARY; T=293.16K
Neutron emission for (n,2n)

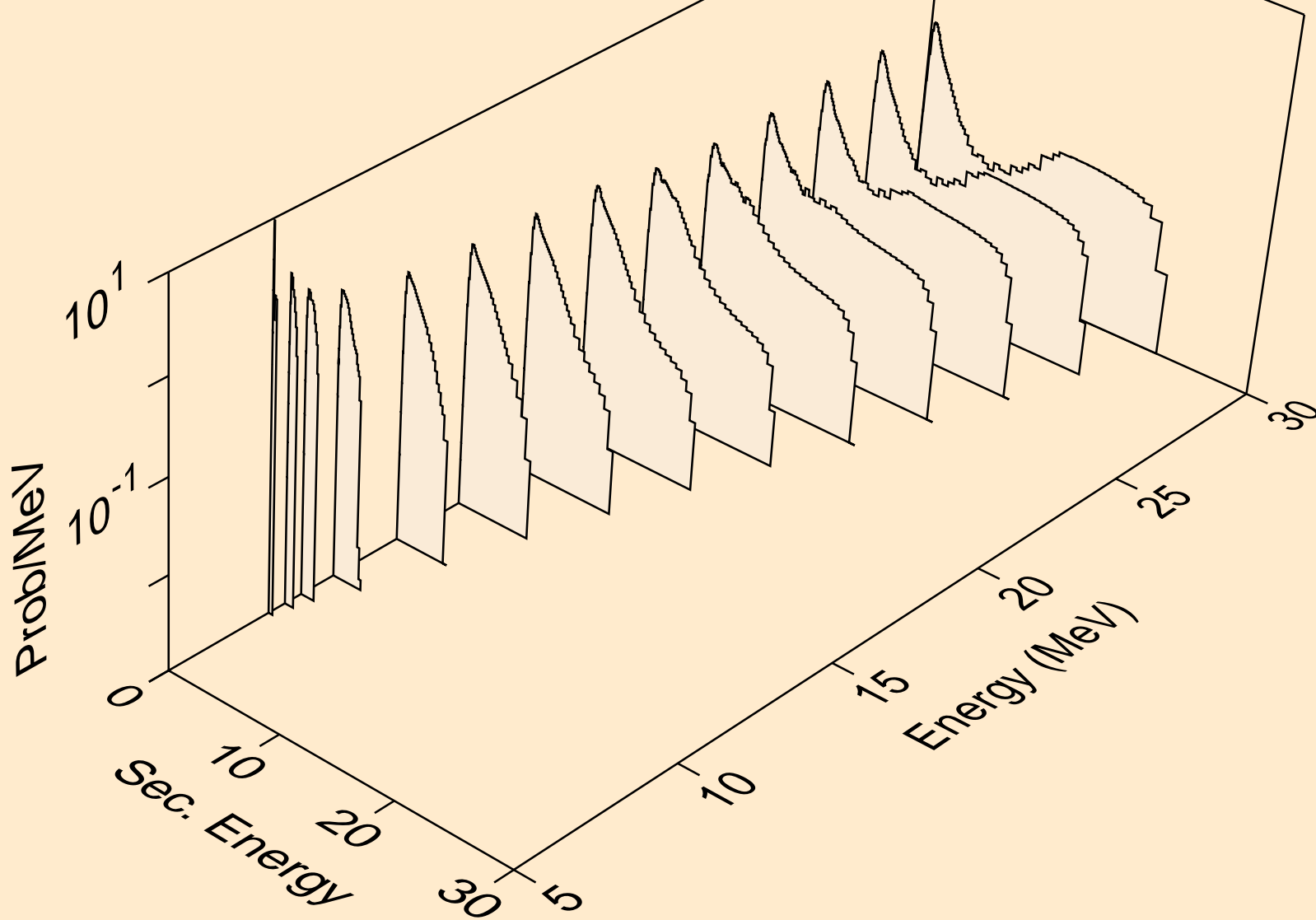

TC096M NEUTRON ACER TENDL-2019 LIBRARY; T=293.16K
Neutron emission for (n,3n)

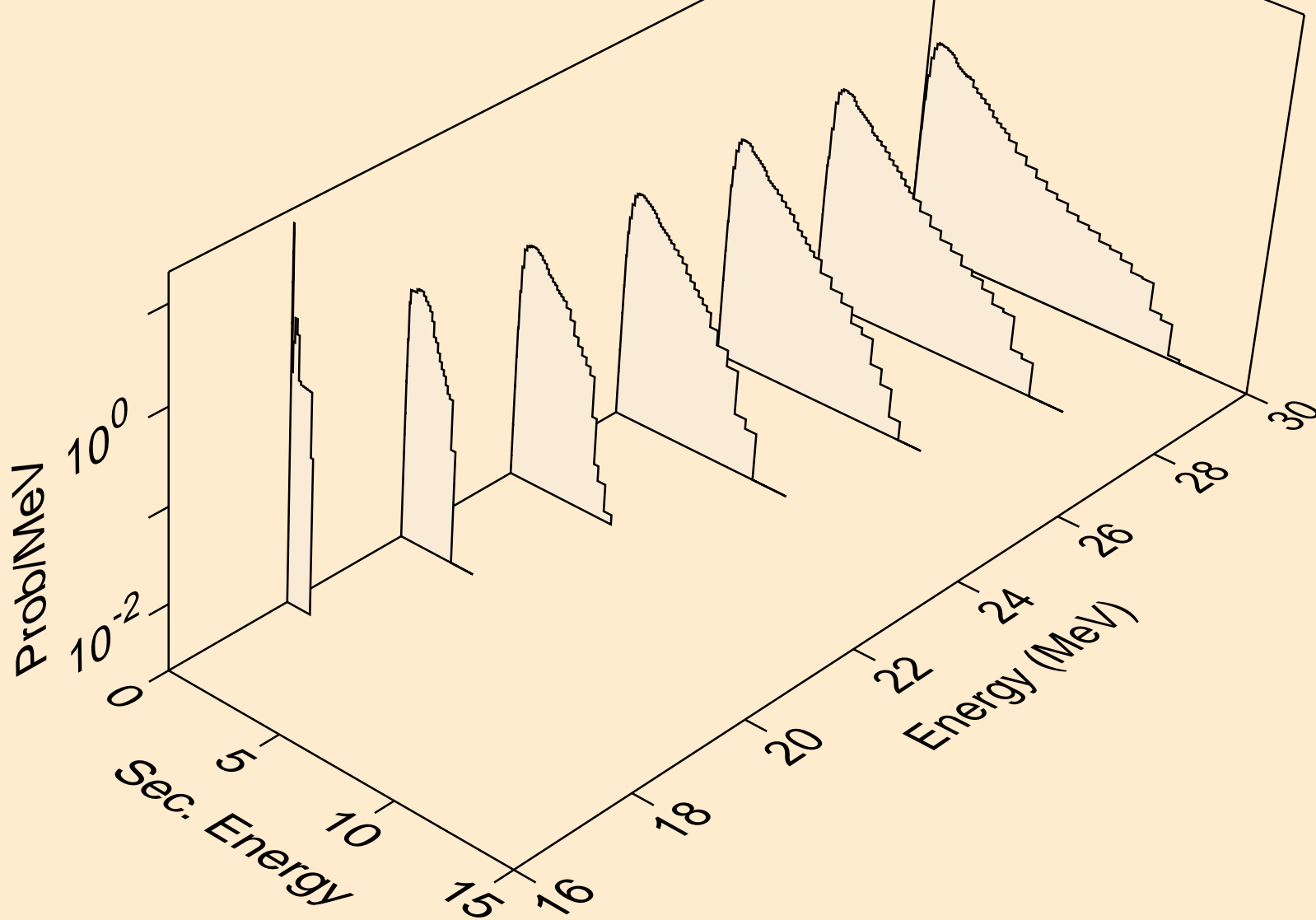

TC096M NEUTRON ACER TENDL-2019 LIBRARY; T=293.16K
Neutron emission for (n,n*)a

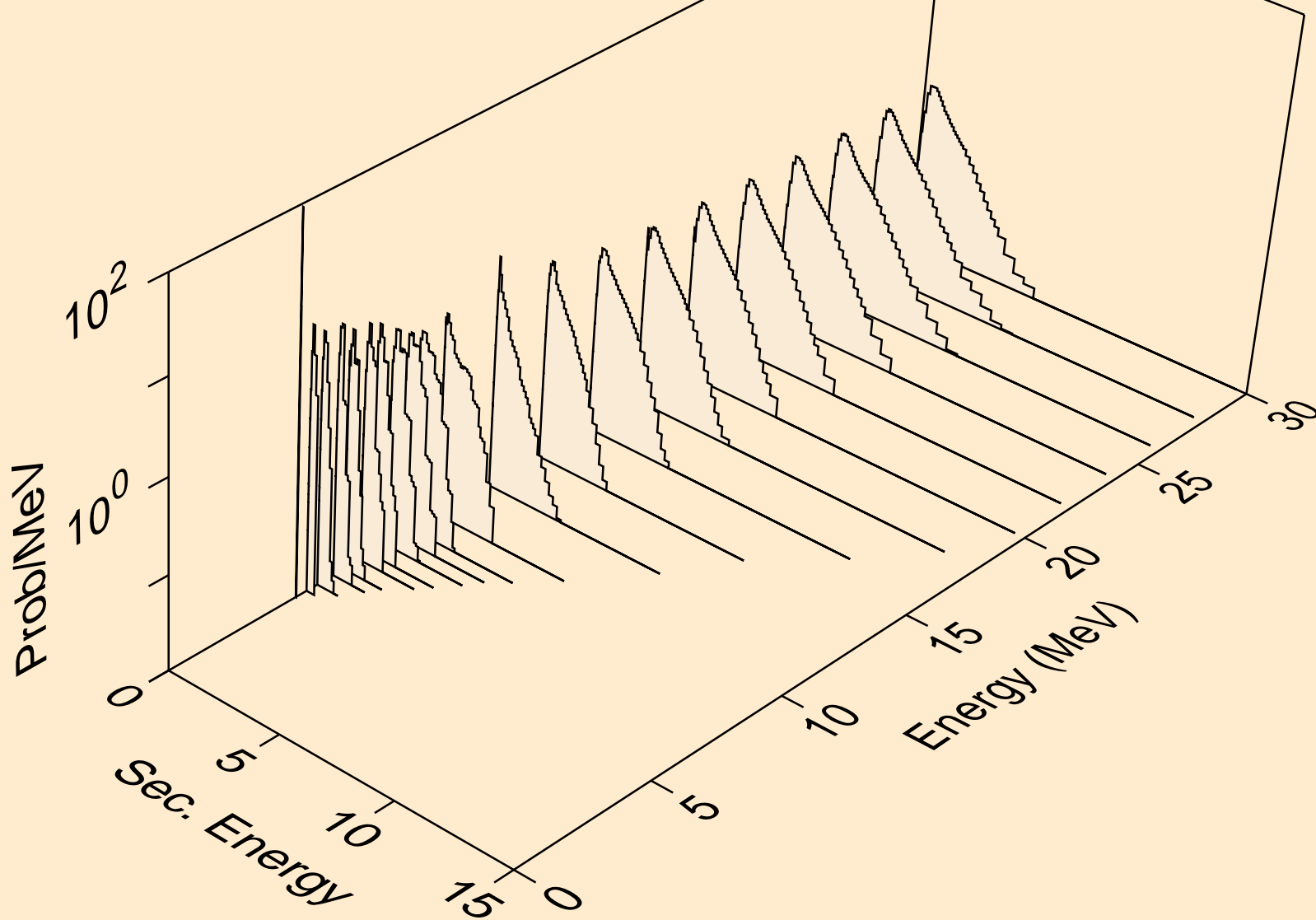

TC096M NEUTRON ACER TENDL-2019 LIBRARY; T=293.16K
Neutron emission for (n,2n)a

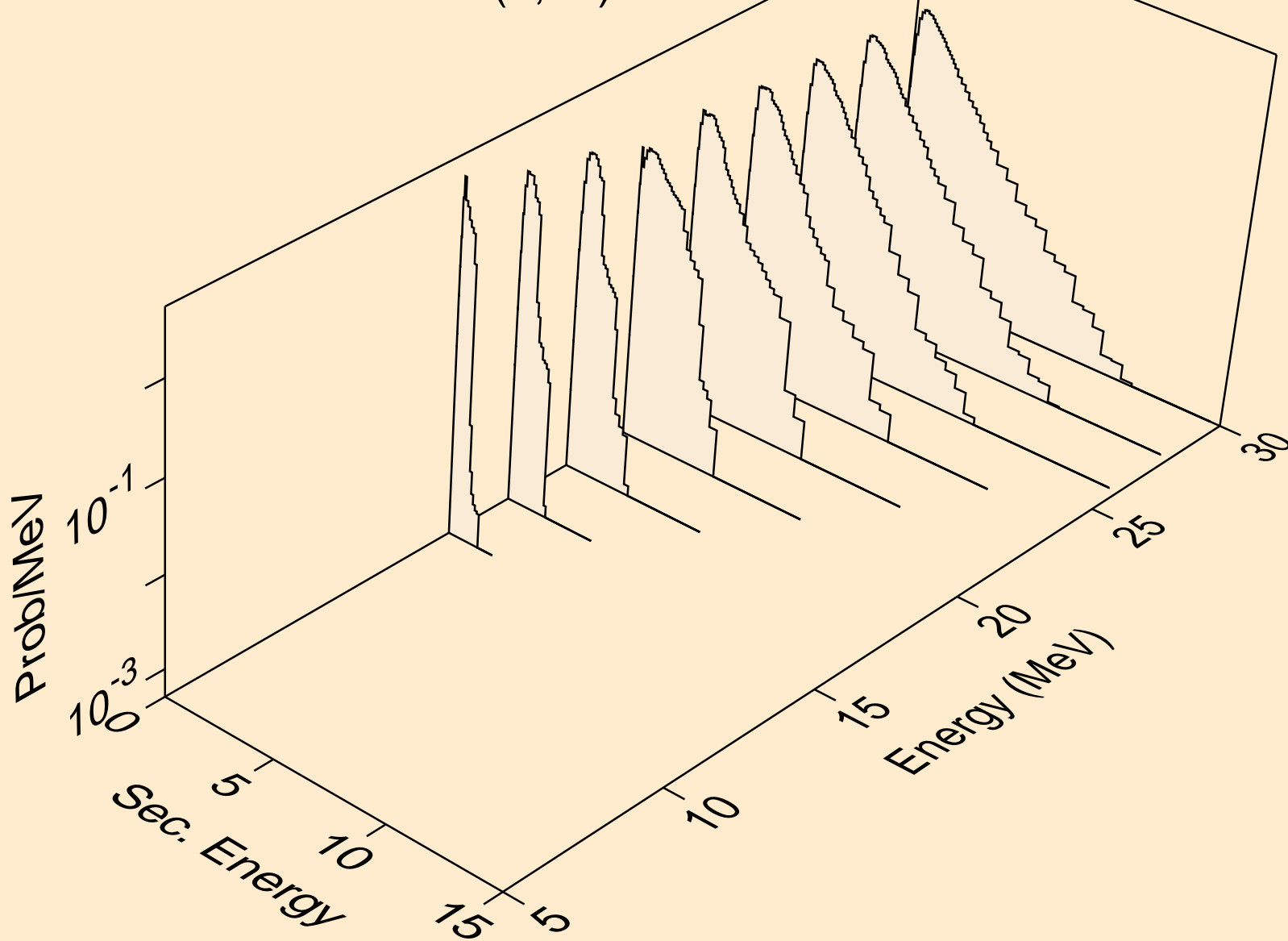

TC096M NEUTRON ACER TENDL-2019 LIBRARY; T=293.16K
Neutron emission for (n,3n)a

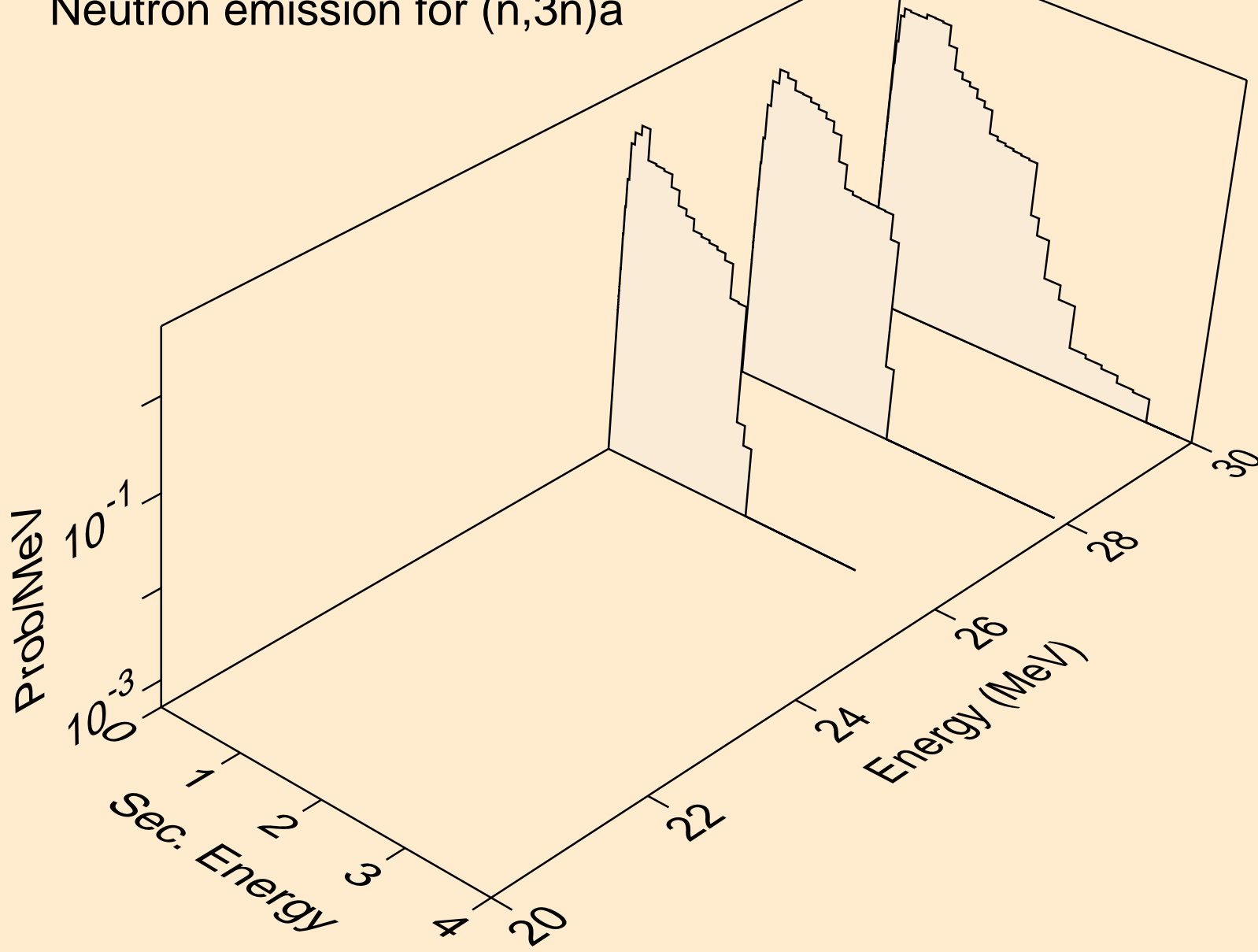

TC096M NEUTRON ACER TENDL-2019 LIBRARY; T=293.16K
Neutron emission for (n,n*)p

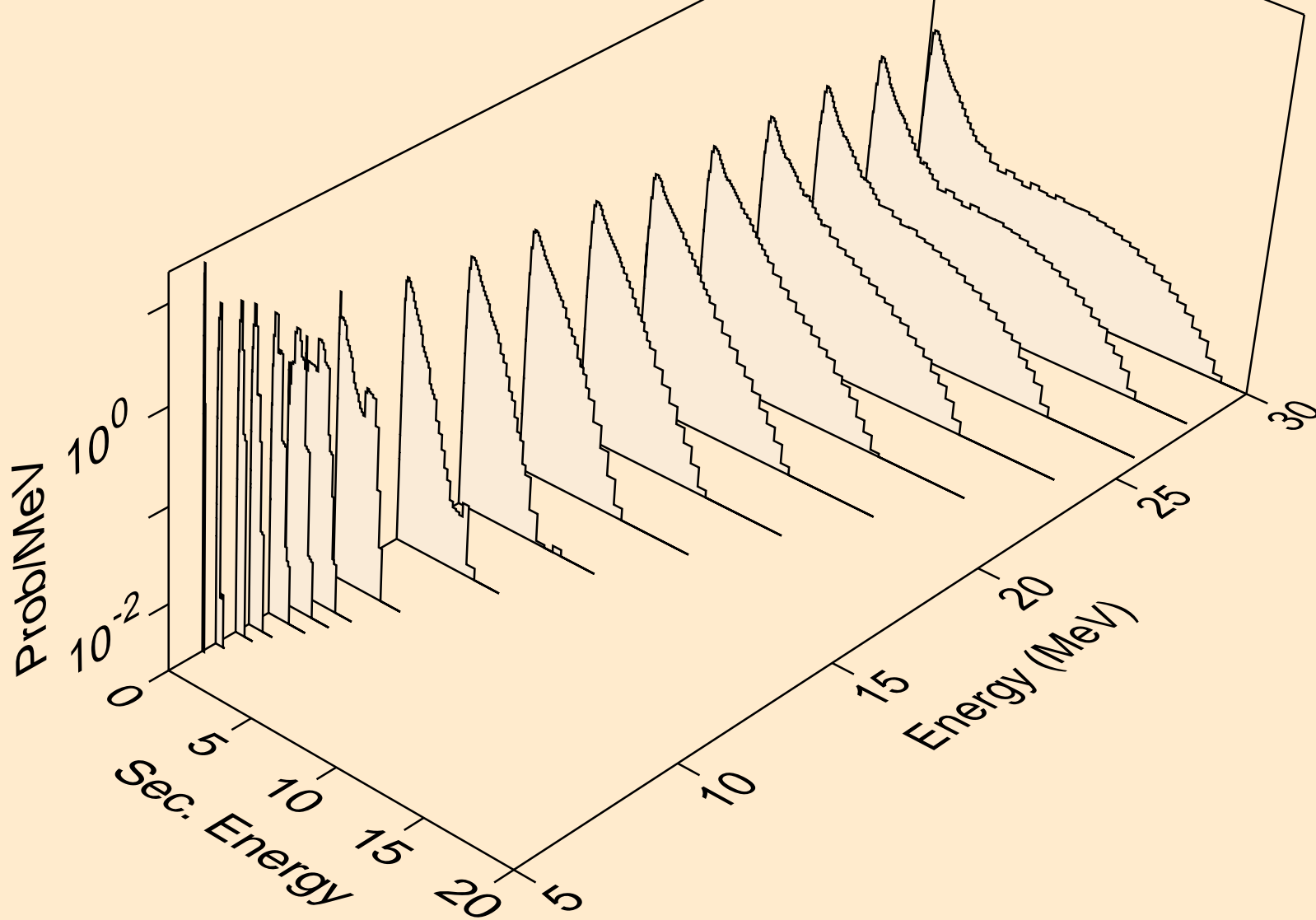

TC096M NEUTRON ACER TENDL-2019 LIBRARY; T=293.16K
Neutron emission for (n,n*)2a

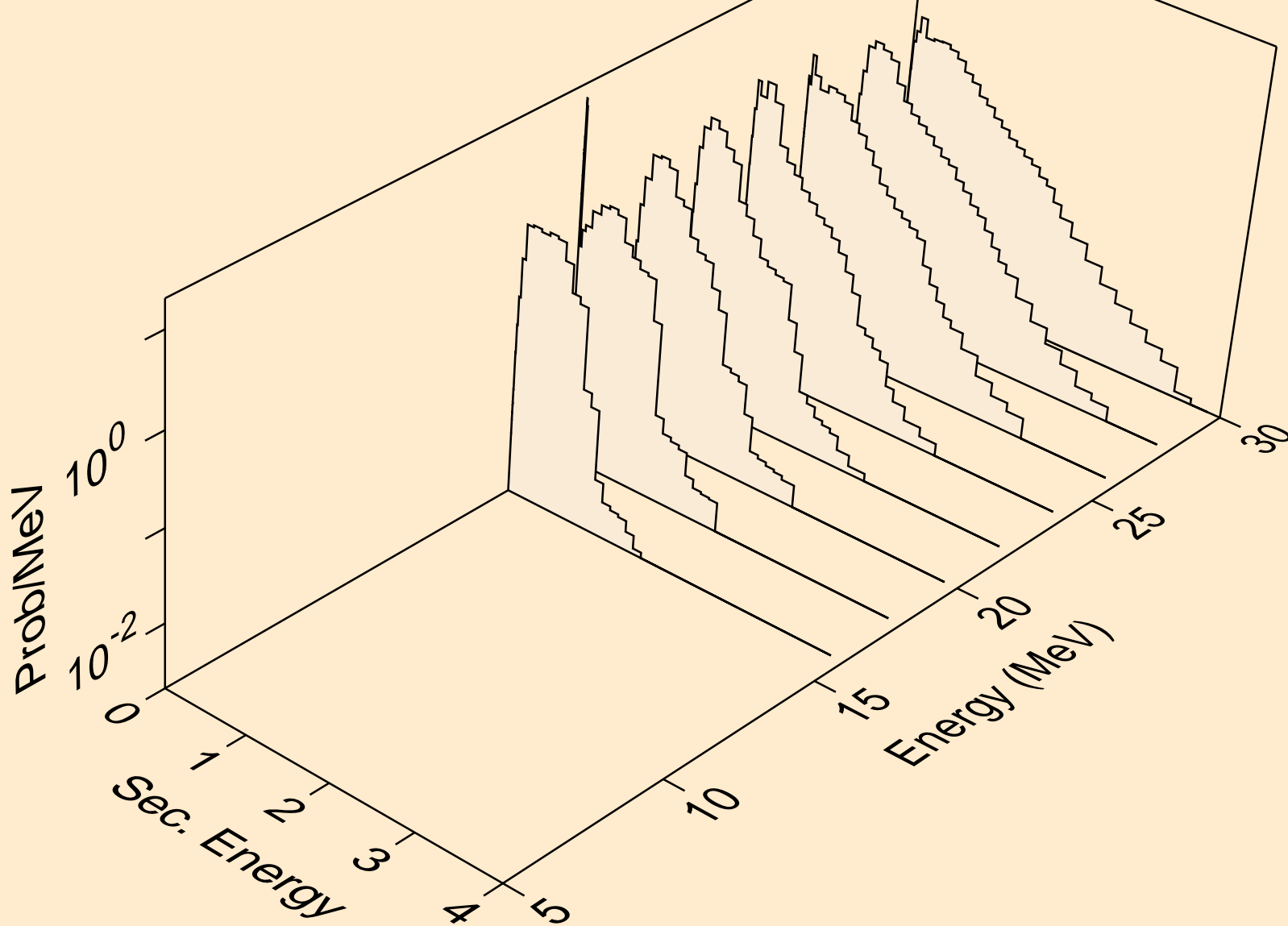

TC096M NEUTRON ACER TENDL-2019 LIBRARY; T=293.16K
Neutron emission for (n,n*)d

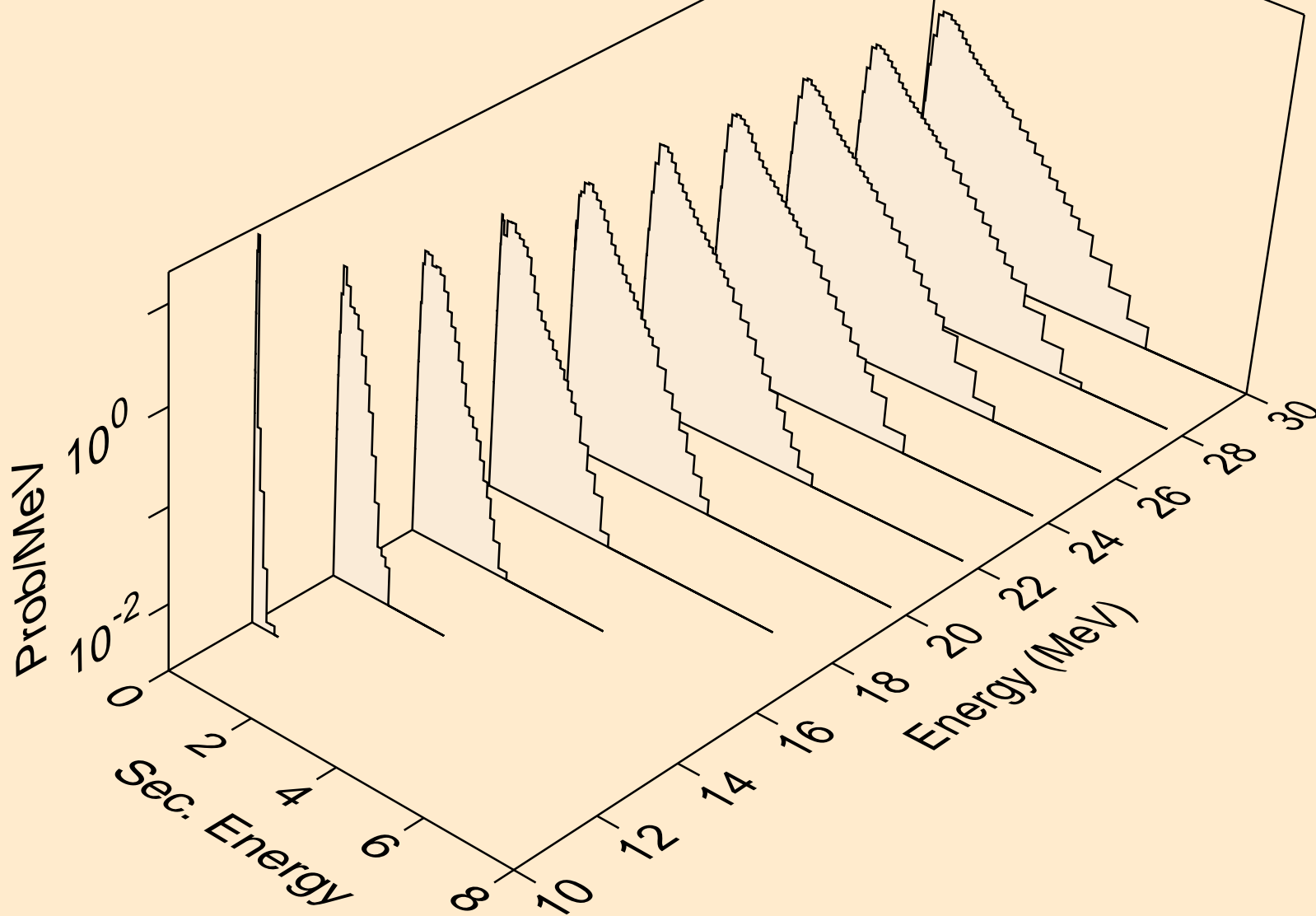

TC096M NEUTRON ACER TENDL-2019 LIBRARY; T=293.16K
Neutron emission for (n,n*)t

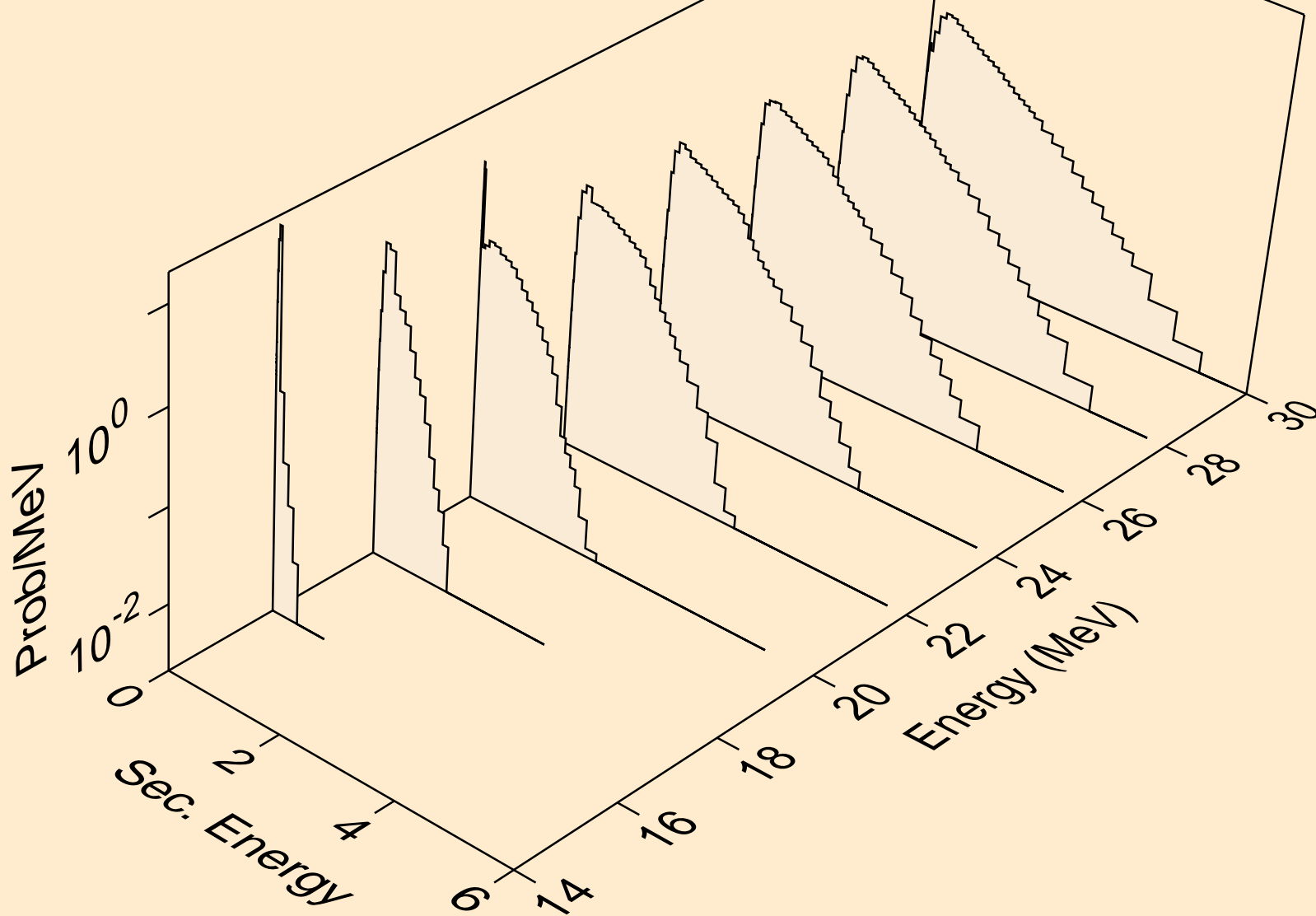

TC096M NEUTRON ACER TENDL-2019 LIBRARY; T=293.16K
Neutron emission for (n,n*)he3

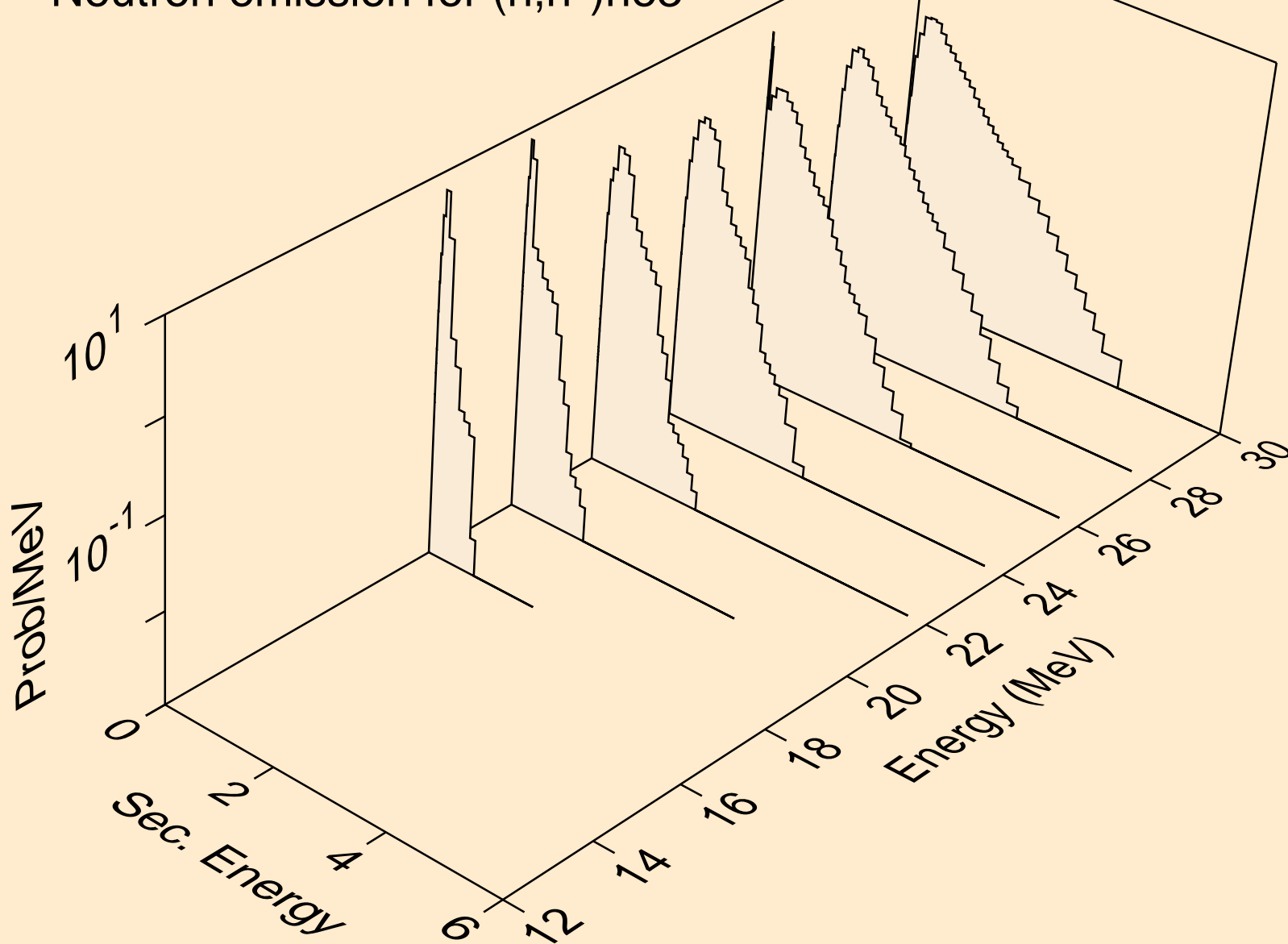

TC096M NEUTRON ACER TENDL-2019 LIBRARY; T=293.16K
Neutron emission for (n,4n)

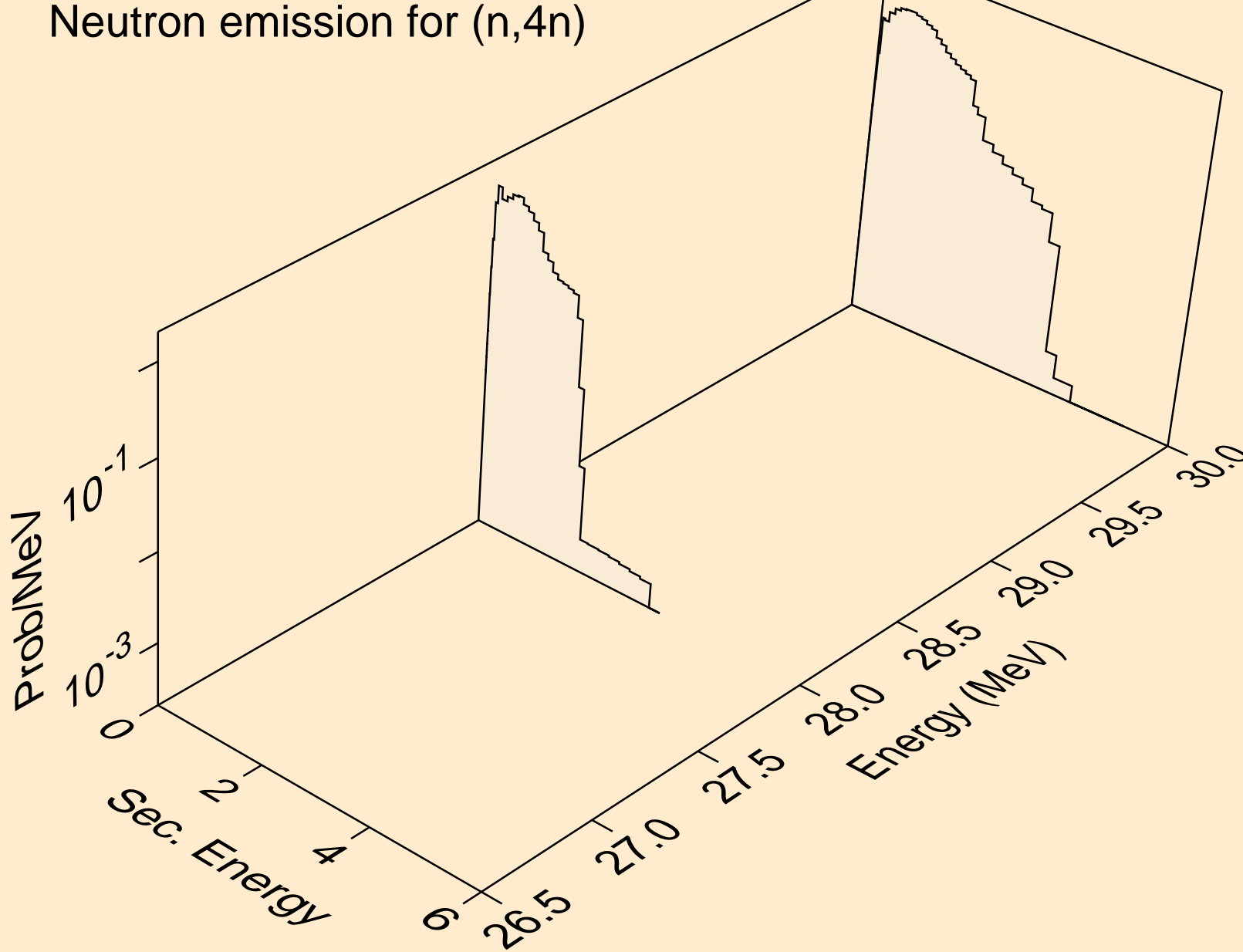

TC096M NEUTRON ACER TENDL-2019 LIBRARY; T=293.16K
Neutron emission for (n,2np)

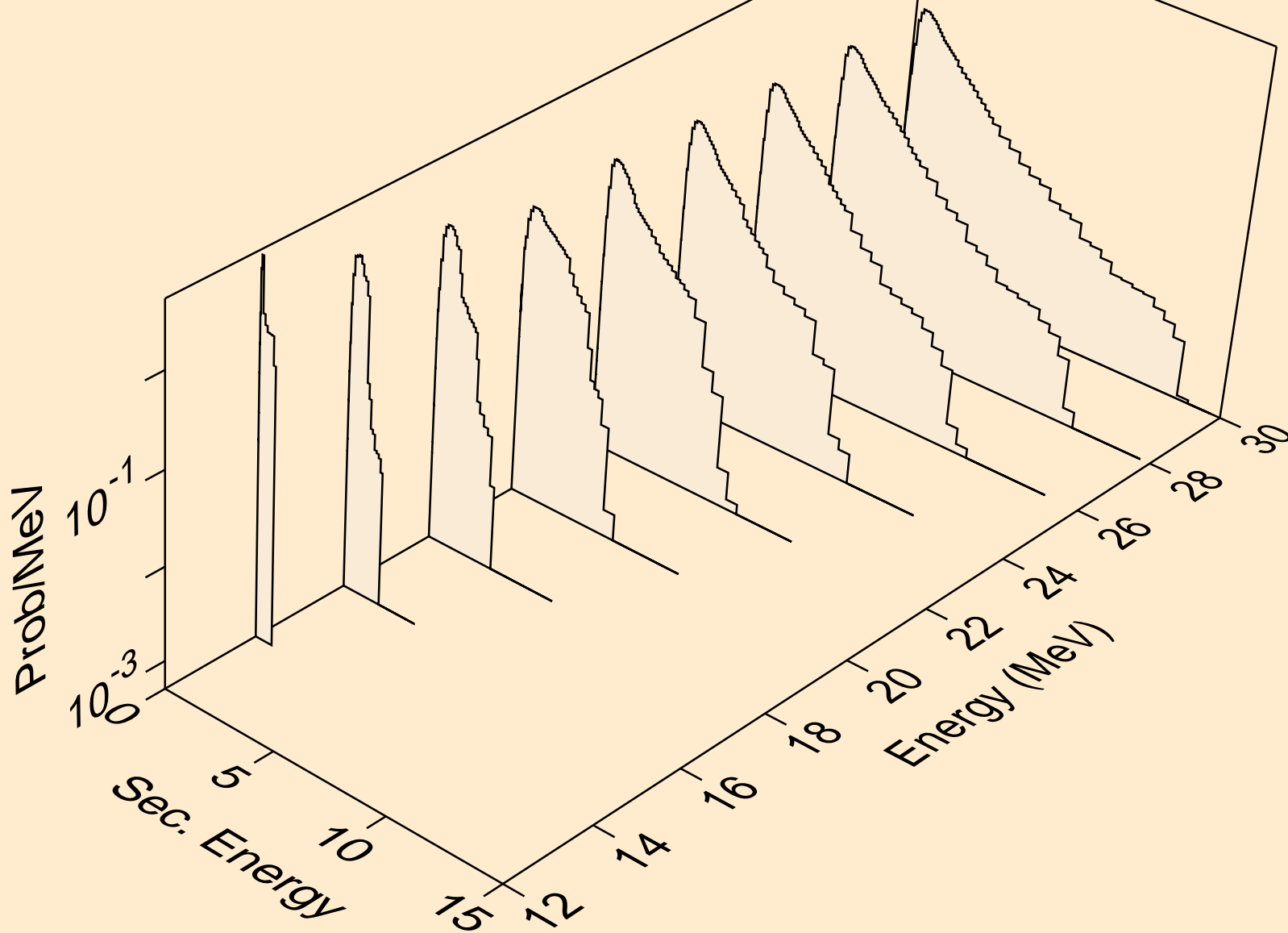

TC096M NEUTRON ACER TENDL-2019 LIBRARY; T=293.16K
Neutron emission for (n,3np)

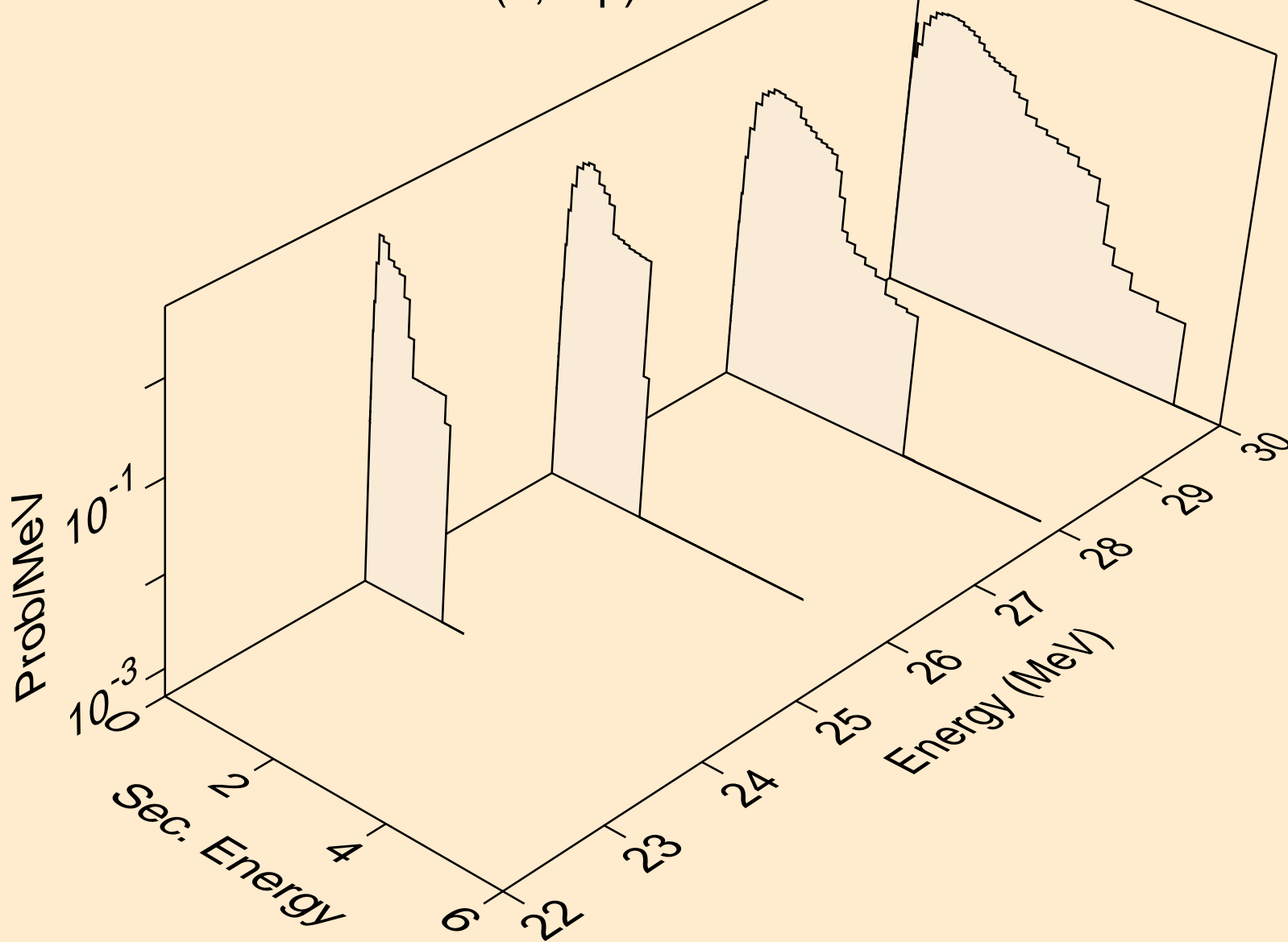

TC096M NEUTRON ACER TENDL-2019 LIBRARY; T=293.16K
Neutron emission for (n,2np)

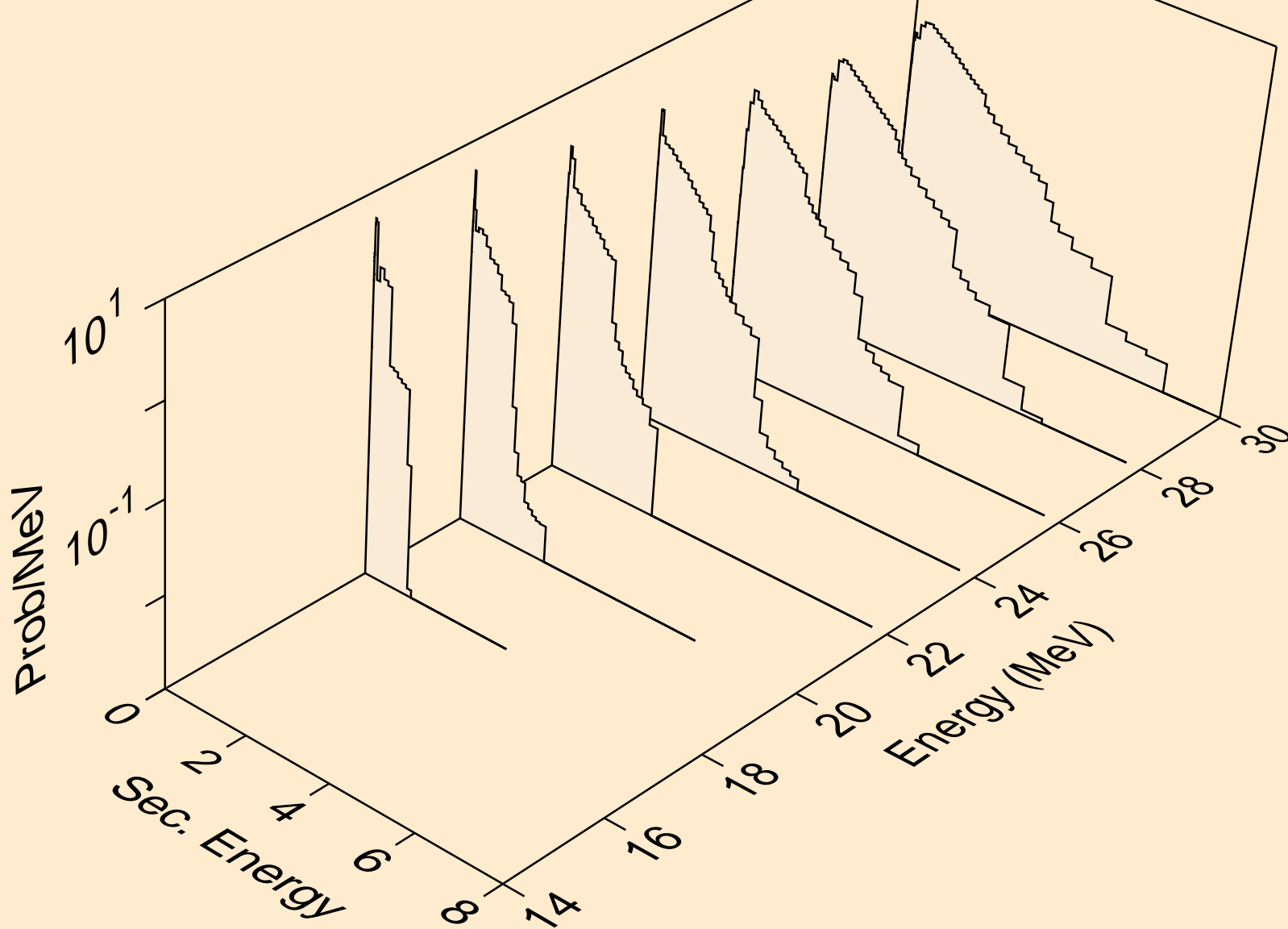

TC096M NEUTRON ACER TENDL-2019 LIBRARY; T=293.16K
Neutron emission for (n,npa)

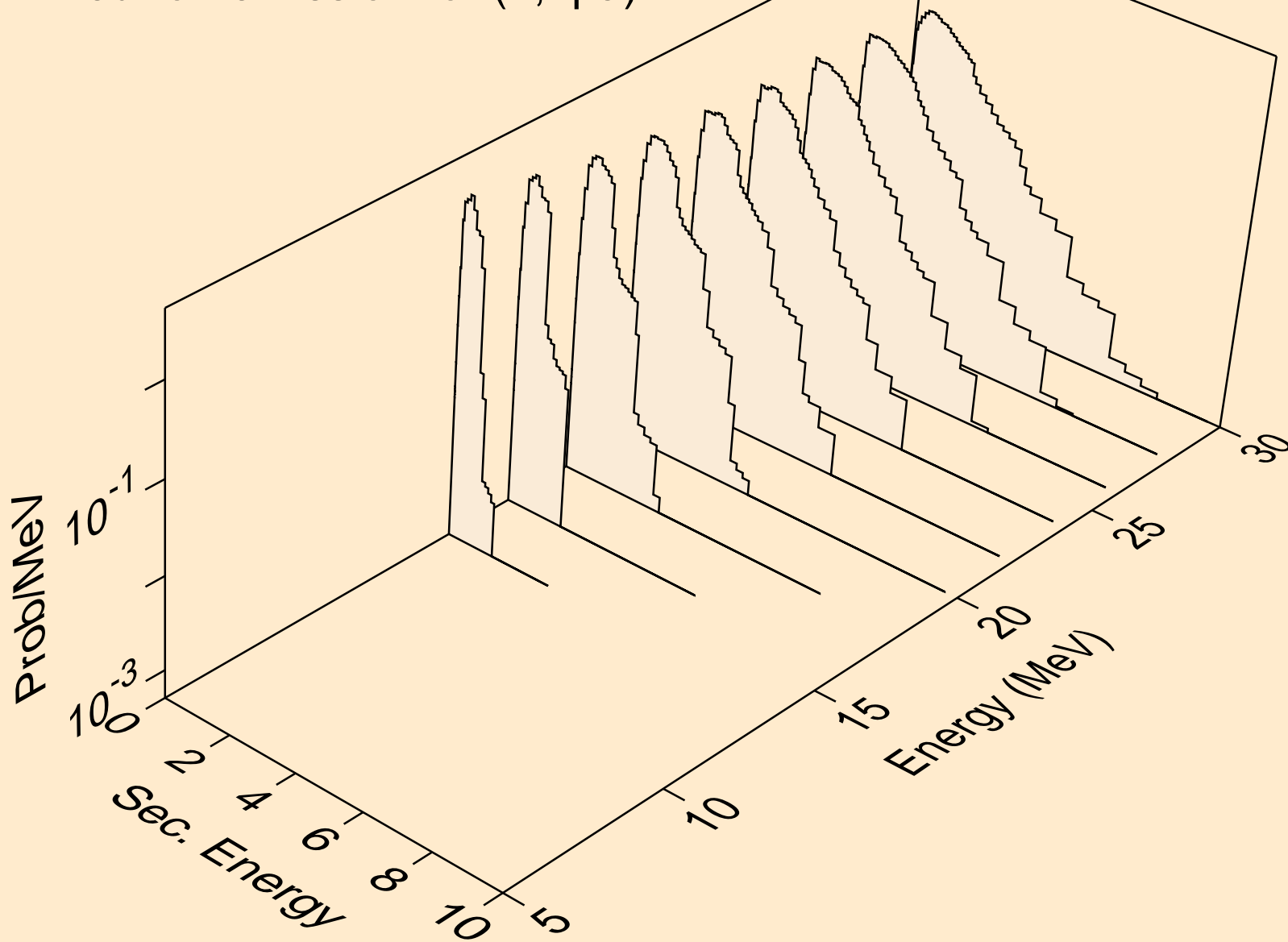

TC096M NEUTRON ACER TENDL-2019 LIBRARY; T=293.16K
Neutron emission for (n,n*c)

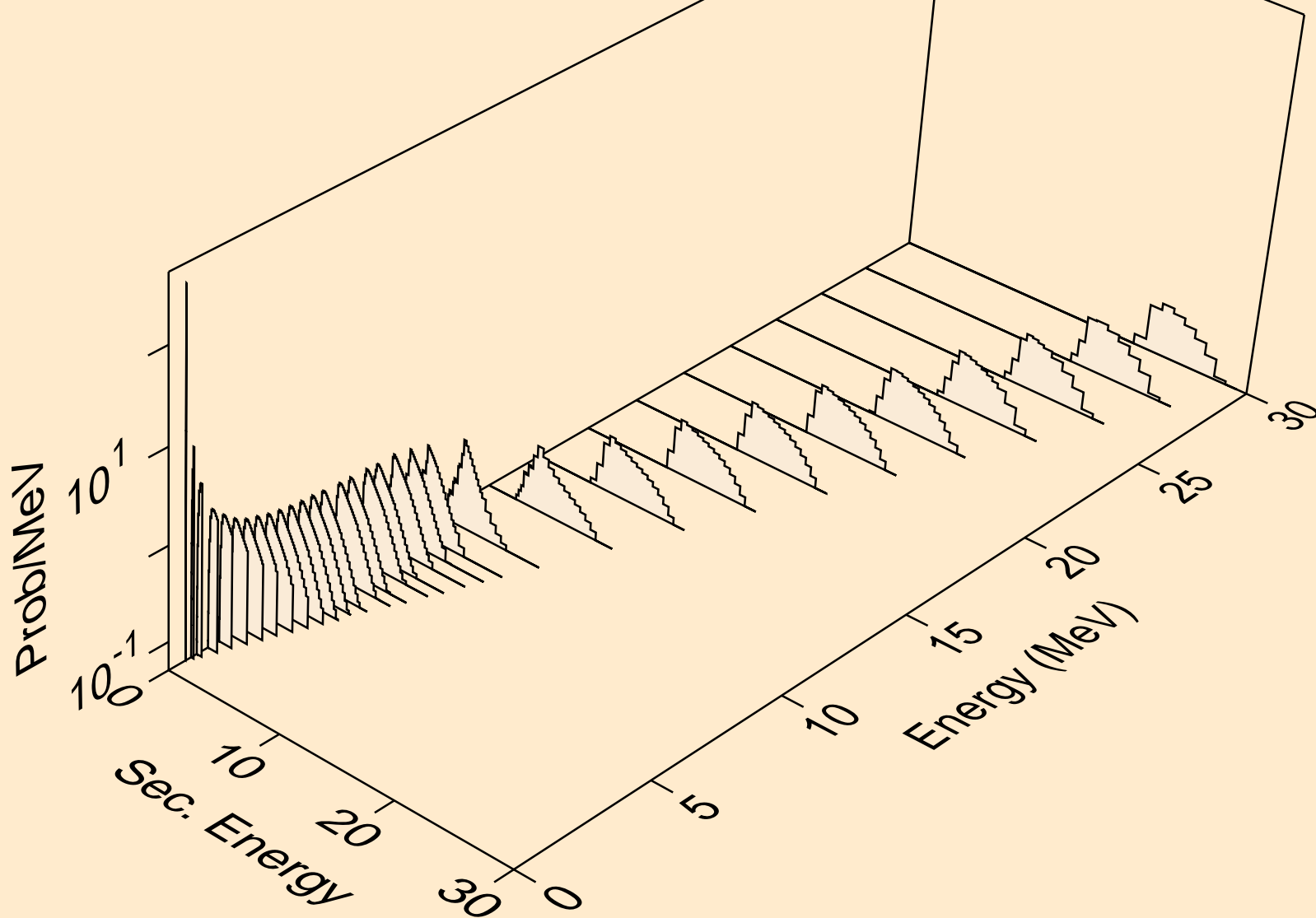

TC096M NEUTRON ACER TENDL-2019 LIBRARY; T=293.16K
Photon emission for (n,x)

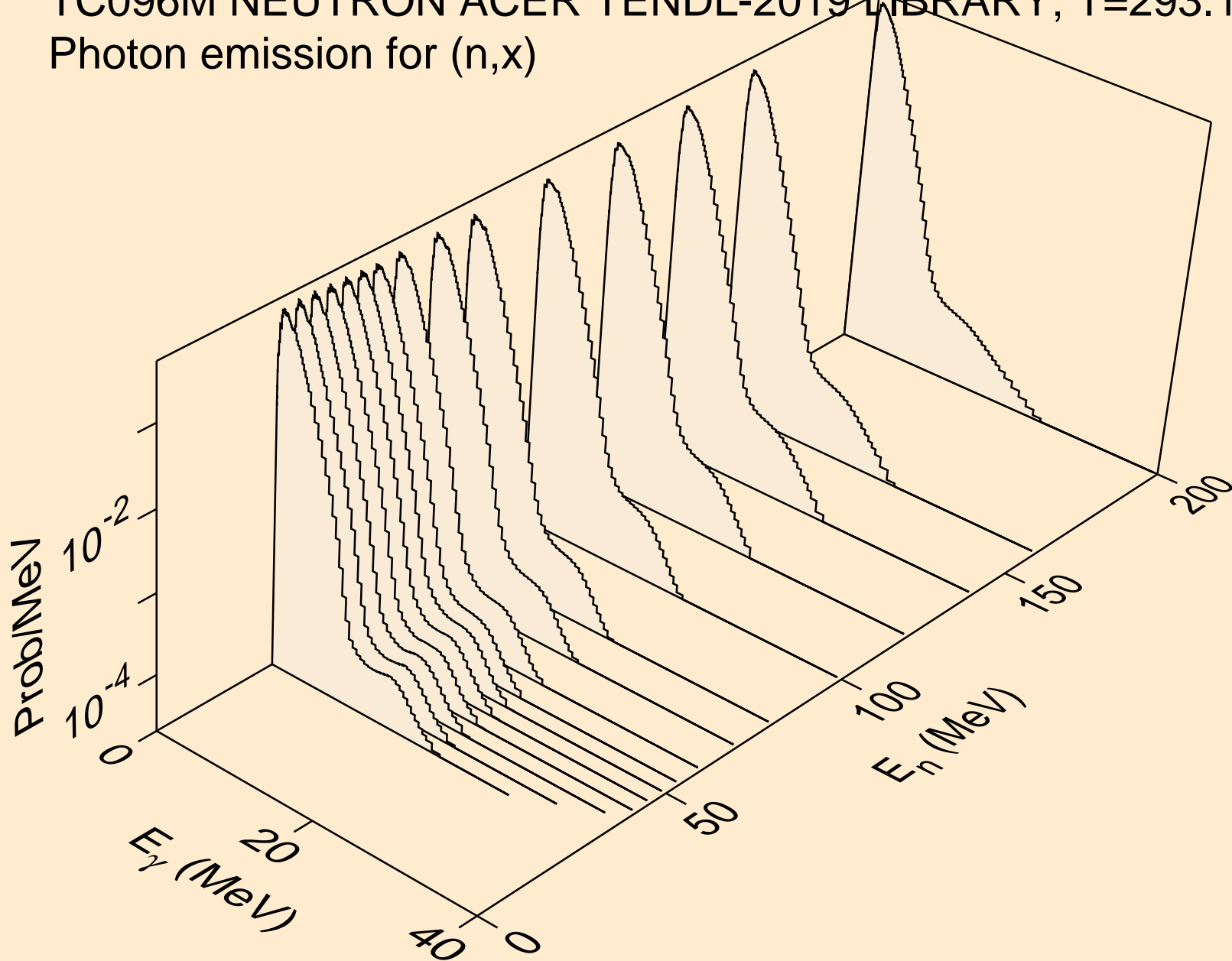

TC096M NEUTRON ACER TENDL-2019 LIBRARY; T=293.16K
Photon emission for (n,2nd)

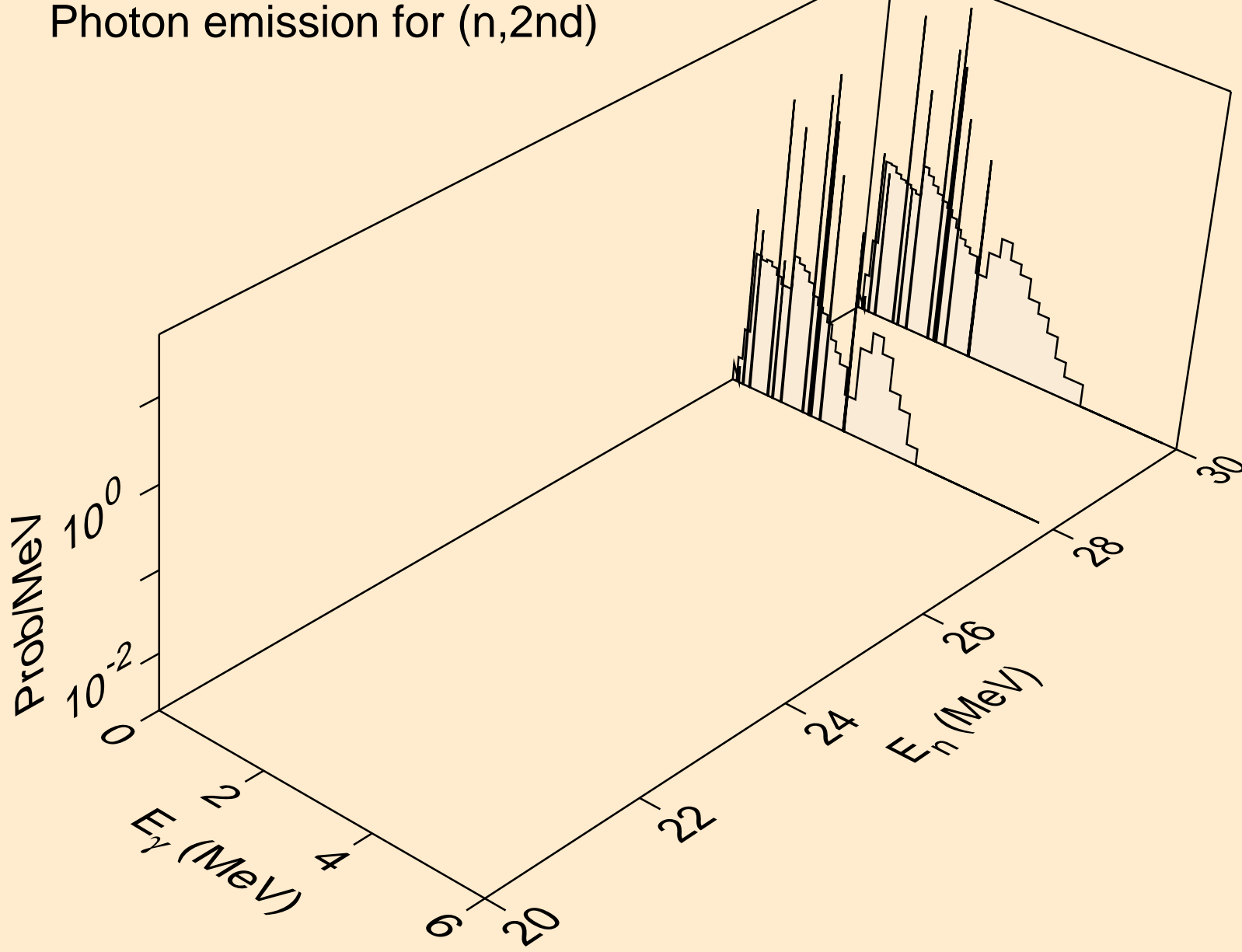

TC096M NEUTRON ACER TENDL-2019 LIBRARY; T=293.16K
Photon emission for (n,2n)

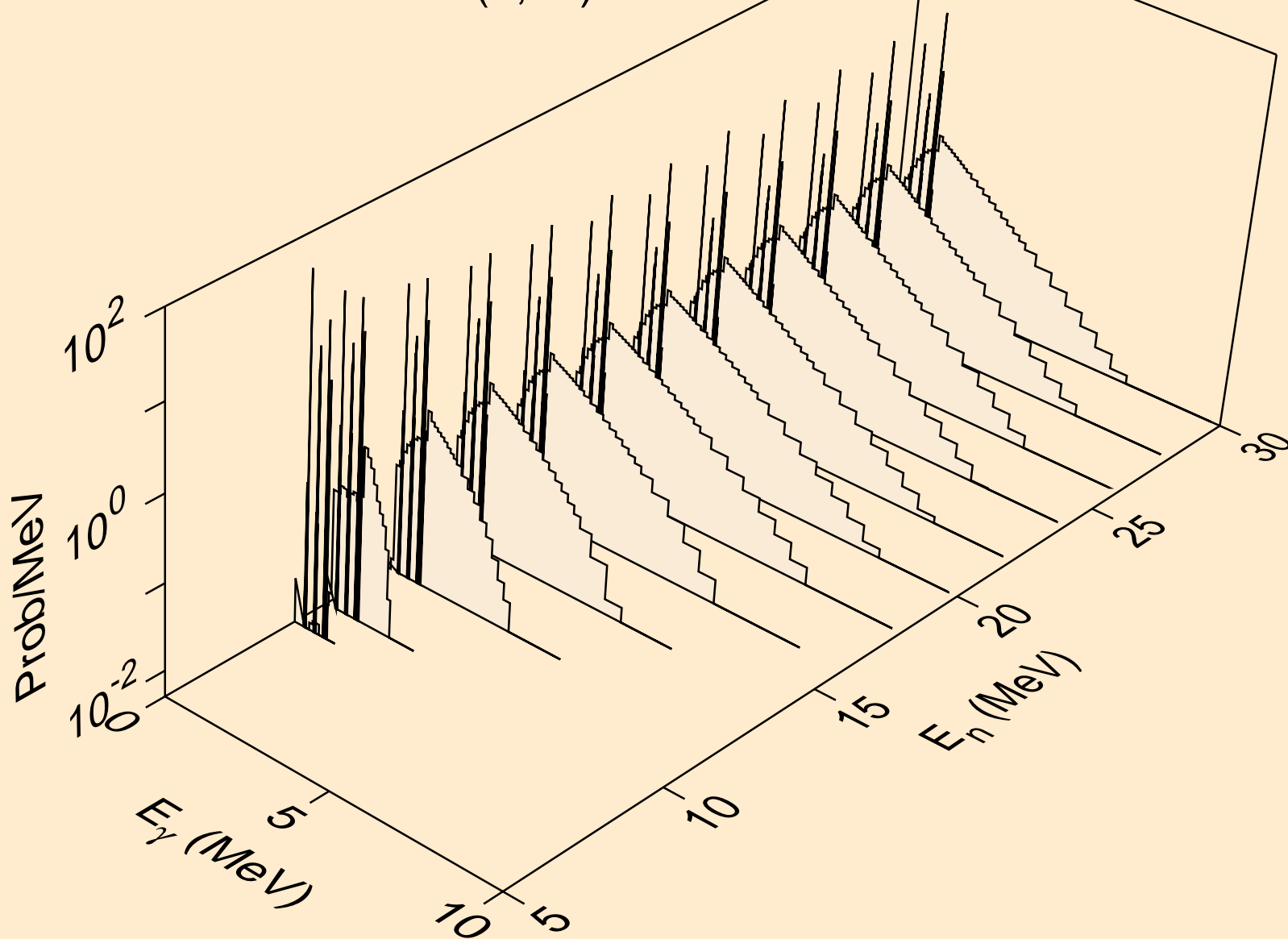

TC096M NEUTRON ACER TENDL-2019 LIBRARY; T=293.16K
Photon emission for (n,3n)

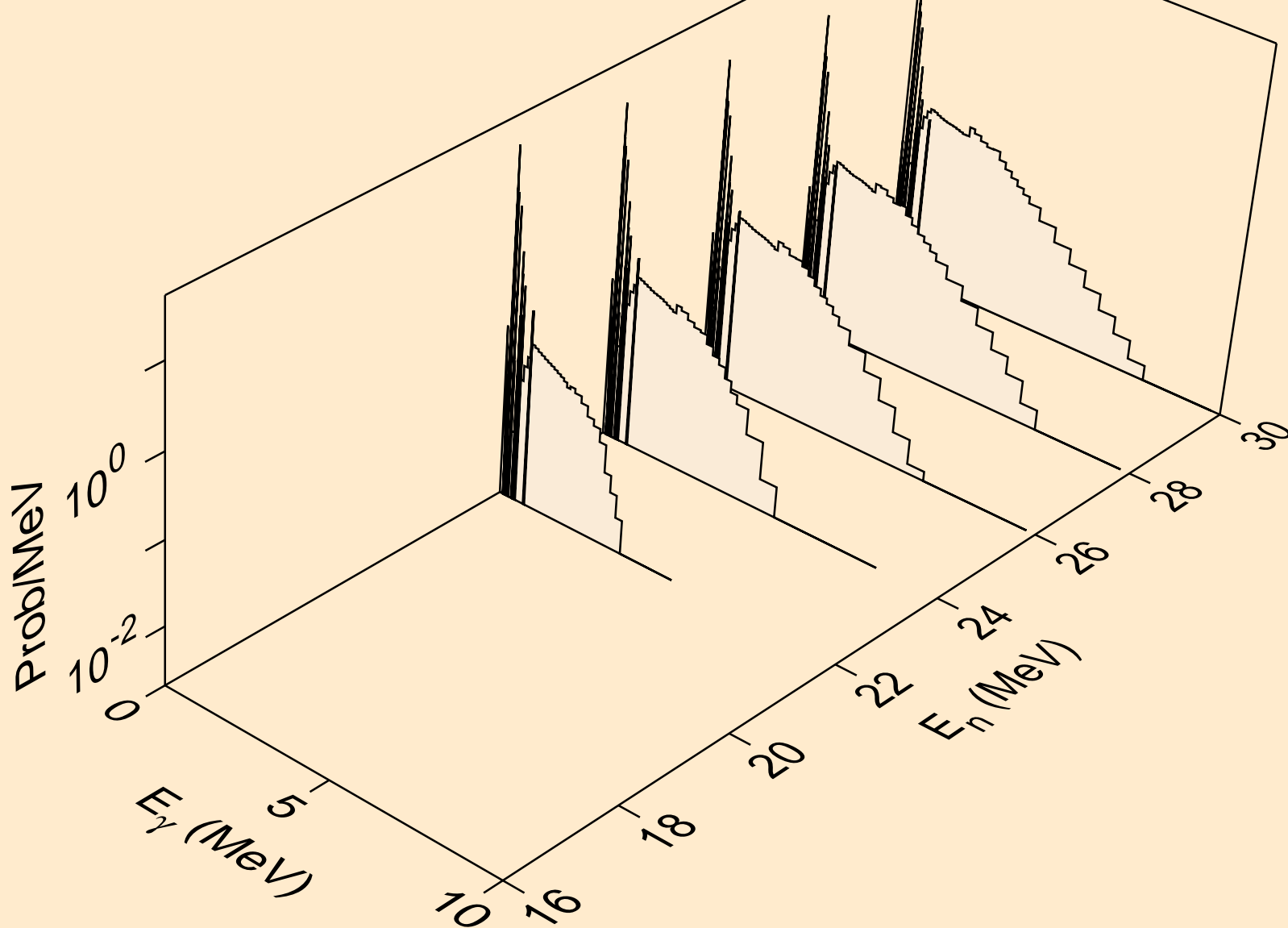

TC096M NEUTRON ACER TENDL-2019 LIBRARY; T=293.16K
Photon emission for (n,n*)a

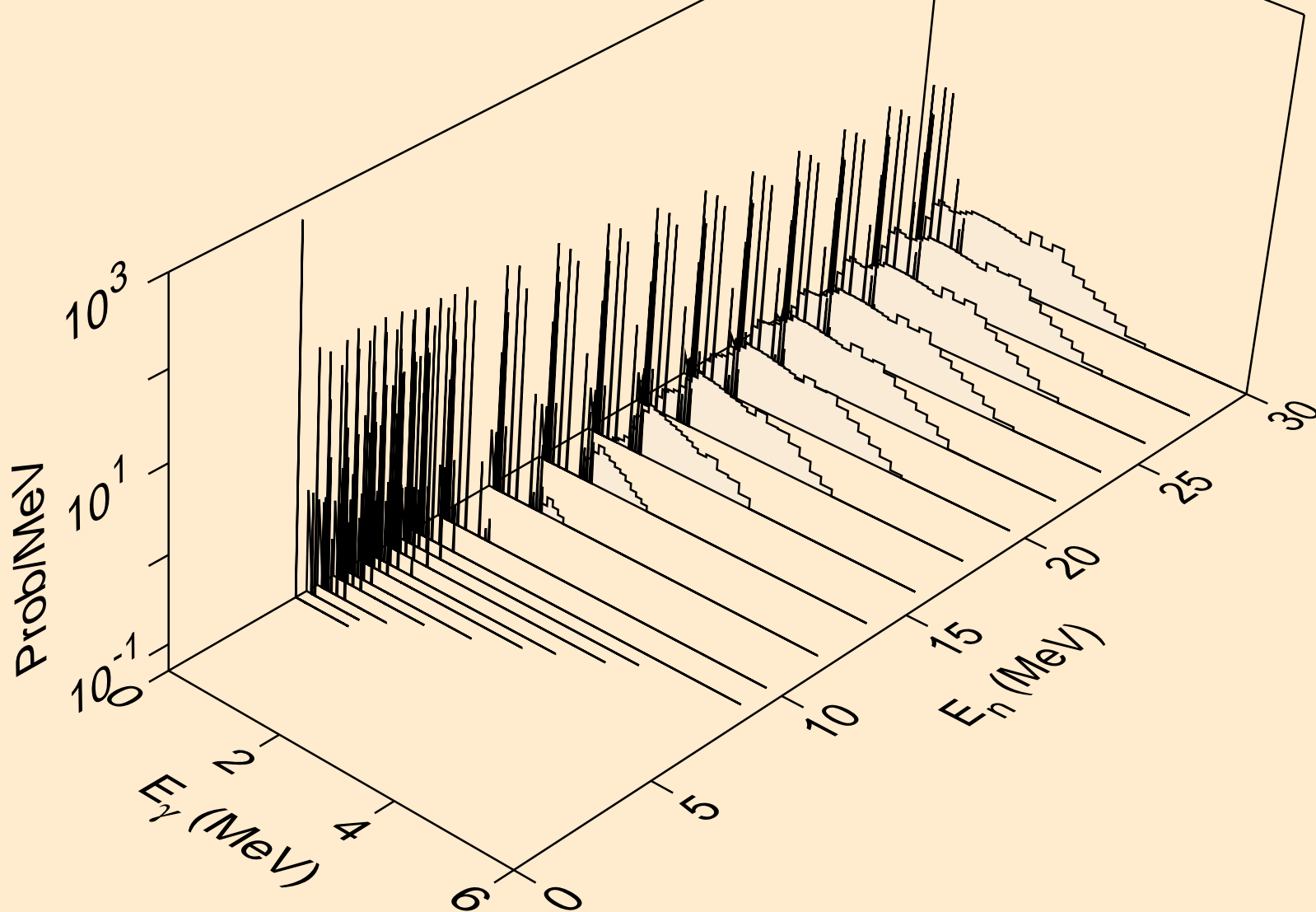

TC096M NEUTRON ACER TENDL-2019 LIBRARY; T=293.16K
Photon emission for (n,2n)a

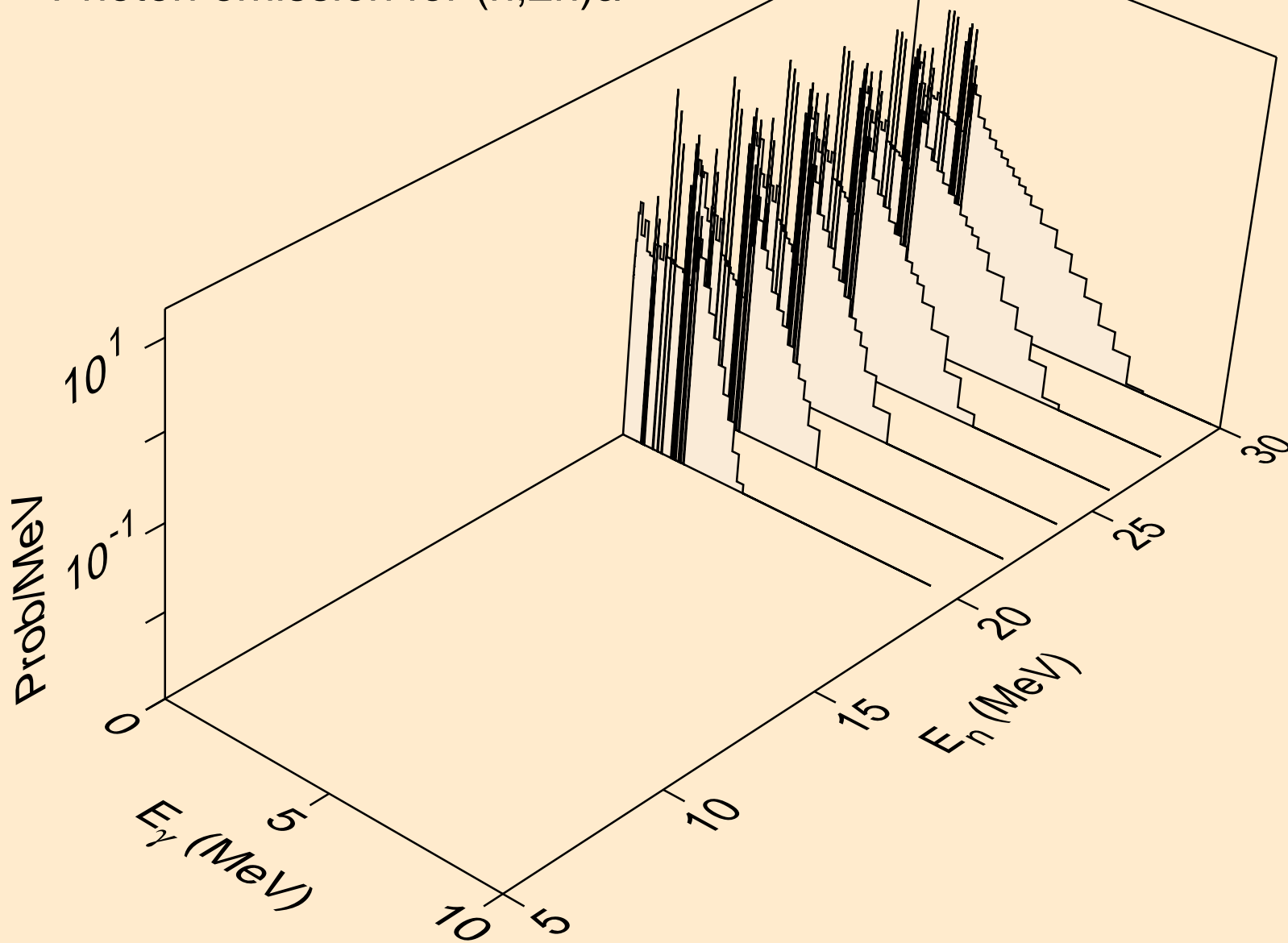

TC096M NEUTRON ACER TENDL-2019 LIBRARY; T=293.16K
Photon emission for (n,3n)a

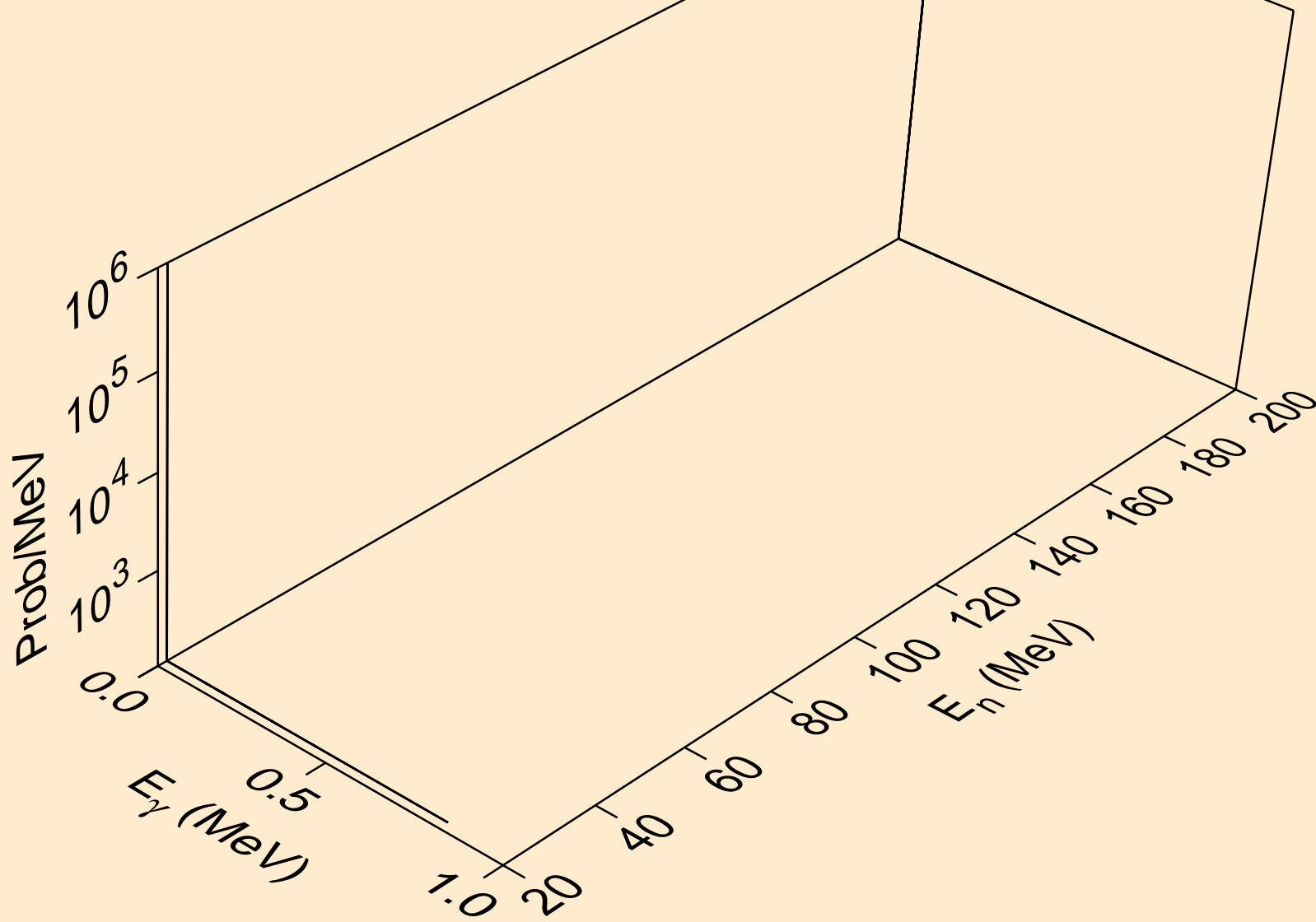

TC096M NEUTRON ACER TENDL-2019 LIBRARY; T=293.16K
Photon emission for (n,n*)p

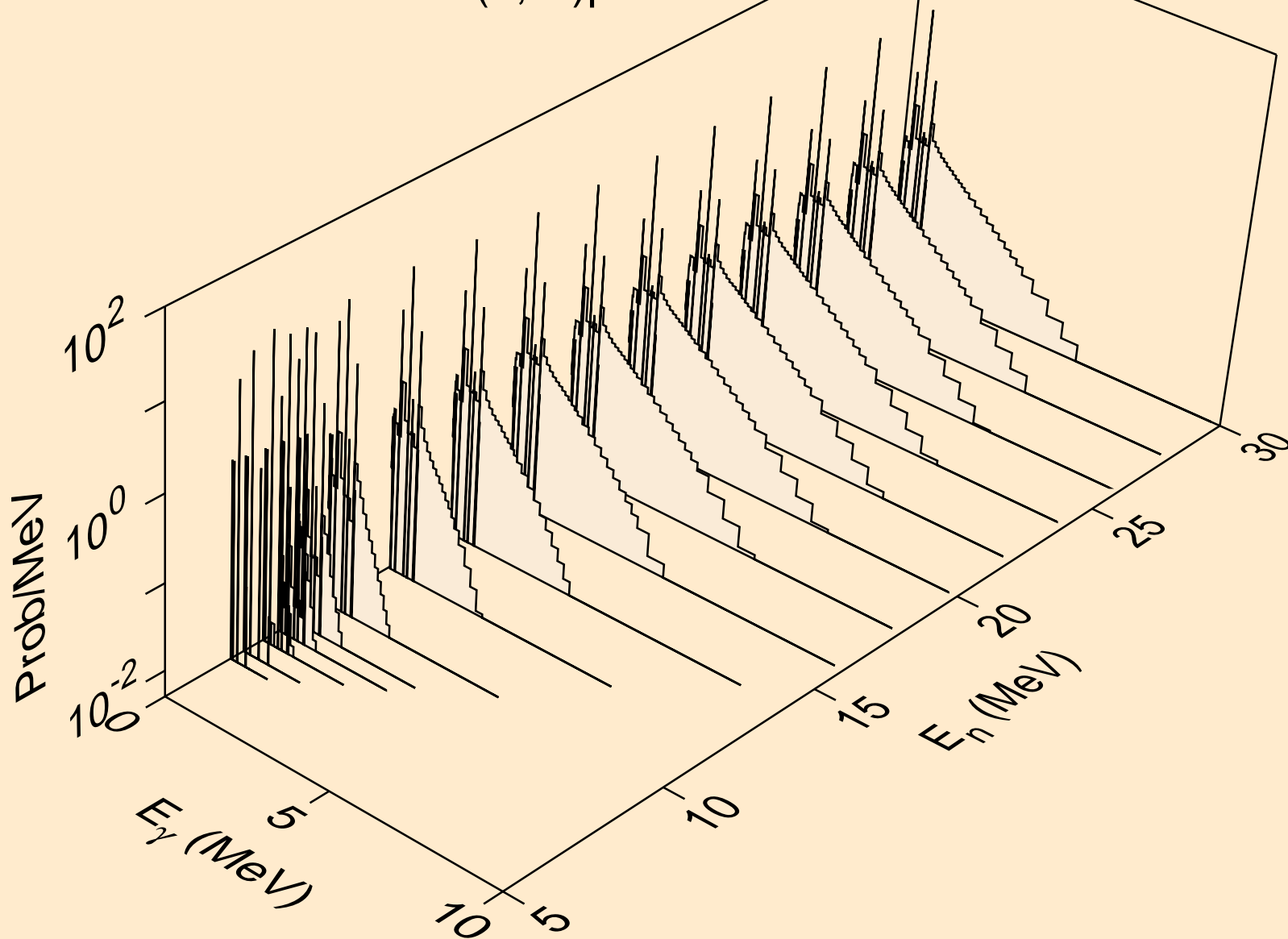

TC096M NEUTRON ACER TENDL-2019 LIBRARY; T=293.16K
Photon emission for (n,n*)2a

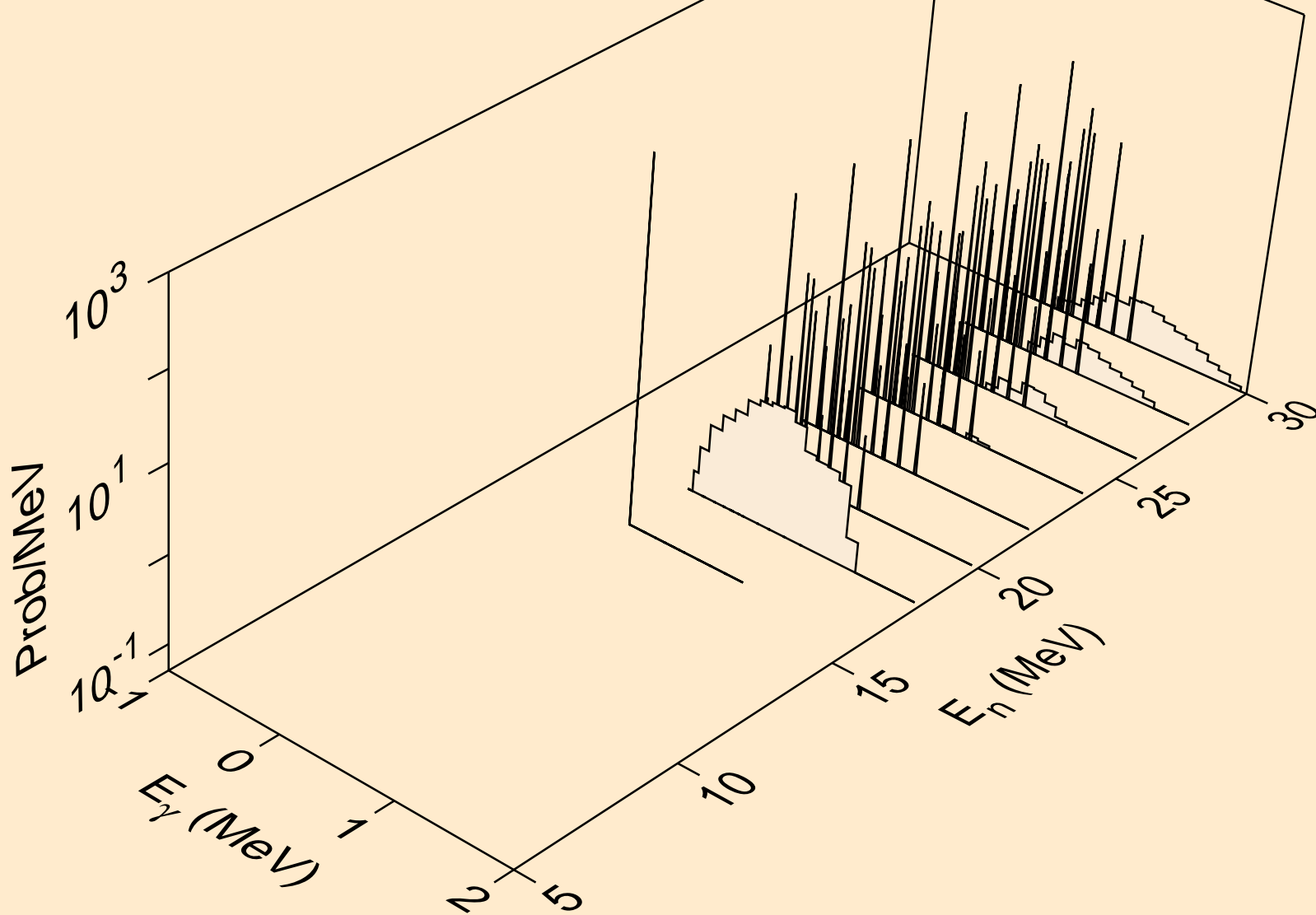

TC096M NEUTRON ACER TENDL-2019 LIBRARY; T=293.16K
Photon emission for (n,n*)d

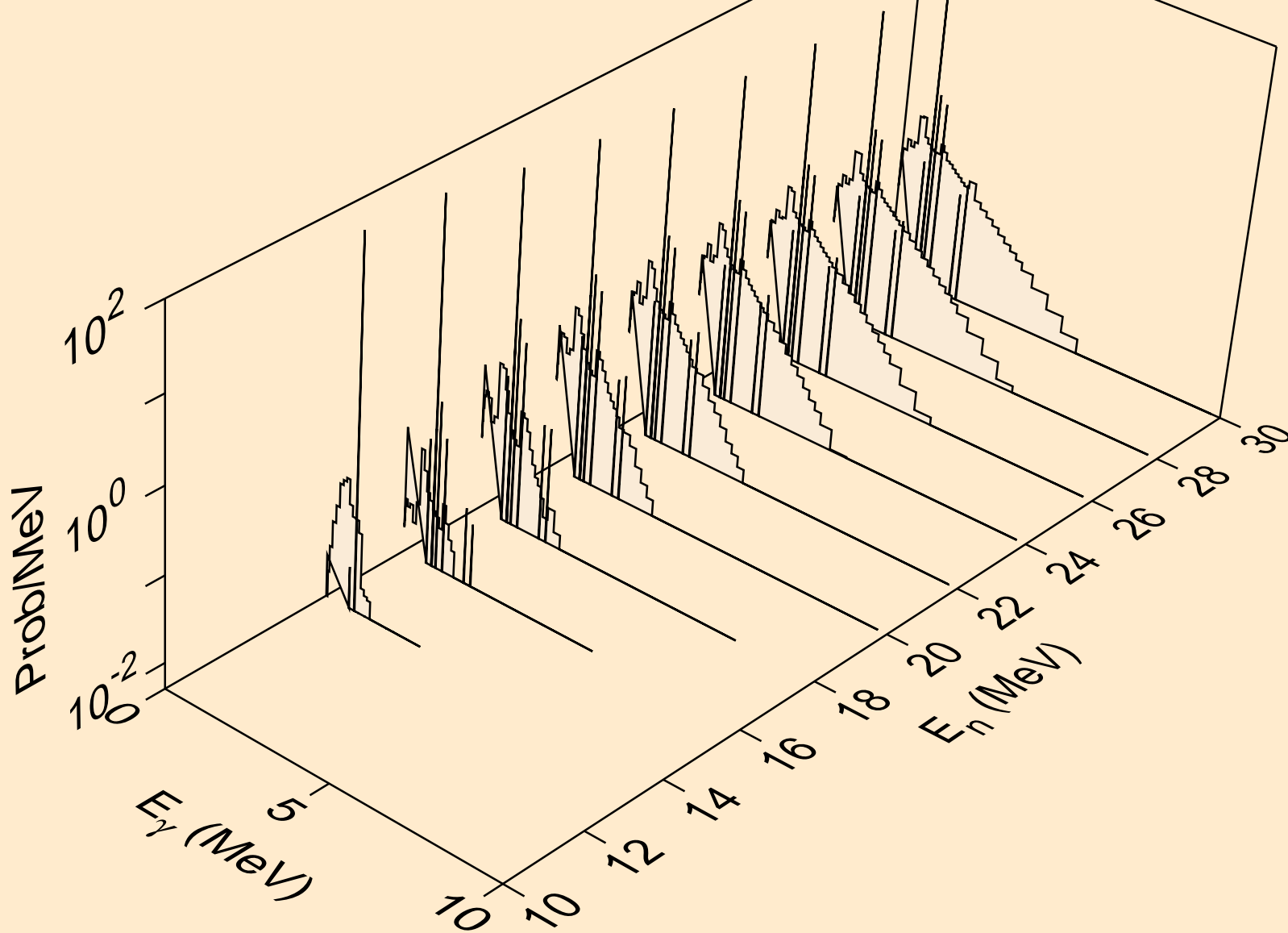

TC096M NEUTRON ACER TENDL-2019 LIBRARY; T=293.16K
Photon emission for (n,n*)t

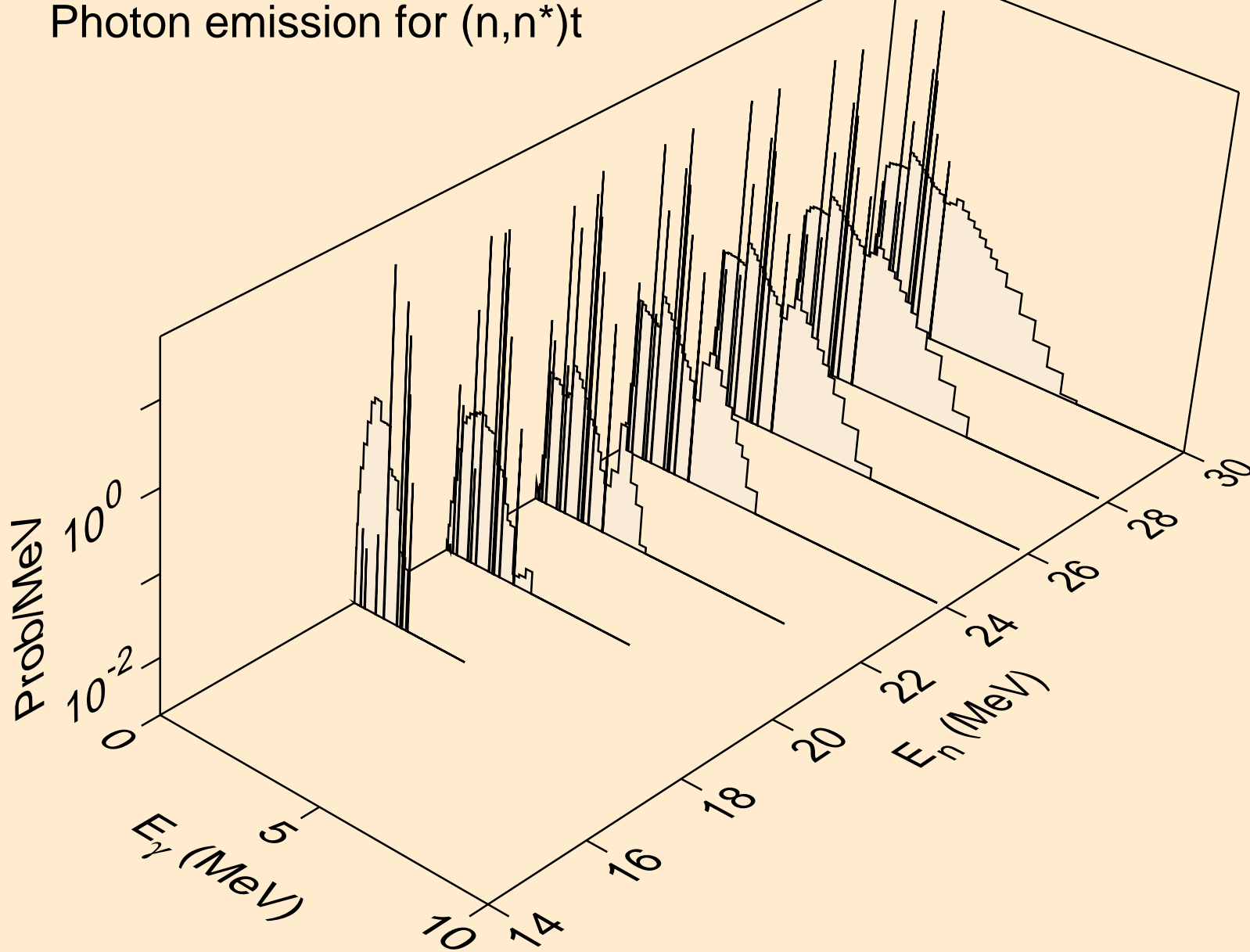

TC096M NEUTRON ACER TENDL-2019 LIBRARY; T=293.16K
Photon emission for (n,n*)he3

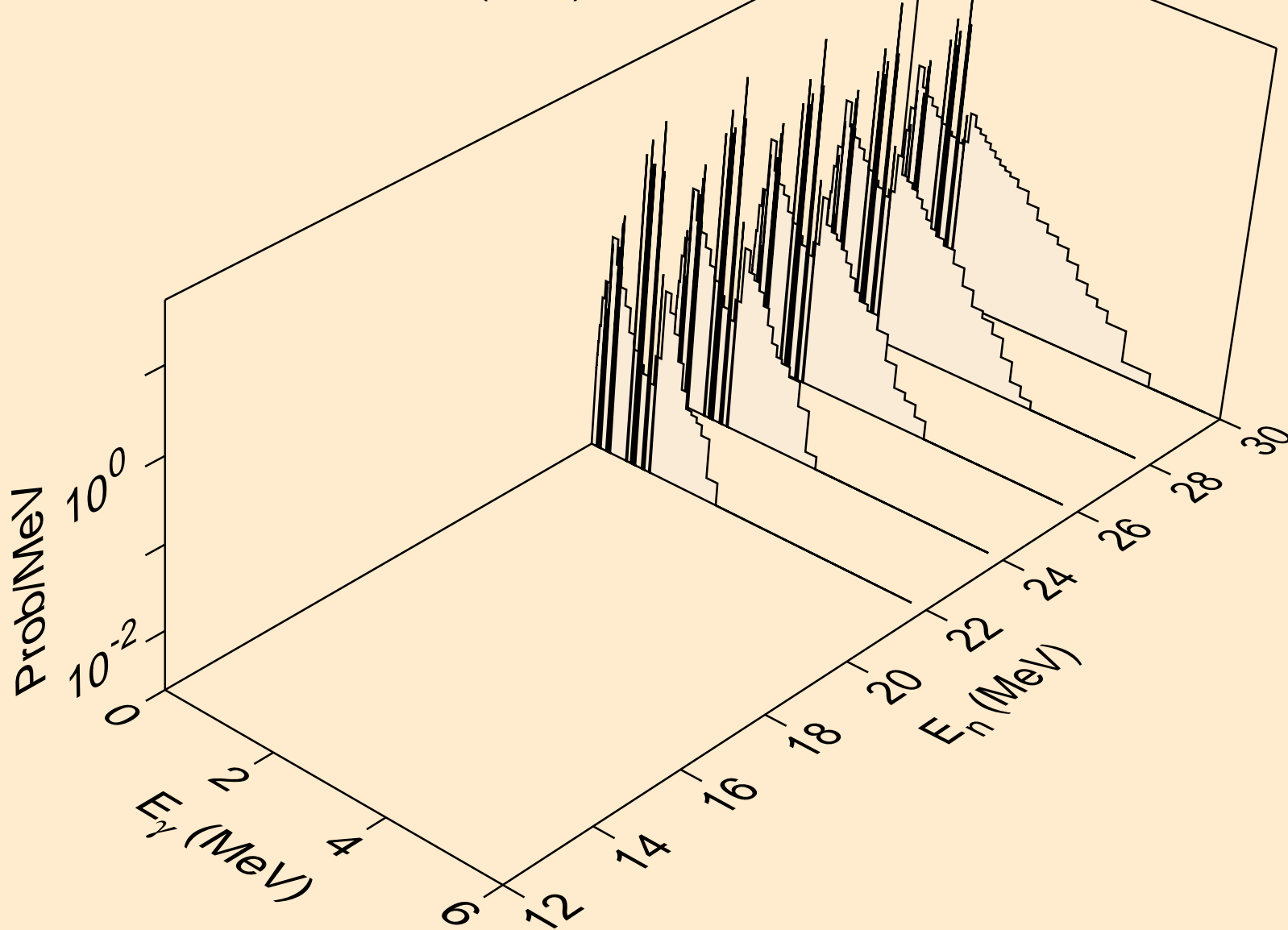

TC096M NEUTRON ACER TENDL-2019 LIBRARY; T=293.16K
Photon emission for (n,4n)

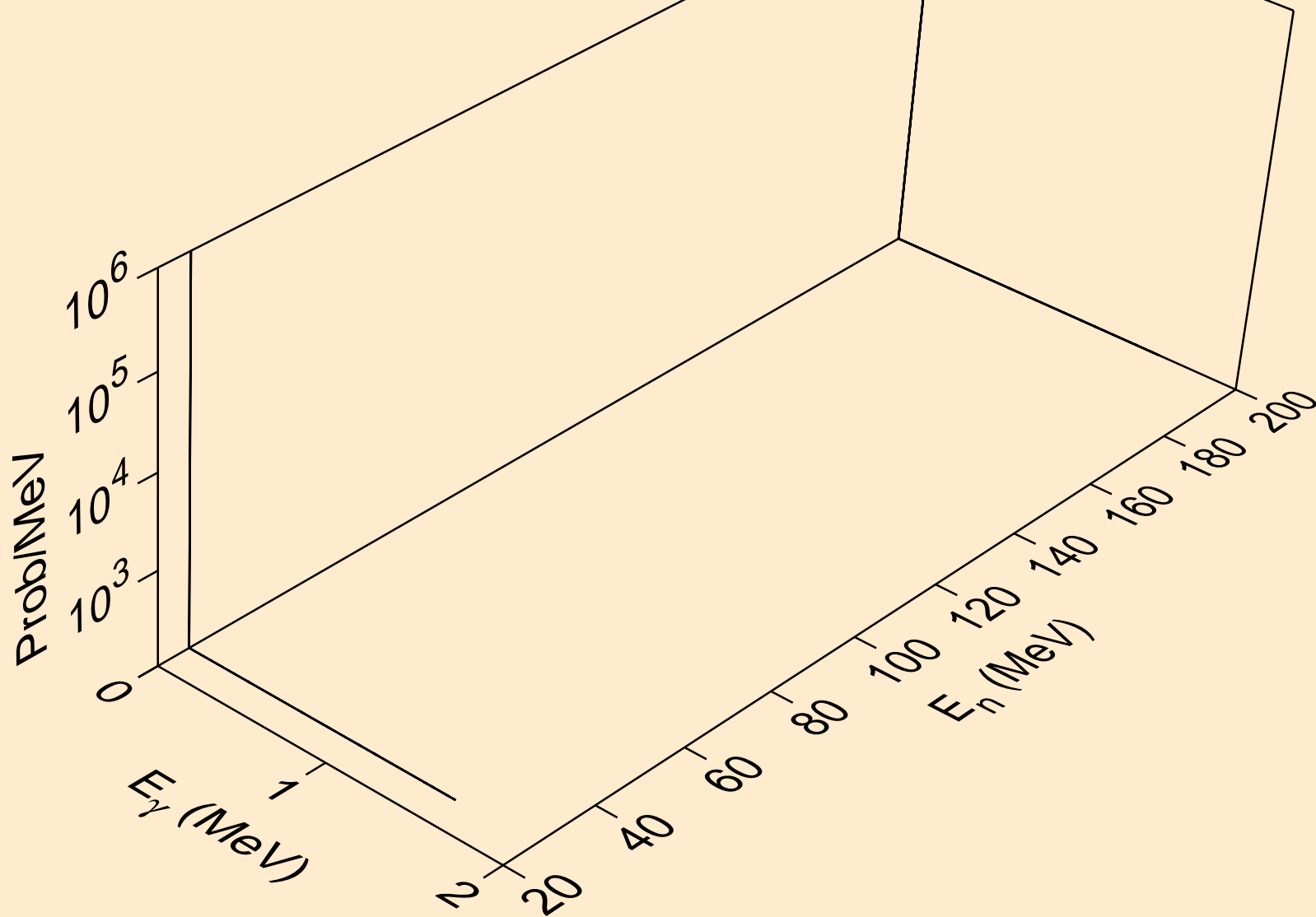

TC096M NEUTRON ACER TENDL-2019 LIBRARY; T=293.16K
Photon emission for (n,2np)

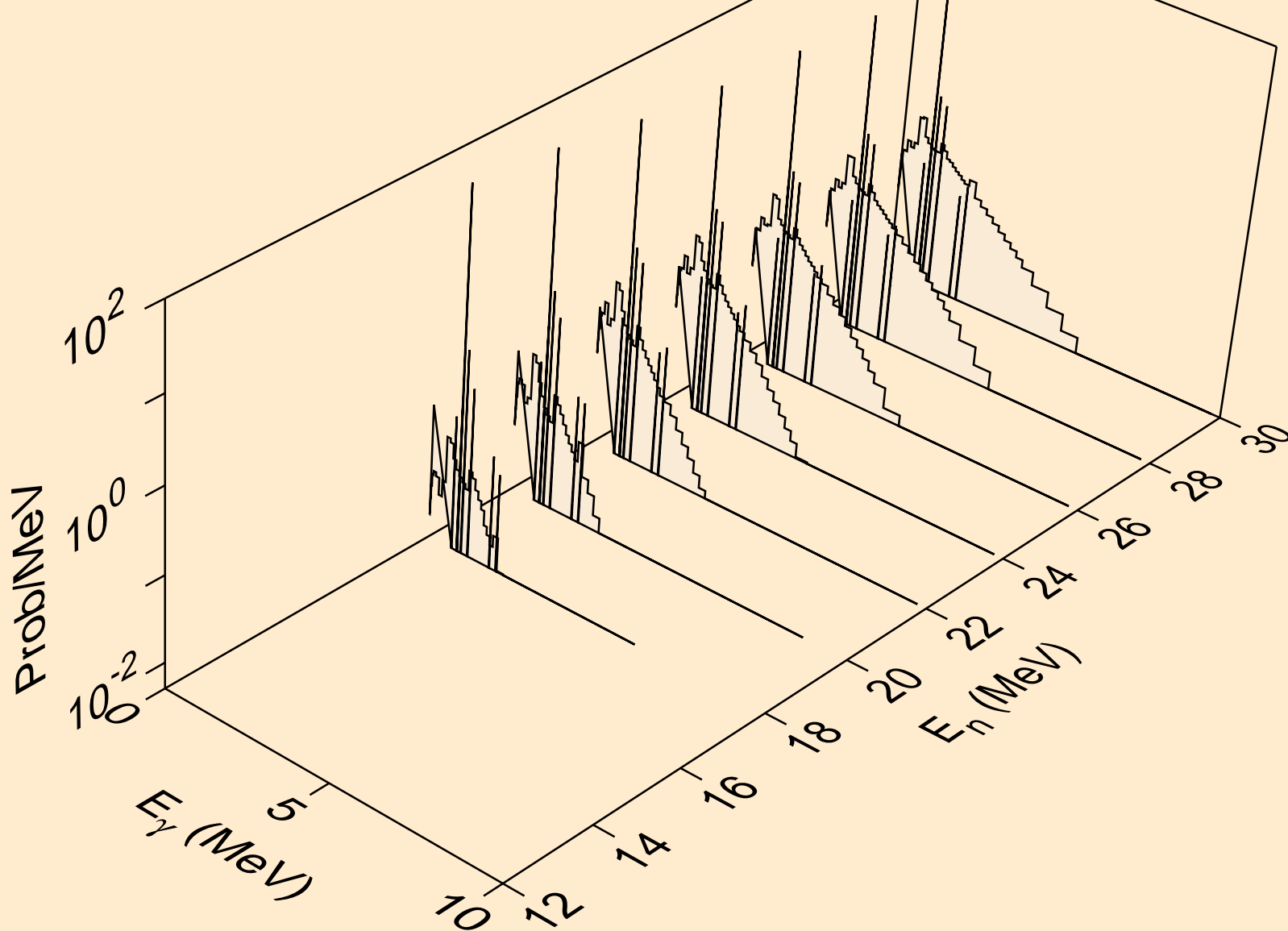

TC096M NEUTRON ACER TENDL-2019 LIBRARY; T=293.16K
Photon emission for (n,3np)

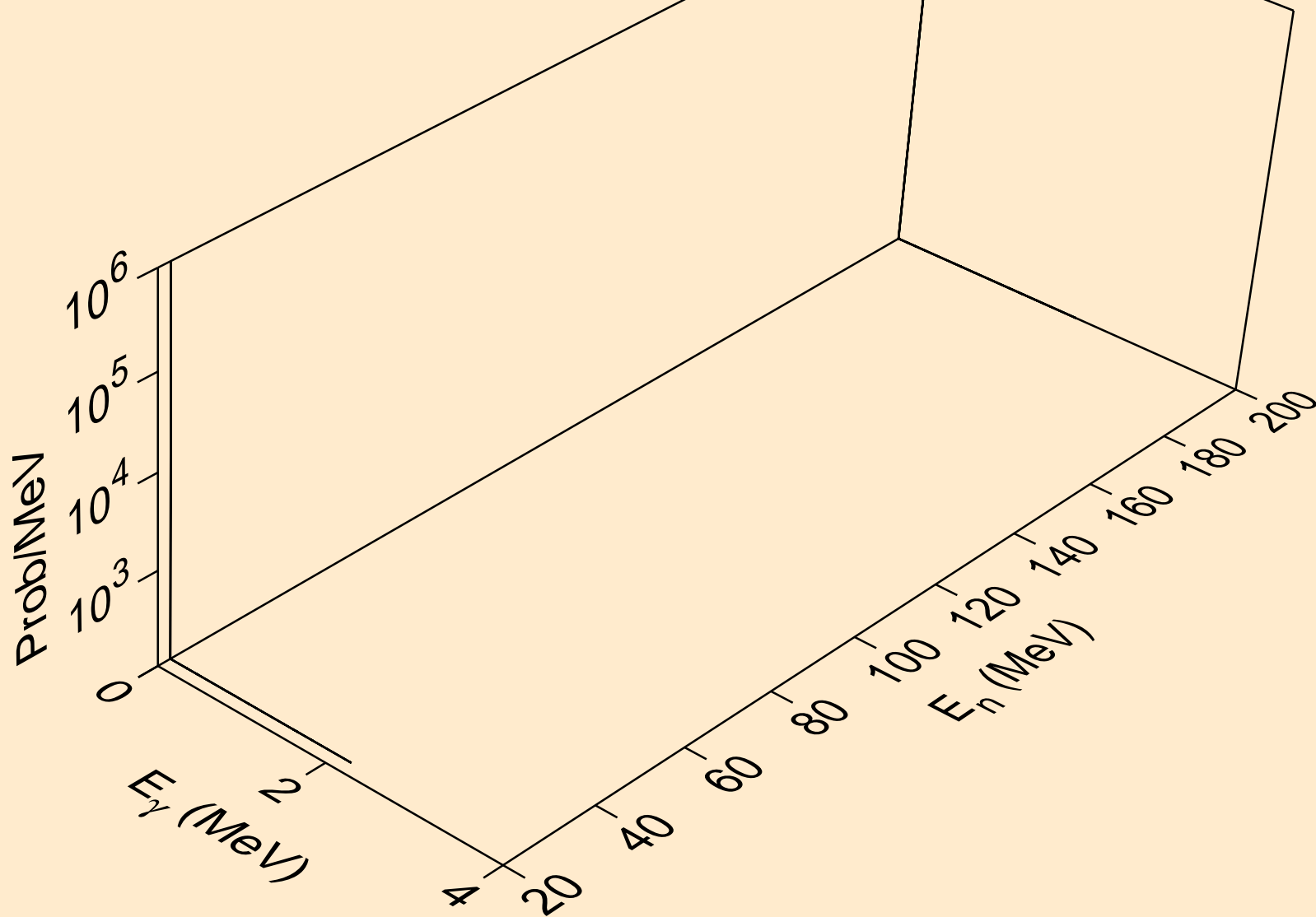

TC096M NEUTRON ACER TENDL-2019 LIBRARY; T=293.16K
Photon emission for (n,2np)

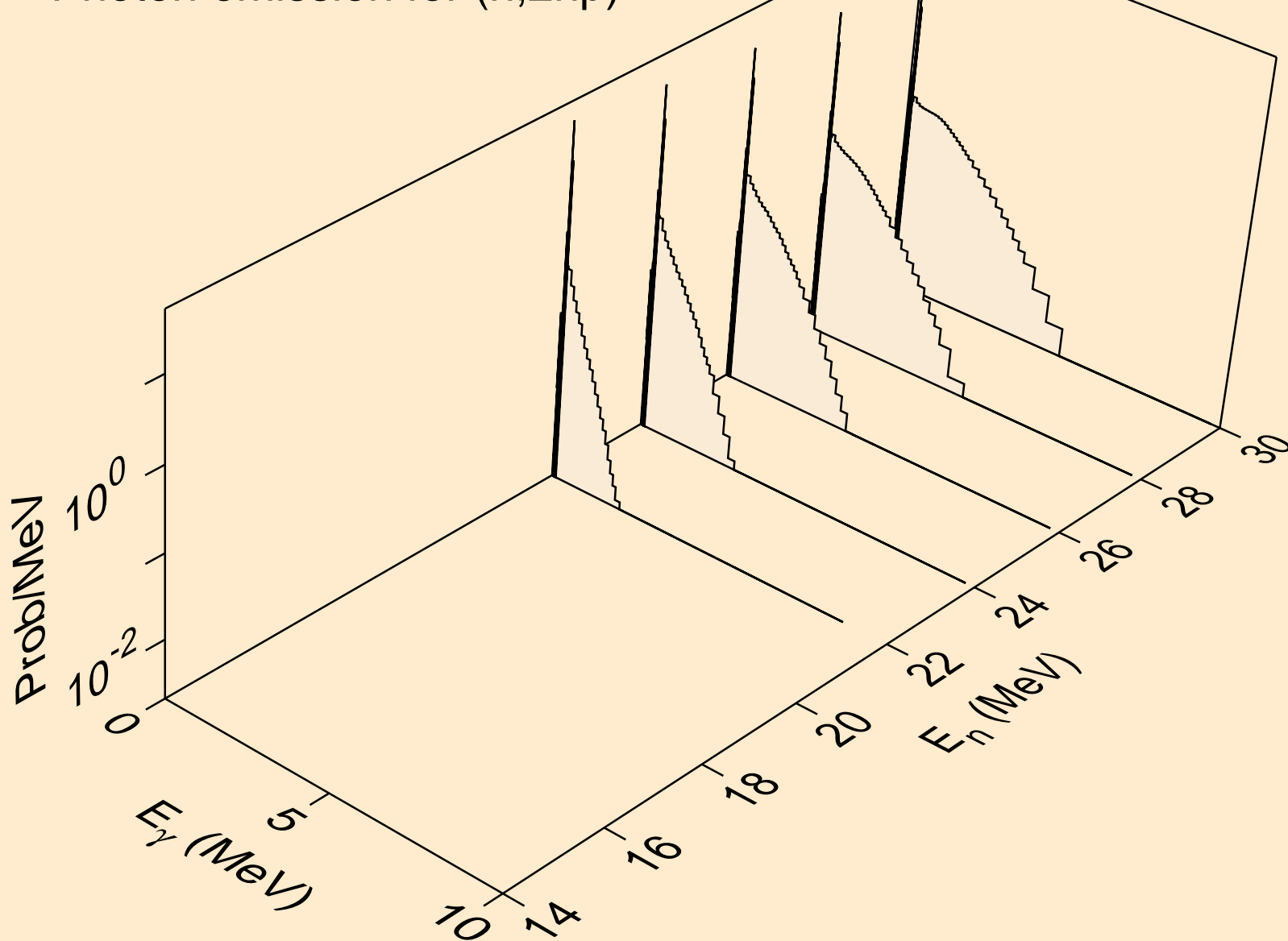

TC096M NEUTRON ACER TENDL-2019 LIBRARY; T=293.16K
Photon emission for (n,npa)

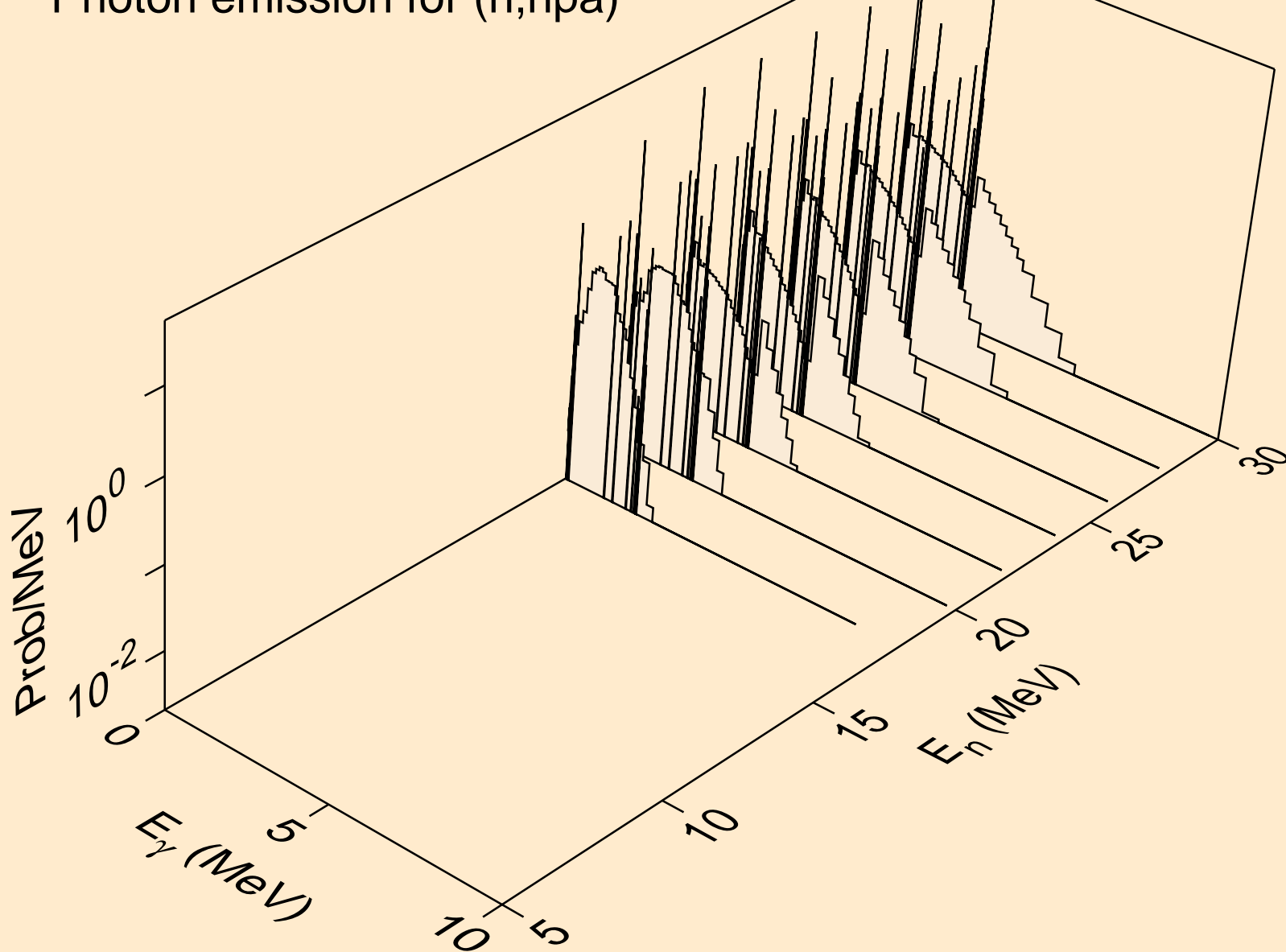

TC096M NEUTRON ACER TENDL-2019 LIBRARY; T=293.16K
Photon emission for (n,n*2)

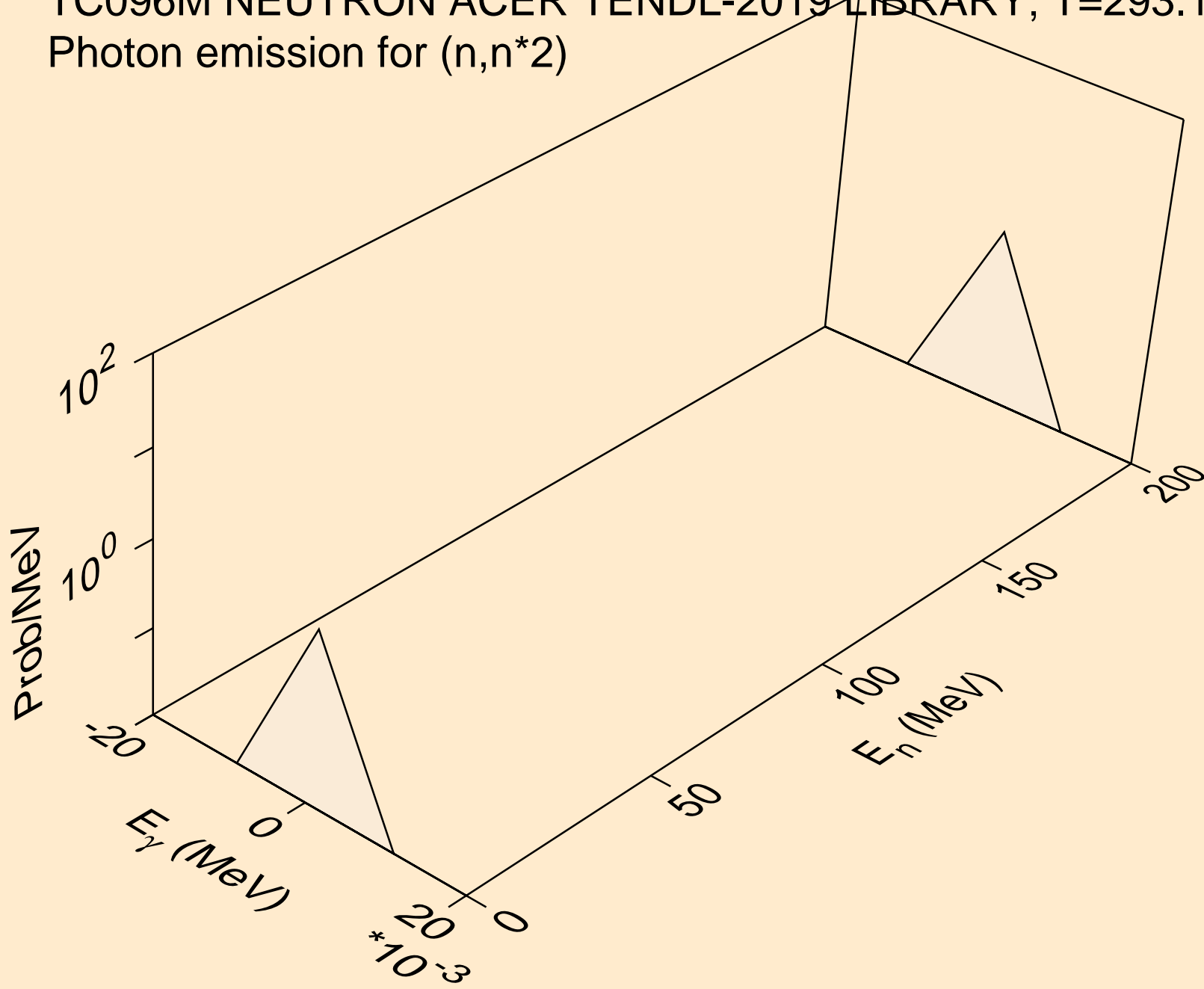

TC096M NEUTRON ACER TENDL-2019 LIBRARY; T=293.16K
Photon emission for (n,n*3)

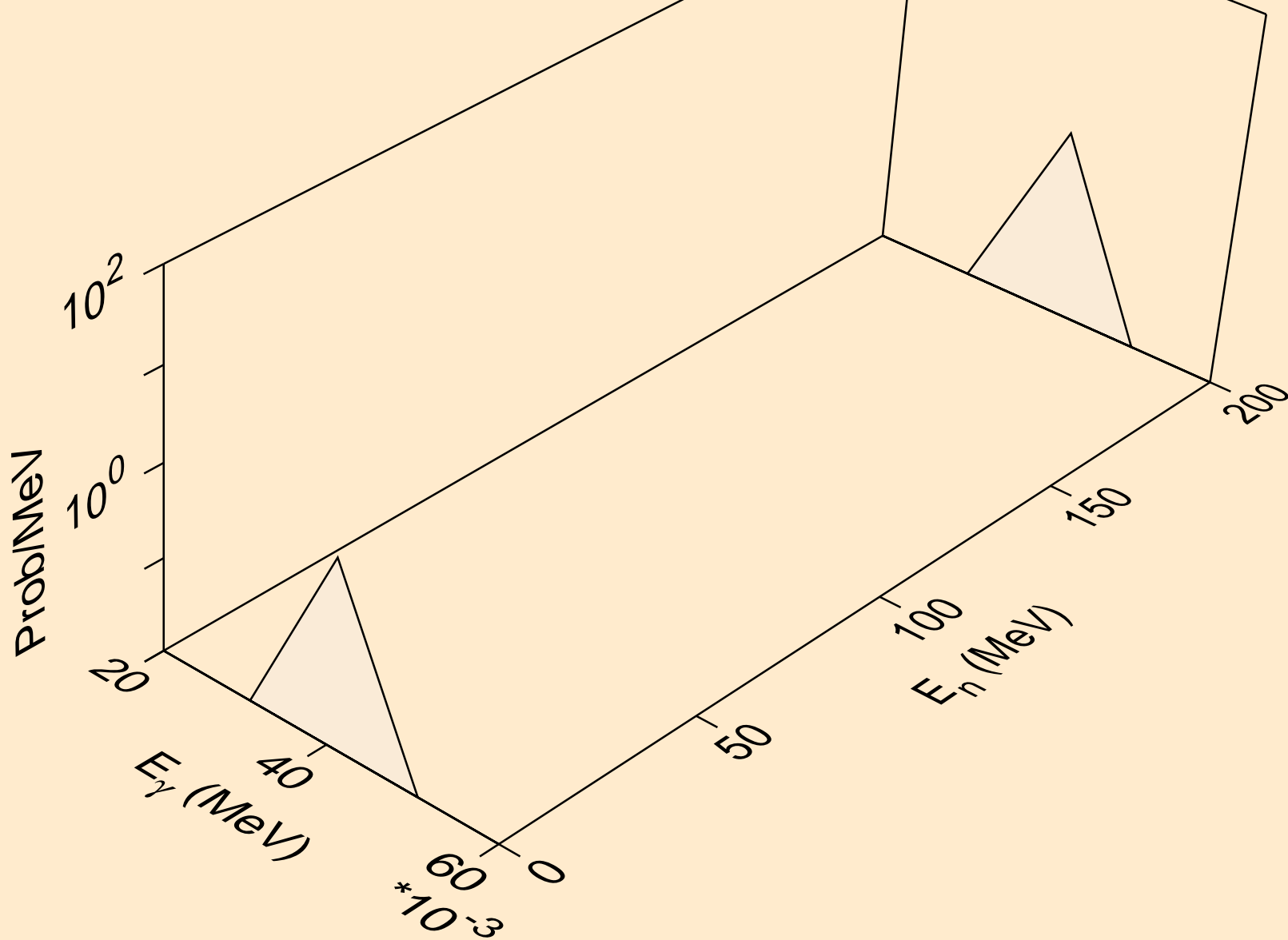

TC096M NEUTRON ACER TENDL-2019 LIBRARY; T=293.16K
Photon emission for (n,n*4)

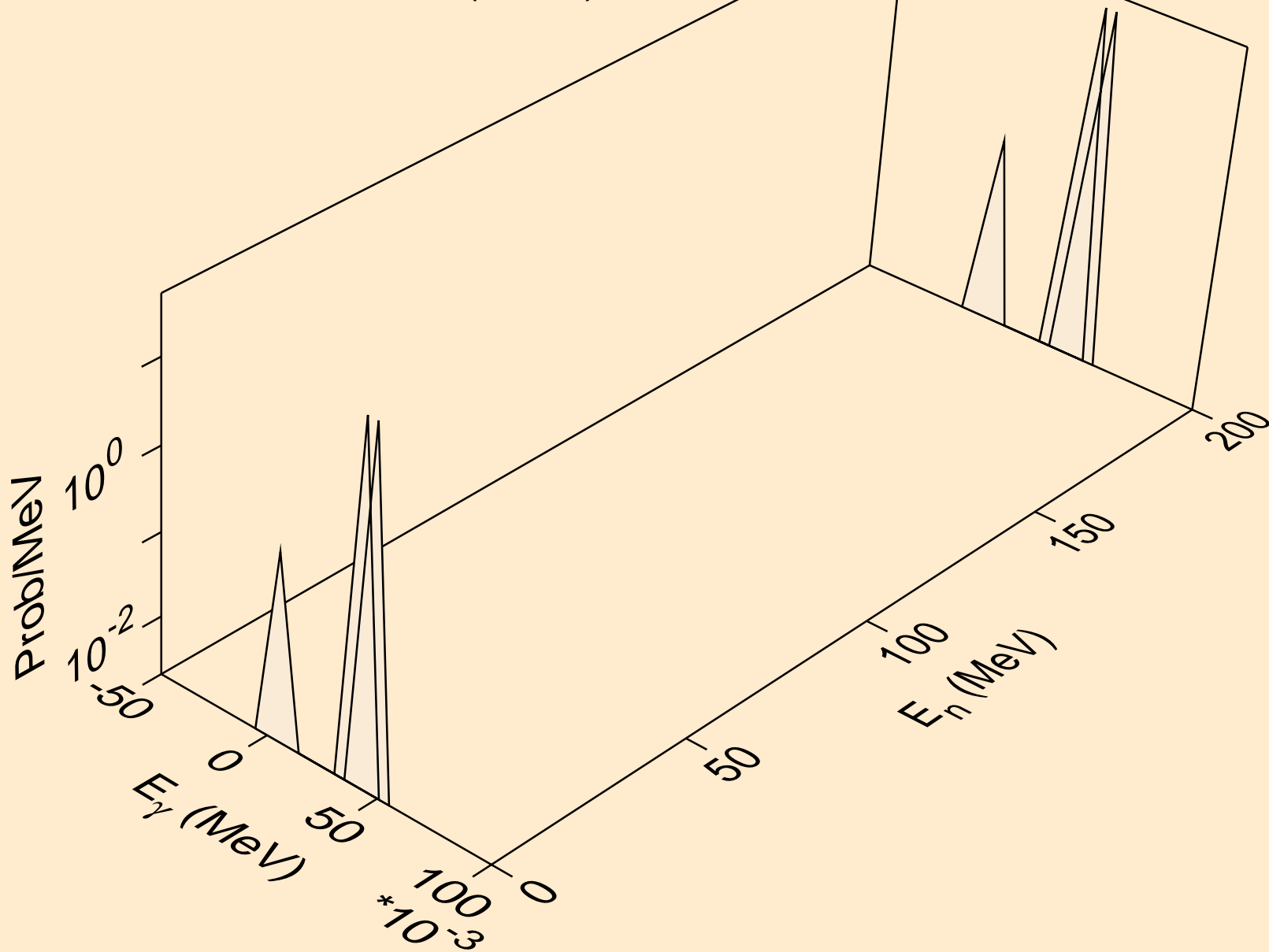

TC096M NEUTRON ACER TENDL-2019 LIBRARY; T=293.16K
Photon emission for (n,n*5)

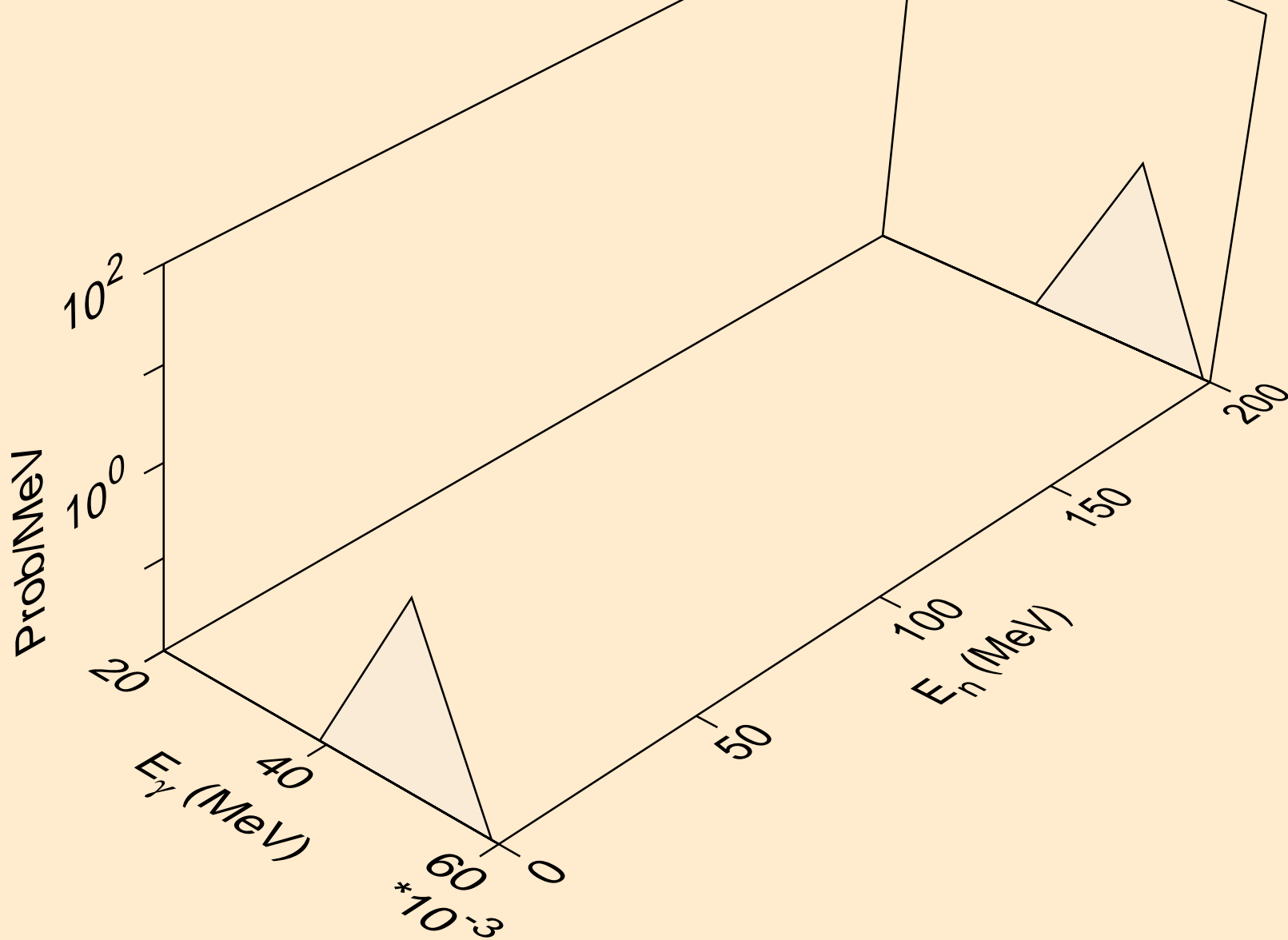

TC096M NEUTRON ACER TENDL-2019 LIBRARY; T=293.16K
Photon emission for (n,n*6)

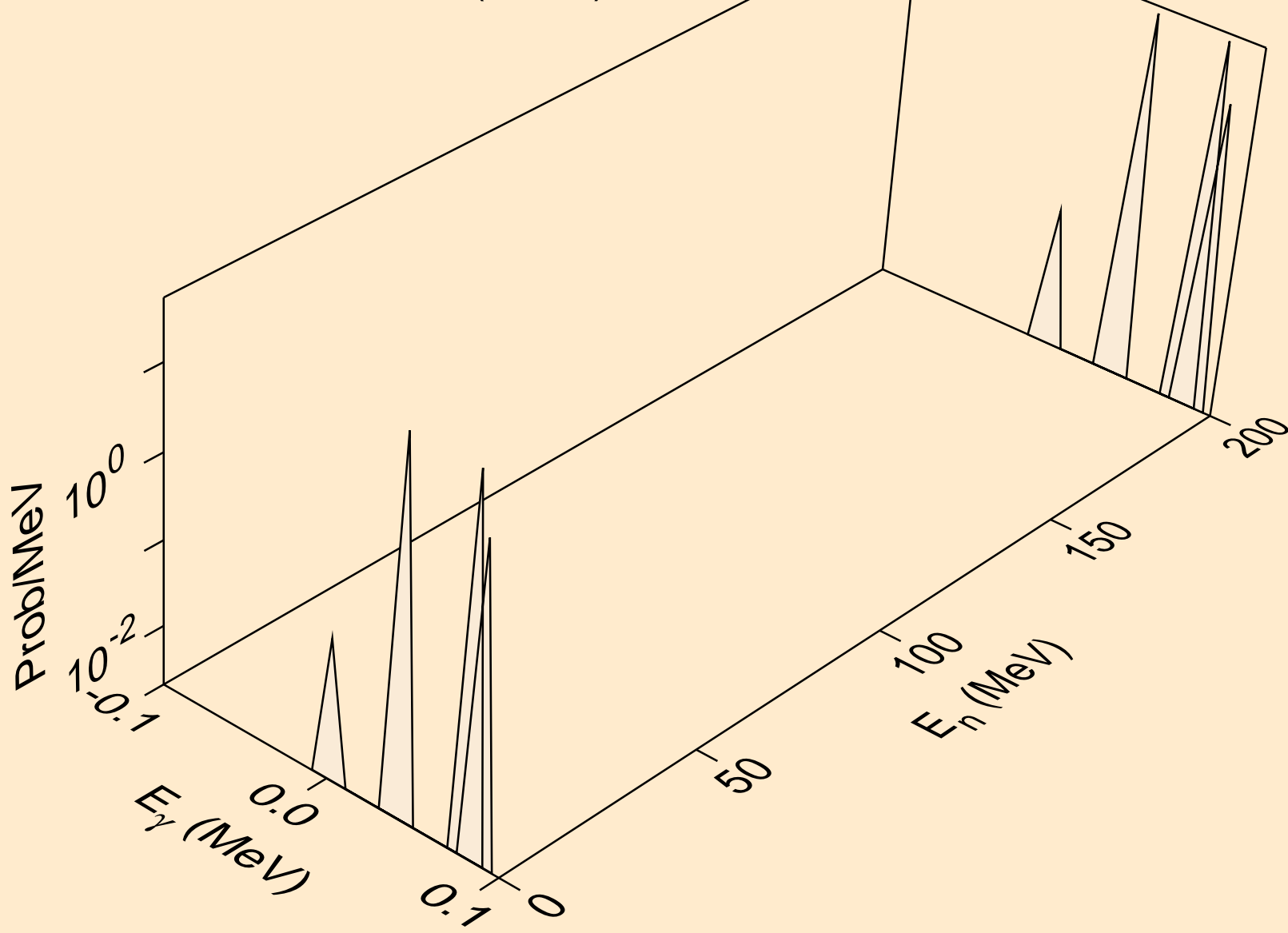

TC096M NEUTRON ACER TENDL-2019 LIBRARY; T=293.16K
Photon emission for (n,n*7)

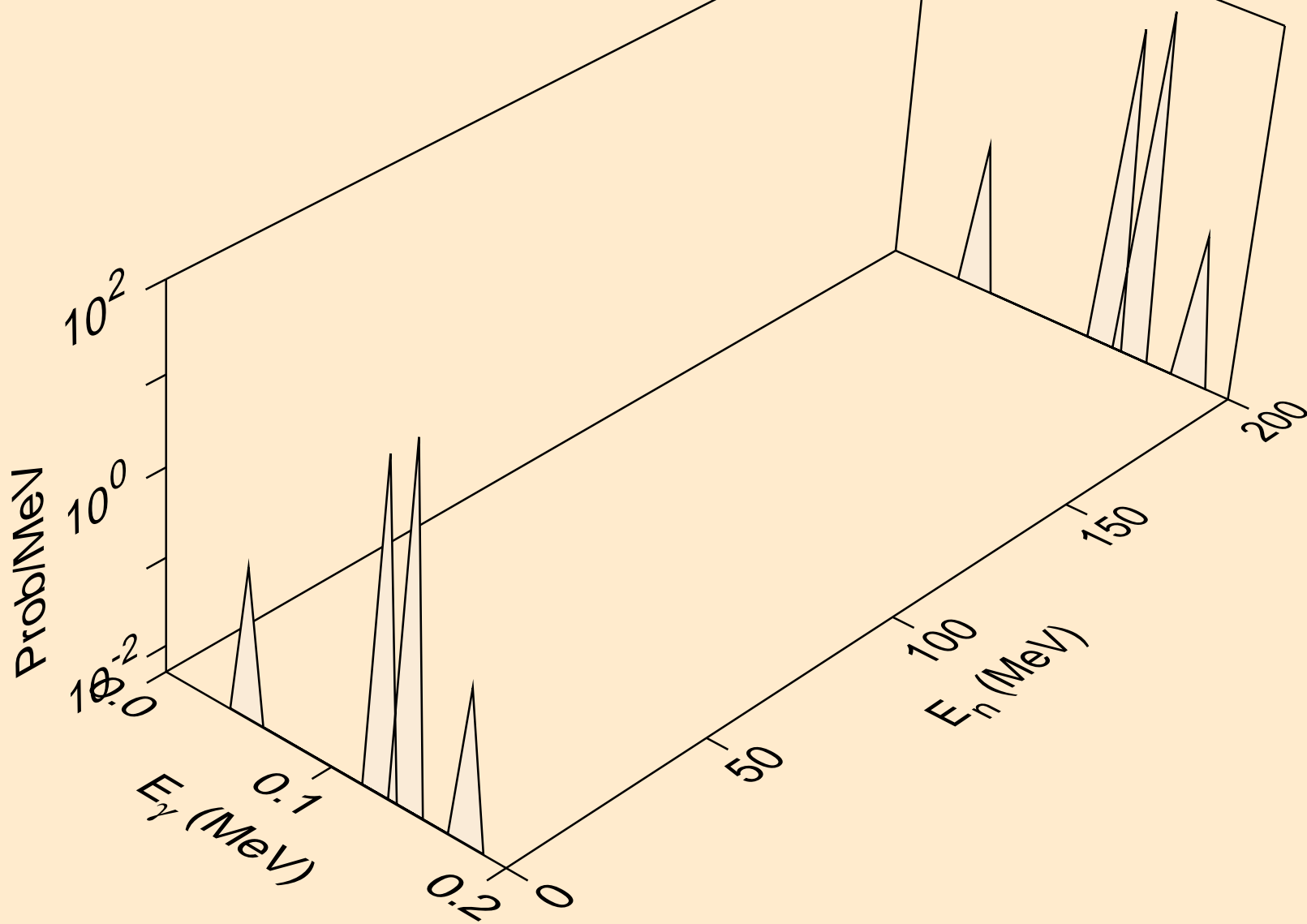

TC096M NEUTRON ACER TENDL-2019 LIBRARY; T=293.16K
Photon emission for (n,n*8)

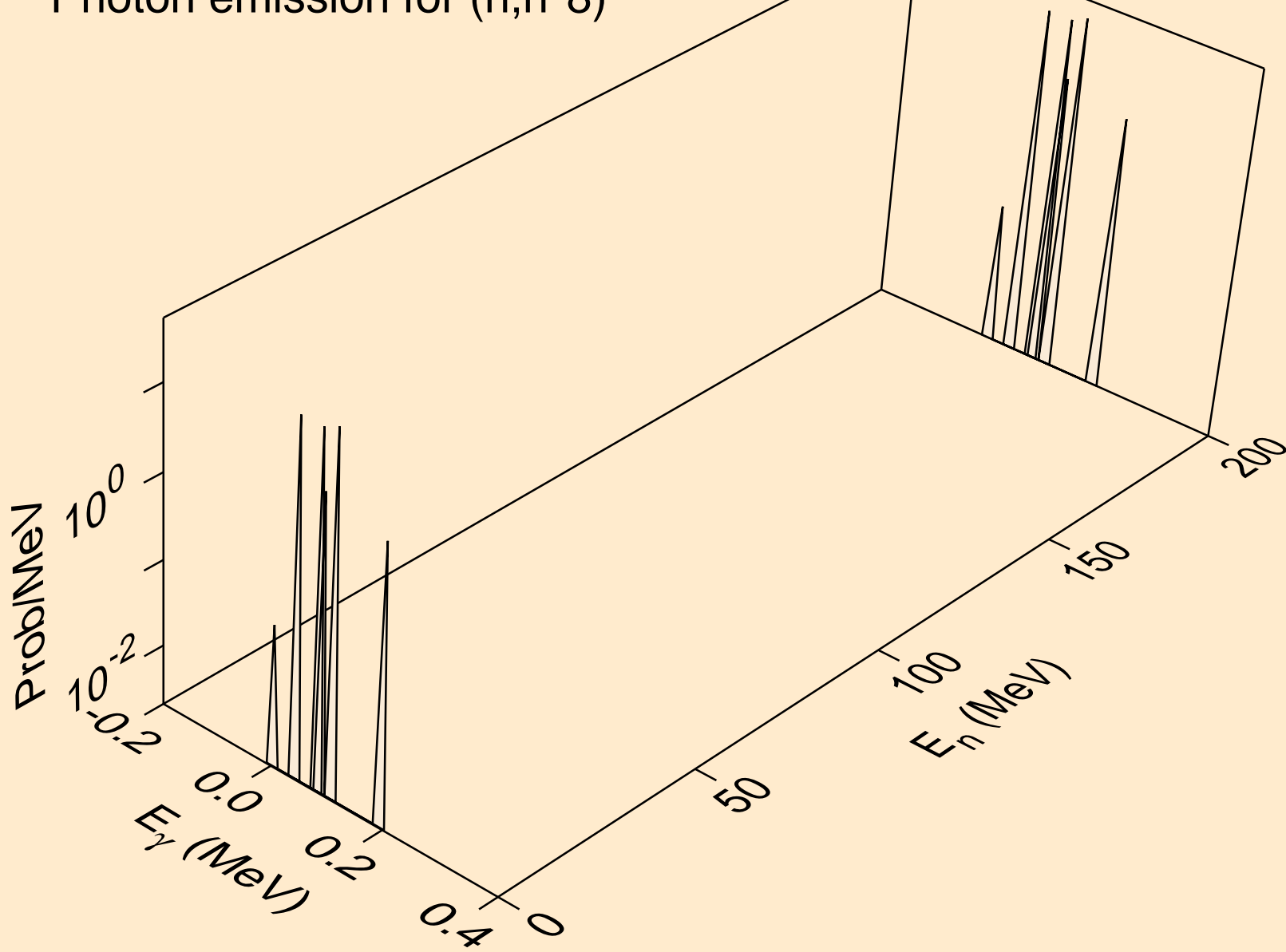

TC096M NEUTRON ACER TENDL-2019 LIBRARY; T=293.16K
Photon emission for (n,n*9)

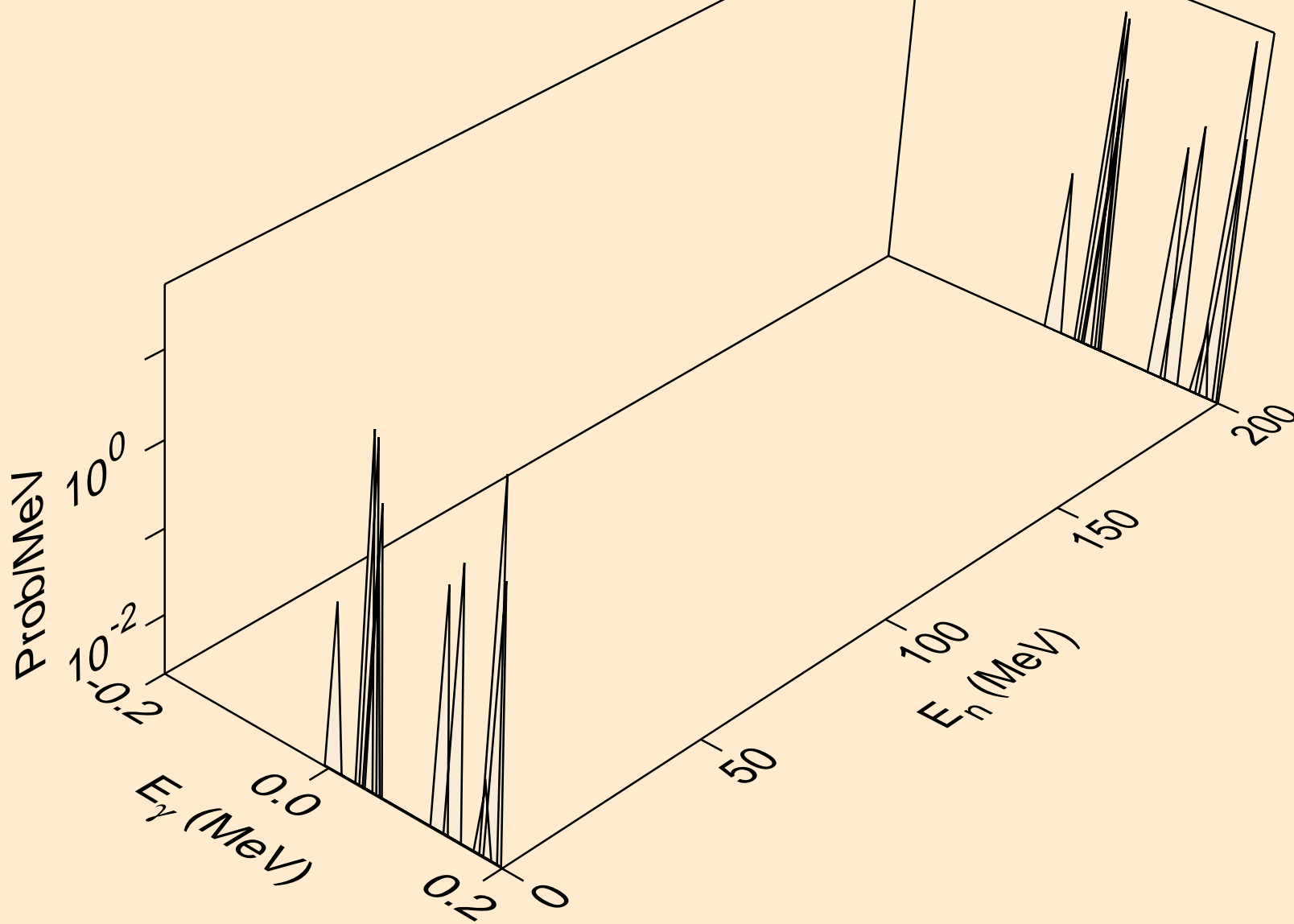

TC096M NEUTRON ACER TENDL-2019 LIBRARY; T=293.16K
Photon emission for (n,n*10)

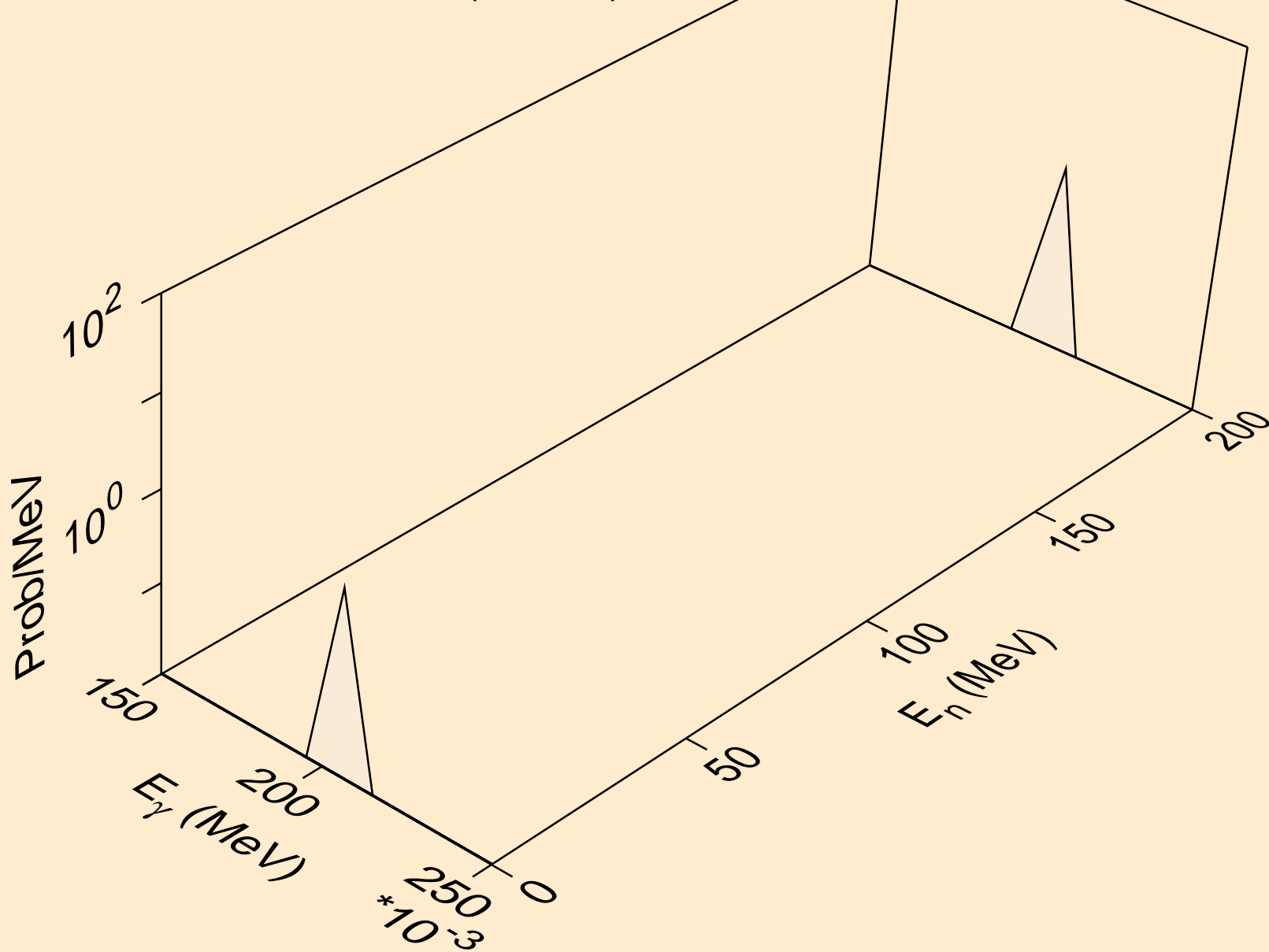

TC096M NEUTRON ACER TENDL-2019 LIBRARY; T=293.16K
Photon emission for (n,n*11)

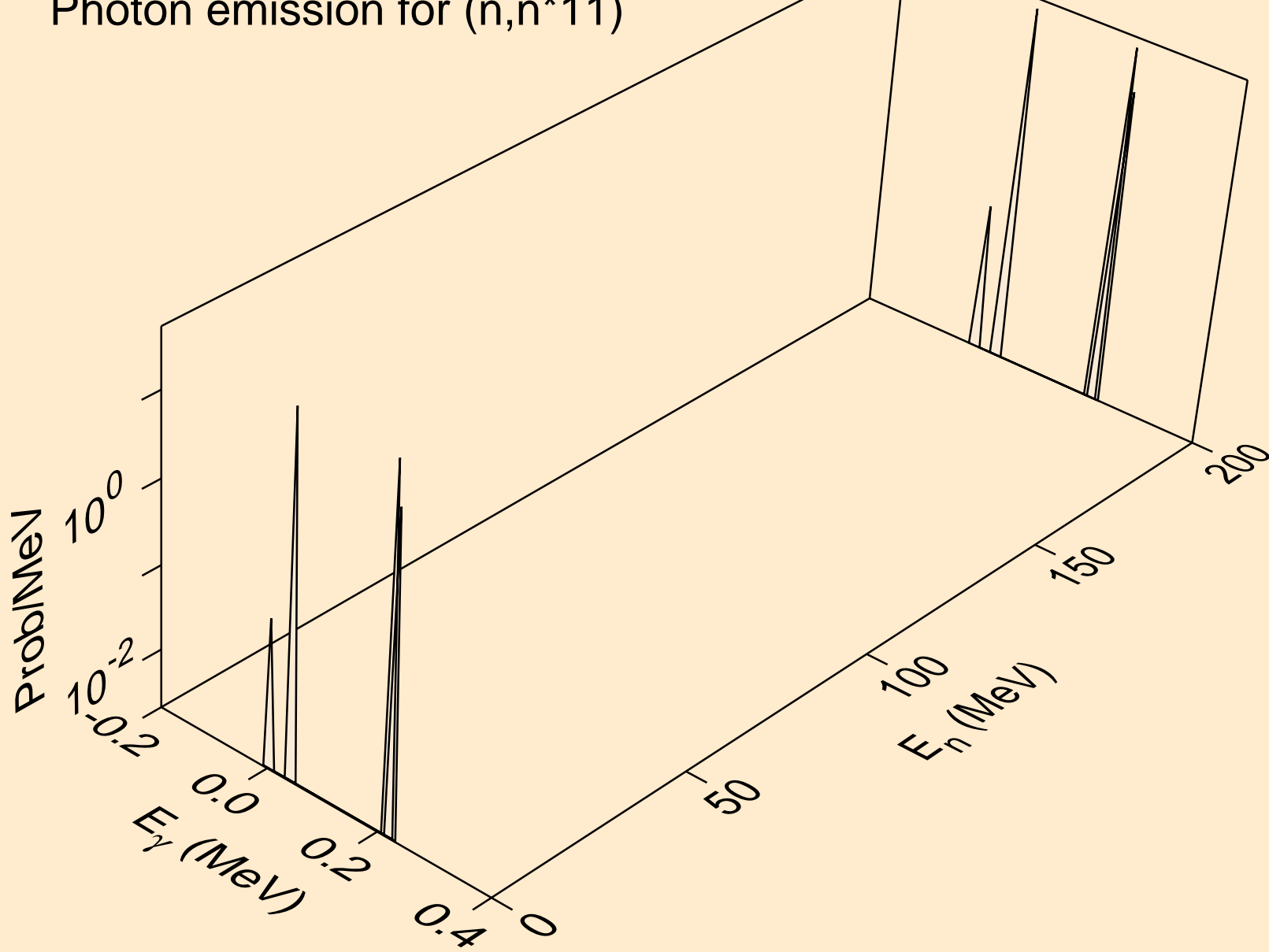

TC096M NEUTRON ACER TENDL-2019 LIBRARY; T=293.16K
Photon emission for (n,n*12)

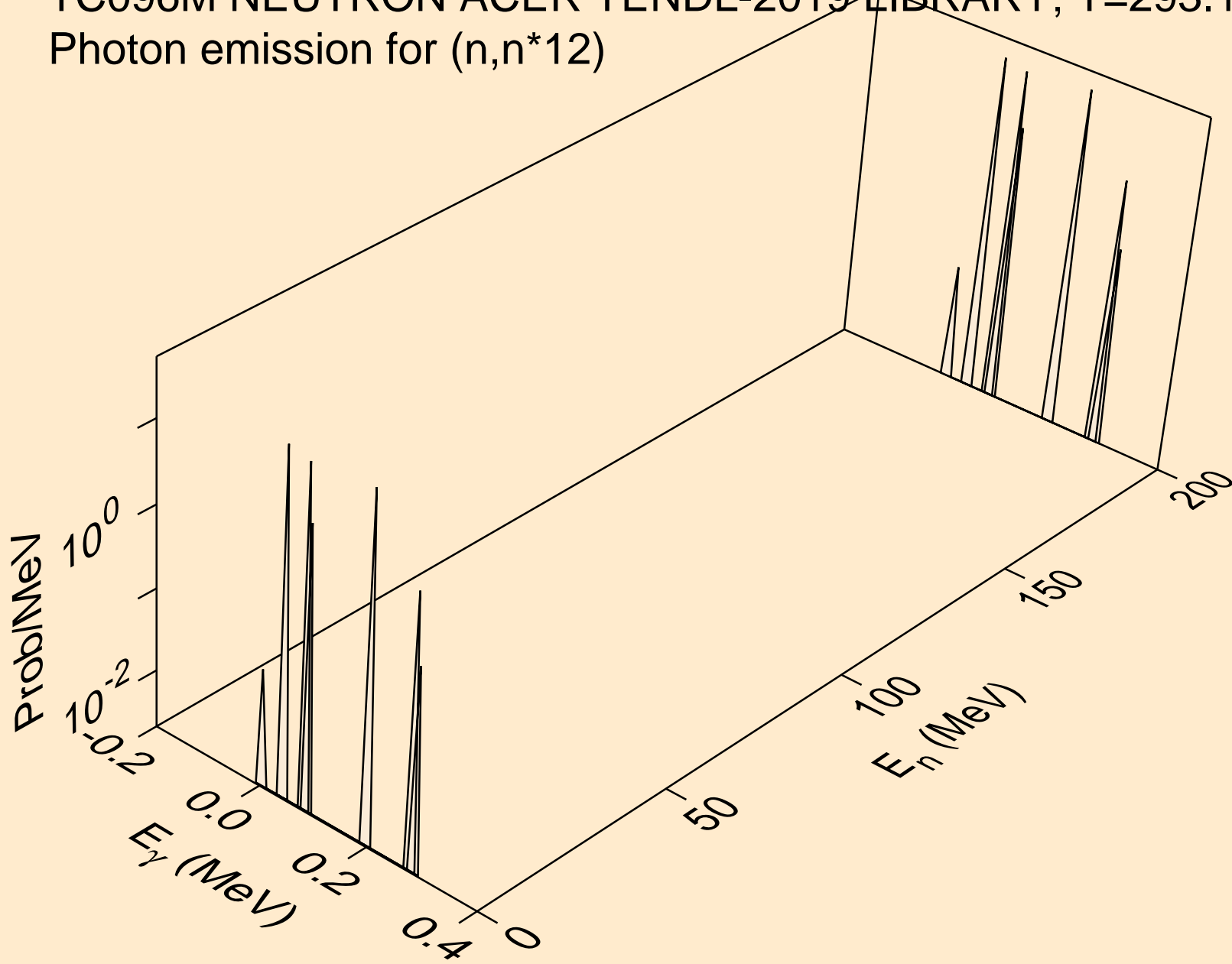

TC096M NEUTRON ACER TENDL-2019 LIBRARY; T=293.16K
Photon emission for (n,n*13)

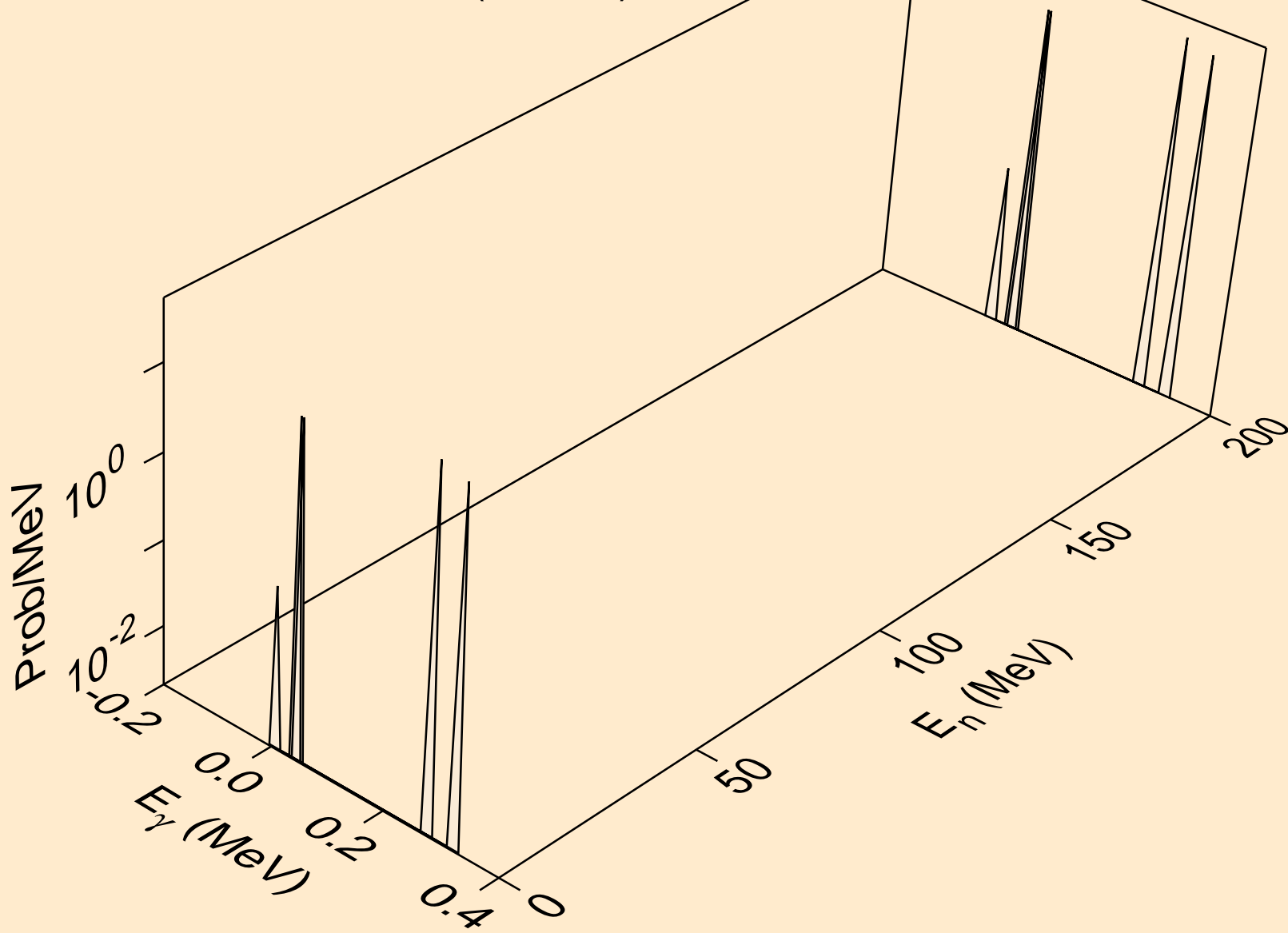

TC096M NEUTRON ACER TENDL-2019 LIBRARY; T=293.16K
Photon emission for (n,n*14)

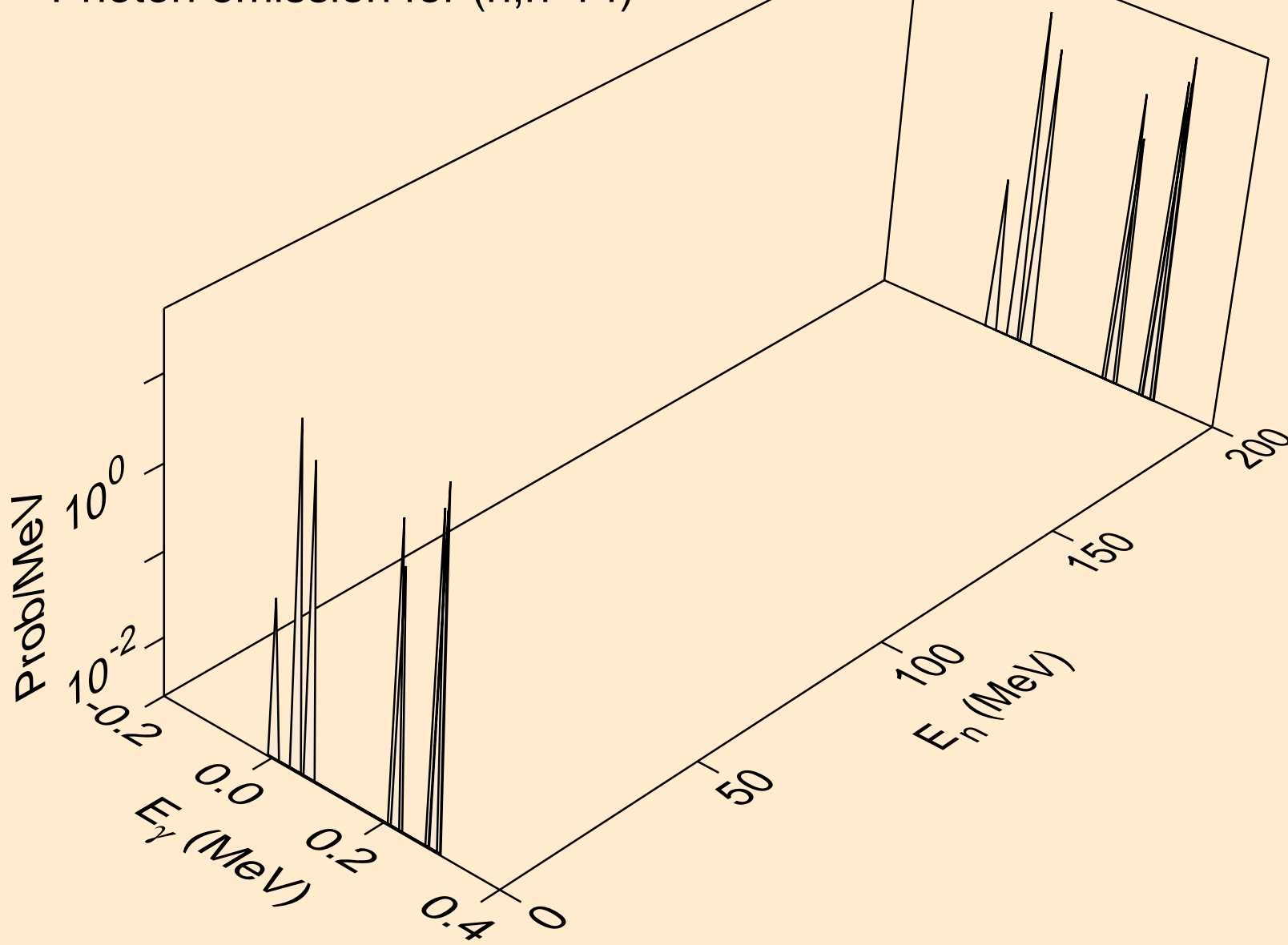

TC096M NEUTRON ACER TENDL-2019 LIBRARY; T=293.16K
Photon emission for (n,n*15)

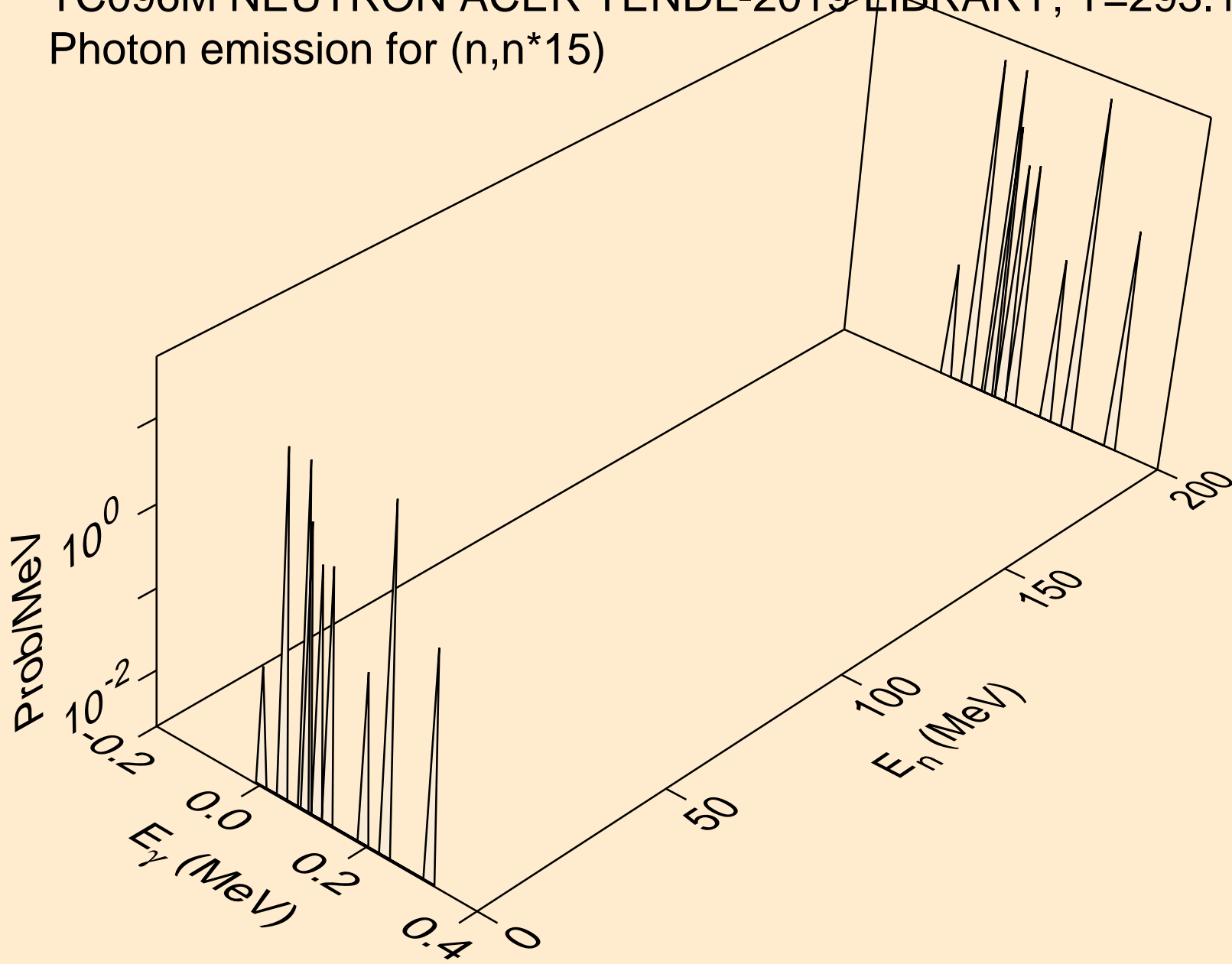

TC096M NEUTRON ACER TENDL-2019 LIBRARY; T=293.16K
Photon emission for (n,n*16)

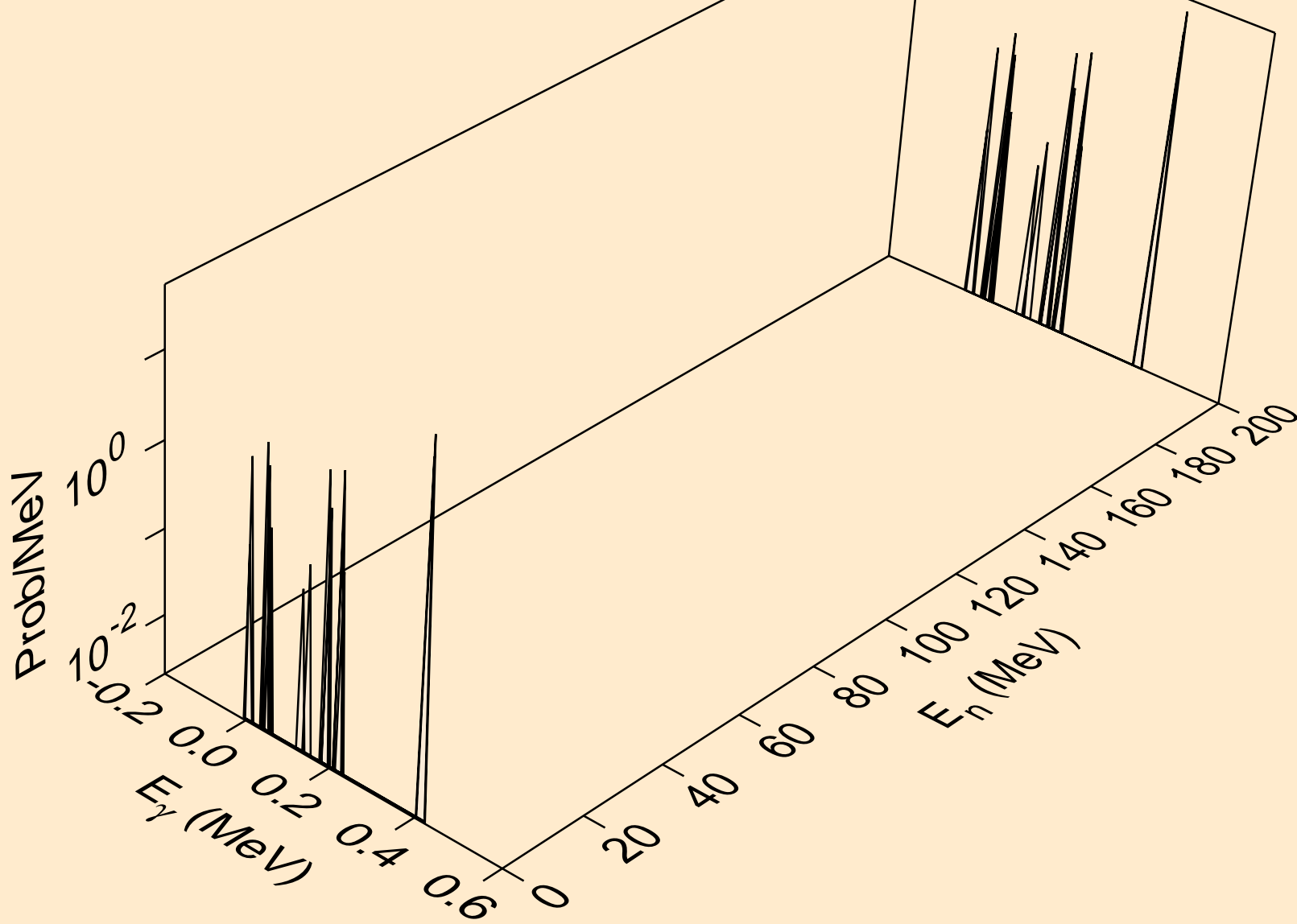

TC096M NEUTRON ACER TENDL-2019 LIBRARY; T=293.16K
Photon emission for (n,n*17)

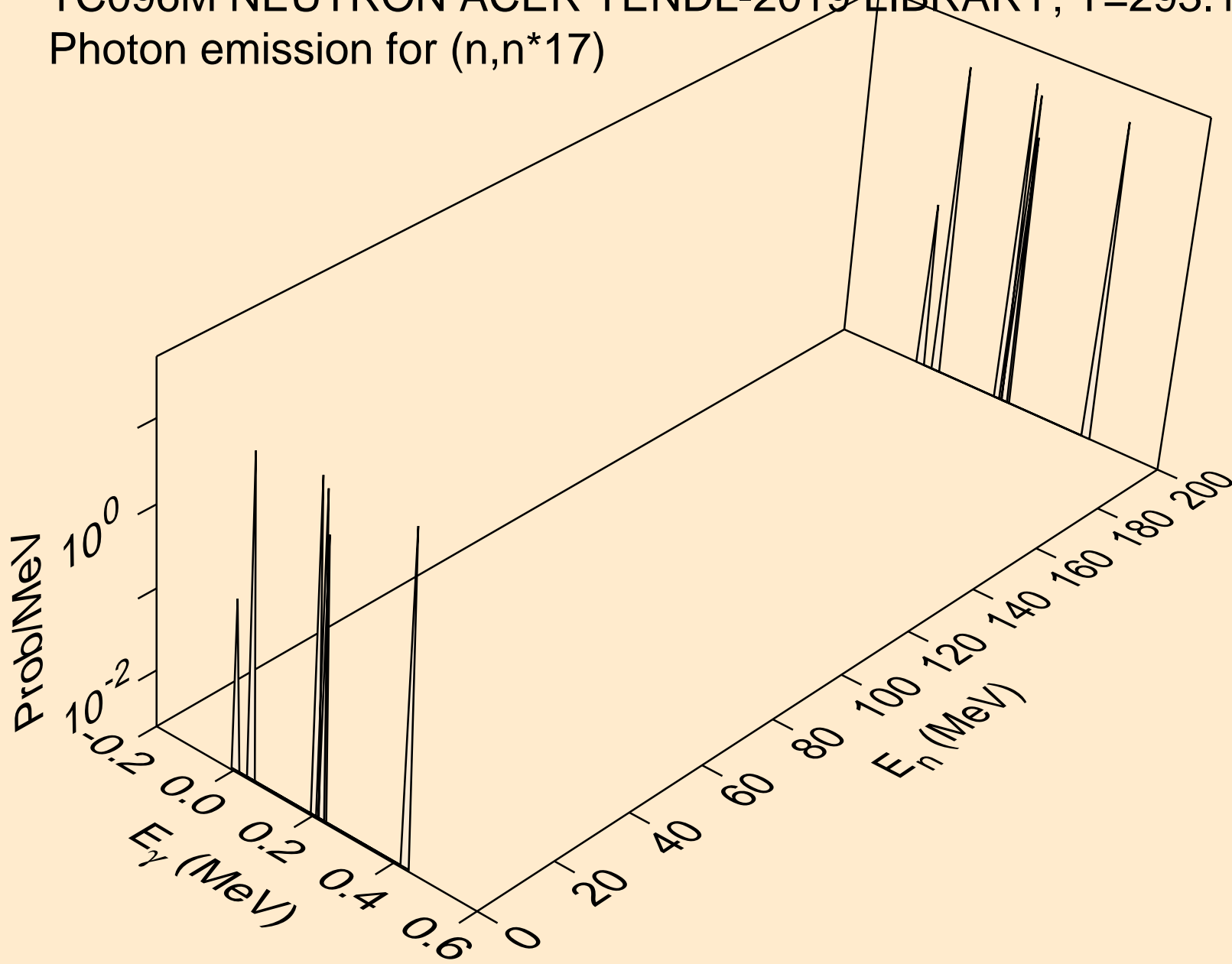

TC096M NEUTRON ACER TENDL-2019 LIBRARY; T=293.16K
Photon emission for (n,n*18)

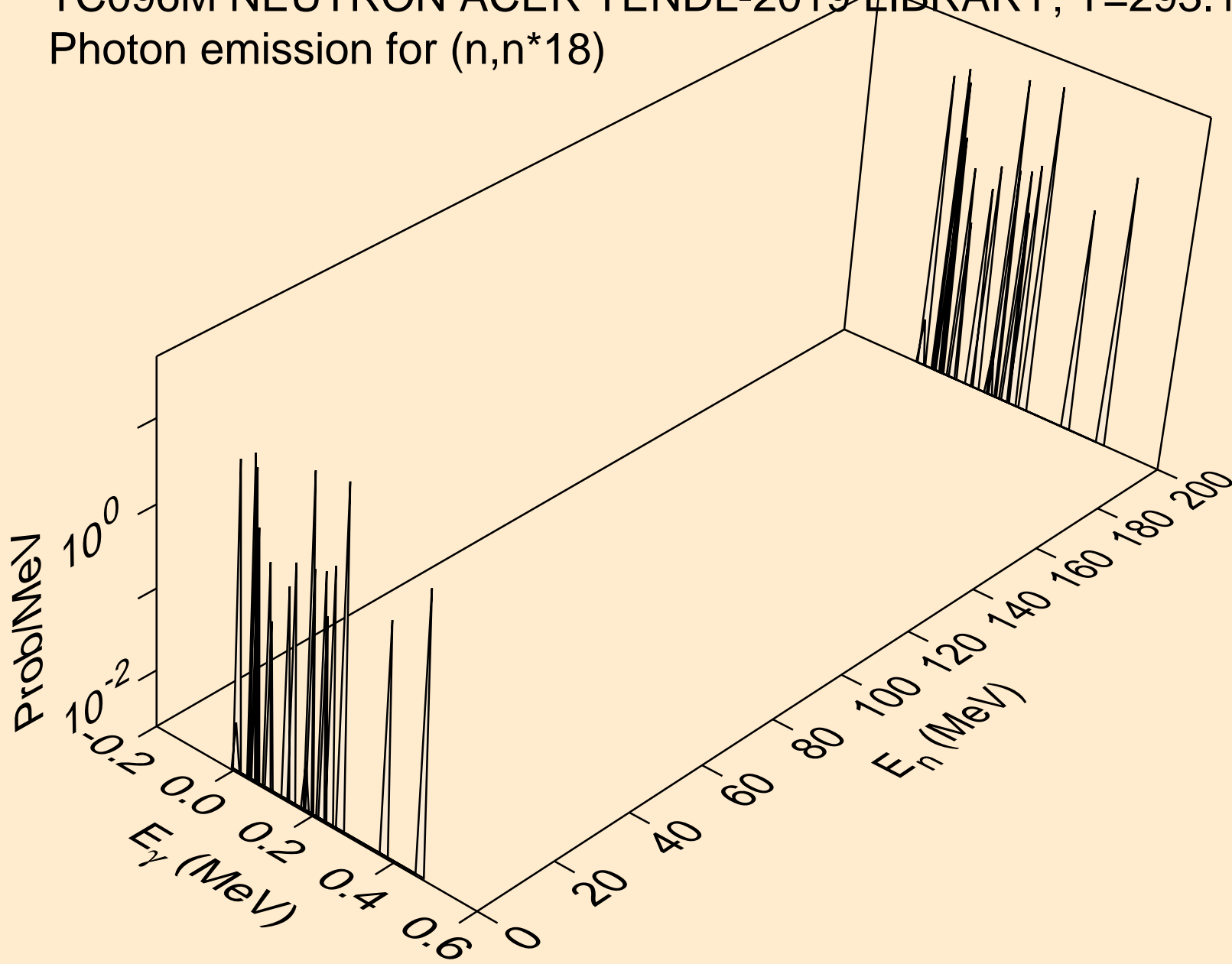

TC096M NEUTRON ACER TENDL-2019 LIBRARY; T=293.16K
Photon emission for (n,n*19)

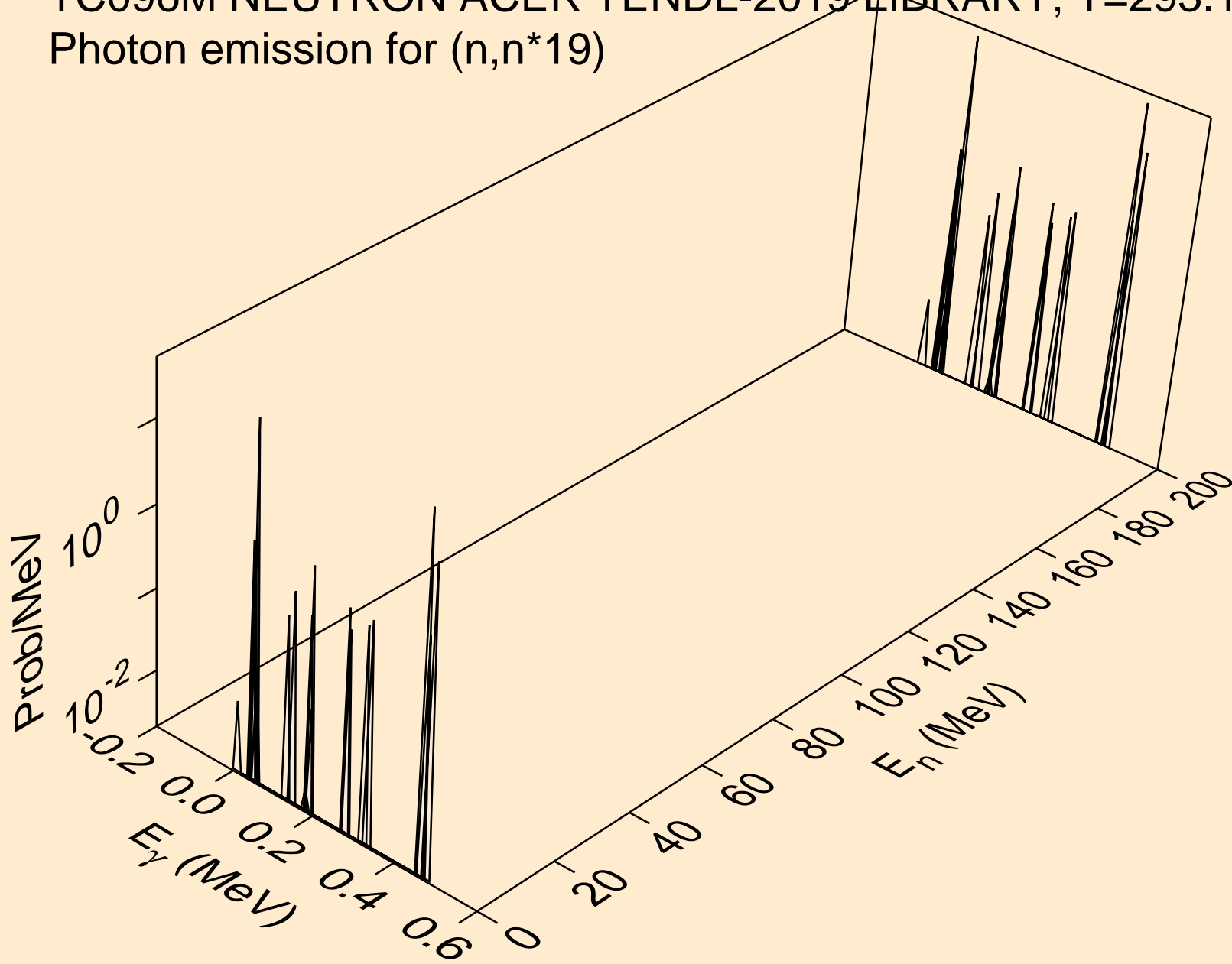

TC096M NEUTRON ACER TENDL-2019 LIBRARY; T=293.16K
Photon emission for (n,n*20)

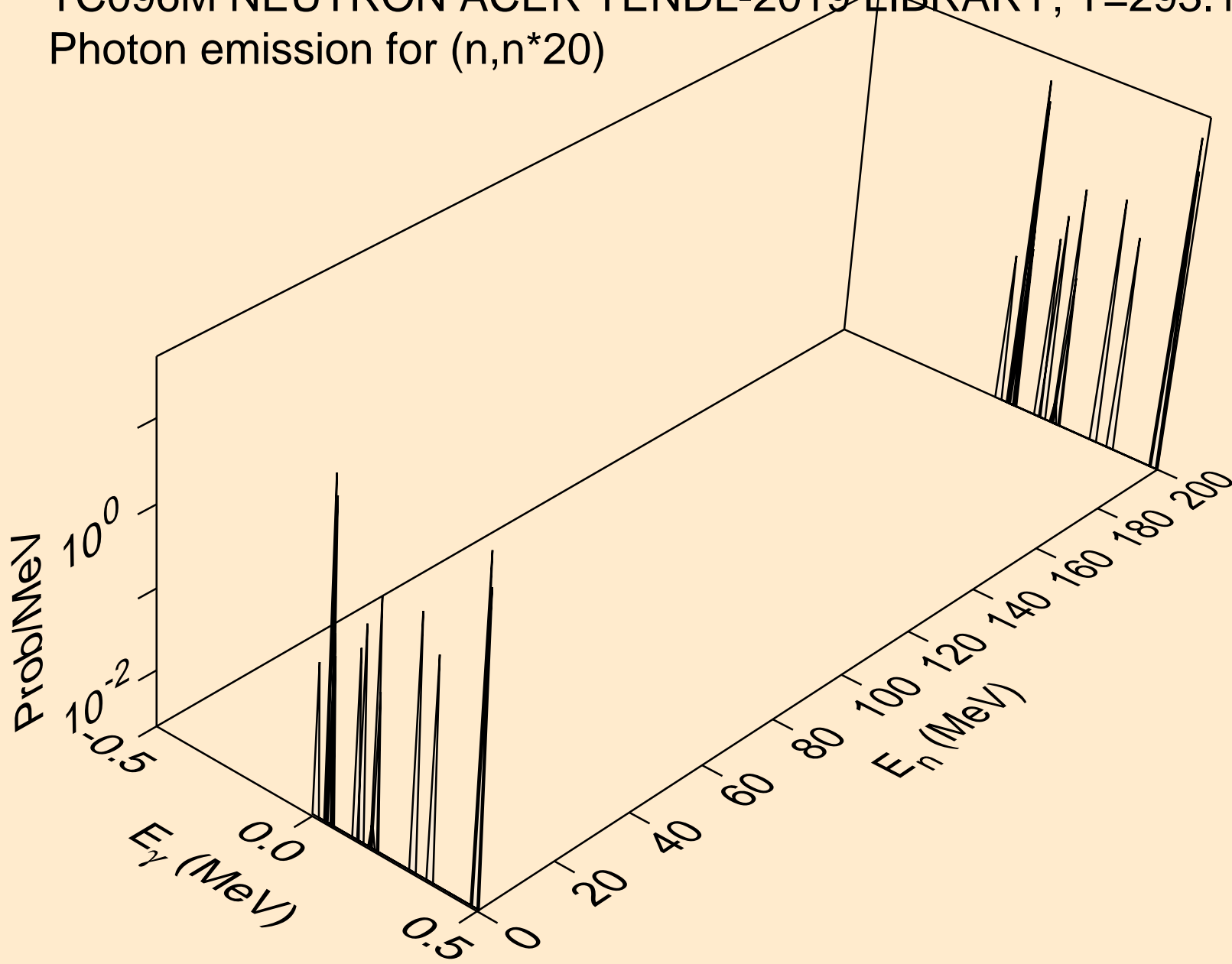

TC096M NEUTRON ACER TENDL-2019 LIBRARY; T=293.16K
Photon emission for (n,n*21)

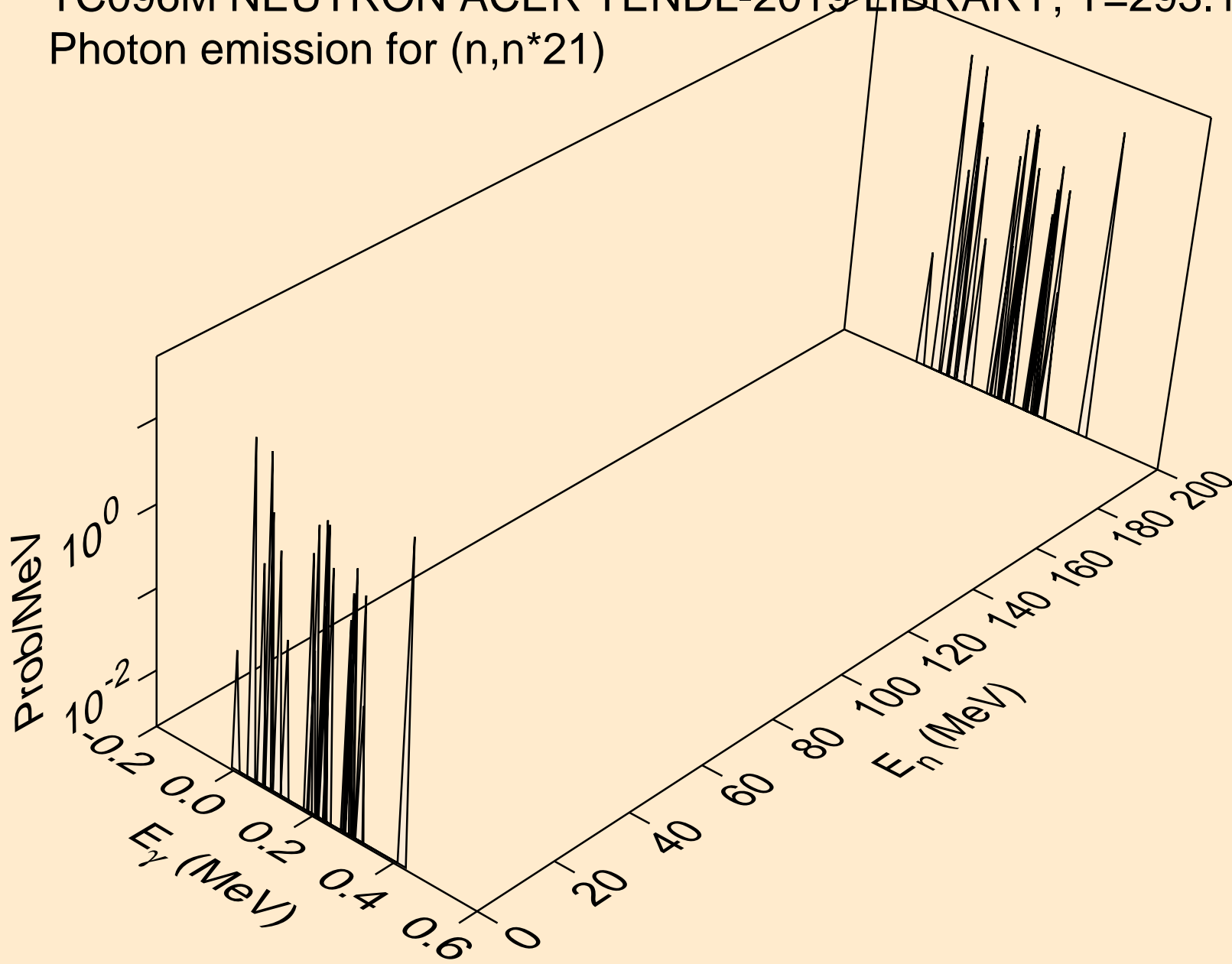

TC096M NEUTRON ACER TENDL-2019 LIBRARY; T=293.16K
Photon emission for (n,n*22)

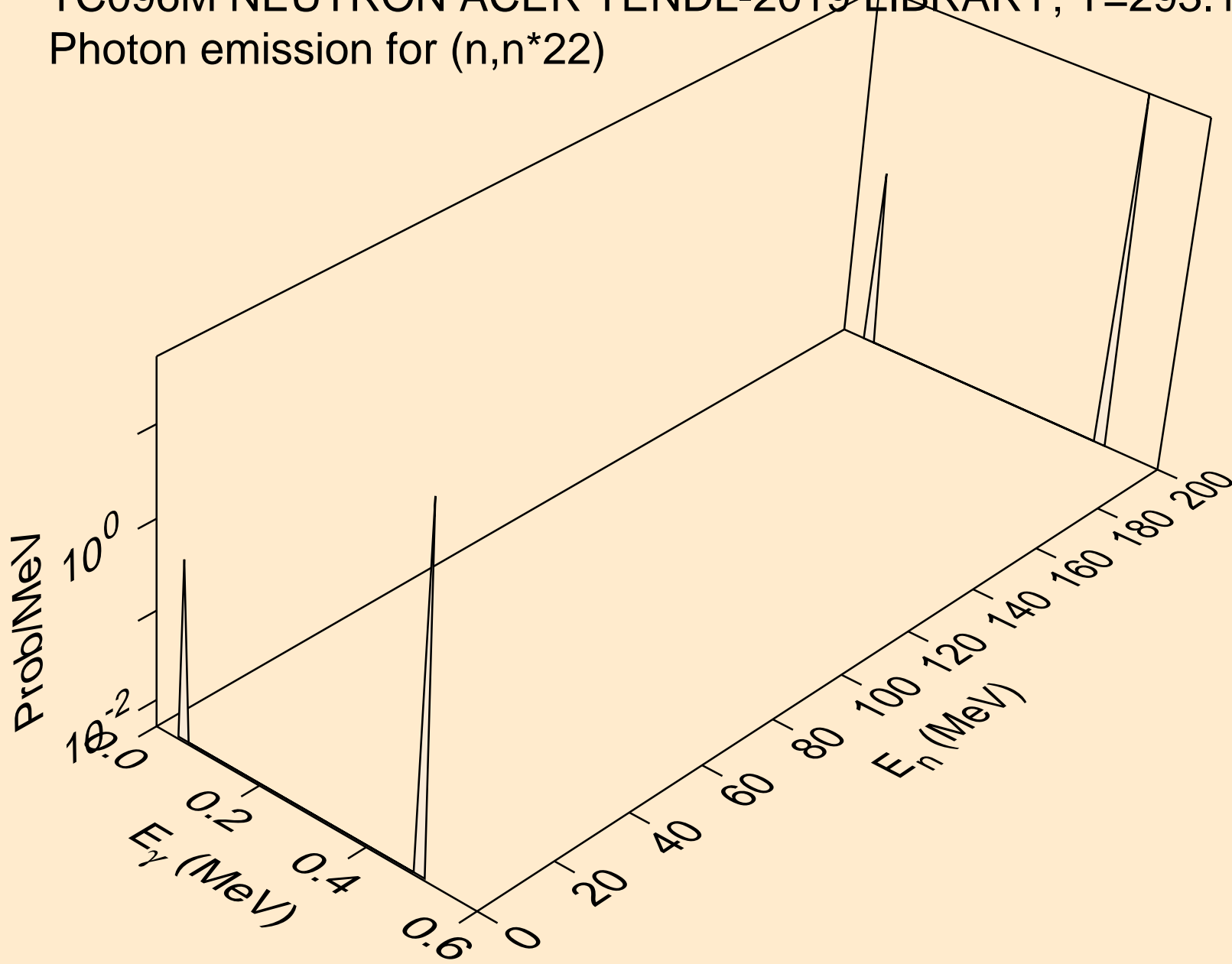

TC096M NEUTRON ACER TENDL-2019 LIBRARY; T=293.16K
Photon emission for (n,n*23)

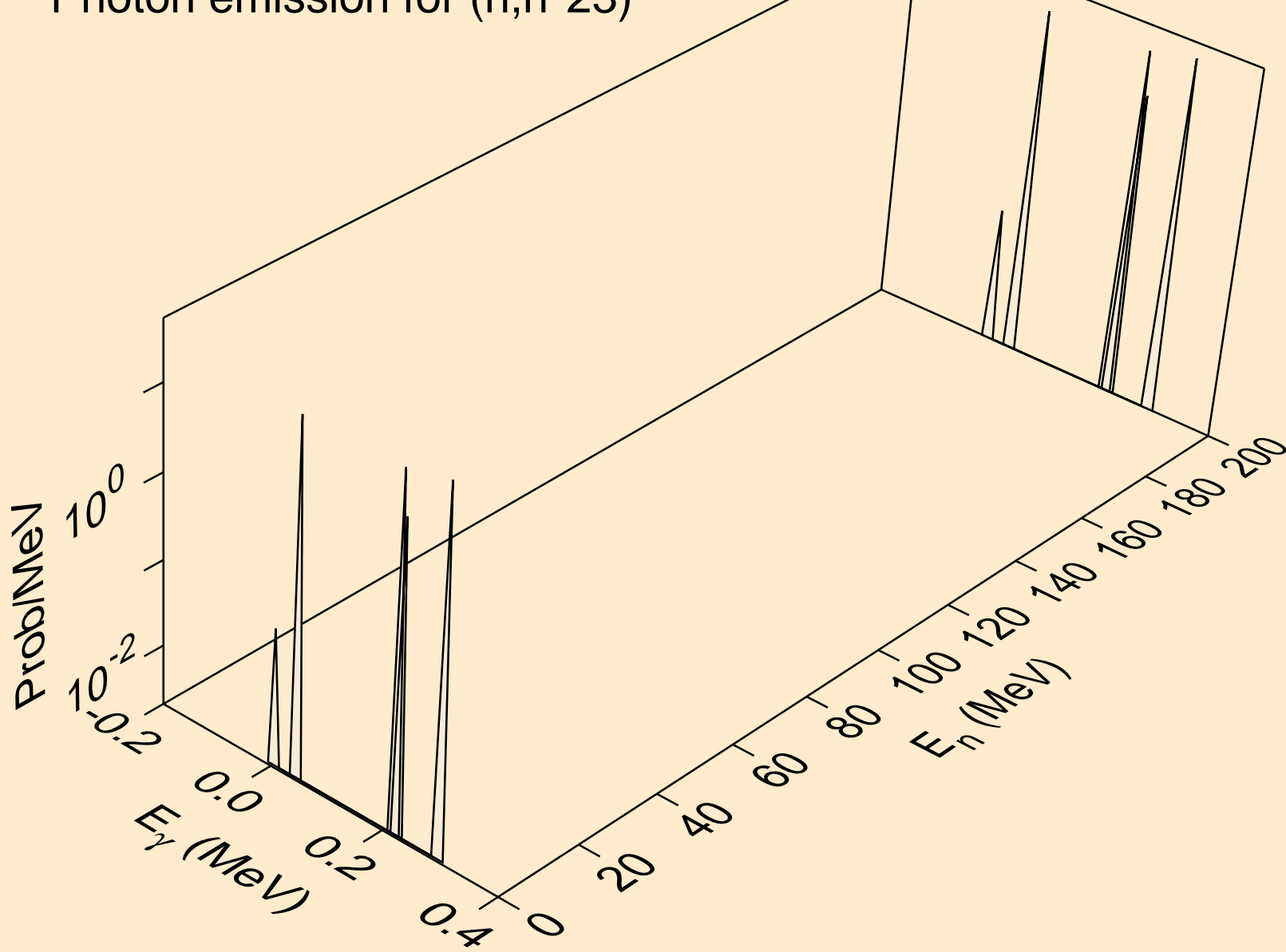

TC096M NEUTRON ACER TENDL-2019 LIBRARY; T=293.16K
Photon emission for (n,n*24)

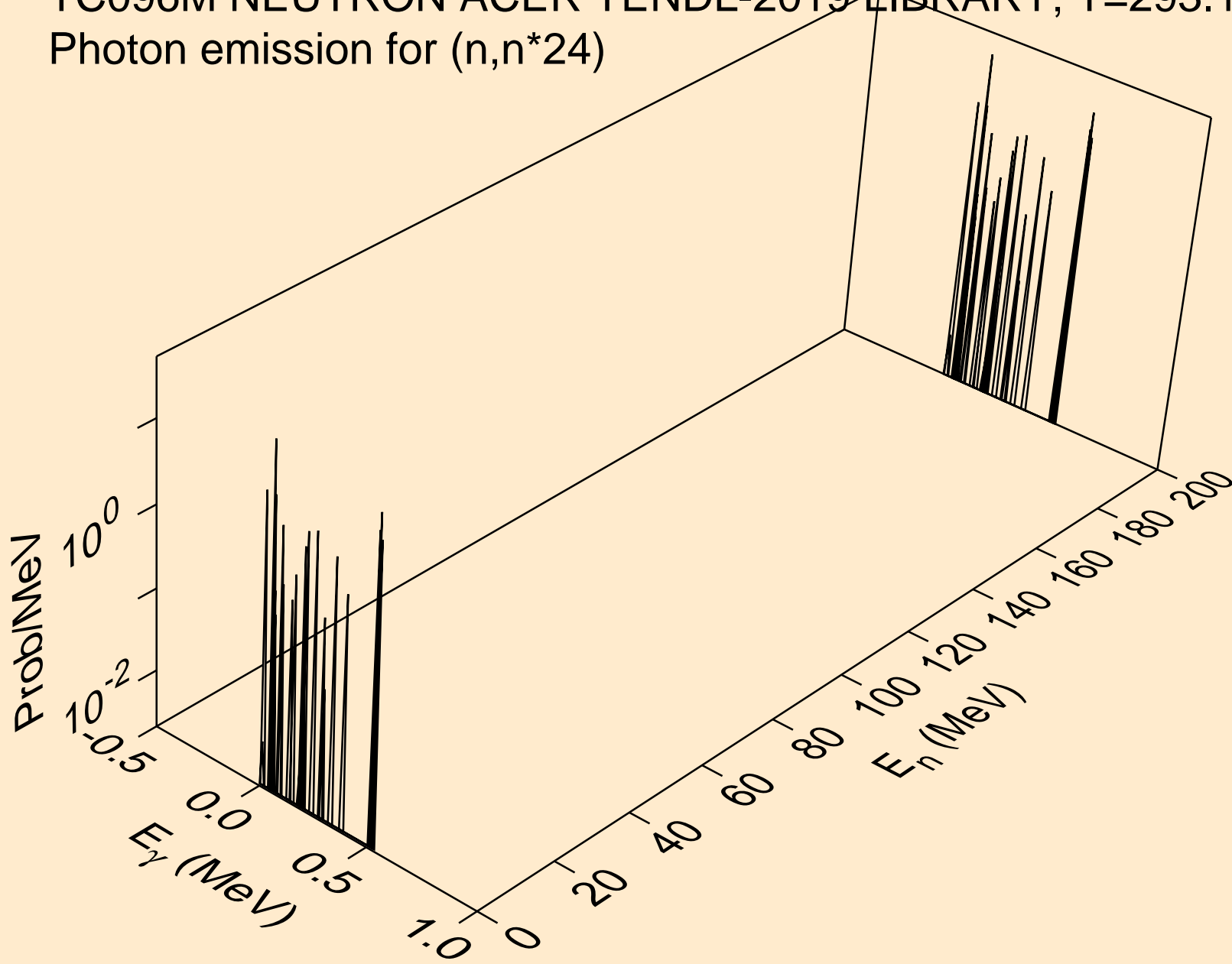

TC096M NEUTRON ACER TENDL-2019 LIBRARY; T=293.16K
Photon emission for (n,n*25)

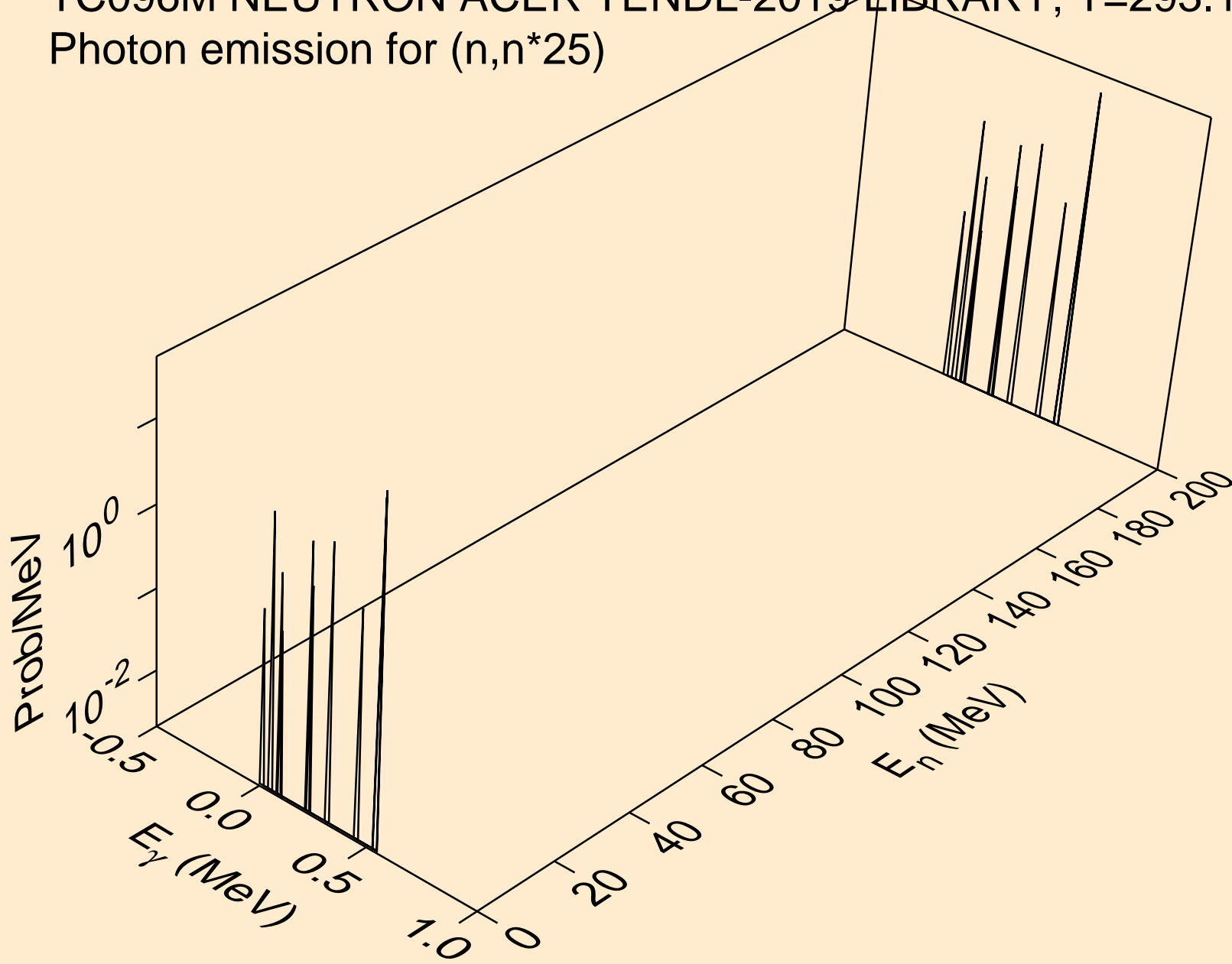

TC096M NEUTRON ACER TENDL-2019 LIBRARY; T=293.16K
Photon emission for (n,n*26)

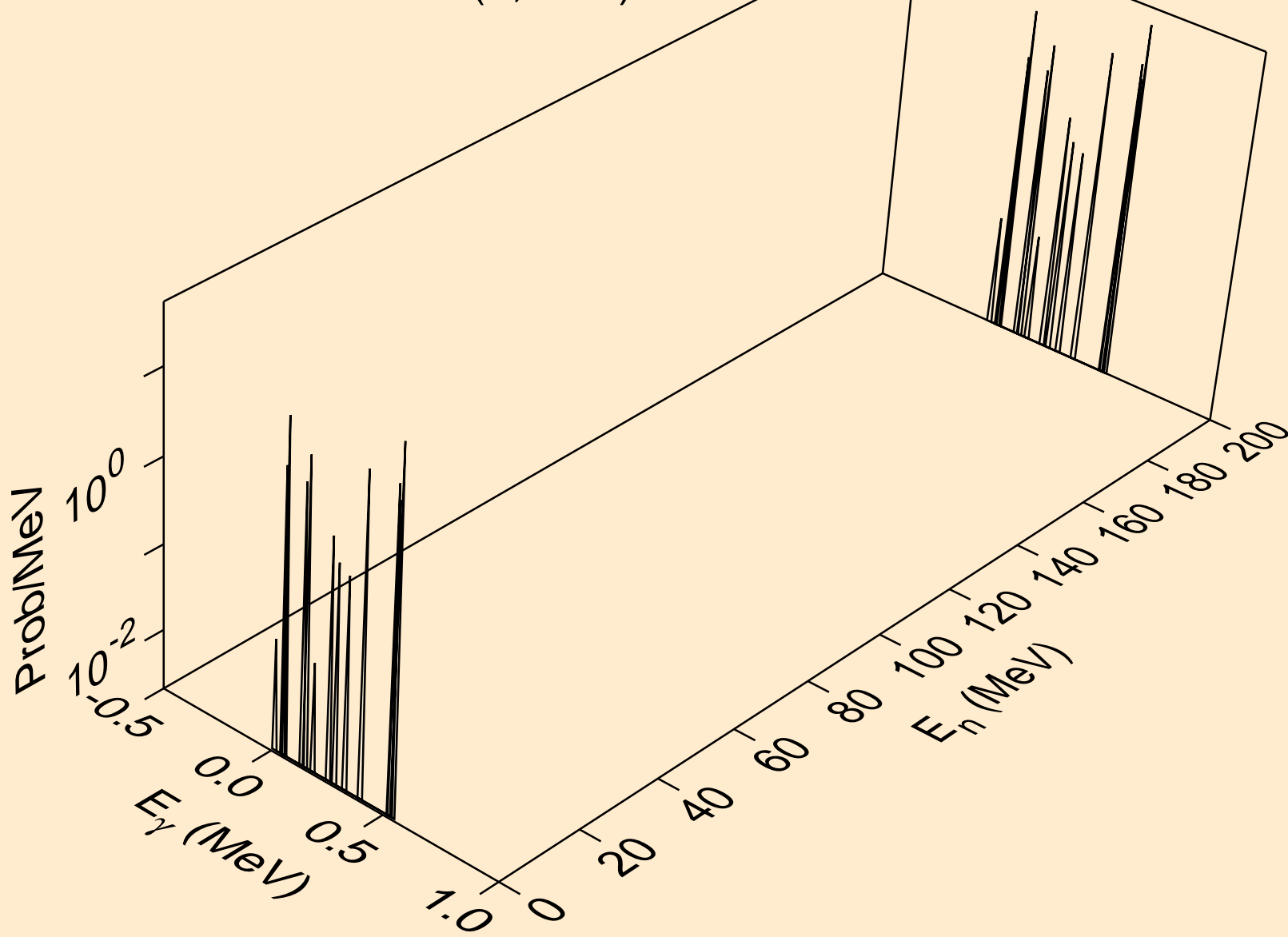

TC096M NEUTRON ACER TENDL-2019 LIBRARY; T=293.16K
Photon emission for (n,n*27)

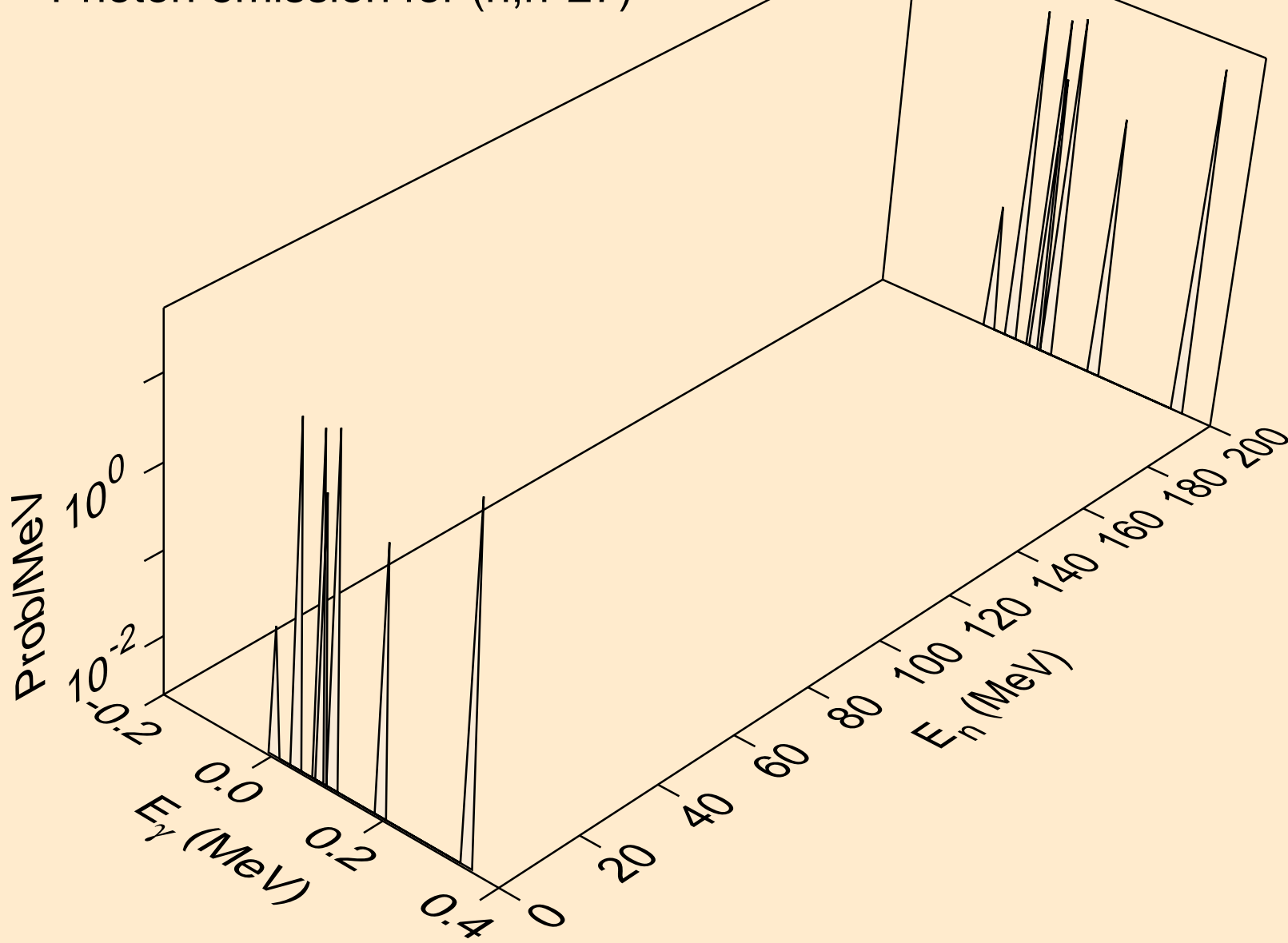

TC096M NEUTRON ACER TENDL-2019 LIBRARY; T=293.16K
Photon emission for (n,n*28)

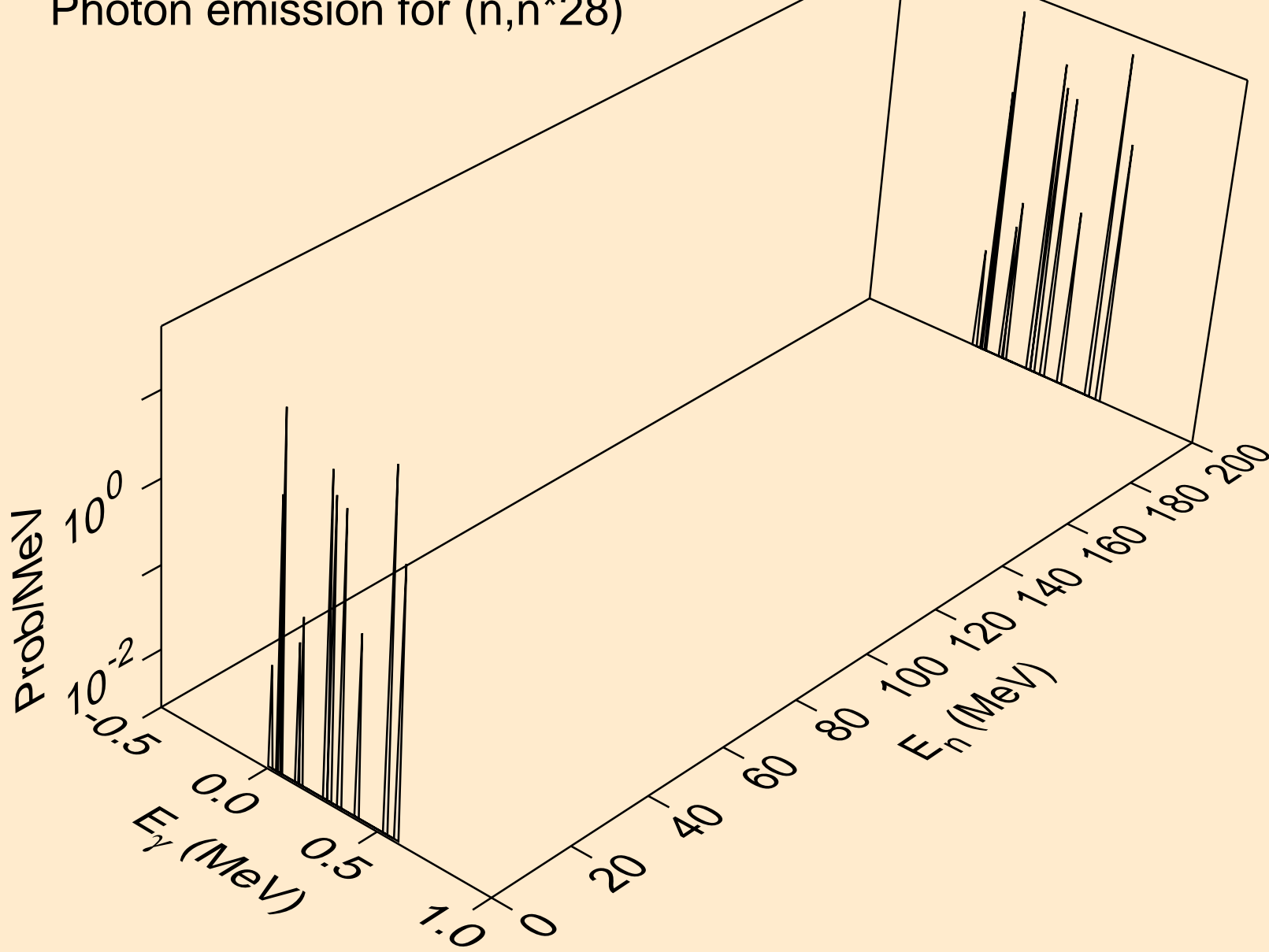

TC096M NEUTRON ACER TENDL-2019 LIBRARY; T=293.16K
Photon emission for (n,n*29)

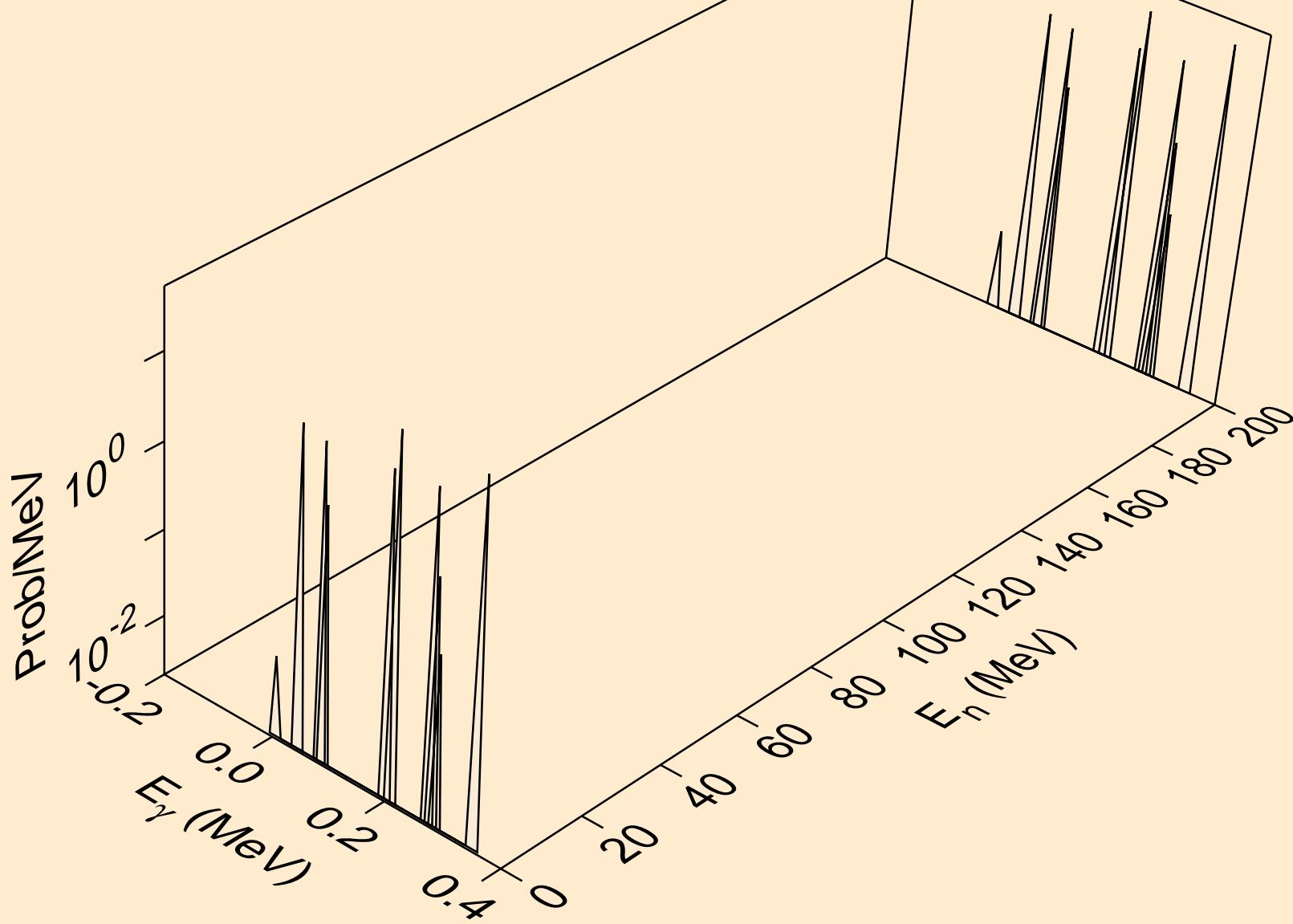

TC096M NEUTRON ACER TENDL-2019 LIBRARY; T=293.16K
Photon emission for (n,n*30)

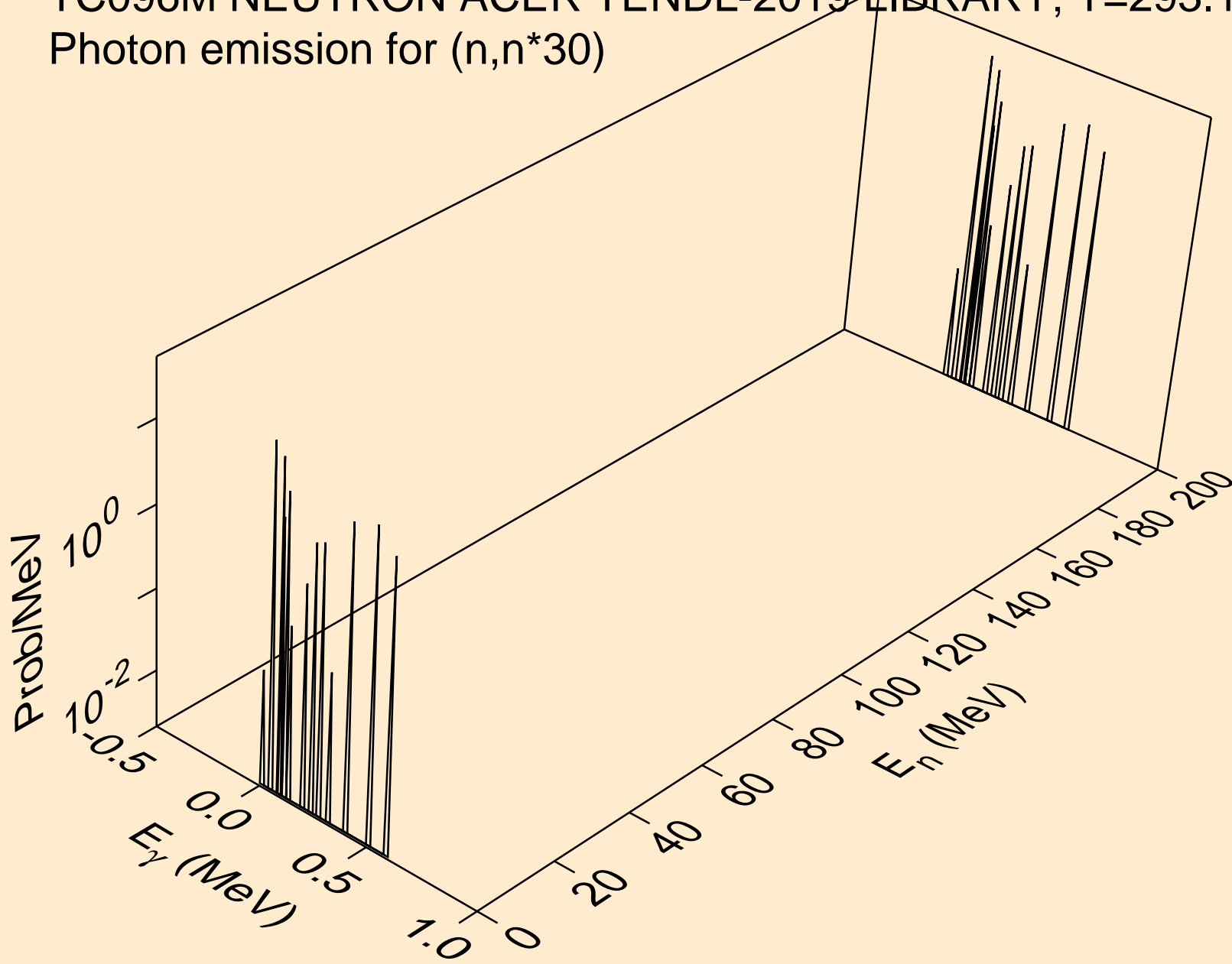

TC096M NEUTRON ACER TENDL-2019 LIBRARY; T=293.16K
Photon emission for (n,n*c)

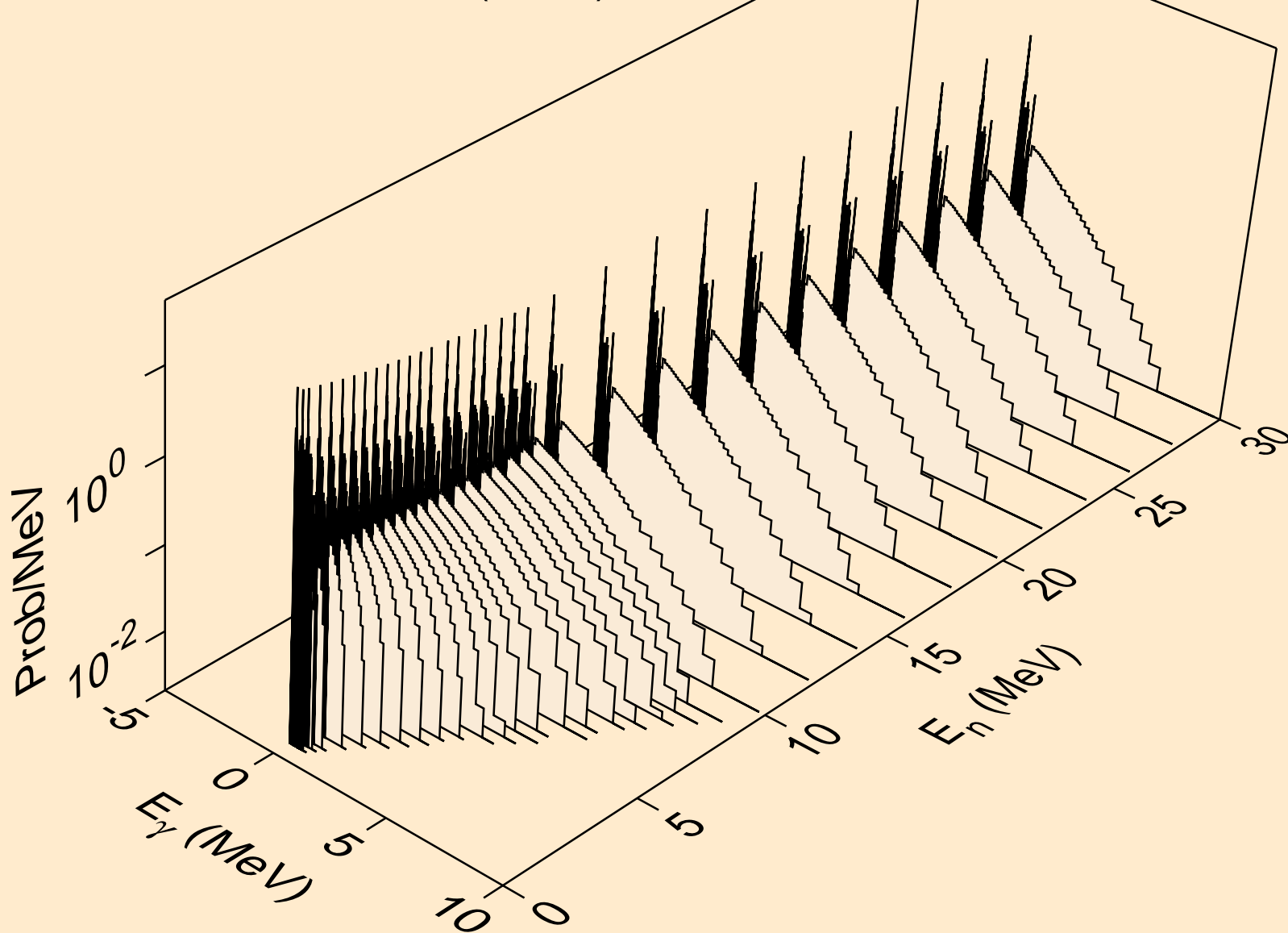

TC096M NEUTRON ACER TENDL-2019 LIBRARY; T=293.16K
Photon emission for (n,gma)

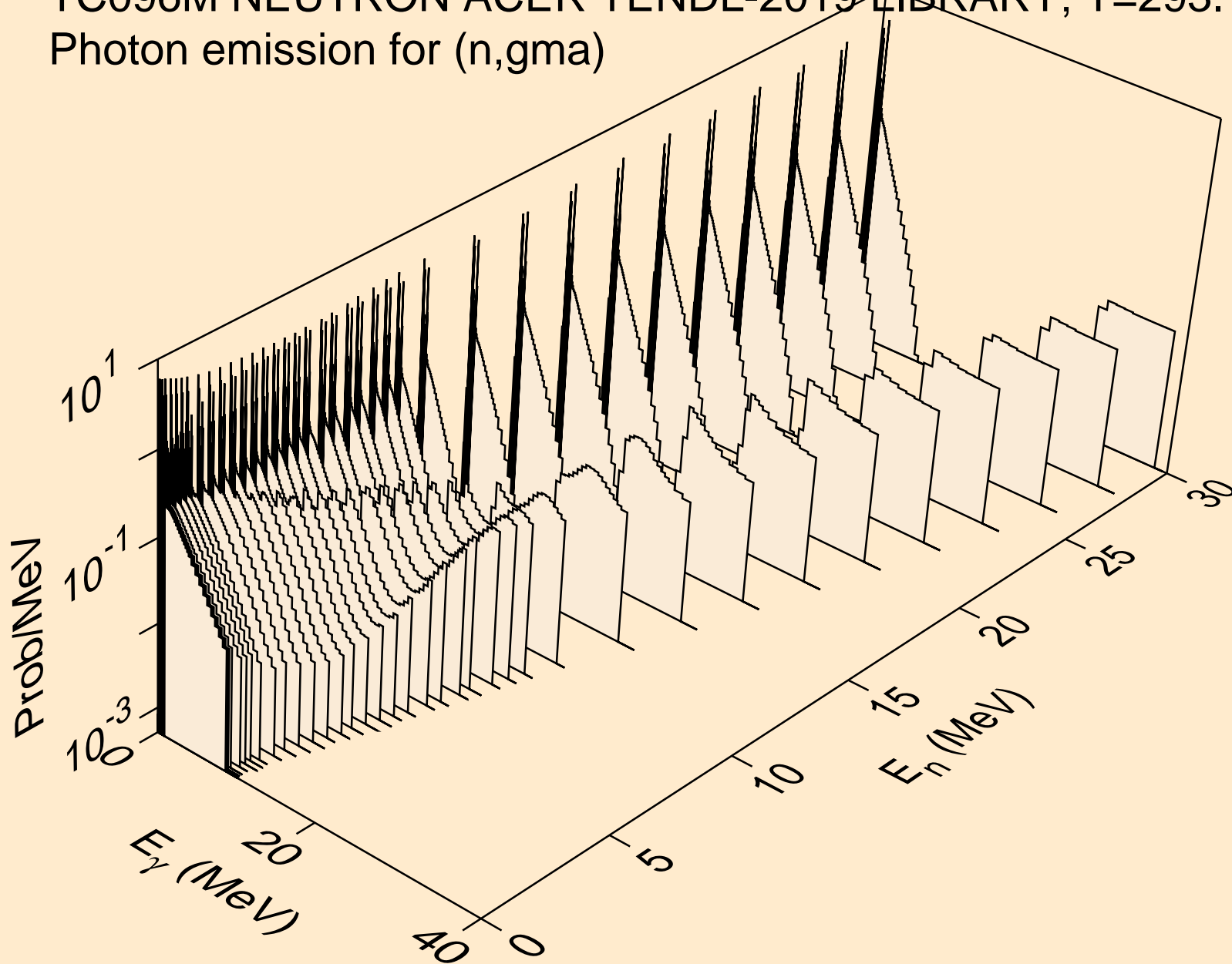

TC096M NEUTRON ACER TENDL-2019 LIBRARY; T=293.16K
Photon emission for (n,p)

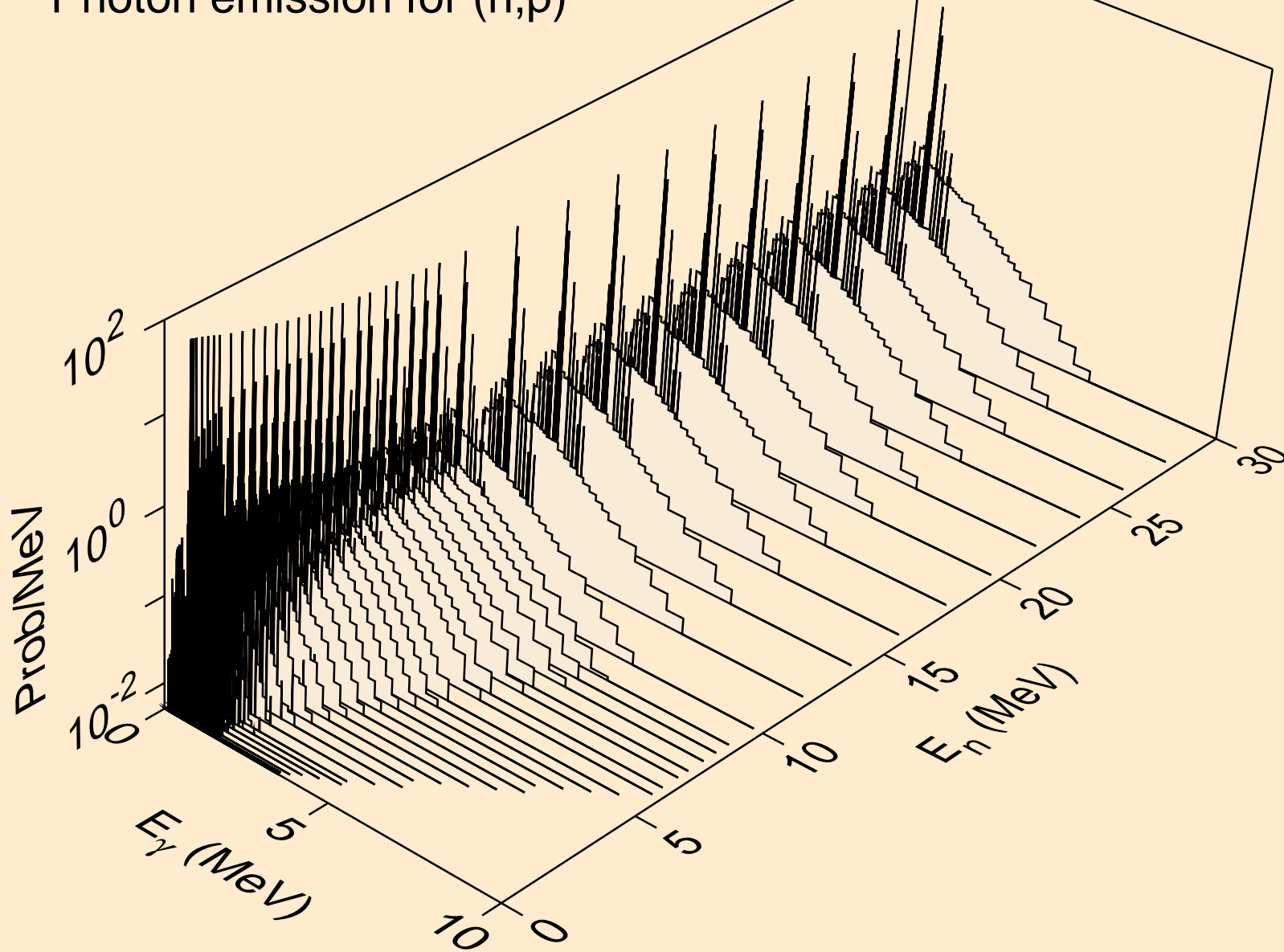

TC096M NEUTRON ACER TENDL-2019 LIBRARY; T=293.16K
Photon emission for (n,d)

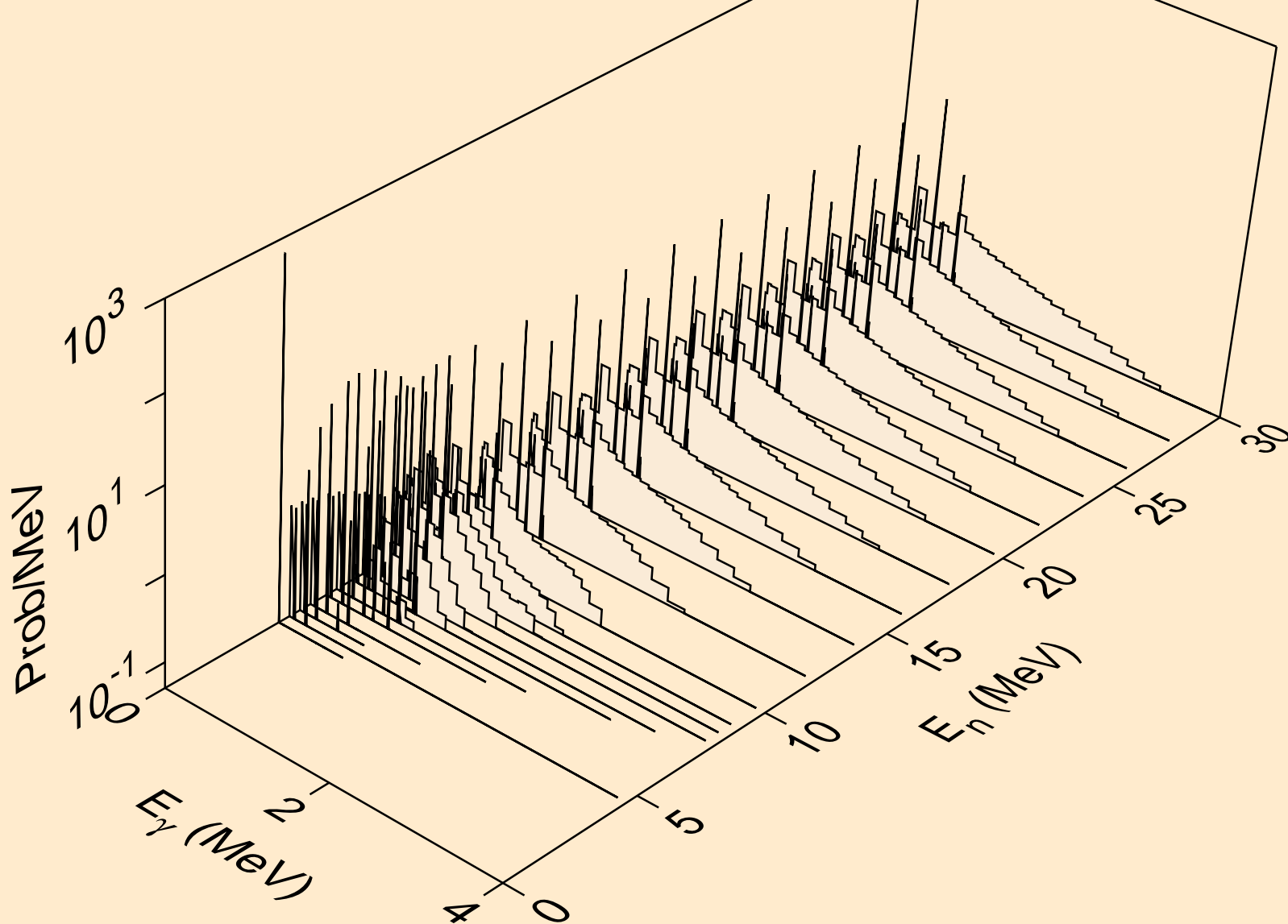

TC096M NEUTRON ACER TENDL-2019 LIBRARY; T=293.16K
Photon emission for (n,t)

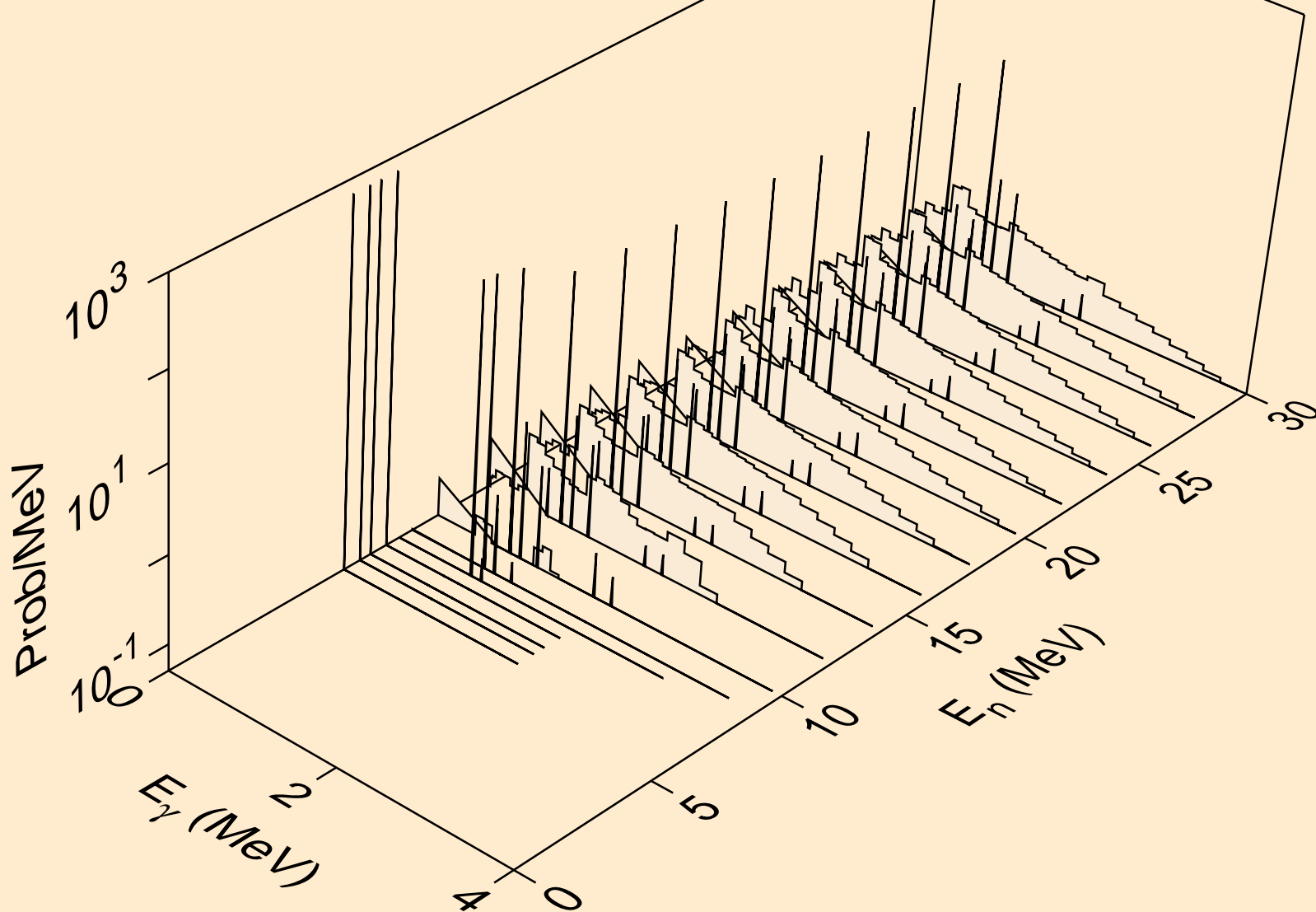

TC096M NEUTRON ACER TENDL-2019 LIBRARY; T=293.16K
Photon emission for (n,he3)

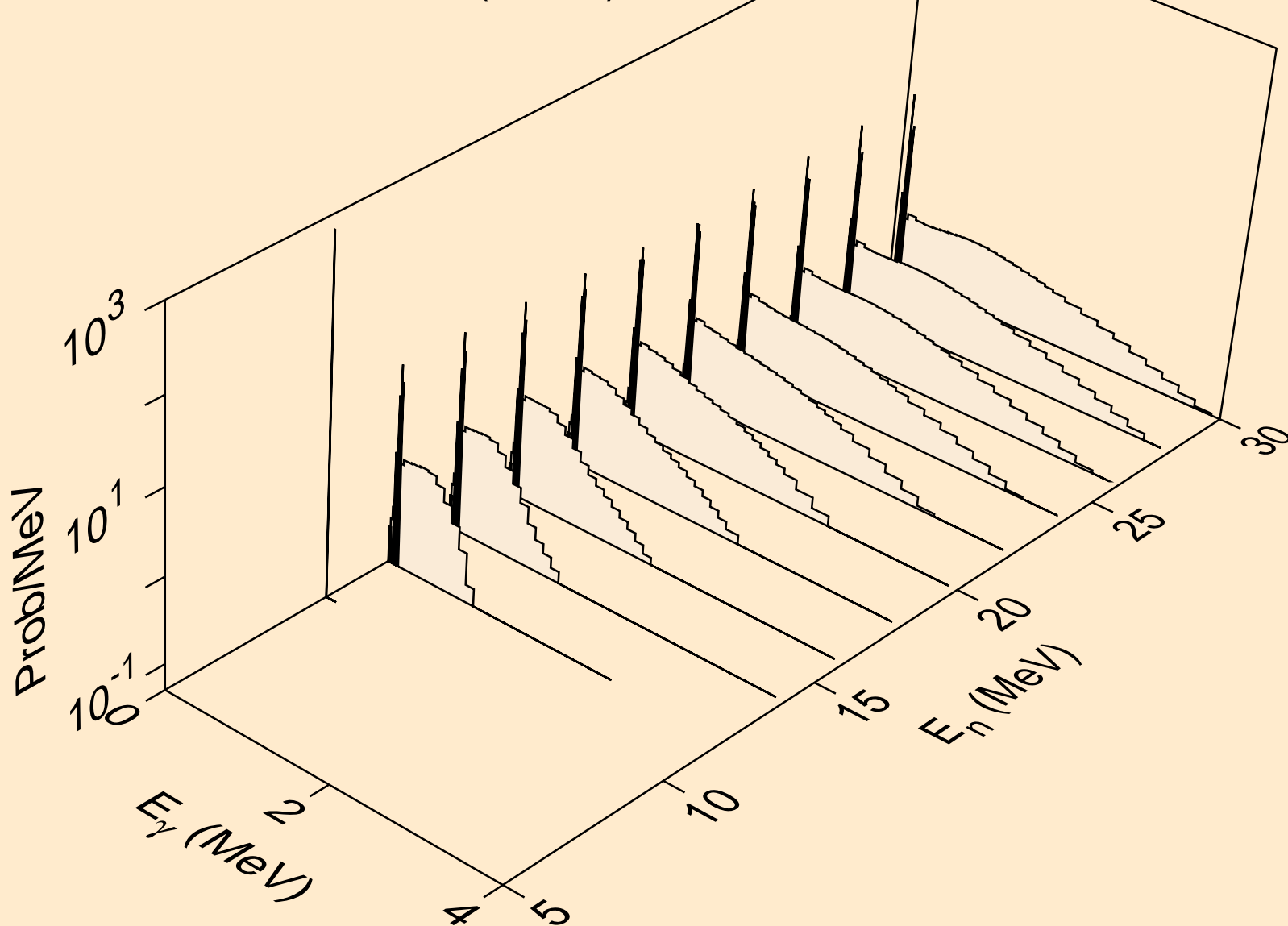

TC096M NEUTRON ACER TENDL-2019 LIBRARY; T=293.16K
Photon emission for (n,a)

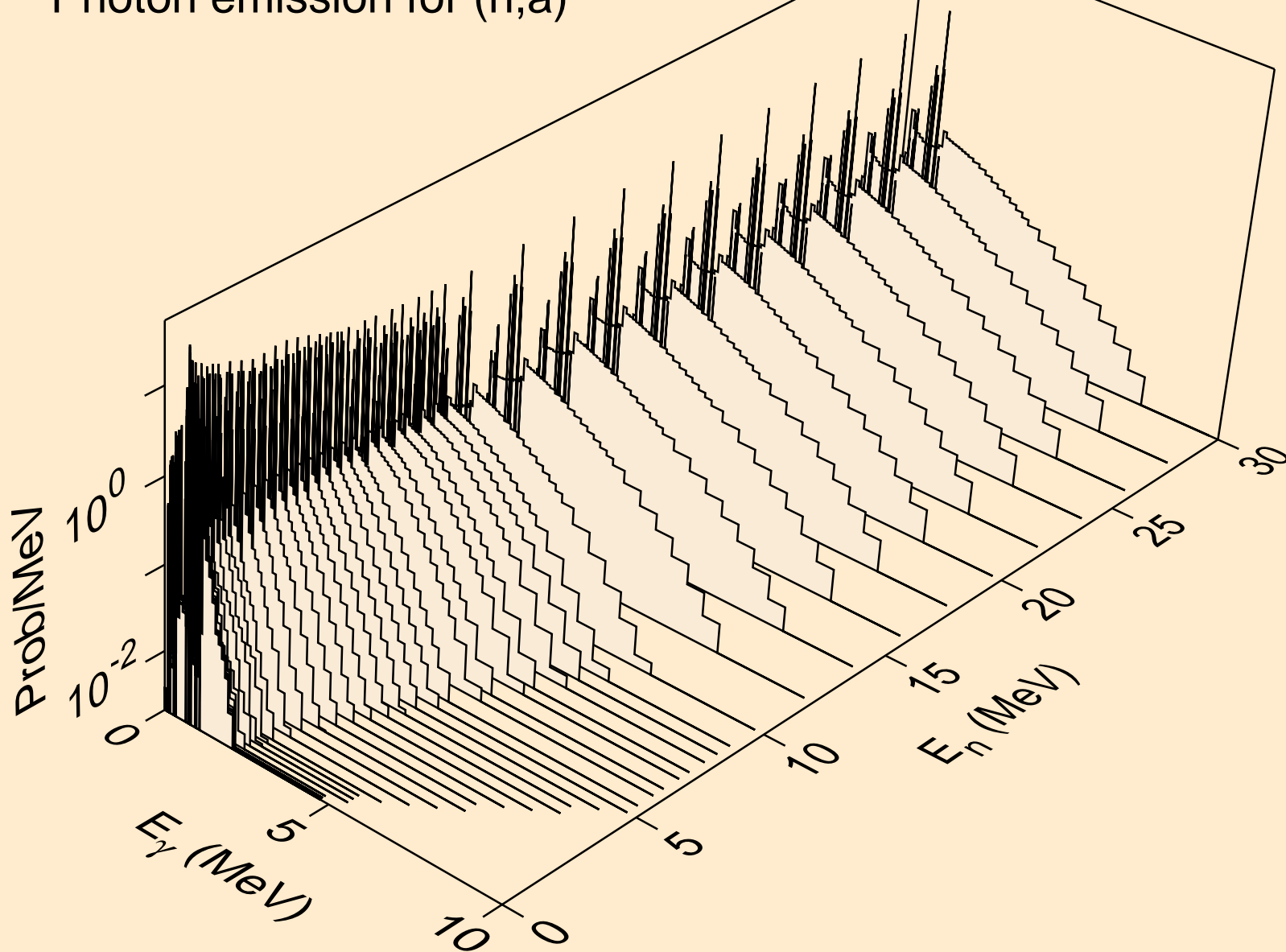

TC096M NEUTRON ACER TENDL-2019 LIBRARY; T=293.16K
Photon emission for (n,2a)

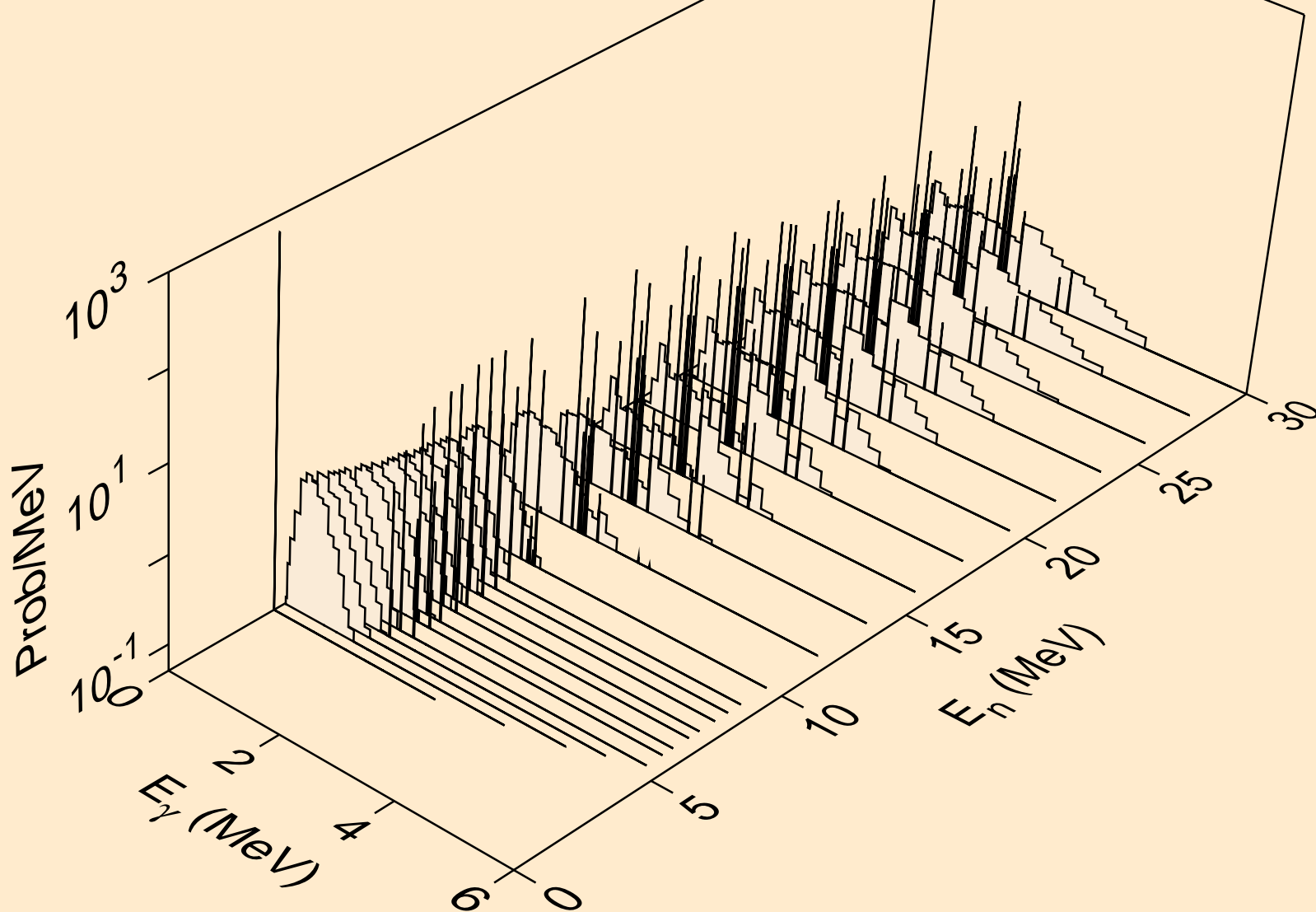

TC096M NEUTRON ACER TENDL-2019 LIBRARY; T=293.16K
Photon emission for (n,2p)

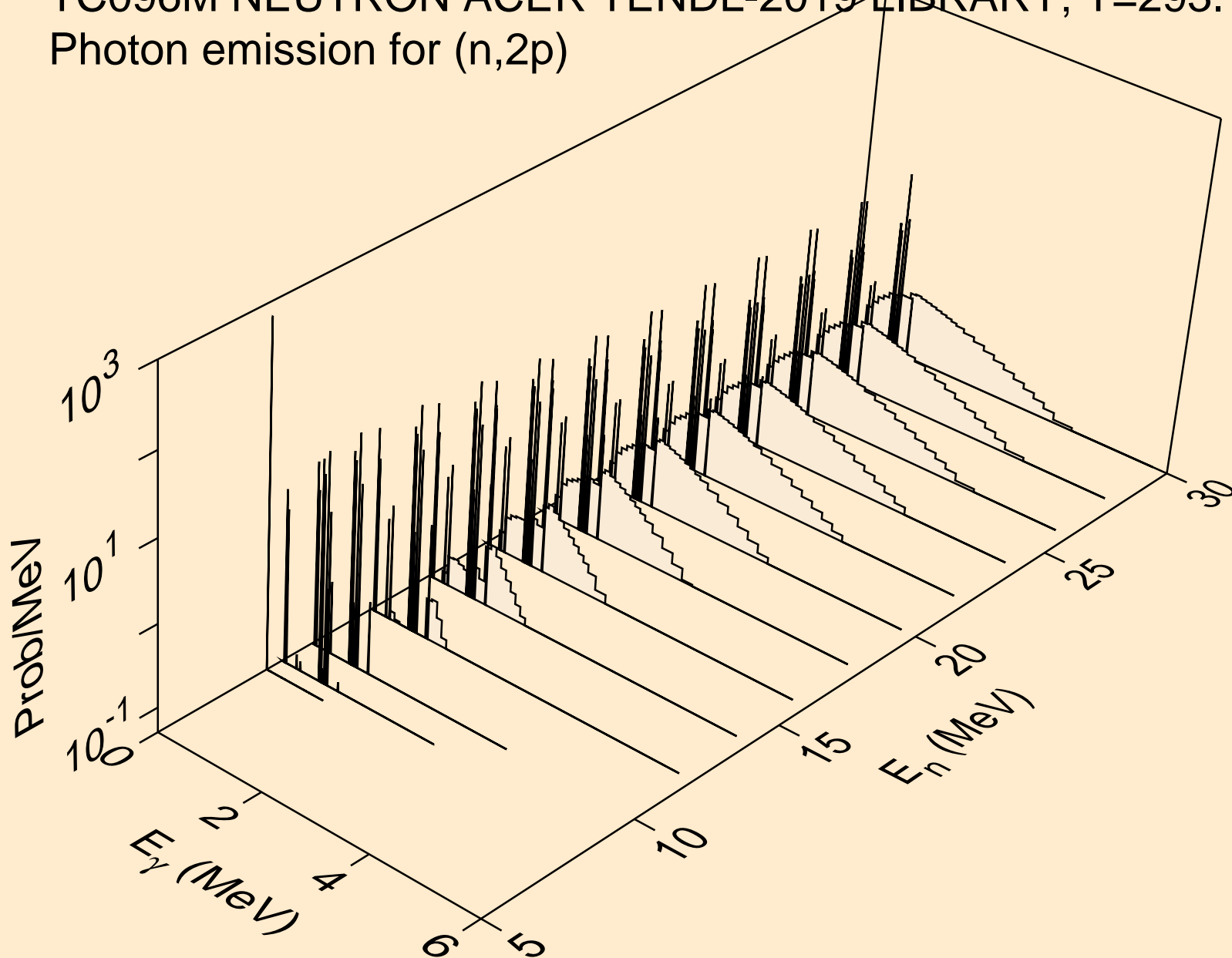

TC096M NEUTRON ACER TENDL-2019 LIBRARY; T=293.16K
Photon emission for (n,p α)

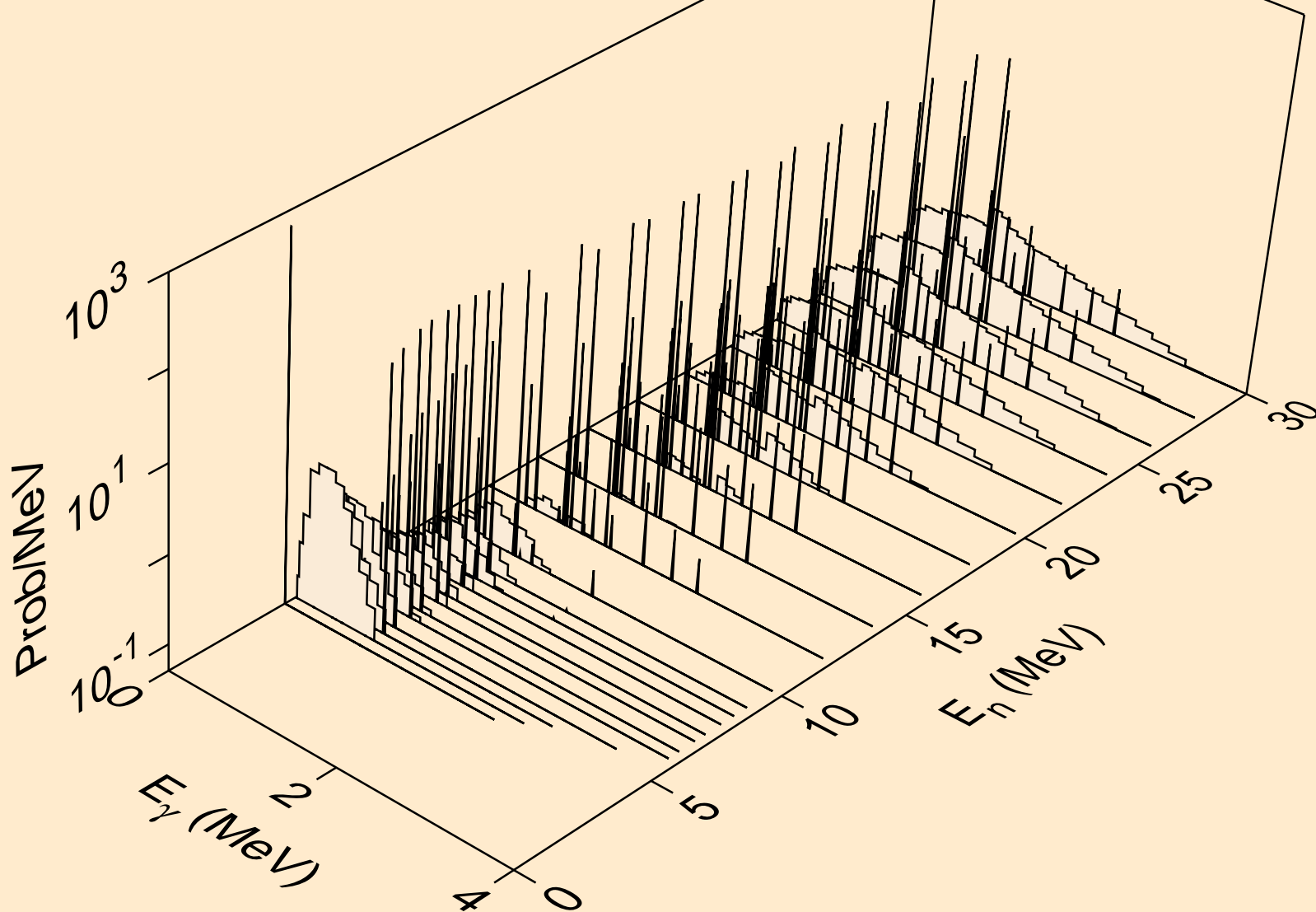

TC096M NEUTRON ACER TENDL-2019 LIBRARY; T=293.16K
Photon emission for (n,pd)

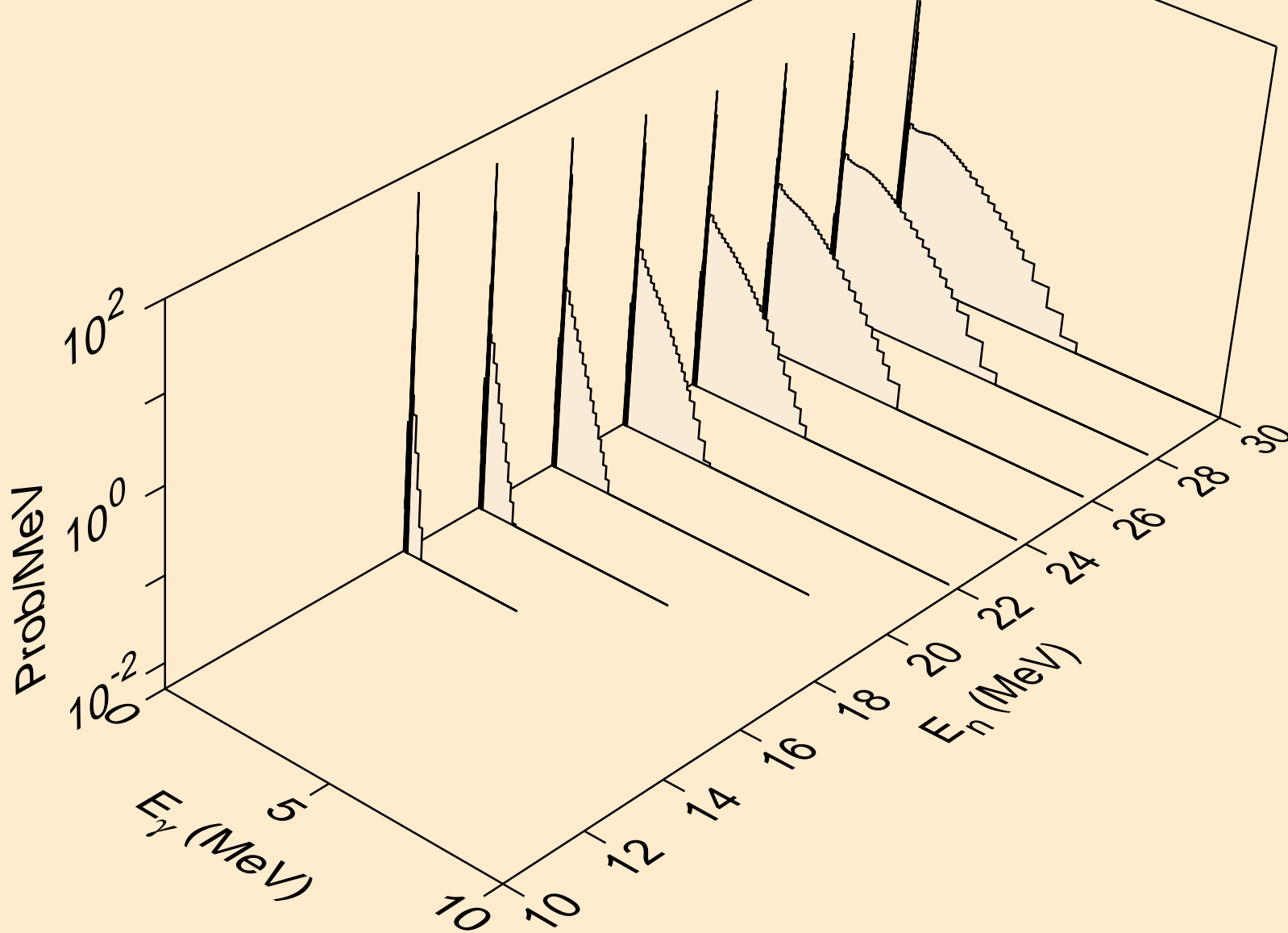

TC096M NEUTRON ACER TENDL-2019 LIBRARY; T=293.16K
Photon emission for (n,pt)

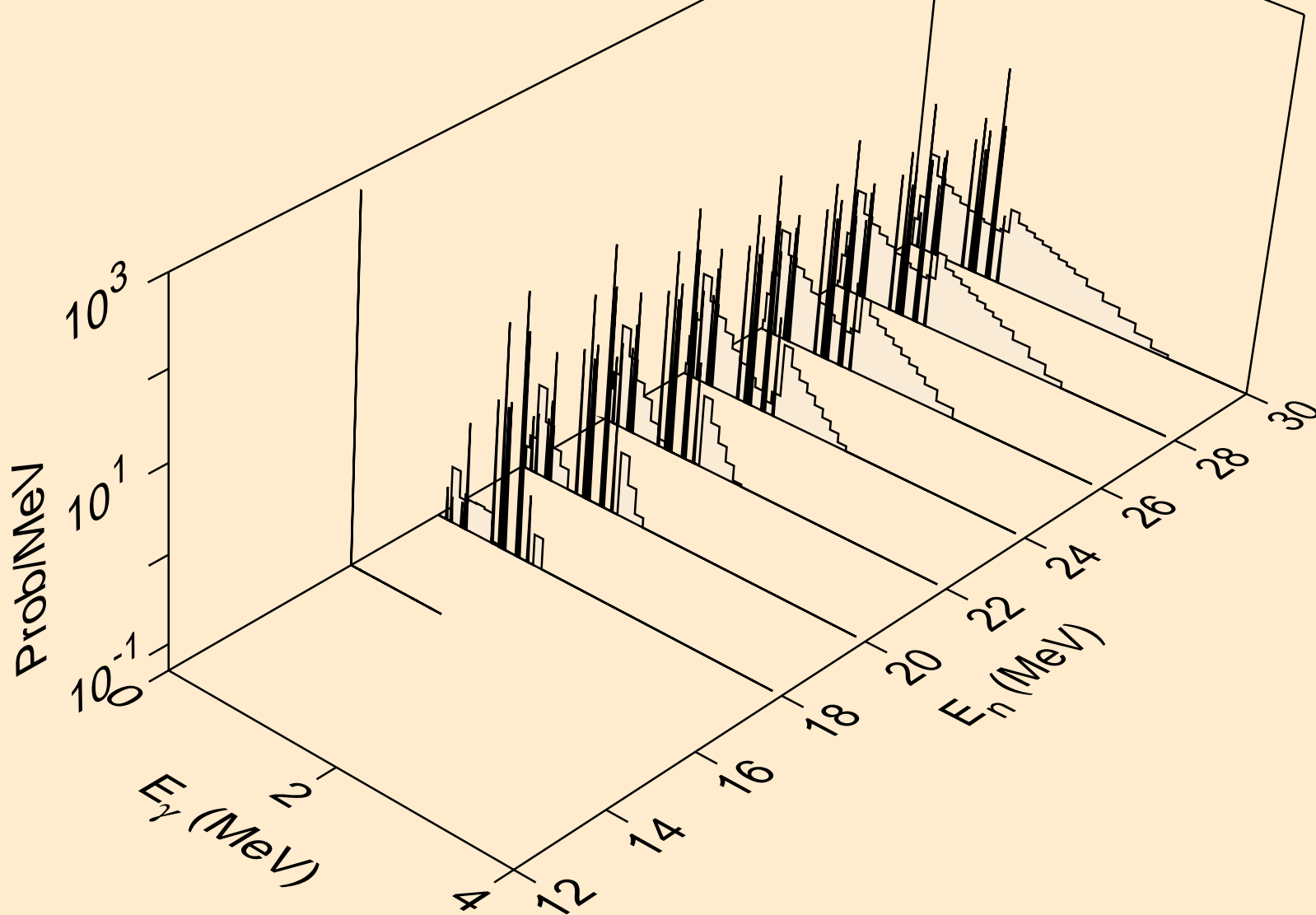

TC096M NEUTRON ACER TENDL-2019 LIBRARY; T=293.16K
Photon emission for (n,da)

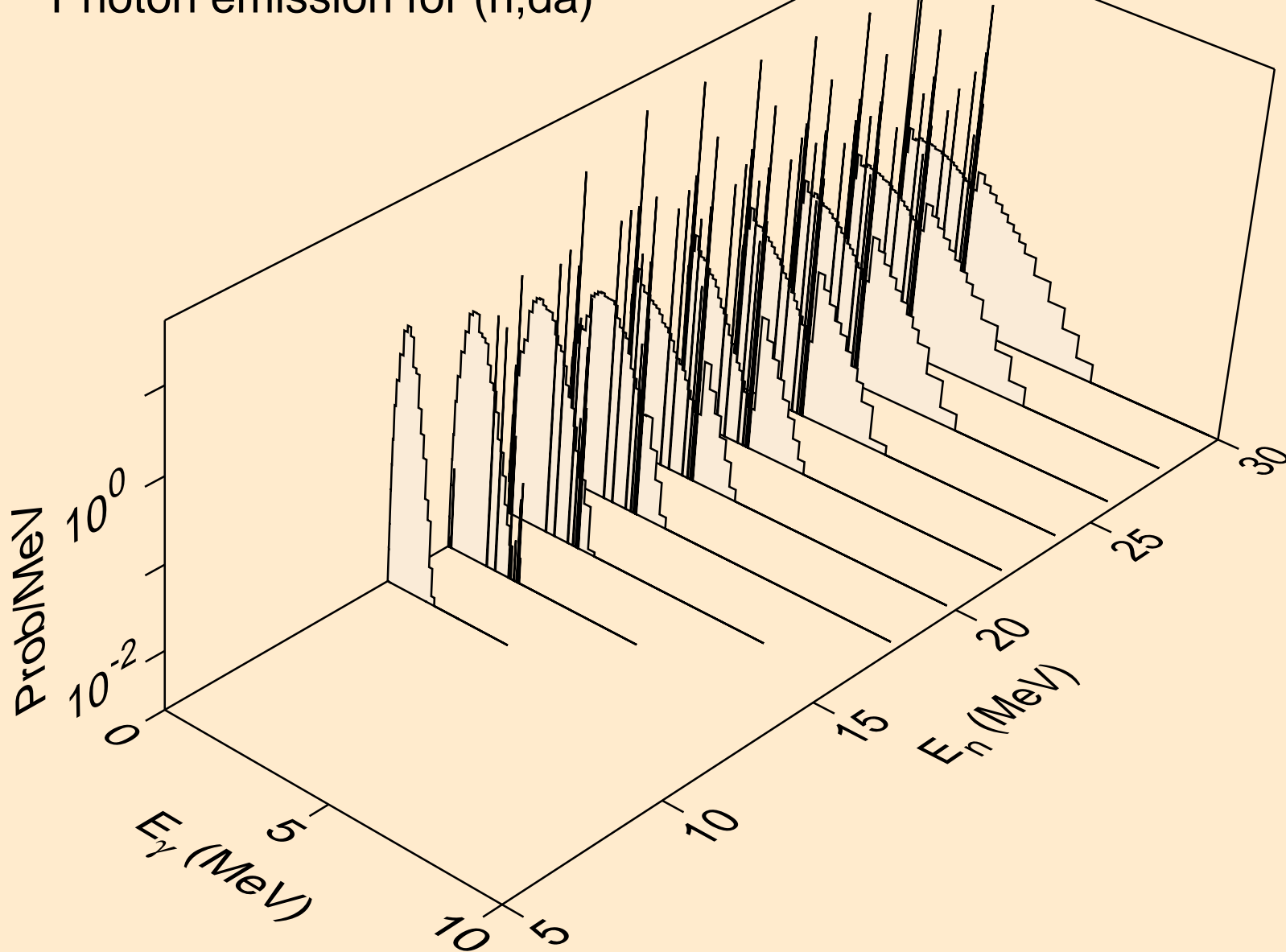

TC096M NEUTRON ACER TENDL-2019 LIBRARY; T=293.16K
thermal capture photon spectrum

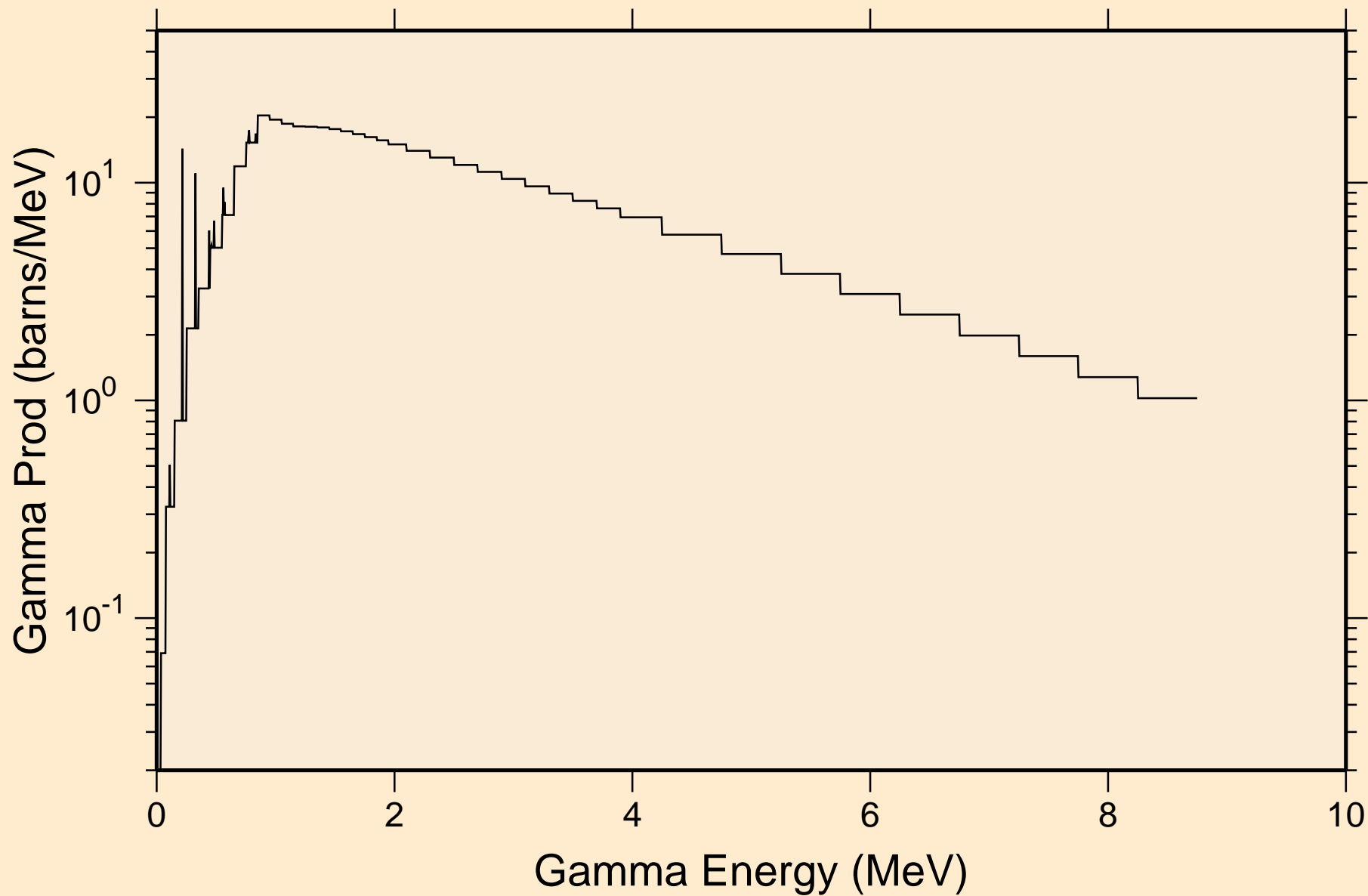

TC096M NEUTRON ACER TENDL-2019 LIBRARY; T=293.16K
14 MeV photon spectrum

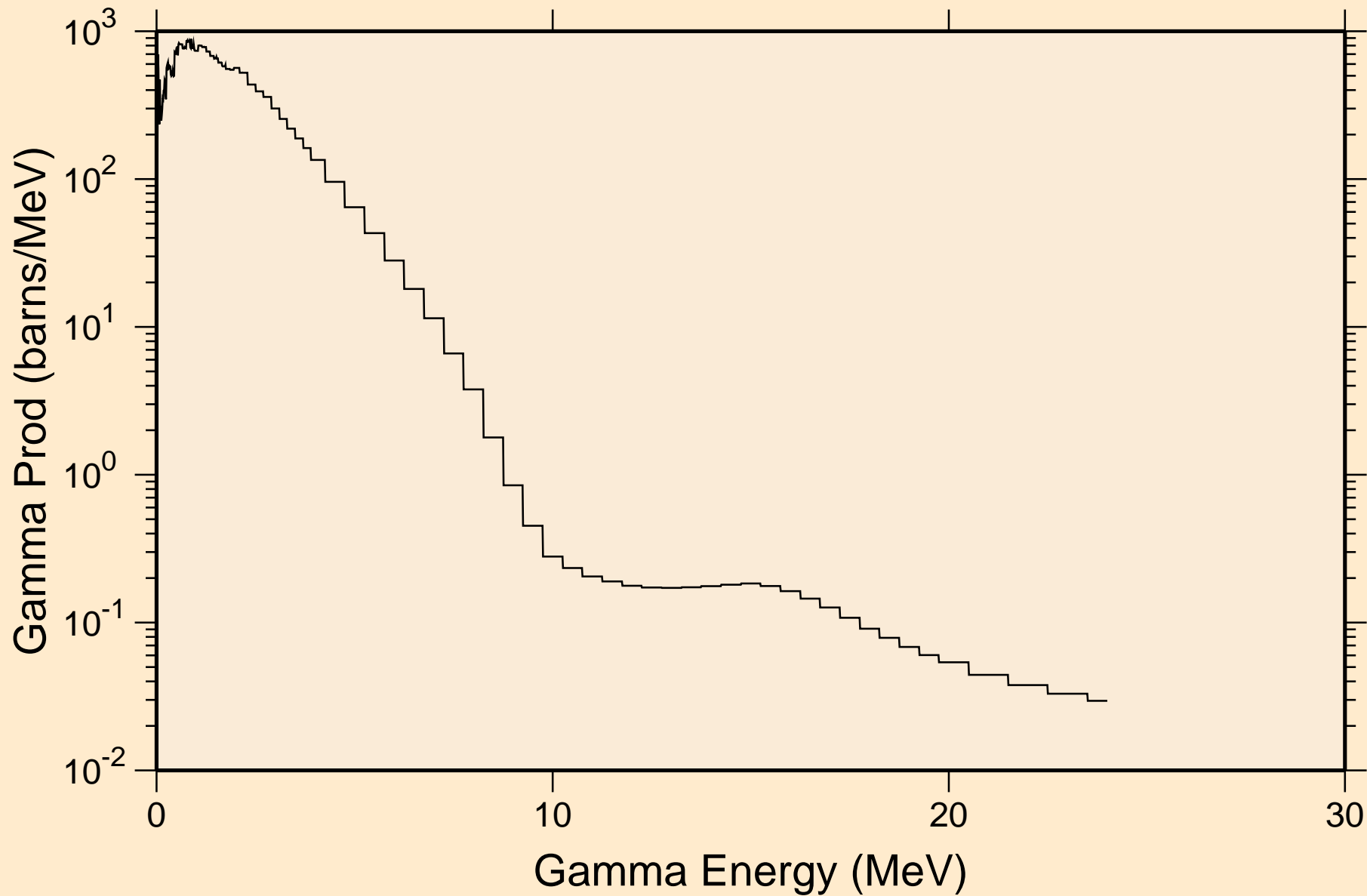

TC096M NEUTRON ACER TENDL-2019 LIBRARY; T=293.16K
Particle heating contributions

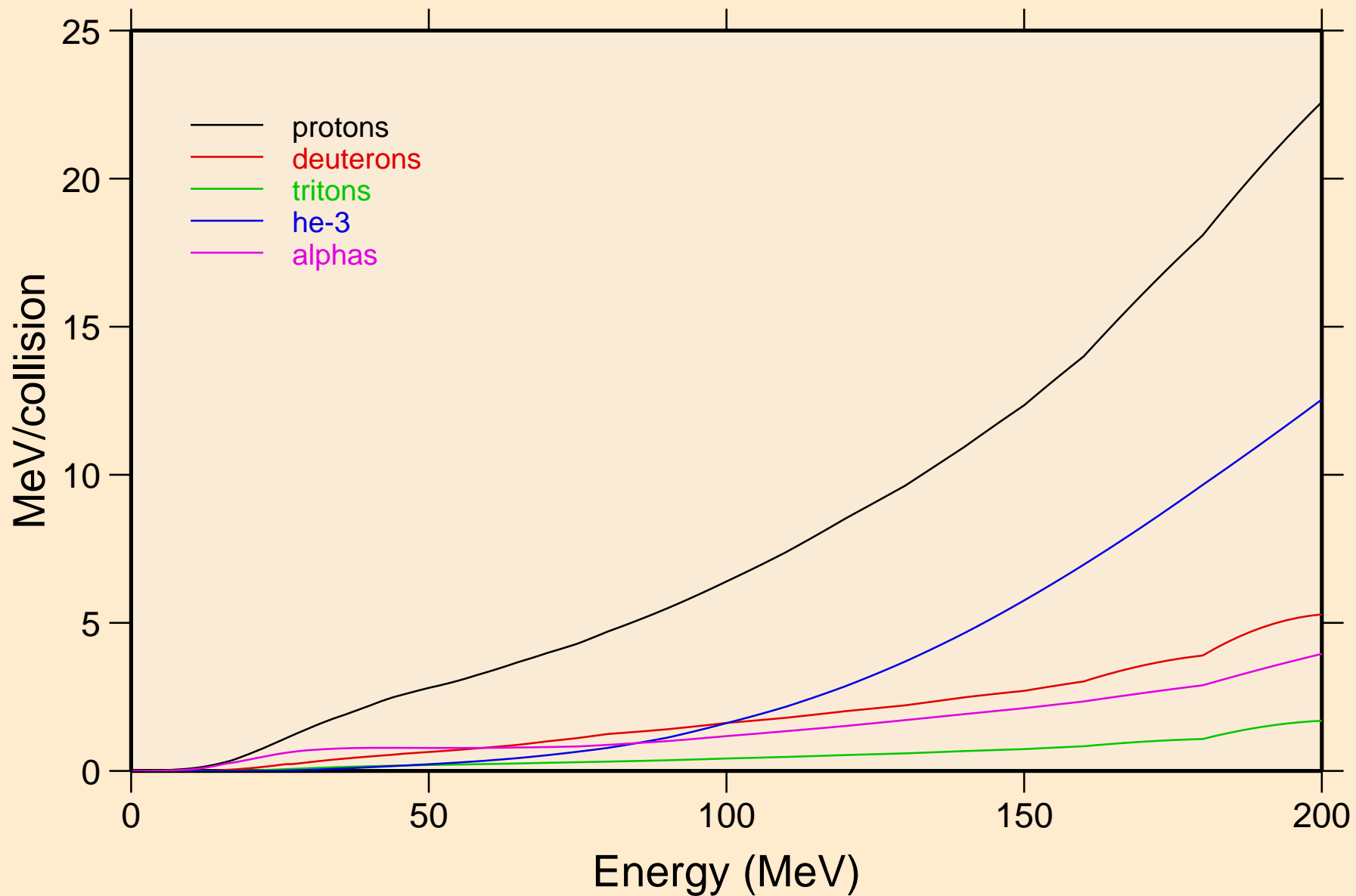

TC096M NEUTRON ACER TENDL-2019 LIBRARY; T=293.16K
Recoil Heating

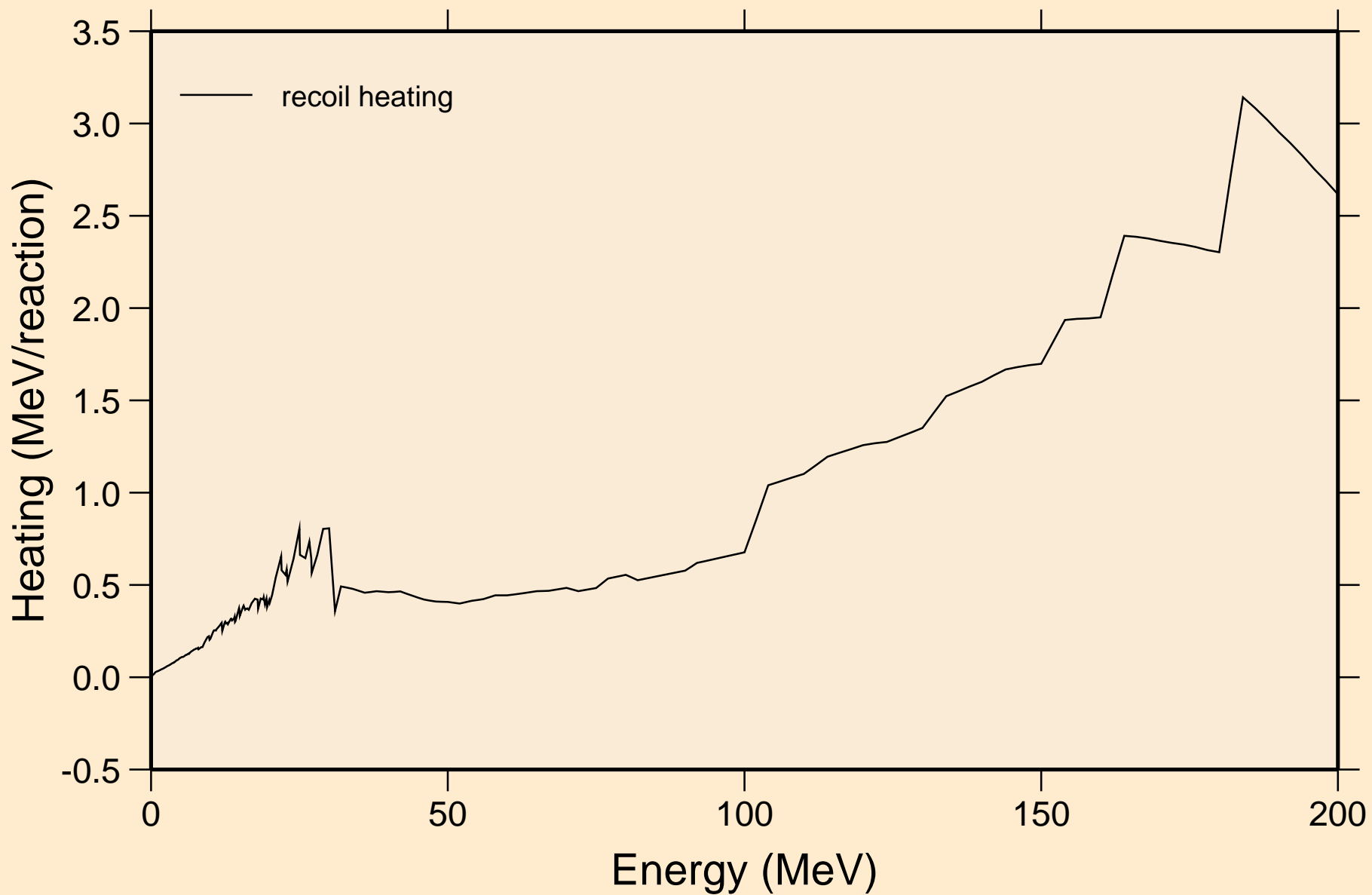

TC096M NEUTRON ACER TENDL-2019 LIBRARY; T=293.16K
Particle production cross sections

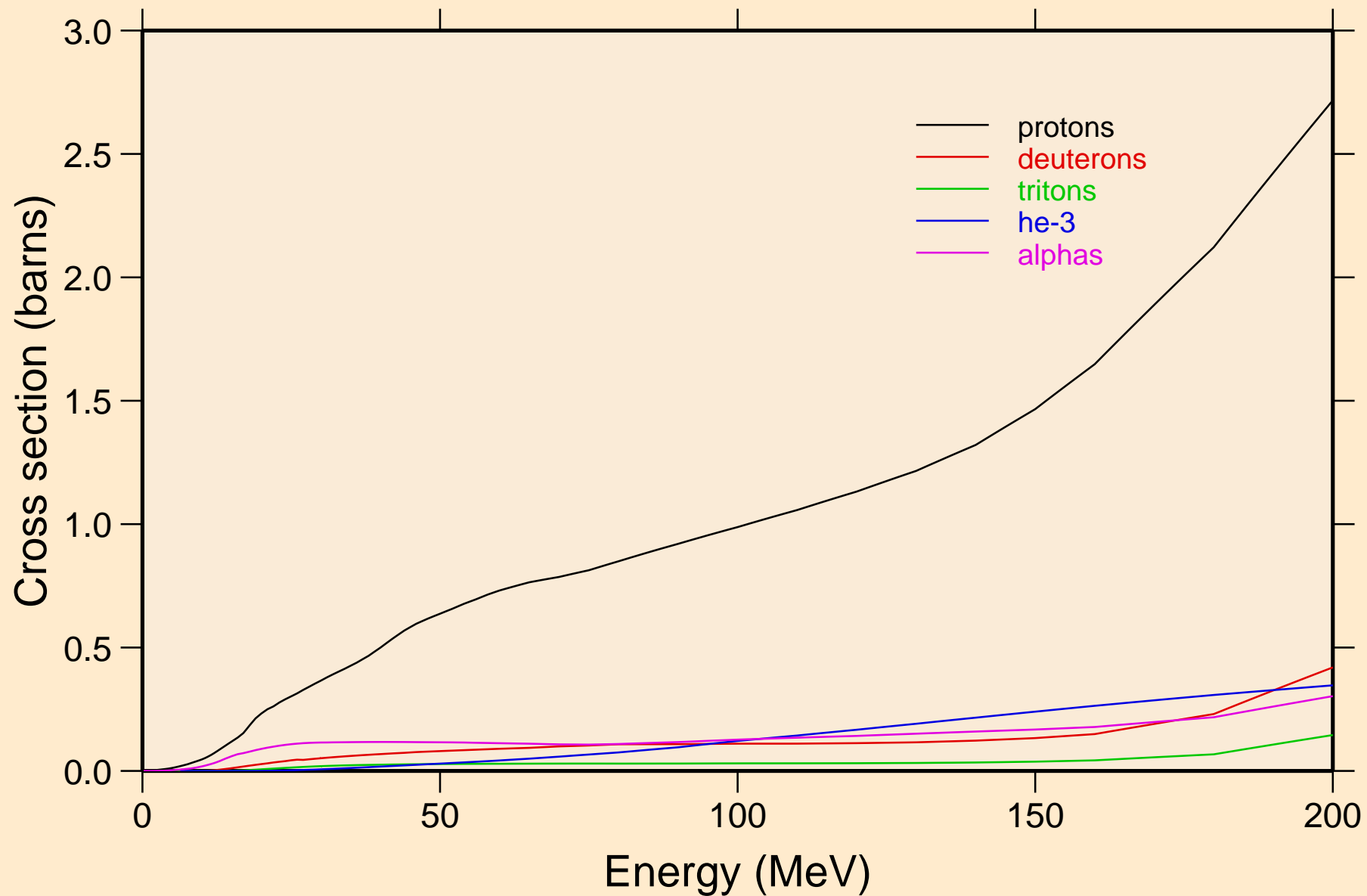

TC096M NEUTRON ACER TENDL-2019 LIBRARY; T=293.16K
protons from (n,x)

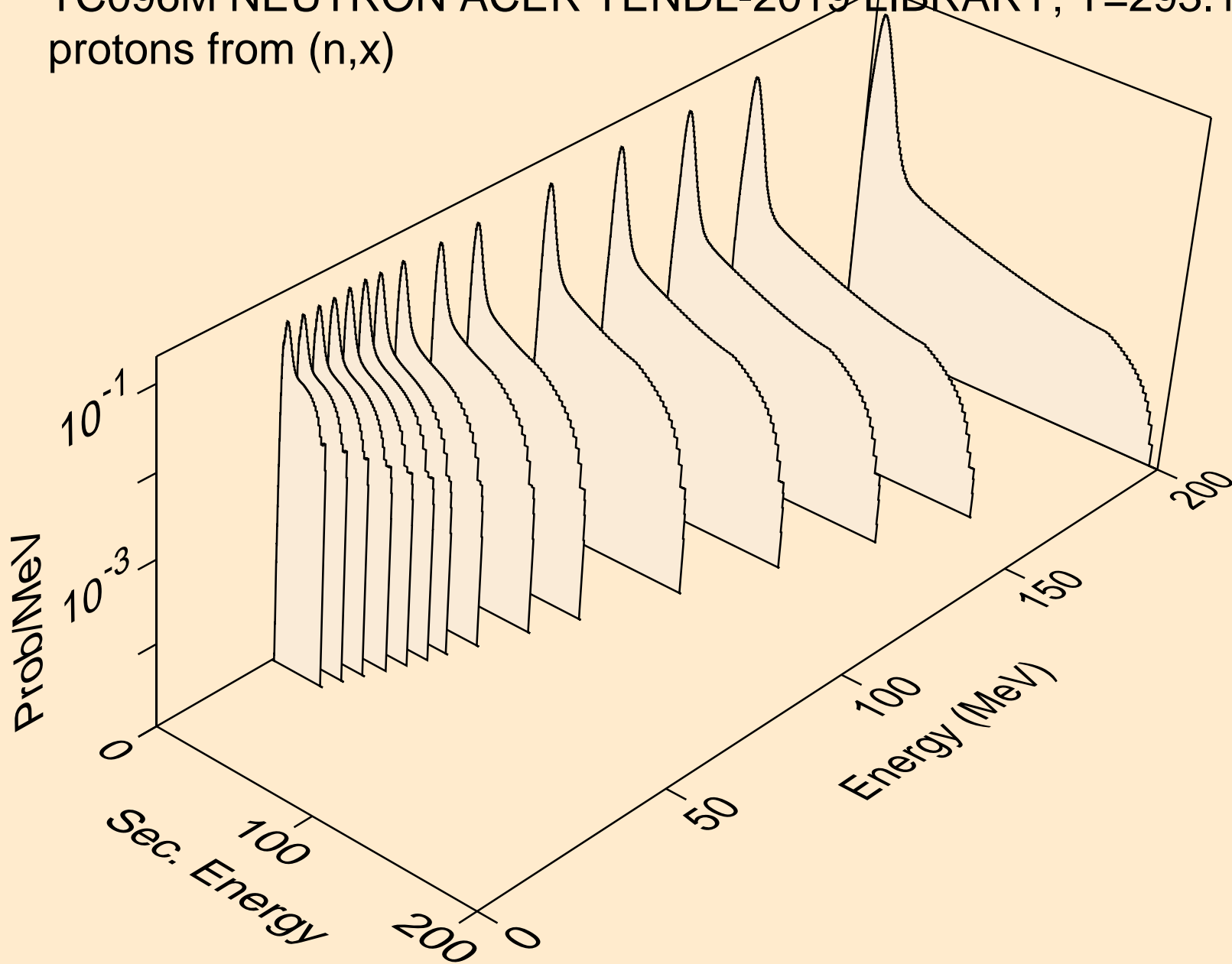

TC096M NEUTRON ACER TENDL-2019 LIBRARY; T=293.16K
protons from (n,n*)p

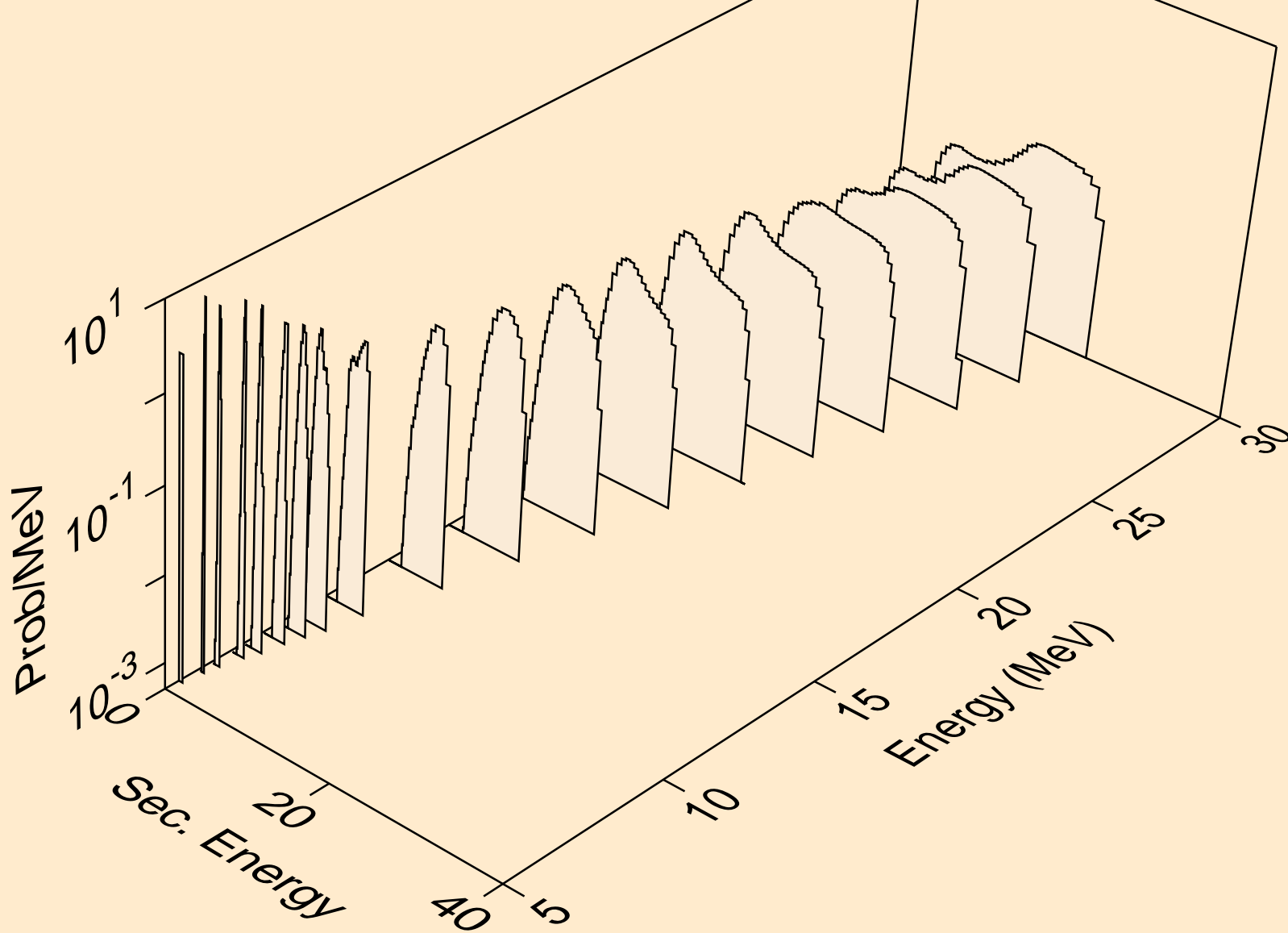

TC096M NEUTRON ACER TENDL-2019 LIBRARY; T=293.16K
protons from (n,2np)

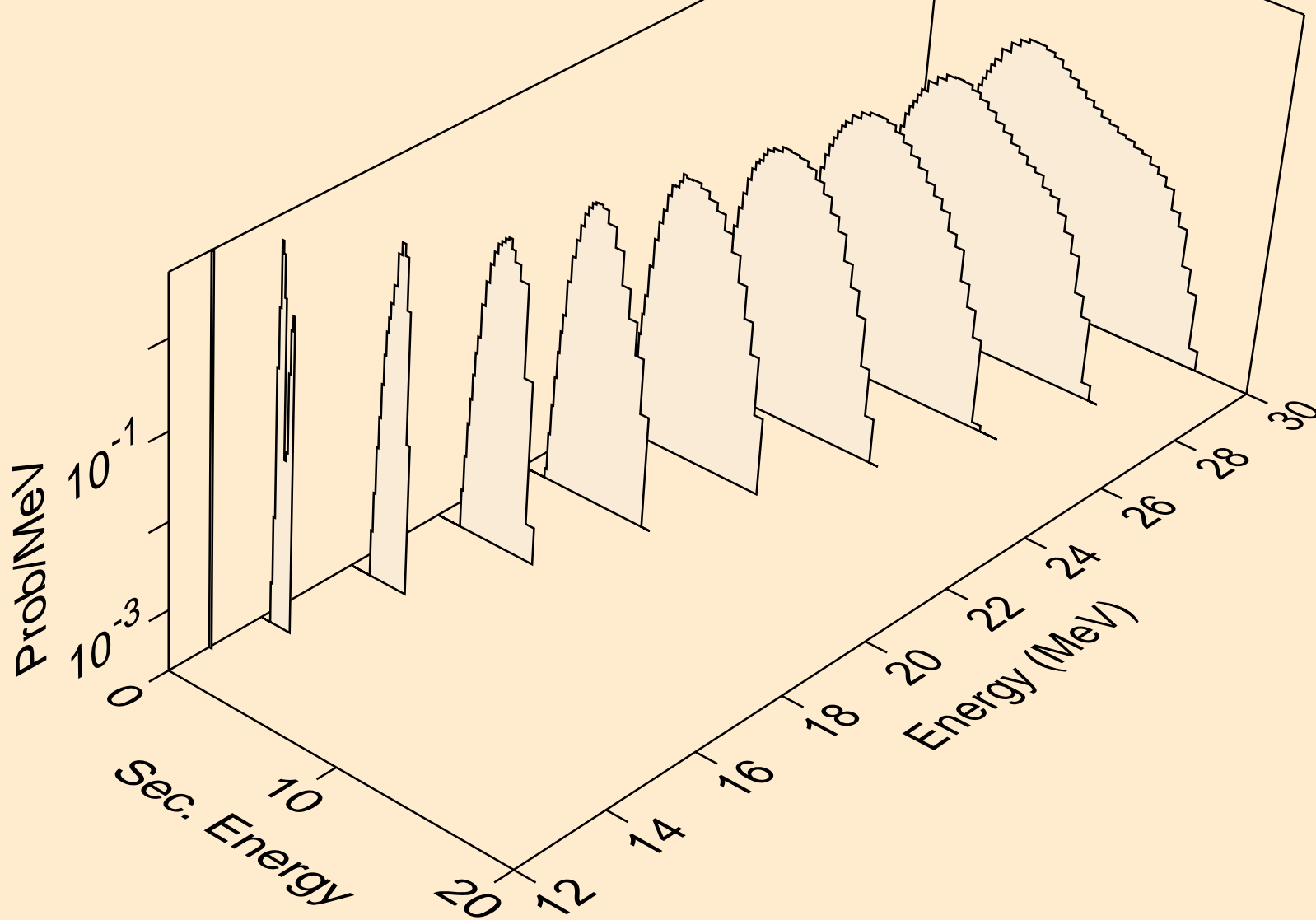

TC096M NEUTRON ACER TENDL-2019 LIBRARY; T=293.16K
protons from (n,3np)

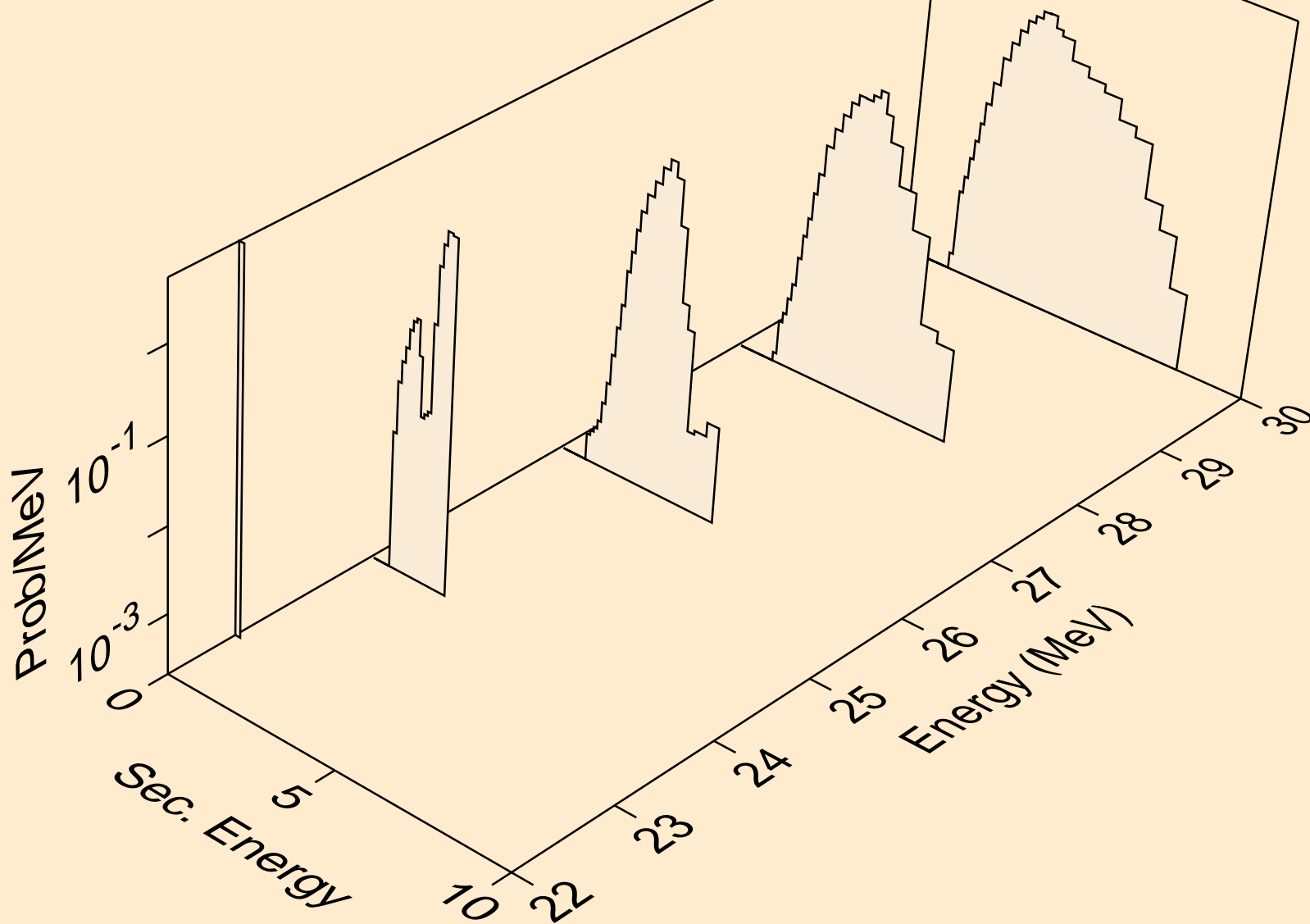

TC096M NEUTRON ACER TENDL-2019 LIBRARY; T=293.16K
protons from (n,2np)

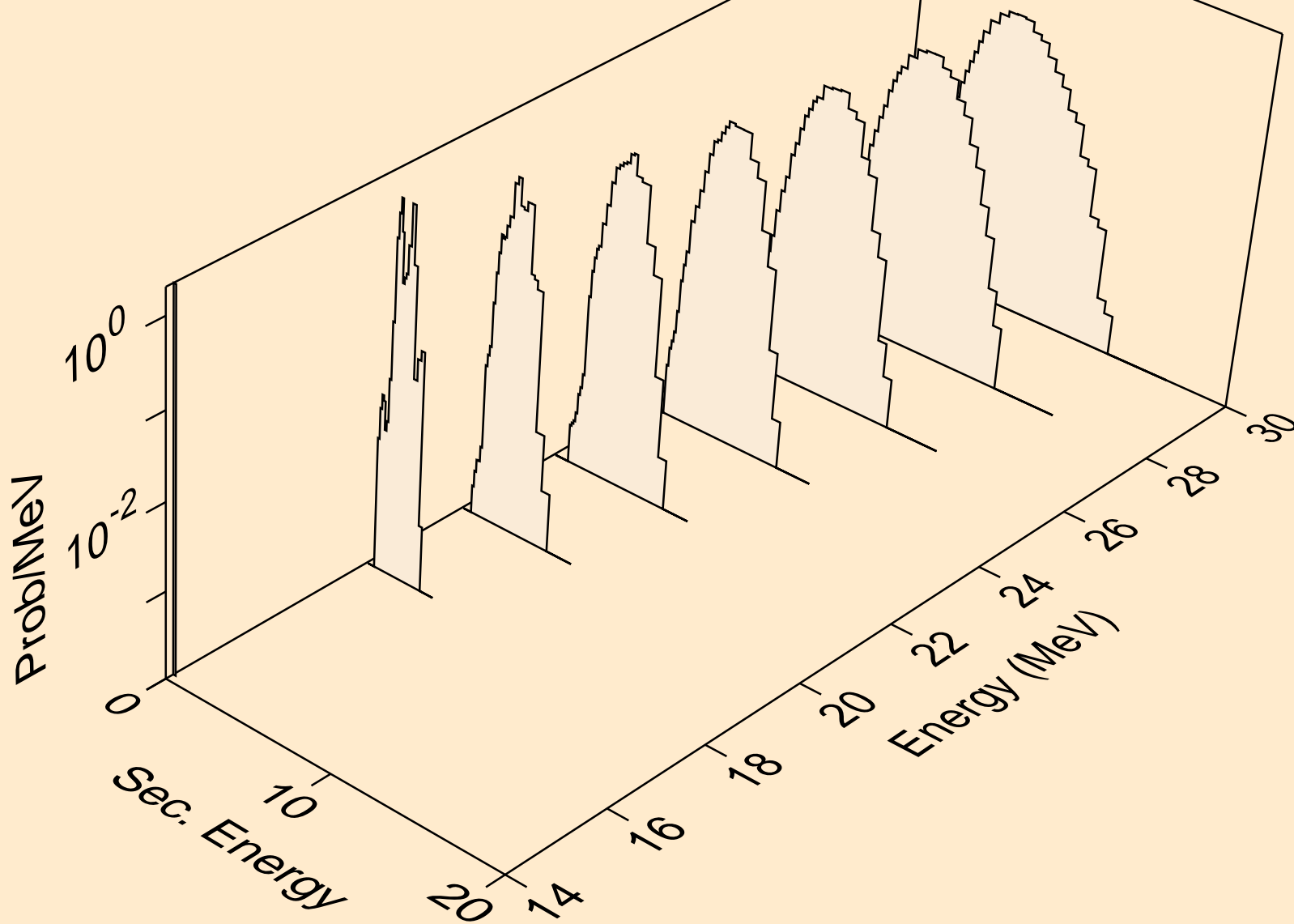

TC096M NEUTRON ACER TENDL-2019 LIBRARY; T=293.16K
protons from (n,npa)

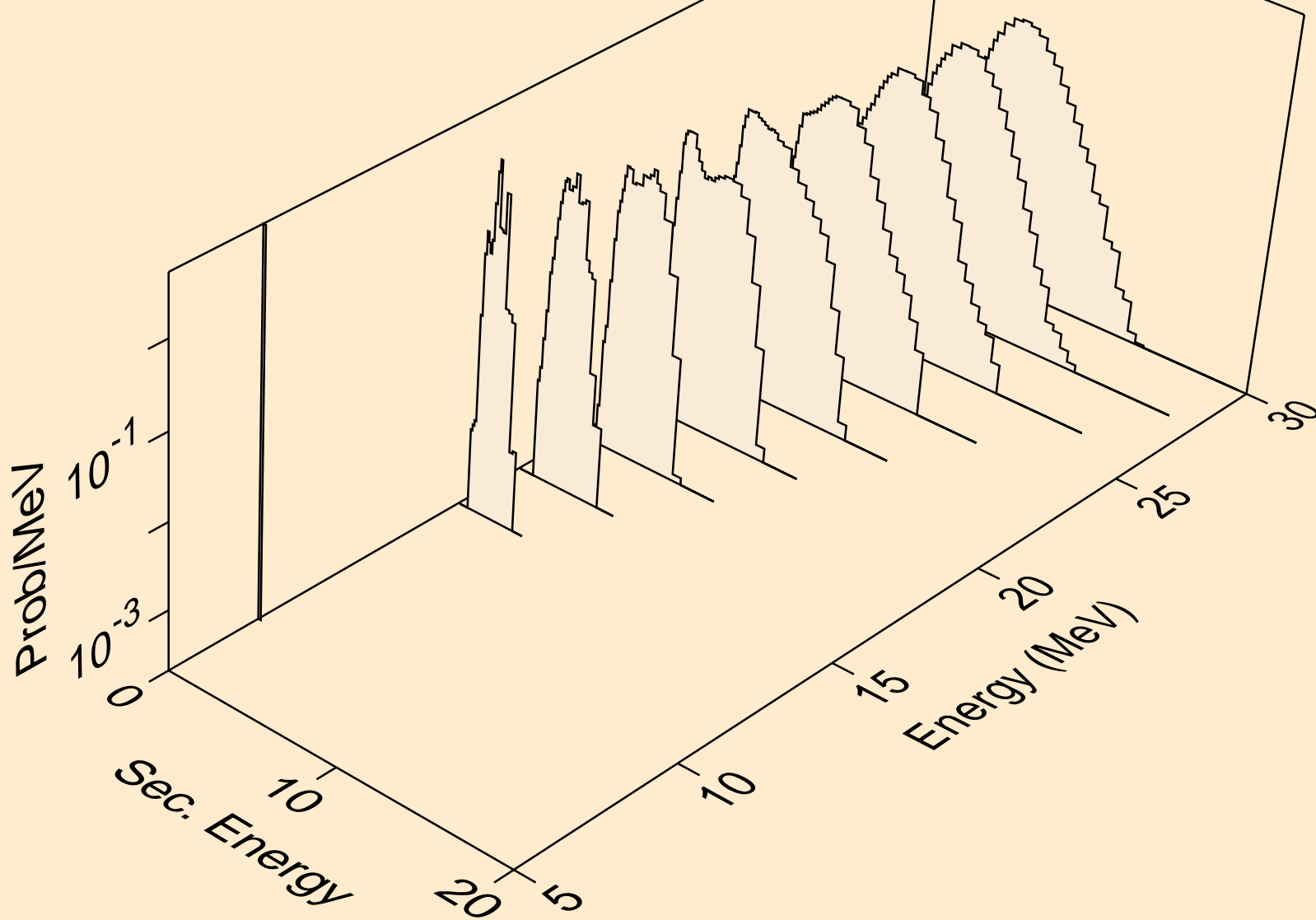

TC096M NEUTRON ACER TENDL-2019 LIBRARY; T=293.16K
protons from (n,p)

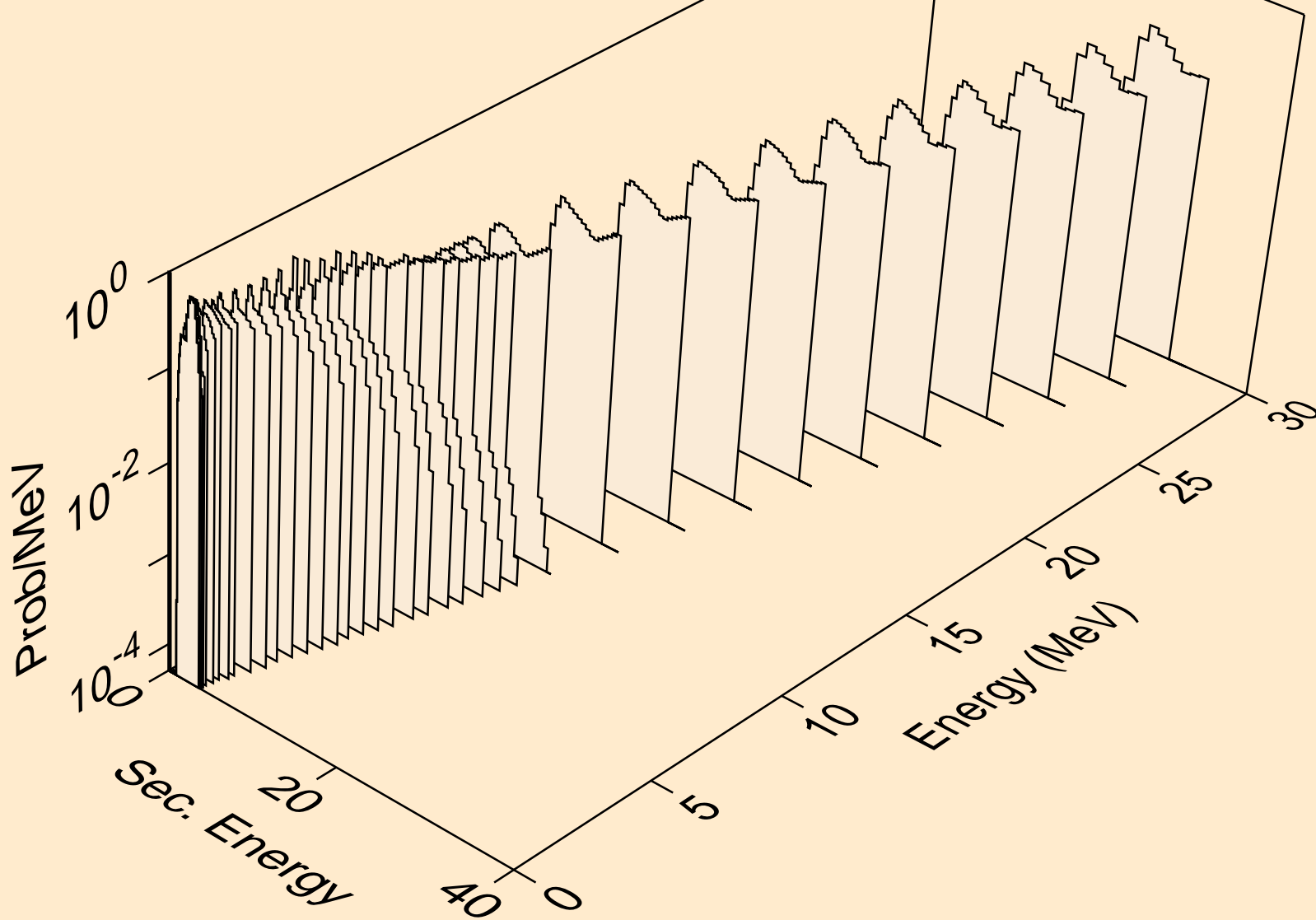

TC096M NEUTRON ACER TENDL-2019 LIBRARY; T=293.16K
protons from (n,2p)

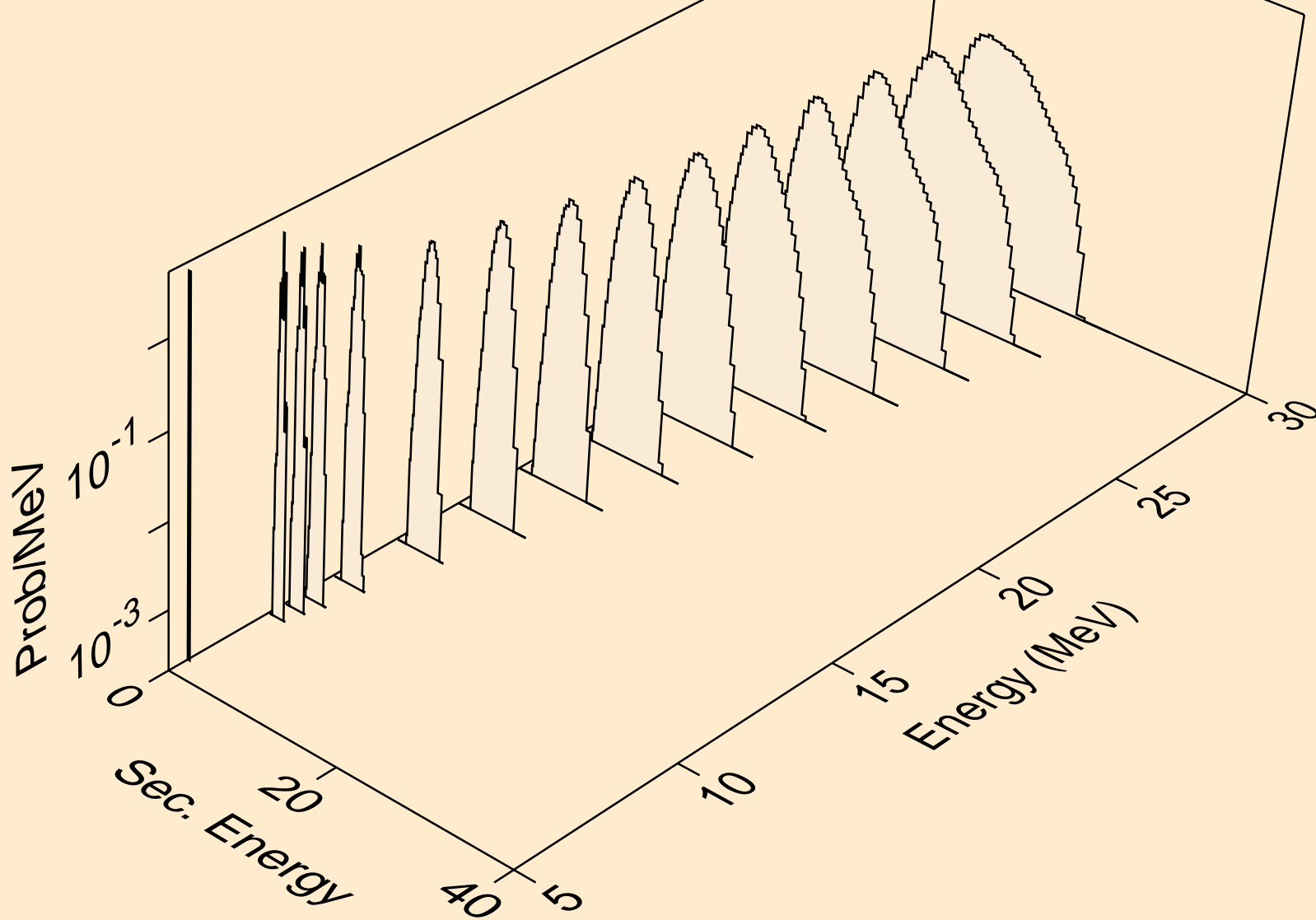

TC096M NEUTRON ACER TENDL-2019 LIBRARY; T=293.16K
protons from (n,p)

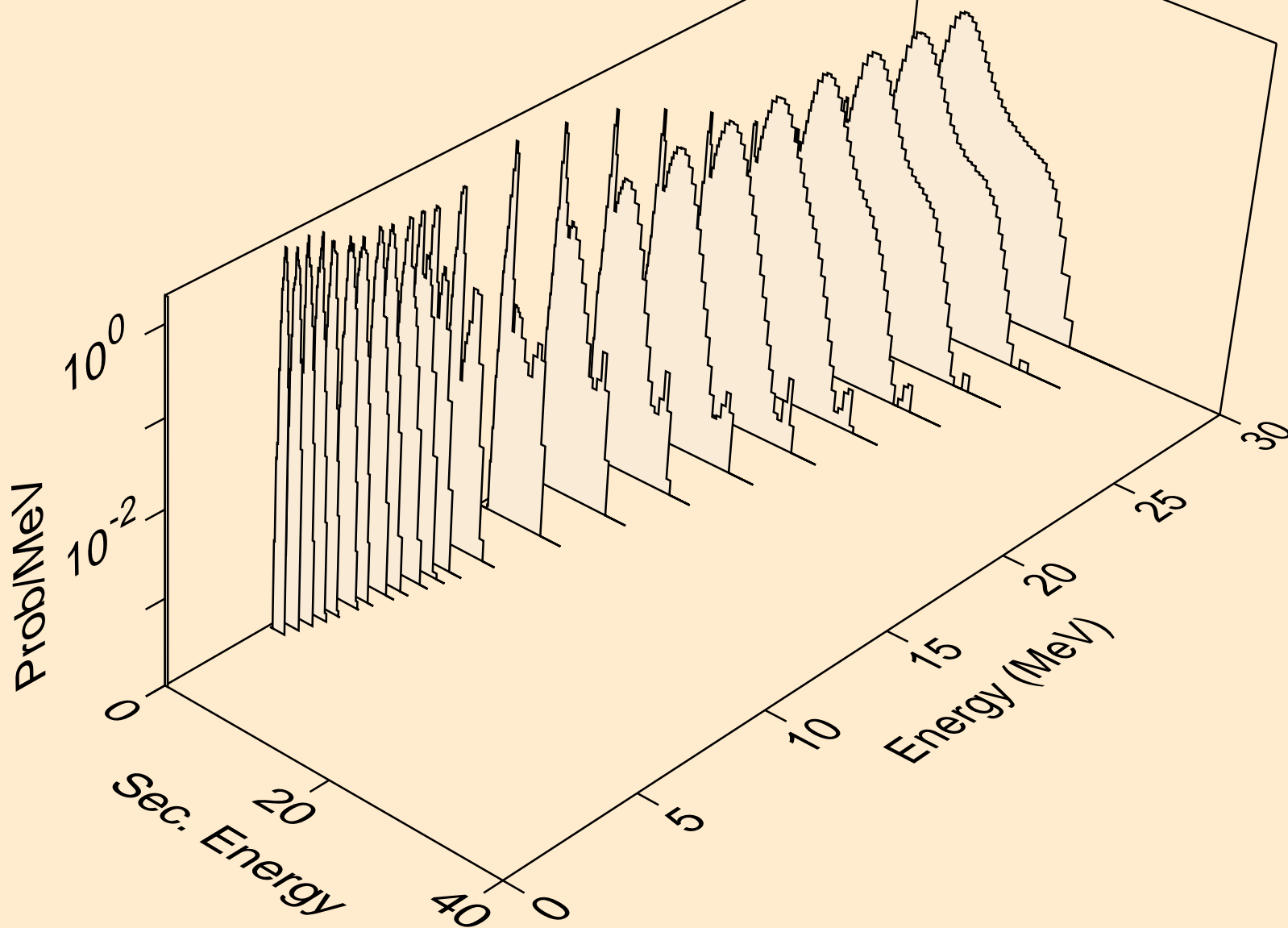

TC096M NEUTRON ACER TENDL-2019 LIBRARY; T=293.16K
protons from (n,pd)

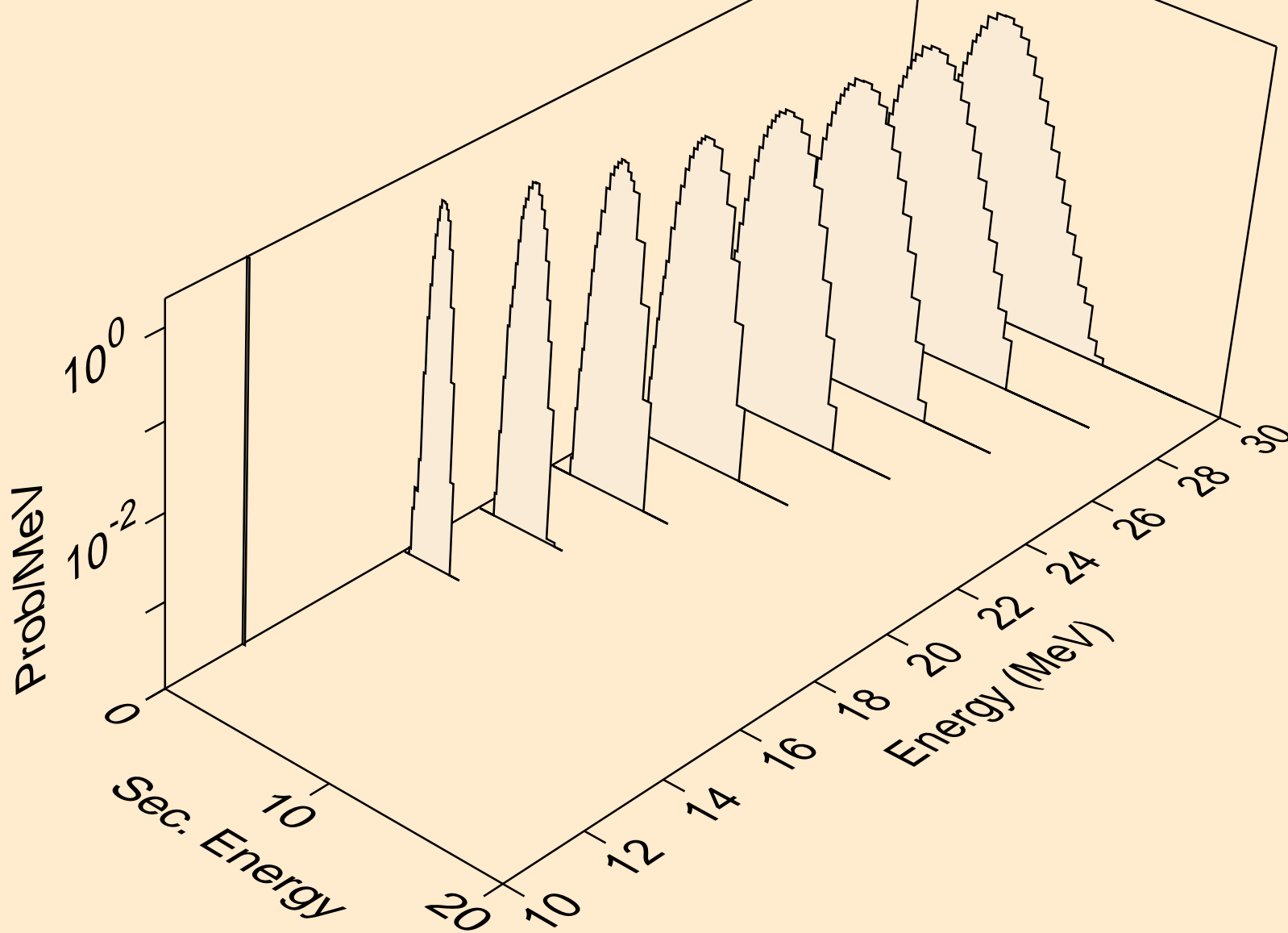

TC096M NEUTRON ACER TENDL-2019 LIBRARY; T=293.16K
protons from (n,pt)

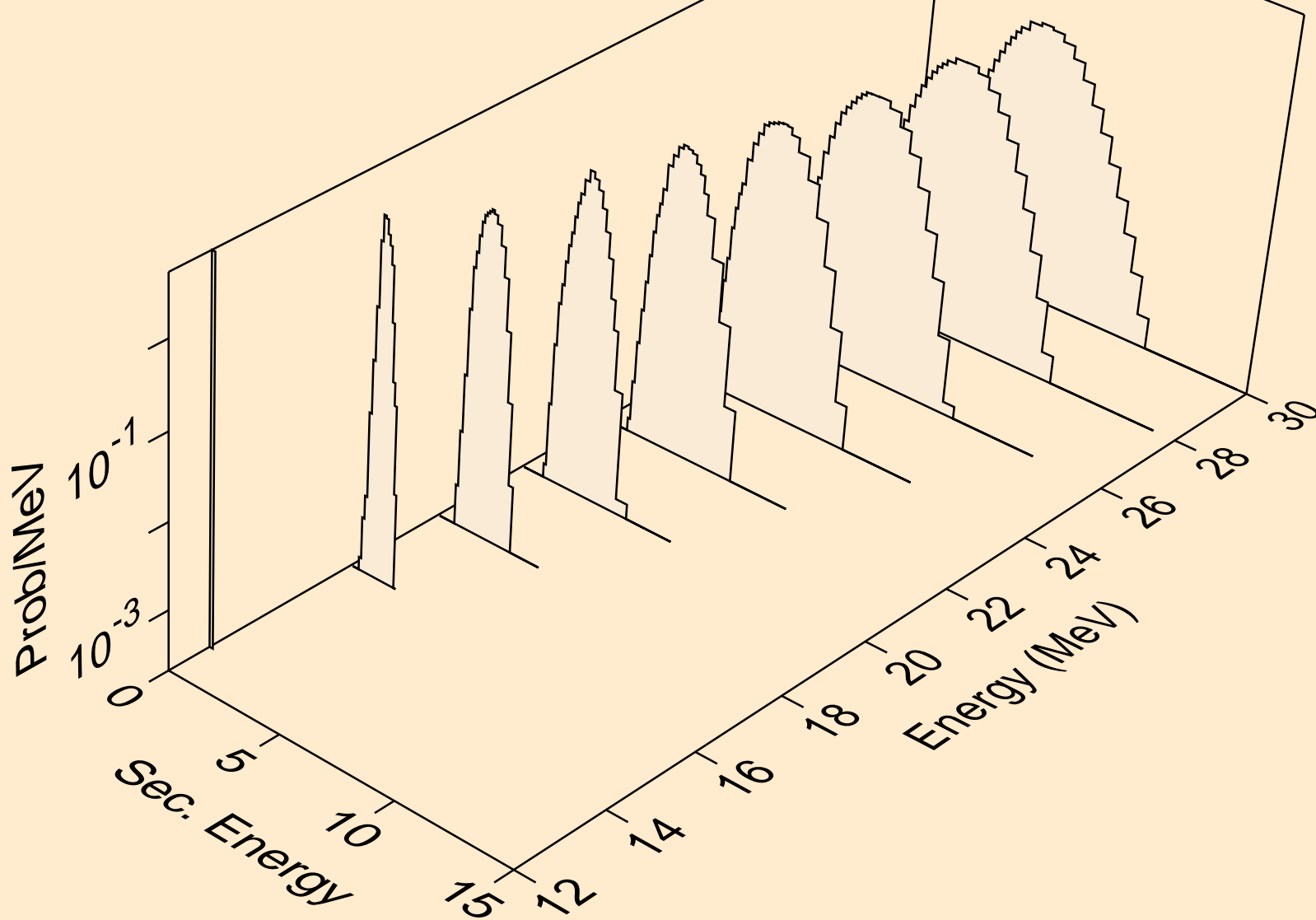

TC096M NEUTRON ACER TENDL-2019 LIBRARY; T=293.16K
deuterons from (n,x)

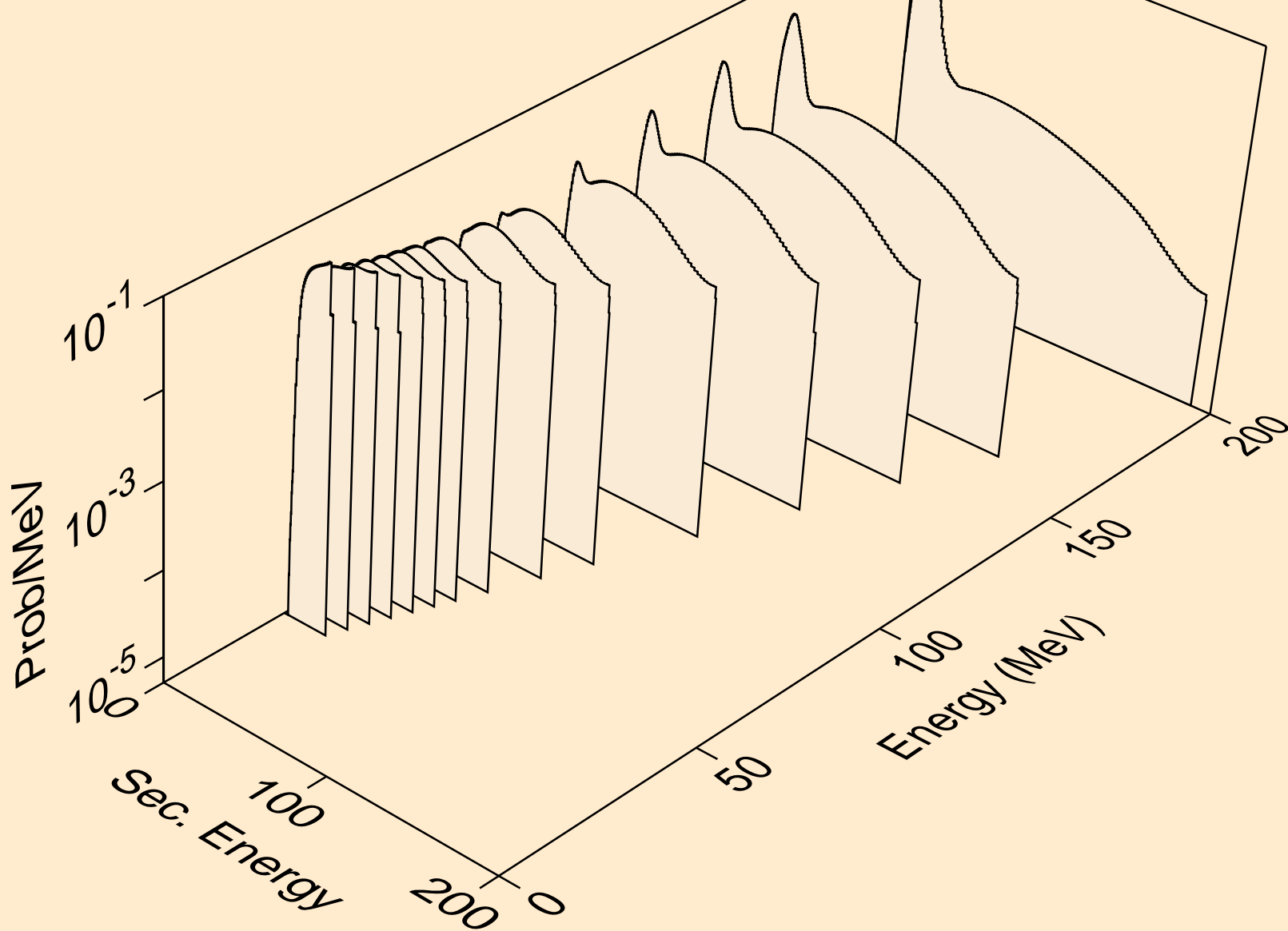

TC096M NEUTRON ACER TENDL-2019 LIBRARY; T=293.16K
deuterons from (n,2nd)

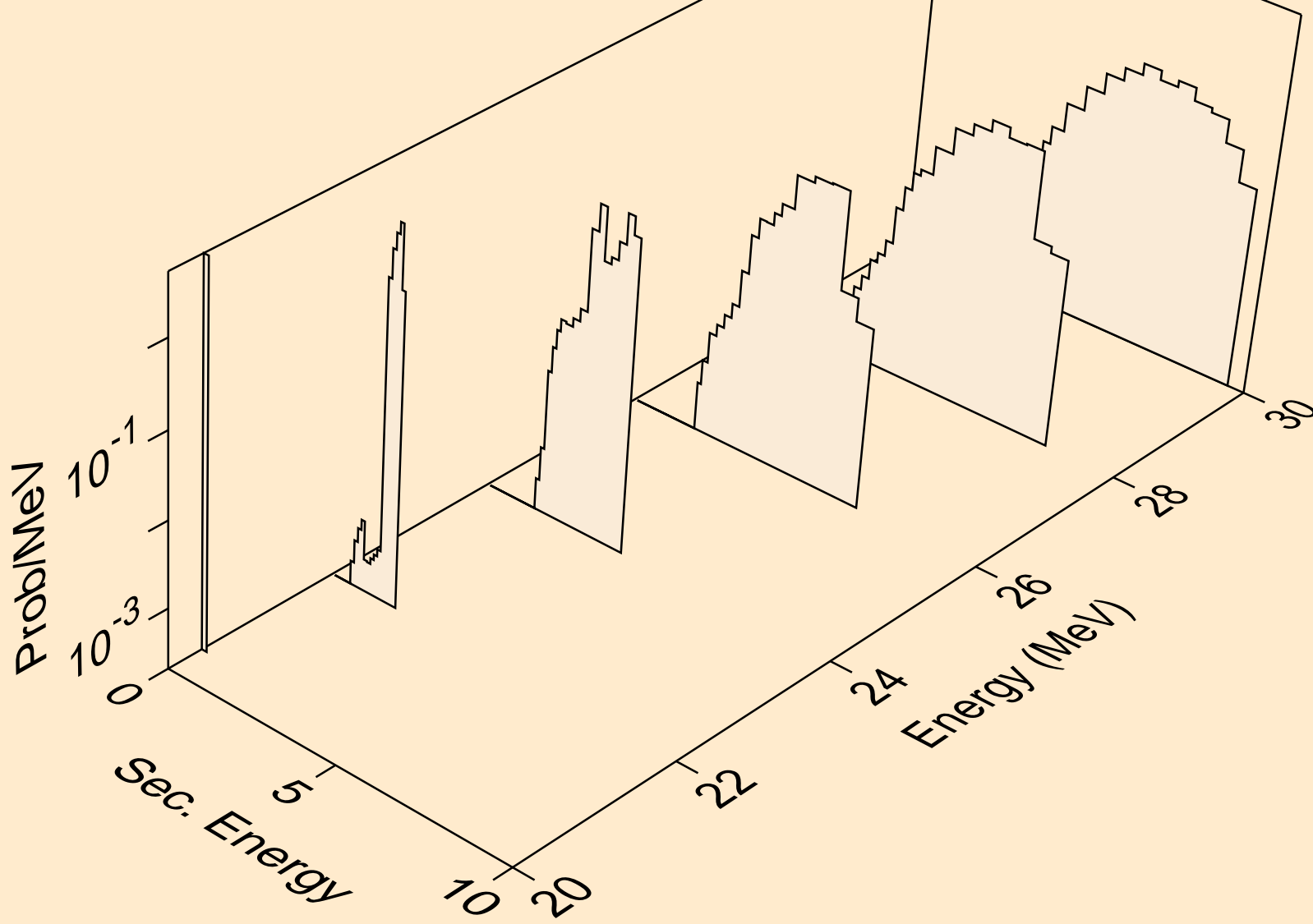

TC096M NEUTRON ACER TENDL-2019 LIBRARY; T=293.16K
deuterons from (n,n*)d

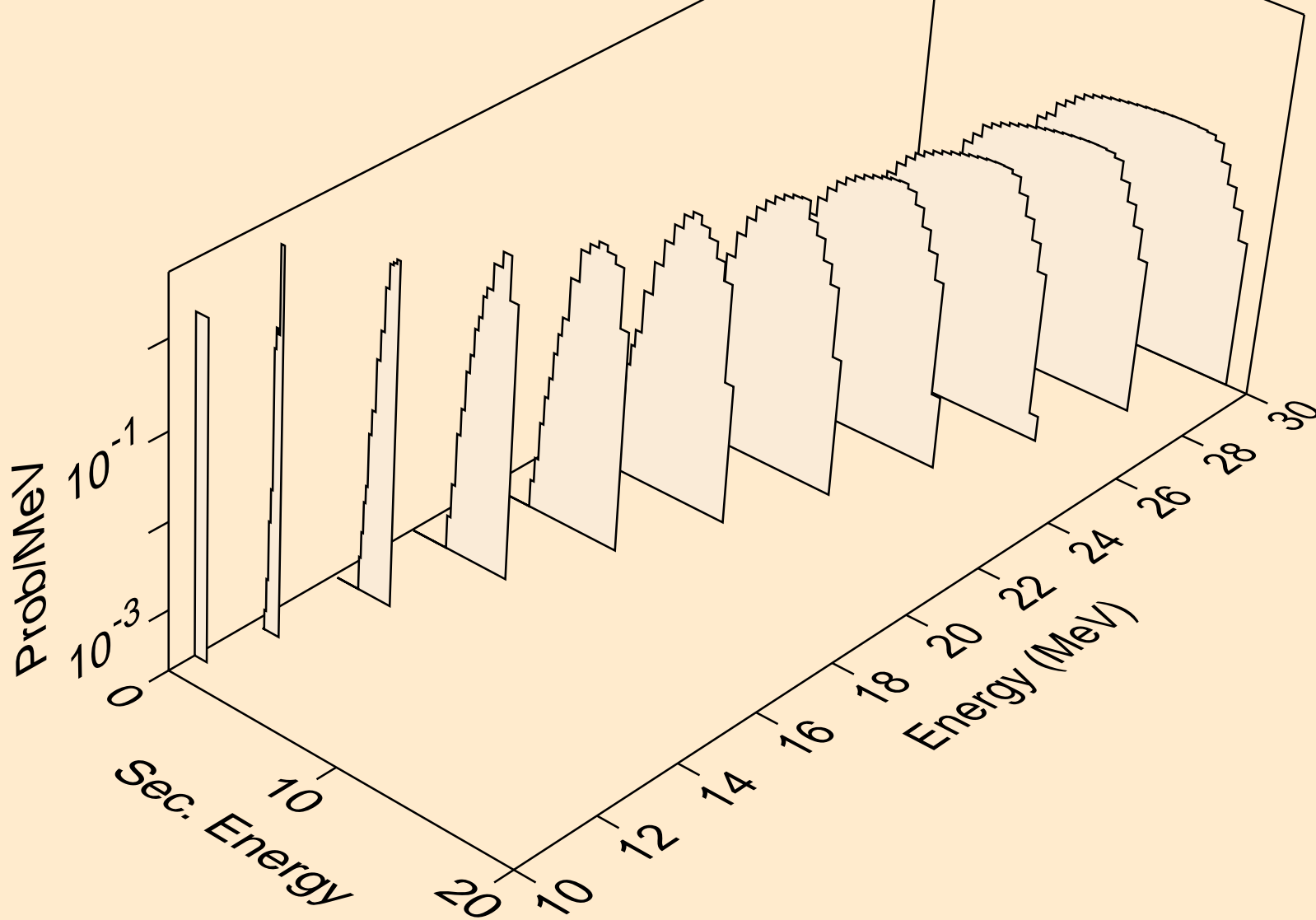

TC096M NEUTRON ACER TENDL-2019 LIBRARY; T=293.16K
deuterons from (n,d)

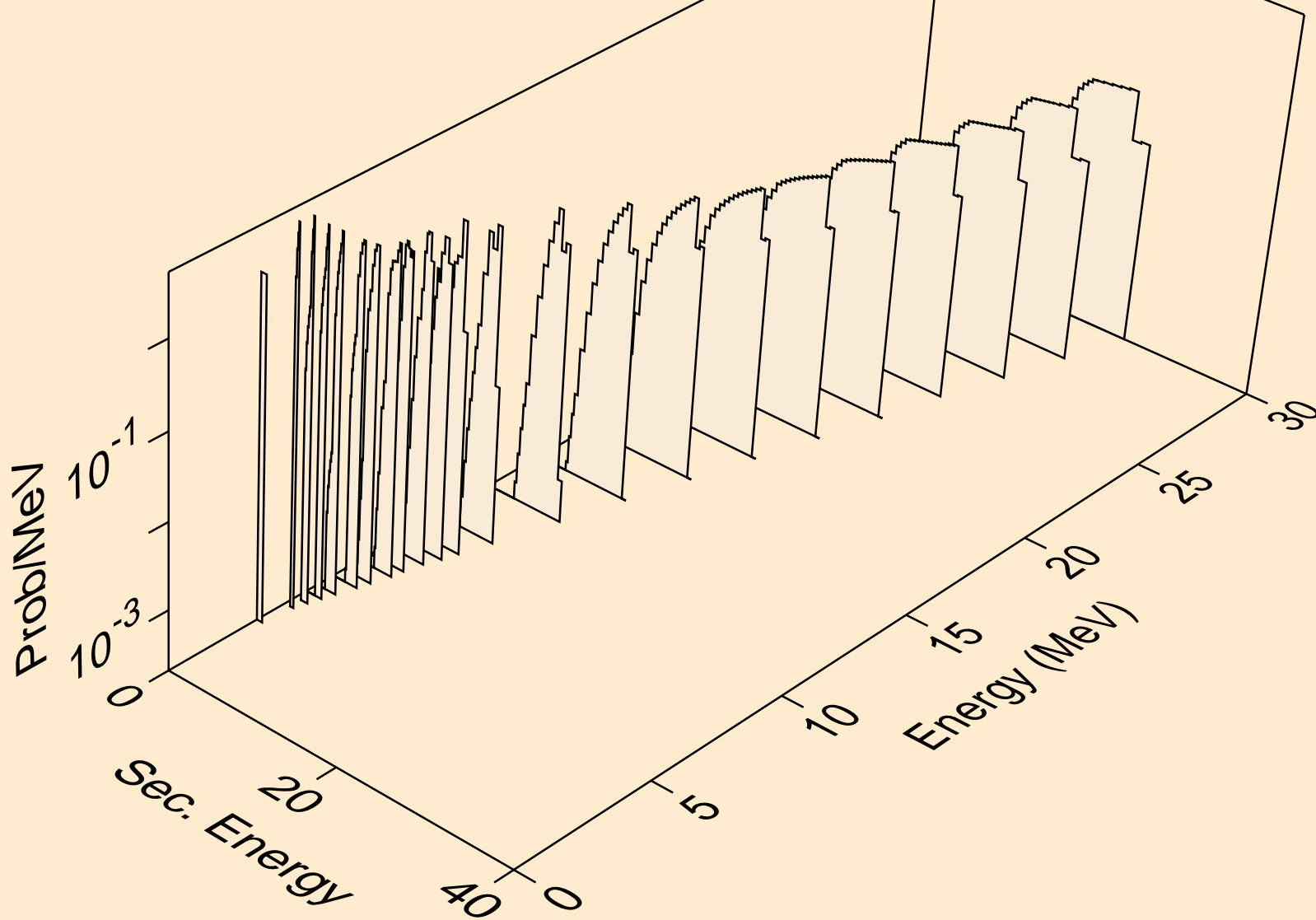

TC096M NEUTRON ACER TENDL-2019 LIBRARY; T=293.16K
deuterons from (n,pd)

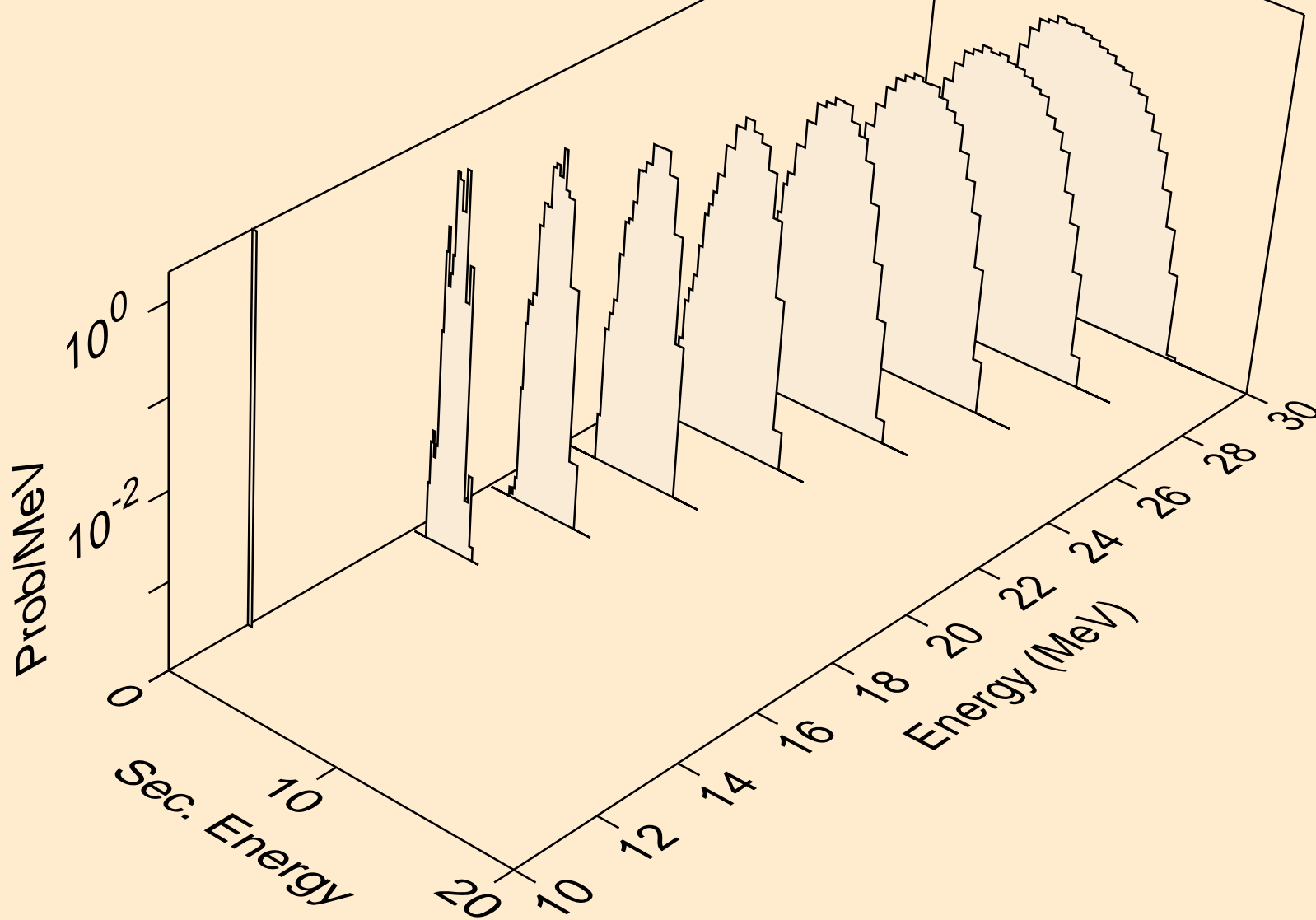

TC096M NEUTRON ACER TENDL-2019 LIBRARY; T=293.16K
deuterons from (n,da)

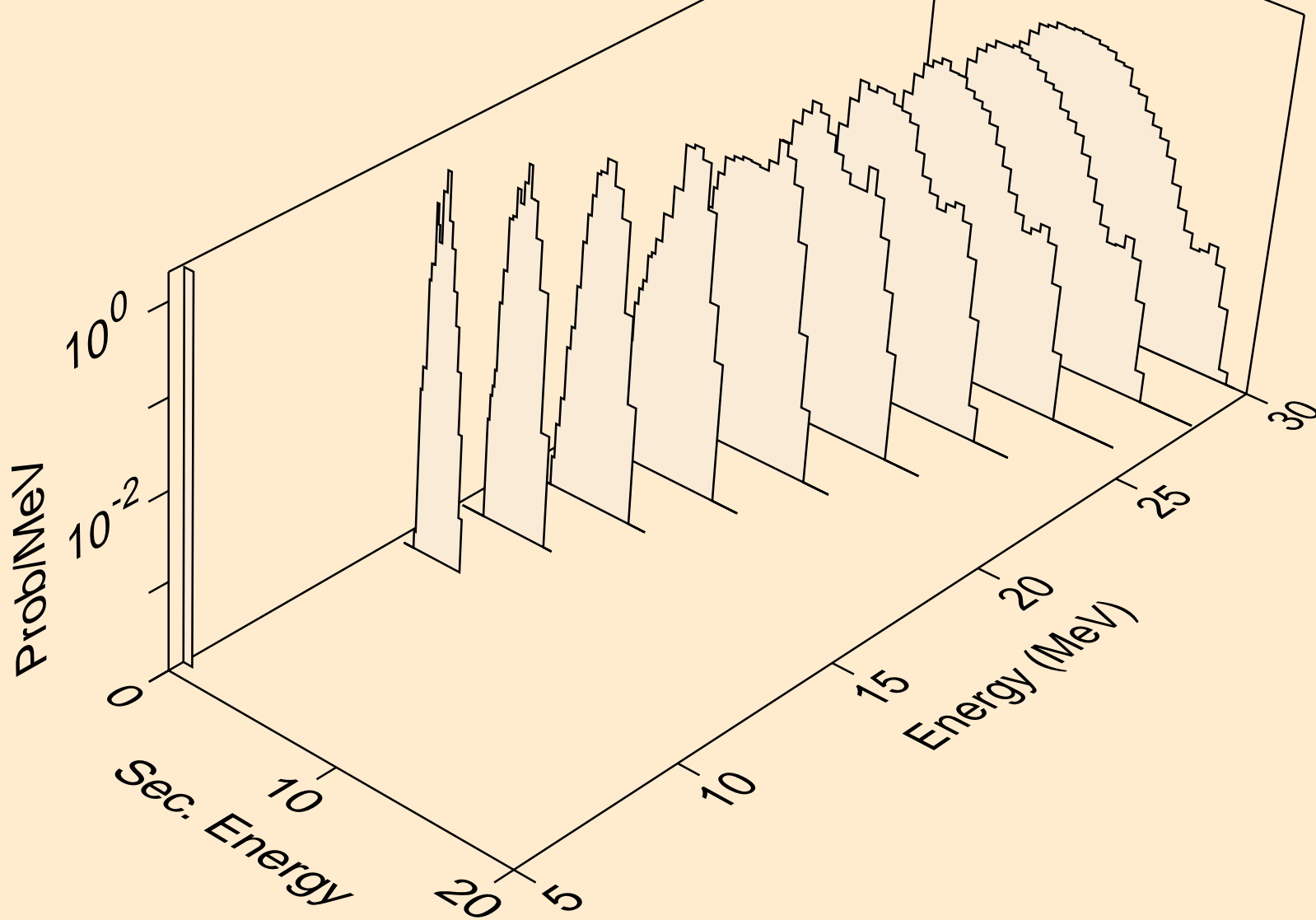

TC096M NEUTRON ACER TENDL-2019 LIBRARY; T=293.16K
tritons from (n,x)

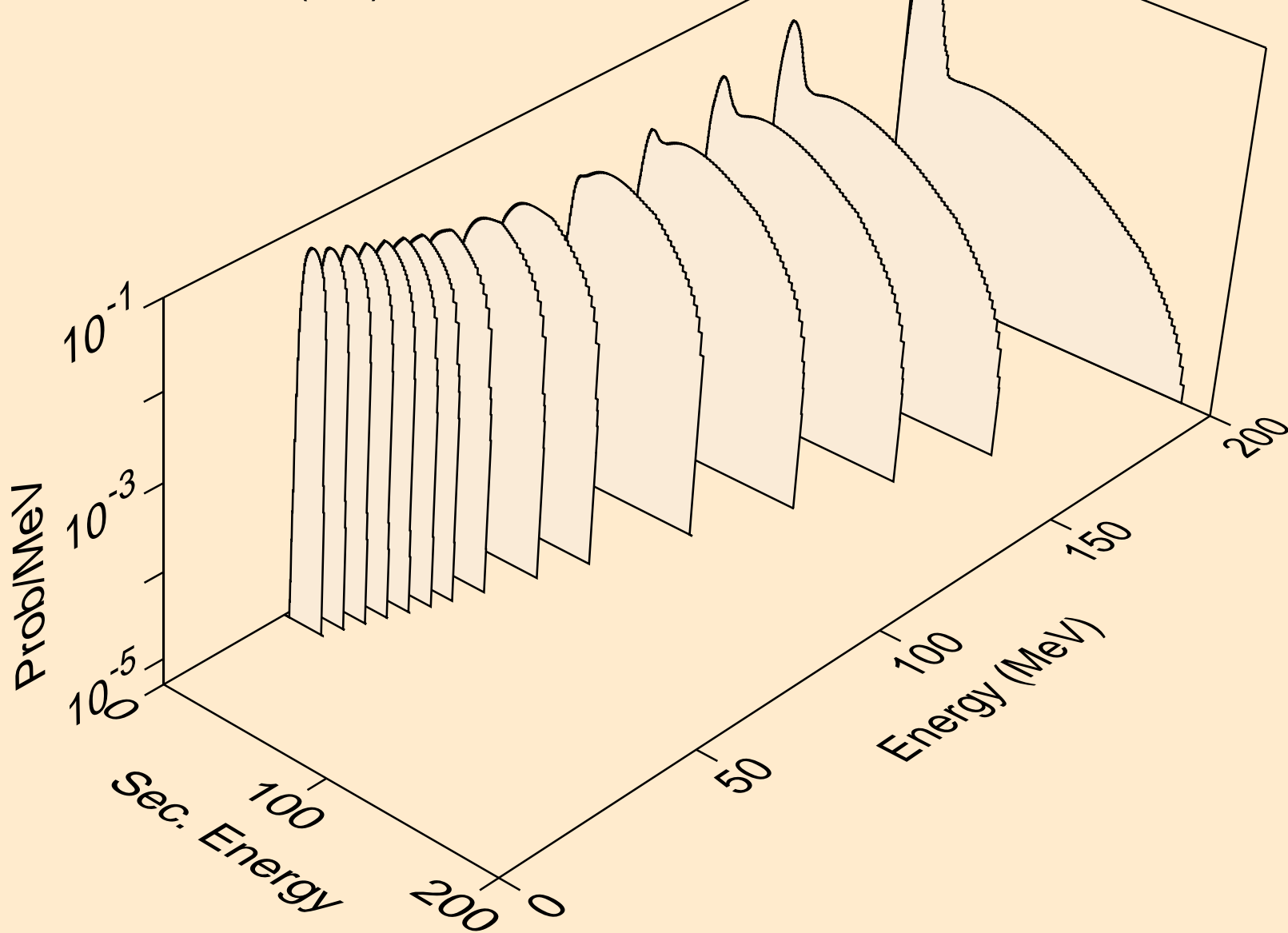

TC096M NEUTRON ACER TENDL-2019 LIBRARY; T=293.16K
tritons from (n,n*)t

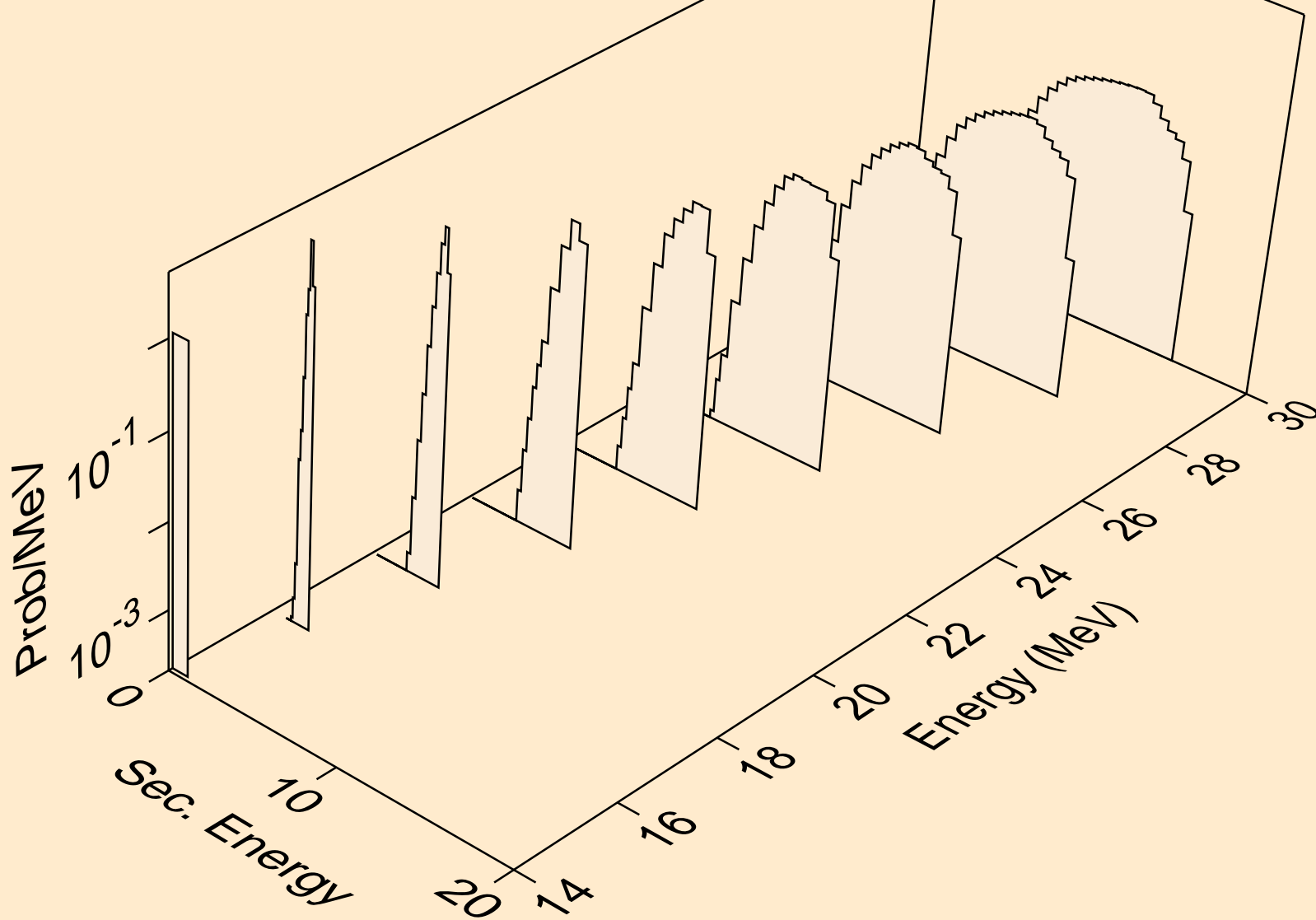

TC096M NEUTRON ACER TENDL-2019 LIBRARY; T=293.16K
tritons from (n,t)

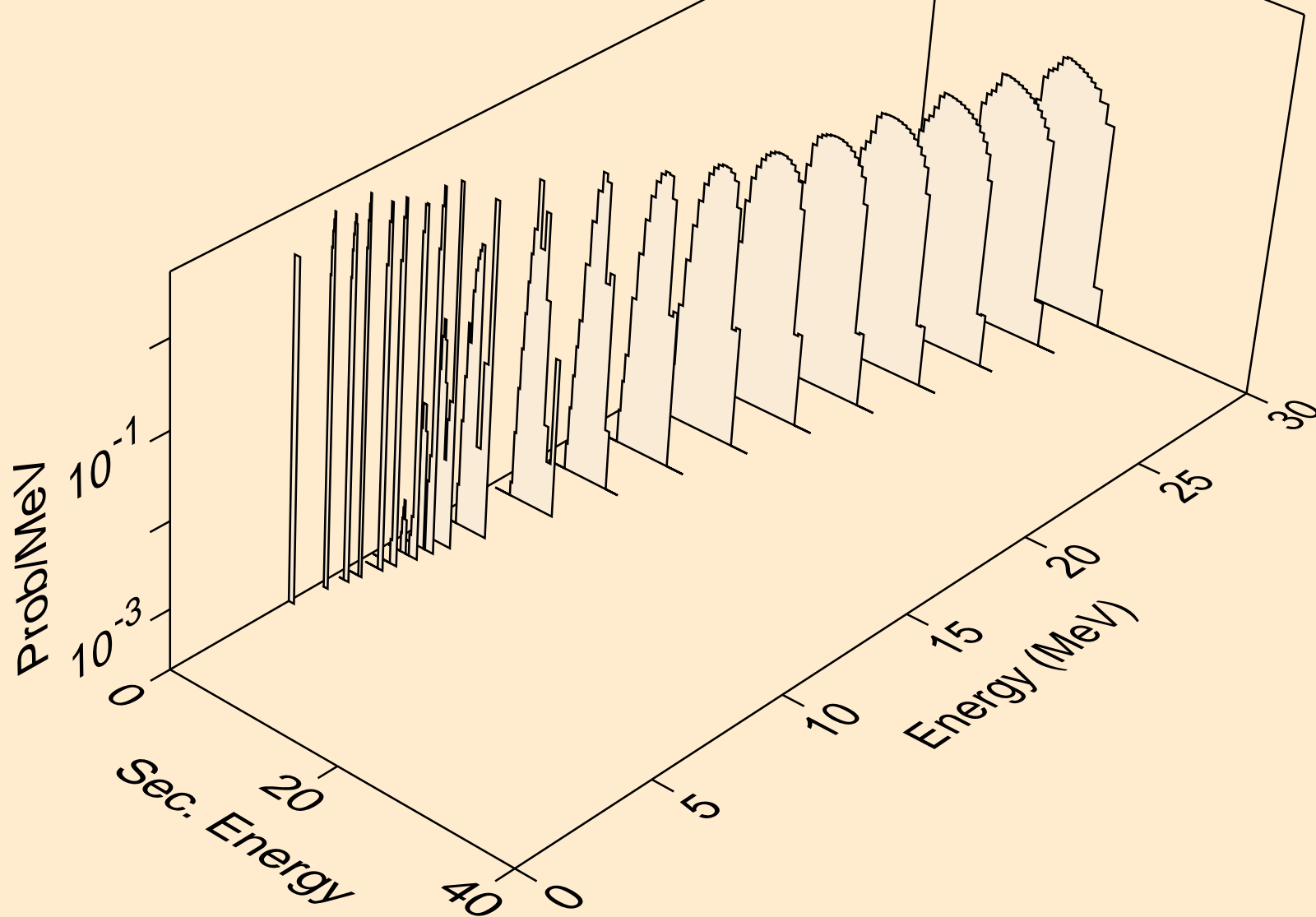

TC096M NEUTRON ACER TENDL-2019 LIBRARY; T=293.16K
tritons from (n,pt)

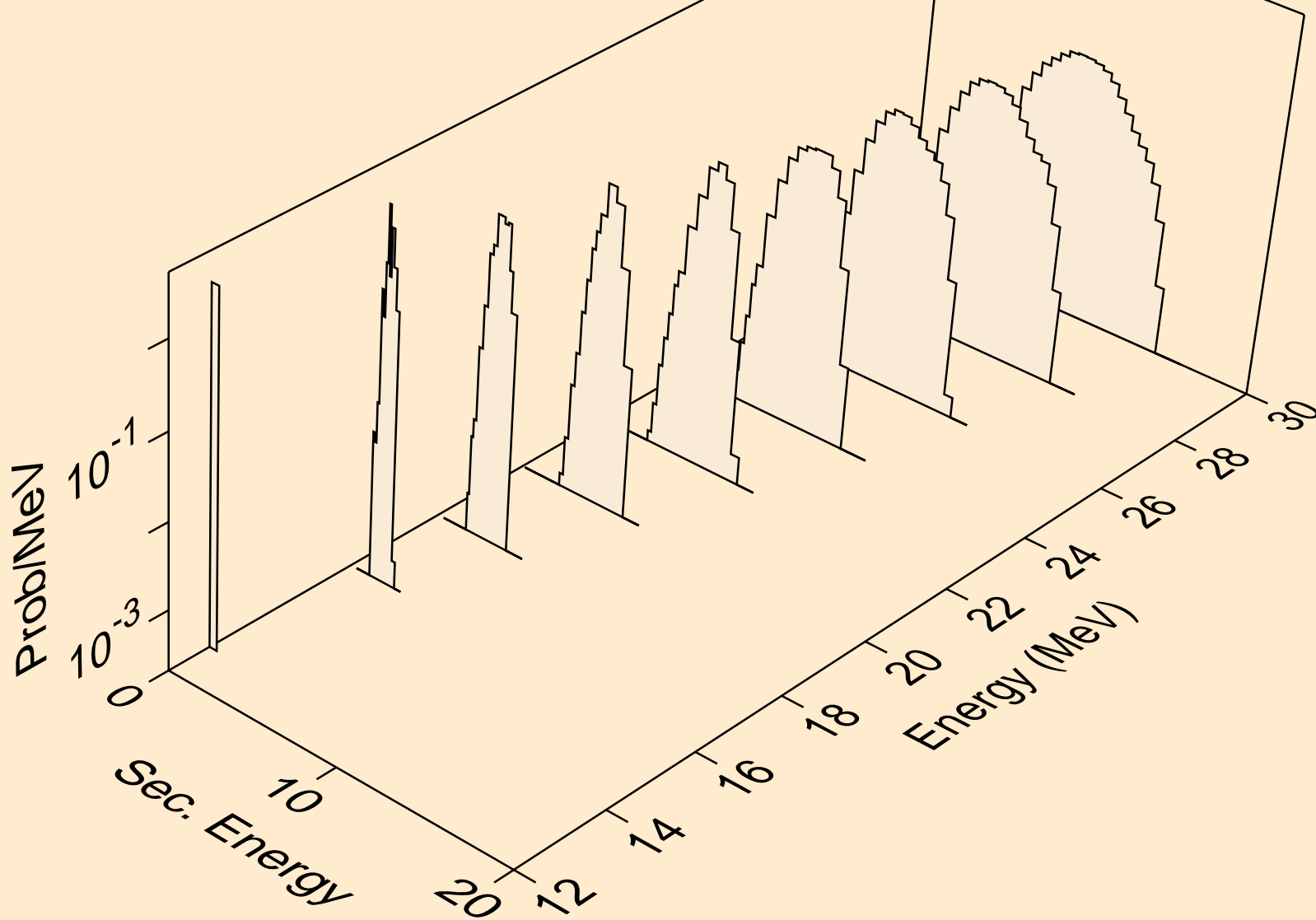

TC096M NEUTRON ACER TENDL-2019 LIBRARY; T=293.16K
he3s from (n,x)

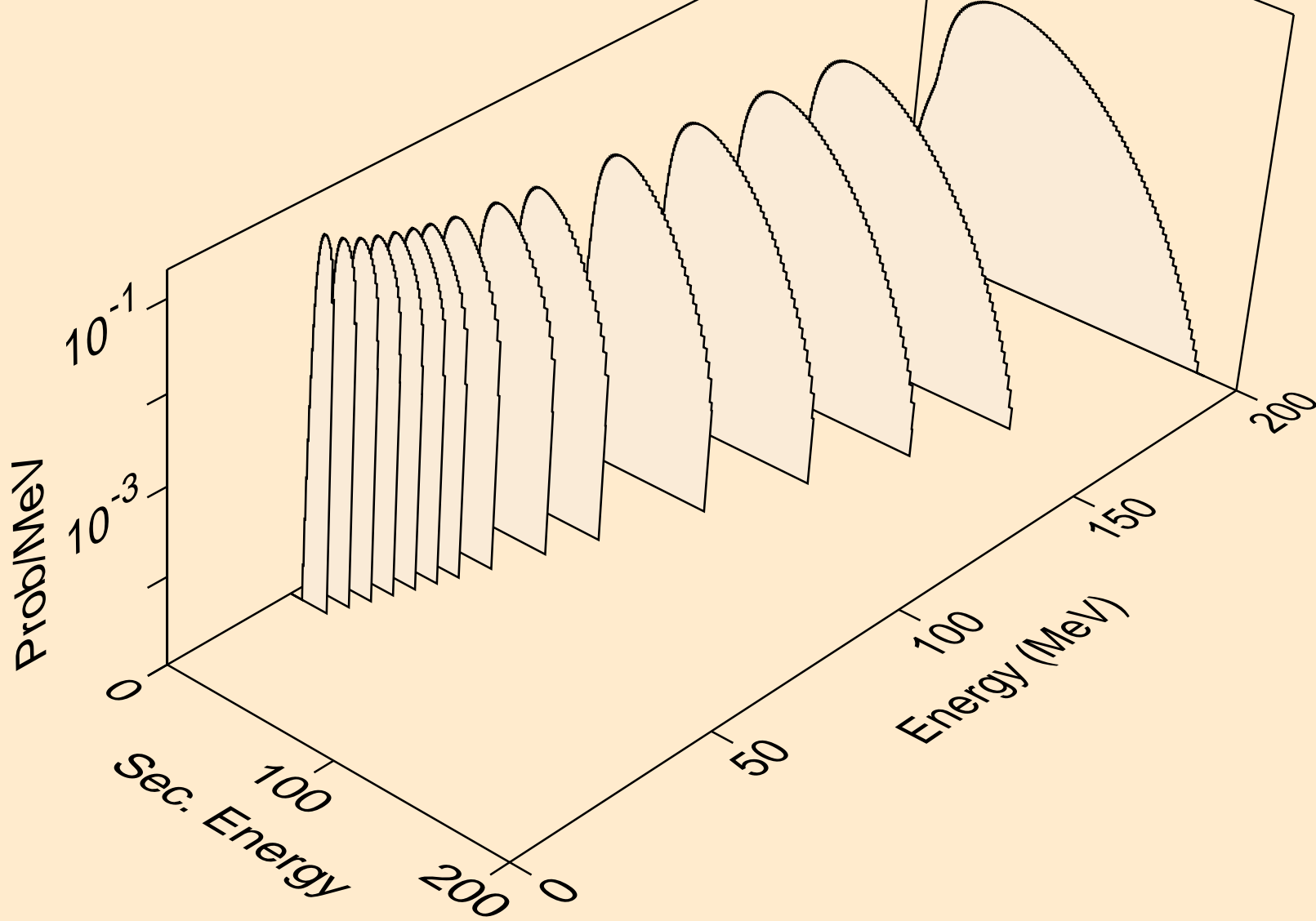

TC096M NEUTRON ACER TENDL-2019 LIBRARY; T=293.16K
he3s from (n,n*)he3

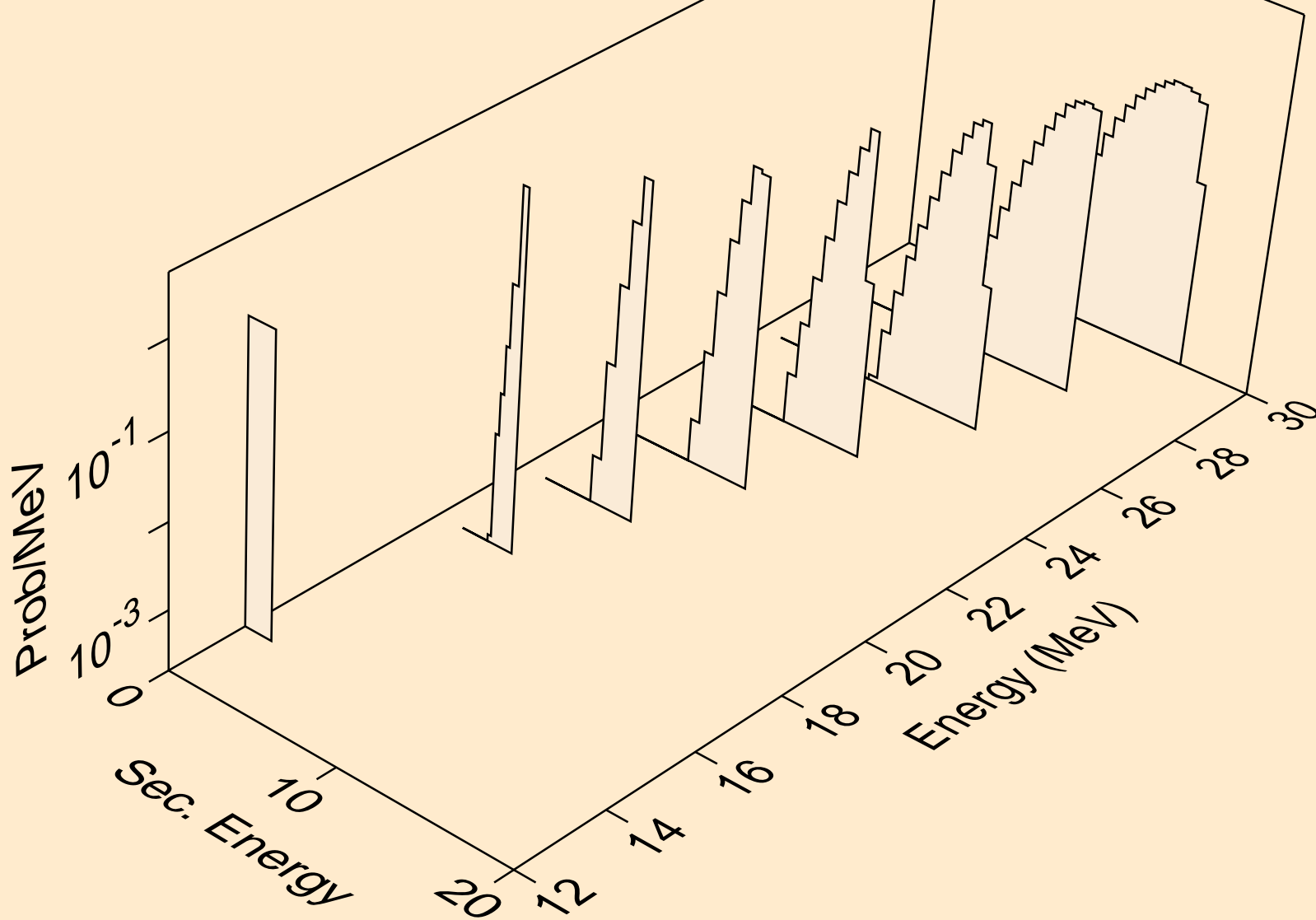

TC096M NEUTRON ACER TENDL-2019 LIBRARY; T=293.16K
he3s from (n,he3)

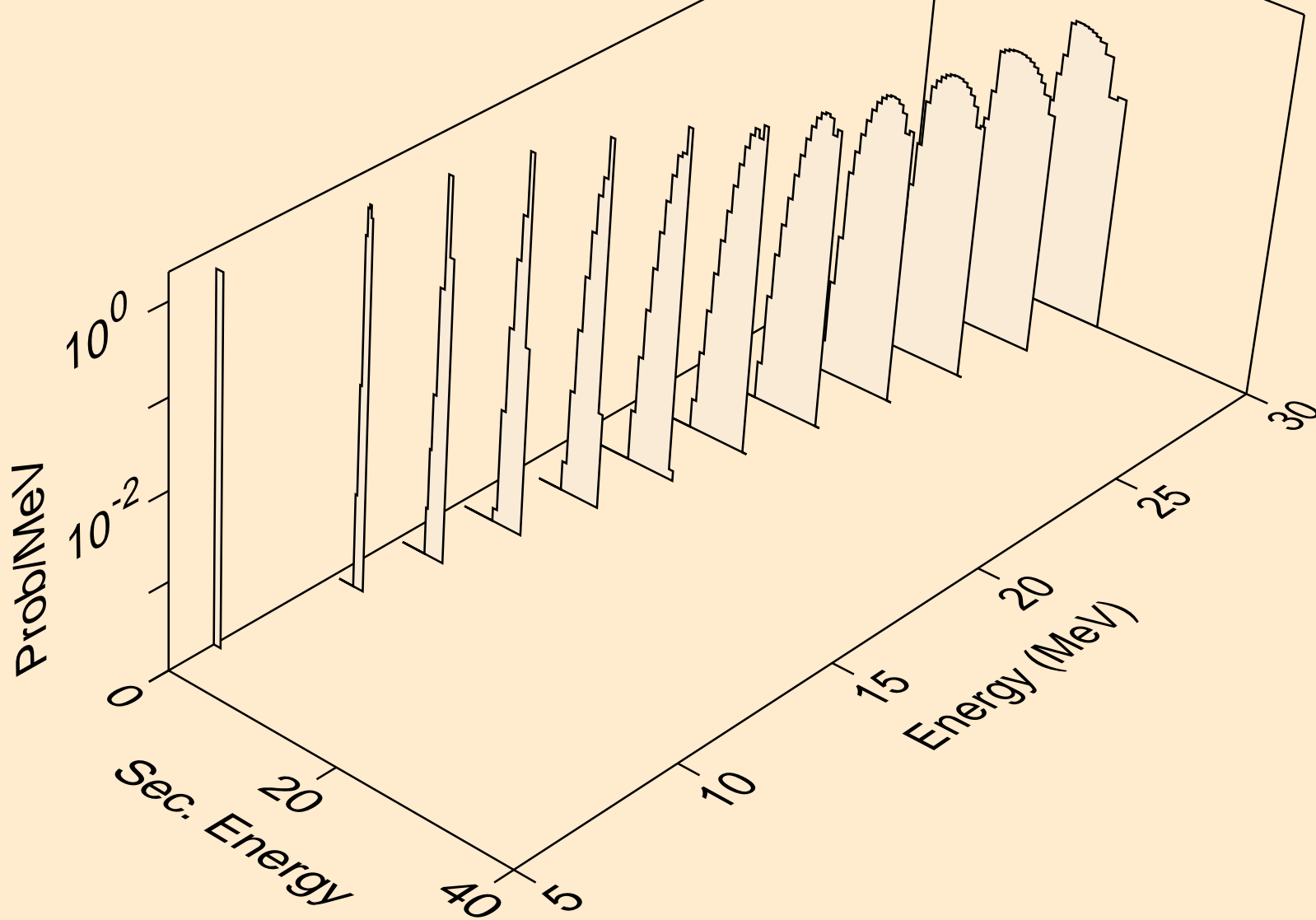

TC096M NEUTRON ACER TENDL-2019 LIBRARY; T=293.16K
alphas from (n,x)

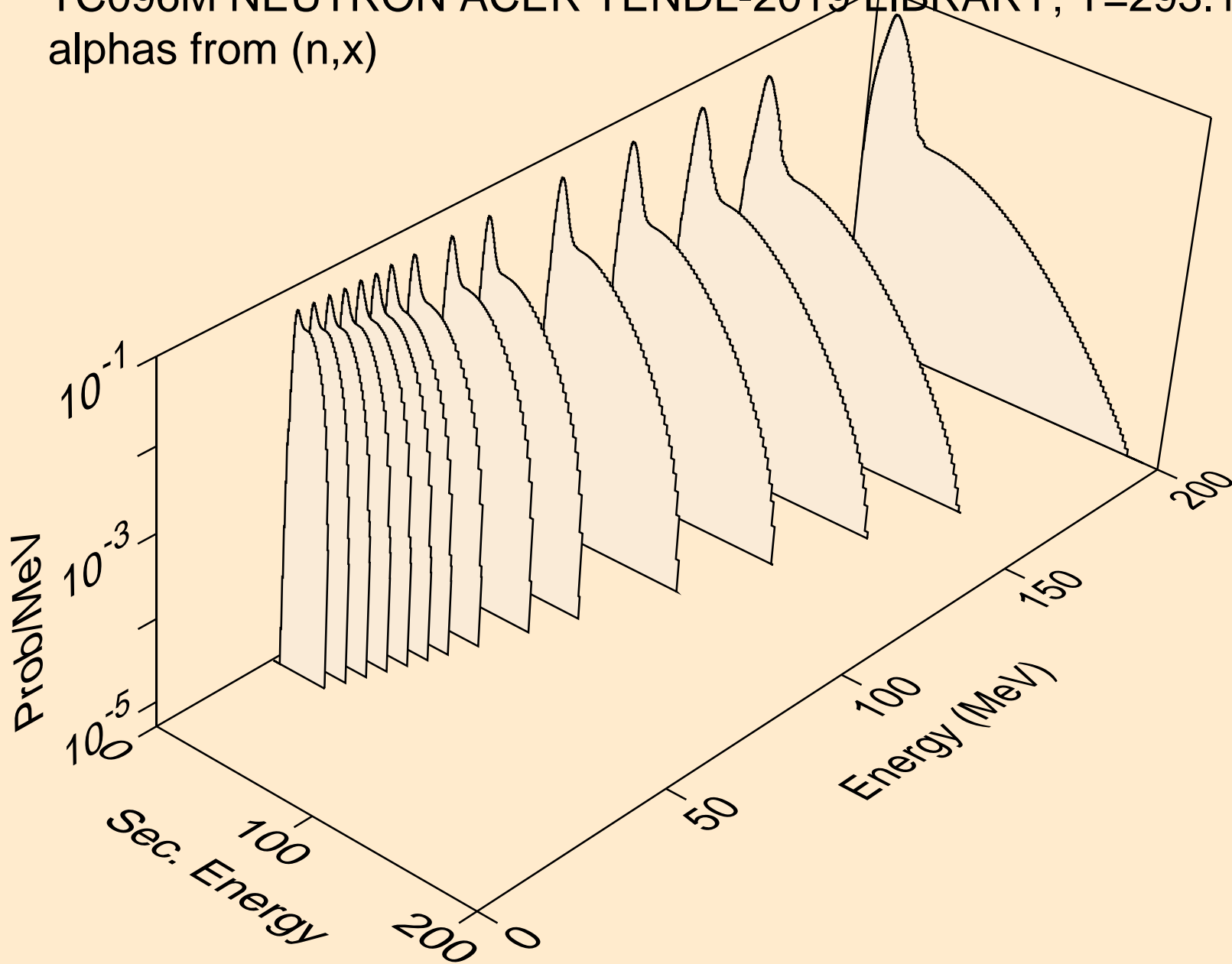

TC096M NEUTRON ACER TENDL-2019 LIBRARY; T=293.16K
alphas from (n,n*)a

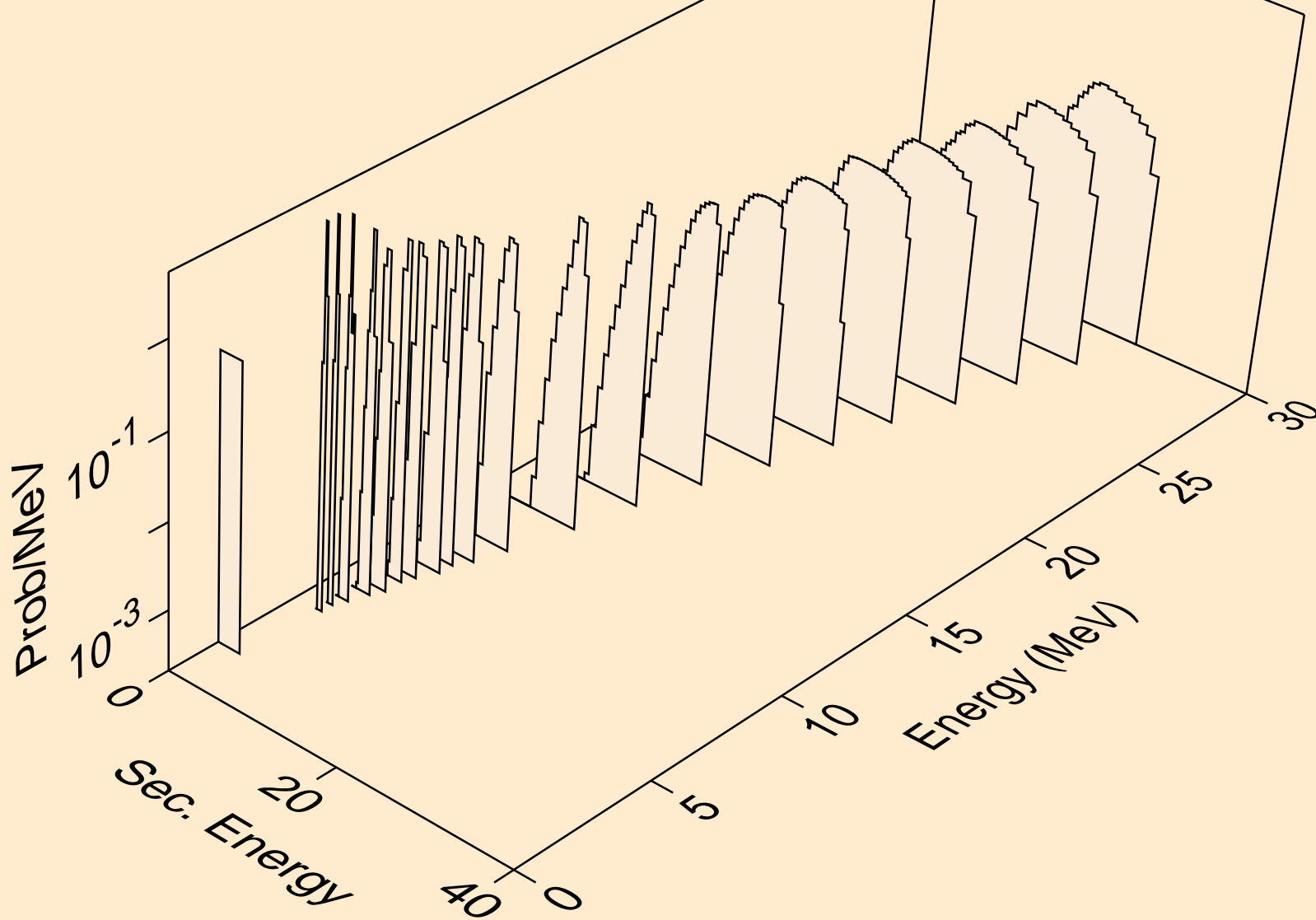

TC096M NEUTRON ACER TENDL-2019 LIBRARY; T=293.16K
alphas from (n,2n)a

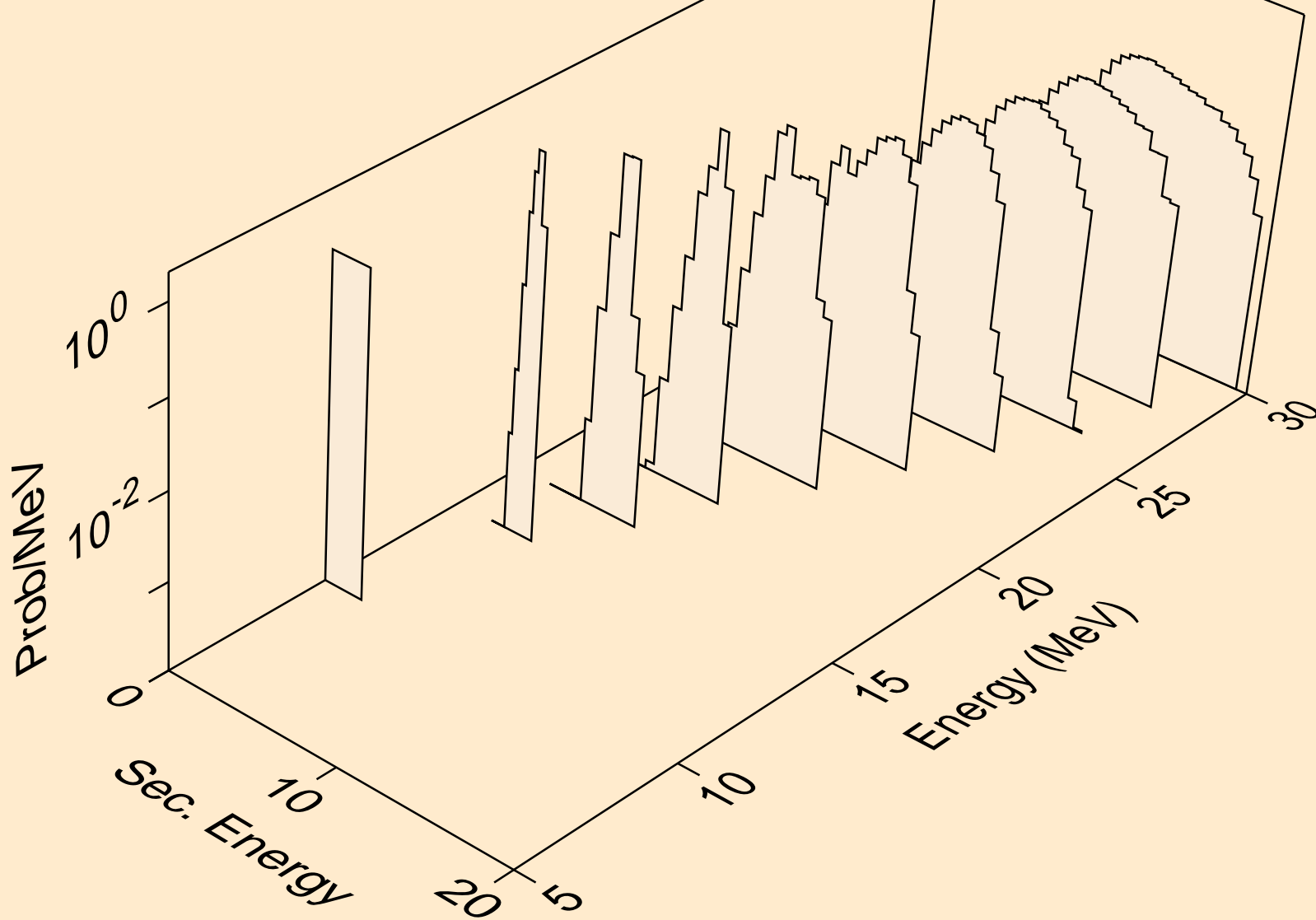

TC096M NEUTRON ACER TENDL-2019 LIBRARY; T=293.16K
alphas from (n,3n)a

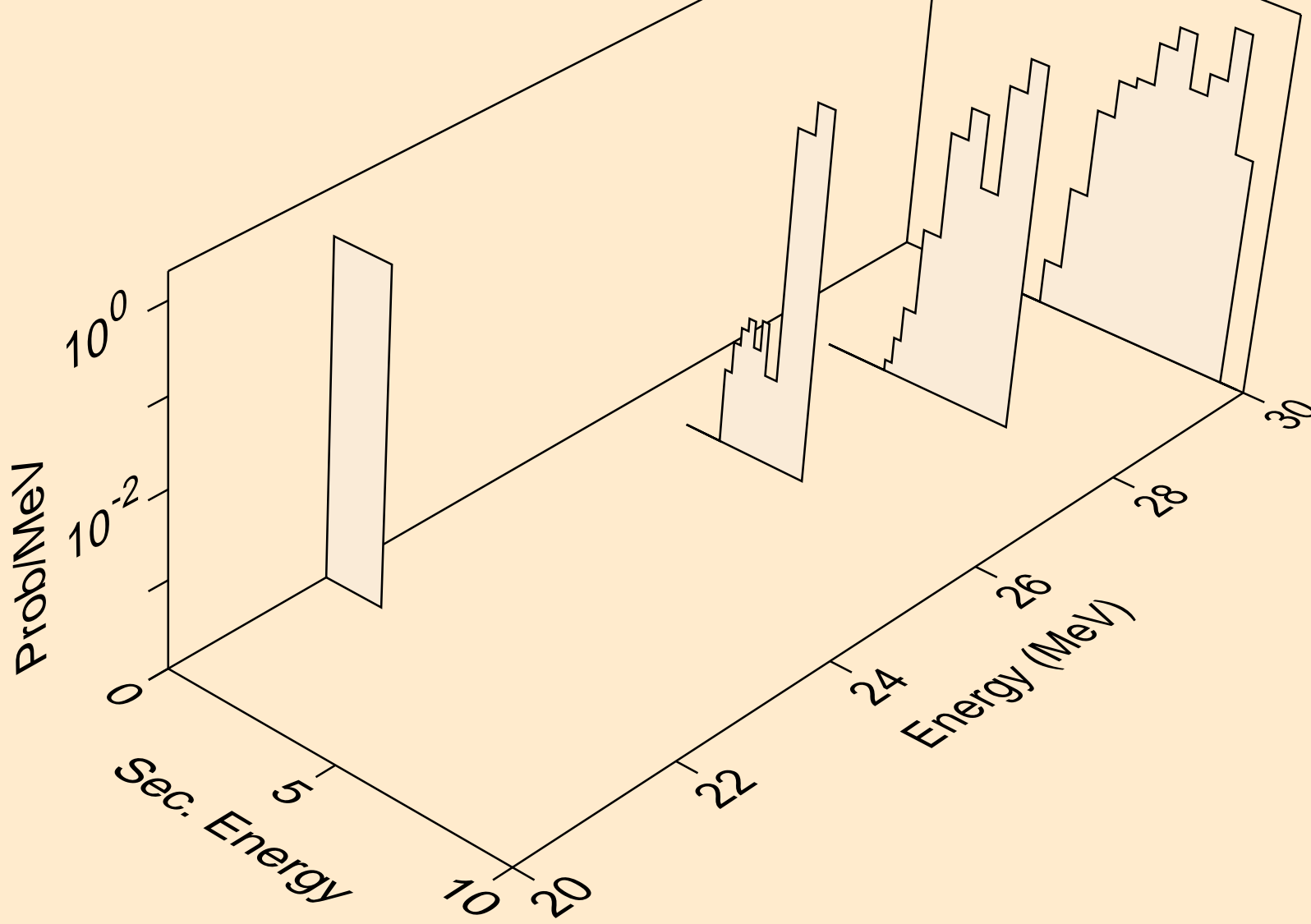

TC096M NEUTRON ACER TENDL-2019 LIBRARY; T=293.16K
alphas from (n,n*)2a

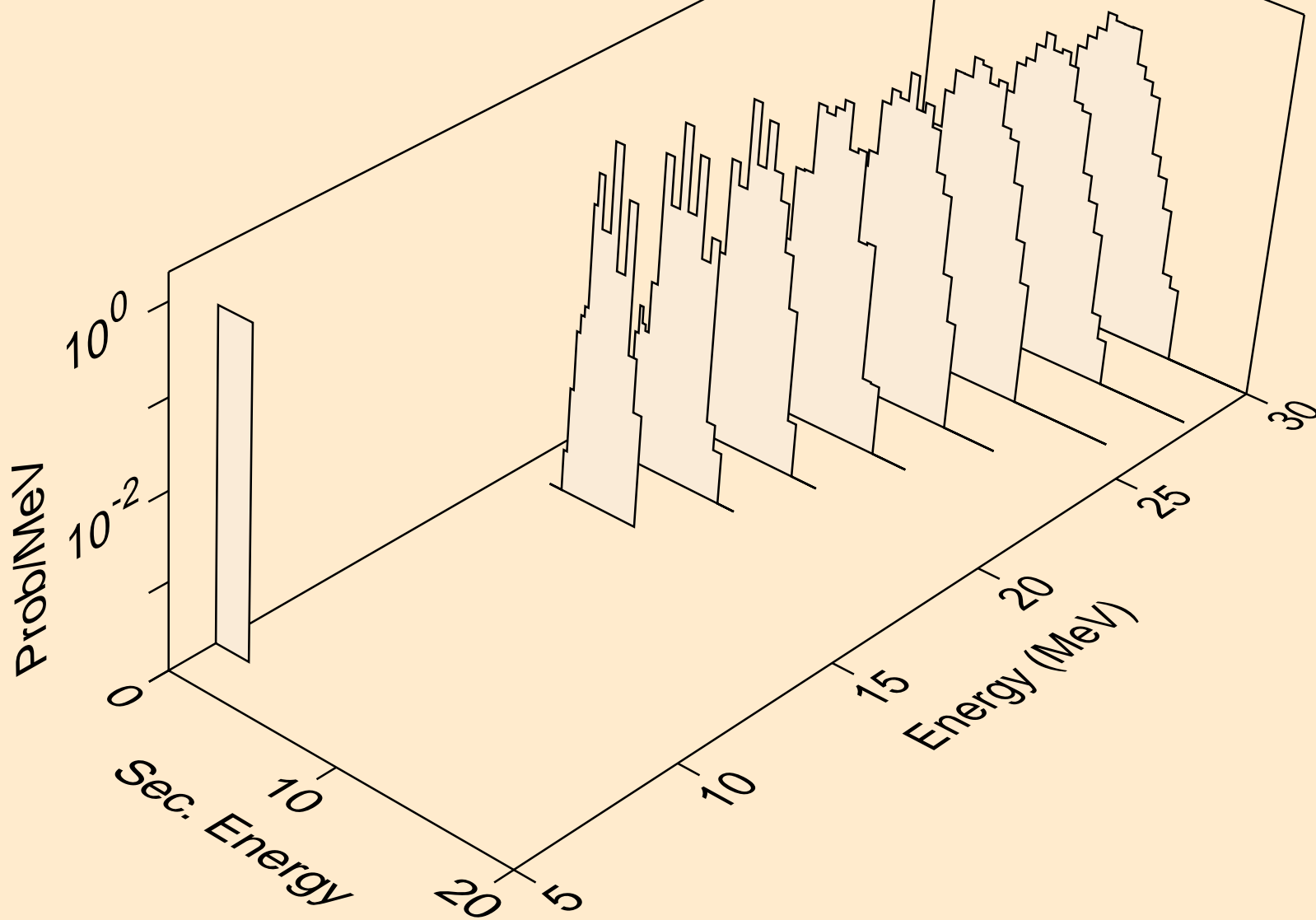

TC096M NEUTRON ACER TENDL-2019 LIBRARY; T=293.16K
alphas from (n,npa)

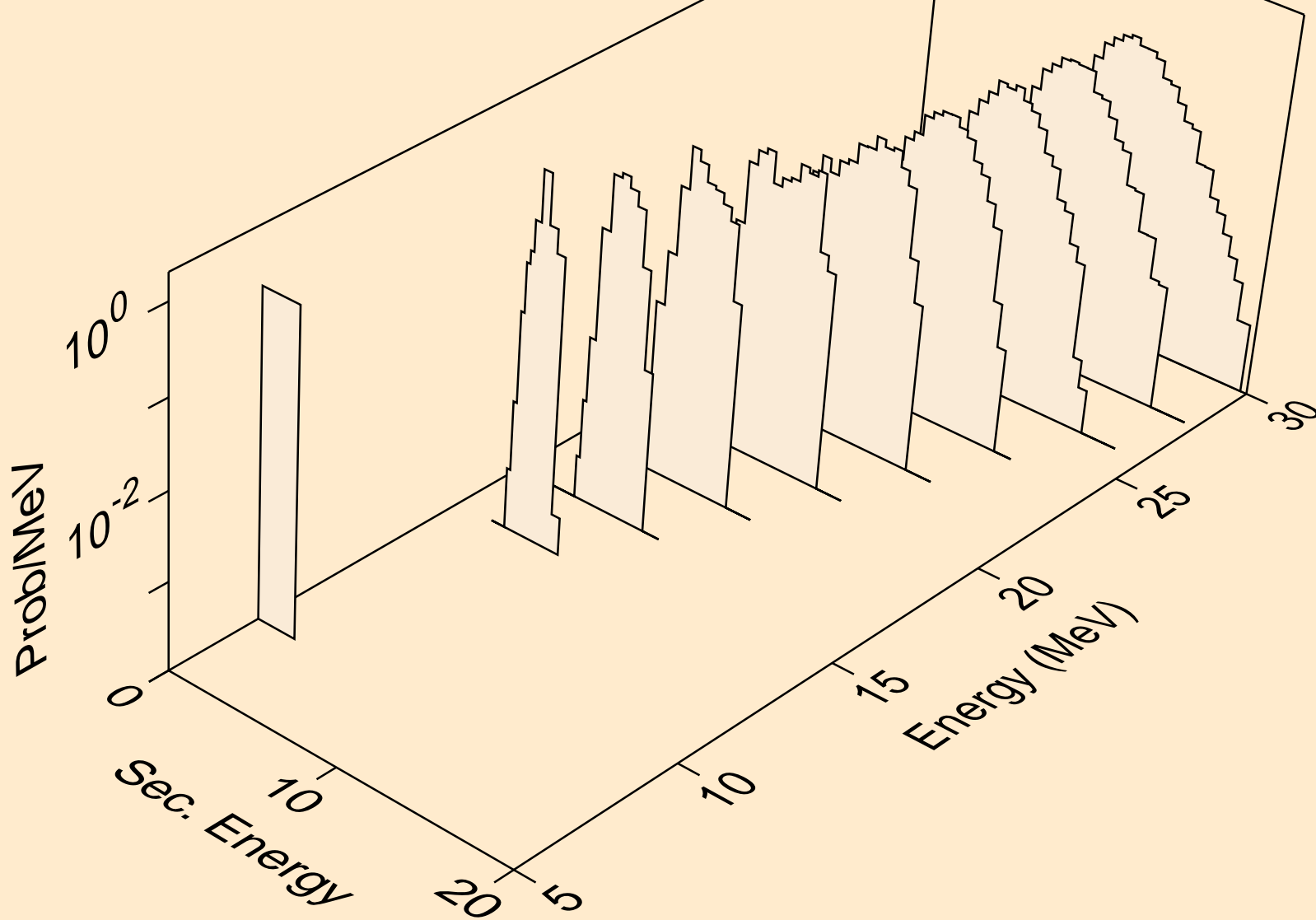

TC096M NEUTRON ACER TENDL-2019 LIBRARY; T=293.16K
alphas from (n,a)

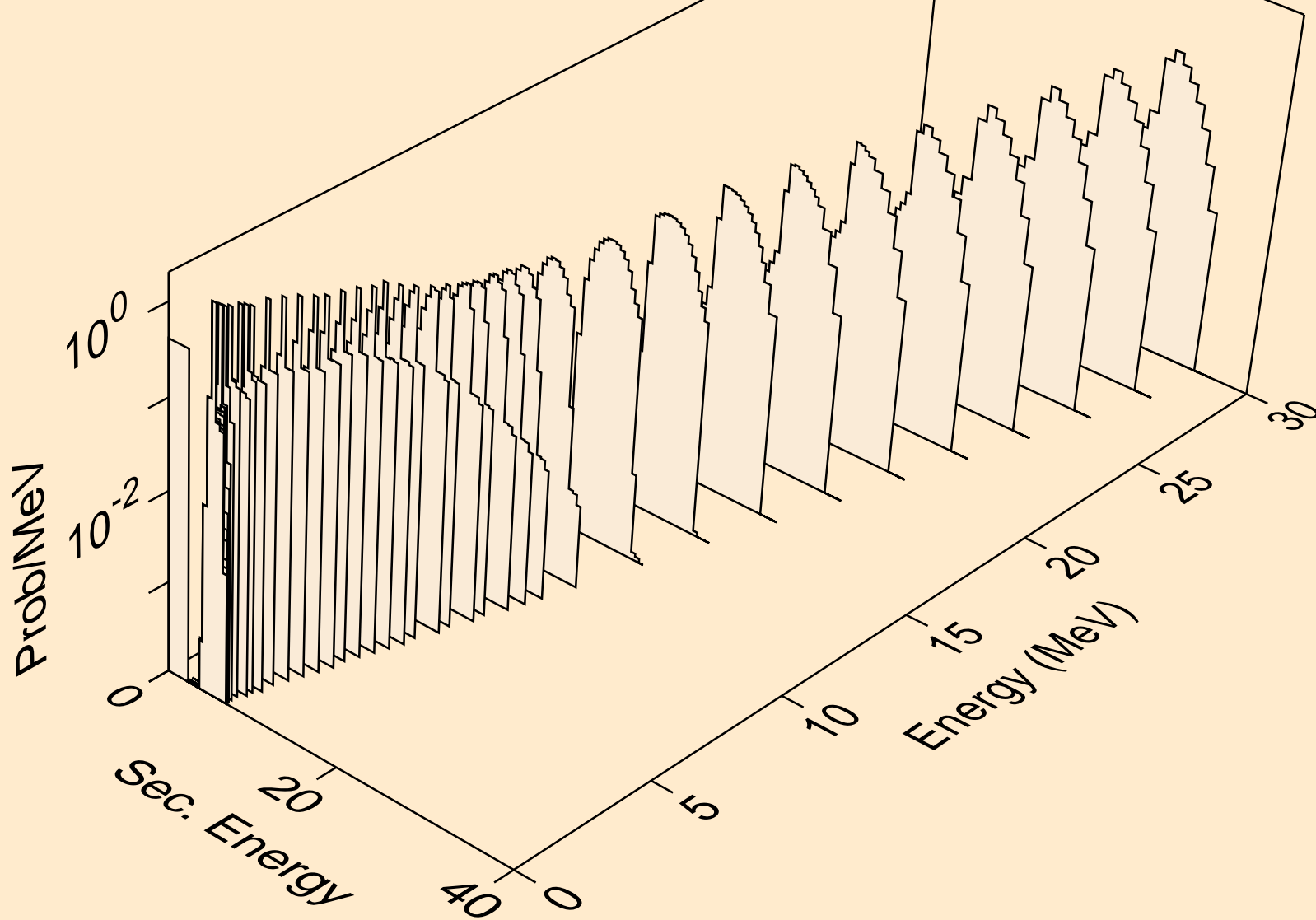

TC096M NEUTRON ACER TENDL-2019 LIBRARY; T=293.16K
alphas from (n,2a)

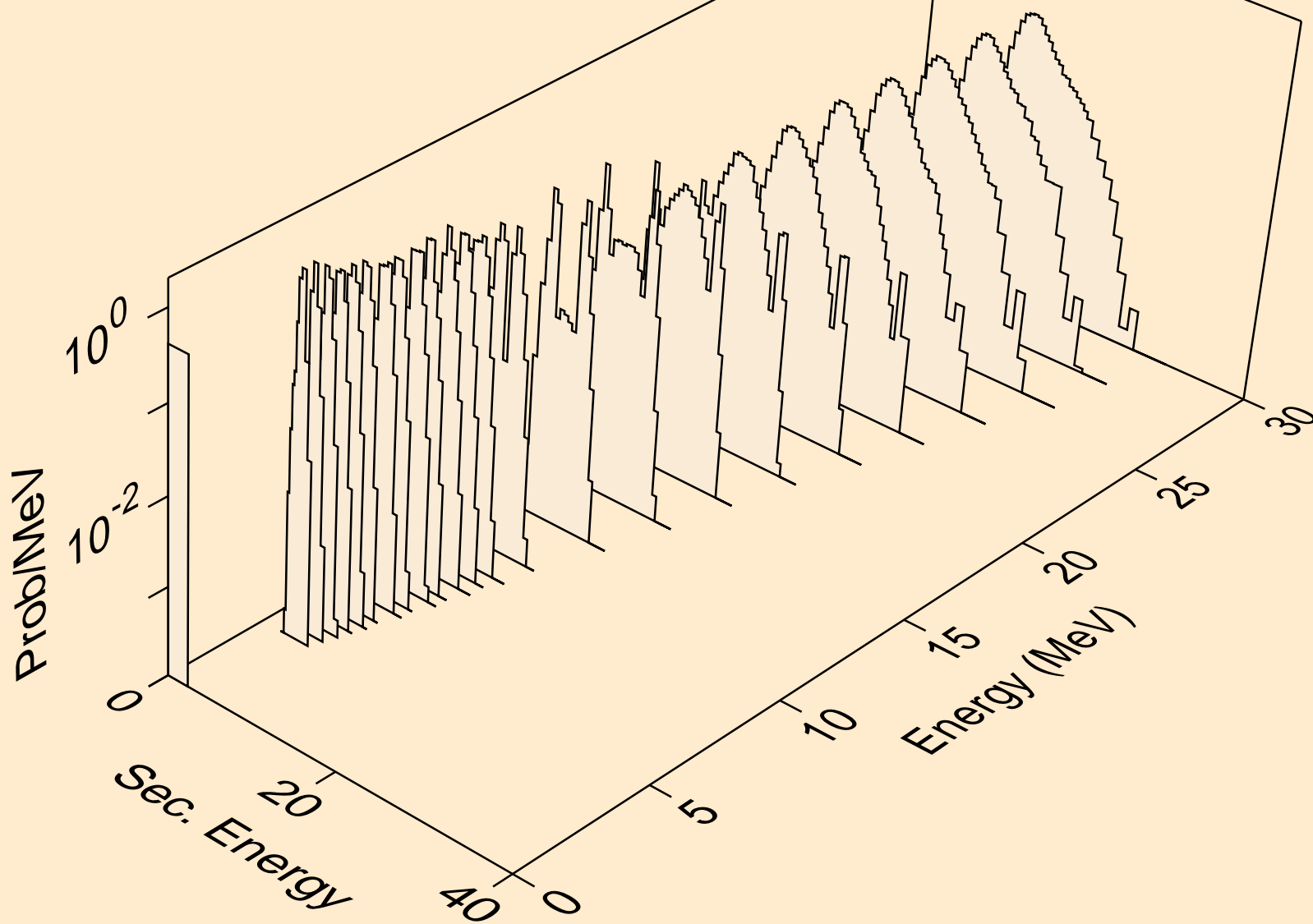

TC096M NEUTRON ACER TENDL-2019 LIBRARY; T=293.16K
alphas from (n,pa)

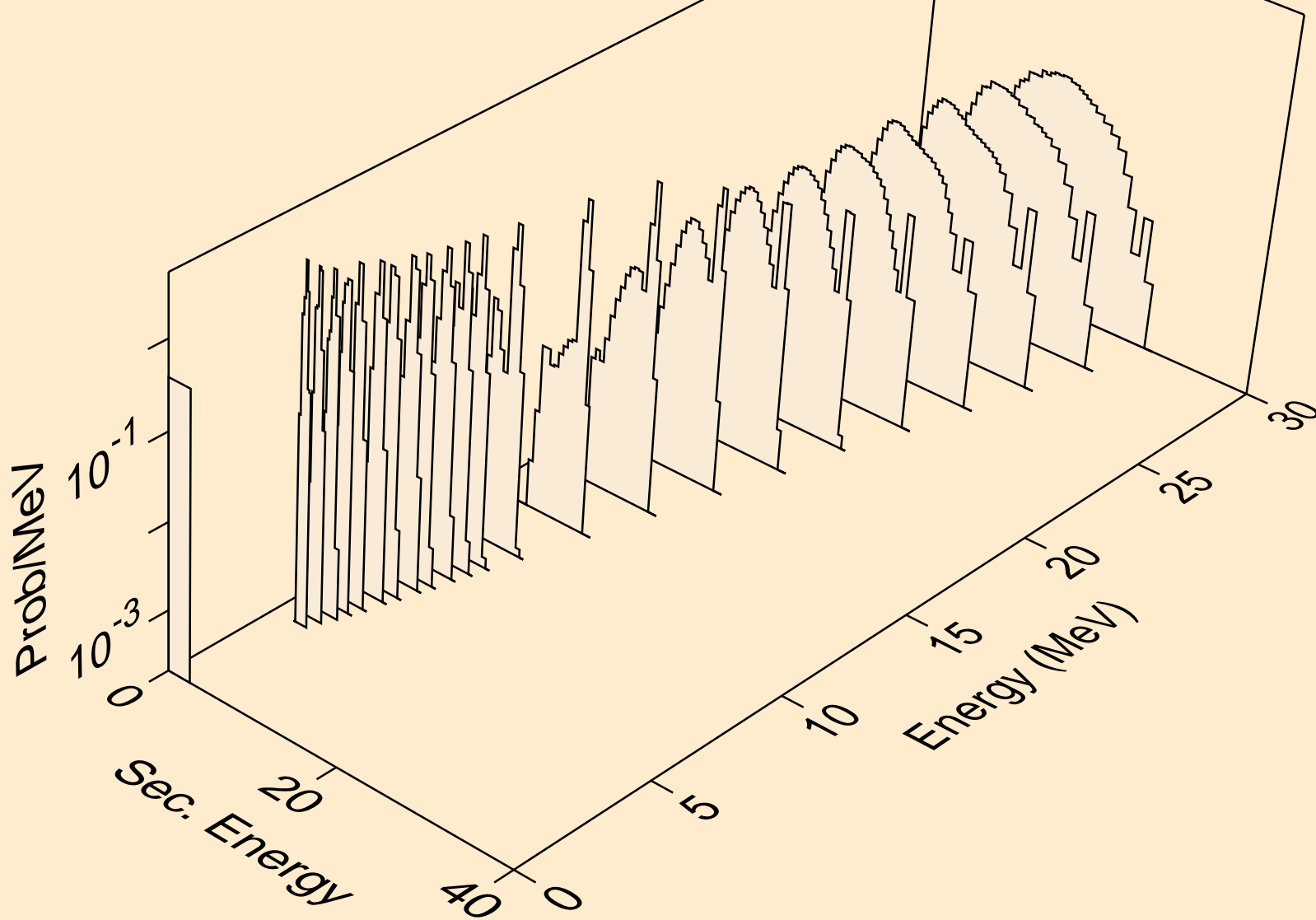

TC096M NEUTRON ACER TENDL-2019 LIBRARY; T=293.16K
alphas from (n,da)

