

TE112 NEUTRON ACER TENDL-2019 LIBRARY; T=293.16K
Principal cross sections

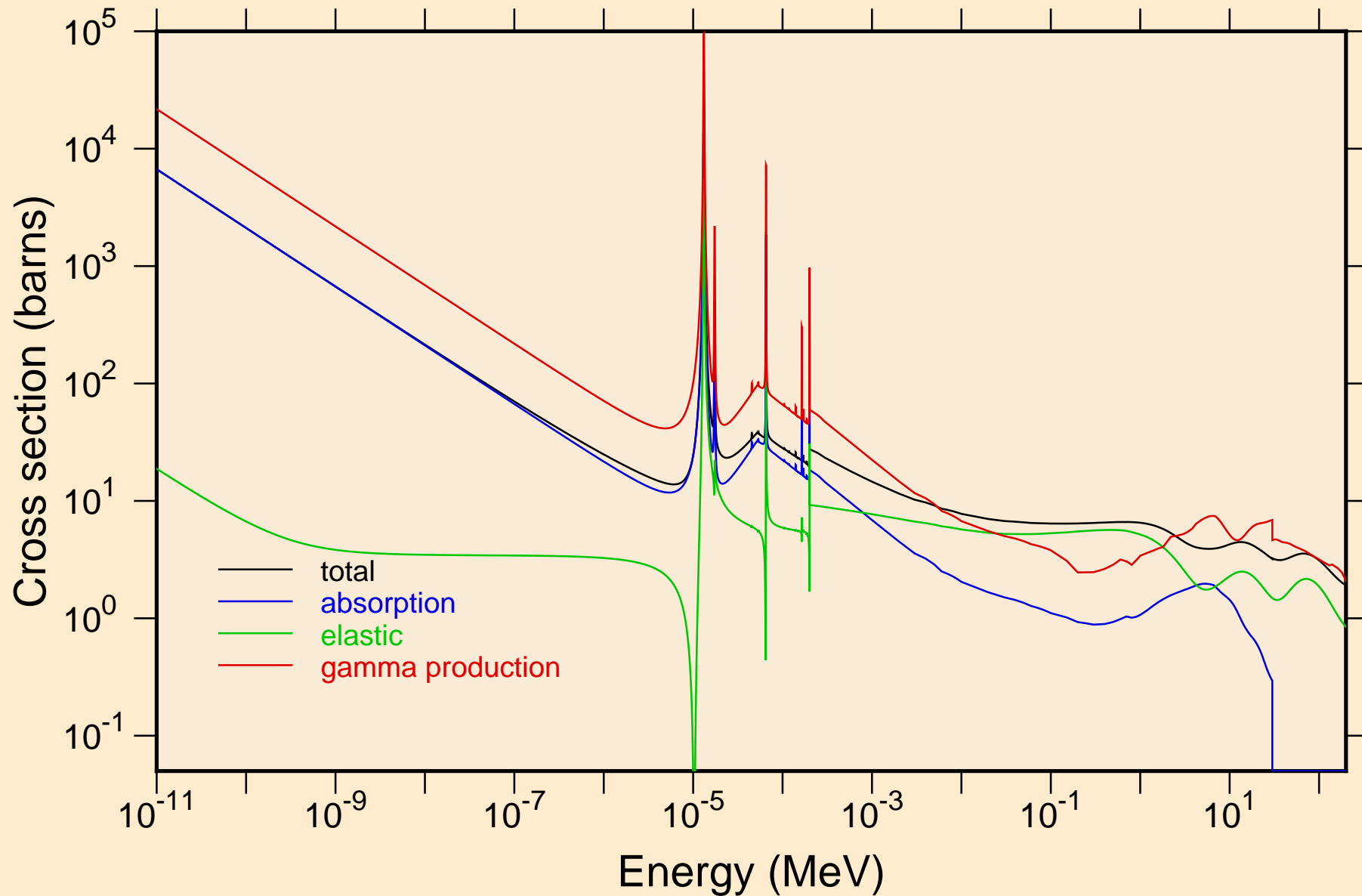

TE112 NEUTRON ACER TENDL-2019 LIBRARY; T=293.16K
resonance total cross section

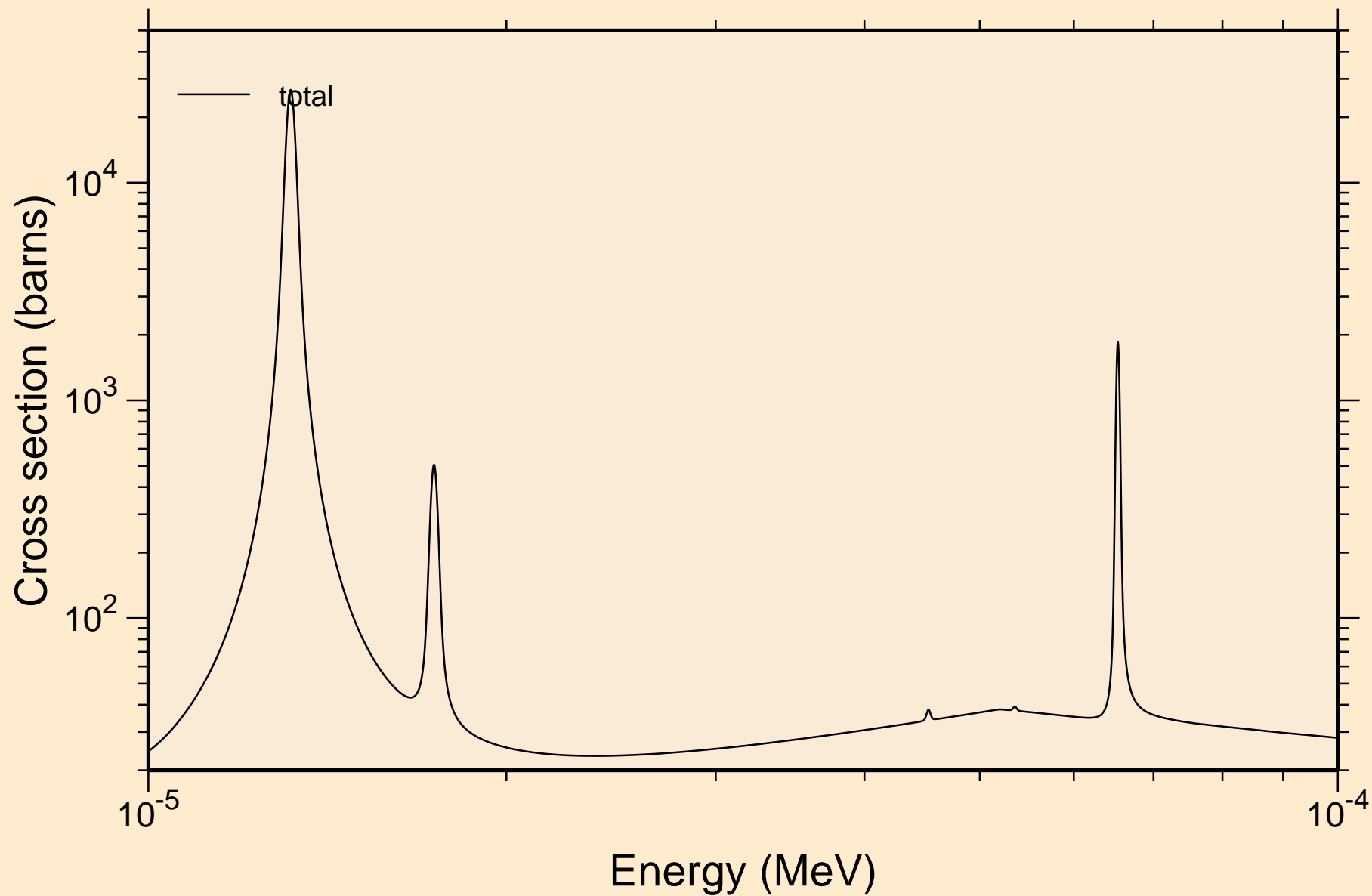

TE112 NEUTRON ACER TENDL-2019 LIBRARY; T=293.16K
resonance total cross section

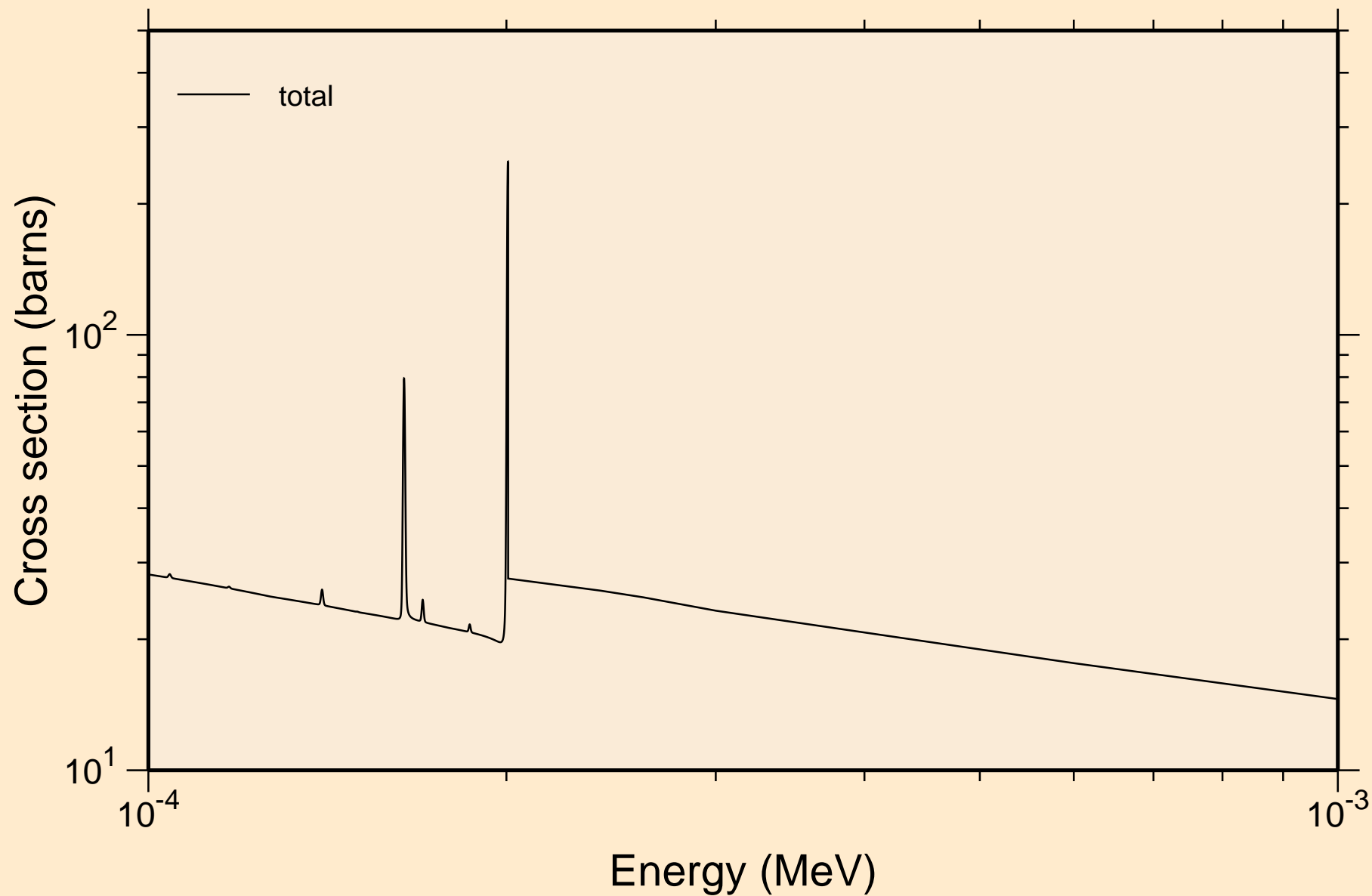

TE112 NEUTRON ACER TENDL-2019 LIBRARY; T=293.16K
resonance total cross section

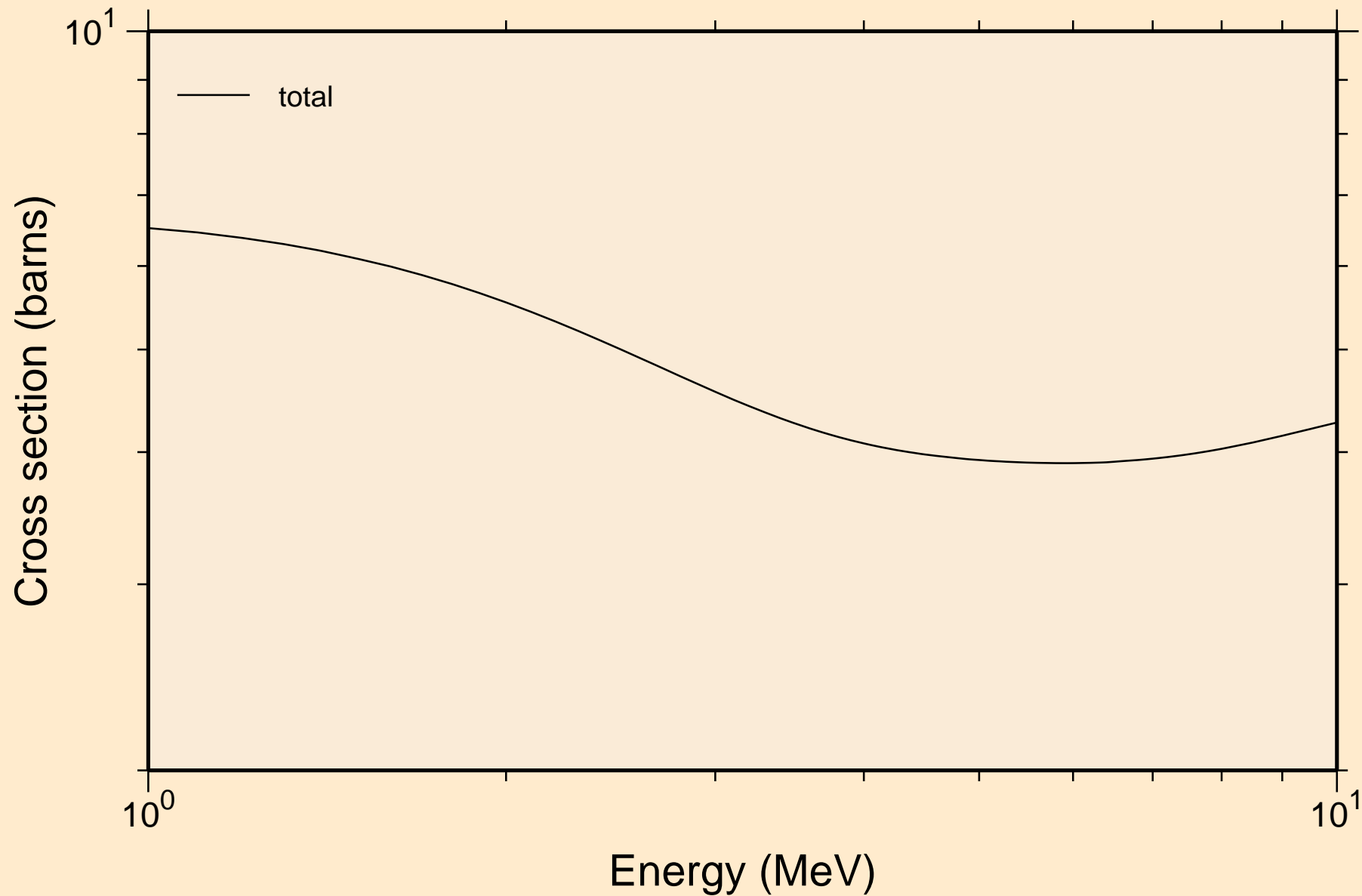

TE112 NEUTRON ACER TENDL-2019 LIBRARY; T=293.16K
resonance absorption cross sections

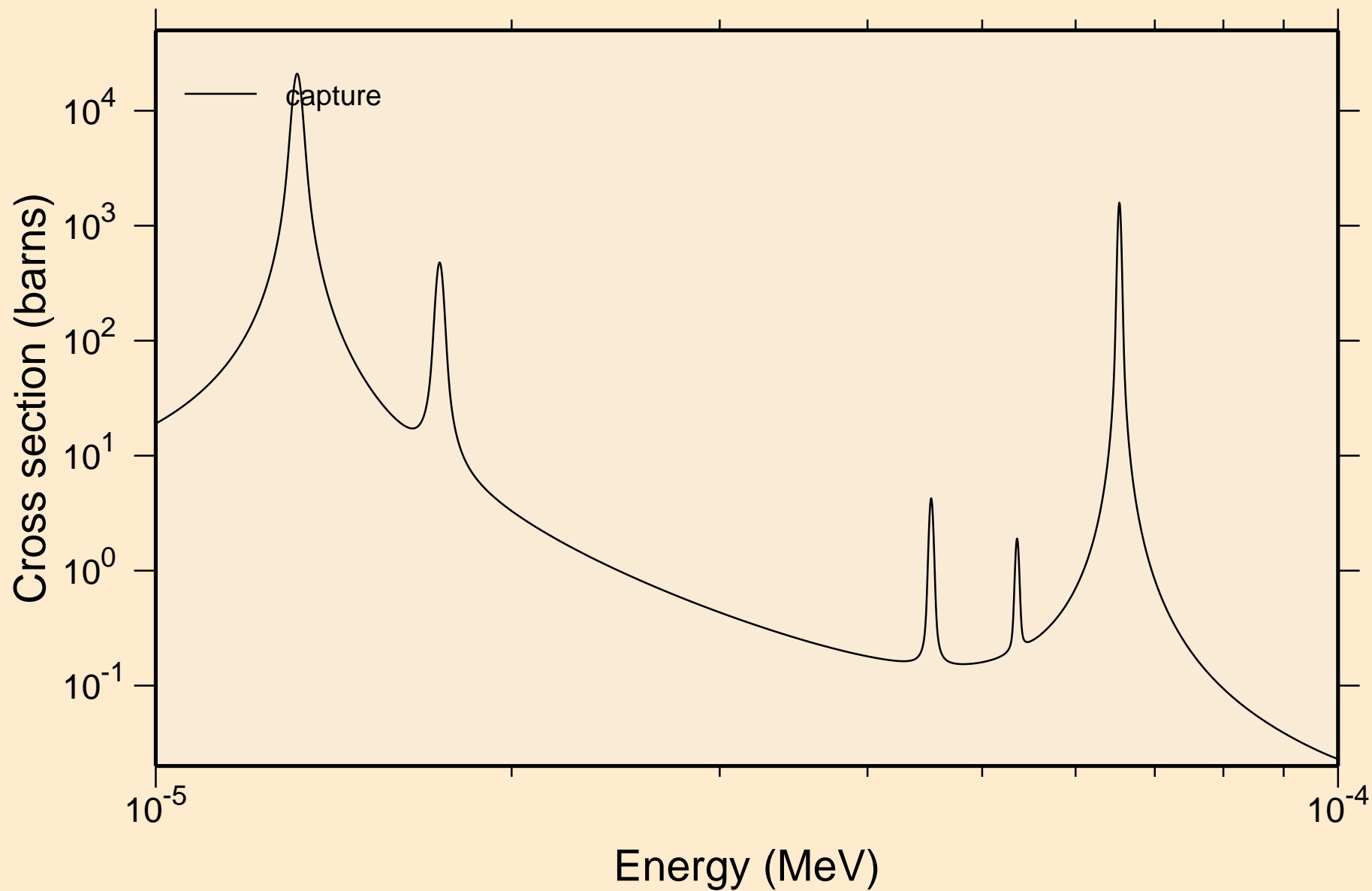

TE112 NEUTRON ACER TENDL-2019 LIBRARY; T=293.16K
resonance absorption cross sections

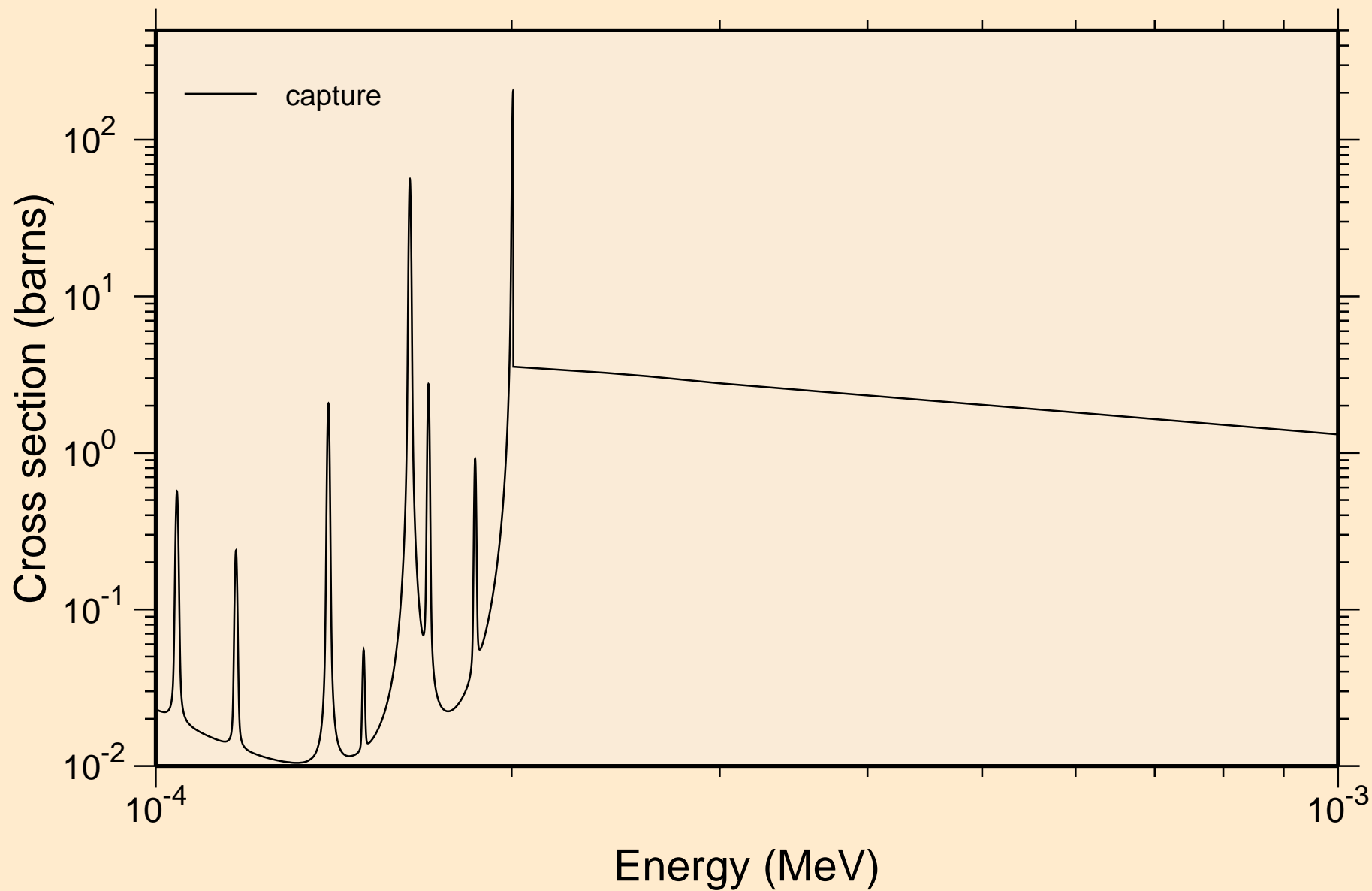

TE112 NEUTRON ACER TENDL-2019 LIBRARY; T=293.16K
resonance absorption cross sections

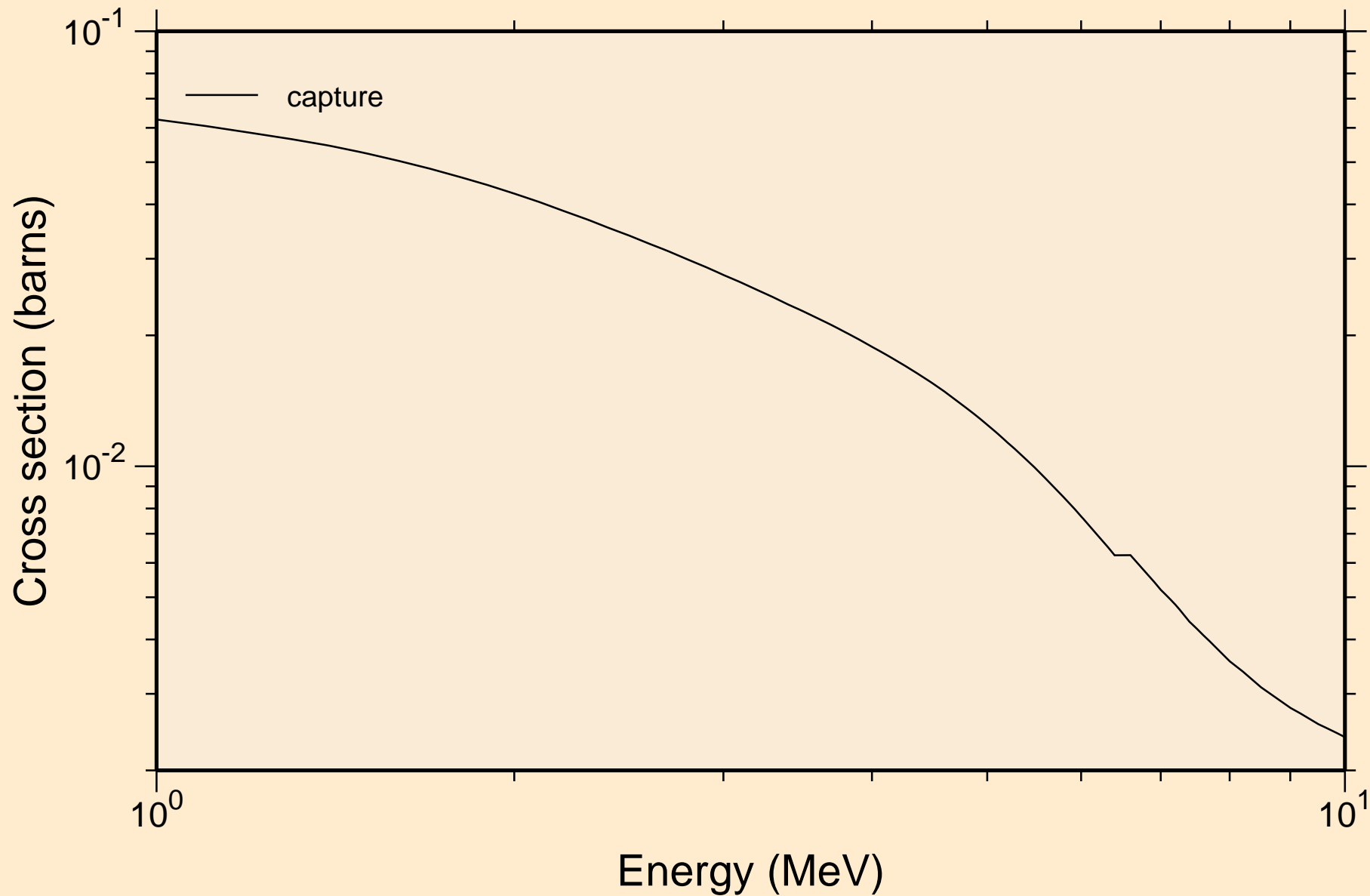

TE112 NEUTRON ACER TENDL-2019 LIBRARY; T=293.16K
Heating

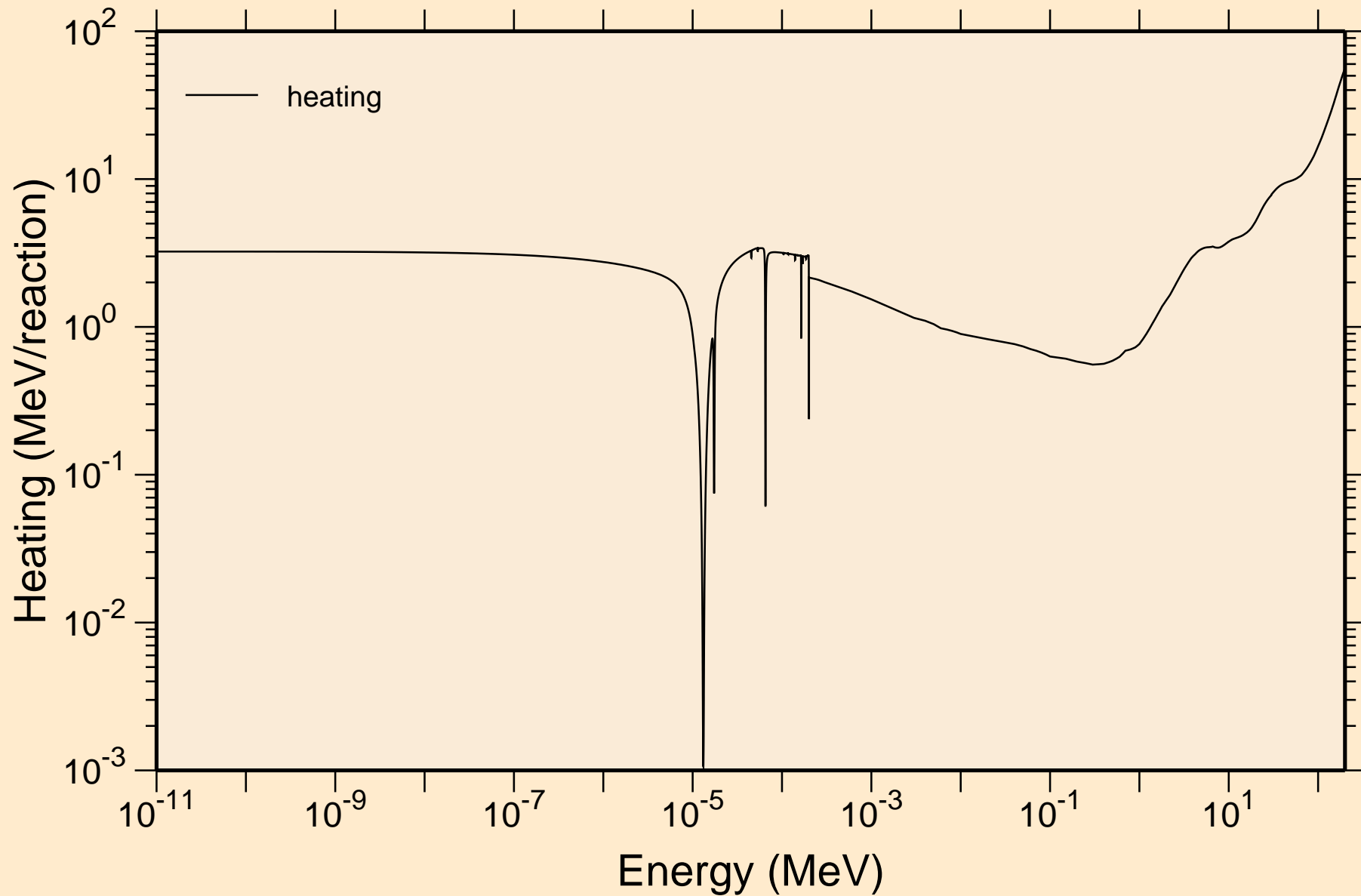

TE112 NEUTRON ACER TENDL-2019 LIBRARY; T=293.16K
Damage

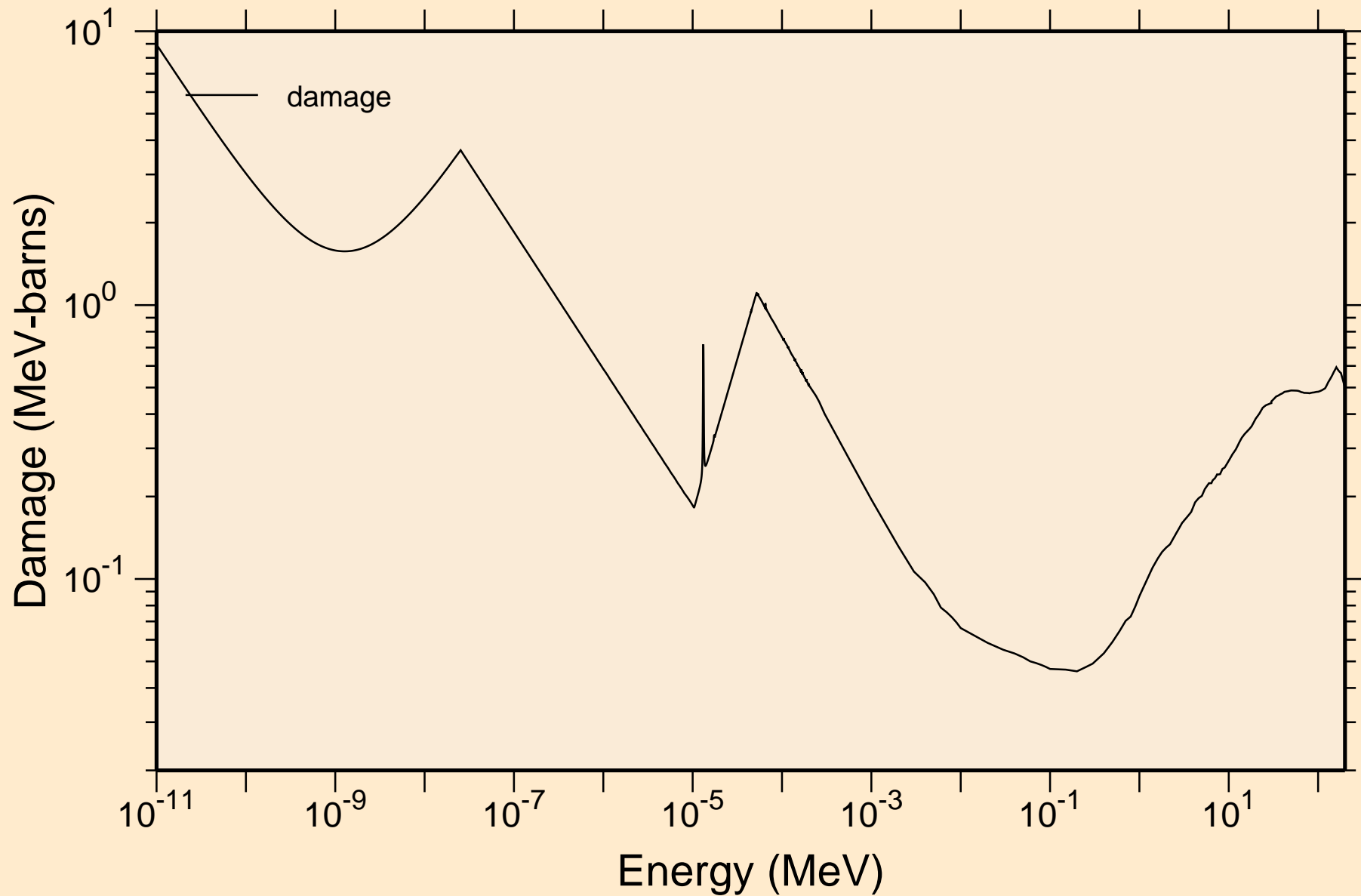

TE112 NEUTRON ACER TENDL-2019 LIBRARY; T=293.16K
Non-threshold reactions

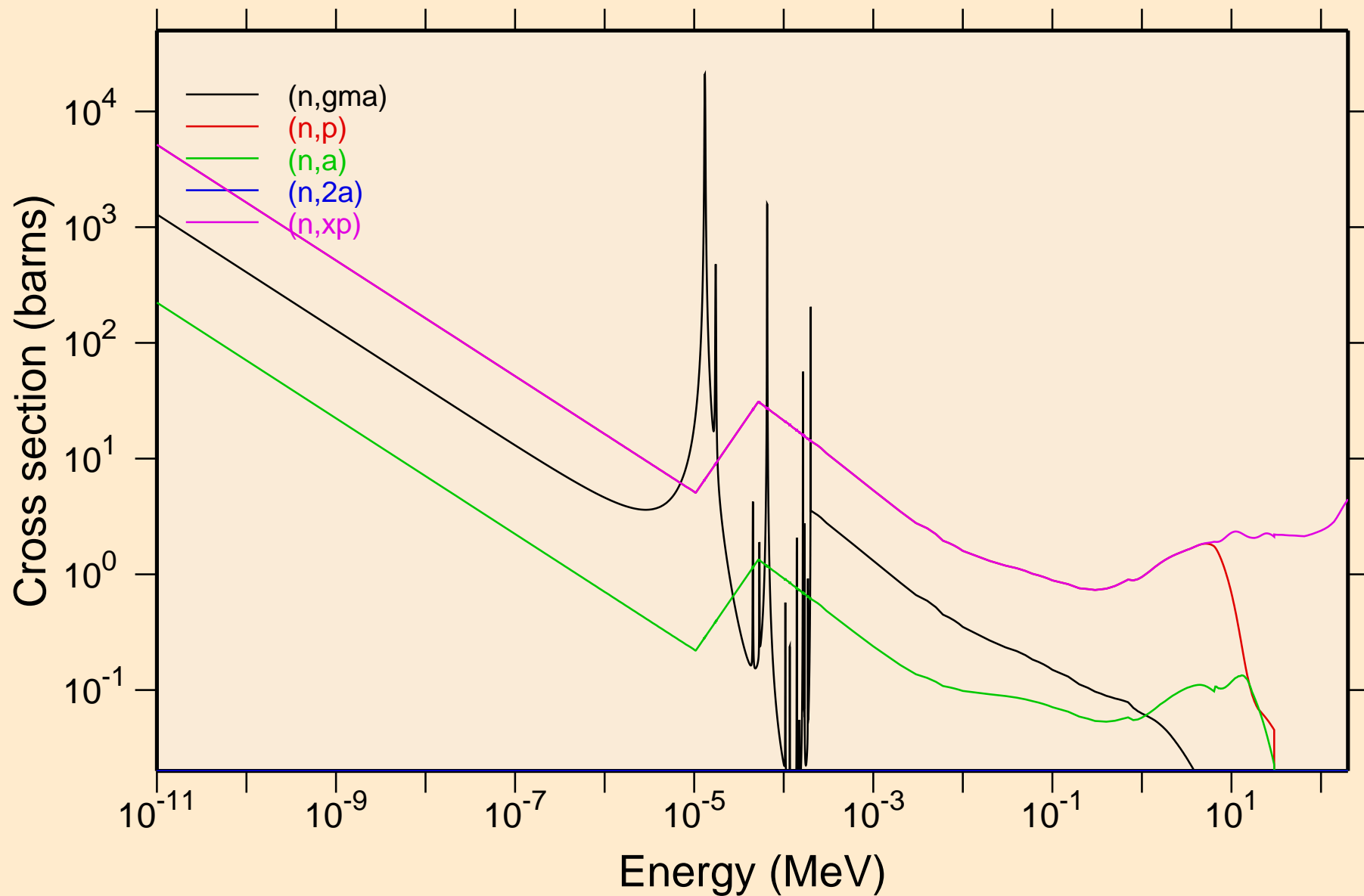

TE112 NEUTRON ACER TENDL-2019 LIBRARY; T=293.16K
Non-threshold reactions

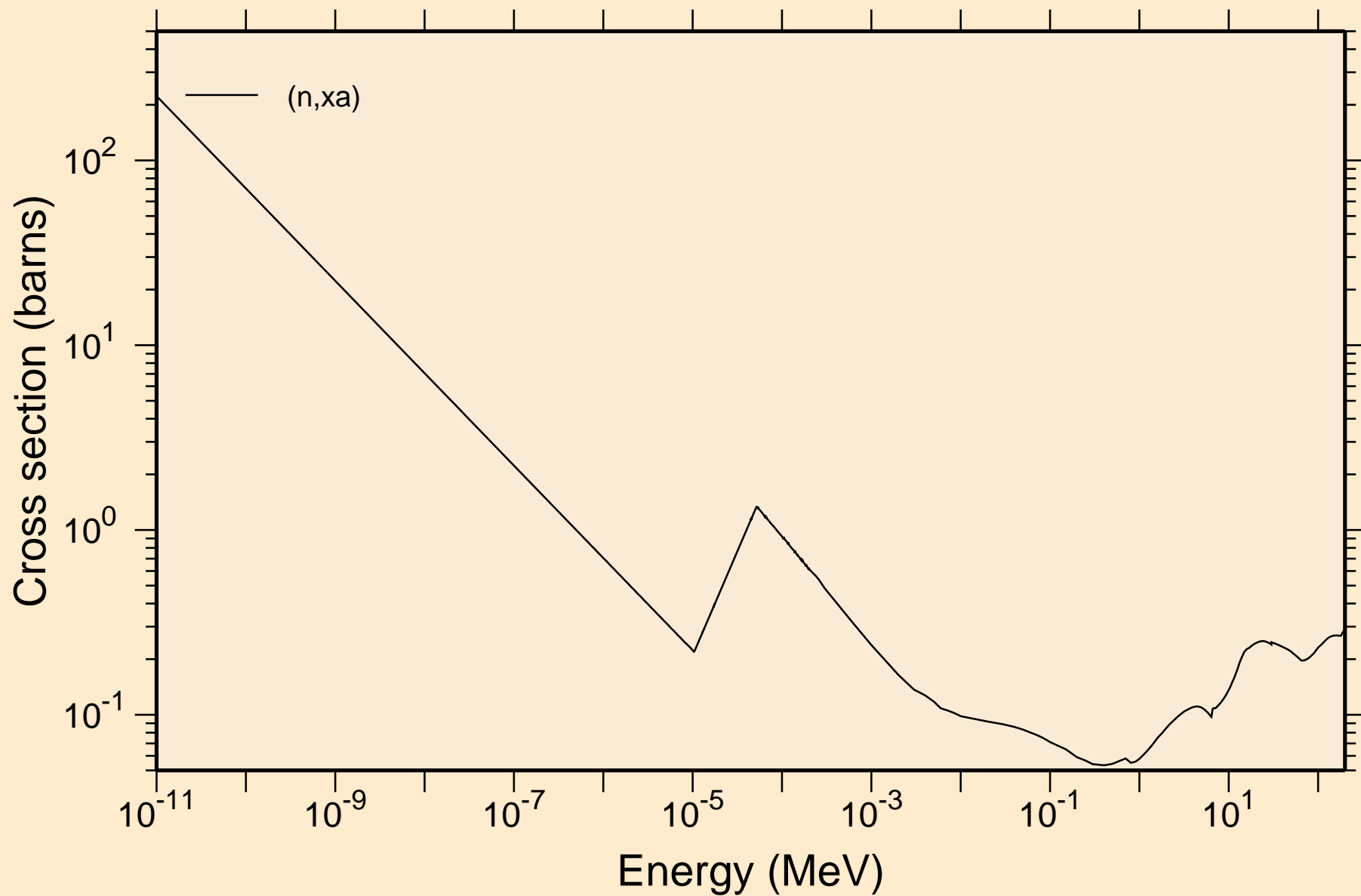

TE112 NEUTRON ACER TENDL-2019 LIBRARY; T=293.16K
Principal cross sections

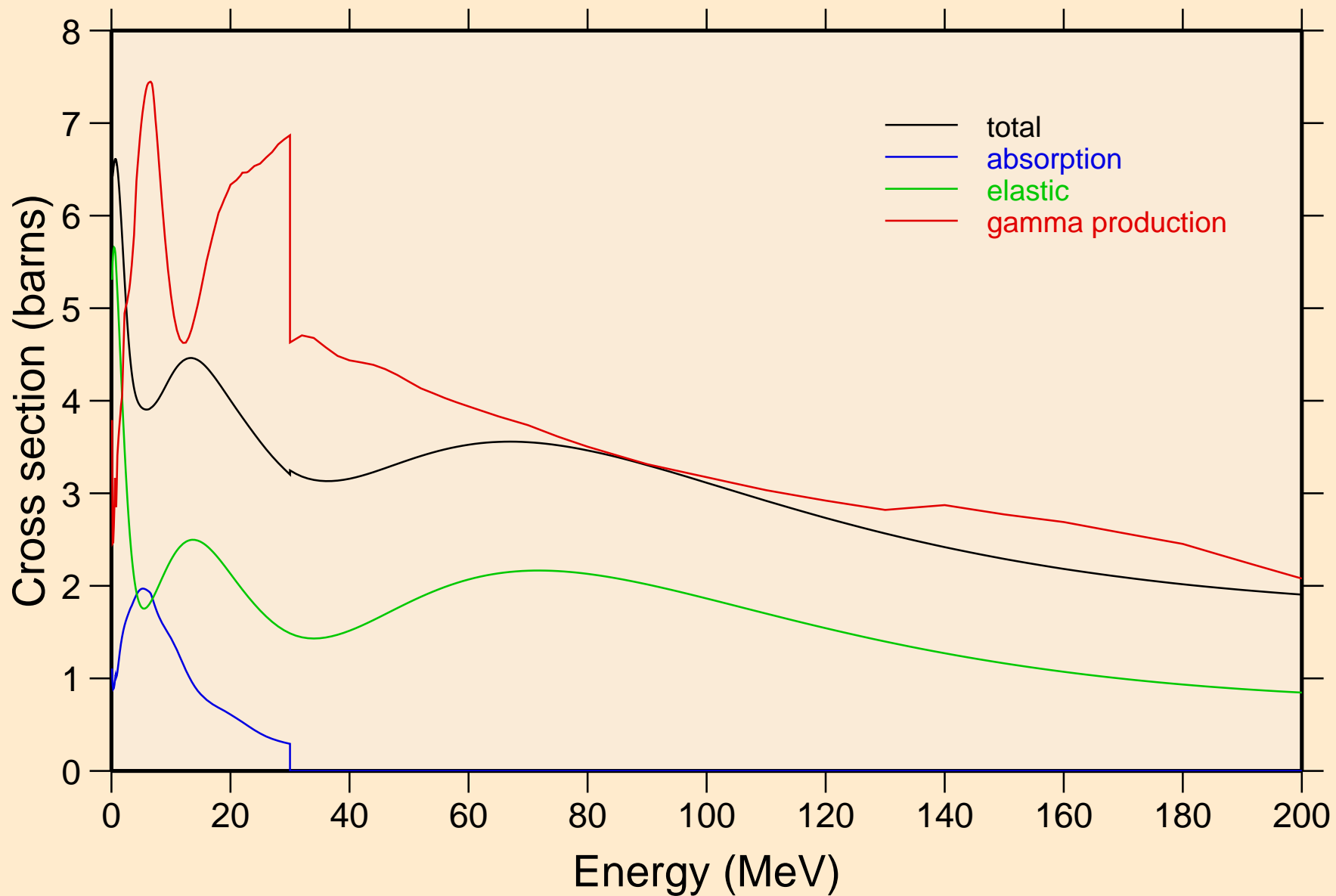

TE112 NEUTRON ACER TENDL-2019 LIBRARY; T=293.16K
Heating

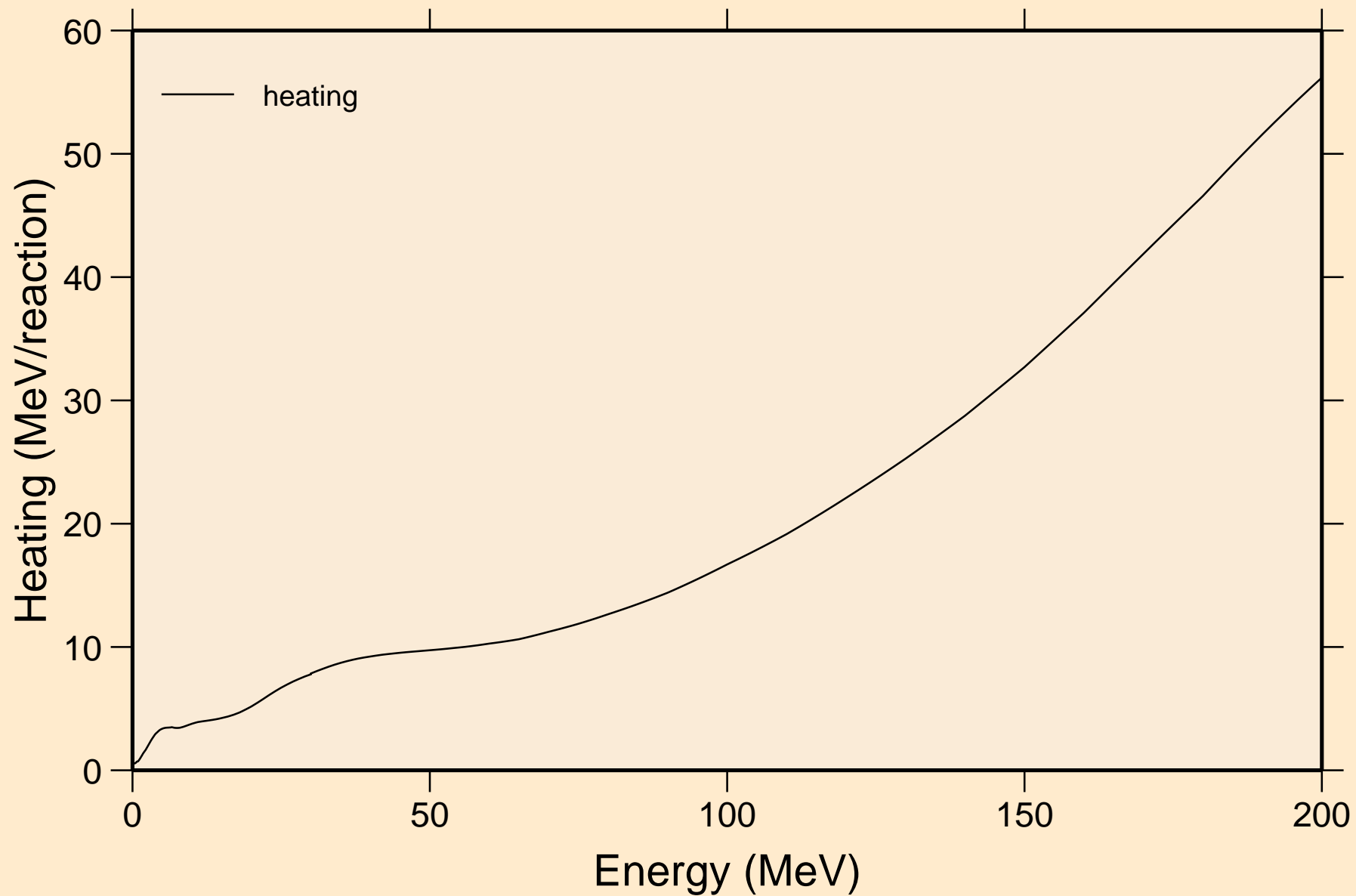

TE112 NEUTRON ACER TENDL-2019 LIBRARY; T=293.16K
Damage

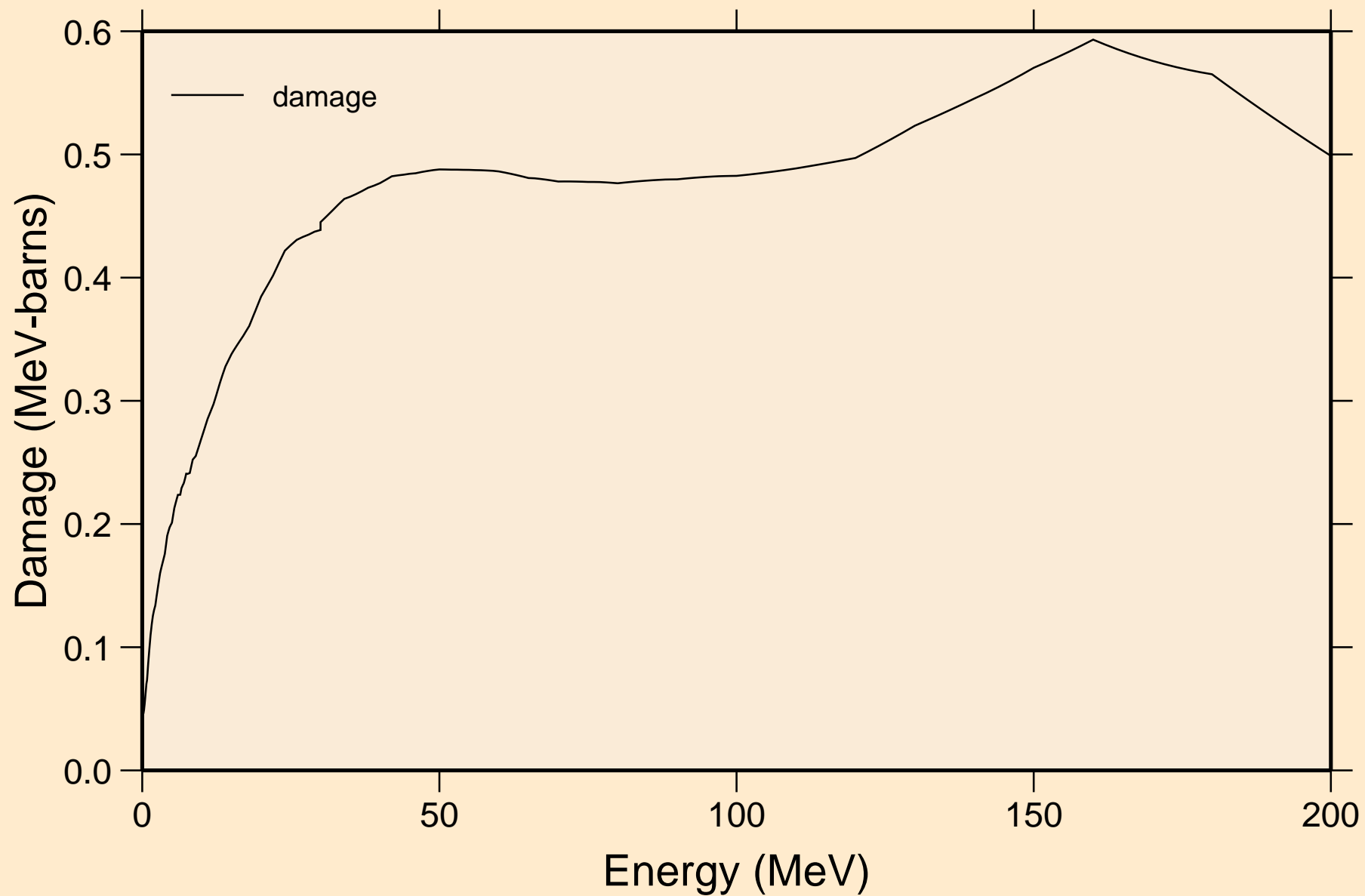

TE112 NEUTRON ACER TENDL-2019 LIBRARY; T=293.16K
Non-threshold reactions

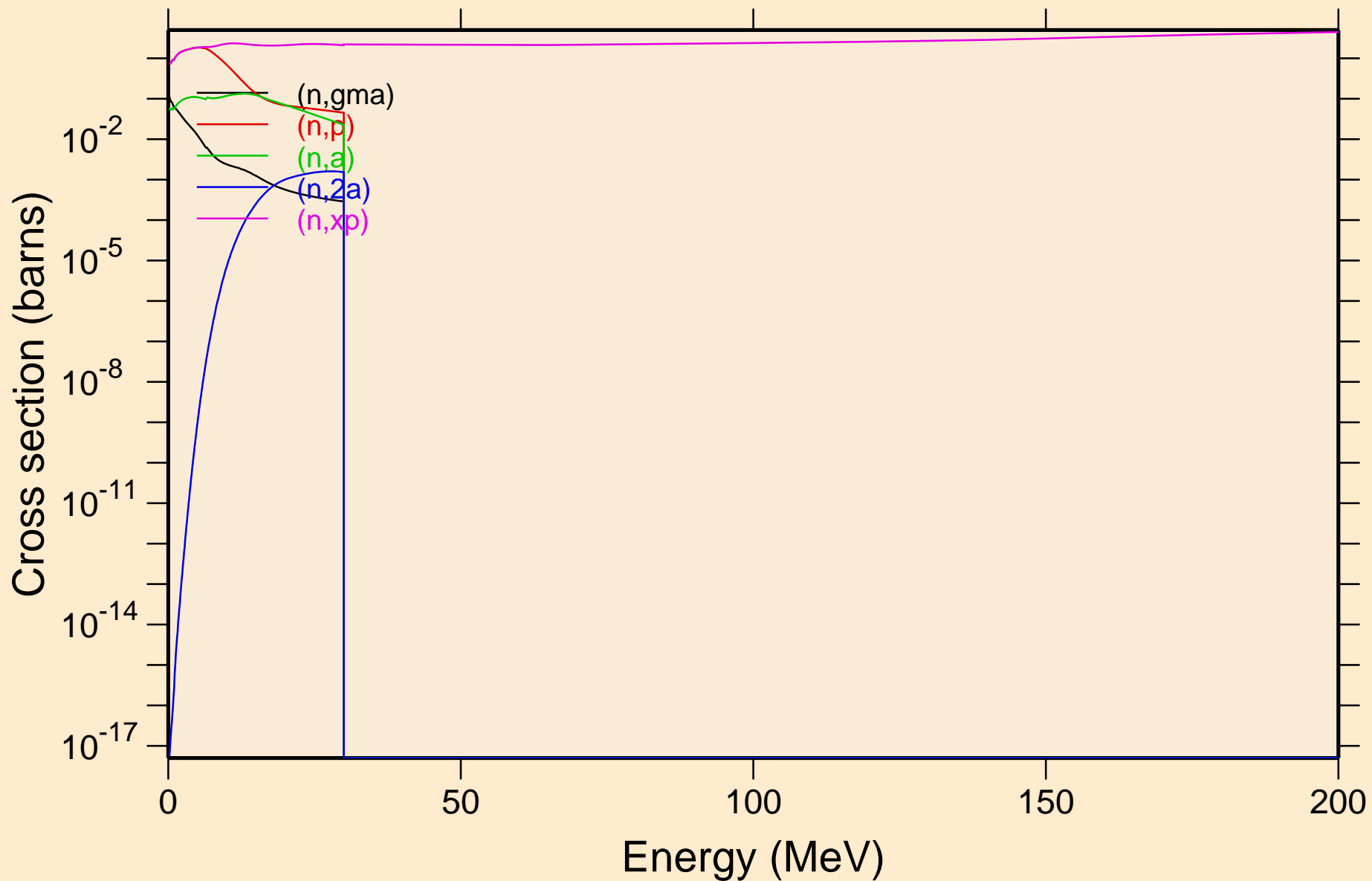

TE112 NEUTRON ACER TENDL-2019 LIBRARY; T=293.16K
Non-threshold reactions

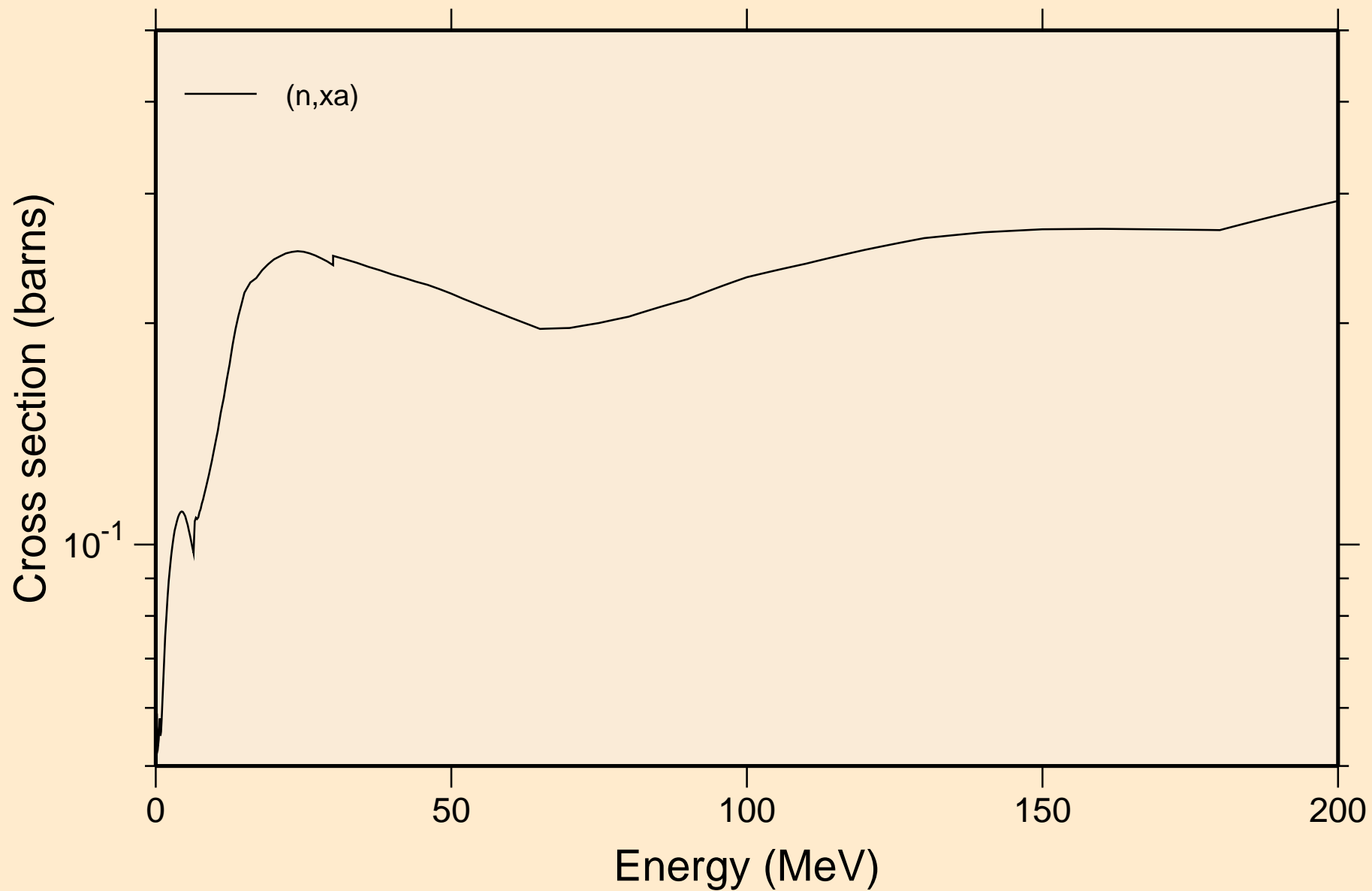

TE112 NEUTRON ACER TENDL-2019 LIBRARY; T=293.16K
Inelastic levels

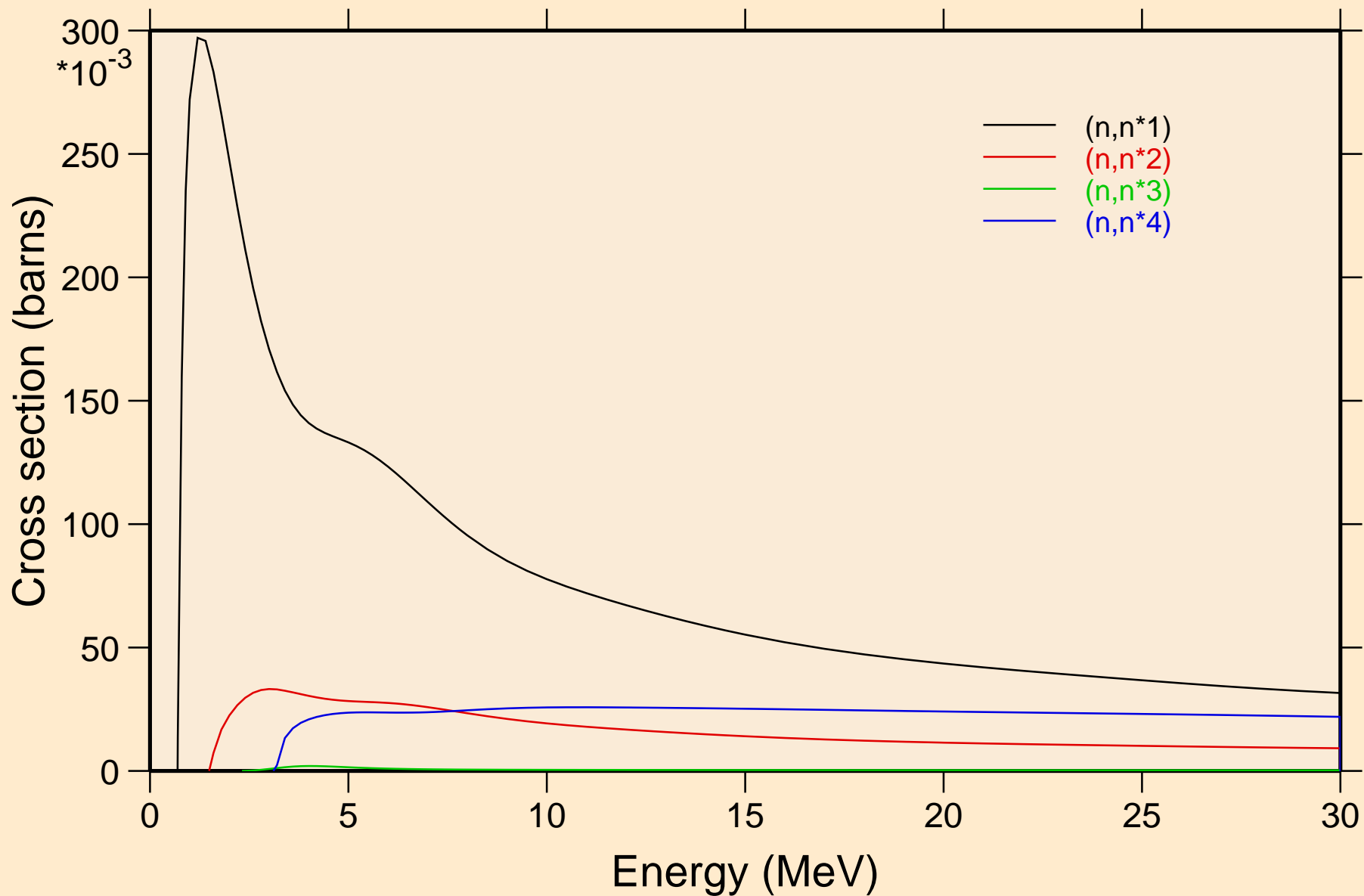

TE112 NEUTRON ACER TENDL-2019 LIBRARY; T=293.16K
Threshold reactions

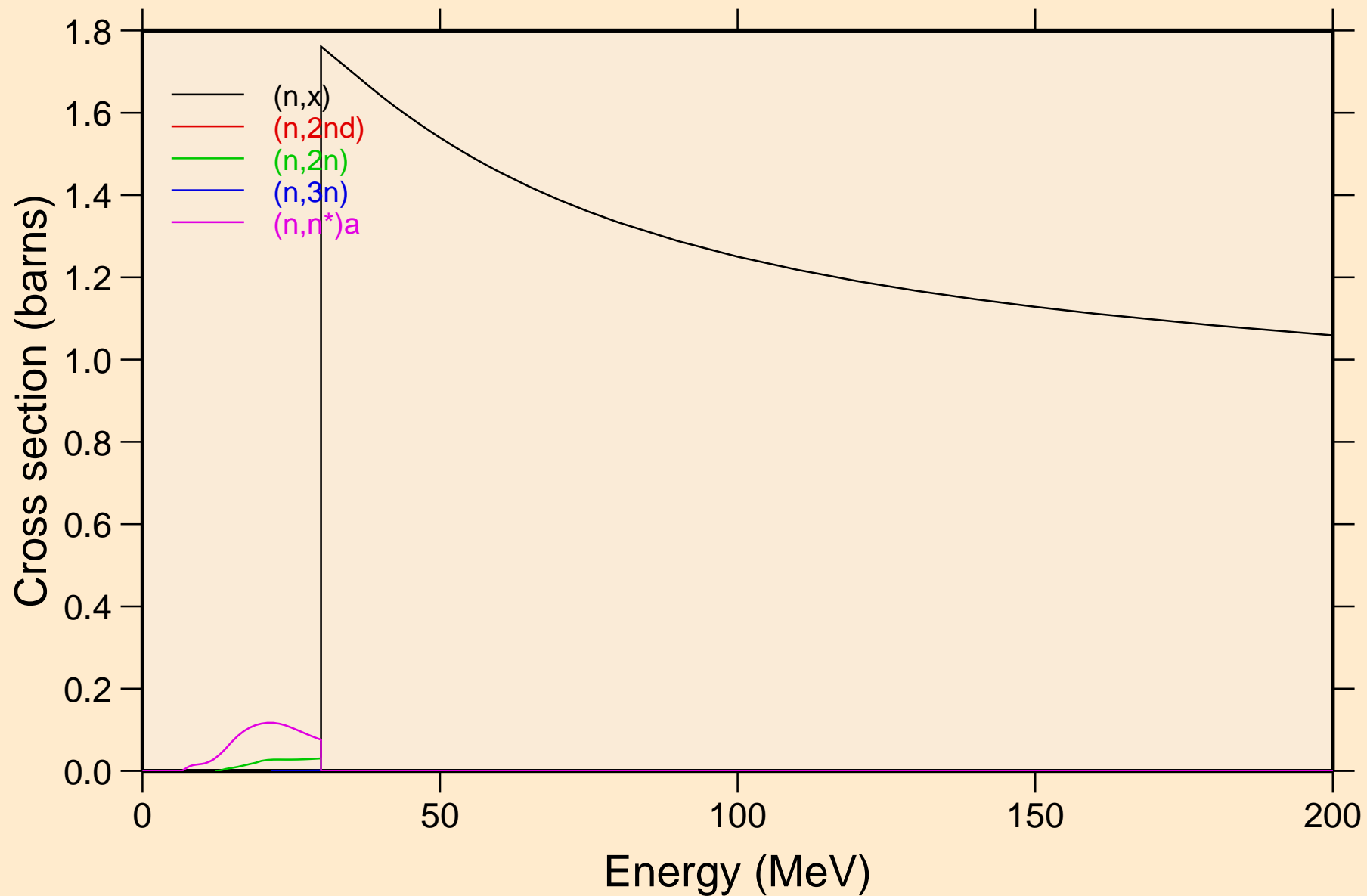

TE112 NEUTRON ACER TENDL-2019 LIBRARY; T=293.16K
Threshold reactions

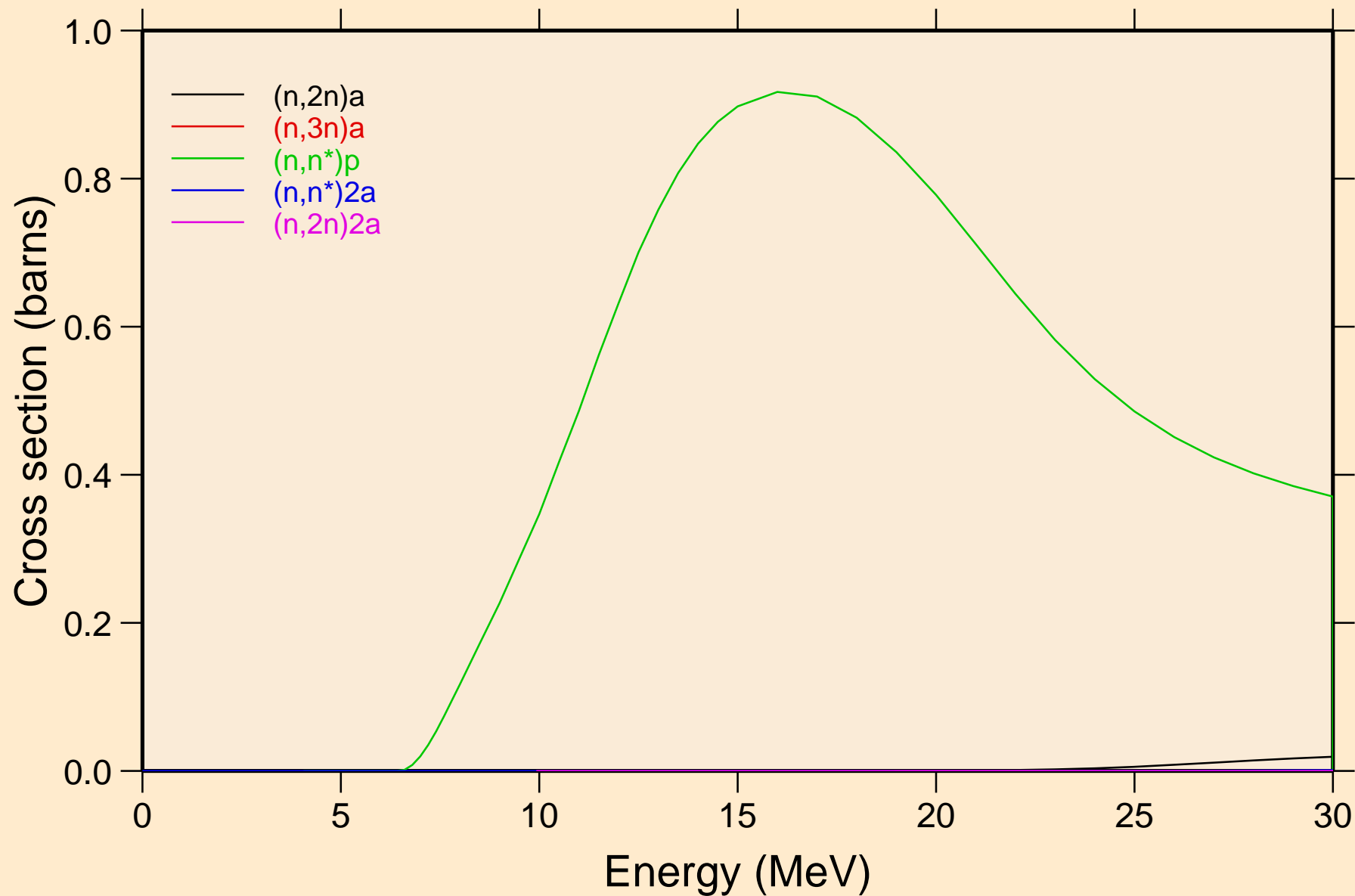

TE112 NEUTRON ACER TENDL-2019 LIBRARY; T=293.16K
Threshold reactions

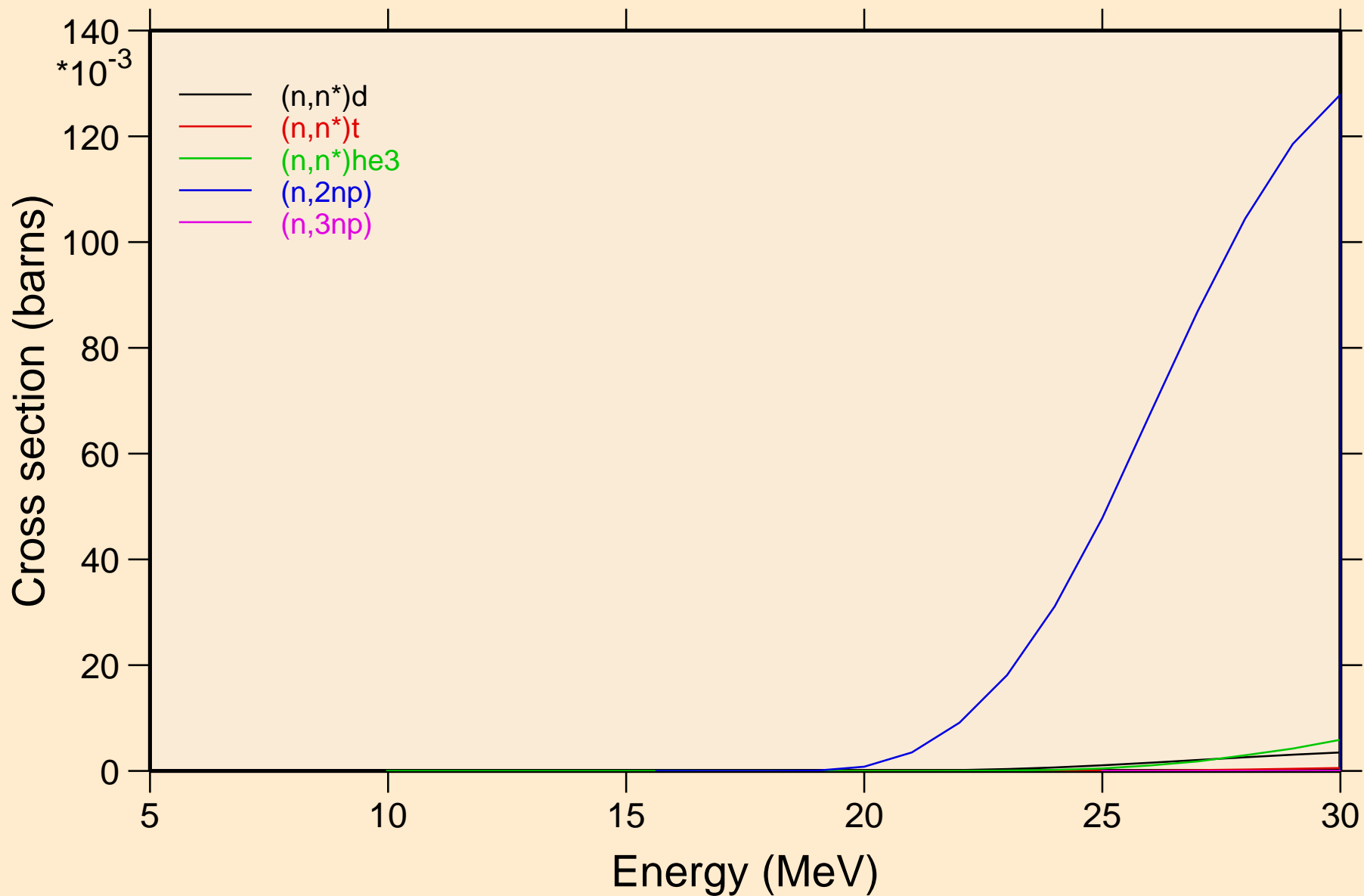

TE112 NEUTRON ACER TENDL-2019 LIBRARY; T=293.16K
Threshold reactions

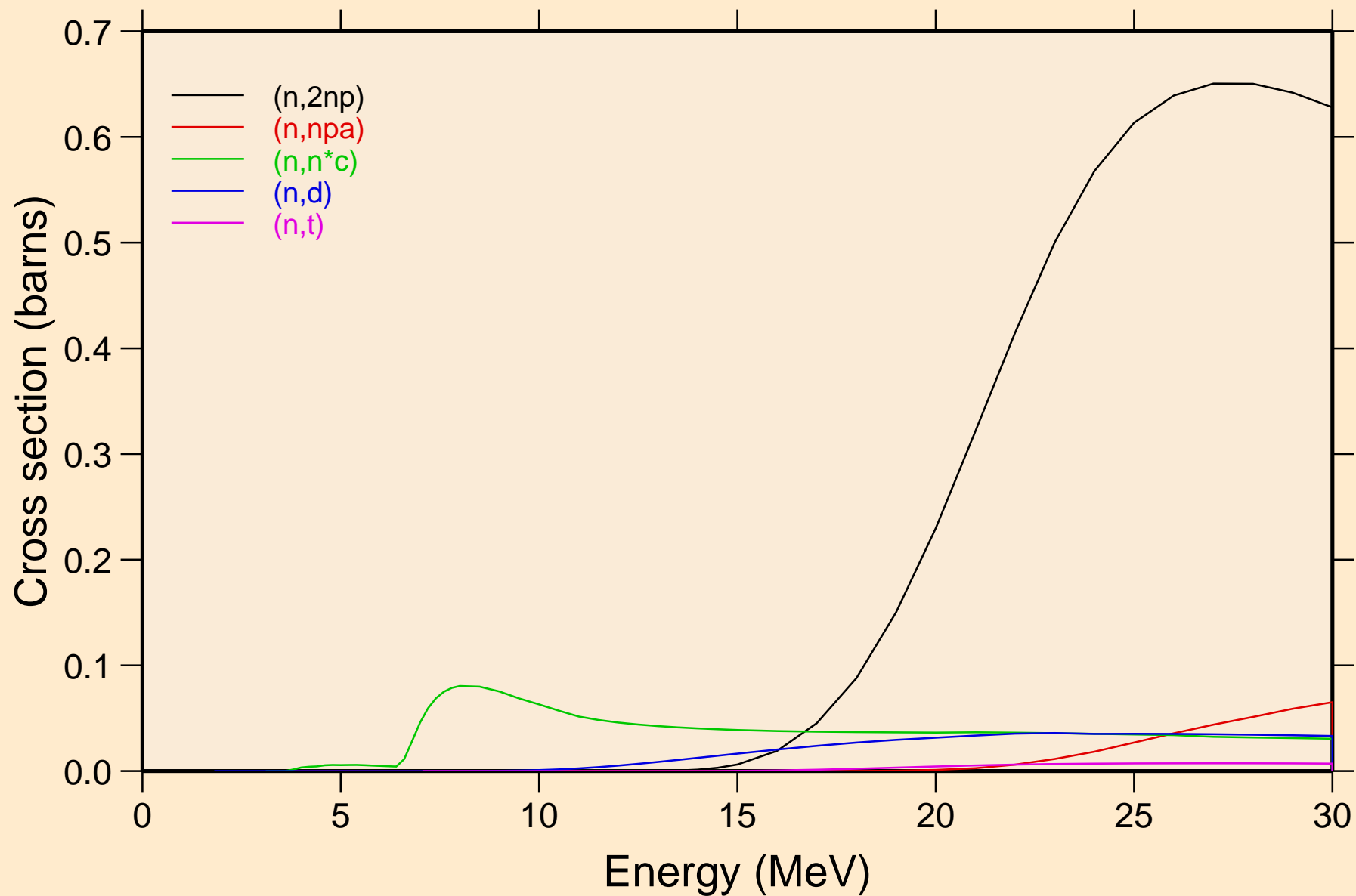

TE112 NEUTRON ACER TENDL-2019 LIBRARY; T=293.16K
Threshold reactions

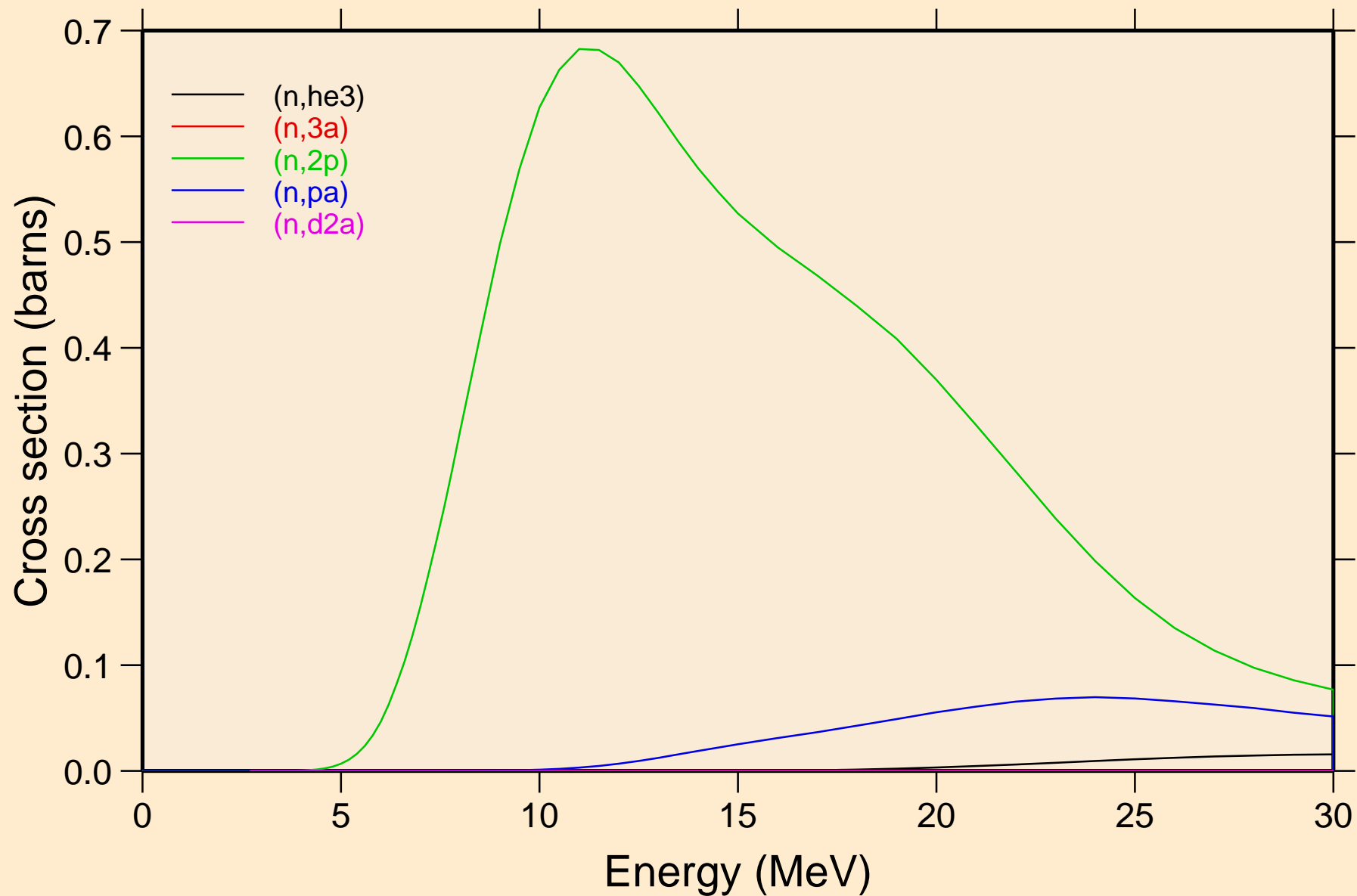

TE112 NEUTRON ACER TENDL-2019 LIBRARY; T=293.16K
Threshold reactions

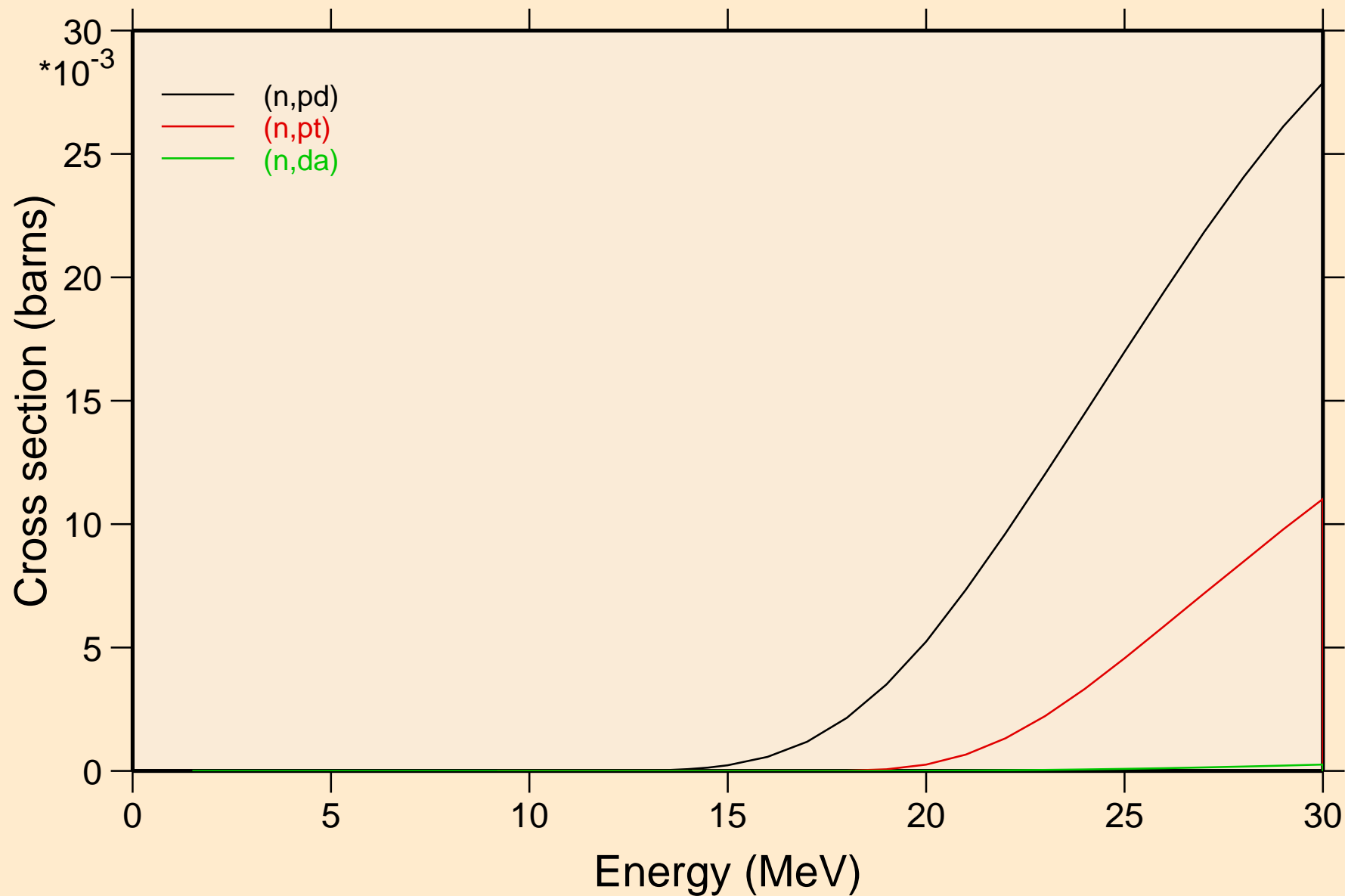

TE112 NEUTRON ACER TENDL-2019 LIBRARY; T=293.16K
Threshold reactions

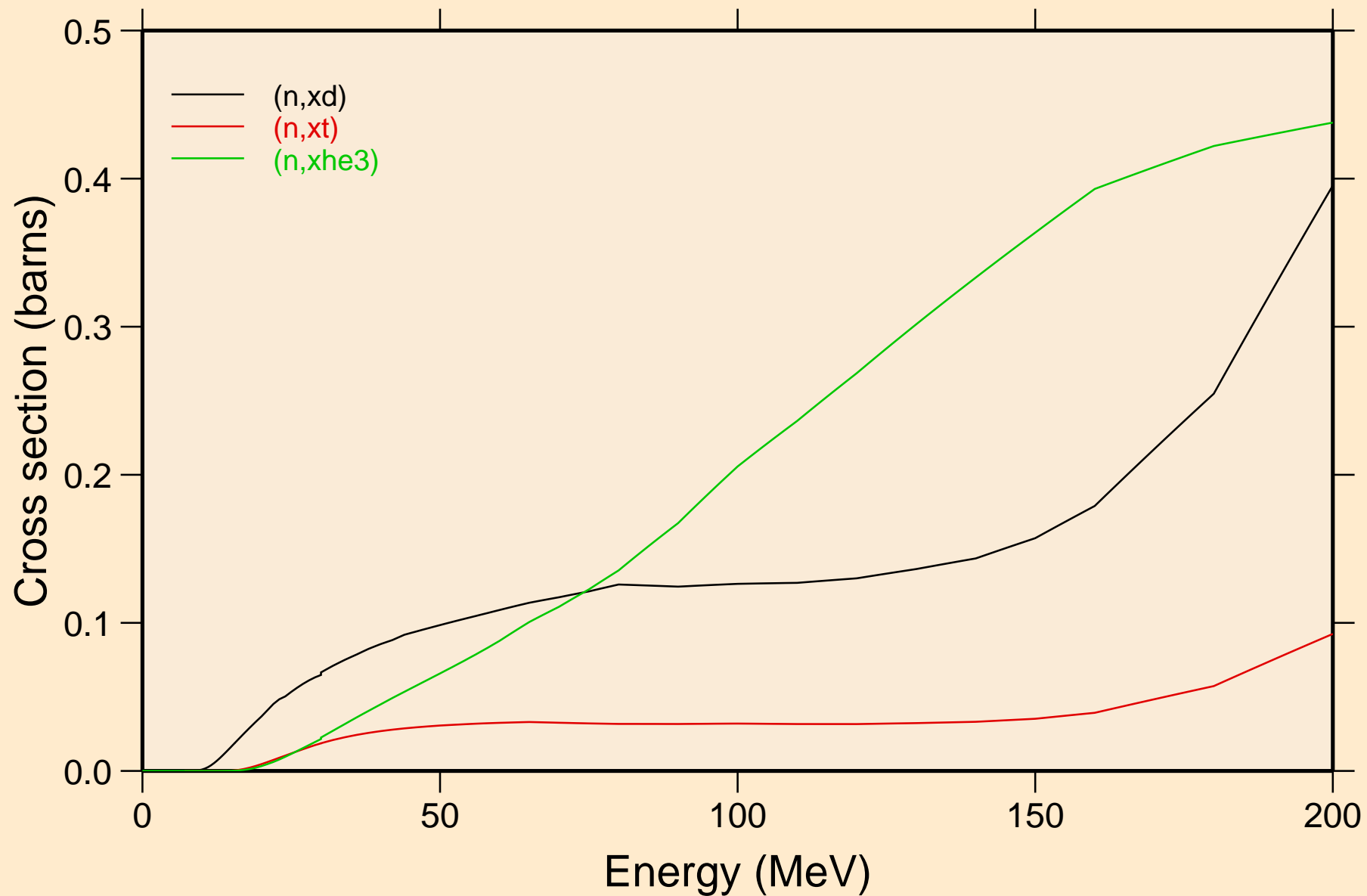

TE112 NEUTRON ACER TENDL-2019 LIBRARY; T=293.16K
angular distribution for elastic

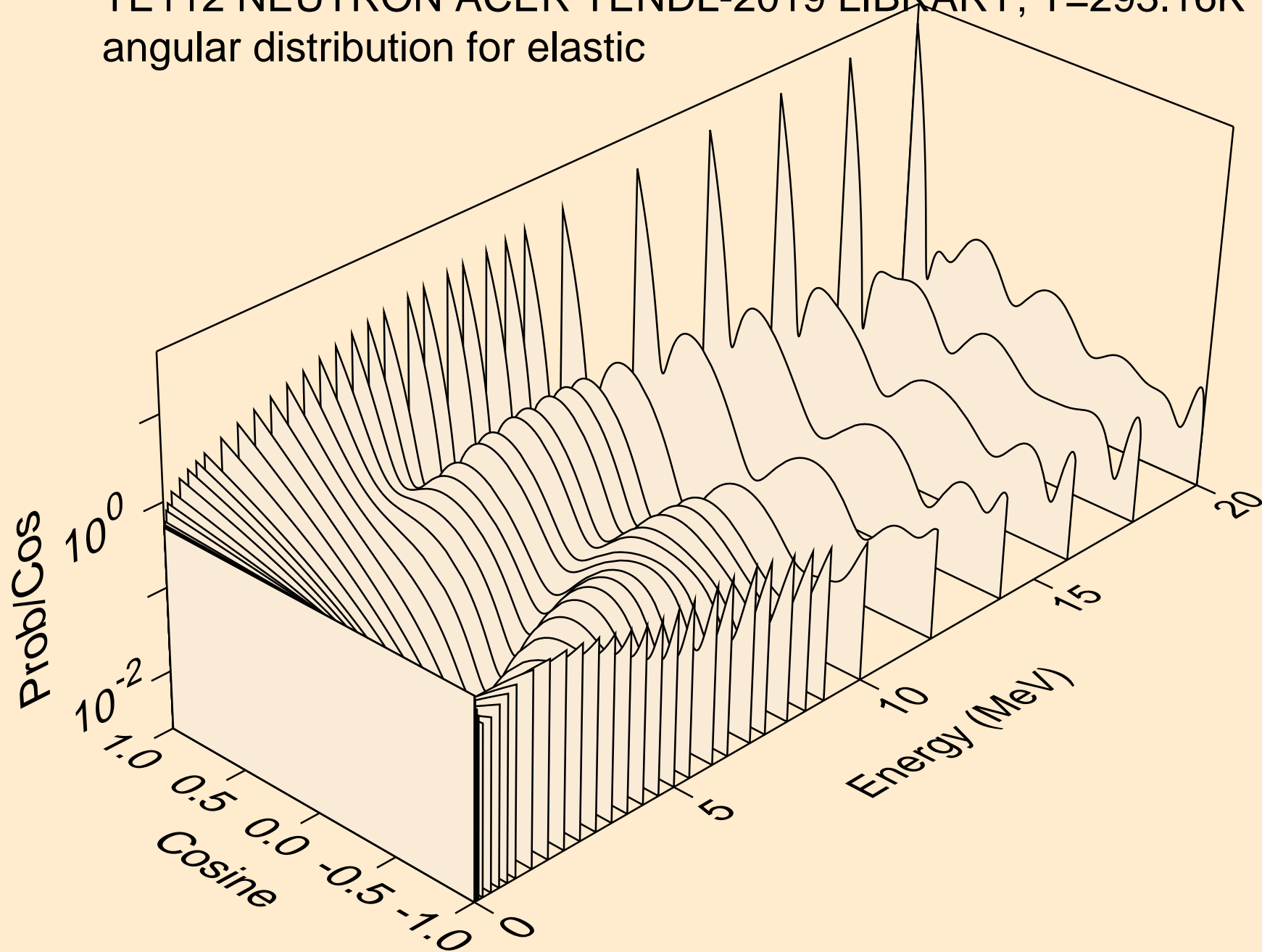

TE112 NEUTRON ACER TENDL-2019 LIBRARY; T=293.16K
angular distribution for elastic

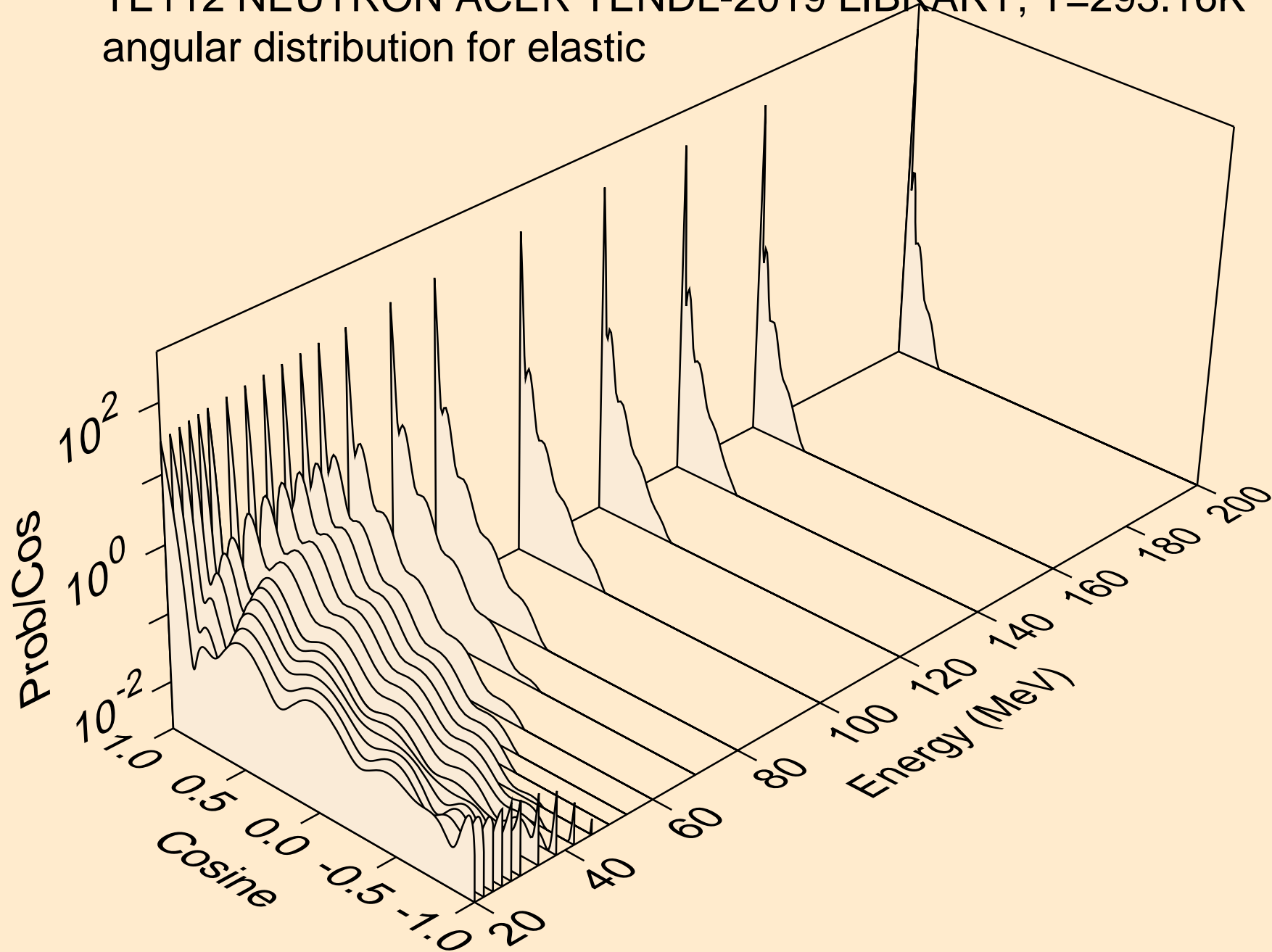

TE112 NEUTRON ACER TENDL-2019 LIBRARY; T=293.16K
angular distribution for (n,n*1)

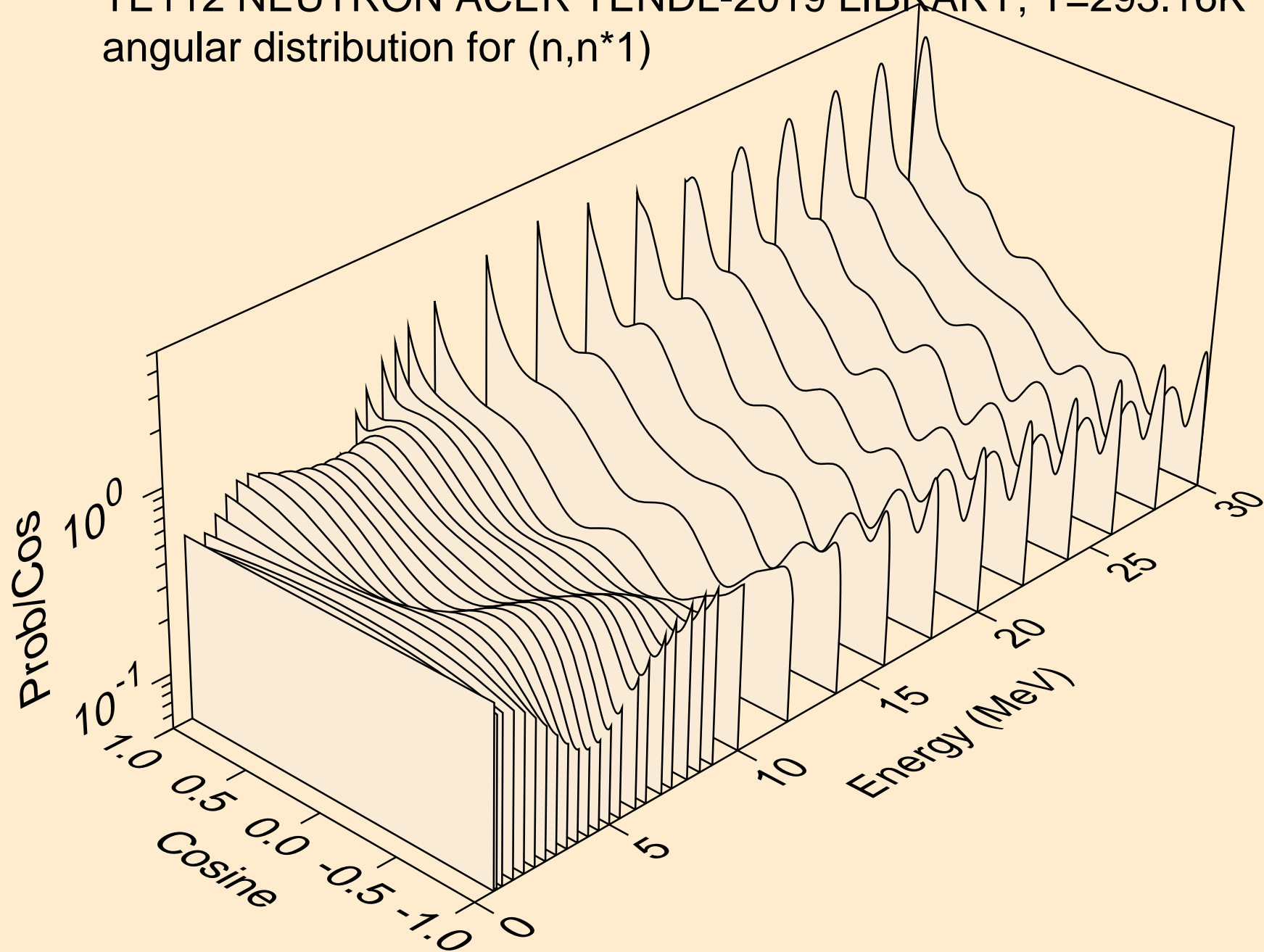

TE112 NEUTRON ACER TENDL-2019 LIBRARY; T=293.16K
angular distribution for (n,n*2)

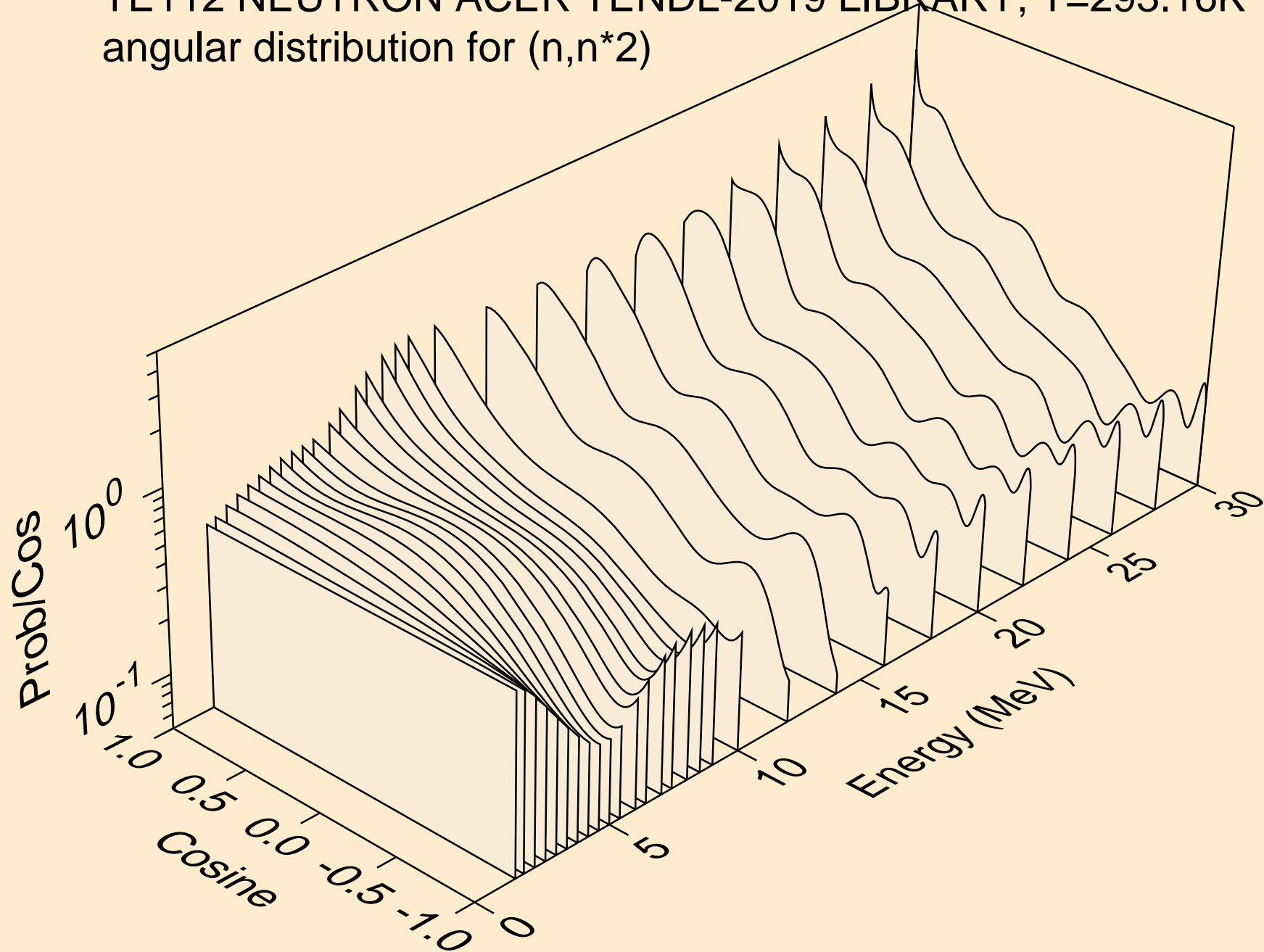

TE112 NEUTRON ACER TENDL-2019 LIBRARY; T=293.16K
angular distribution for (n,n*3)

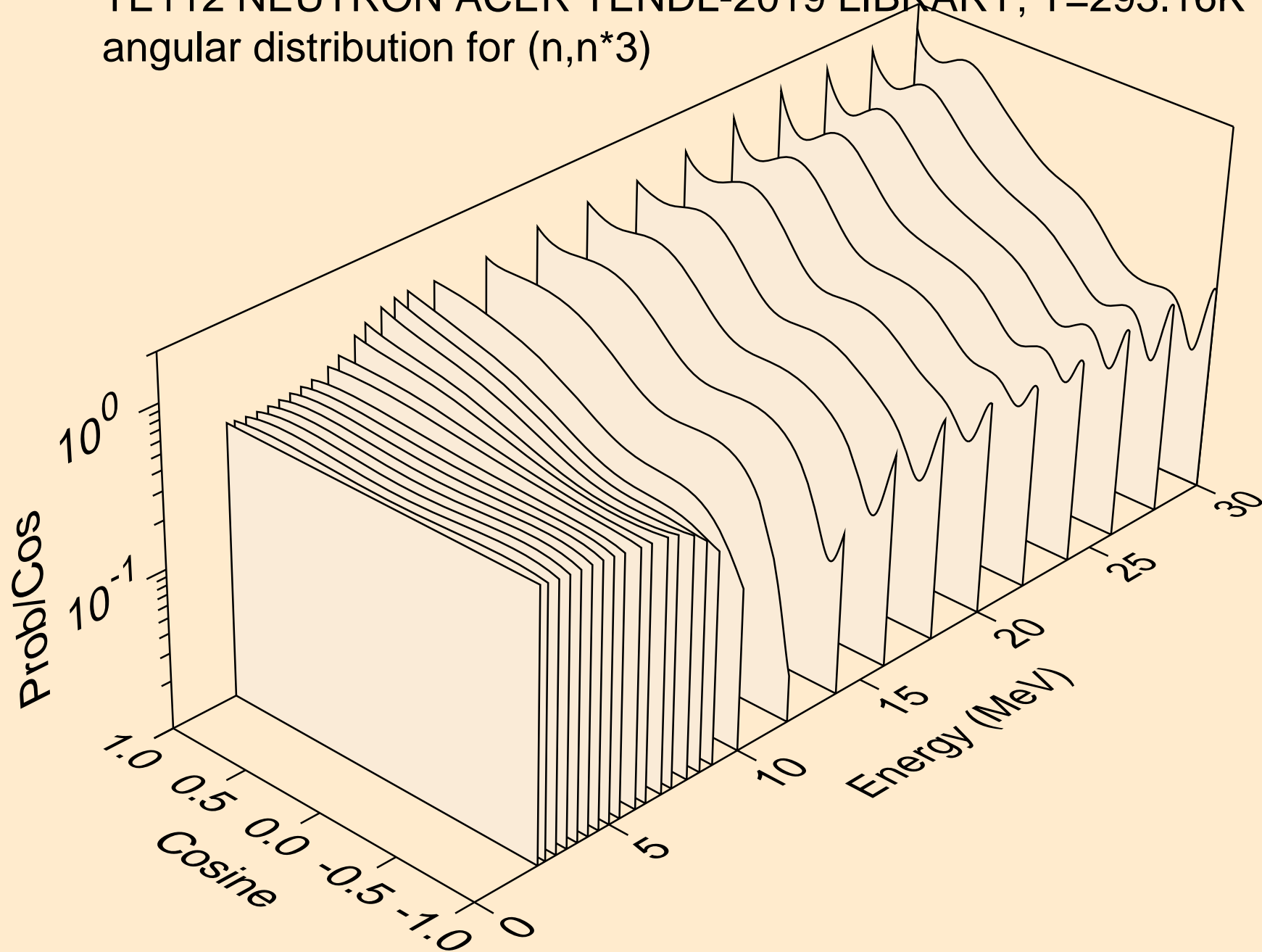

TE112 NEUTRON ACER TENDL-2019 LIBRARY; T=293.16K
angular distribution for (n,n*4)

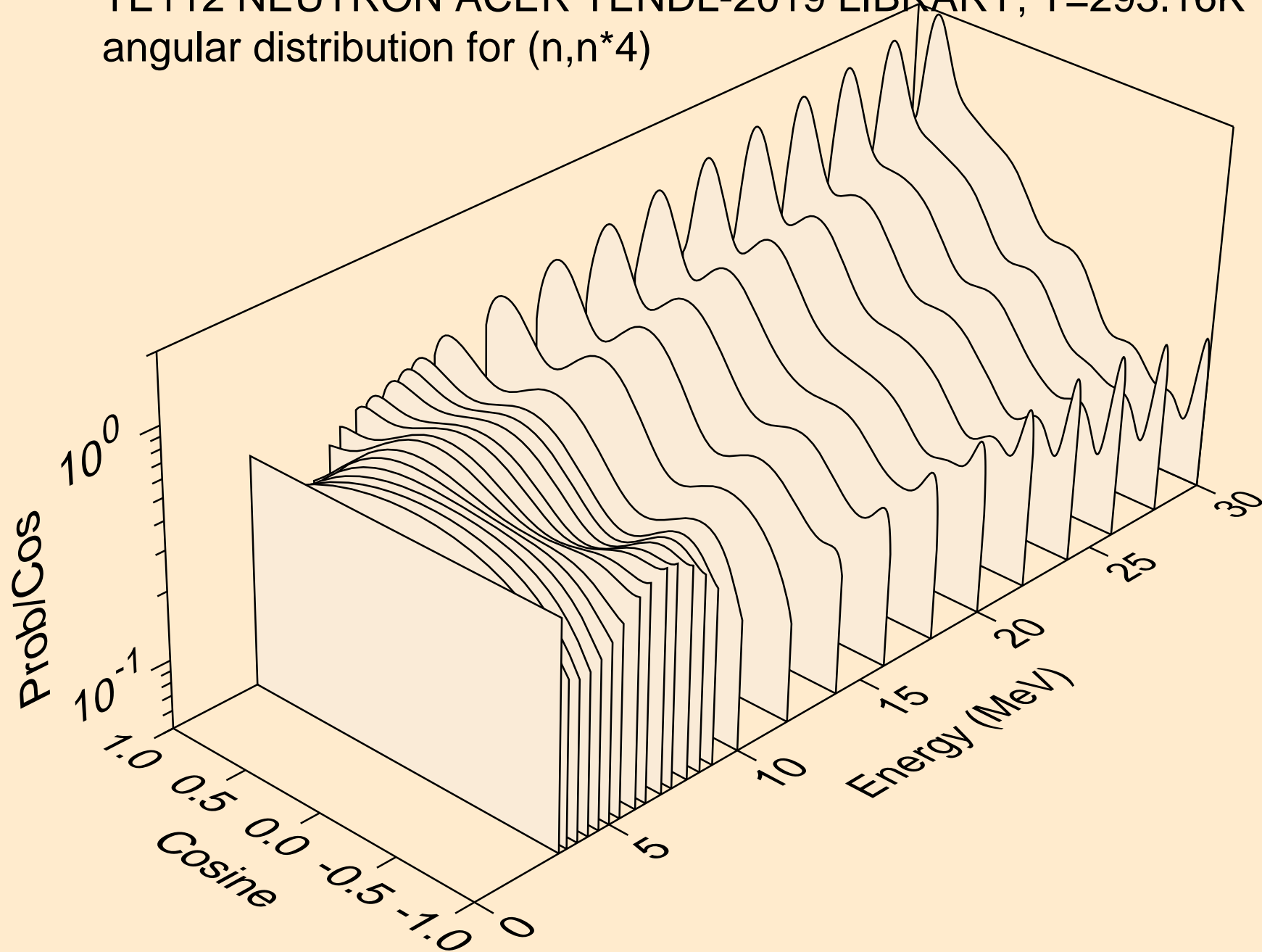

TE112 NEUTRON ACER TENDL-2019 LIBRARY; T=293.16K
Neutron emission for (n,x)

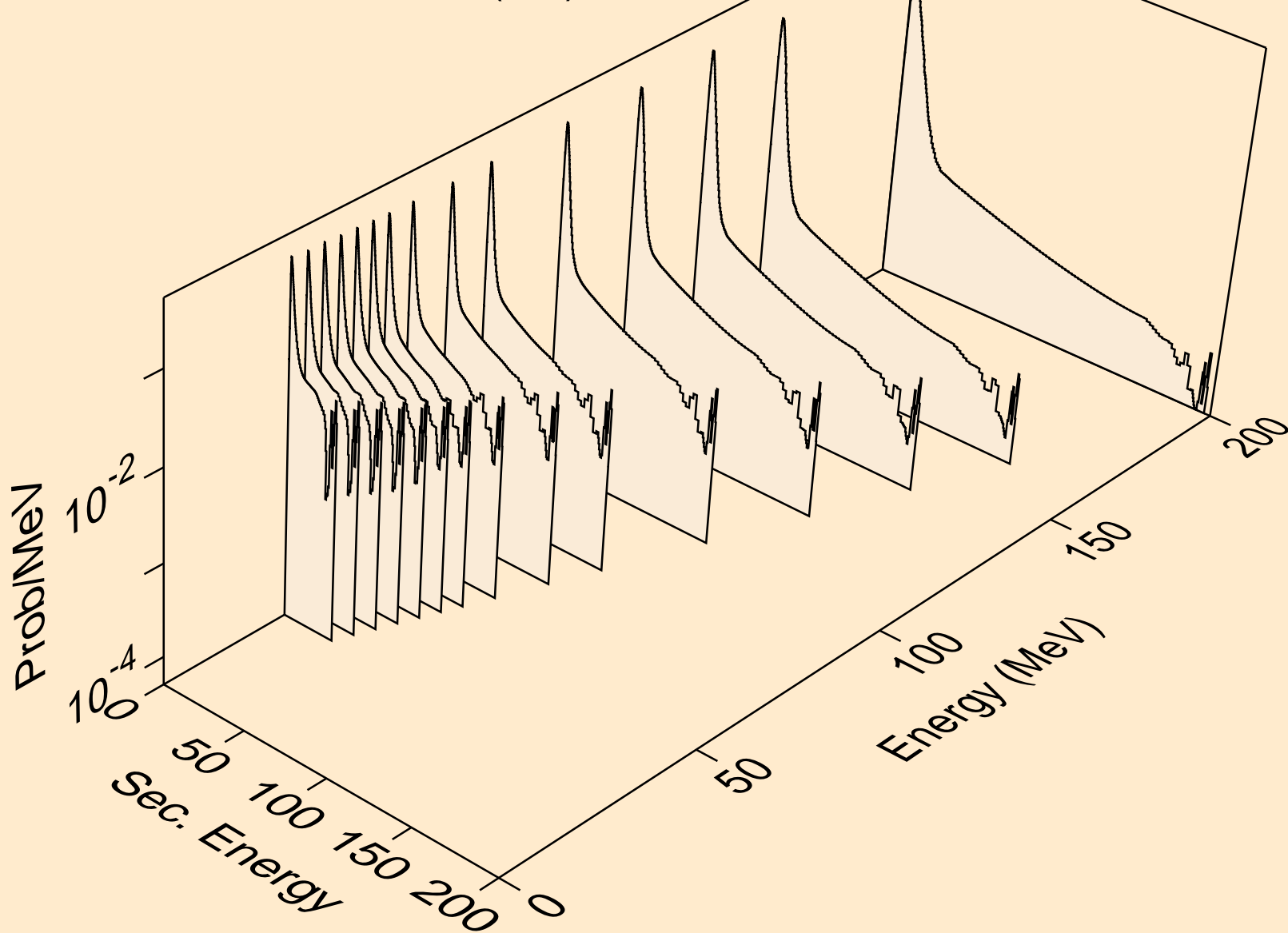

TE112 NEUTRON ACER TENDL-2019 LIBRARY; T=293.16K
Neutron emission for (n,2nd)

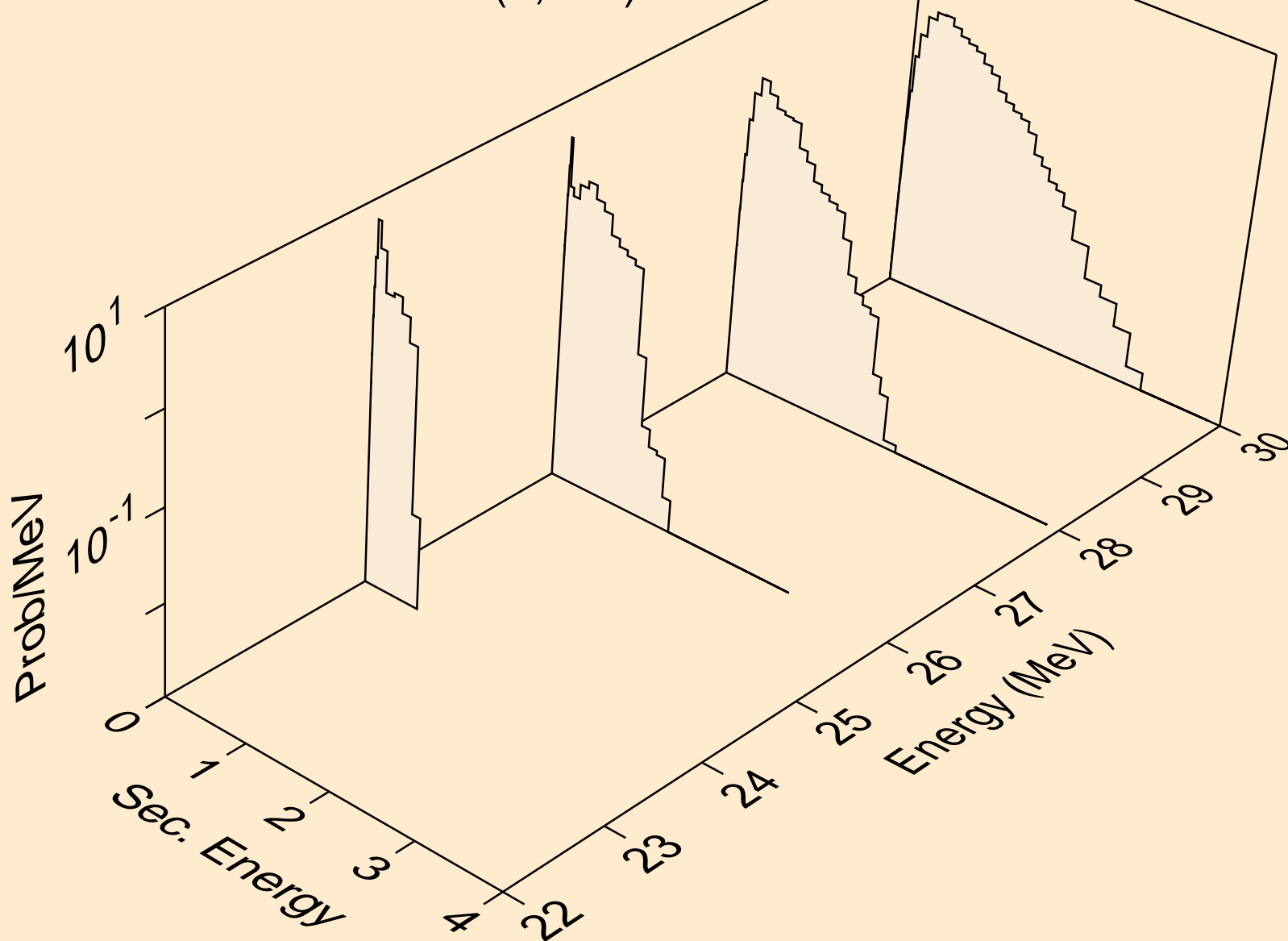

TE112 NEUTRON ACER TENDL-2019 LIBRARY; T=293.16K
Neutron emission for (n,2n)

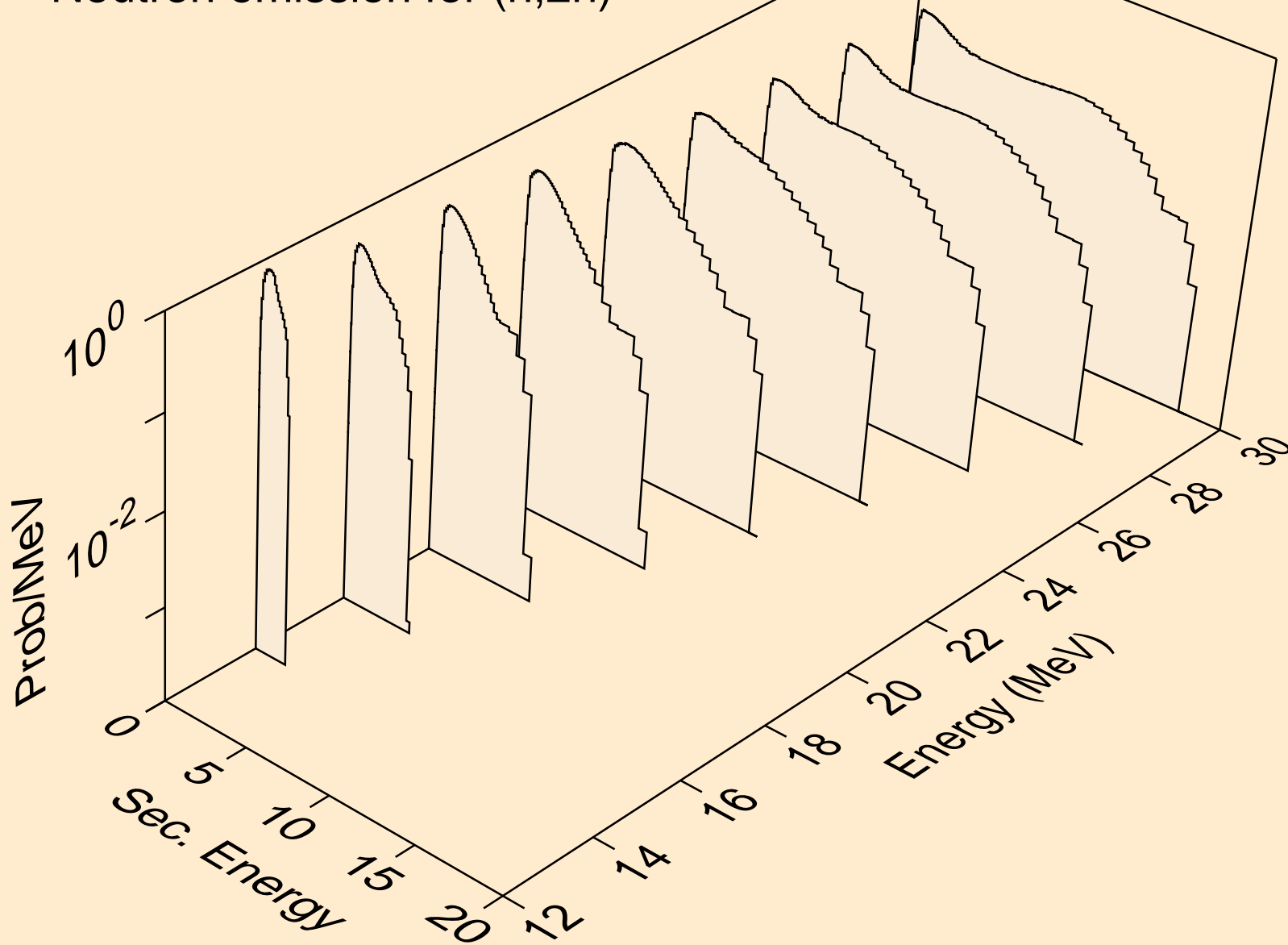

TE112 NEUTRON ACER TENDL-2019 LIBRARY; T=293.16K
Neutron emission for (n,3n)

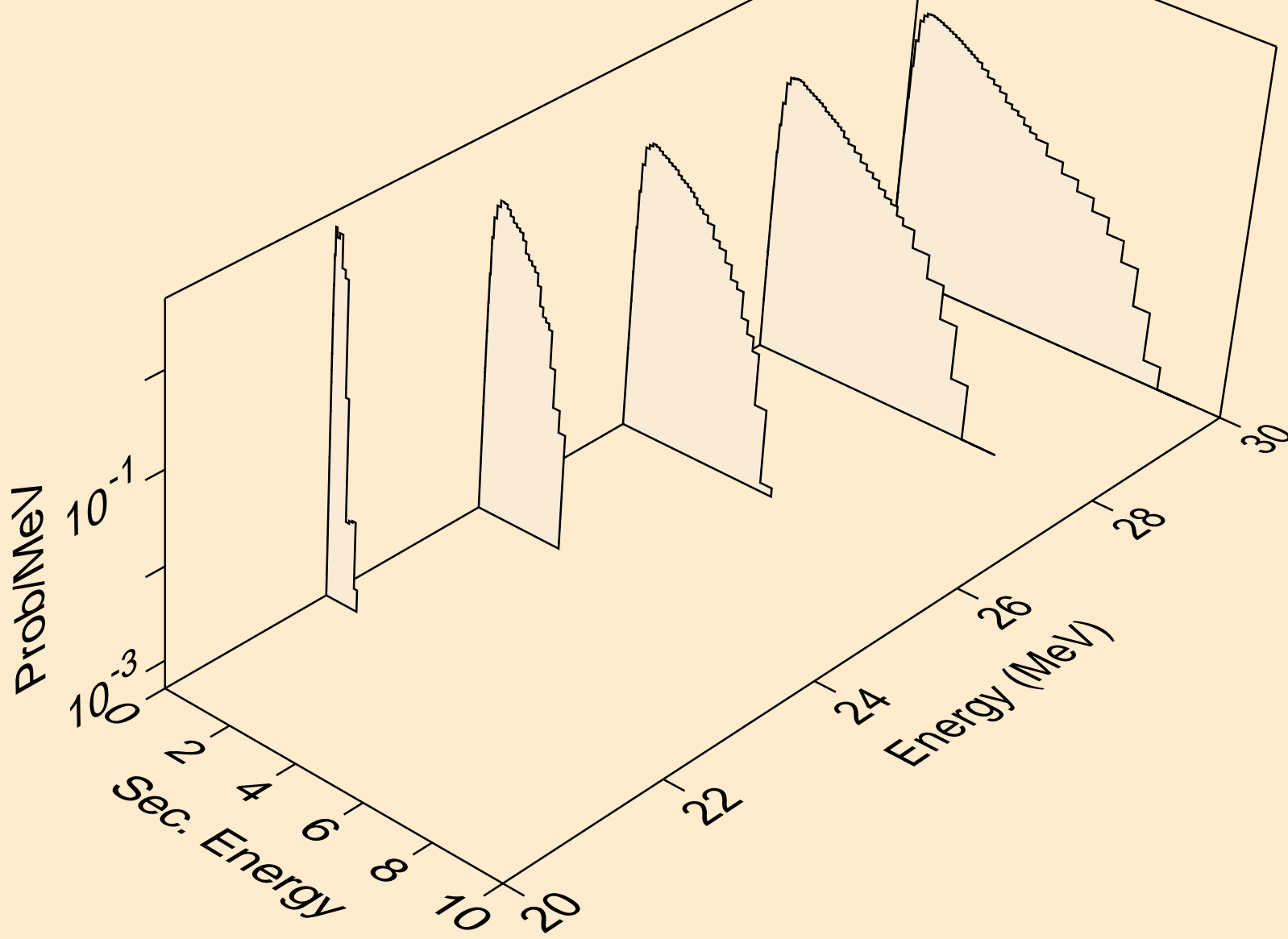

TE112 NEUTRON ACER TENDL-2019 LIBRARY; T=293.16K
Neutron emission for (n,n*)a

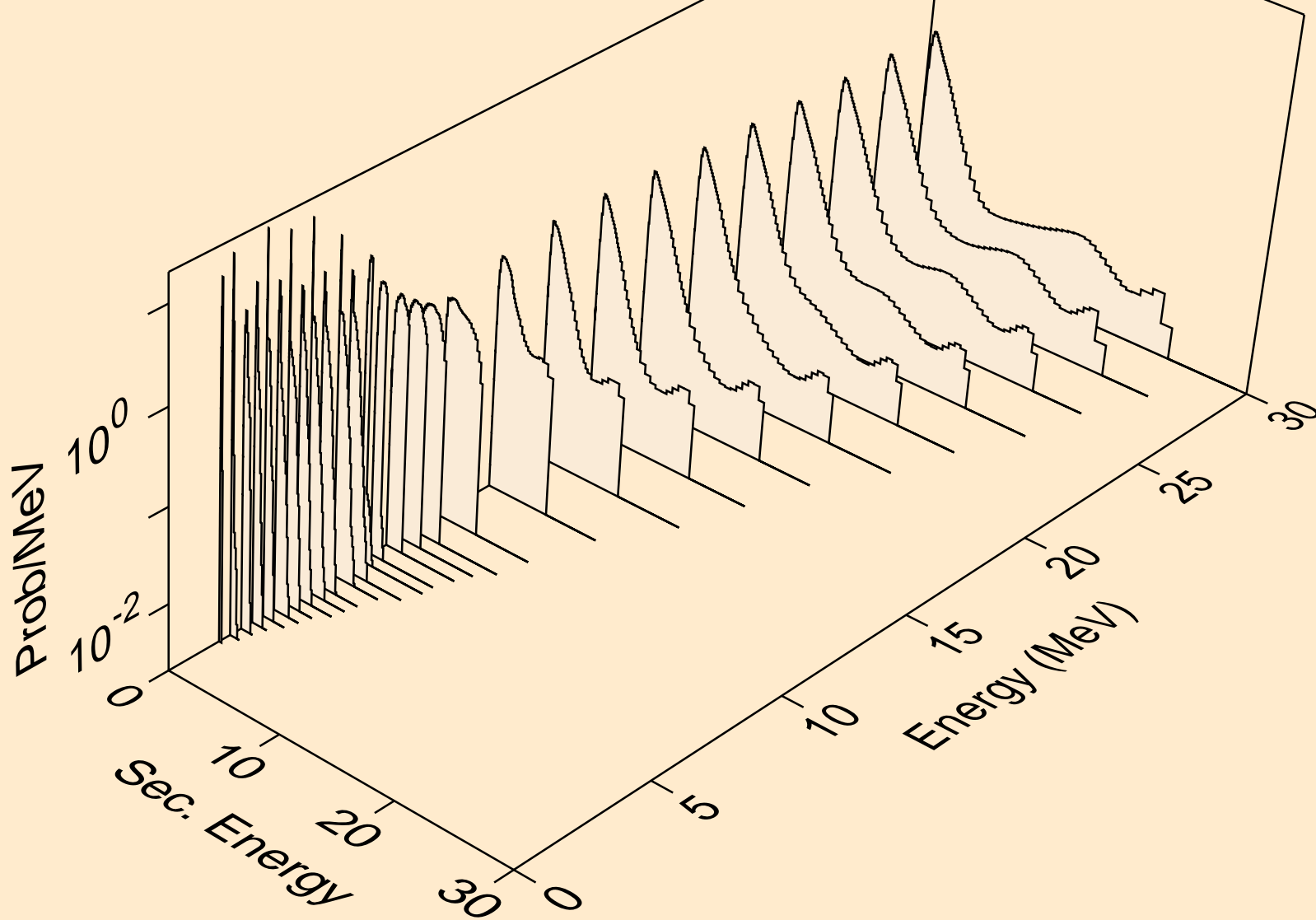

TE112 NEUTRON ACER TENDL-2019 LIBRARY; T=293.16K
Neutron emission for (n,2n)a

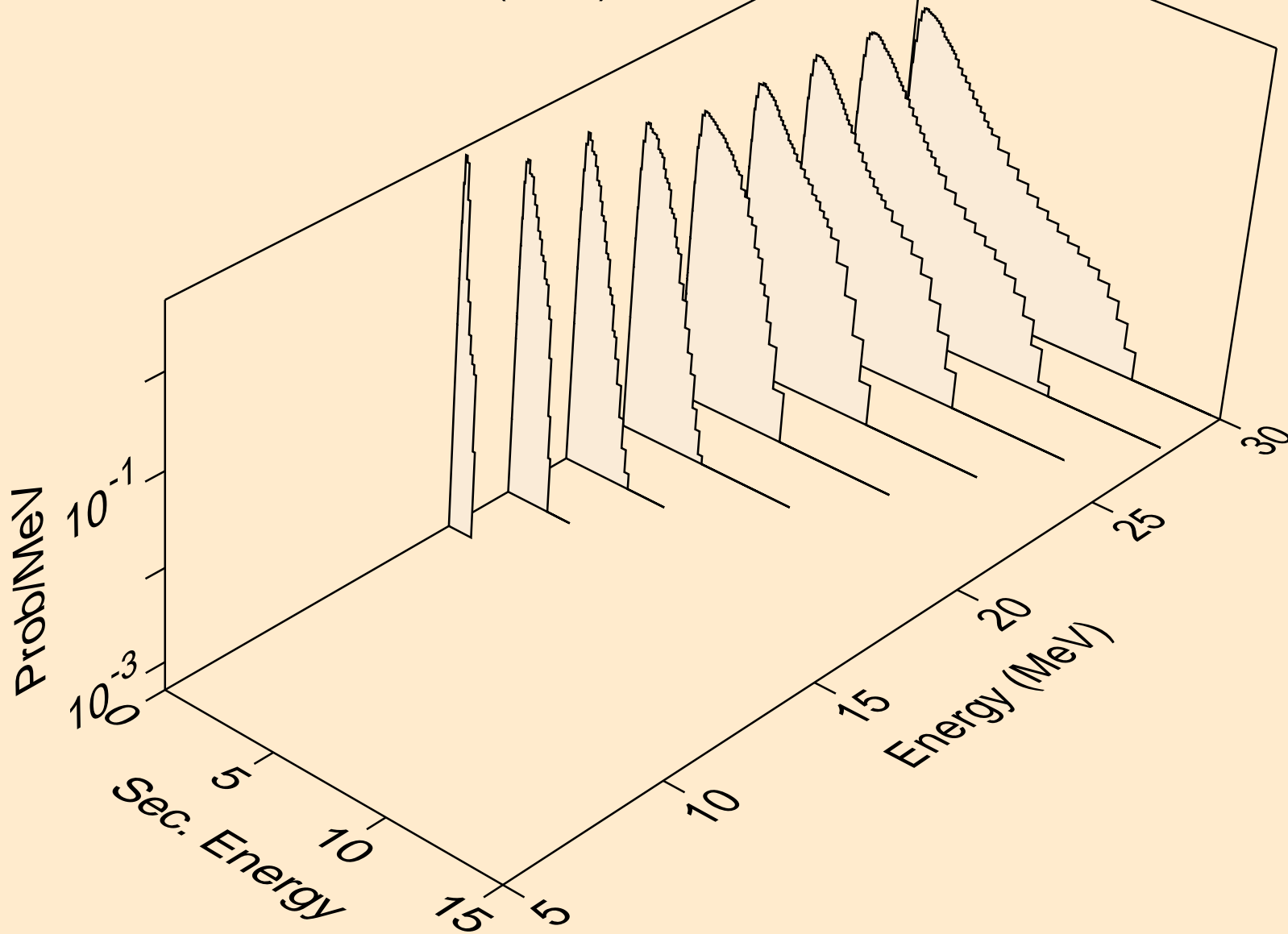

TE112 NEUTRON ACER TENDL-2019 LIBRARY; T=293.16K
Neutron emission for (n,3n)a

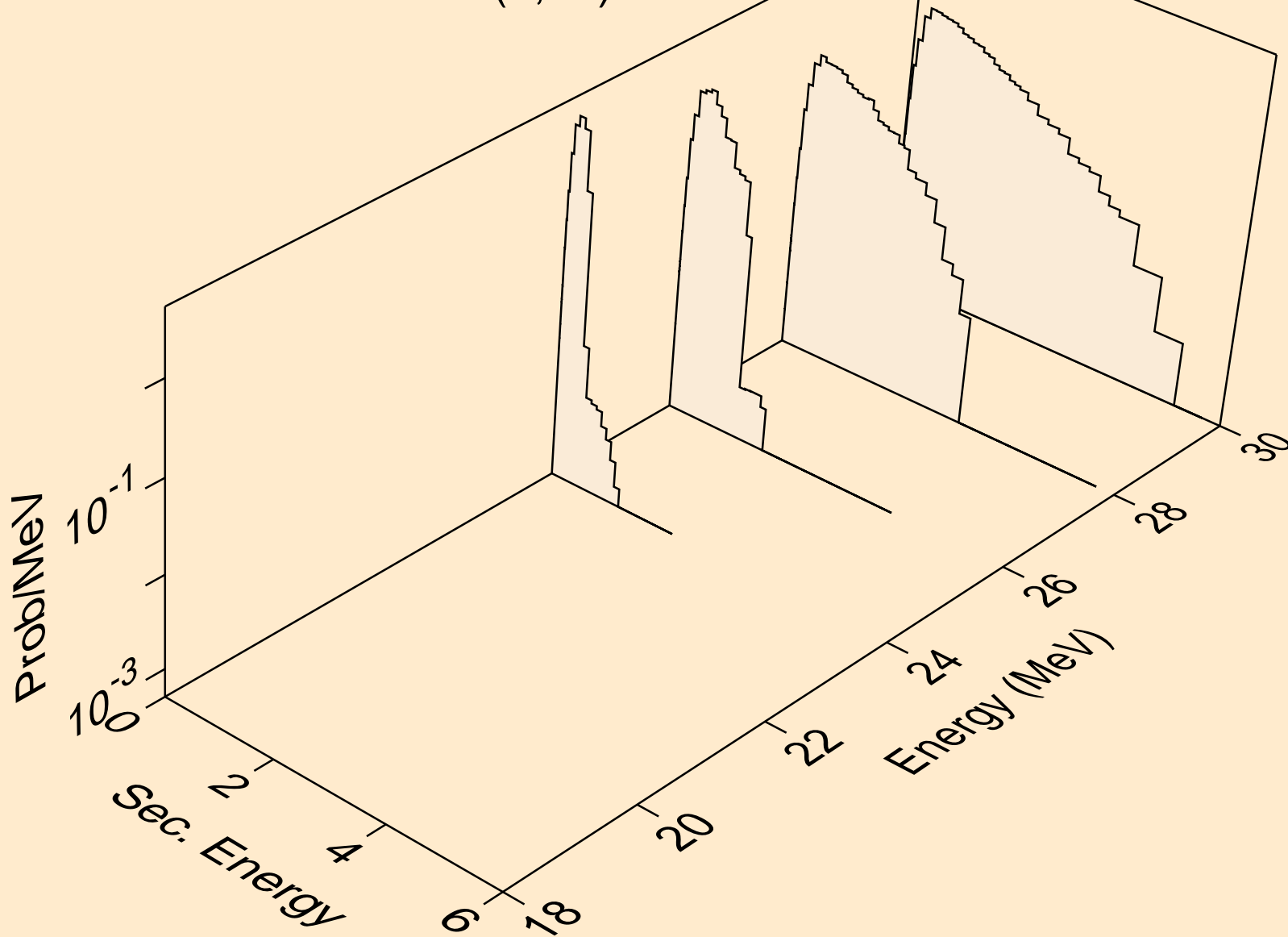

TE112 NEUTRON ACER TENDL-2019 LIBRARY; T=293.16K
Neutron emission for (n,n*)p

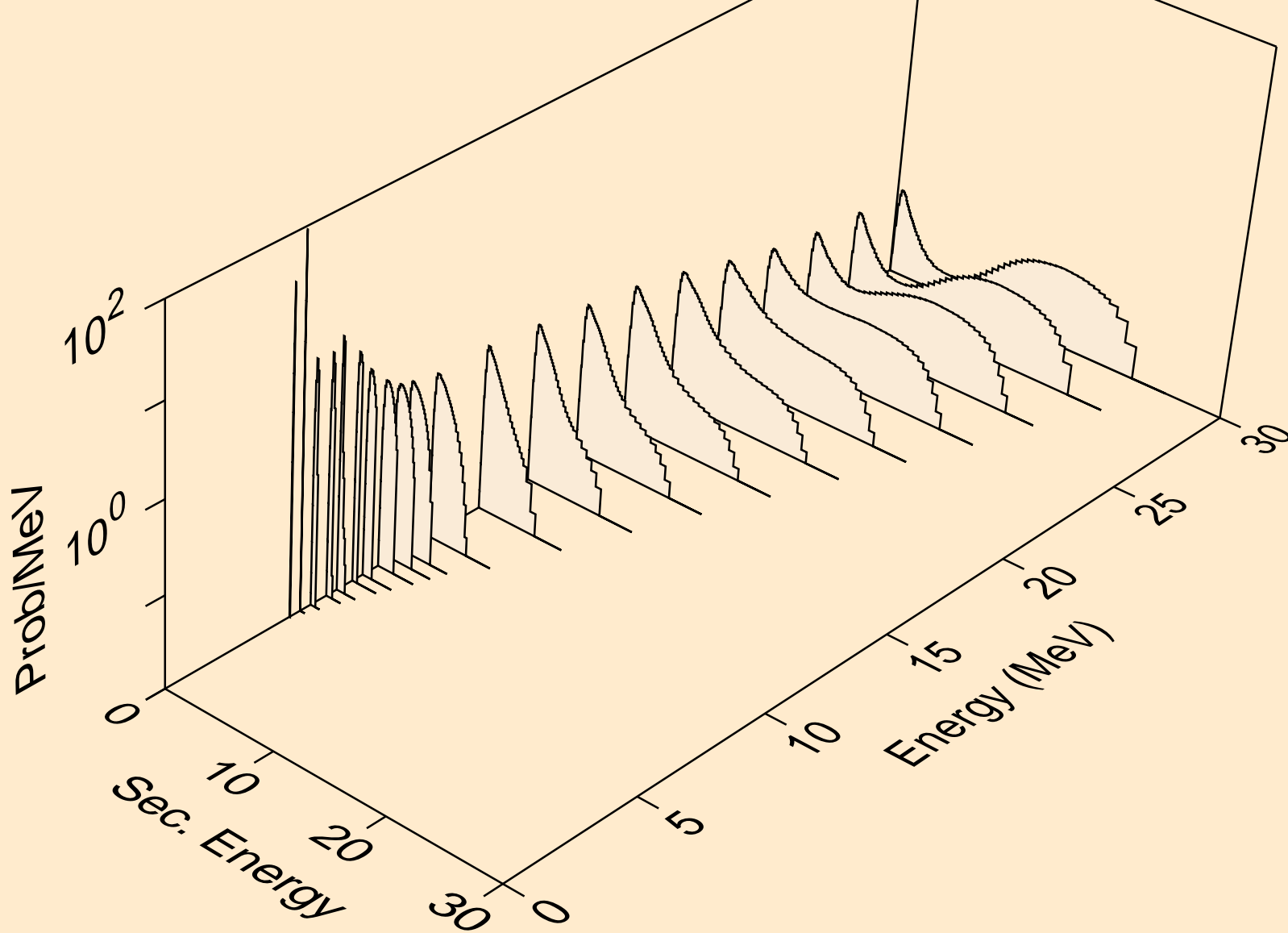

TE112 NEUTRON ACER TENDL-2019 LIBRARY; T=293.16K
Neutron emission for (n,n*)2a

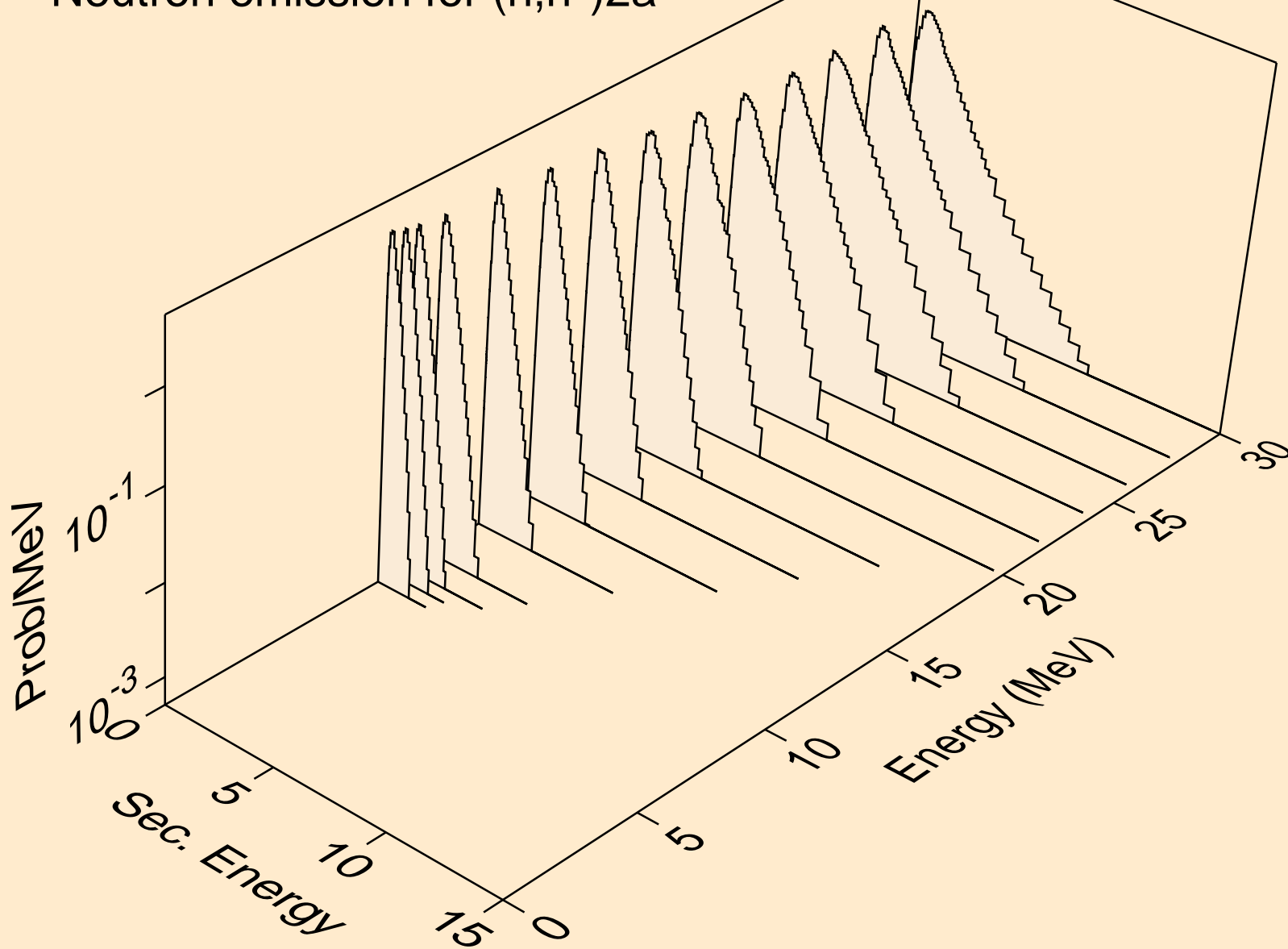

TE112 NEUTRON ACER TENDL-2019 LIBRARY; T=293.16K
Neutron emission for (n,2n)2a

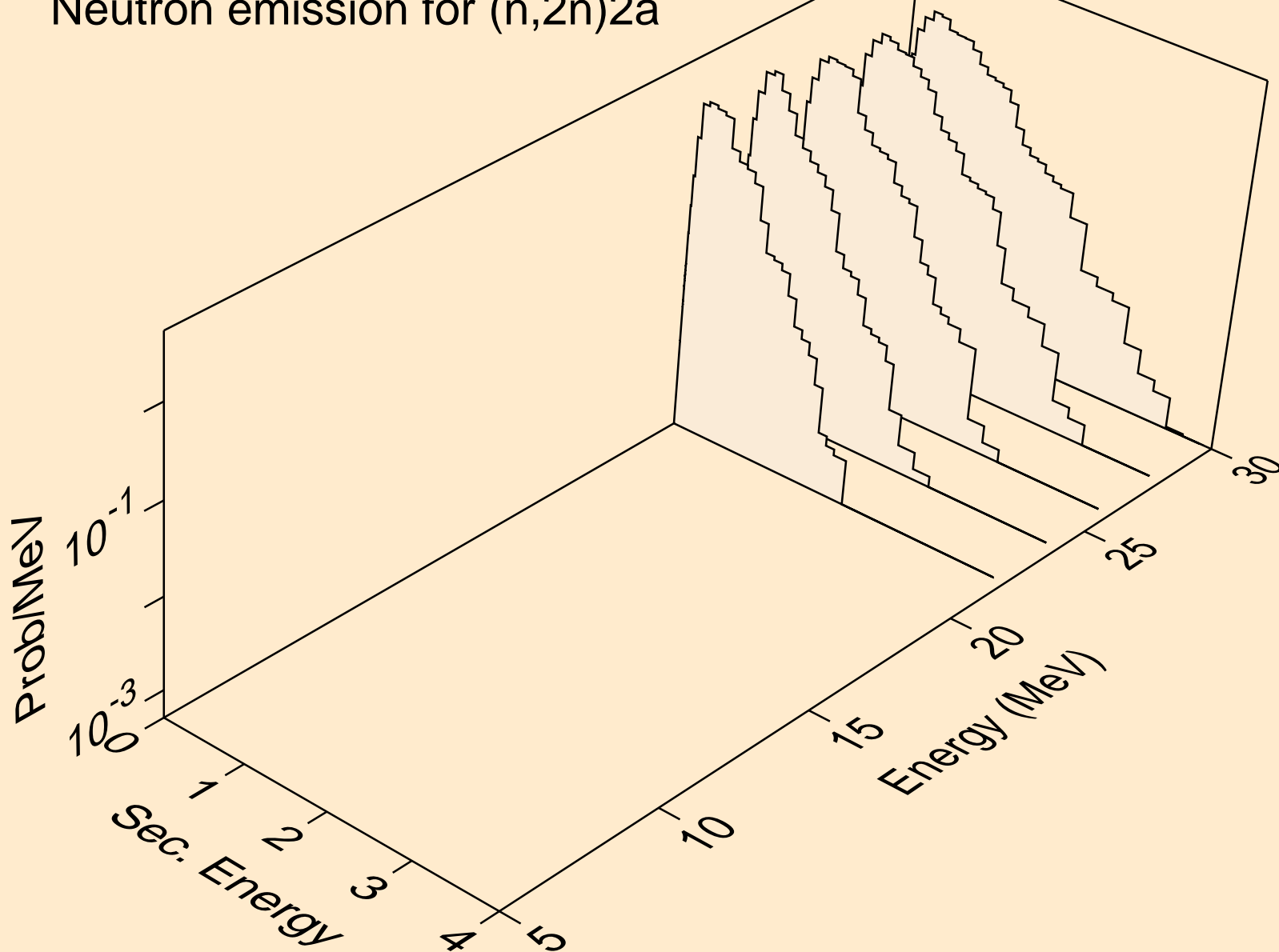

TE112 NEUTRON ACER TENDL-2019 LIBRARY; T=293.16K
Neutron emission for (n,n*)d

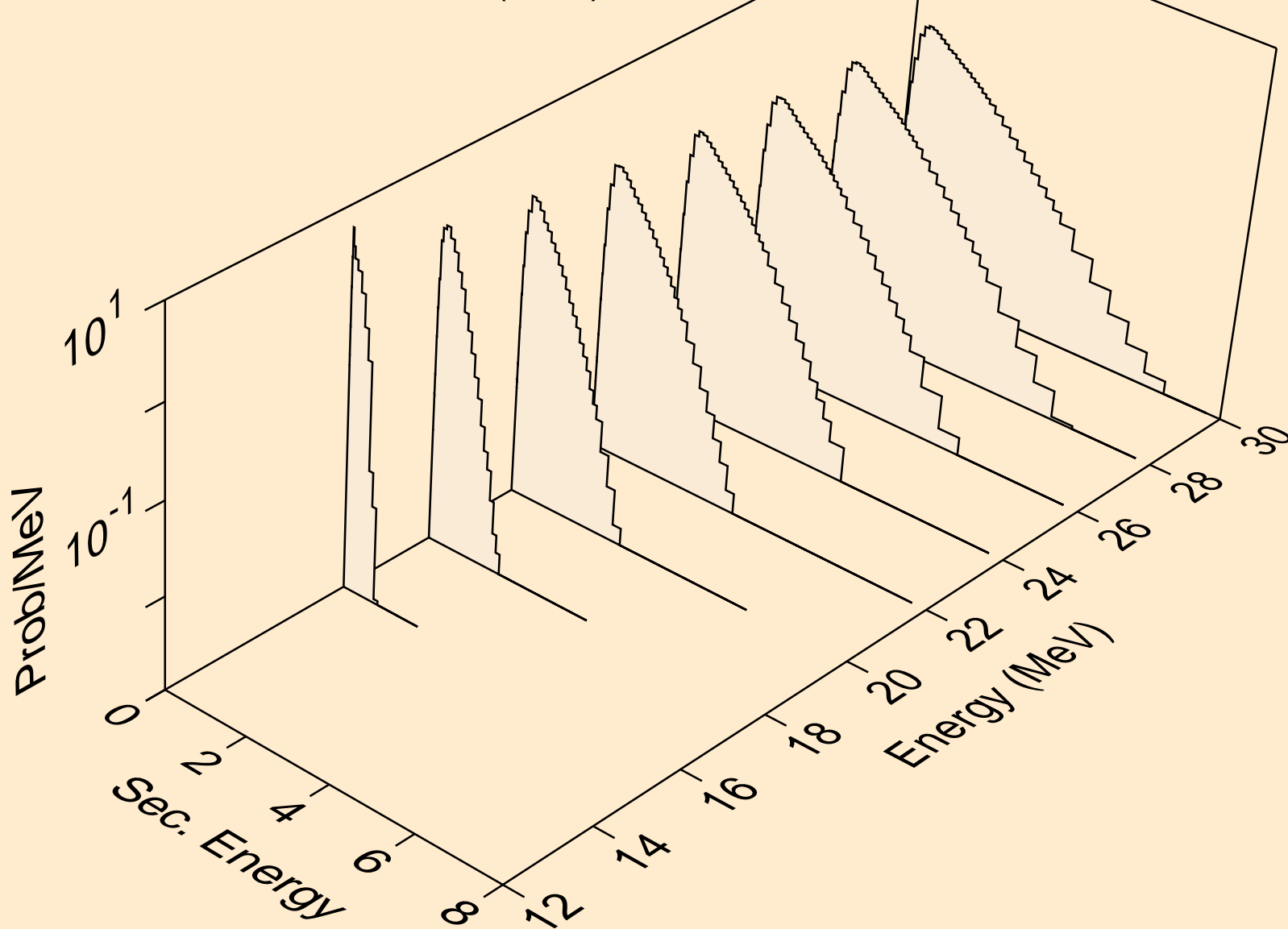

TE112 NEUTRON ACER TENDL-2019 LIBRARY; T=293.16K
Neutron emission for (n,n*)t

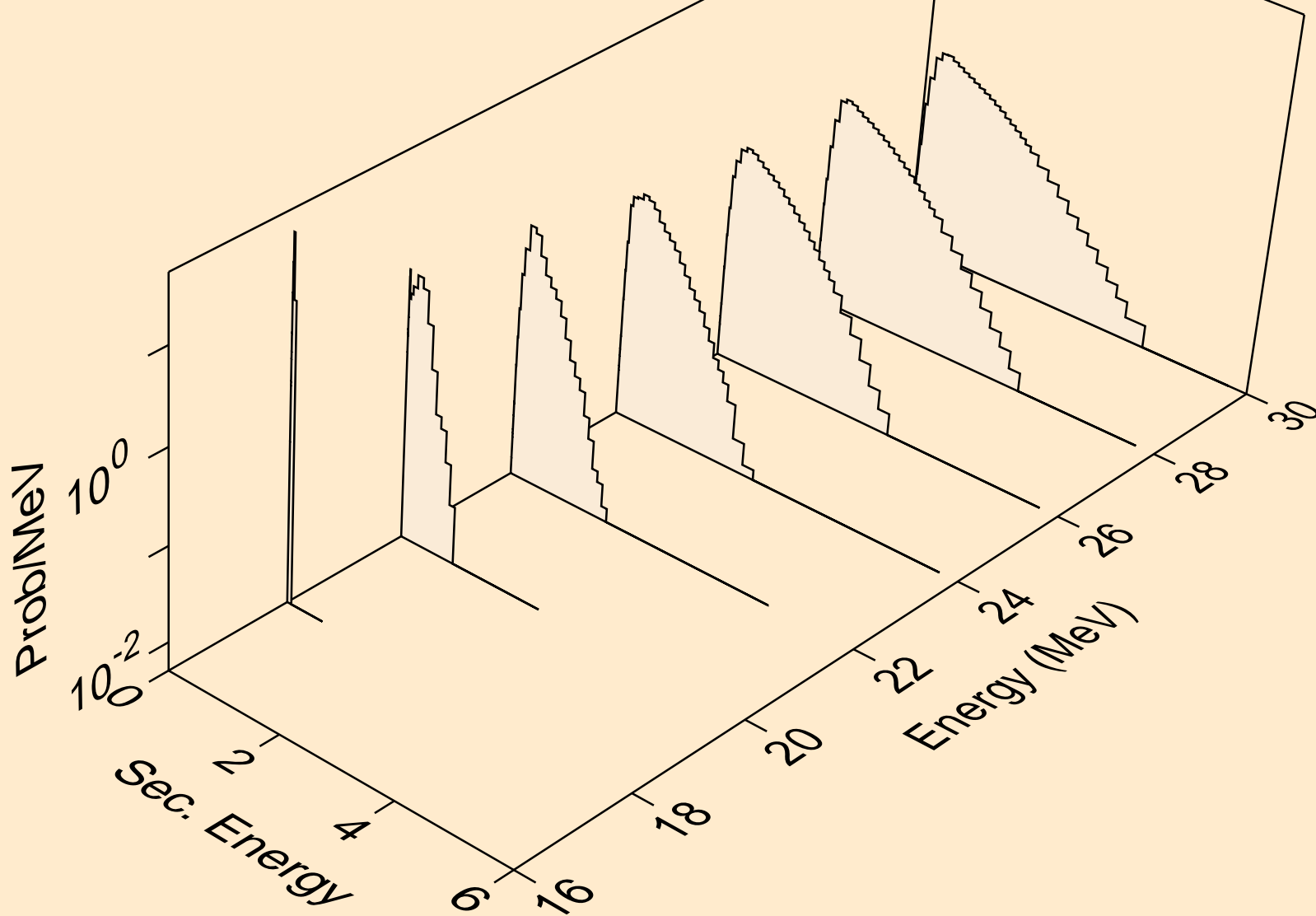

TE112 NEUTRON ACER TENDL-2019 LIBRARY; T=293.16K
Neutron emission for (n,n*)he3

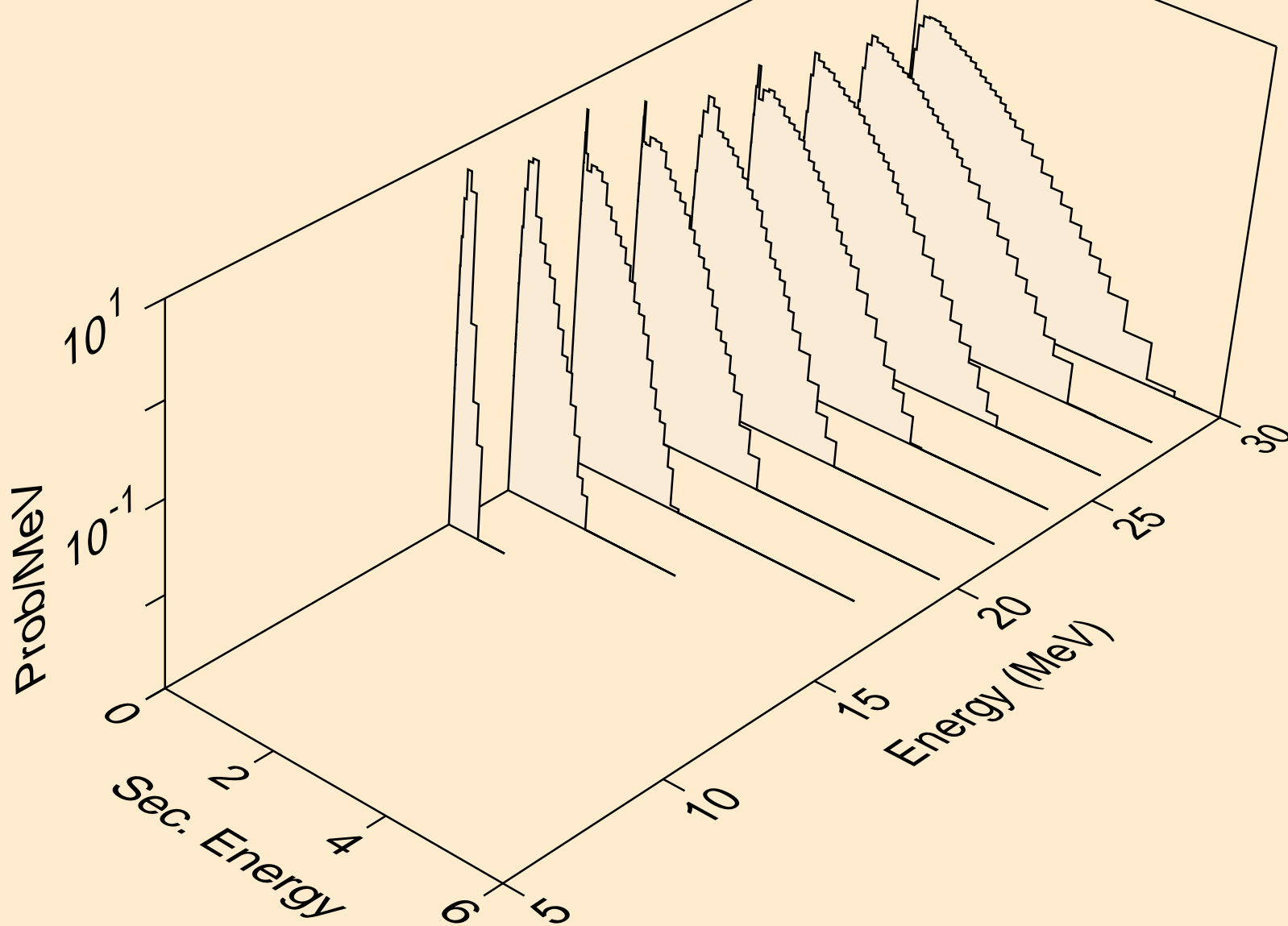

TE112 NEUTRON ACER TENDL-2019 LIBRARY; T=293.16K
Neutron emission for (n,2np)

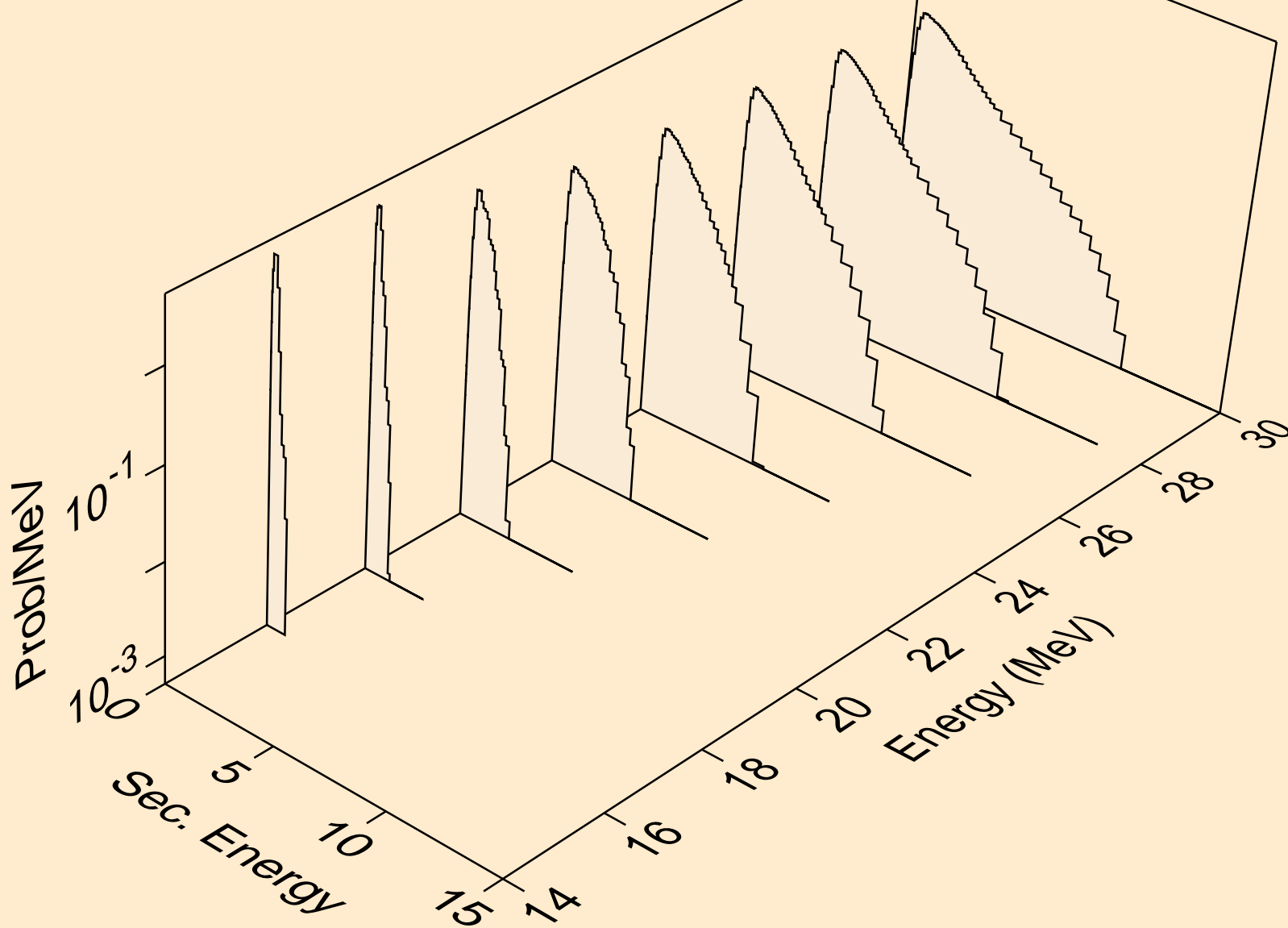

TE112 NEUTRON ACER TENDL-2019 LIBRARY; T=293.16K
Neutron emission for (n,3np)

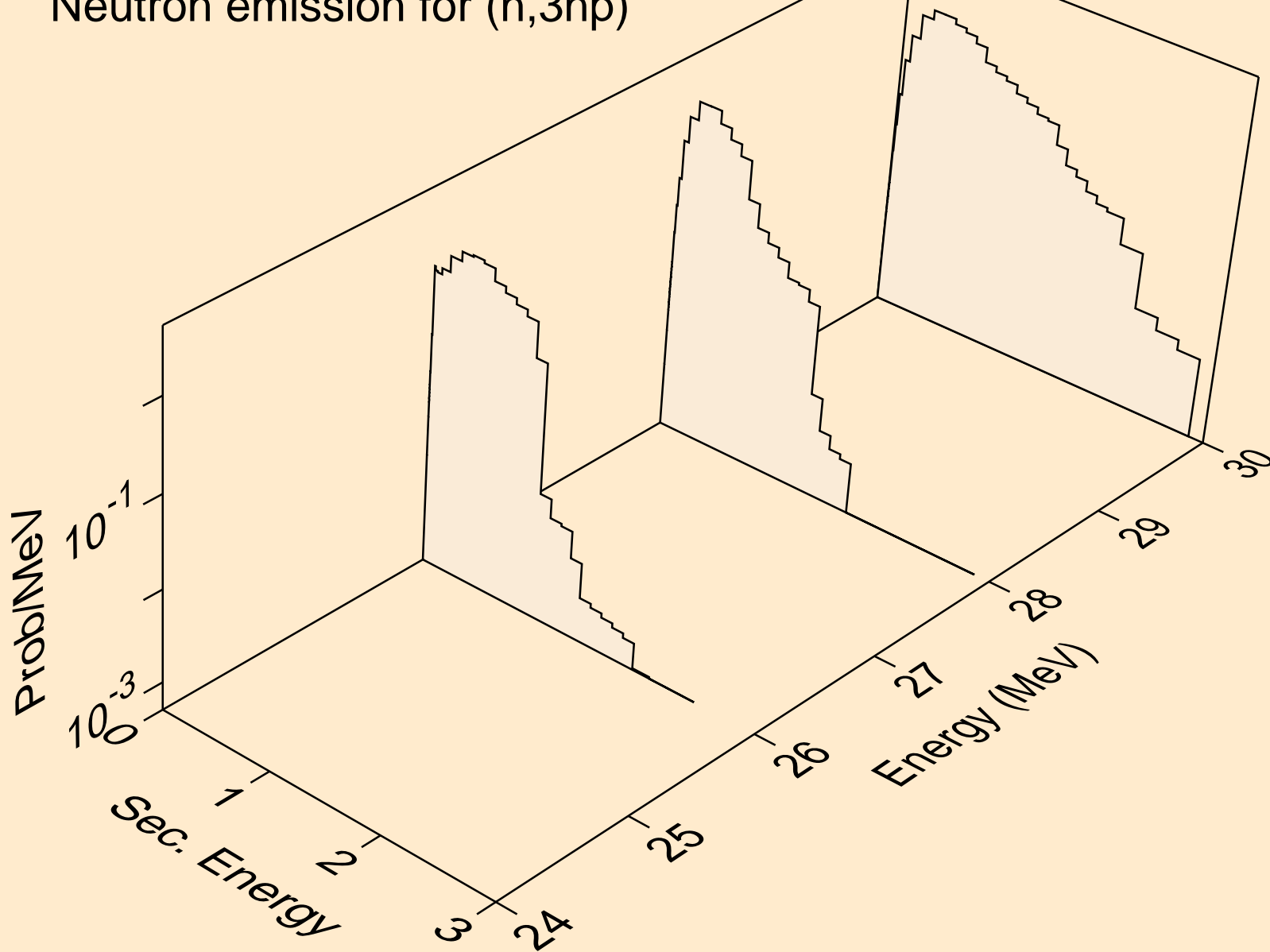

TE112 NEUTRON ACER TENDL-2019 LIBRARY; T=293.16K
Neutron emission for (n,2np)

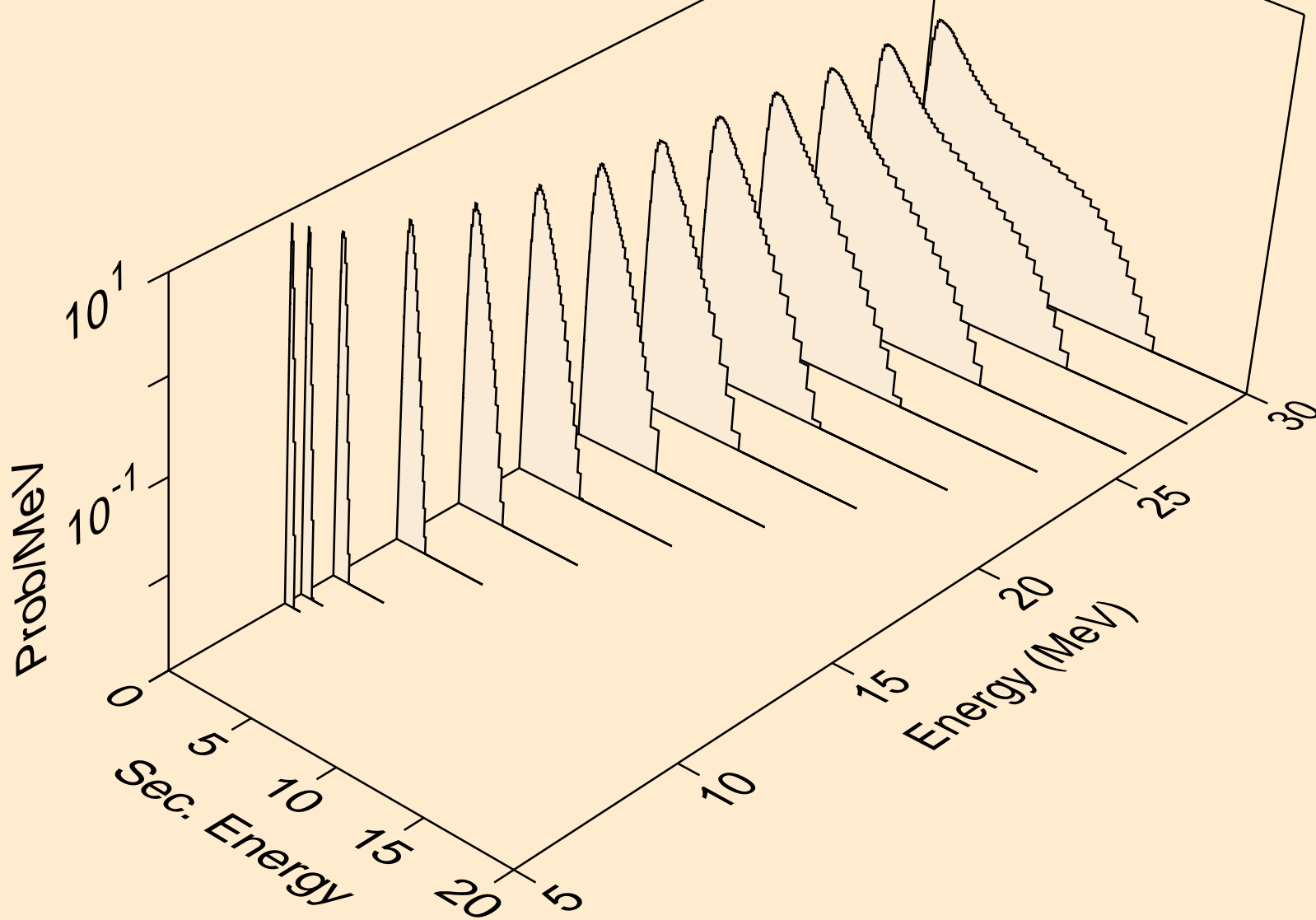

TE112 NEUTRON ACER TENDL-2019 LIBRARY; T=293.16K
Neutron emission for (n,npa)

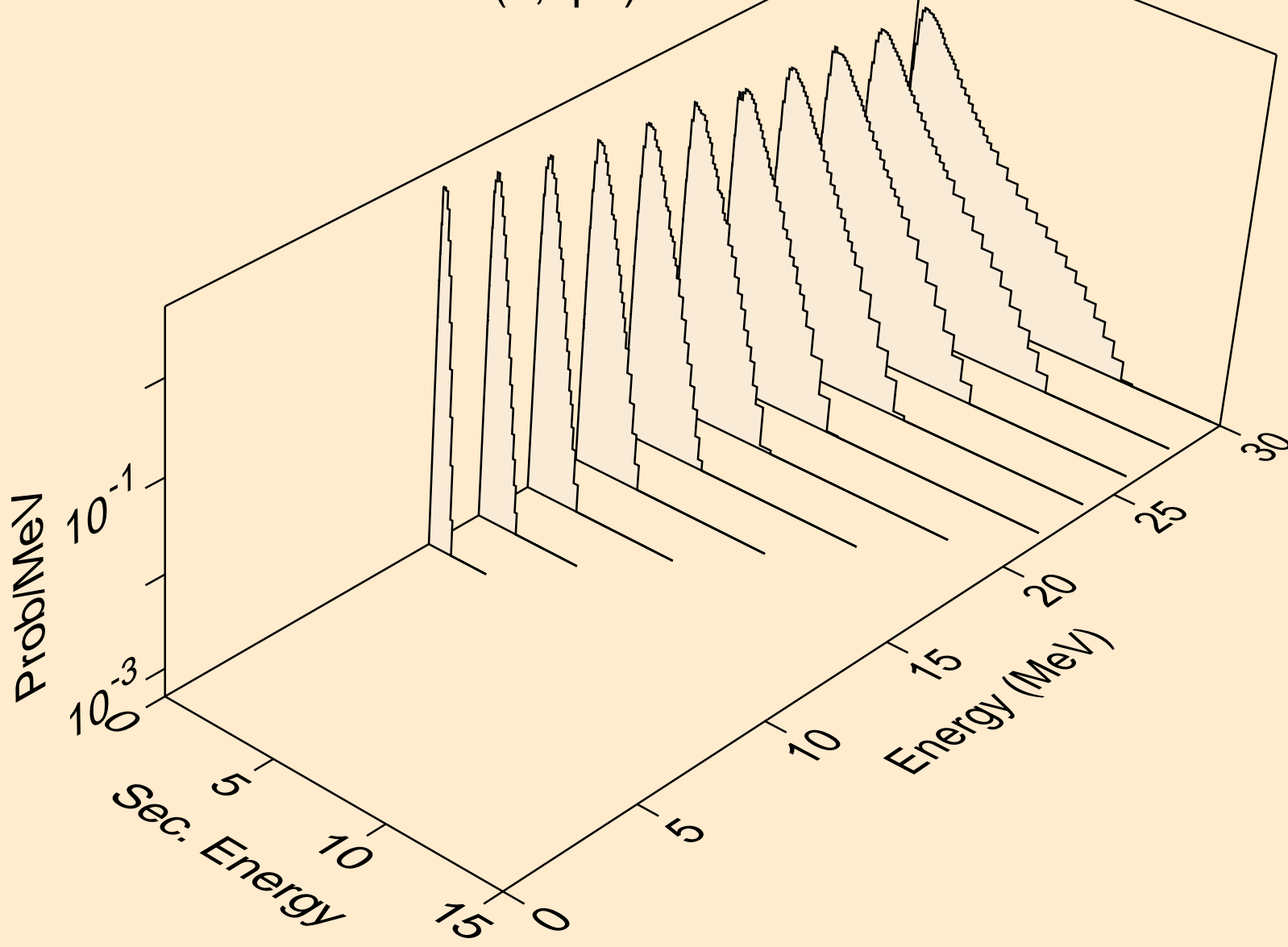

TE112 NEUTRON ACER TENDL-2019 LIBRARY; T=293.16K
Neutron emission for (n,n*c)

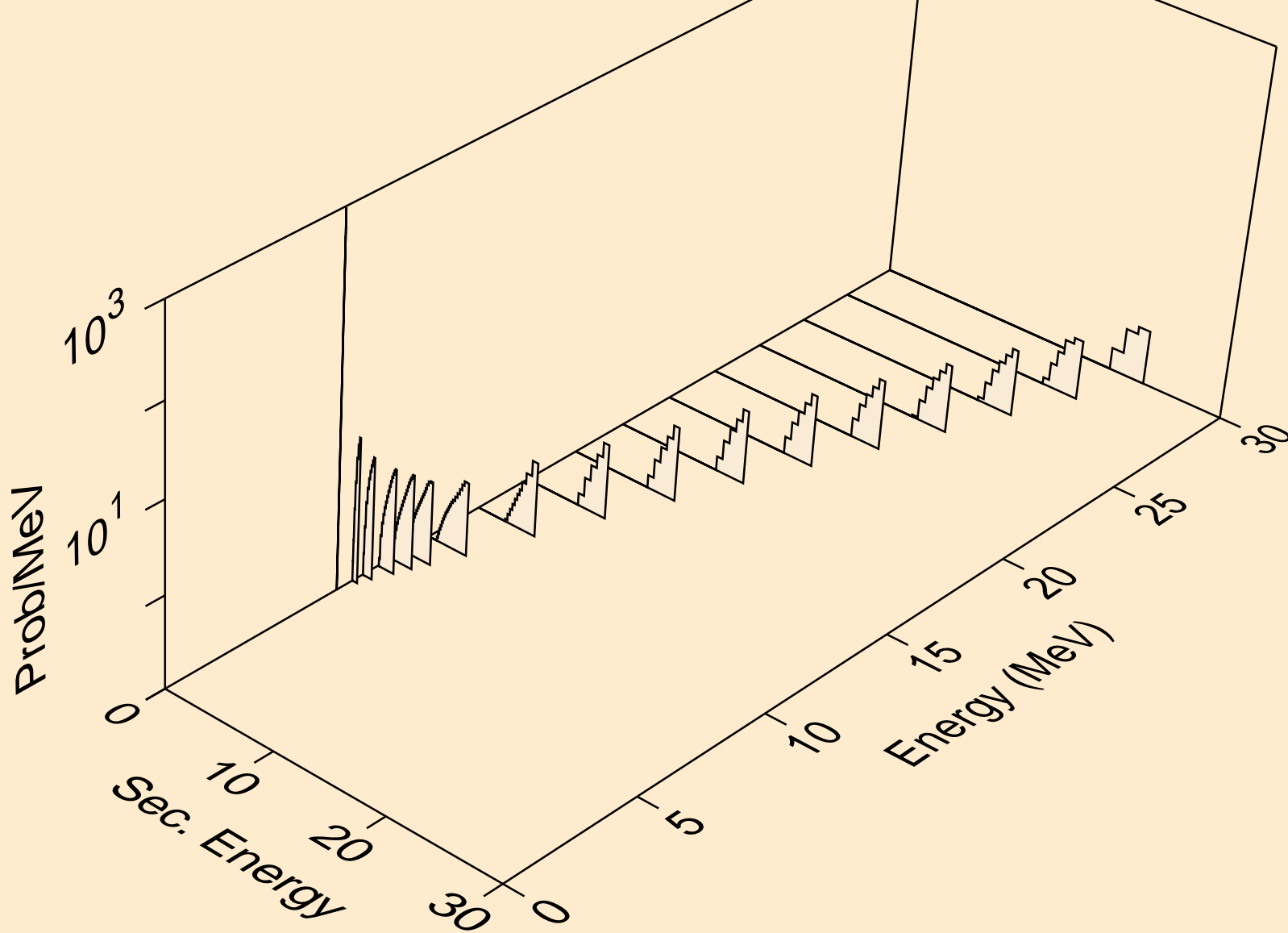

TE112 NEUTRON ACER TENDL-2019 LIBRARY; T=293.16K
Photon emission for (n,x)

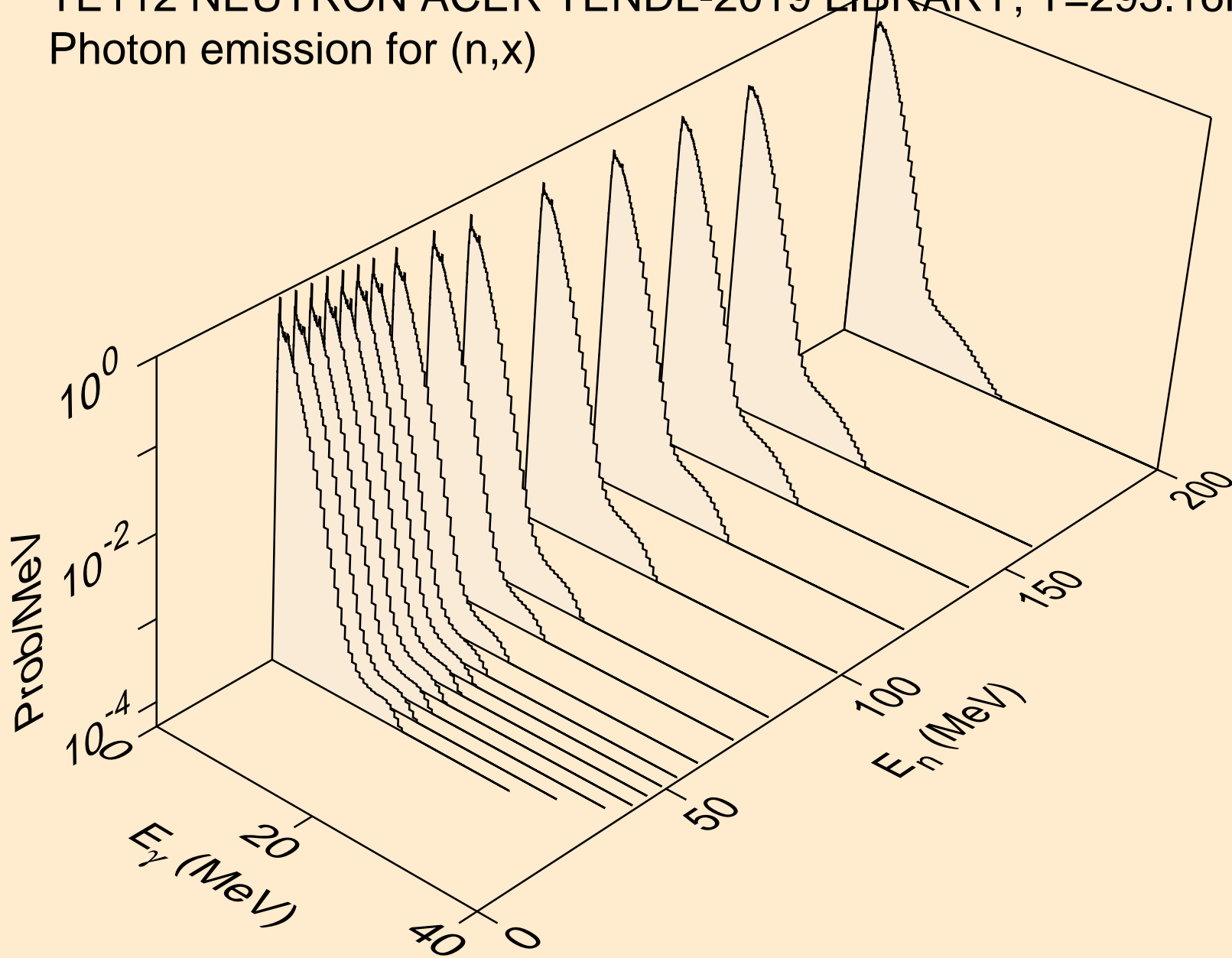

TE112 NEUTRON ACER TENDL-2019 LIBRARY; T=293.16K
Photon emission for (n,2nd)

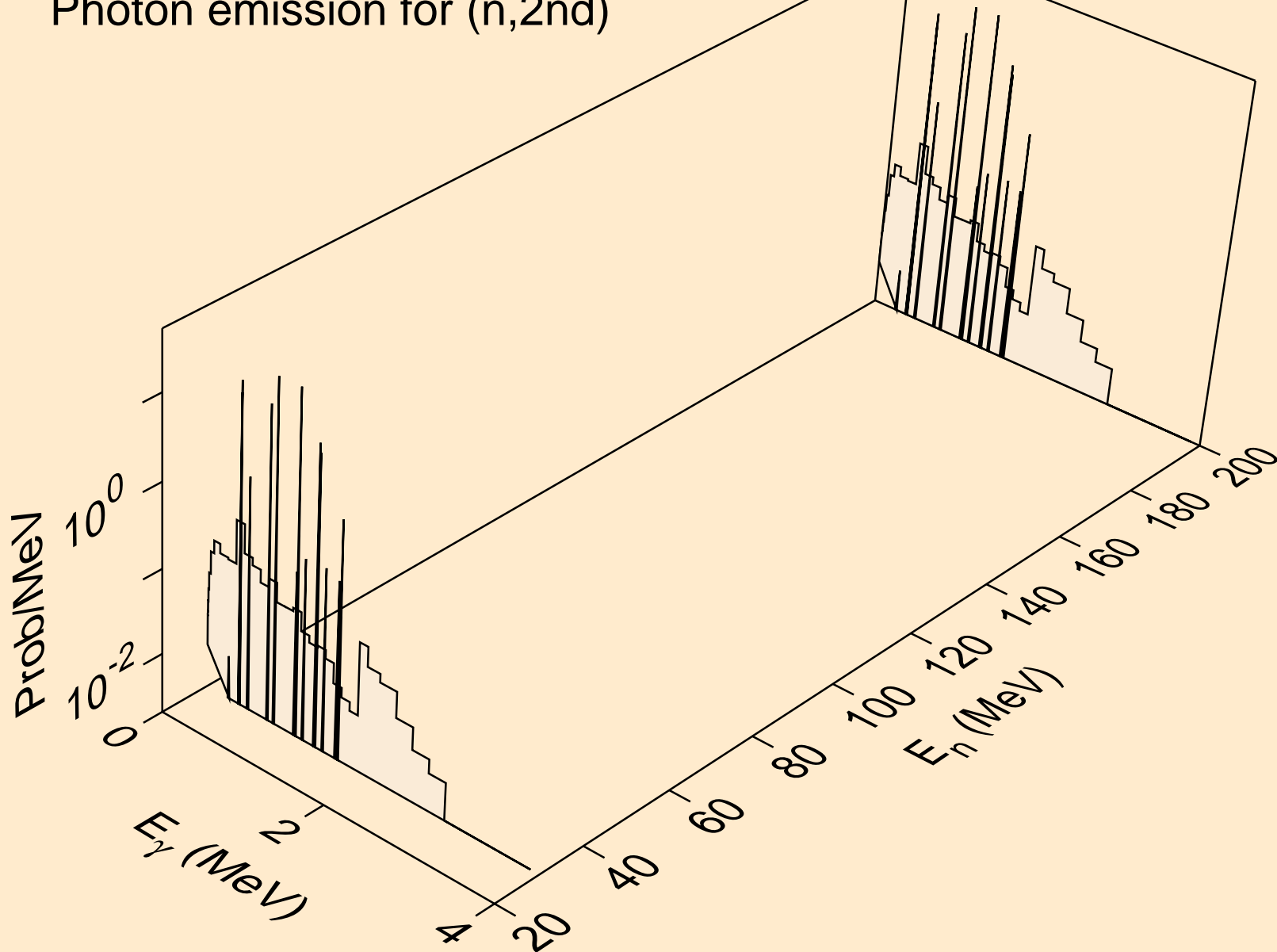

TE112 NEUTRON ACER TENDL-2019 LIBRARY; T=293.16K
Photon emission for (n,2n)

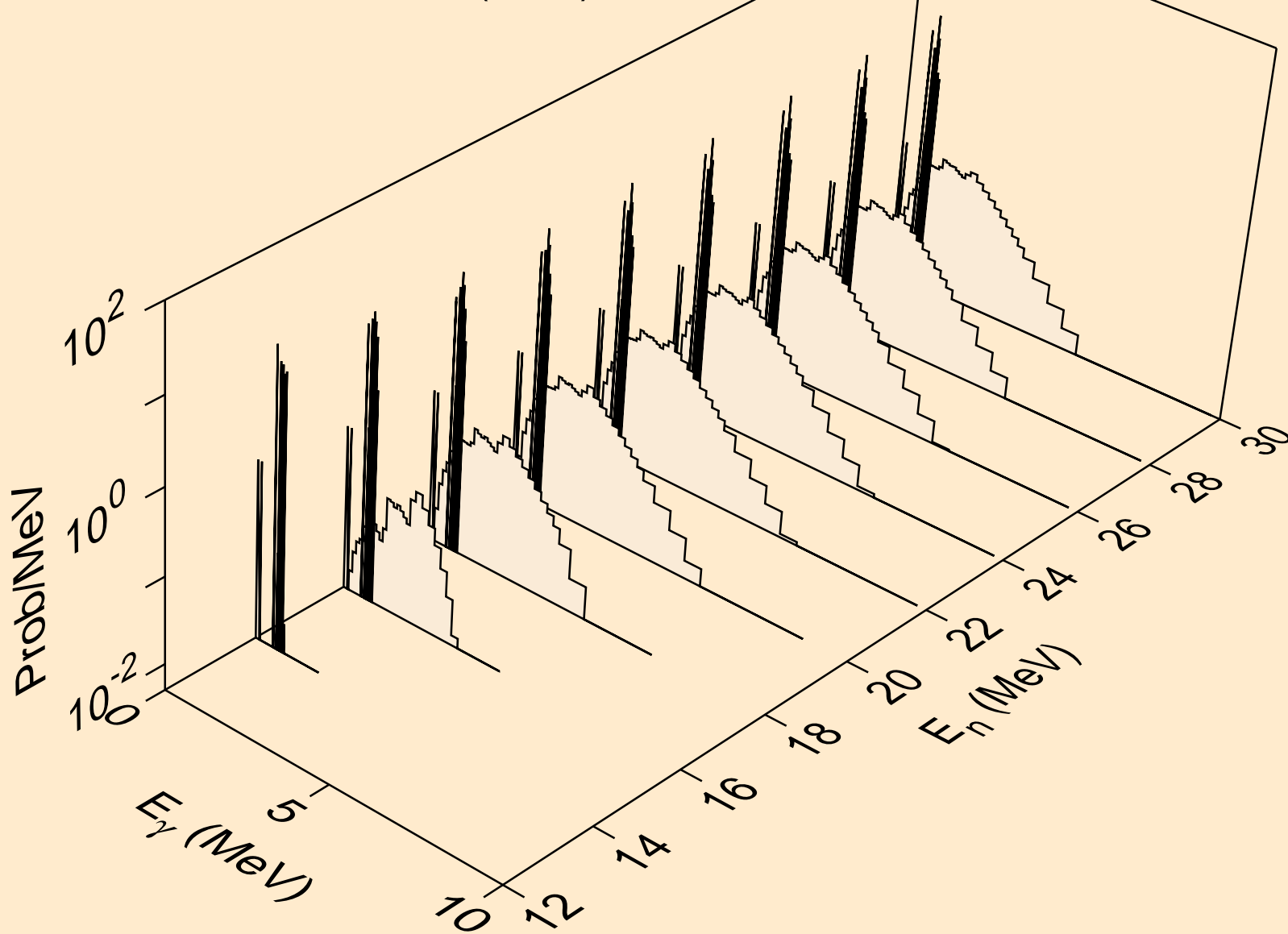

TE112 NEUTRON ACER TENDL-2019 LIBRARY; T=293.16K
Photon emission for (n,3n)

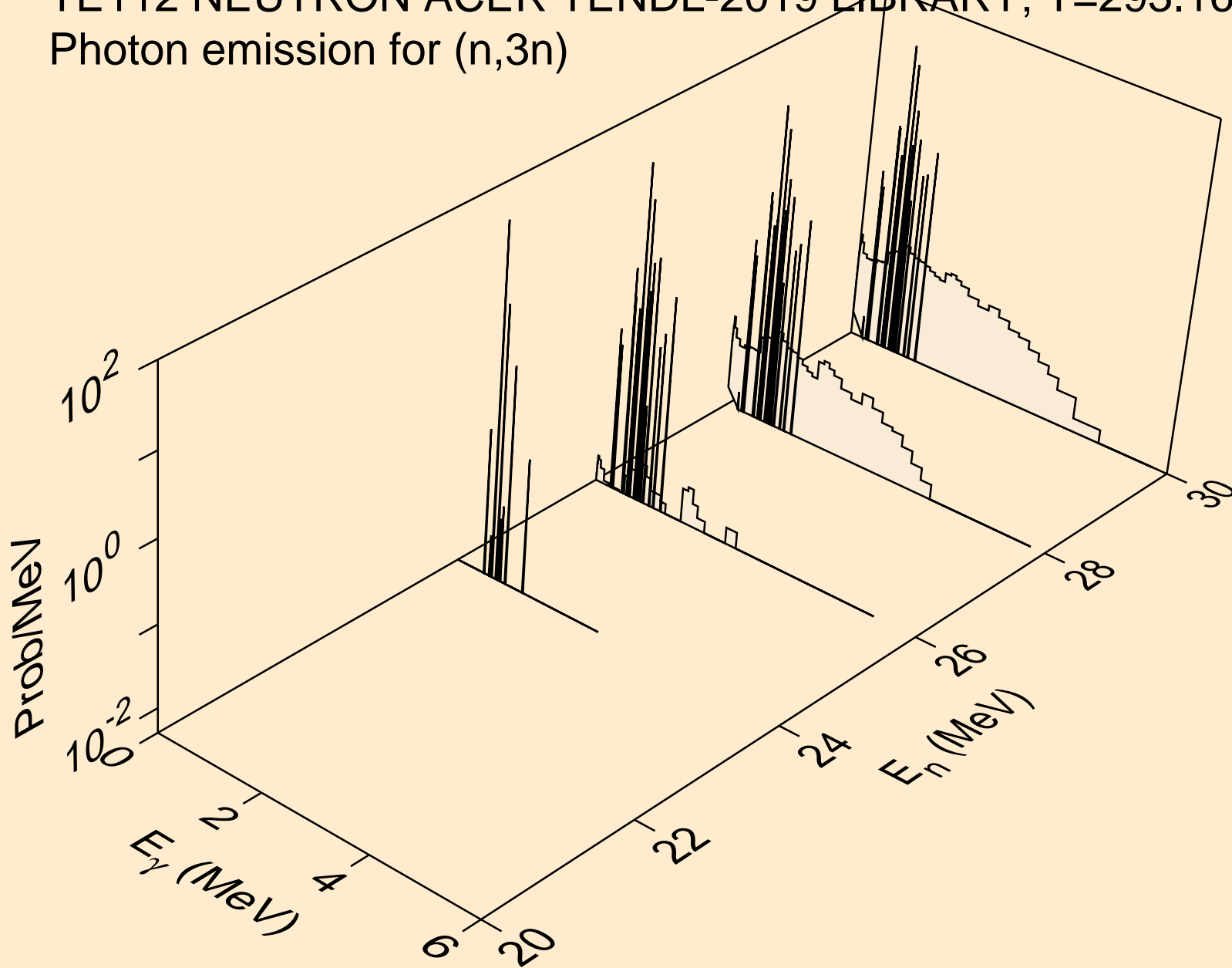

TE112 NEUTRON ACER TENDL-2019 LIBRARY; T=293.16K
Photon emission for (n,n*)a

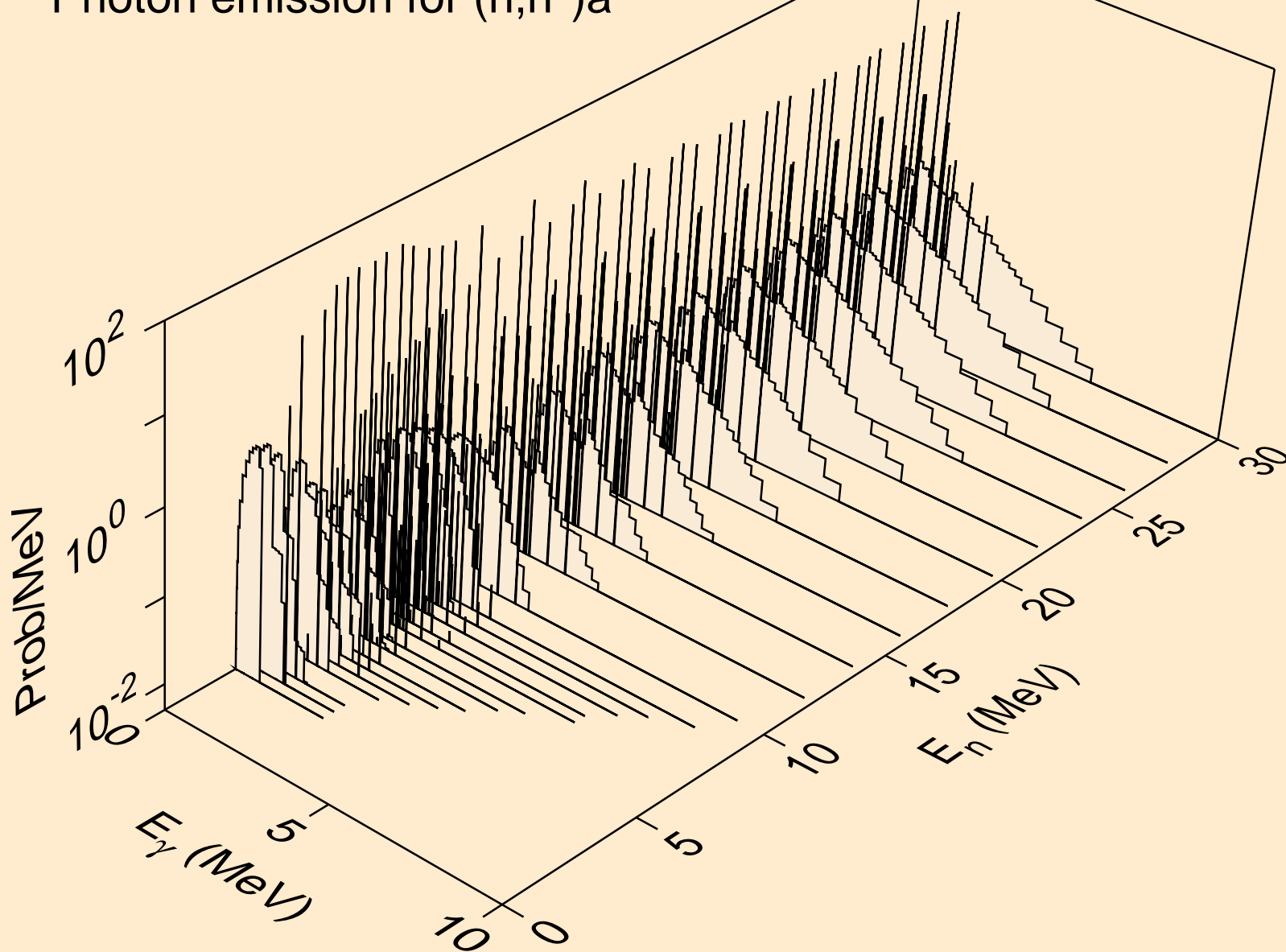

TE112 NEUTRON ACER TENDL-2019 LIBRARY; T=293.16K
Photon emission for (n,2n)a

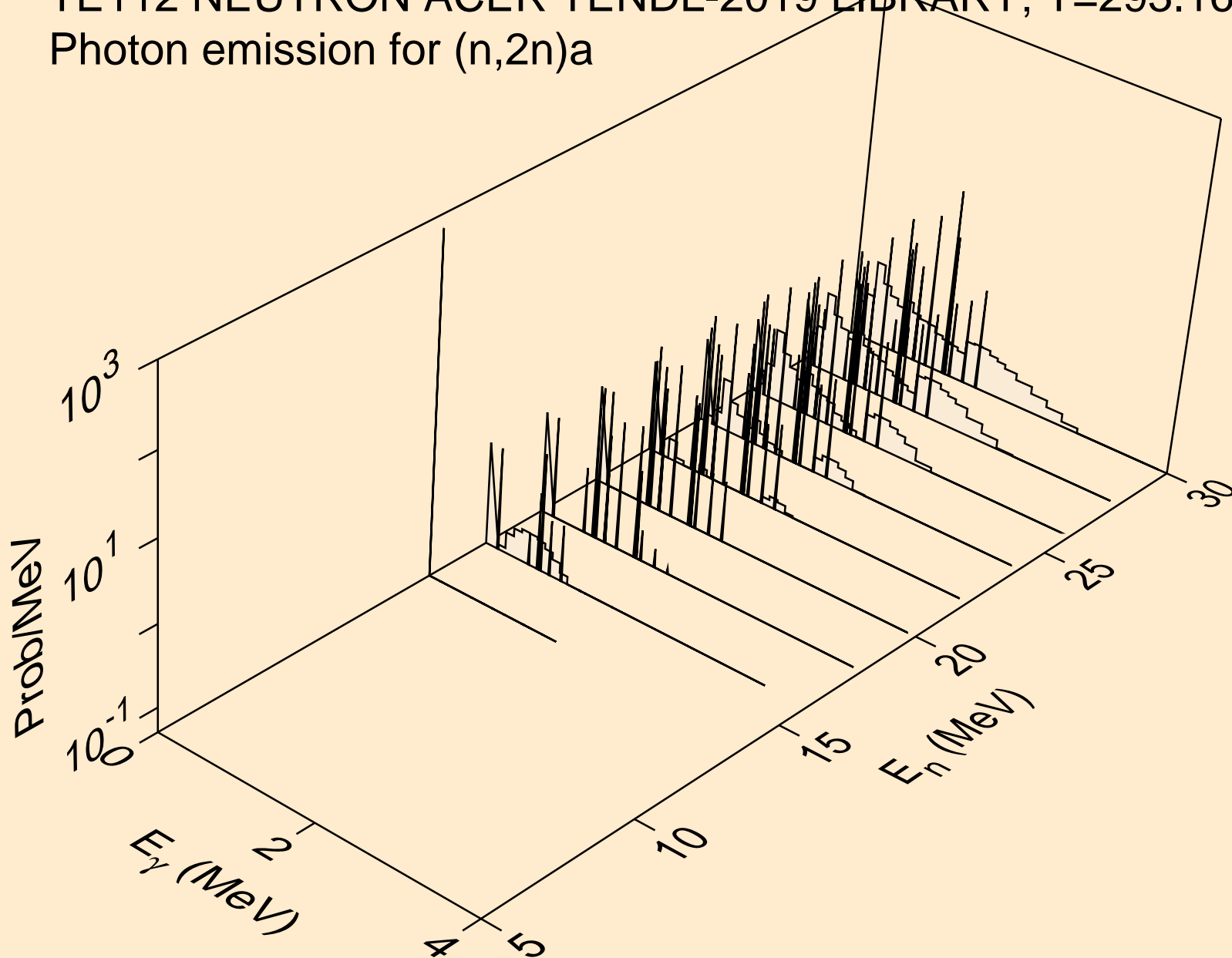

TE112 NEUTRON ACER TENDL-2019 LIBRARY; T=293.16K
Photon emission for (n,3n)a

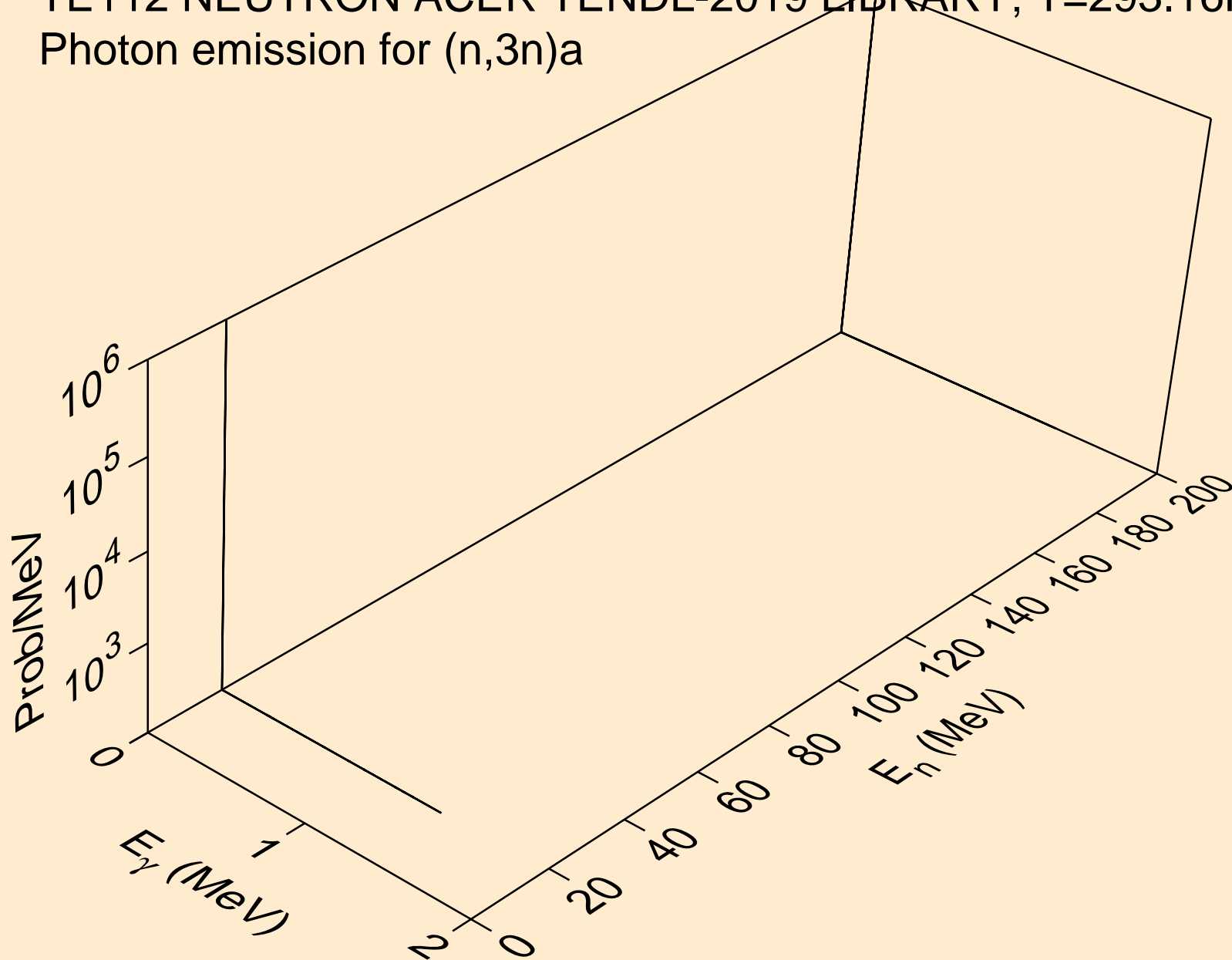

TE112 NEUTRON ACER TENDL-2019 LIBRARY; T=293.16K
Photon emission for (n,n*)p

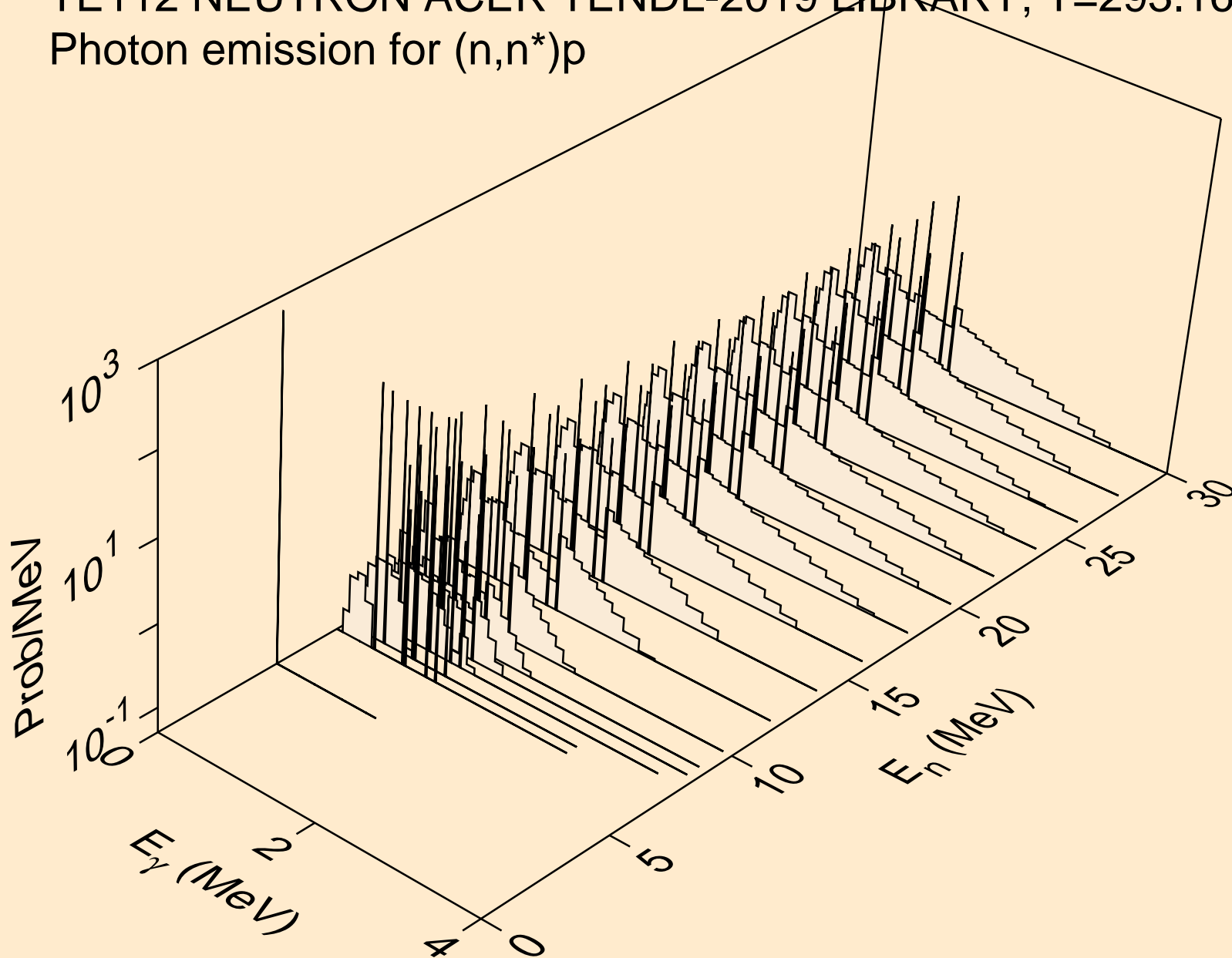

TE112 NEUTRON ACER TENDL-2019 LIBRARY; T=293.16K
Photon emission for (n,n*)2a

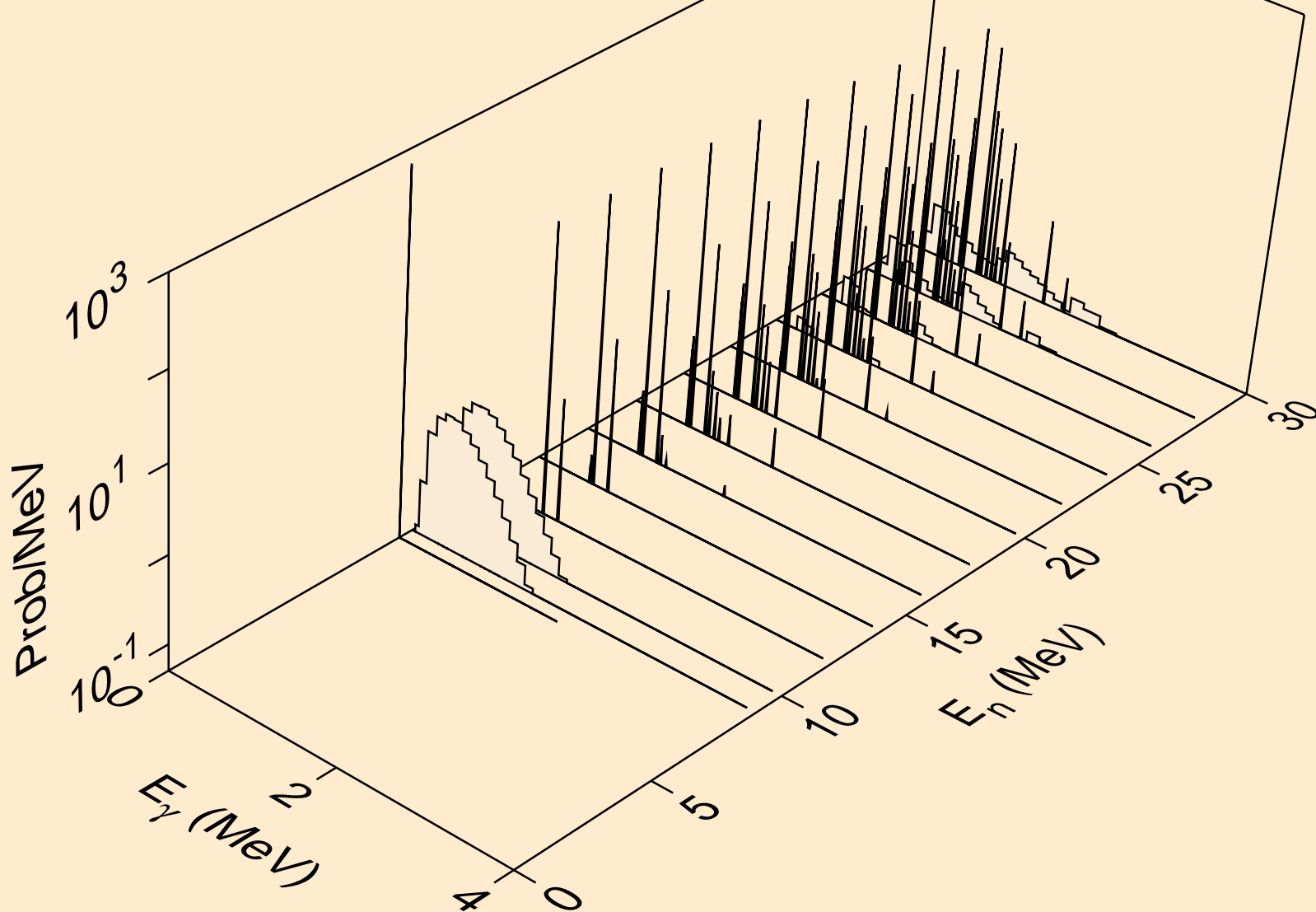

TE112 NEUTRON ACER TENDL-2019 LIBRARY; T=293.16K
Photon emission for (n,2n)2a

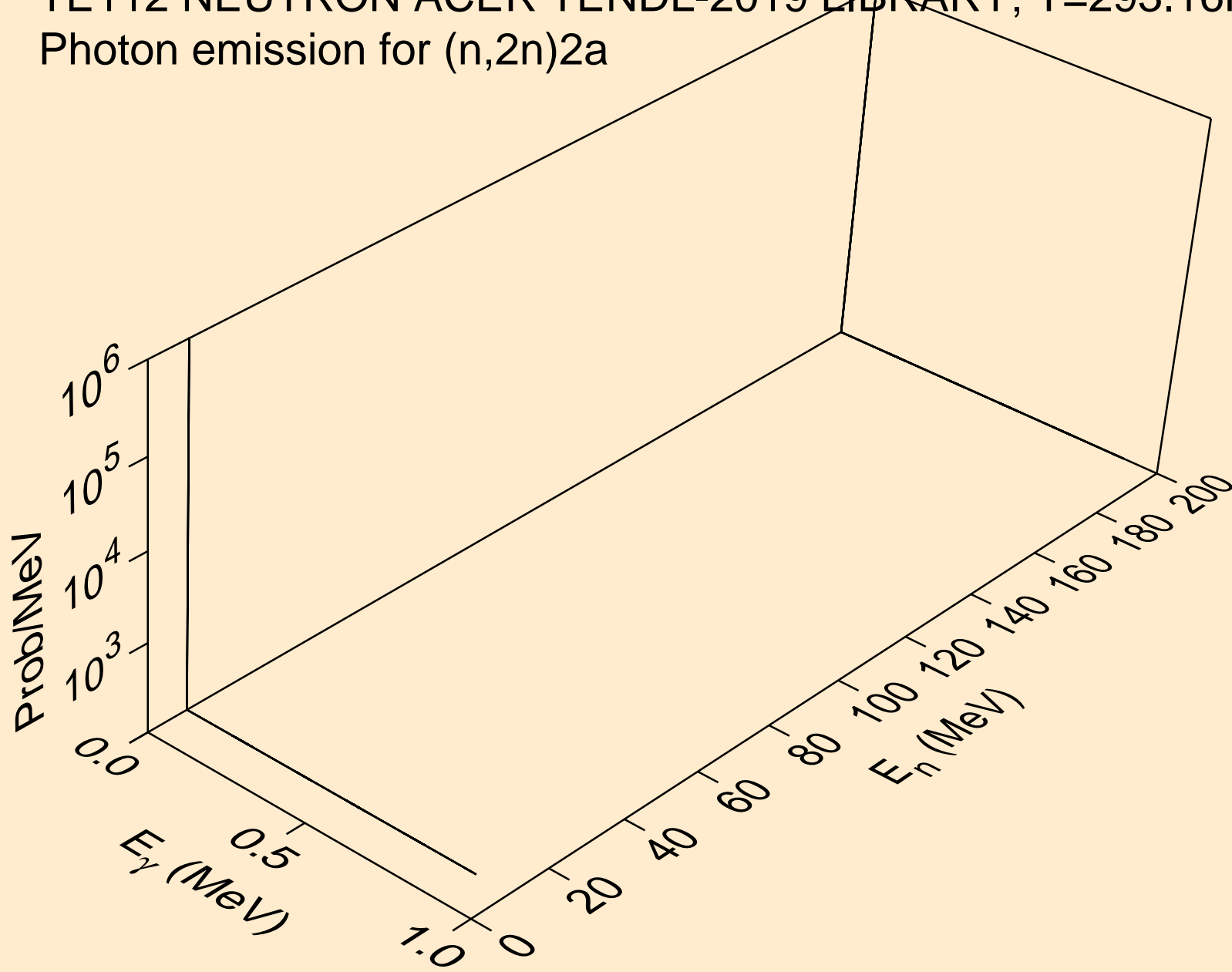

TE112 NEUTRON ACER TENDL-2019 LIBRARY; T=293.16K
Photon emission for (n,n*)d

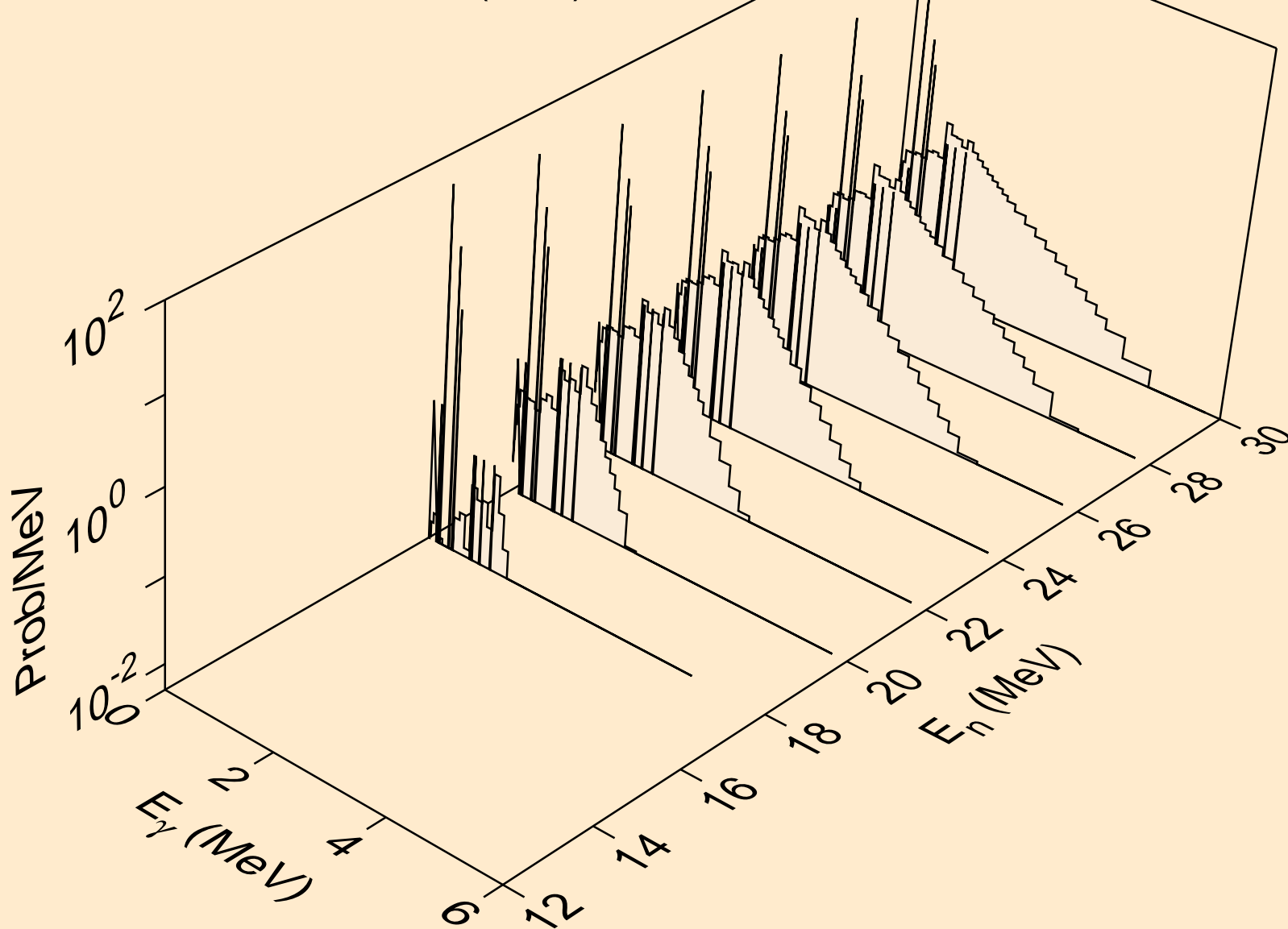

TE112 NEUTRON ACER TENDL-2019 LIBRARY; T=293.16K
Photon emission for (n,n*)t

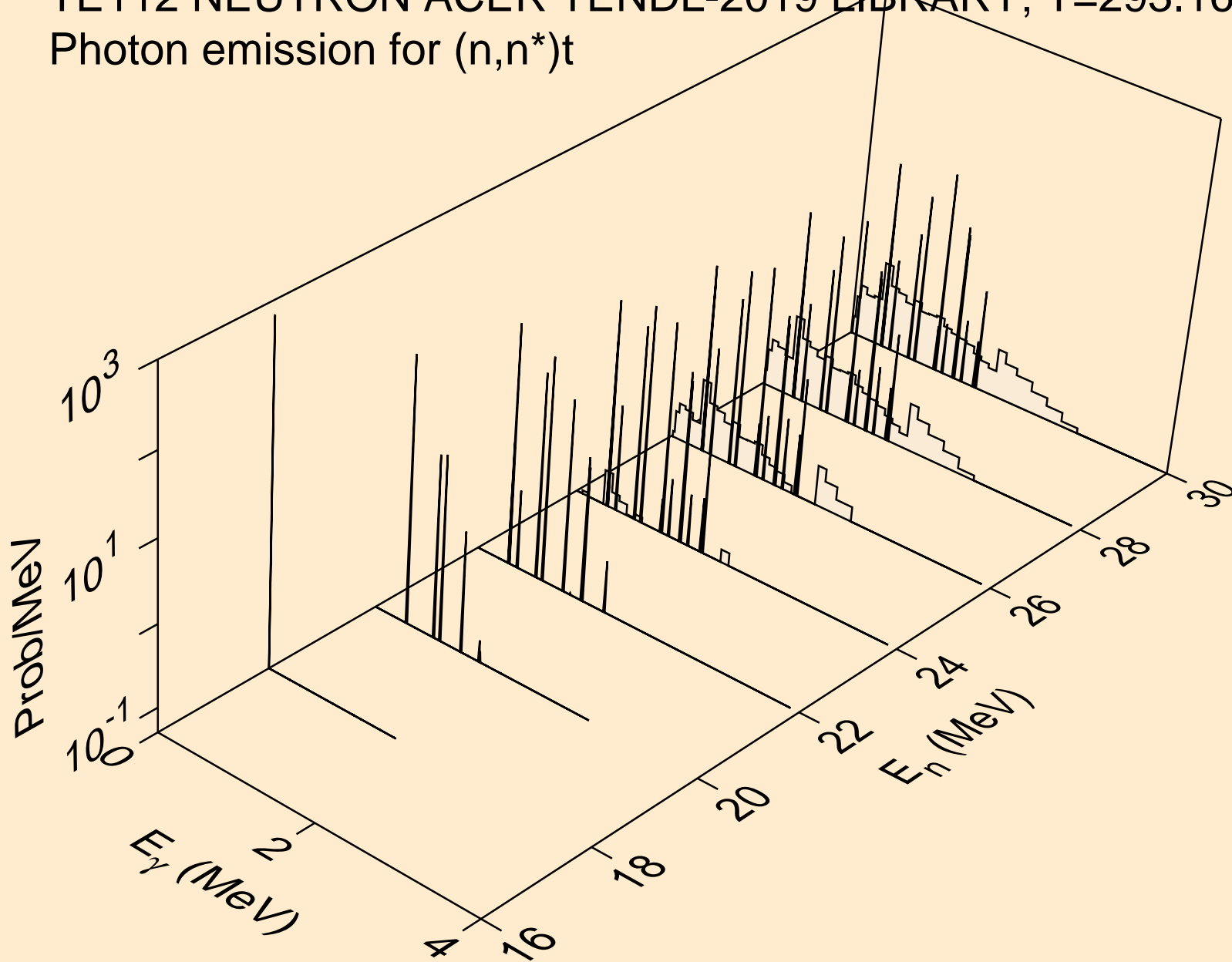

TE112 NEUTRON ACER TENDL-2019 LIBRARY; T=293.16K
Photon emission for (n,n*)he3

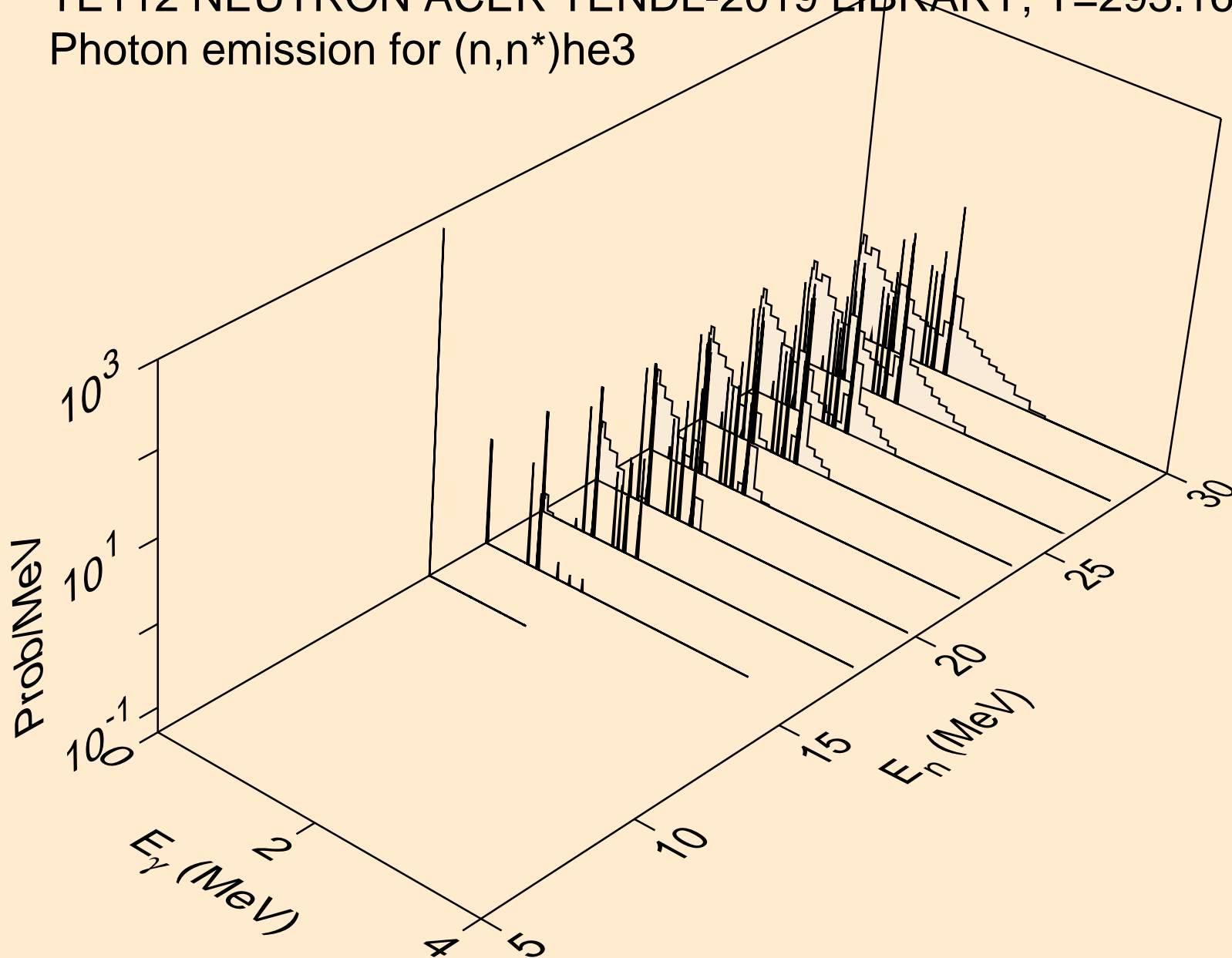

TE112 NEUTRON ACER TENDL-2019 LIBRARY; T=293.16K
Photon emission for (n,2np)

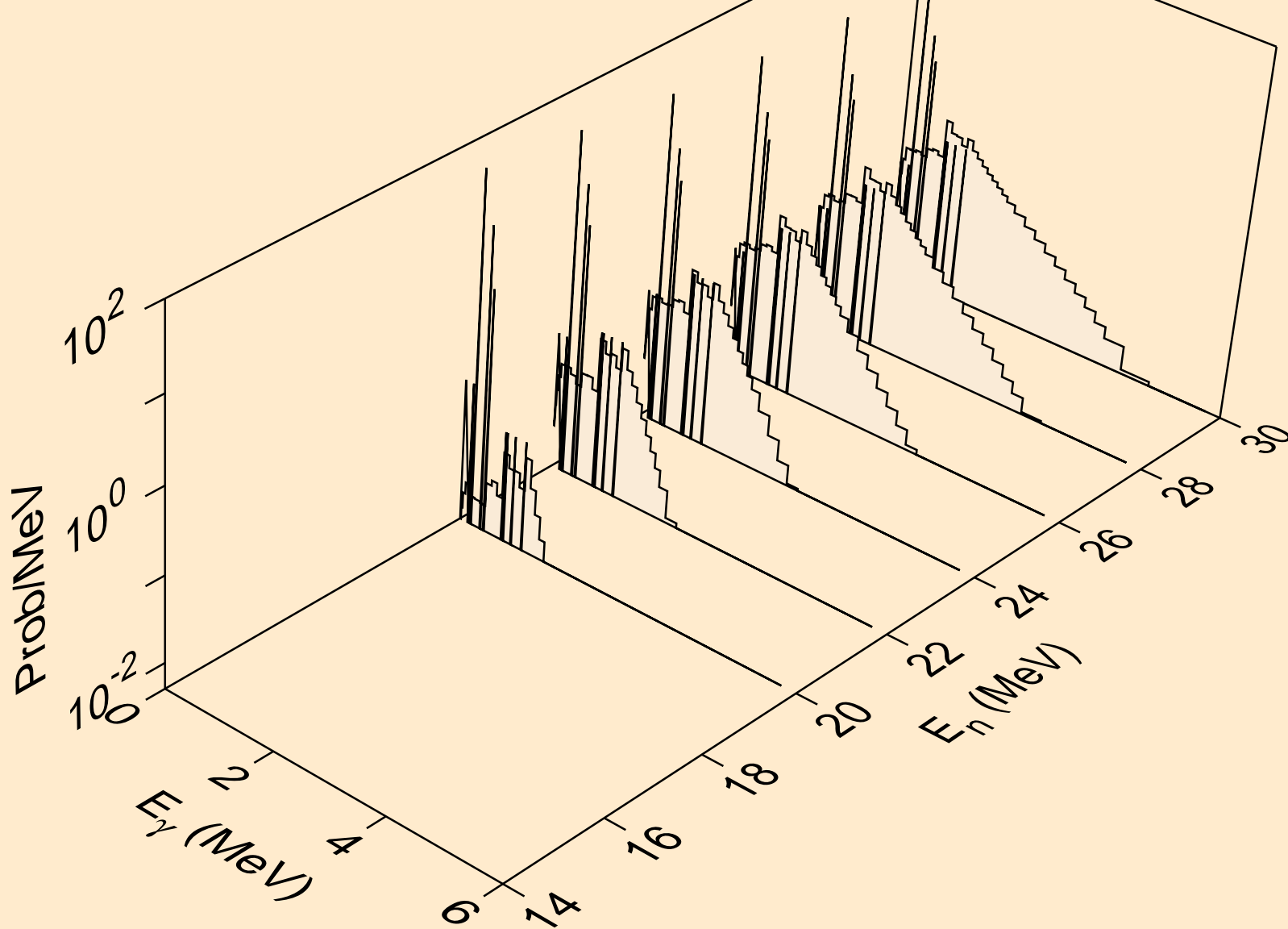

TE112 NEUTRON ACER TENDL-2019 LIBRARY; T=293.16K
Photon emission for (n,3np)

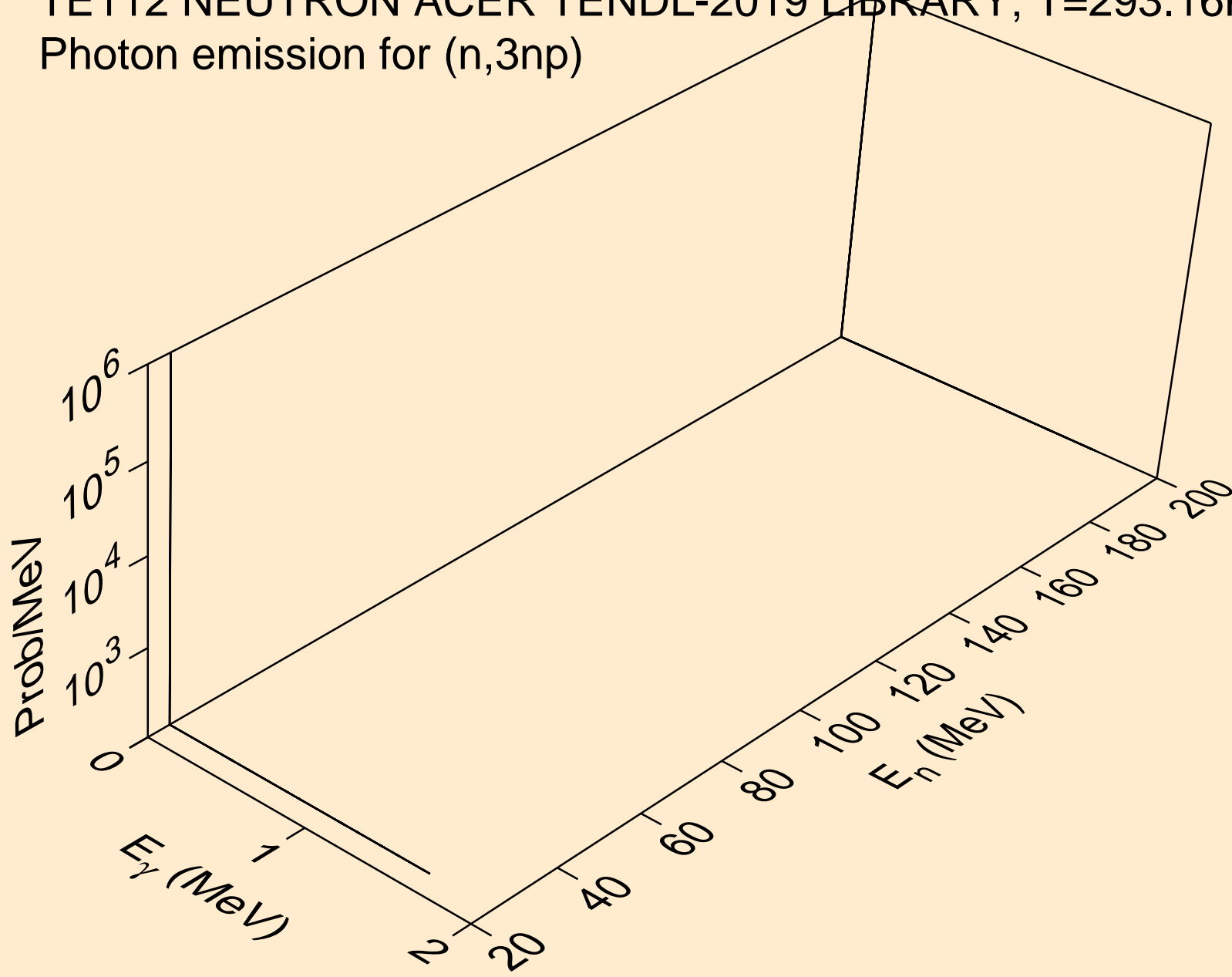

TE112 NEUTRON ACER TENDL-2019 LIBRARY; T=293.16K
Photon emission for (n,2np)

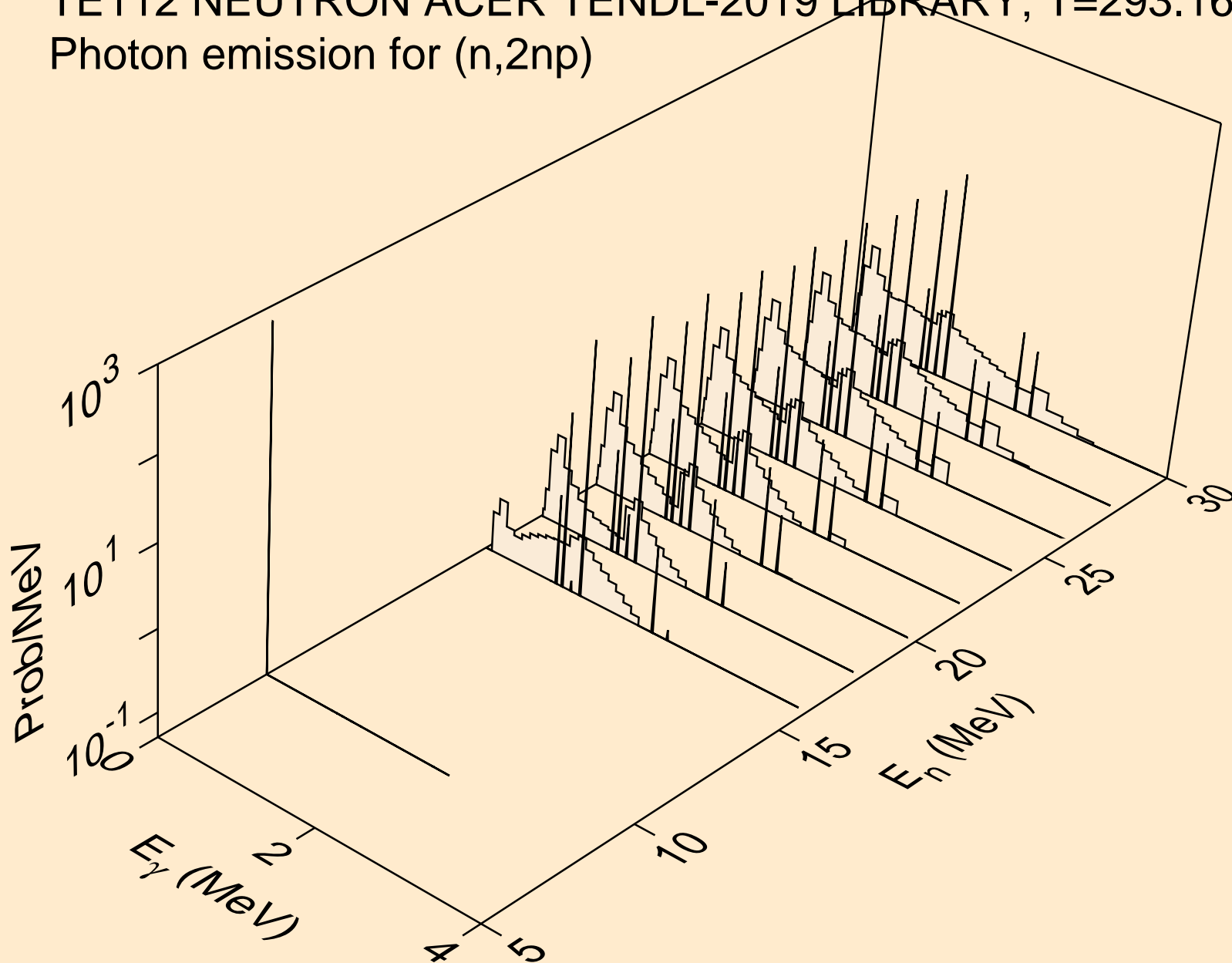

TE112 NEUTRON ACER TENDL-2019 LIBRARY; T=293.16K
Photon emission for (n,npa)

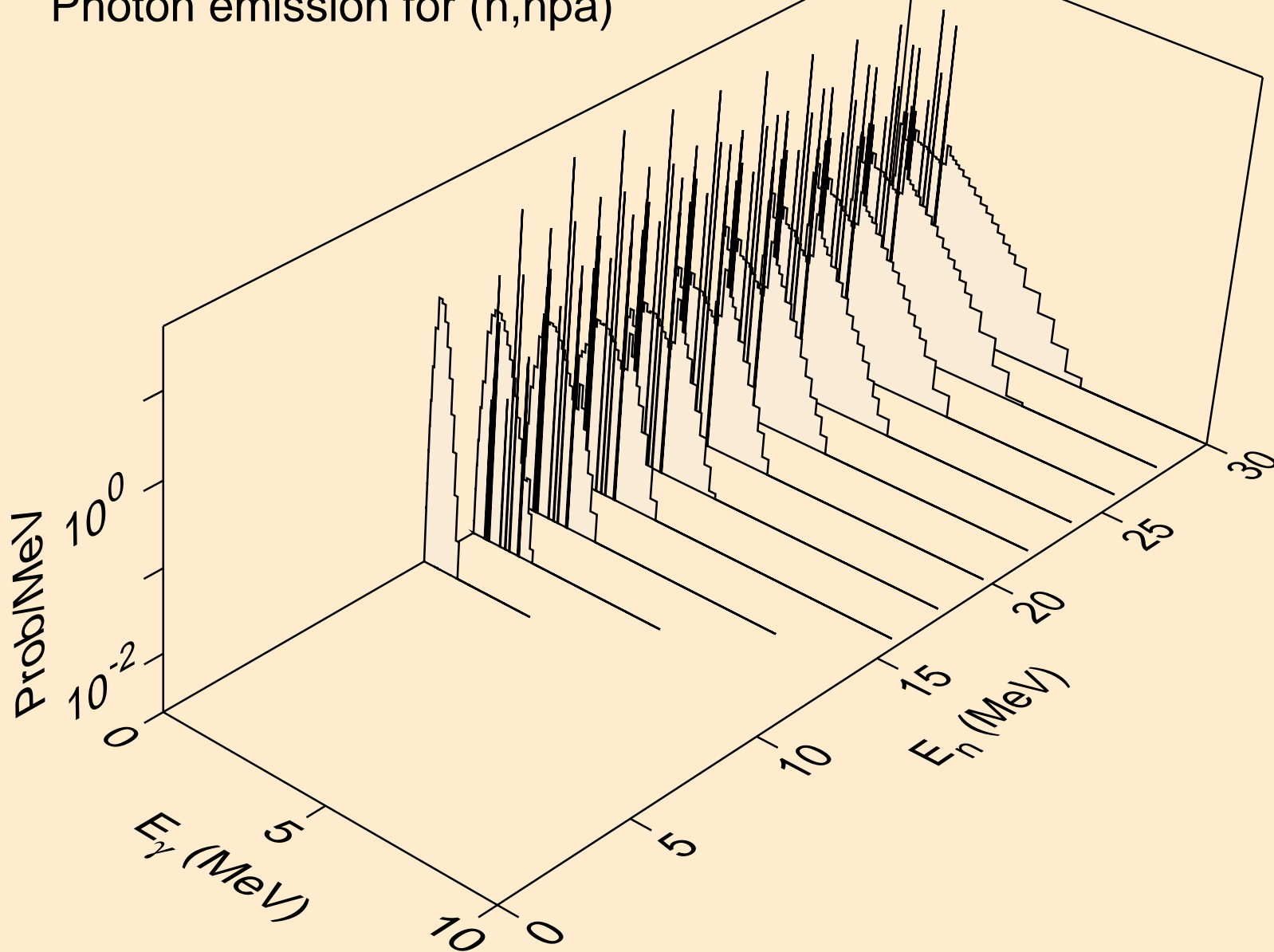

TE112 NEUTRON ACER TENDL-2019 LIBRARY; T=293.16K
Photon emission for (n,n*c)

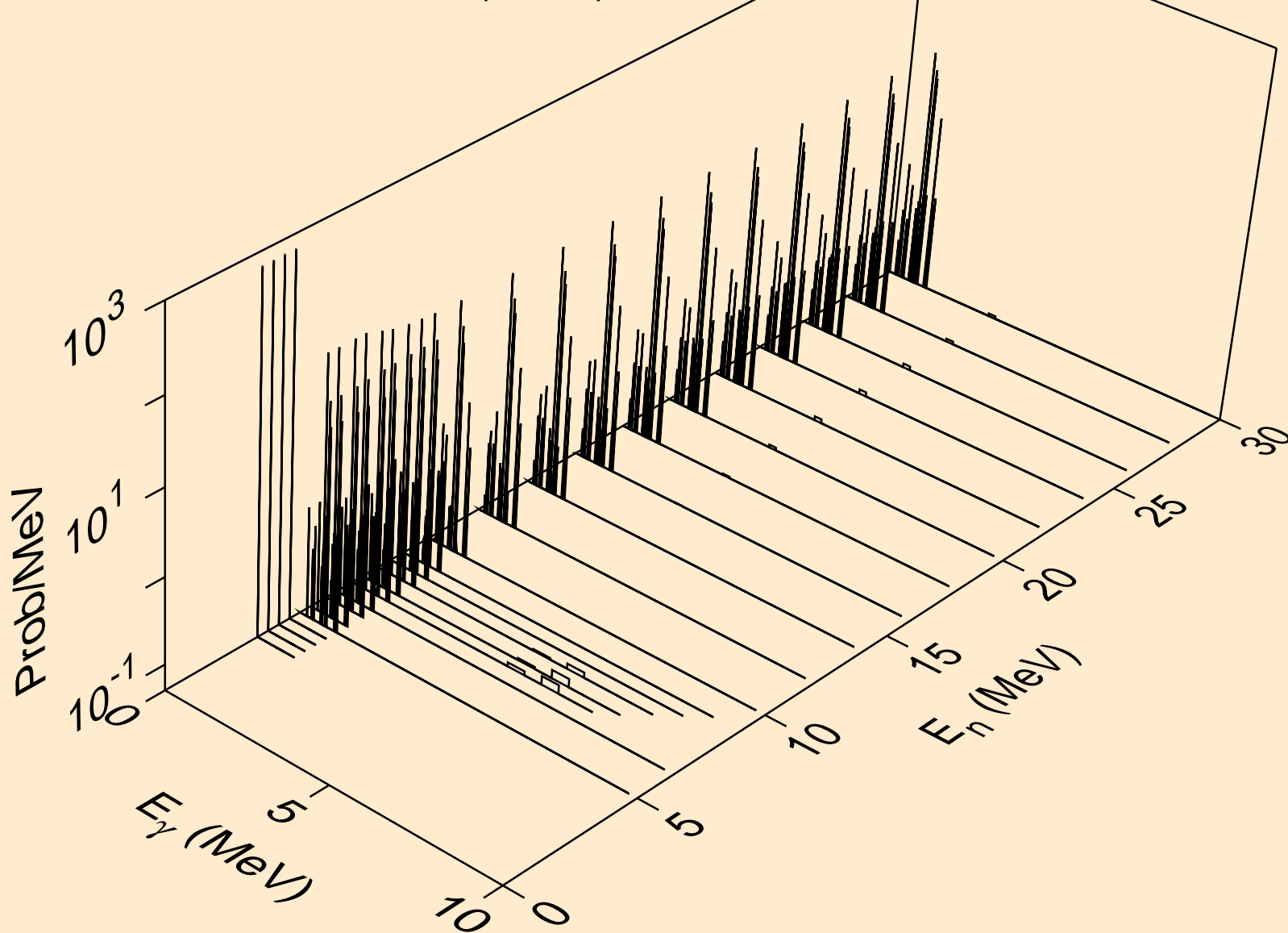

TE112 NEUTRON ACER TENDL-2019 LIBRARY; T=293.16K
Photon emission for (n,gma)

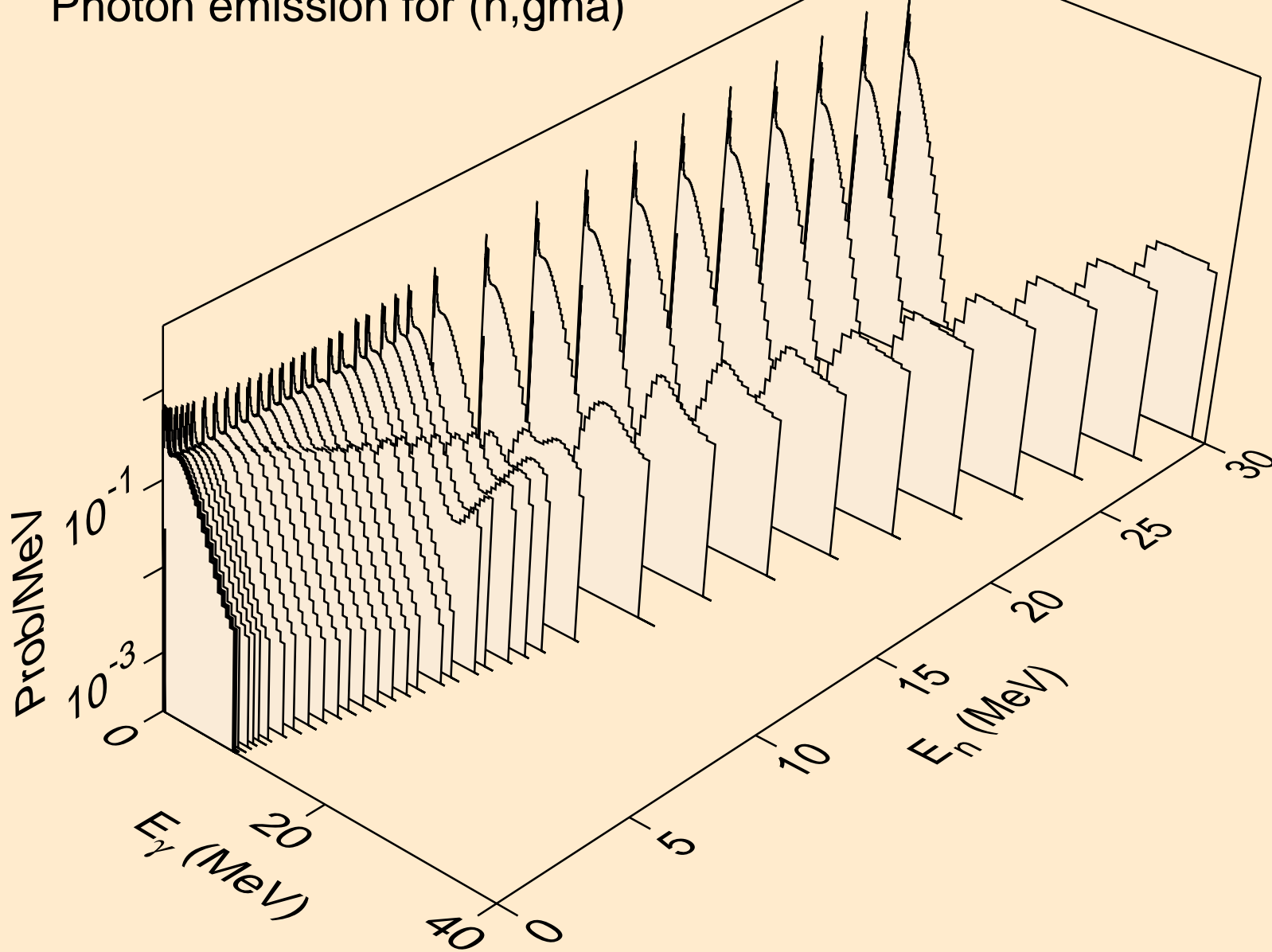

TE112 NEUTRON ACER TENDL-2019 LIBRARY; T=293.16K
Photon emission for (n,p)

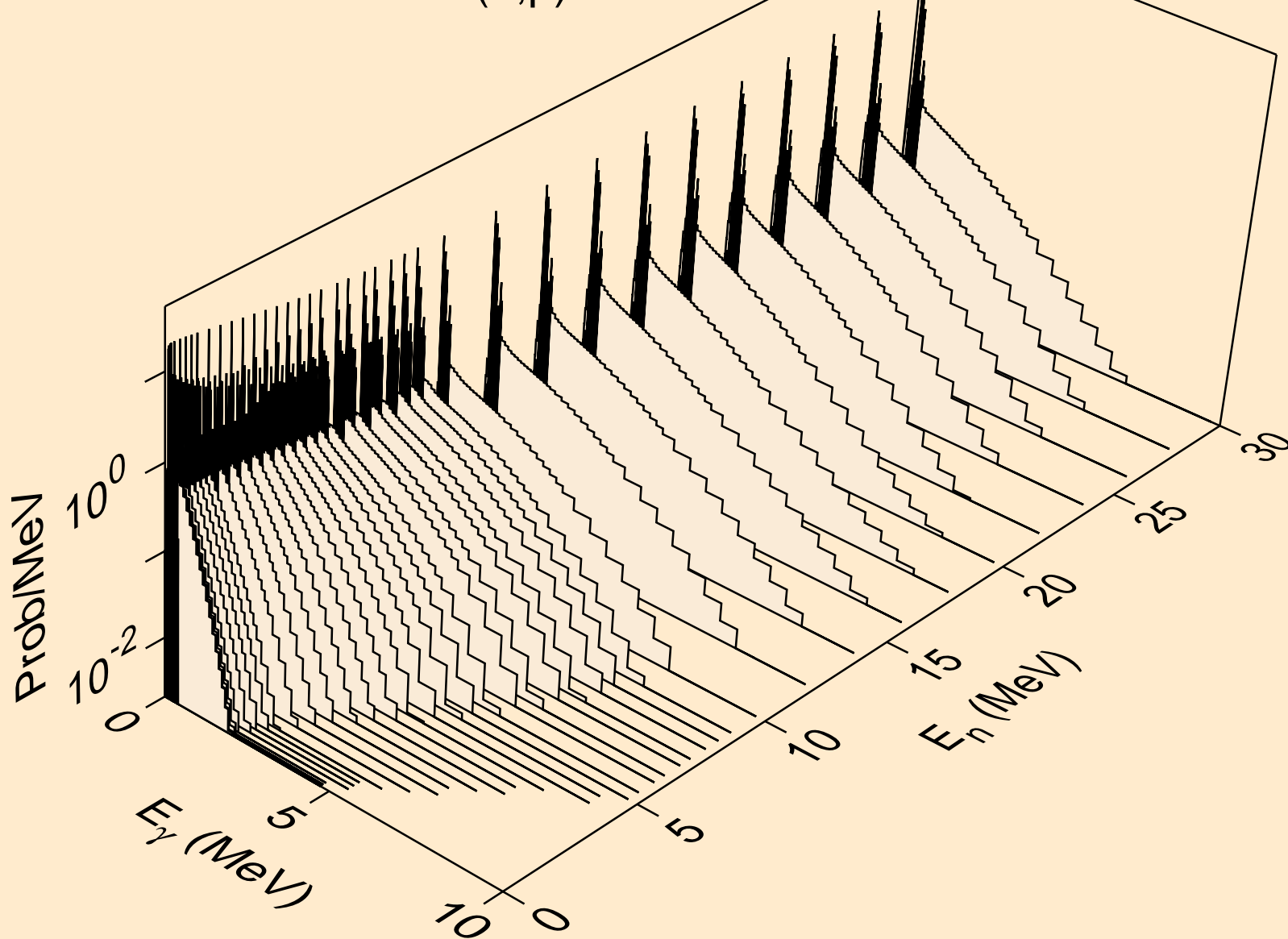

TE112 NEUTRON ACER TENDL-2019 LIBRARY; T=293.16K
Photon emission for (n,d)

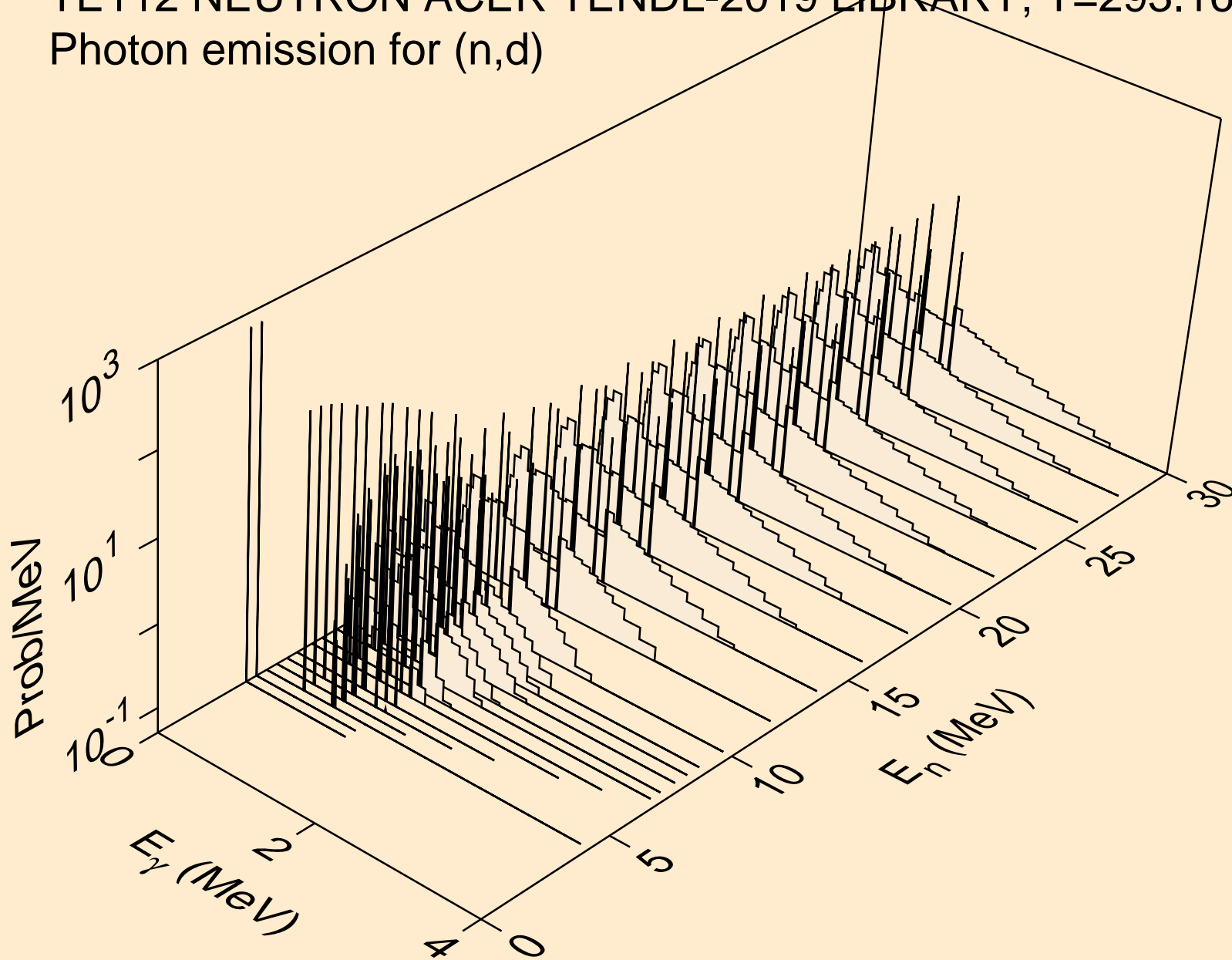

TE112 NEUTRON ACER TENDL-2019 LIBRARY; T=293.16K
Photon emission for (n,t)

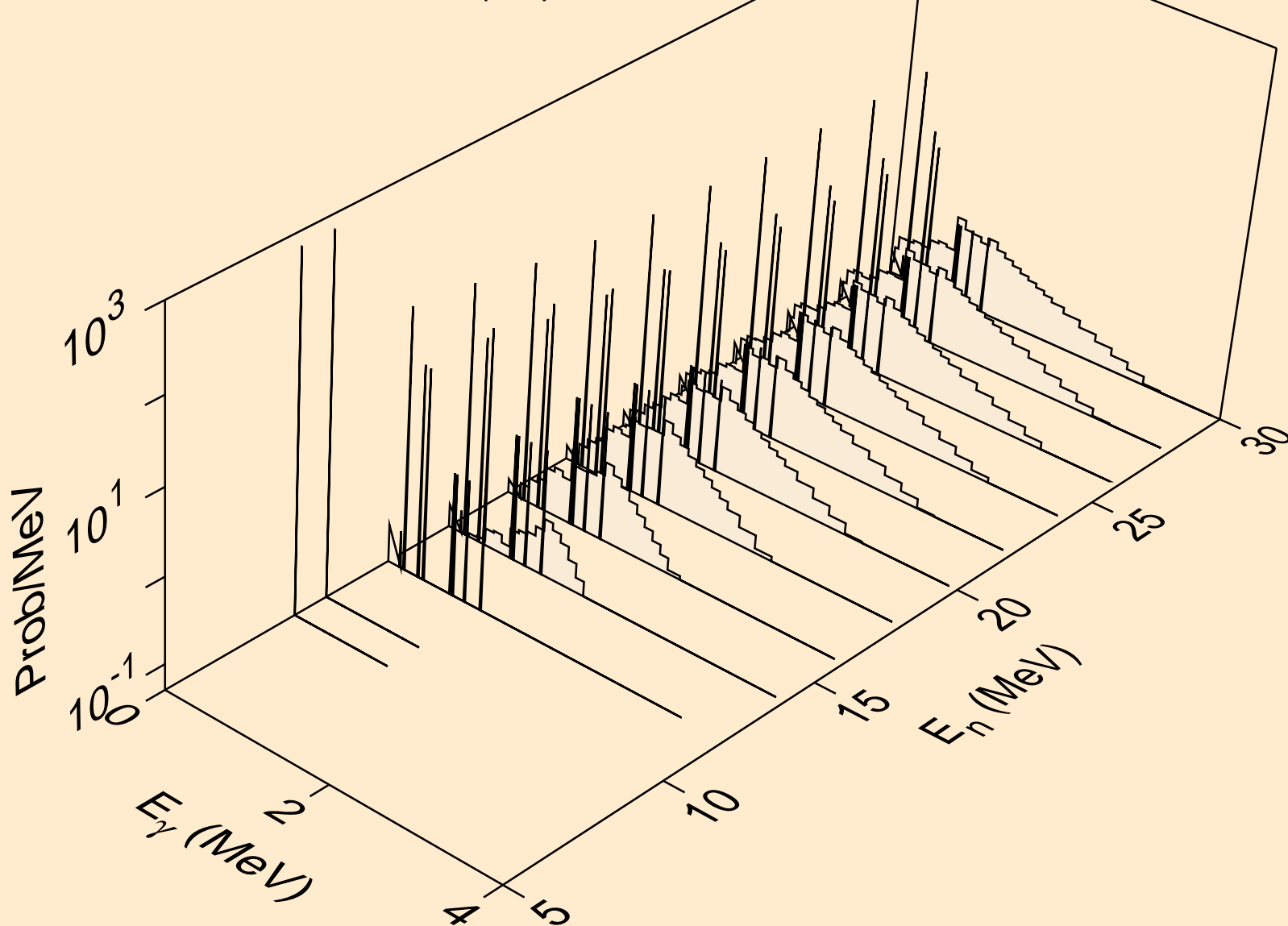

TE112 NEUTRON ACER TENDL-2019 LIBRARY; T=293.16K
Photon emission for (n,he3)

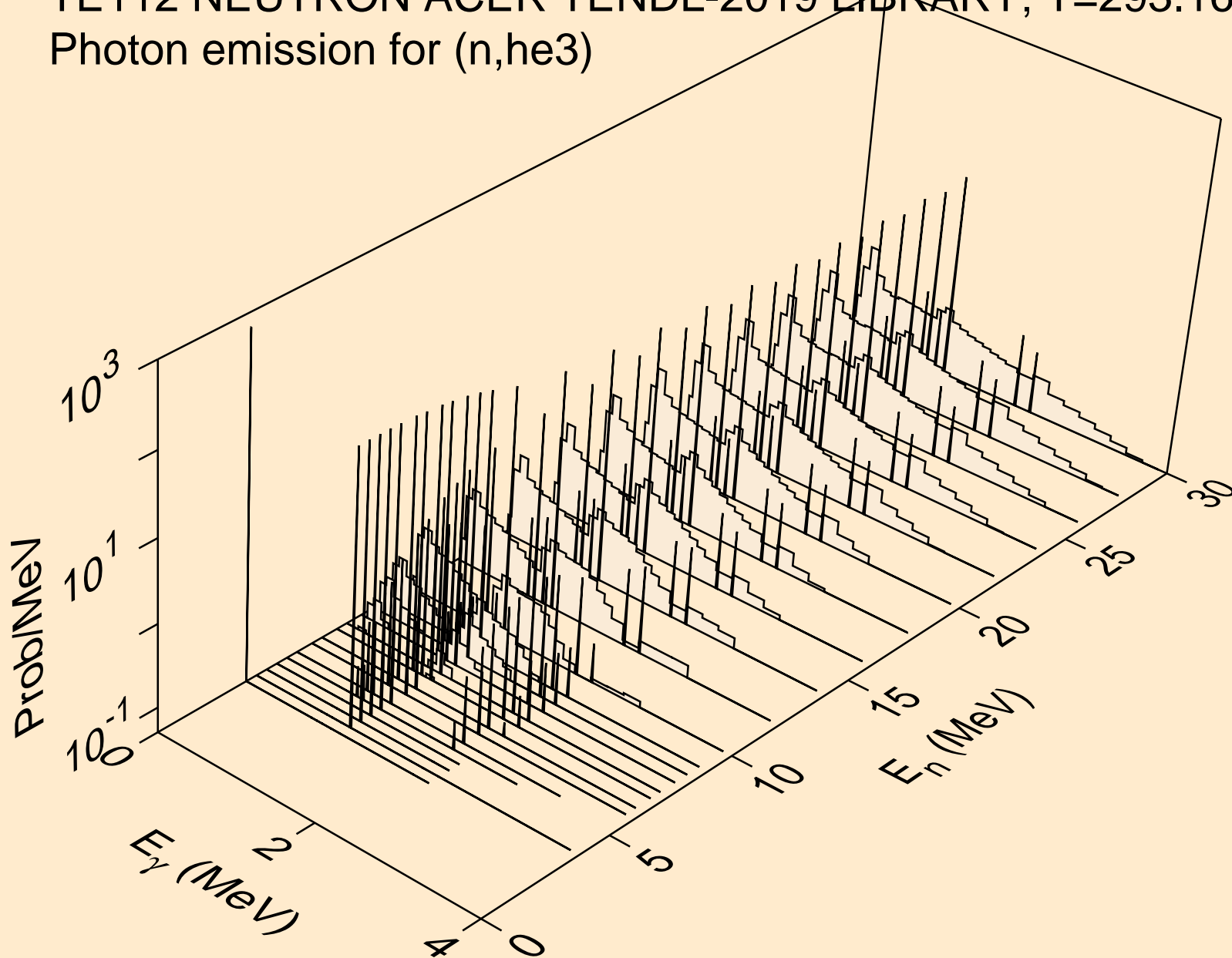

TE112 NEUTRON ACER TENDL-2019 LIBRARY; T=293.16K
Photon emission for (n,a)

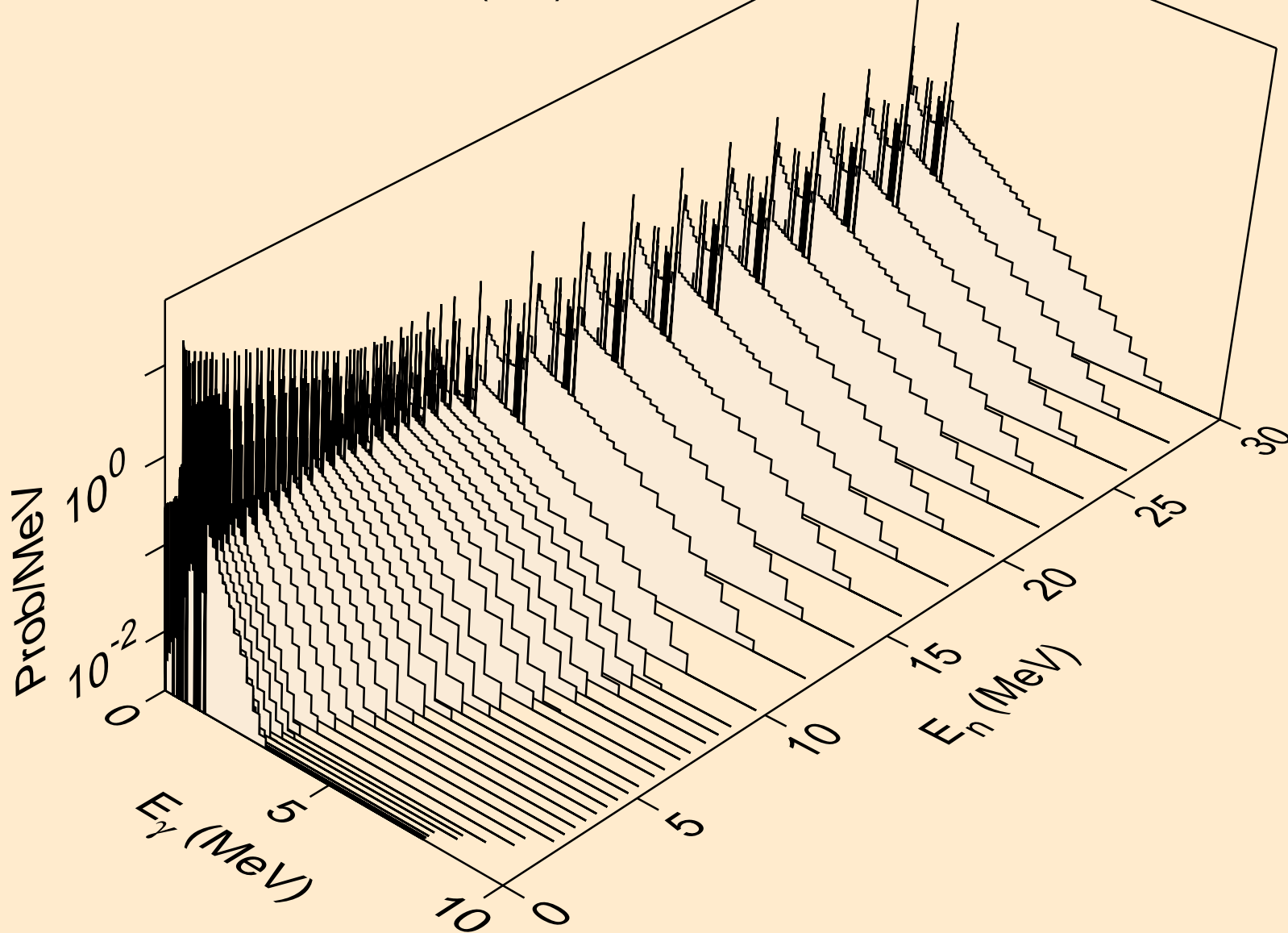

TE112 NEUTRON ACER TENDL-2019 LIBRARY; T=293.16K
Photon emission for (n,2a)

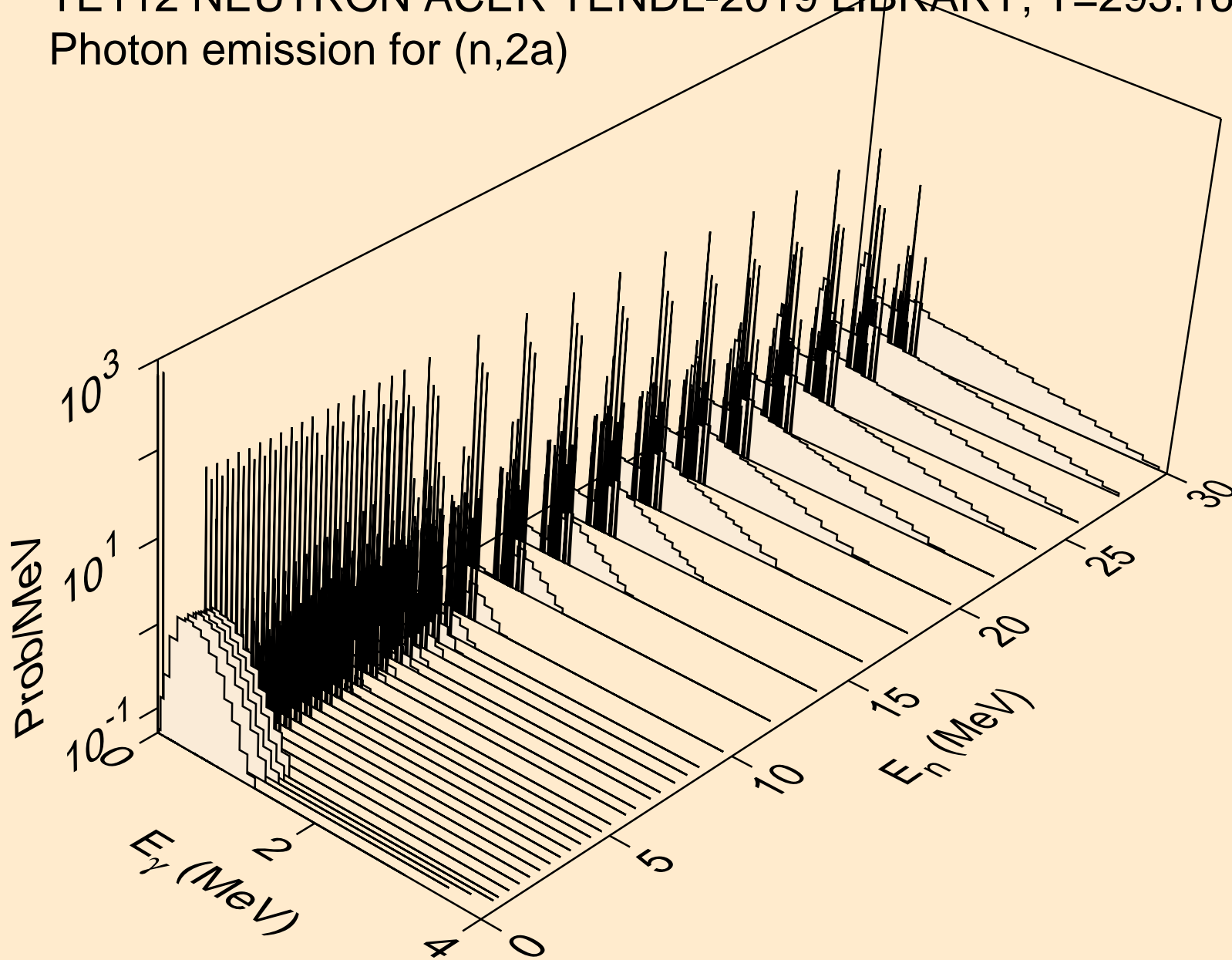

TE112 NEUTRON ACER TENDL-2019 LIBRARY; T=293.16K
Photon emission for (n,3a)

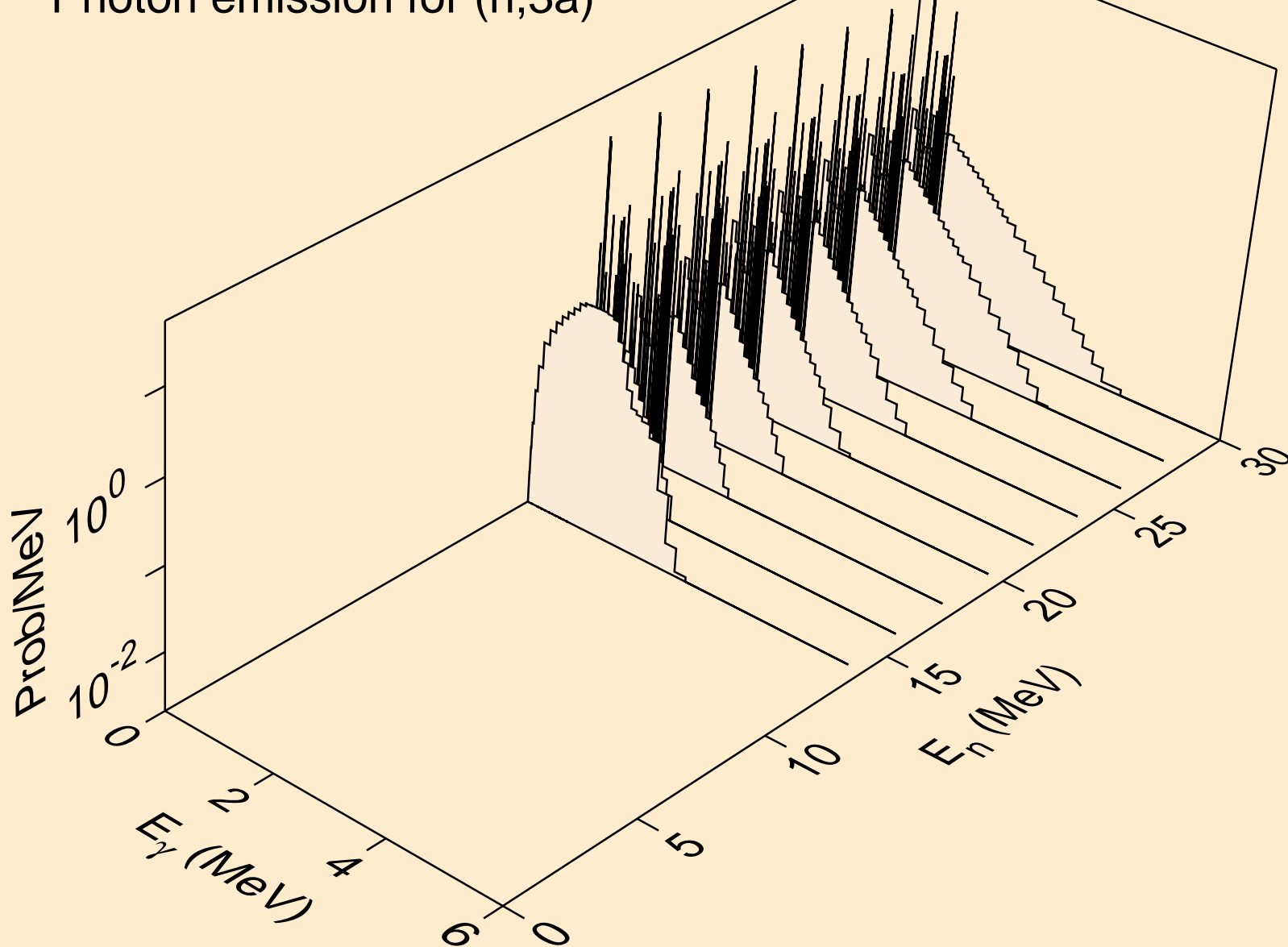

TE112 NEUTRON ACER TENDL-2019 LIBRARY; T=293.16K
Photon emission for (n,2p)

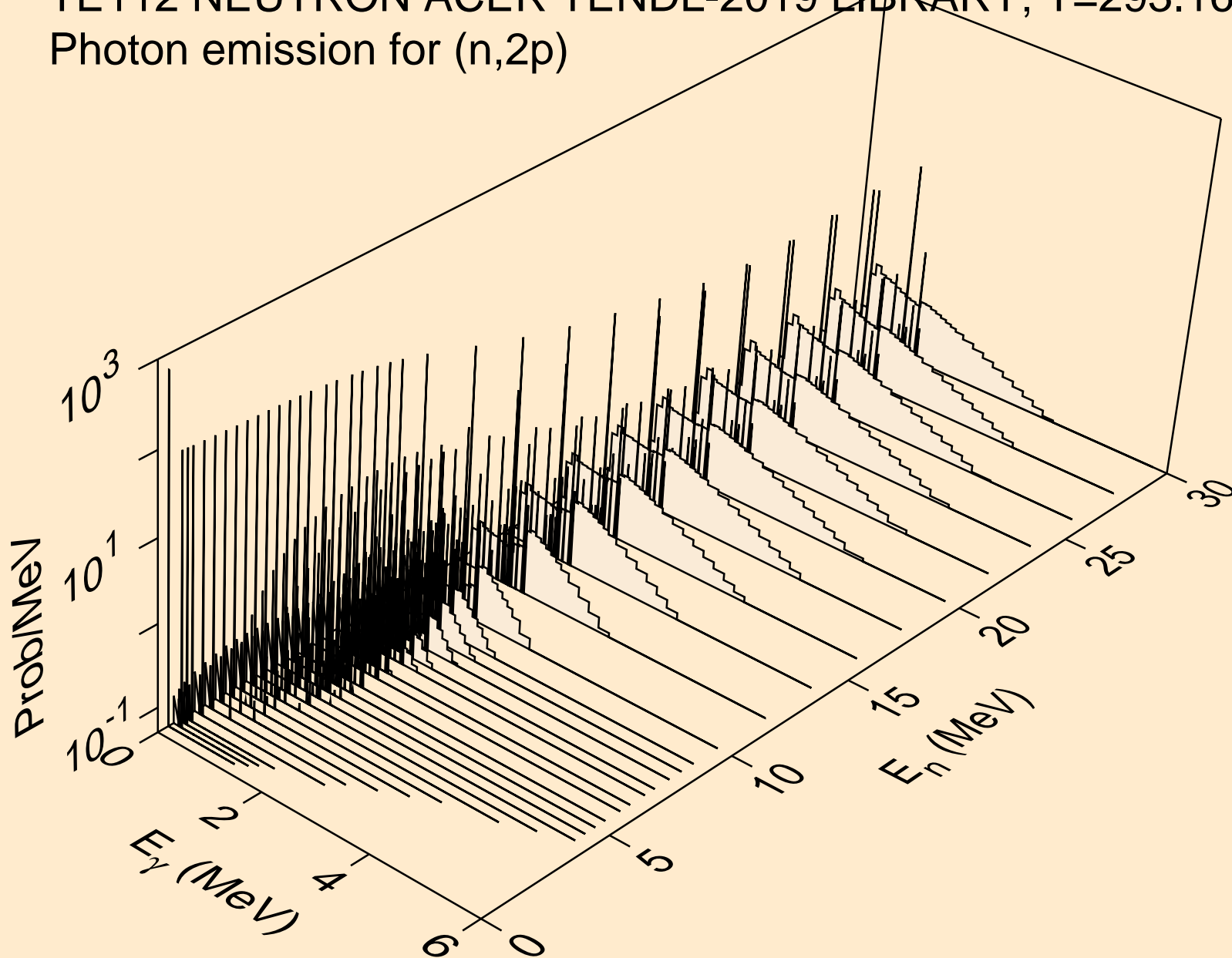

TE112 NEUTRON ACER TENDL-2019 LIBRARY; T=293.16K
Photon emission for (n,p α)

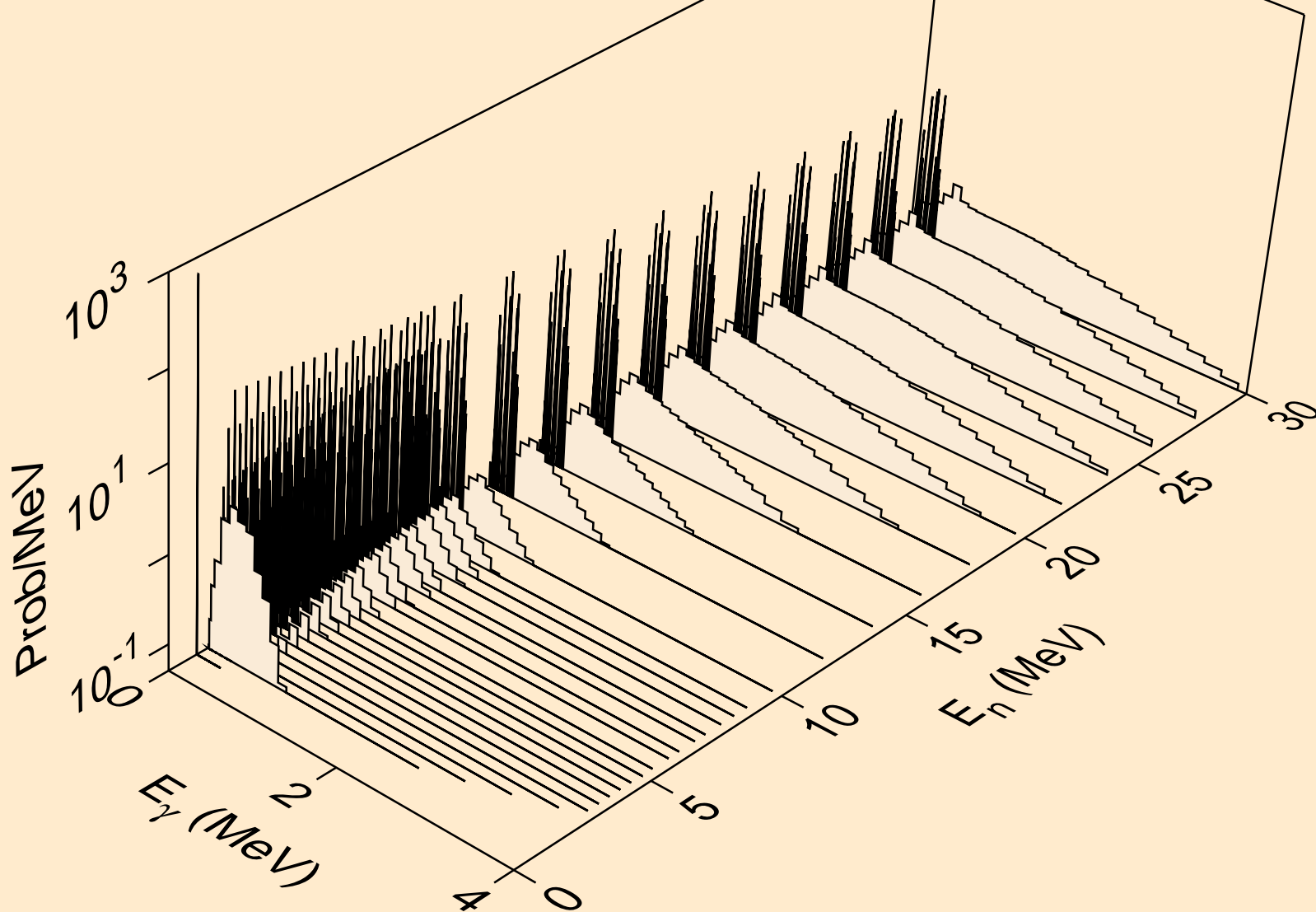

TE112 NEUTRON ACER TENDL-2019 LIBRARY; T=293.16K
Photon emission for (n,d2a)

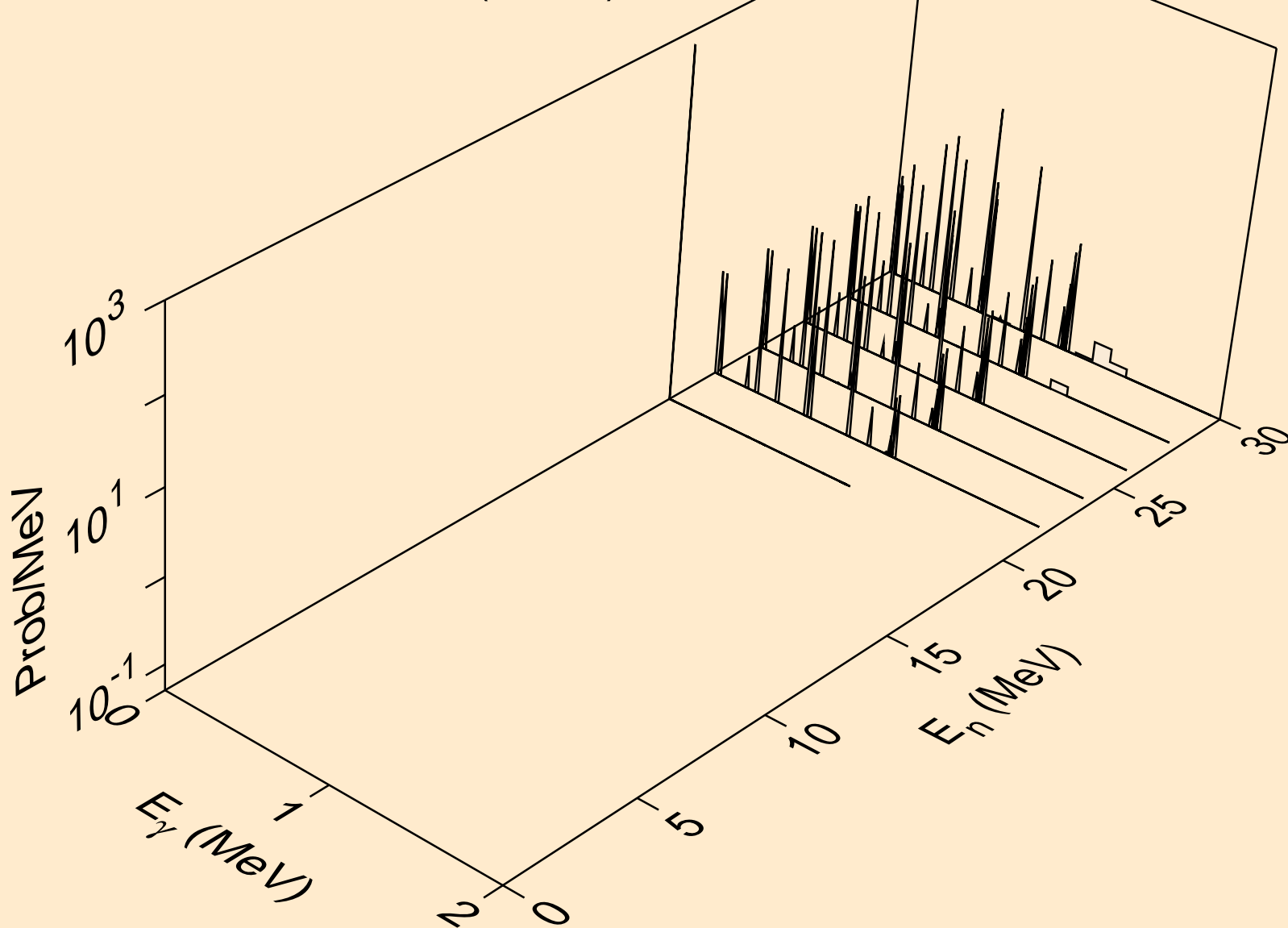

TE112 NEUTRON ACER TENDL-2019 LIBRARY; T=293.16K
Photon emission for (n,pd)

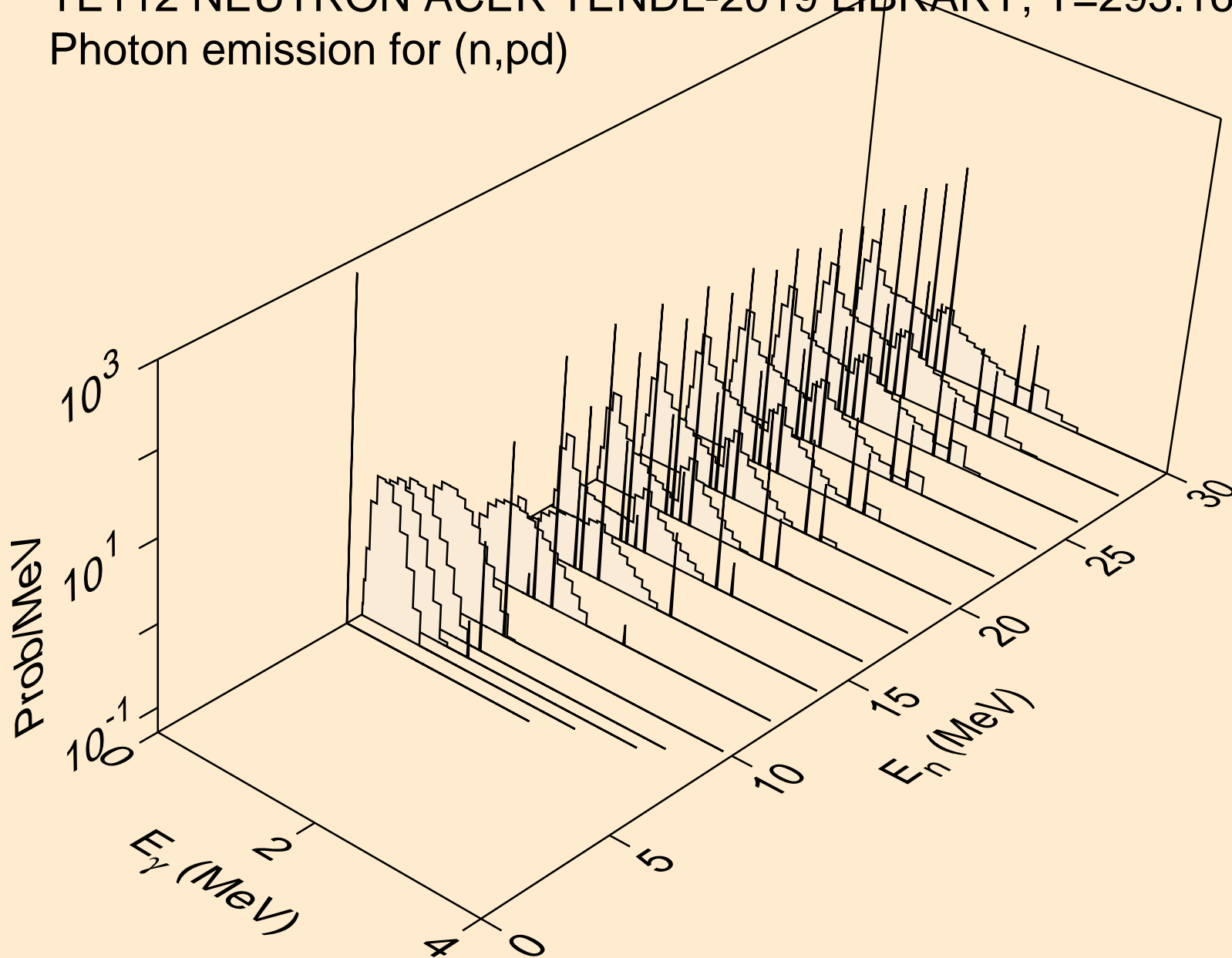

TE112 NEUTRON ACER TENDL-2019 LIBRARY; T=293.16K
Photon emission for (n,pt)

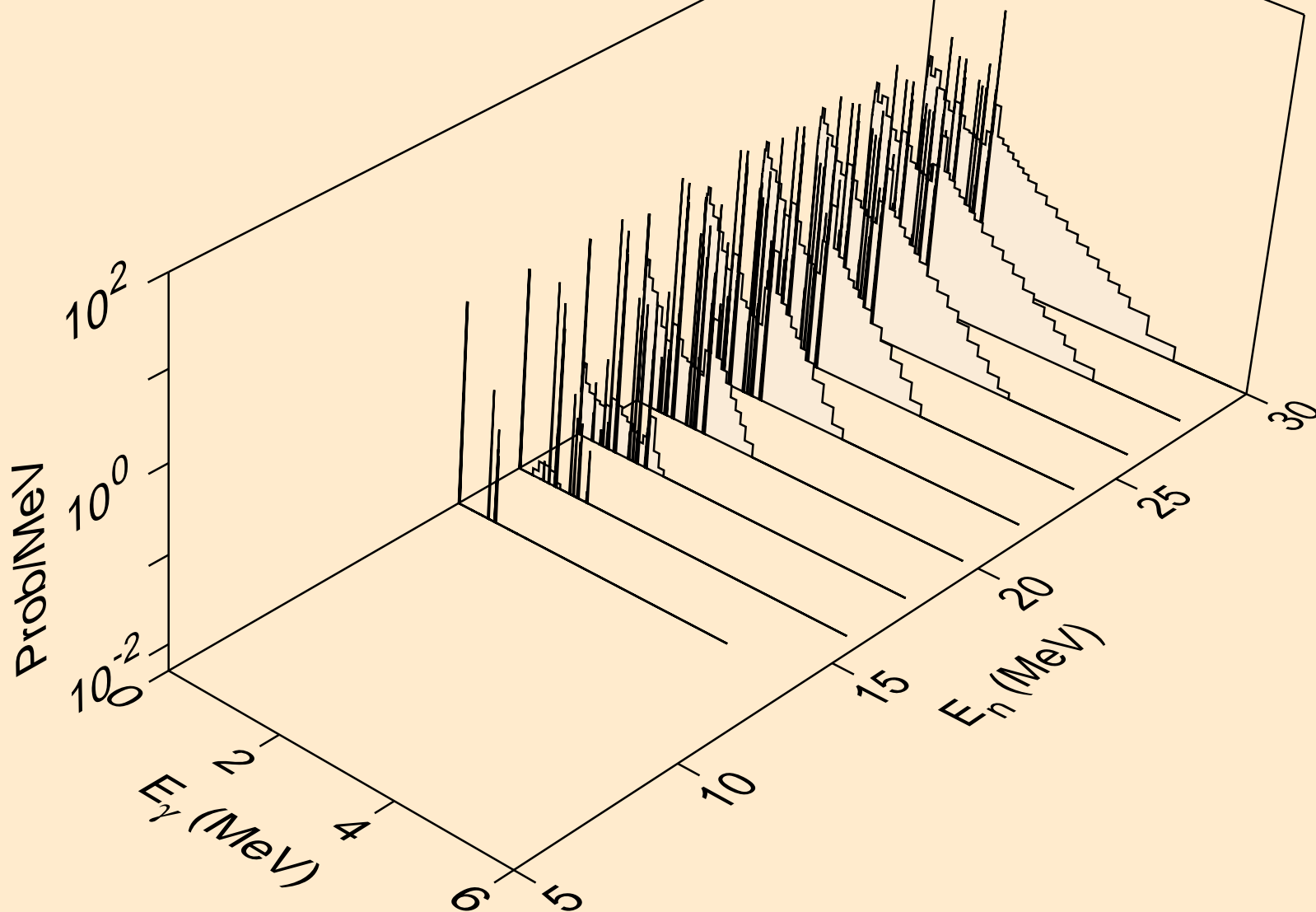

TE112 NEUTRON ACER TENDL-2019 LIBRARY; T=293.16K
Photon emission for (n,da)

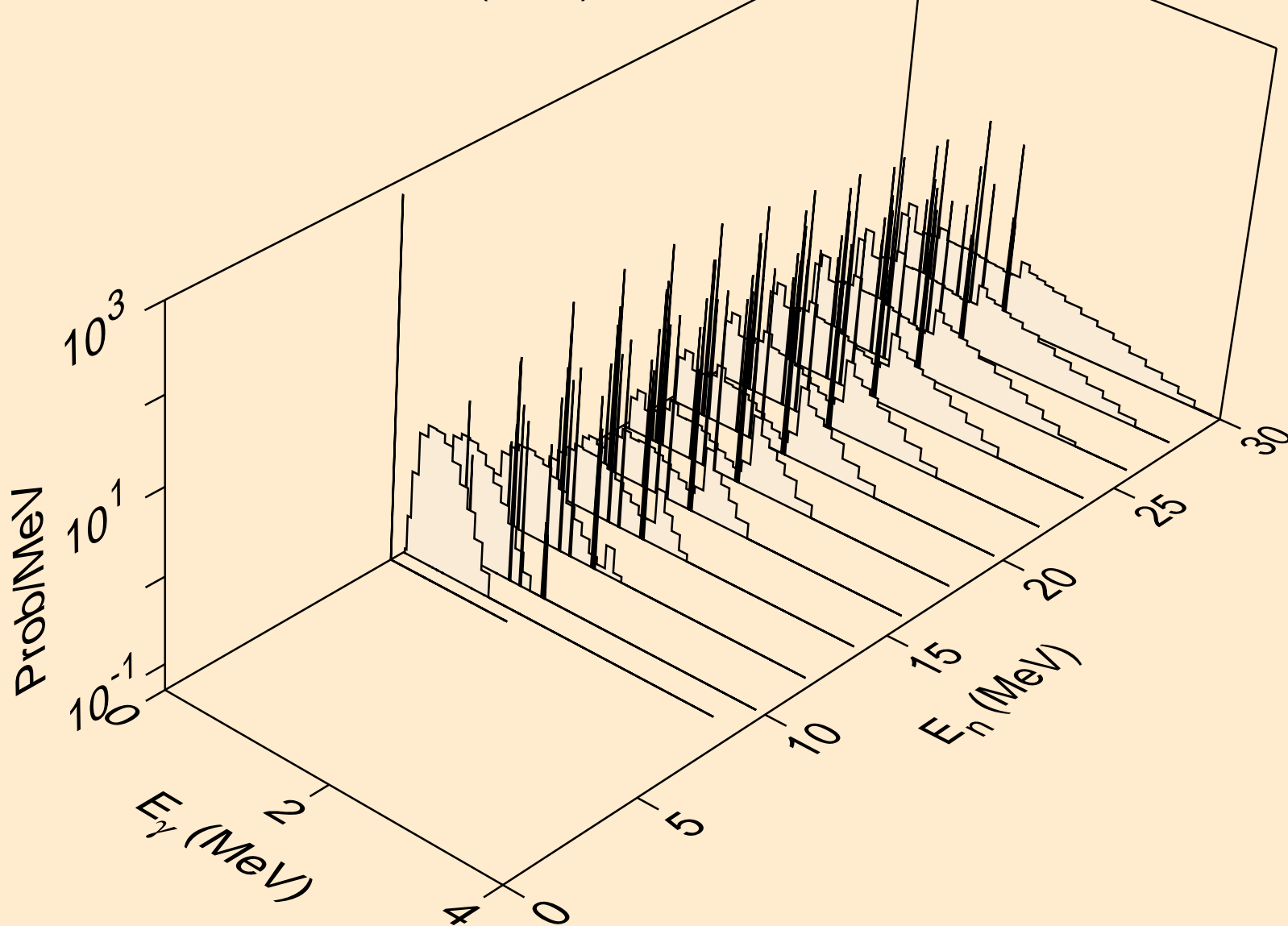

TE112 NEUTRON ACER TENDL-2019 LIBRARY; T=293.16K
thermal capture photon spectrum

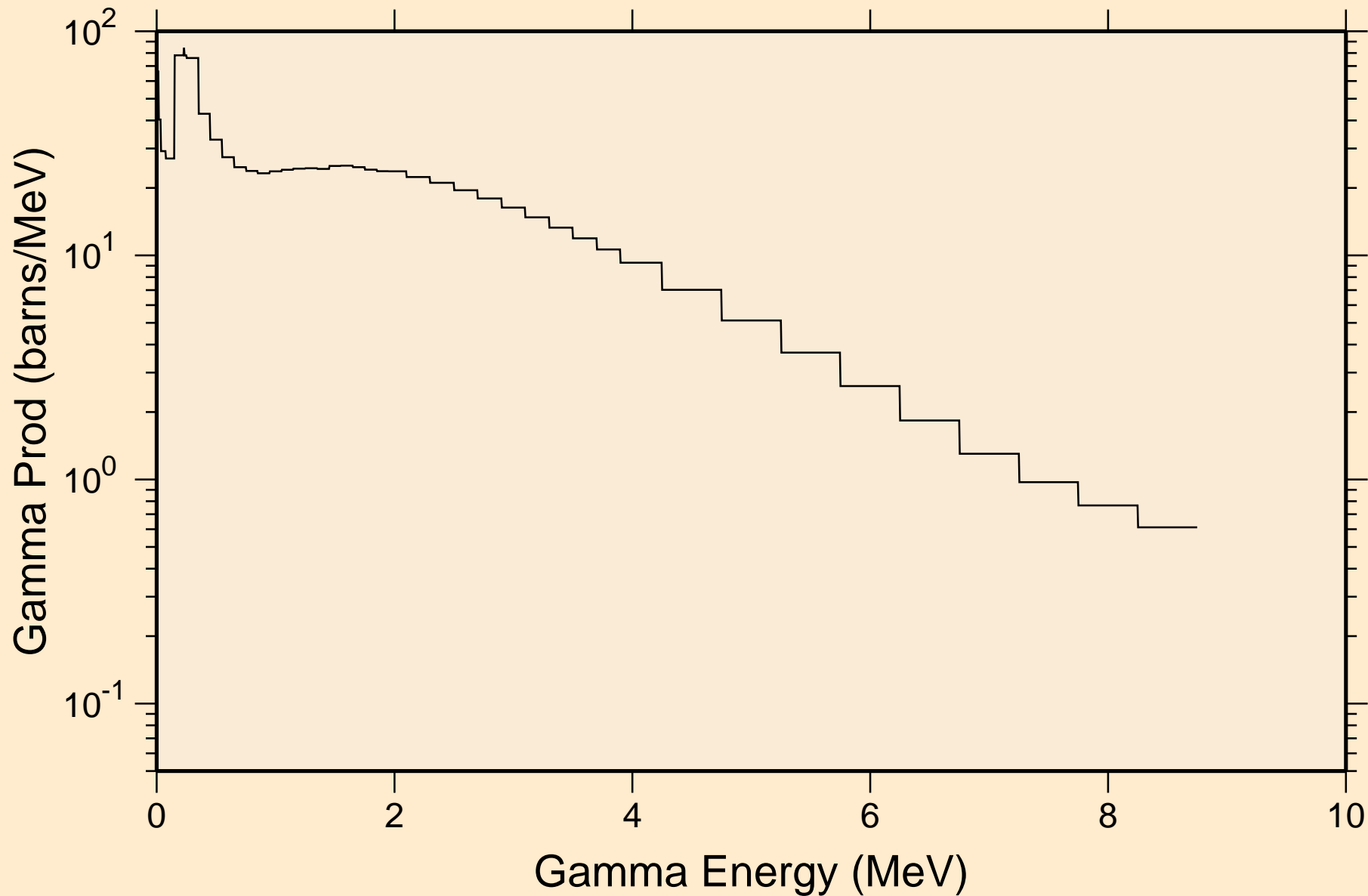

TE112 NEUTRON ACER TENDL-2019 LIBRARY; T=293.16K
14 MeV photon spectrum

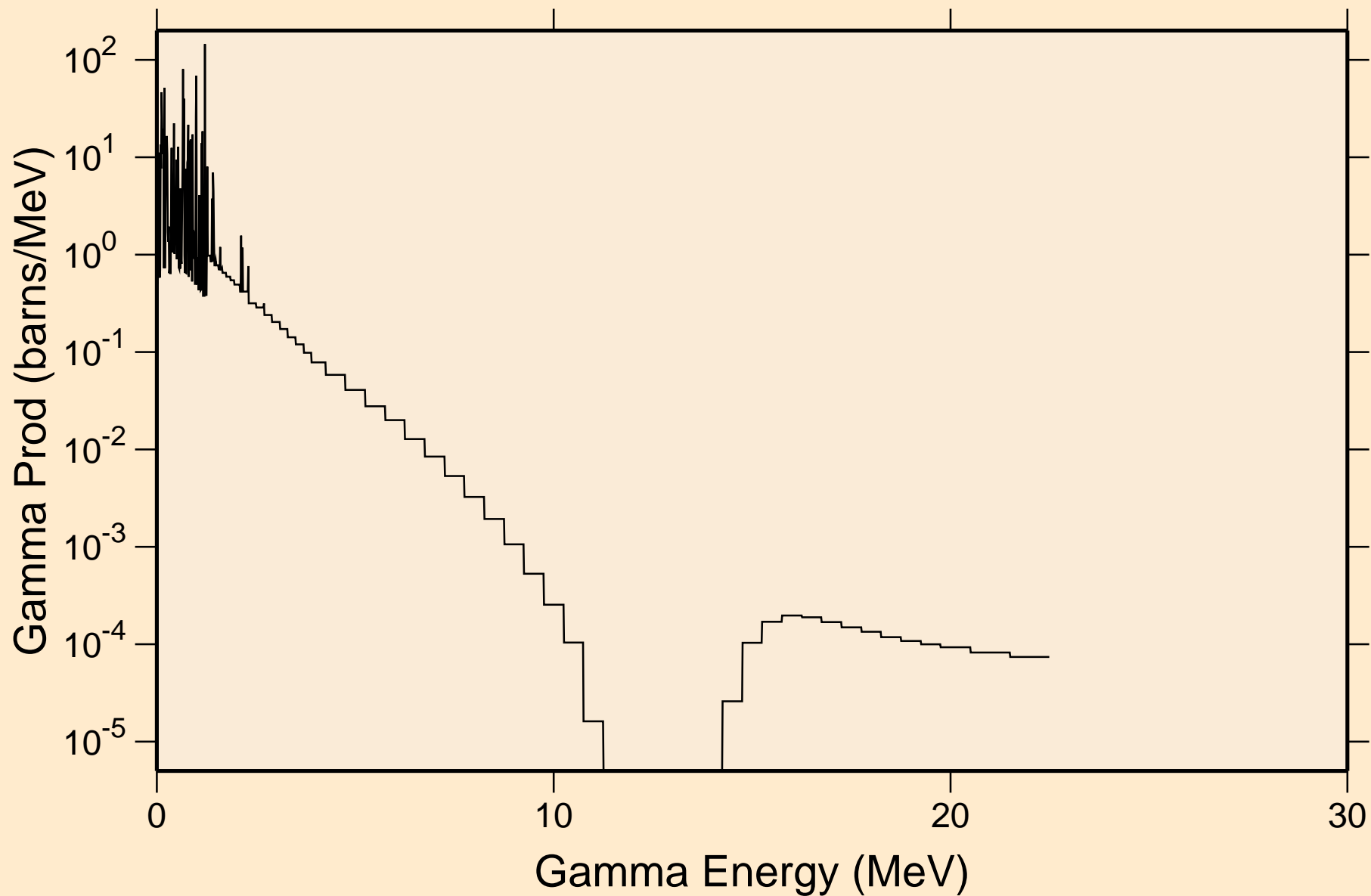

TE112 NEUTRON ACER TENDL-2019 LIBRARY; T=293.16K

Particle heating contributions

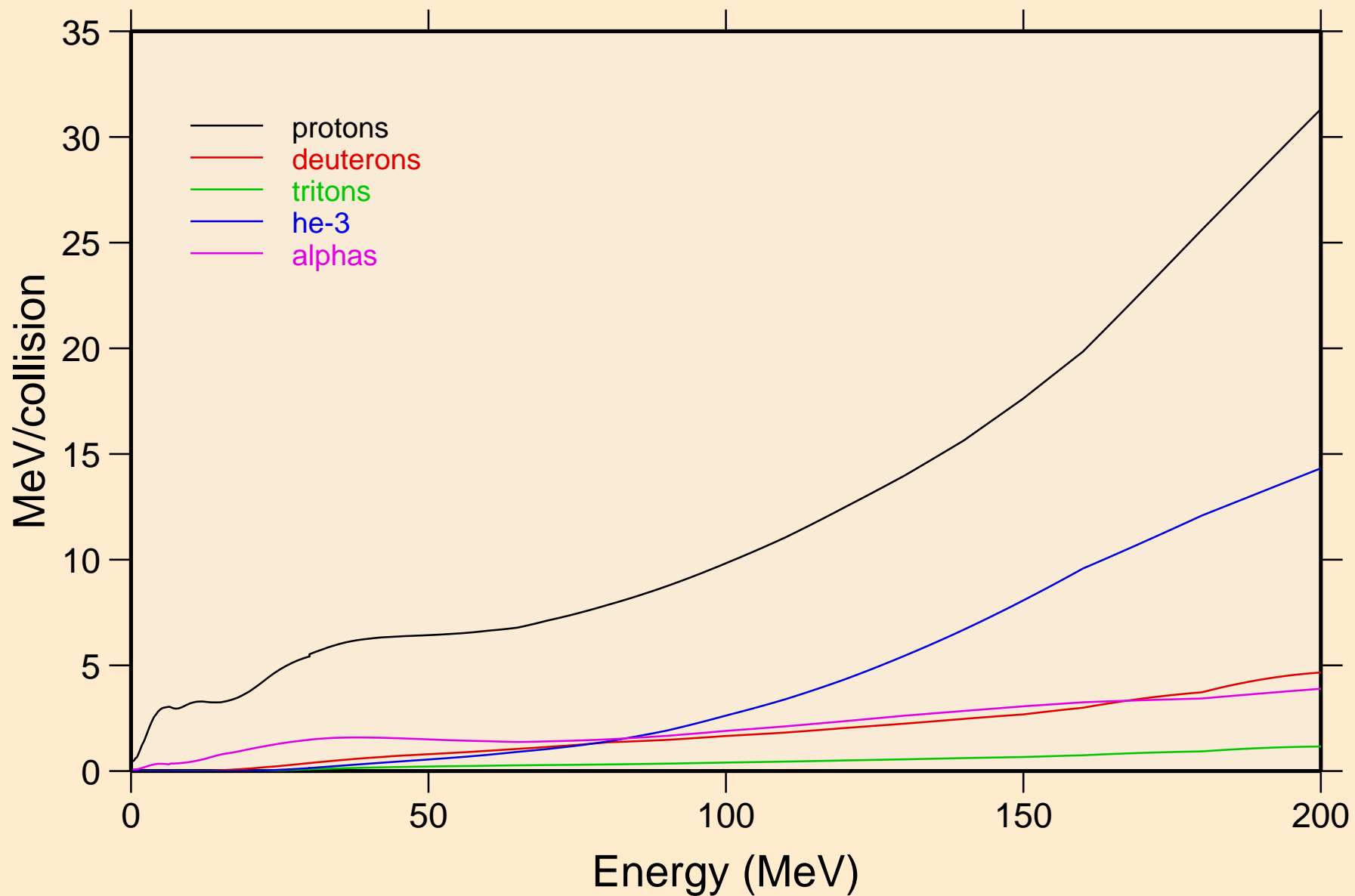

TE112 NEUTRON ACER TENDL-2019 LIBRARY; T=293.16K
Recoil Heating

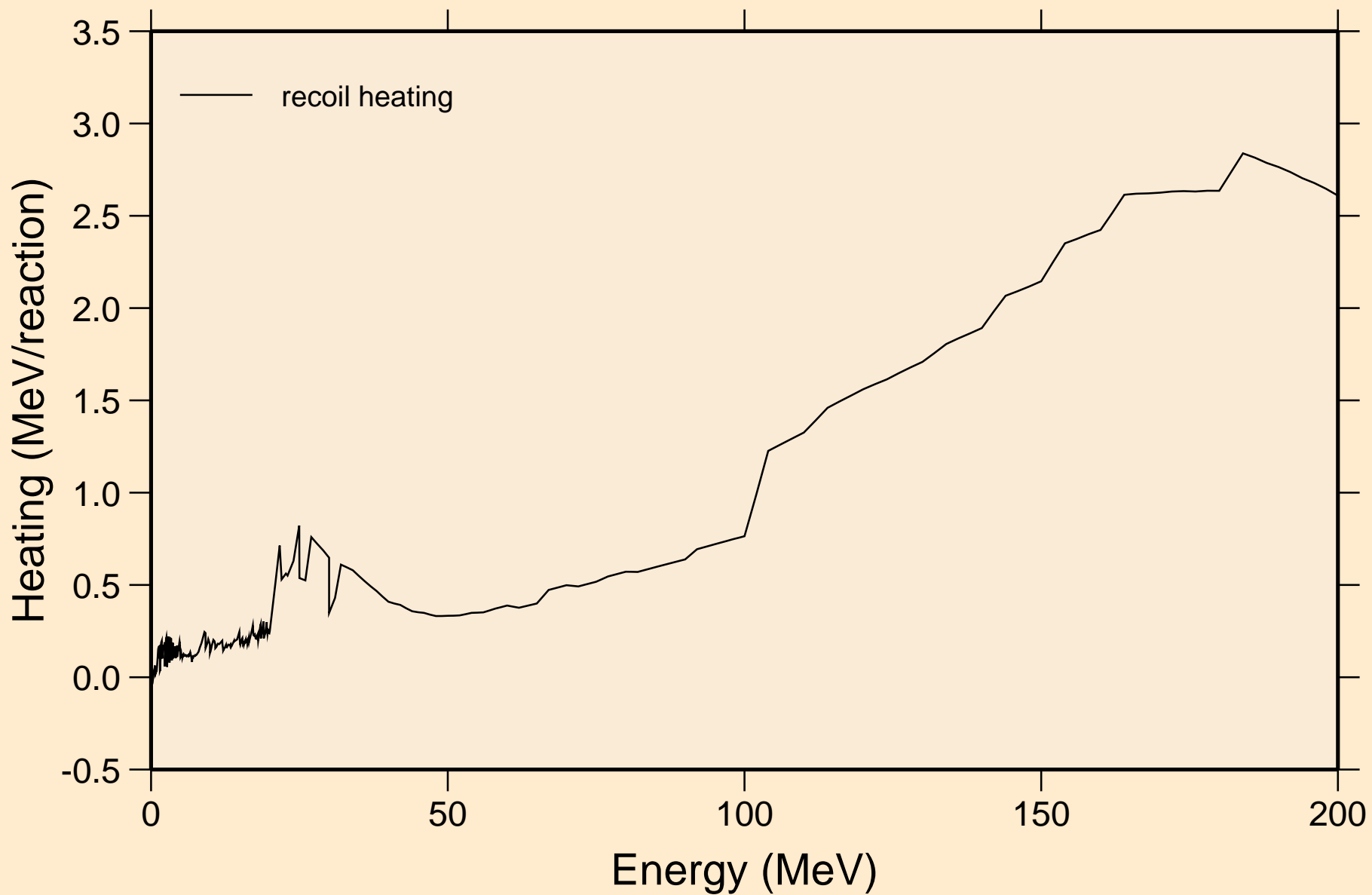

TE112 NEUTRON ACER TENDL-2019 LIBRARY; T=293.16K
Particle production cross sections

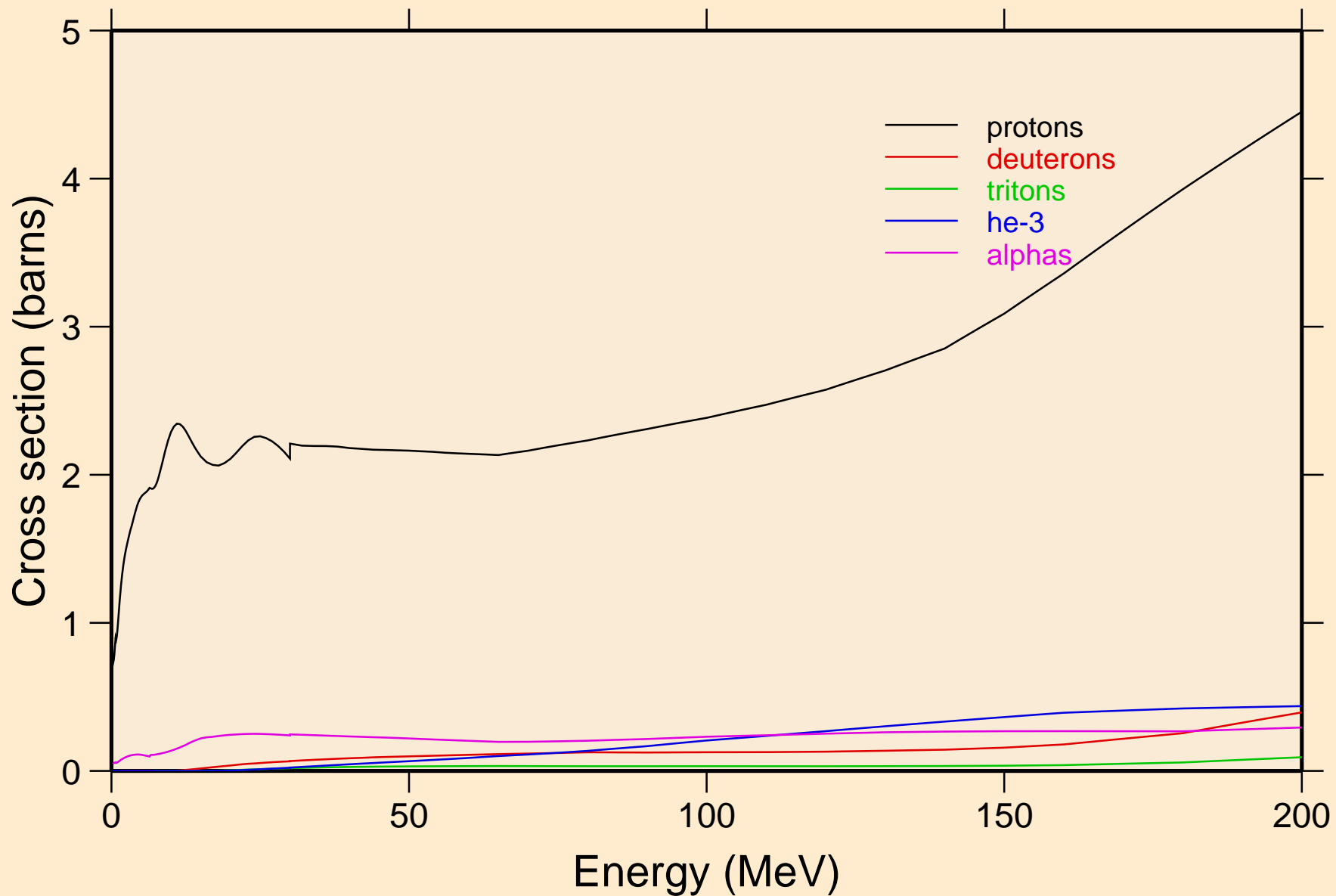

TE112 NEUTRON ACER TENDL-2019 LIBRARY; T=293.16K
protons from (n,x)

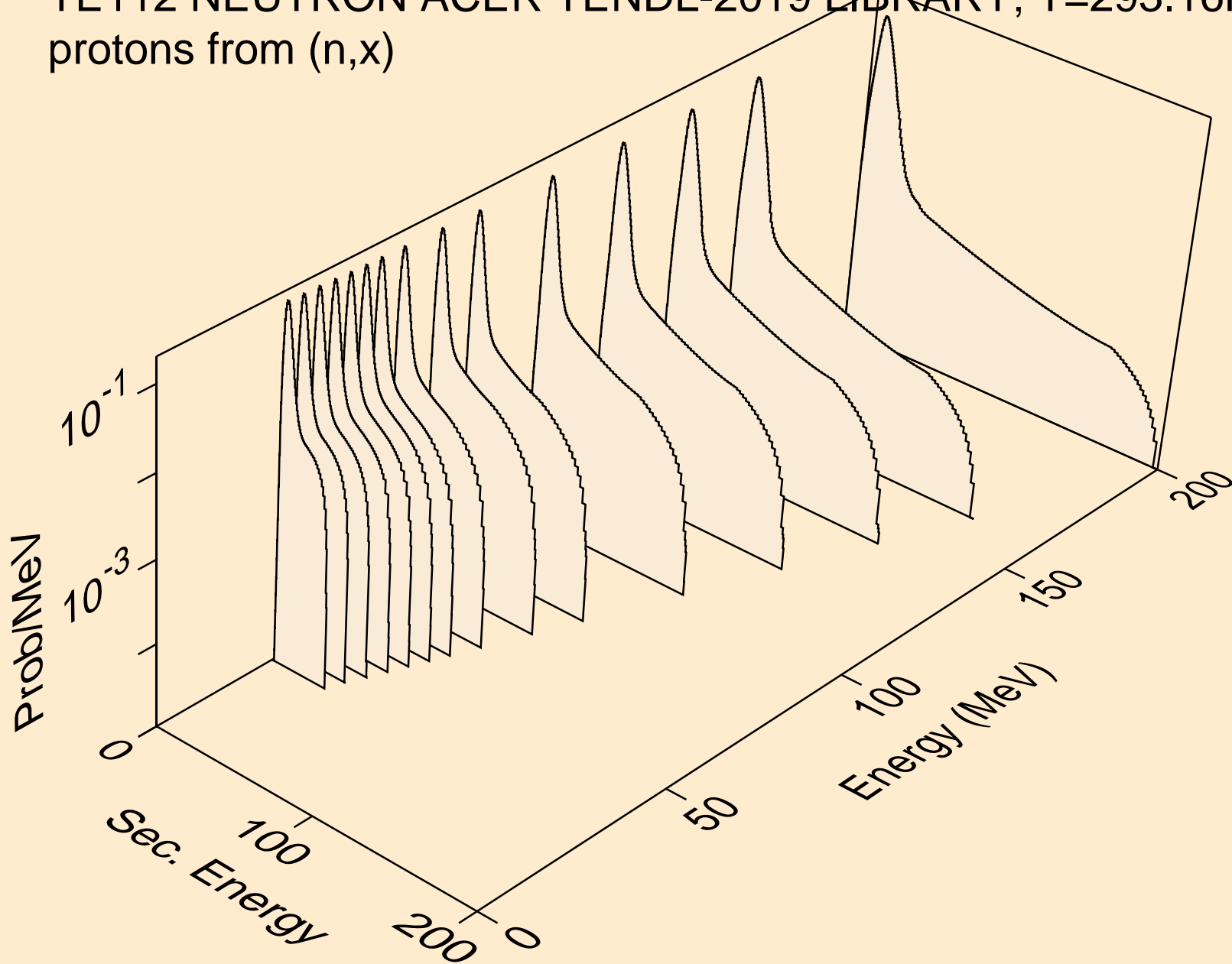

TE112 NEUTRON ACER TENDL-2019 LIBRARY; T=293.16K
protons from (n,n*)p

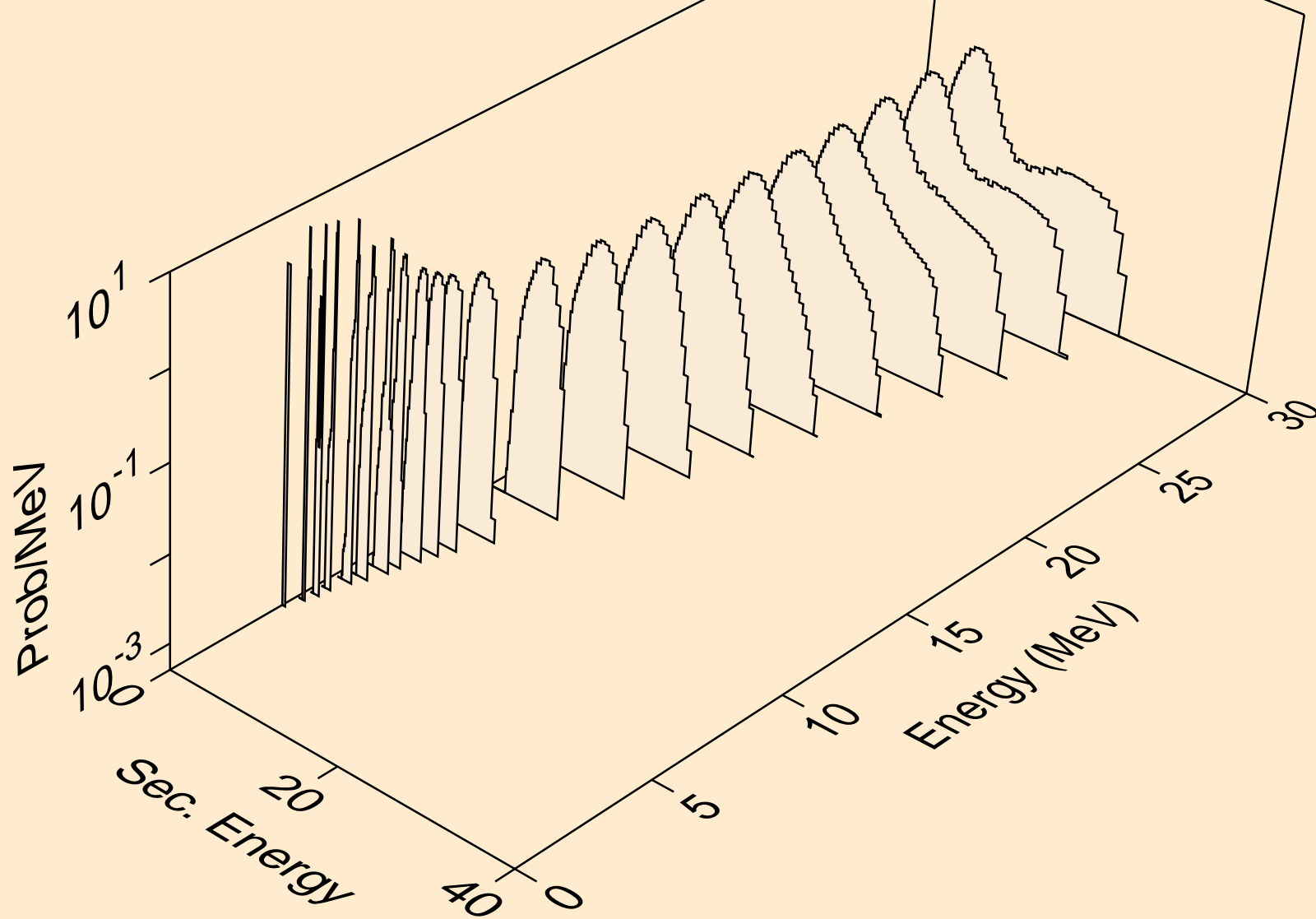

TE112 NEUTRON ACER TENDL-2019 LIBRARY; T=293.16K
protons from (n,2np)

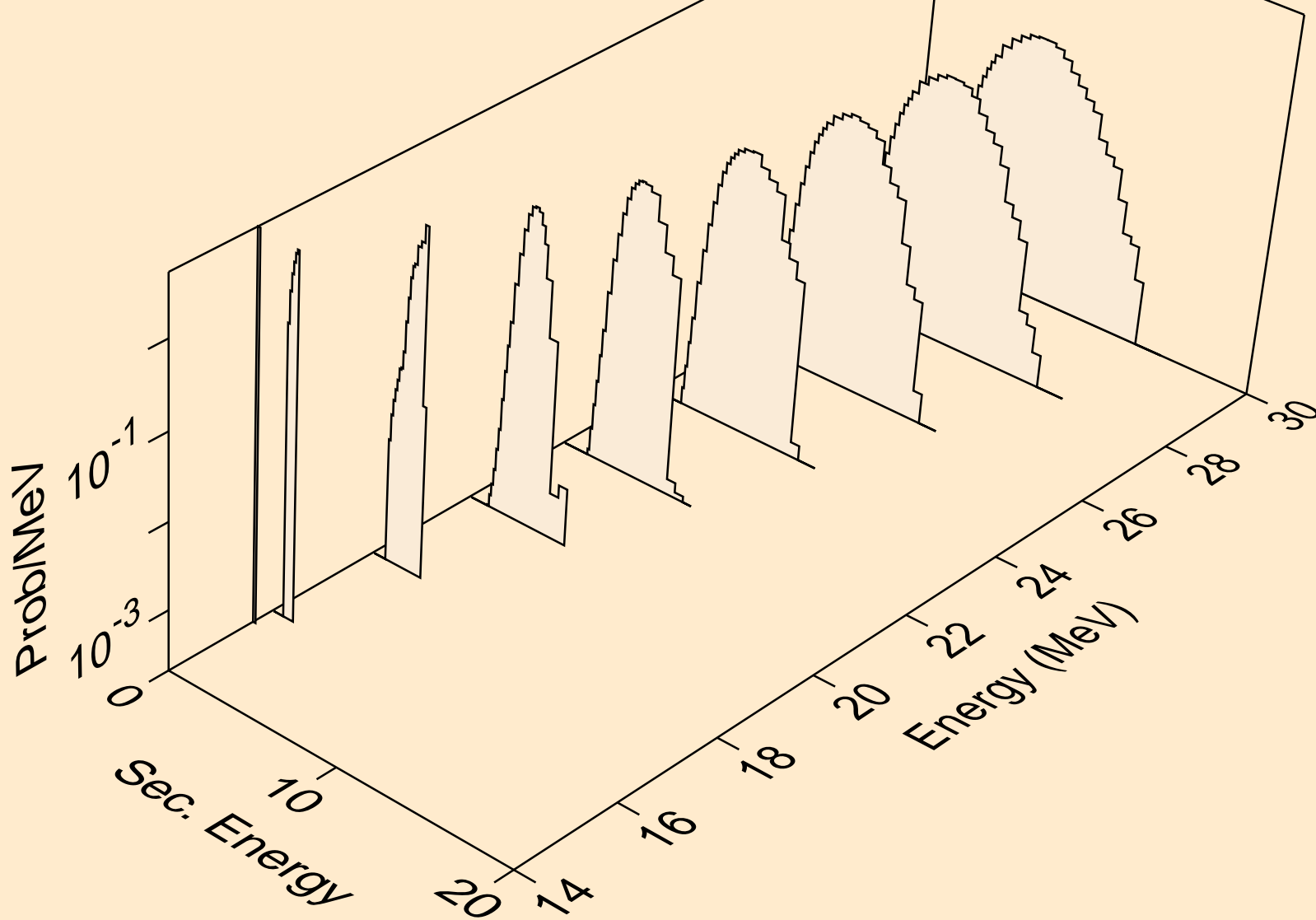

TE112 NEUTRON ACER TENDL-2019 LIBRARY; T=293.16K
protons from (n,3np)

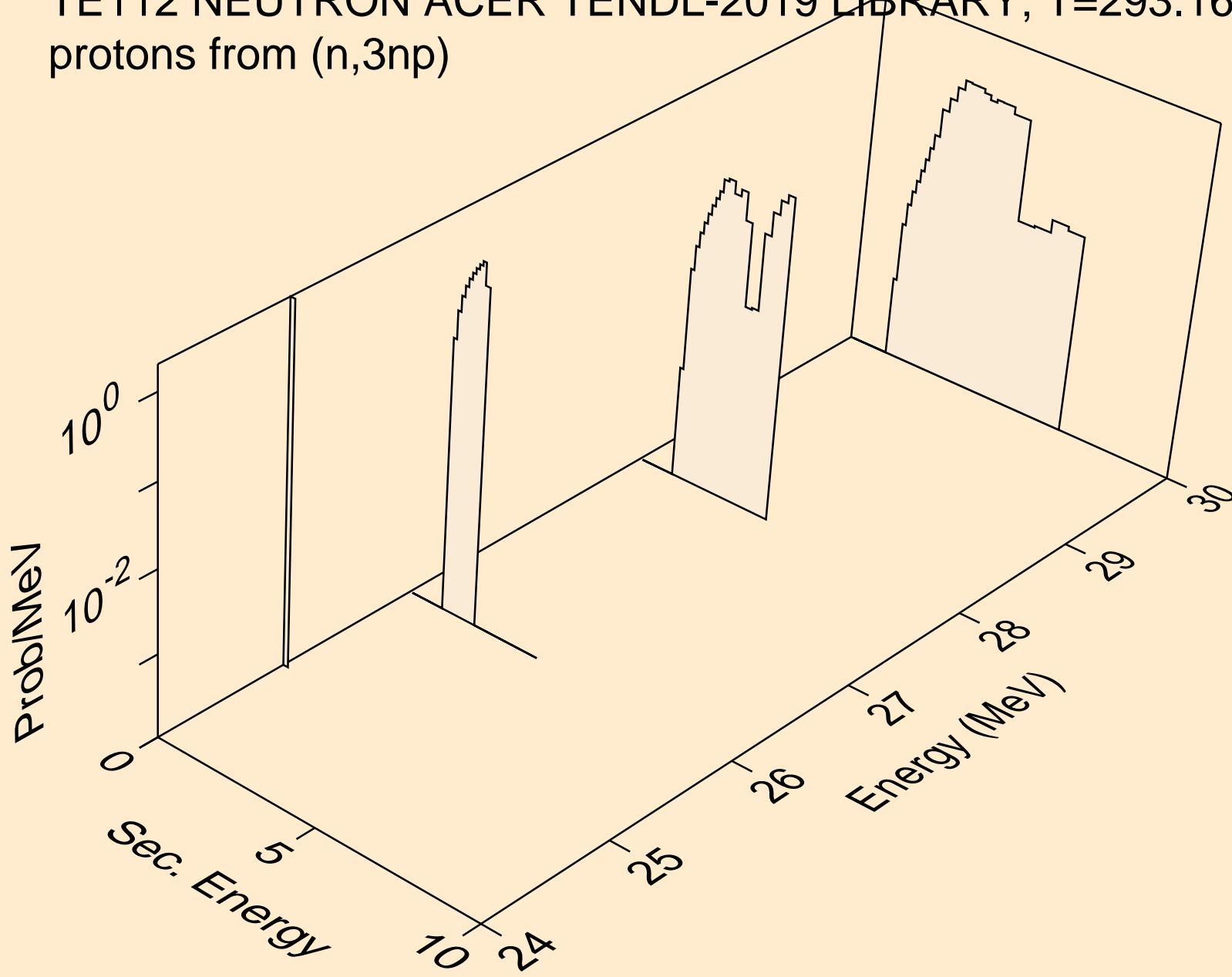

TE112 NEUTRON ACER TENDL-2019 LIBRARY; T=293.16K
protons from (n,2np)

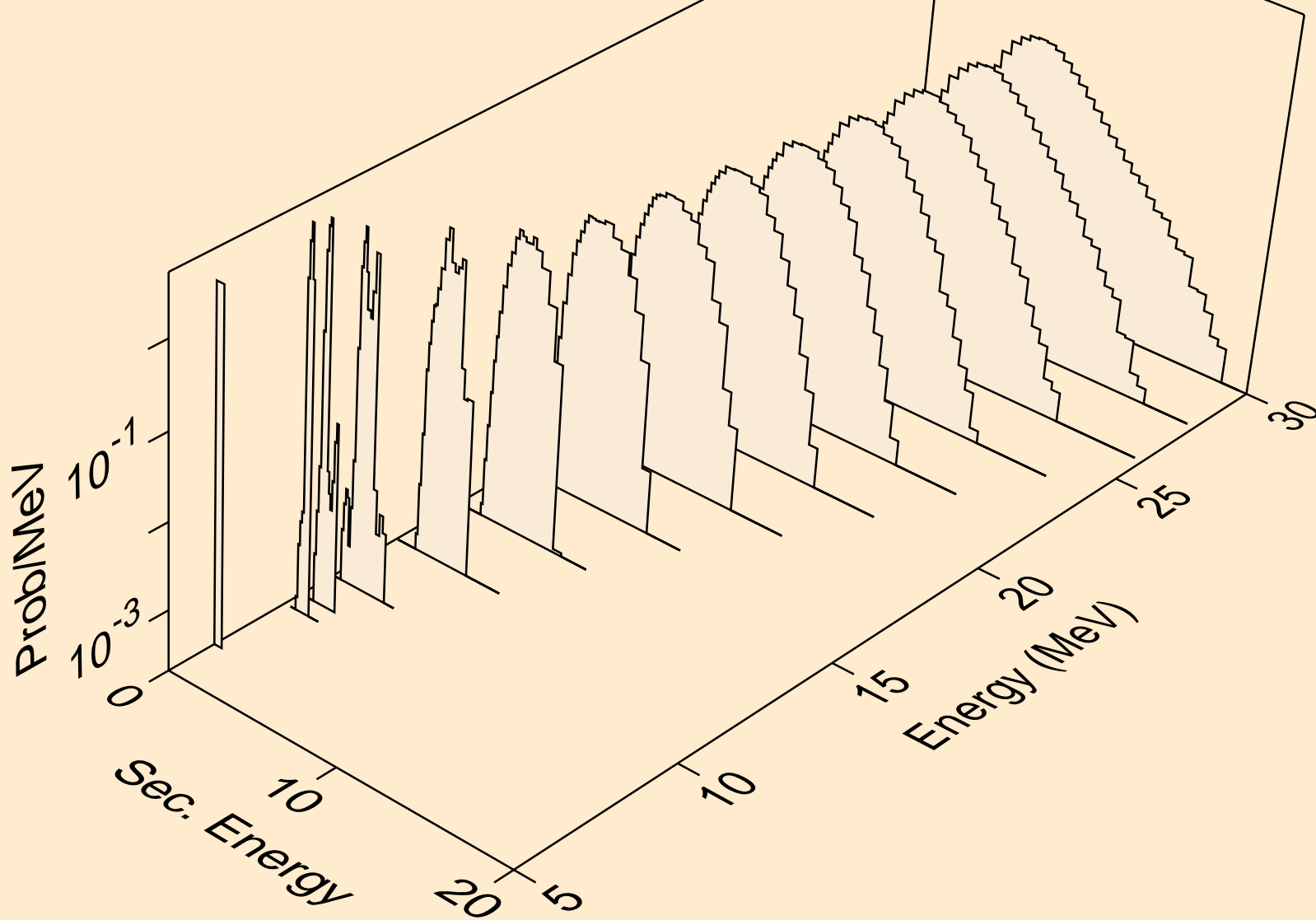

TE112 NEUTRON ACER TENDL-2019 LIBRARY; T=293.16K
protons from (n,npa)

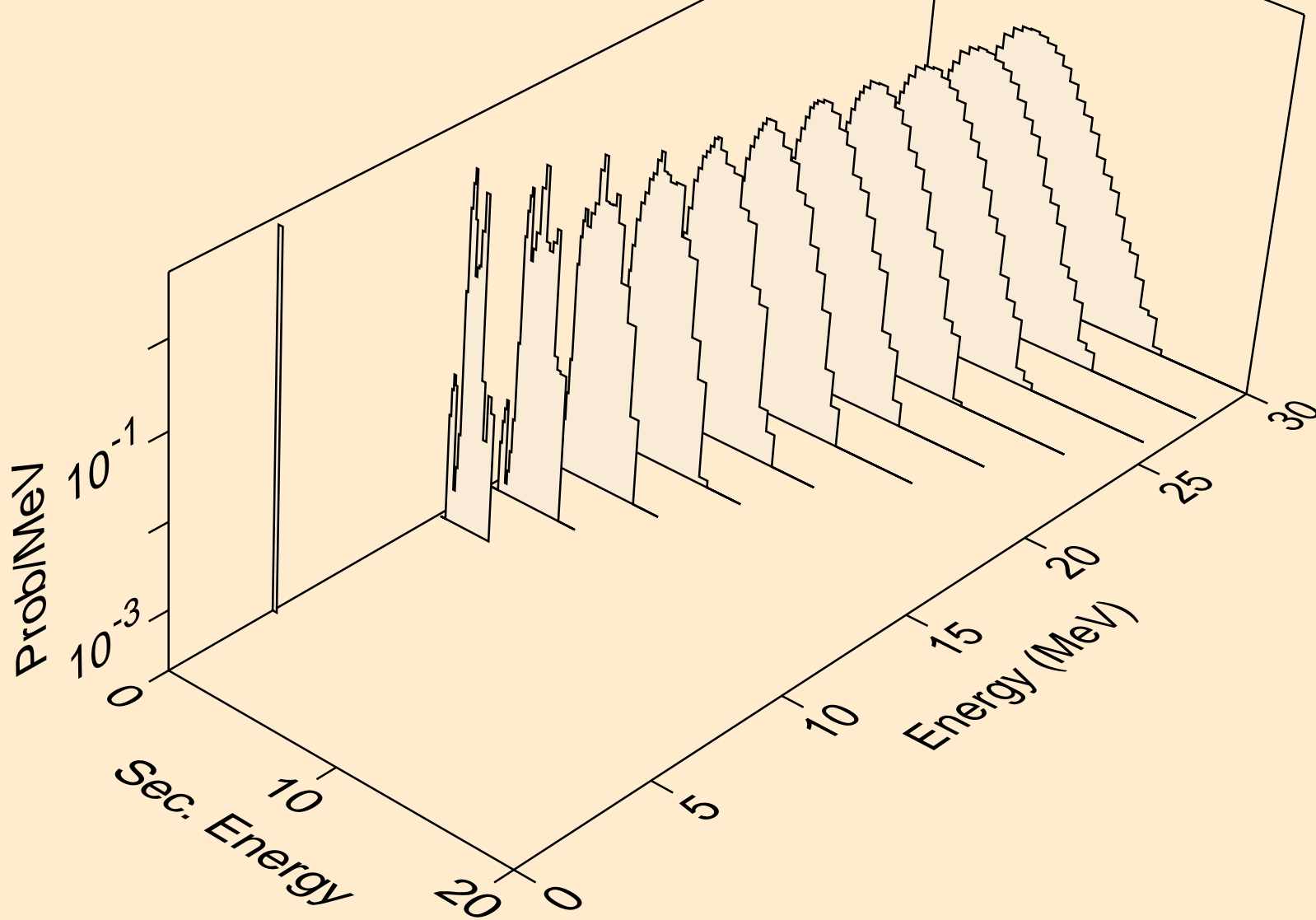

TE112 NEUTRON ACER TENDL-2019 LIBRARY; T=293.16K
protons from (n,p)

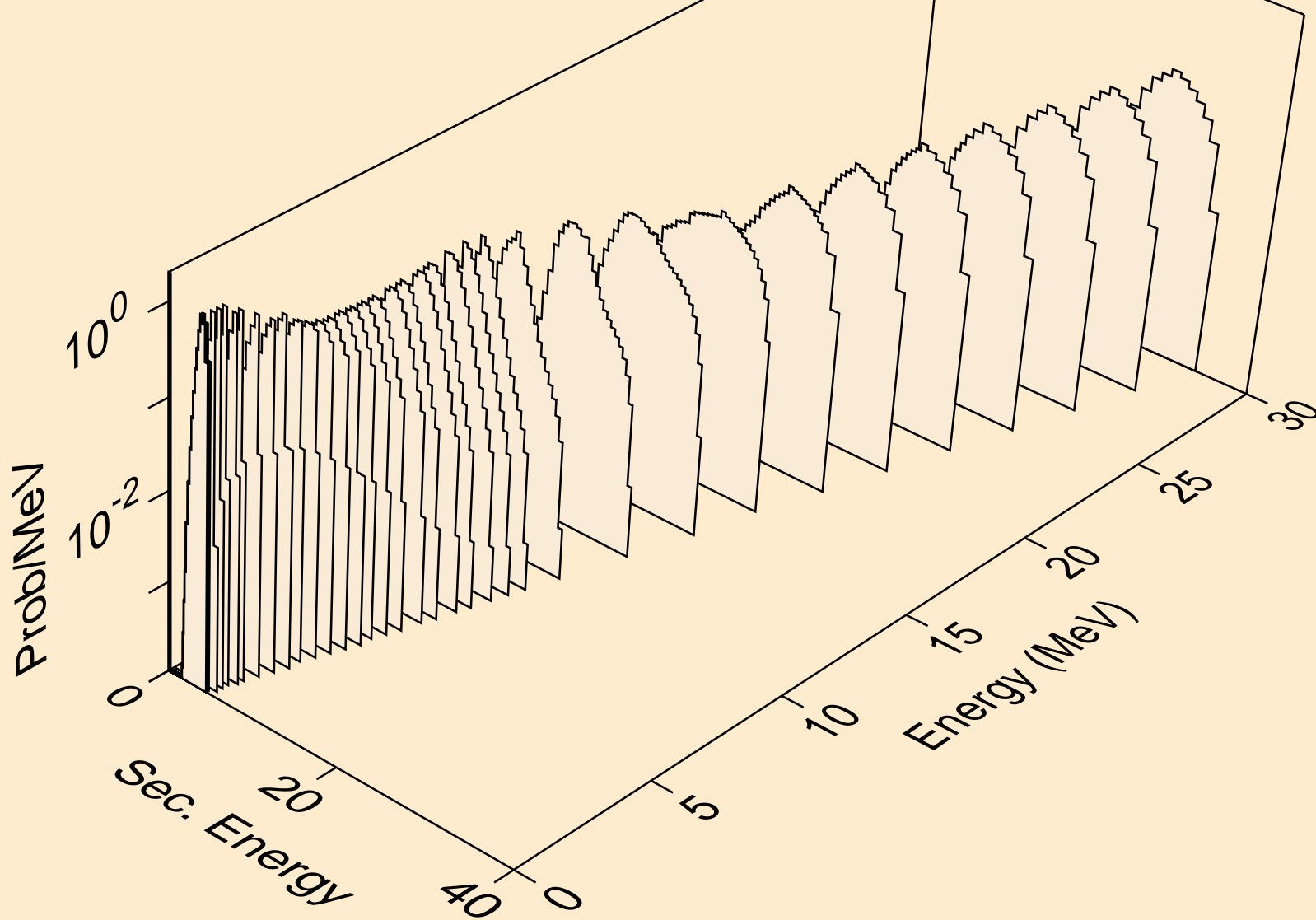

TE112 NEUTRON ACER TENDL-2019 LIBRARY; T=293.16K
protons from (n,2p)

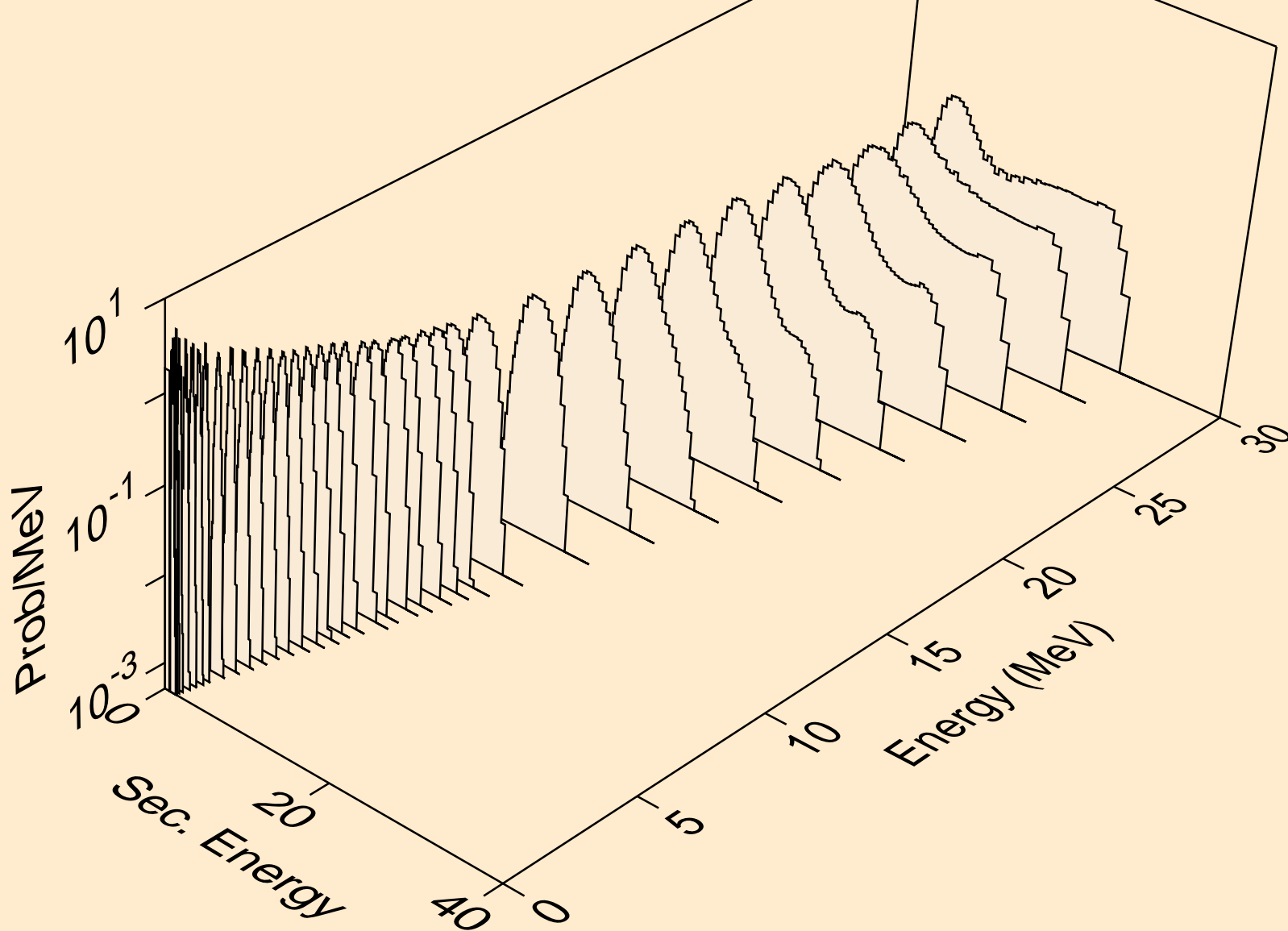

TE112 NEUTRON ACER TENDL-2019 LIBRARY; T=293.16K
protons from (n,p)

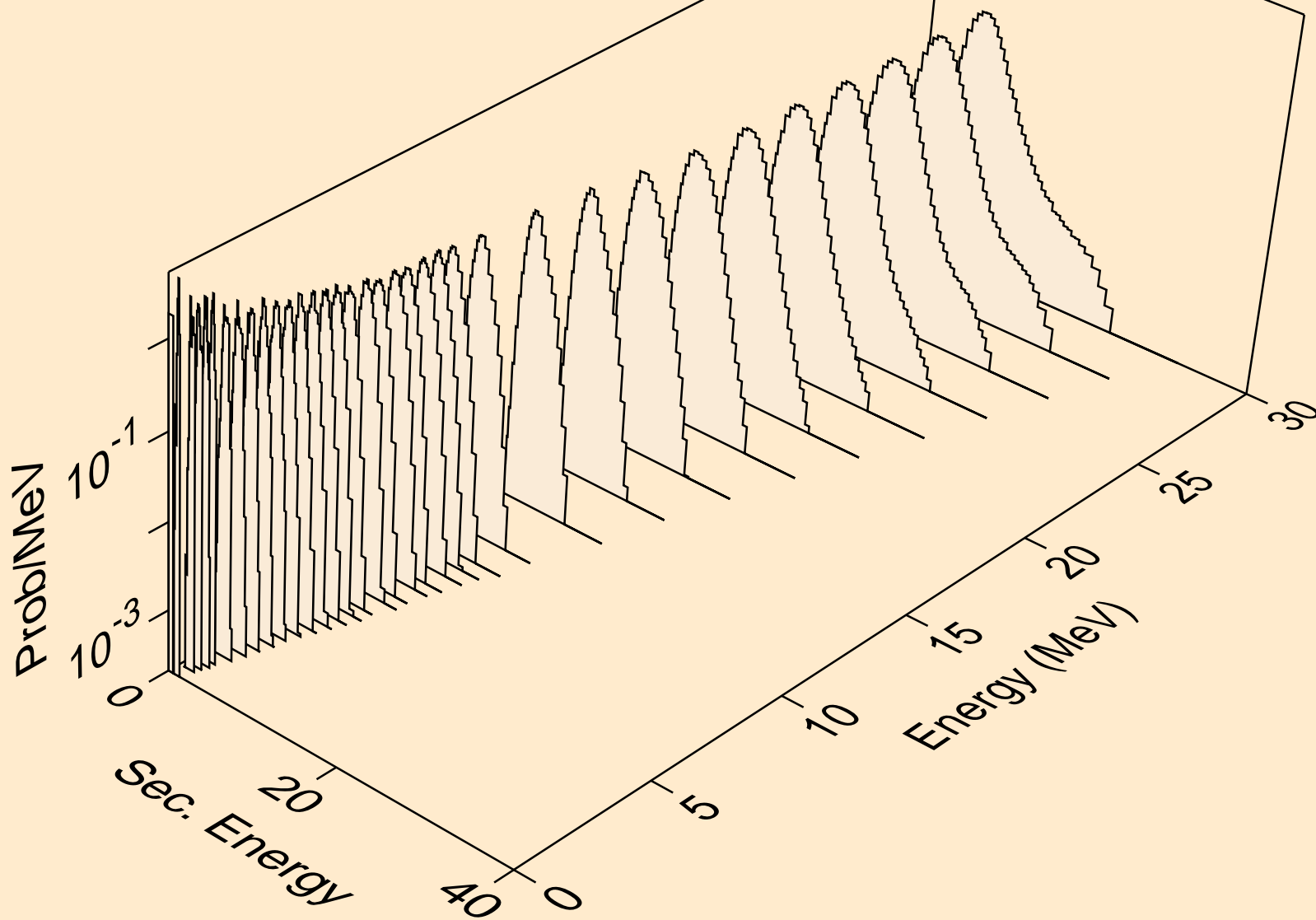

TE112 NEUTRON ACER TENDL-2019 LIBRARY; T=293.16K
protons from (n,pd)

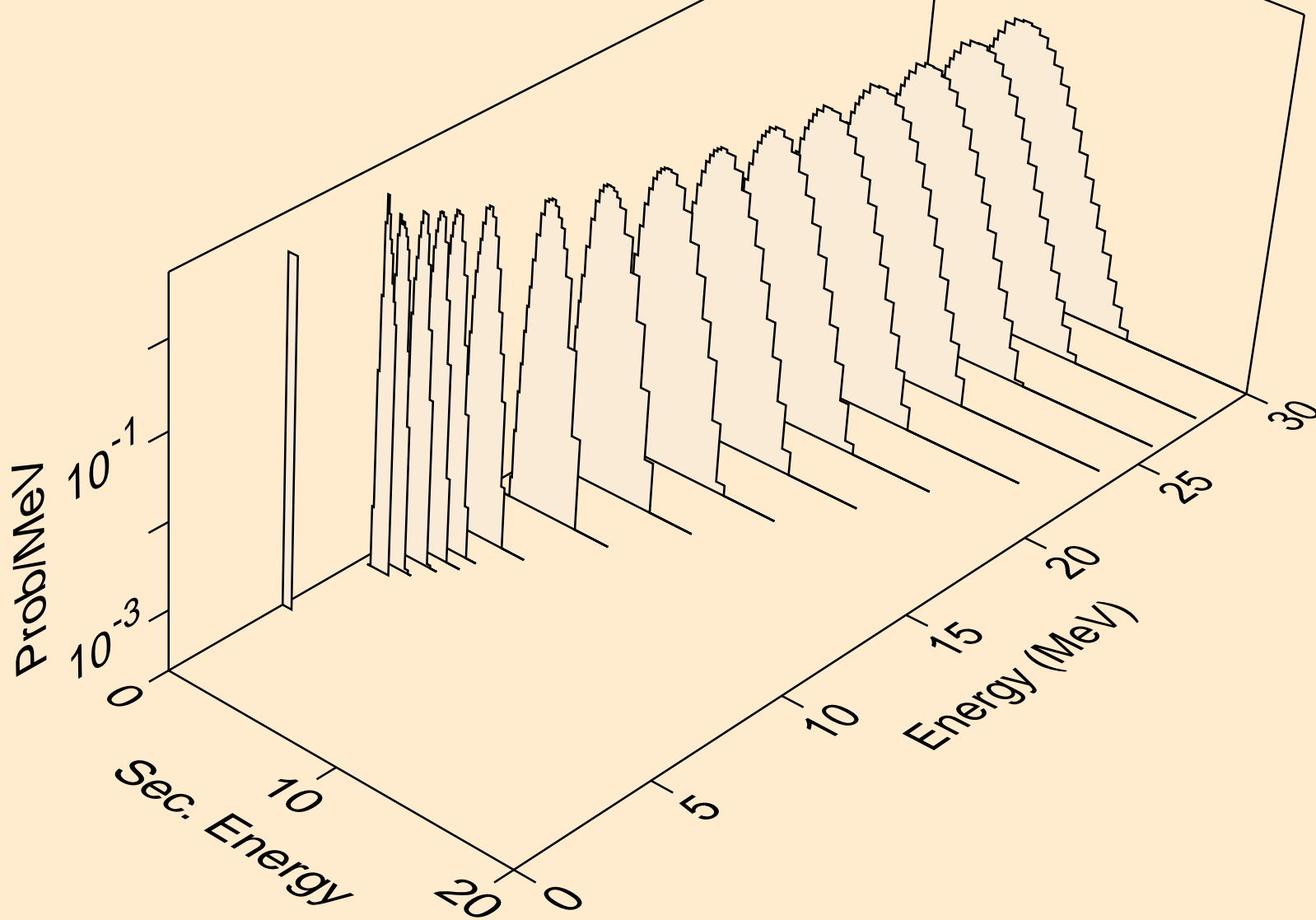

TE112 NEUTRON ACER TENDL-2019 LIBRARY; T=293.16K
protons from (n,pt)

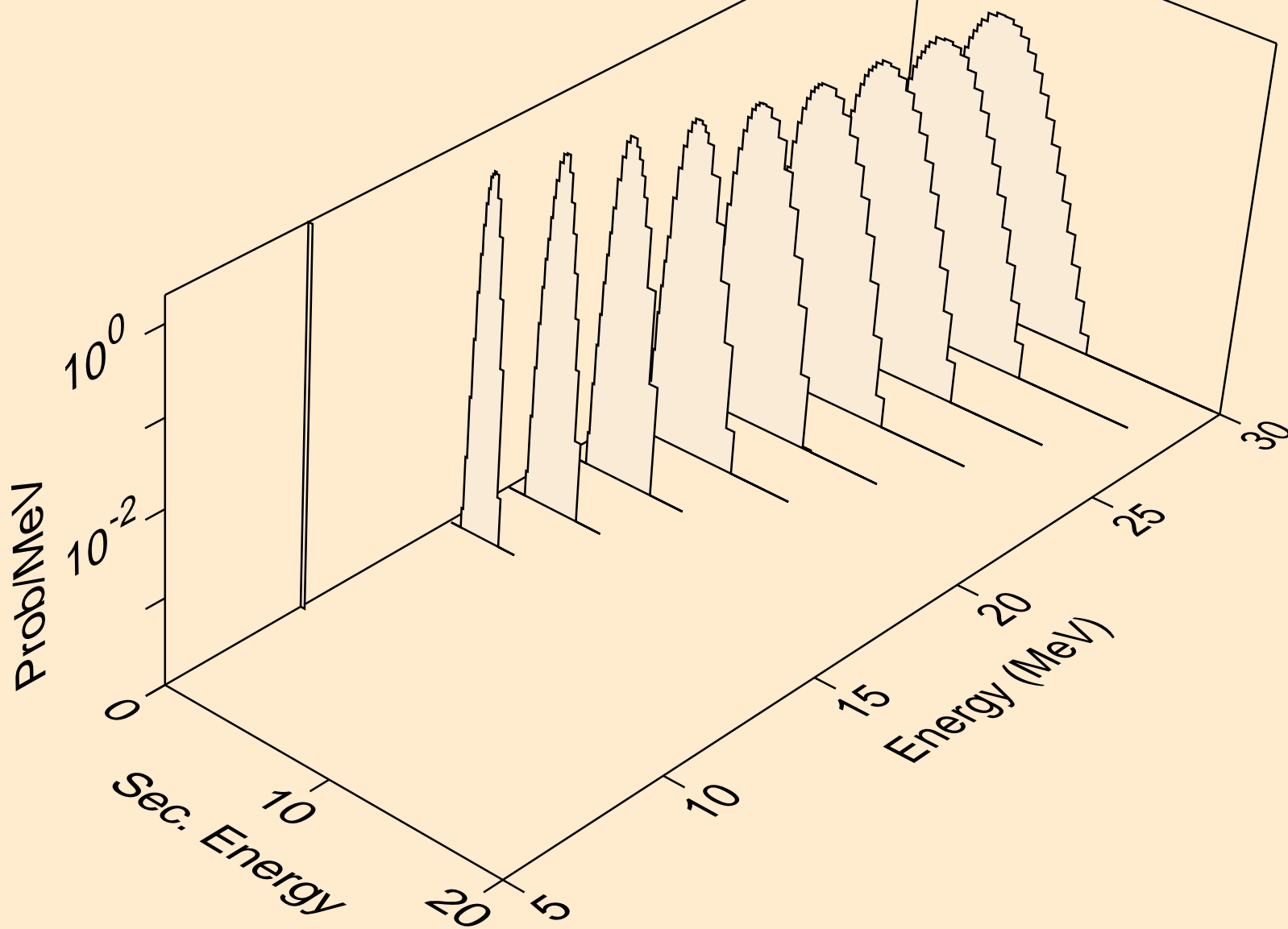

TE112 NEUTRON ACER TENDL-2019 LIBRARY; T=293.16K
deuterons from (n,x)

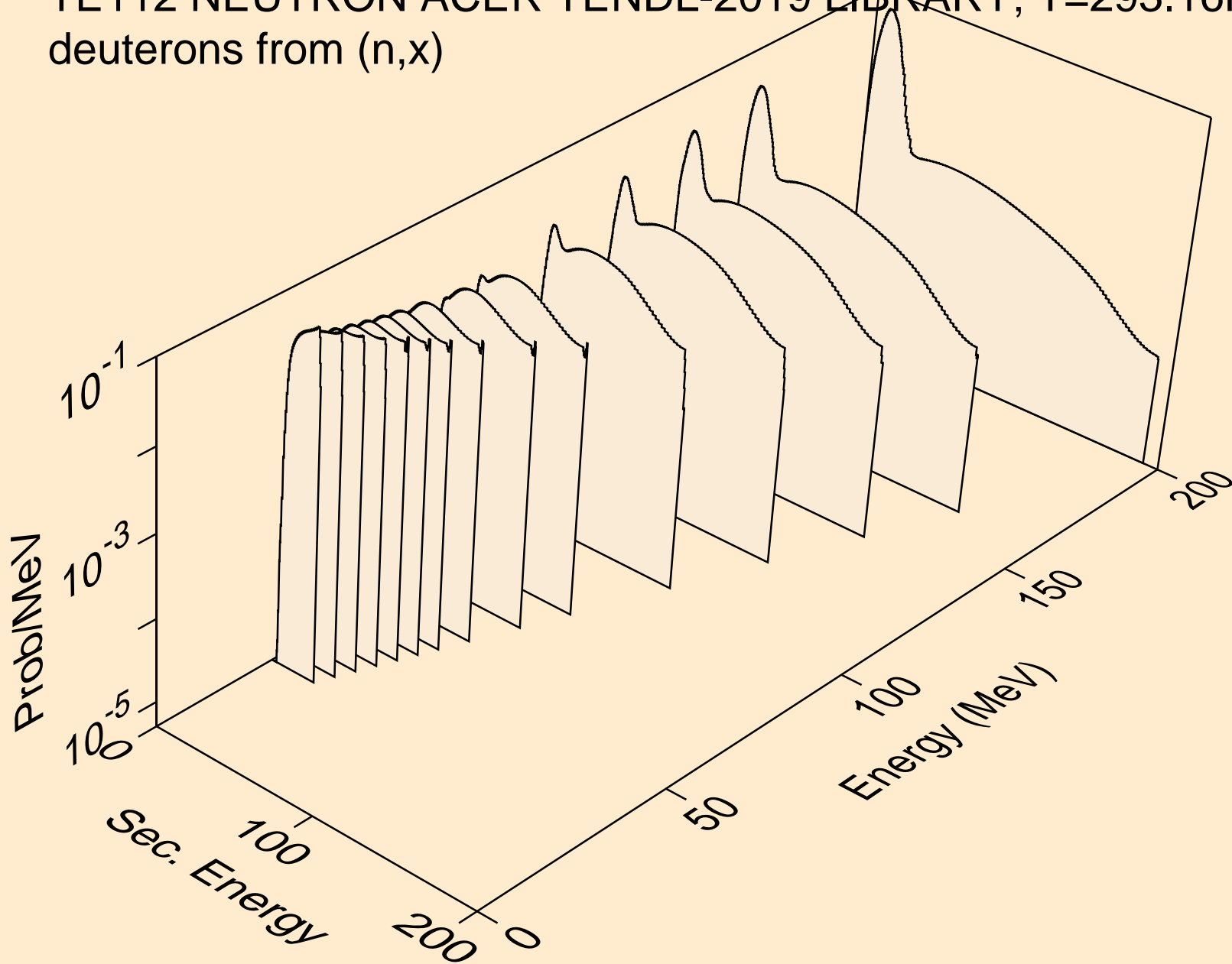

TE112 NEUTRON ACER TENDL-2019 LIBRARY; T=293.16K
deuterons from (n,2nd)

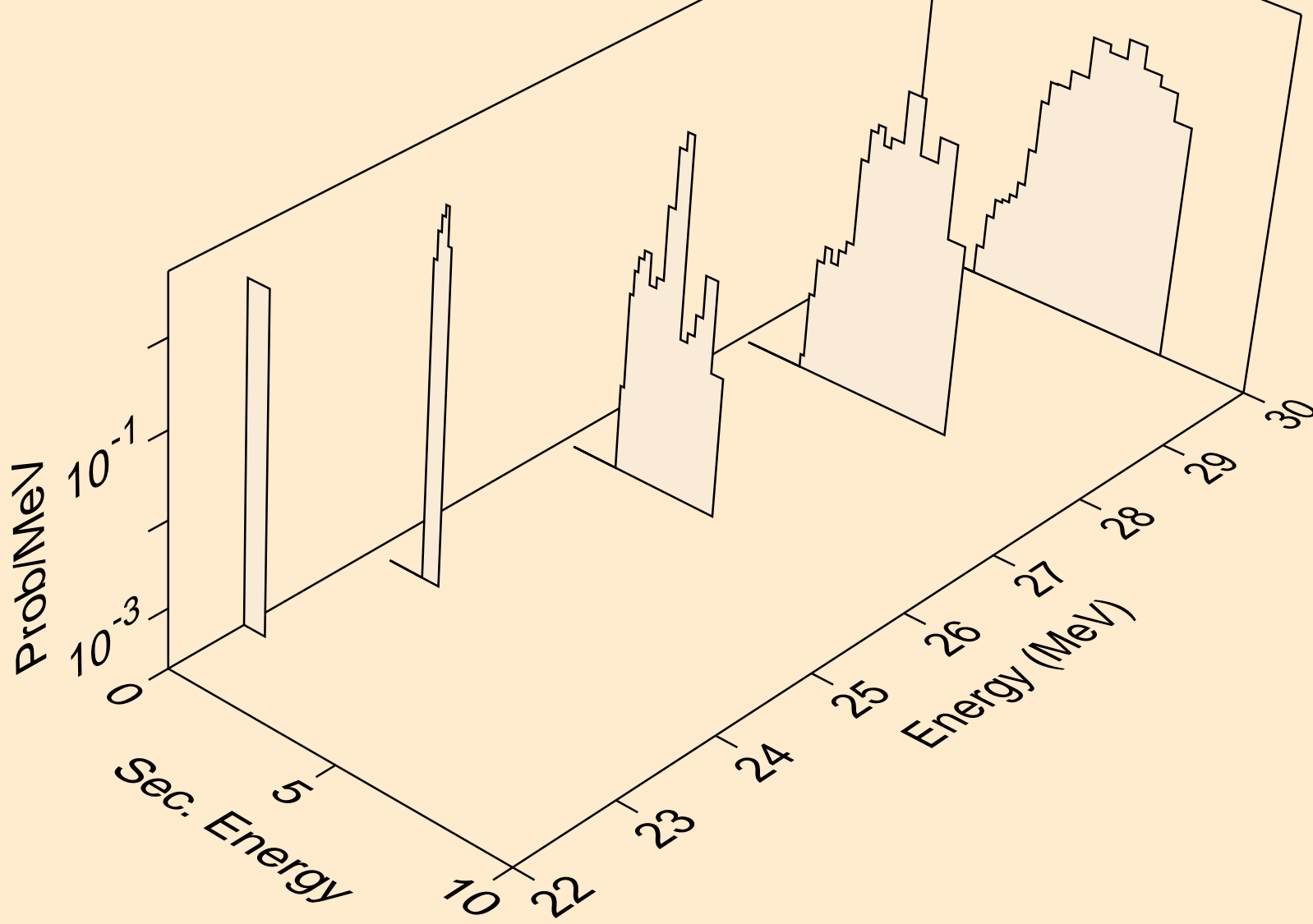

TE112 NEUTRON ACER TENDL-2019 LIBRARY; T=293.16K
deuterons from (n,n*)d

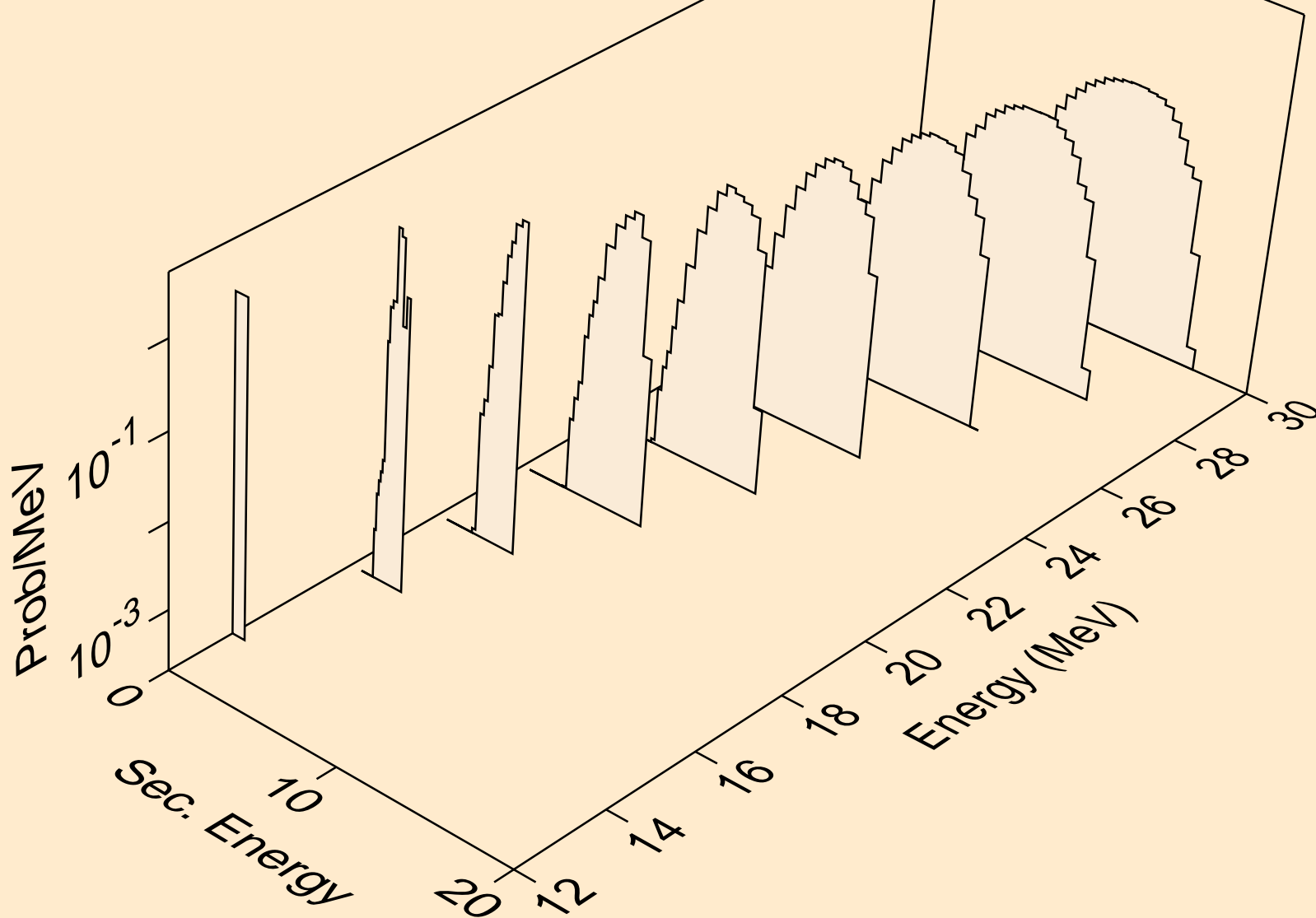

TE112 NEUTRON ACER TENDL-2019 LIBRARY; T=293.16K
deuterons from (n,d)

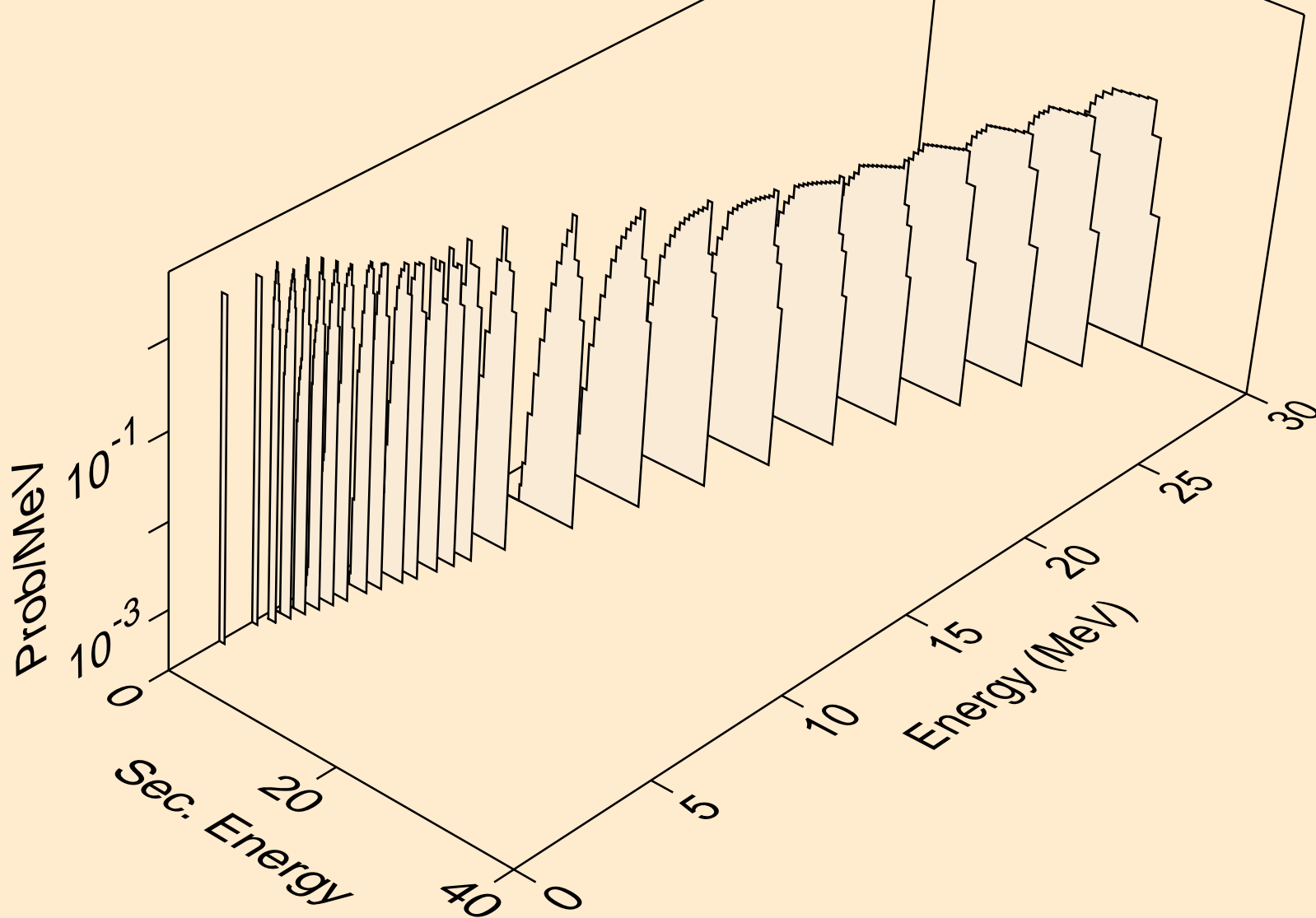

TE112 NEUTRON ACER TENDL-2019 LIBRARY; T=293.16K
deuterons from (n,d2a)

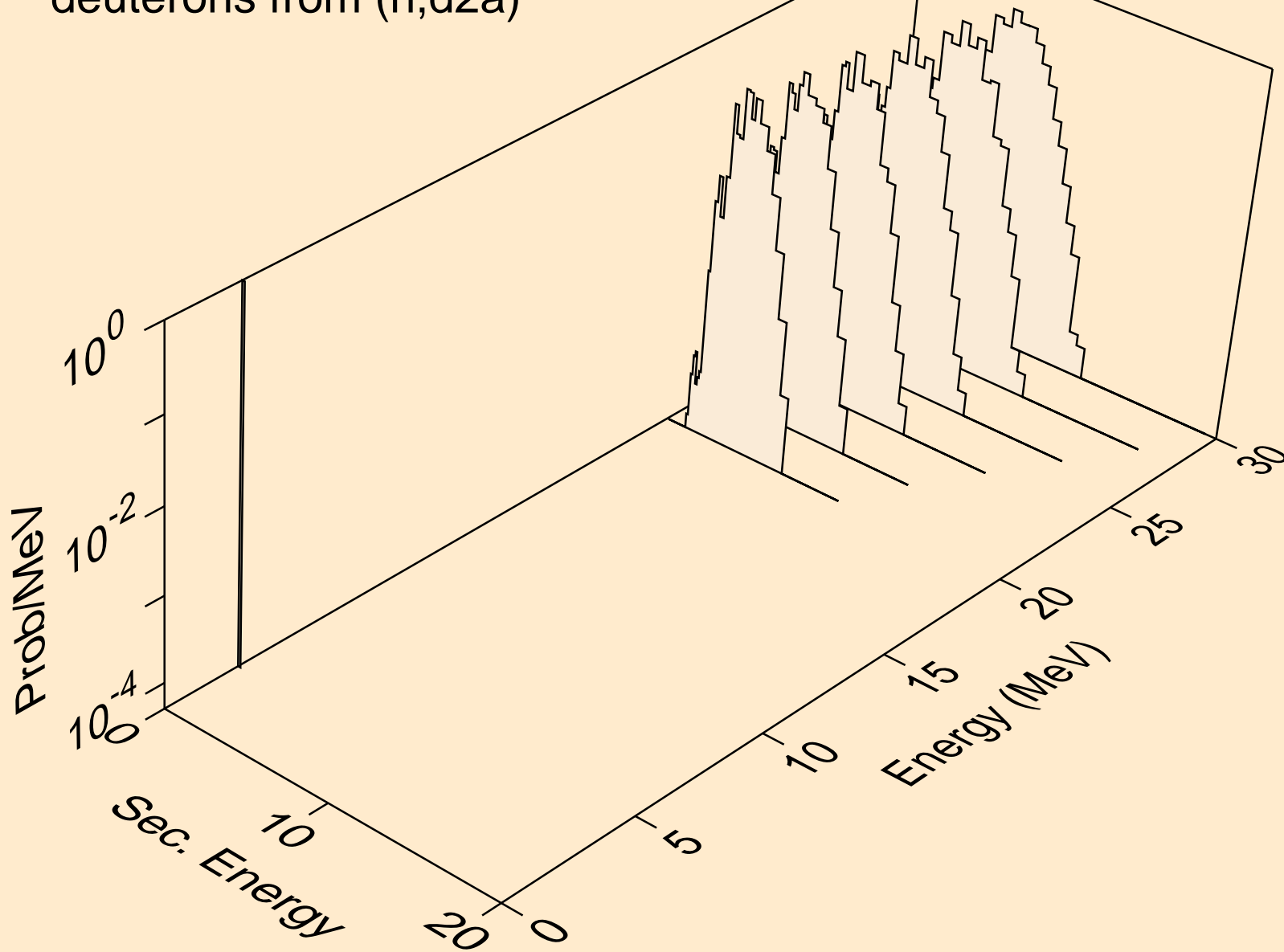

TE112 NEUTRON ACER TENDL-2019 LIBRARY; T=293.16K
deuterons from (n,pd)

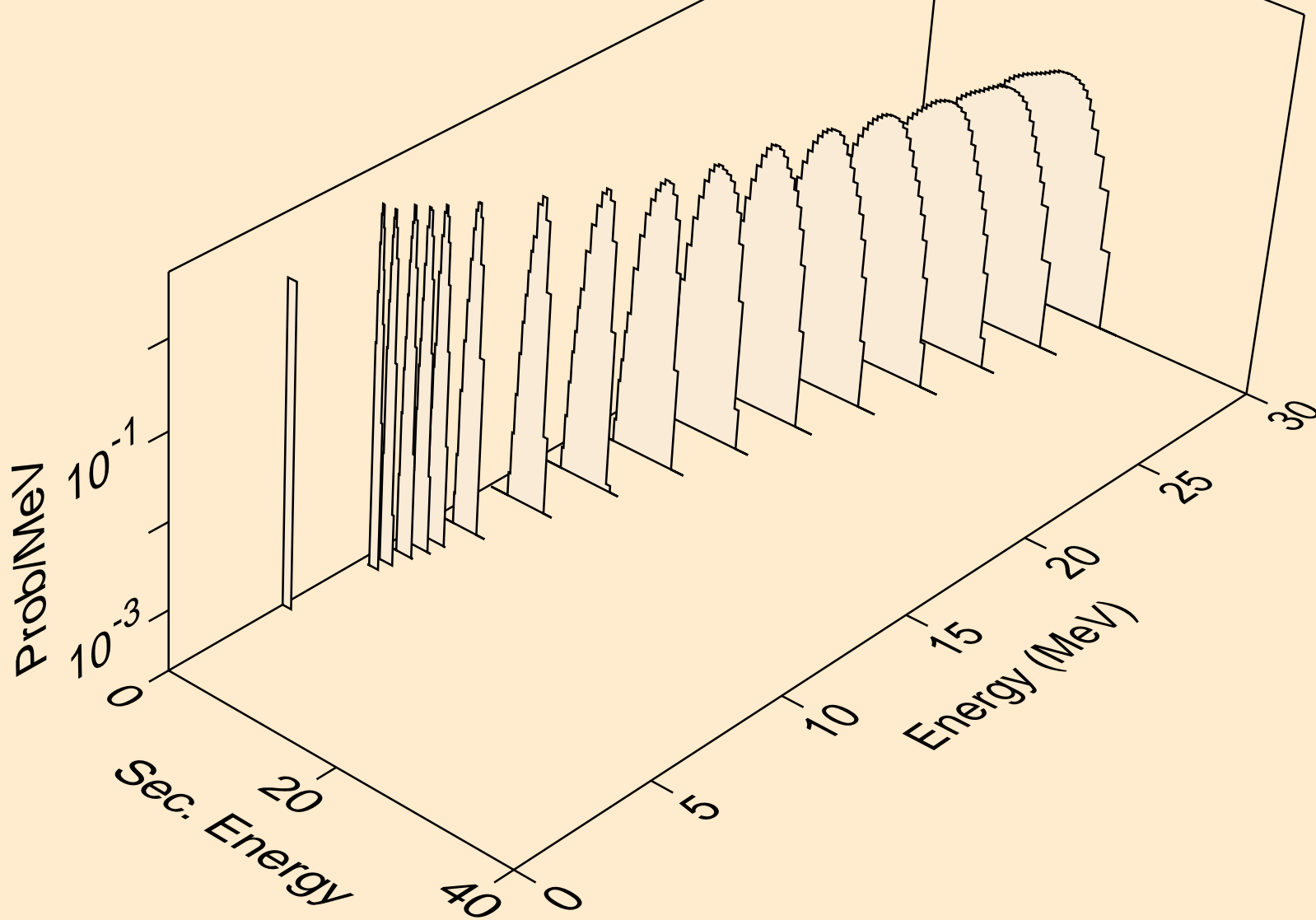

TE112 NEUTRON ACER TENDL-2019 LIBRARY; T=293.16K
deuterons from (n,da)

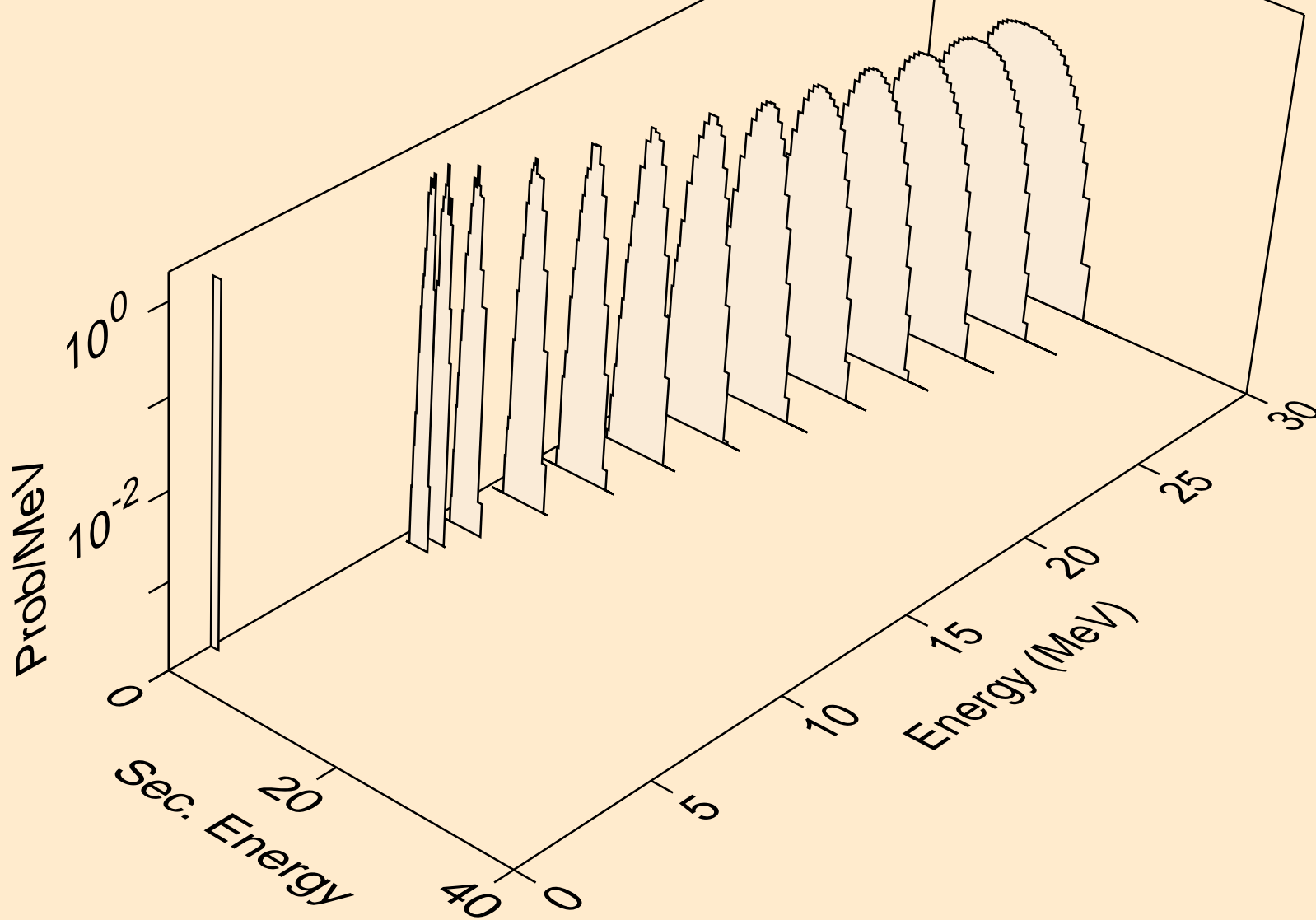

TE112 NEUTRON ACER TENDL-2019 LIBRARY; T=293.16K
tritons from (n,x)

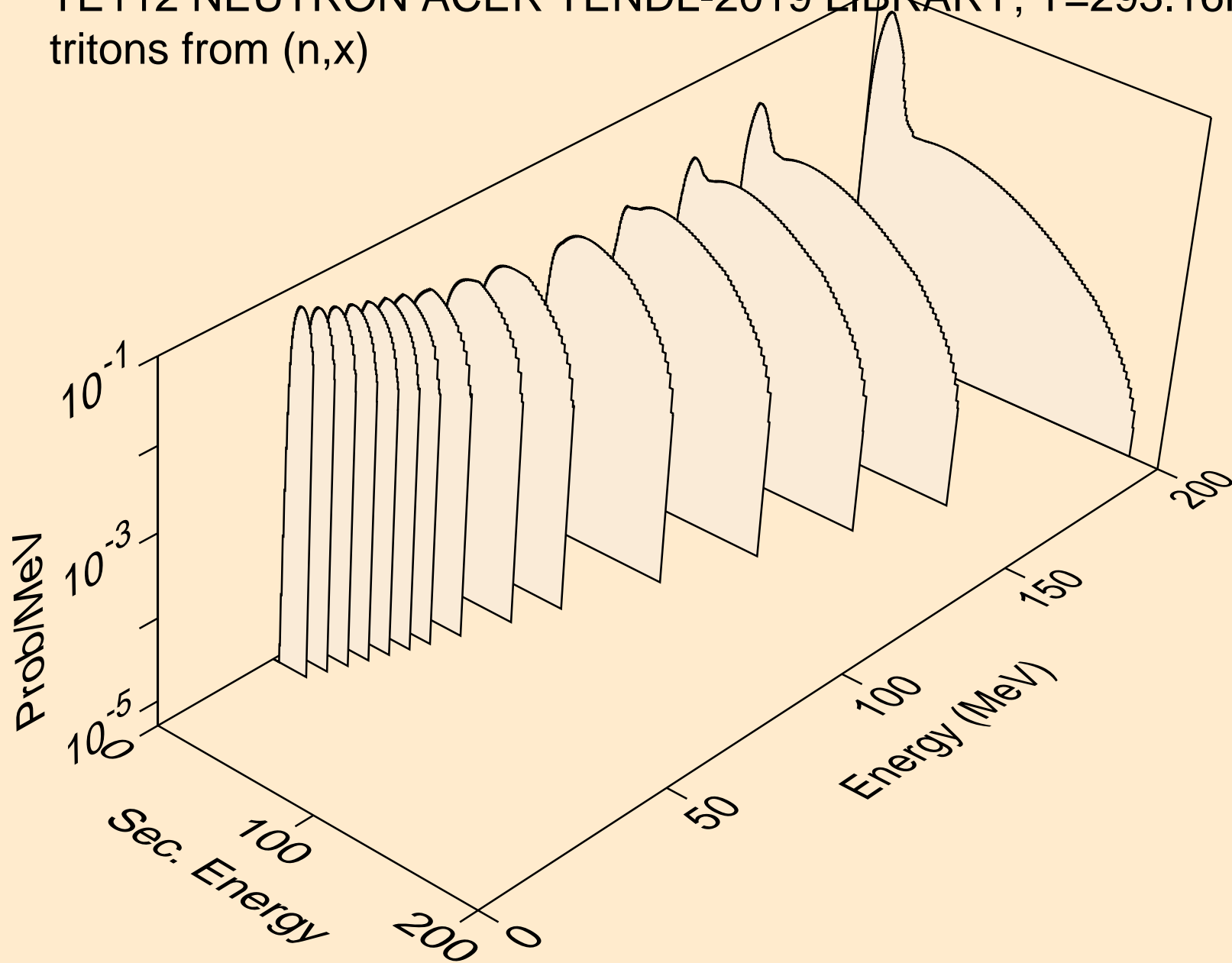

TE112 NEUTRON ACER TENDL-2019 LIBRARY; T=293.16K
tritons from (n,n*)t

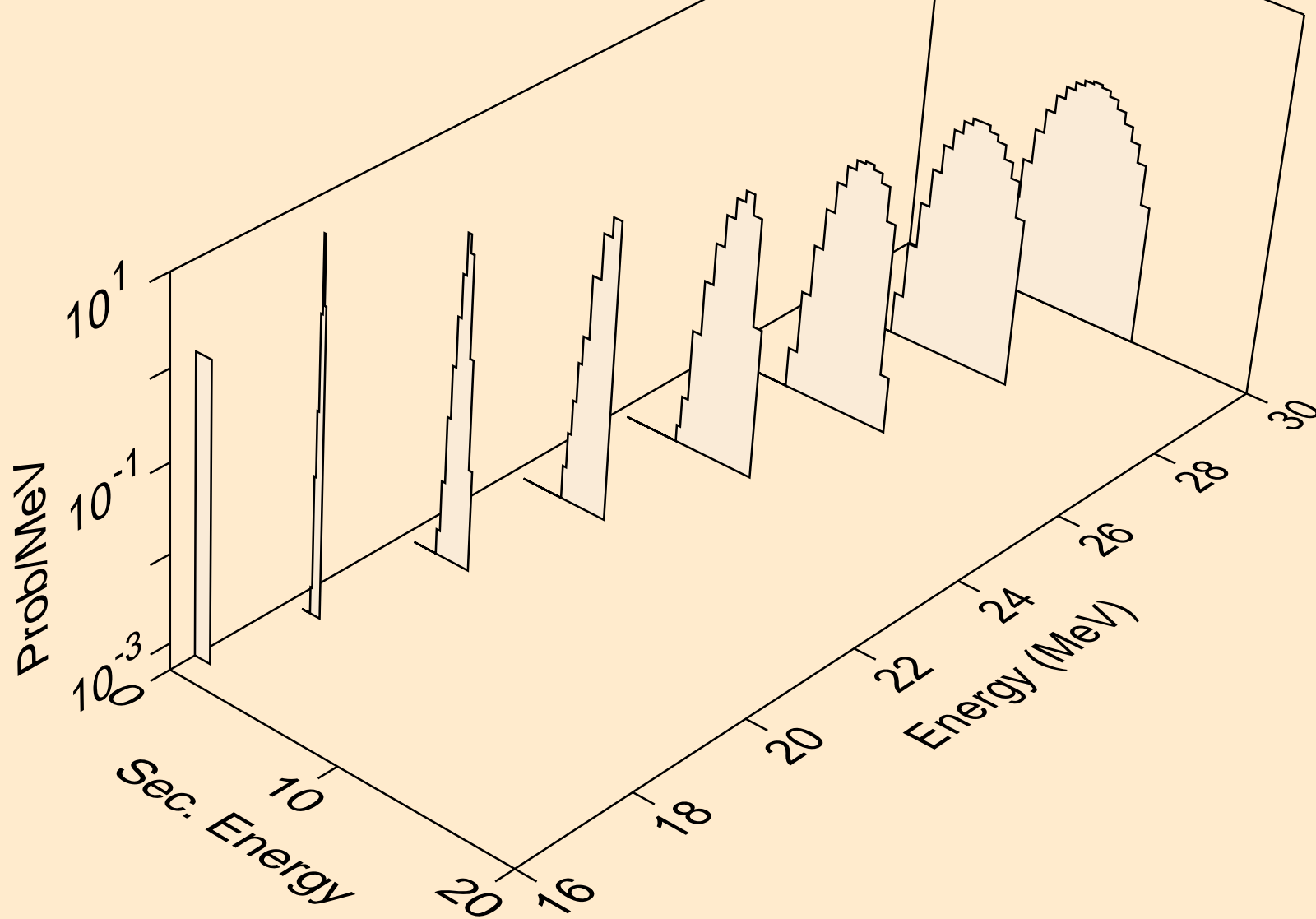

TE112 NEUTRON ACER TENDL-2019 LIBRARY; T=293.16K
tritons from (n,t)

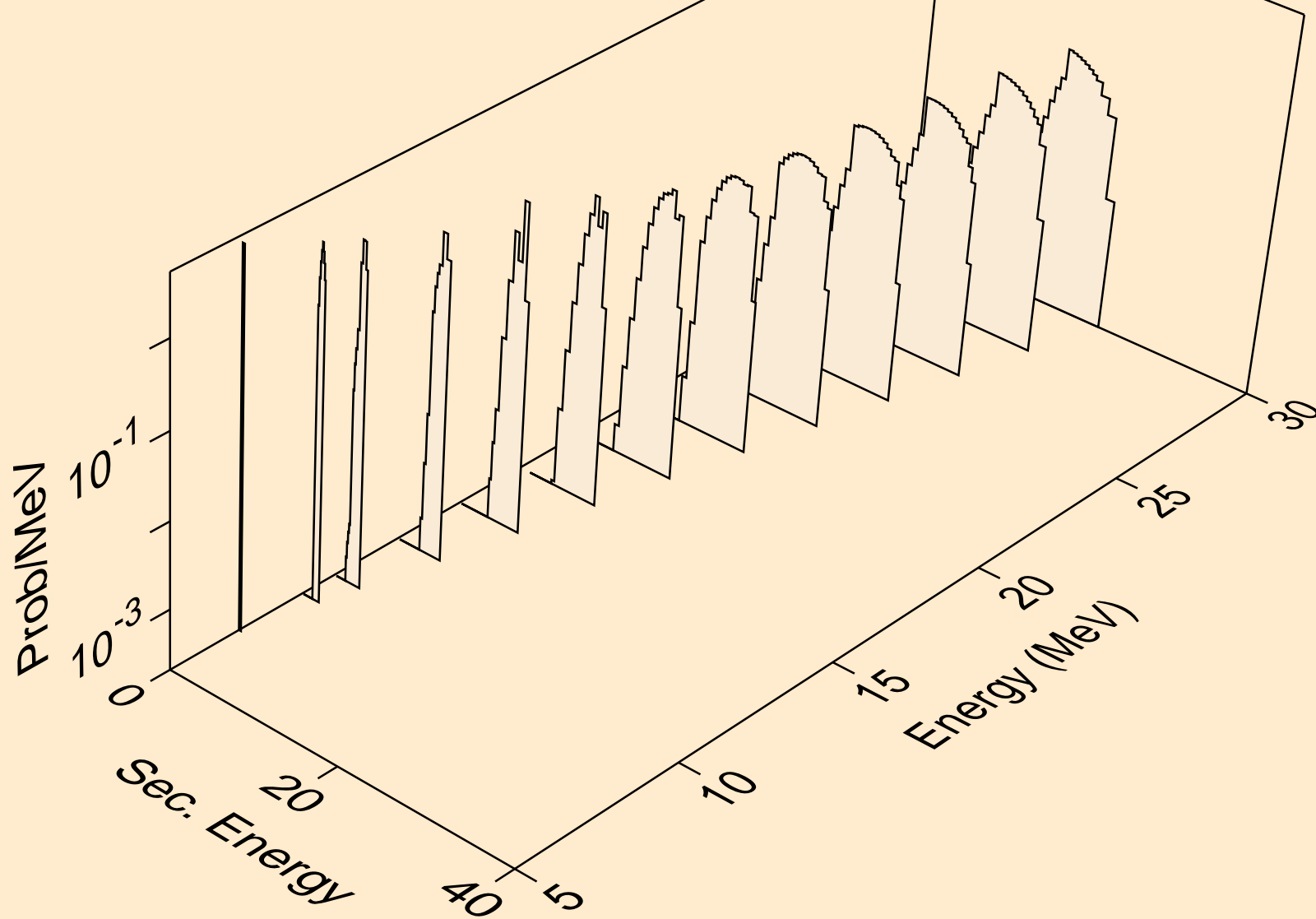

TE112 NEUTRON ACER TENDL-2019 LIBRARY; T=293.16K
tritons from (n,pt)

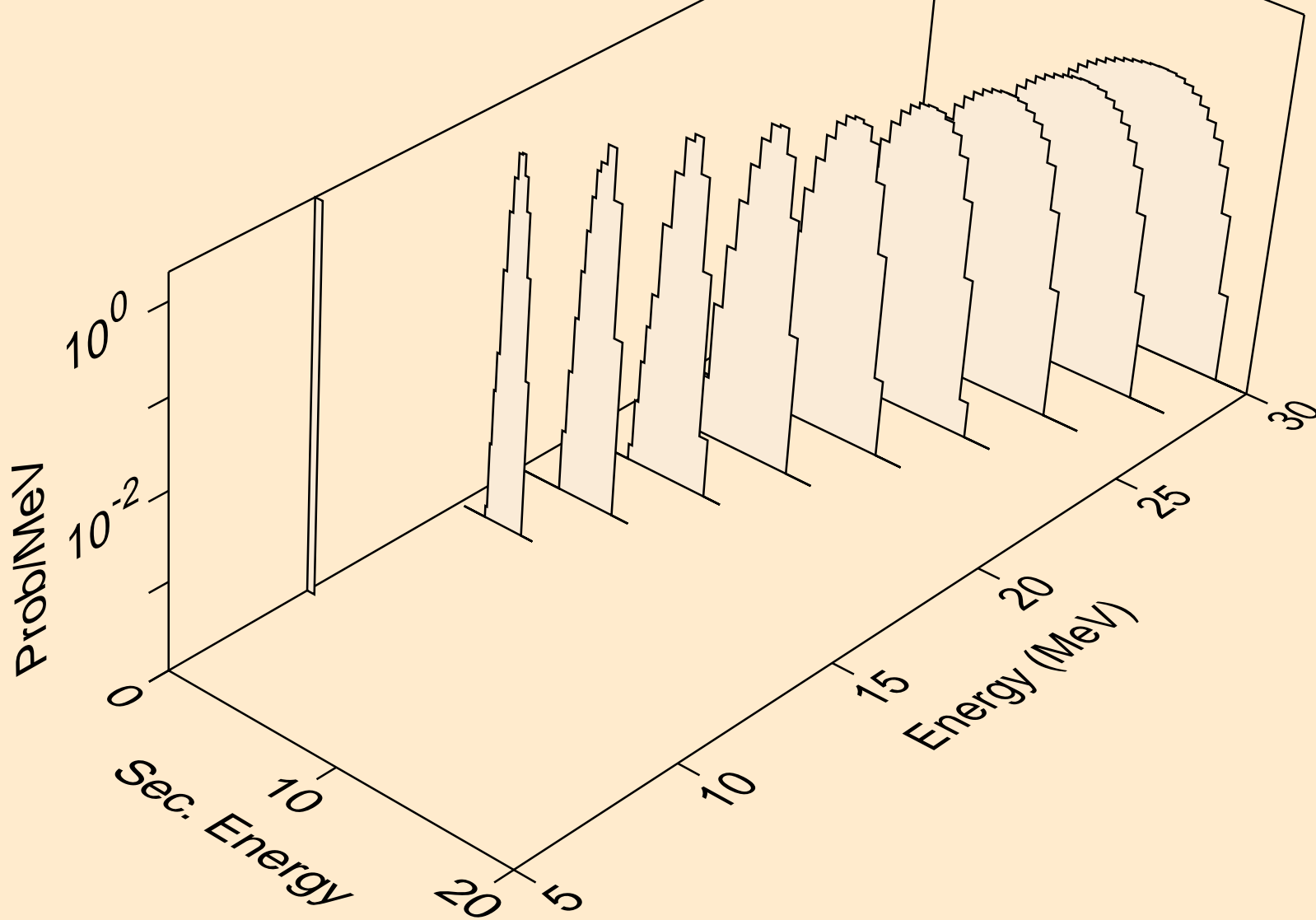

TE112 NEUTRON ACER TENDL-2019 LIBRARY; T=293.16K
he3s from (n,x)

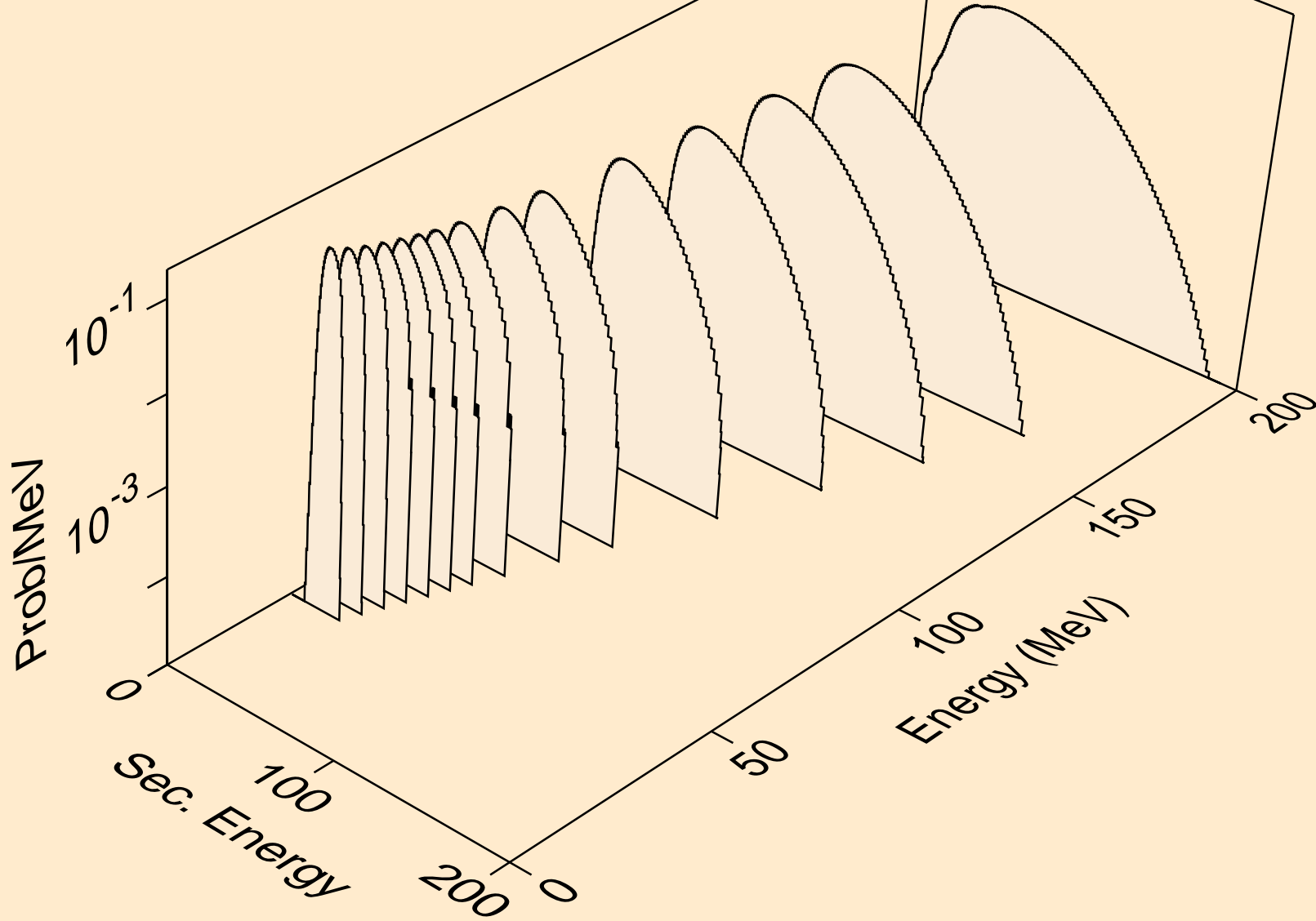

TE112 NEUTRON ACER TENDL-2019 LIBRARY; T=293.16K
he3s from (n,n*)he3

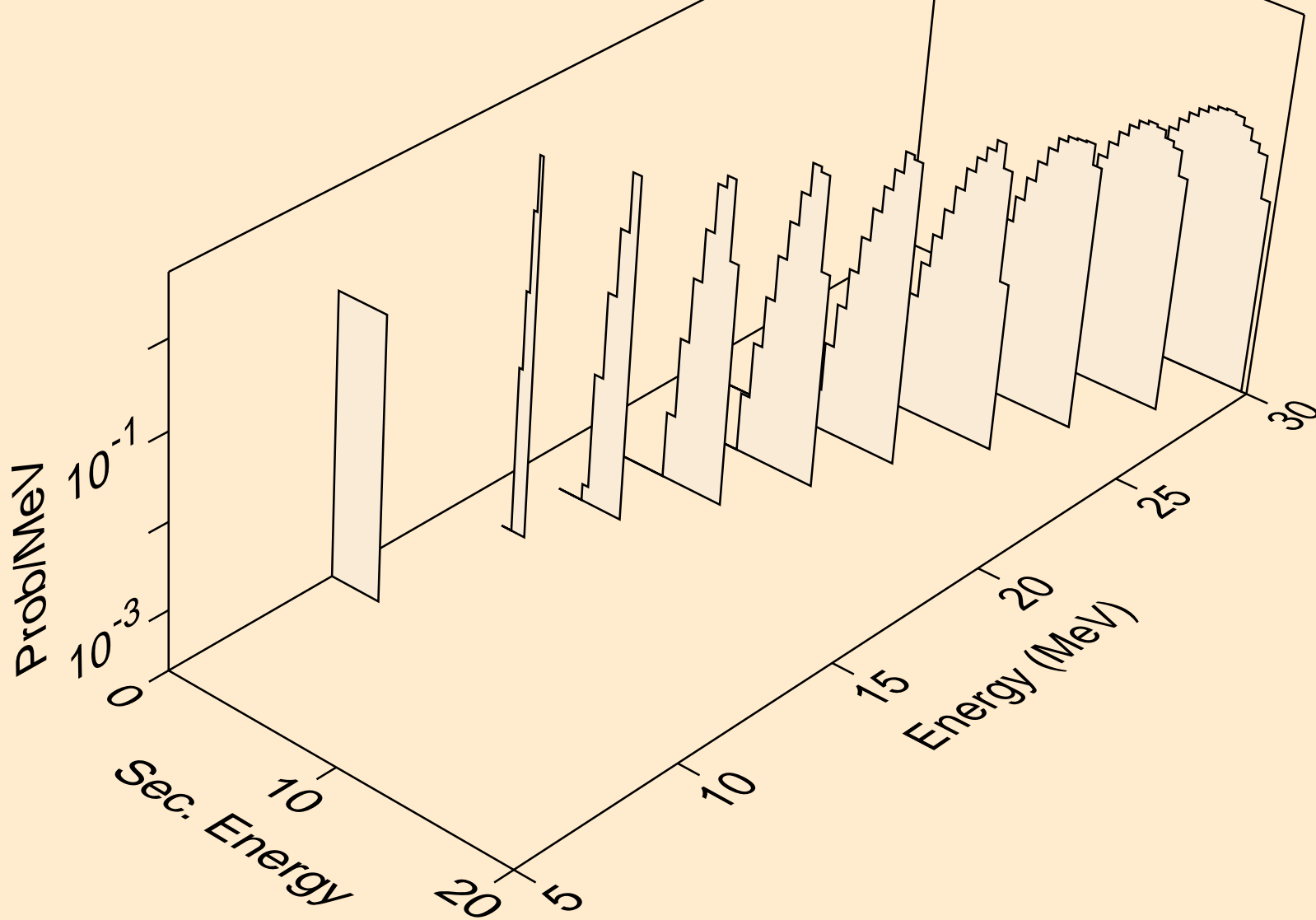

TE112 NEUTRON ACER TENDL-2019 LIBRARY; T=293.16K
he3s from (n,he3)

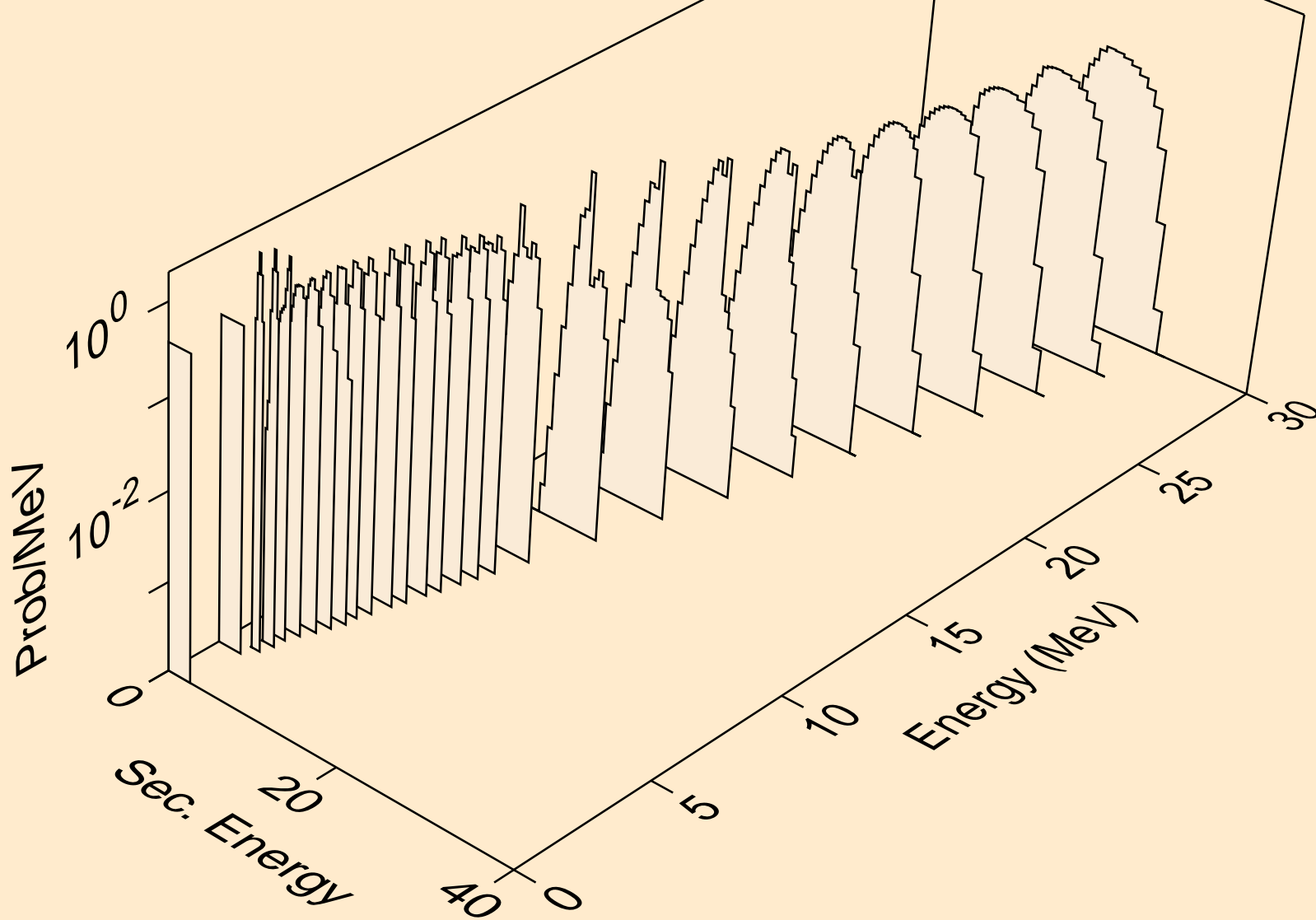

TE112 NEUTRON ACER TENDL-2019 LIBRARY; T=293.16K
alphas from (n,x)

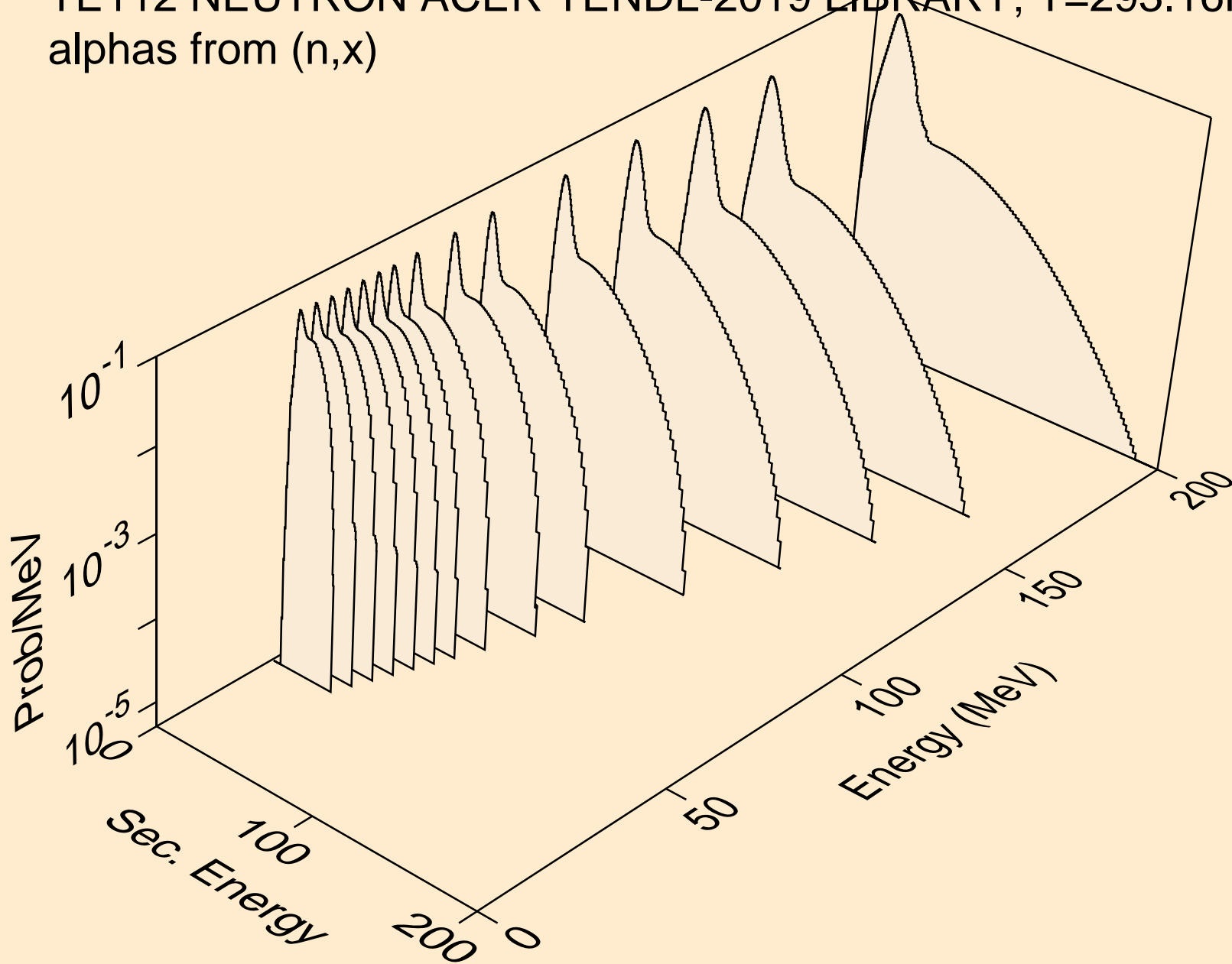

TE112 NEUTRON ACER TENDL-2019 LIBRARY; T=293.16K
alphas from (n,n*)a

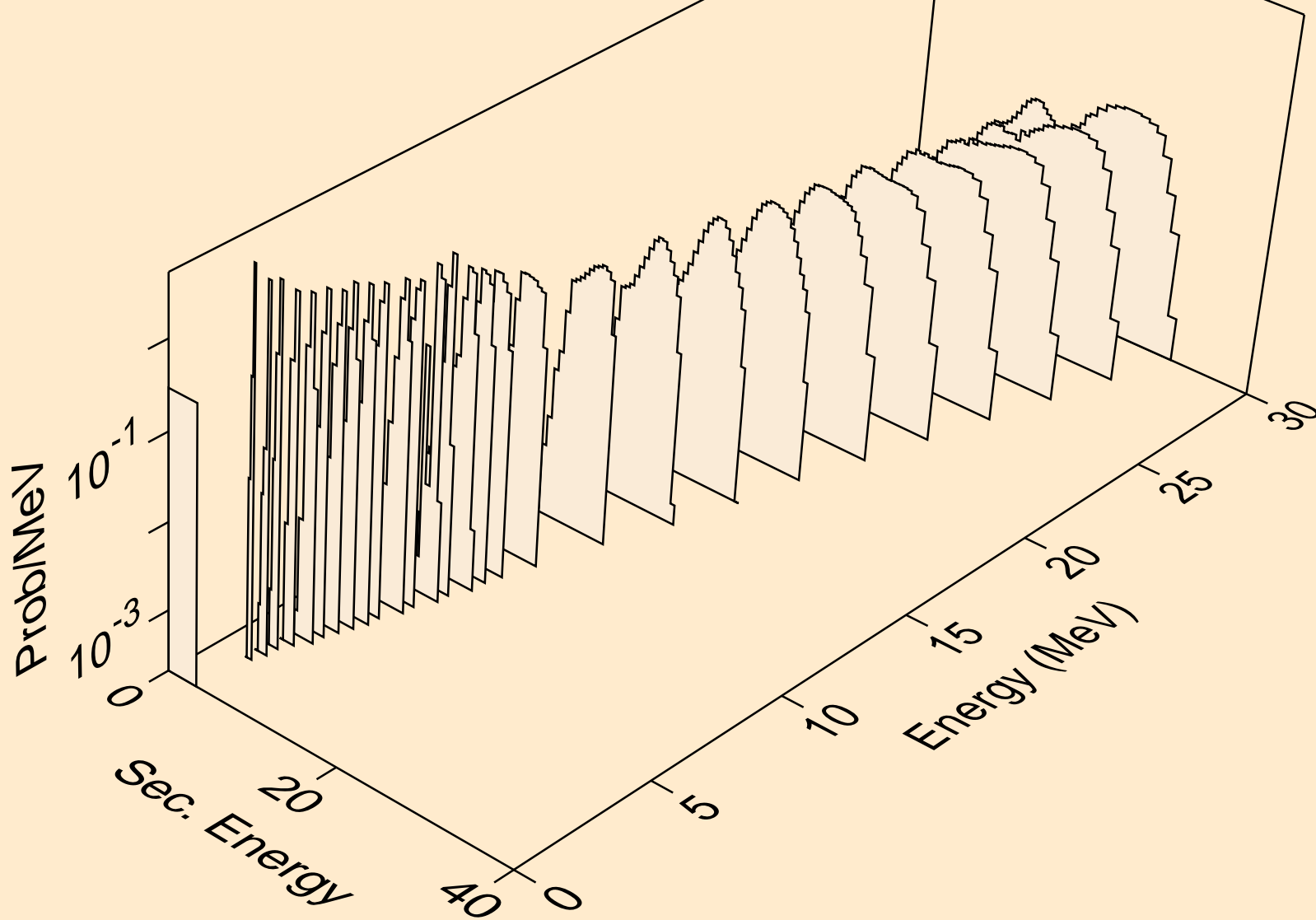

TE112 NEUTRON ACER TENDL-2019 LIBRARY; T=293.16K
alphas from (n,2n)a

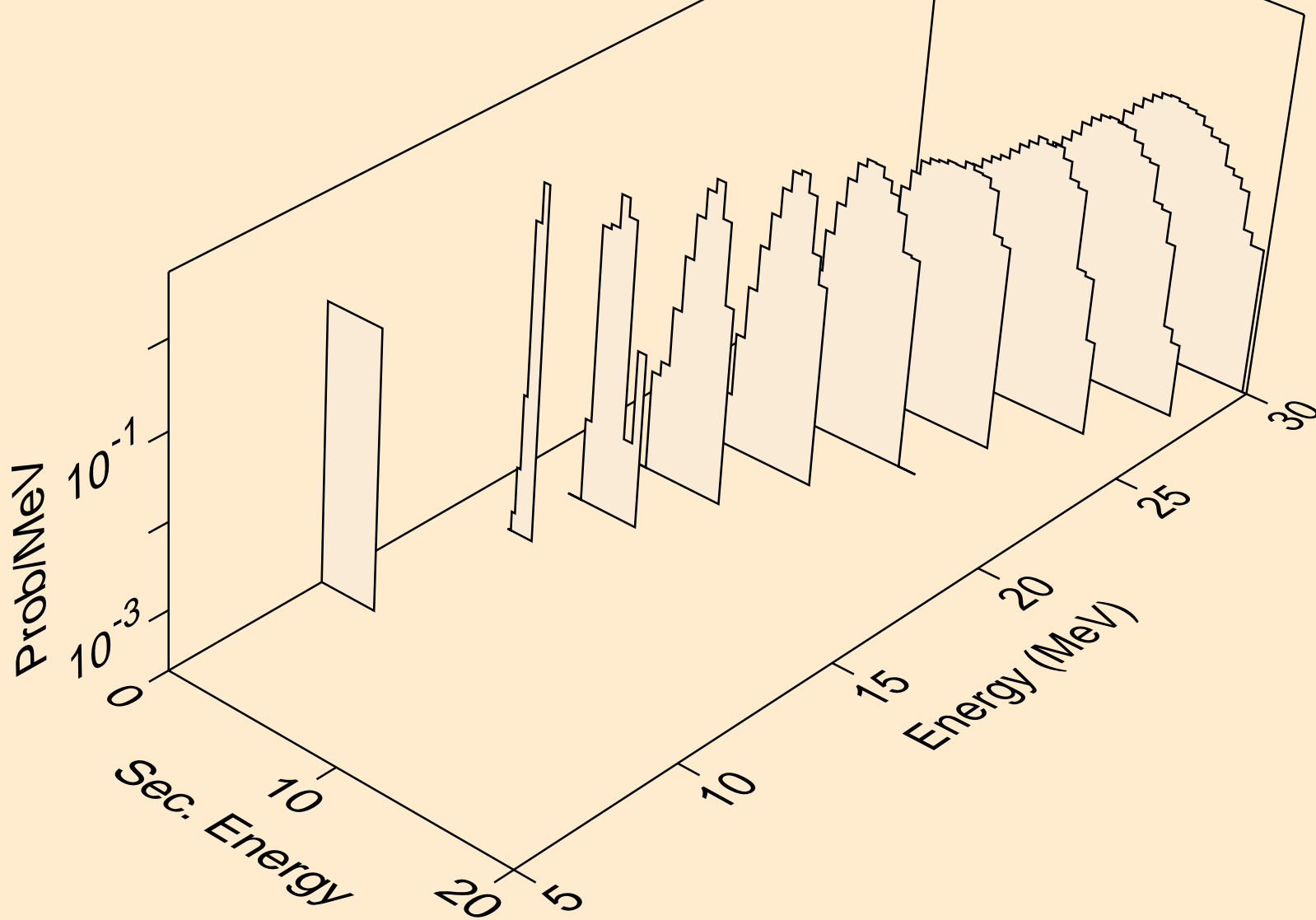

TE112 NEUTRON ACER TENDL-2019 LIBRARY; T=293.16K
alphas from (n,3n)a

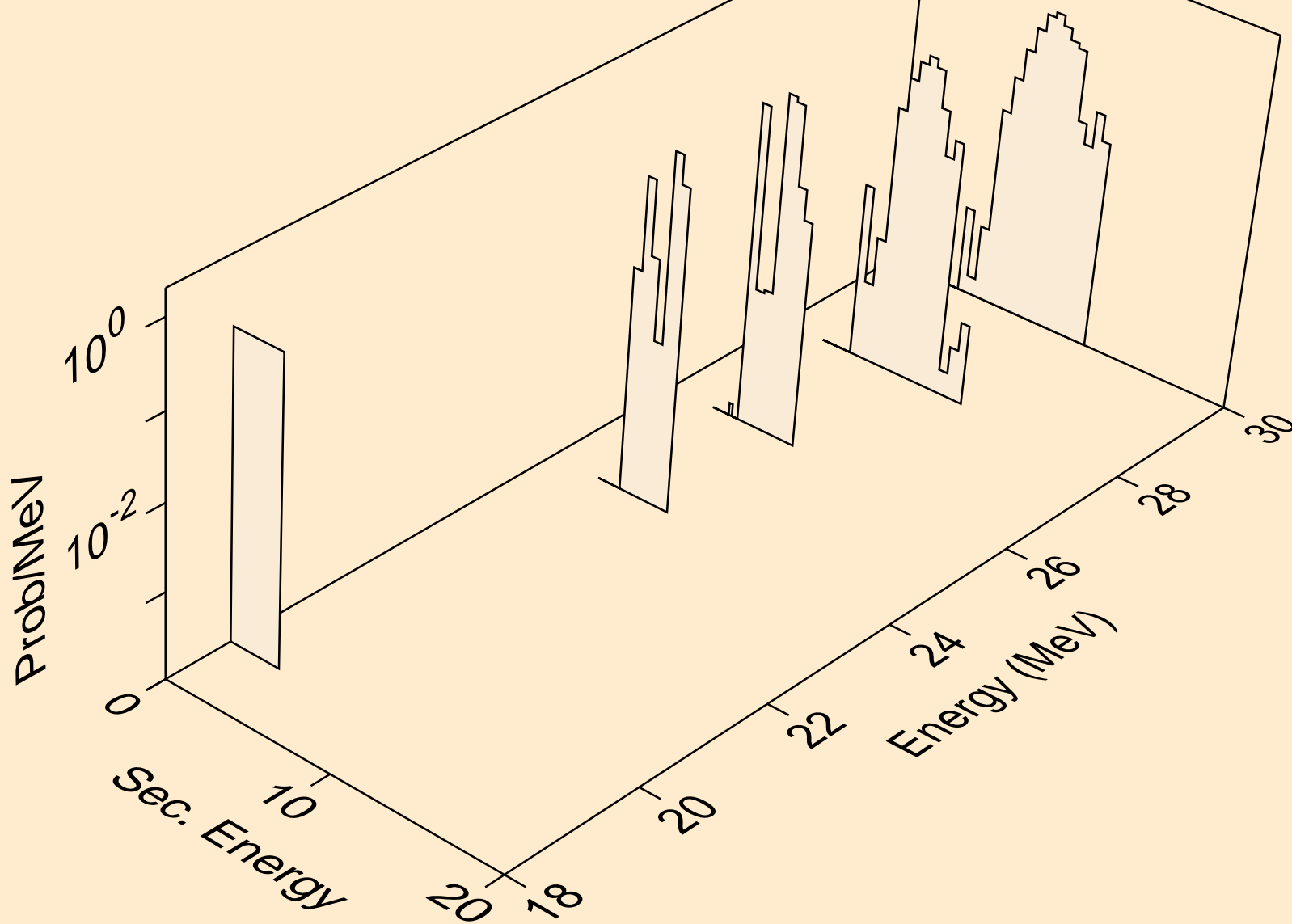

TE112 NEUTRON ACER TENDL-2019 LIBRARY; T=293.16K
alphas from (n,n*)2a

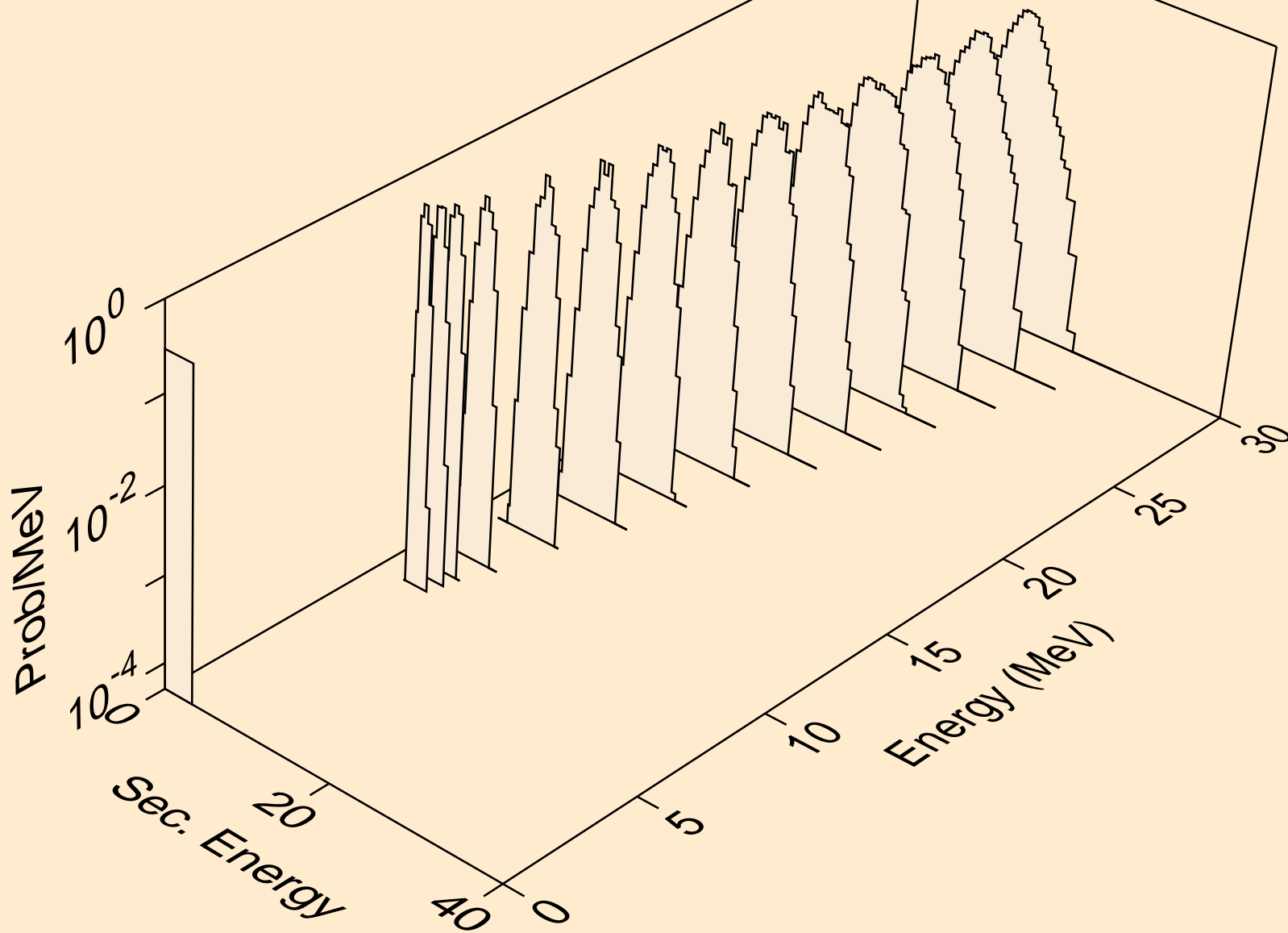

TE112 NEUTRON ACER TENDL-2019 LIBRARY; T=293.16K
alphas from (n,2n)2a

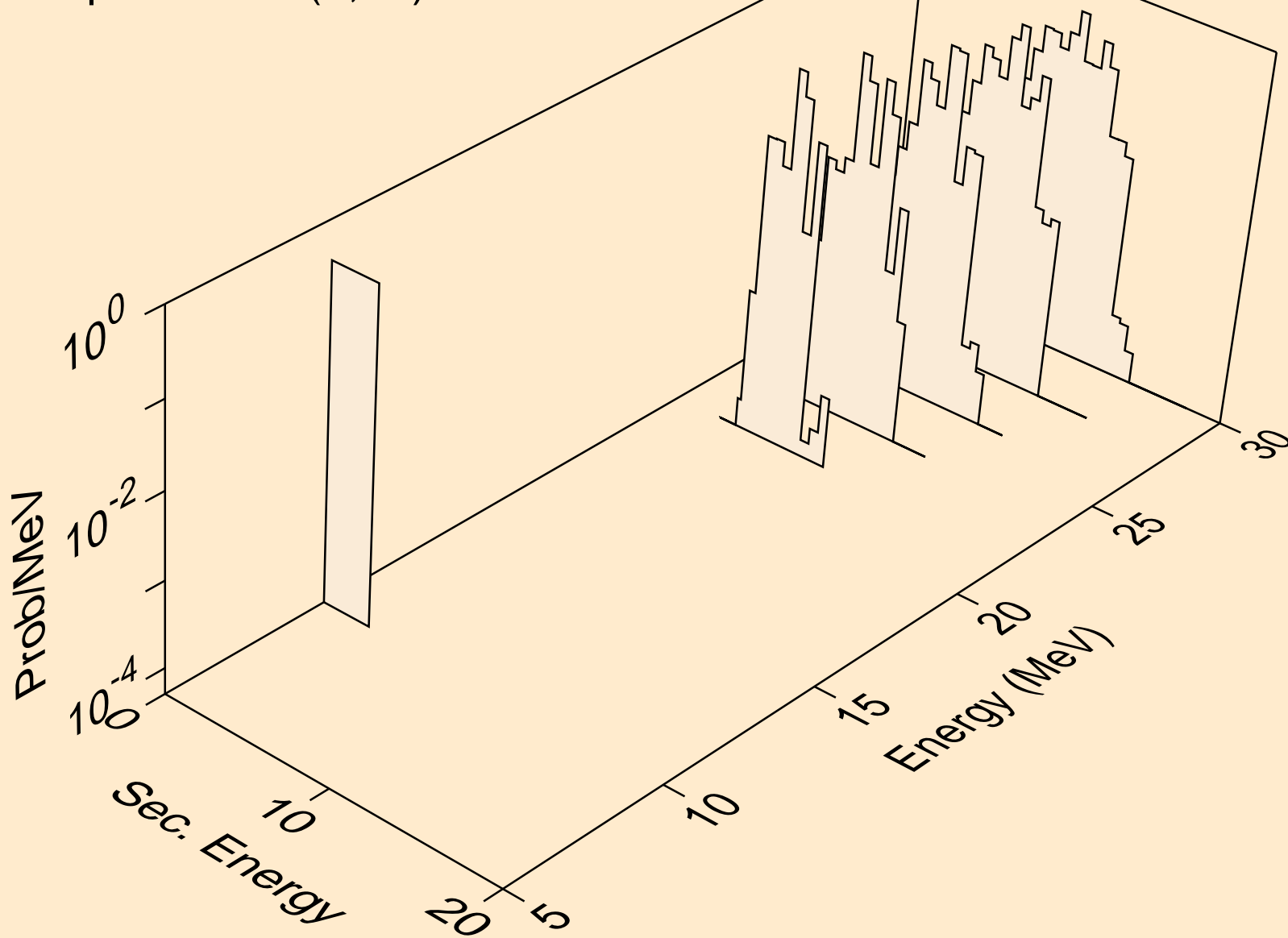

TE112 NEUTRON ACER TENDL-2019 LIBRARY; T=293.16K
alphas from (n,npa)

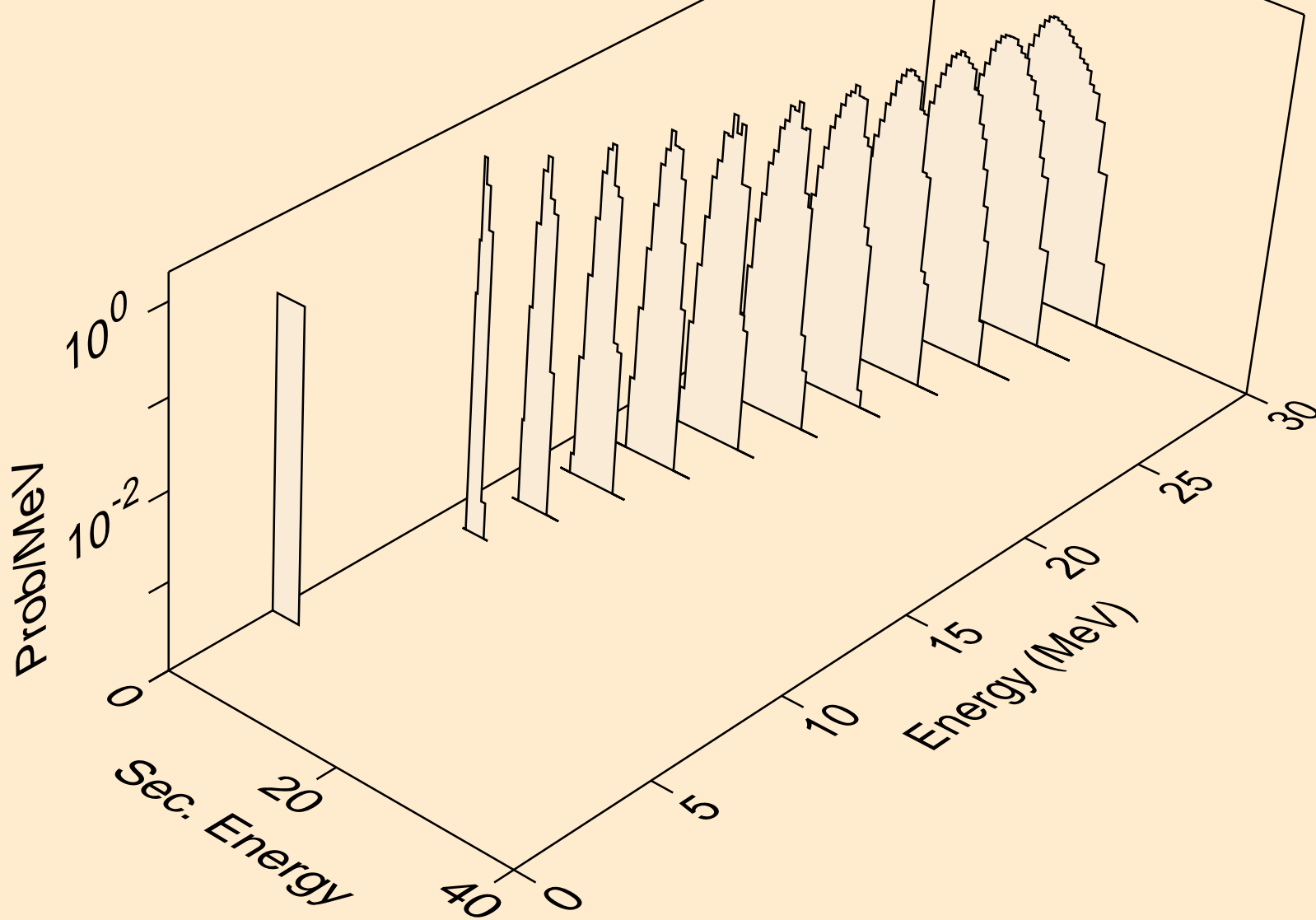

TE112 NEUTRON ACER TENDL-2019 LIBRARY; T=293.16K
alphas from (n,a)

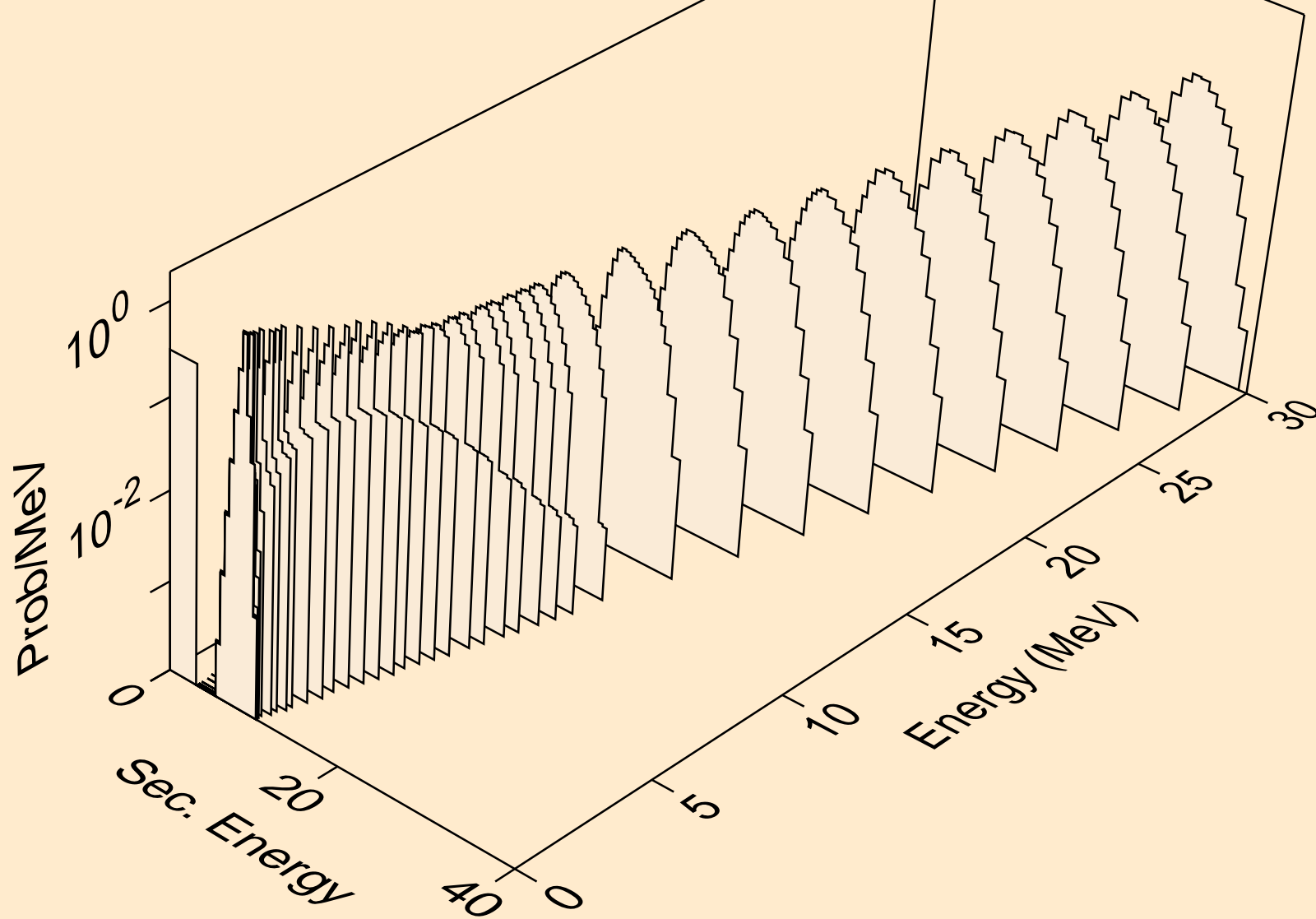

TE112 NEUTRON ACER TENDL-2019 LIBRARY; T=293.16K
alphas from (n,2a)

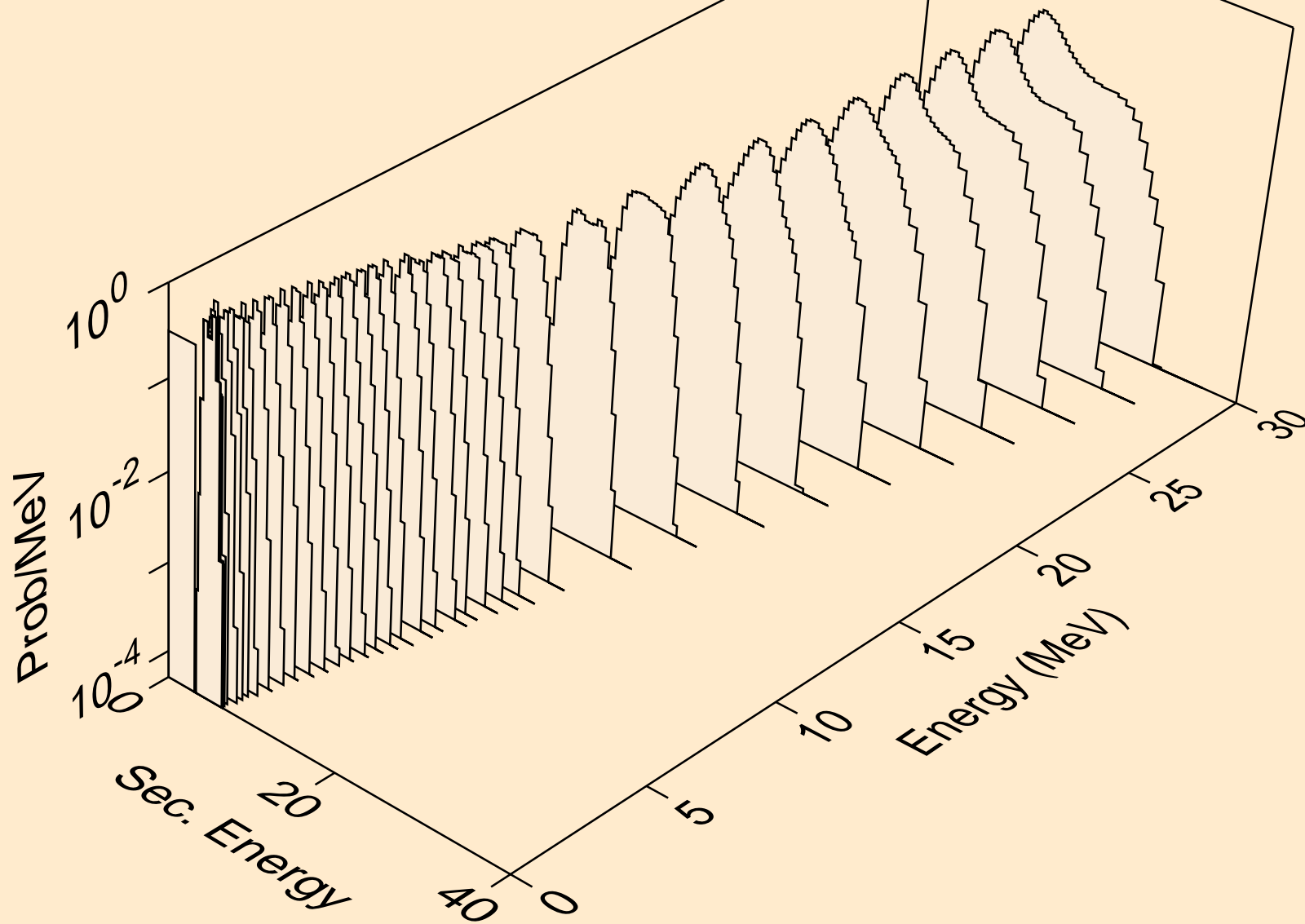

TE112 NEUTRON ACER TENDL-2019 LIBRARY; T=293.16K
alphas from (n,3a)

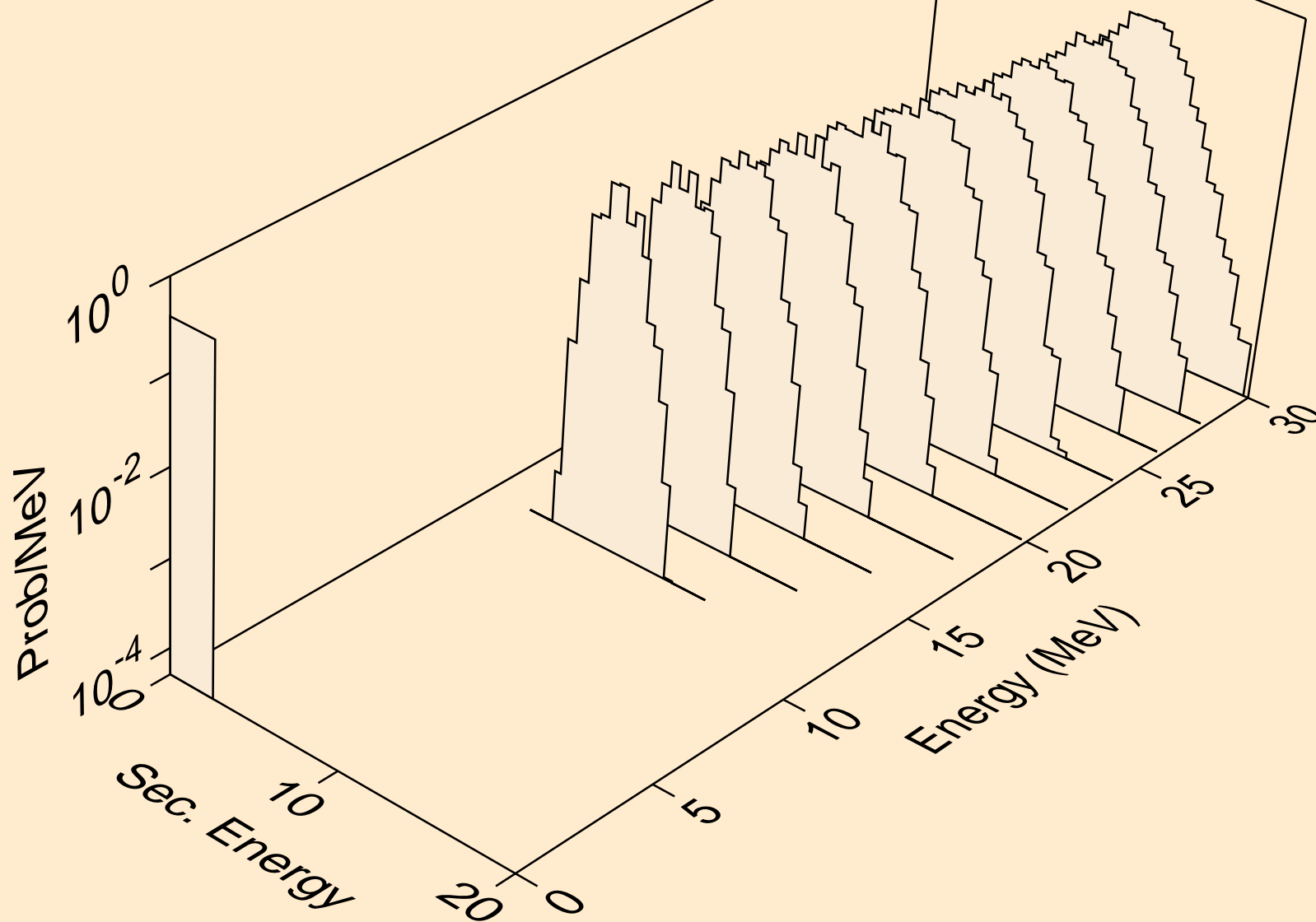

TE112 NEUTRON ACER TENDL-2019 LIBRARY; T=293.16K
alphas from (n,pa)

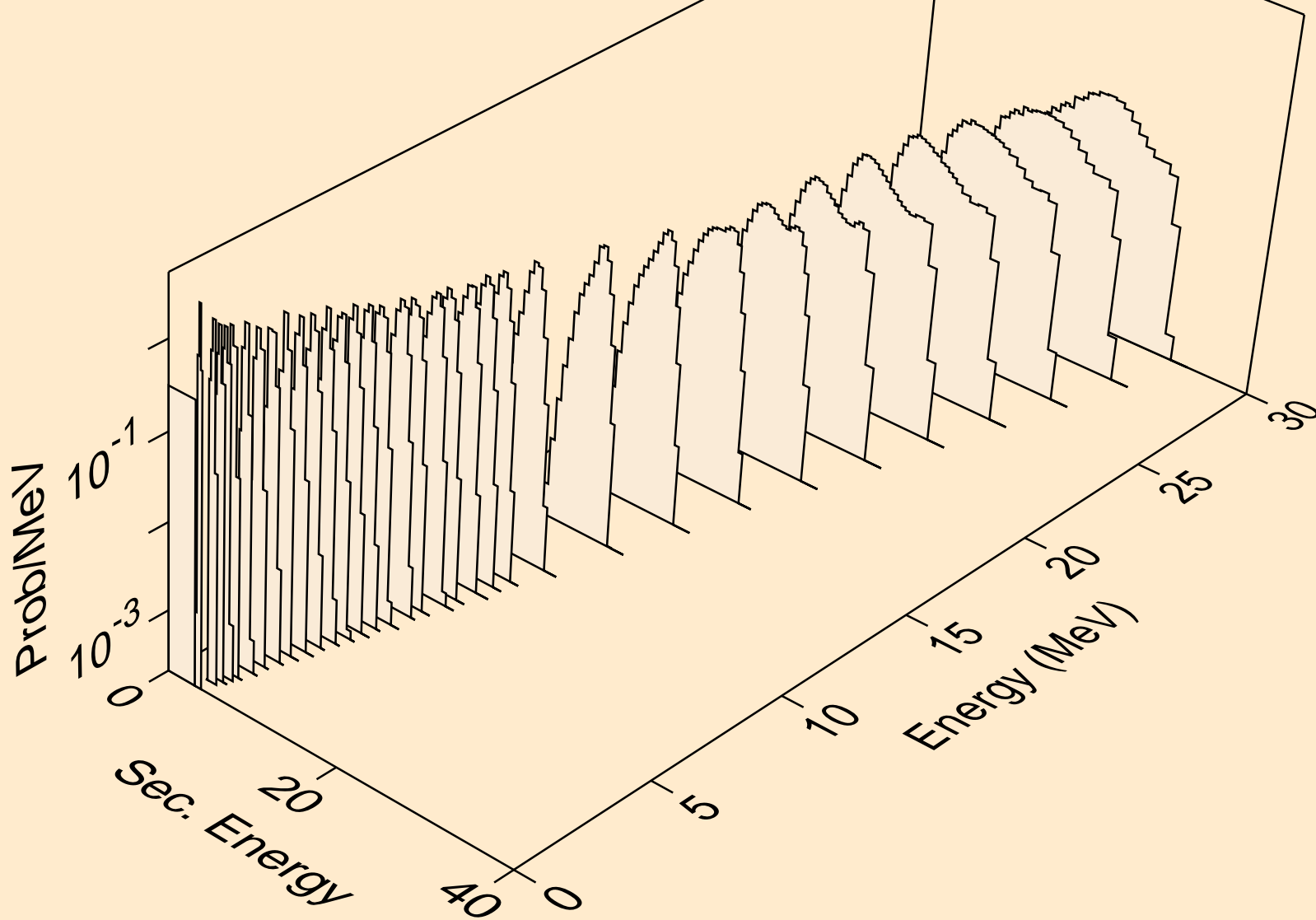

TE112 NEUTRON ACER TENDL-2019 LIBRARY; T=293.16K
alphas from (n,d2a)

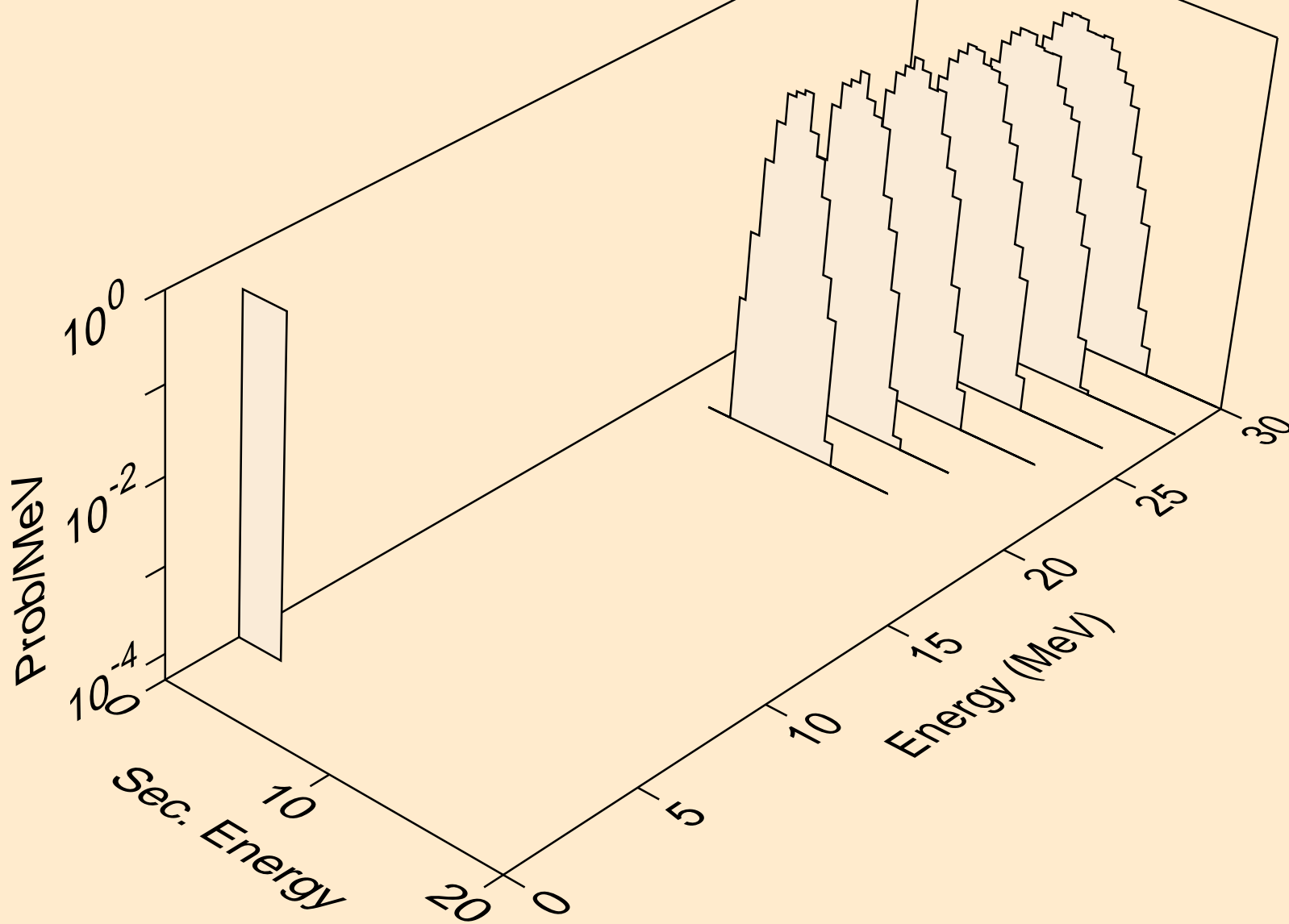

TE112 NEUTRON ACER TENDL-2019 LIBRARY; T=293.16K
alphas from (n,da)

