

TI055 NEUTRON ACER TENDL-2019 LIBRARY; T=293.16K
Principal cross sections

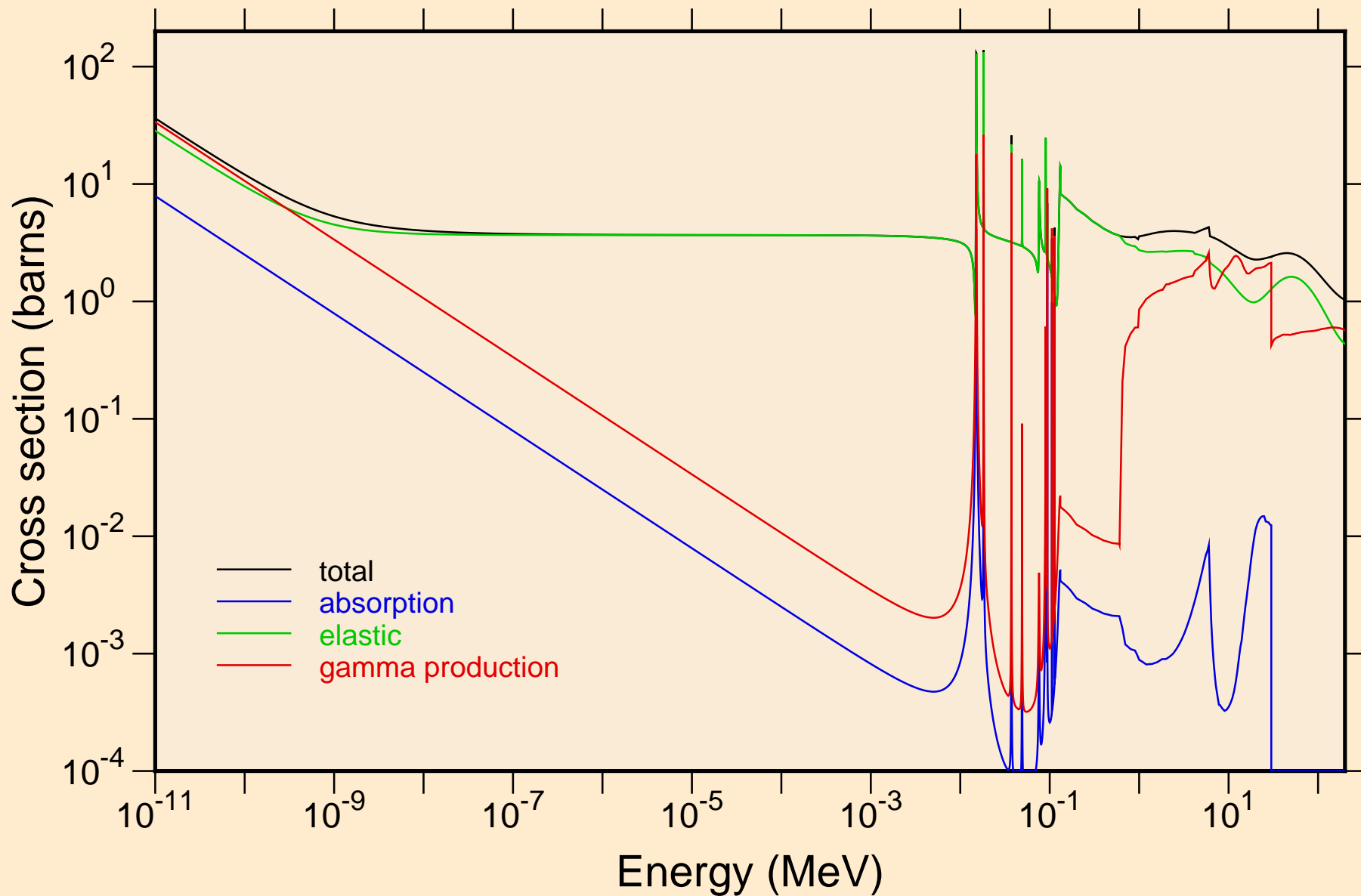

TI055 NEUTRON ACER TENDL-2019 LIBRARY; T=293.16K
resonance total cross section

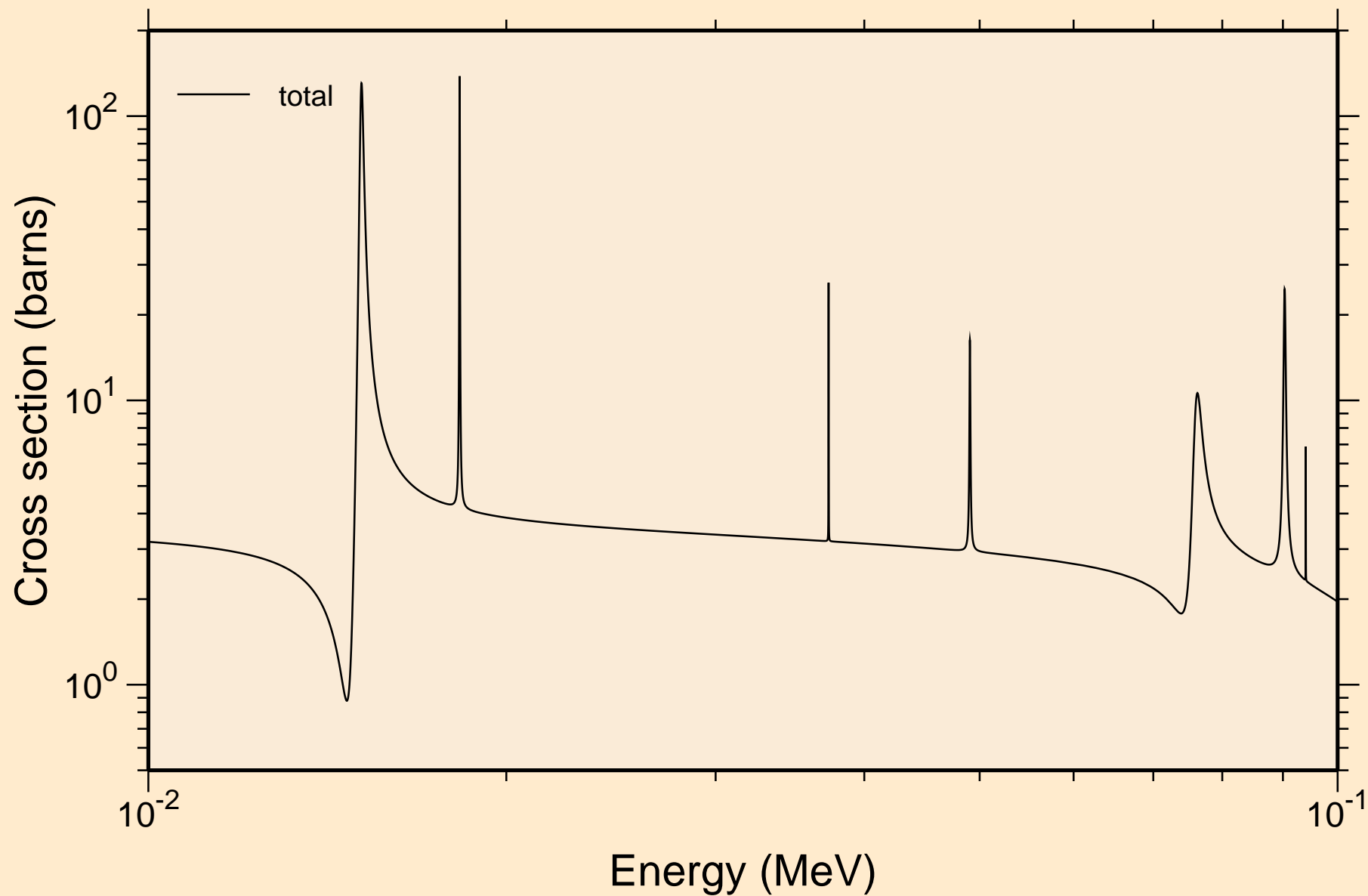

TI055 NEUTRON ACER TENDL-2019 LIBRARY; T=293.16K
resonance total cross section

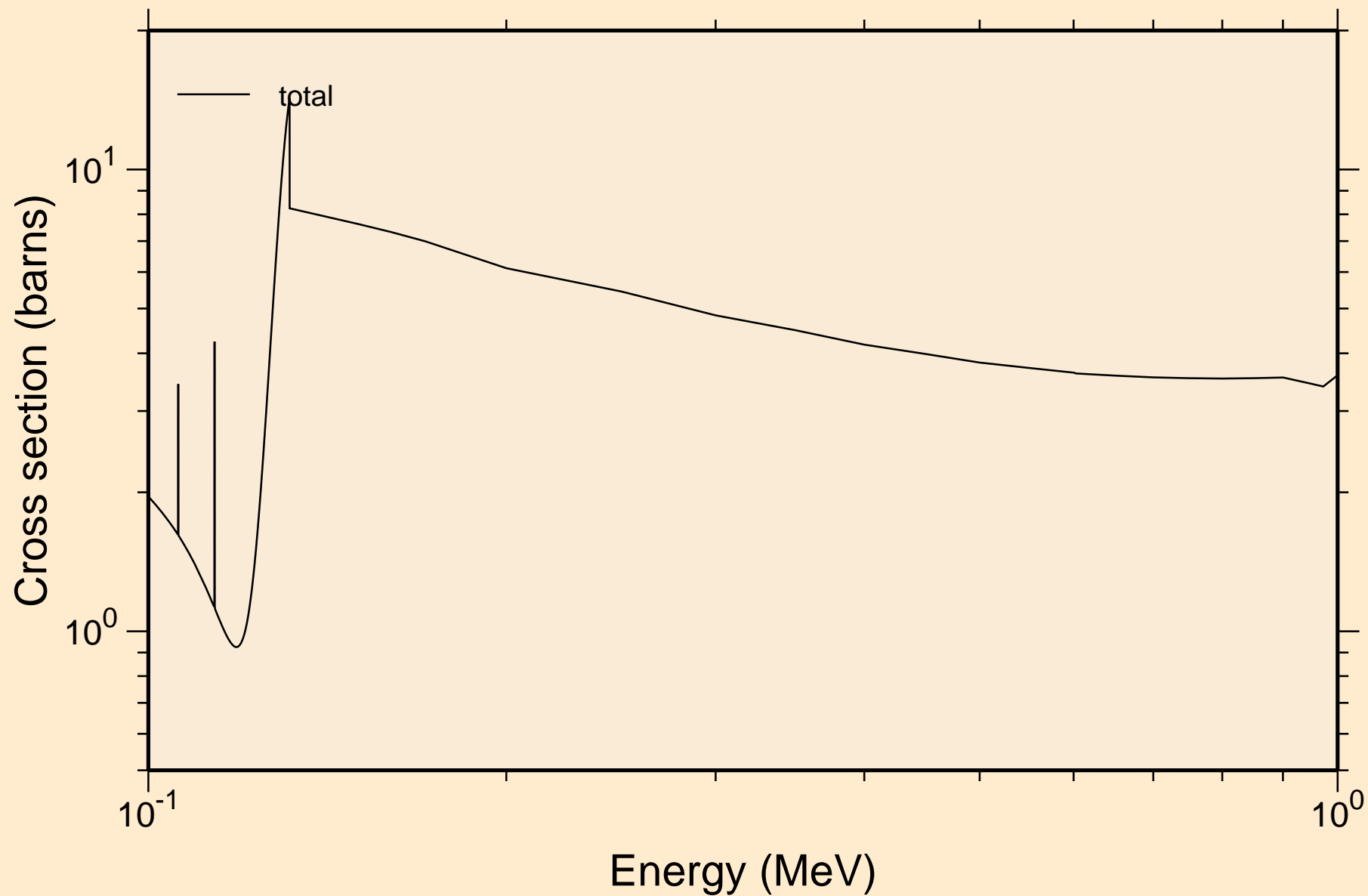

TI055 NEUTRON ACER TENDL-2019 LIBRARY; T=293.16K
resonance total cross section

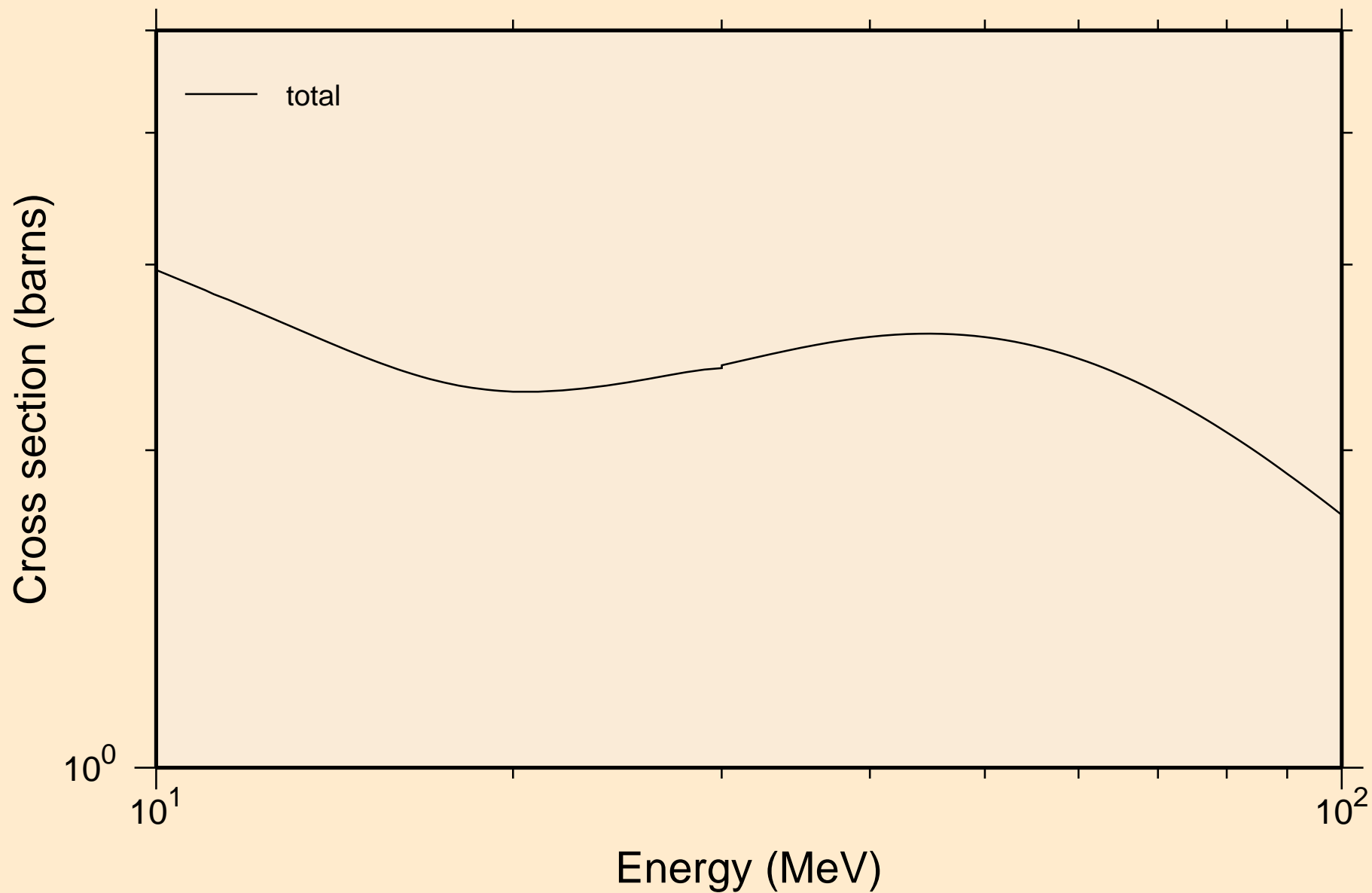

TI055 NEUTRON ACER TENDL-2019 LIBRARY; T=293.16K
resonance absorption cross sections

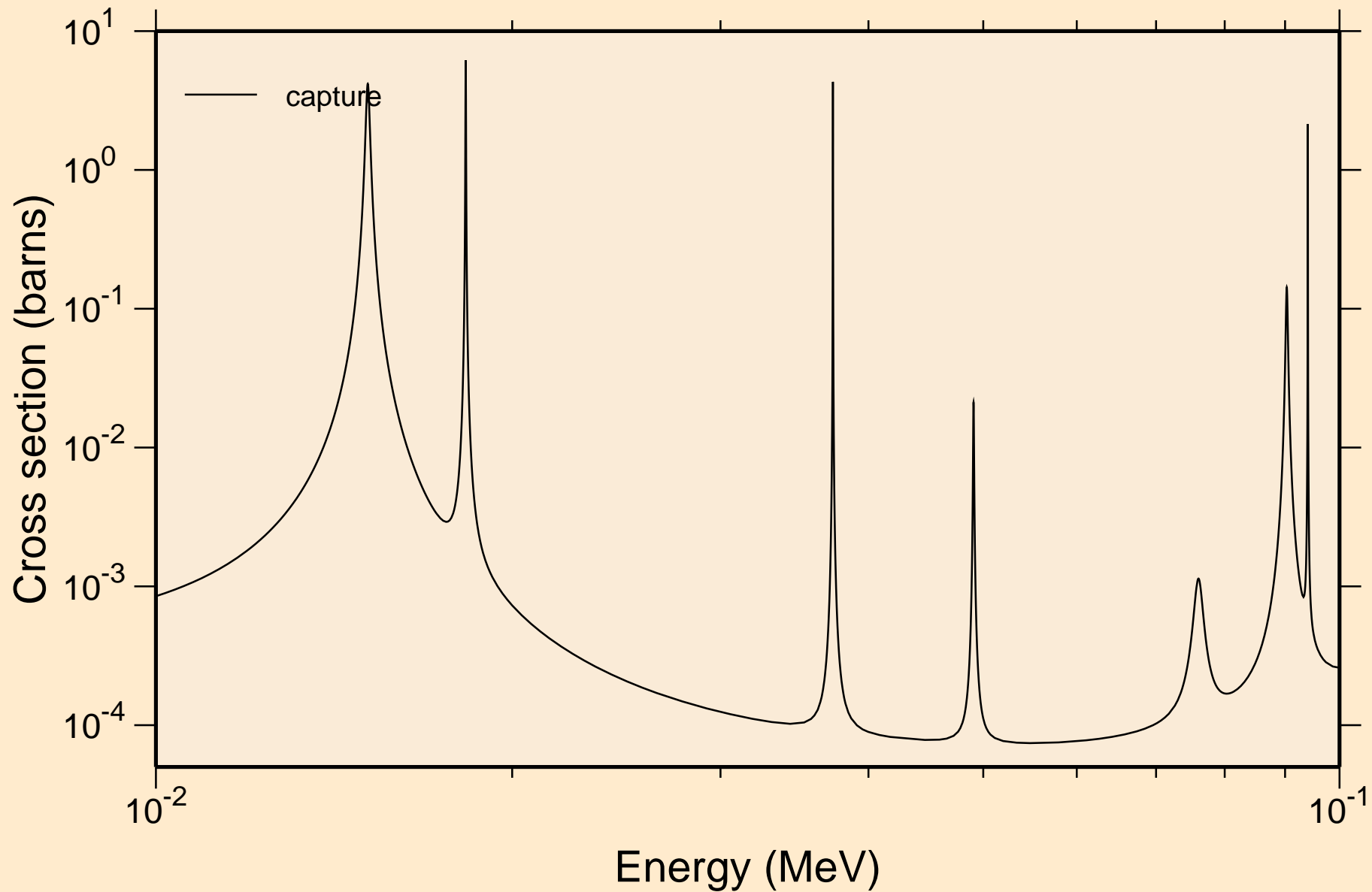

TI055 NEUTRON ACER TENDL-2019 LIBRARY; T=293.16K
resonance absorption cross sections

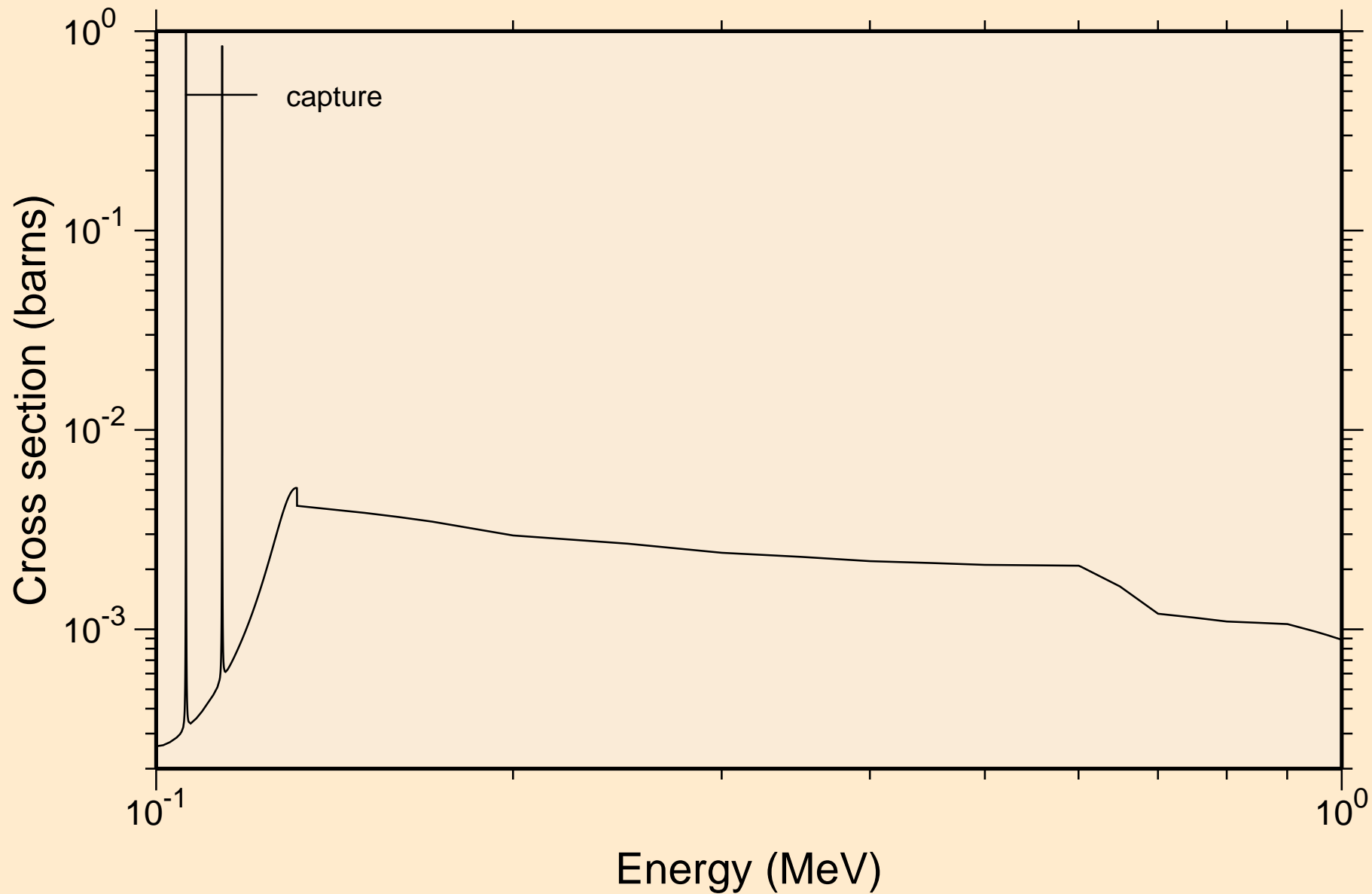

TI055 NEUTRON ACER TENDL-2019 LIBRARY; T=293.16K
resonance absorption cross sections

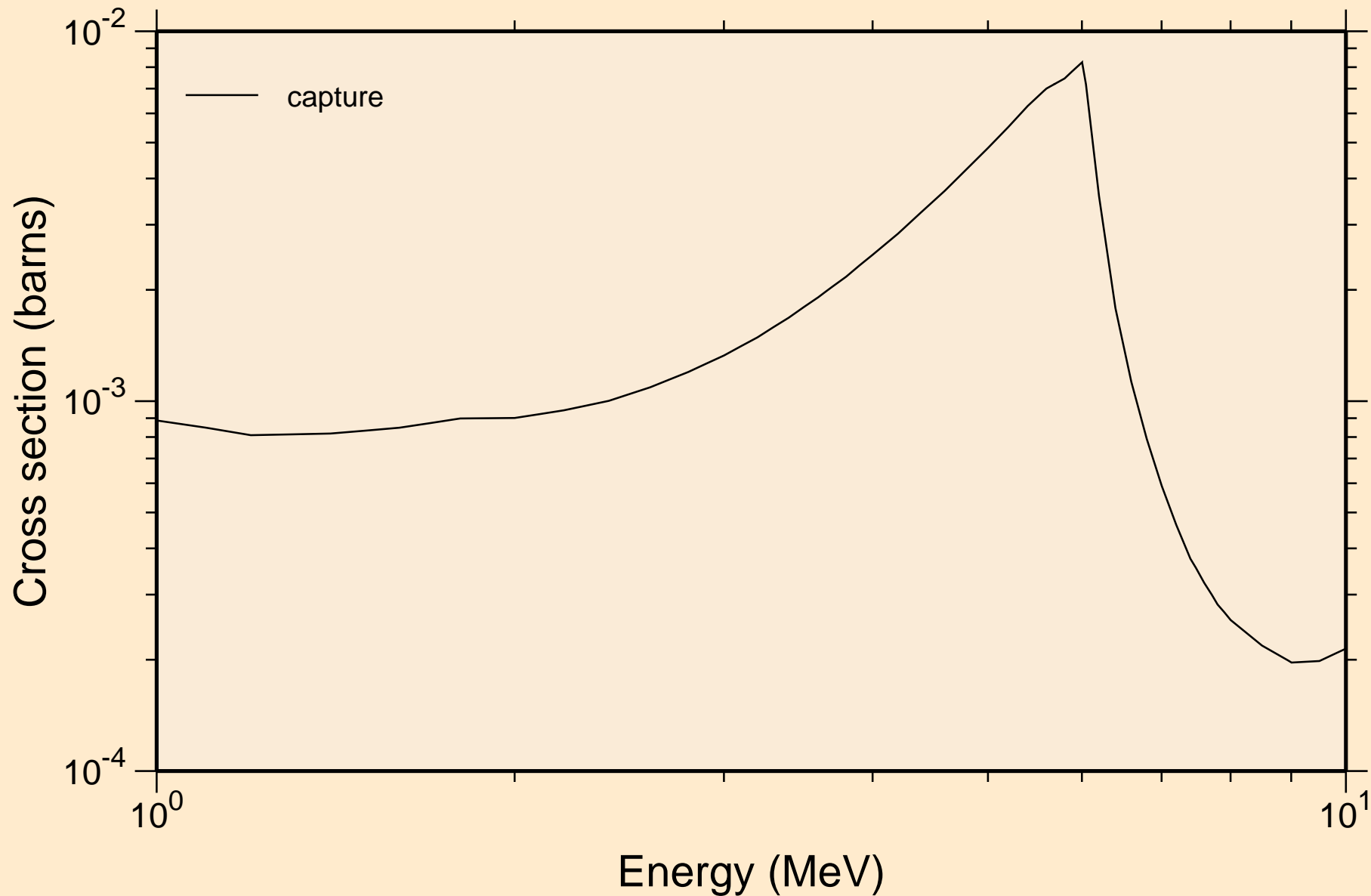

TI055 NEUTRON ACER TENDL-2019 LIBRARY; T=293.16K
Heating

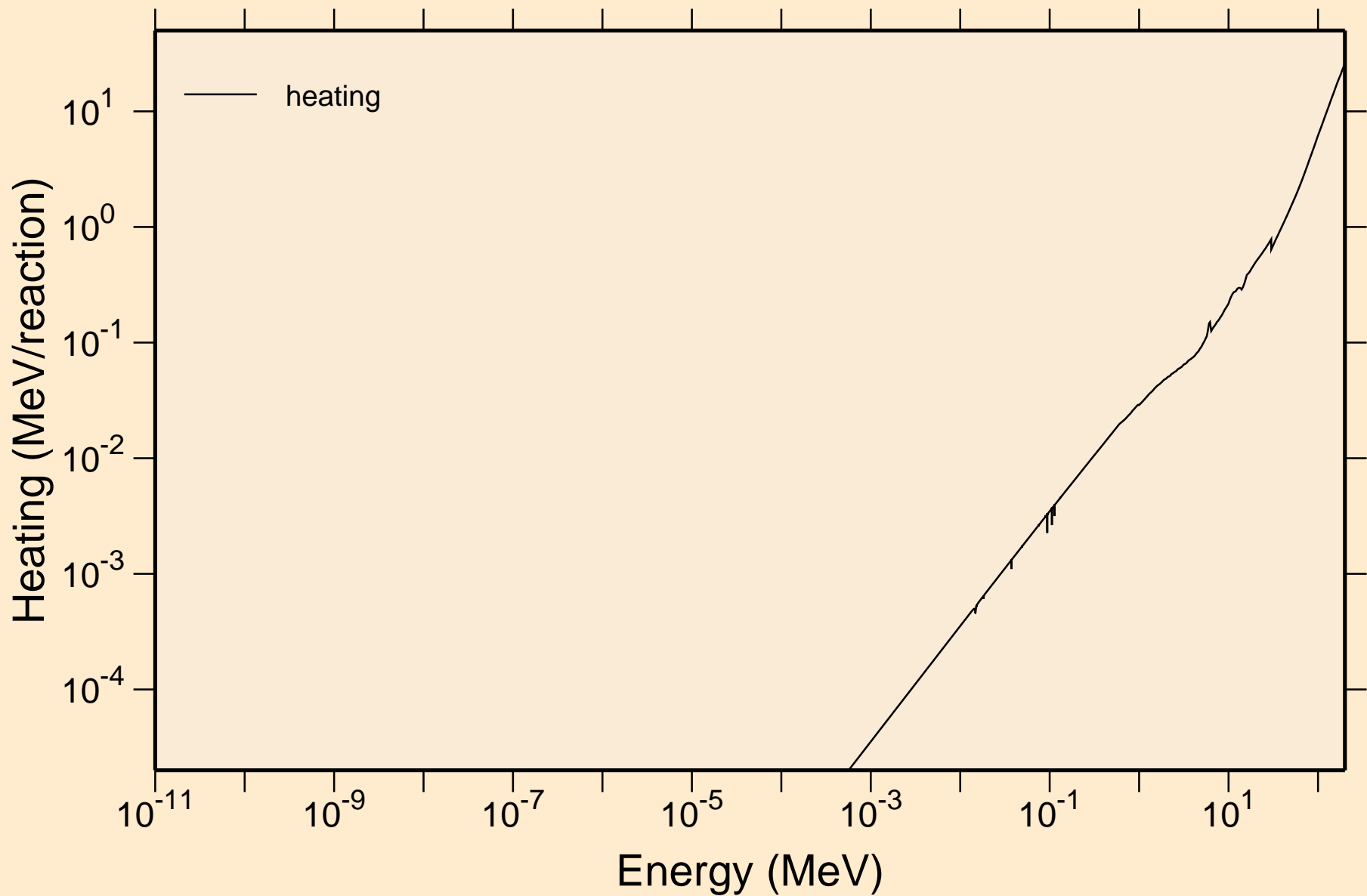

TI055 NEUTRON ACER TENDL-2019 LIBRARY; T=293.16K
Damage

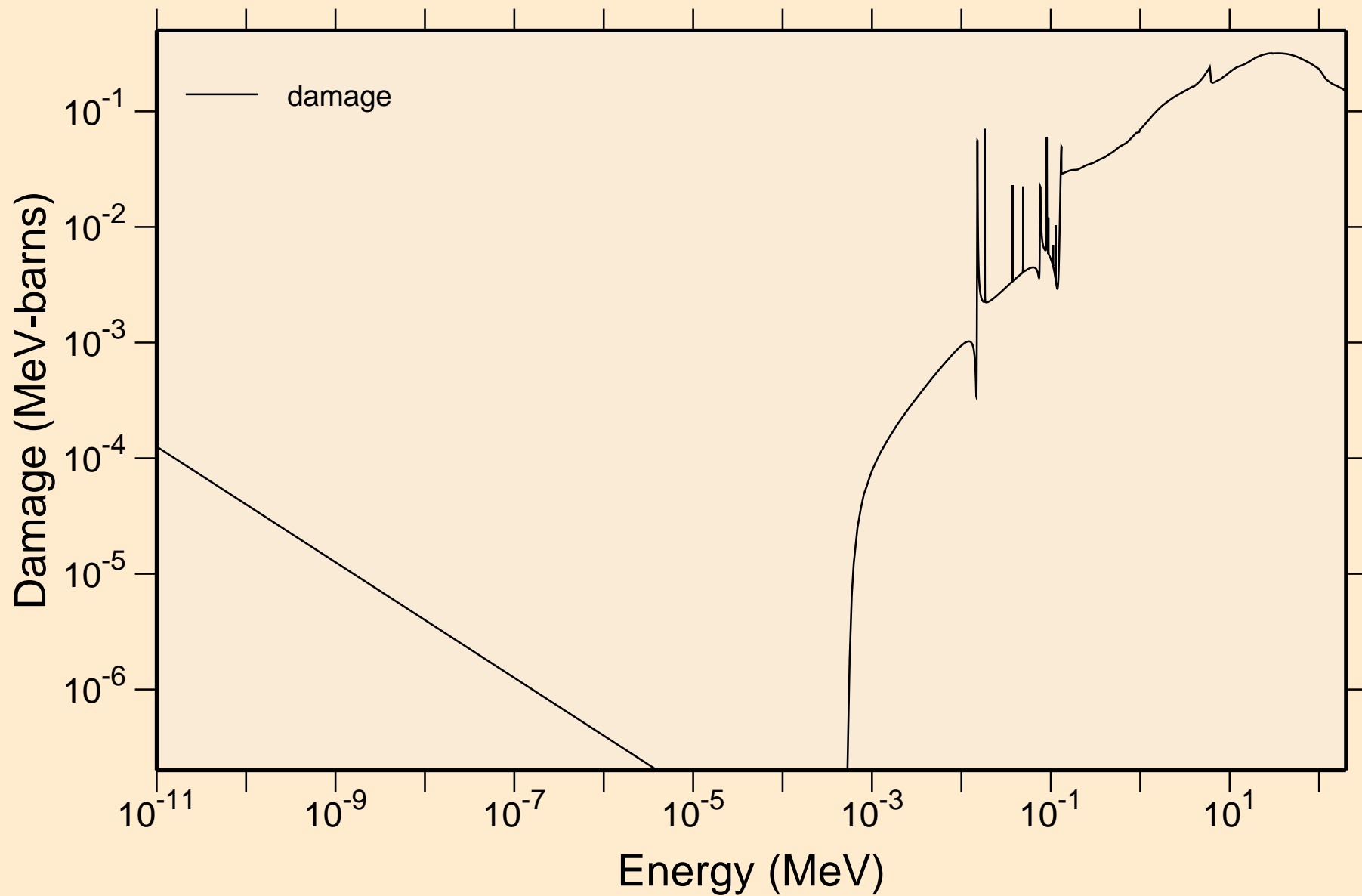

TI055 NEUTRON ACER TENDL-2019 LIBRARY; T=293.16K
Non-threshold reactions

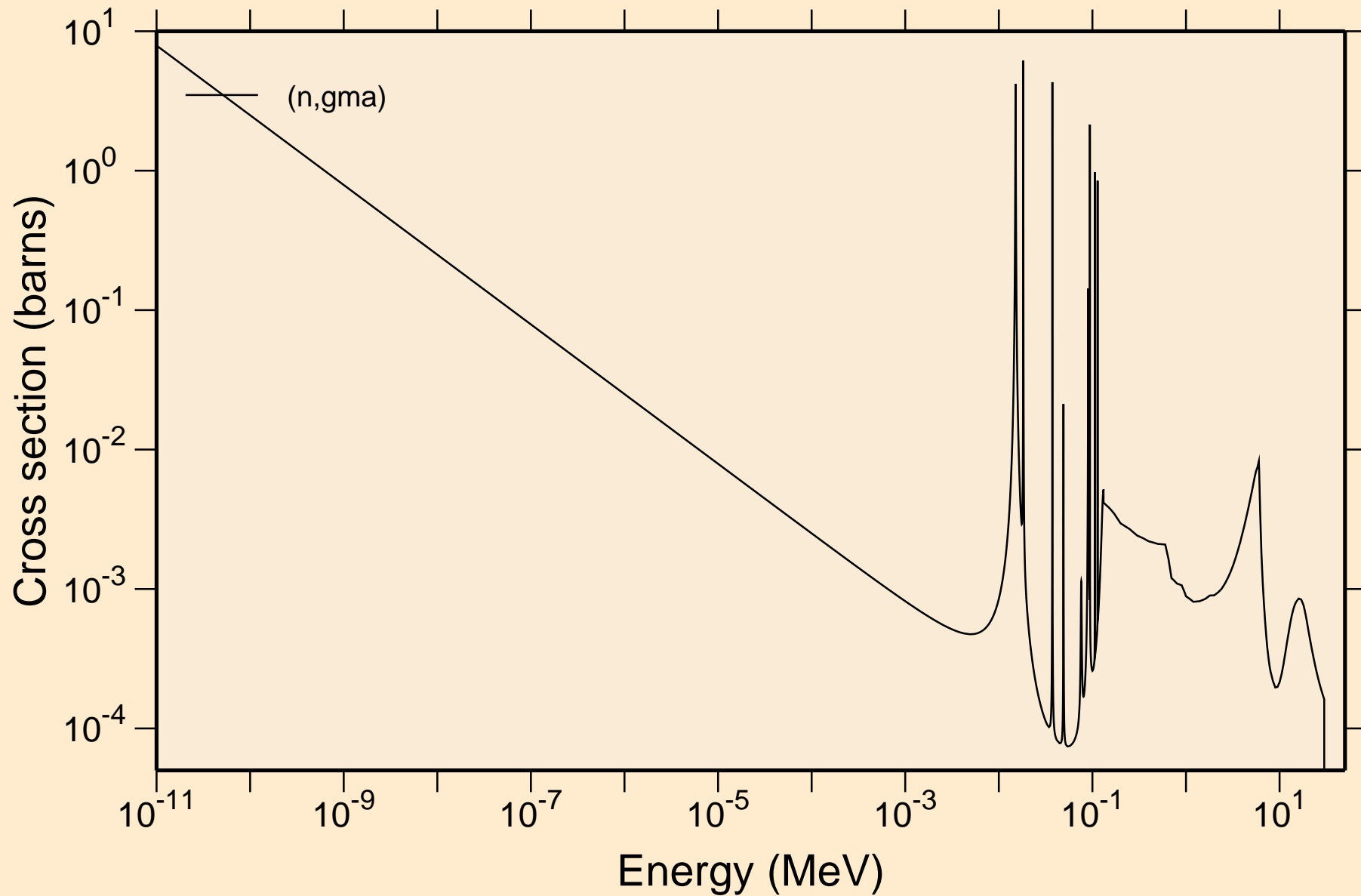

TI055 NEUTRON ACER TENDL-2019 LIBRARY; T=293.16K
Principal cross sections

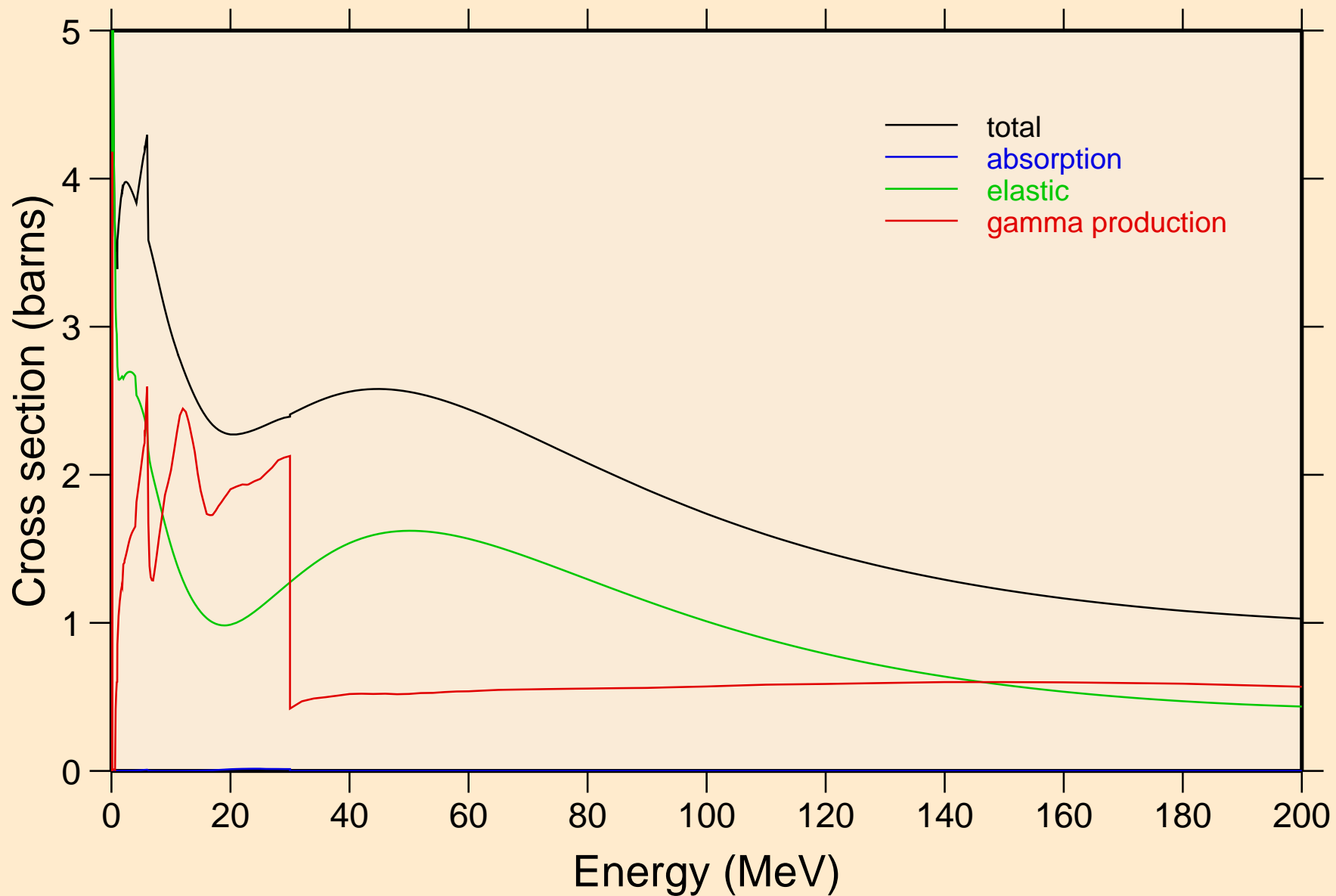

TI055 NEUTRON ACER TENDL-2019 LIBRARY; T=293.16K
Heating

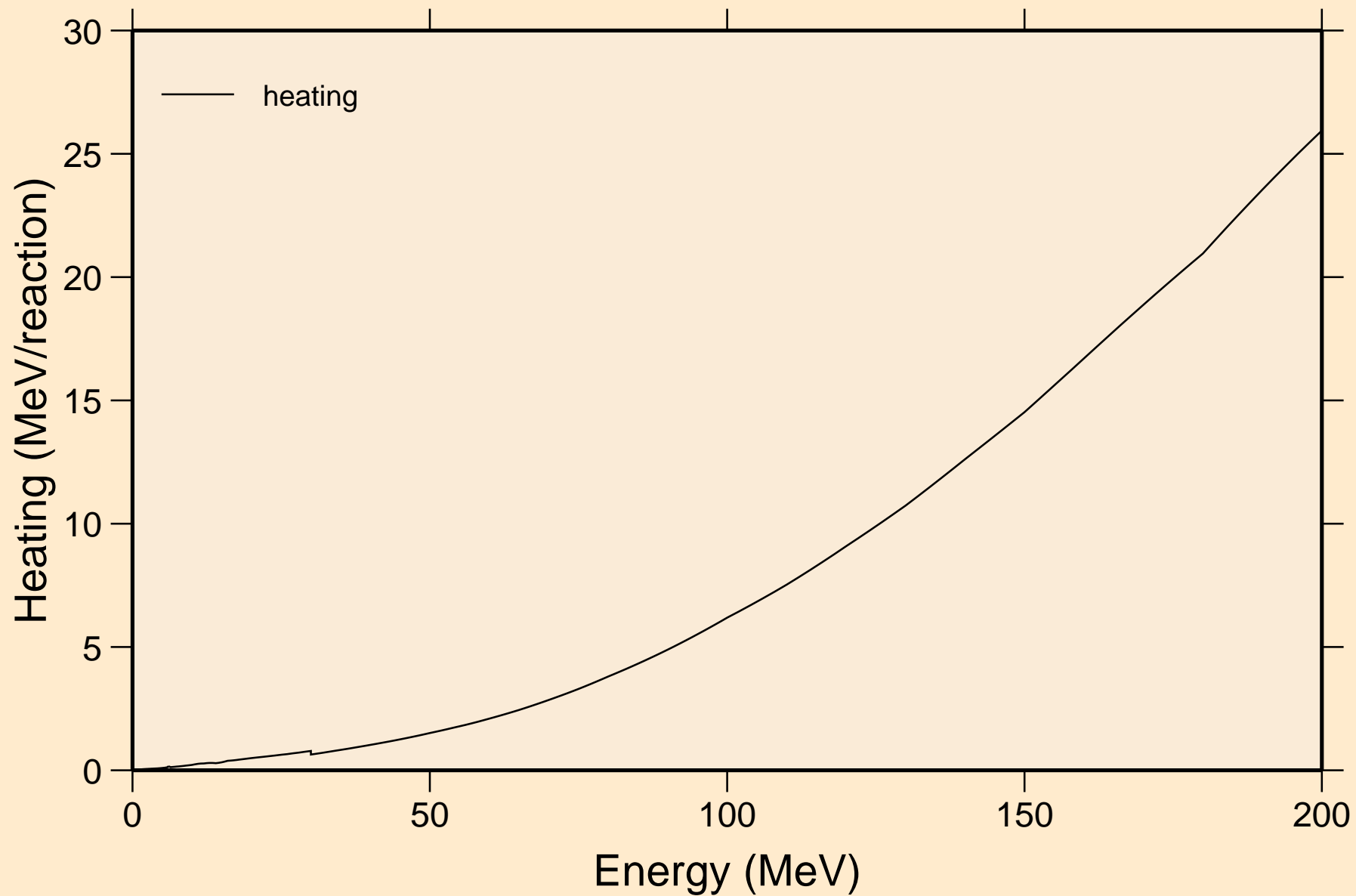

TI055 NEUTRON ACER TENDL-2019 LIBRARY; T=293.16K
Damage

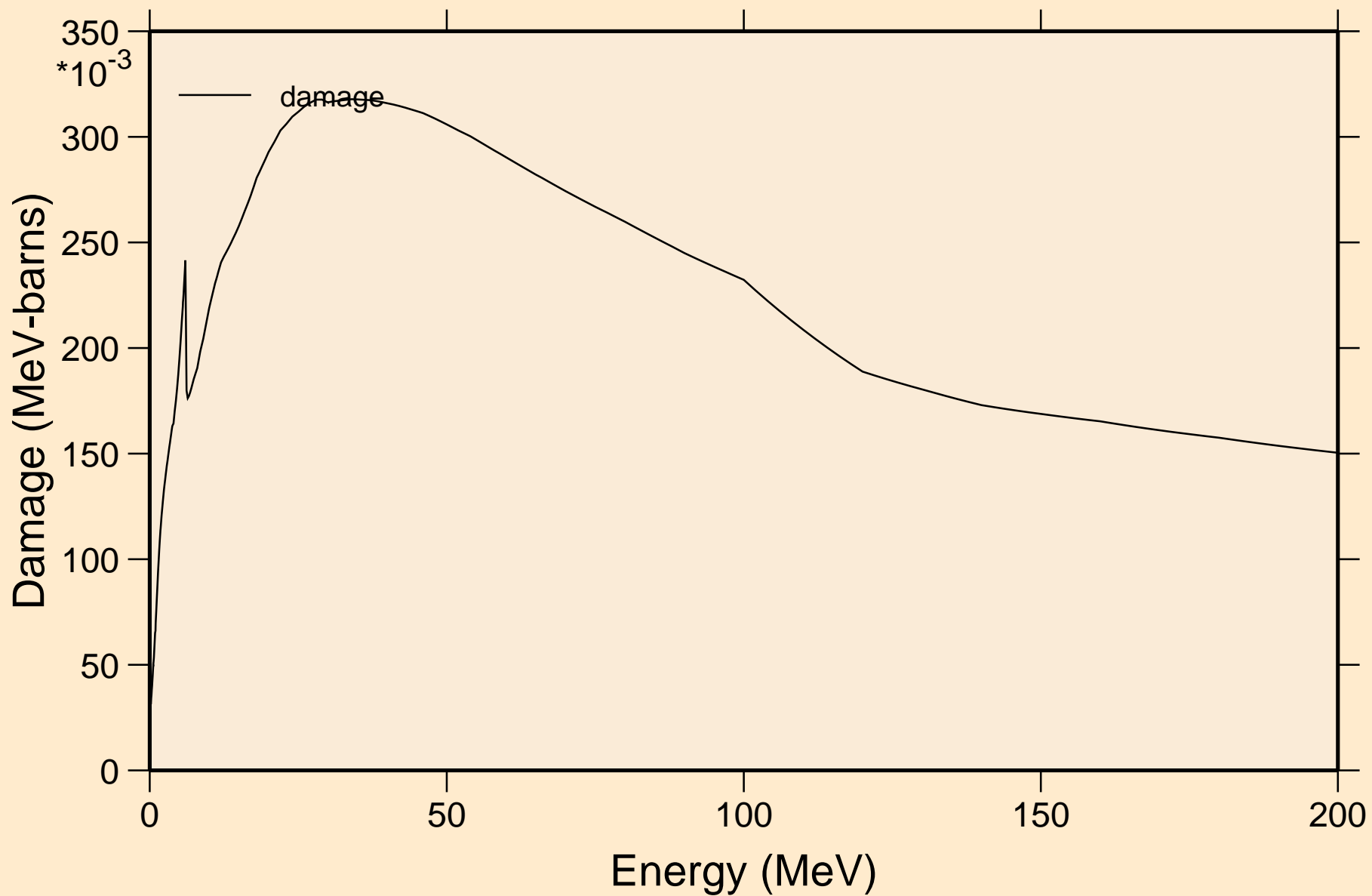

TI055 NEUTRON ACER TENDL-2019 LIBRARY; T=293.16K
Non-threshold reactions

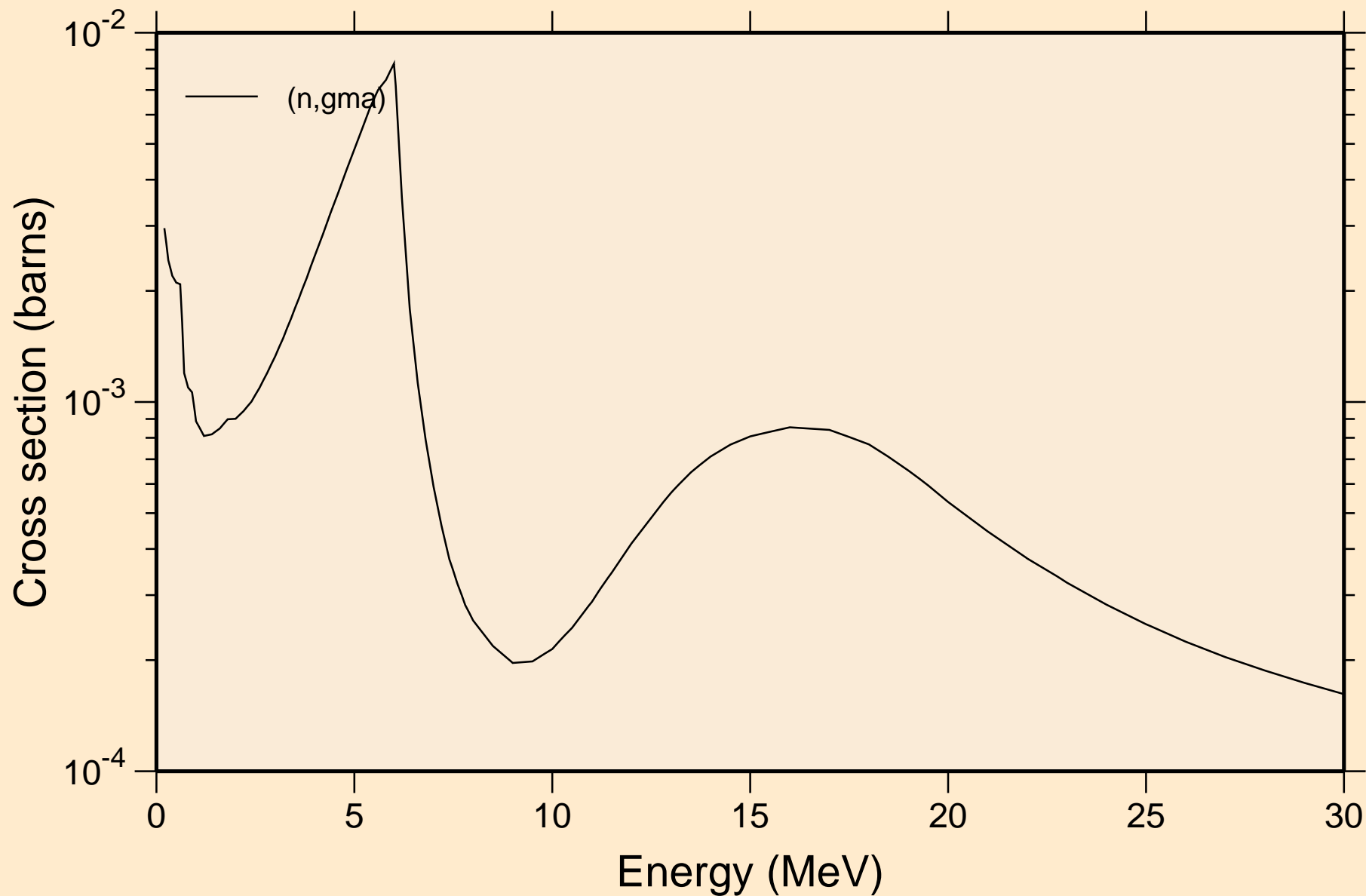

TI055 NEUTRON ACER TENDL-2019 LIBRARY; T=293.16K
Inelastic levels

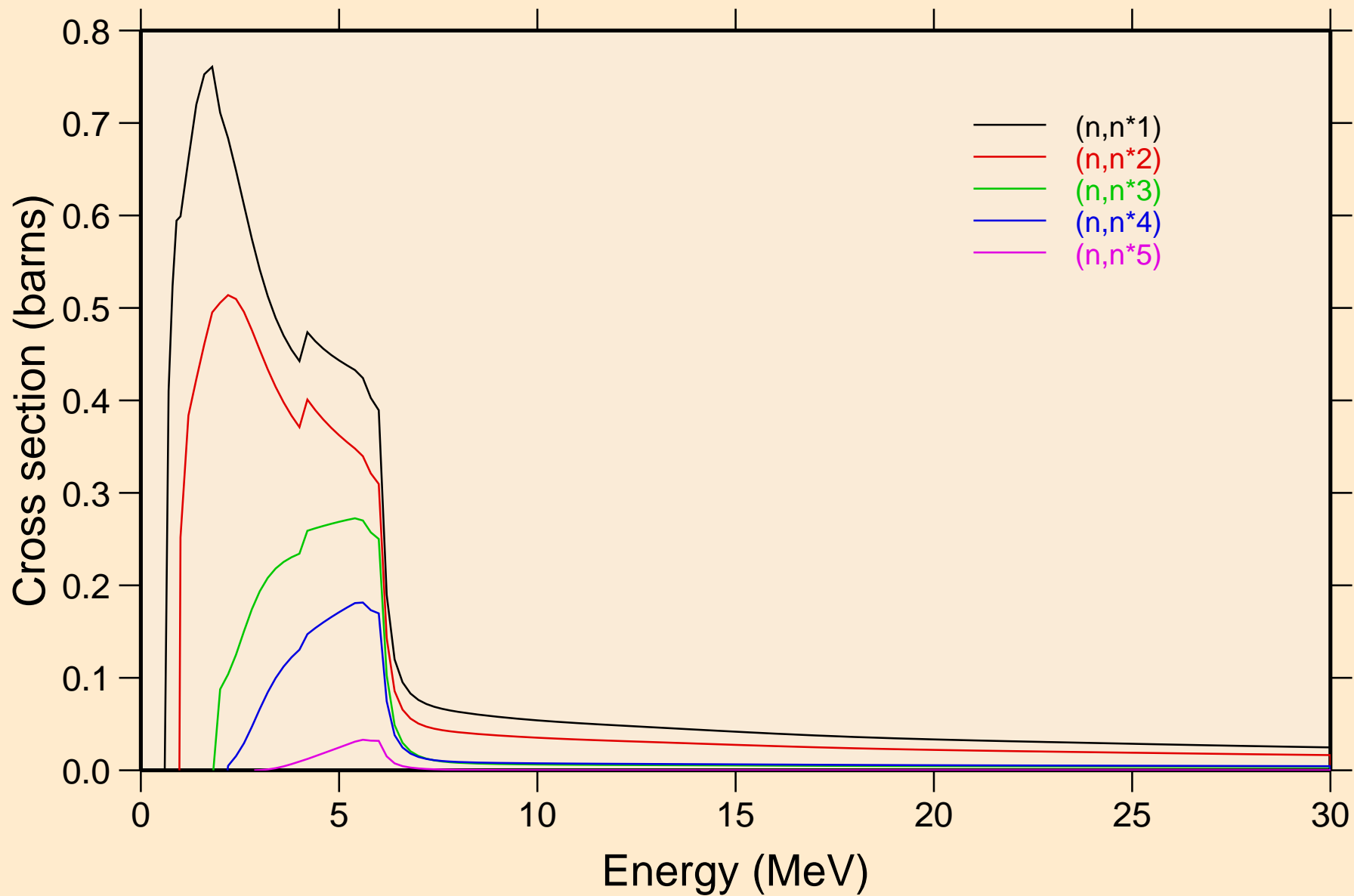

TI055 NEUTRON ACER TENDL-2019 LIBRARY; T=293.16K
Inelastic levels

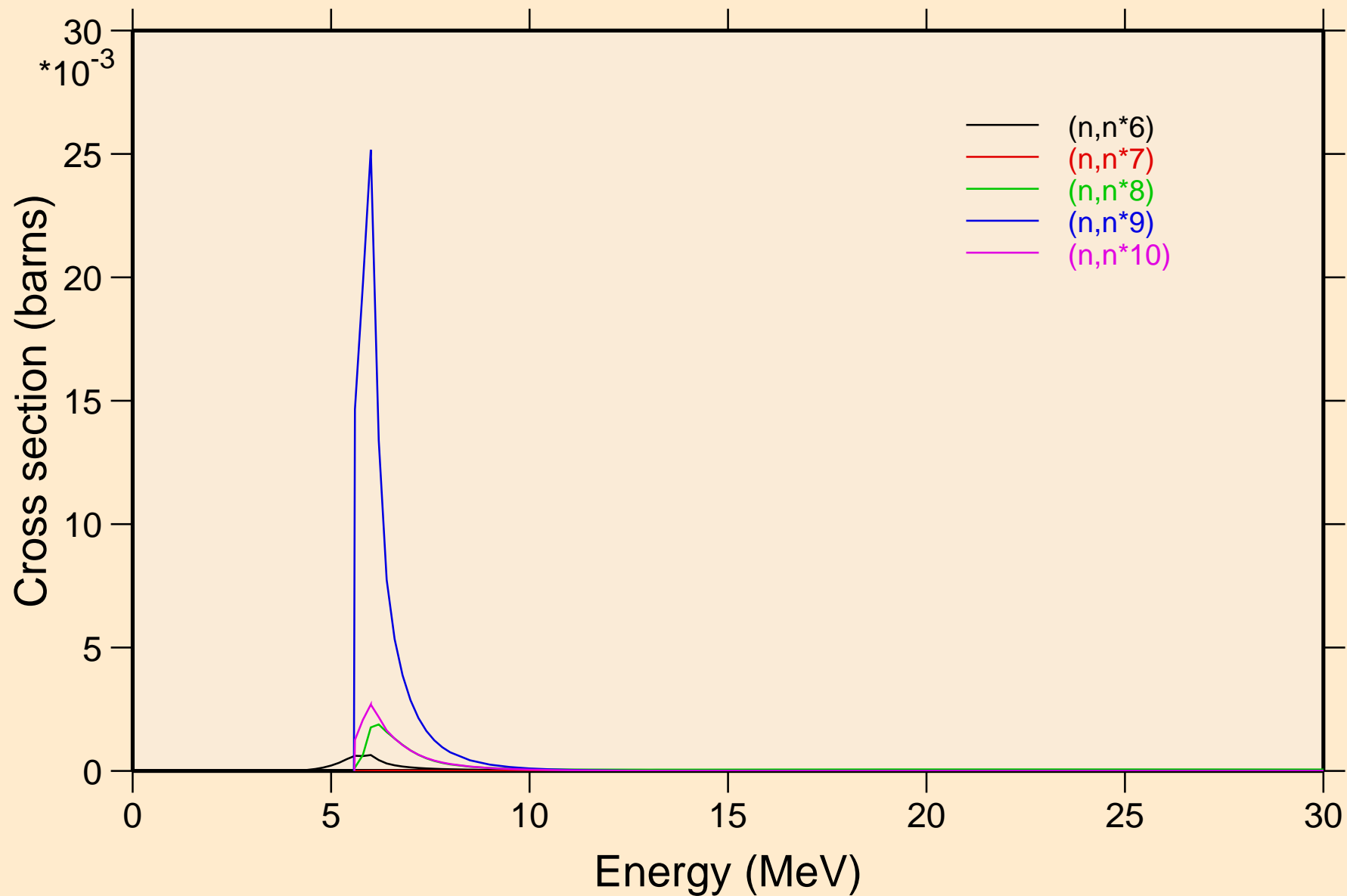

TI055 NEUTRON ACER TENDL-2019 LIBRARY; T=293.16K
Inelastic levels

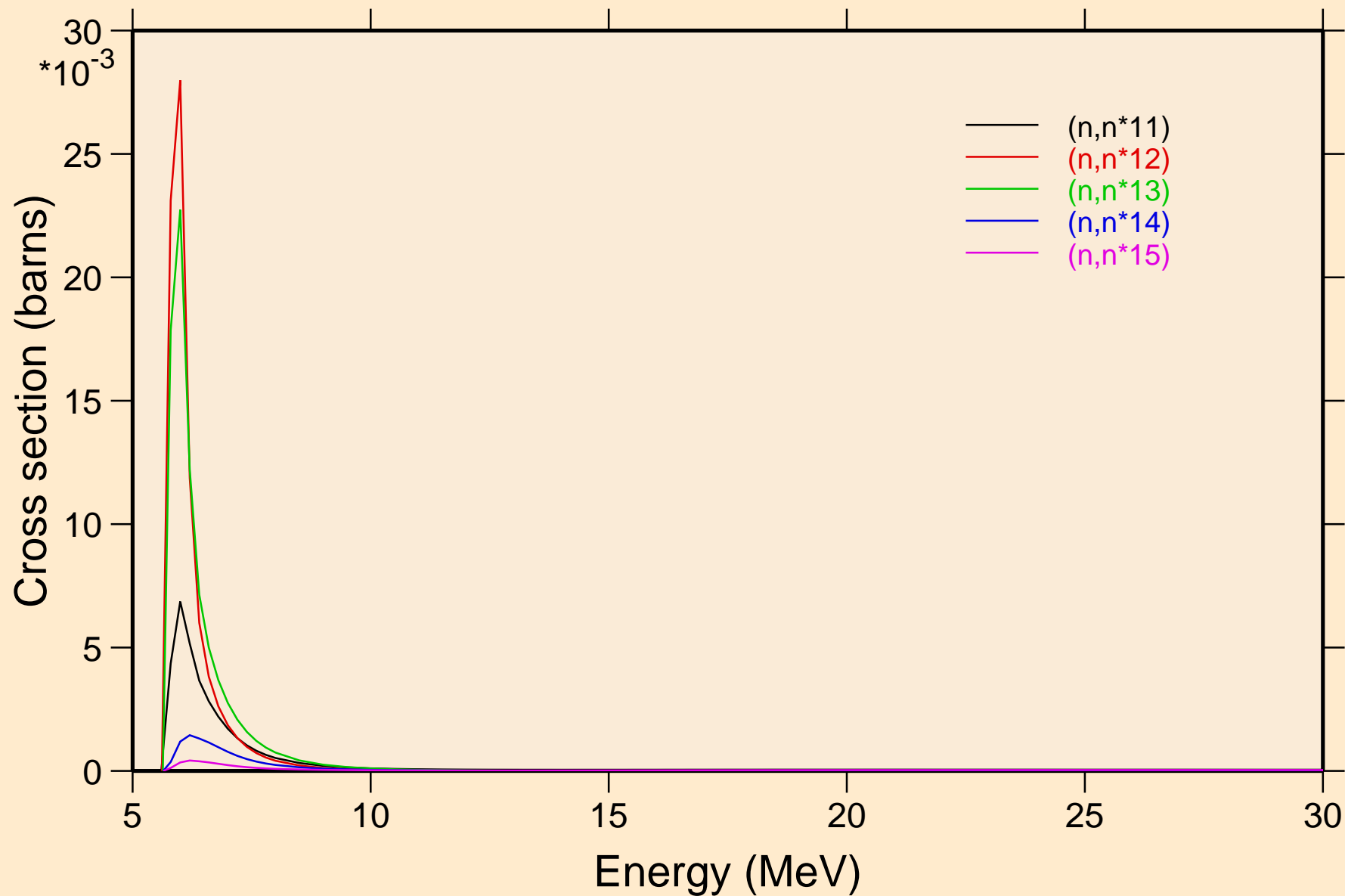

TI055 NEUTRON ACER TENDL-2019 LIBRARY; T=293.16K
Inelastic levels

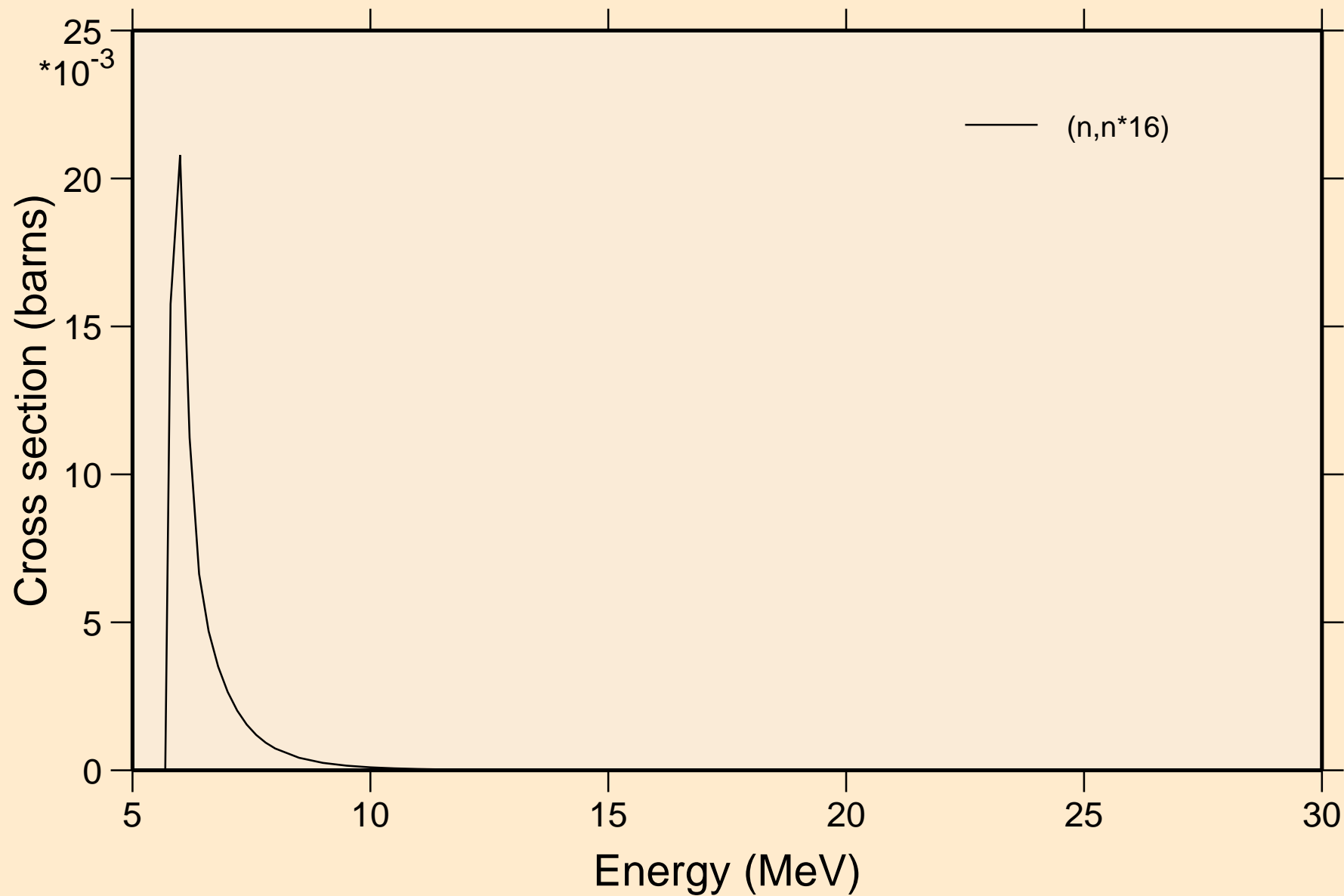

TI055 NEUTRON ACER TENDL-2019 LIBRARY; T=293.16K
Threshold reactions

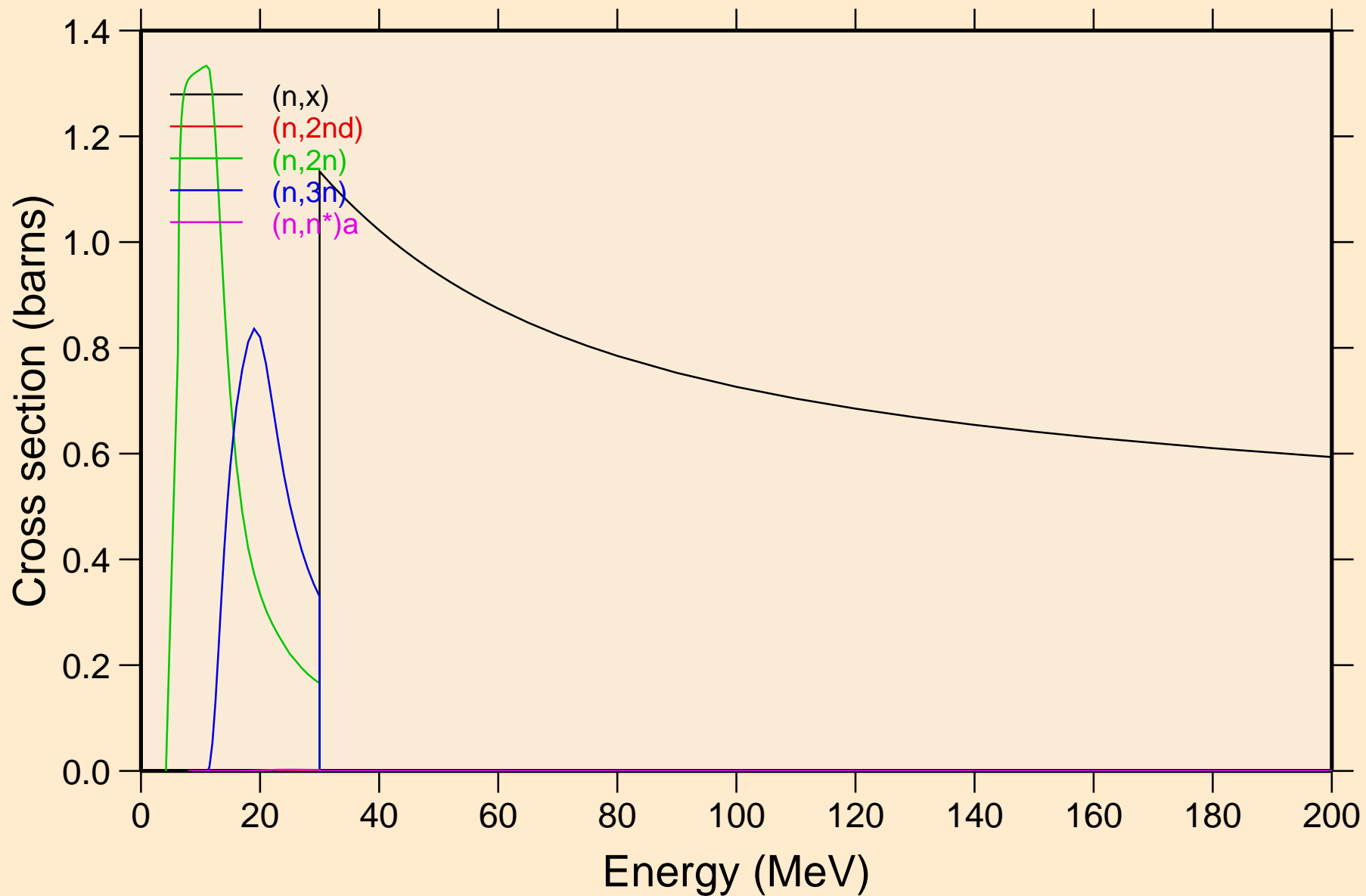

TI055 NEUTRON ACER TENDL-2019 LIBRARY; T=293.16K
Threshold reactions

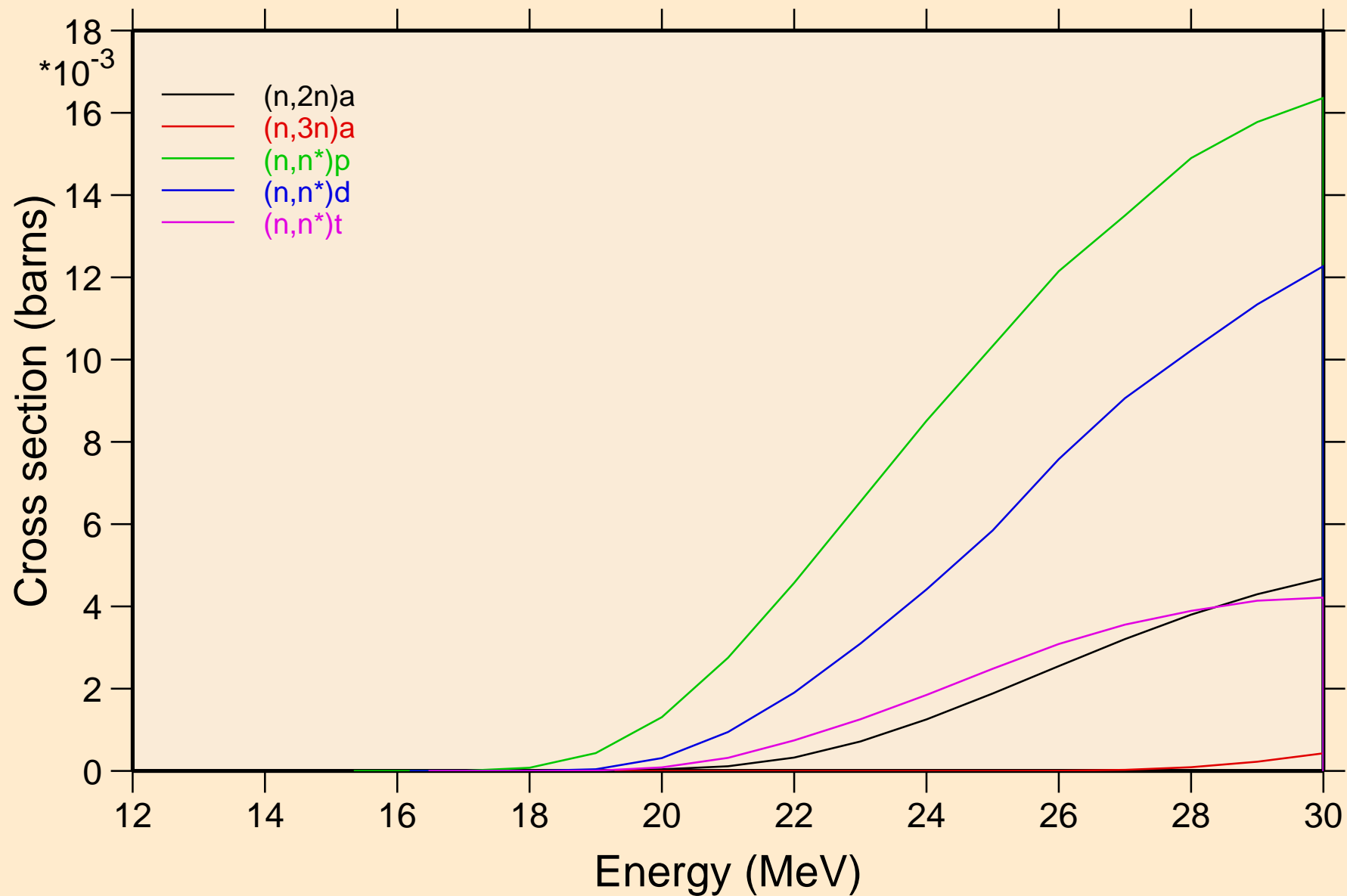

TI055 NEUTRON ACER TENDL-2019 LIBRARY; T=293.16K
Threshold reactions

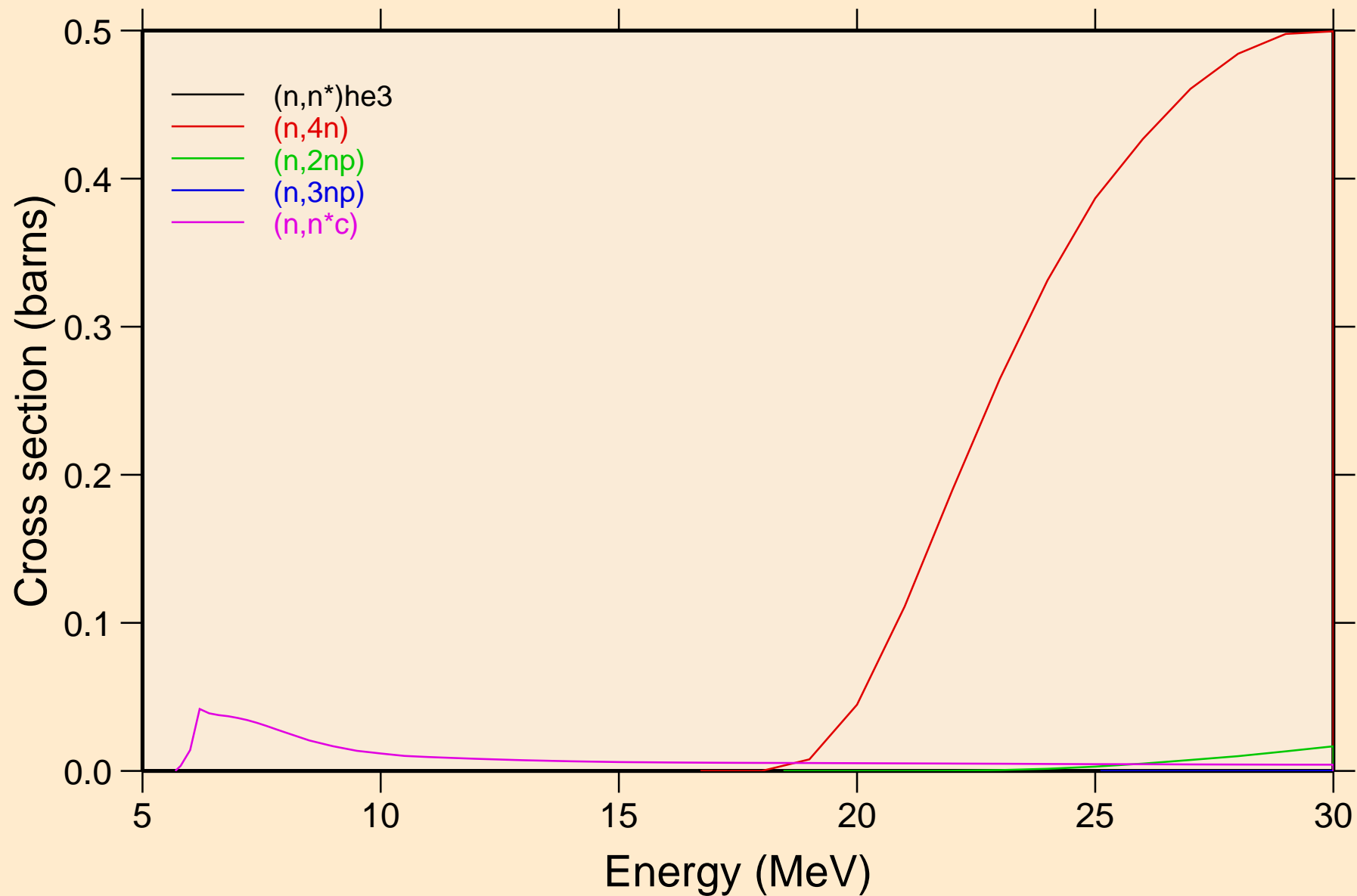

TI055 NEUTRON ACER TENDL-2019 LIBRARY; T=293.16K
Threshold reactions

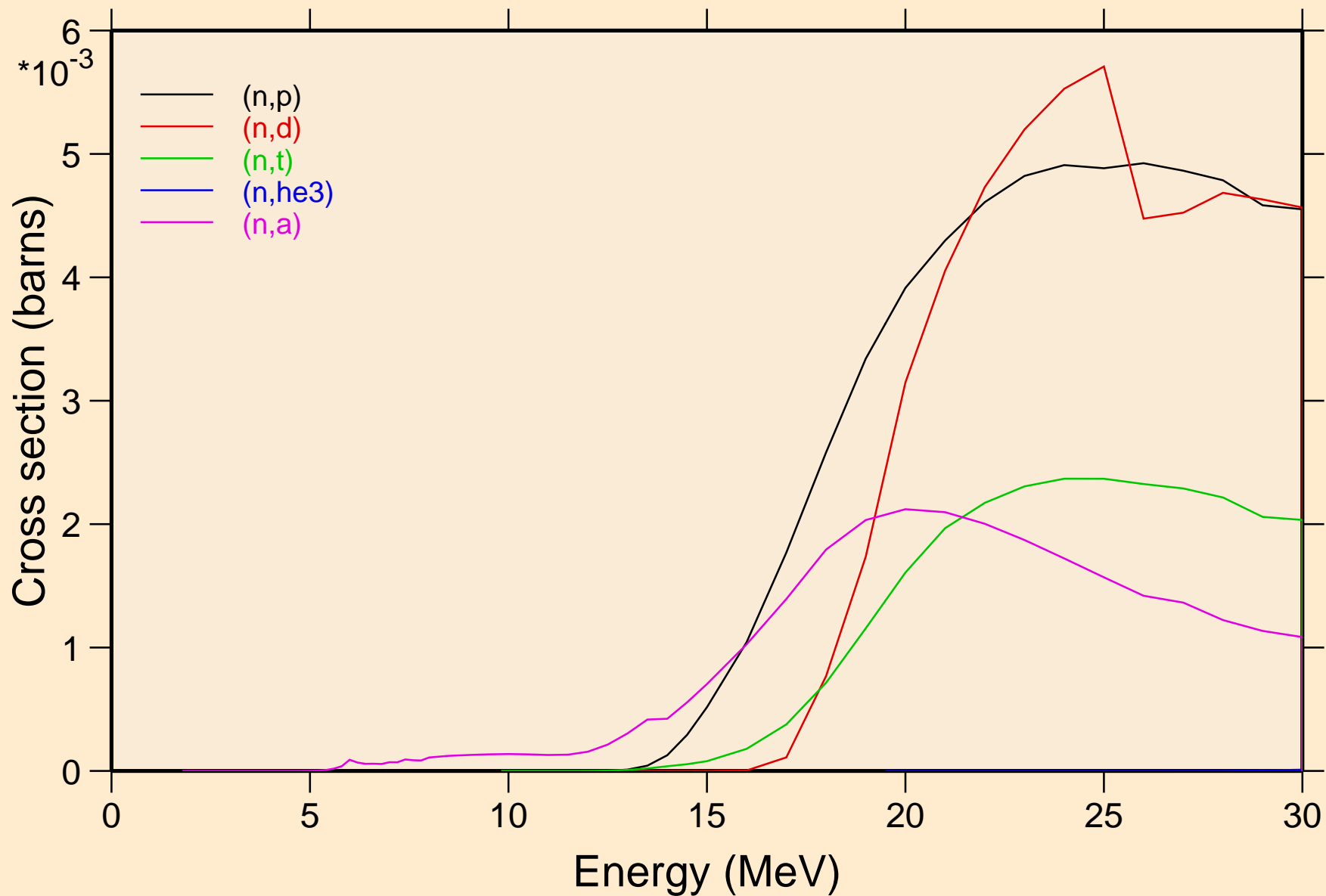

TI055 NEUTRON ACER TENDL-2019 LIBRARY; T=293.16K
Threshold reactions

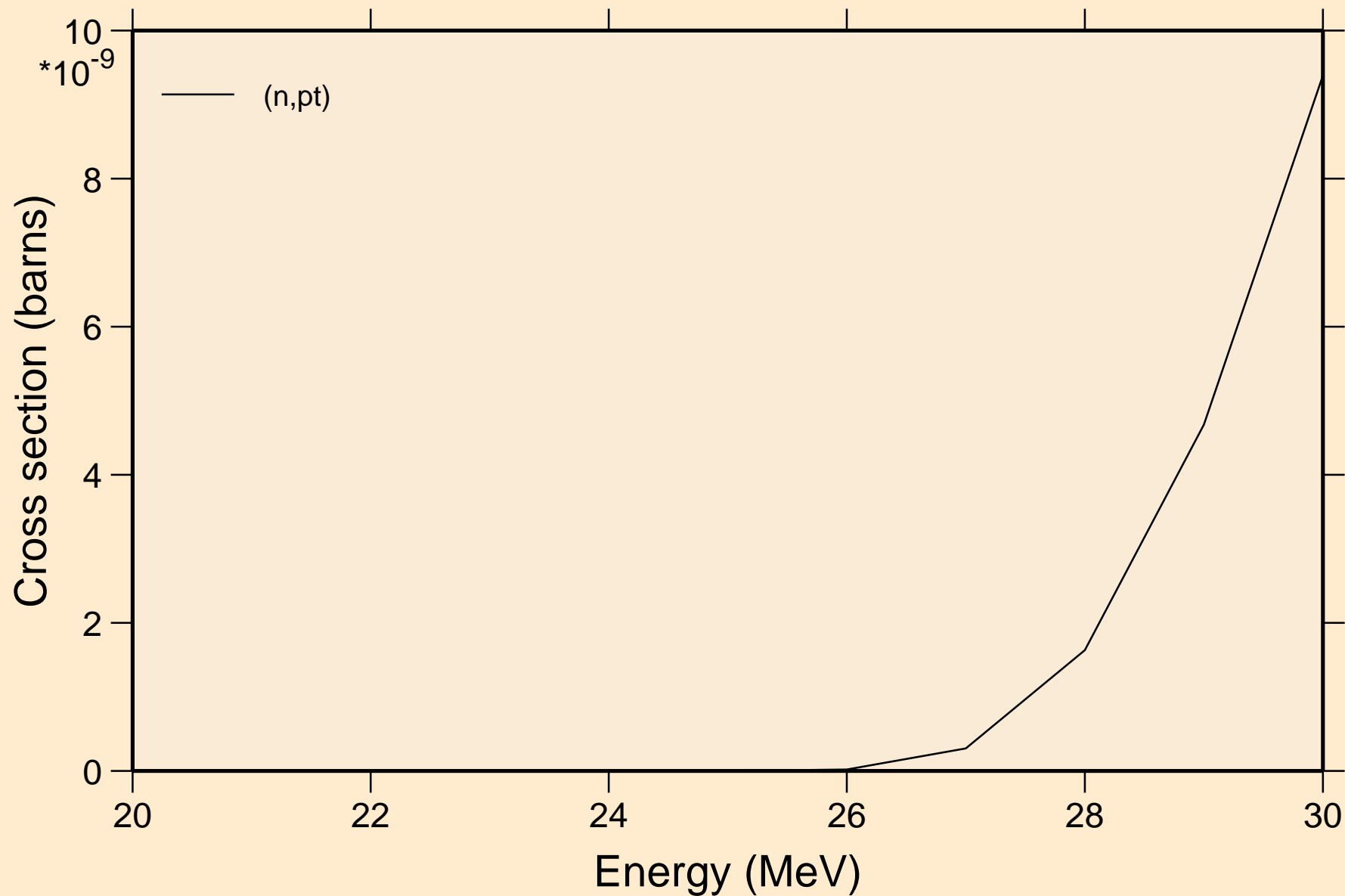

TI055 NEUTRON ACER TENDL-2019 LIBRARY; T=293.16K
Threshold reactions

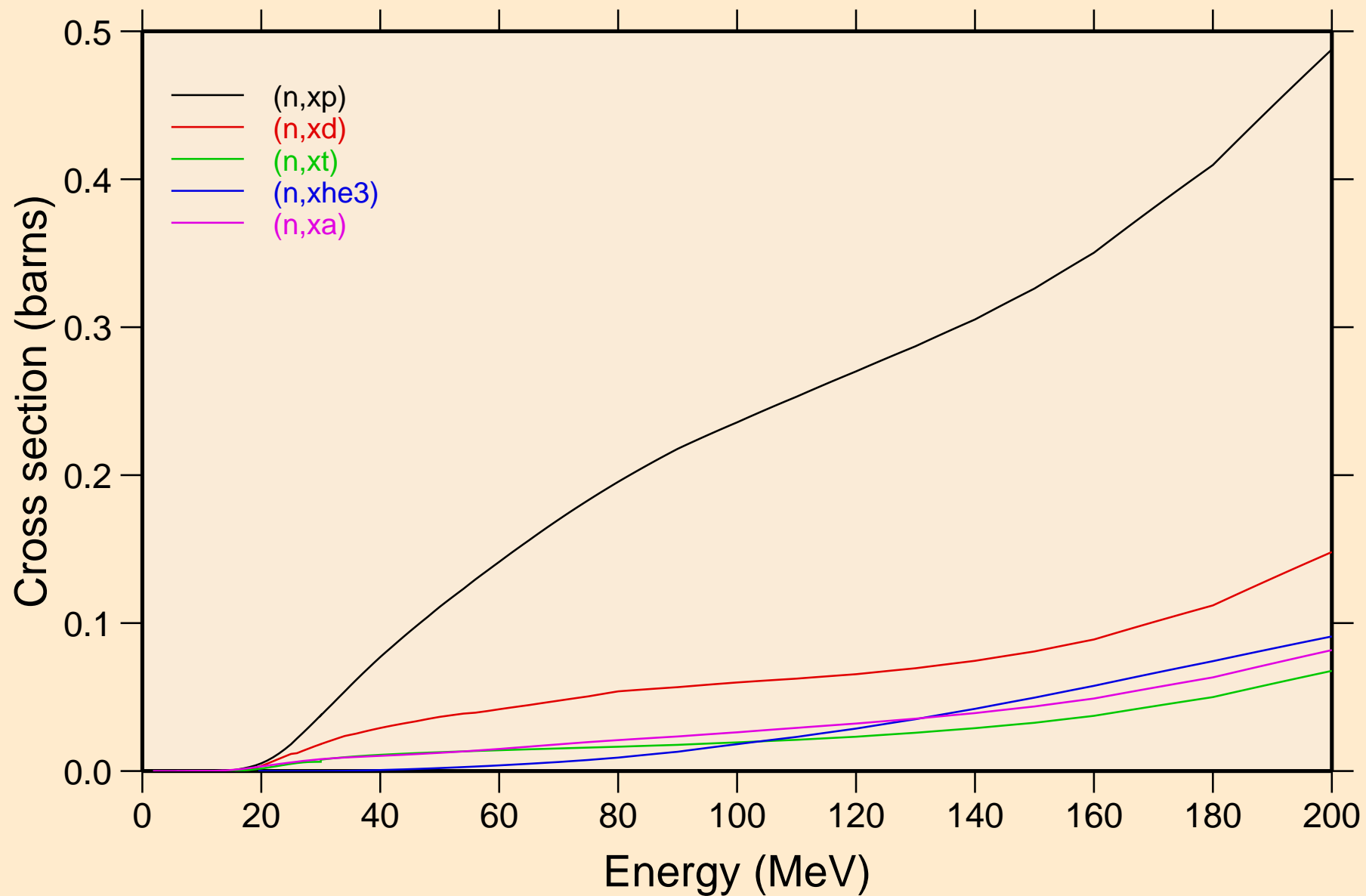

TI055 NEUTRON ACER TENDL-2019 LIBRARY; T=293.16K
angular distribution for elastic

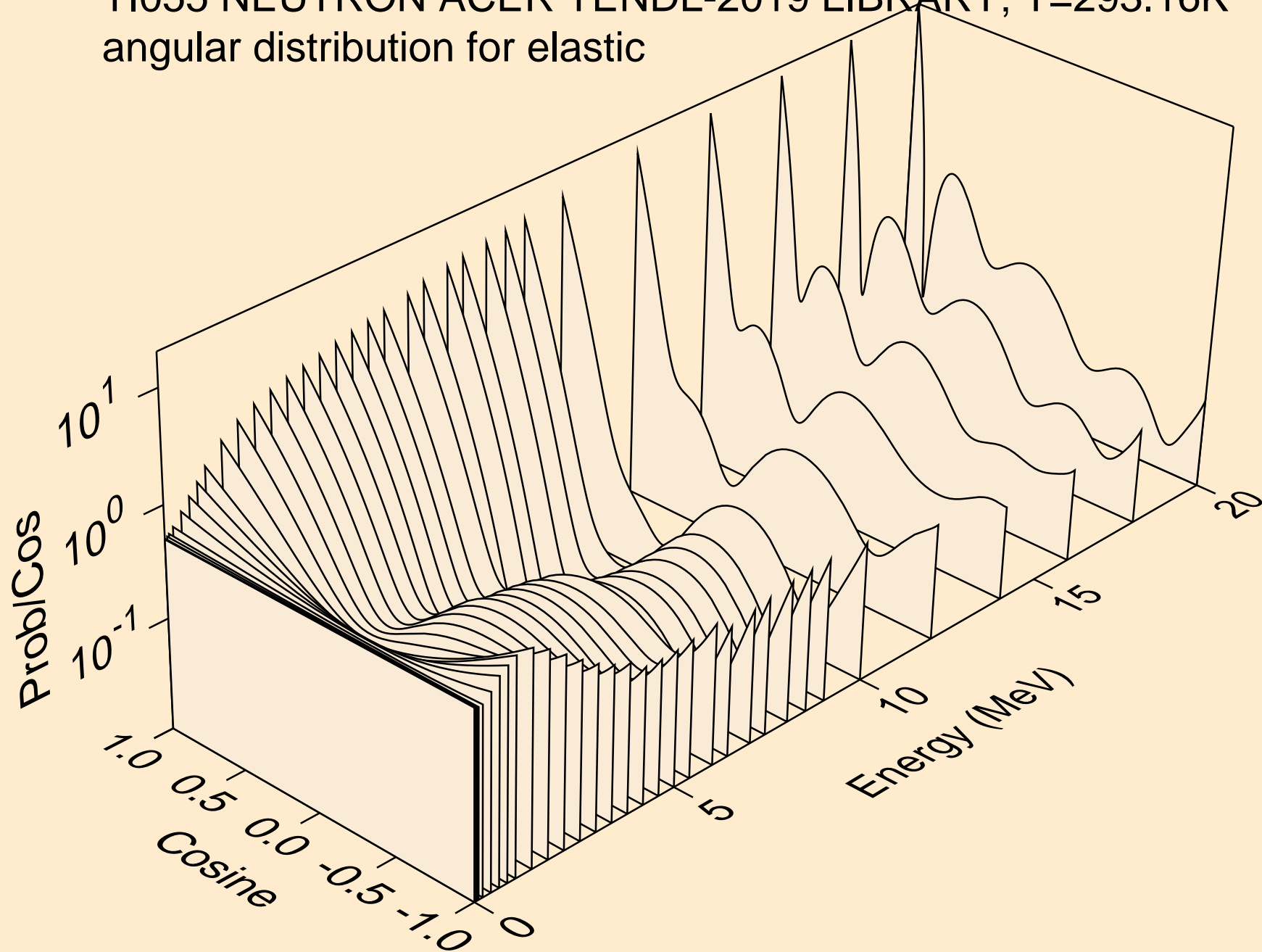

TI055 NEUTRON ACER TENDL-2019 LIBRARY; T=293.16K
angular distribution for elastic

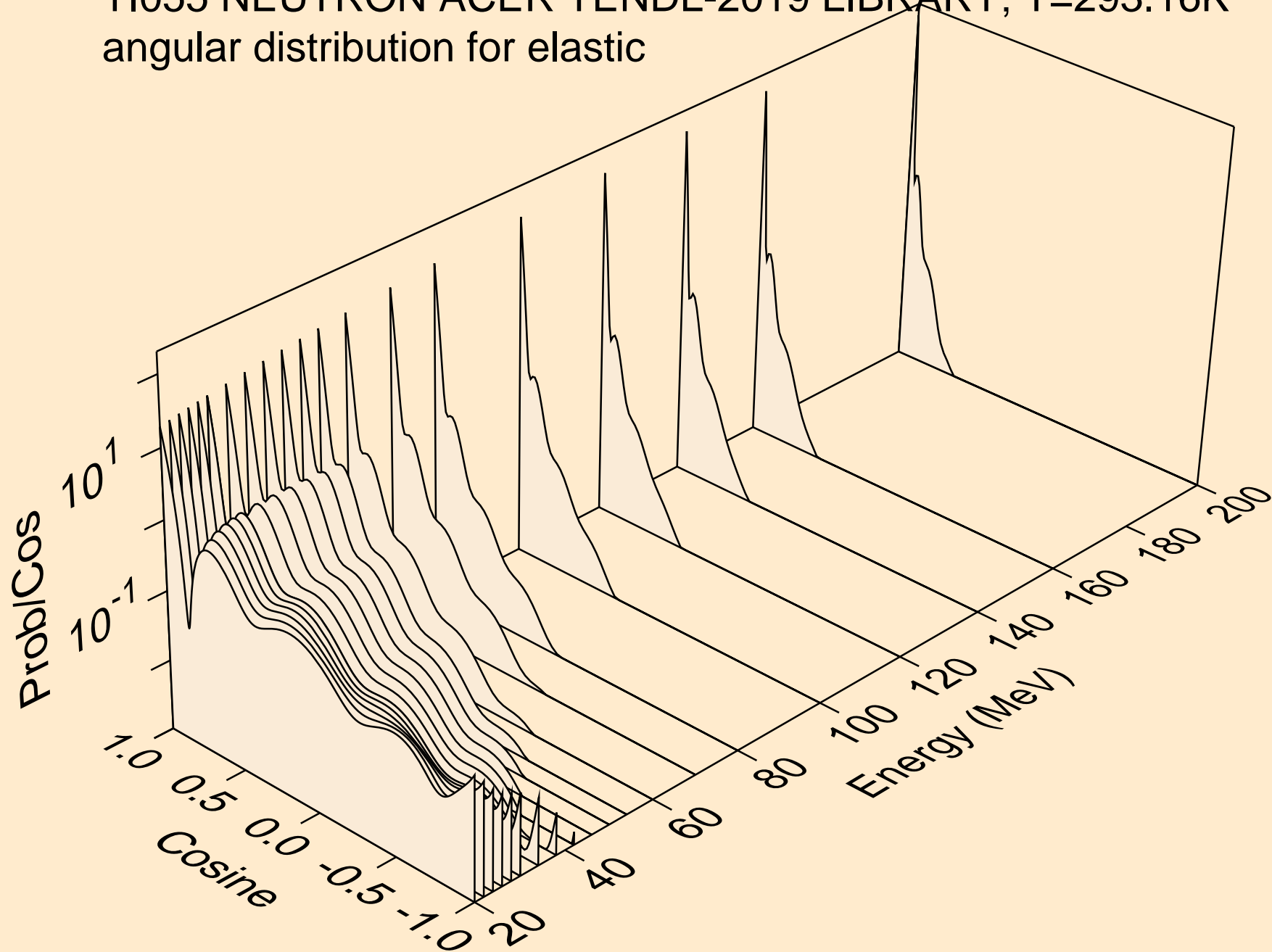

TI055 NEUTRON ACER TENDL-2019 LIBRARY; T=293.16K
angular distribution for (n,n*1)

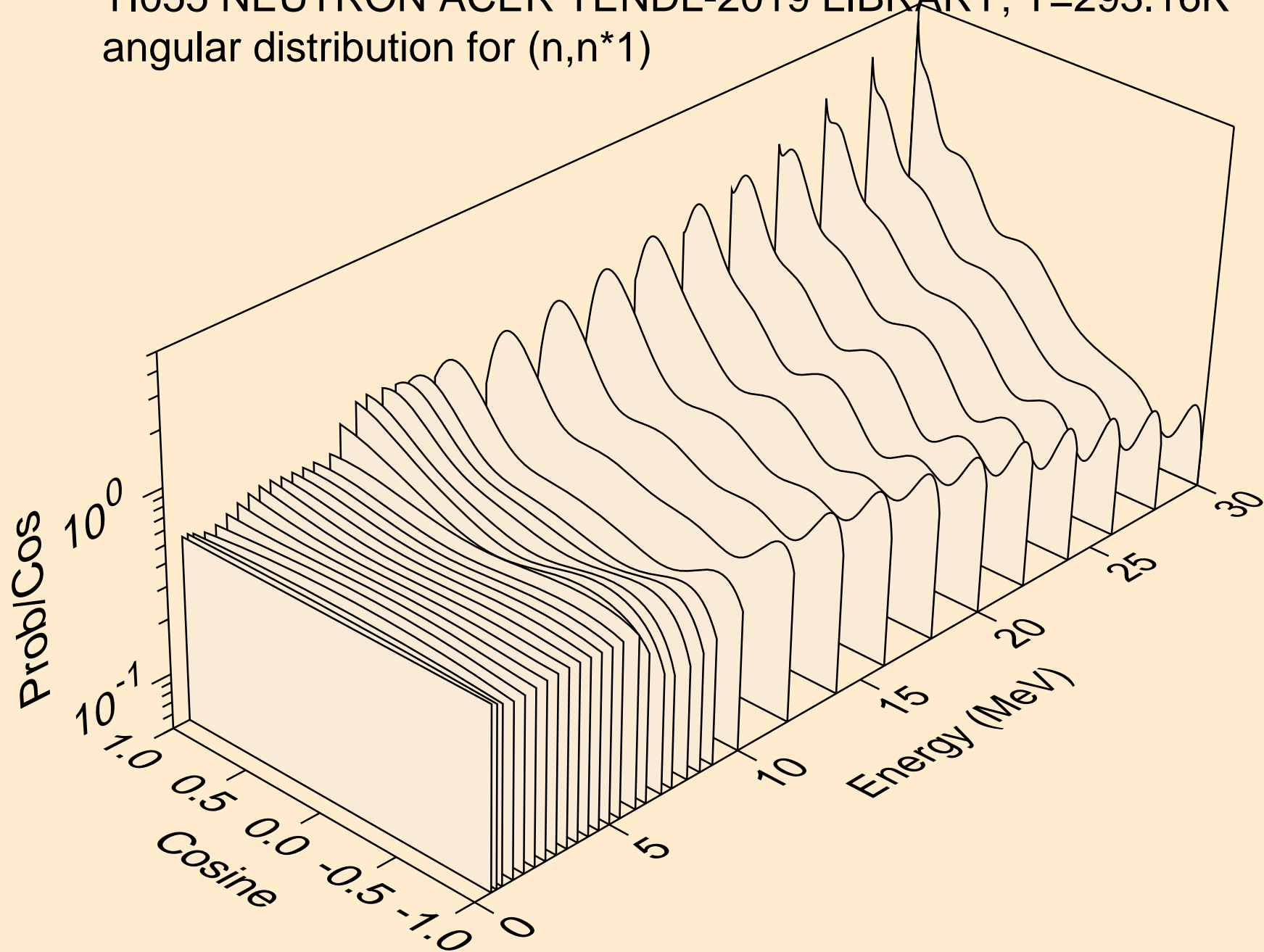

TI055 NEUTRON ACER TENDL-2019 LIBRARY; T=293.16K
angular distribution for (n,n*2)

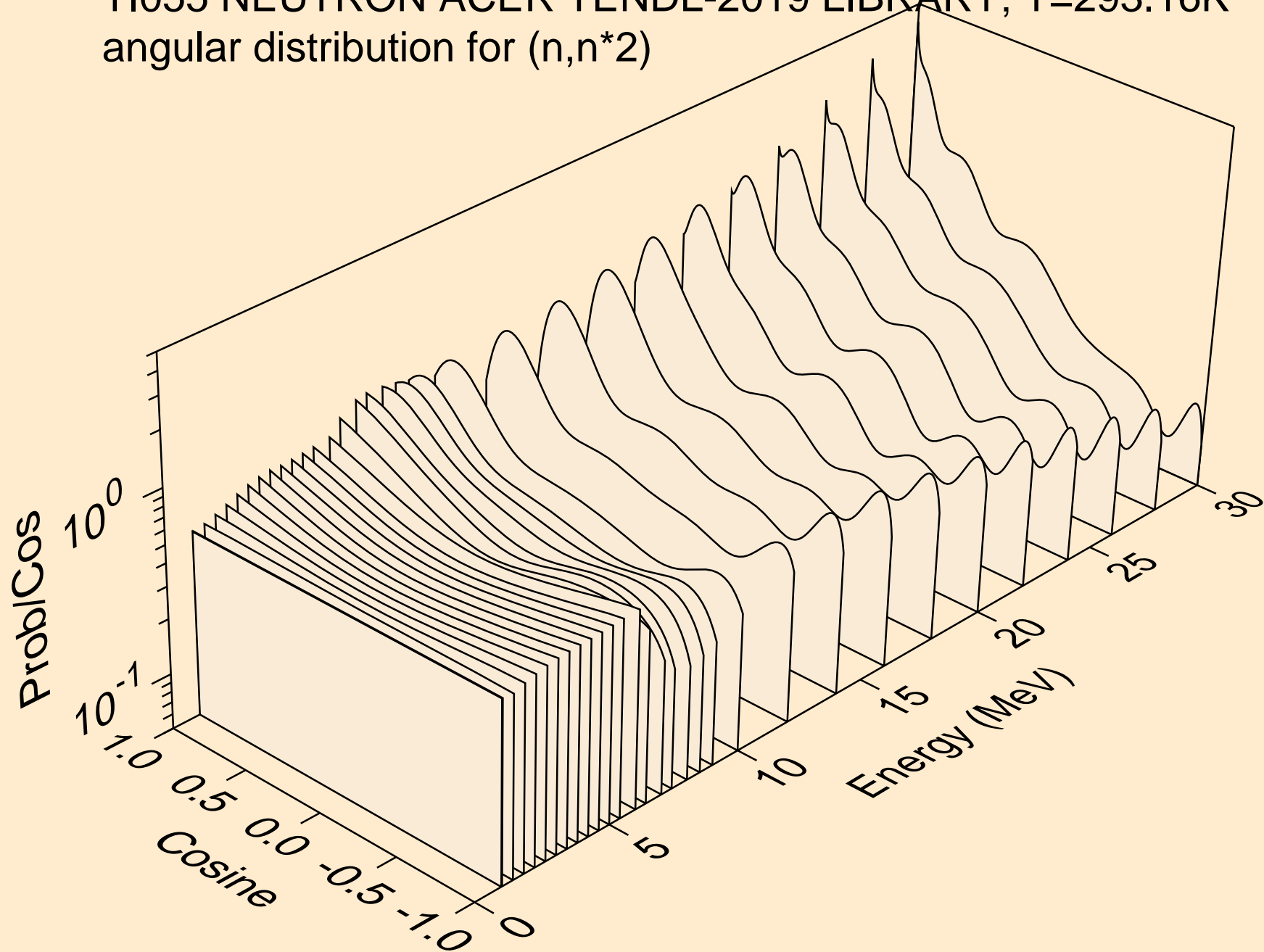

TI055 NEUTRON ACER TENDL-2019 LIBRARY; T=293.16K
angular distribution for (n,n*3)

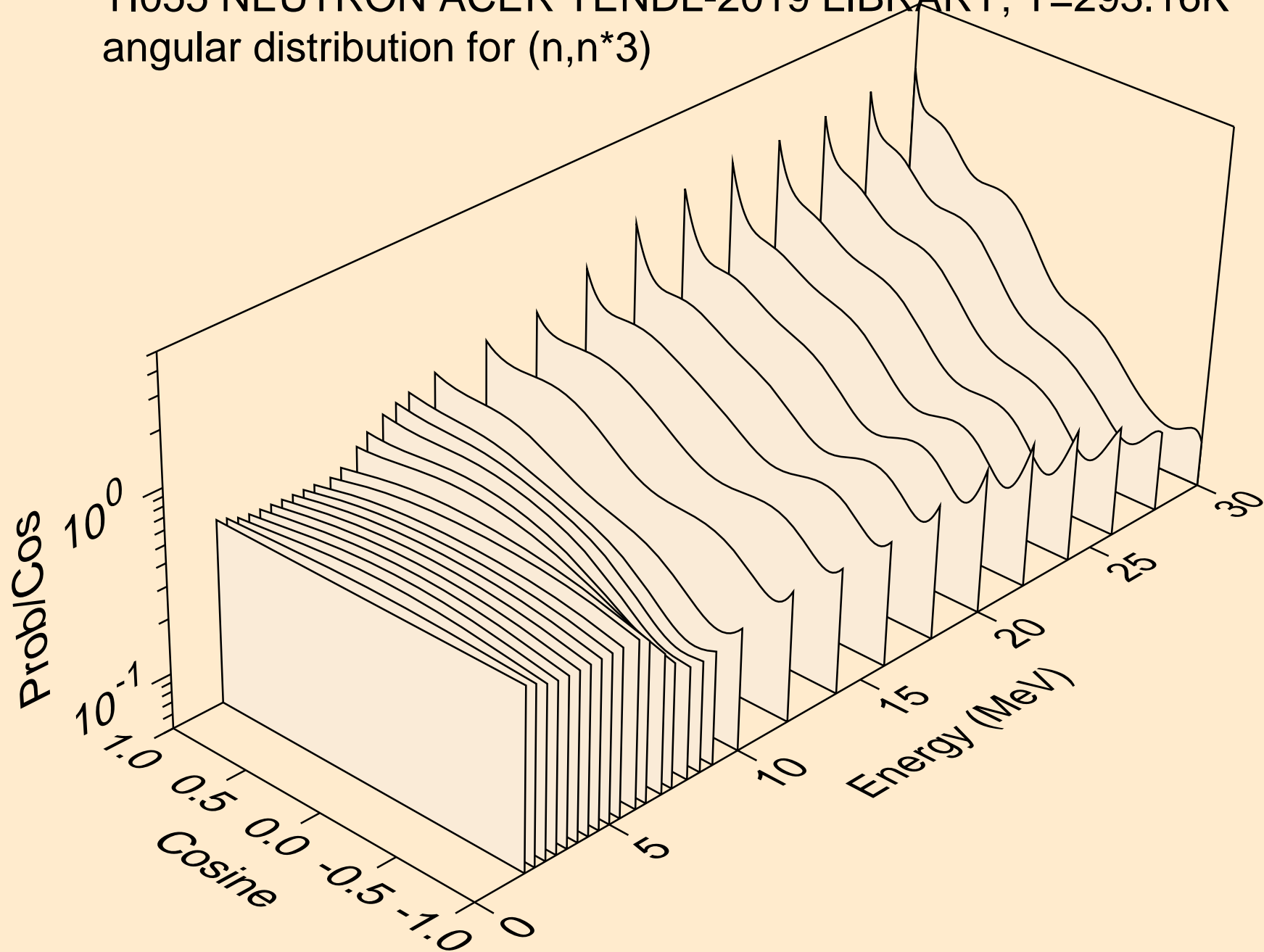

TI055 NEUTRON ACER TENDL-2019 LIBRARY; T=293.16K
angular distribution for (n,n*4)

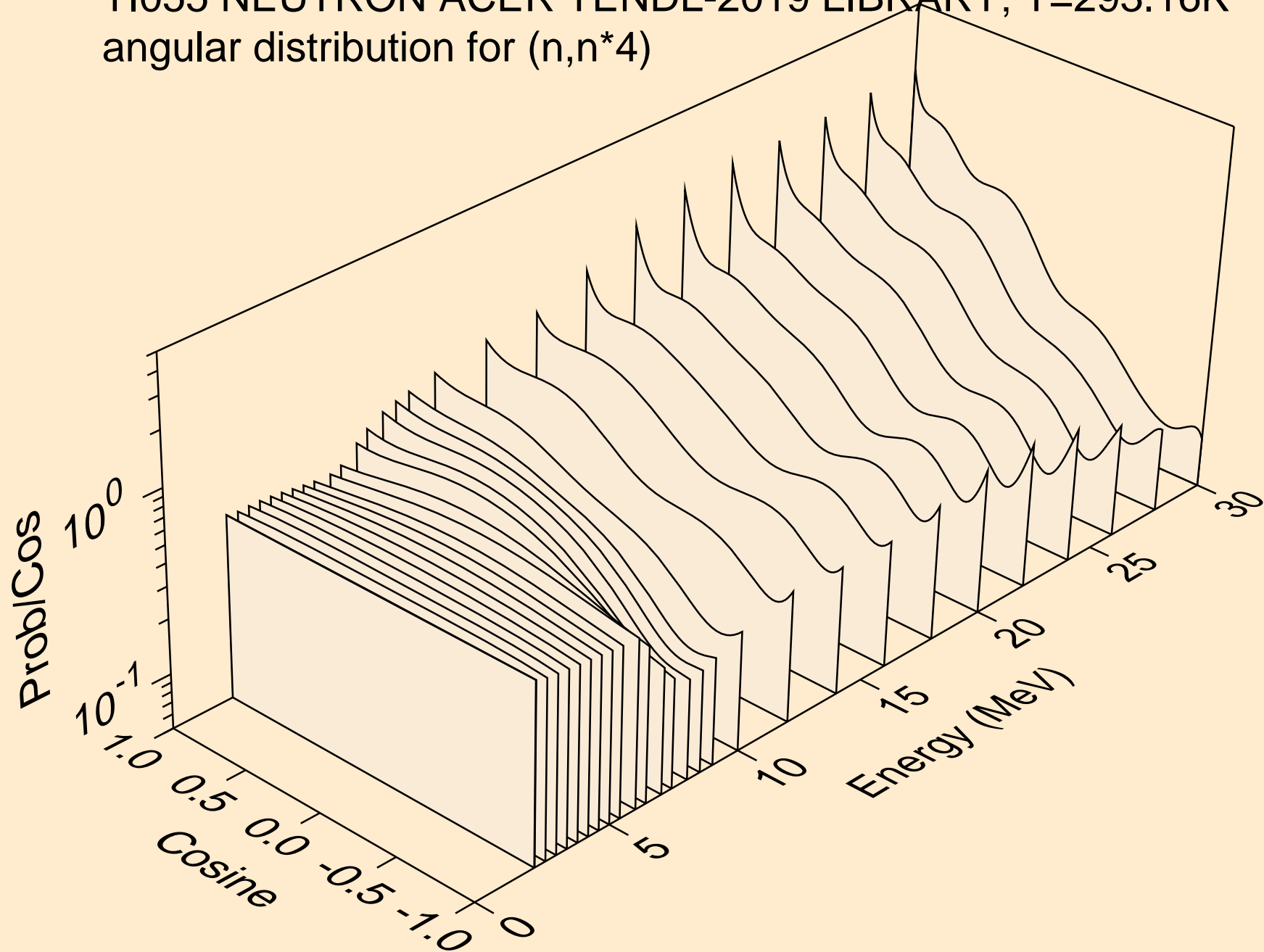

TI055 NEUTRON ACER TENDL-2019 LIBRARY; T=293.16K
angular distribution for (n,n*5)

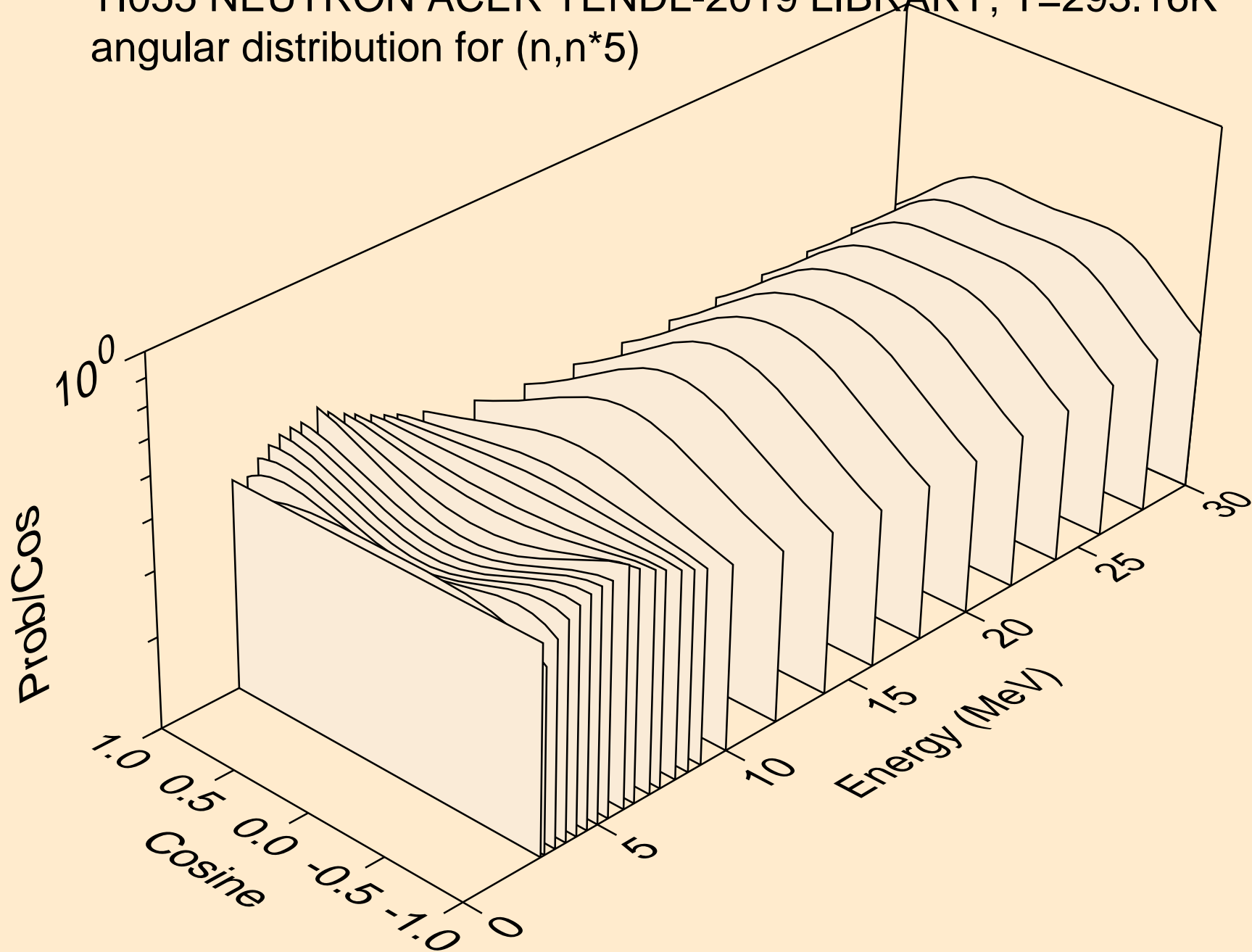

TI055 NEUTRON ACER TENDL-2019 LIBRARY; T=293.16K
angular distribution for (n,n*6)

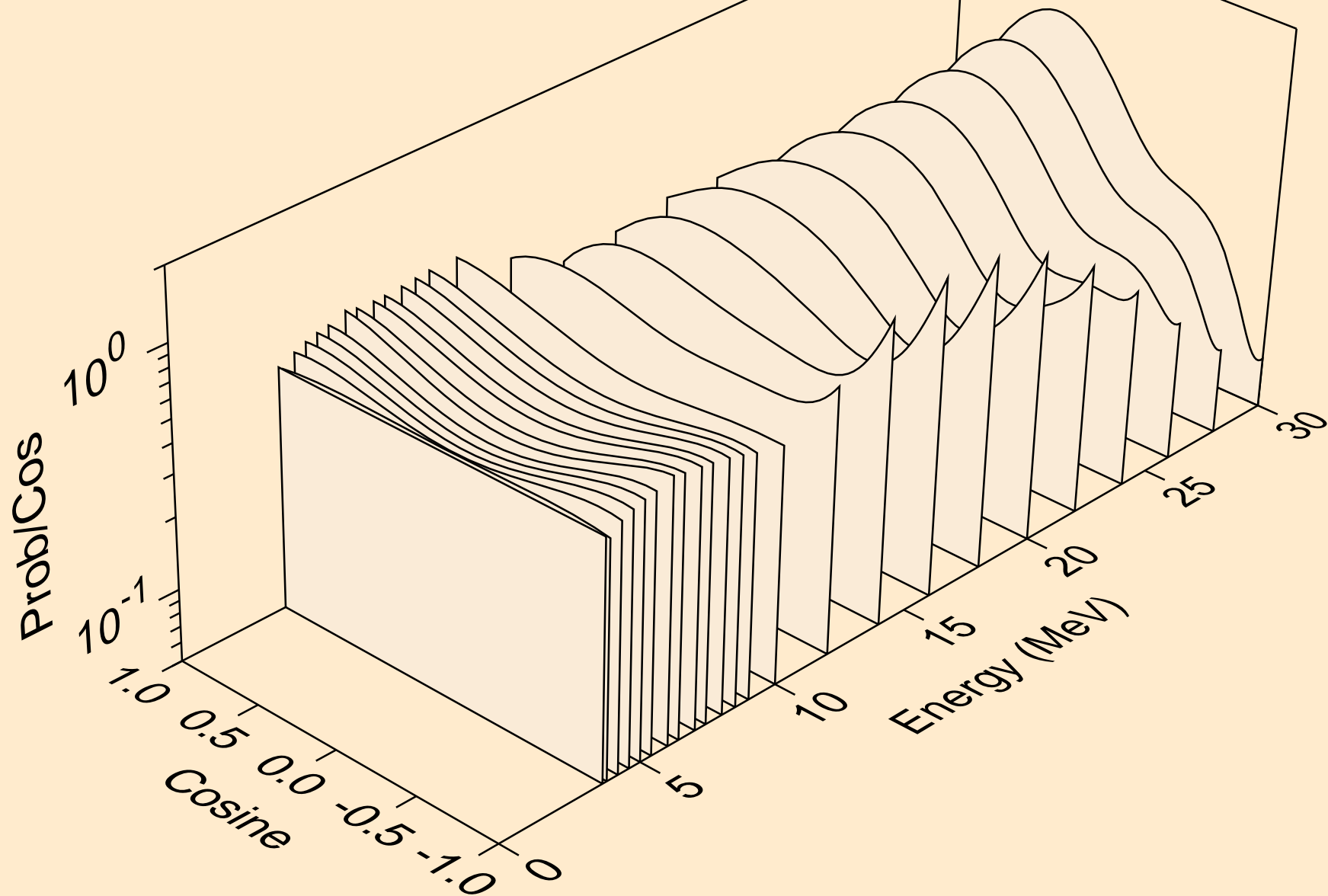

TI055 NEUTRON ACER TENDL-2019 LIBRARY; T=293.16K
angular distribution for (n,n*7)

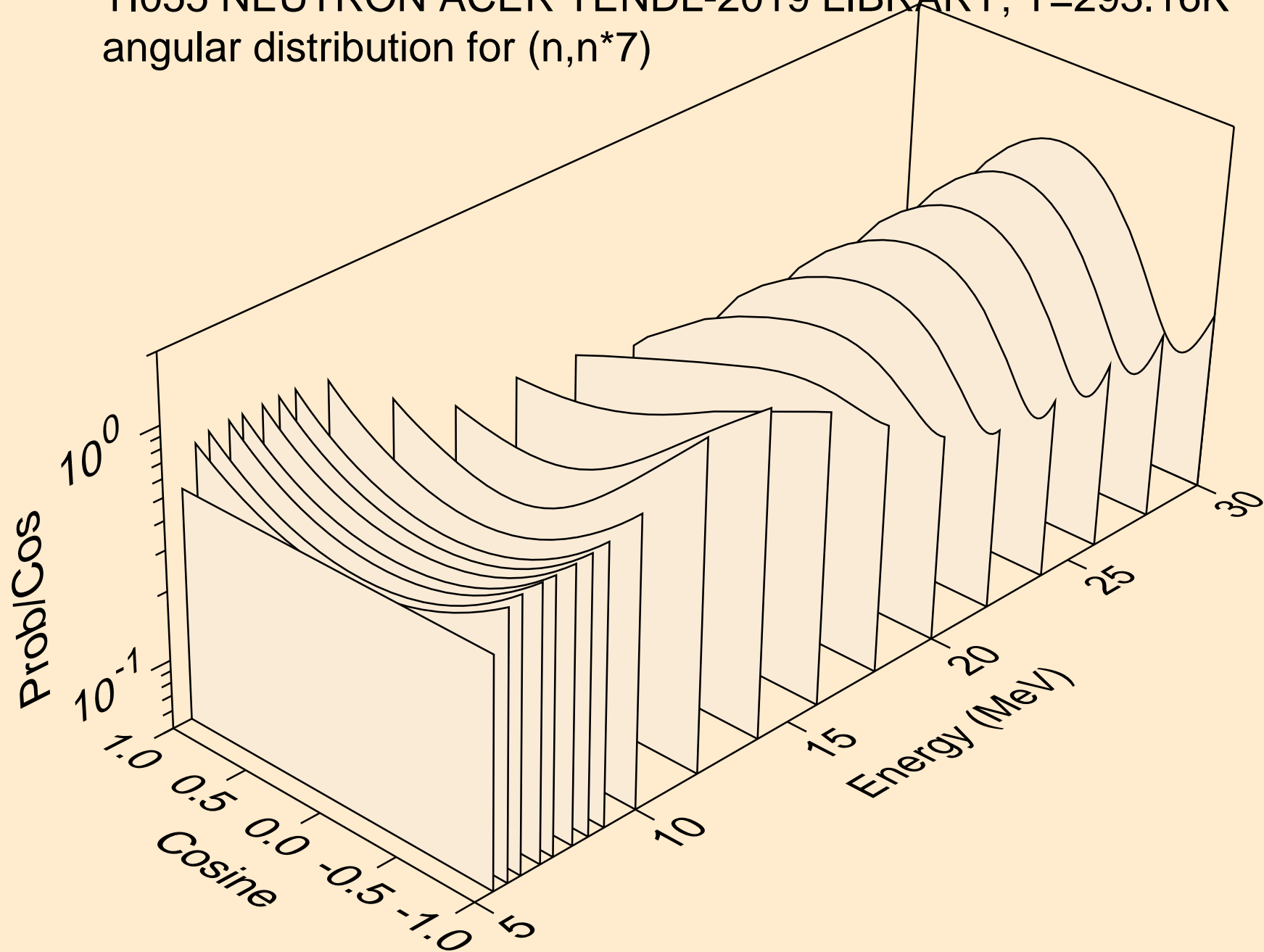

TI055 NEUTRON ACER TENDL-2019 LIBRARY; T=293.16K
angular distribution for (n,n*8)

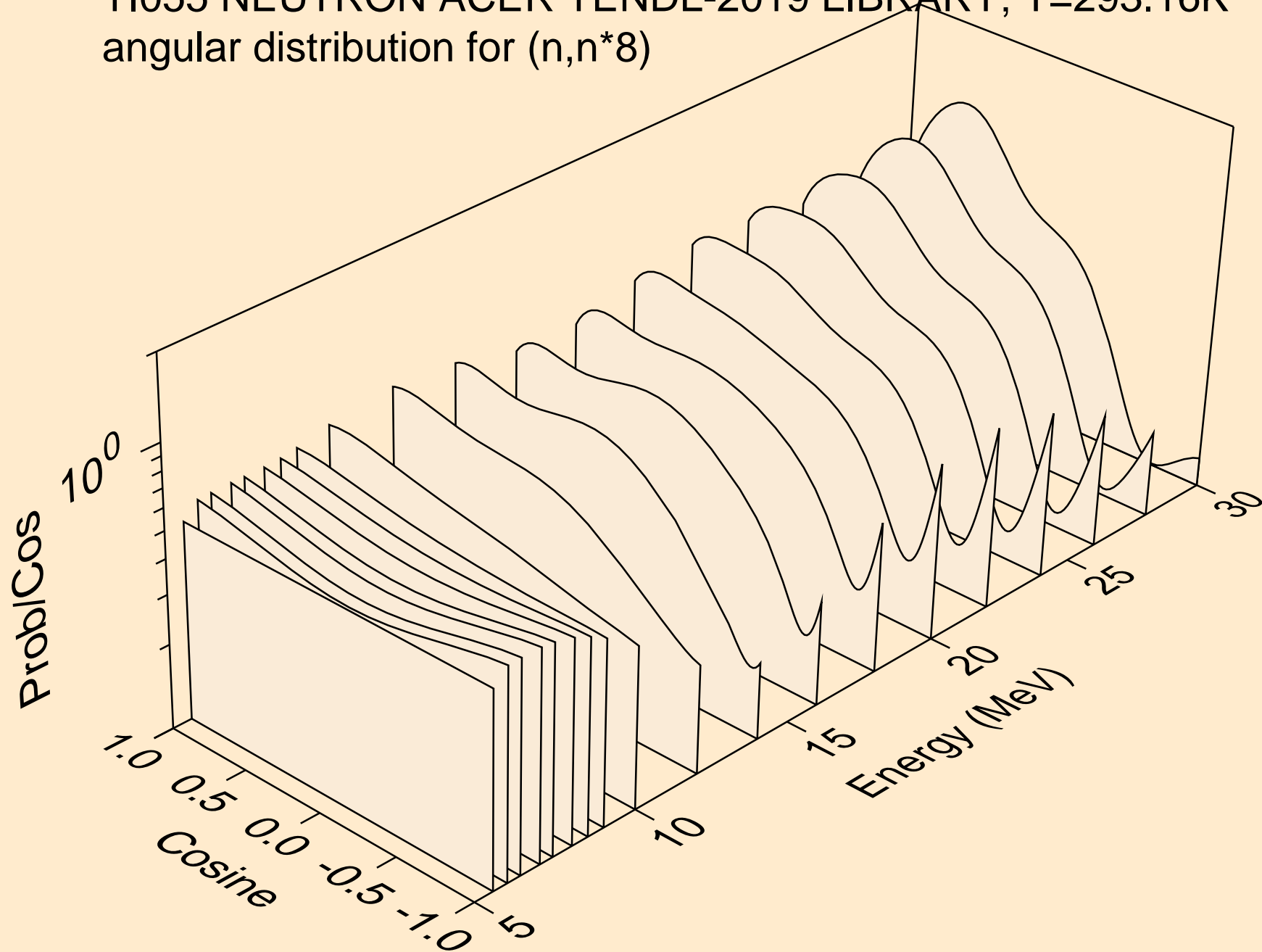

TI055 NEUTRON ACER TENDL-2019 LIBRARY; T=293.16K
angular distribution for (n,n*9)

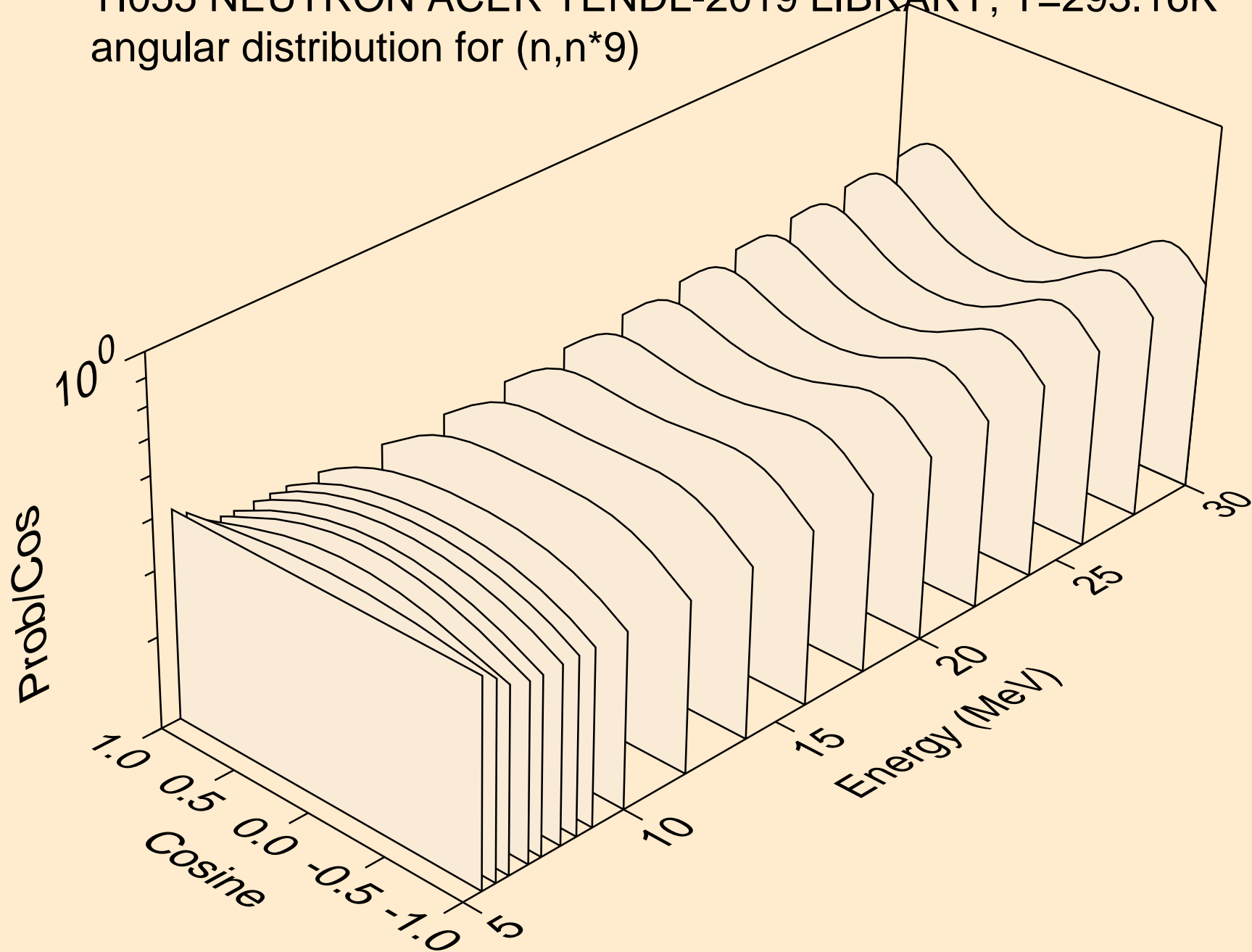

TI055 NEUTRON ACER TENDL-2019 LIBRARY; T=293.16K
angular distribution for (n,n*10)

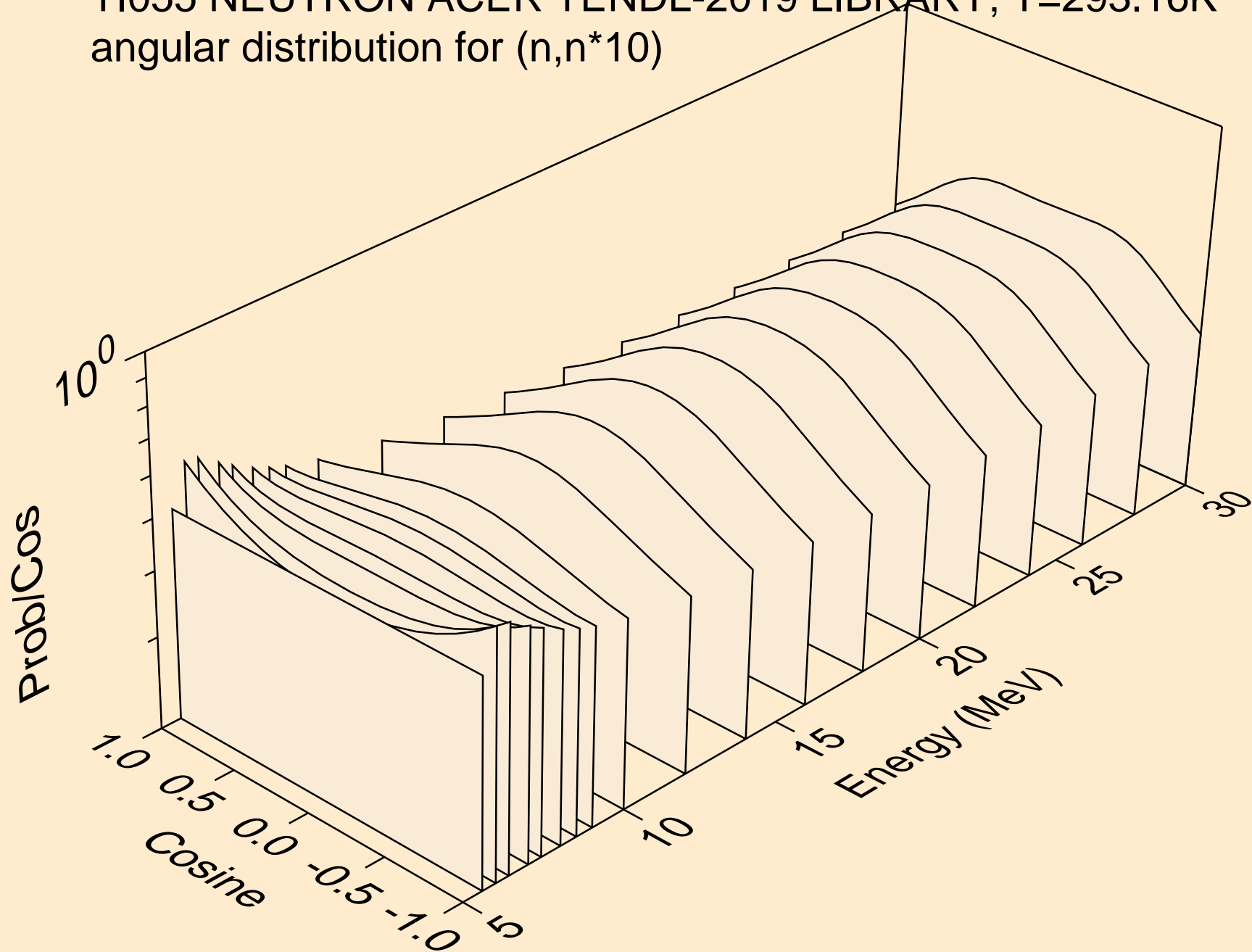

TI055 NEUTRON ACER TENDL-2019 LIBRARY; T=293.16K
angular distribution for (n,n*11)

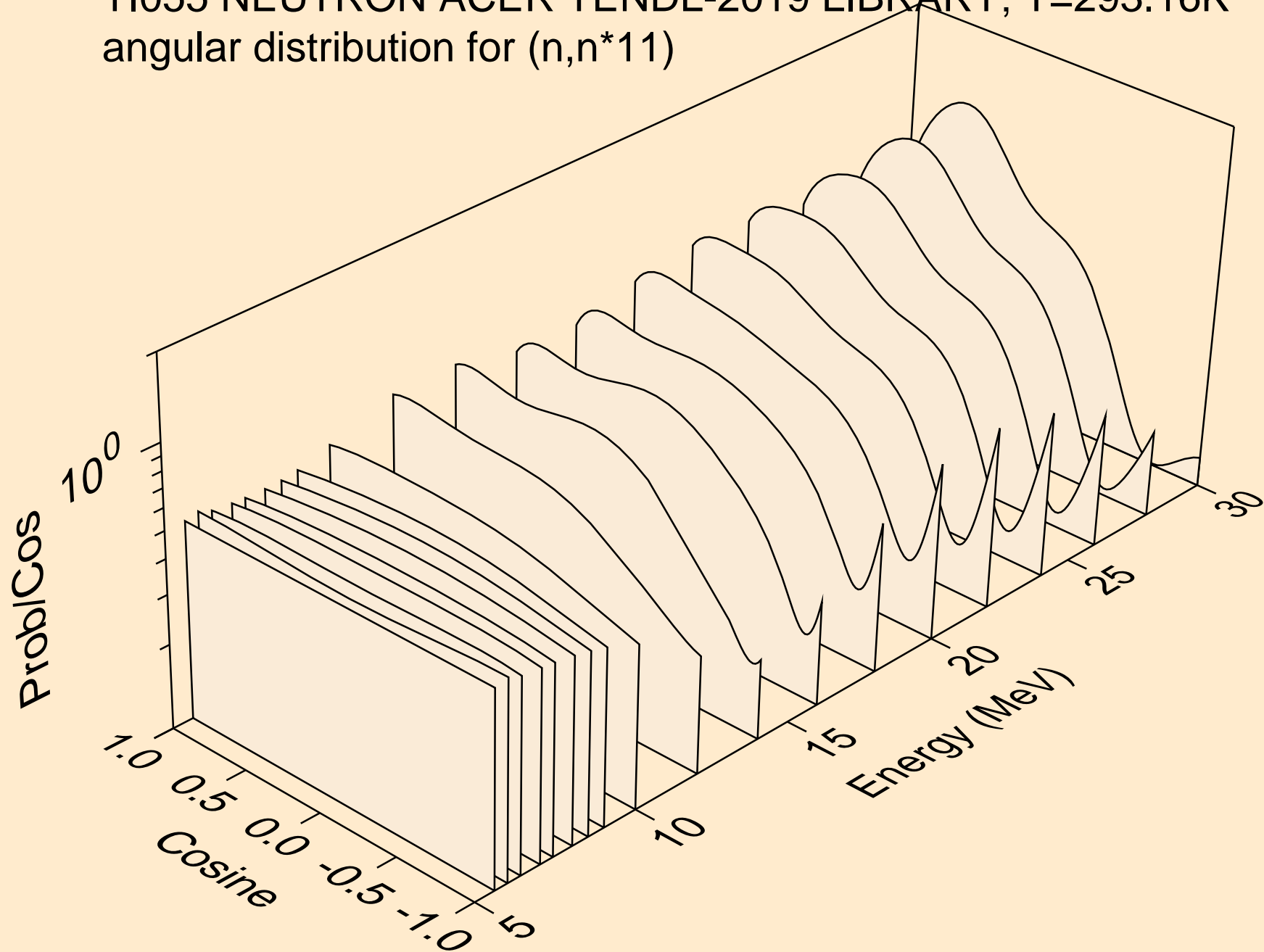

TI055 NEUTRON ACER TENDL-2019 LIBRARY; T=293.16K
angular distribution for (n,n*12)

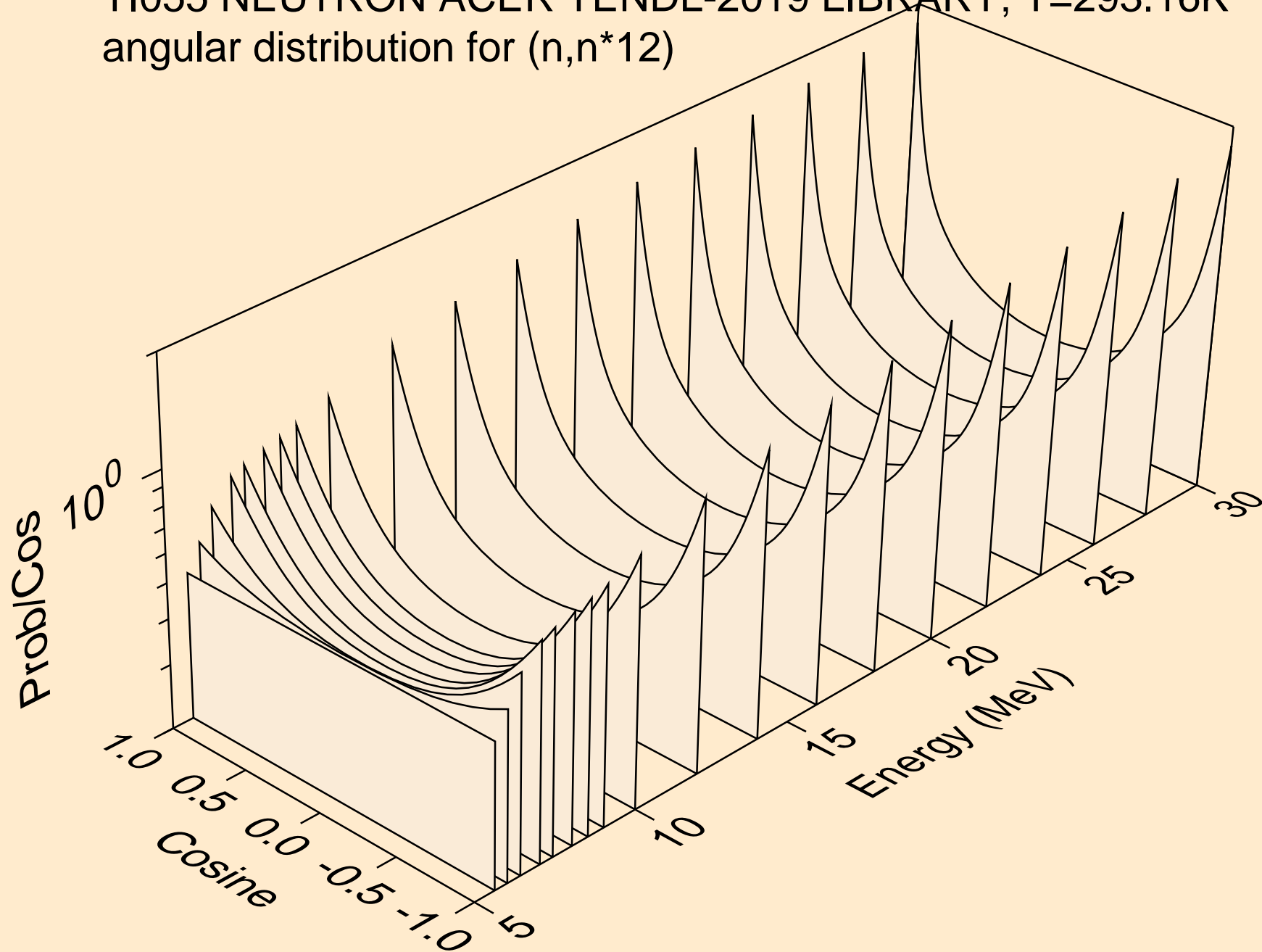

TI055 NEUTRON ACER TENDL-2019 LIBRARY; T=293.16K
angular distribution for (n,n*13)

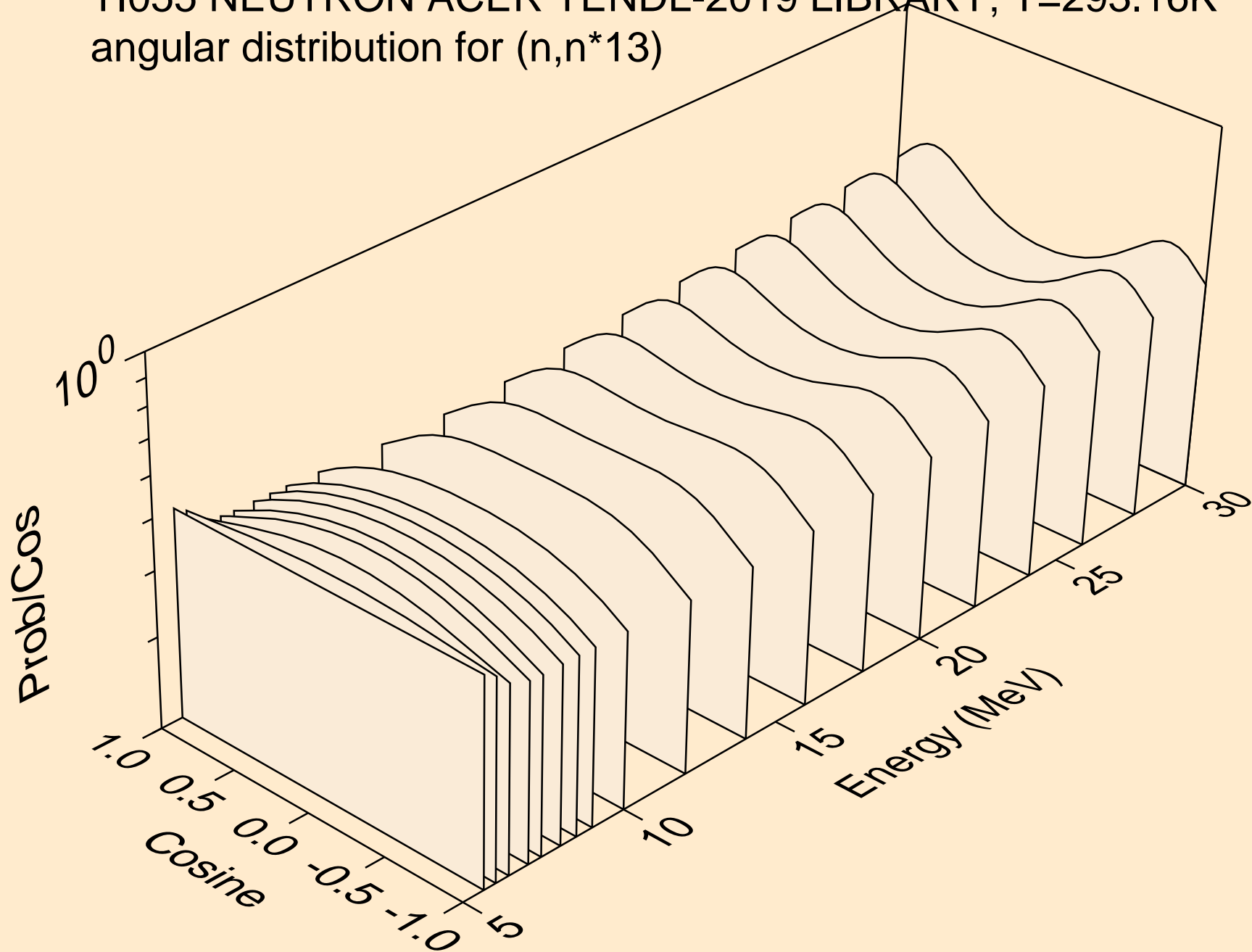

TI055 NEUTRON ACER TENDL-2019 LIBRARY; T=293.16K
angular distribution for (n,n*14)

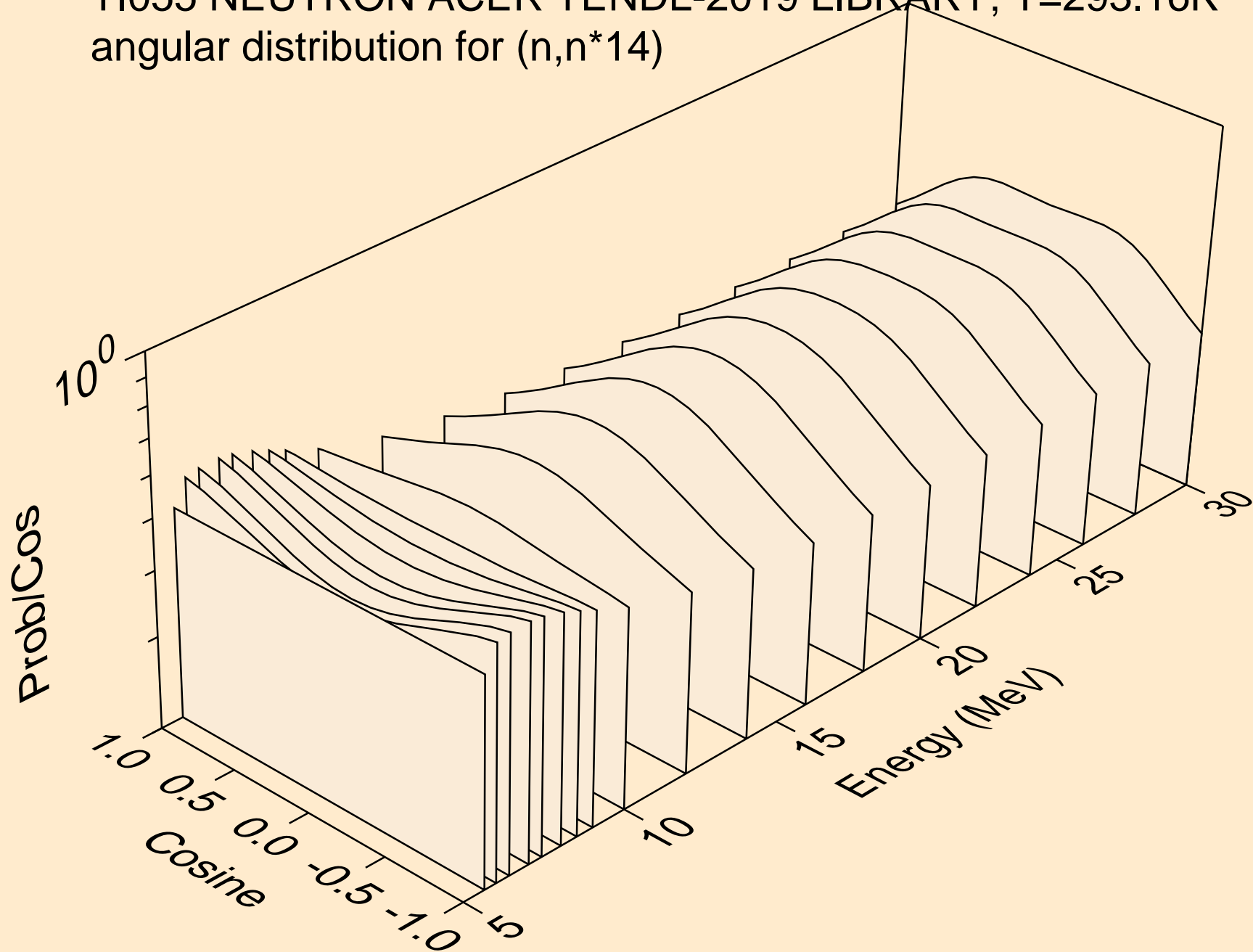

TI055 NEUTRON ACER TENDL-2019 LIBRARY; T=293.16K
angular distribution for (n,n*15)

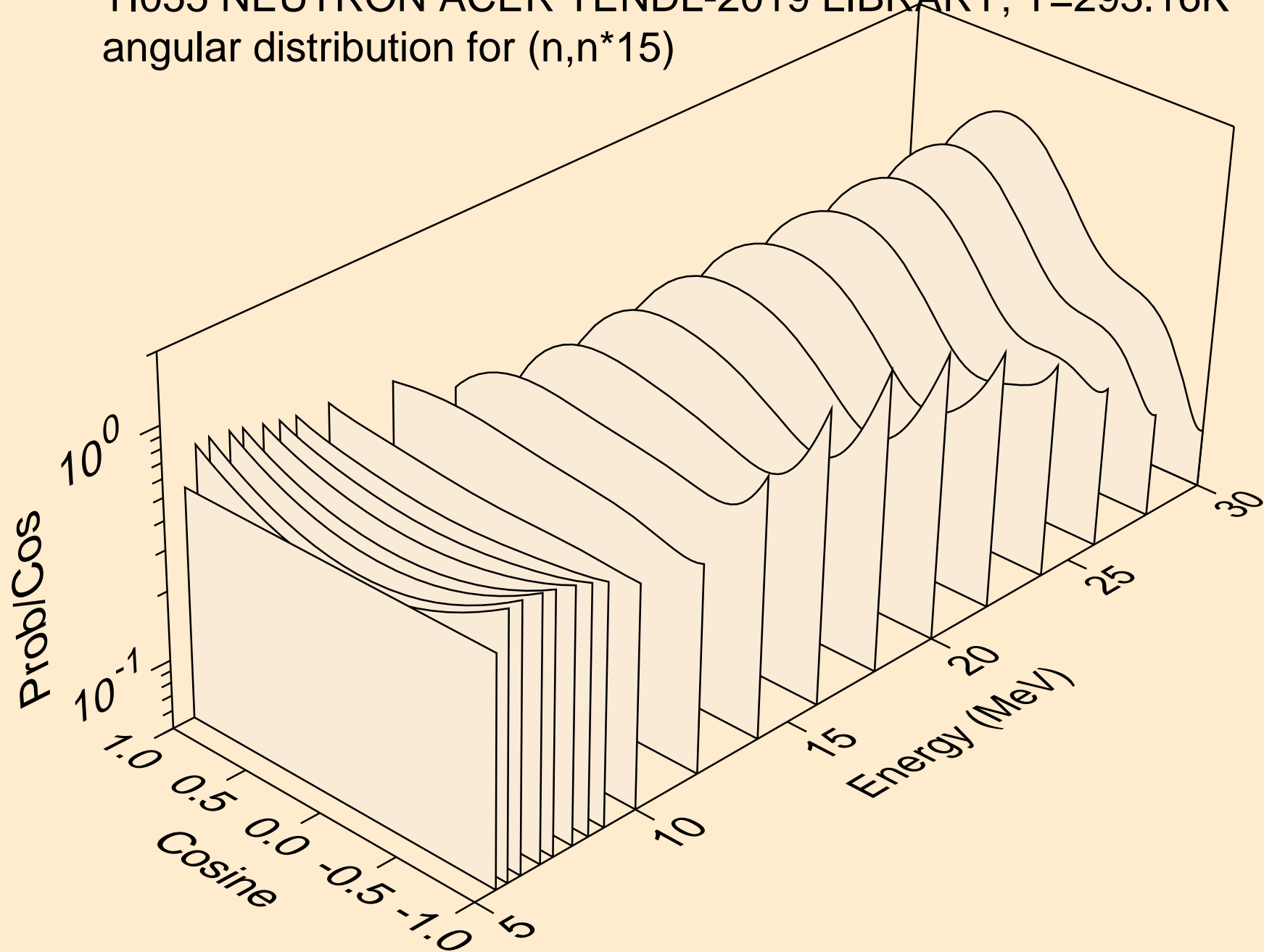

TI055 NEUTRON ACER TENDL-2019 LIBRARY; T=293.16K
angular distribution for (n,n*16)

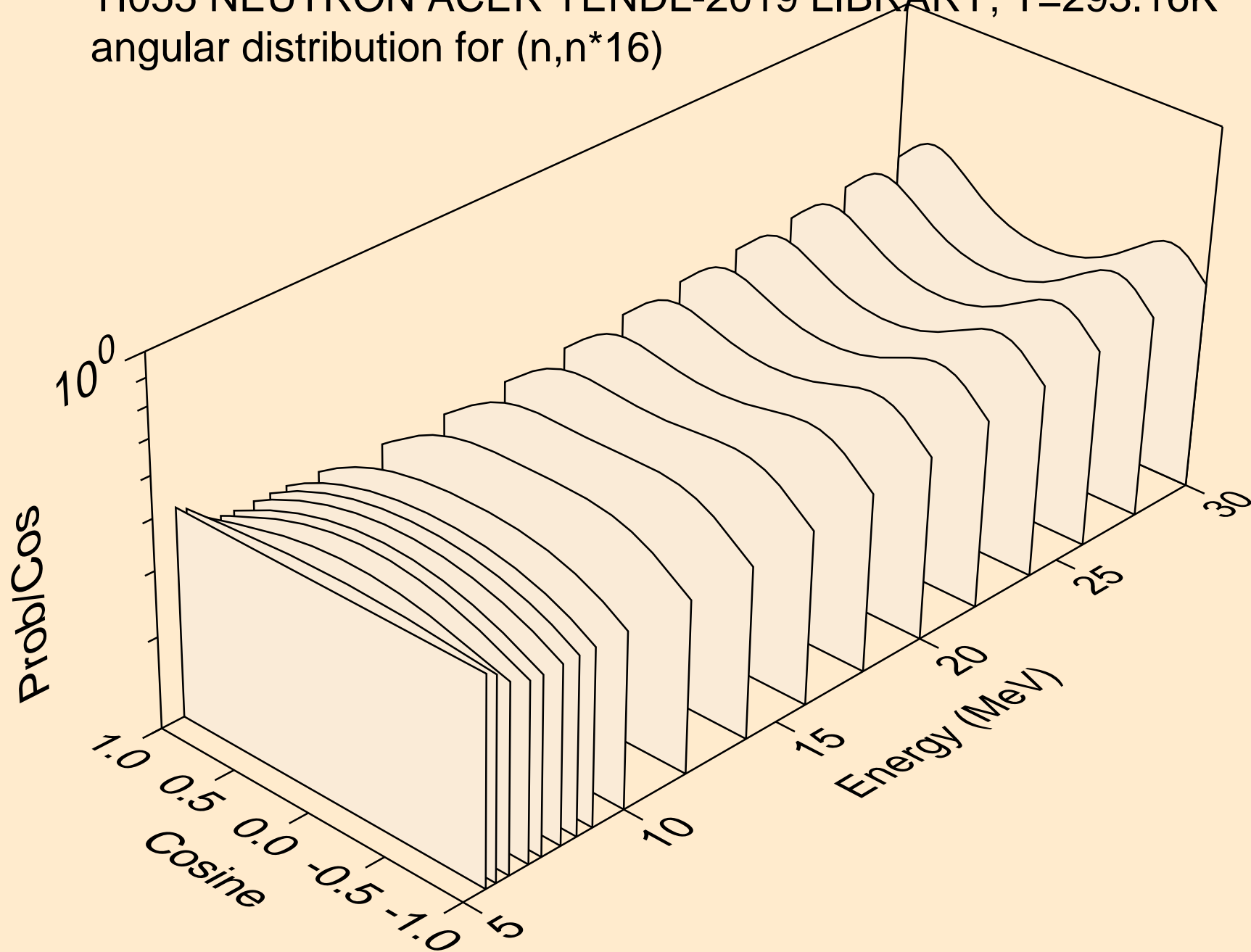

TI055 NEUTRON ACER TENDL-2019 LIBRARY; T=293.16K
Neutron emission for (n,x)

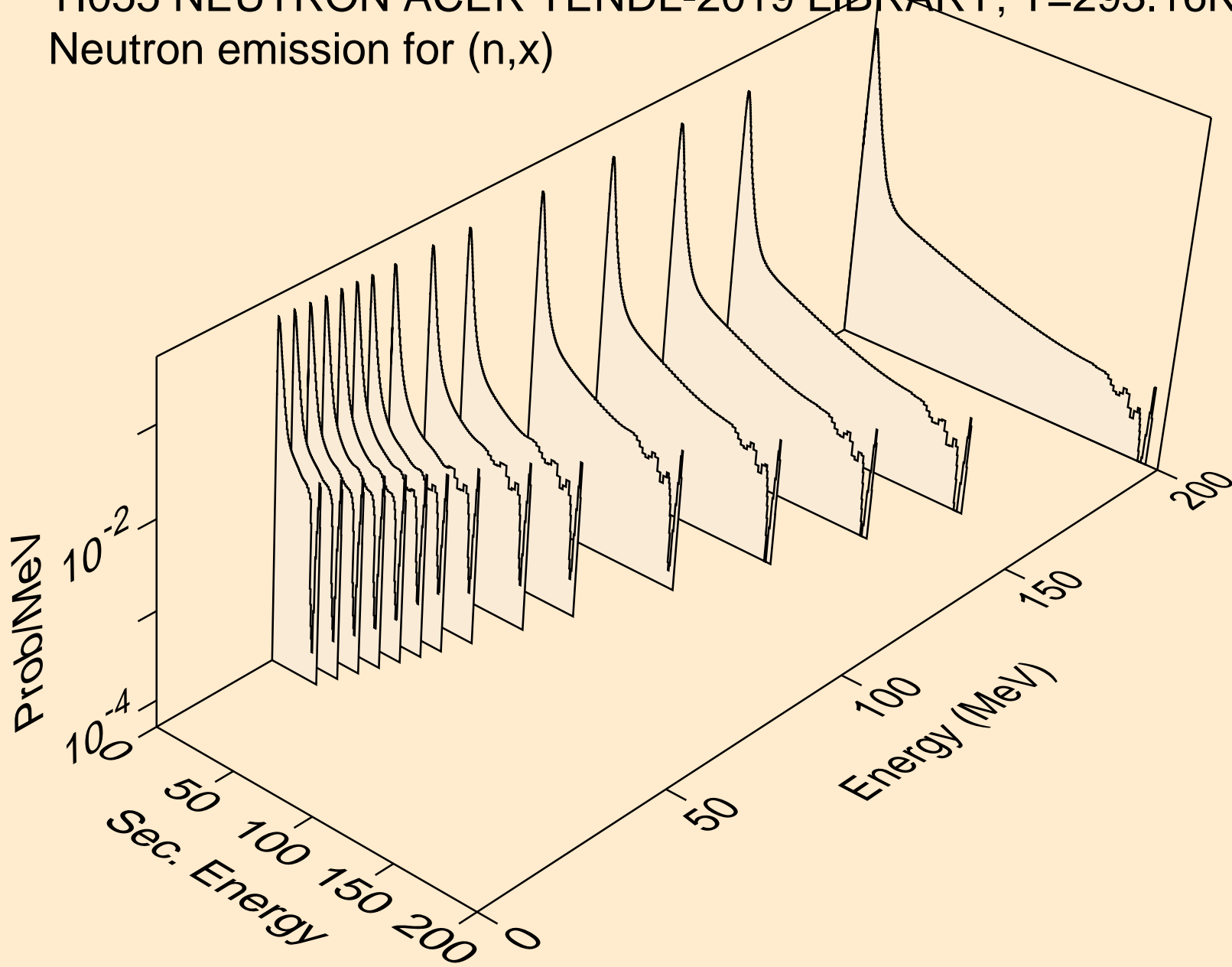

TI055 NEUTRON ACER TENDL-2019 LIBRARY; T=293.16K
Neutron emission for (n,2nd)

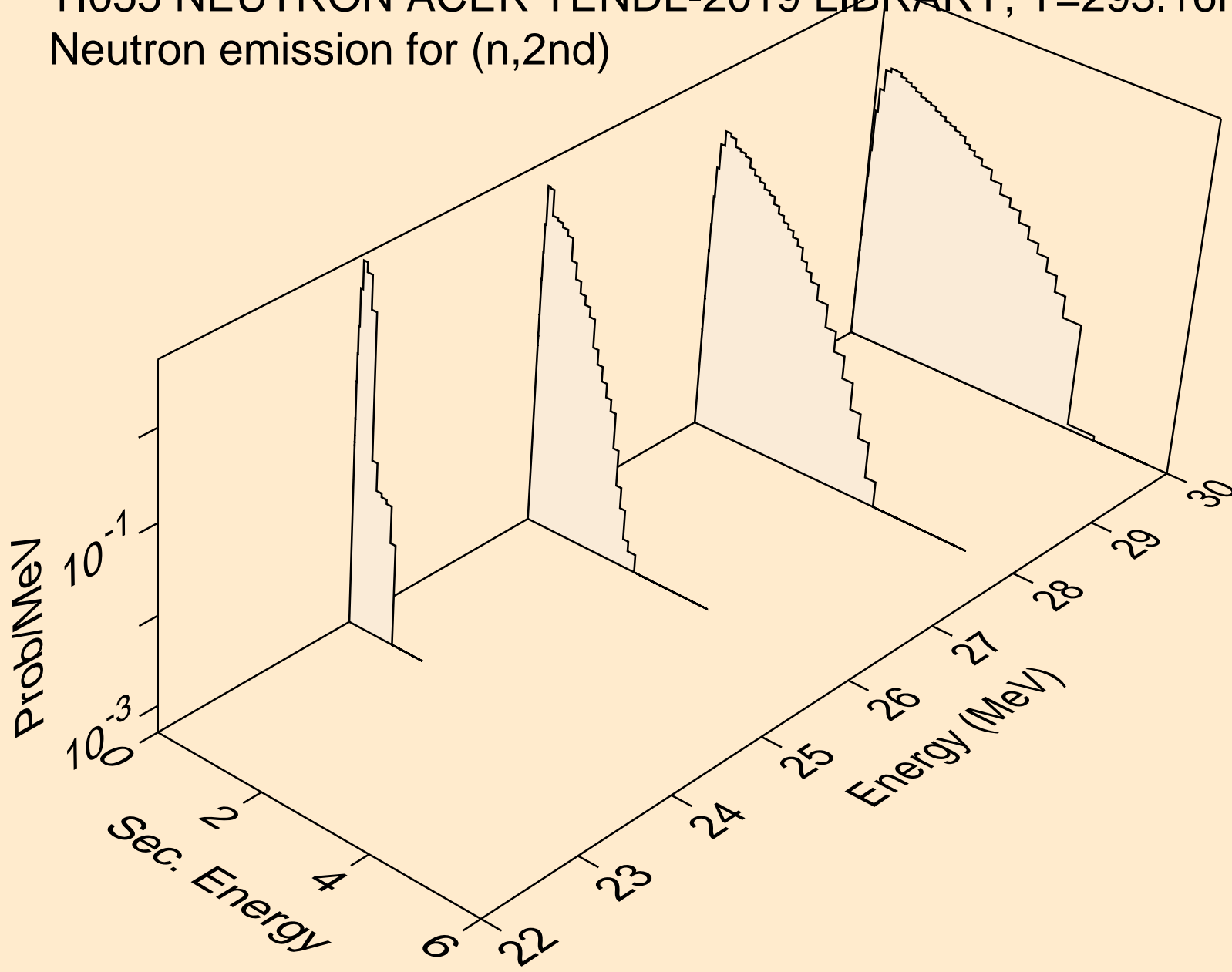

TI055 NEUTRON ACER TENDL-2019 LIBRARY; T=293.16K
Neutron emission for (n,2n)

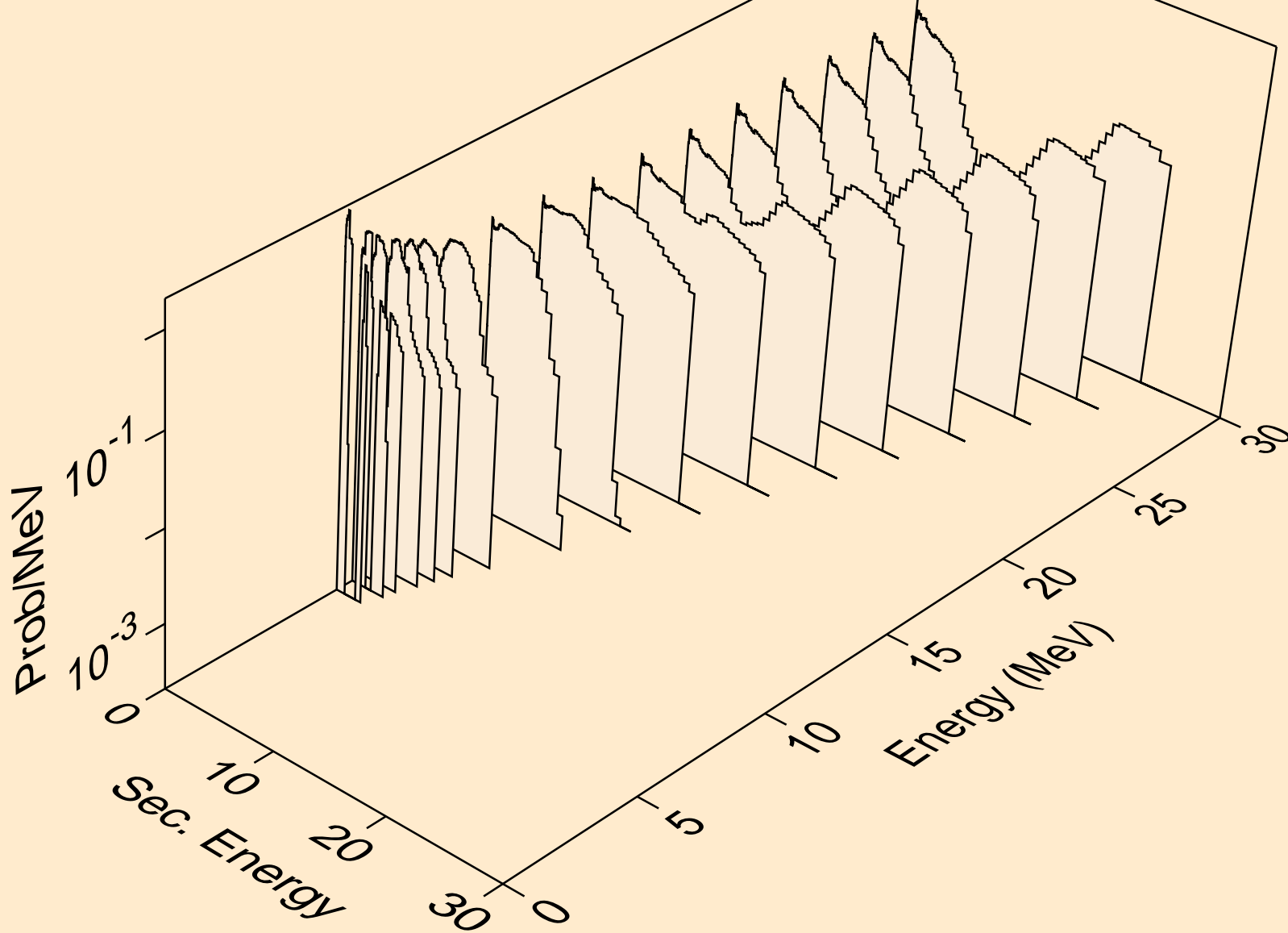

TI055 NEUTRON ACER TENDL-2019 LIBRARY; T=293.16K
Neutron emission for (n,3n)

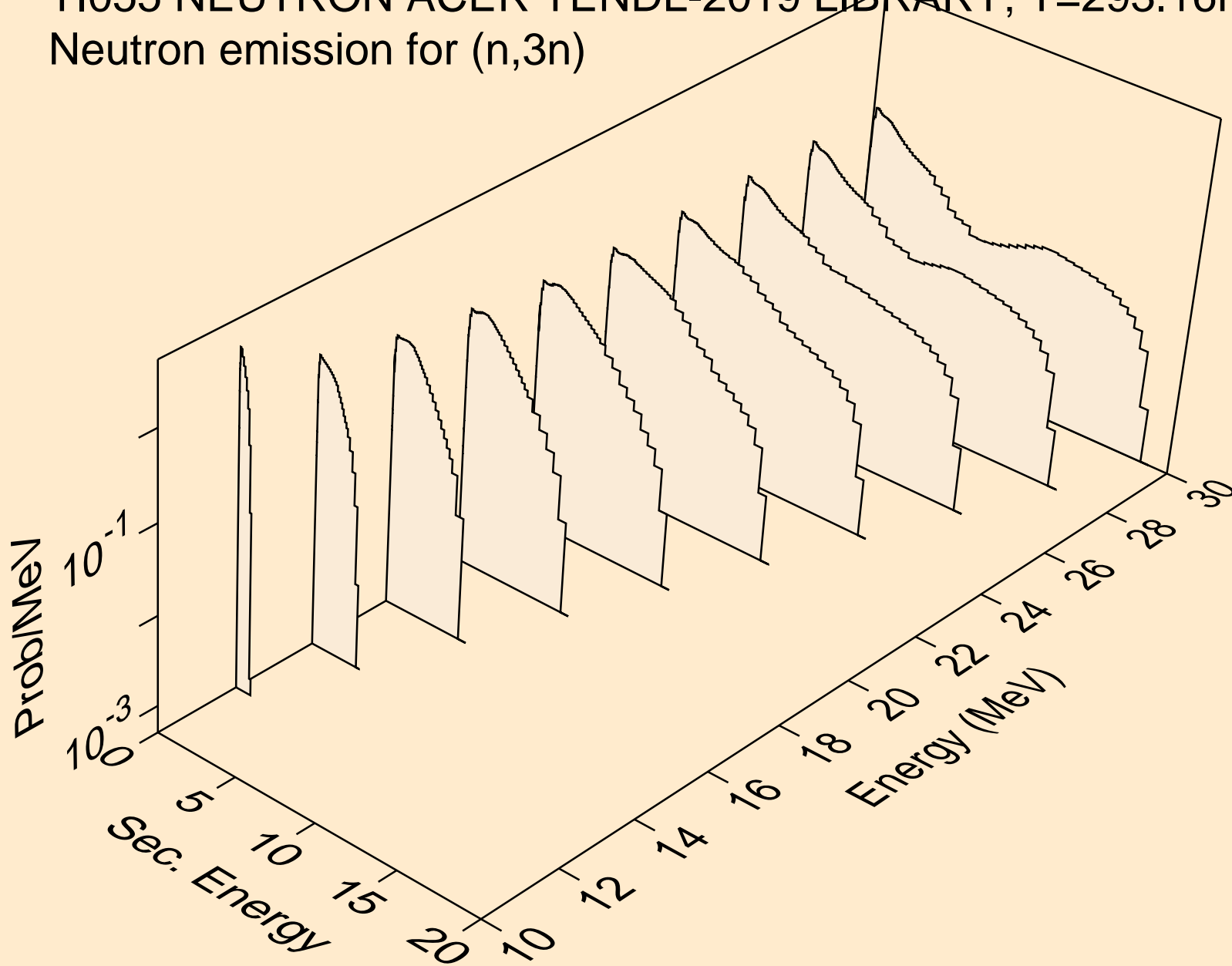

TI055 NEUTRON ACER TENDL-2019 LIBRARY; T=293.16K
Neutron emission for (n,n*)a

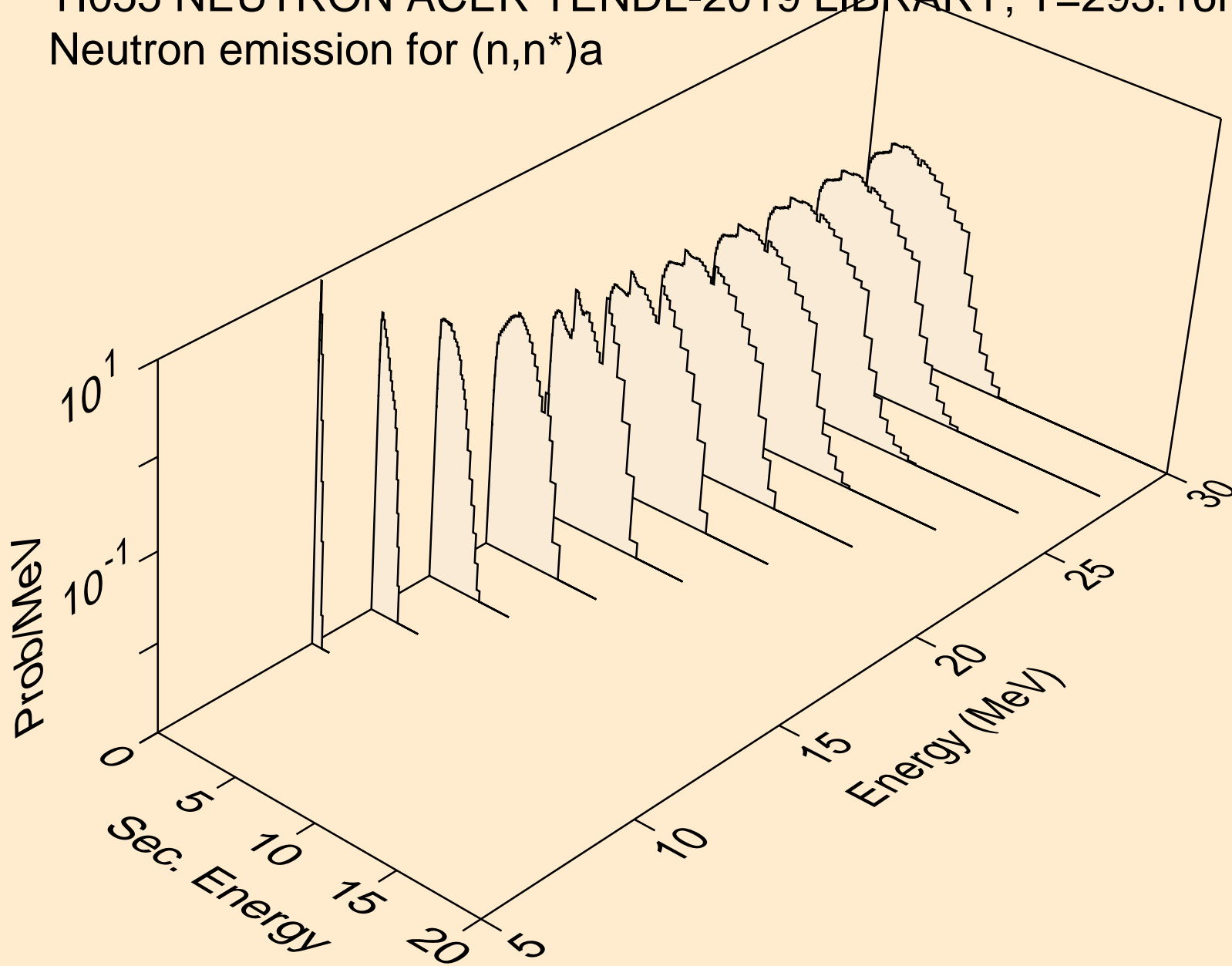

TI055 NEUTRON ACER TENDL-2019 LIBRARY; T=293.16K
Neutron emission for (n,2n)a

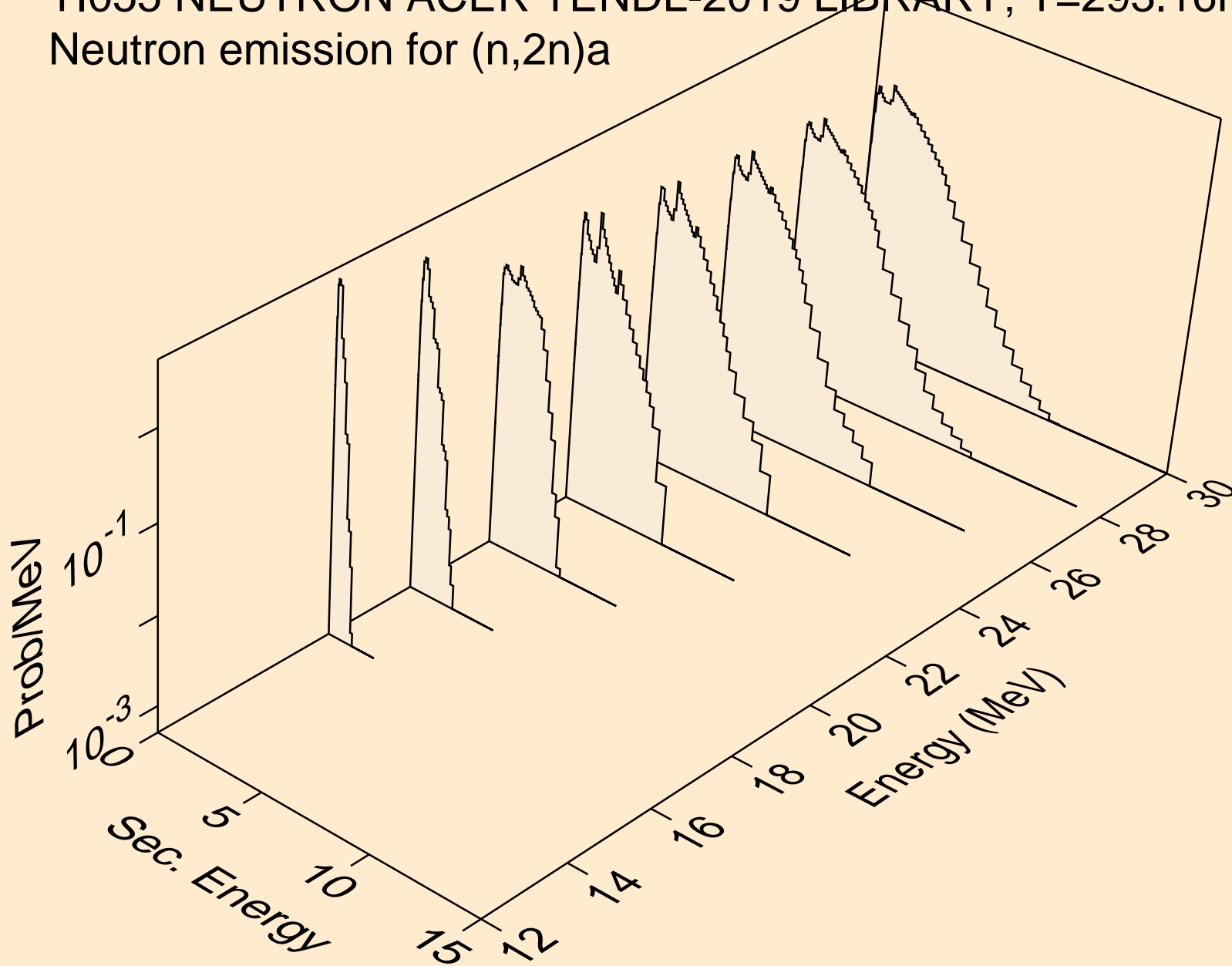

TI055 NEUTRON ACER TENDL-2019 LIBRARY; T=293.16K
Neutron emission for (n,3n)a

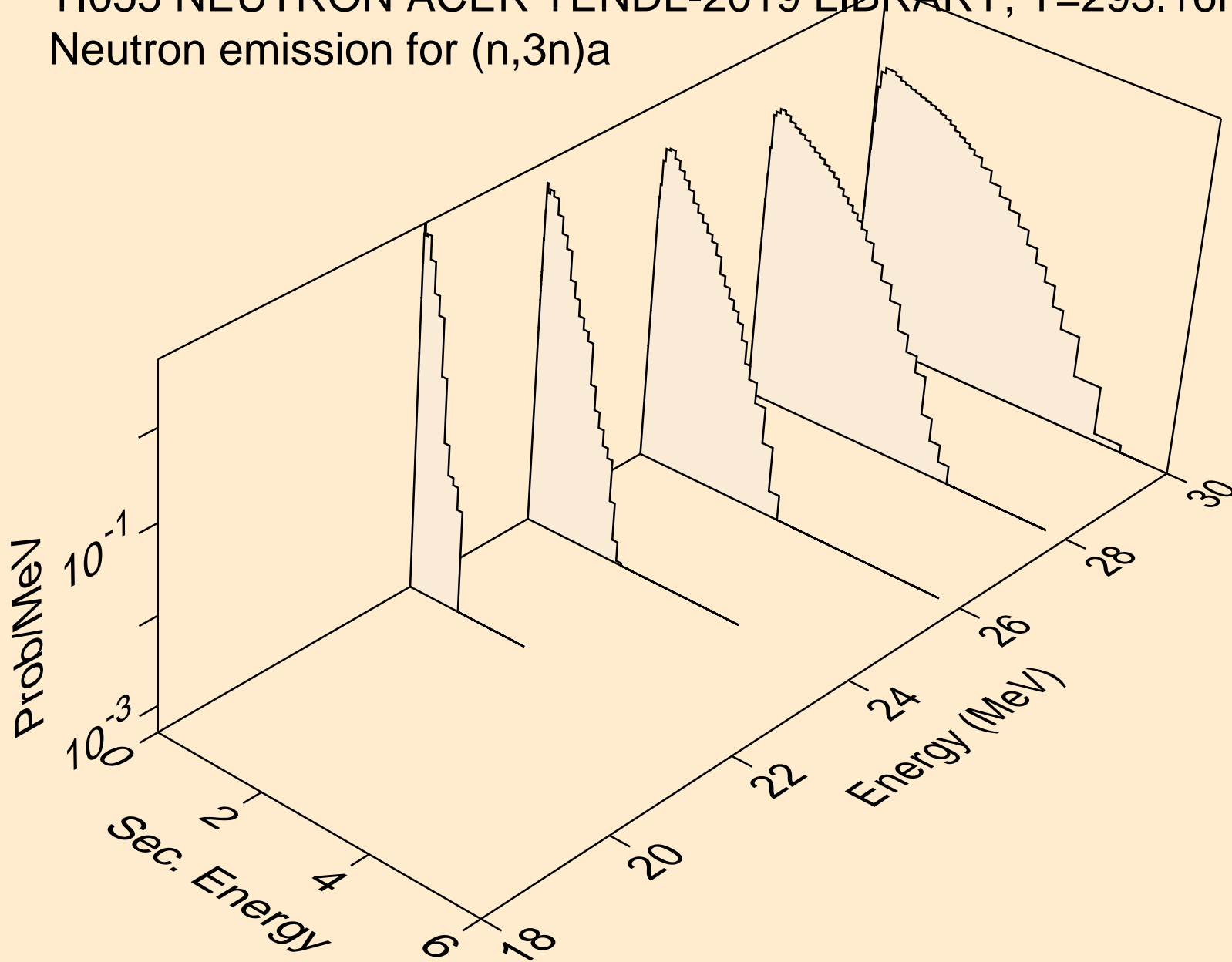

TI055 NEUTRON ACER TENDL-2019 LIBRARY; T=293.16K
Neutron emission for (n,n*)p

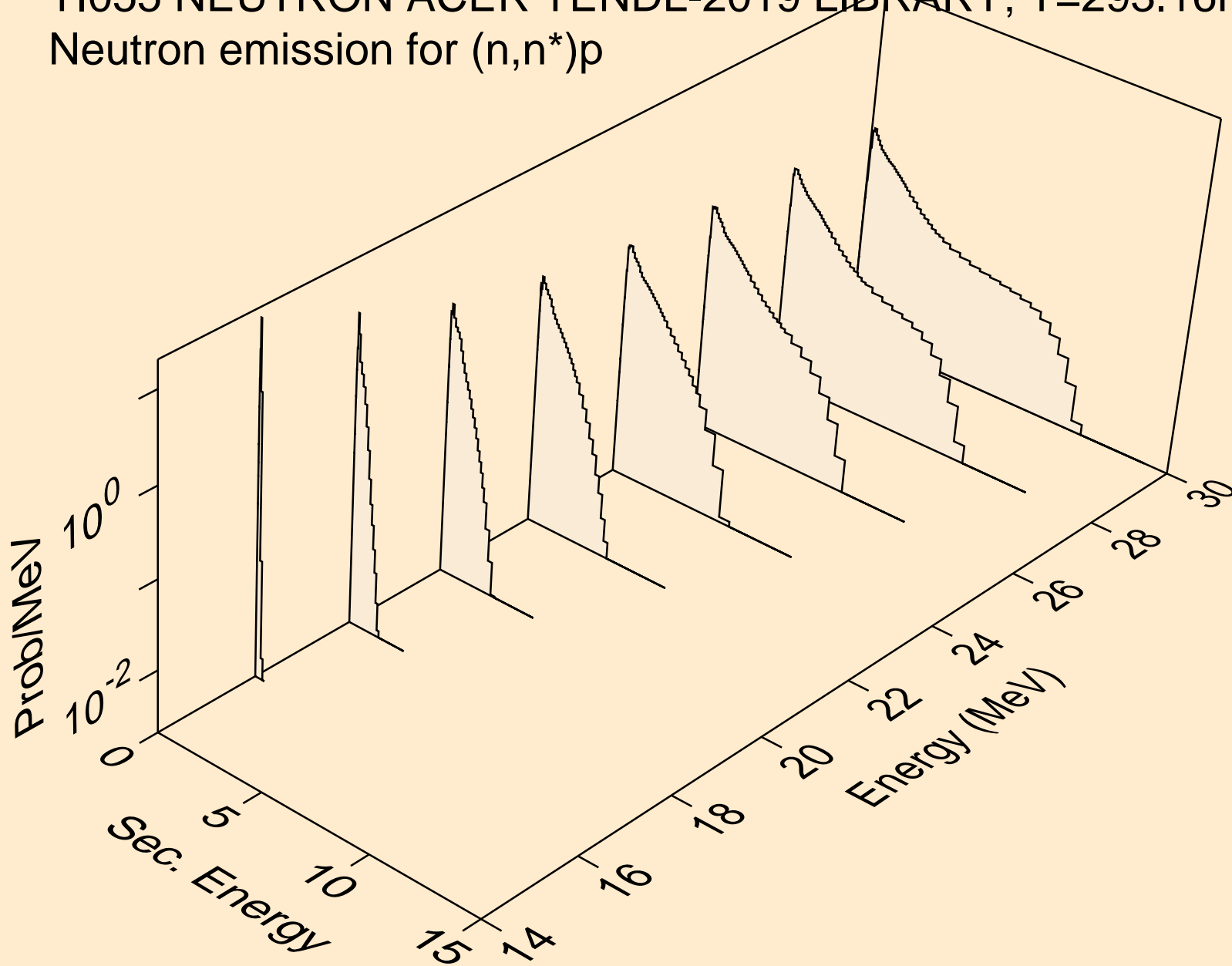

TI055 NEUTRON ACER TENDL-2019 LIBRARY; T=293.16K
Neutron emission for (n,n*)d

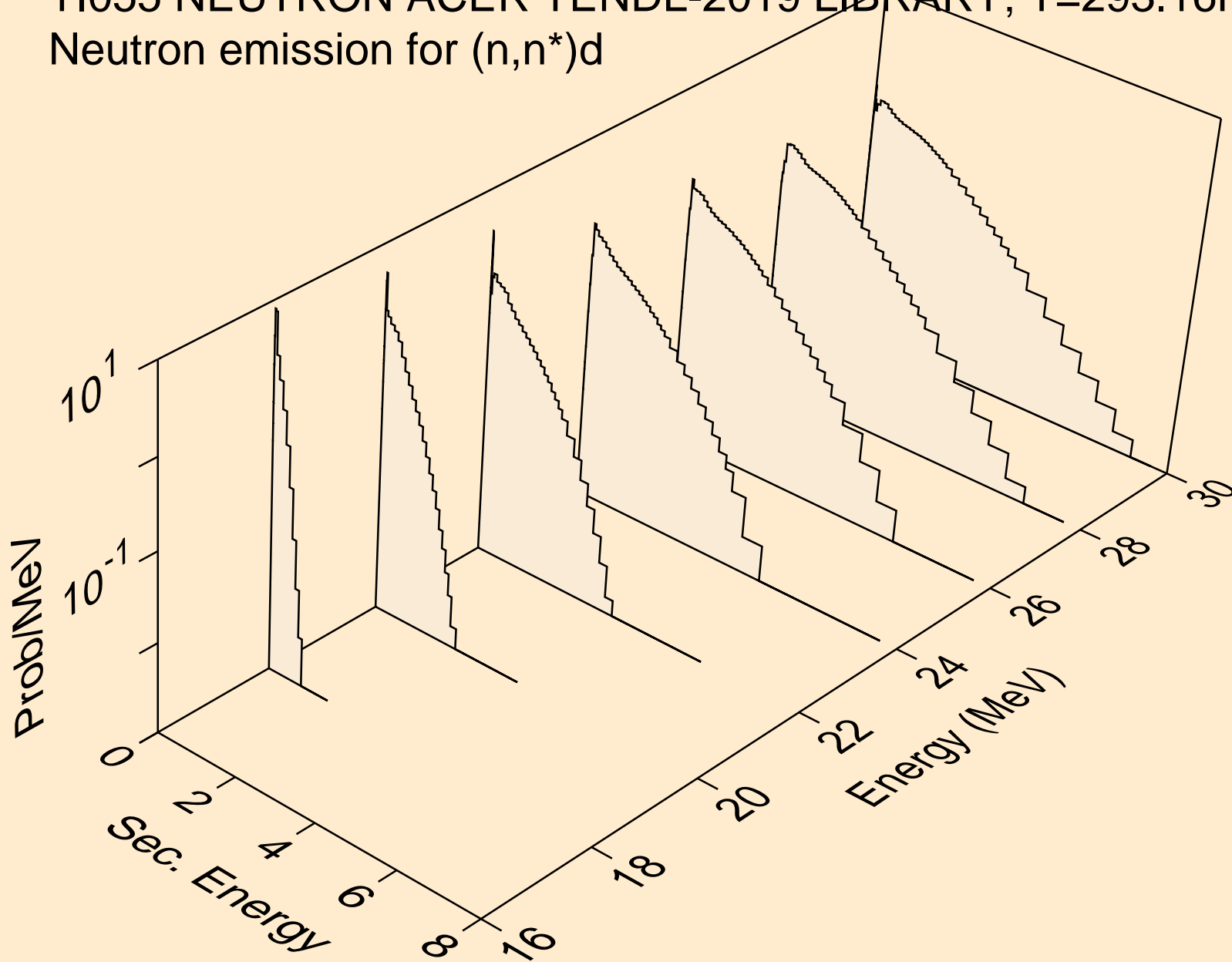

TI055 NEUTRON ACER TENDL-2019 LIBRARY; T=293.16K
Neutron emission for (n,n*)t

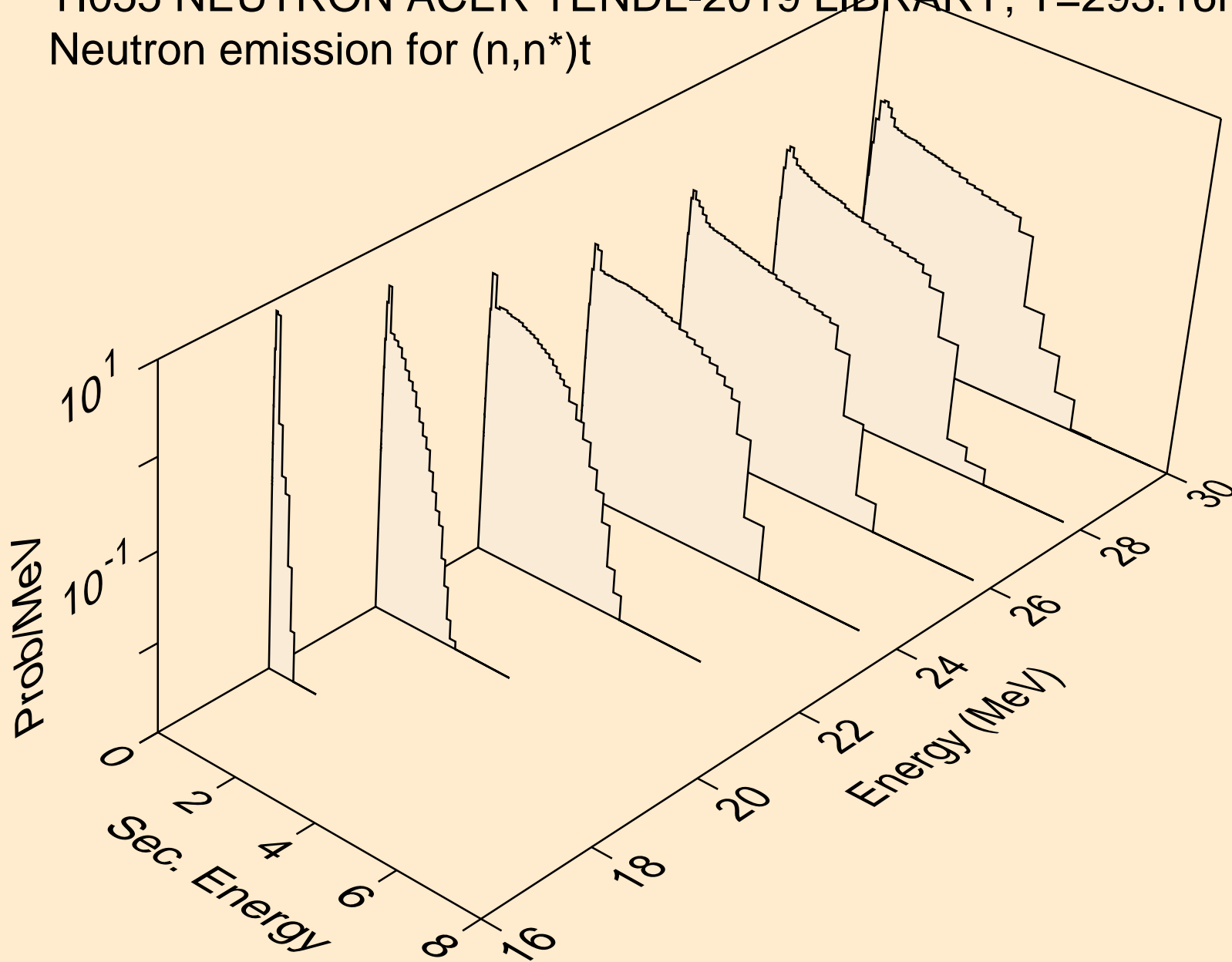

TI055 NEUTRON ACER TENDL-2019 LIBRARY; T=293.16K
Neutron emission for (n,n*)he3

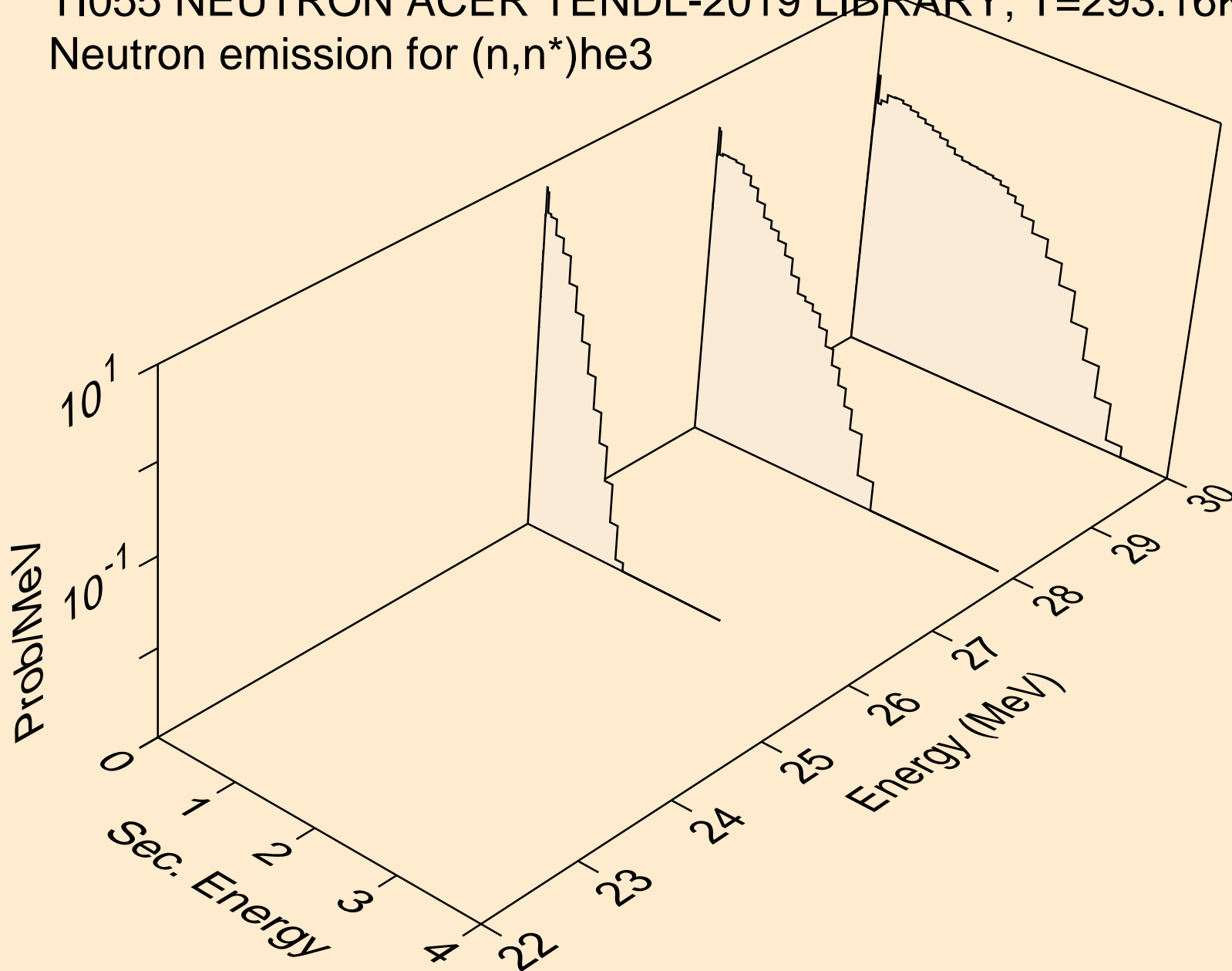

TI055 NEUTRON ACER TENDL-2019 LIBRARY; T=293.16K
Neutron emission for (n,4n)

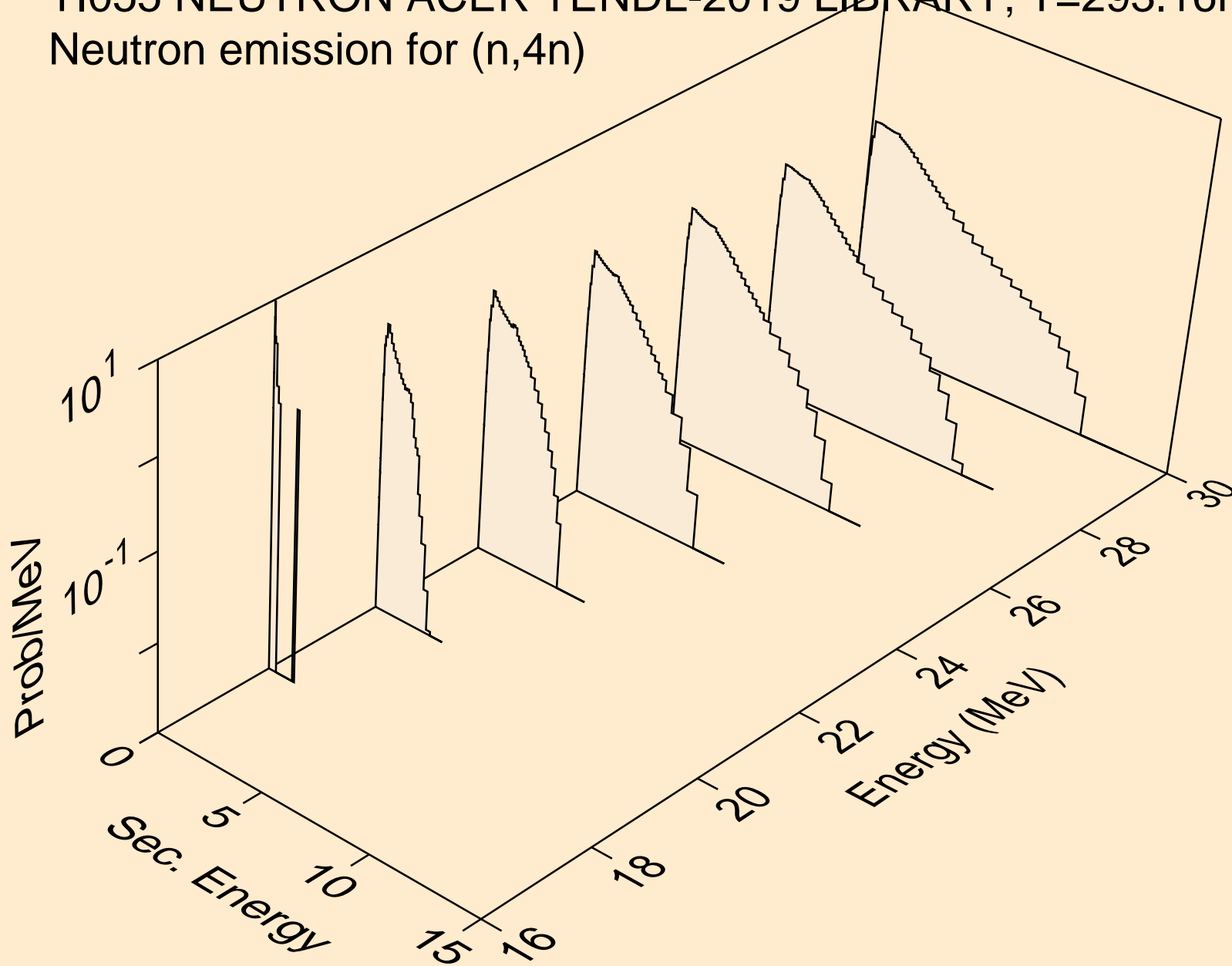

TI055 NEUTRON ACER TENDL-2019 LIBRARY; T=293.16K
Neutron emission for (n,2np)

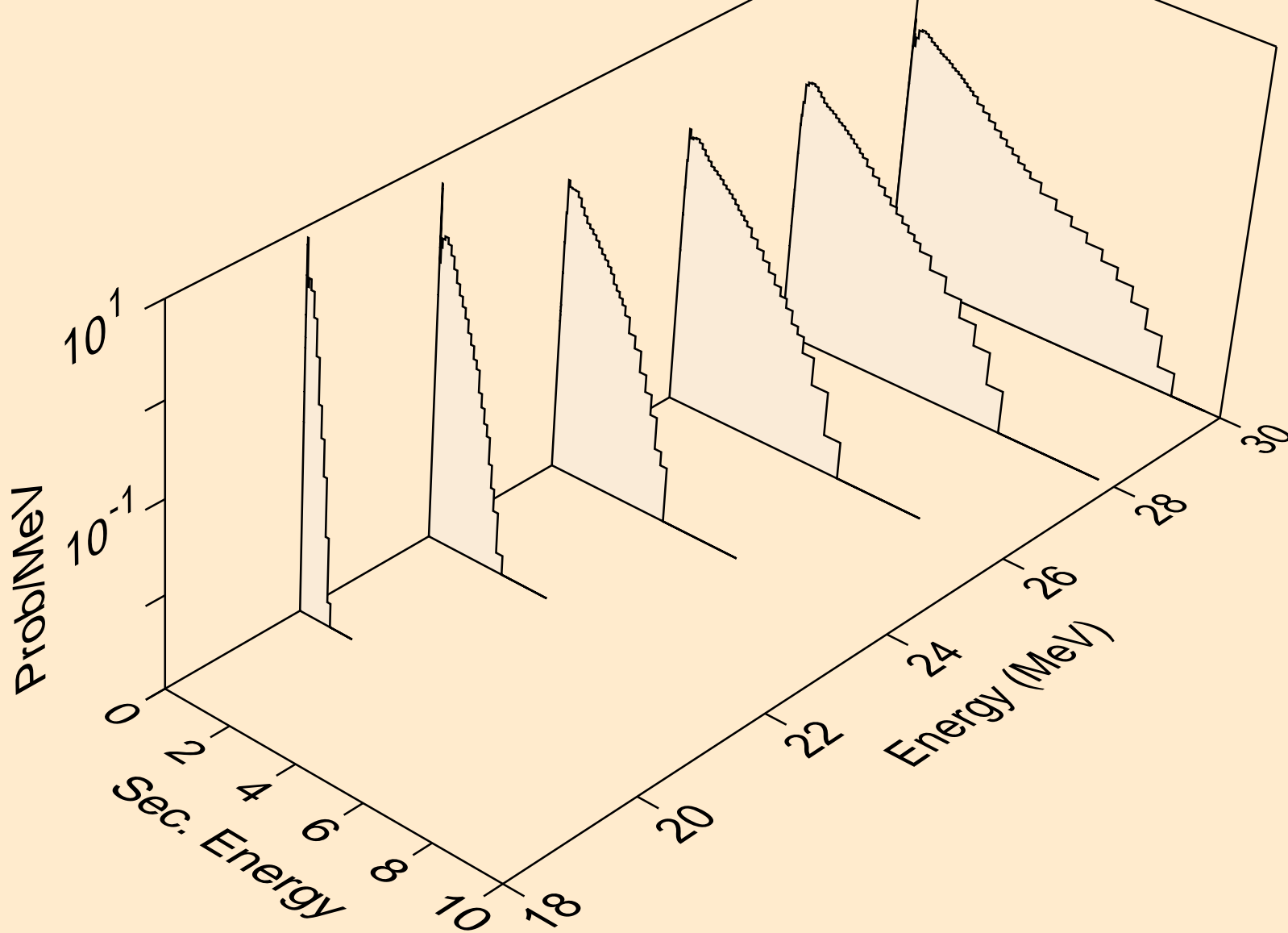

TI055 NEUTRON ACER TENDL-2019 LIBRARY; T=293.16K
Neutron emission for (n,3np)

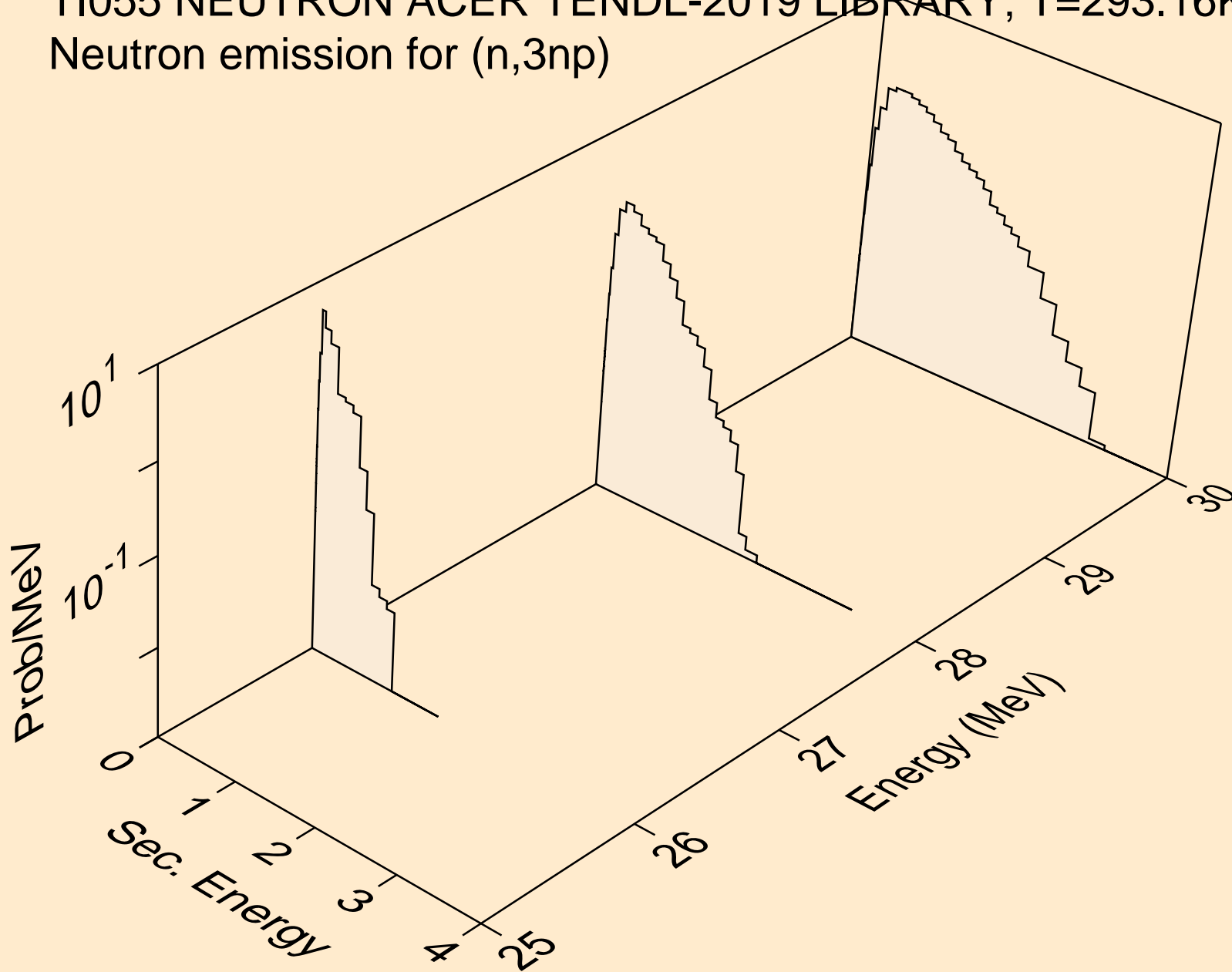

TI055 NEUTRON ACER TENDL-2019 LIBRARY; T=293.16K
Neutron emission for (n,n*c)

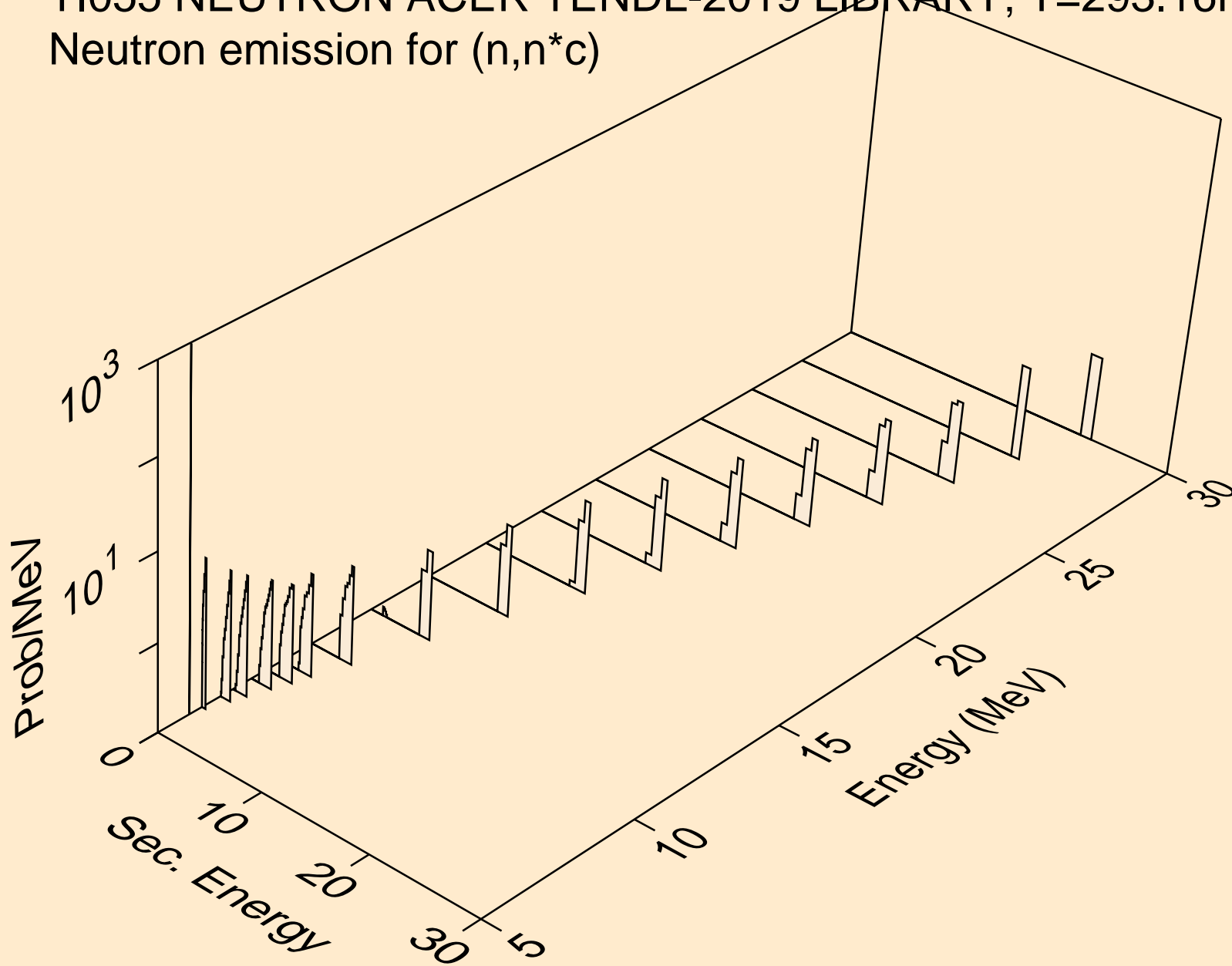

TI055 NEUTRON ACER TENDL-2019 LIBRARY; T=293.16K
Photon emission for (n,x)

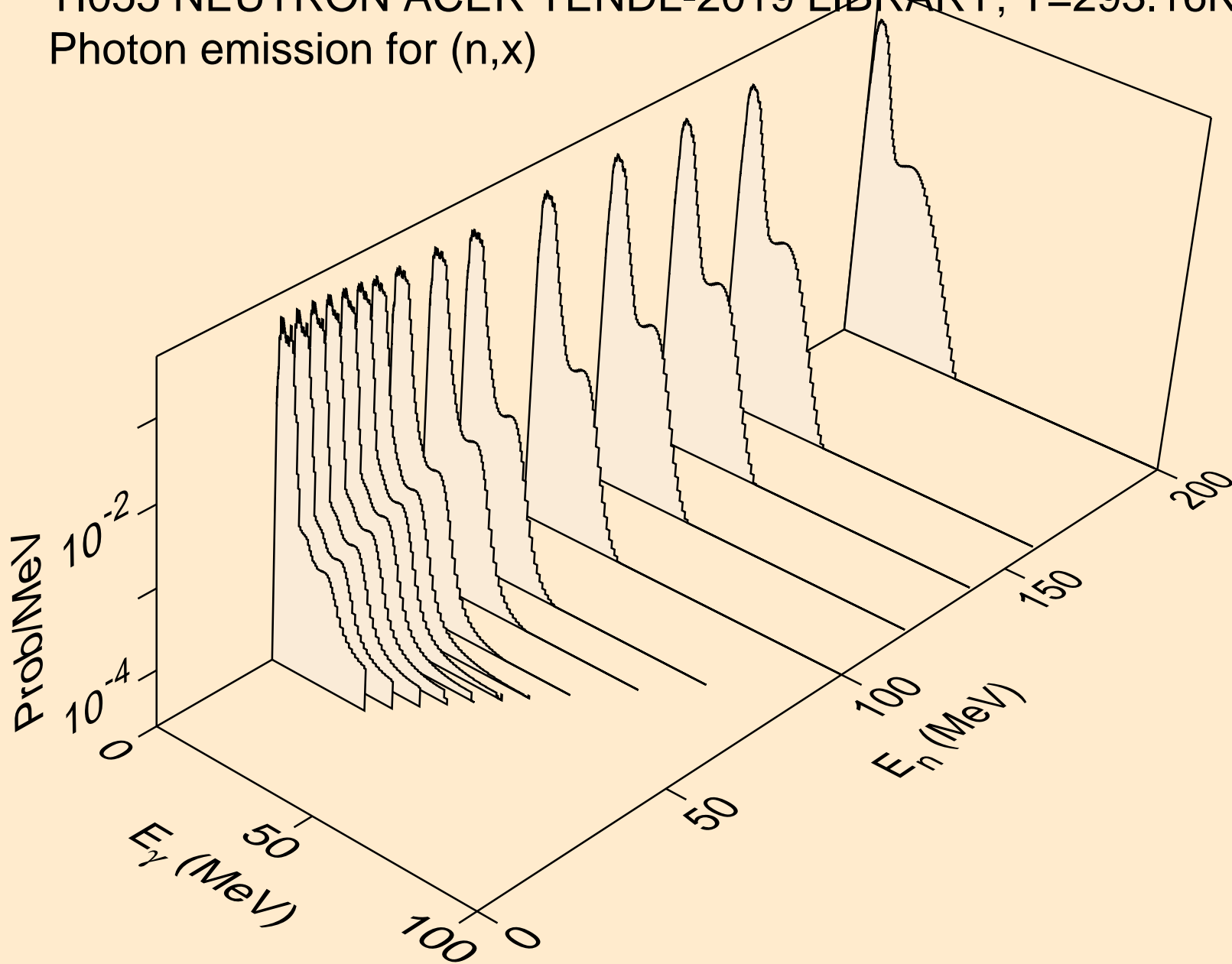

TI055 NEUTRON ACER TENDL-2019 LIBRARY; T=293.16K
Photon emission for (n,2nd)

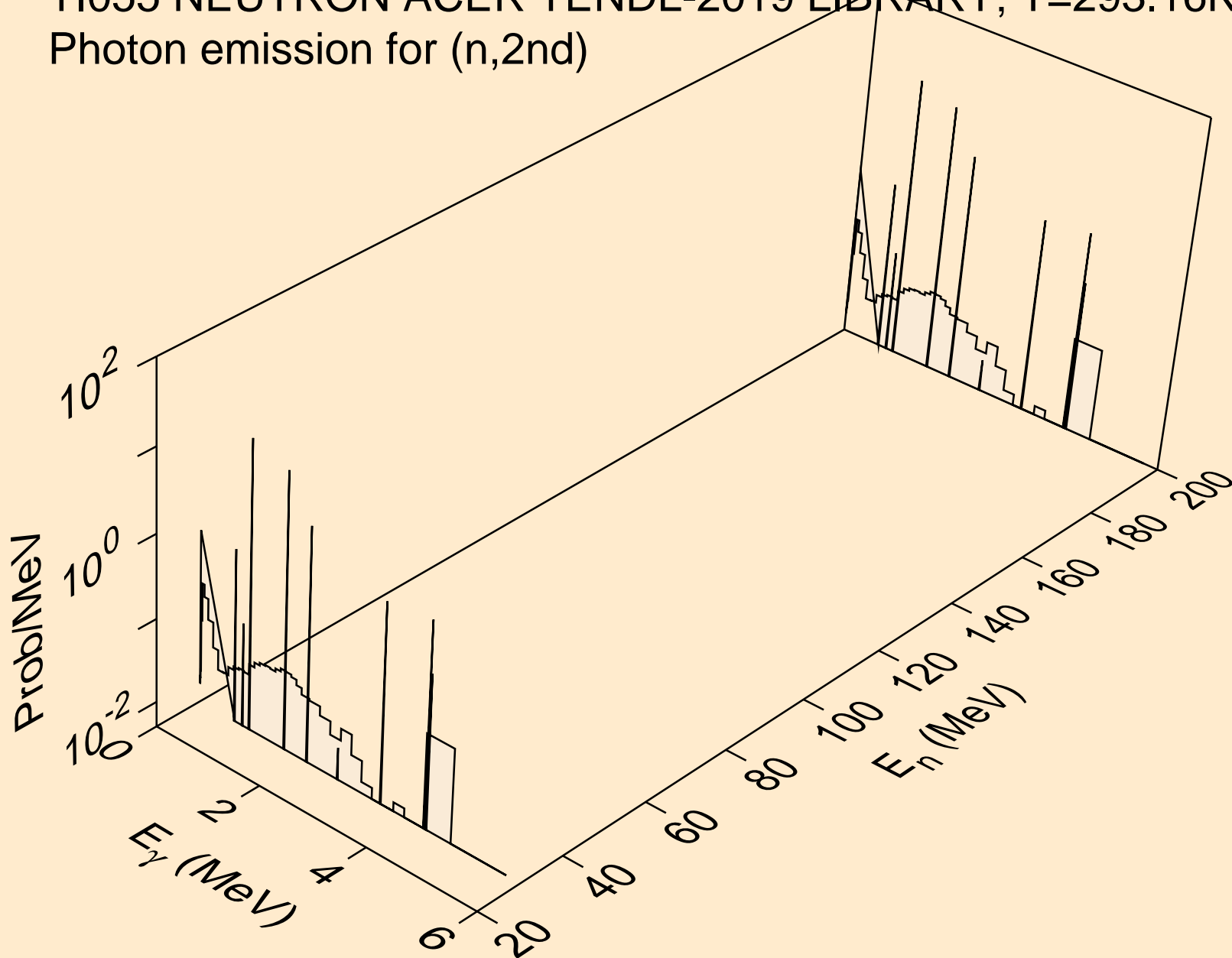

TI055 NEUTRON ACER TENDL-2019 LIBRARY; T=293.16K
Photon emission for (n,2n)

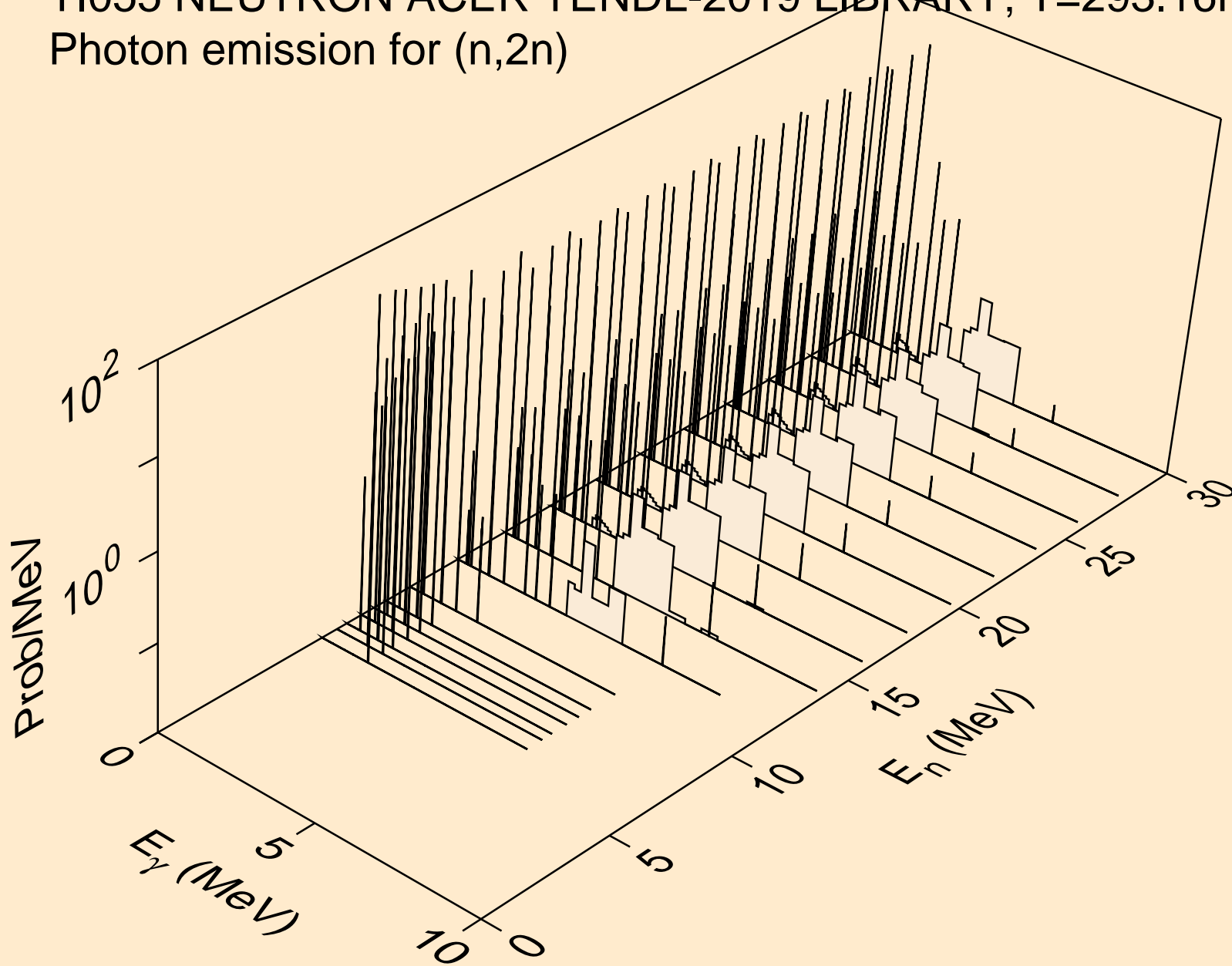

TI055 NEUTRON ACER TENDL-2019 LIBRARY; T=293.16K
Photon emission for (n,3n)

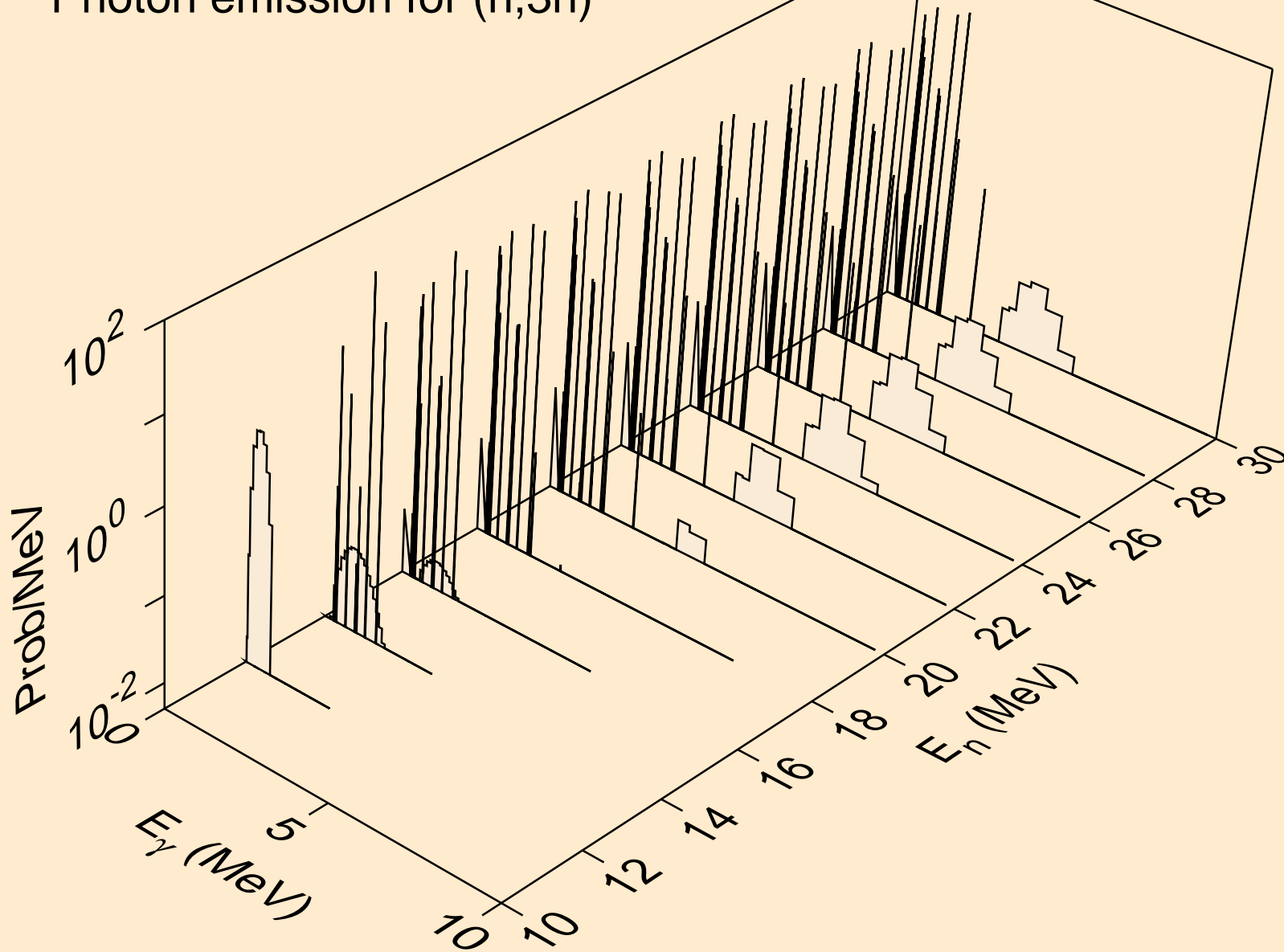

TI055 NEUTRON ACER TENDL-2019 LIBRARY; T=293.16K
Photon emission for (n,n*)a

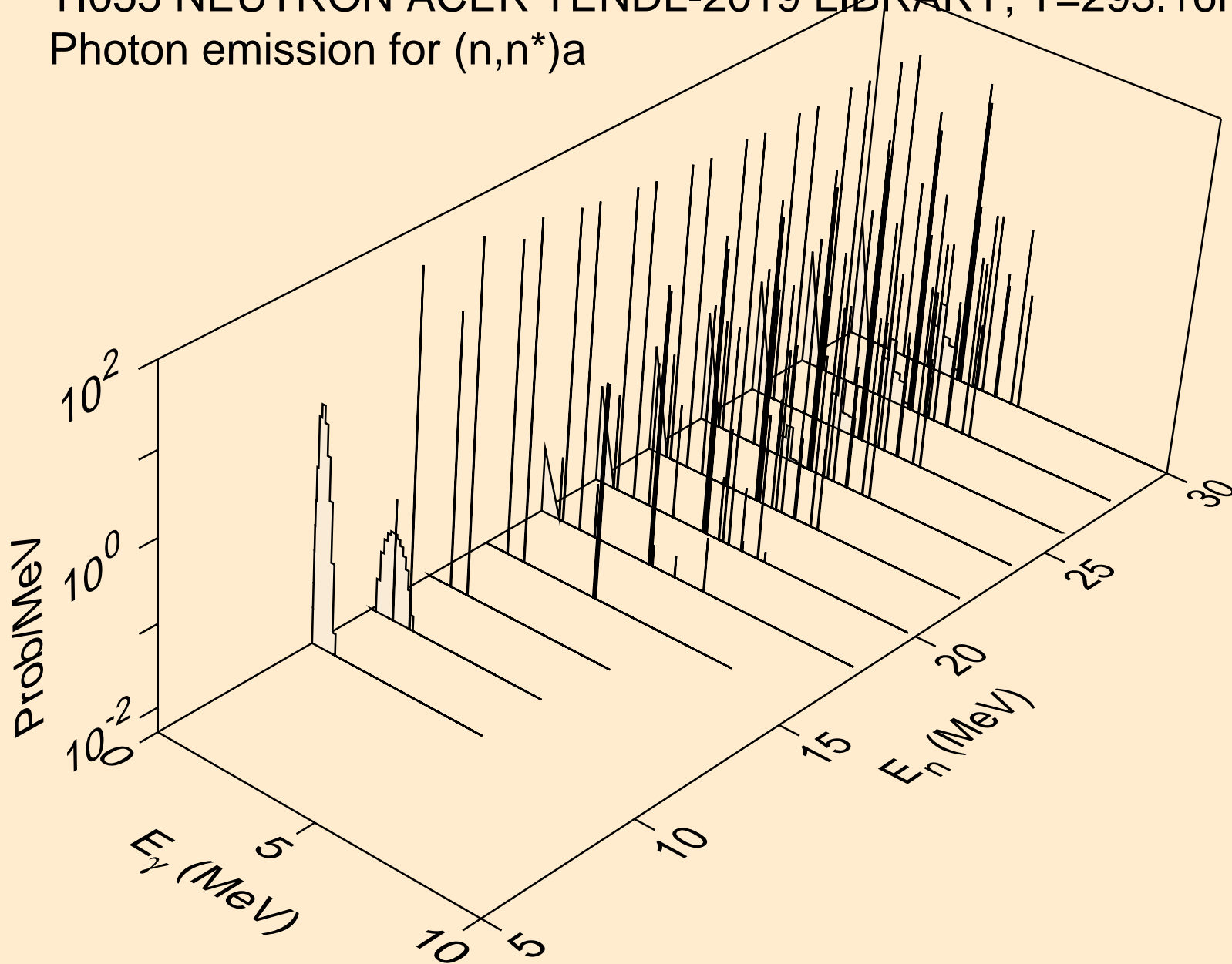

TI055 NEUTRON ACER TENDL-2019 LIBRARY; T=293.16K
Photon emission for (n,2n)a

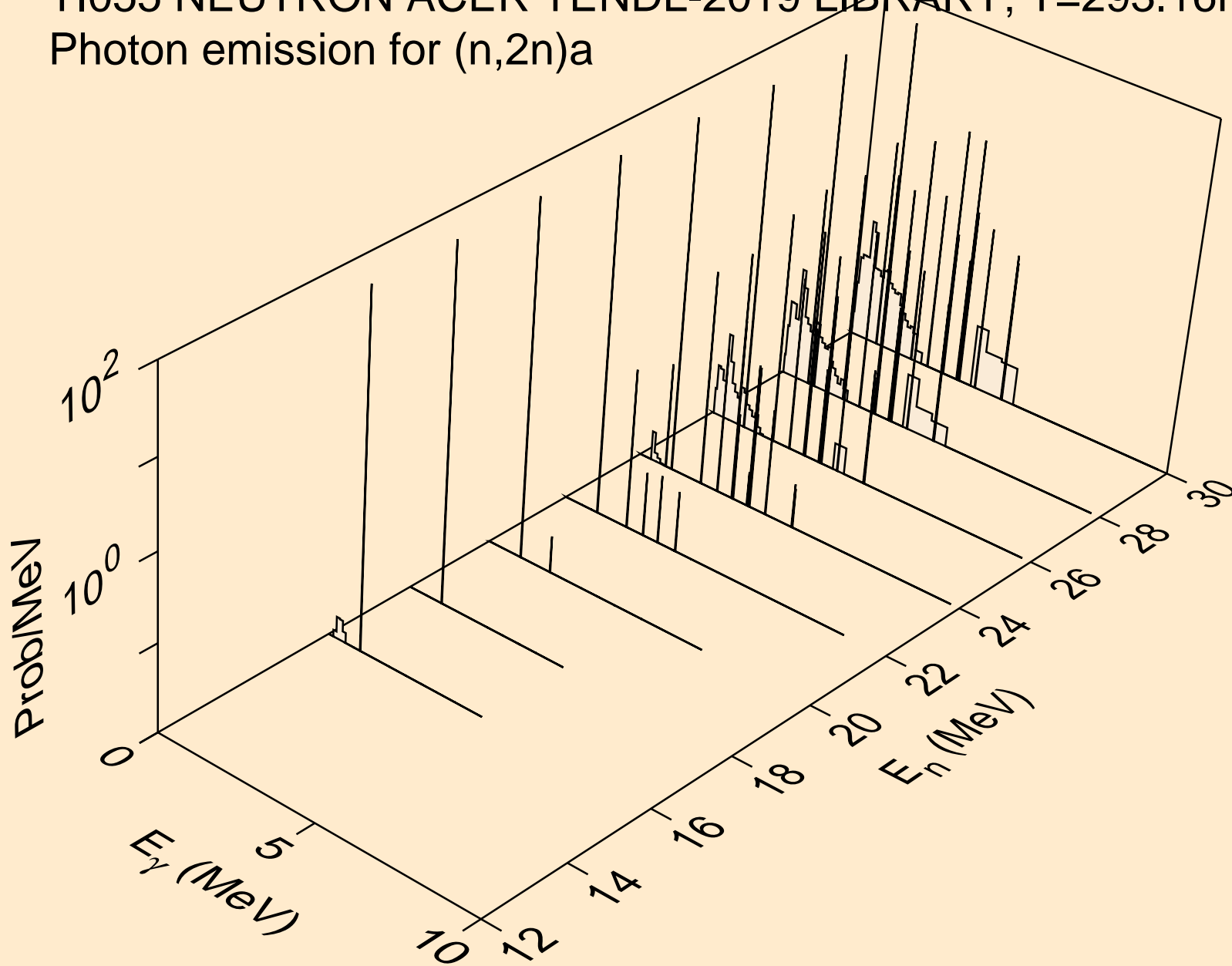

TI055 NEUTRON ACER TENDL-2019 LIBRARY; T=293.16K
Photon emission for (n,3n)a

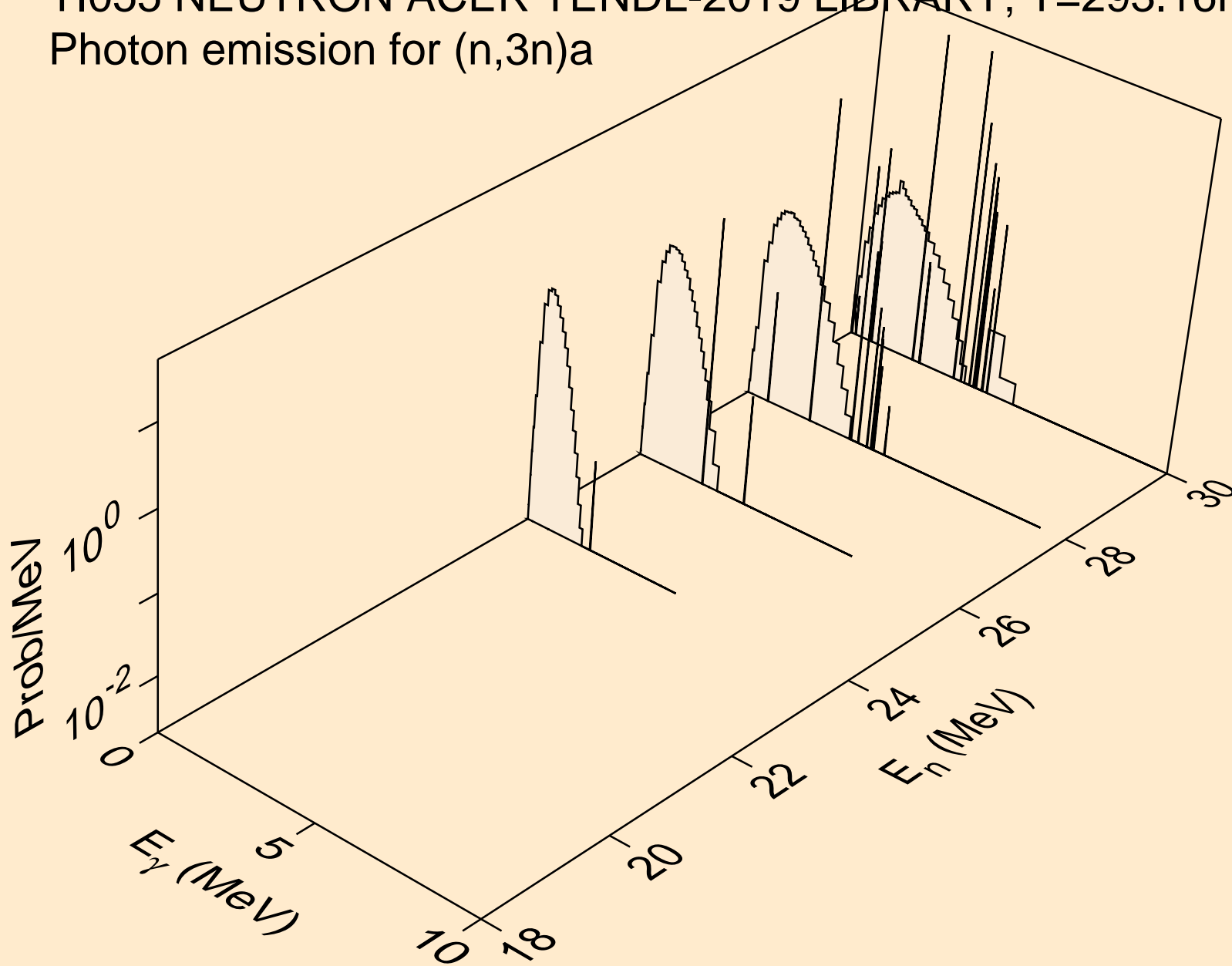

TI055 NEUTRON ACER TENDL-2019 LIBRARY; T=293.16K
Photon emission for (n,n*)p

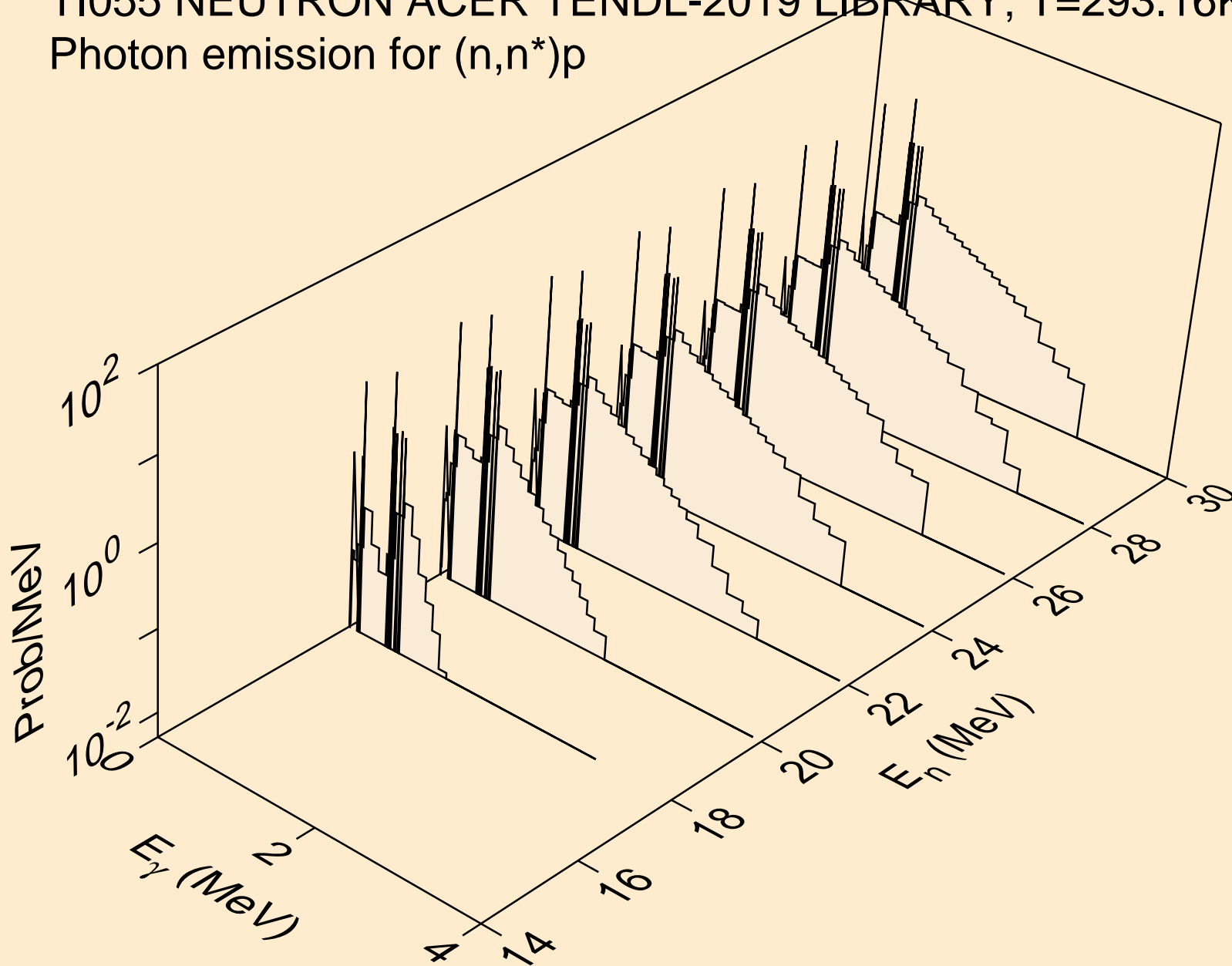

TI055 NEUTRON ACER TENDL-2019 LIBRARY; T=293.16K
Photon emission for (n,n*)d

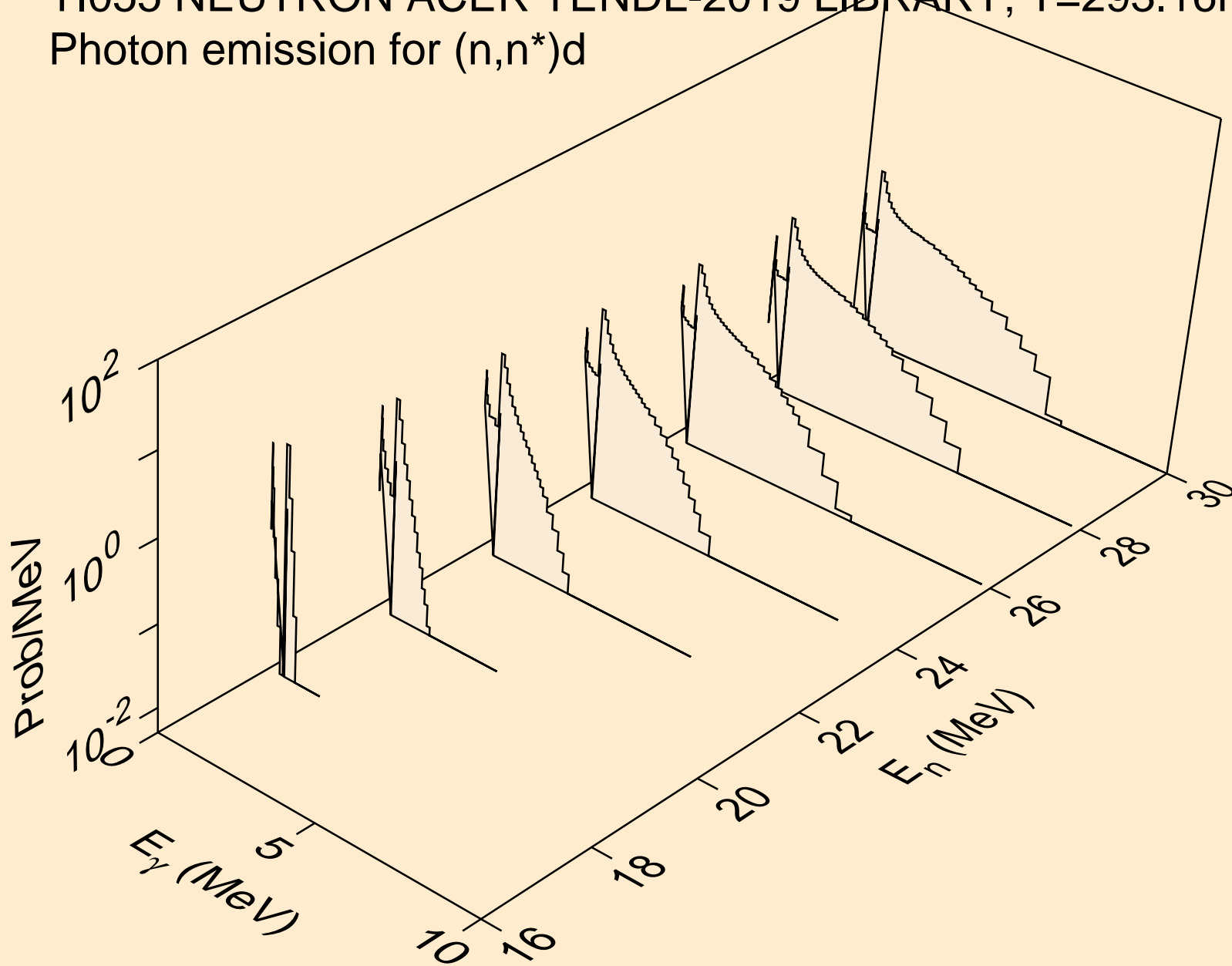

TI055 NEUTRON ACER TENDL-2019 LIBRARY; T=293.16K
Photon emission for (n,n*)t

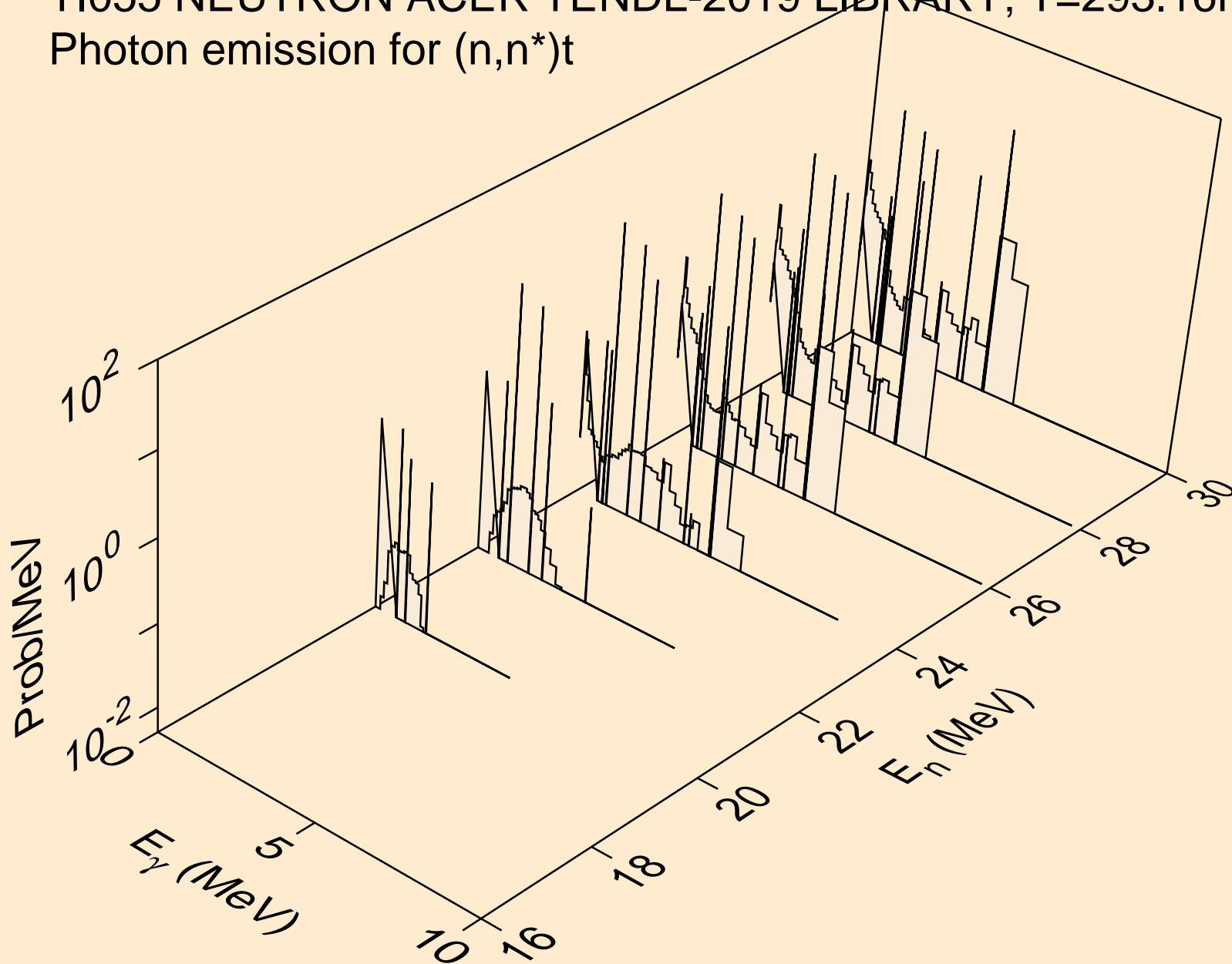

TI055 NEUTRON ACER TENDL-2019 LIBRARY; T=293.16K
Photon emission for (n,n*)he3

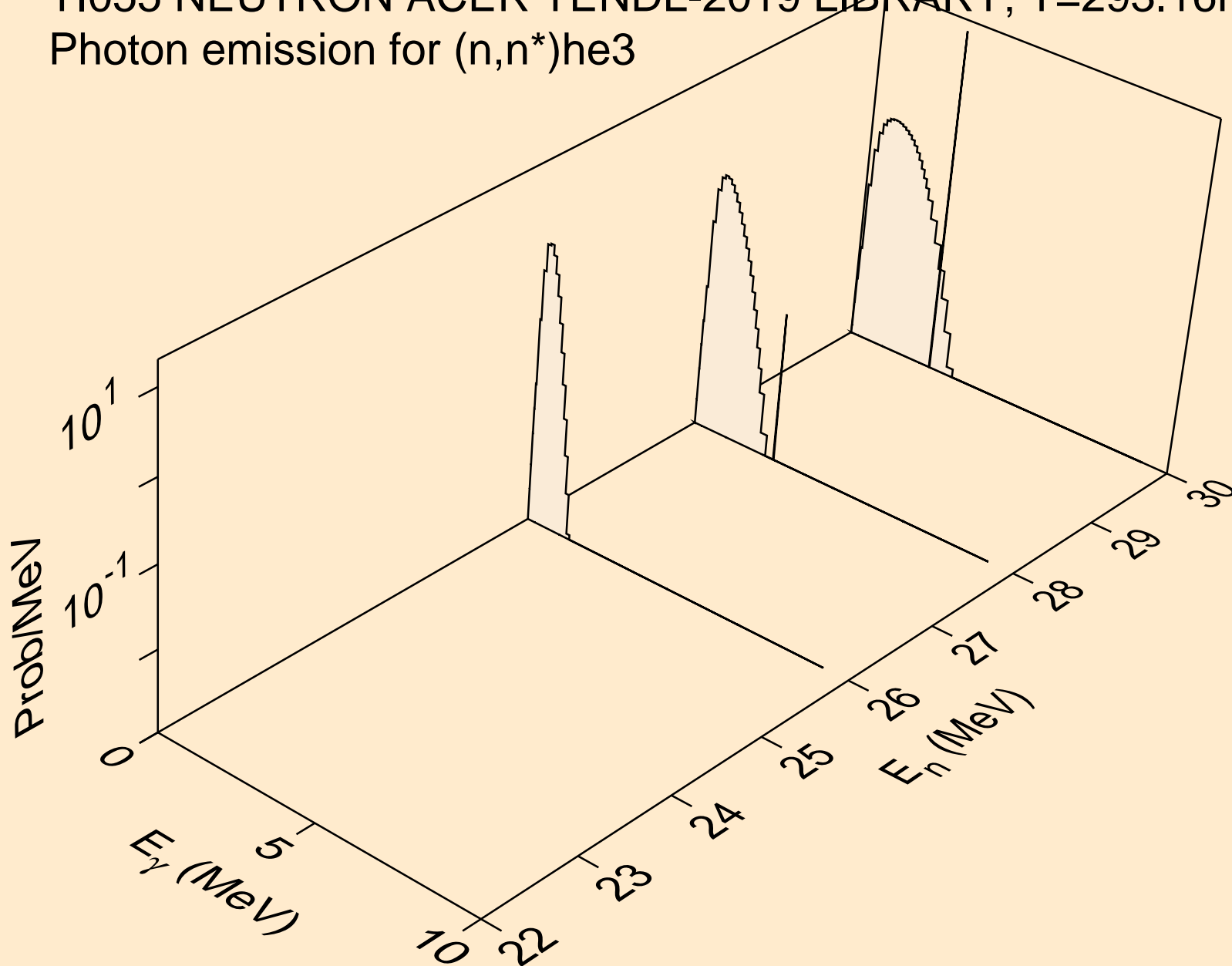

TI055 NEUTRON ACER TENDL-2019 LIBRARY; T=293.16K
Photon emission for (n,4n)

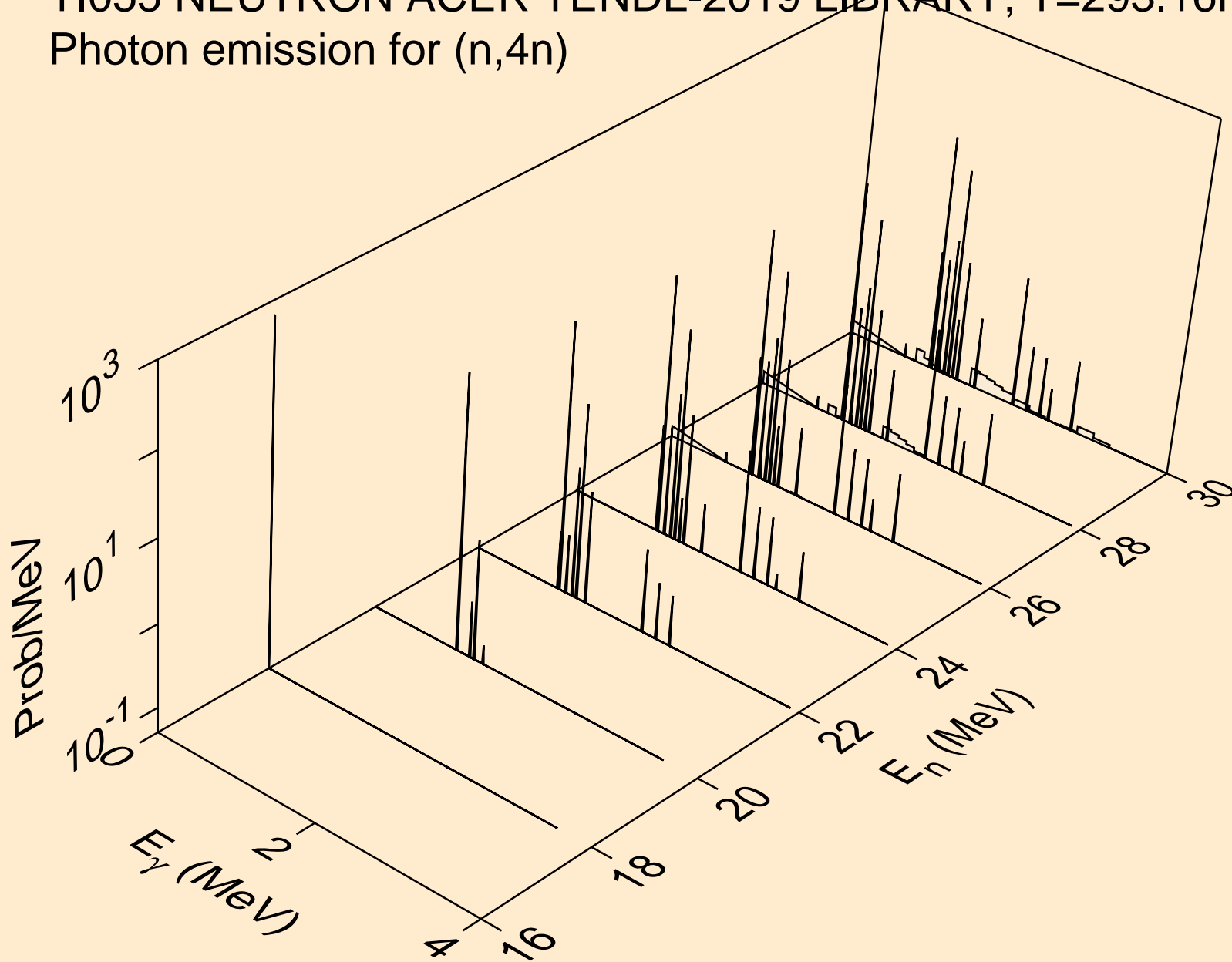

TI055 NEUTRON ACER TENDL-2019 LIBRARY; T=293.16K
Photon emission for (n,2np)

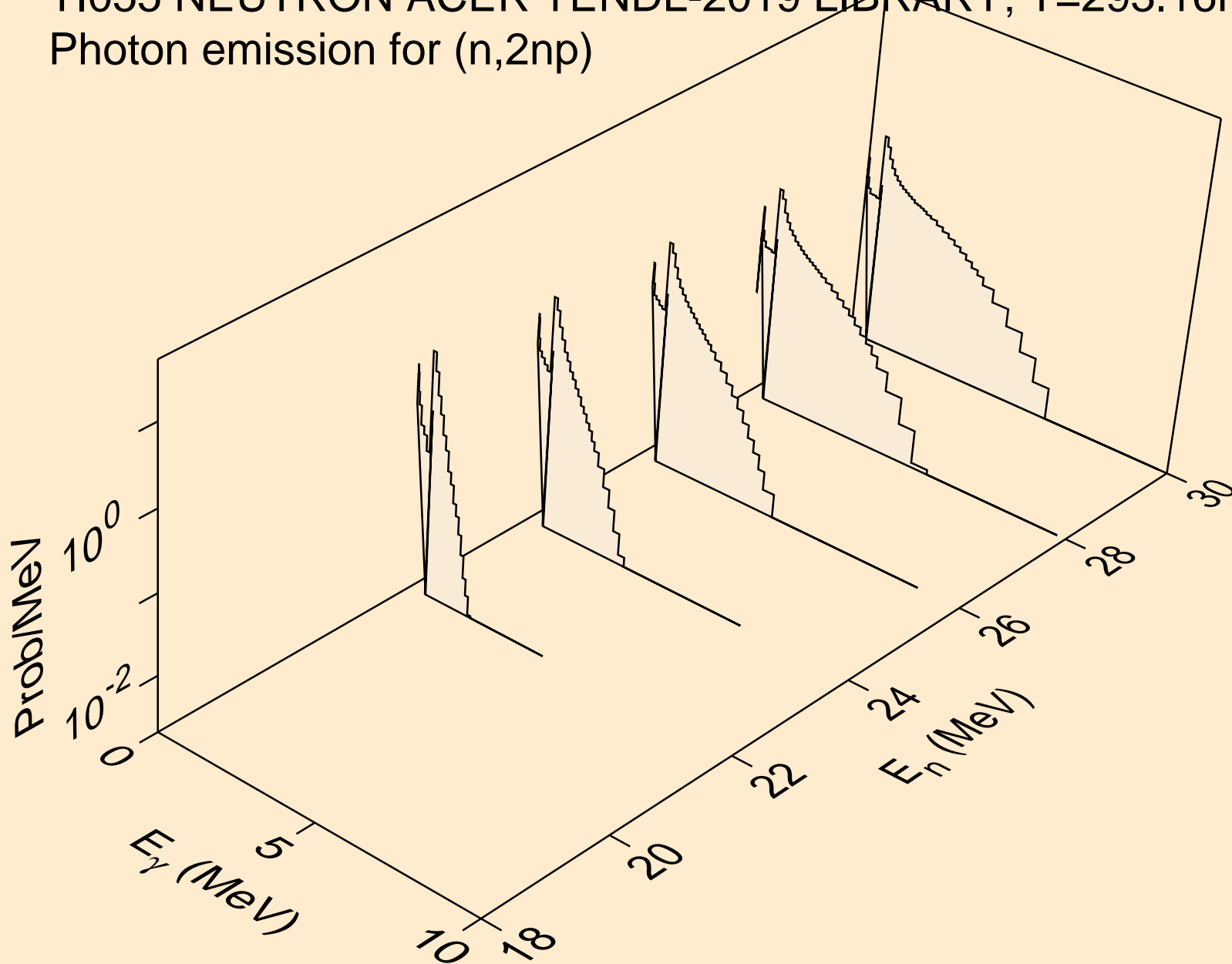

TI055 NEUTRON ACER TENDL-2019 LIBRARY; T=293.16K
Photon emission for (n,3np)

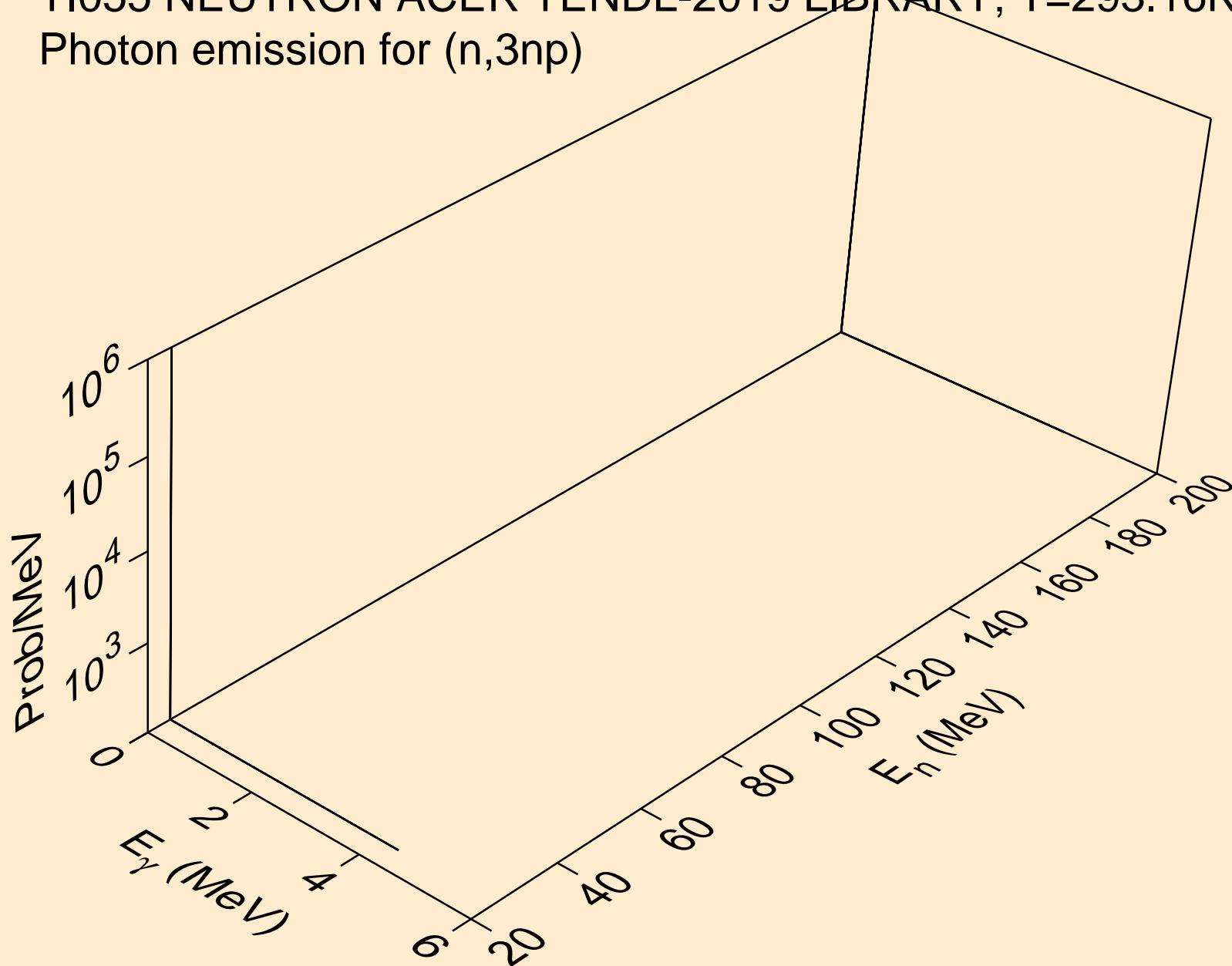

TI055 NEUTRON ACER TENDL-2019 LIBRARY; T=293.16K
Photon emission for (n,n*c)

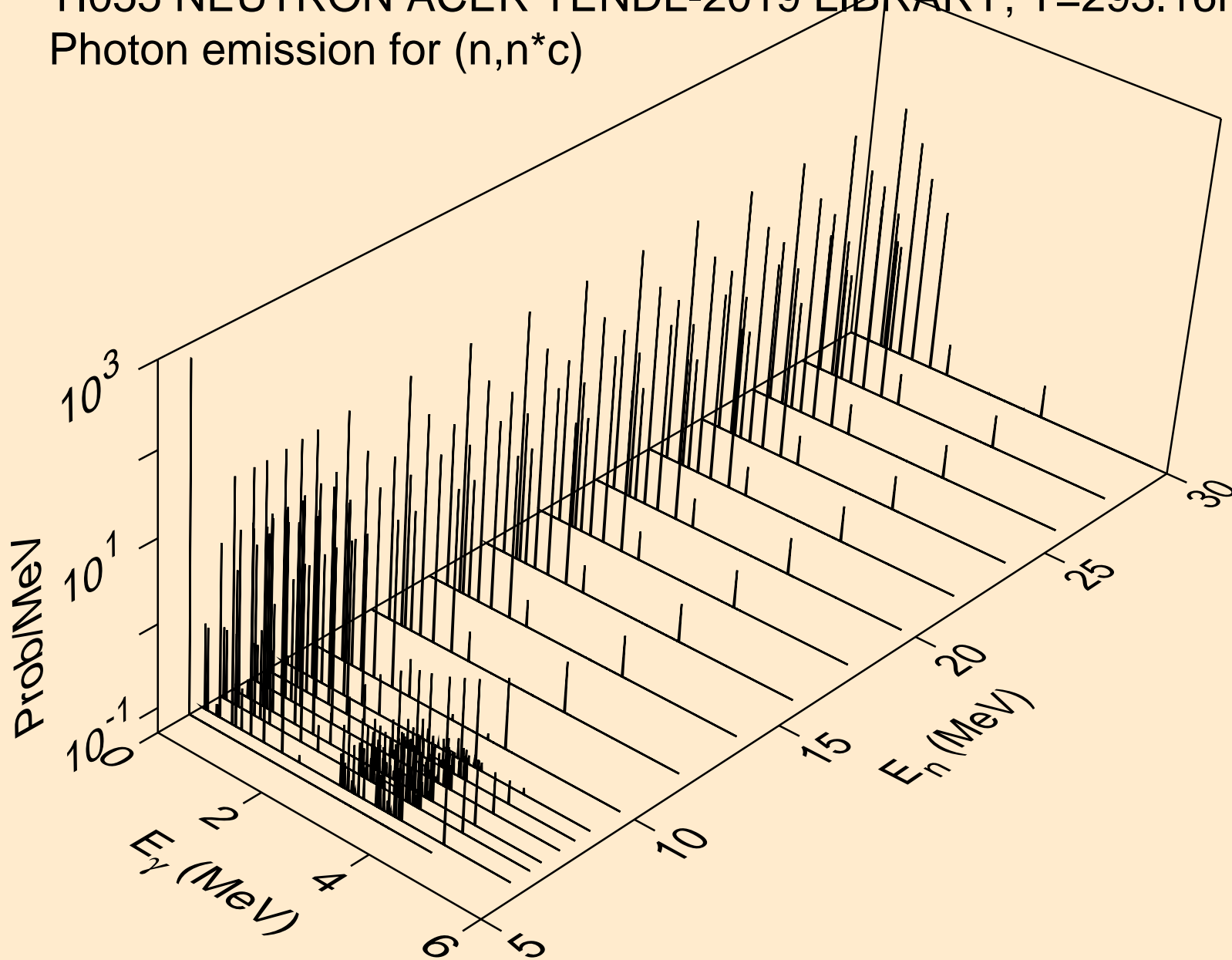

TI055 NEUTRON ACER TENDL-2019 LIBRARY; T=293.16K
Photon emission for (n,gma)

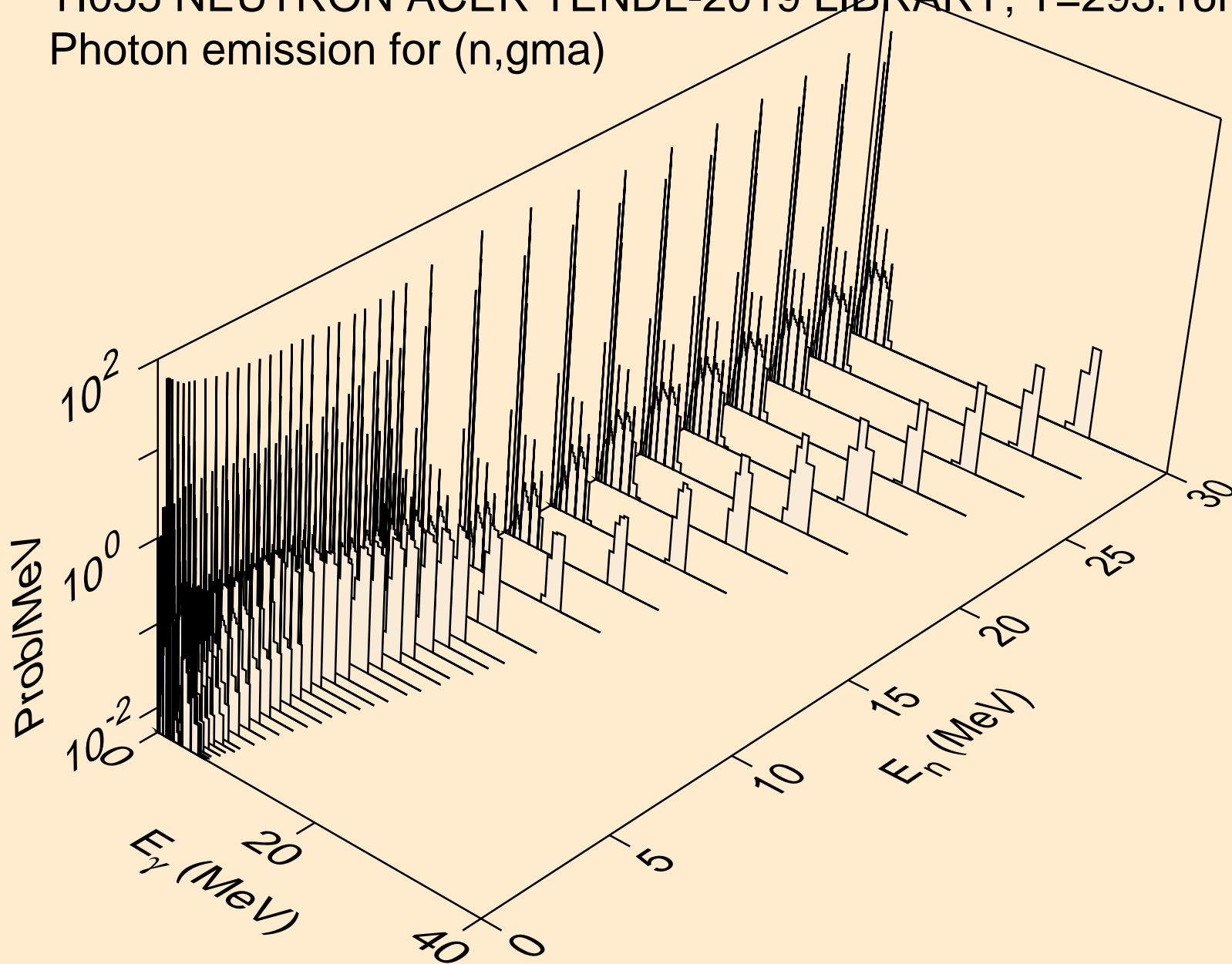

TI055 NEUTRON ACER TENDL-2019 LIBRARY; T=293.16K
Photon emission for (n,p)

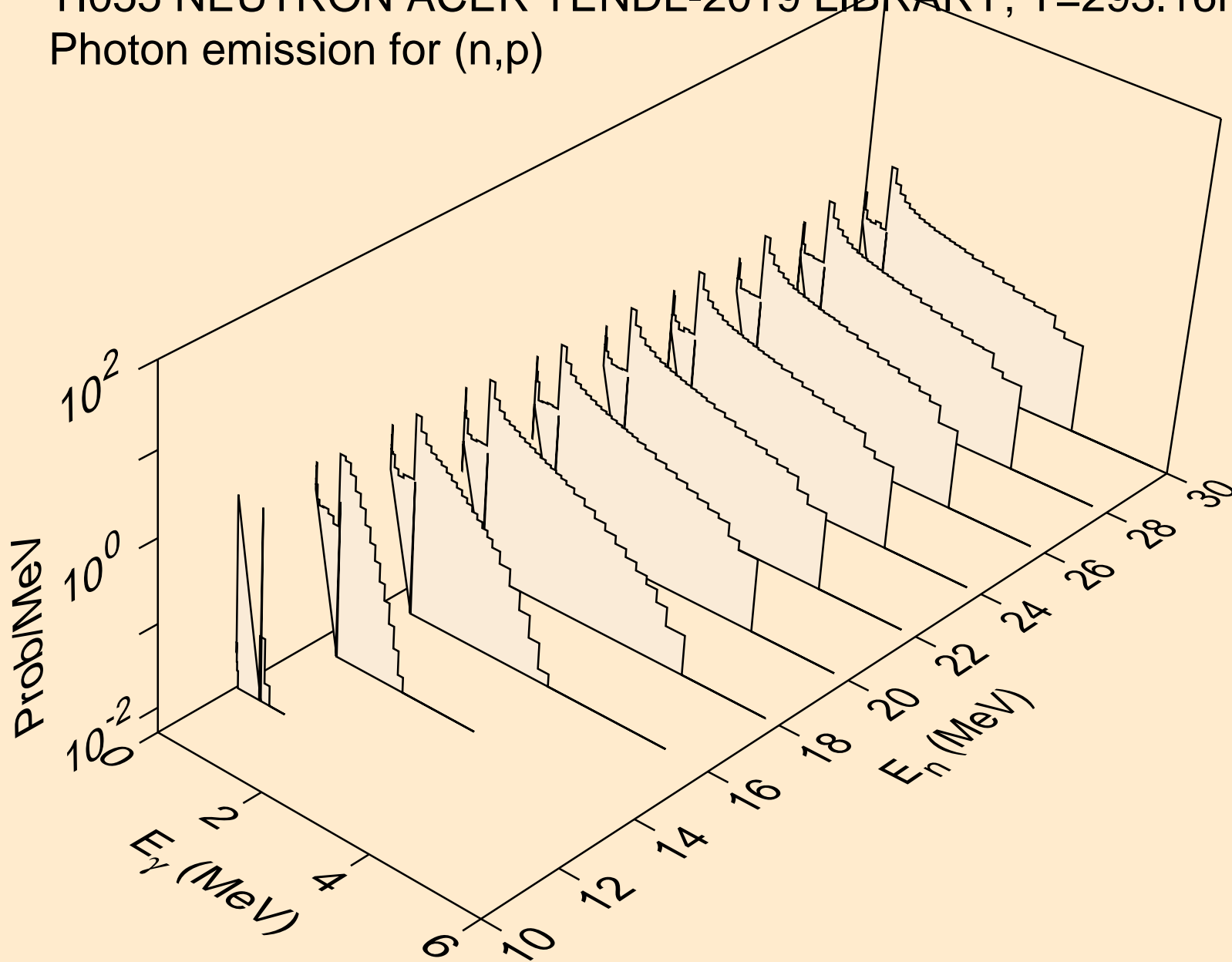

TI055 NEUTRON ACER TENDL-2019 LIBRARY; T=293.16K
Photon emission for (n,d)

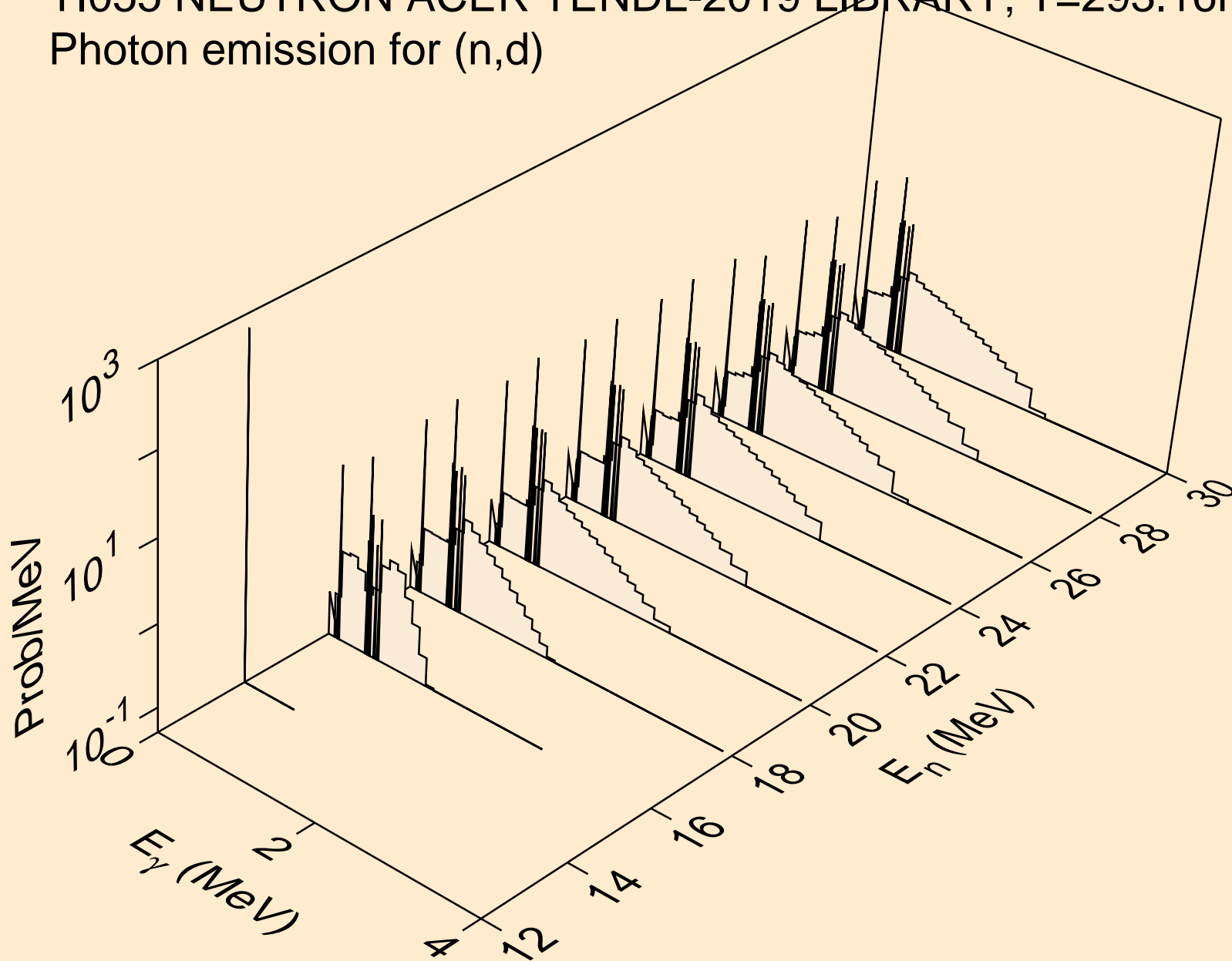

TI055 NEUTRON ACER TENDL-2019 LIBRARY; T=293.16K
Photon emission for (n,t)

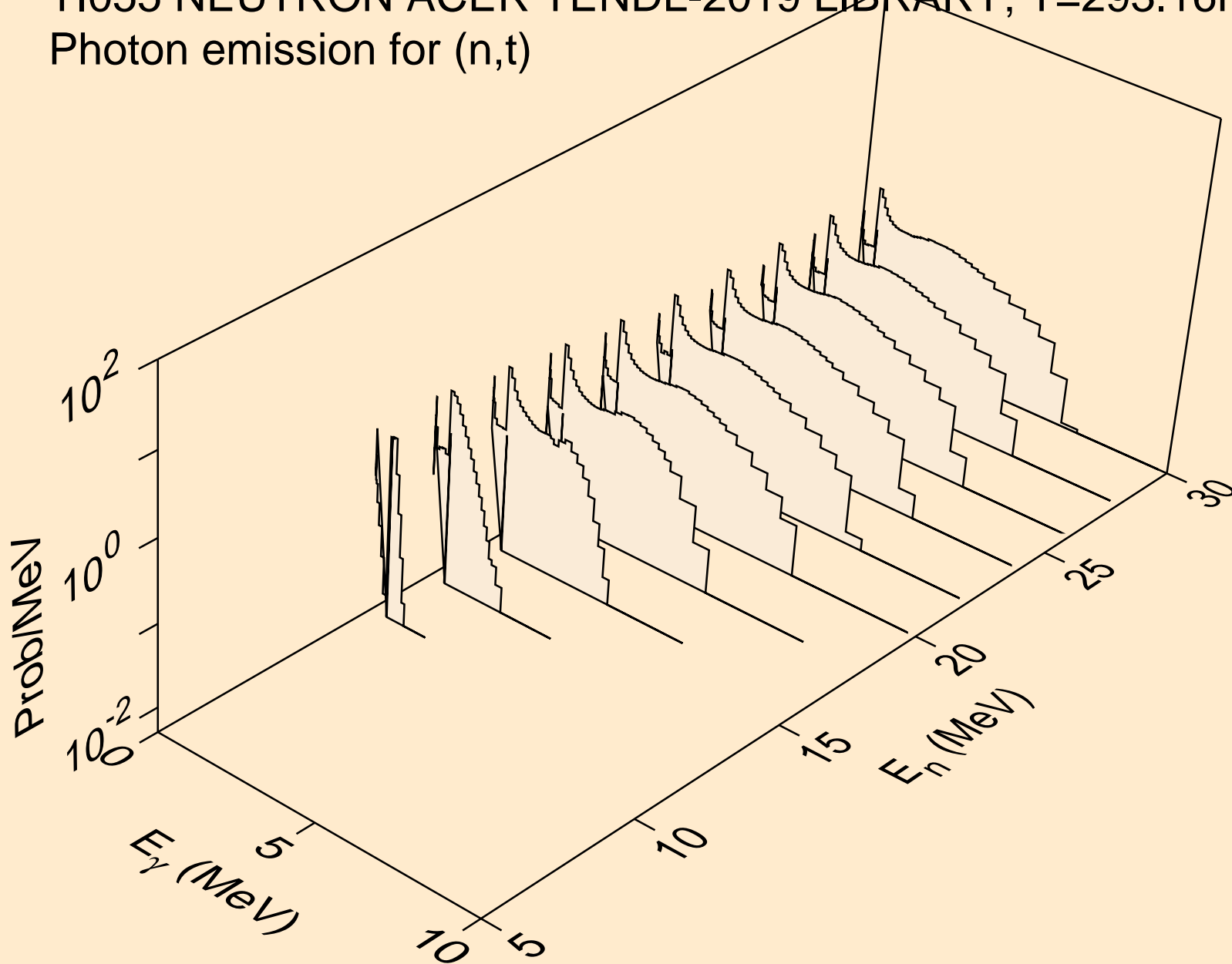

TI055 NEUTRON ACER TENDL-2019 LIBRARY; T=293.16K
Photon emission for (n,he3)

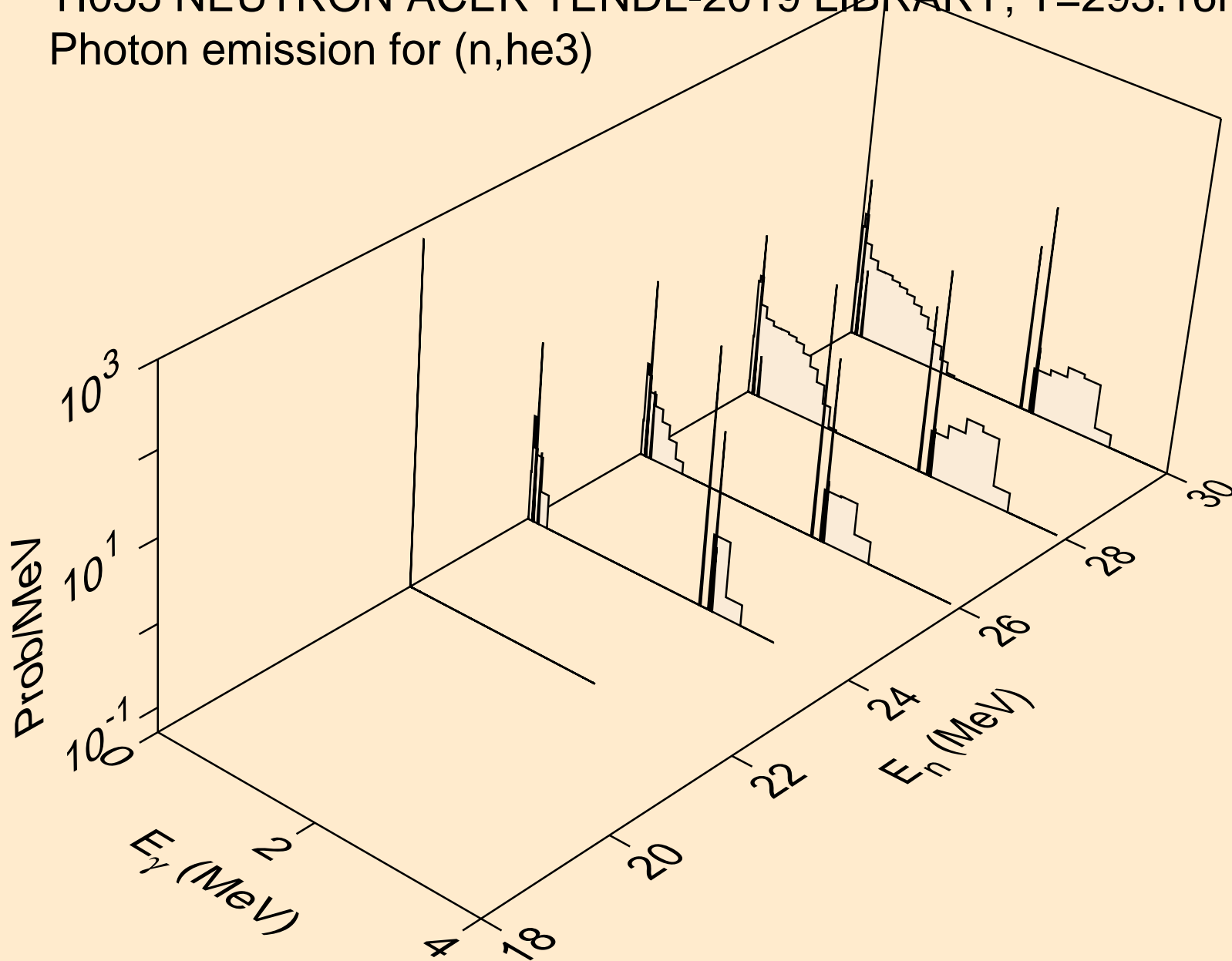

TI055 NEUTRON ACER TENDL-2019 LIBRARY; T=293.16K
Photon emission for (n,a)

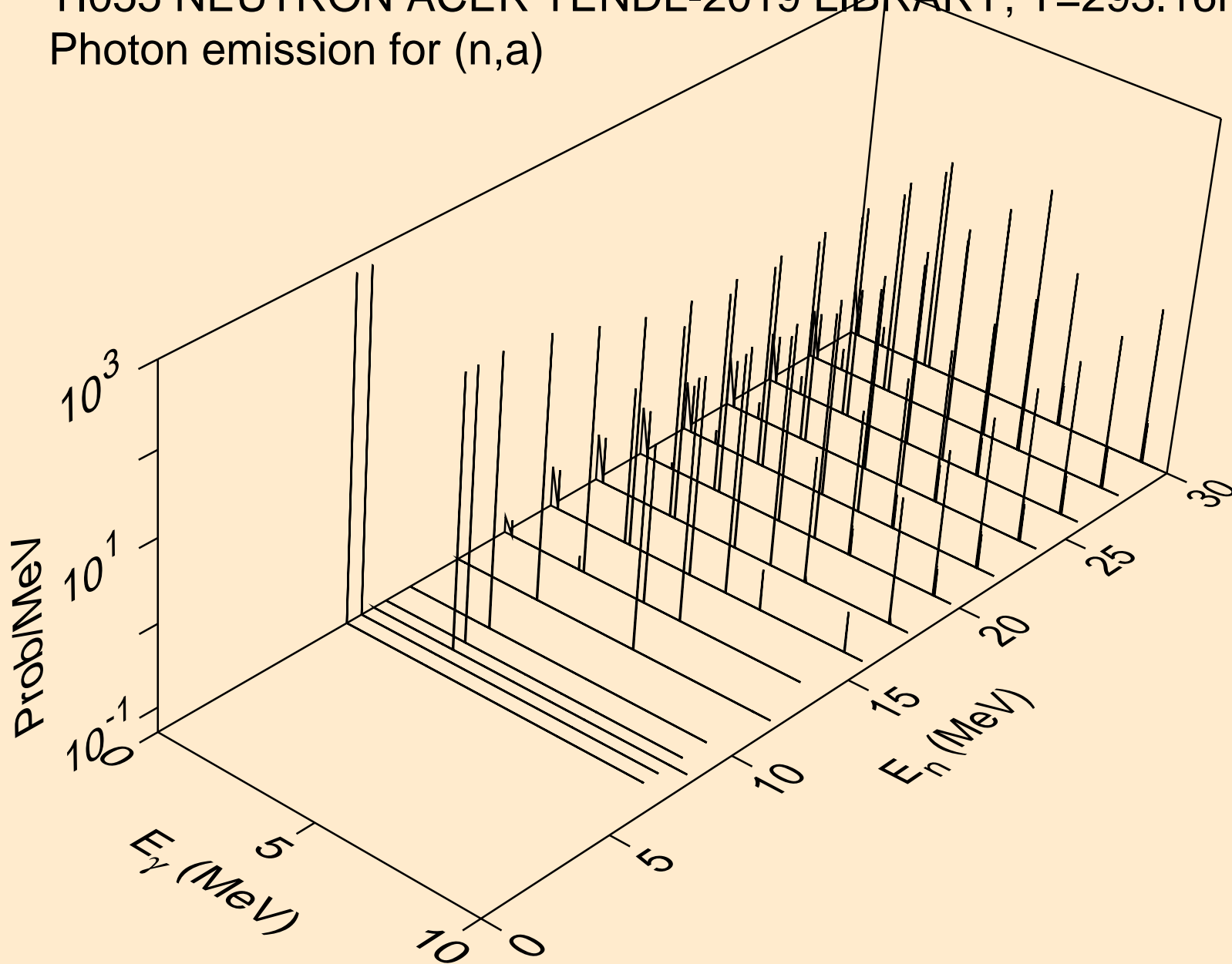

TI055 NEUTRON ACER TENDL-2019 LIBRARY; T=293.16K
Photon emission for (n,pt)

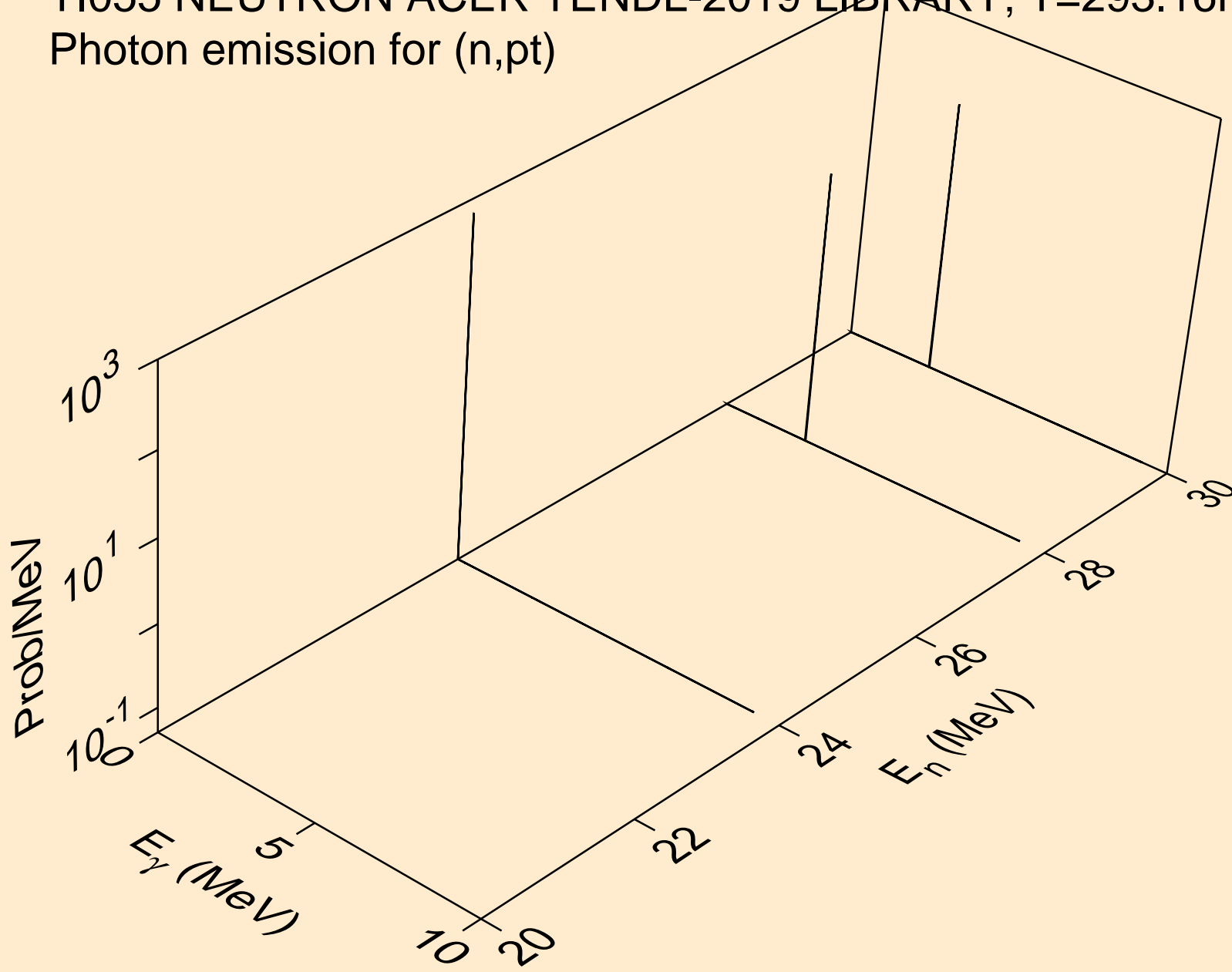

TI055 NEUTRON ACER TENDL-2019 LIBRARY; T=293.16K
thermal capture photon spectrum

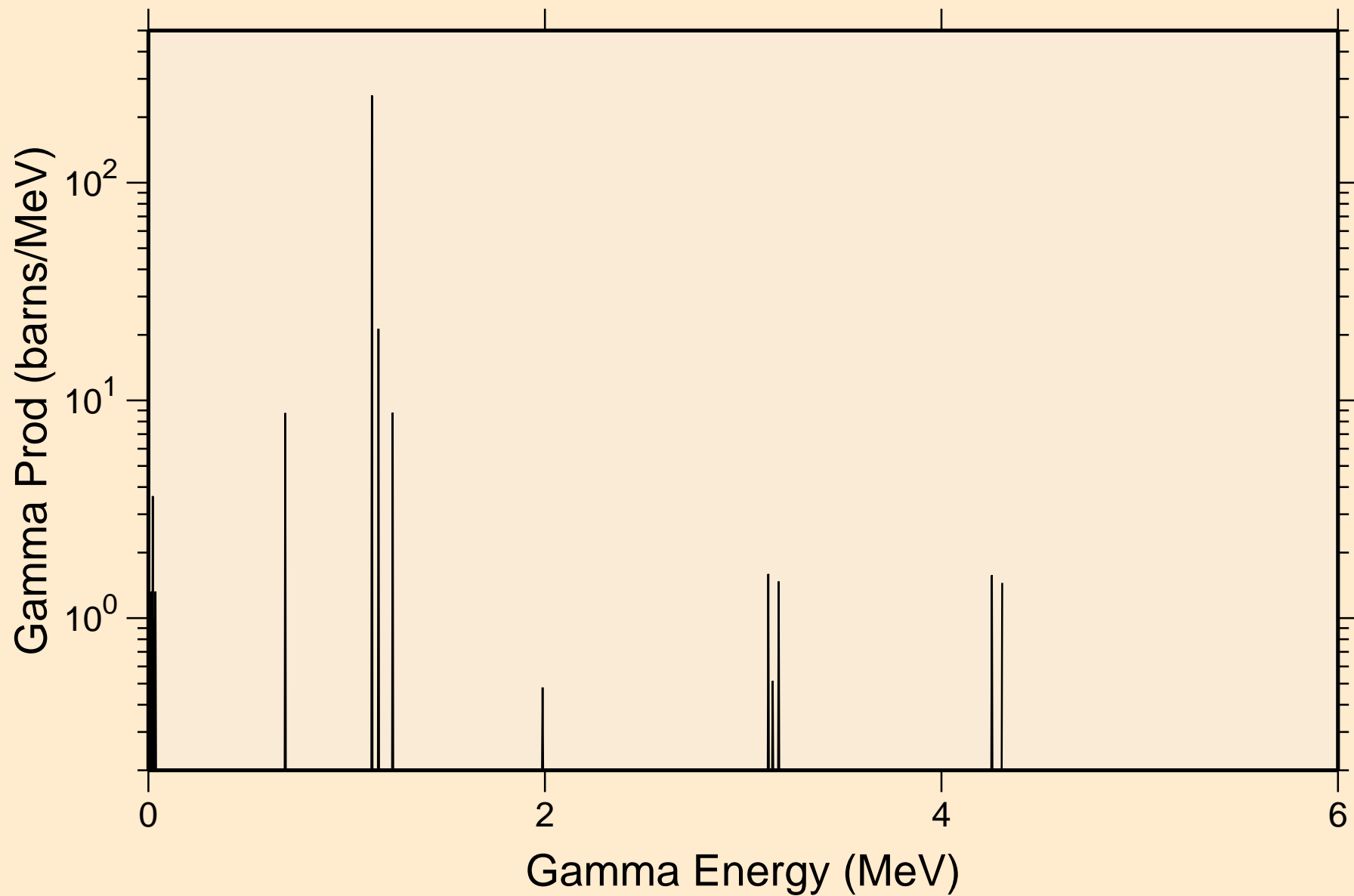

TI055 NEUTRON ACER TENDL-2019 LIBRARY; T=293.16K
14 MeV photon spectrum

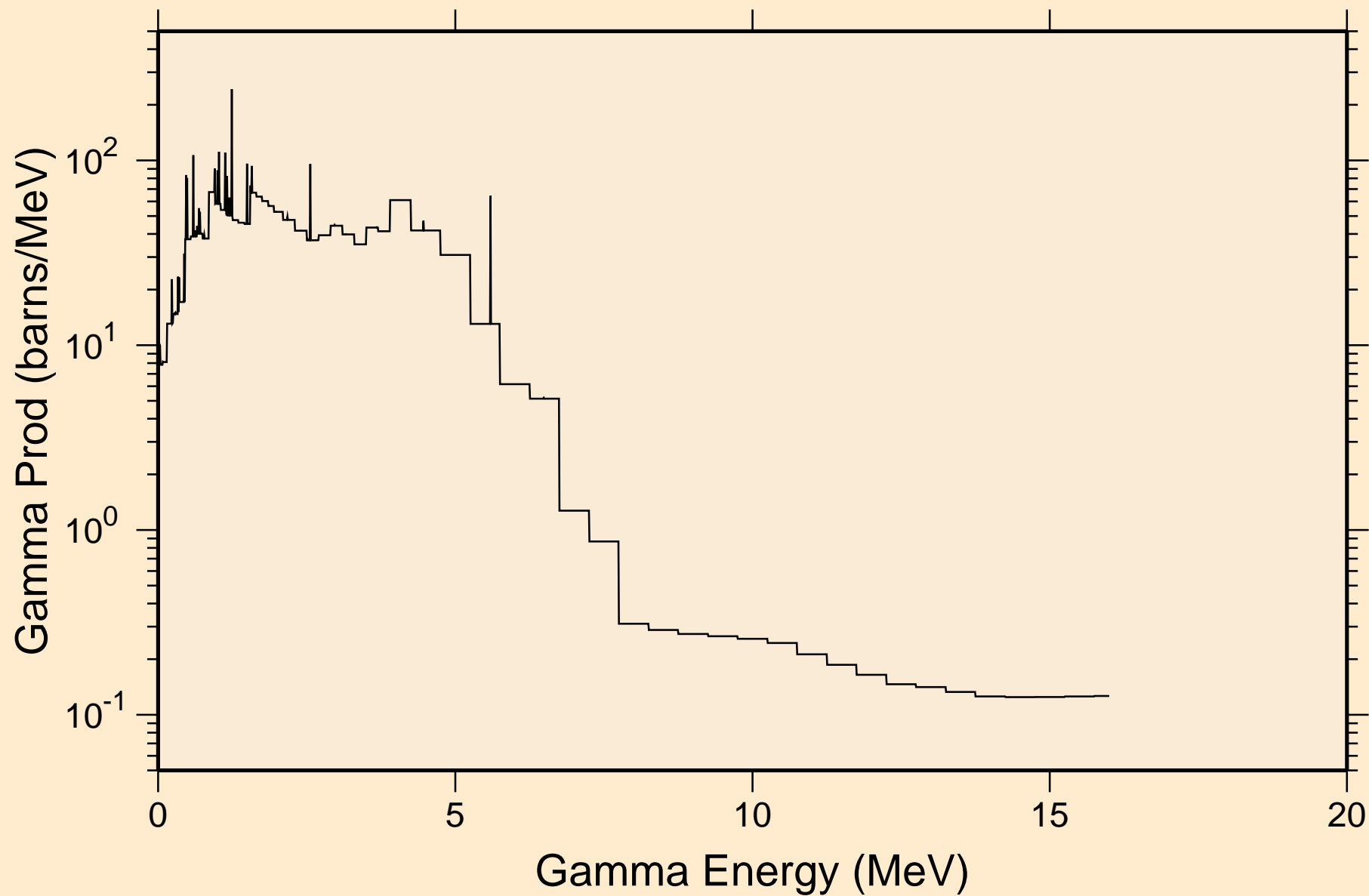

TI055 NEUTRON ACER TENDL-2019 LIBRARY; T=293.16K
Particle heating contributions

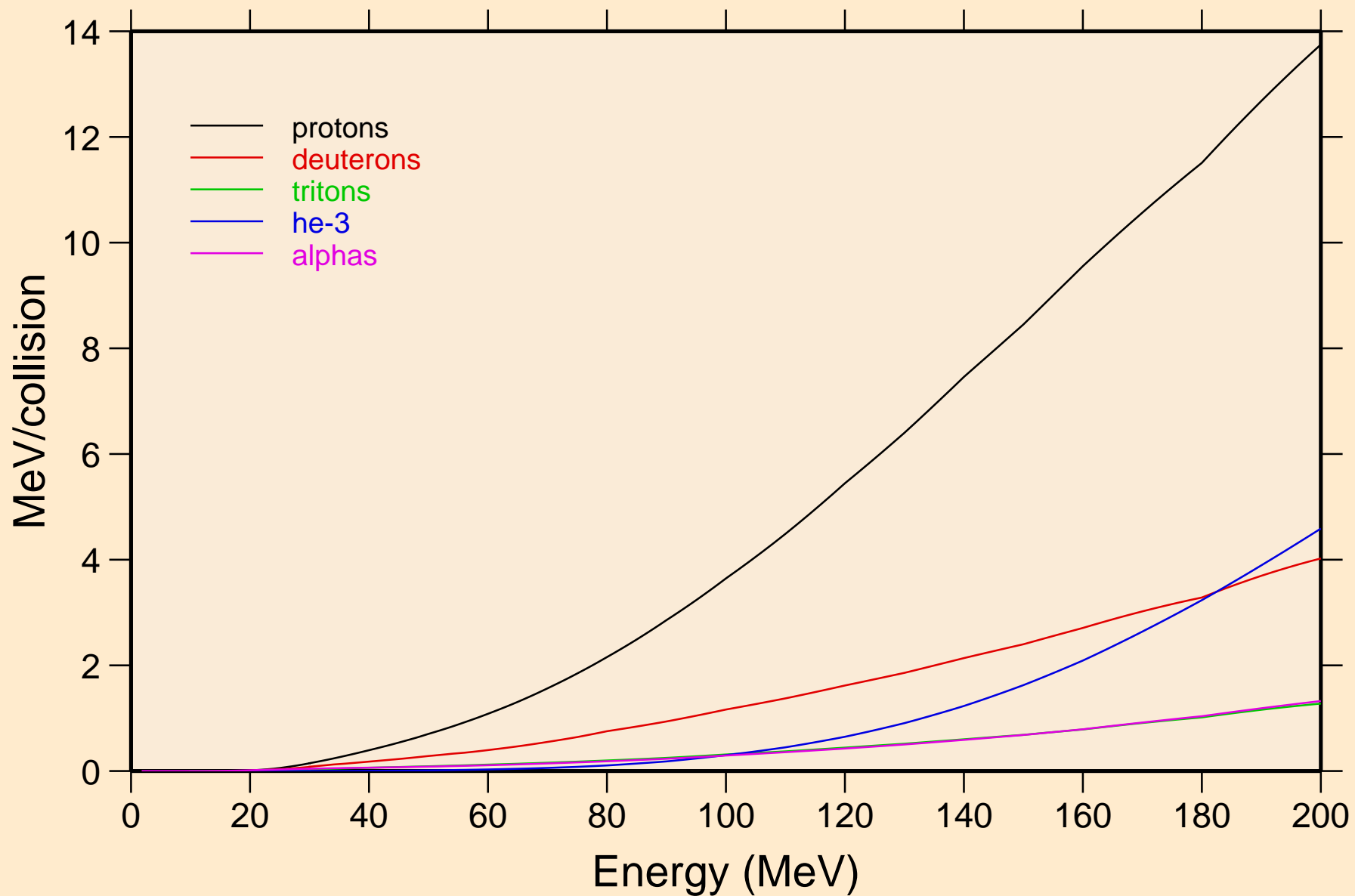

TI055 NEUTRON ACER TENDL-2019 LIBRARY; T=293.16K
Recoil Heating

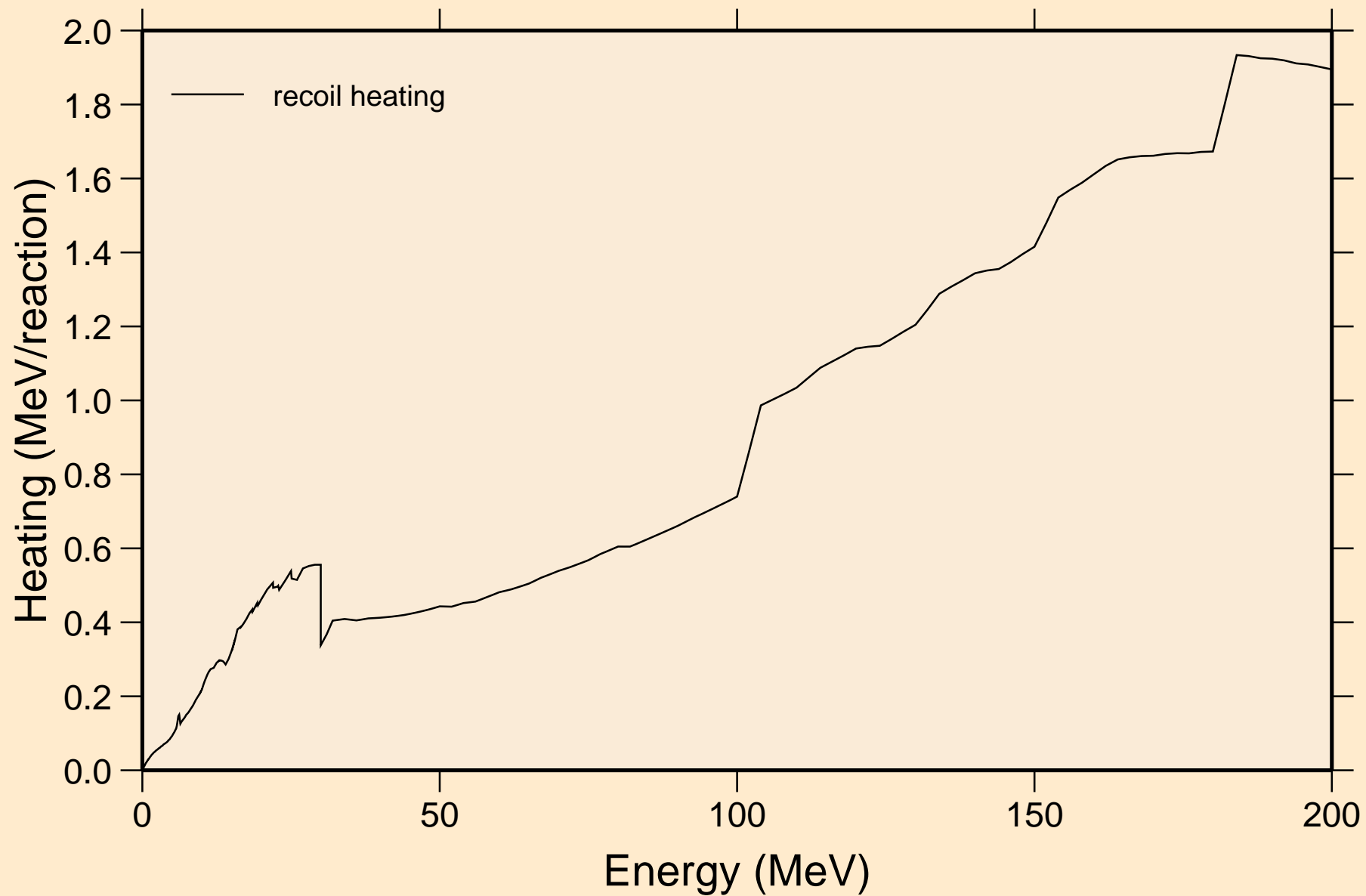

TI055 NEUTRON ACER TENDL-2019 LIBRARY; T=293.16K
Particle production cross sections

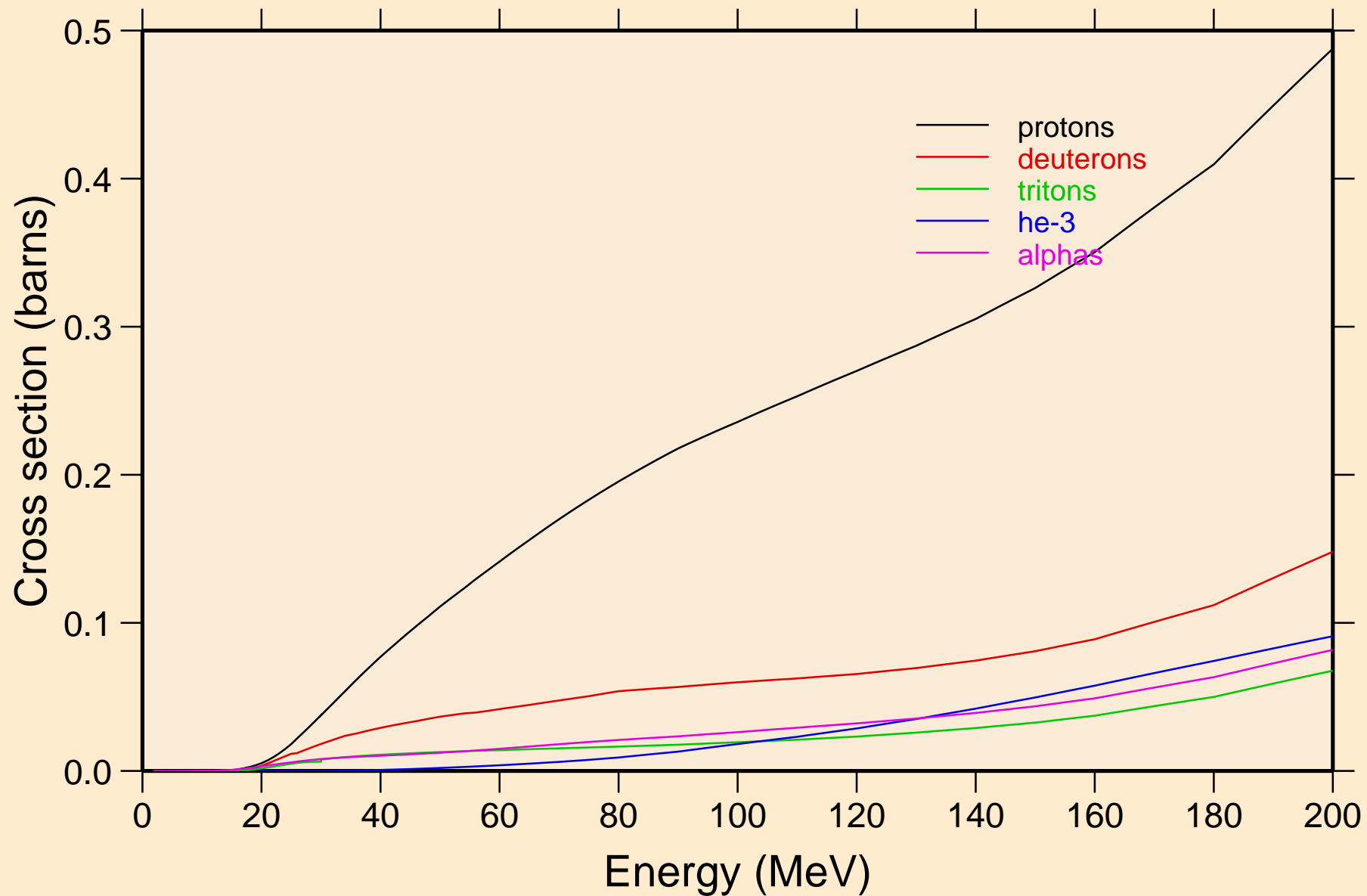

TI055 NEUTRON ACER TENDL-2019 LIBRARY; T=293.16K
protons from (n,x)

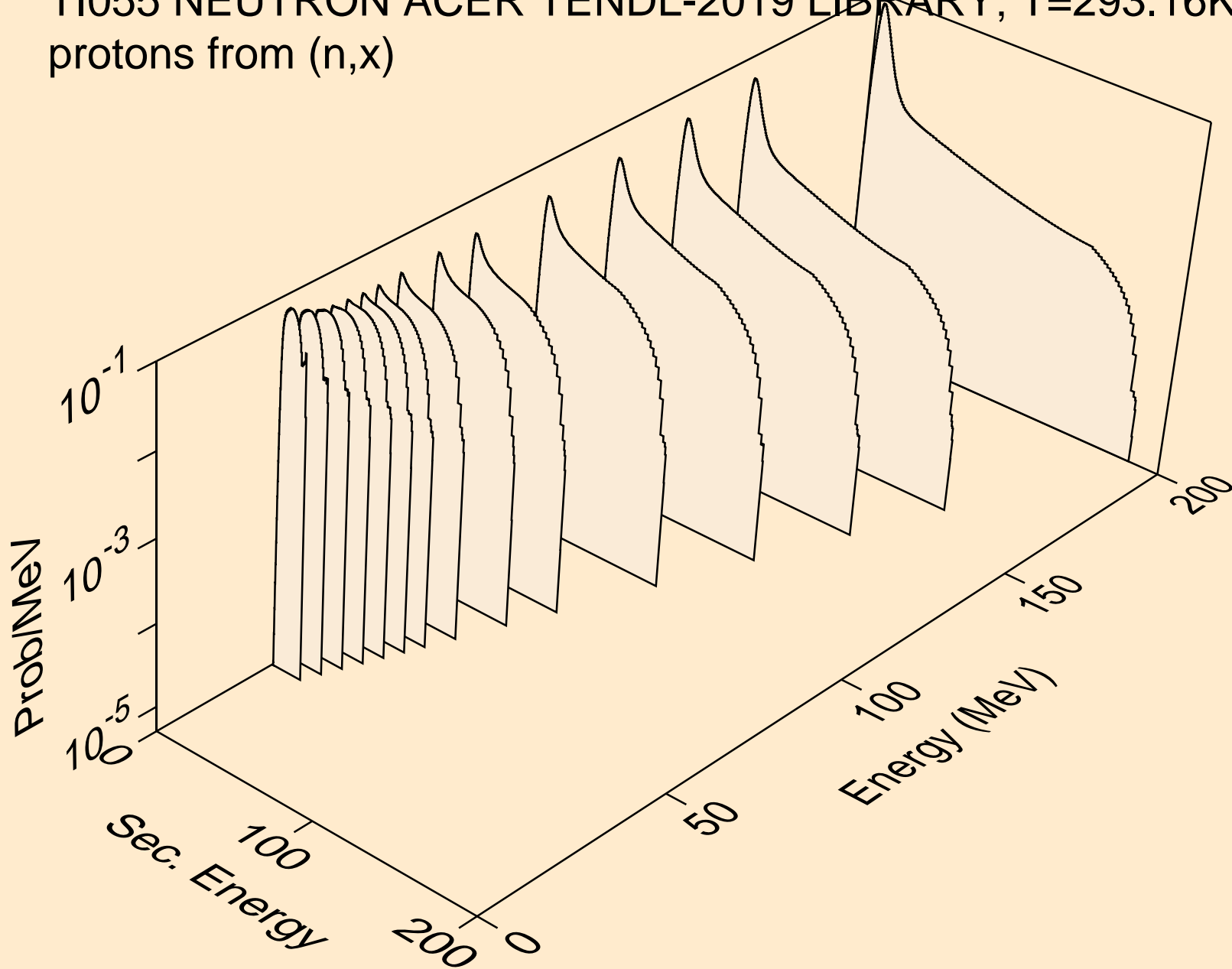

TI055 NEUTRON ACER TENDL-2019 LIBRARY; T=293.16K
protons from (n,n*)p

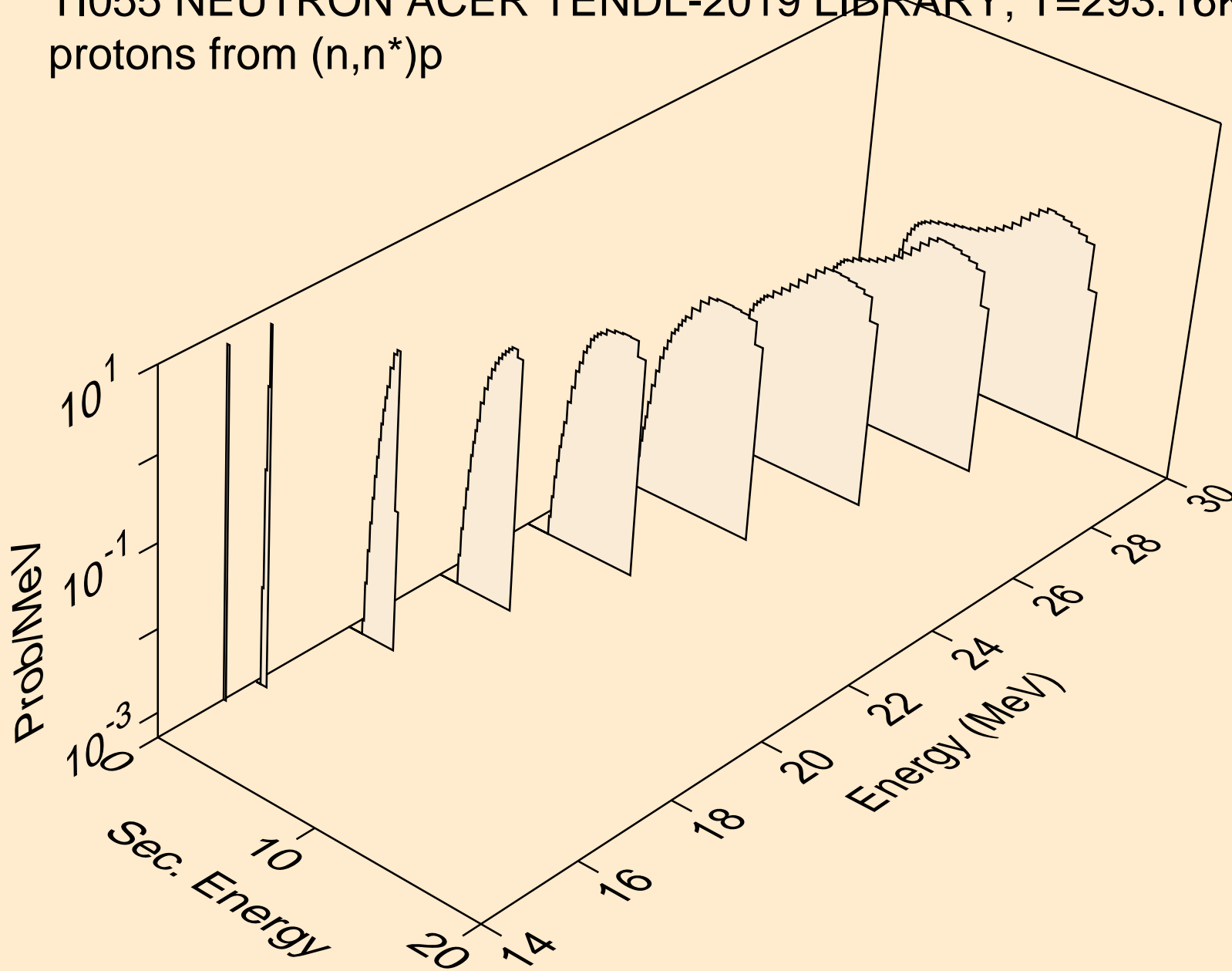

TI055 NEUTRON ACER TENDL-2019 LIBRARY; T=293.16K
protons from (n,2np)

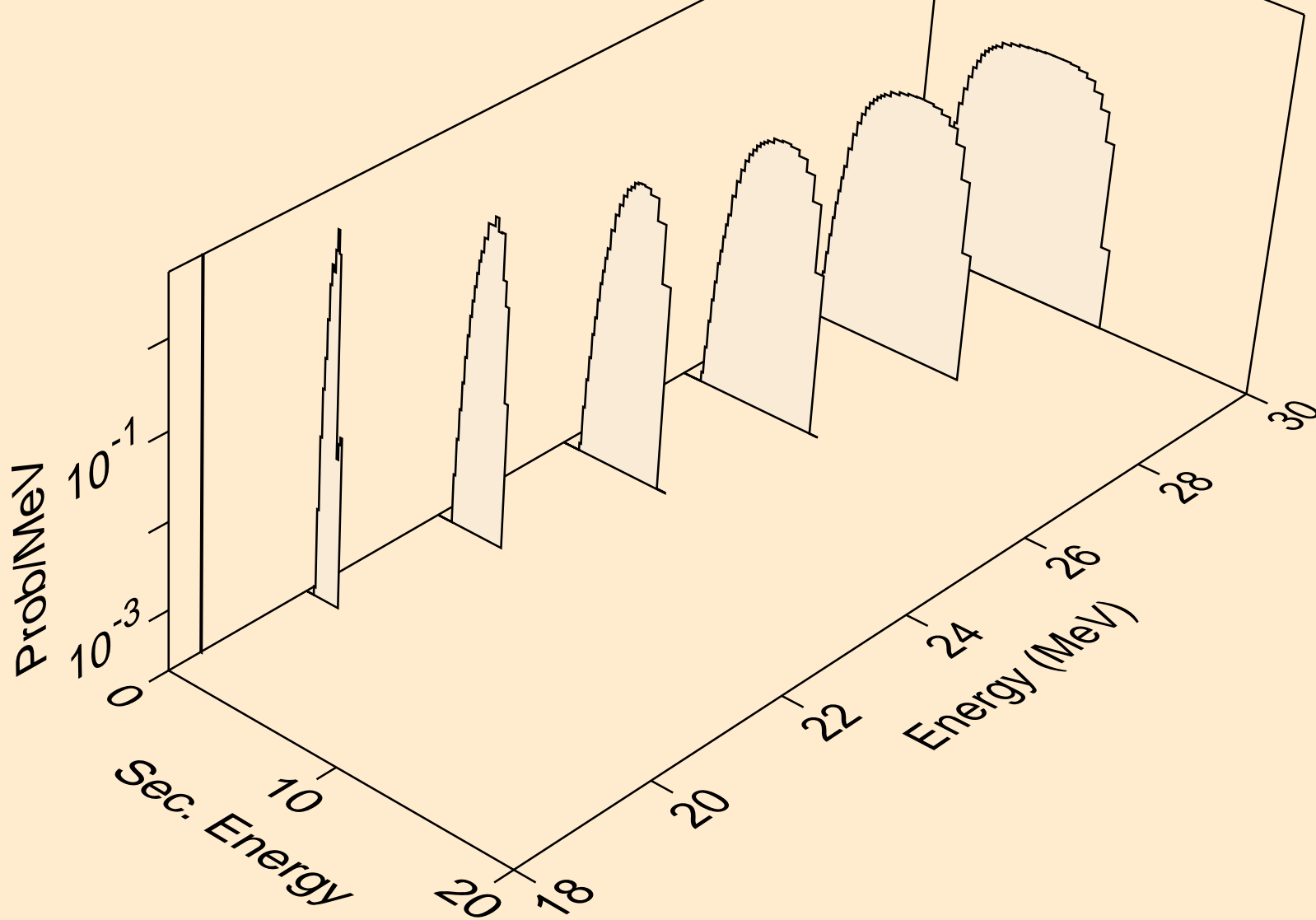

TI055 NEUTRON ACER TENDL-2019 LIBRARY; T=293.16K
protons from (n,3np)

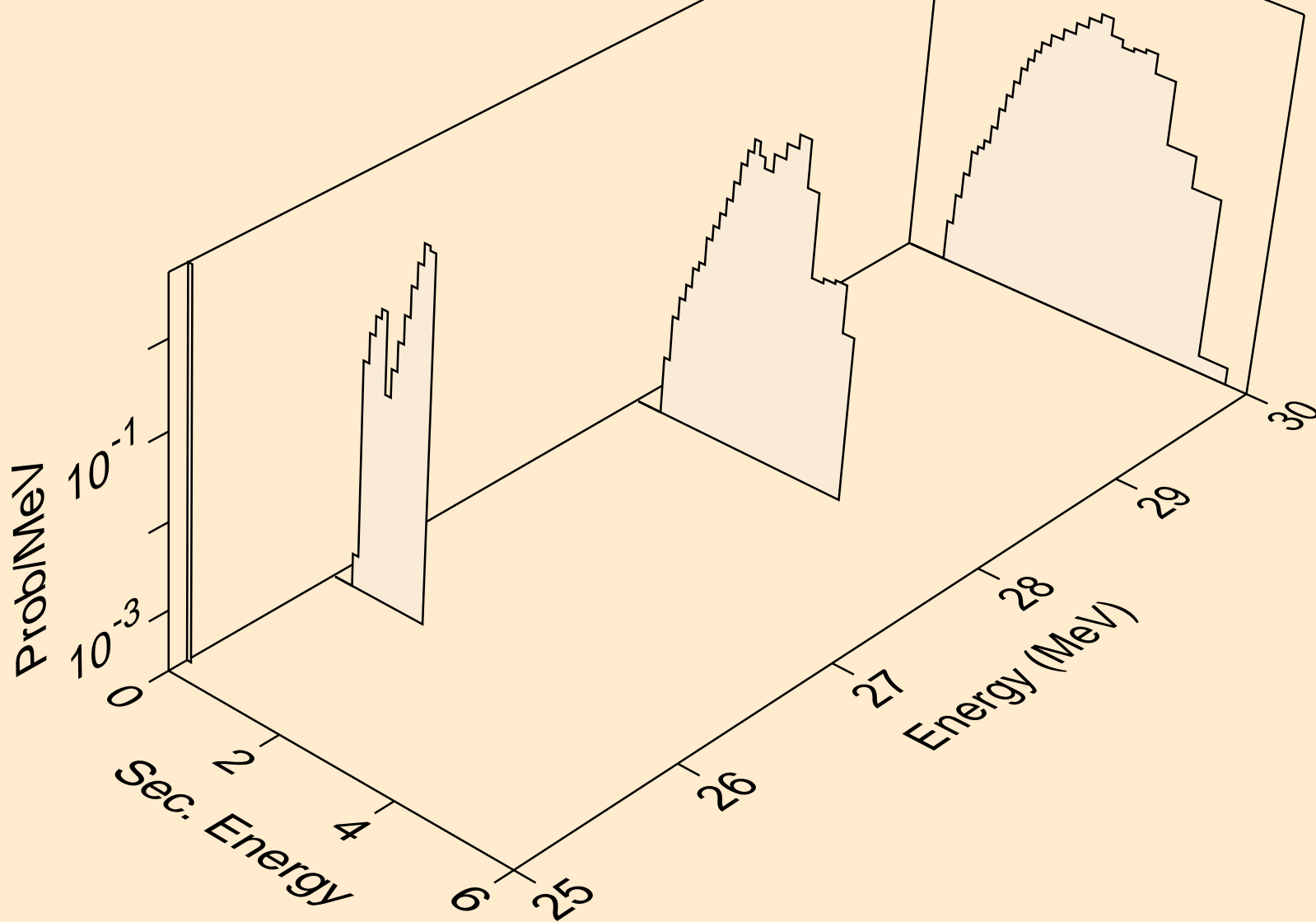

TI055 NEUTRON ACER TENDL-2019 LIBRARY; T=293.16K
protons from (n,p)

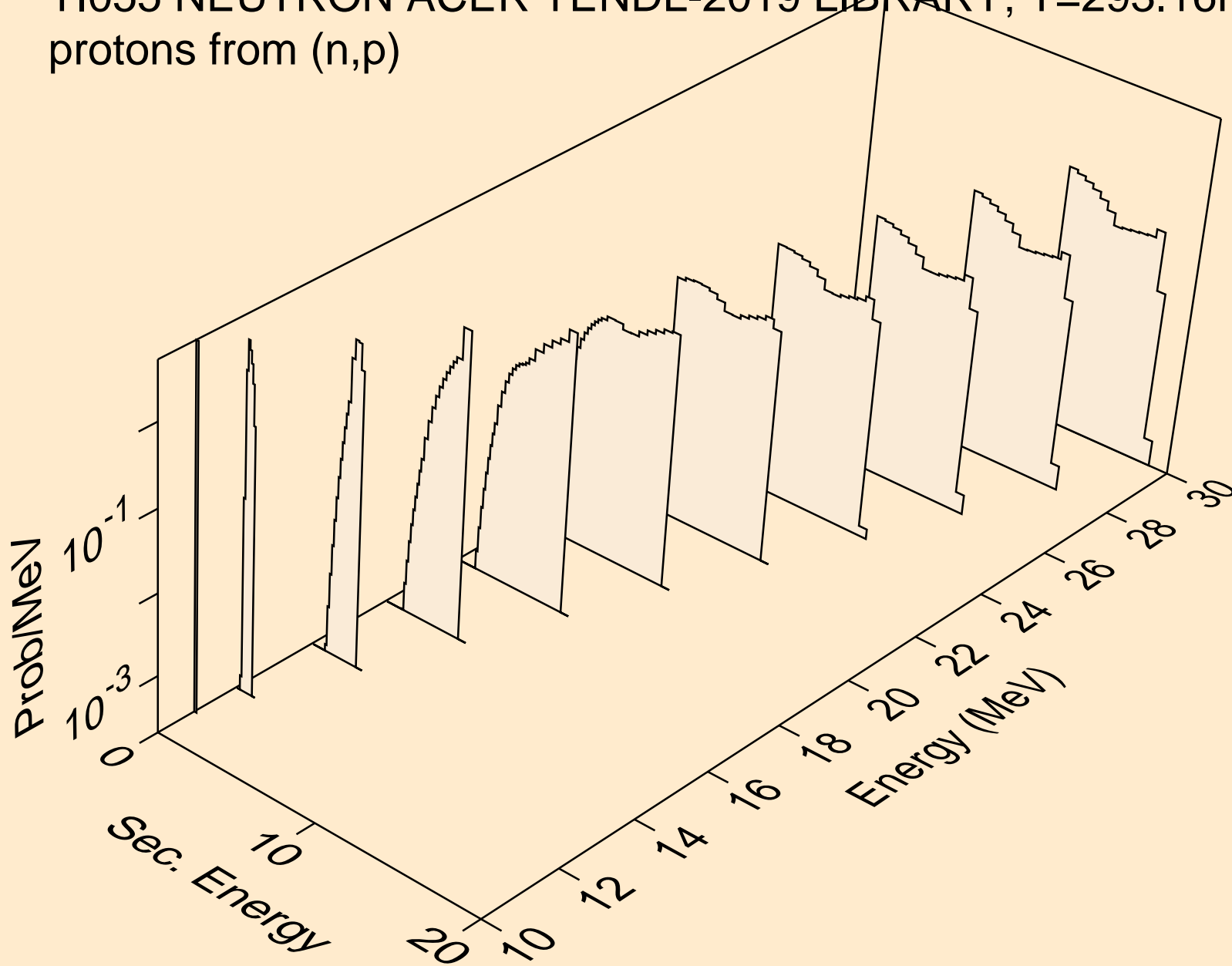

TI055 NEUTRON ACER TENDL-2019 LIBRARY; T=293.16K
protons from (n,pt)

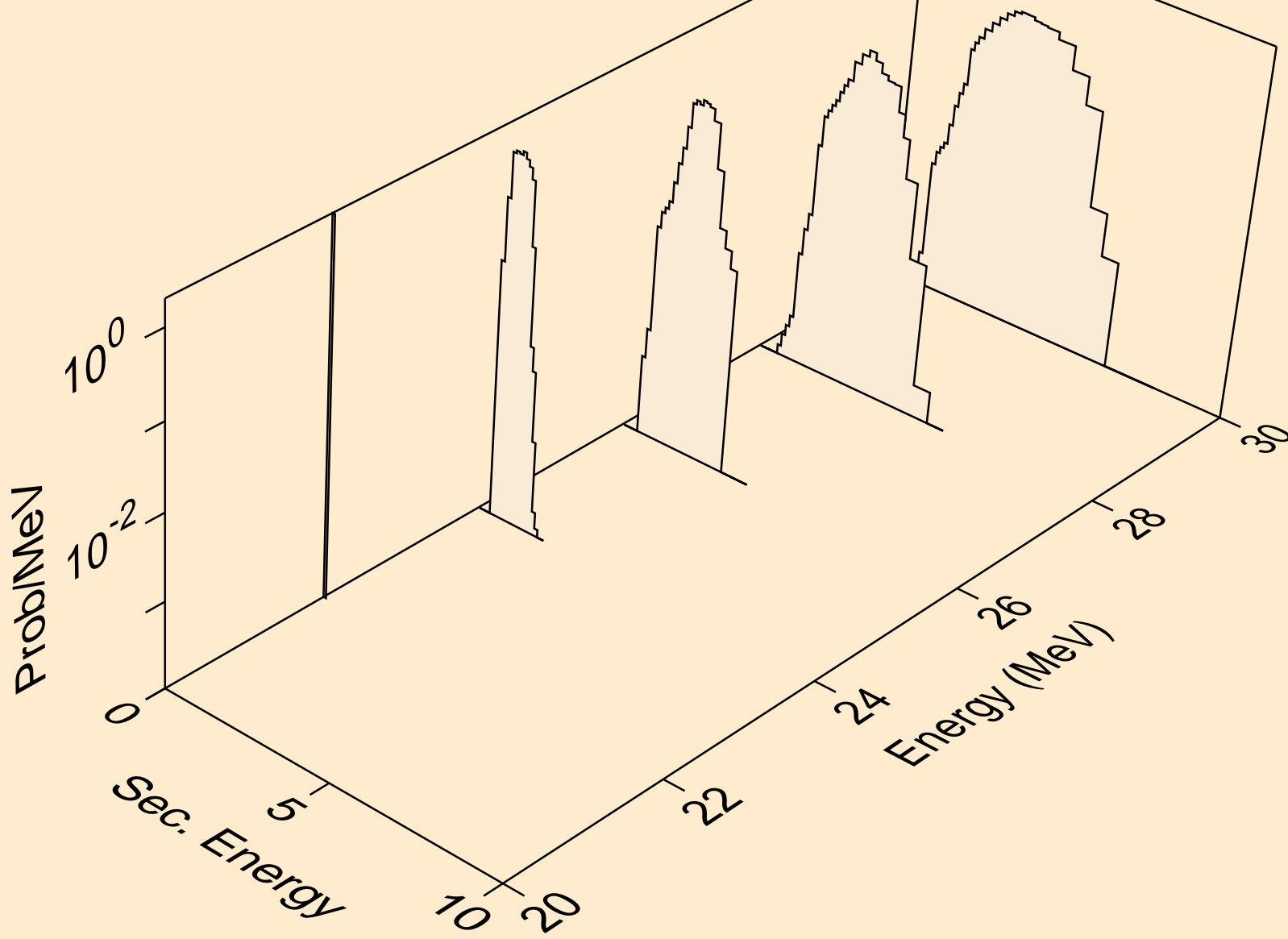

TI055 NEUTRON ACER TENDL-2019 LIBRARY; T=293.16K
deuterons from (n,x)

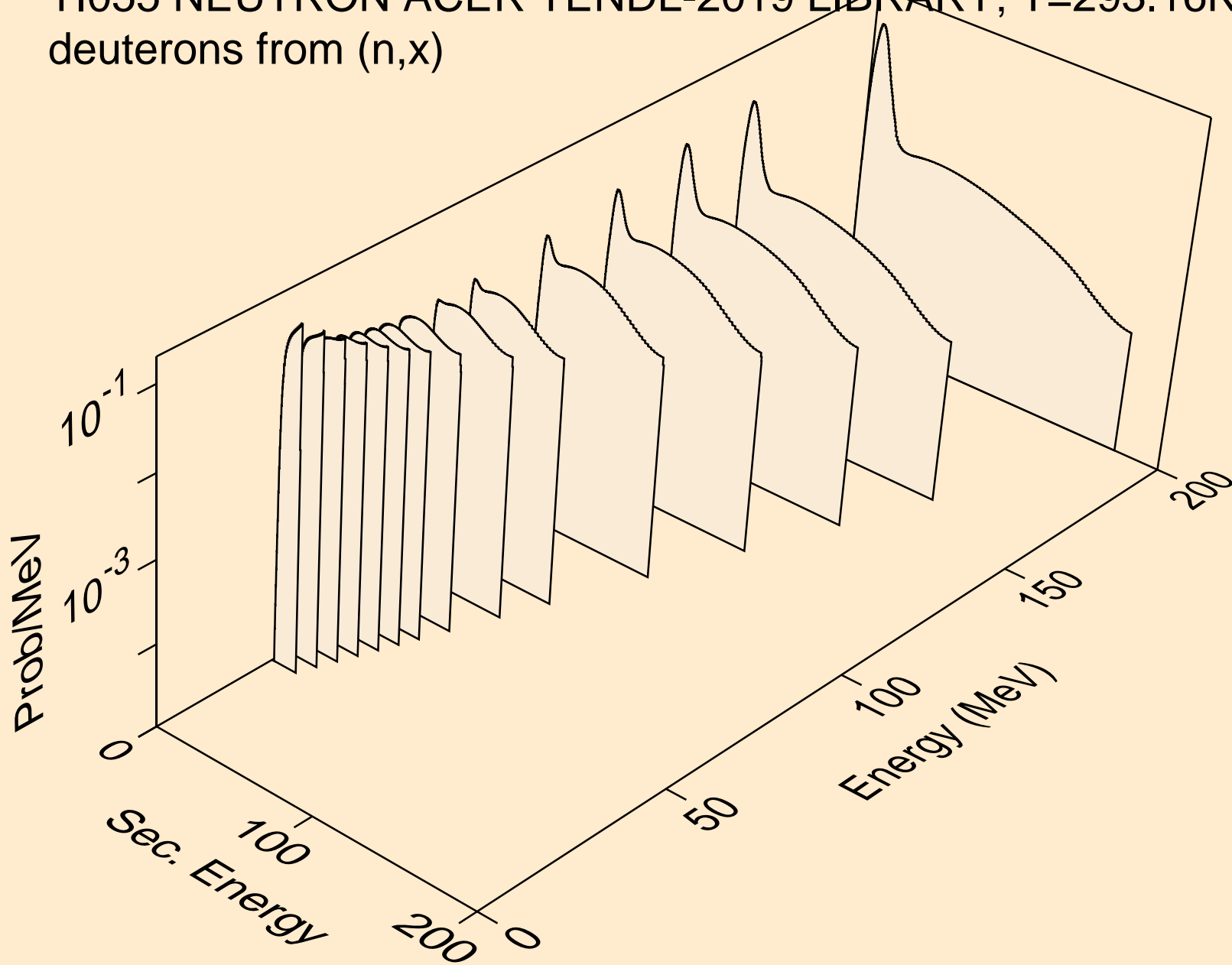

TI055 NEUTRON ACER TENDL-2019 LIBRARY; T=293.16K
deuterons from (n,2nd)

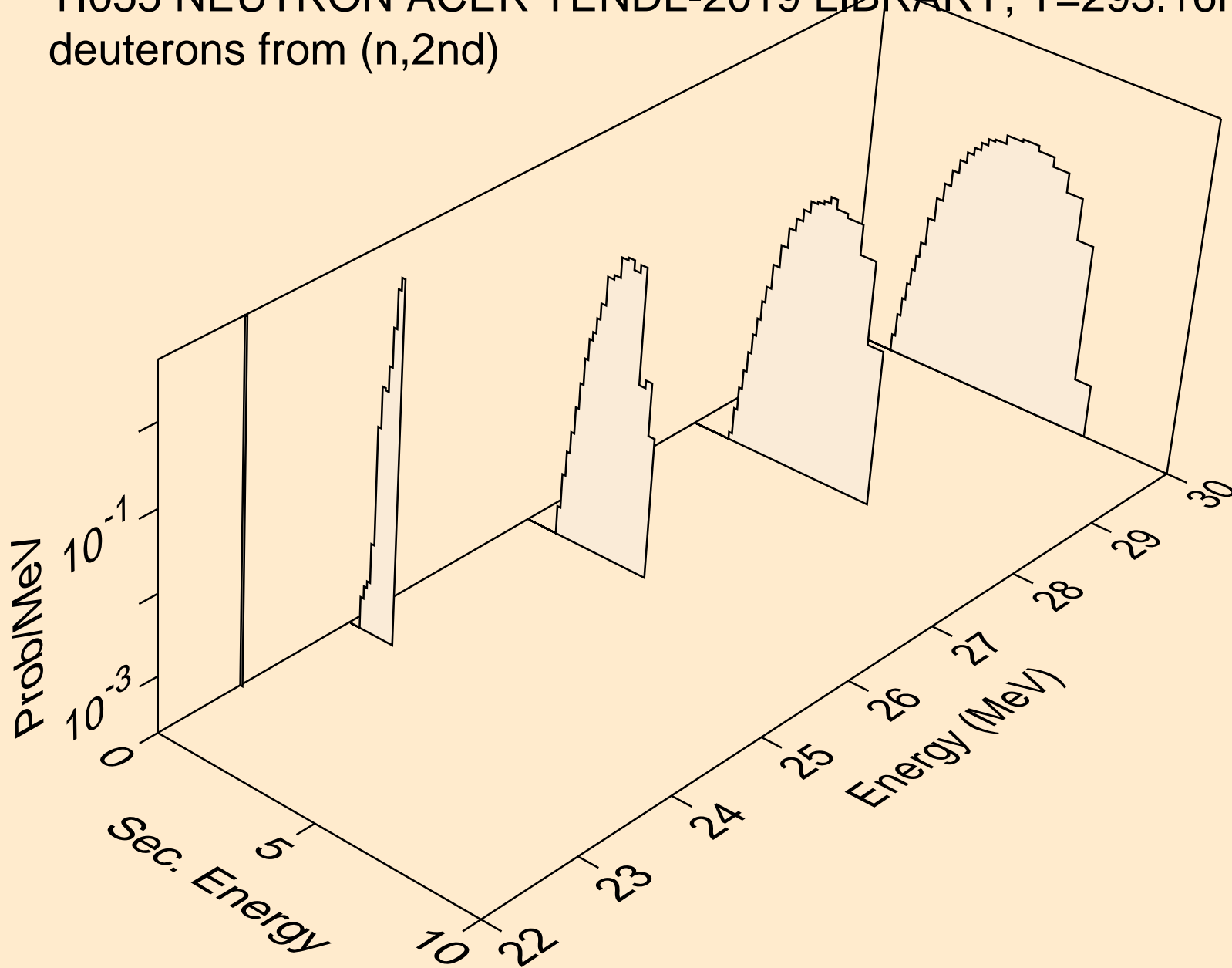

TI055 NEUTRON ACER TENDL-2019 LIBRARY; T=293.16K
deuterons from (n,n*)d

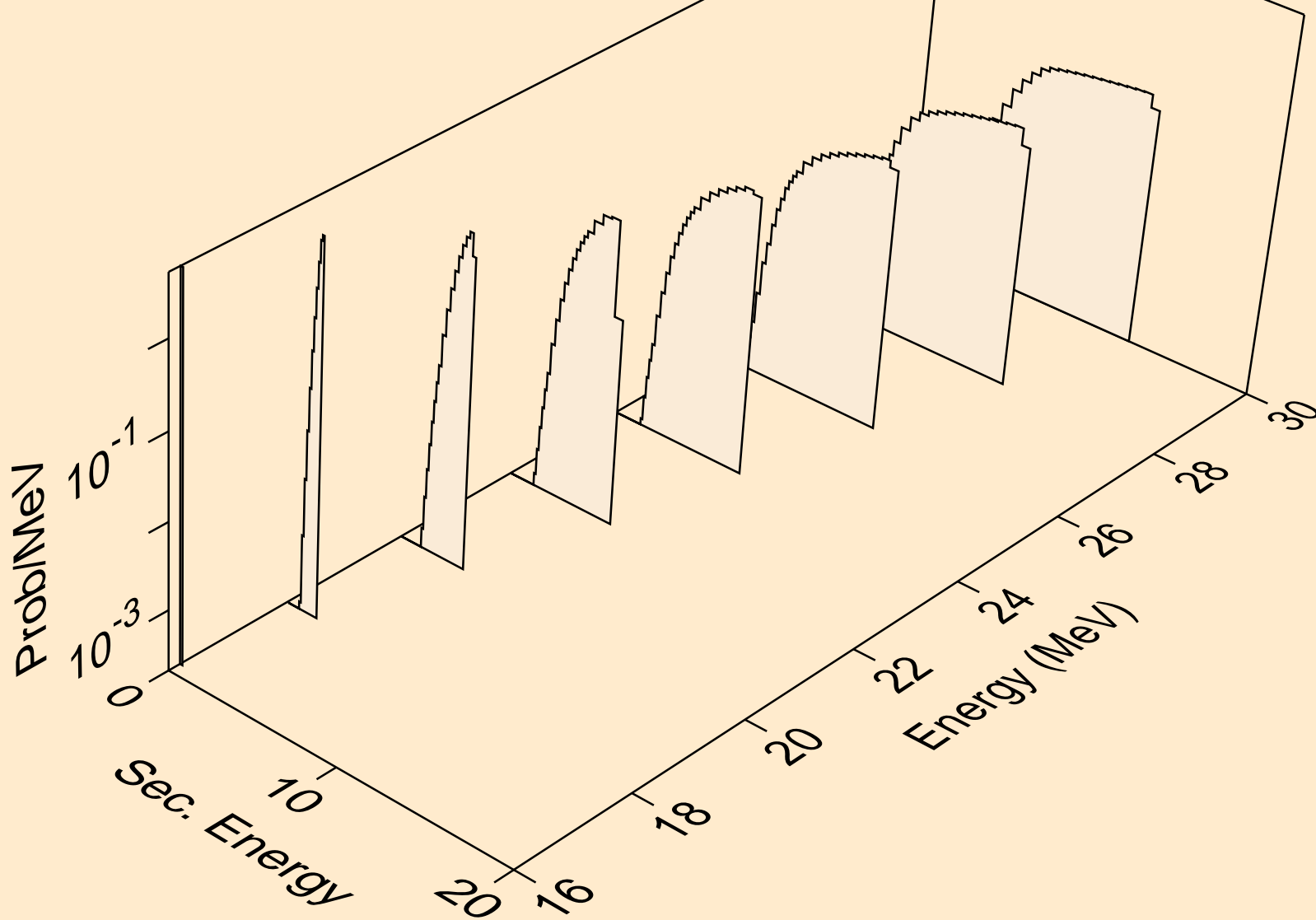

TI055 NEUTRON ACER TENDL-2019 LIBRARY; T=293.16K
deuterons from (n,d)

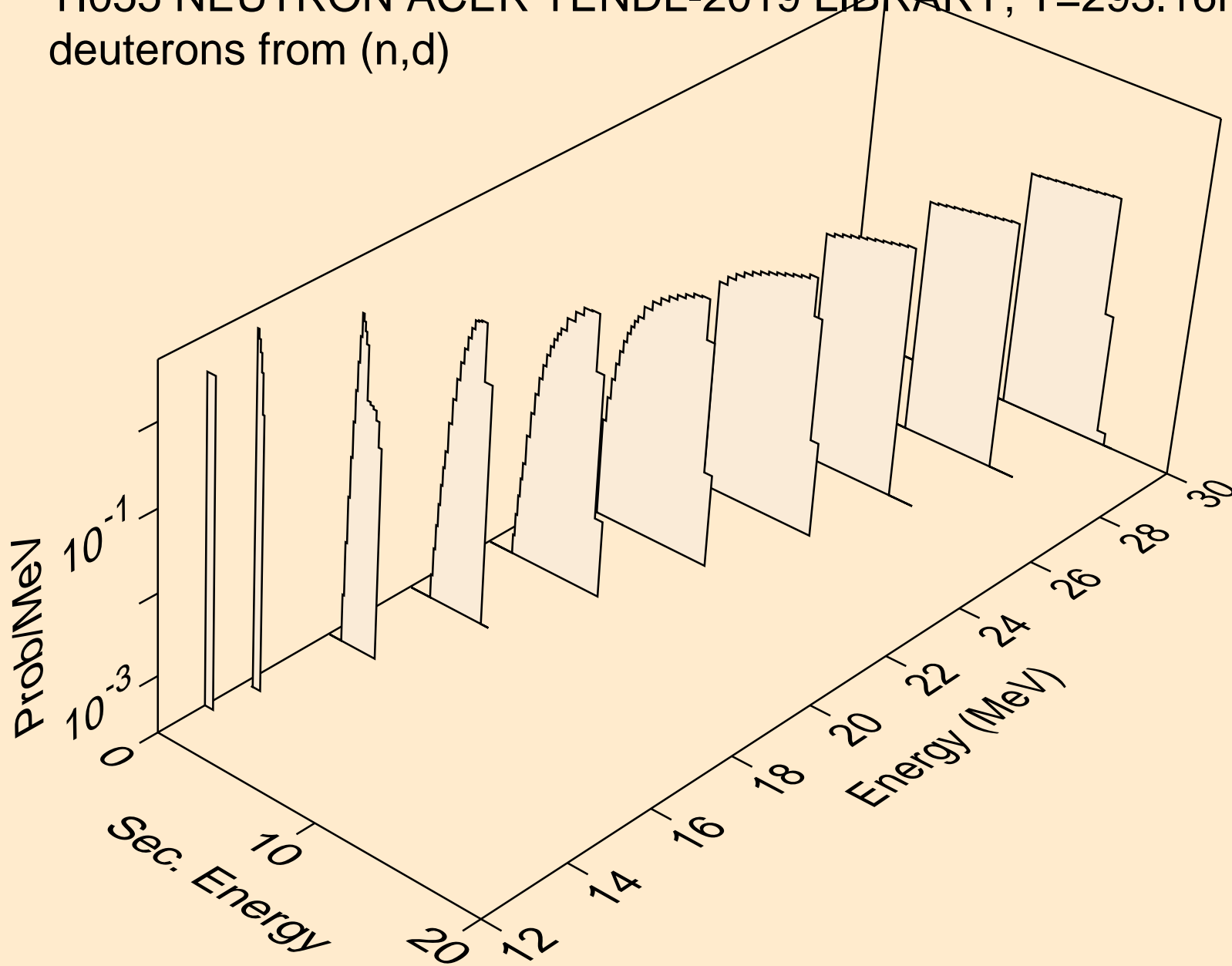

TI055 NEUTRON ACER TENDL-2019 LIBRARY; T=293.16K
tritons from (n,x)

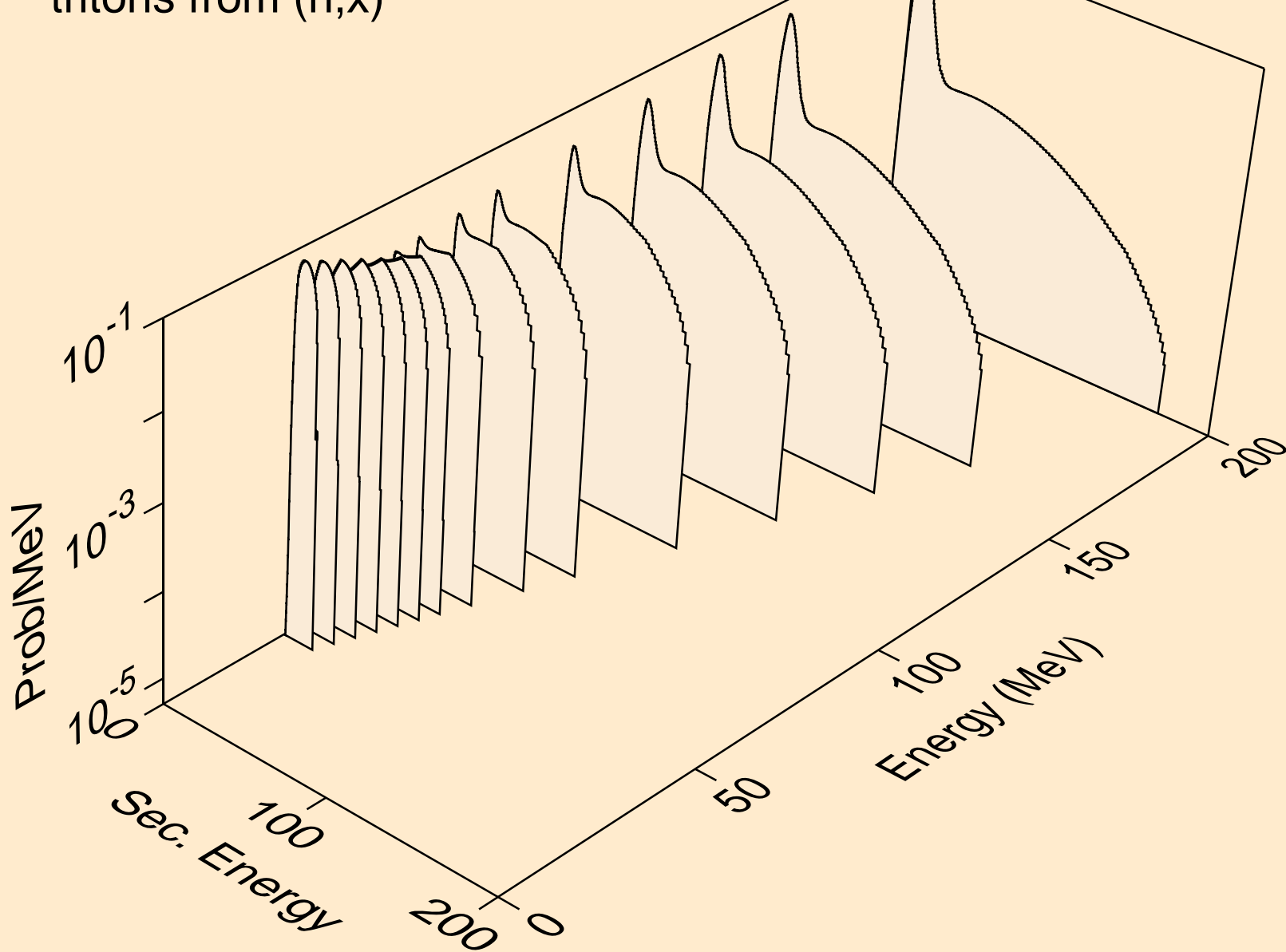

TI055 NEUTRON ACER TENDL-2019 LIBRARY; T=293.16K
tritons from (n,n*)t

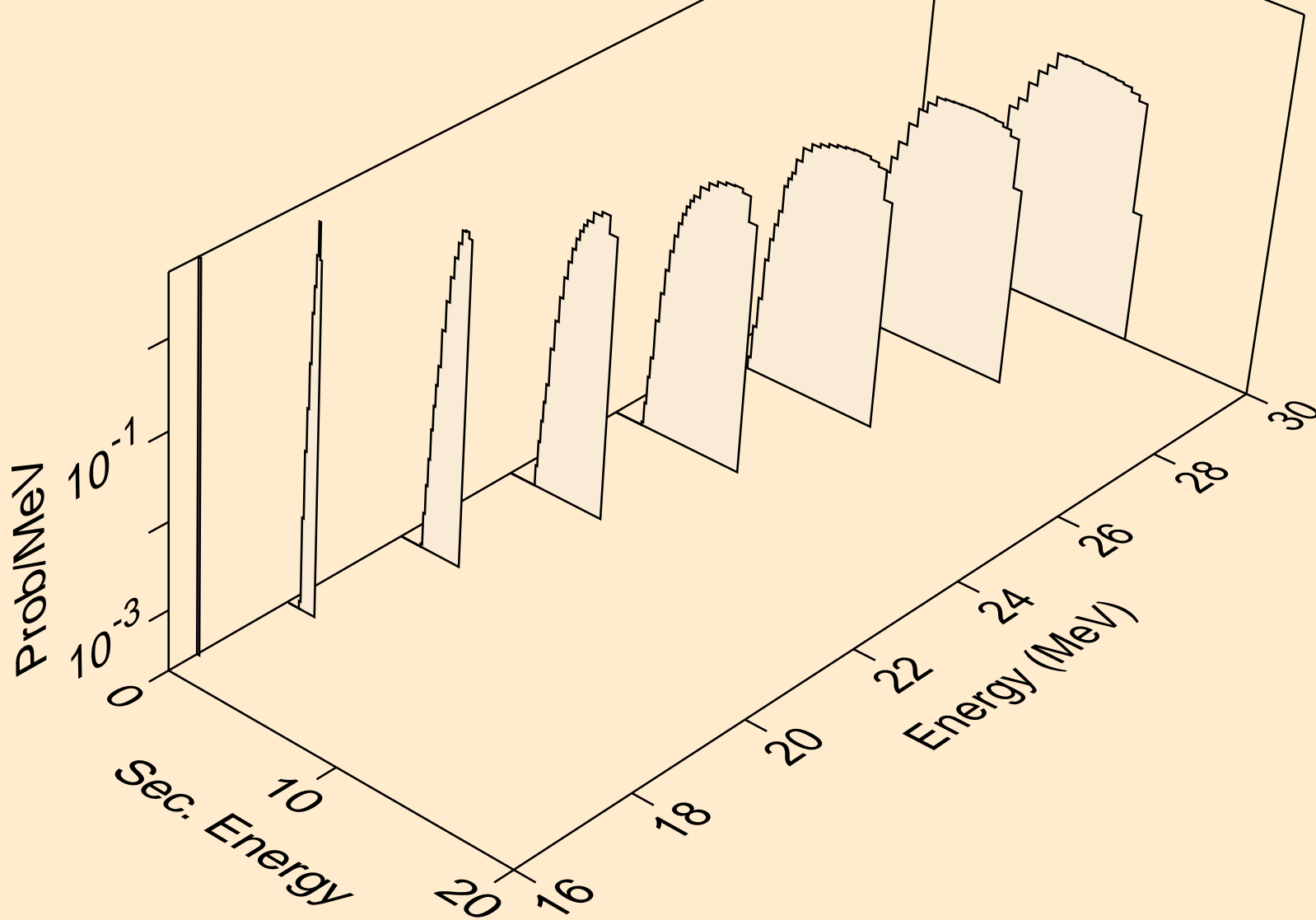

TI055 NEUTRON ACER TENDL-2019 LIBRARY; T=293.16K
tritons from (n,t)

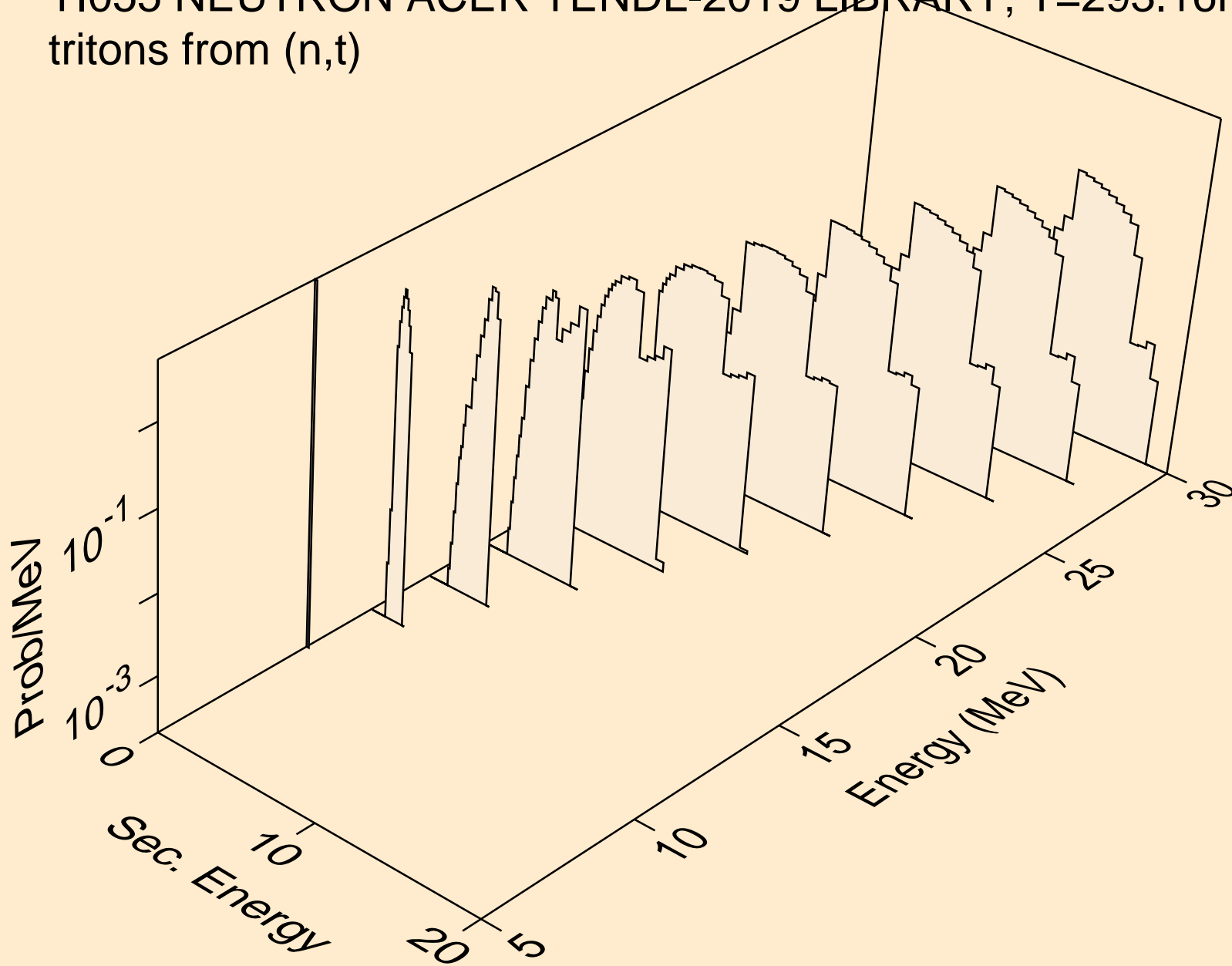

TI055 NEUTRON ACER TENDL-2019 LIBRARY; T=293.16K
tritons from (n,pt)

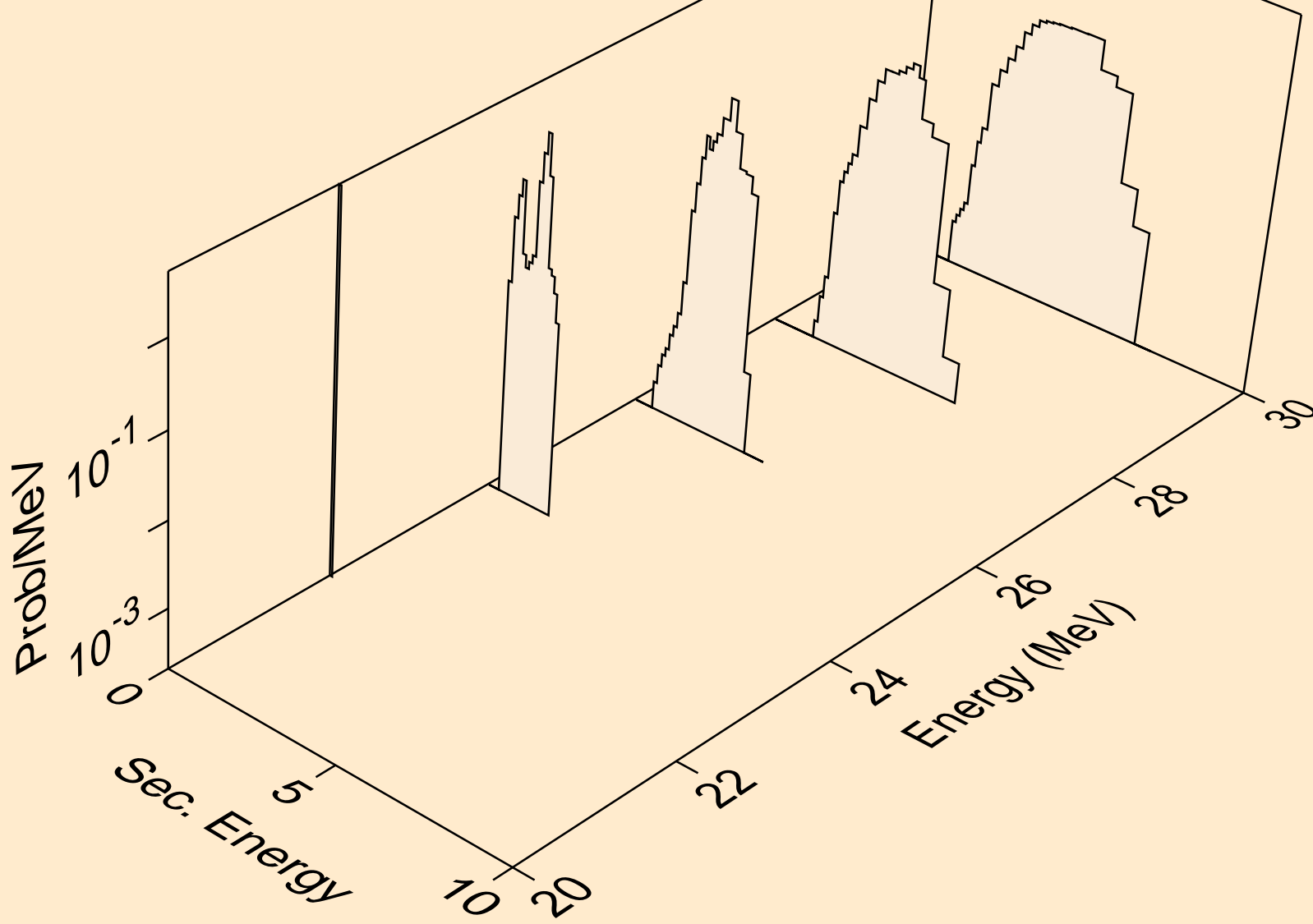

TI055 NEUTRON ACER TENDL-2019 LIBRARY; T=293.16K
he3s from (n,x)

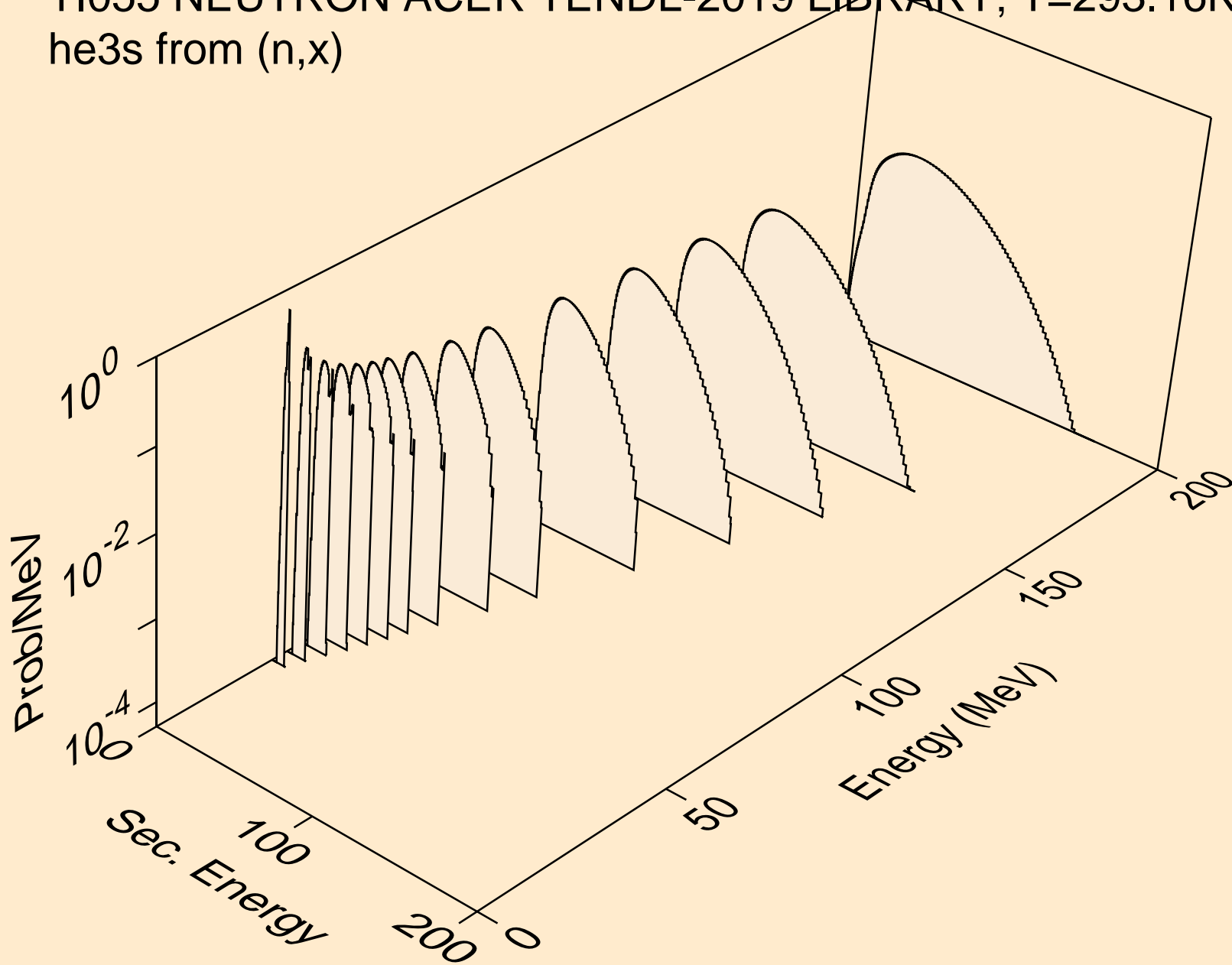

TI055 NEUTRON ACER TENDL-2019 LIBRARY; T=293.16K
he3s from (n,n*)he3

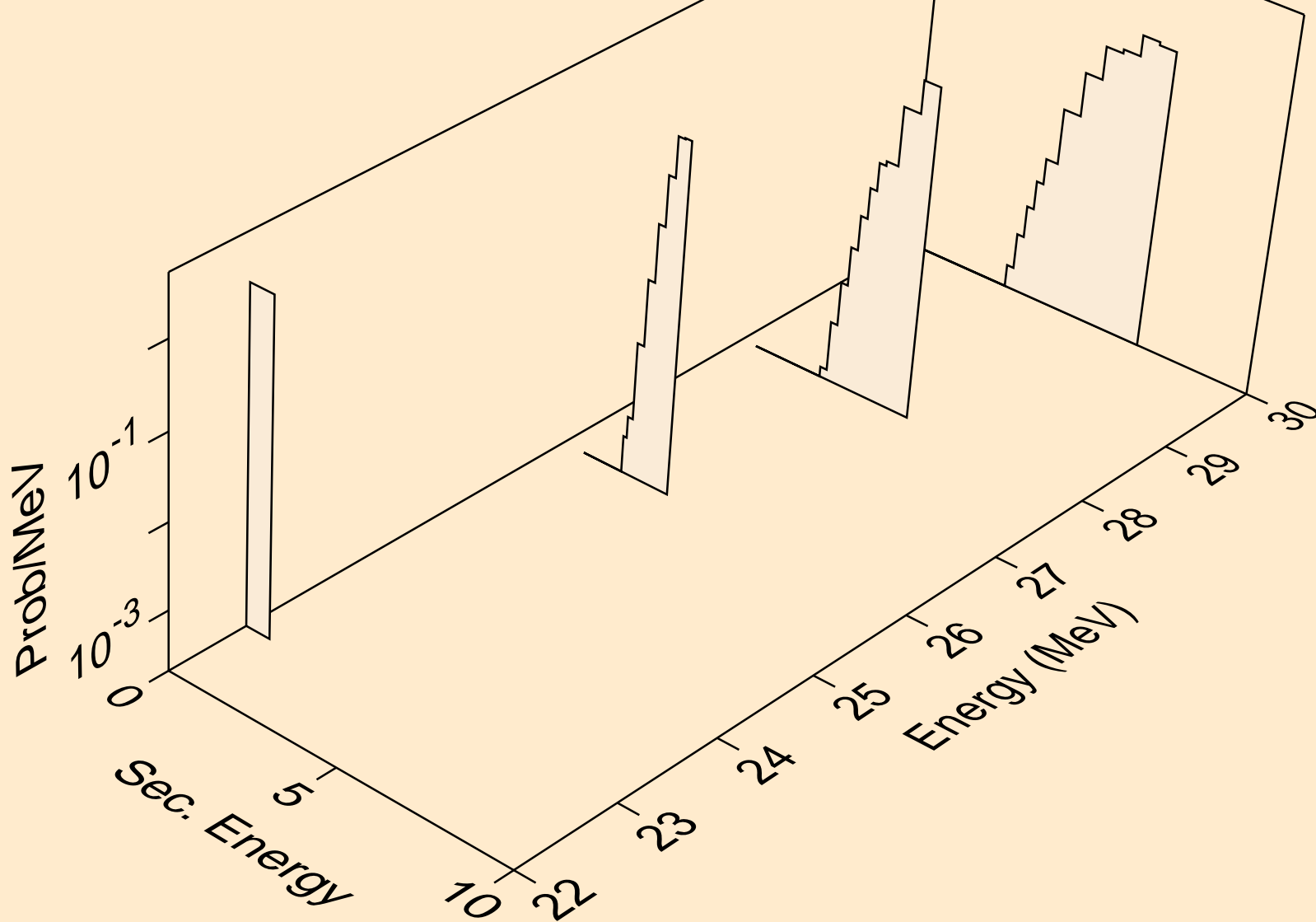

TI055 NEUTRON ACER TENDL-2019 LIBRARY; T=293.16K
he3s from (n,he3)

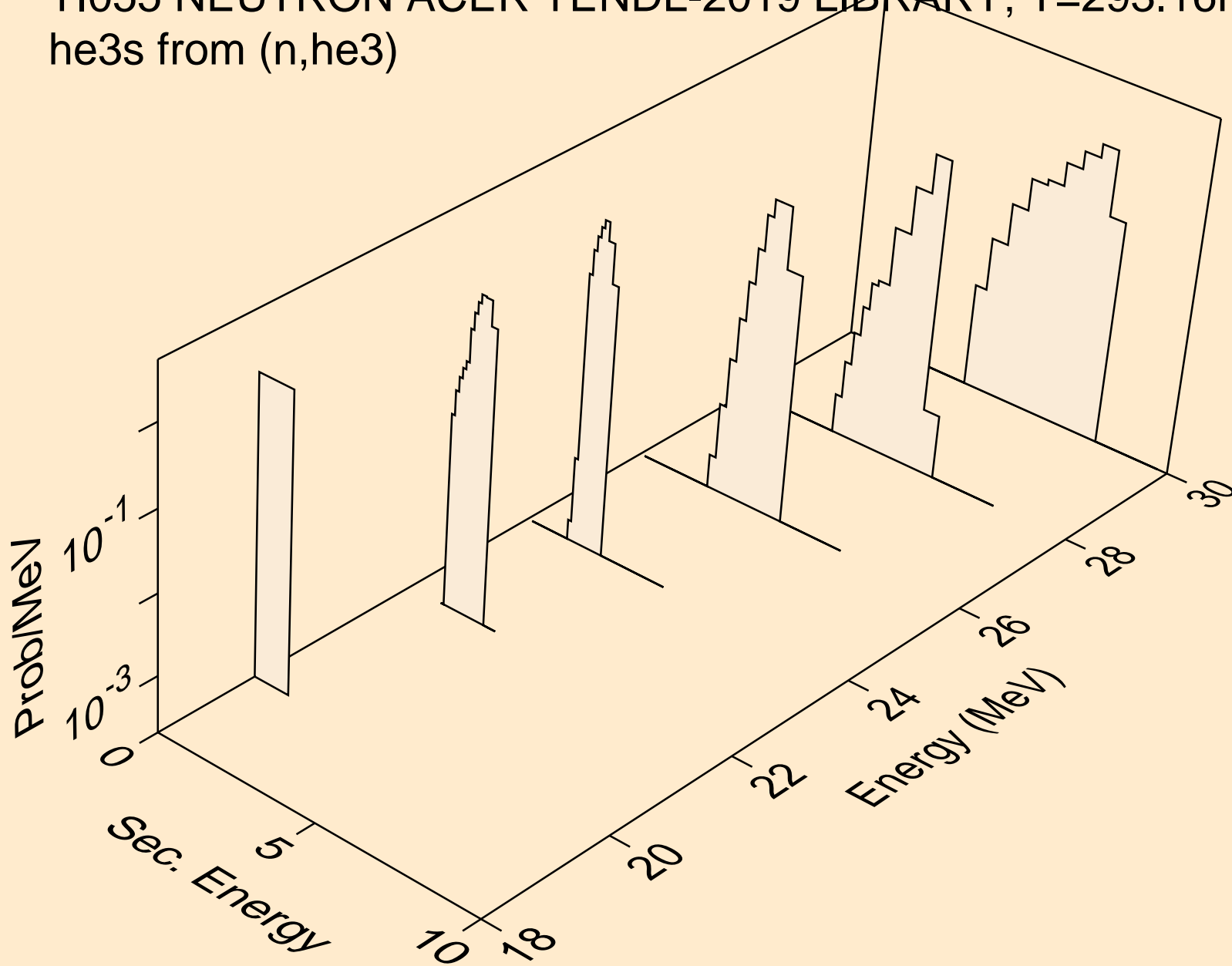

TI055 NEUTRON ACER TENDL-2019 LIBRARY; T=293.16K
alphas from (n,x)

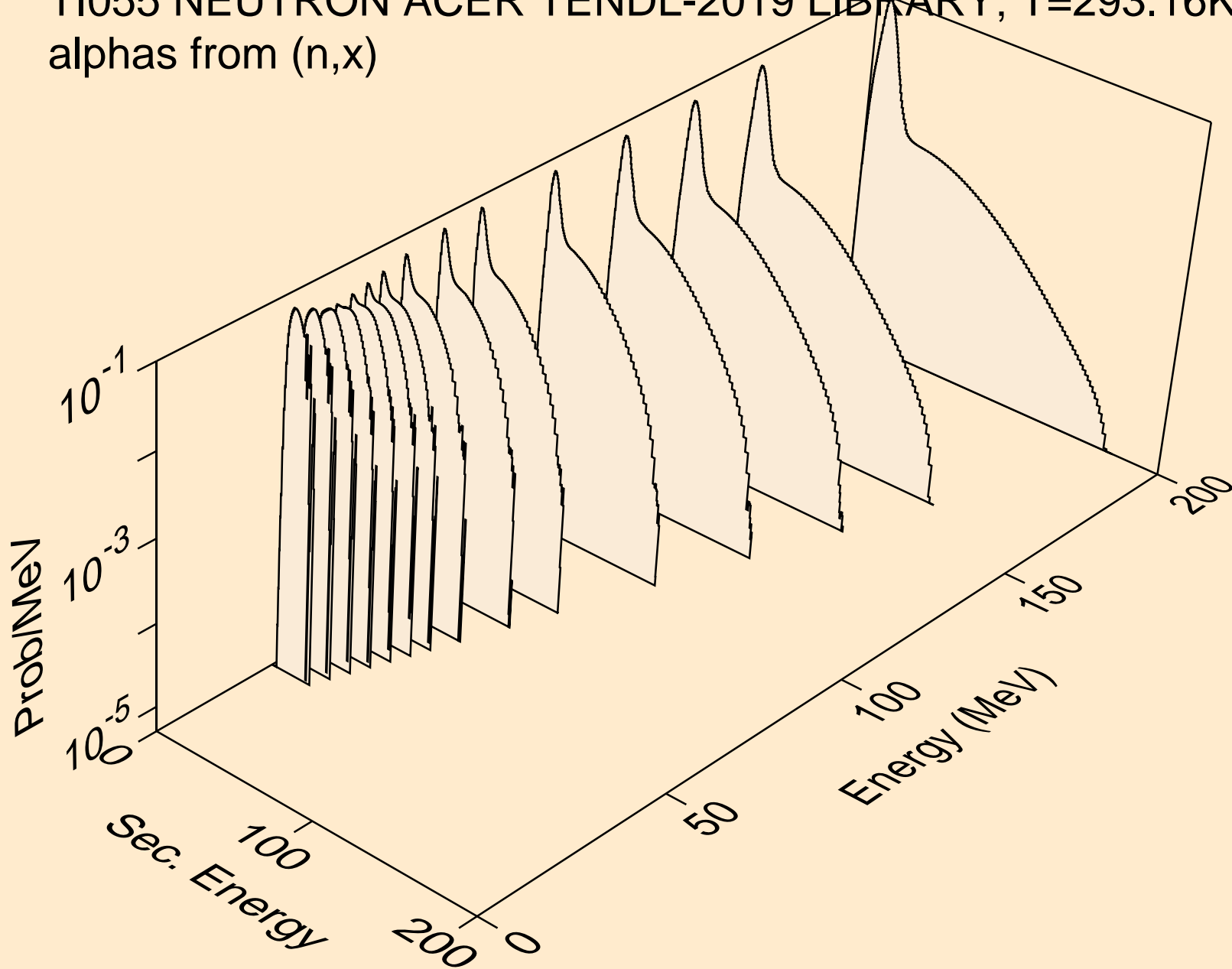

TI055 NEUTRON ACER TENDL-2019 LIBRARY; T=293.16K
alphas from (n,n*)a

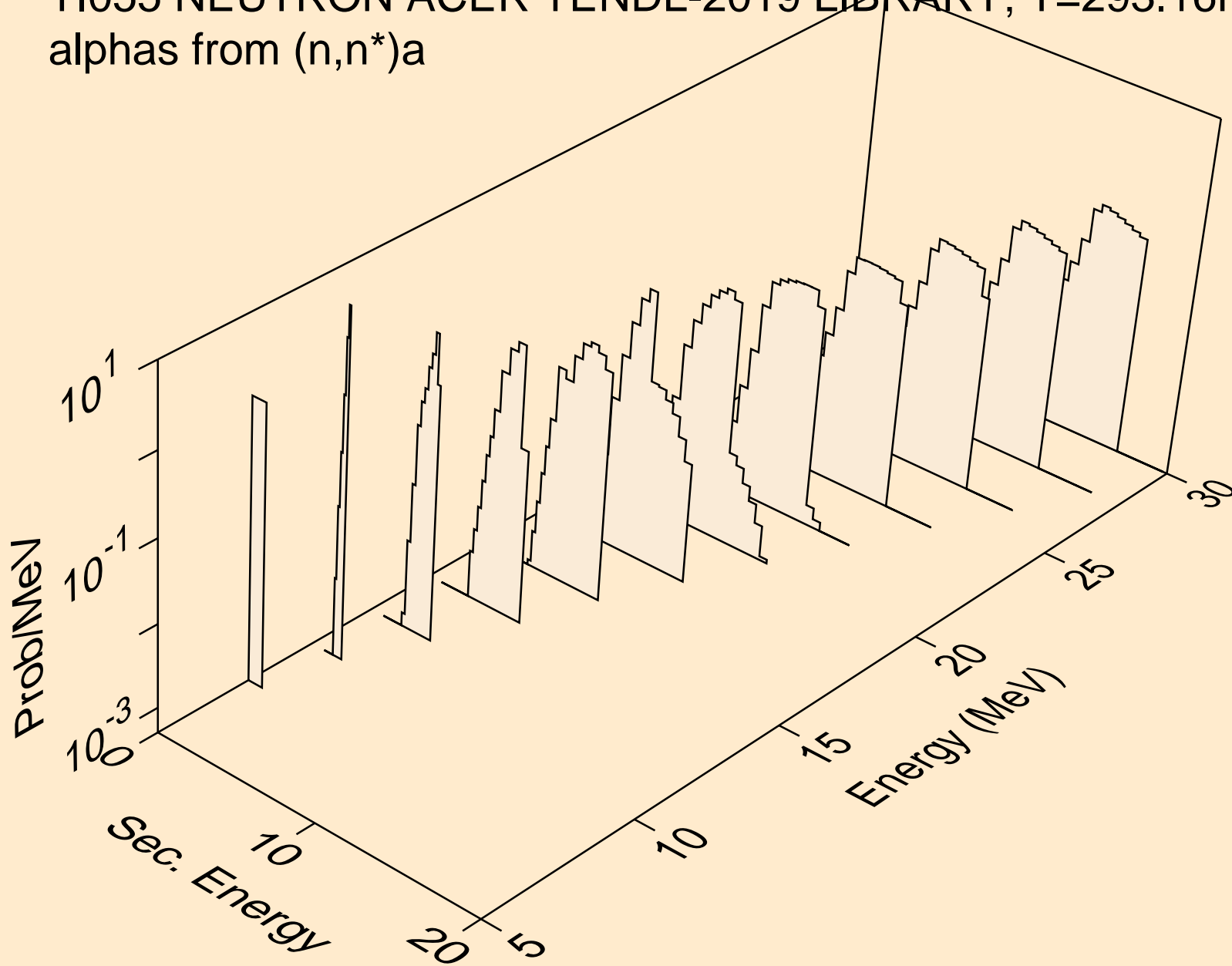

TI055 NEUTRON ACER TENDL-2019 LIBRARY; T=293.16K
alphas from (n,2n)a

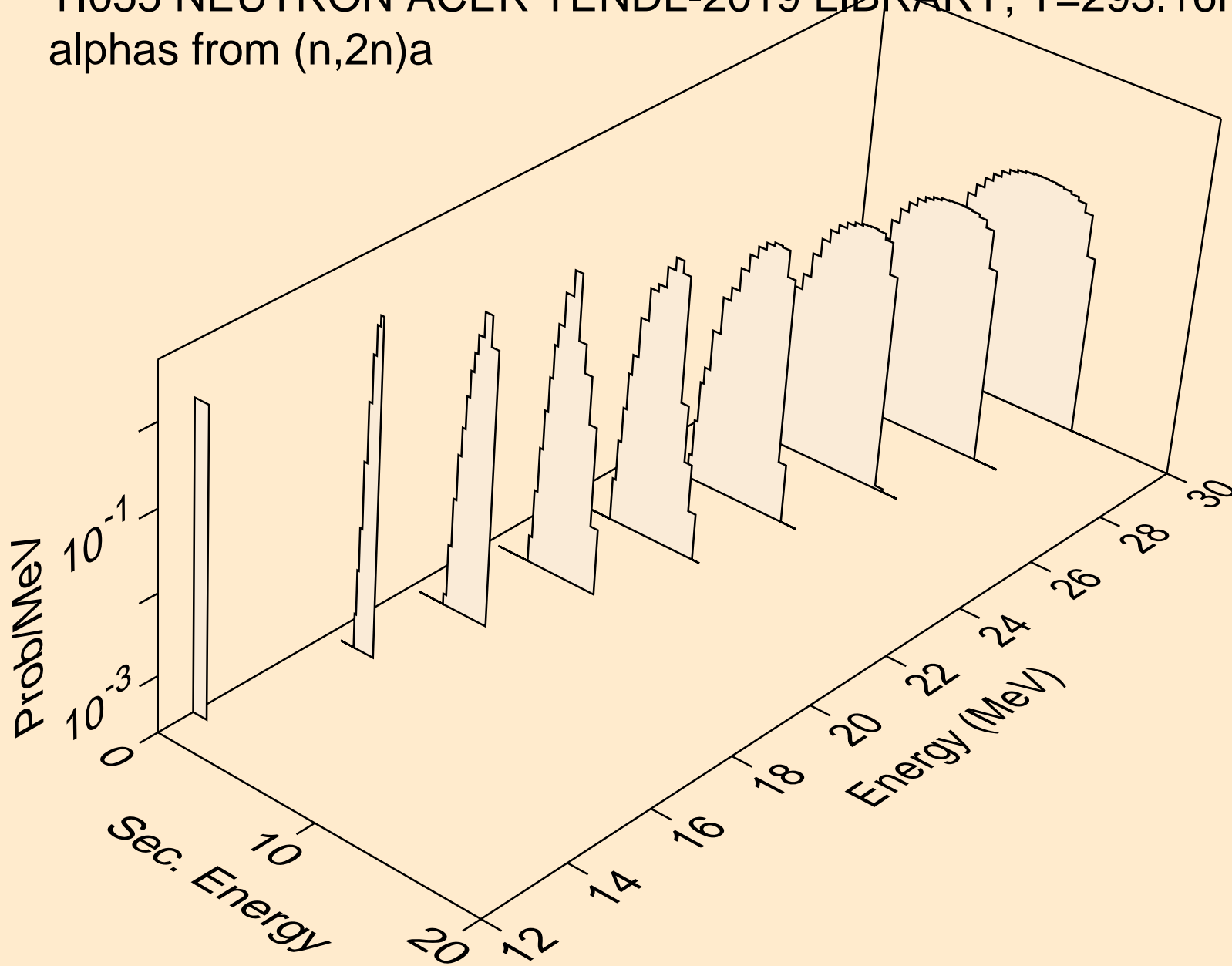

TI055 NEUTRON ACER TENDL-2019 LIBRARY; T=293.16K
alphas from (n,3n)a

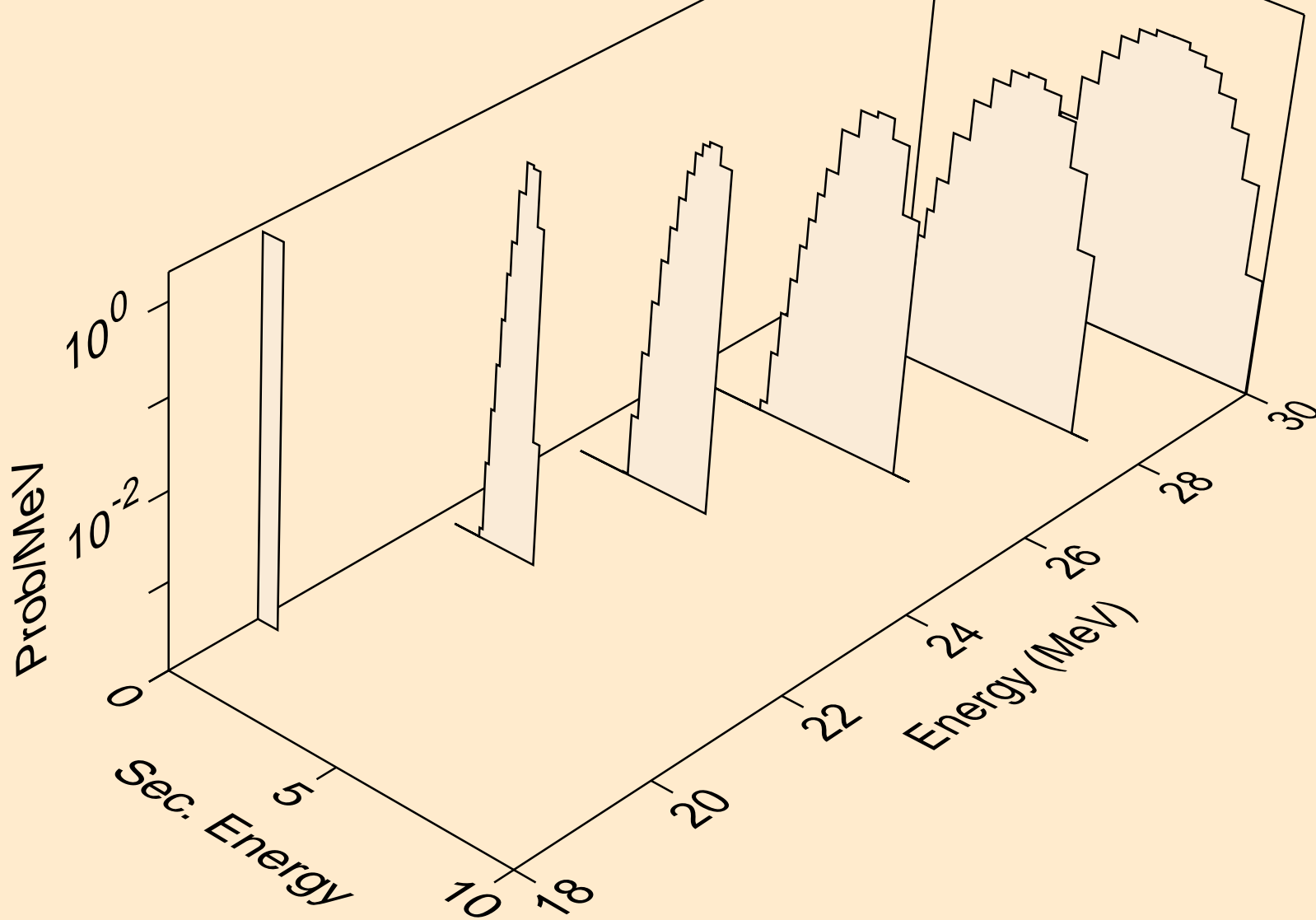

TI055 NEUTRON ACER TENDL-2019 LIBRARY; T=293.16K
alphas from (n,a)

