

TL183 NEUTRON ACER TENDL-2019 LIBRARY; T=293.16K
Principal cross sections

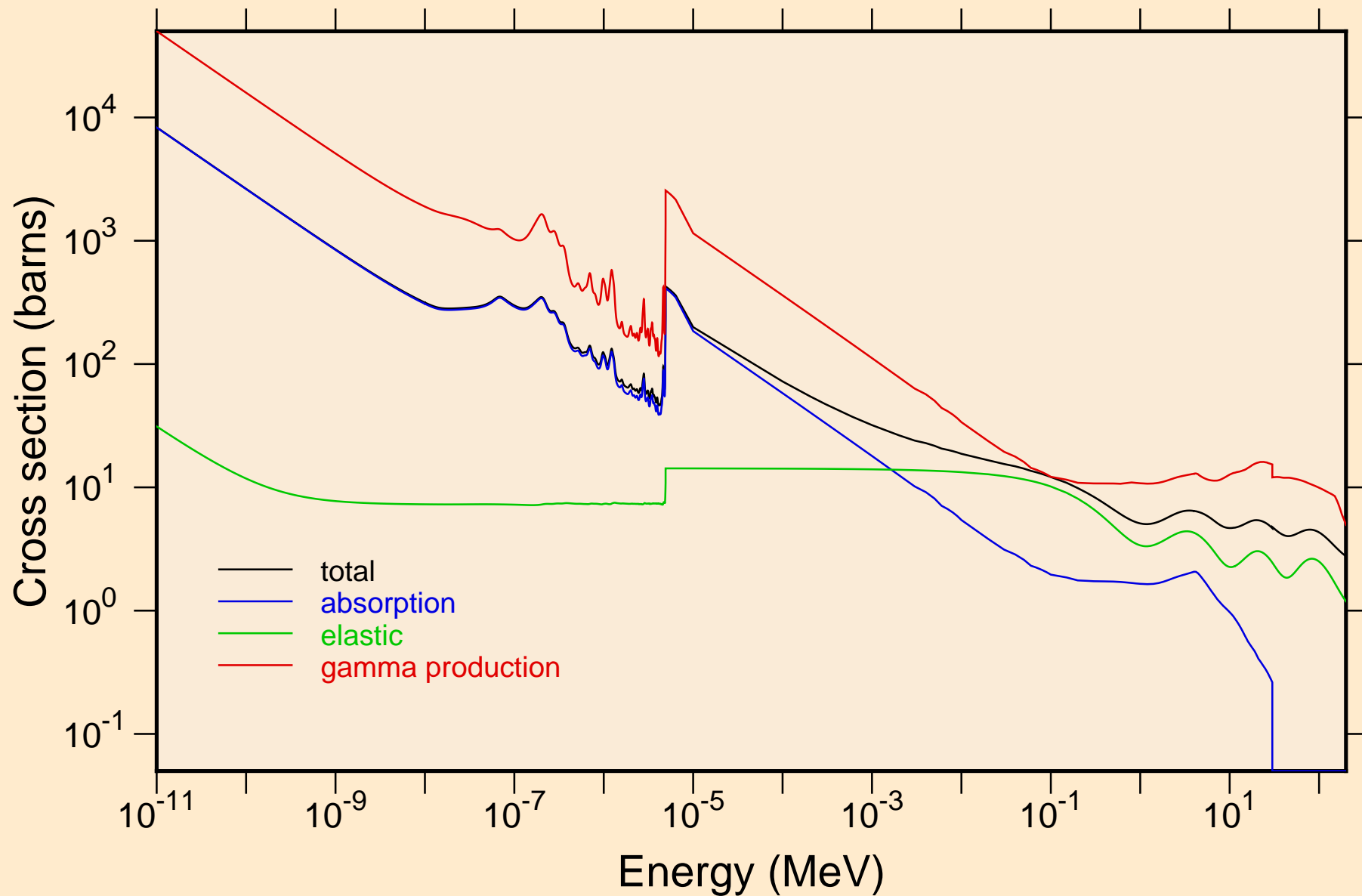

TL183 NEUTRON ACER TENDL-2019 LIBRARY; T=293.16K
resonance total cross section

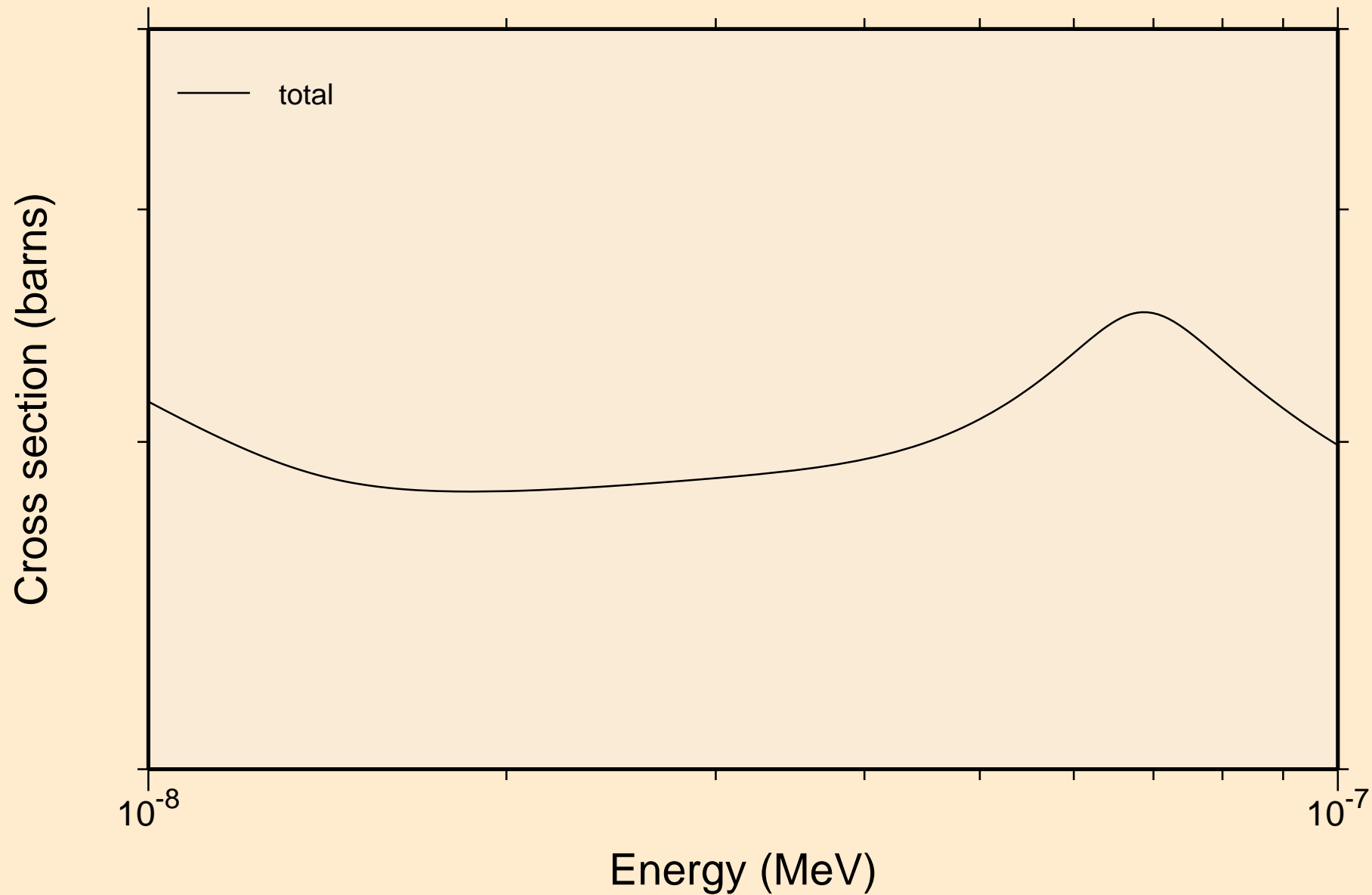

TL183 NEUTRON ACER TENDL-2019 LIBRARY; T=293.16K
resonance total cross section

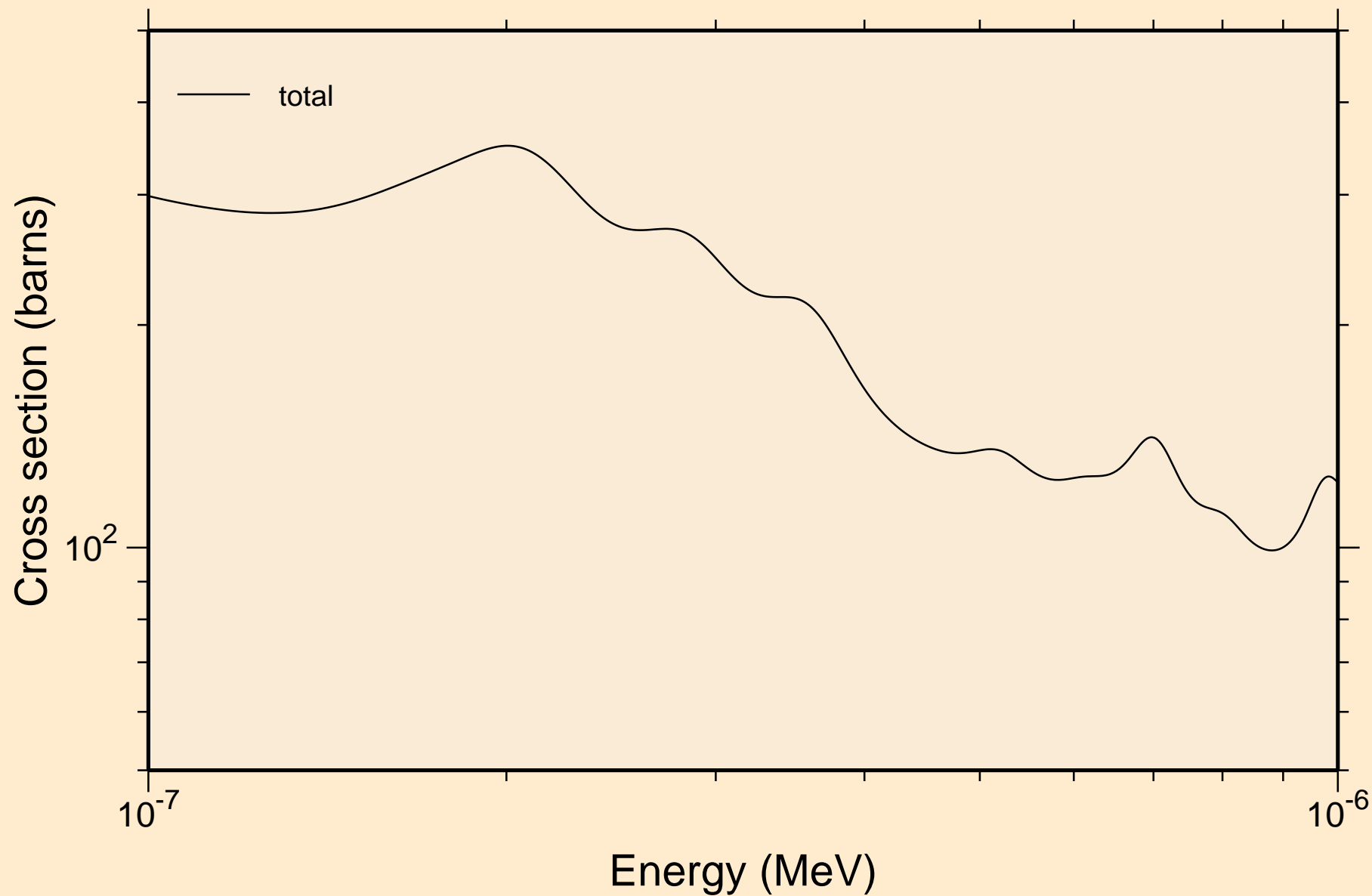

TL183 NEUTRON ACER TENDL-2019 LIBRARY; T=293.16K
resonance total cross section

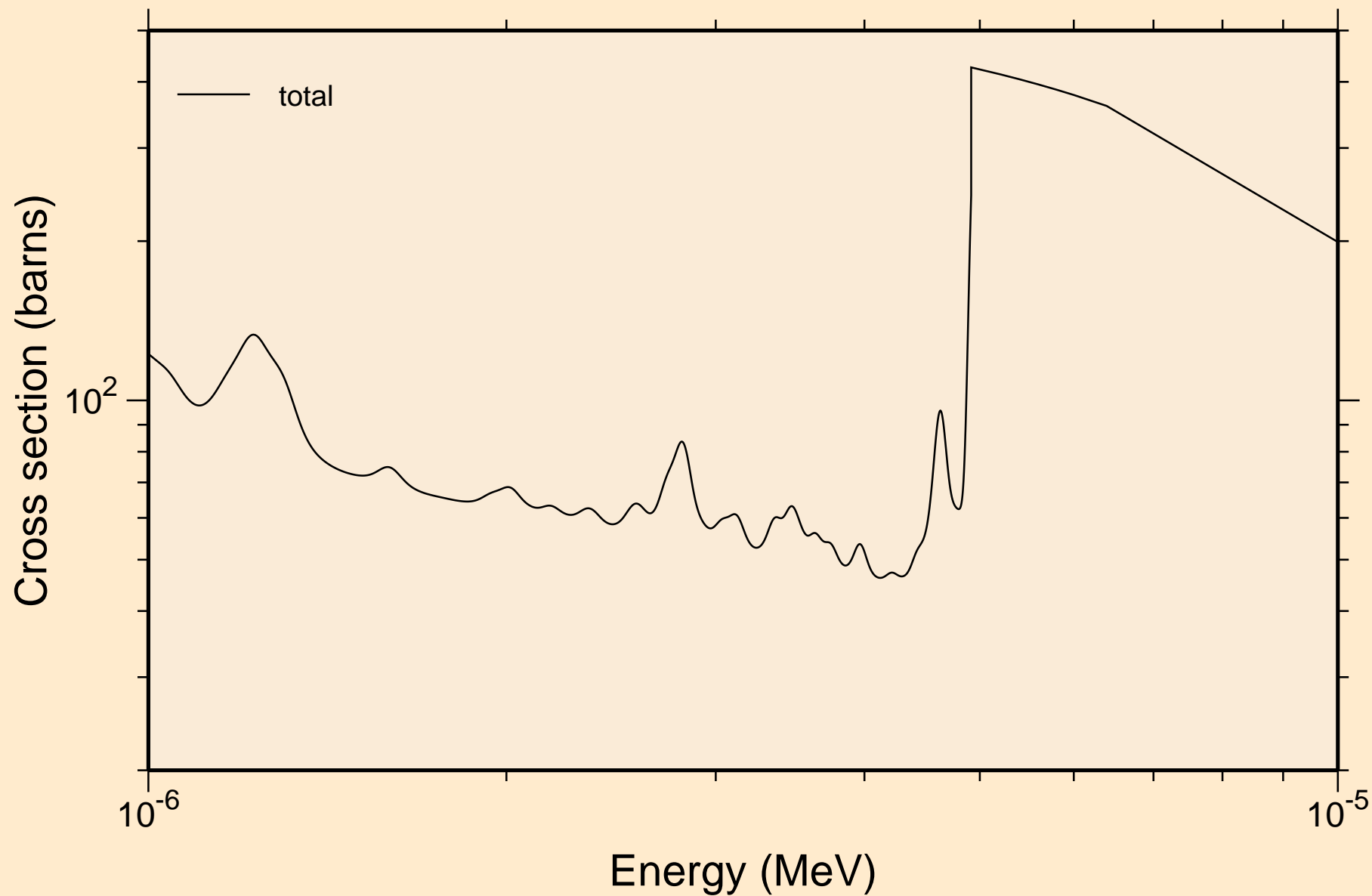

TL183 NEUTRON ACER TENDL-2019 LIBRARY; T=293.16K
resonance total cross section

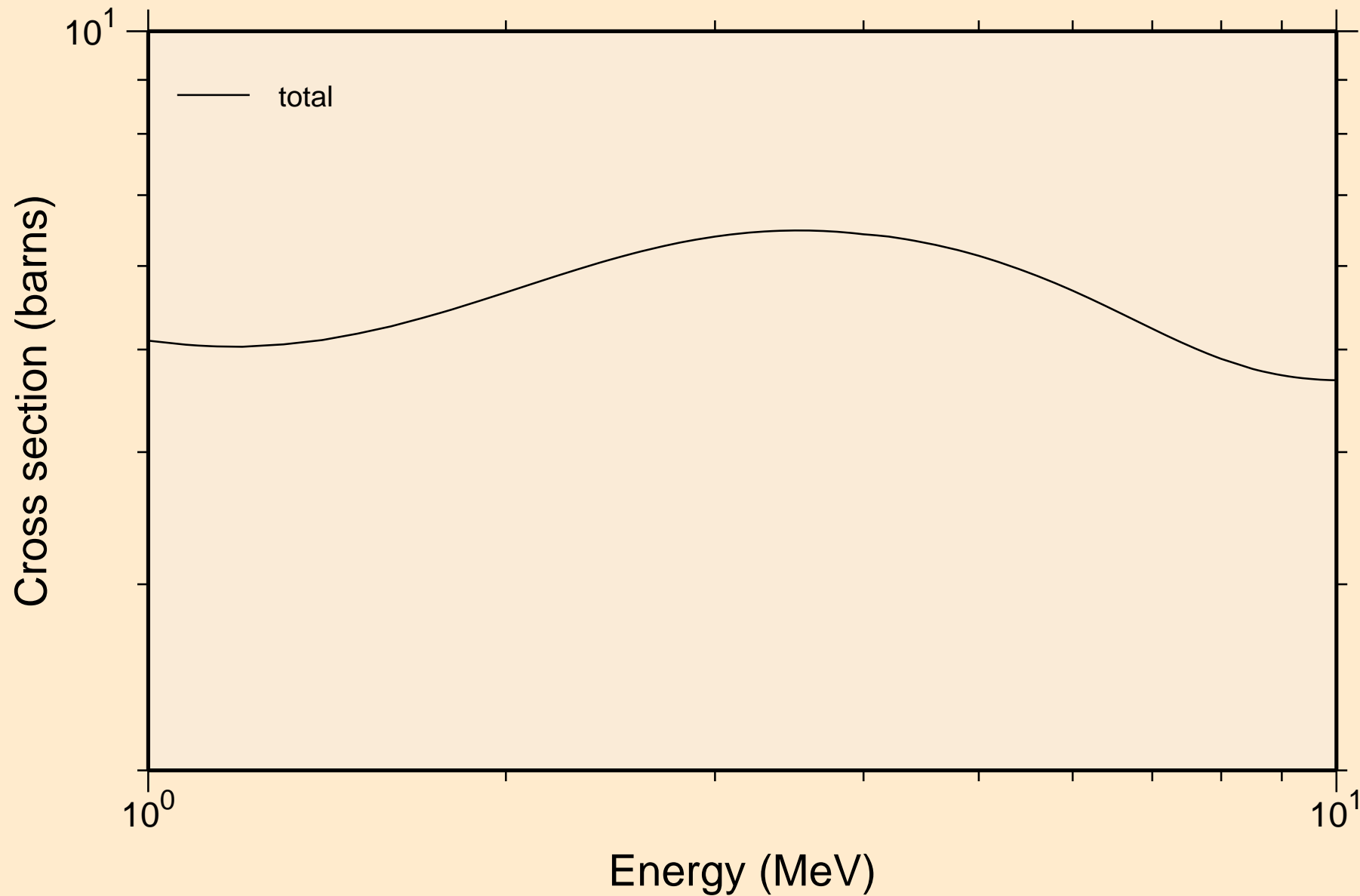

TL183 NEUTRON ACER TENDL-2019 LIBRARY; T=293.16K
resonance absorption cross sections

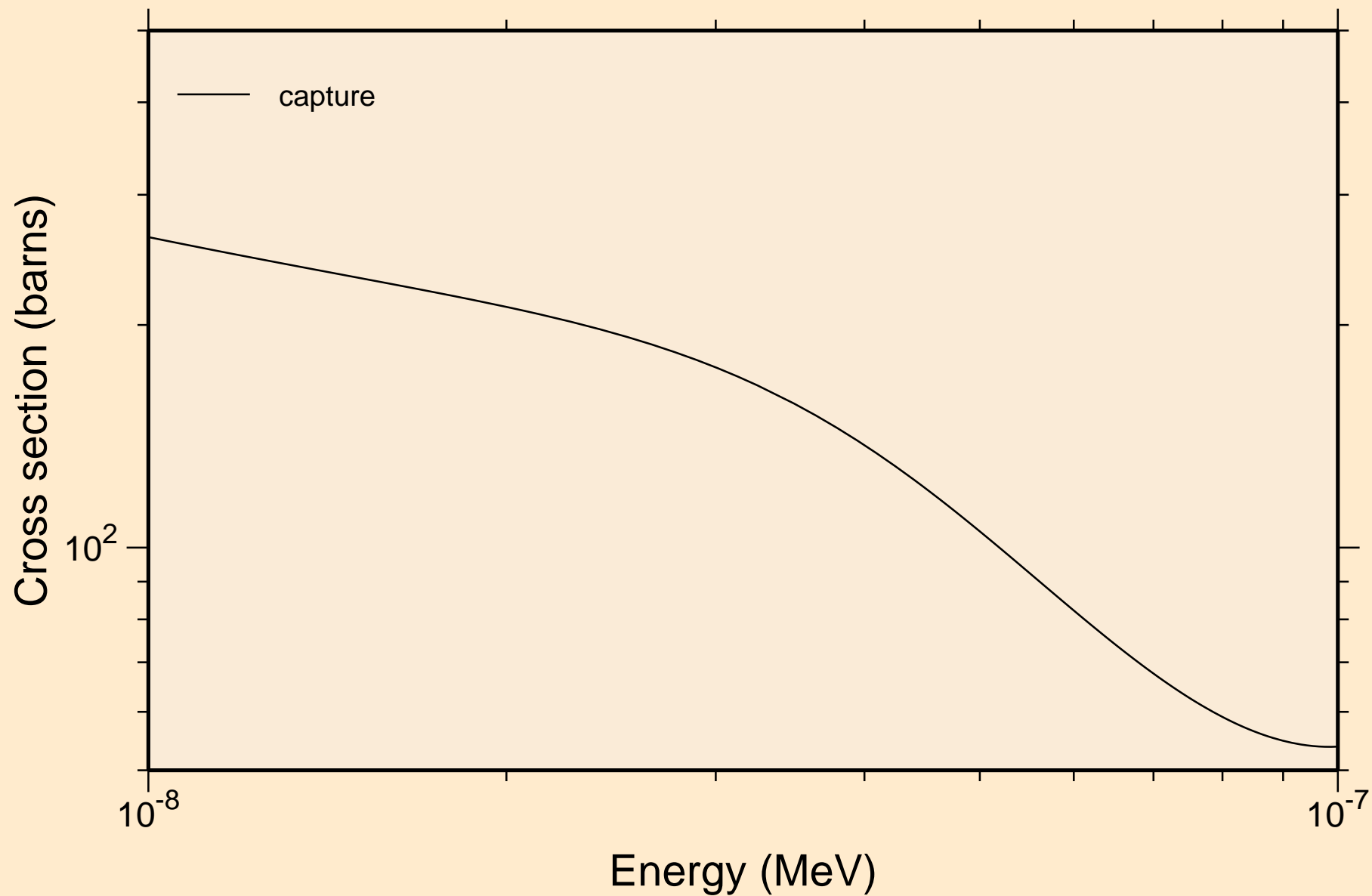

TL183 NEUTRON ACER TENDL-2019 LIBRARY; T=293.16K
resonance absorption cross sections

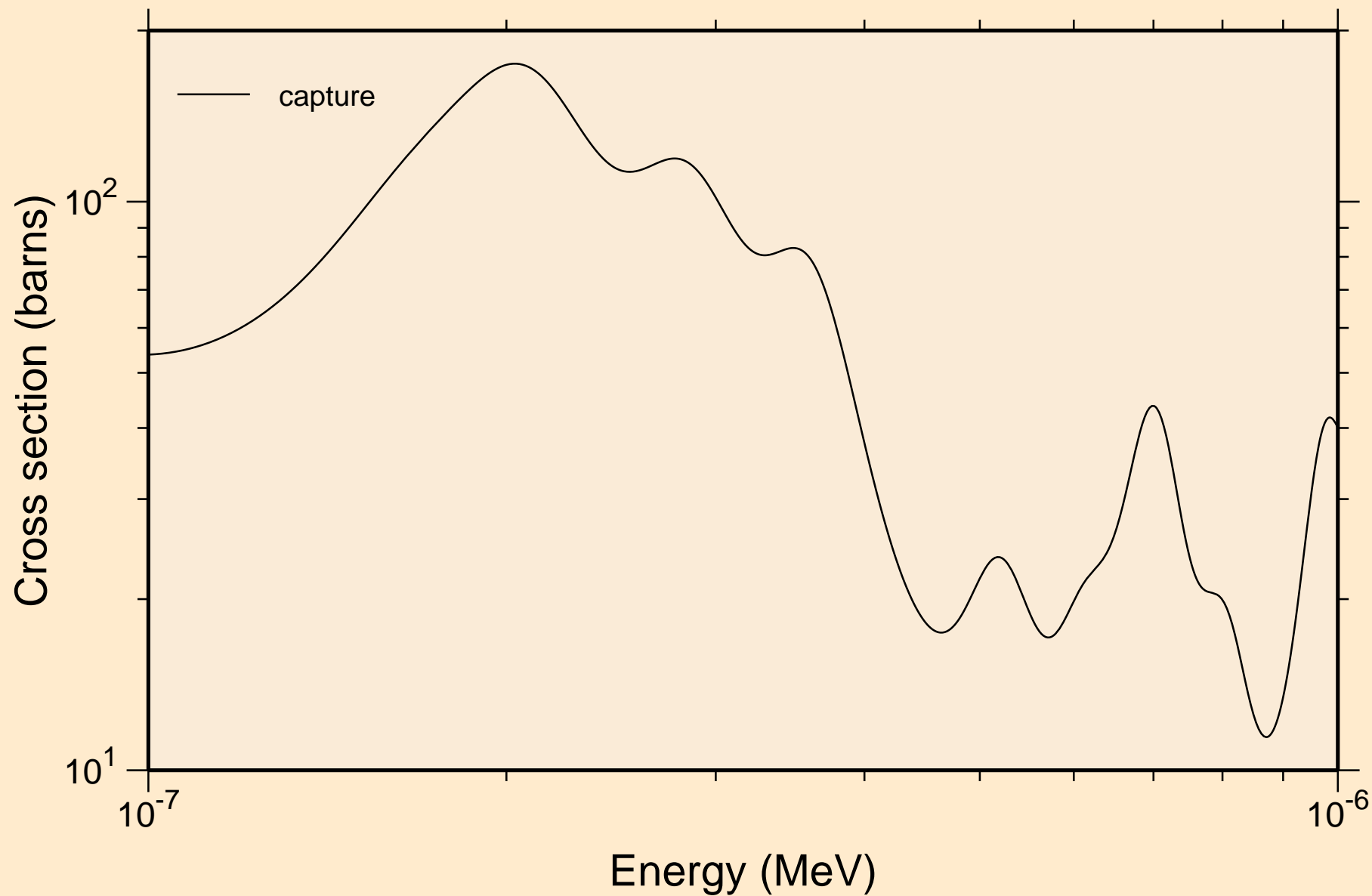

TL183 NEUTRON ACER TENDL-2019 LIBRARY; T=293.16K
resonance absorption cross sections

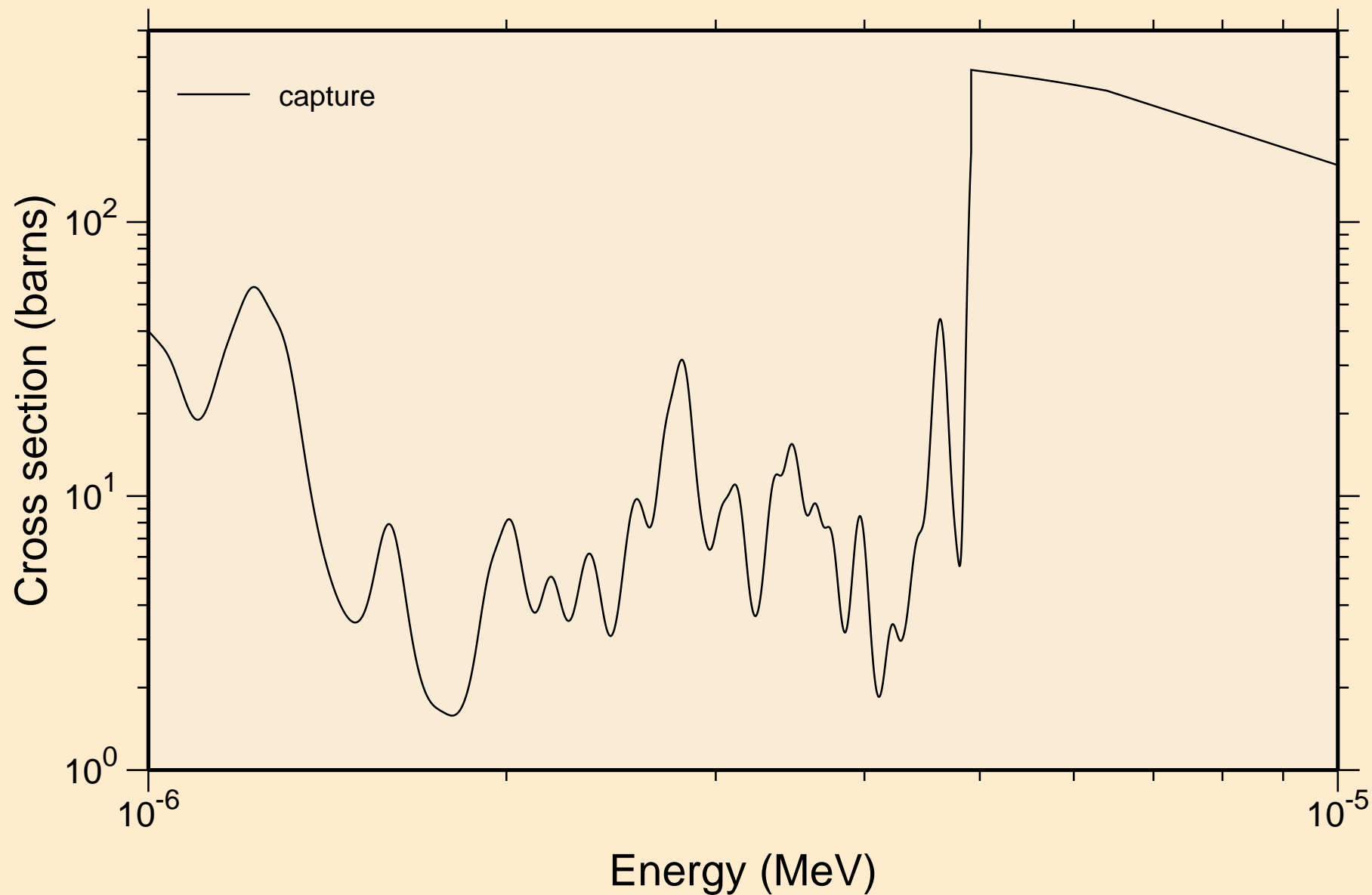

TL183 NEUTRON ACER TENDL-2019 LIBRARY; T=293.16K
resonance absorption cross sections

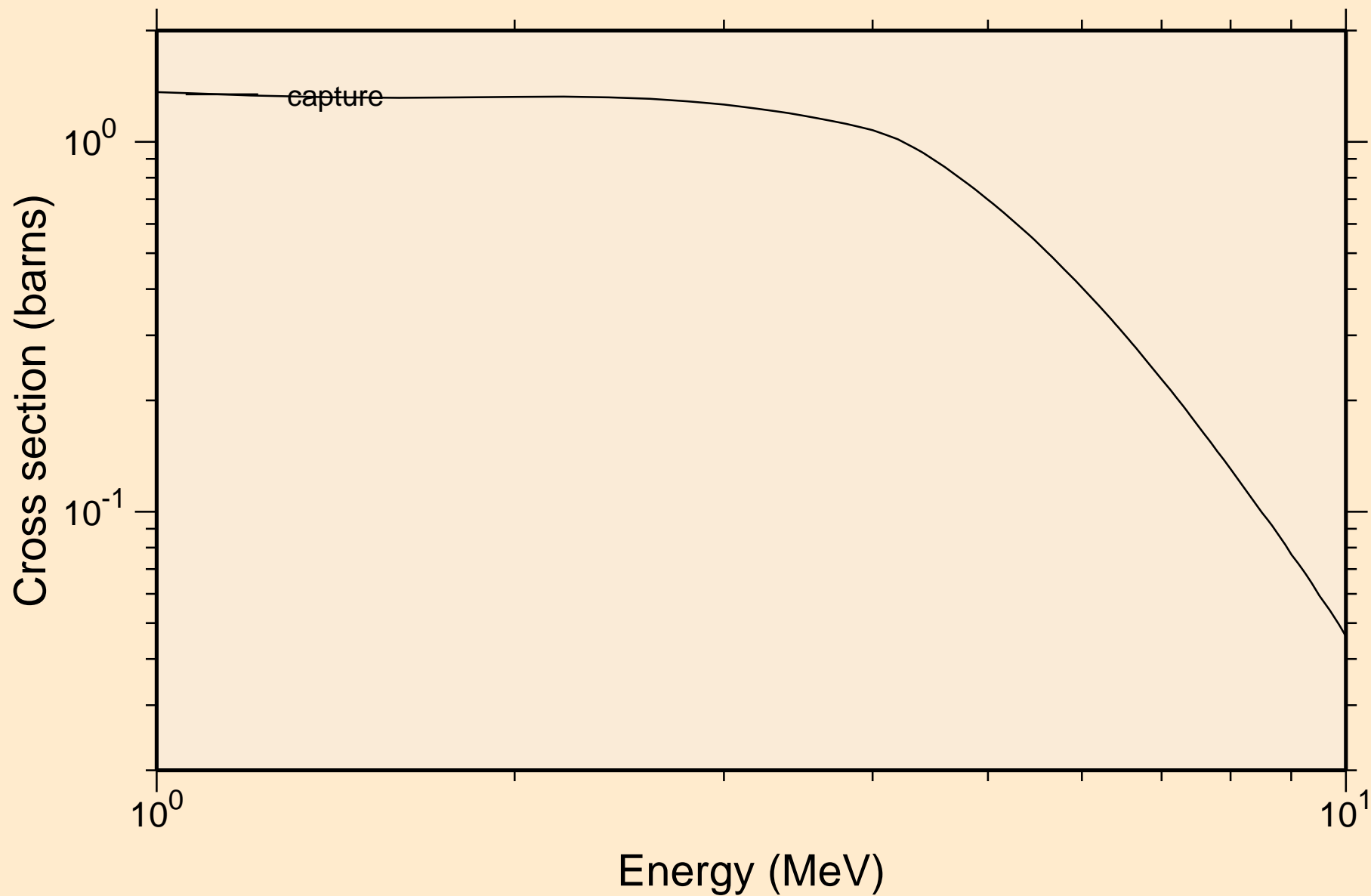

TL183 NEUTRON ACER TENDL-2019 LIBRARY; T=293.16K
Heating

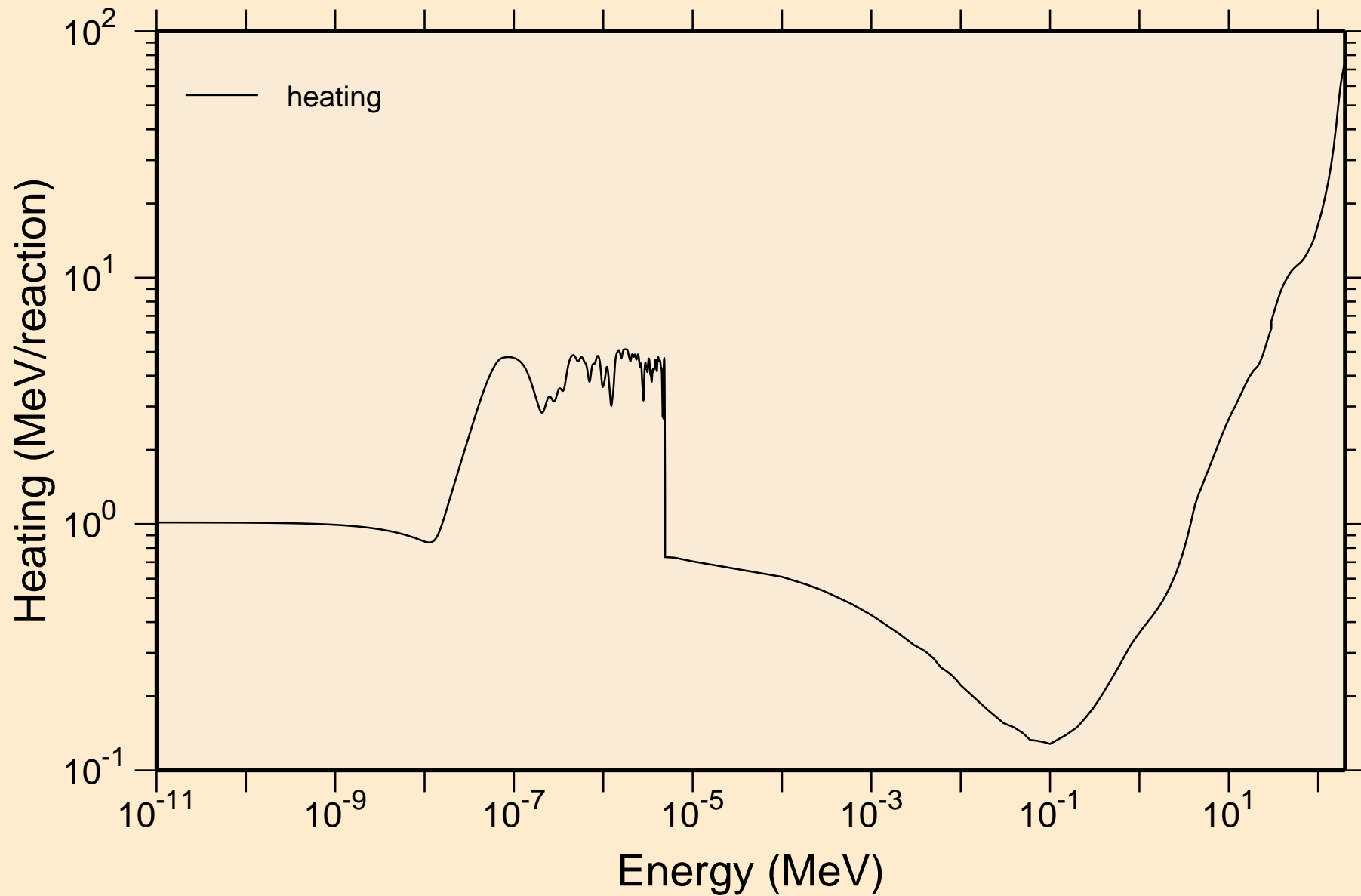

TL183 NEUTRON ACER TENDL-2019 LIBRARY; T=293.16K
Damage

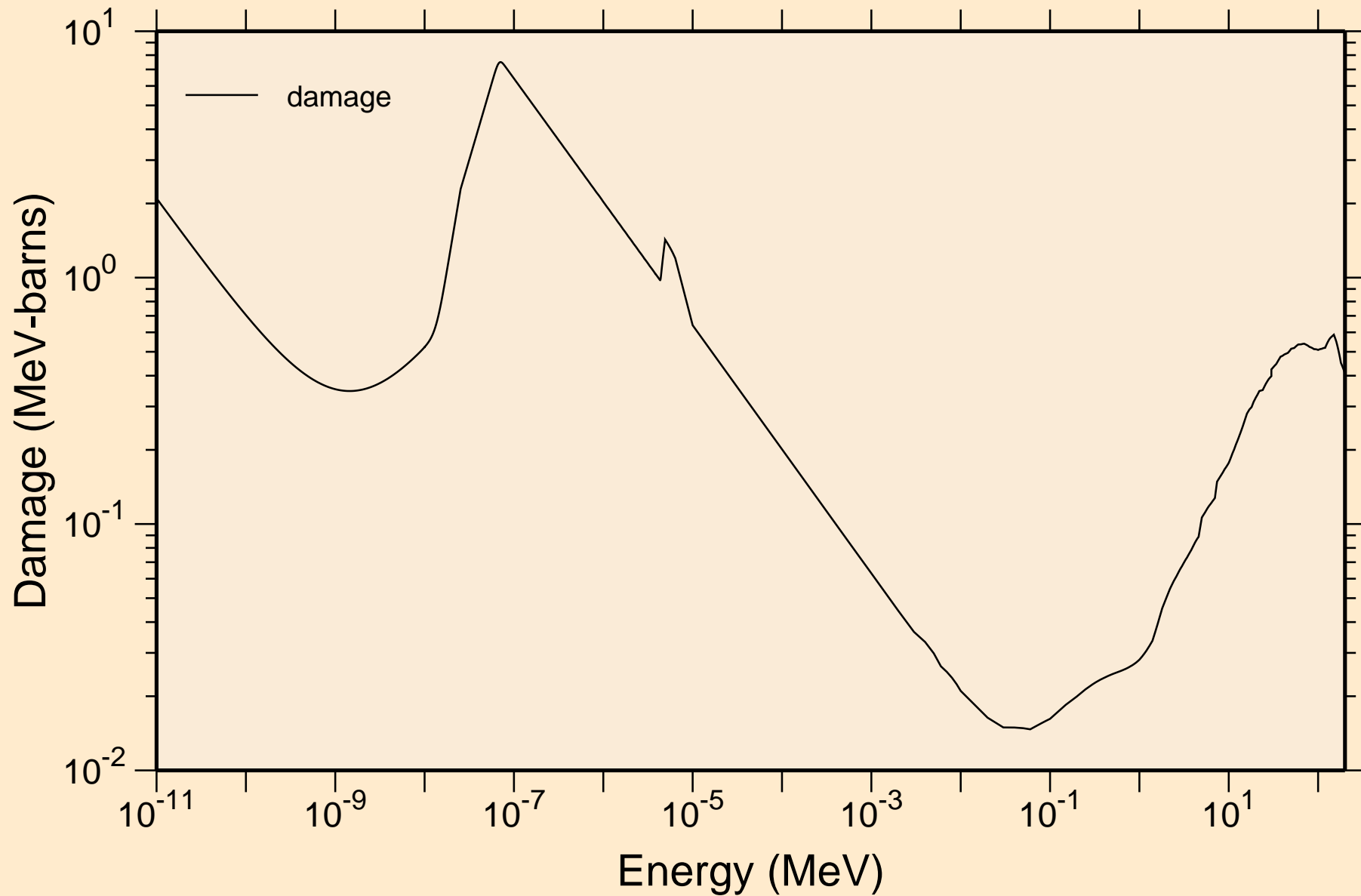

TL183 NEUTRON ACER TENDL-2019 LIBRARY; T=293.16K
Non-threshold reactions

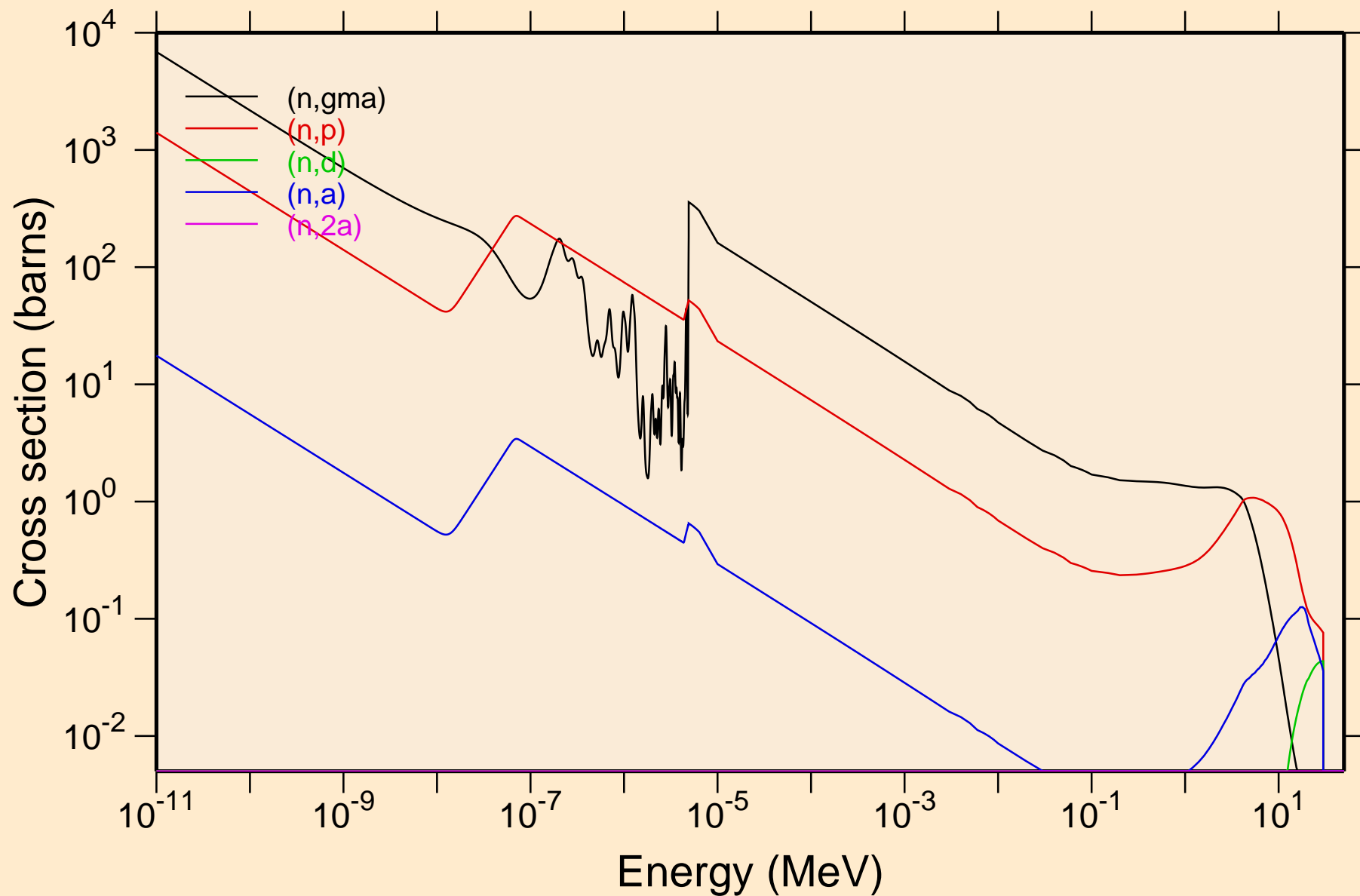

TL183 NEUTRON ACER TENDL-2019 LIBRARY; T=293.16K
Non-threshold reactions

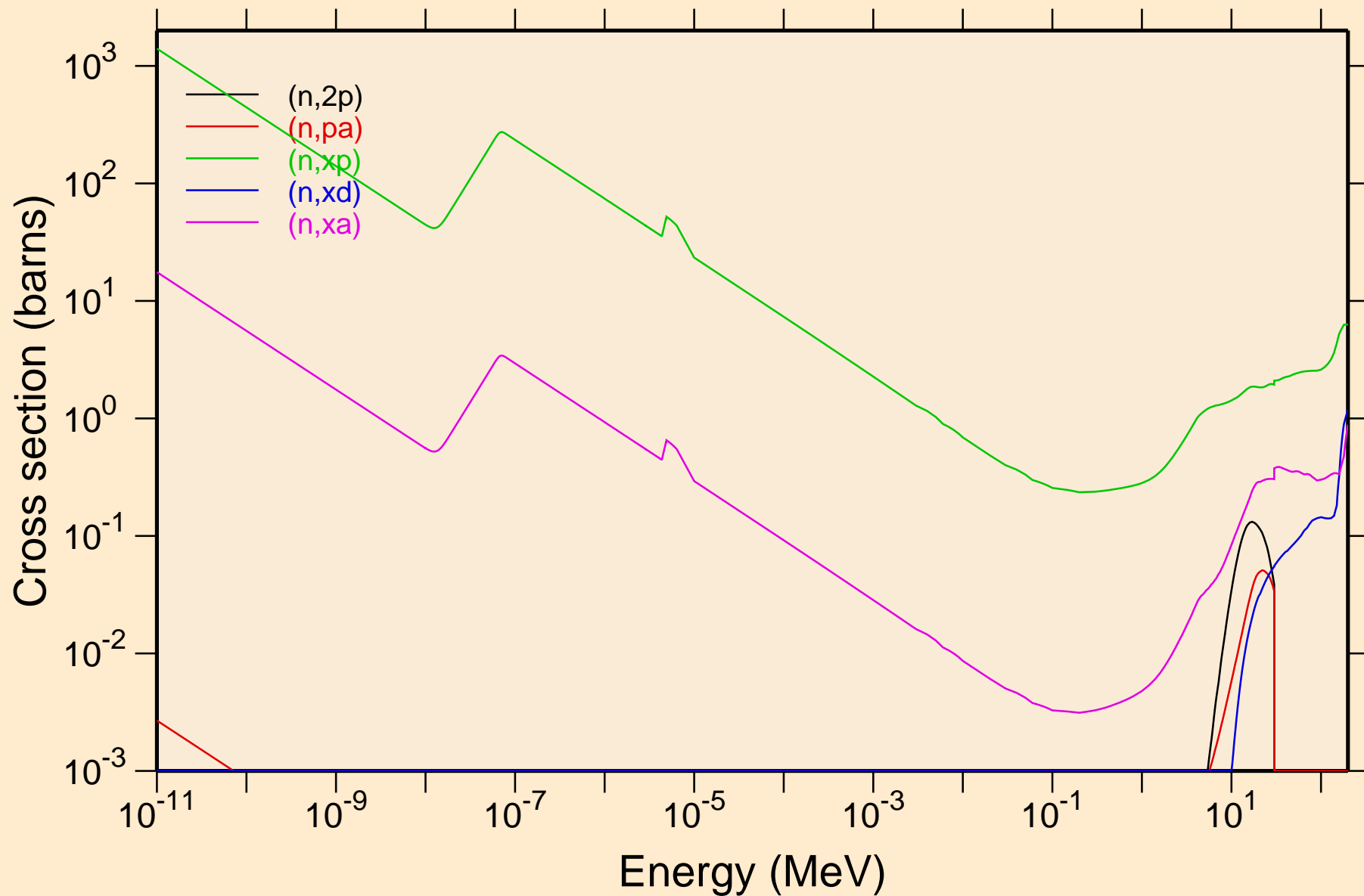

TL183 NEUTRON ACER TENDL-2019 LIBRARY; T=293.16K
Principal cross sections

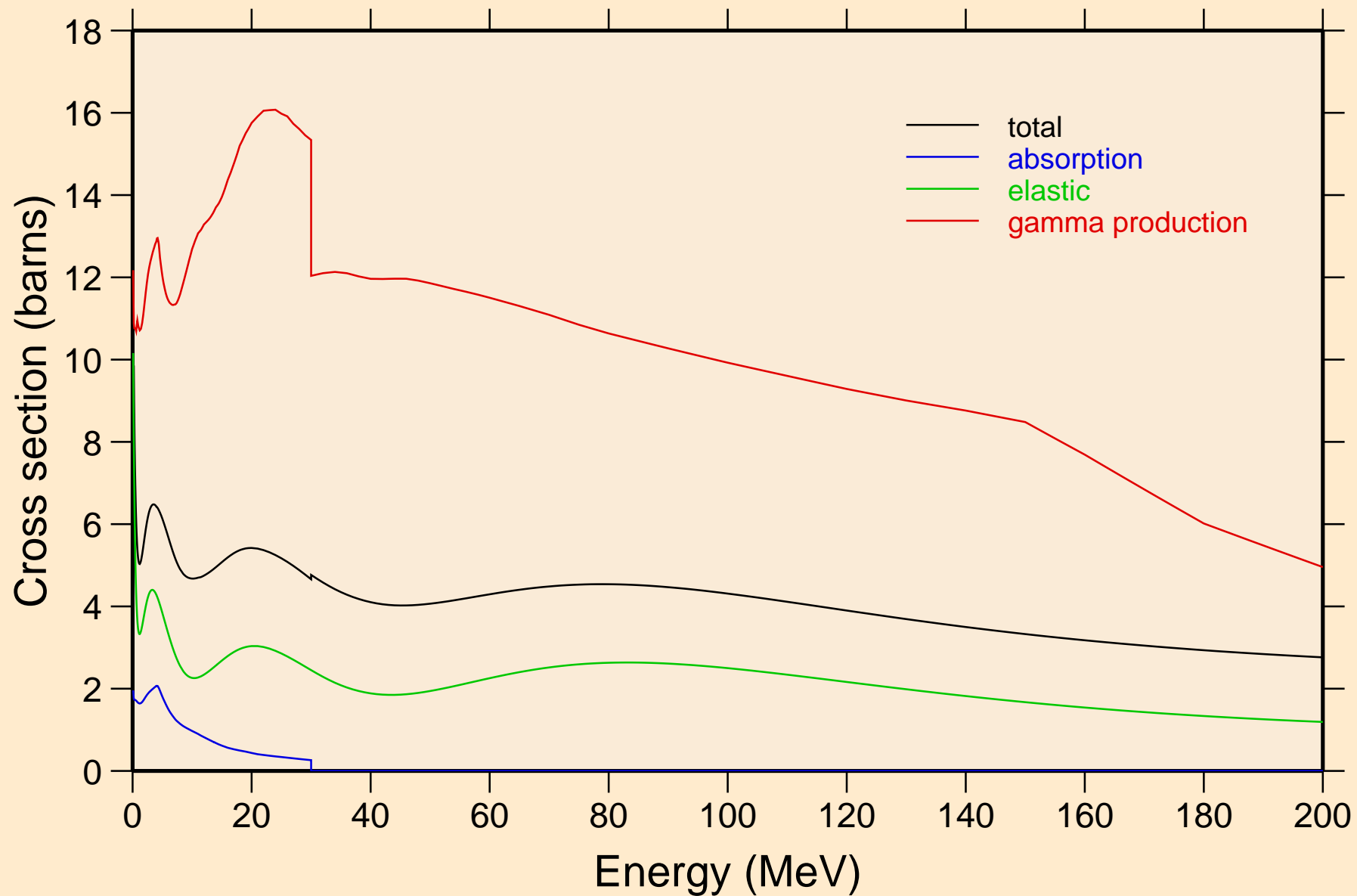

TL183 NEUTRON ACER TENDL-2019 LIBRARY; T=293.16K
Heating

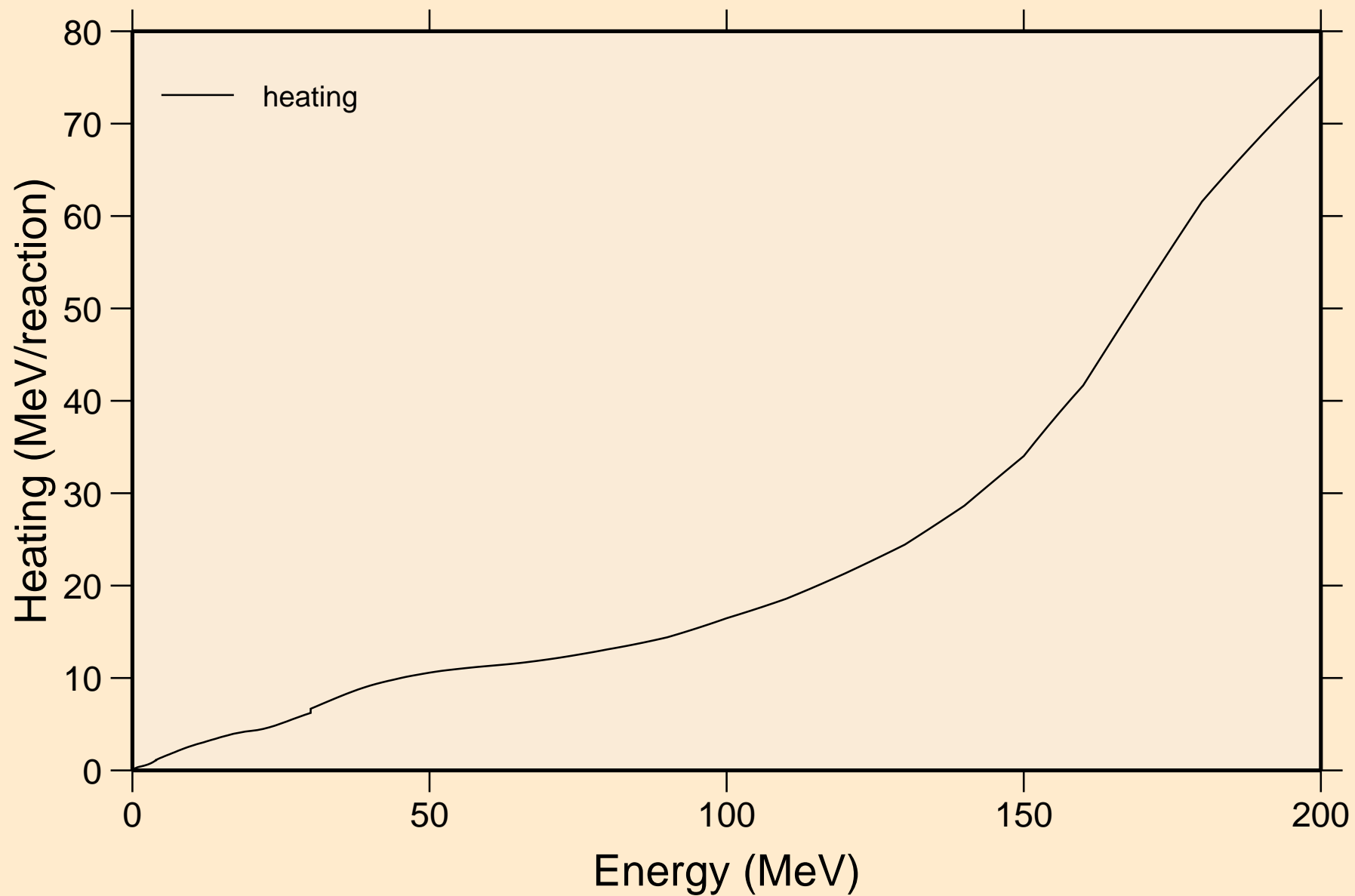

TL183 NEUTRON ACER TENDL-2019 LIBRARY; T=293.16K
Damage

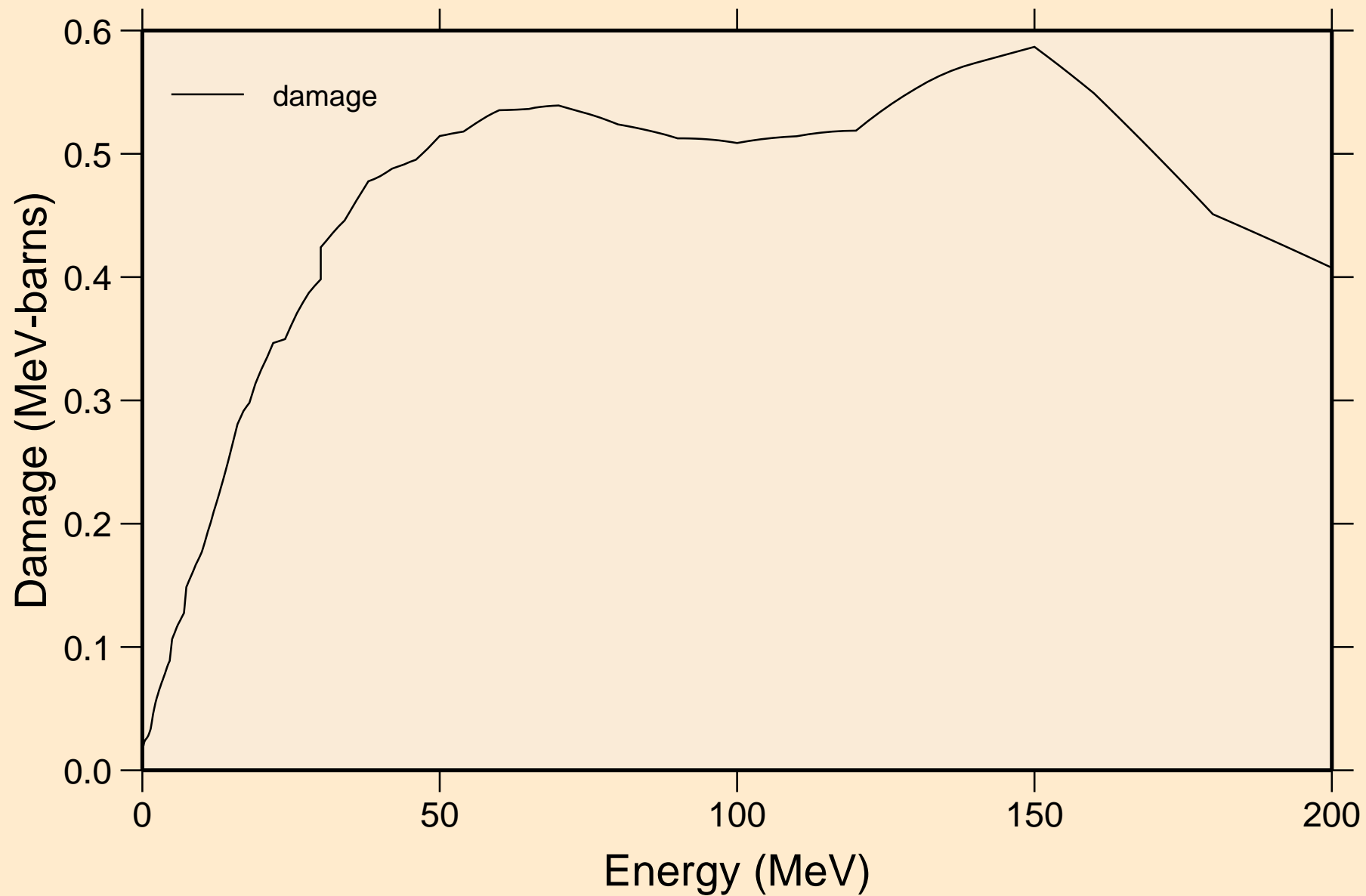

TL183 NEUTRON ACER TENDL-2019 LIBRARY; T=293.16K
Non-threshold reactions

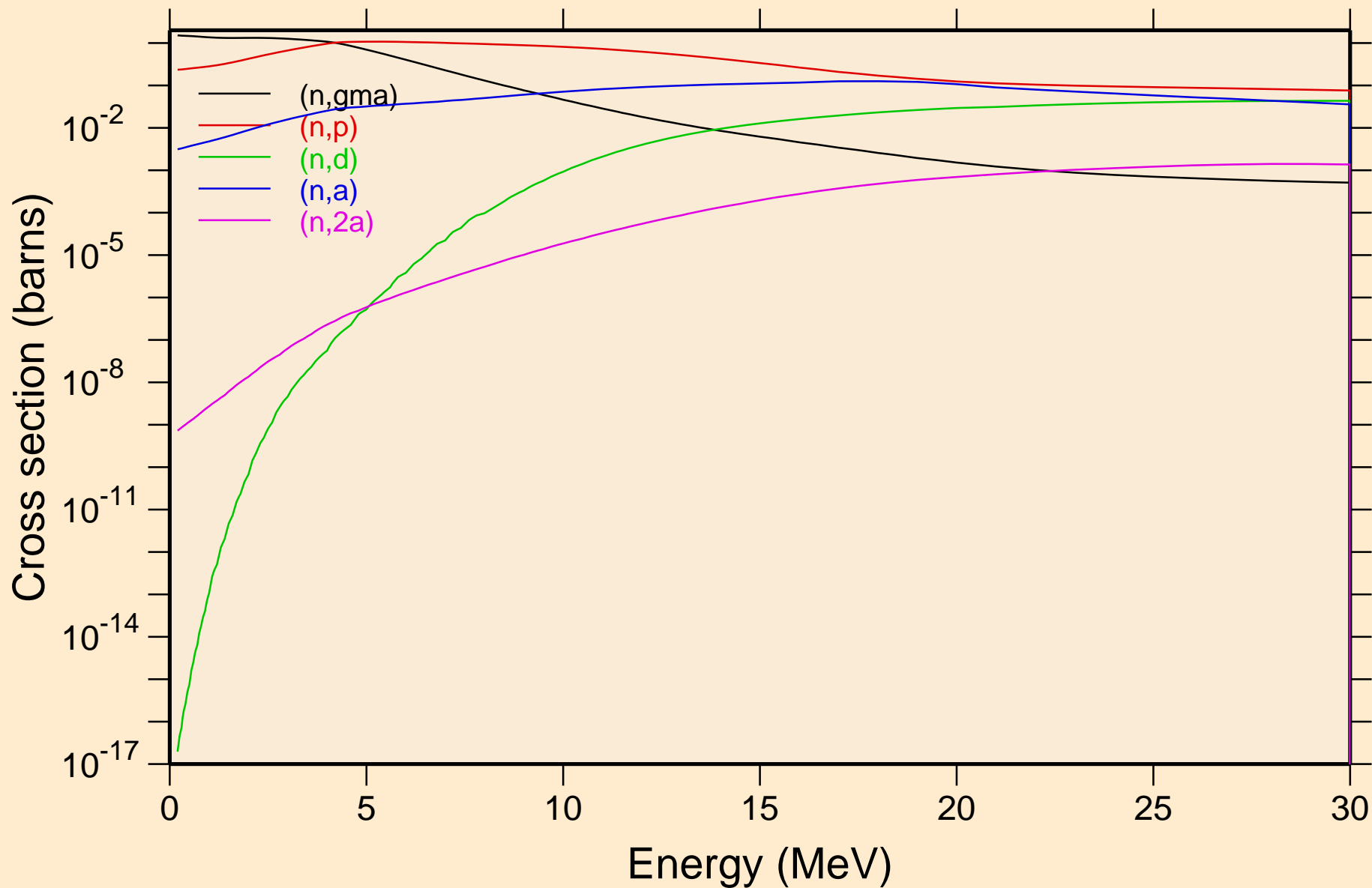

TL183 NEUTRON ACER TENDL-2019 LIBRARY; T=293.16K
Non-threshold reactions

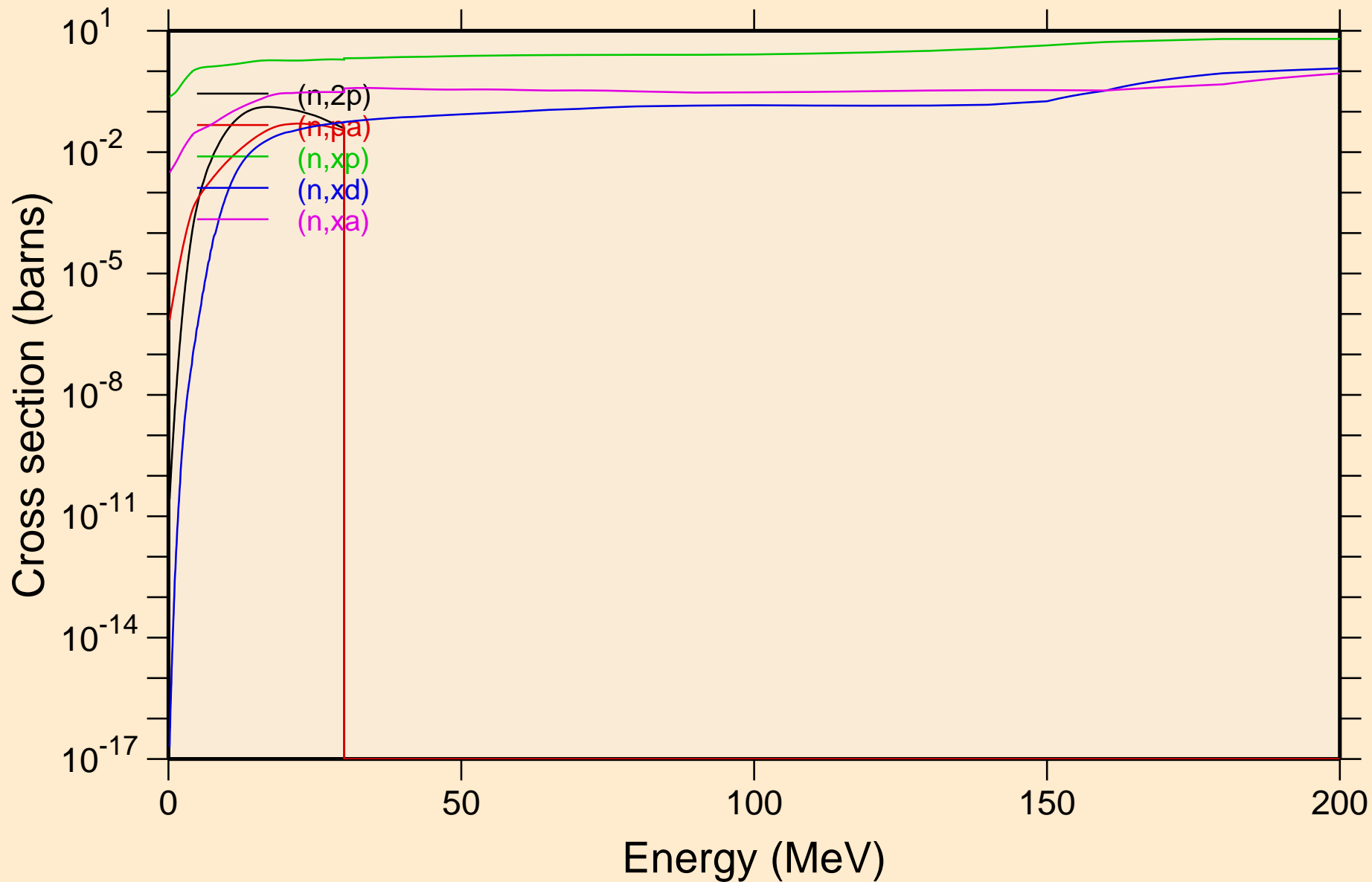

TL183 NEUTRON ACER TENDL-2019 LIBRARY; T=293.16K
Inelastic levels

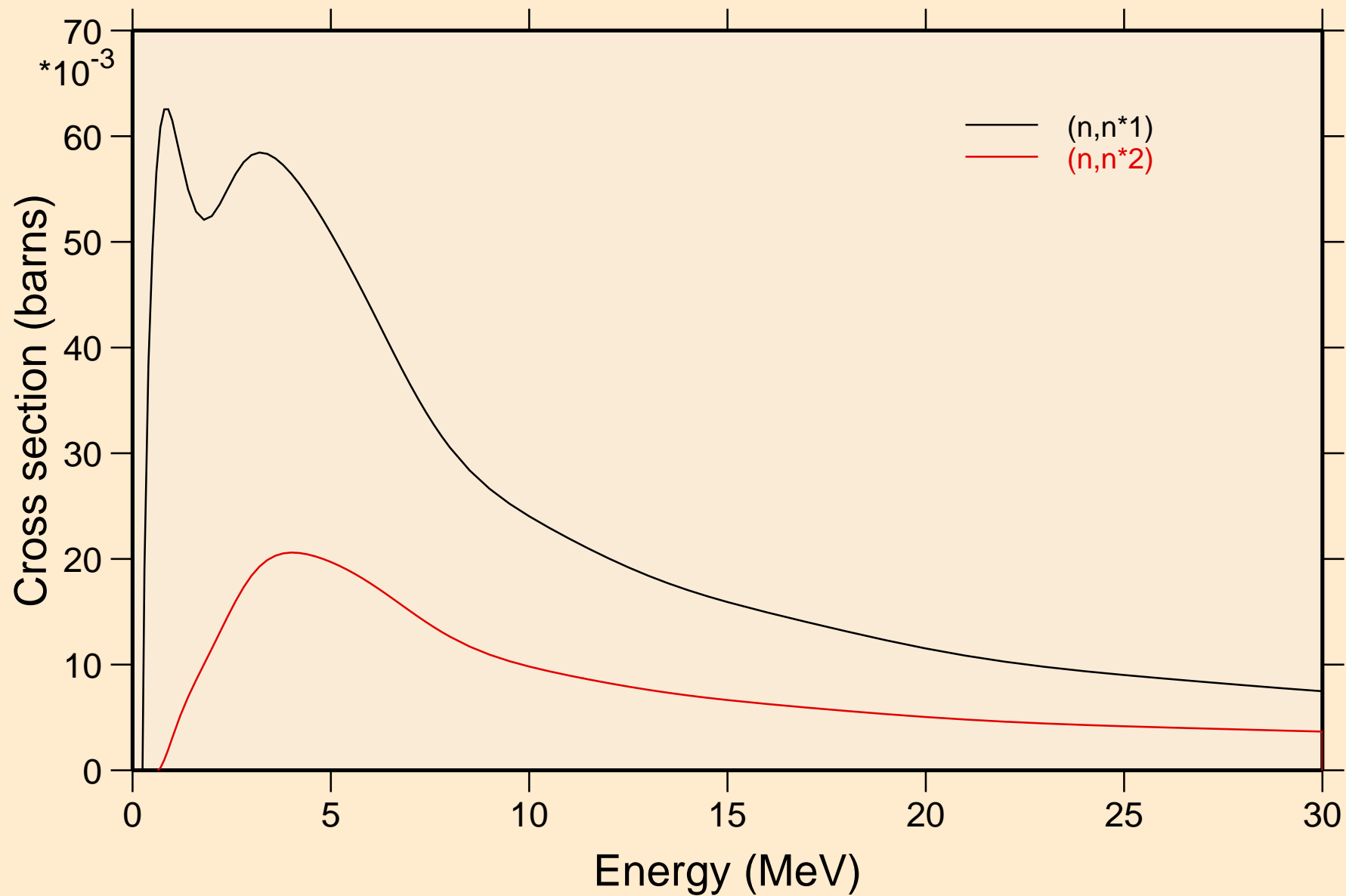

TL183 NEUTRON ACER TENDL-2019 LIBRARY; T=293.16K
Threshold reactions

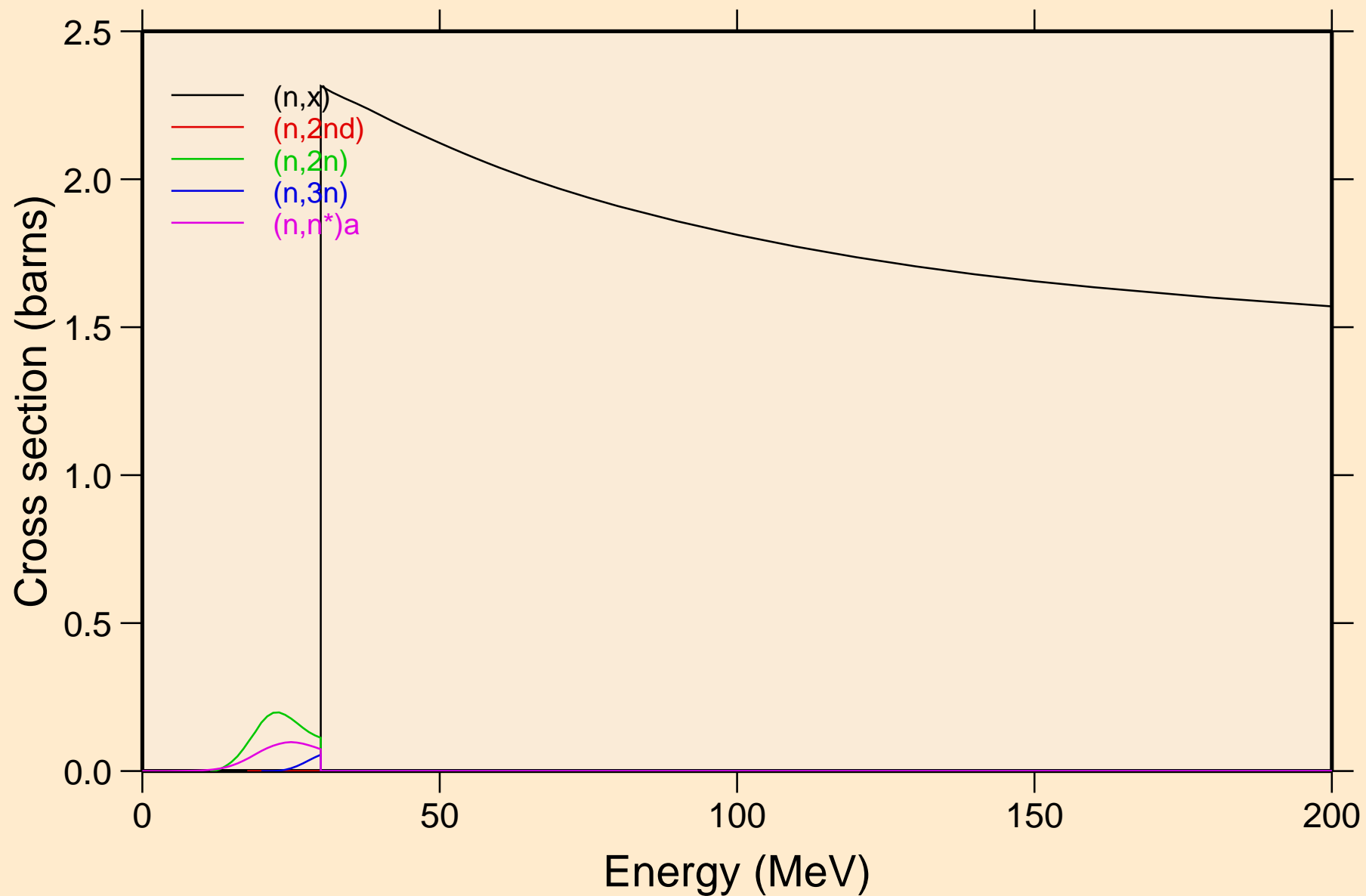

TL183 NEUTRON ACER TENDL-2019 LIBRARY; T=293.16K
Threshold reactions

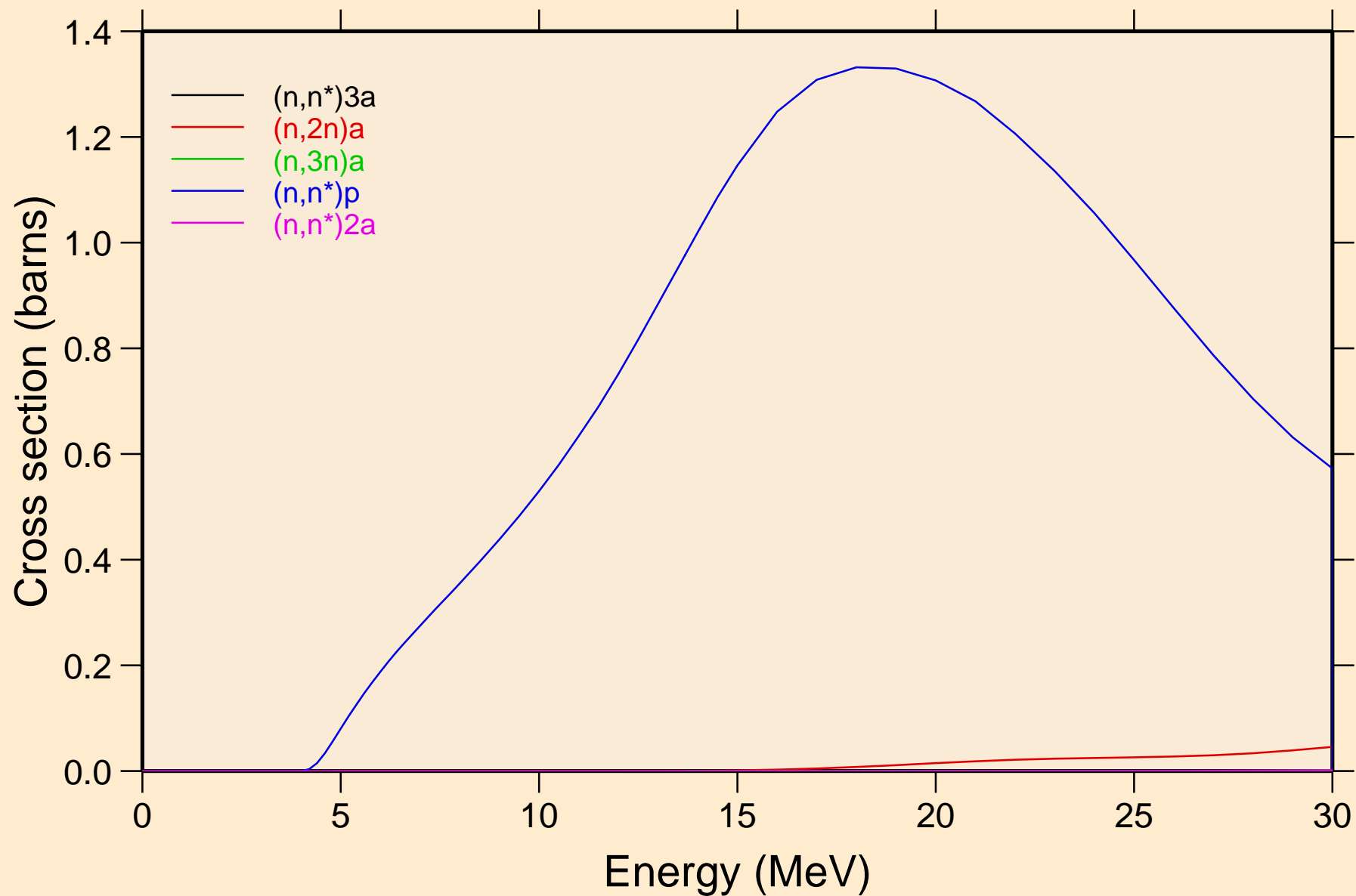

TL183 NEUTRON ACER TENDL-2019 LIBRARY; T=293.16K
Threshold reactions

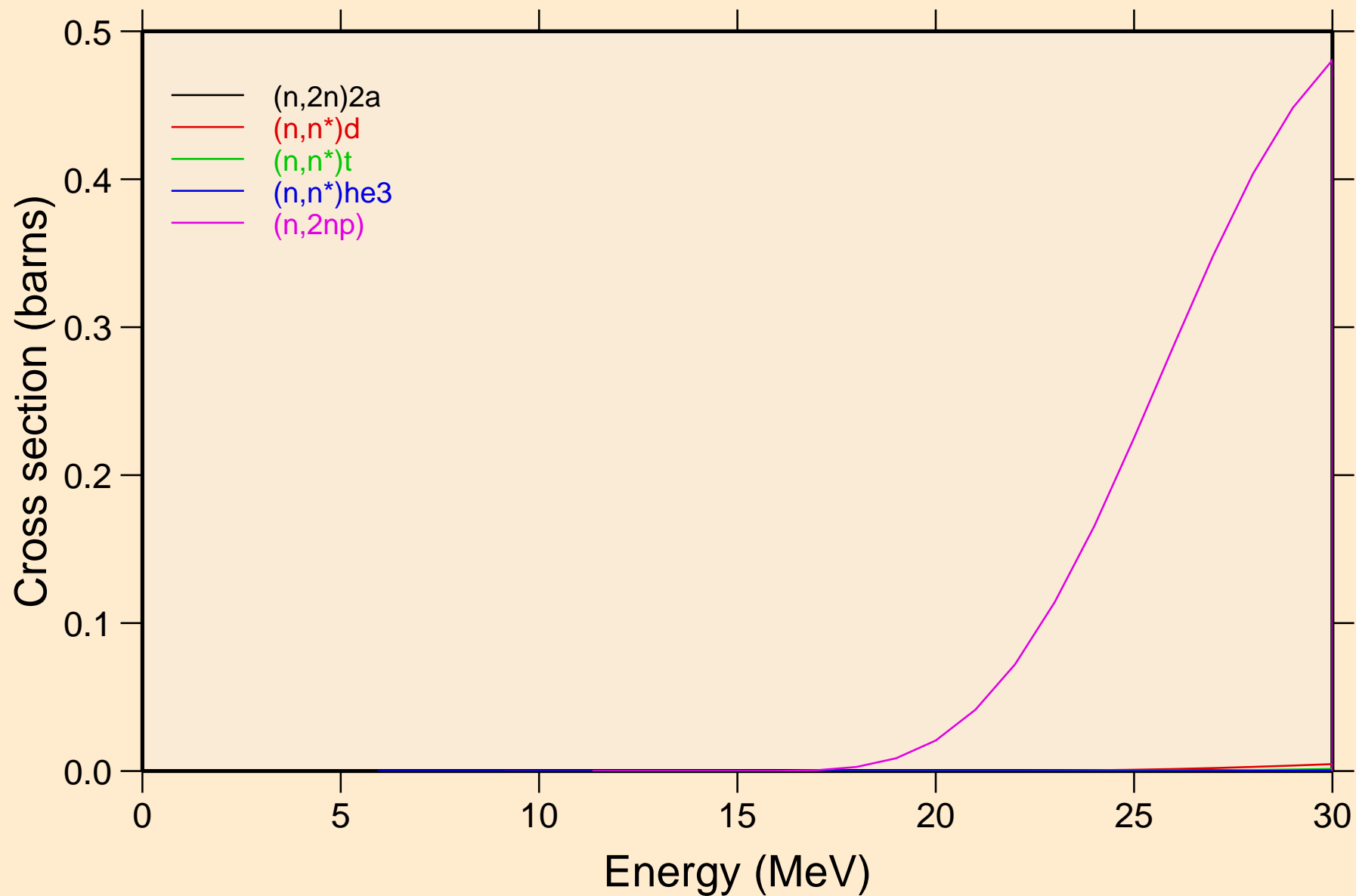

TL183 NEUTRON ACER TENDL-2019 LIBRARY; T=293.16K
Threshold reactions

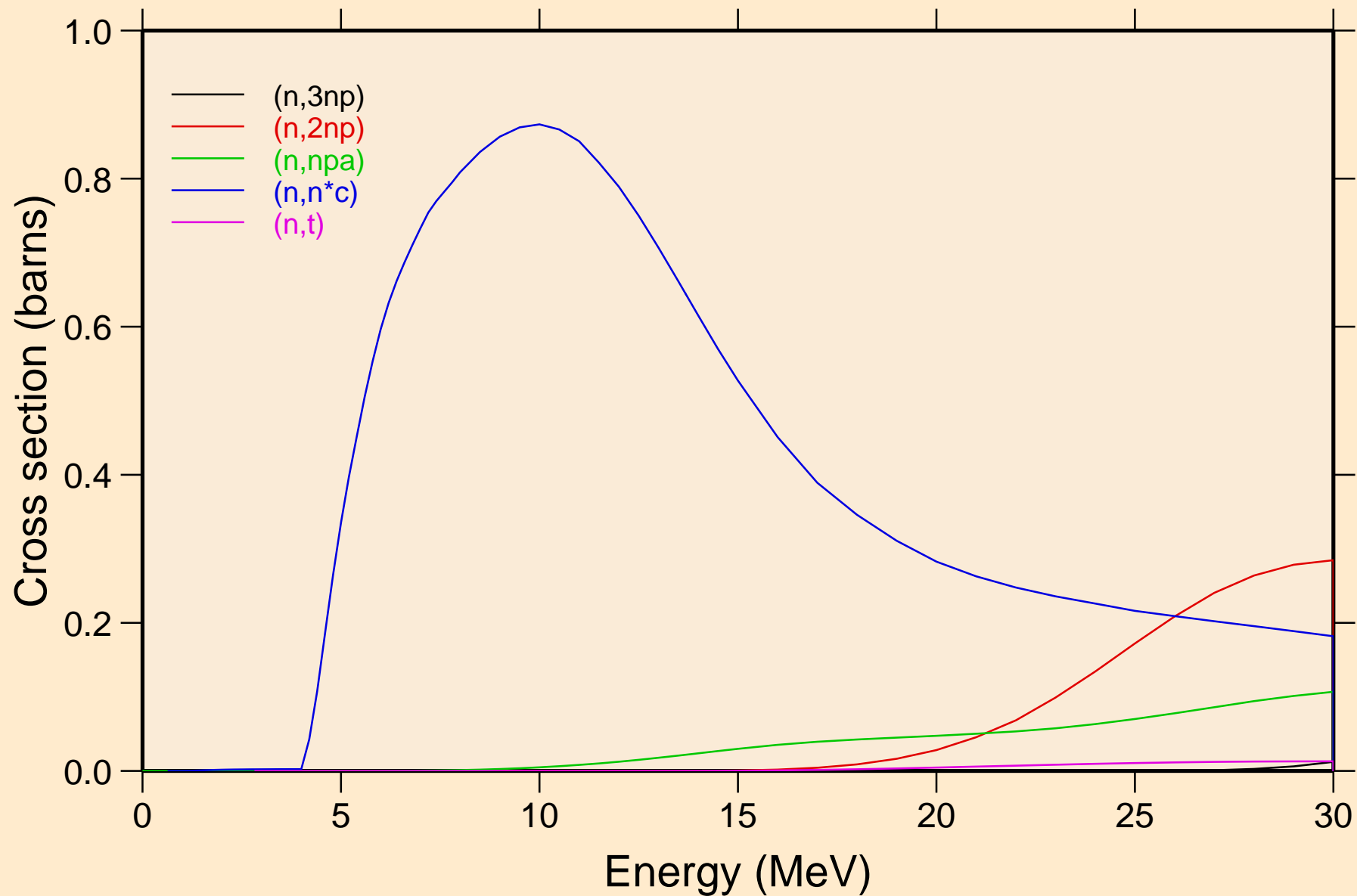

TL183 NEUTRON ACER TENDL-2019 LIBRARY; T=293.16K
Threshold reactions

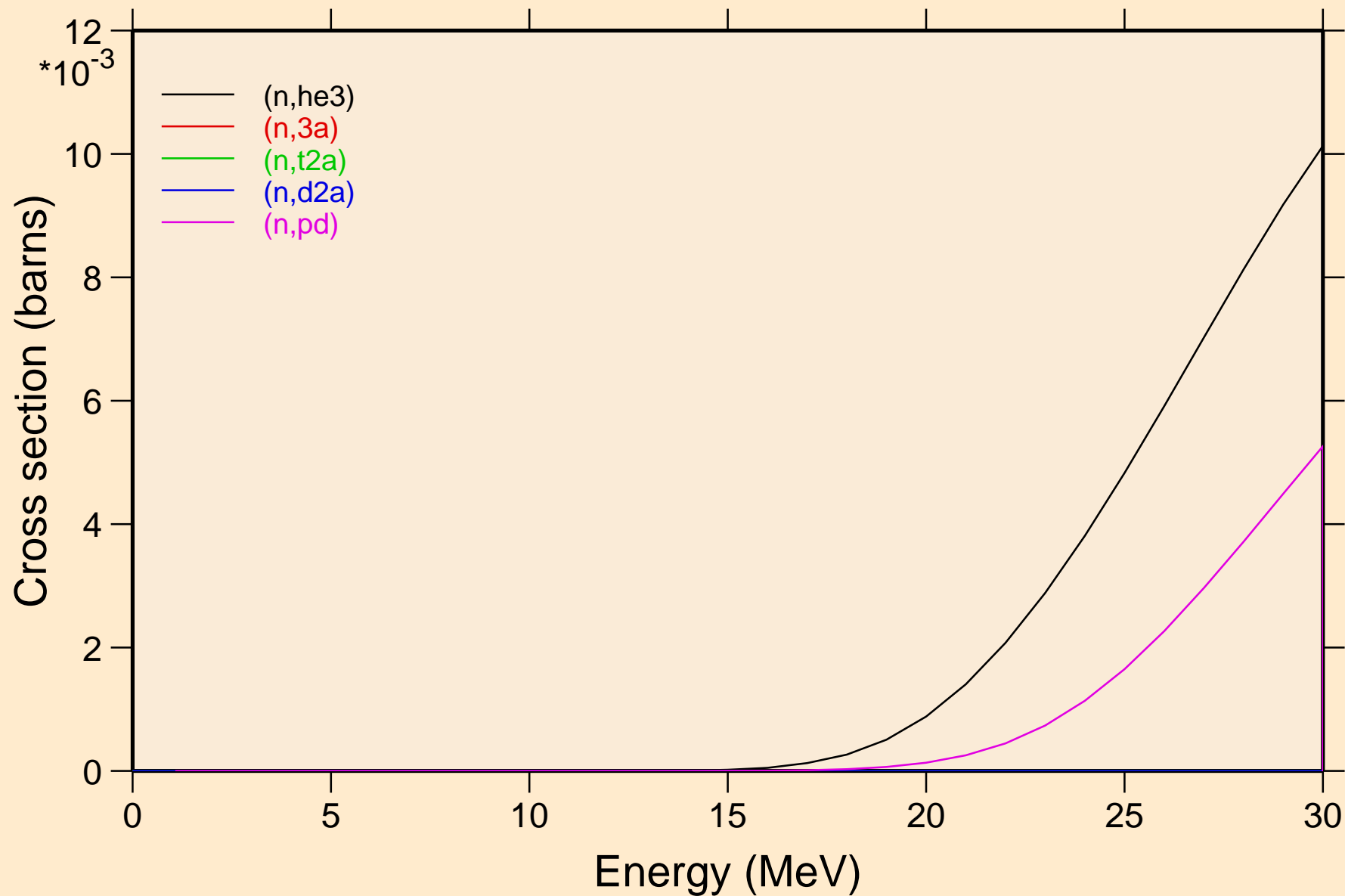

TL183 NEUTRON ACER TENDL-2019 LIBRARY; T=293.16K
Threshold reactions

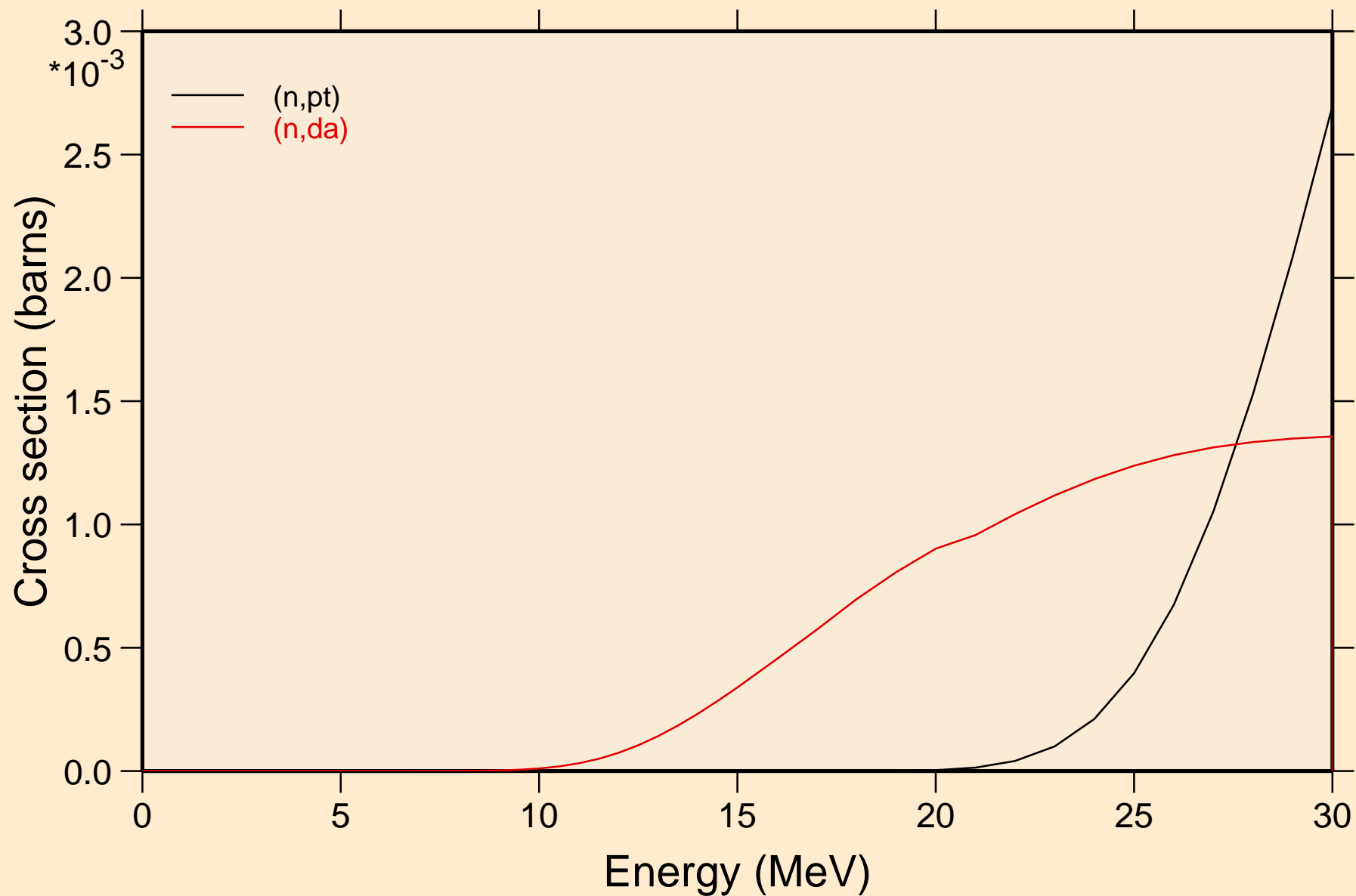

TL183 NEUTRON ACER TENDL-2019 LIBRARY; T=293.16K
Threshold reactions

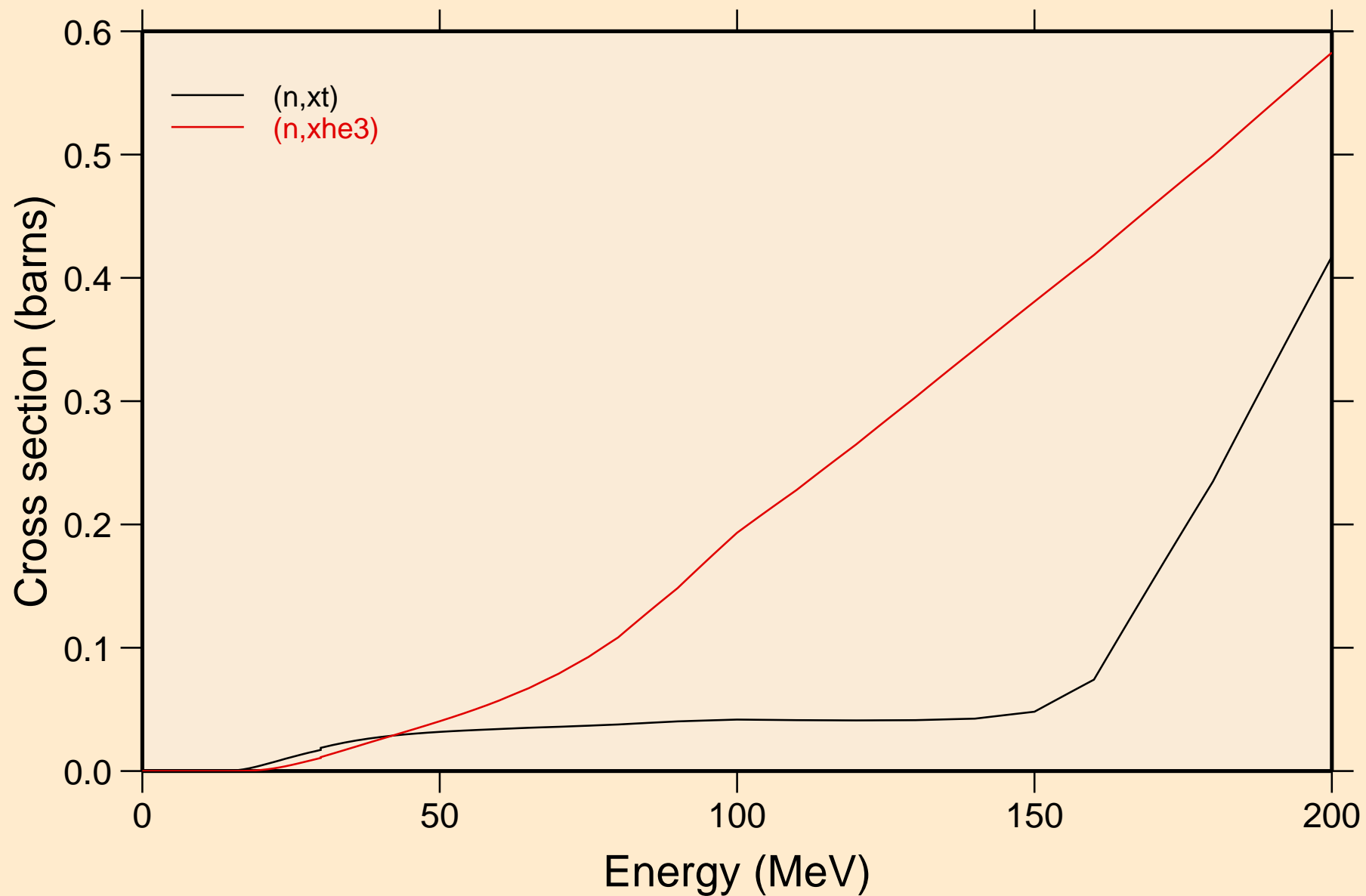

TL183 NEUTRON ACER TENDL-2019 LIBRARY; T=293.16K
angular distribution for elastic

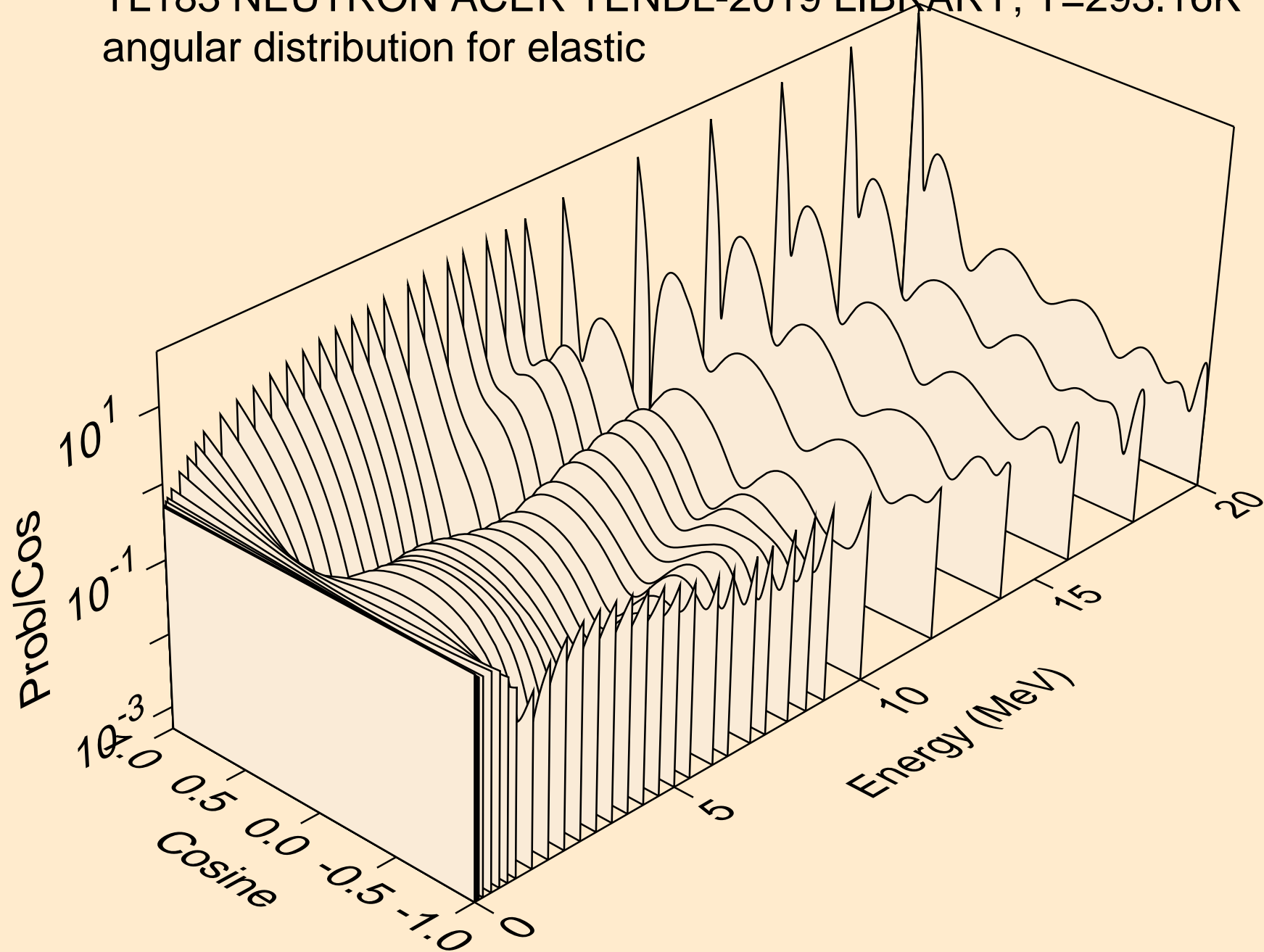

TL183 NEUTRON ACER TENDL-2019 LIBRARY; T=293.16K
angular distribution for elastic

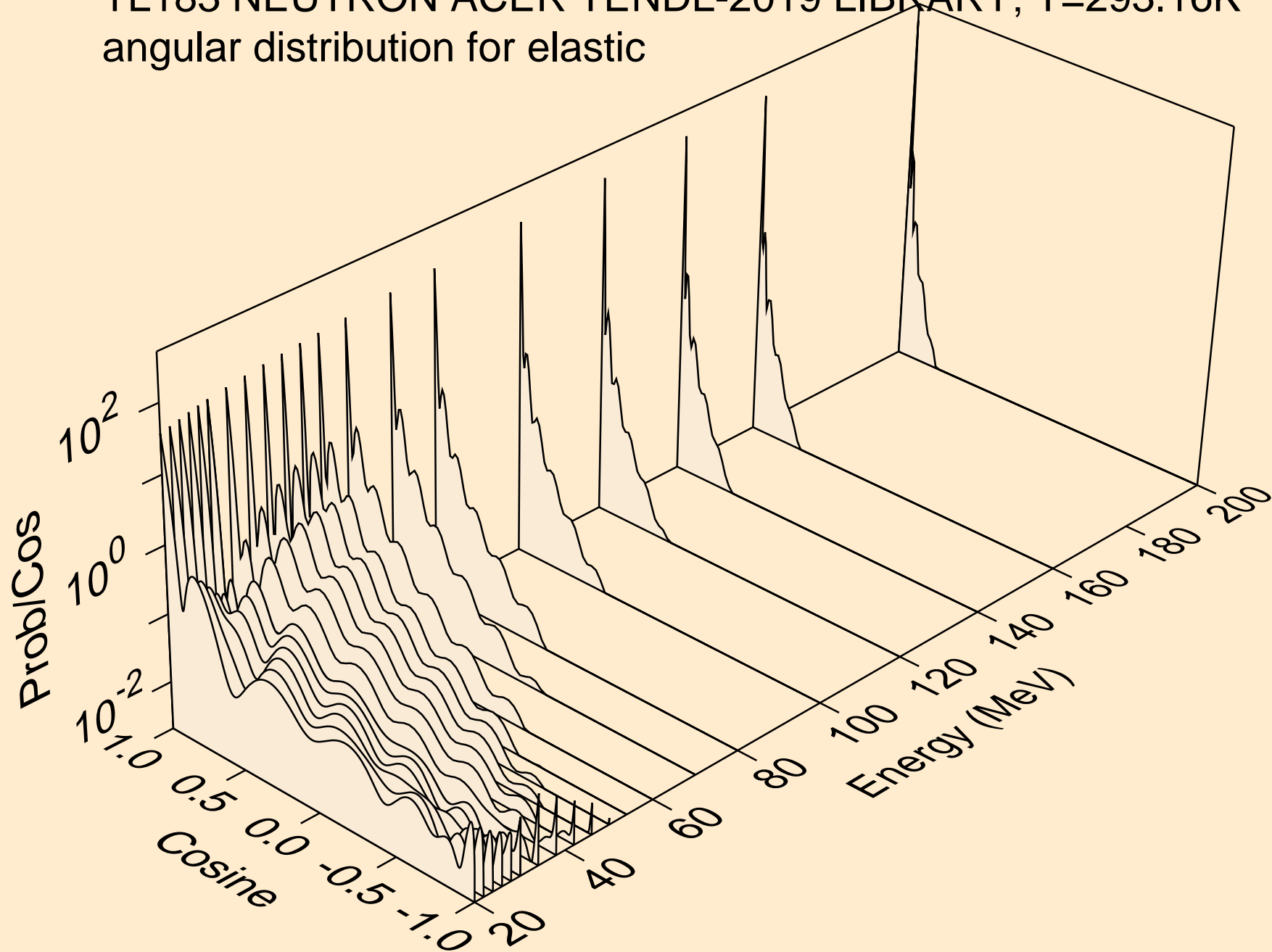

TL183 NEUTRON ACER TENDL-2019 LIBRARY; T=293.16K
angular distribution for (n,n*1)

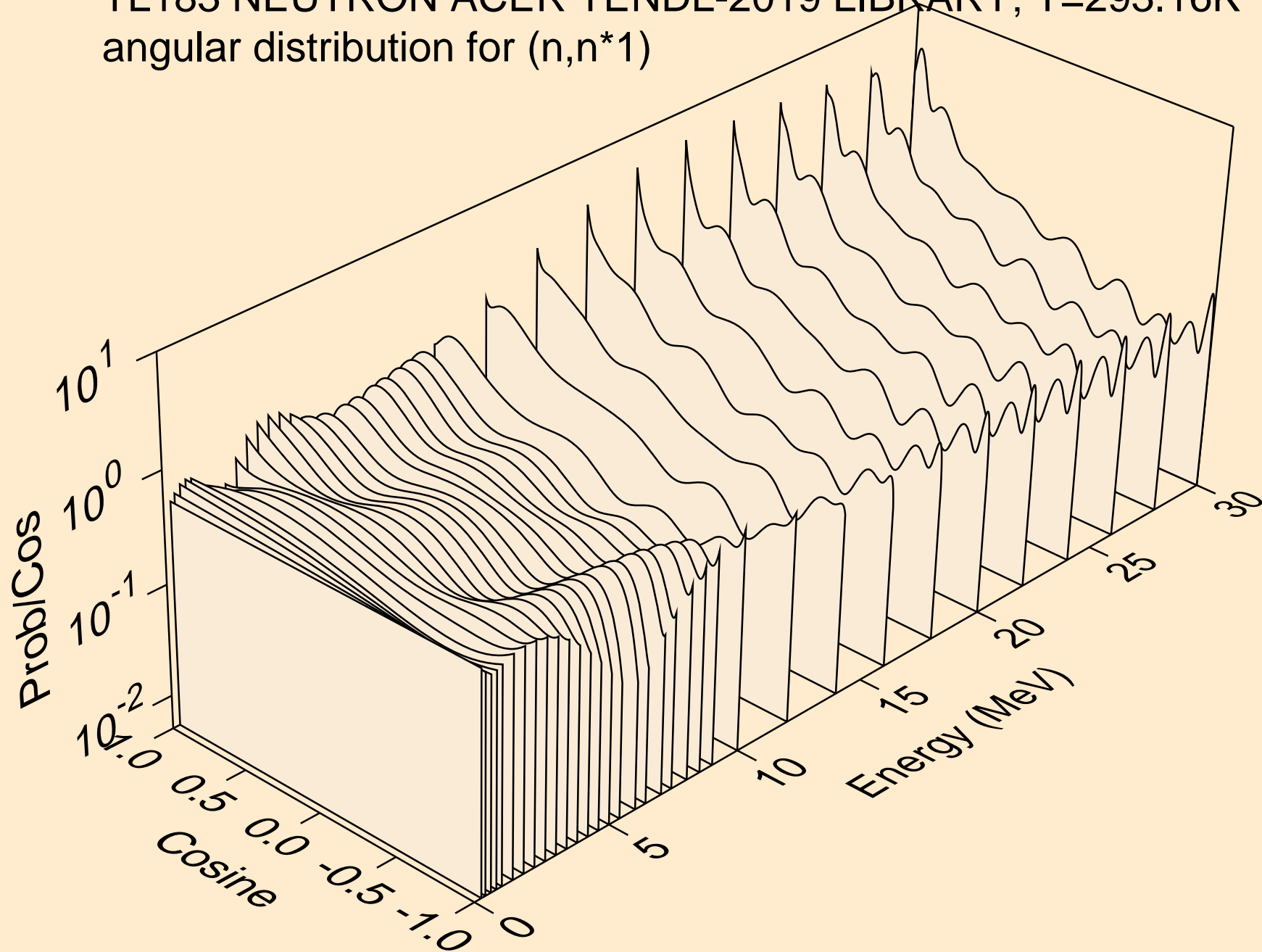

TL183 NEUTRON ACER TENDL-2019 LIBRARY; T=293.16K
angular distribution for (n,n*2)

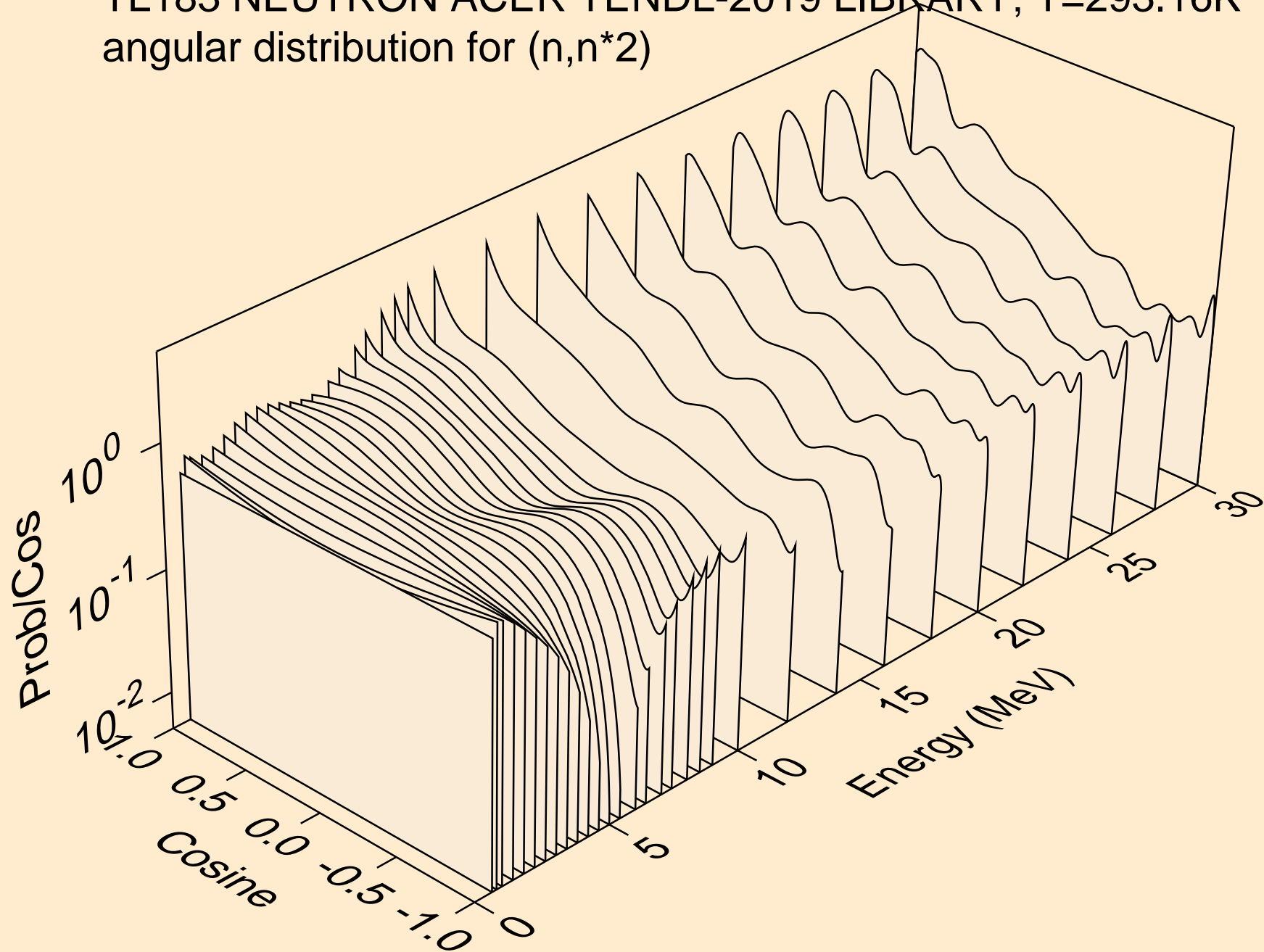

TL183 NEUTRON ACER TENDL-2019 LIBRARY; T=293.16K
Neutron emission for (n,x)

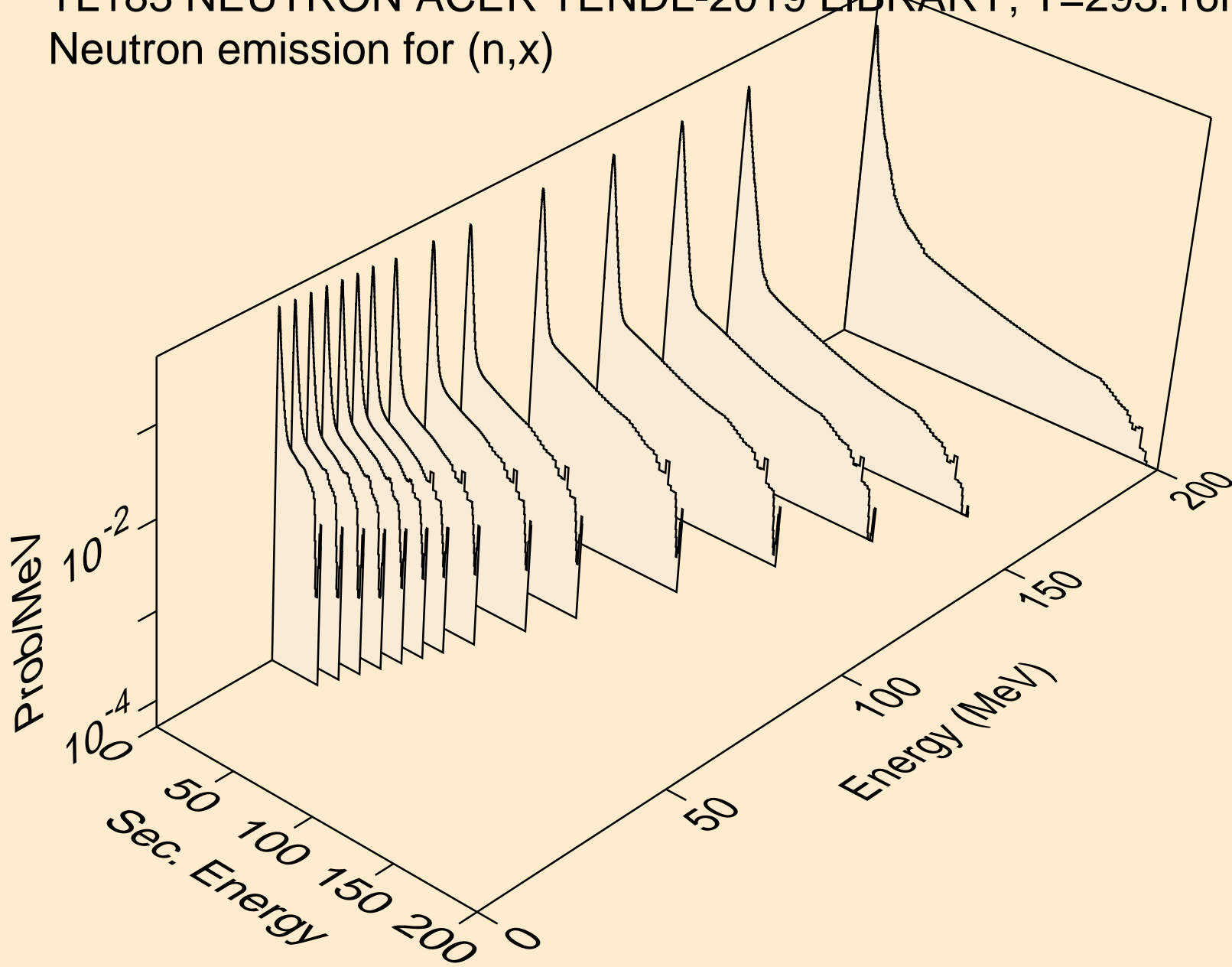

TL183 NEUTRON ACER TENDL-2019 LIBRARY; T=293.16K
Neutron emission for (n,2nd)

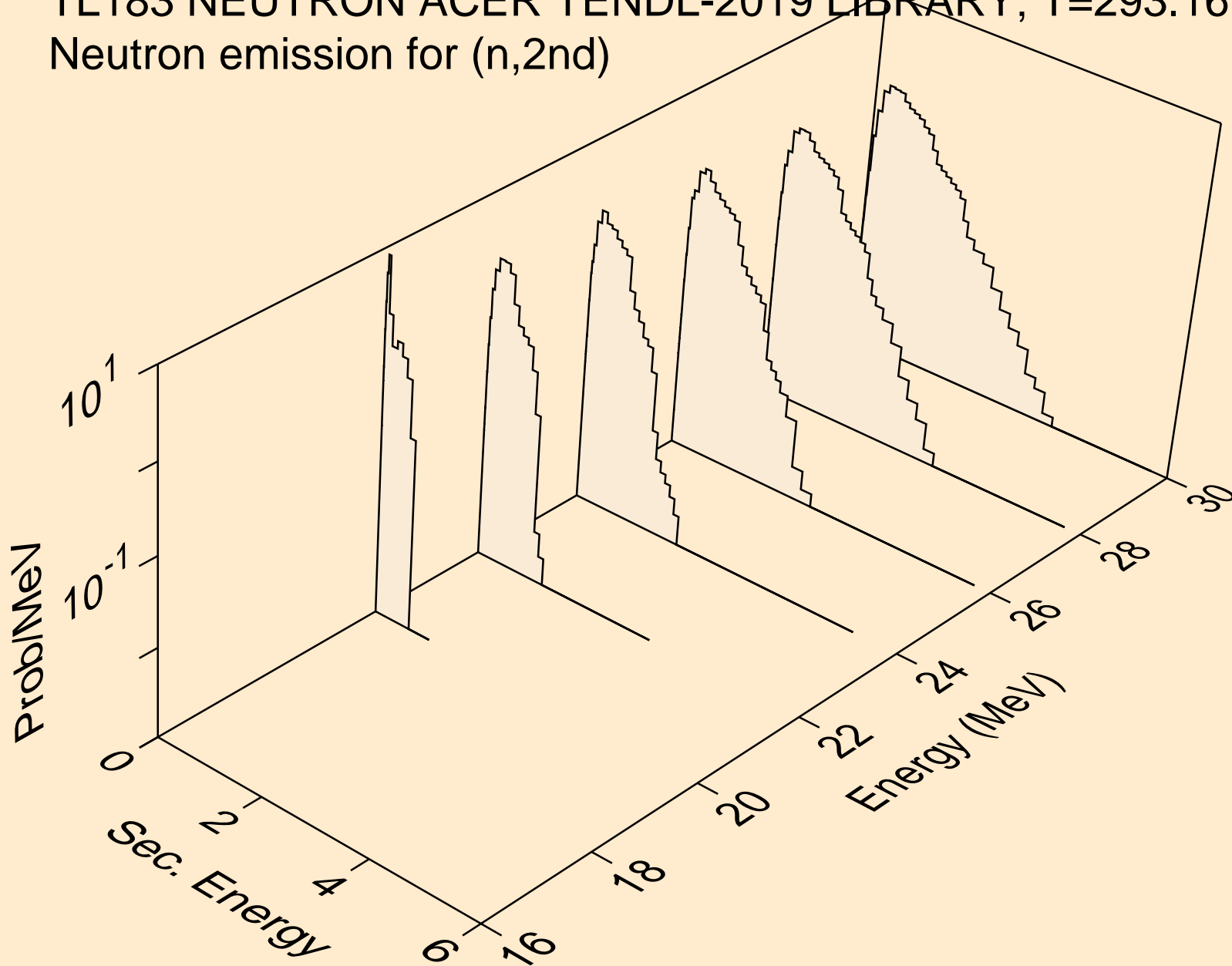

TL183 NEUTRON ACER TENDL-2019 LIBRARY; T=293.16K
Neutron emission for (n,2n)

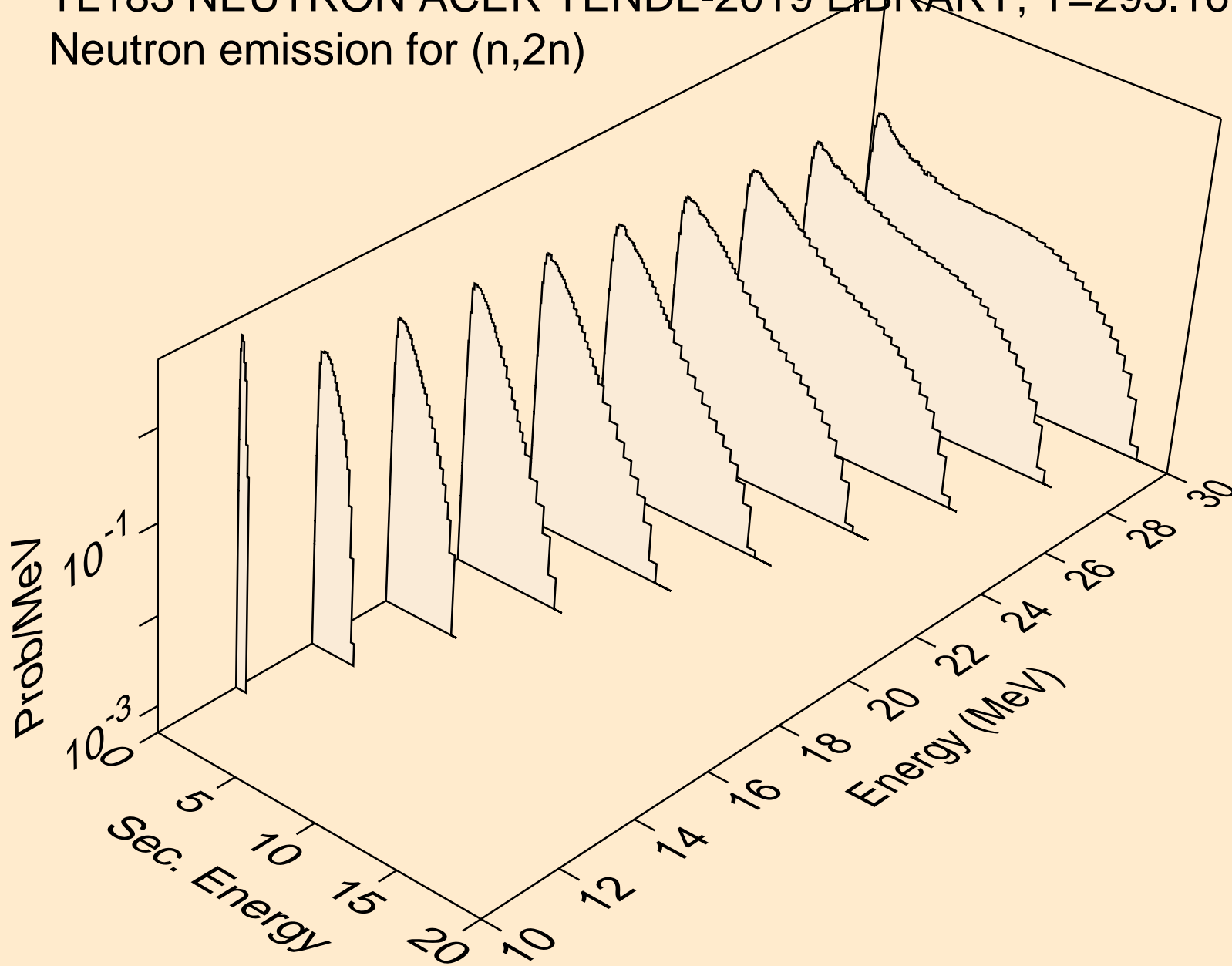

TL183 NEUTRON ACER TENDL-2019 LIBRARY; T=293.16K
Neutron emission for (n,3n)

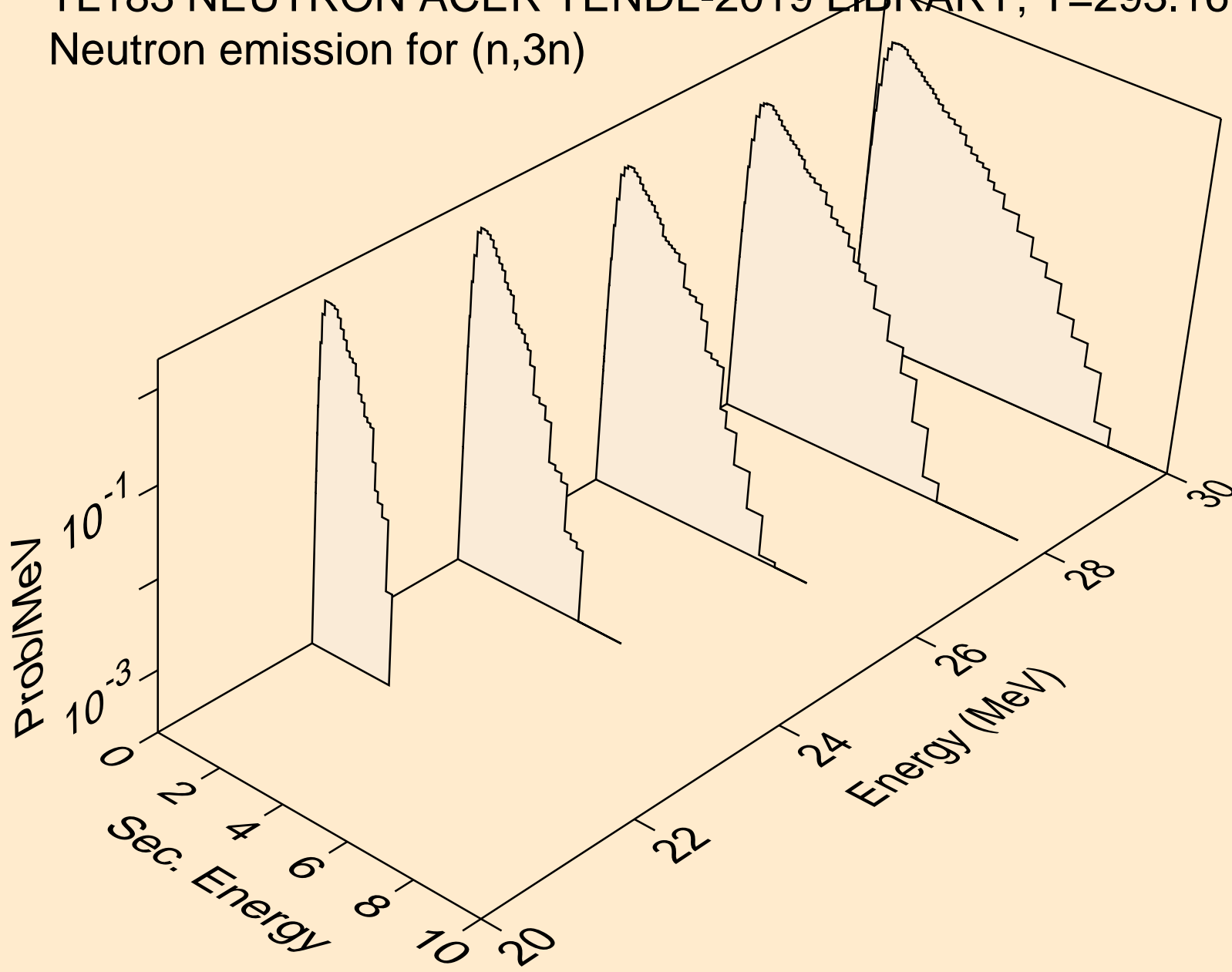

TL183 NEUTRON ACER TENDL-2019 LIBRARY; T=293.16K
Neutron emission for (n,n*)a

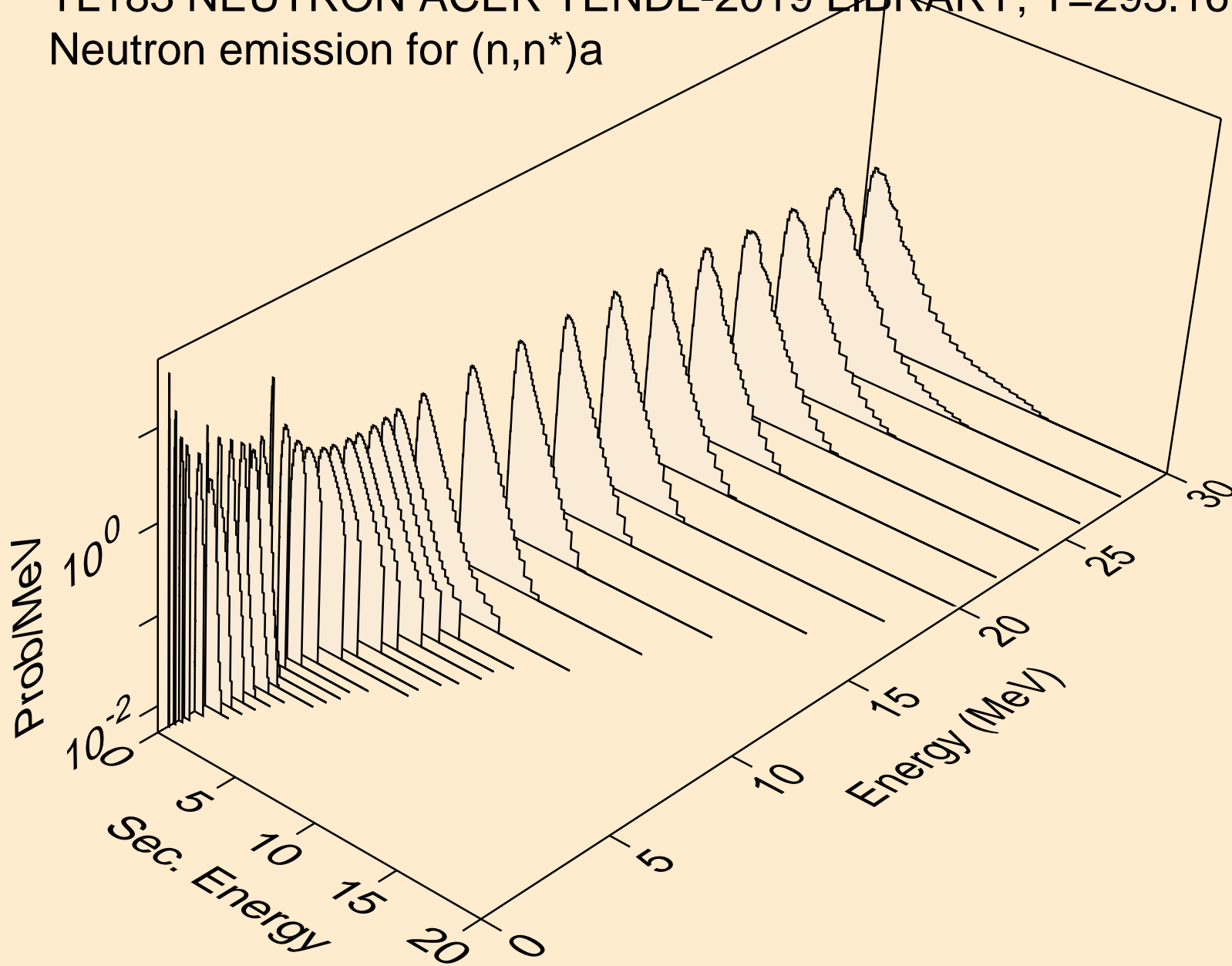

TL183 NEUTRON ACER TENDL-2019 LIBRARY; T=293.16K
Neutron emission for (n,n*)3a

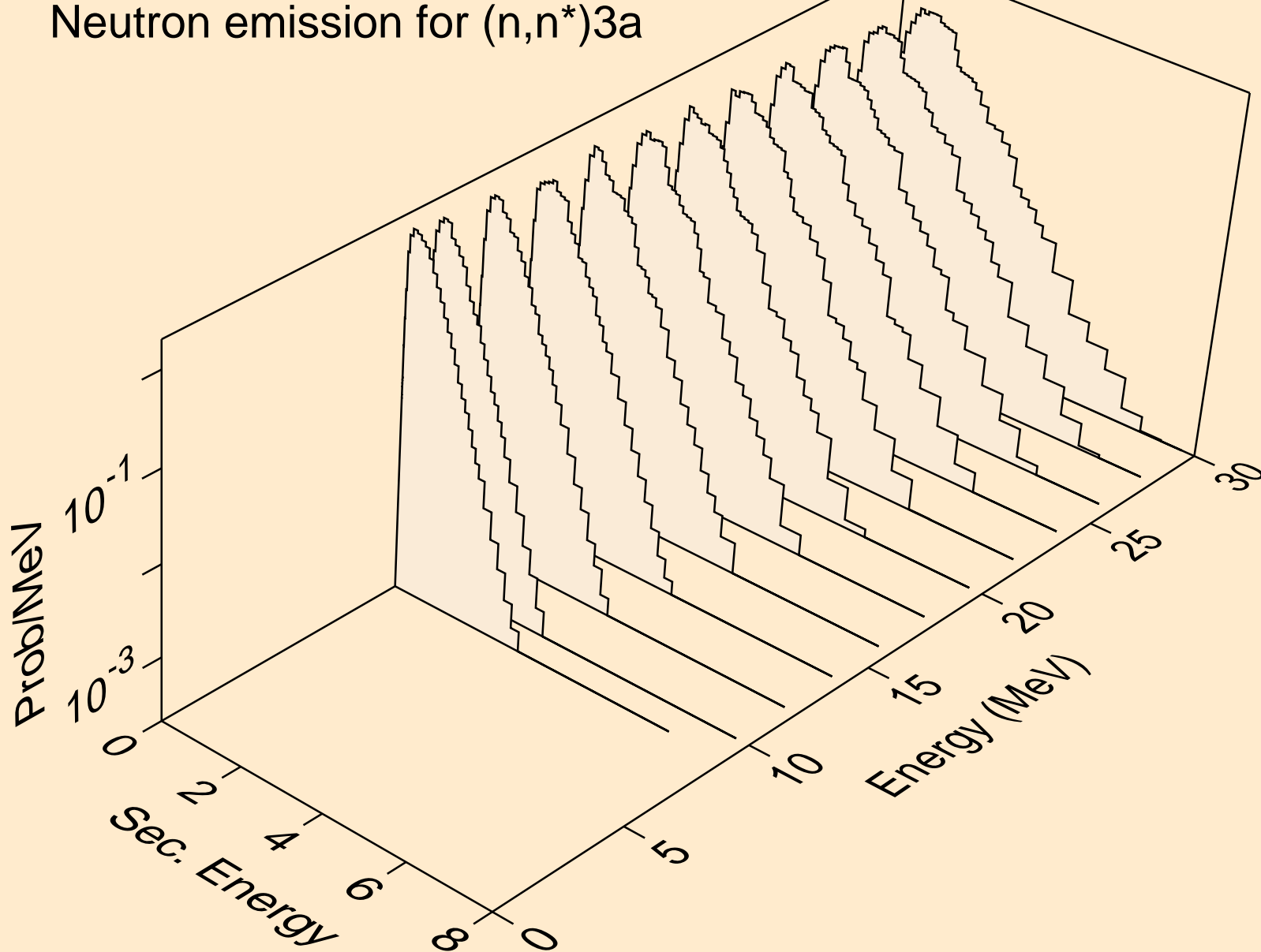

TL183 NEUTRON ACER TENDL-2019 LIBRARY; T=293.16K
Neutron emission for (n,2n)a

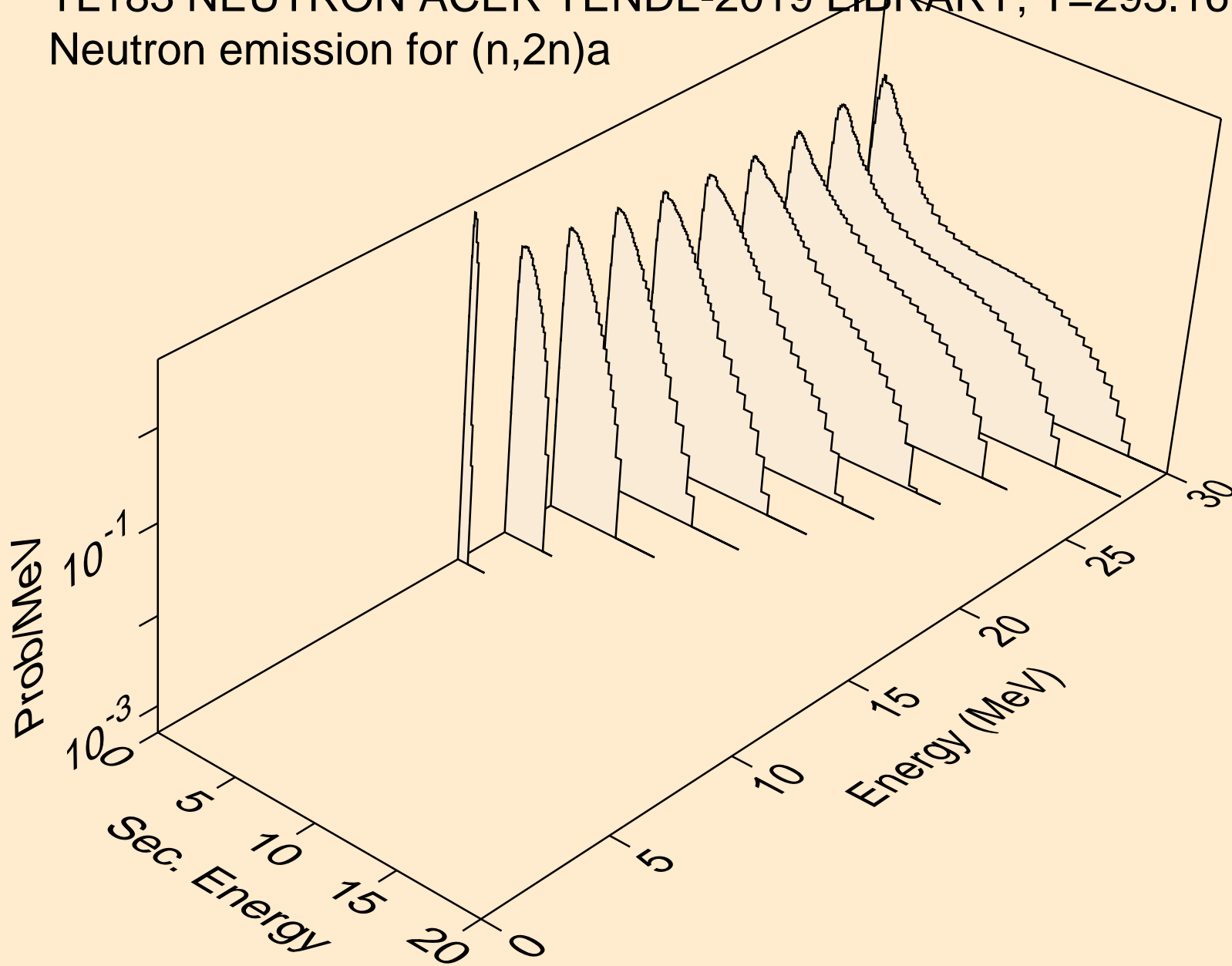

TL183 NEUTRON ACER TENDL-2019 LIBRARY; T=293.16K
Neutron emission for (n,3n)a

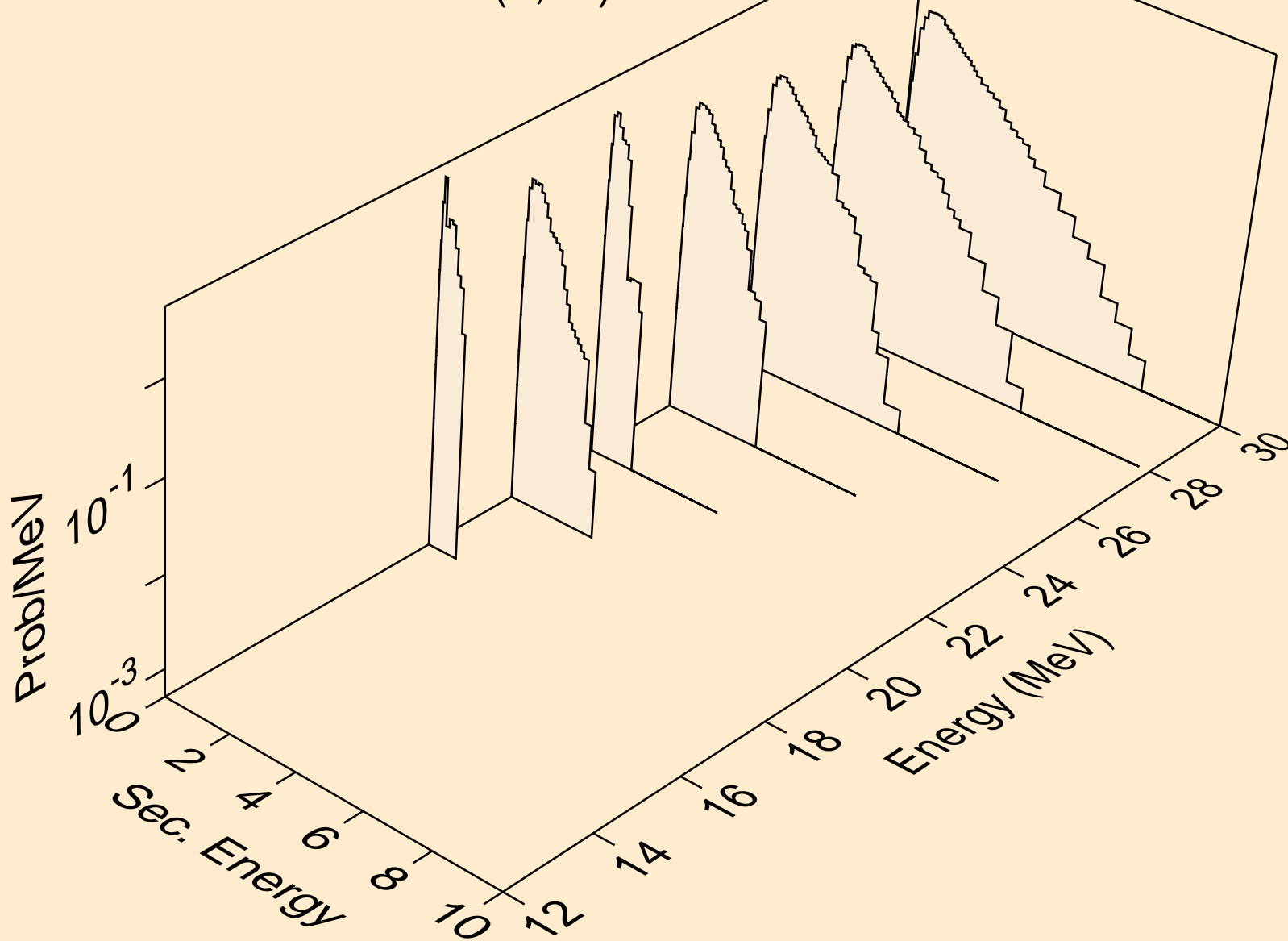

TL183 NEUTRON ACER TENDL-2019 LIBRARY; T=293.16K
Neutron emission for (n,n*)p

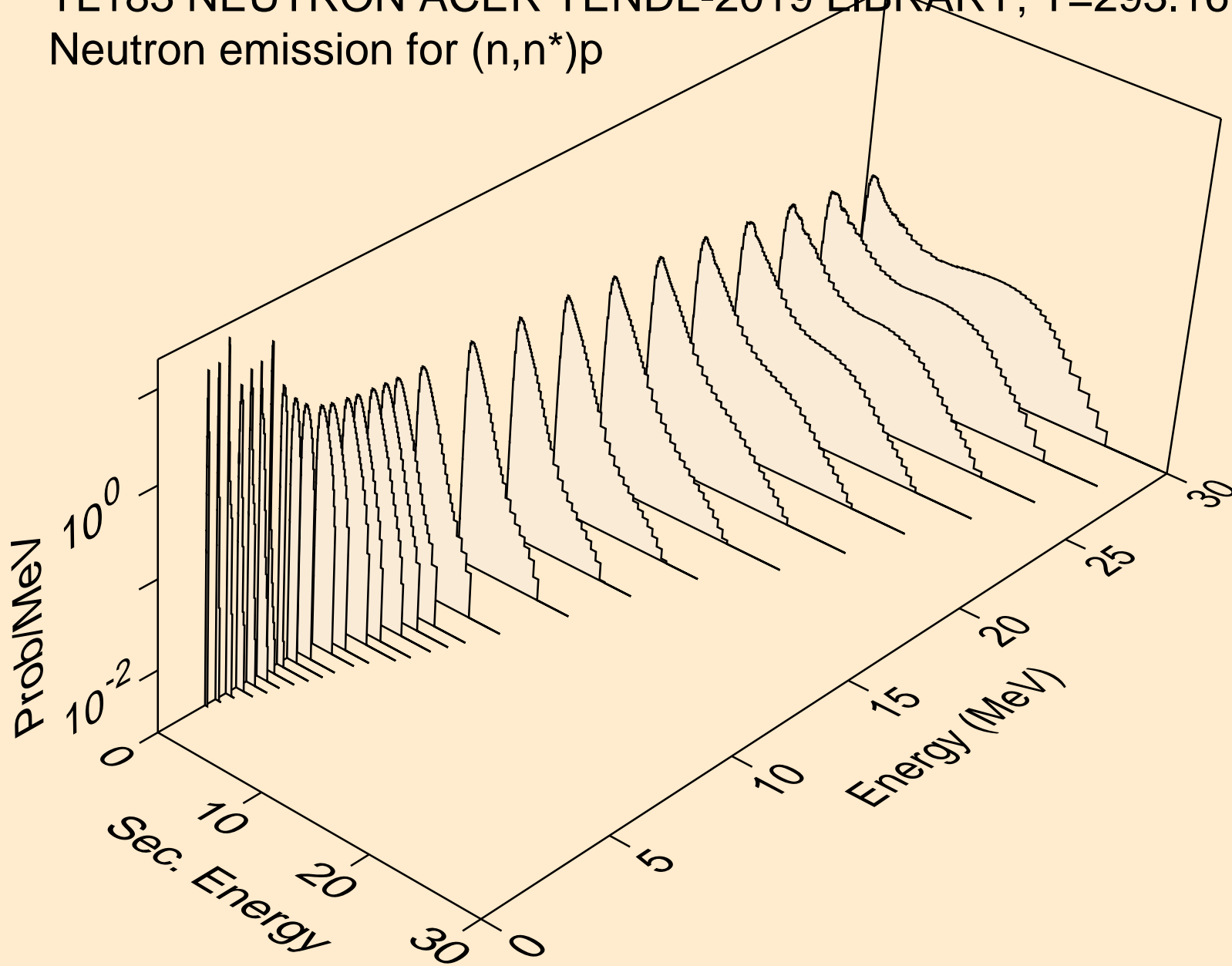

TL183 NEUTRON ACER TENDL-2019 LIBRARY; T=293.16K
Neutron emission for (n,n*)2a

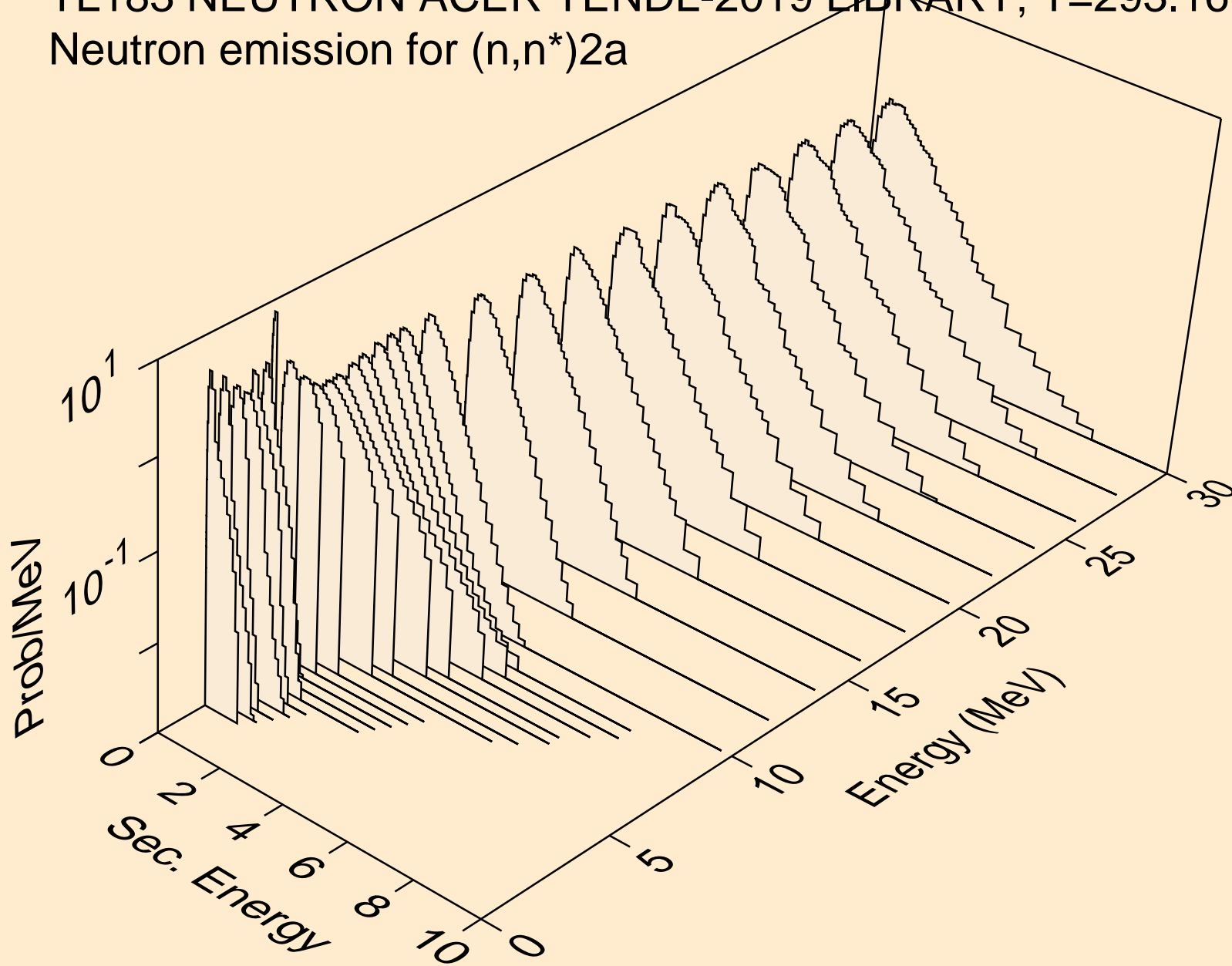

TL183 NEUTRON ACER TENDL-2019 LIBRARY; T=293.16K
Neutron emission for (n,2n)2a

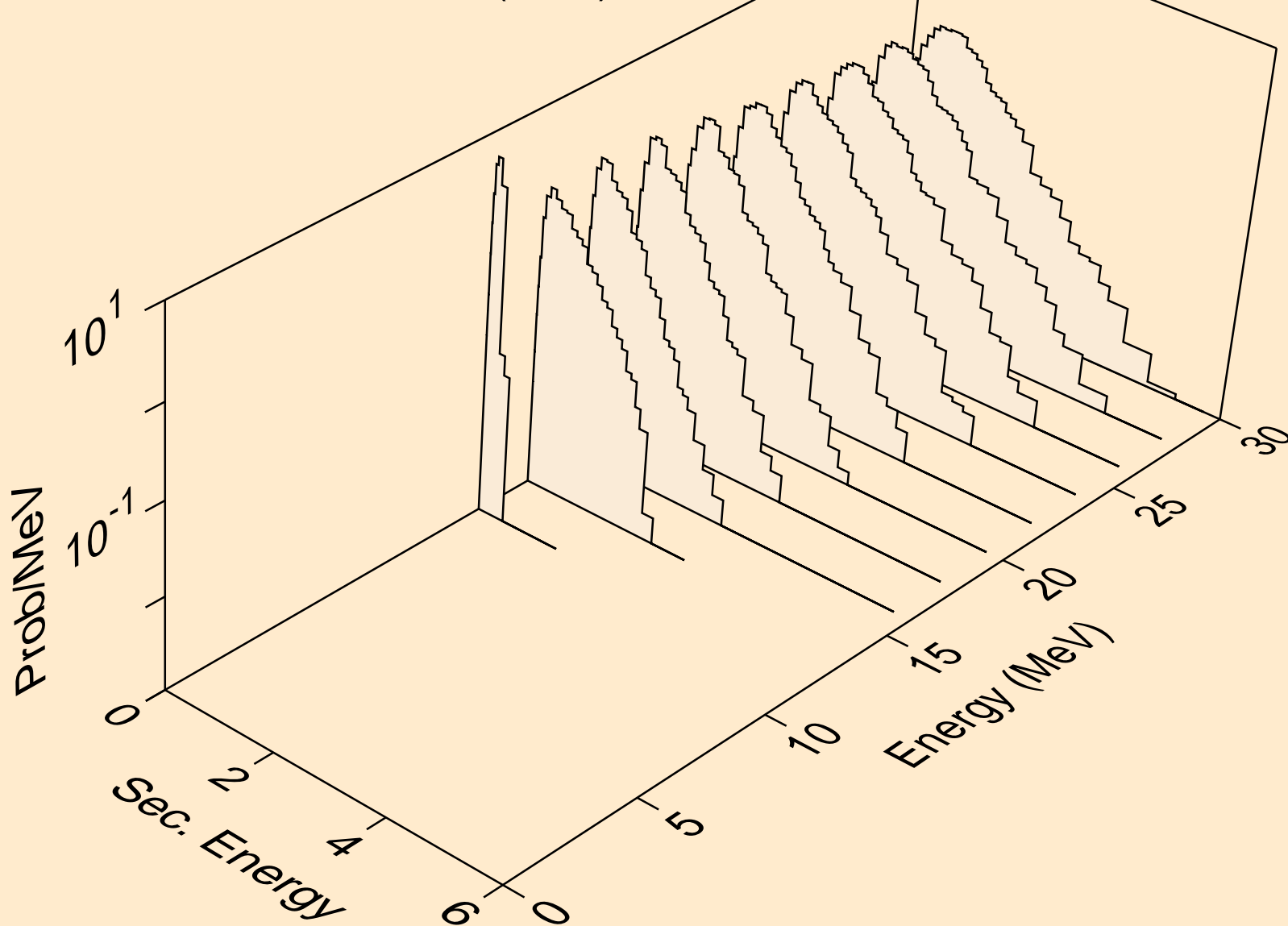

TL183 NEUTRON ACER TENDL-2019 LIBRARY; T=293.16K
Neutron emission for (n,n*)d

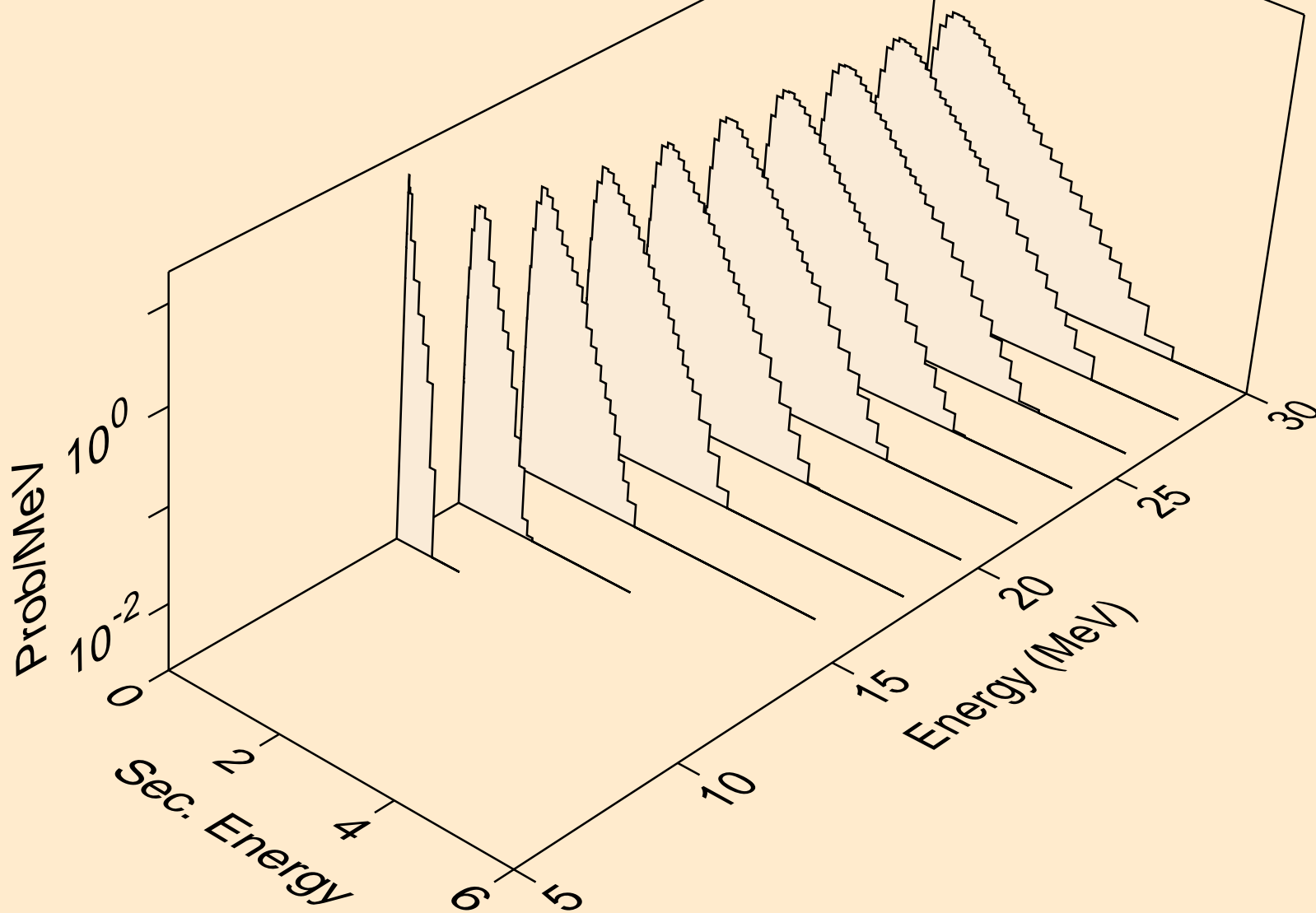

TL183 NEUTRON ACER TENDL-2019 LIBRARY; T=293.16K
Neutron emission for (n,n*)t

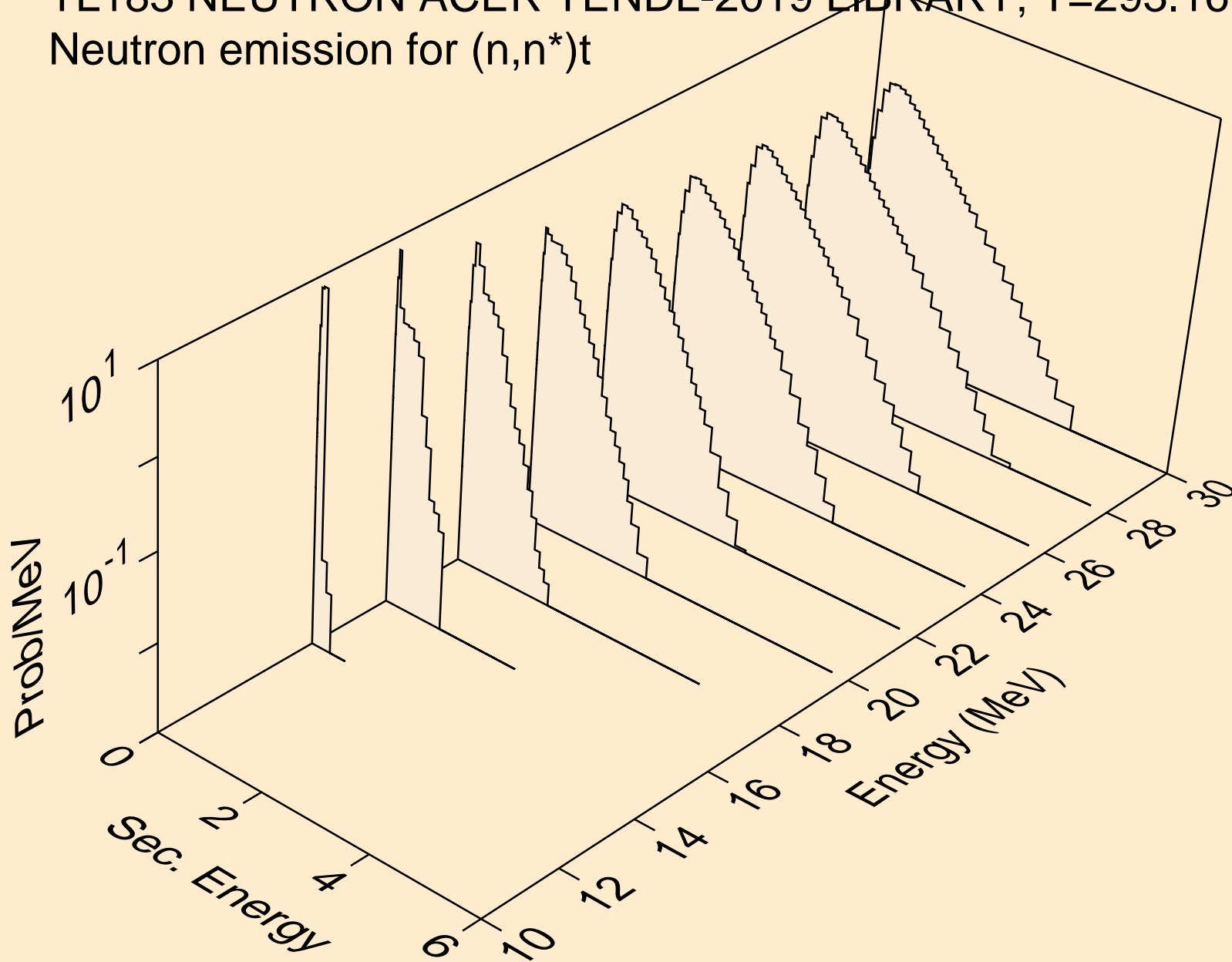

TL183 NEUTRON ACER TENDL-2019 LIBRARY; T=293.16K
Neutron emission for (n,n*)he3

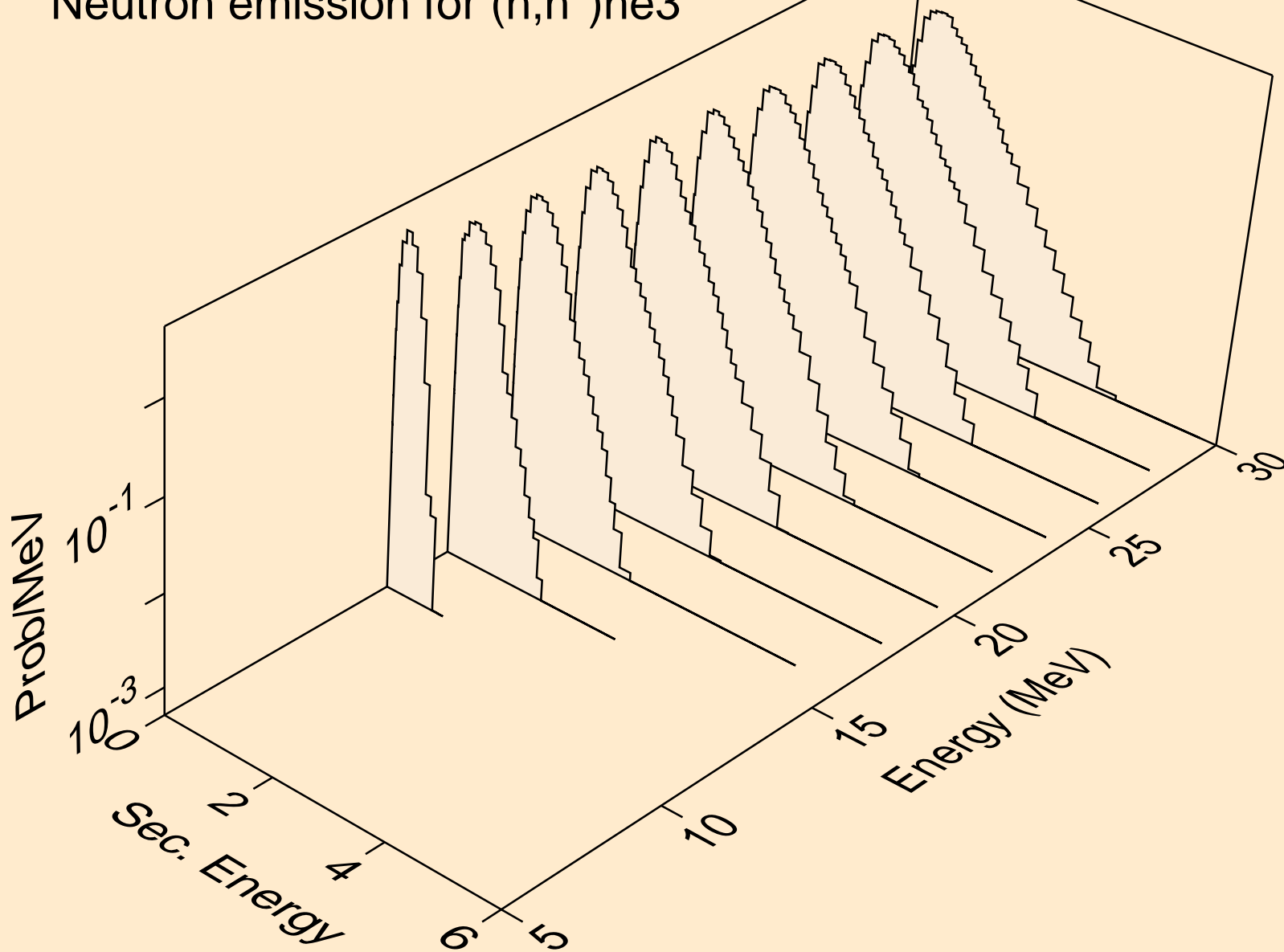

TL183 NEUTRON ACER TENDL-2019 LIBRARY; T=293.16K
Neutron emission for (n,2np)

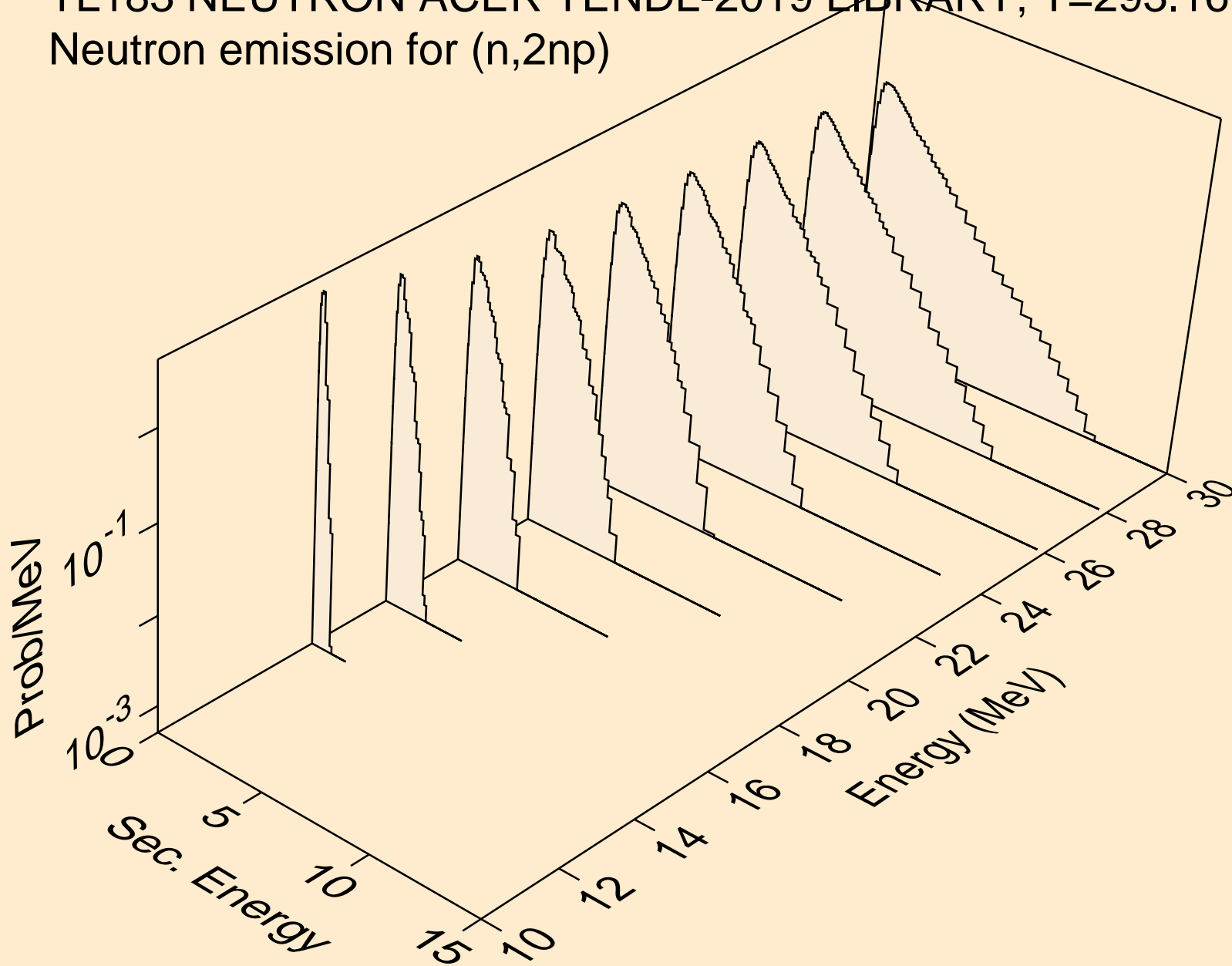

TL183 NEUTRON ACER TENDL-2019 LIBRARY; T=293.16K
Neutron emission for (n,3np)

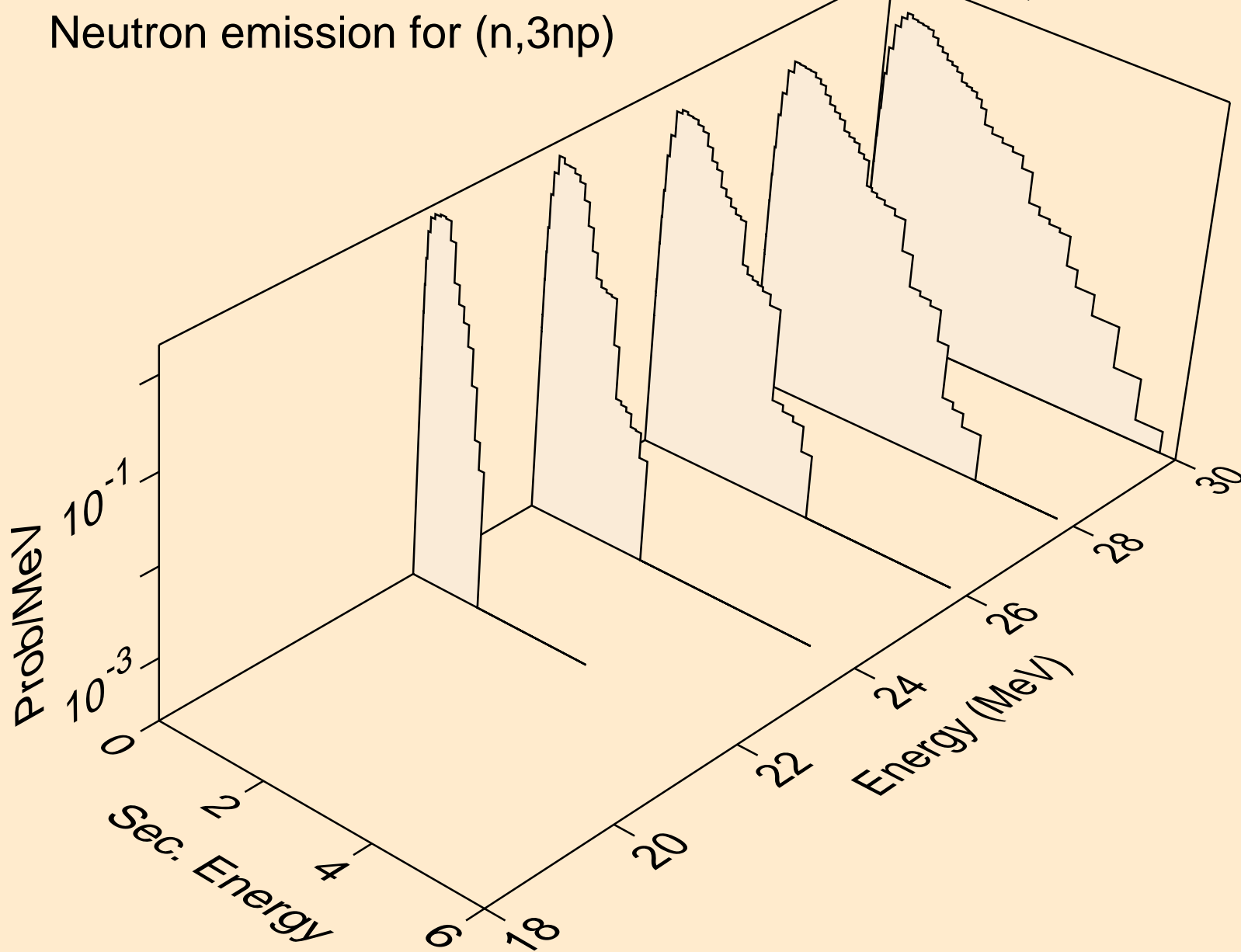

TL183 NEUTRON ACER TENDL-2019 LIBRARY; T=293.16K
Neutron emission for (n,2np)

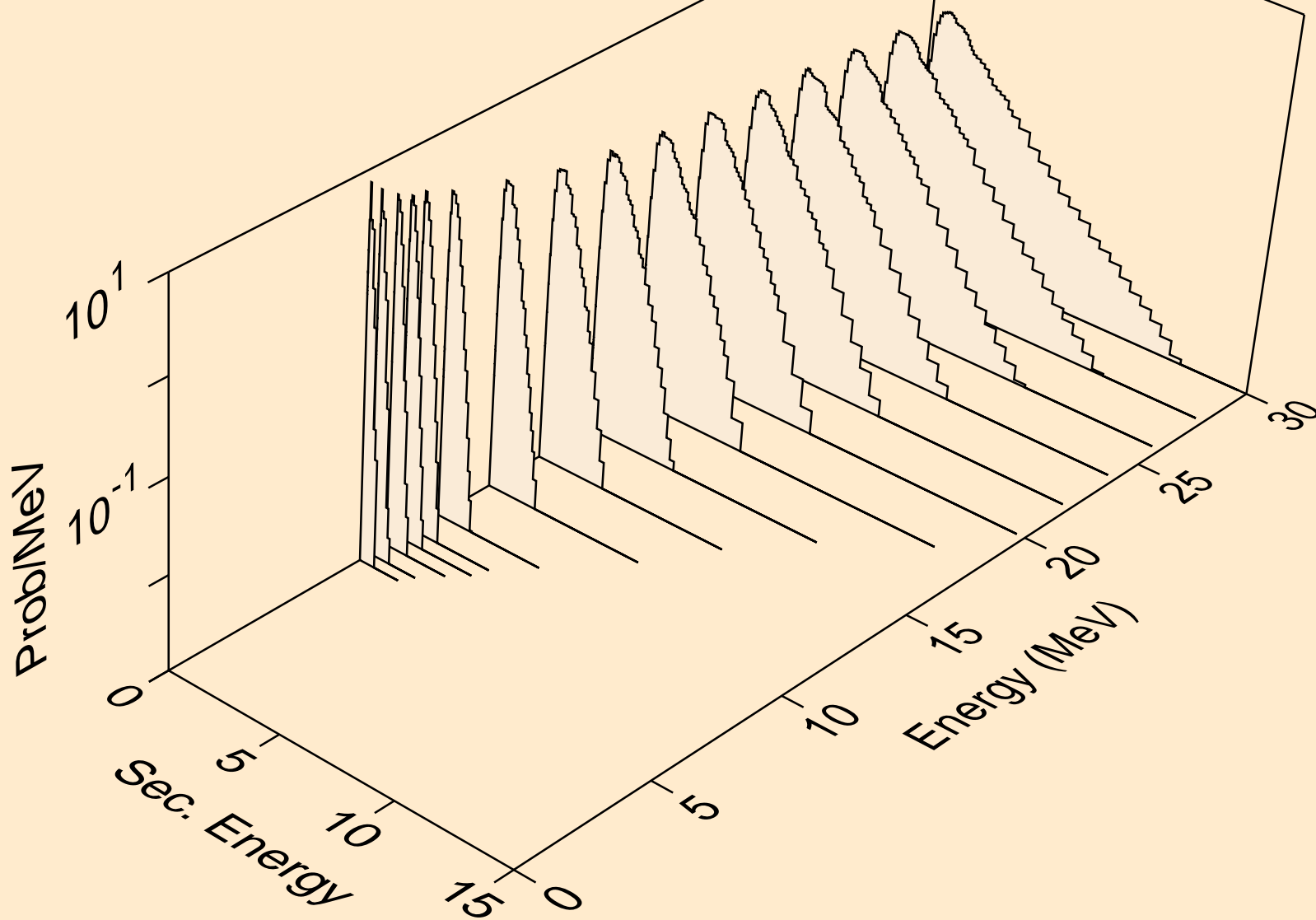

TL183 NEUTRON ACER TENDL-2019 LIBRARY; T=293.16K
Neutron emission for (n,npa)

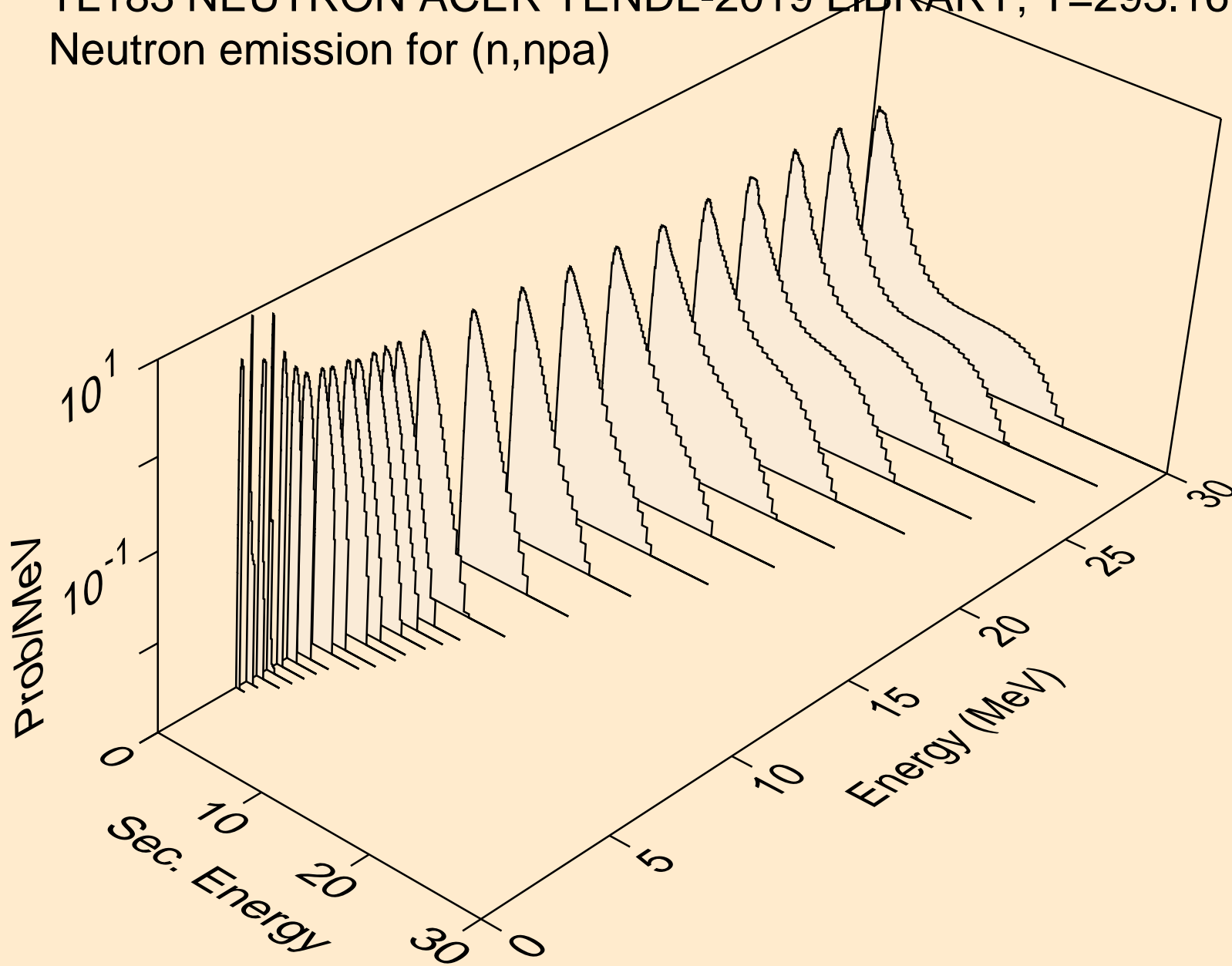

TL183 NEUTRON ACER TENDL-2019 LIBRARY; T=293.16K
Neutron emission for (n,n*c)

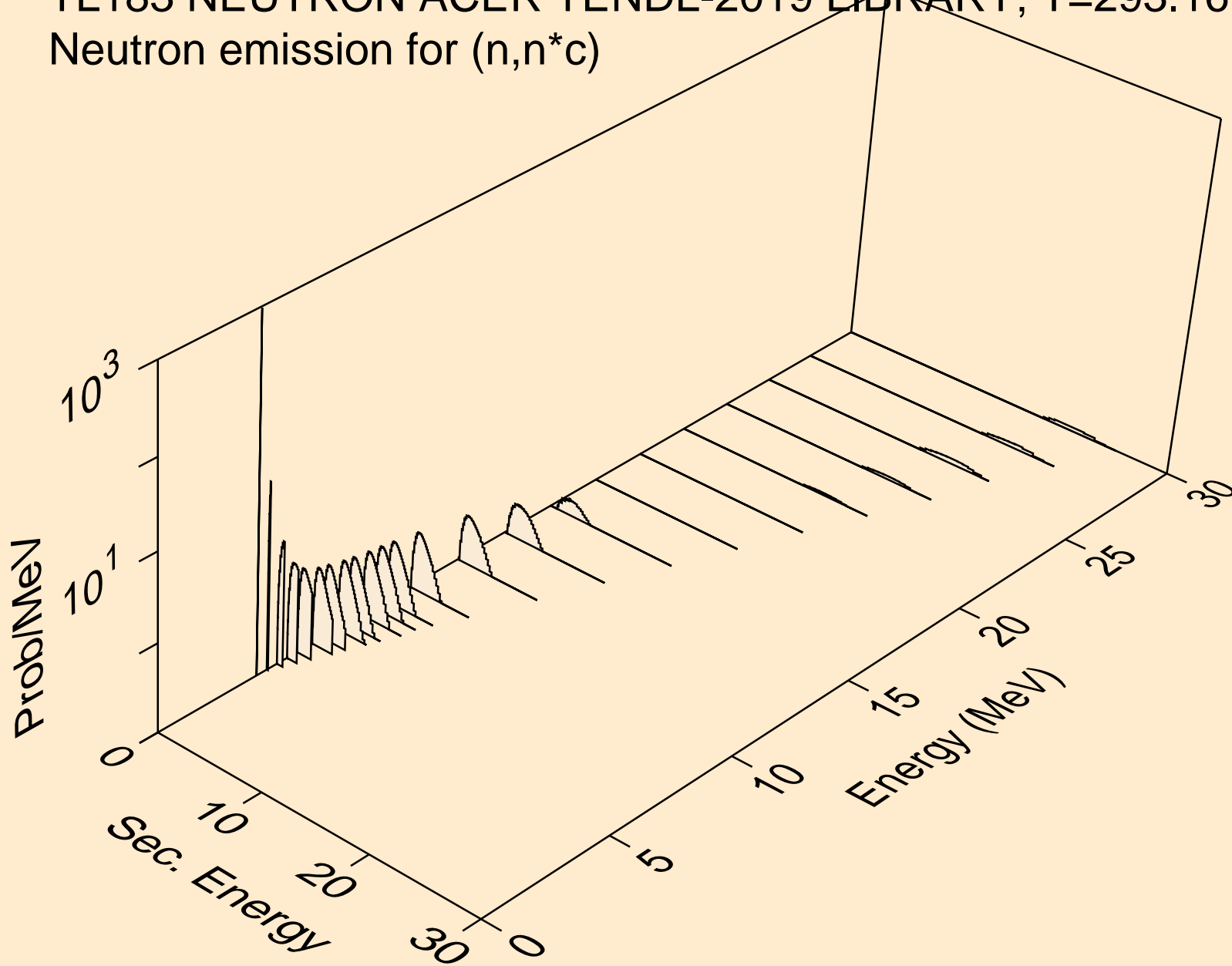

TL183 NEUTRON ACER TENDL-2019 LIBRARY; T=293.16K
Photon emission for (n,x)

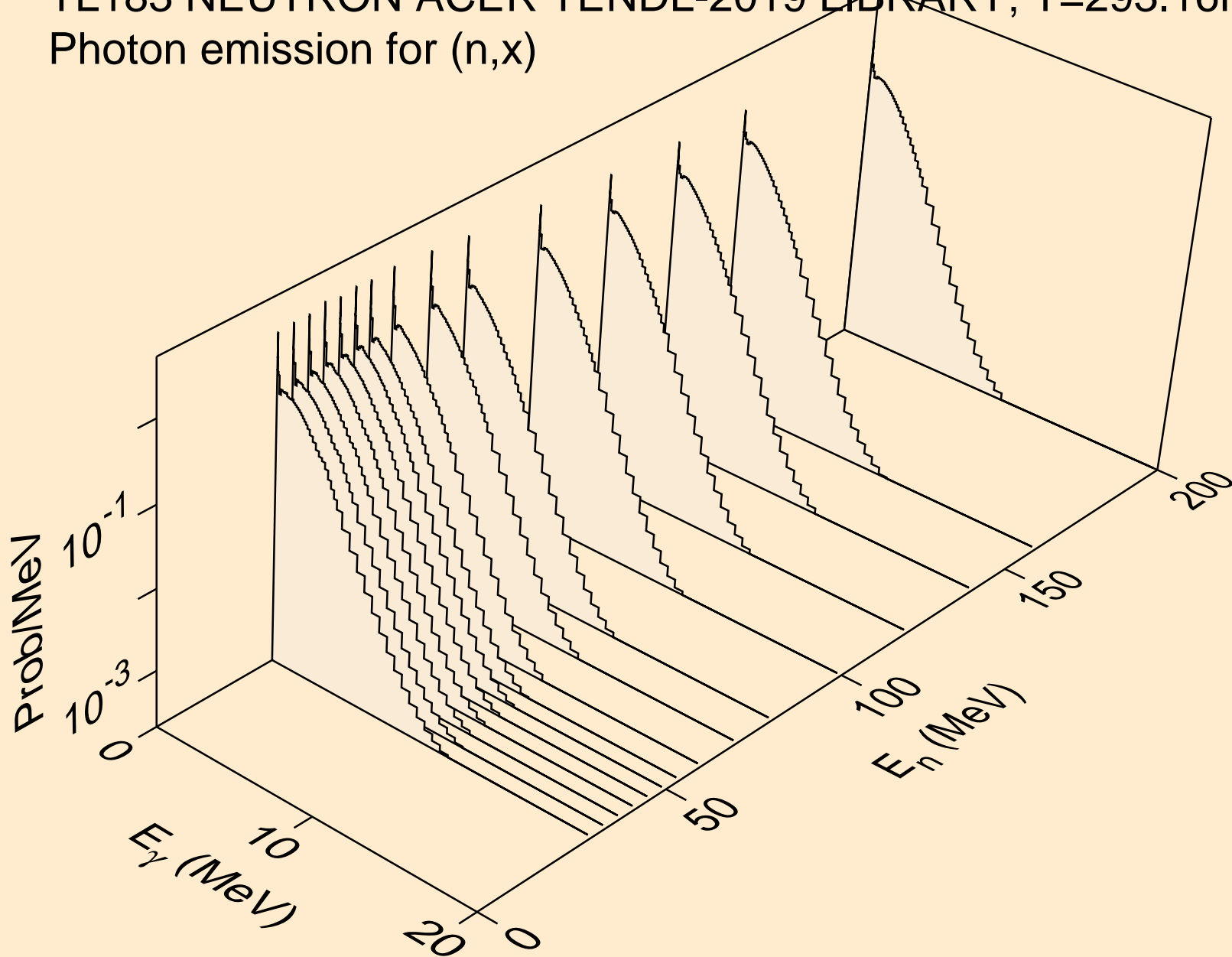

TL183 NEUTRON ACER TENDL-2019 LIBRARY; T=293.16K
Photon emission for (n,2nd)

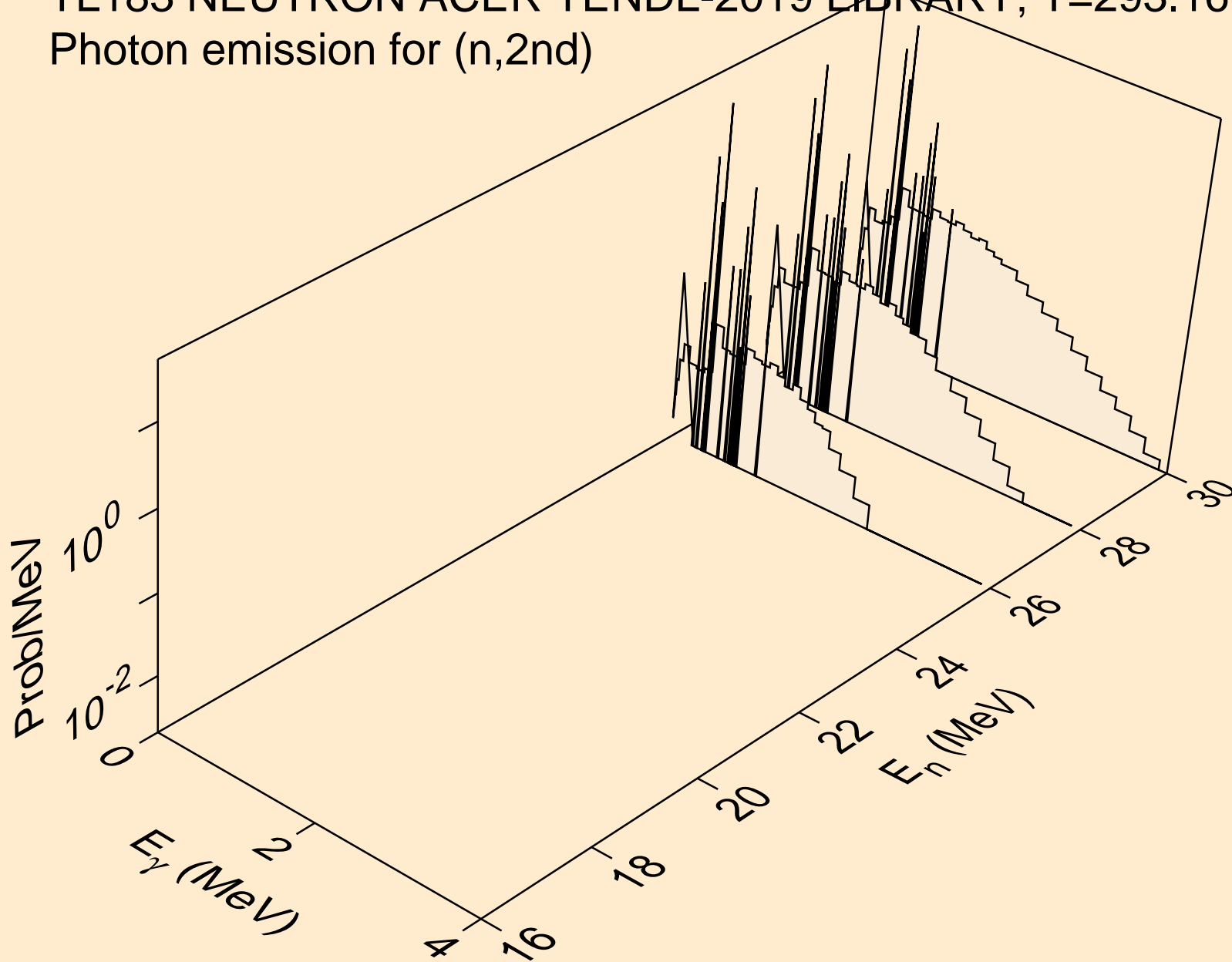

TL183 NEUTRON ACER TENDL-2019 LIBRARY; T=293.16K
Photon emission for (n,2n)

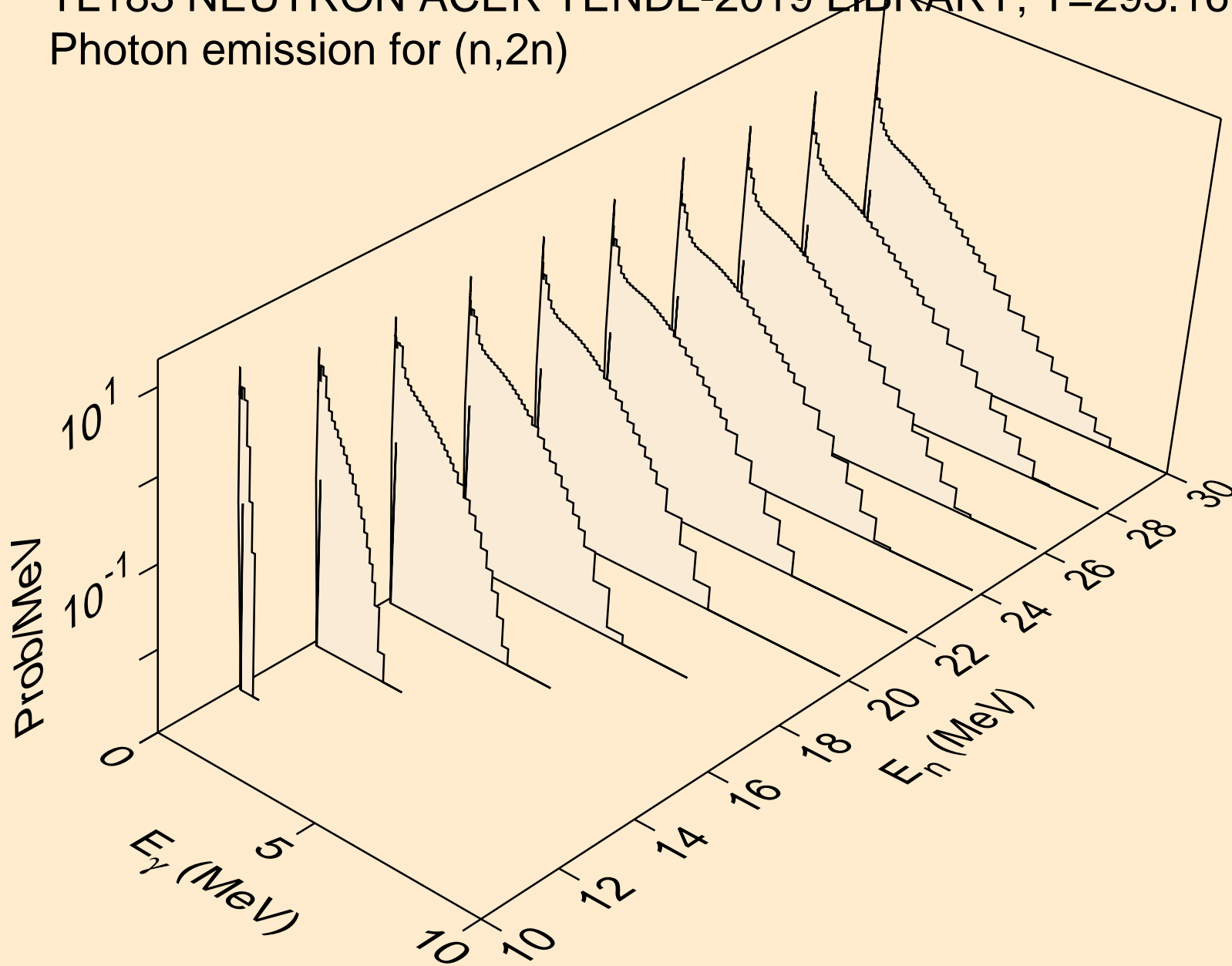

TL183 NEUTRON ACER TENDL-2019 LIBRARY; T=293.16K
Photon emission for (n,3n)

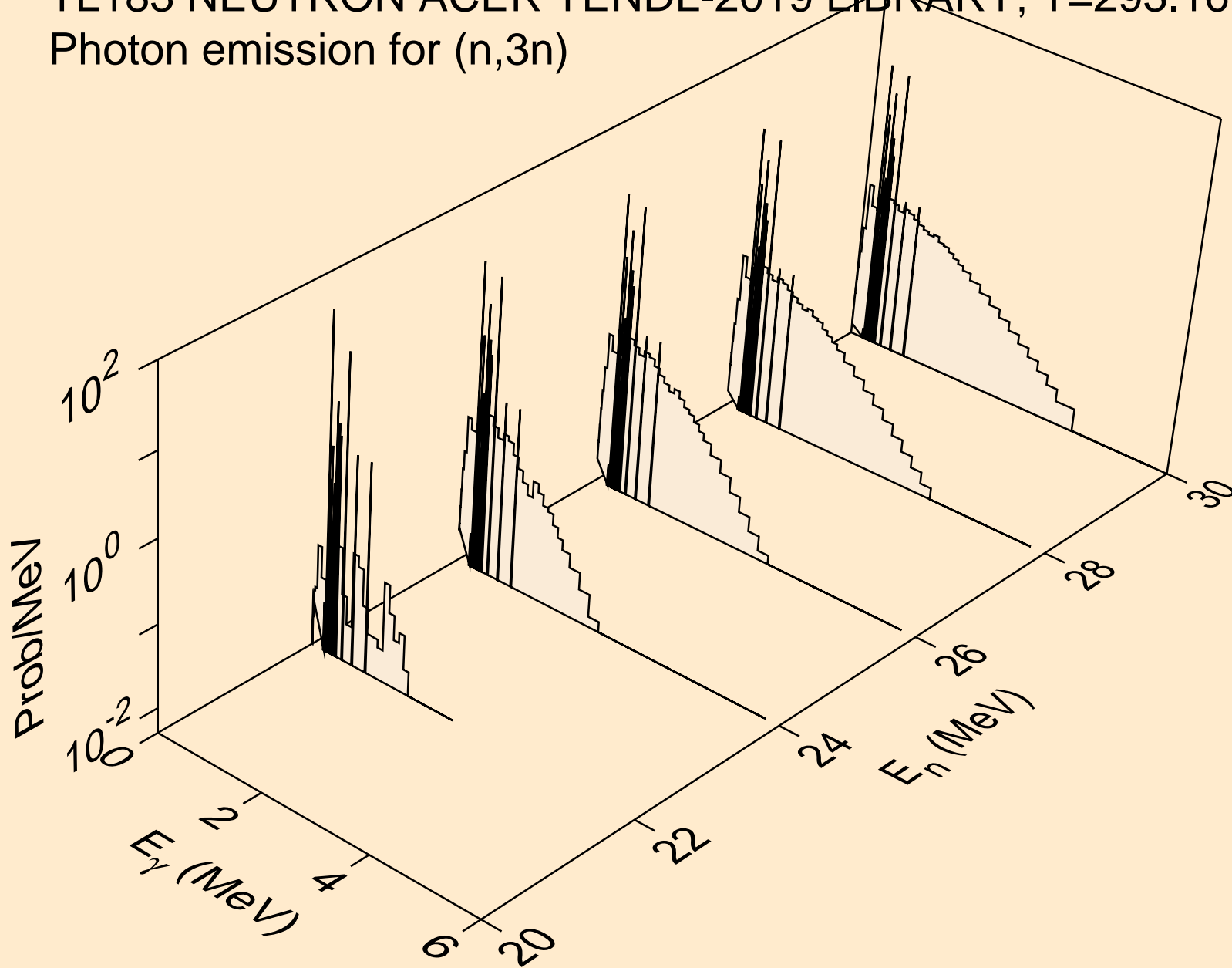

TL183 NEUTRON ACER TENDL-2019 LIBRARY; T=293.16K
Photon emission for (n,n*)a

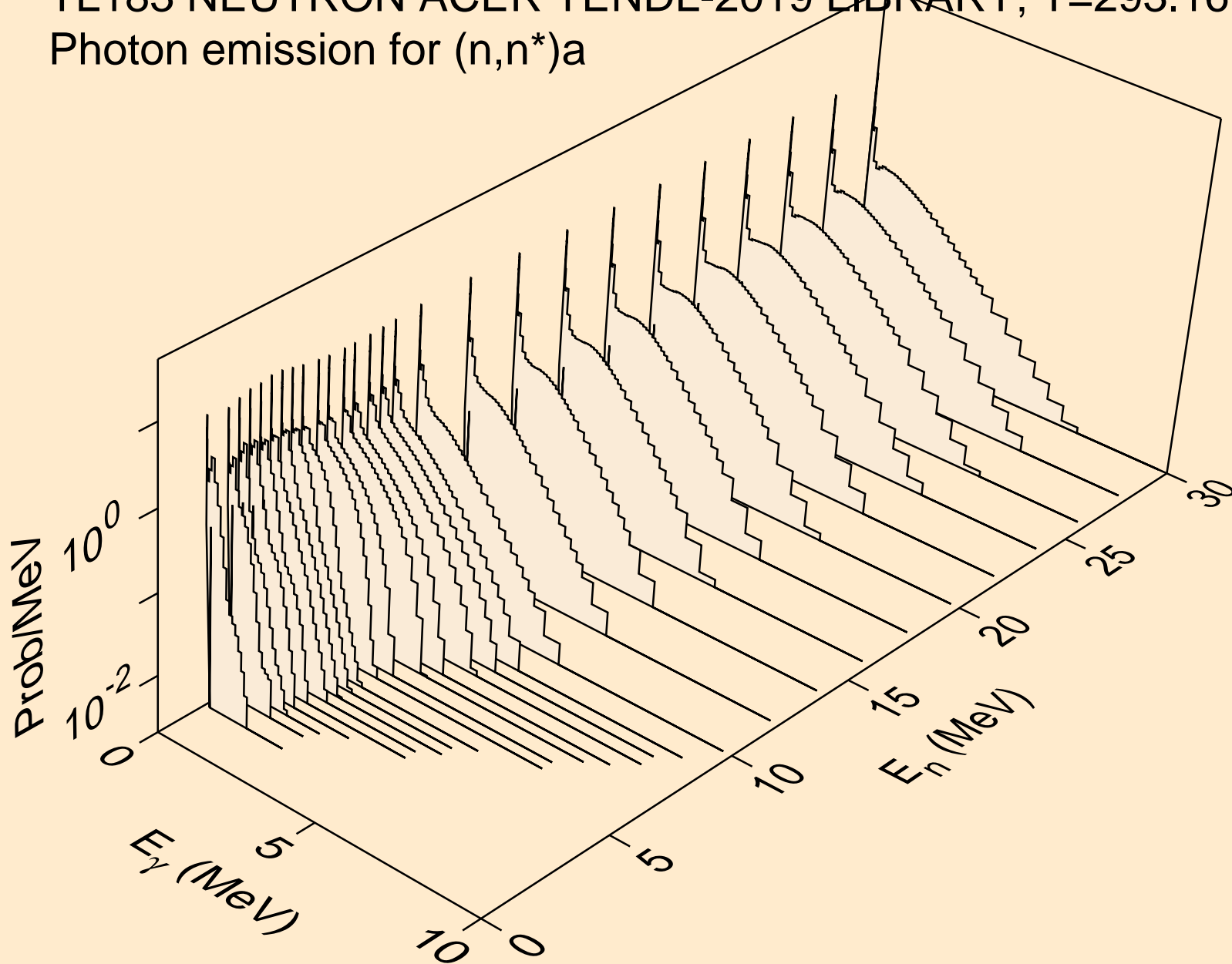

TL183 NEUTRON ACER TENDL-2019 LIBRARY; T=293.16K
Photon emission for (n,n*)3a

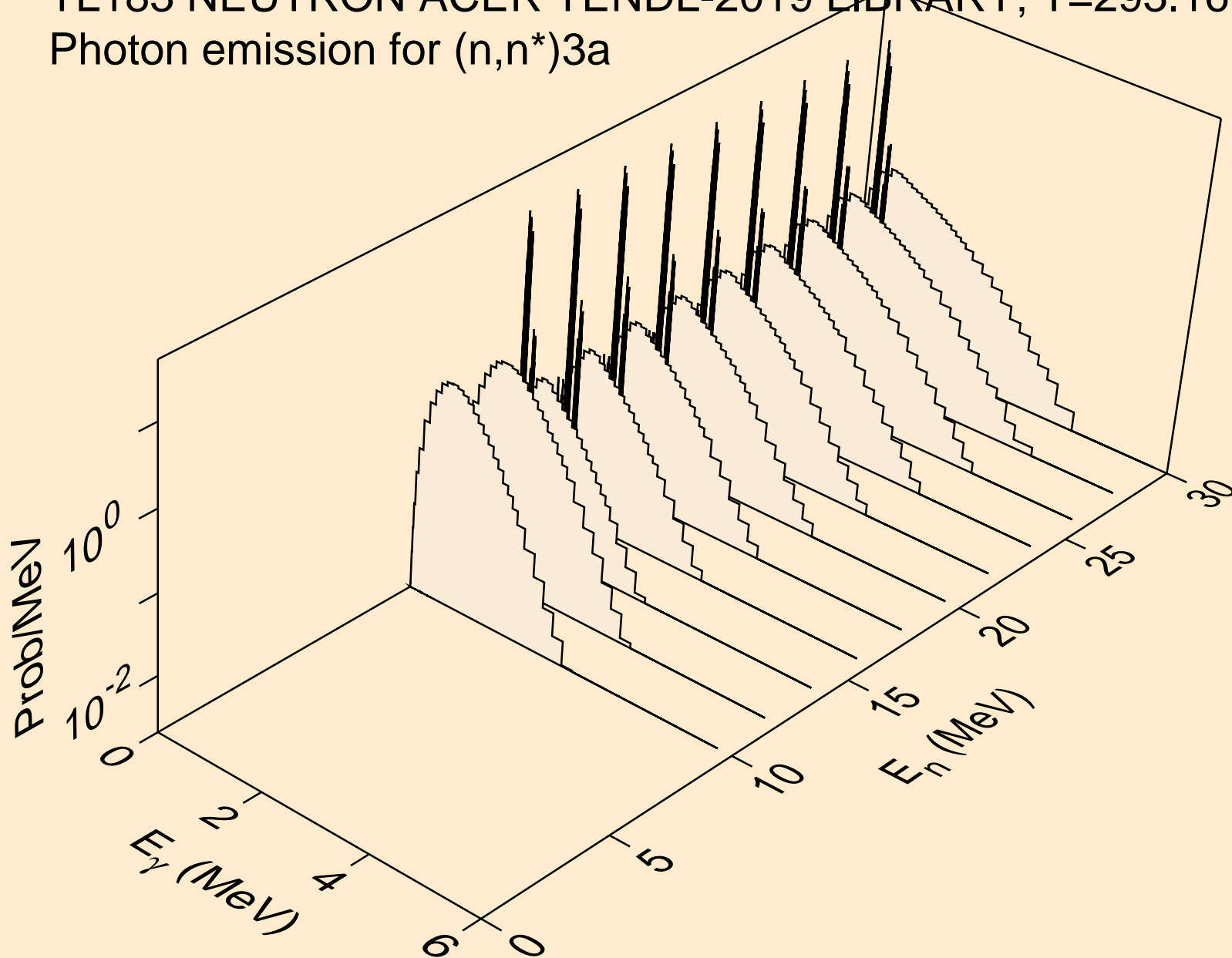

TL183 NEUTRON ACER TENDL-2019 LIBRARY; T=293.16K
Photon emission for (n,2n)a

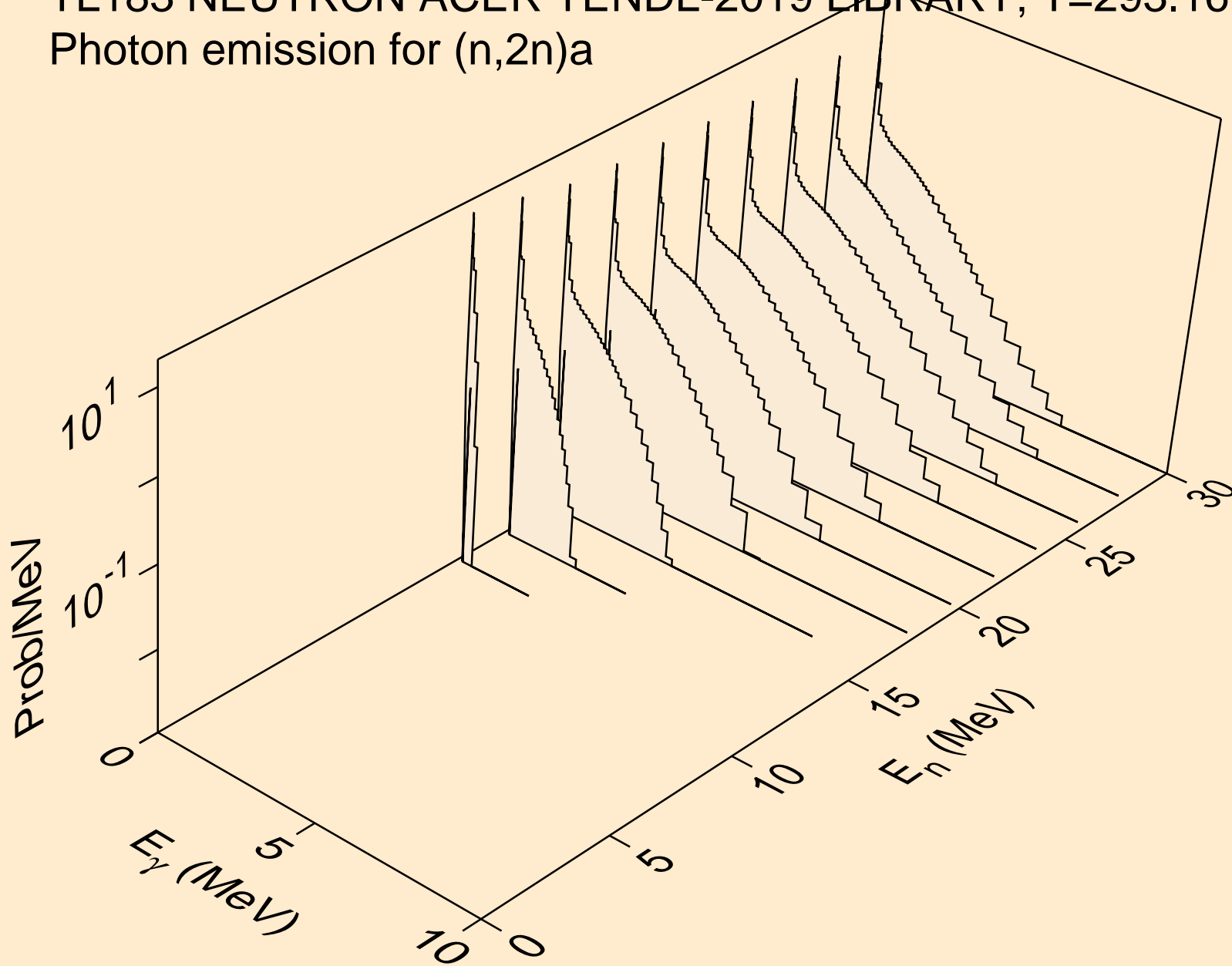

TL183 NEUTRON ACER TENDL-2019 LIBRARY; T=293.16K
Photon emission for (n,3n)a

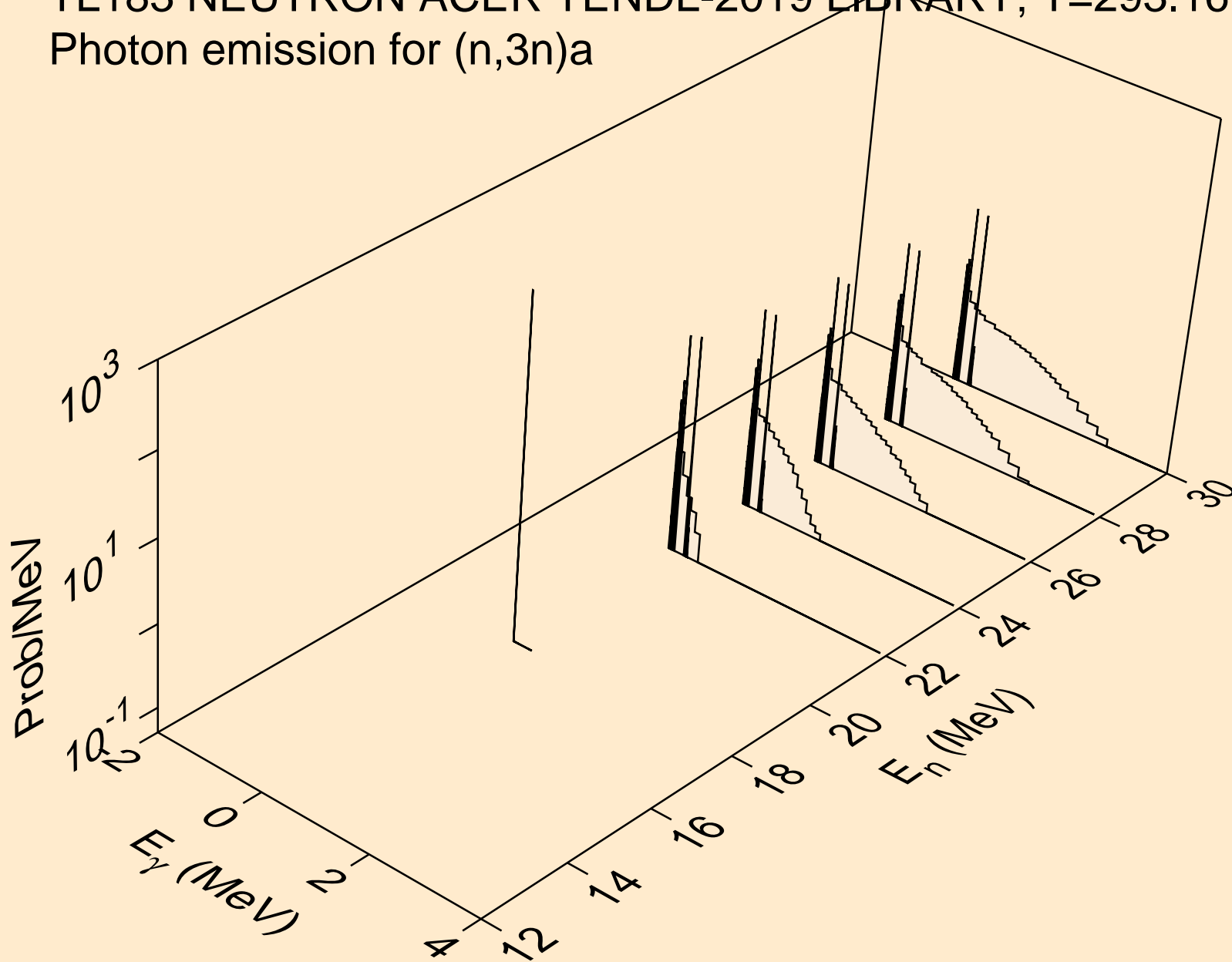

TL183 NEUTRON ACER TENDL-2019 LIBRARY; T=293.16K
Photon emission for (n,n*)p

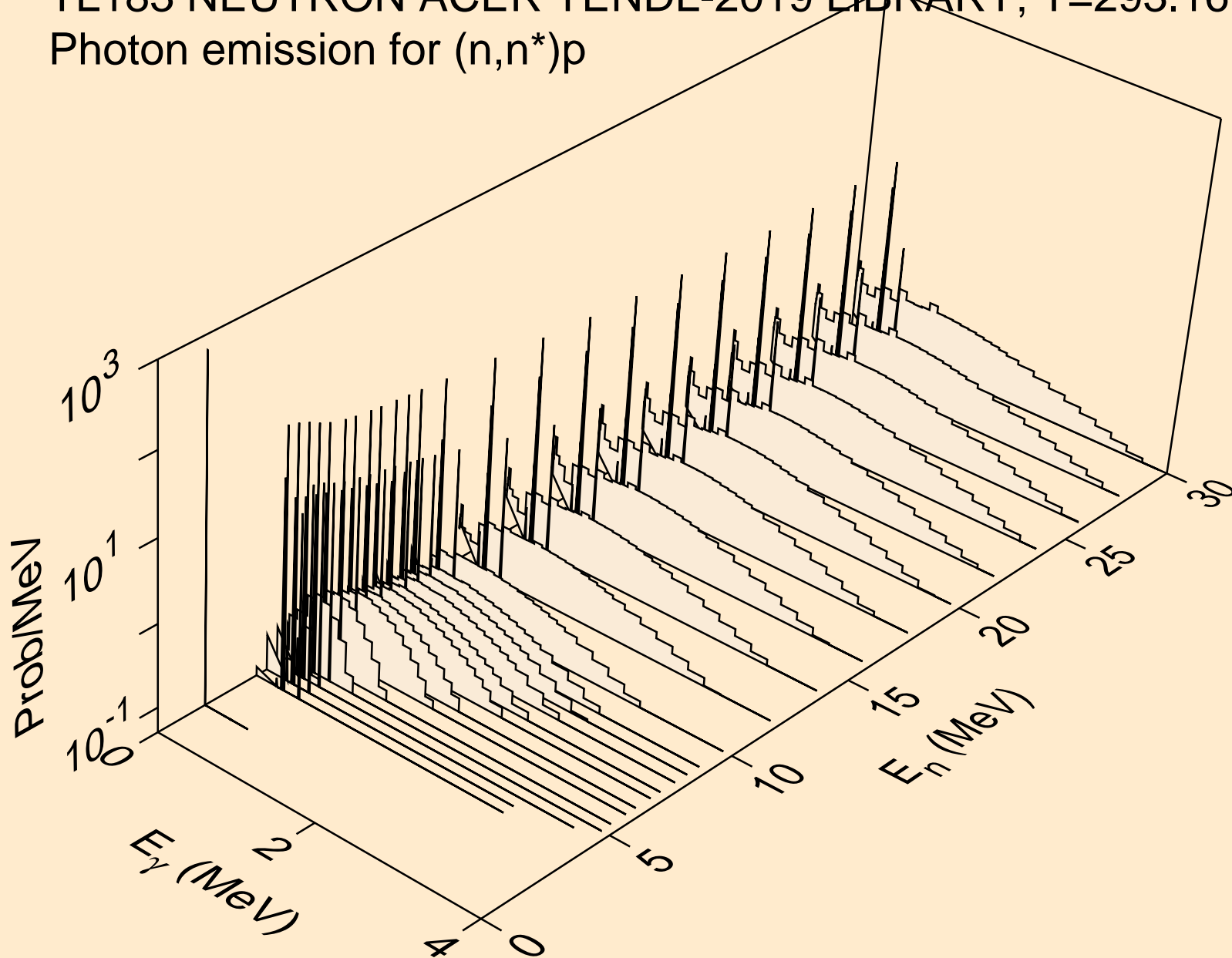

TL183 NEUTRON ACER TENDL-2019 LIBRARY; T=293.16K
Photon emission for (n,n*)2a

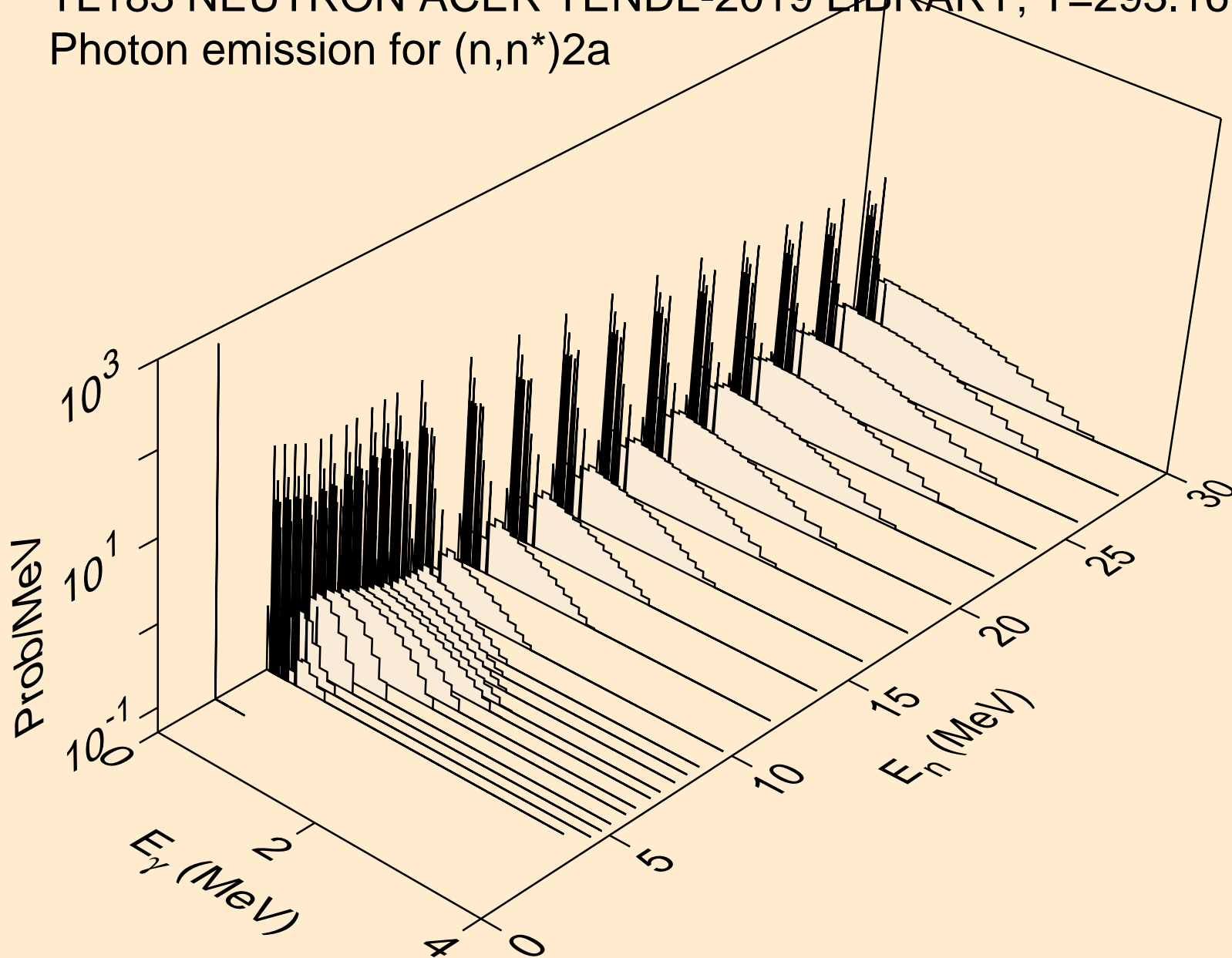

TL183 NEUTRON ACER TENDL-2019 LIBRARY; T=293.16K
Photon emission for (n,2n)2a

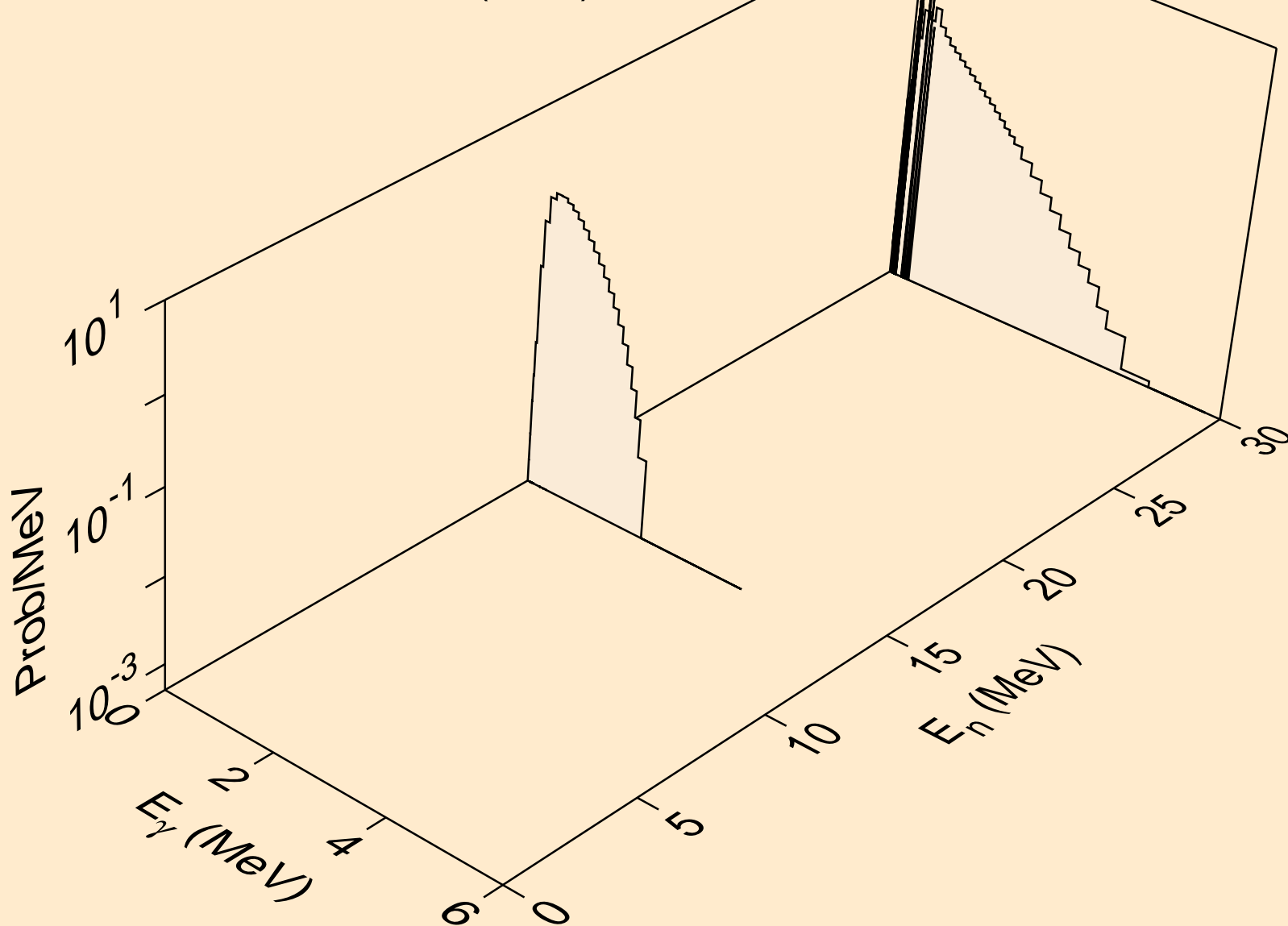

TL183 NEUTRON ACER TENDL-2019 LIBRARY; T=293.16K
Photon emission for (n,n*)d

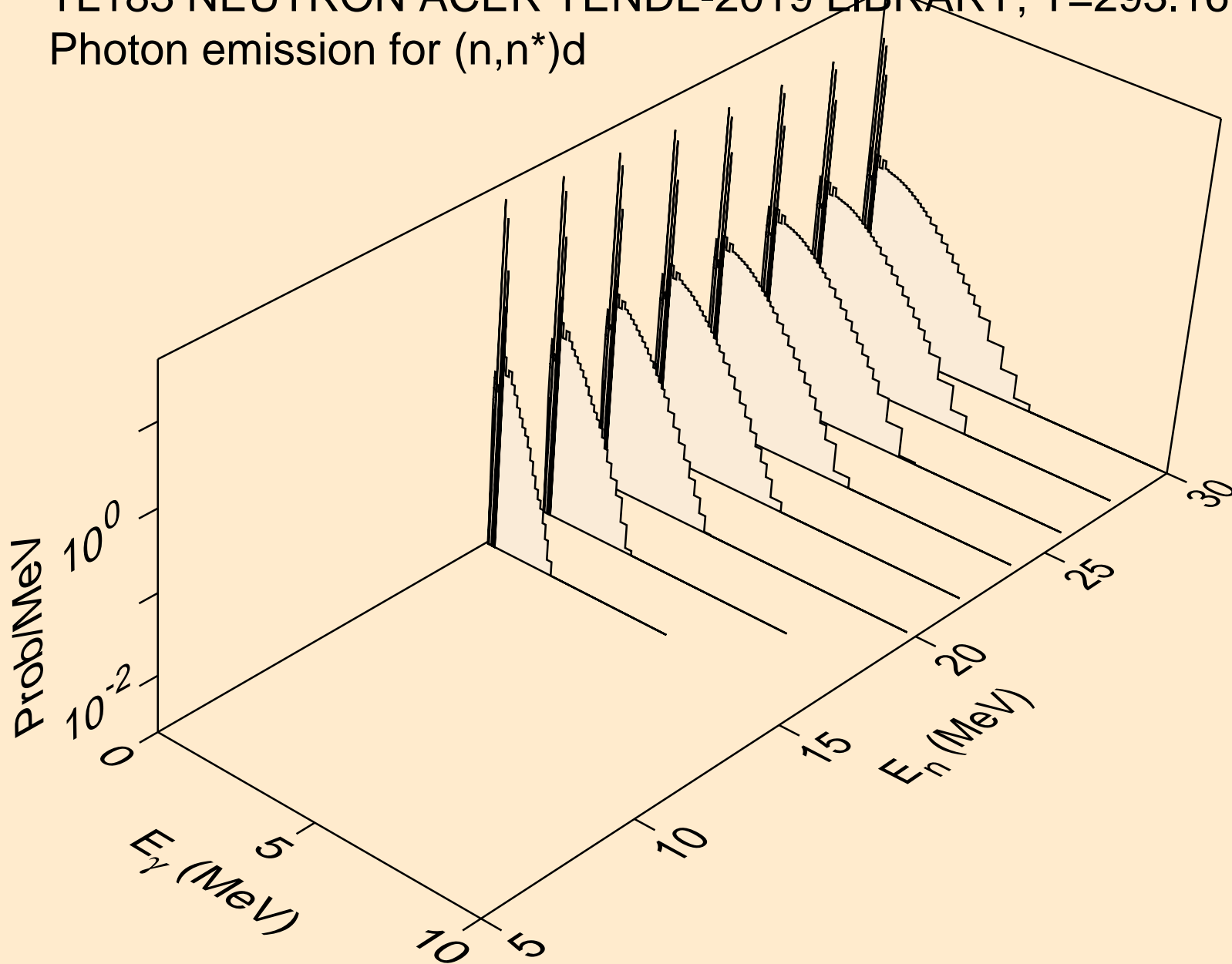

TL183 NEUTRON ACER TENDL-2019 LIBRARY; T=293.16K
Photon emission for (n,n*)t

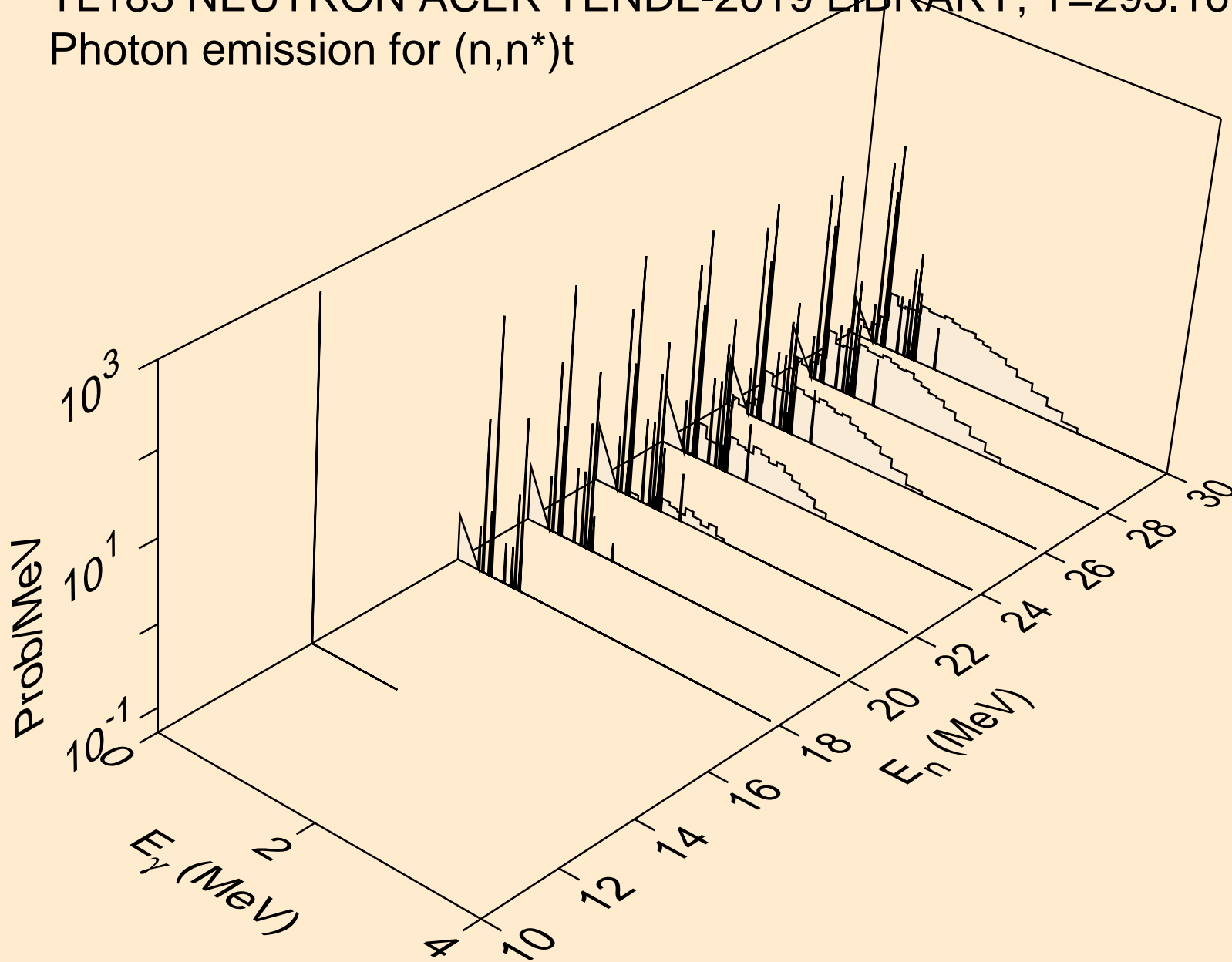

TL183 NEUTRON ACER TENDL-2019 LIBRARY; T=293.16K
Photon emission for (n,n*)he3

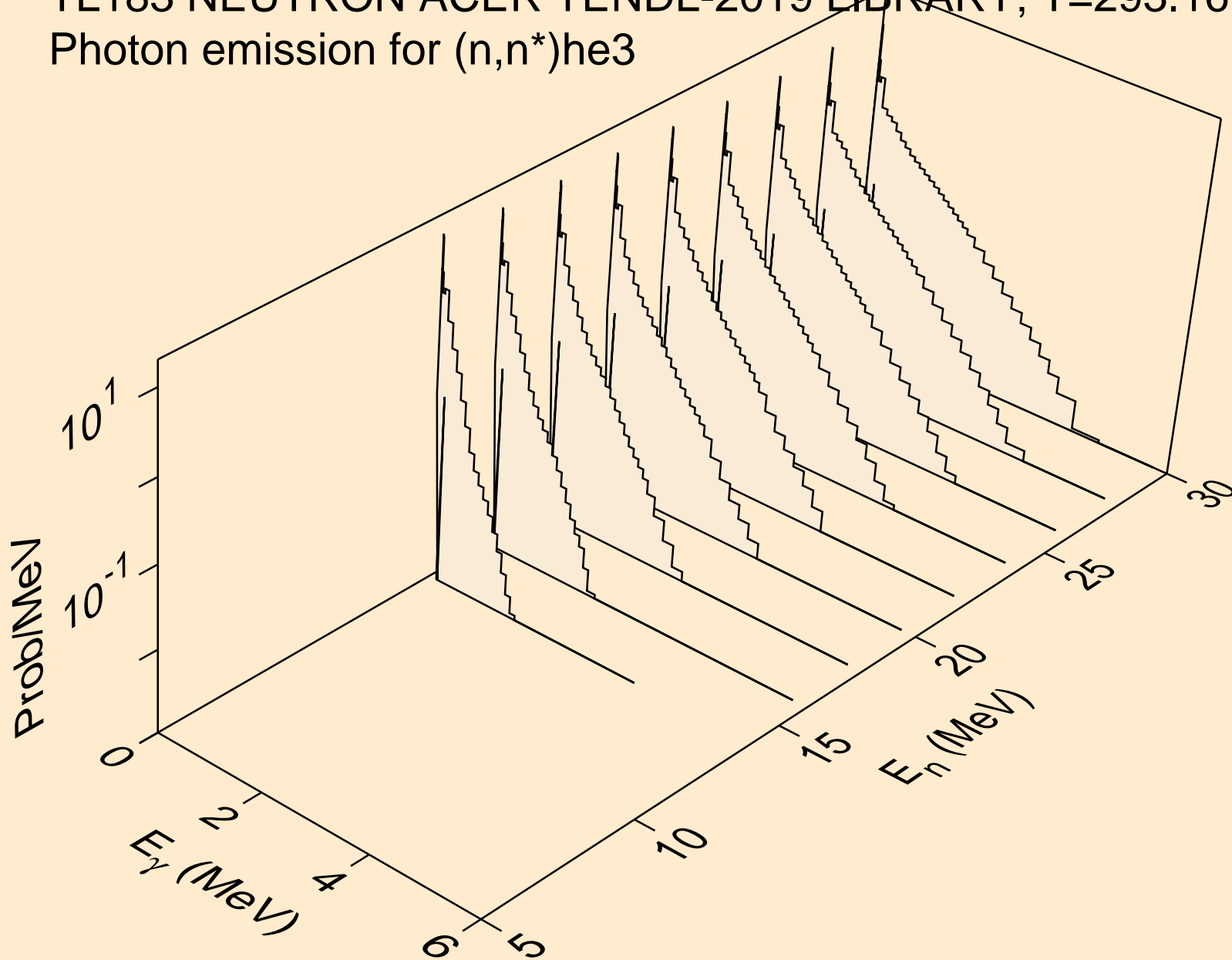

TL183 NEUTRON ACER TENDL-2019 LIBRARY; T=293.16K
Photon emission for (n,2np)

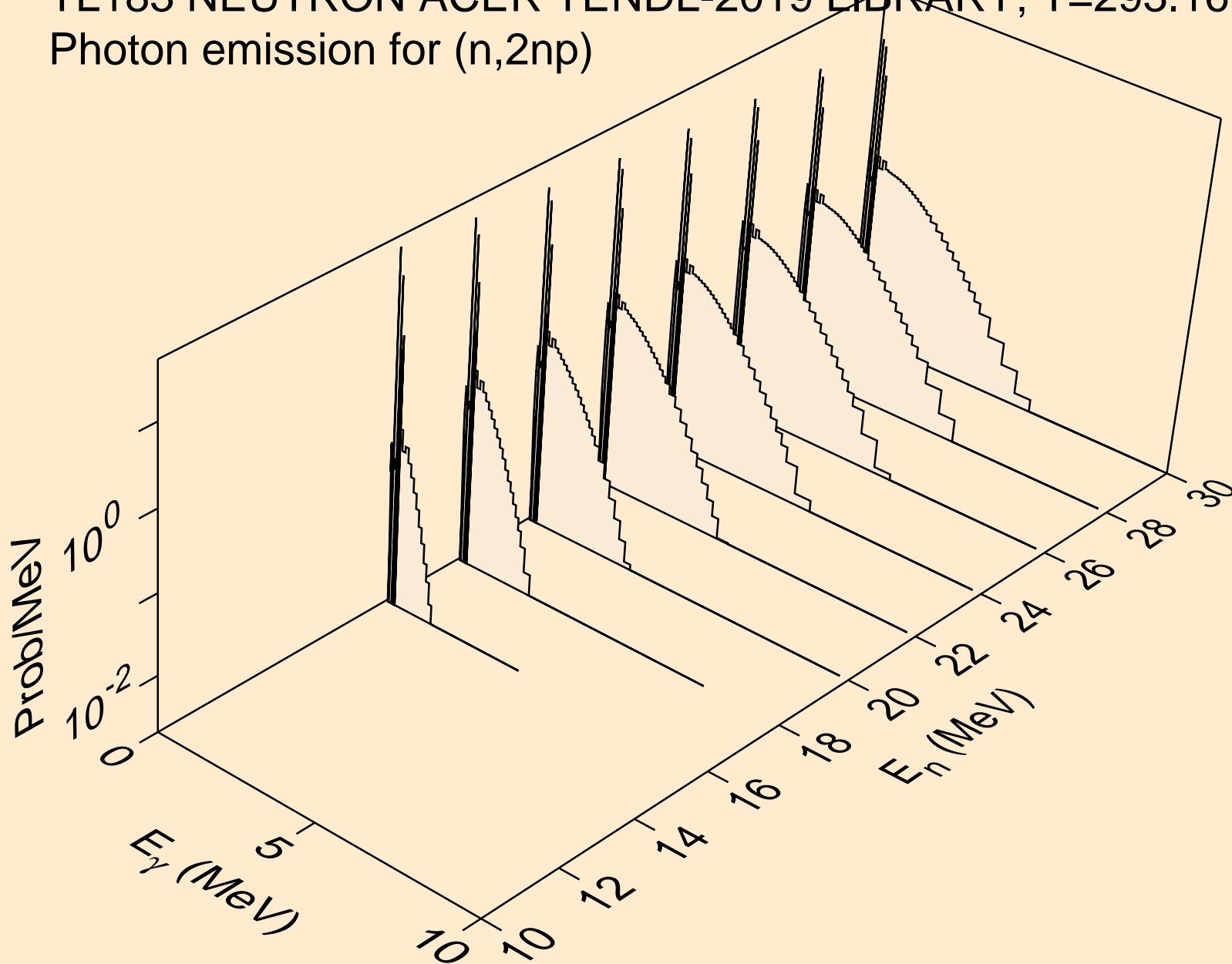

TL183 NEUTRON ACER TENDL-2019 LIBRARY; T=293.16K
Photon emission for (n,3np)

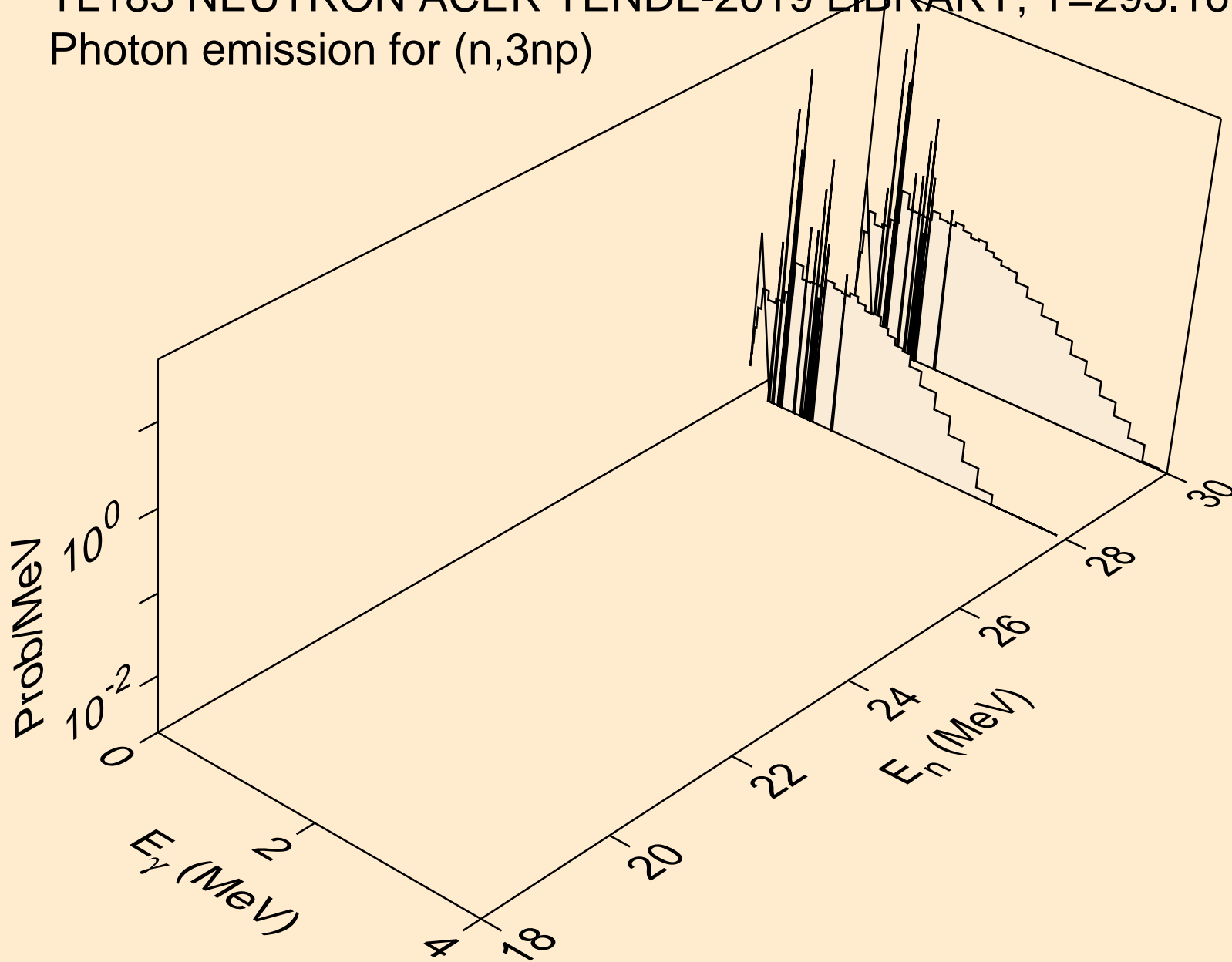

TL183 NEUTRON ACER TENDL-2019 LIBRARY; T=293.16K
Photon emission for (n,2np)

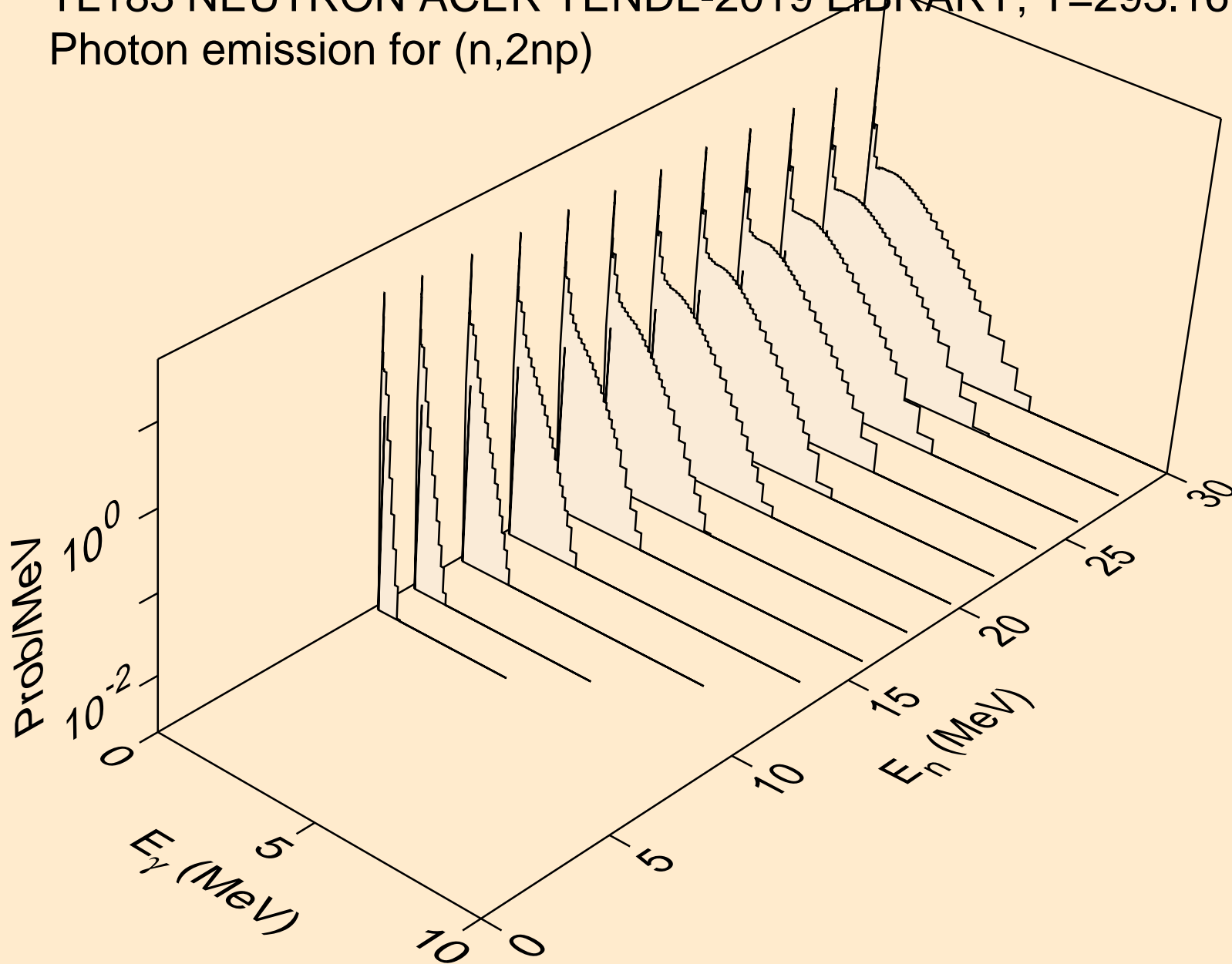

TL183 NEUTRON ACER TENDL-2019 LIBRARY; T=293.16K
Photon emission for (n,npa)

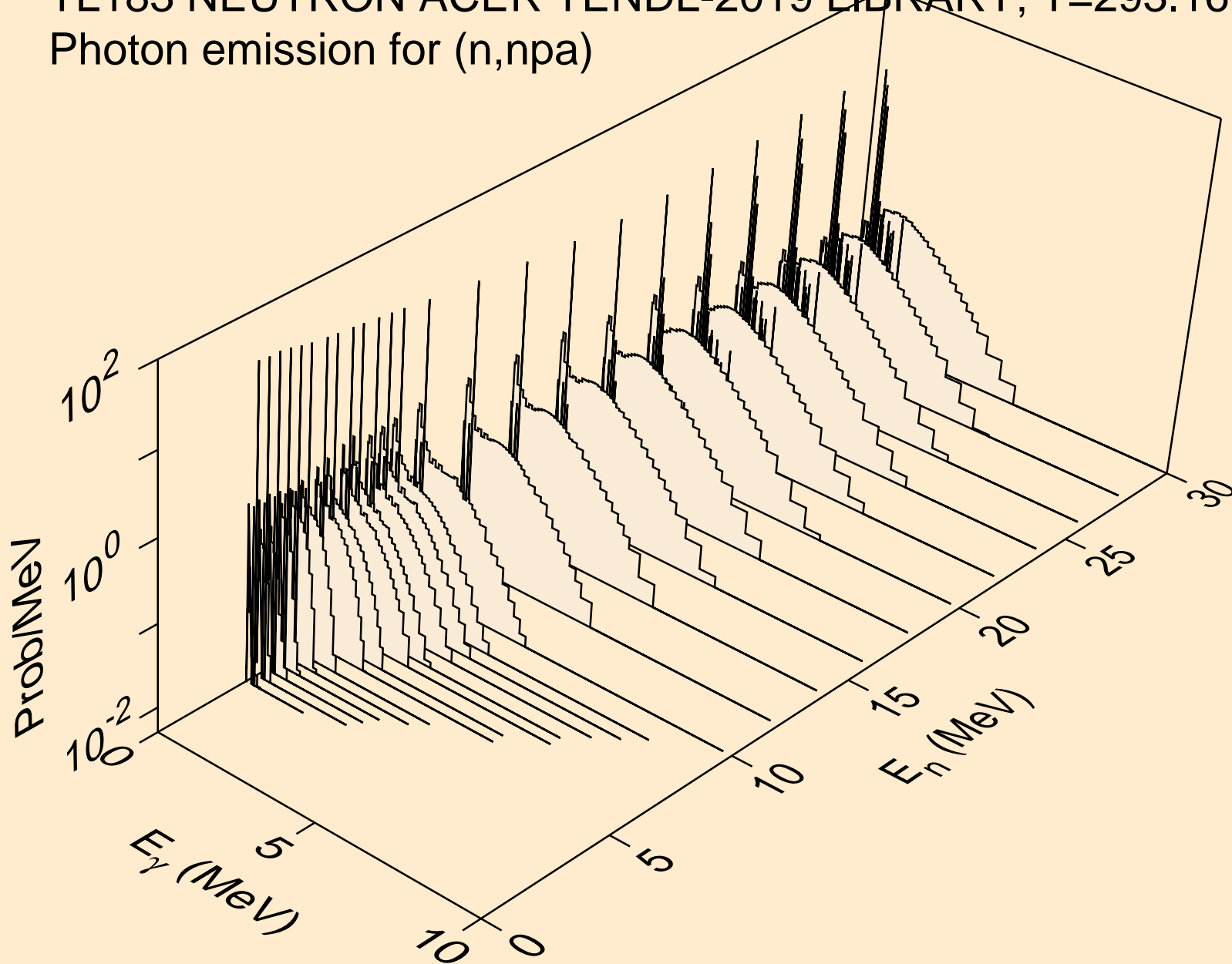

TL183 NEUTRON ACER TENDL-2019 LIBRARY; T=293.16K
Photon emission for (n,n*c)

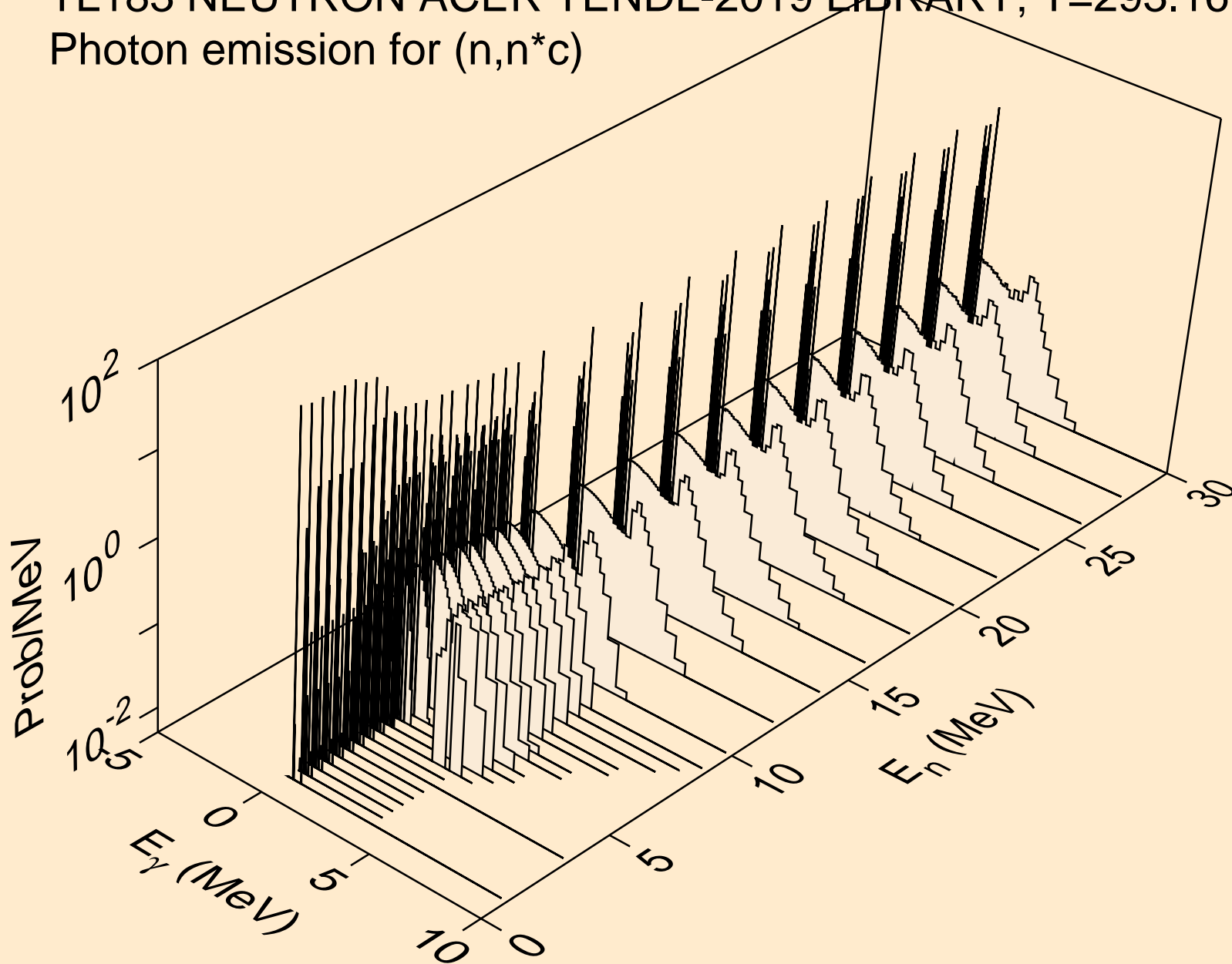

TL183 NEUTRON ACER TENDL-2019 LIBRARY; T=293.16K
Photon emission for (n,gma)

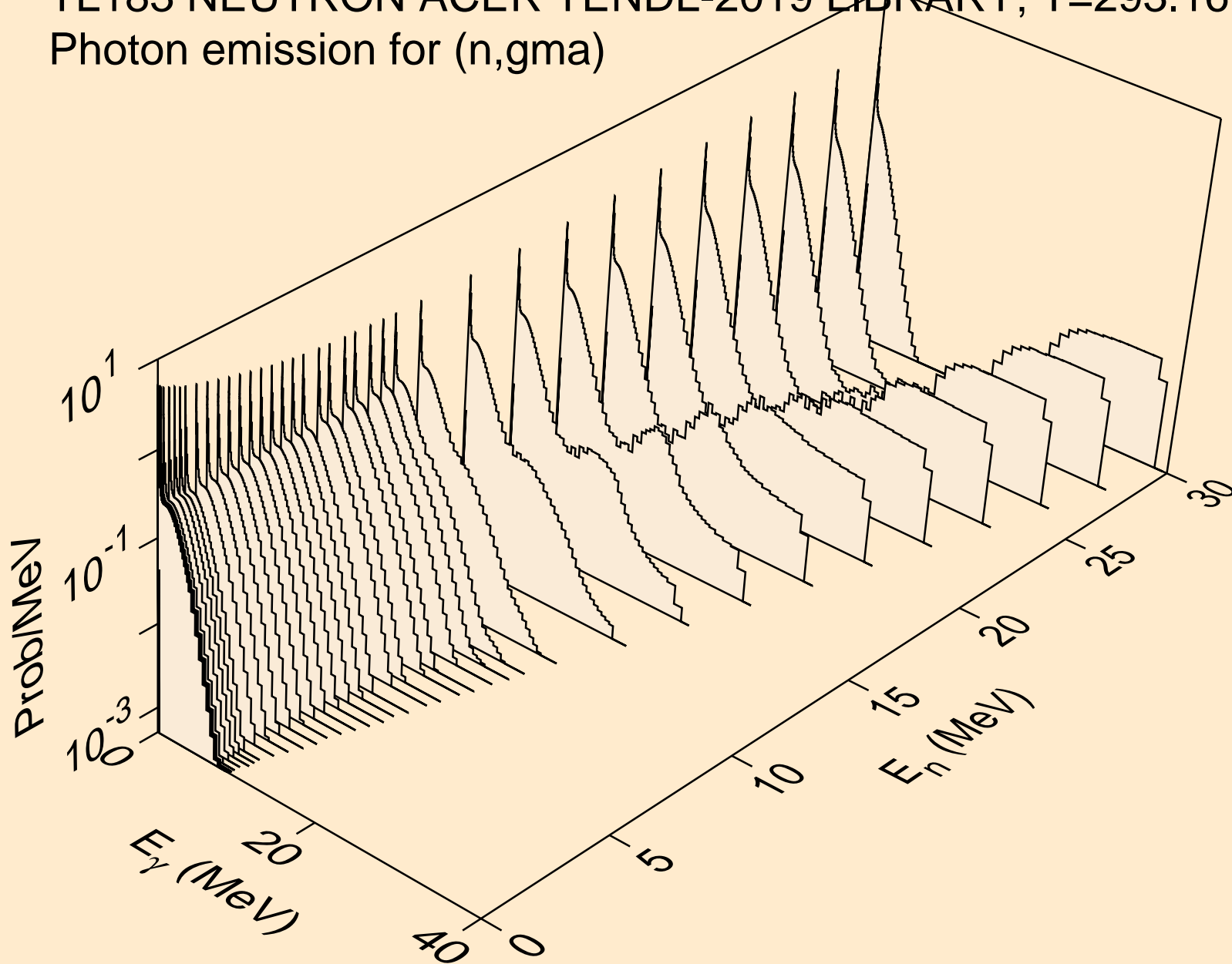

TL183 NEUTRON ACER TENDL-2019 LIBRARY; T=293.16K
Photon emission for (n,p)

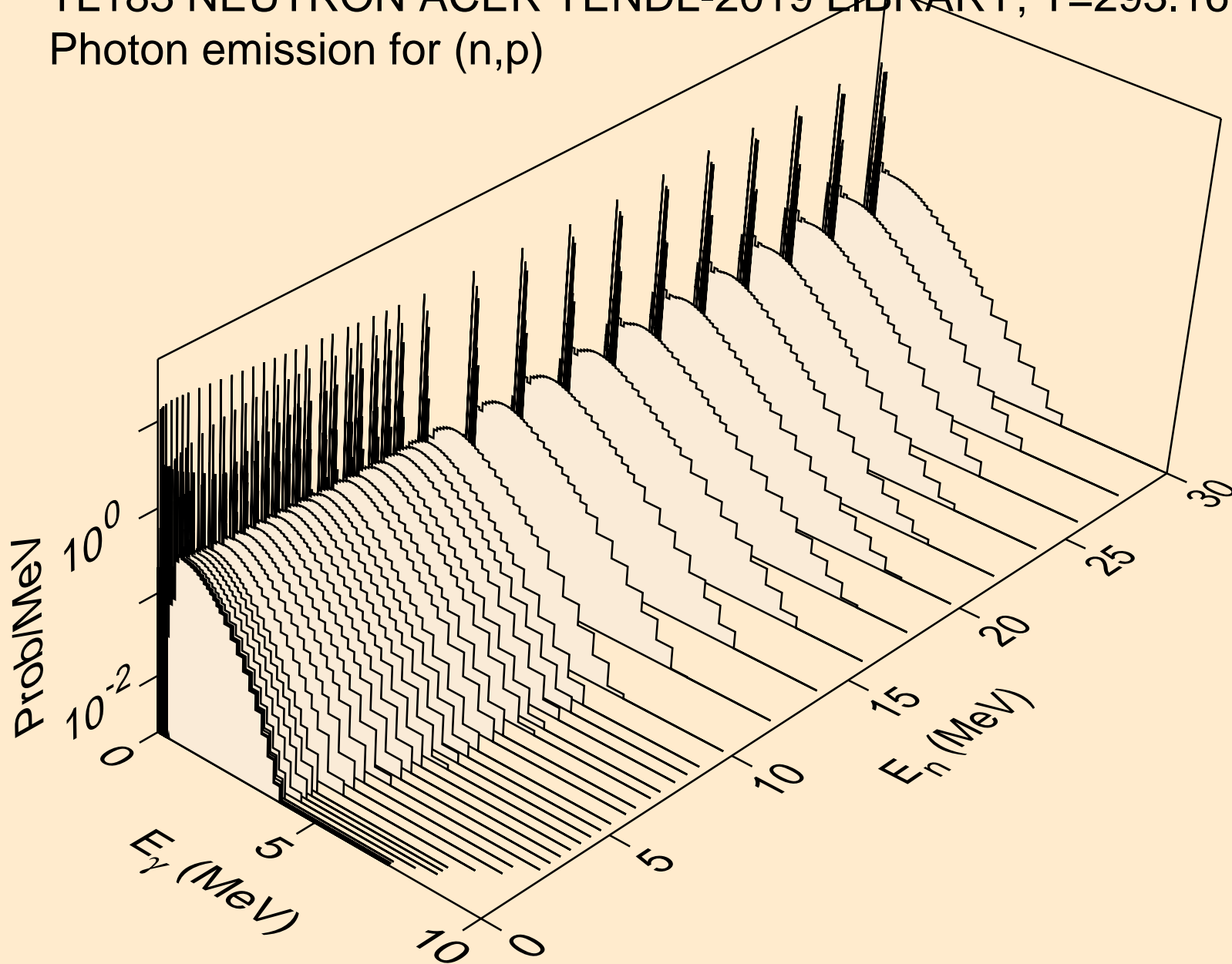

TL183 NEUTRON ACER TENDL-2019 LIBRARY; T=293.16K
Photon emission for (n,d)

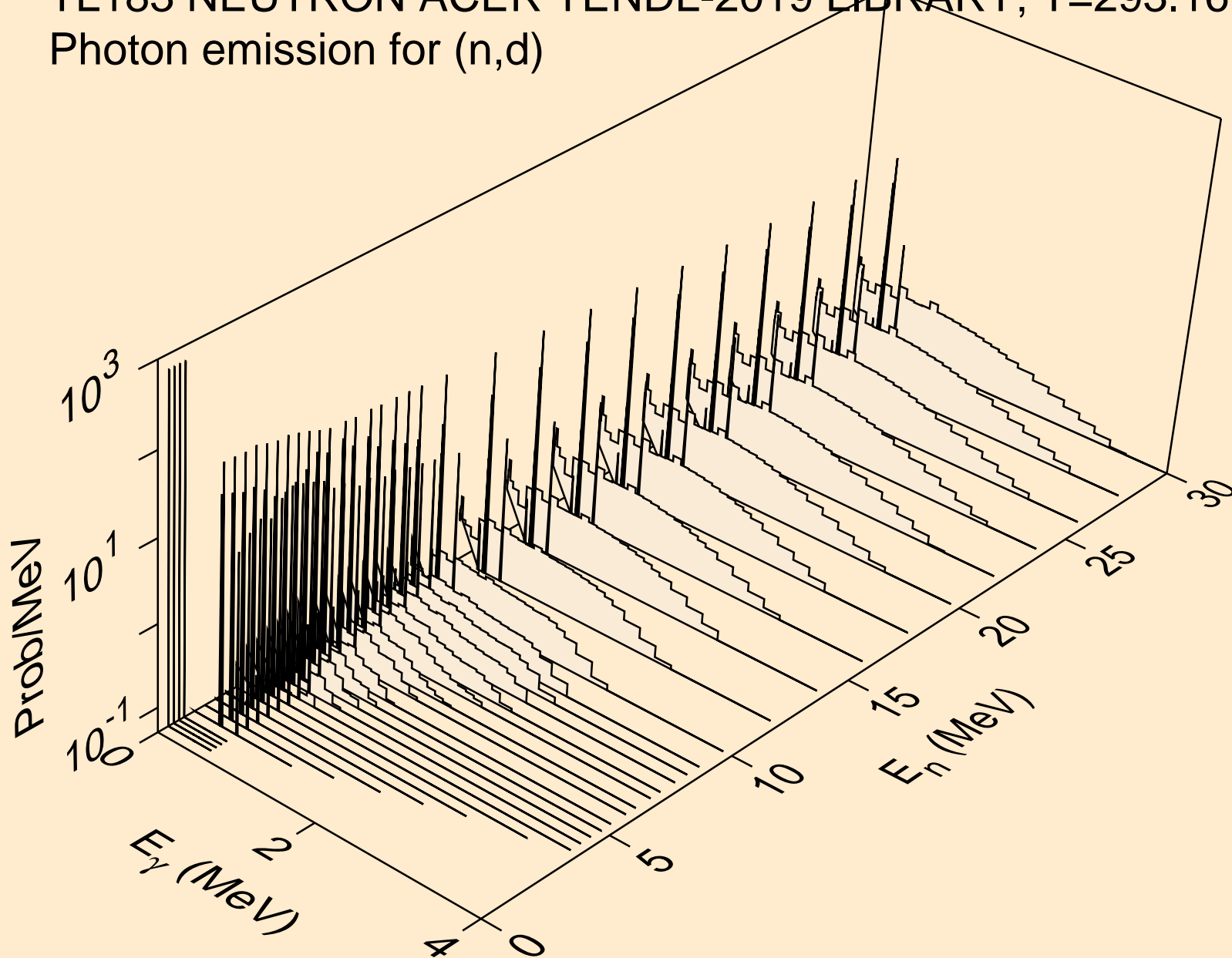

TL183 NEUTRON ACER TENDL-2019 LIBRARY; T=293.16K
Photon emission for (n,t)

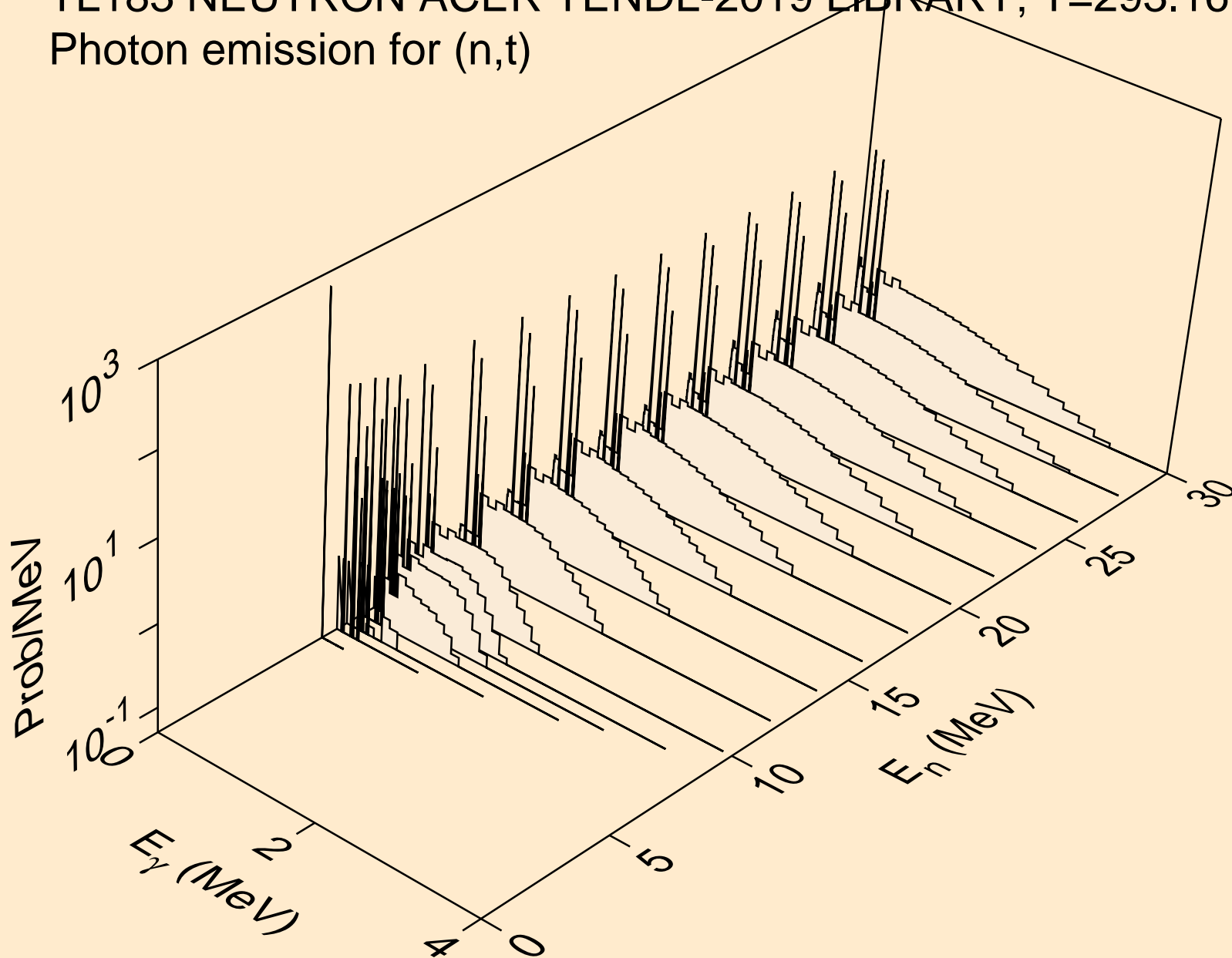

TL183 NEUTRON ACER TENDL-2019 LIBRARY; T=293.16K
Photon emission for (n,he3)

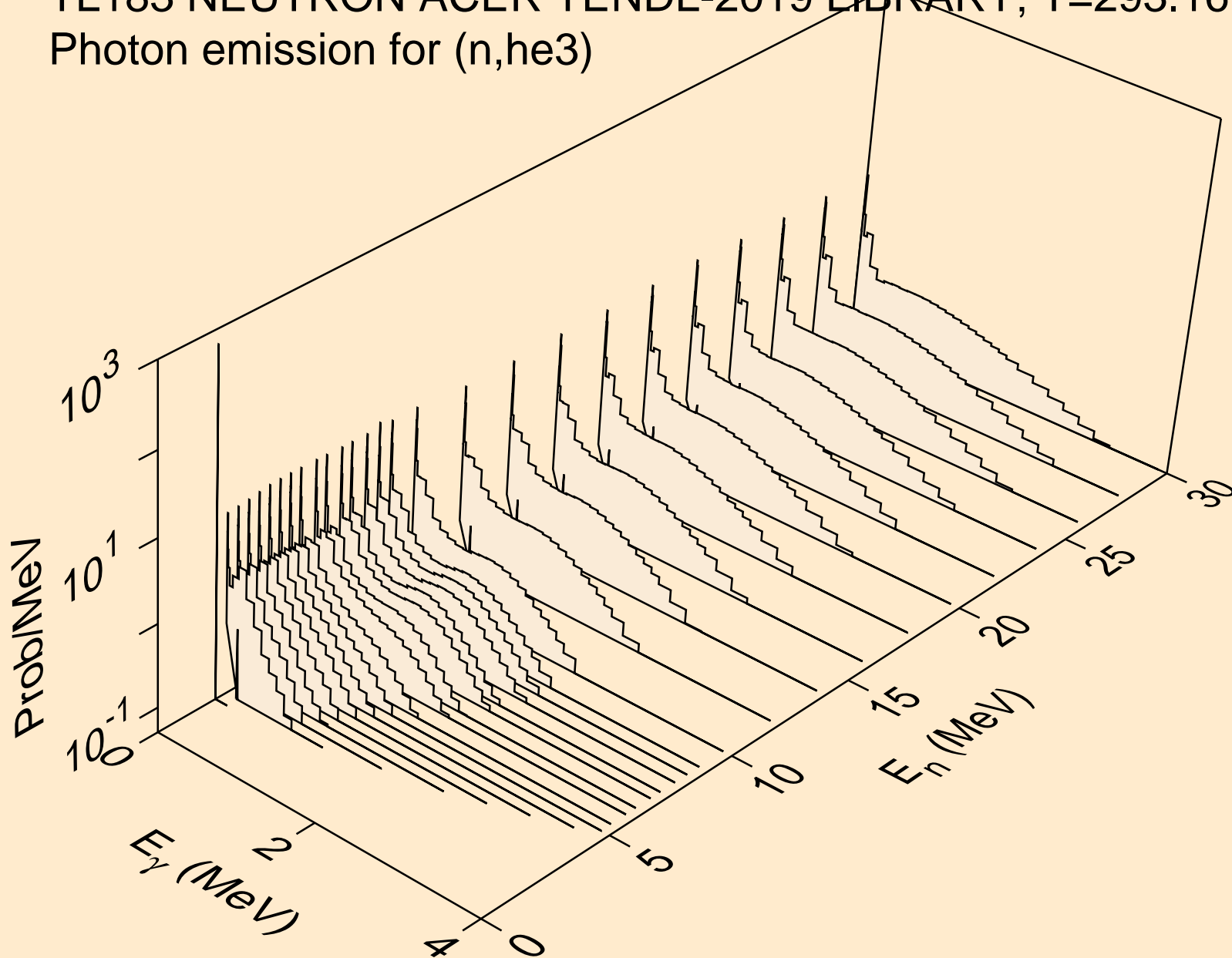

TL183 NEUTRON ACER TENDL-2019 LIBRARY; T=293.16K
Photon emission for (n,a)

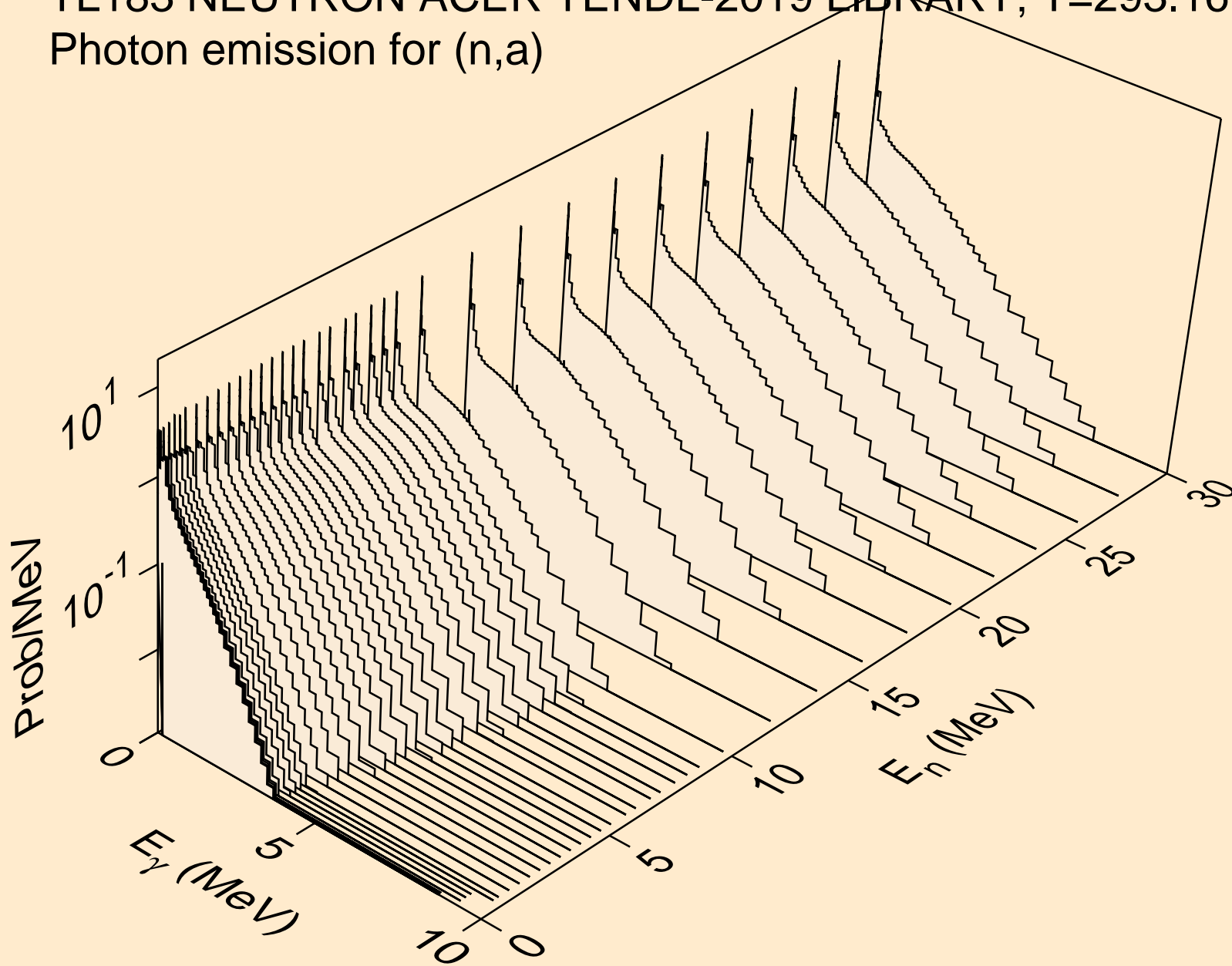

TL183 NEUTRON ACER TENDL-2019 LIBRARY; T=293.16K
Photon emission for (n,2a)

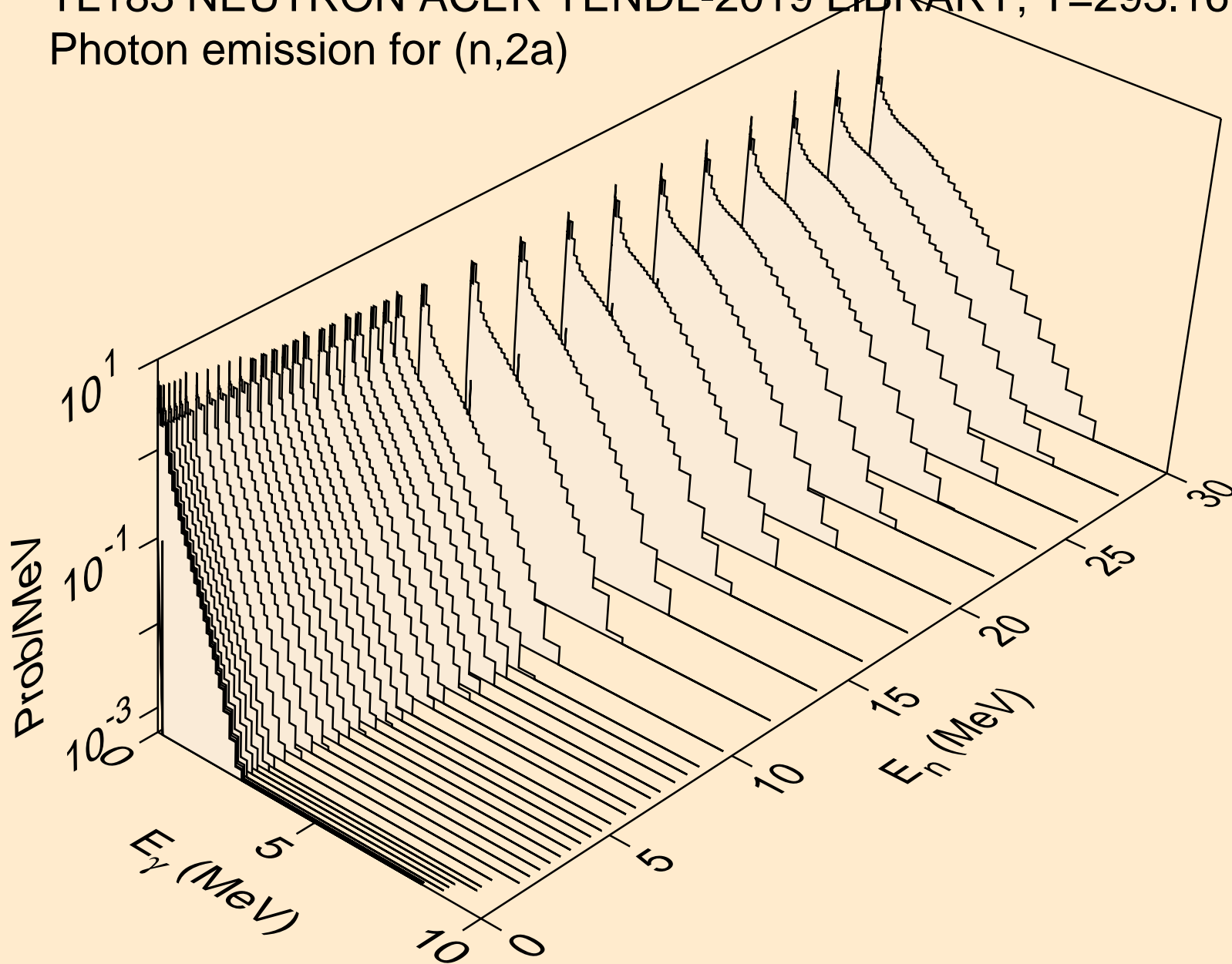

TL183 NEUTRON ACER TENDL-2019 LIBRARY; T=293.16K
Photon emission for (n,3a)

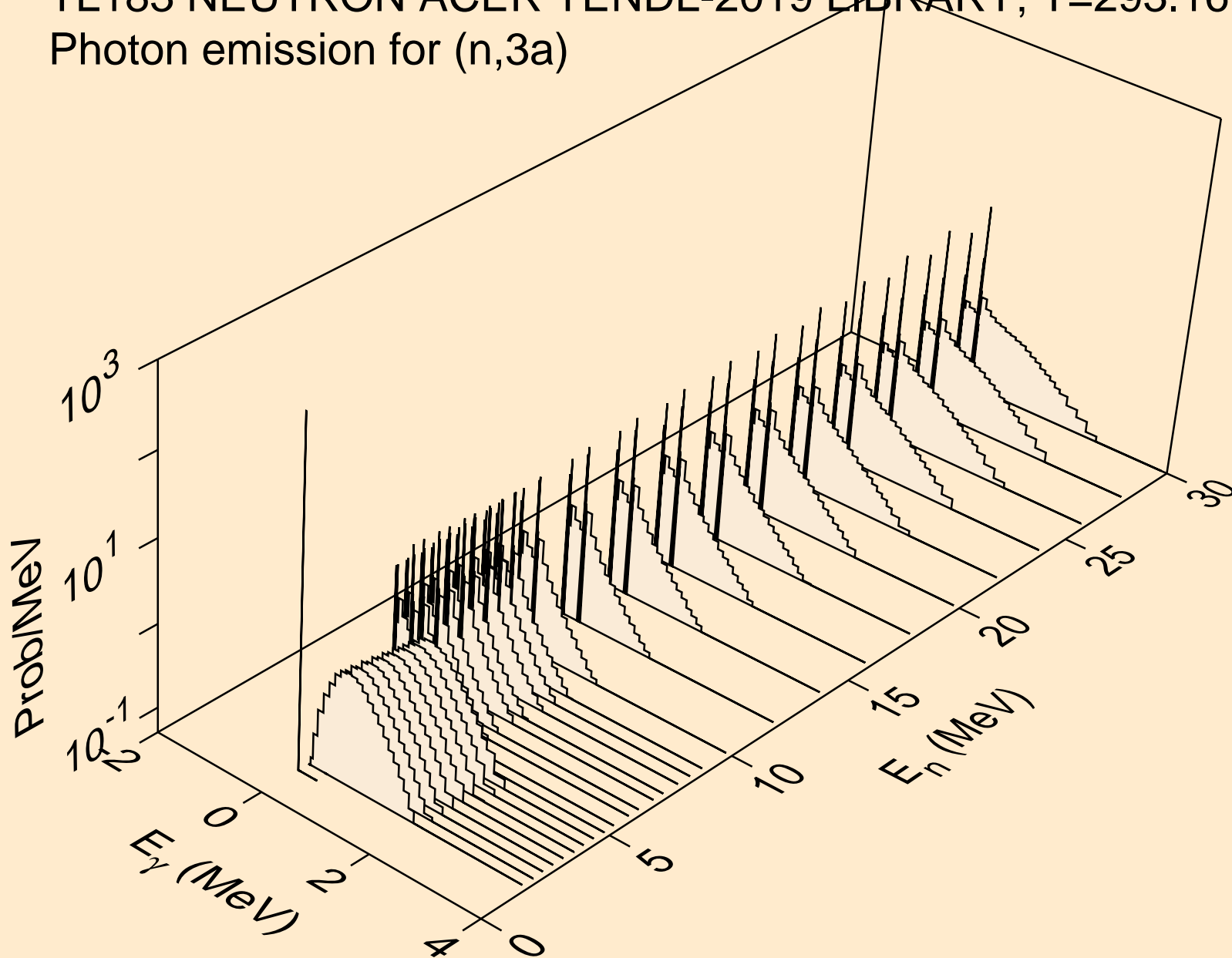

TL183 NEUTRON ACER TENDL-2019 LIBRARY; T=293.16K
Photon emission for (n,2p)

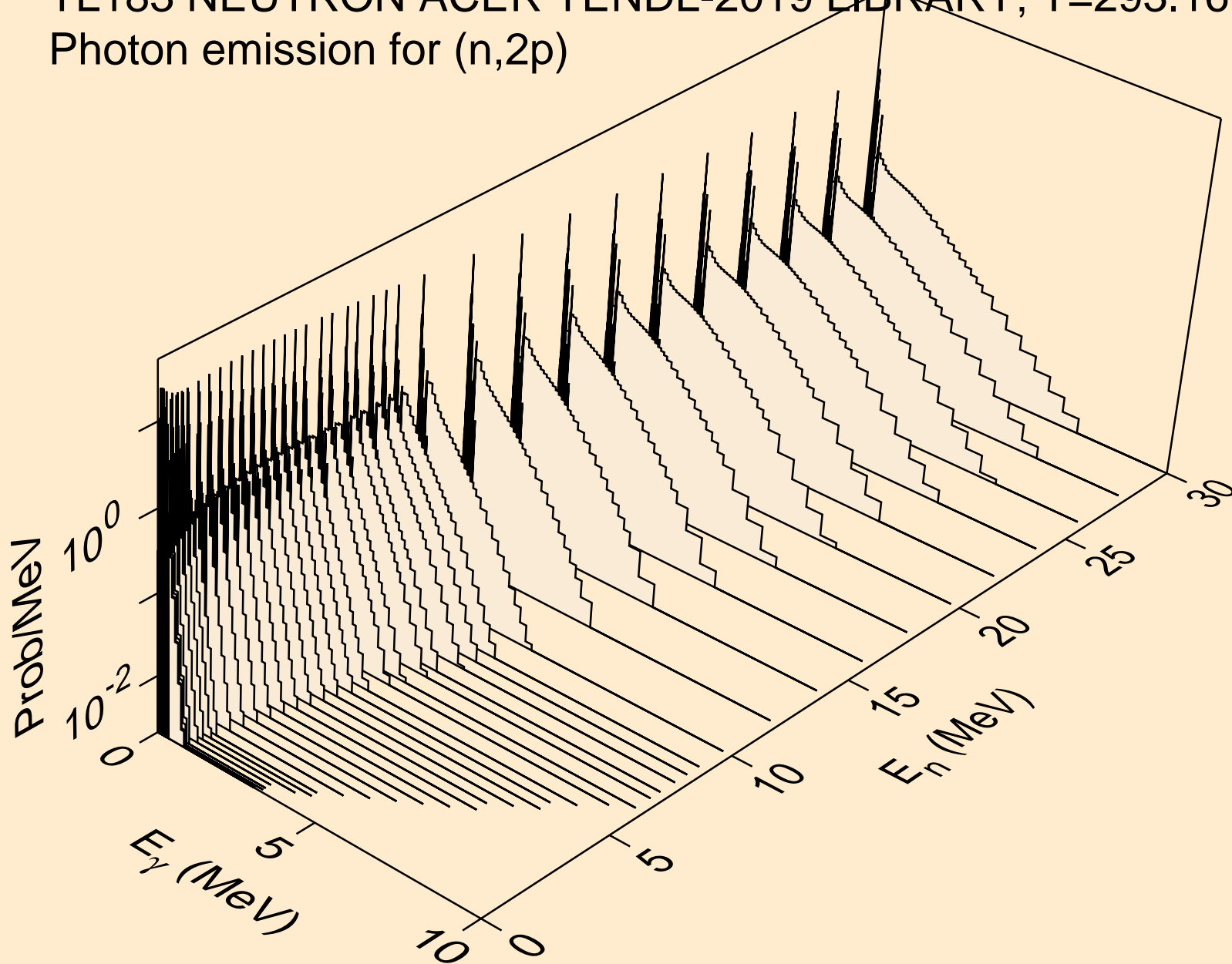

TL183 NEUTRON ACER TENDL-2019 LIBRARY; T=293.16K
Photon emission for (n,p)

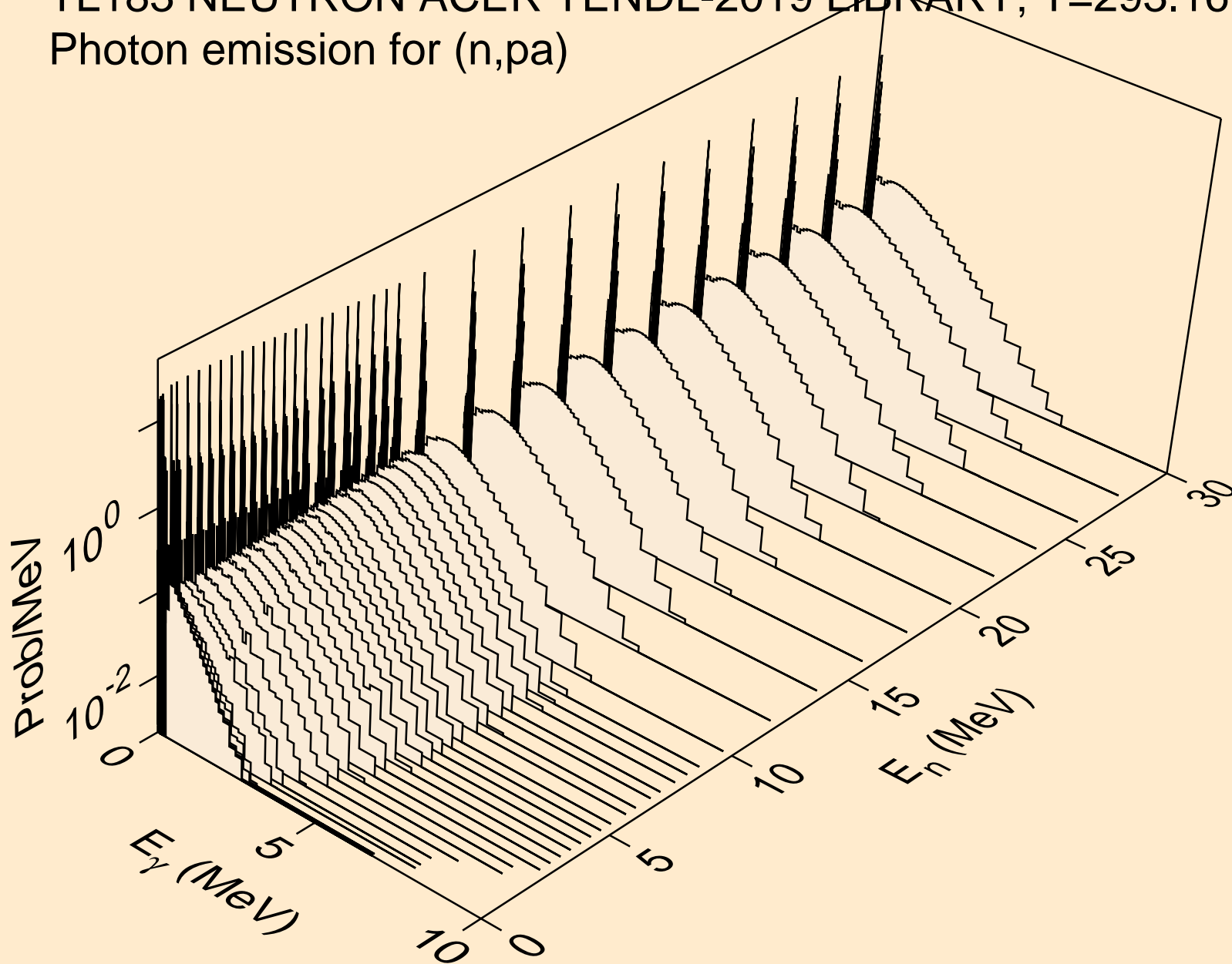

TL183 NEUTRON ACER TENDL-2019 LIBRARY; T=293.16K
Photon emission for (n,t2a)

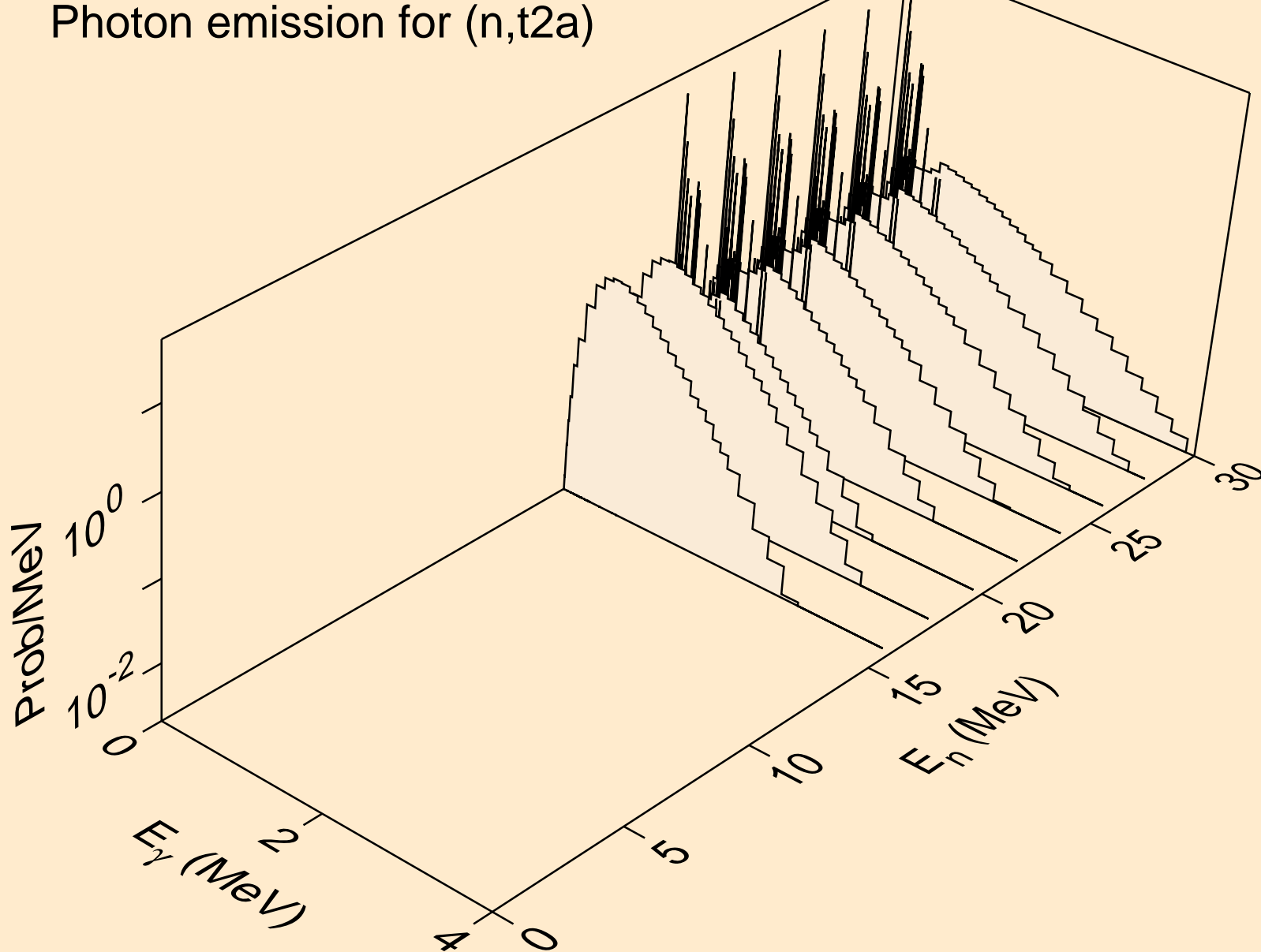

TL183 NEUTRON ACER TENDL-2019 LIBRARY; T=293.16K
Photon emission for (n,d2a)

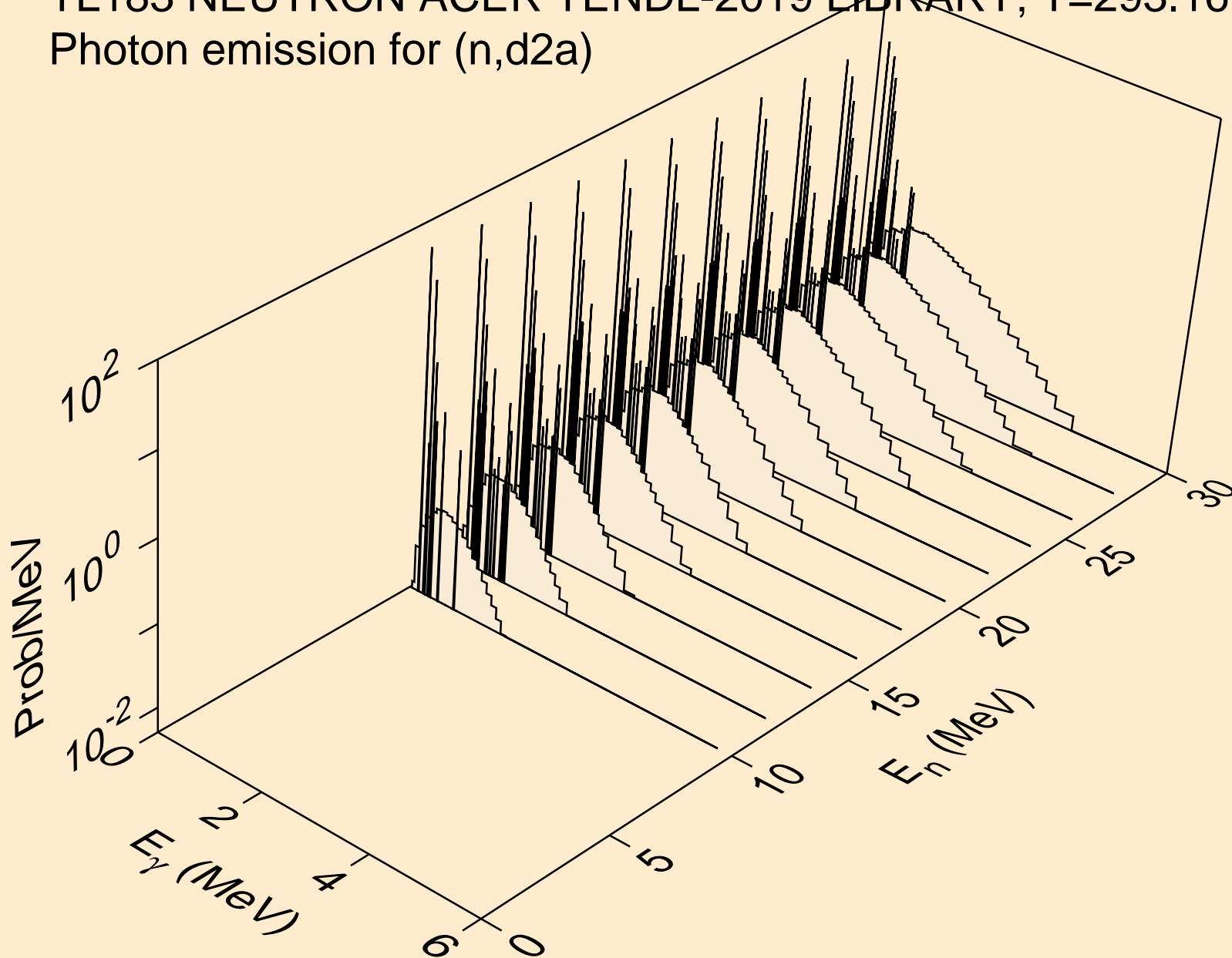

TL183 NEUTRON ACER TENDL-2019 LIBRARY; T=293.16K
Photon emission for (n,pd)

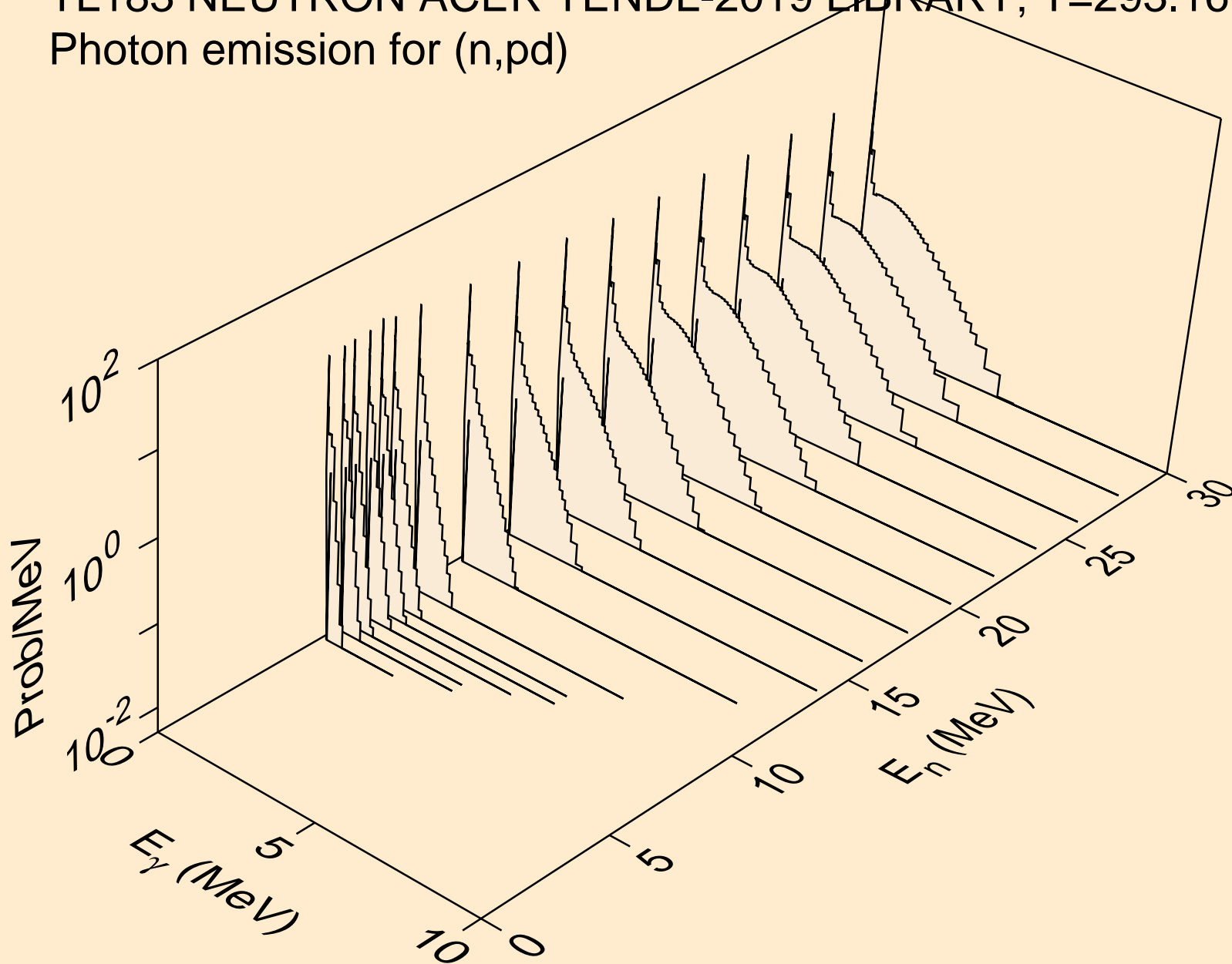

TL183 NEUTRON ACER TENDL-2019 LIBRARY; T=293.16K
Photon emission for (n,pt)

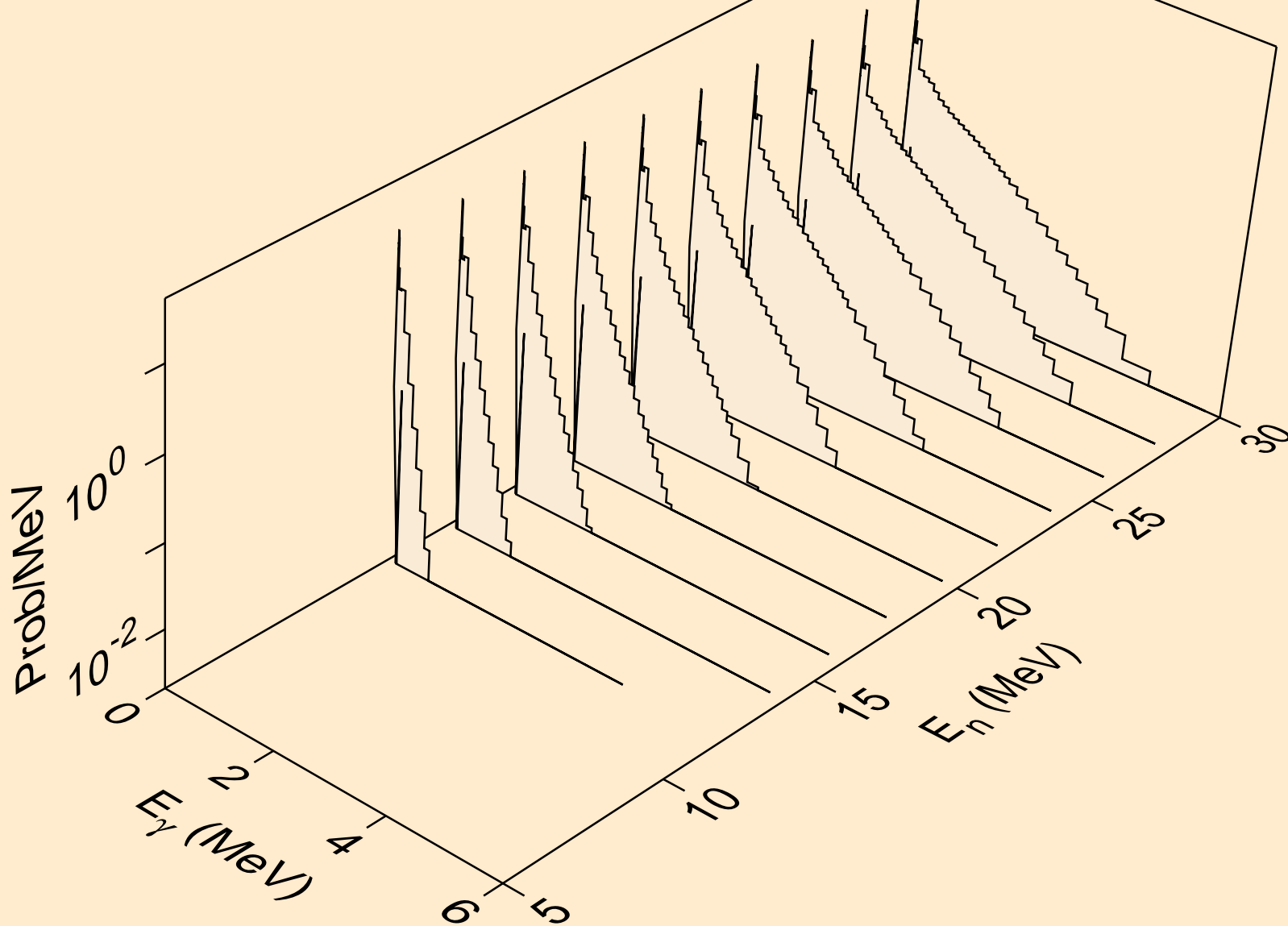

TL183 NEUTRON ACER TENDL-2019 LIBRARY; T=293.16K
Photon emission for (n,da)

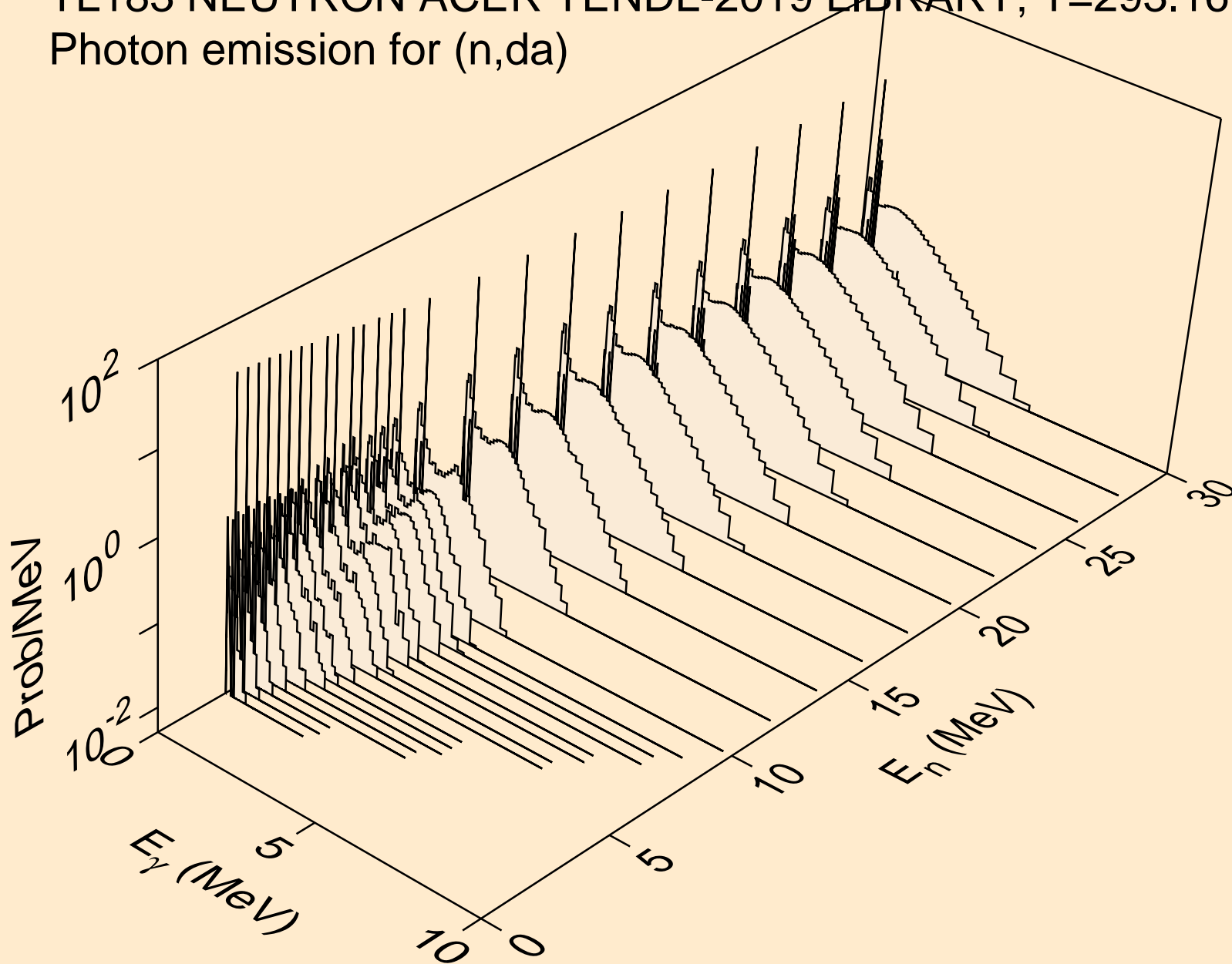

TL183 NEUTRON ACER TENDL-2019 LIBRARY; T=293.16K
thermal capture photon spectrum

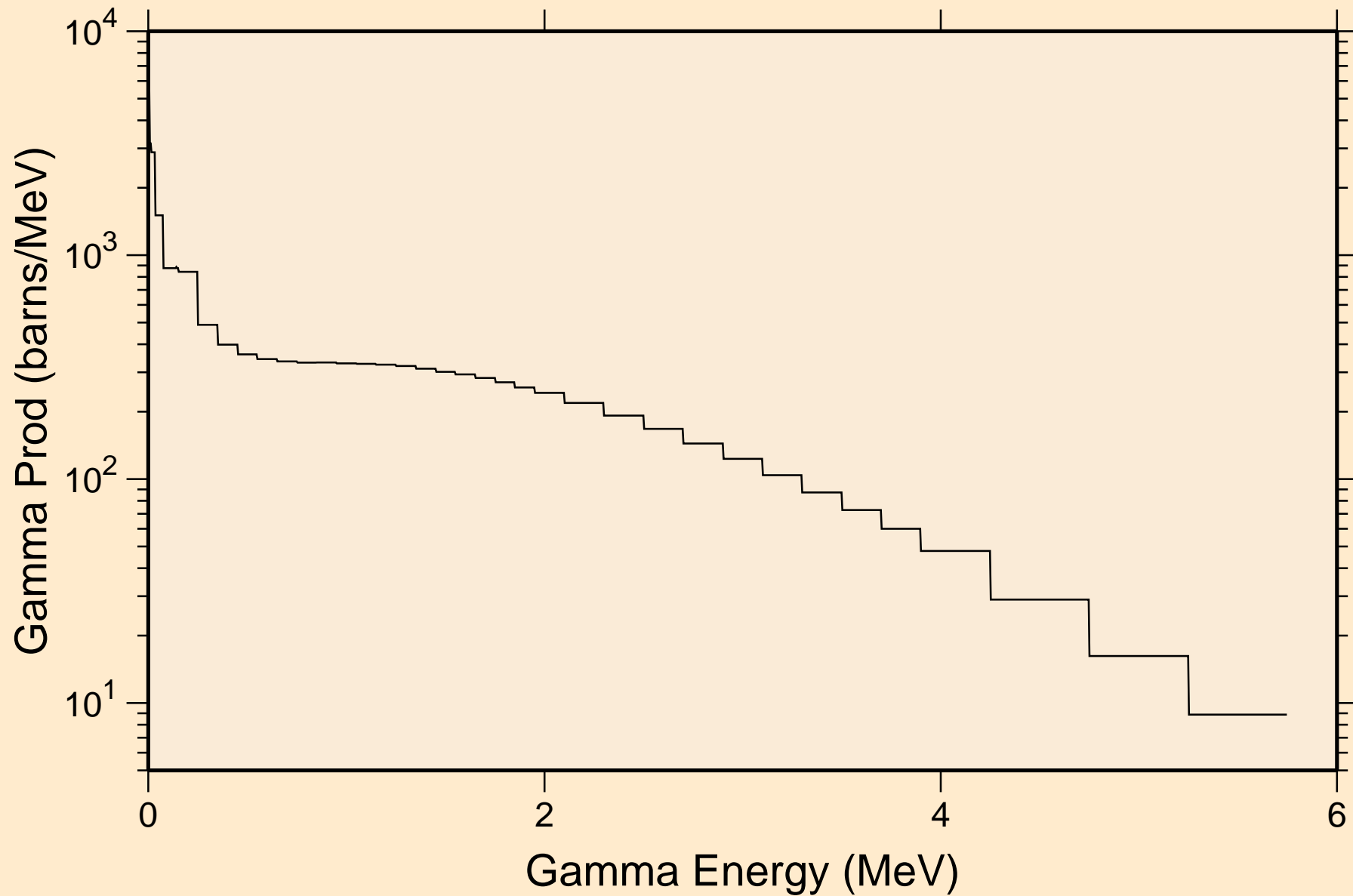

TL183 NEUTRON ACER TENDL-2019 LIBRARY; T=293.16K
14 MeV photon spectrum

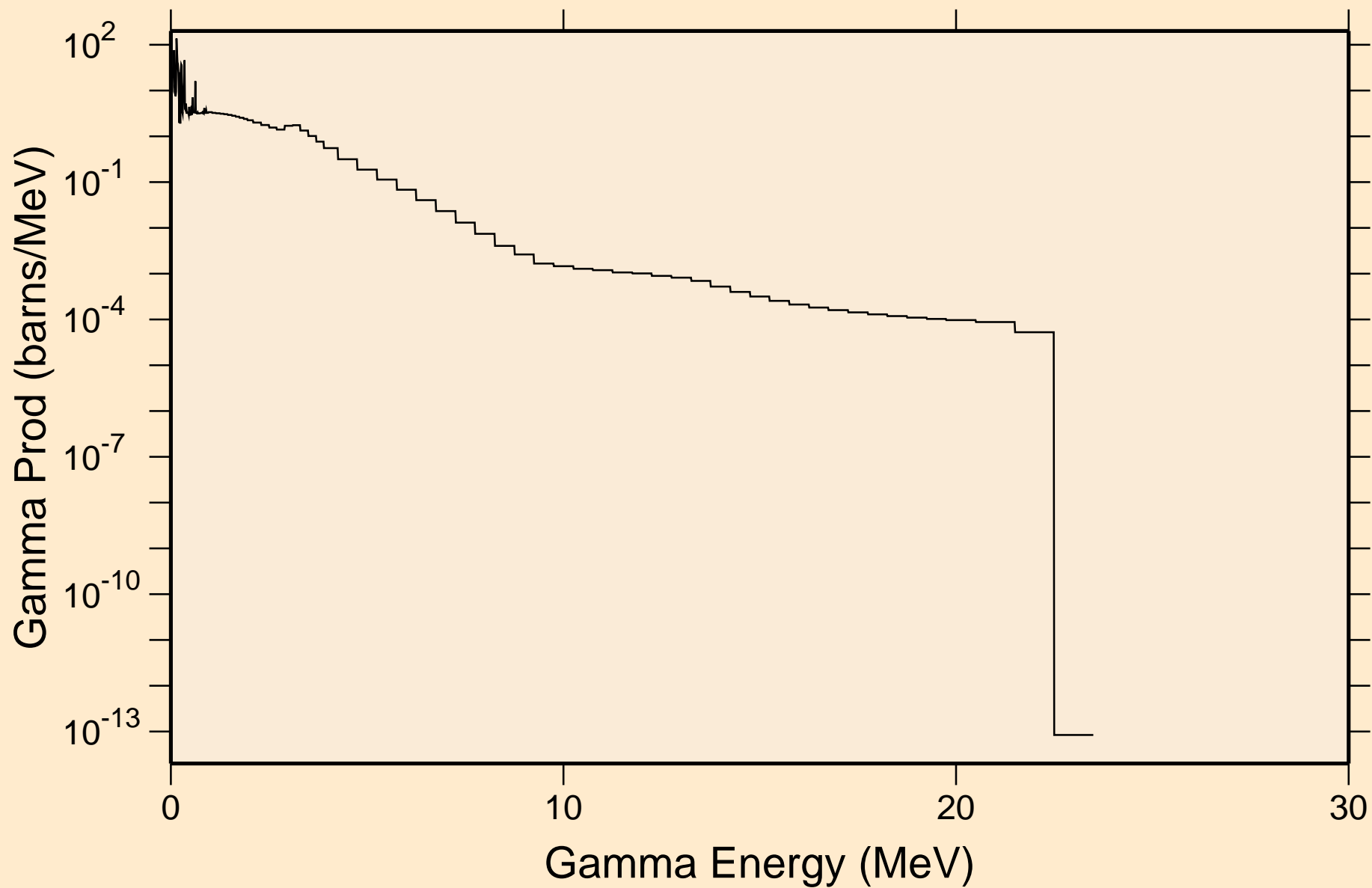

TL183 NEUTRON ACER TENDL-2019 LIBRARY; T=293.16K
Particle heating contributions

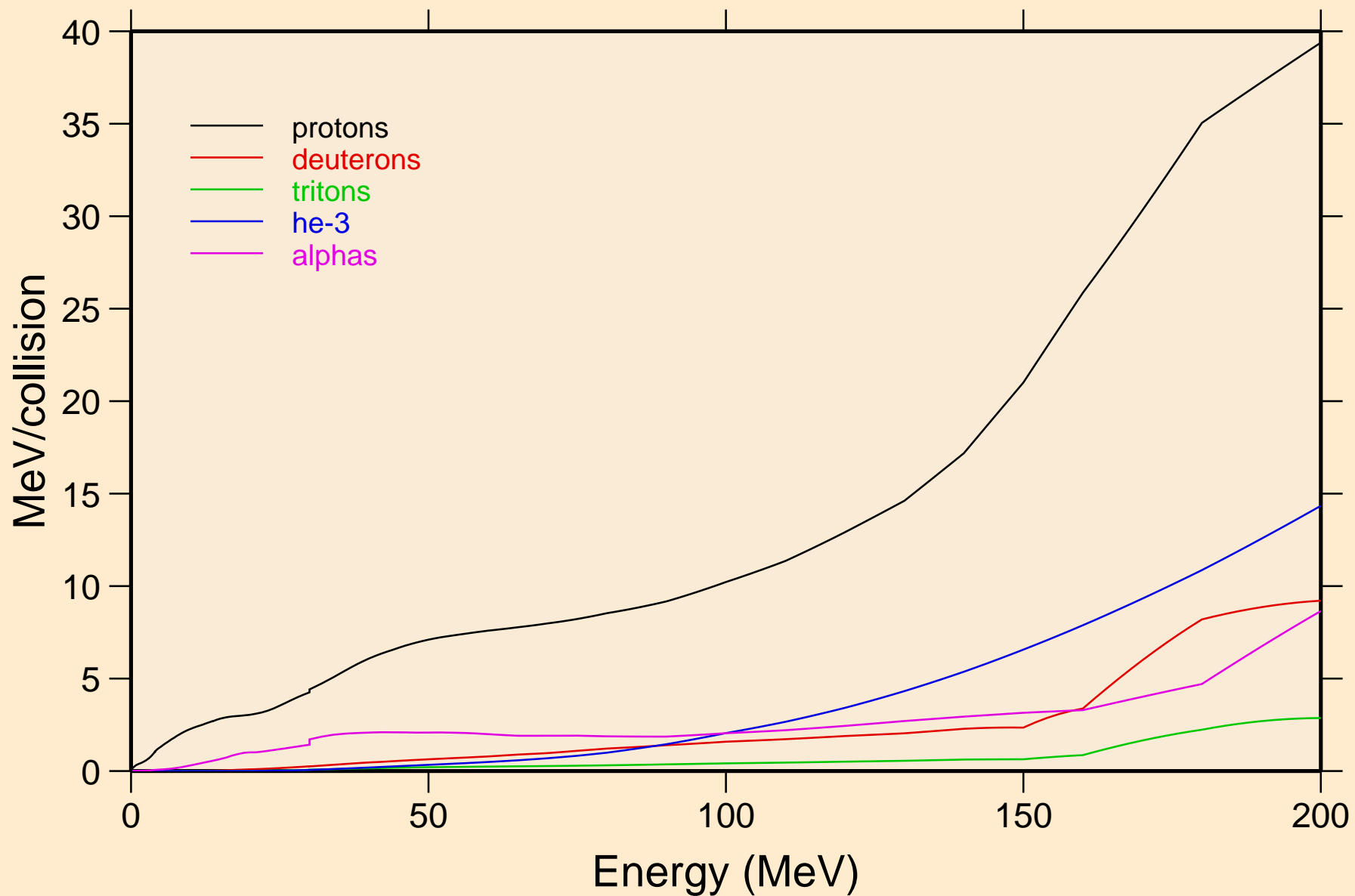

TL183 NEUTRON ACER TENDL-2019 LIBRARY; T=293.16K
Recoil Heating

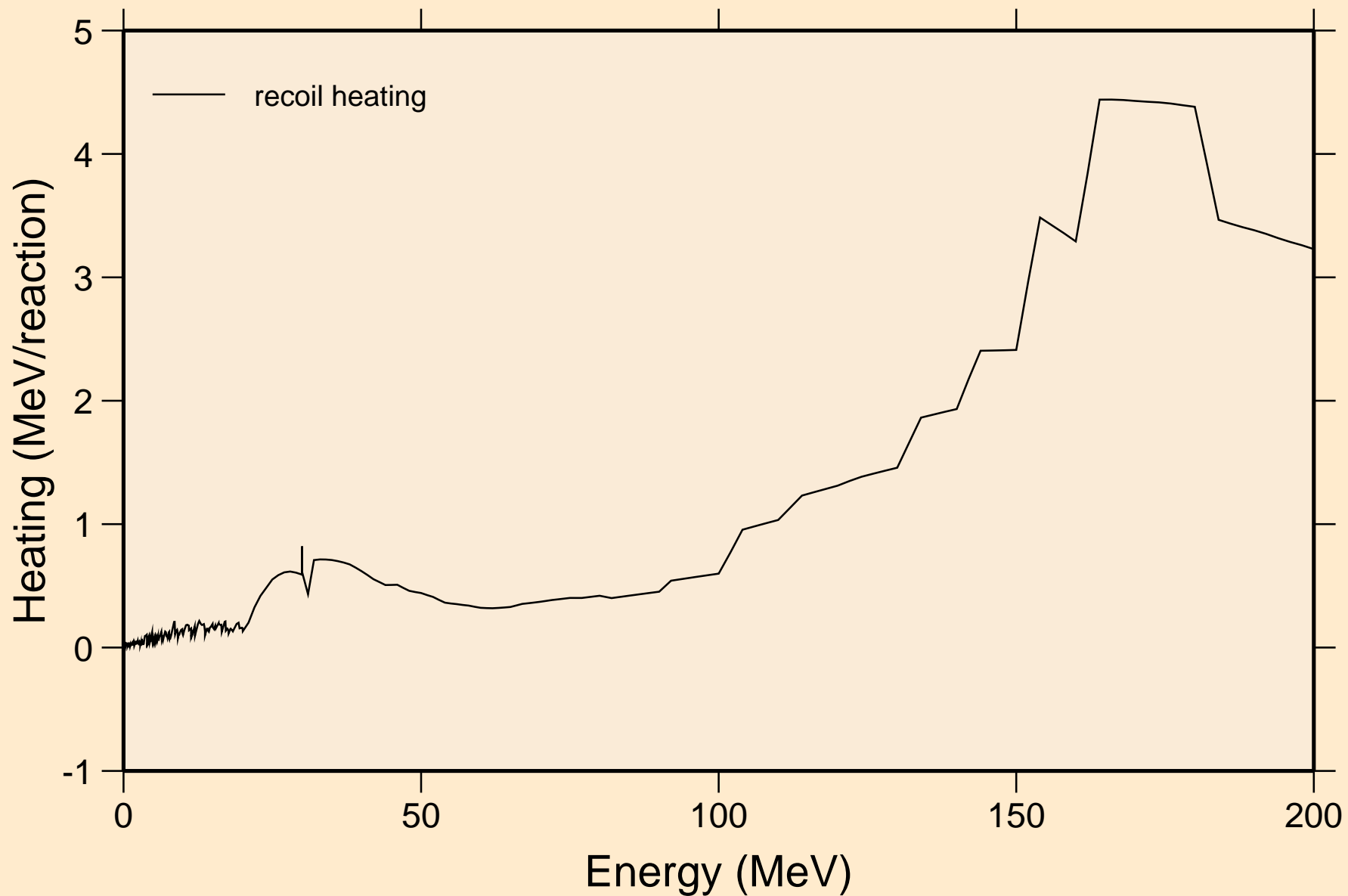

TL183 NEUTRON ACER TENDL-2019 LIBRARY; T=293.16K
Particle production cross sections

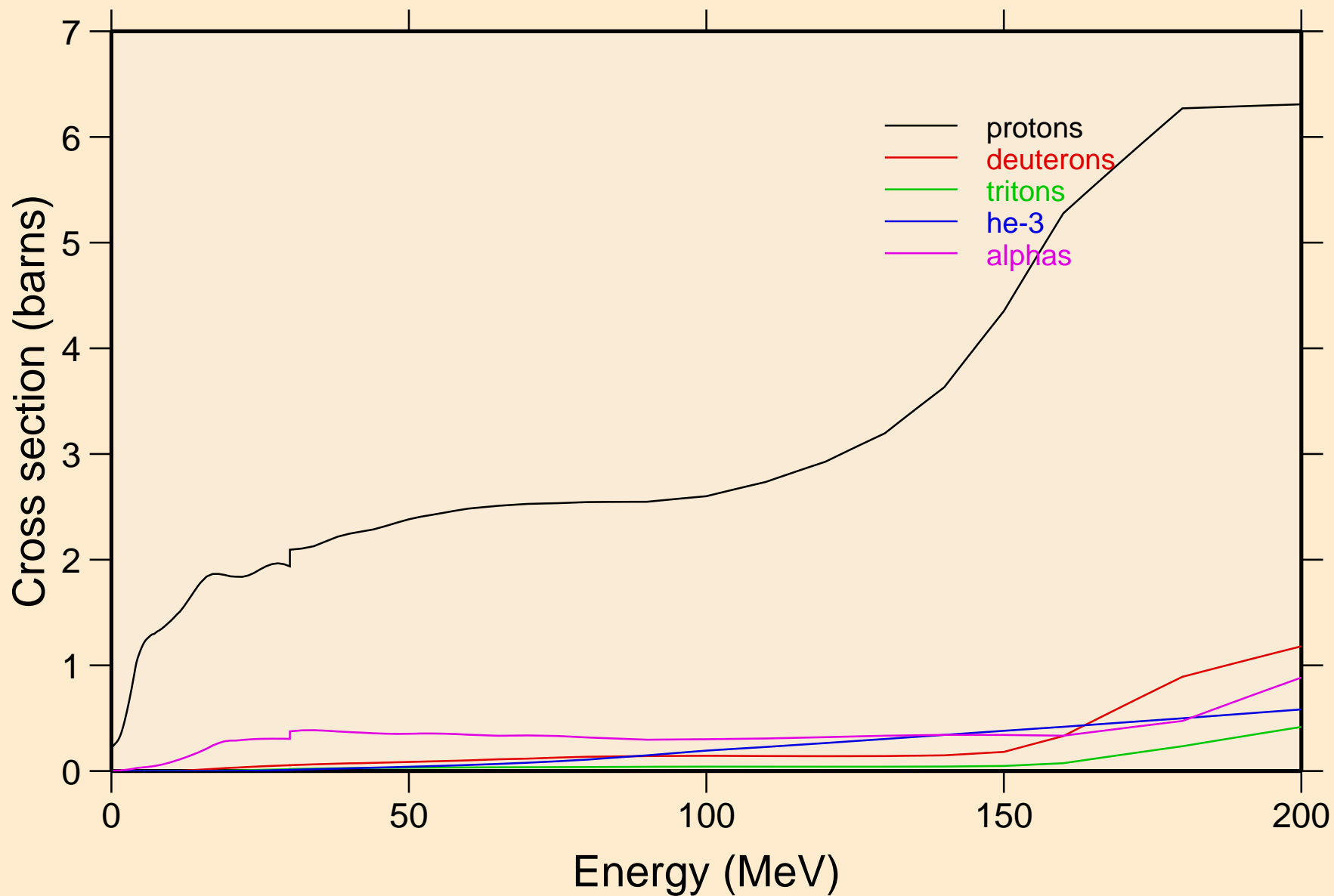

TL183 NEUTRON ACER TENDL-2019 LIBRARY; T=293.16K
protons from (n,x)

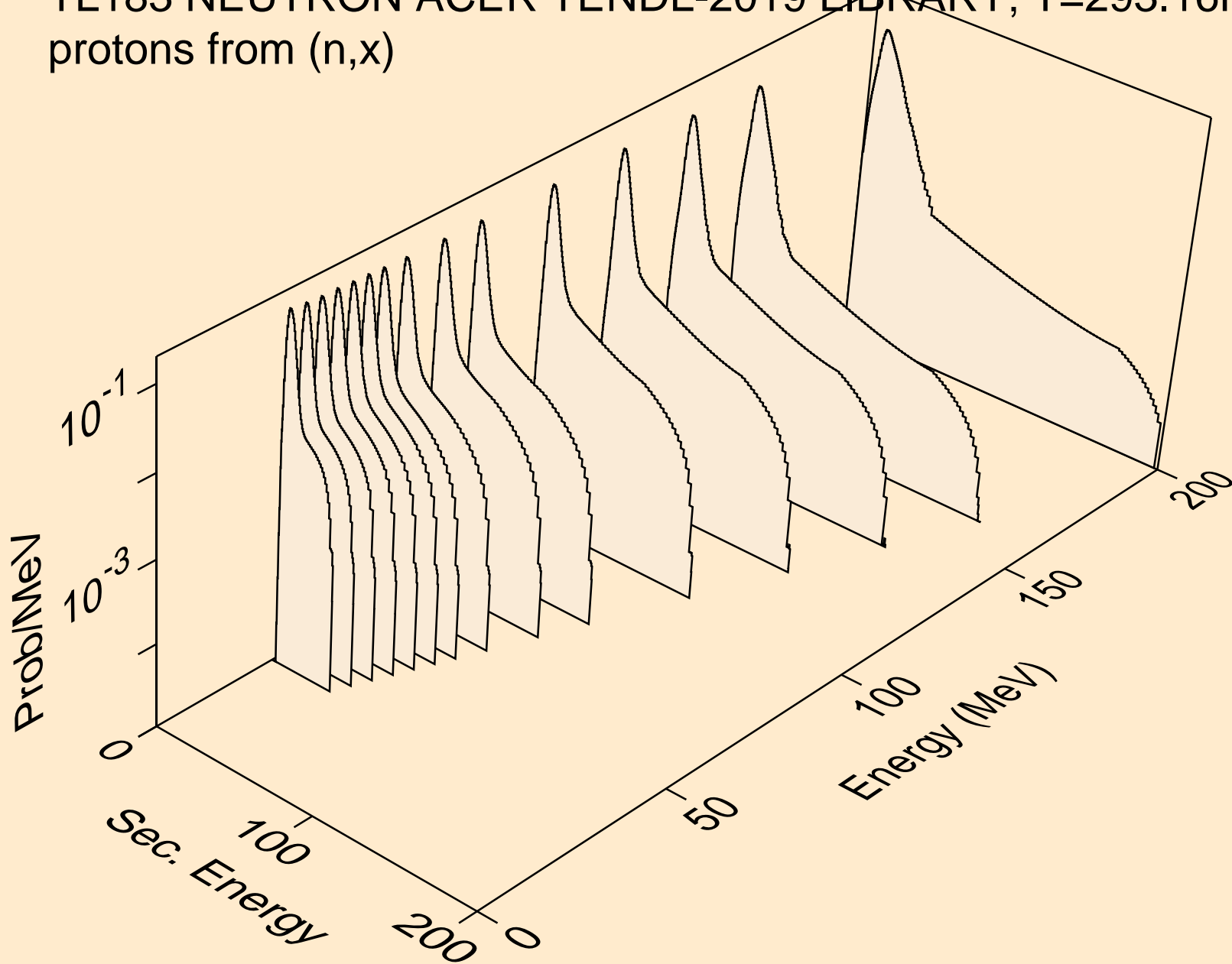

TL183 NEUTRON ACER TENDL-2019 LIBRARY; T=293.16K
protons from (n,n*)p

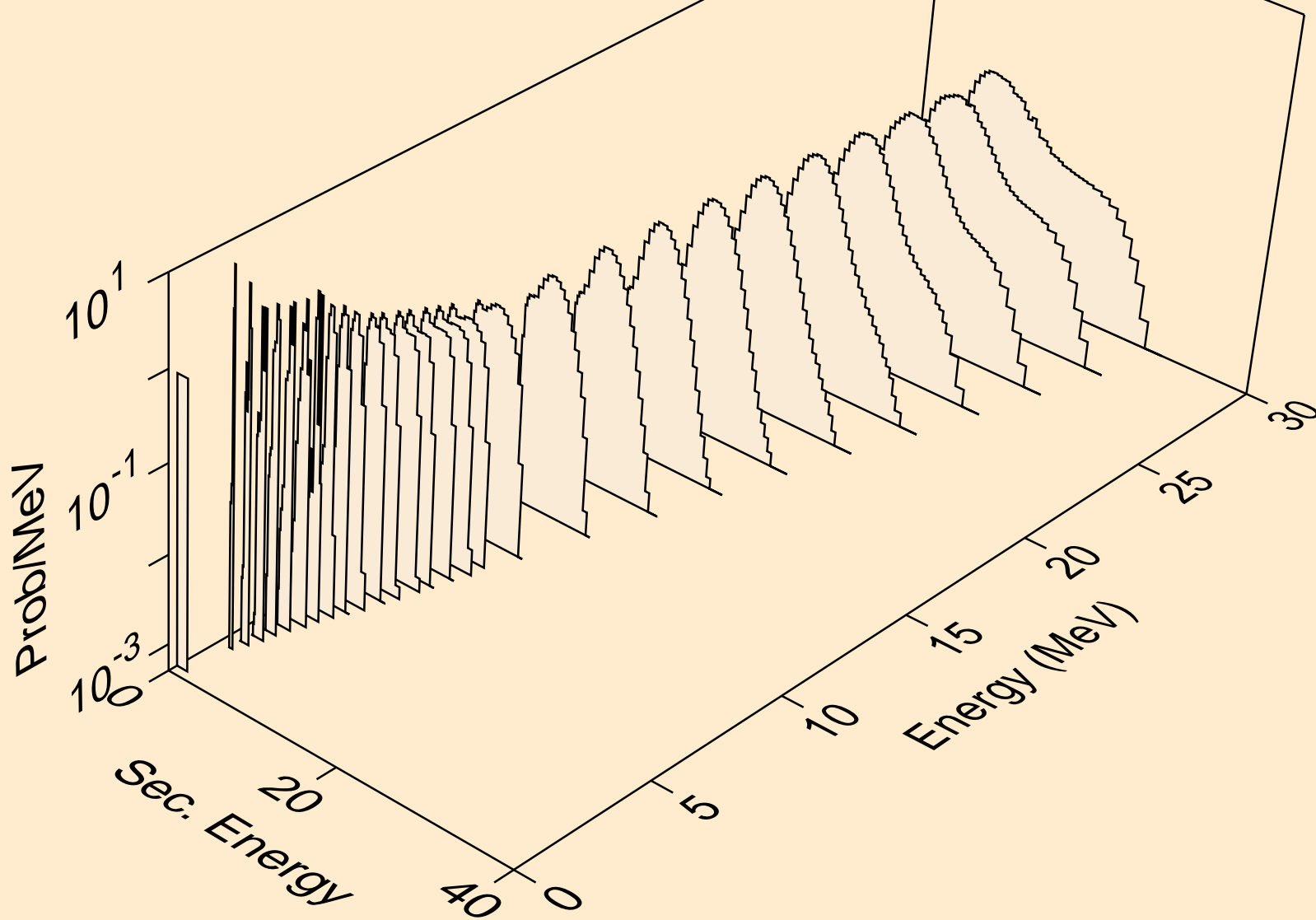

TL183 NEUTRON ACER TENDL-2019 LIBRARY; T=293.16K
protons from (n,2np)

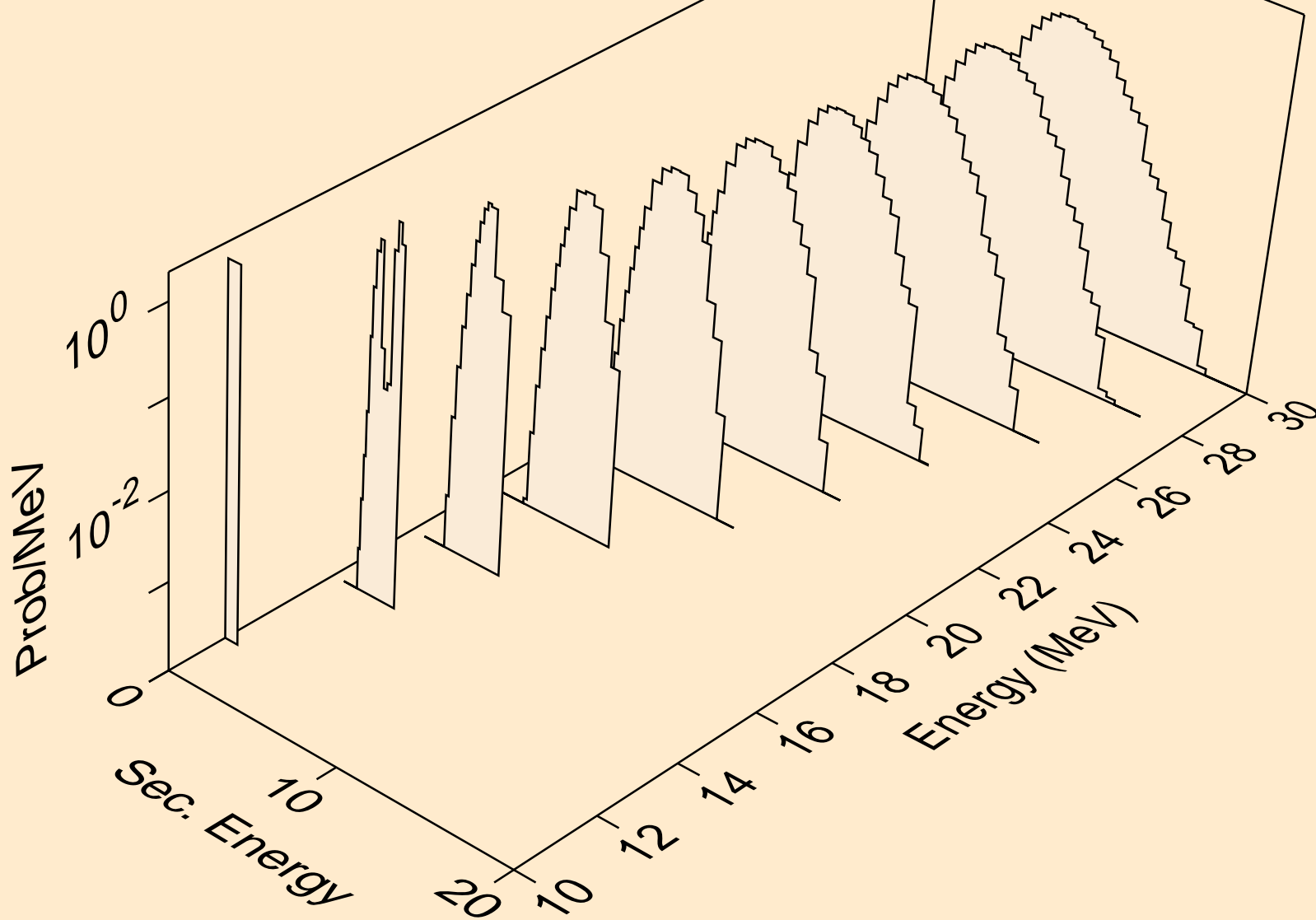

TL183 NEUTRON ACER TENDL-2019 LIBRARY; T=293.16K
protons from (n,3np)

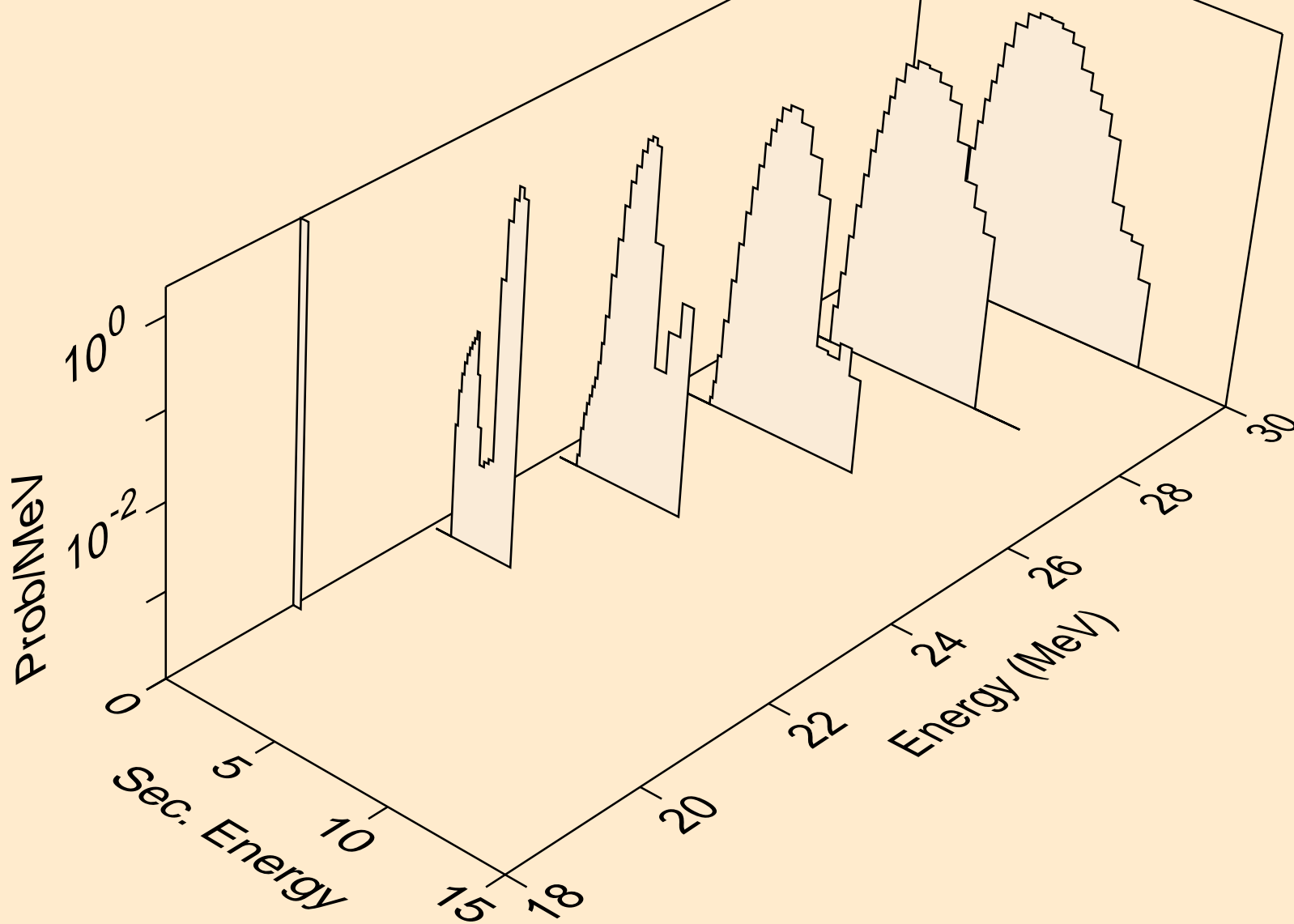

TL183 NEUTRON ACER TENDL-2019 LIBRARY; T=293.16K
protons from (n,2np)

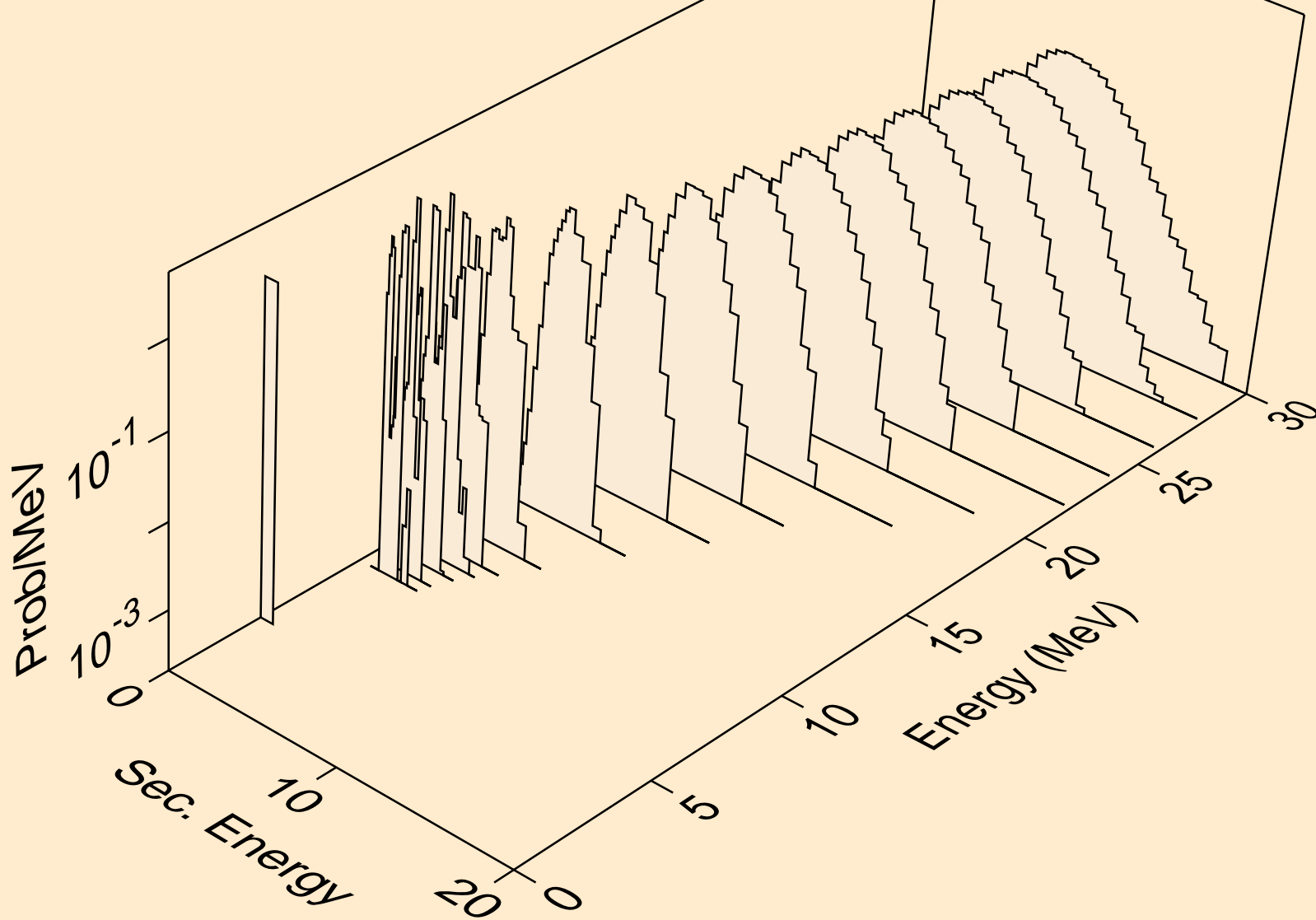

TL183 NEUTRON ACER TENDL-2019 LIBRARY; T=293.16K
protons from (n,npa)

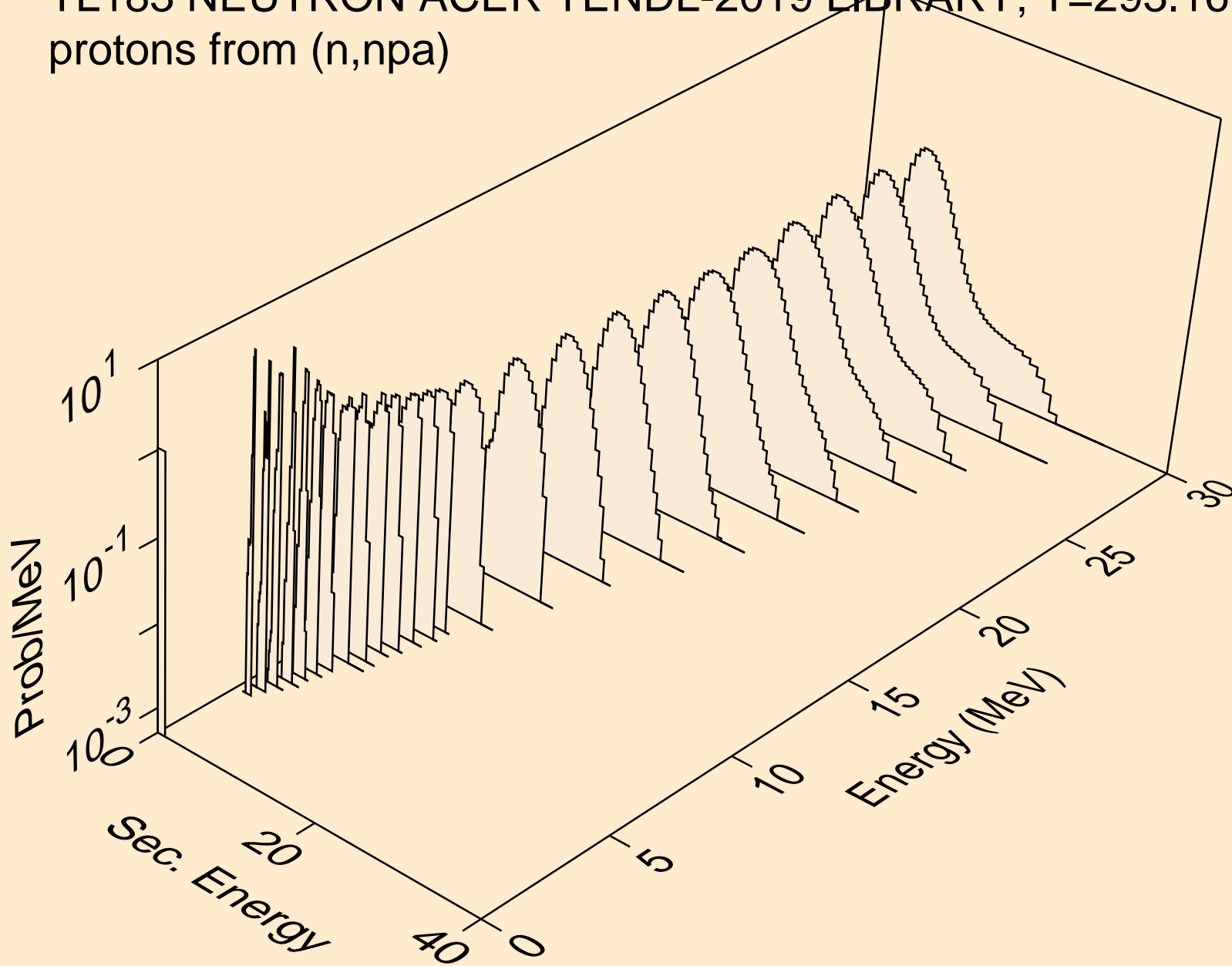

TL183 NEUTRON ACER TENDL-2019 LIBRARY; T=293.16K
protons from (n,p)

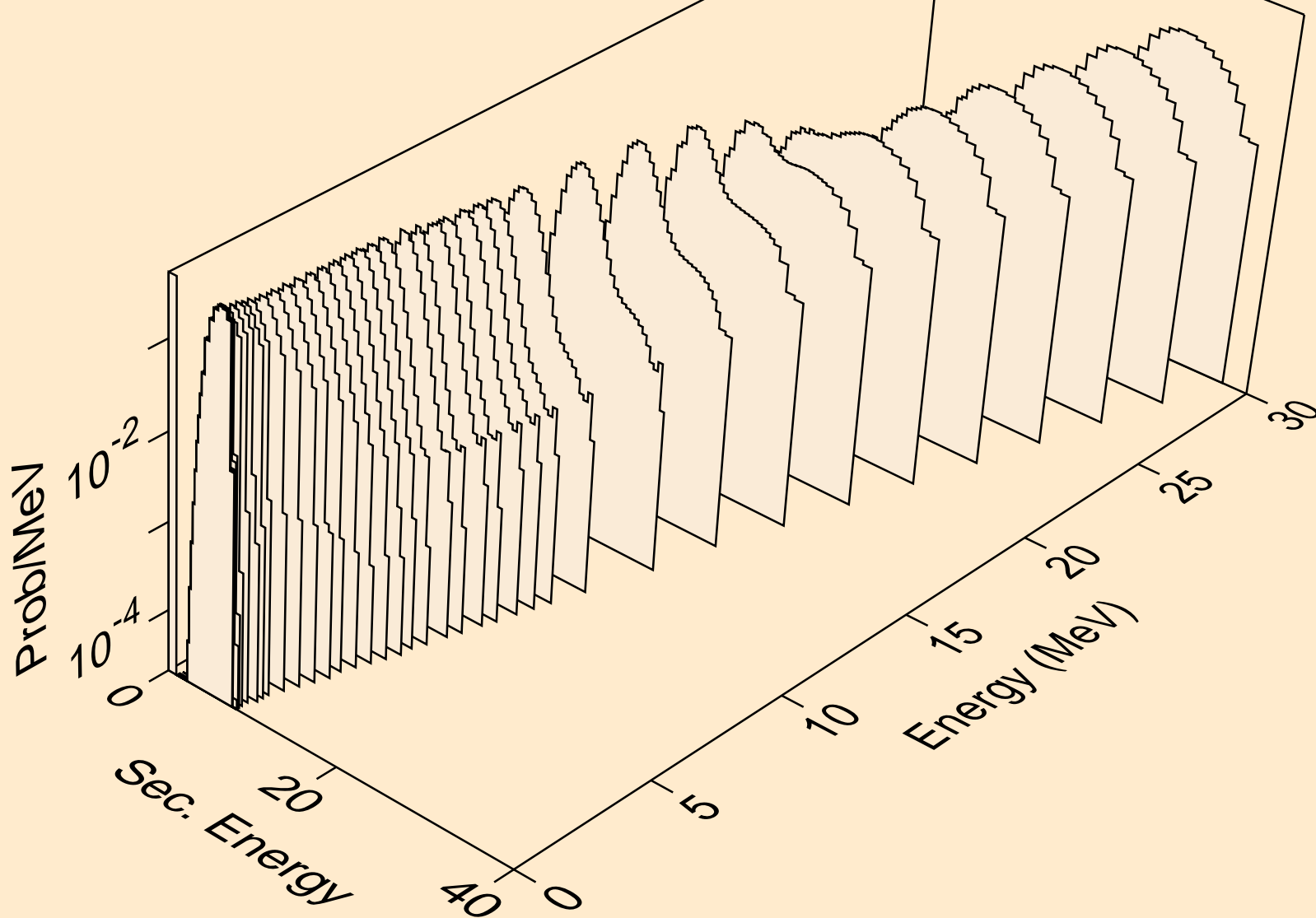

TL183 NEUTRON ACER TENDL-2019 LIBRARY; T=293.16K
protons from (n,2p)

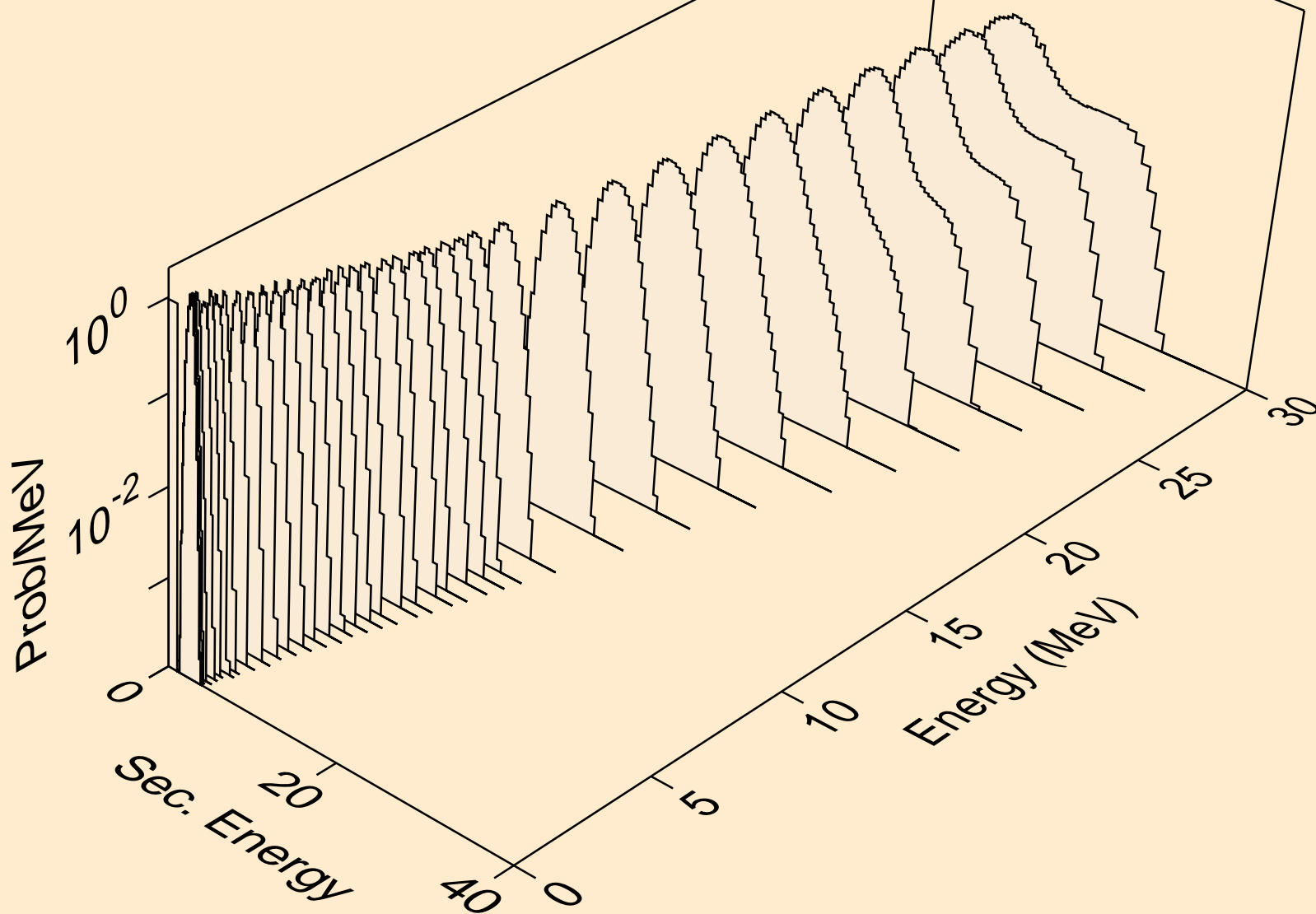

TL183 NEUTRON ACER TENDL-2019 LIBRARY; T=293.16K
protons from (n,p)

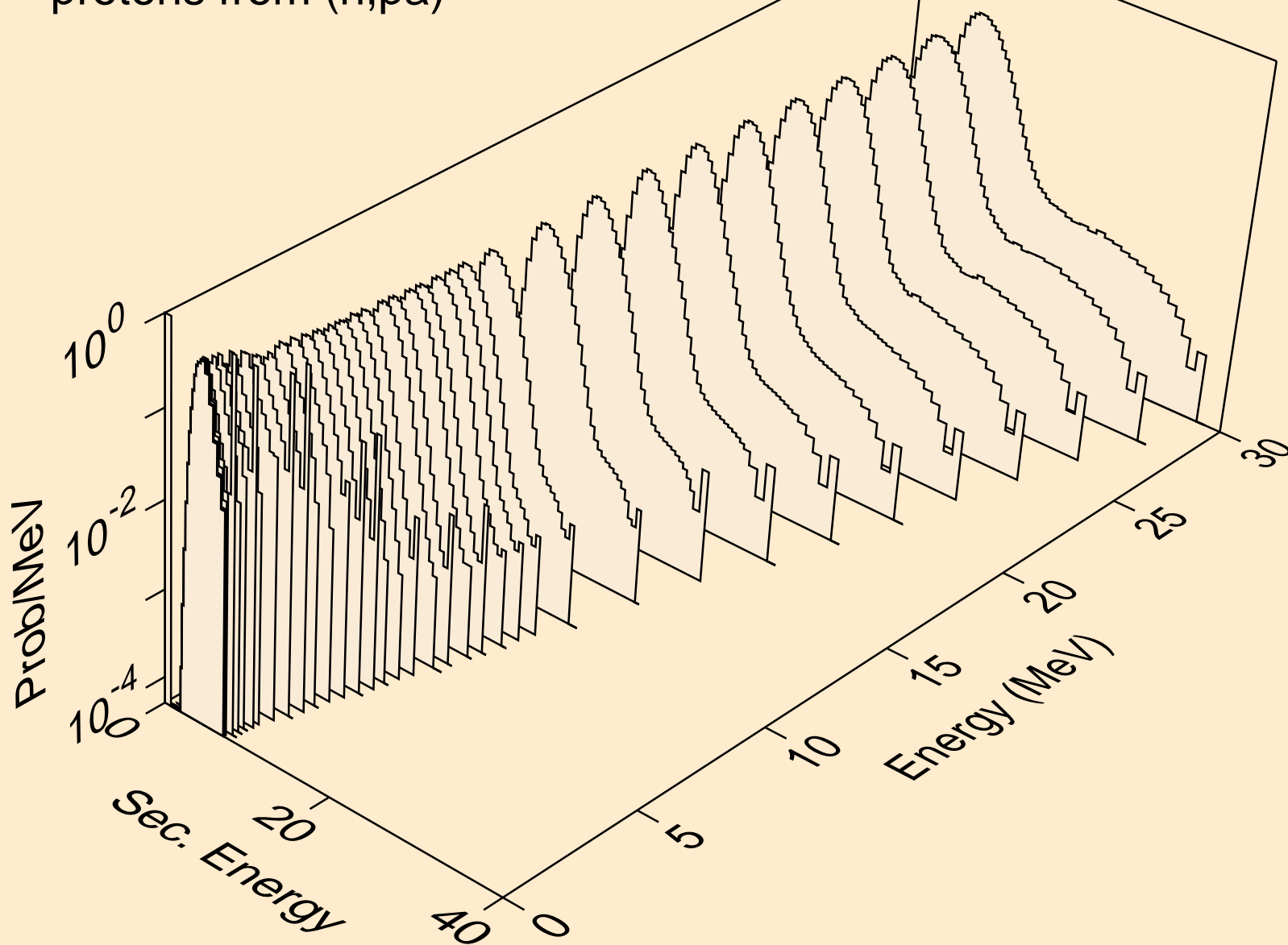

TL183 NEUTRON ACER TENDL-2019 LIBRARY; T=293.16K
protons from (n,pd)

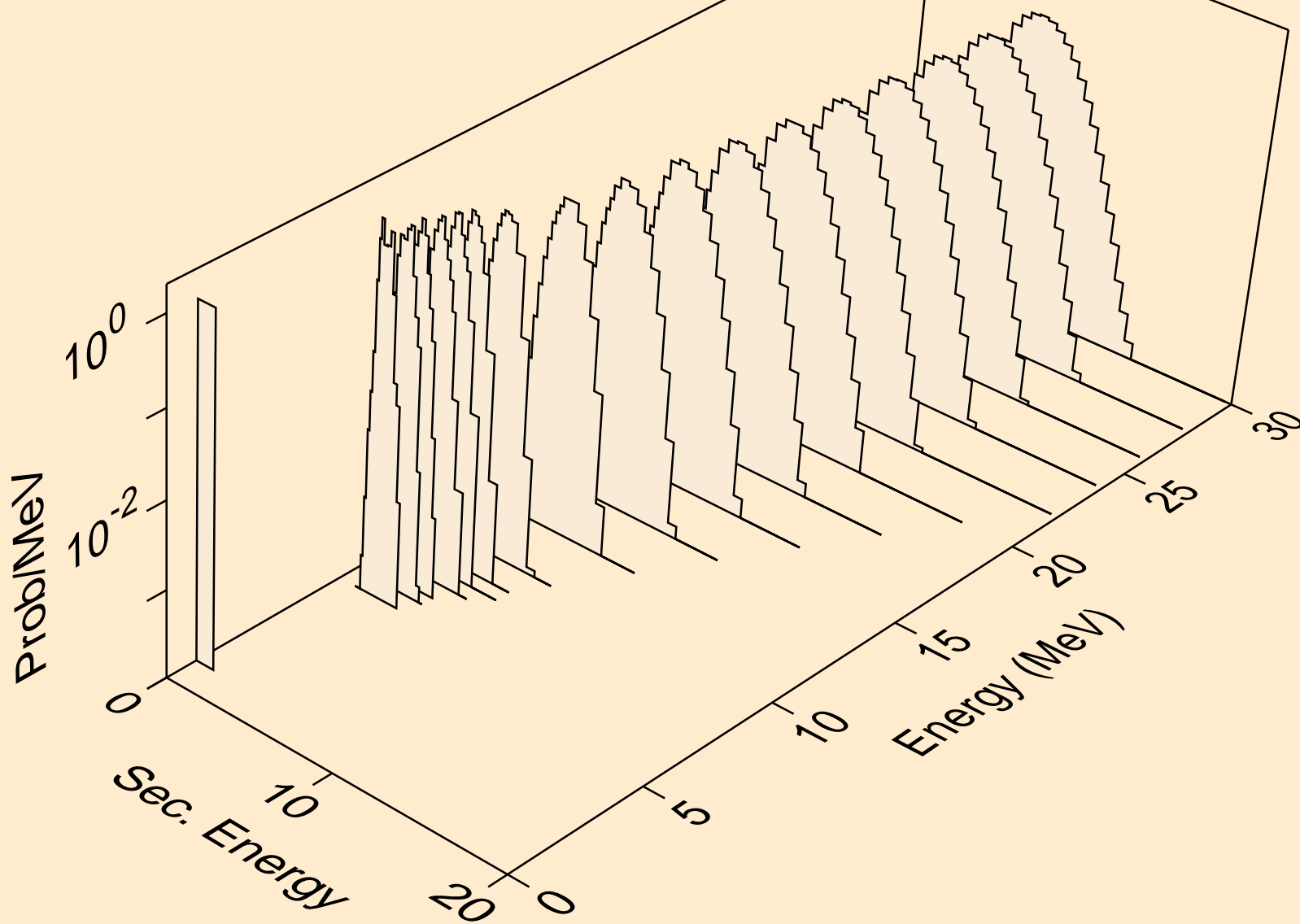

TL183 NEUTRON ACER TENDL-2019 LIBRARY; T=293.16K
protons from (n,pt)

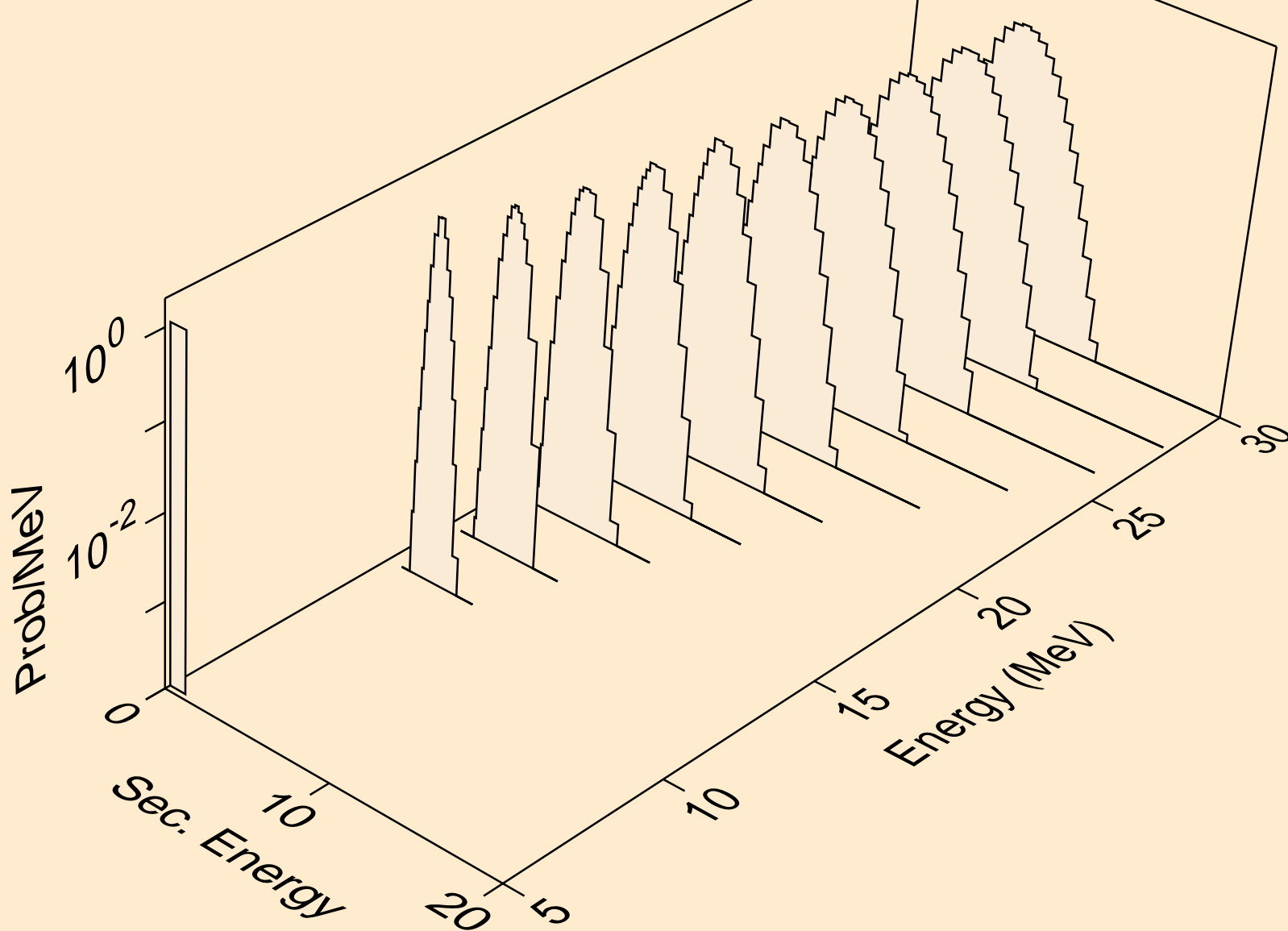

TL183 NEUTRON ACER TENDL-2019 LIBRARY; T=293.16K
deuterons from (n,x)

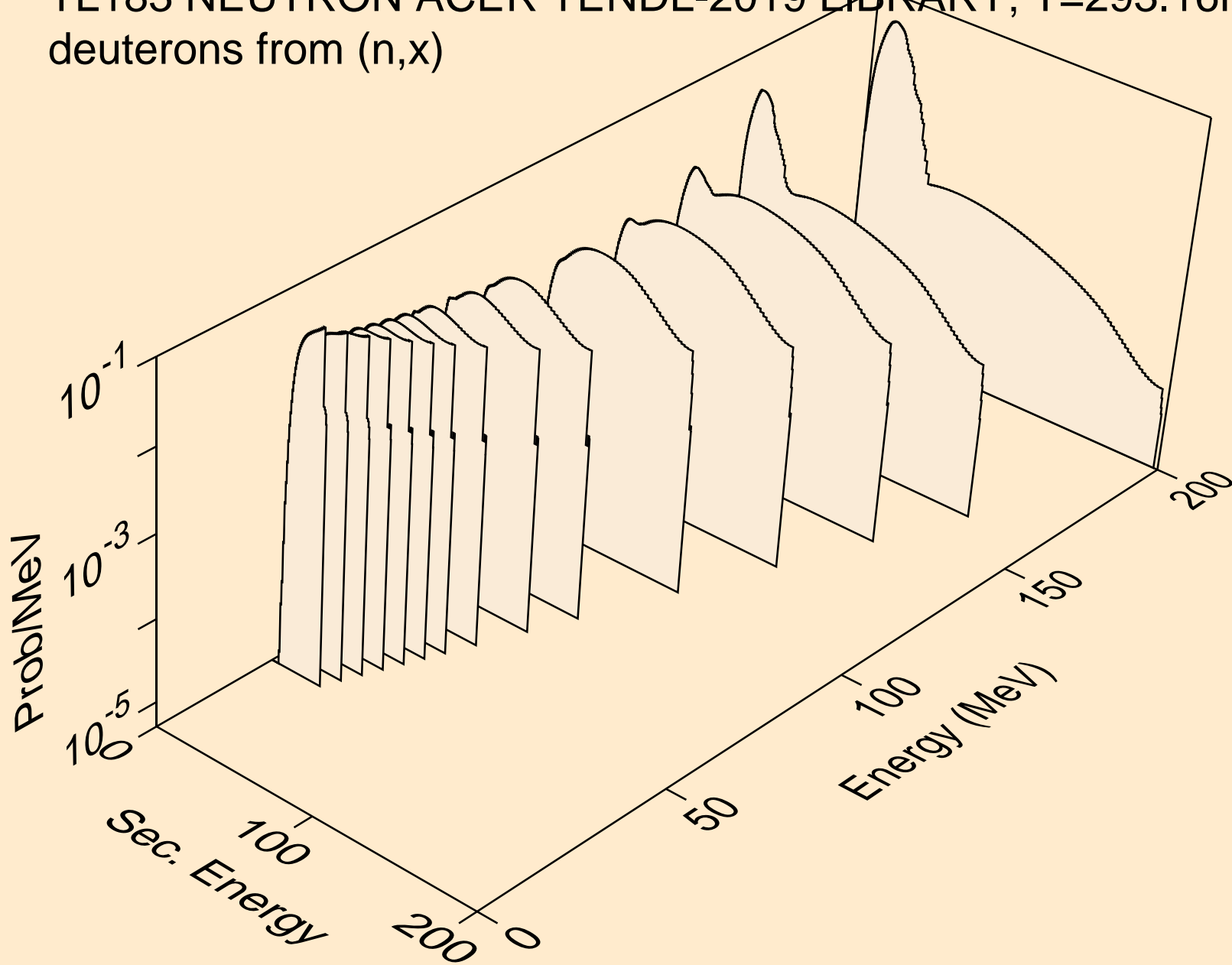

TL183 NEUTRON ACER TENDL-2019 LIBRARY; T=293.16K
deuterons from (n,2nd)

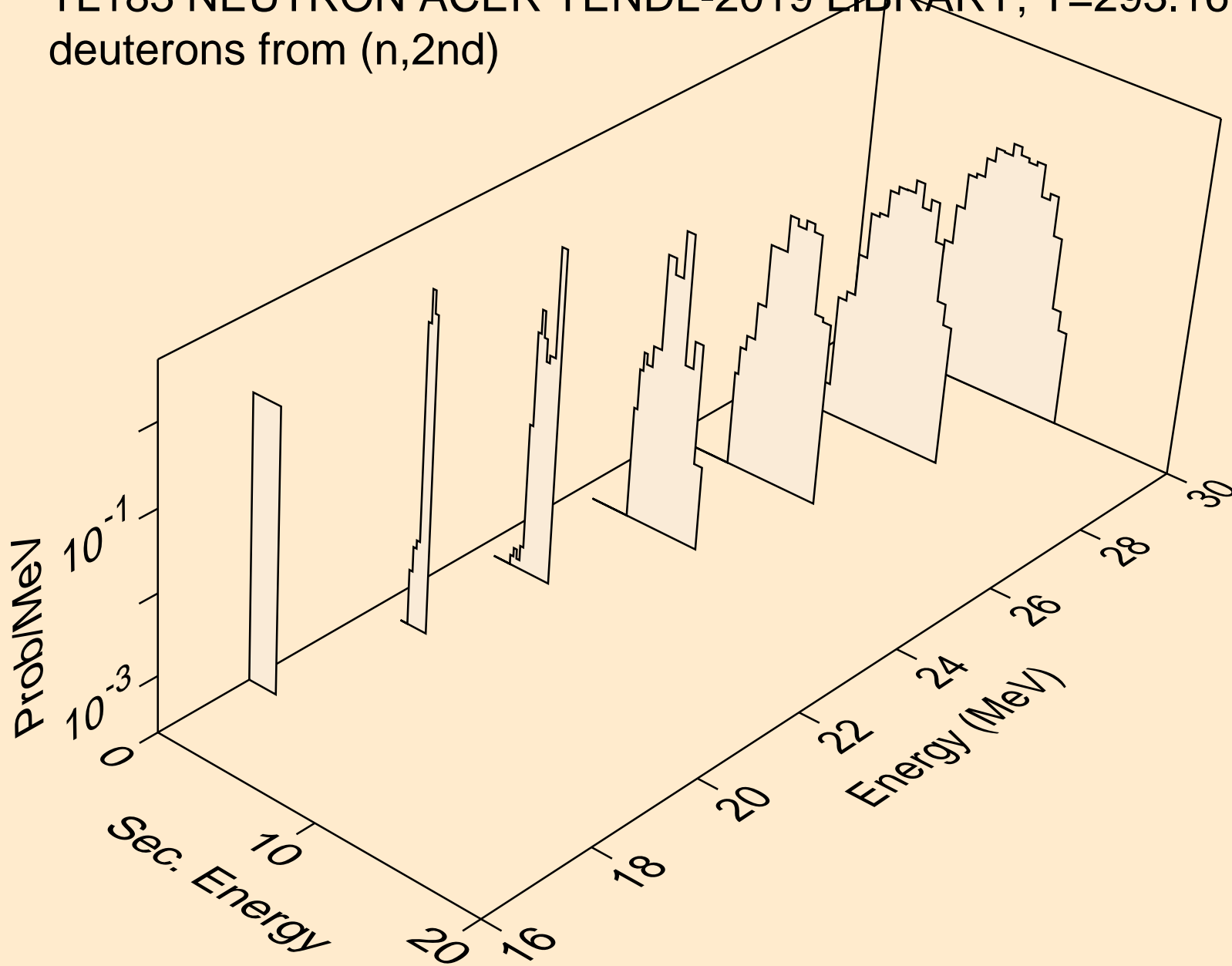

TL183 NEUTRON ACER TENDL-2019 LIBRARY; T=293.16K
deuterons from (n,n*)d

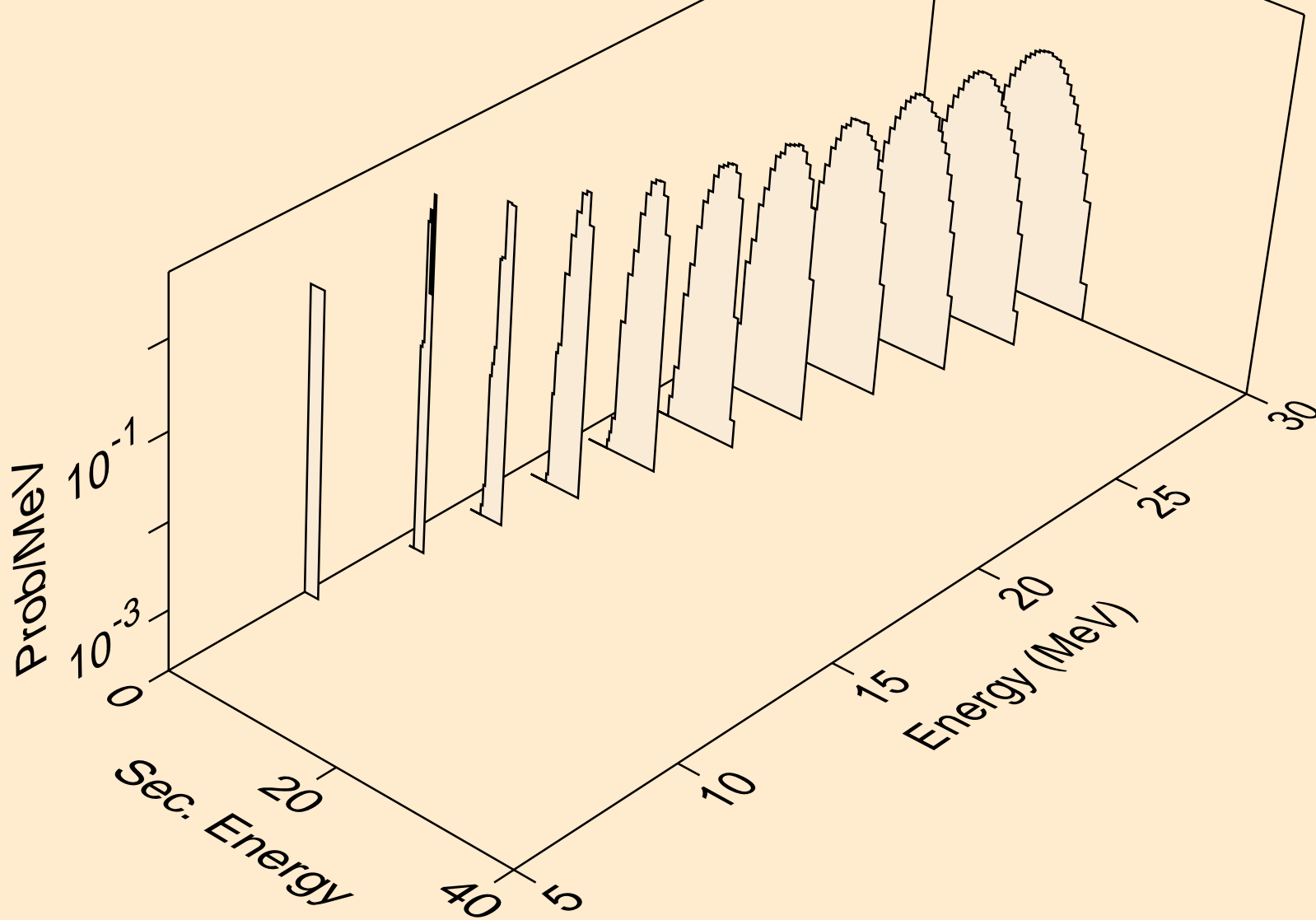

TL183 NEUTRON ACER TENDL-2019 LIBRARY; T=293.16K
deuterons from (n,d)

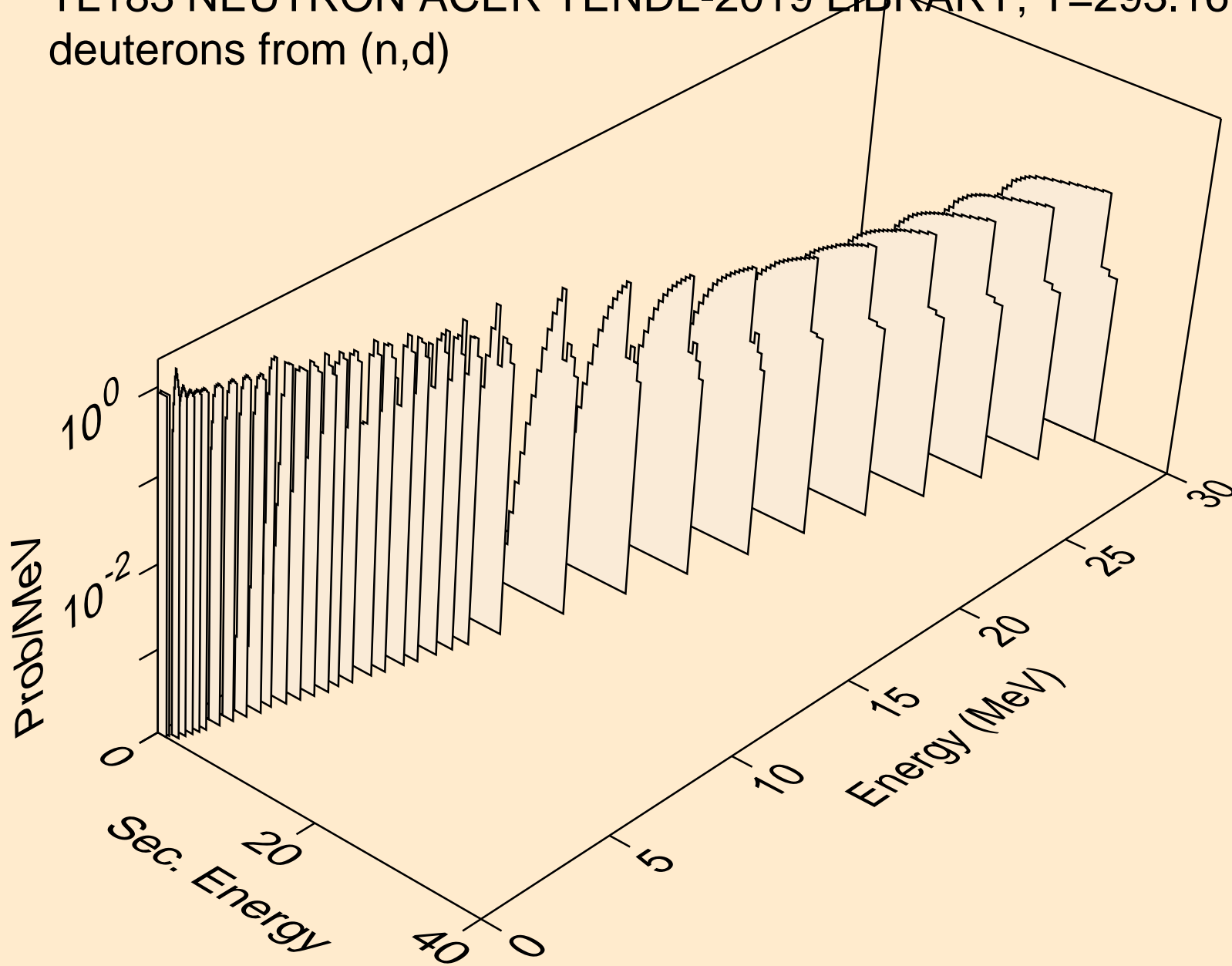

TL183 NEUTRON ACER TENDL-2019 LIBRARY; T=293.16K
deuterons from (n,d2a)

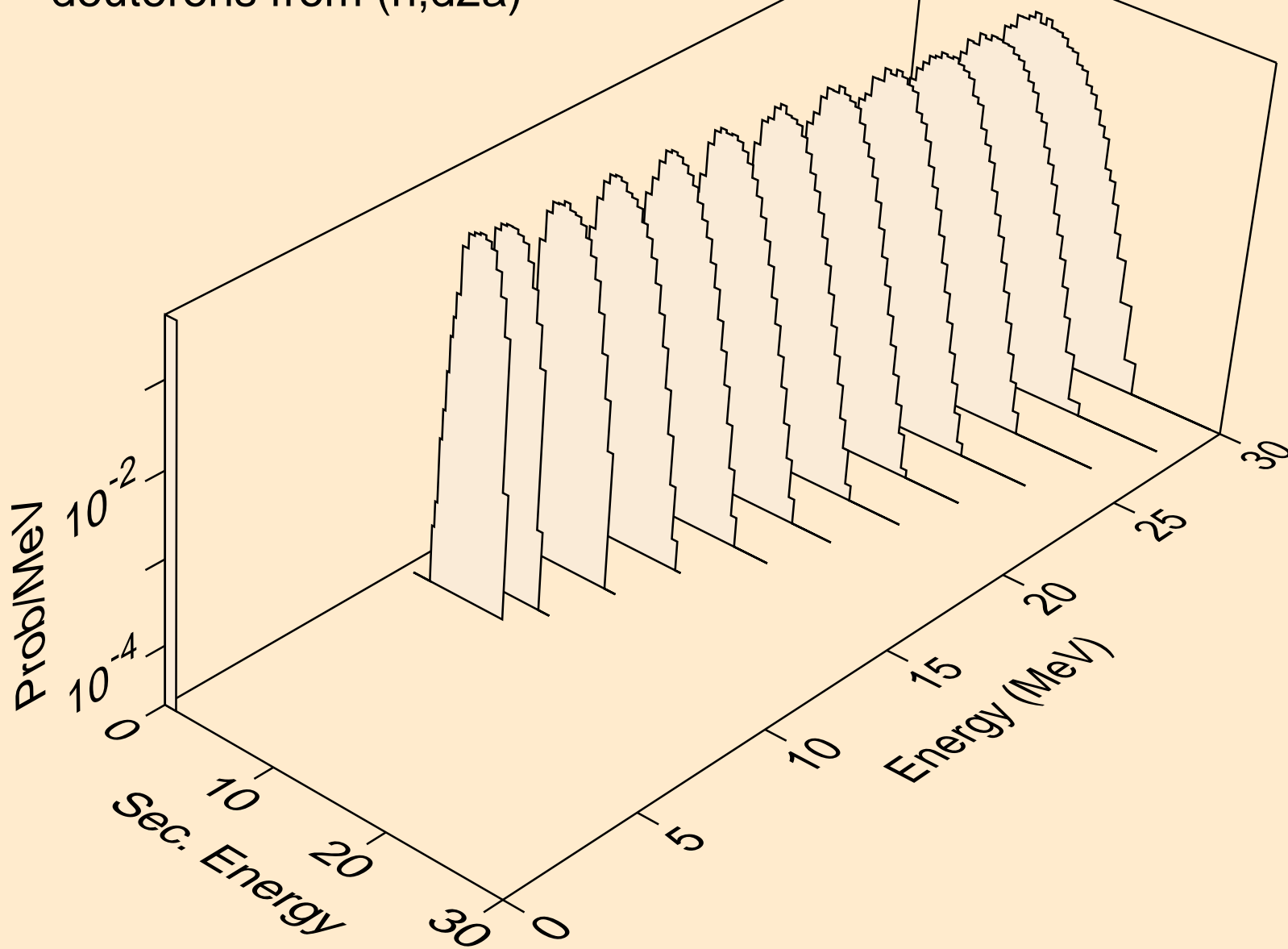

TL183 NEUTRON ACER TENDL-2019 LIBRARY; T=293.16K
deuterons from (n,pd)

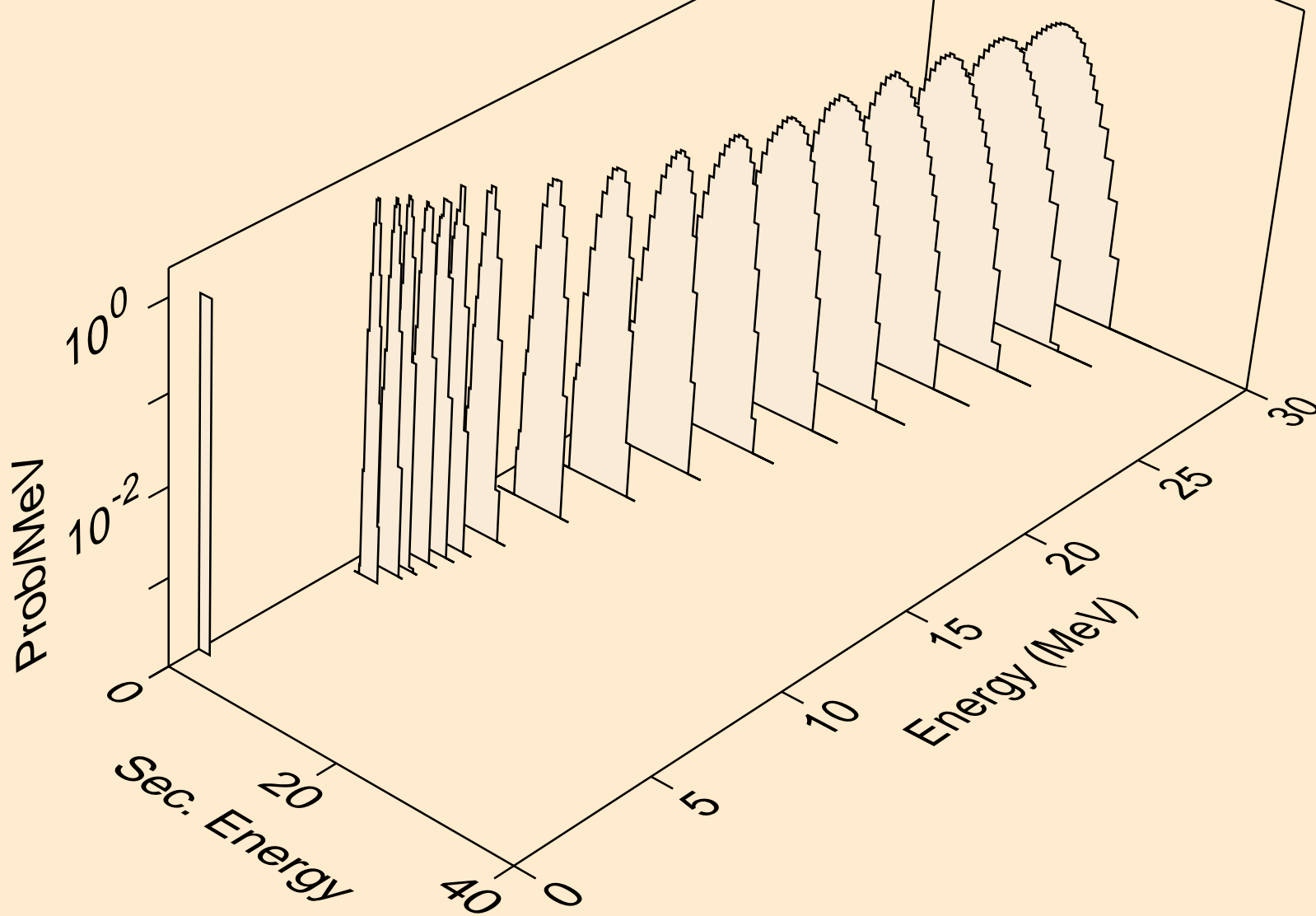

TL183 NEUTRON ACER TENDL-2019 LIBRARY; T=293.16K
deuterons from (n,da)

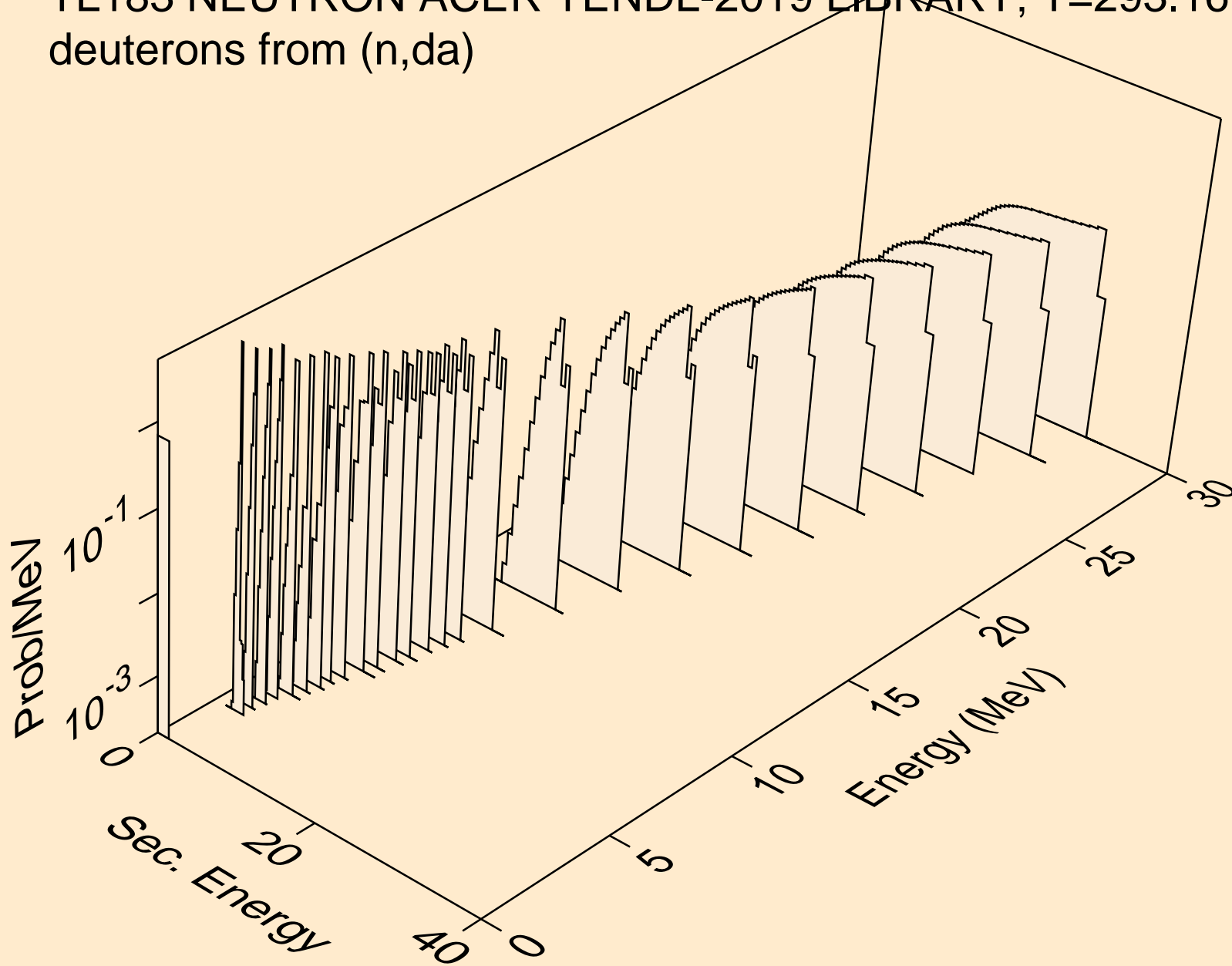

TL183 NEUTRON ACER TENDL-2019 LIBRARY; T=293.16K
tritons from (n,x)

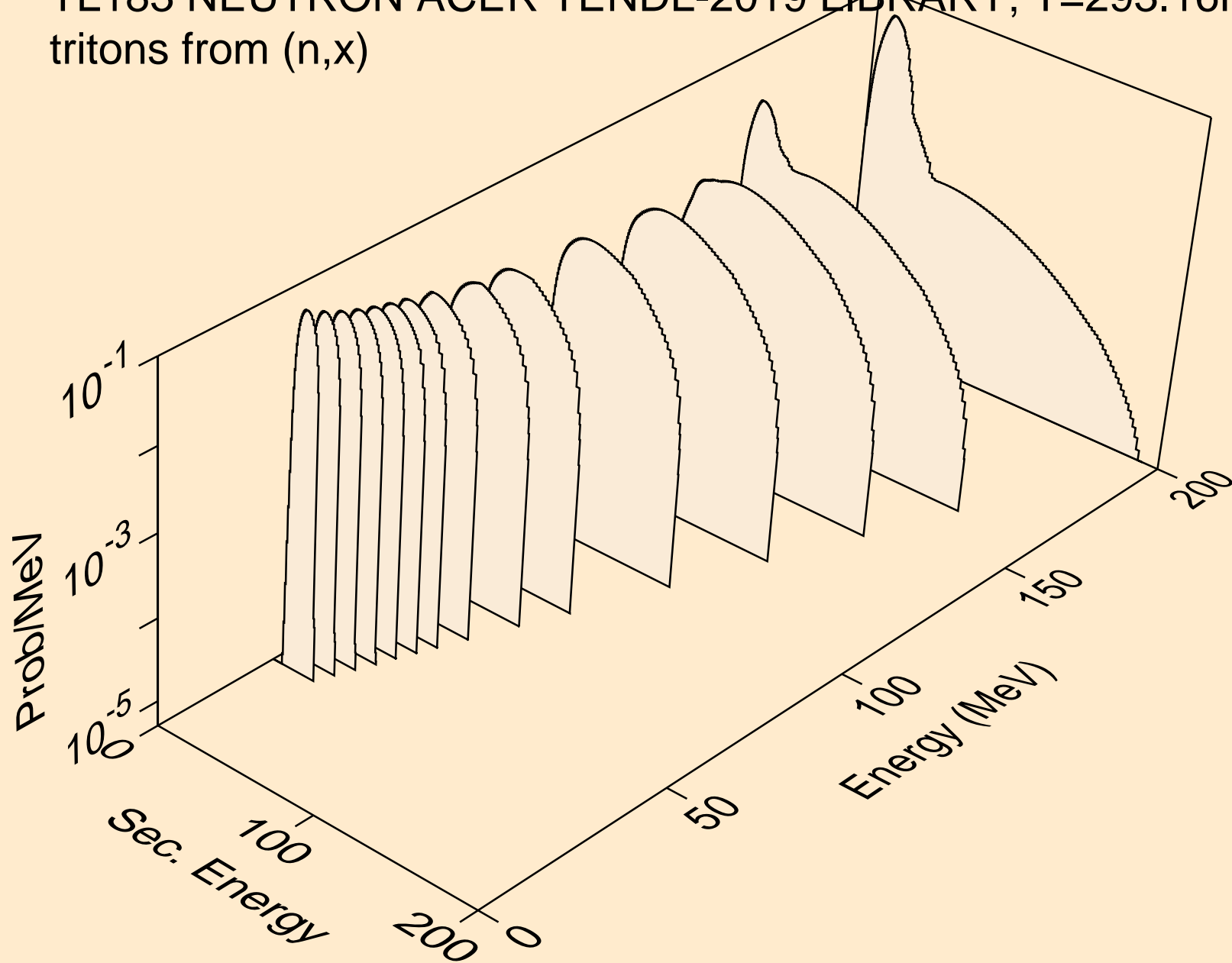

TL183 NEUTRON ACER TENDL-2019 LIBRARY; T=293.16K
tritons from (n,n*)t

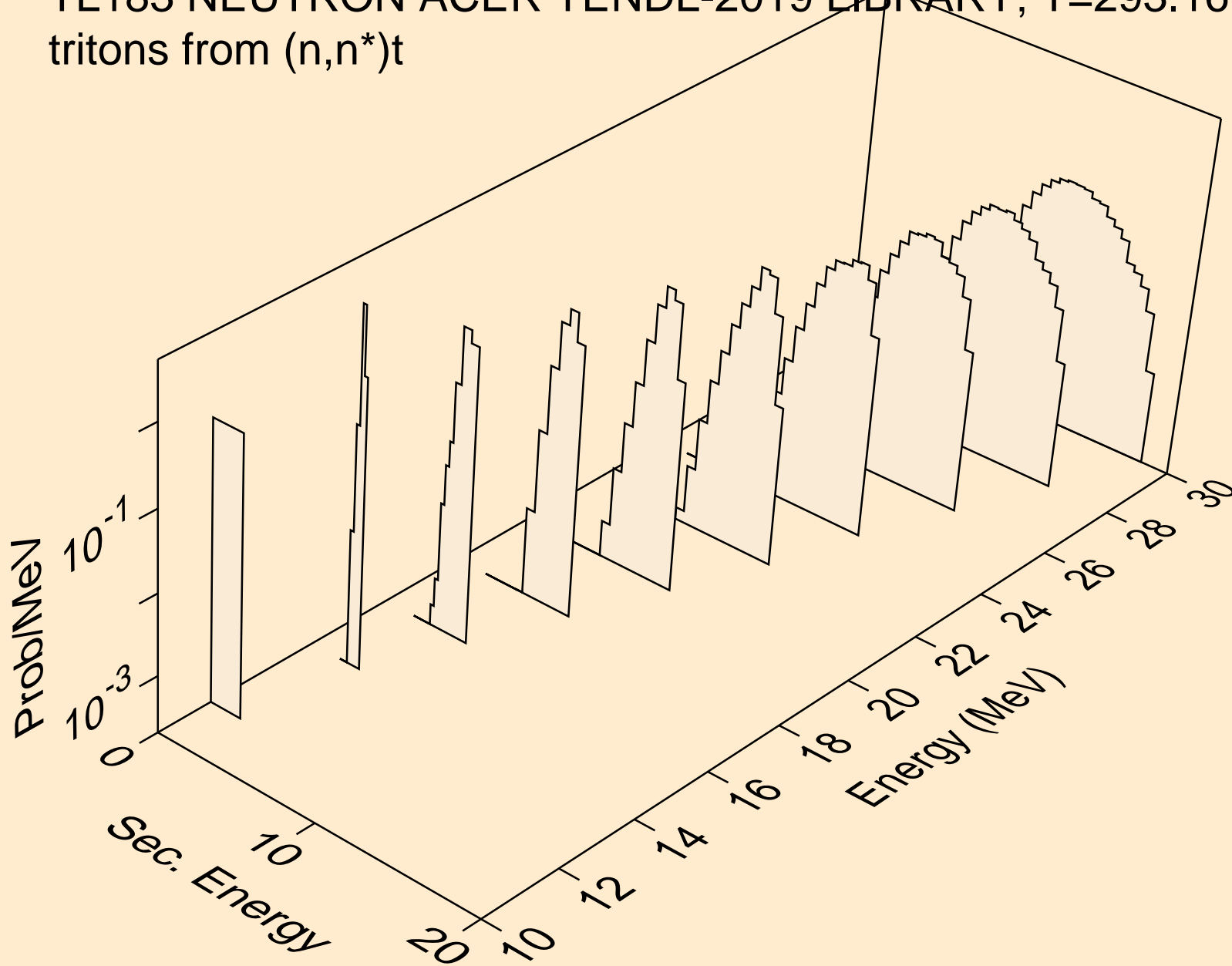

TL183 NEUTRON ACER TENDL-2019 LIBRARY; T=293.16K
tritons from (n,t)

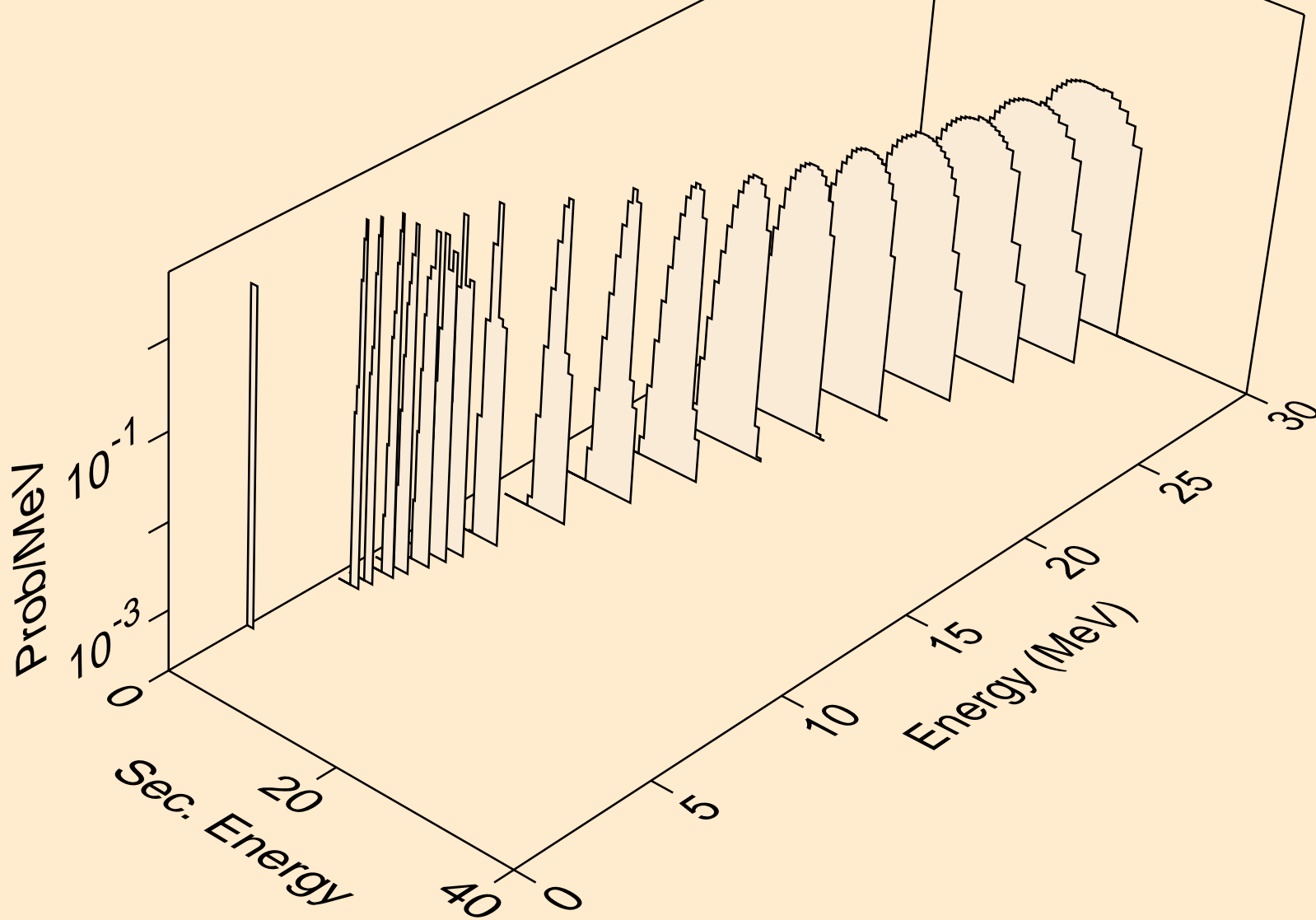

TL183 NEUTRON ACER TENDL-2019 LIBRARY; T=293.16K
tritons from (n,t2a)

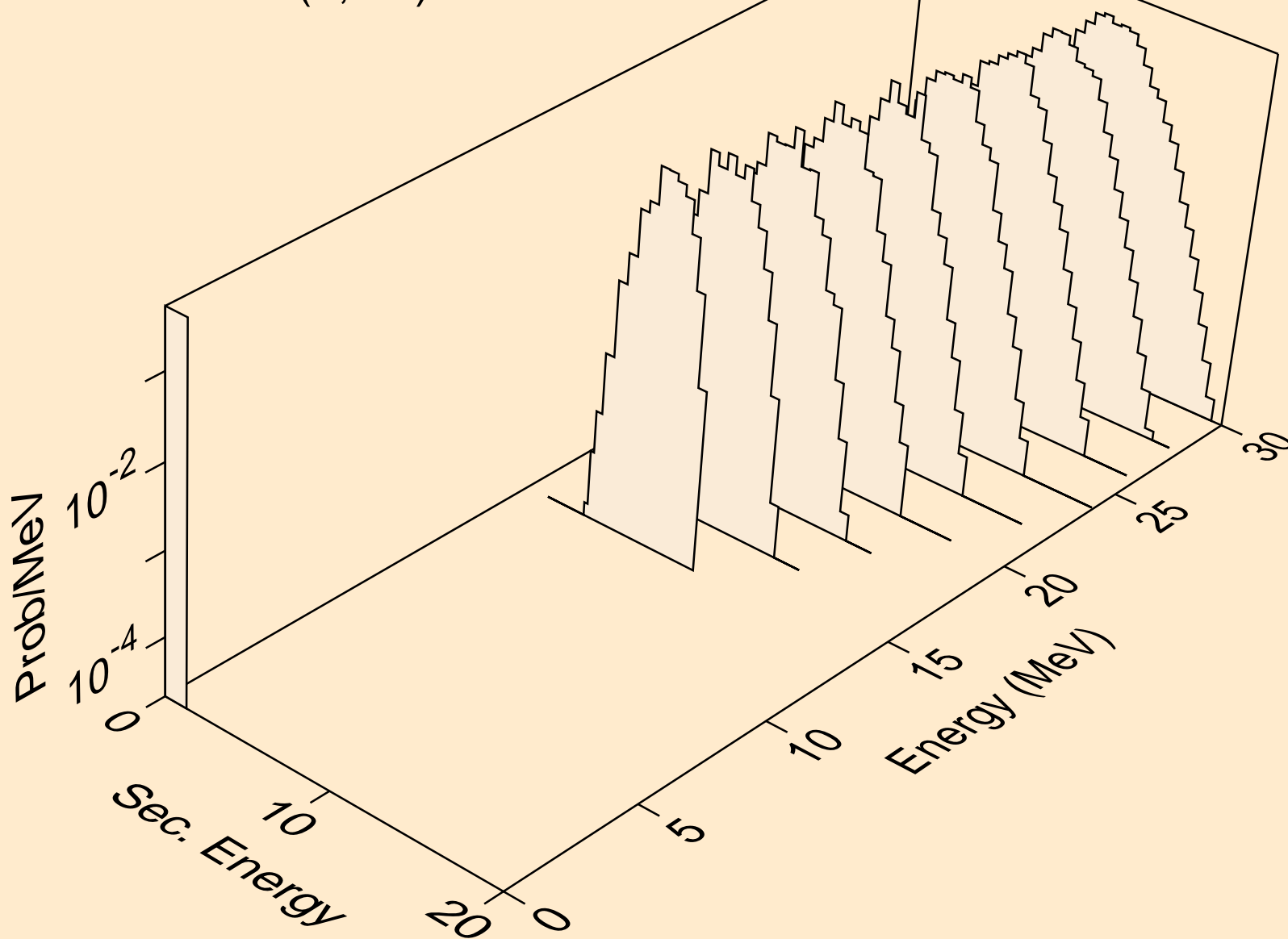

TL183 NEUTRON ACER TENDL-2019 LIBRARY; T=293.16K
tritons from (n,pt)

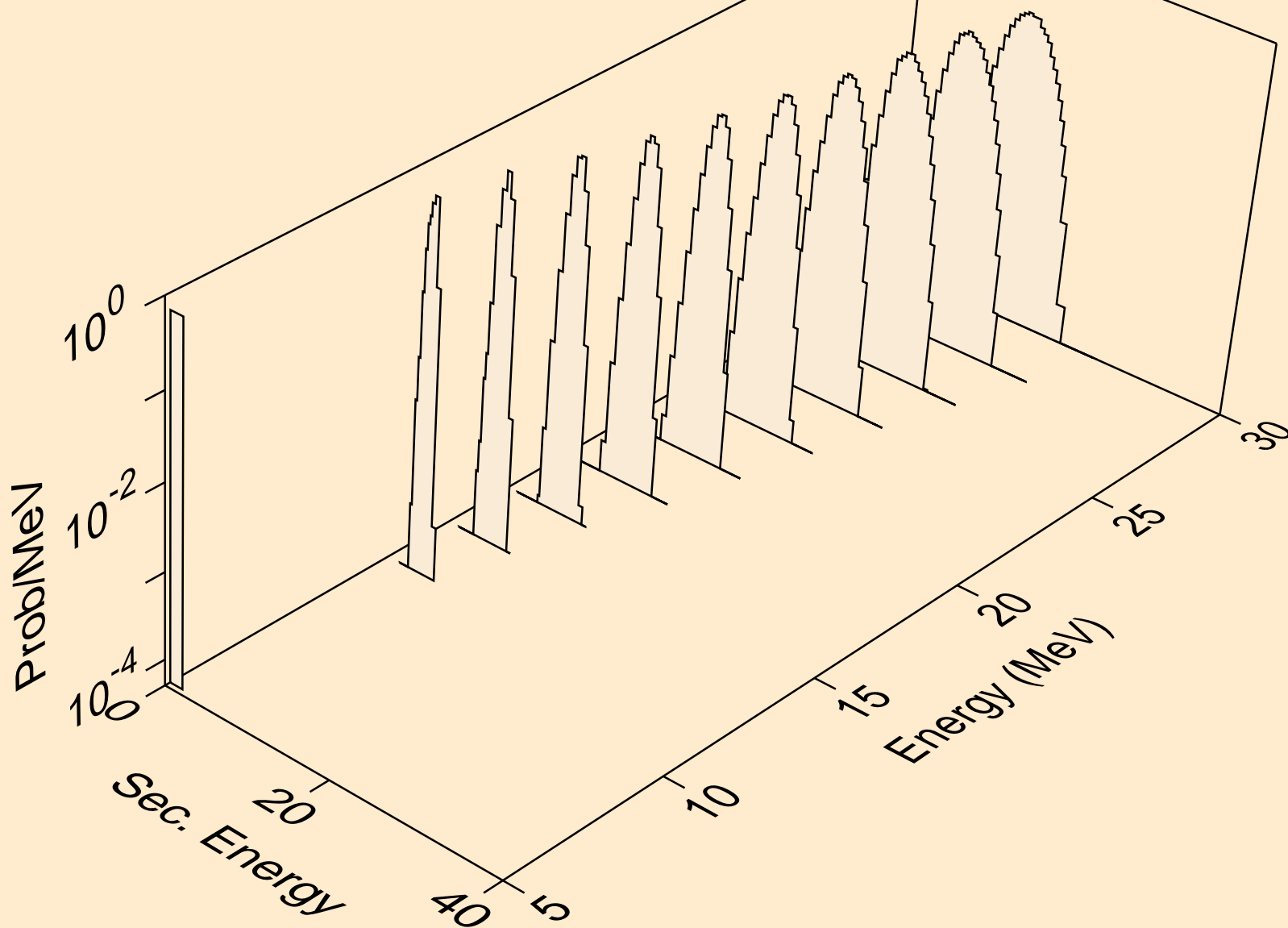

TL183 NEUTRON ACER TENDL-2019 LIBRARY; T=293.16K
he3s from (n,x)

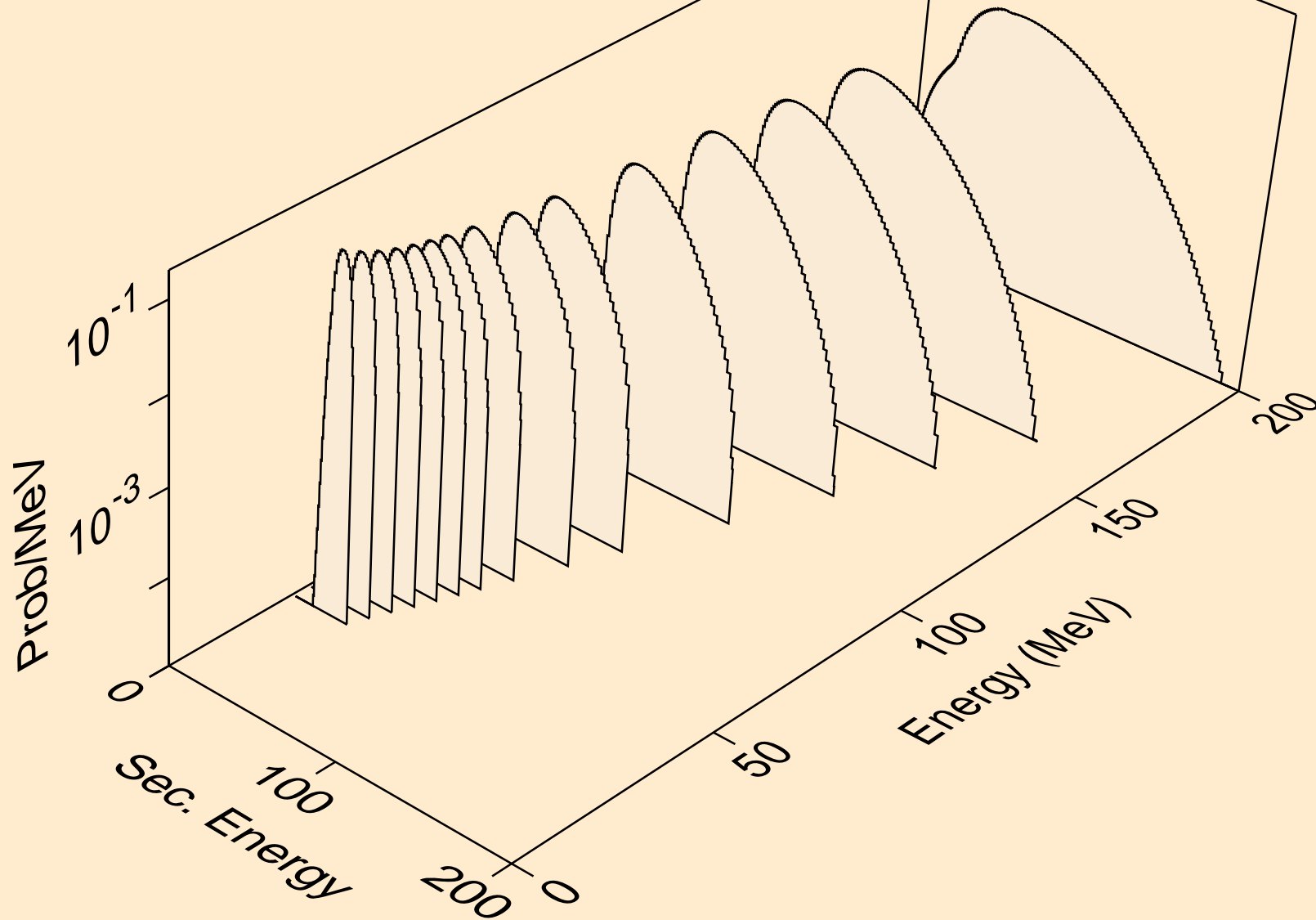

TL183 NEUTRON ACER TENDL-2019 LIBRARY; T=293.16K
he3s from (n,n*)he3

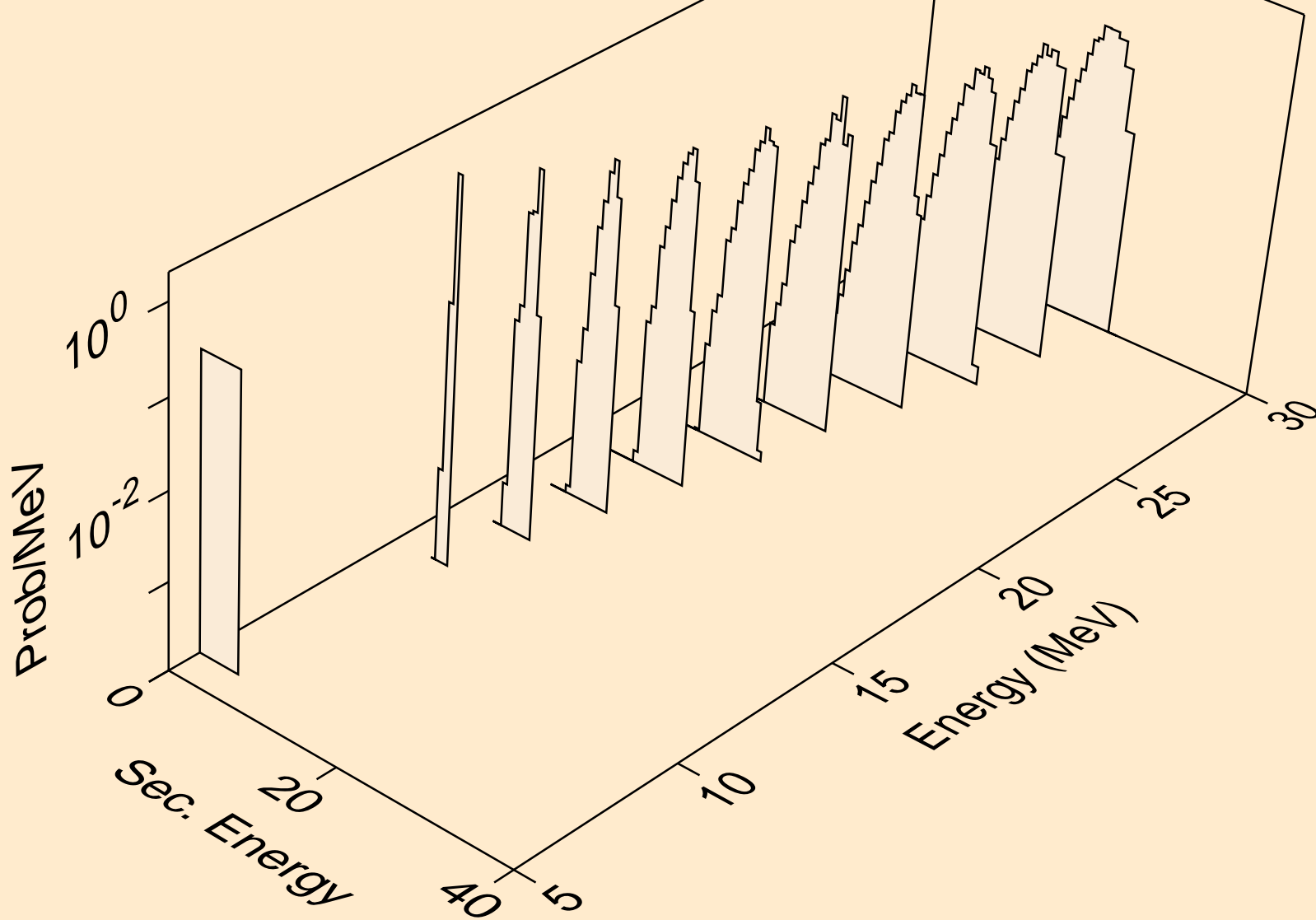

TL183 NEUTRON ACER TENDL-2019 LIBRARY; T=293.16K
he3s from (n,he3)

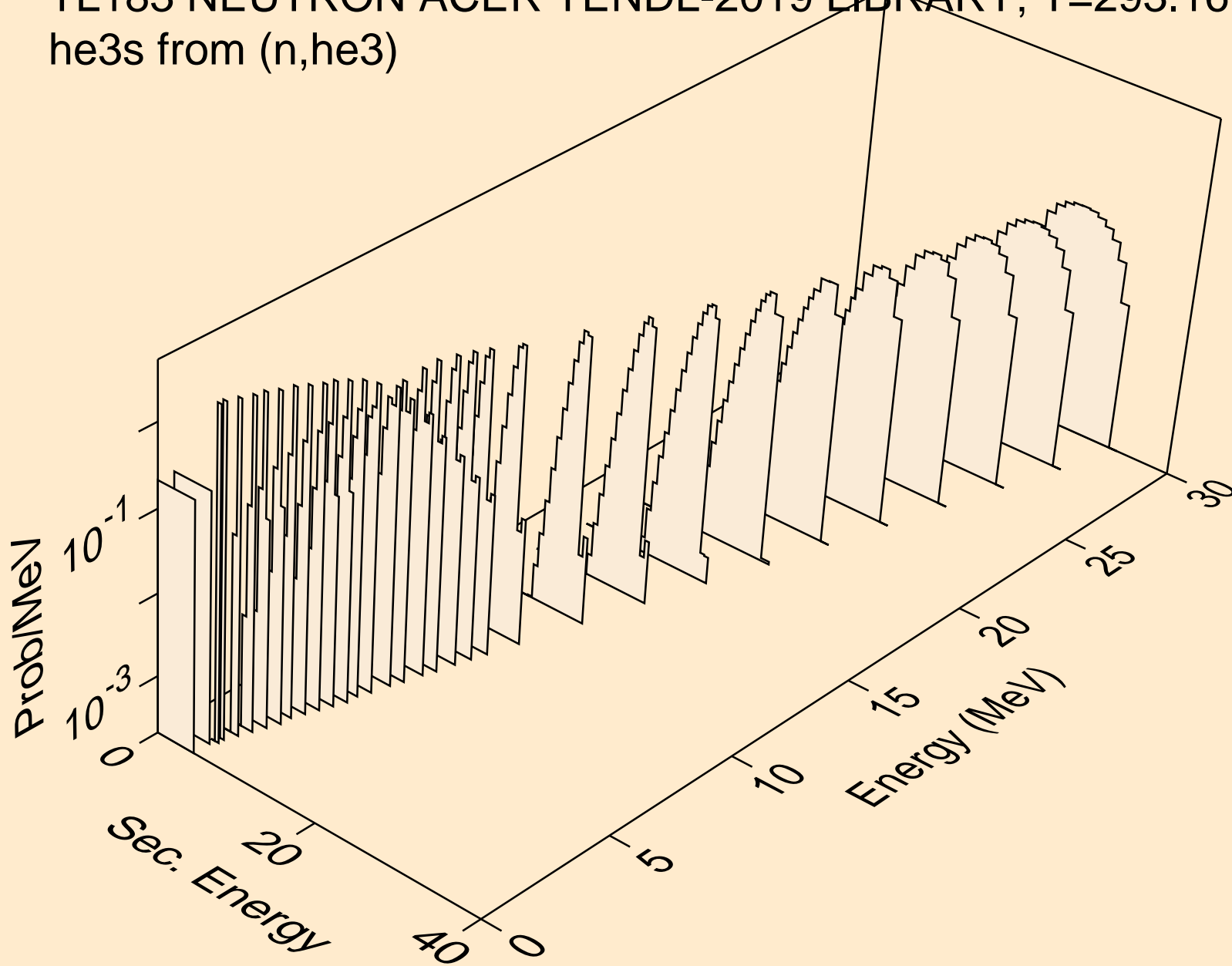

TL183 NEUTRON ACER TENDL-2019 LIBRARY; T=293.16K
alphas from (n,x)

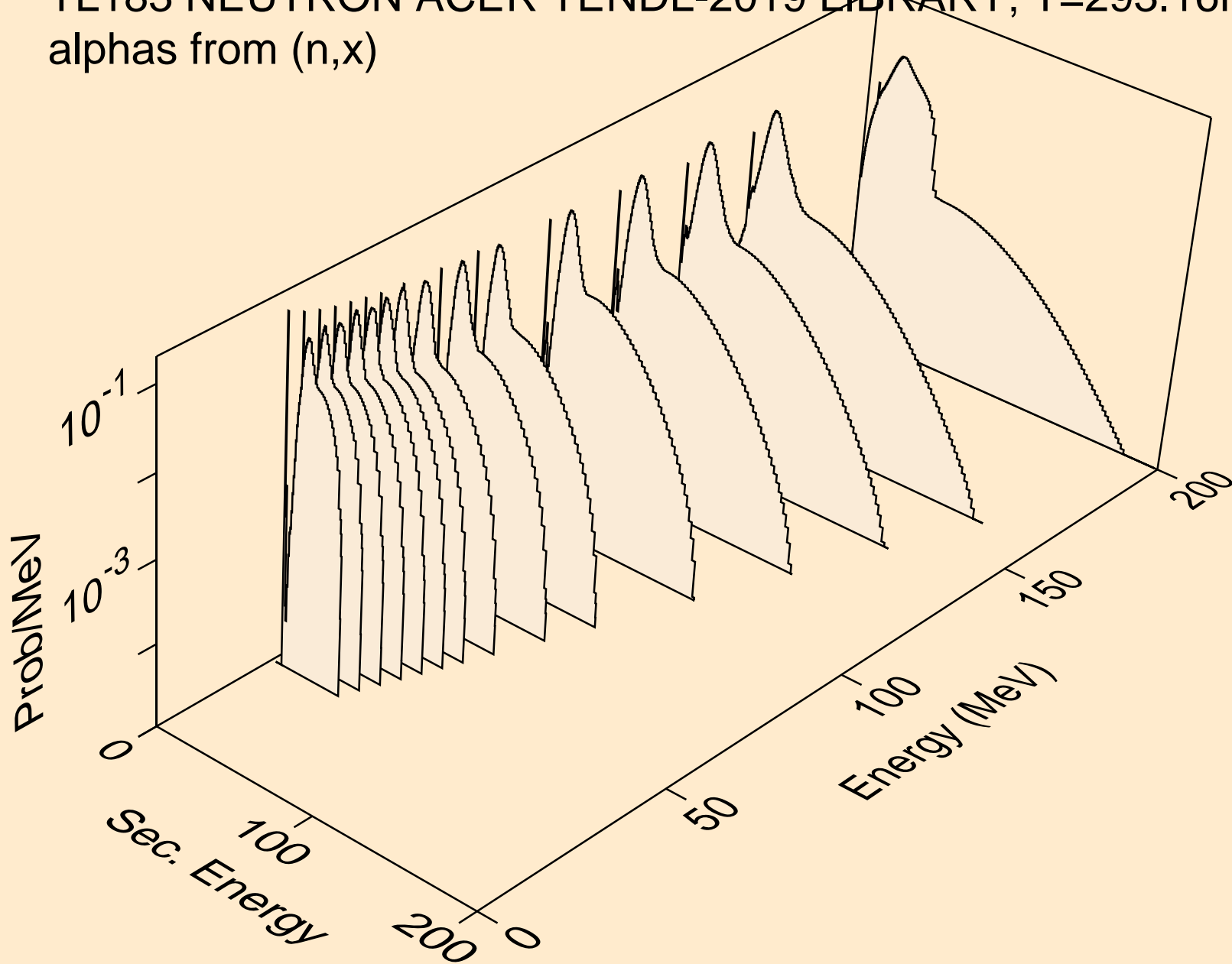

TL183 NEUTRON ACER TENDL-2019 LIBRARY; T=293.16K
alphas from (n,n*)a

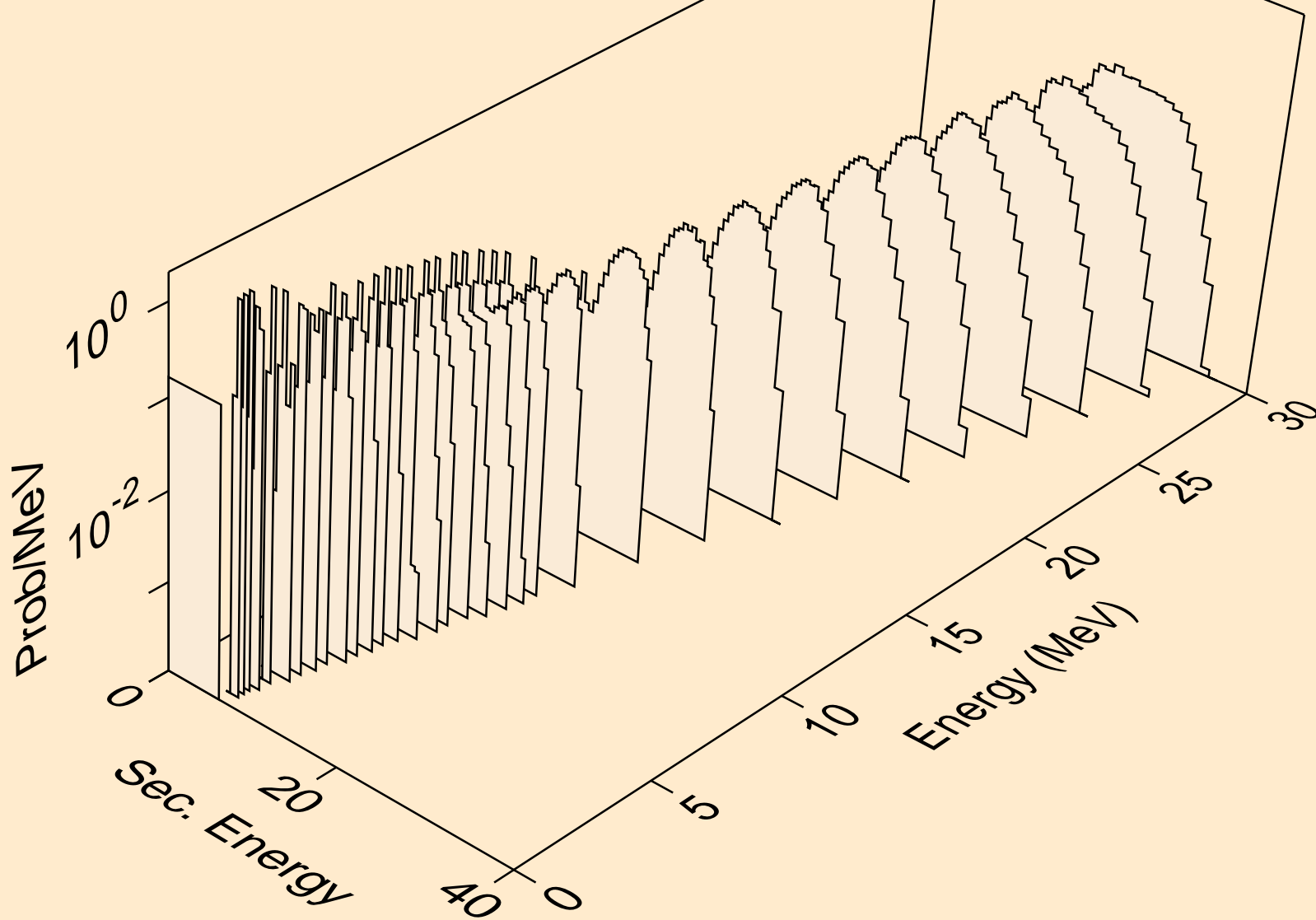

TL183 NEUTRON ACER TENDL-2019 LIBRARY; T=293.16K
alphas from (n,n*)3a

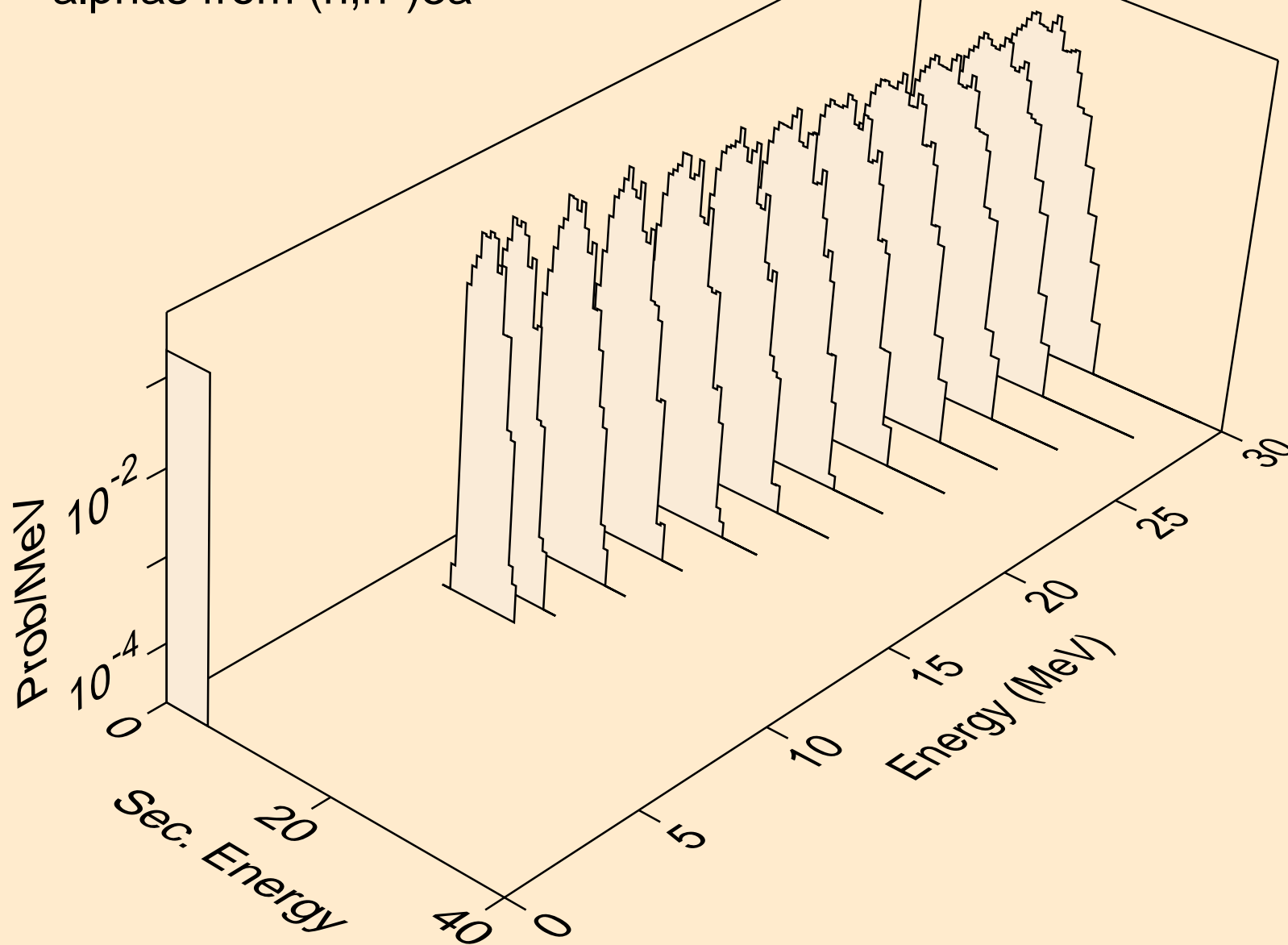

TL183 NEUTRON ACER TENDL-2019 LIBRARY; T=293.16K
alphas from (n,2n)a

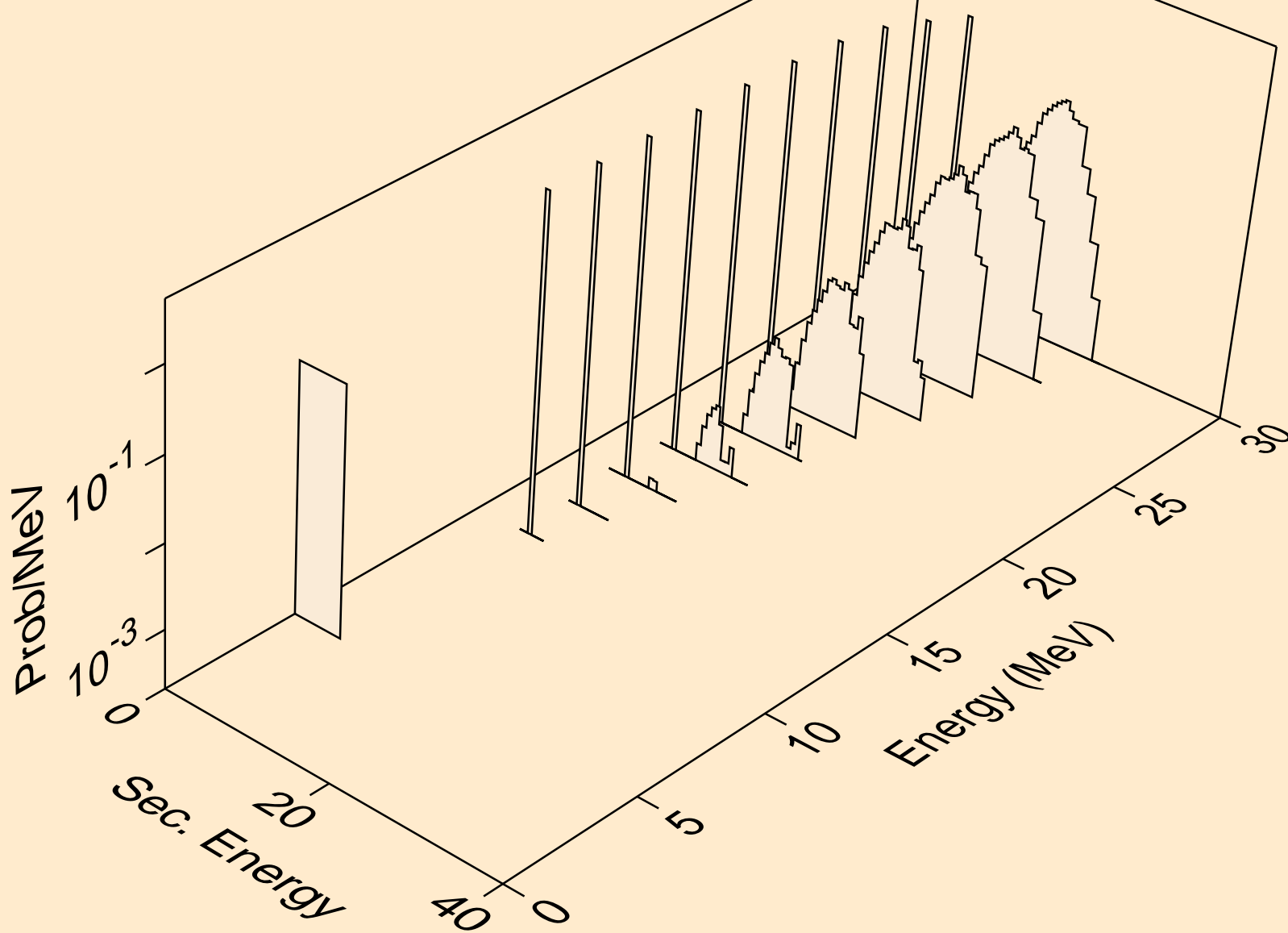

TL183 NEUTRON ACER TENDL-2019 LIBRARY; T=293.16K
alphas from (n,3n)a

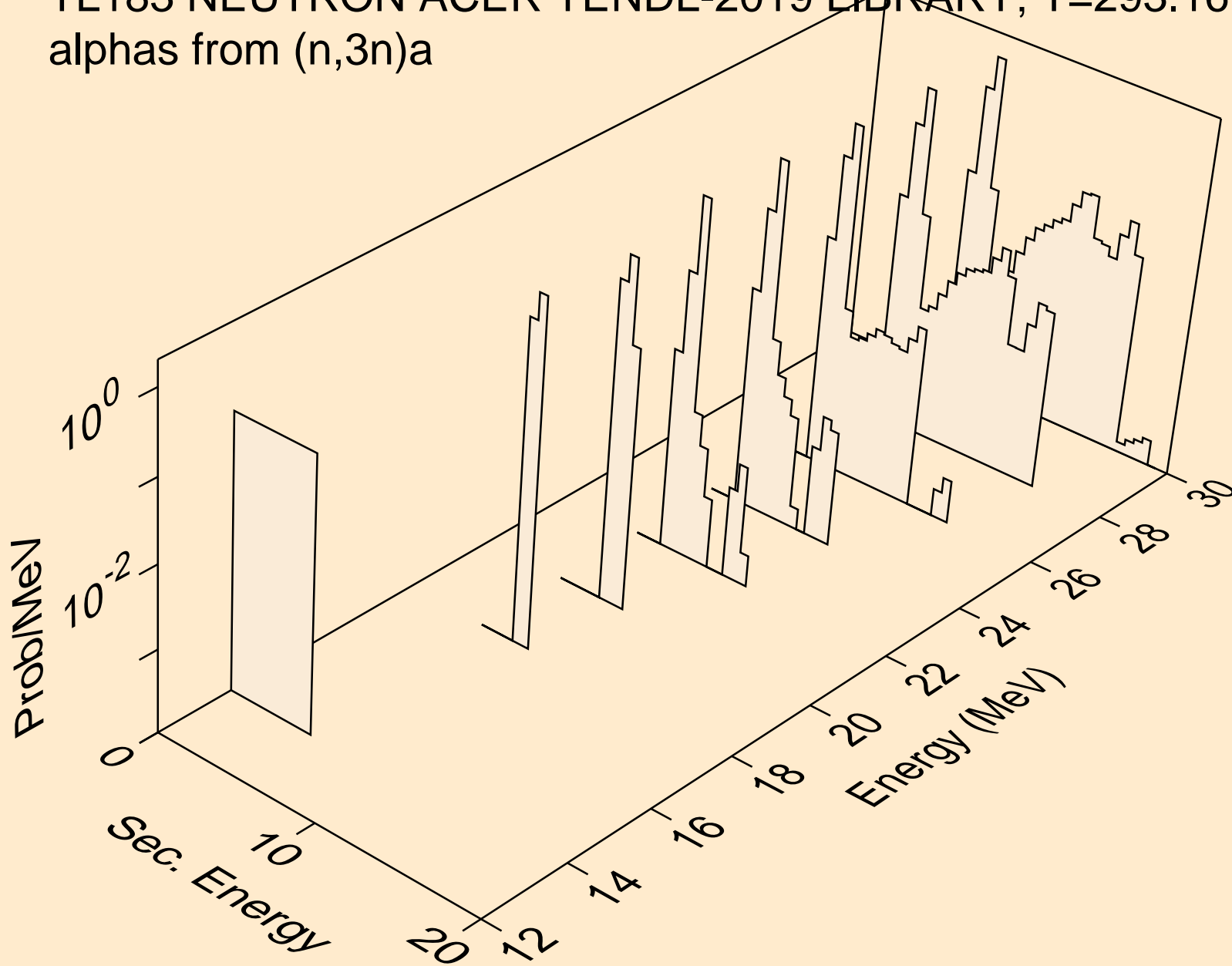

TL183 NEUTRON ACER TENDL-2019 LIBRARY; T=293.16K
alphas from (n,n*)2a

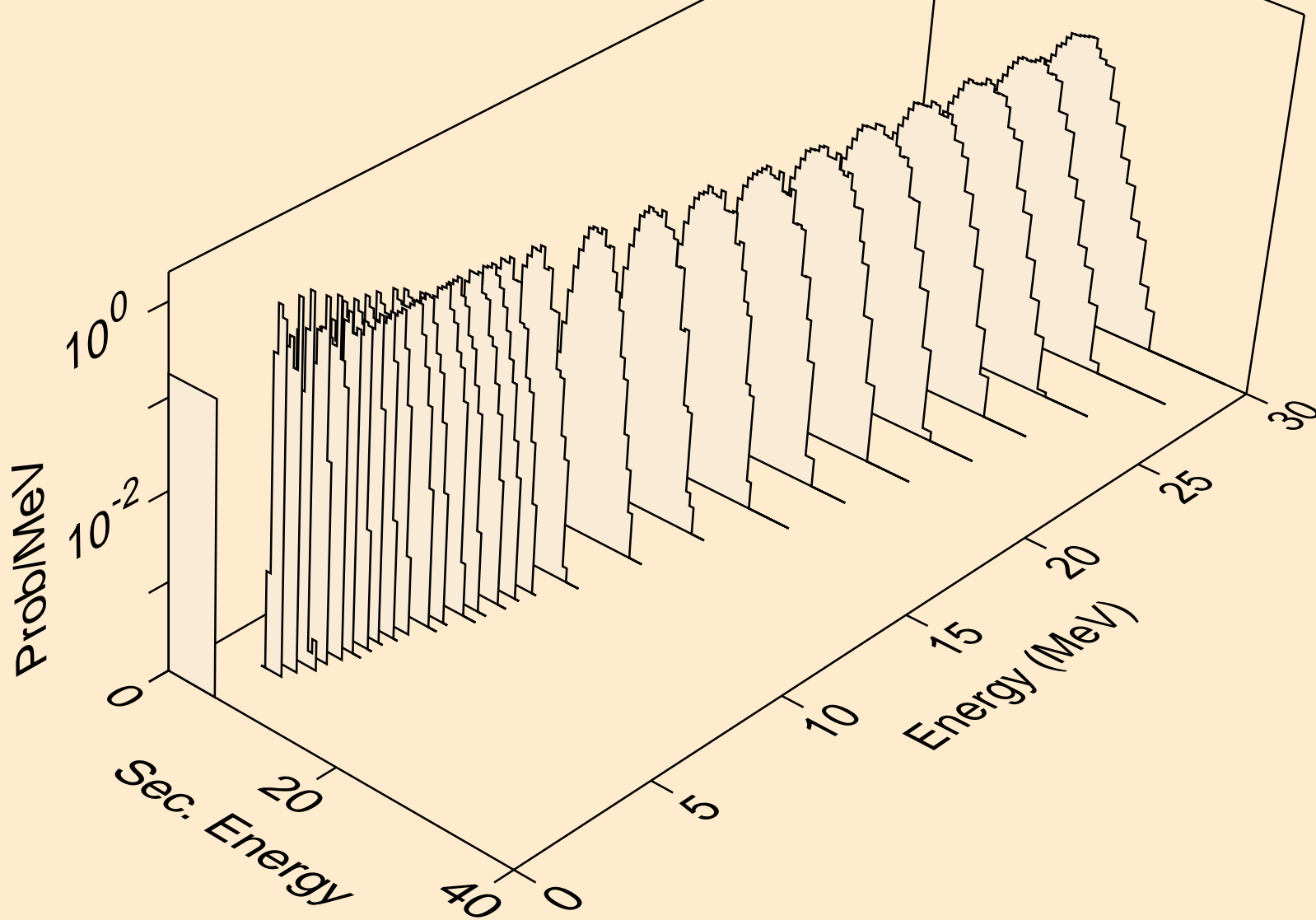

TL183 NEUTRON ACER TENDL-2019 LIBRARY; T=293.16K
alphas from (n,2n)2a

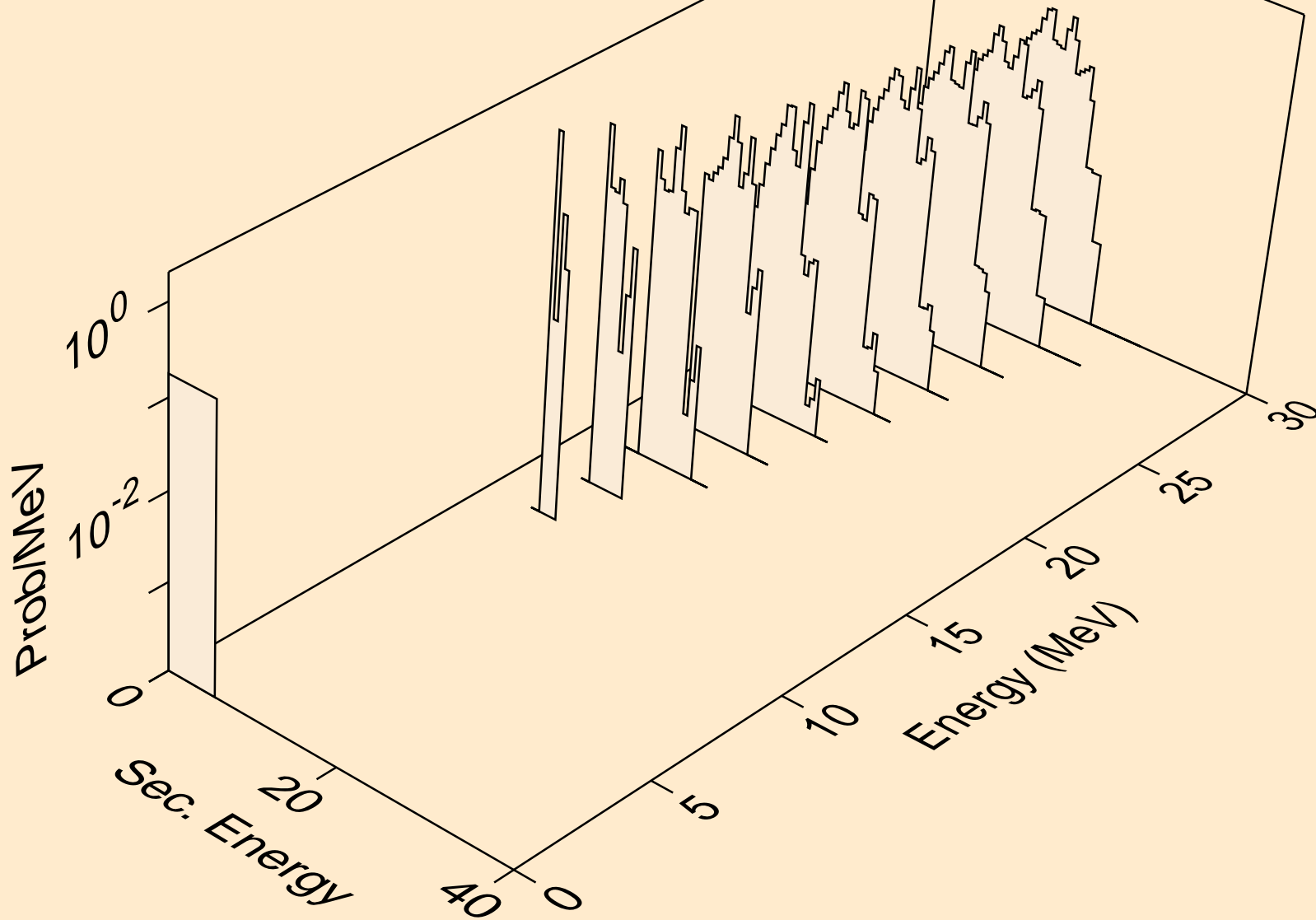

TL183 NEUTRON ACER TENDL-2019 LIBRARY; T=293.16K
alphas from (n,npa)

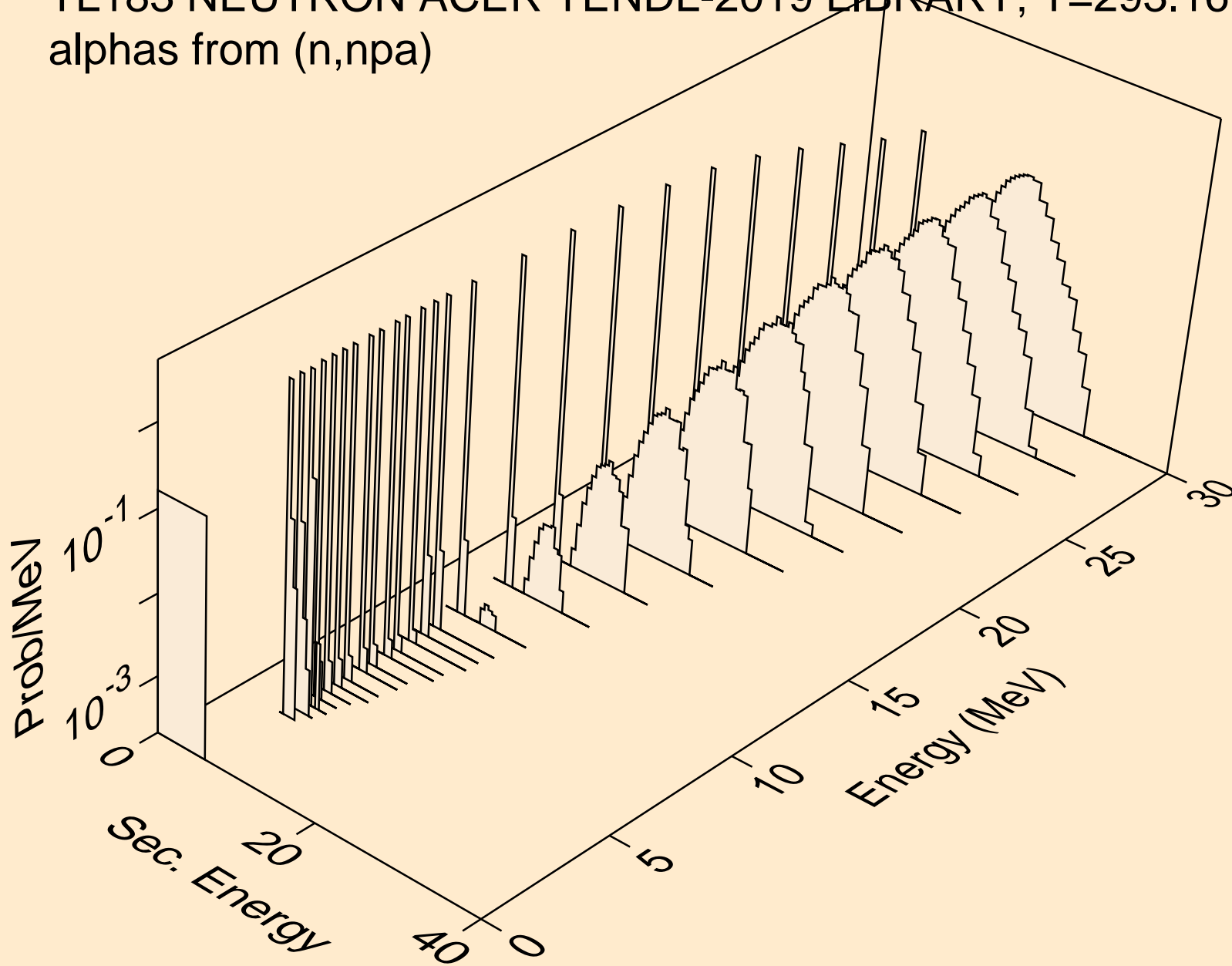

TL183 NEUTRON ACER TENDL-2019 LIBRARY; T=293.16K
alphas from (n,a)

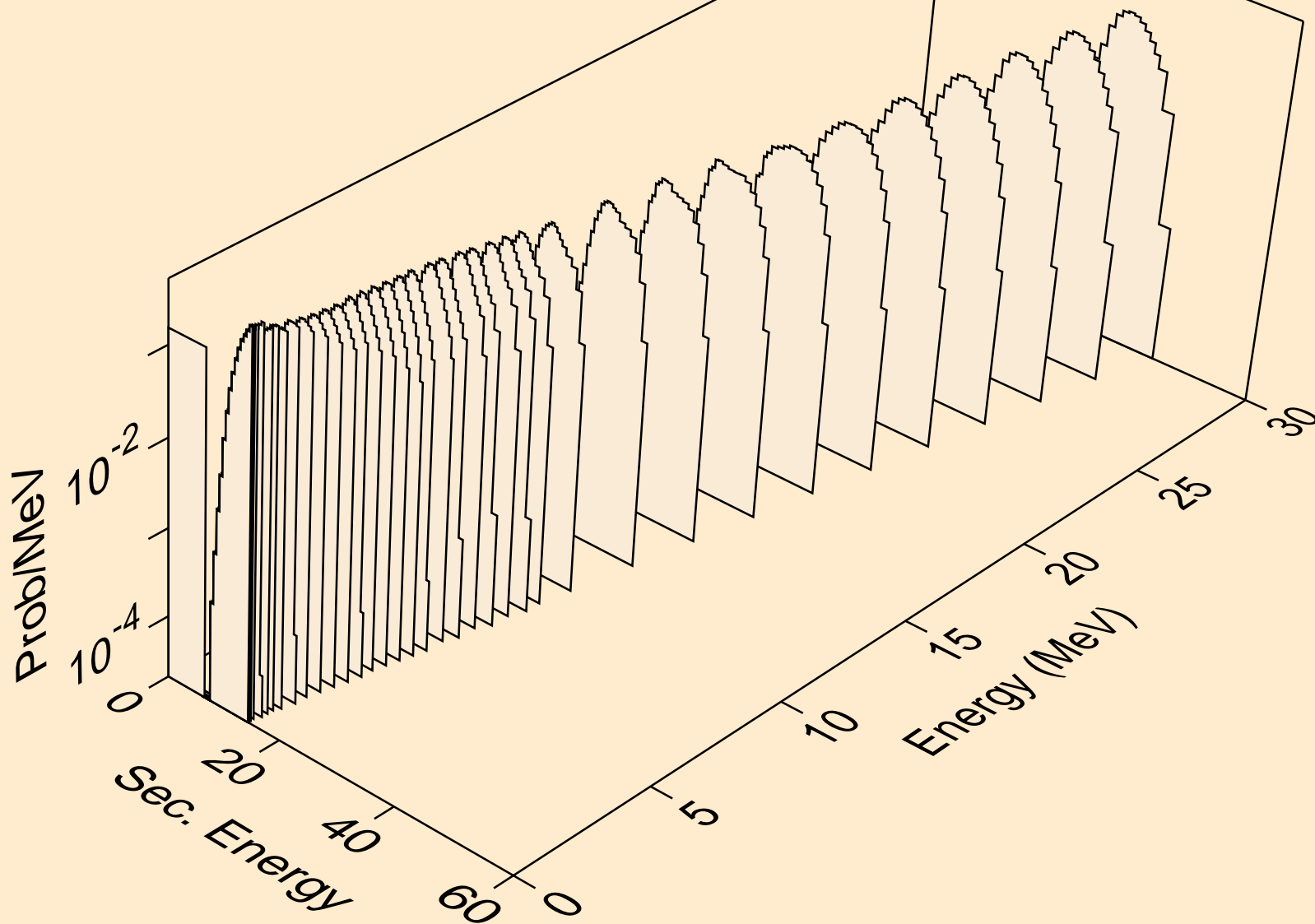

TL183 NEUTRON ACER TENDL-2019 LIBRARY; T=293.16K
alphas from (n,2a)

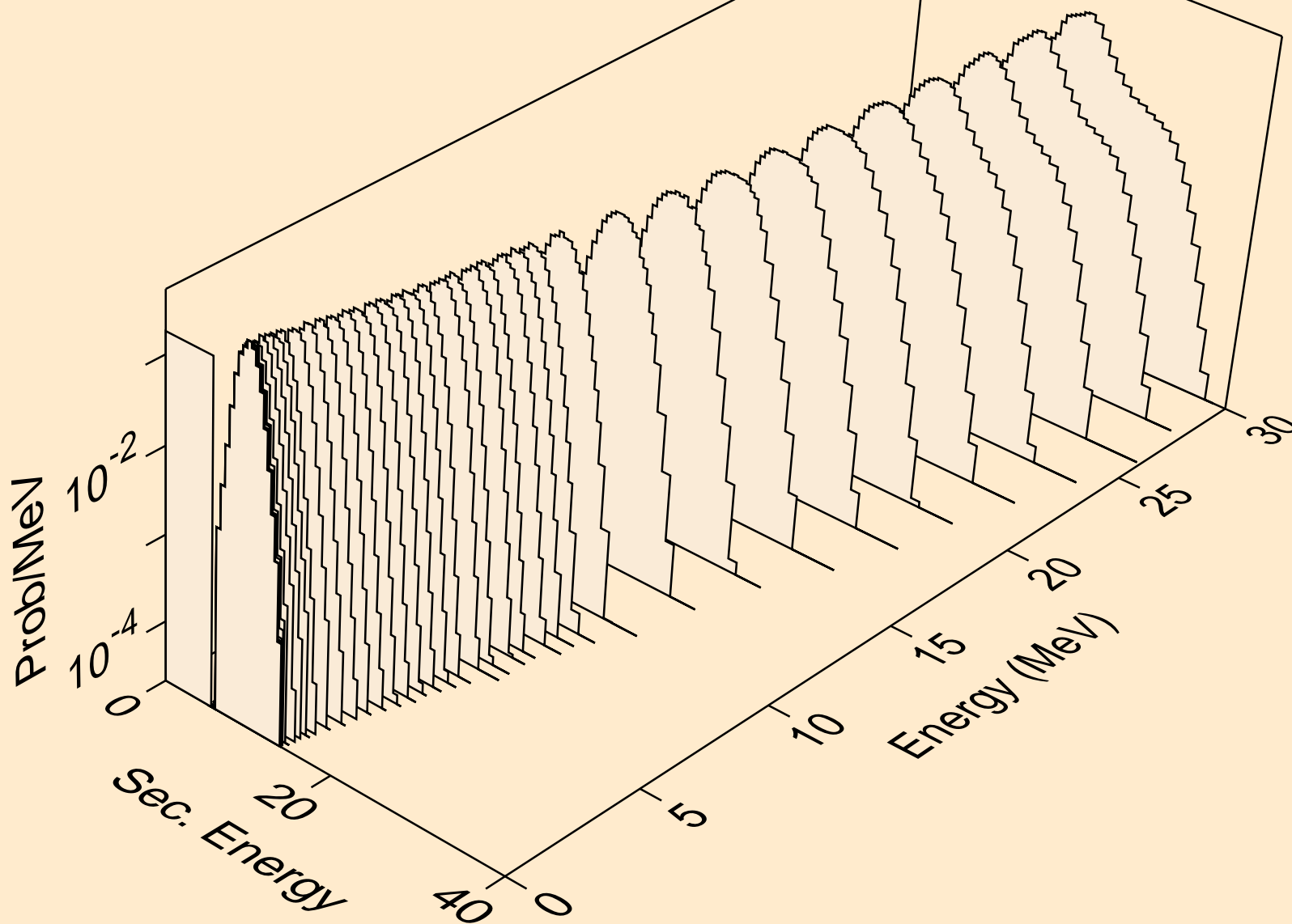

TL183 NEUTRON ACER TENDL-2019 LIBRARY; T=293.16K
alphas from (n,3a)

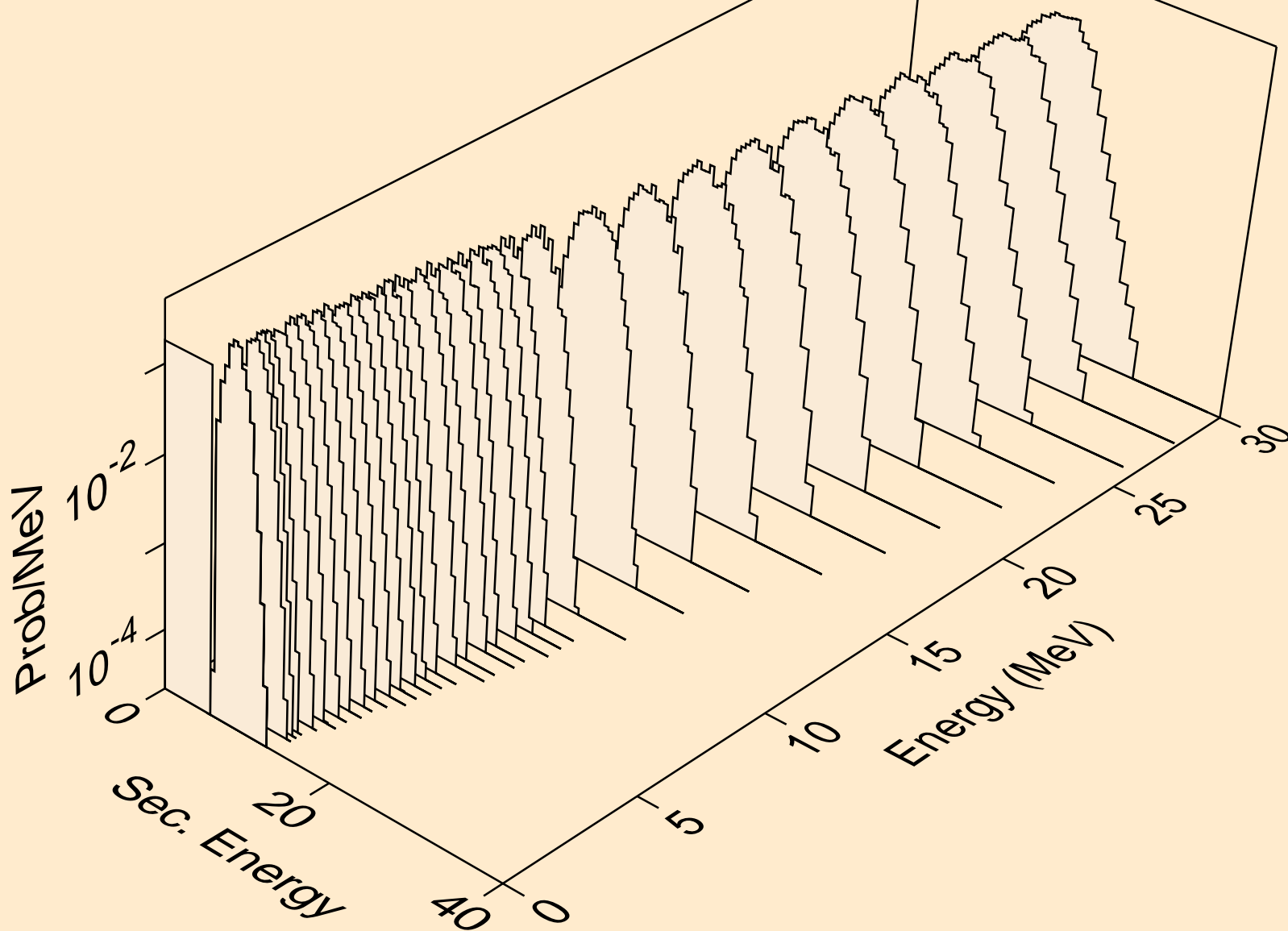

TL183 NEUTRON ACER TENDL-2019 LIBRARY; T=293.16K
alphas from (n,pa)

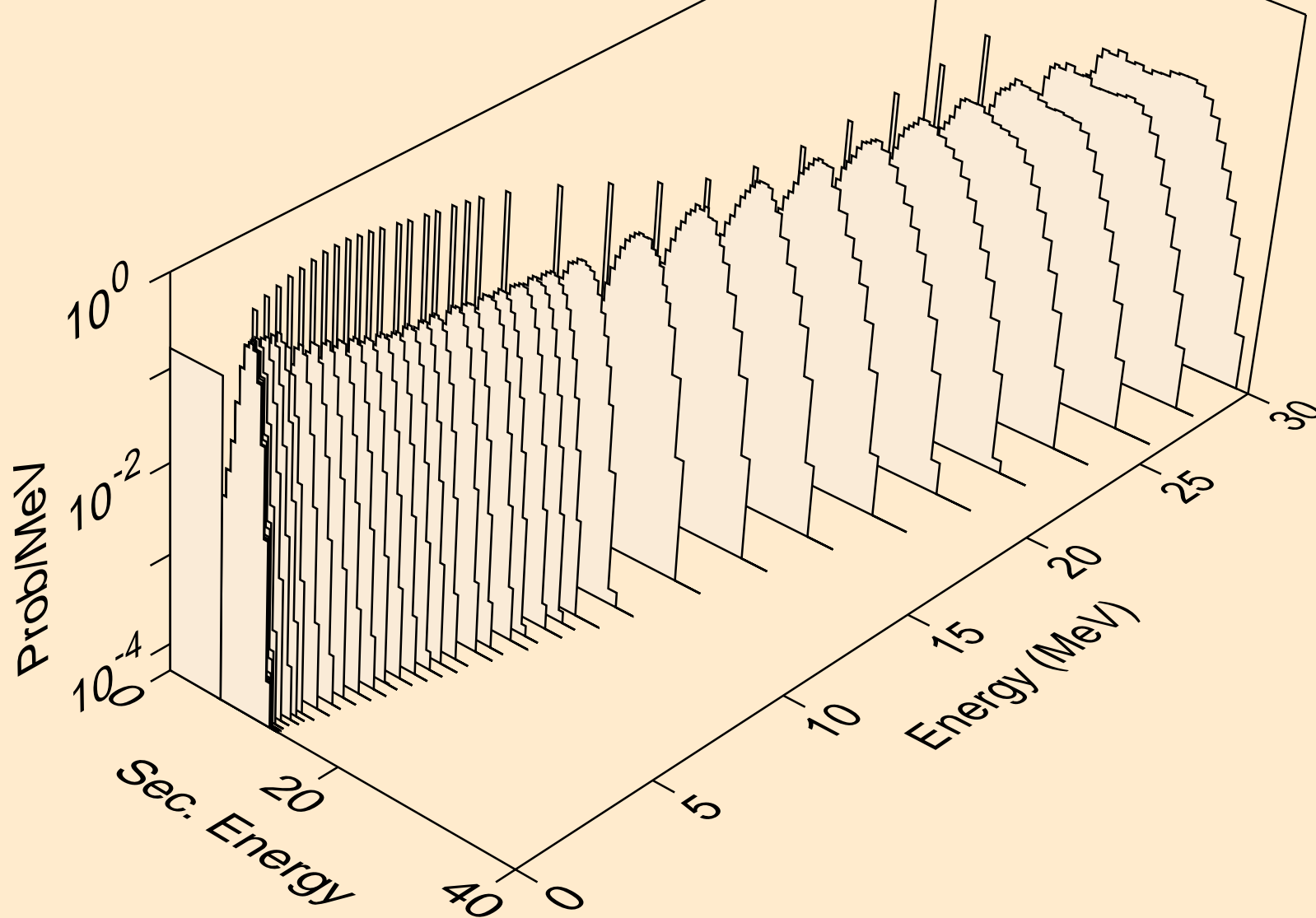

TL183 NEUTRON ACER TENDL-2019 LIBRARY; T=293.16K
alphas from (n,t2a)

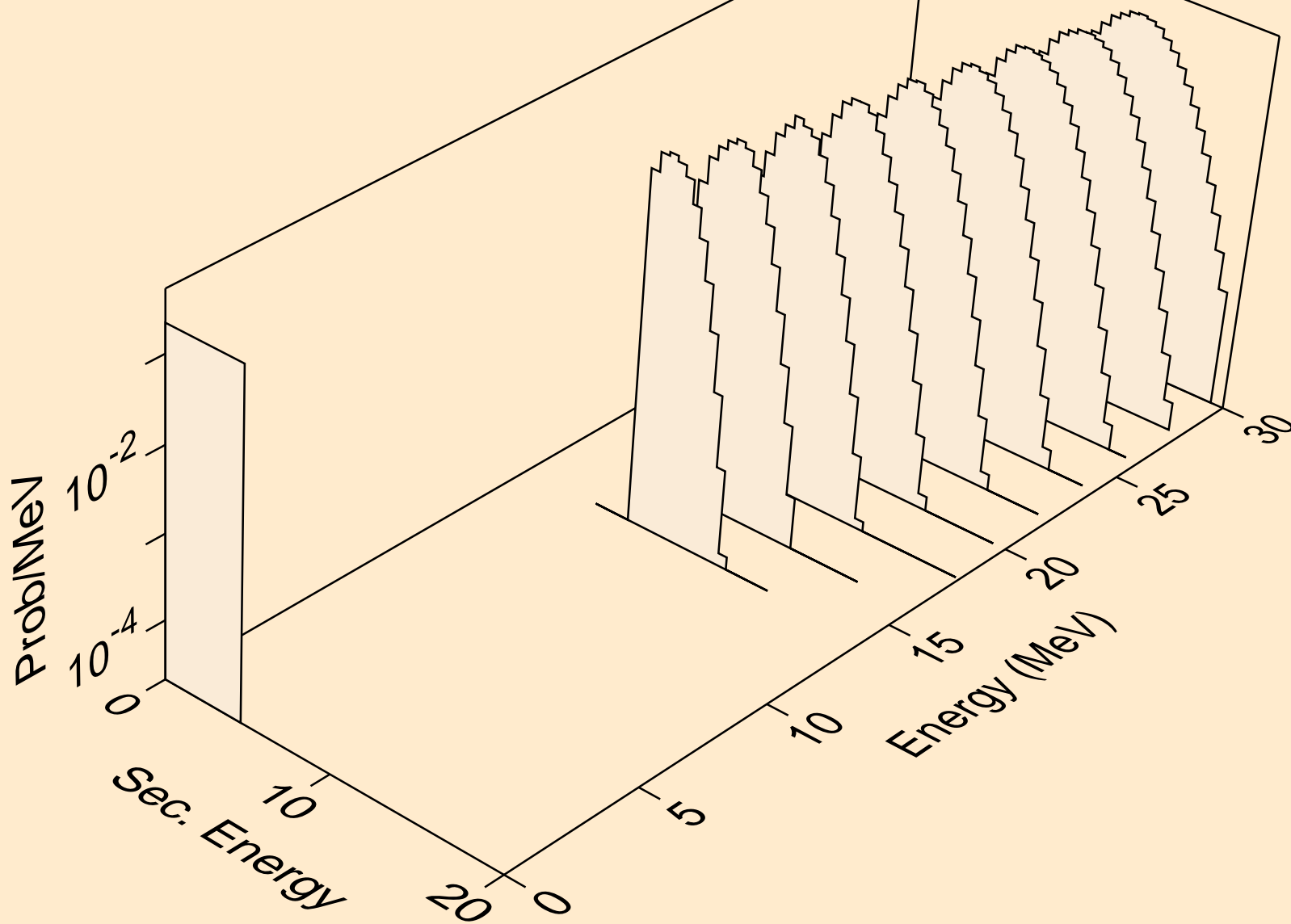

TL183 NEUTRON ACER TENDL-2019 LIBRARY; T=293.16K
alphas from (n,d2a)

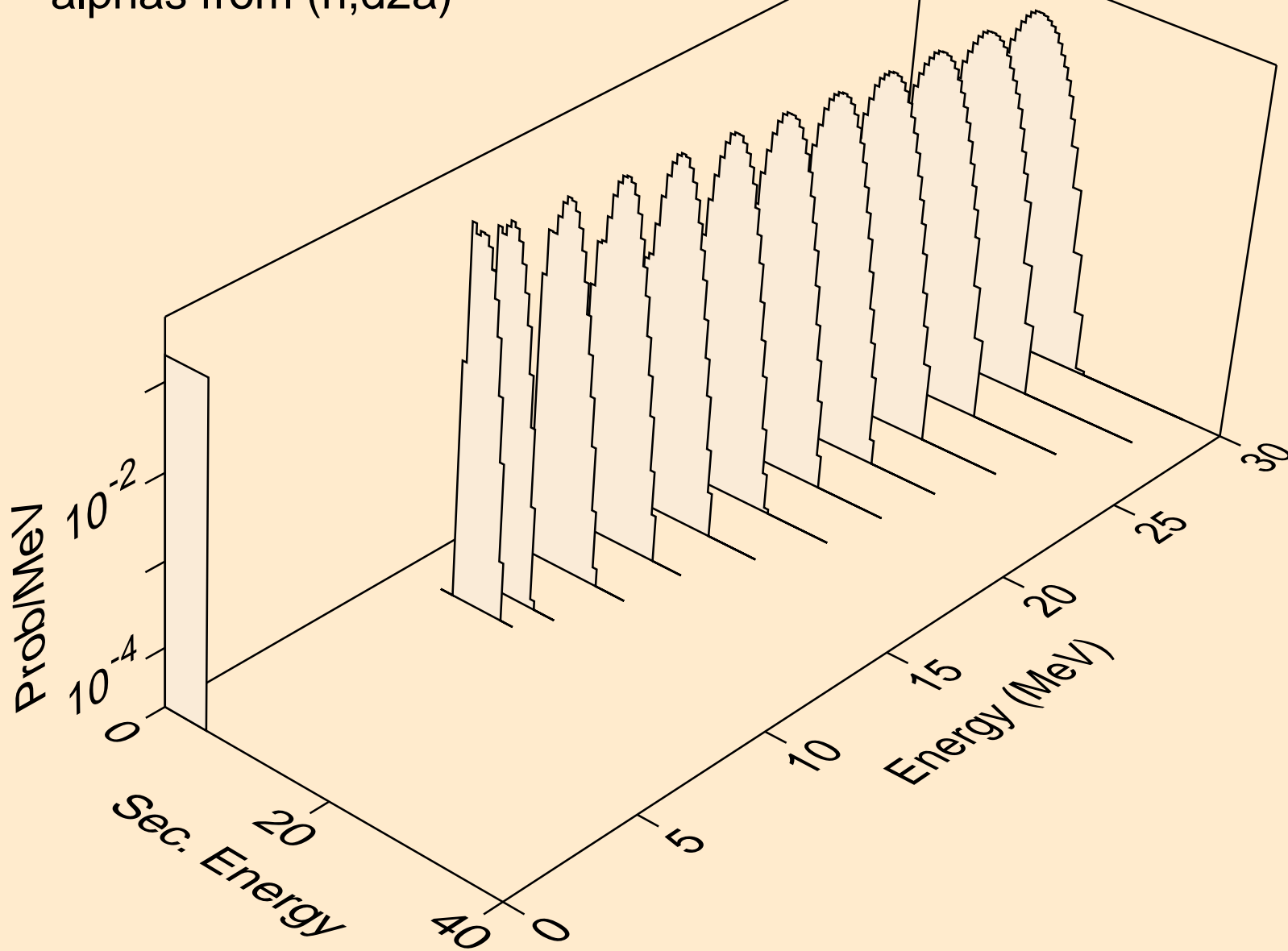

TL183 NEUTRON ACER TENDL-2019 LIBRARY; T=293.16K
alphas from (n,da)

