

V050 NEUTRON ACER TENDL-2019 LIBRARY; T=293.16K
Principal cross sections

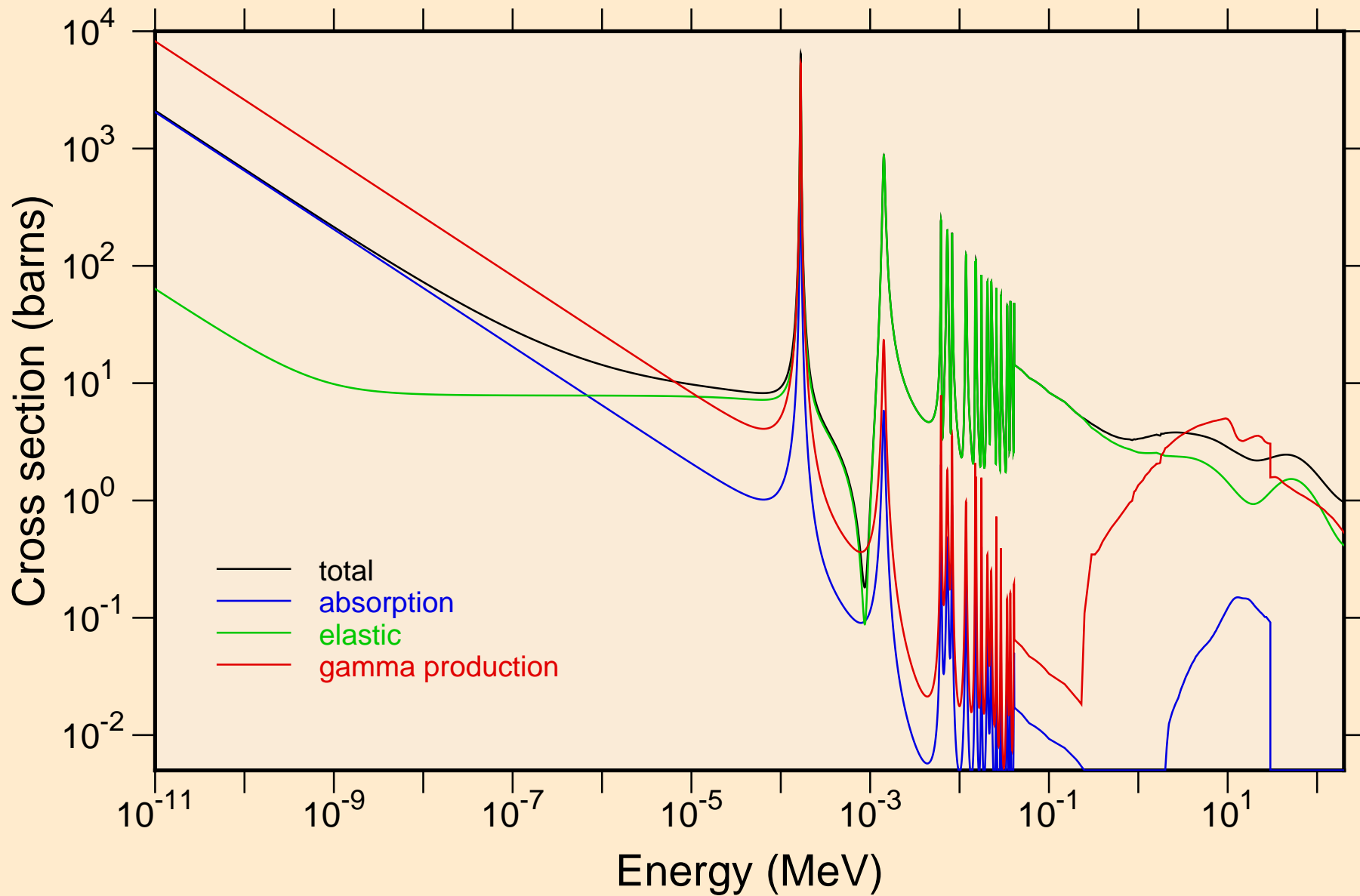

V050 NEUTRON ACER TENDL-2019 LIBRARY; T=293.16K
resonance total cross section

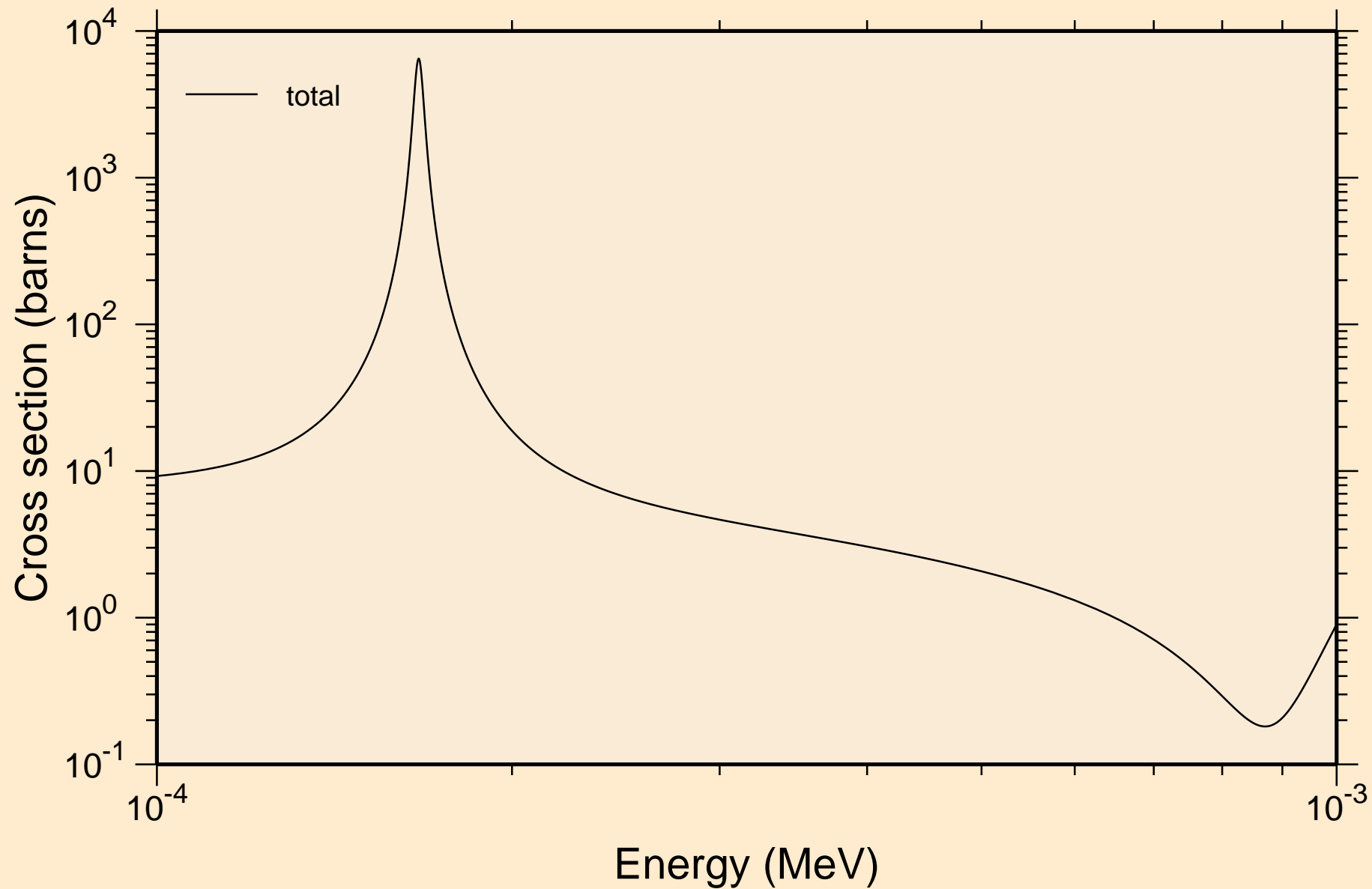

V050 NEUTRON ACER TENDL-2019 LIBRARY; T=293.16K
resonance total cross section

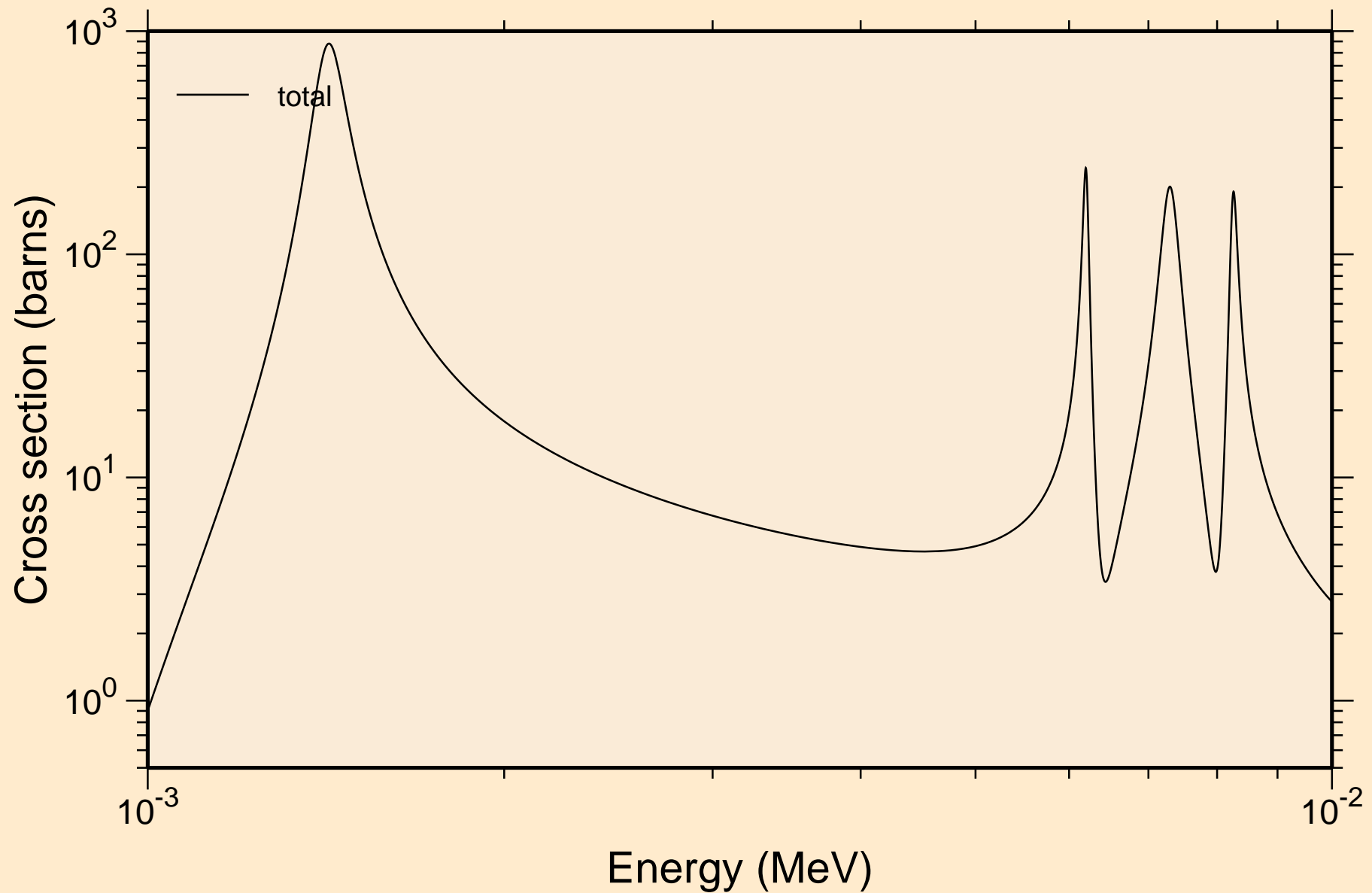

V050 NEUTRON ACER TENDL-2019 LIBRARY; T=293.16K
resonance total cross section

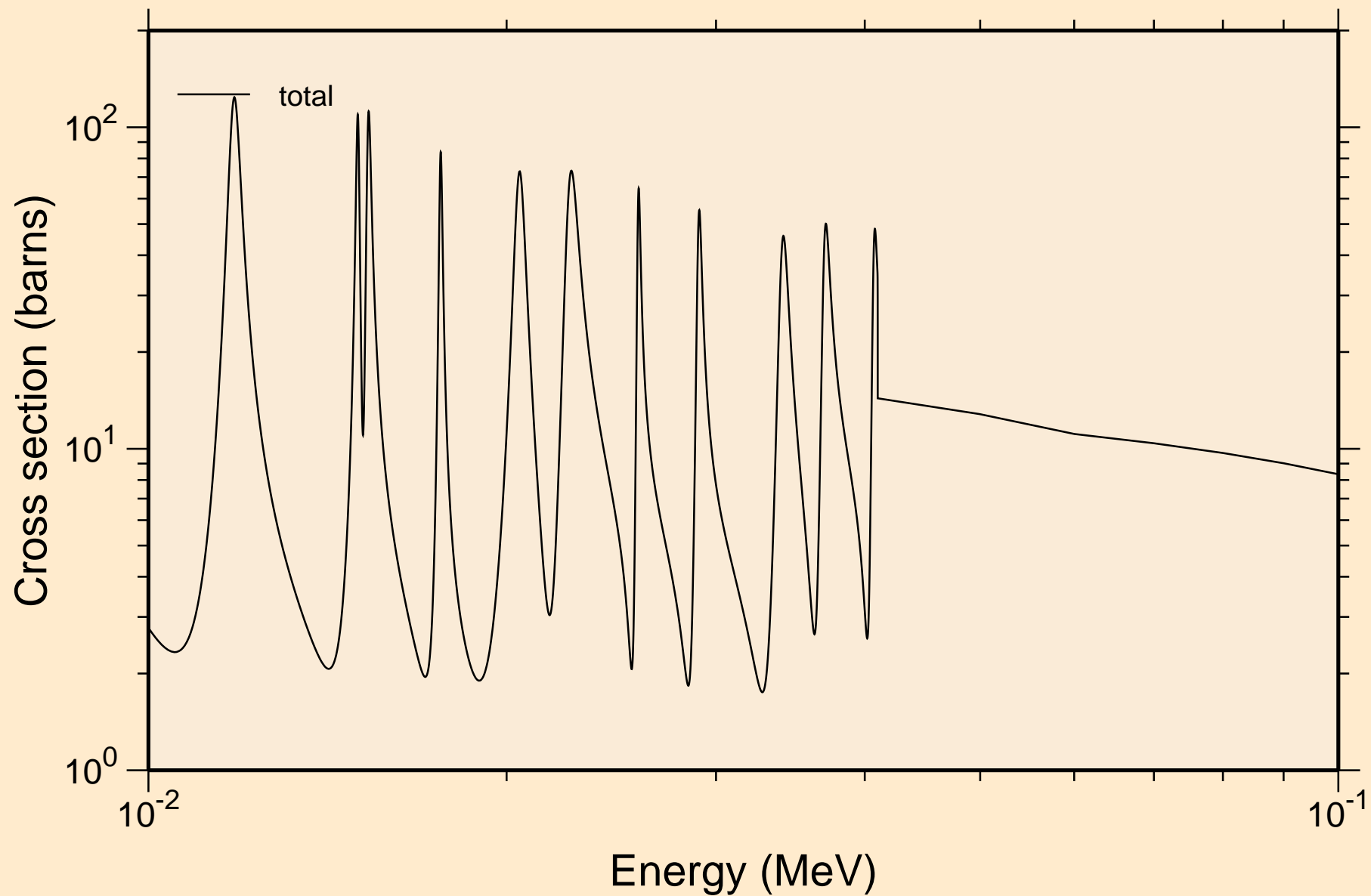

V050 NEUTRON ACER TENDL-2019 LIBRARY; T=293.16K
resonance total cross section

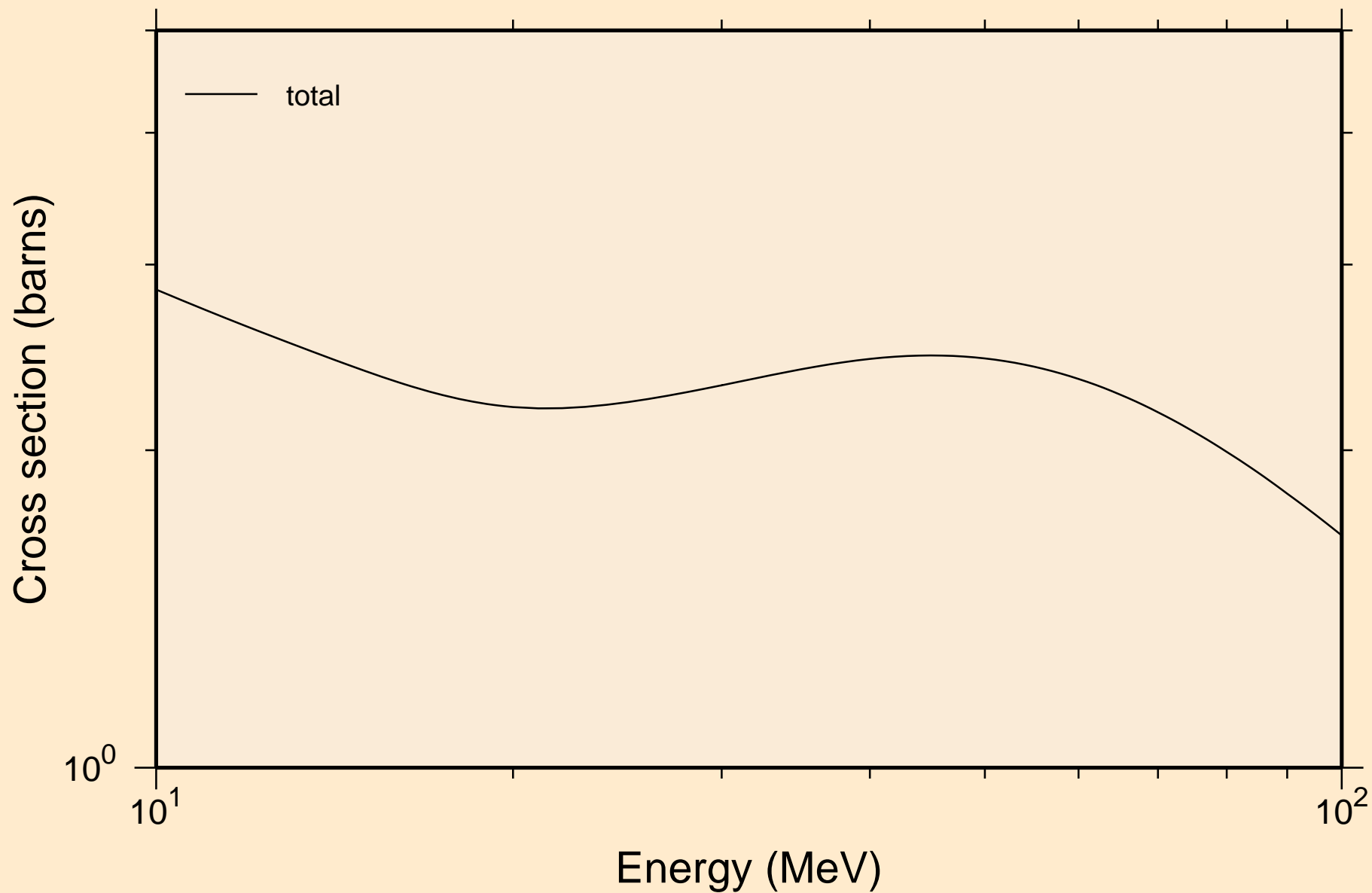

V050 NEUTRON ACER TENDL-2019 LIBRARY; T=293.16K
resonance absorption cross sections

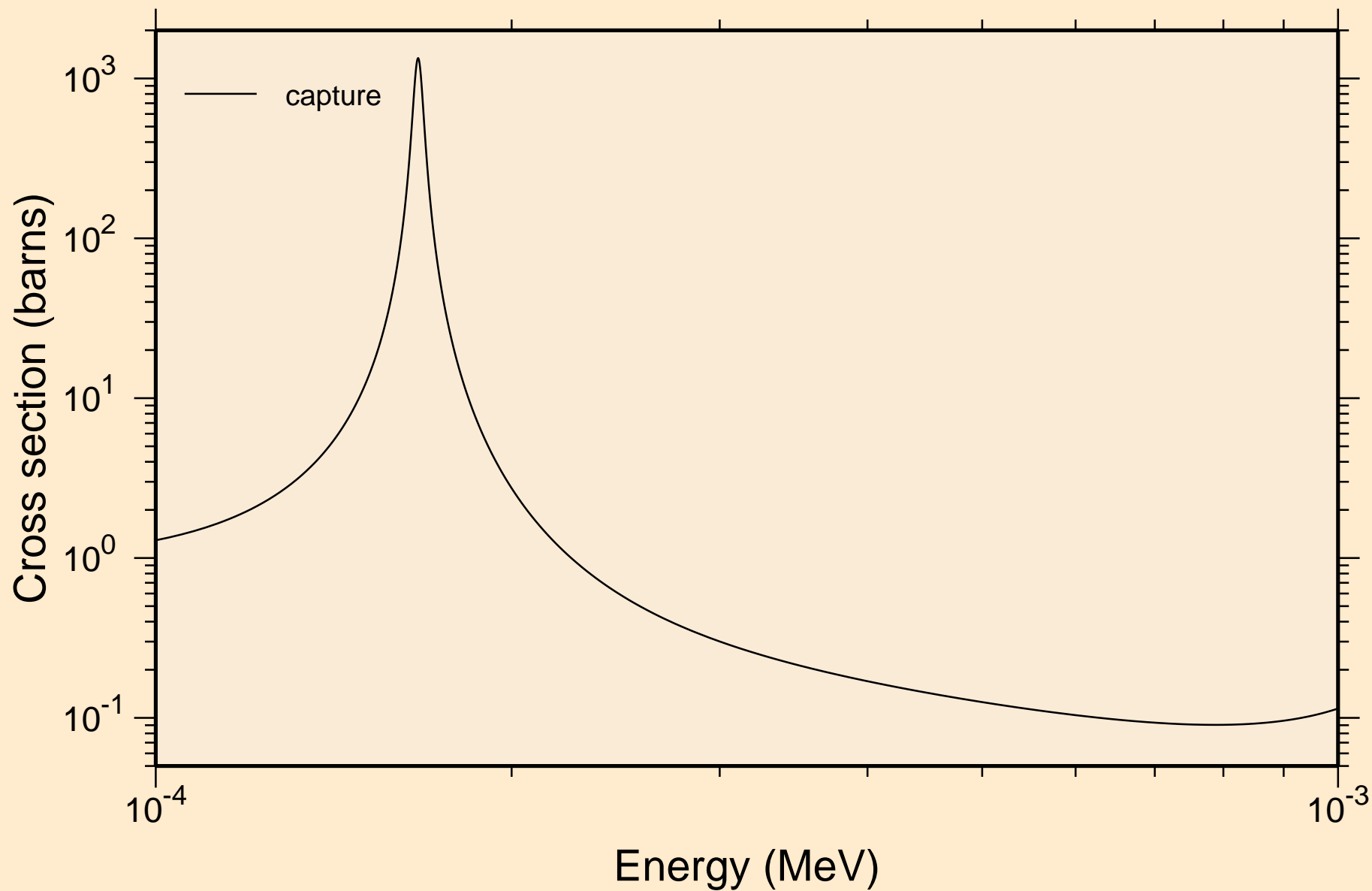

V050 NEUTRON ACER TENDL-2019 LIBRARY; T=293.16K
resonance absorption cross sections

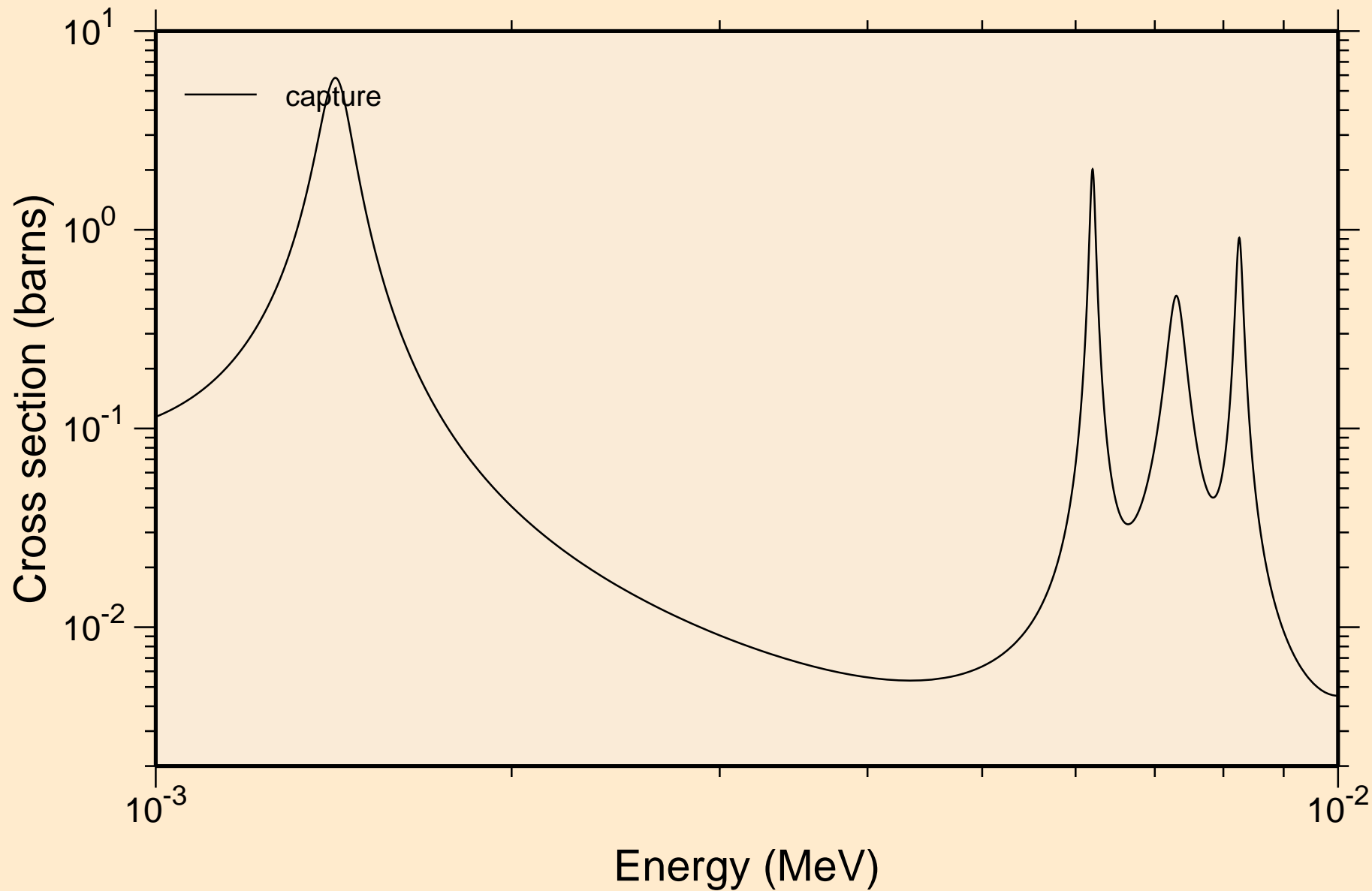

V050 NEUTRON ACER TENDL-2019 LIBRARY; T=293.16K
resonance absorption cross sections

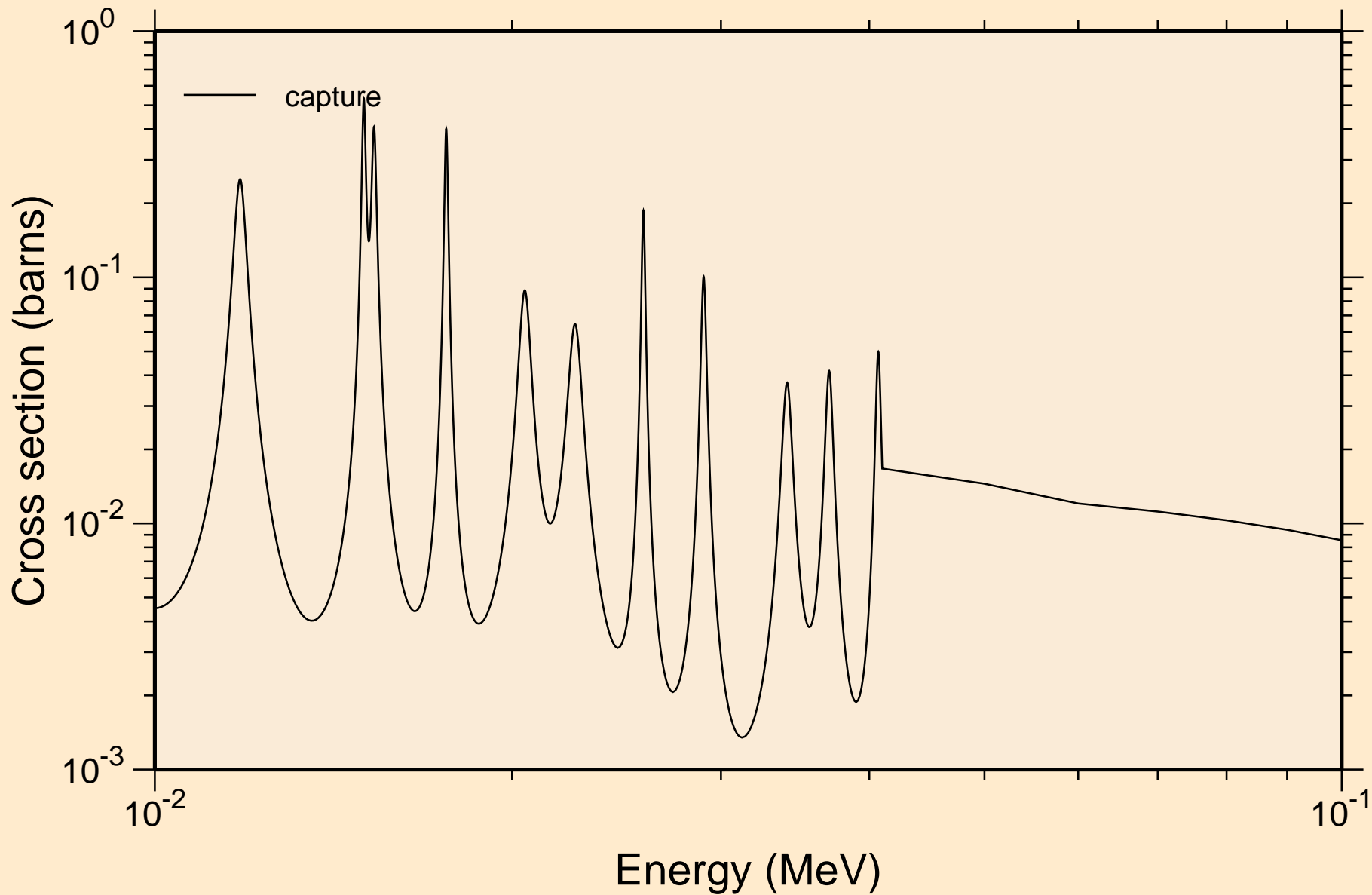

V050 NEUTRON ACER TENDL-2019 LIBRARY; T=293.16K
resonance absorption cross sections

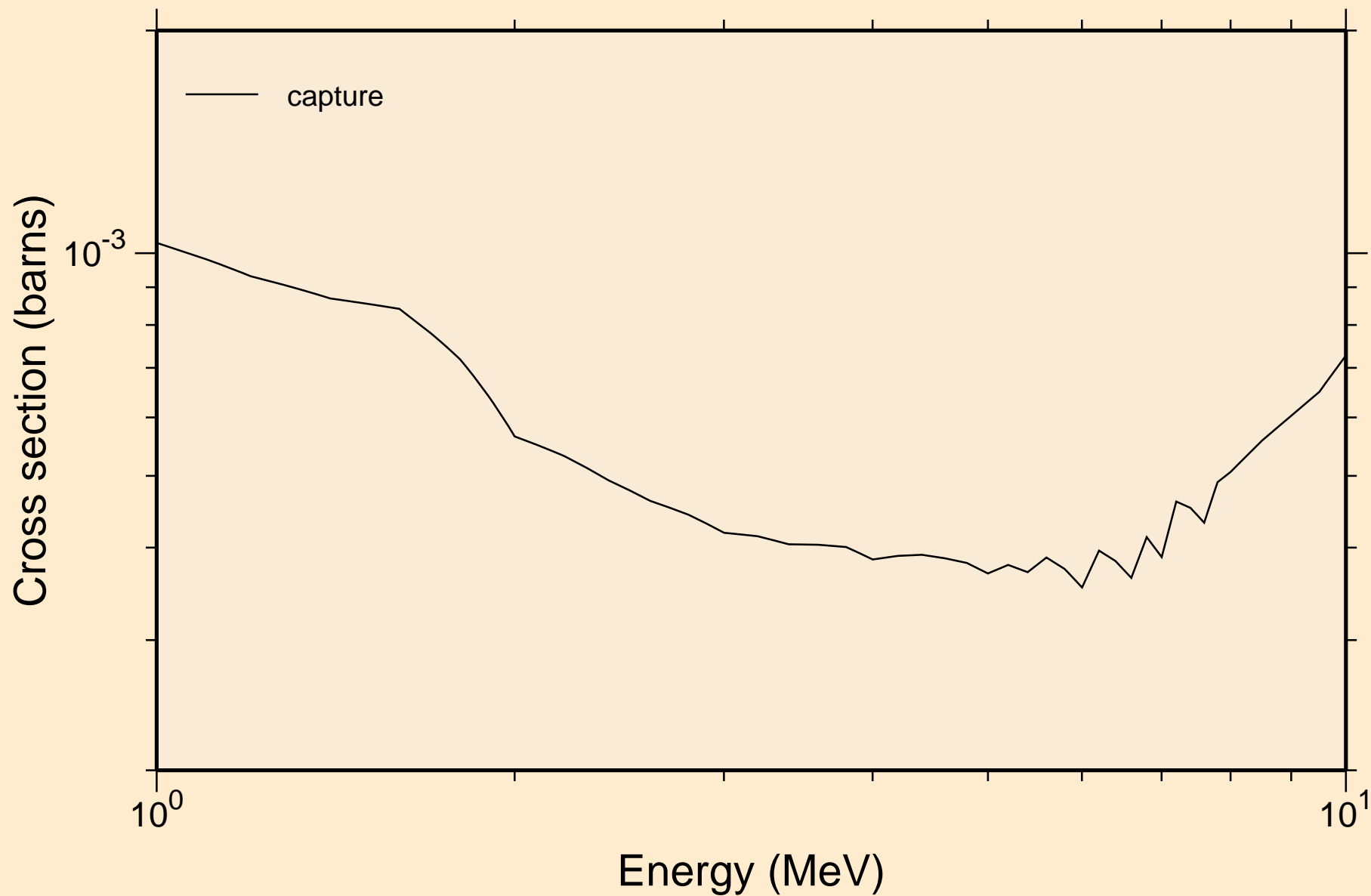

V050 NEUTRON ACER TENDL-2019 LIBRARY; T=293.16K
Heating

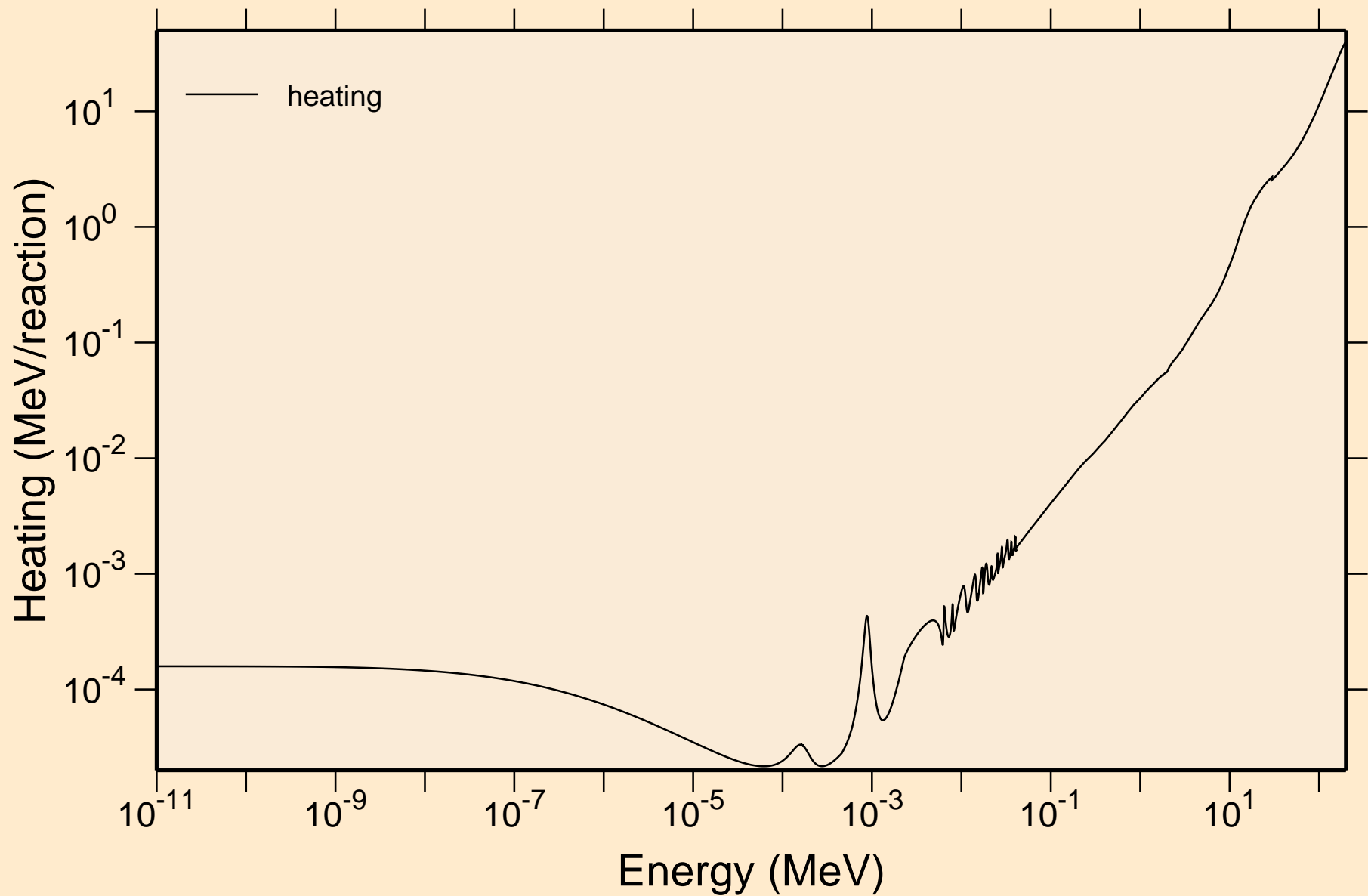

V050 NEUTRON ACER TENDL-2019 LIBRARY; T=293.16K
Damage

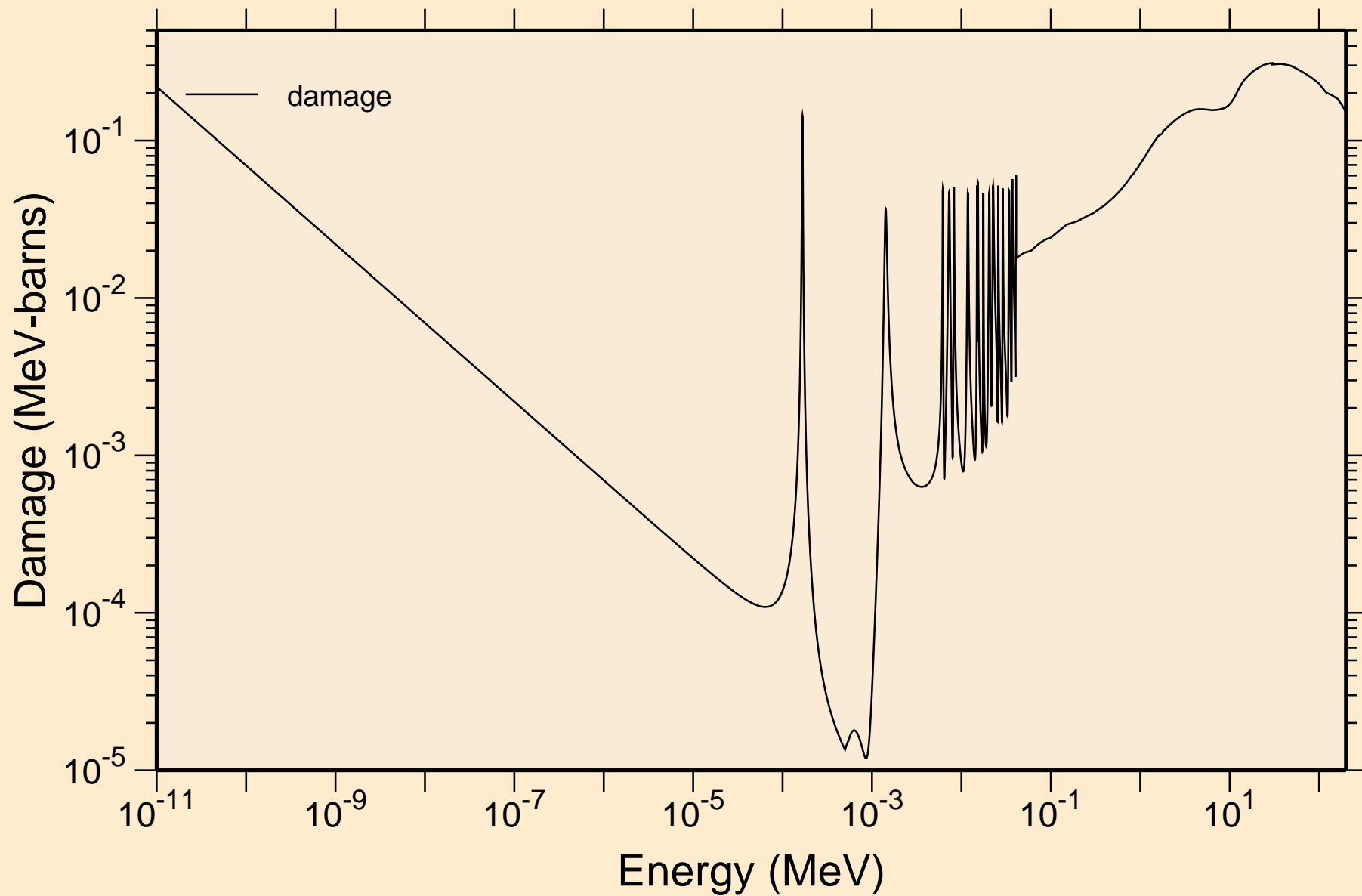

V050 NEUTRON ACER TENDL-2019 LIBRARY; T=293.16K
Non-threshold reactions

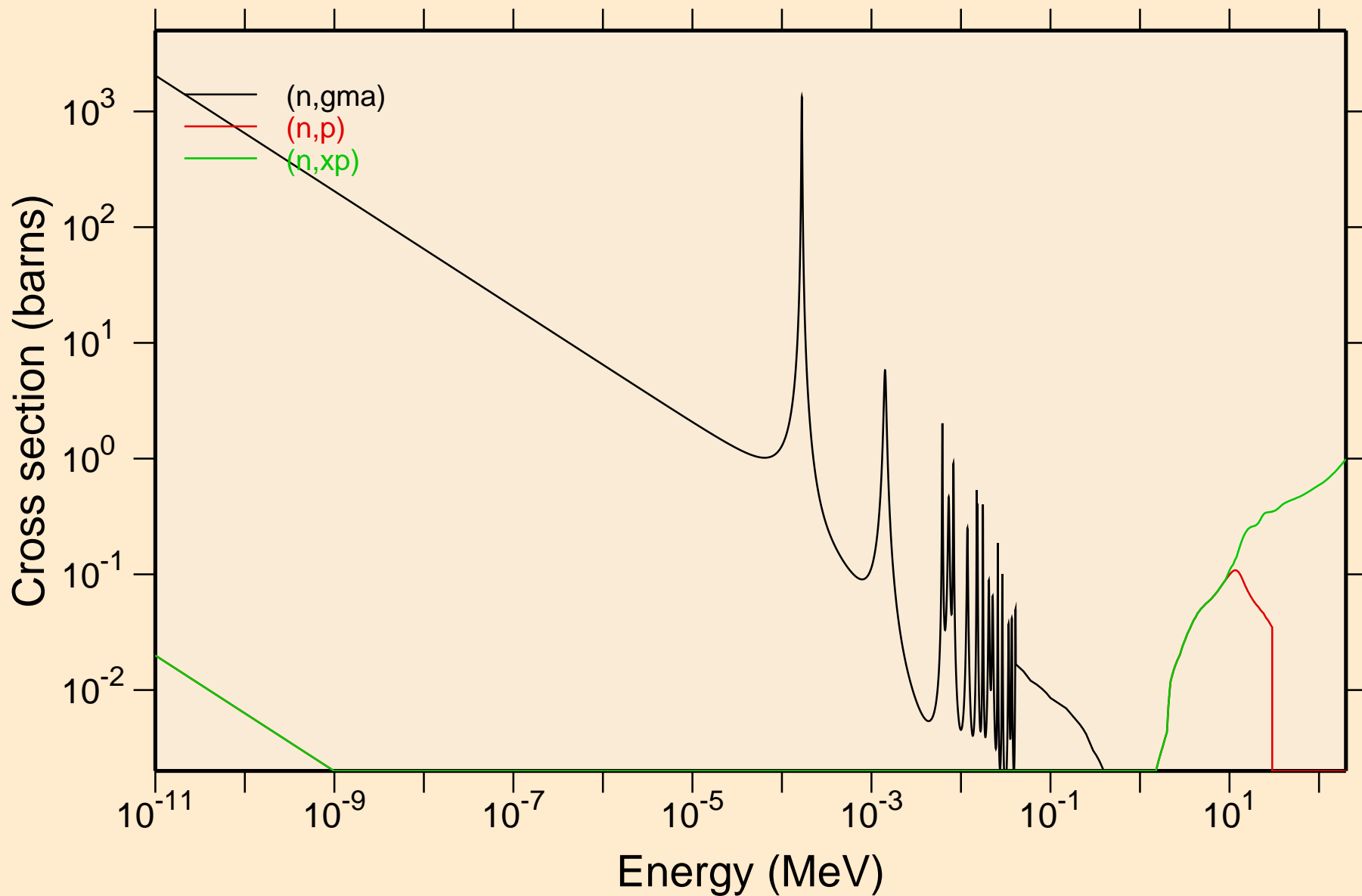

V050 NEUTRON ACER TENDL-2019 LIBRARY; T=293.16K
Principal cross sections

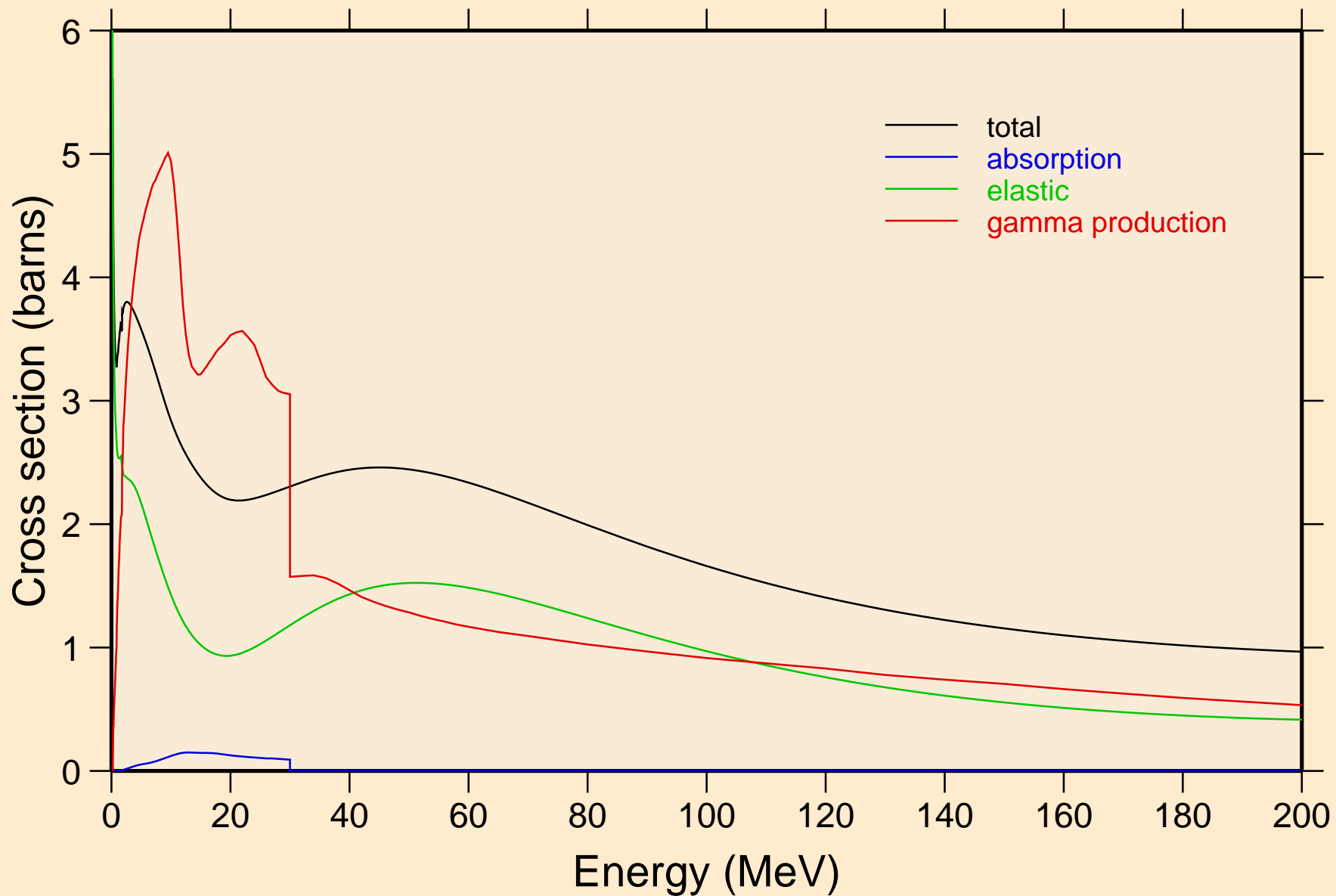

V050 NEUTRON ACER TENDL-2019 LIBRARY; T=293.16K
Heating

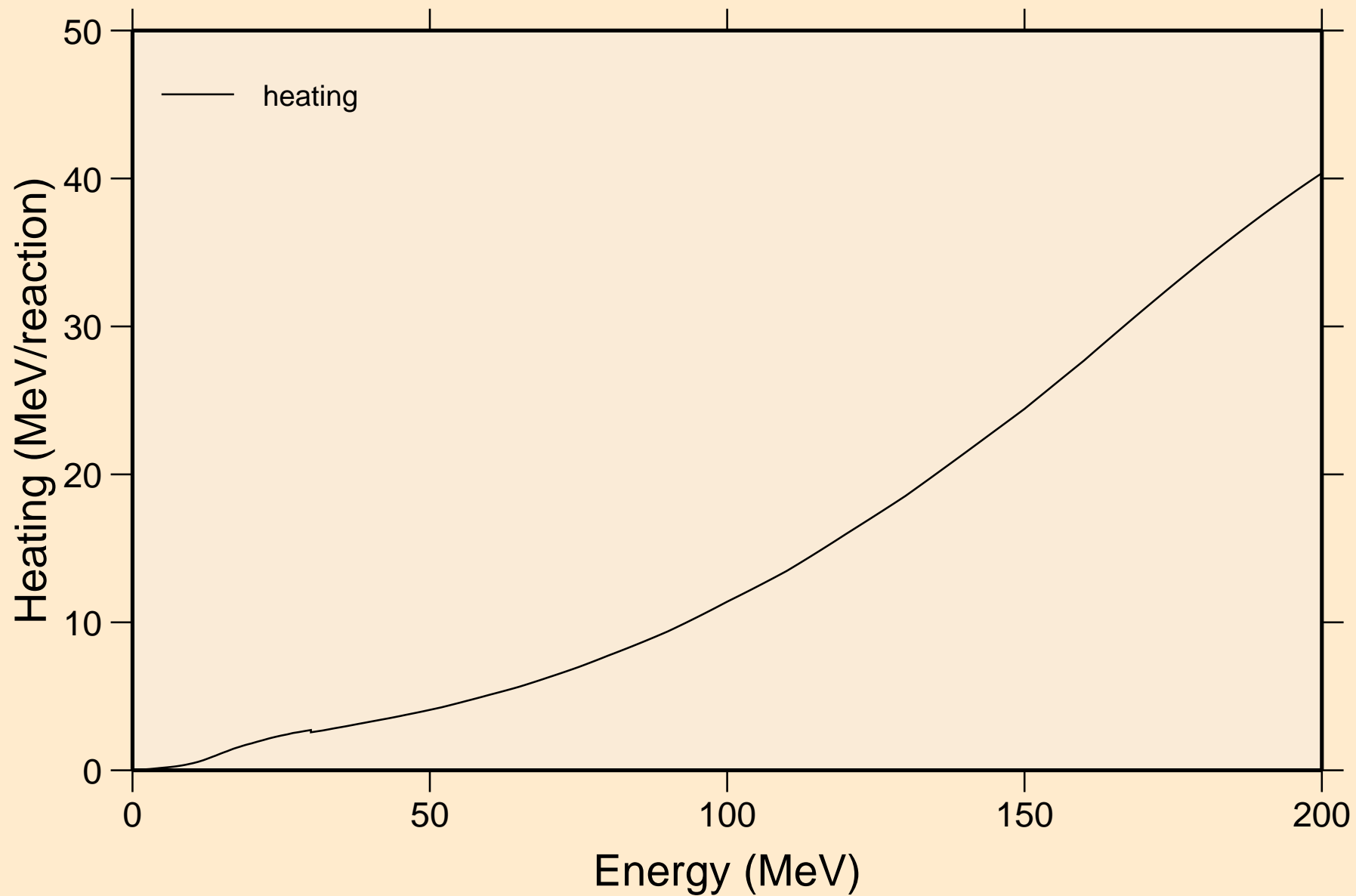

V050 NEUTRON ACER TENDL-2019 LIBRARY; T=293.16K
Damage

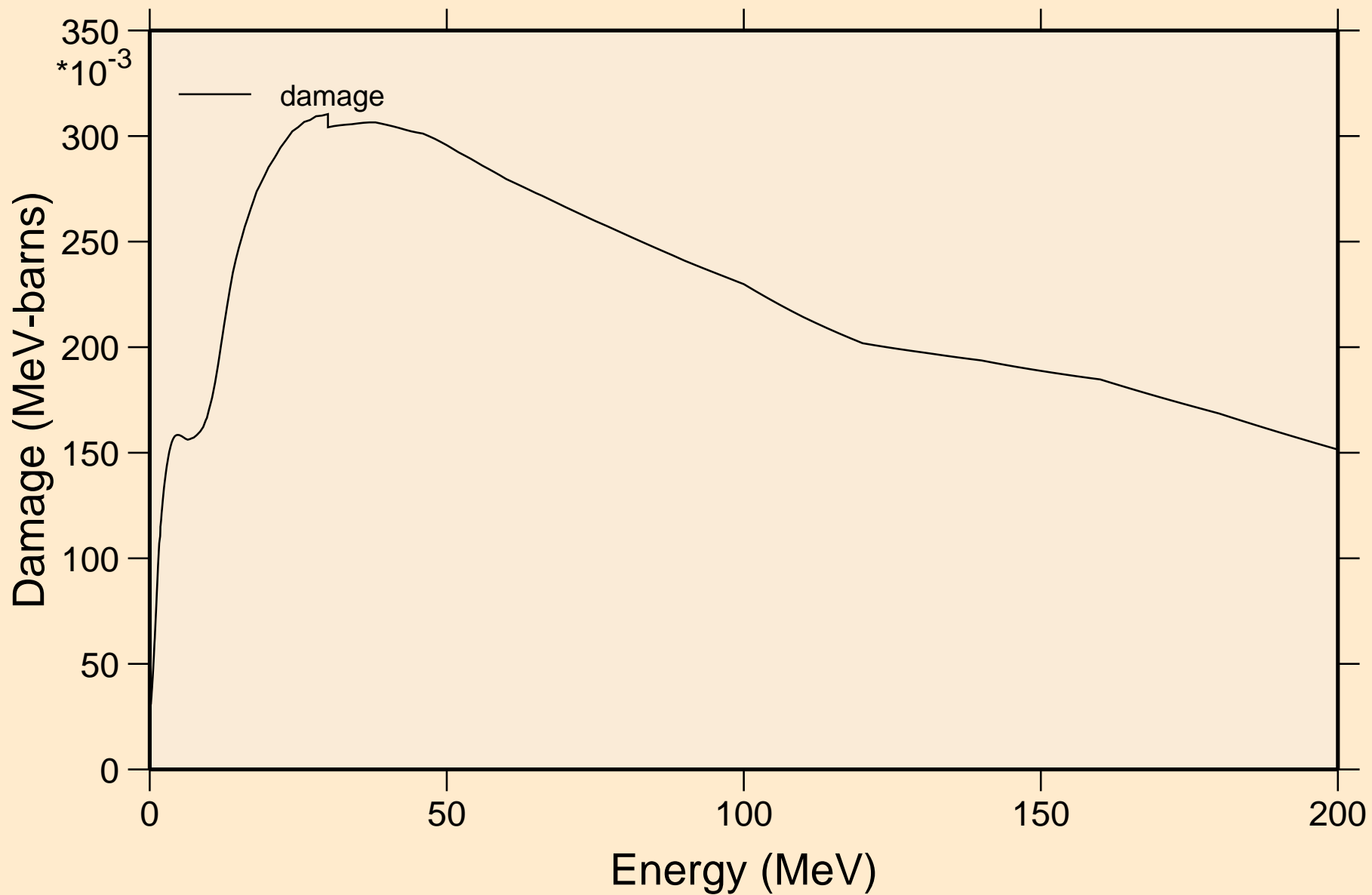

V050 NEUTRON ACER TENDL-2019 LIBRARY; T=293.16K
Non-threshold reactions

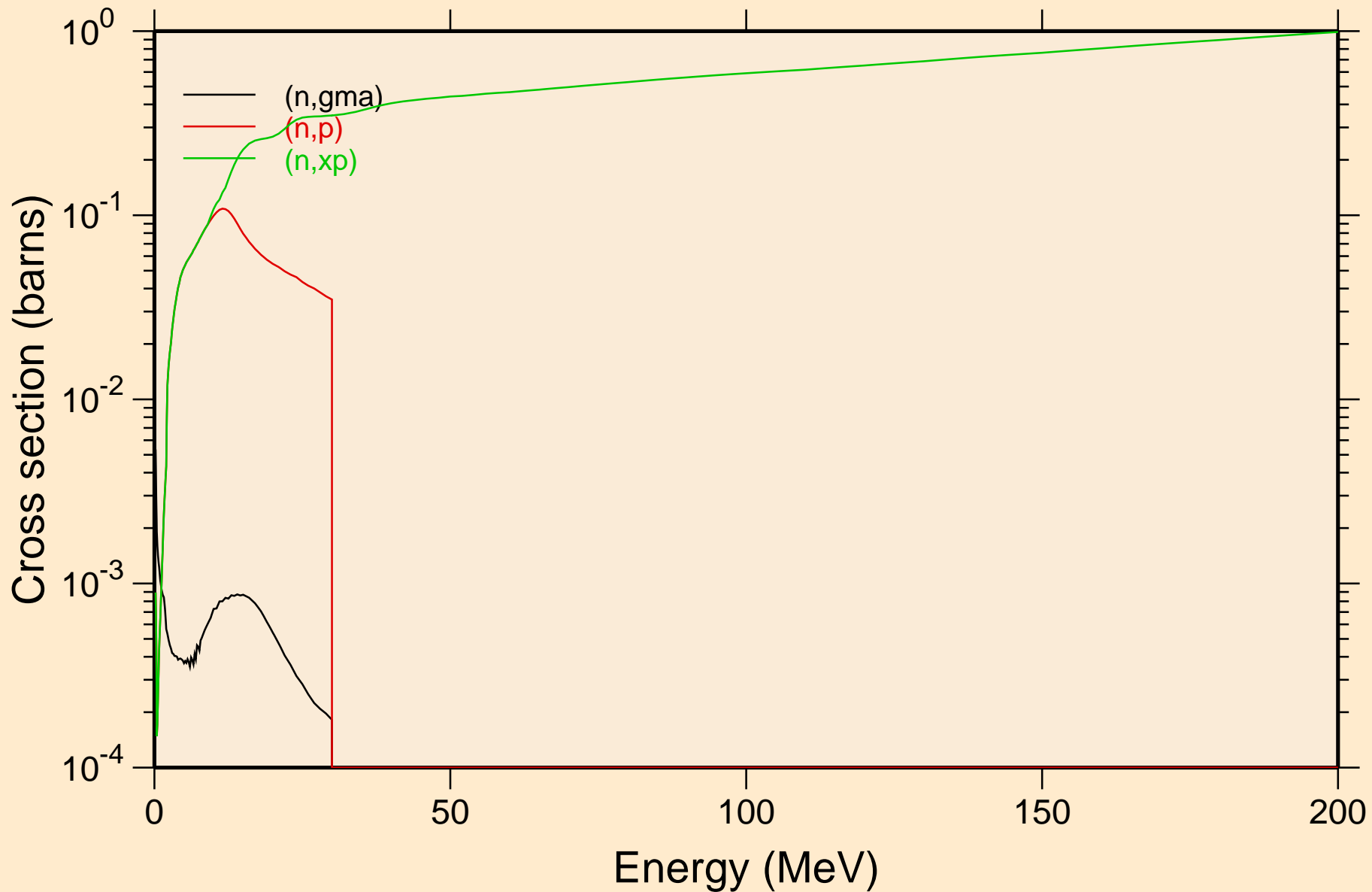

V050 NEUTRON ACER TENDL-2019 LIBRARY; T=293.16K
Inelastic levels

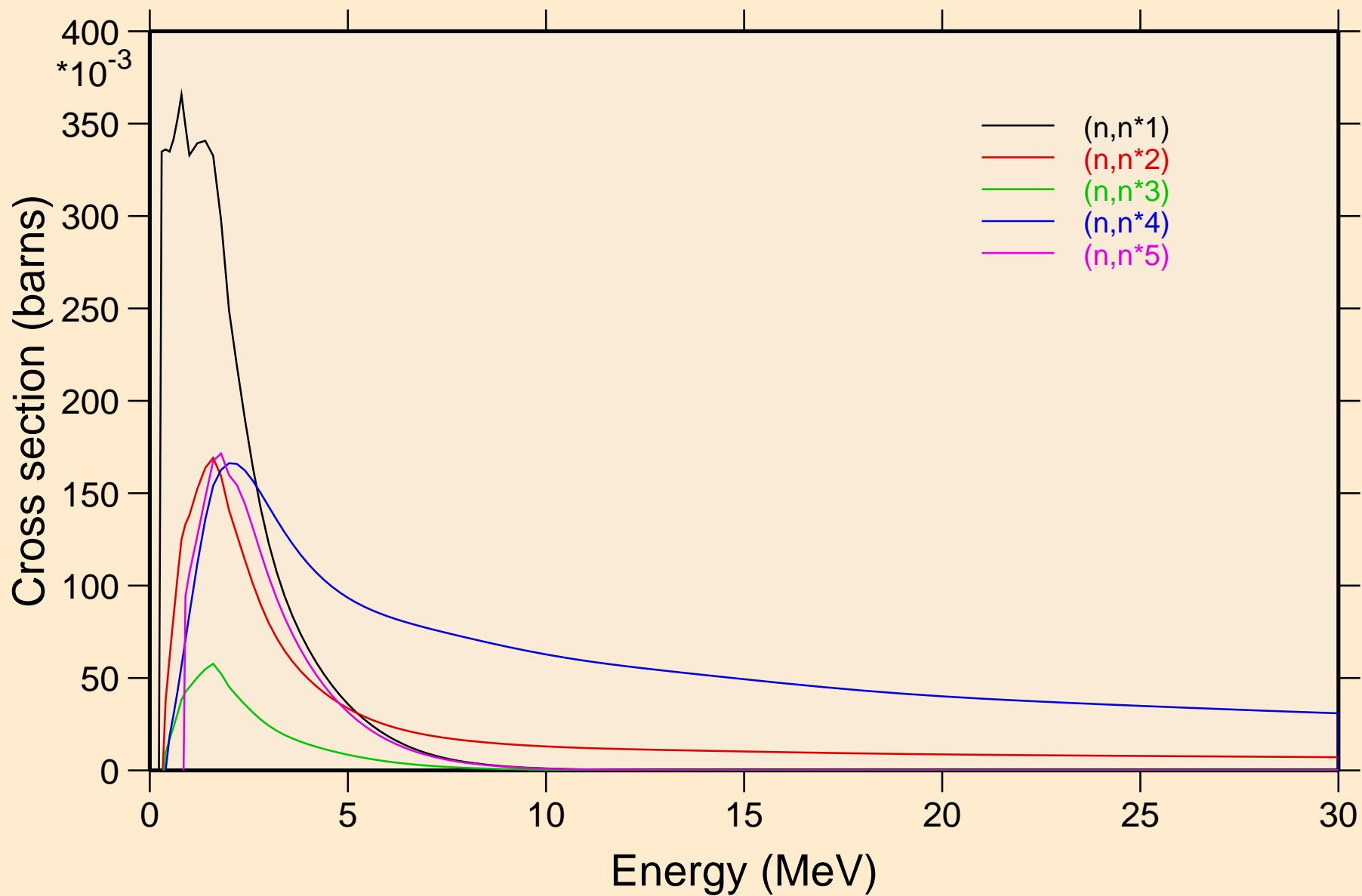

V050 NEUTRON ACER TENDL-2019 LIBRARY; T=293.16K
Inelastic levels

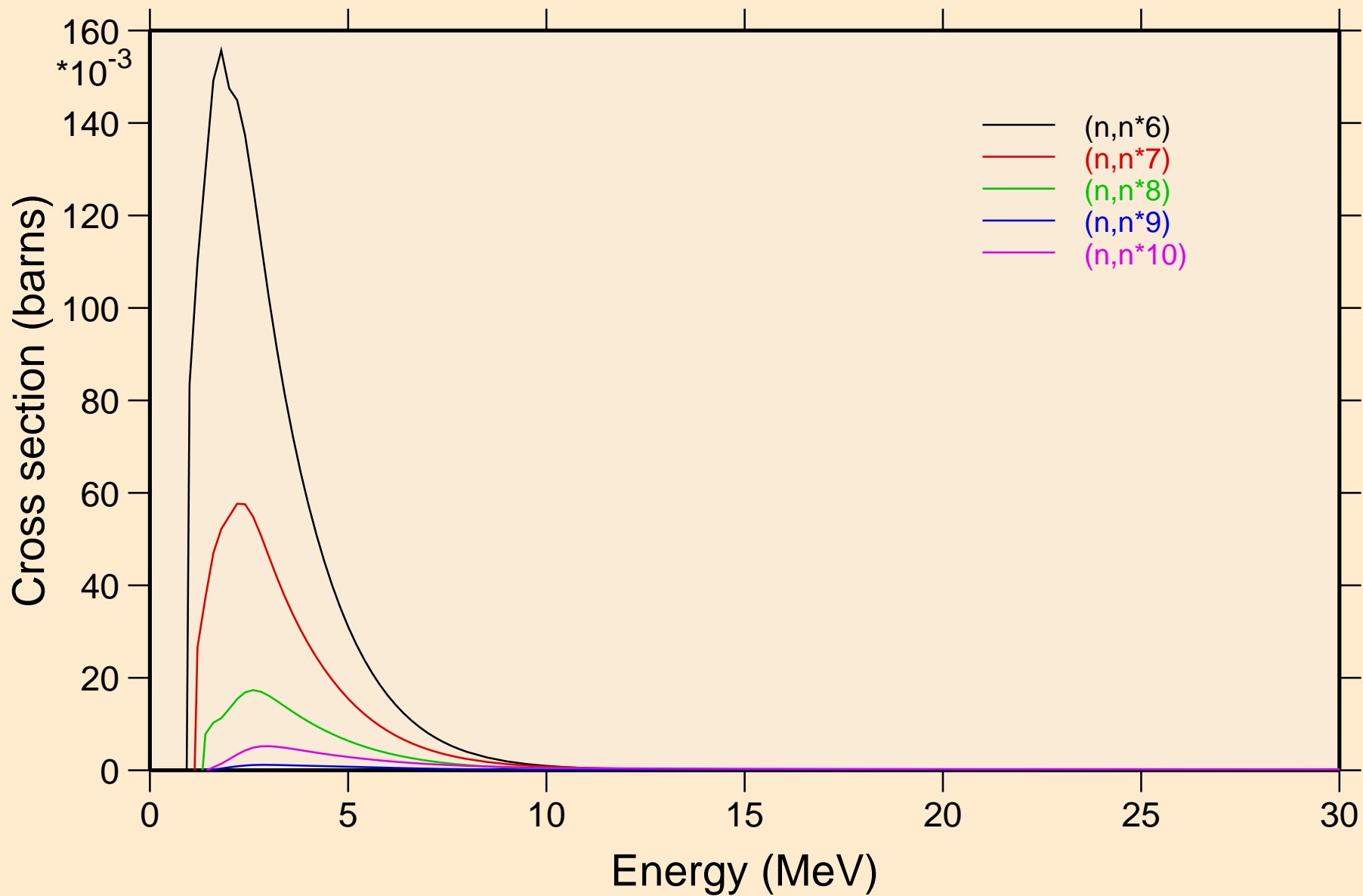

V050 NEUTRON ACER TENDL-2019 LIBRARY; T=293.16K
Inelastic levels

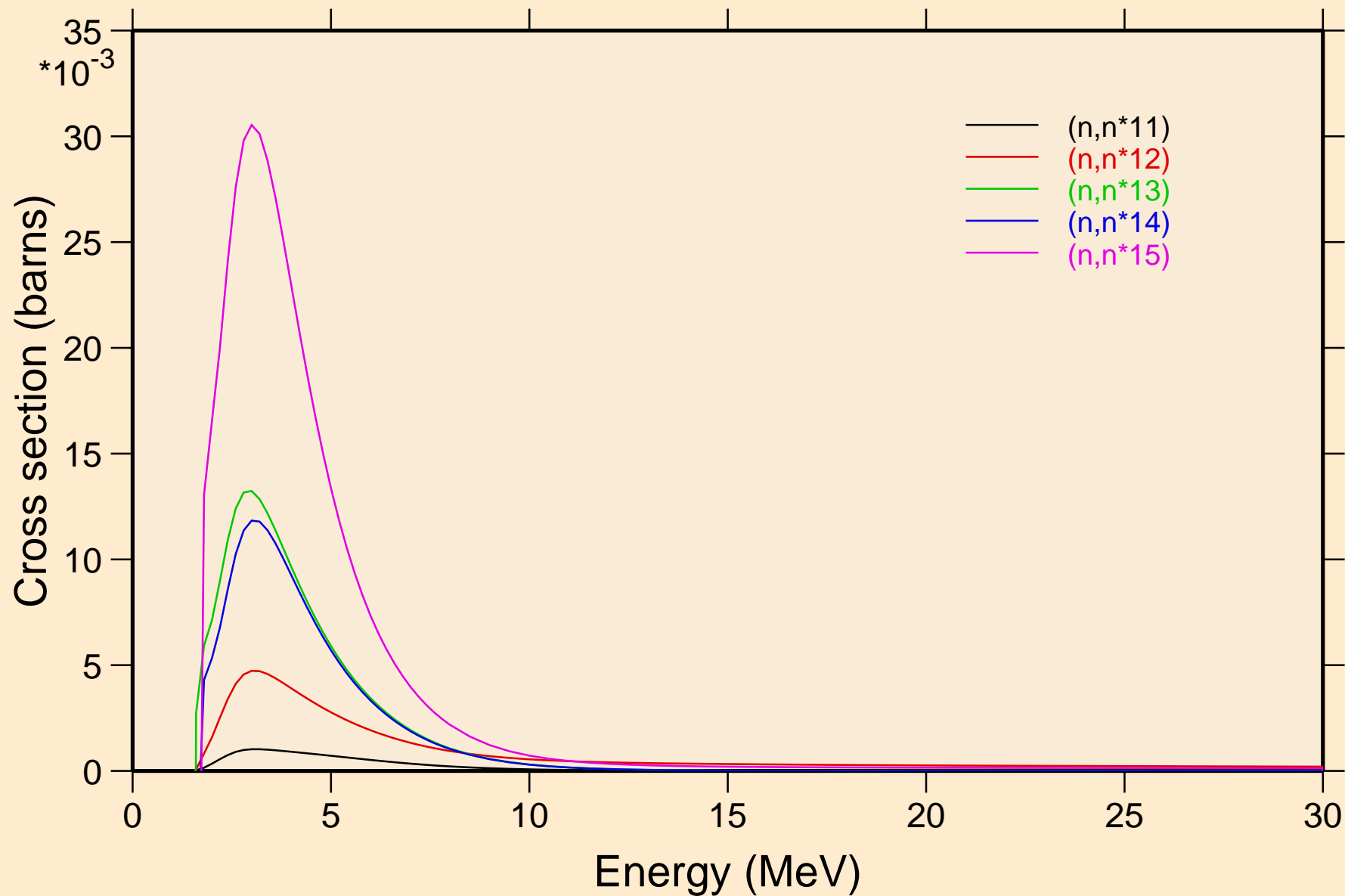

V050 NEUTRON ACER TENDL-2019 LIBRARY; T=293.16K
Inelastic levels

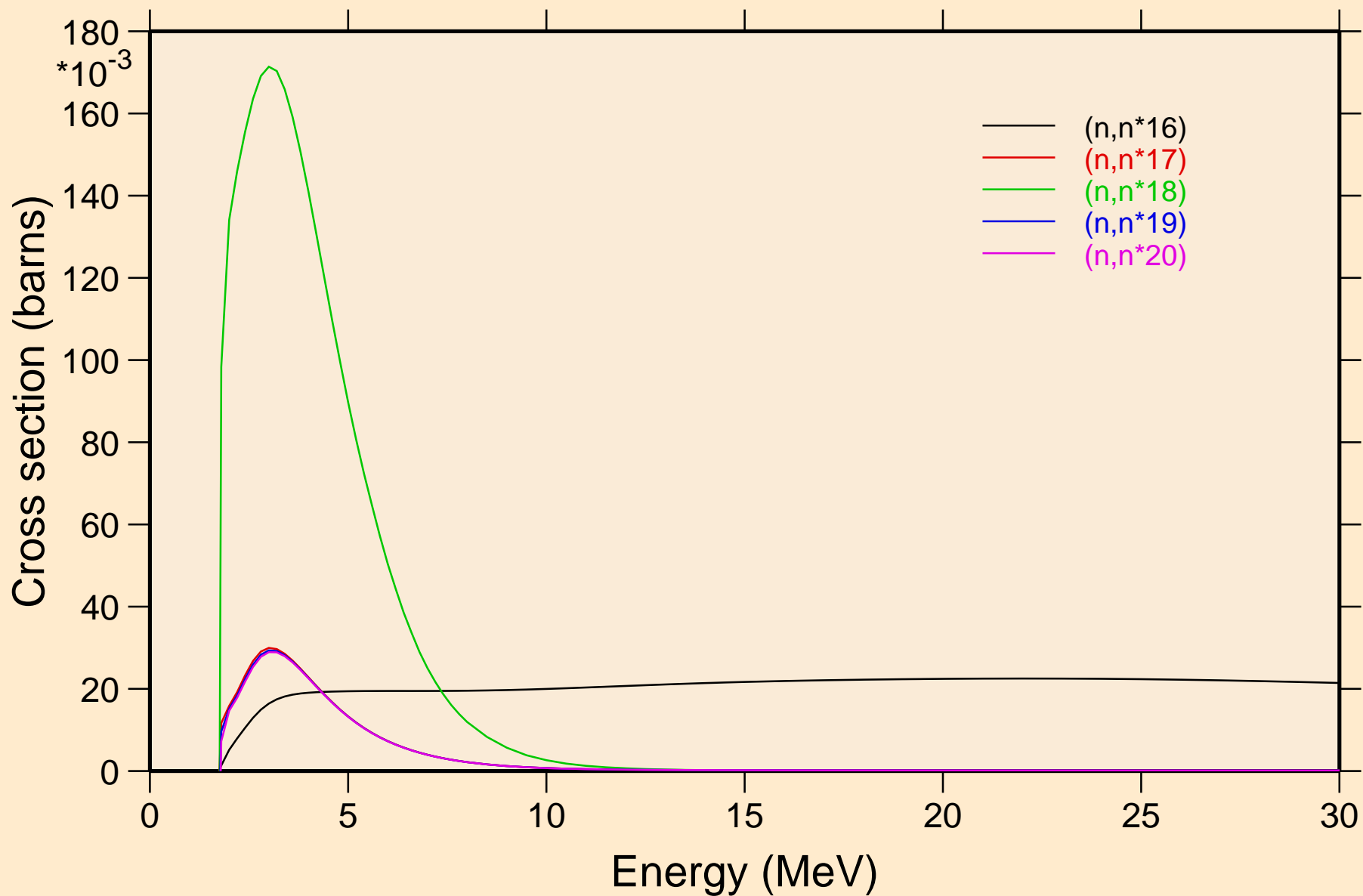

V050 NEUTRON ACER TENDL-2019 LIBRARY; T=293.16K
Inelastic levels

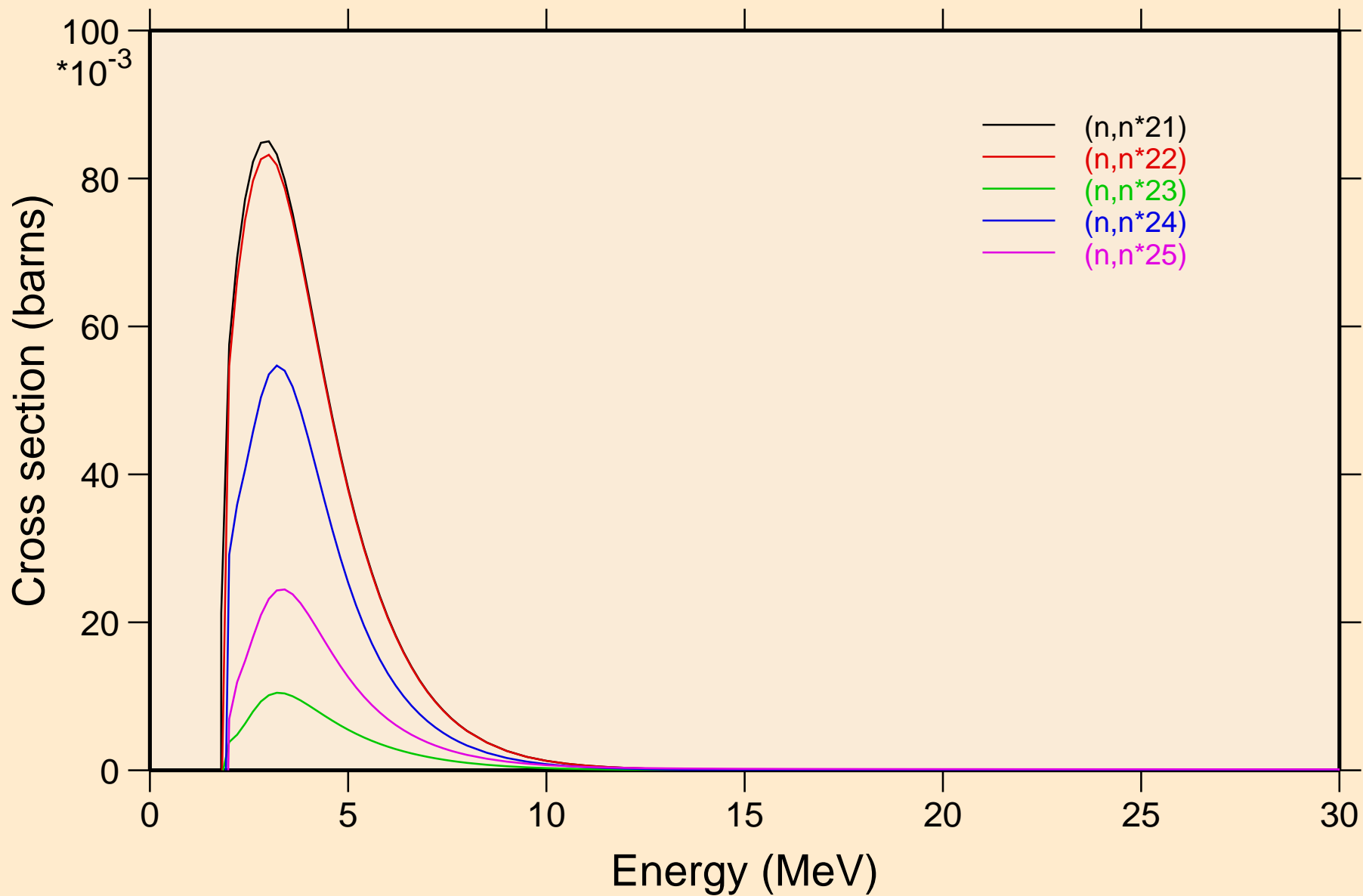

V050 NEUTRON ACER TENDL-2019 LIBRARY; T=293.16K
Inelastic levels

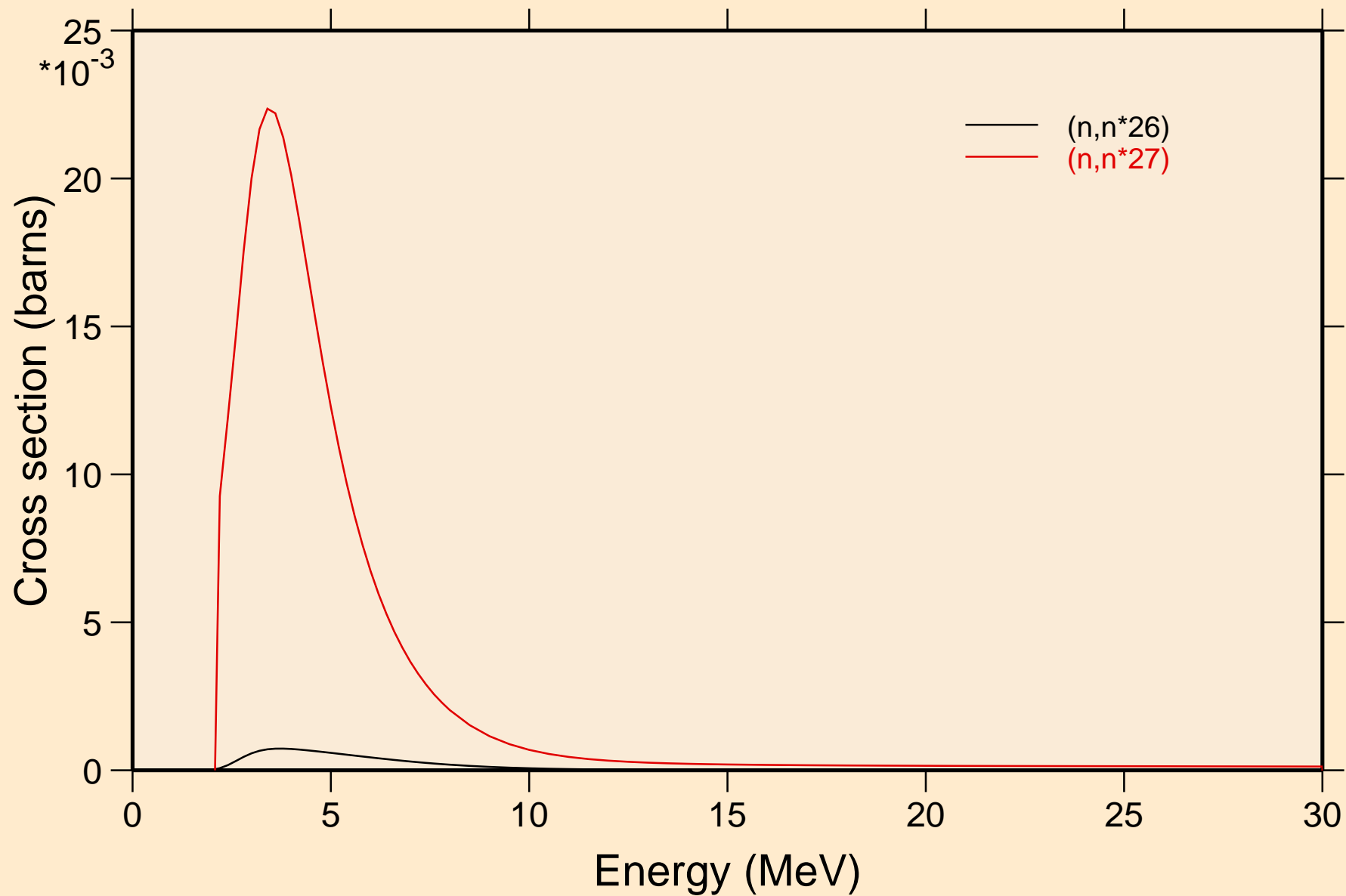

V050 NEUTRON ACER TENDL-2019 LIBRARY; T=293.16K
Threshold reactions

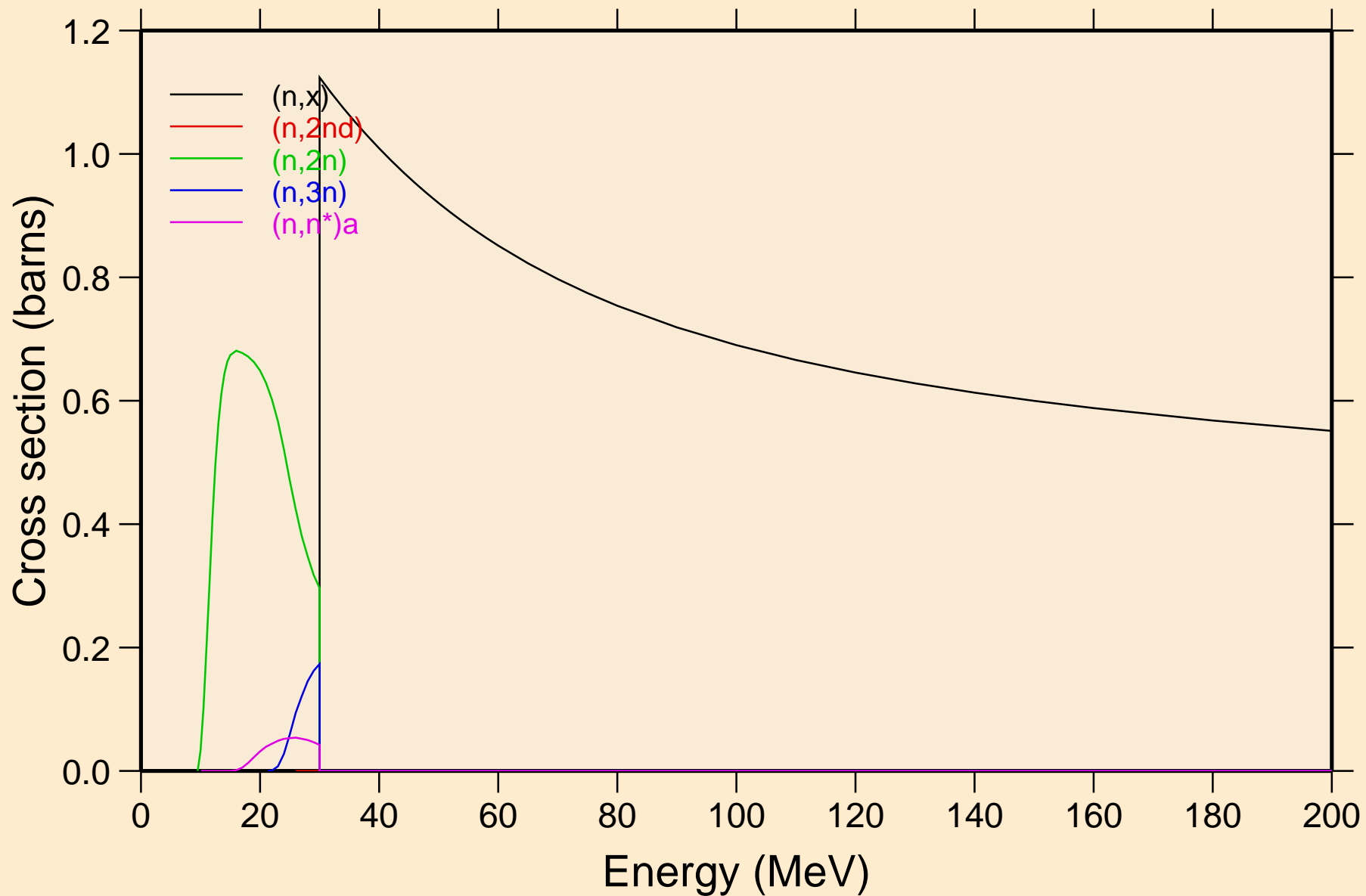

V050 NEUTRON ACER TENDL-2019 LIBRARY; T=293.16K
Threshold reactions

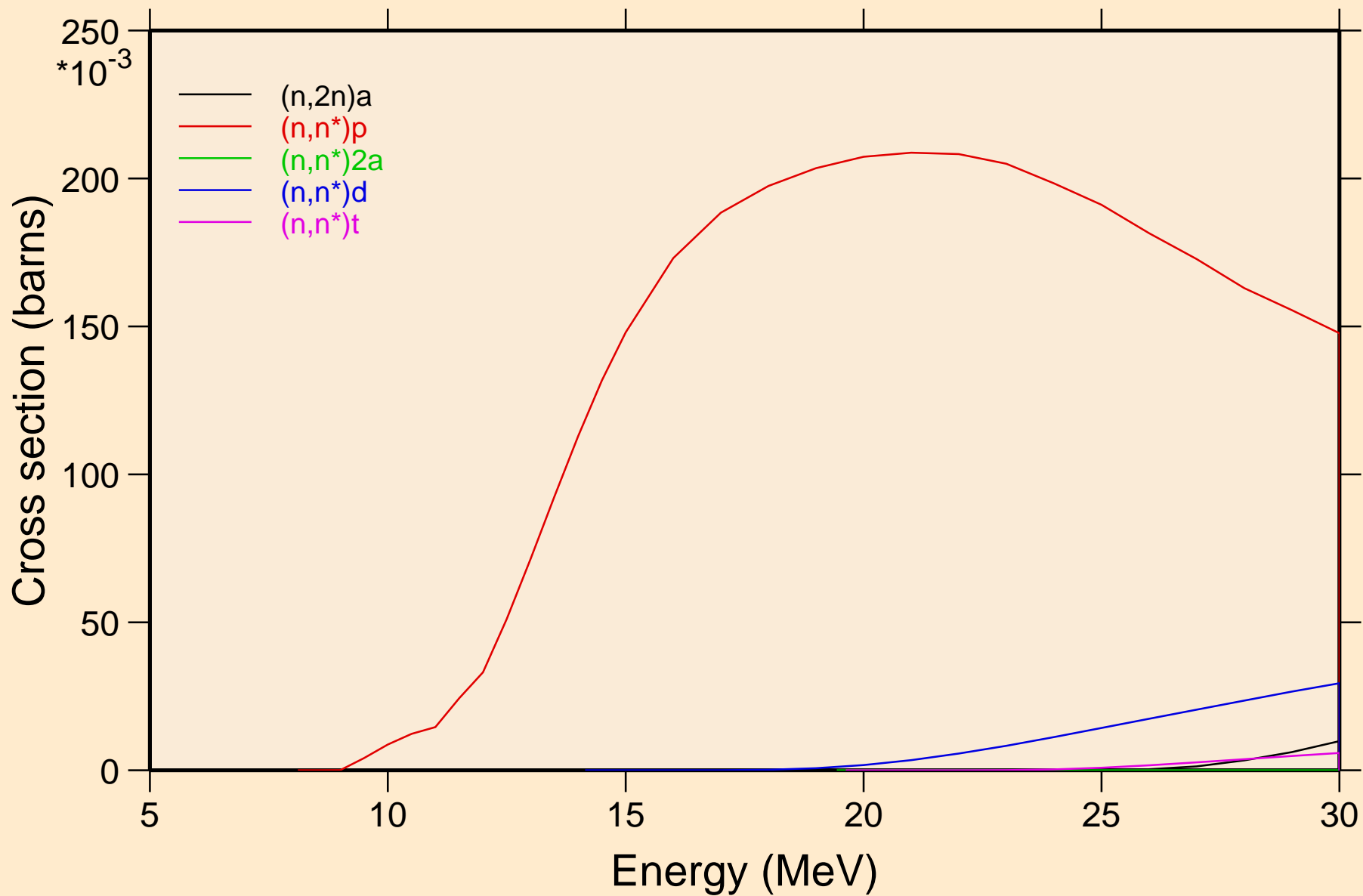

V050 NEUTRON ACER TENDL-2019 LIBRARY; T=293.16K
Threshold reactions

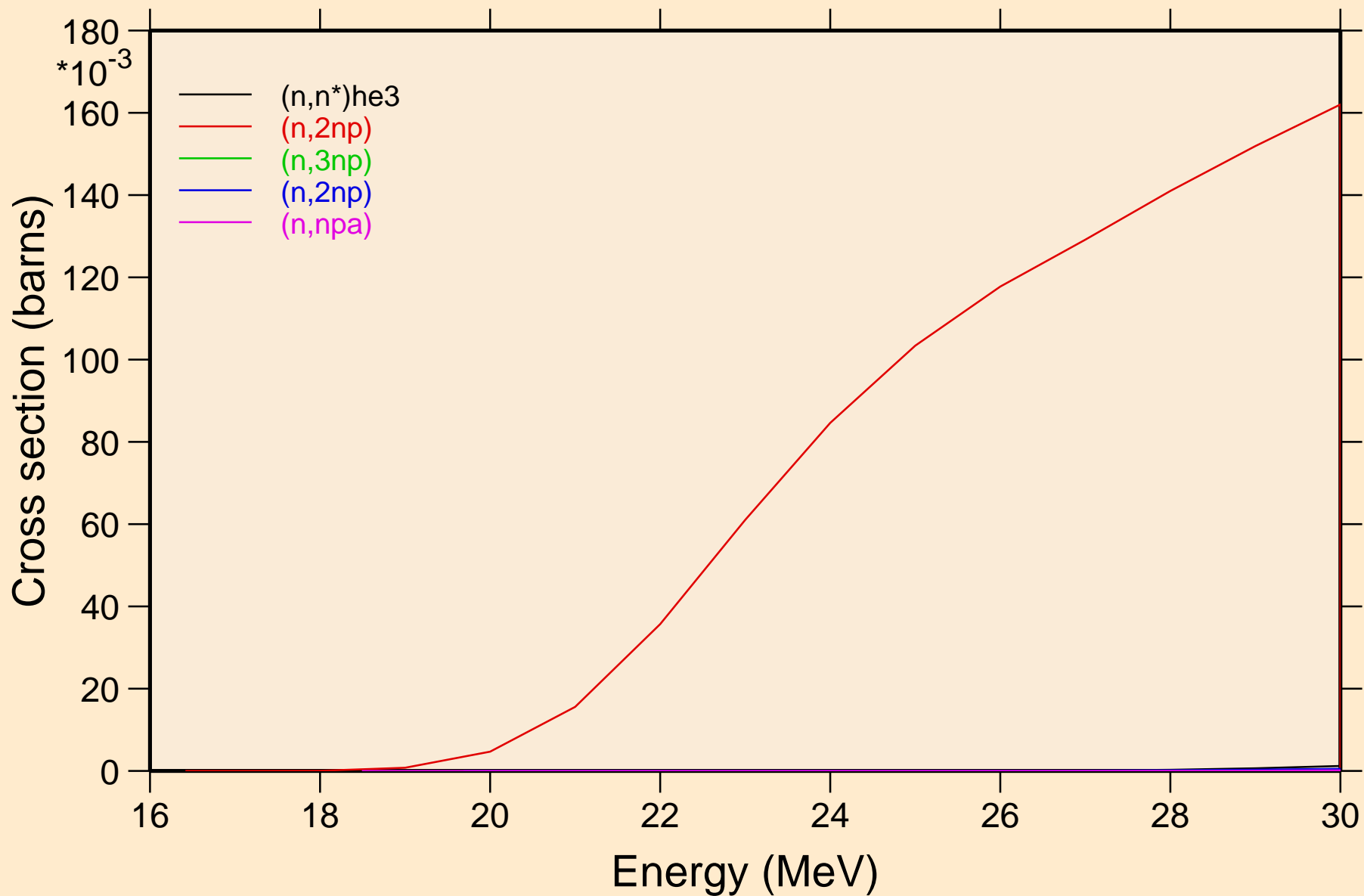

V050 NEUTRON ACER TENDL-2019 LIBRARY; T=293.16K
Threshold reactions

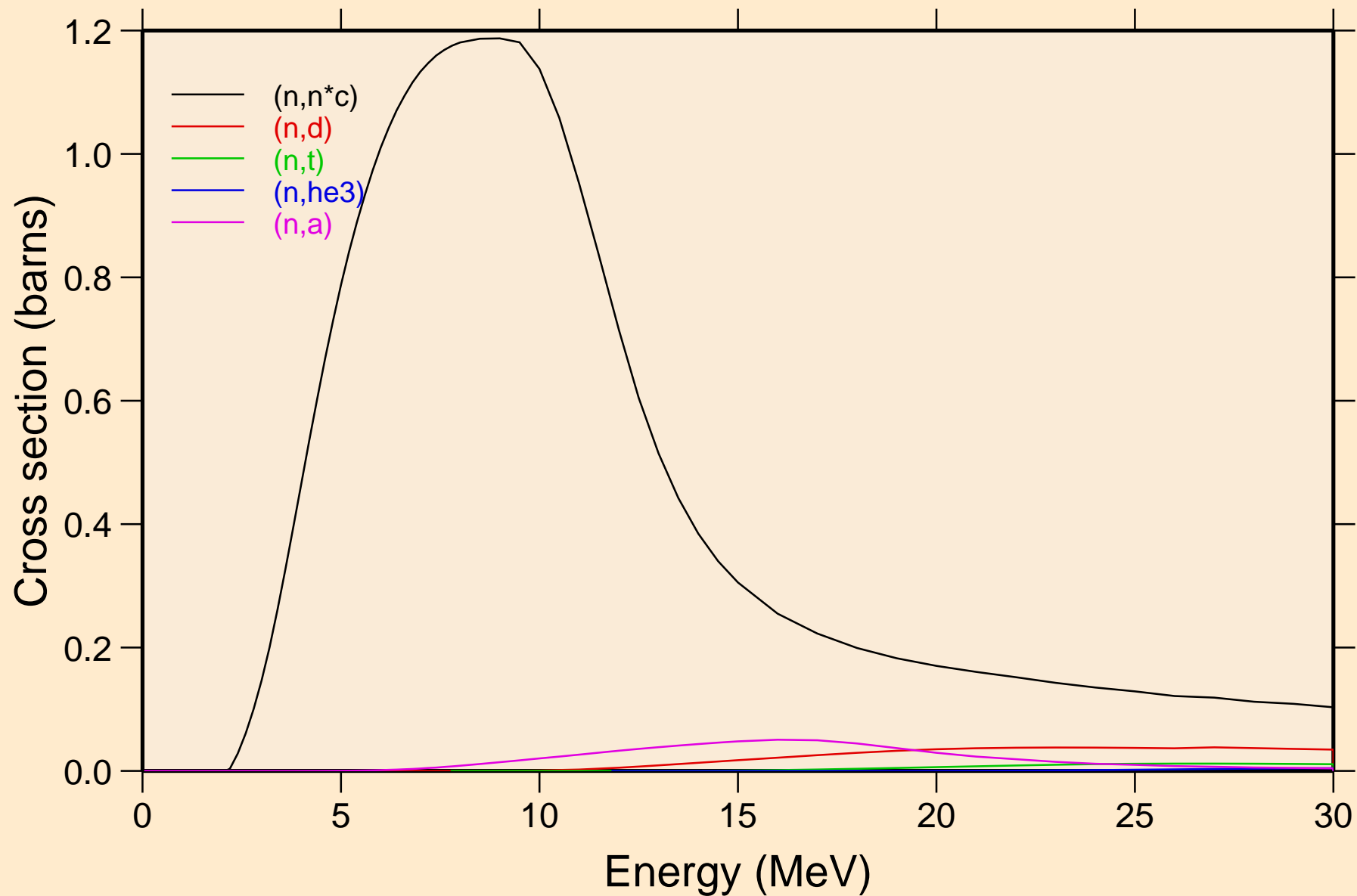

V050 NEUTRON ACER TENDL-2019 LIBRARY; T=293.16K
Threshold reactions

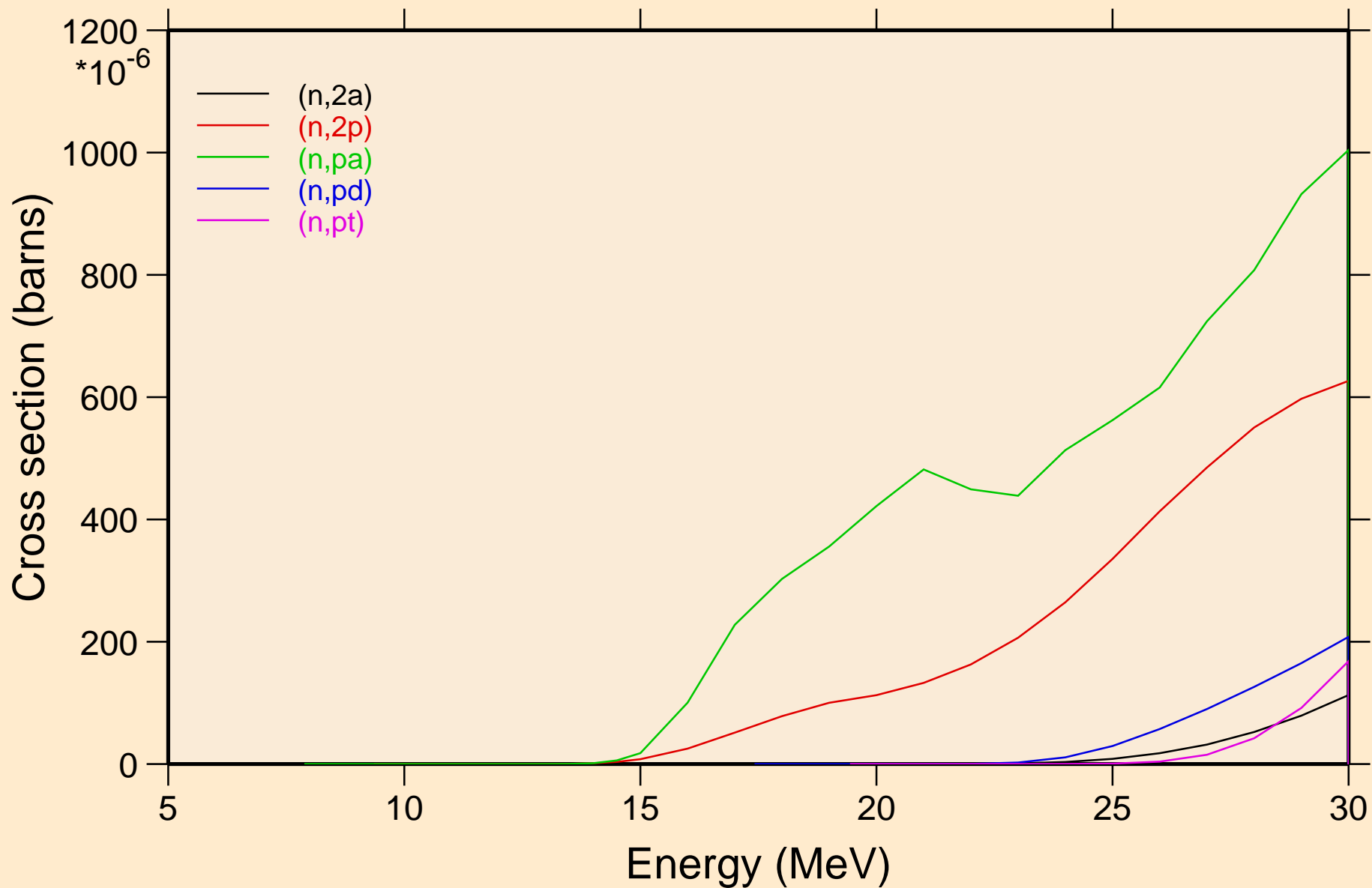

V050 NEUTRON ACER TENDL-2019 LIBRARY; T=293.16K
Threshold reactions

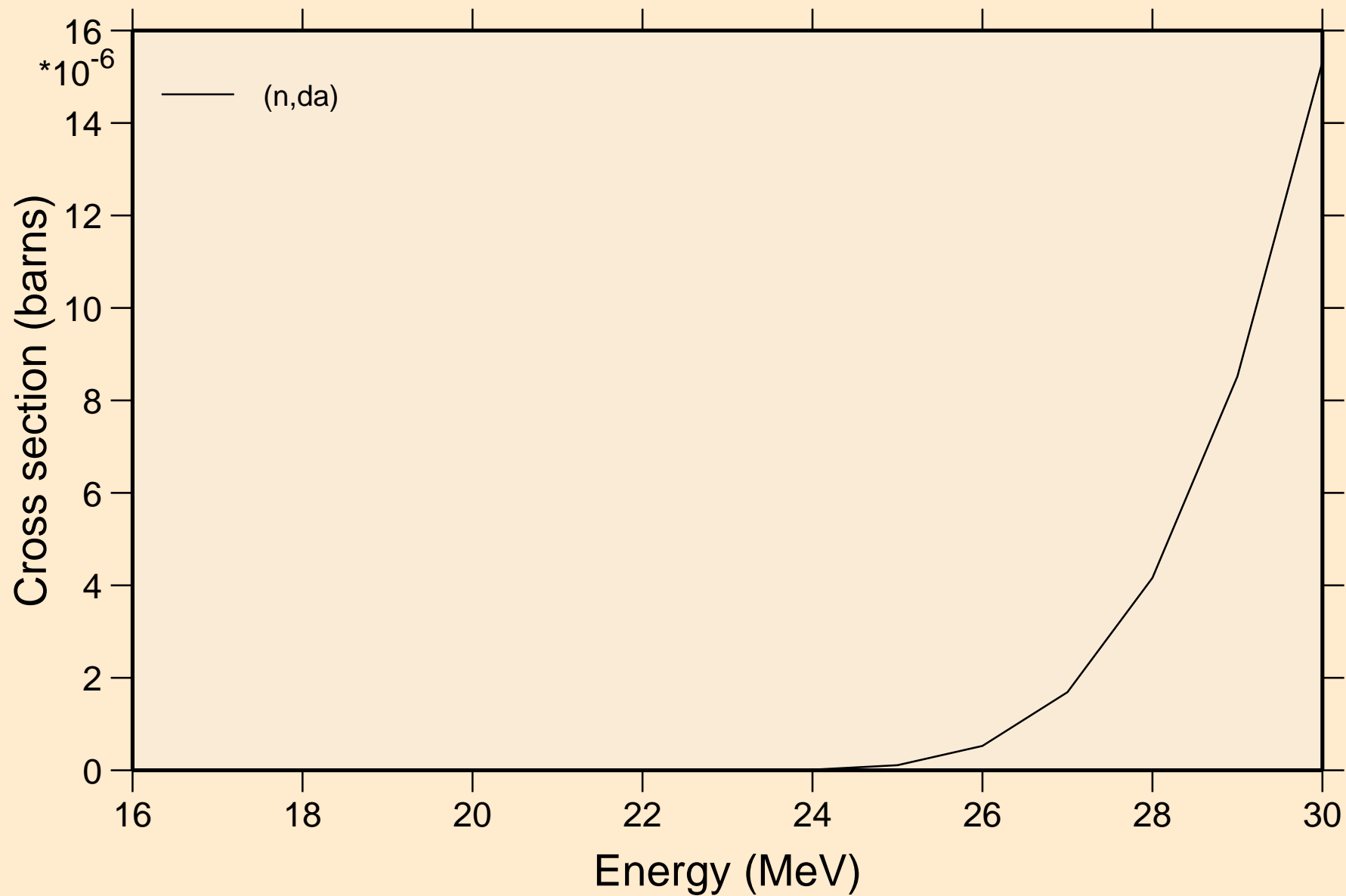

V050 NEUTRON ACER TENDL-2019 LIBRARY; T=293.16K
Threshold reactions

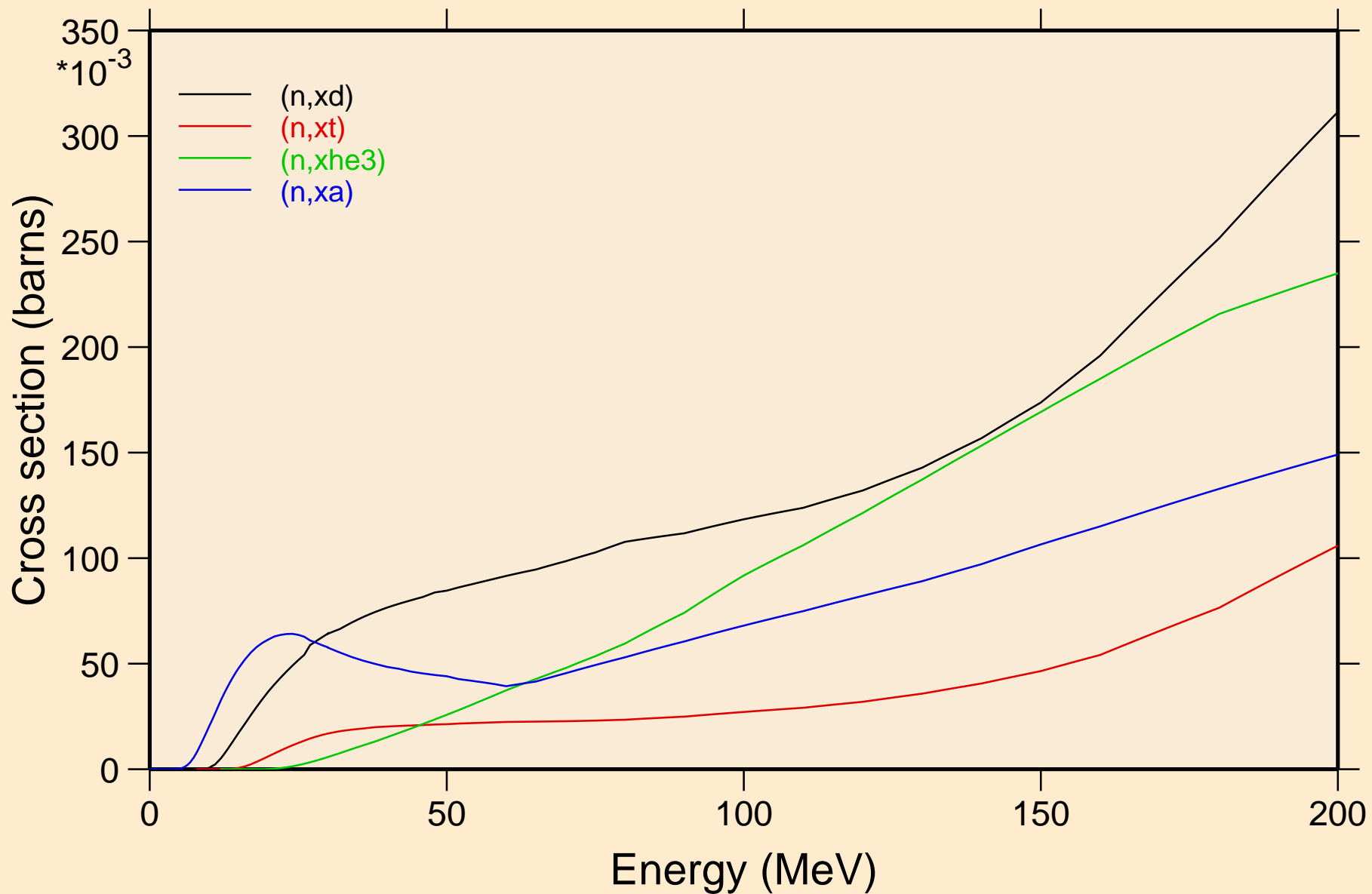

V050 NEUTRON ACER TENDL-2019 LIBRARY; T=293.16K
angular distribution for elastic

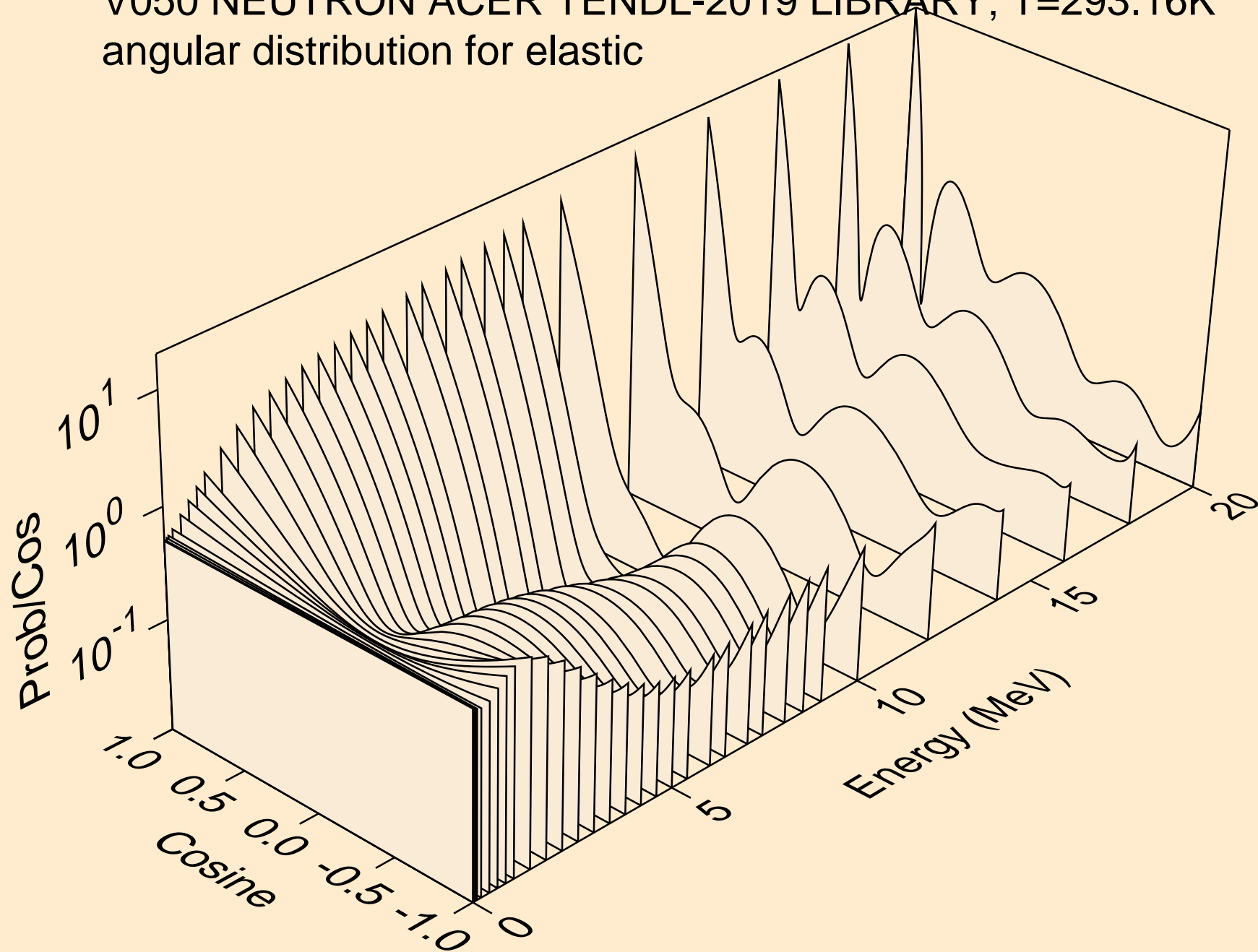

V050 NEUTRON ACER TENDL-2019 LIBRARY; T=293.16K
angular distribution for elastic

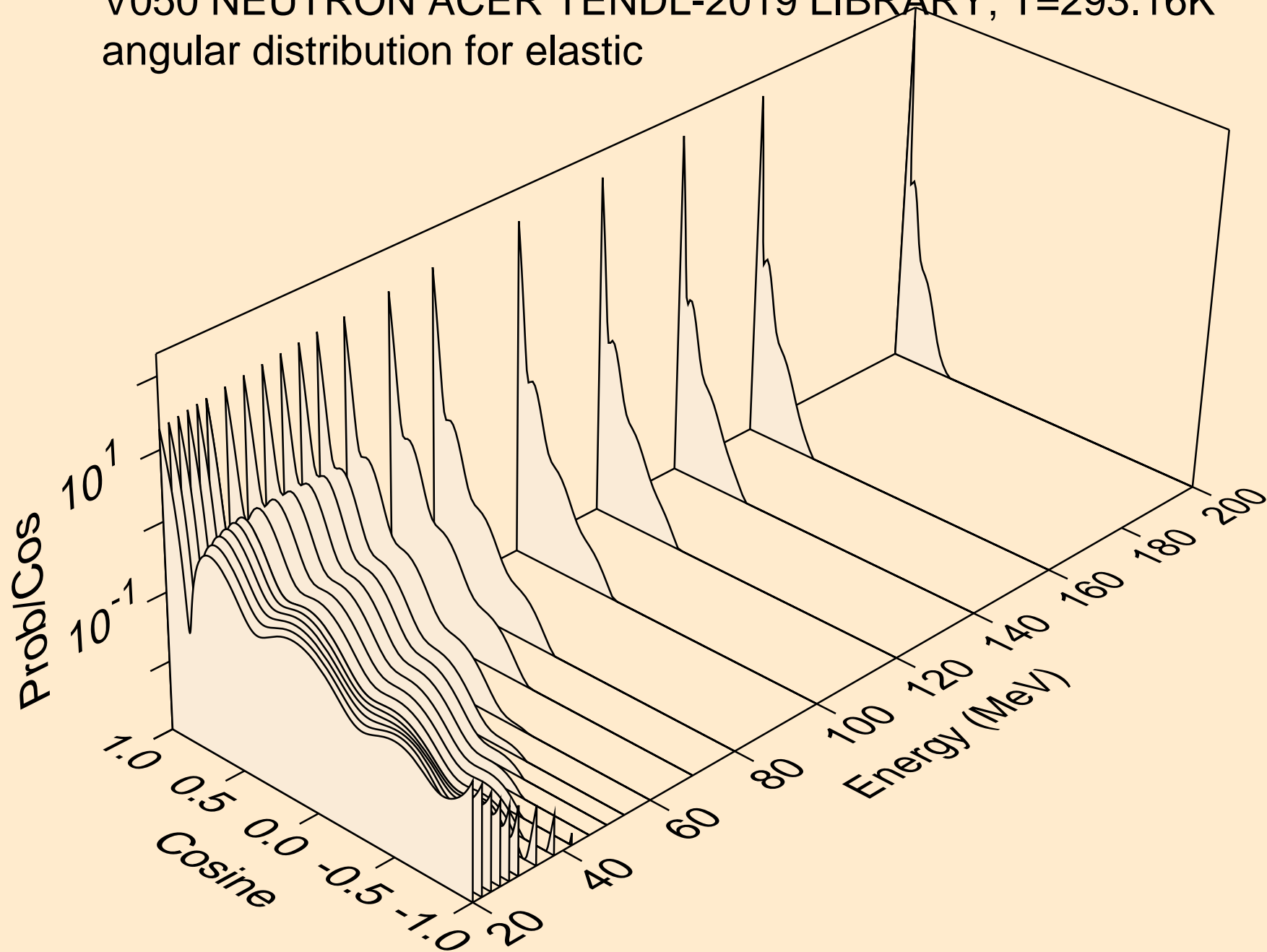

V050 NEUTRON ACER TENDL-2019 LIBRARY; T=293.16K
angular distribution for (n,n*1)

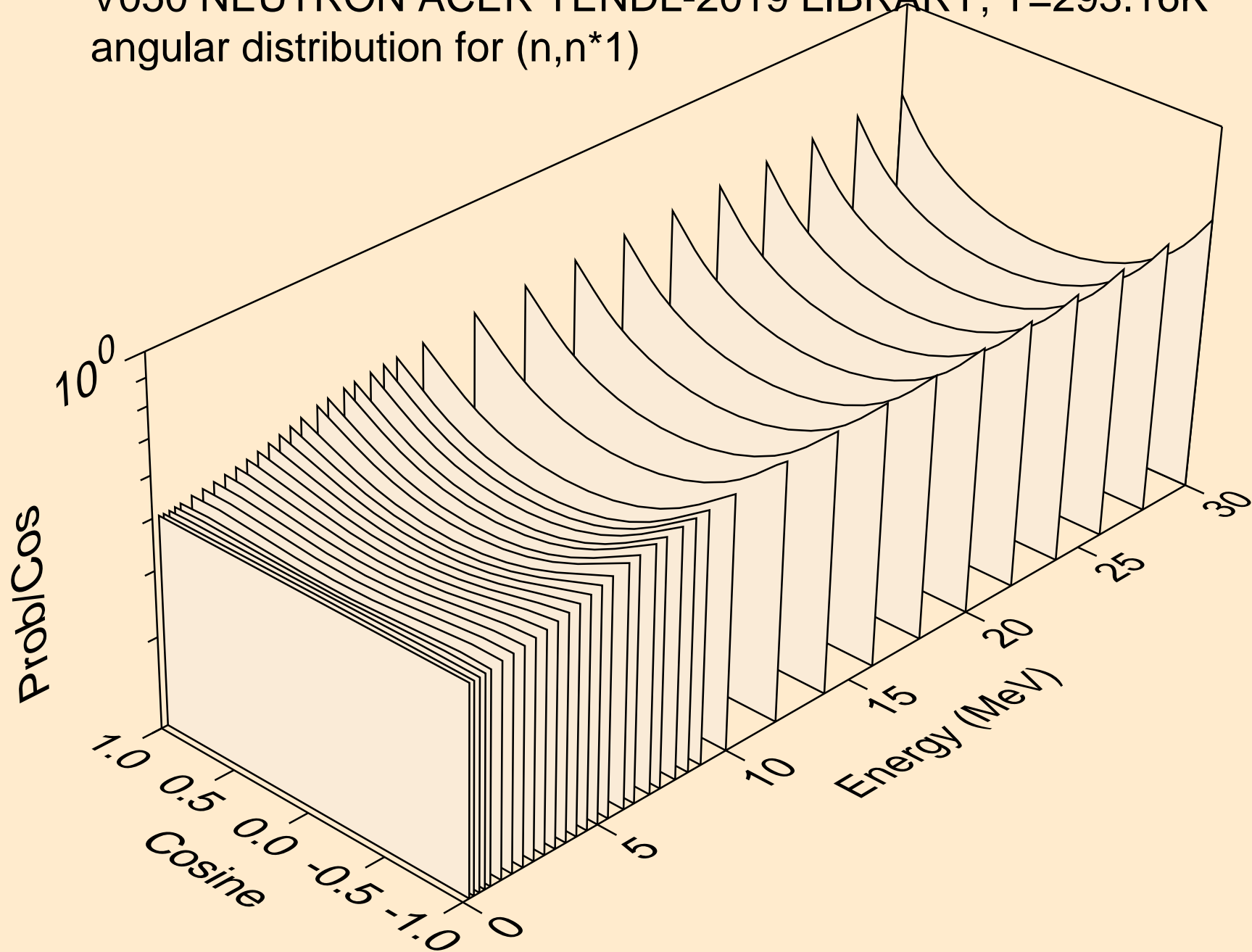

V050 NEUTRON ACER TENDL-2019 LIBRARY; T=293.16K
angular distribution for (n,n*2)

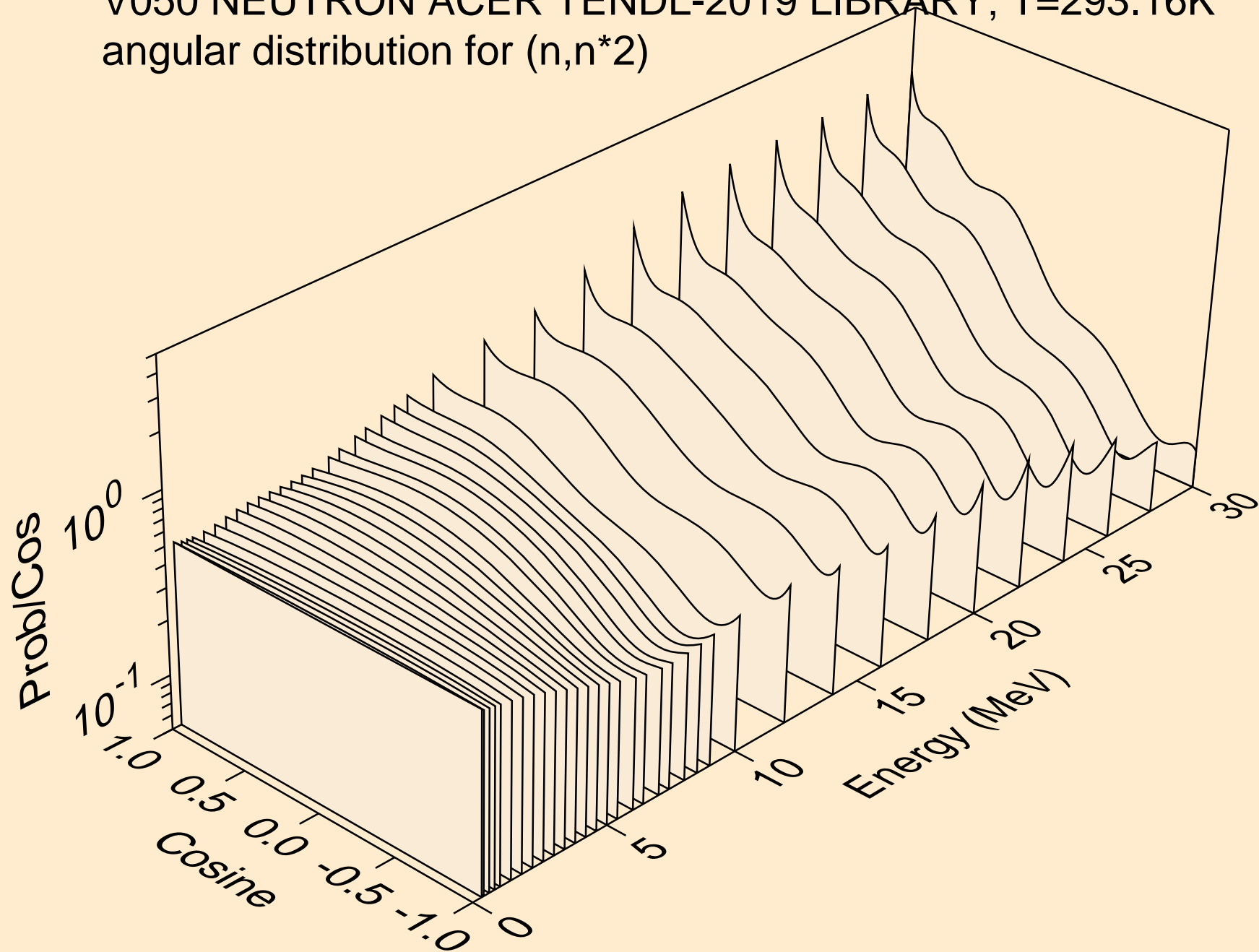

V050 NEUTRON ACER TENDL-2019 LIBRARY; T=293.16K
angular distribution for (n,n*3)

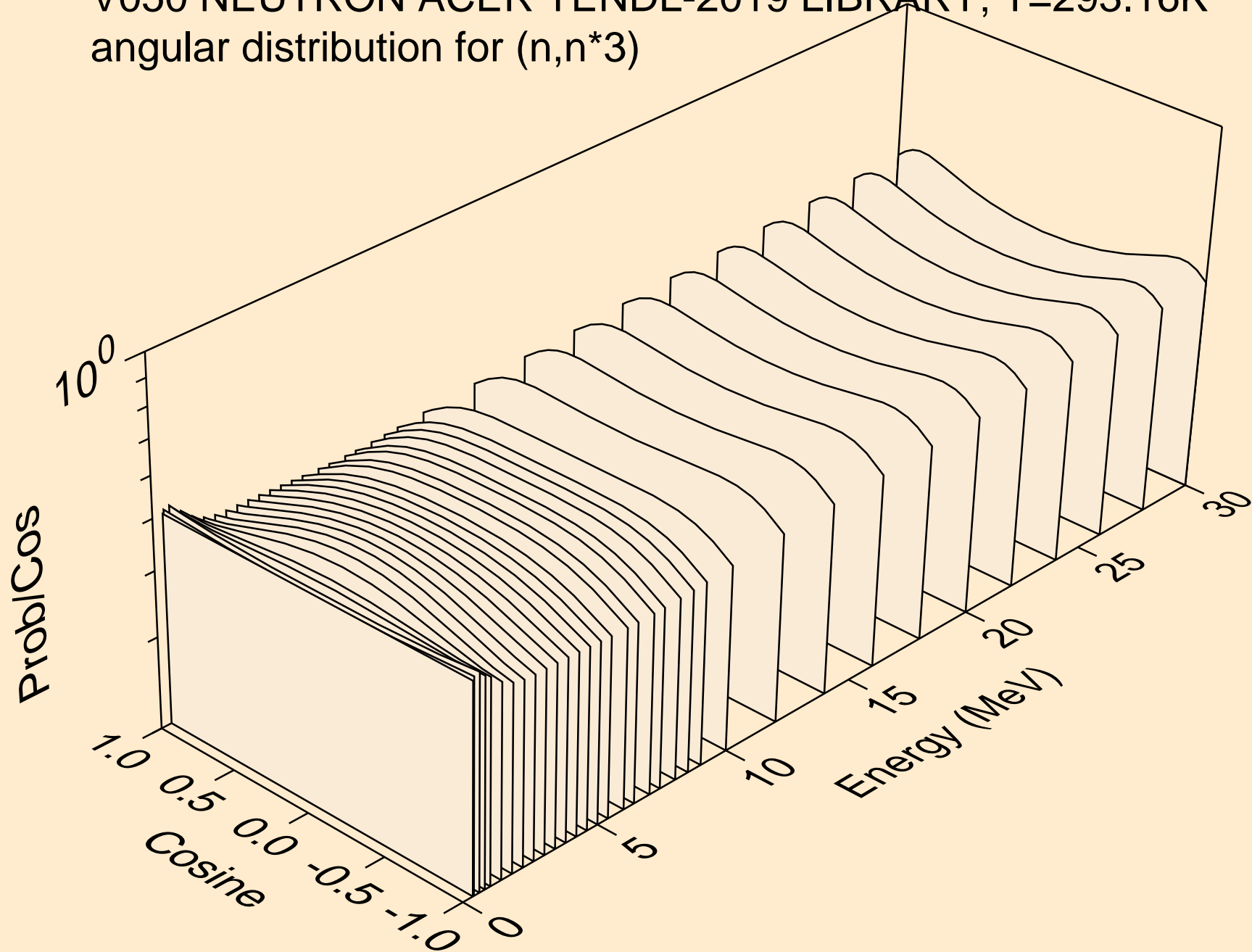

V050 NEUTRON ACER TENDL-2019 LIBRARY; T=293.16K
angular distribution for (n,n*4)

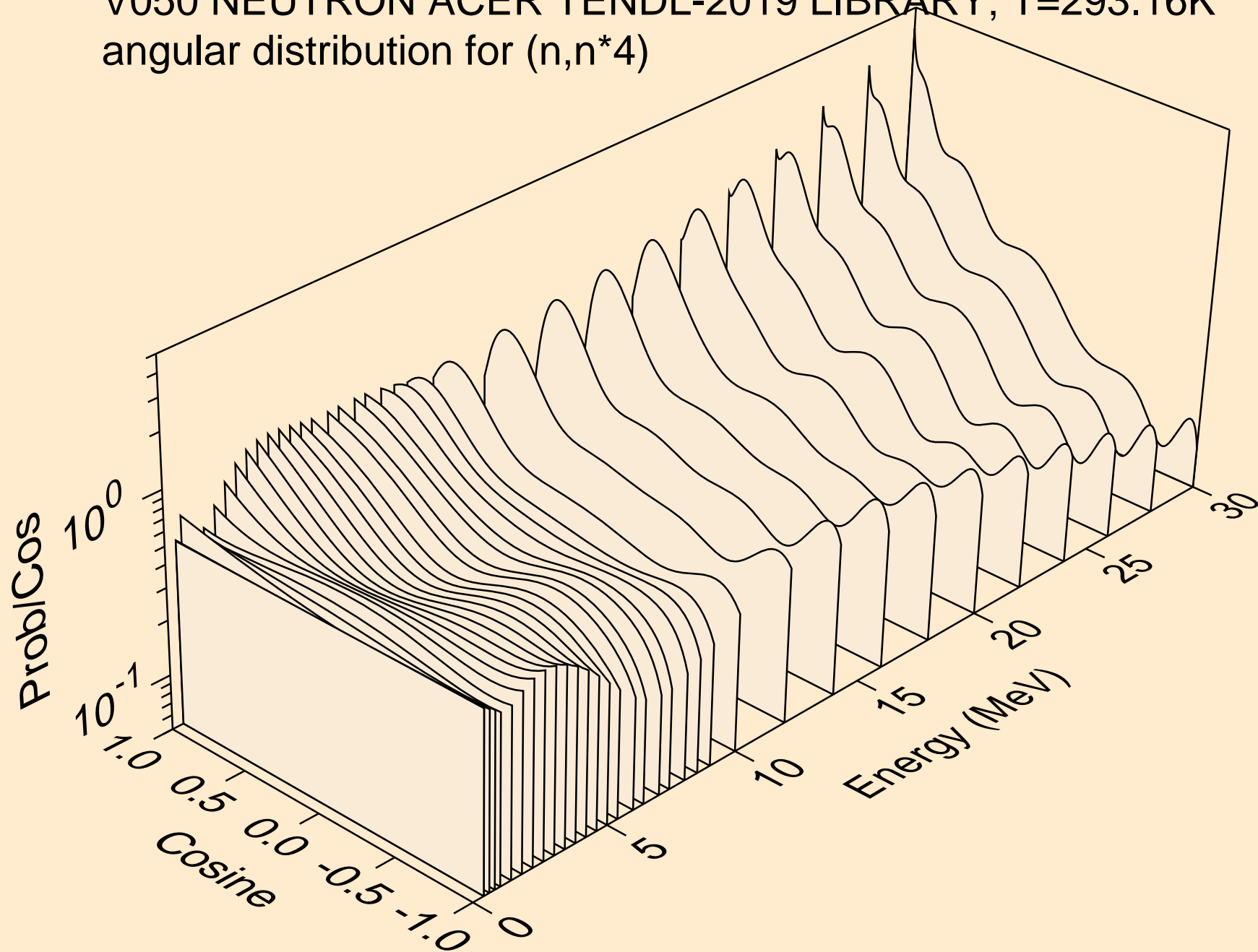

V050 NEUTRON ACER TENDL-2019 LIBRARY; T=293.16K
angular distribution for (n,n*5)

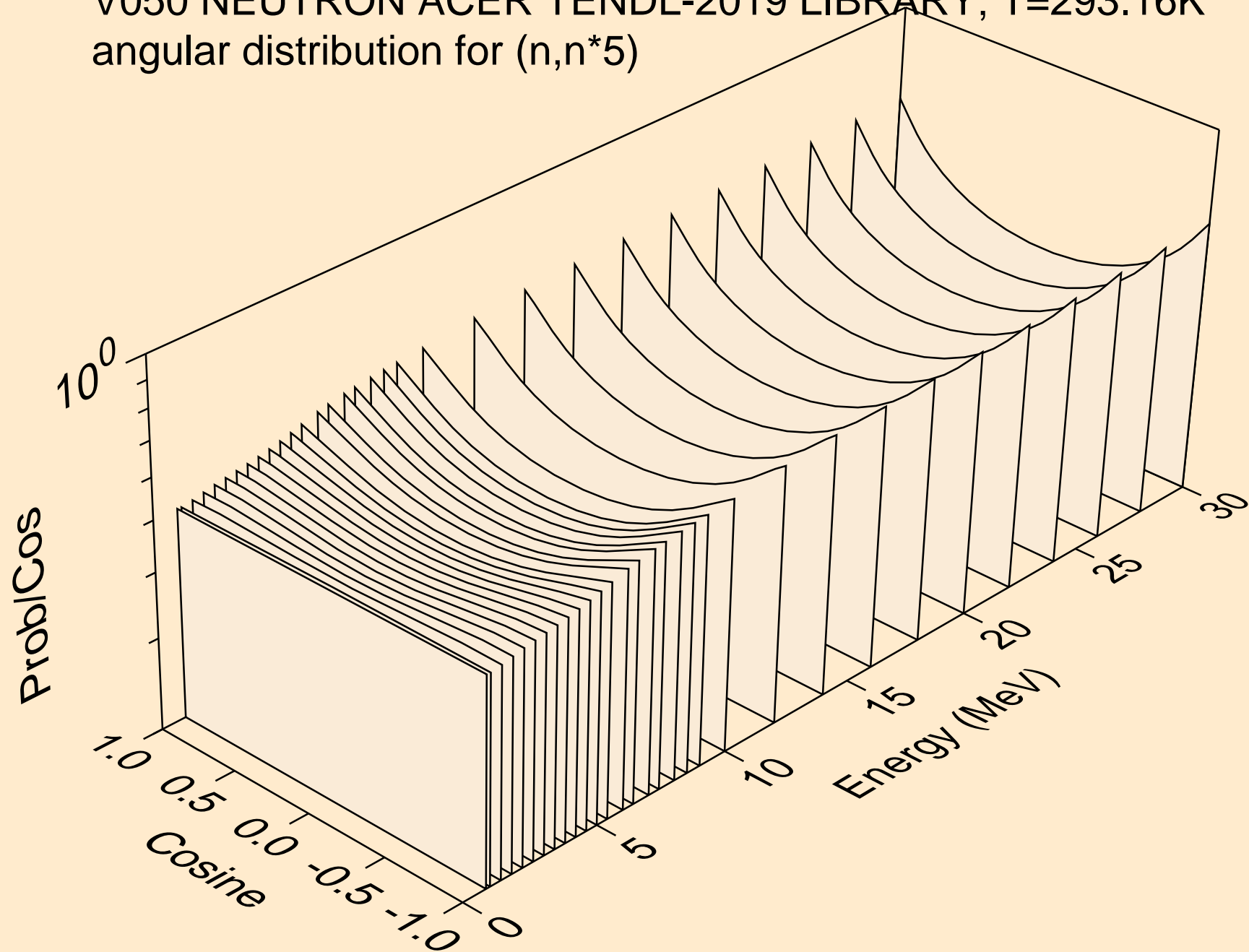

V050 NEUTRON ACER TENDL-2019 LIBRARY; T=293.16K
angular distribution for (n,n*6)

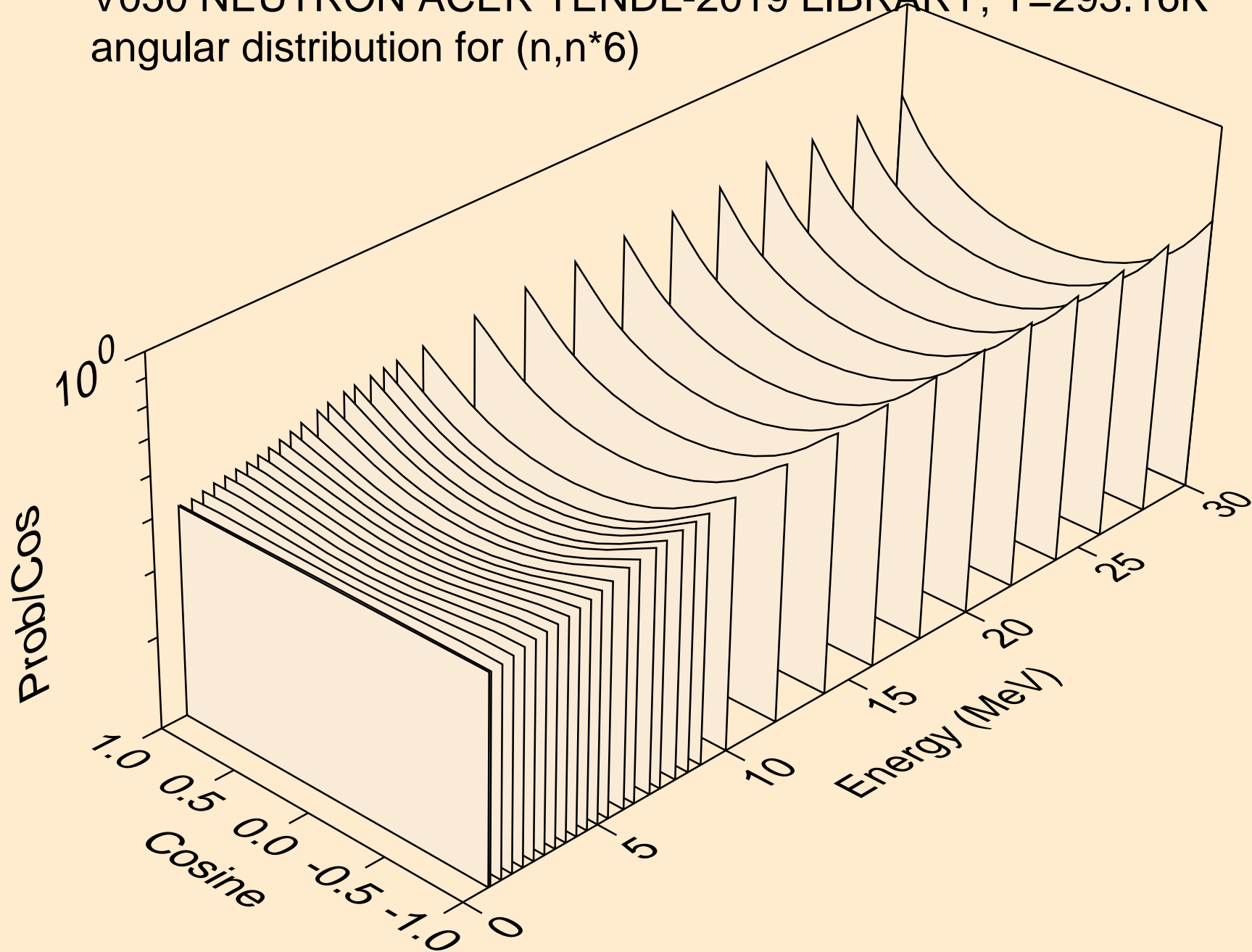

V050 NEUTRON ACER TENDL-2019 LIBRARY; T=293.16K
angular distribution for (n,n*7)

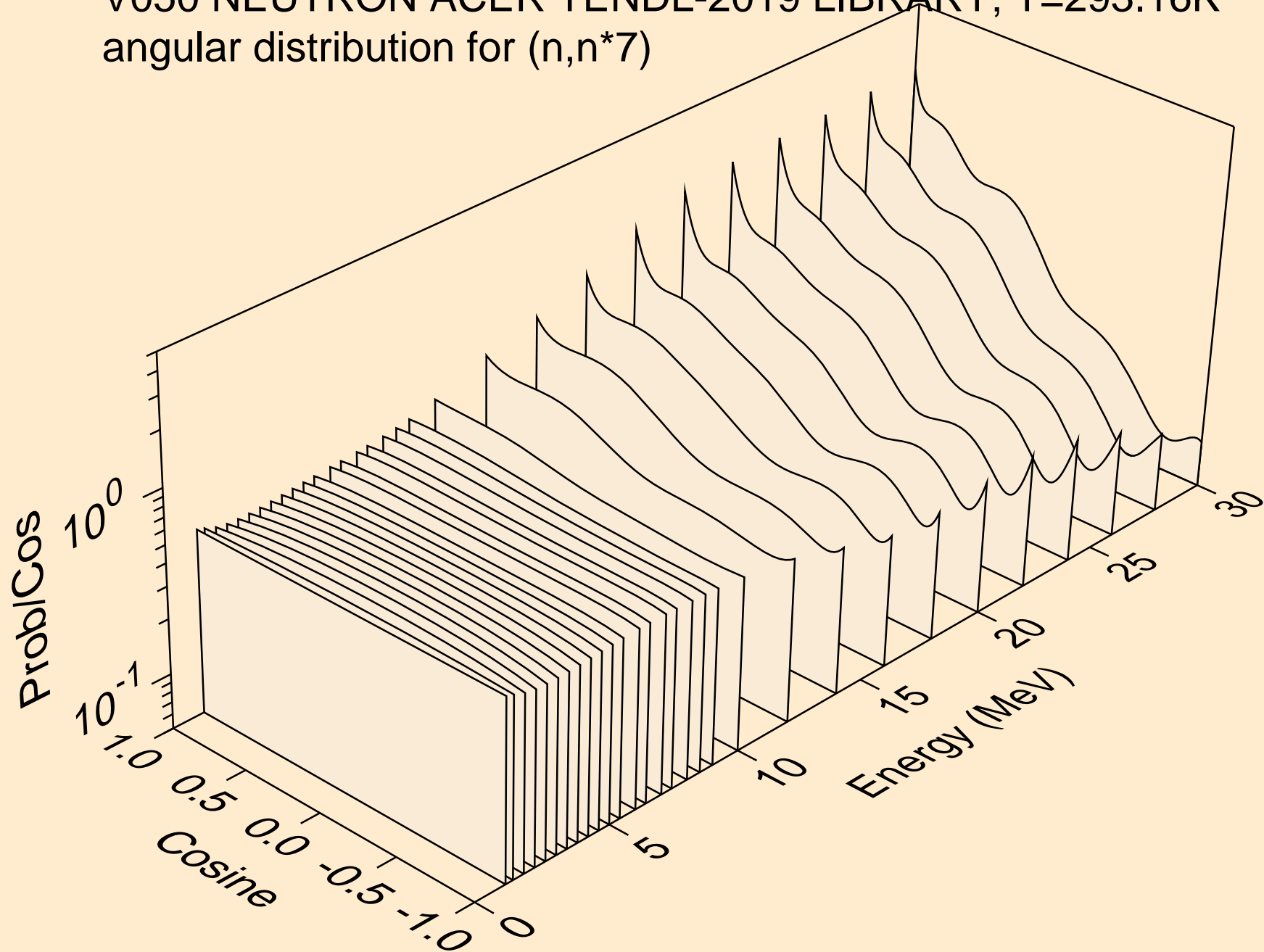

V050 NEUTRON ACER TENDL-2019 LIBRARY; T=293.16K
angular distribution for (n,n*8)

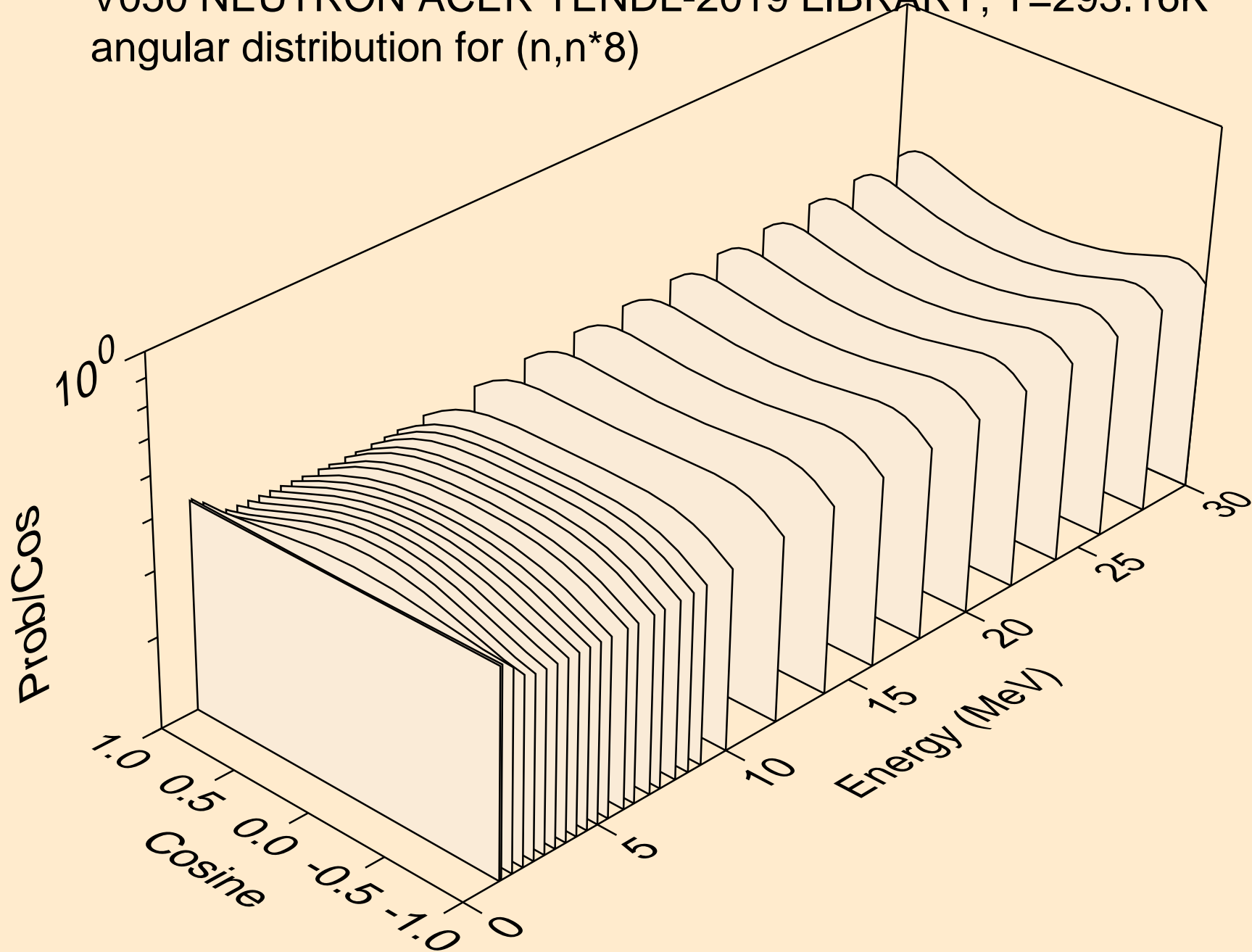

V050 NEUTRON ACER TENDL-2019 LIBRARY; T=293.16K
angular distribution for (n,n*9)

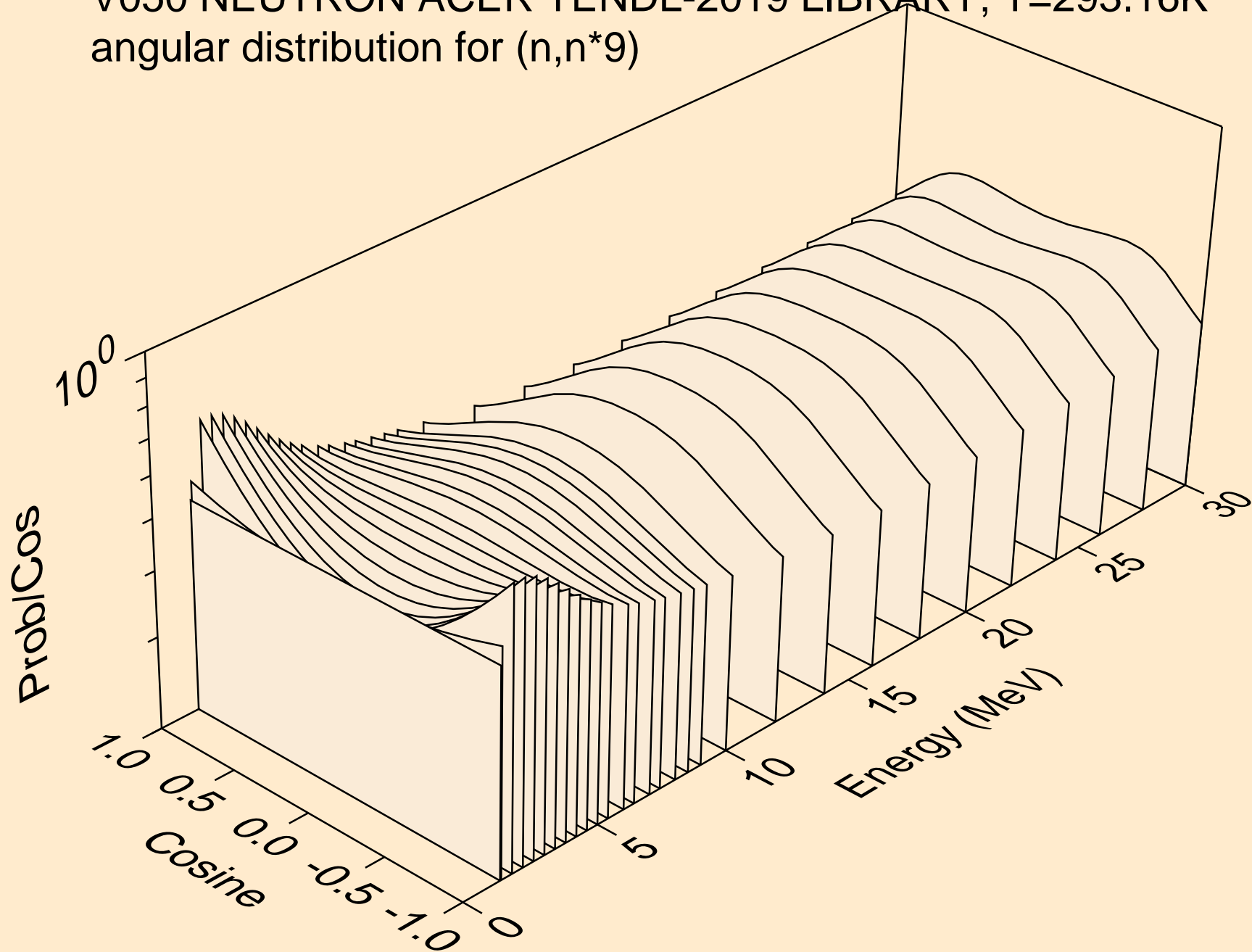

V050 NEUTRON ACER TENDL-2019 LIBRARY; T=293.16K
angular distribution for (n,n*10)

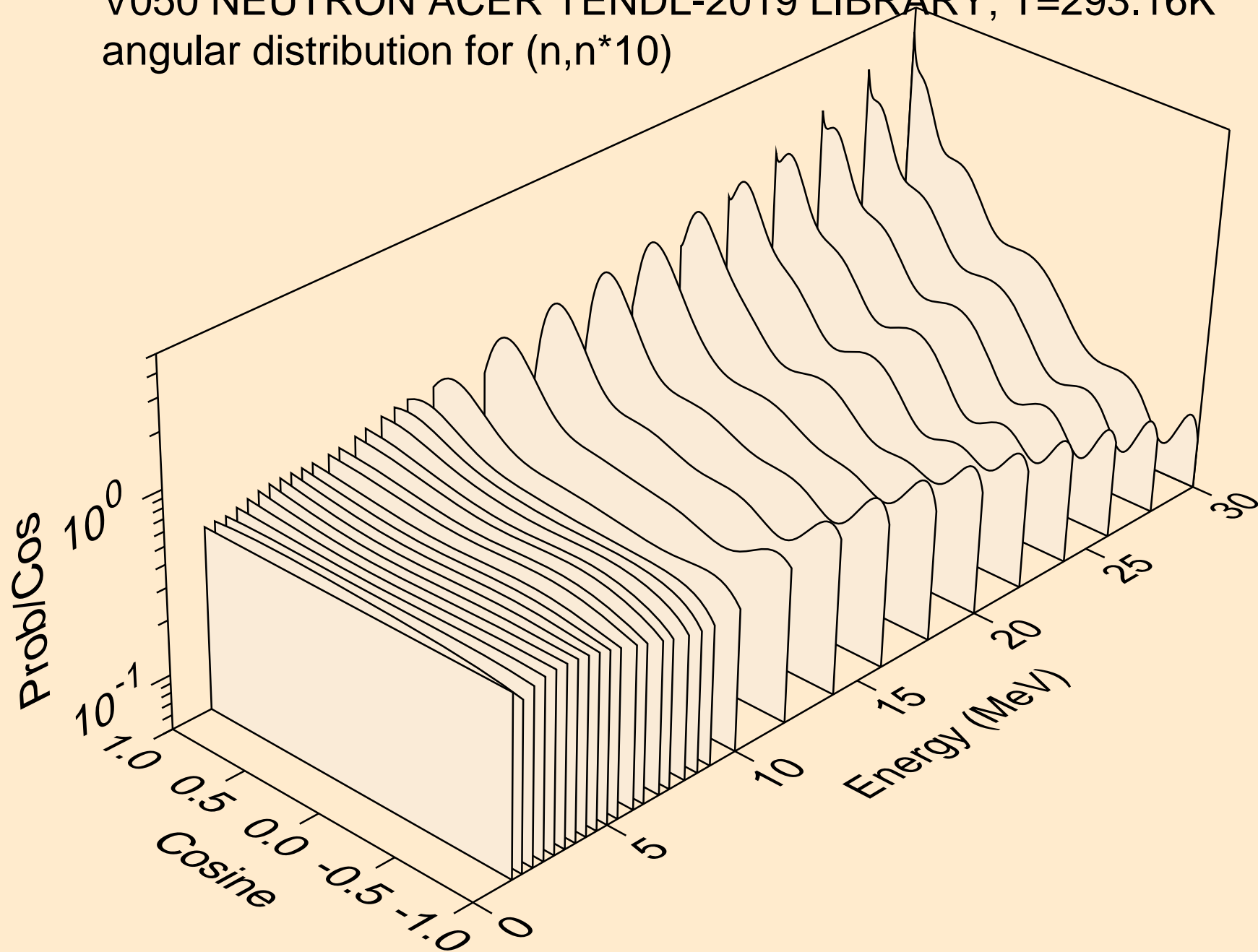

V050 NEUTRON ACER TENDL-2019 LIBRARY; T=293.16K
angular distribution for (n,n*11)

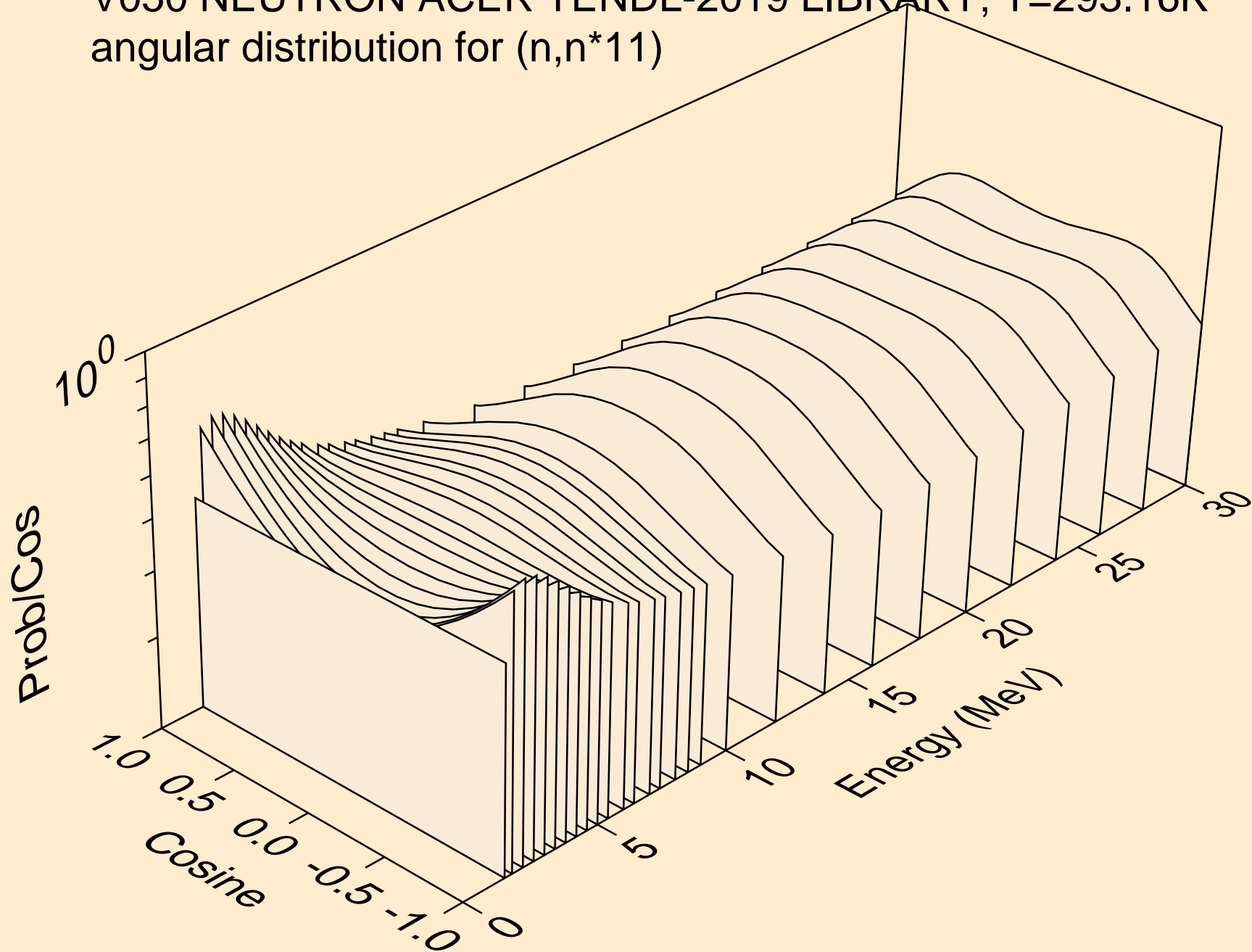

V050 NEUTRON ACER TENDL-2019 LIBRARY; T=293.16K
angular distribution for (n,n*12)

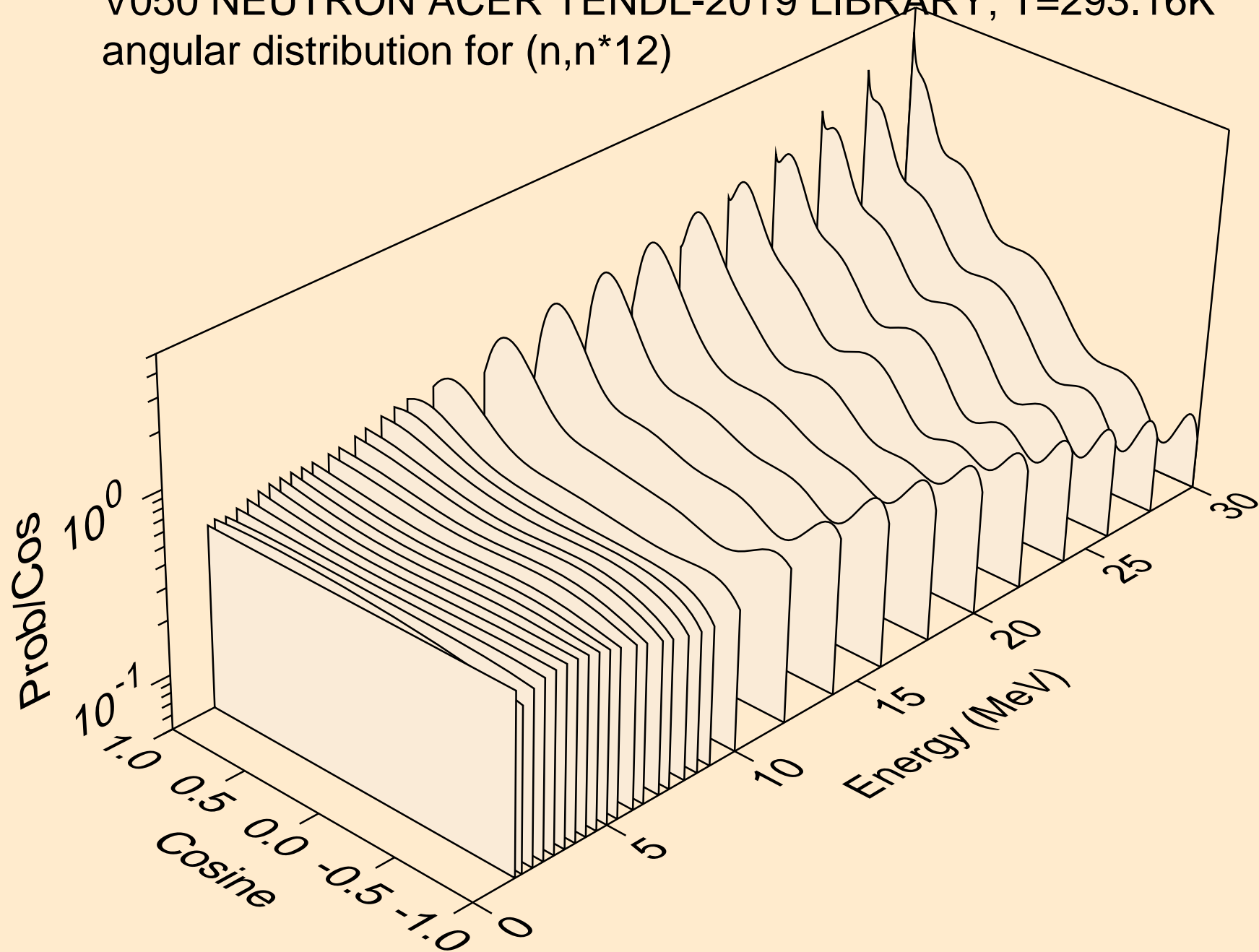

V050 NEUTRON ACER TENDL-2019 LIBRARY; T=293.16K
angular distribution for (n,n*13)

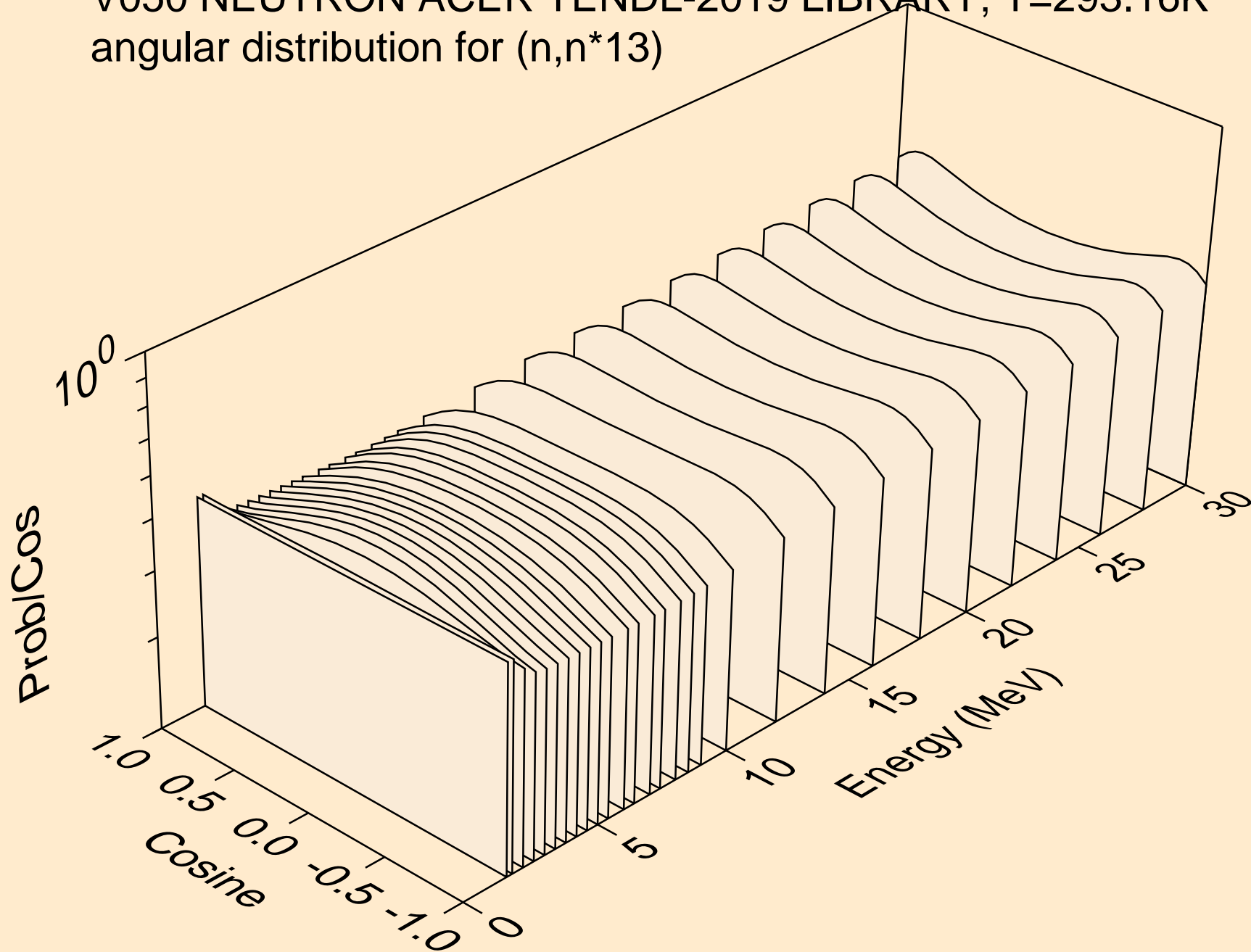

V050 NEUTRON ACER TENDL-2019 LIBRARY; T=293.16K
angular distribution for (n,n*14)

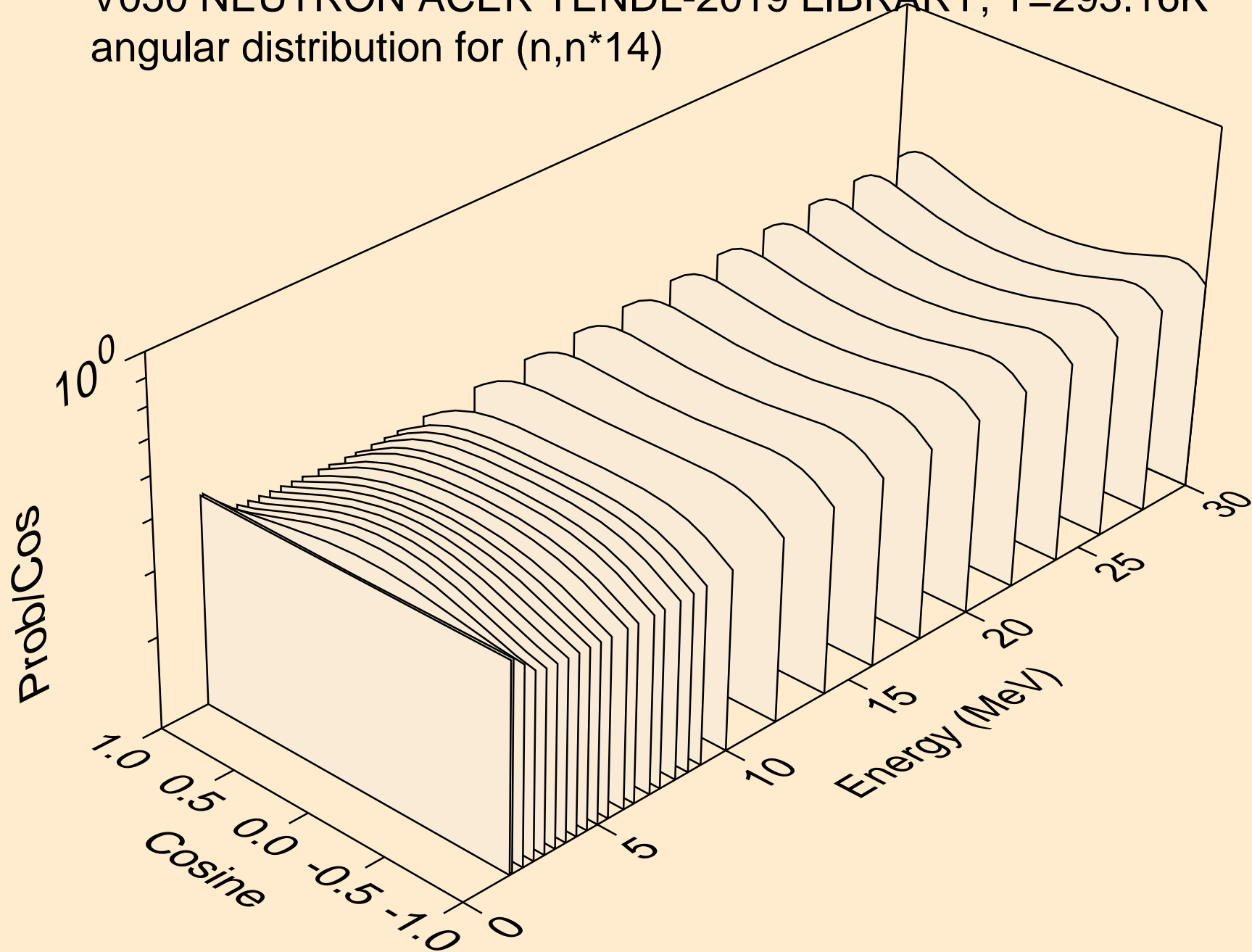

V050 NEUTRON ACER TENDL-2019 LIBRARY; T=293.16K
angular distribution for (n,n*15)

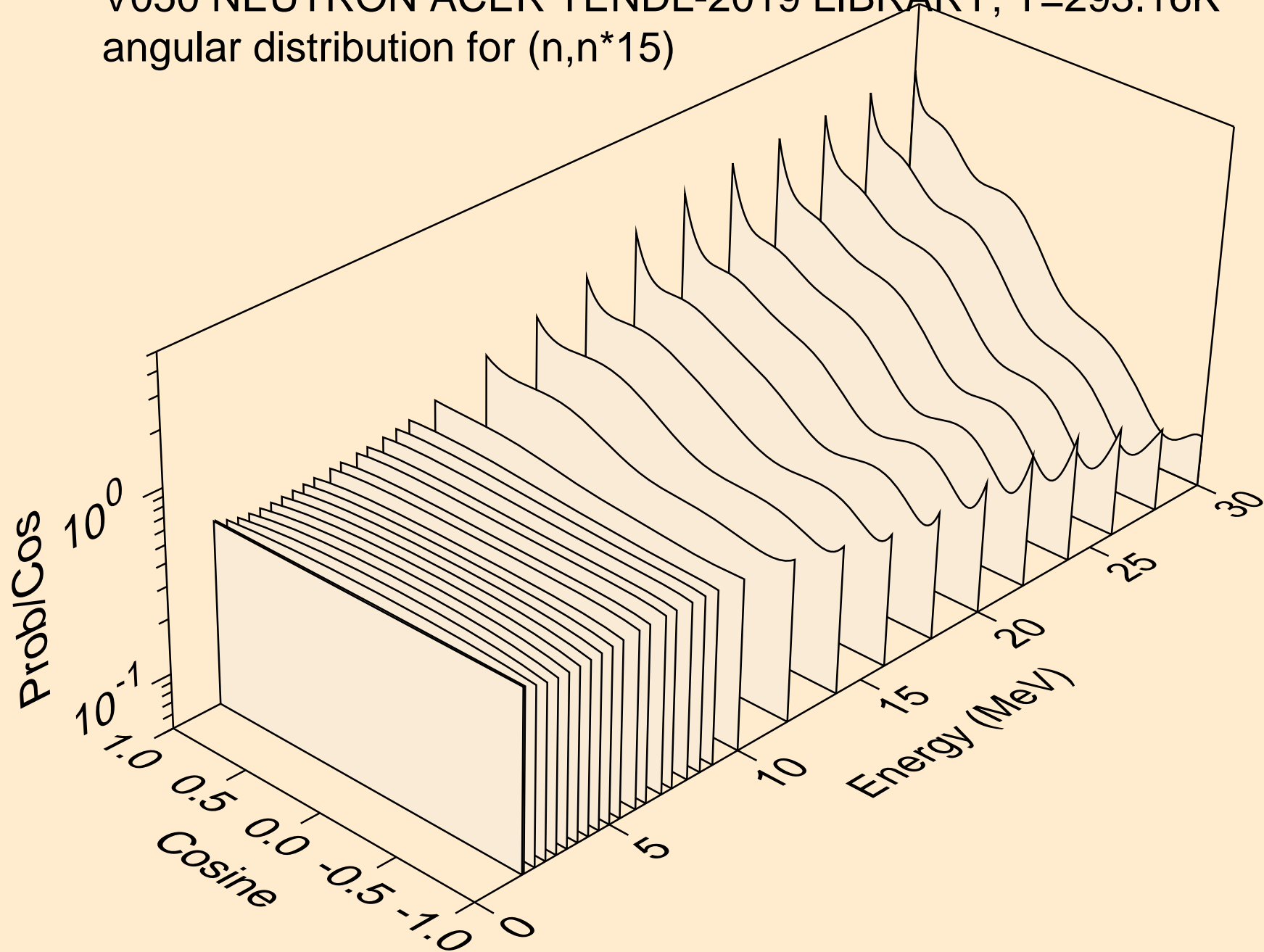

V050 NEUTRON ACER TENDL-2019 LIBRARY; T=293.16K
angular distribution for (n,n*16)

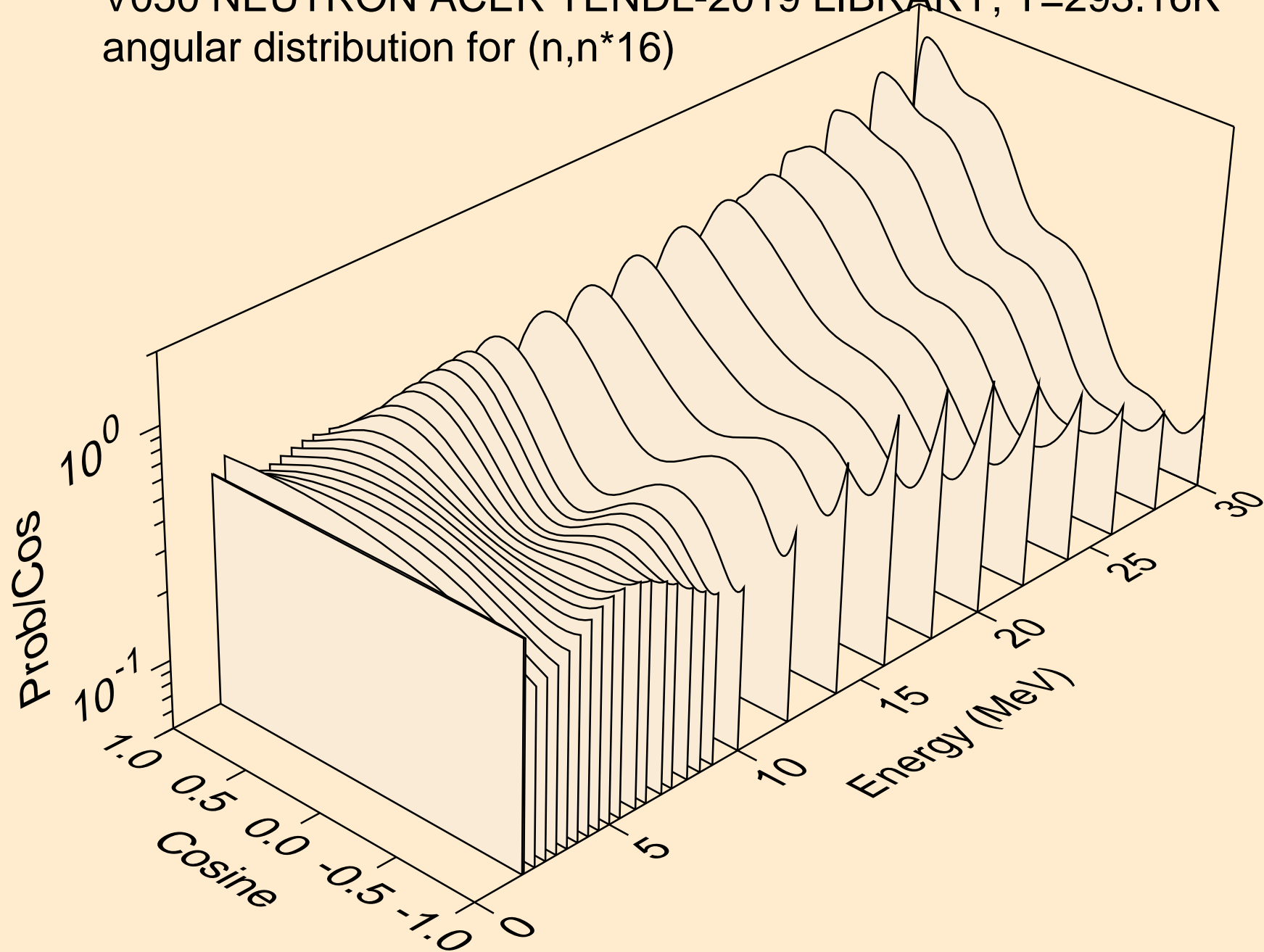

V050 NEUTRON ACER TENDL-2019 LIBRARY; T=293.16K
angular distribution for (n,n*17)

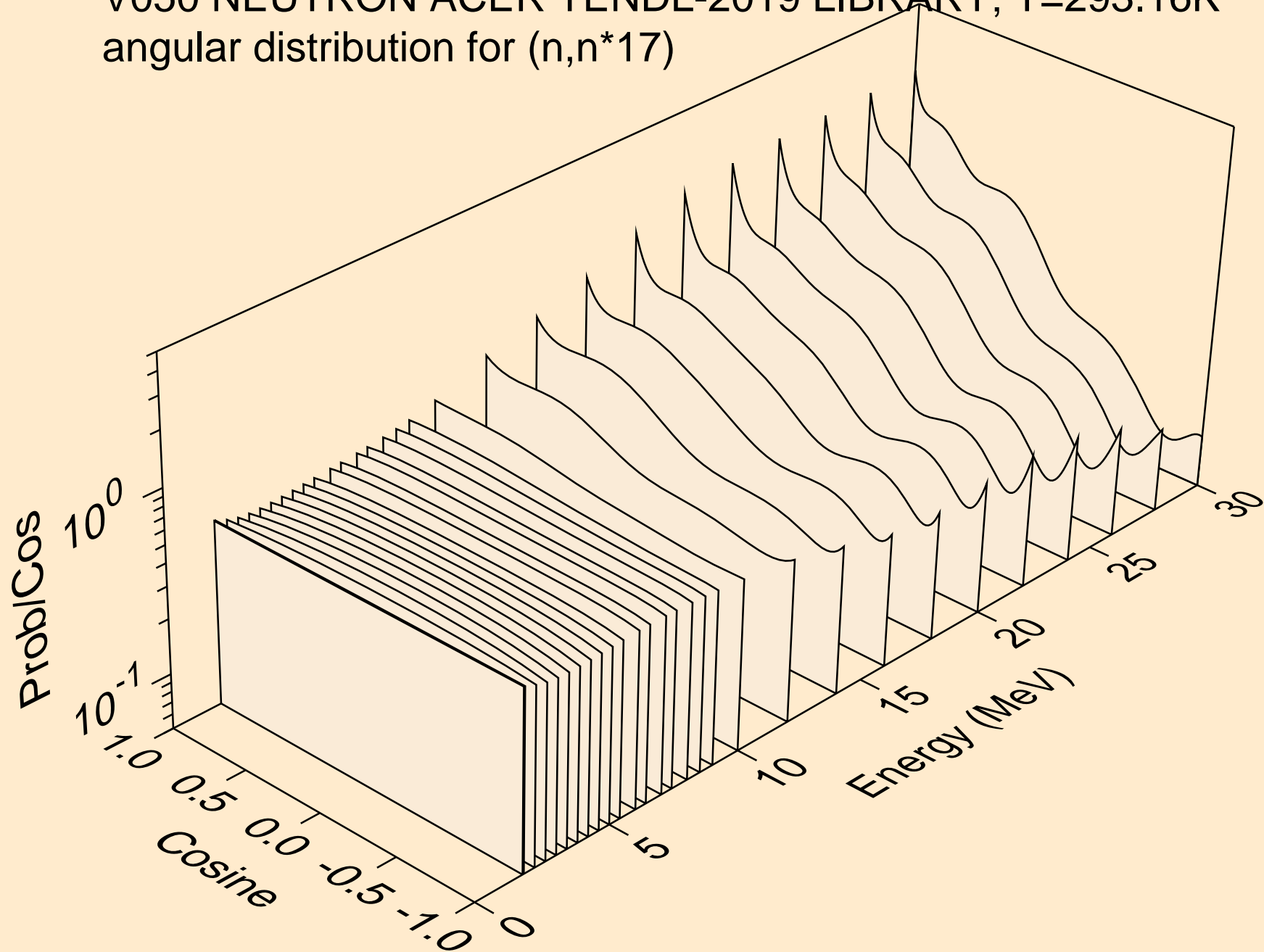

V050 NEUTRON ACER TENDL-2019 LIBRARY; T=293.16K
angular distribution for (n,n*18)

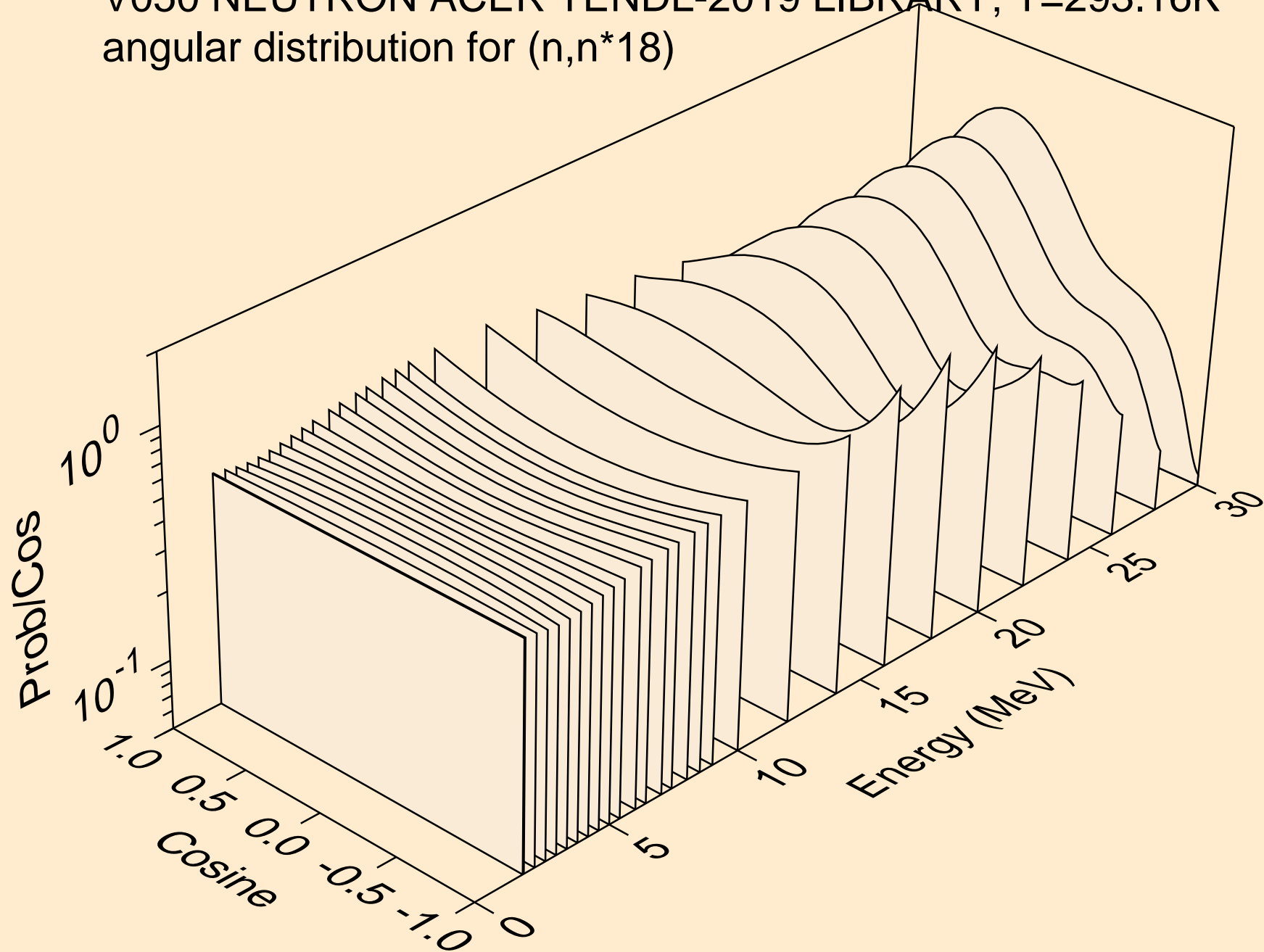

V050 NEUTRON ACER TENDL-2019 LIBRARY; T=293.16K
angular distribution for (n,n*19)

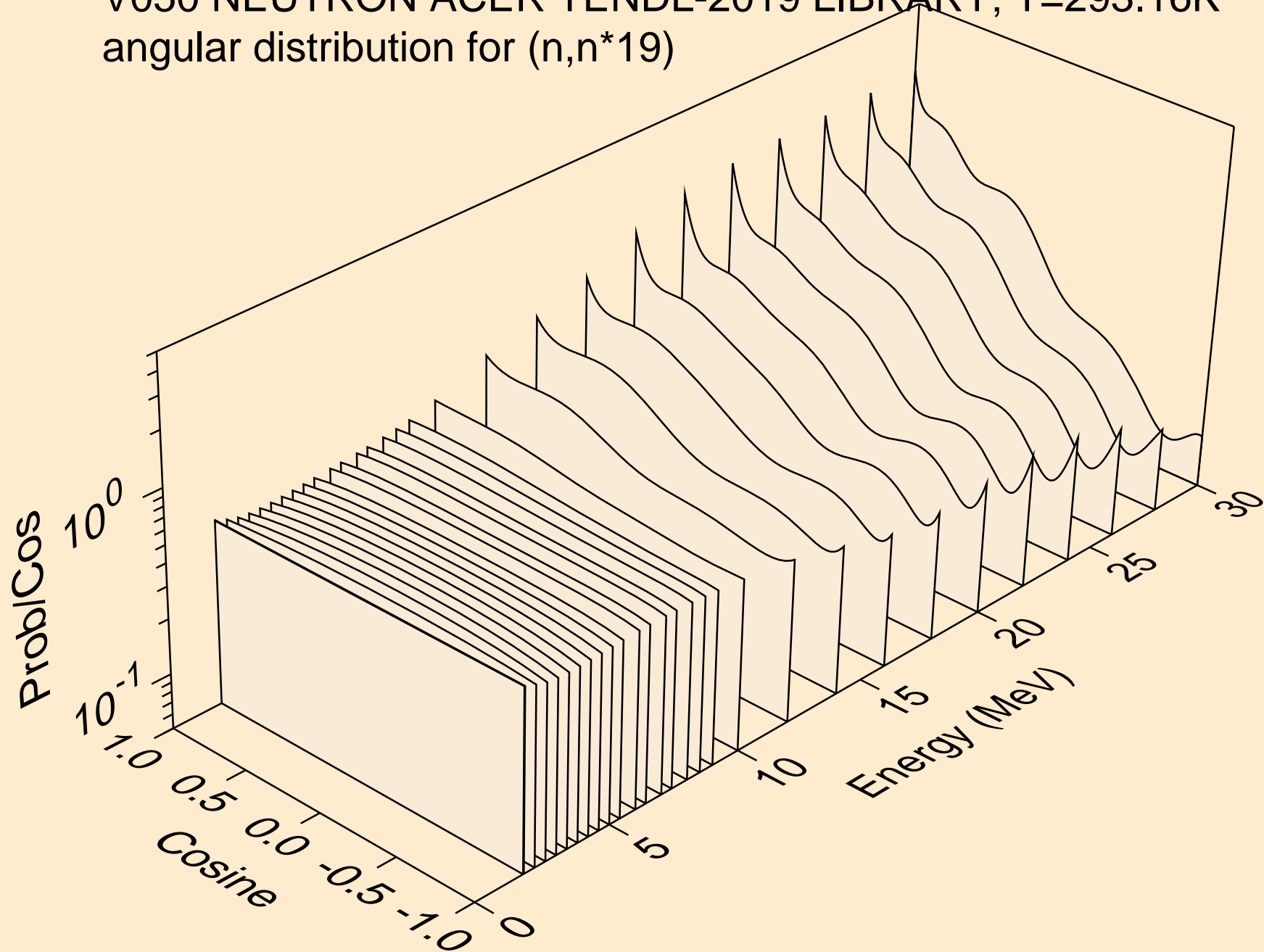

V050 NEUTRON ACER TENDL-2019 LIBRARY; T=293.16K
angular distribution for (n,n*20)

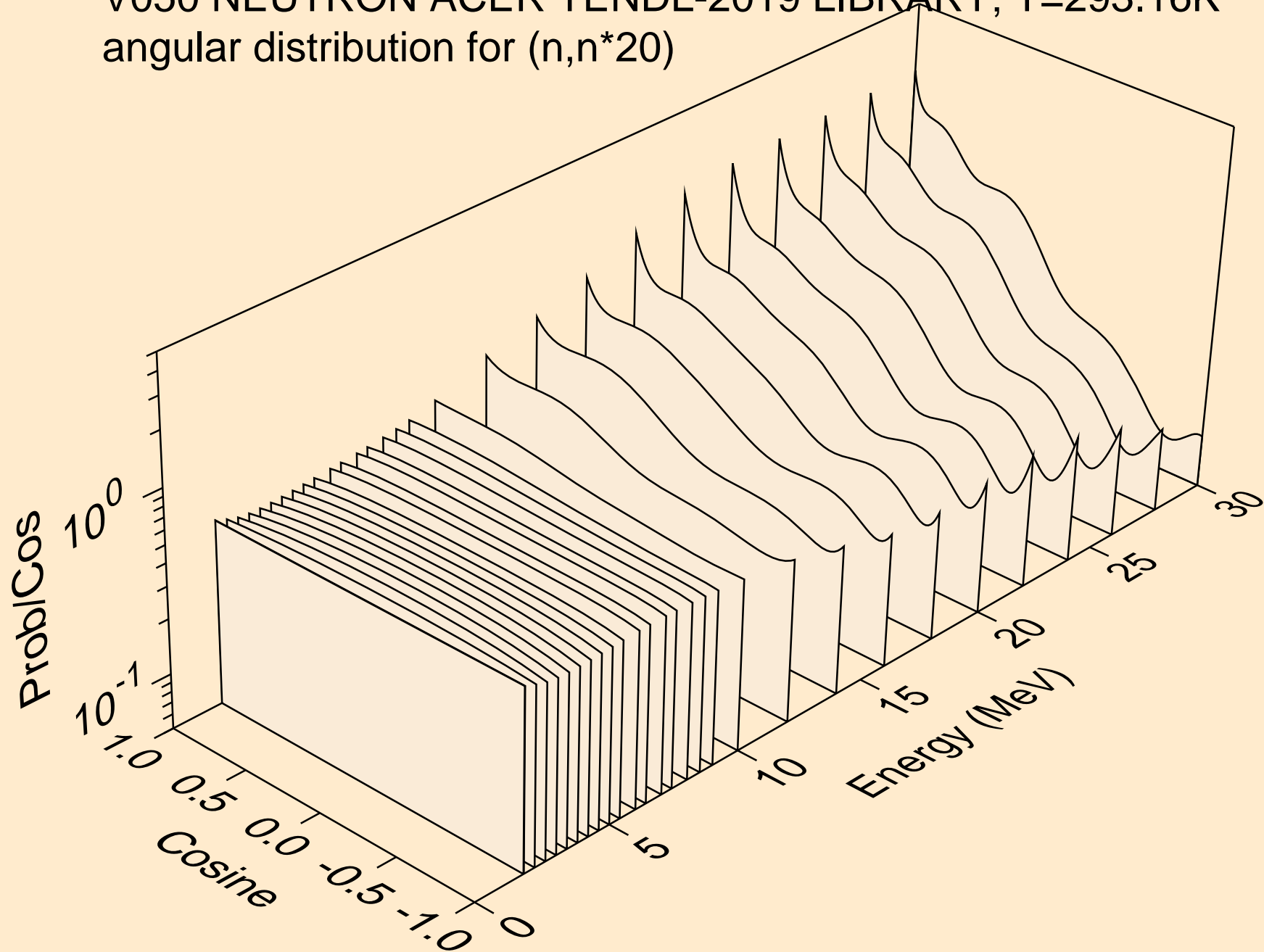

V050 NEUTRON ACER TENDL-2019 LIBRARY; T=293.16K
angular distribution for (n,n*21)

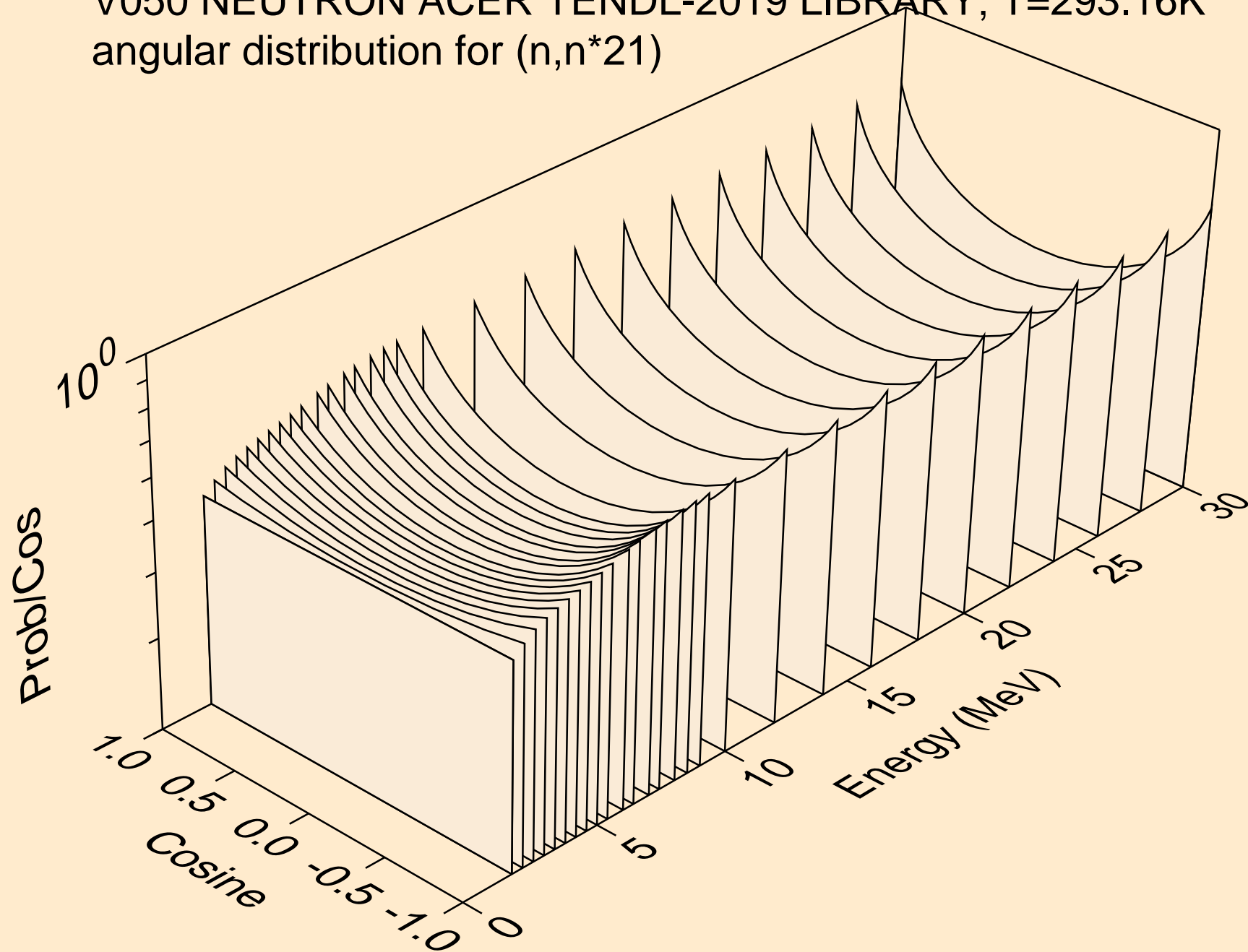

V050 NEUTRON ACER TENDL-2019 LIBRARY; T=293.16K
angular distribution for (n,n*22)

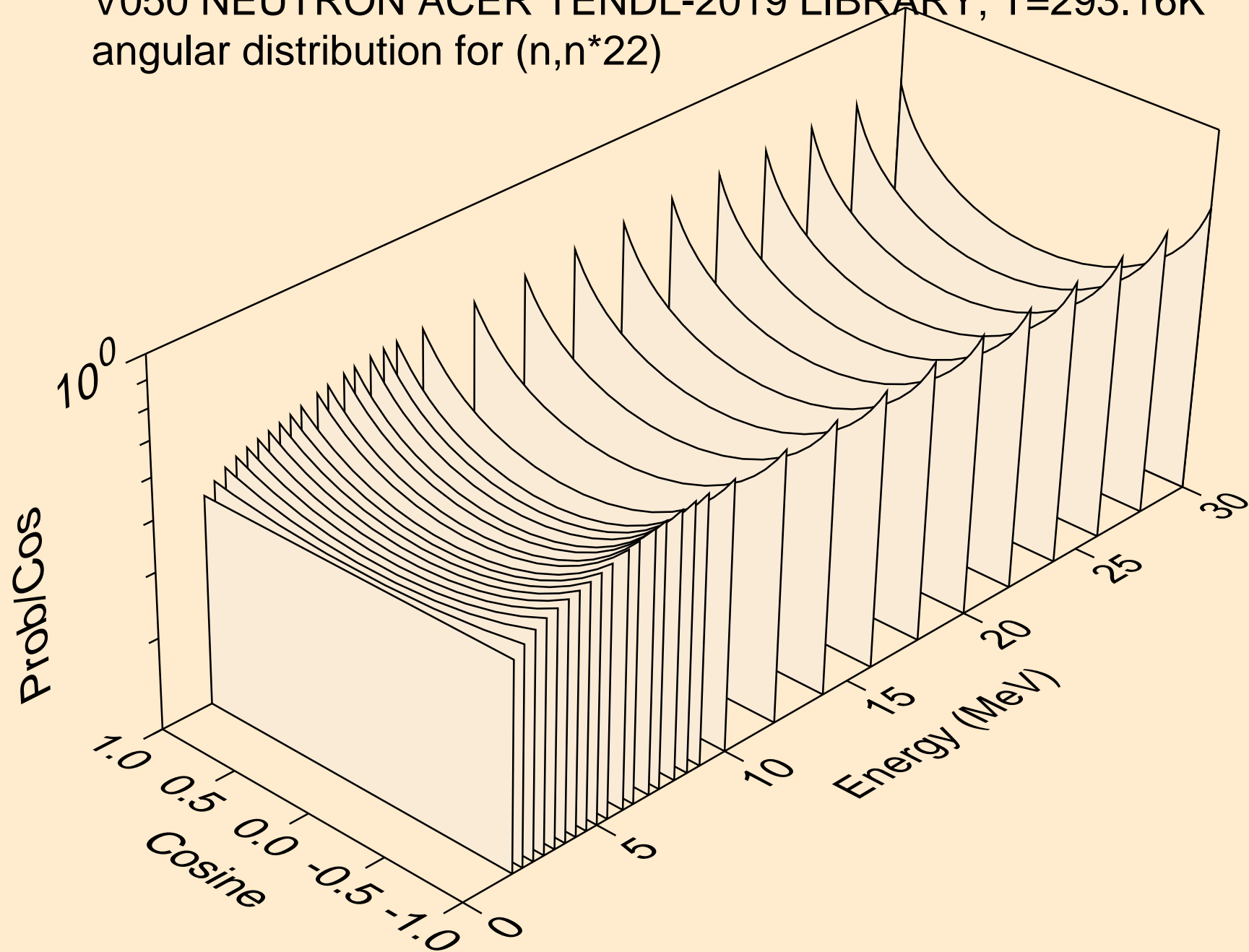

V050 NEUTRON ACER TENDL-2019 LIBRARY; T=293.16K
angular distribution for (n,n*23)

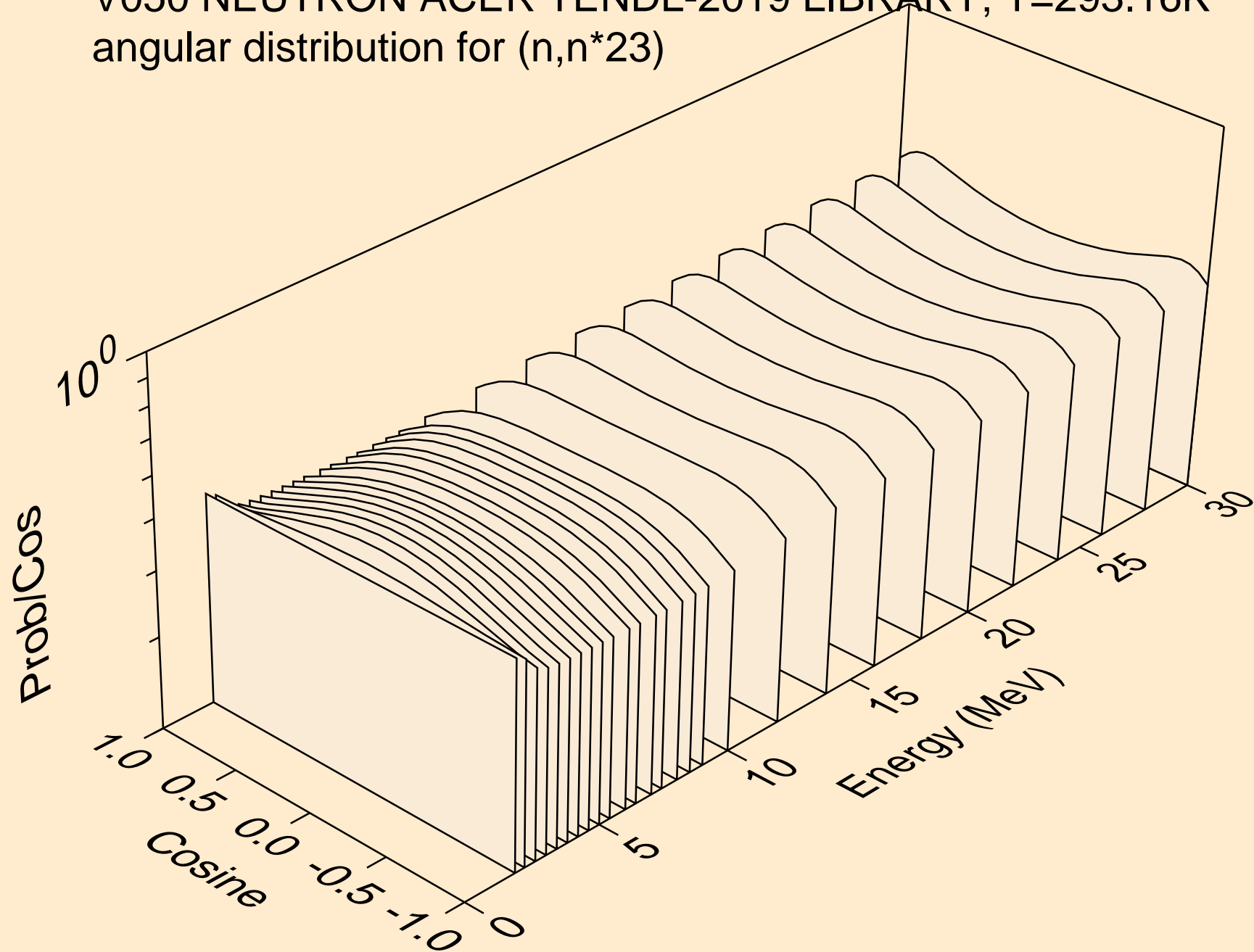

V050 NEUTRON ACER TENDL-2019 LIBRARY; T=293.16K
angular distribution for (n,n*24)

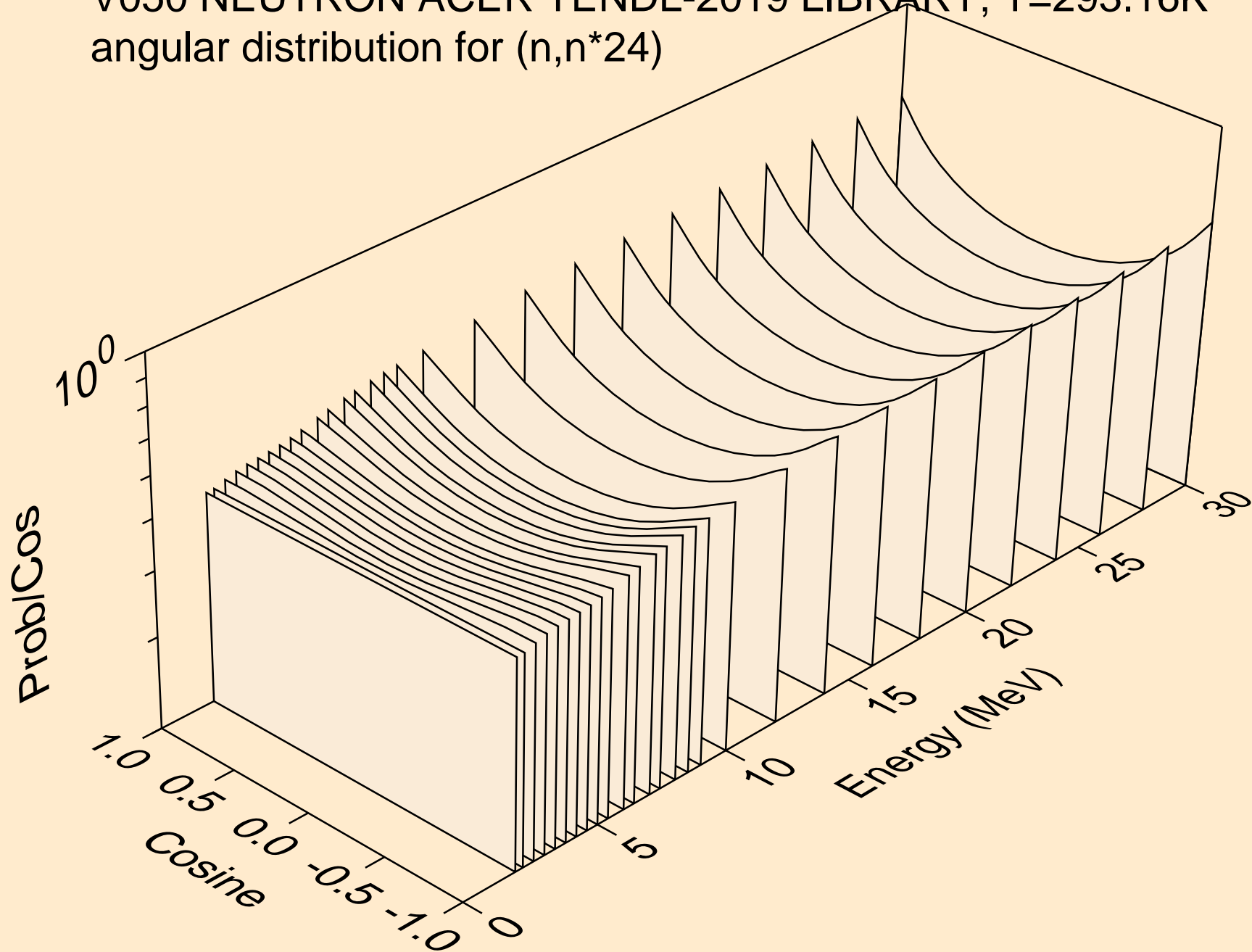

V050 NEUTRON ACER TENDL-2019 LIBRARY; T=293.16K
angular distribution for (n,n*25)

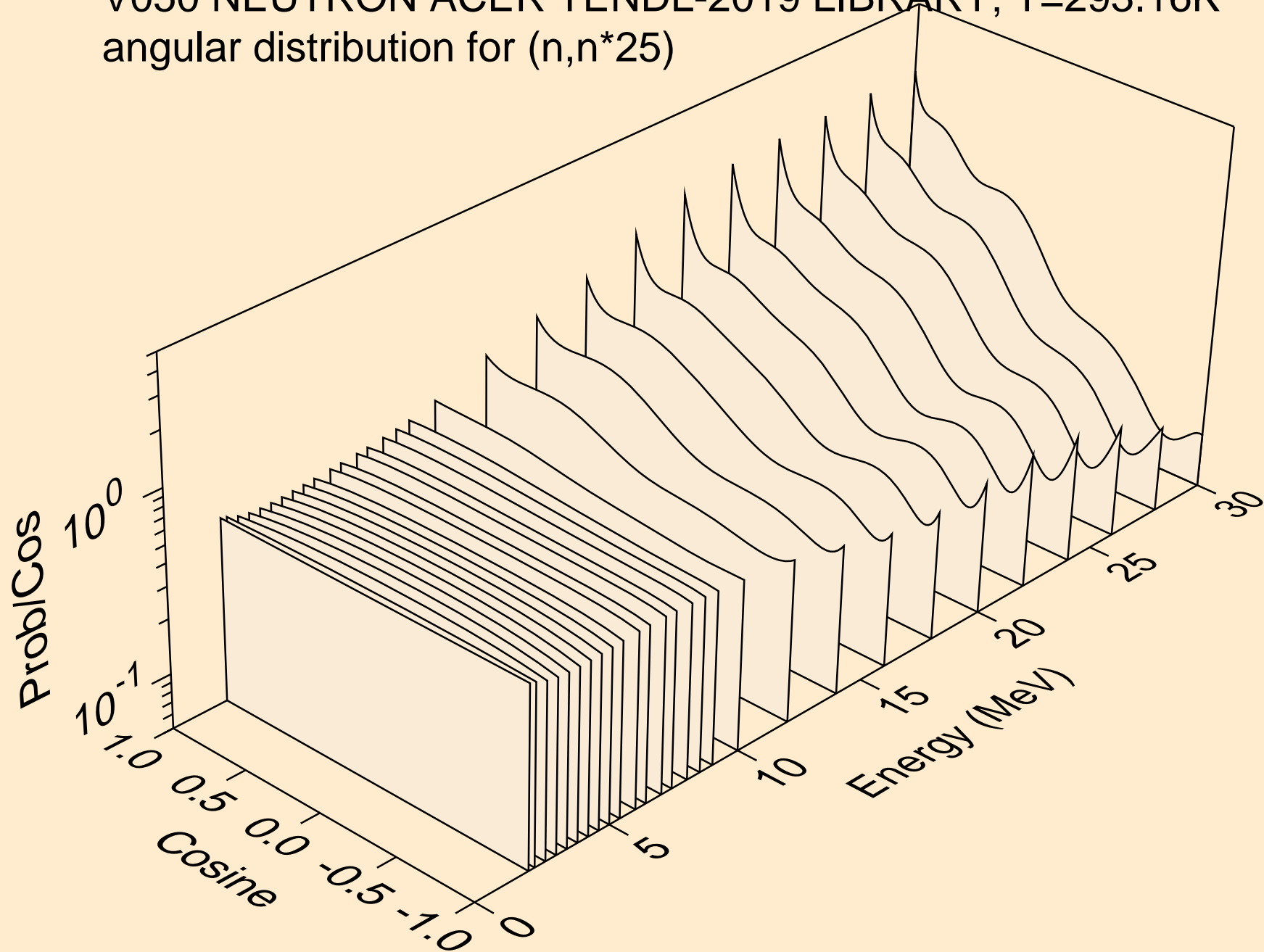

V050 NEUTRON ACER TENDL-2019 LIBRARY; T=293.16K
angular distribution for (n,n*26)

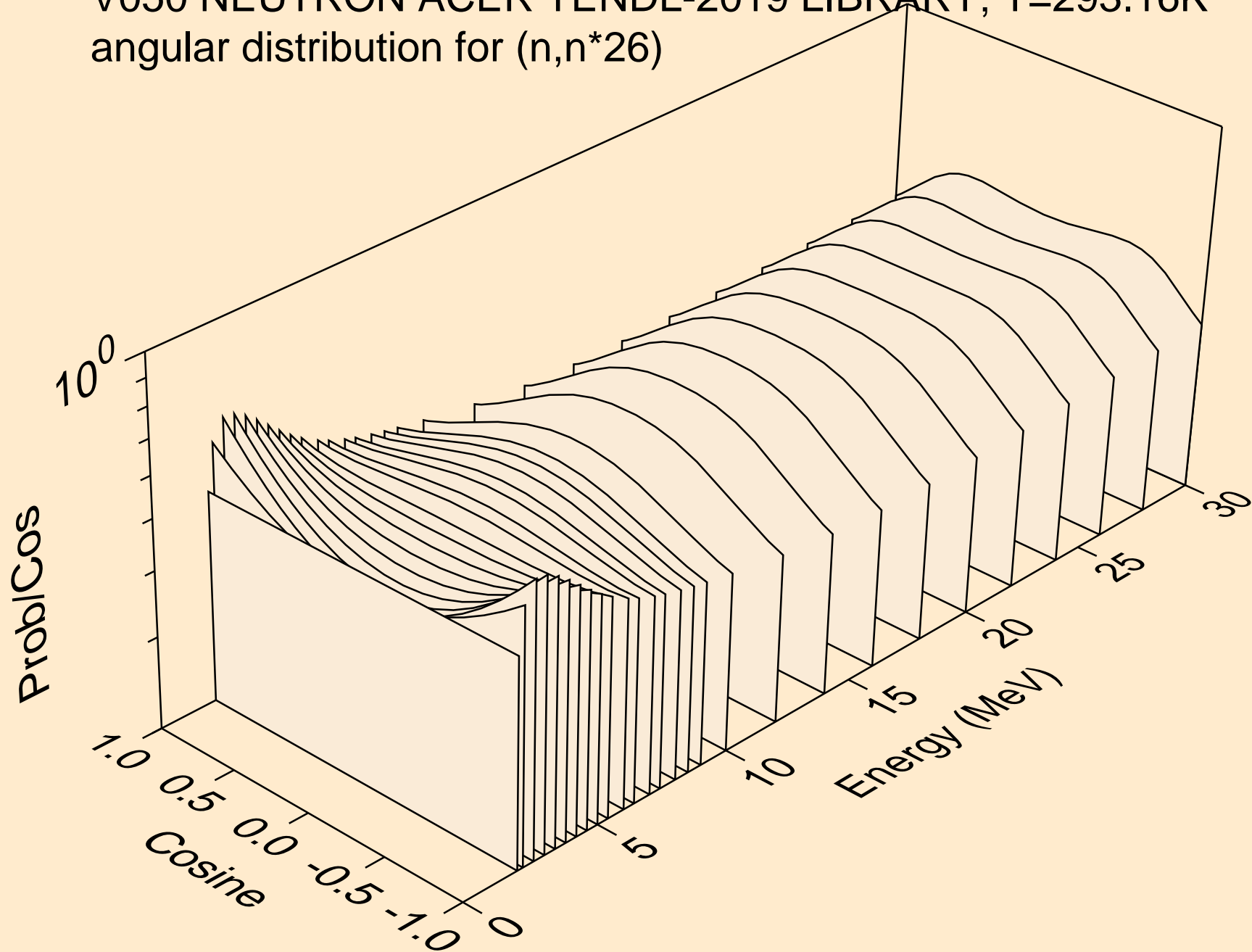

V050 NEUTRON ACER TENDL-2019 LIBRARY; T=293.16K
angular distribution for (n,n*27)

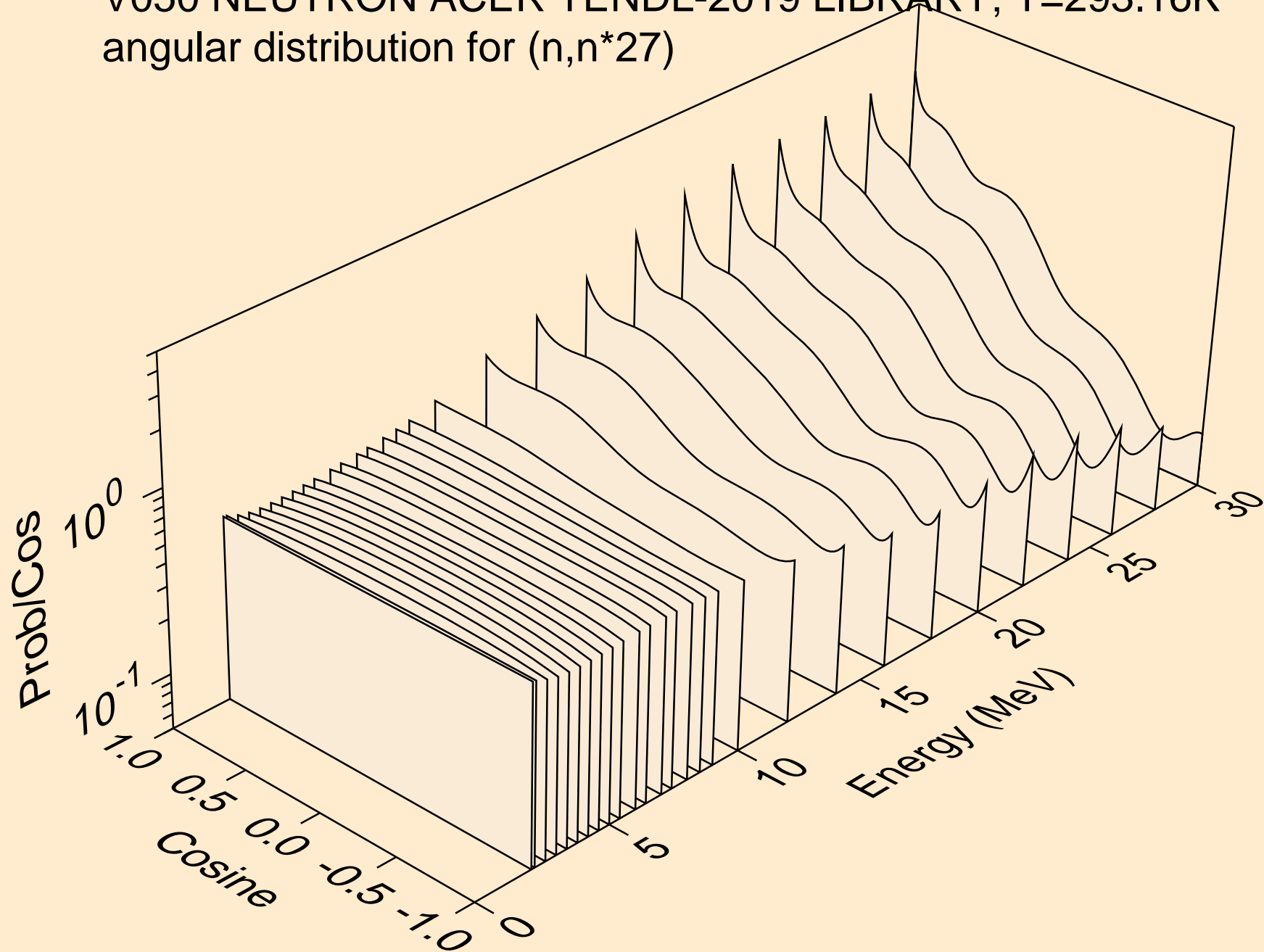

V050 NEUTRON ACER TENDL-2019 LIBRARY; T=293.16K
Neutron emission for (n,x)

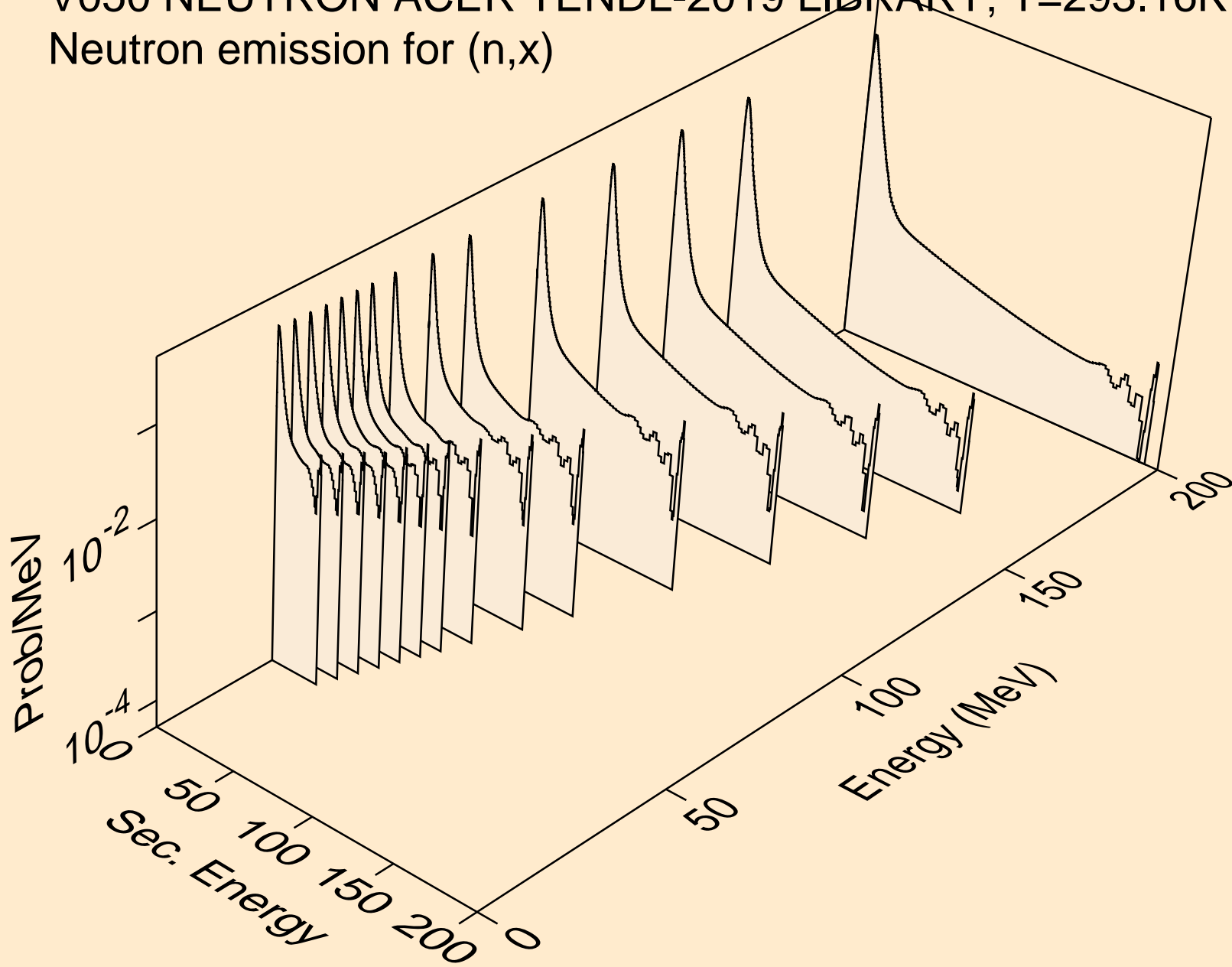

V050 NEUTRON ACER TENDL-2019 LIBRARY; T=293.16K
Neutron emission for (n,2nd)

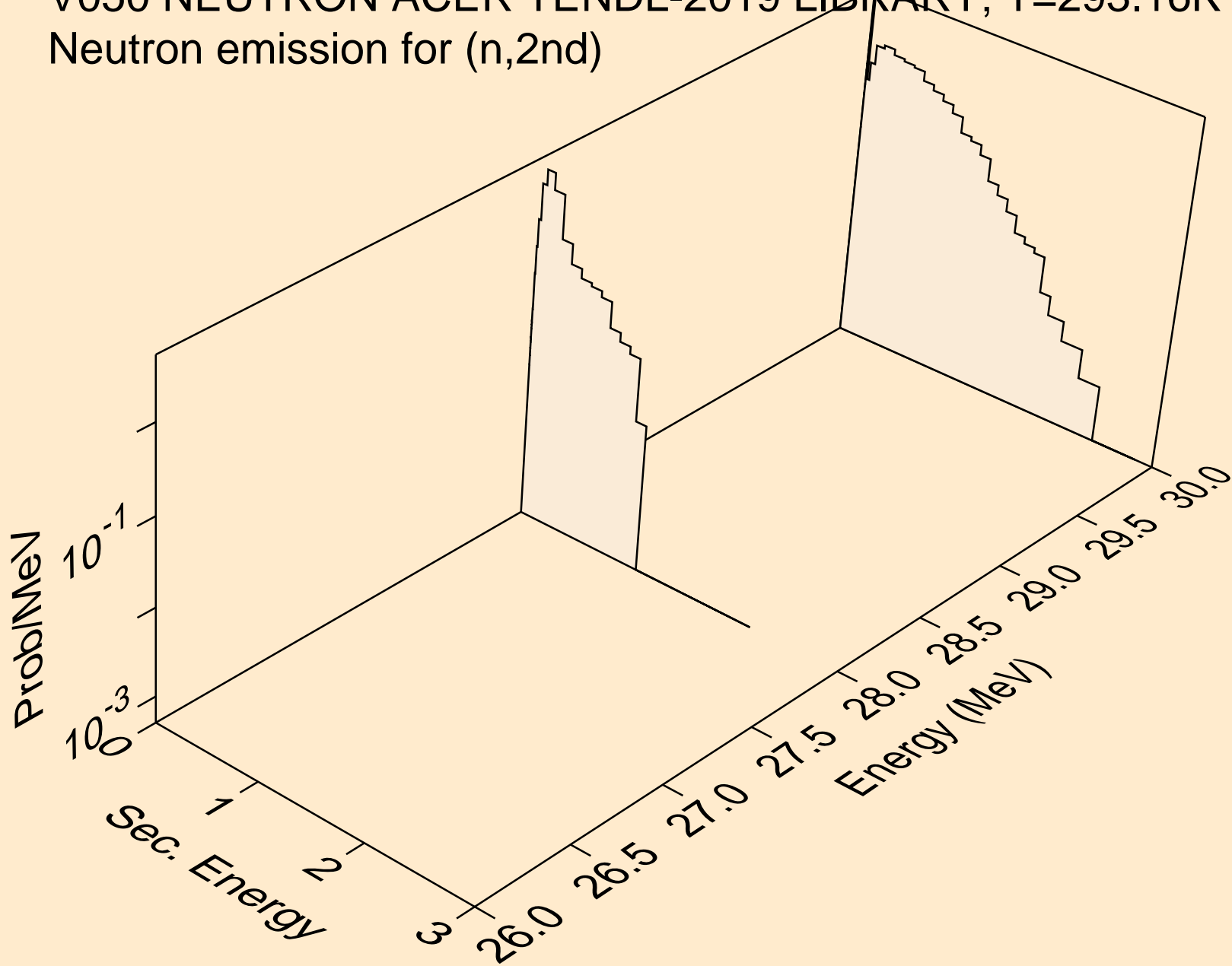

V050 NEUTRON ACER TENDL-2019 LIBRARY; T=293.16K
Neutron emission for (n,2n)

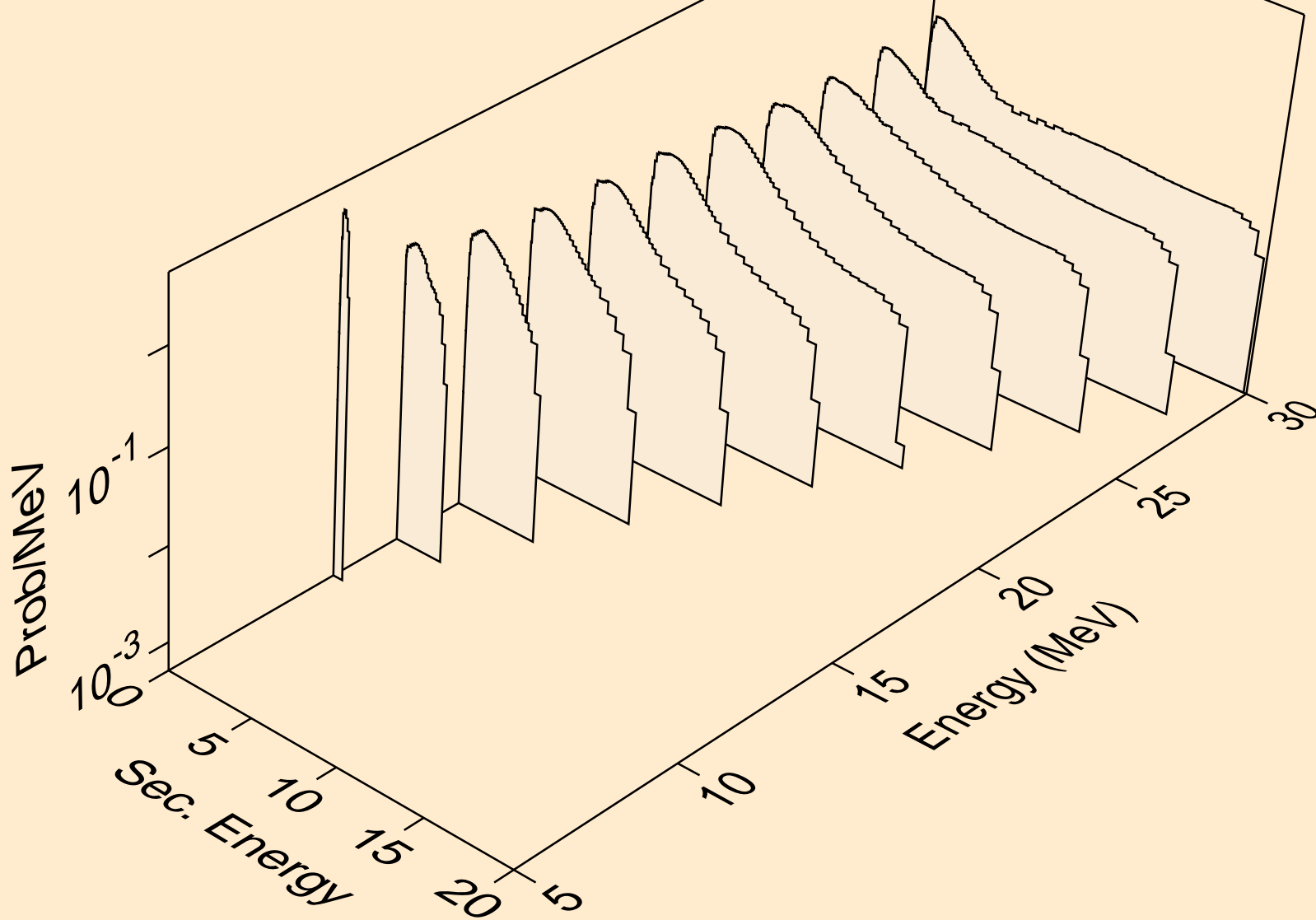

V050 NEUTRON ACER TENDL-2019 LIBRARY; T=293.16K
Neutron emission for (n,3n)

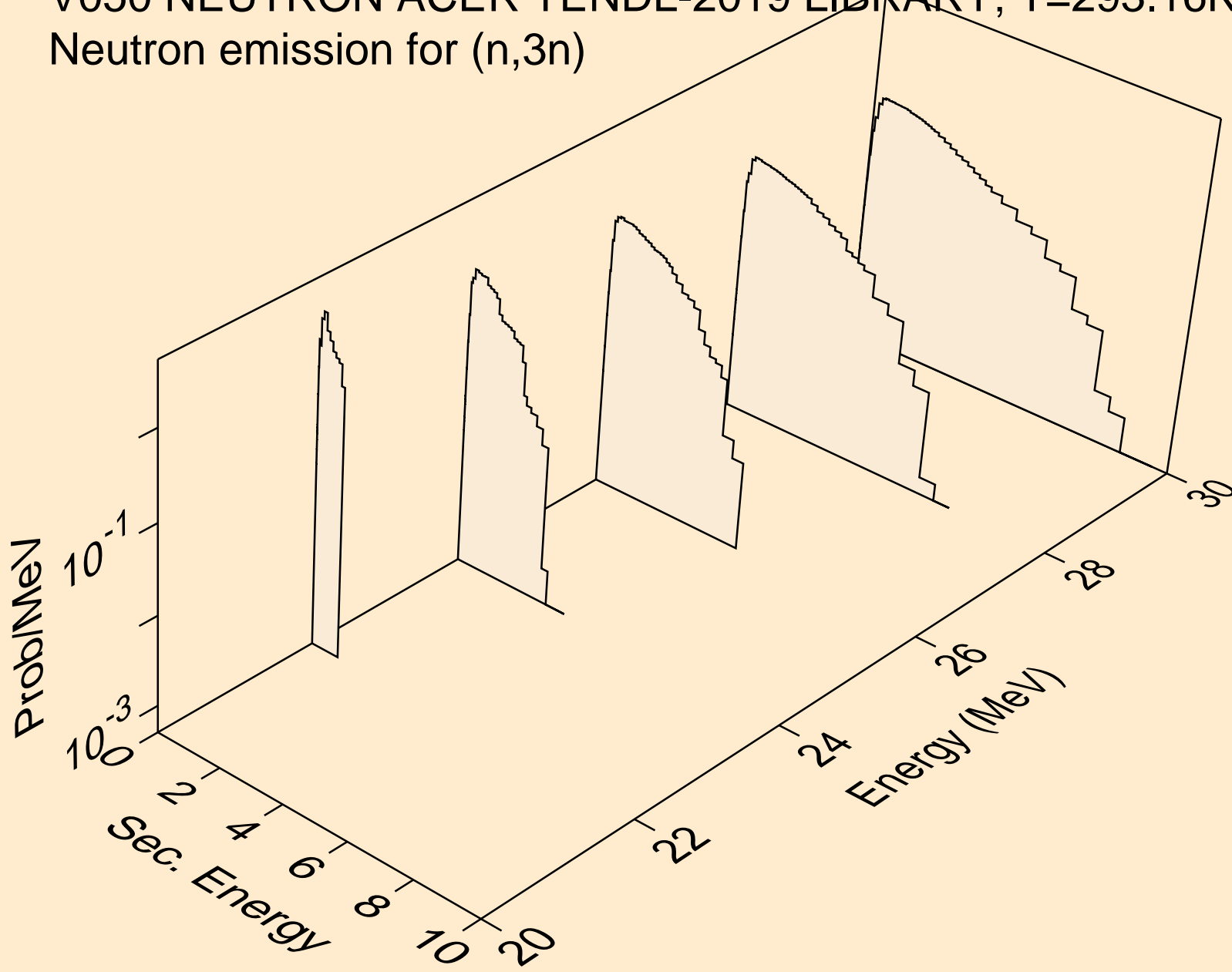

V050 NEUTRON ACER TENDL-2019 LIBRARY; T=293.16K
Neutron emission for (n,n*)a

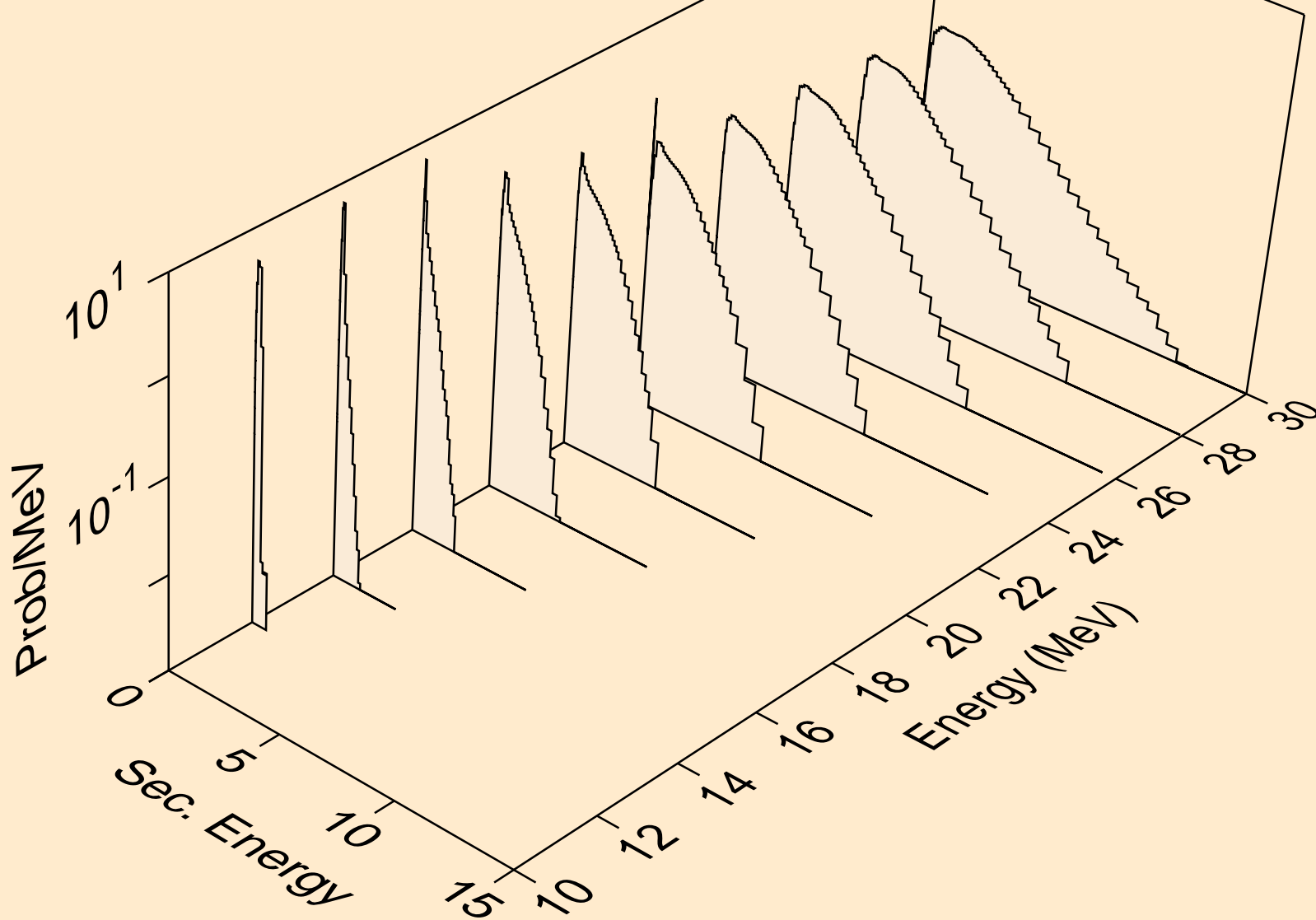

V050 NEUTRON ACER TENDL-2019 LIBRARY; T=293.16K
Neutron emission for (n,2n)a

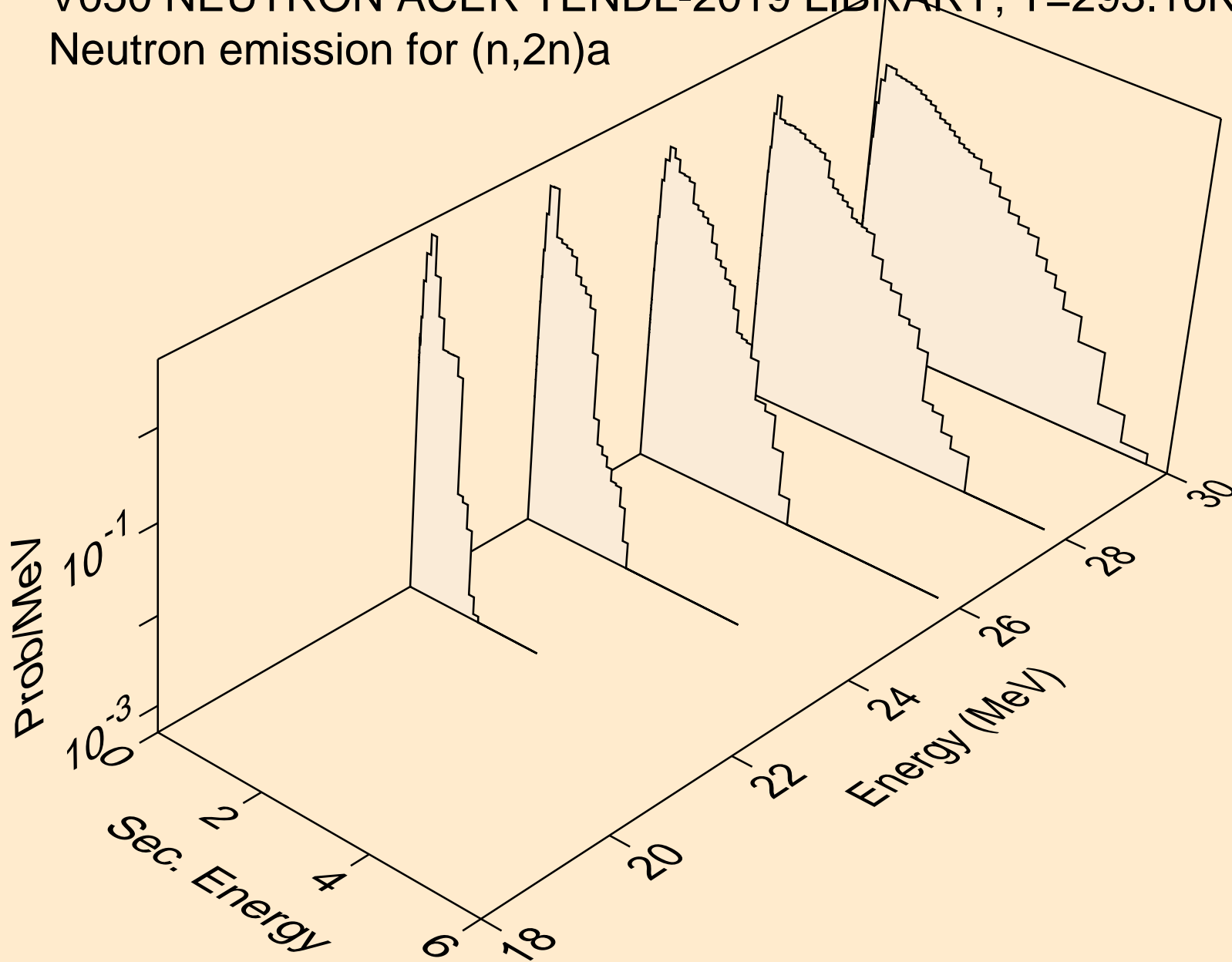

V050 NEUTRON ACER TENDL-2019 LIBRARY; T=293.16K
Neutron emission for (n,n*)p

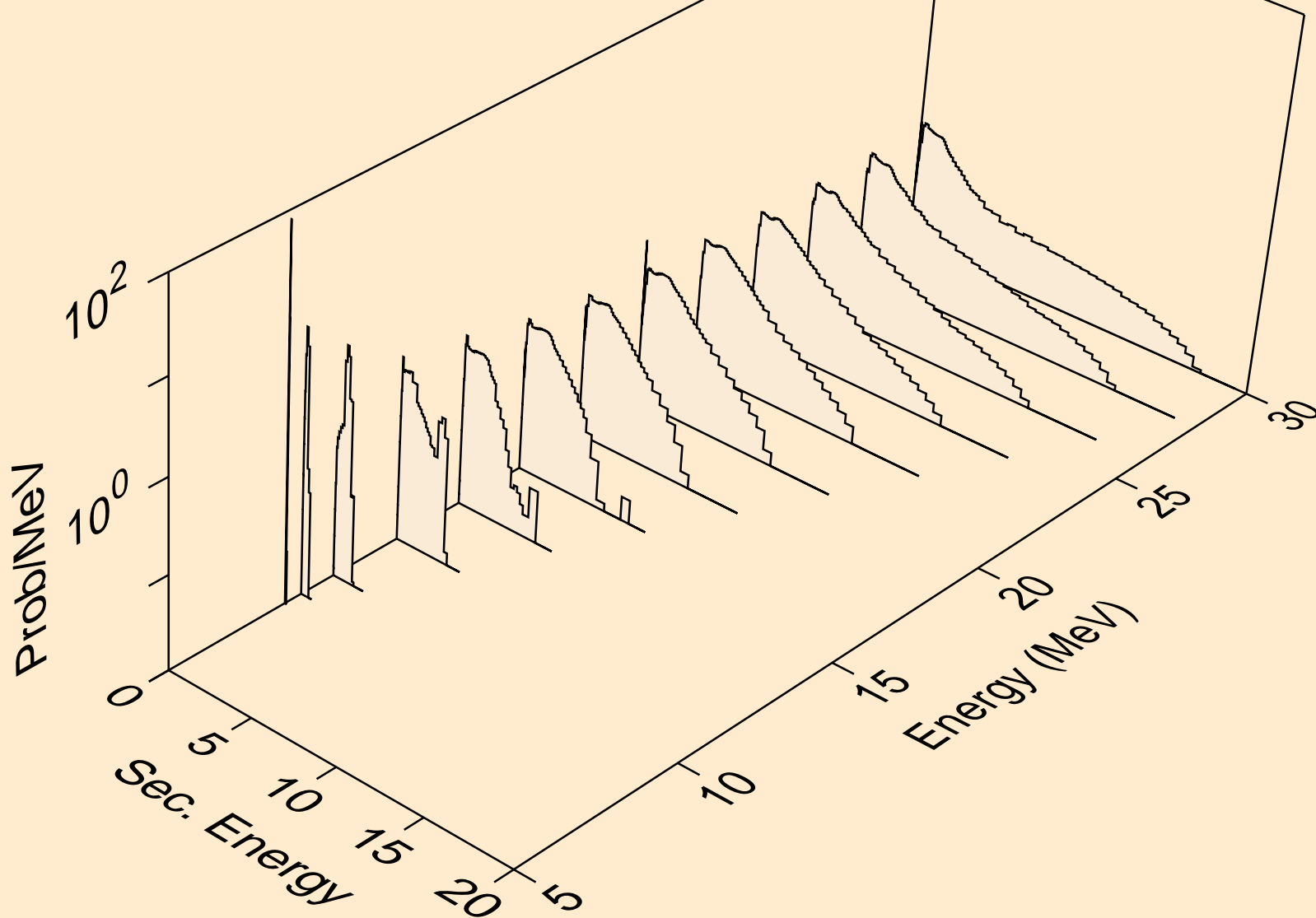

V050 NEUTRON ACER TENDL-2019 LIBRARY; T=293.16K
Neutron emission for (n,n*)2a

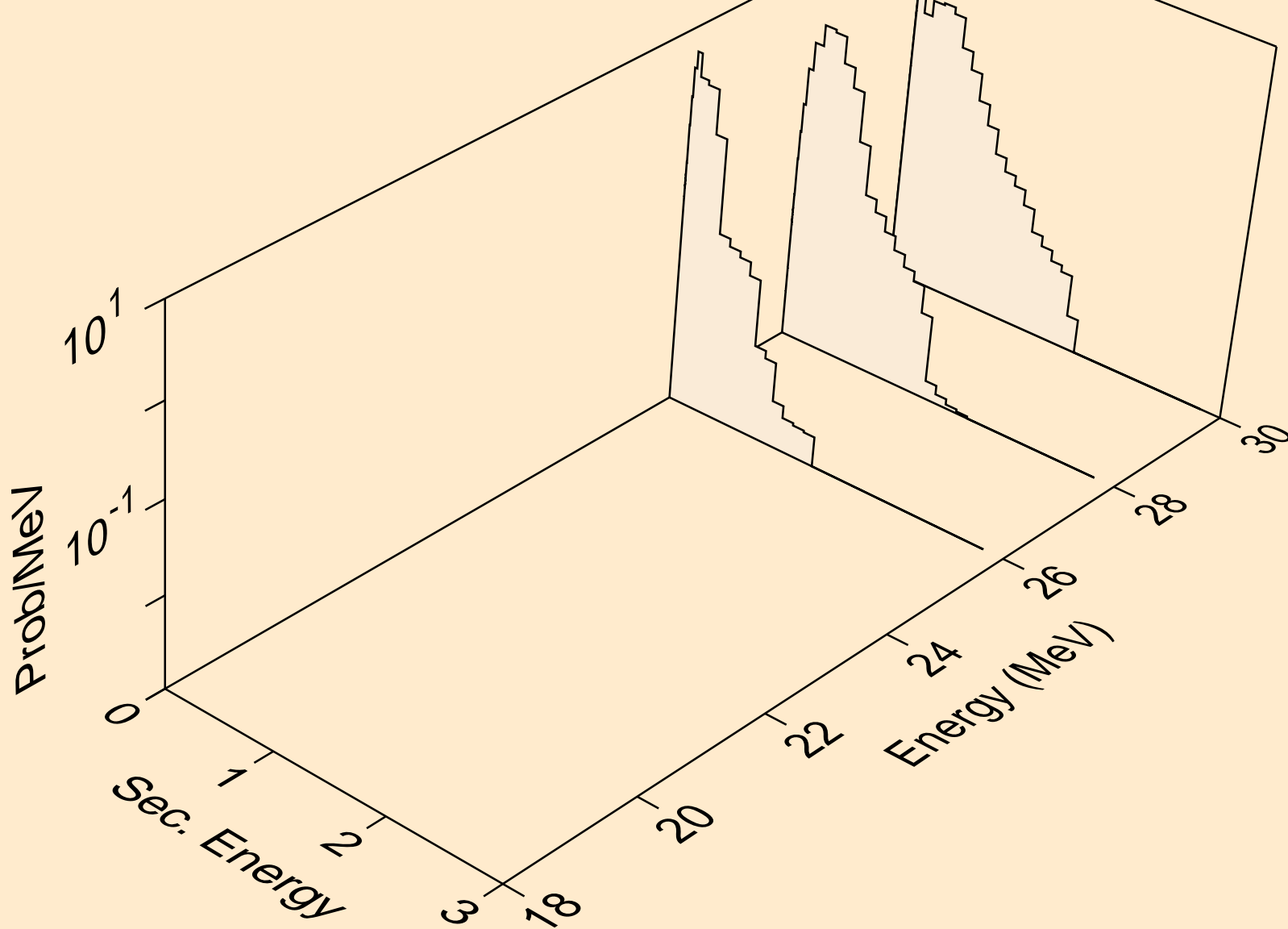

V050 NEUTRON ACER TENDL-2019 LIBRARY; T=293.16K
Neutron emission for (n,n*)d

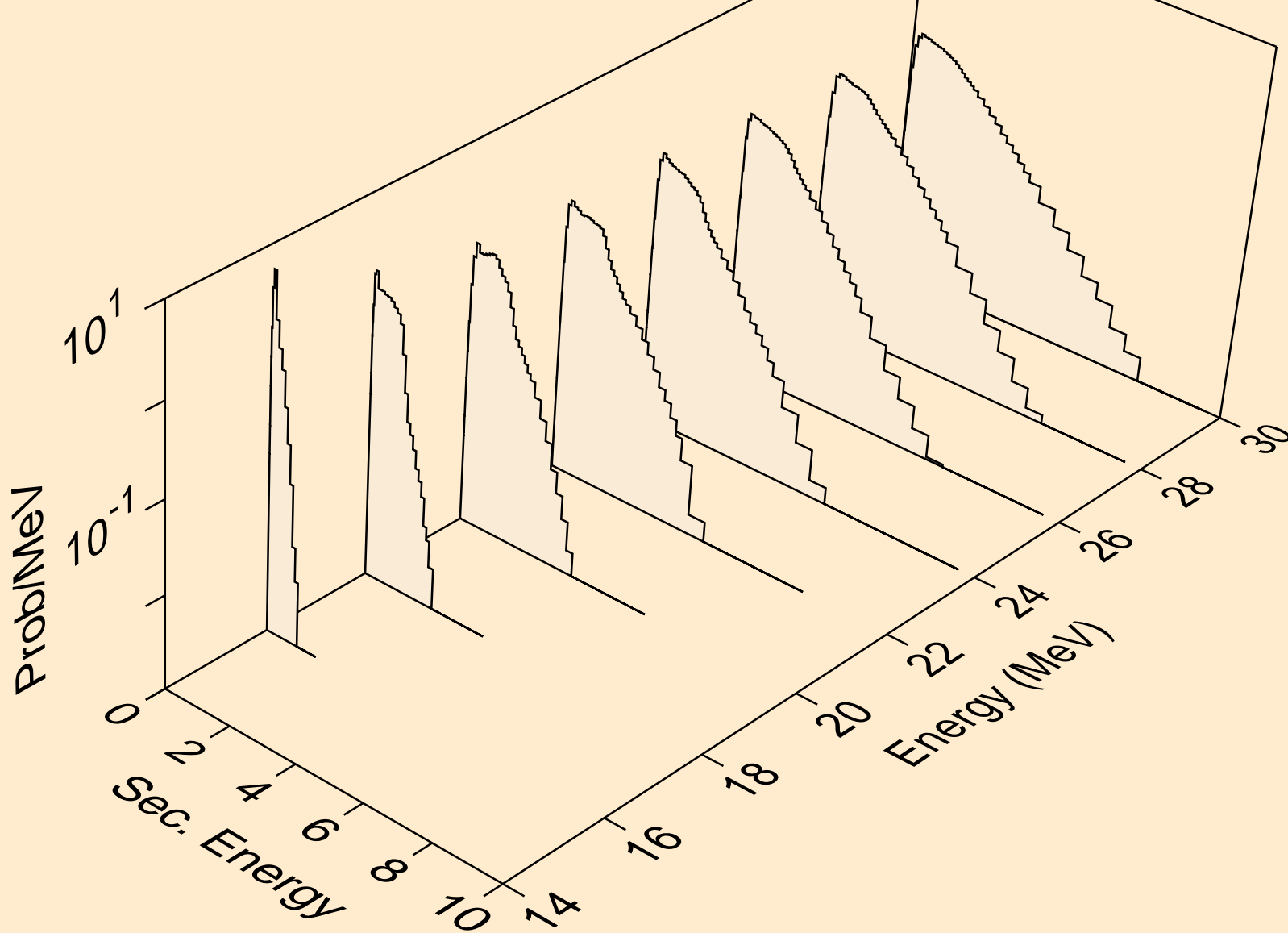

V050 NEUTRON ACER TENDL-2019 LIBRARY; T=293.16K
Neutron emission for (n,n*)t

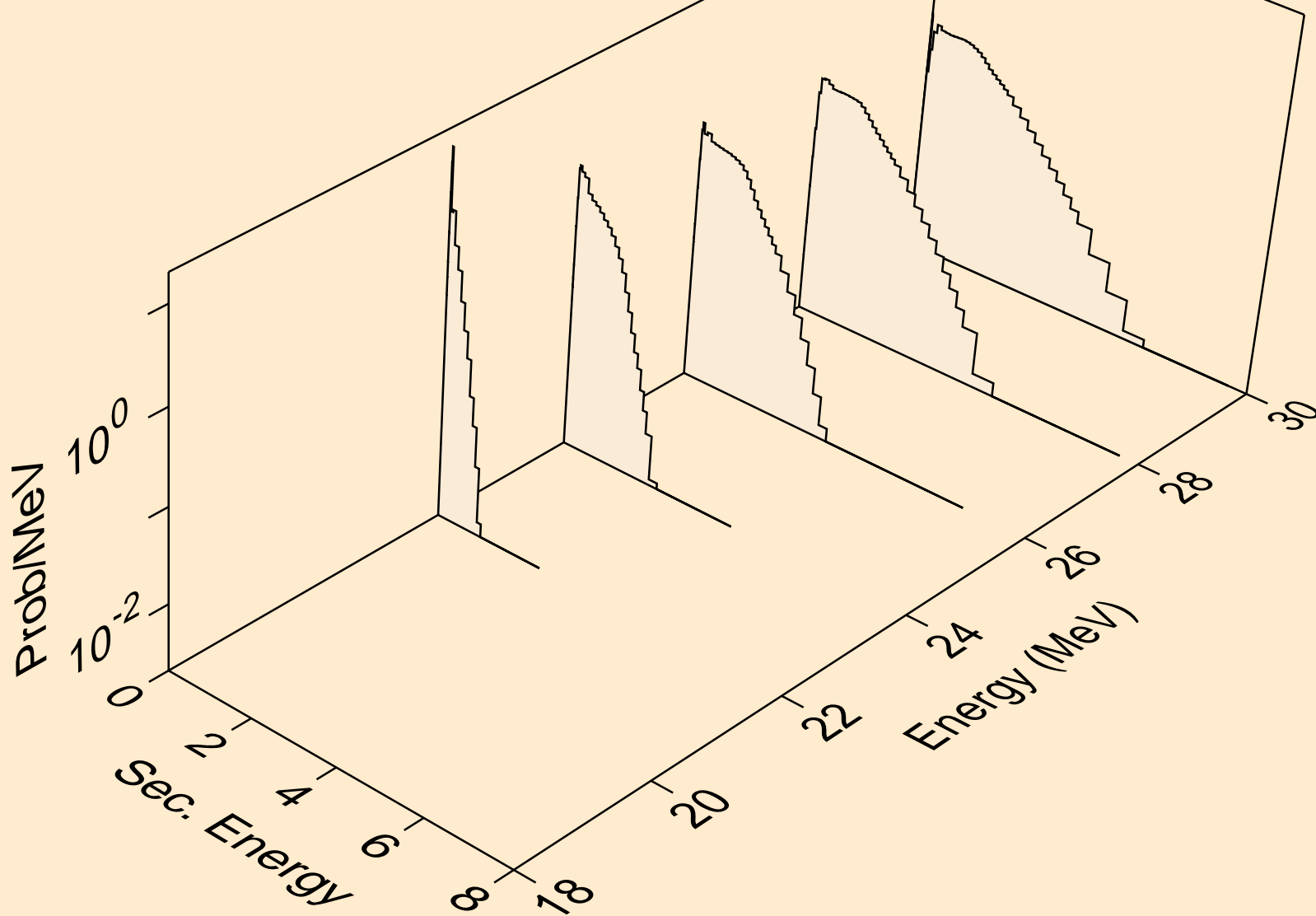

V050 NEUTRON ACER TENDL-2019 LIBRARY; T=293.16K
Neutron emission for (n,n*)he3

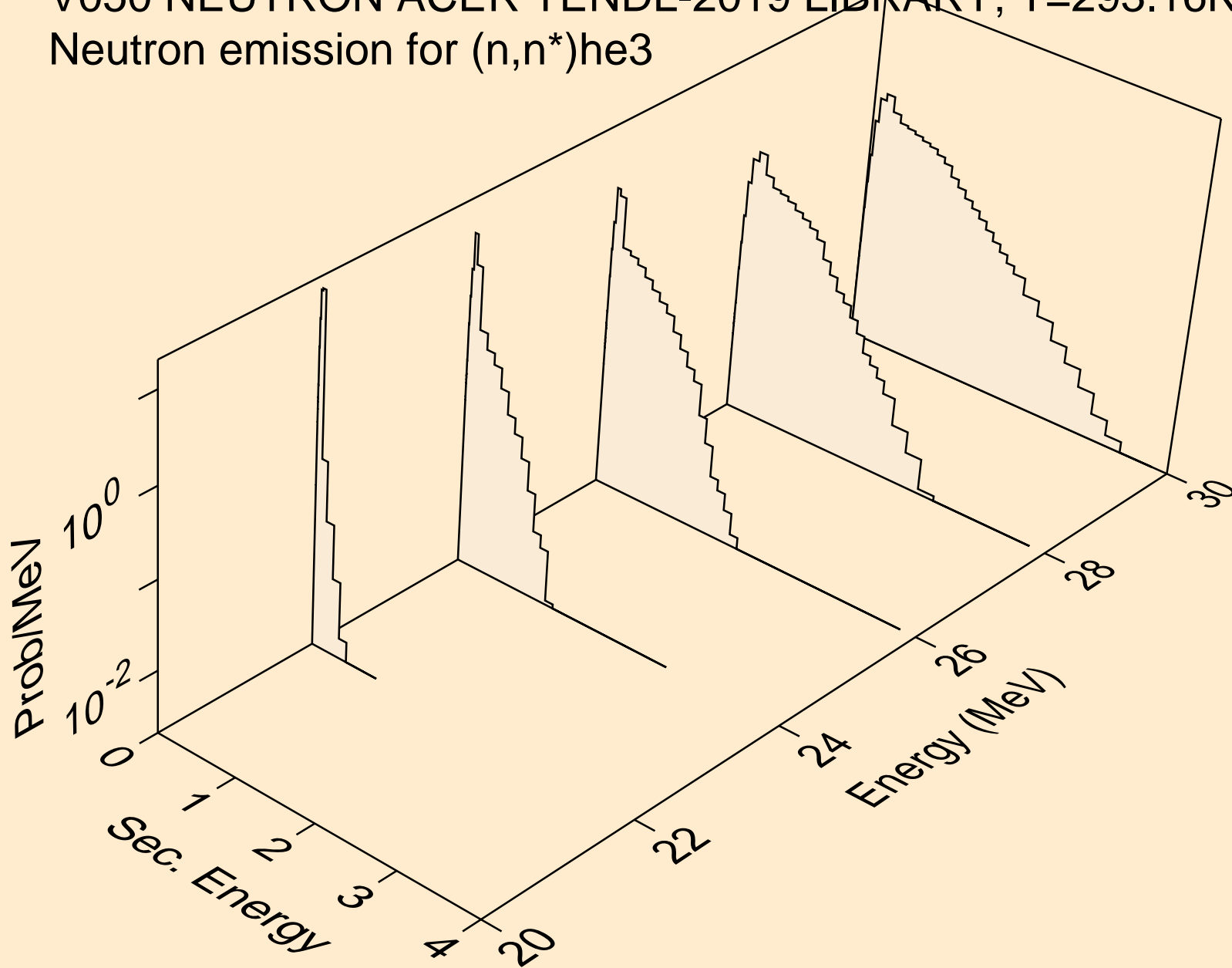

V050 NEUTRON ACER TENDL-2019 LIBRARY; T=293.16K
Neutron emission for (n,2np)

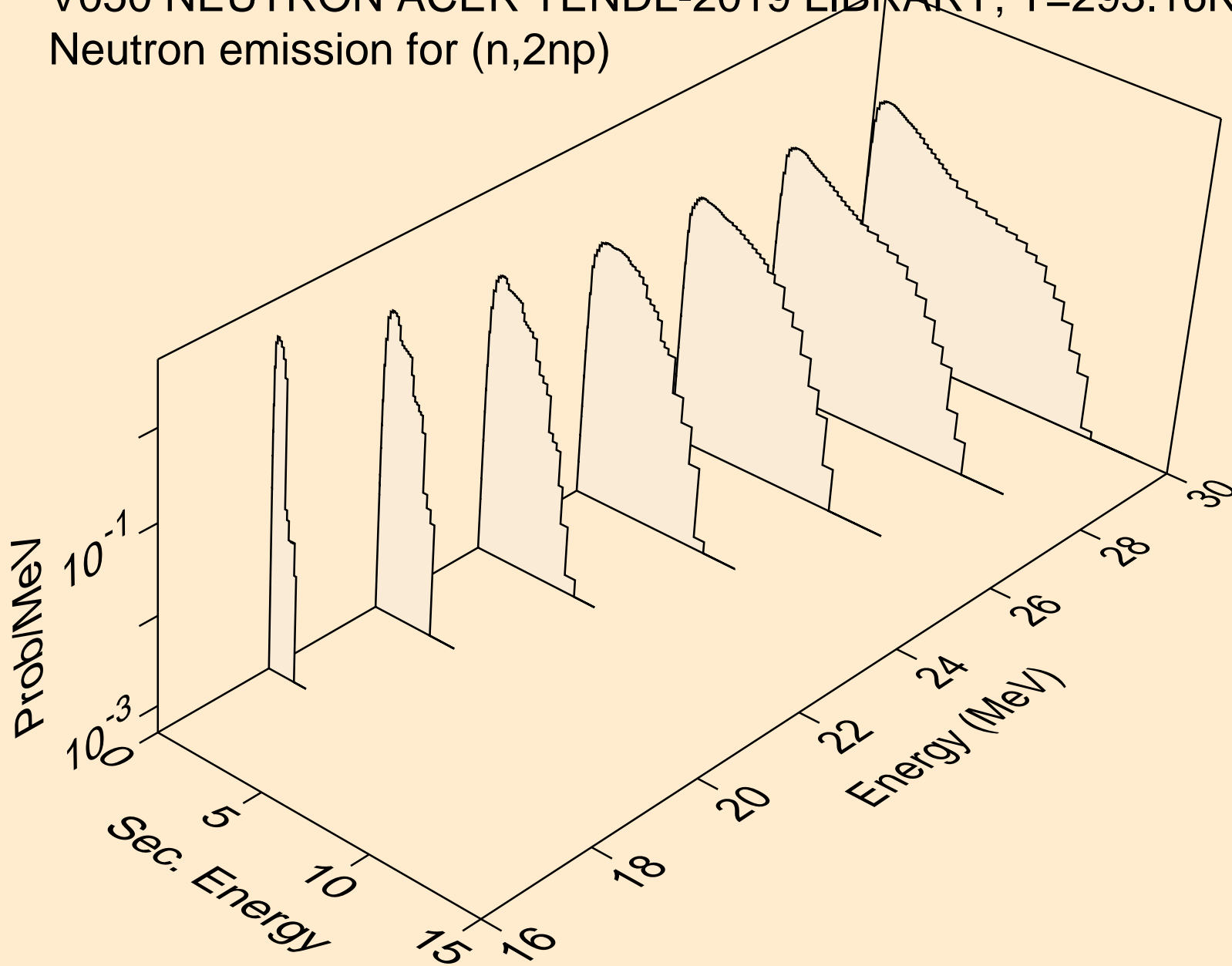

V050 NEUTRON ACER TENDL-2019 LIBRARY; T=293.16K
Neutron emission for (n,3np)

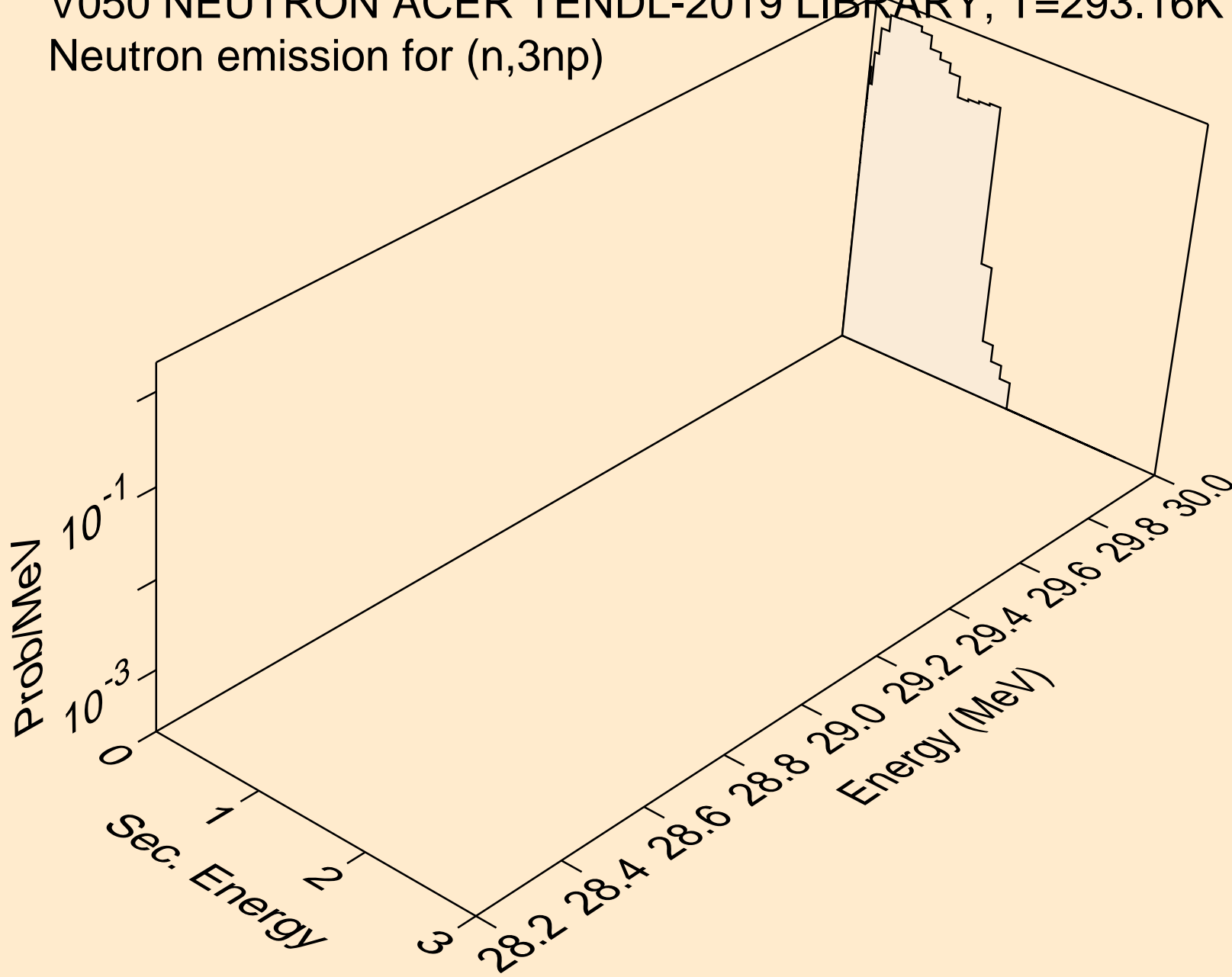

V050 NEUTRON ACER TENDL-2019 LIBRARY; T=293.16K
Neutron emission for (n,2np)

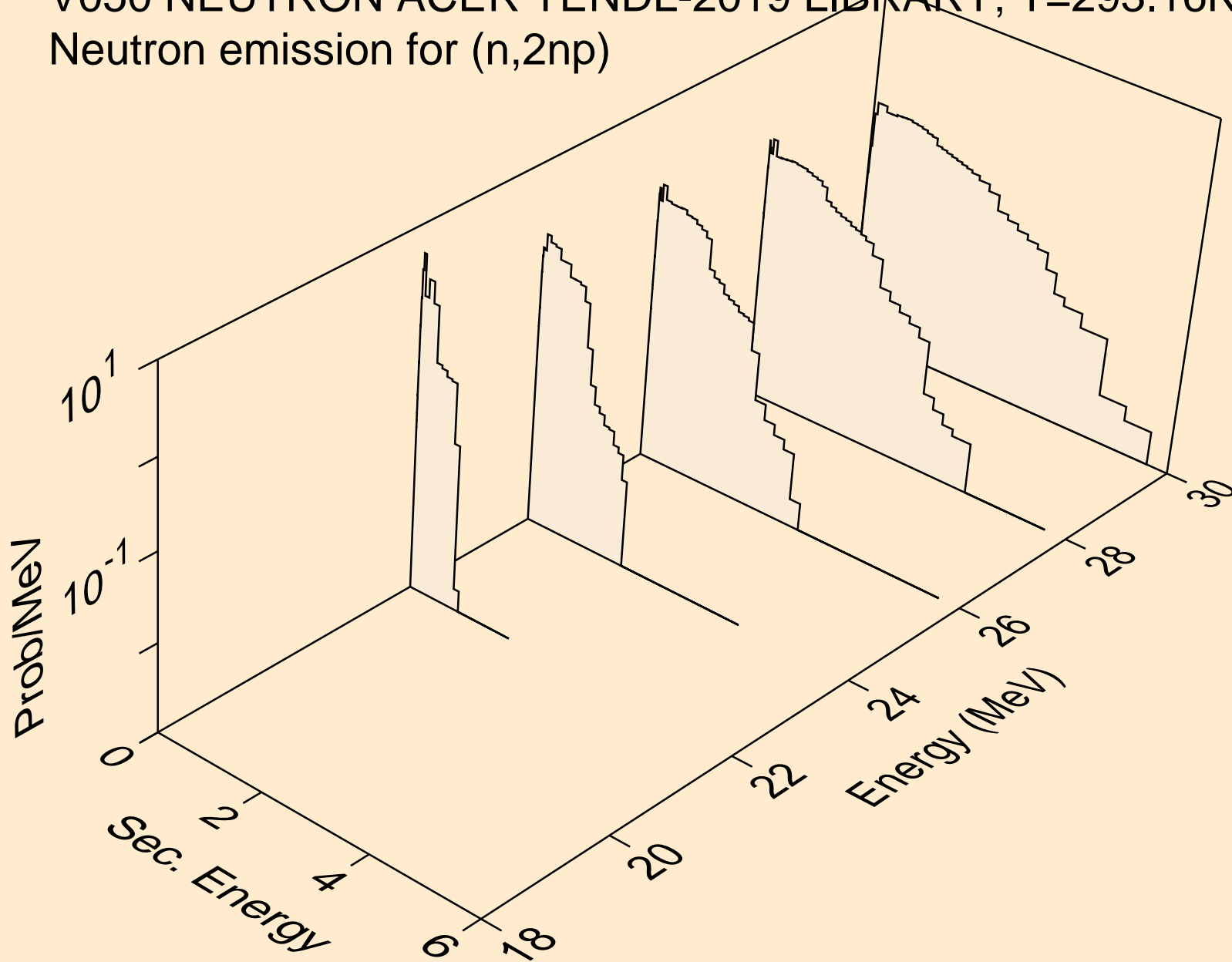

V050 NEUTRON ACER TENDL-2019 LIBRARY; T=293.16K
Neutron emission for (n,npa)

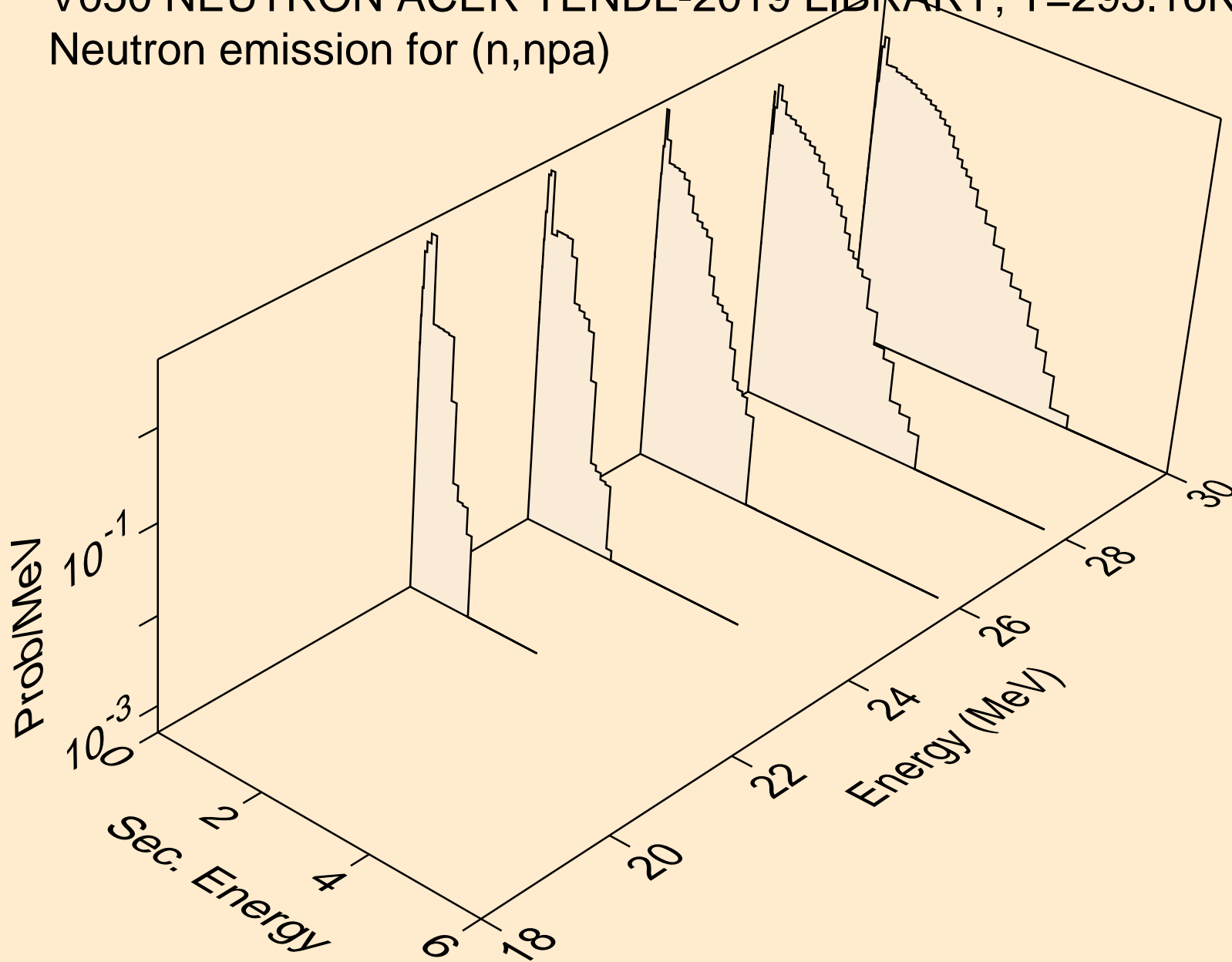

V050 NEUTRON ACER TENDL-2019 LIBRARY; T=293.16K
Neutron emission for (n,n*c)

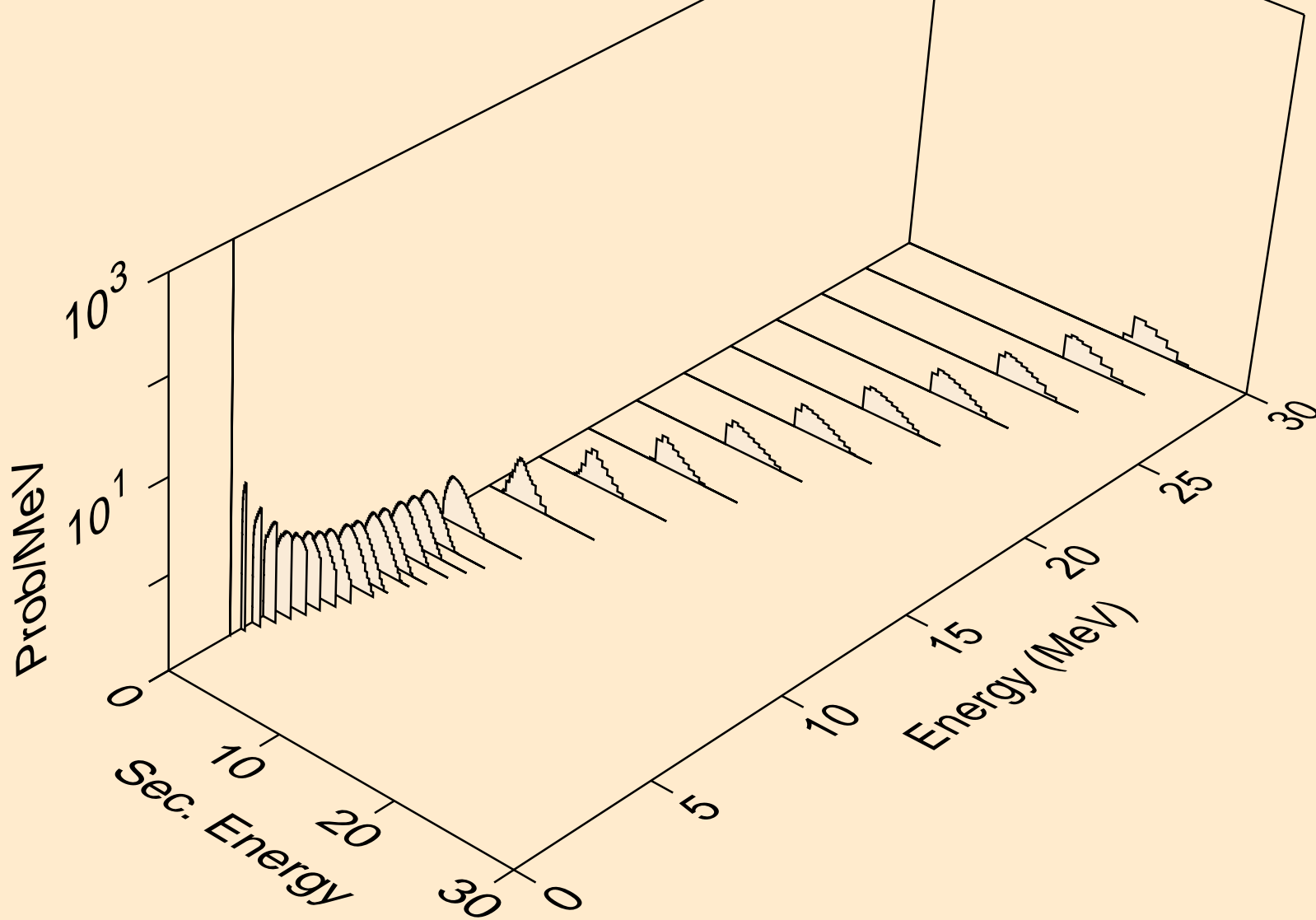

V050 NEUTRON ACER TENDL-2019 LIBRARY; T=293.16K
Photon emission for (n,x)

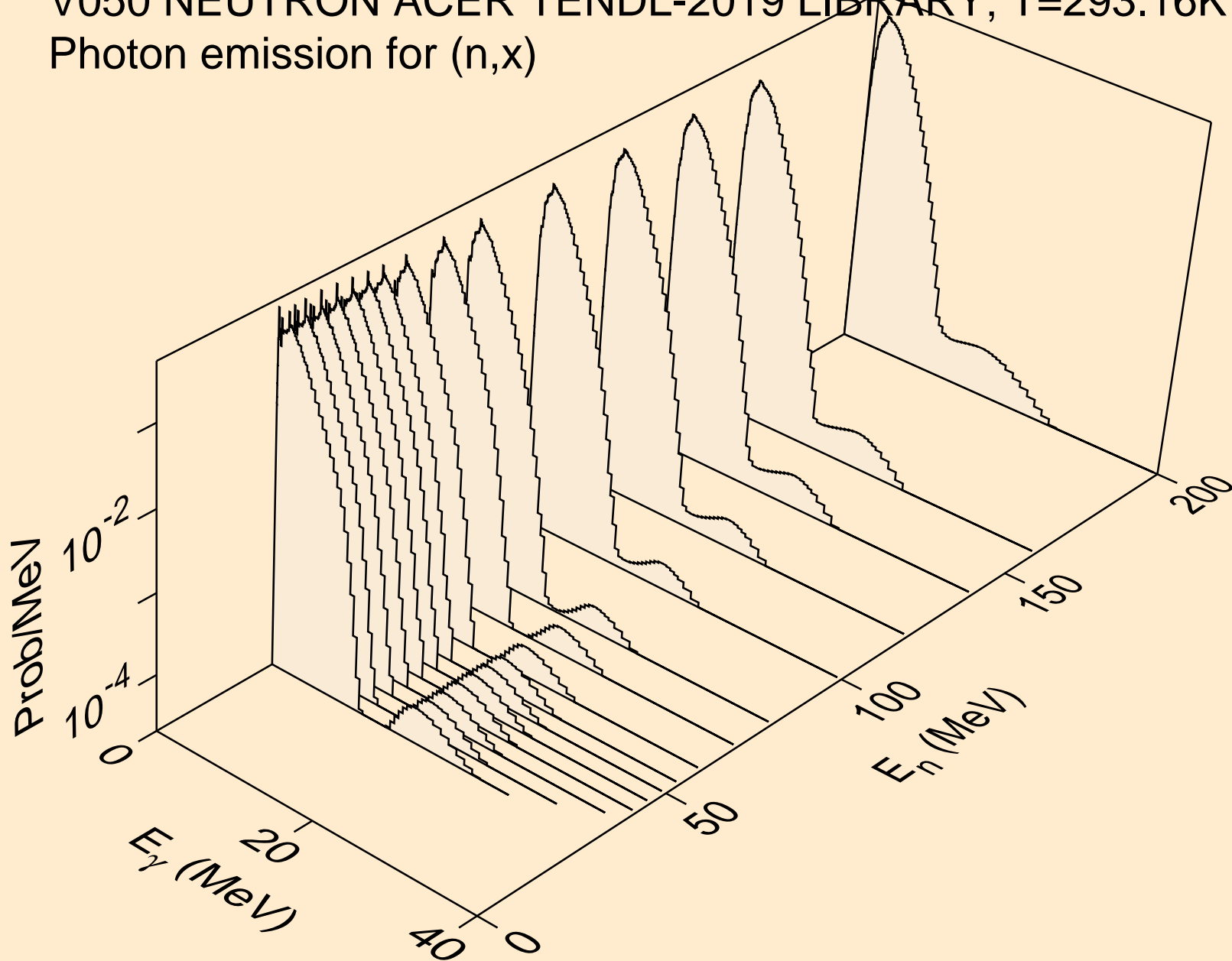

V050 NEUTRON ACER TENDL-2019 LIBRARY; T=293.16K
Photon emission for (n,2nd)

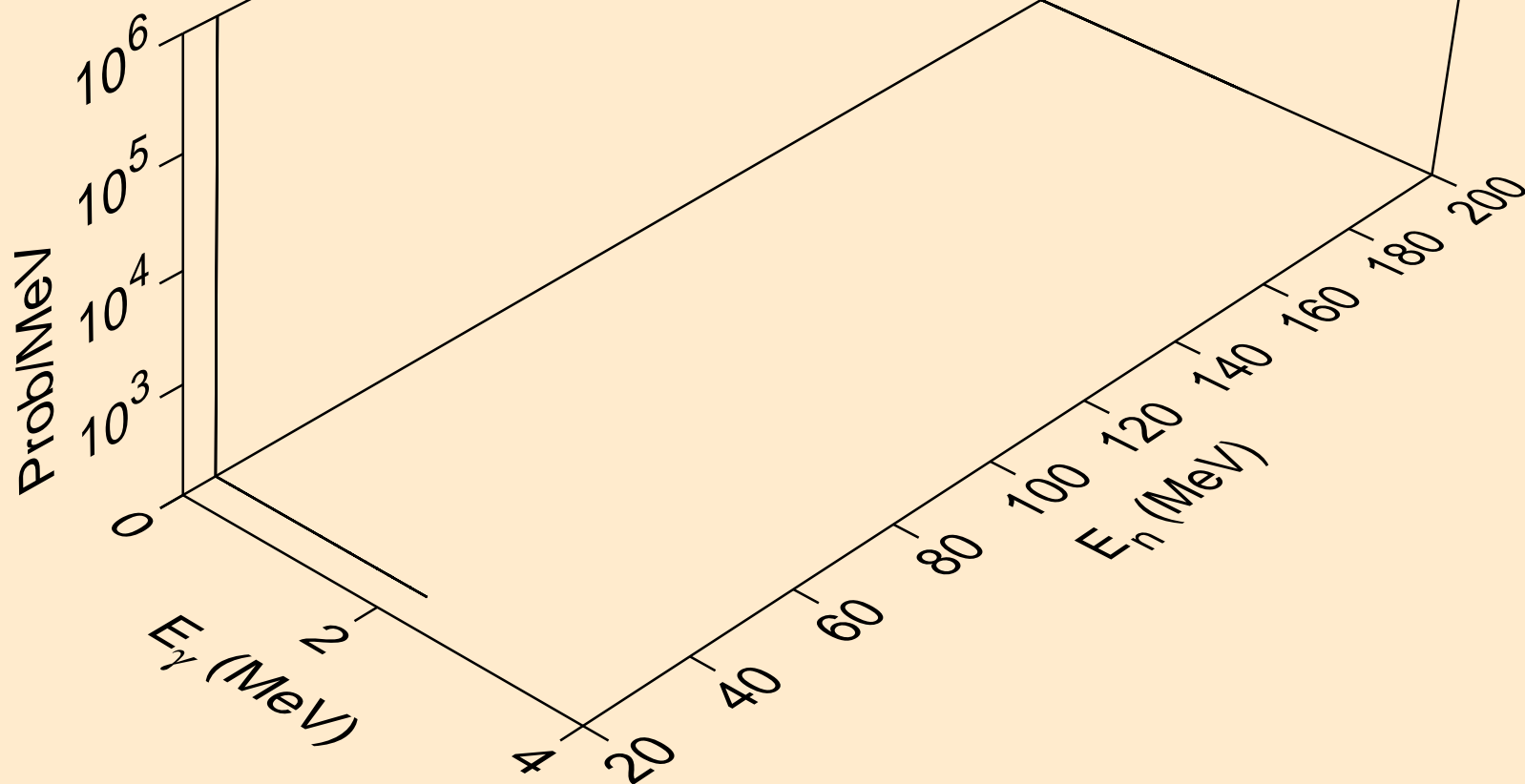

V050 NEUTRON ACER TENDL-2019 LIBRARY; T=293.16K
Photon emission for (n,2n)

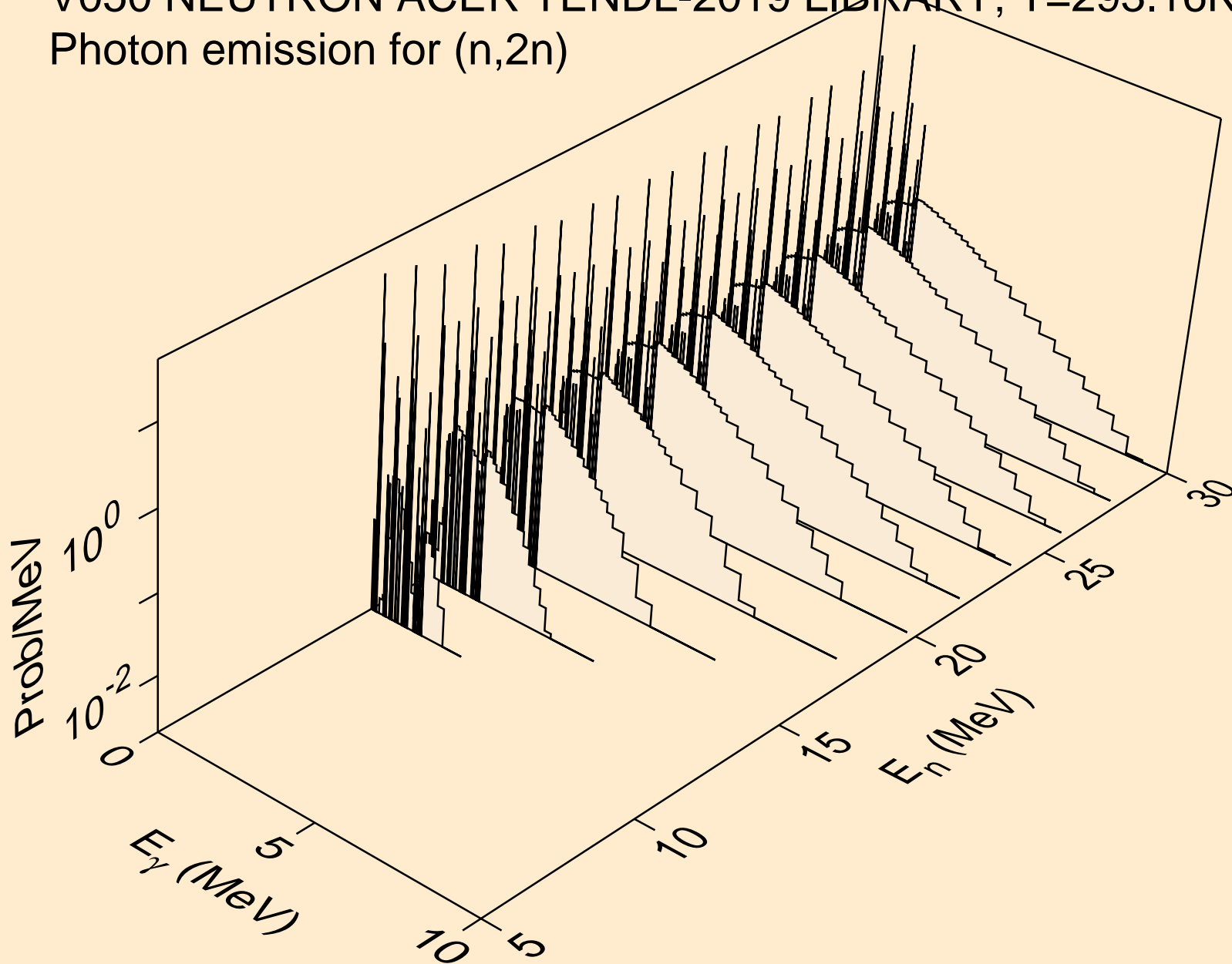

V050 NEUTRON ACER TENDL-2019 LIBRARY; T=293.16K
Photon emission for (n,3n)

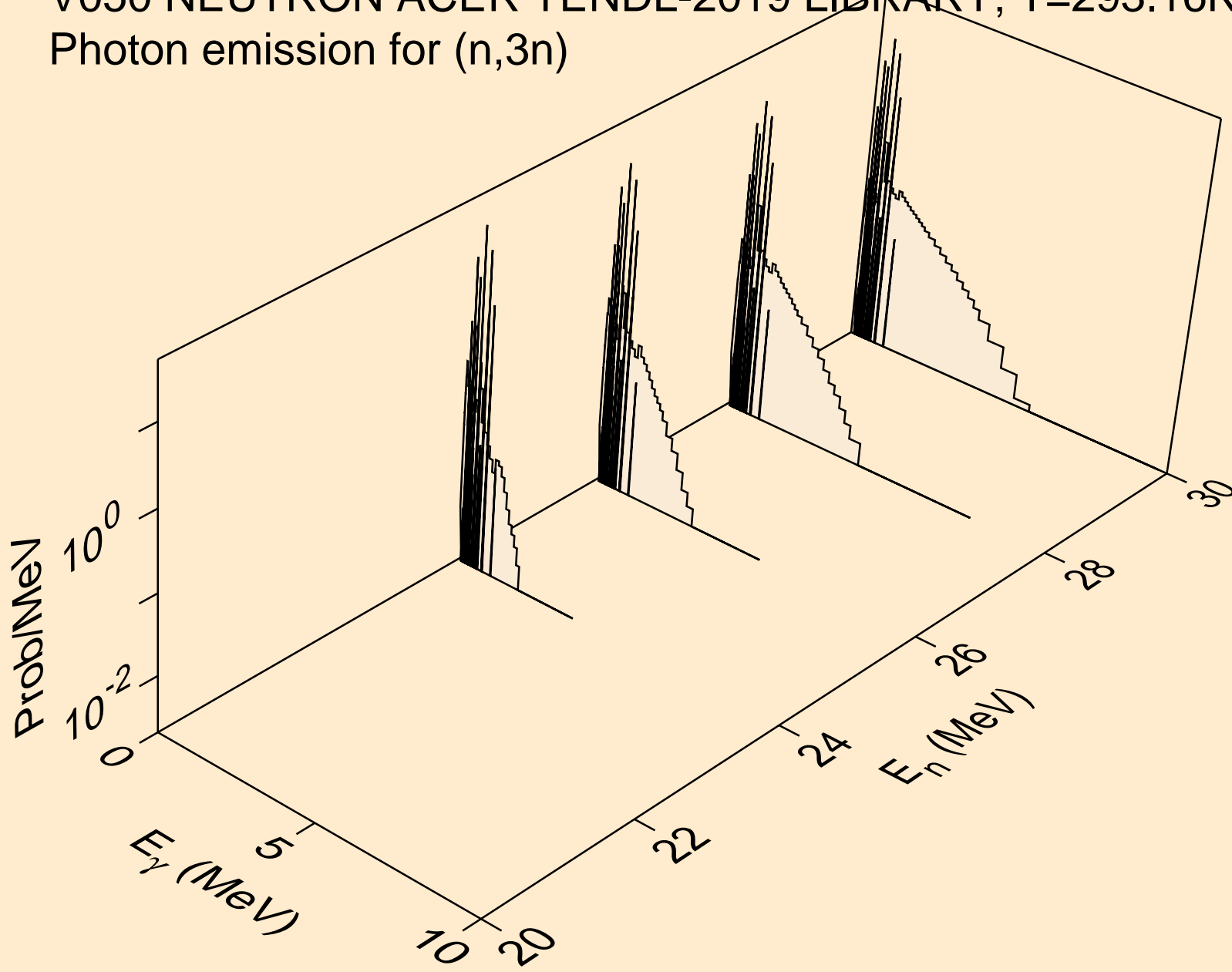

V050 NEUTRON ACER TENDL-2019 LIBRARY; T=293.16K
Photon emission for (n,n*)a

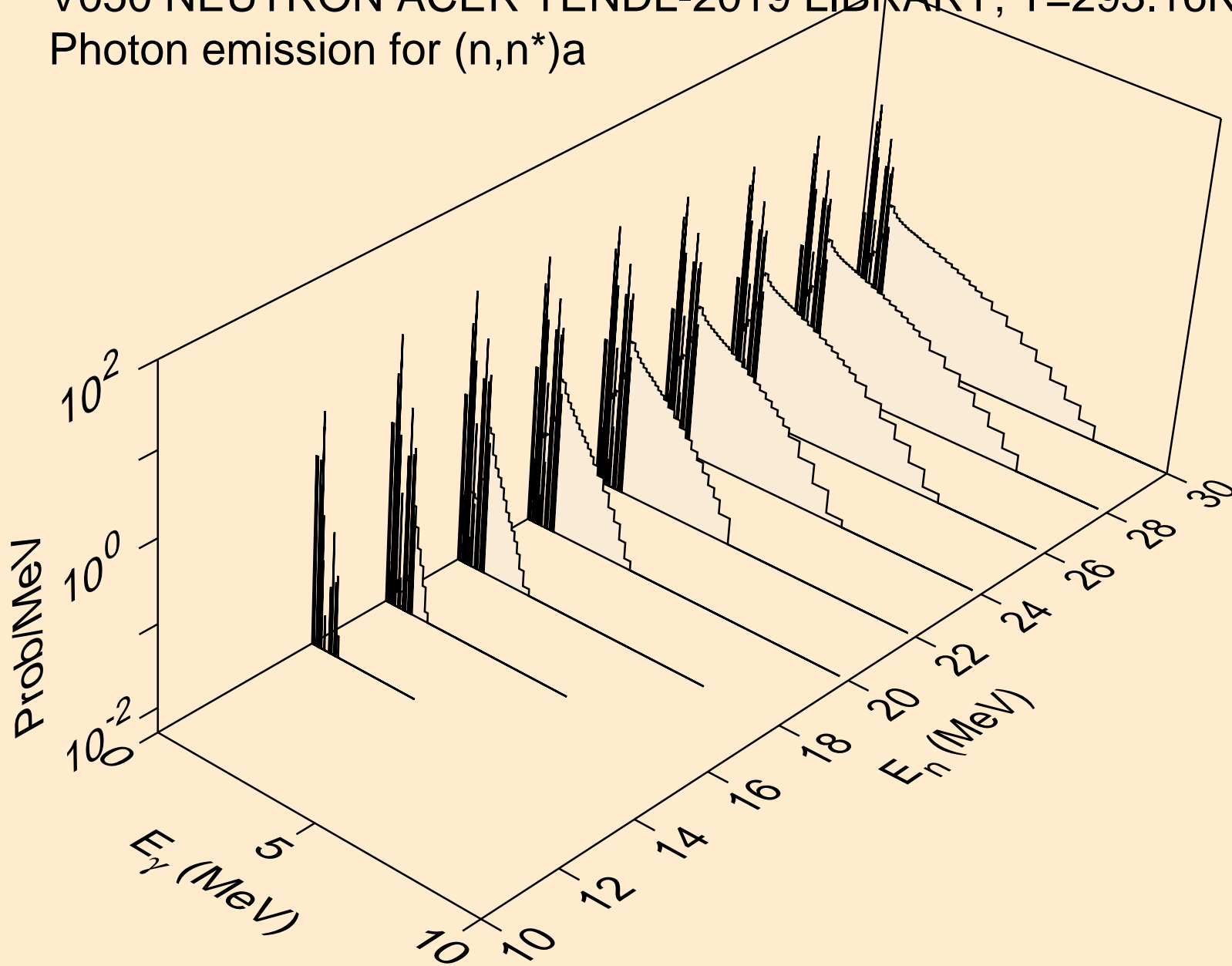

V050 NEUTRON ACER TENDL-2019 LIBRARY; T=293.16K
Photon emission for (n,2n)a

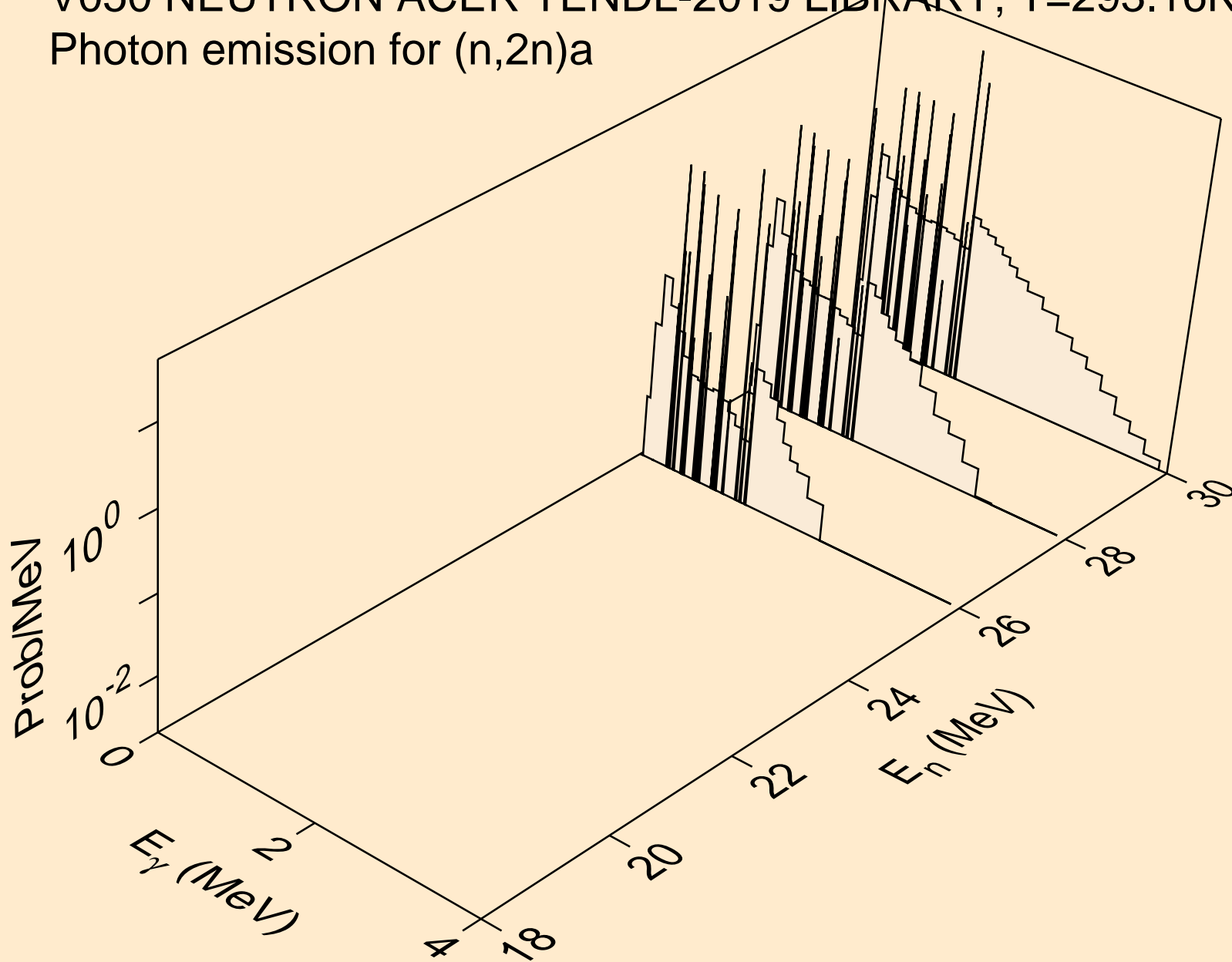

V050 NEUTRON ACER TENDL-2019 LIBRARY; T=293.16K
Photon emission for (n,n*)p

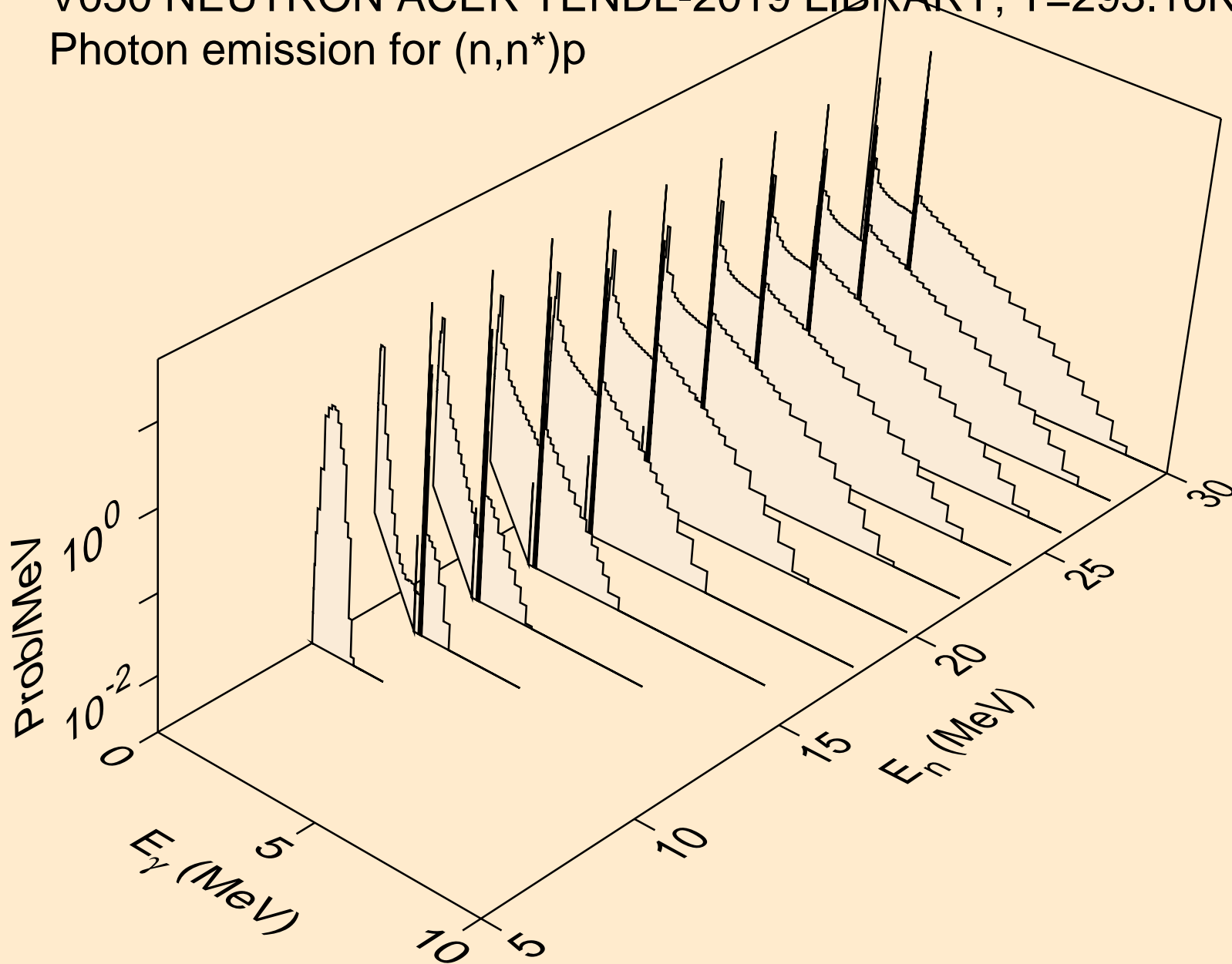

V050 NEUTRON ACER TENDL-2019 LIBRARY; T=293.16K
Photon emission for (n,n*)2a

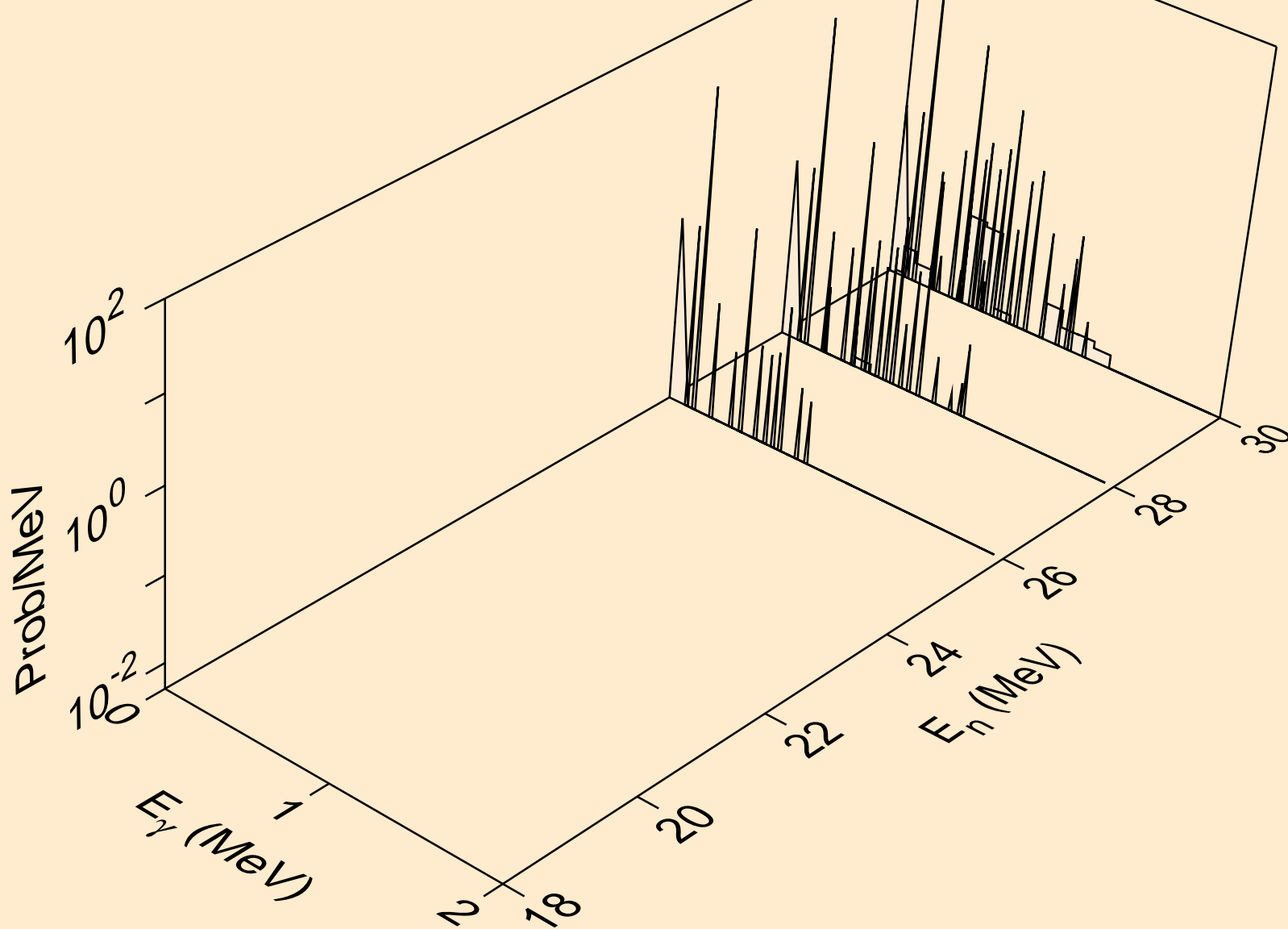

V050 NEUTRON ACER TENDL-2019 LIBRARY; T=293.16K
Photon emission for (n,n*)d

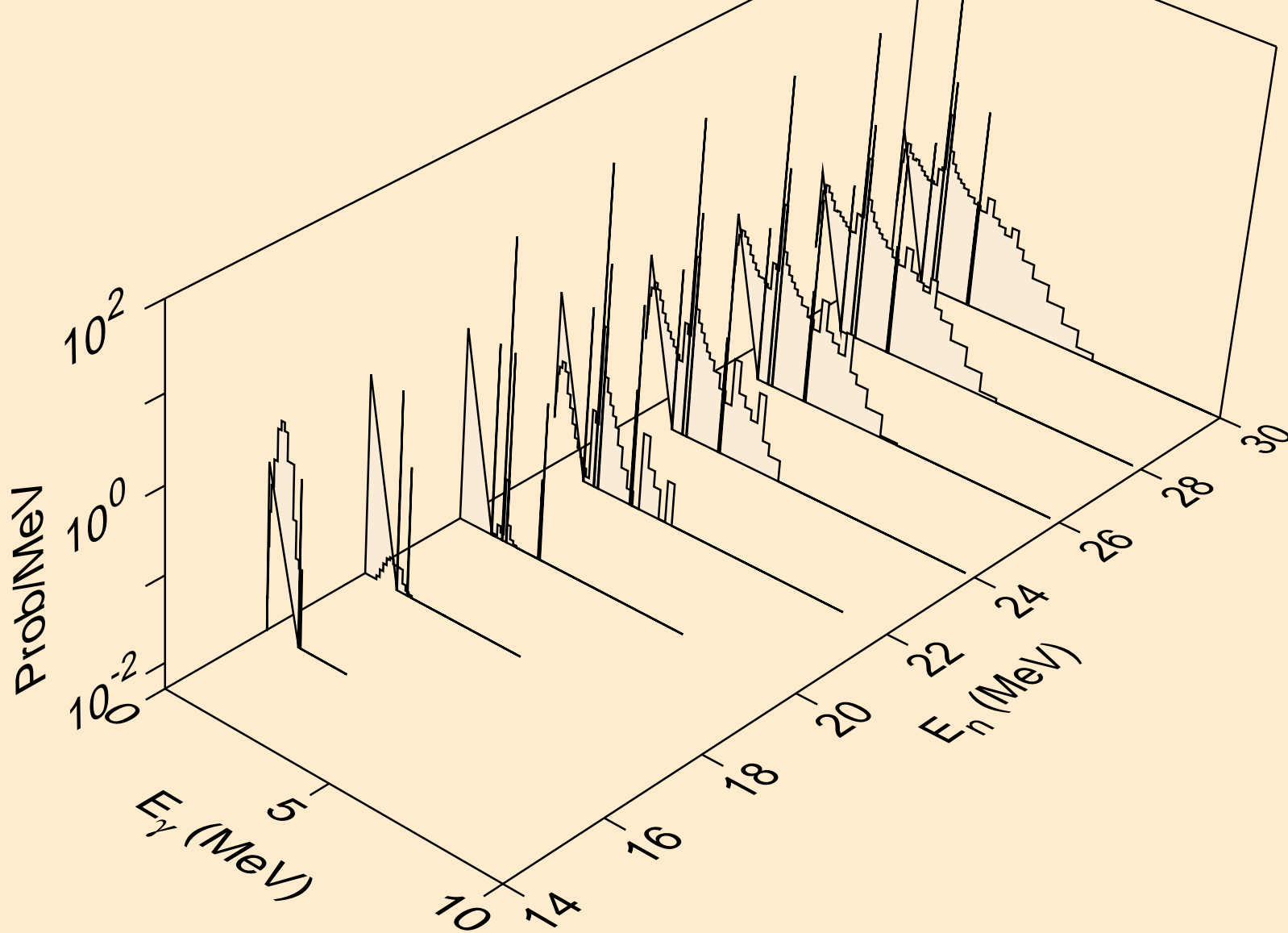

V050 NEUTRON ACER TENDL-2019 LIBRARY; T=293.16K
Photon emission for (n,n*)t

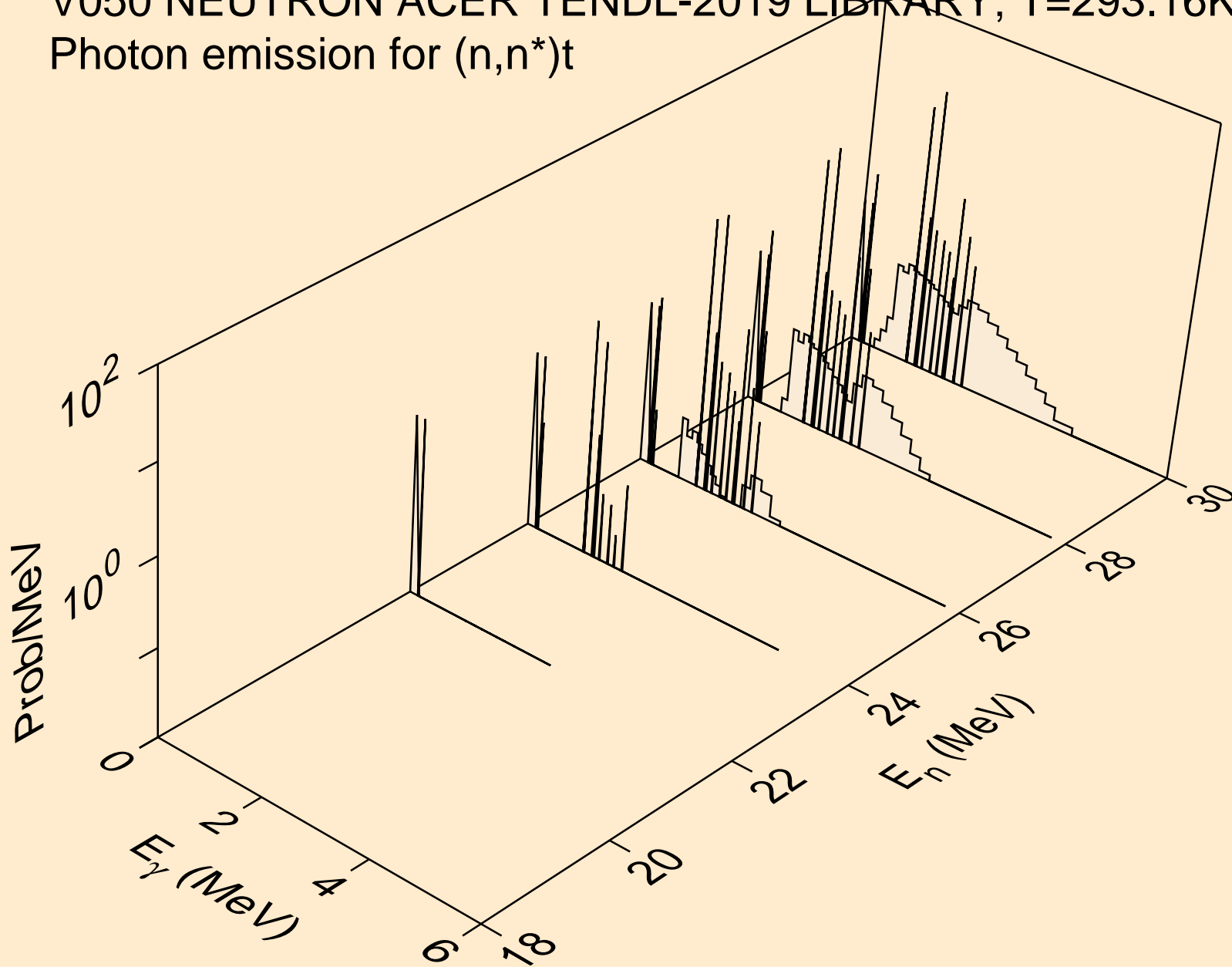

V050 NEUTRON ACER TENDL-2019 LIBRARY; T=293.16K
Photon emission for (n,n*)he3

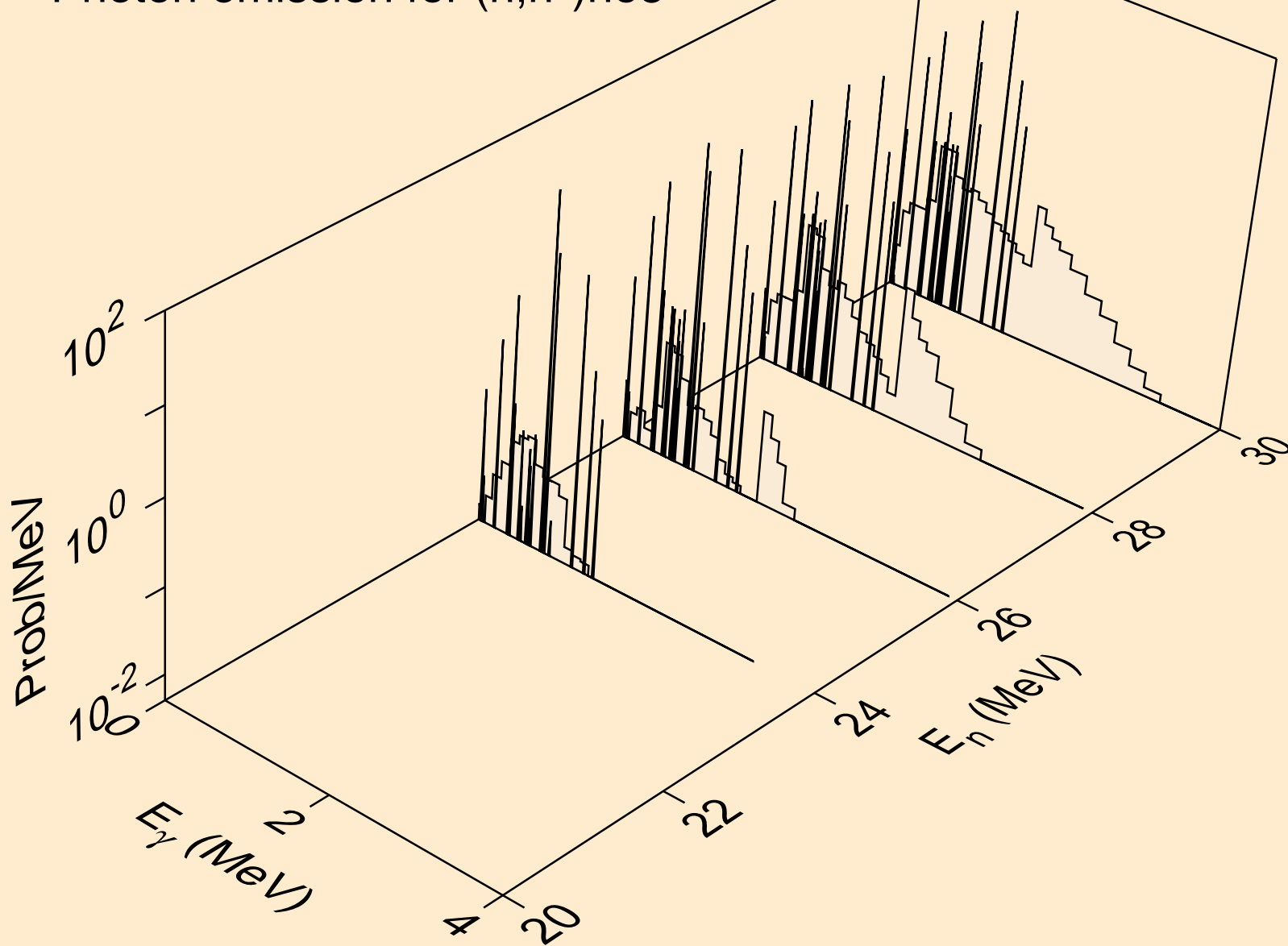

V050 NEUTRON ACER TENDL-2019 LIBRARY; T=293.16K
Photon emission for (n,2np)

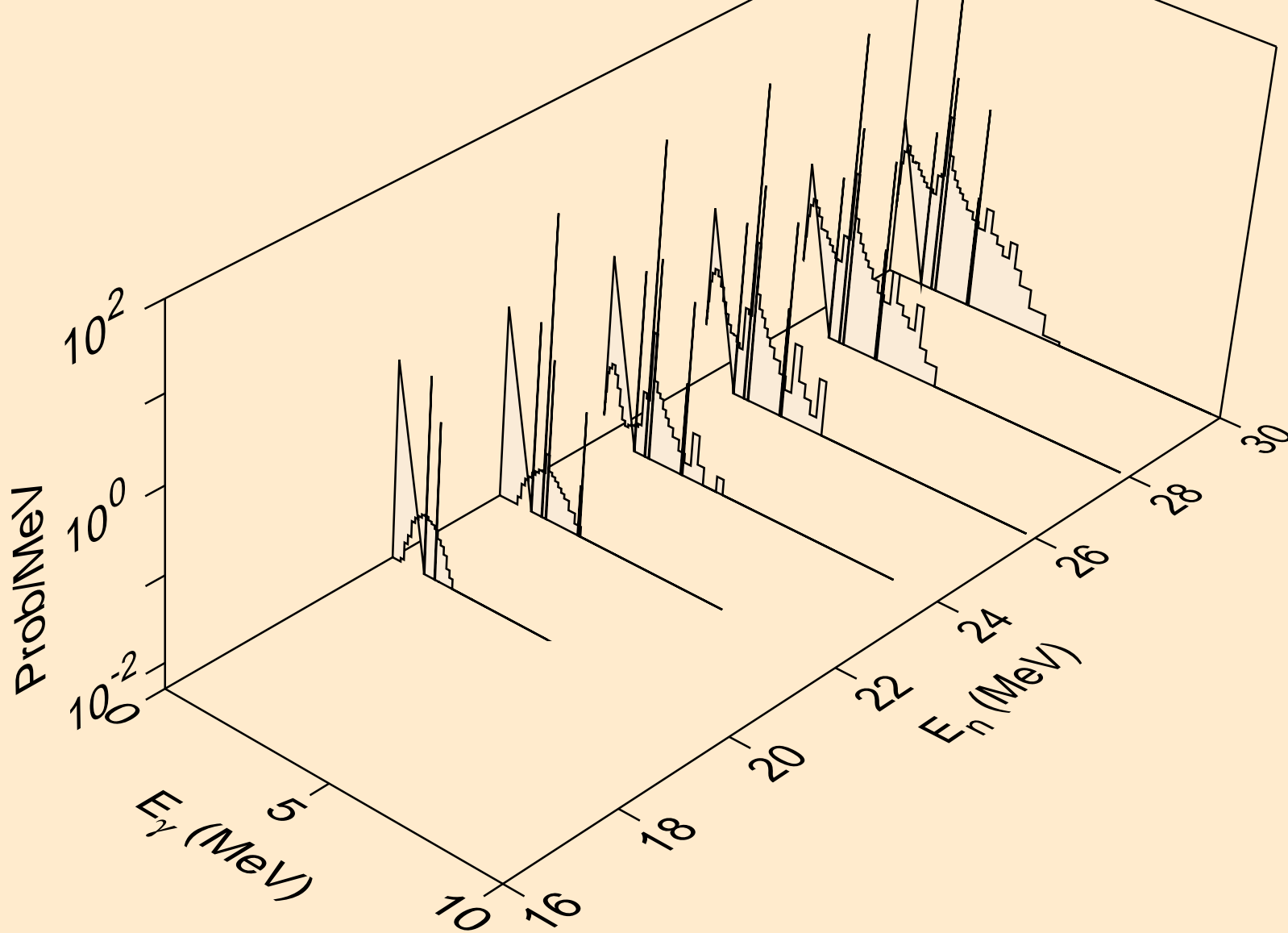

V050 NEUTRON ACER TENDL-2019 LIBRARY; T=293.16K
Photon emission for (n,3np)

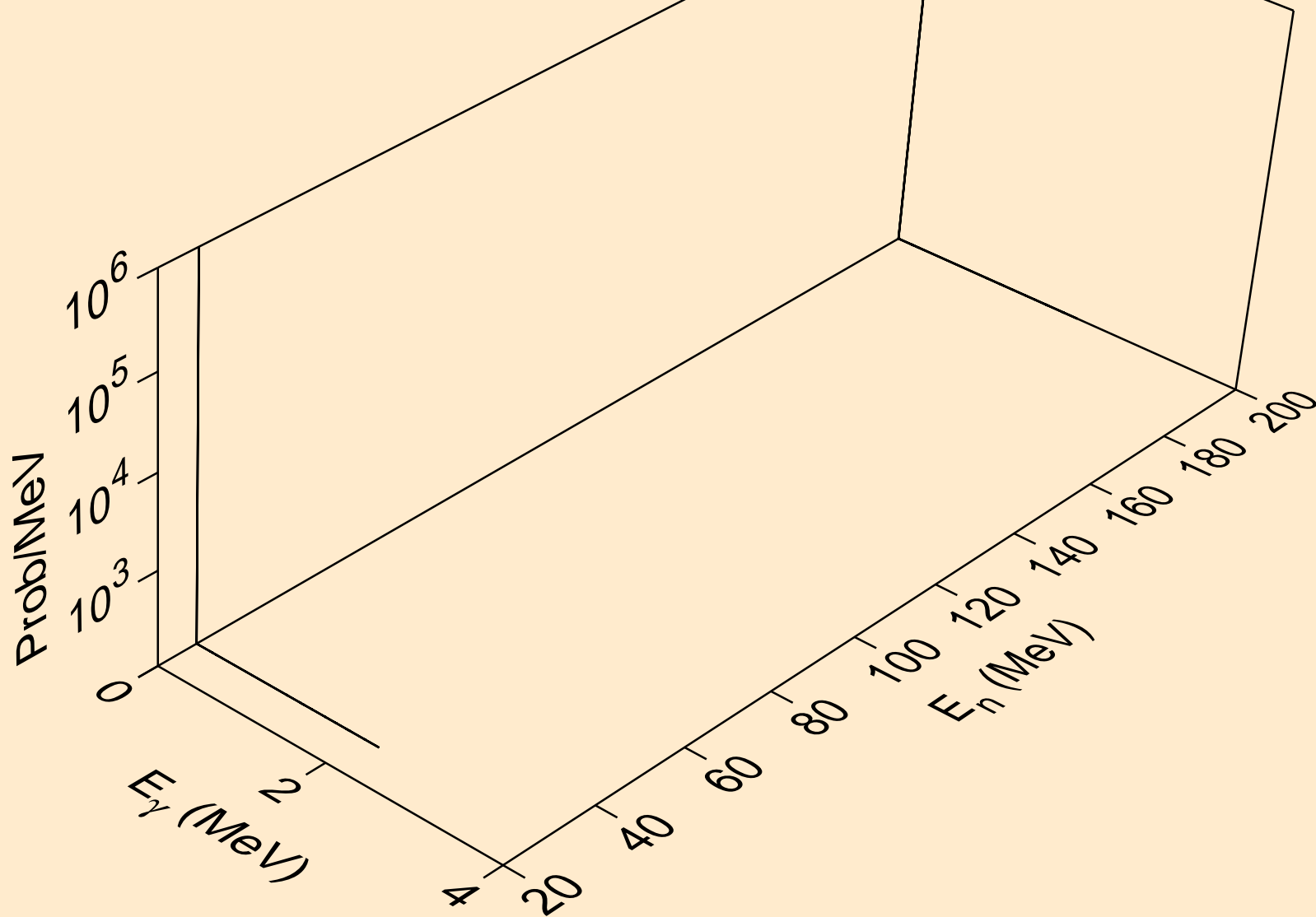

V050 NEUTRON ACER TENDL-2019 LIBRARY; T=293.16K
Photon emission for (n,2np)

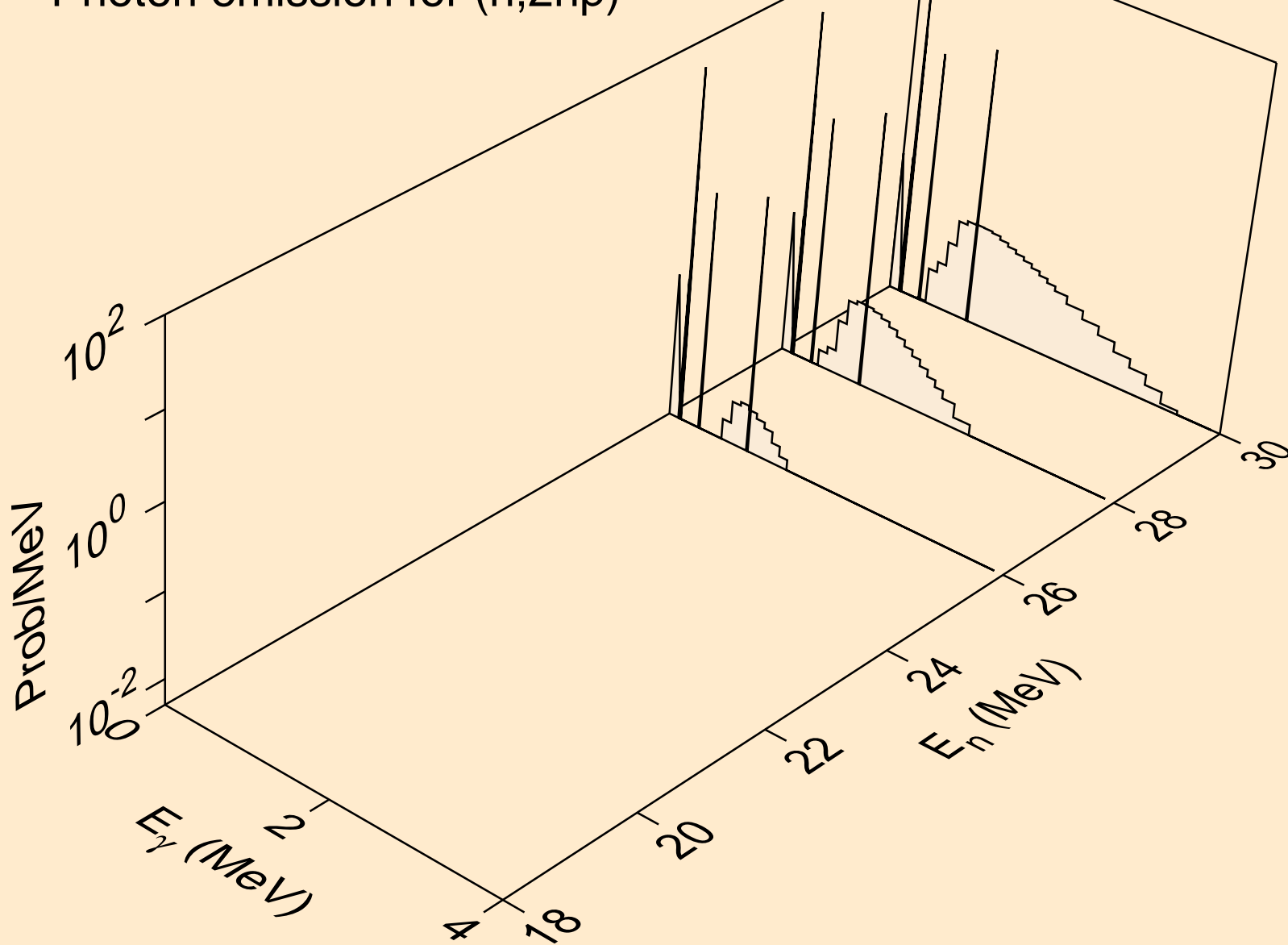

V050 NEUTRON ACER TENDL-2019 LIBRARY; T=293.16K
Photon emission for (n,npa)

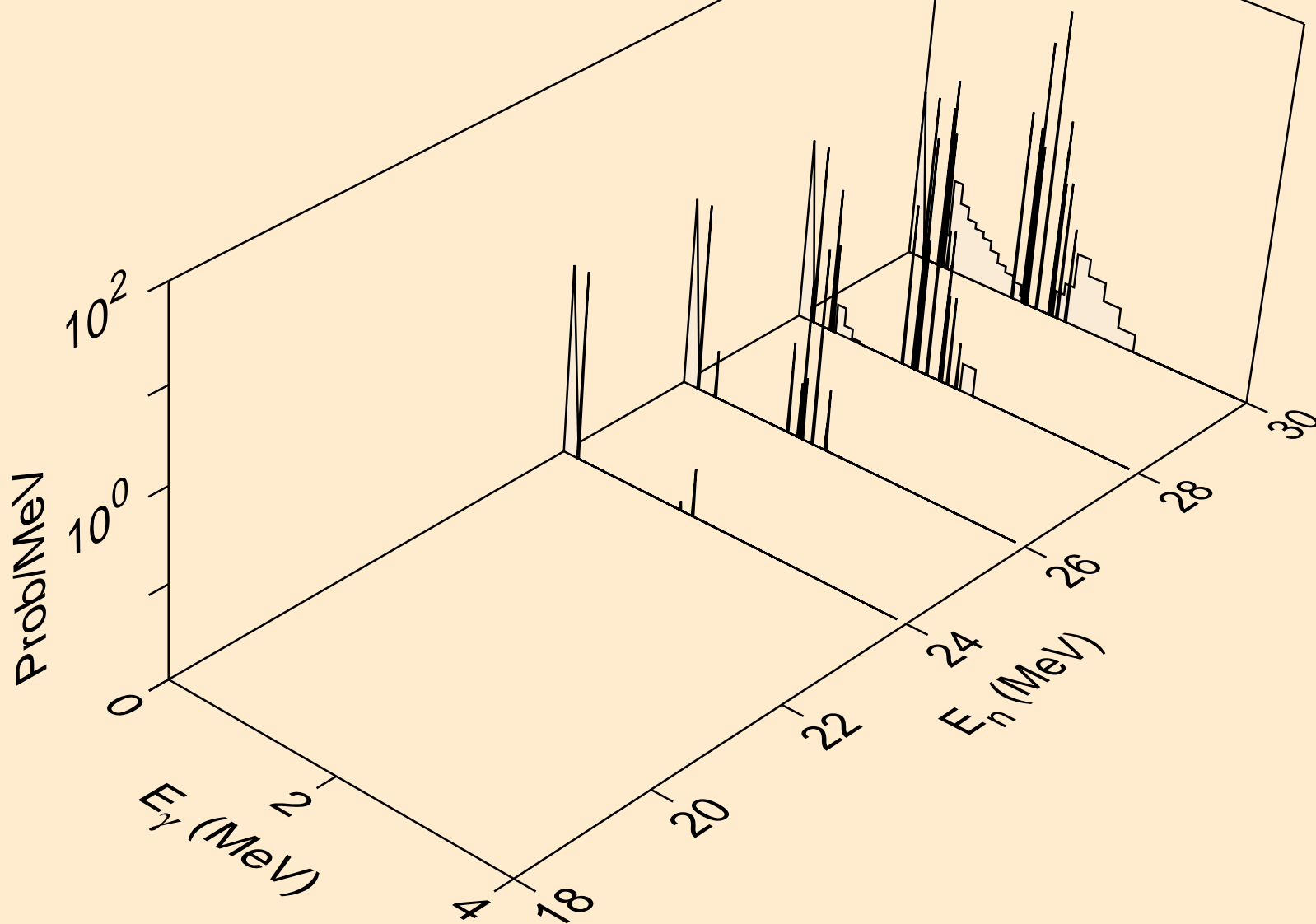

V050 NEUTRON ACER TENDL-2019 LIBRARY; T=293.16K
Photon emission for (n,n*c)

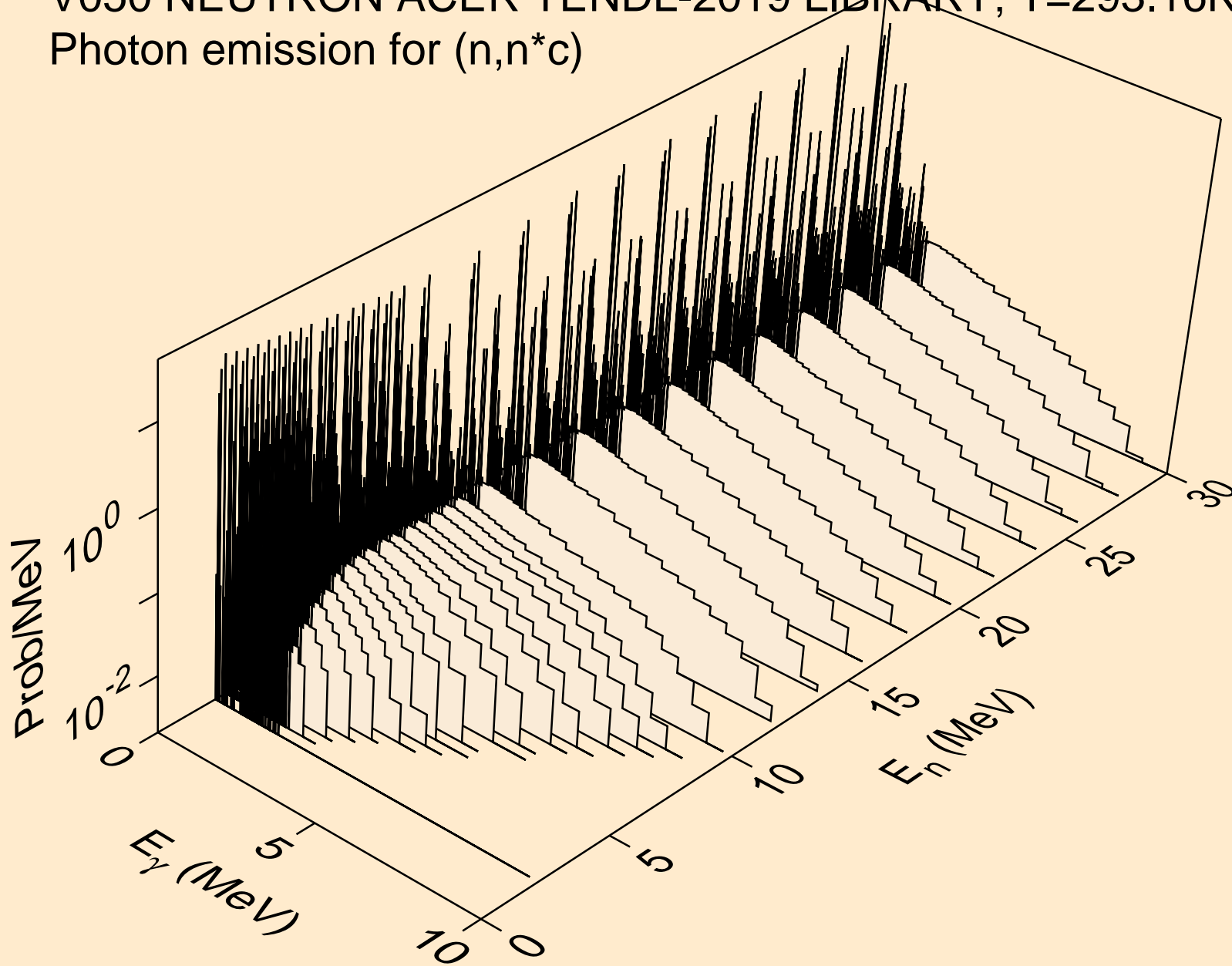

V050 NEUTRON ACER TENDL-2019 LIBRARY; T=293.16K
Photon emission for (n,gma)

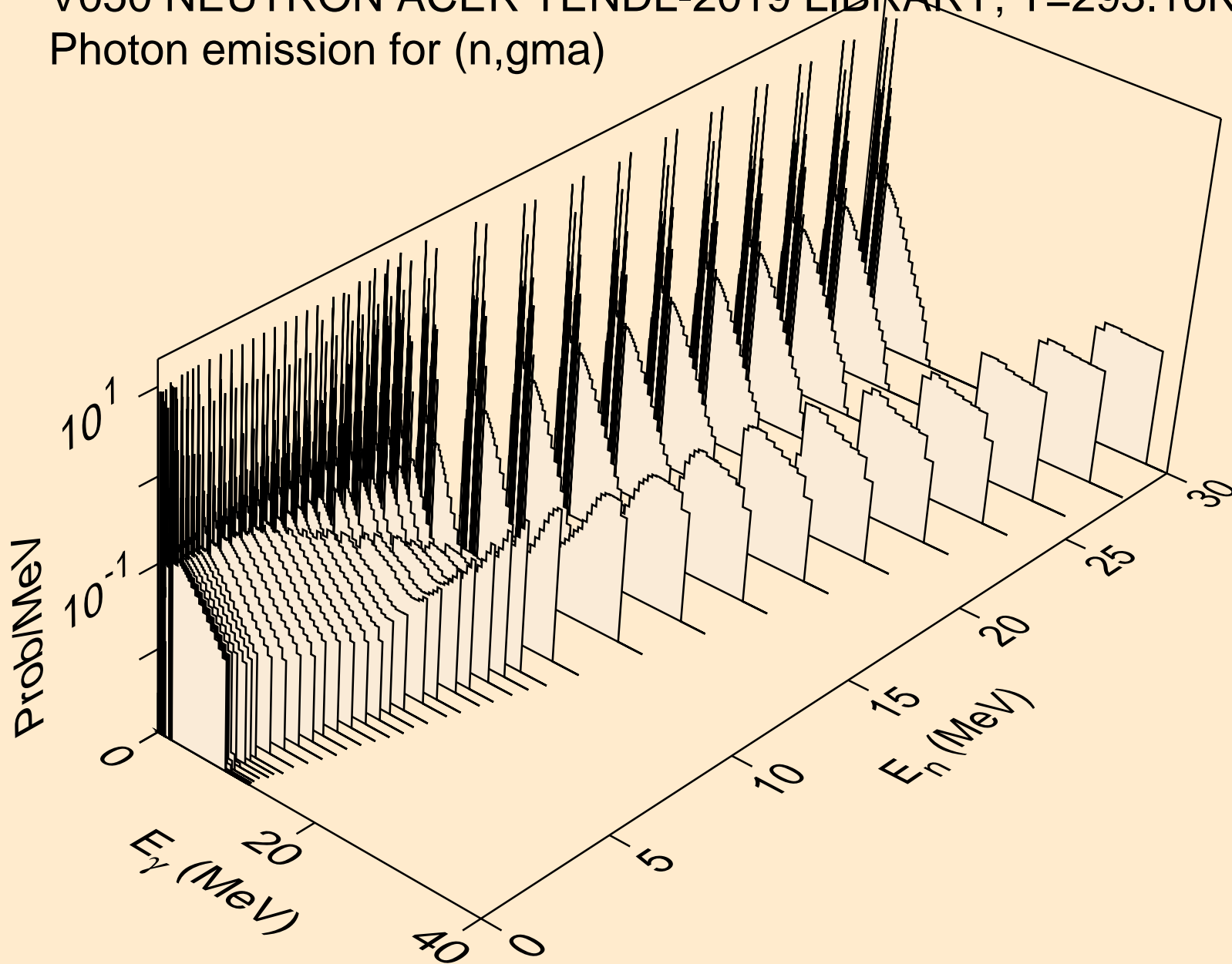

V050 NEUTRON ACER TENDL-2019 LIBRARY; T=293.16K
Photon emission for (n,p)

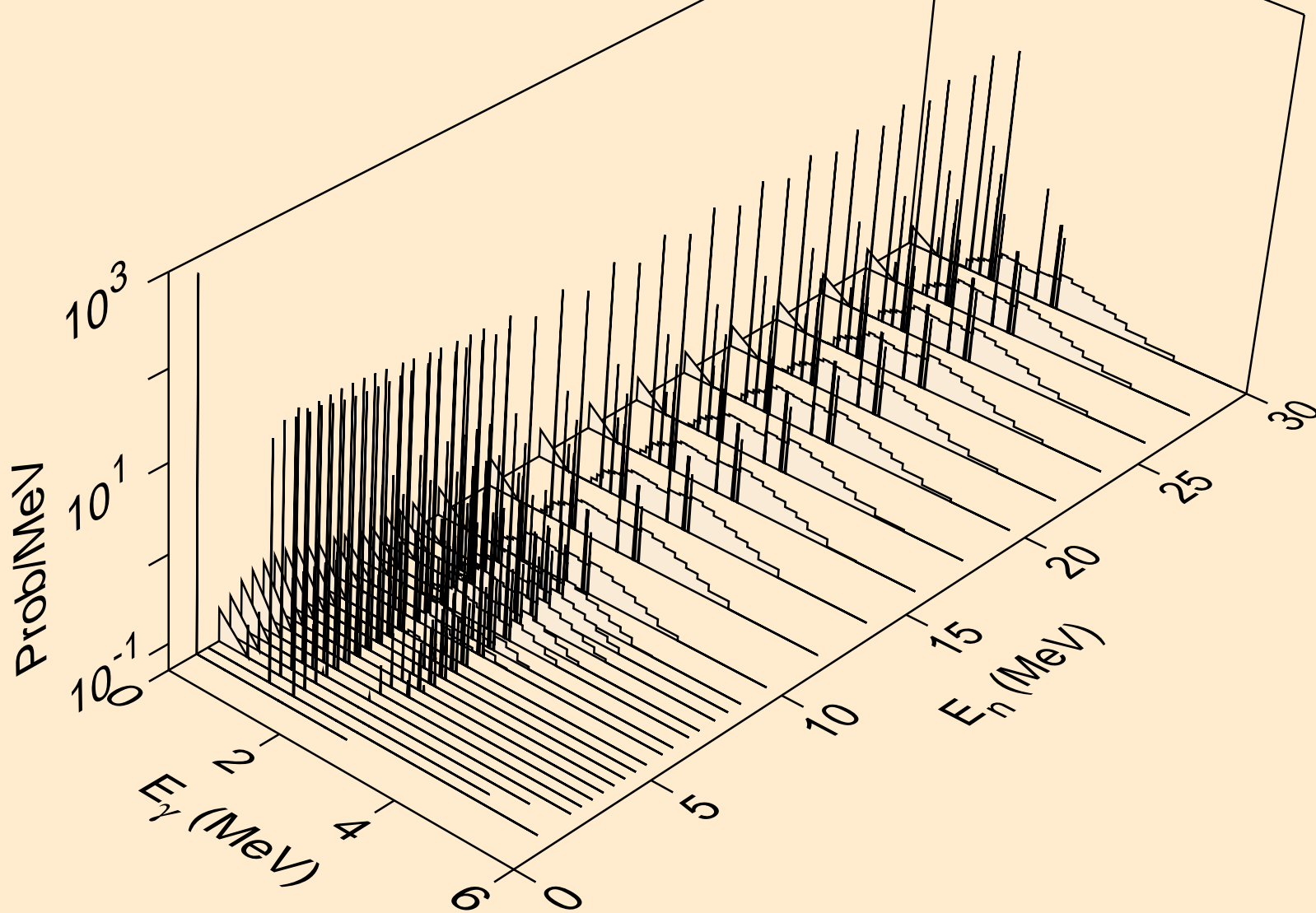

V050 NEUTRON ACER TENDL-2019 LIBRARY; T=293.16K
Photon emission for (n,d)

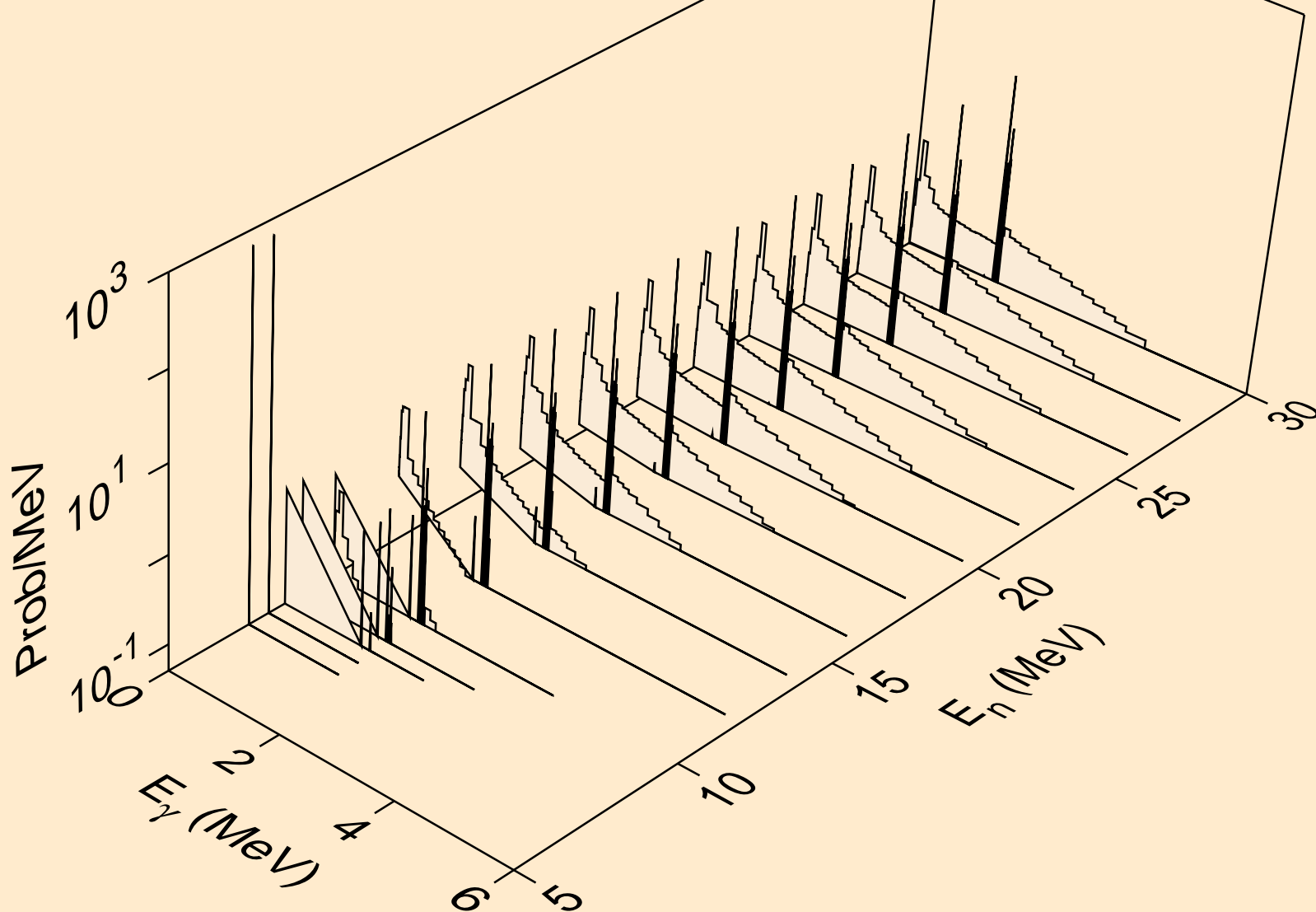

V050 NEUTRON ACER TENDL-2019 LIBRARY; T=293.16K
Photon emission for (n,t)

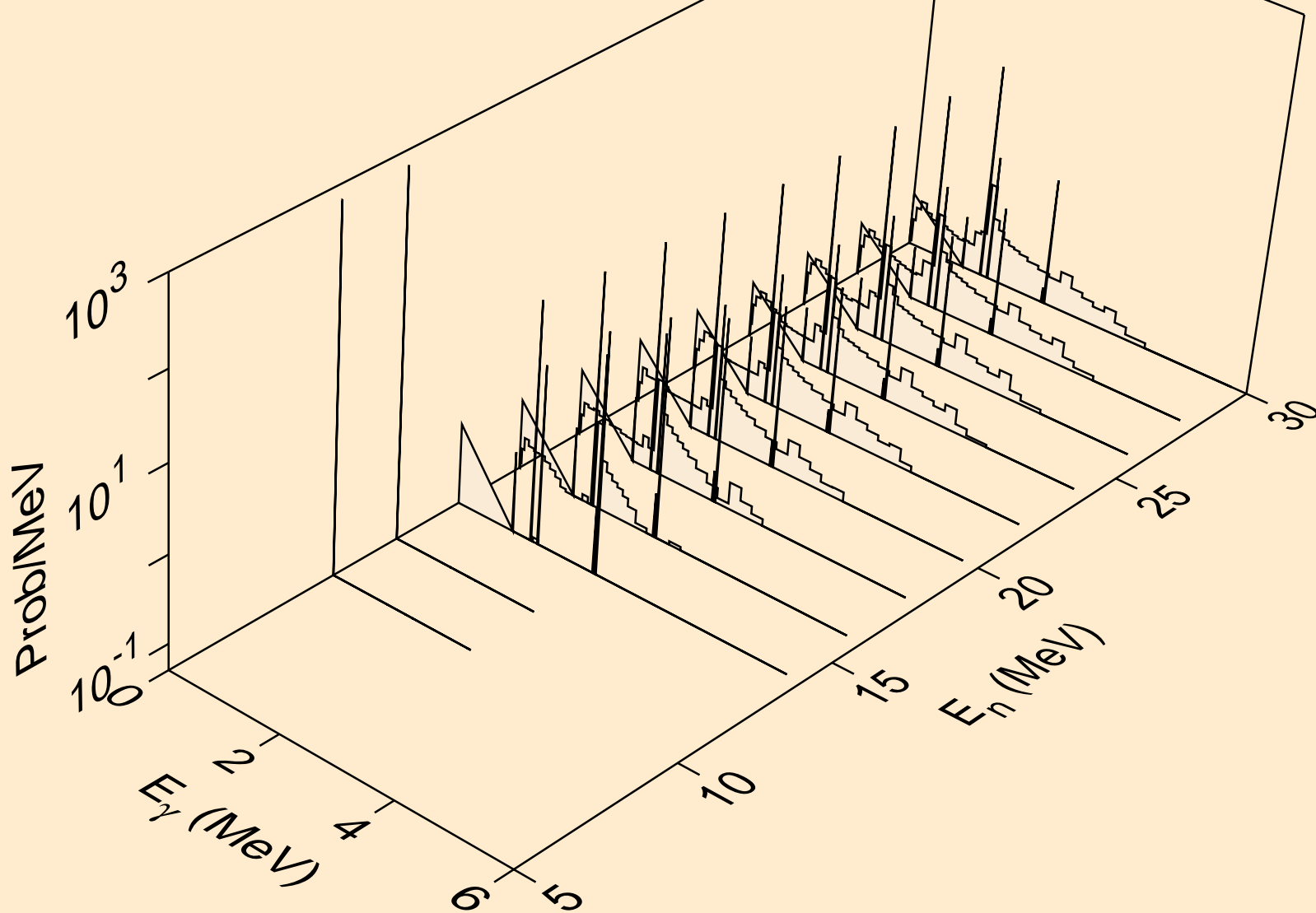

V050 NEUTRON ACER TENDL-2019 LIBRARY; T=293.16K
Photon emission for (n,he3)

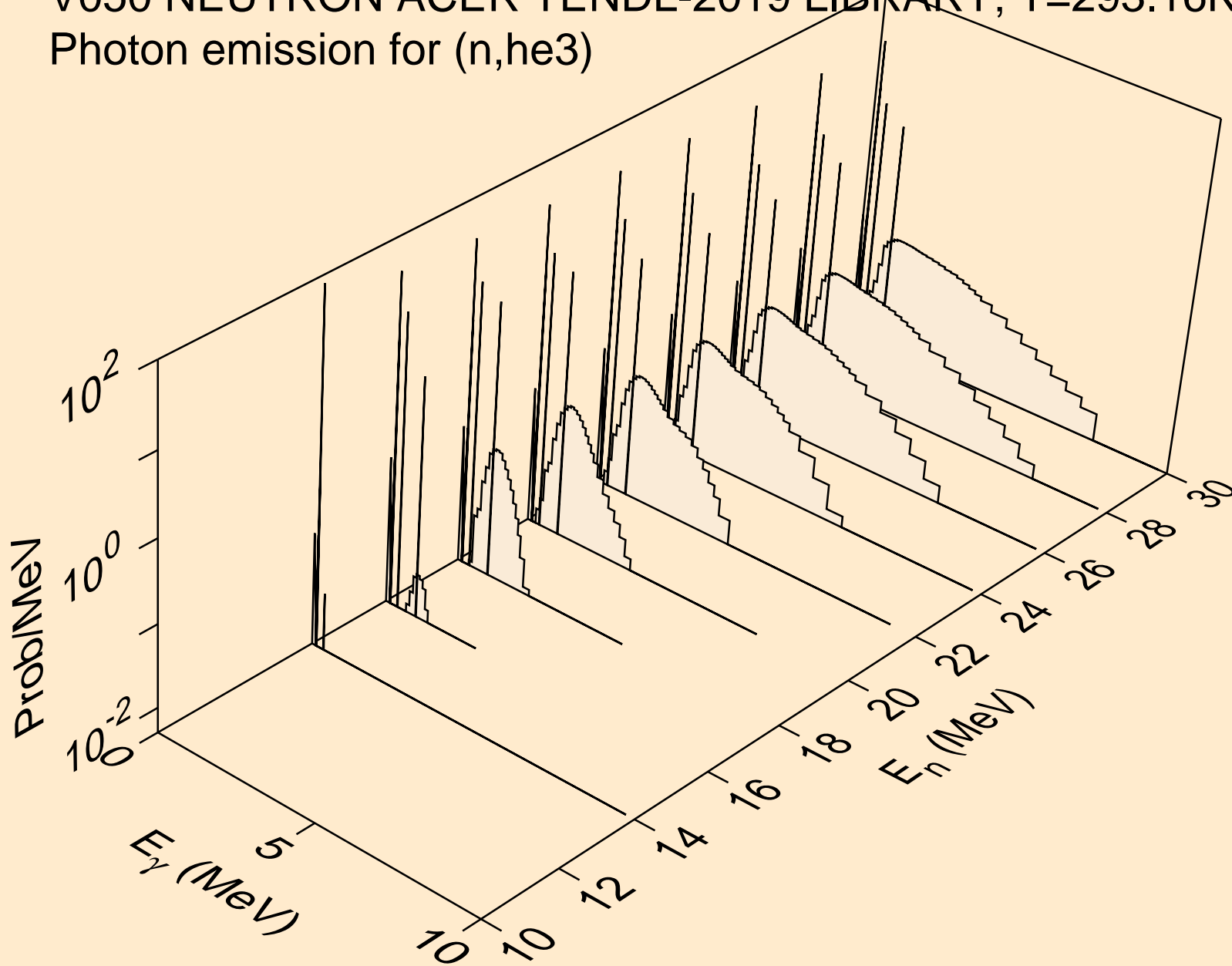

V050 NEUTRON ACER TENDL-2019 LIBRARY; T=293.16K
Photon emission for (n,a)

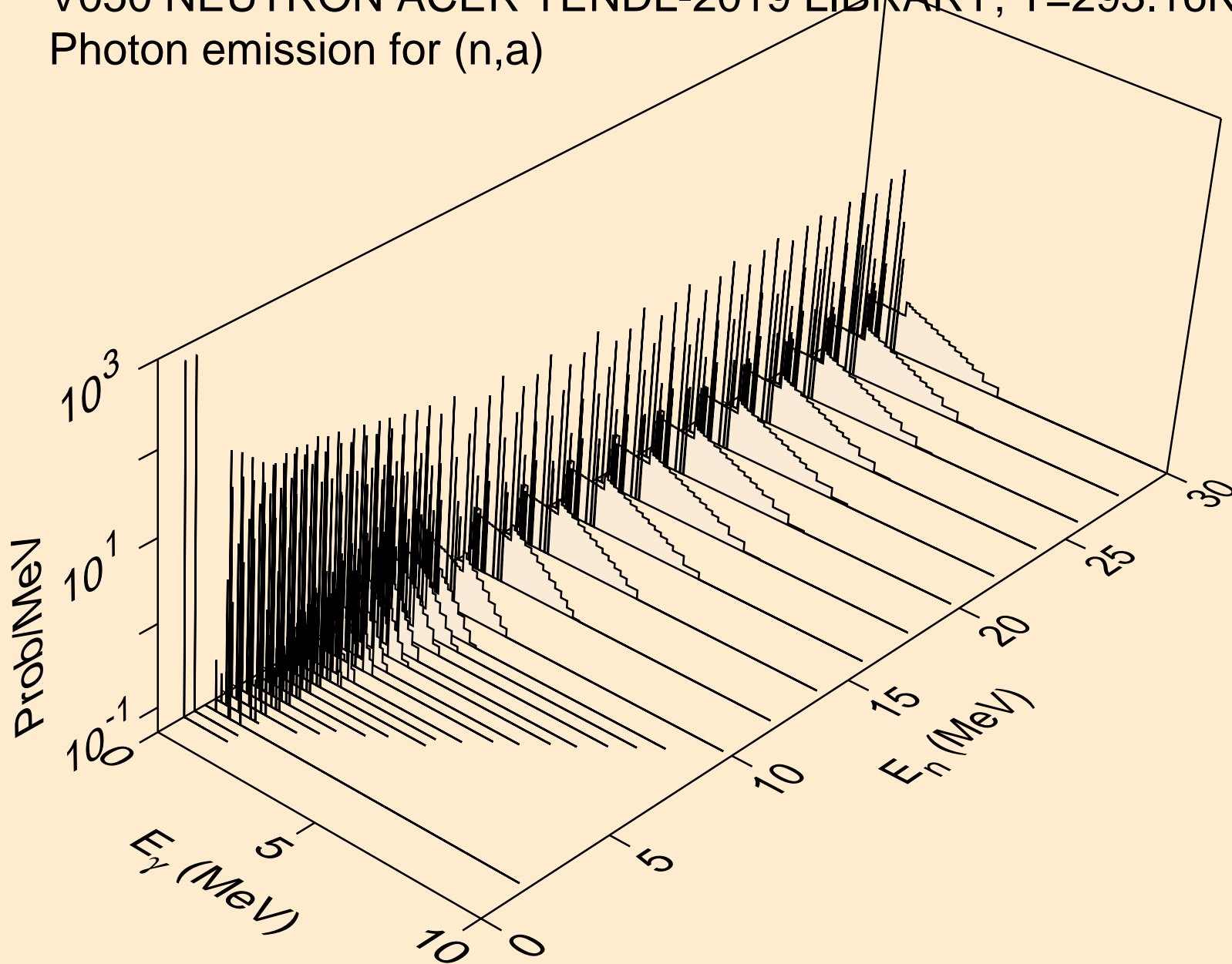

V050 NEUTRON ACER TENDL-2019 LIBRARY; T=293.16K
Photon emission for (n,2a)

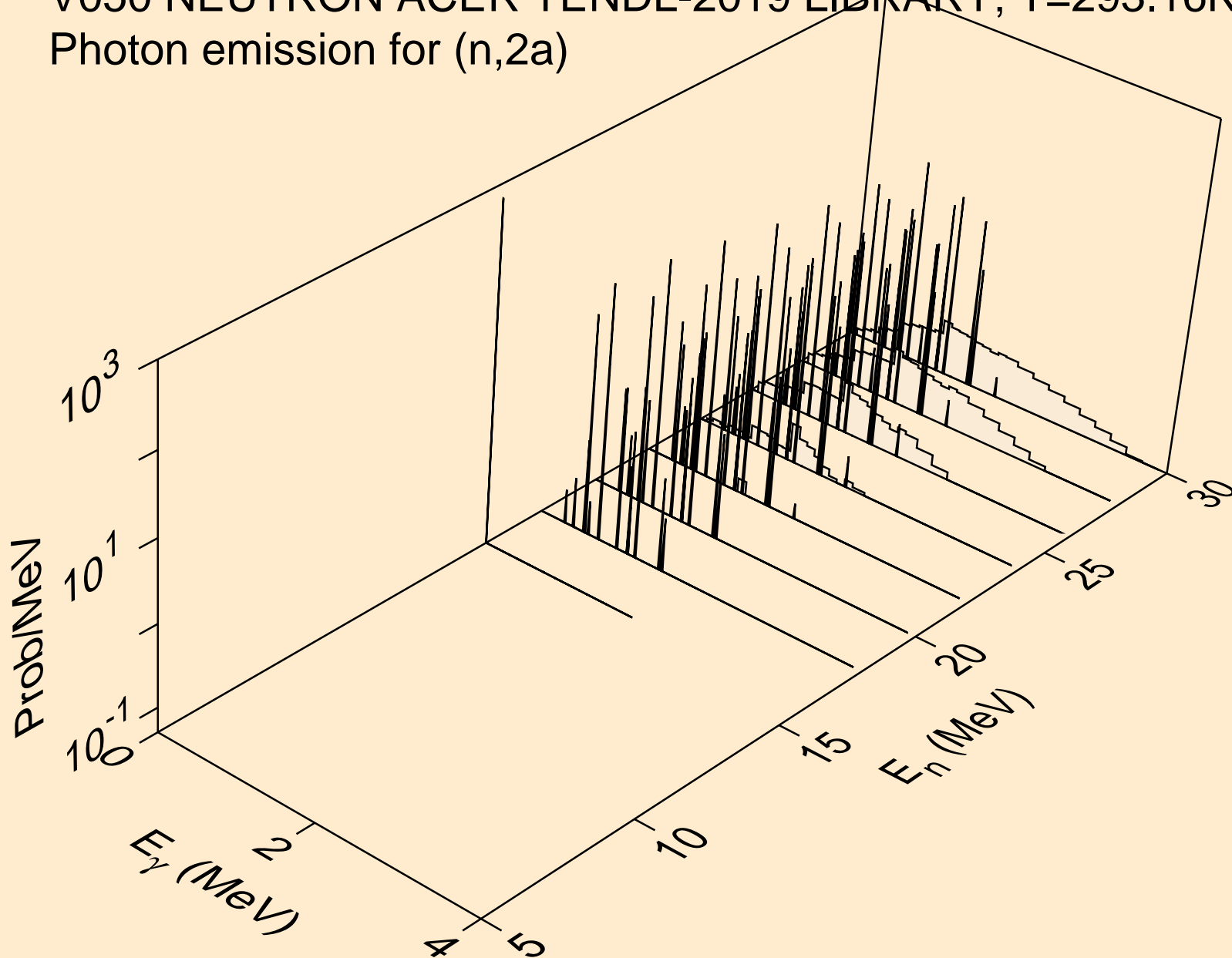

V050 NEUTRON ACER TENDL-2019 LIBRARY; T=293.16K
Photon emission for (n,2p)

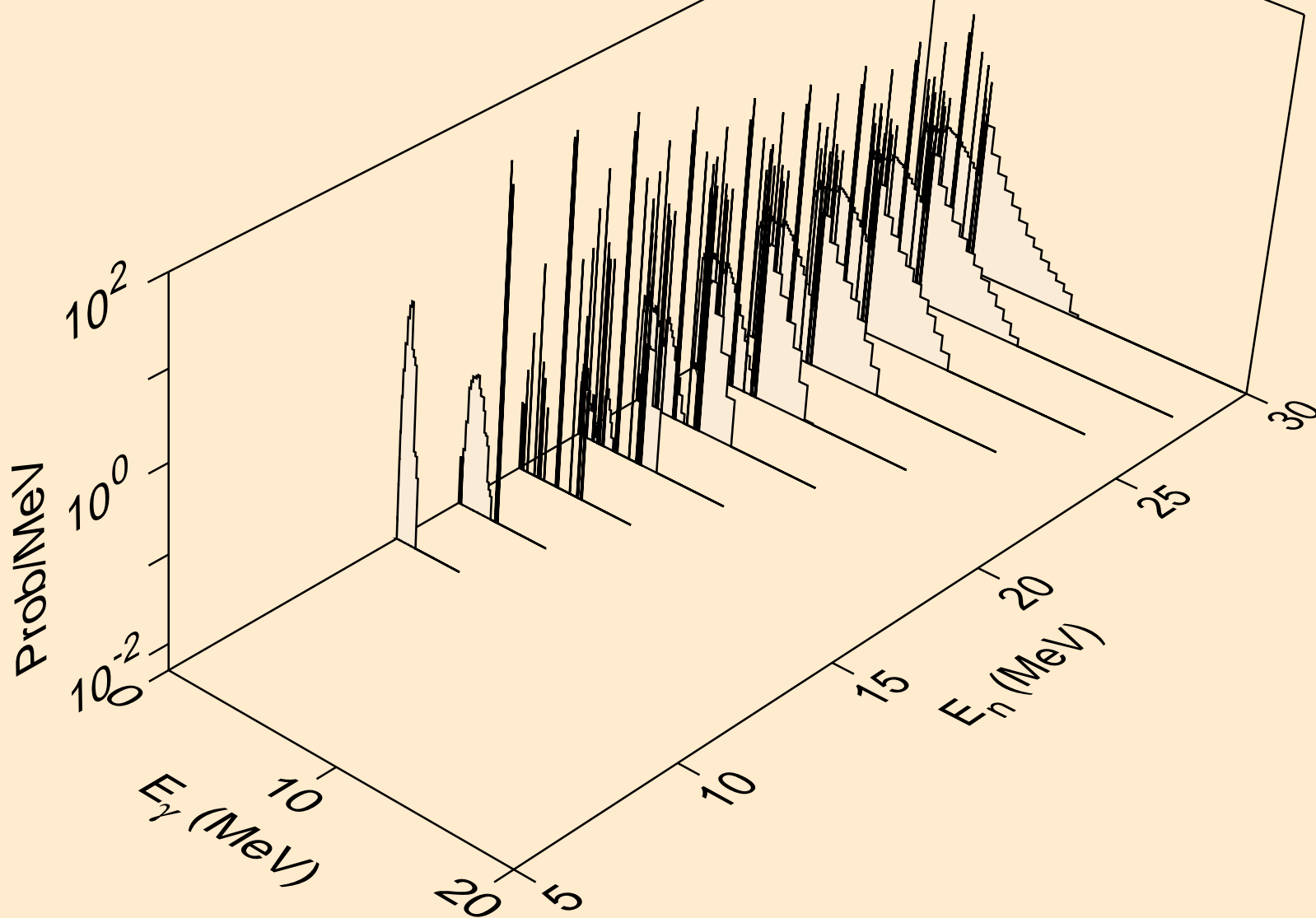

V050 NEUTRON ACER TENDL-2019 LIBRARY; T=293.16K
Photon emission for (n,p α)

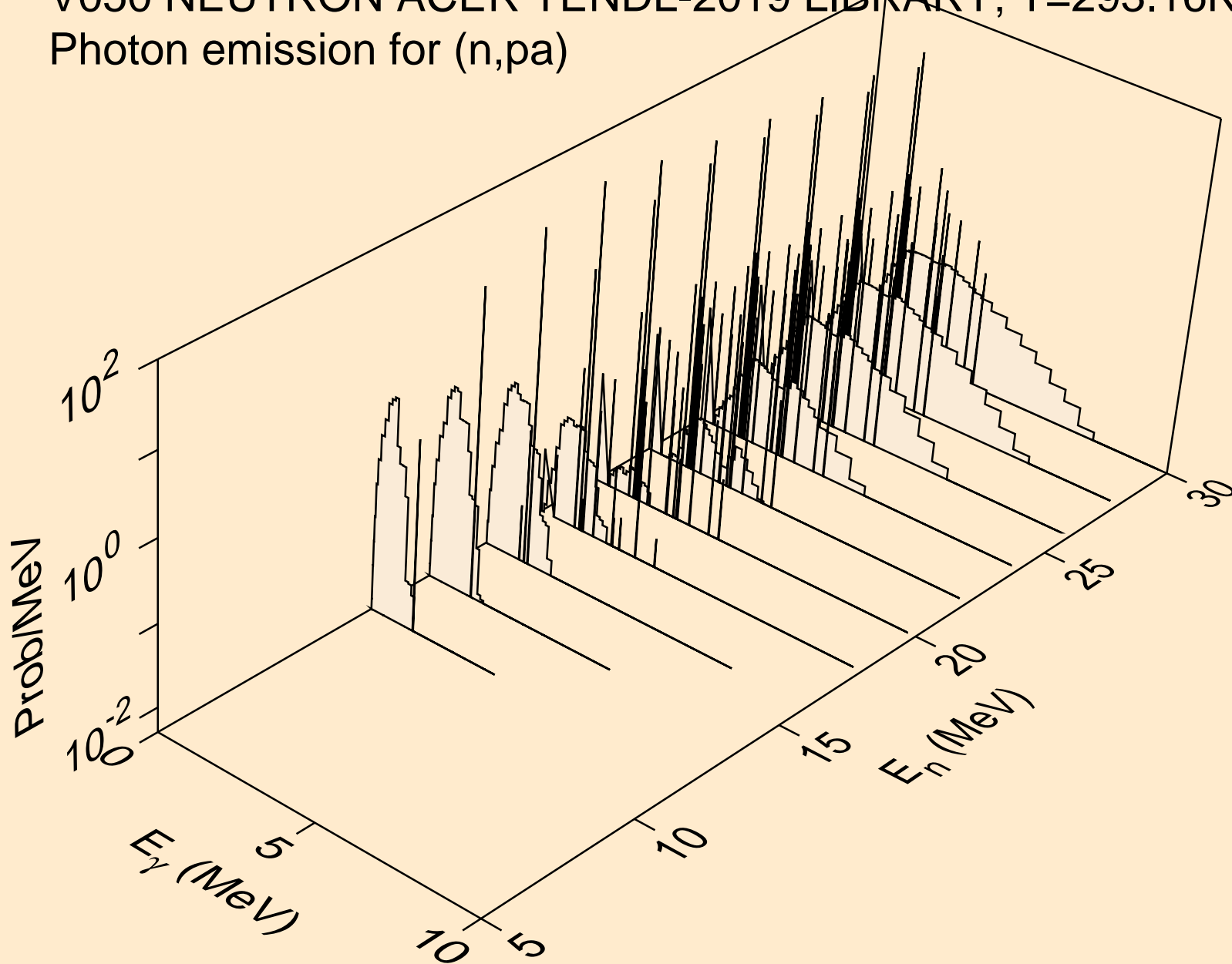

V050 NEUTRON ACER TENDL-2019 LIBRARY; T=293.16K
Photon emission for (n,pd)

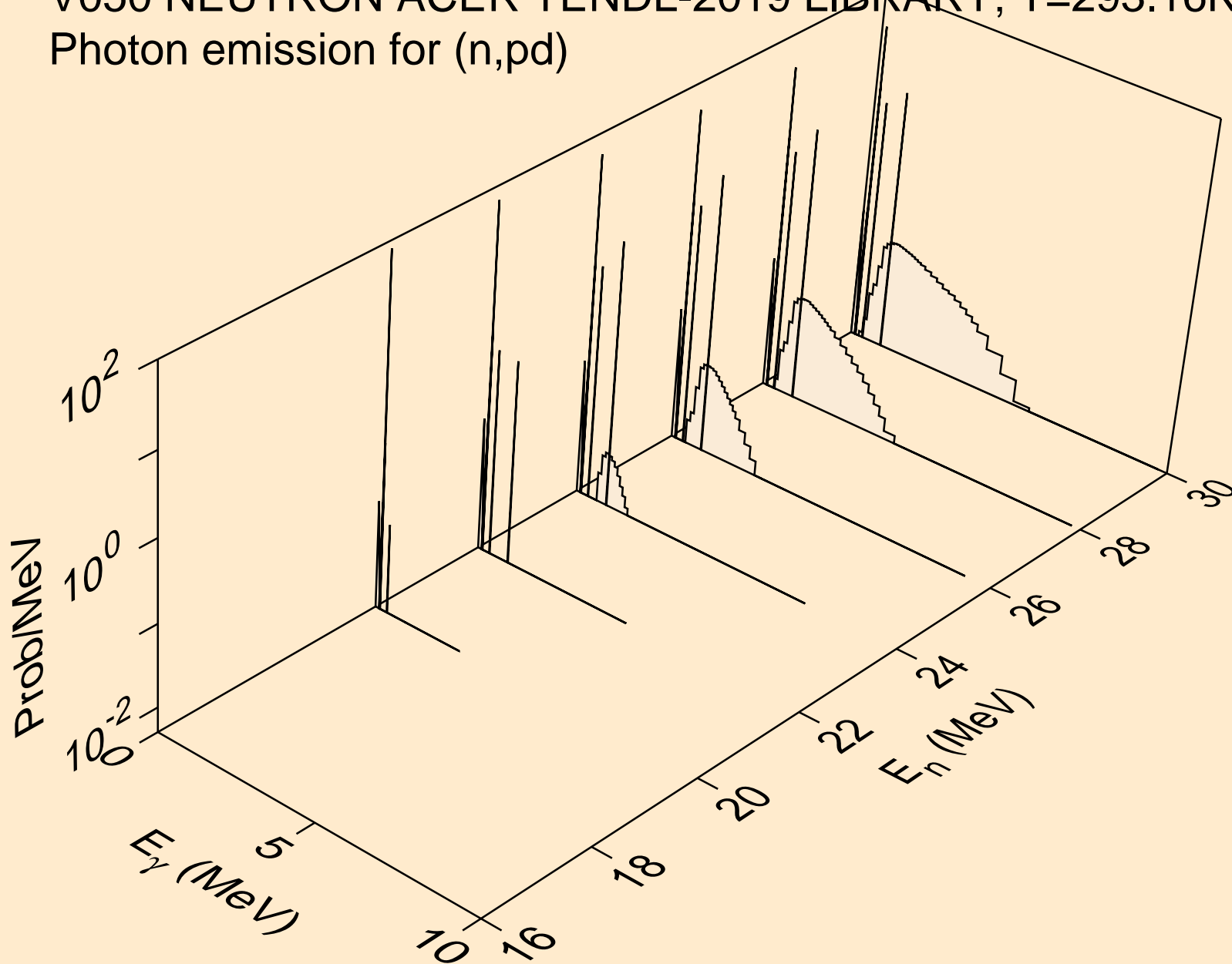

V050 NEUTRON ACER TENDL-2019 LIBRARY; T=293.16K
Photon emission for (n,pt)

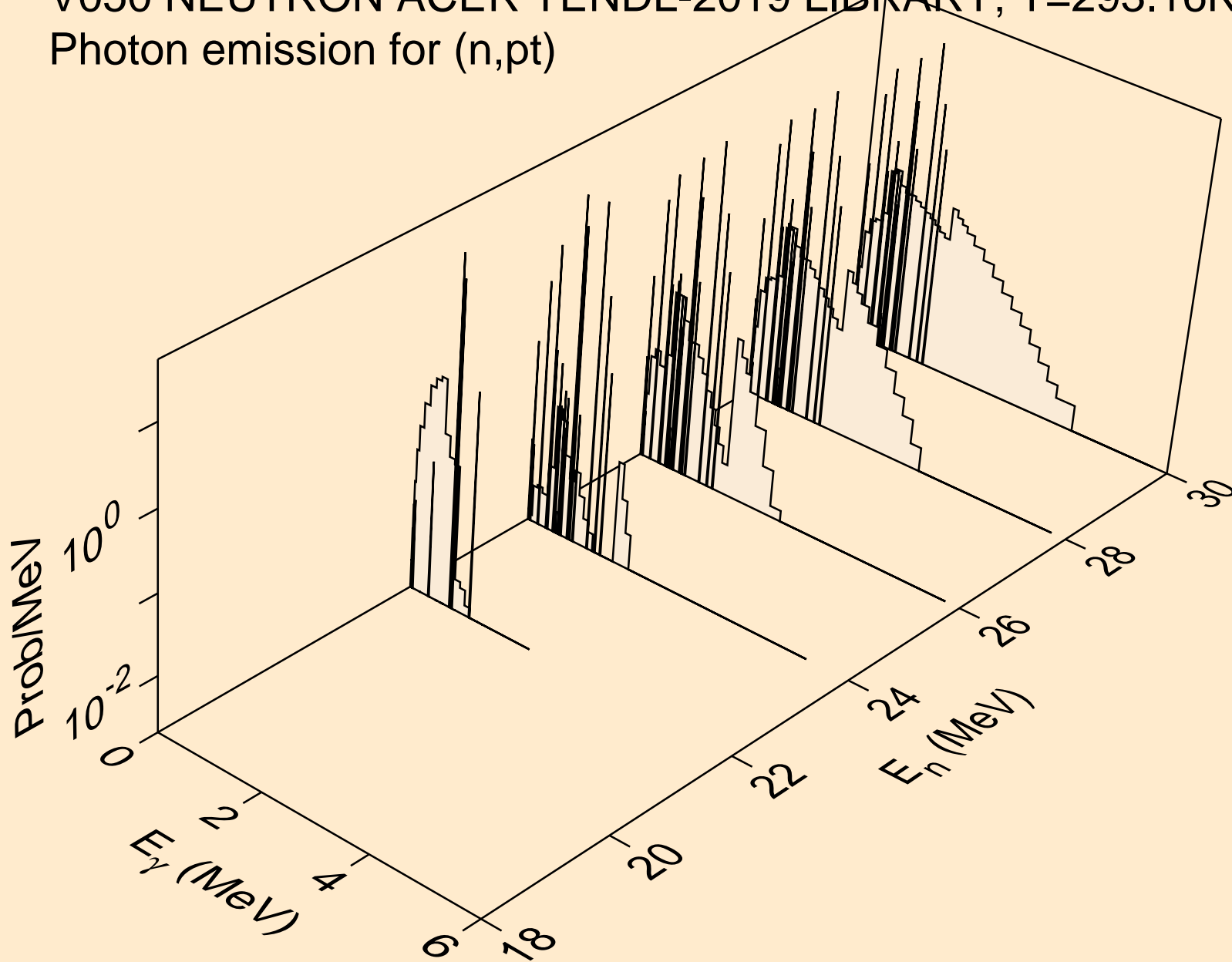

V050 NEUTRON ACER TENDL-2019 LIBRARY; T=293.16K
Photon emission for (n,da)

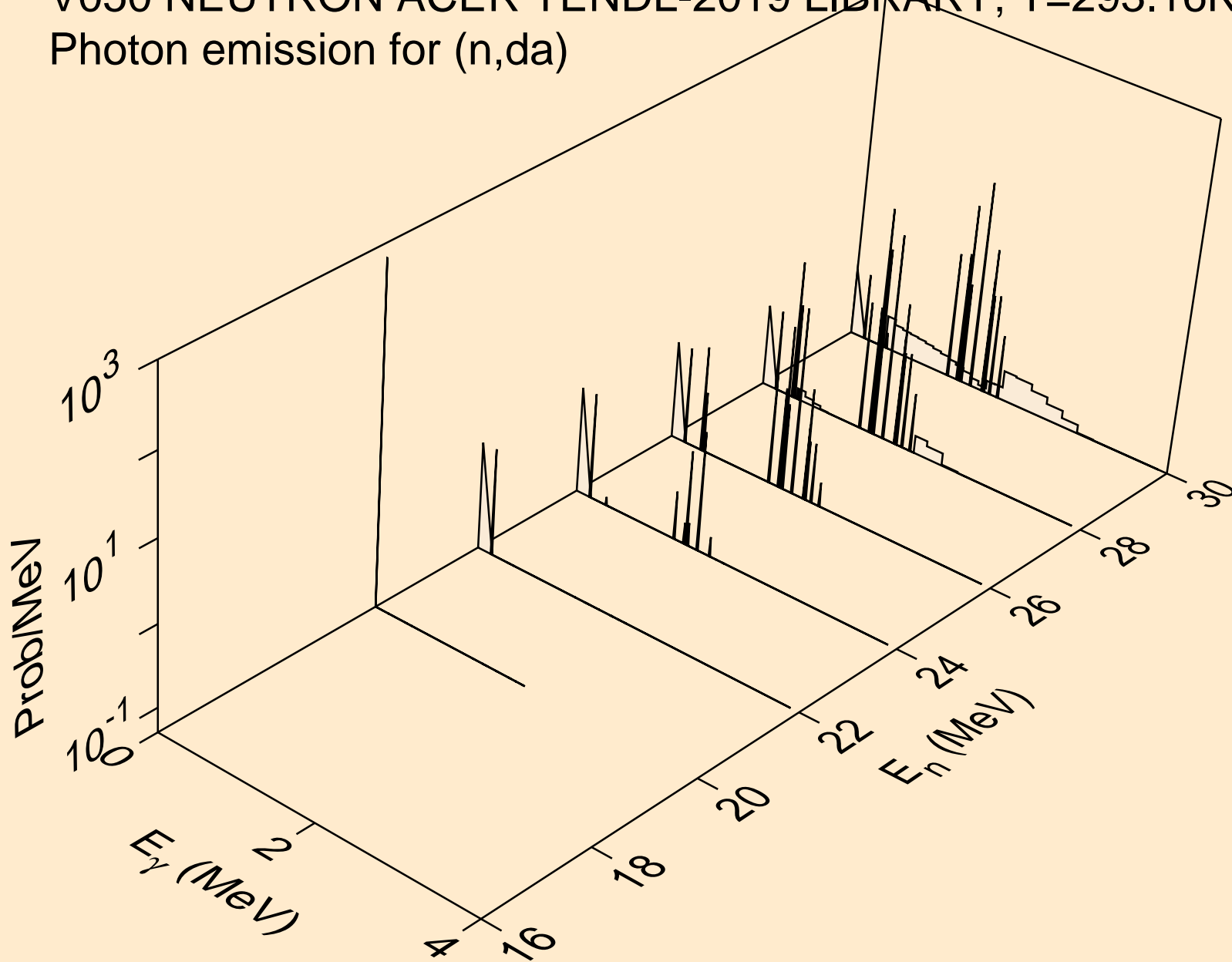

V050 NEUTRON ACER TENDL-2019 LIBRARY; T=293.16K
thermal capture photon spectrum

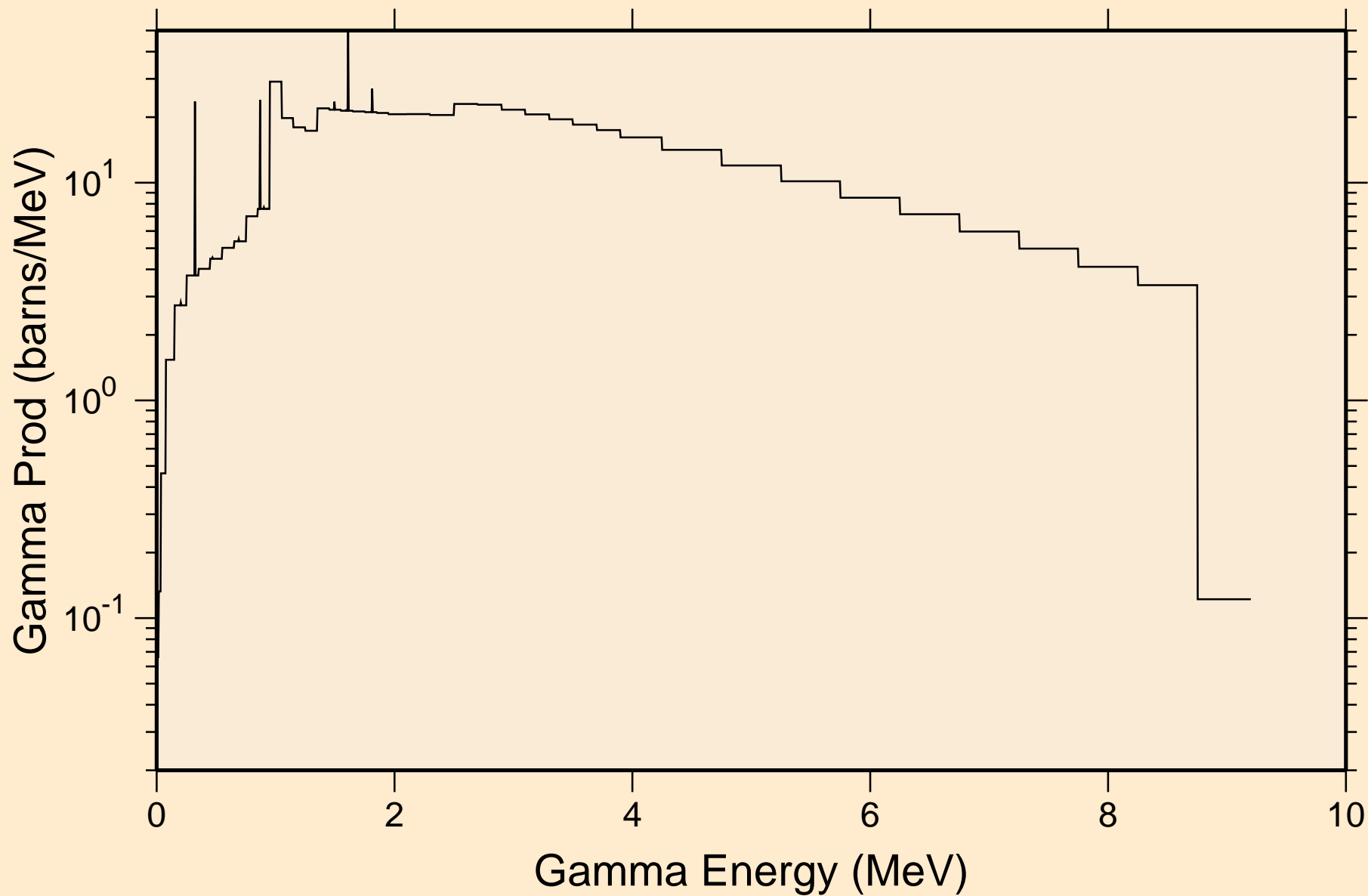

V050 NEUTRON ACER TENDL-2019 LIBRARY; T=293.16K
14 MeV photon spectrum

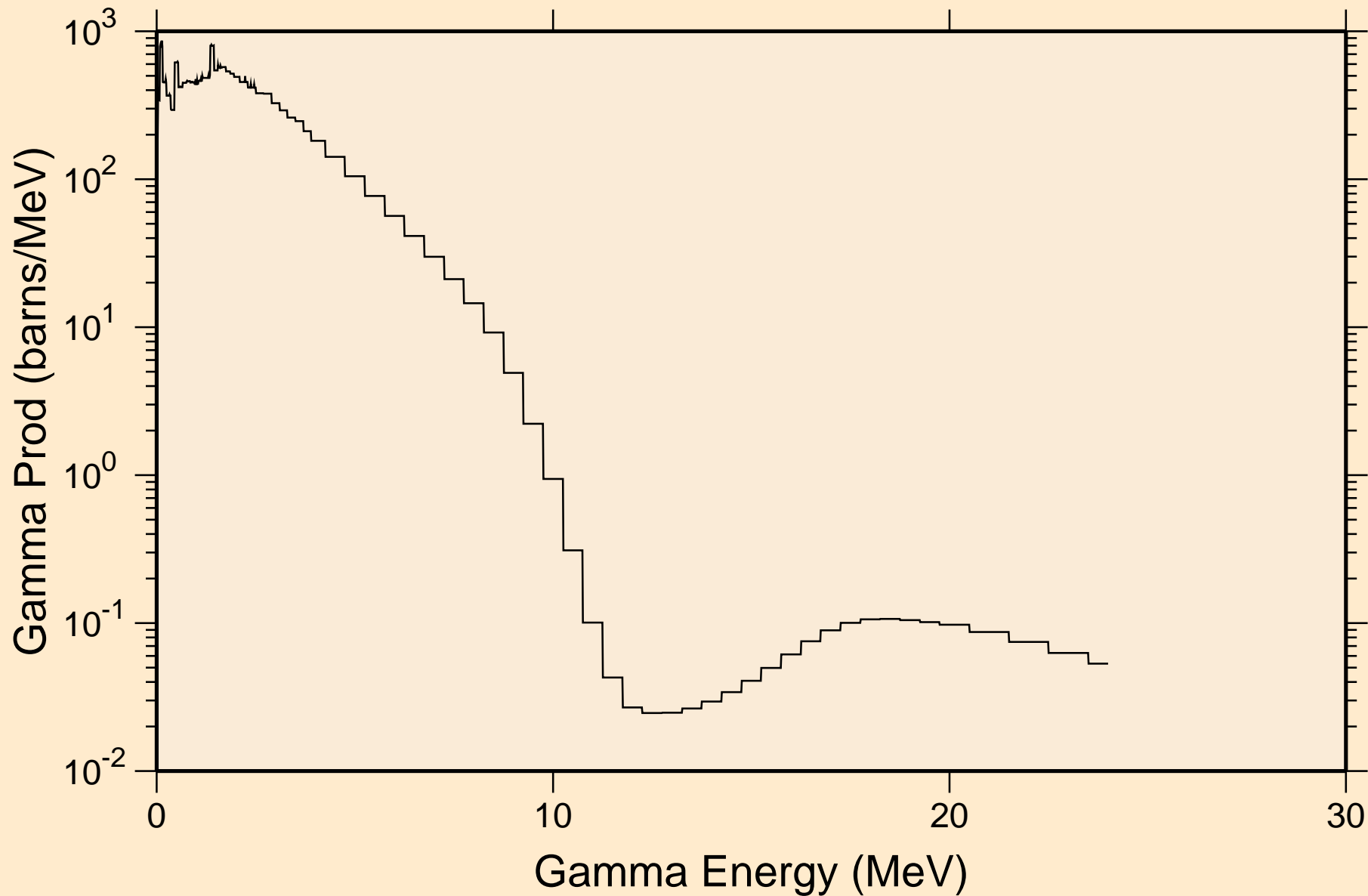

V050 NEUTRON ACER TENDL-2019 LIBRARY; T=293.16K
Particle heating contributions

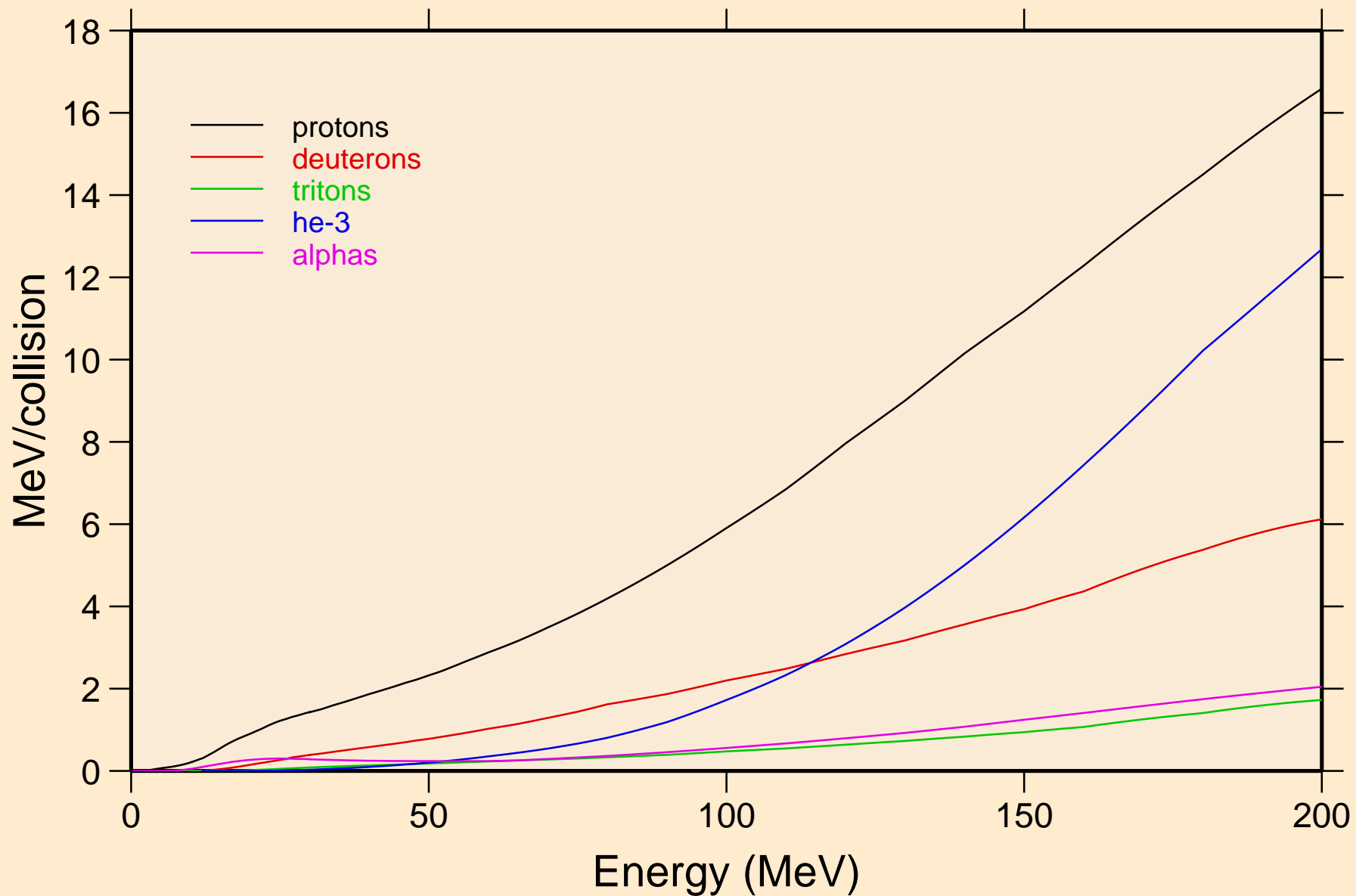

V050 NEUTRON ACER TENDL-2019 LIBRARY; T=293.16K
Recoil Heating

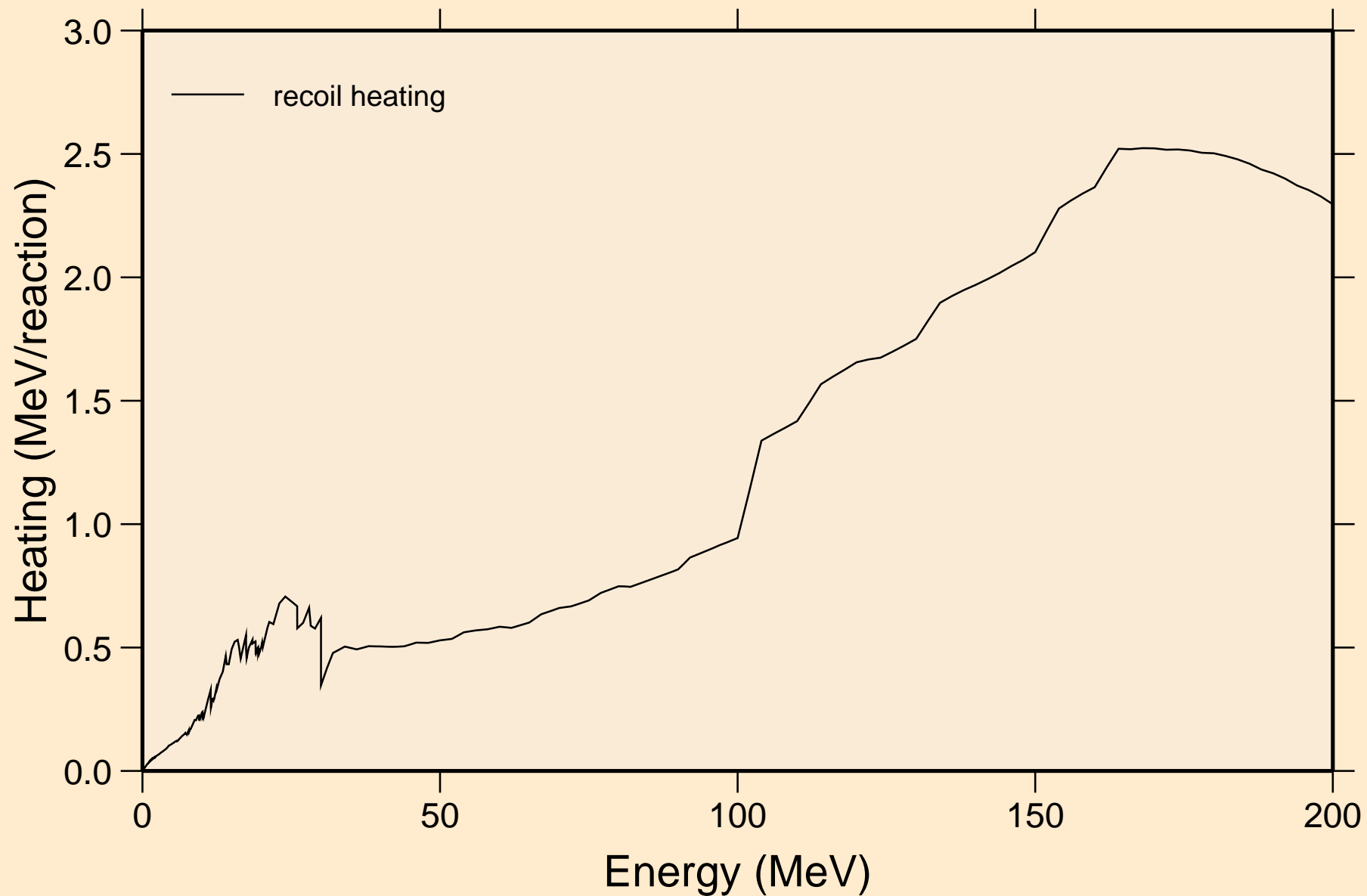

V050 NEUTRON ACER TENDL-2019 LIBRARY; T=293.16K
Particle production cross sections

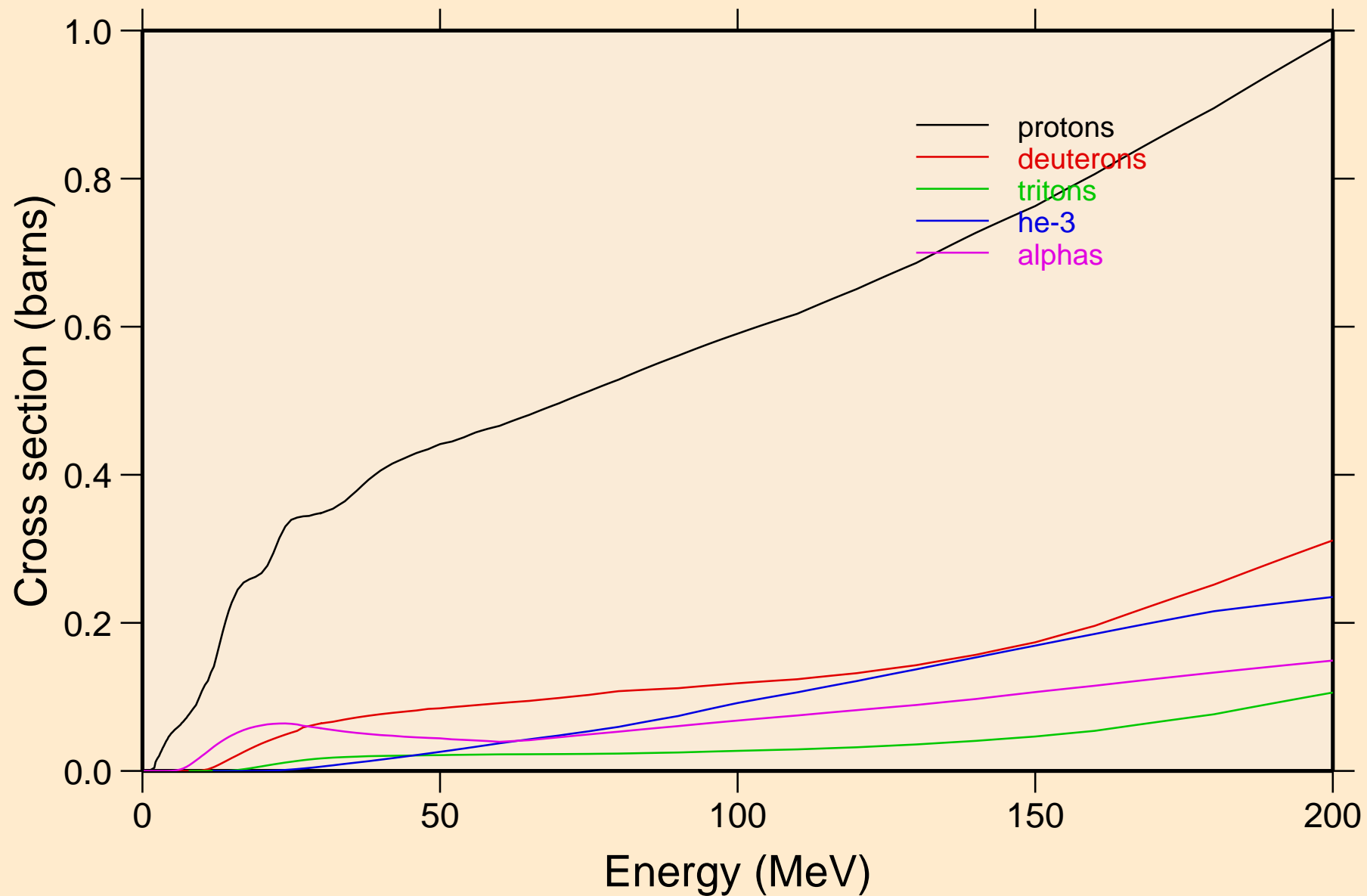

V050 NEUTRON ACER TENDL-2019 LIBRARY; T=293.16K
protons from (n,x)

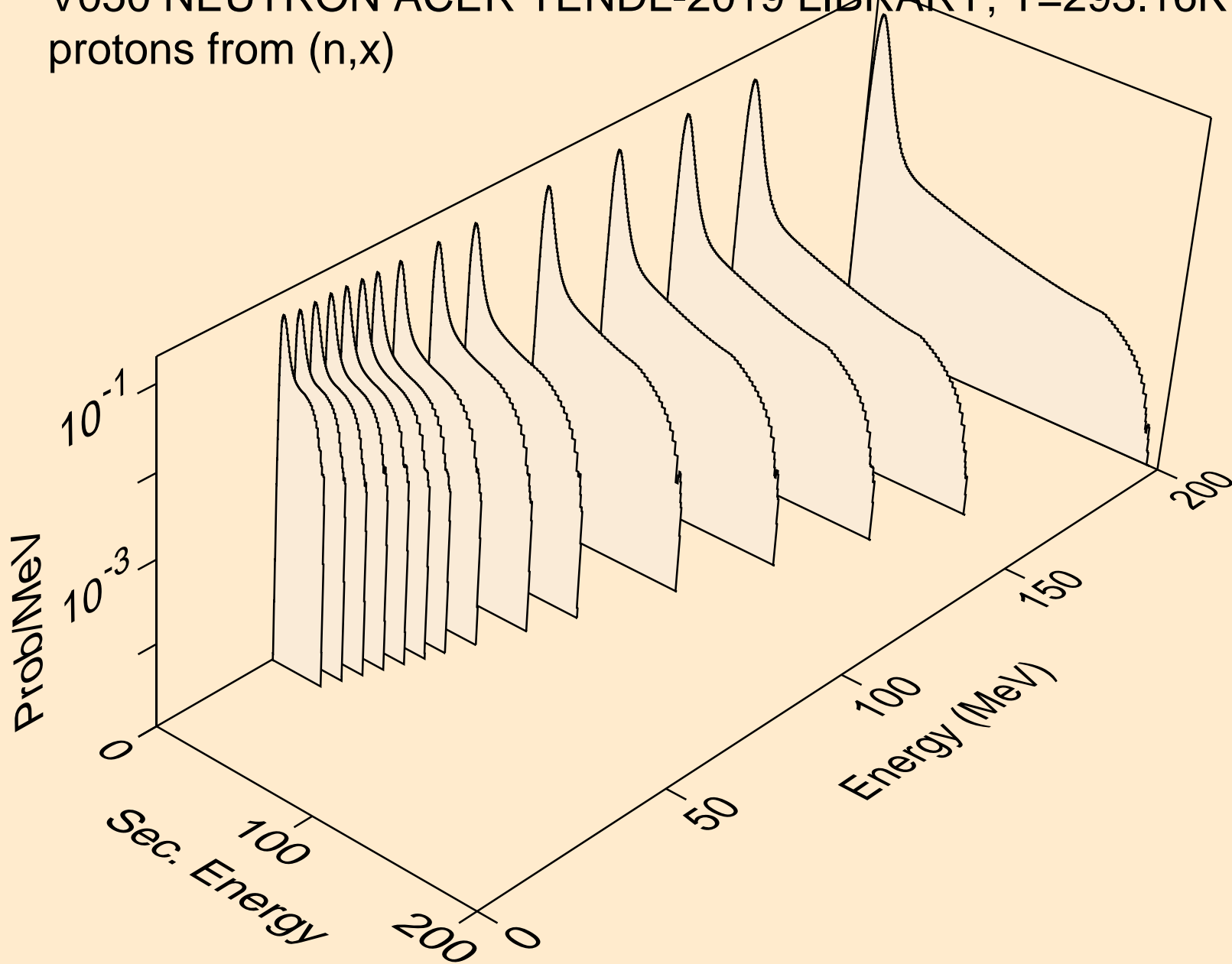

V050 NEUTRON ACER TENDL-2019 LIBRARY; T=293.16K
protons from (n,n*)p

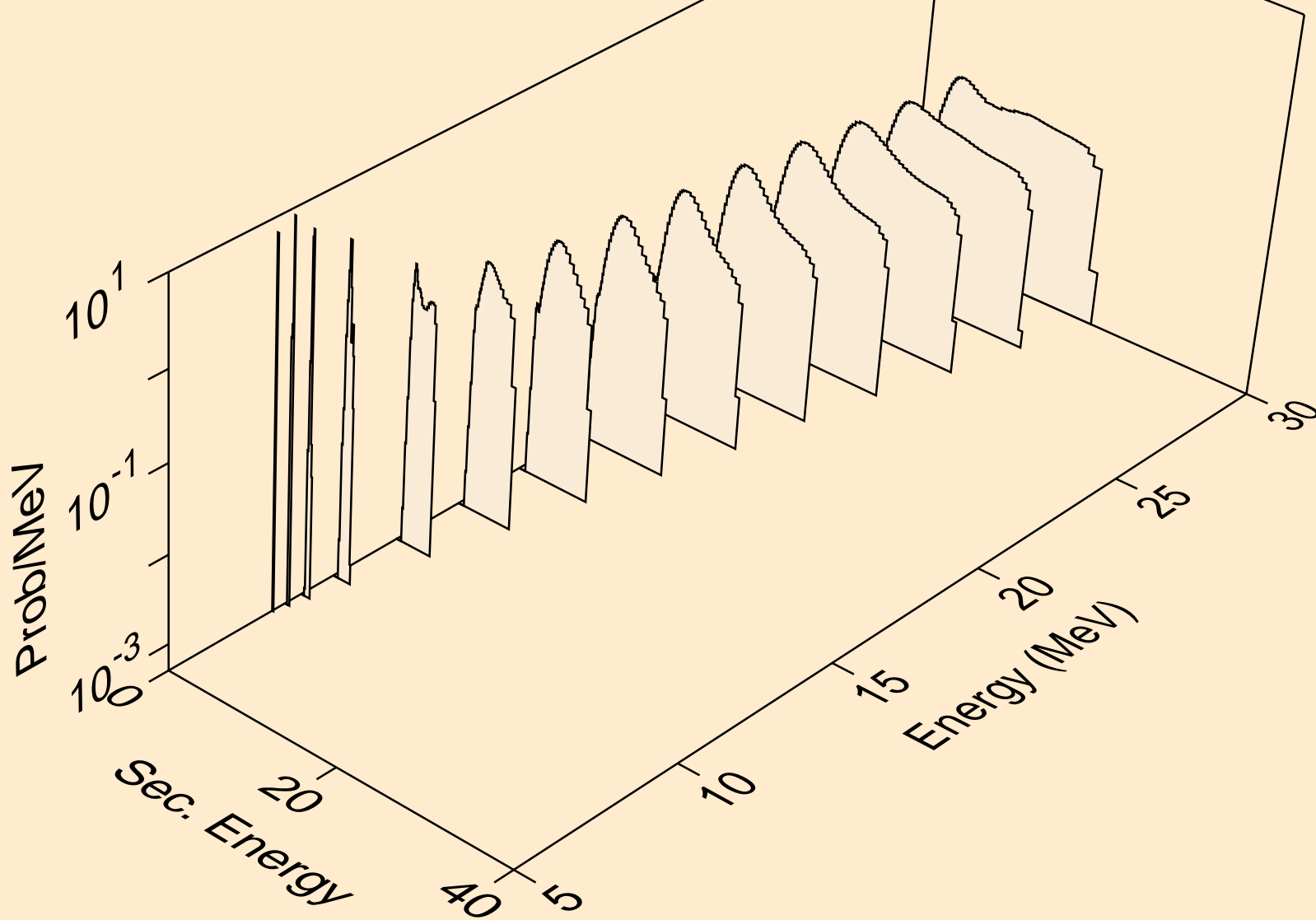

V050 NEUTRON ACER TENDL-2019 LIBRARY; T=293.16K
protons from (n,2np)

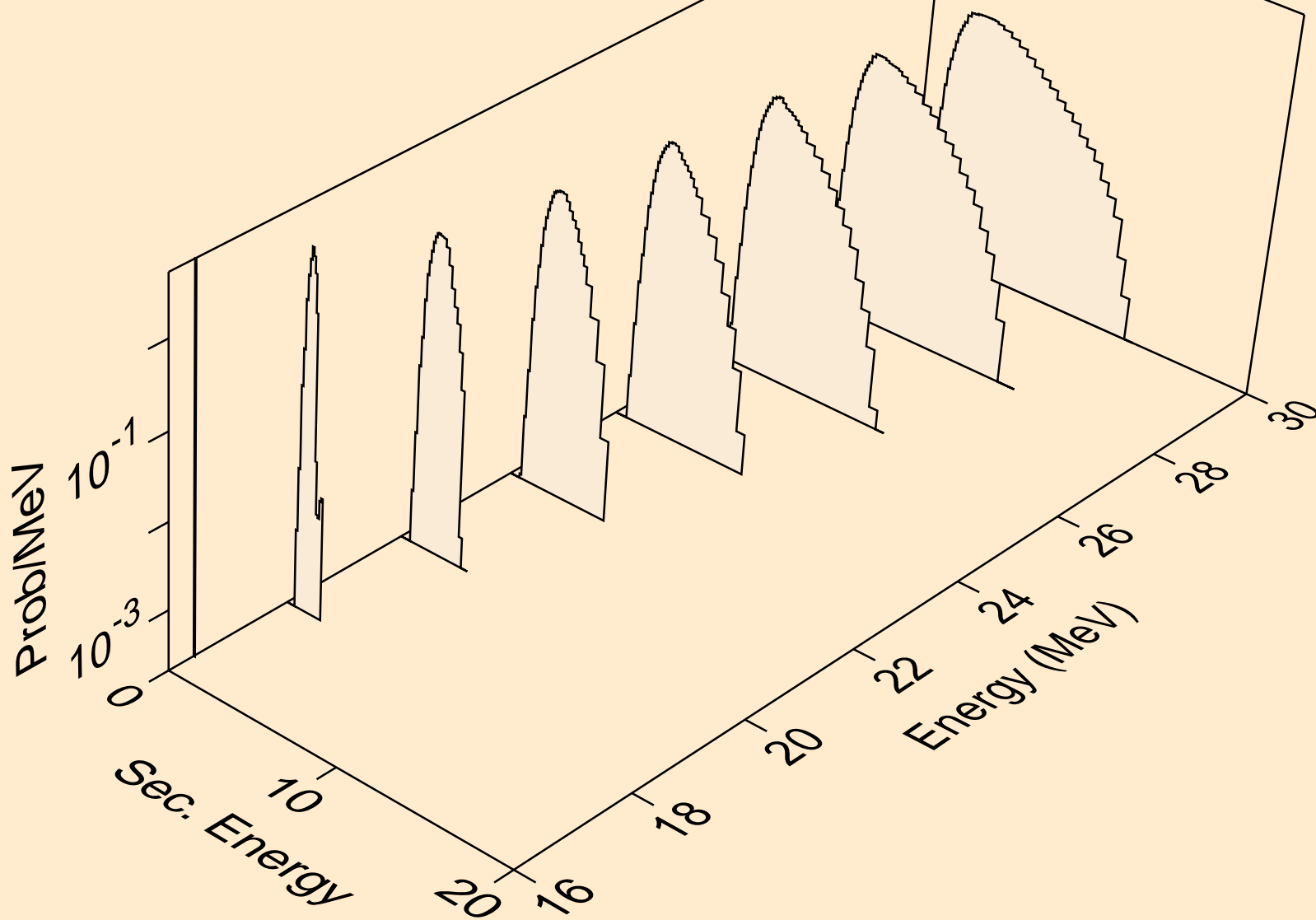

V050 NEUTRON ACER TENDL-2019 LIBRARY; T=293.16K
protons from (n,3np)

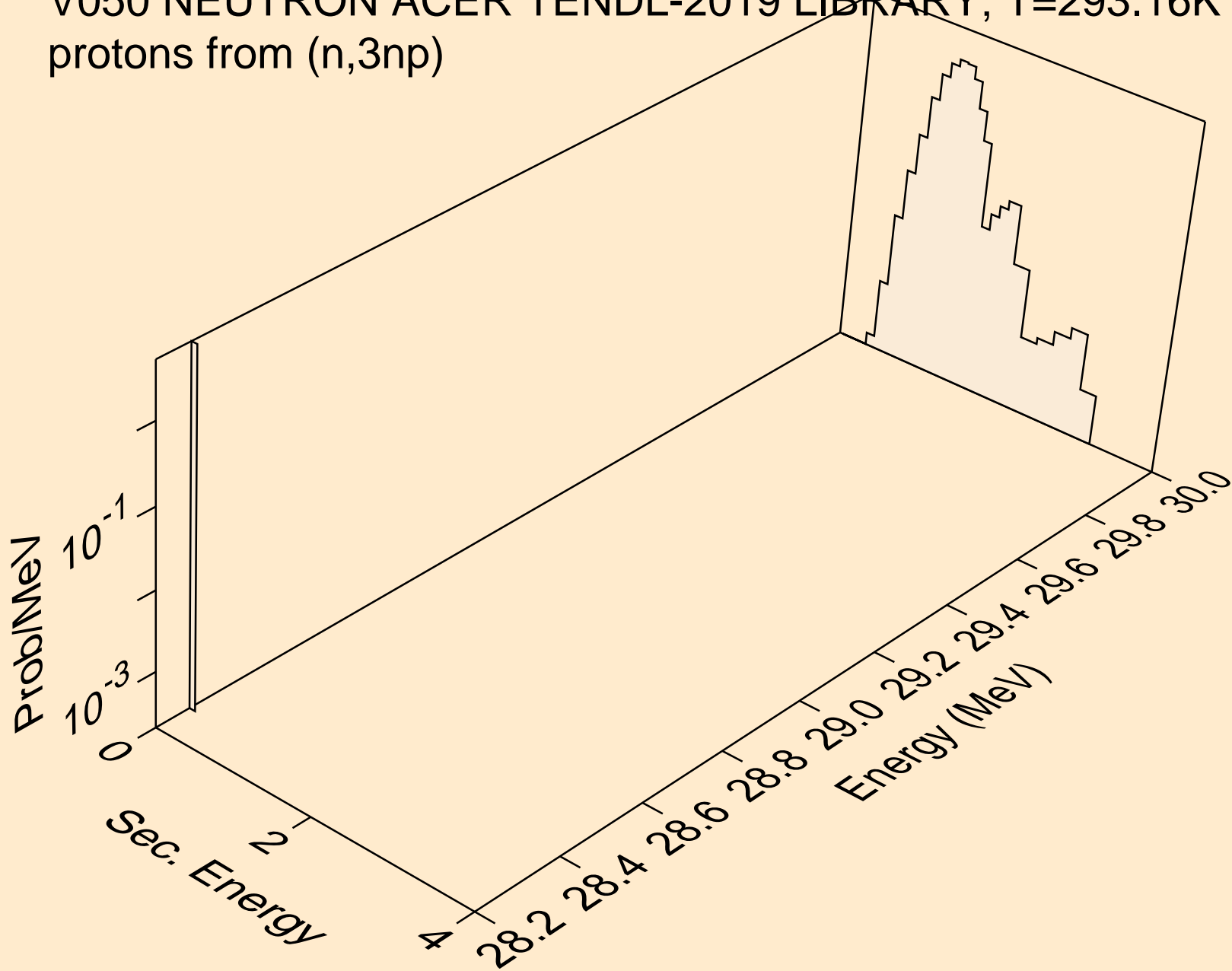

V050 NEUTRON ACER TENDL-2019 LIBRARY; T=293.16K
protons from (n,2np)

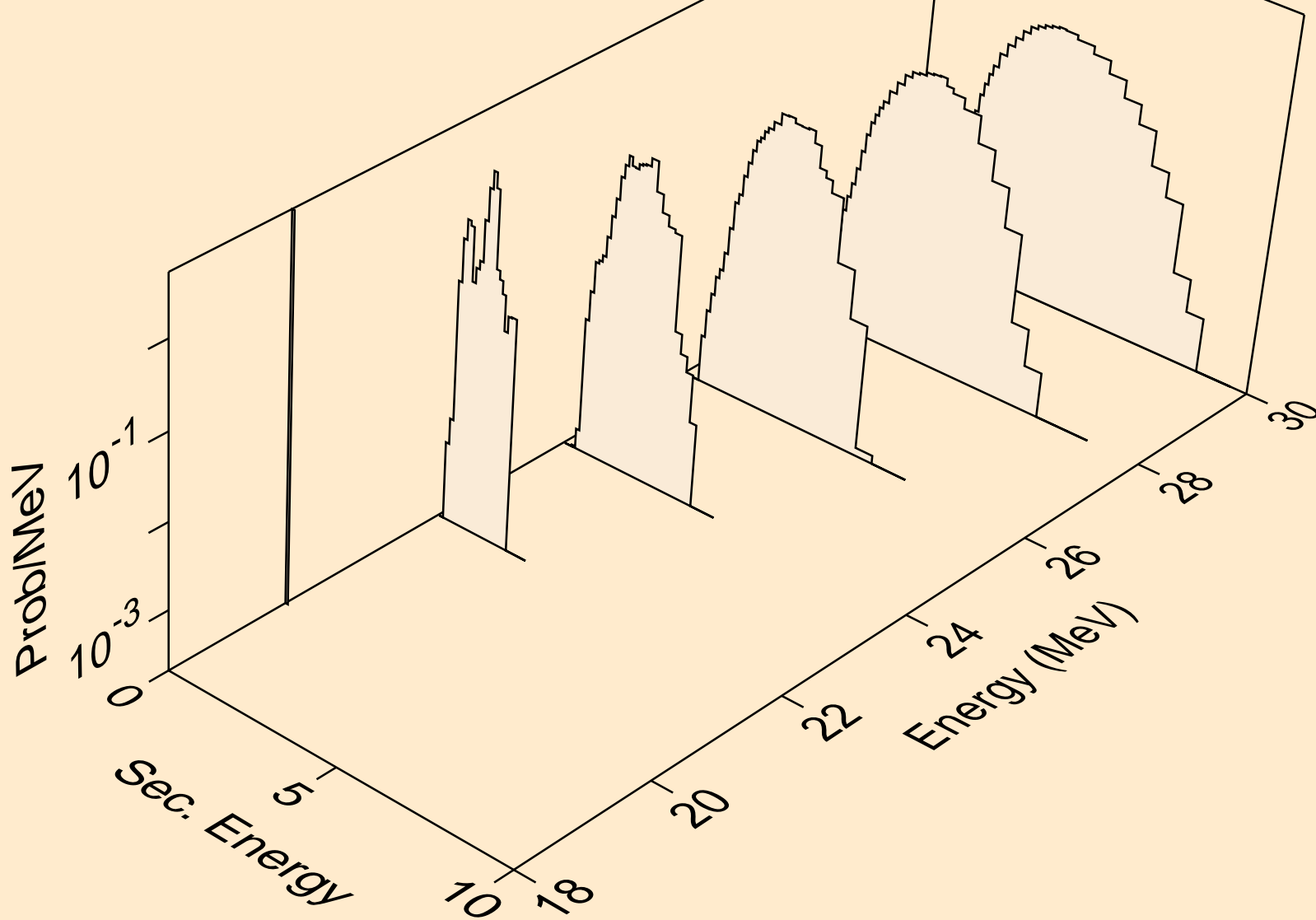

V050 NEUTRON ACER TENDL-2019 LIBRARY; T=293.16K
protons from (n,npa)

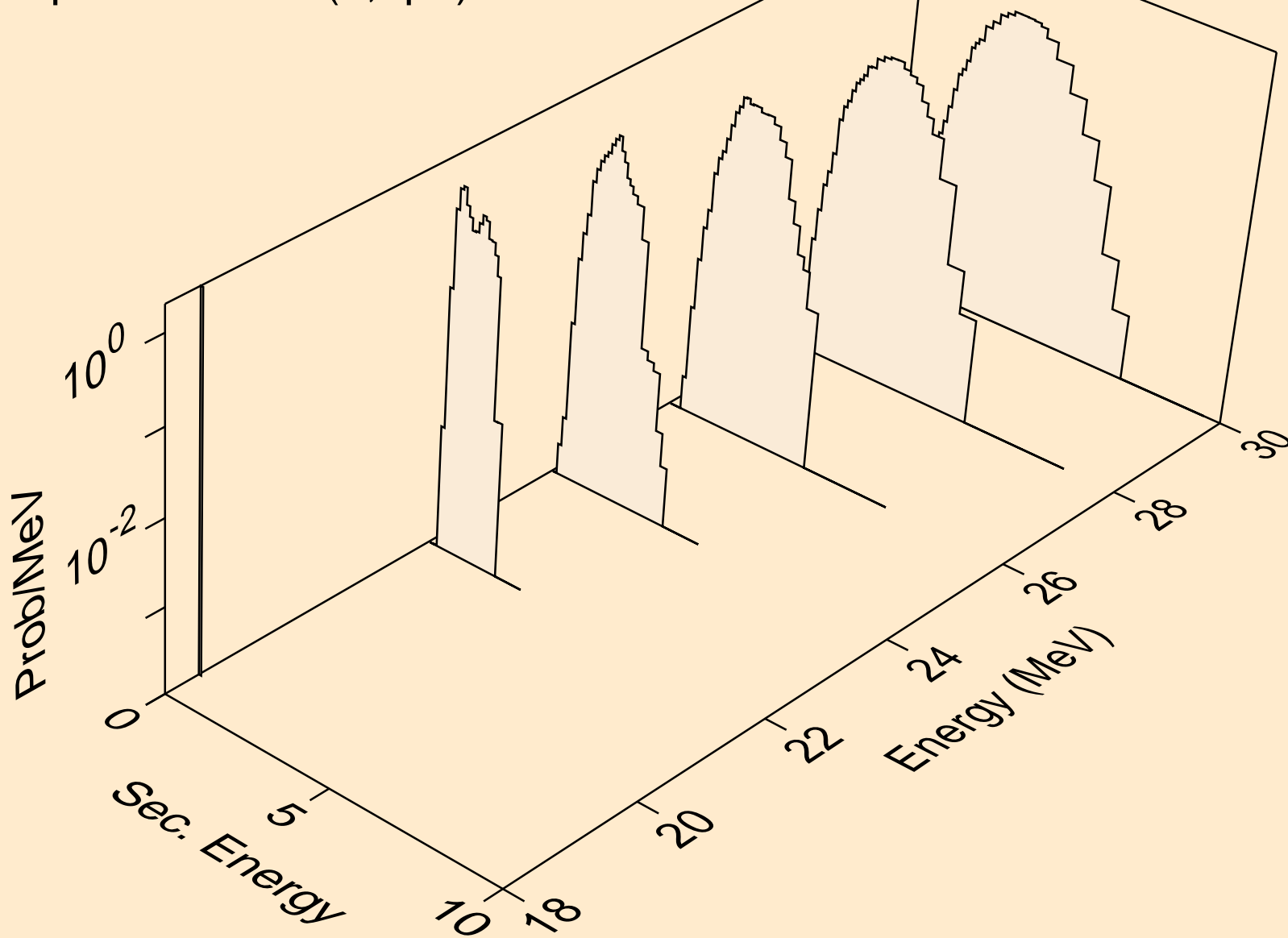

V050 NEUTRON ACER TENDL-2019 LIBRARY; T=293.16K
protons from (n,p)

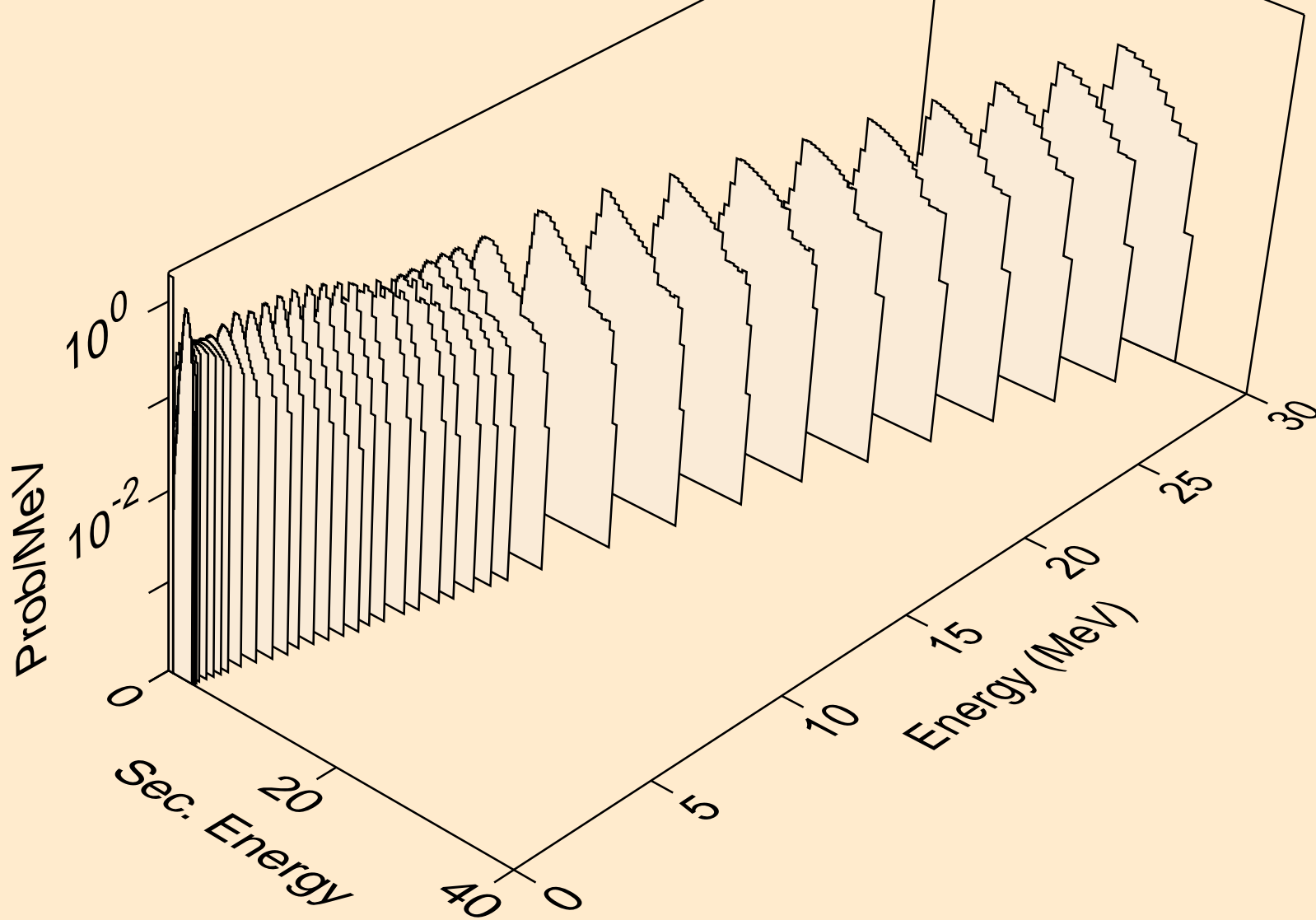

V050 NEUTRON ACER TENDL-2019 LIBRARY; T=293.16K
protons from (n,2p)

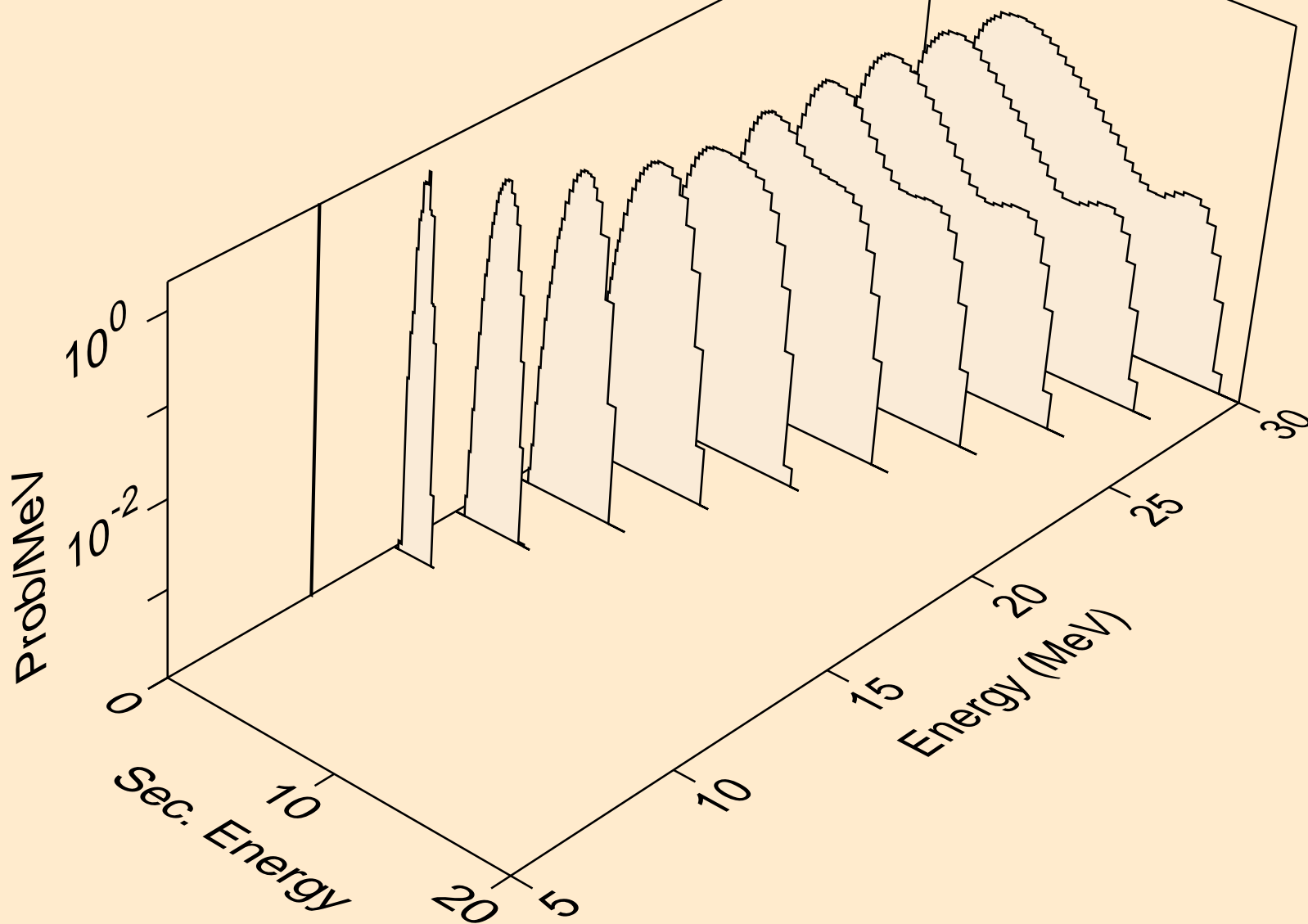

V050 NEUTRON ACER TENDL-2019 LIBRARY; T=293.16K
protons from (n,p)

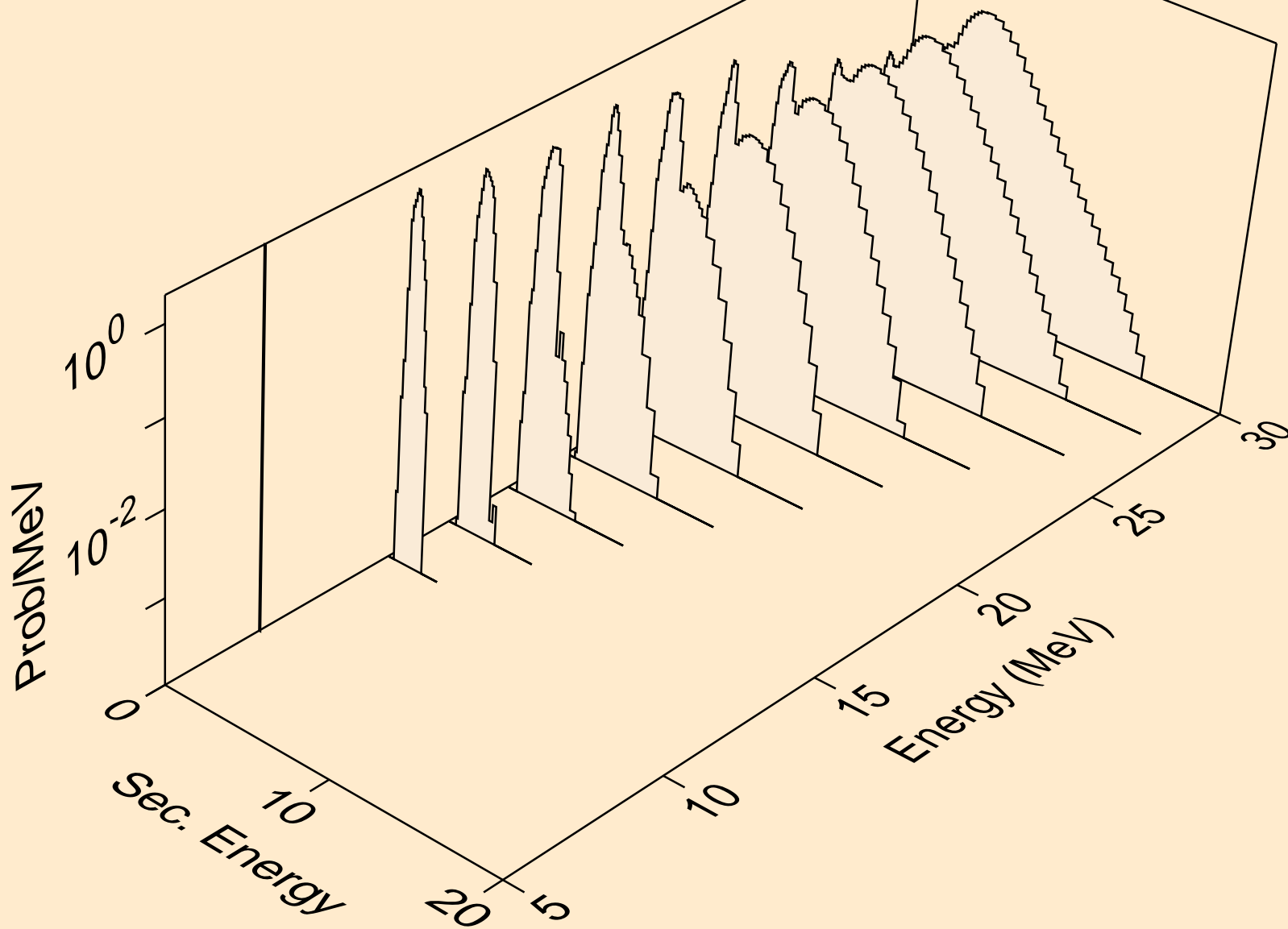

V050 NEUTRON ACER TENDL-2019 LIBRARY; T=293.16K
protons from (n,pd)

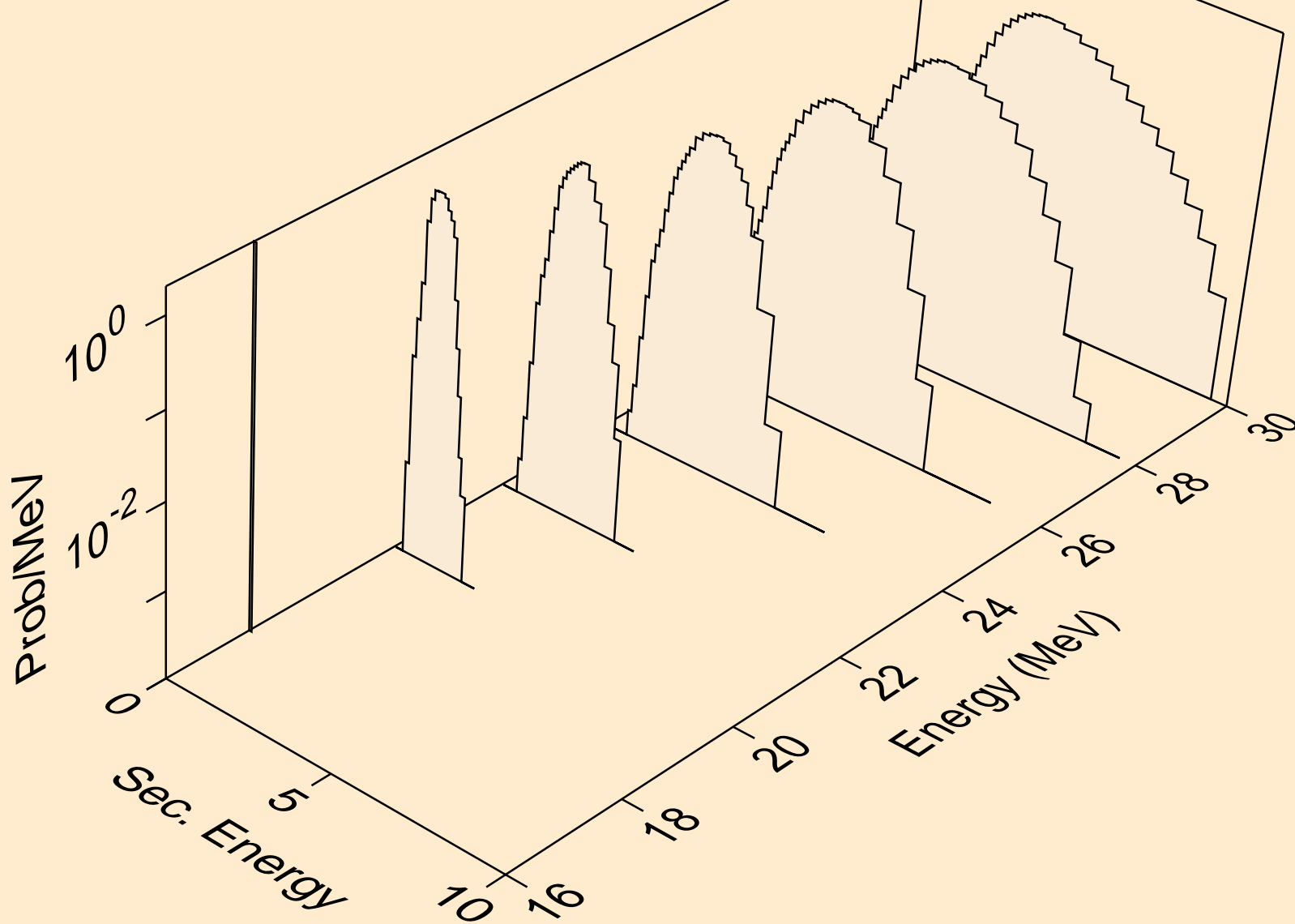

V050 NEUTRON ACER TENDL-2019 LIBRARY; T=293.16K
protons from (n,pt)

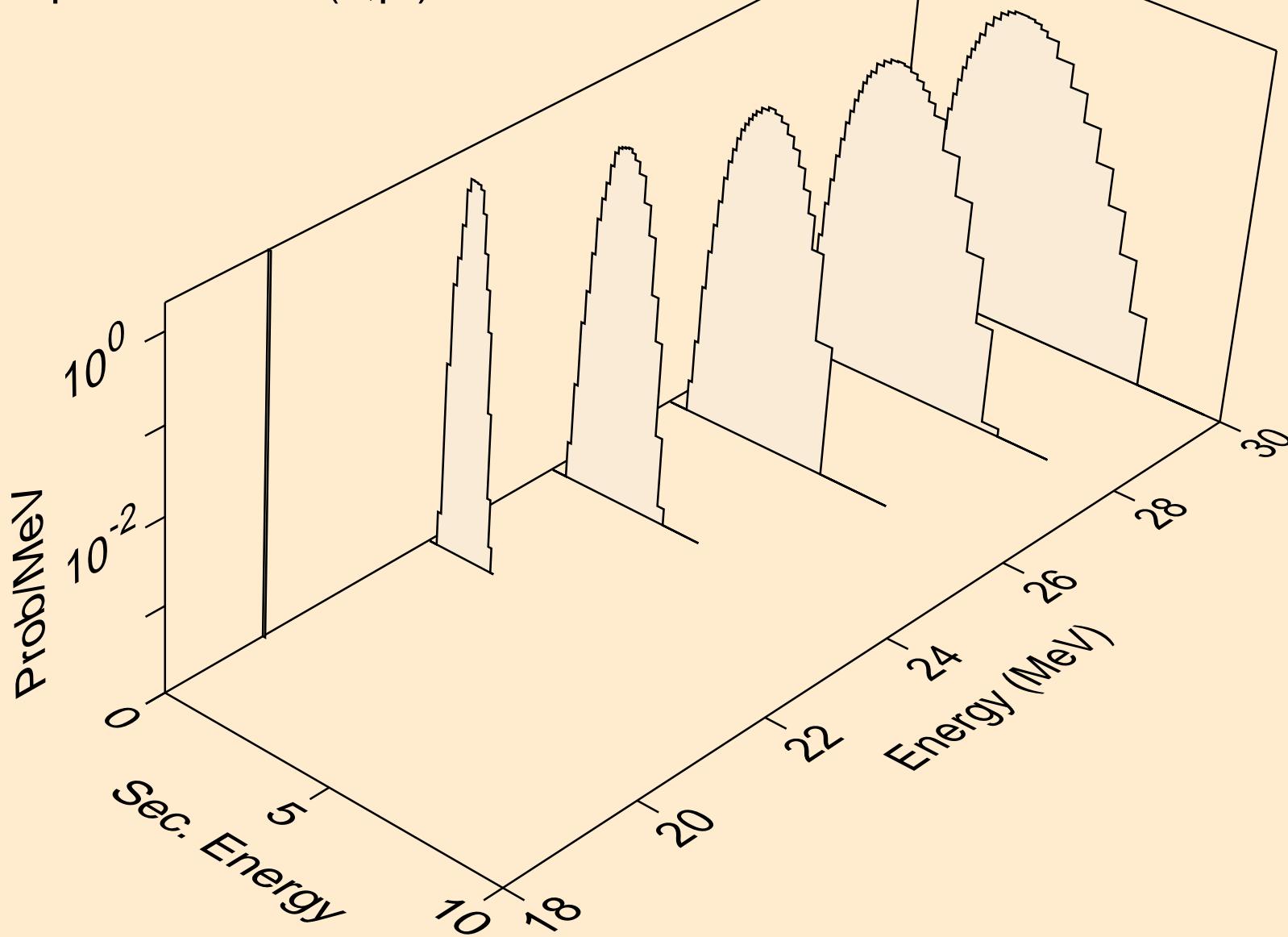

V050 NEUTRON ACER TENDL-2019 LIBRARY; T=293.16K
deuterons from (n,x)

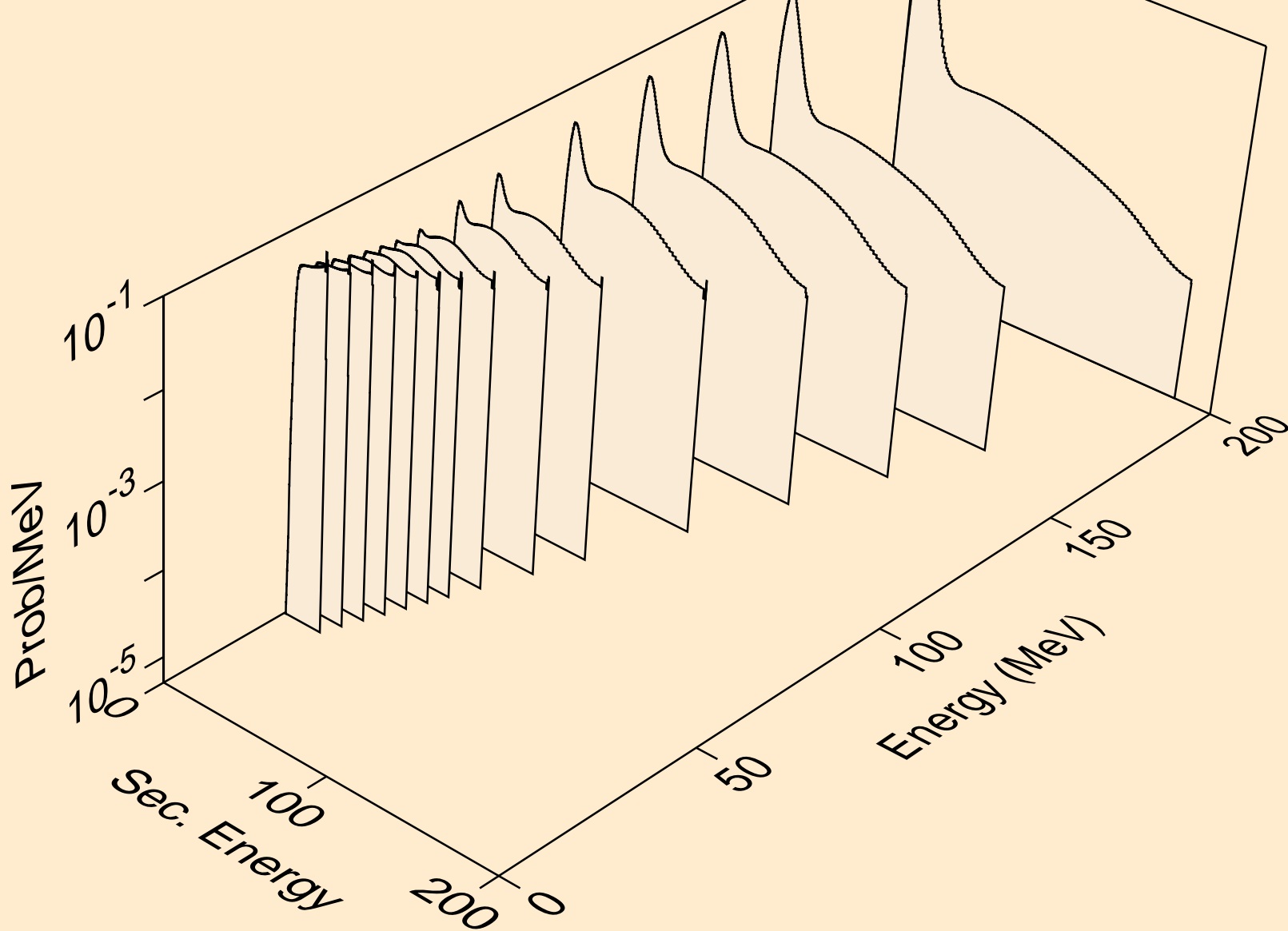

V050 NEUTRON ACER TENDL-2019 LIBRARY; T=293.16K
deuterons from (n,2nd)

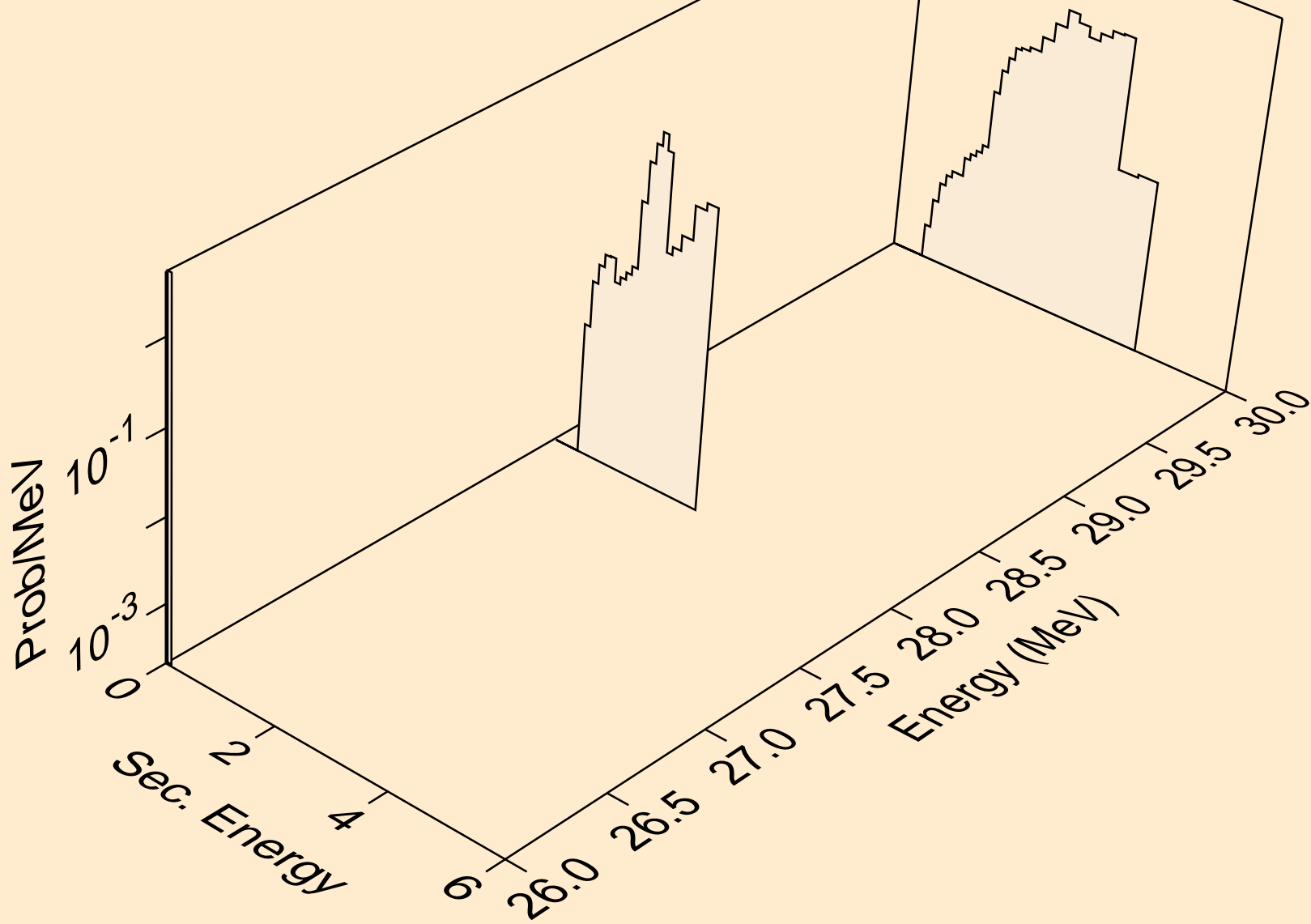

V050 NEUTRON ACER TENDL-2019 LIBRARY; T=293.16K
deuterons from (n,n*)d

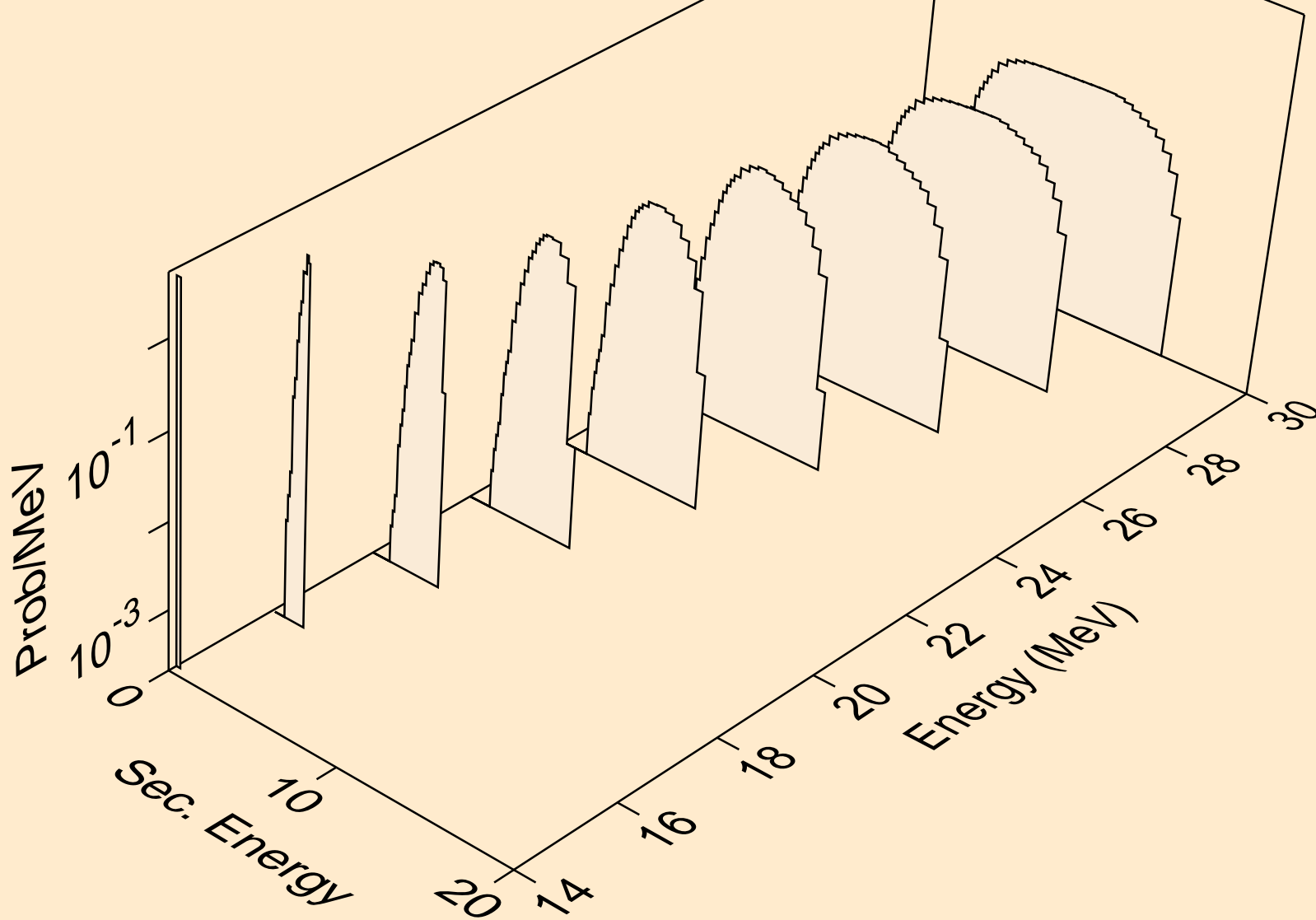

V050 NEUTRON ACER TENDL-2019 LIBRARY; T=293.16K
deuterons from (n,d)

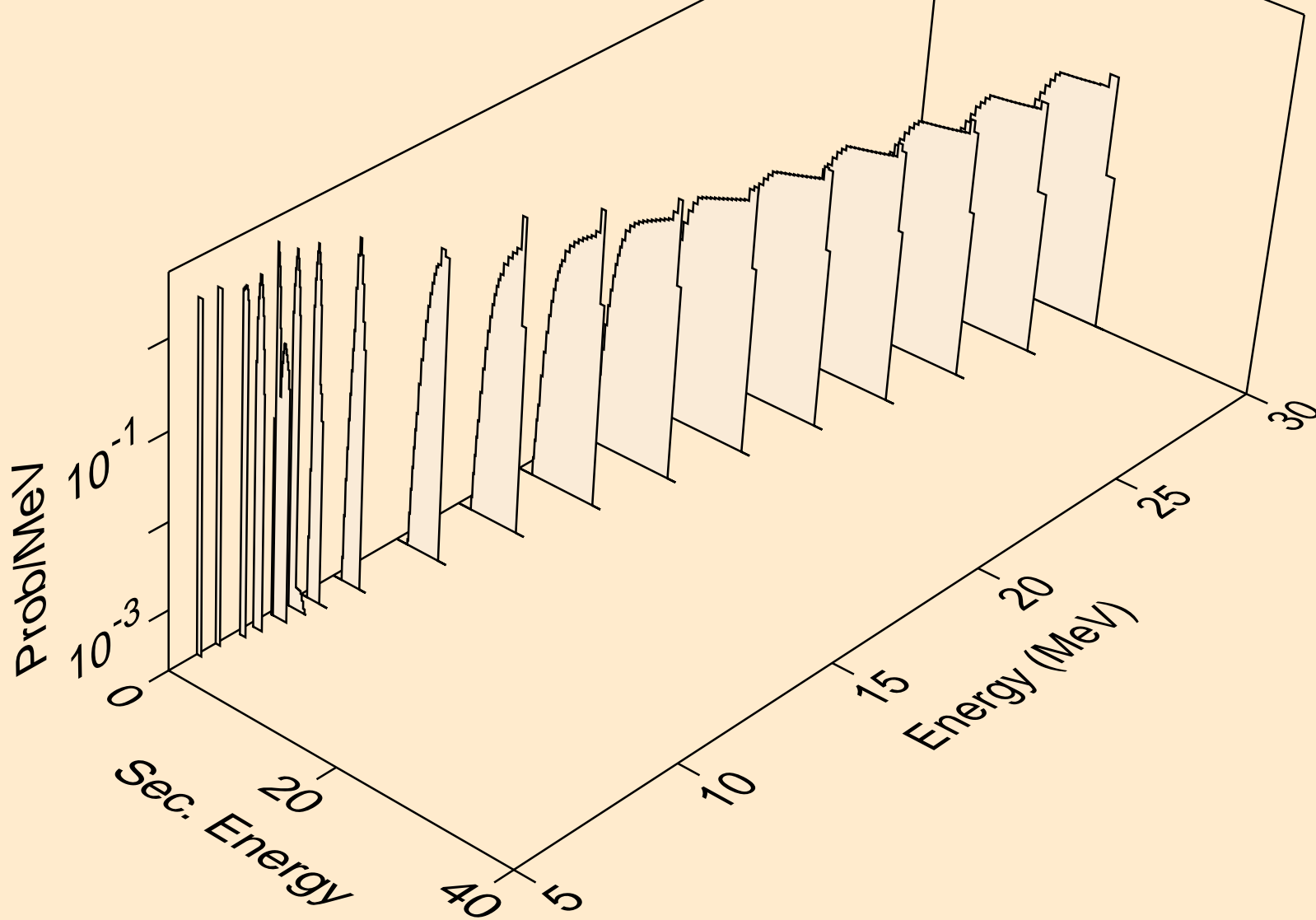

V050 NEUTRON ACER TENDL-2019 LIBRARY; T=293.16K
deuterons from (n,pd)

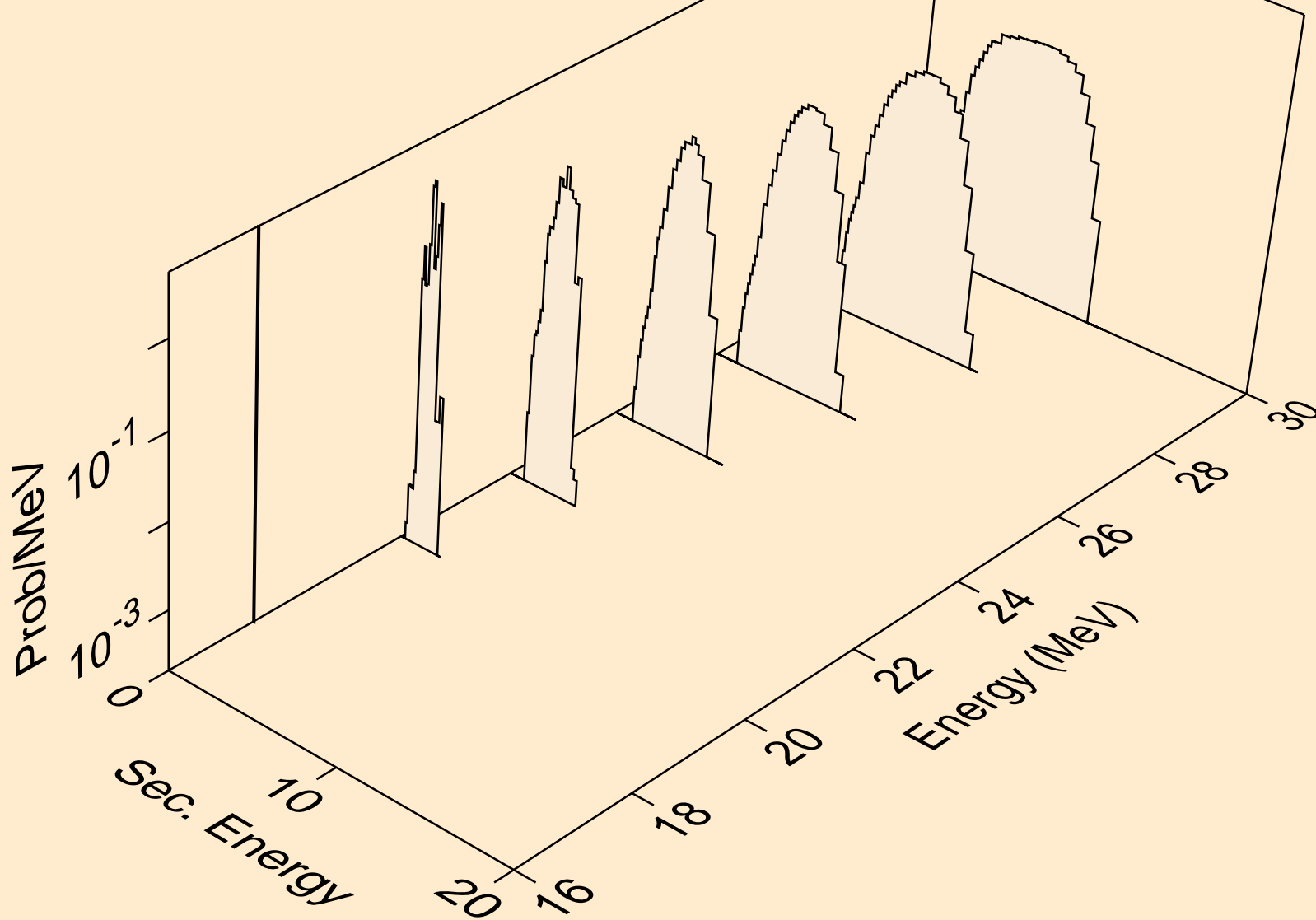

V050 NEUTRON ACER TENDL-2019 LIBRARY; T=293.16K
deuterons from (n,da)

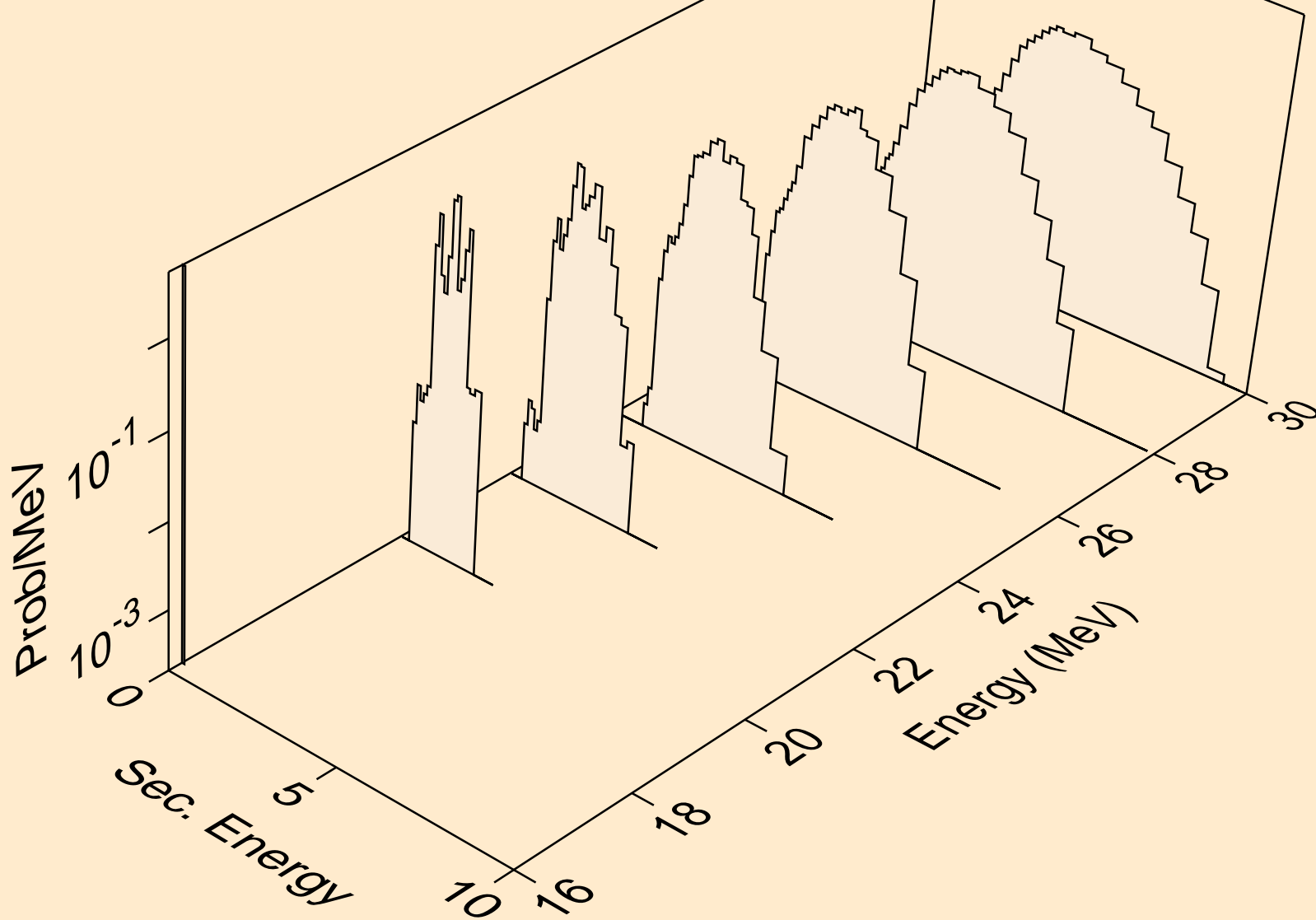

V050 NEUTRON ACER TENDL-2019 LIBRARY; T=293.16K
tritons from (n,x)

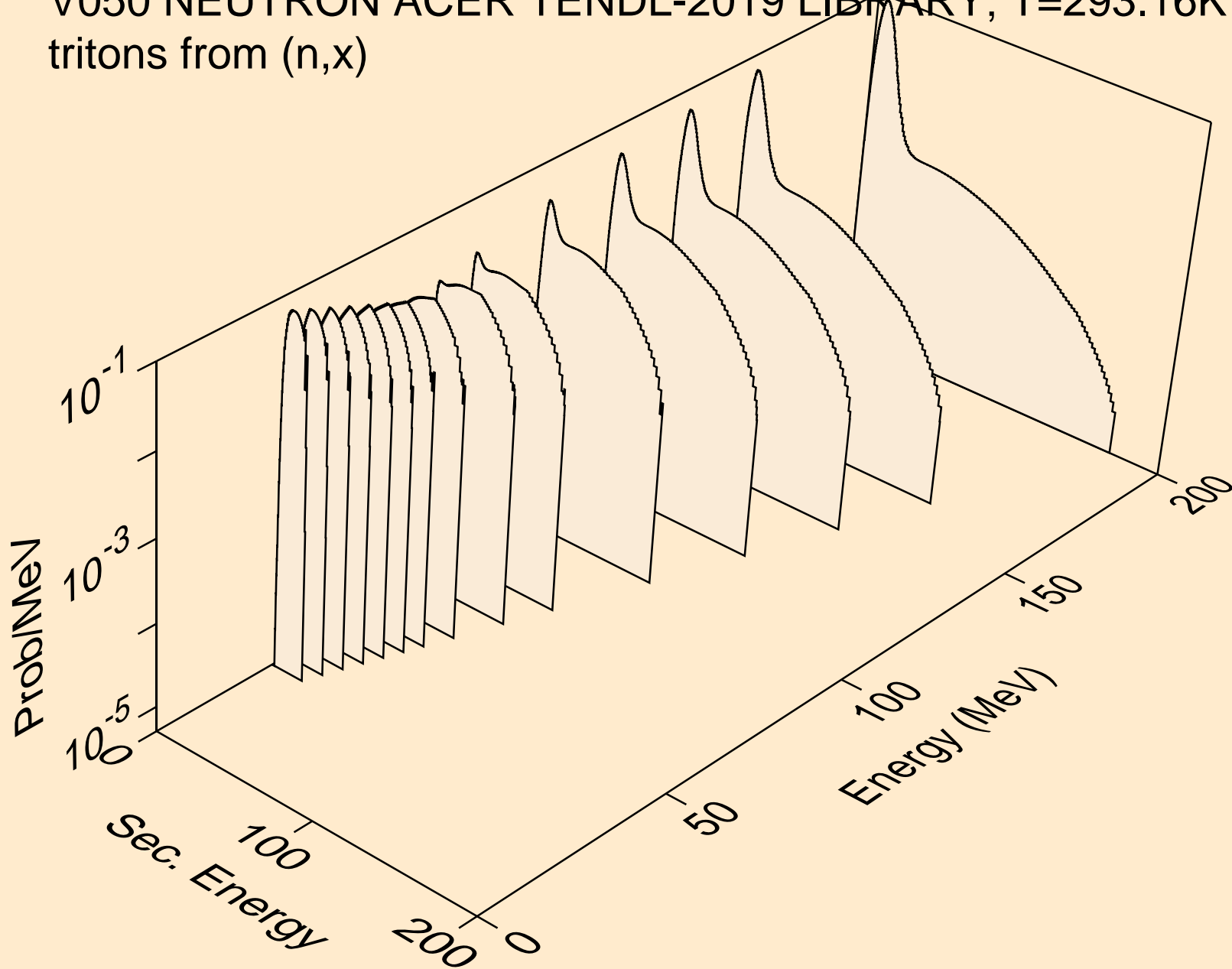

V050 NEUTRON ACER TENDL-2019 LIBRARY; T=293.16K
tritons from (n,n*)t

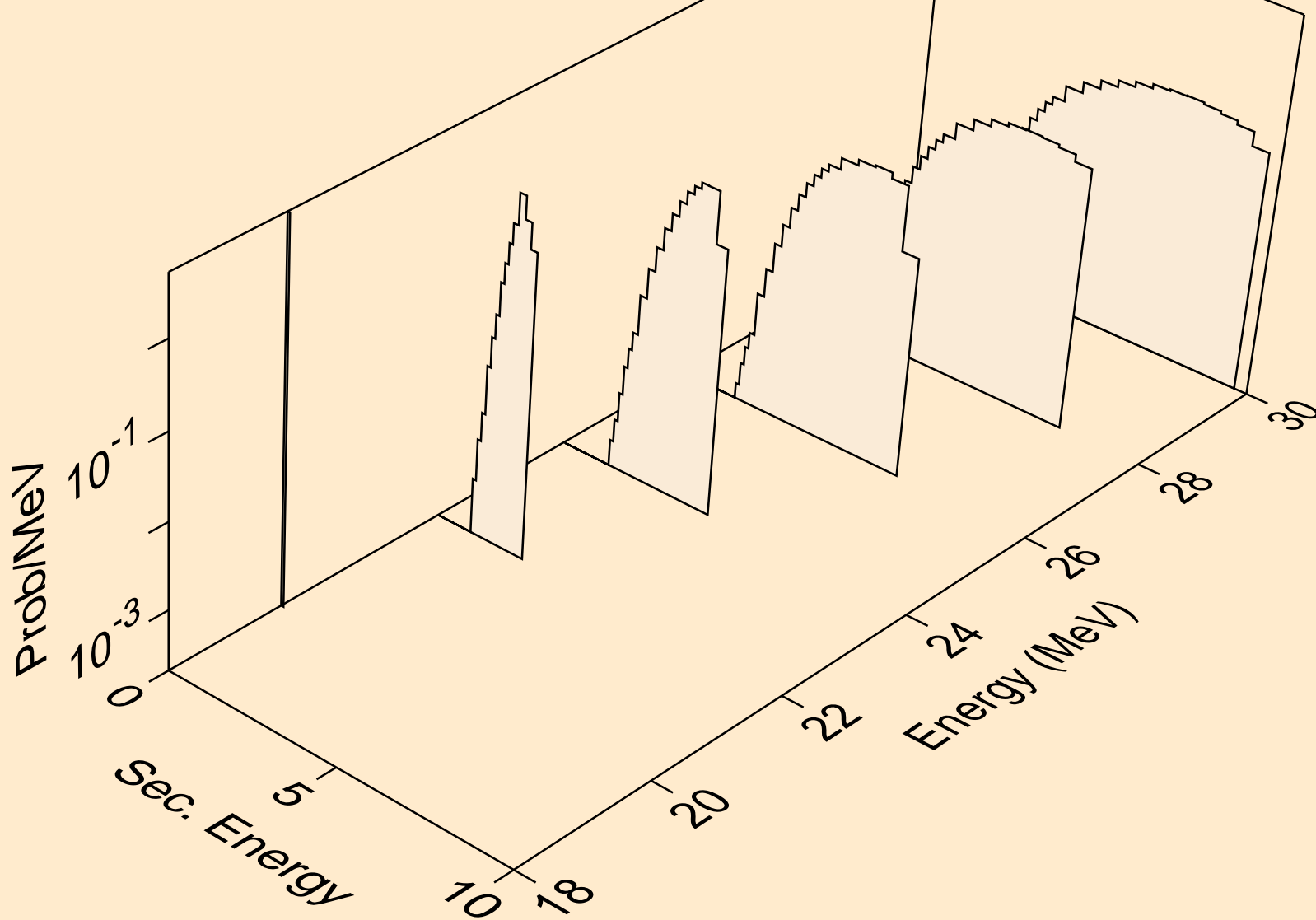

V050 NEUTRON ACER TENDL-2019 LIBRARY; T=293.16K
tritons from (n,t)

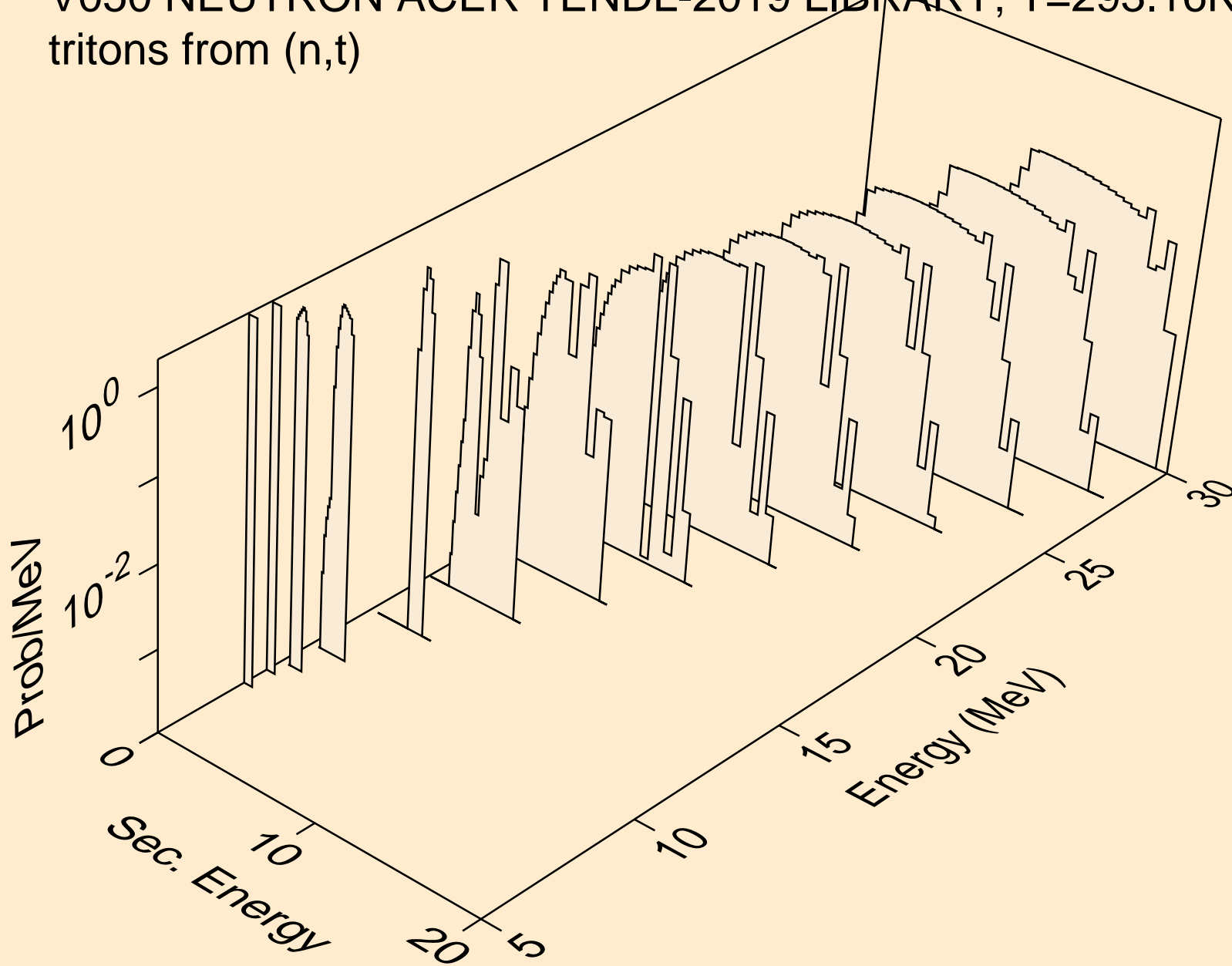

V050 NEUTRON ACER TENDL-2019 LIBRARY; T=293.16K
tritons from (n,pt)

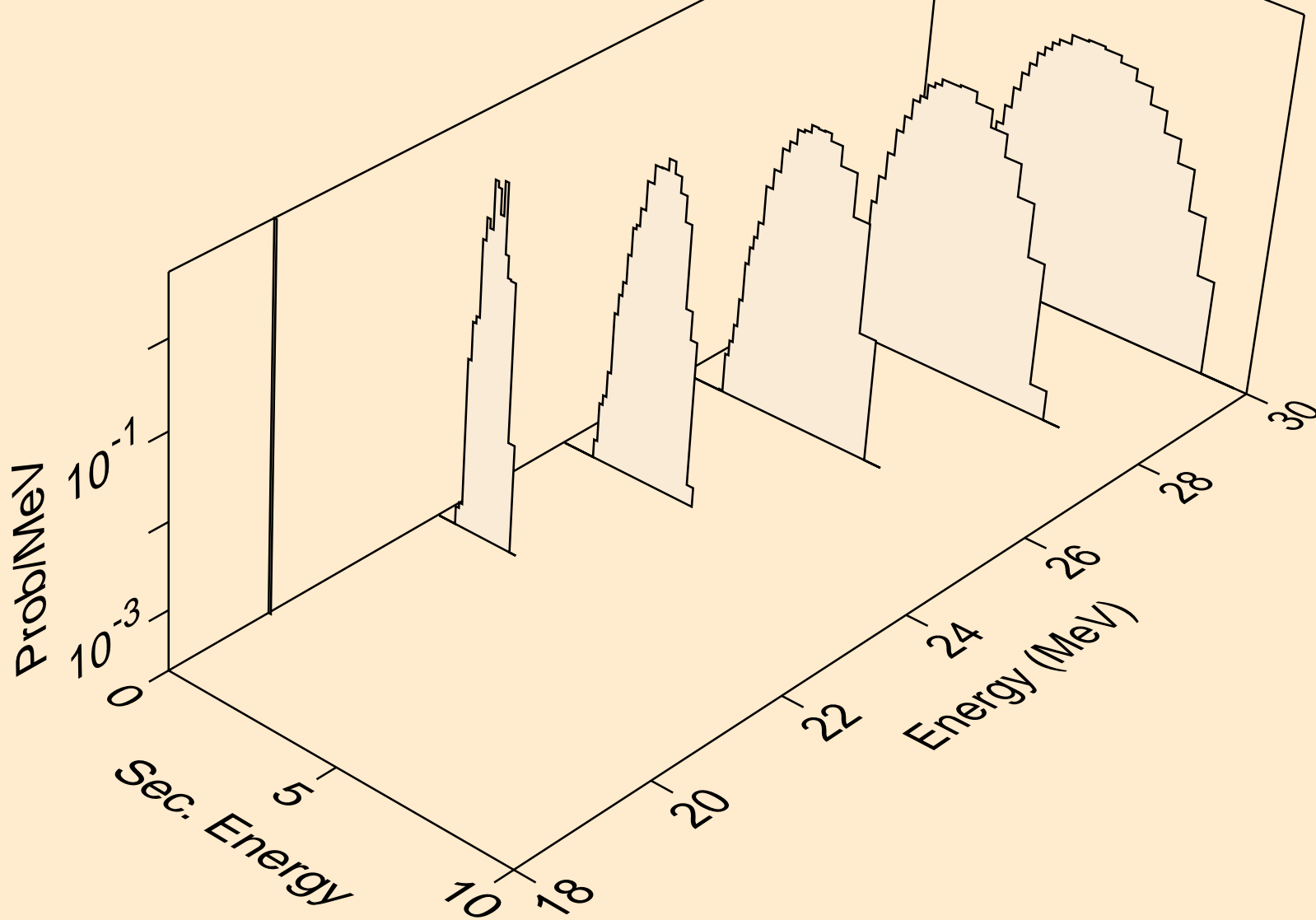

V050 NEUTRON ACER TENDL-2019 LIBRARY; T=293.16K
he3s from (n,x)

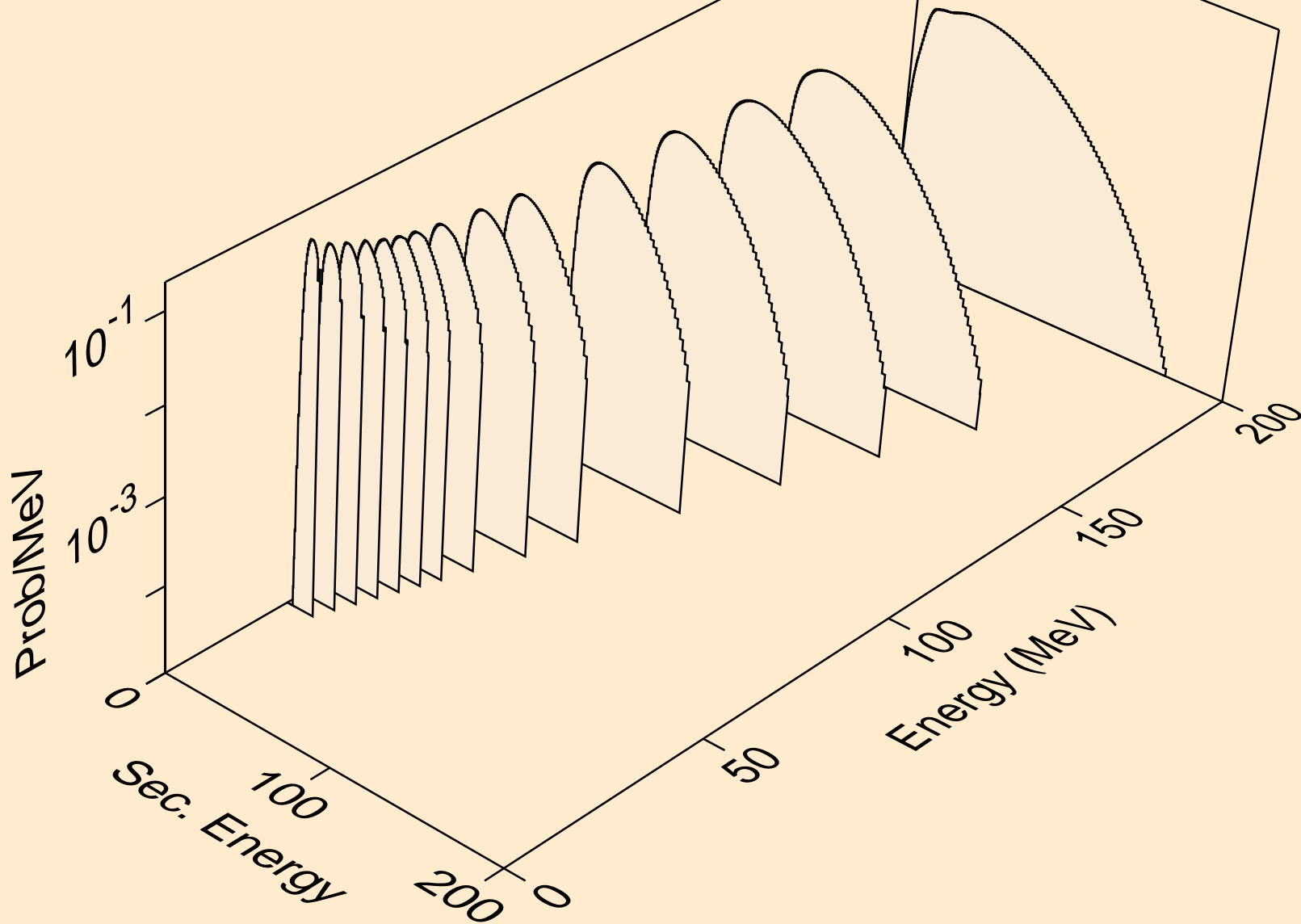

V050 NEUTRON ACER TENDL-2019 LIBRARY; T=293.16K
he3s from (n,n*)he3

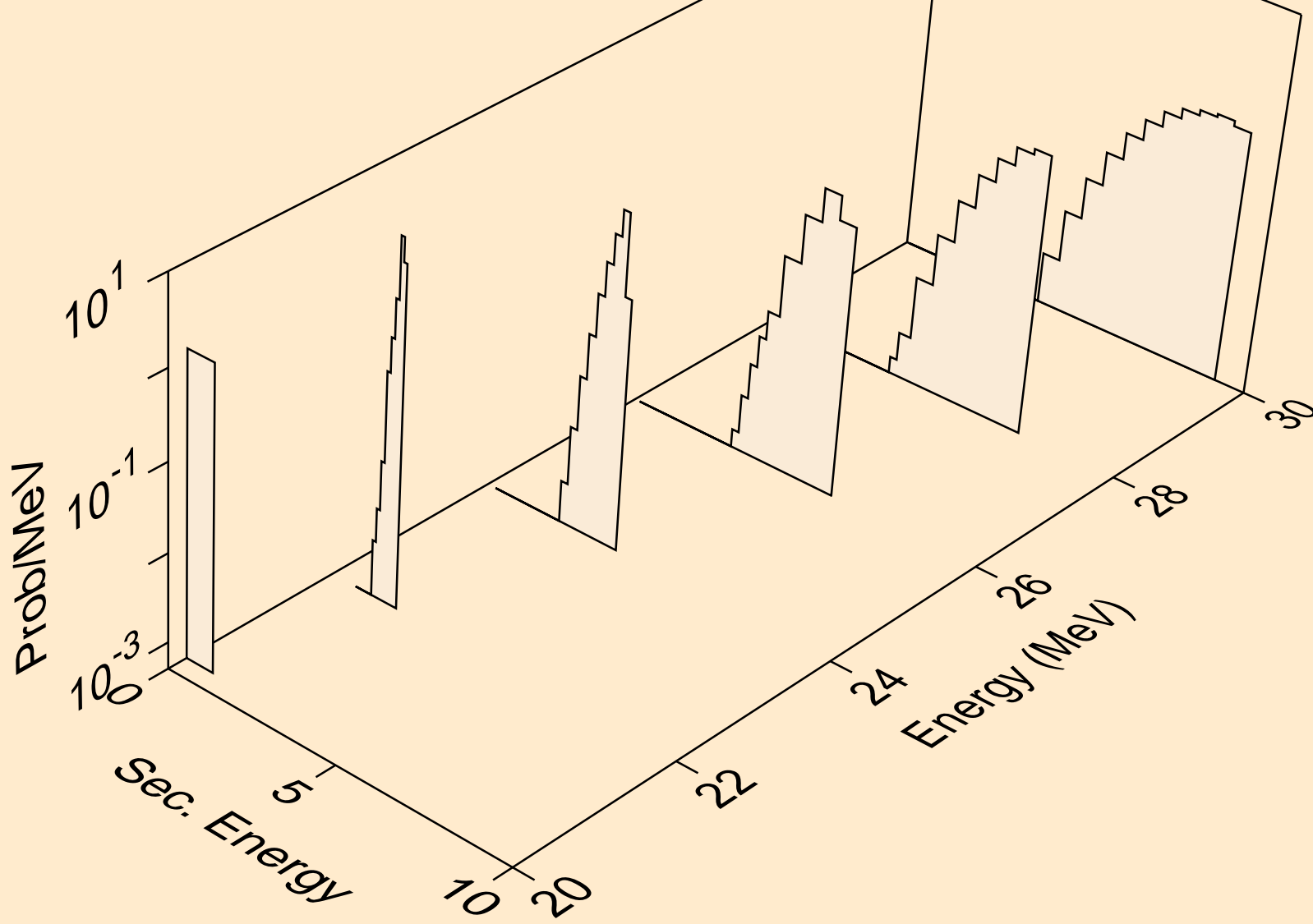

V050 NEUTRON ACER TENDL-2019 LIBRARY; T=293.16K
he3s from (n,he3)

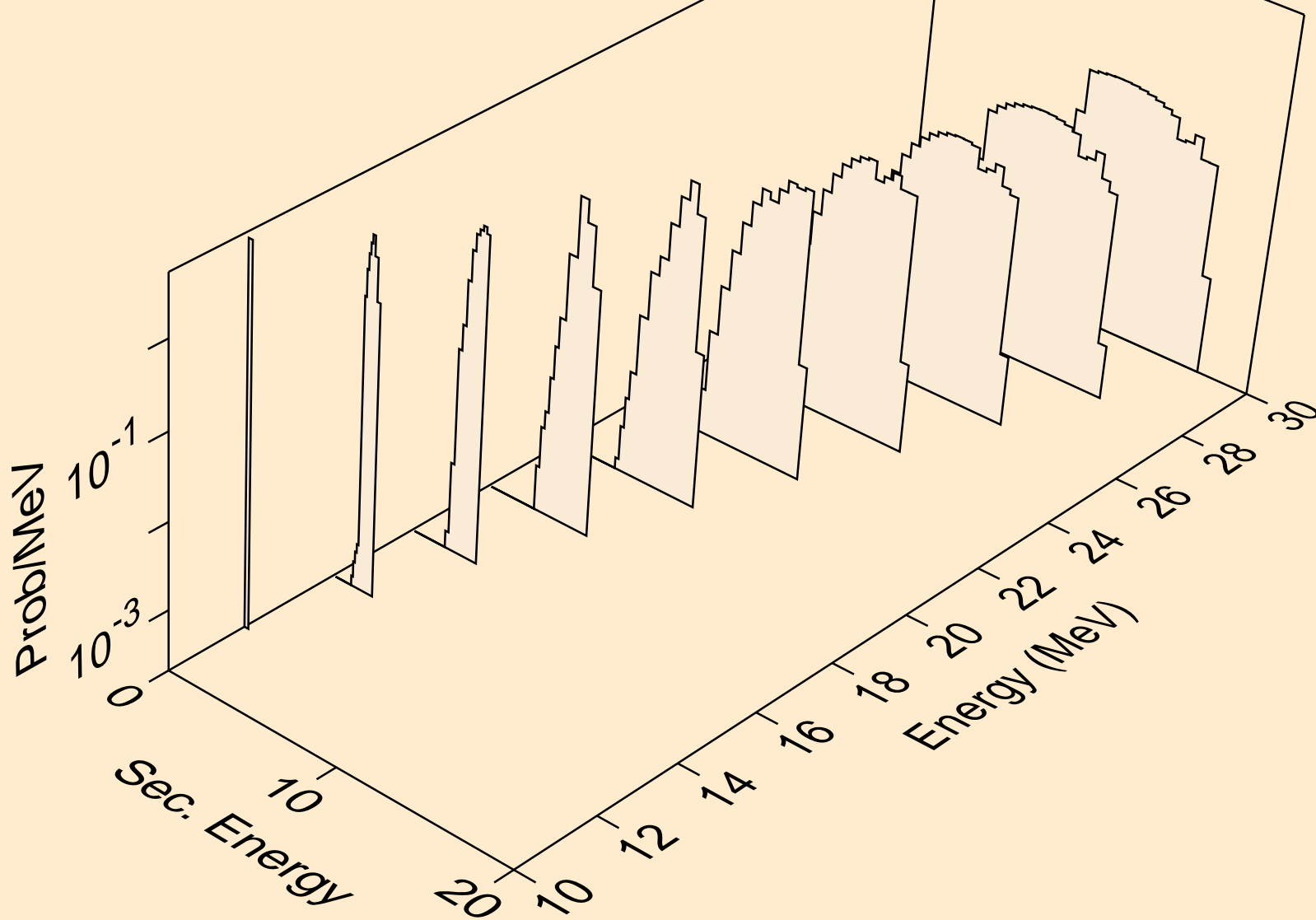

V050 NEUTRON ACER TENDL-2019 LIBRARY; T=293.16K
alphas from (n,x)

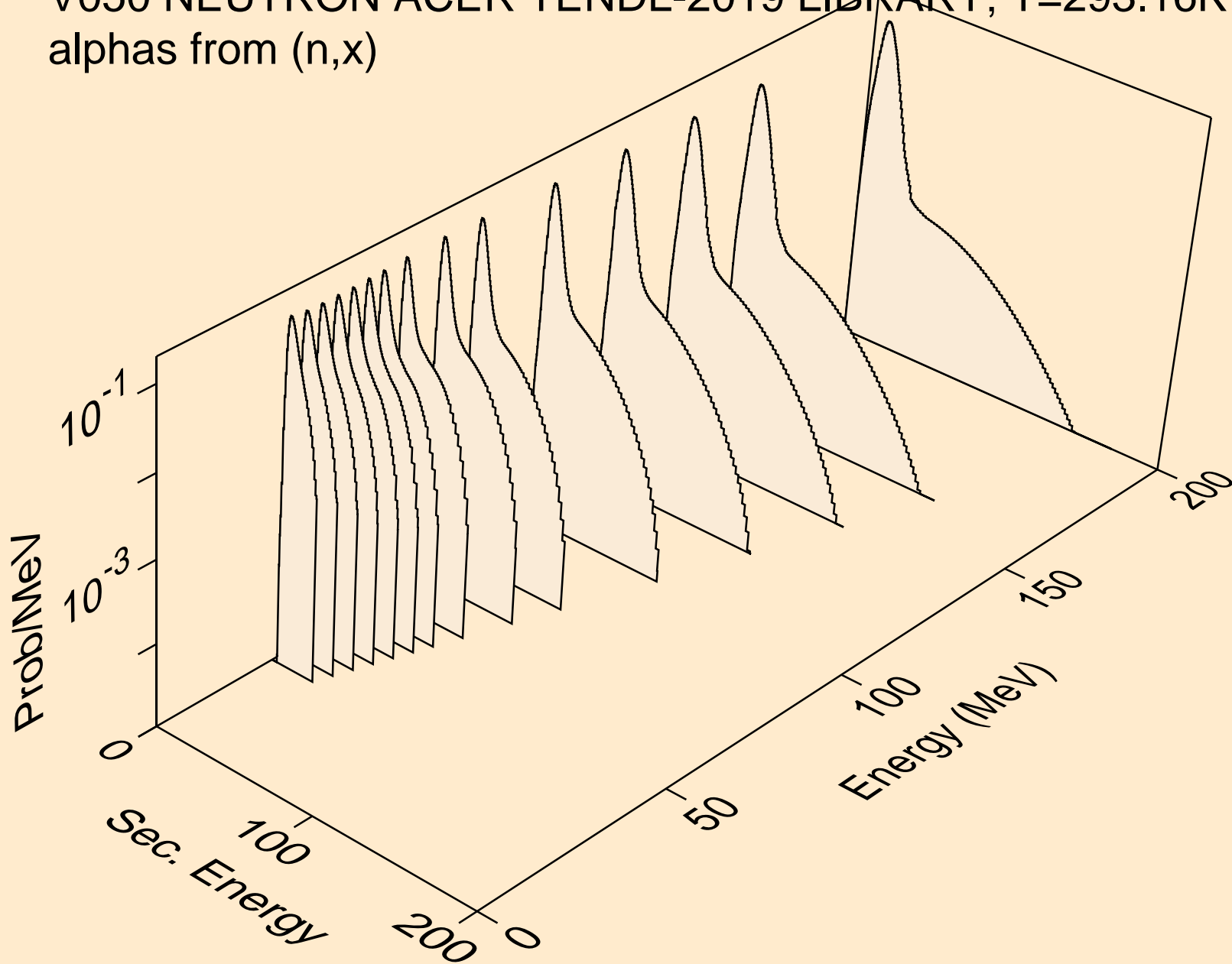

V050 NEUTRON ACER TENDL-2019 LIBRARY; T=293.16K
alphas from (n,n*)a

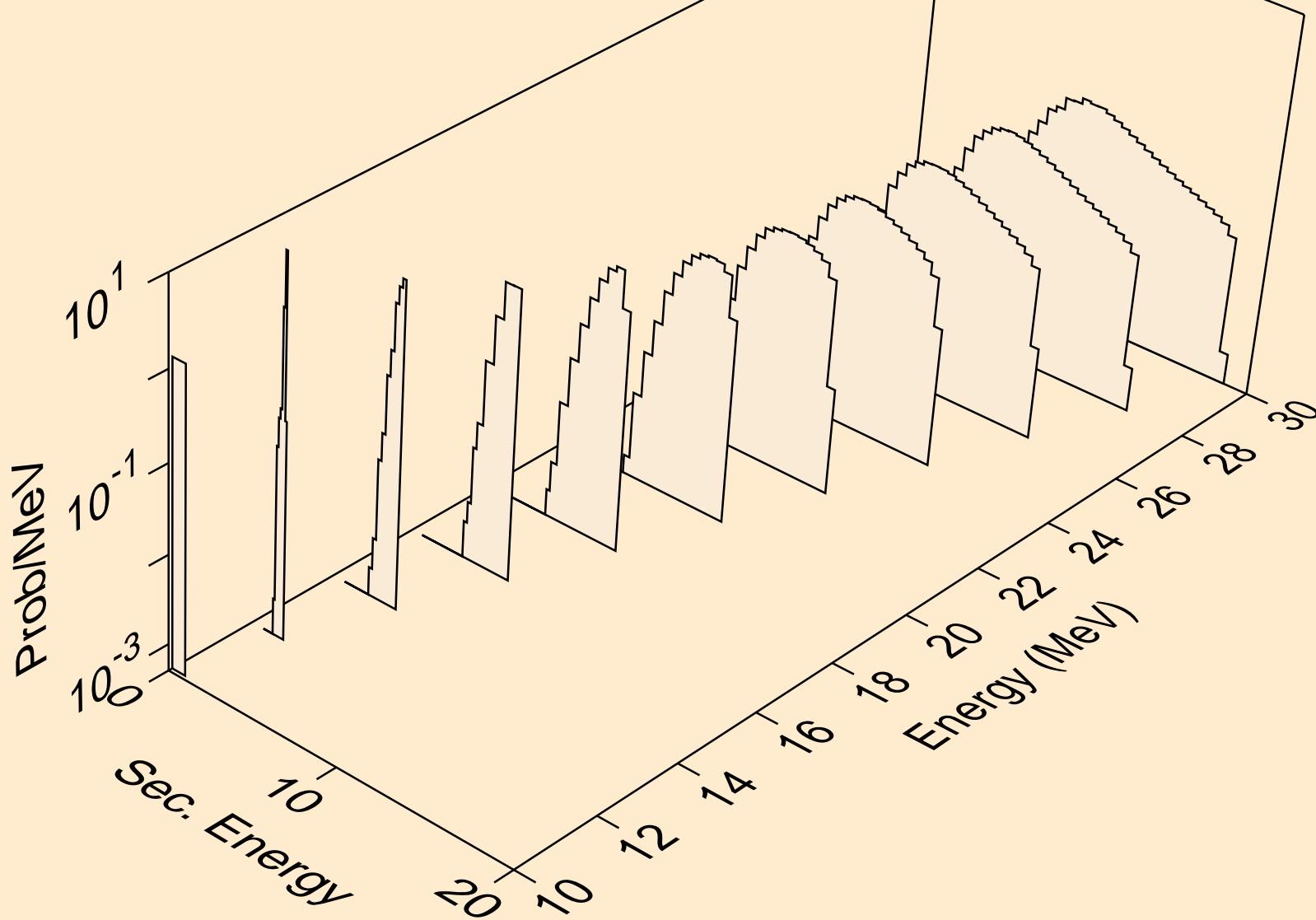

V050 NEUTRON ACER TENDL-2019 LIBRARY; T=293.16K
alphas from (n,2n)a

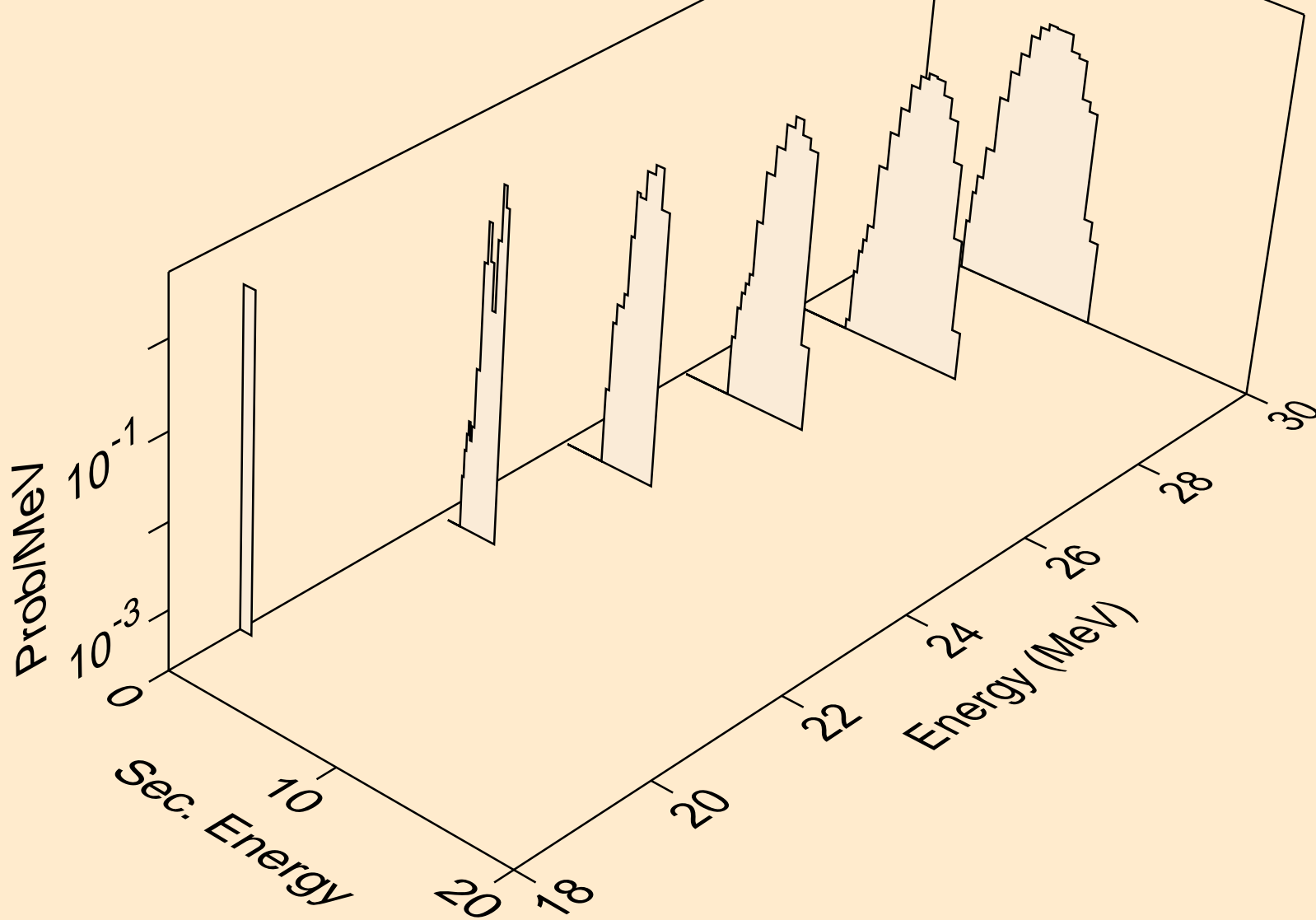

V050 NEUTRON ACER TENDL-2019 LIBRARY; T=293.16K
alphas from (n,n*)2a

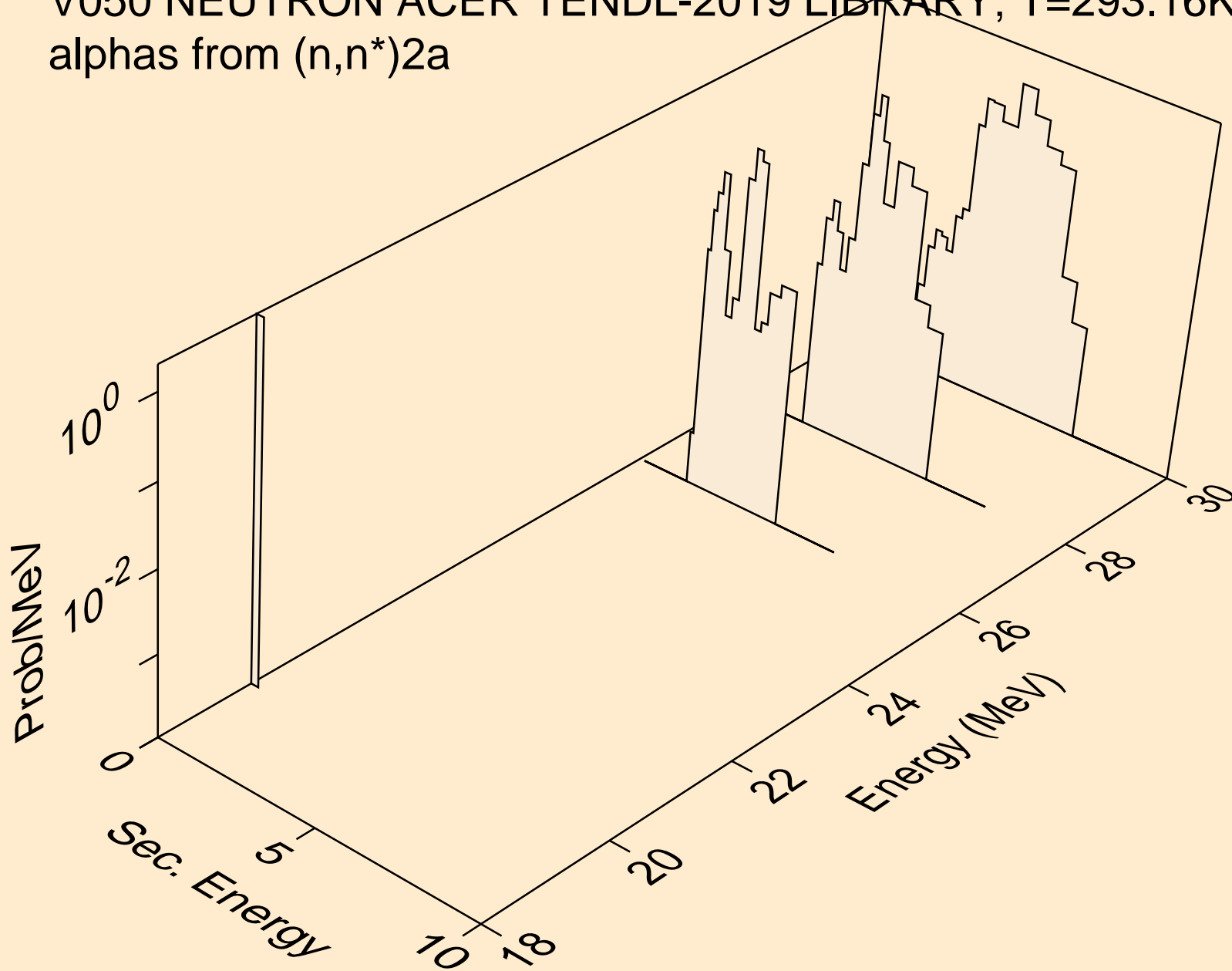

V050 NEUTRON ACER TENDL-2019 LIBRARY; T=293.16K
alphas from (n,npa)

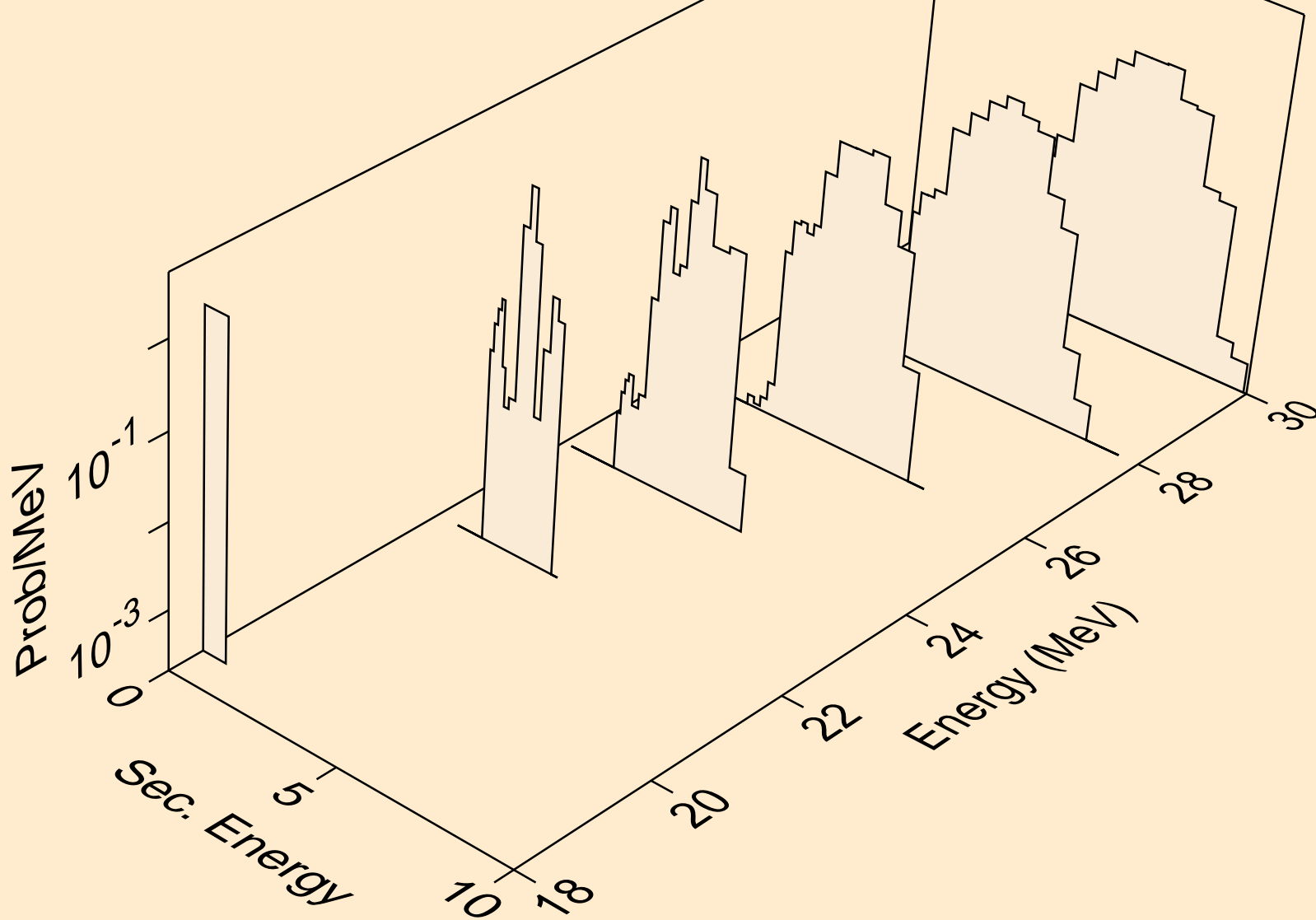

V050 NEUTRON ACER TENDL-2019 LIBRARY; T=293.16K
alphas from (n,a)

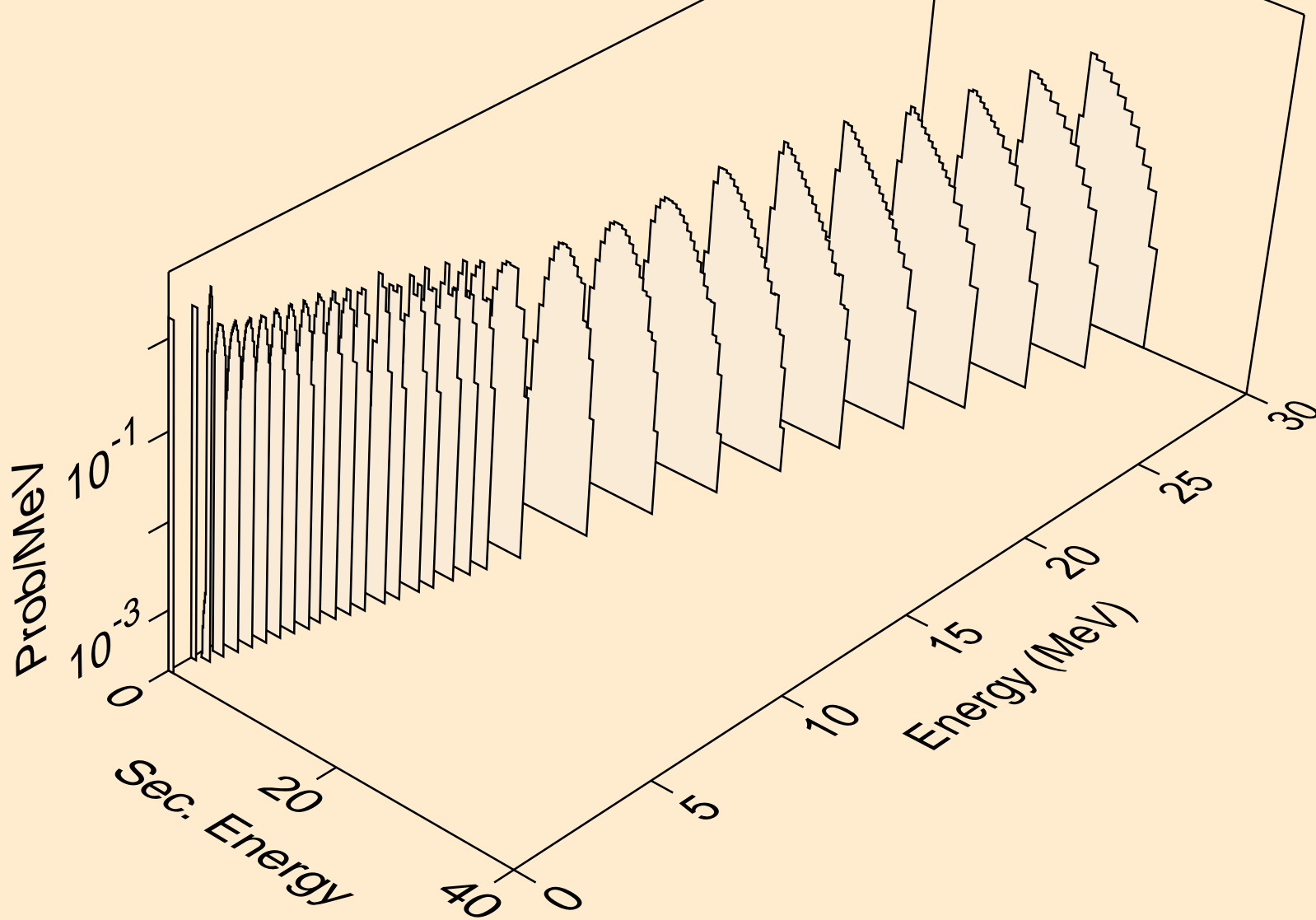

V050 NEUTRON ACER TENDL-2019 LIBRARY; T=293.16K
alphas from (n,2a)

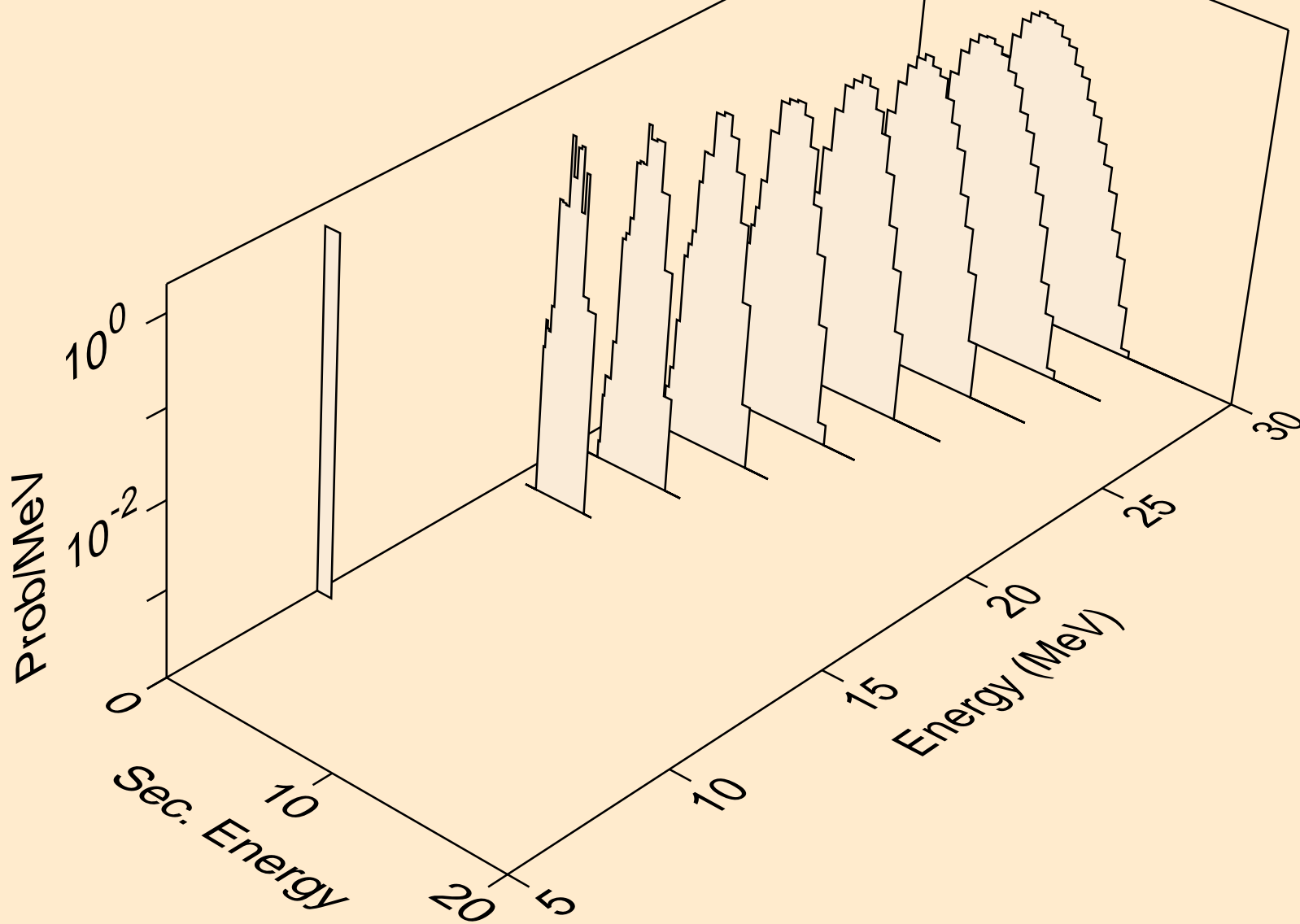

V050 NEUTRON ACER TENDL-2019 LIBRARY; T=293.16K
alphas from (n,pa)

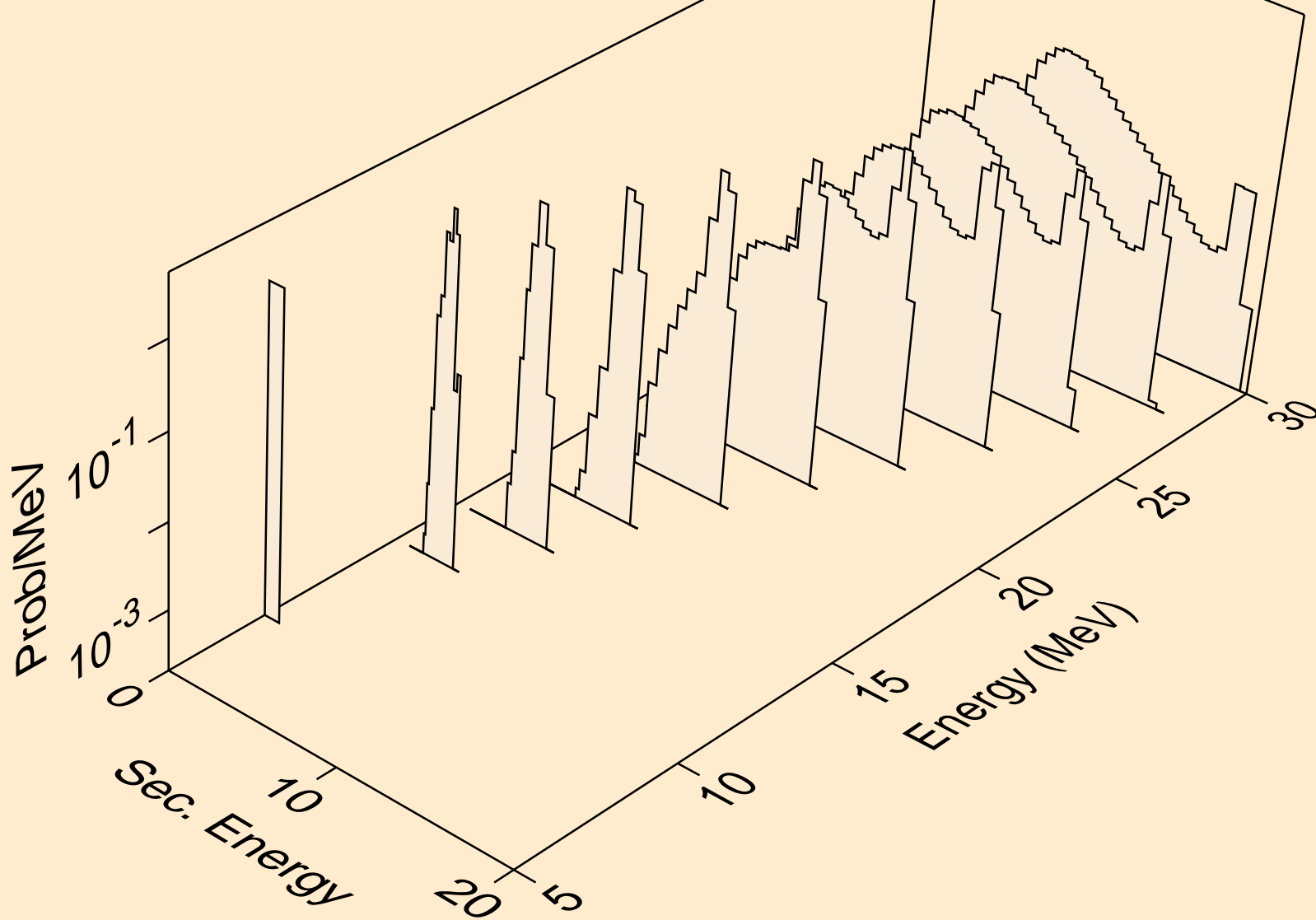

V050 NEUTRON ACER TENDL-2019 LIBRARY; T=293.16K
alphas from (n,da)

