

W166 NEUTRON ACER TENDL-2019 LIBRARY; T=293.16K
Principal cross sections

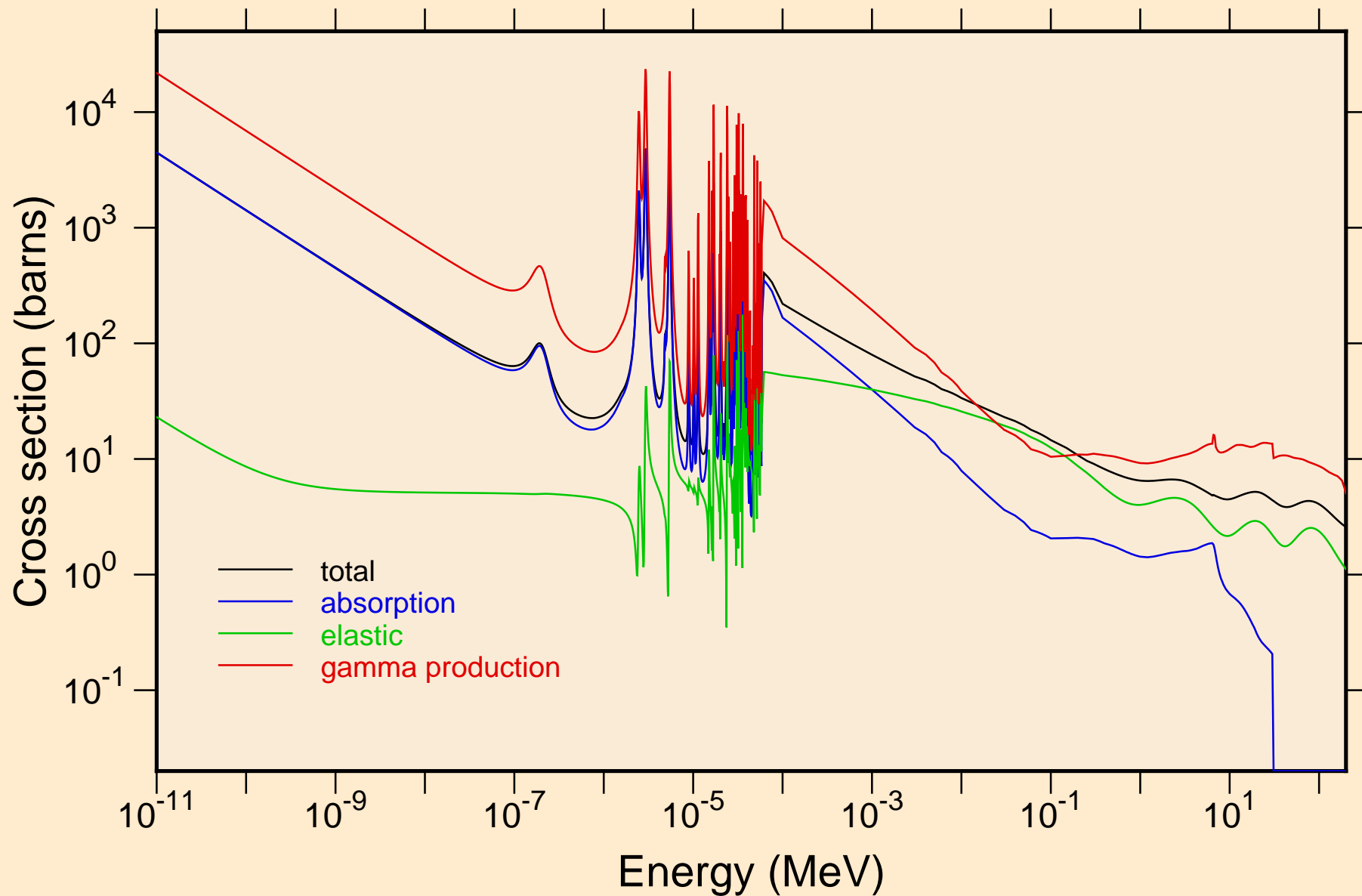

W166 NEUTRON ACER TENDL-2019 LIBRARY; T=293.16K
resonance total cross section

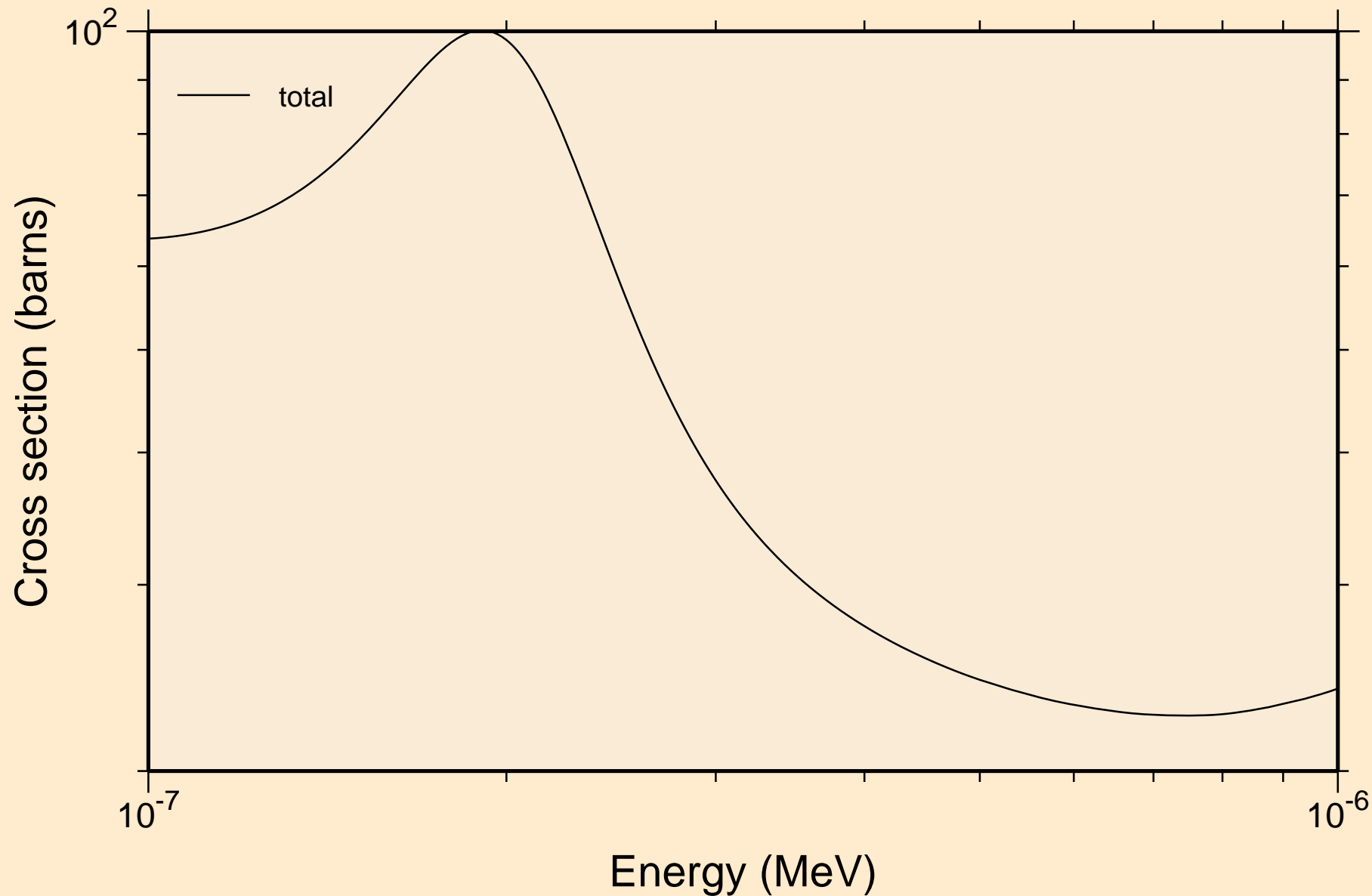

W166 NEUTRON ACER TENDL-2019 LIBRARY; T=293.16K
resonance total cross section

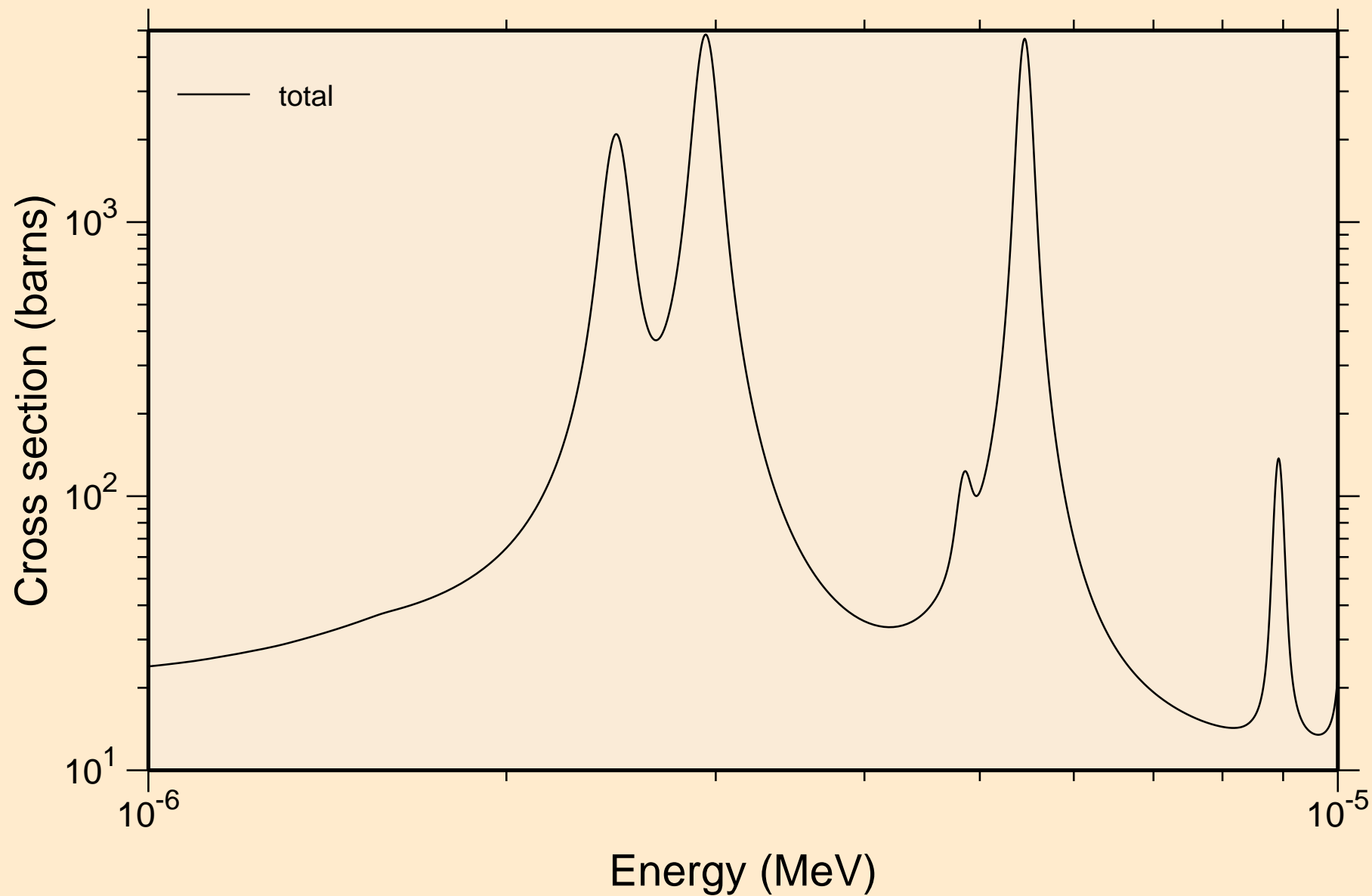

W166 NEUTRON ACER TENDL-2019 LIBRARY; T=293.16K
resonance total cross section

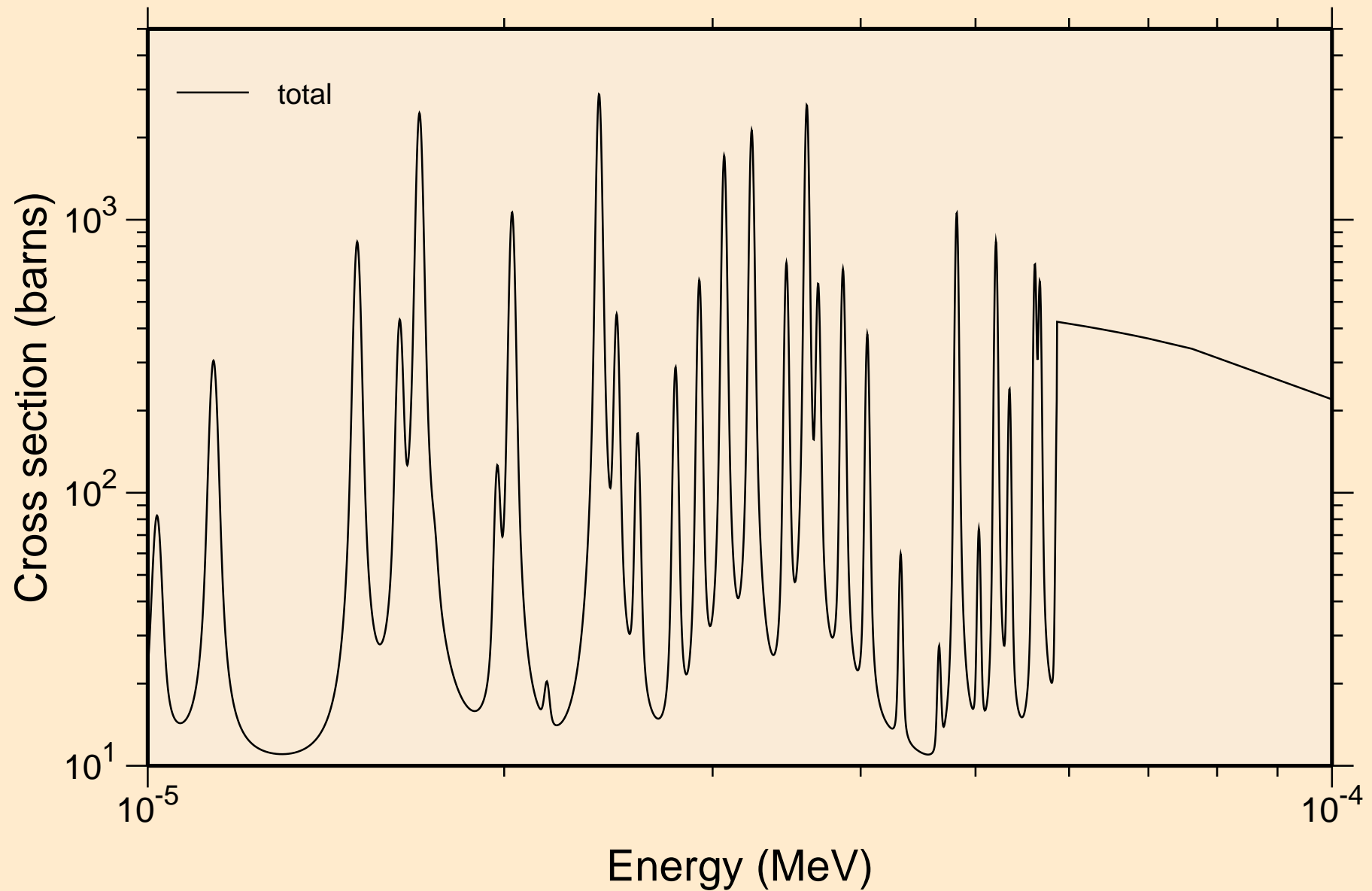

W166 NEUTRON ACER TENDL-2019 LIBRARY; T=293.16K
resonance total cross section

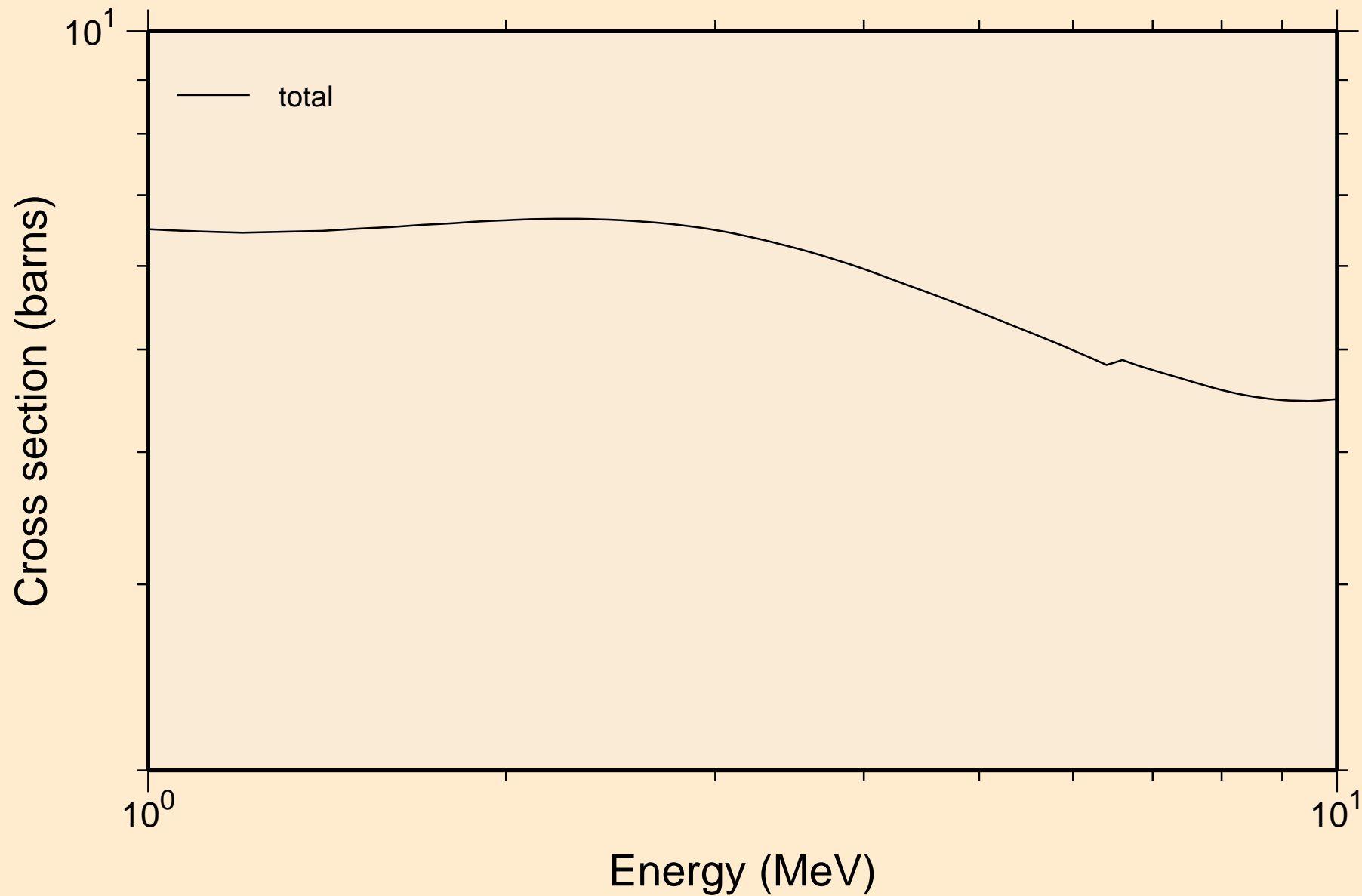

W166 NEUTRON ACER TENDL-2019 LIBRARY; T=293.16K
resonance absorption cross sections

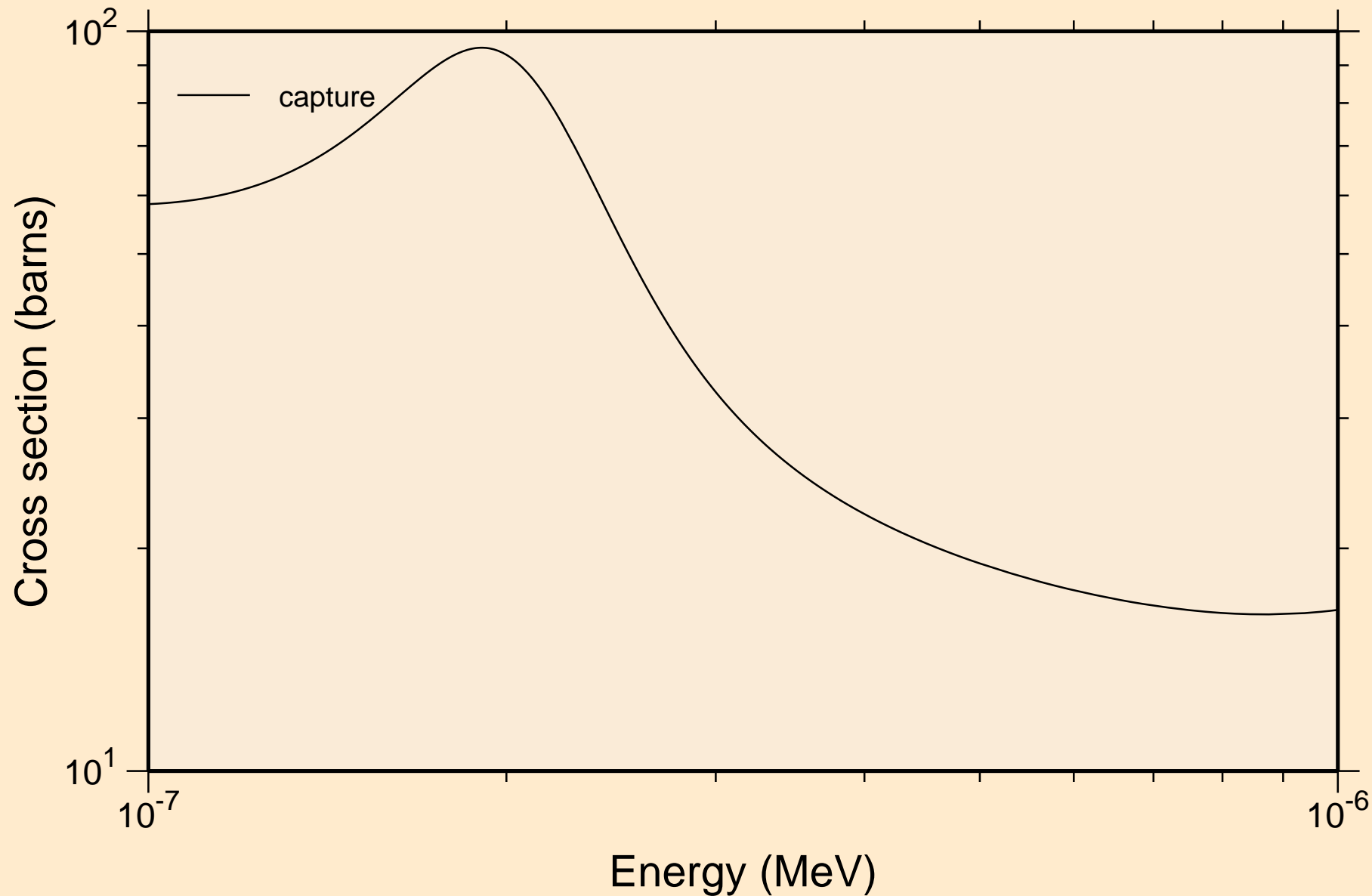

W166 NEUTRON ACER TENDL-2019 LIBRARY; T=293.16K
resonance absorption cross sections

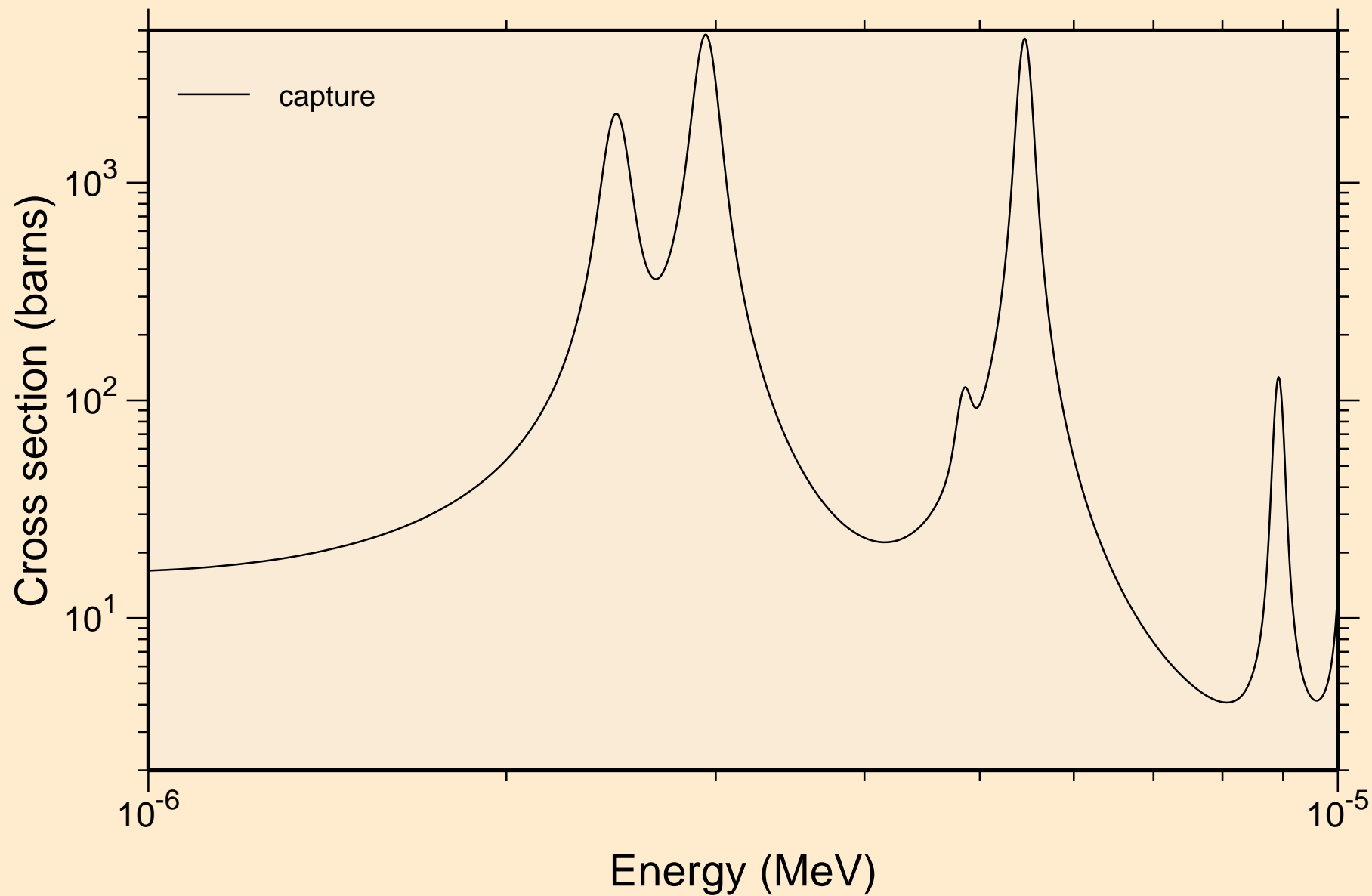

W166 NEUTRON ACER TENDL-2019 LIBRARY; T=293.16K
resonance absorption cross sections

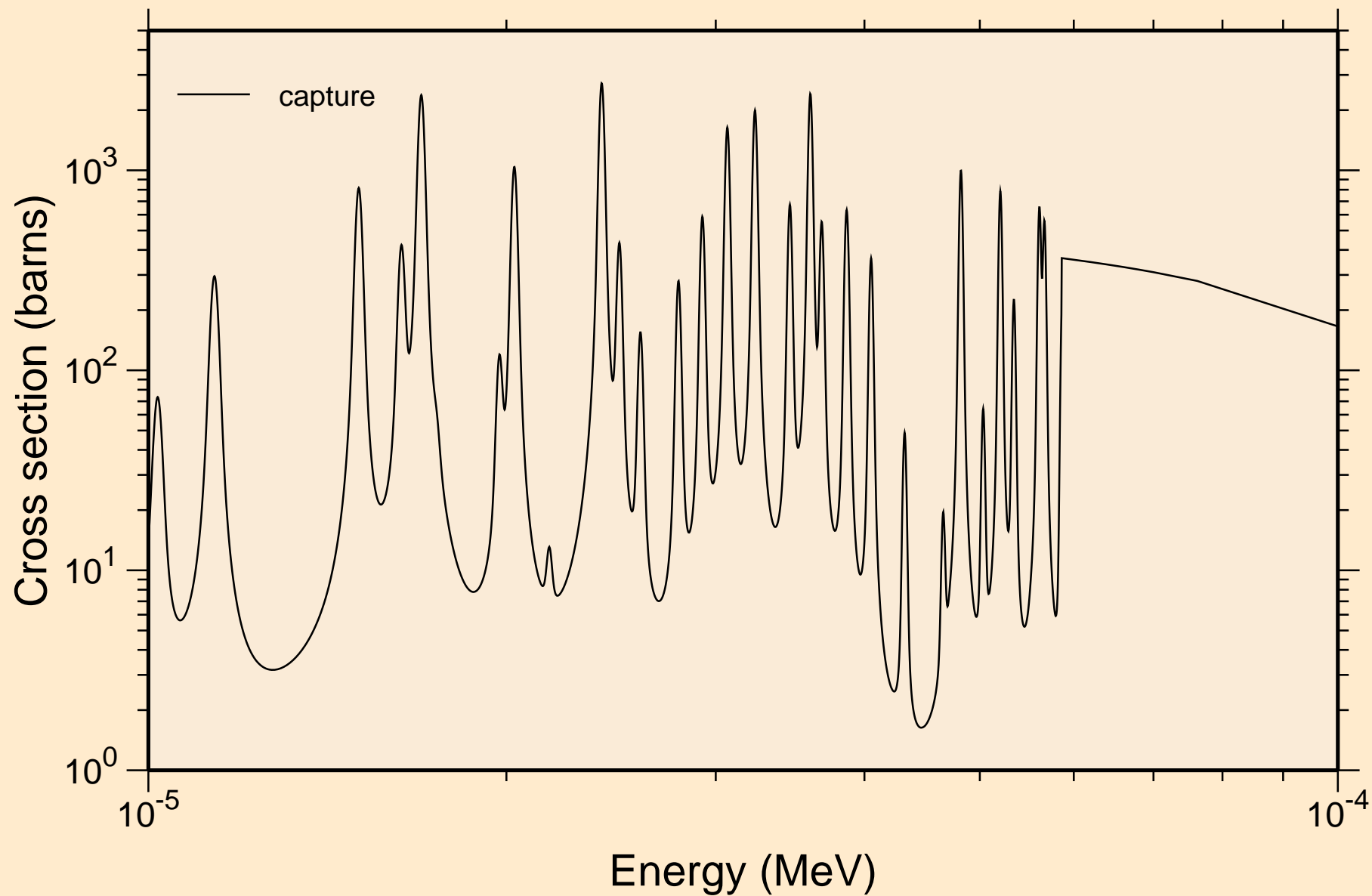

W166 NEUTRON ACER TENDL-2019 LIBRARY; T=293.16K
resonance absorption cross sections

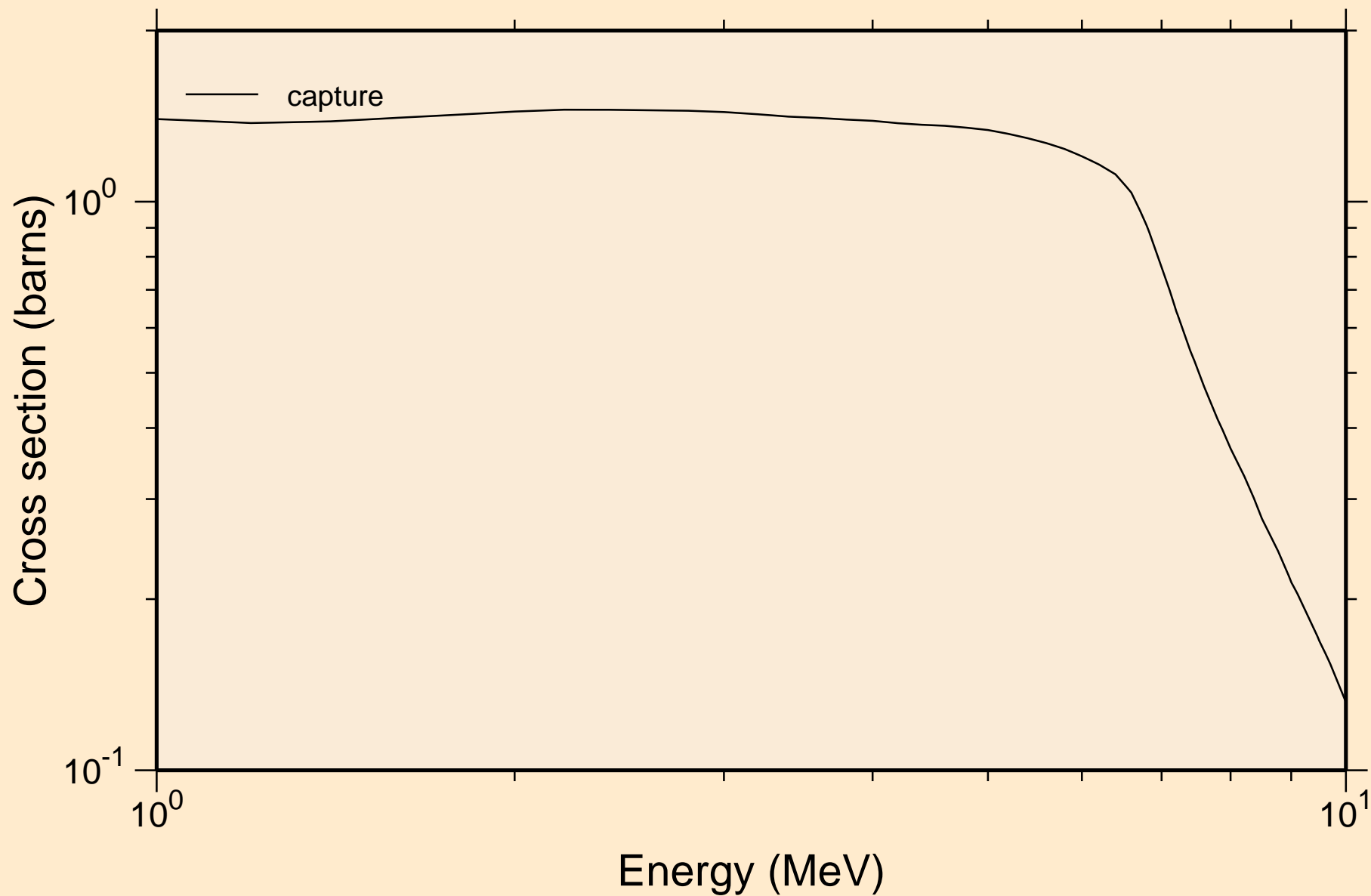

W166 NEUTRON ACER TENDL-2019 LIBRARY; T=293.16K
Heating

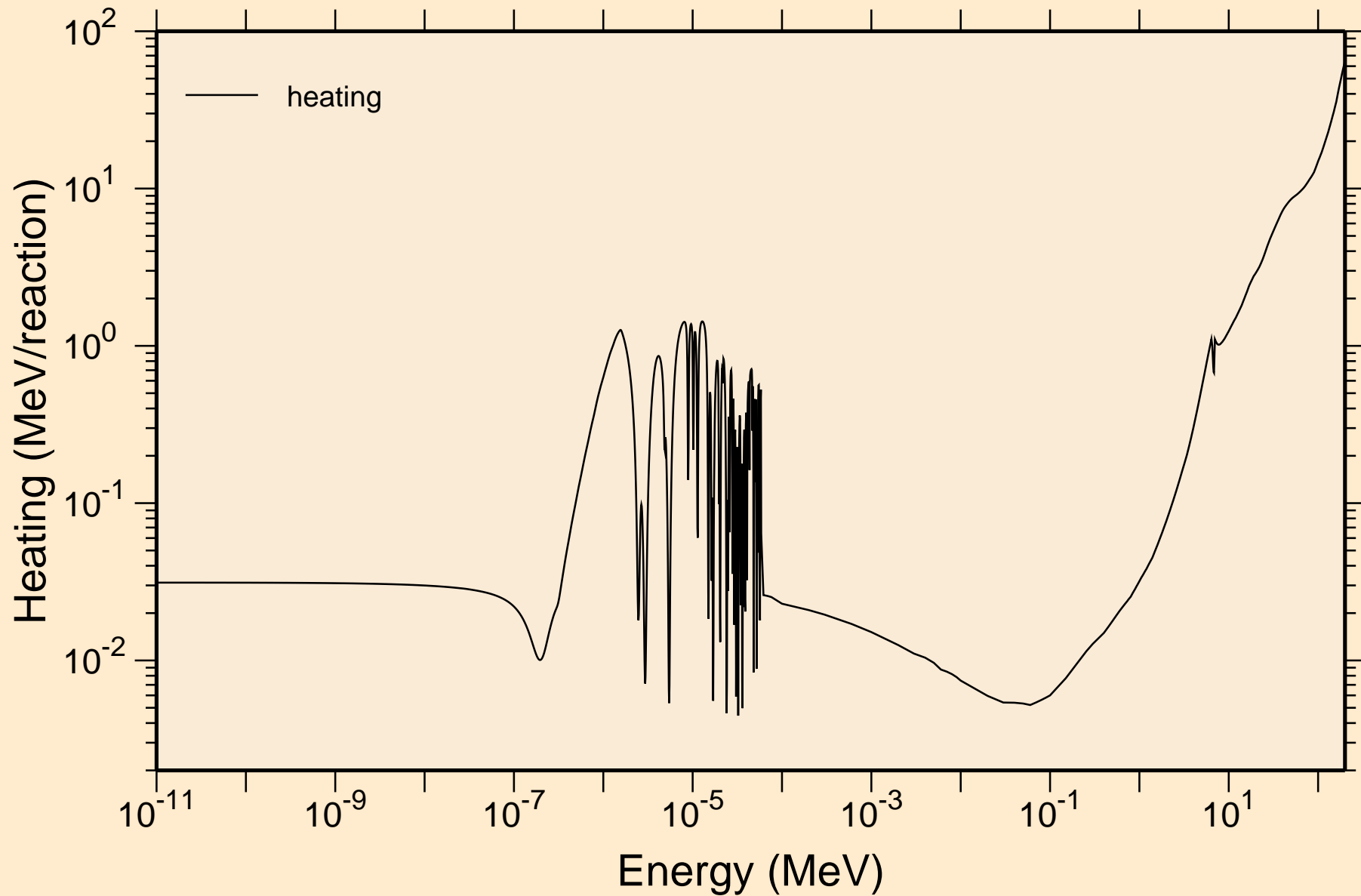

W166 NEUTRON ACER TENDL-2019 LIBRARY; T=293.16K
Damage

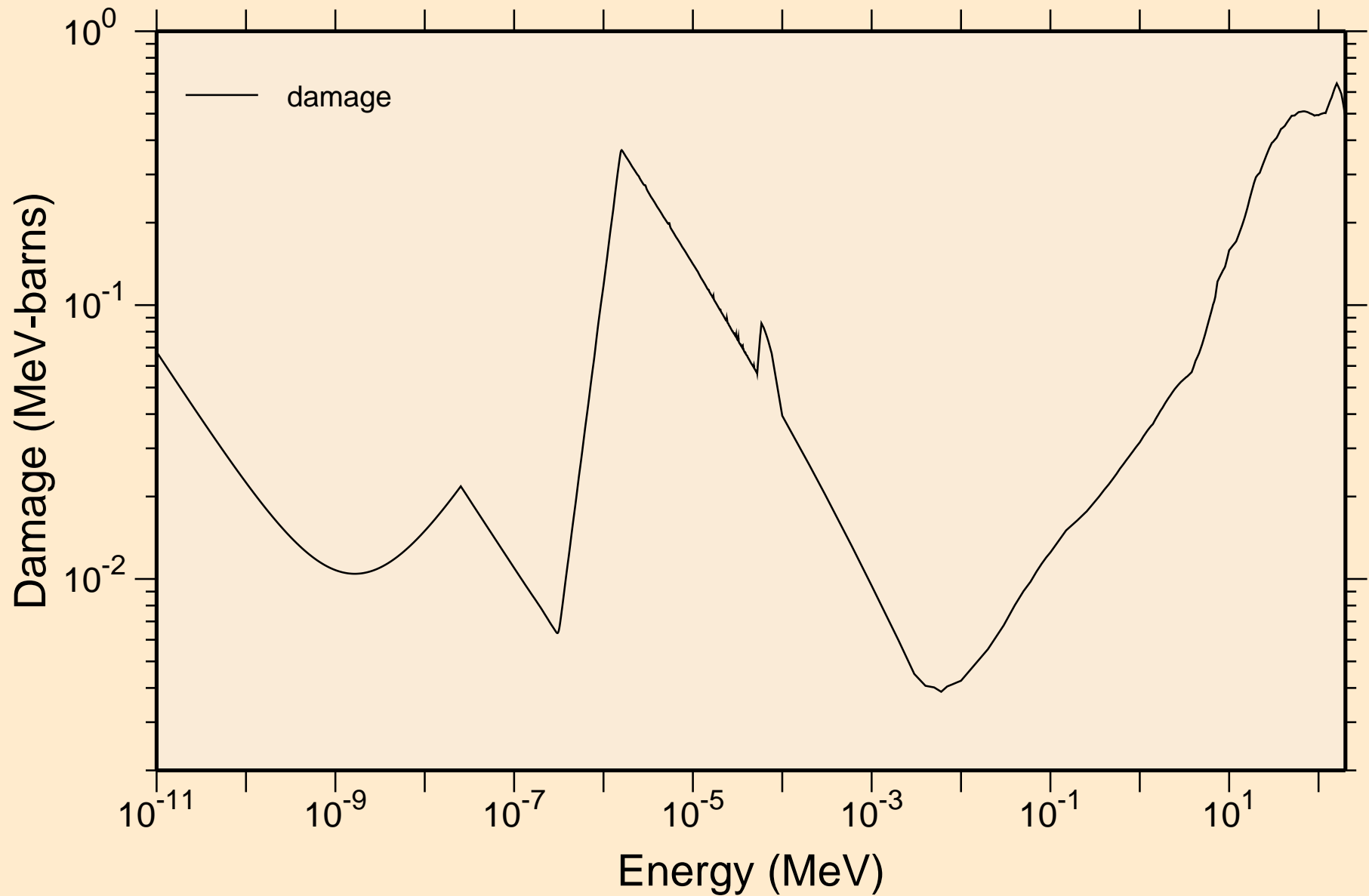

W166 NEUTRON ACER TENDL-2019 LIBRARY; T=293.16K
Non-threshold reactions

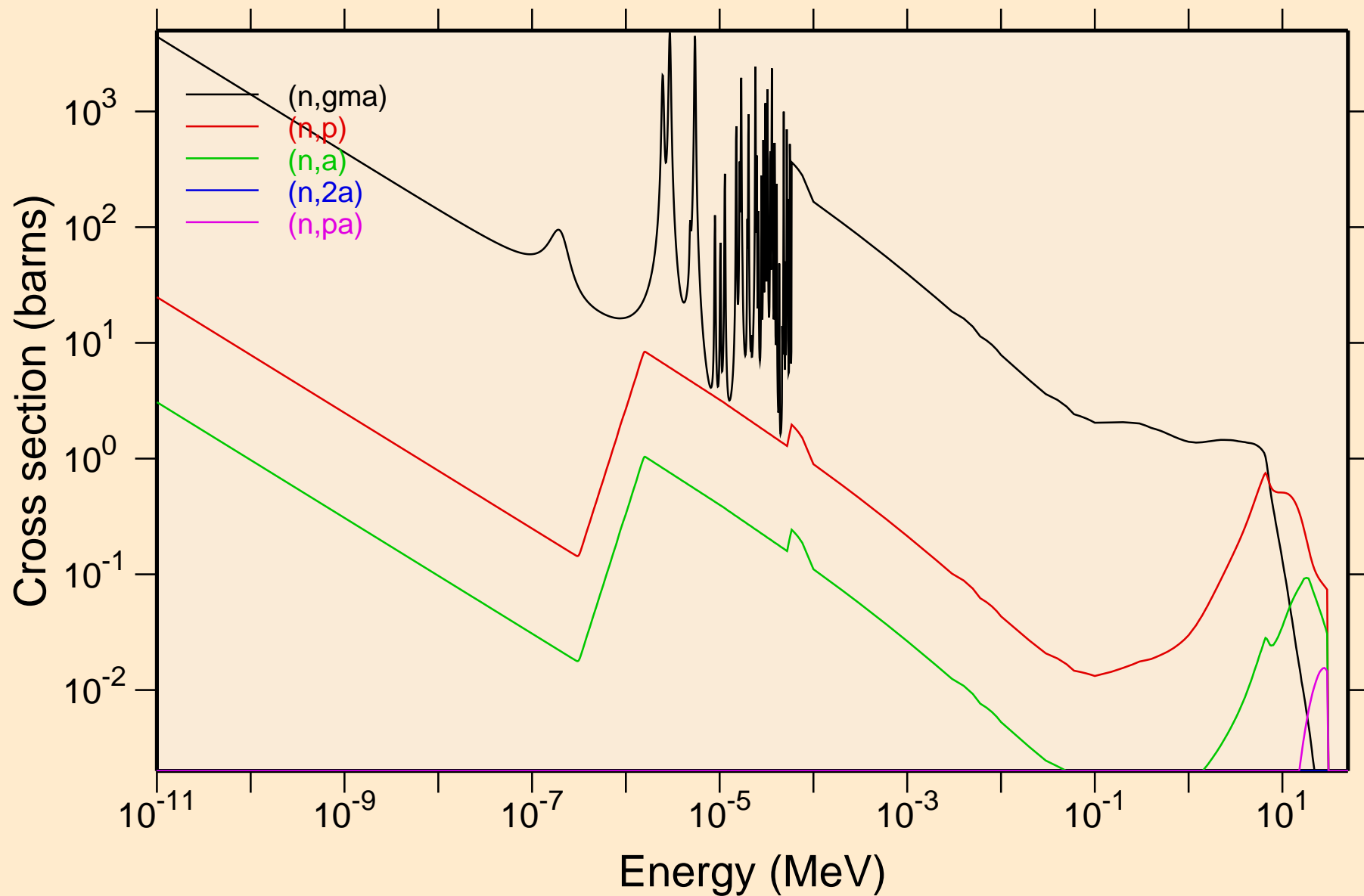

W166 NEUTRON ACER TENDL-2019 LIBRARY; T=293.16K
Non-threshold reactions

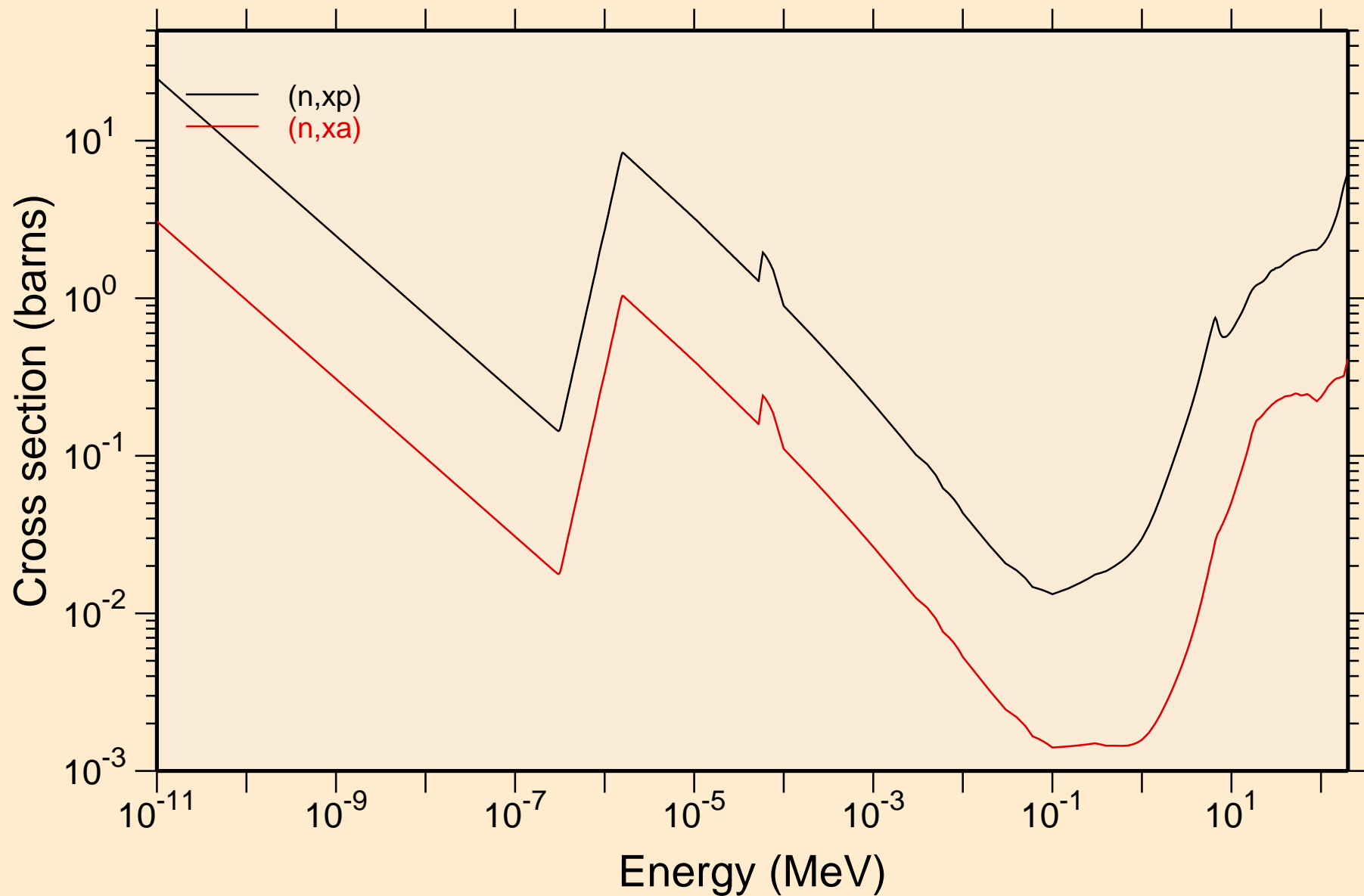

W166 NEUTRON ACER TENDL-2019 LIBRARY; T=293.16K

Principal cross sections

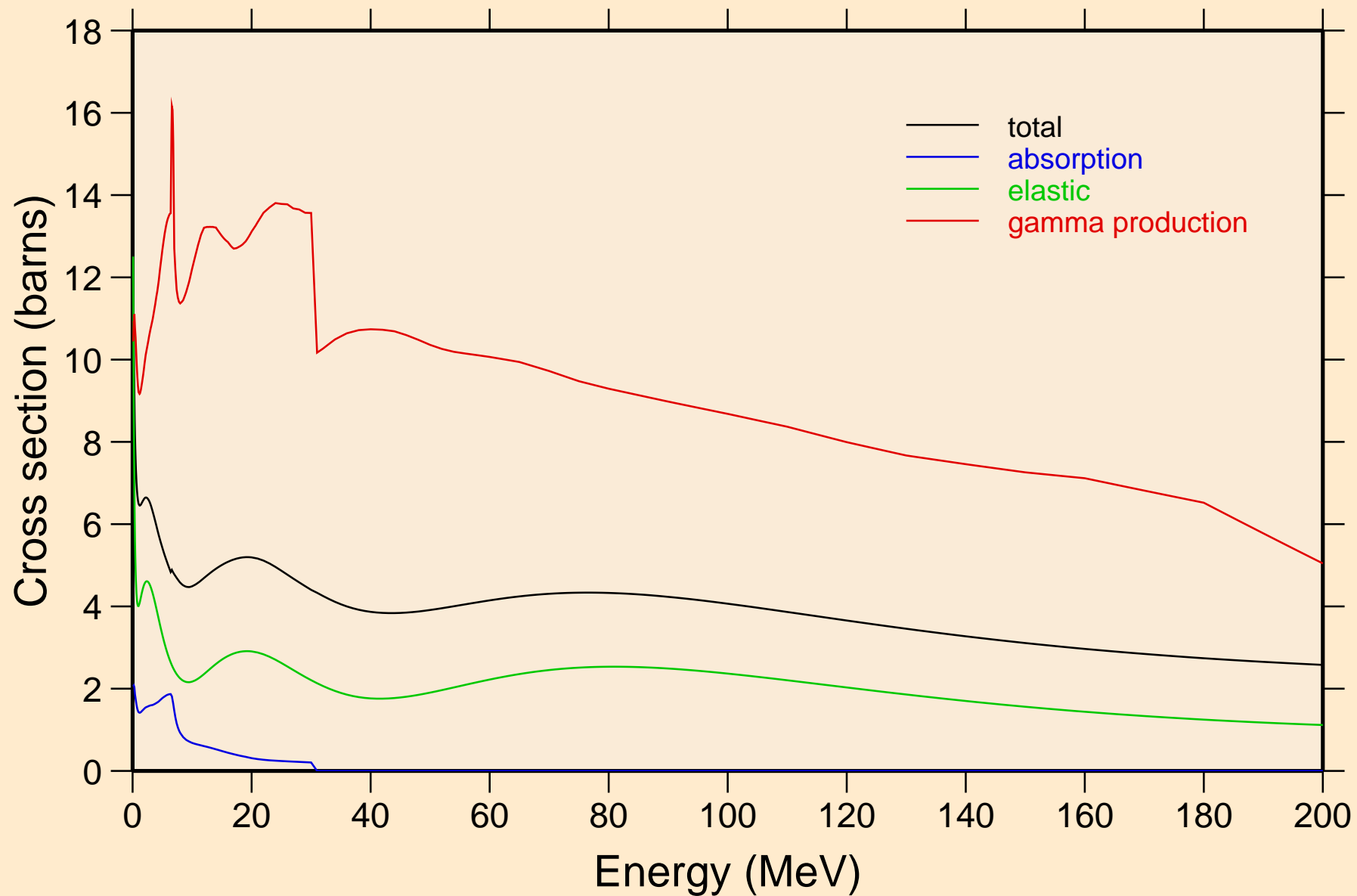

W166 NEUTRON ACER TENDL-2019 LIBRARY; T=293.16K
Heating

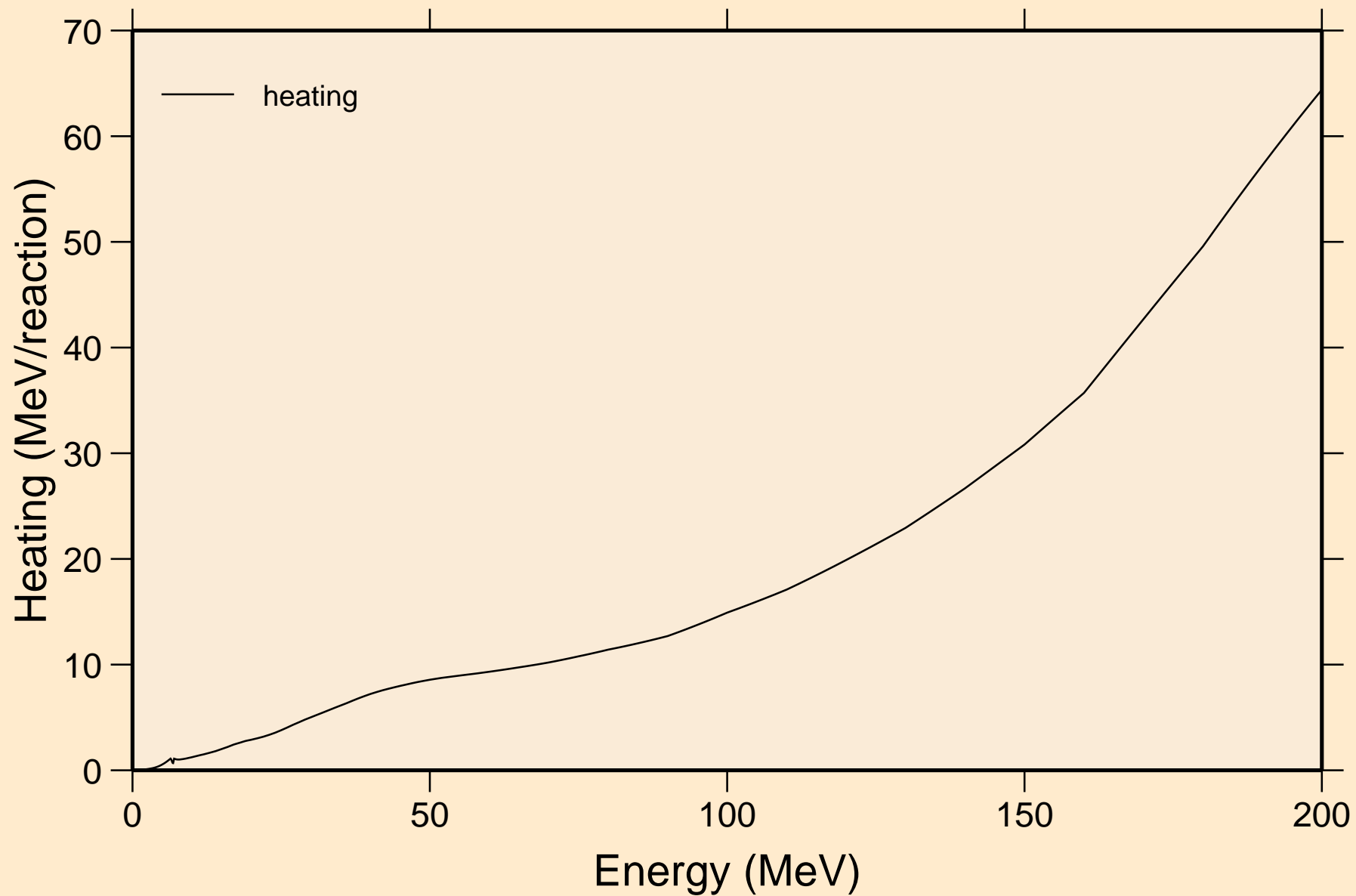

W166 NEUTRON ACER TENDL-2019 LIBRARY; T=293.16K
Damage

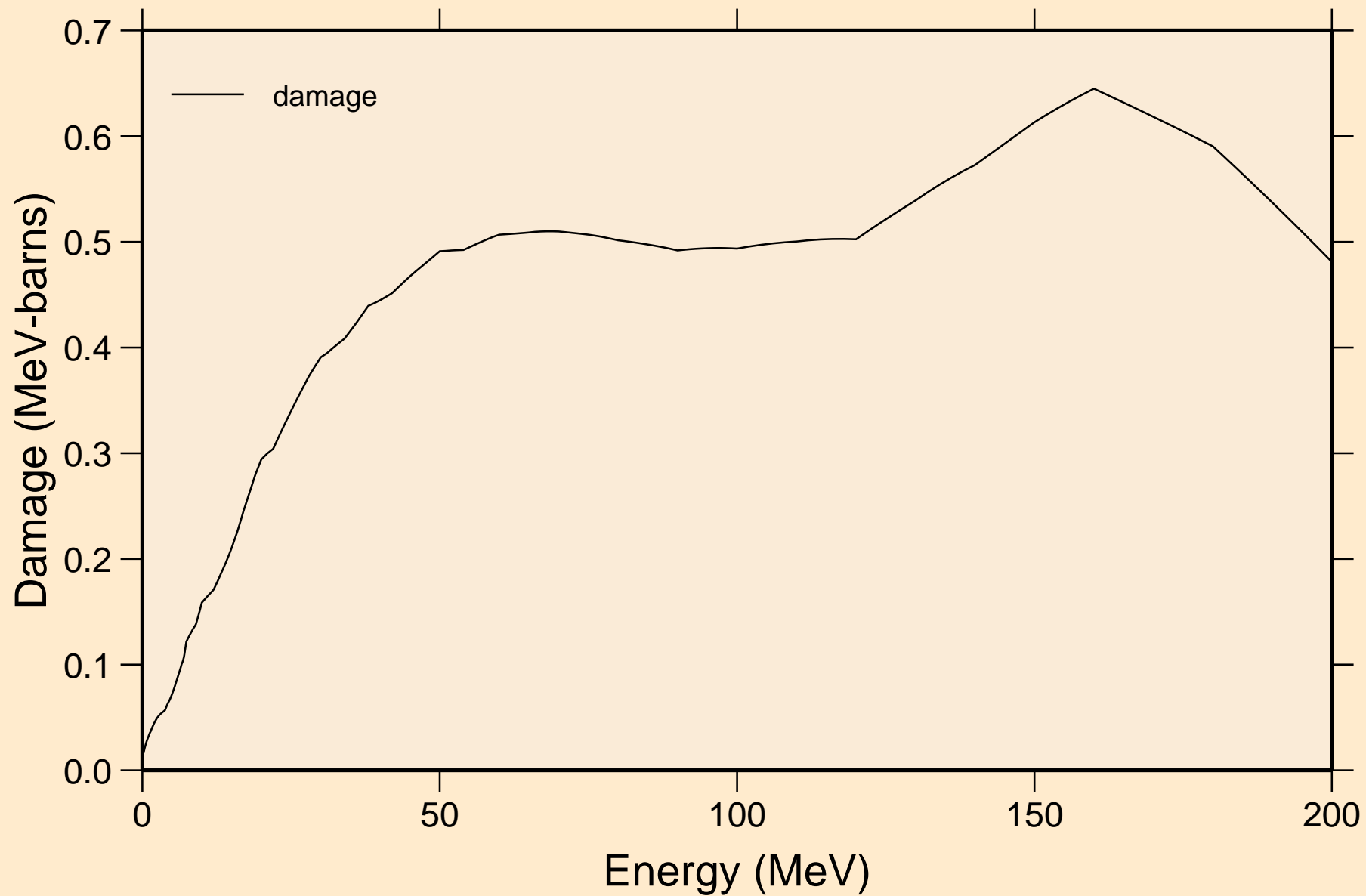

W166 NEUTRON ACER TENDL-2019 LIBRARY; T=293.16K
Non-threshold reactions

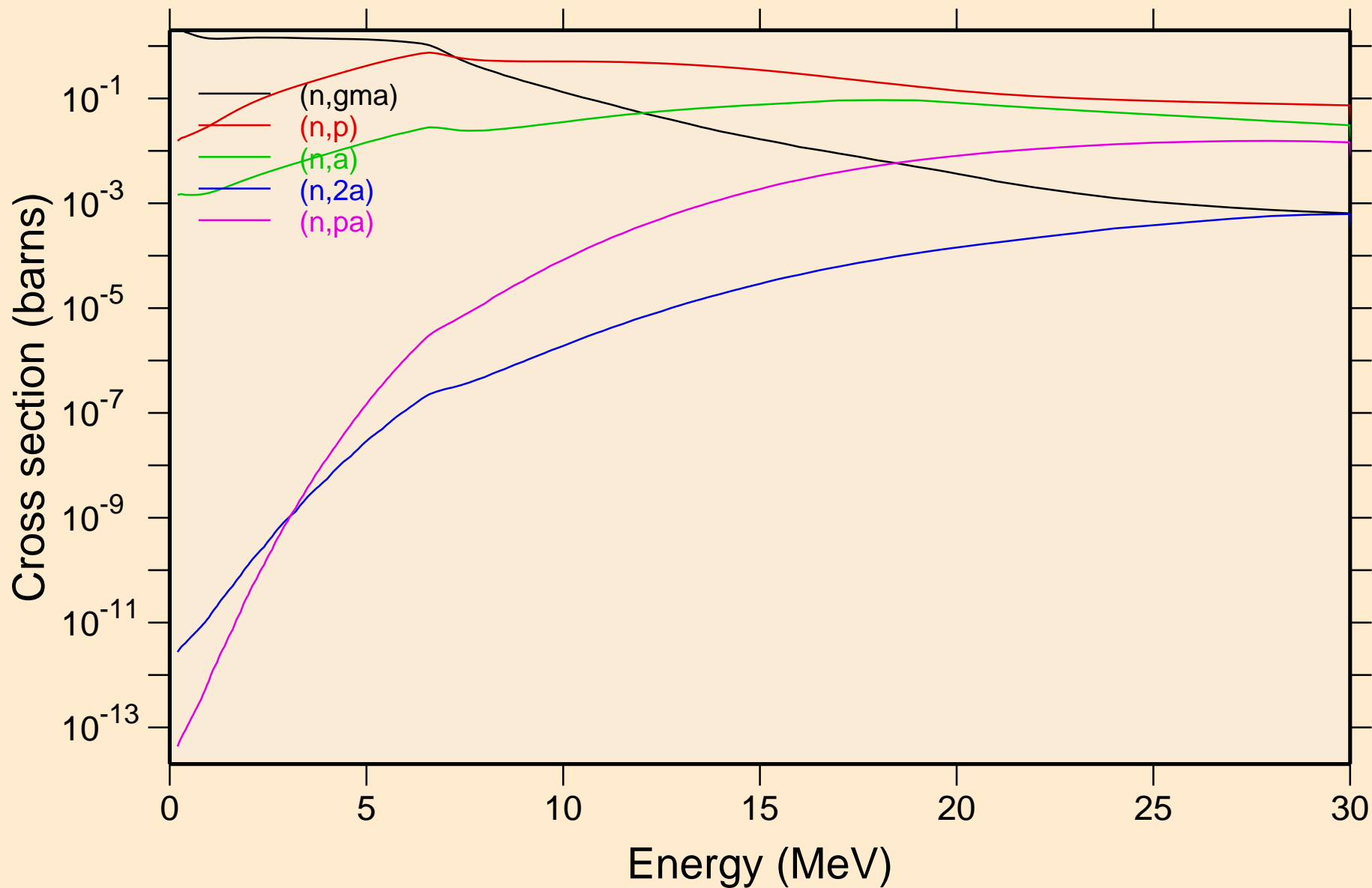

W166 NEUTRON ACER TENDL-2019 LIBRARY; T=293.16K
Non-threshold reactions

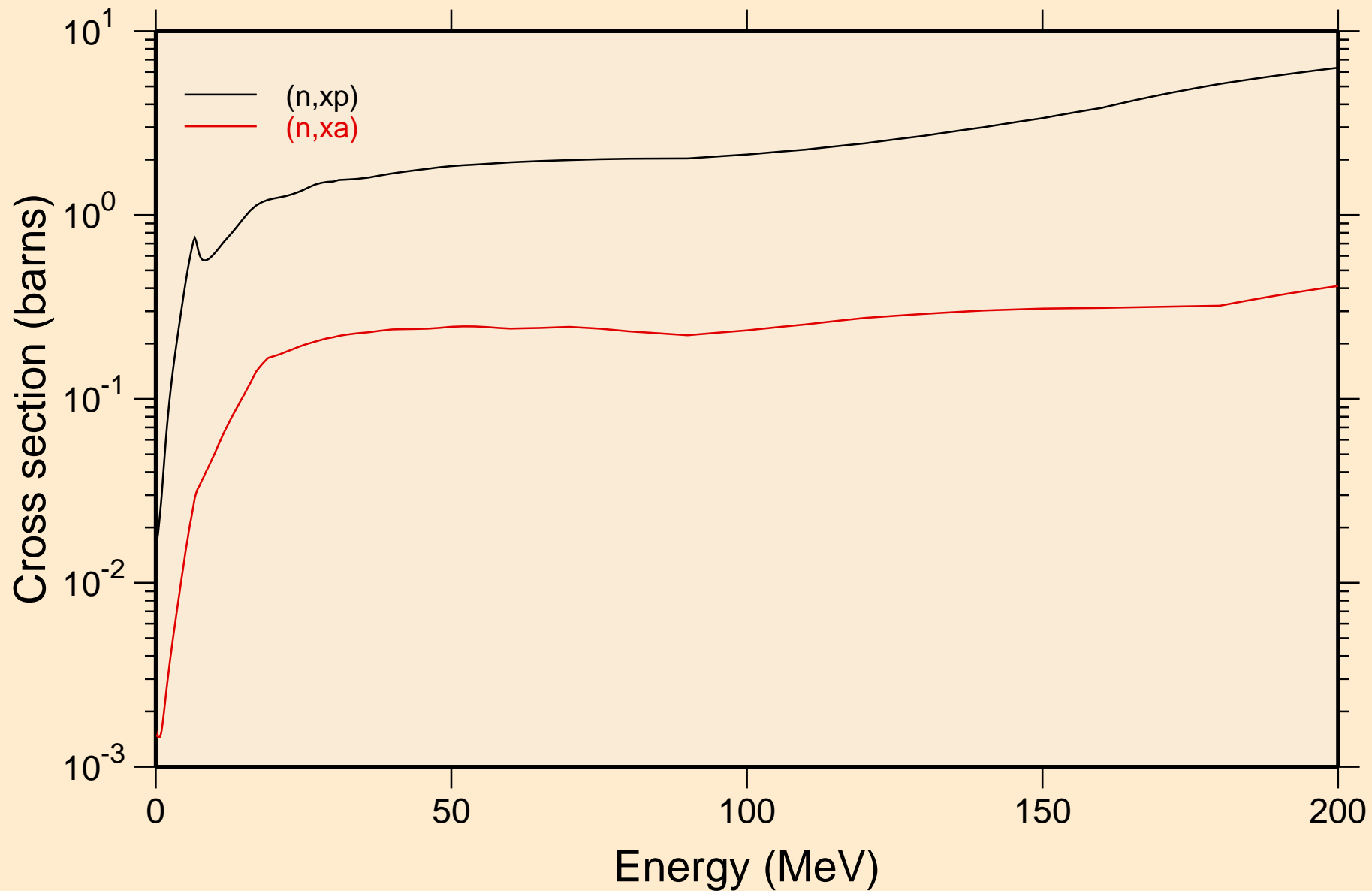

W166 NEUTRON ACER TENDL-2019 LIBRARY; T=293.16K
Inelastic levels

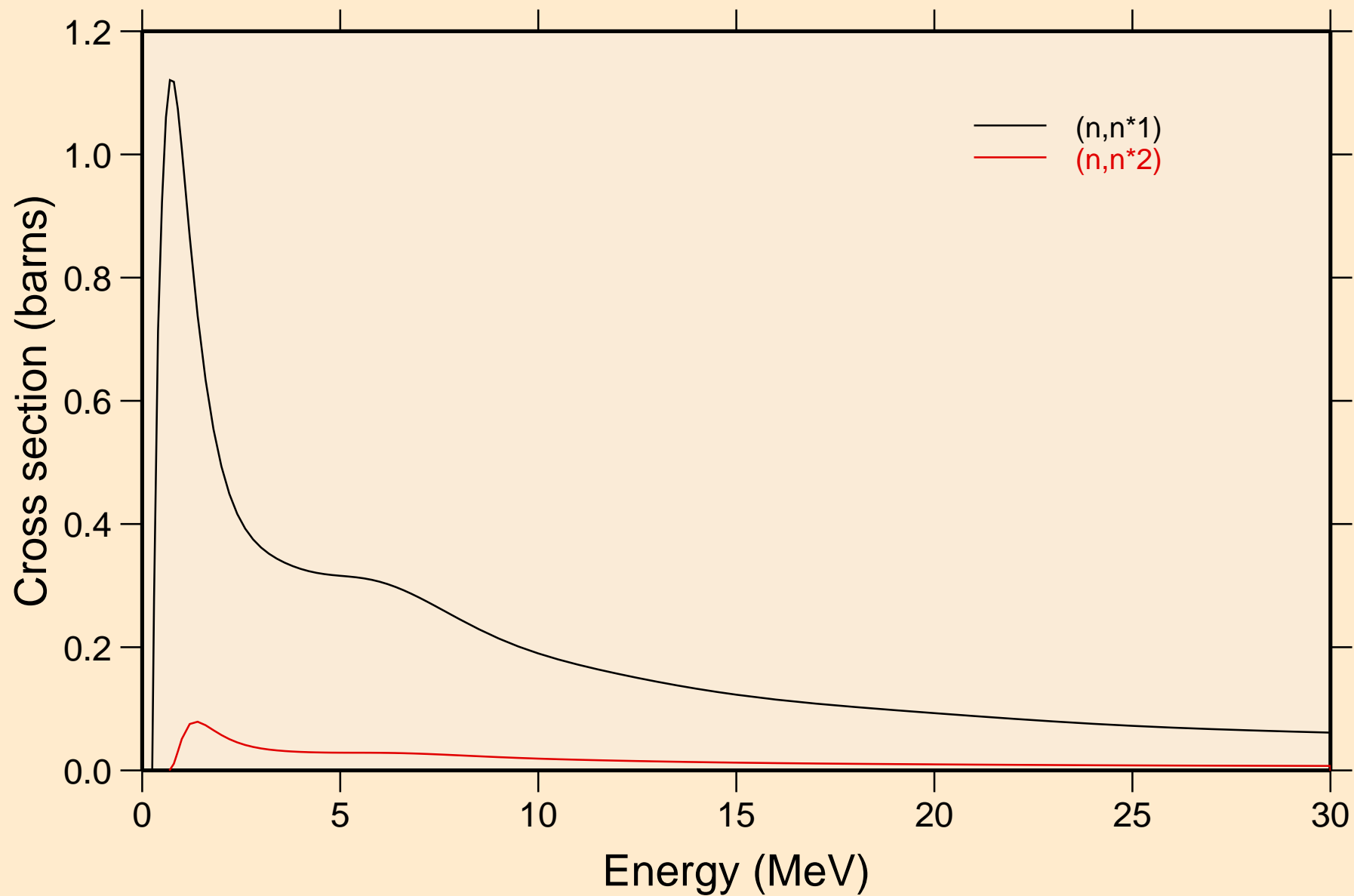

W166 NEUTRON ACER TENDL-2019 LIBRARY; T=293.16K
Threshold reactions

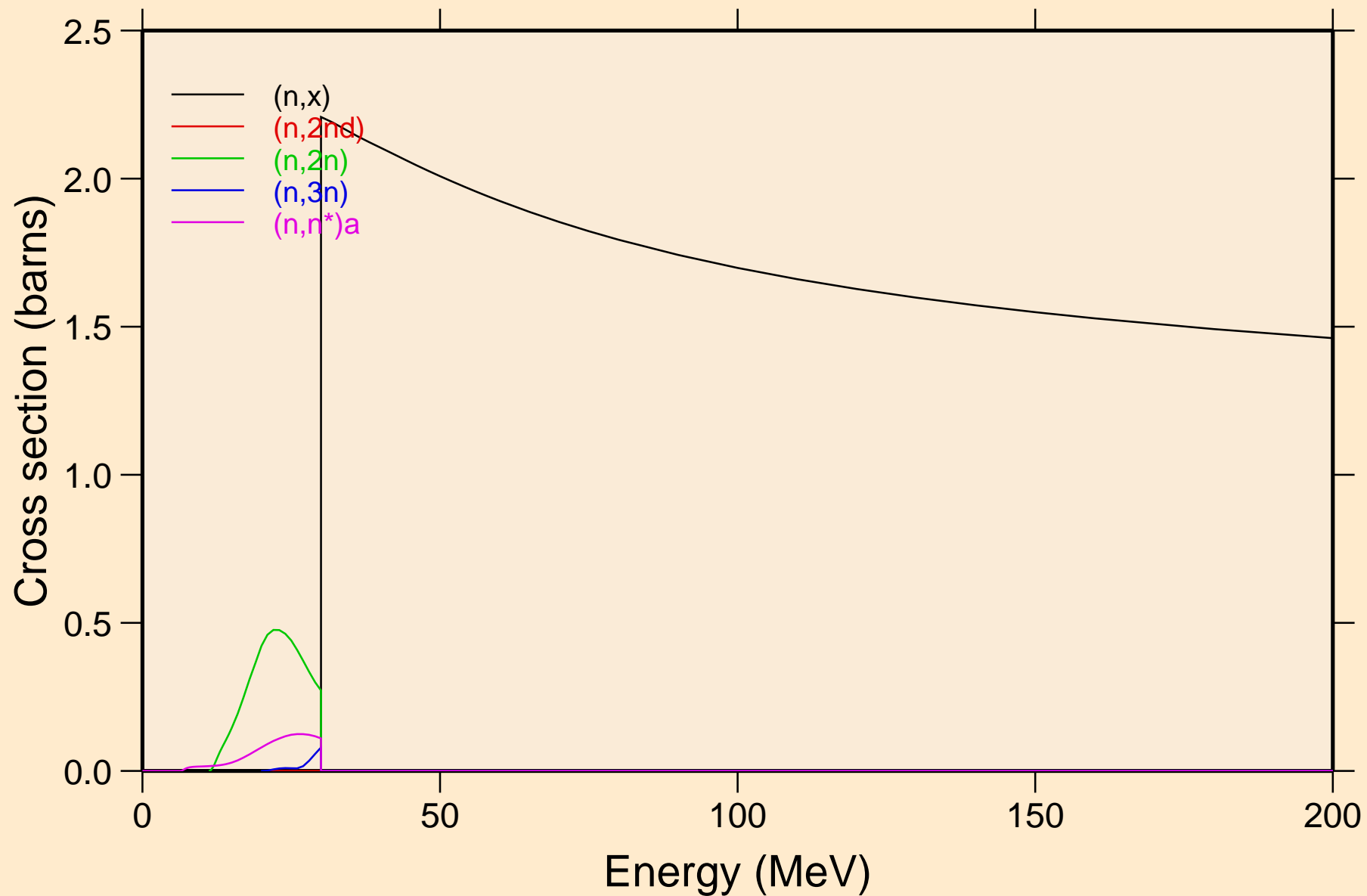

W166 NEUTRON ACER TENDL-2019 LIBRARY; T=293.16K
Threshold reactions

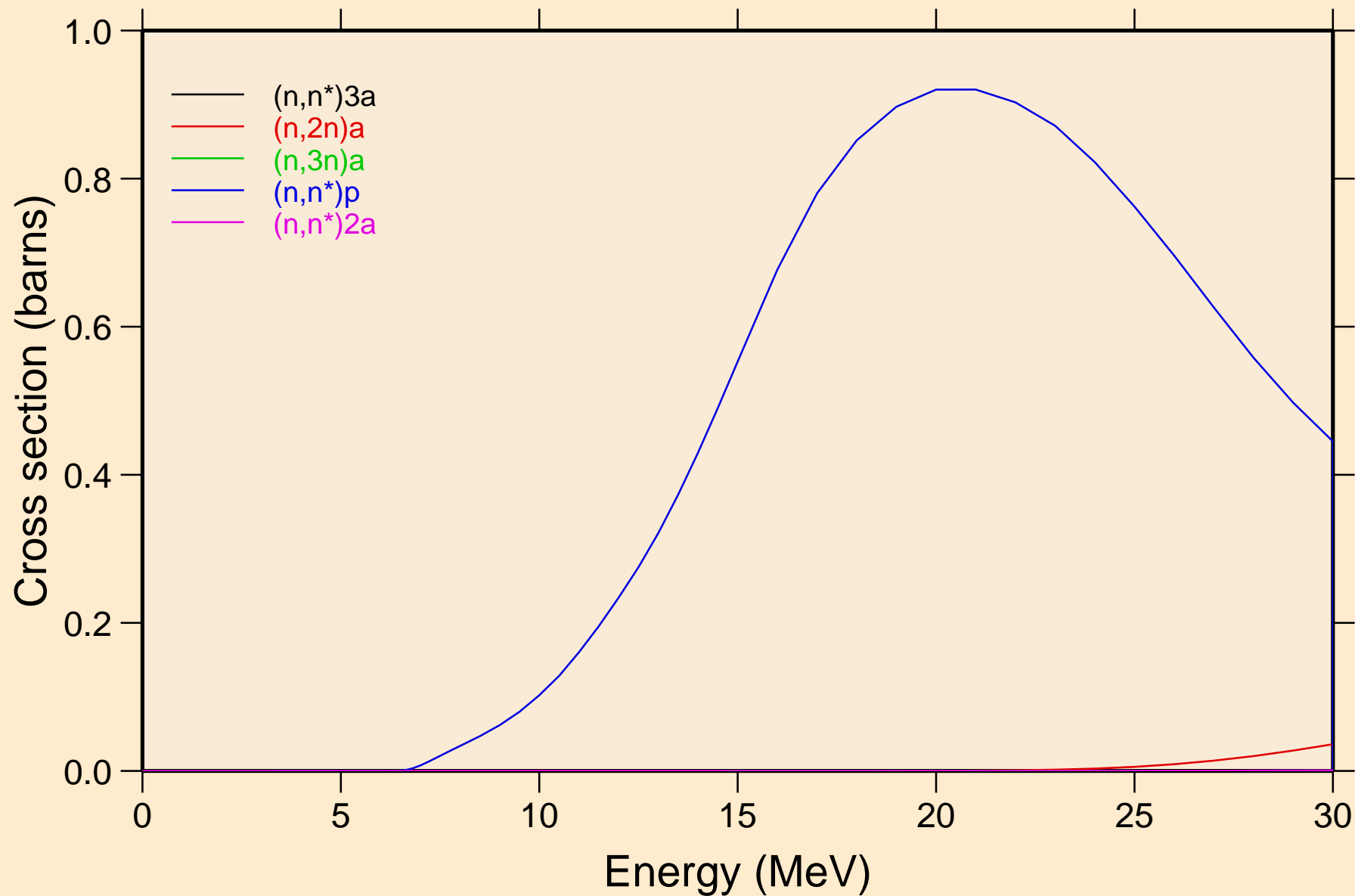

W166 NEUTRON ACER TENDL-2019 LIBRARY; T=293.16K
Threshold reactions

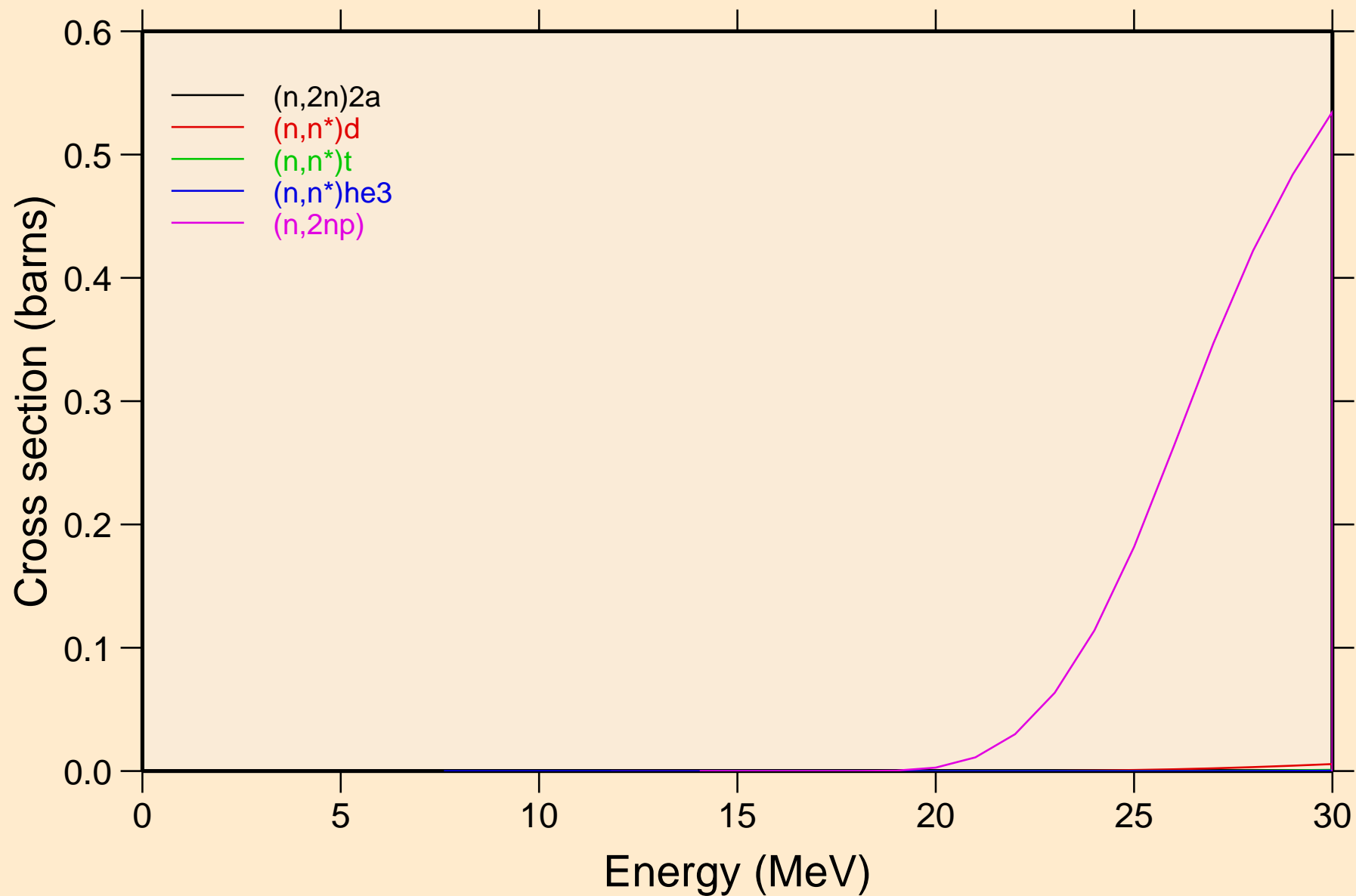

W166 NEUTRON ACER TENDL-2019 LIBRARY; T=293.16K
Threshold reactions

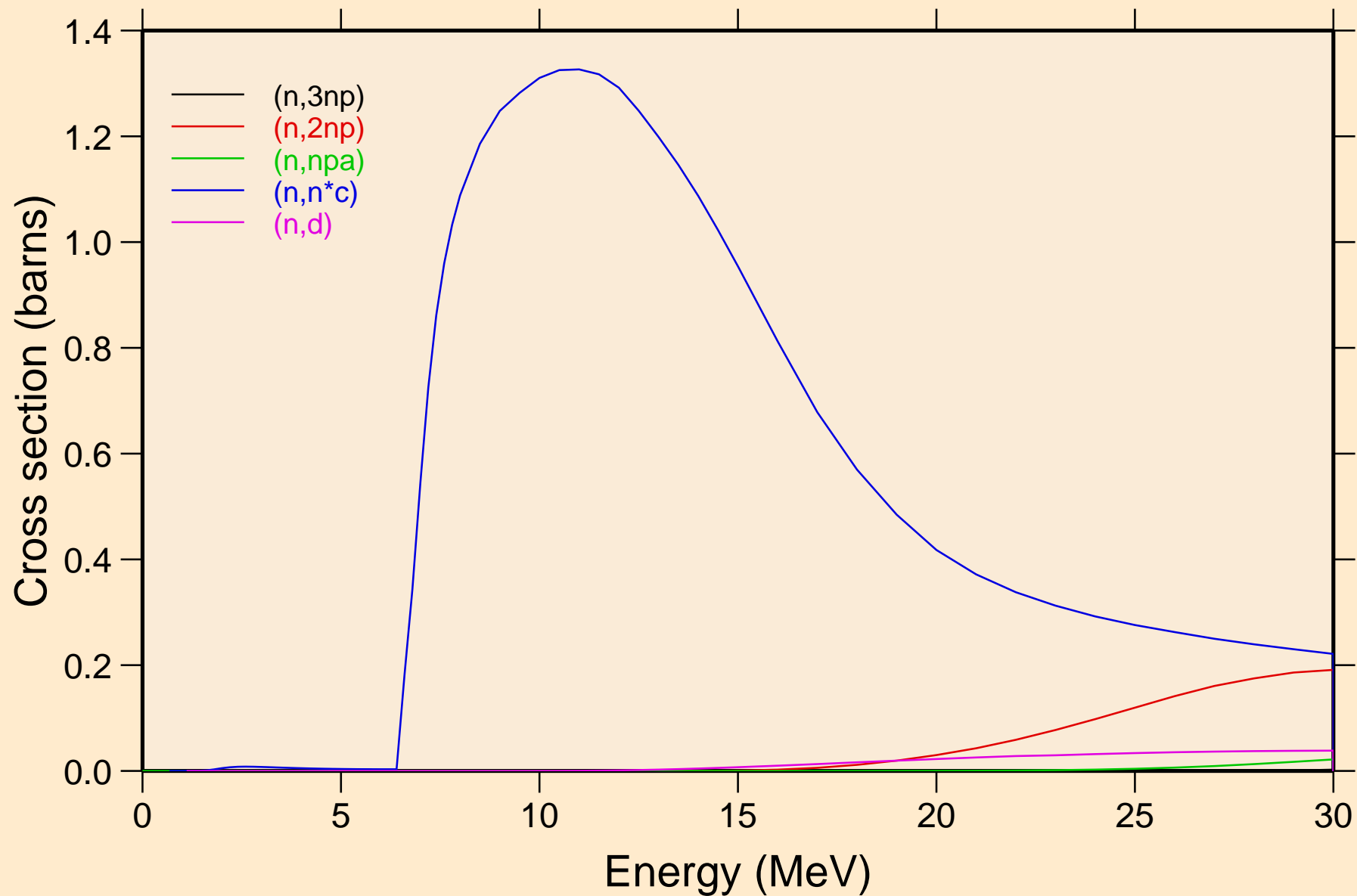

W166 NEUTRON ACER TENDL-2019 LIBRARY; T=293.16K
Threshold reactions

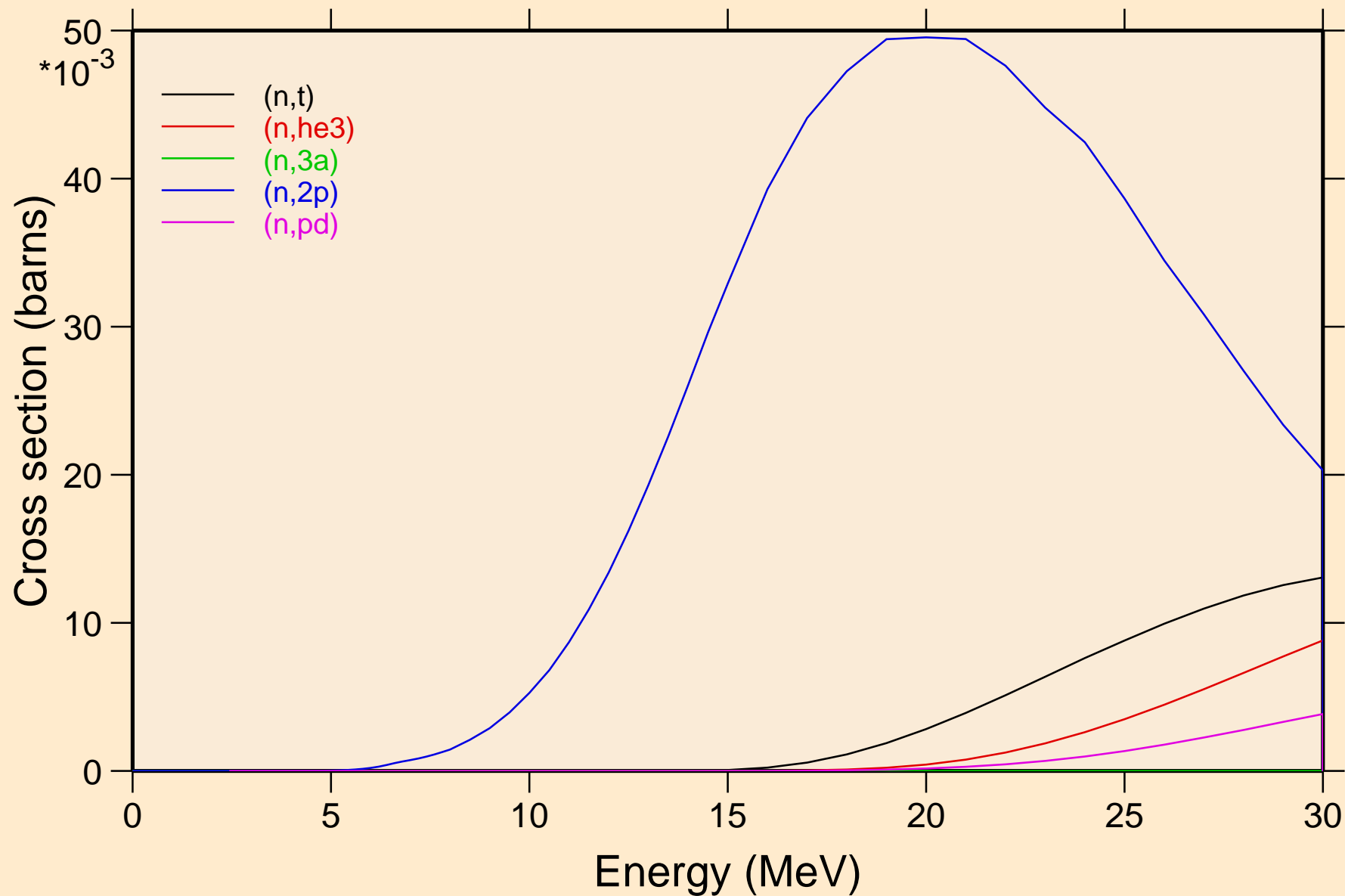

W166 NEUTRON ACER TENDL-2019 LIBRARY; T=293.16K
Threshold reactions

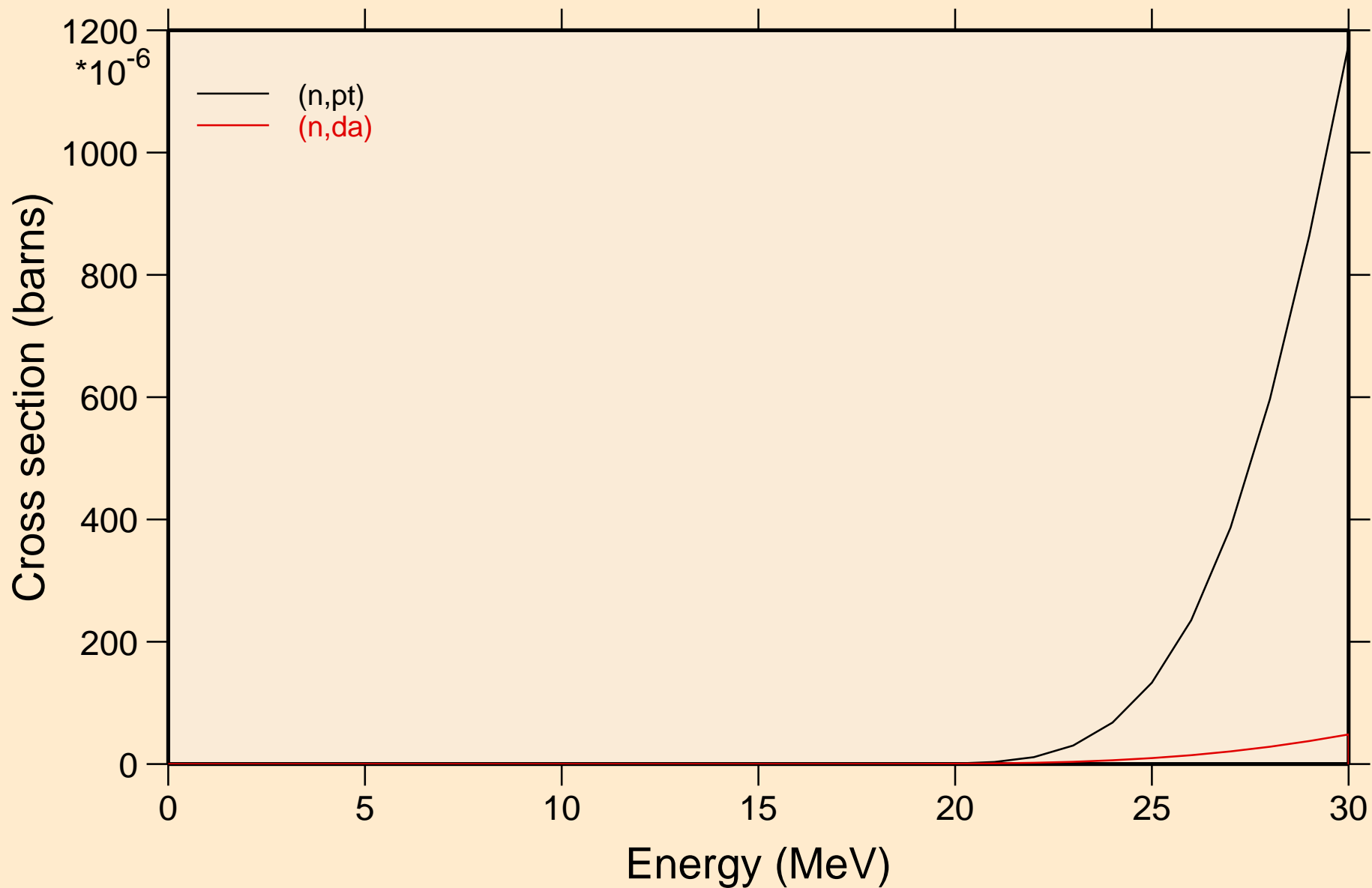

W166 NEUTRON ACER TENDL-2019 LIBRARY; T=293.16K
Threshold reactions

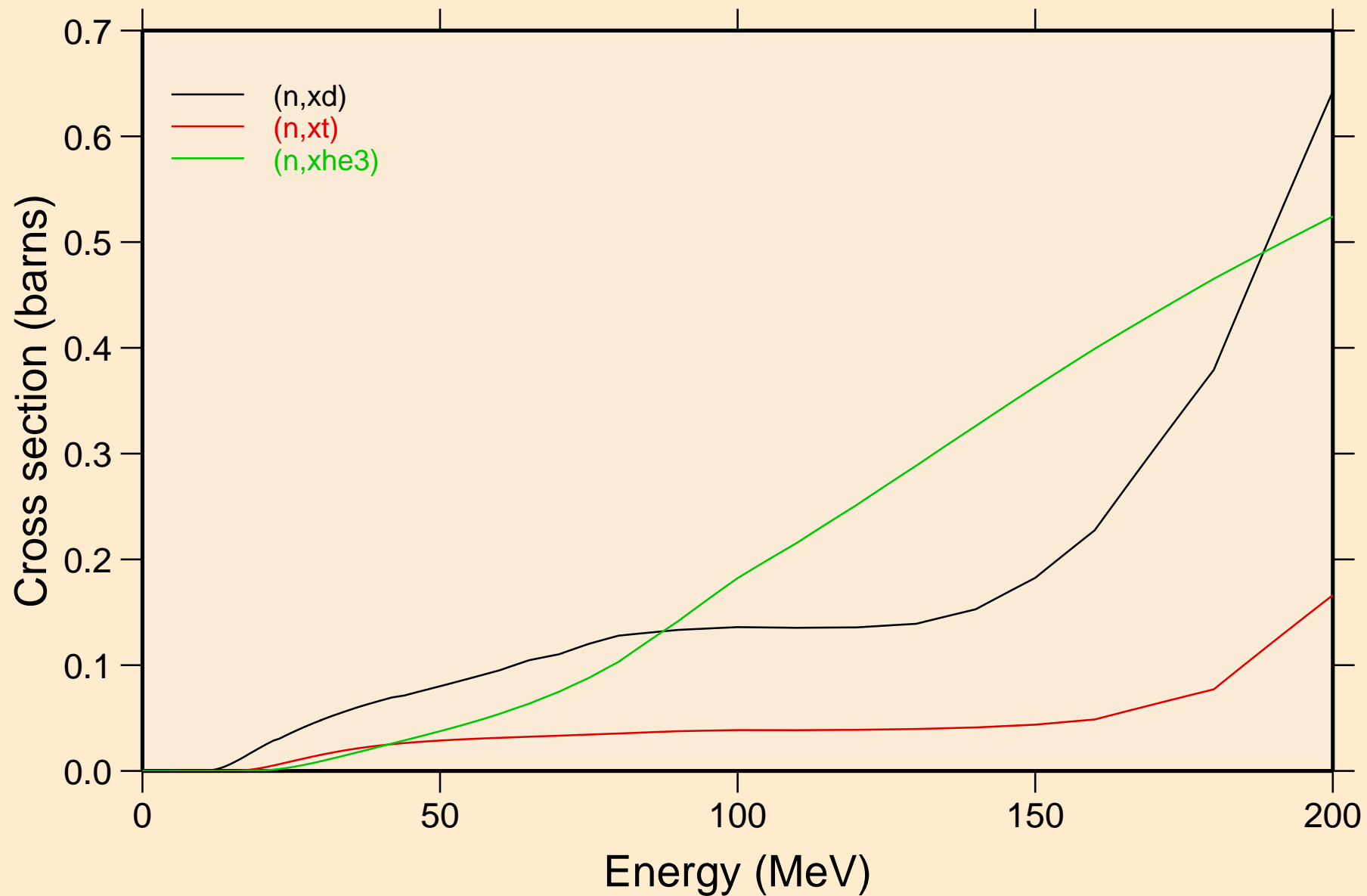

W166 NEUTRON ACER TENDL-2019 LIBRARY; T=293.16K
angular distribution for elastic

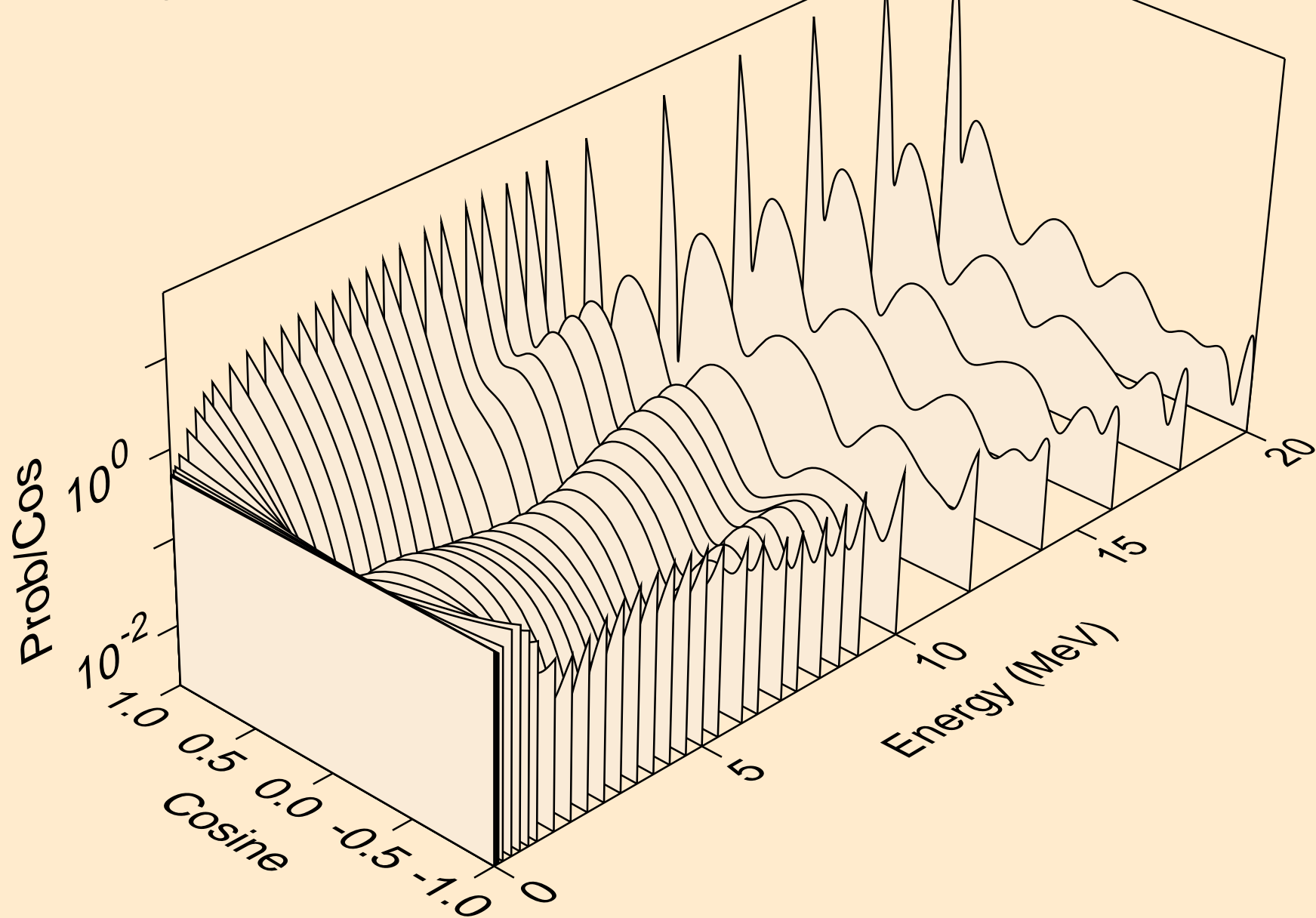

W166 NEUTRON ACER TENDL-2019 LIBRARY; T=293.16K
angular distribution for elastic

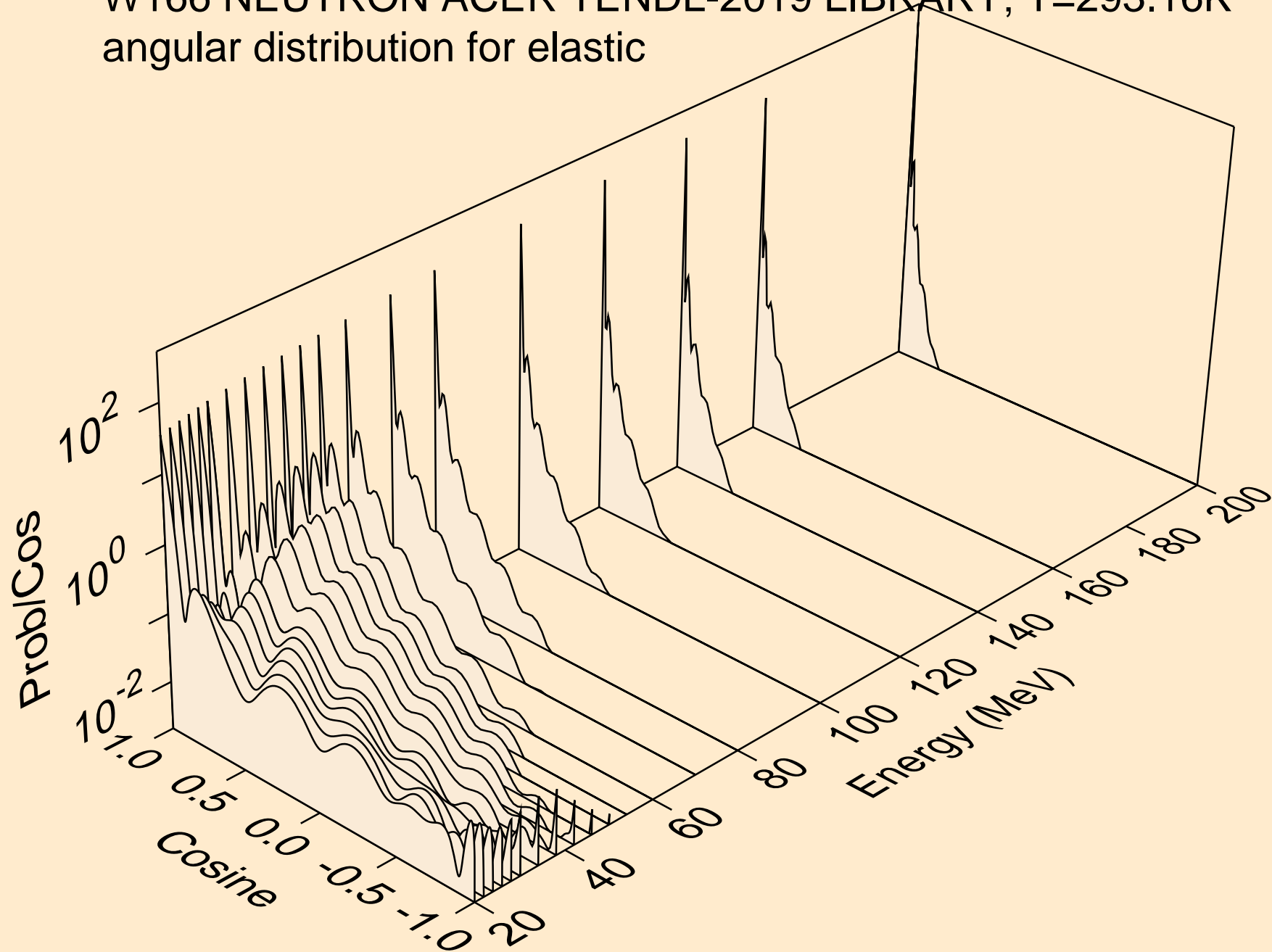

W166 NEUTRON ACER TENDL-2019 LIBRARY; T=293.16K
angular distribution for (n,n*1)

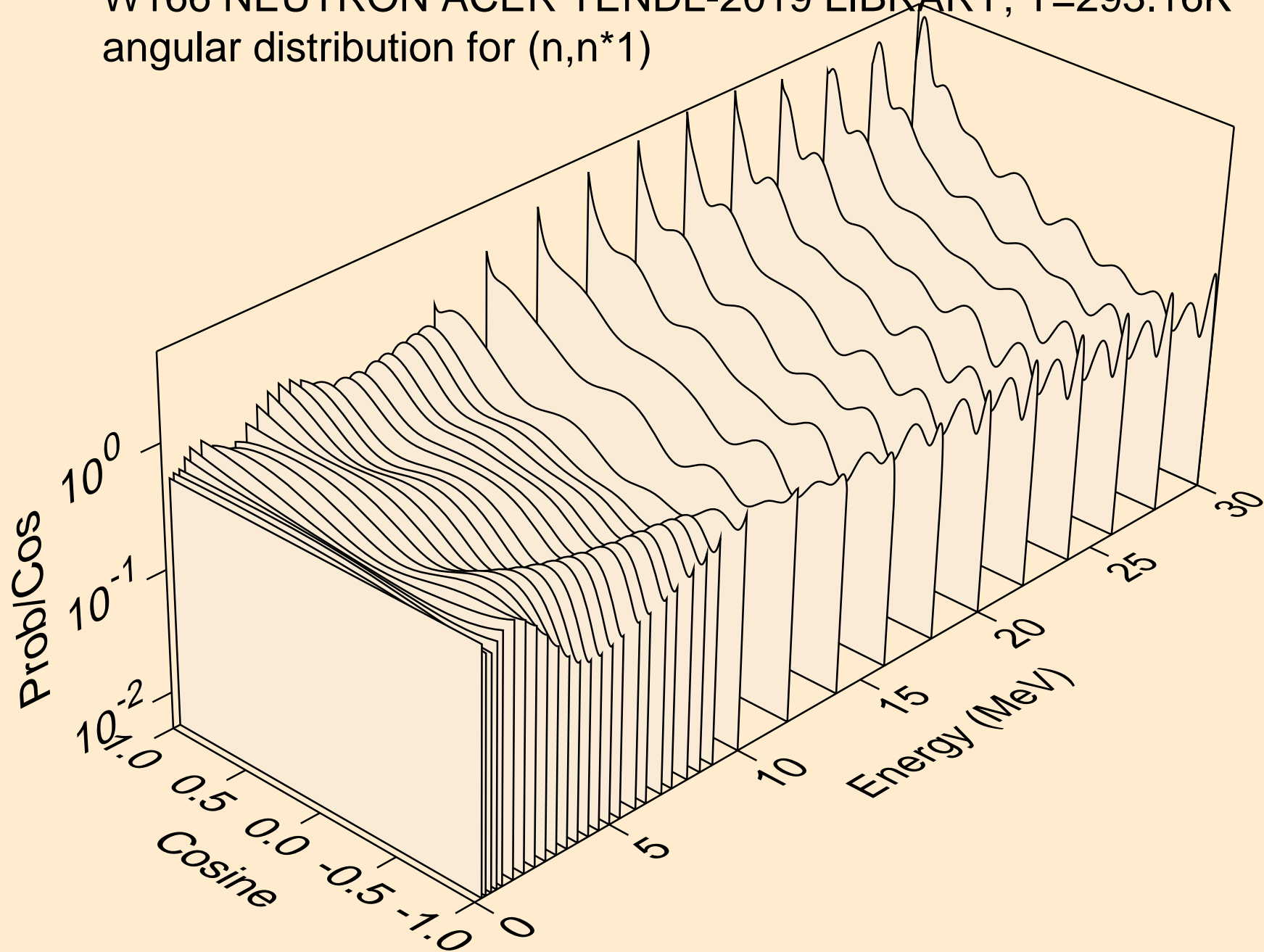

W166 NEUTRON ACER TENDL-2019 LIBRARY; T=293.16K
angular distribution for (n,n*2)

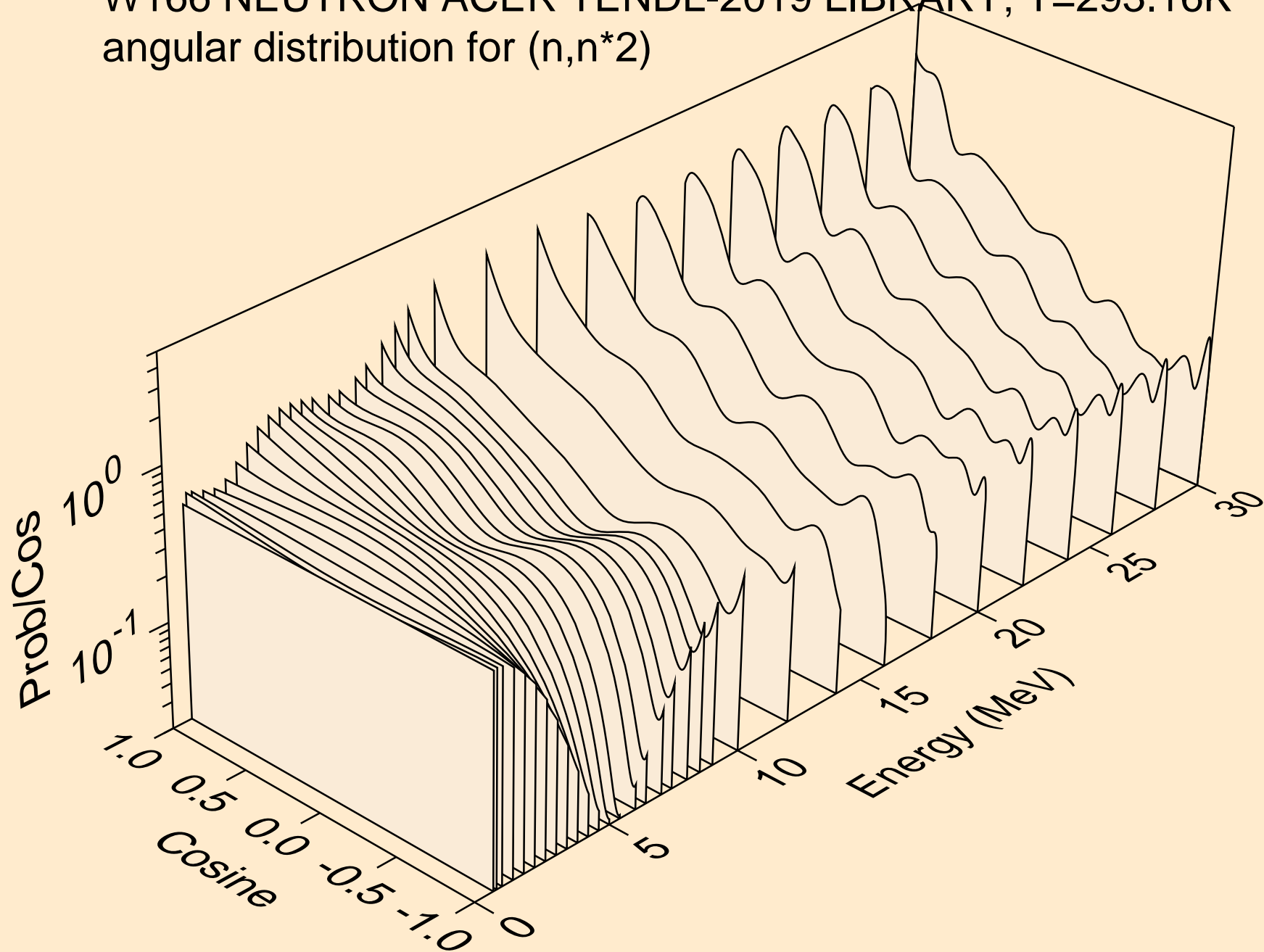

W166 NEUTRON ACER TENDL-2019 LIBRARY; T=293.16K
Neutron emission for (n,x)

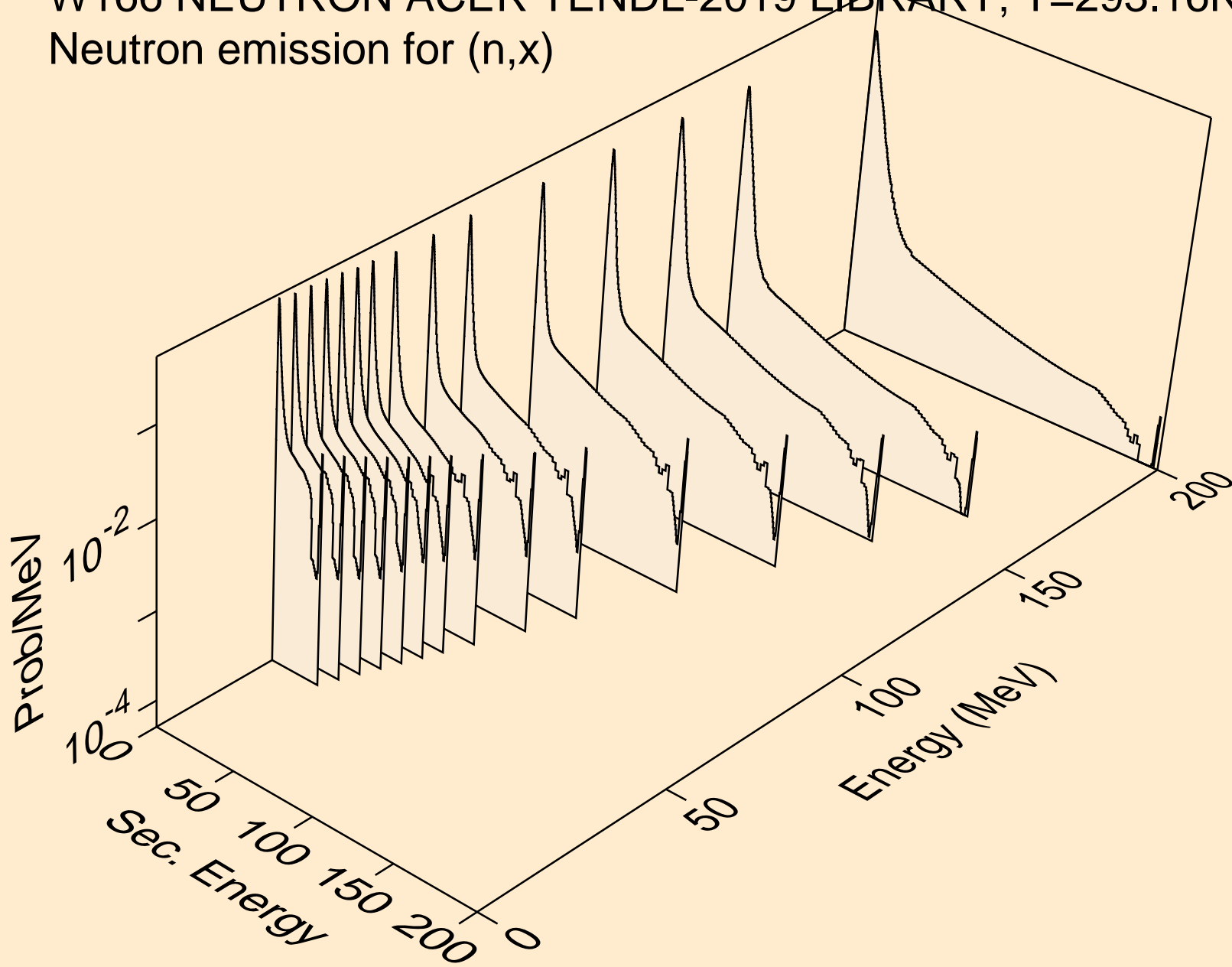

W166 NEUTRON ACER TENDL-2019 LIBRARY; T=293.16K
Neutron emission for (n,2nd)

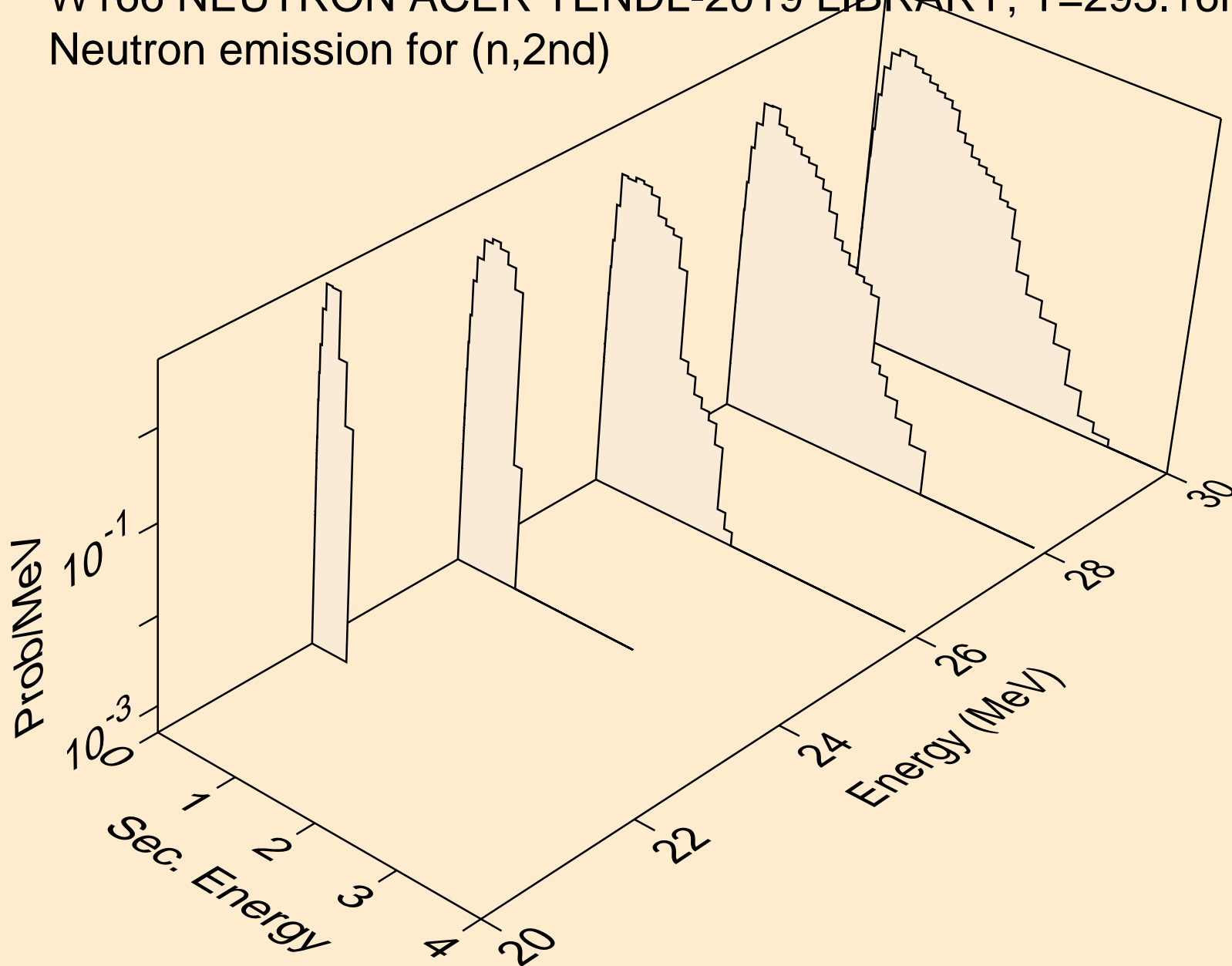

W166 NEUTRON ACER TENDL-2019 LIBRARY; T=293.16K
Neutron emission for (n,2n)

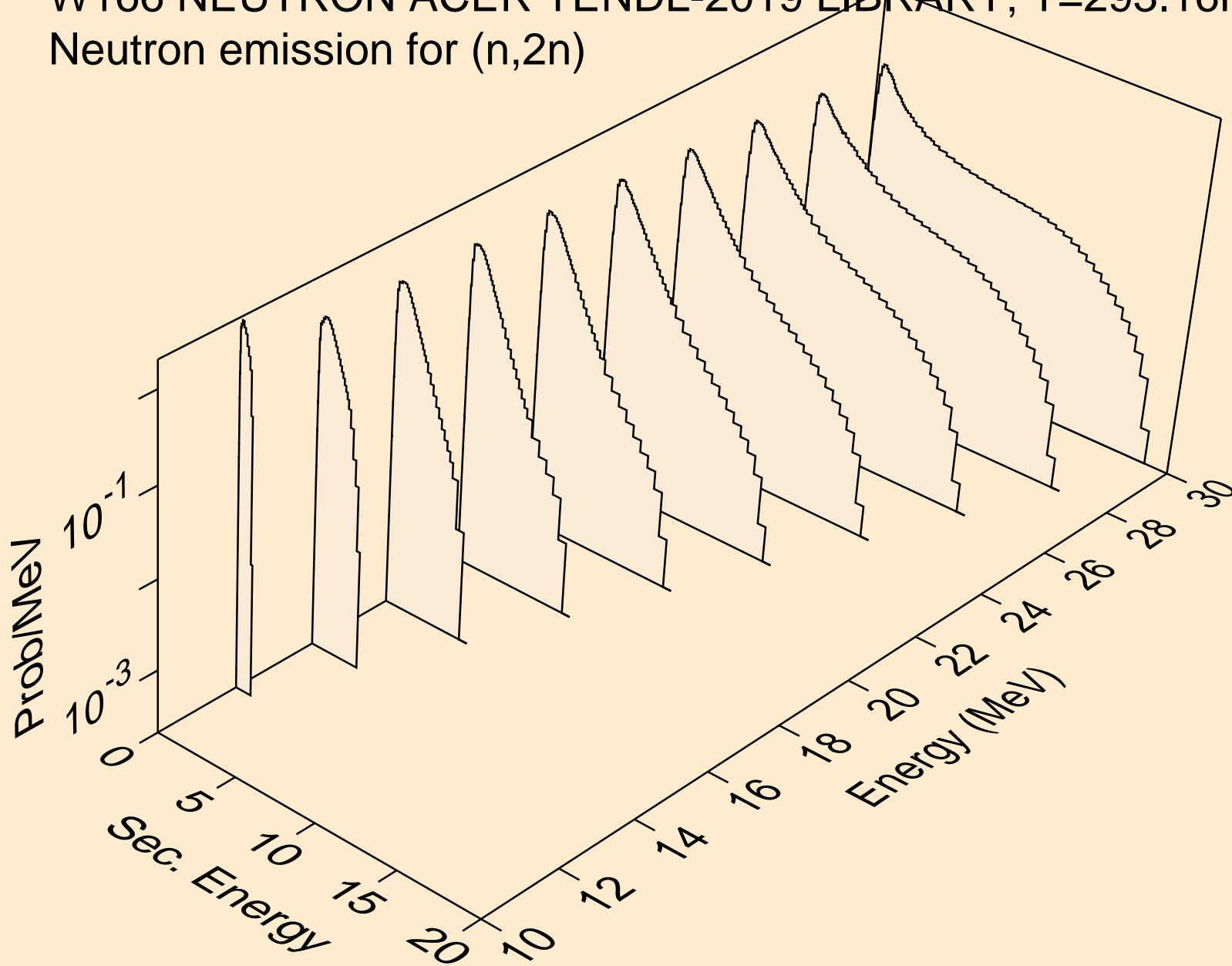

W166 NEUTRON ACER TENDL-2019 LIBRARY; T=293.16K
Neutron emission for (n,3n)

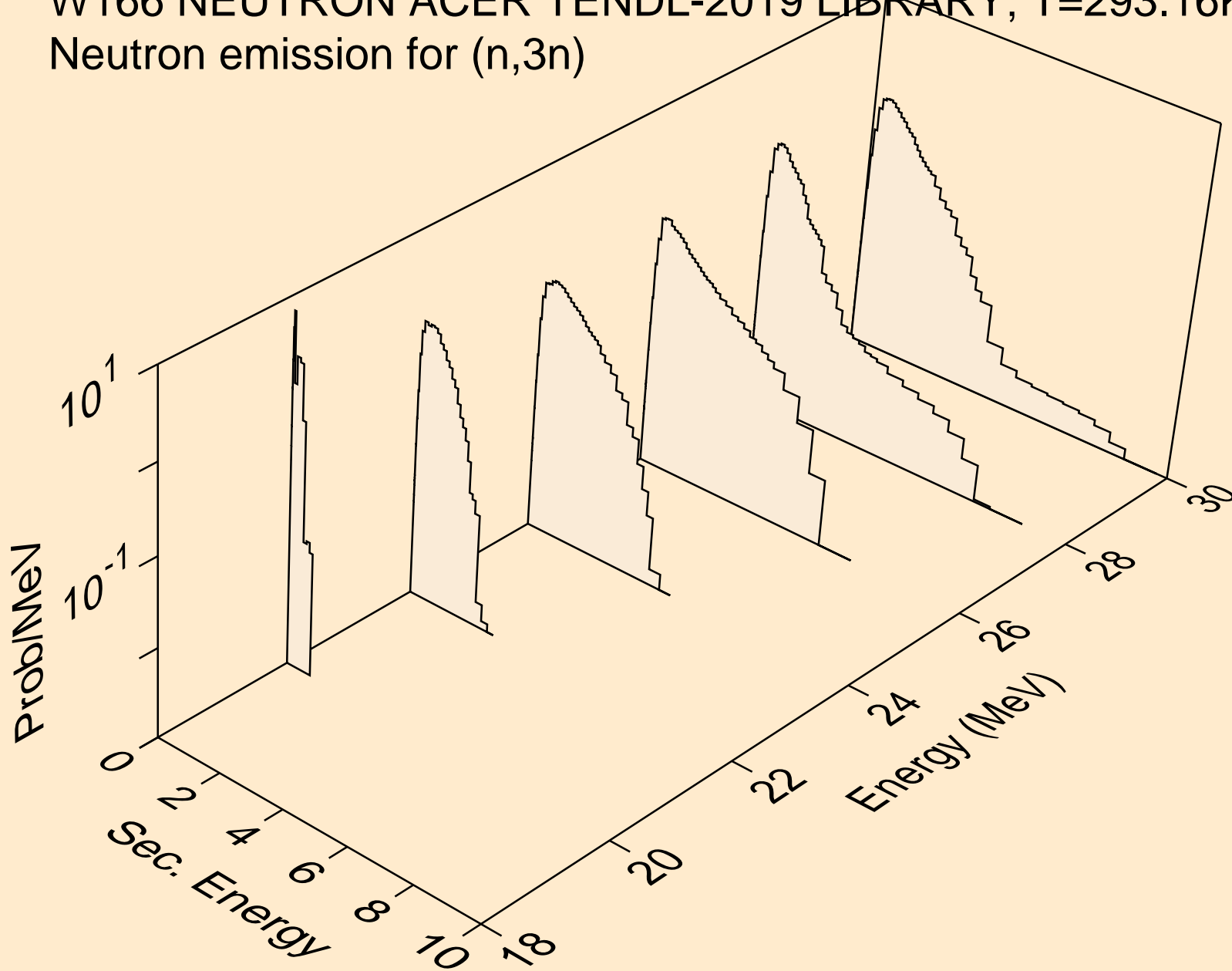

W166 NEUTRON ACER TENDL-2019 LIBRARY; T=293.16K
Neutron emission for (n,n*)a

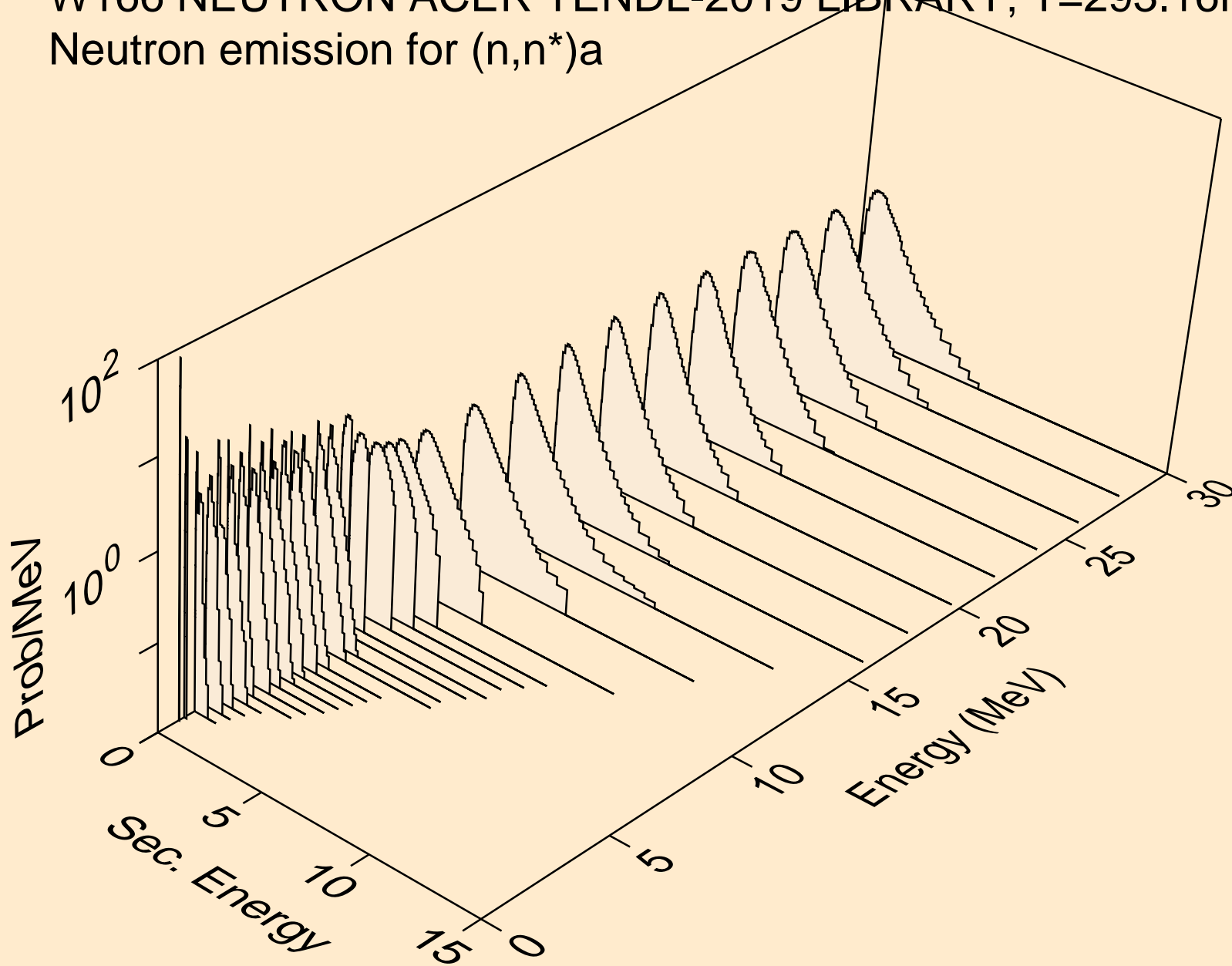

W166 NEUTRON ACER TENDL-2019 LIBRARY; T=293.16K
Neutron emission for (n,n*)3a

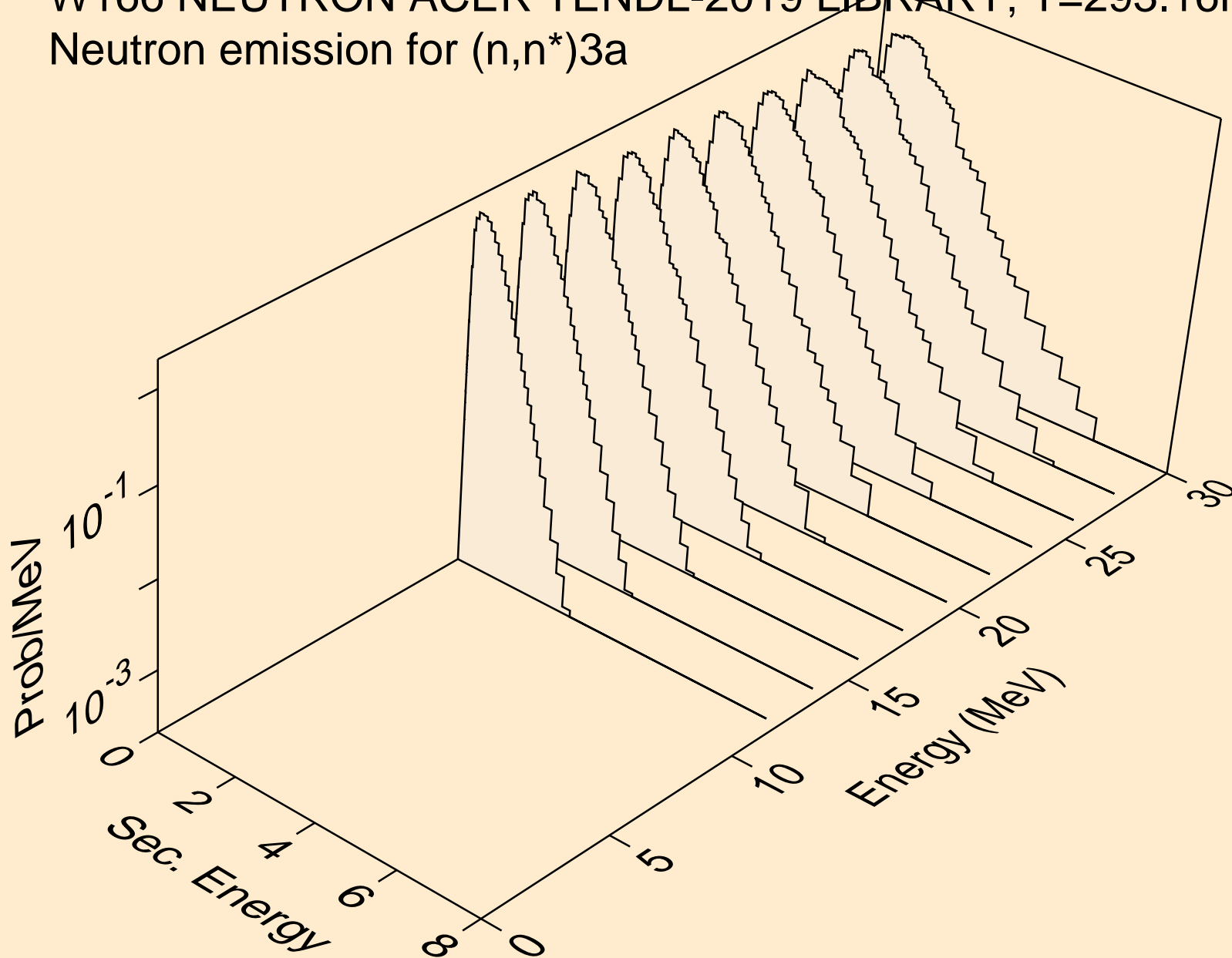

W166 NEUTRON ACER TENDL-2019 LIBRARY; T=293.16K
Neutron emission for (n,2n)a

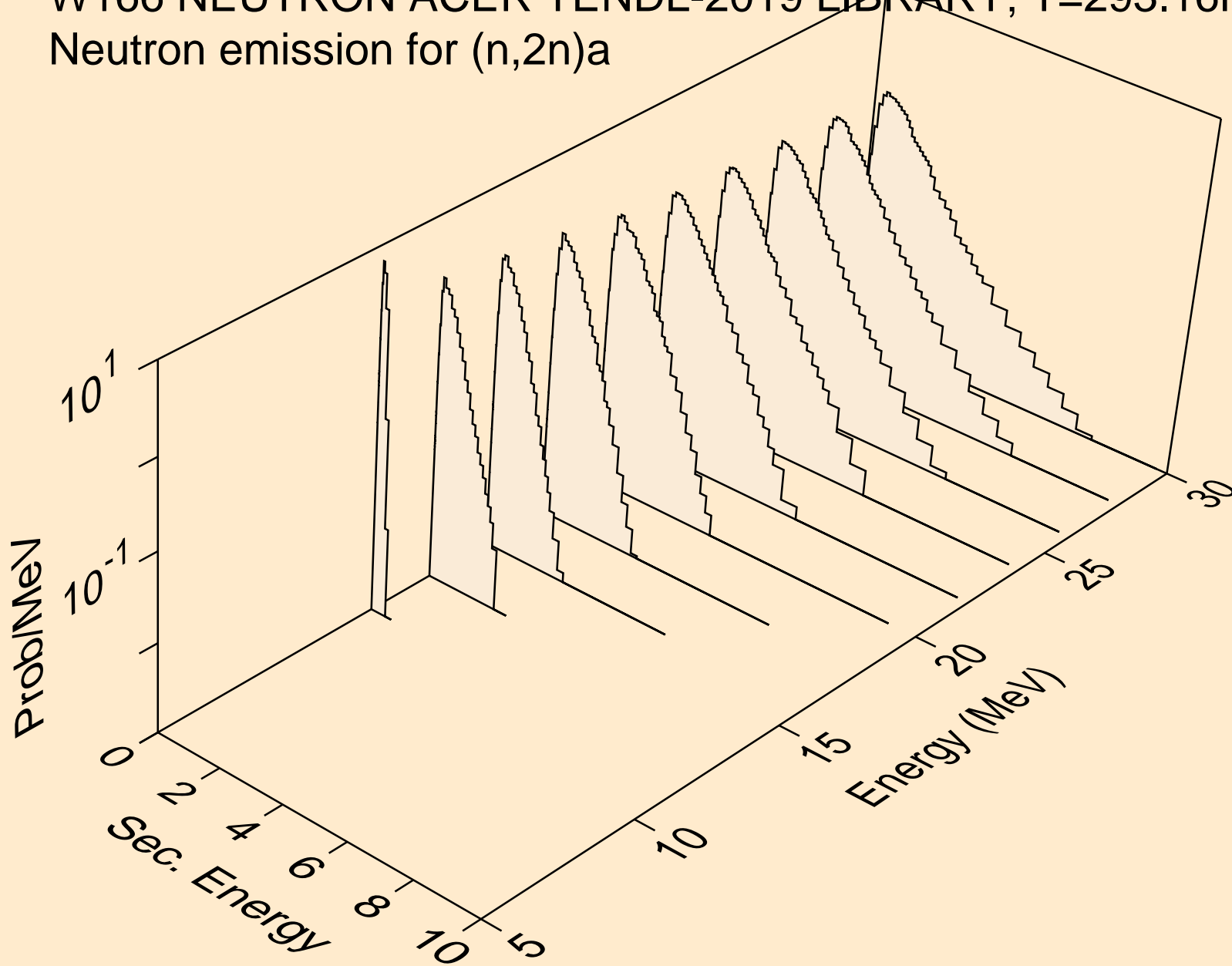

W166 NEUTRON ACER TENDL-2019 LIBRARY; T=293.16K
Neutron emission for (n,3n)a

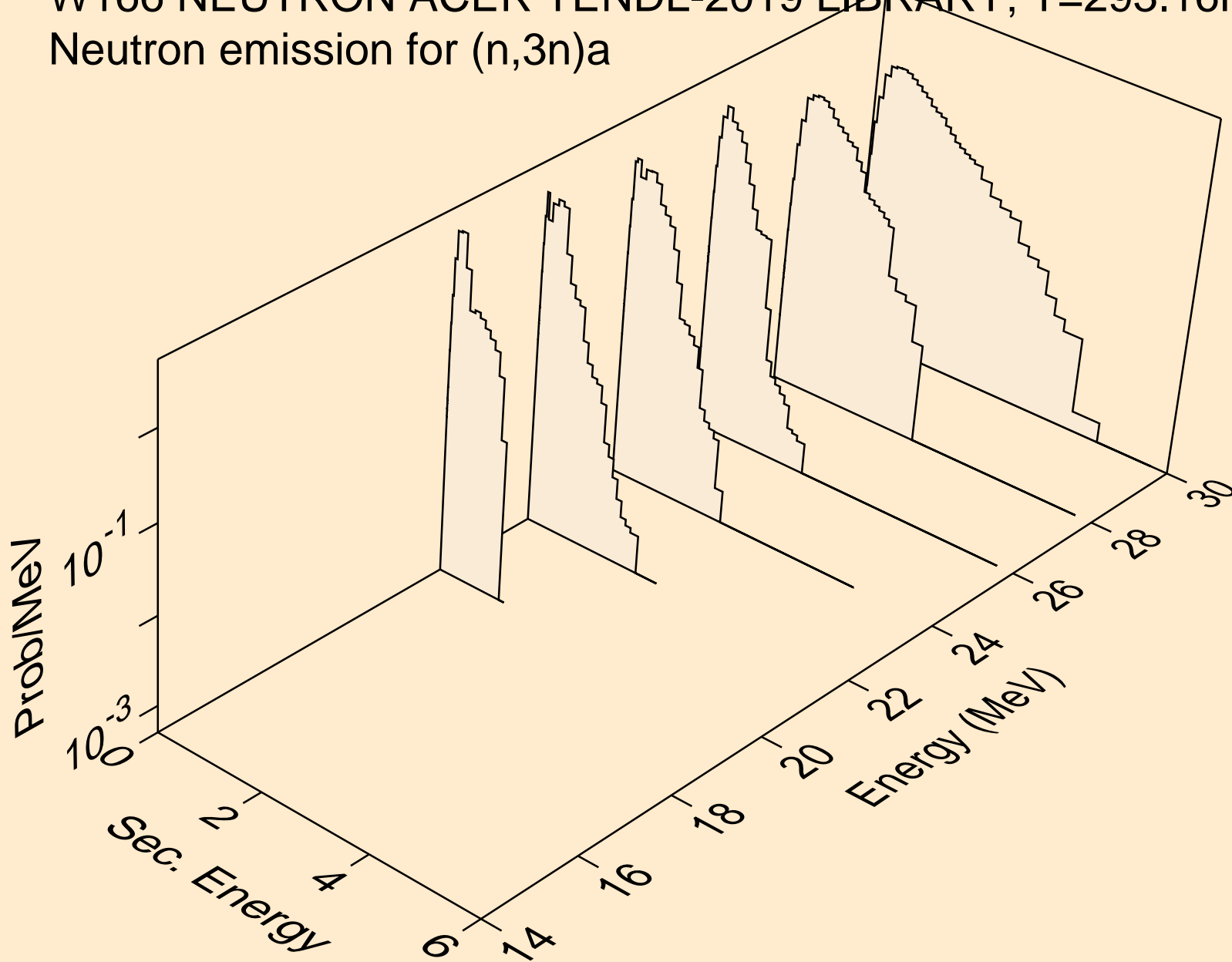

W166 NEUTRON ACER TENDL-2019 LIBRARY; T=293.16K
Neutron emission for (n,n*)p

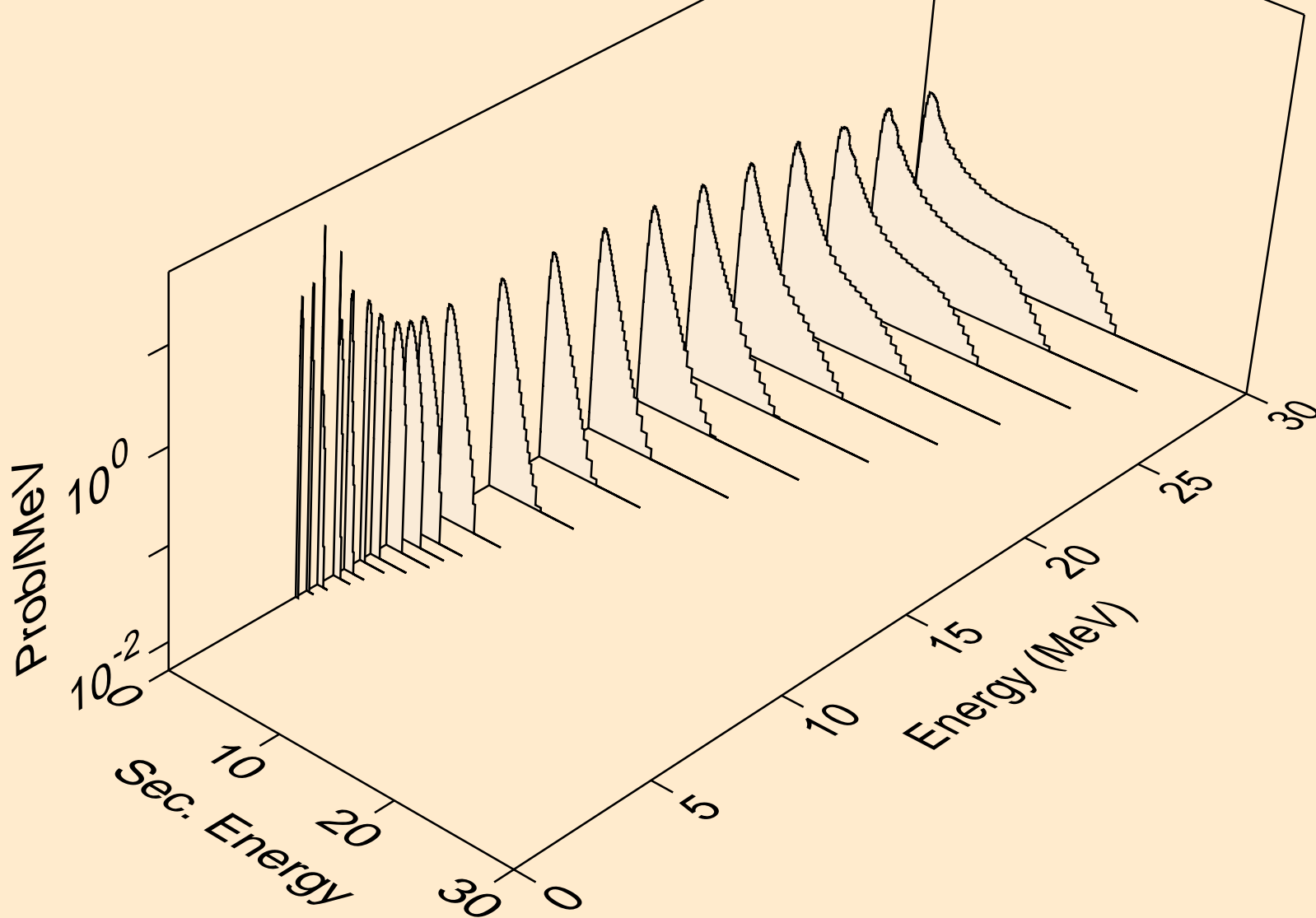

W166 NEUTRON ACER TENDL-2019 LIBRARY; T=293.16K
Neutron emission for (n,n*)2a

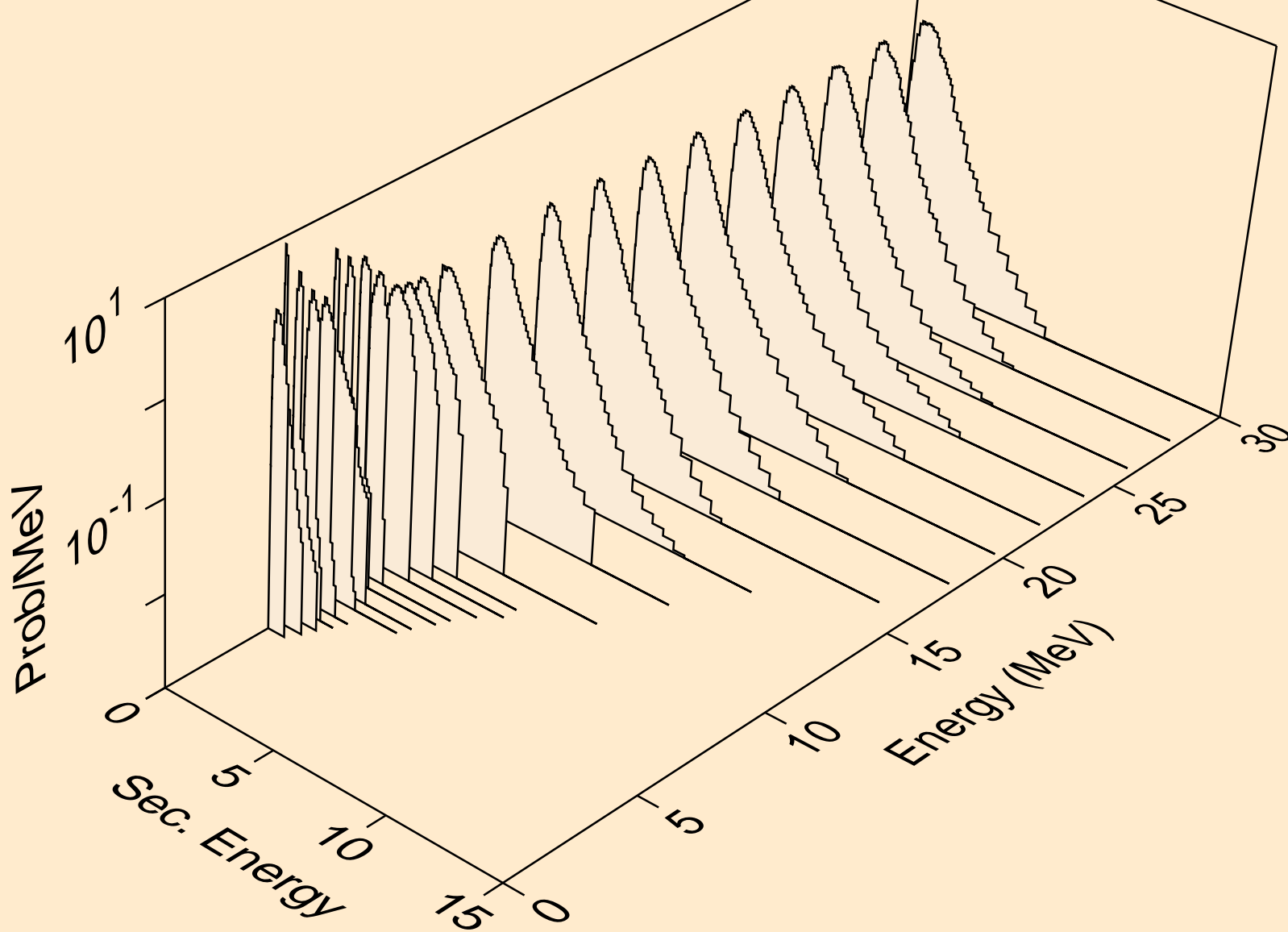

W166 NEUTRON ACER TENDL-2019 LIBRARY; T=293.16K
Neutron emission for (n,2n)2a

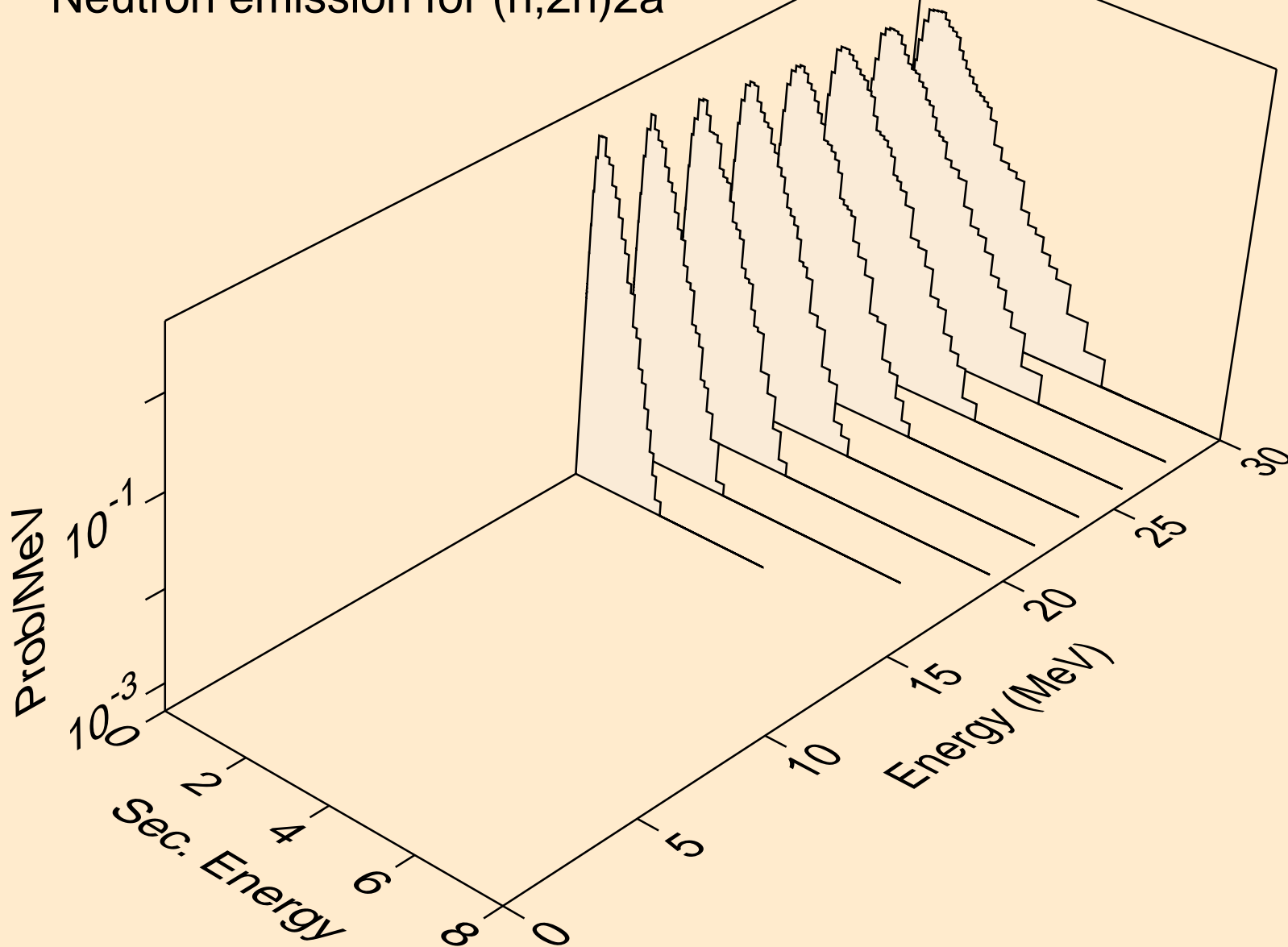

W166 NEUTRON ACER TENDL-2019 LIBRARY; T=293.16K
Neutron emission for (n,n*)d

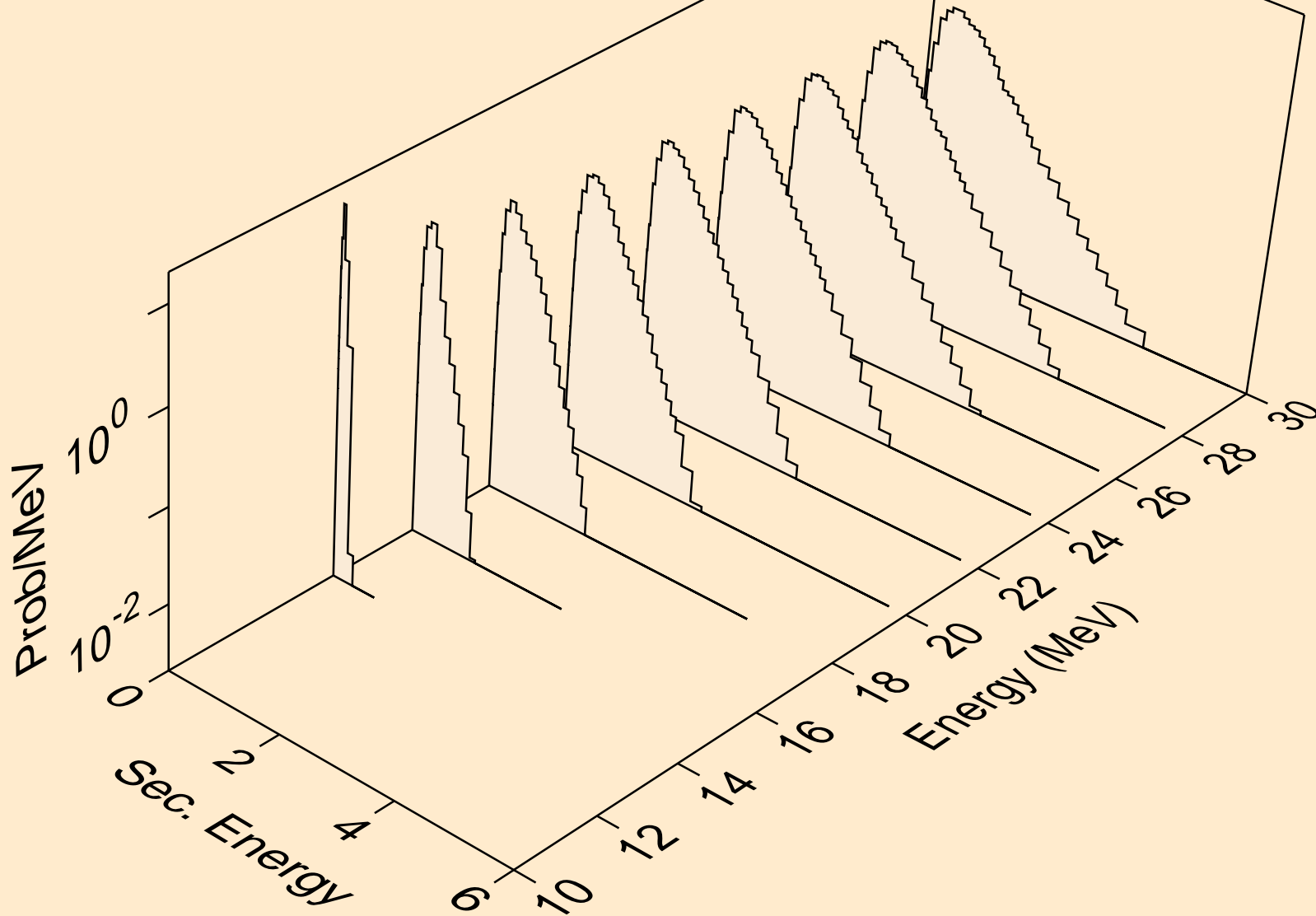

W166 NEUTRON ACER TENDL-2019 LIBRARY; T=293.16K
Neutron emission for (n,n*)t

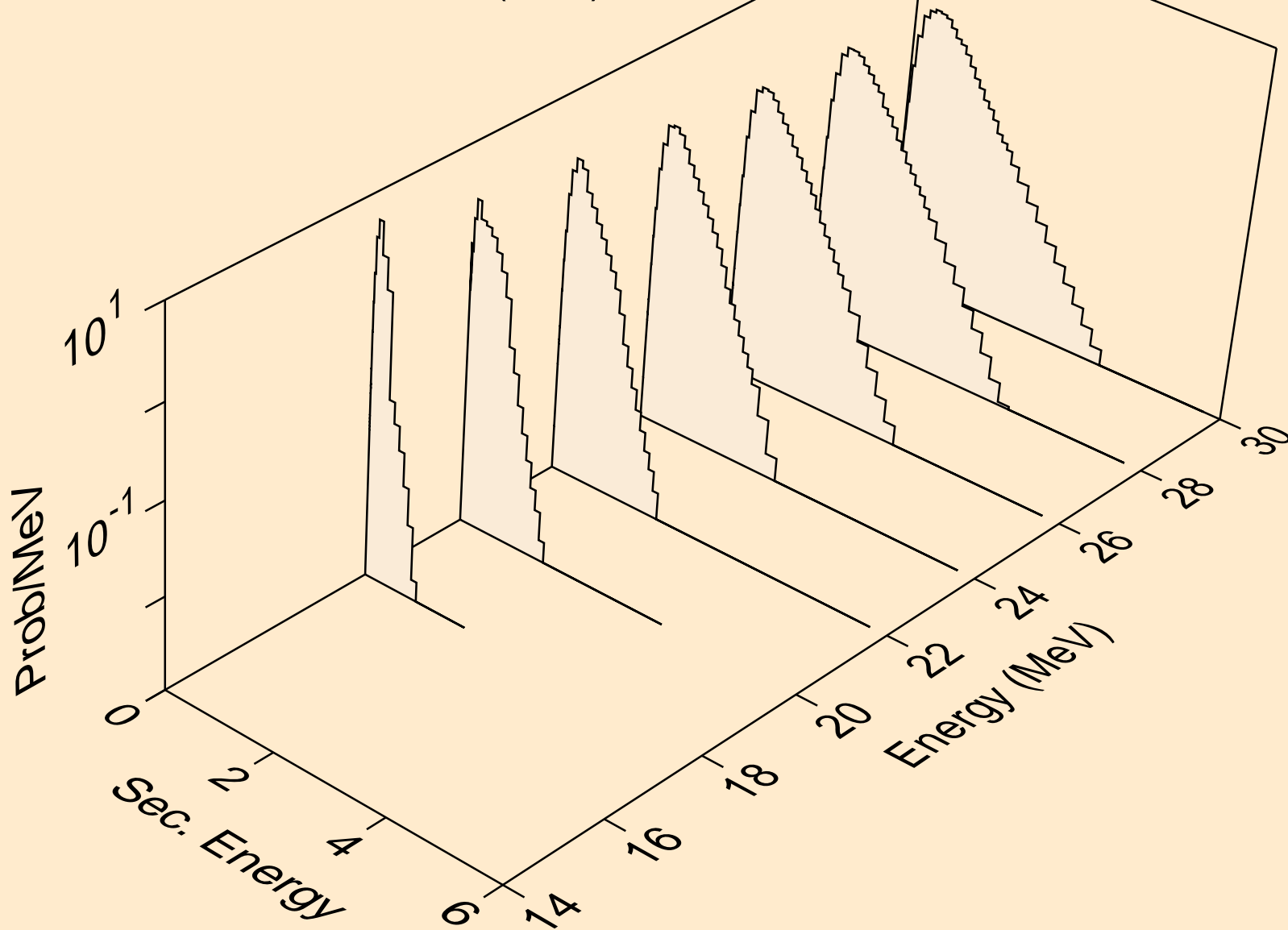

W166 NEUTRON ACER TENDL-2019 LIBRARY; T=293.16K
Neutron emission for (n,n*)he3

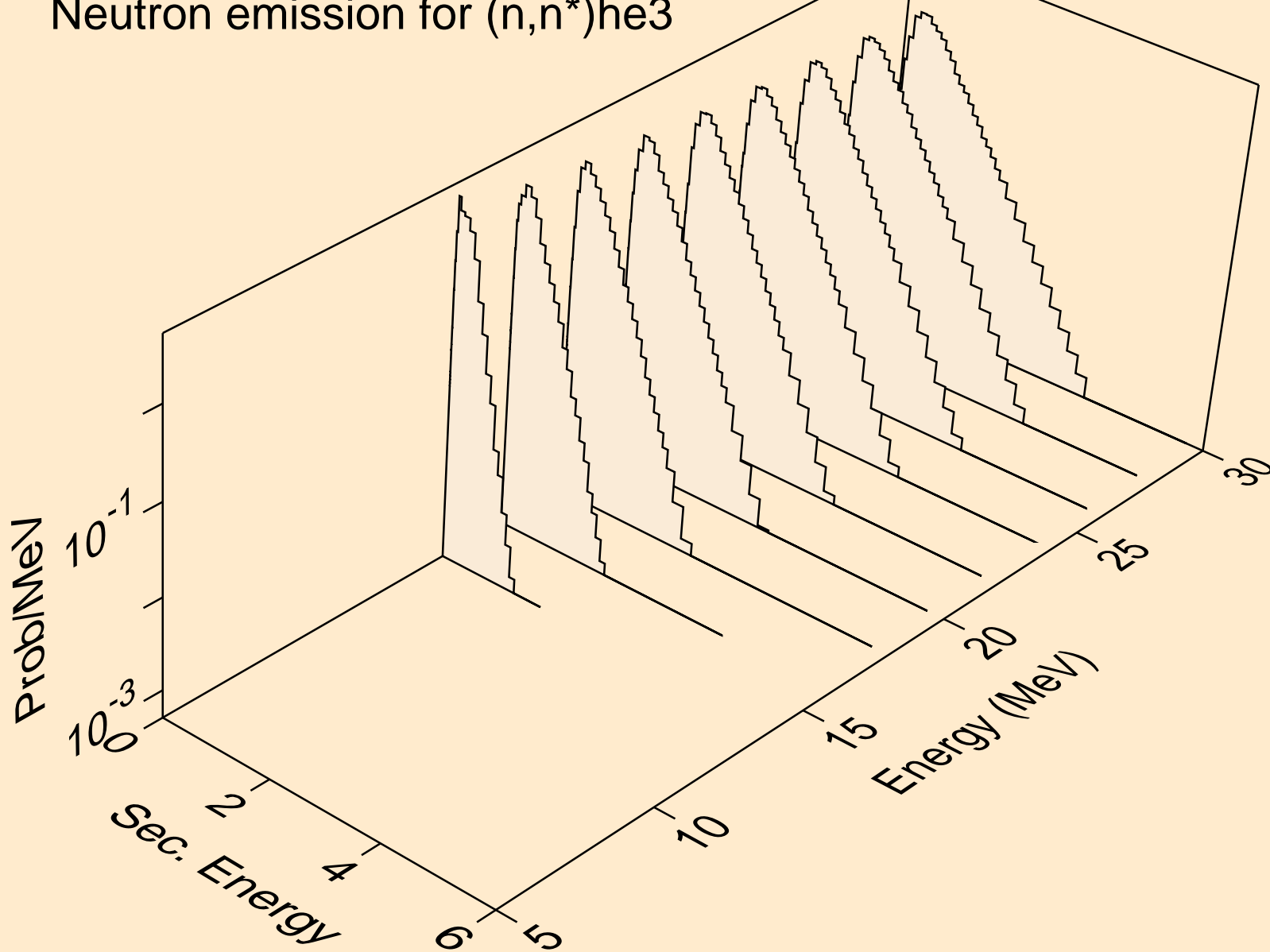

W166 NEUTRON ACER TENDL-2019 LIBRARY; T=293.16K
Neutron emission for (n,2np)

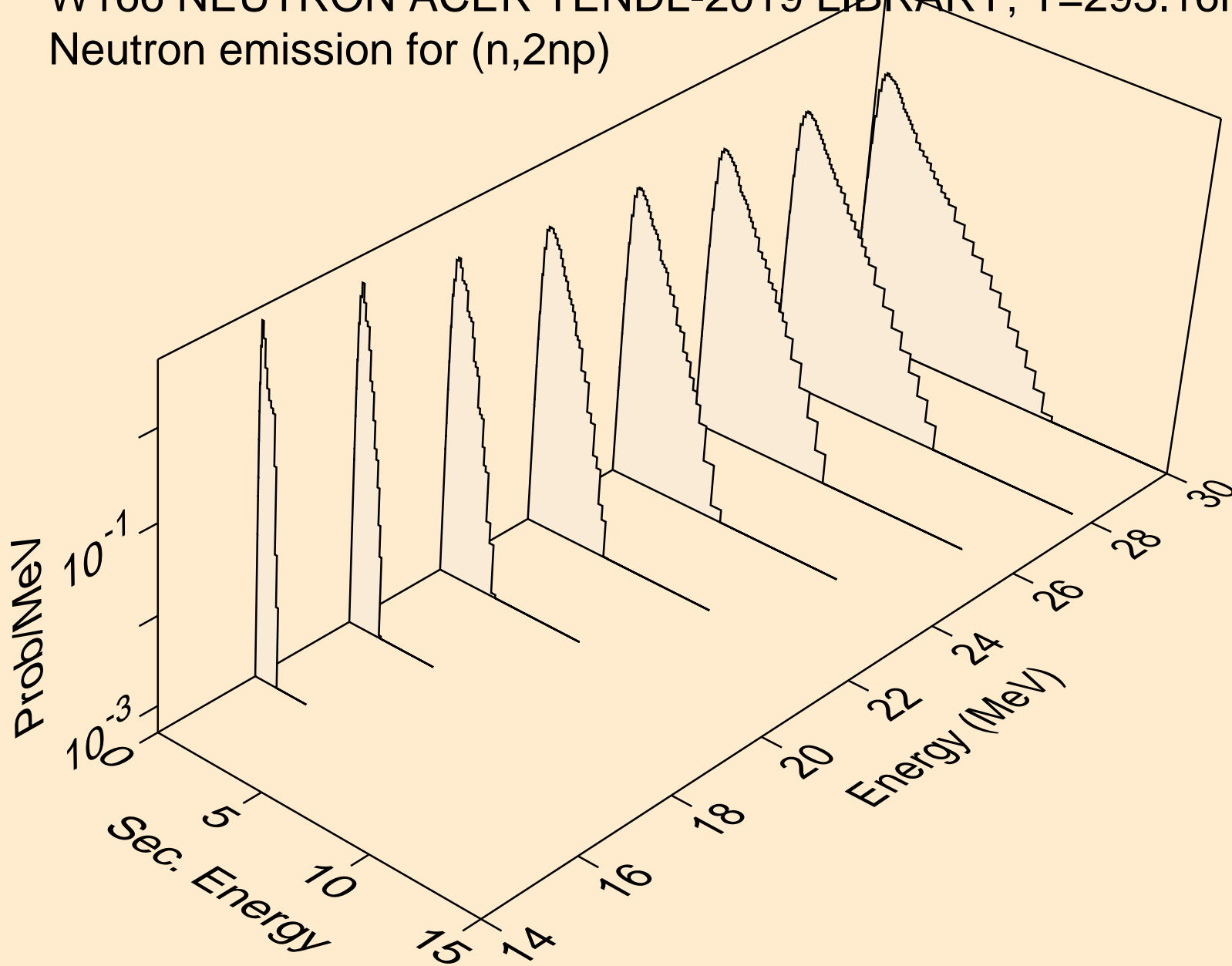

W166 NEUTRON ACER TENDL-2019 LIBRARY; T=293.16K
Neutron emission for (n,3np)

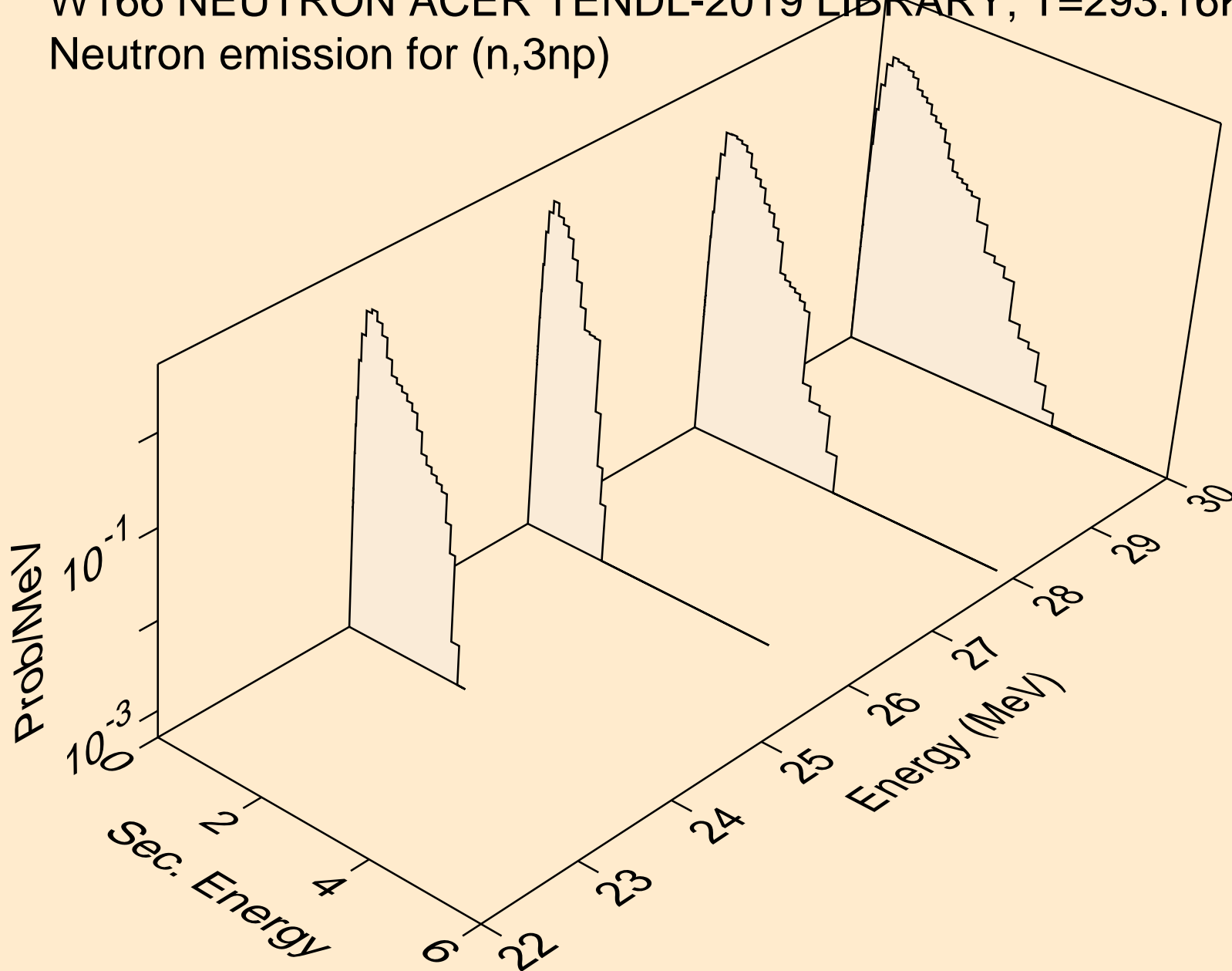

W166 NEUTRON ACER TENDL-2019 LIBRARY; T=293.16K
Neutron emission for (n,2np)

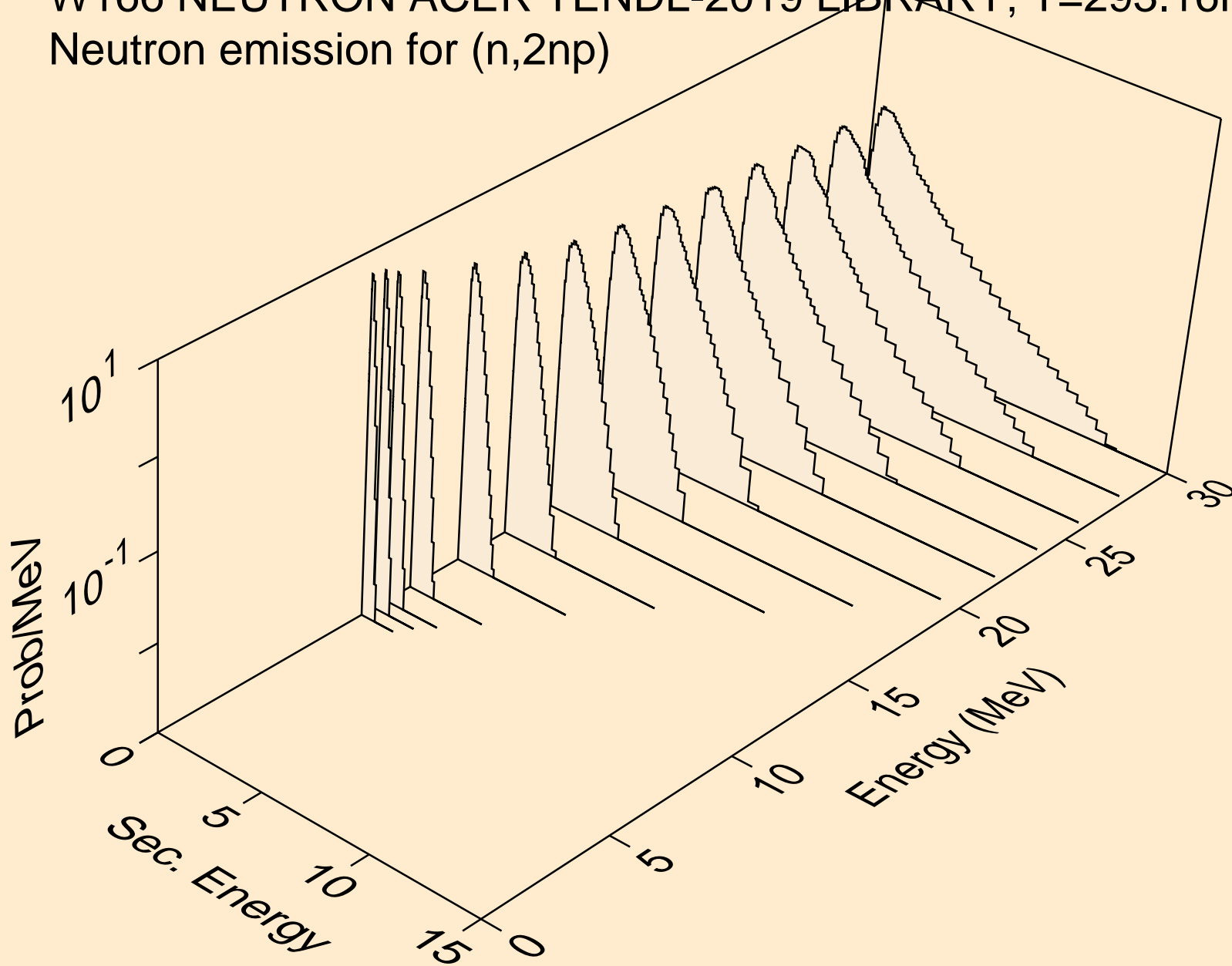

W166 NEUTRON ACER TENDL-2019 LIBRARY; T=293.16K
Neutron emission for (n,npa)

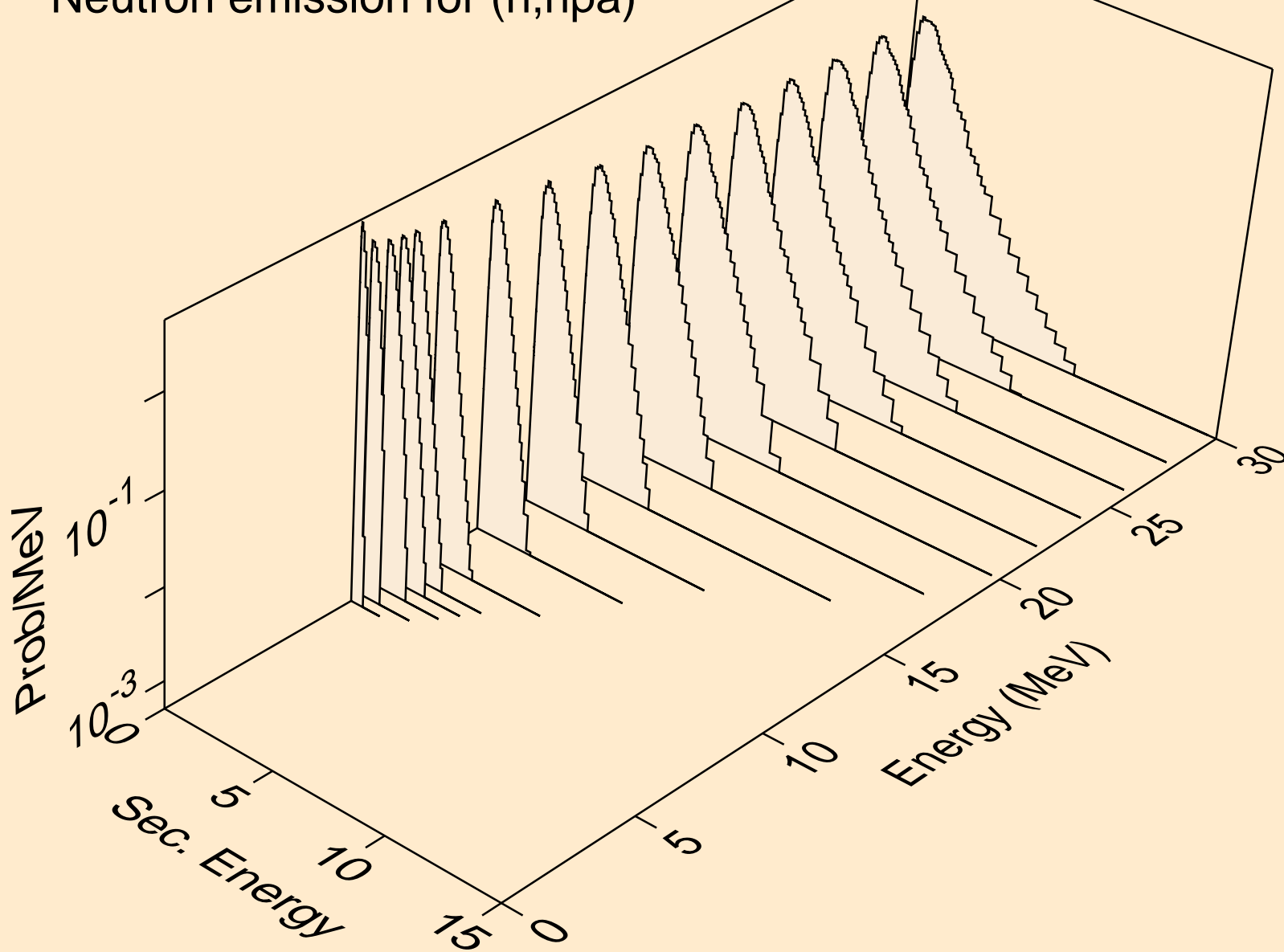

W166 NEUTRON ACER TENDL-2019 LIBRARY; T=293.16K
Neutron emission for (n,n*c)

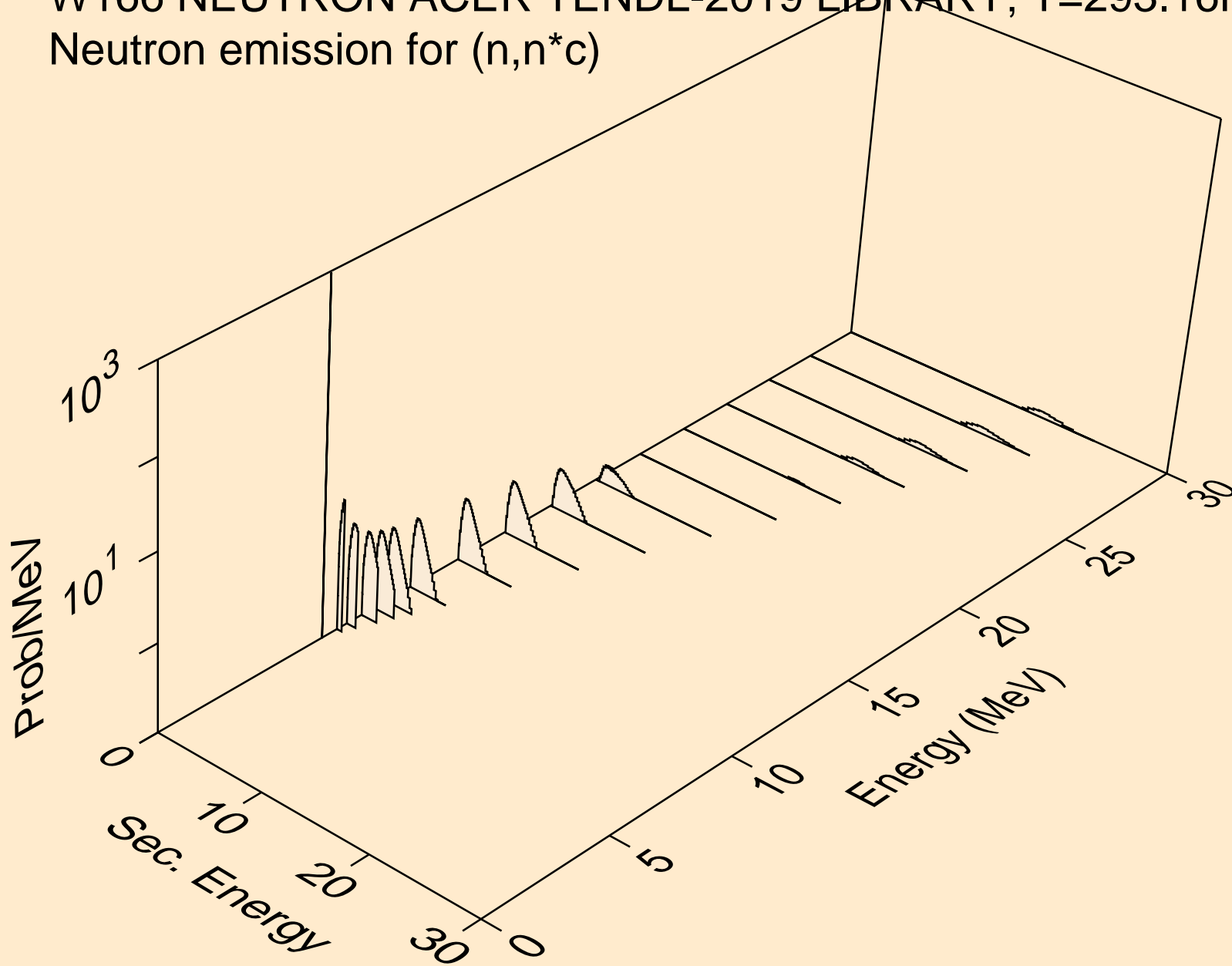

W166 NEUTRON ACER TENDL-2019 LIBRARY; T=293.16K
Photon emission for (n,x)

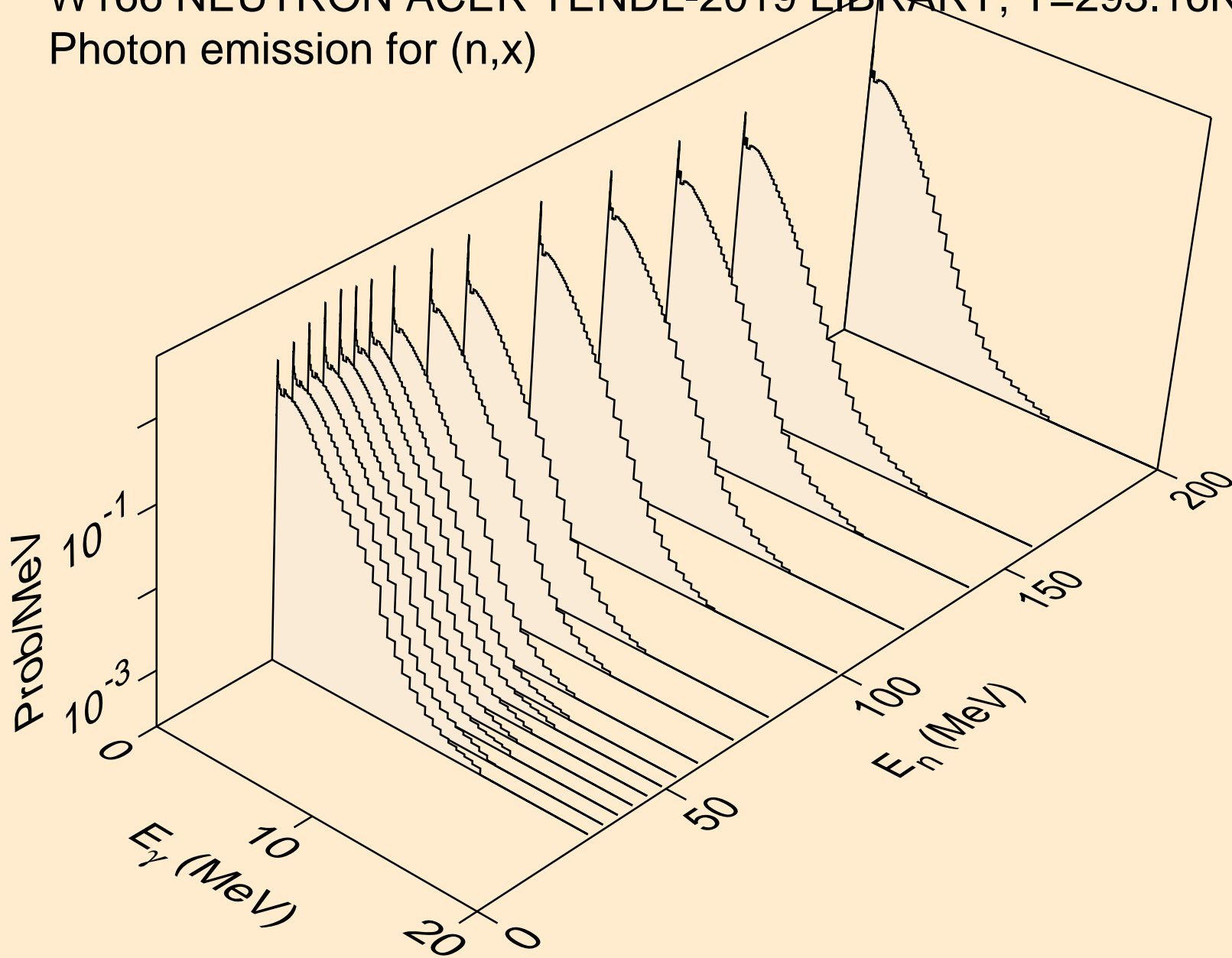

W166 NEUTRON ACER TENDL-2019 LIBRARY; T=293.16K
Photon emission for (n,2nd)

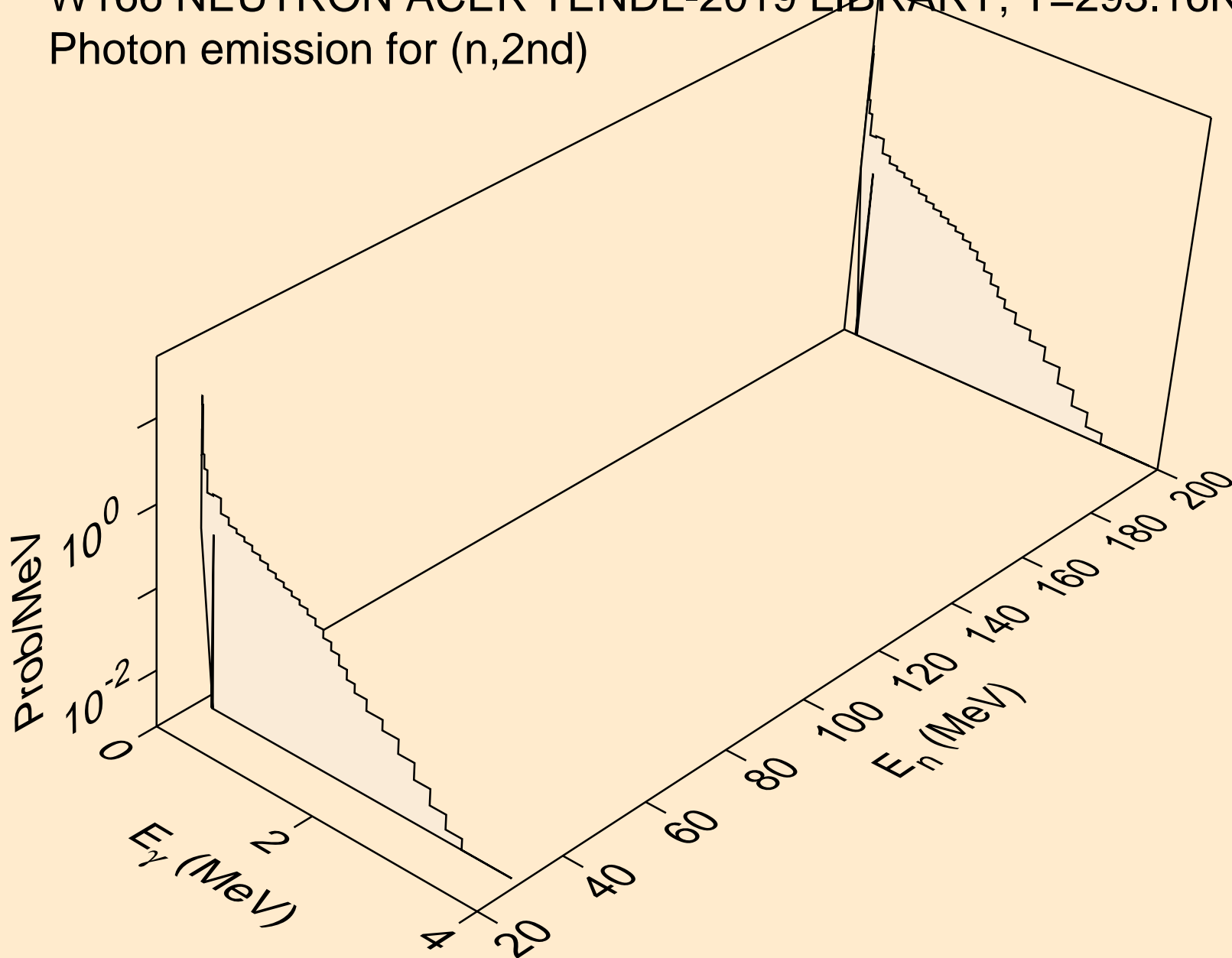

W166 NEUTRON ACER TENDL-2019 LIBRARY; T=293.16K
Photon emission for (n,2n)

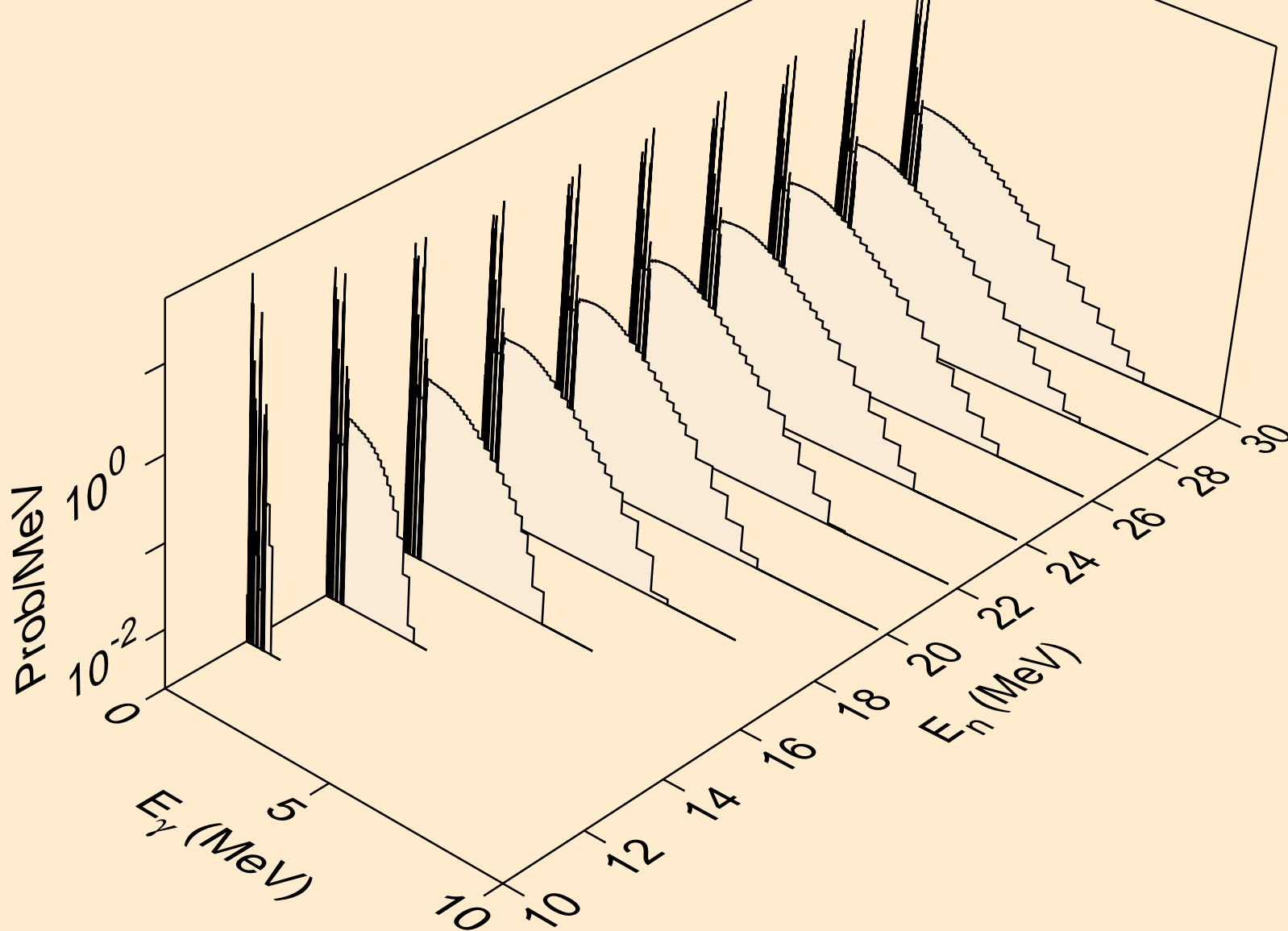

W166 NEUTRON ACER TENDL-2019 LIBRARY; T=293.16K
Photon emission for (n,3n)

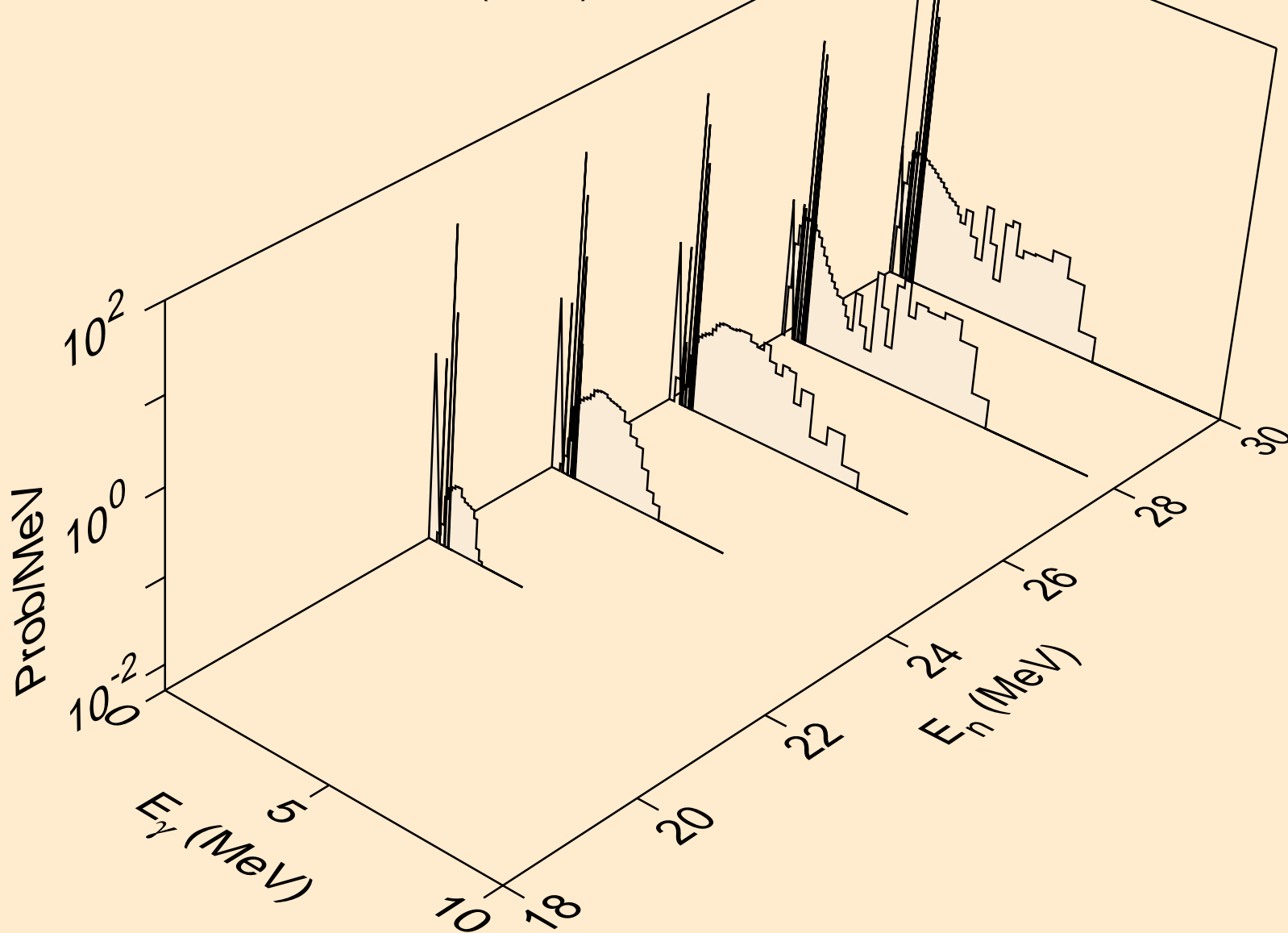

W166 NEUTRON ACER TENDL-2019 LIBRARY; T=293.16K
Photon emission for (n,n*)a

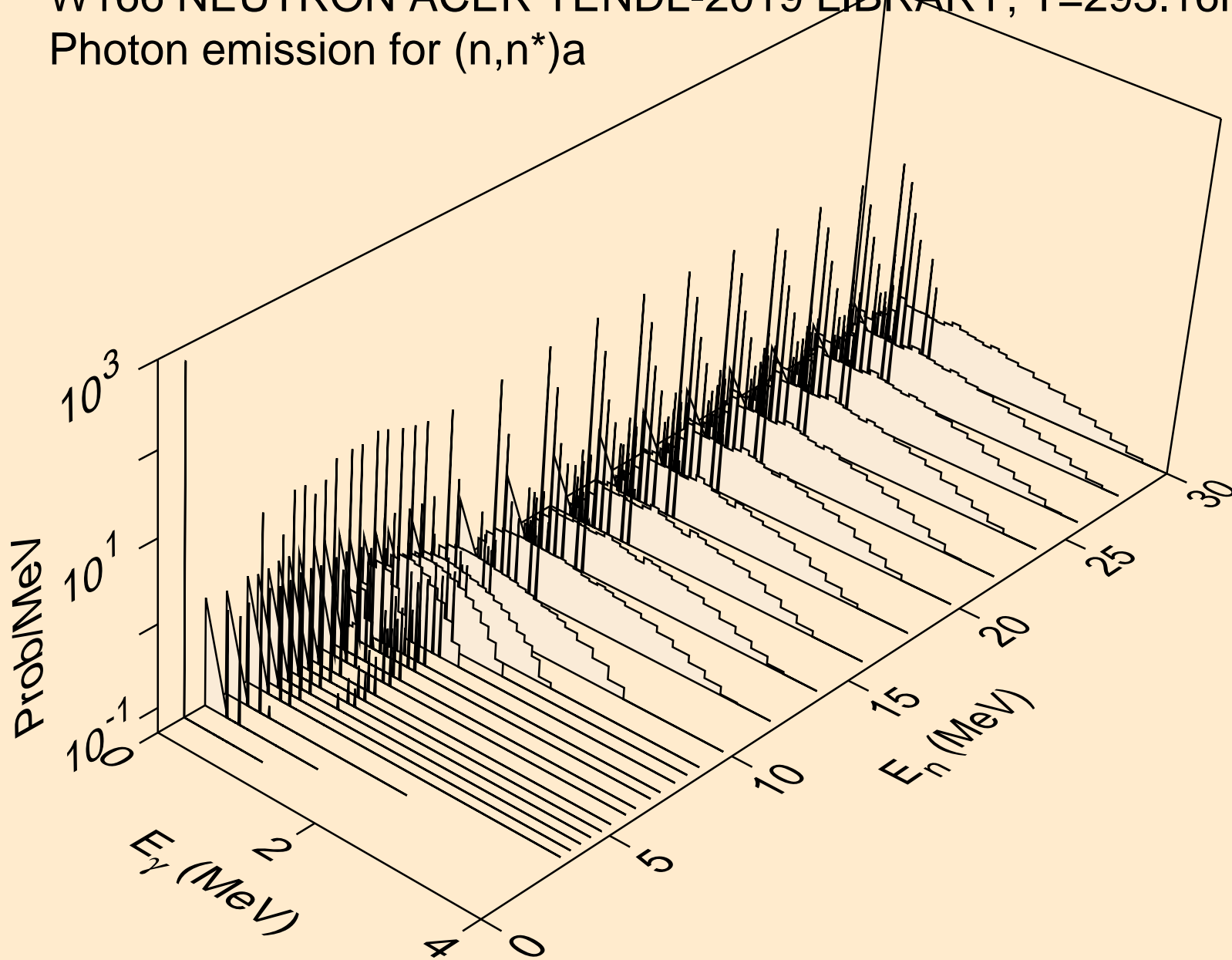

W166 NEUTRON ACER TENDL-2019 LIBRARY; T=293.16K
Photon emission for (n,n*)3a

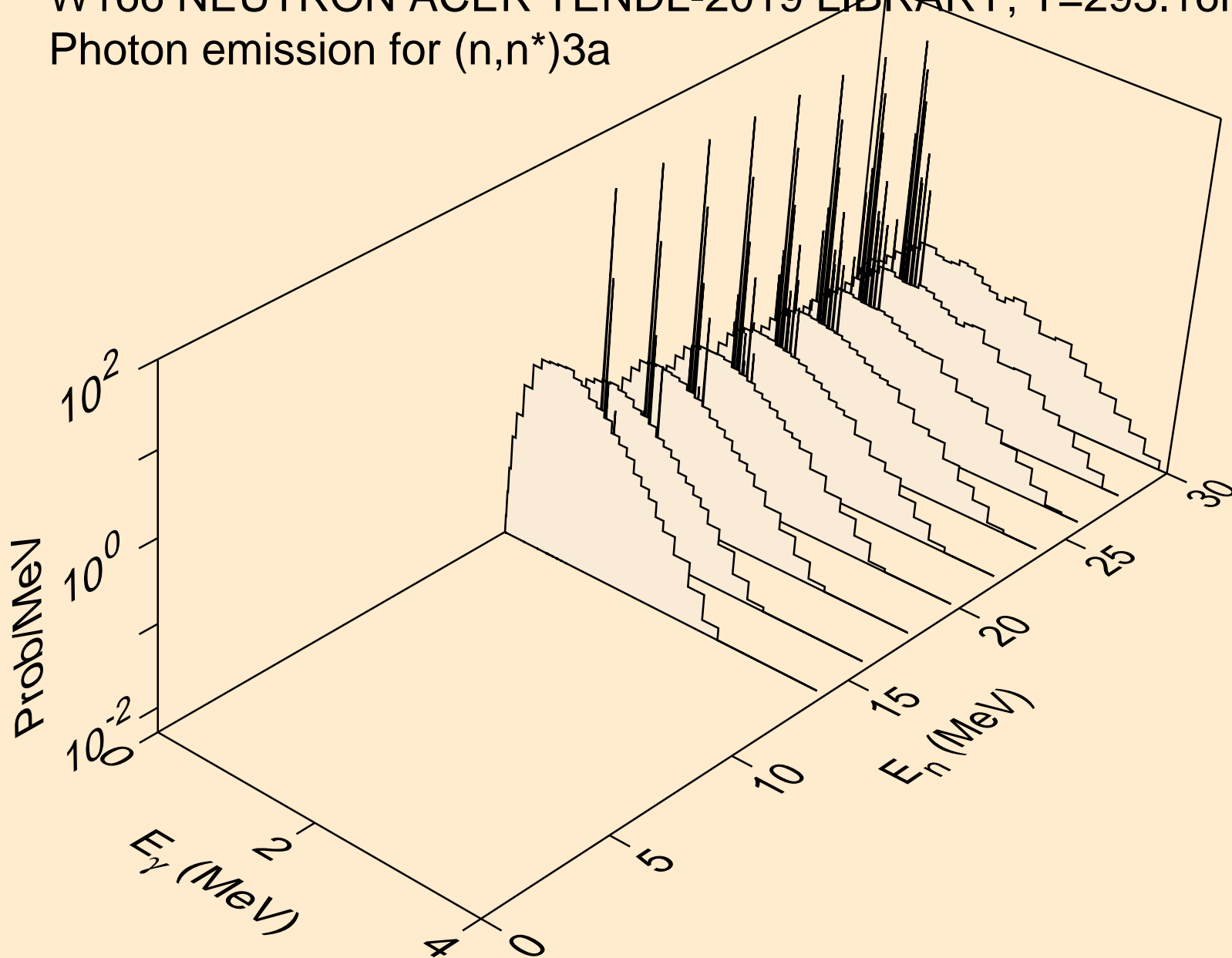

W166 NEUTRON ACER TENDL-2019 LIBRARY; T=293.16K
Photon emission for (n,2n)a

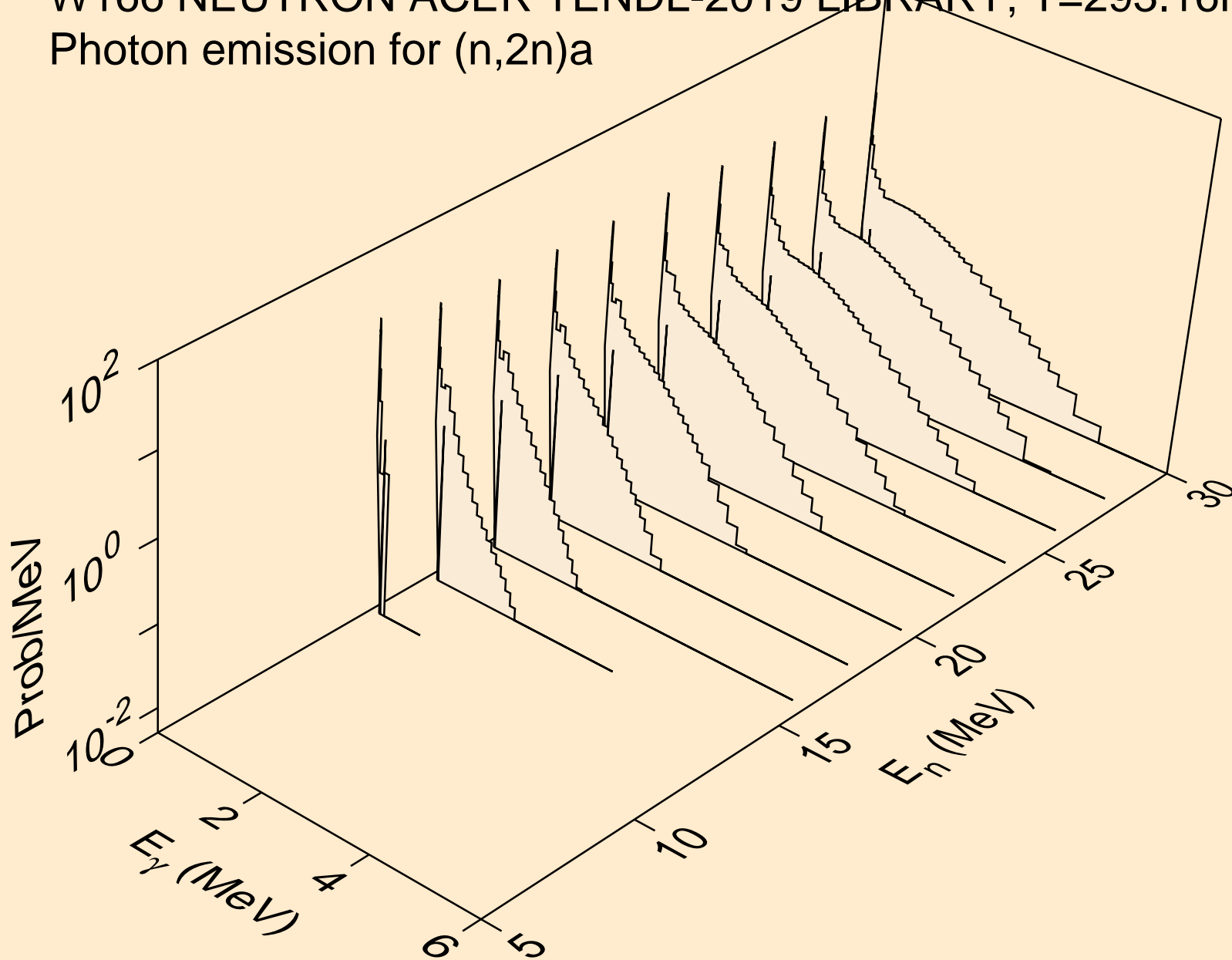

W166 NEUTRON ACER TENDL-2019 LIBRARY; T=293.16K
Photon emission for (n,3n)a

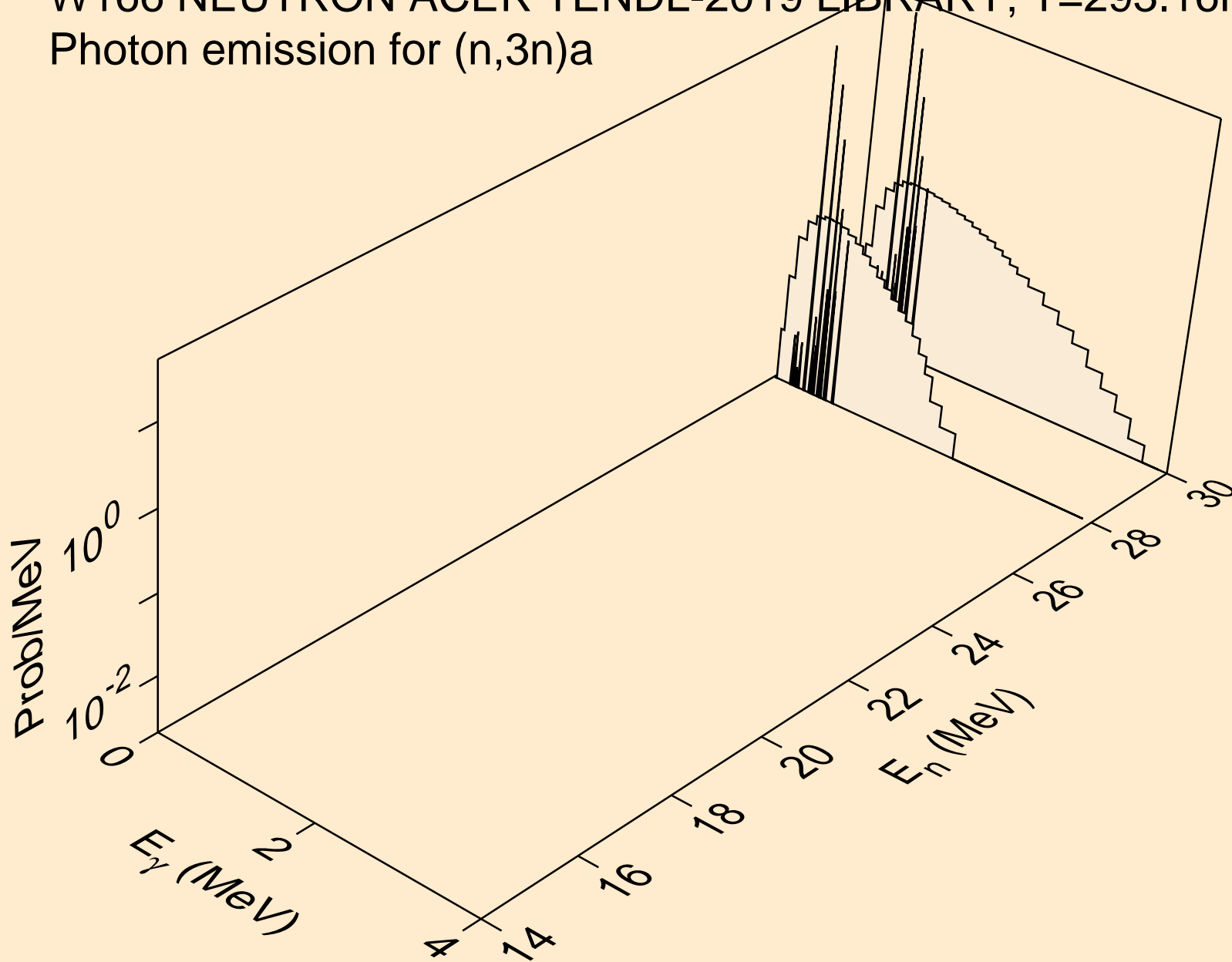

W166 NEUTRON ACER TENDL-2019 LIBRARY; T=293.16K
Photon emission for (n,n*)p

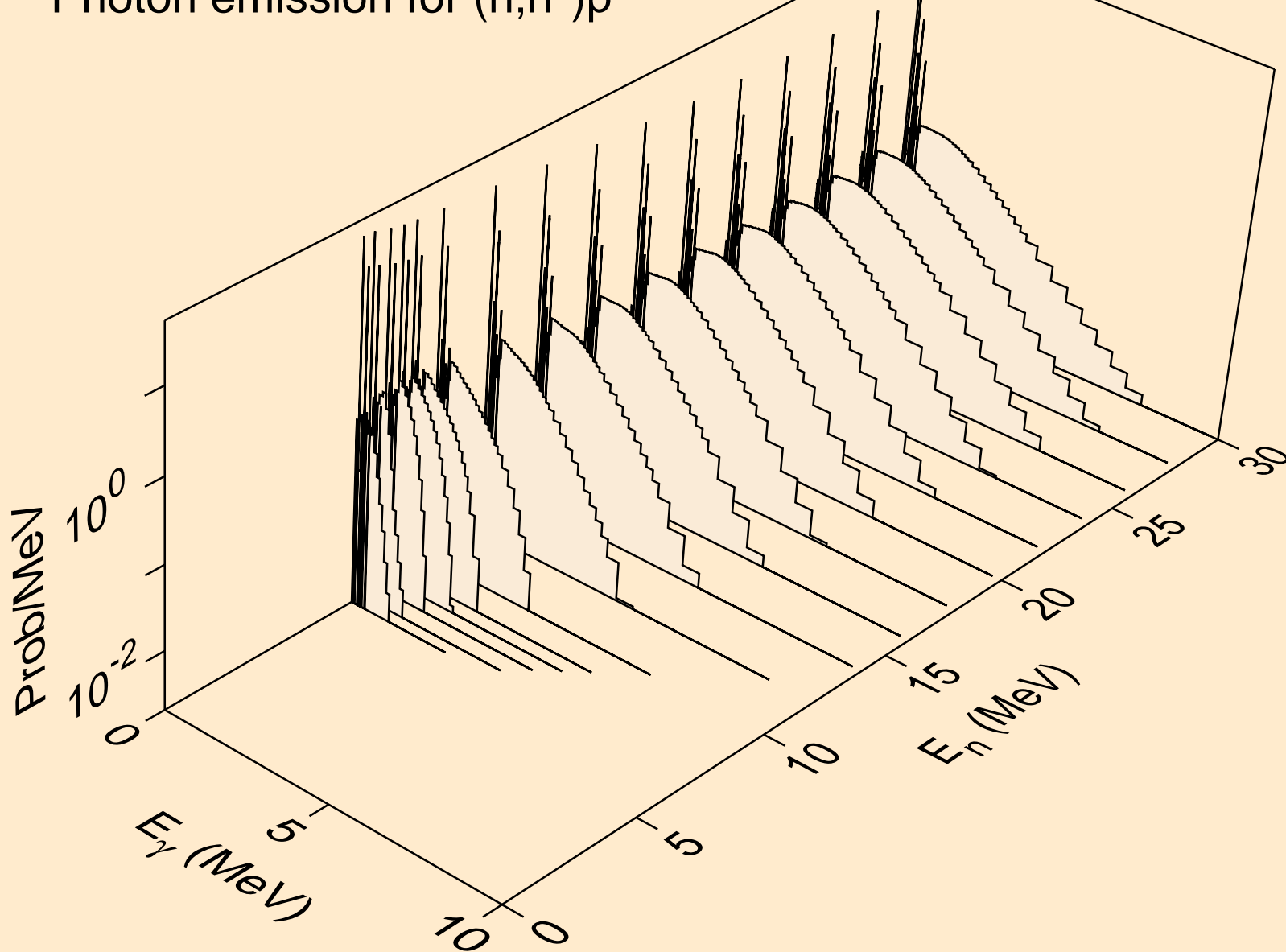

W166 NEUTRON ACER TENDL-2019 LIBRARY; T=293.16K
Photon emission for (n,n*)2a

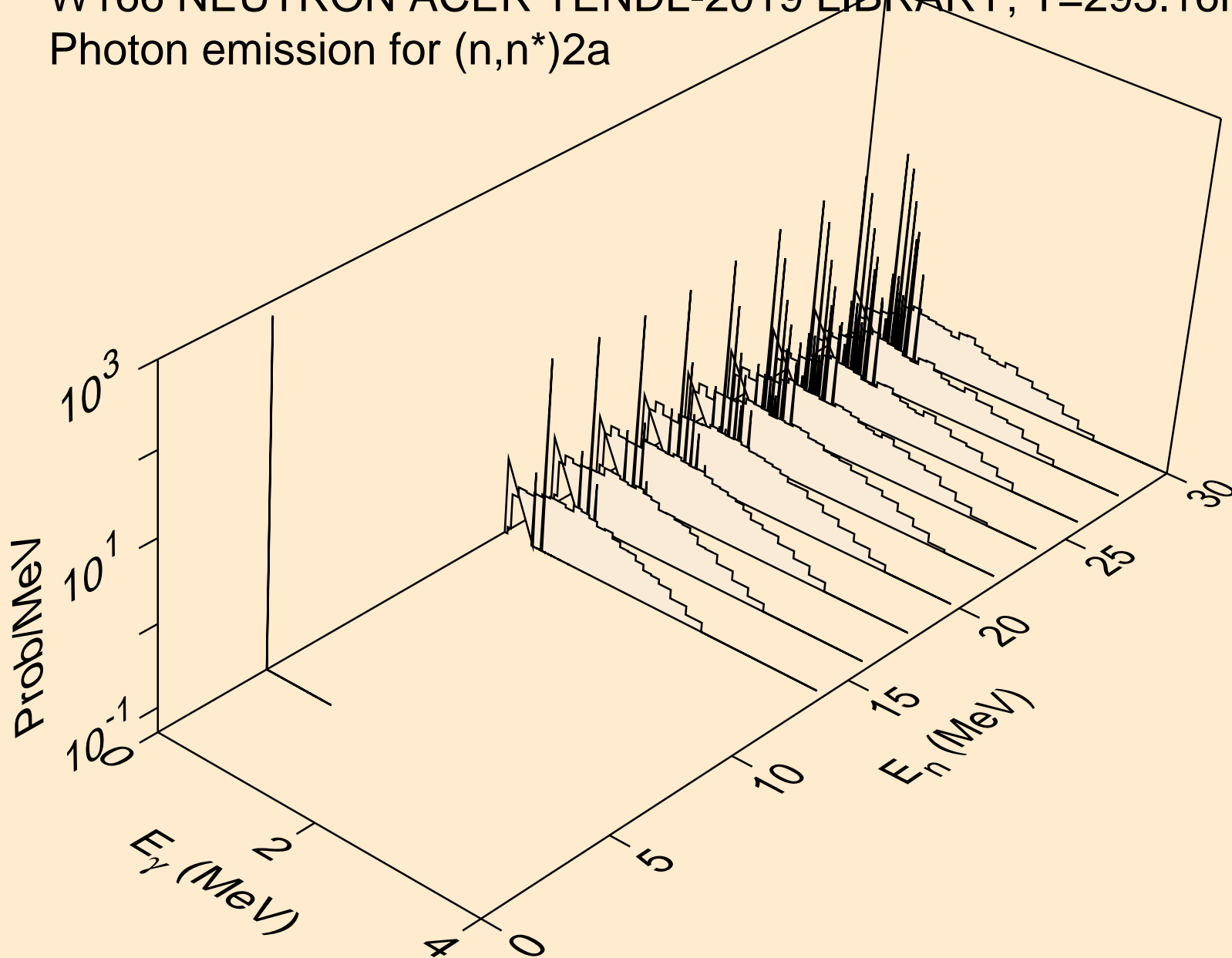

W166 NEUTRON ACER TENDL-2019 LIBRARY; T=293.16K
Photon emission for (n,2n)2a

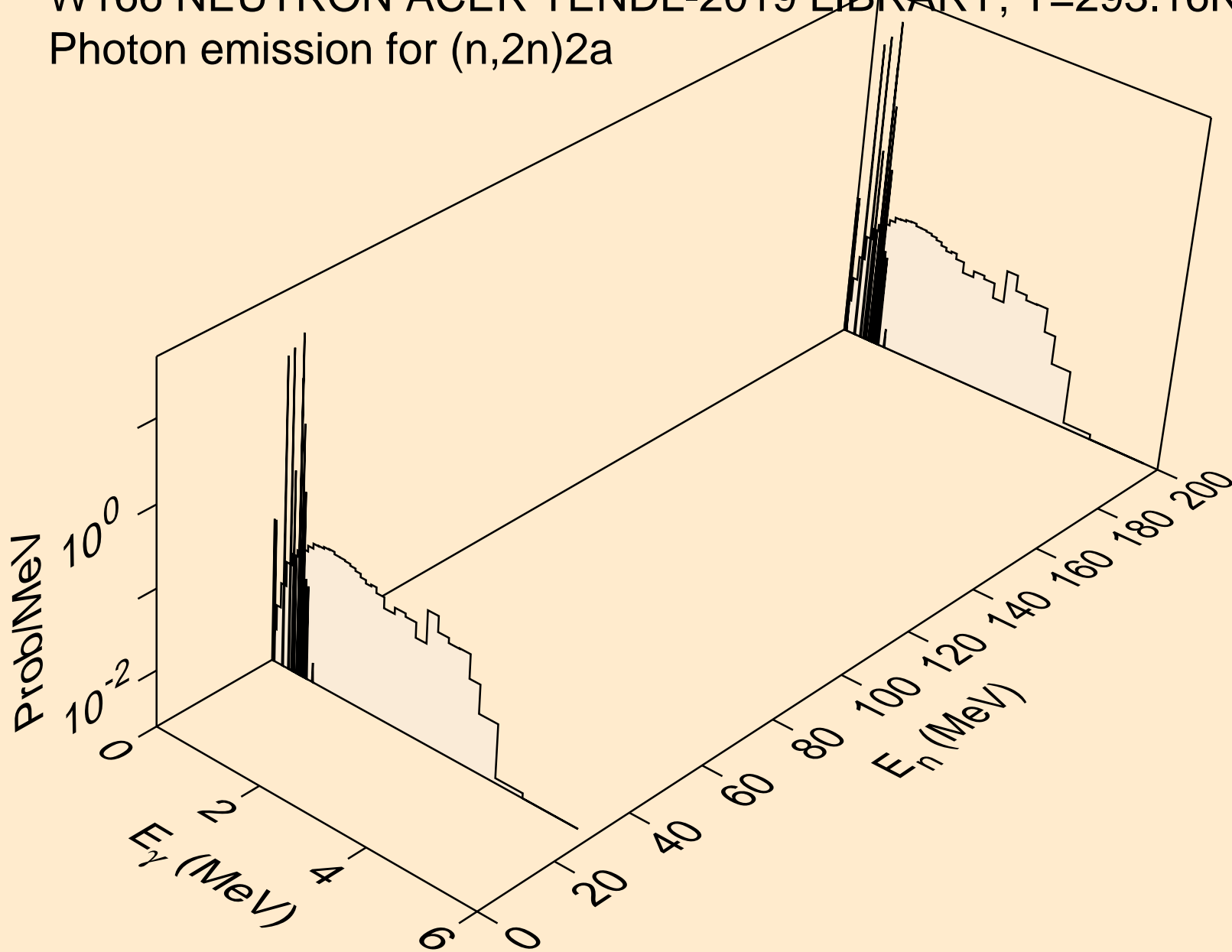

W166 NEUTRON ACER TENDL-2019 LIBRARY; T=293.16K
Photon emission for (n,n*)d

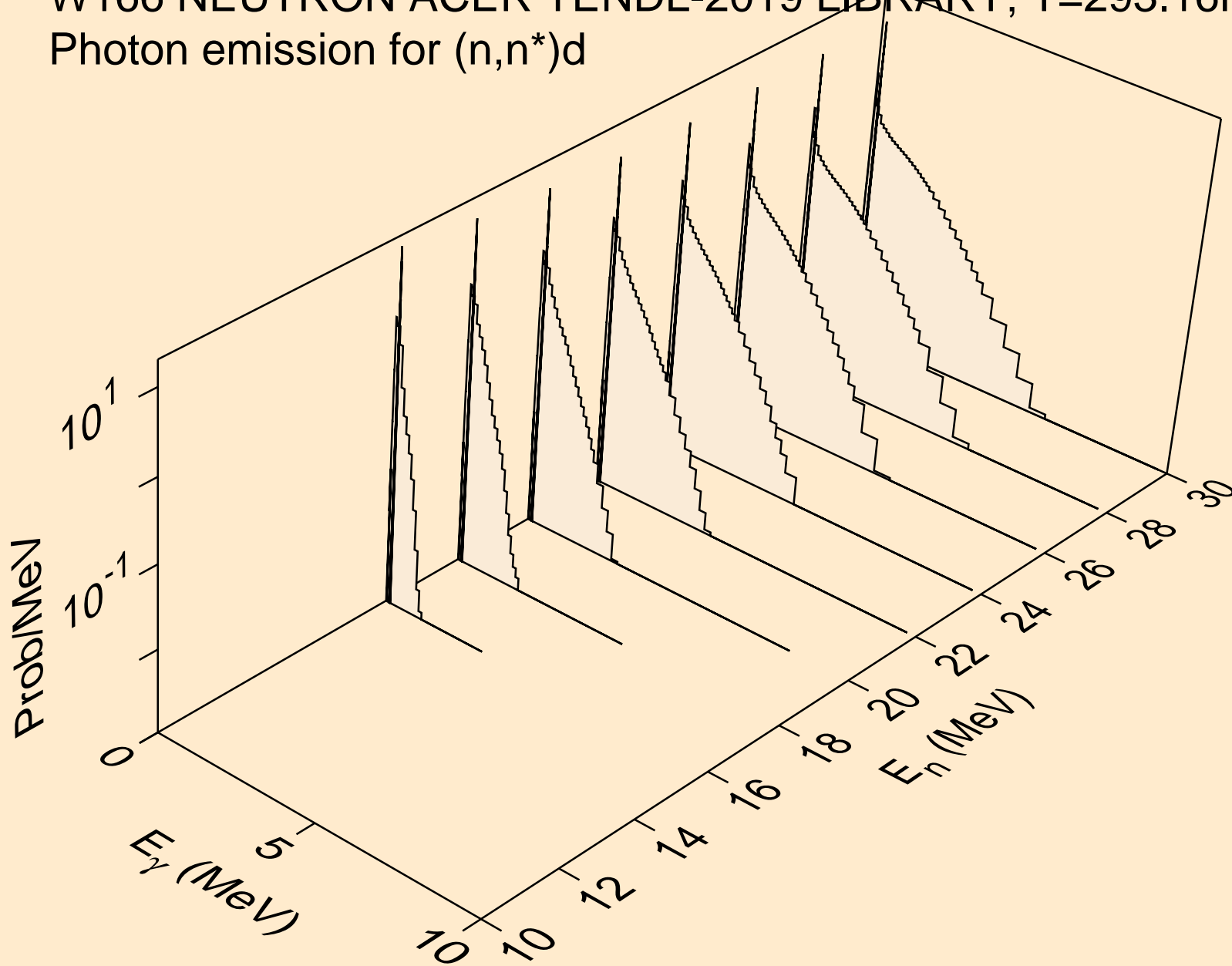

W166 NEUTRON ACER TENDL-2019 LIBRARY; T=293.16K
Photon emission for (n,n*)t

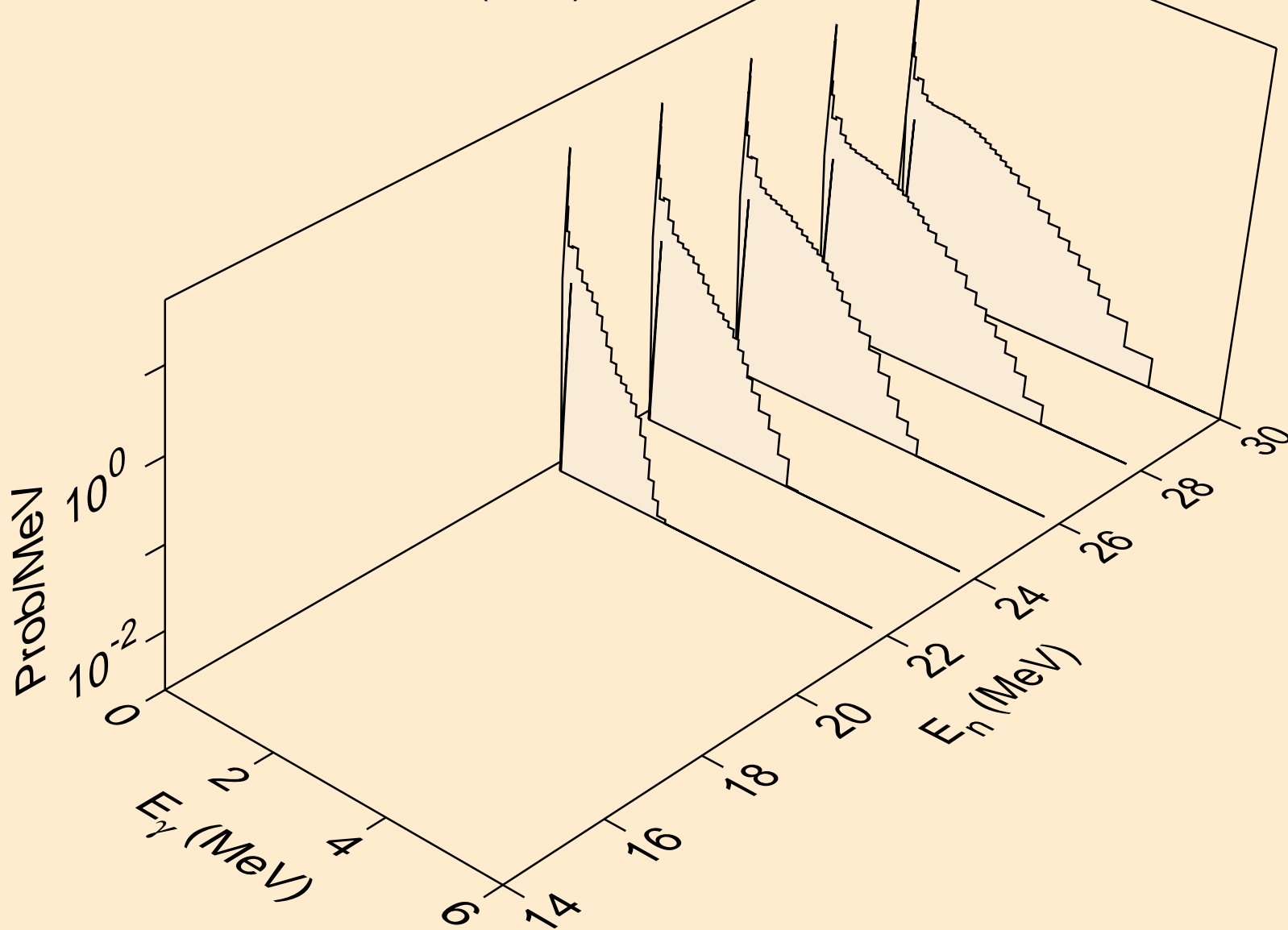

W166 NEUTRON ACER TENDL-2019 LIBRARY; T=293.16K
Photon emission for (n,n*)he3

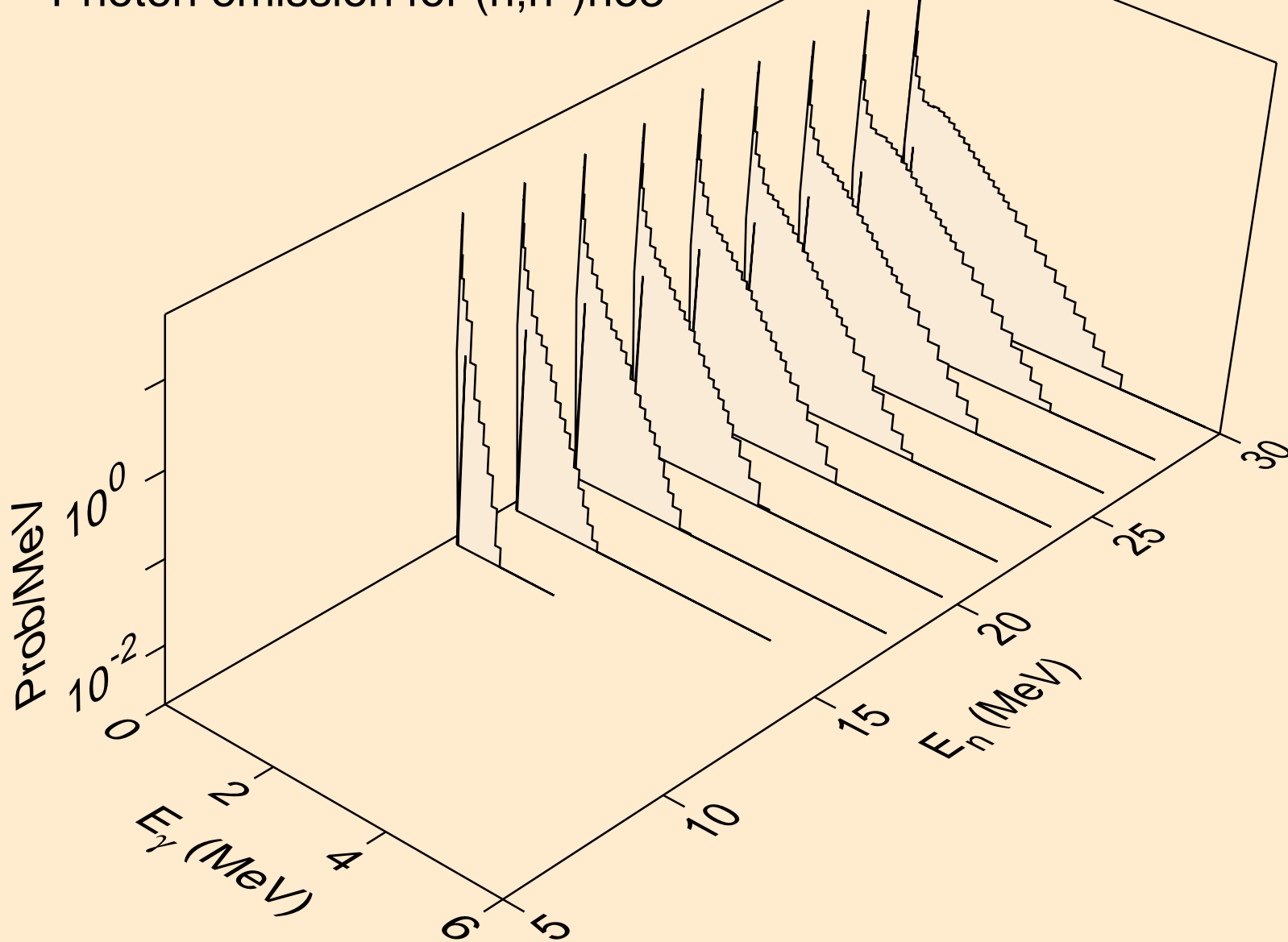

W166 NEUTRON ACER TENDL-2019 LIBRARY; T=293.16K
Photon emission for (n,2np)

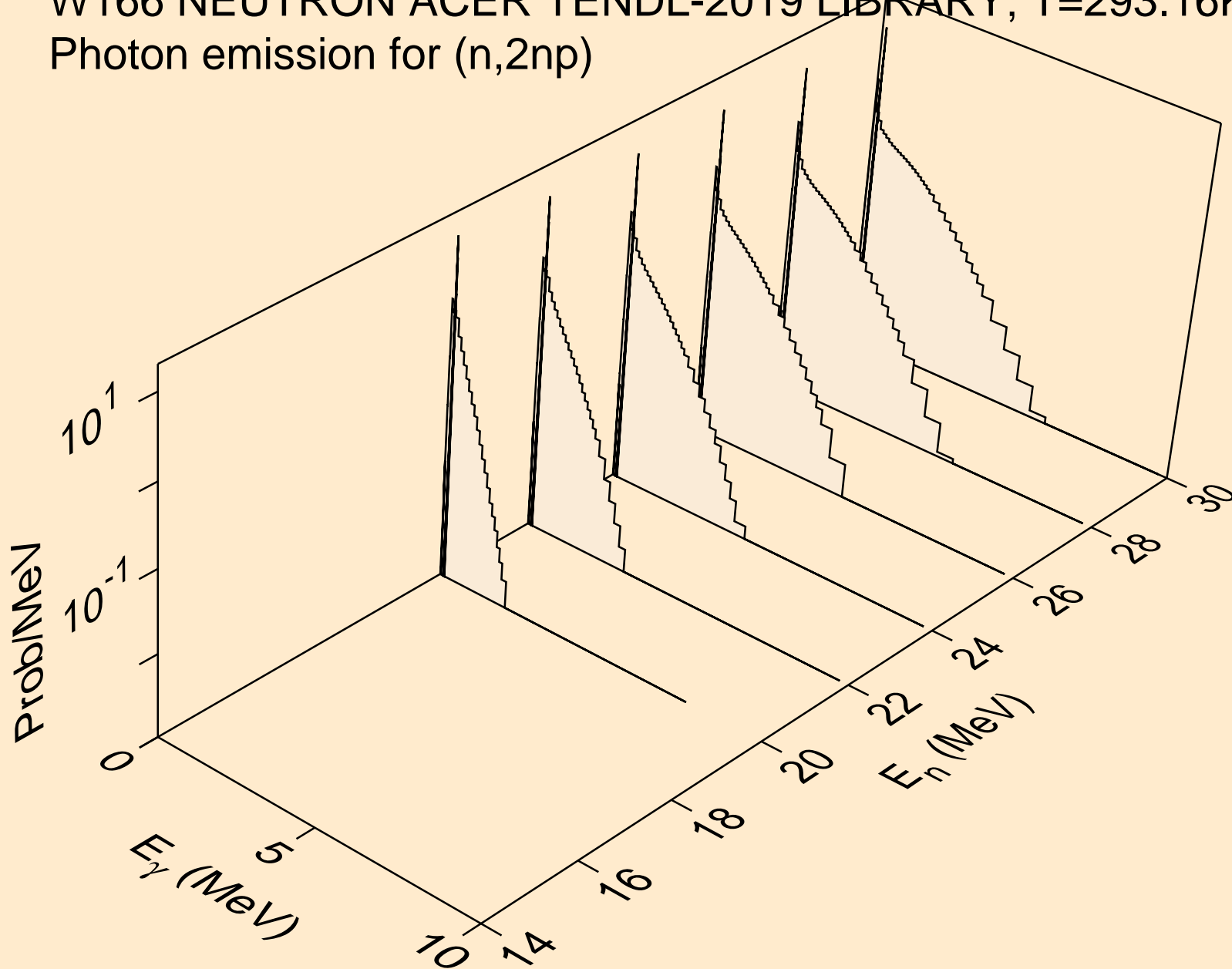

W166 NEUTRON ACER TENDL-2019 LIBRARY; T=293.16K
Photon emission for (n,3np)

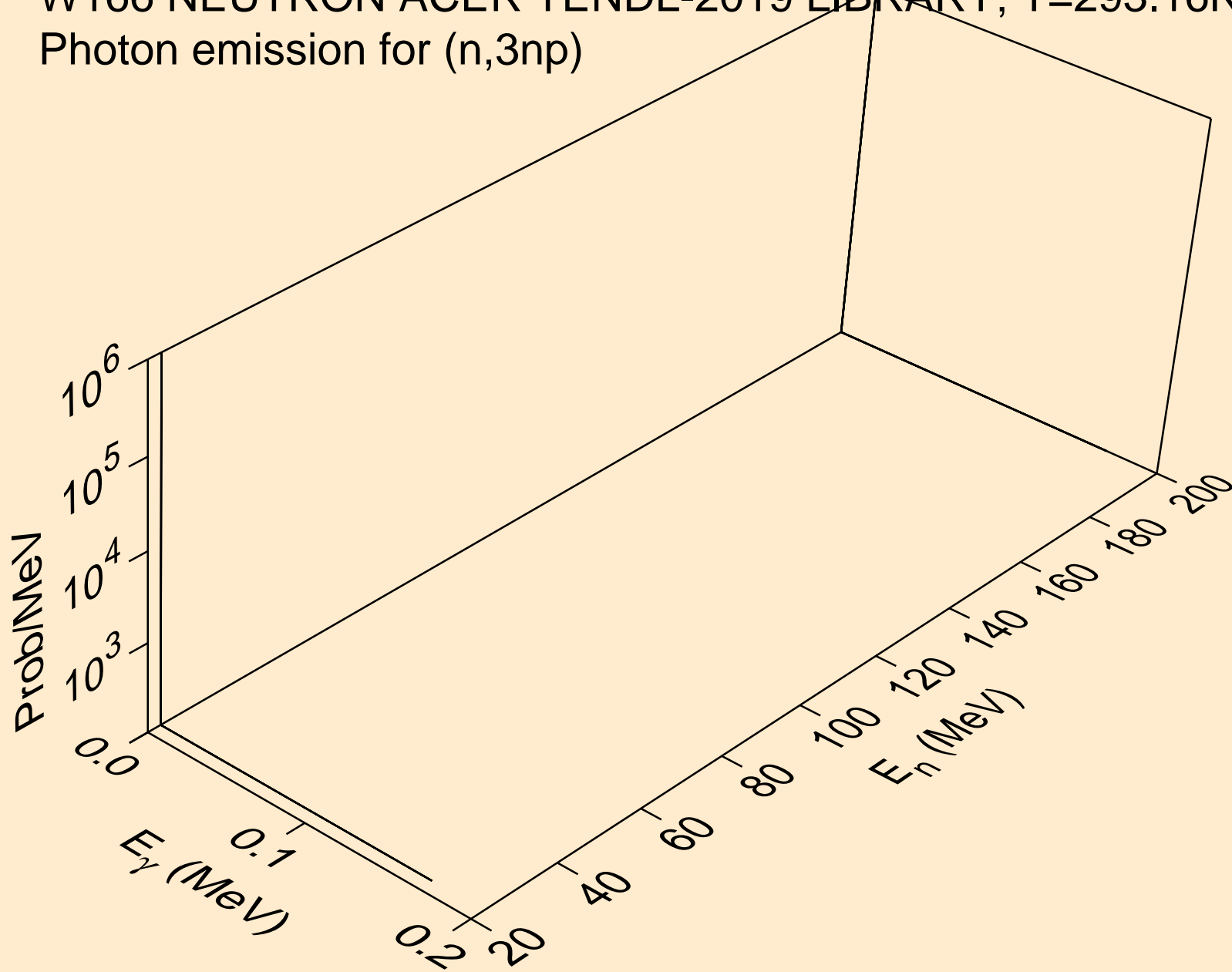

W166 NEUTRON ACER TENDL-2019 LIBRARY; T=293.16K
Photon emission for (n,2np)

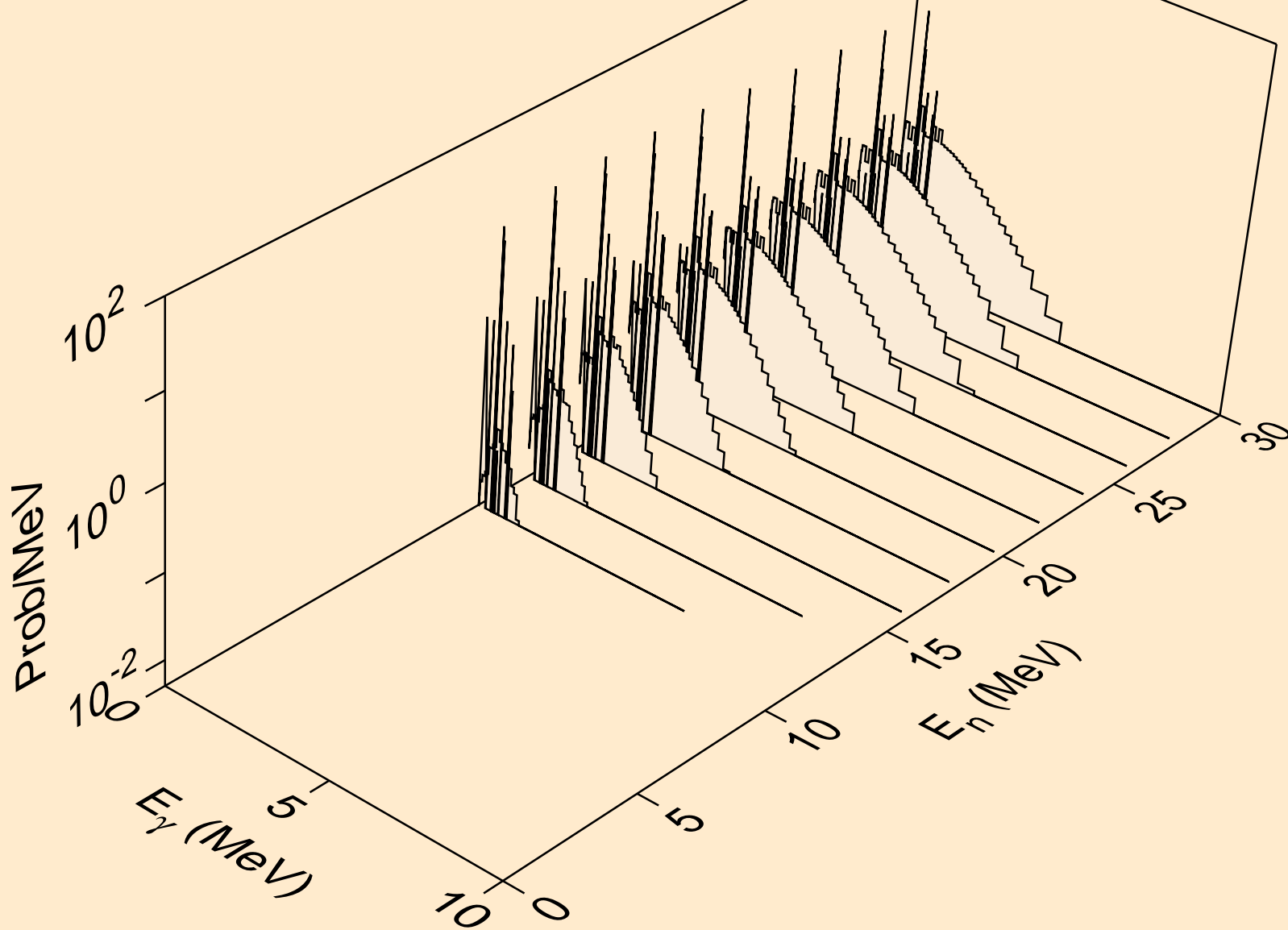

W166 NEUTRON ACER TENDL-2019 LIBRARY; T=293.16K
Photon emission for (n,npa)

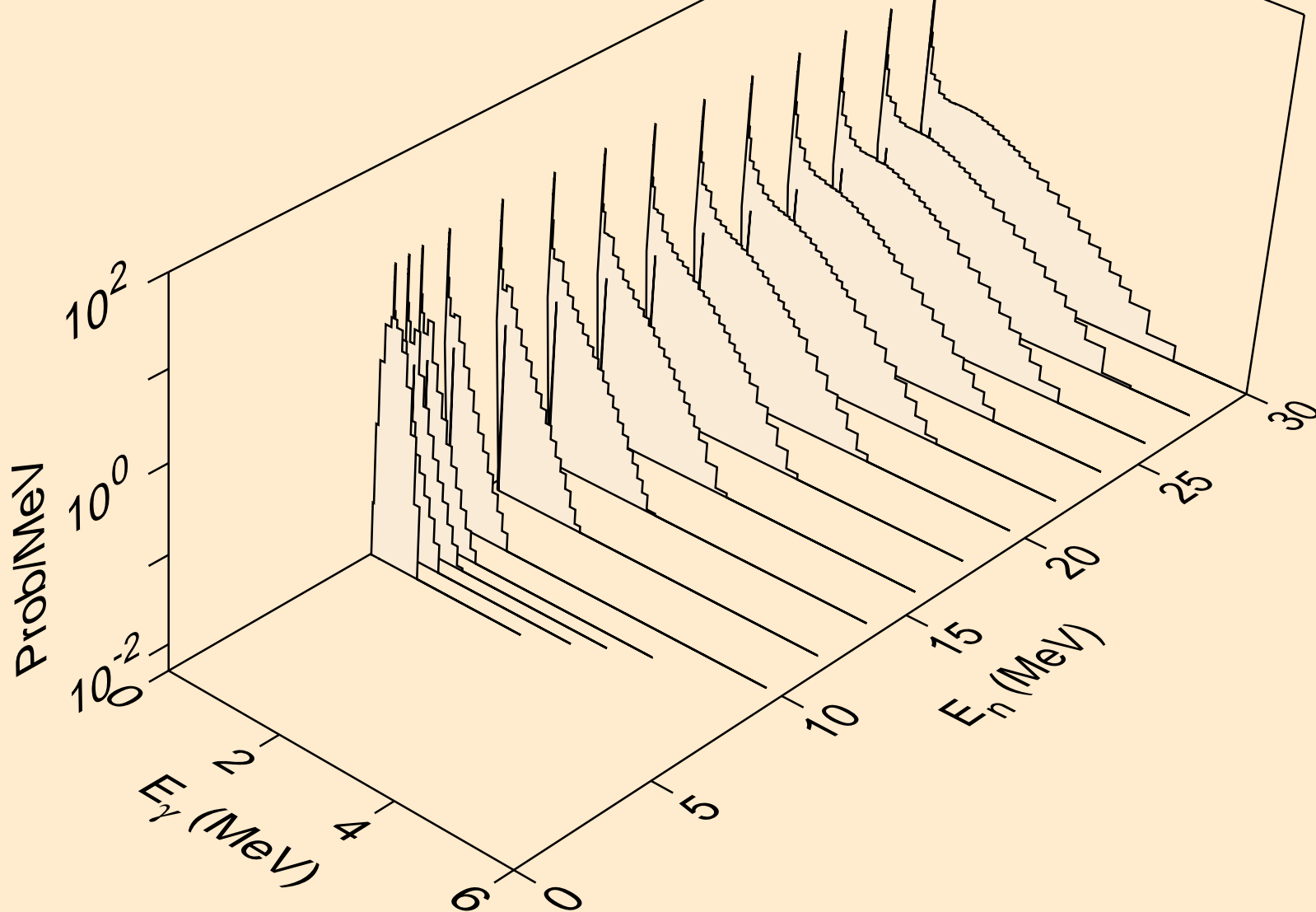

W166 NEUTRON ACER TENDL-2019 LIBRARY; T=293.16K
Photon emission for (n,n*c)

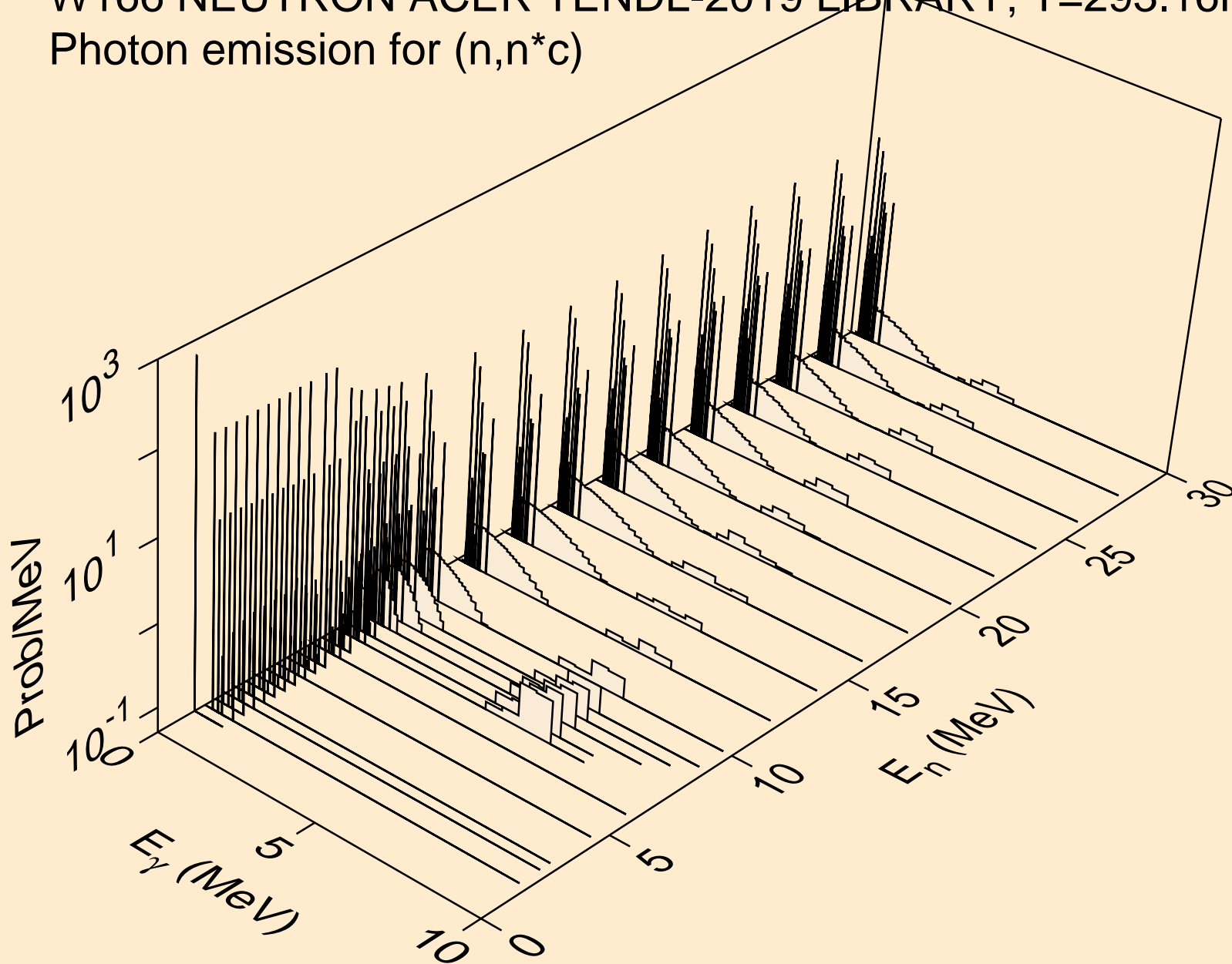

W166 NEUTRON ACER TENDL-2019 LIBRARY; T=293.16K
Photon emission for (n,gma)

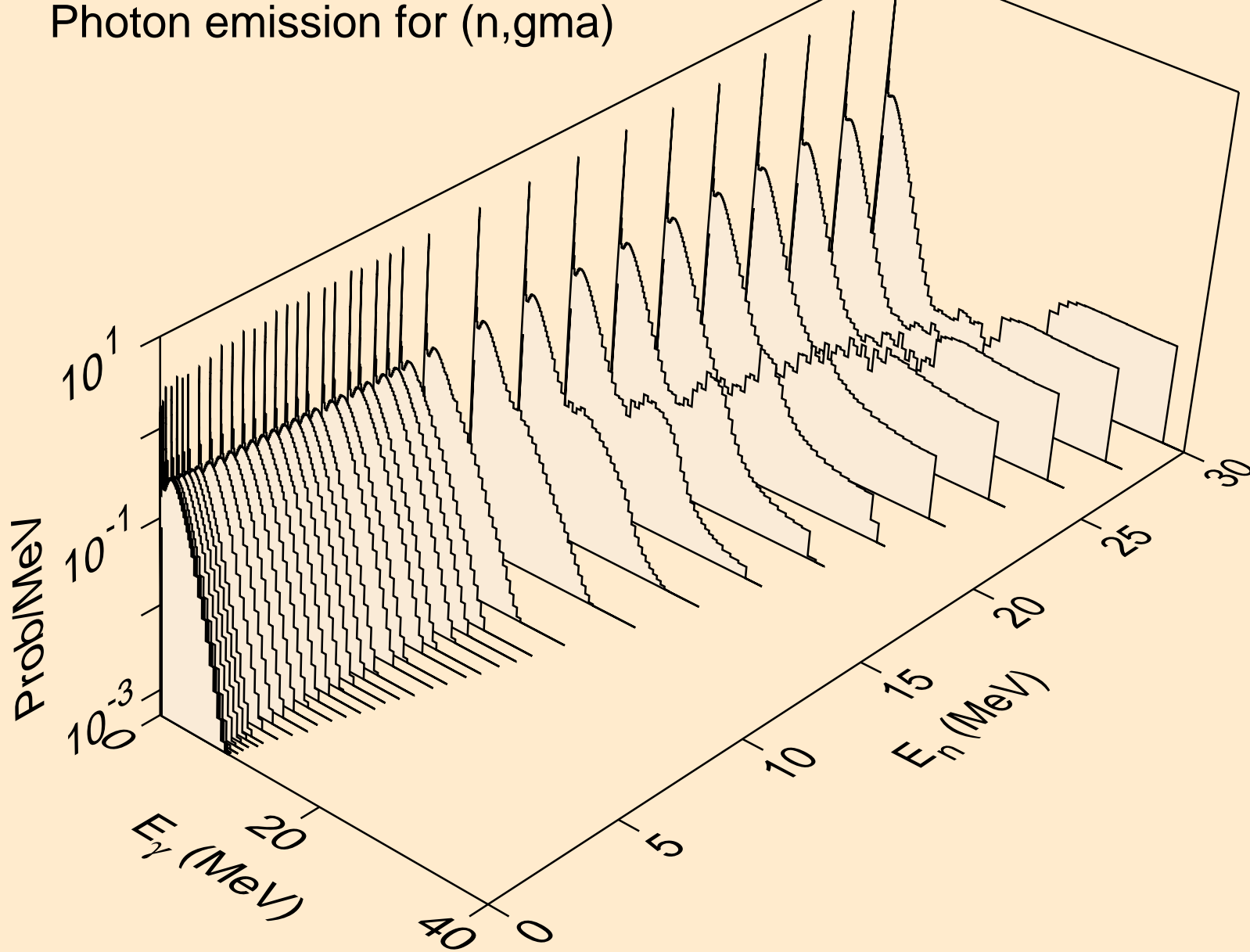

W166 NEUTRON ACER TENDL-2019 LIBRARY; T=293.16K
Photon emission for (n,p)

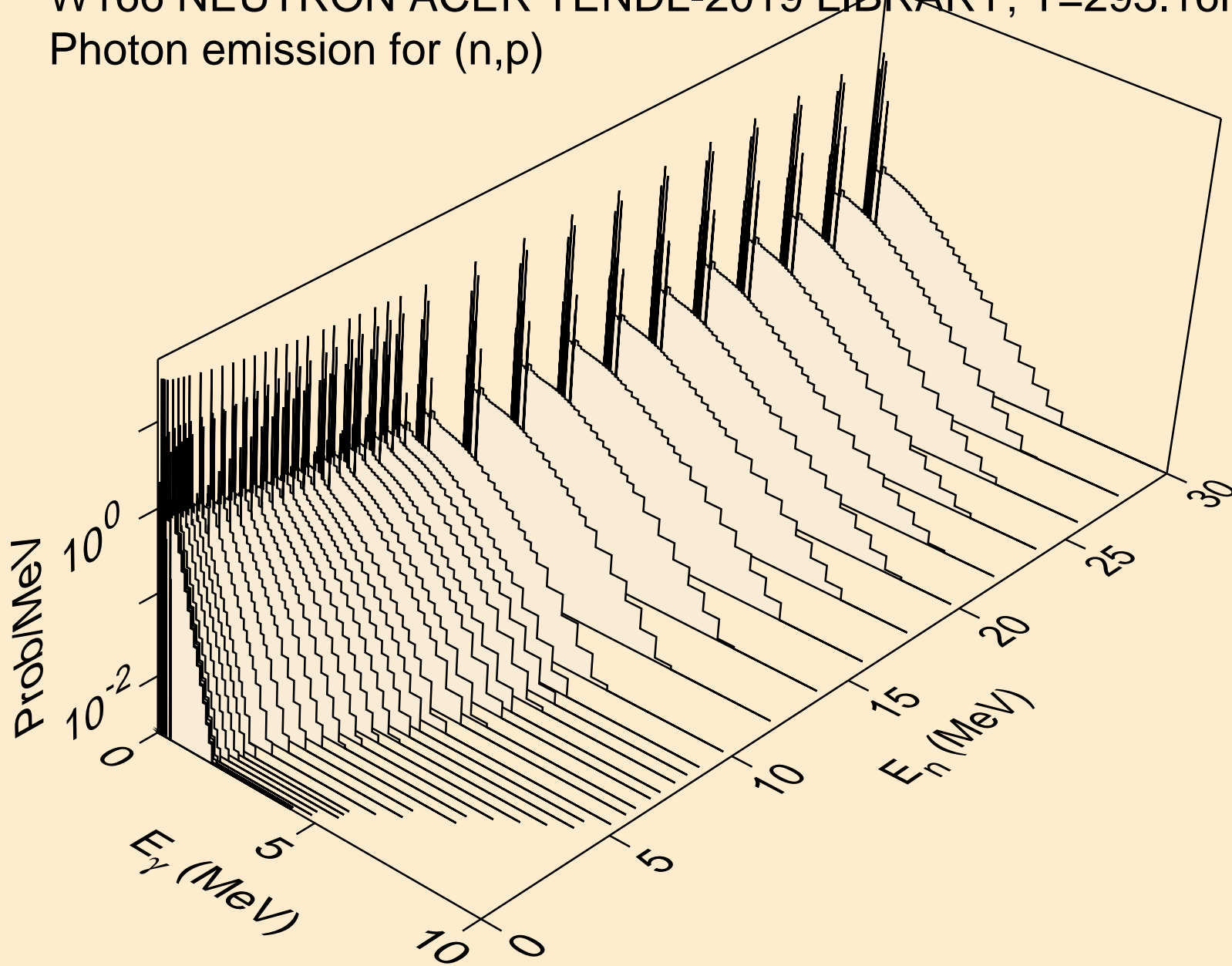

W166 NEUTRON ACER TENDL-2019 LIBRARY; T=293.16K
Photon emission for (n,d)

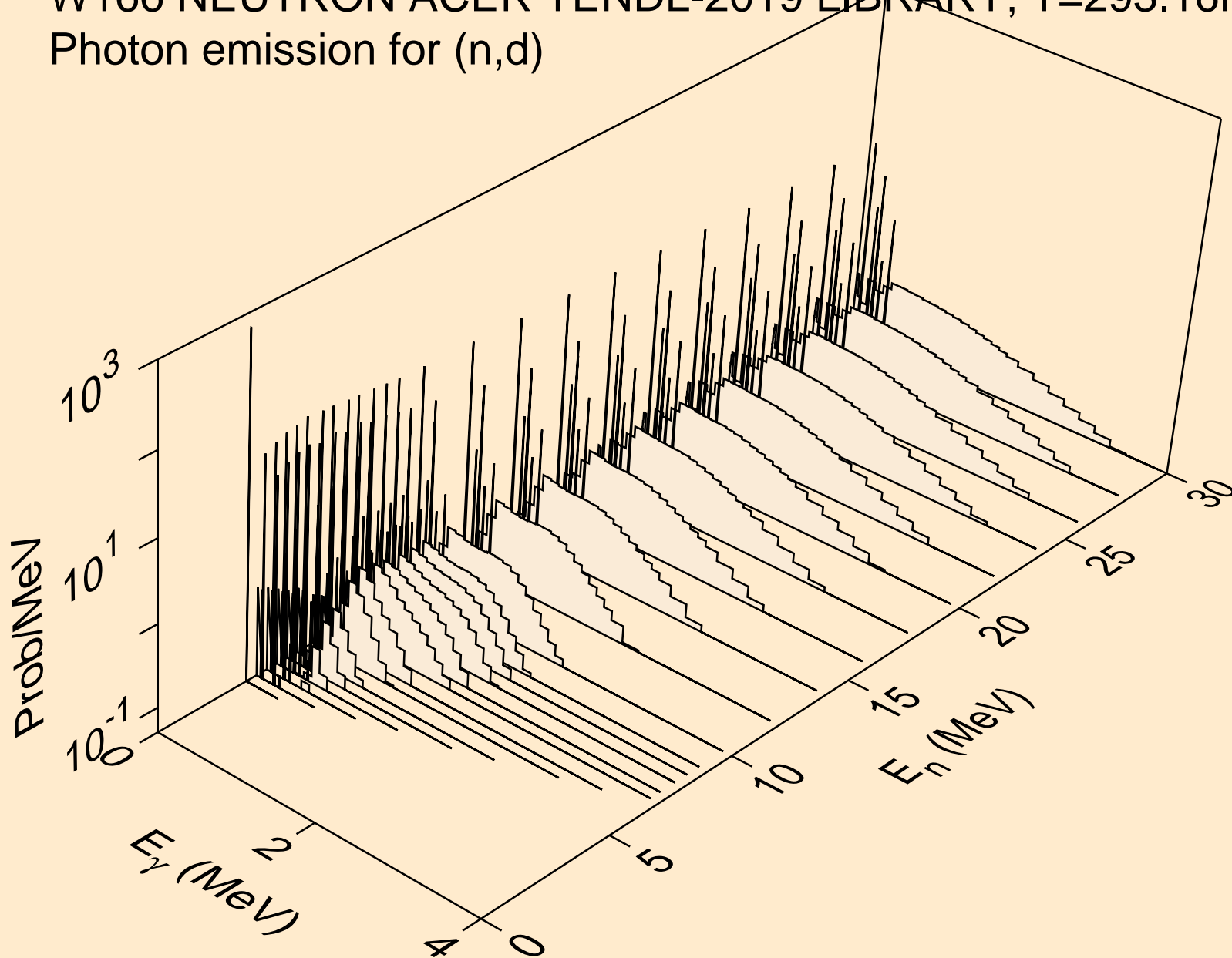

W166 NEUTRON ACER TENDL-2019 LIBRARY; T=293.16K
Photon emission for (n,t)

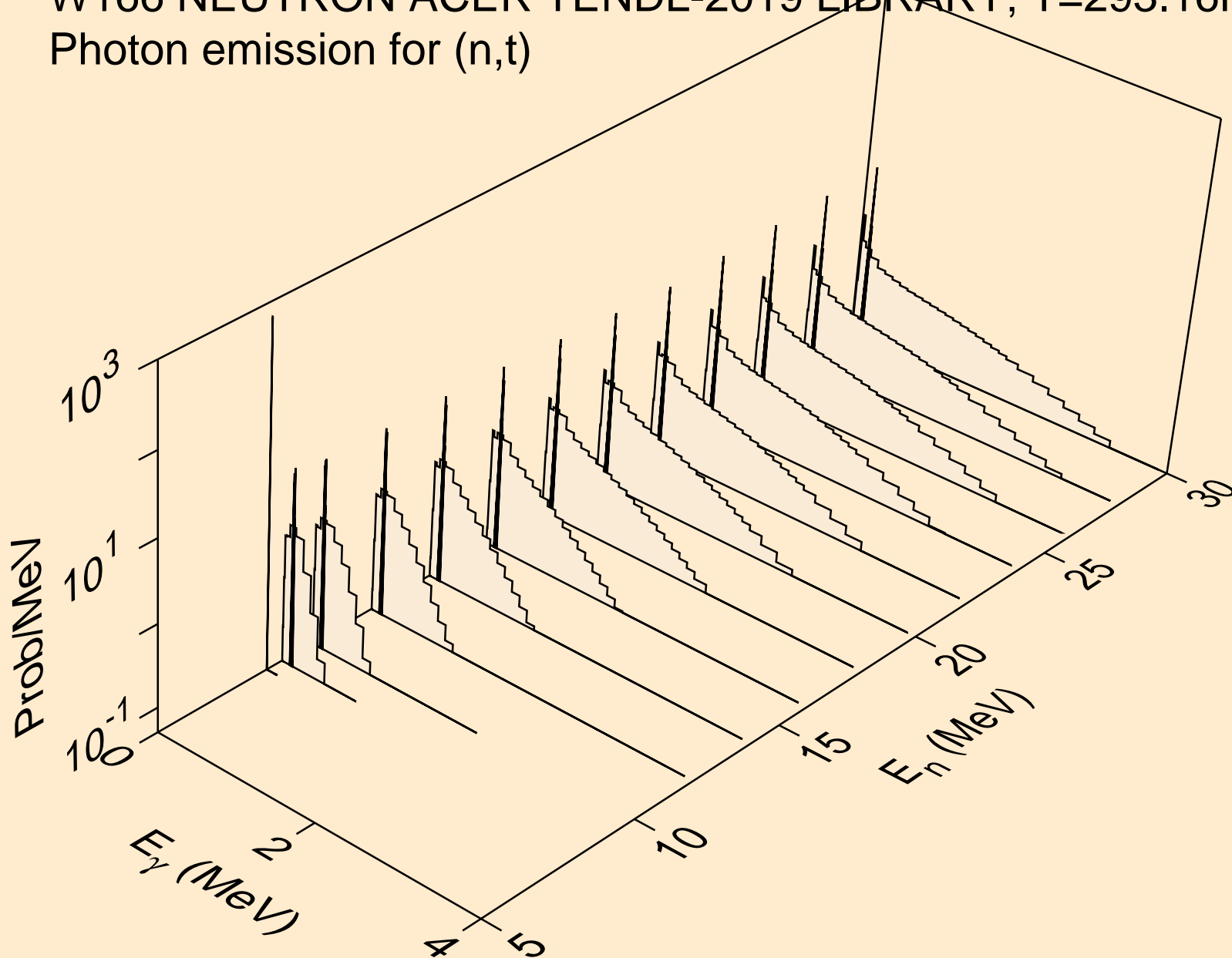

W166 NEUTRON ACER TENDL-2019 LIBRARY; T=293.16K
Photon emission for (n,he3)

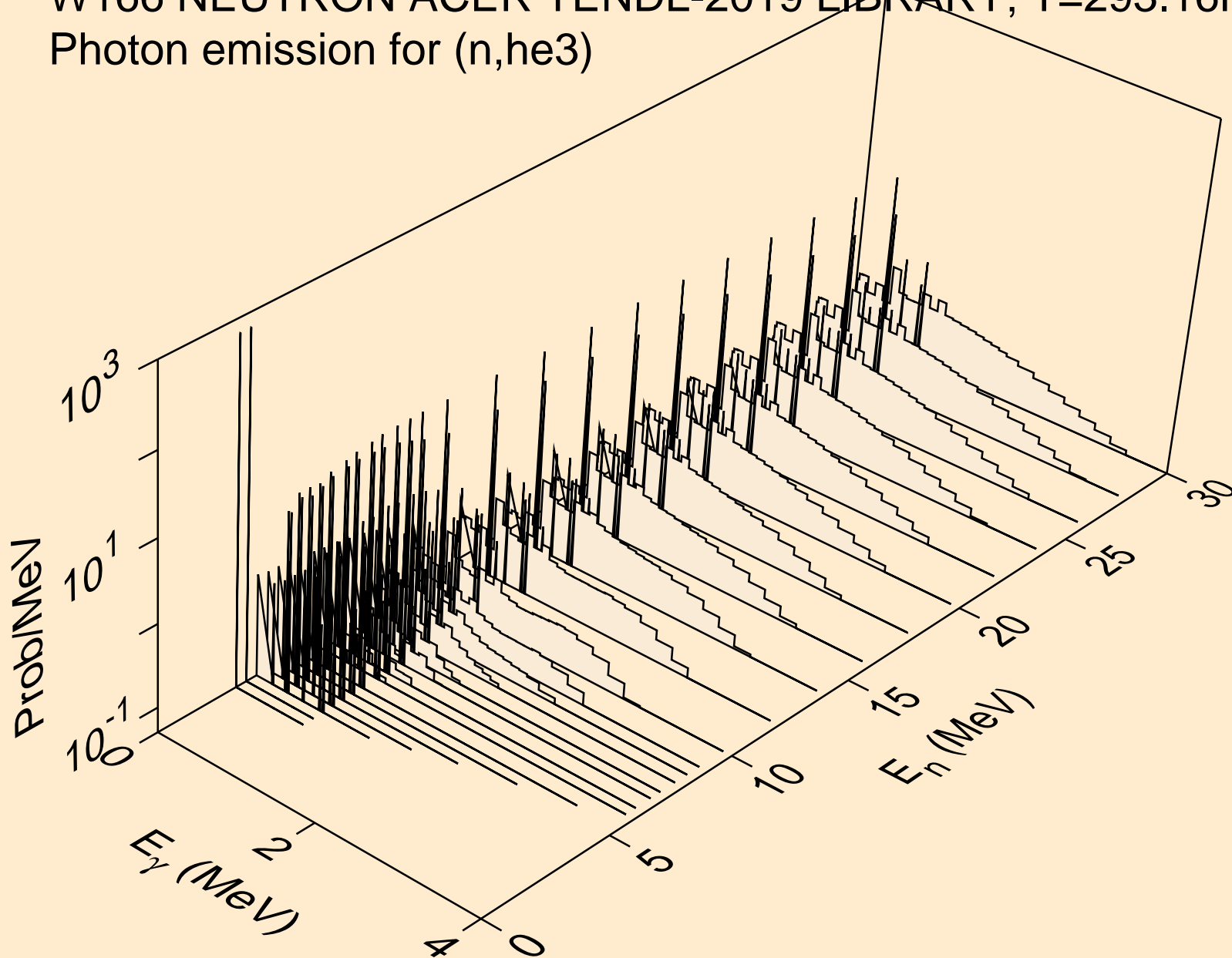

W166 NEUTRON ACER TENDL-2019 LIBRARY; T=293.16K
Photon emission for (n,a)

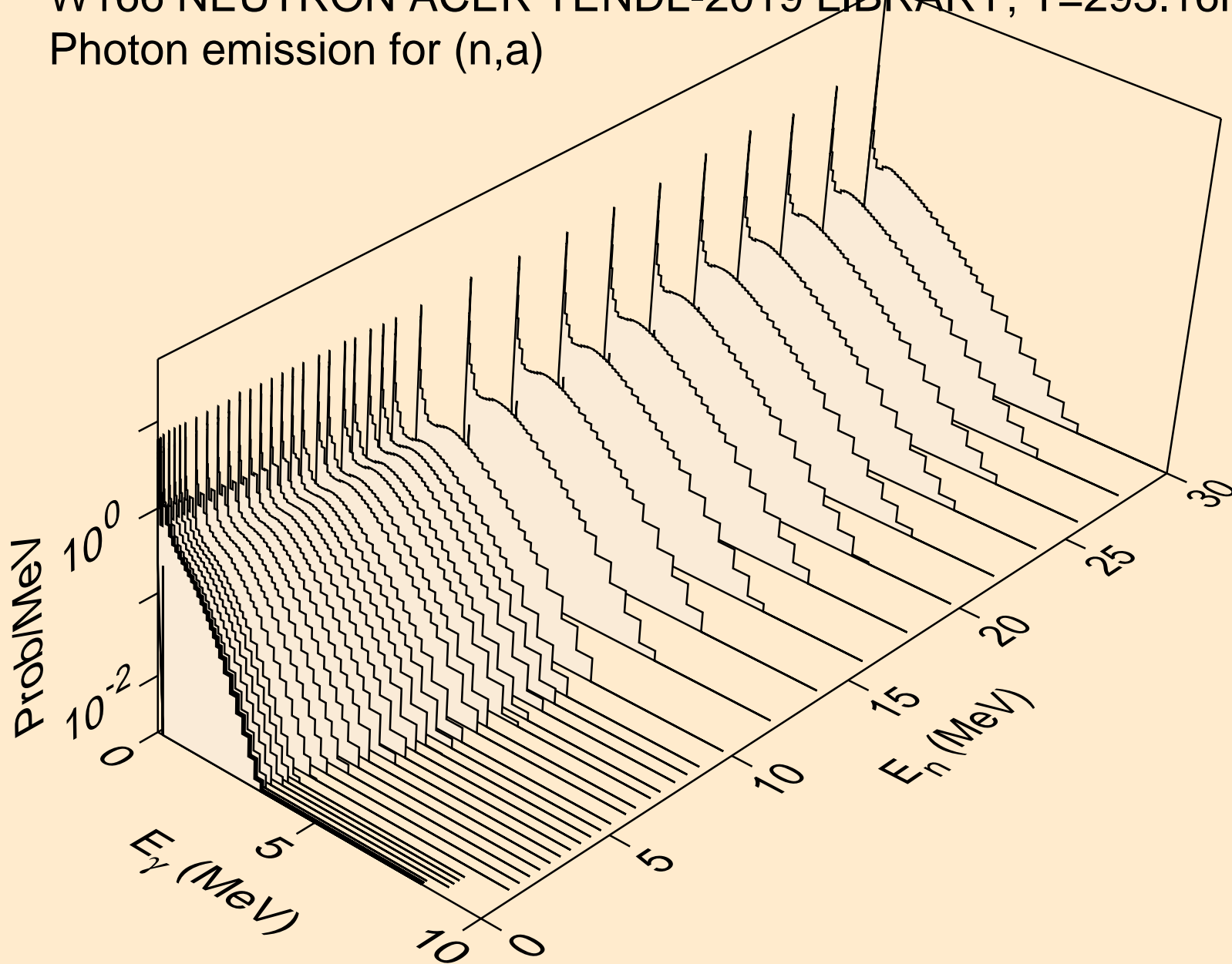

W166 NEUTRON ACER TENDL-2019 LIBRARY; T=293.16K
Photon emission for (n,2a)

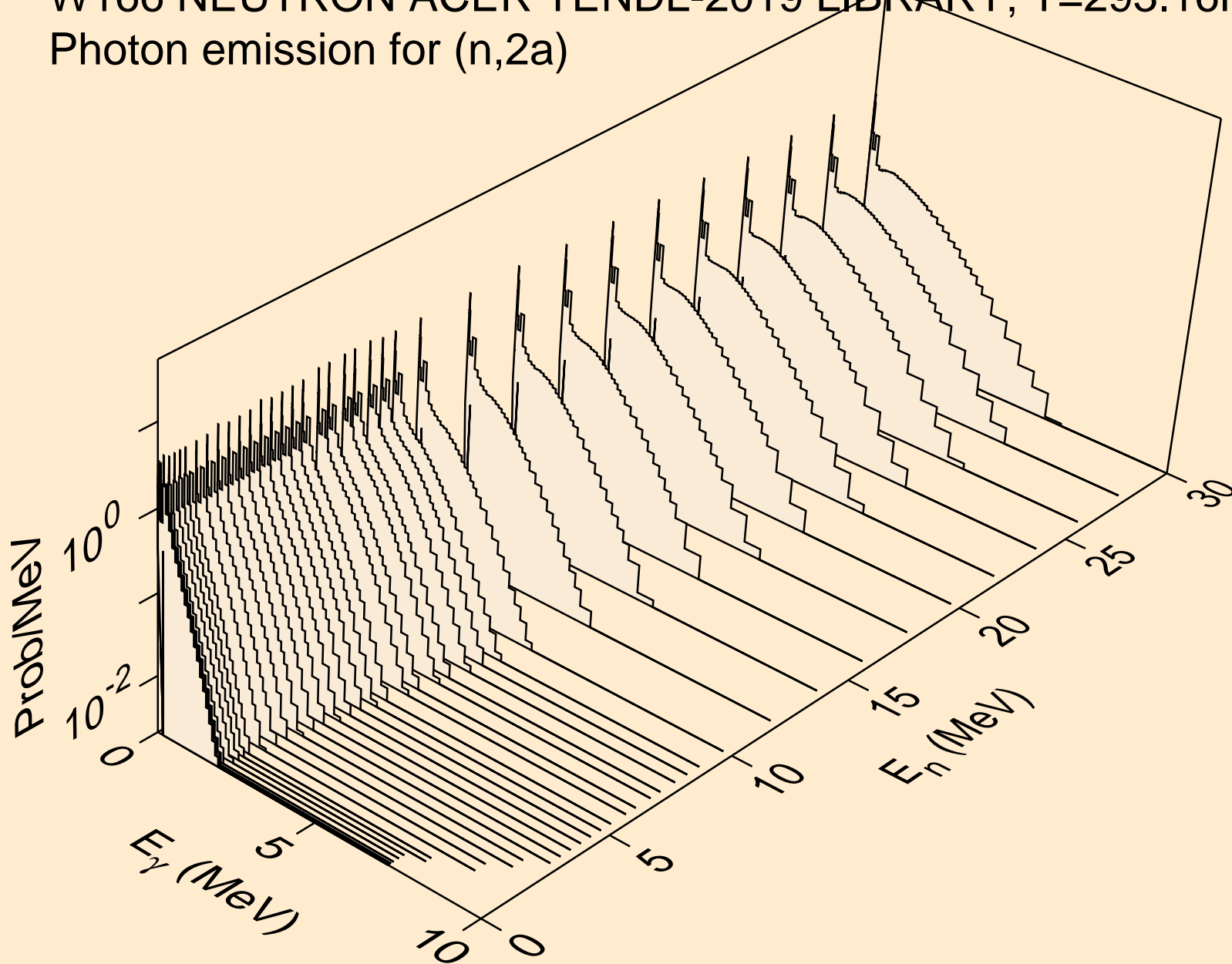

W166 NEUTRON ACER TENDL-2019 LIBRARY; T=293.16K
Photon emission for (n,3a)

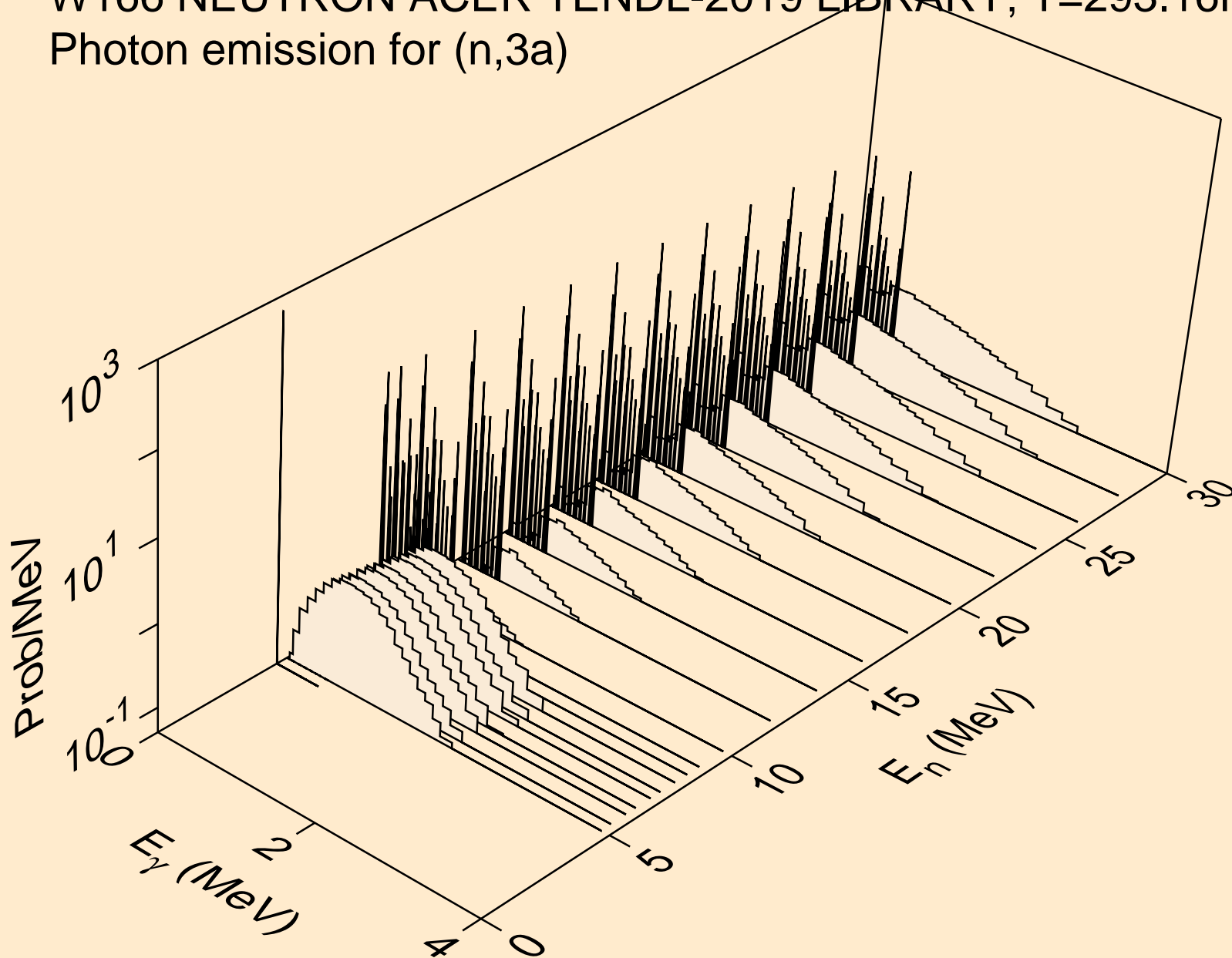

W166 NEUTRON ACER TENDL-2019 LIBRARY; T=293.16K
Photon emission for (n,2p)

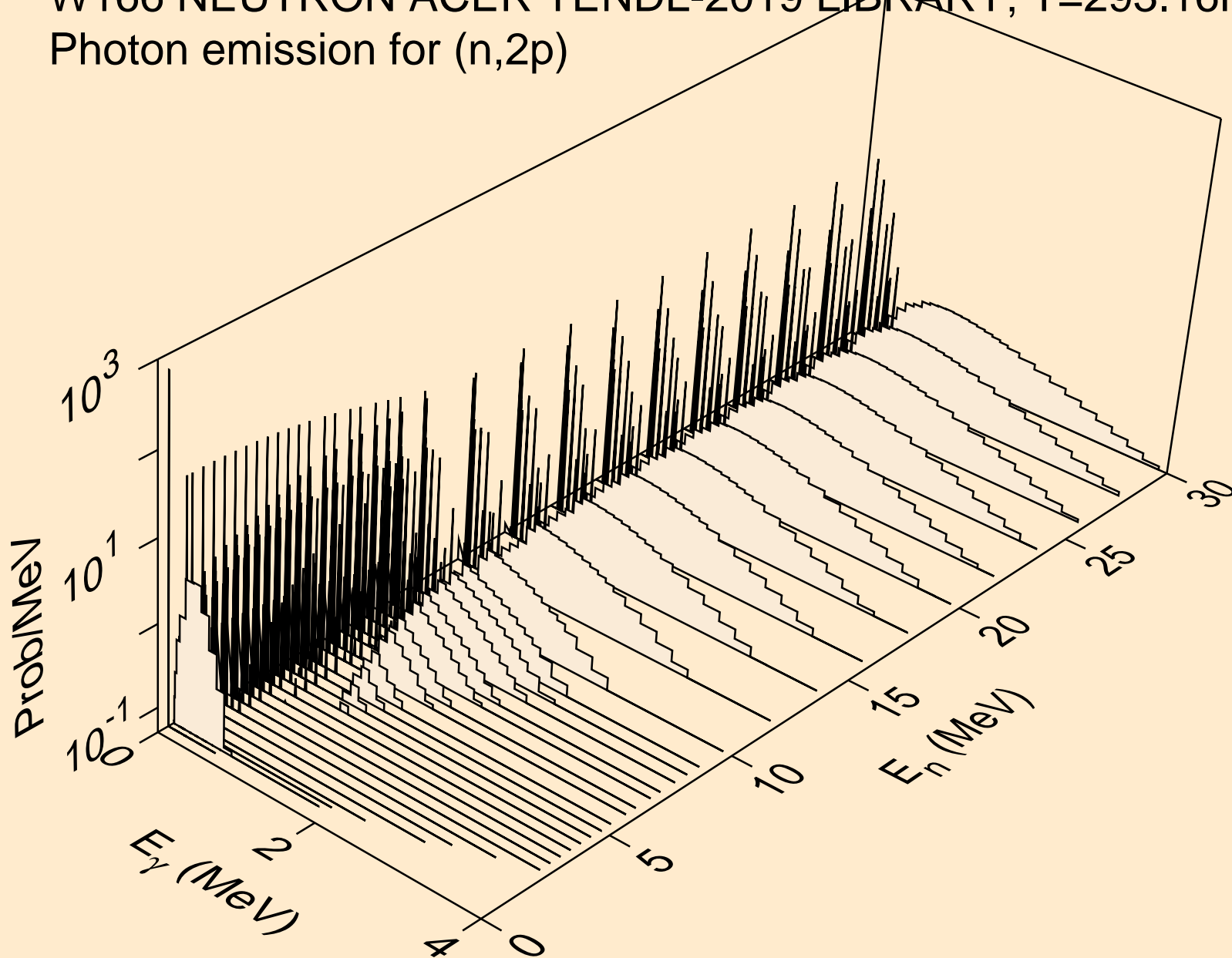

W166 NEUTRON ACER TENDL-2019 LIBRARY; T=293.16K
Photon emission for (n,p α)

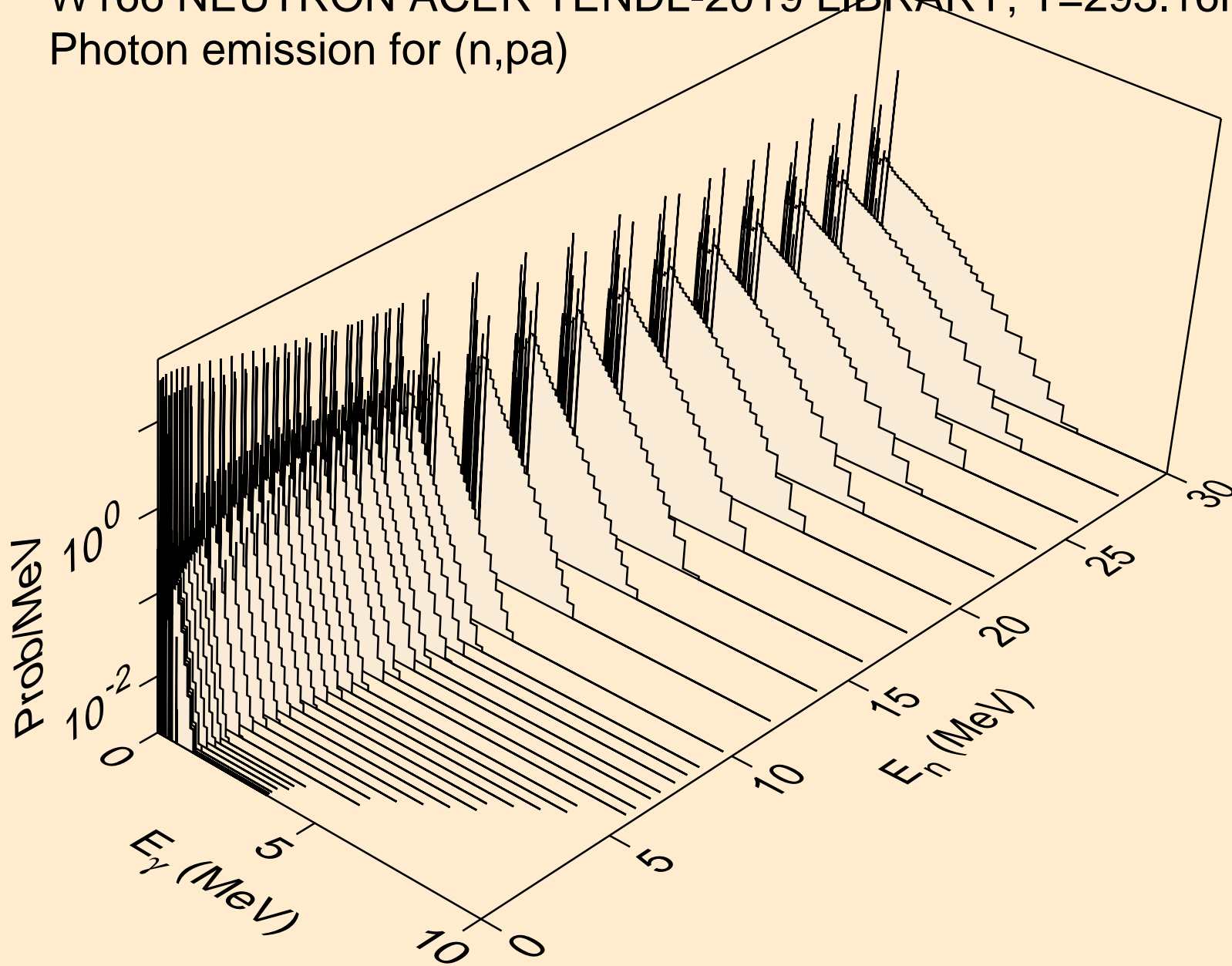

W166 NEUTRON ACER TENDL-2019 LIBRARY; T=293.16K
Photon emission for (n,pd)

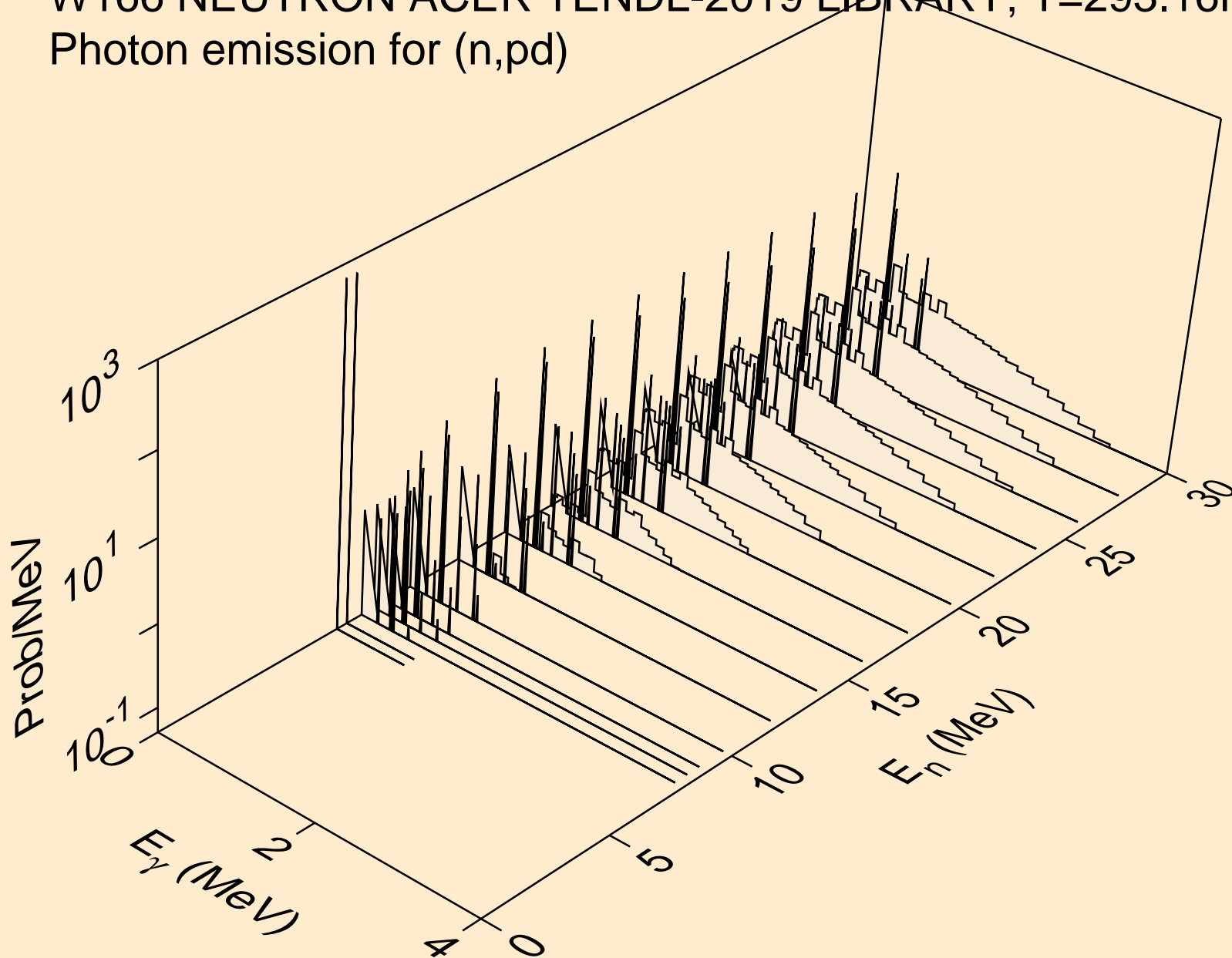

W166 NEUTRON ACER TENDL-2019 LIBRARY; T=293.16K
Photon emission for (n,pt)

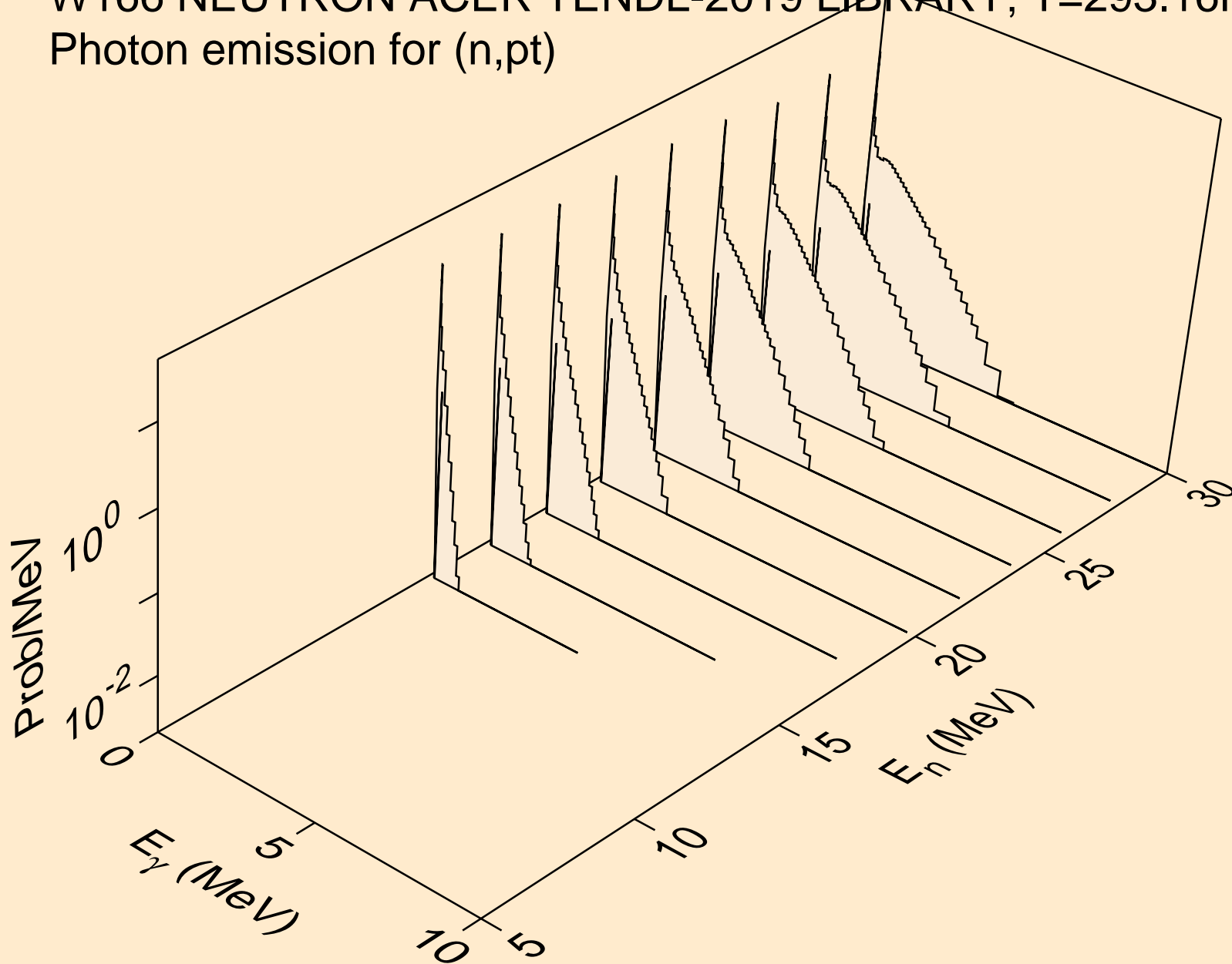

W166 NEUTRON ACER TENDL-2019 LIBRARY; T=293.16K
Photon emission for (n,da)

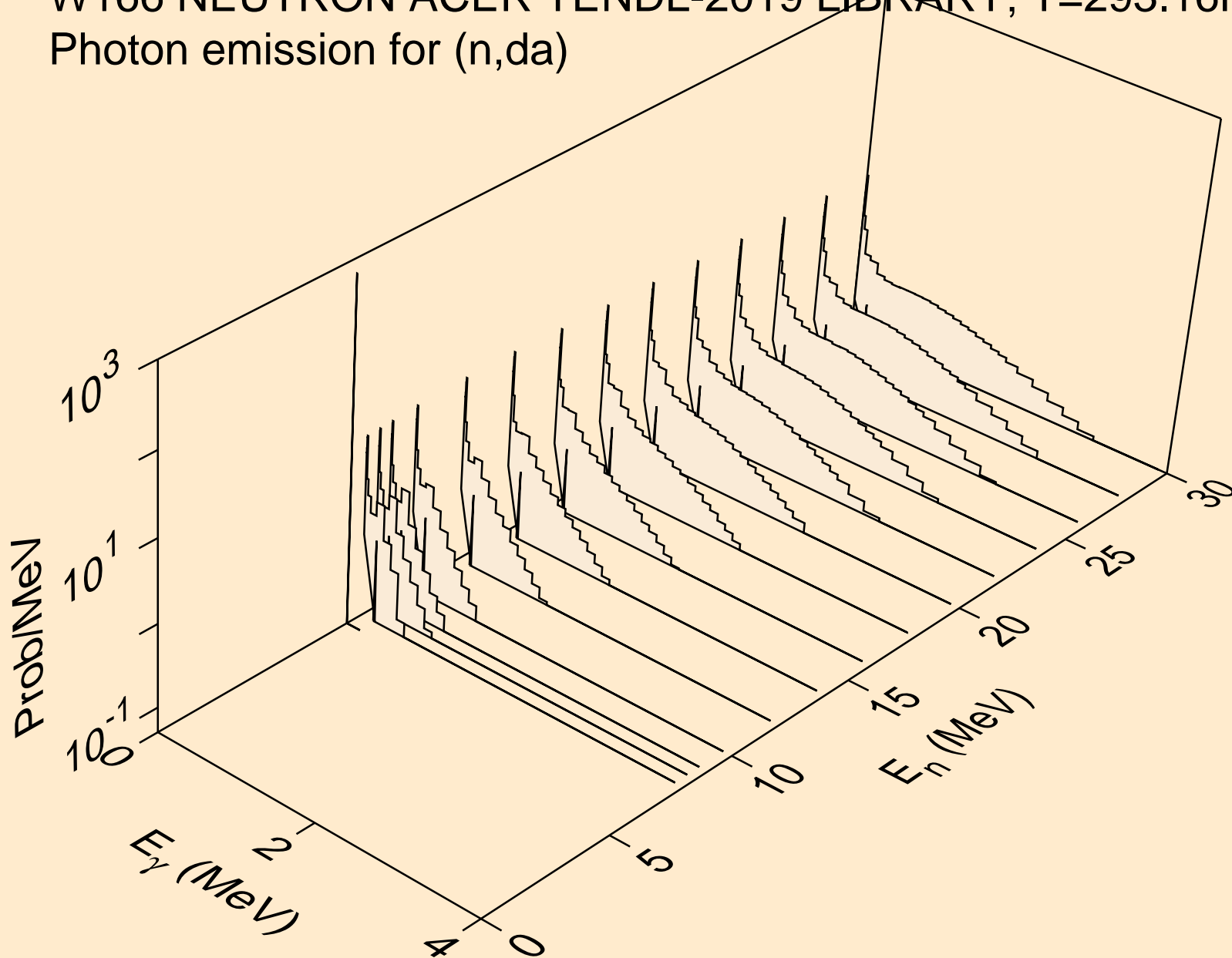

W166 NEUTRON ACER TENDL-2019 LIBRARY; T=293.16K
thermal capture photon spectrum

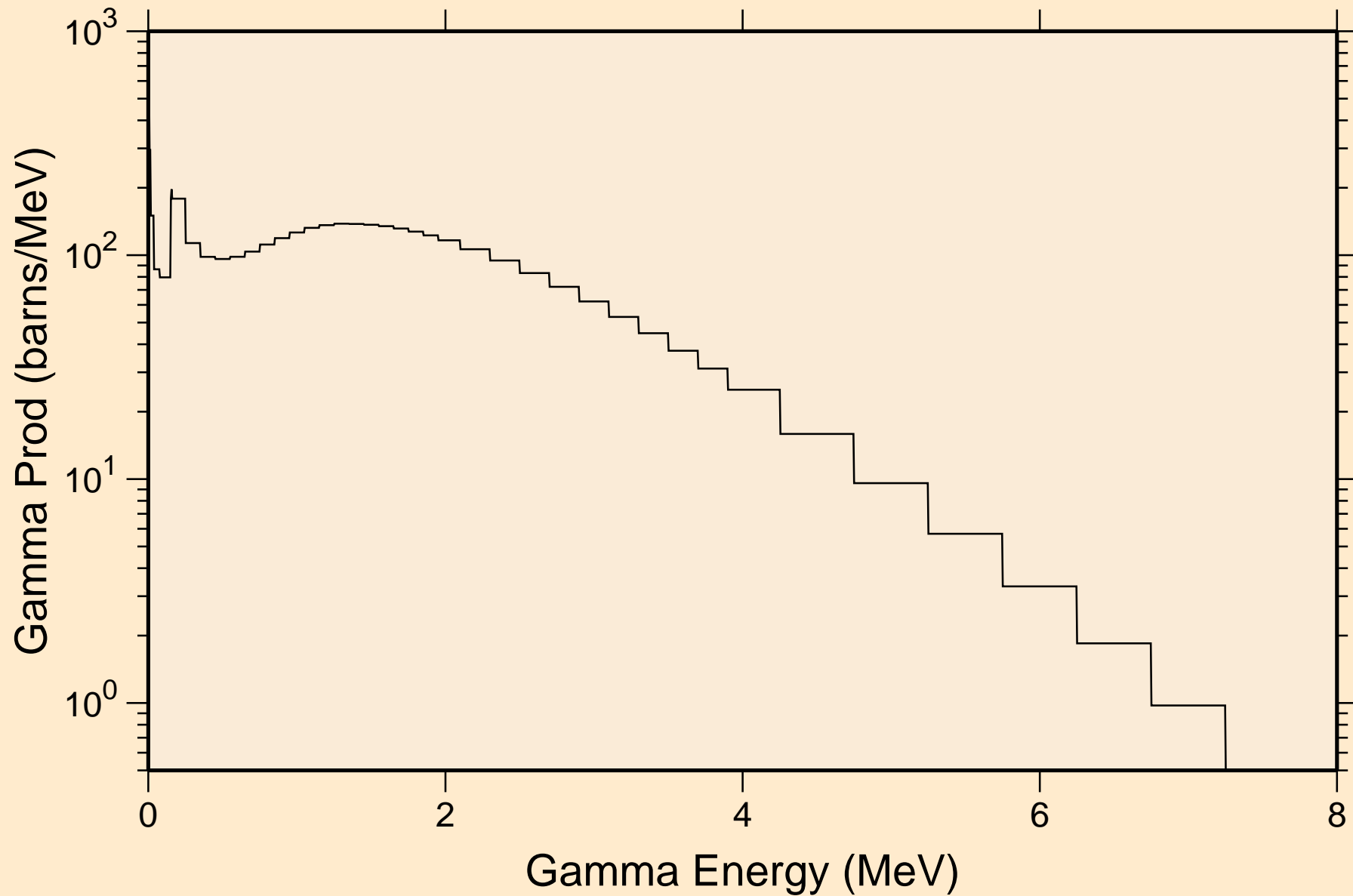

W166 NEUTRON ACER TENDL-2019 LIBRARY; T=293.16K
14 MeV photon spectrum

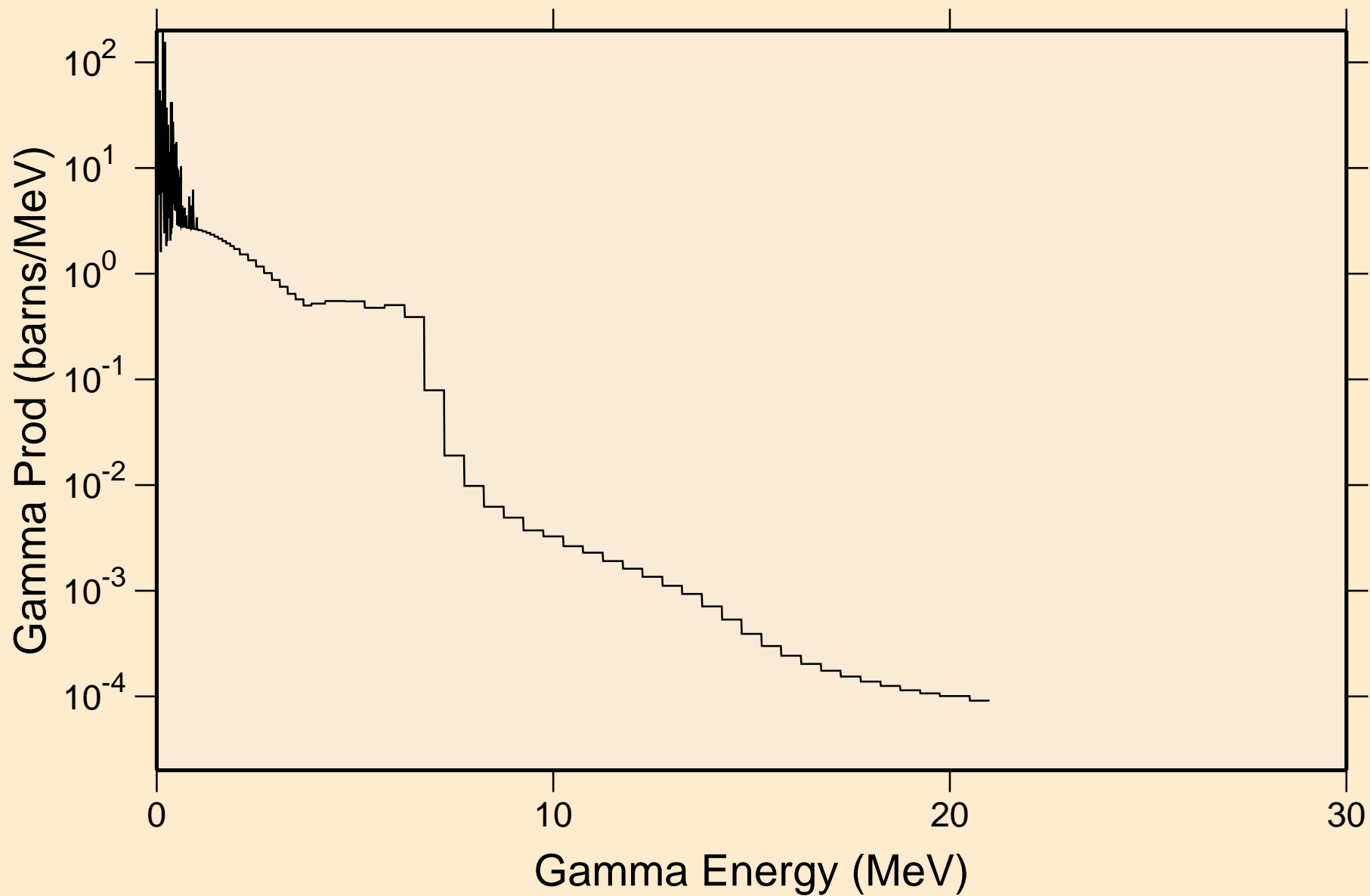

W166 NEUTRON ACER TENDL-2019 LIBRARY; T=293.16K
Particle heating contributions

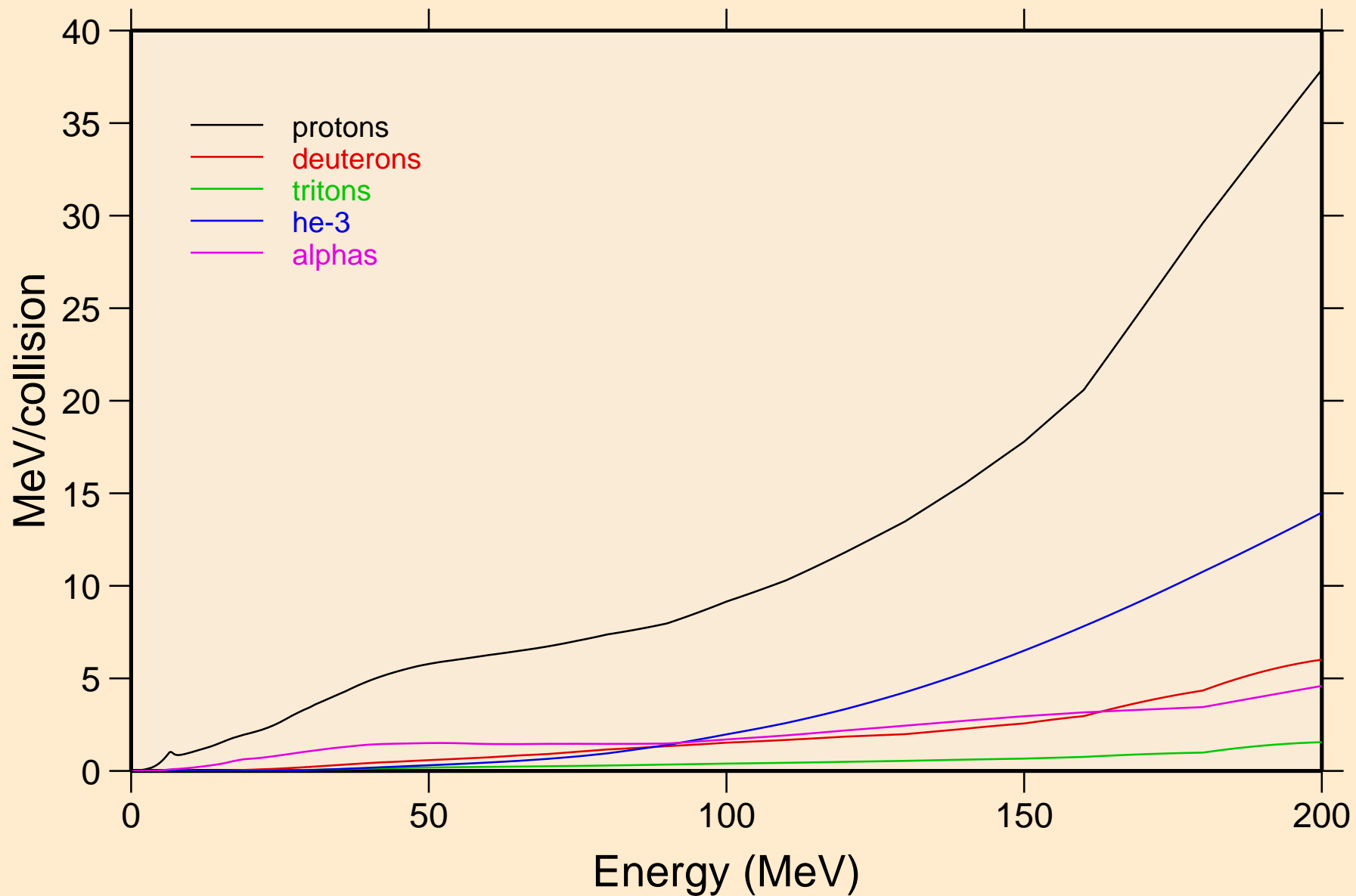

W166 NEUTRON ACER TENDL-2019 LIBRARY; T=293.16K
Recoil Heating

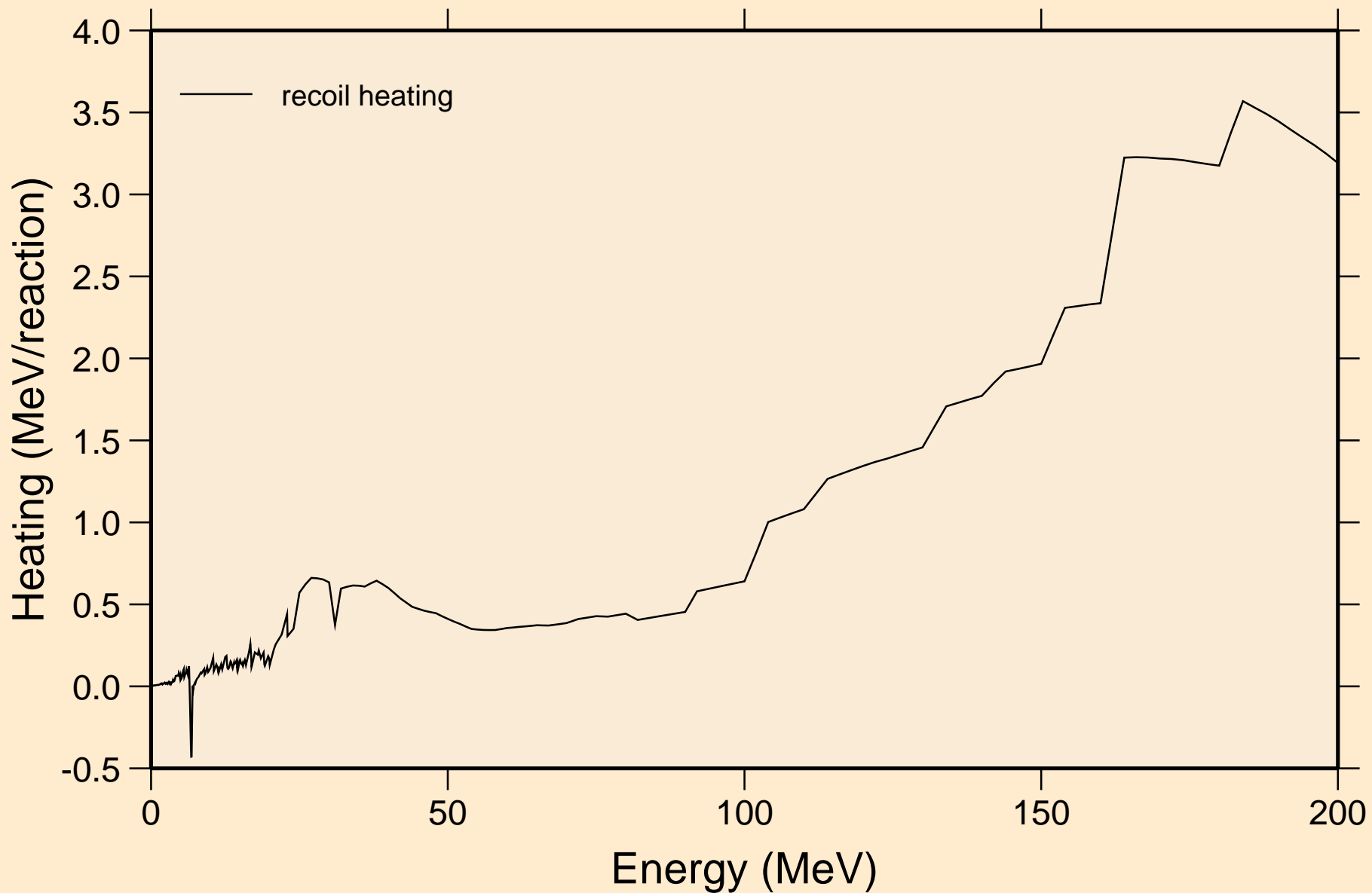

W166 NEUTRON ACER TENDL-2019 LIBRARY; T=293.16K
Particle production cross sections

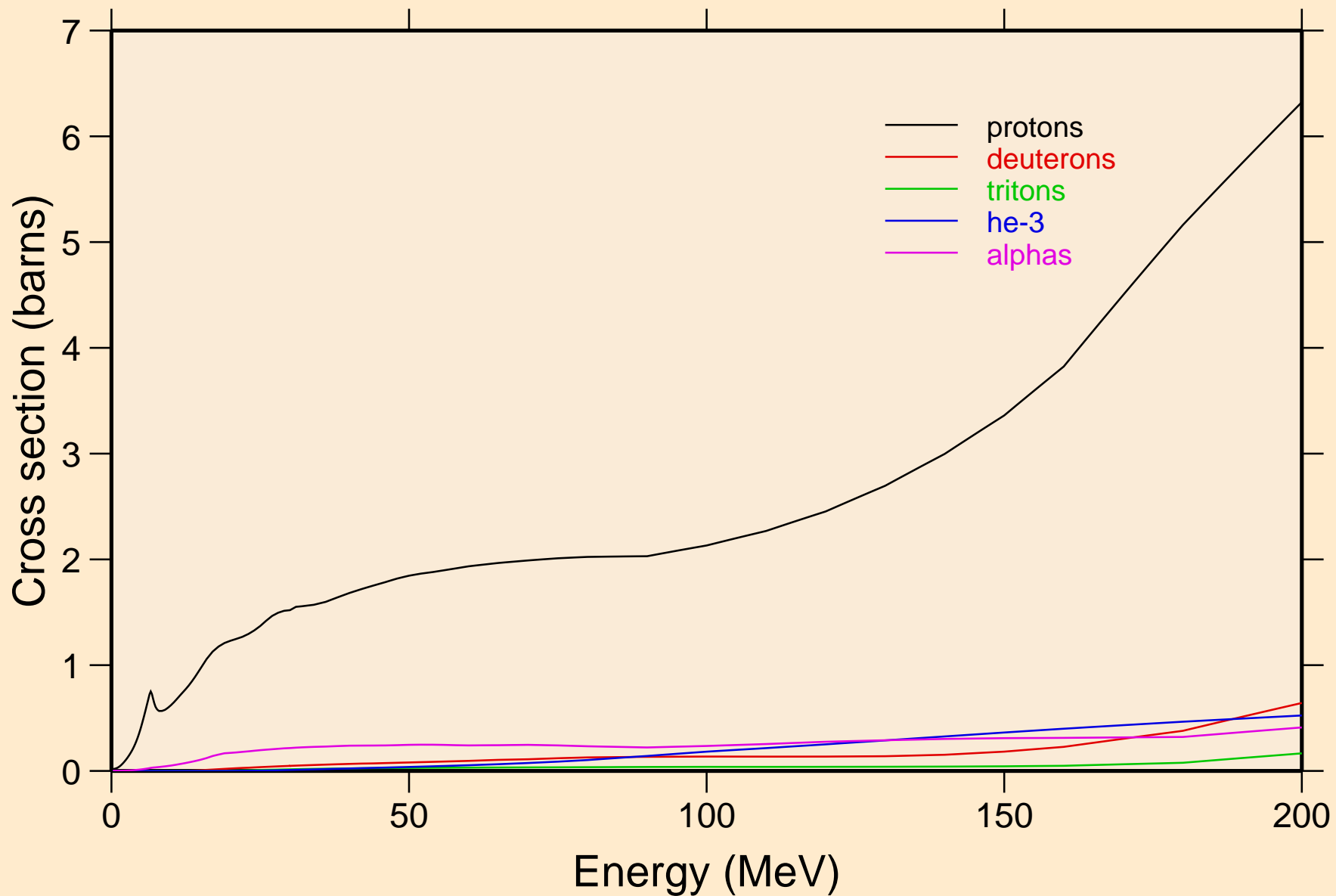

W166 NEUTRON ACER TENDL-2019 LIBRARY; T=293.16K
protons from (n,x)

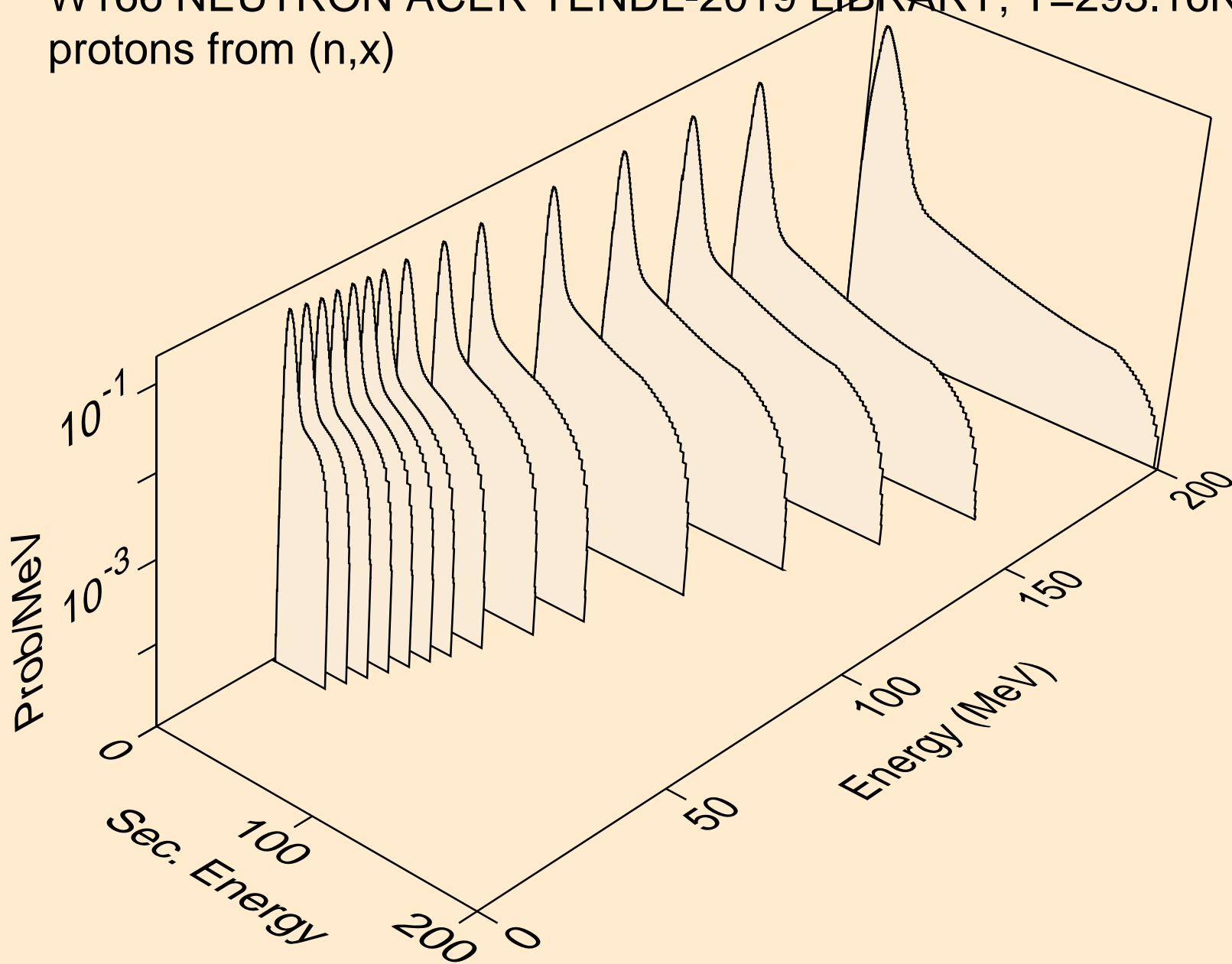

W166 NEUTRON ACER TENDL-2019 LIBRARY; T=293.16K
protons from (n,n*)p

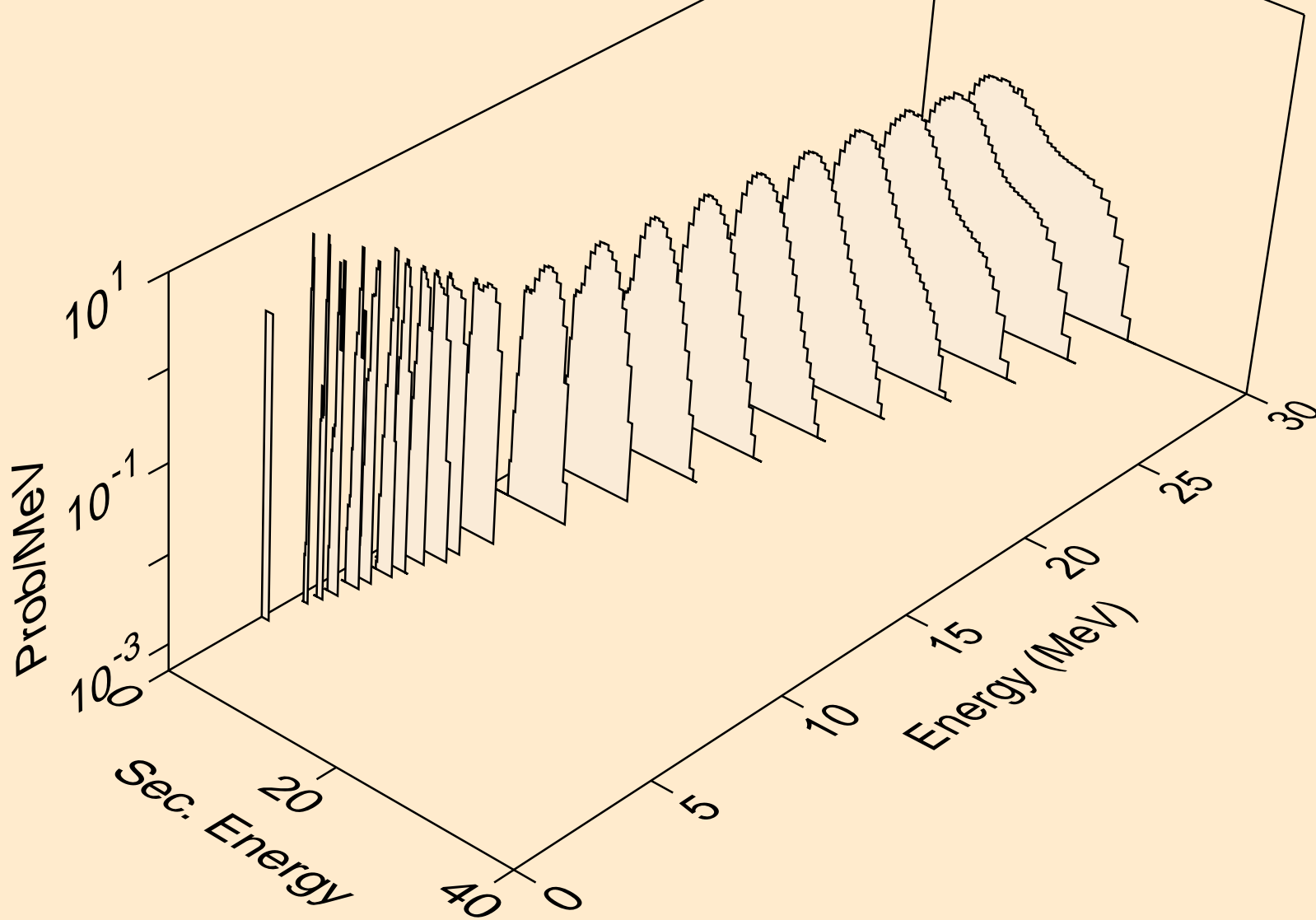

W166 NEUTRON ACER TENDL-2019 LIBRARY; T=293.16K
protons from (n,2np)

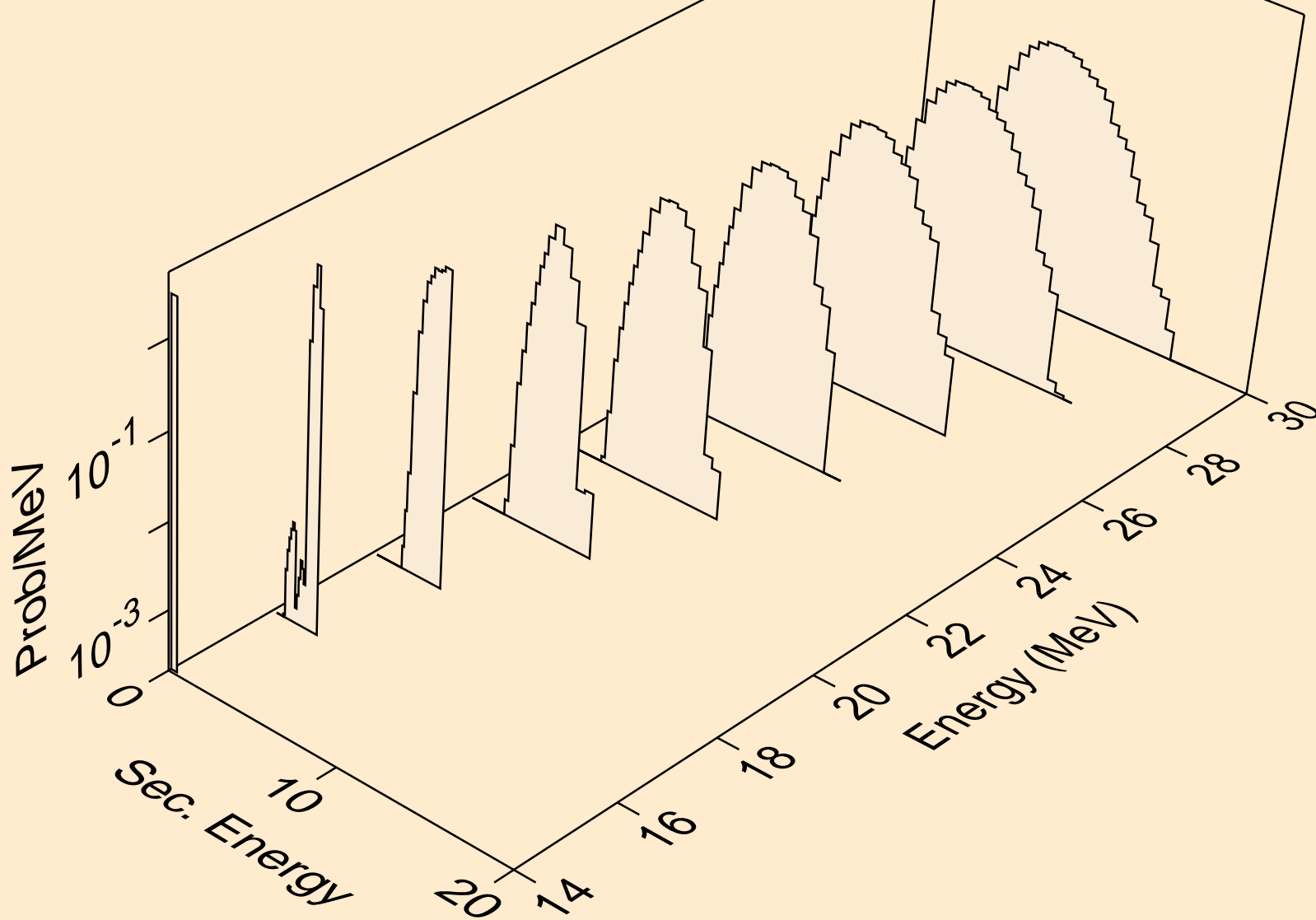

W166 NEUTRON ACER TENDL-2019 LIBRARY; T=293.16K
protons from (n,3np)

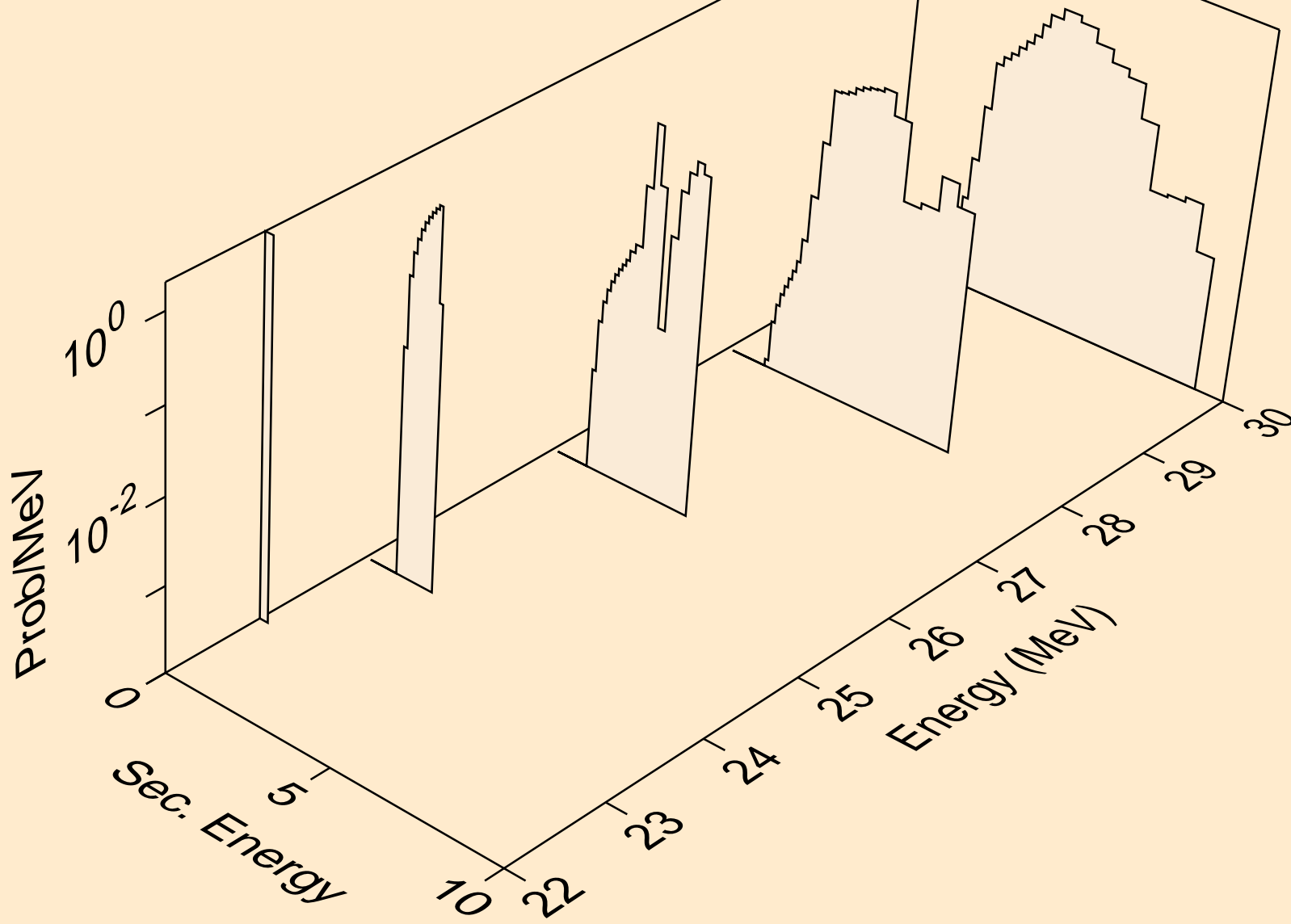

W166 NEUTRON ACER TENDL-2019 LIBRARY; T=293.16K
protons from (n,2np)

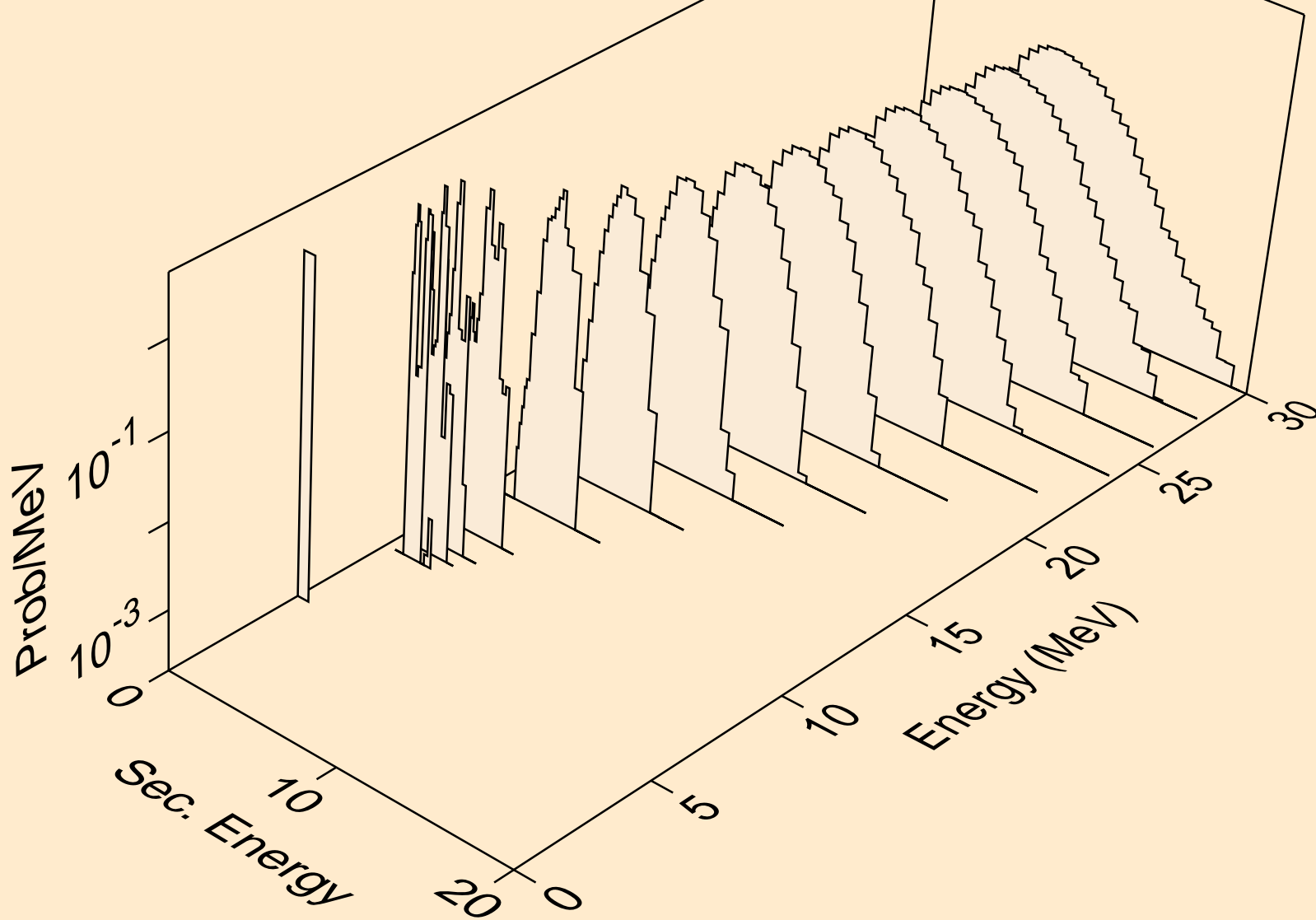

W166 NEUTRON ACER TENDL-2019 LIBRARY; T=293.16K
protons from (n,npa)

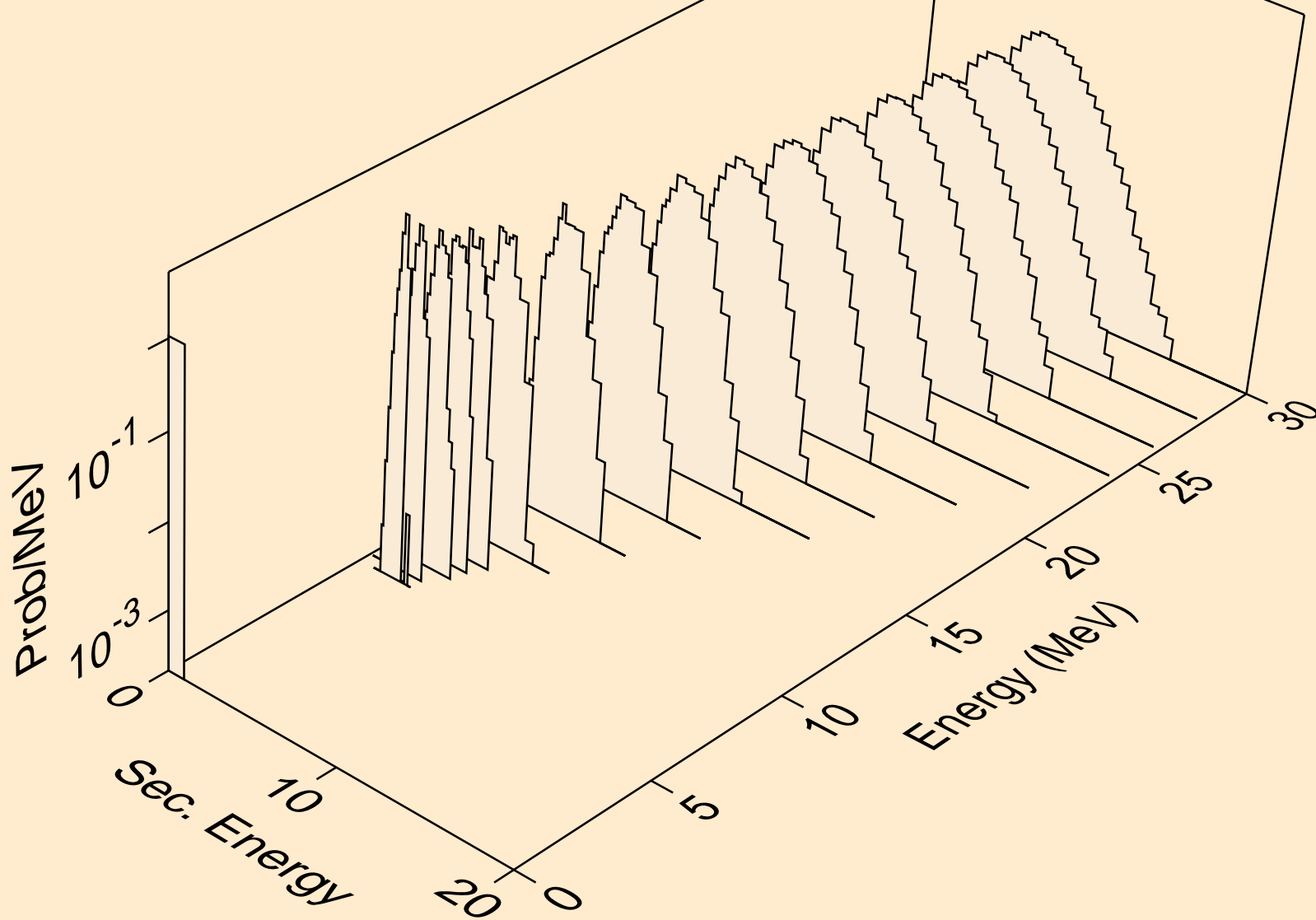

W166 NEUTRON ACER TENDL-2019 LIBRARY; T=293.16K
protons from (n,p)

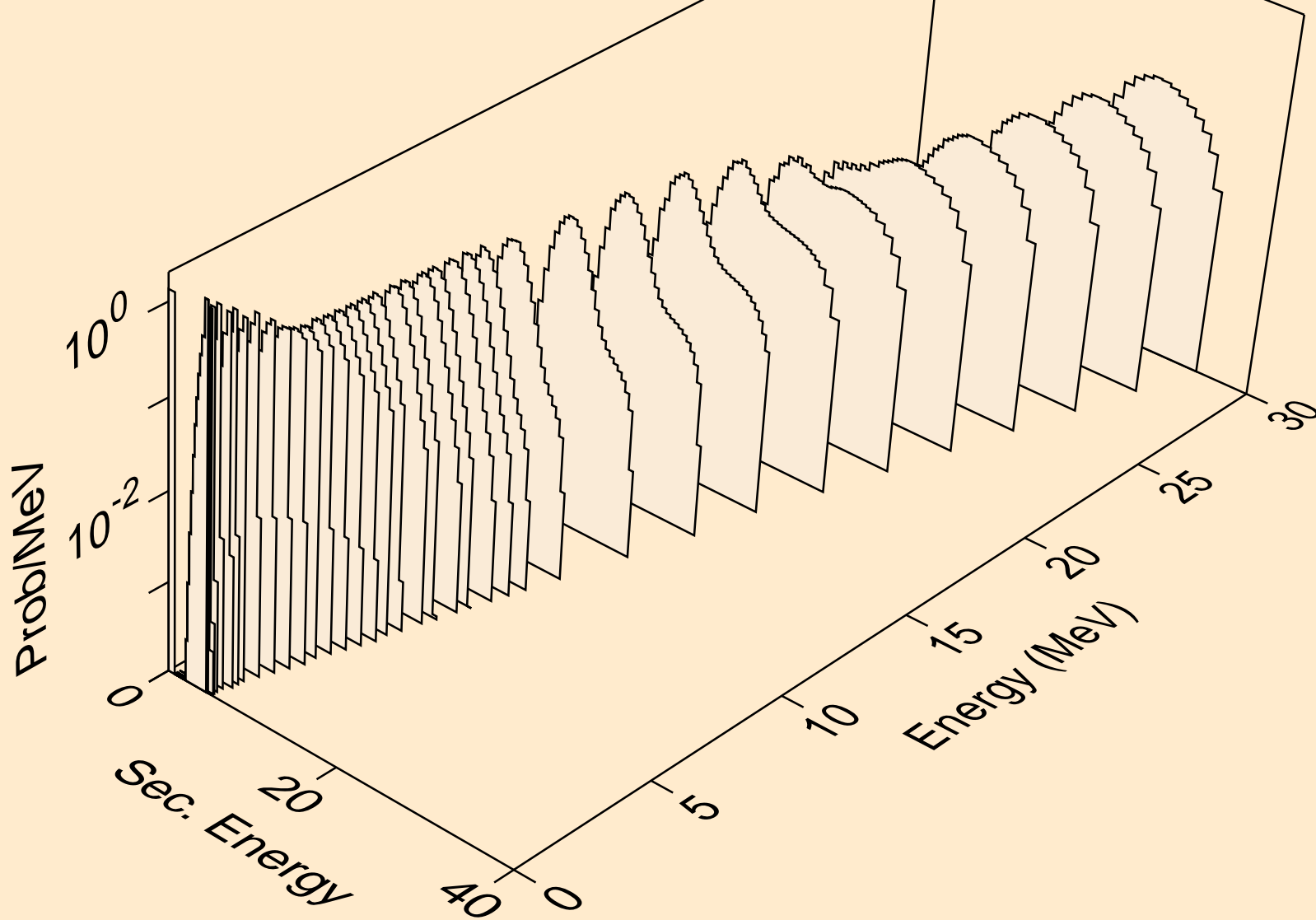

W166 NEUTRON ACER TENDL-2019 LIBRARY; T=293.16K
protons from (n,2p)

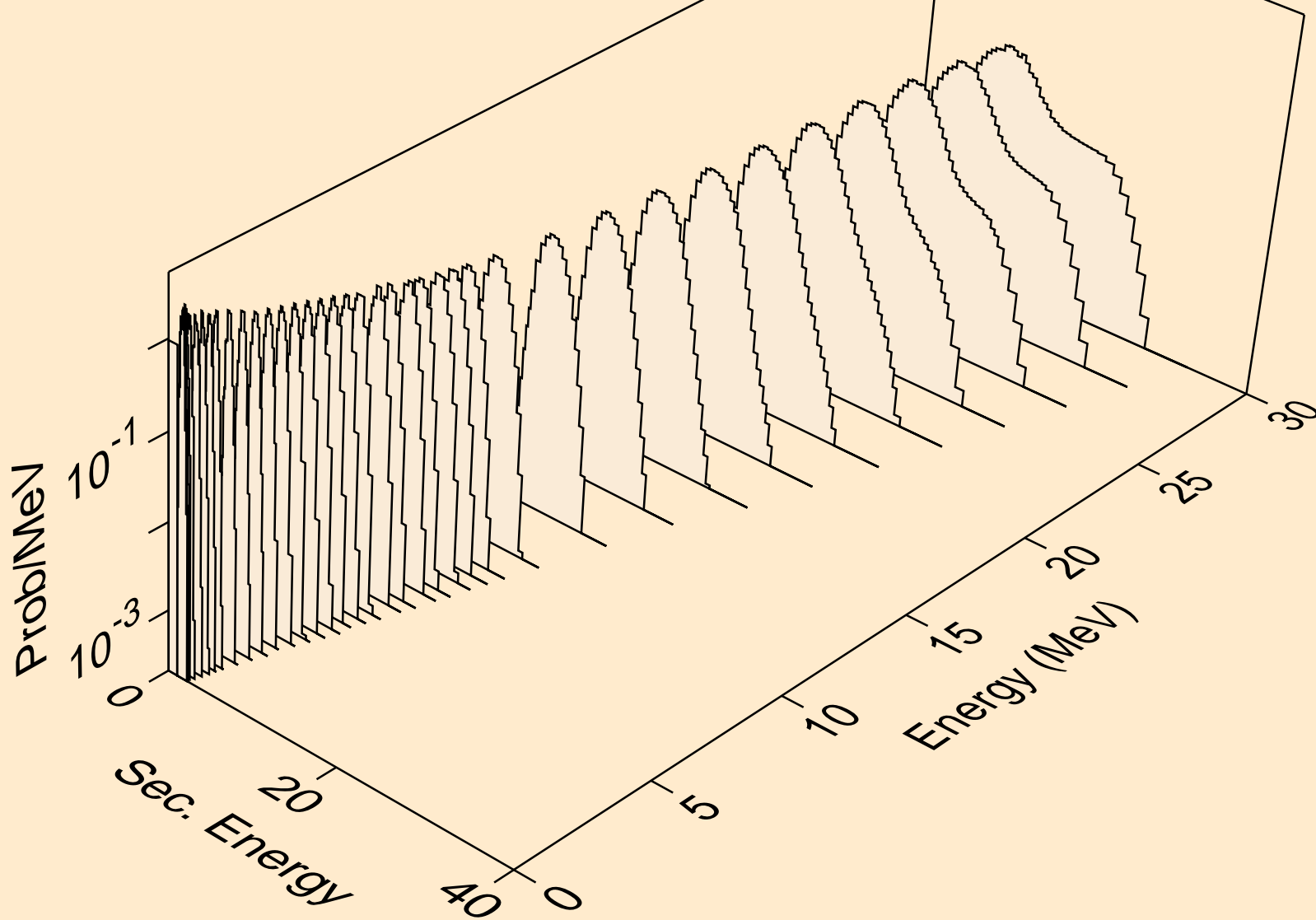

W166 NEUTRON ACER TENDL-2019 LIBRARY; T=293.16K
protons from (n,p)

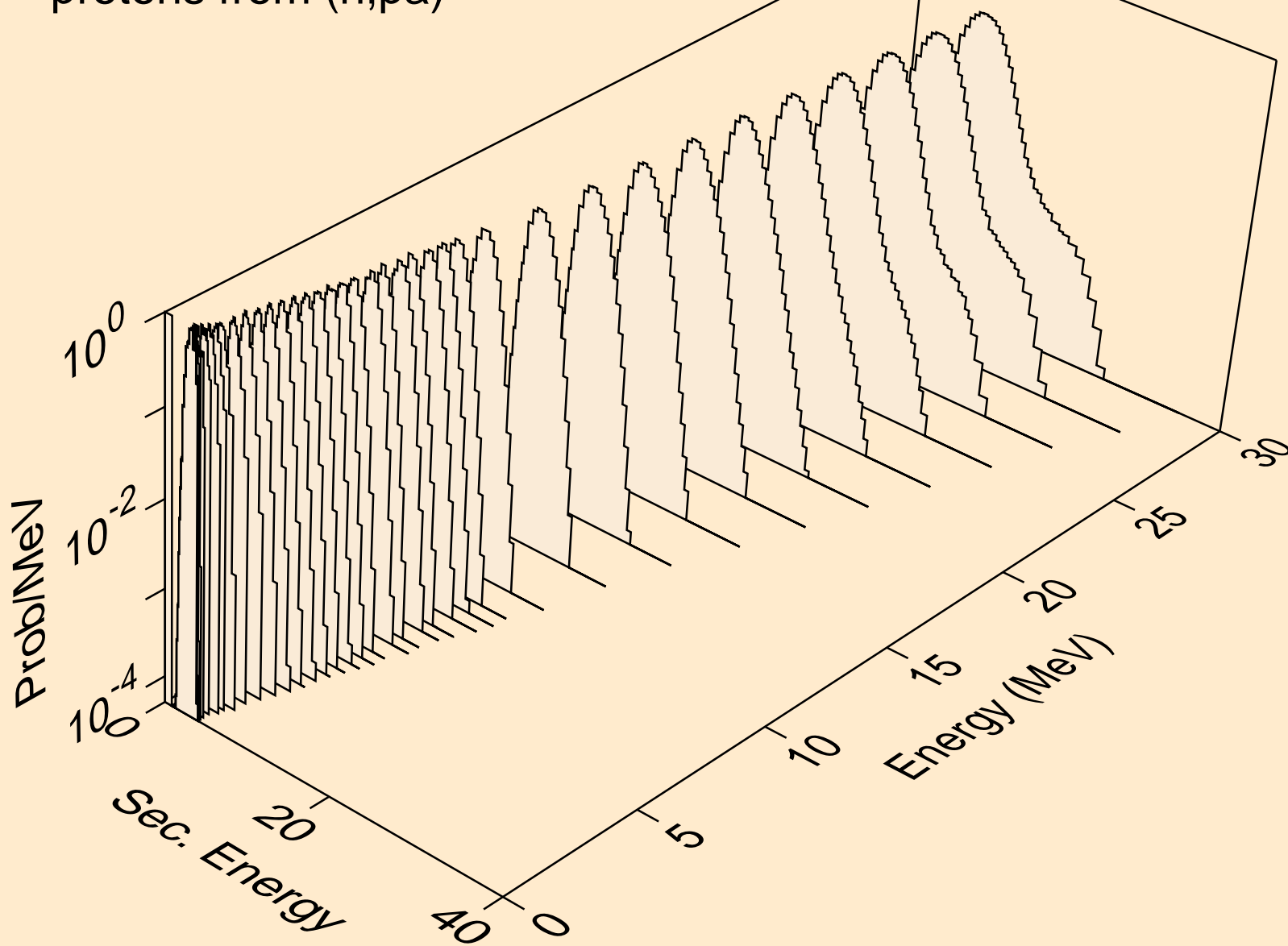

W166 NEUTRON ACER TENDL-2019 LIBRARY; T=293.16K
protons from (n,pd)

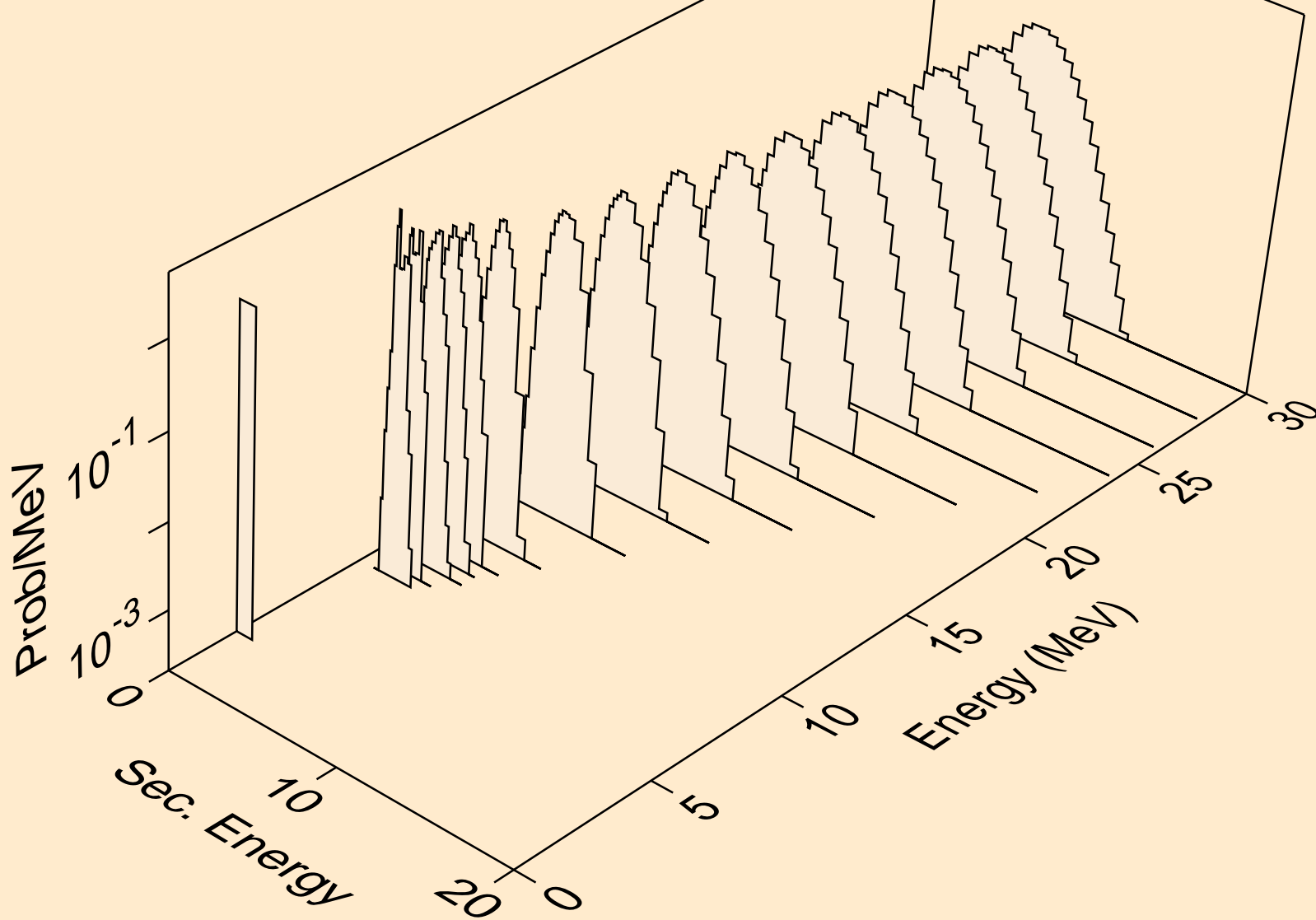

W166 NEUTRON ACER TENDL-2019 LIBRARY; T=293.16K
protons from (n,pt)

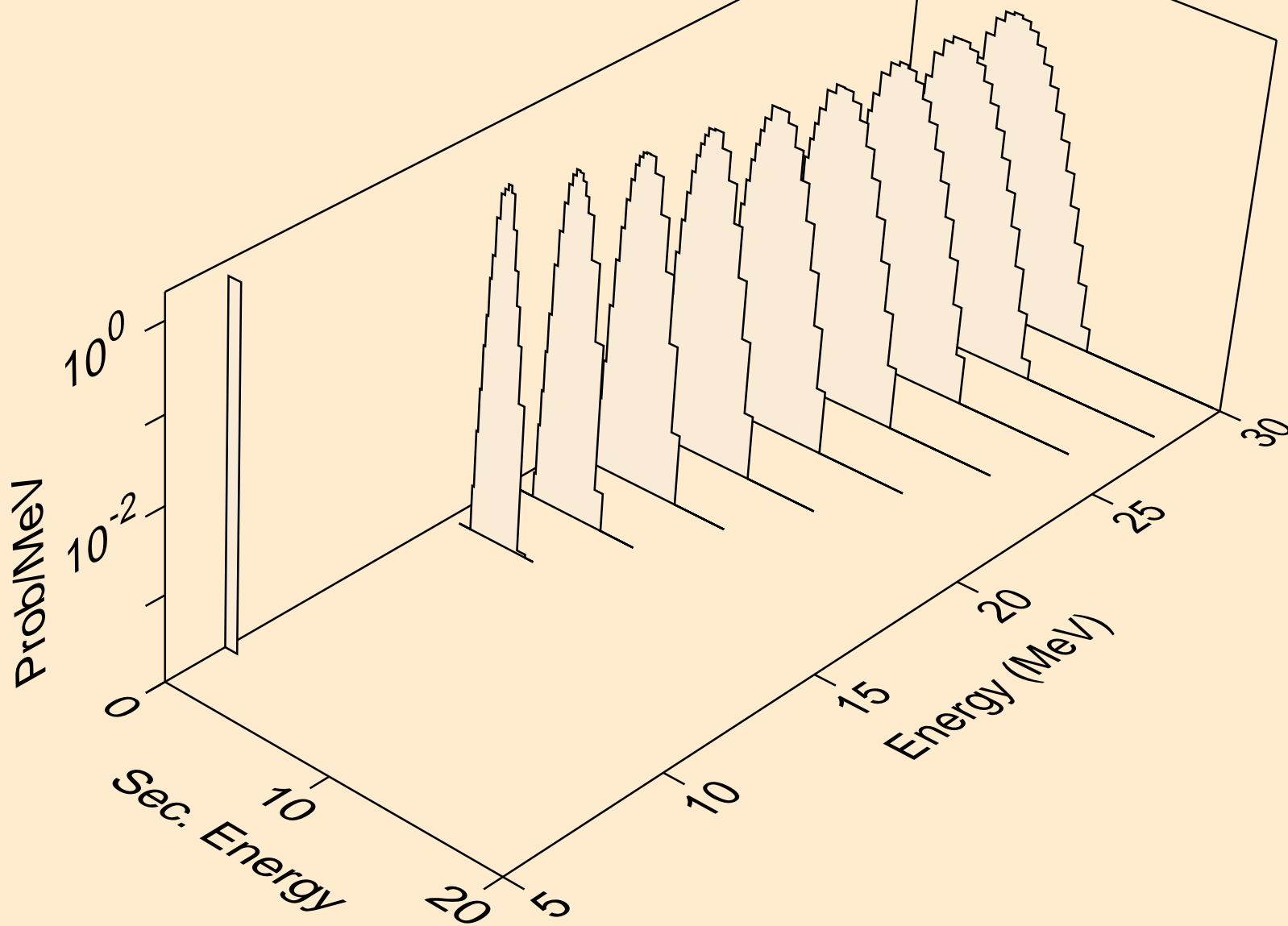

W166 NEUTRON ACER TENDL-2019 LIBRARY; T=293.16K
deuterons from (n,x)

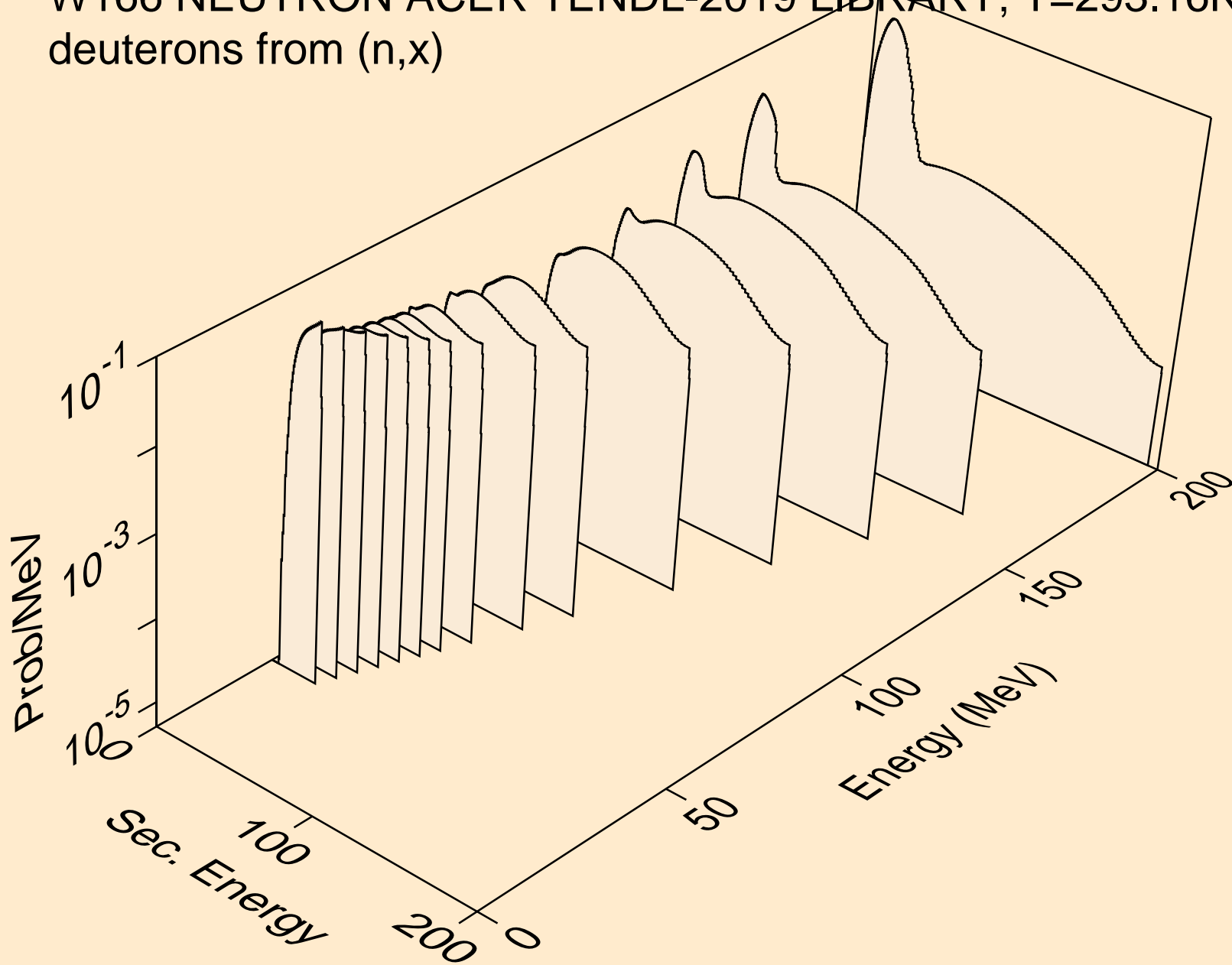

W166 NEUTRON ACER TENDL-2019 LIBRARY; T=293.16K
deuterons from (n,2nd)

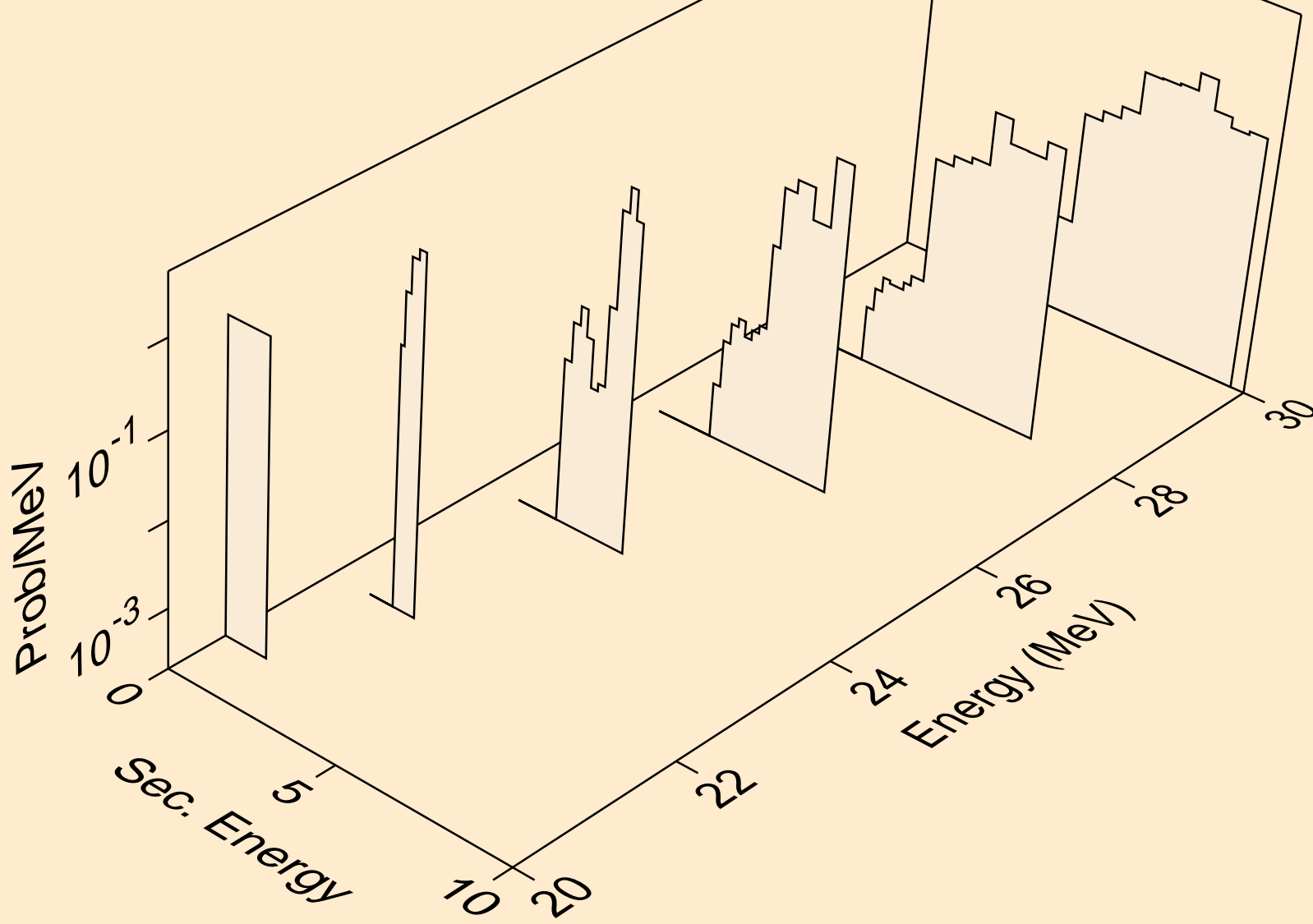

W166 NEUTRON ACER TENDL-2019 LIBRARY; T=293.16K
deuterons from (n,n*)d

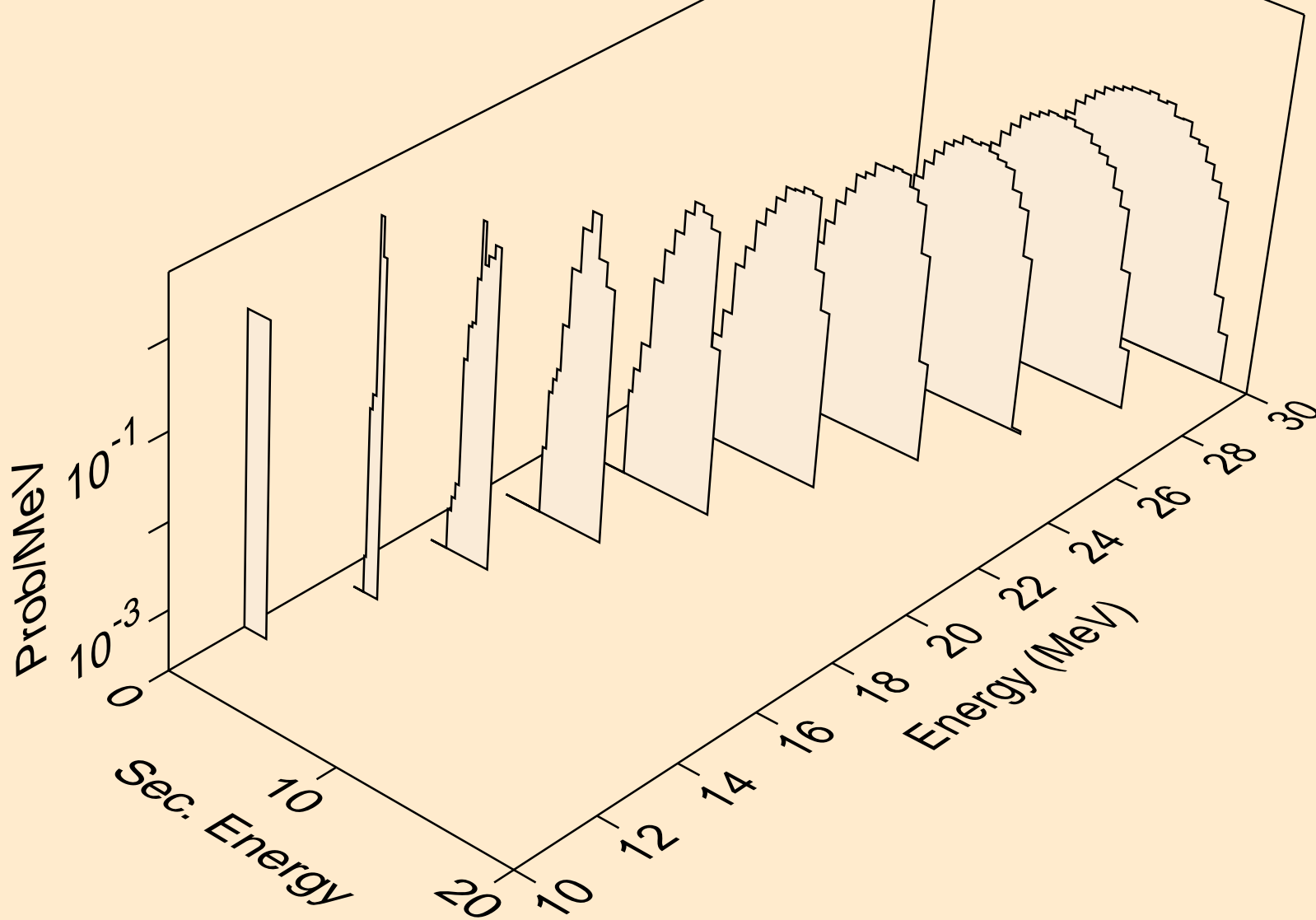

W166 NEUTRON ACER TENDL-2019 LIBRARY; T=293.16K
deuterons from (n,d)

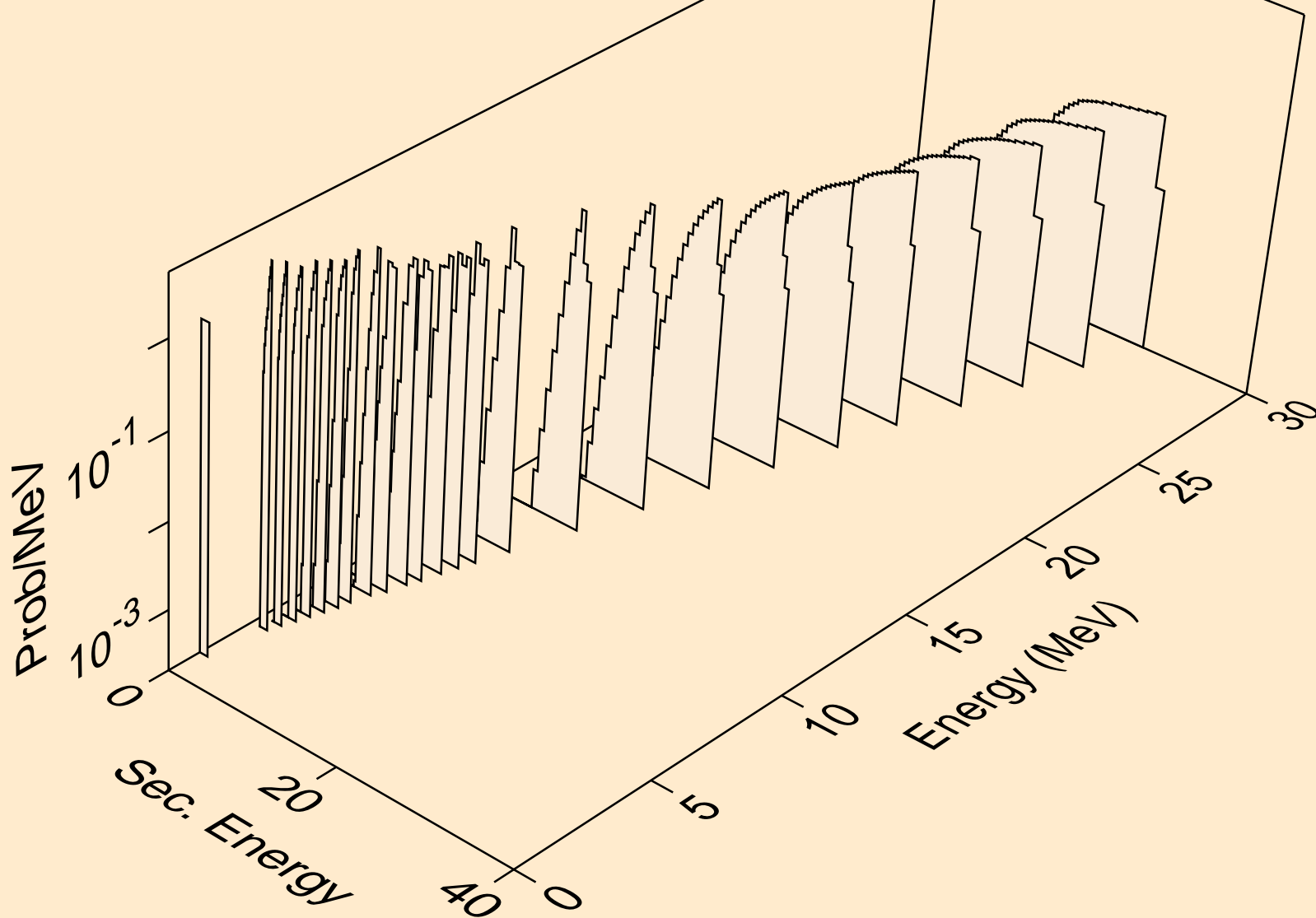

W166 NEUTRON ACER TENDL-2019 LIBRARY; T=293.16K
deuterons from (n,pd)

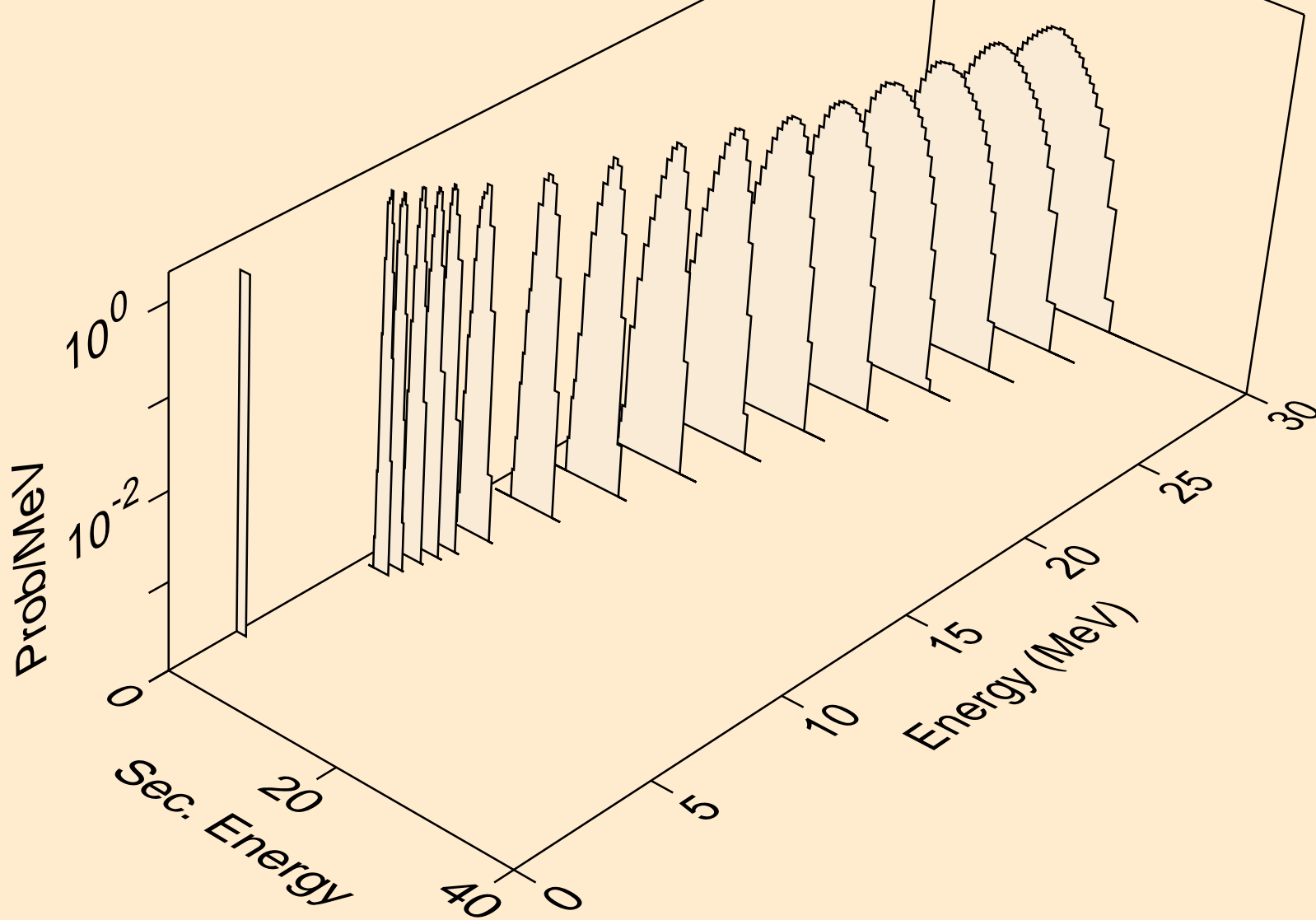

W166 NEUTRON ACER TENDL-2019 LIBRARY; T=293.16K
deuterons from (n,da)

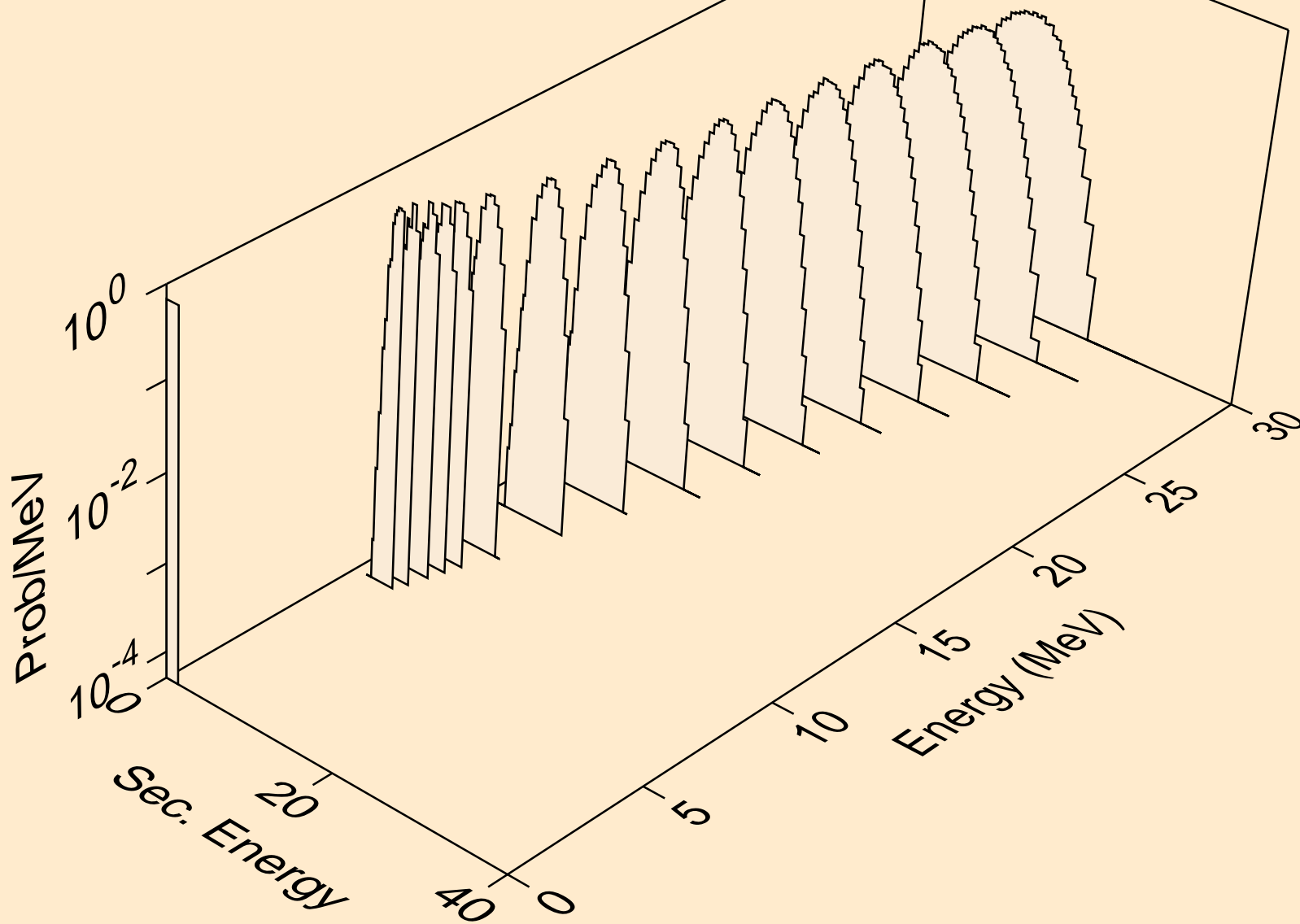

W166 NEUTRON ACER TENDL-2019 LIBRARY; T=293.16K
tritons from (n,x)

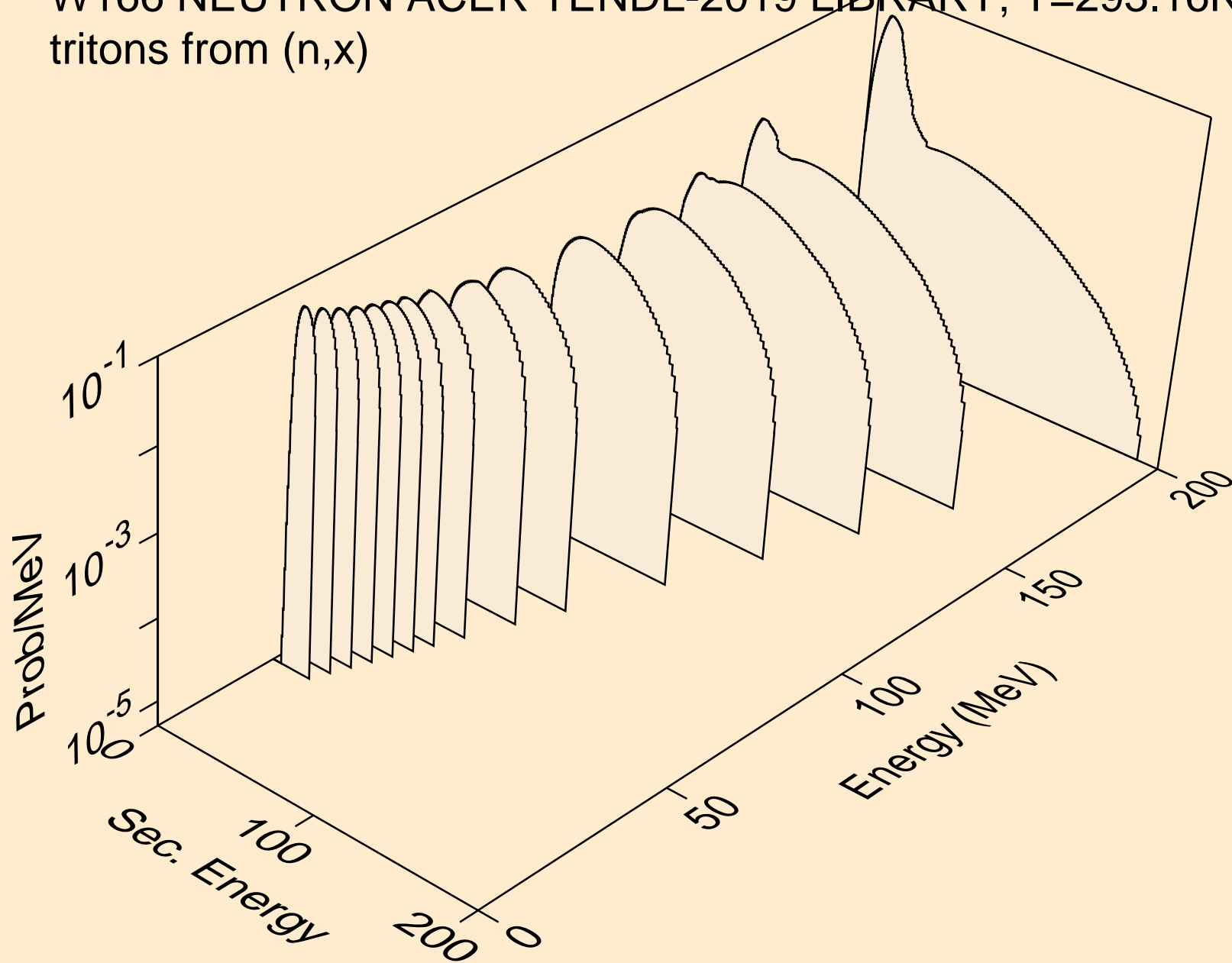

W166 NEUTRON ACER TENDL-2019 LIBRARY; T=293.16K
tritons from (n,n*)t

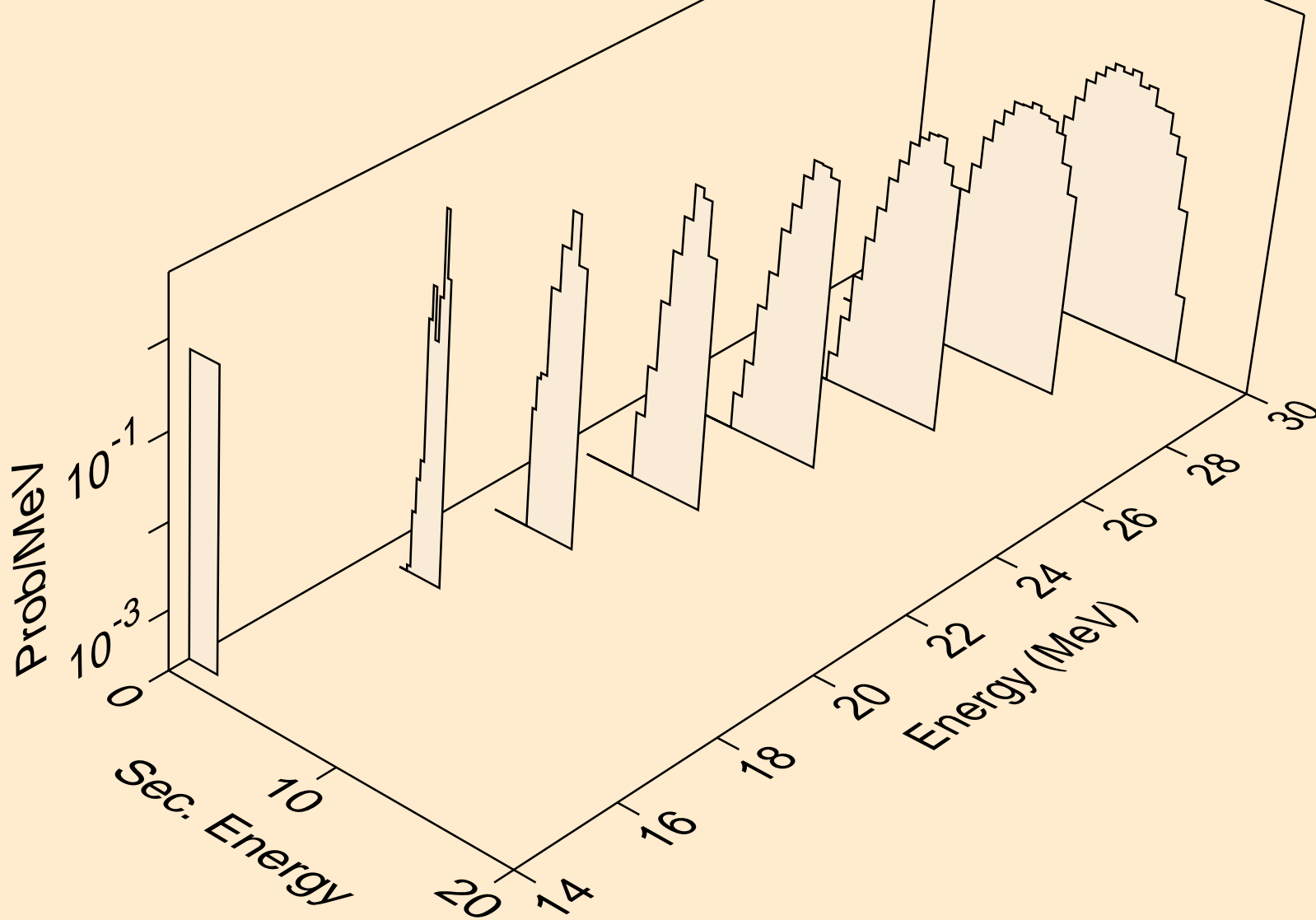

W166 NEUTRON ACER TENDL-2019 LIBRARY; T=293.16K
tritons from (n,t)

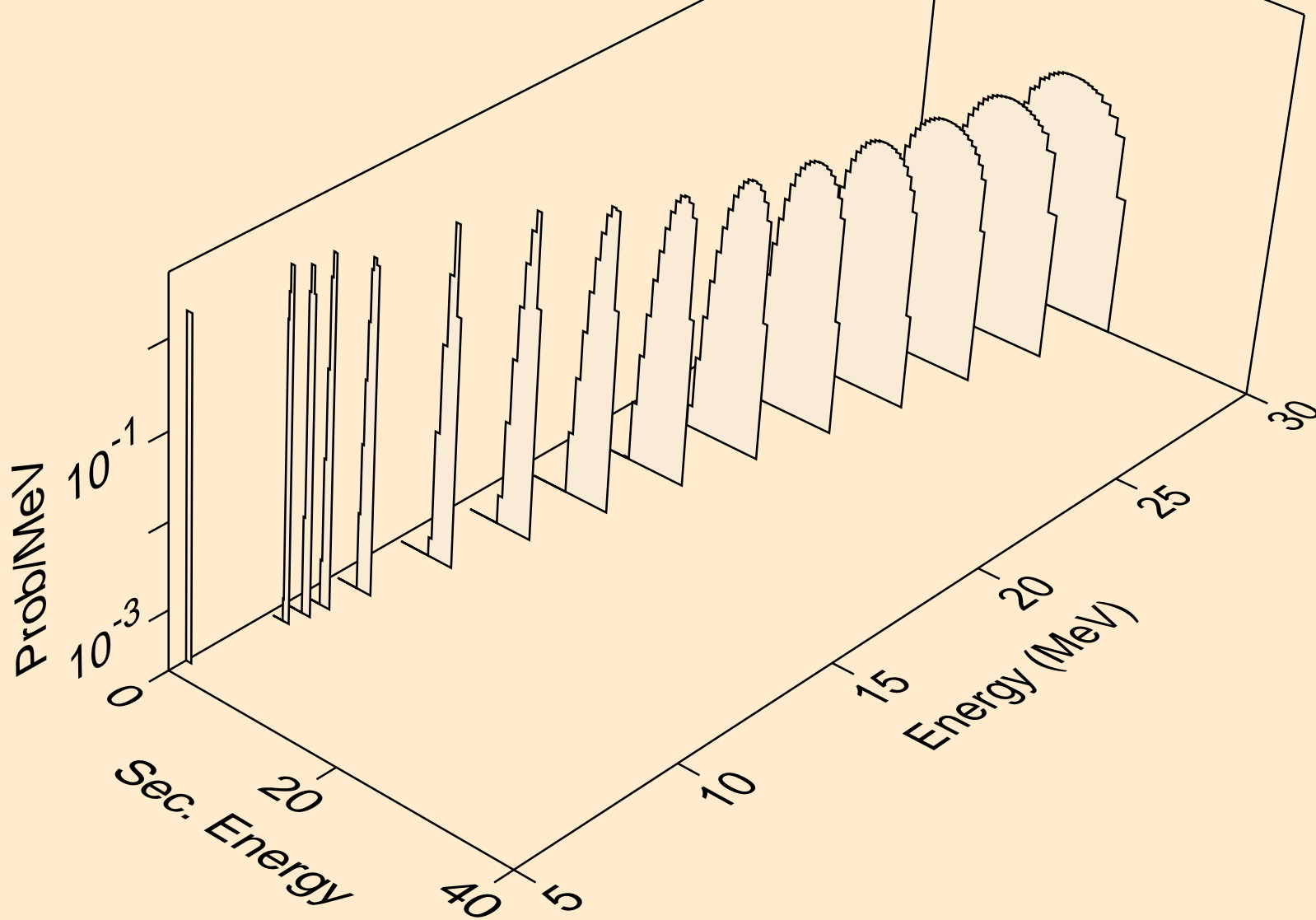

W166 NEUTRON ACER TENDL-2019 LIBRARY; T=293.16K
tritons from (n,pt)

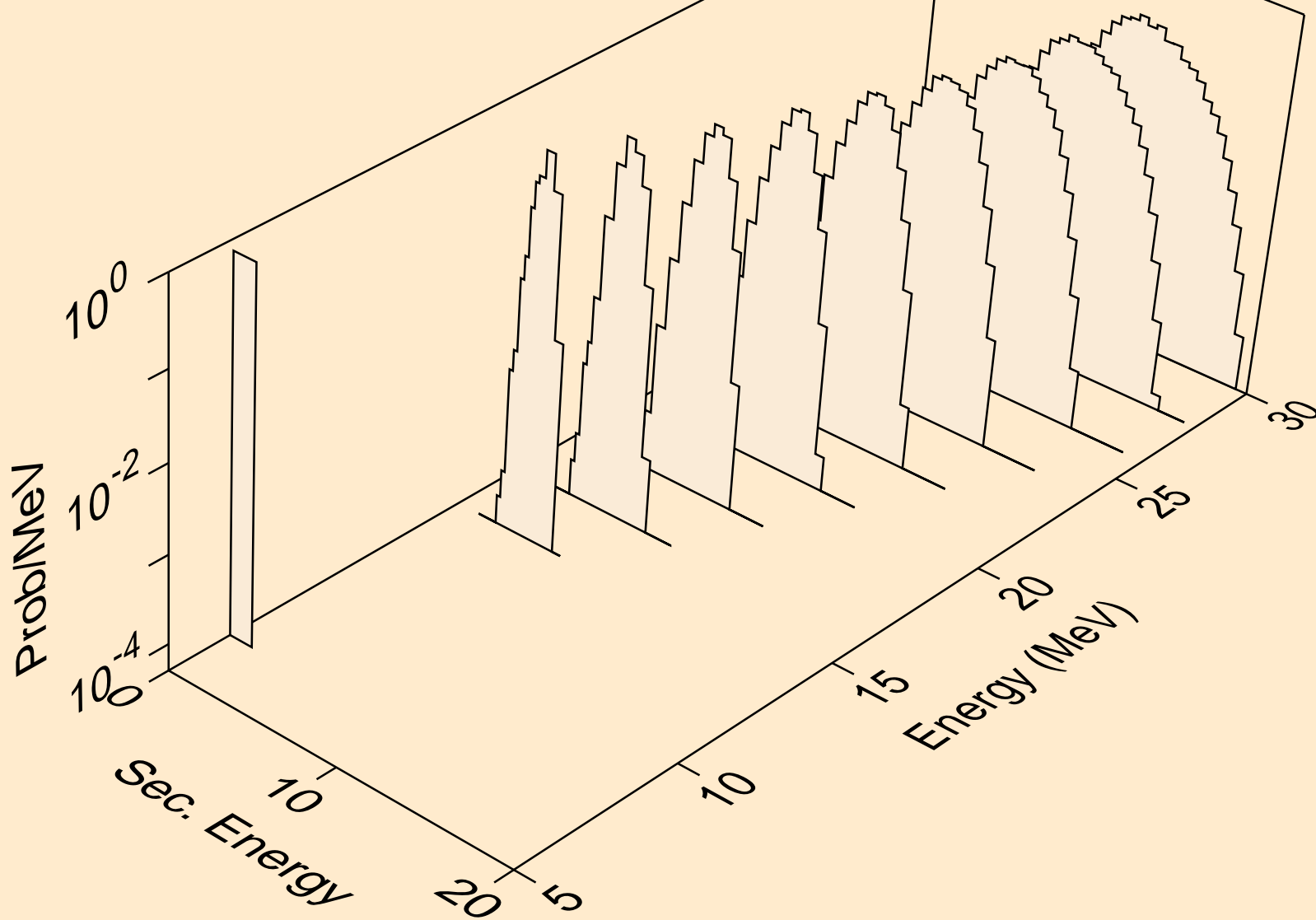

W166 NEUTRON ACER TENDL-2019 LIBRARY; T=293.16K
he3s from (n,x)

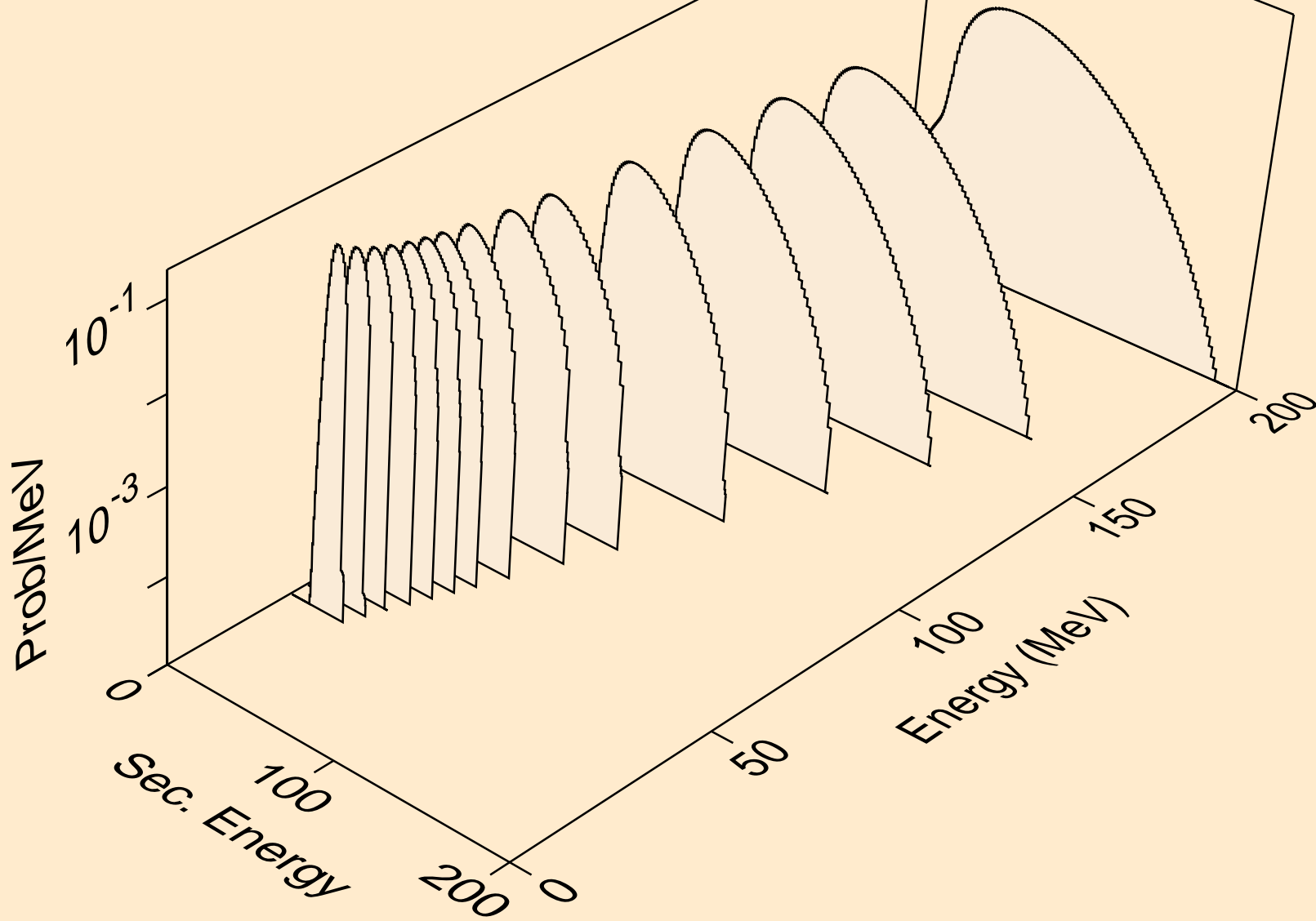

W166 NEUTRON ACER TENDL-2019 LIBRARY; T=293.16K
he3s from (n,n*)he3

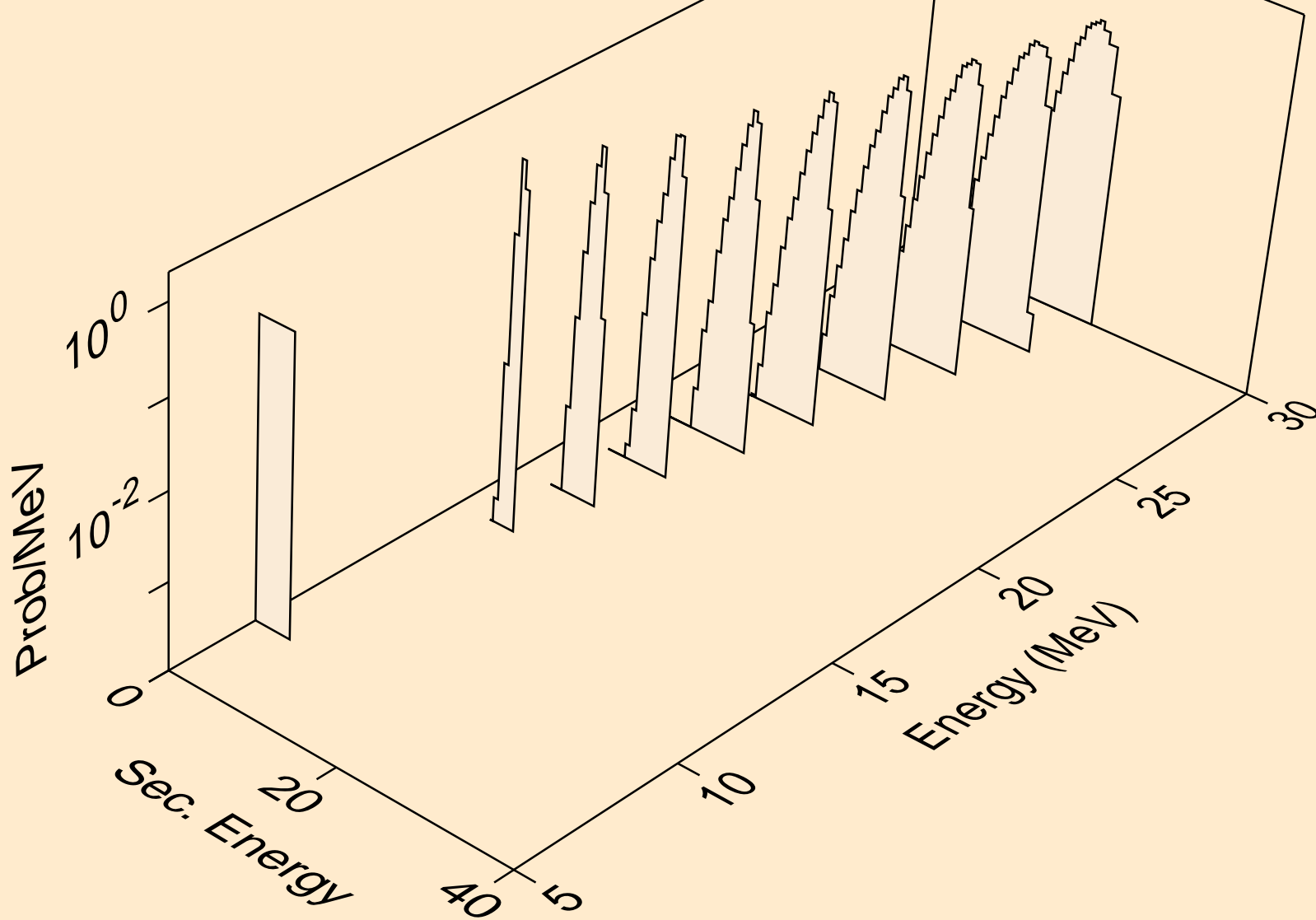

W166 NEUTRON ACER TENDL-2019 LIBRARY; T=293.16K
he3s from (n,he3)

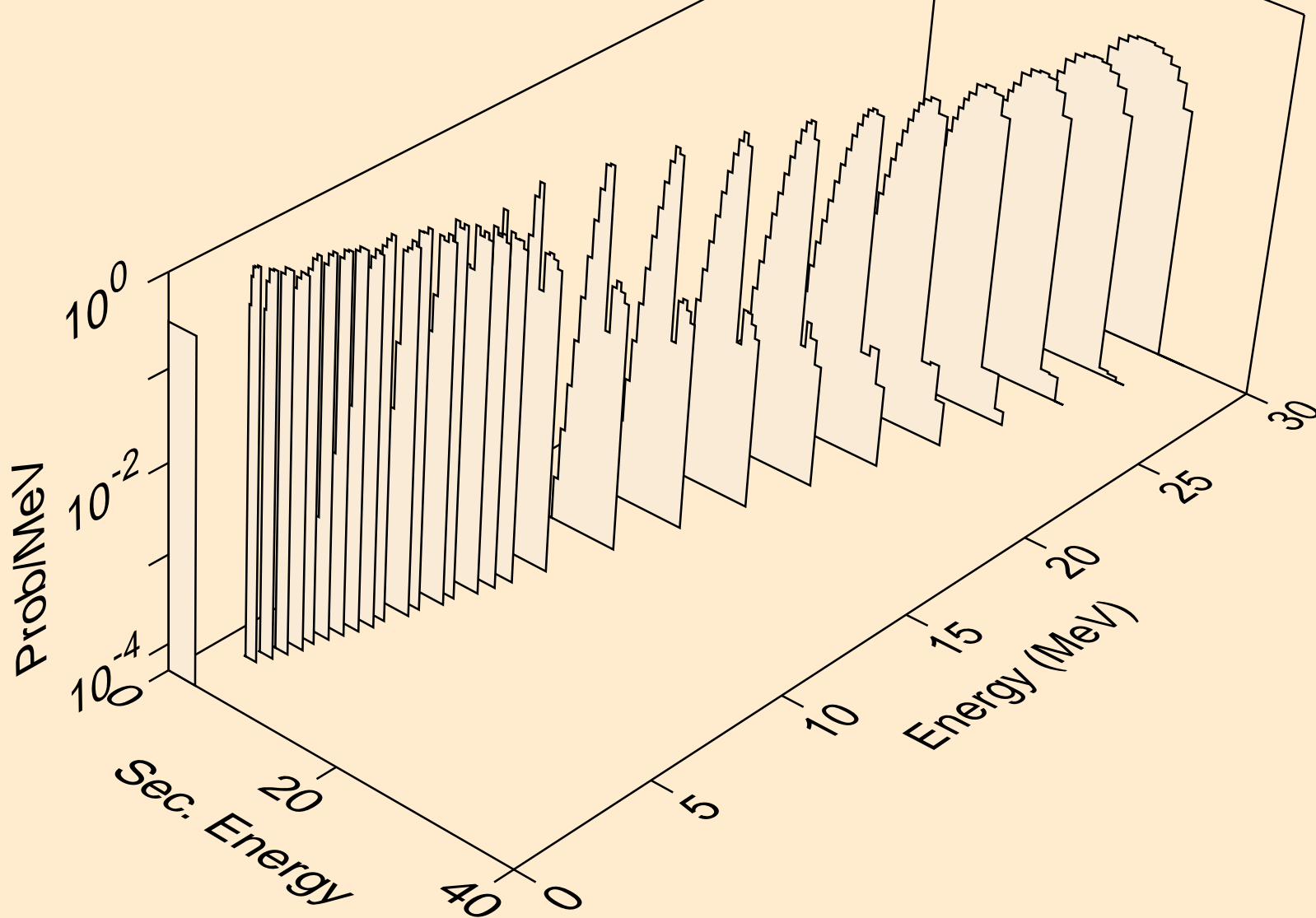

W166 NEUTRON ACER TENDL-2019 LIBRARY; T=293.16K
alphas from (n,x)

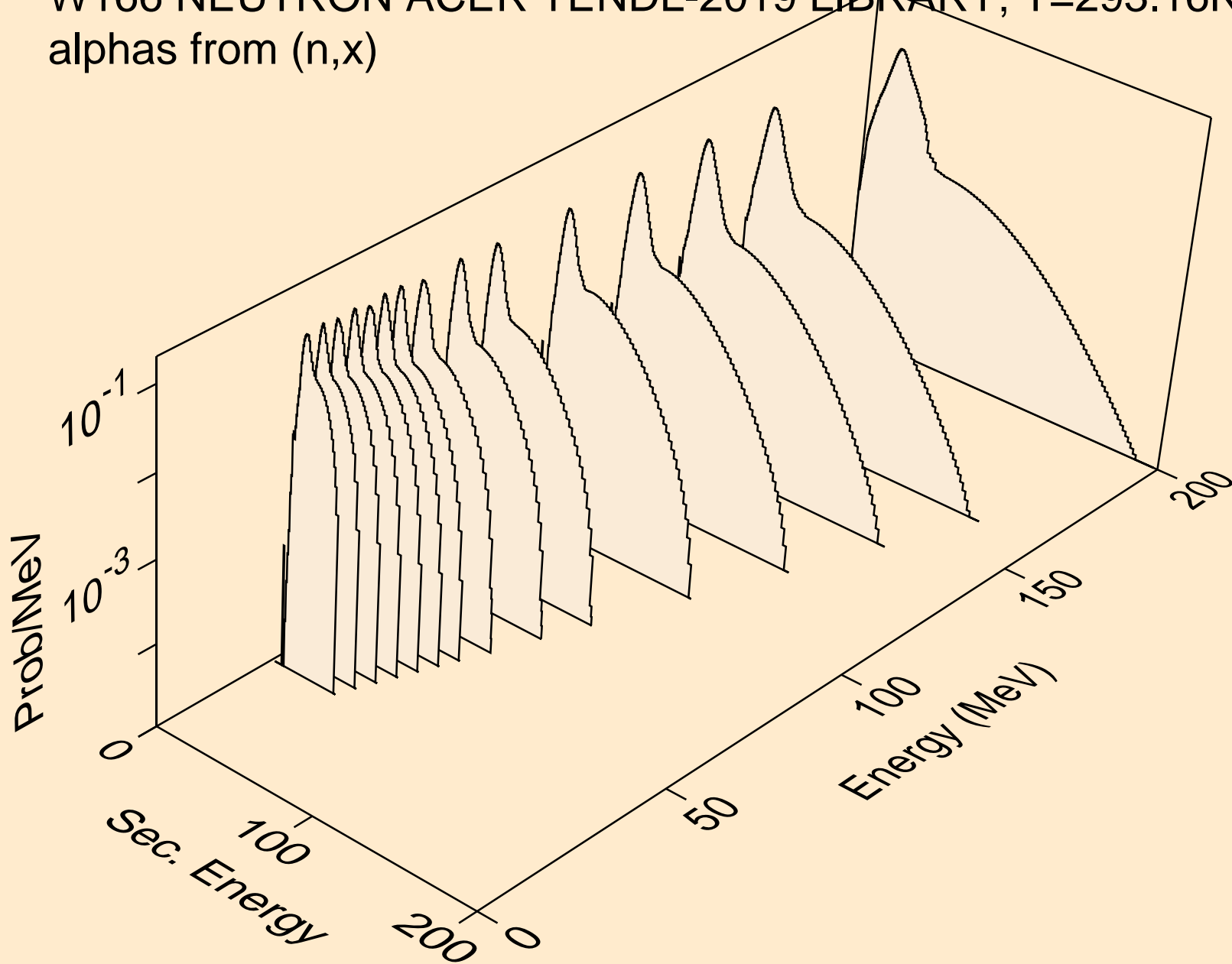

W166 NEUTRON ACER TENDL-2019 LIBRARY; T=293.16K
alphas from (n,n*)a

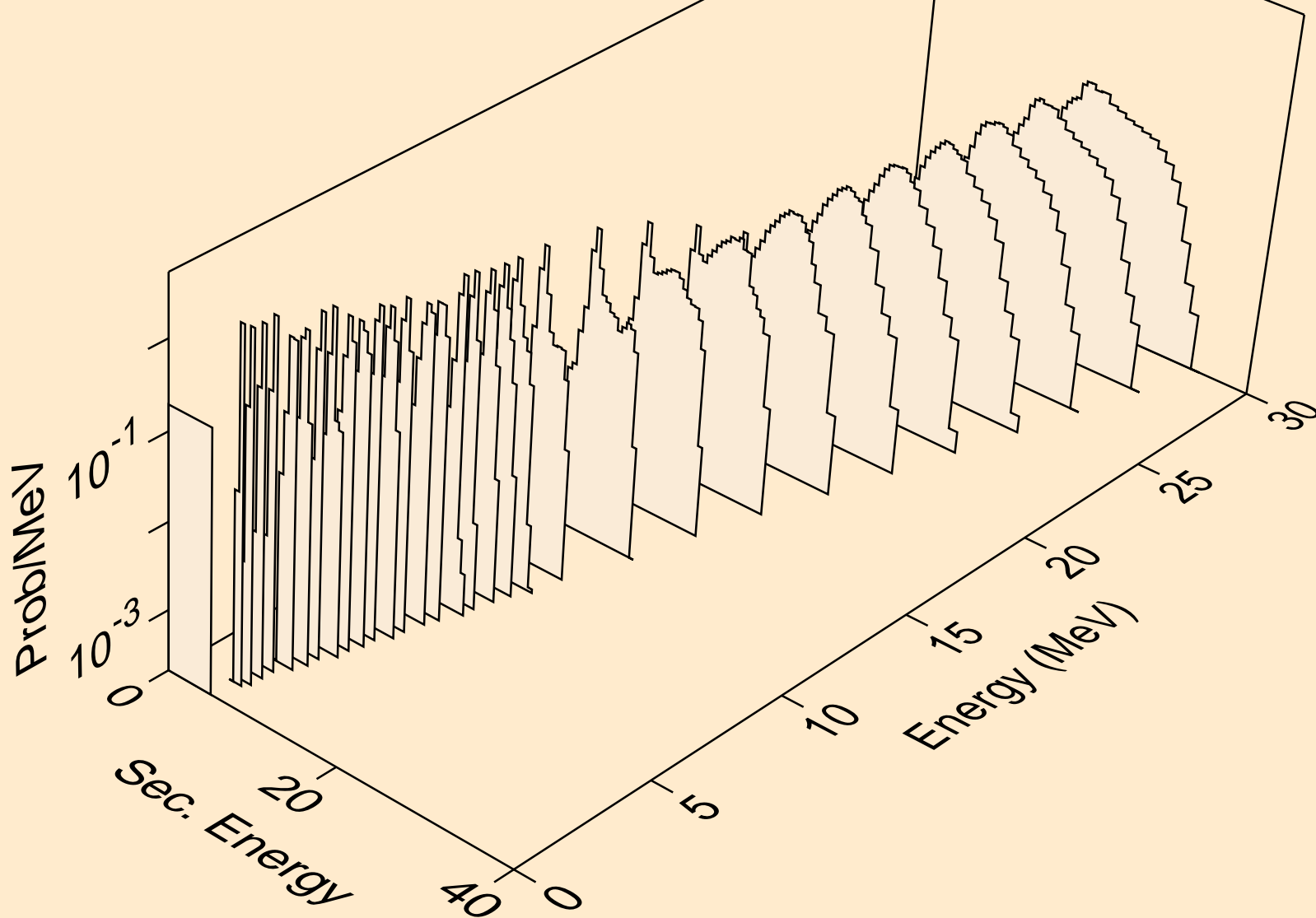

W166 NEUTRON ACER TENDL-2019 LIBRARY; T=293.16K
alphas from (n,n*)3a

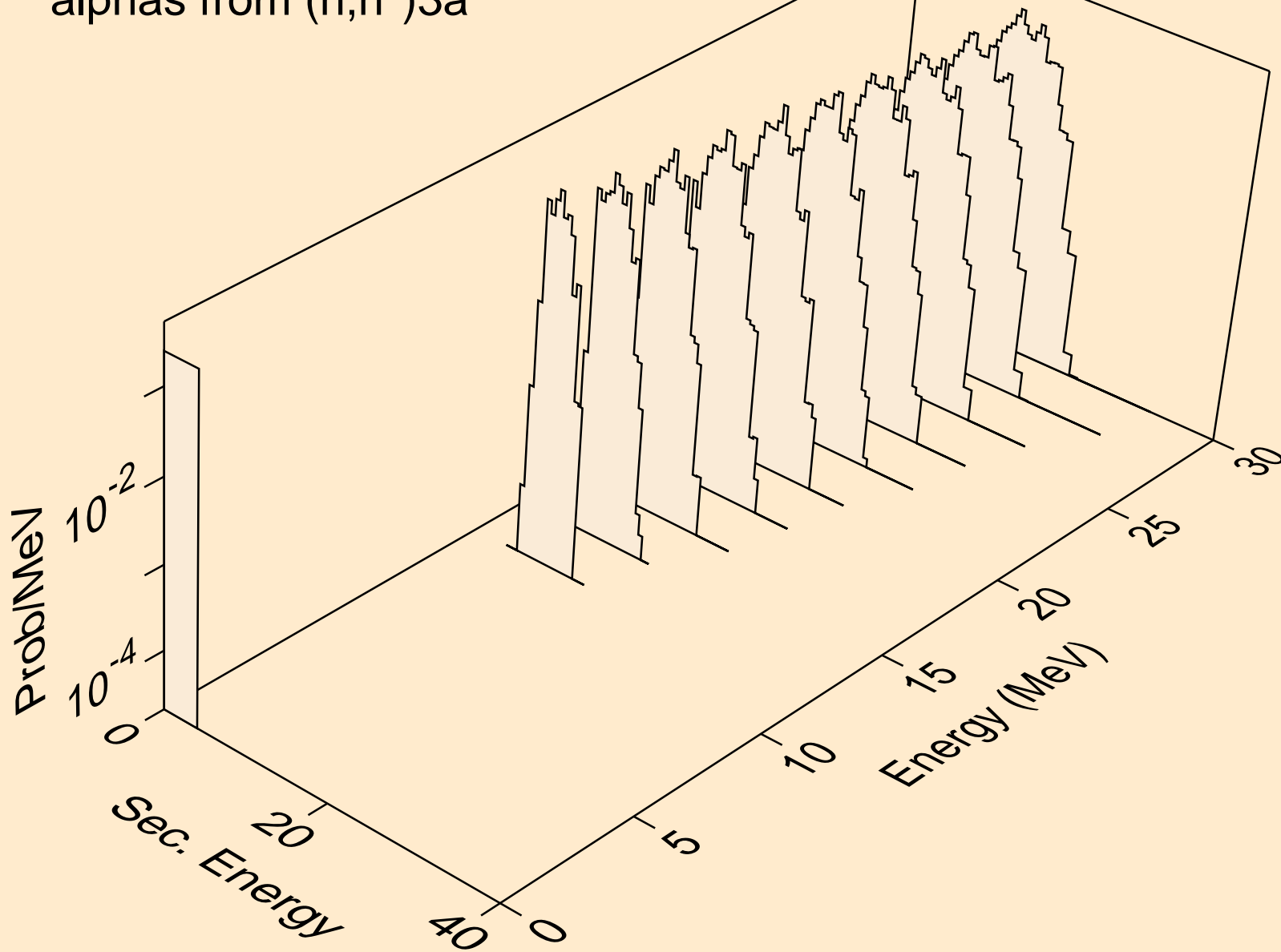

W166 NEUTRON ACER TENDL-2019 LIBRARY; T=293.16K
alphas from (n,2n)a

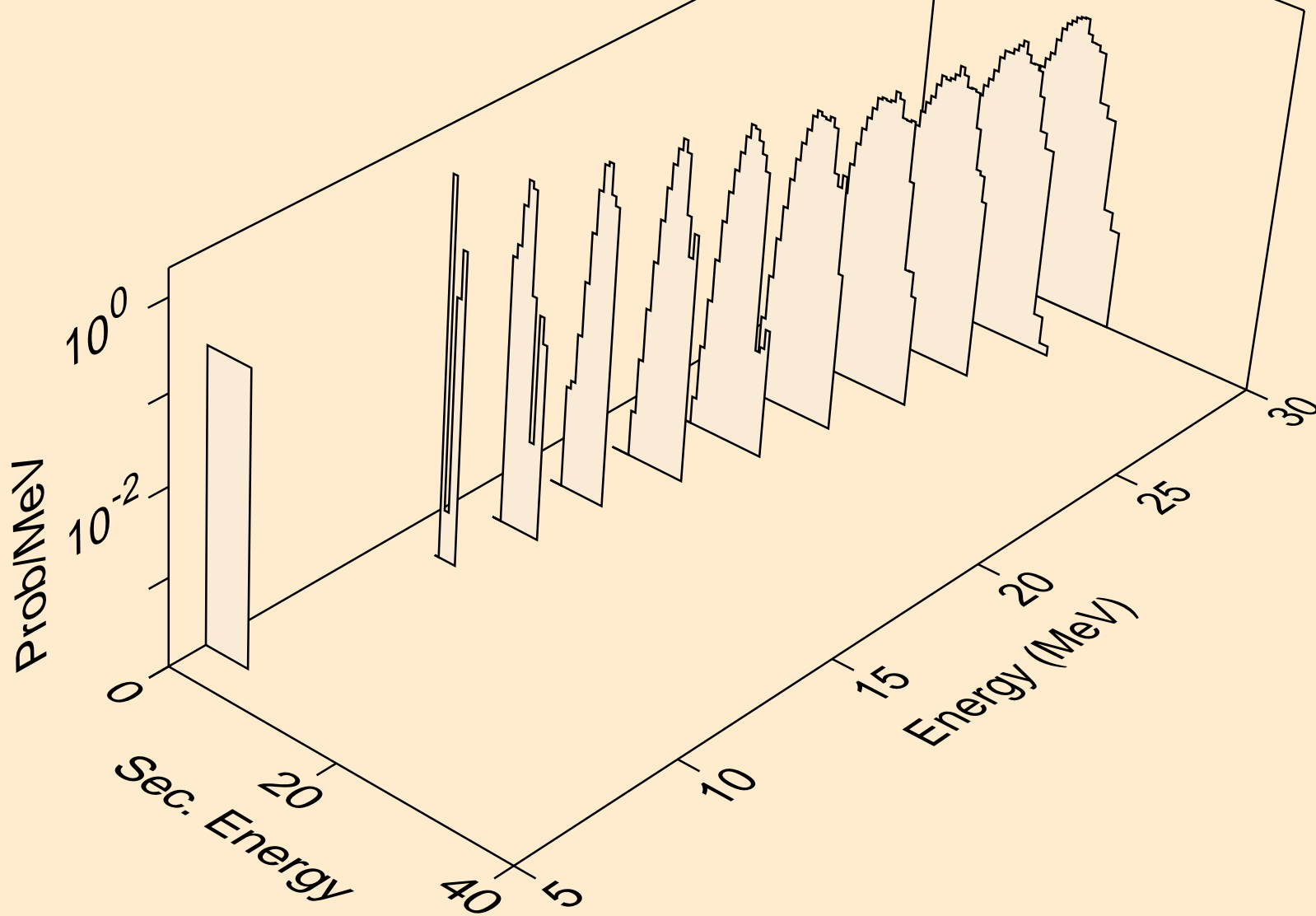

W166 NEUTRON ACER TENDL-2019 LIBRARY; T=293.16K
alphas from (n,3n)a

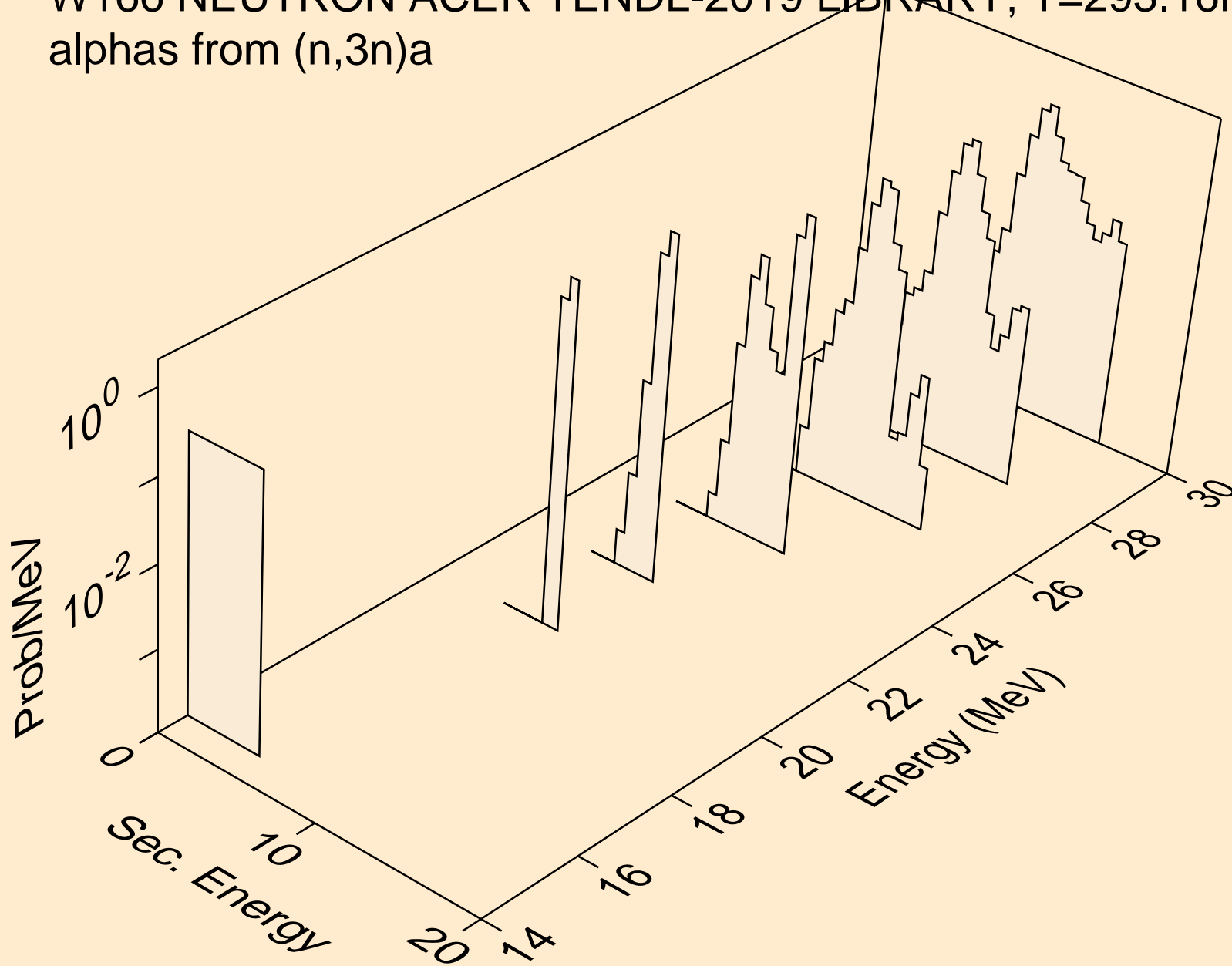

W166 NEUTRON ACER TENDL-2019 LIBRARY; T=293.16K
alphas from (n,n*)2a

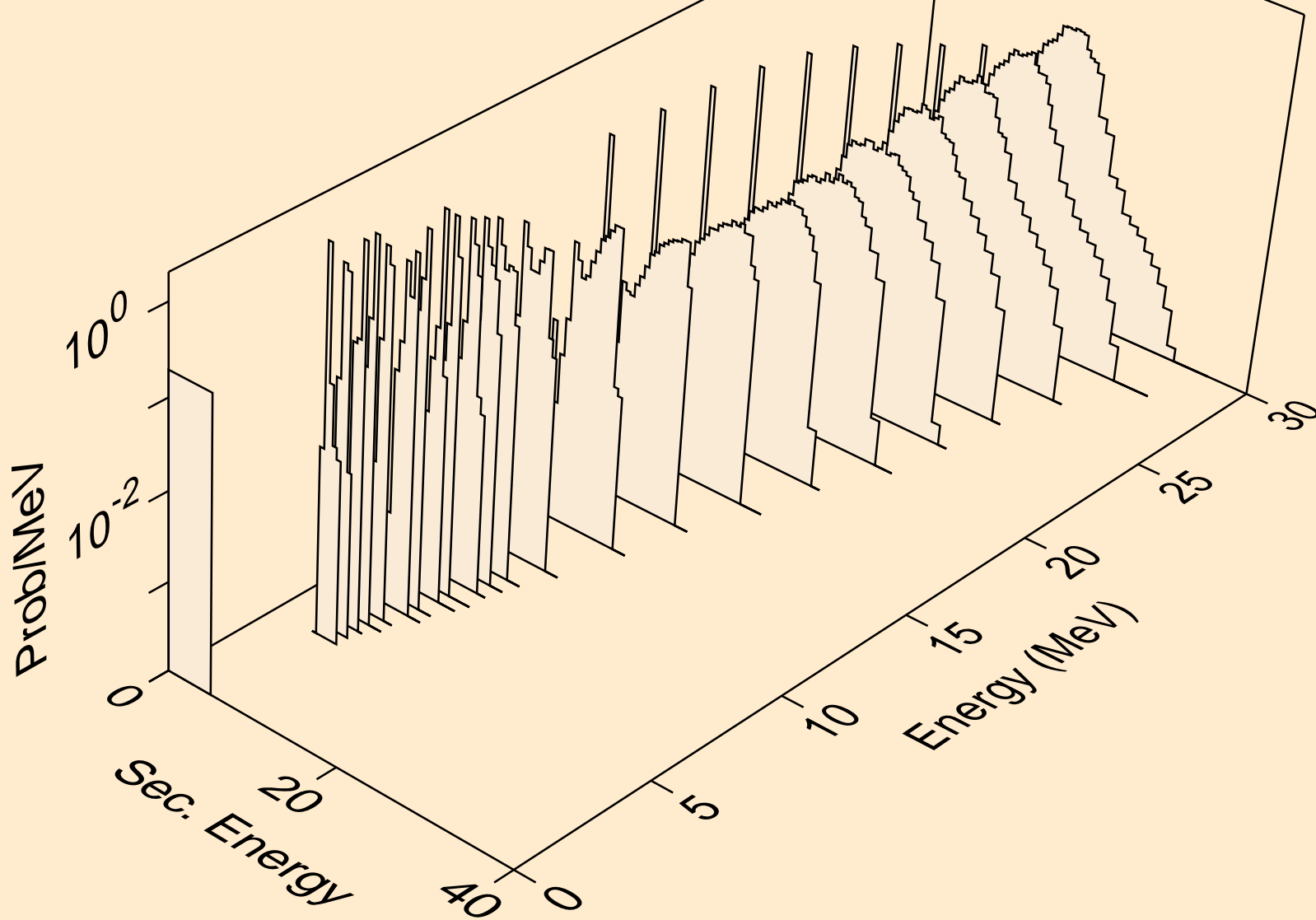

W166 NEUTRON ACER TENDL-2019 LIBRARY; T=293.16K
alphas from (n,2n)2a

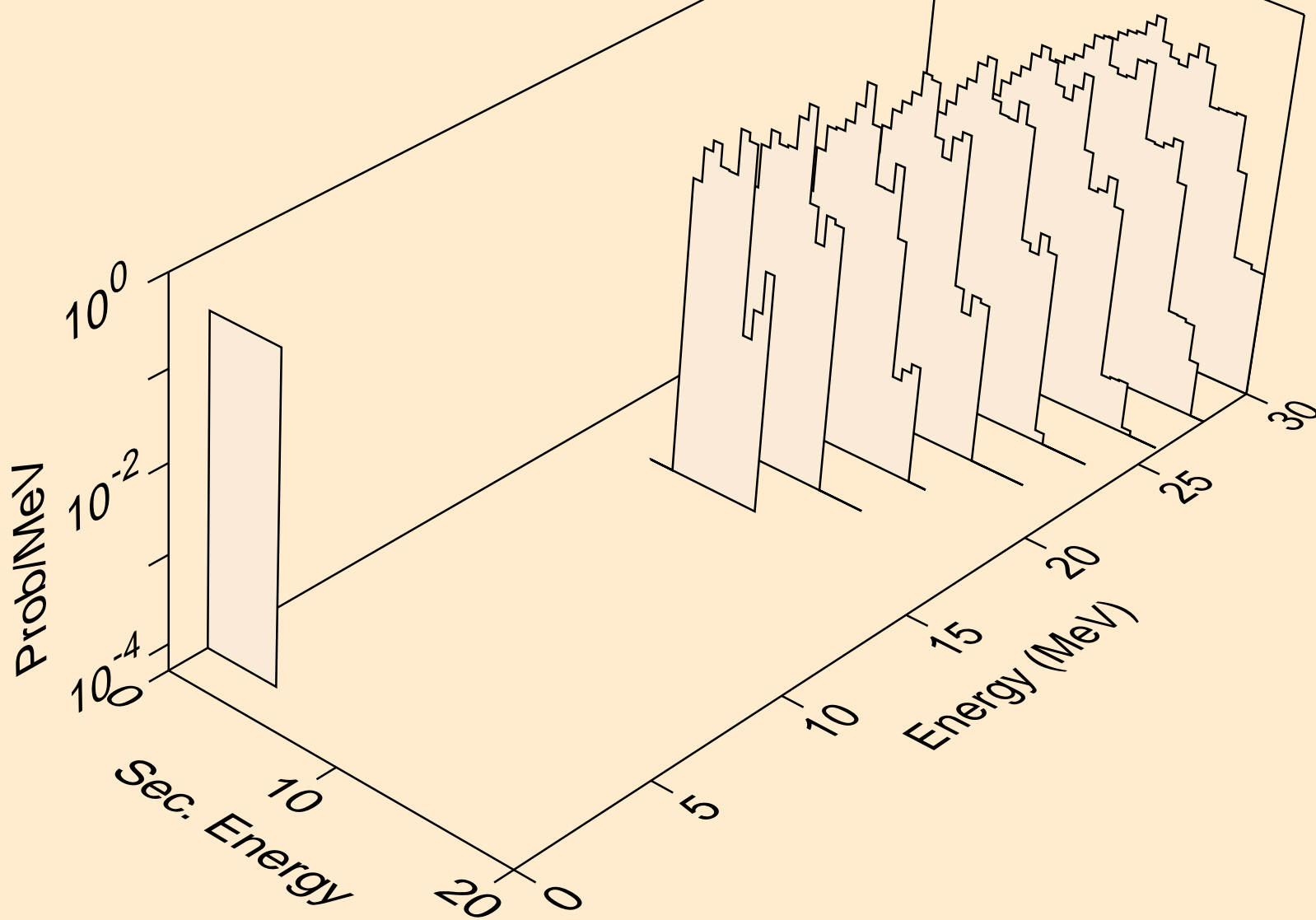

W166 NEUTRON ACER TENDL-2019 LIBRARY; T=293.16K
alphas from (n,npa)

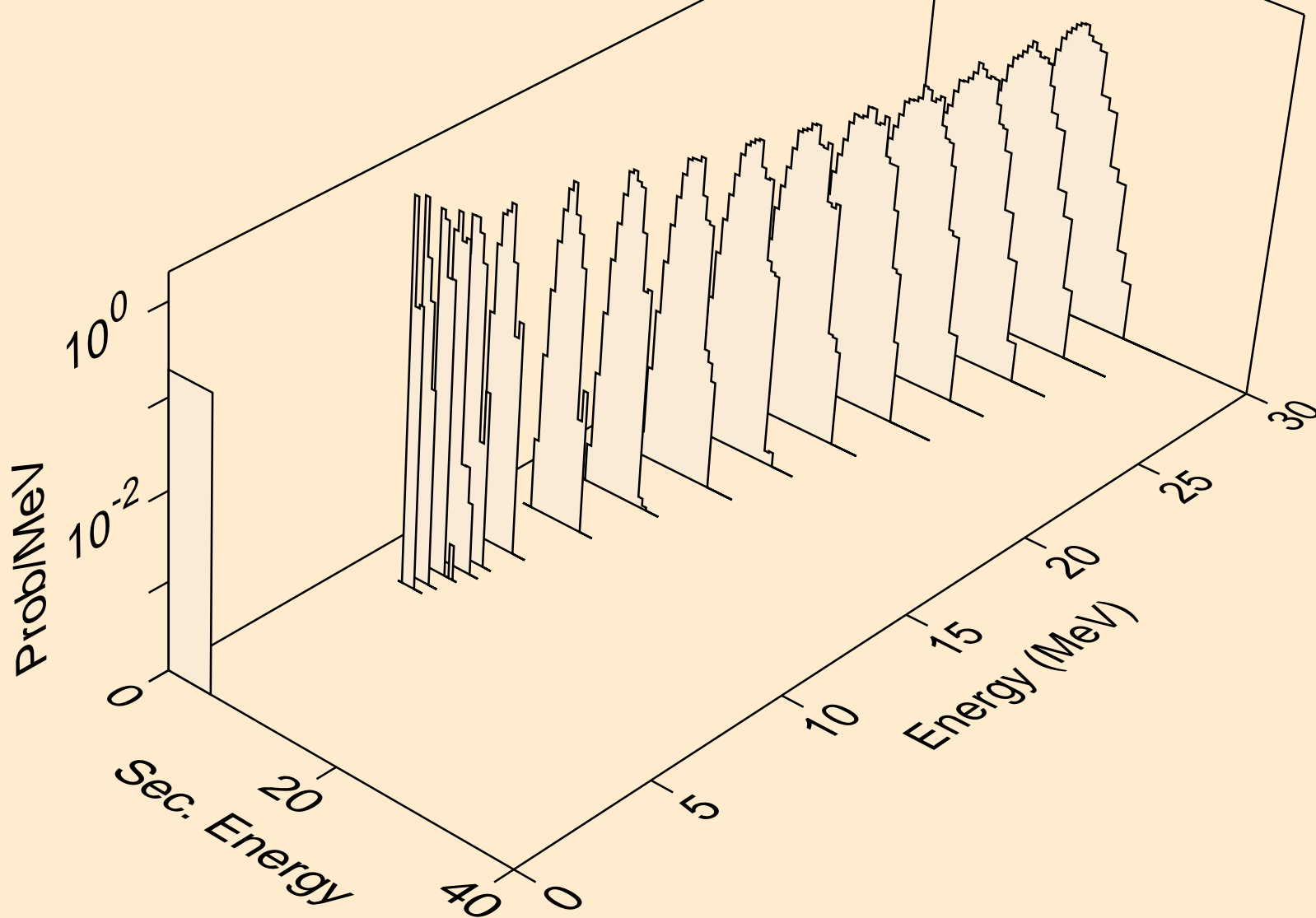

W166 NEUTRON ACER TENDL-2019 LIBRARY; T=293.16K
alphas from (n,a)

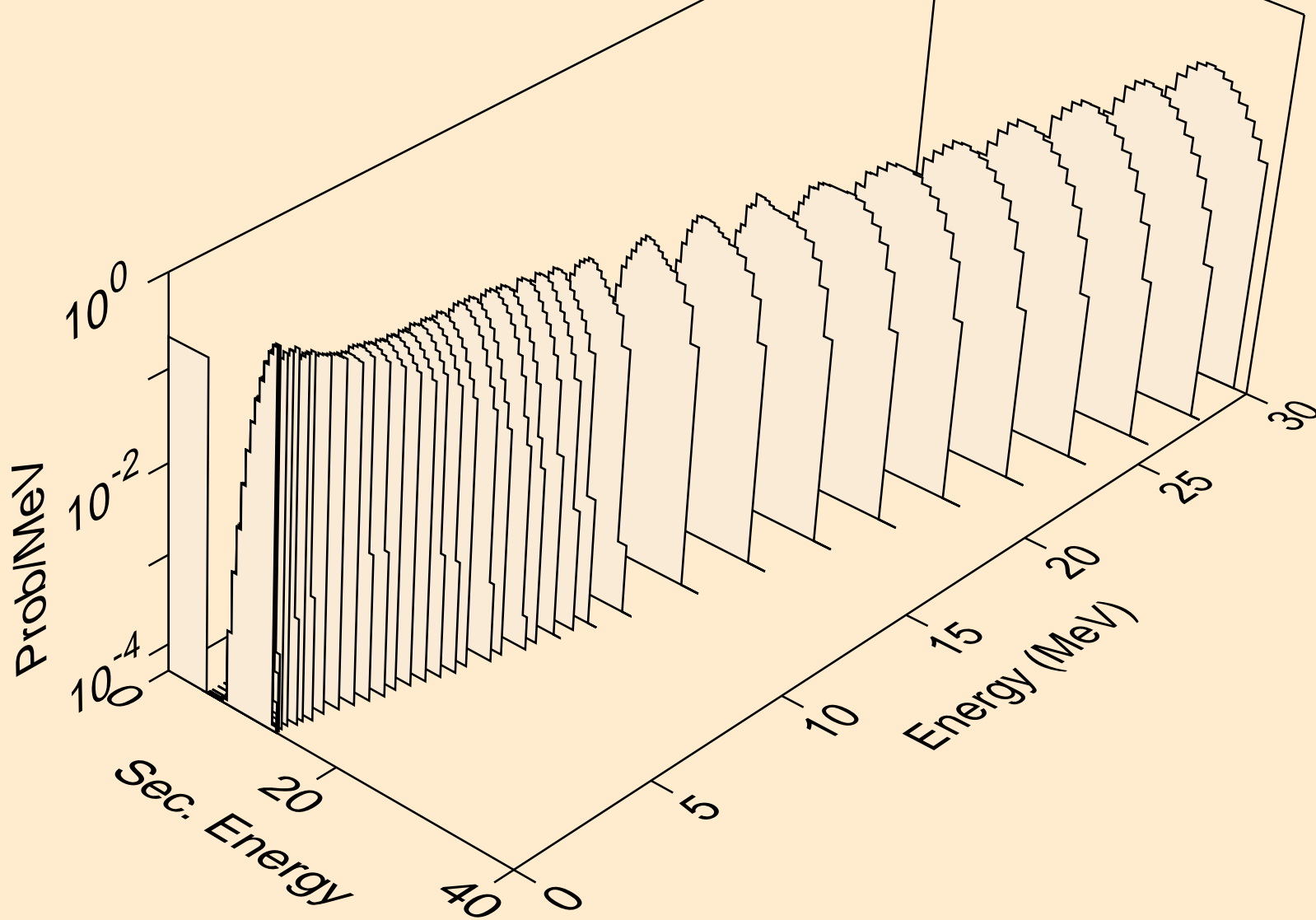

W166 NEUTRON ACER TENDL-2019 LIBRARY; T=293.16K
alphas from (n,2a)

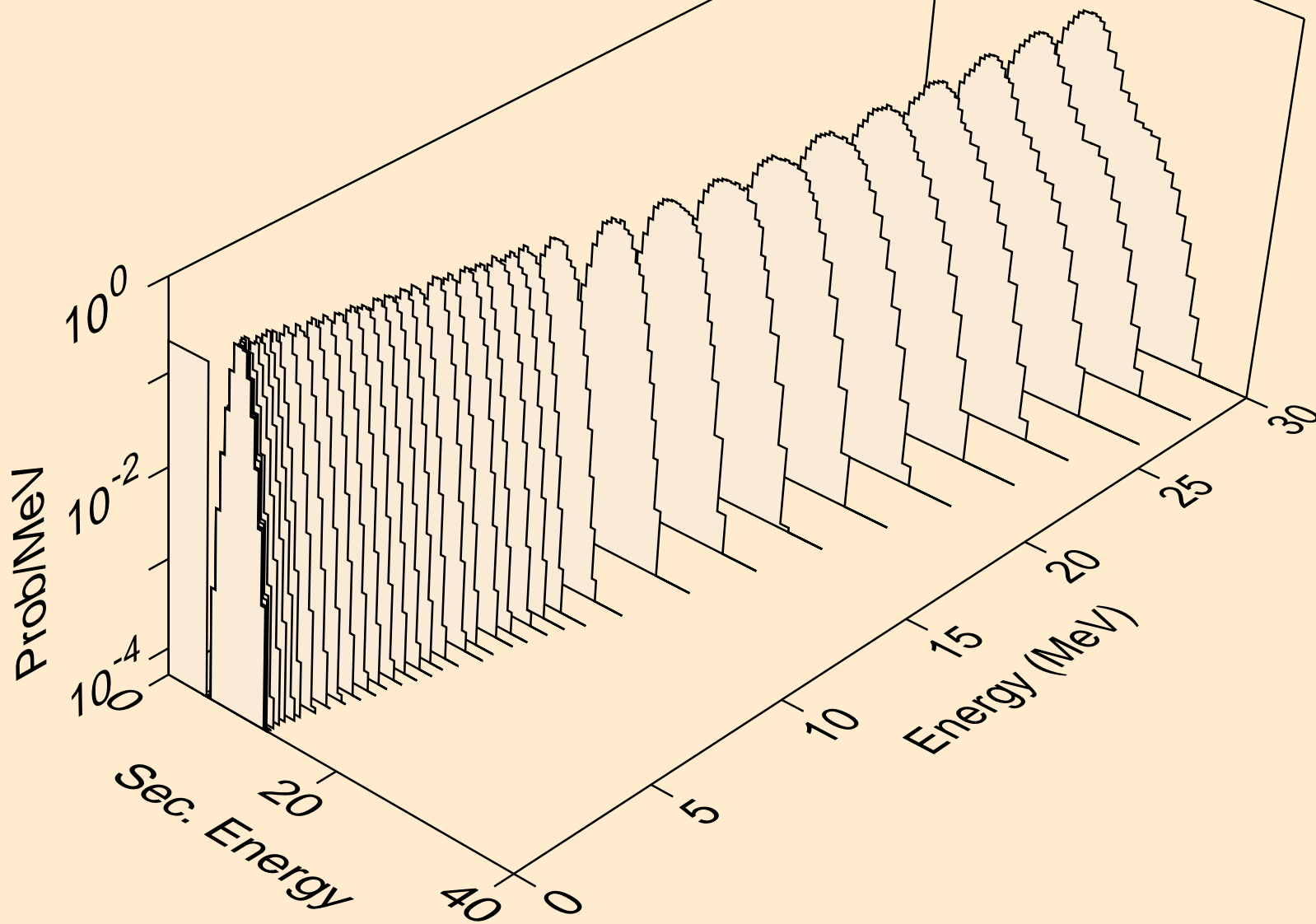

W166 NEUTRON ACER TENDL-2019 LIBRARY; T=293.16K
alphas from (n,3a)

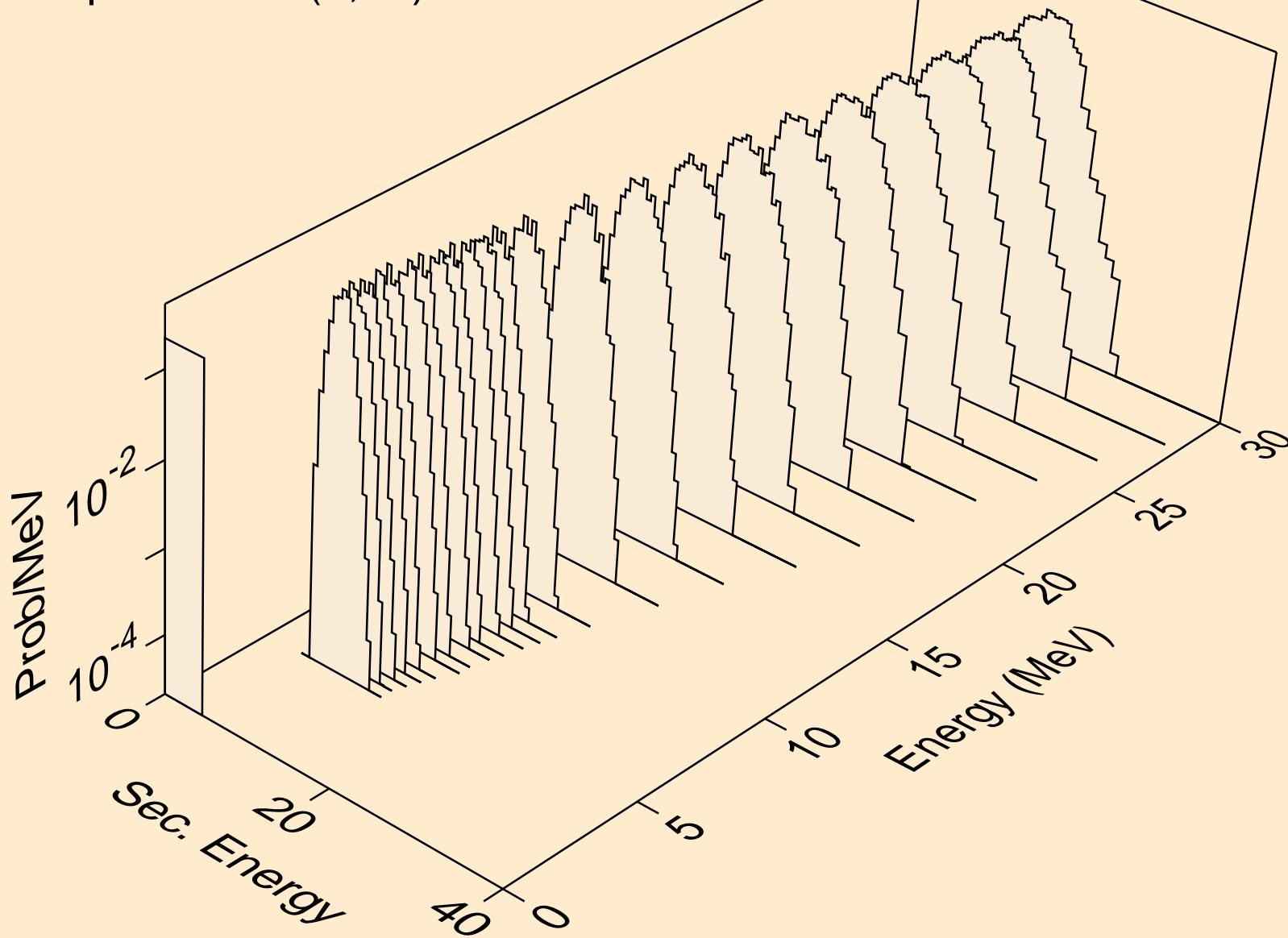

W166 NEUTRON ACER TENDL-2019 LIBRARY; T=293.16K
alphas from (n,p)

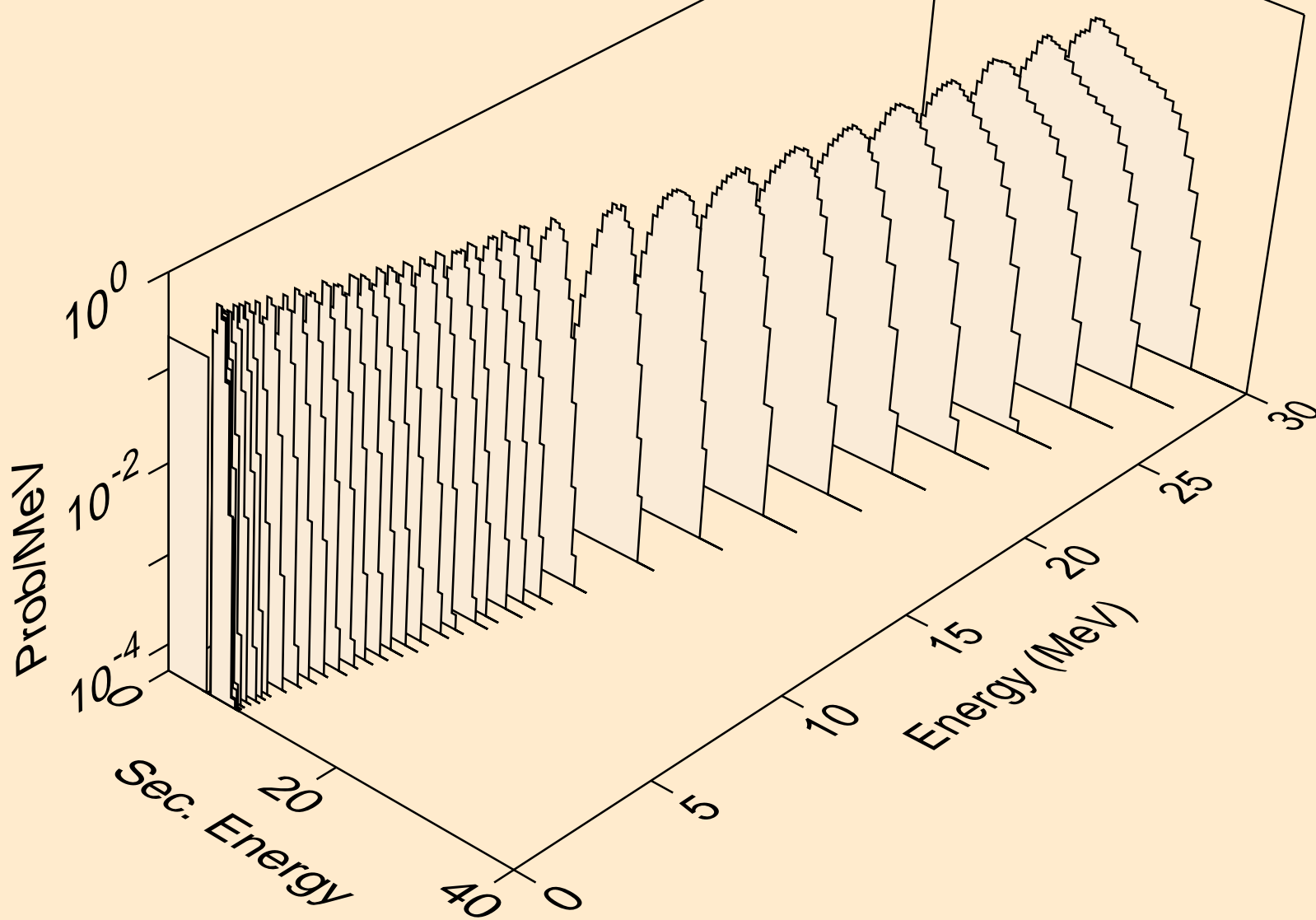

W166 NEUTRON ACER TENDL-2019 LIBRARY; T=293.16K
alphas from (n,da)

