

W167 NEUTRON ACER TENDL-2019 LIBRARY; T=293.16K
Principal cross sections

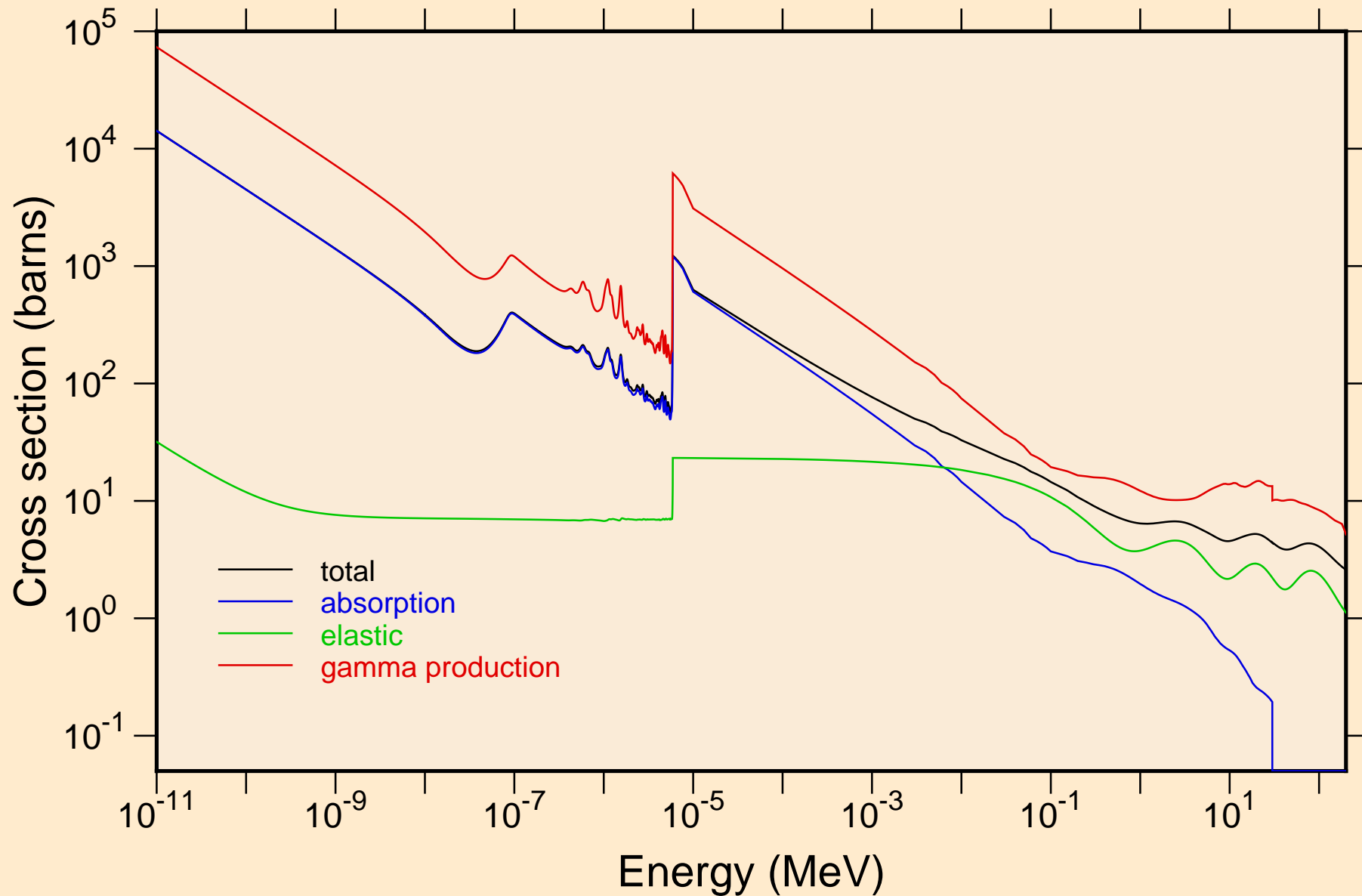

W167 NEUTRON ACER TENDL-2019 LIBRARY; T=293.16K
resonance total cross section

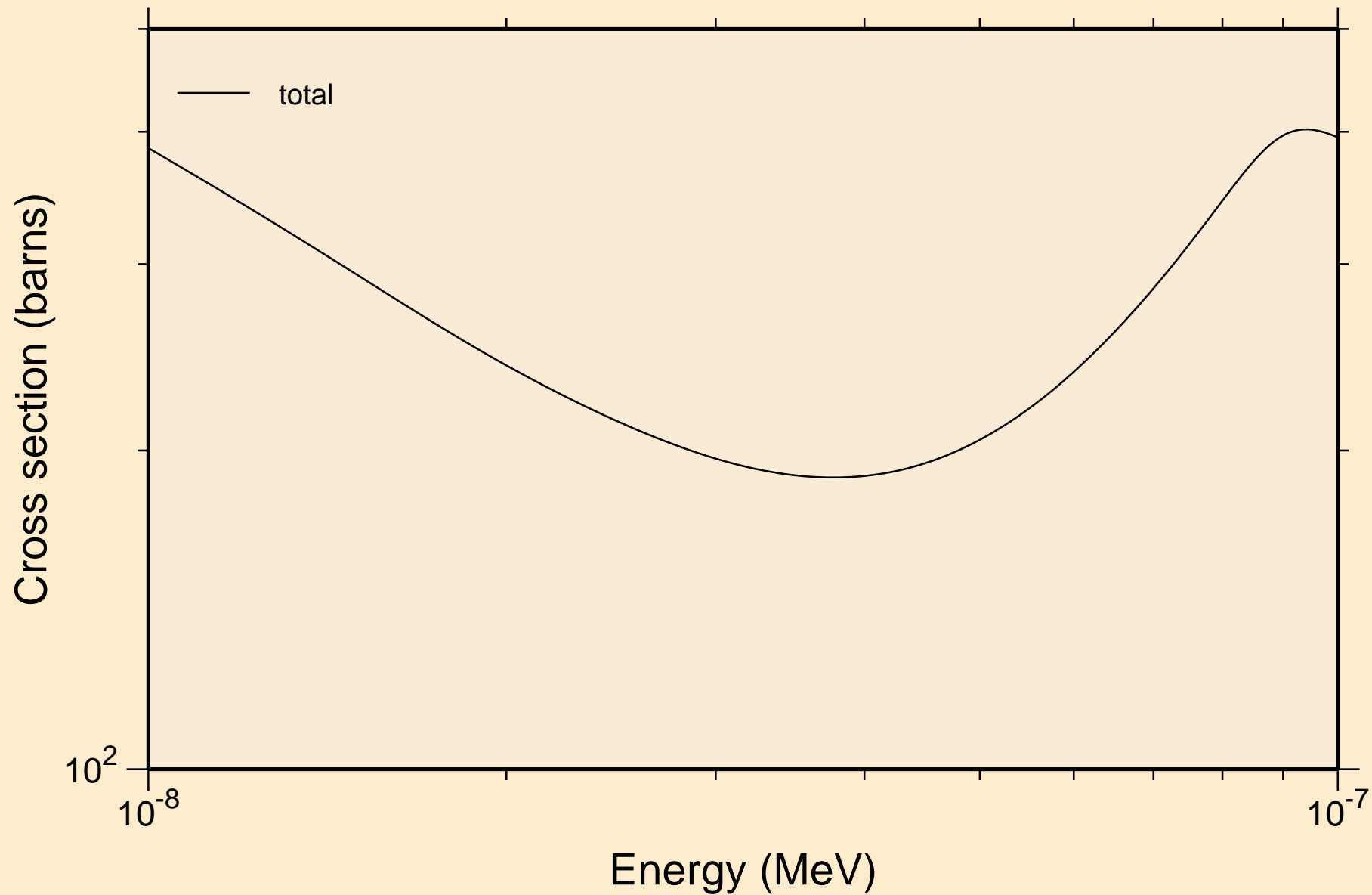

W167 NEUTRON ACER TENDL-2019 LIBRARY; T=293.16K
resonance total cross section

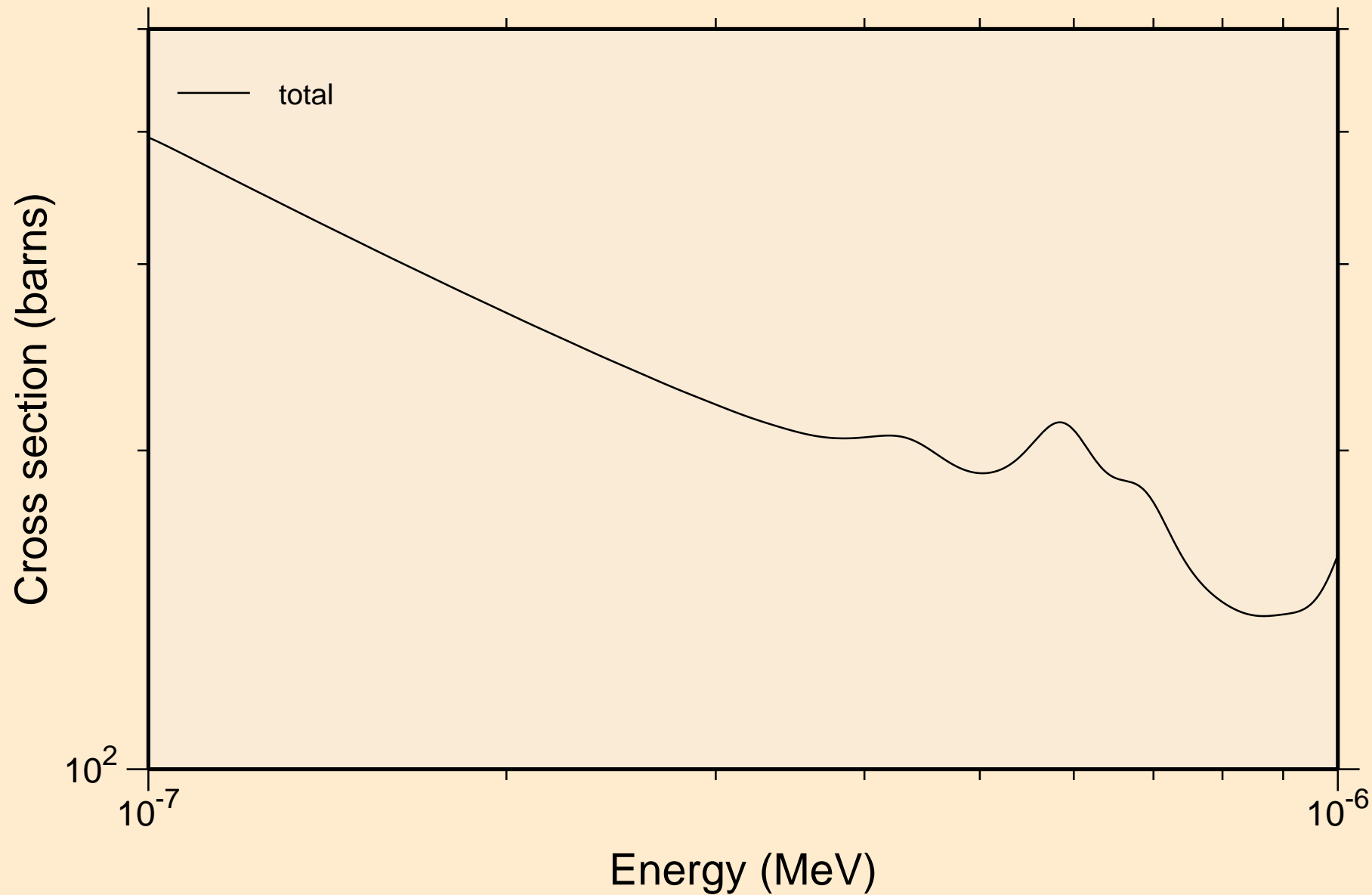

W167 NEUTRON ACER TENDL-2019 LIBRARY; T=293.16K
resonance total cross section

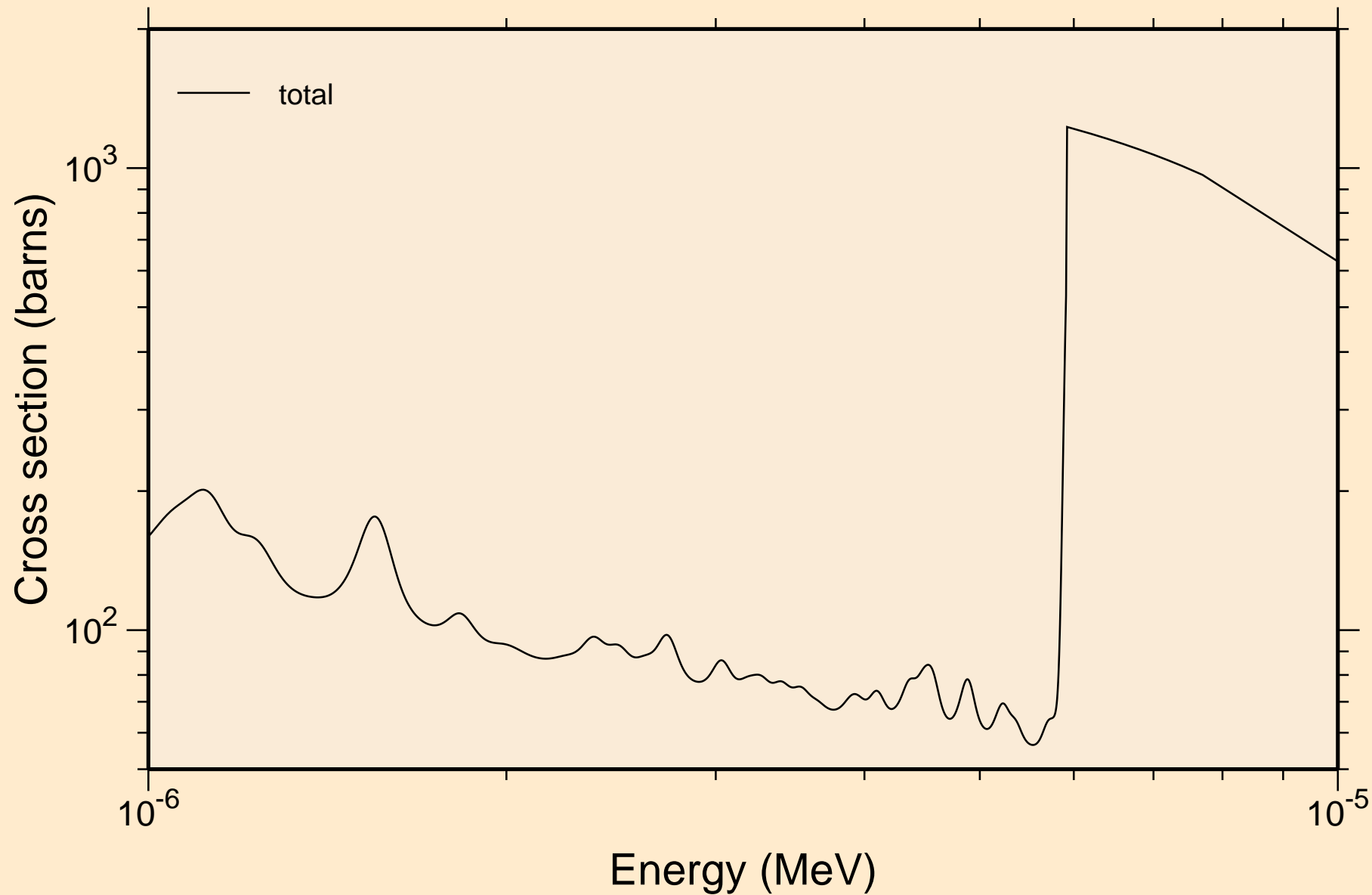

W167 NEUTRON ACER TENDL-2019 LIBRARY; T=293.16K
resonance total cross section

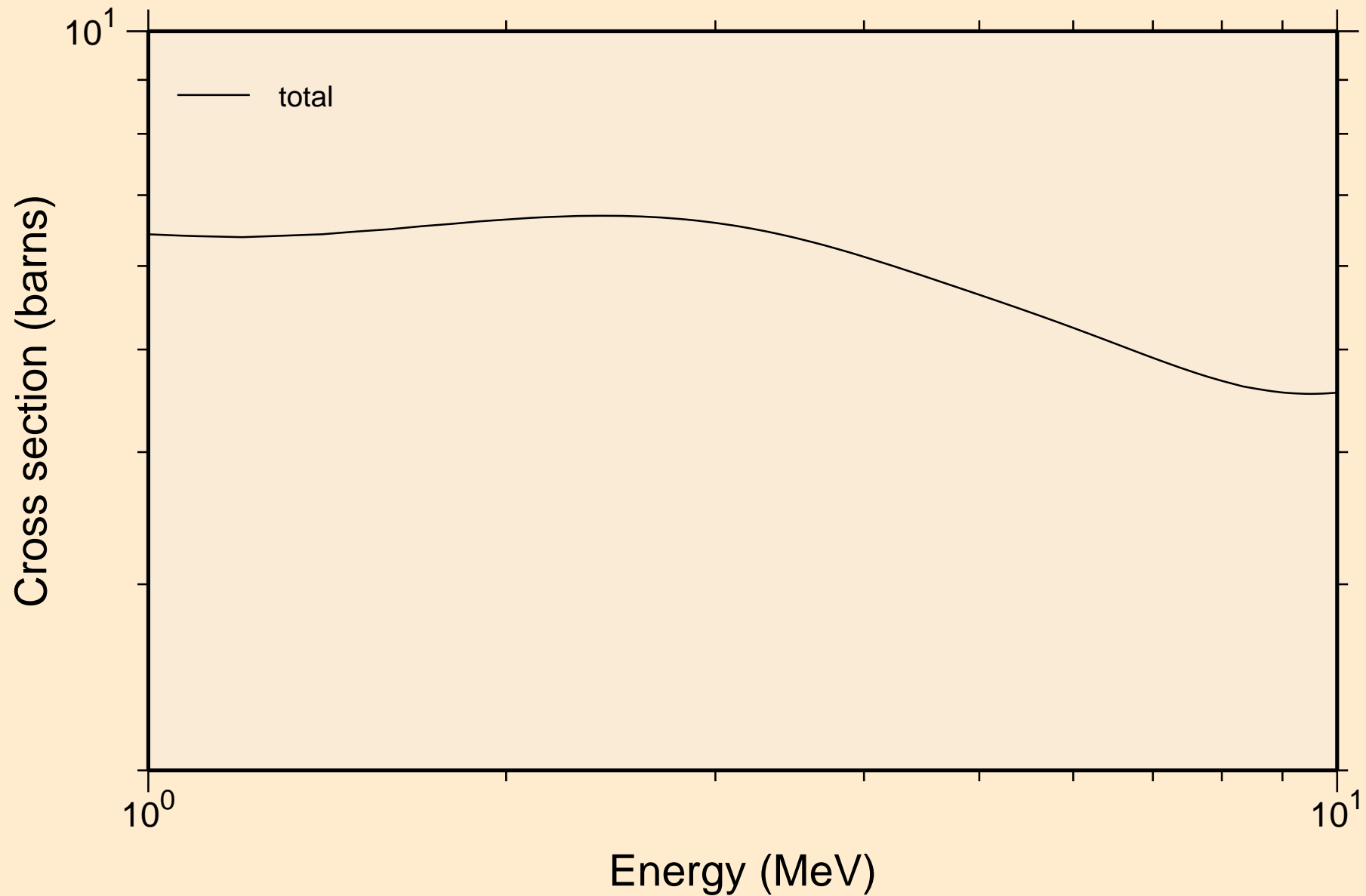

W167 NEUTRON ACER TENDL-2019 LIBRARY; T=293.16K
resonance absorption cross sections

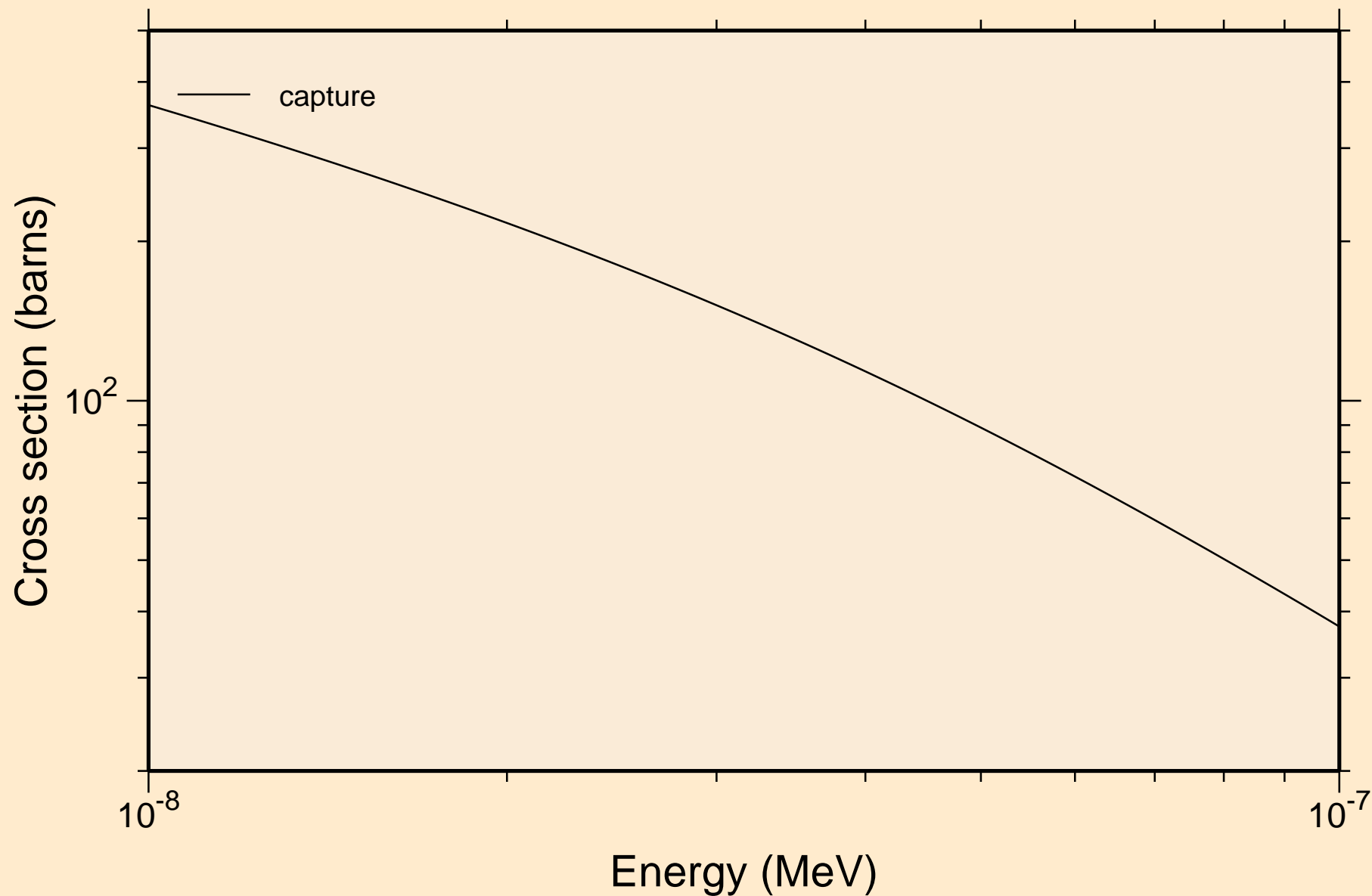

W167 NEUTRON ACER TENDL-2019 LIBRARY; T=293.16K
resonance absorption cross sections

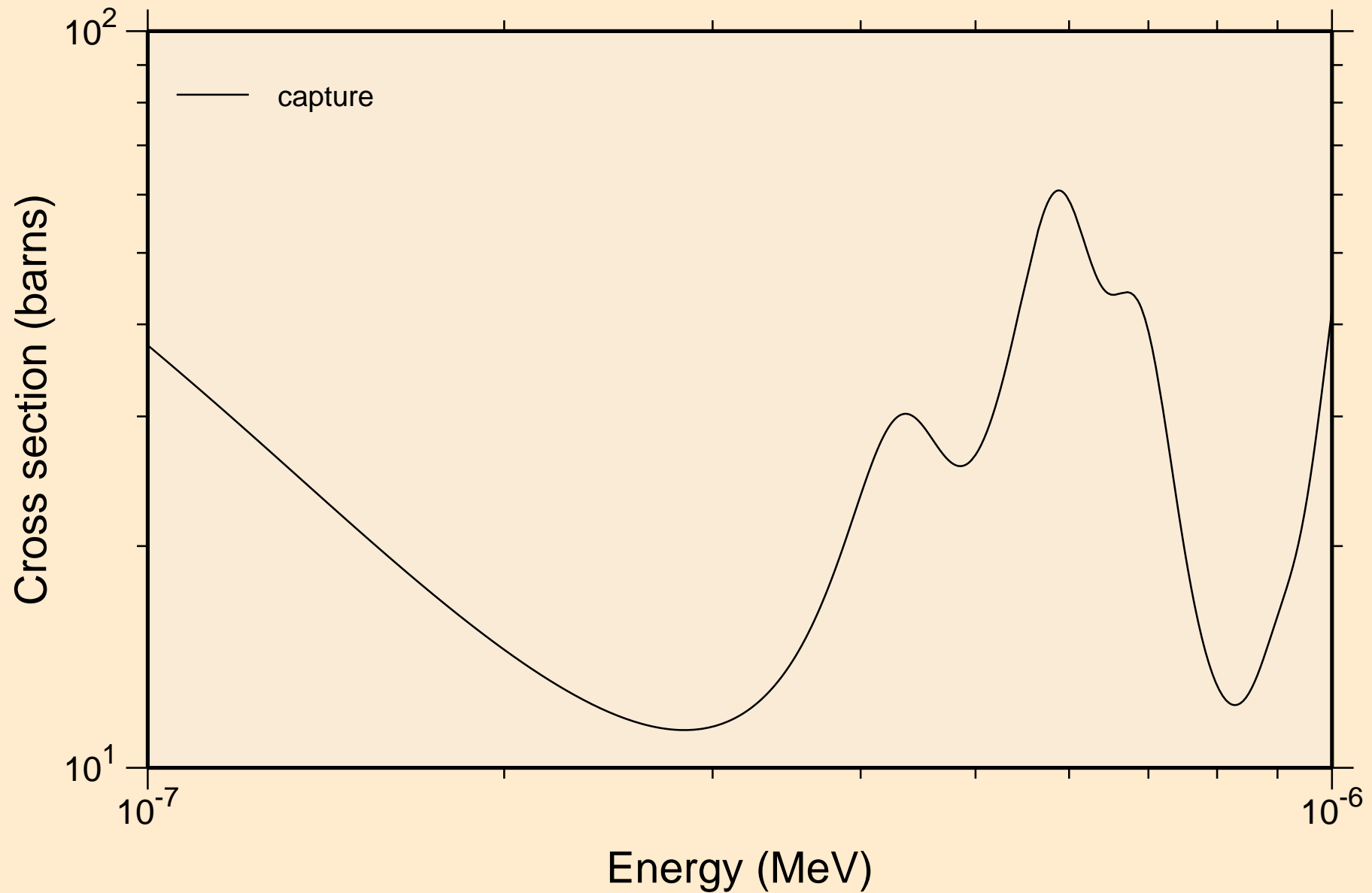

W167 NEUTRON ACER TENDL-2019 LIBRARY; T=293.16K
resonance absorption cross sections

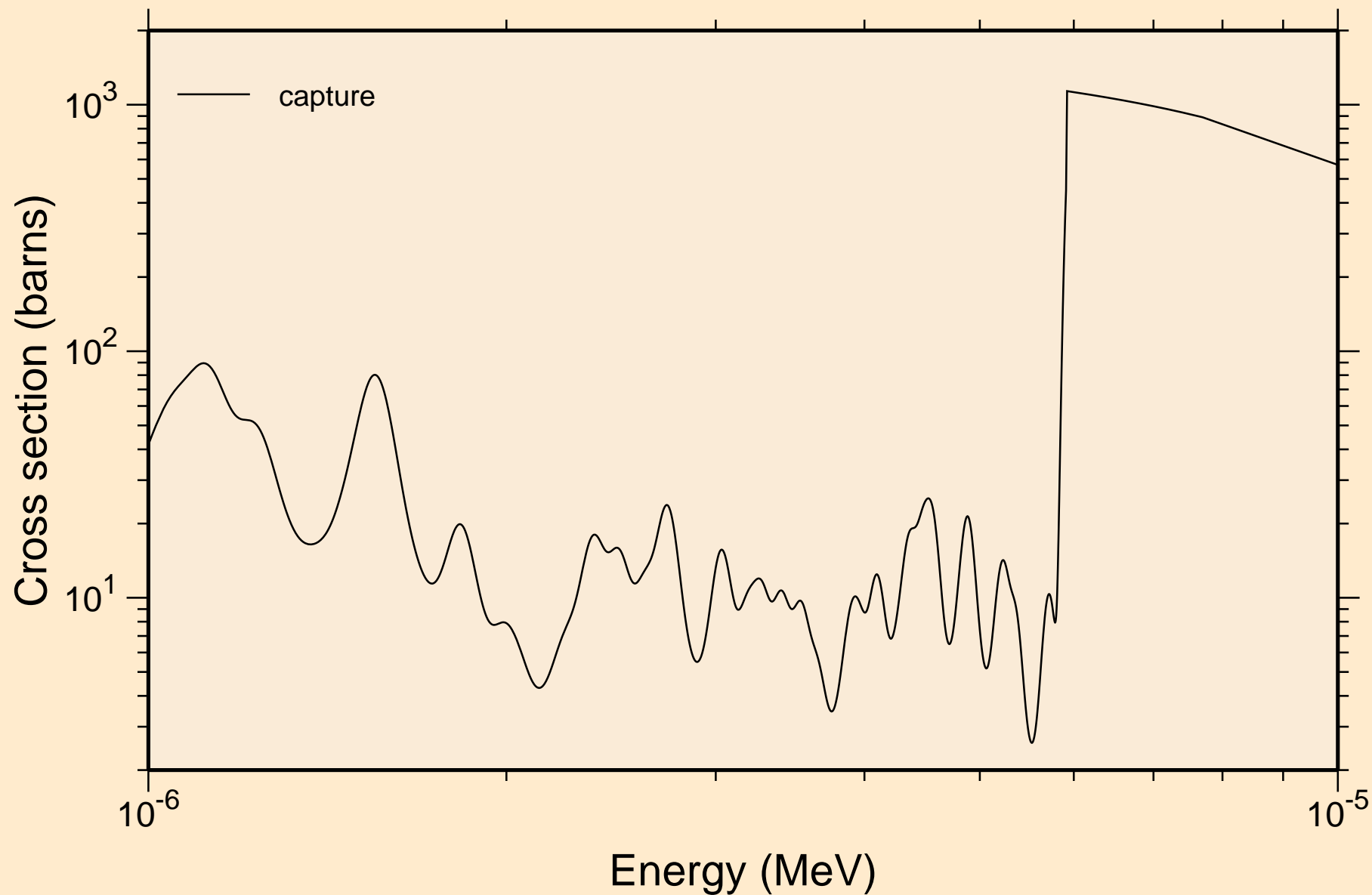

W167 NEUTRON ACER TENDL-2019 LIBRARY; T=293.16K
resonance absorption cross sections

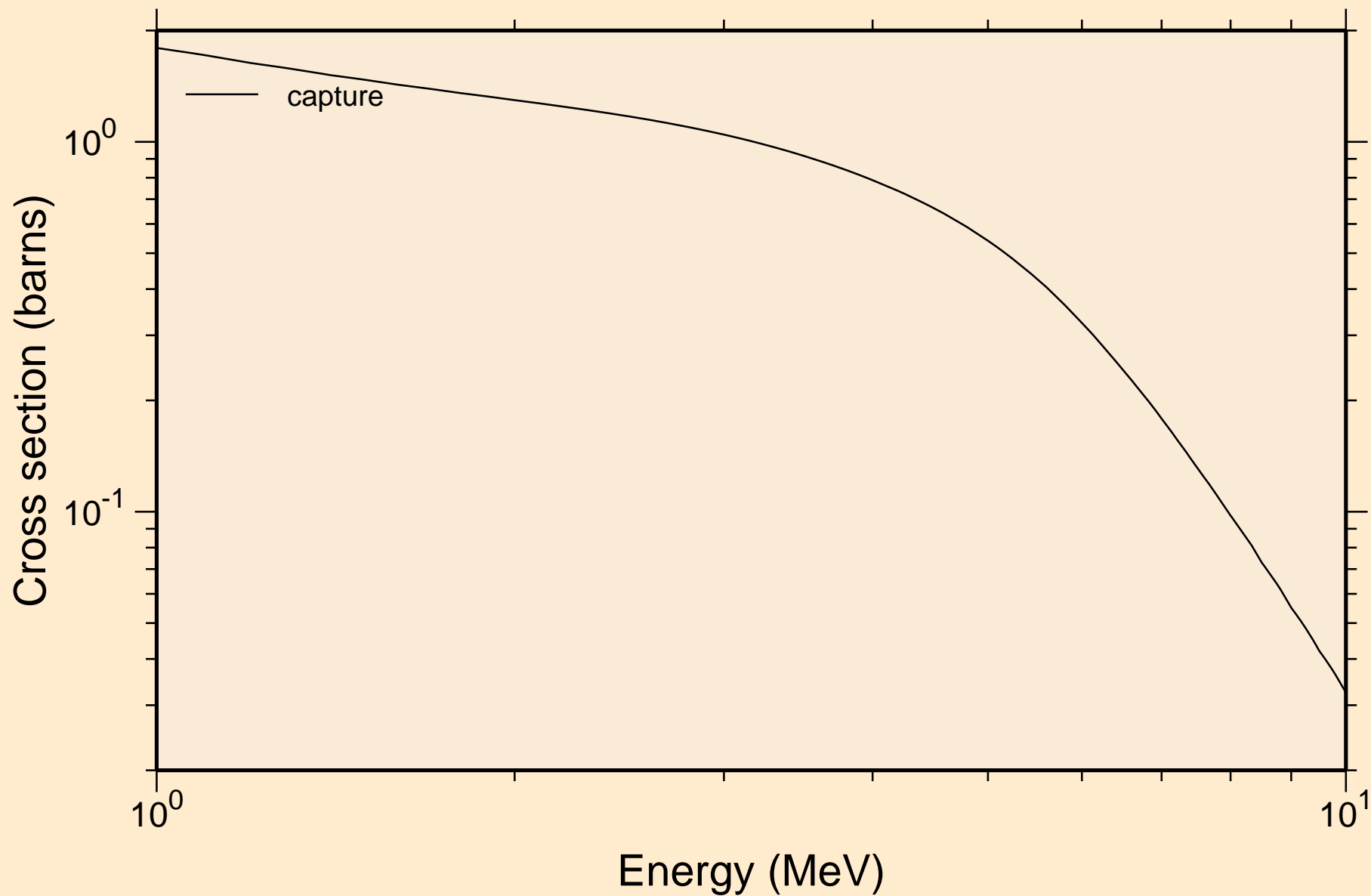

W167 NEUTRON ACER TENDL-2019 LIBRARY; T=293.16K
Heating

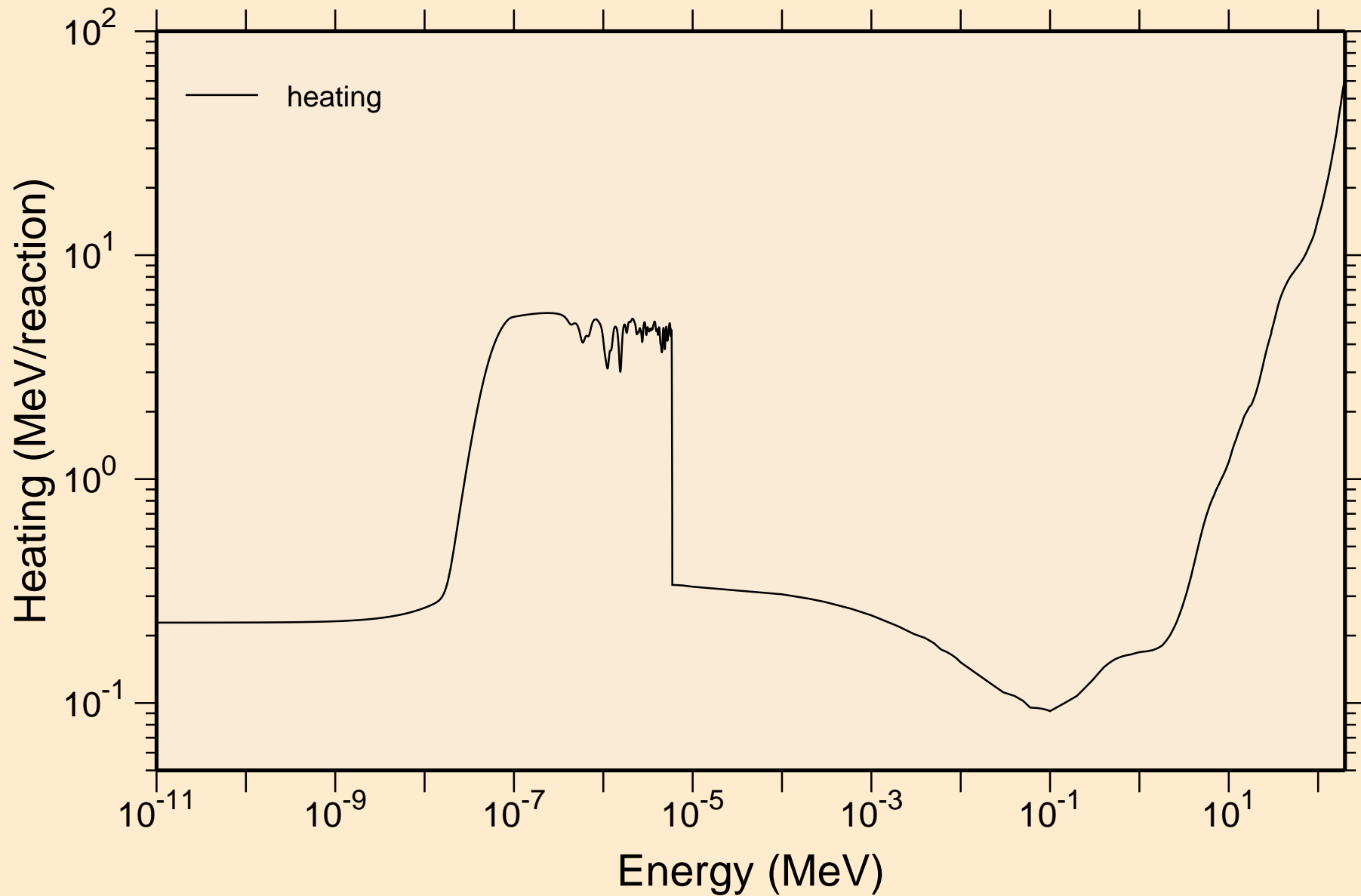

W167 NEUTRON ACER TENDL-2019 LIBRARY; T=293.16K
Damage

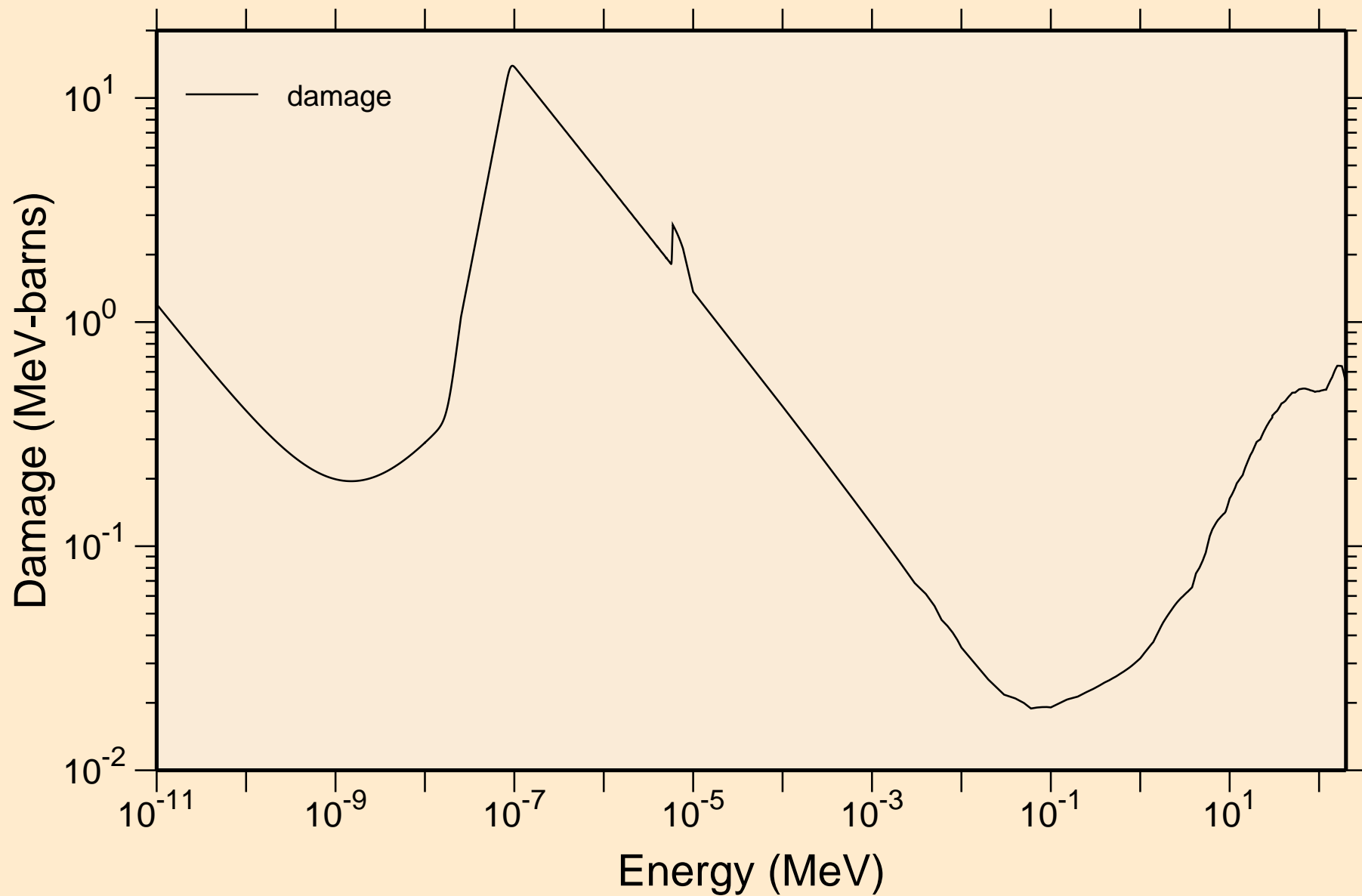

W167 NEUTRON ACER TENDL-2019 LIBRARY; T=293.16K
Non-threshold reactions

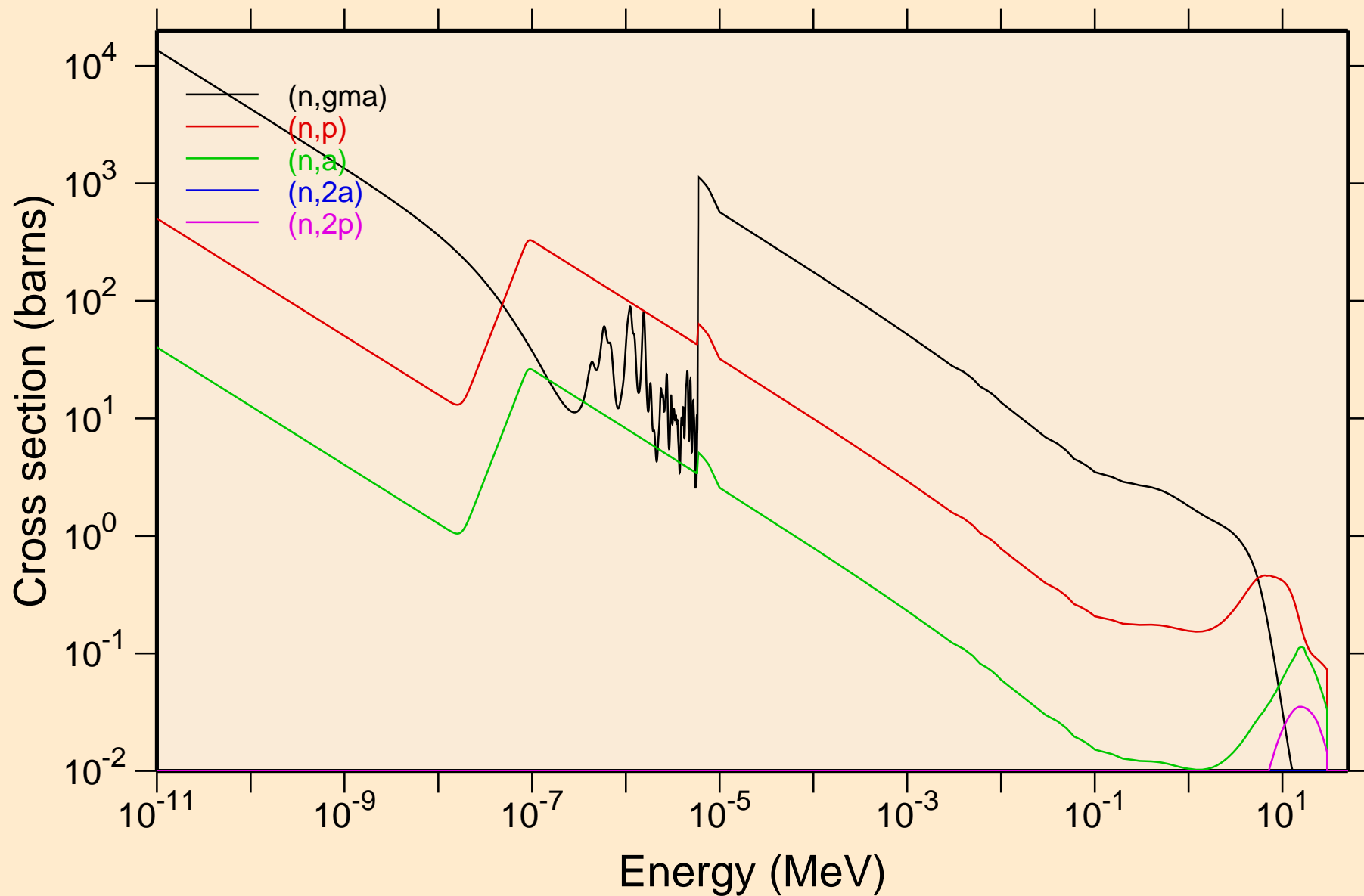

W167 NEUTRON ACER TENDL-2019 LIBRARY; T=293.16K
Non-threshold reactions

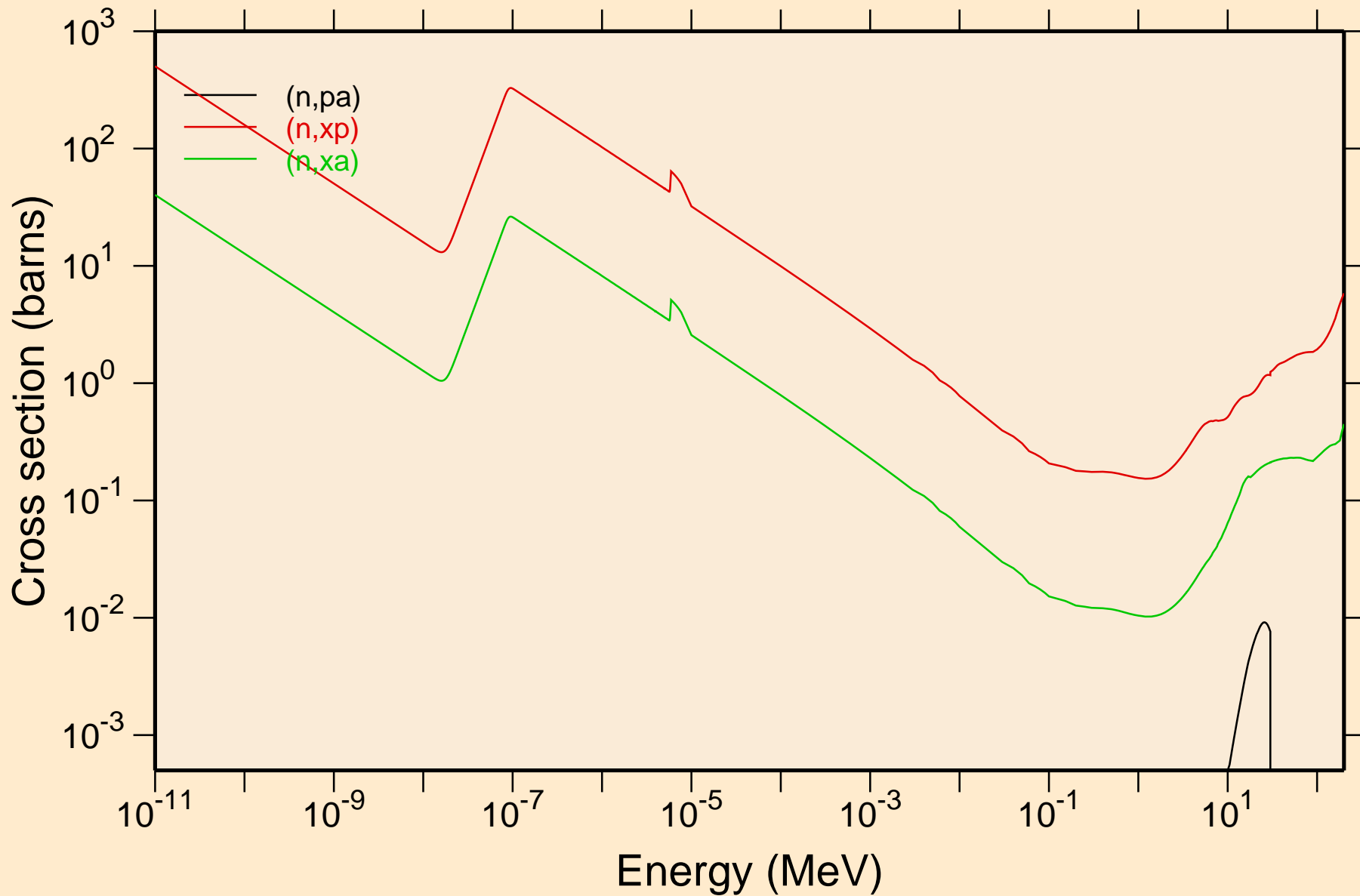

W167 NEUTRON ACER TENDL-2019 LIBRARY; T=293.16K
Principal cross sections

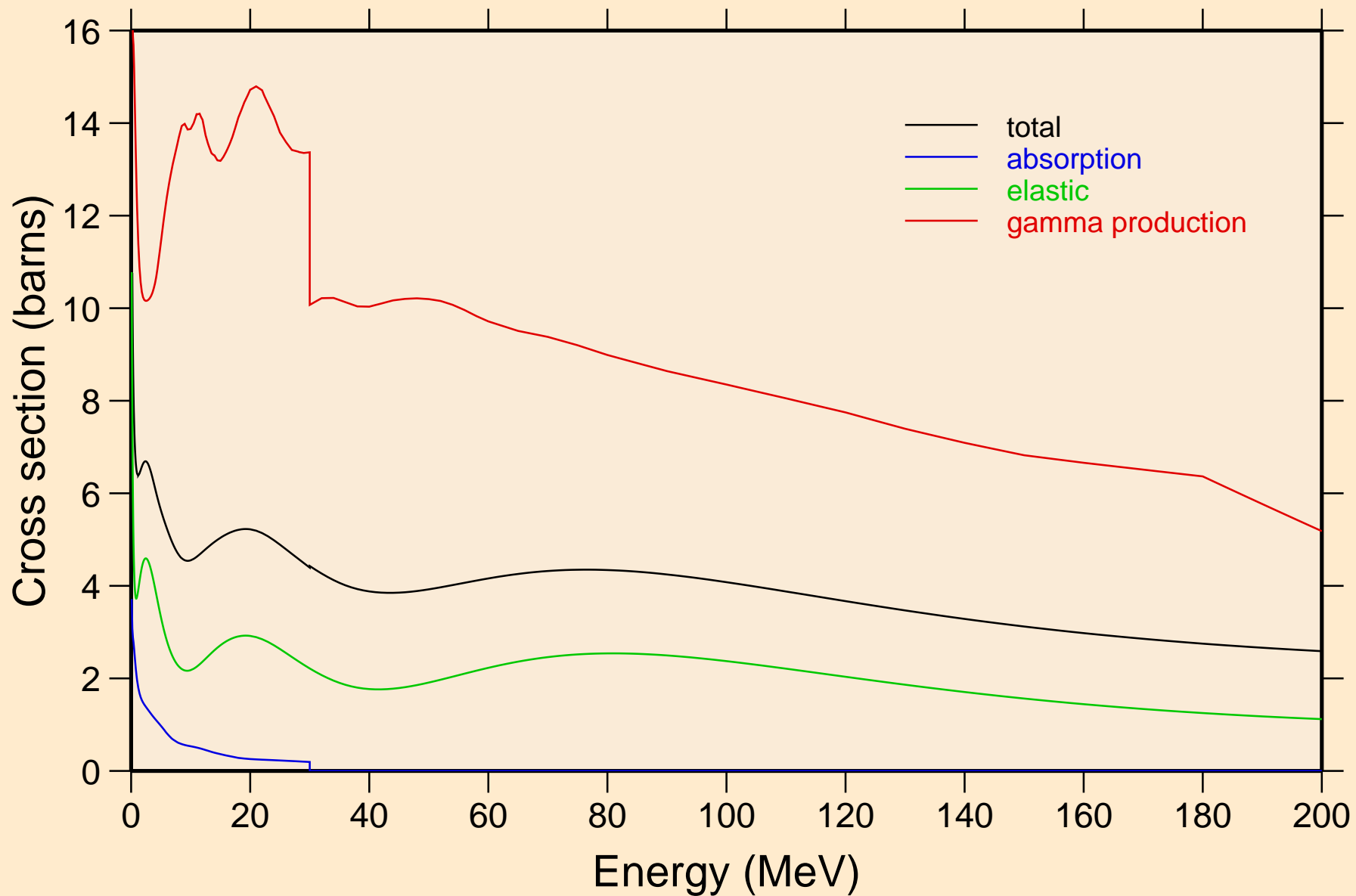

W167 NEUTRON ACER TENDL-2019 LIBRARY; T=293.16K
Heating

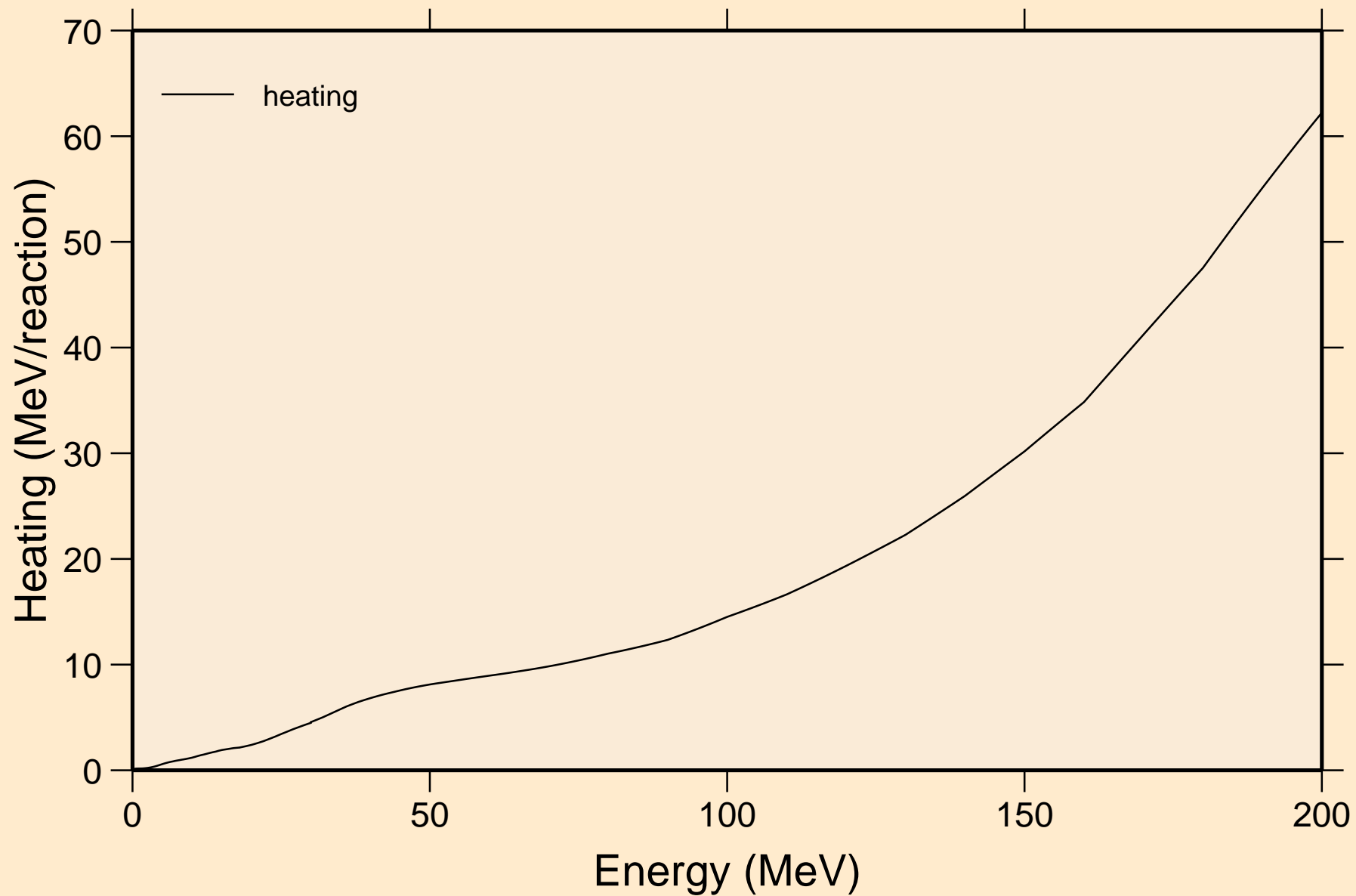

W167 NEUTRON ACER TENDL-2019 LIBRARY; T=293.16K
Damage

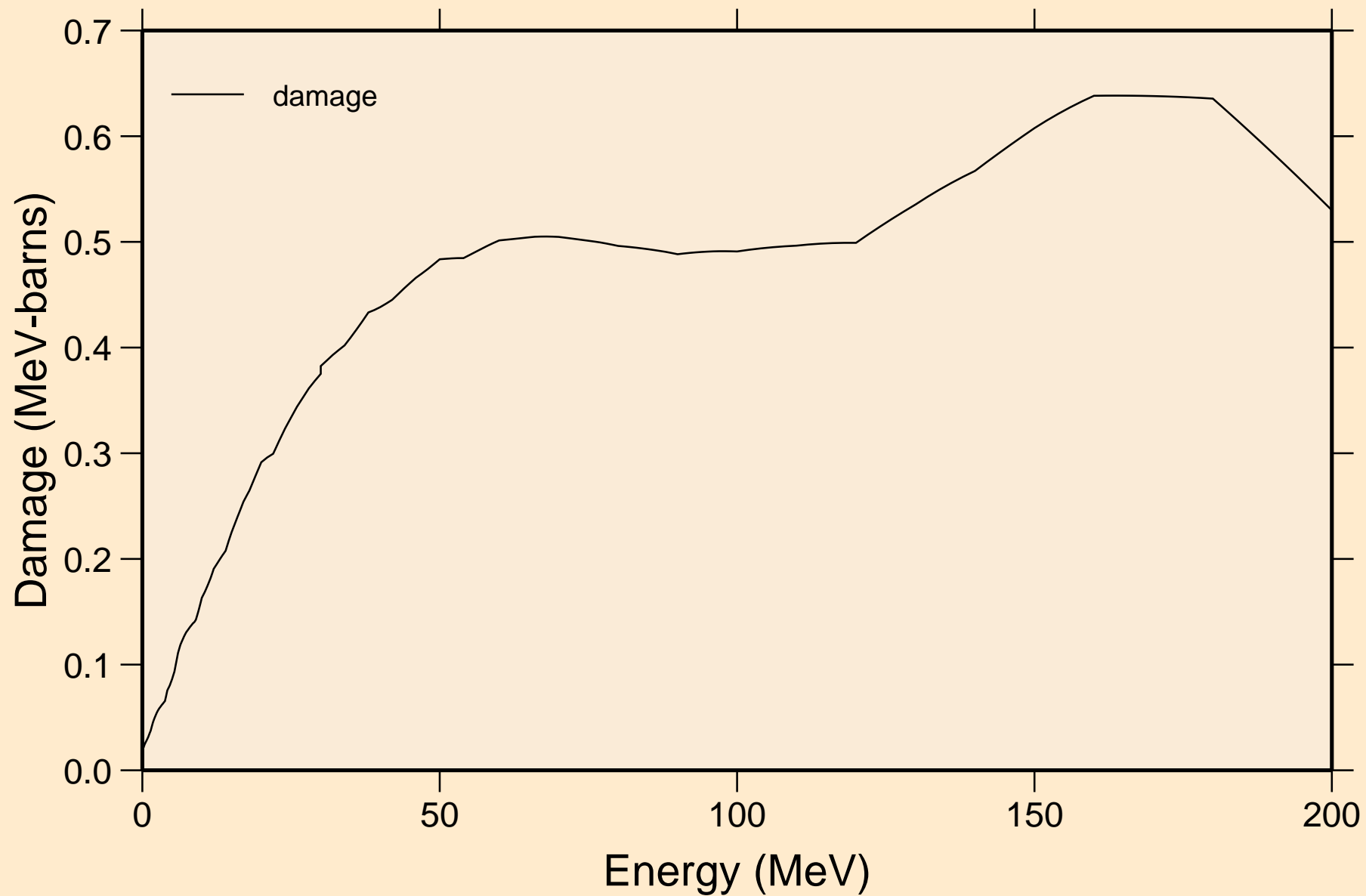

W167 NEUTRON ACER TENDL-2019 LIBRARY; T=293.16K
Non-threshold reactions

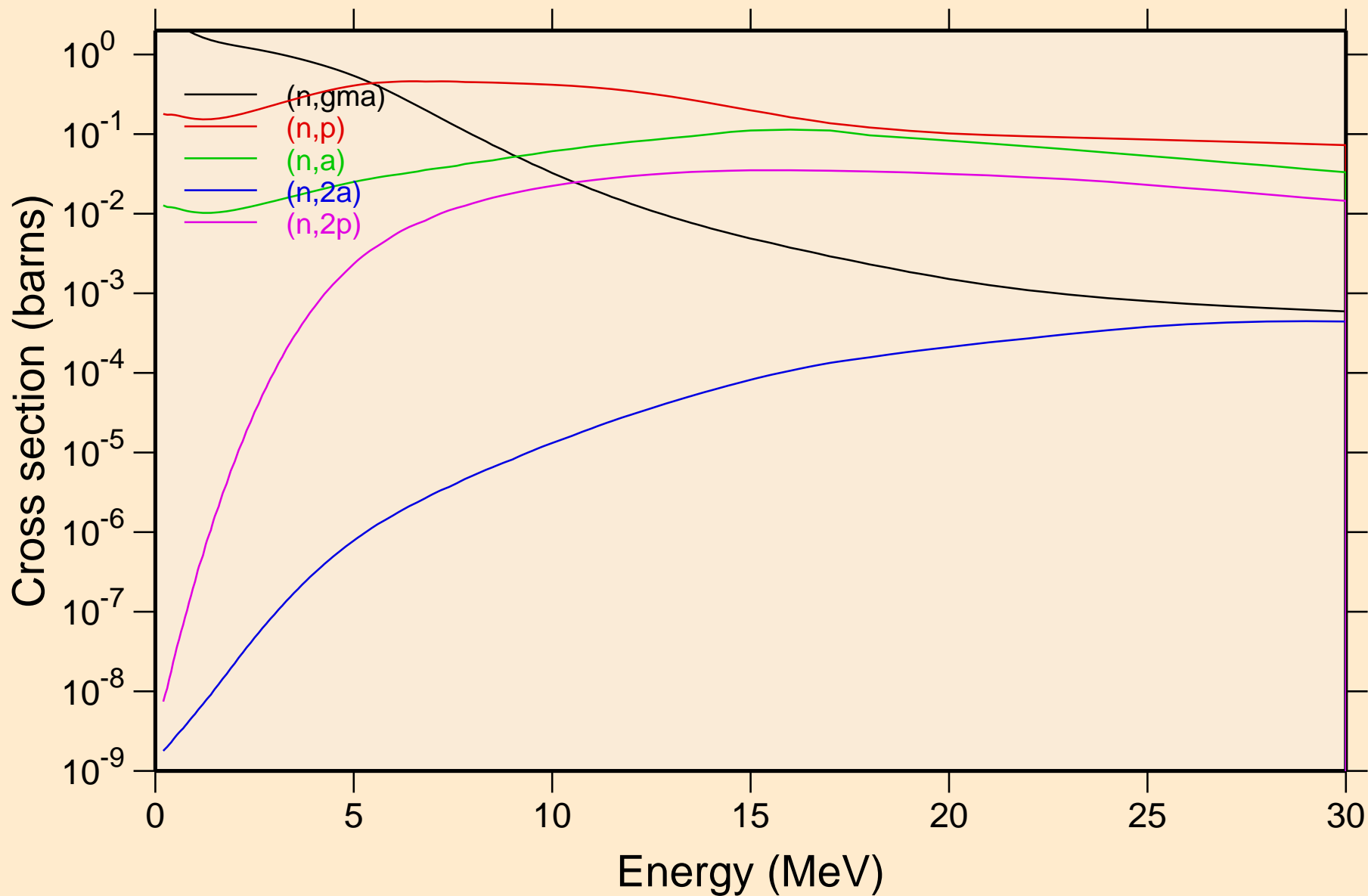

W167 NEUTRON ACER TENDL-2019 LIBRARY; T=293.16K
Non-threshold reactions

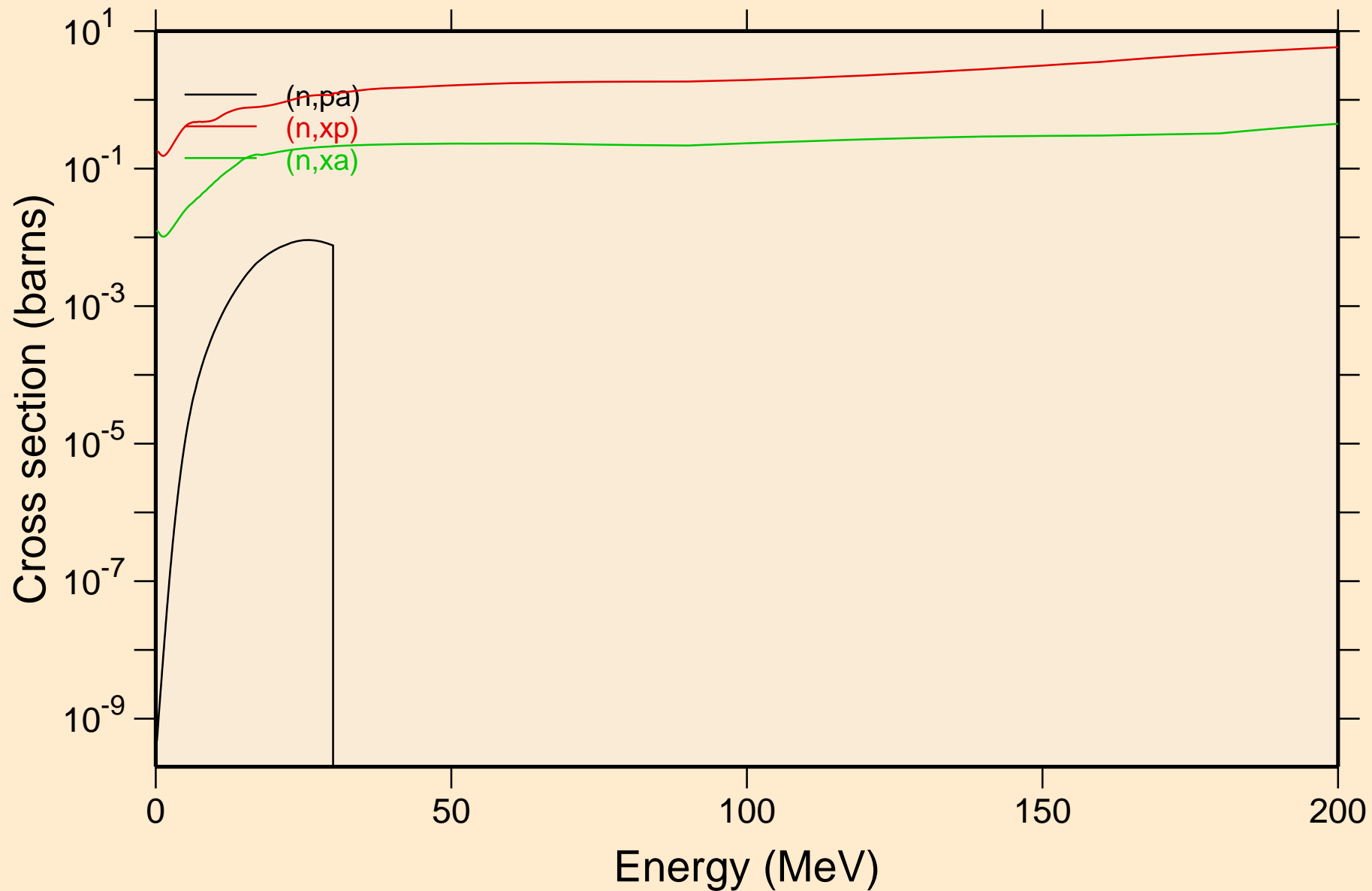

W167 NEUTRON ACER TENDL-2019 LIBRARY; T=293.16K
Inelastic levels

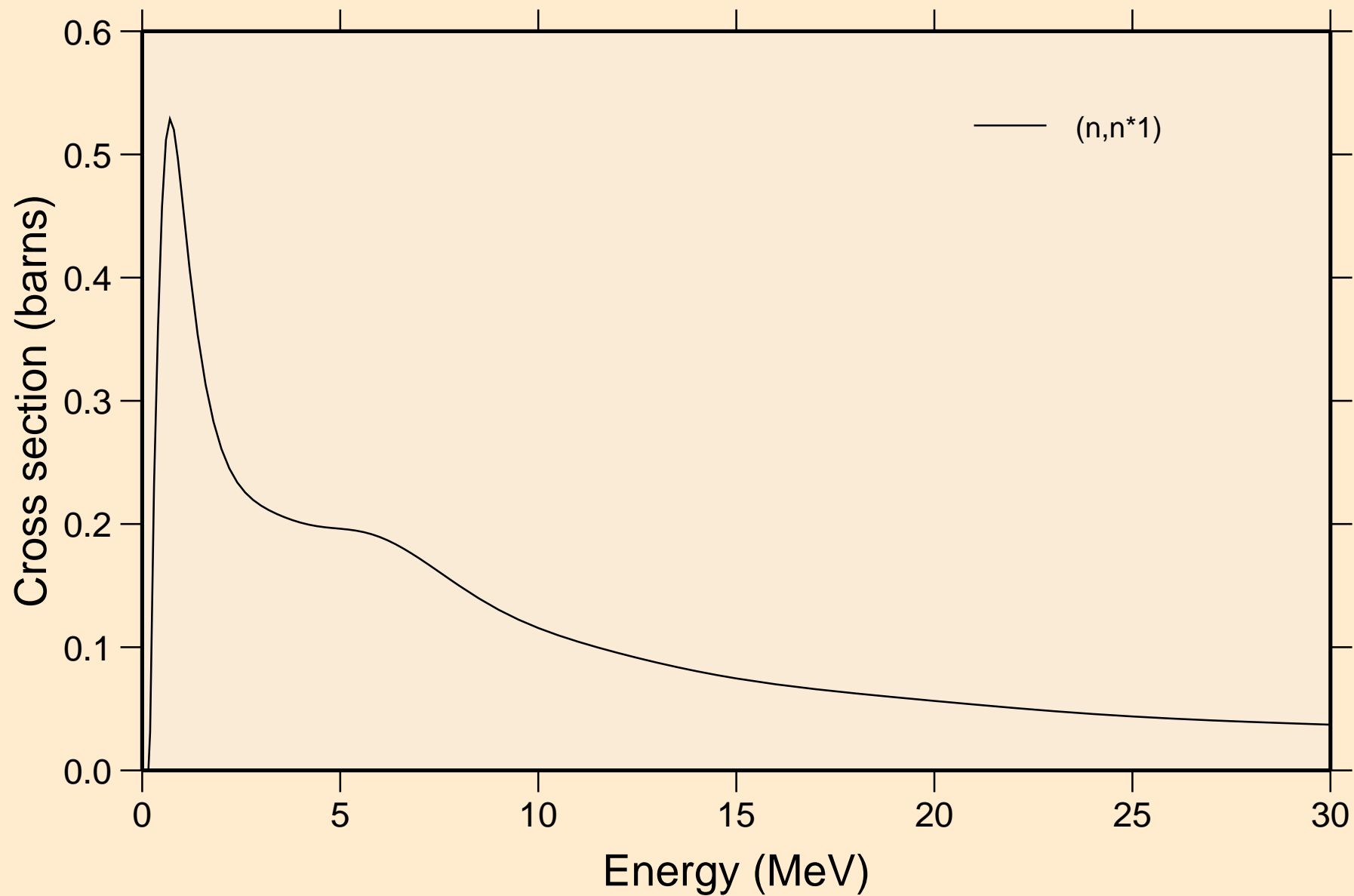

W167 NEUTRON ACER TENDL-2019 LIBRARY; T=293.16K
Threshold reactions

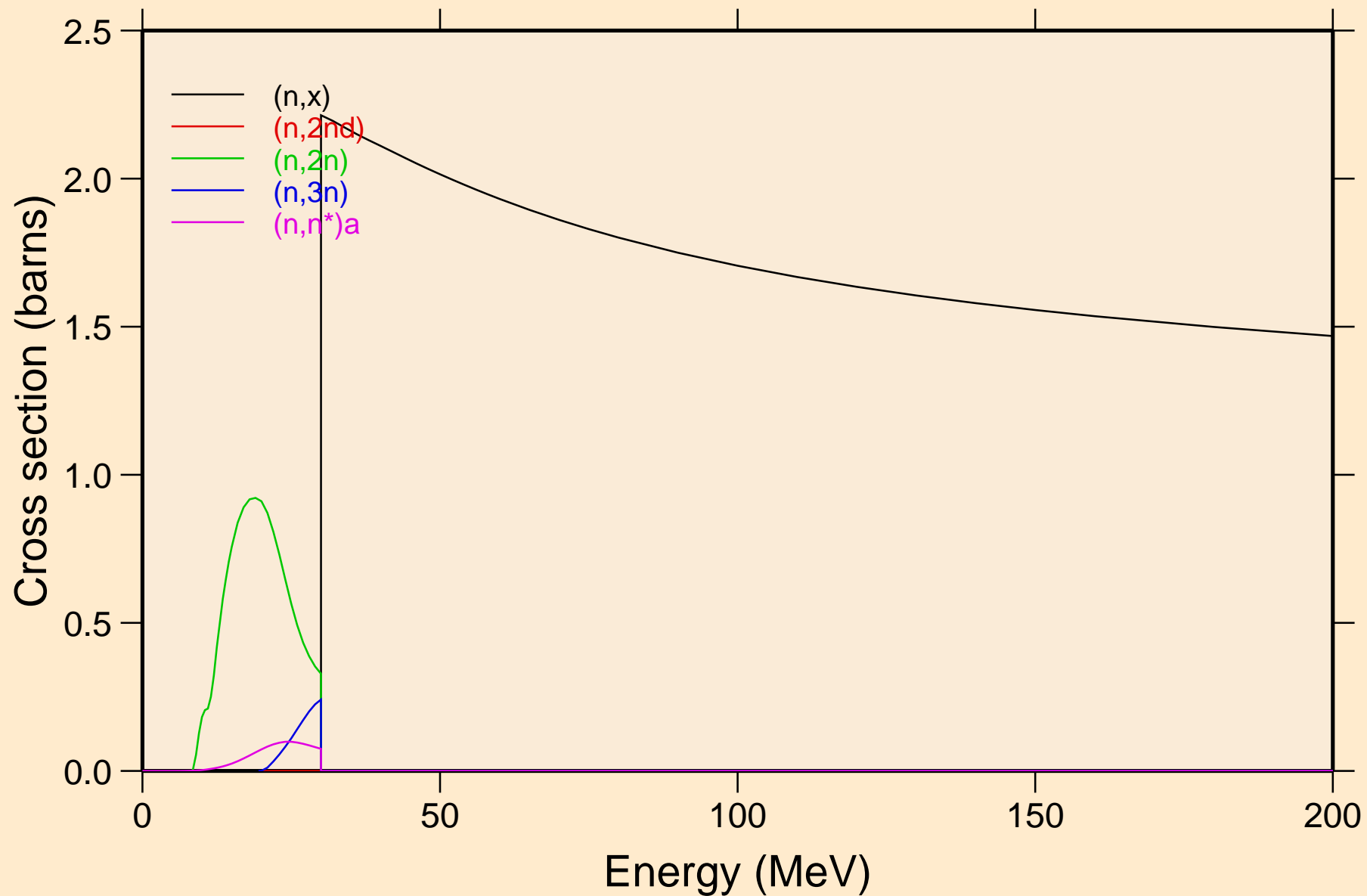

W167 NEUTRON ACER TENDL-2019 LIBRARY; T=293.16K
Threshold reactions

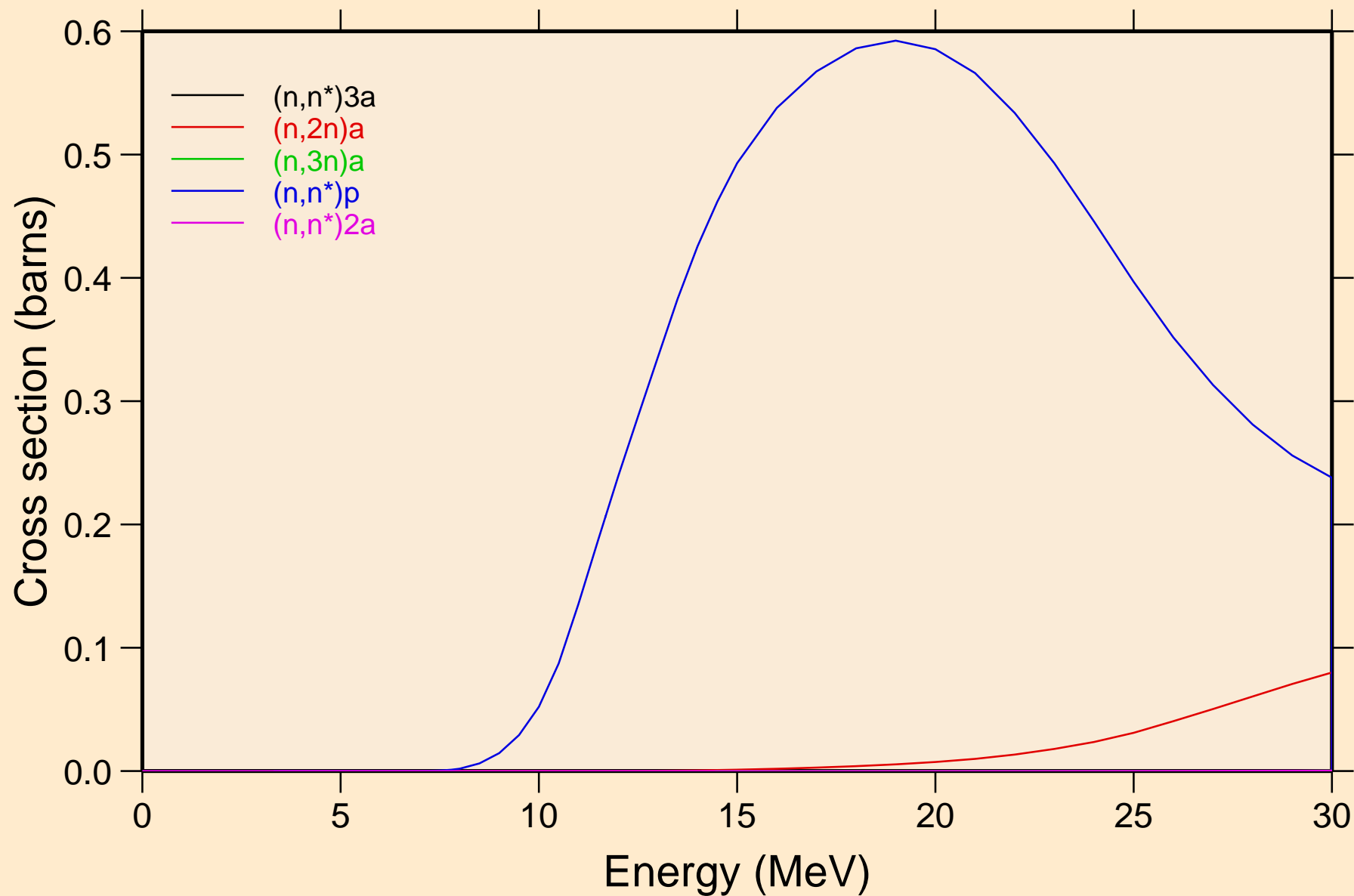

W167 NEUTRON ACER TENDL-2019 LIBRARY; T=293.16K
Threshold reactions

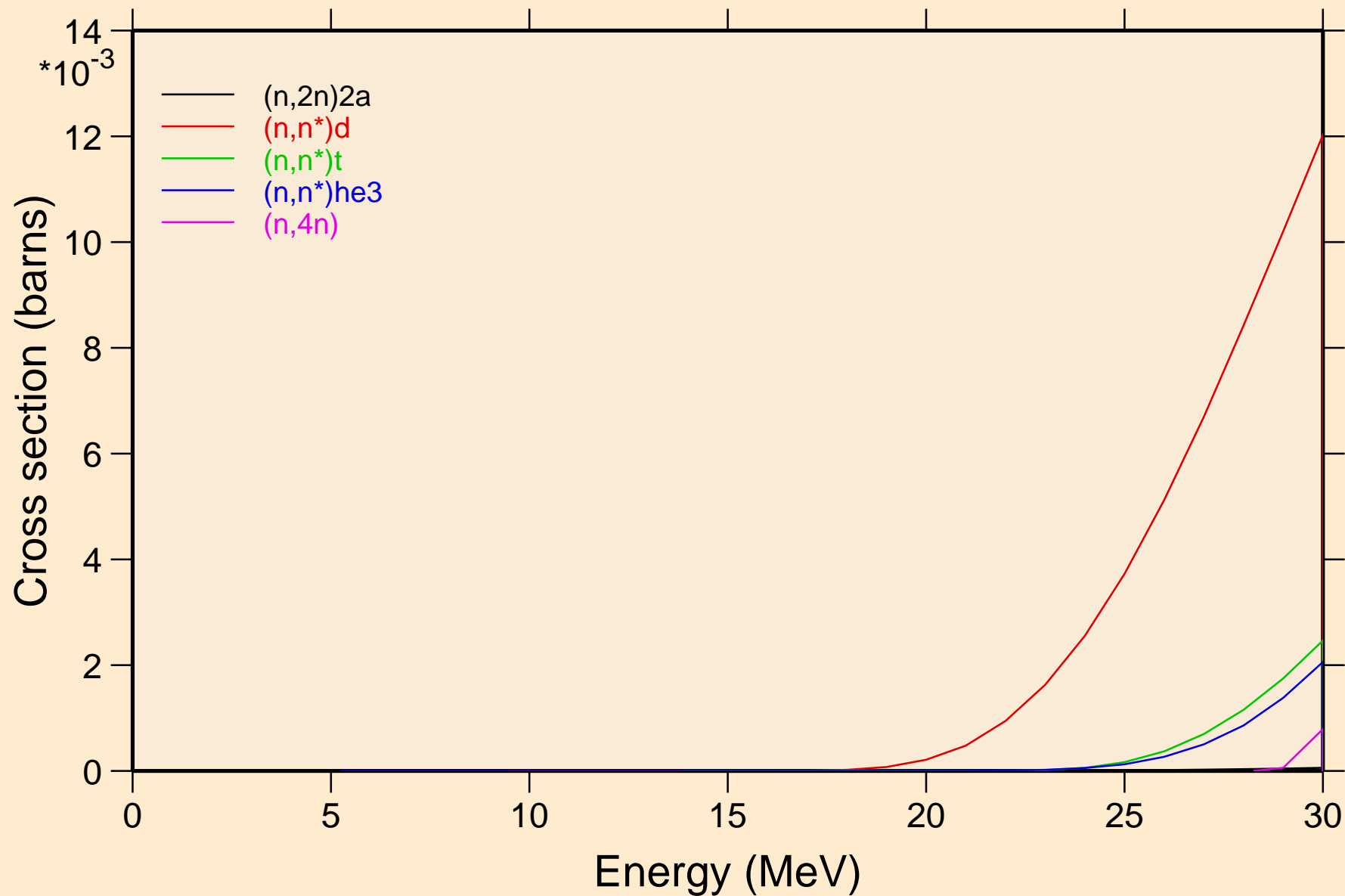

W167 NEUTRON ACER TENDL-2019 LIBRARY; T=293.16K
Threshold reactions

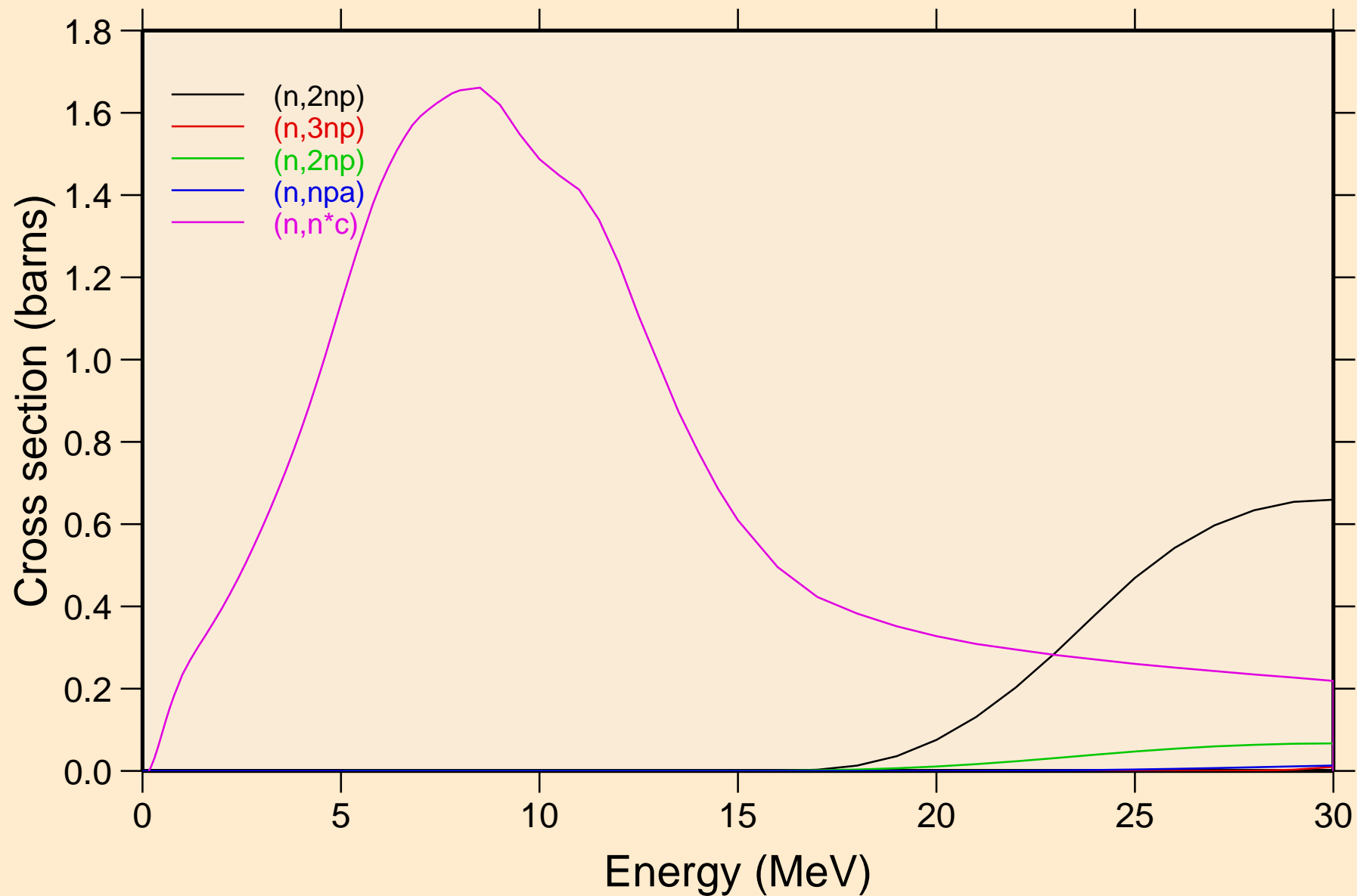

W167 NEUTRON ACER TENDL-2019 LIBRARY; T=293.16K
Threshold reactions

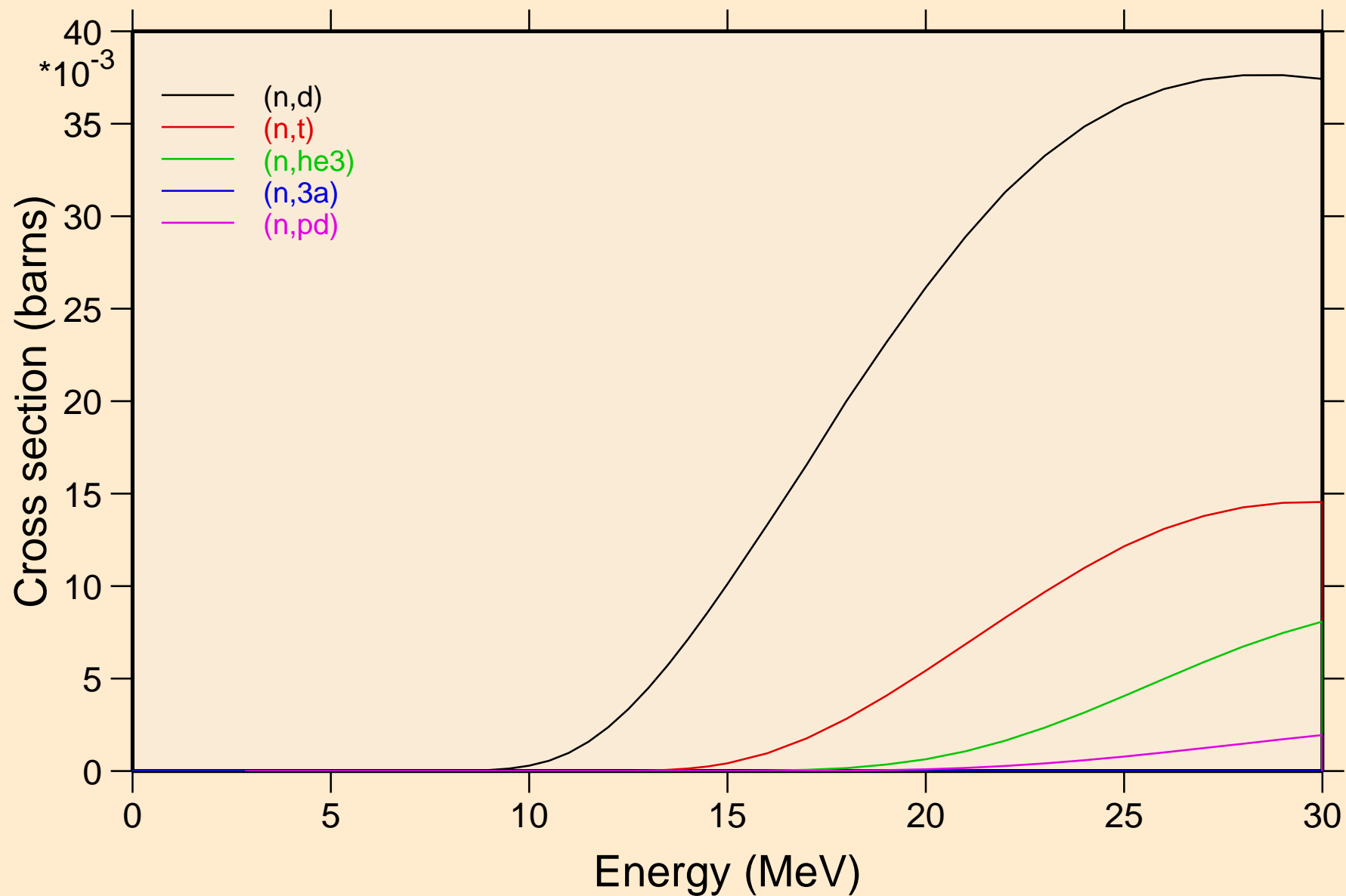

W167 NEUTRON ACER TENDL-2019 LIBRARY; T=293.16K
Threshold reactions

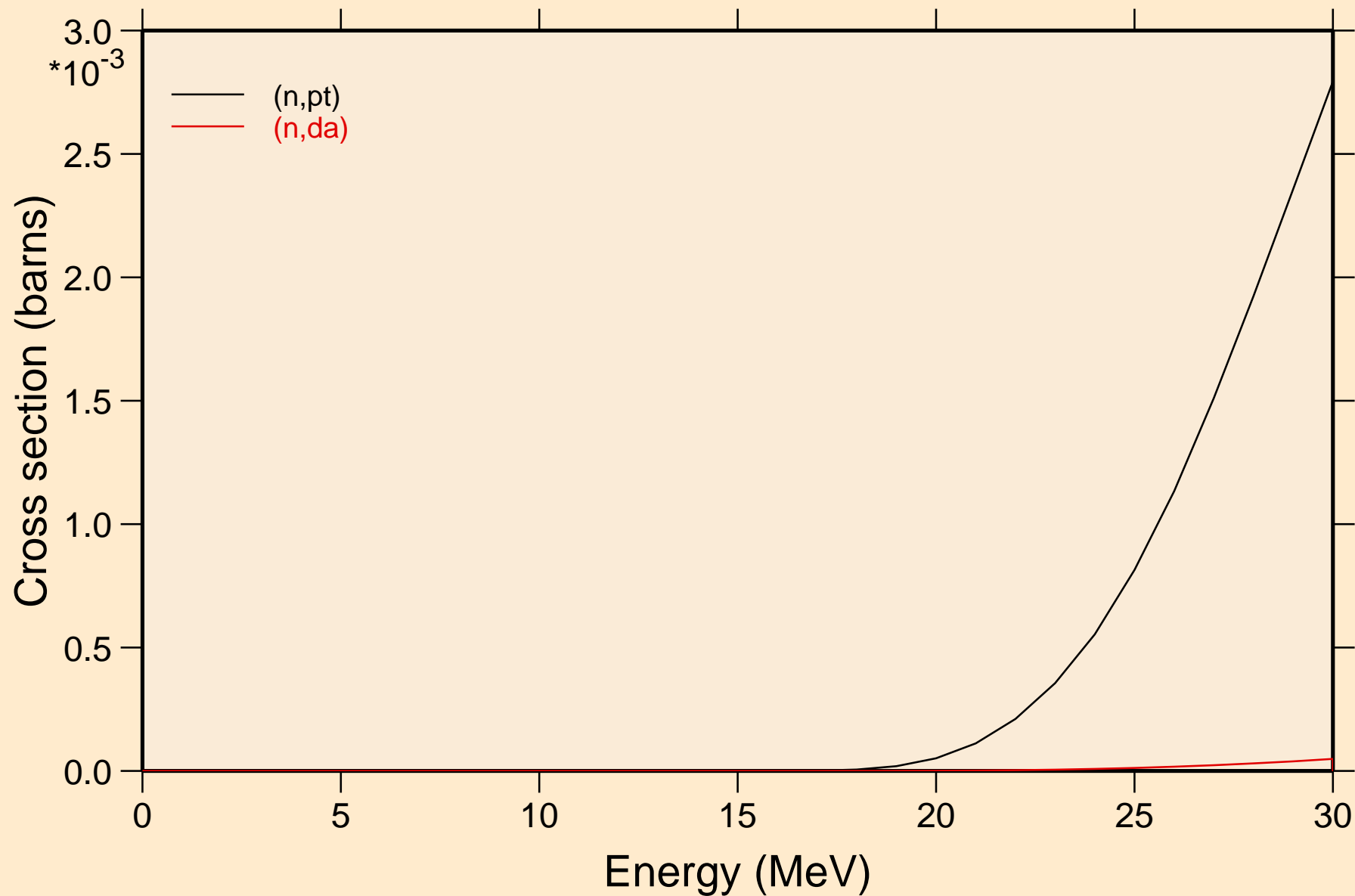

W167 NEUTRON ACER TENDL-2019 LIBRARY; T=293.16K
Threshold reactions

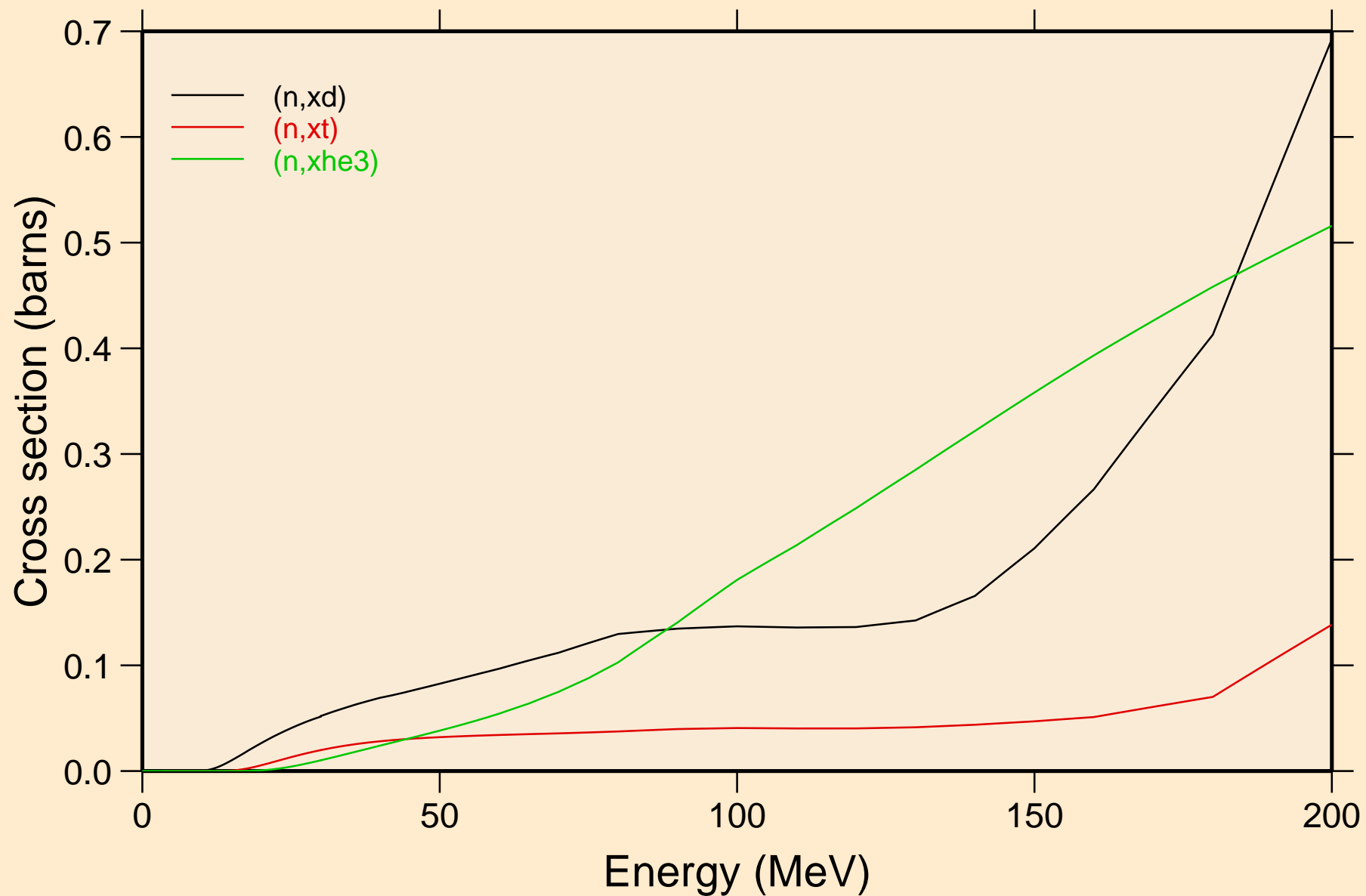

W167 NEUTRON ACER TENDL-2019 LIBRARY; T=293.16K
angular distribution for elastic

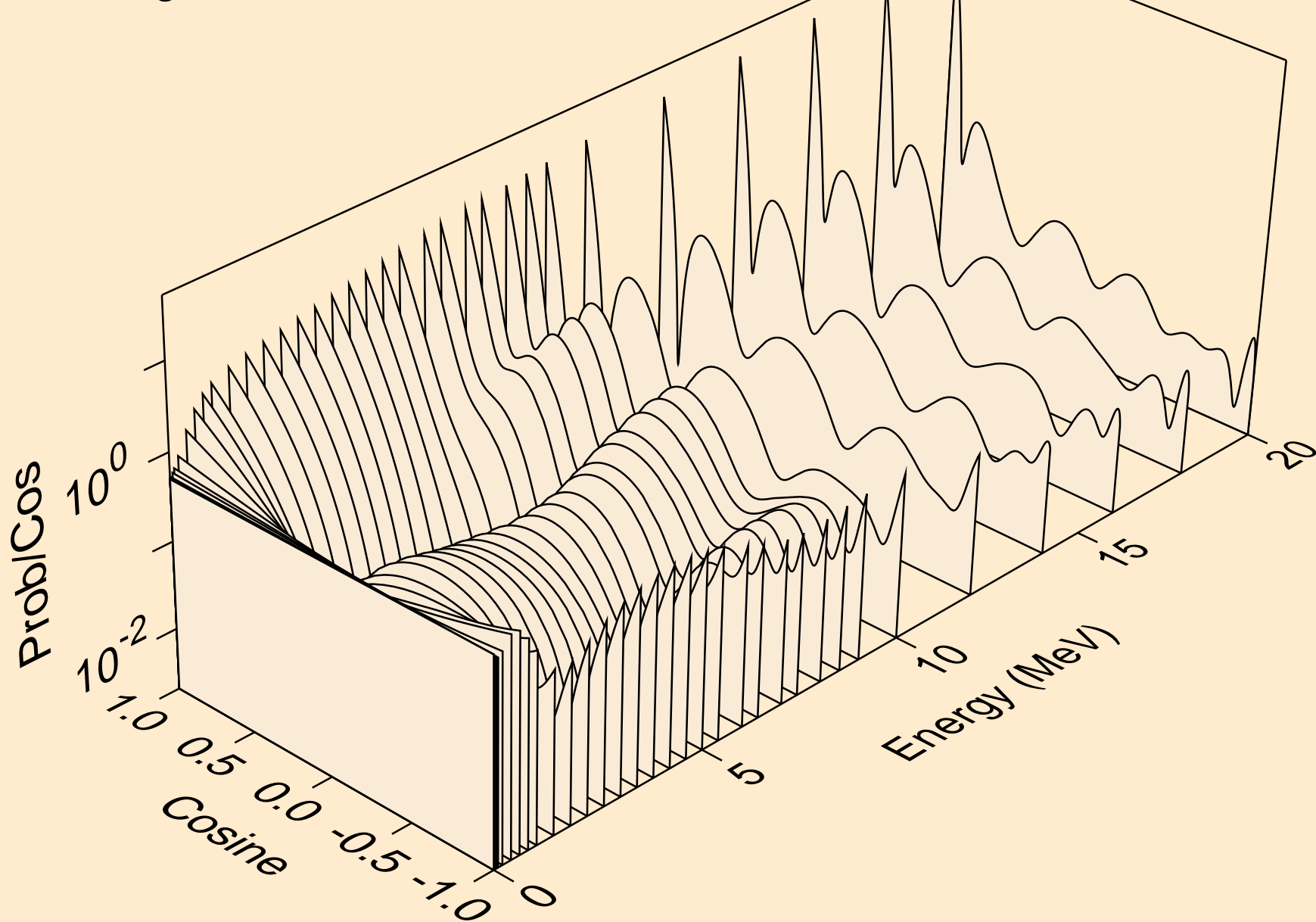

W167 NEUTRON ACER TENDL-2019 LIBRARY; T=293.16K
angular distribution for elastic

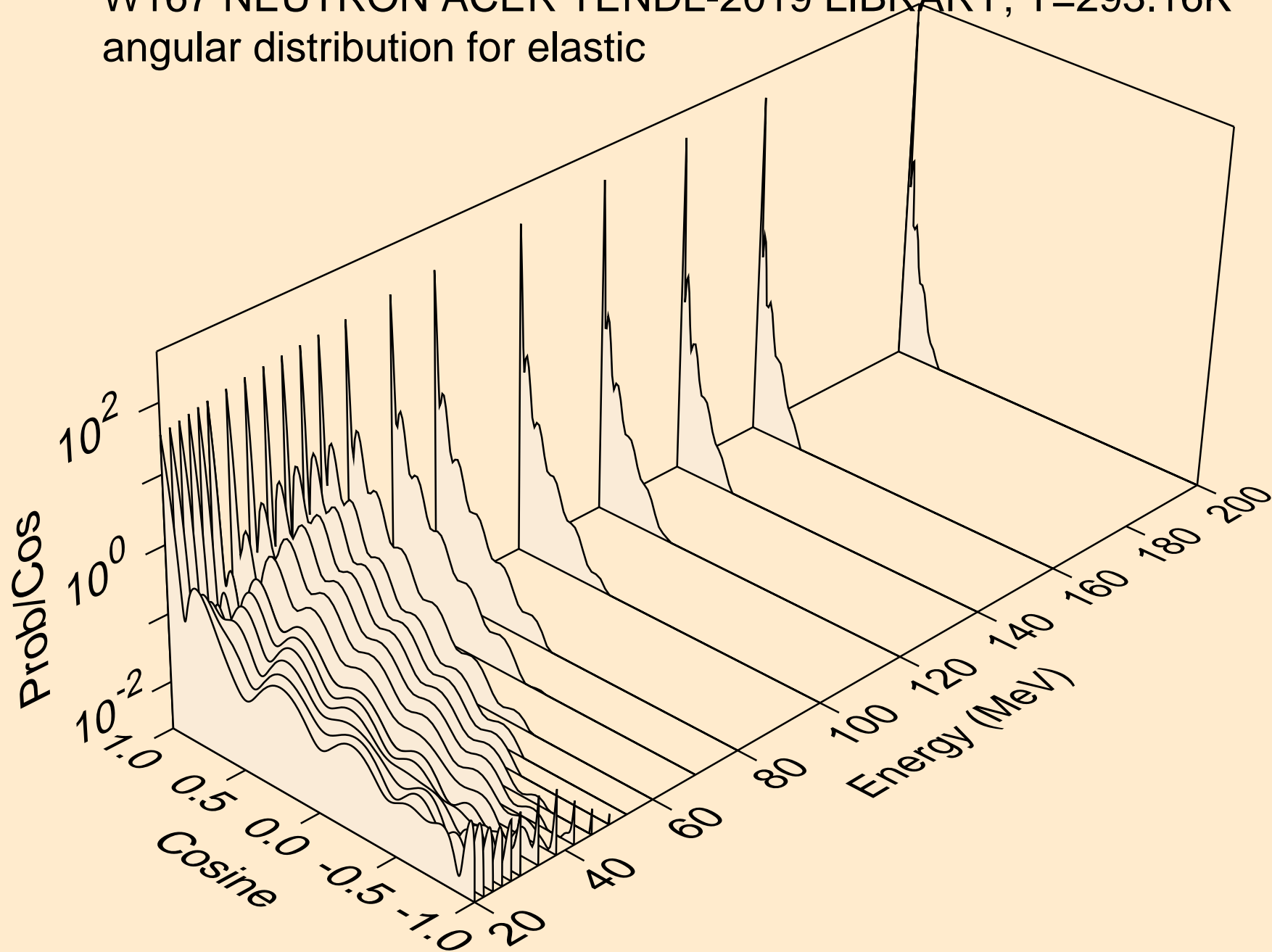

W167 NEUTRON ACER TENDL-2019 LIBRARY; T=293.16K
angular distribution for (n,n*1)

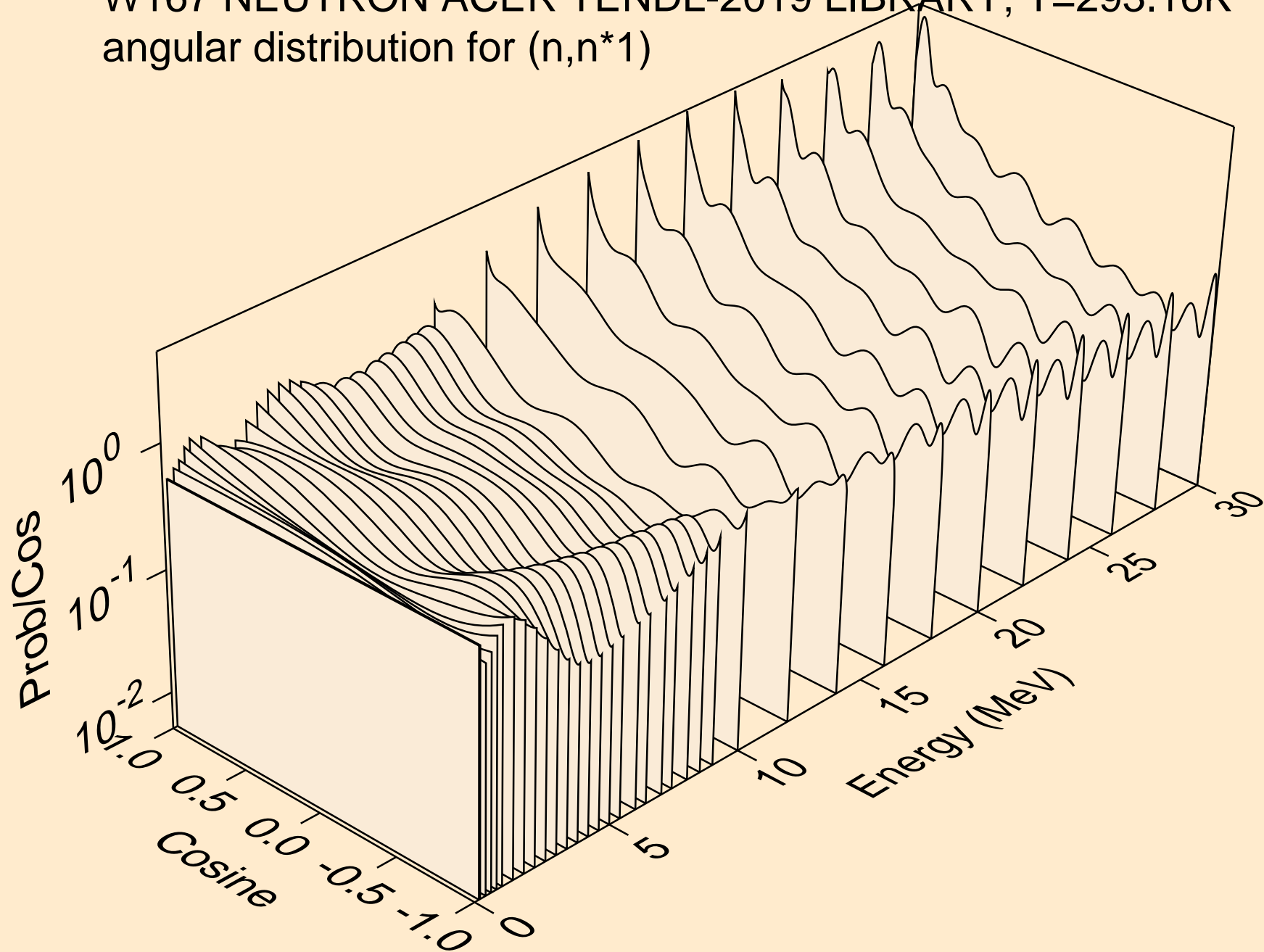

W167 NEUTRON ACER TENDL-2019 LIBRARY; T=293.16K
Neutron emission for (n,x)

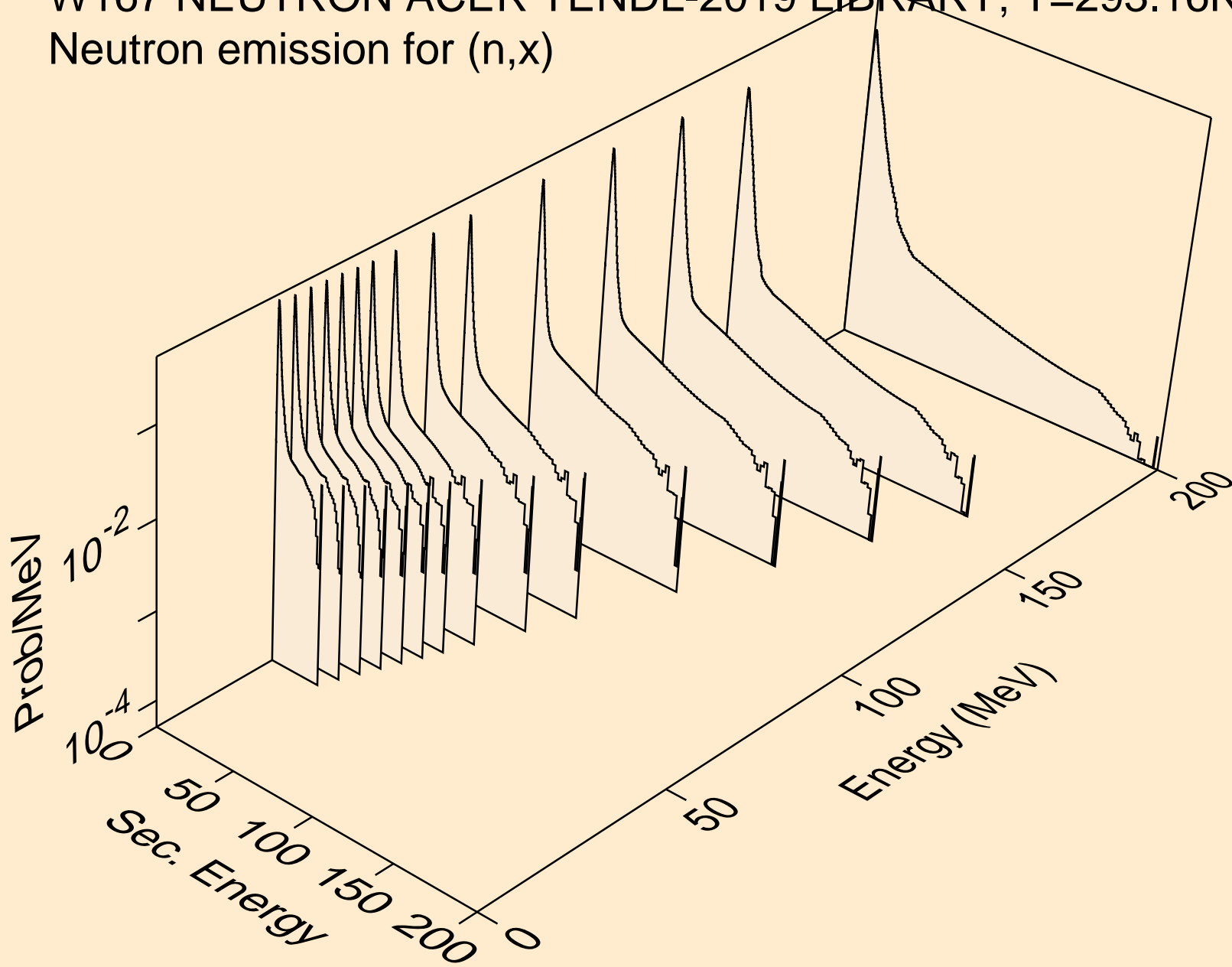

W167 NEUTRON ACER TENDL-2019 LIBRARY; T=293.16K
Neutron emission for (n,2nd)

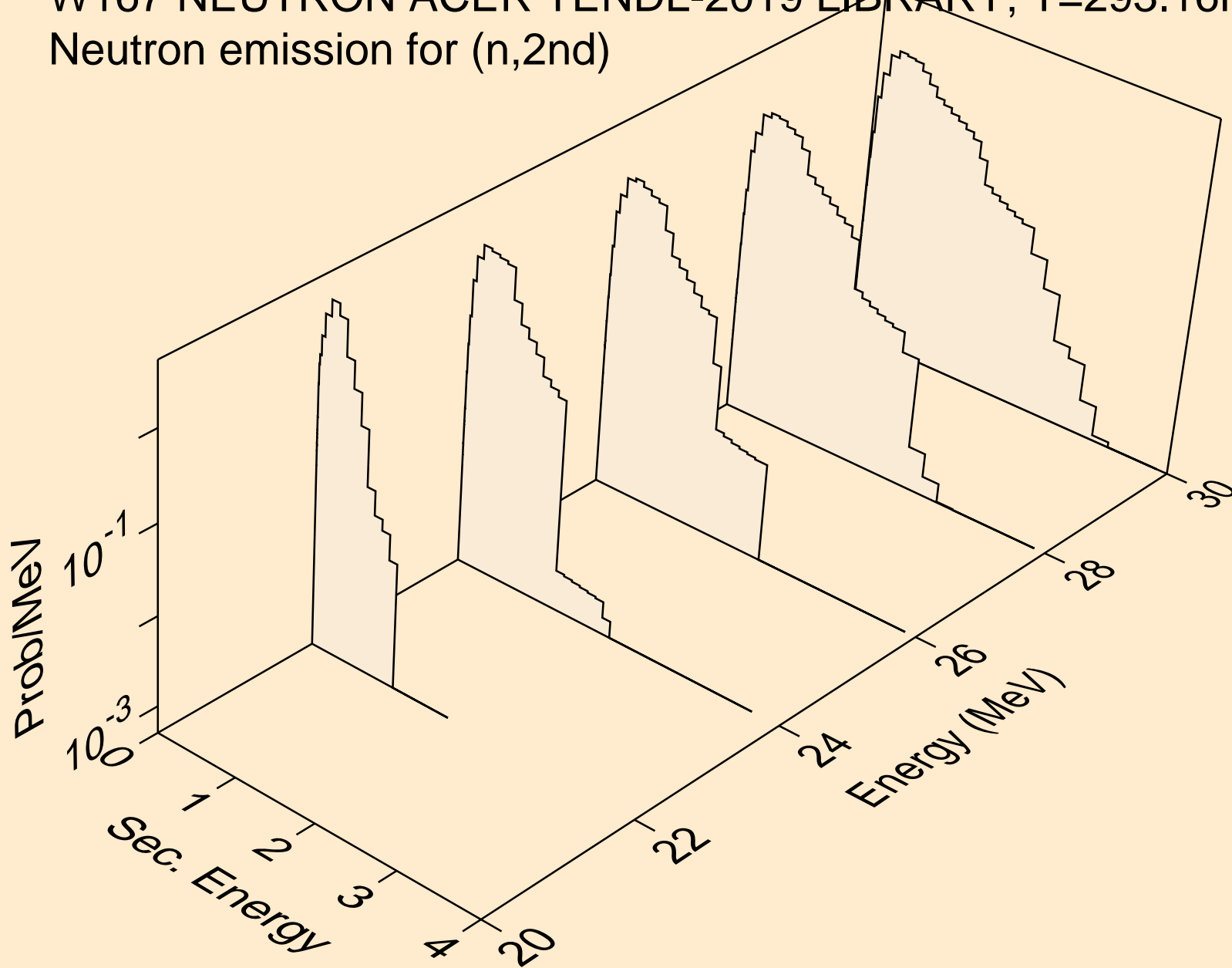

W167 NEUTRON ACER TENDL-2019 LIBRARY; T=293.16K
Neutron emission for (n,2n)

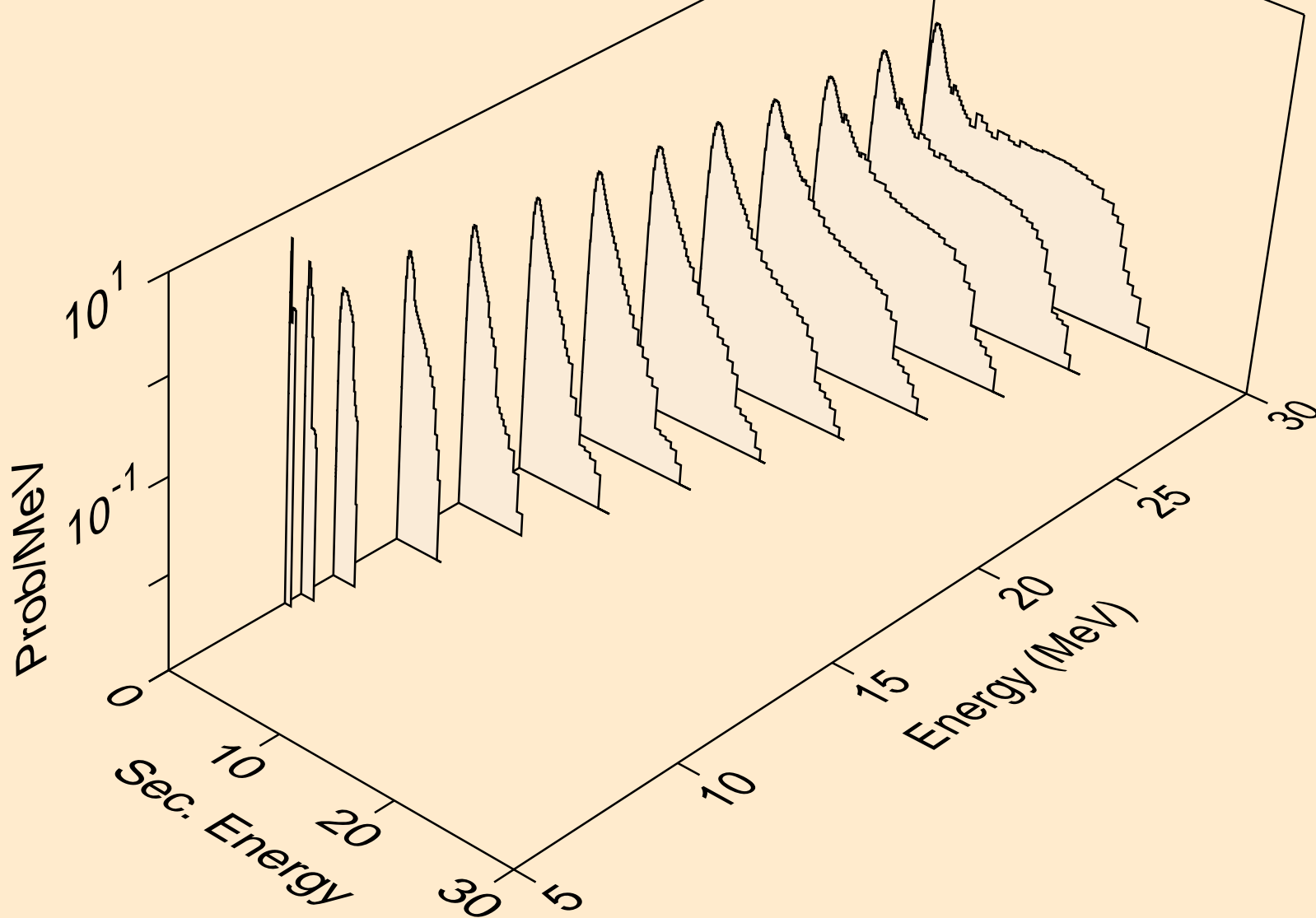

W167 NEUTRON ACER TENDL-2019 LIBRARY; T=293.16K
Neutron emission for (n,3n)

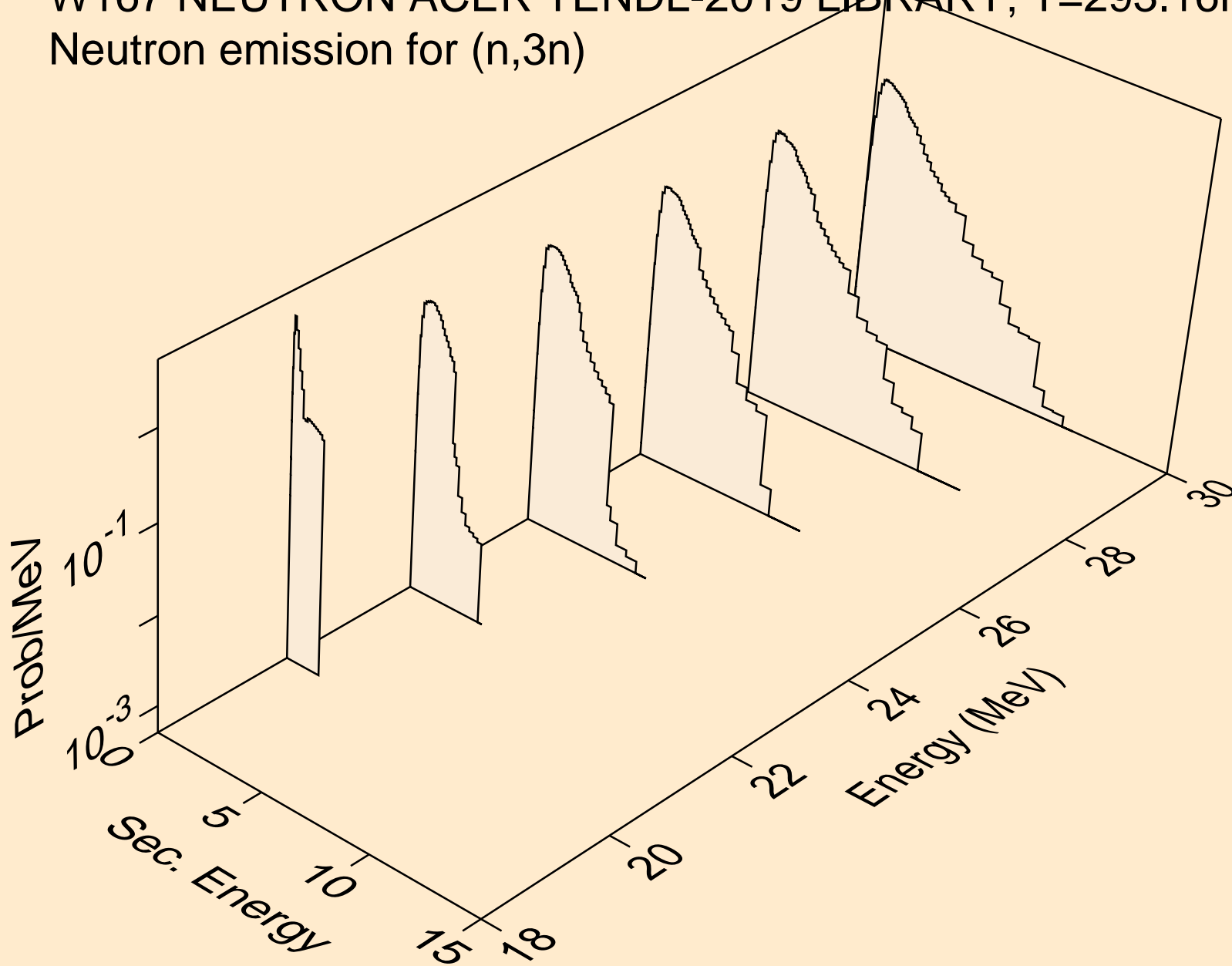

W167 NEUTRON ACER TENDL-2019 LIBRARY; T=293.16K
Neutron emission for (n,n*)a

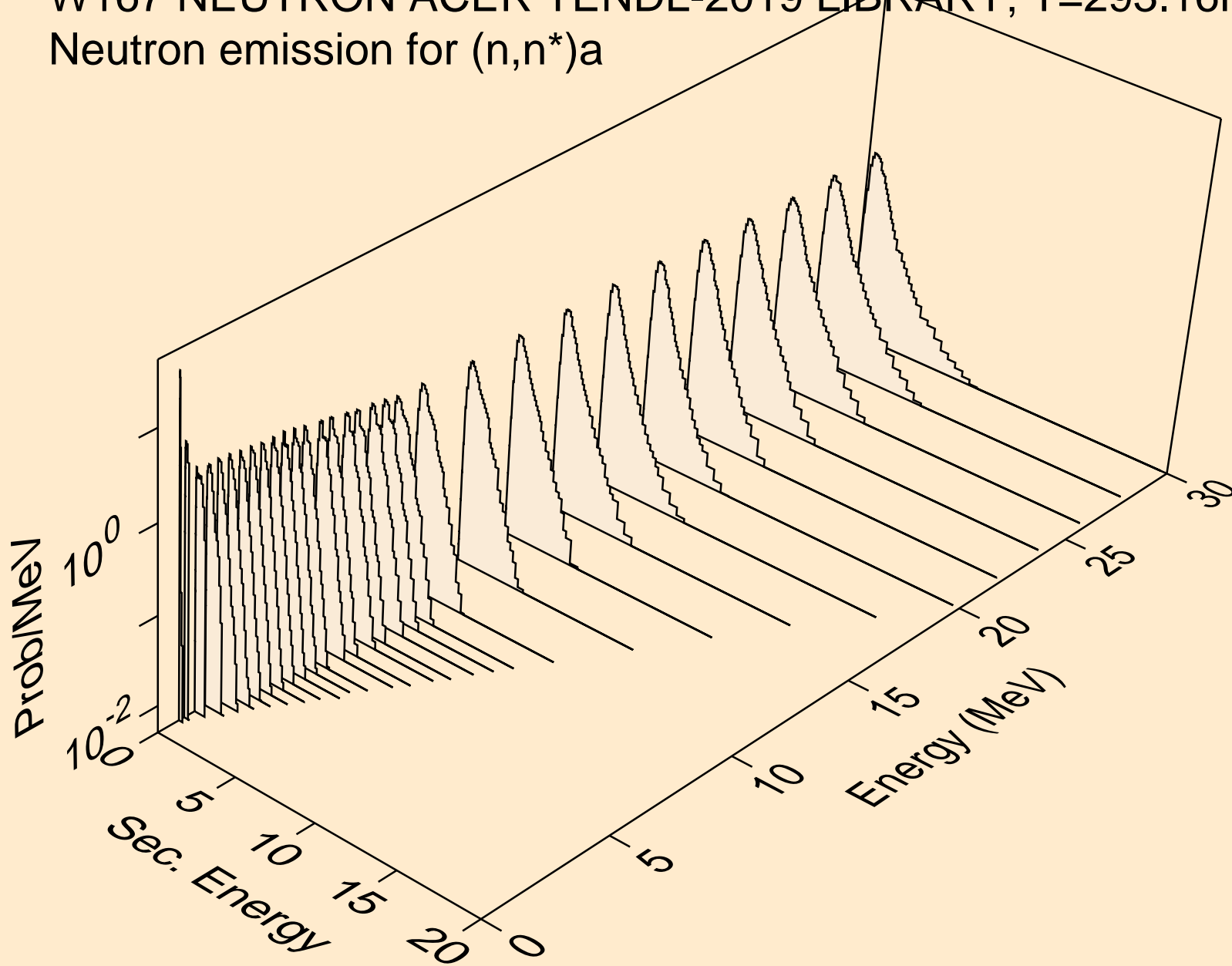

W167 NEUTRON ACER TENDL-2019 LIBRARY; T=293.16K
Neutron emission for (n,n*)3a

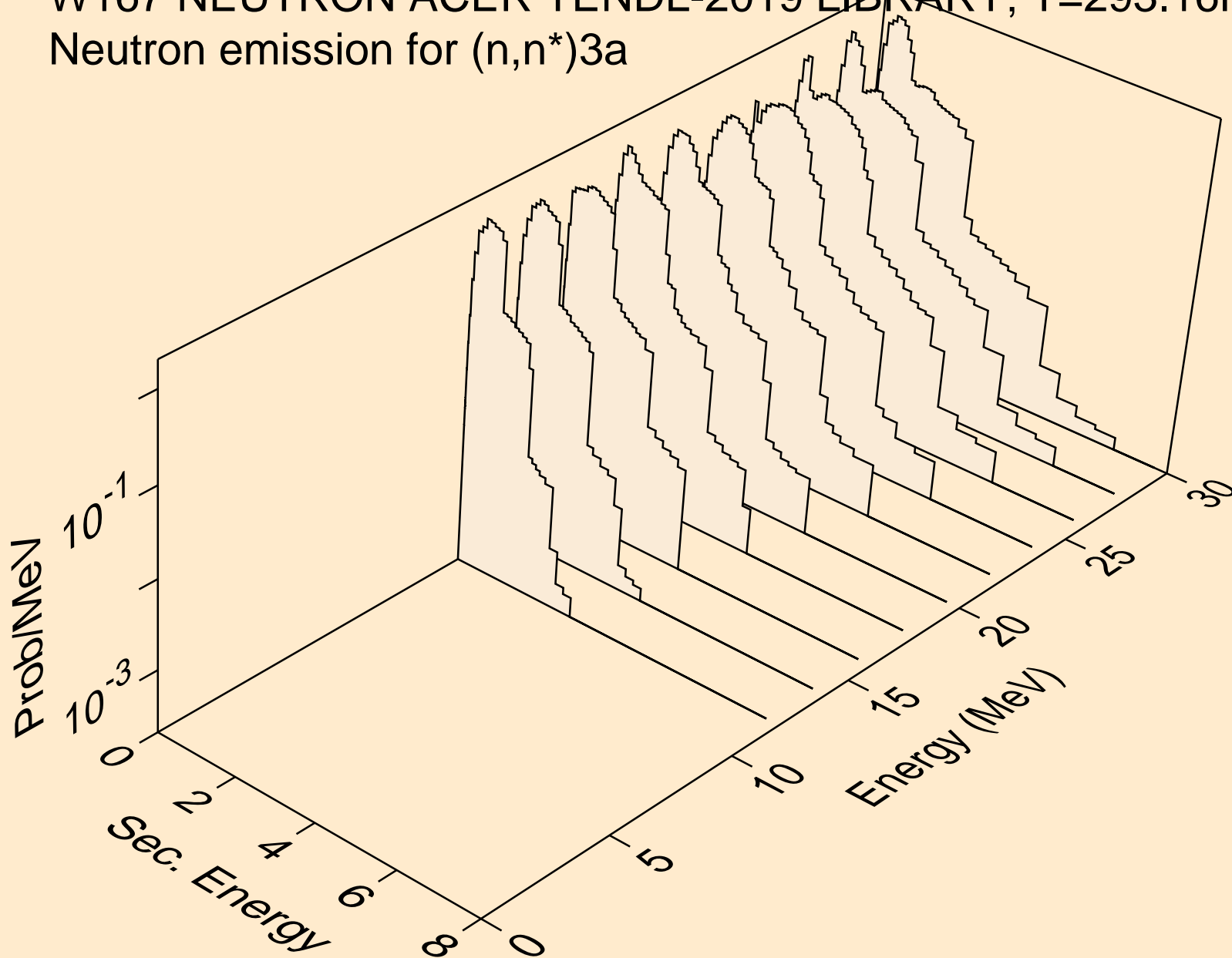

W167 NEUTRON ACER TENDL-2019 LIBRARY; T=293.16K
Neutron emission for (n,2n)a

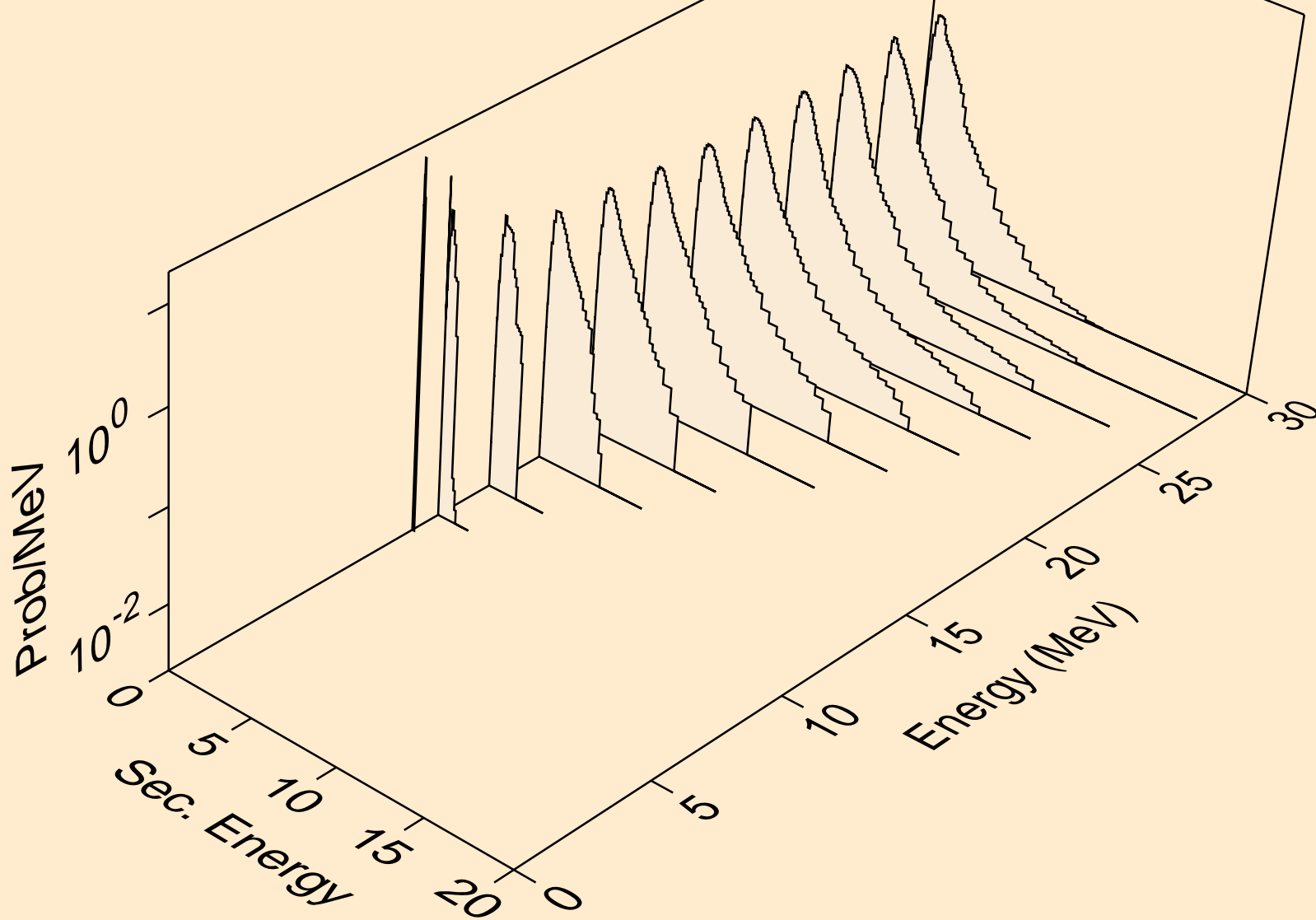

W167 NEUTRON ACER TENDL-2019 LIBRARY; T=293.16K
Neutron emission for (n,3n)a

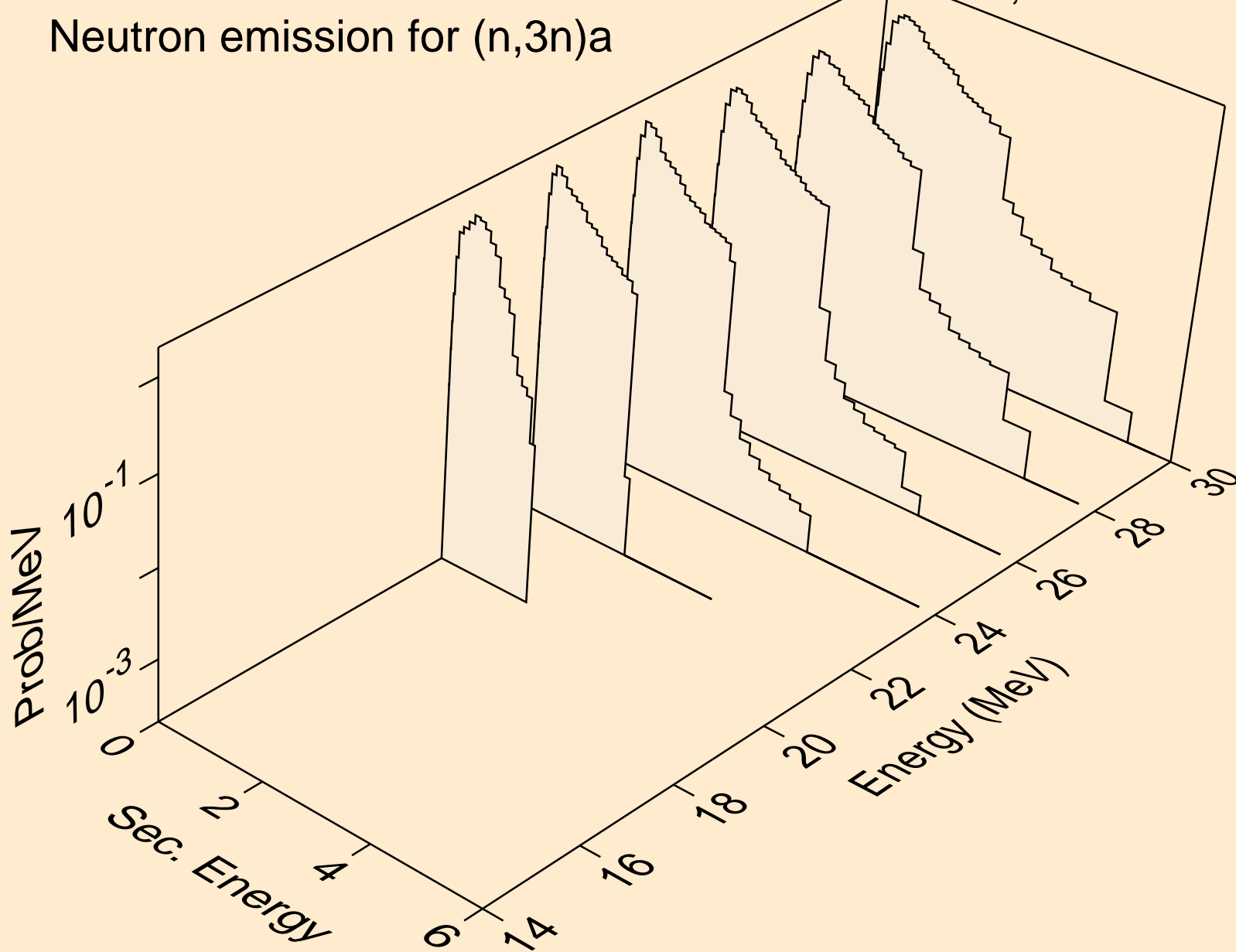

W167 NEUTRON ACER TENDL-2019 LIBRARY; T=293.16K
Neutron emission for (n,n*)p

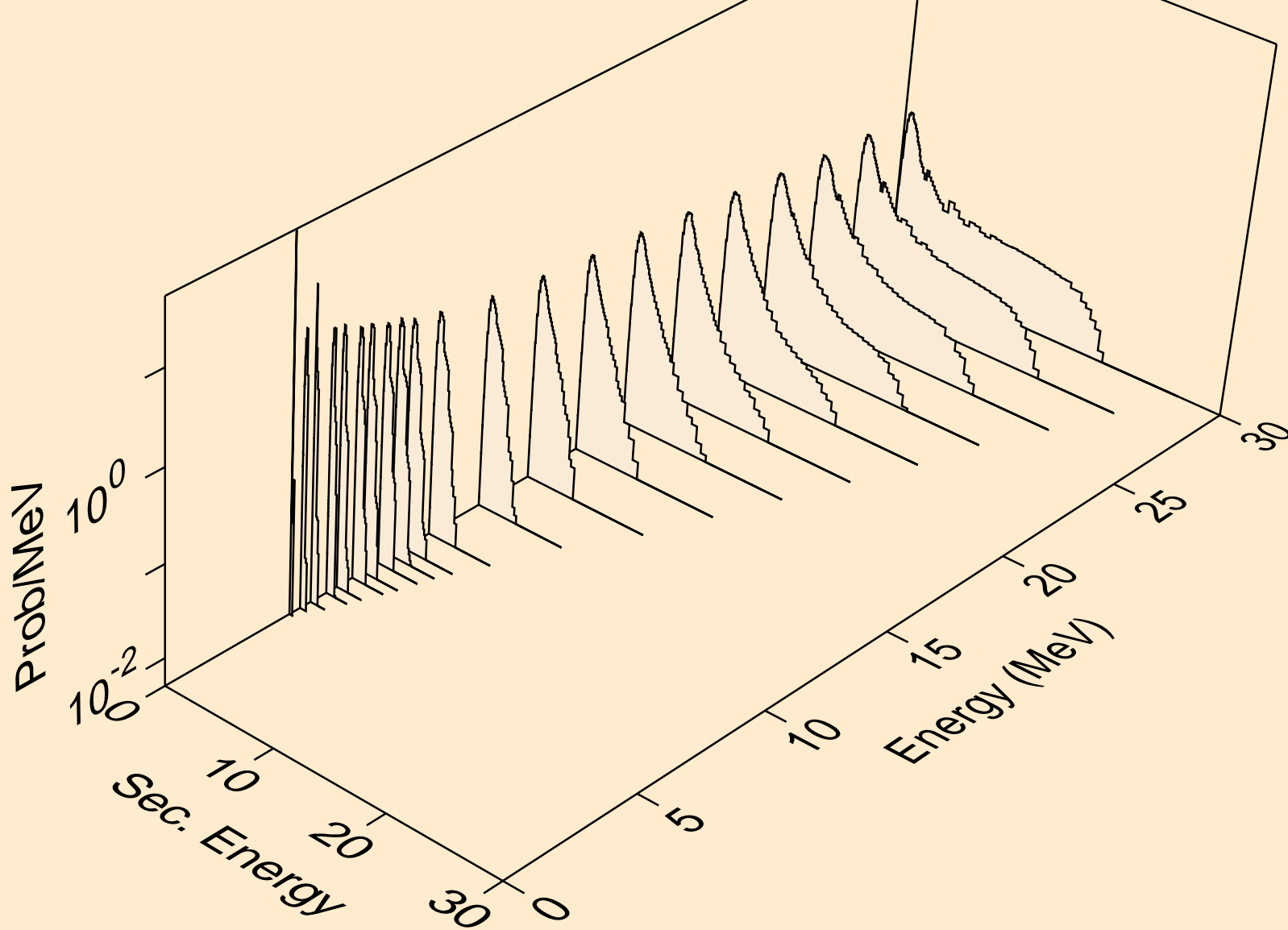

W167 NEUTRON ACER TENDL-2019 LIBRARY; T=293.16K
Neutron emission for (n,n*)2a

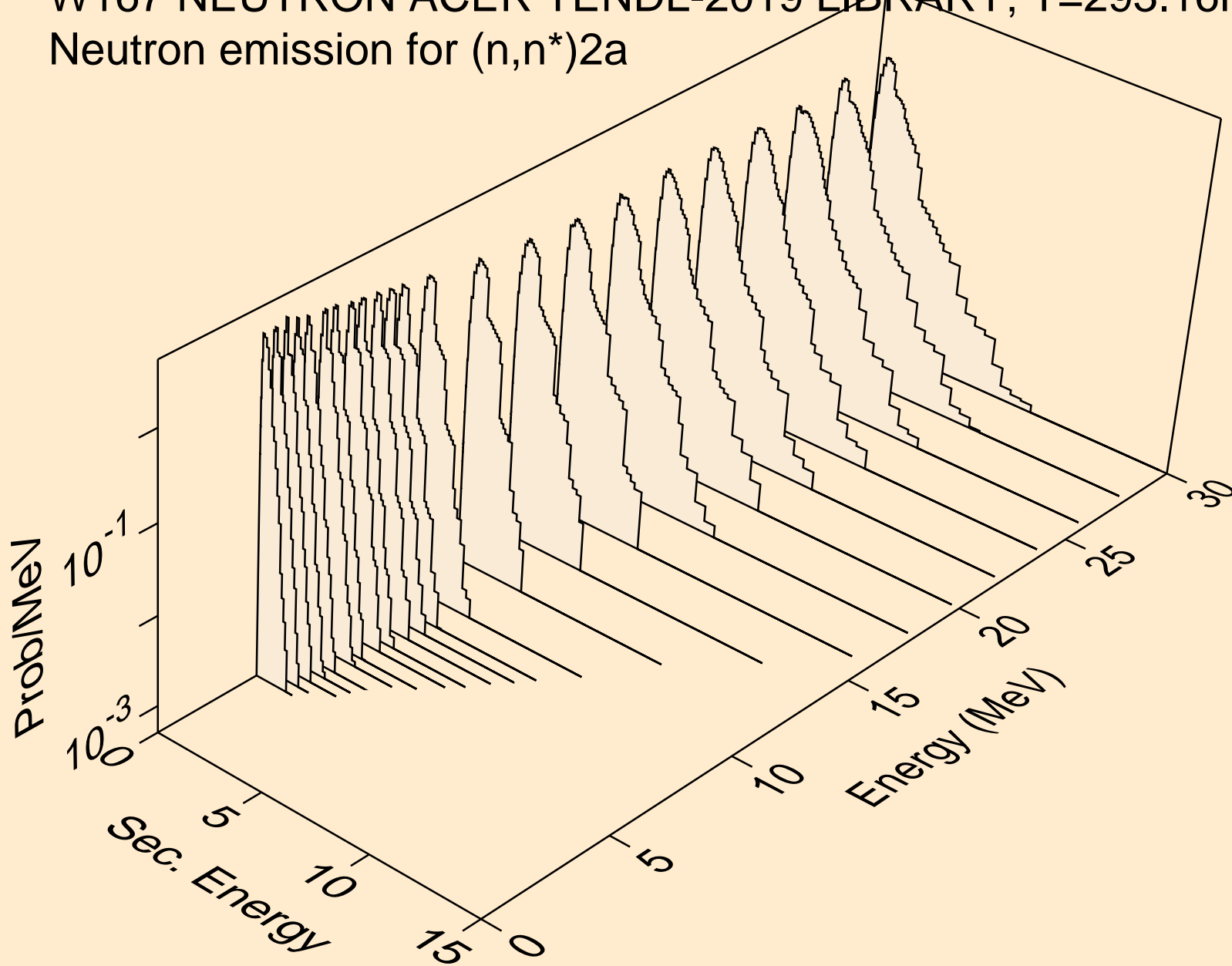

W167 NEUTRON ACER TENDL-2019 LIBRARY; T=293.16K
Neutron emission for (n,2n)2a

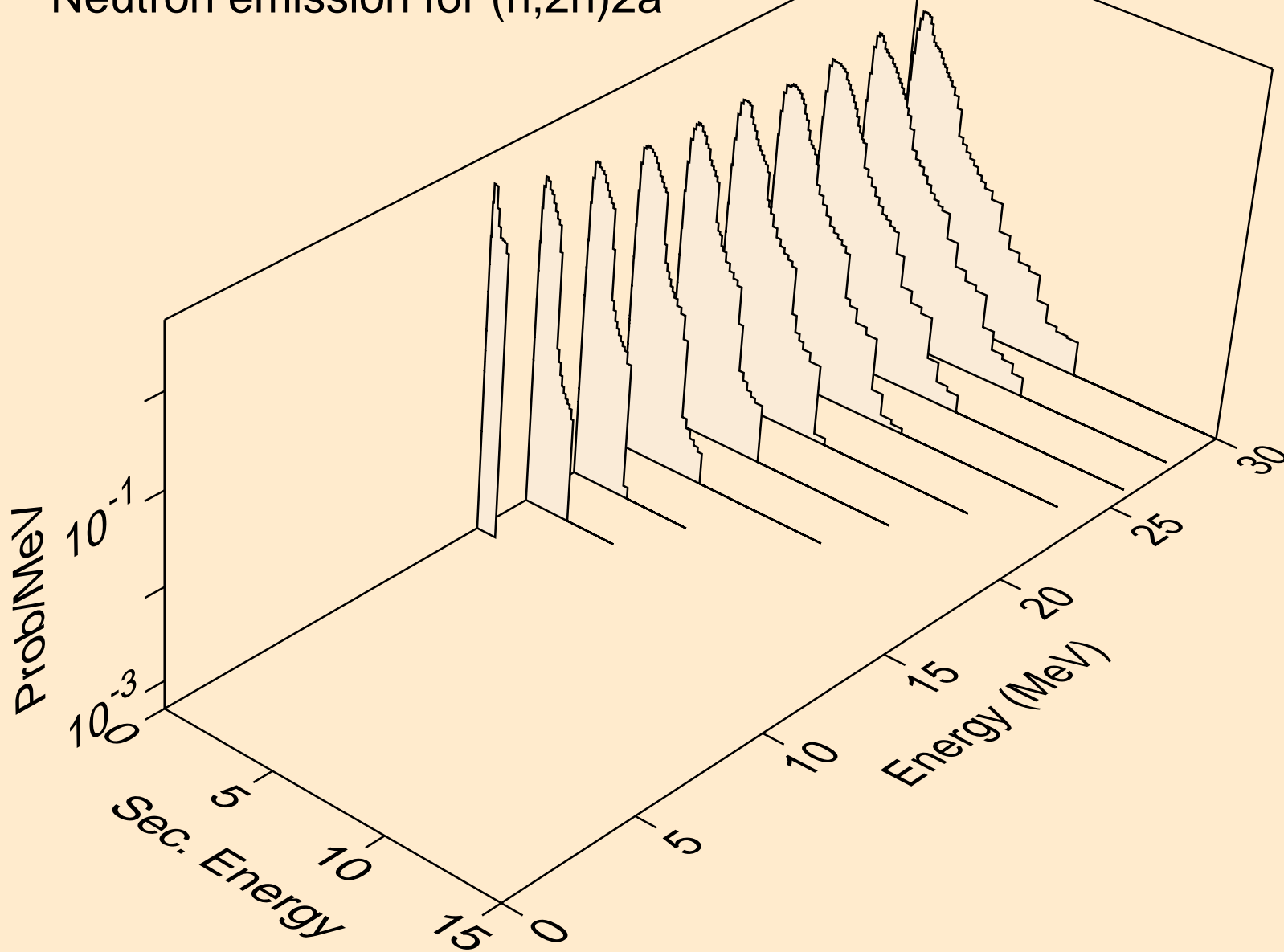

W167 NEUTRON ACER TENDL-2019 LIBRARY; T=293.16K
Neutron emission for (n,n*)d

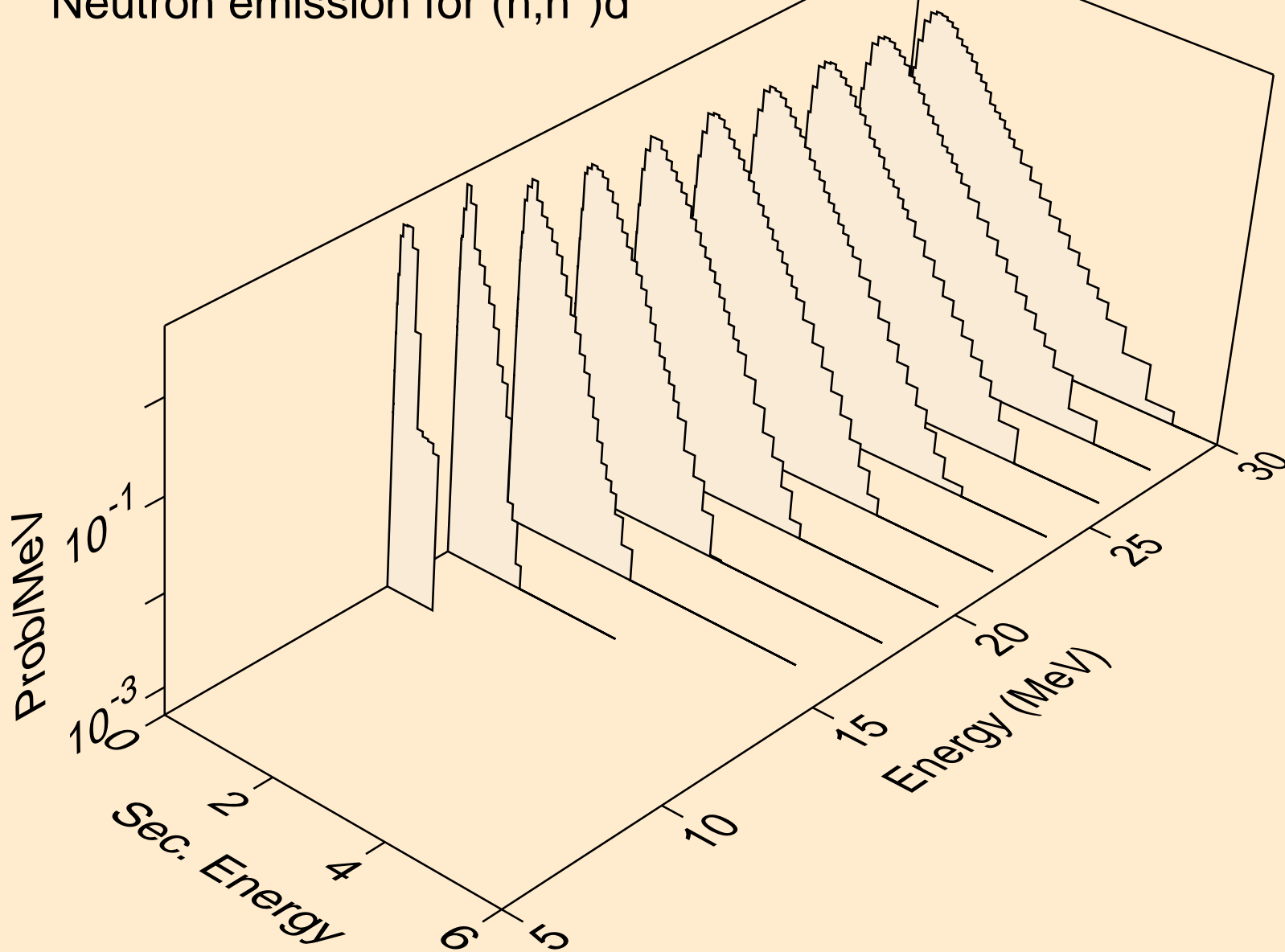

W167 NEUTRON ACER TENDL-2019 LIBRARY; T=293.16K
Neutron emission for (n,n*)t

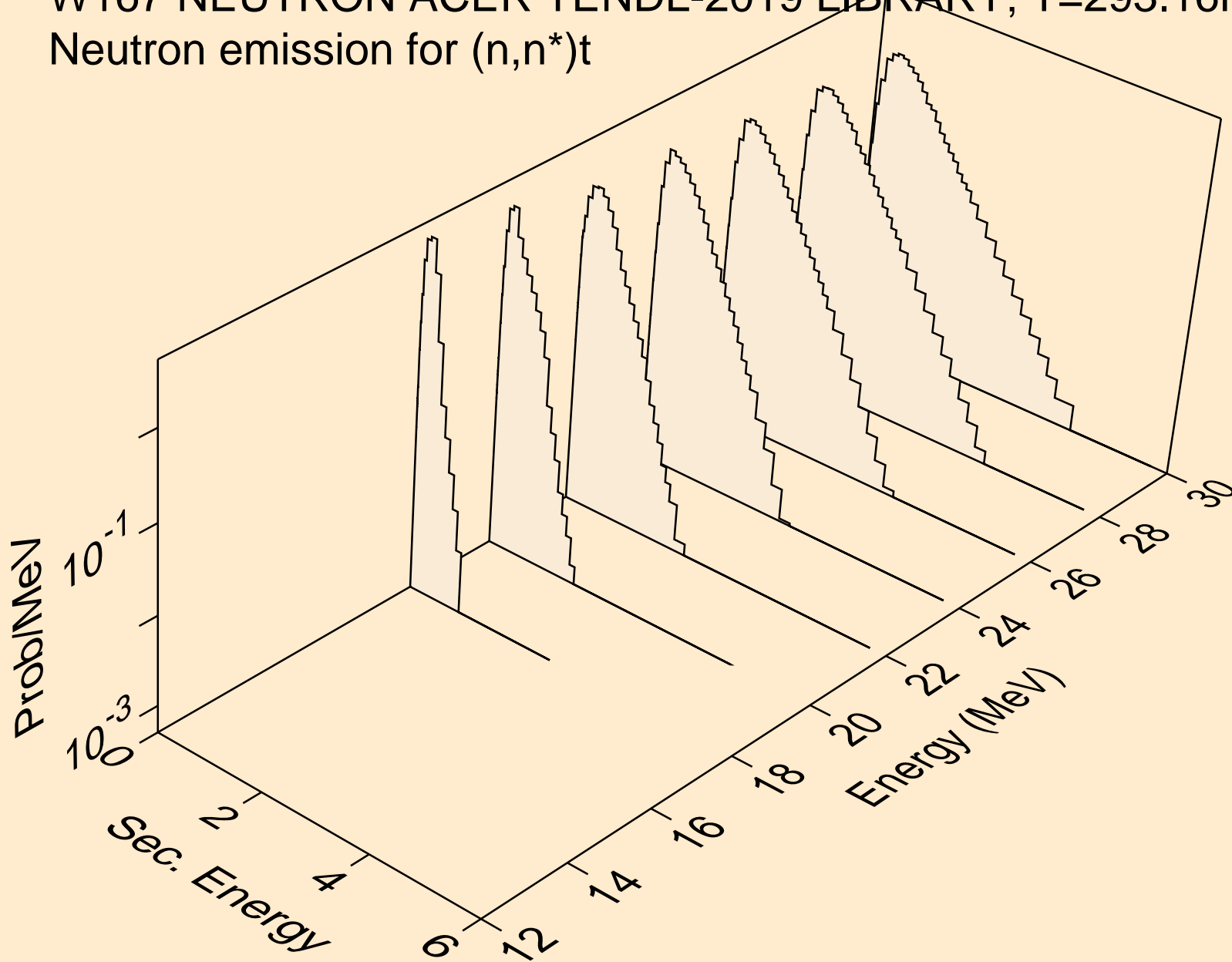

W167 NEUTRON ACER TENDL-2019 LIBRARY; T=293.16K
Neutron emission for (n,n*)he3

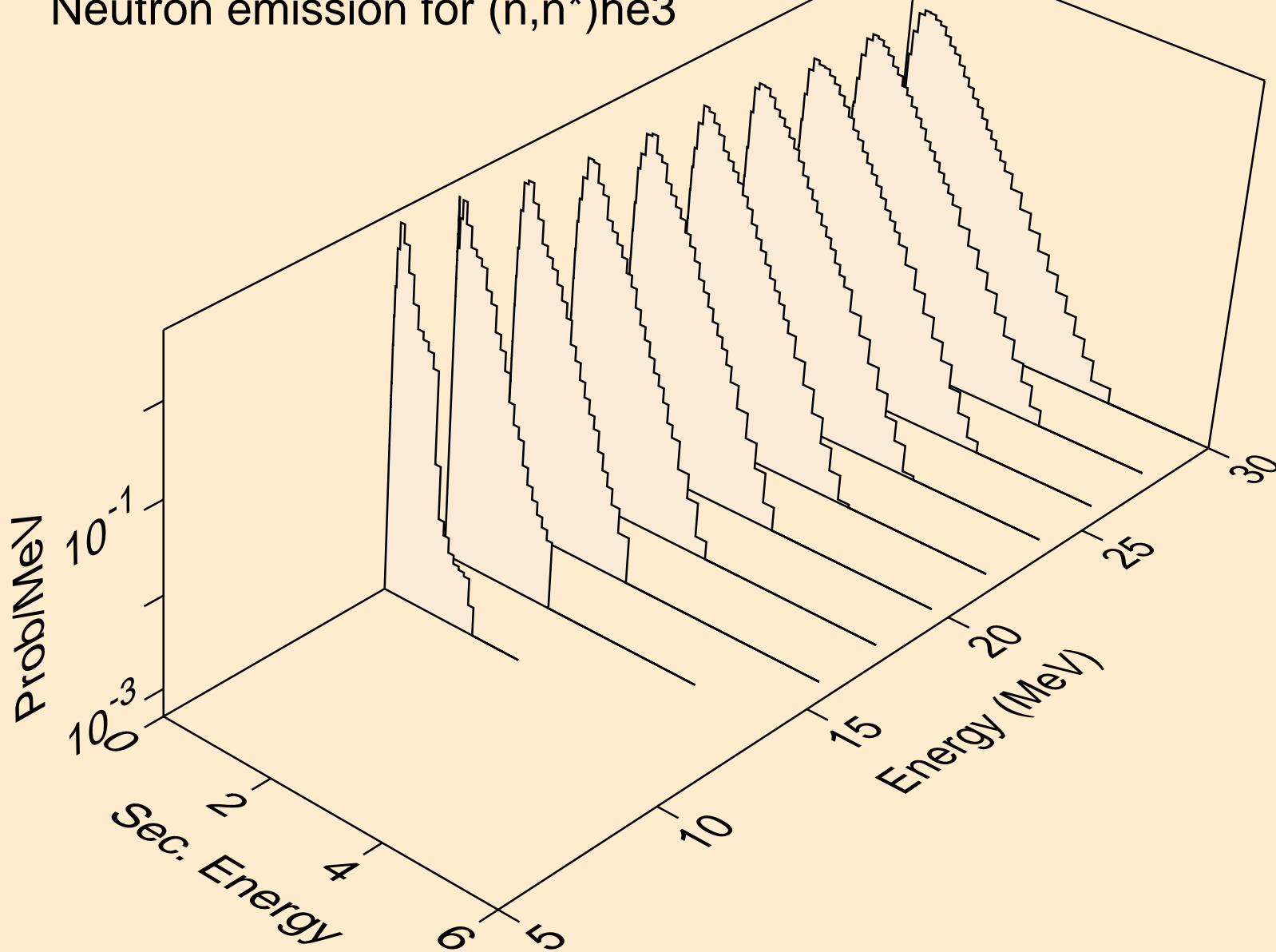

W167 NEUTRON ACER TENDL-2019 LIBRARY; T=293.16K
Neutron emission for (n,4n)

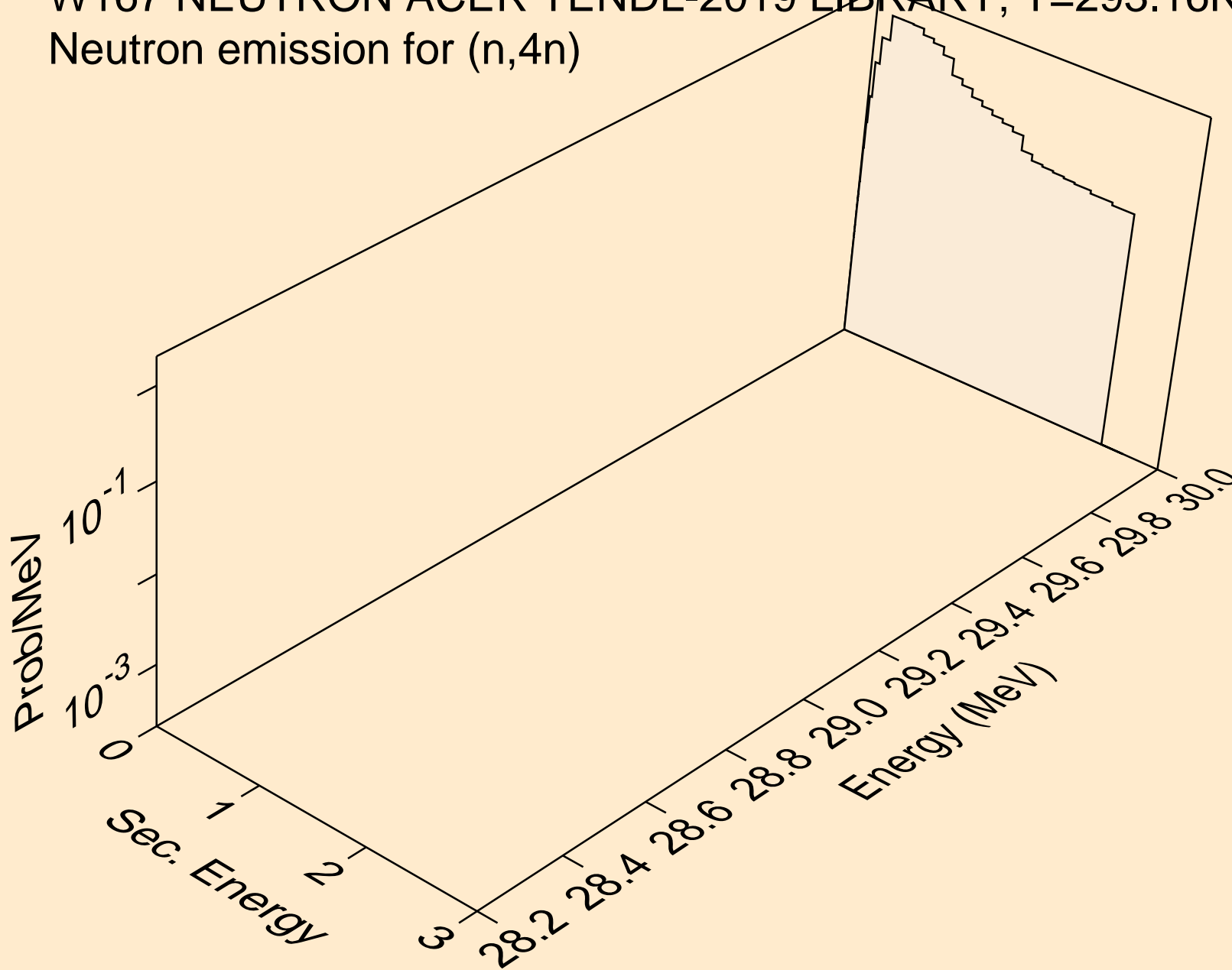

W167 NEUTRON ACER TENDL-2019 LIBRARY; T=293.16K
Neutron emission for (n,2np)

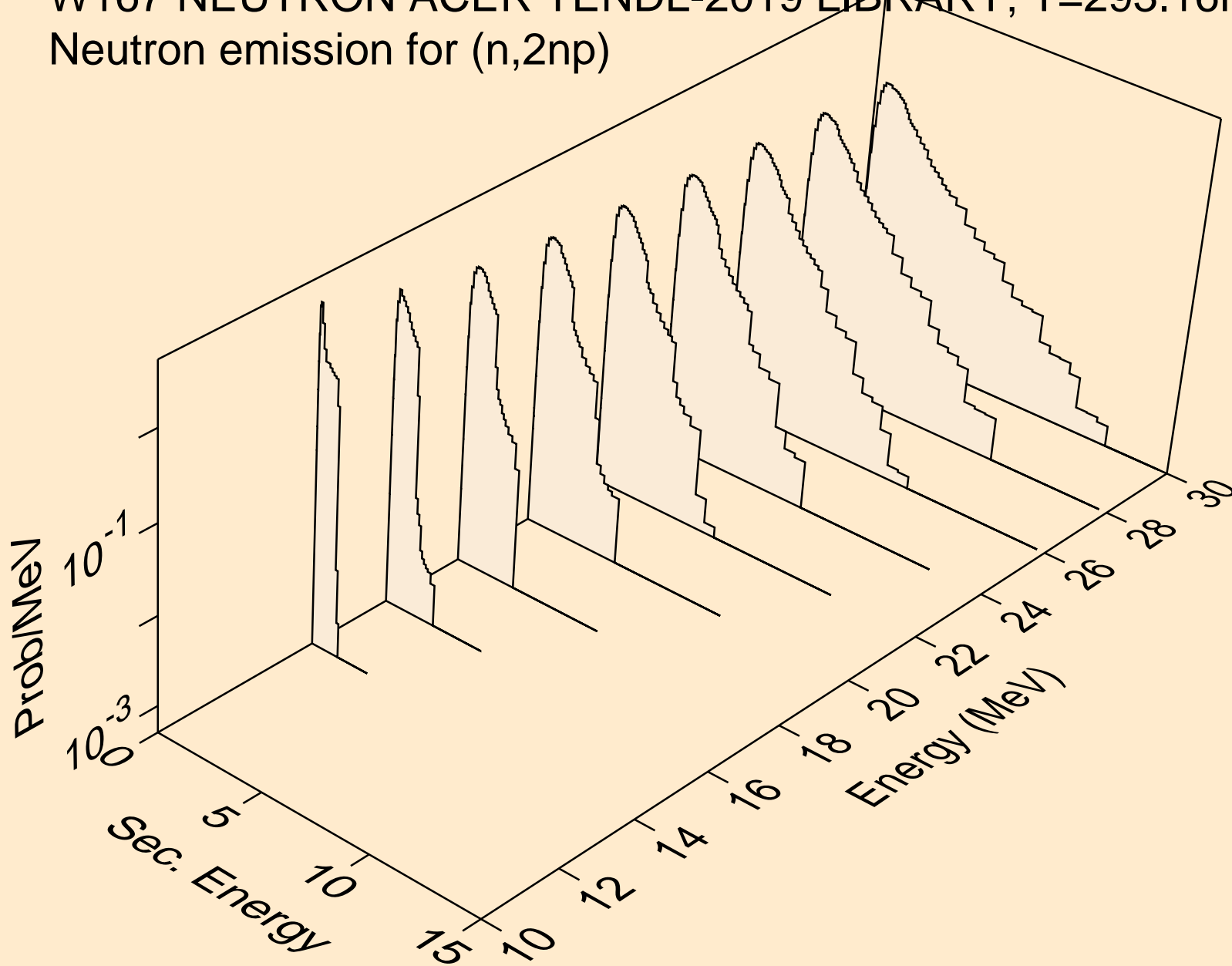

W167 NEUTRON ACER TENDL-2019 LIBRARY; T=293.16K
Neutron emission for (n,3np)

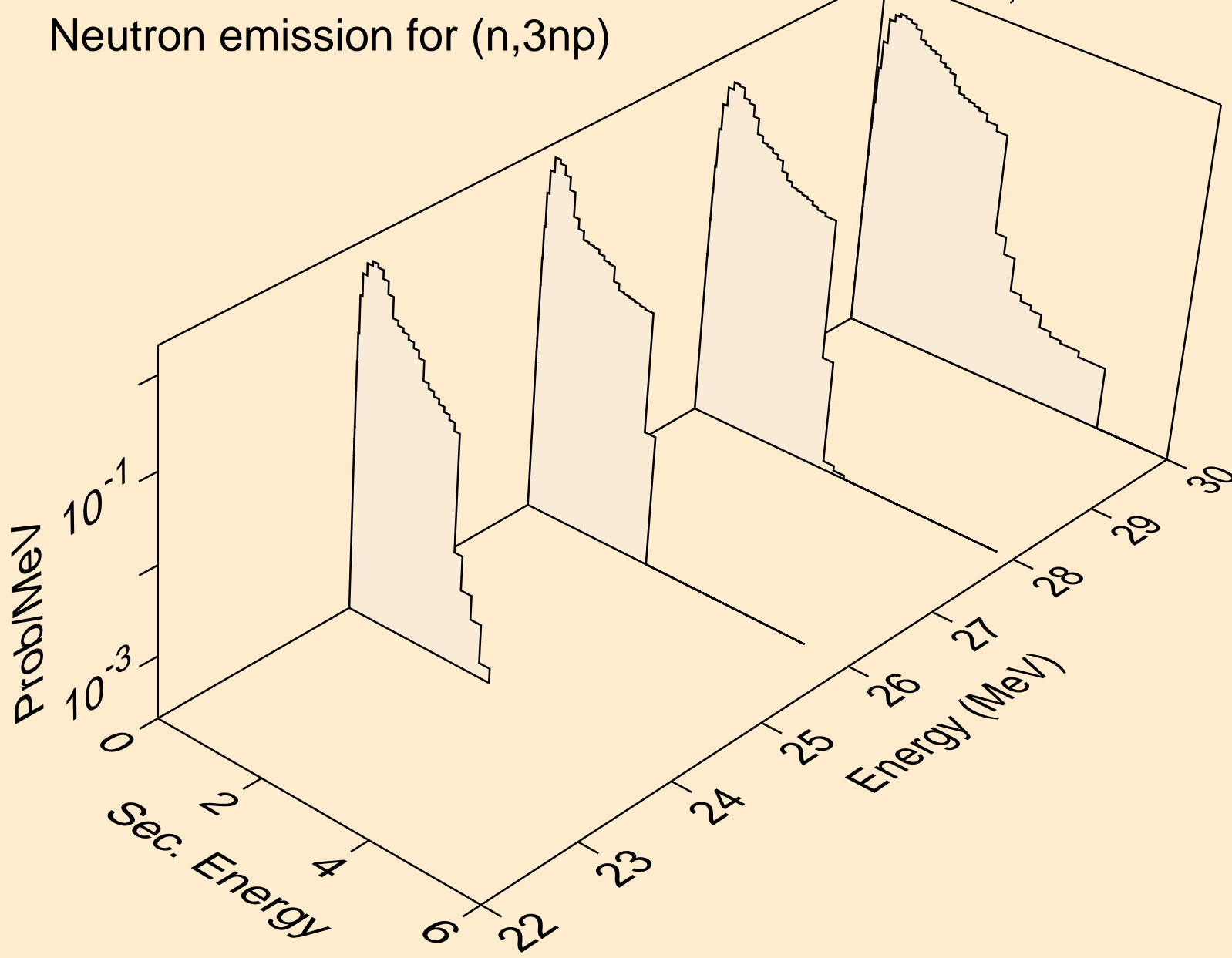

W167 NEUTRON ACER TENDL-2019 LIBRARY; T=293.16K
Neutron emission for (n,2np)

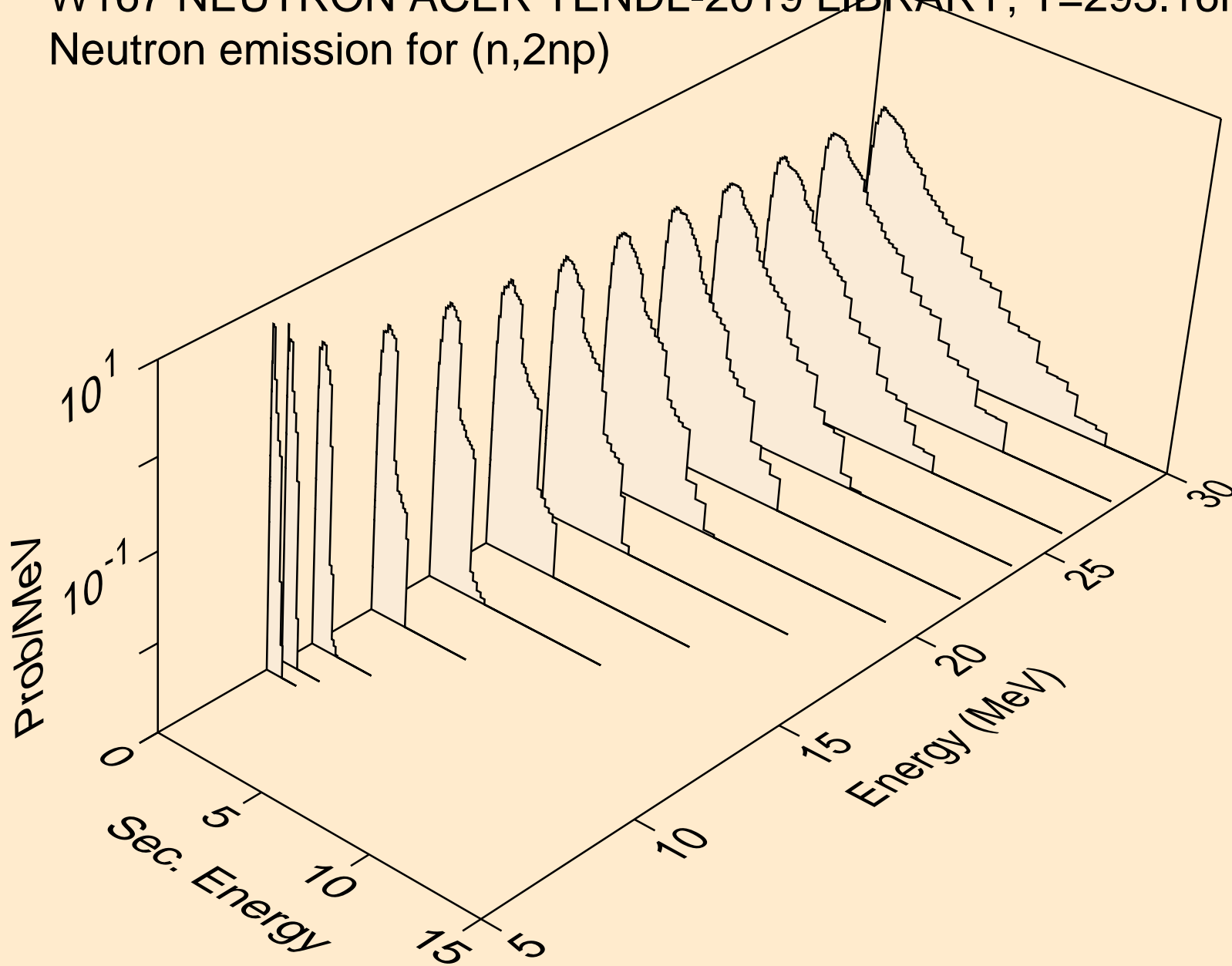

W167 NEUTRON ACER TENDL-2019 LIBRARY; T=293.16K
Neutron emission for (n,npa)

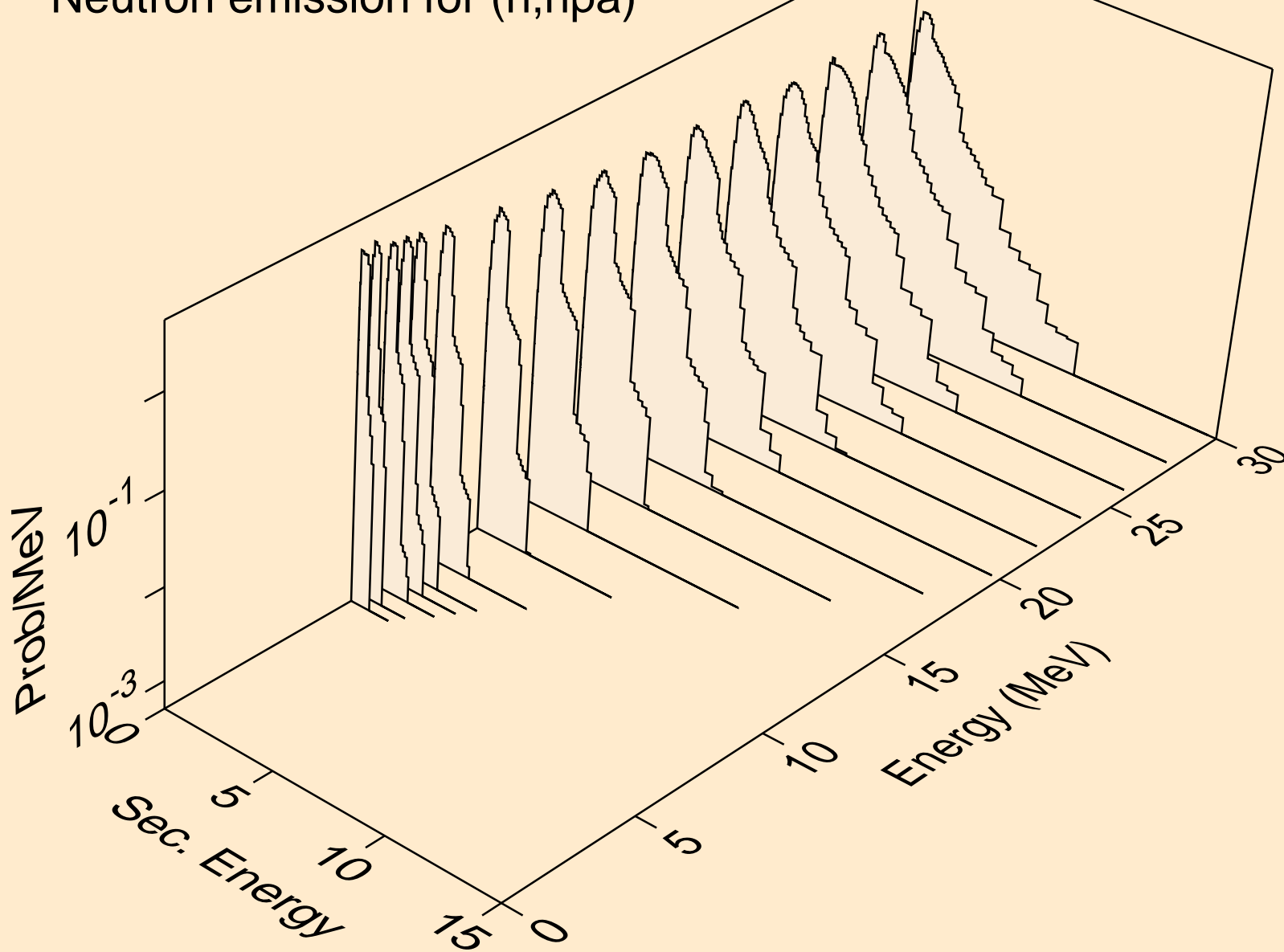

W167 NEUTRON ACER TENDL-2019 LIBRARY; T=293.16K
Neutron emission for (n,n*c)

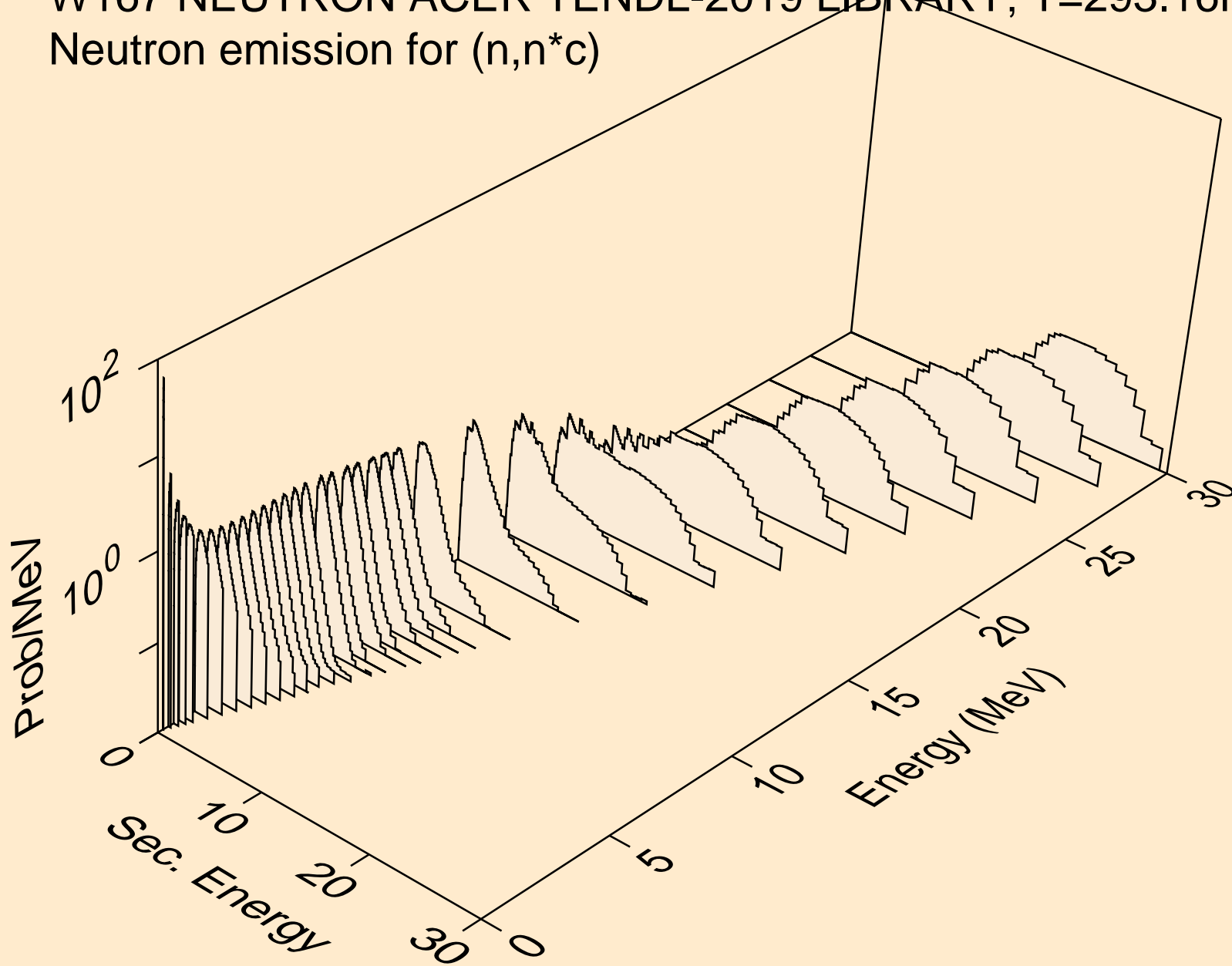

W167 NEUTRON ACER TENDL-2019 LIBRARY; T=293.16K
Photon emission for (n,x)

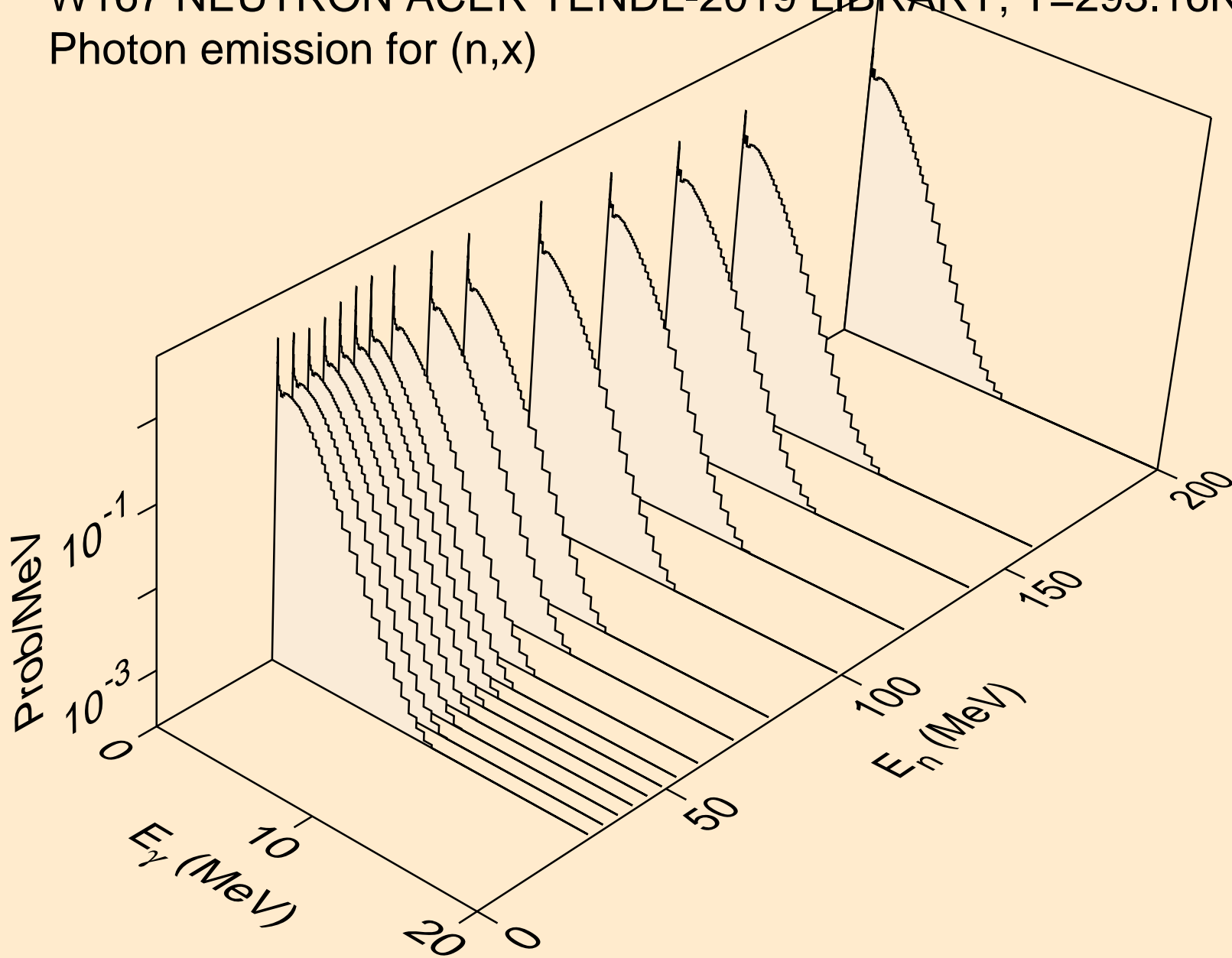

W167 NEUTRON ACER TENDL-2019 LIBRARY; T=293.16K
Photon emission for (n,2nd)

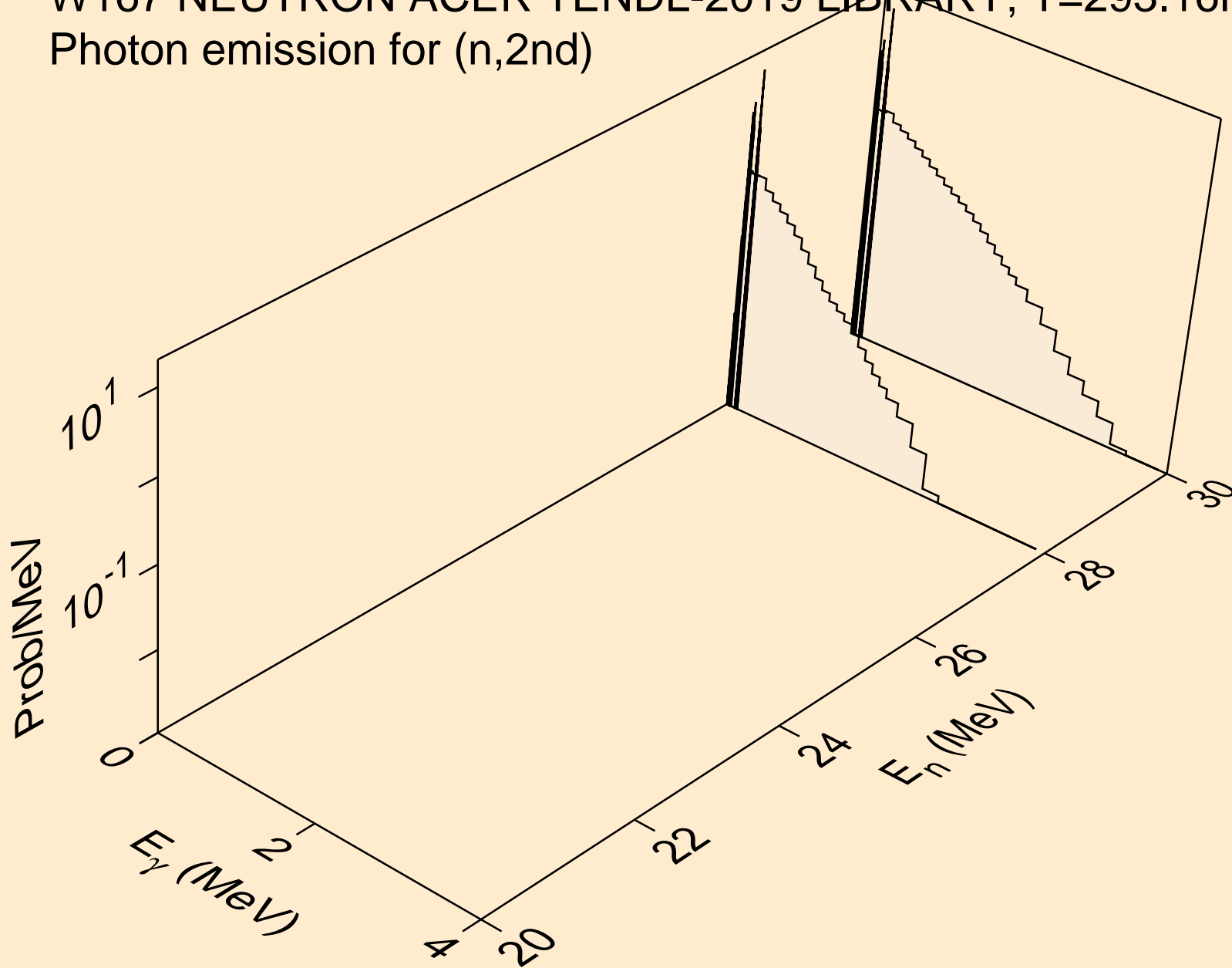

W167 NEUTRON ACER TENDL-2019 LIBRARY; T=293.16K
Photon emission for (n,2n)

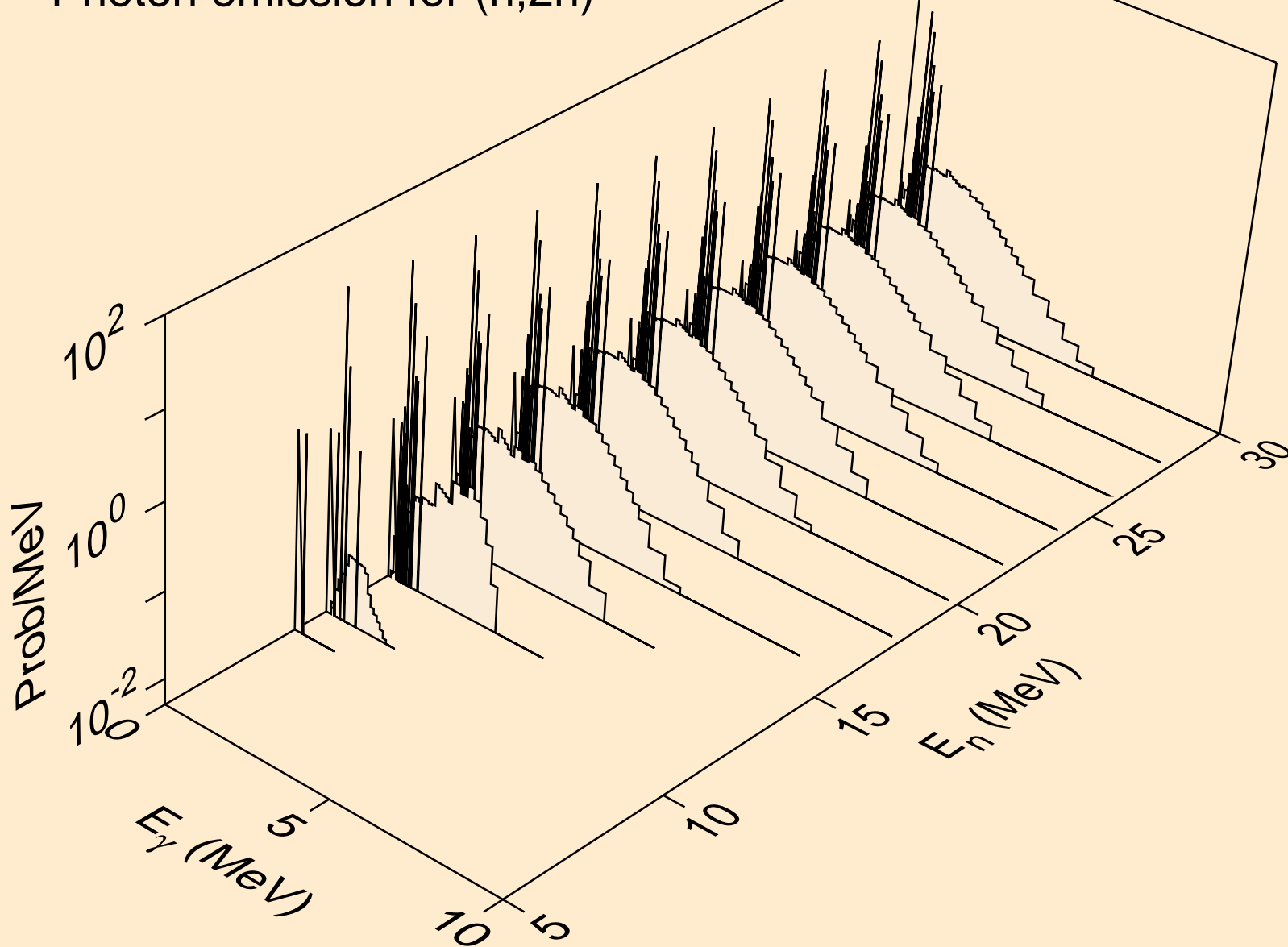

W167 NEUTRON ACER TENDL-2019 LIBRARY; T=293.16K
Photon emission for (n,3n)

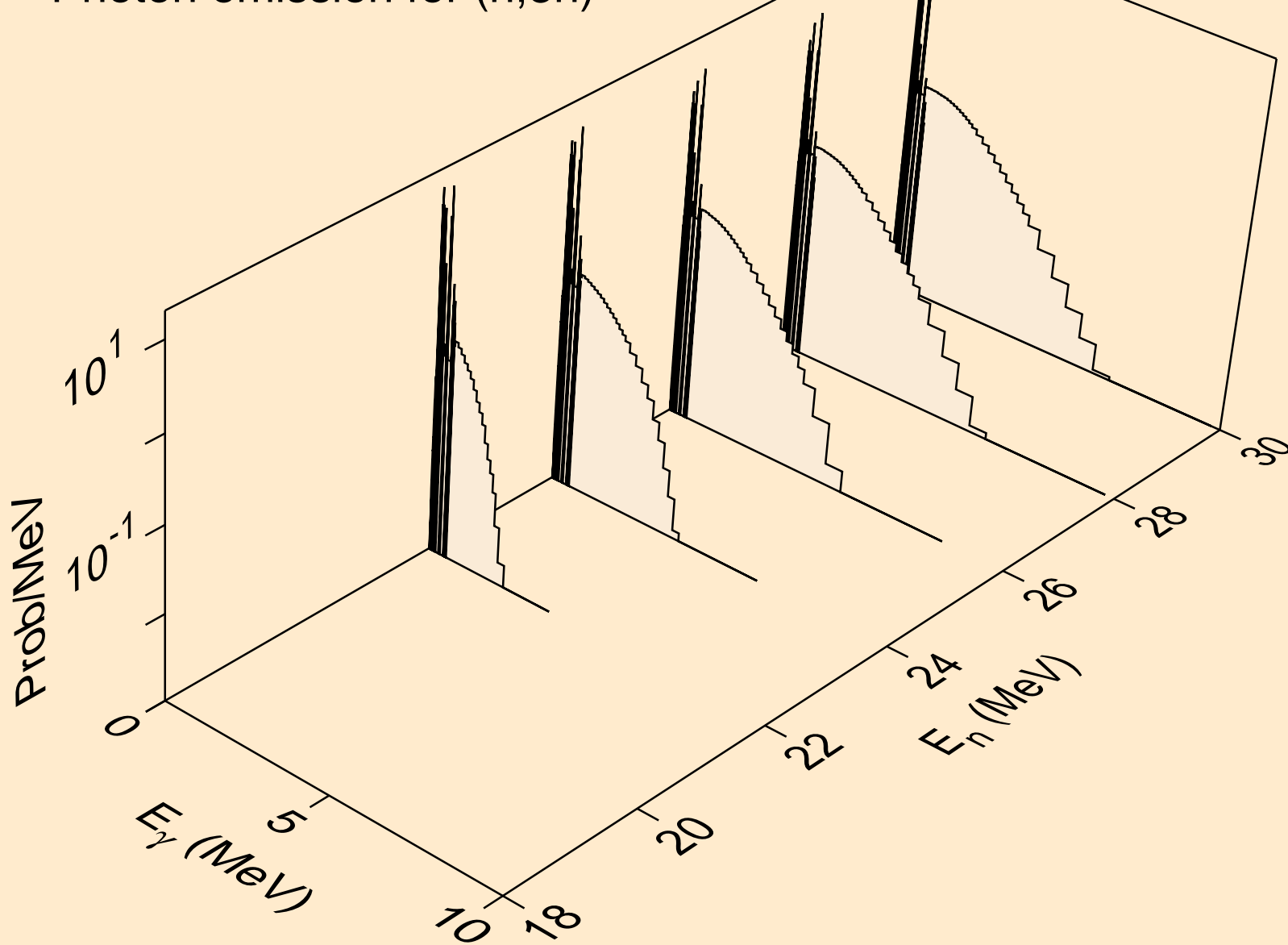

W167 NEUTRON ACER TENDL-2019 LIBRARY; T=293.16K
Photon emission for (n,n*)a

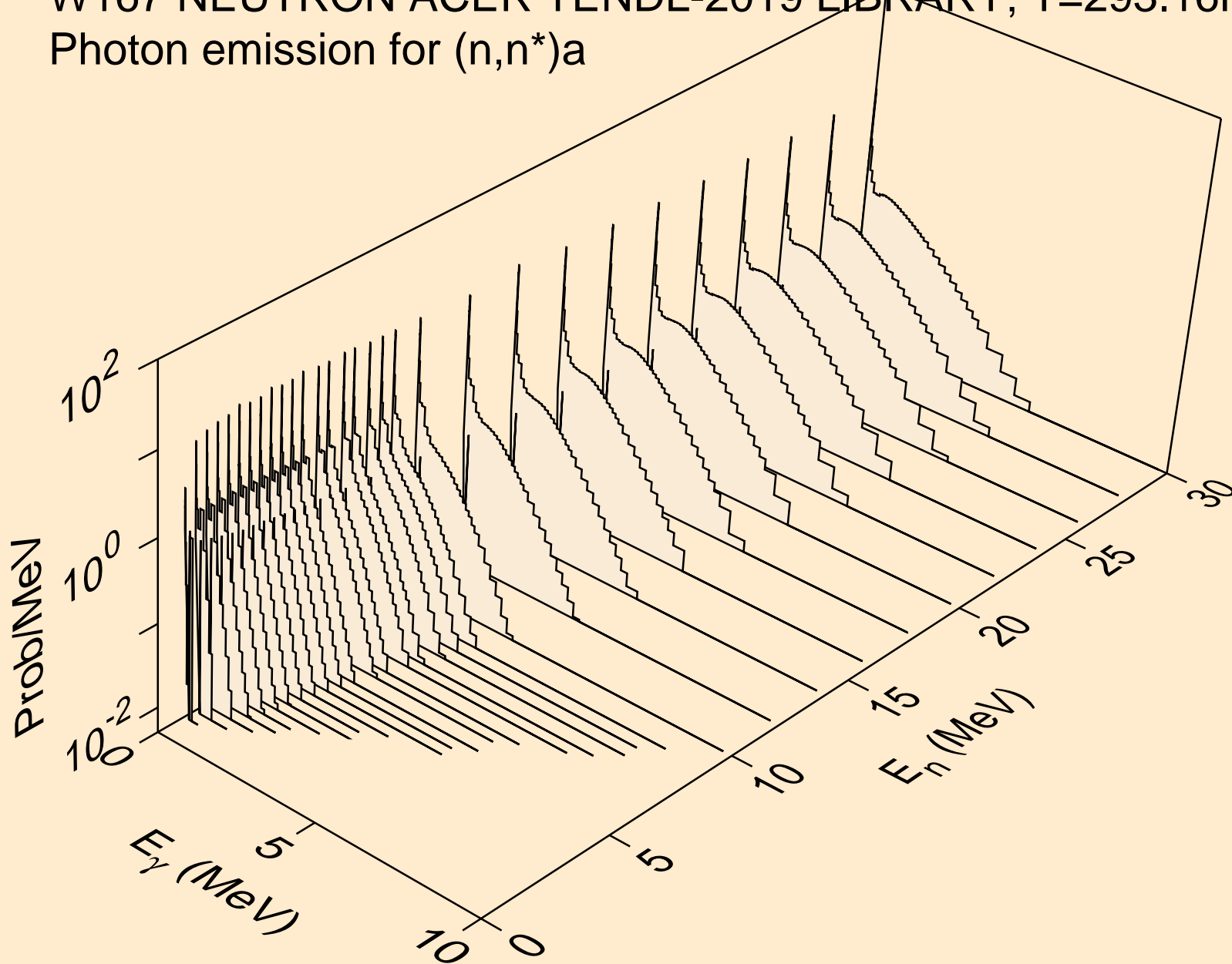

W167 NEUTRON ACER TENDL-2019 LIBRARY; T=293.16K
Photon emission for (n,n*)3a

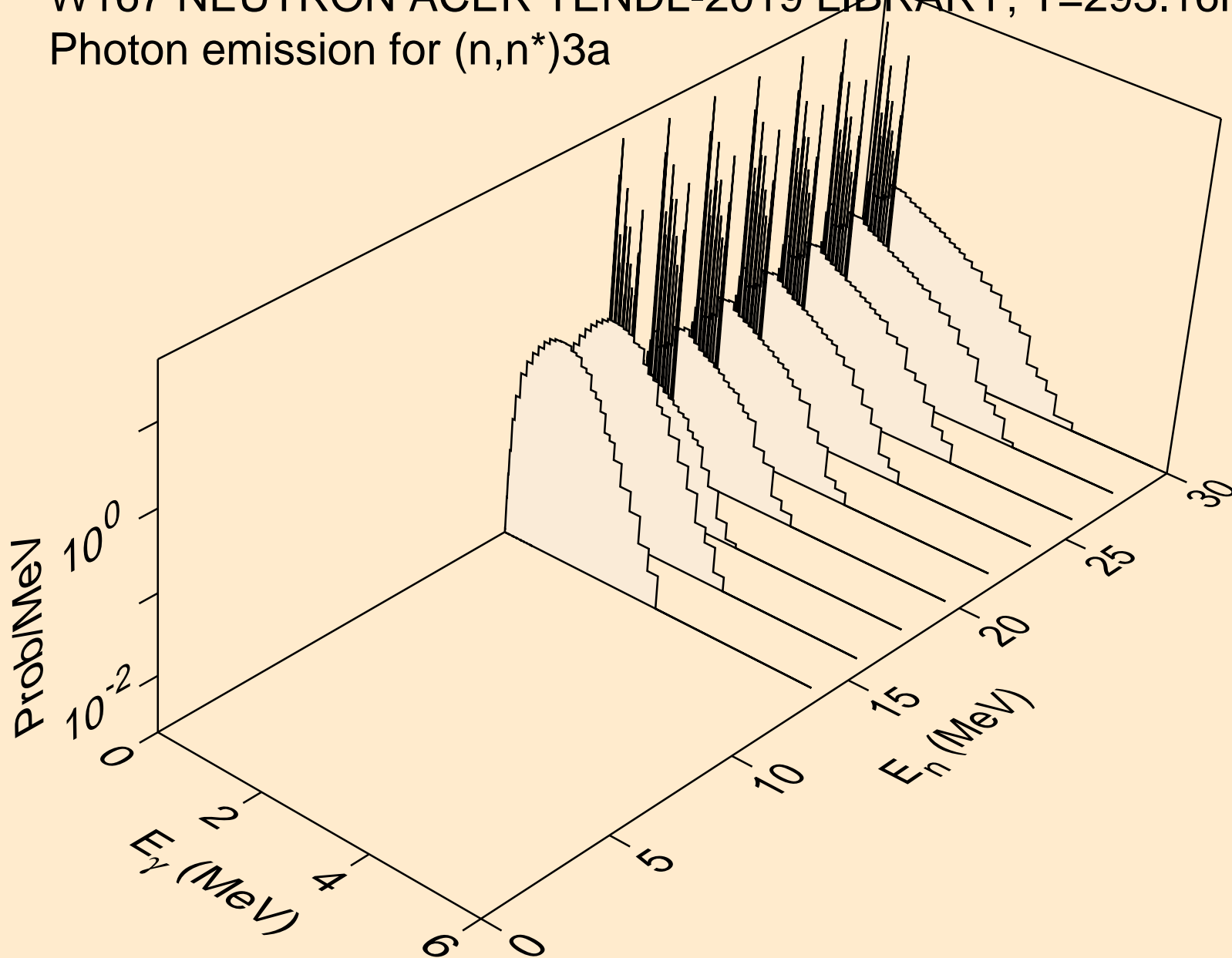

W167 NEUTRON ACER TENDL-2019 LIBRARY; T=293.16K
Photon emission for (n,2n)a

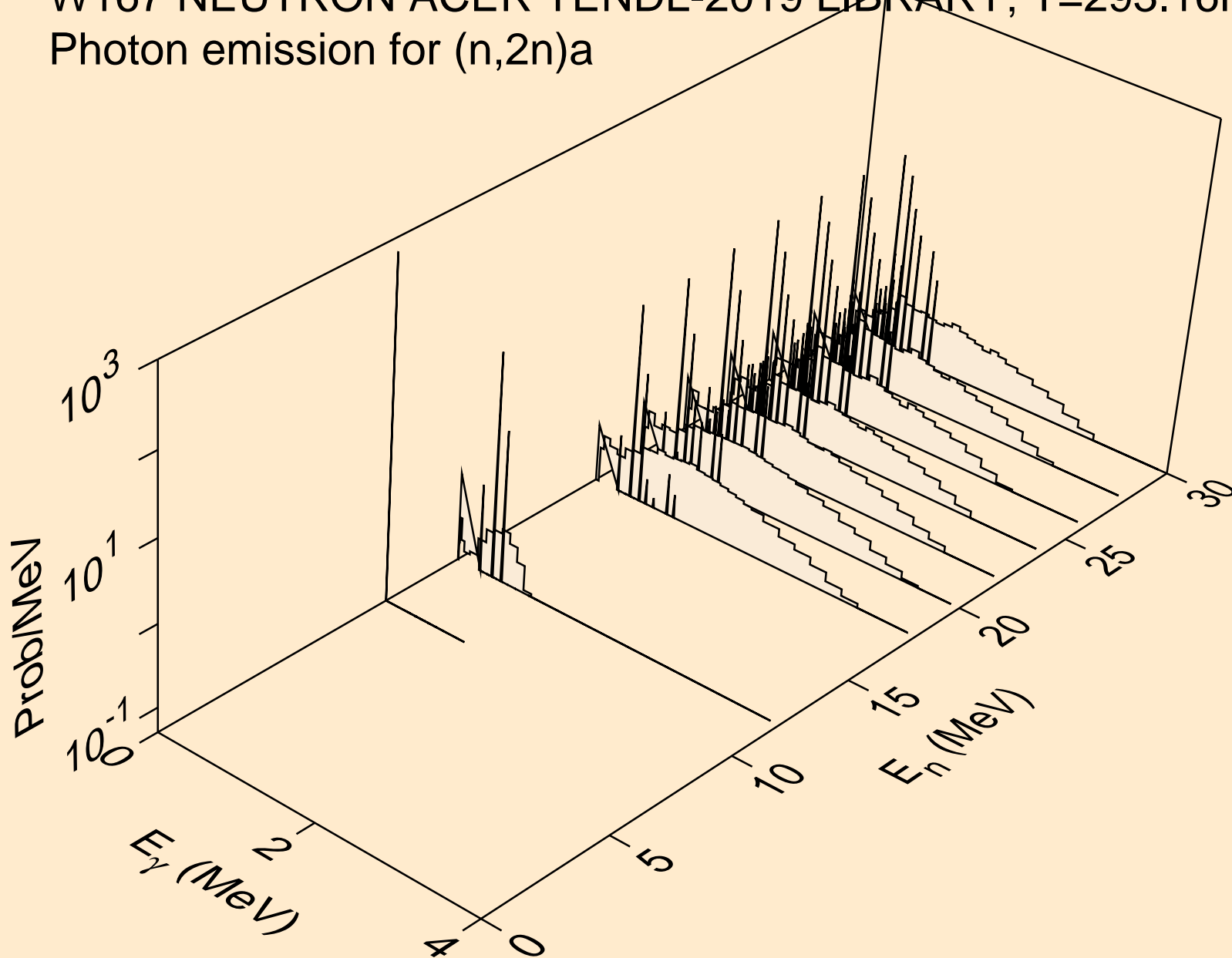

W167 NEUTRON ACER TENDL-2019 LIBRARY; T=293.16K
Photon emission for (n,3n)a

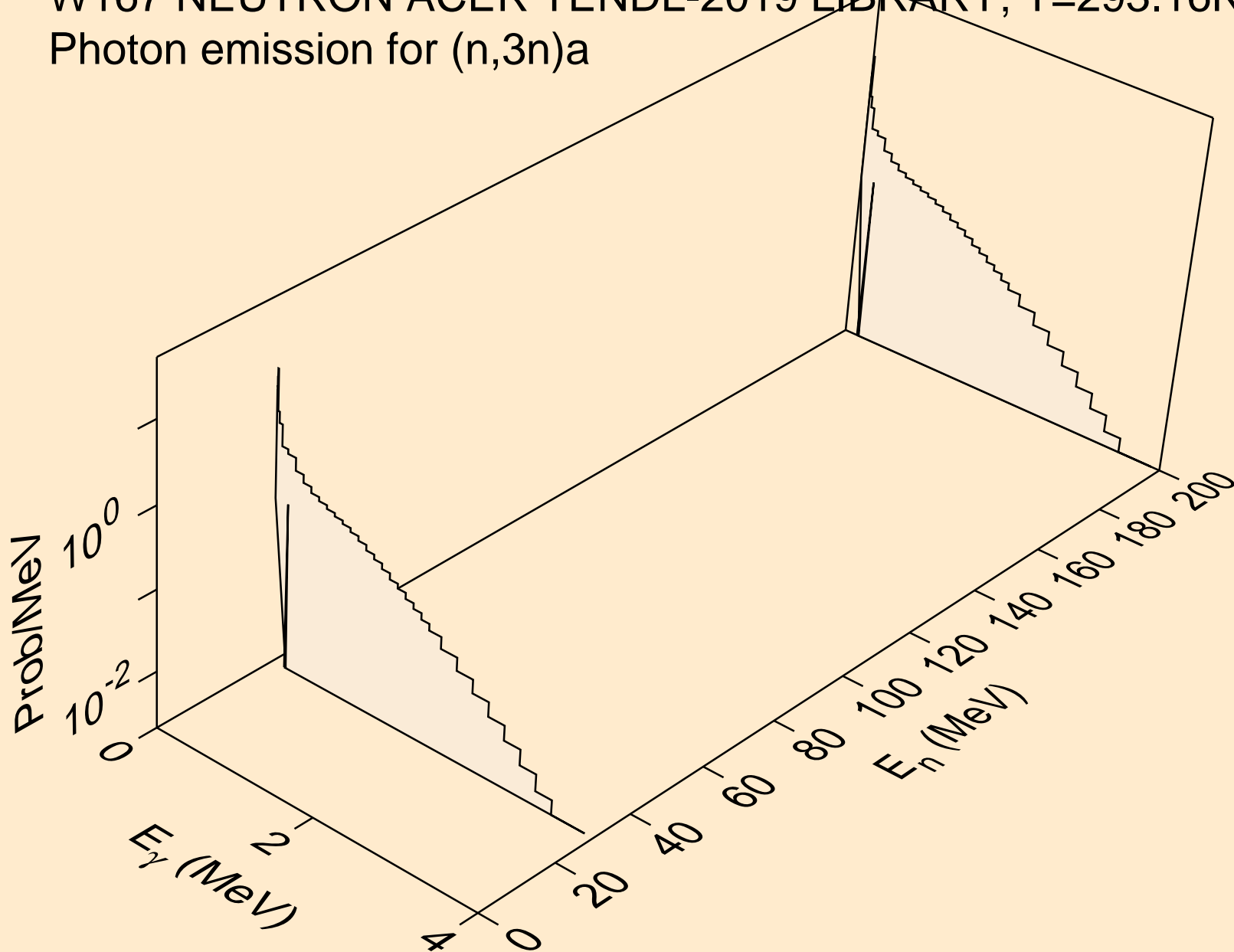

W167 NEUTRON ACER TENDL-2019 LIBRARY; T=293.16K
Photon emission for (n,n*)p

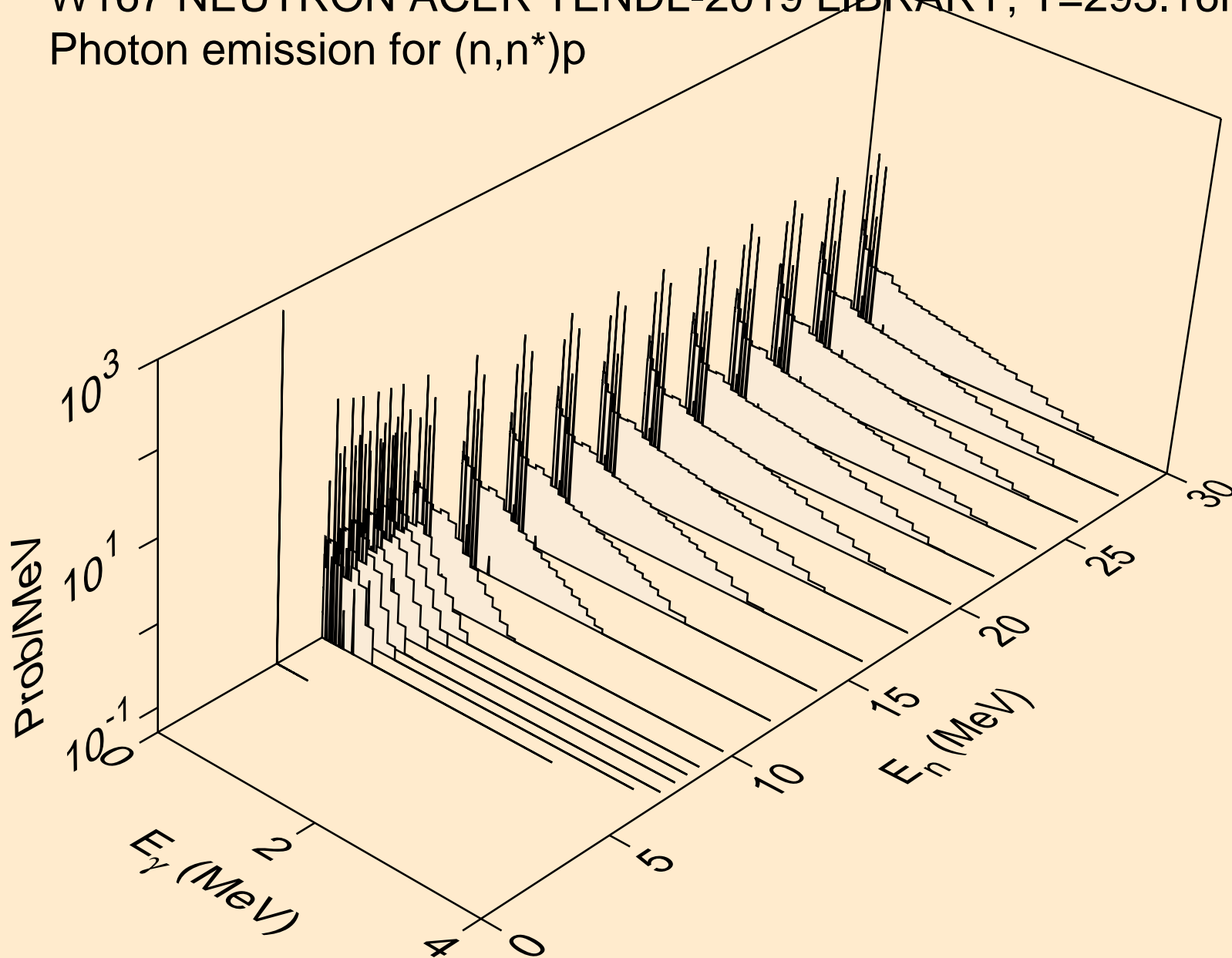

W167 NEUTRON ACER TENDL-2019 LIBRARY; T=293.16K
Photon emission for (n,n*)2a

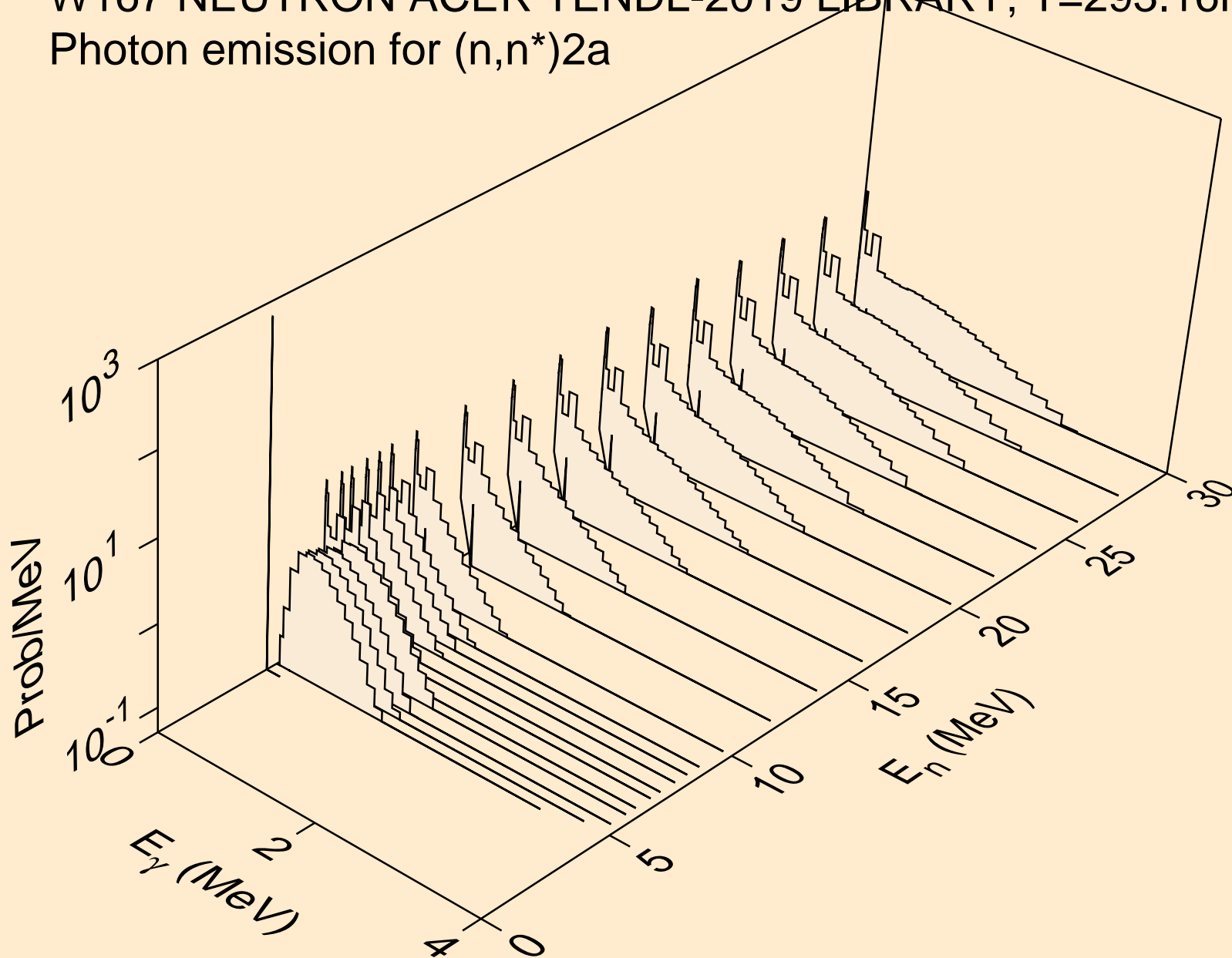

W167 NEUTRON ACER TENDL-2019 LIBRARY; T=293.16K
Photon emission for (n,2n)2a

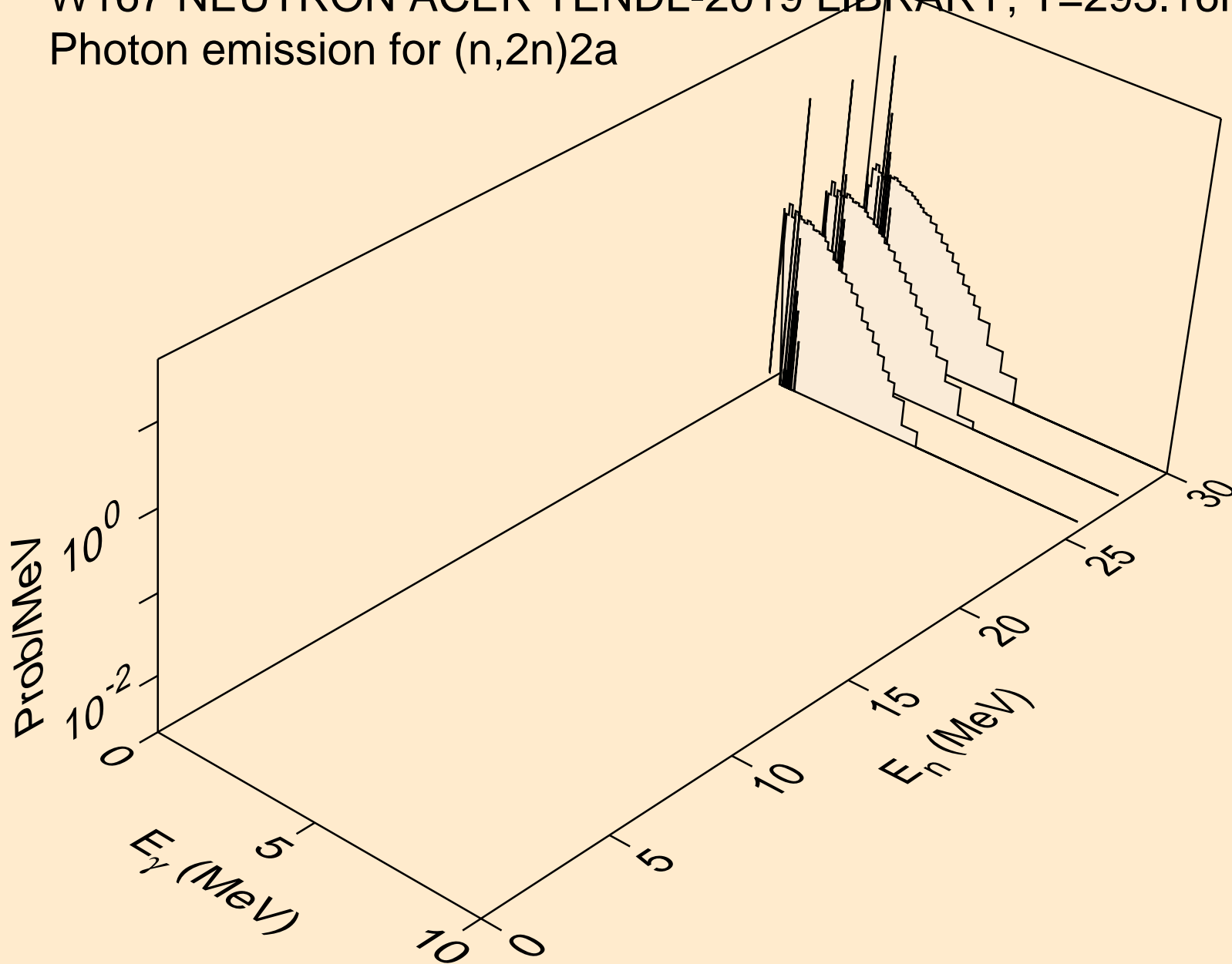

W167 NEUTRON ACER TENDL-2019 LIBRARY; T=293.16K
Photon emission for (n,n*)d

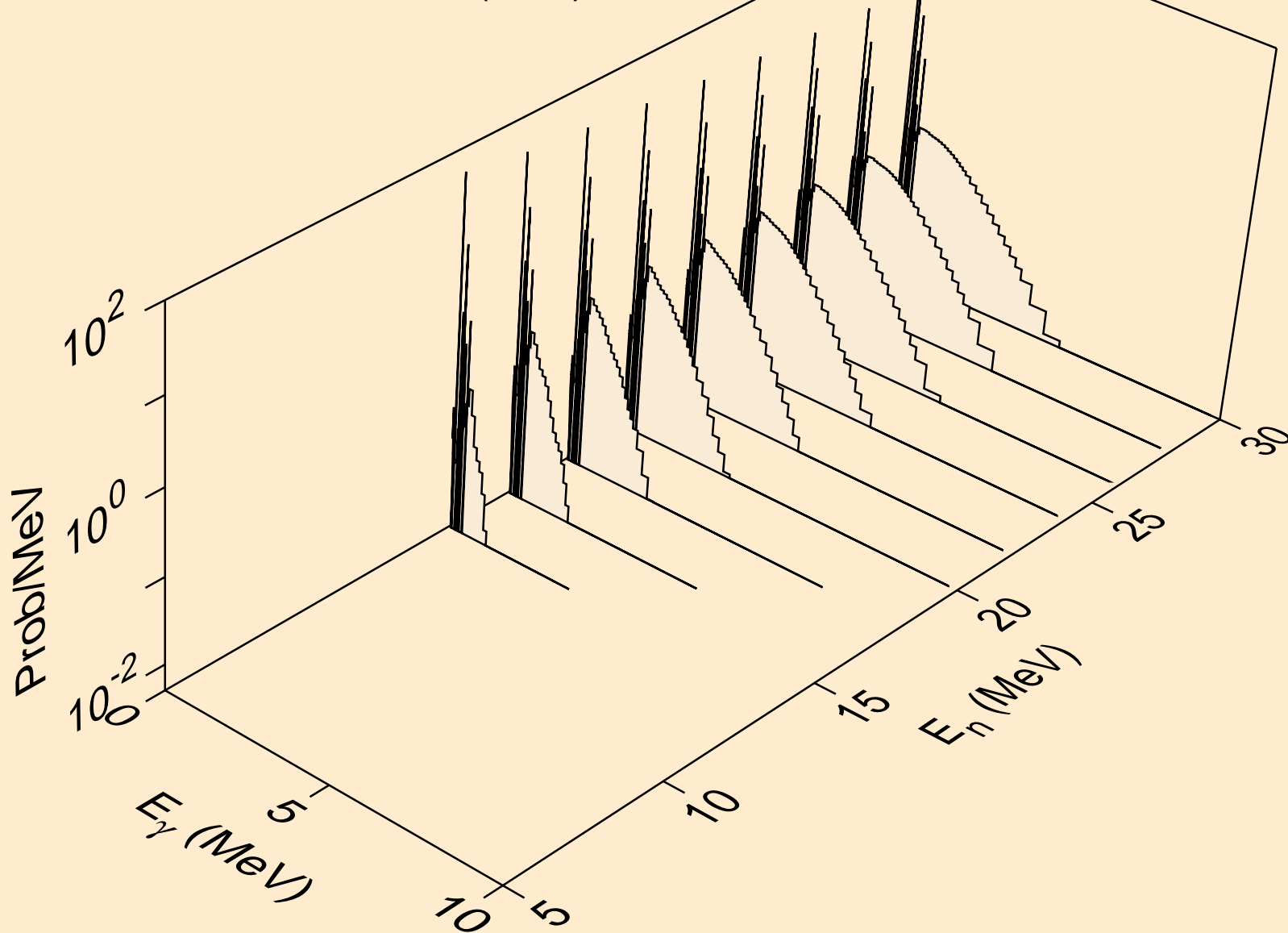

W167 NEUTRON ACER TENDL-2019 LIBRARY; T=293.16K
Photon emission for (n,n*)t

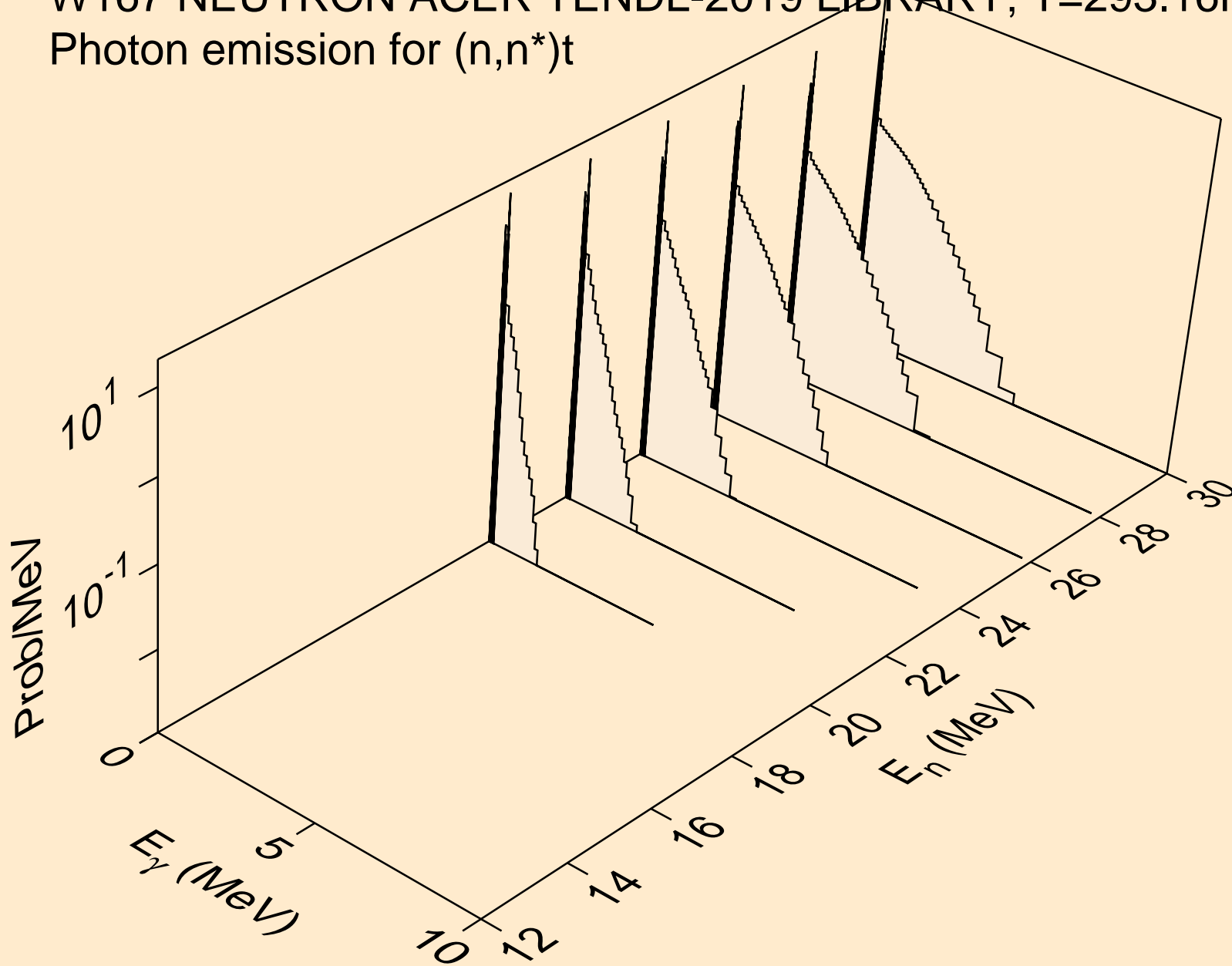

W167 NEUTRON ACER TENDL-2019 LIBRARY; T=293.16K
Photon emission for (n,n*)he3

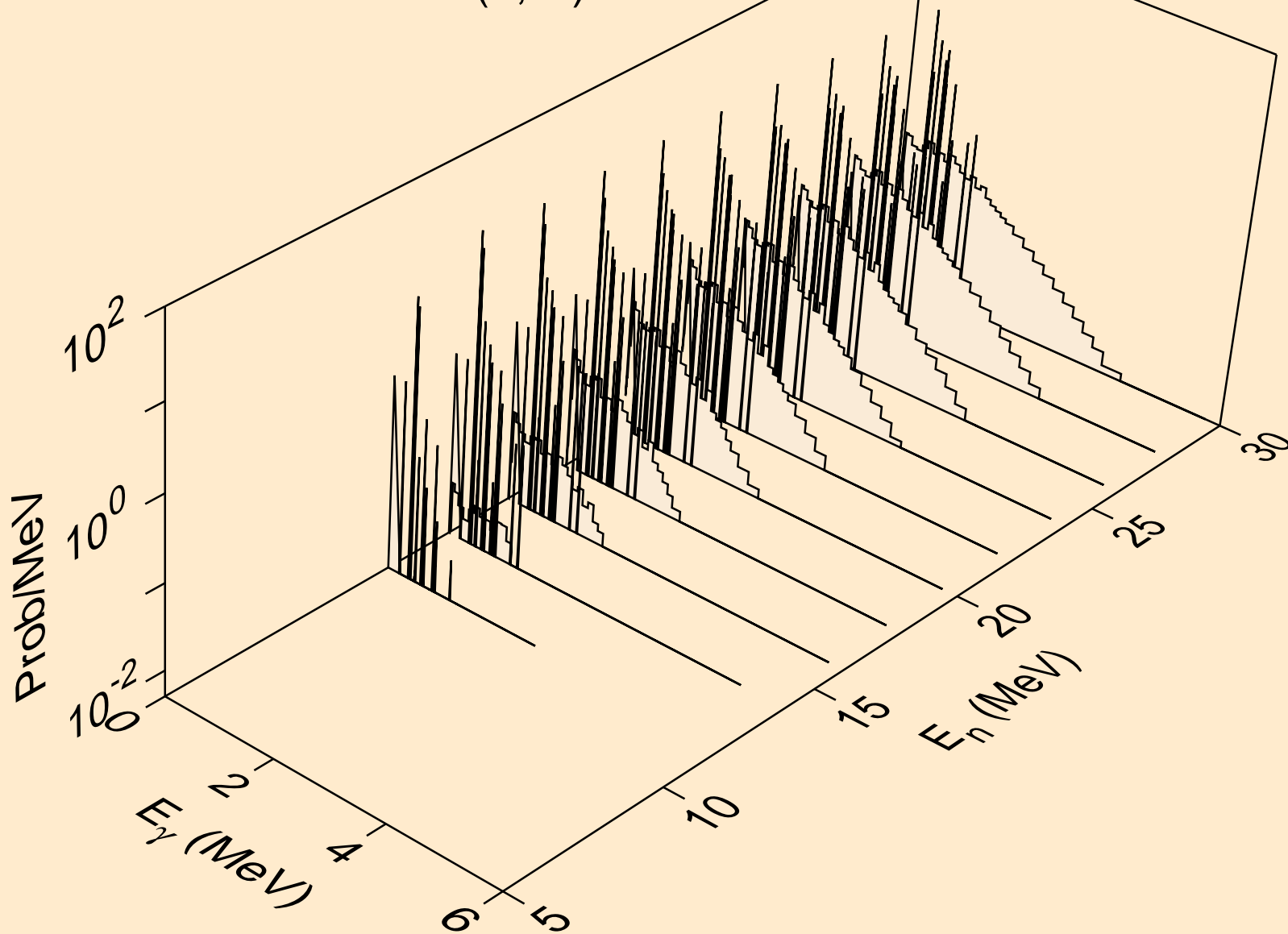

W167 NEUTRON ACER TENDL-2019 LIBRARY; T=293.16K
Photon emission for (n,4n)

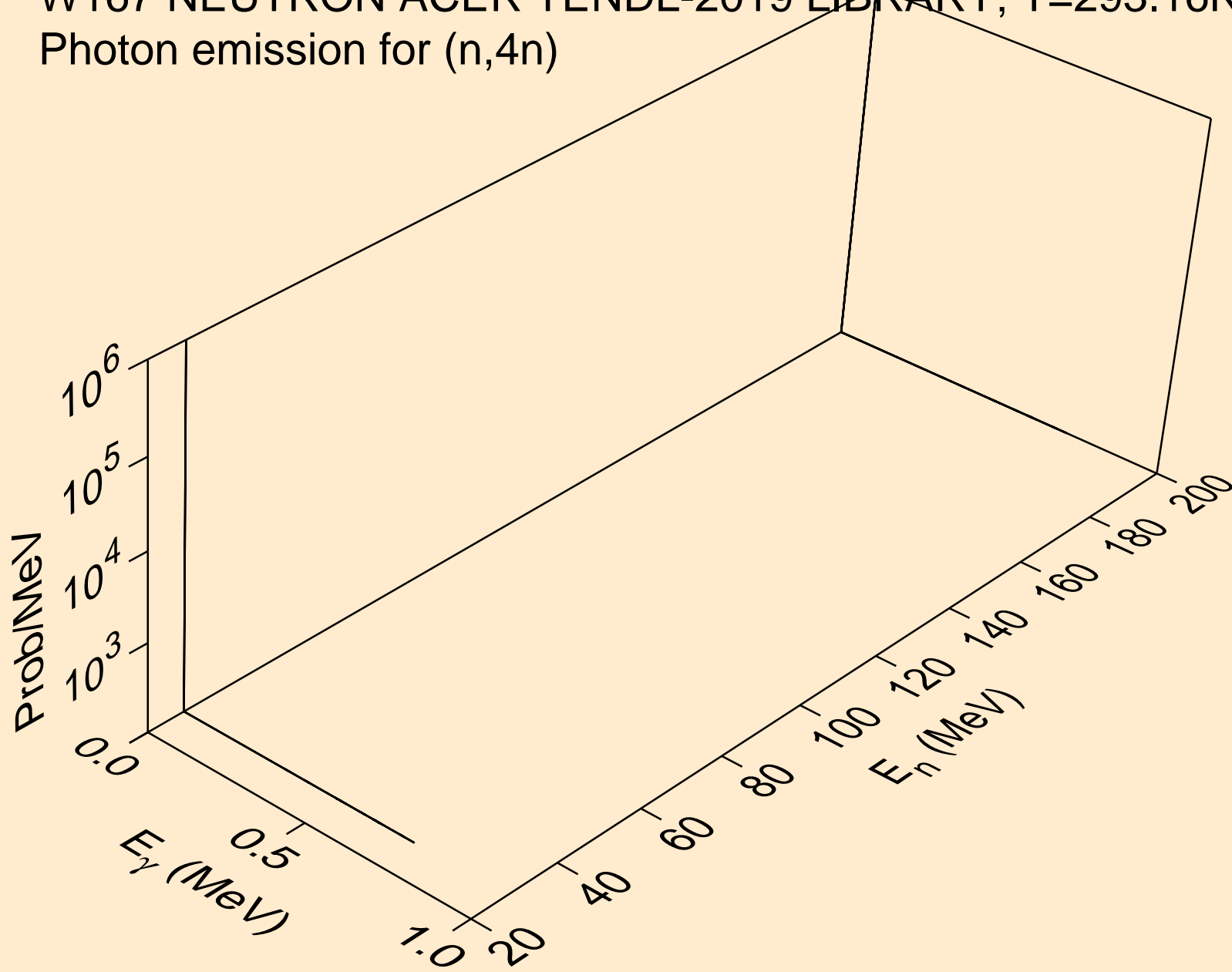

W167 NEUTRON ACER TENDL-2019 LIBRARY; T=293.16K
Photon emission for (n,2np)

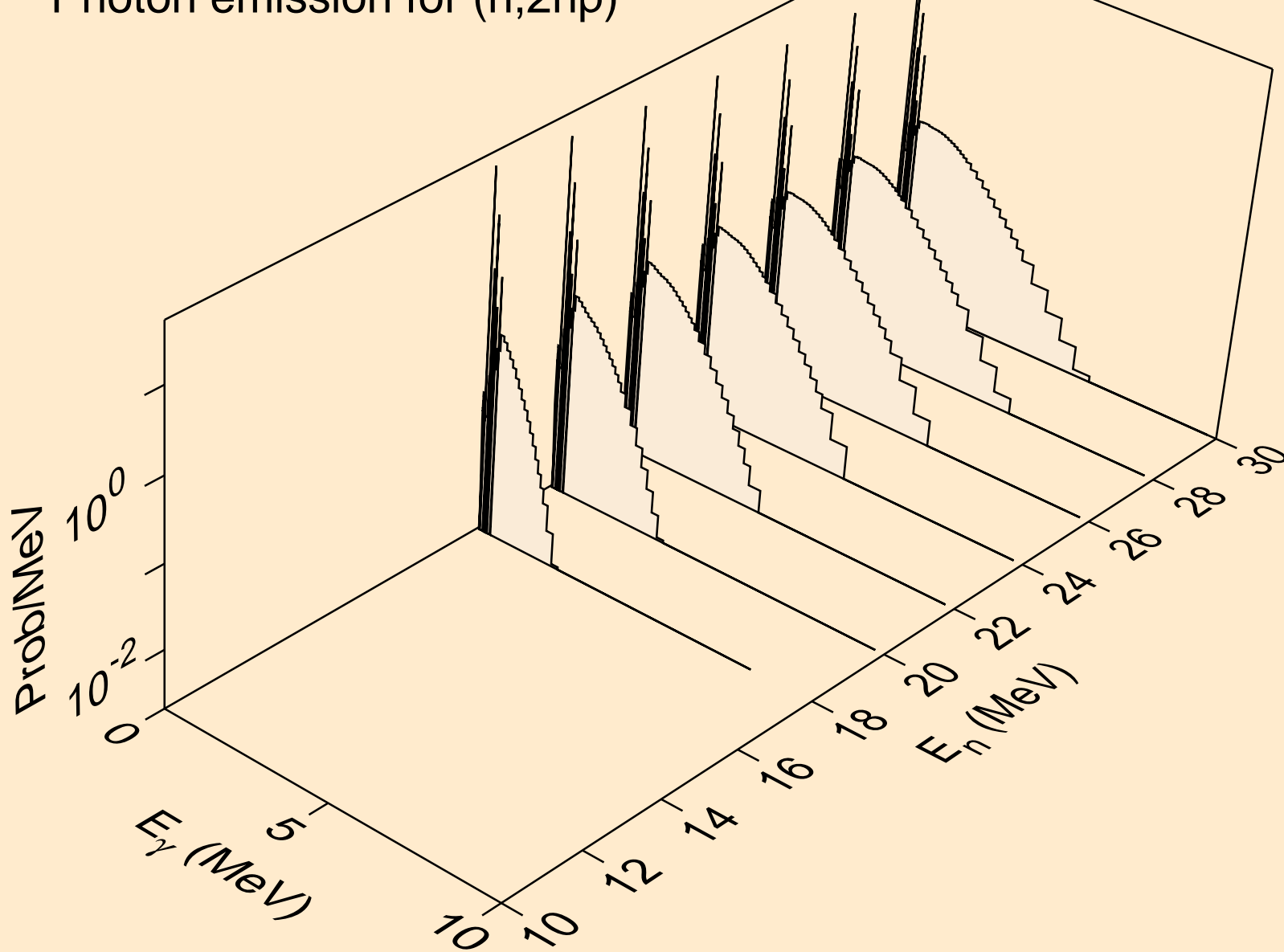

W167 NEUTRON ACER TENDL-2019 LIBRARY; T=293.16K
Photon emission for (n,3np)

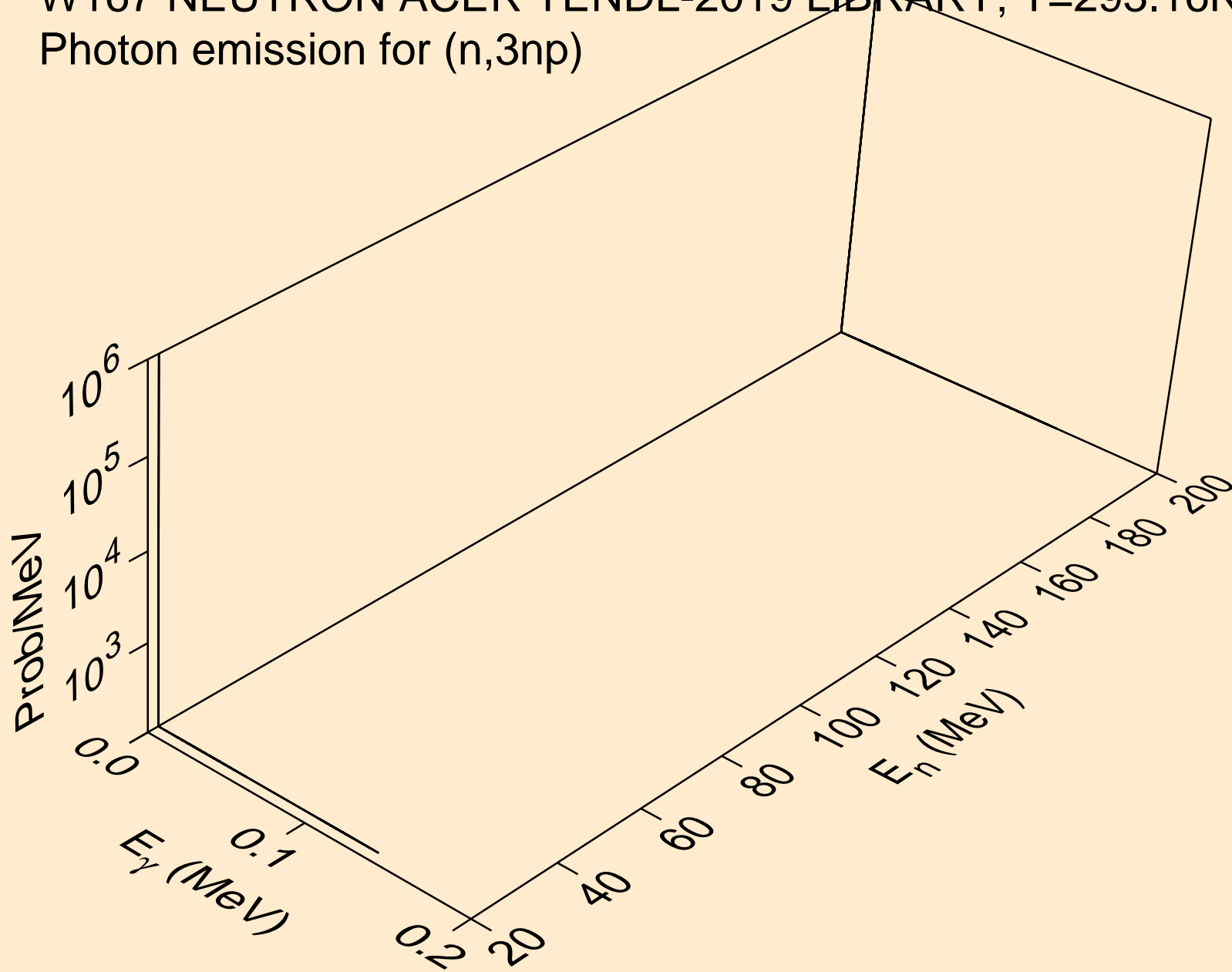

W167 NEUTRON ACER TENDL-2019 LIBRARY; T=293.16K
Photon emission for (n,2np)

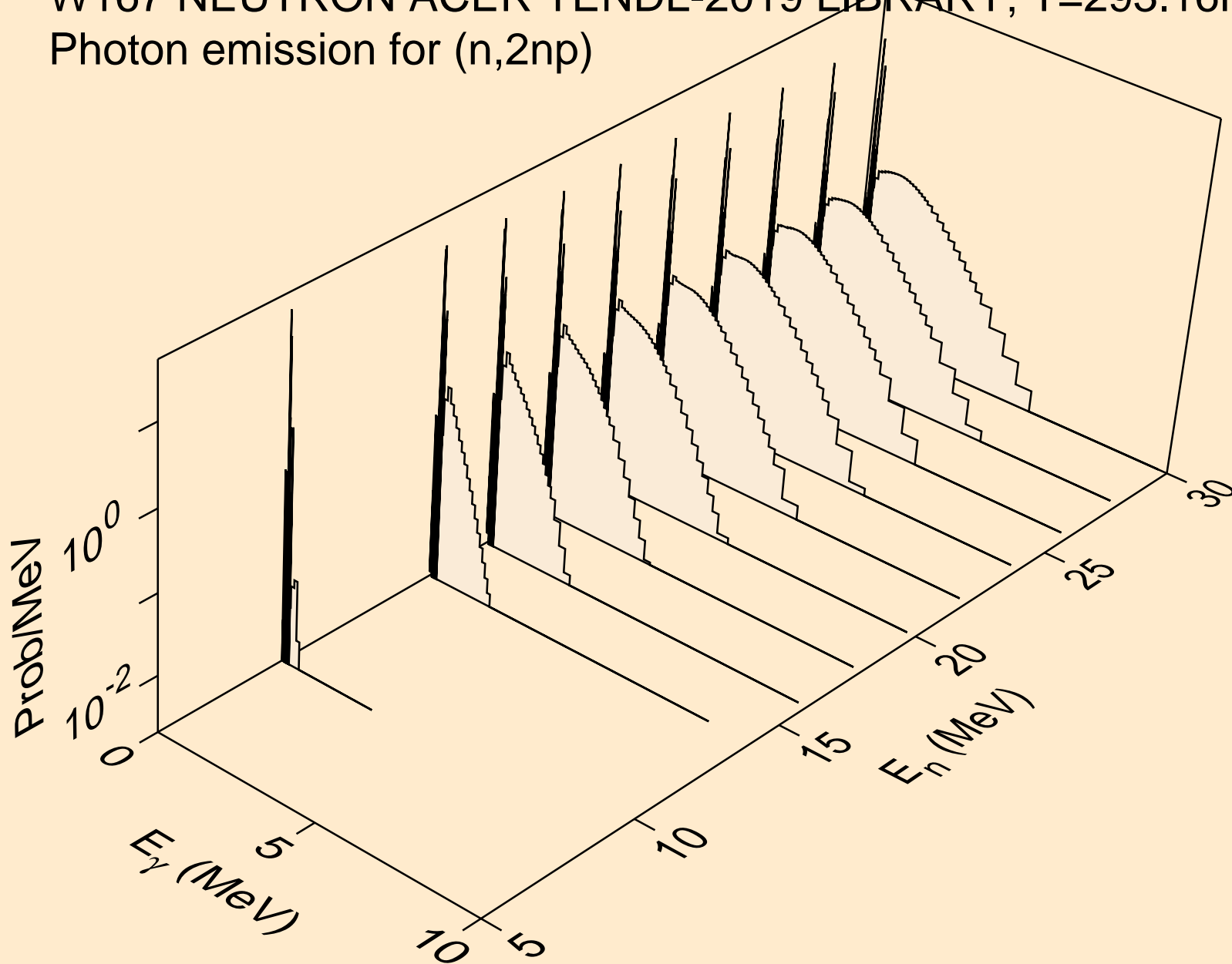

W167 NEUTRON ACER TENDL-2019 LIBRARY; T=293.16K
Photon emission for (n,npa)

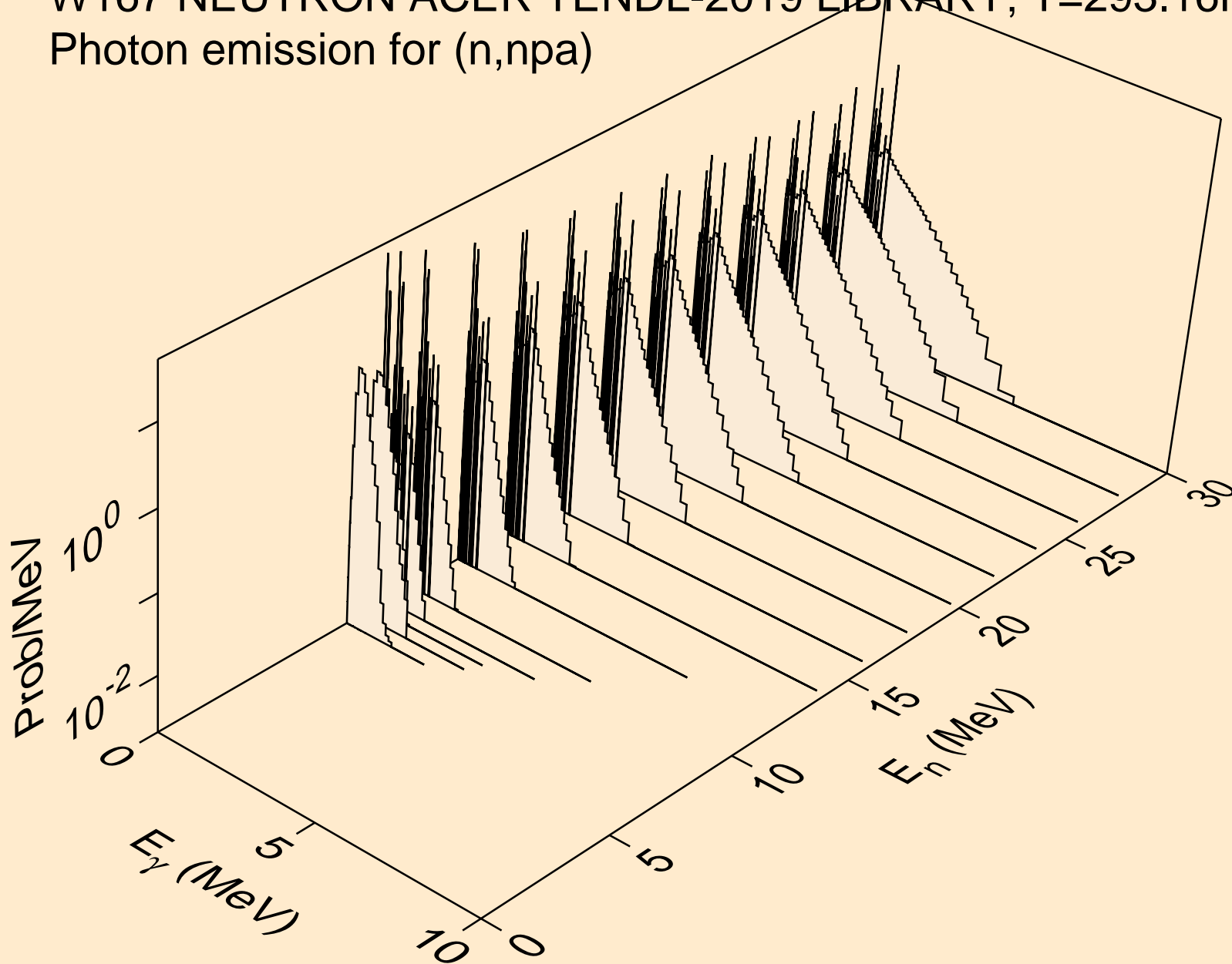

W167 NEUTRON ACER TENDL-2019 LIBRARY; T=293.16K
Photon emission for (n,n*c)

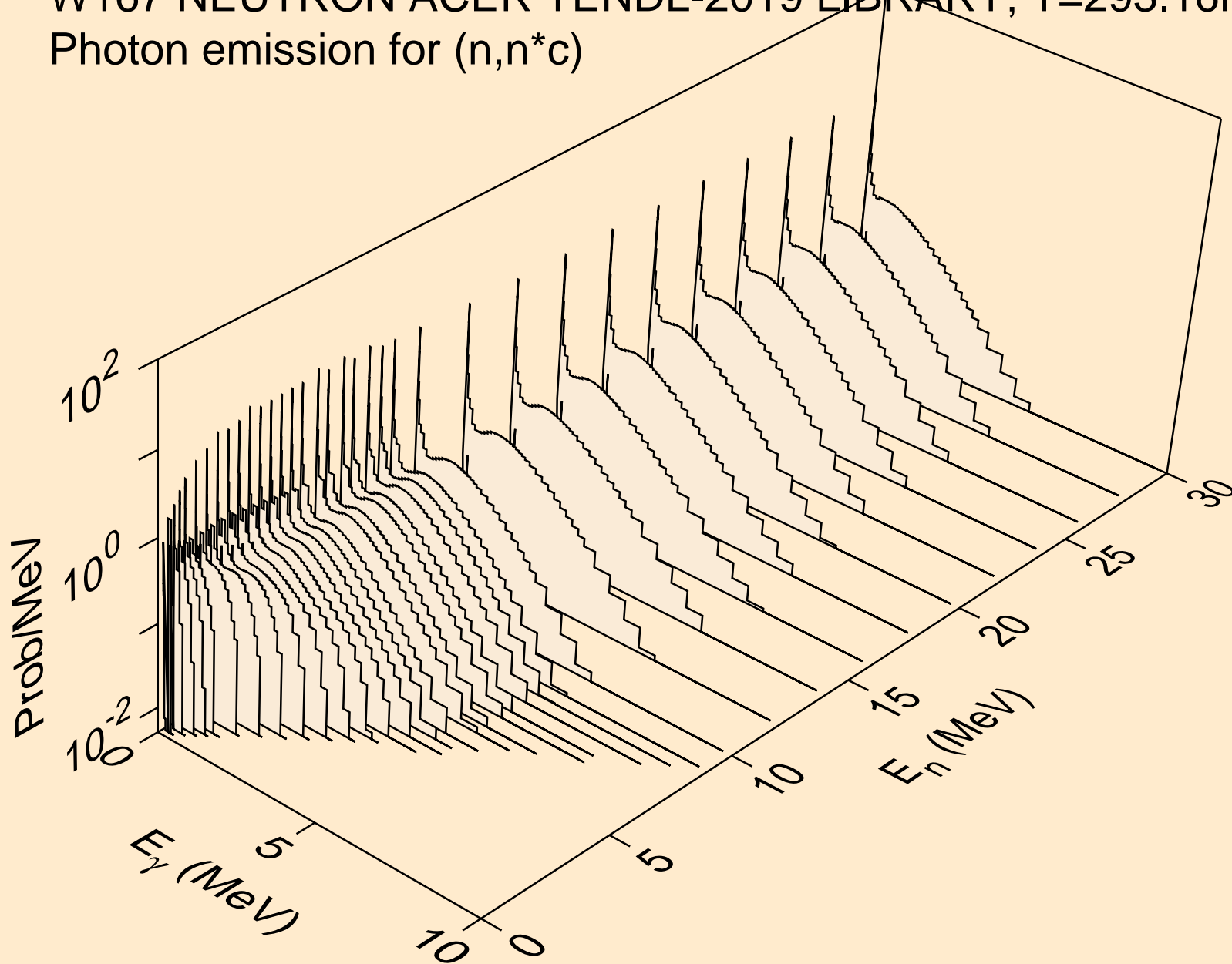

W167 NEUTRON ACER TENDL-2019 LIBRARY; T=293.16K
Photon emission for (n,gma)

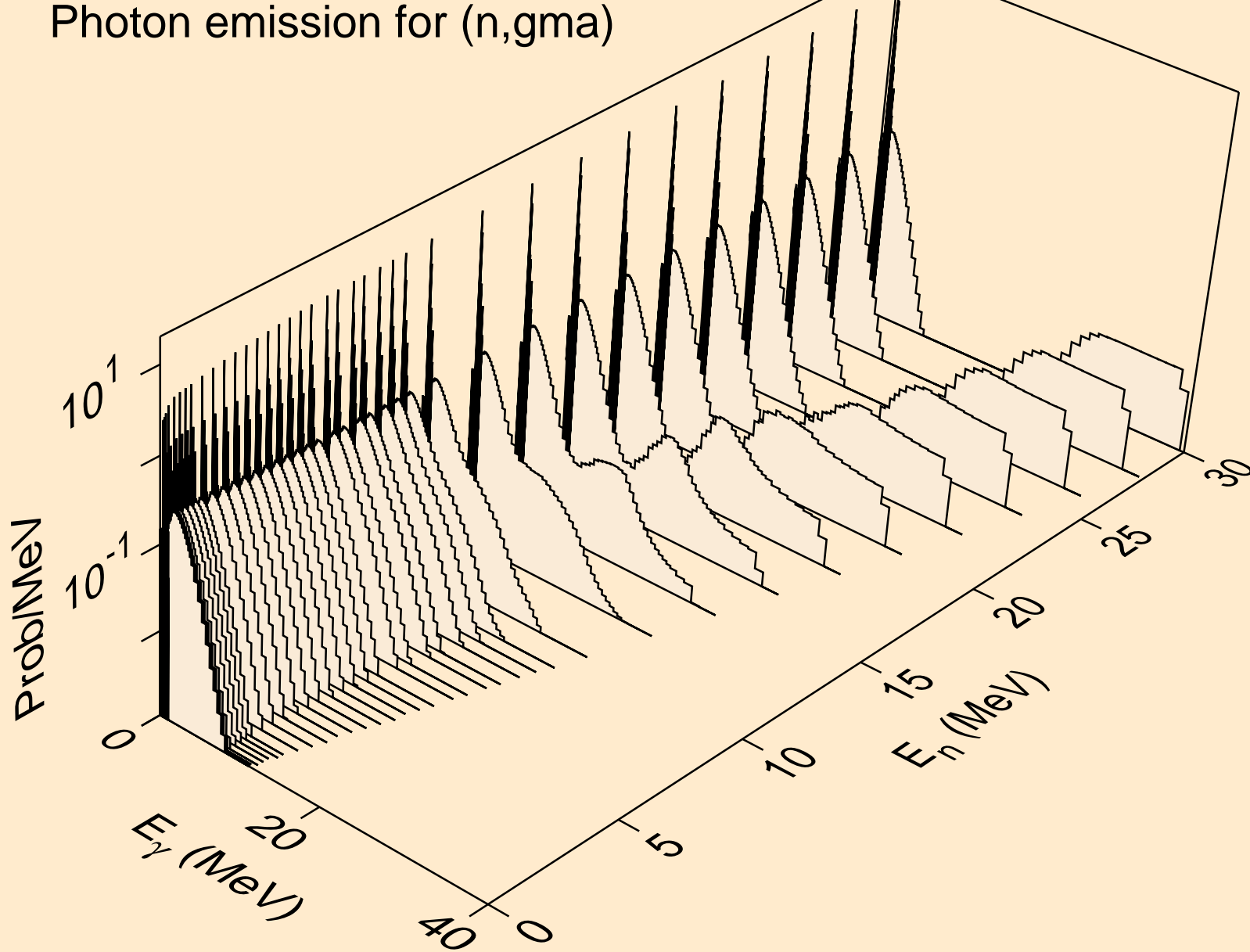

W167 NEUTRON ACER TENDL-2019 LIBRARY; T=293.16K
Photon emission for (n,p)

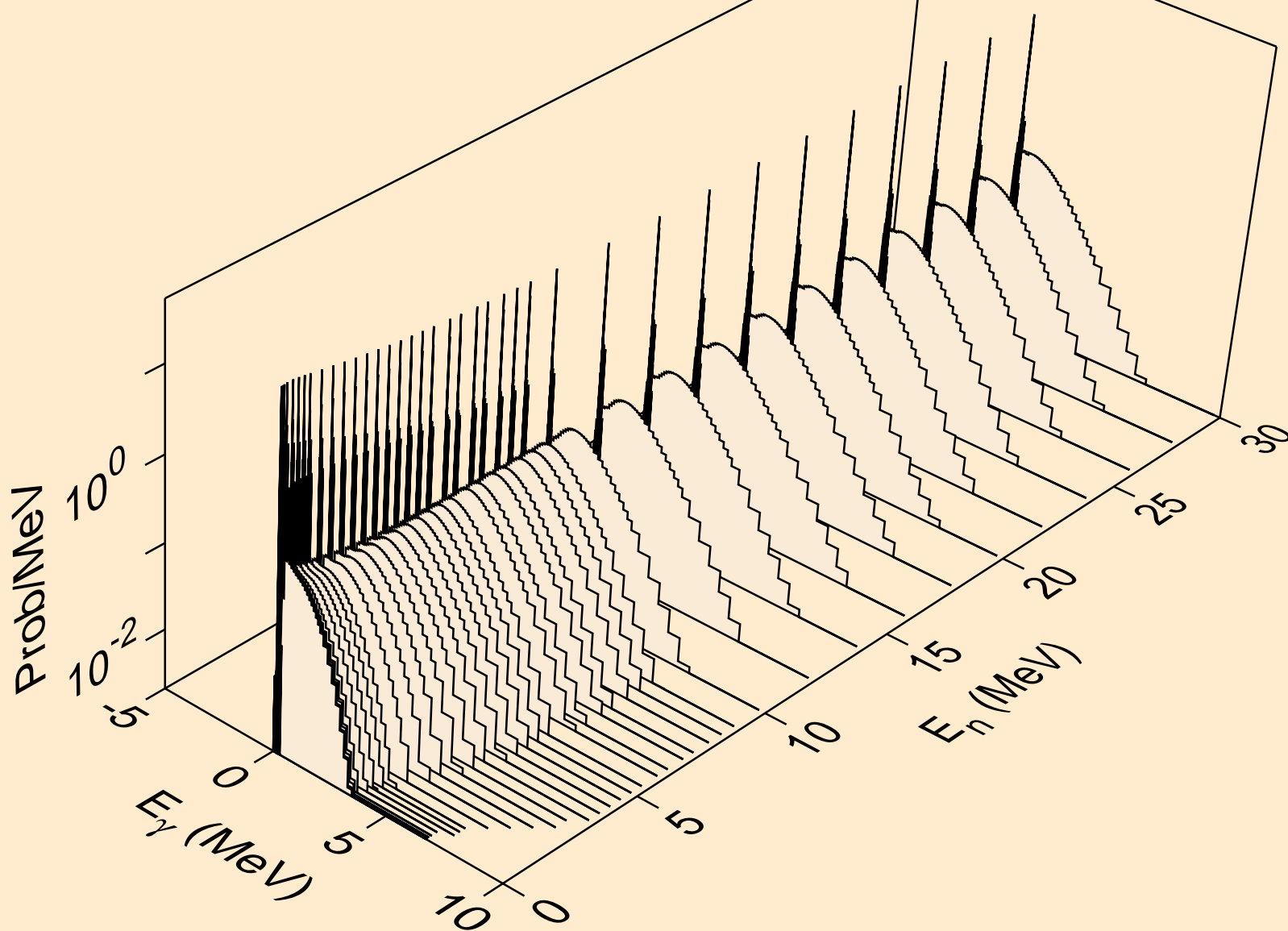

W167 NEUTRON ACER TENDL-2019 LIBRARY; T=293.16K
Photon emission for (n,d)

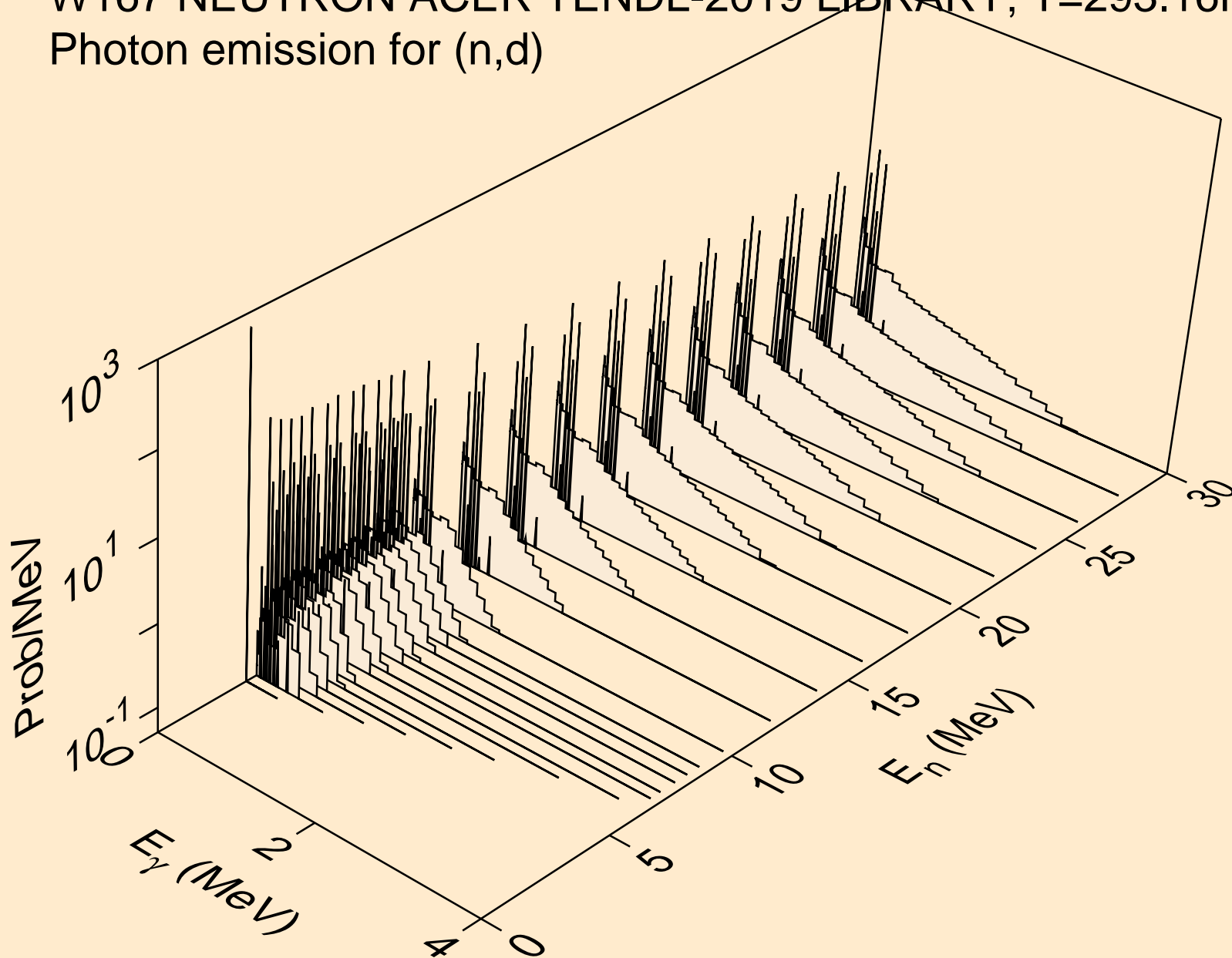

W167 NEUTRON ACER TENDL-2019 LIBRARY; T=293.16K
Photon emission for (n,t)

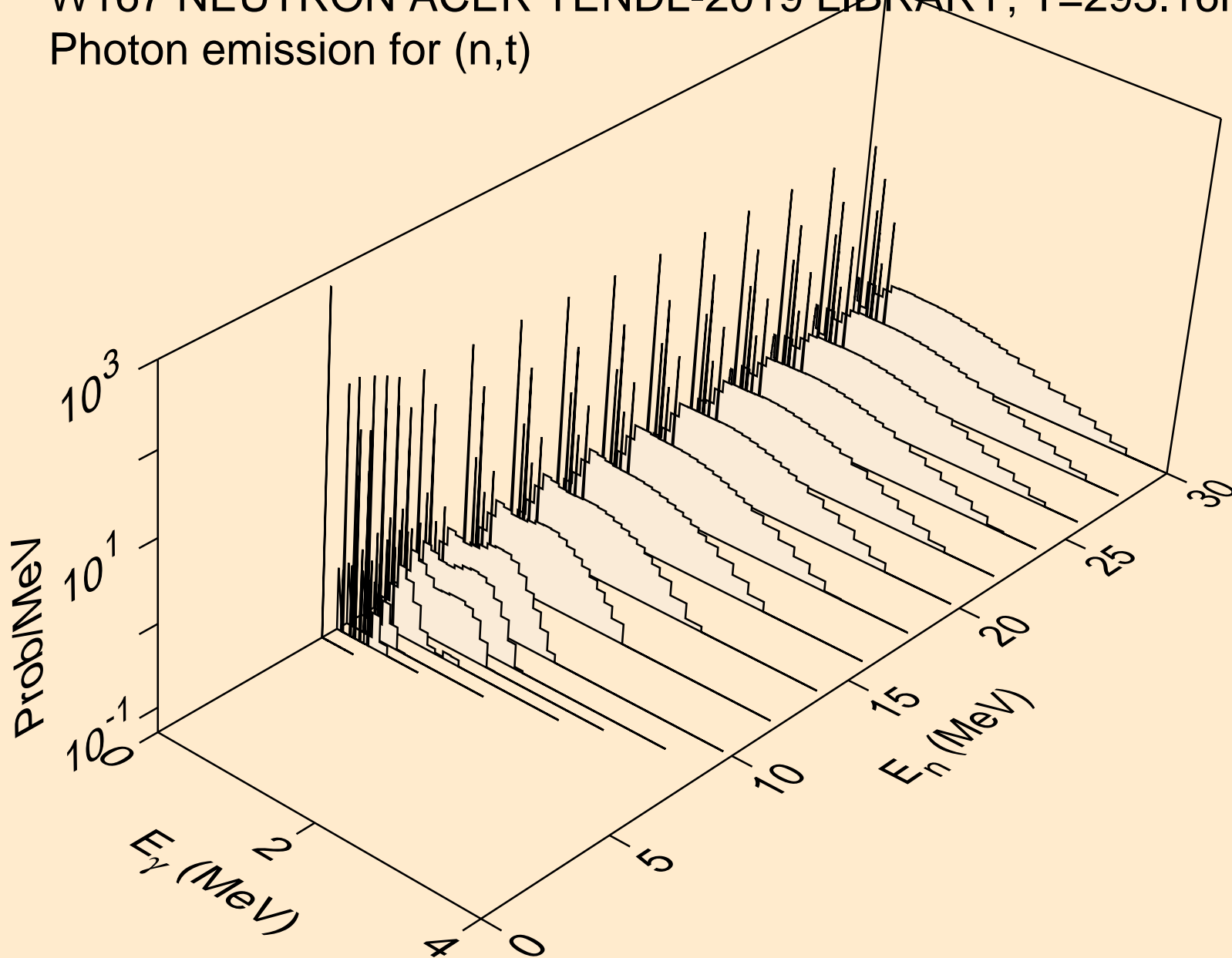

W167 NEUTRON ACER TENDL-2019 LIBRARY; T=293.16K
Photon emission for (n,he3)

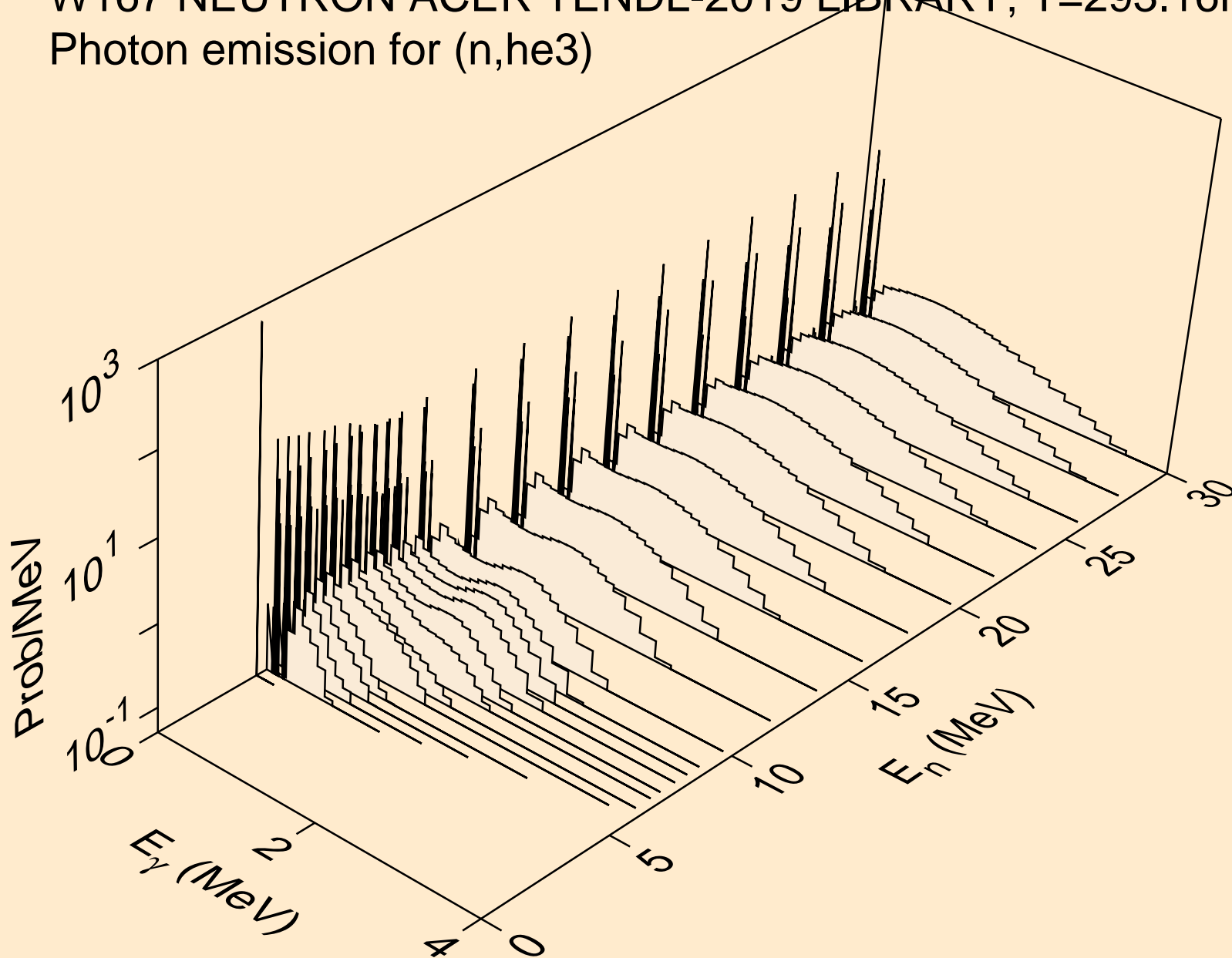

W167 NEUTRON ACER TENDL-2019 LIBRARY; T=293.16K
Photon emission for (n,a)

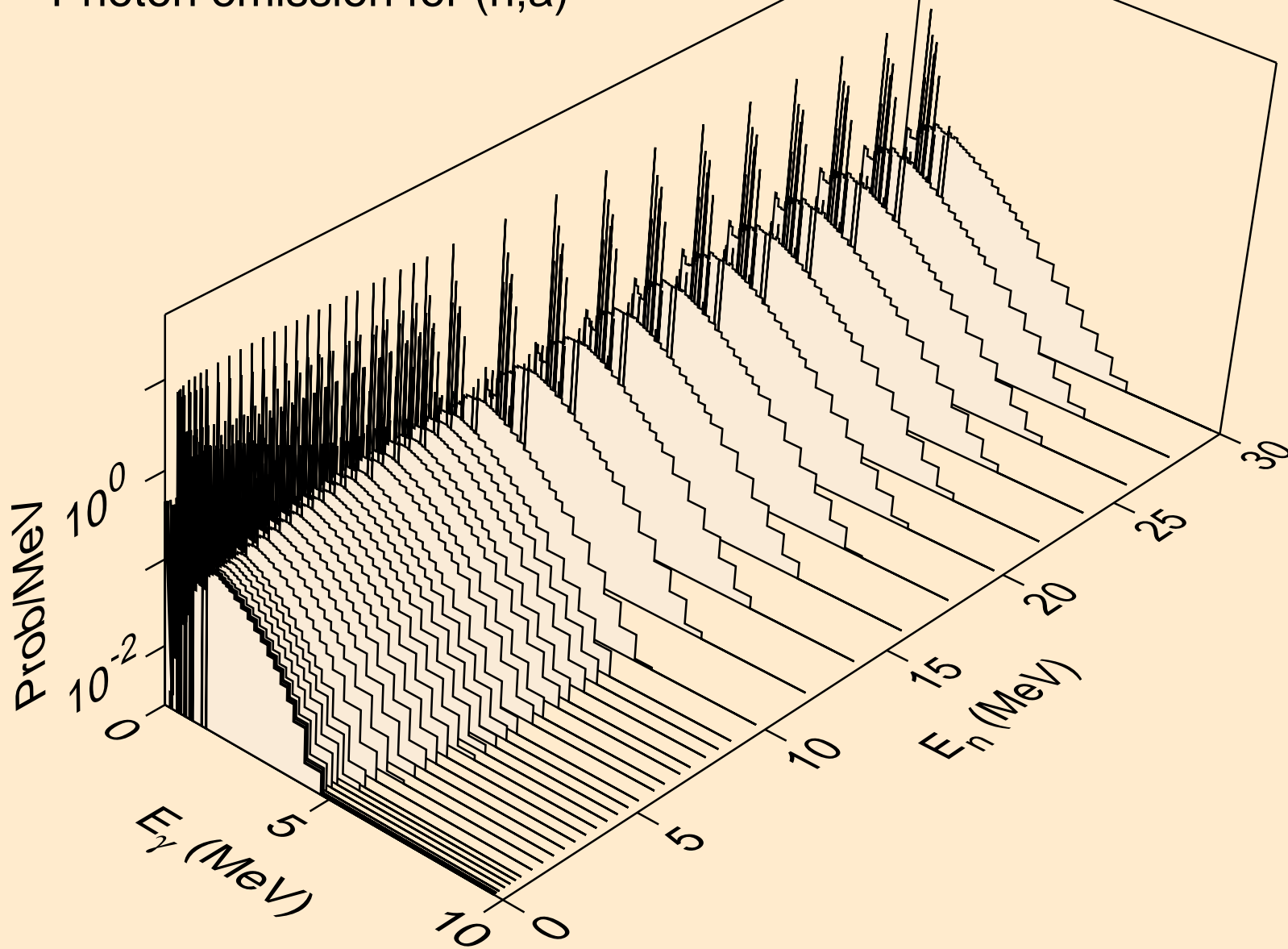

W167 NEUTRON ACER TENDL-2019 LIBRARY; T=293.16K
Photon emission for (n,2a)

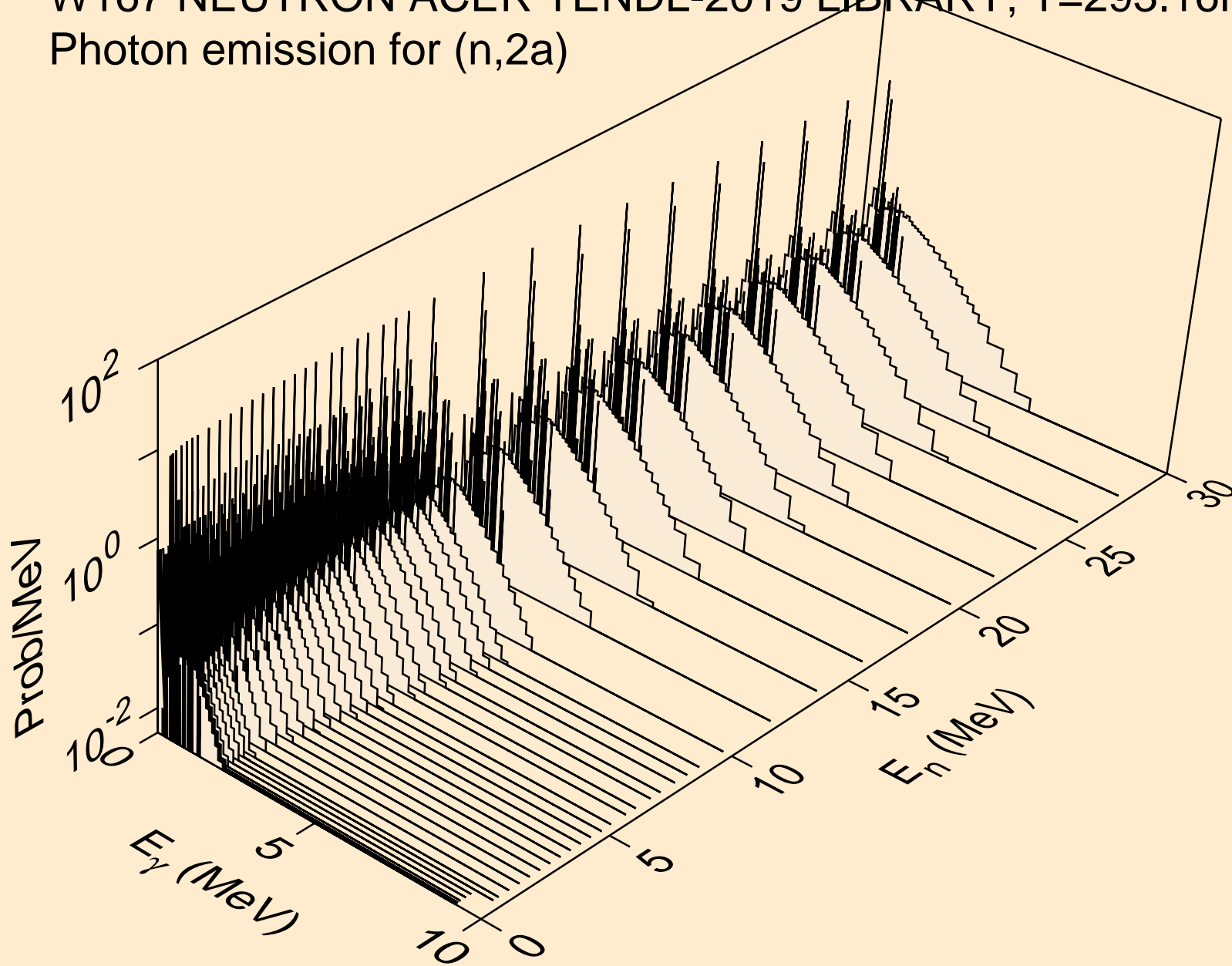

W167 NEUTRON ACER TENDL-2019 LIBRARY; T=293.16K
Photon emission for (n,3a)

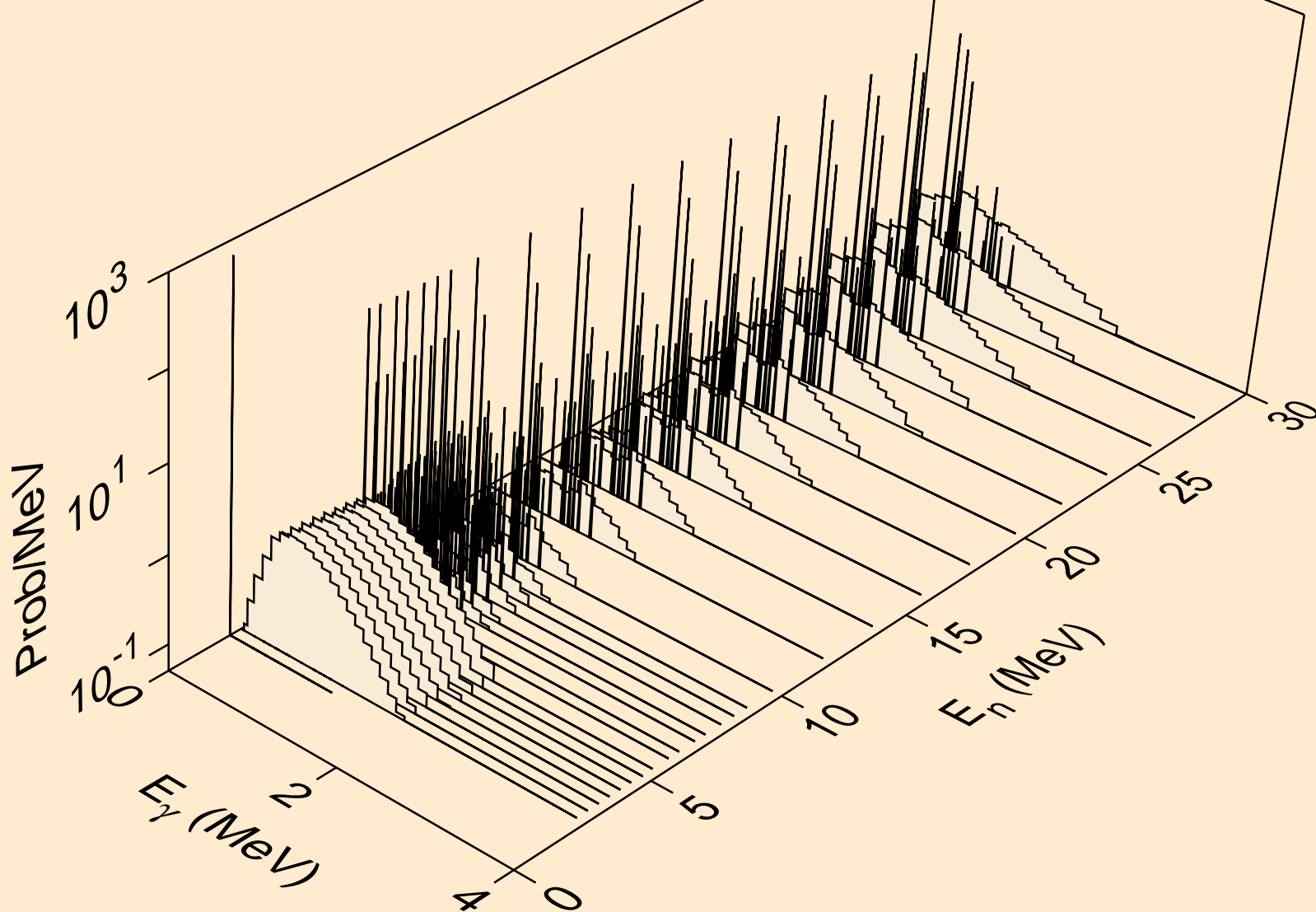

W167 NEUTRON ACER TENDL-2019 LIBRARY; T=293.16K
Photon emission for (n,2p)

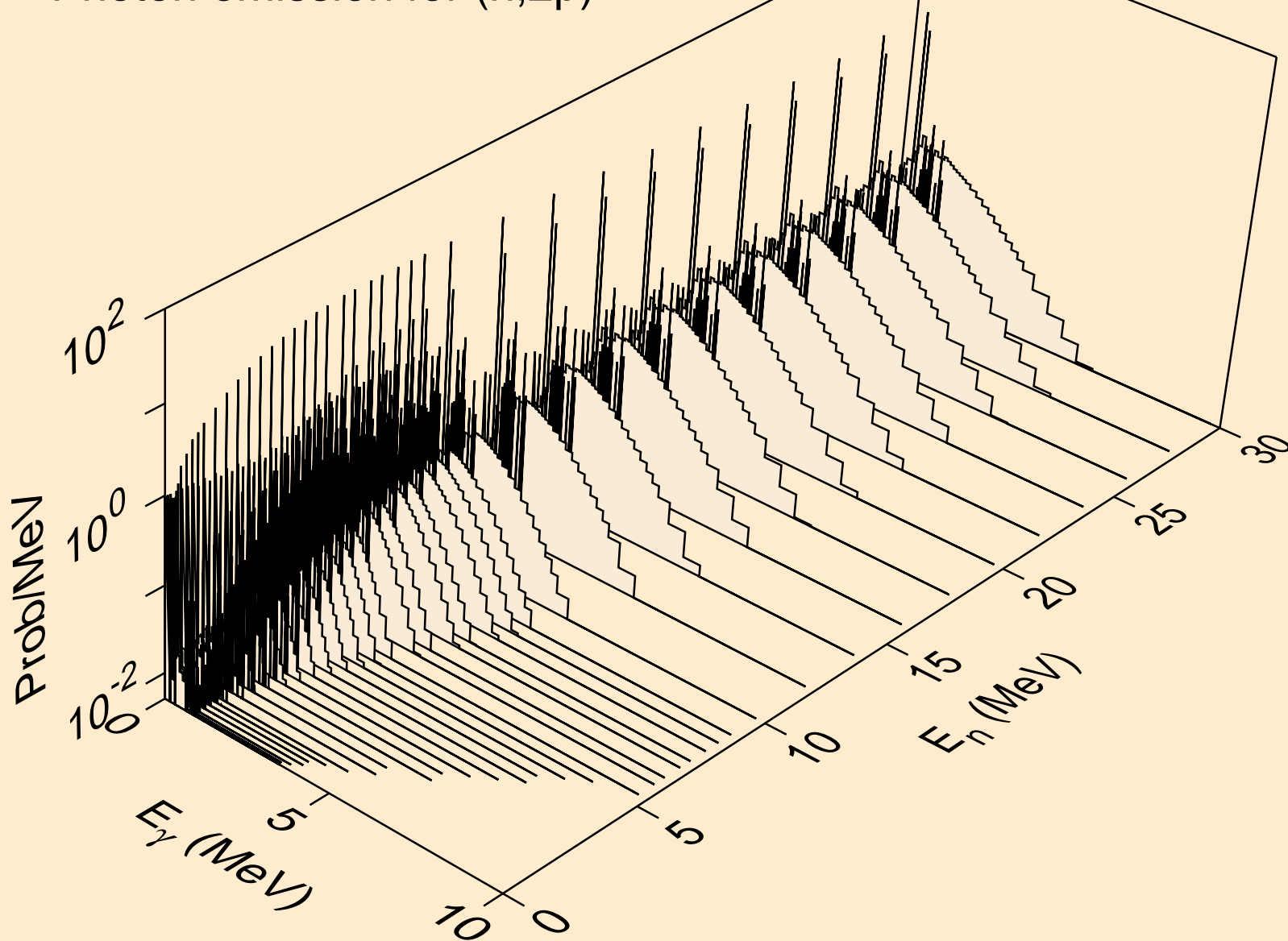

W167 NEUTRON ACER TENDL-2019 LIBRARY; T=293.16K
Photon emission for (n,p α)

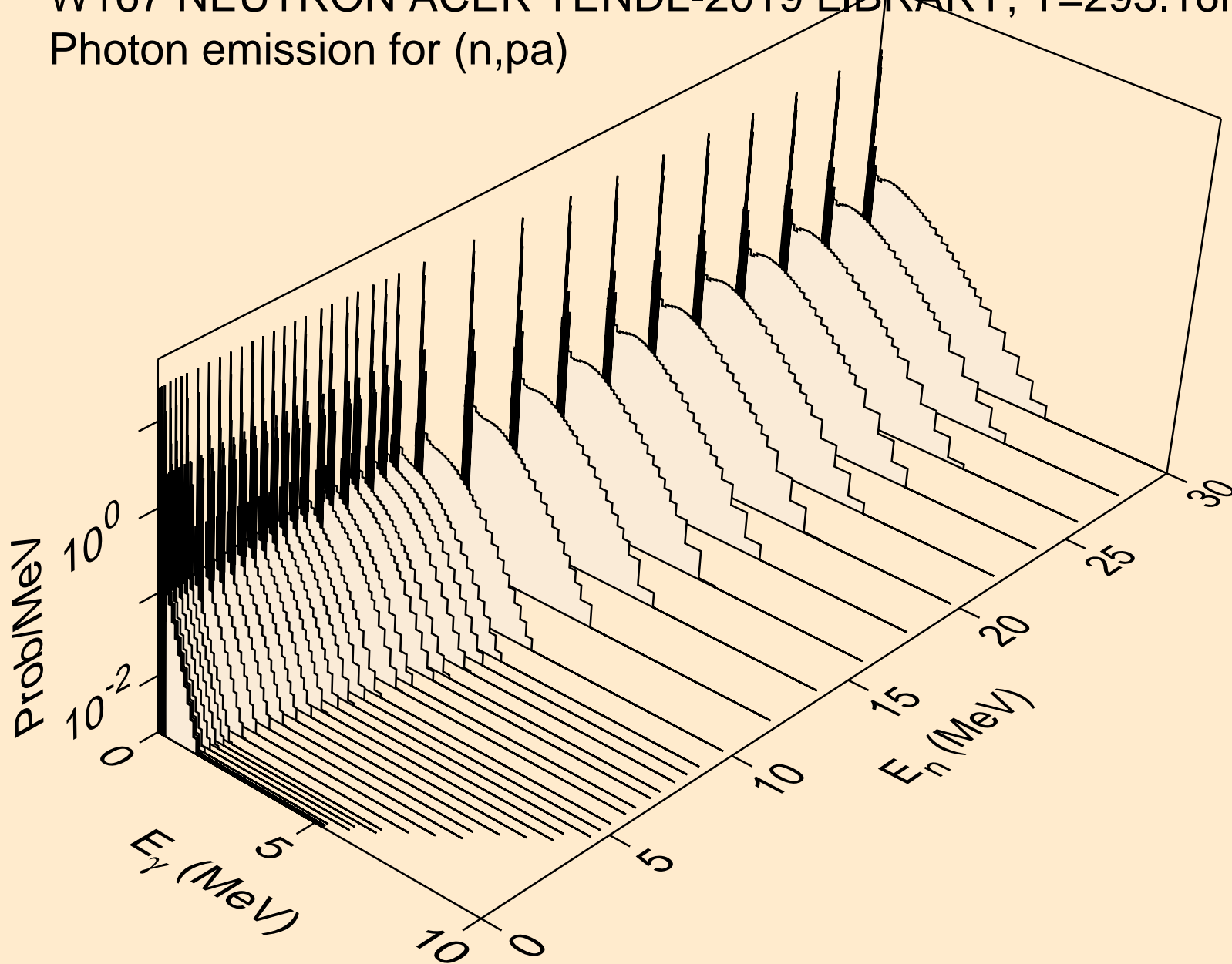

W167 NEUTRON ACER TENDL-2019 LIBRARY; T=293.16K
Photon emission for (n,pd)

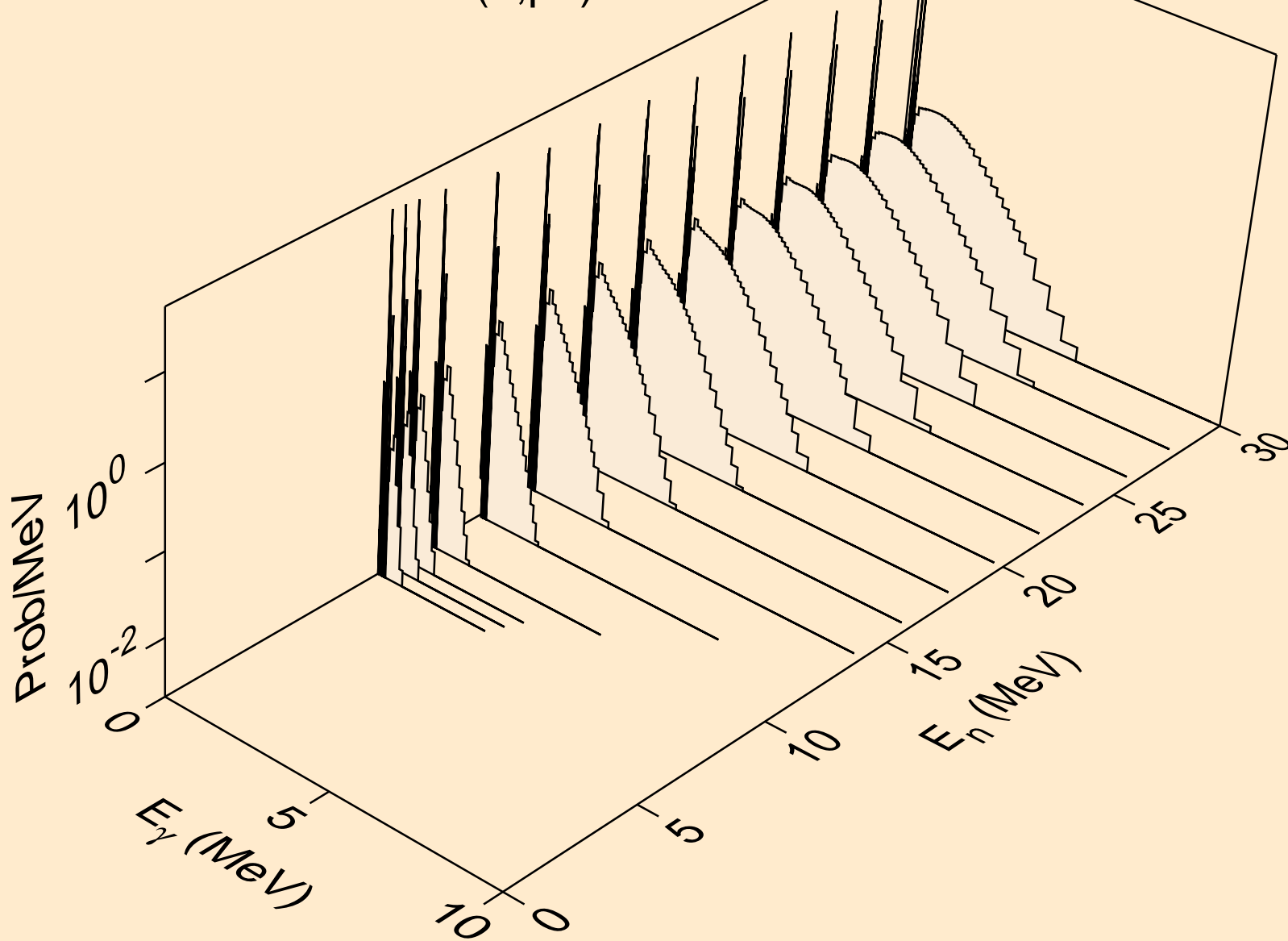

W167 NEUTRON ACER TENDL-2019 LIBRARY; T=293.16K
Photon emission for (n,pt)

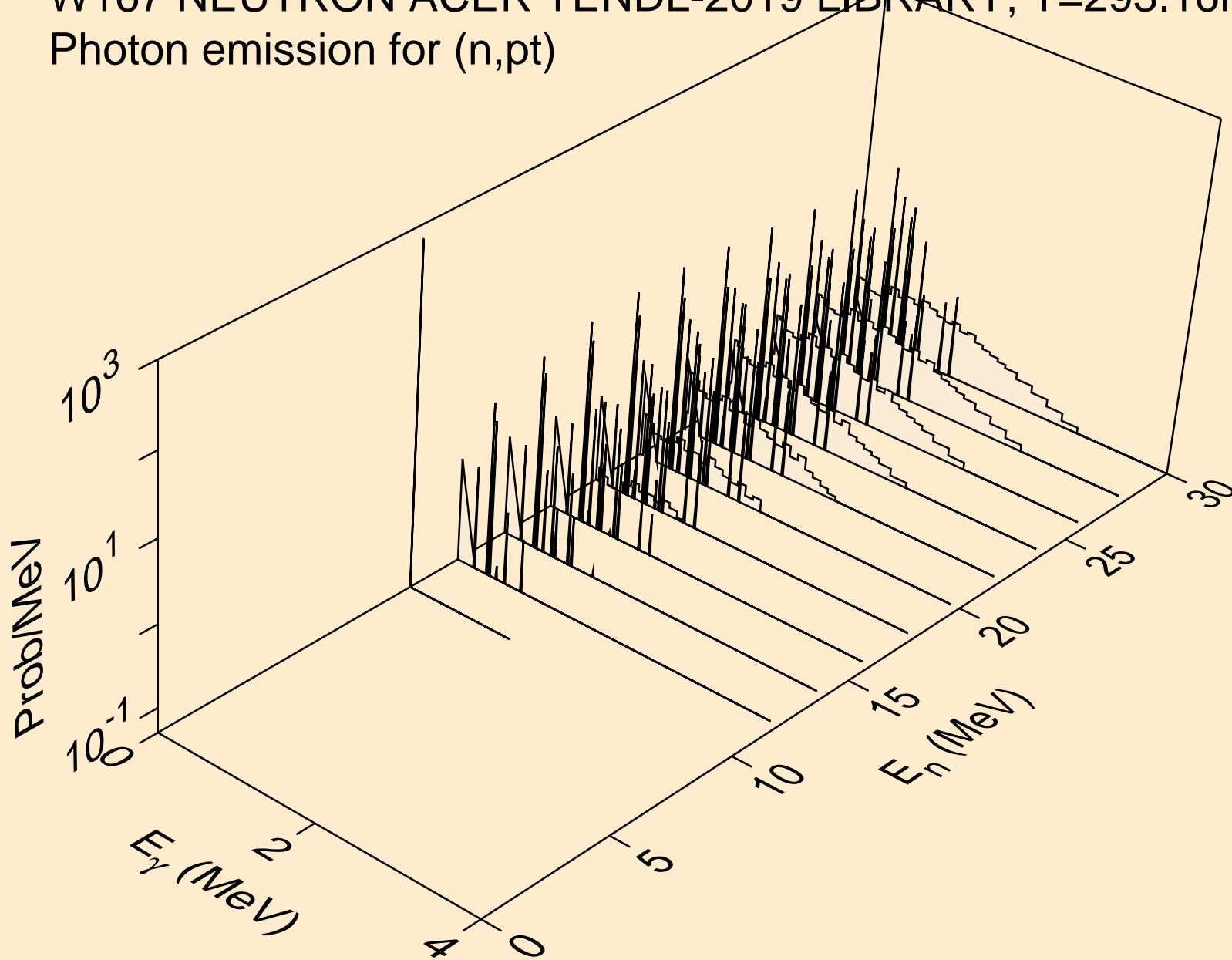

W167 NEUTRON ACER TENDL-2019 LIBRARY; T=293.16K
Photon emission for (n,da)

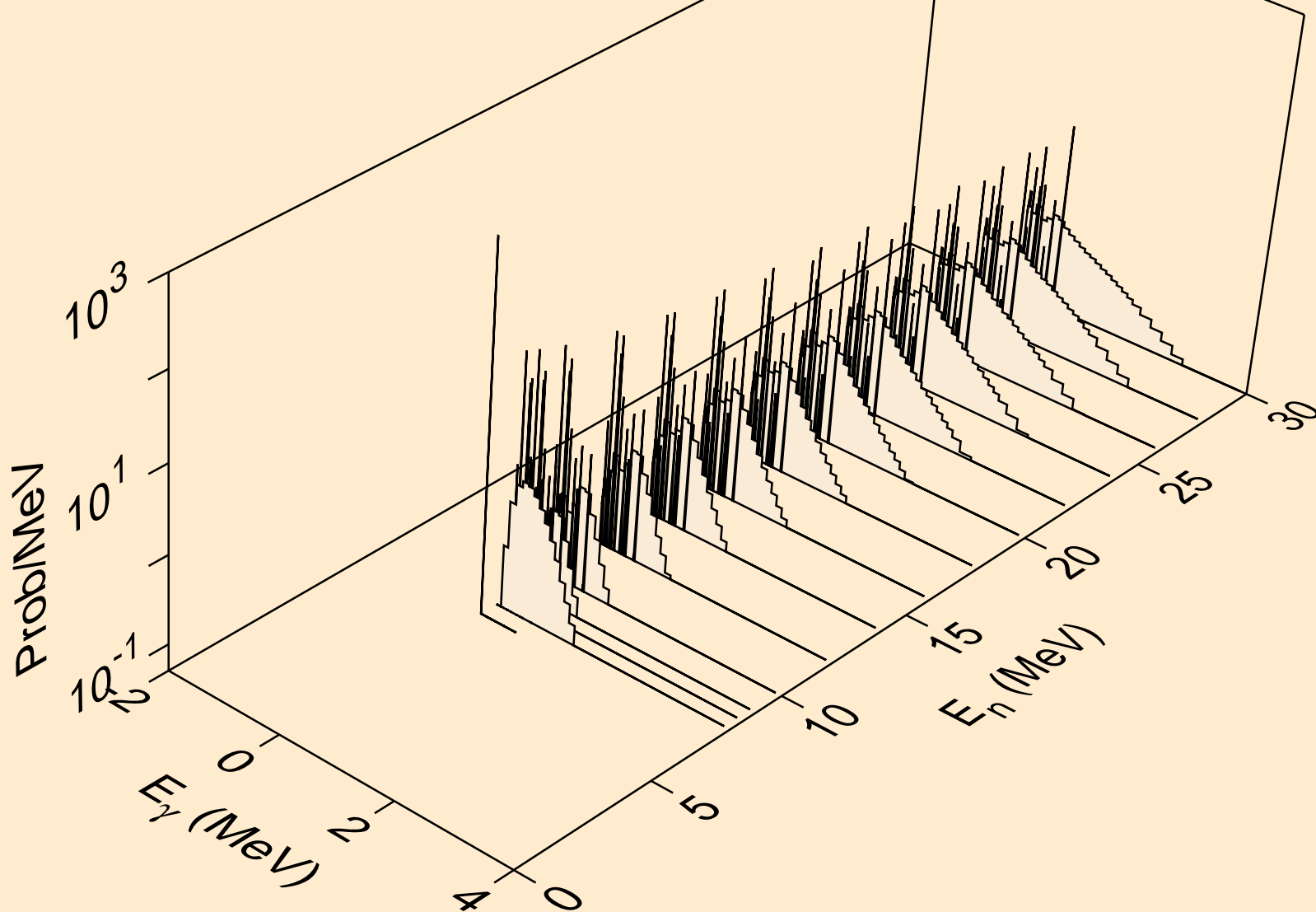

W167 NEUTRON ACER TENDL-2019 LIBRARY; T=293.16K
thermal capture photon spectrum

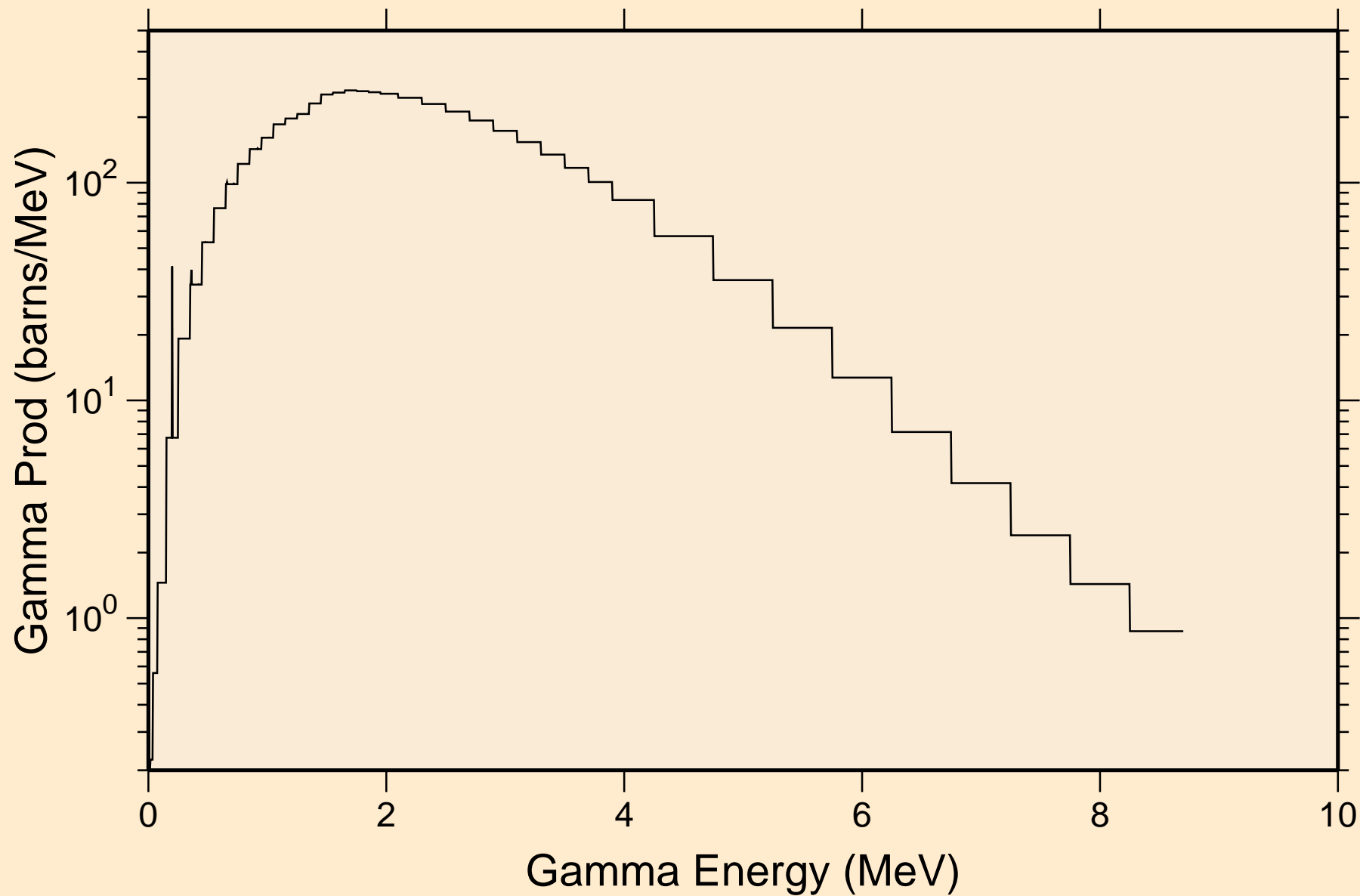

W167 NEUTRON ACER TENDL-2019 LIBRARY; T=293.16K
14 MeV photon spectrum

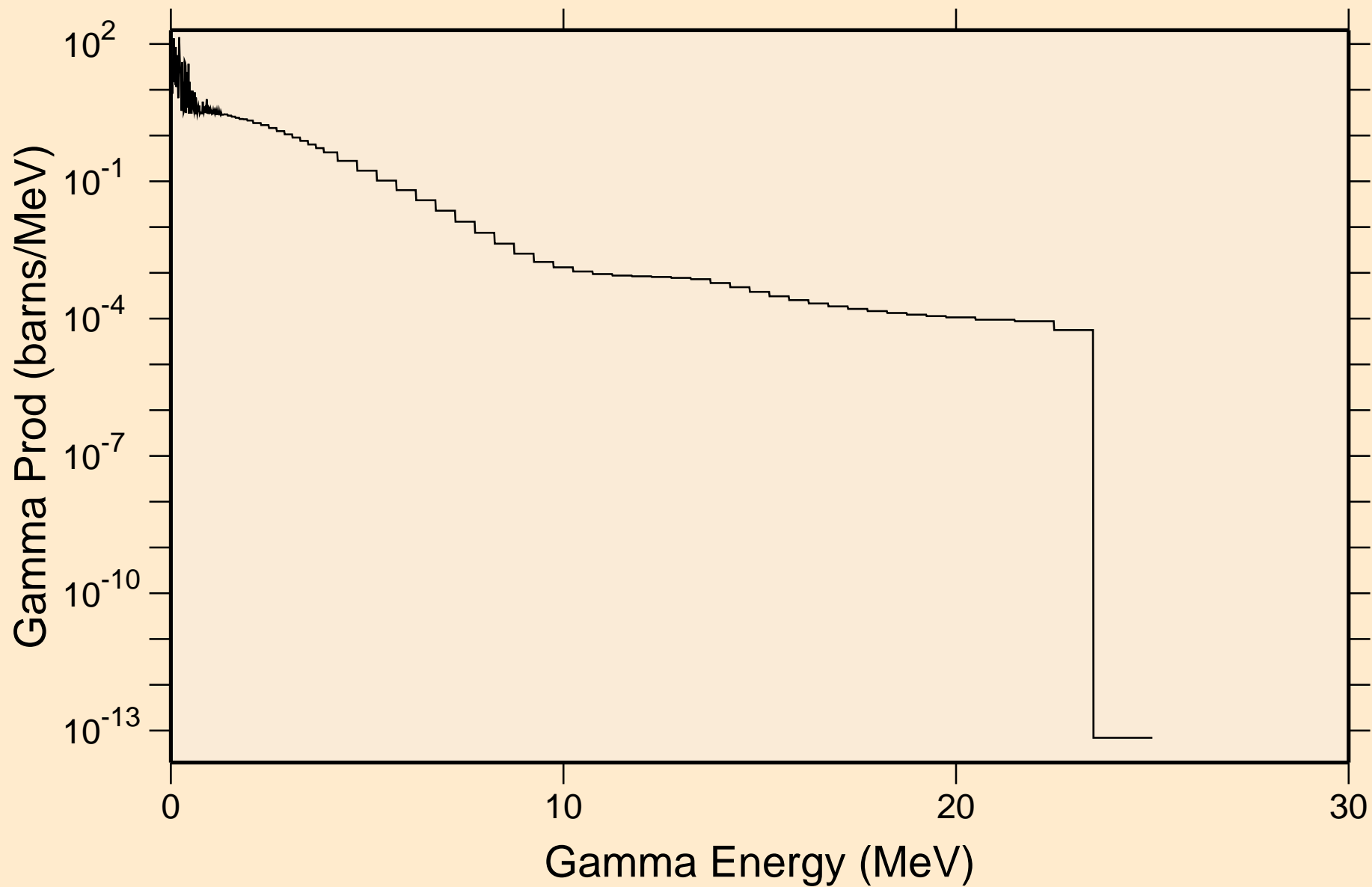

W167 NEUTRON ACER TENDL-2019 LIBRARY; T=293.16K

Particle heating contributions

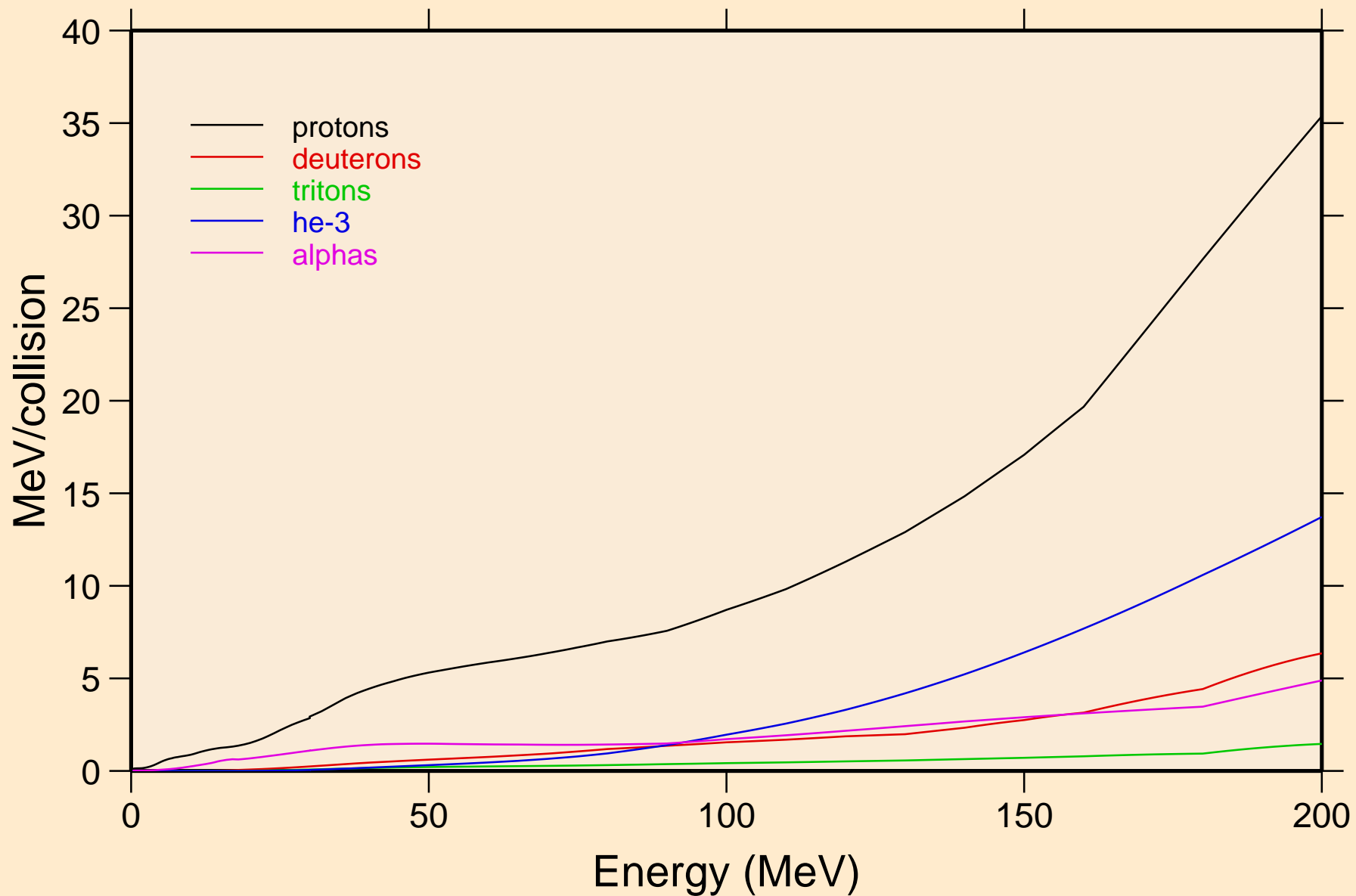

W167 NEUTRON ACER TENDL-2019 LIBRARY; T=293.16K
Recoil Heating

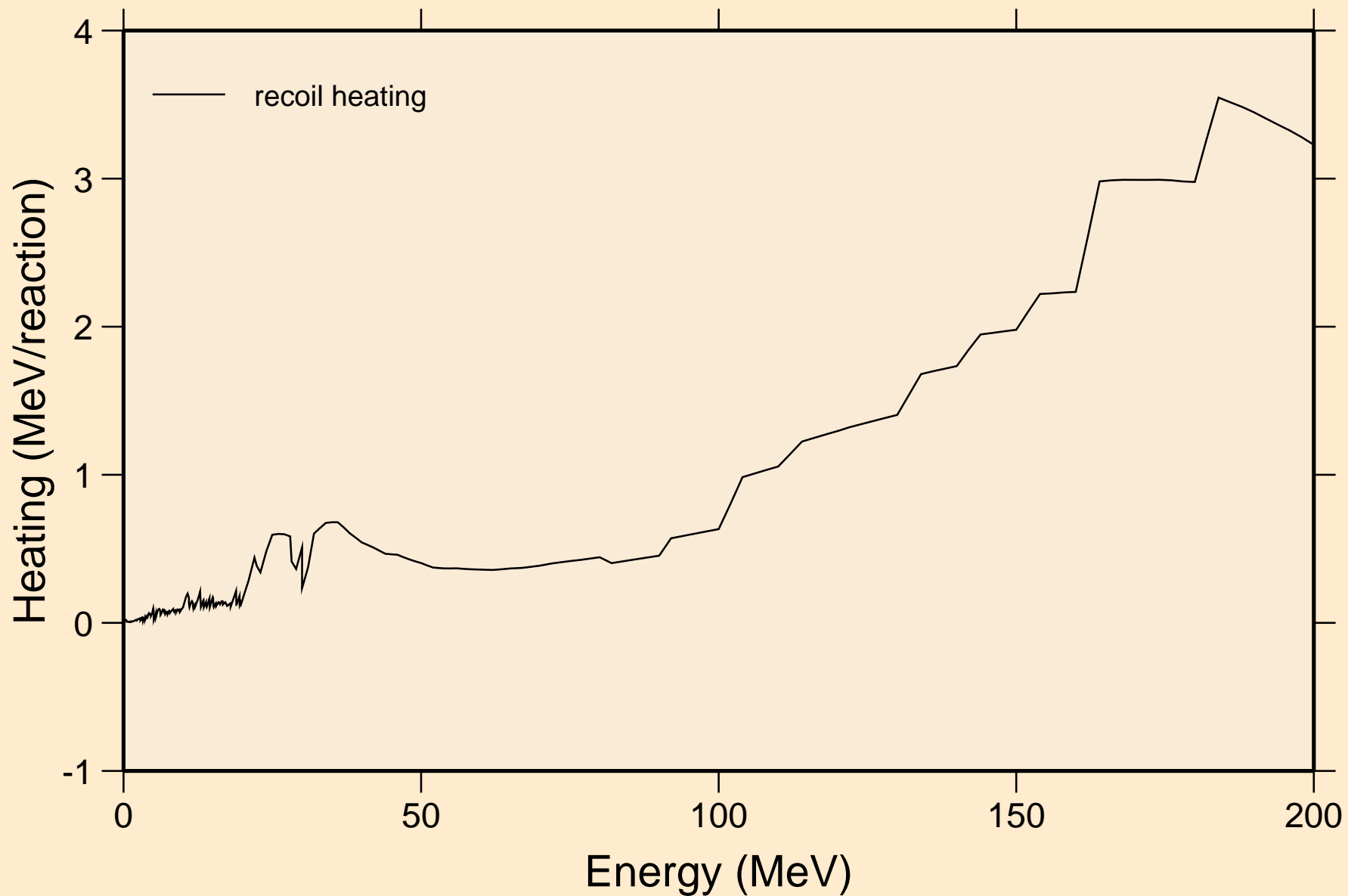

W167 NEUTRON ACER TENDL-2019 LIBRARY; T=293.16K
Particle production cross sections

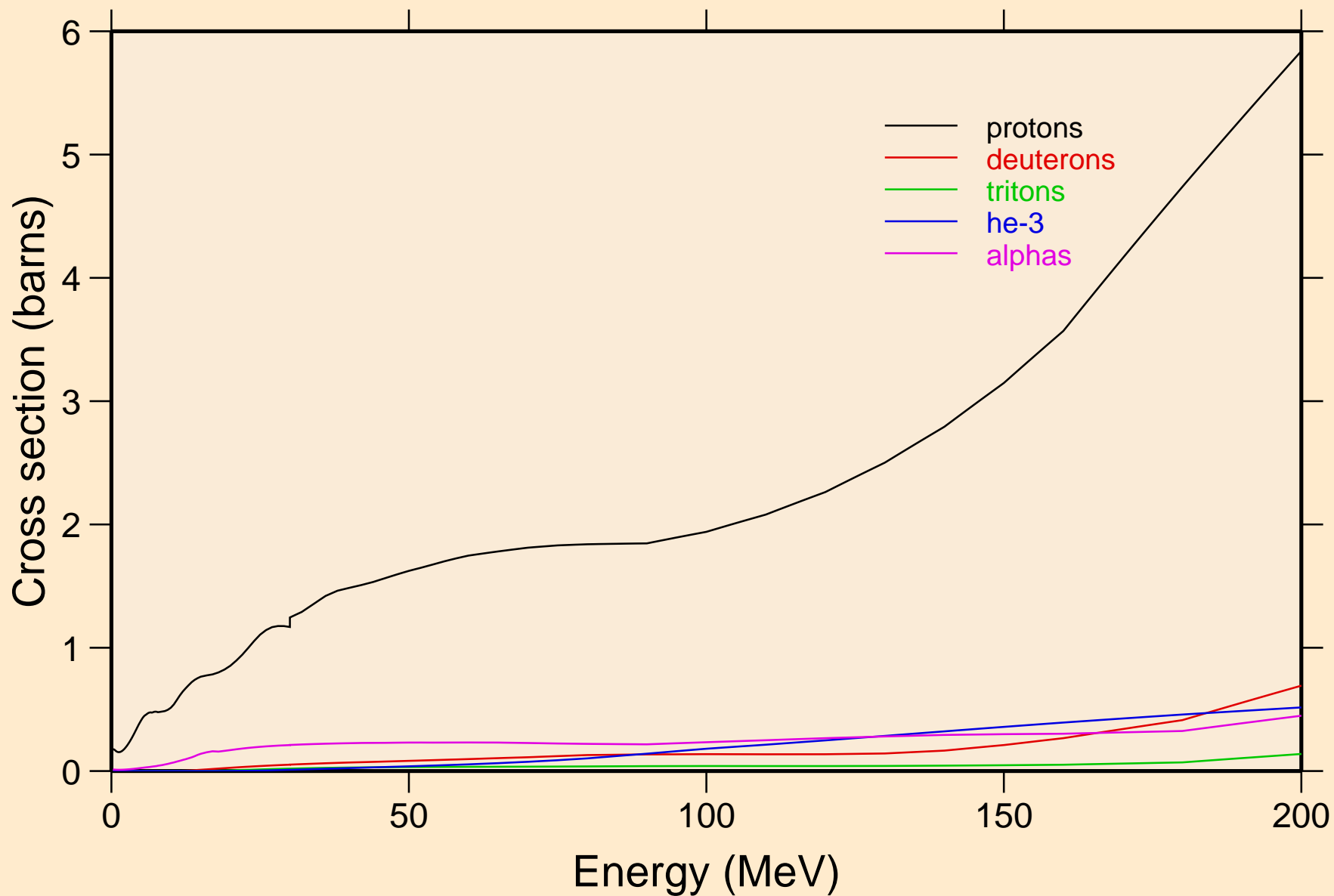

W167 NEUTRON ACER TENDL-2019 LIBRARY; T=293.16K
protons from (n,x)

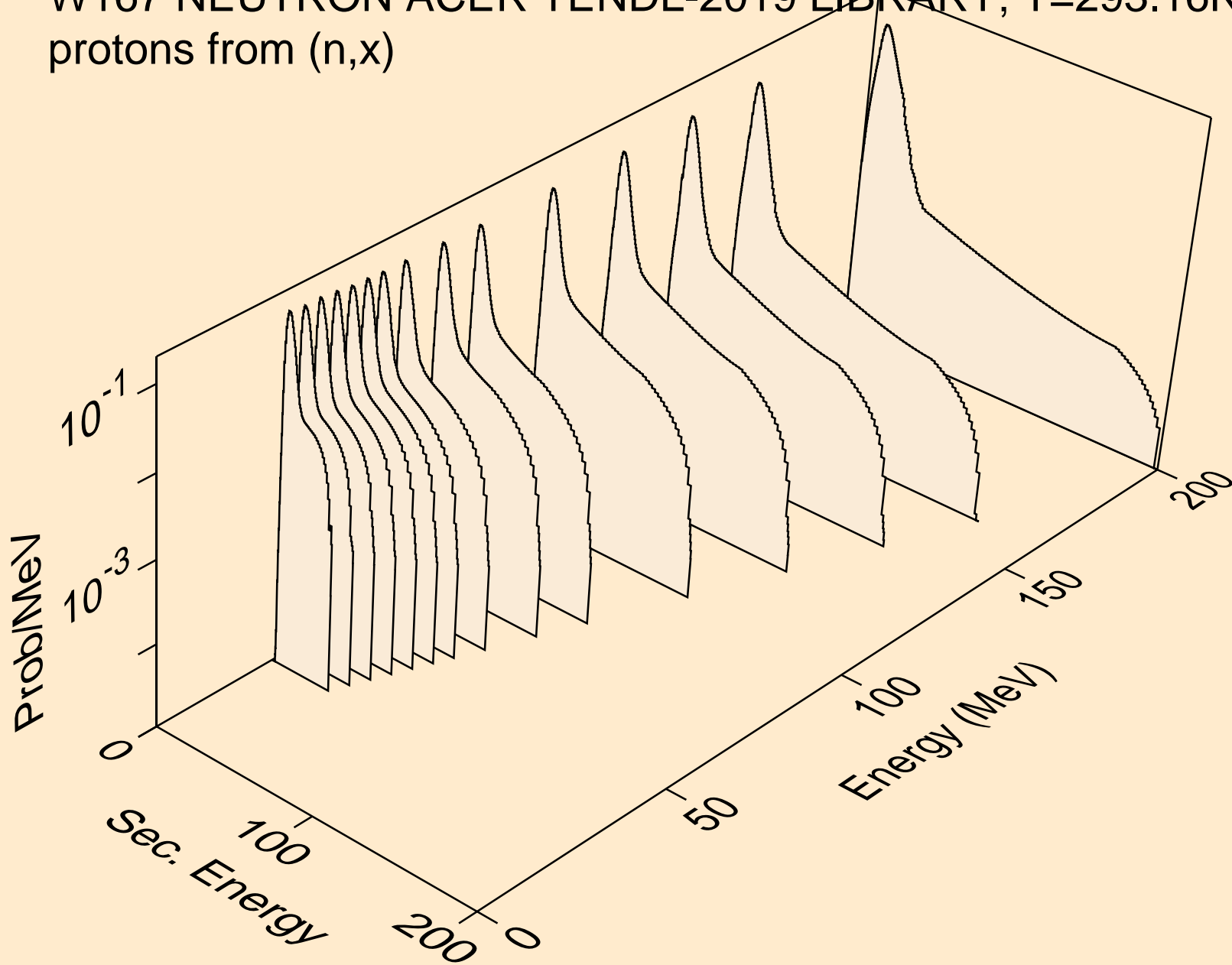

W167 NEUTRON ACER TENDL-2019 LIBRARY; T=293.16K
protons from (n,n*)p

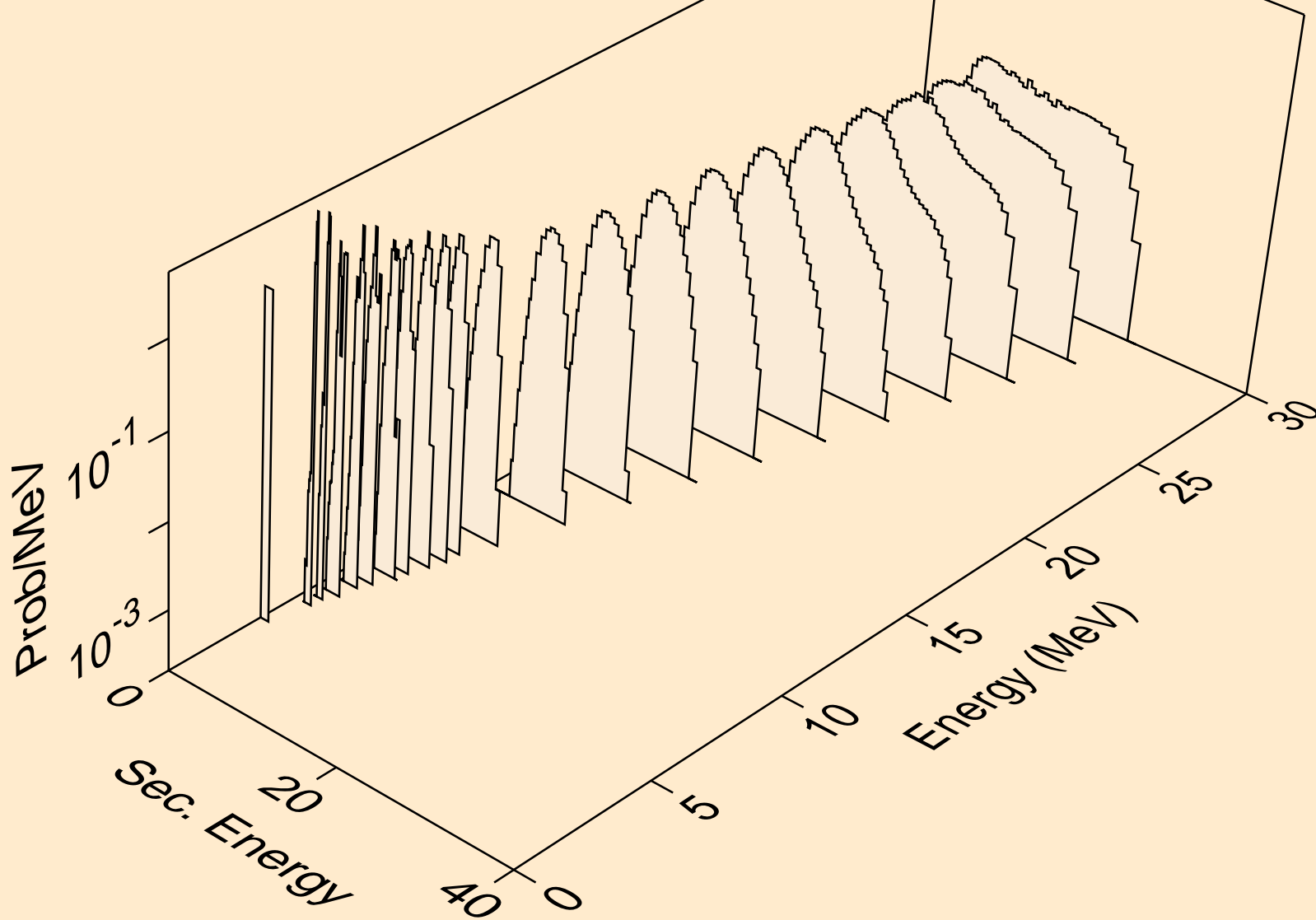

W167 NEUTRON ACER TENDL-2019 LIBRARY; T=293.16K
protons from (n,2np)

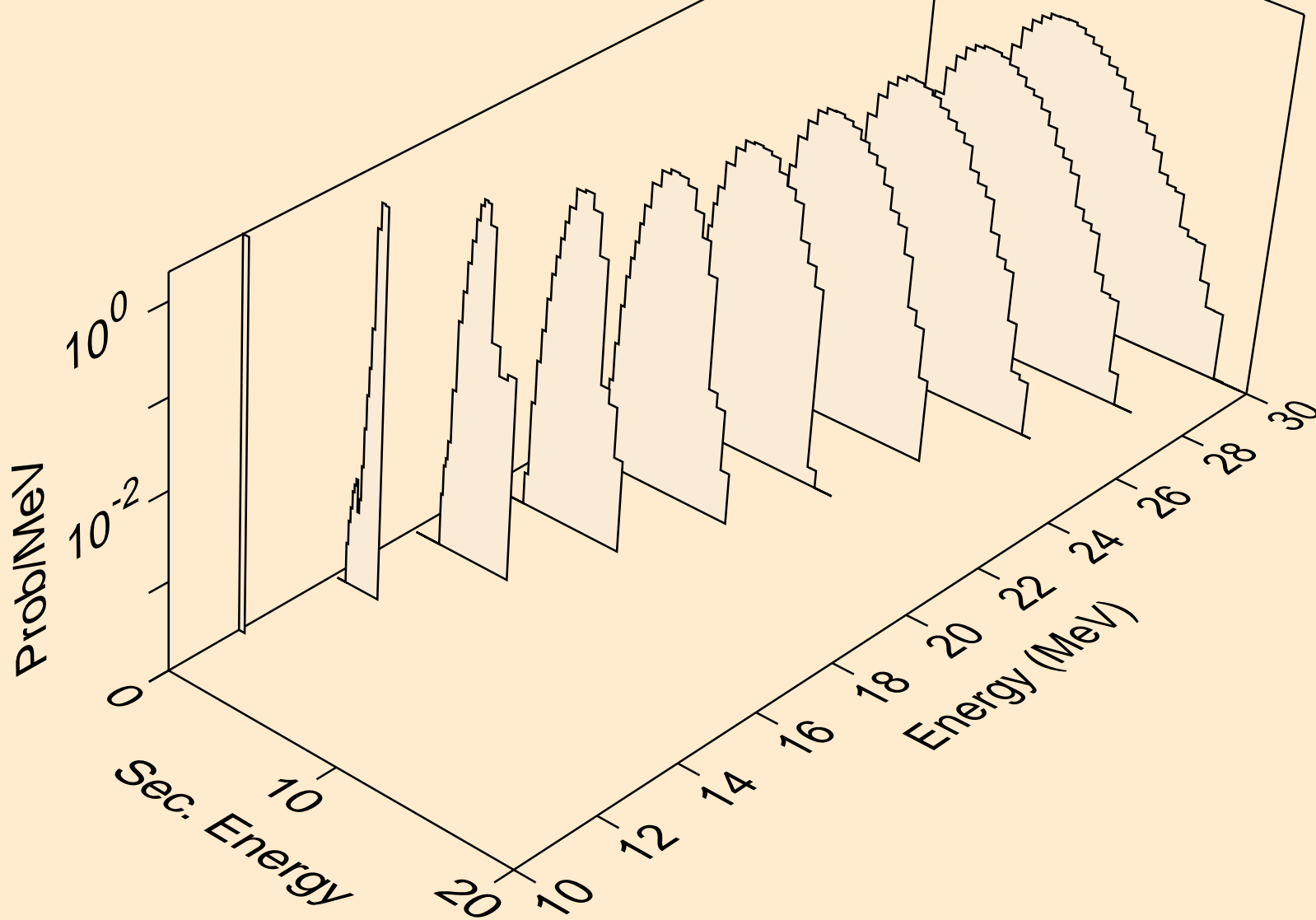

W167 NEUTRON ACER TENDL-2019 LIBRARY; T=293.16K
protons from (n,3np)

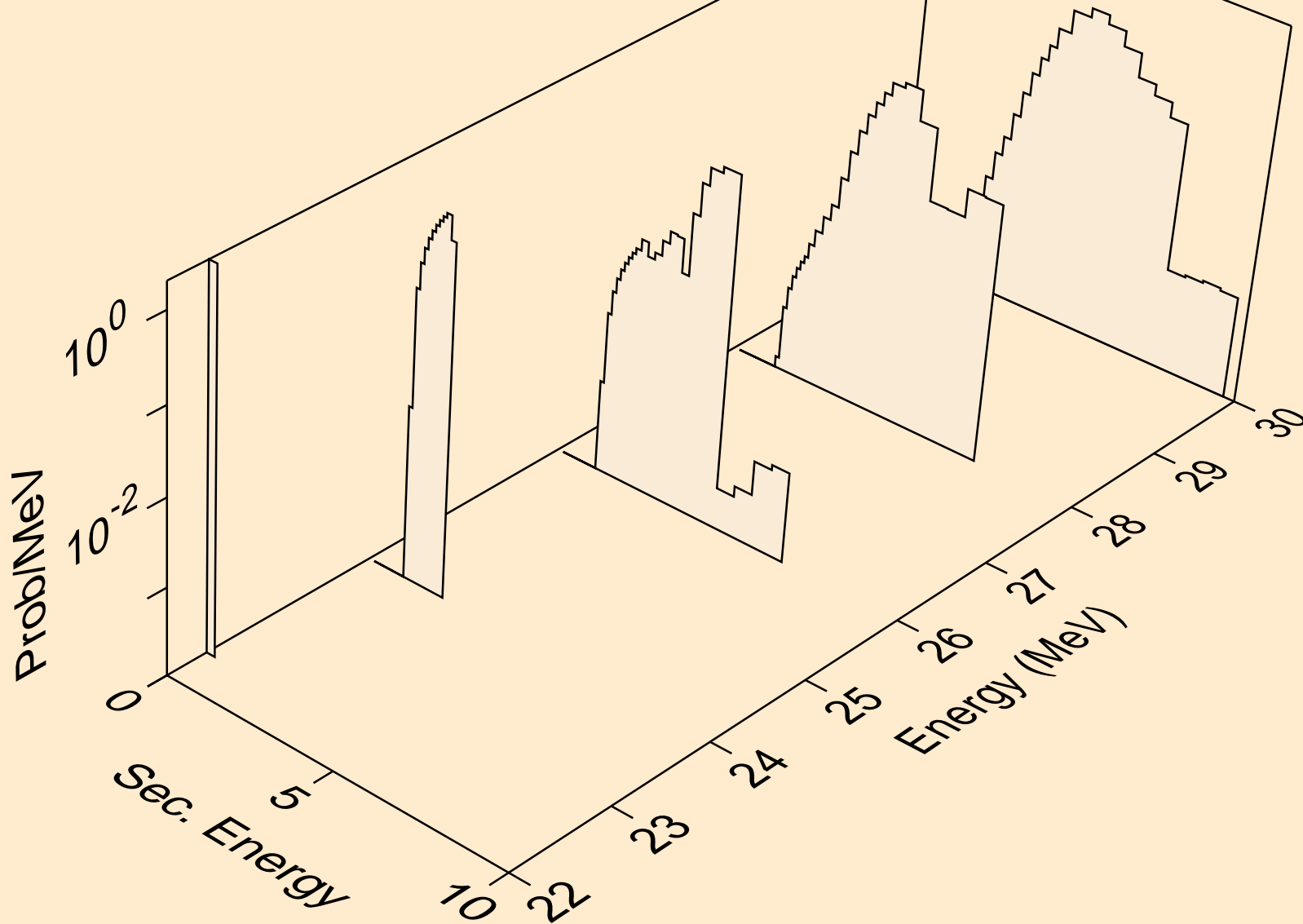

W167 NEUTRON ACER TENDL-2019 LIBRARY; T=293.16K
protons from (n,2np)

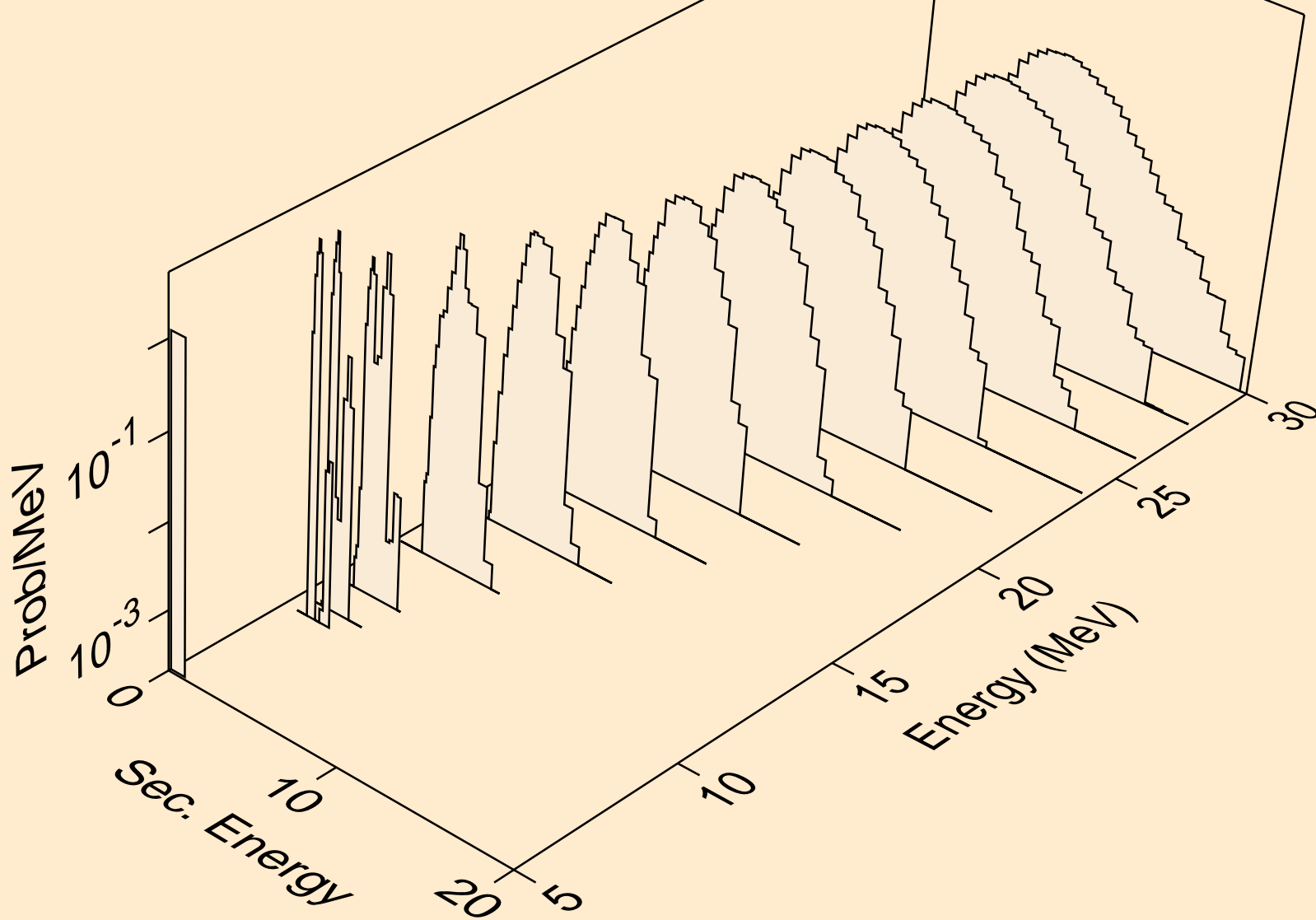

W167 NEUTRON ACER TENDL-2019 LIBRARY; T=293.16K
protons from (n,npa)

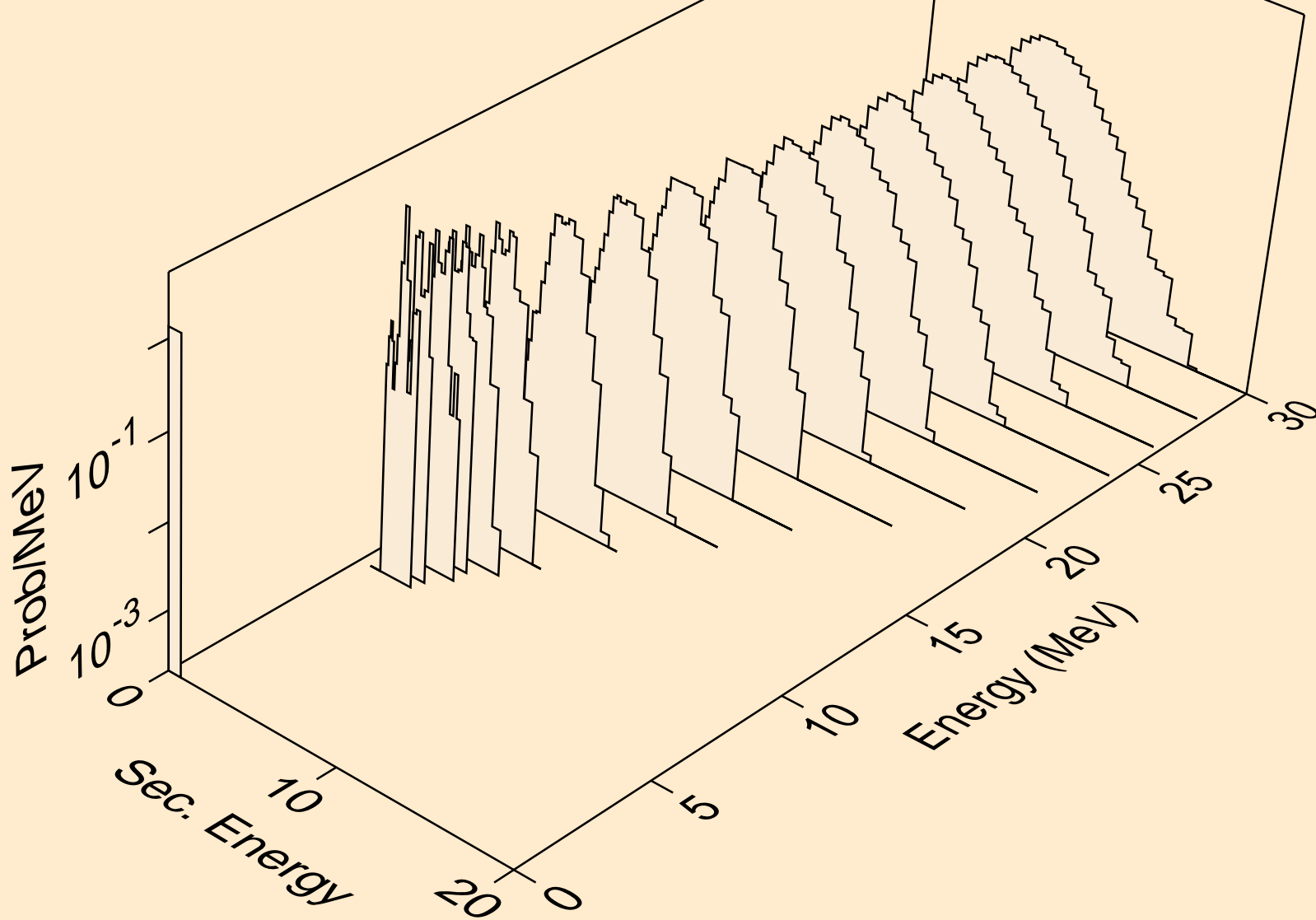

W167 NEUTRON ACER TENDL-2019 LIBRARY; T=293.16K
protons from (n,p)

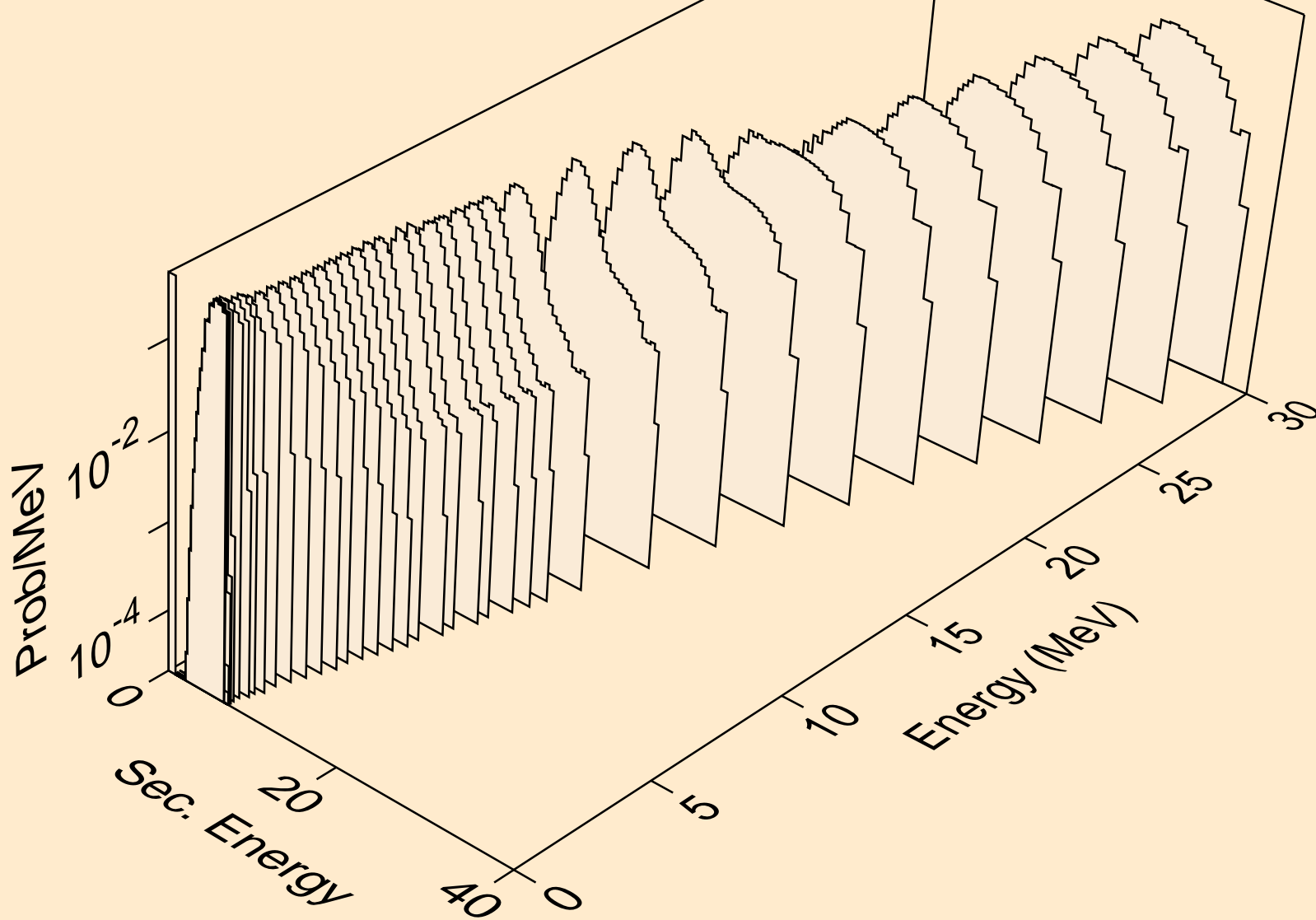

W167 NEUTRON ACER TENDL-2019 LIBRARY; T=293.16K
protons from (n,2p)

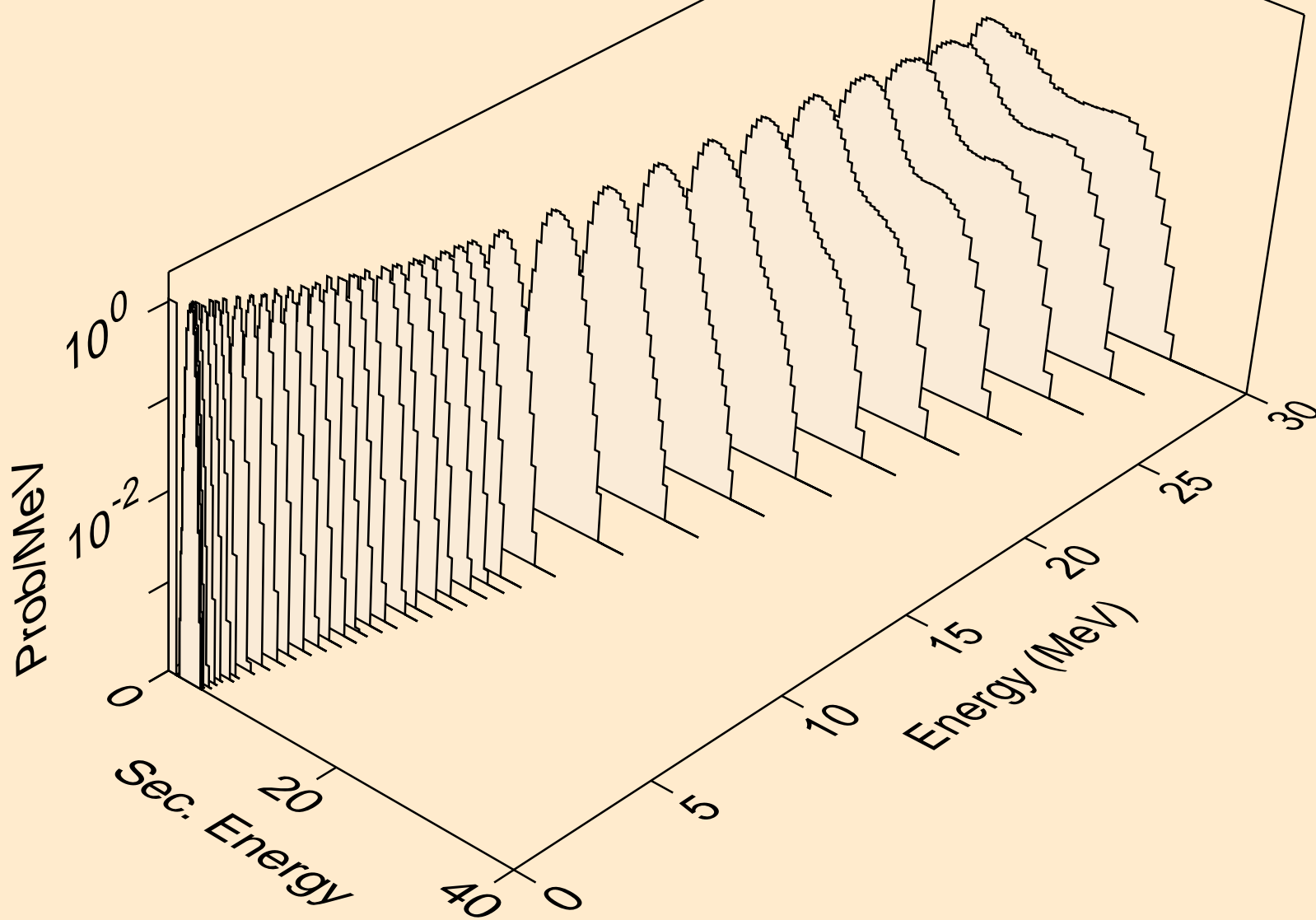

W167 NEUTRON ACER TENDL-2019 LIBRARY; T=293.16K
protons from (n,p)

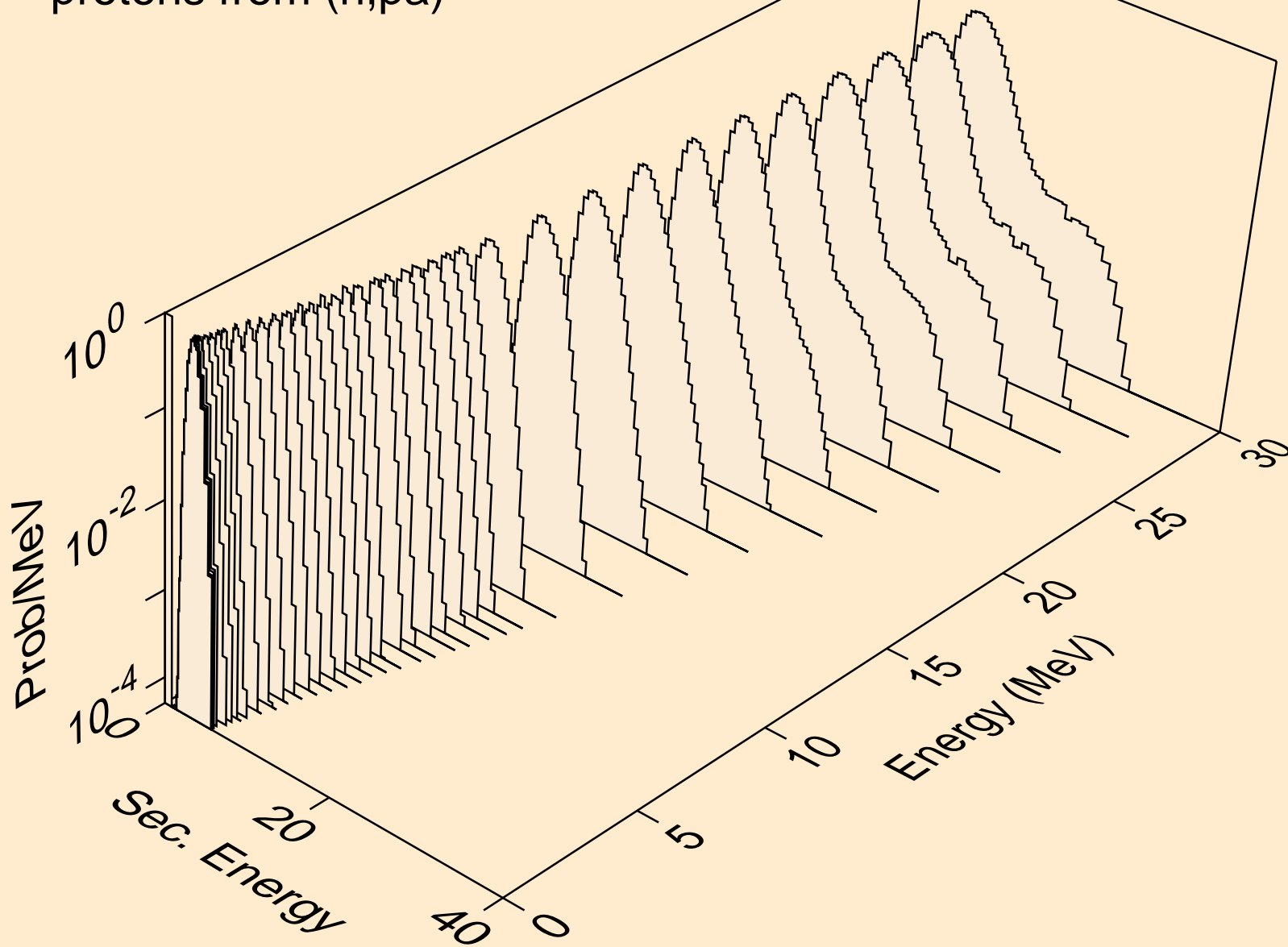

W167 NEUTRON ACER TENDL-2019 LIBRARY; T=293.16K
protons from (n,pd)

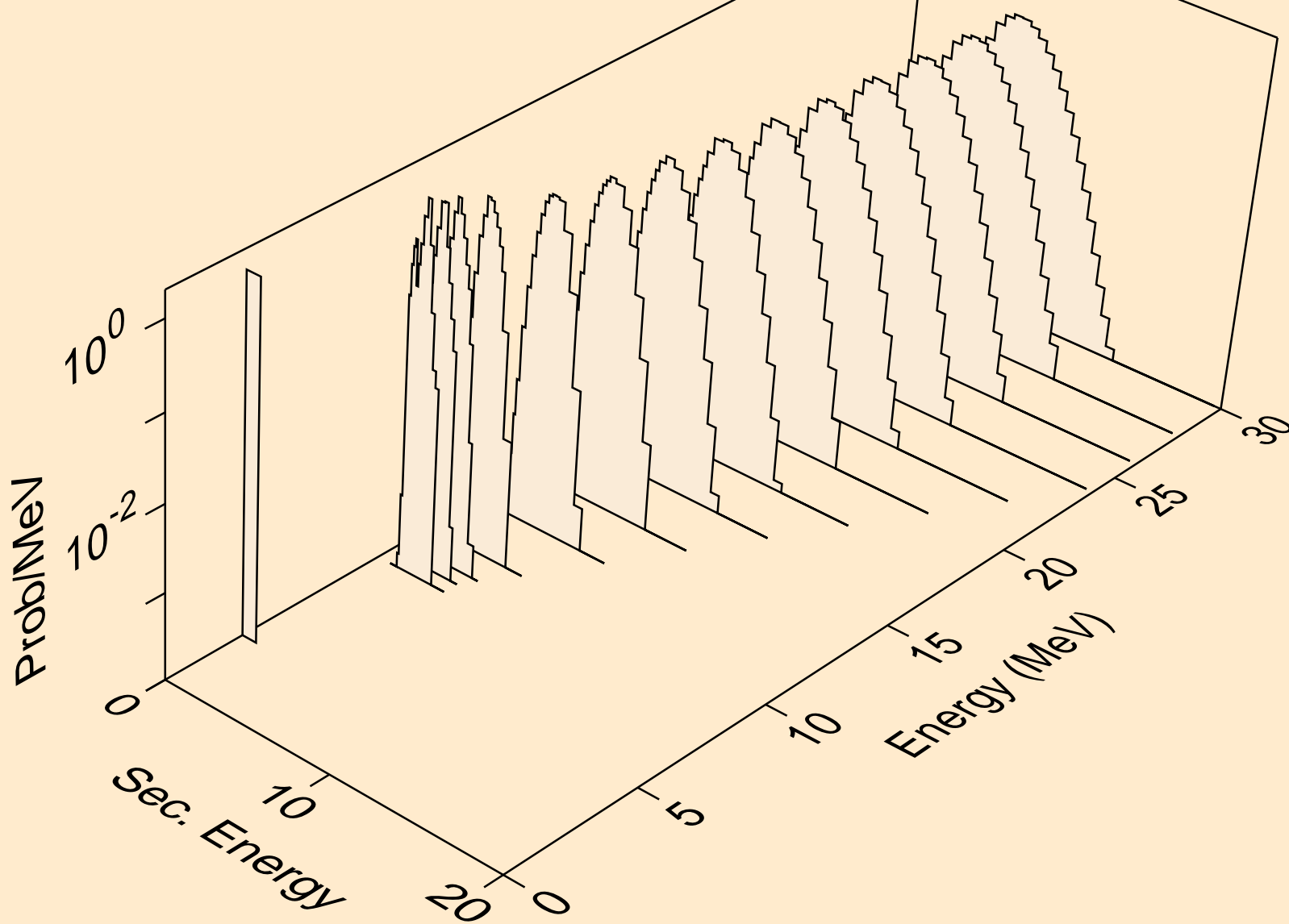

W167 NEUTRON ACER TENDL-2019 LIBRARY; T=293.16K
protons from (n,pt)

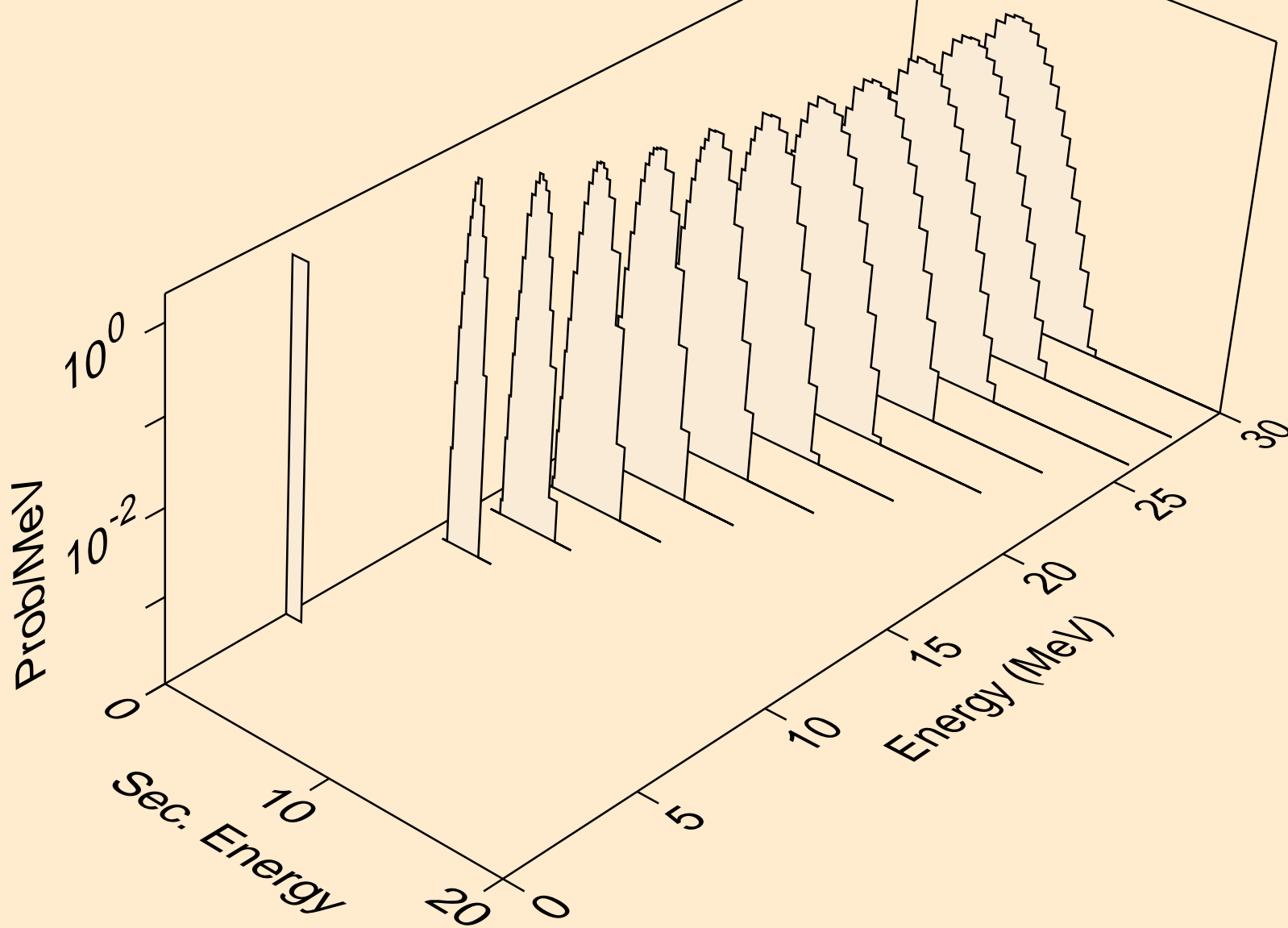

W167 NEUTRON ACER TENDL-2019 LIBRARY; T=293.16K
deuterons from (n,x)

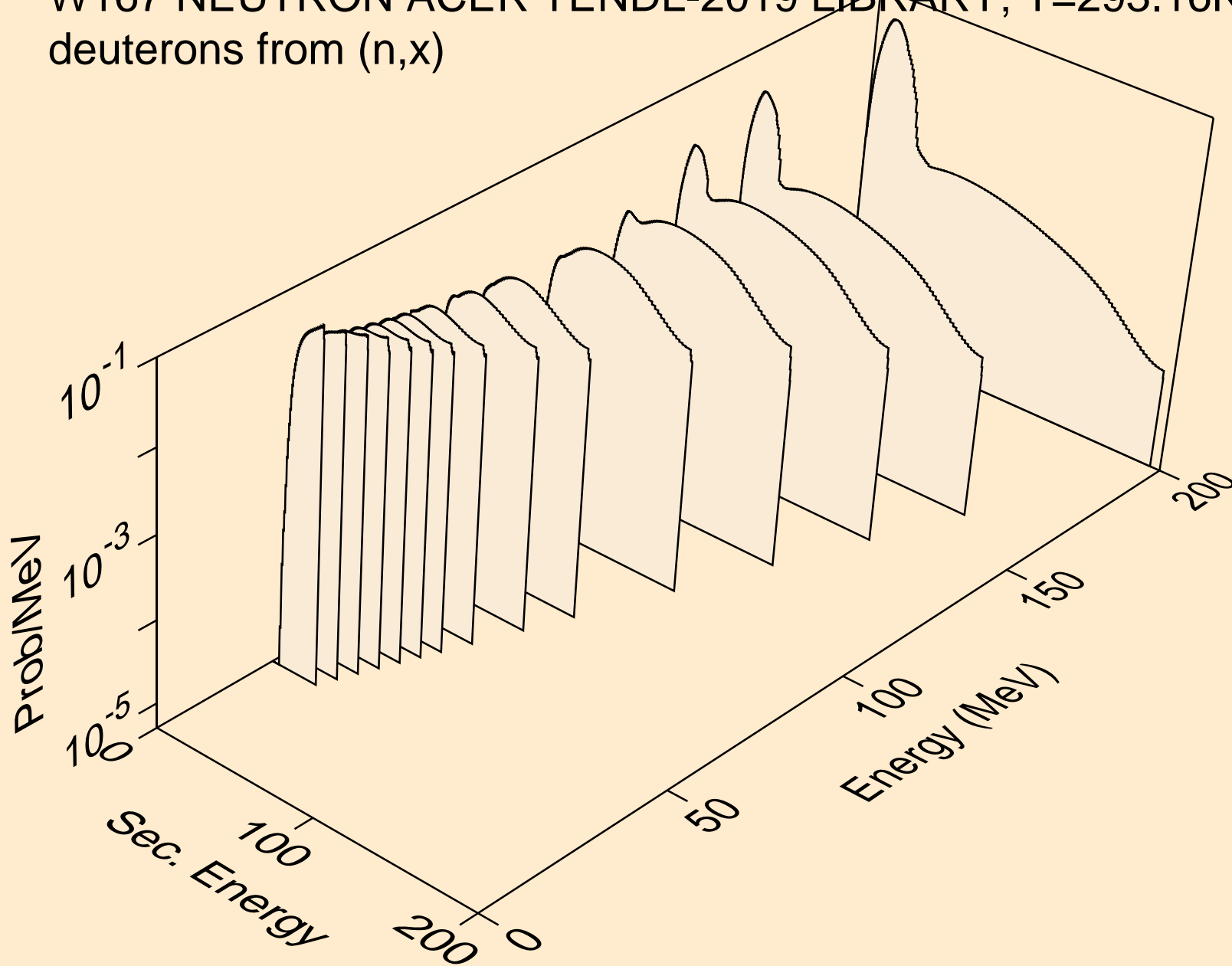

W167 NEUTRON ACER TENDL-2019 LIBRARY; T=293.16K
deuterons from (n,2nd)

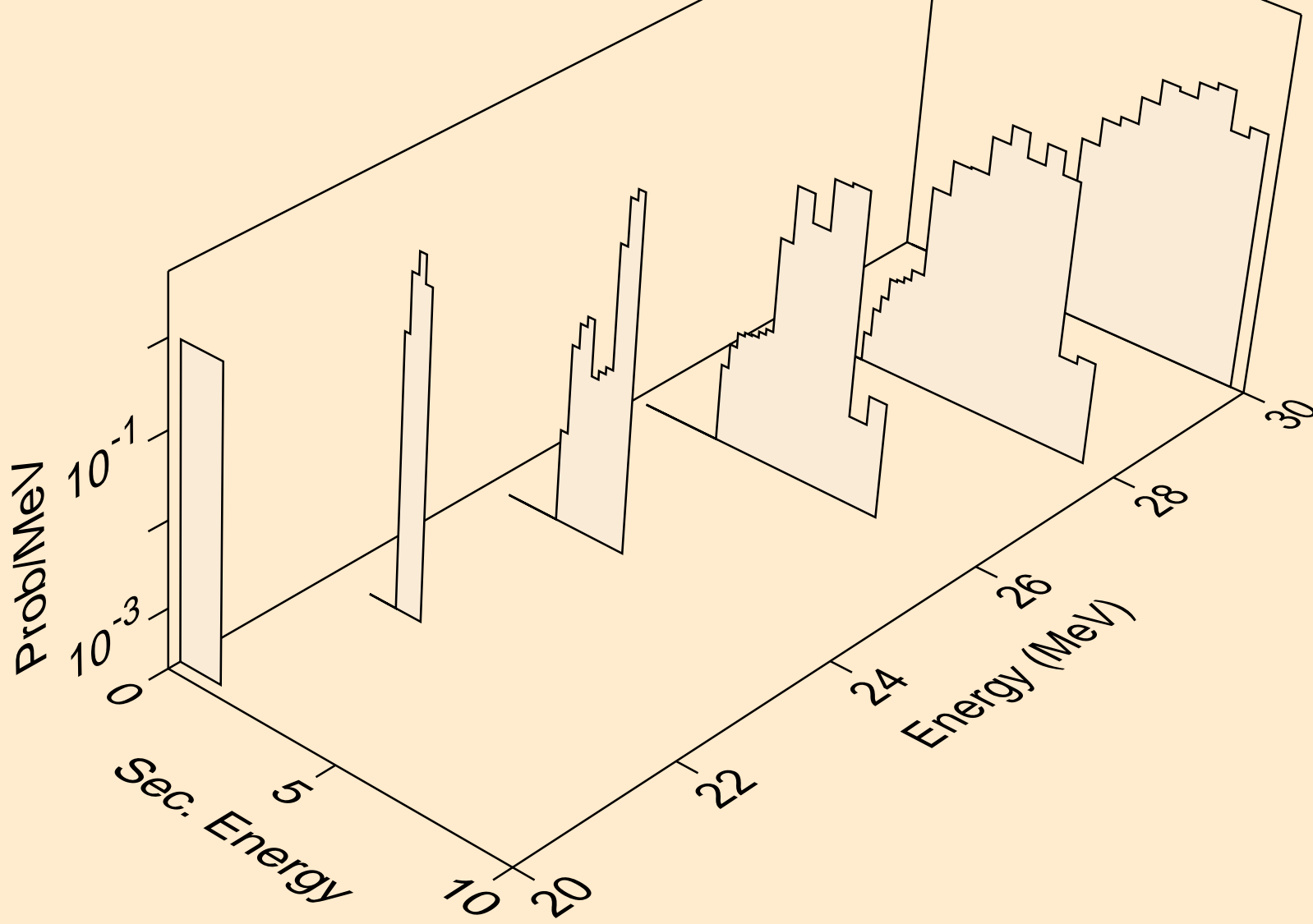

W167 NEUTRON ACER TENDL-2019 LIBRARY; T=293.16K
deuterons from (n,n*)d

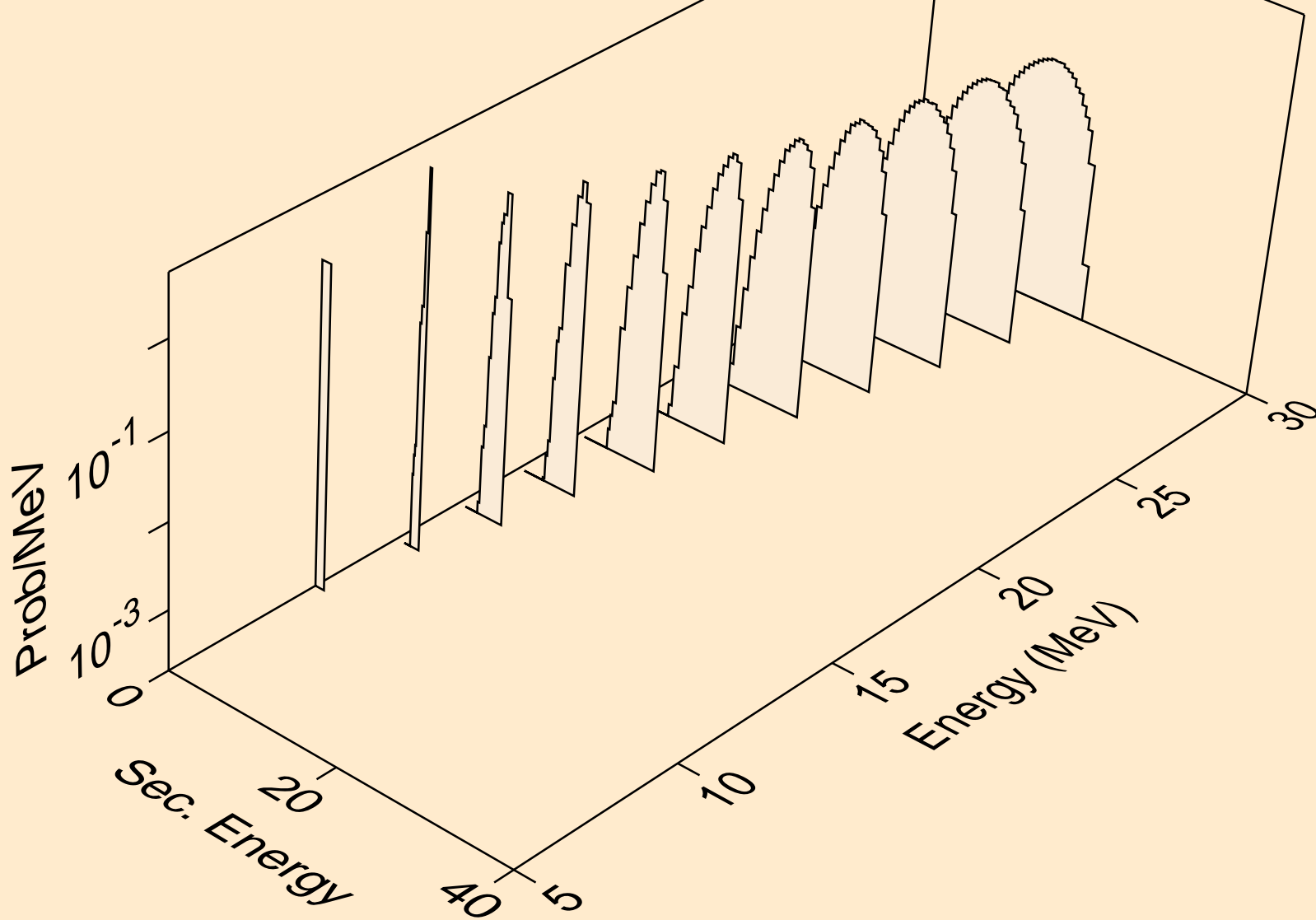

W167 NEUTRON ACER TENDL-2019 LIBRARY; T=293.16K
deuterons from (n,d)

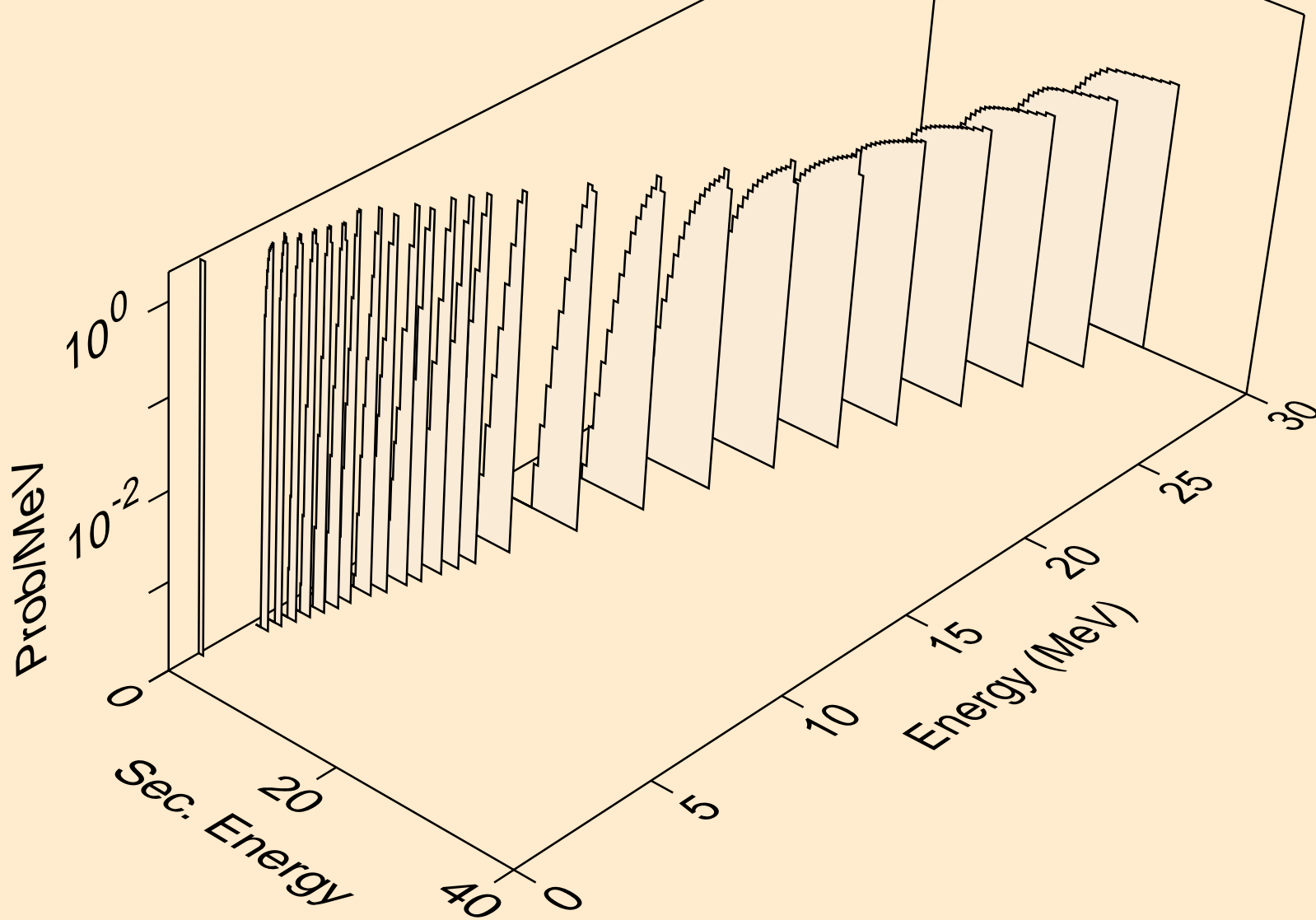

W167 NEUTRON ACER TENDL-2019 LIBRARY; T=293.16K
deuterons from (n,pd)

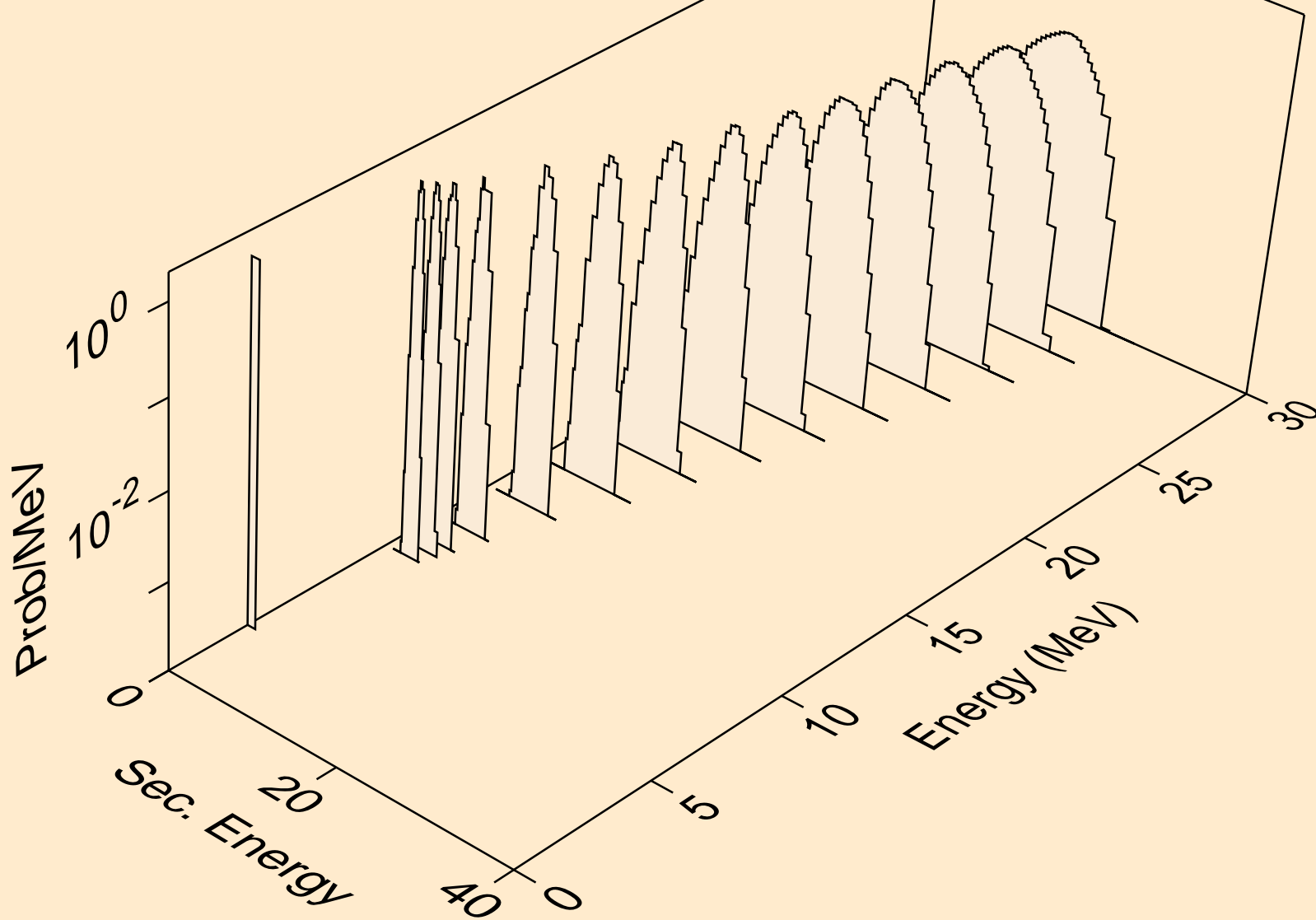

W167 NEUTRON ACER TENDL-2019 LIBRARY; T=293.16K
deuterons from (n,da)

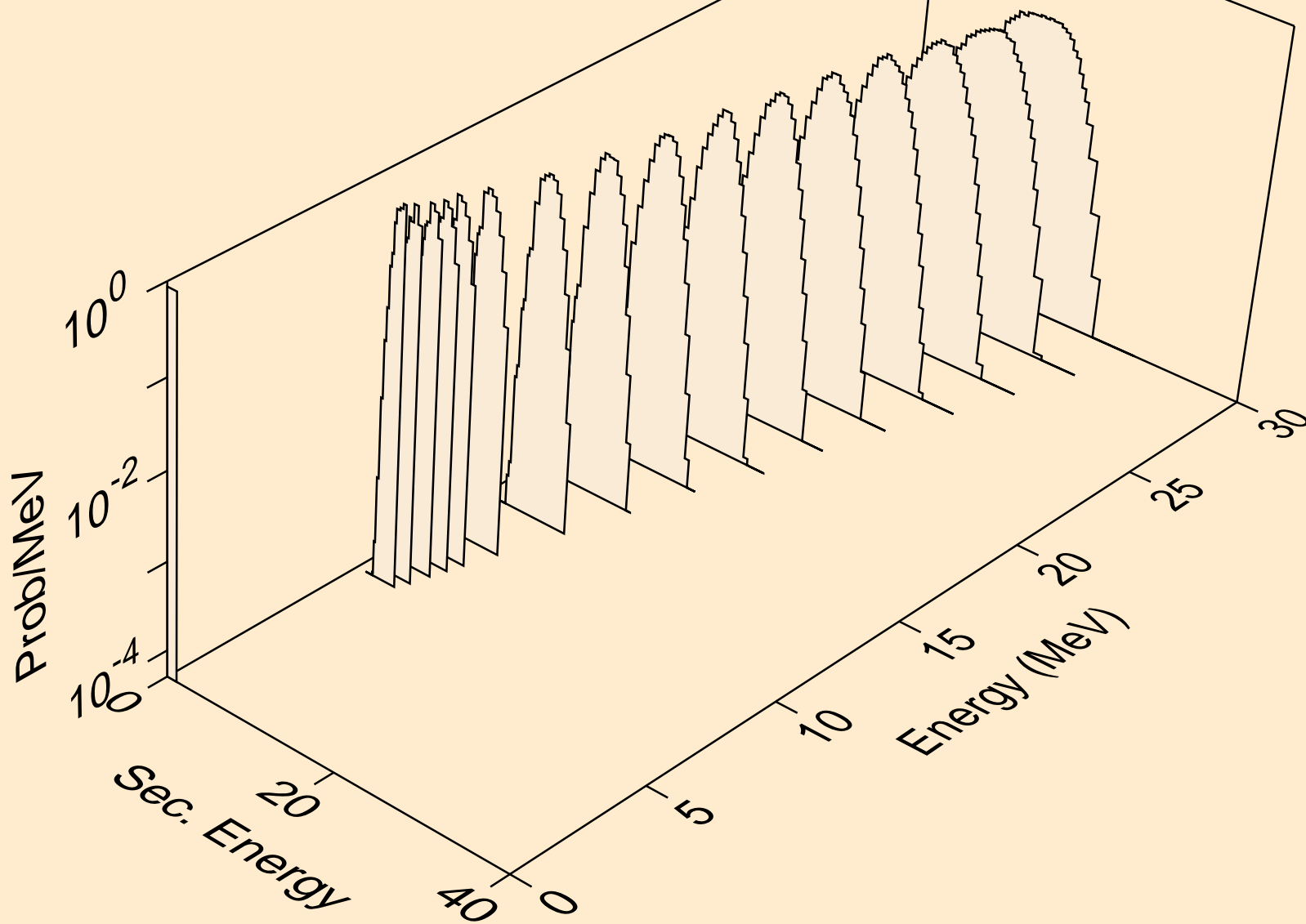

W167 NEUTRON ACER TENDL-2019 LIBRARY; T=293.16K
tritons from (n,x)

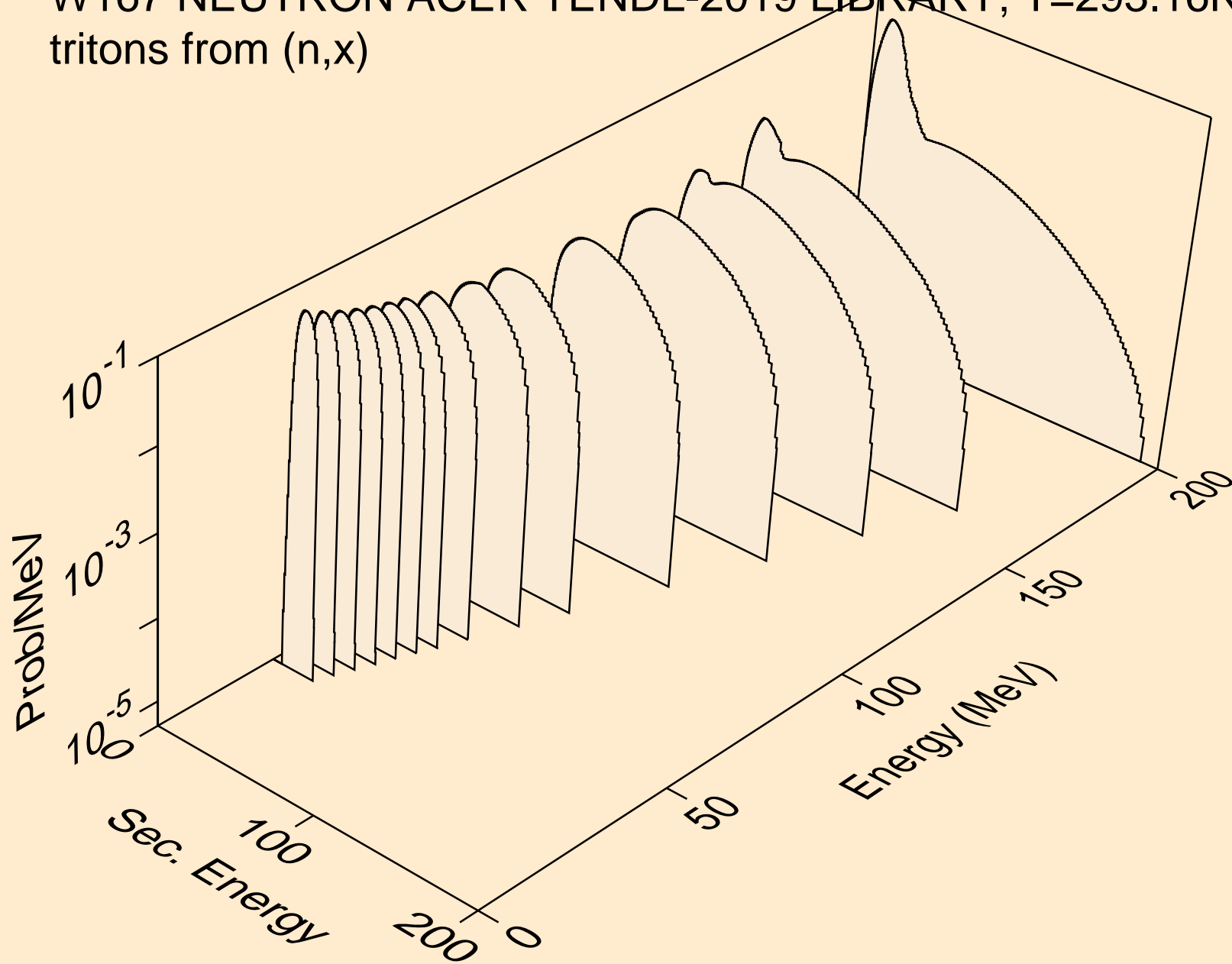

W167 NEUTRON ACER TENDL-2019 LIBRARY; T=293.16K
tritons from (n,n*)t

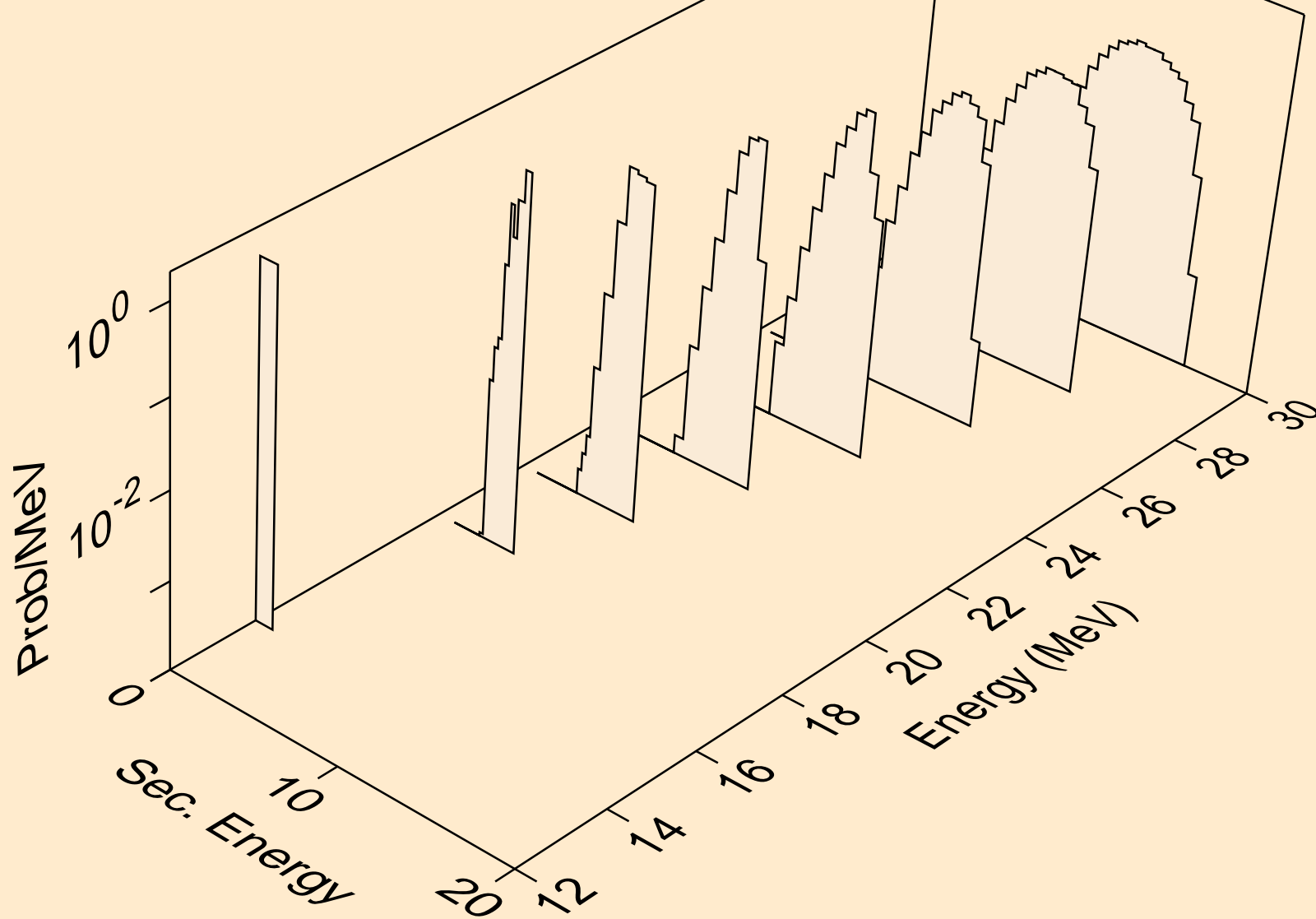

W167 NEUTRON ACER TENDL-2019 LIBRARY; T=293.16K
tritons from (n,t)

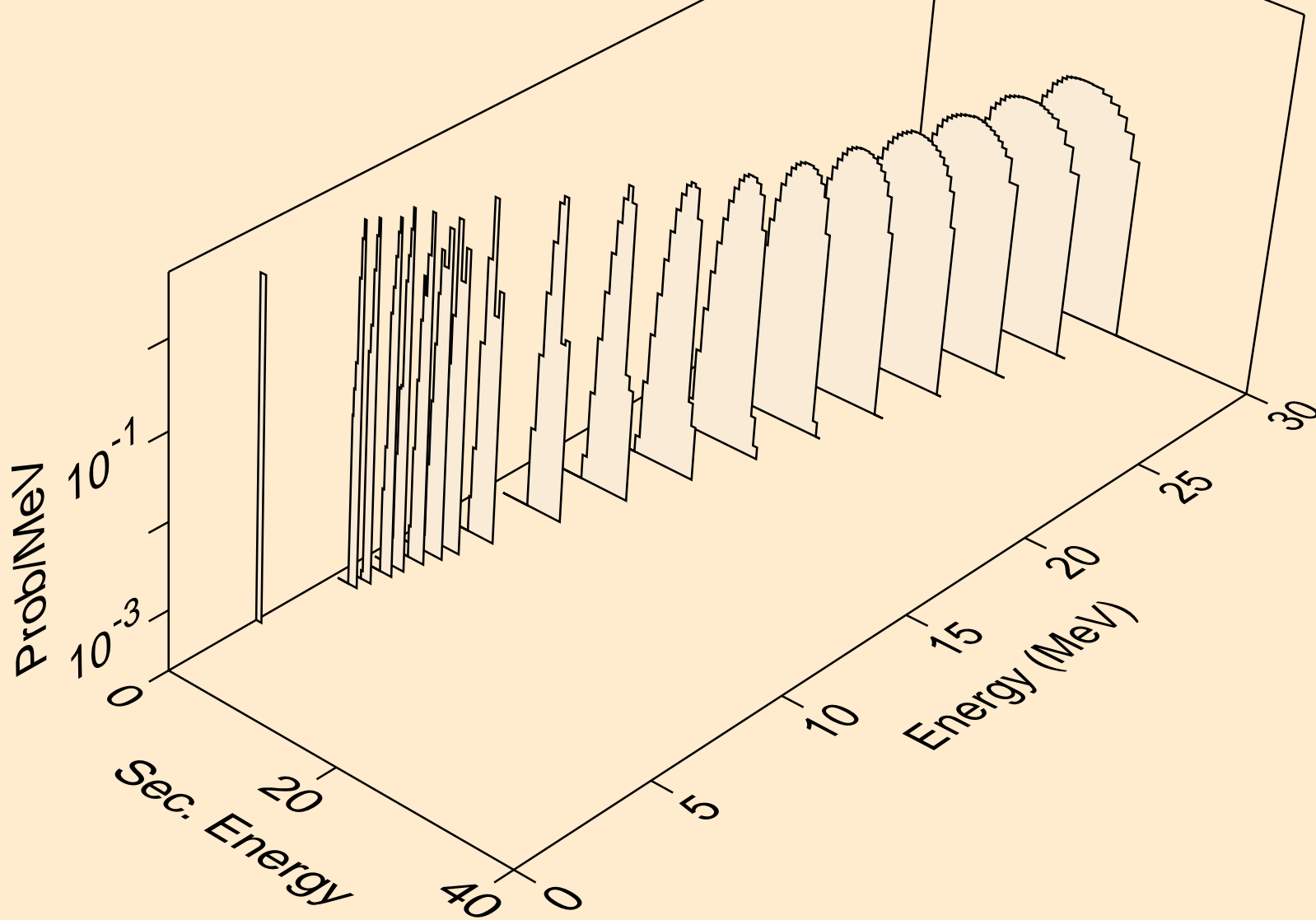

W167 NEUTRON ACER TENDL-2019 LIBRARY; T=293.16K
tritons from (n,pt)

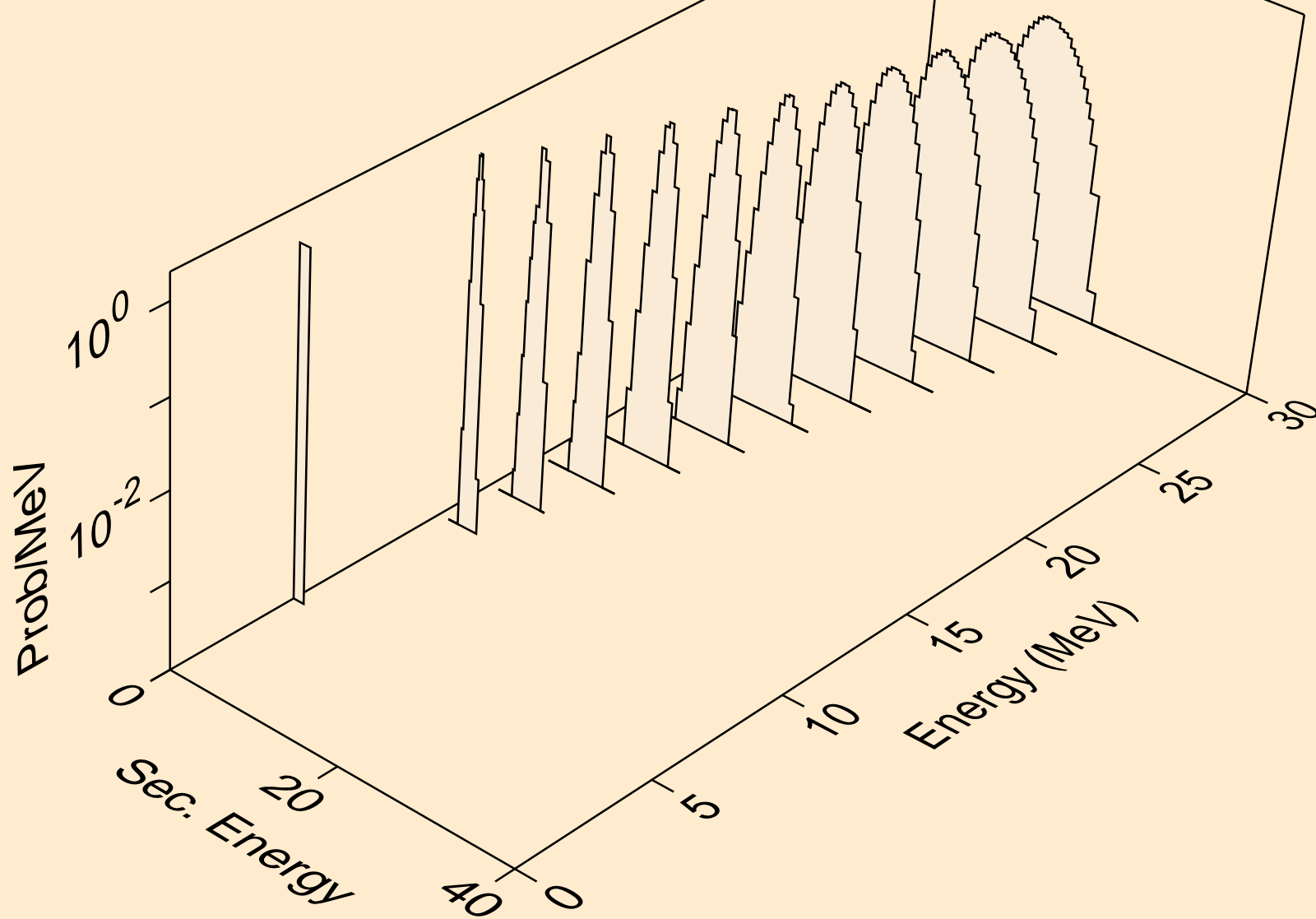

W167 NEUTRON ACER TENDL-2019 LIBRARY; T=293.16K
he3s from (n,x)

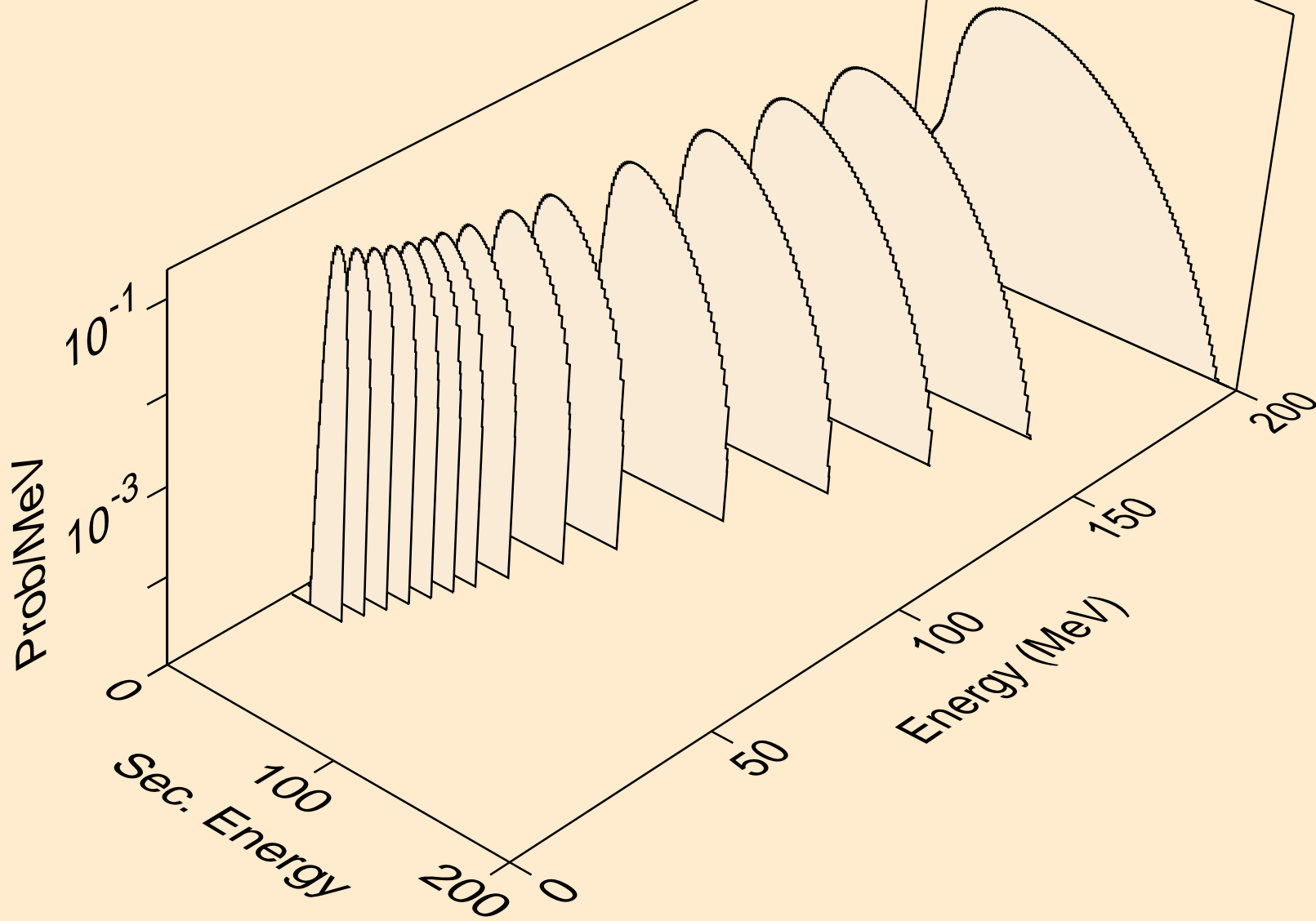

W167 NEUTRON ACER TENDL-2019 LIBRARY; T=293.16K
he3s from (n,n*)he3

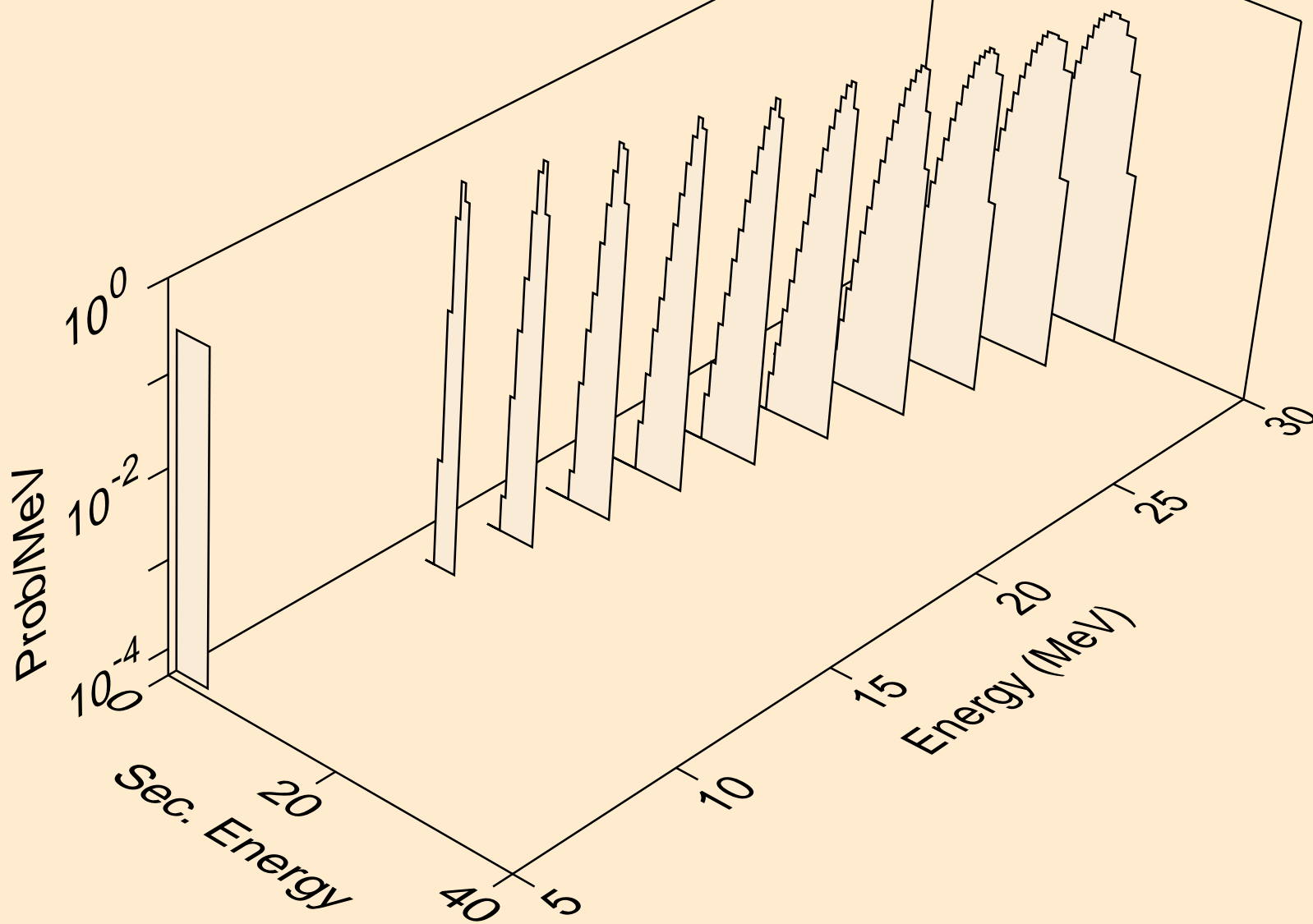

W167 NEUTRON ACER TENDL-2019 LIBRARY; T=293.16K
he3s from (n,he3)

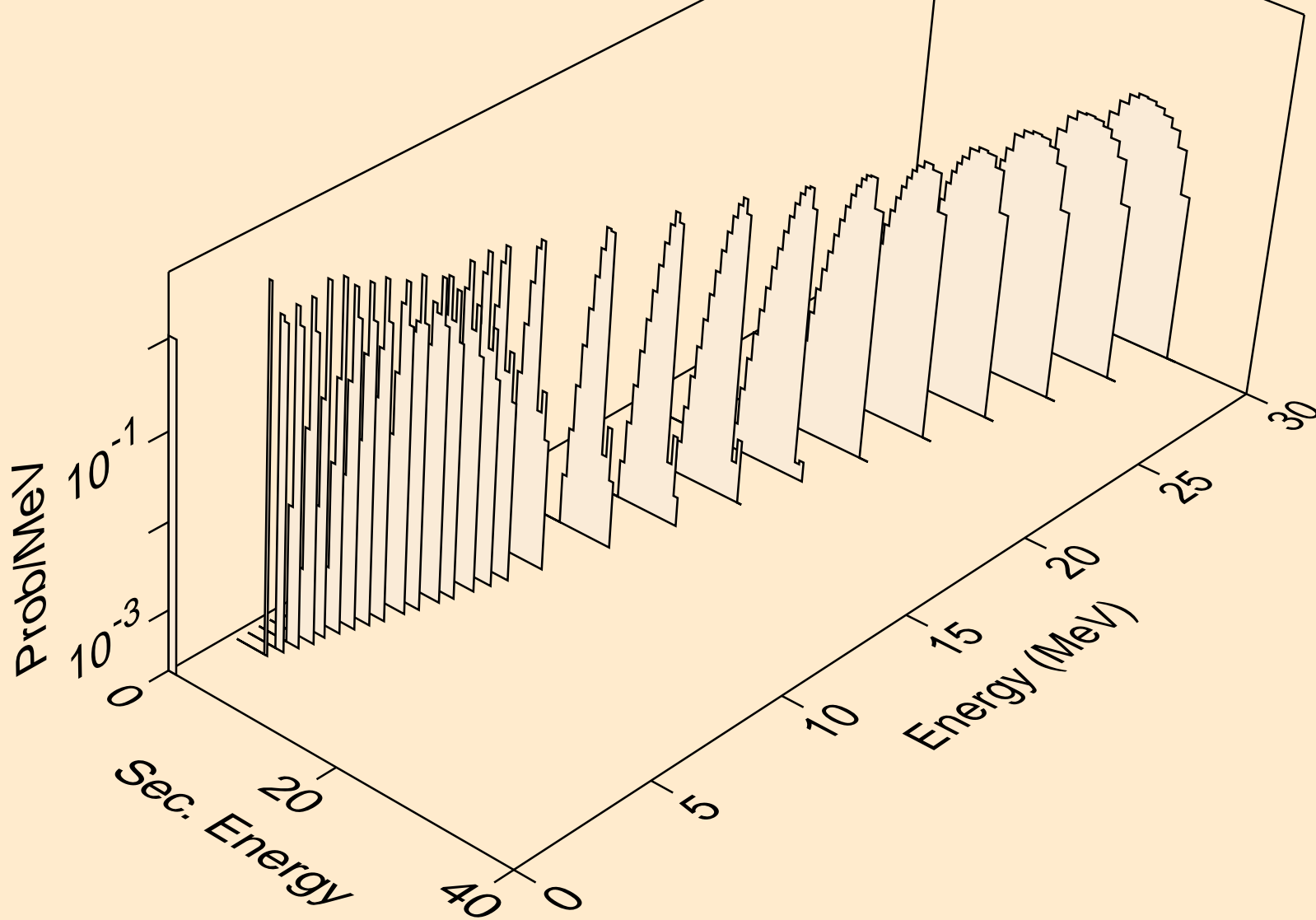

W167 NEUTRON ACER TENDL-2019 LIBRARY; T=293.16K
alphas from (n,x)

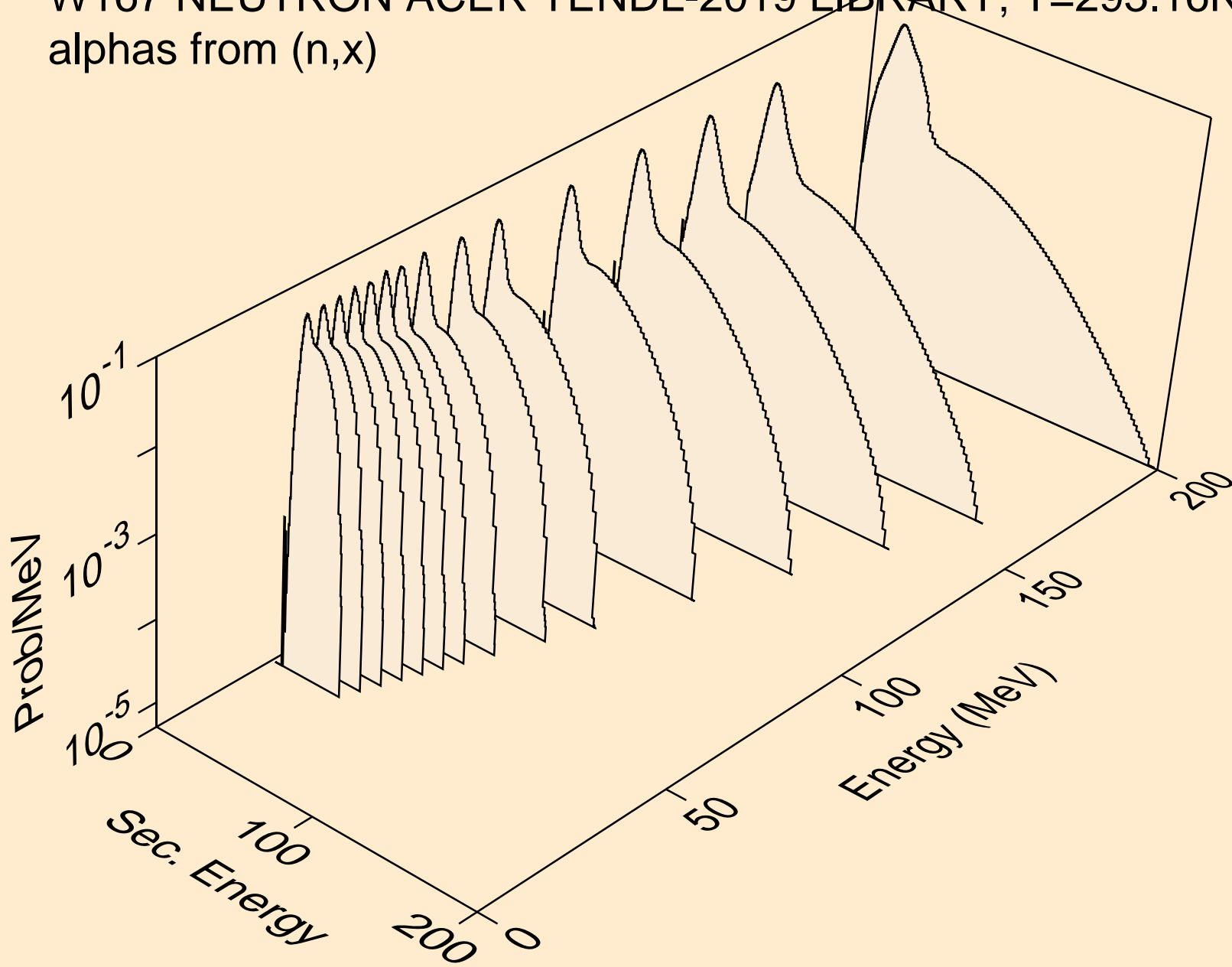

W167 NEUTRON ACER TENDL-2019 LIBRARY; T=293.16K
alphas from (n,n*)a

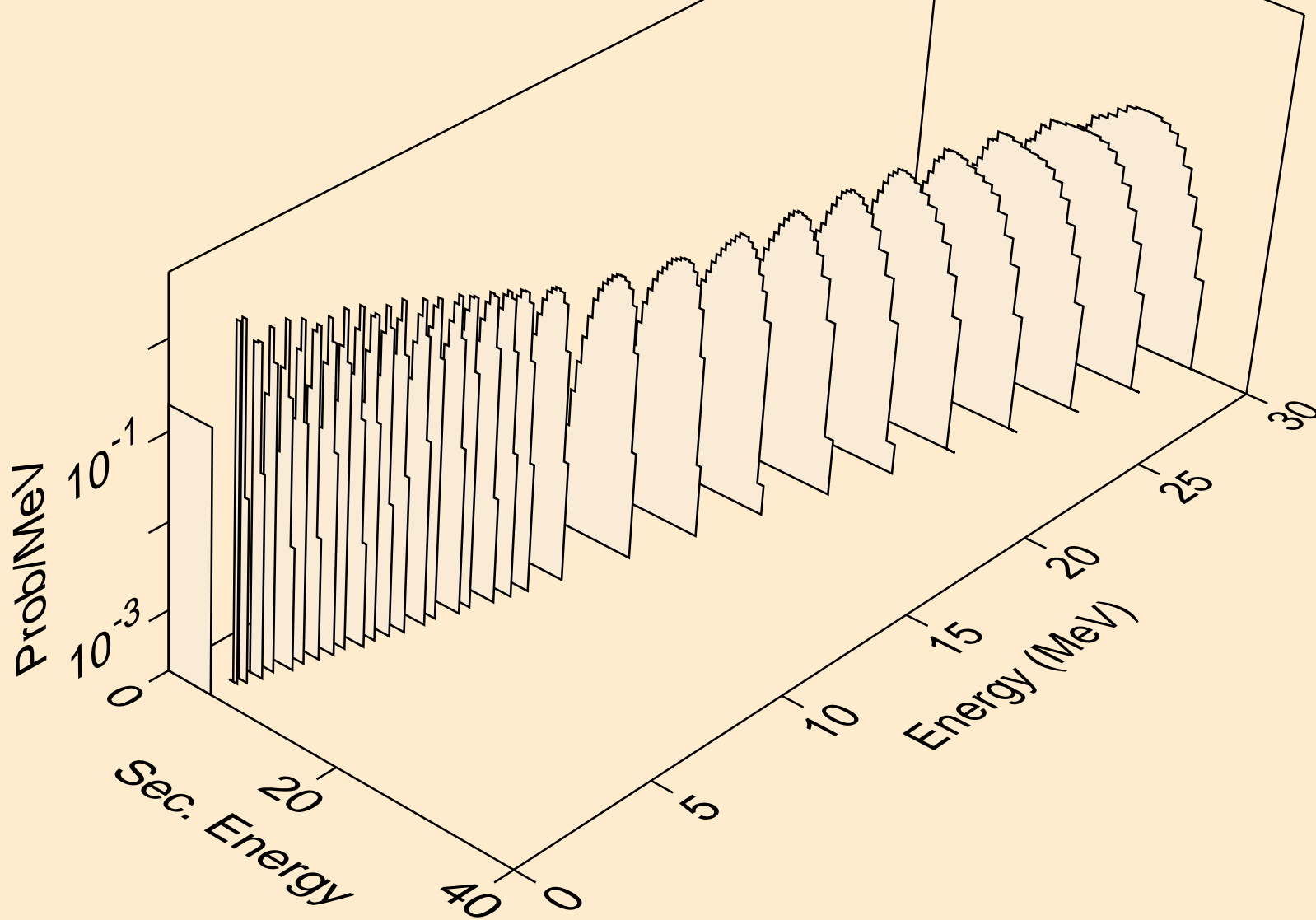

W167 NEUTRON ACER TENDL-2019 LIBRARY; T=293.16K
alphas from (n,n*)3a

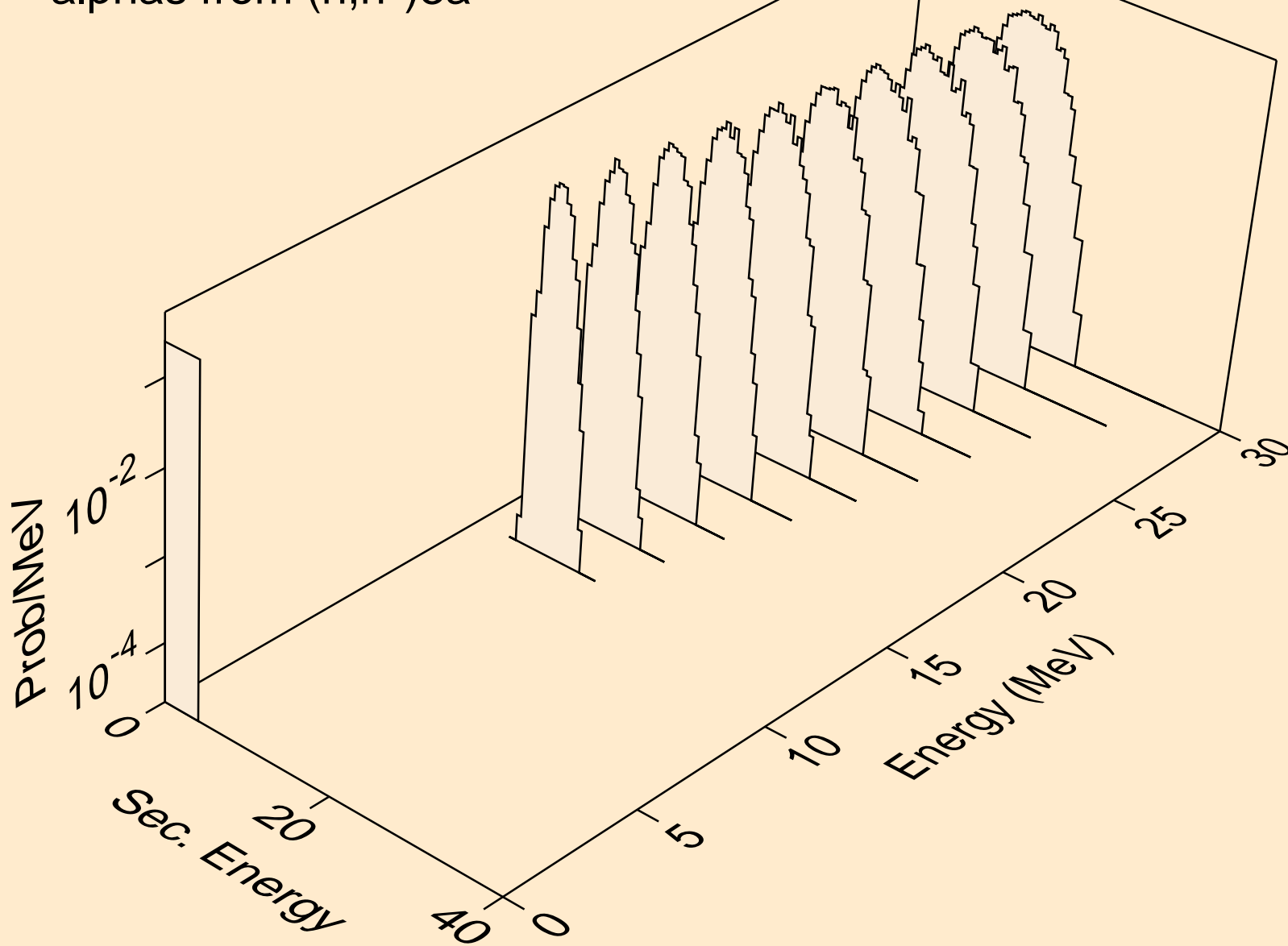

W167 NEUTRON ACER TENDL-2019 LIBRARY; T=293.16K
alphas from (n,2n)a

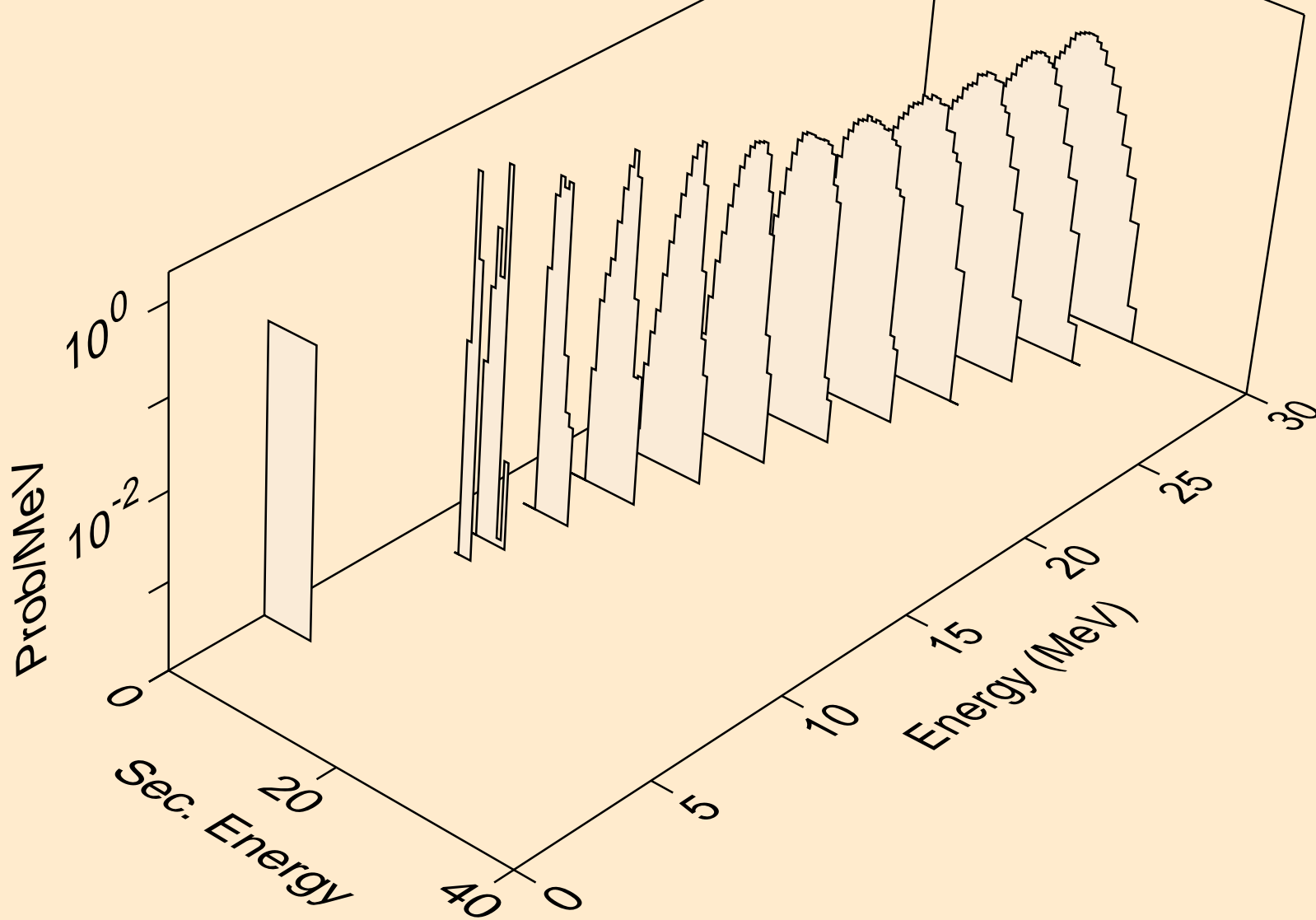

W167 NEUTRON ACER TENDL-2019 LIBRARY; T=293.16K
alphas from (n,3n)a

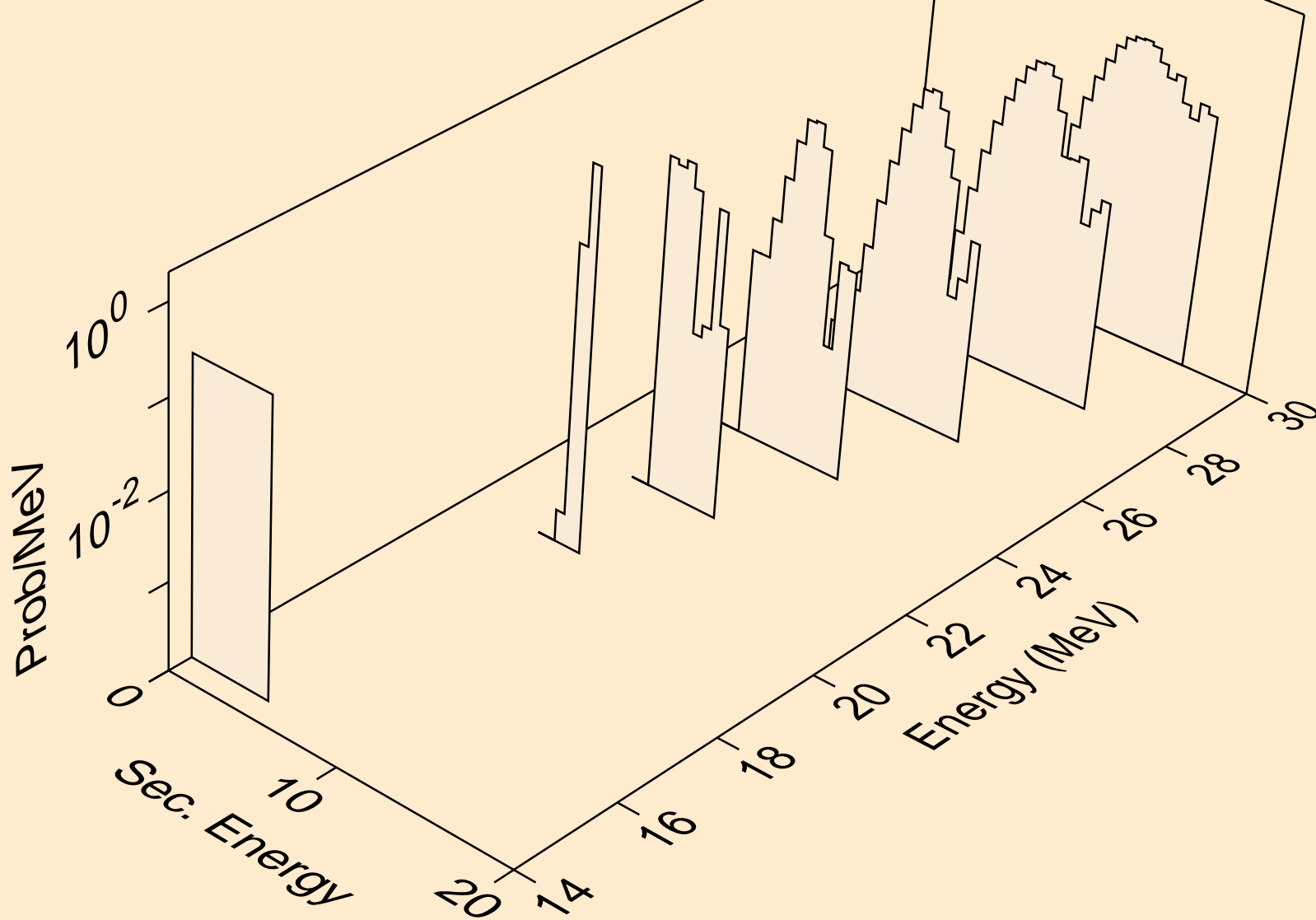

W167 NEUTRON ACER TENDL-2019 LIBRARY; T=293.16K
alphas from (n,n*)2a

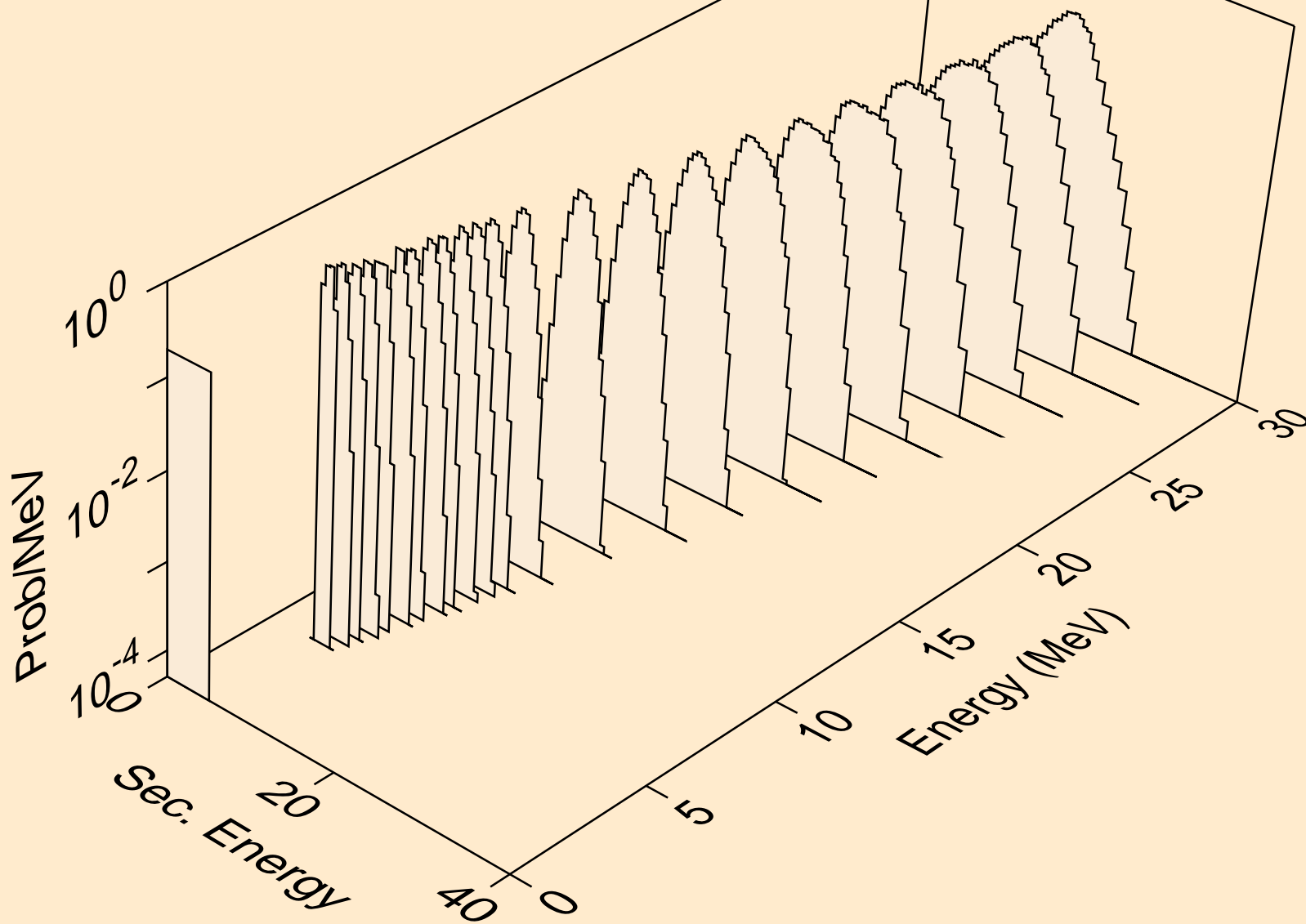

W167 NEUTRON ACER TENDL-2019 LIBRARY; T=293.16K
alphas from (n,2n)2a

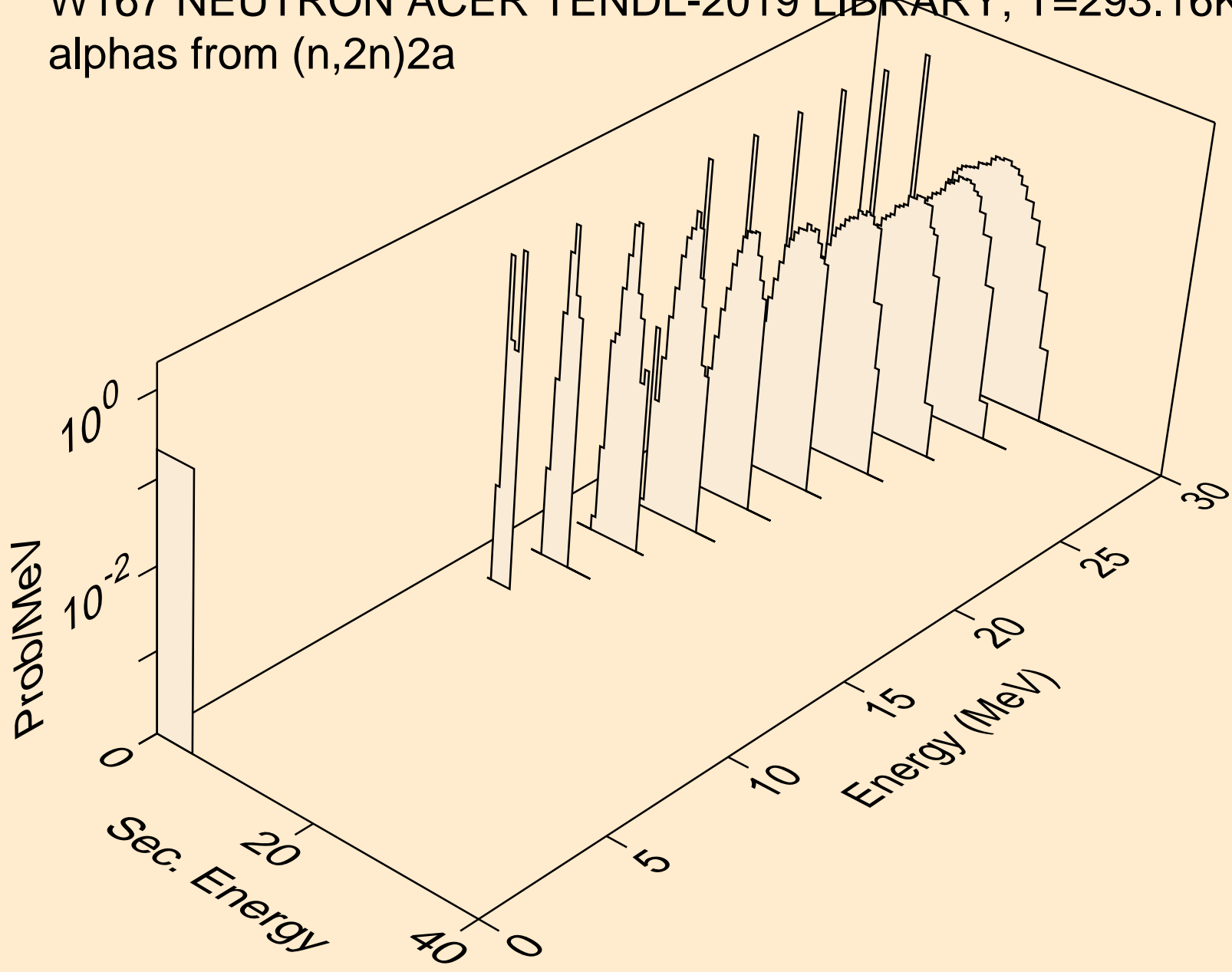

W167 NEUTRON ACER TENDL-2019 LIBRARY; T=293.16K
alphas from (n,npa)

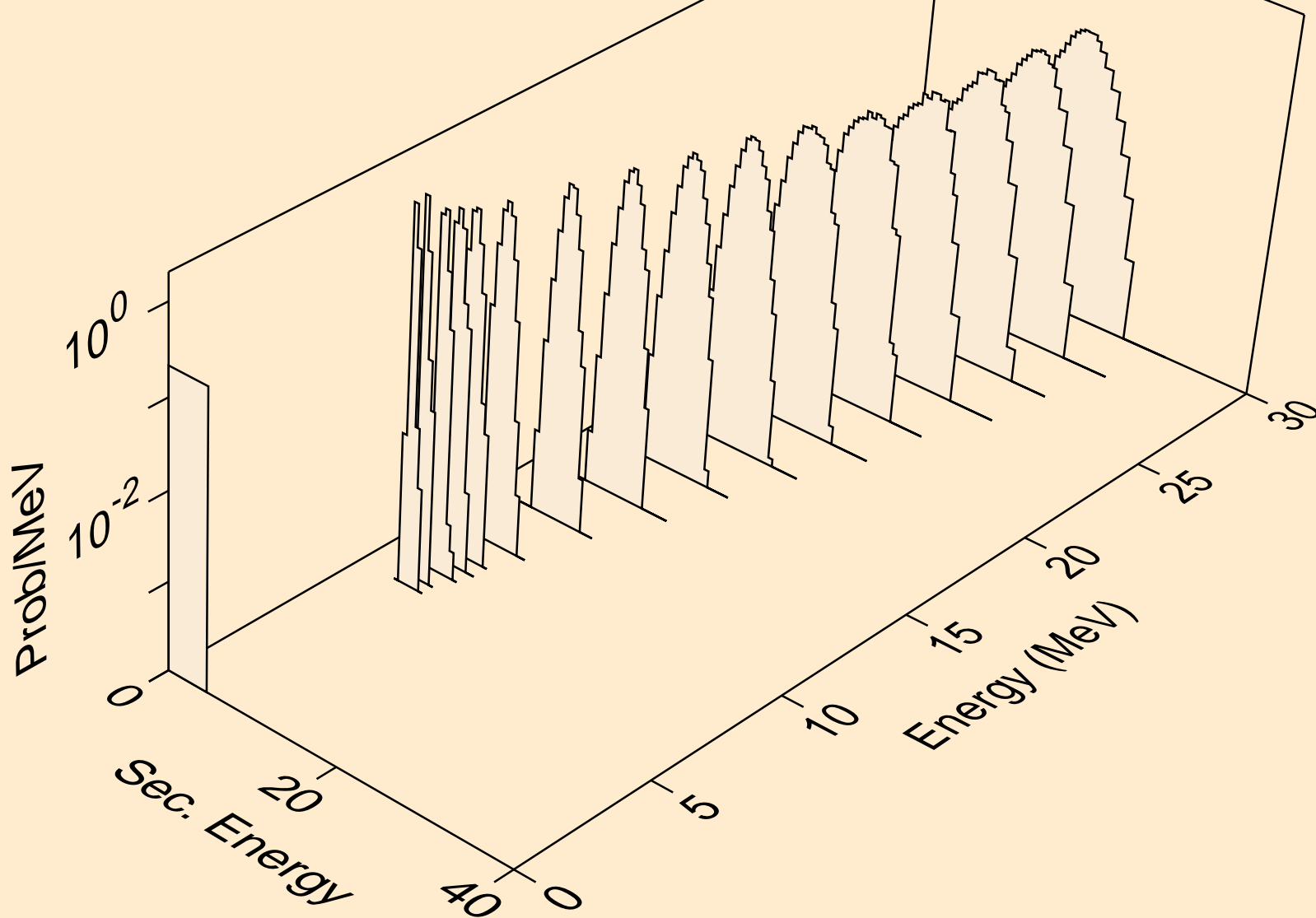

W167 NEUTRON ACER TENDL-2019 LIBRARY; T=293.16K
alphas from (n,a)

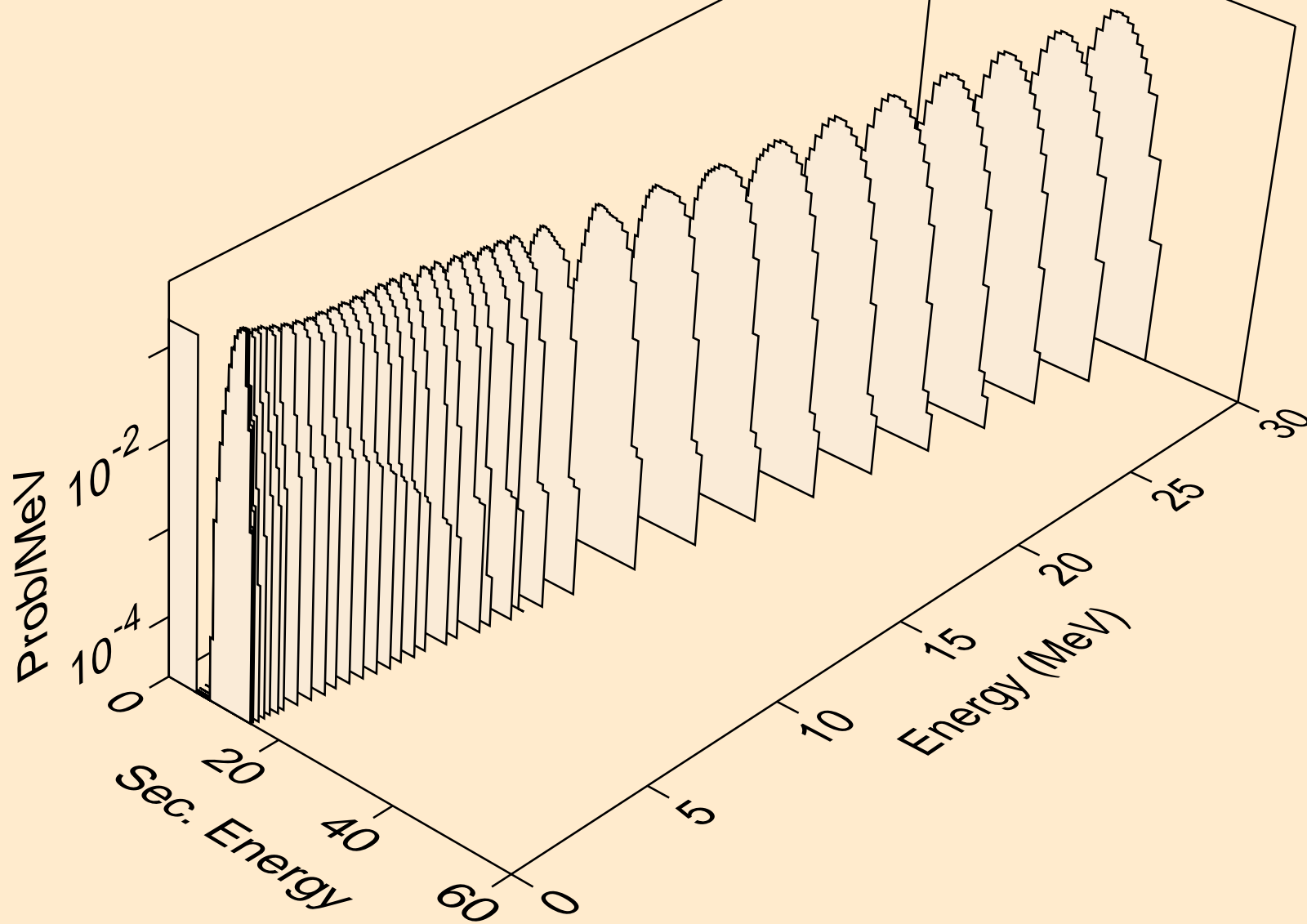

W167 NEUTRON ACER TENDL-2019 LIBRARY; T=293.16K
alphas from (n,2a)

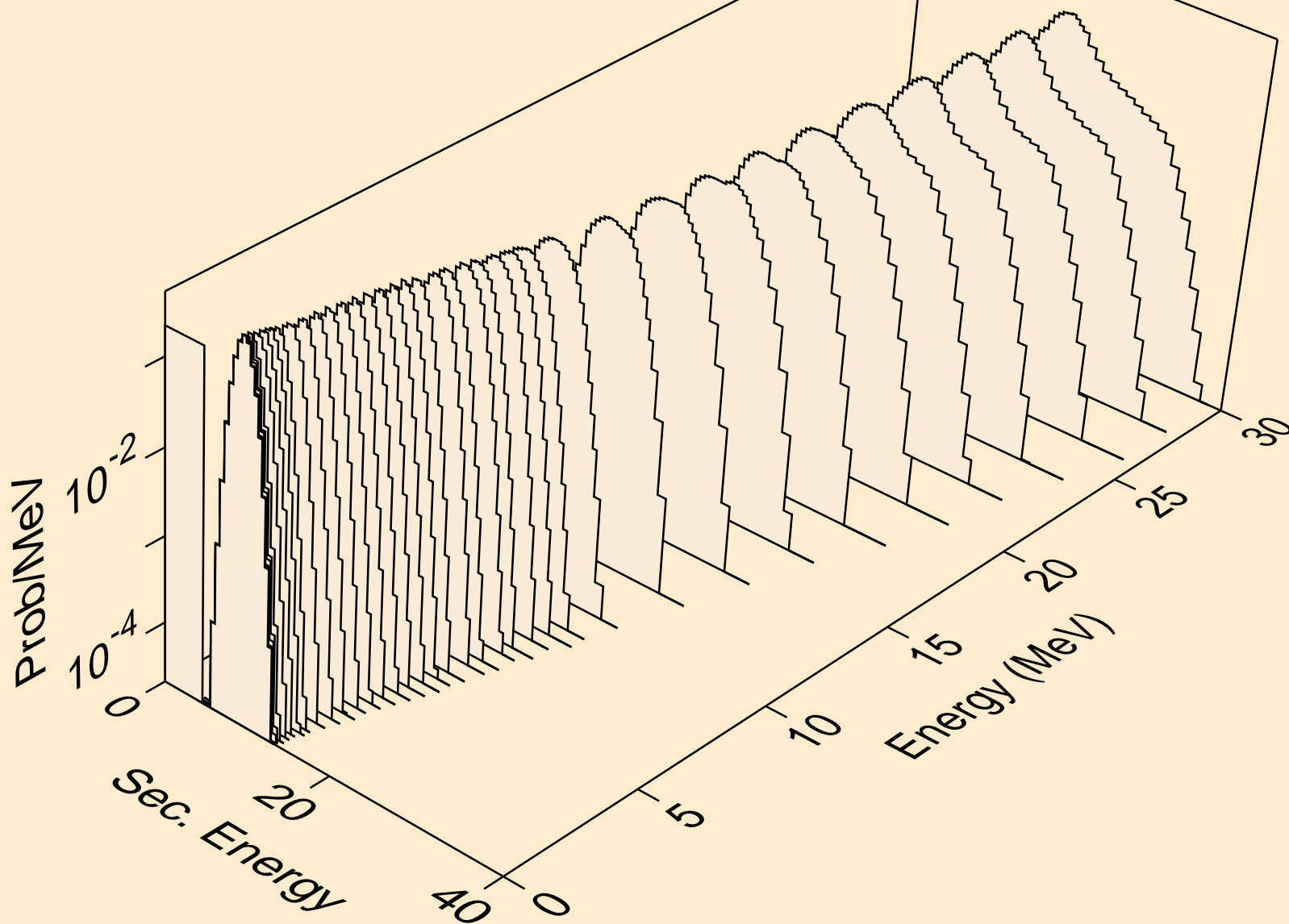

W167 NEUTRON ACER TENDL-2019 LIBRARY; T=293.16K
alphas from (n,3a)

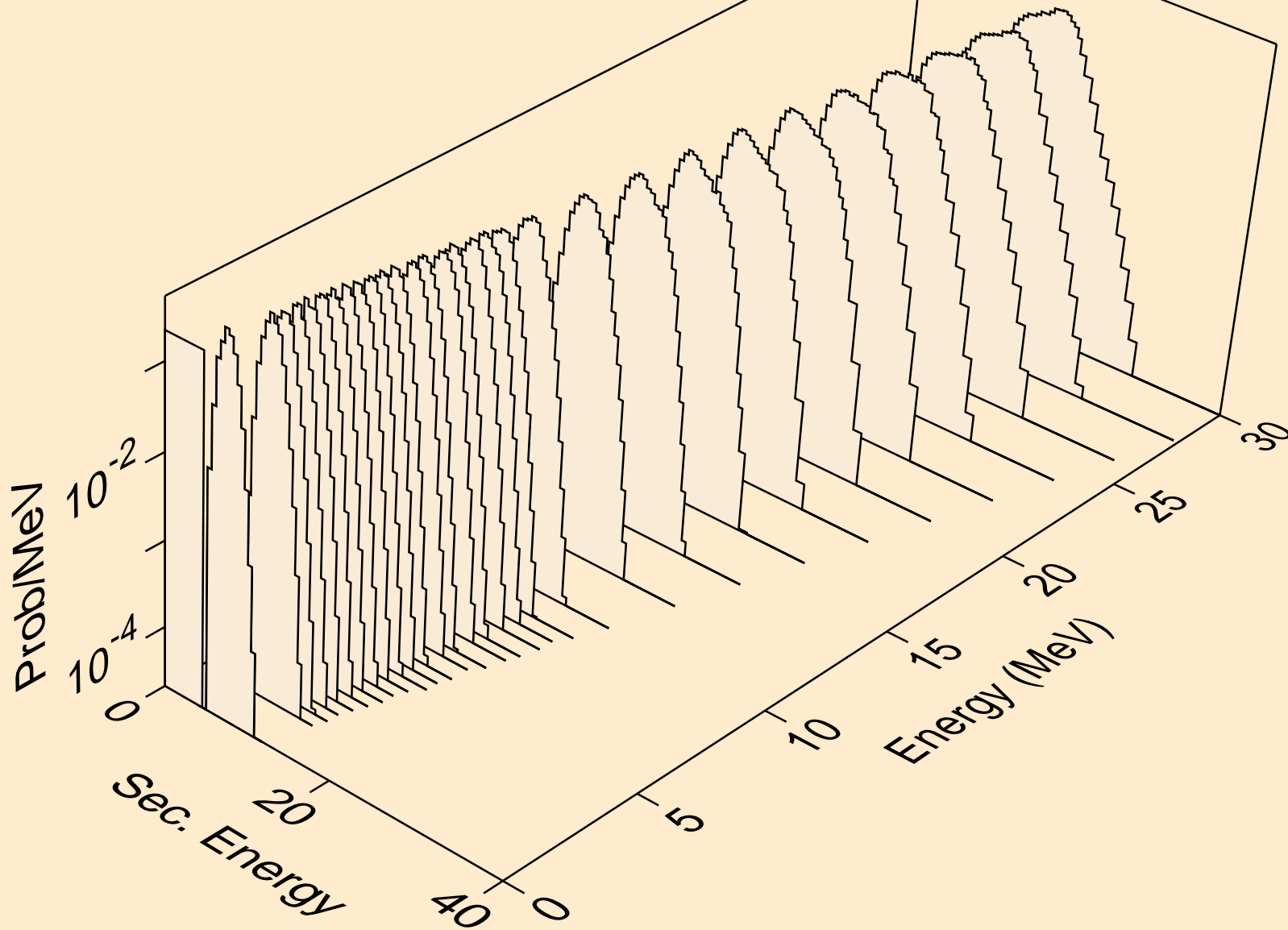

W167 NEUTRON ACER TENDL-2019 LIBRARY; T=293.16K
alphas from (n,p)

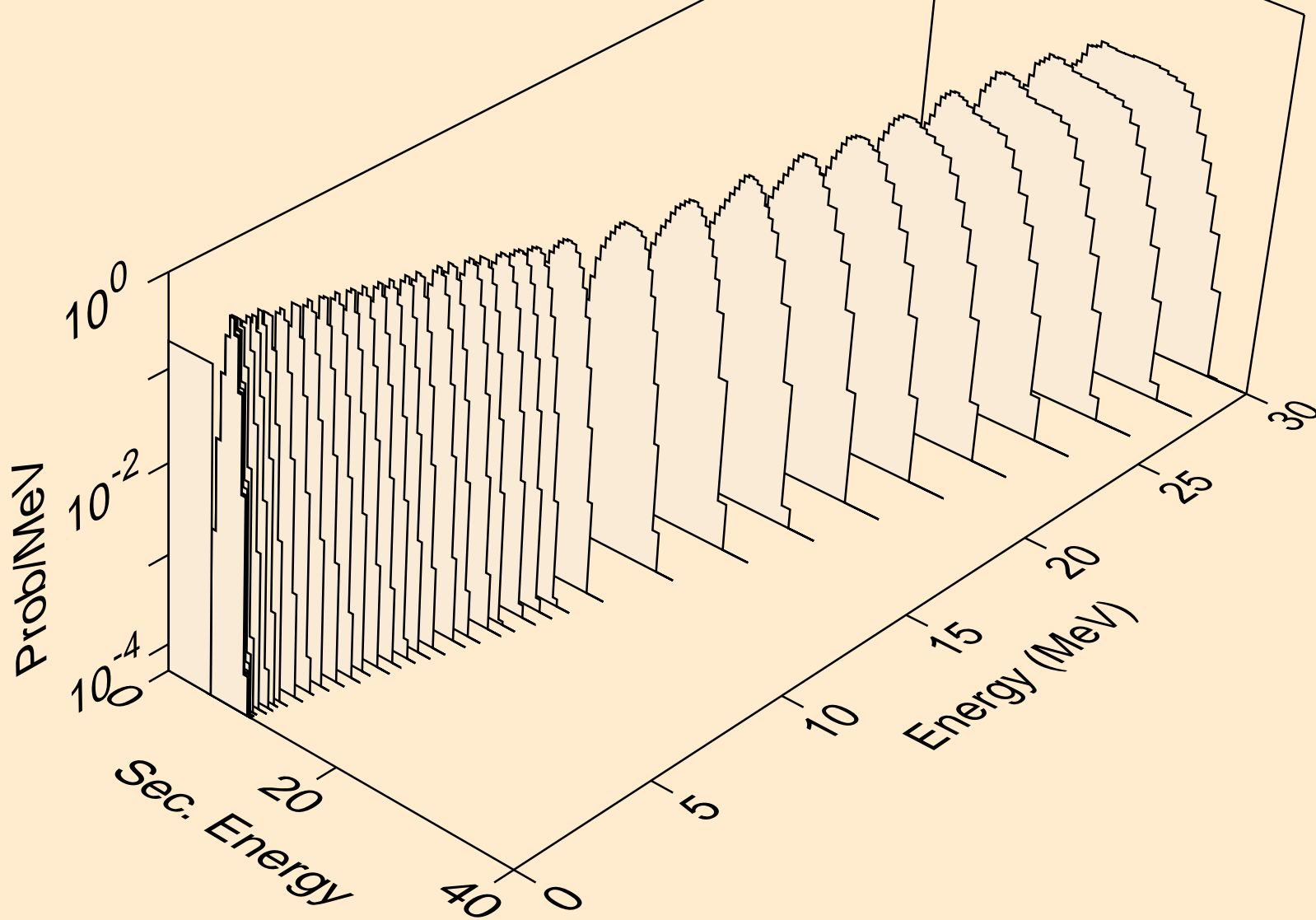

W167 NEUTRON ACER TENDL-2019 LIBRARY; T=293.16K
alphas from (n,da)

