

W171 NEUTRON ACER TENDL-2019 LIBRARY; T=293.16K  
Principal cross sections

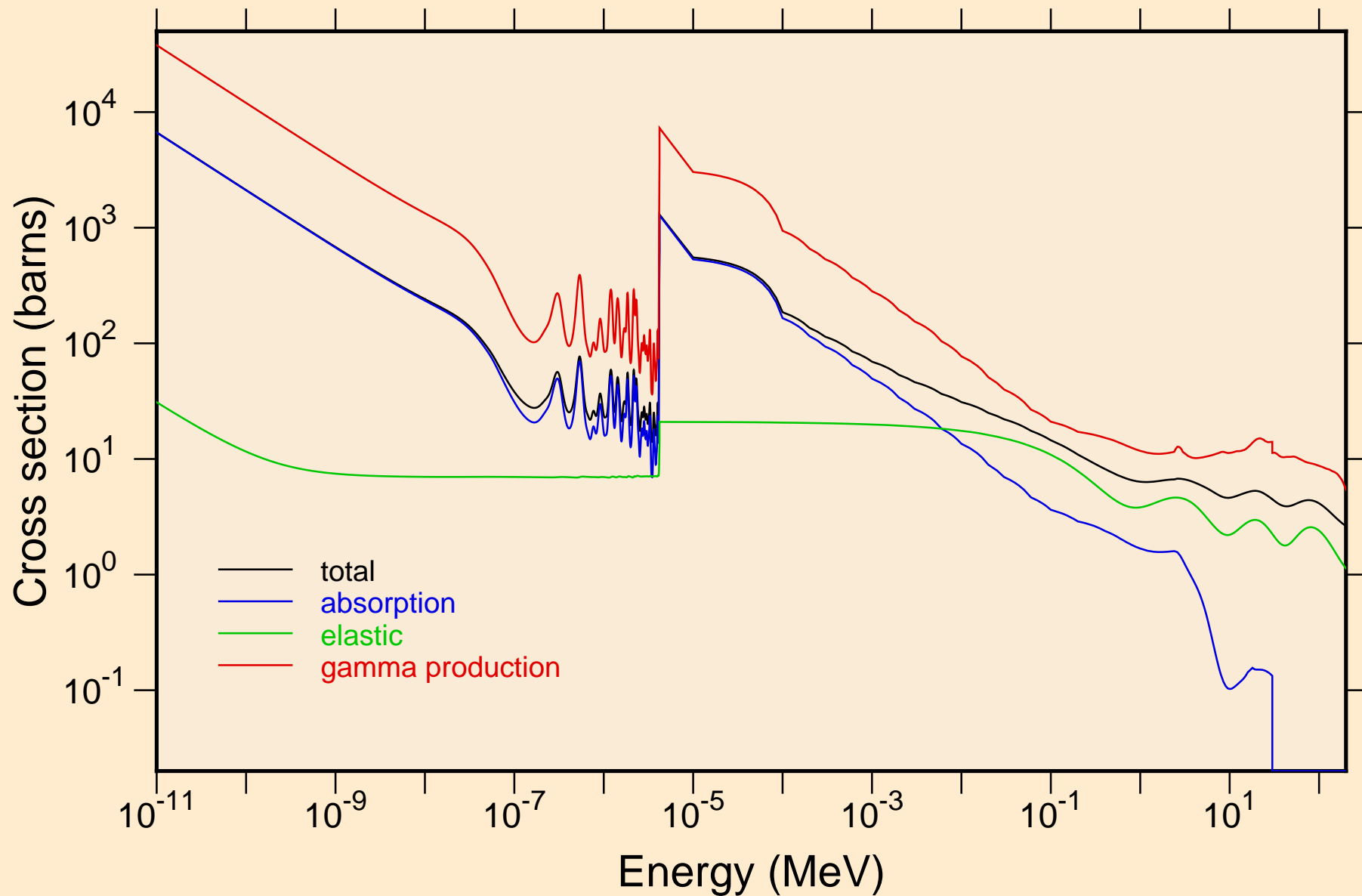

W171 NEUTRON ACER TENDL-2019 LIBRARY; T=293.16K  
resonance total cross section

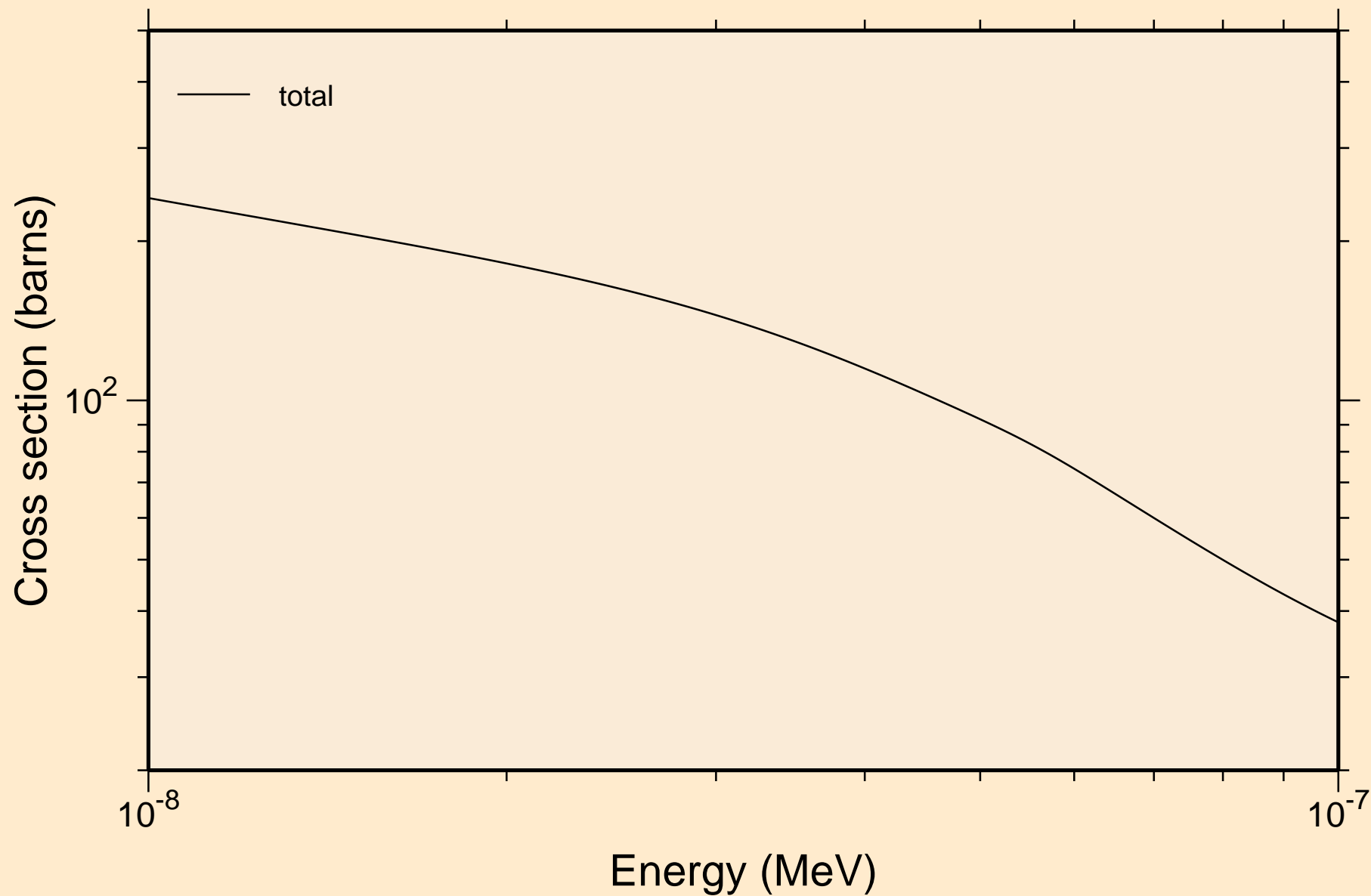

W171 NEUTRON ACER TENDL-2019 LIBRARY; T=293.16K  
resonance total cross section

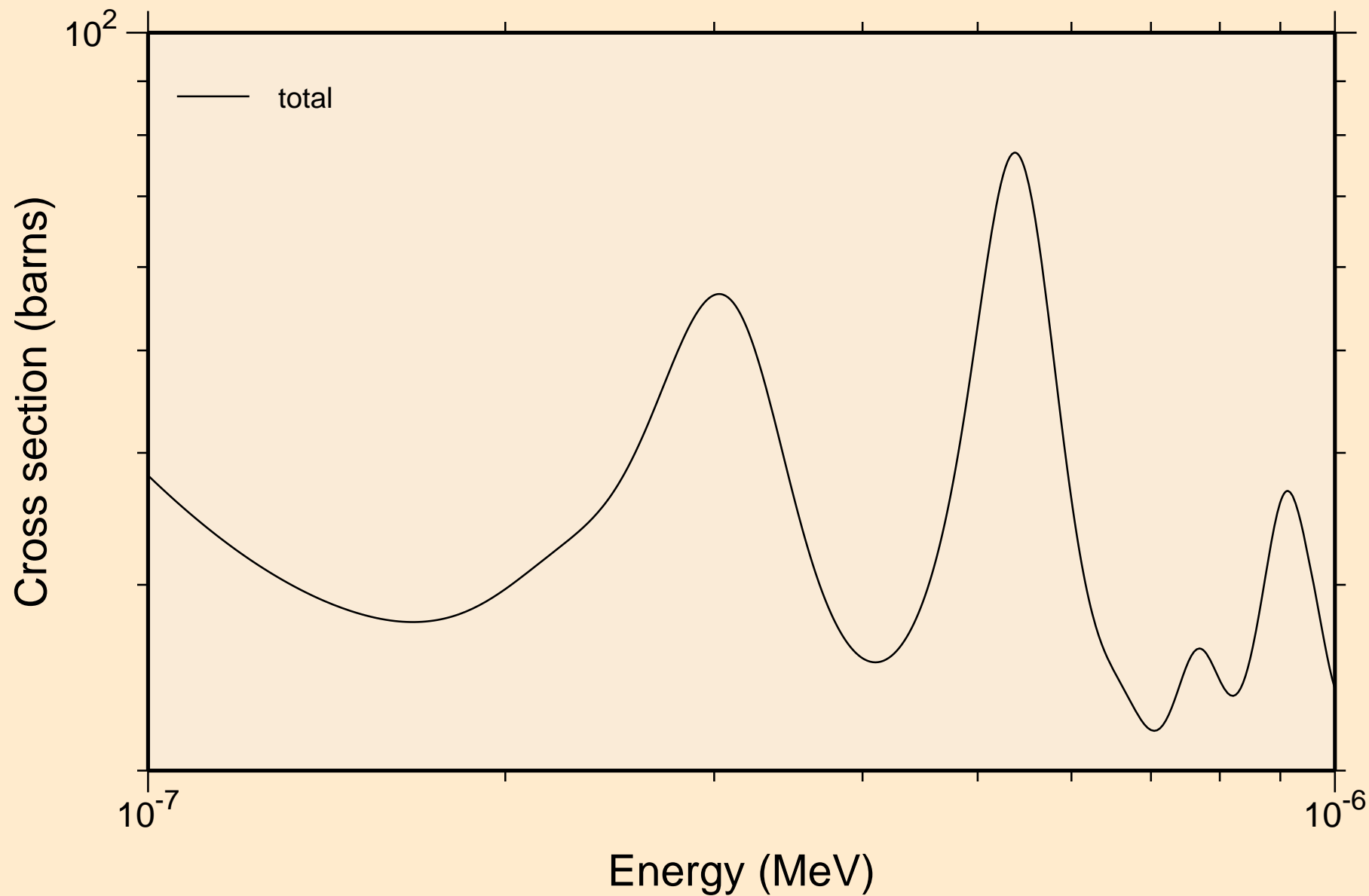

W171 NEUTRON ACER TENDL-2019 LIBRARY; T=293.16K  
resonance total cross section

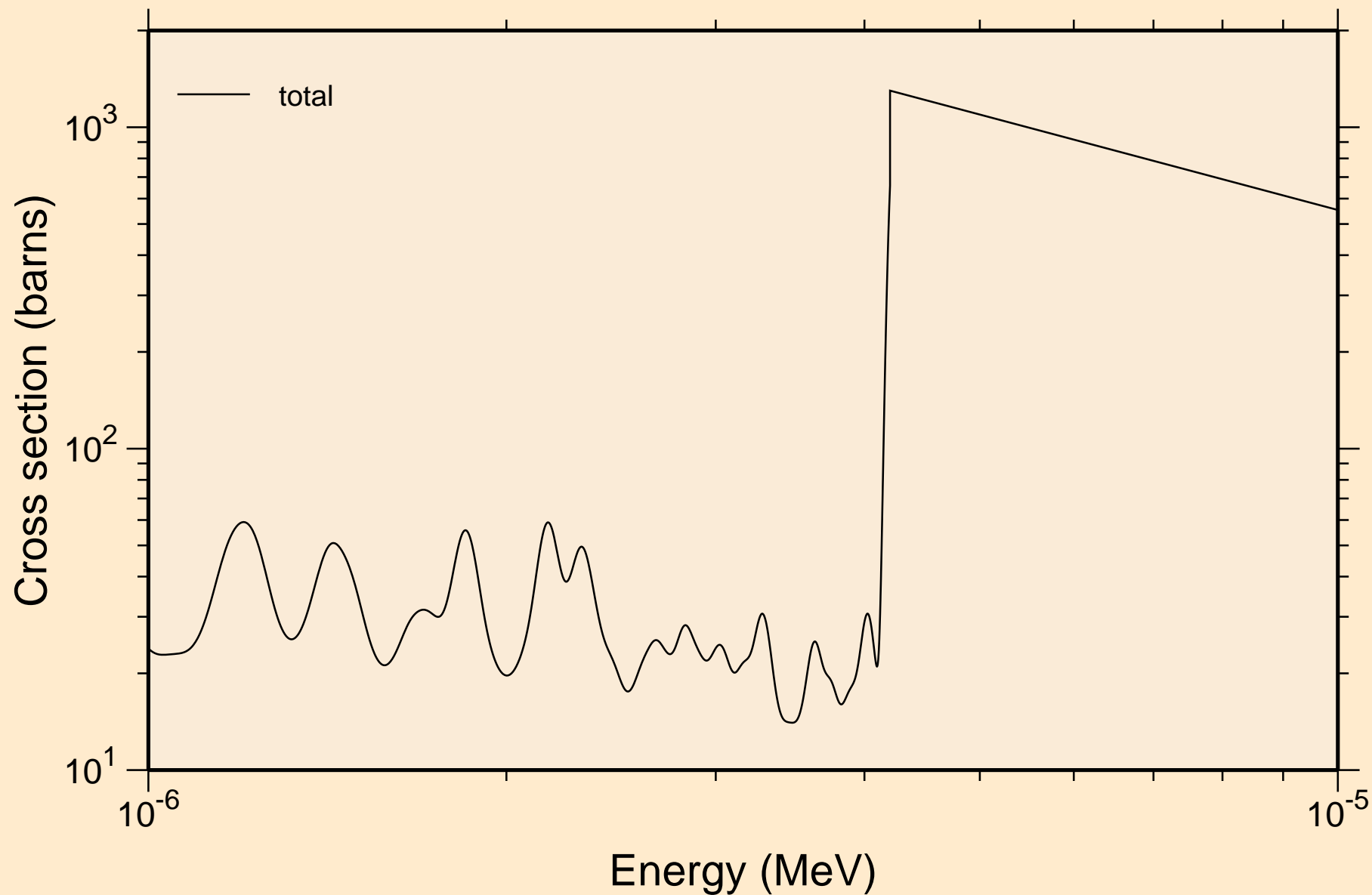

W171 NEUTRON ACER TENDL-2019 LIBRARY; T=293.16K  
resonance total cross section

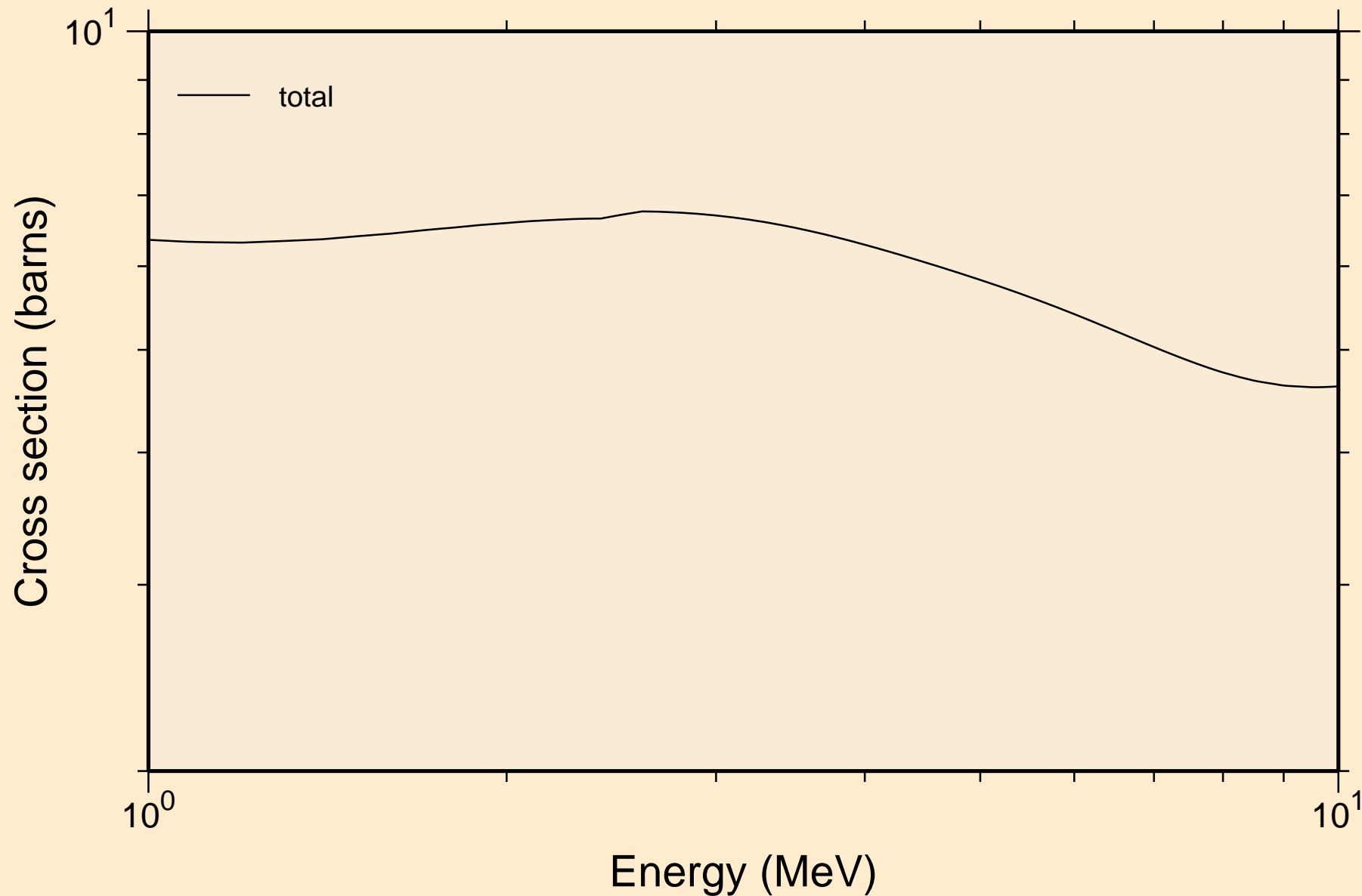

W171 NEUTRON ACER TENDL-2019 LIBRARY; T=293.16K  
resonance absorption cross sections

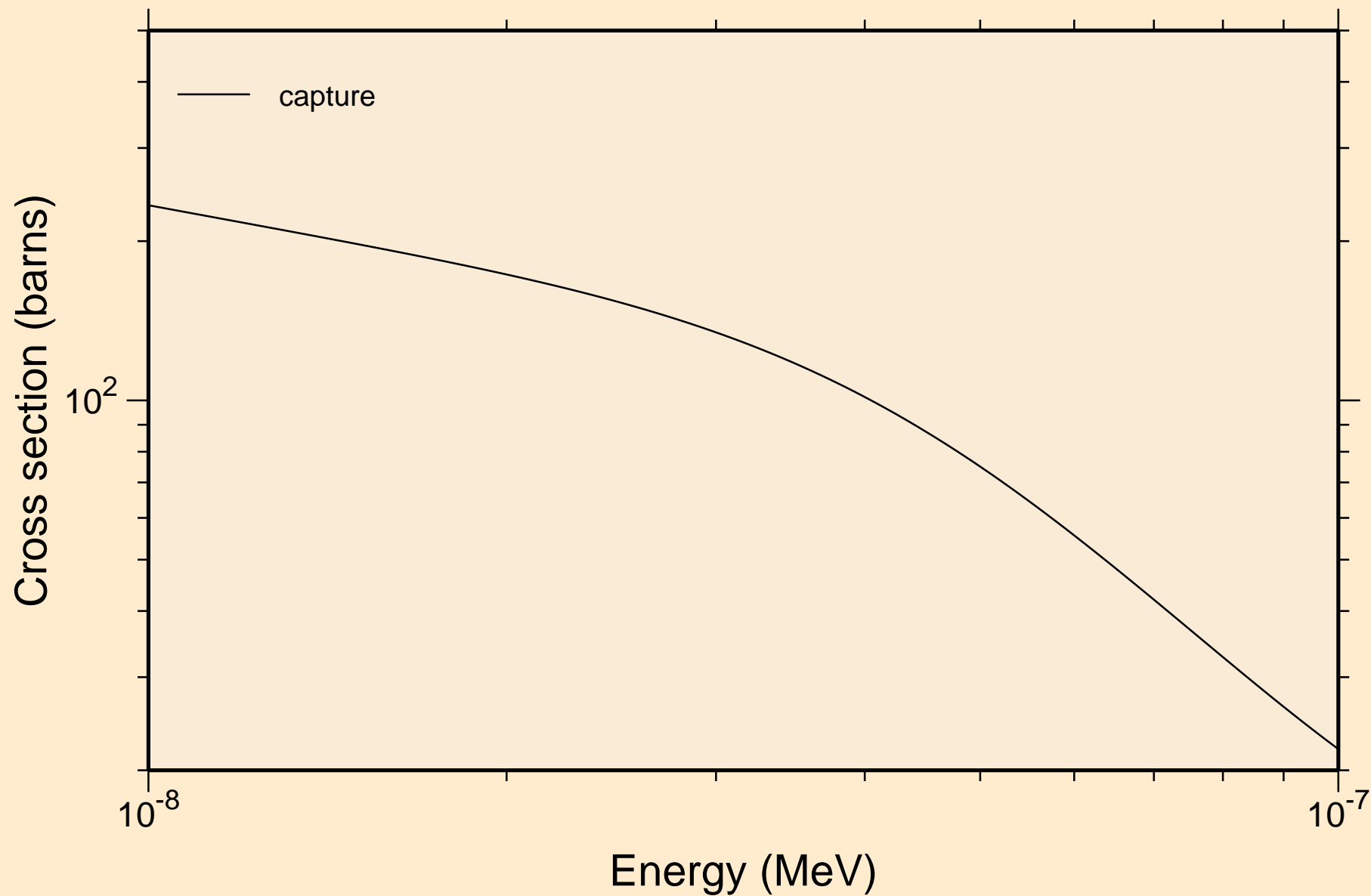

W171 NEUTRON ACER TENDL-2019 LIBRARY; T=293.16K  
resonance absorption cross sections

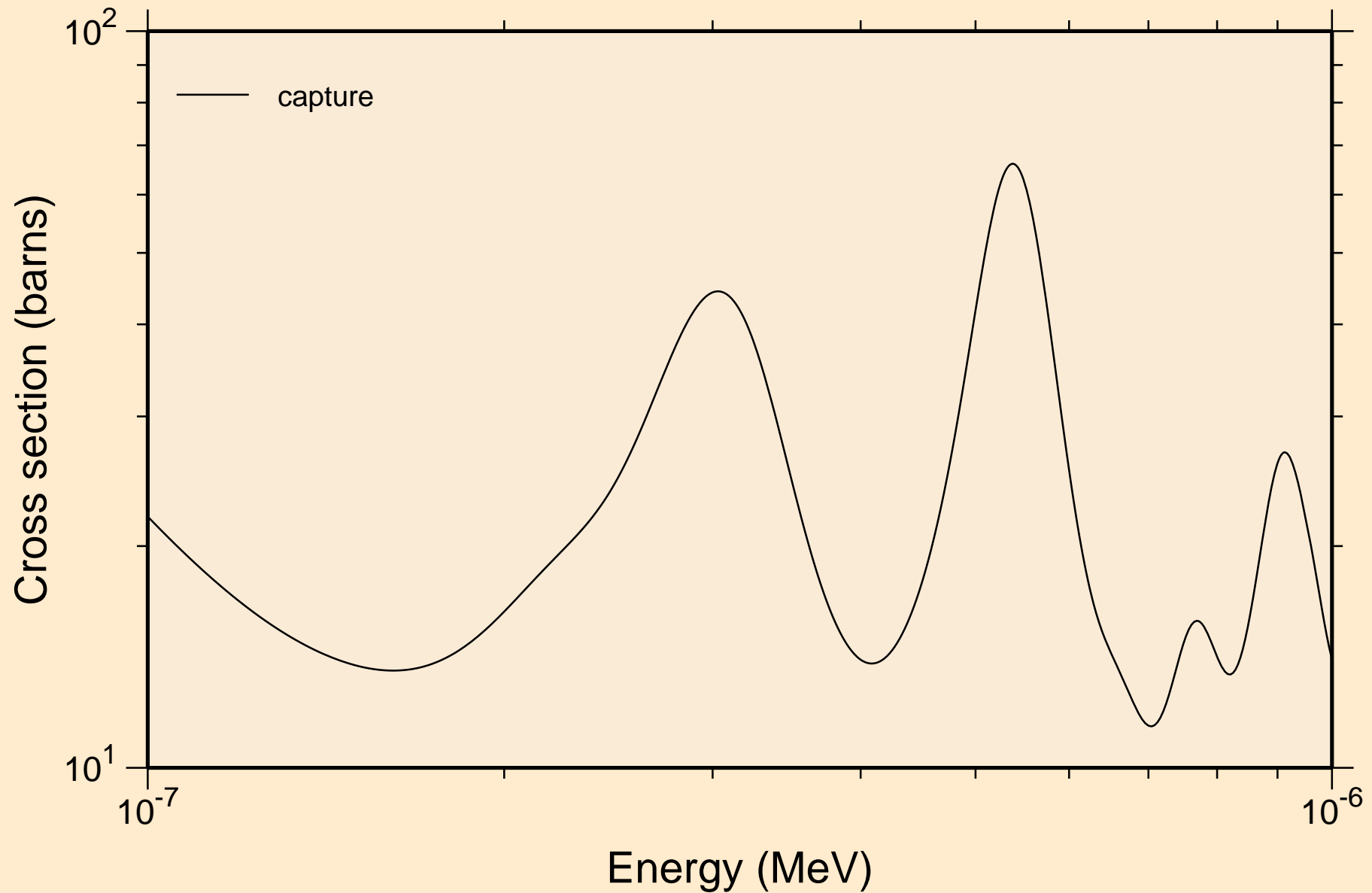

W171 NEUTRON ACER TENDL-2019 LIBRARY; T=293.16K  
resonance absorption cross sections

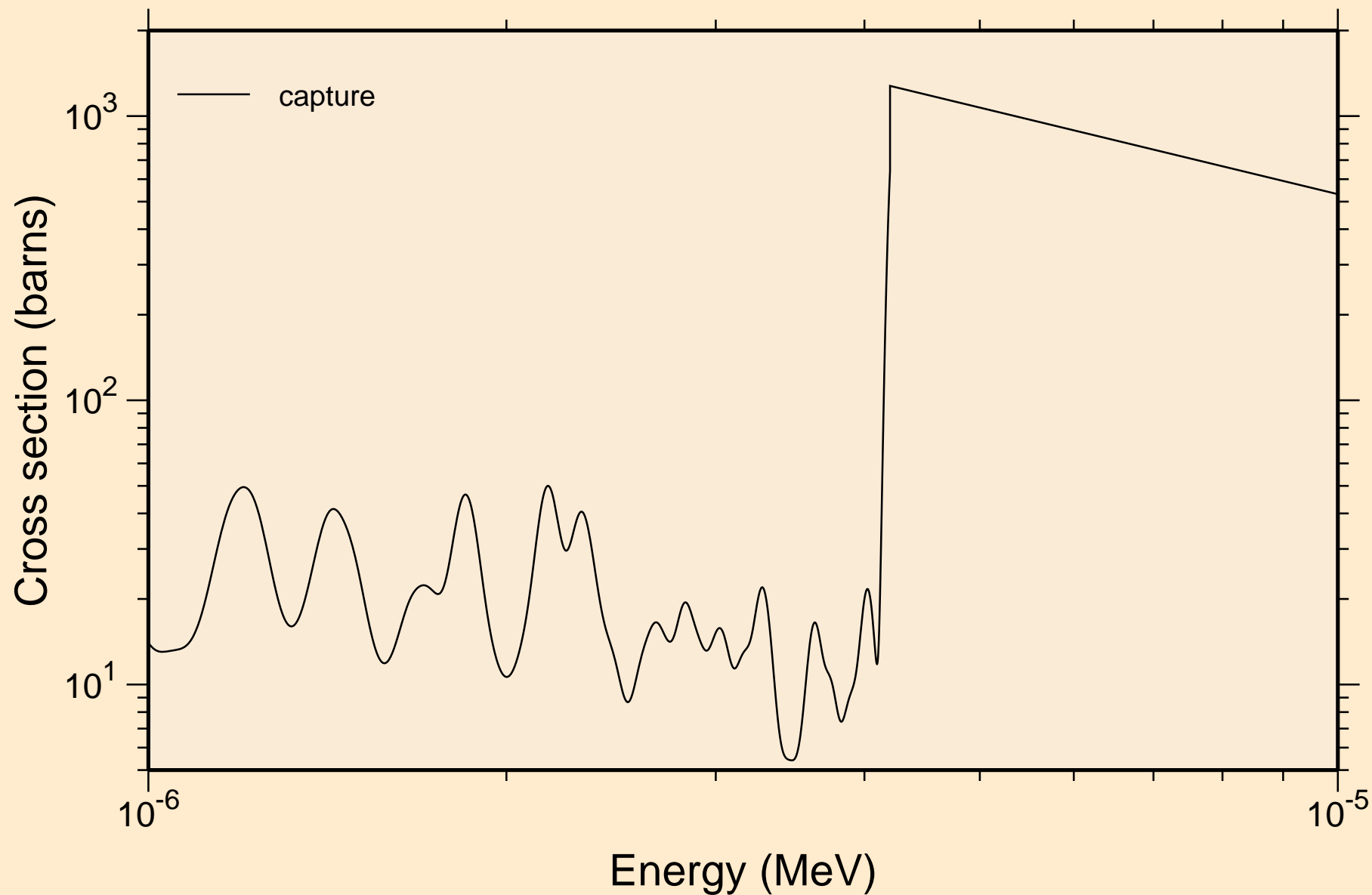



W171 NEUTRON ACER TENDL-2019 LIBRARY; T=293.16K  
resonance absorption cross sections

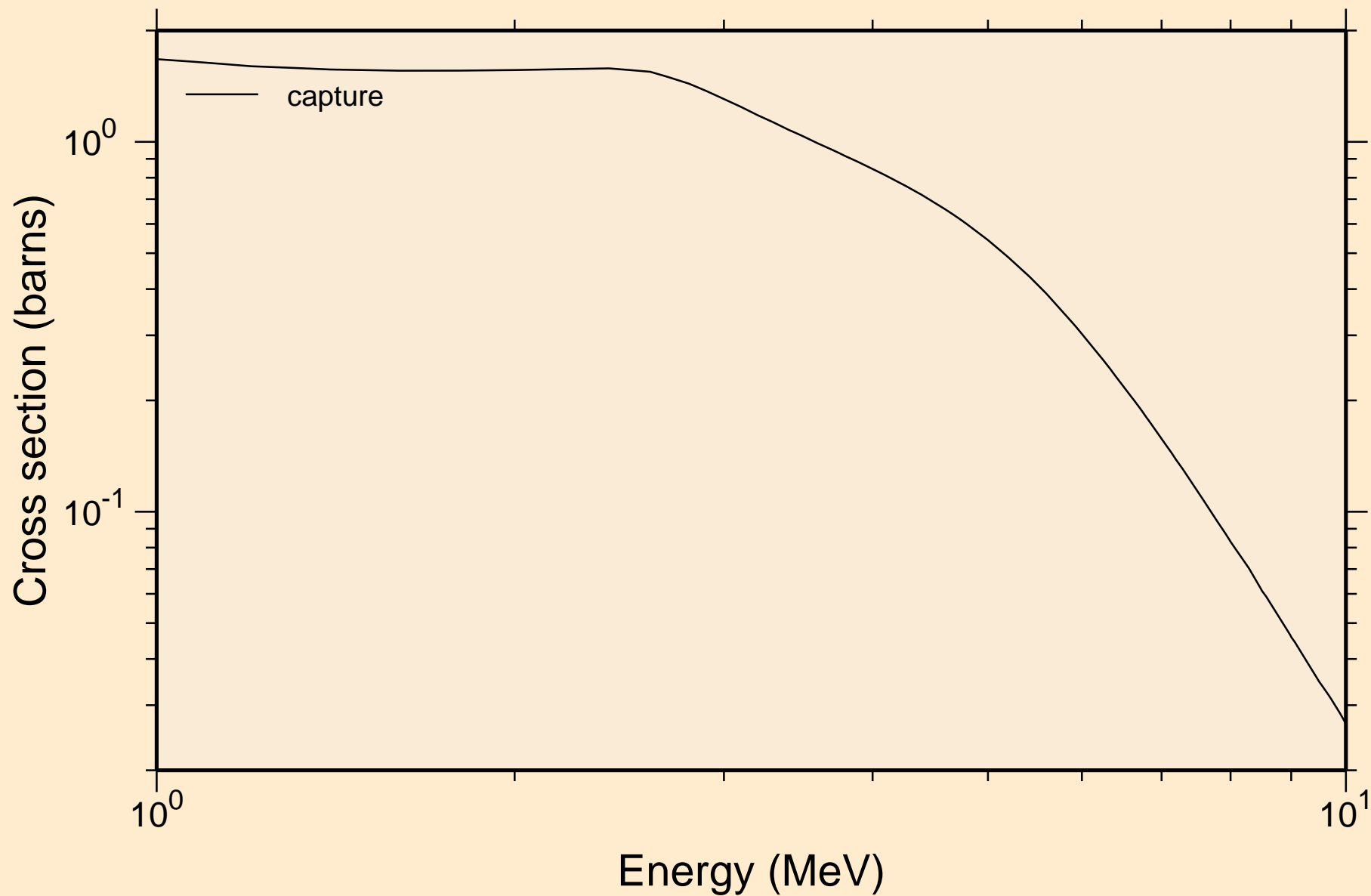

W171 NEUTRON ACER TENDL-2019 LIBRARY; T=293.16K  
Heating

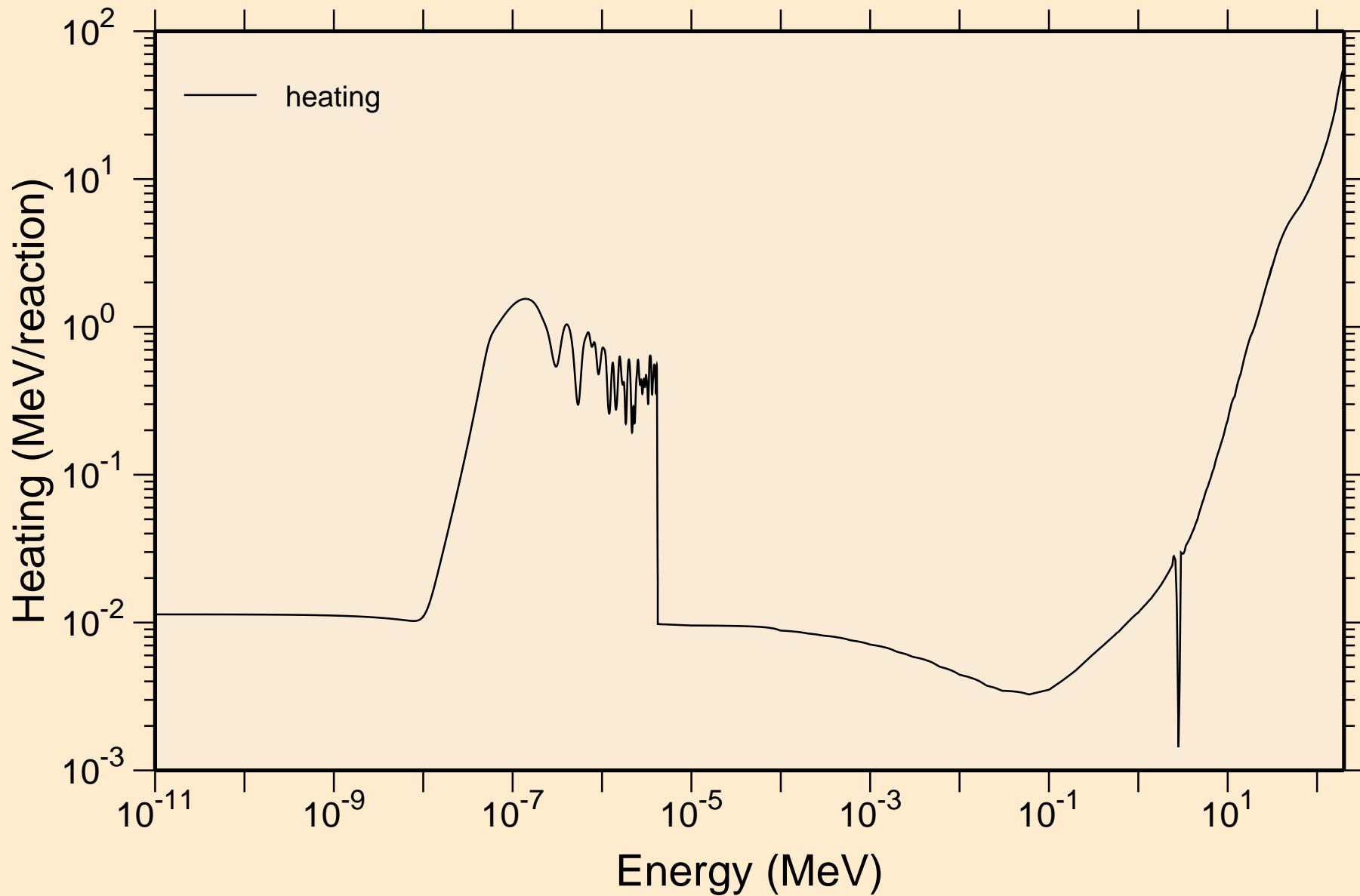

W171 NEUTRON ACER TENDL-2019 LIBRARY; T=293.16K  
Damage

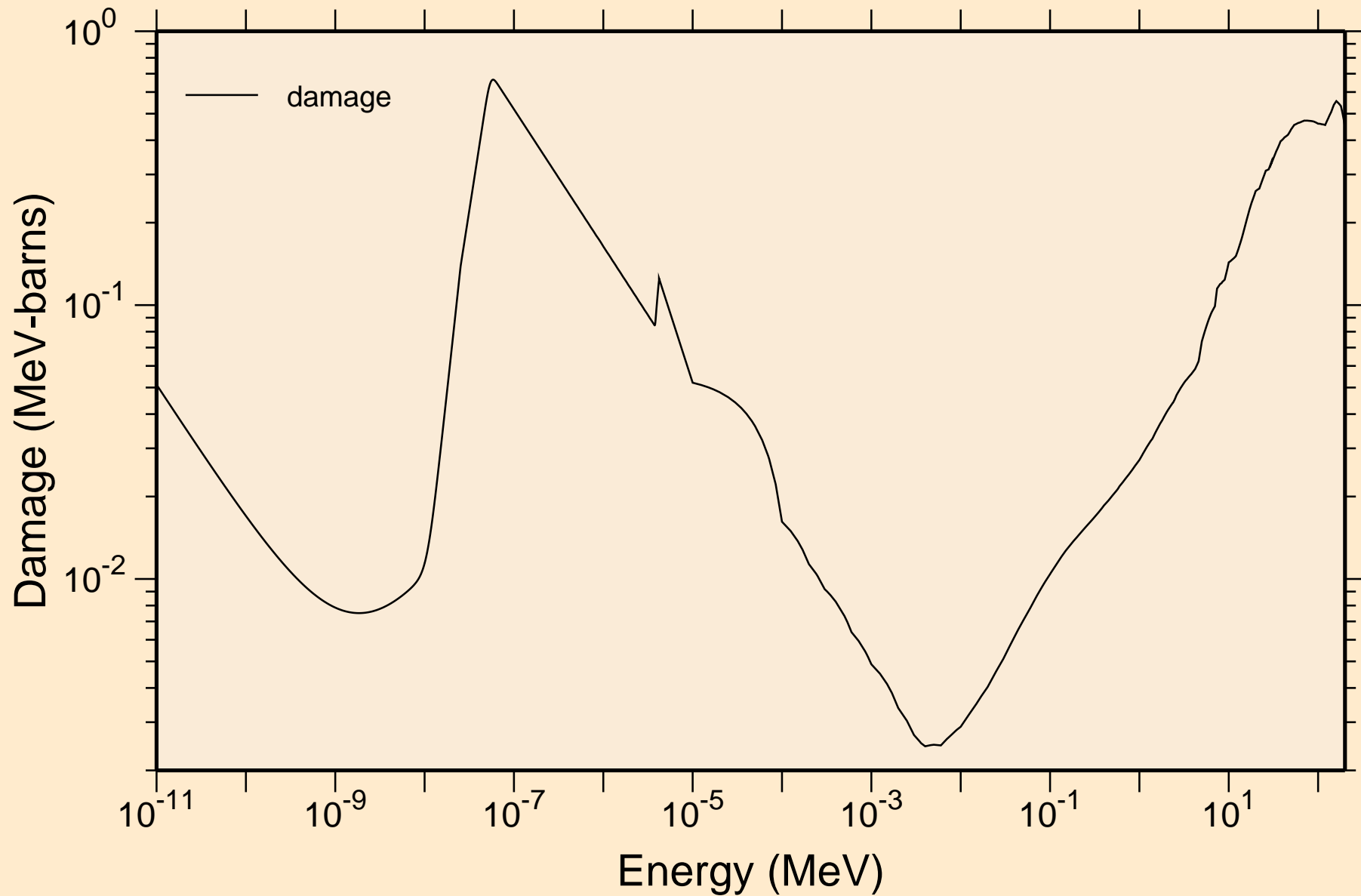

W171 NEUTRON ACER TENDL-2019 LIBRARY; T=293.16K  
Non-threshold reactions

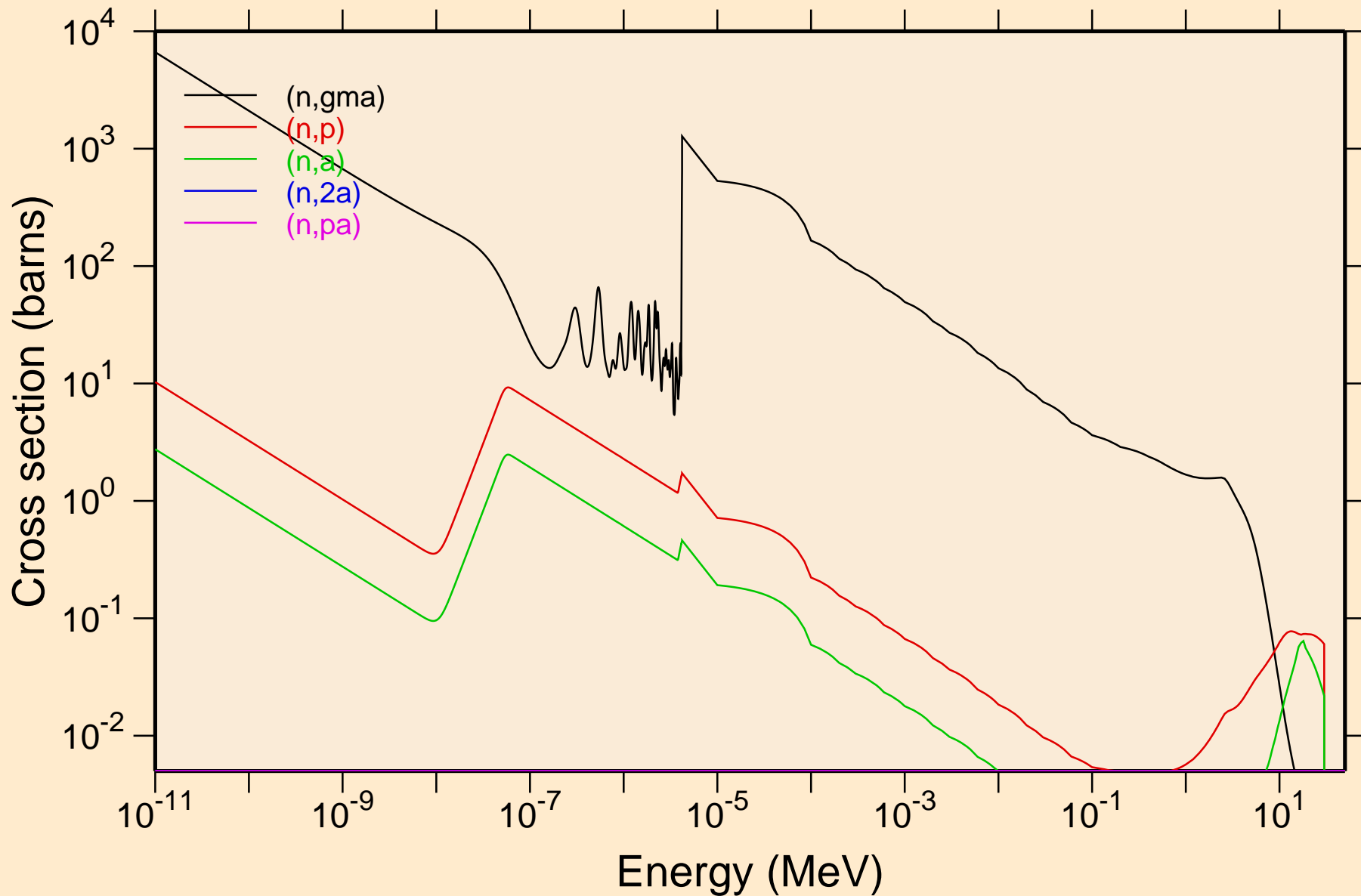

W171 NEUTRON ACER TENDL-2019 LIBRARY; T=293.16K  
Non-threshold reactions

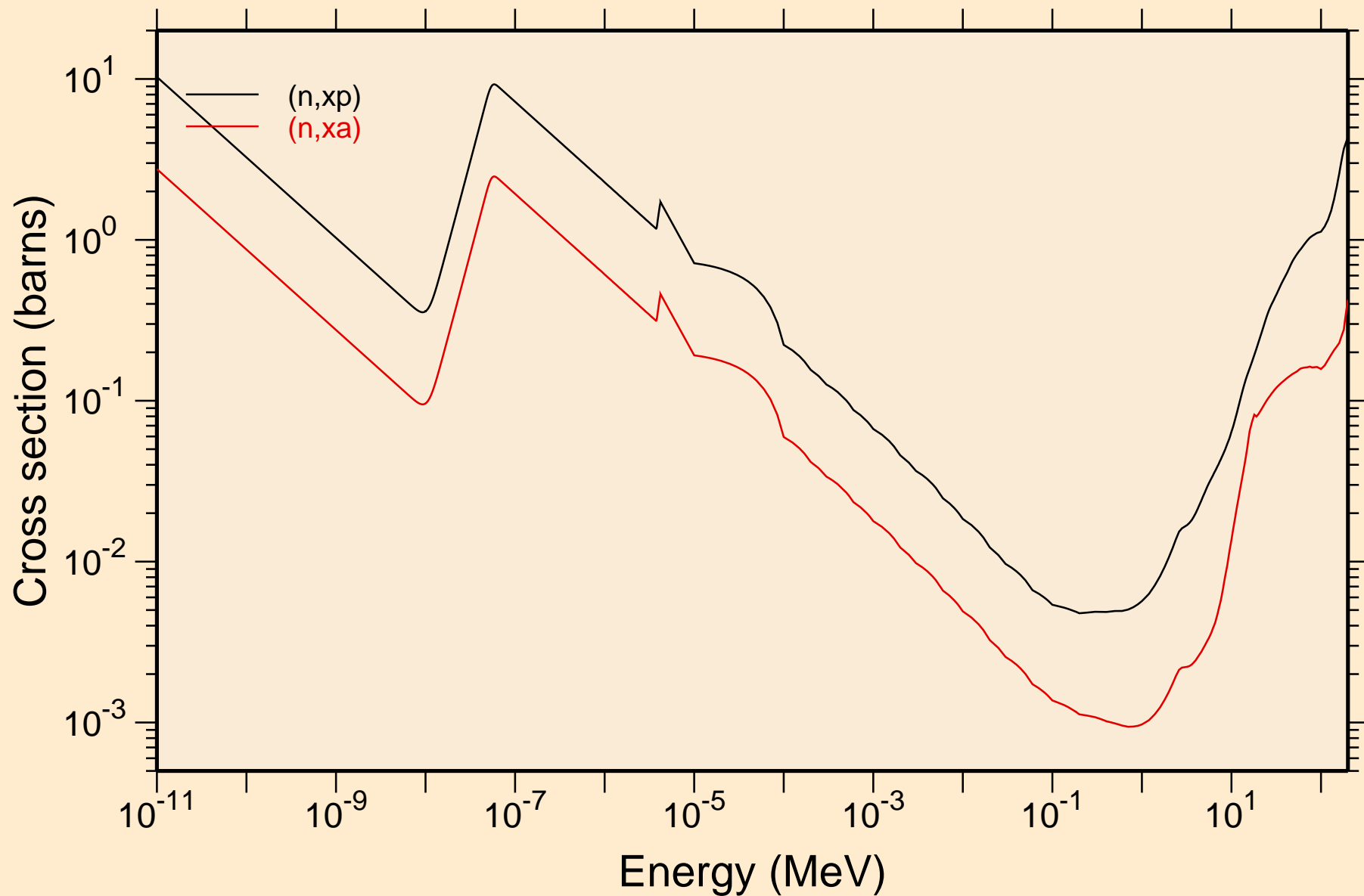

W171 NEUTRON ACER TENDL-2019 LIBRARY; T=293.16K  
Principal cross sections

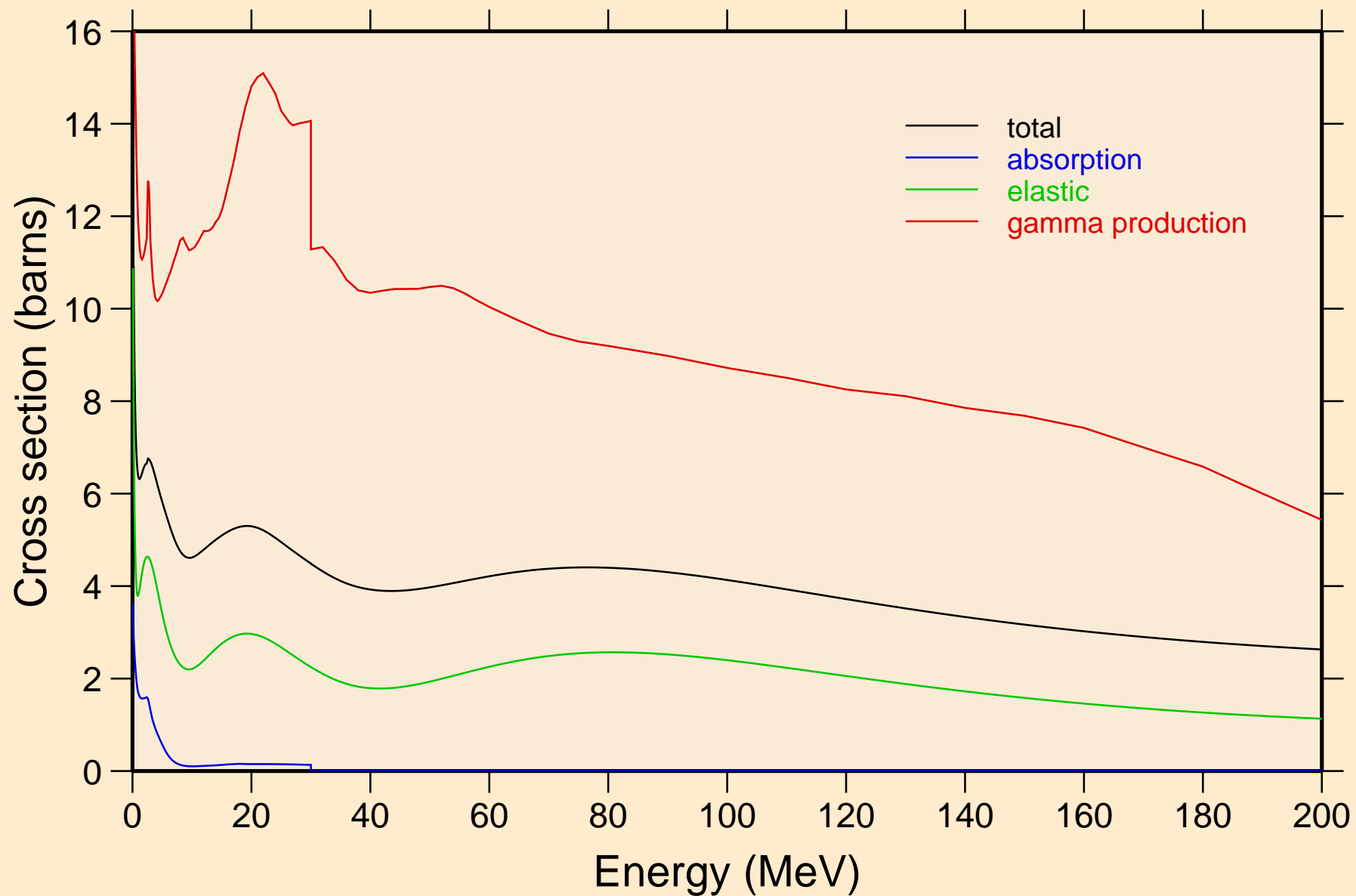

W171 NEUTRON ACER TENDL-2019 LIBRARY; T=293.16K  
Heating

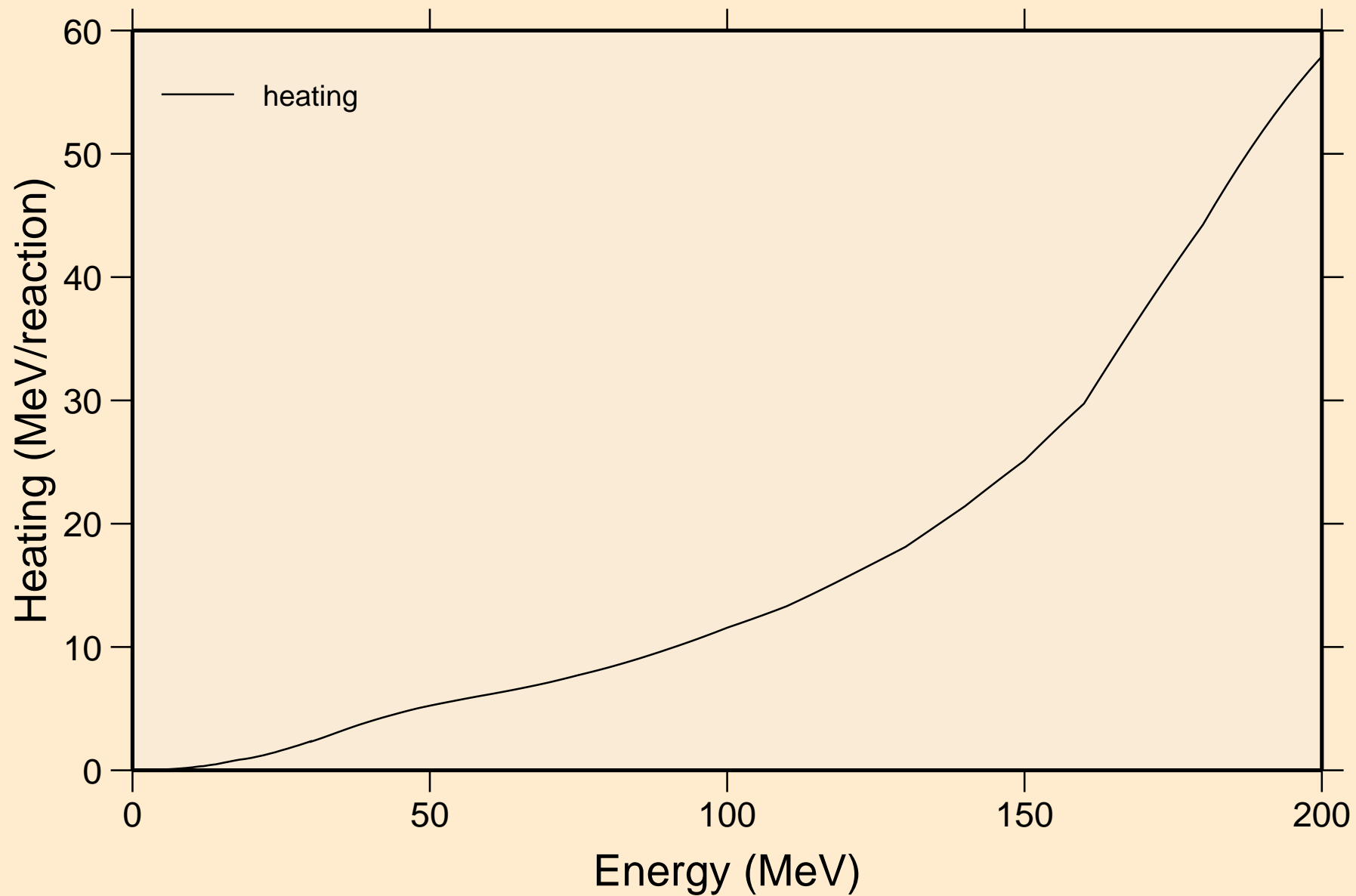

W171 NEUTRON ACER TENDL-2019 LIBRARY; T=293.16K  
Damage

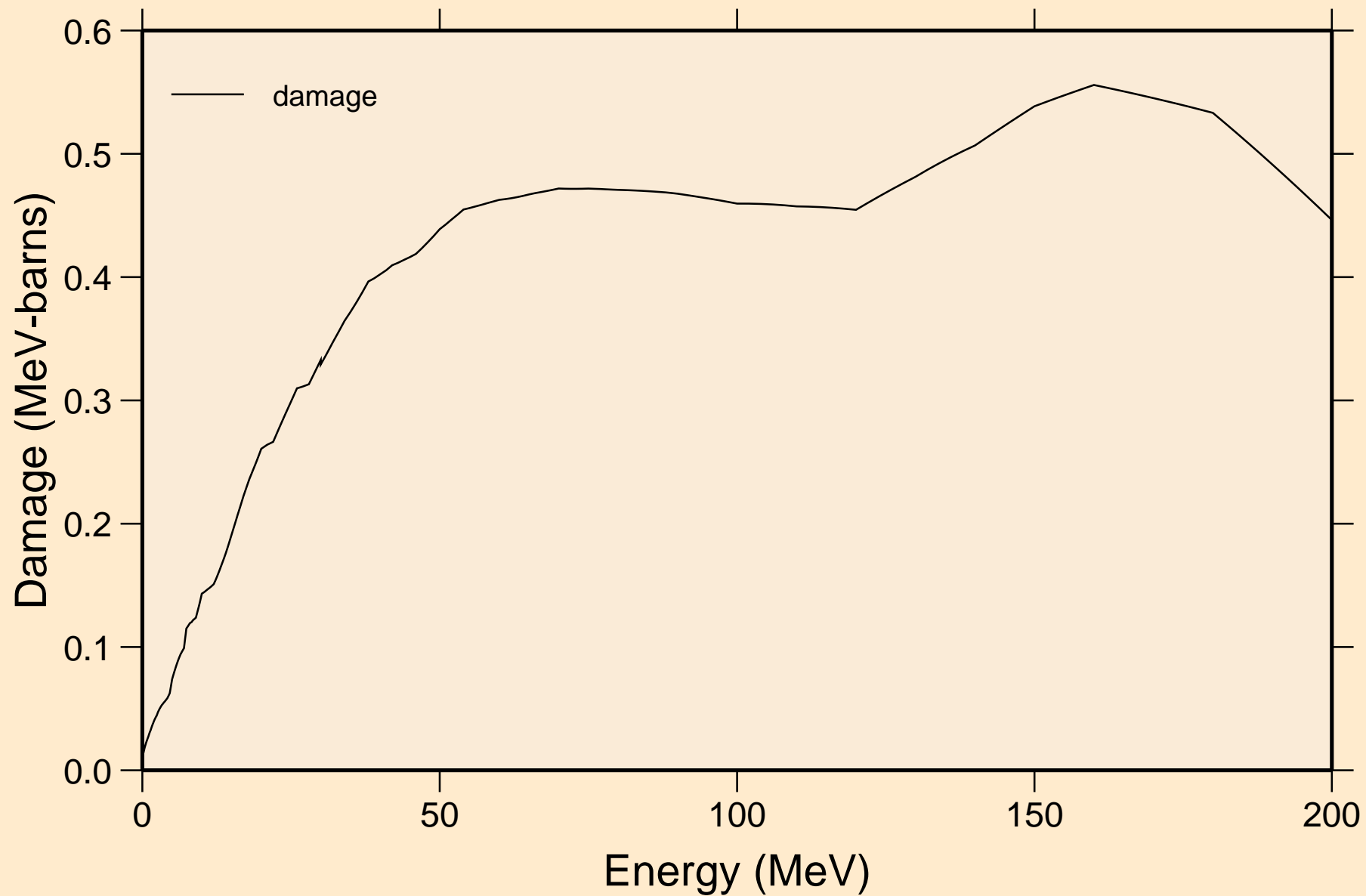



W171 NEUTRON ACER TENDL-2019 LIBRARY; T=293.16K  
Non-threshold reactions

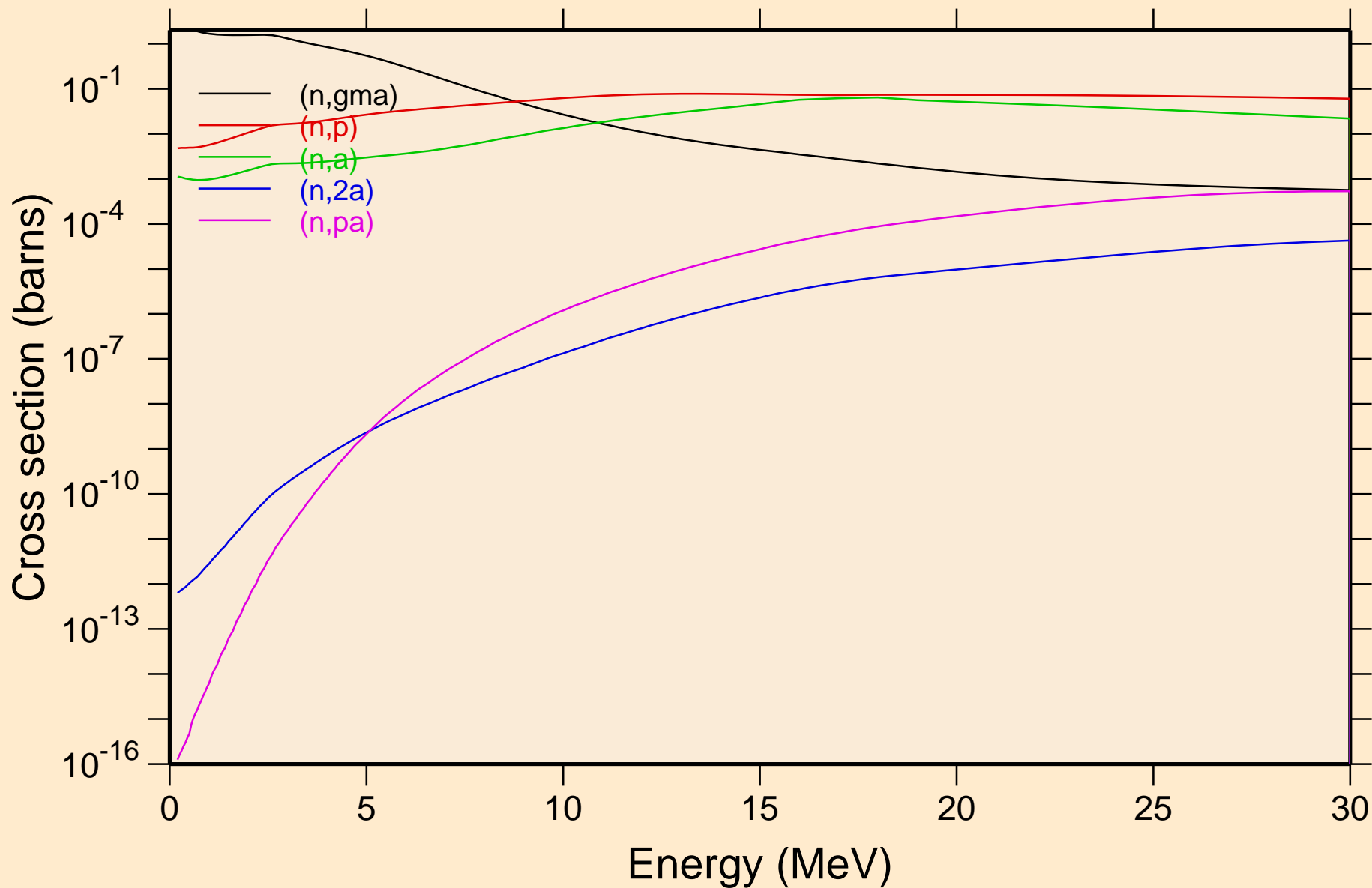

W171 NEUTRON ACER TENDL-2019 LIBRARY; T=293.16K  
Non-threshold reactions

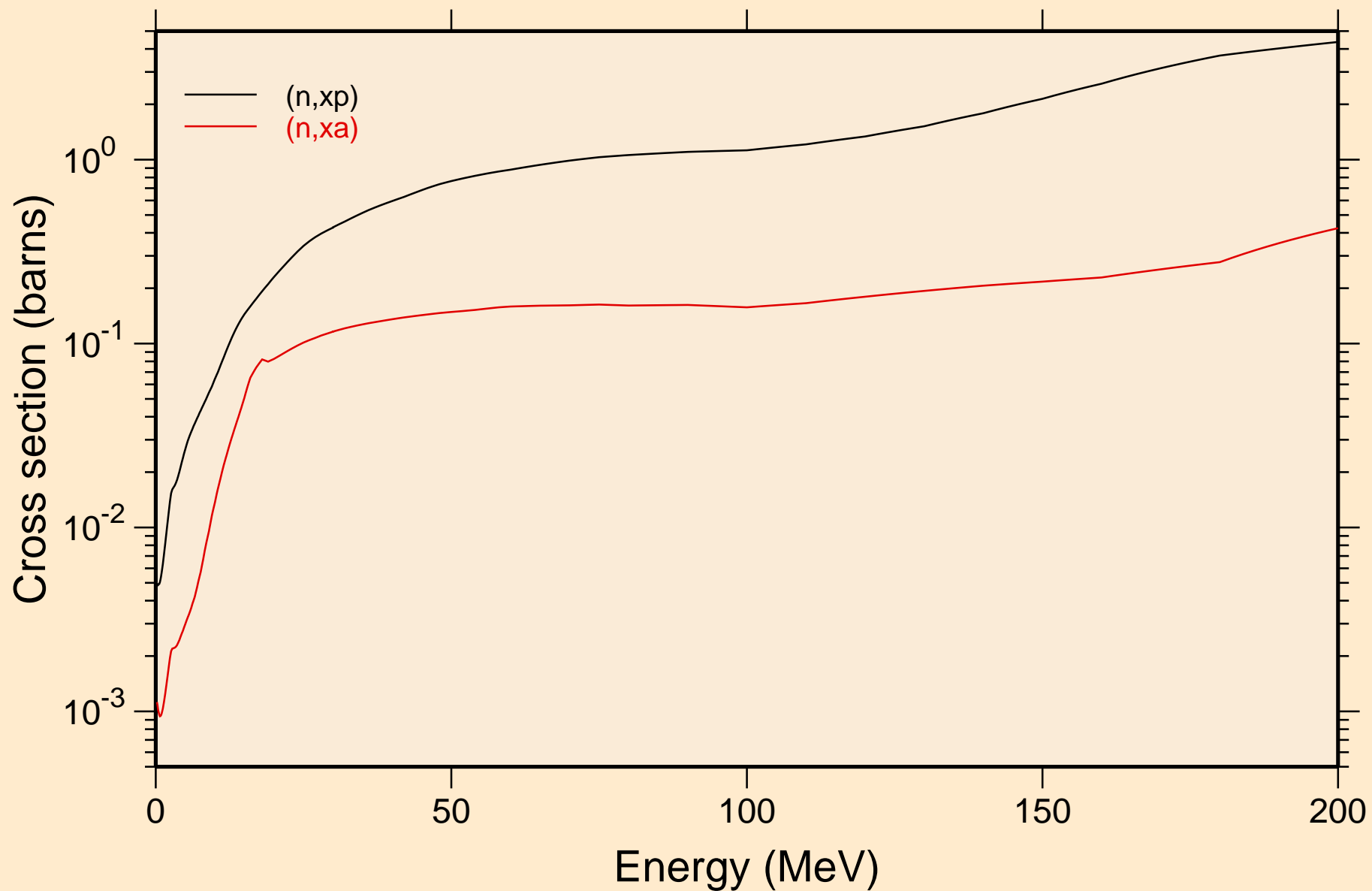

W171 NEUTRON ACER TENDL-2019 LIBRARY; T=293.16K  
Inelastic levels

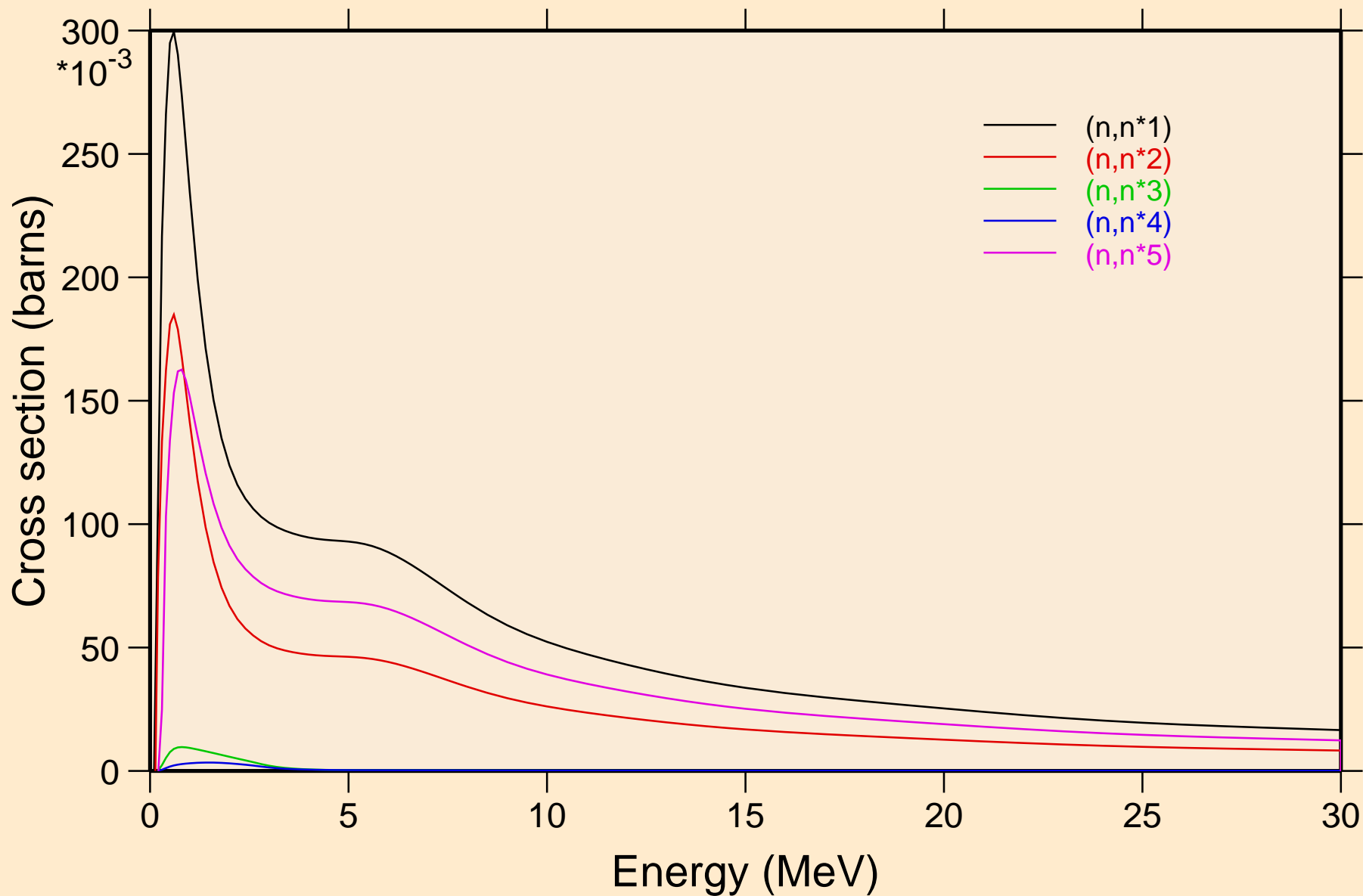

W171 NEUTRON ACER TENDL-2019 LIBRARY; T=293.16K  
Inelastic levels

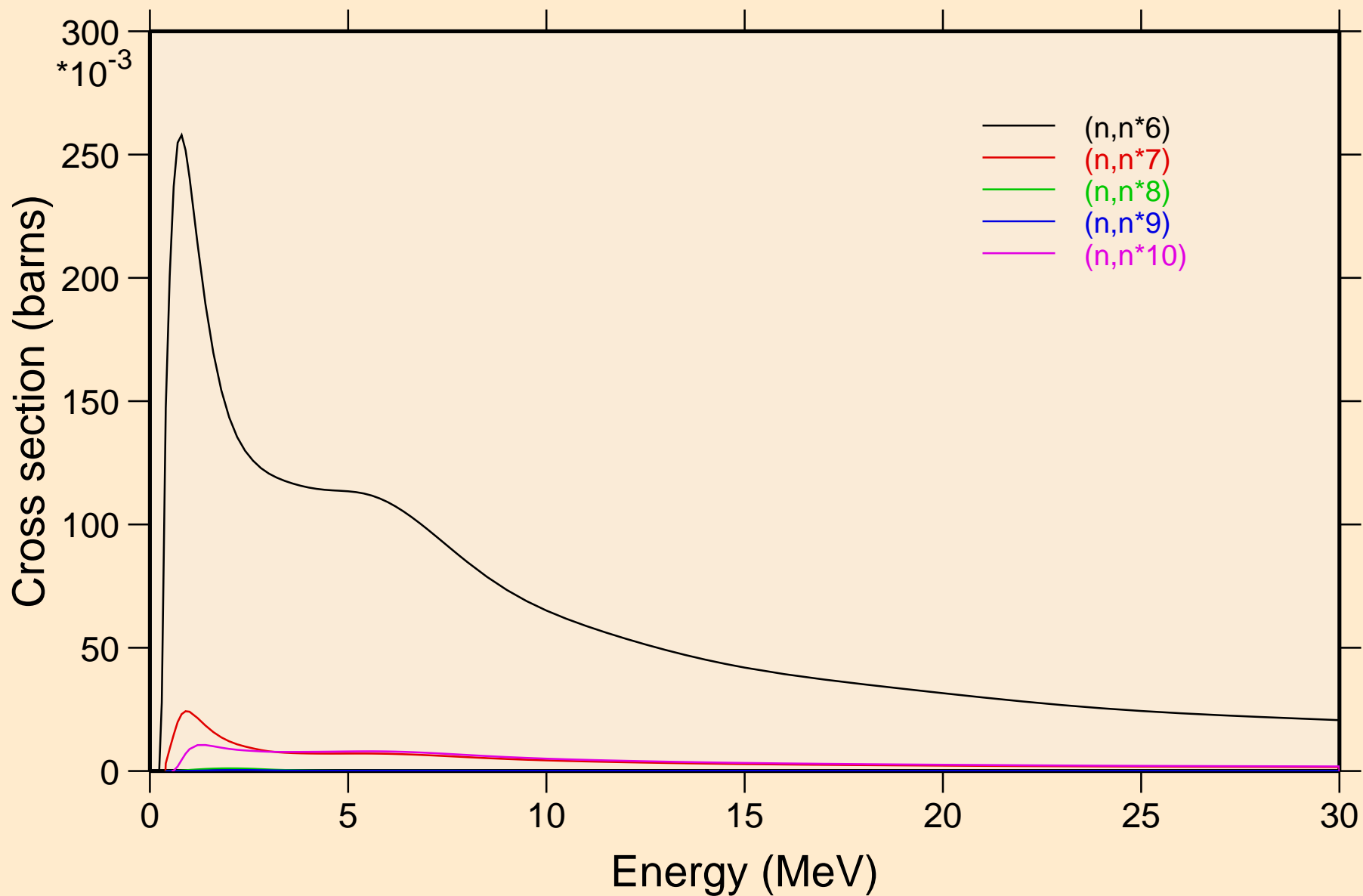

W171 NEUTRON ACER TENDL-2019 LIBRARY; T=293.16K  
Inelastic levels

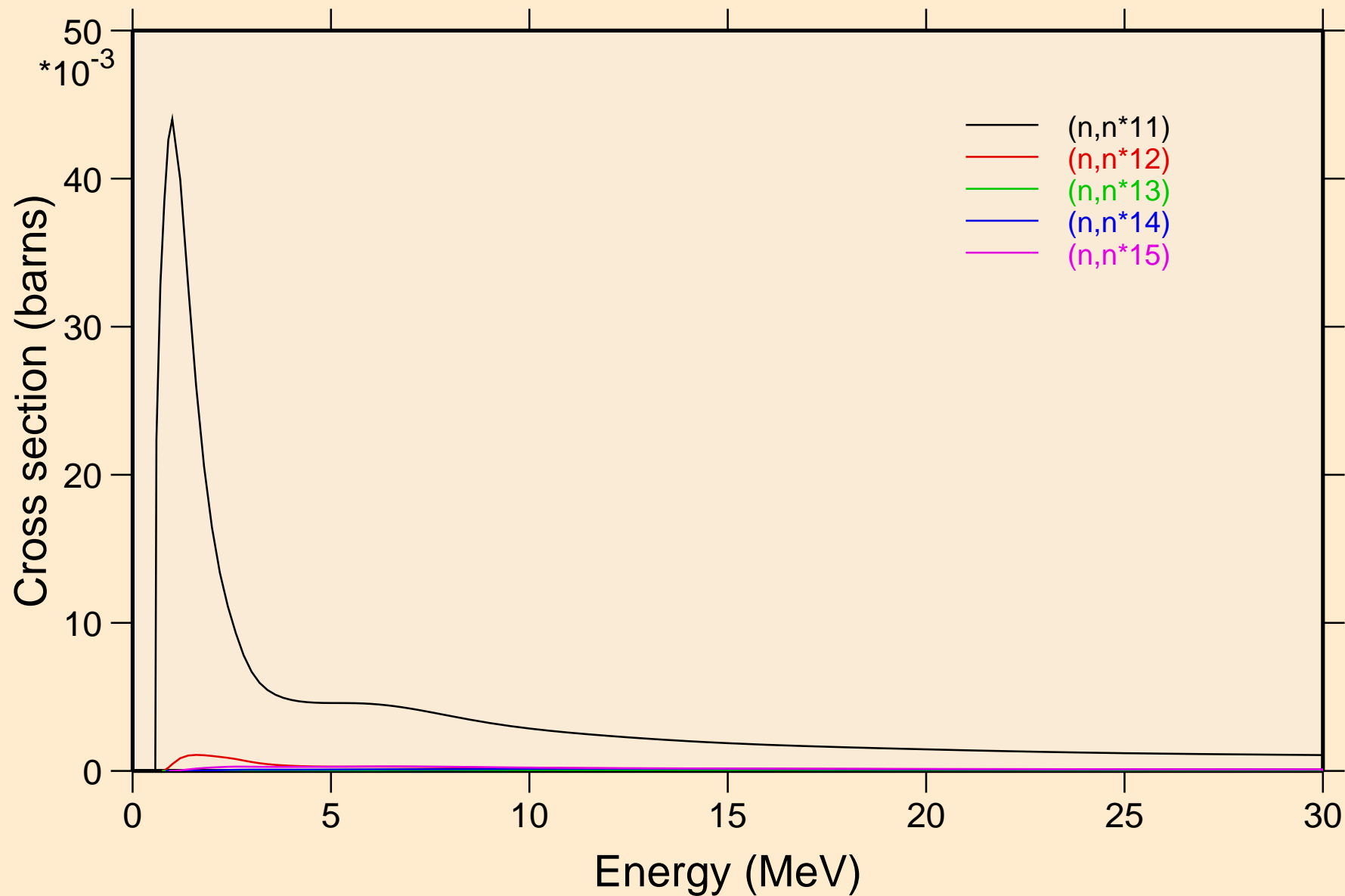

W171 NEUTRON ACER TENDL-2019 LIBRARY; T=293.16K  
Inelastic levels

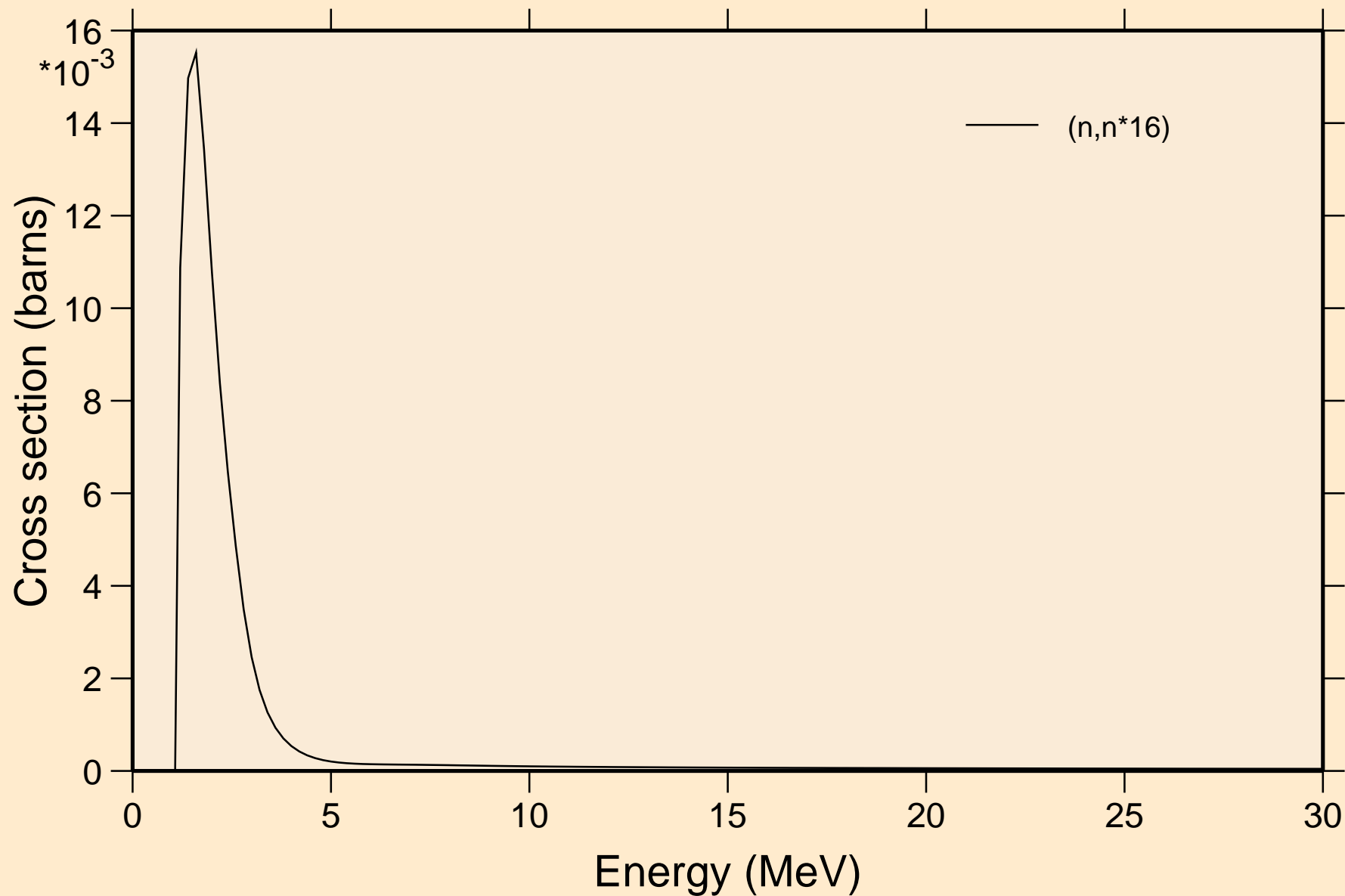

W171 NEUTRON ACER TENDL-2019 LIBRARY; T=293.16K  
Threshold reactions

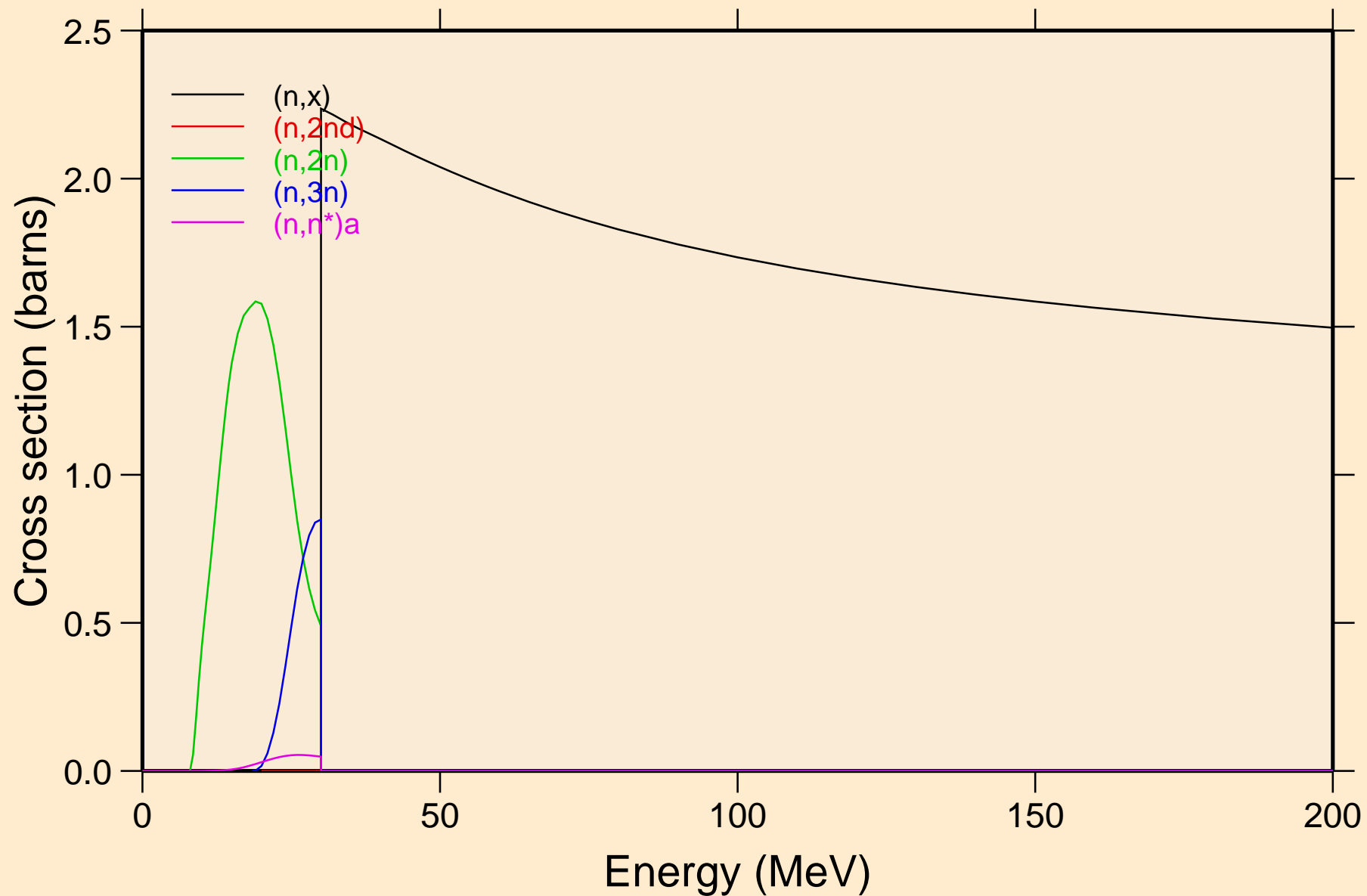

W171 NEUTRON ACER TENDL-2019 LIBRARY; T=293.16K  
Threshold reactions

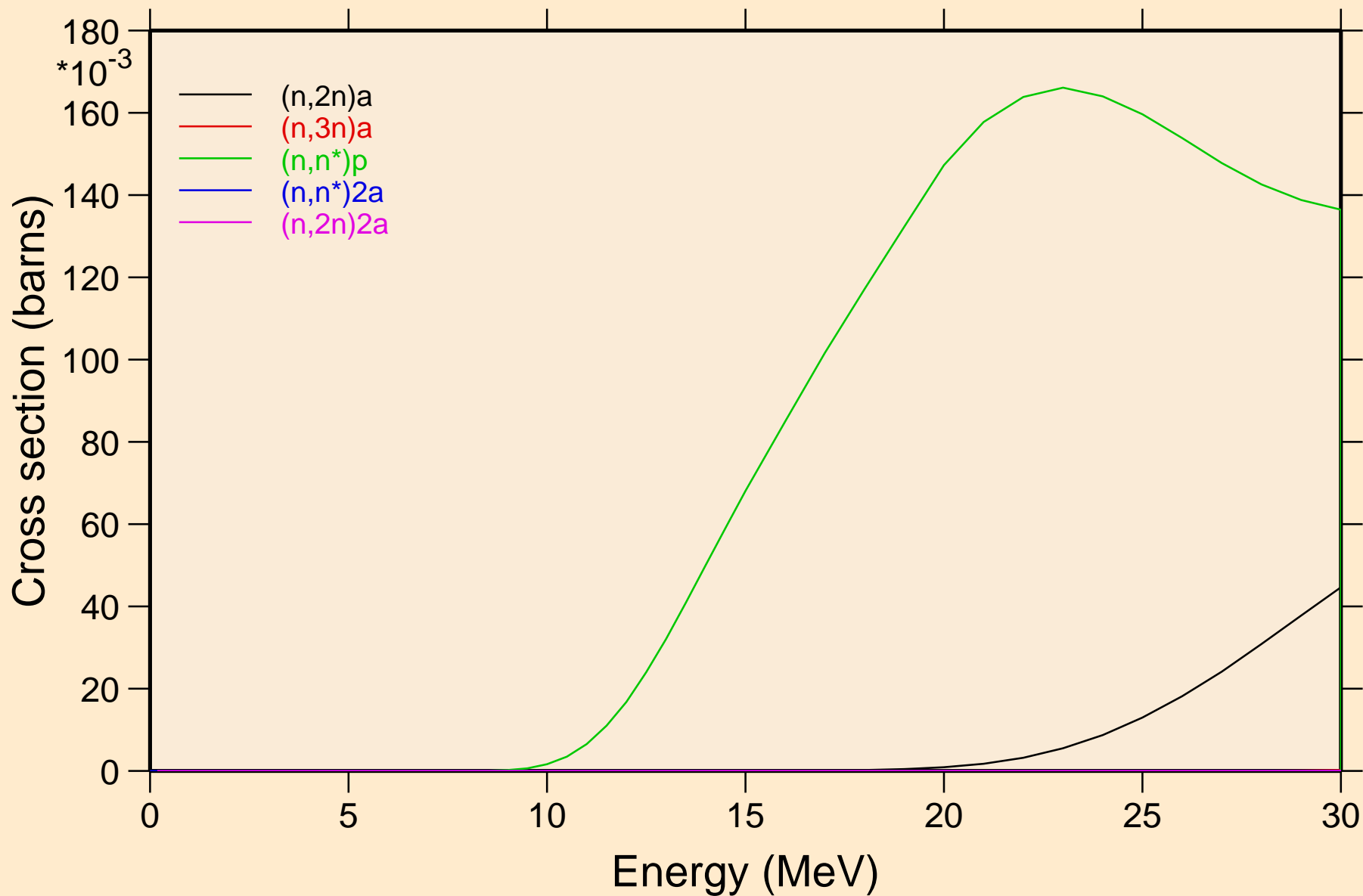



W171 NEUTRON ACER TENDL-2019 LIBRARY; T=293.16K  
Threshold reactions

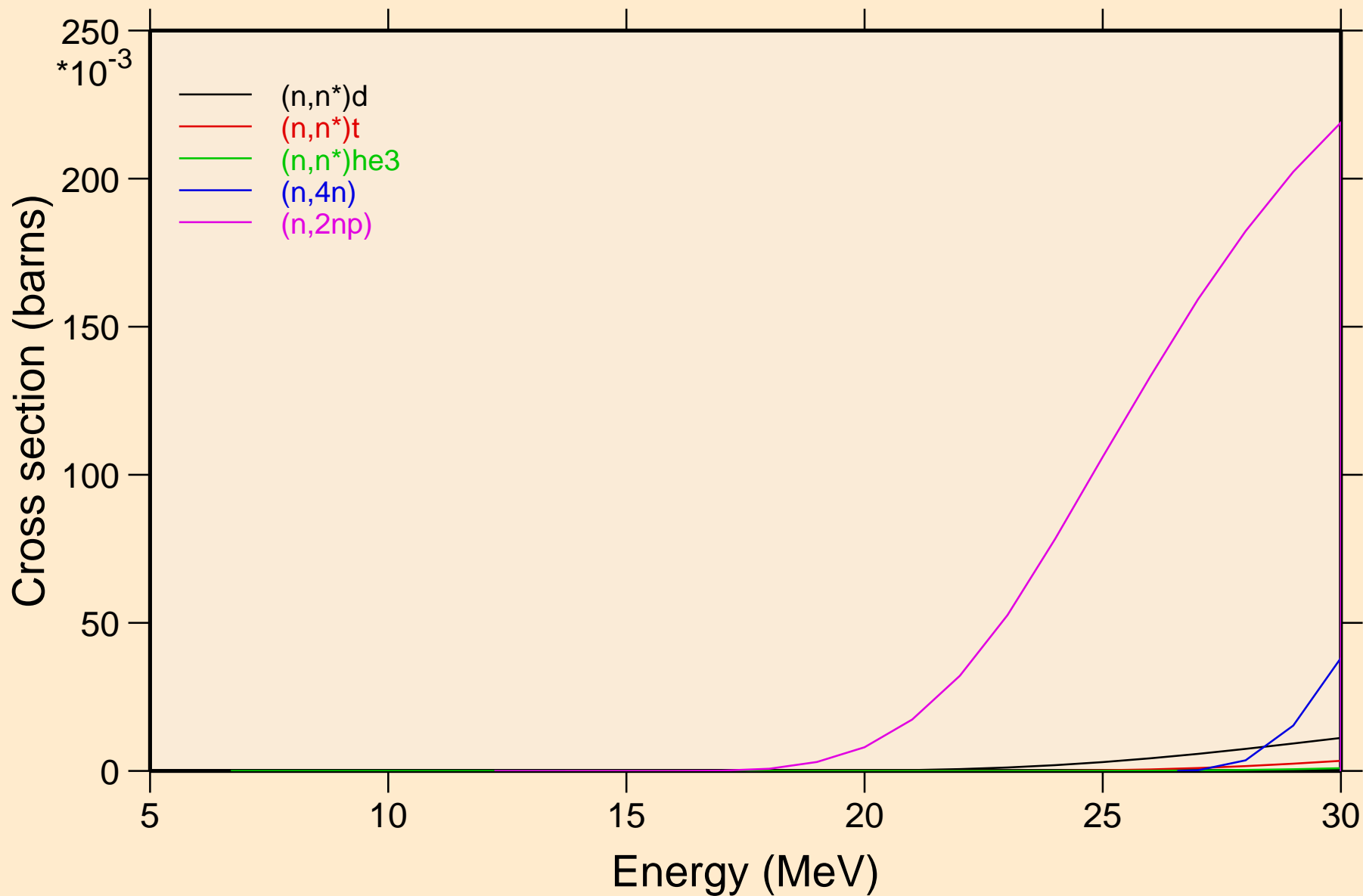

W171 NEUTRON ACER TENDL-2019 LIBRARY; T=293.16K  
Threshold reactions

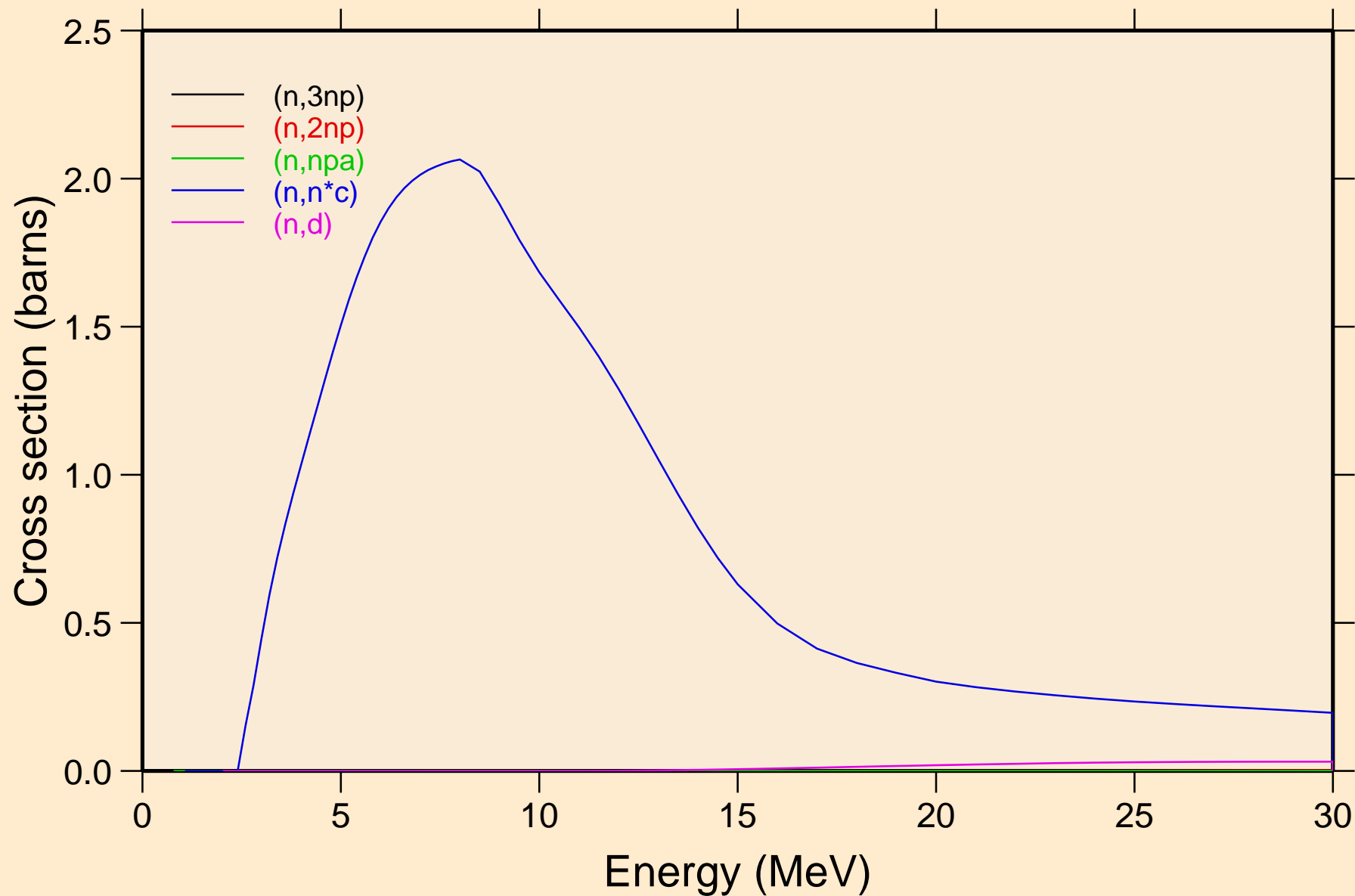

W171 NEUTRON ACER TENDL-2019 LIBRARY; T=293.16K  
Threshold reactions

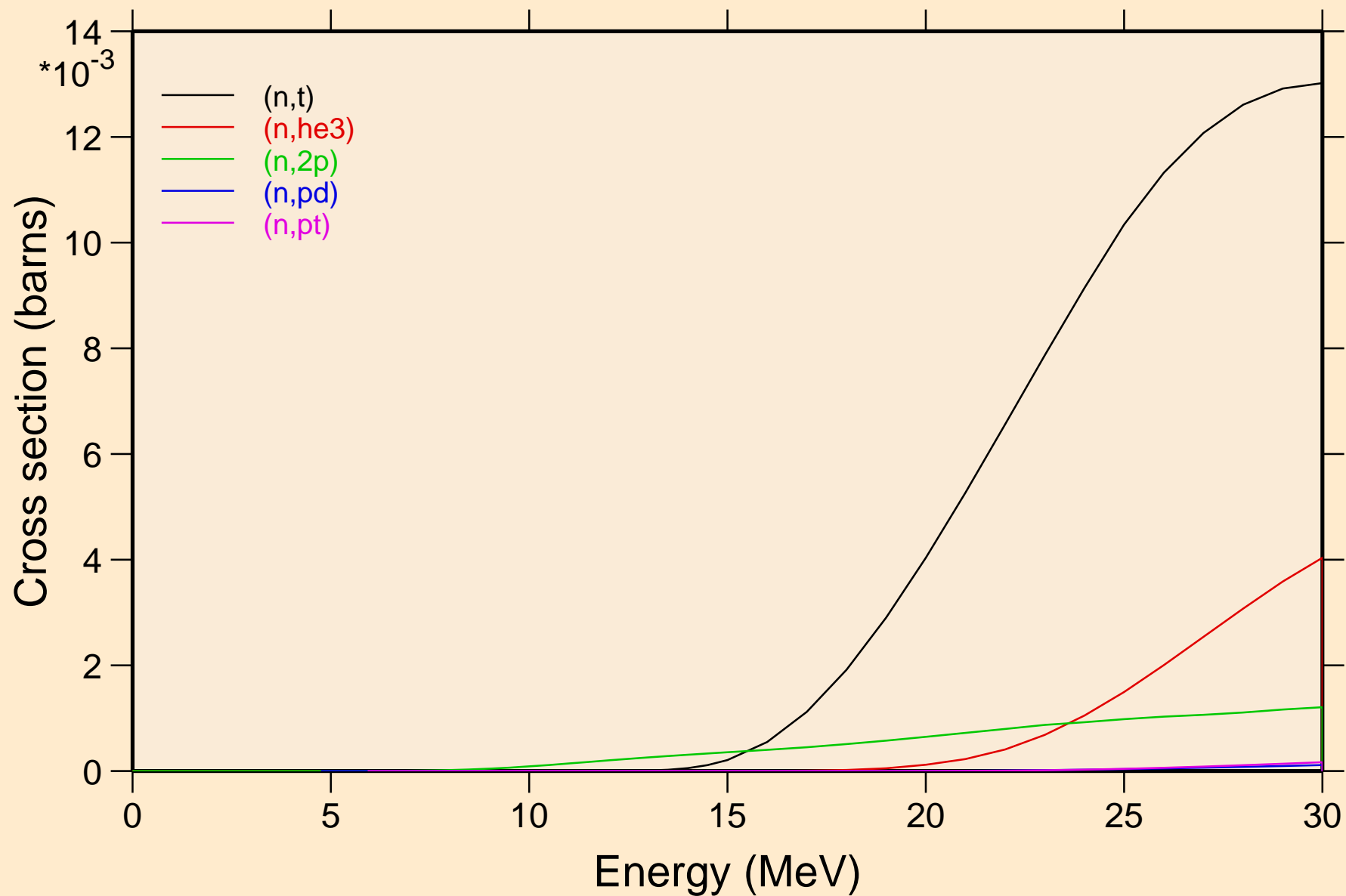

W171 NEUTRON ACER TENDL-2019 LIBRARY; T=293.16K  
Threshold reactions

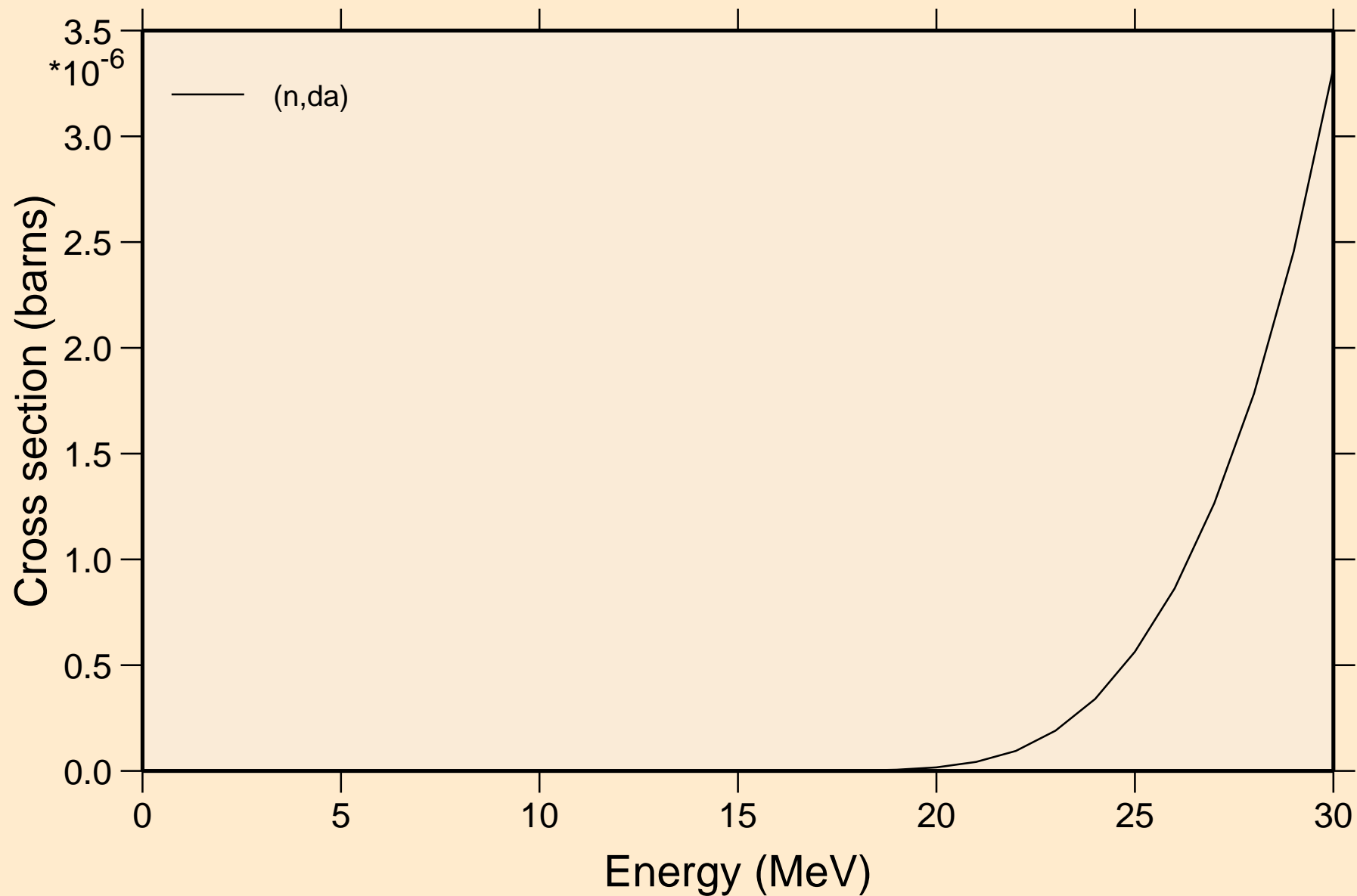

W171 NEUTRON ACER TENDL-2019 LIBRARY; T=293.16K  
Threshold reactions

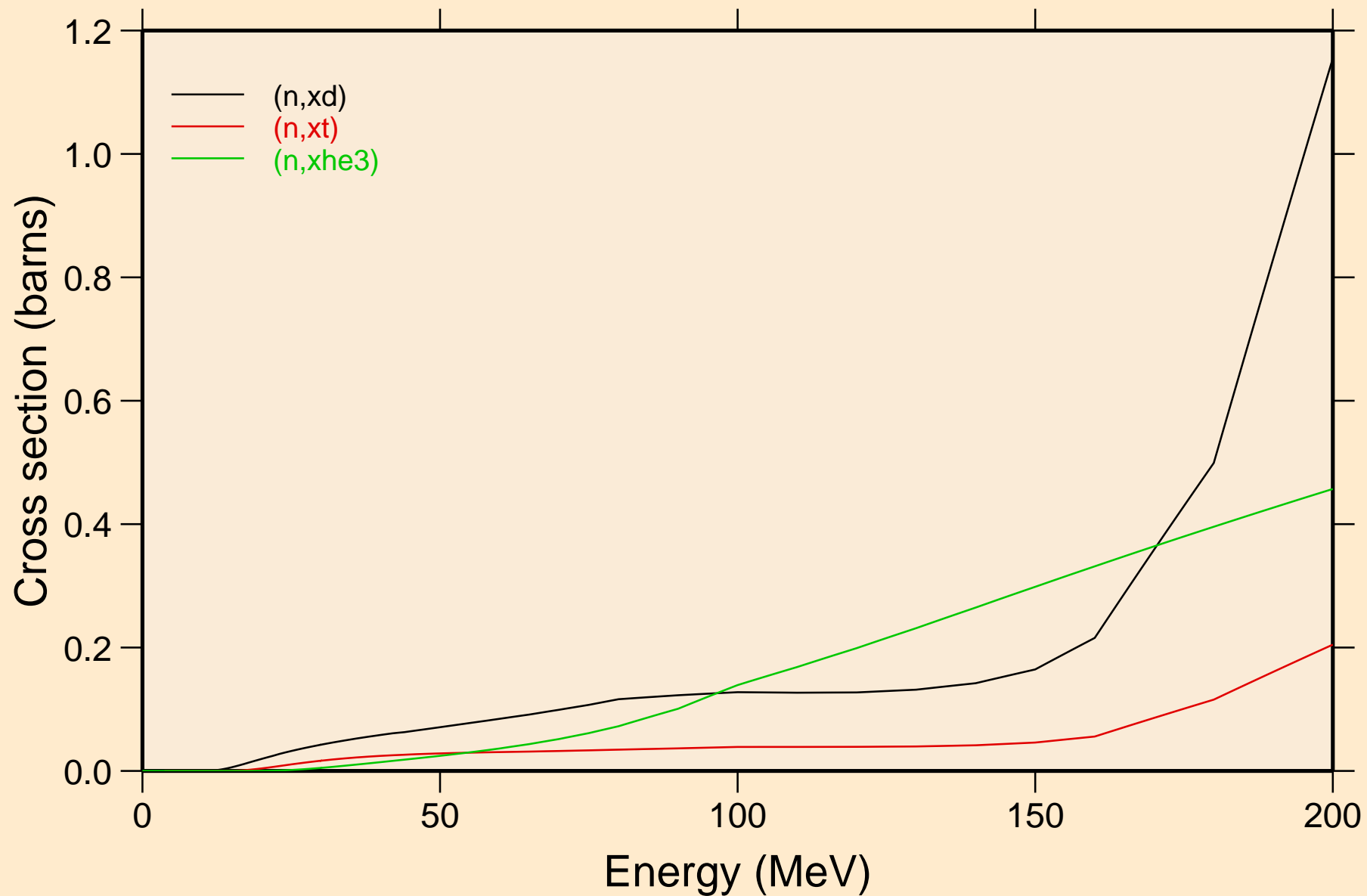

W171 NEUTRON ACER TENDL-2019 LIBRARY; T=293.16K  
angular distribution for elastic

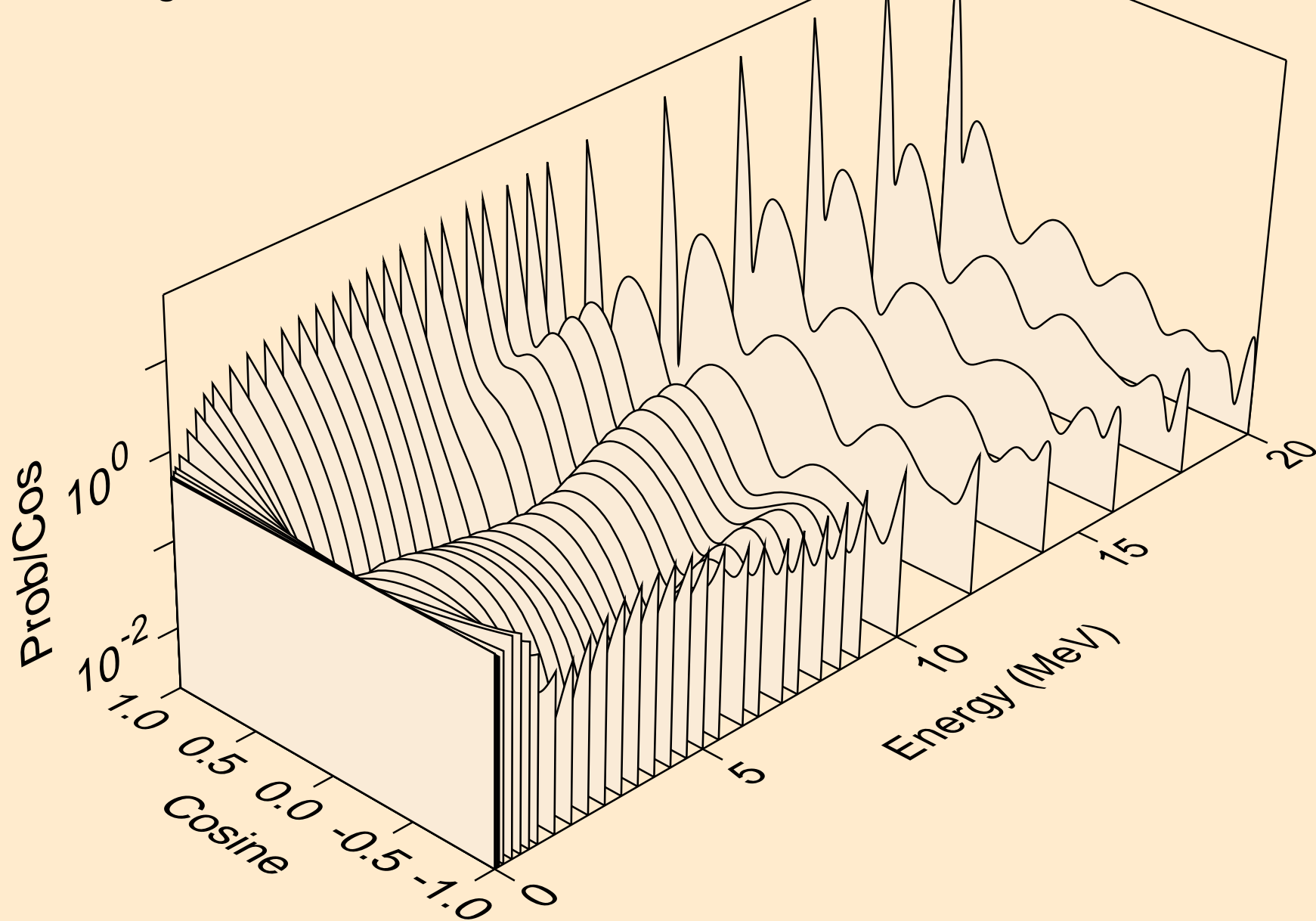

W171 NEUTRON ACER TENDL-2019 LIBRARY; T=293.16K  
angular distribution for elastic

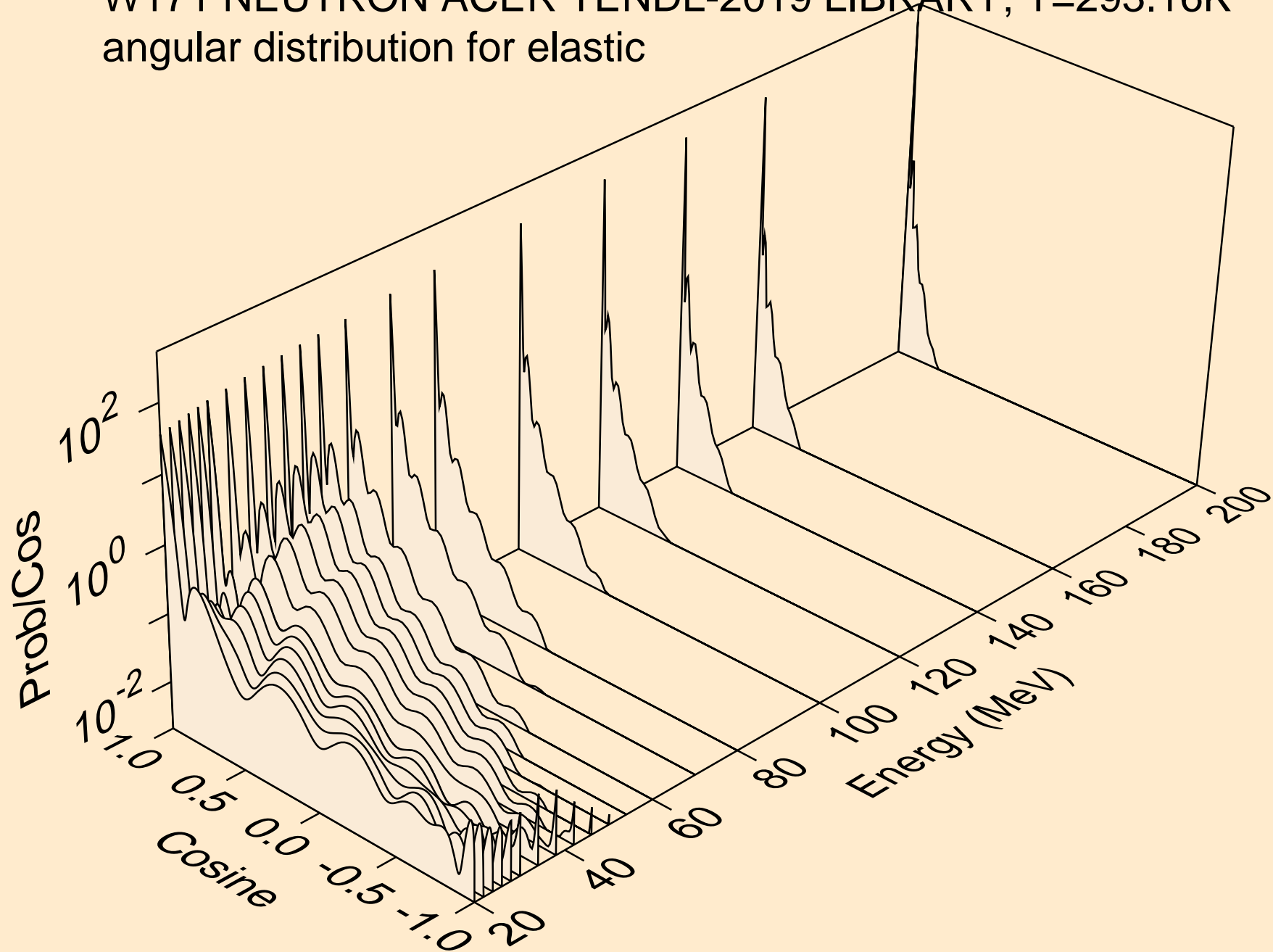

W171 NEUTRON ACER TENDL-2019 LIBRARY; T=293.16K  
angular distribution for (n,n\*1)

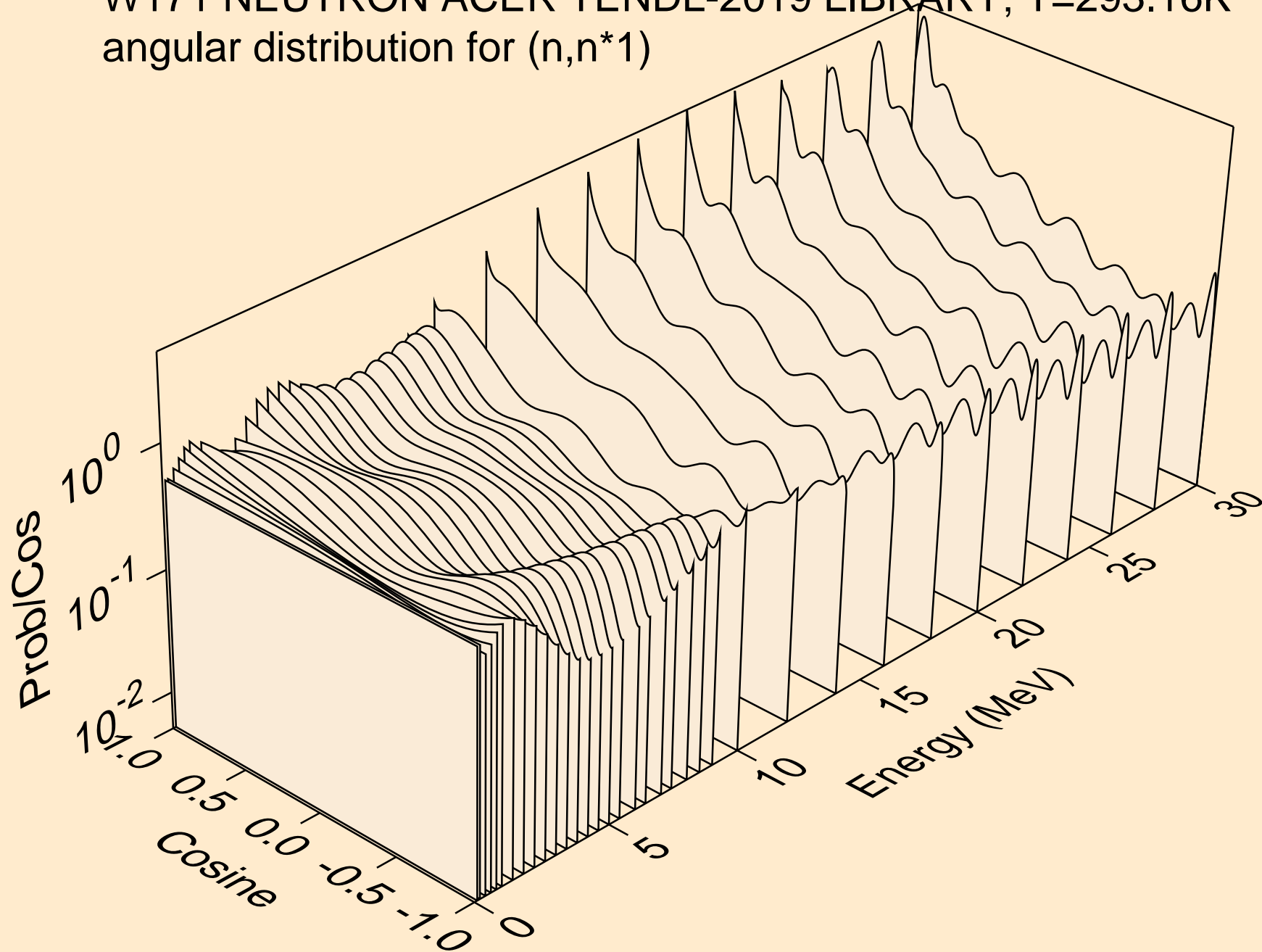



W171 NEUTRON ACER TENDL-2019 LIBRARY; T=293.16K  
angular distribution for (n,n\*2)

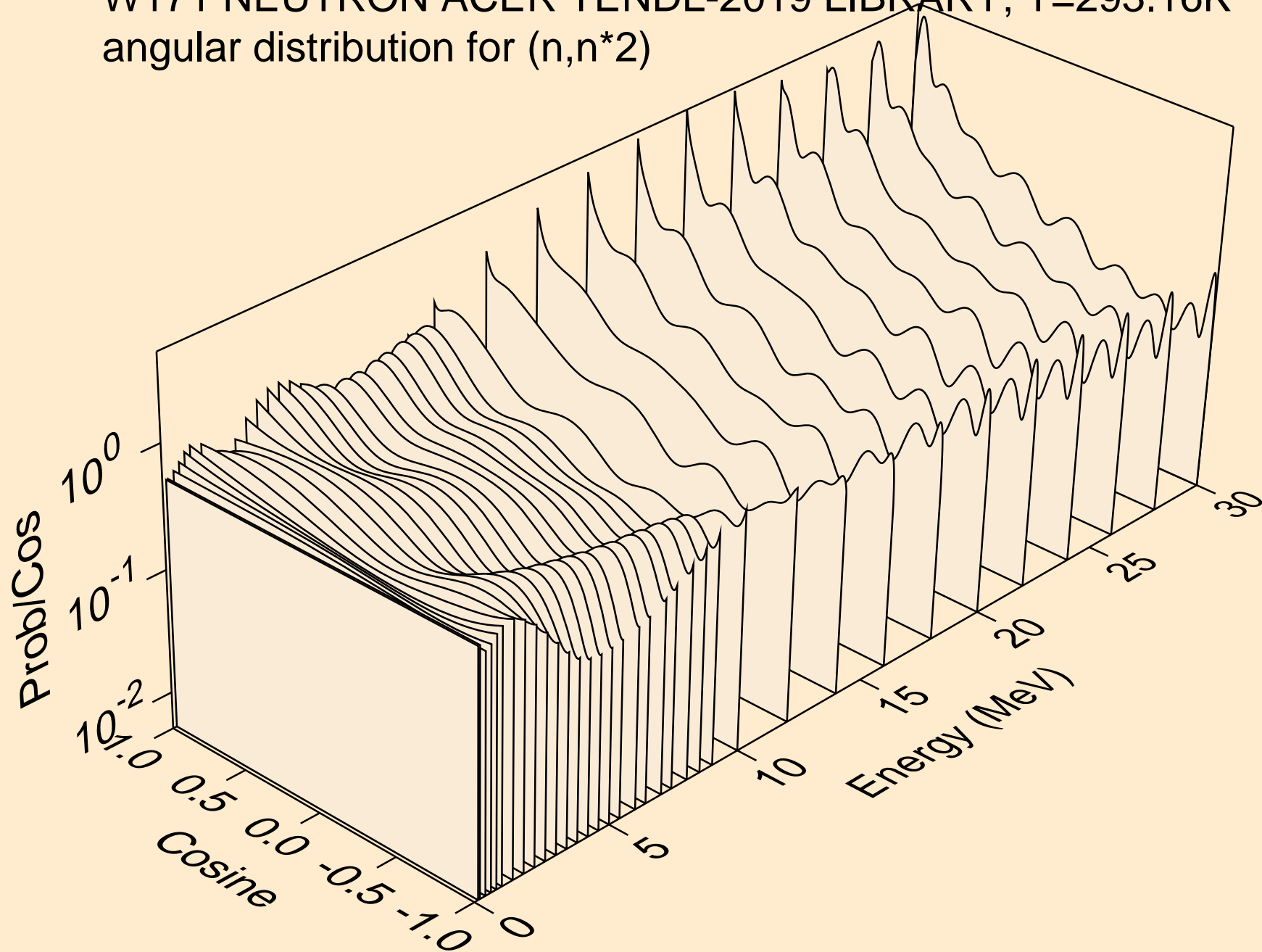

W171 NEUTRON ACER TENDL-2019 LIBRARY; T=293.16K  
angular distribution for (n,n\*3)

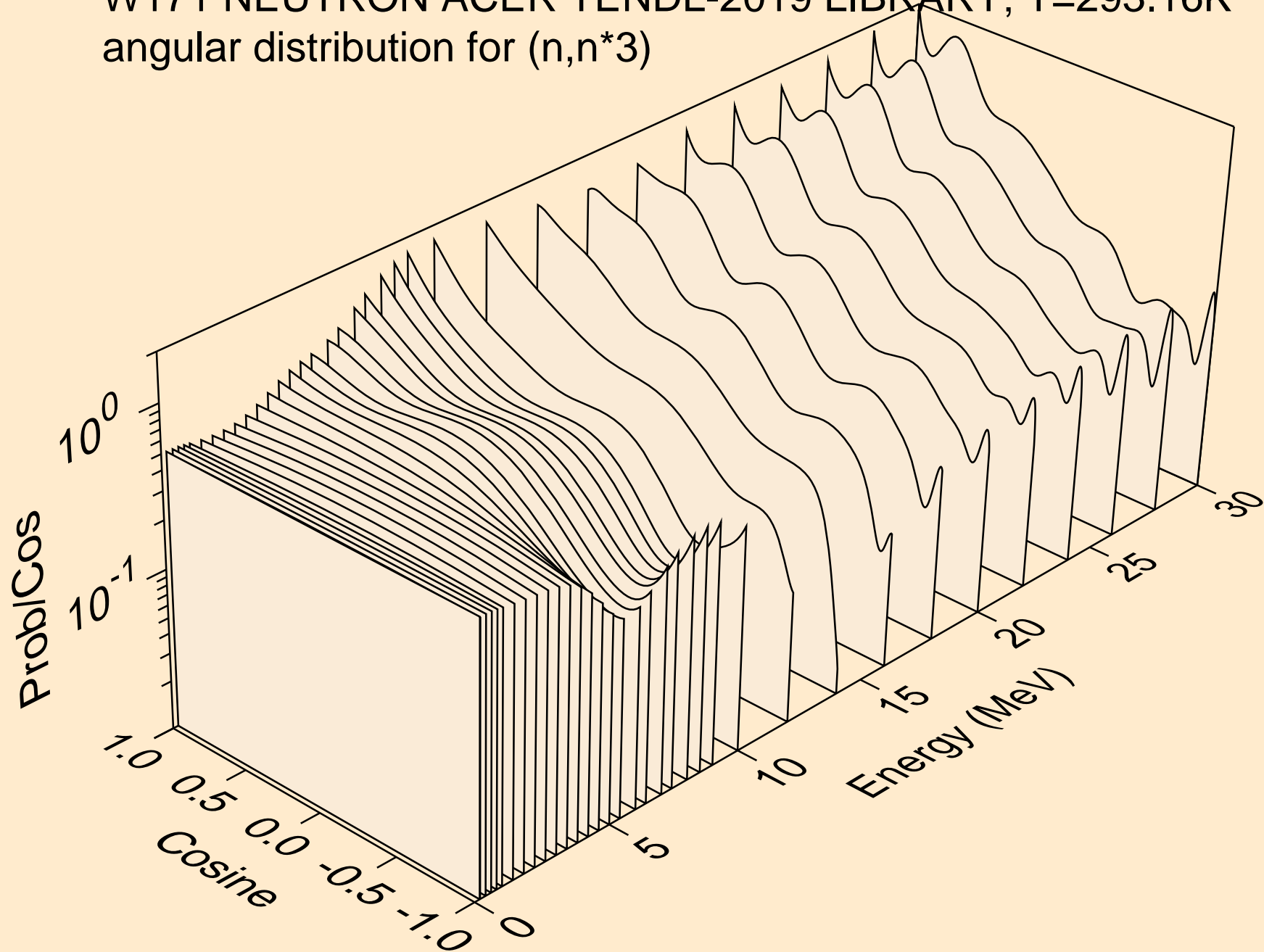

W171 NEUTRON ACER TENDL-2019 LIBRARY; T=293.16K  
angular distribution for (n,n\*4)

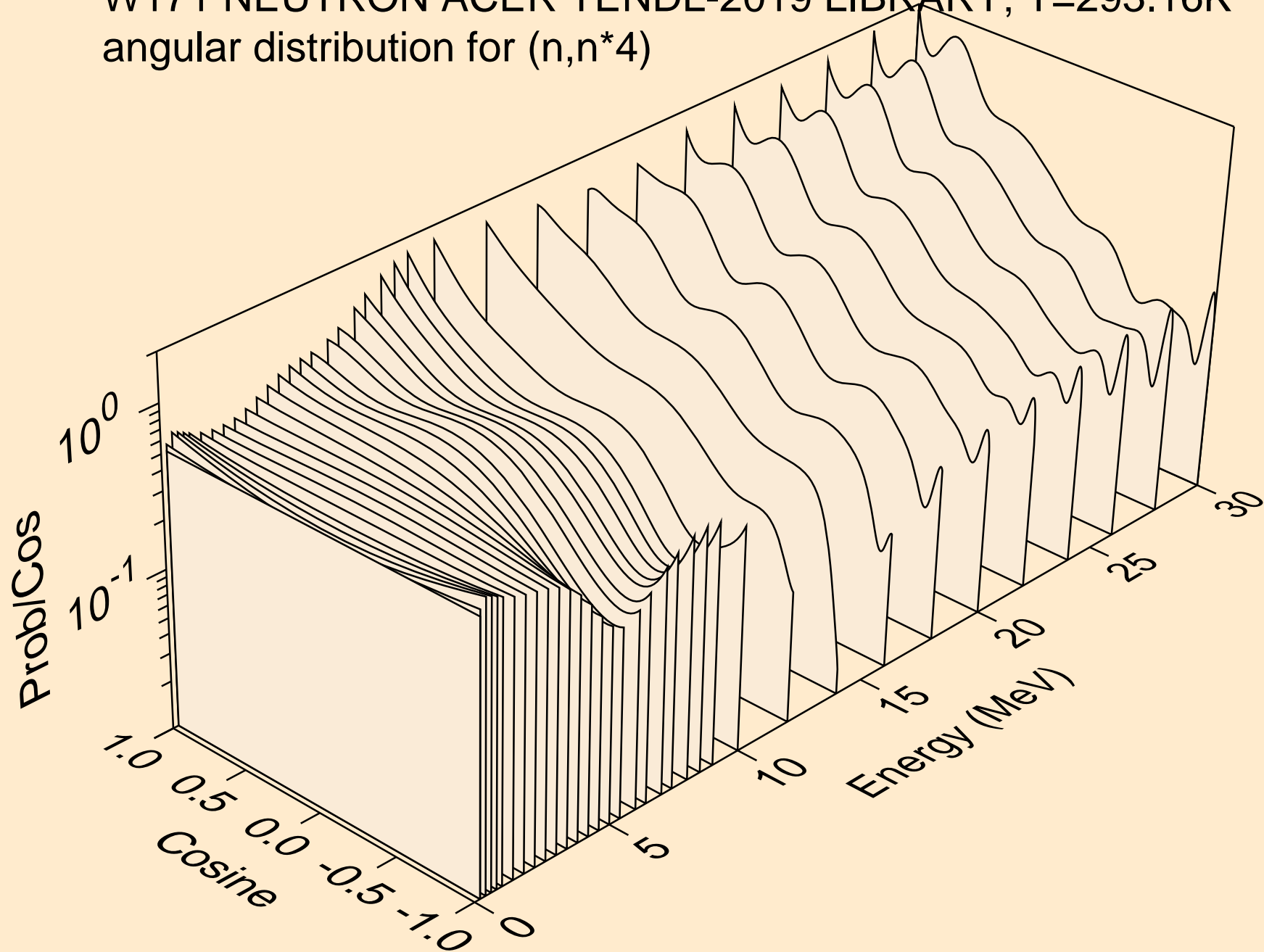

W171 NEUTRON ACER TENDL-2019 LIBRARY; T=293.16K  
angular distribution for (n,n\*5)

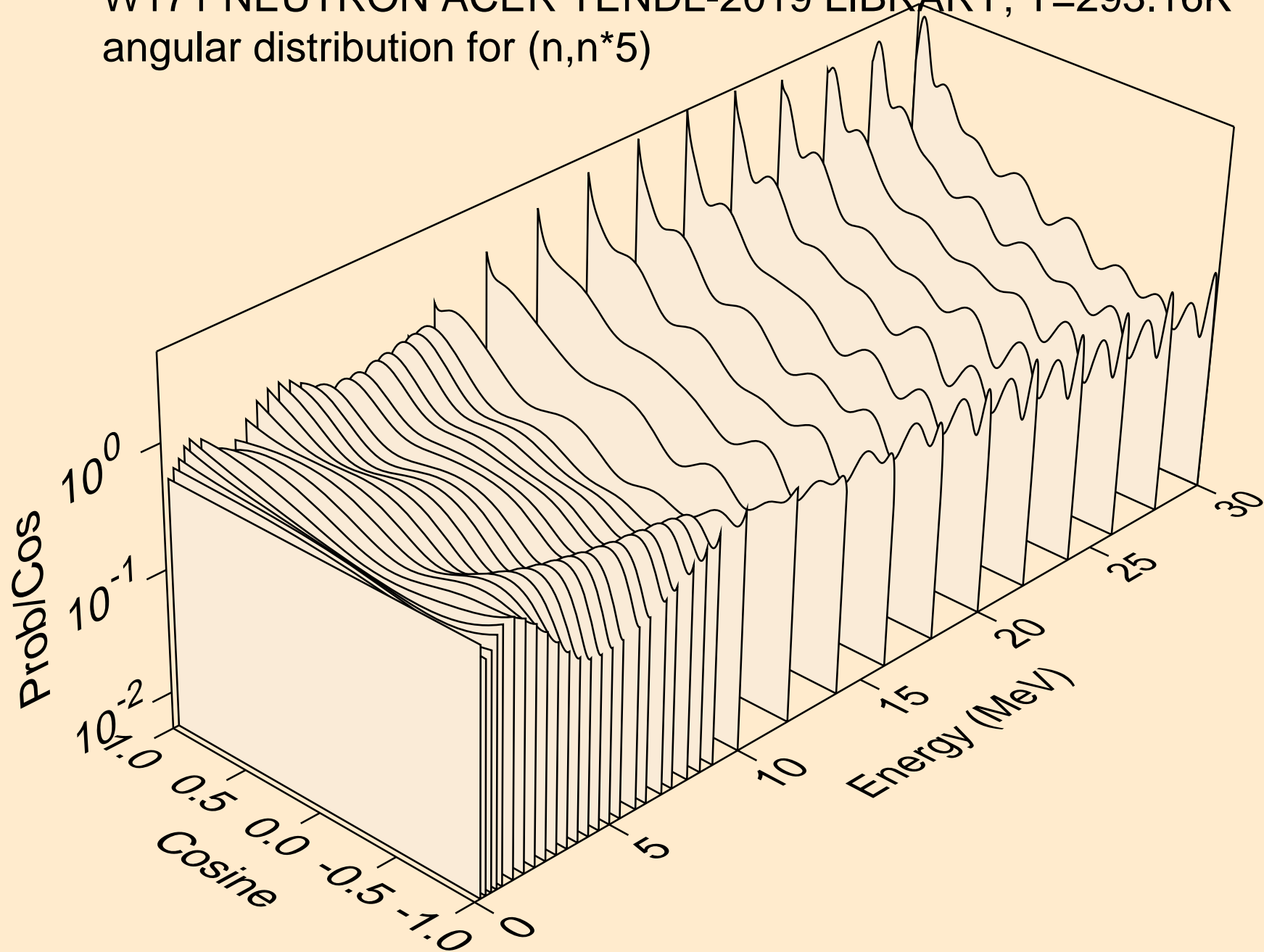

W171 NEUTRON ACER TENDL-2019 LIBRARY; T=293.16K  
angular distribution for (n,n\*6)

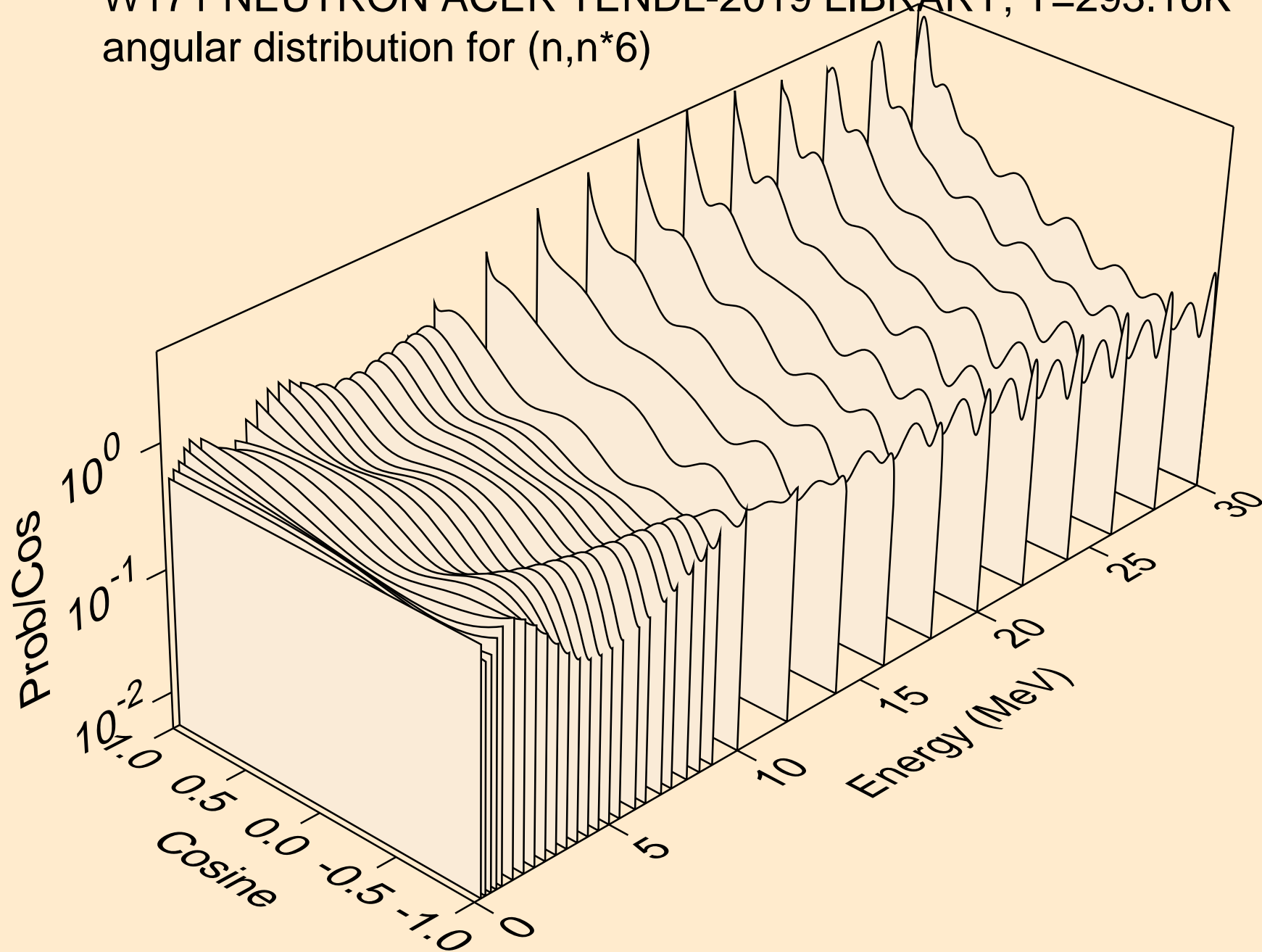

W171 NEUTRON ACER TENDL-2019 LIBRARY; T=293.16K  
angular distribution for (n,n\*7)

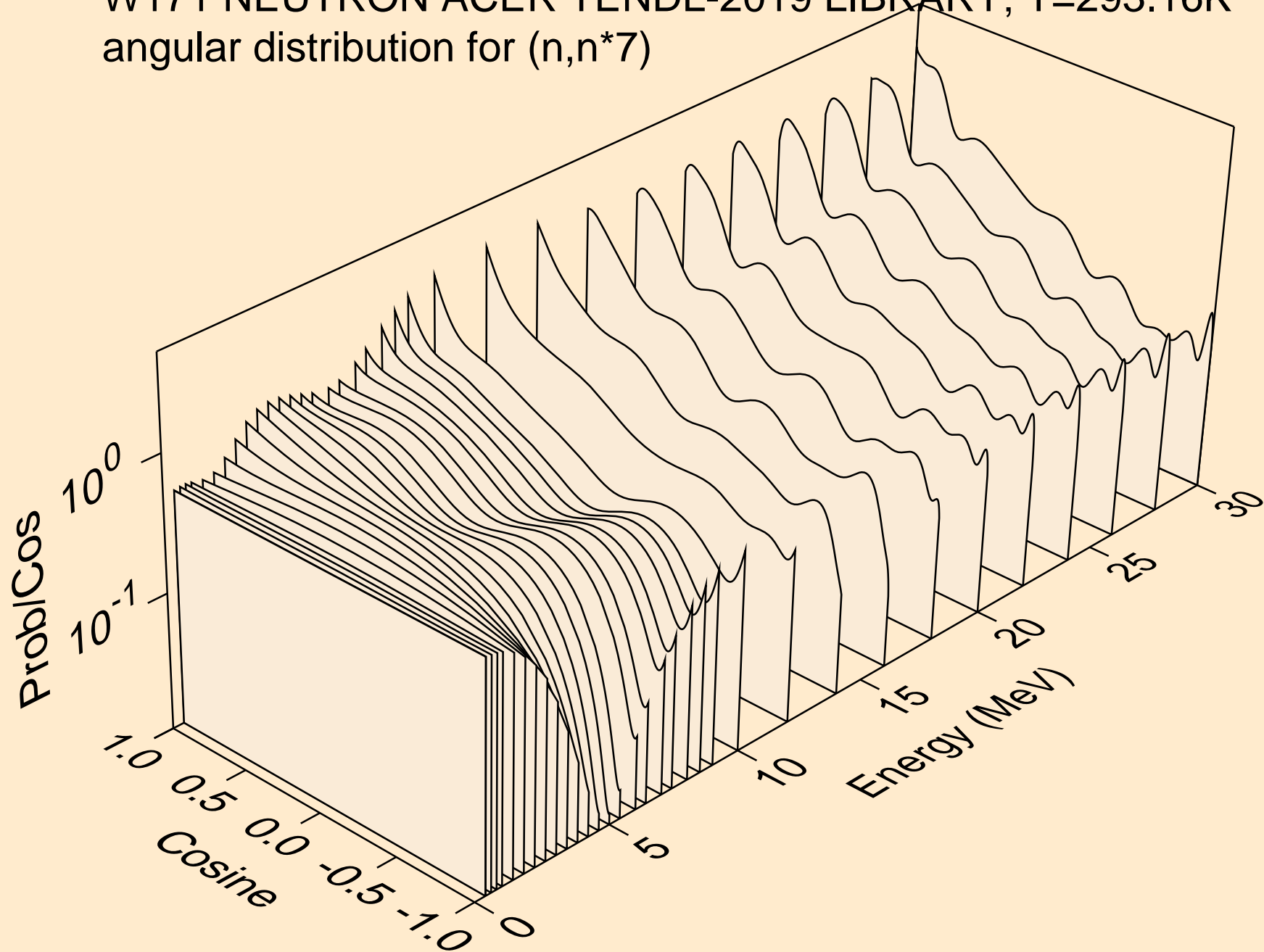

W171 NEUTRON ACER TENDL-2019 LIBRARY; T=293.16K  
angular distribution for (n,n\*8)

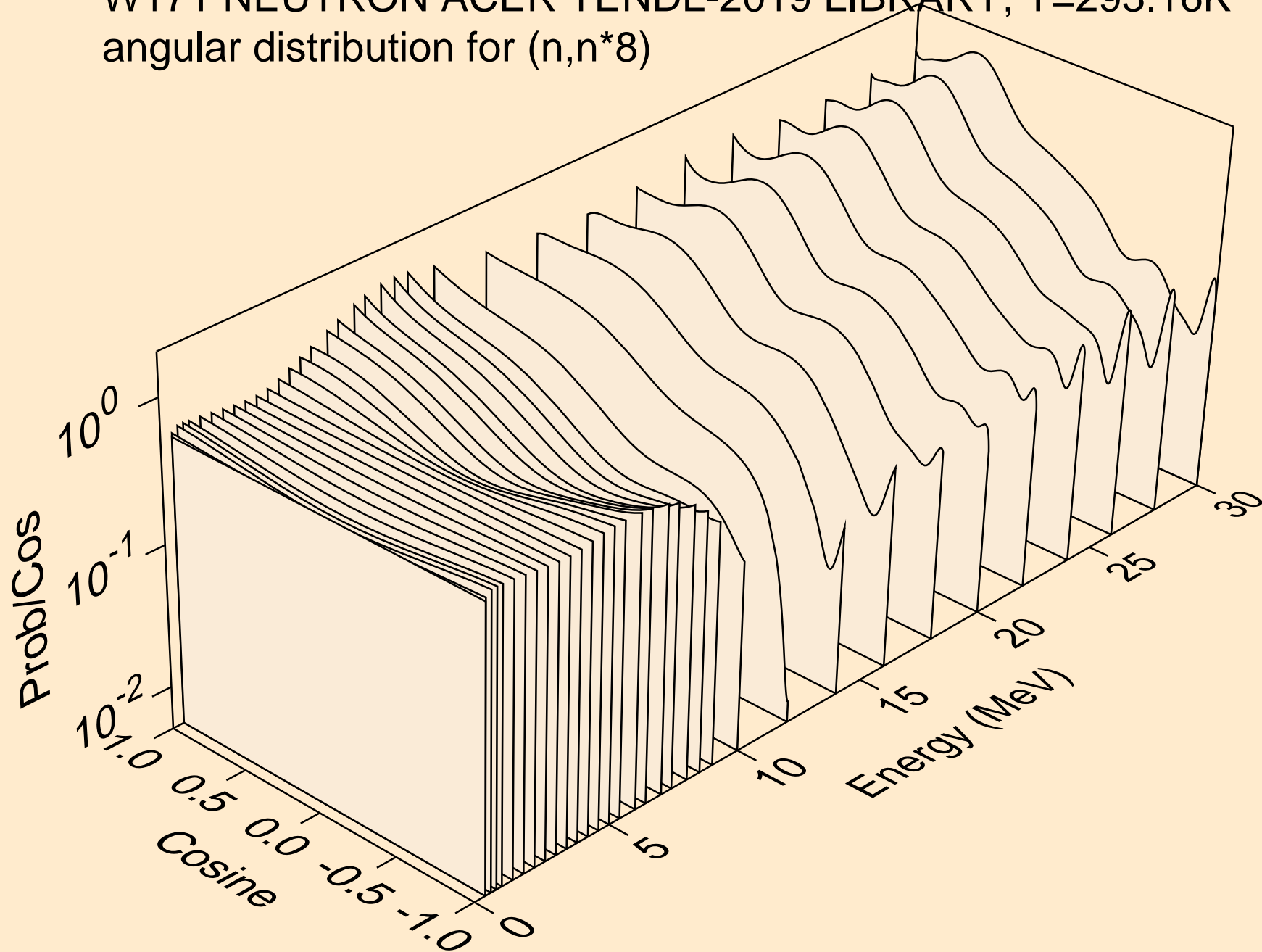



W171 NEUTRON ACER TENDL-2019 LIBRARY; T=293.16K  
angular distribution for (n,n\*9)

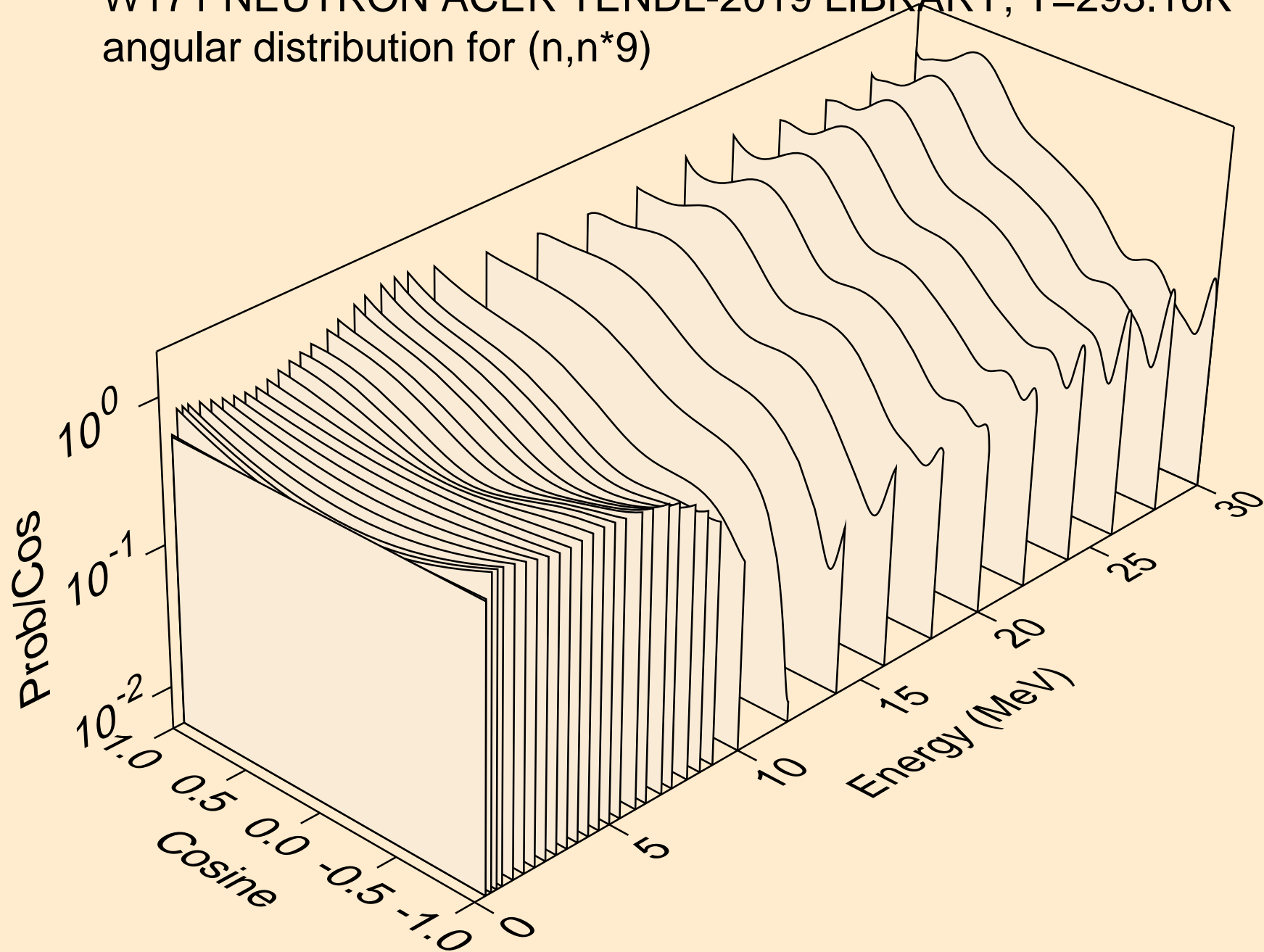



W171 NEUTRON ACER TENDL-2019 LIBRARY; T=293.16K  
angular distribution for (n,n\*10)

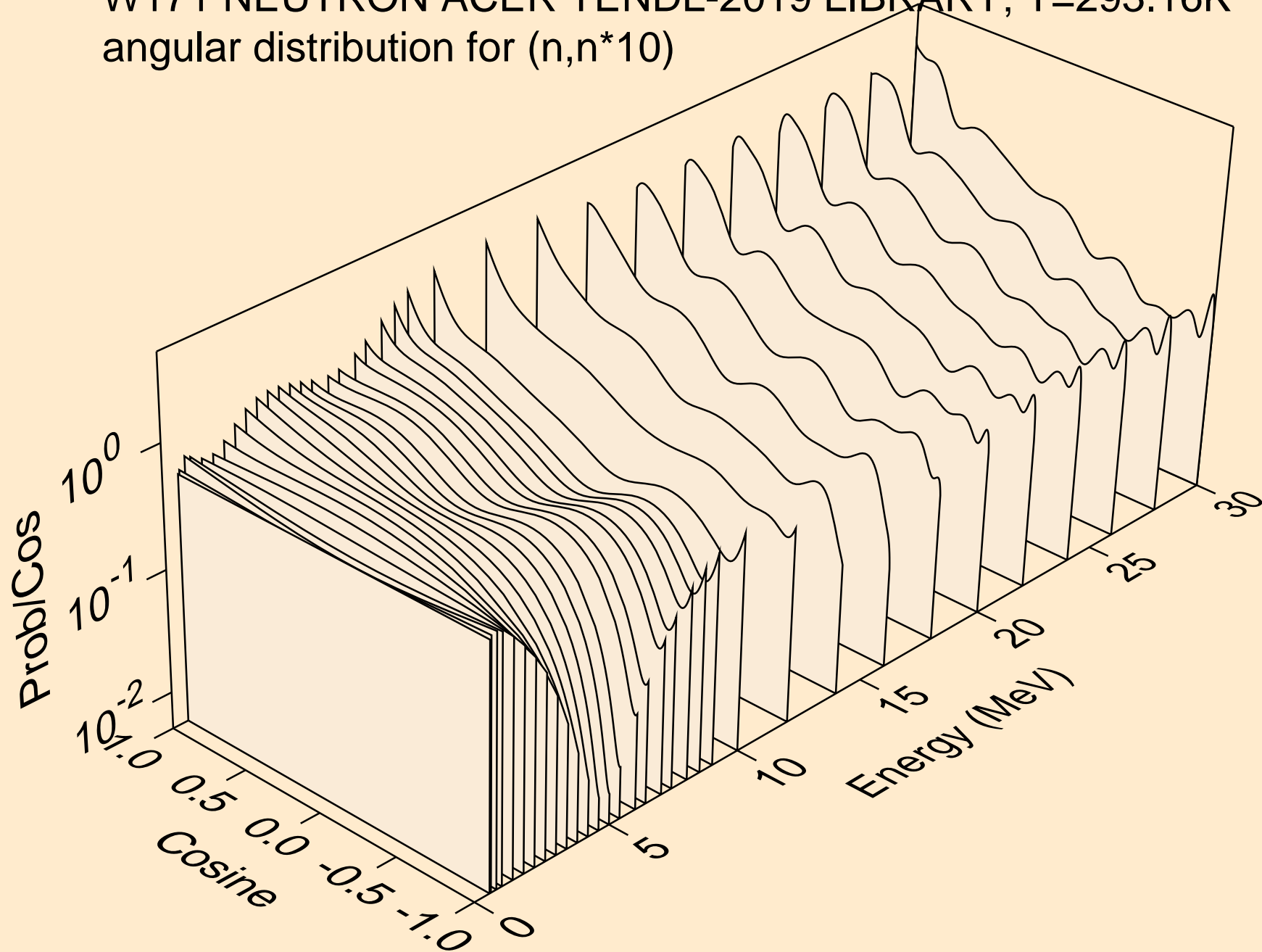

W171 NEUTRON ACER TENDL-2019 LIBRARY; T=293.16K  
angular distribution for (n,n\*11)

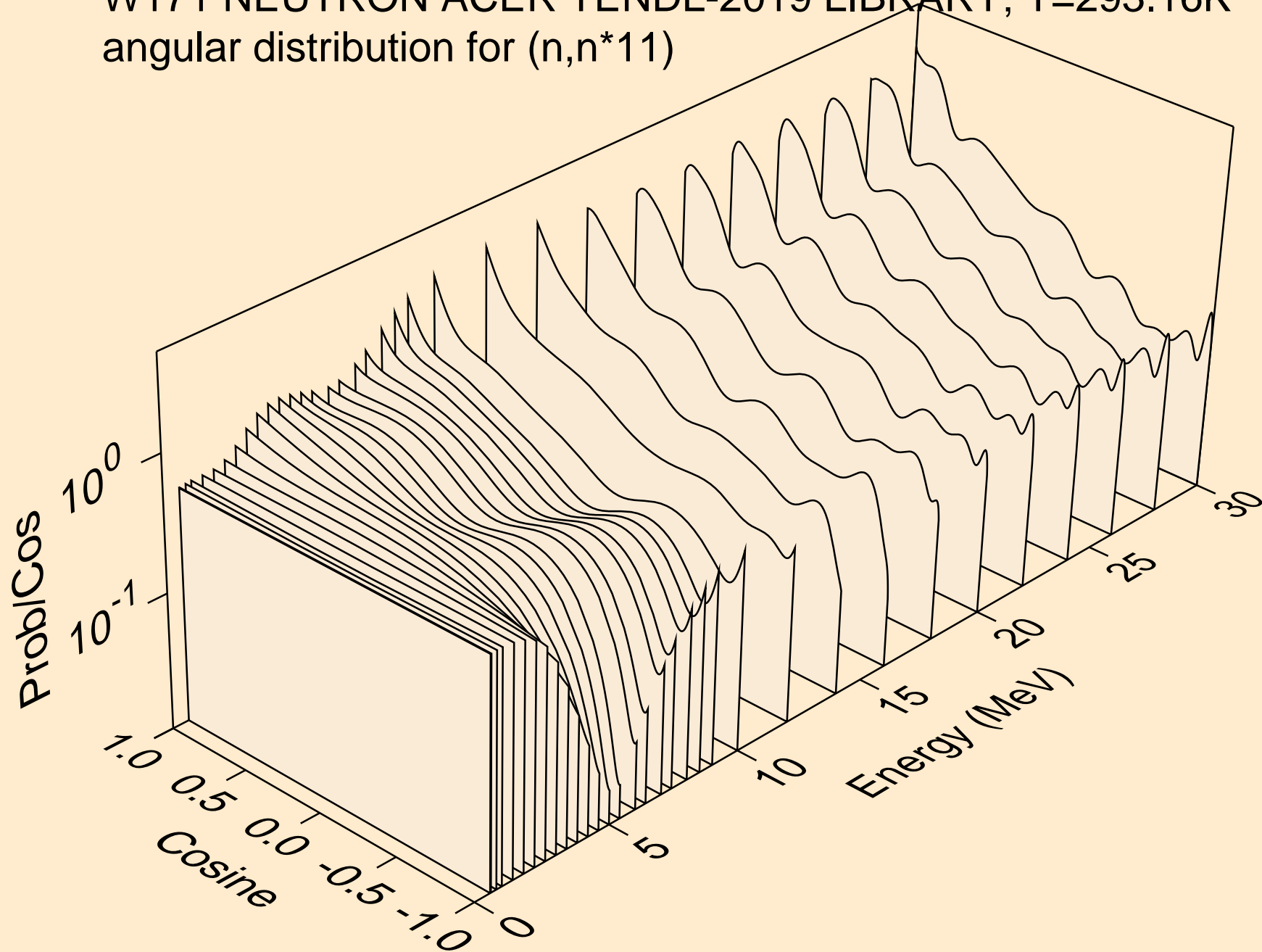

W171 NEUTRON ACER TENDL-2019 LIBRARY; T=293.16K  
angular distribution for (n,n\*12)

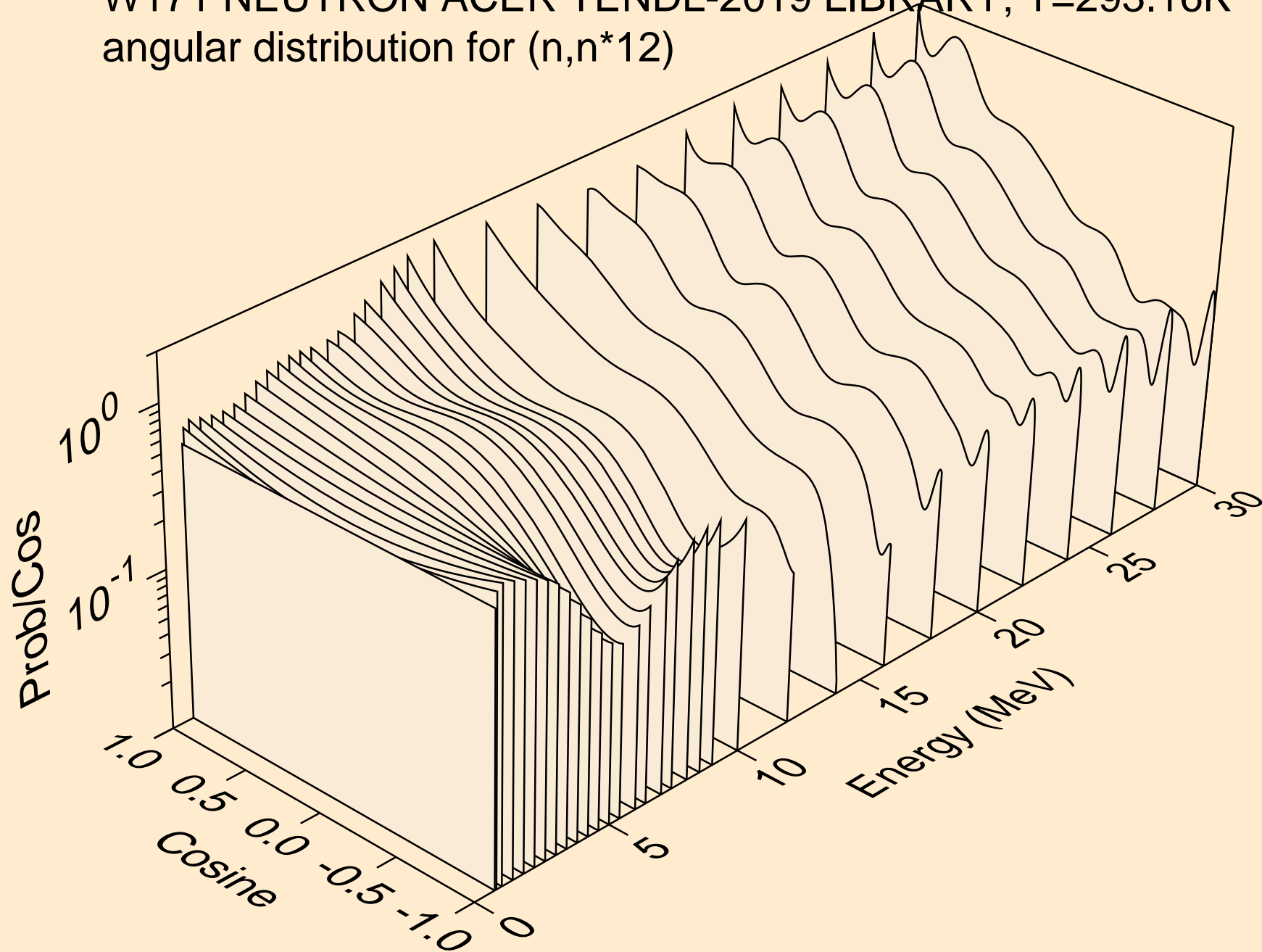

W171 NEUTRON ACER TENDL-2019 LIBRARY; T=293.16K  
angular distribution for (n,n\*13)

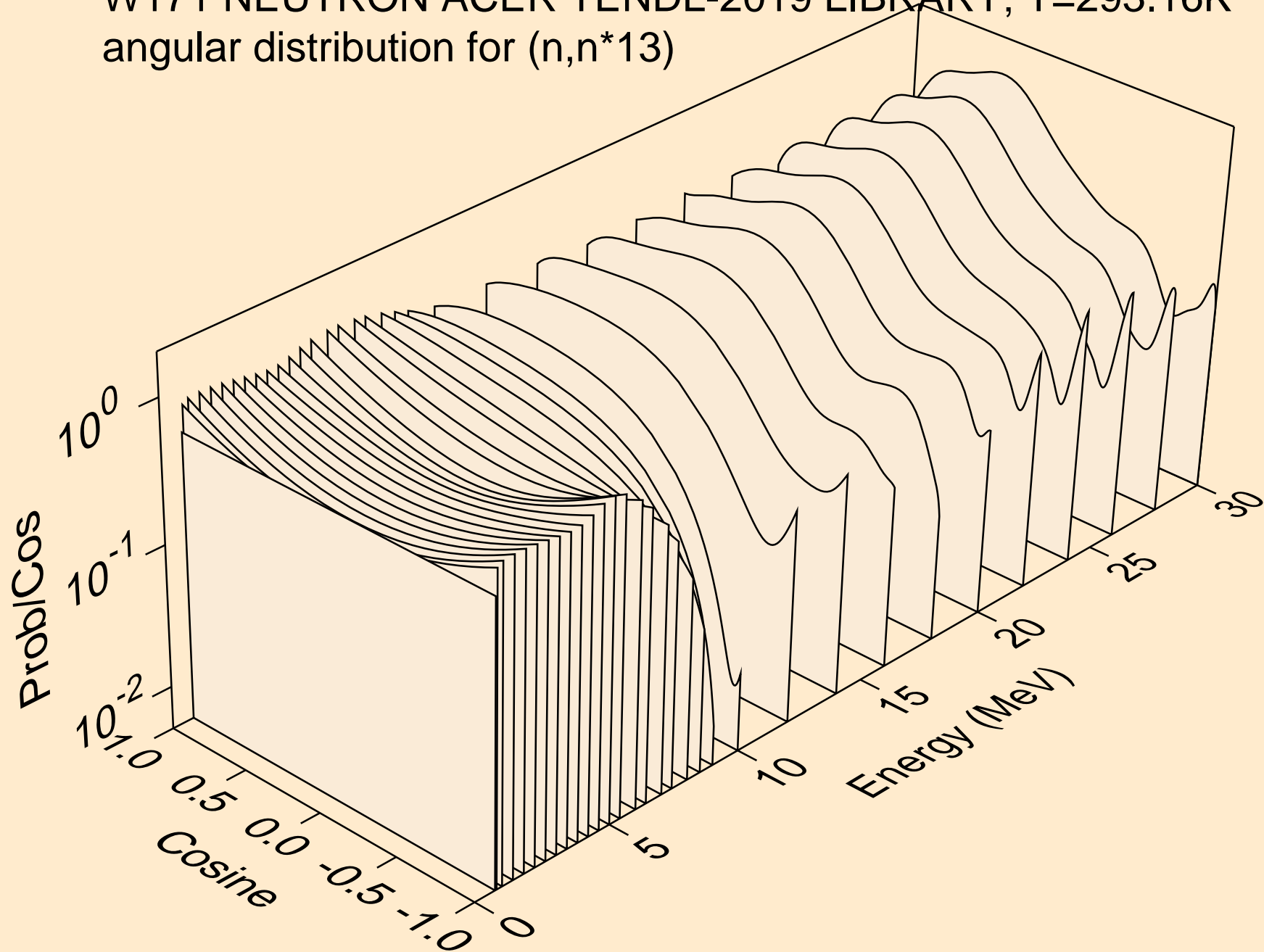

W171 NEUTRON ACER TENDL-2019 LIBRARY; T=293.16K  
angular distribution for (n,n\*14)

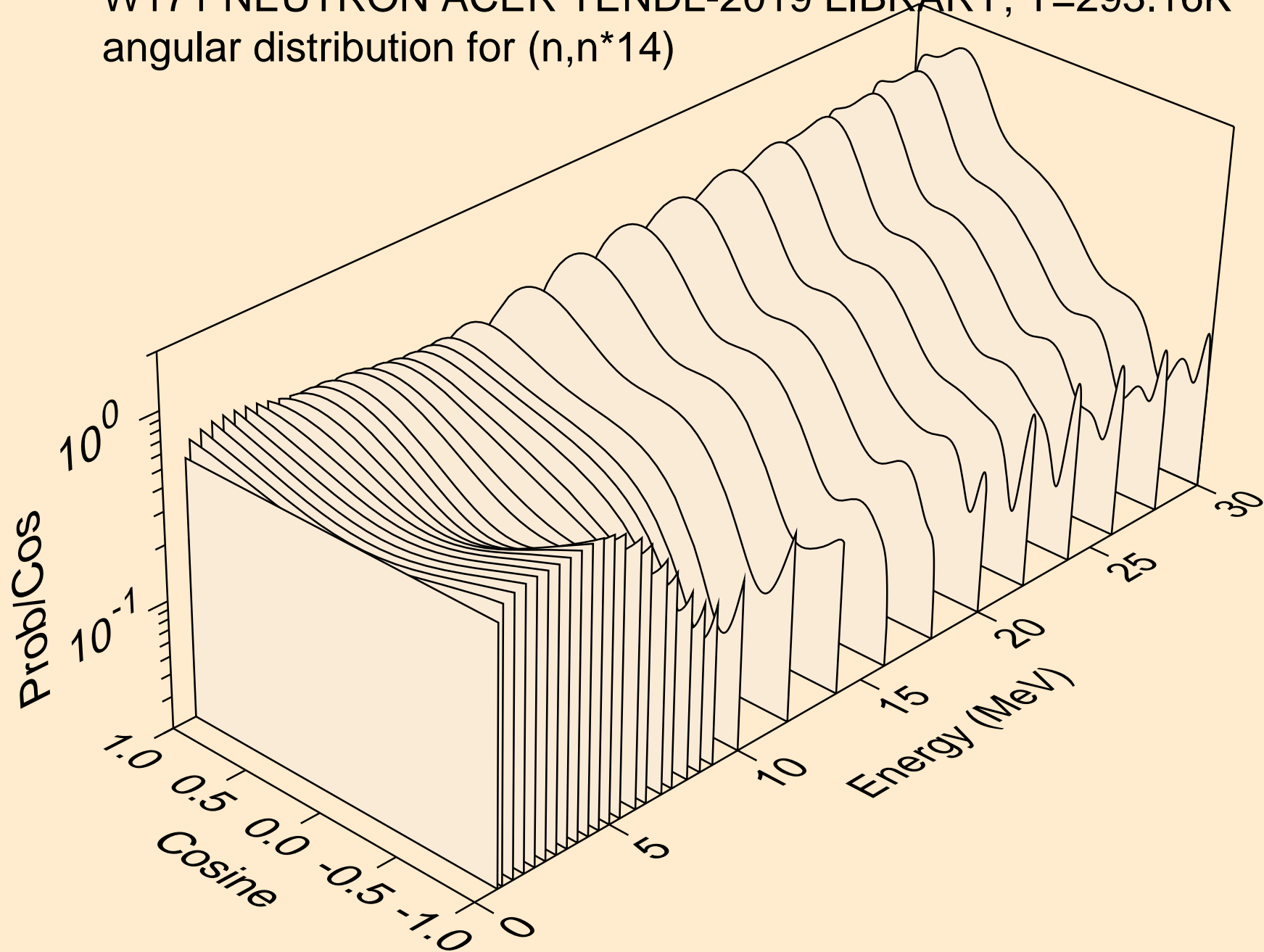

W171 NEUTRON ACER TENDL-2019 LIBRARY; T=293.16K  
angular distribution for (n,n\*15)

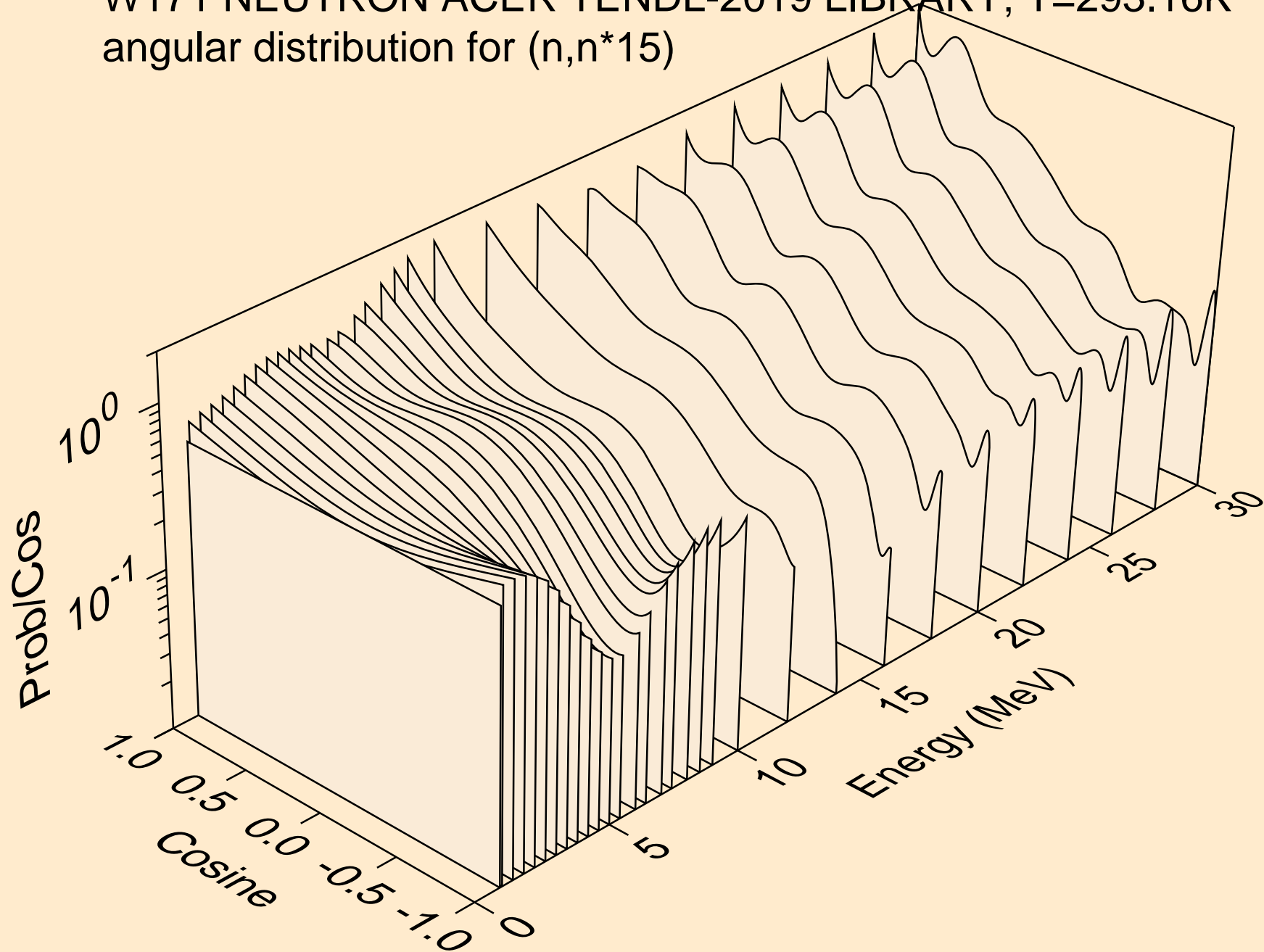

W171 NEUTRON ACER TENDL-2019 LIBRARY; T=293.16K  
angular distribution for (n,n\*16)

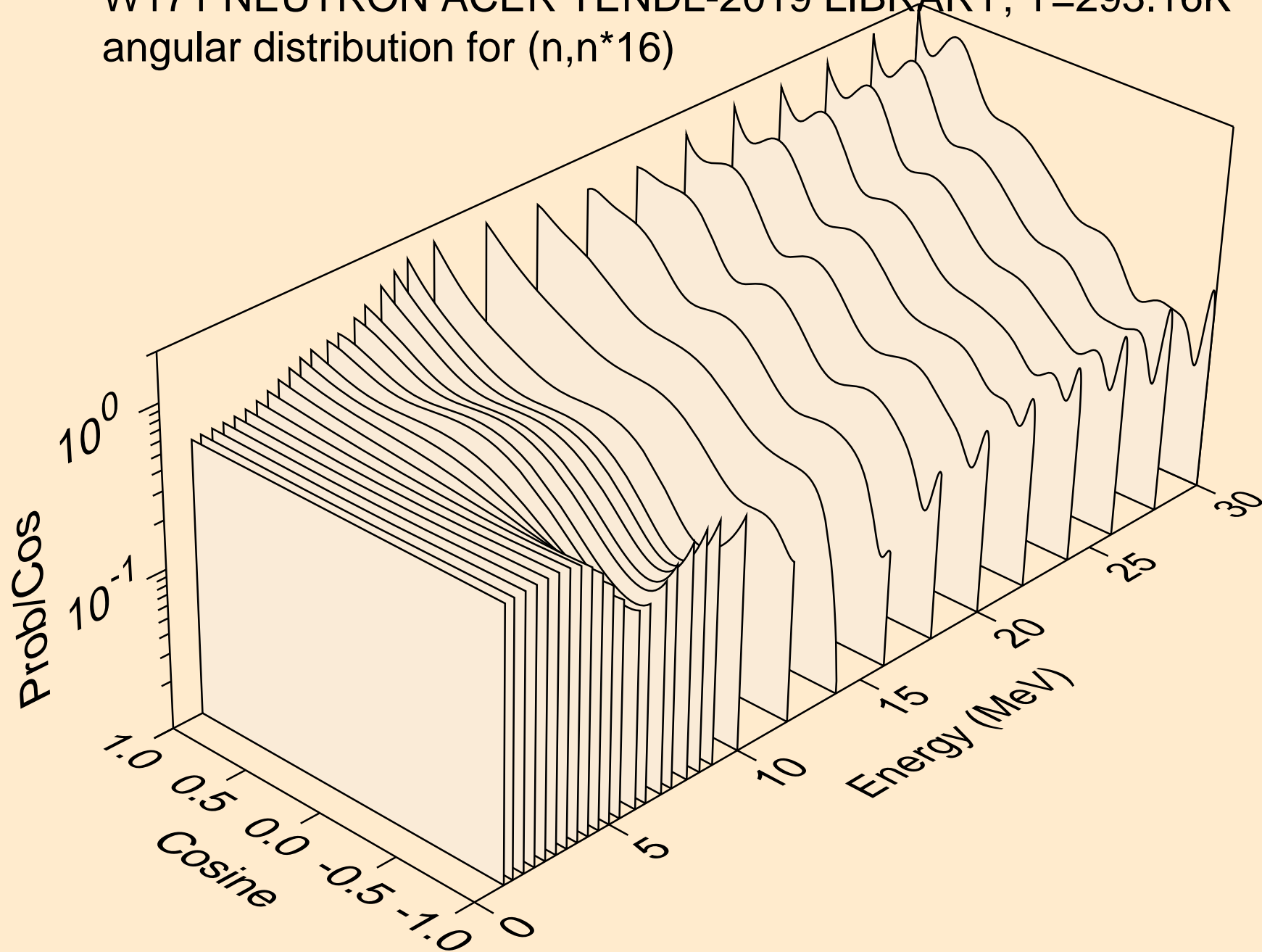

W171 NEUTRON ACER TENDL-2019 LIBRARY; T=293.16K  
Neutron emission for (n,x)

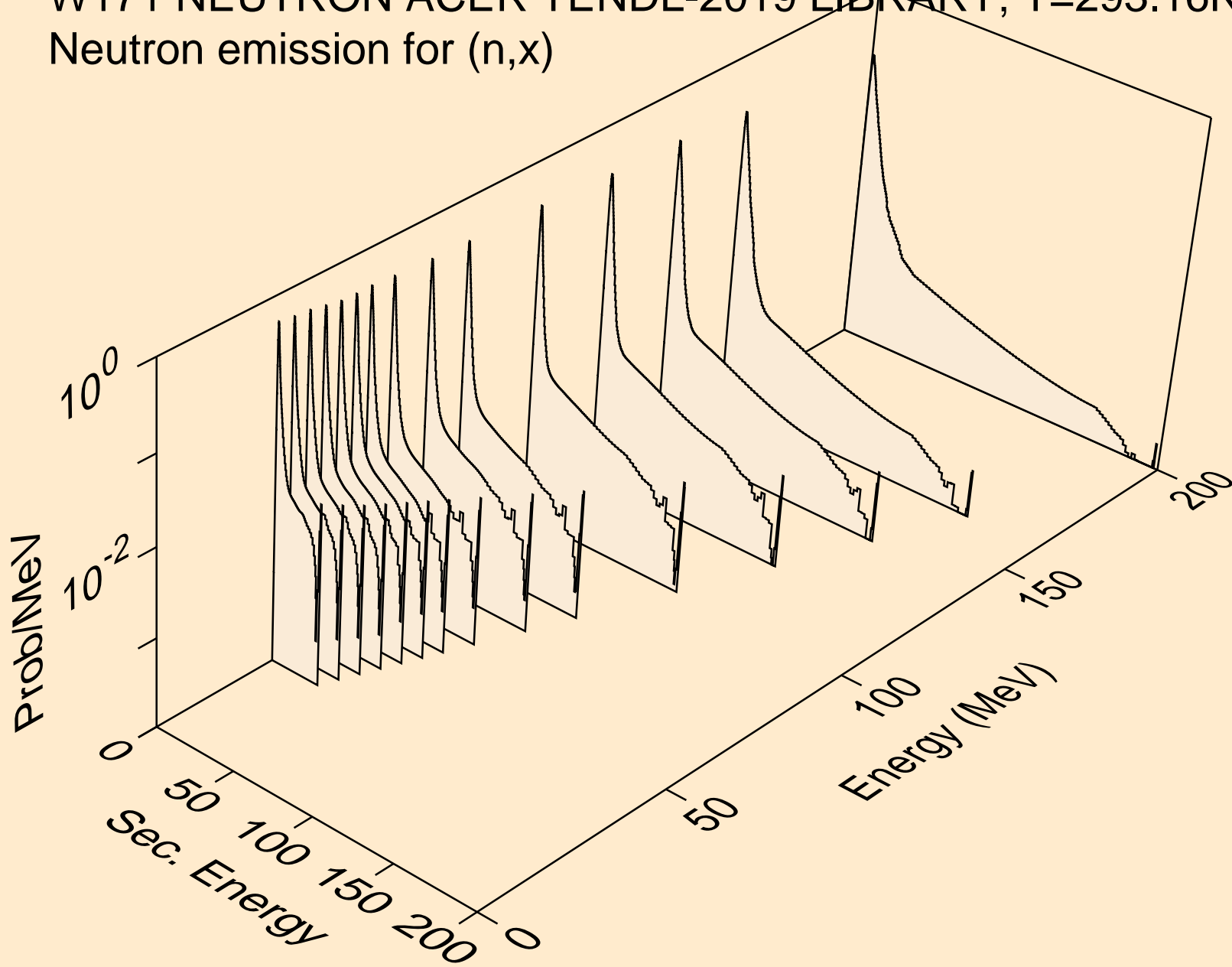



W171 NEUTRON ACER TENDL-2019 LIBRARY; T=293.16K  
Neutron emission for (n,2nd)

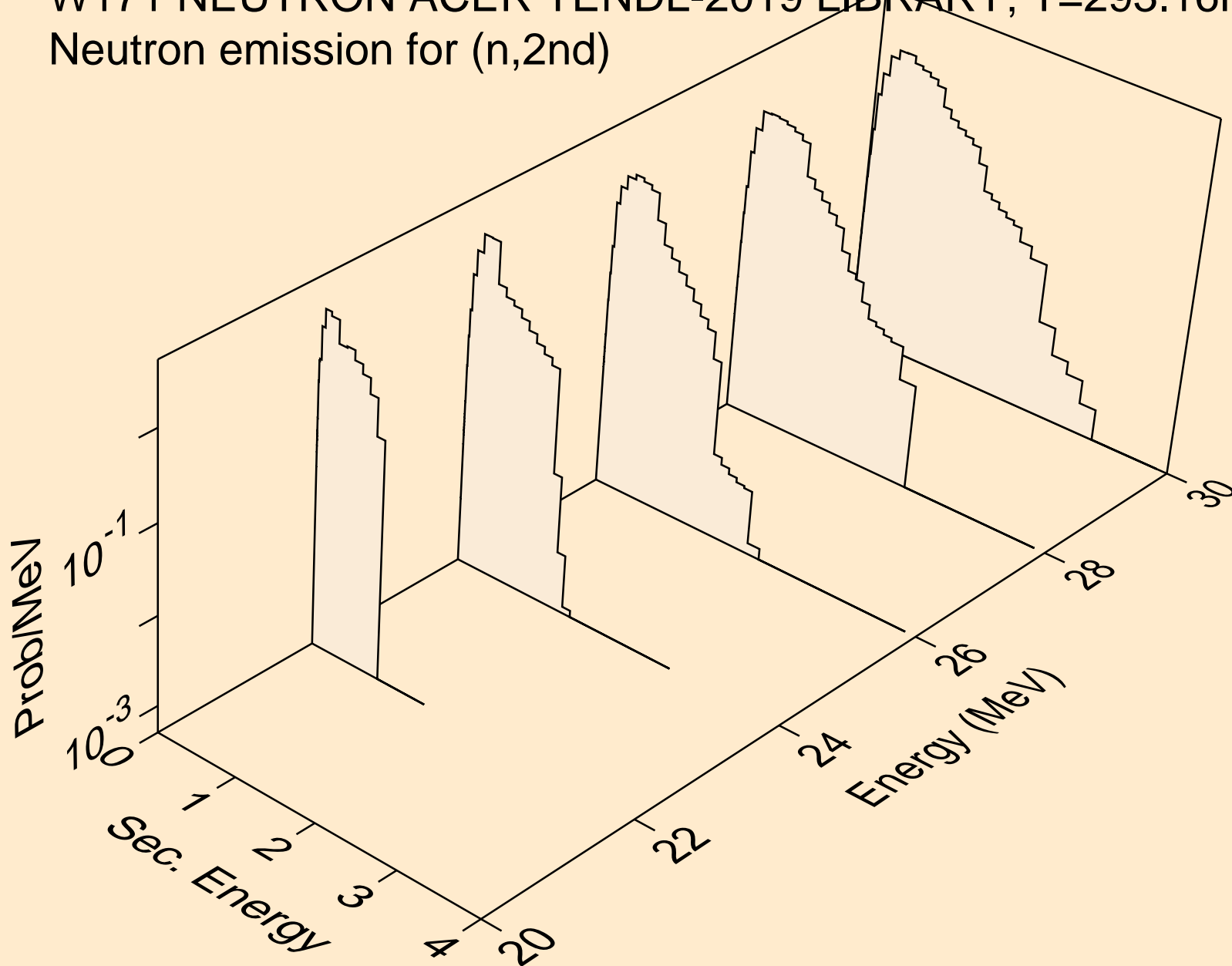

W171 NEUTRON ACER TENDL-2019 LIBRARY; T=293.16K  
Neutron emission for (n,2n)

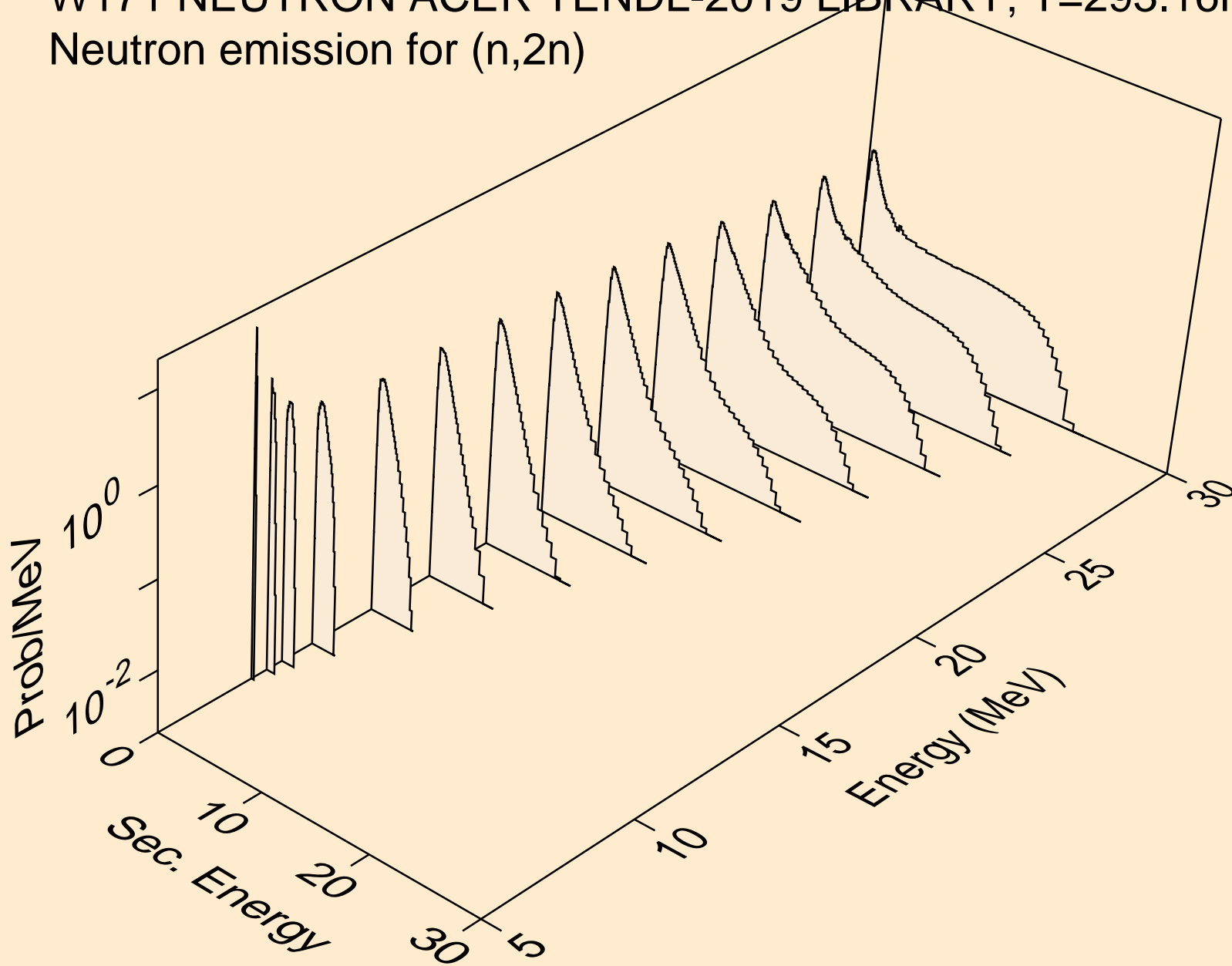

W171 NEUTRON ACER TENDL-2019 LIBRARY; T=293.16K  
Neutron emission for (n,3n)

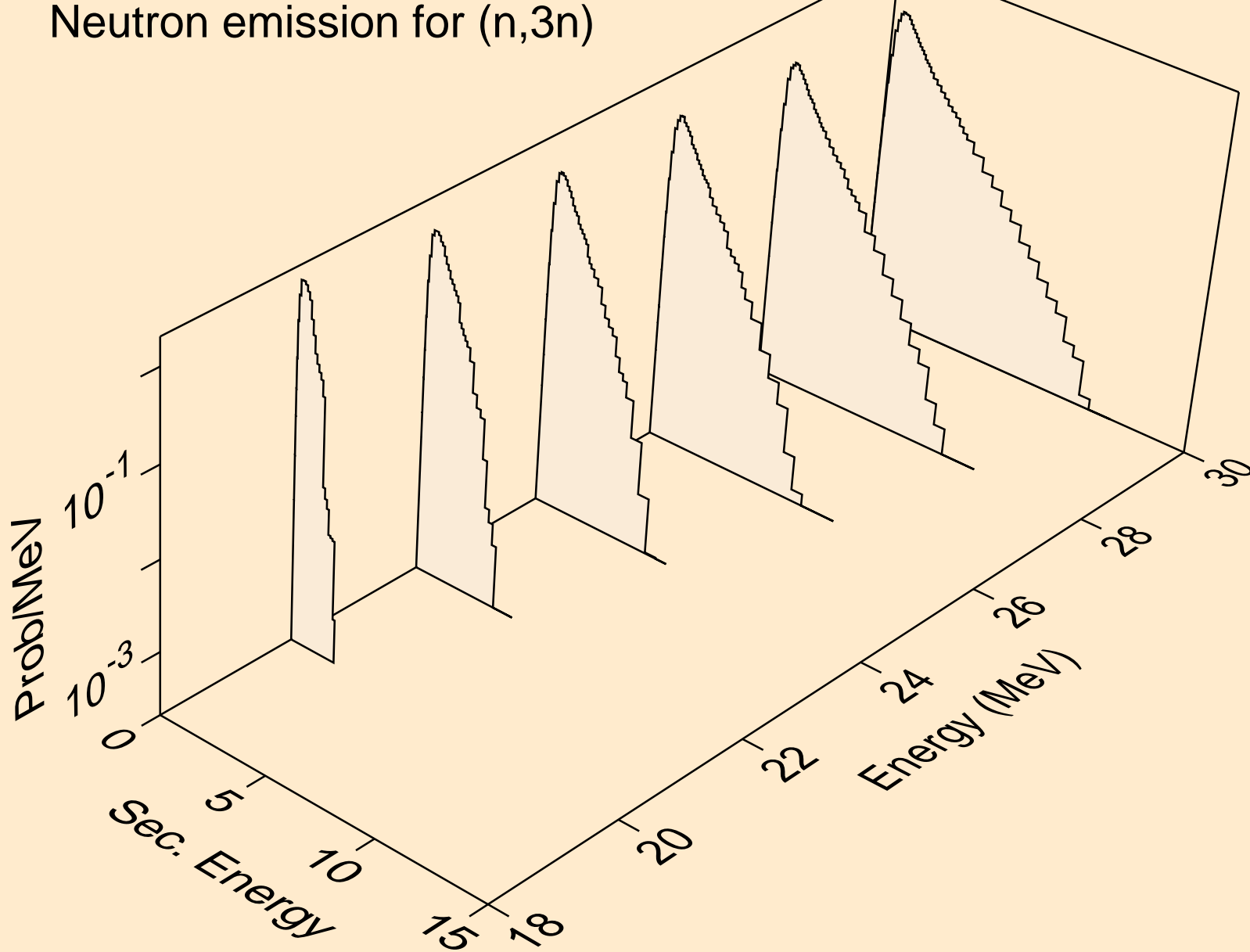

W171 NEUTRON ACER TENDL-2019 LIBRARY; T=293.16K  
Neutron emission for (n,n\*)a

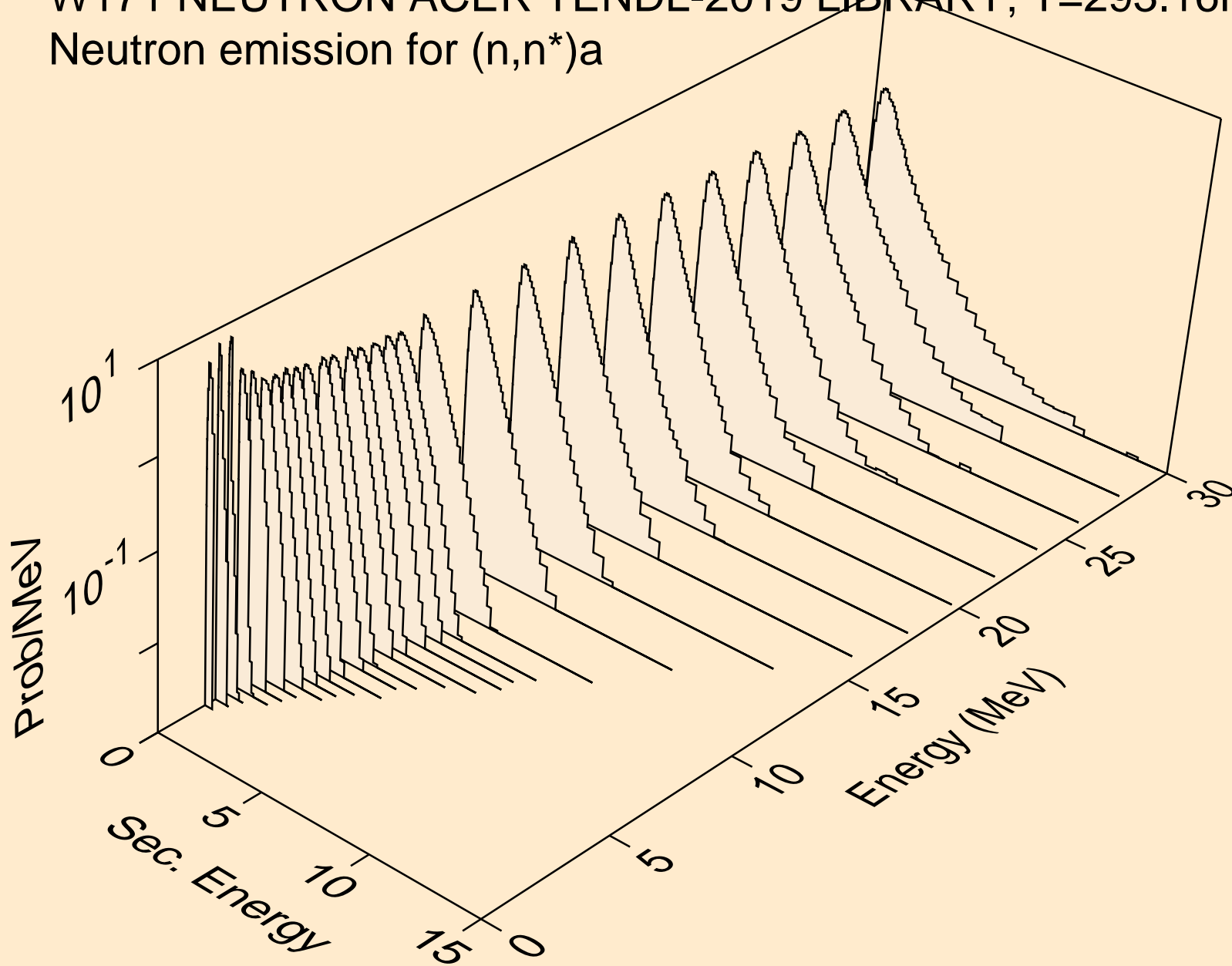

W171 NEUTRON ACER TENDL-2019 LIBRARY; T=293.16K  
Neutron emission for (n,2n)a

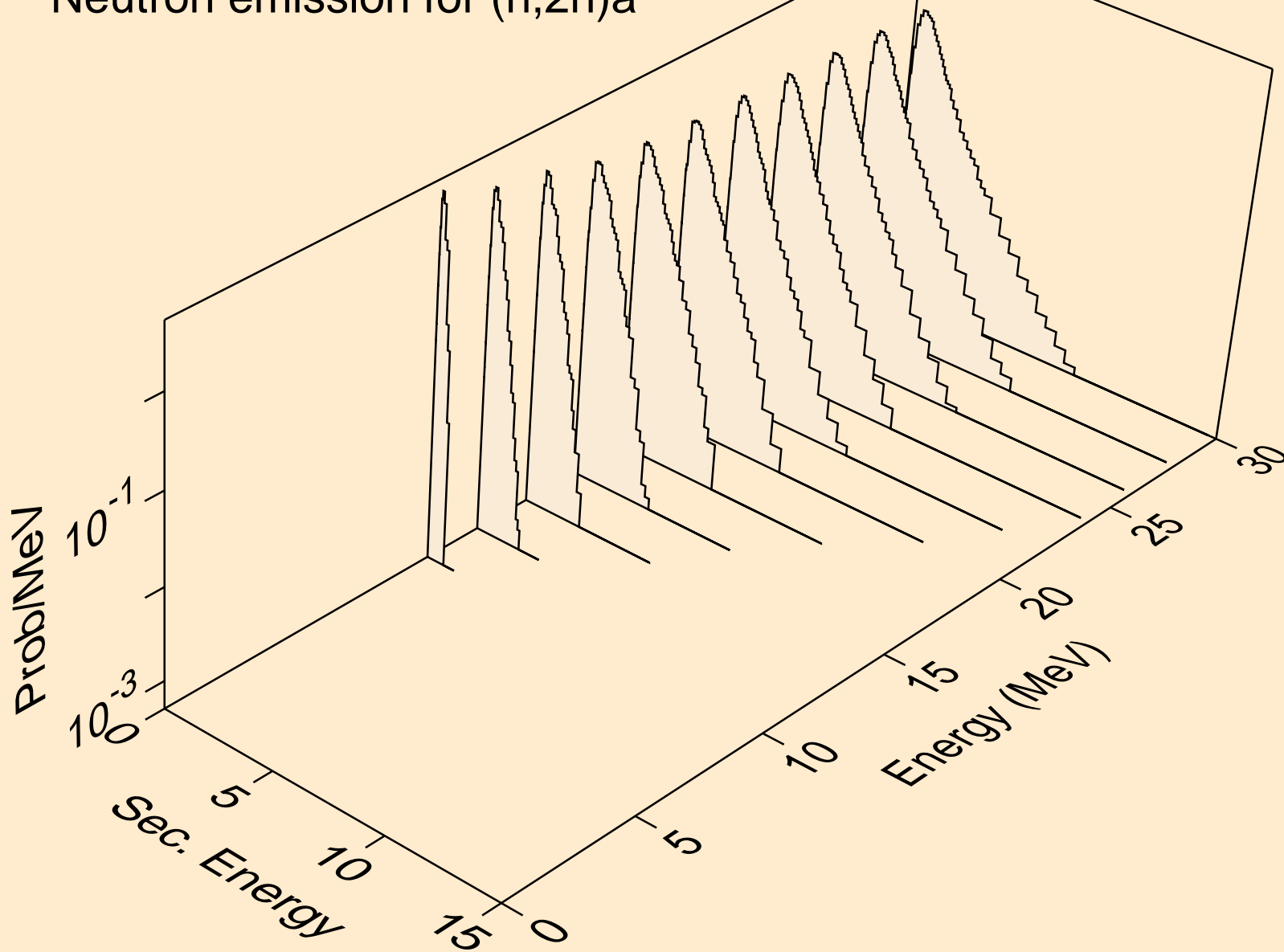

W171 NEUTRON ACER TENDL-2019 LIBRARY; T=293.16K  
Neutron emission for (n,3n)a

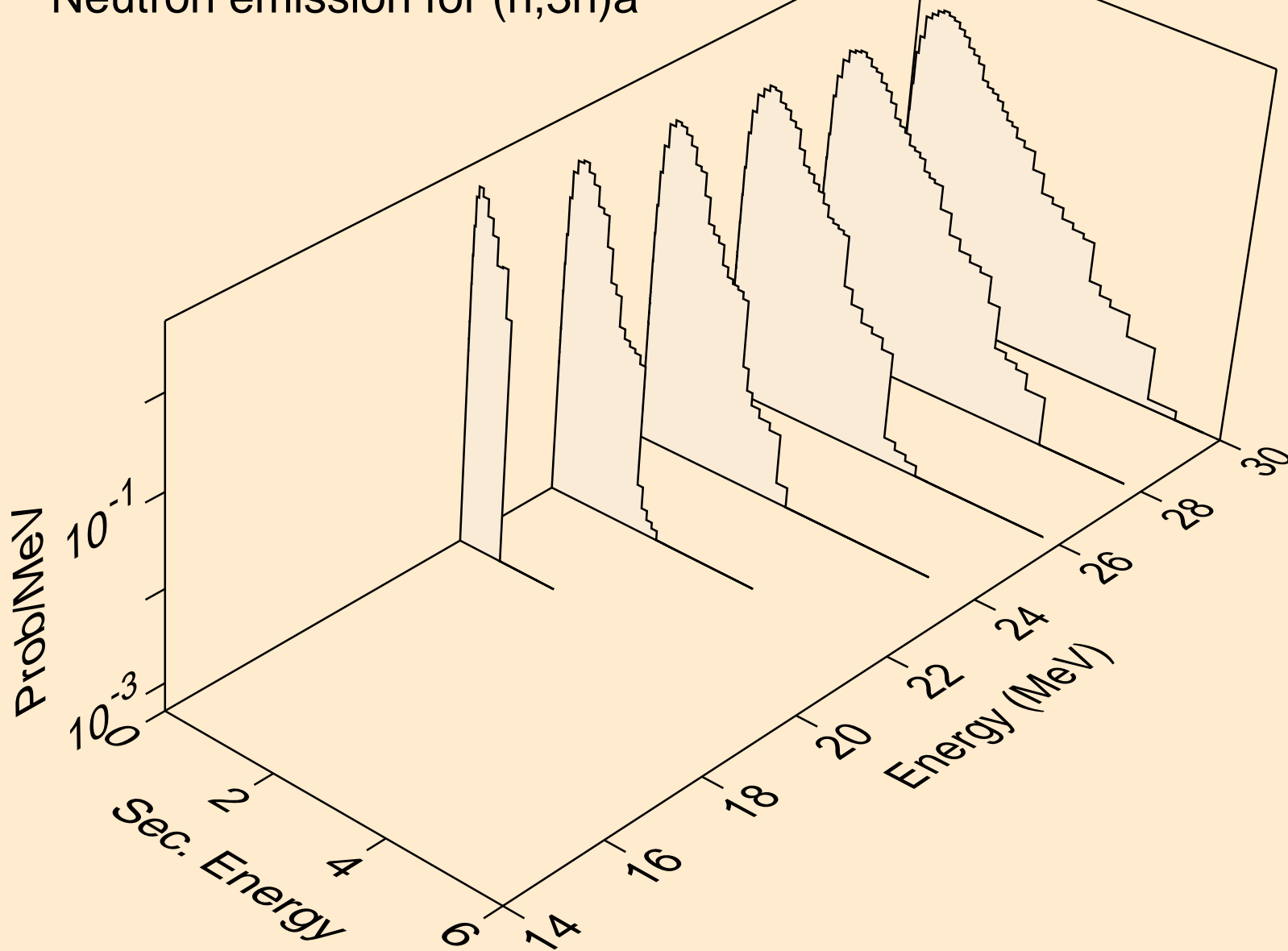

W171 NEUTRON ACER TENDL-2019 LIBRARY; T=293.16K  
Neutron emission for (n,n\*)p

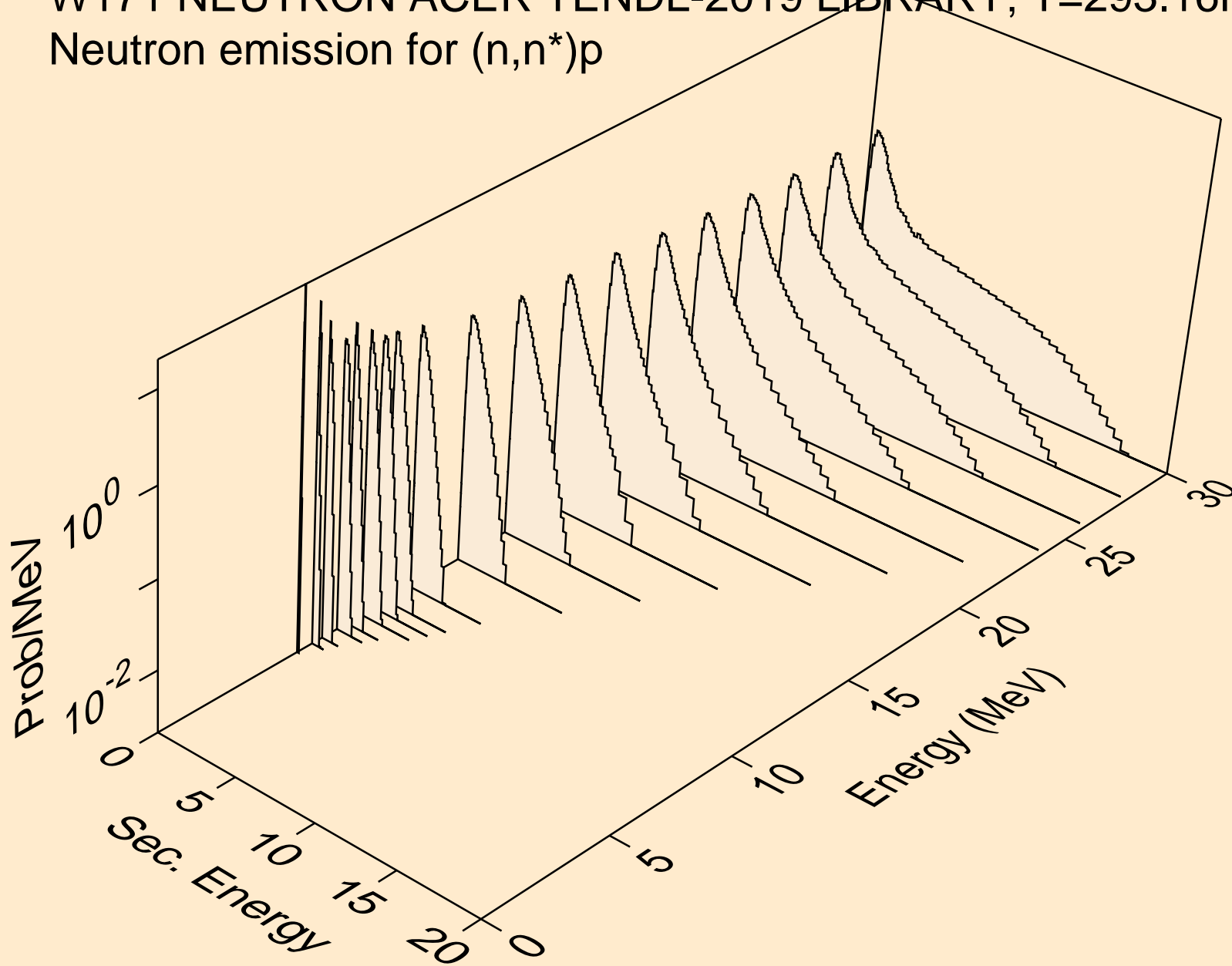

W171 NEUTRON ACER TENDL-2019 LIBRARY; T=293.16K  
Neutron emission for (n,n\*)2a

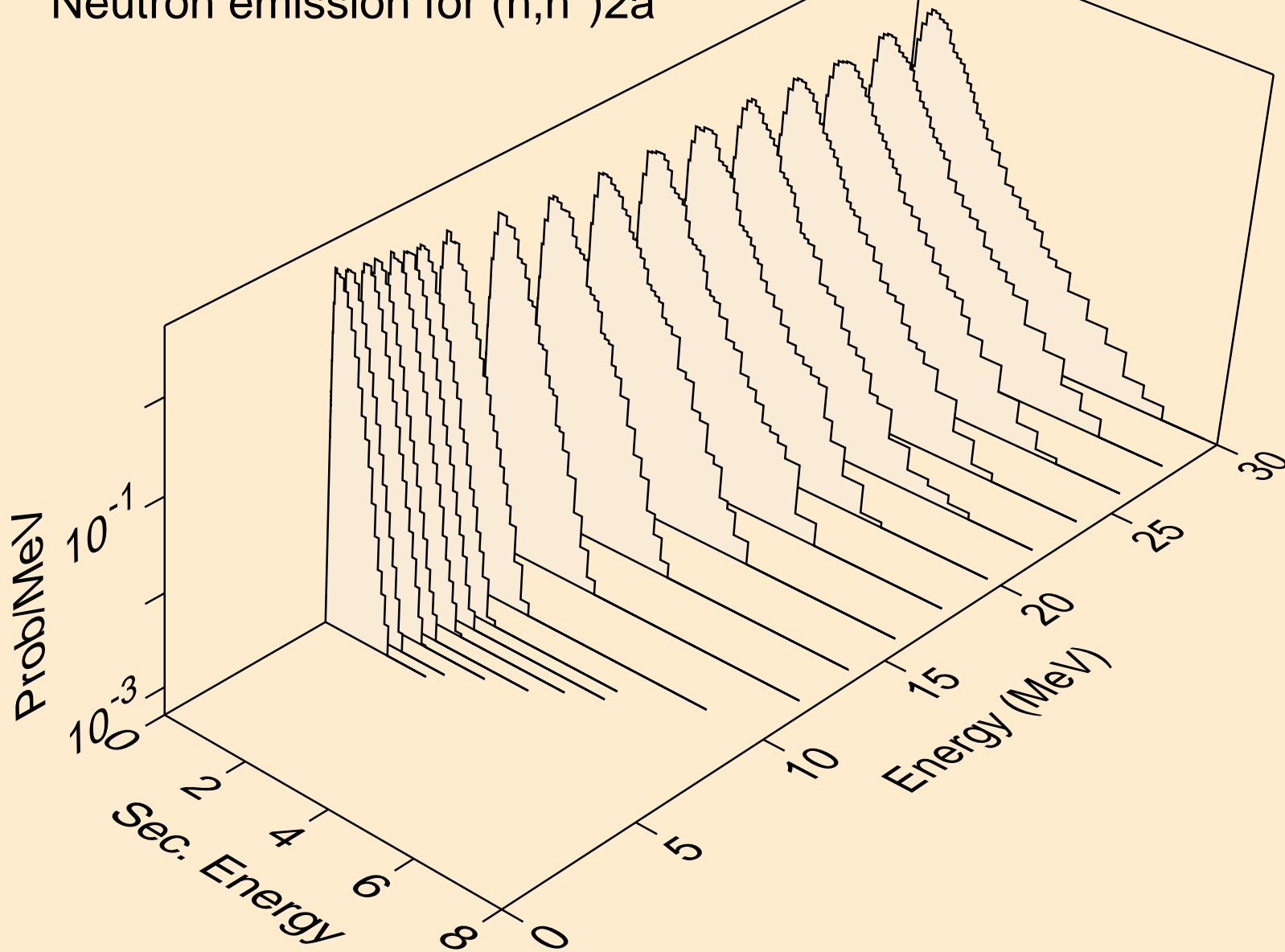



W171 NEUTRON ACER TENDL-2019 LIBRARY; T=293.16K  
Neutron emission for (n,2n)2a

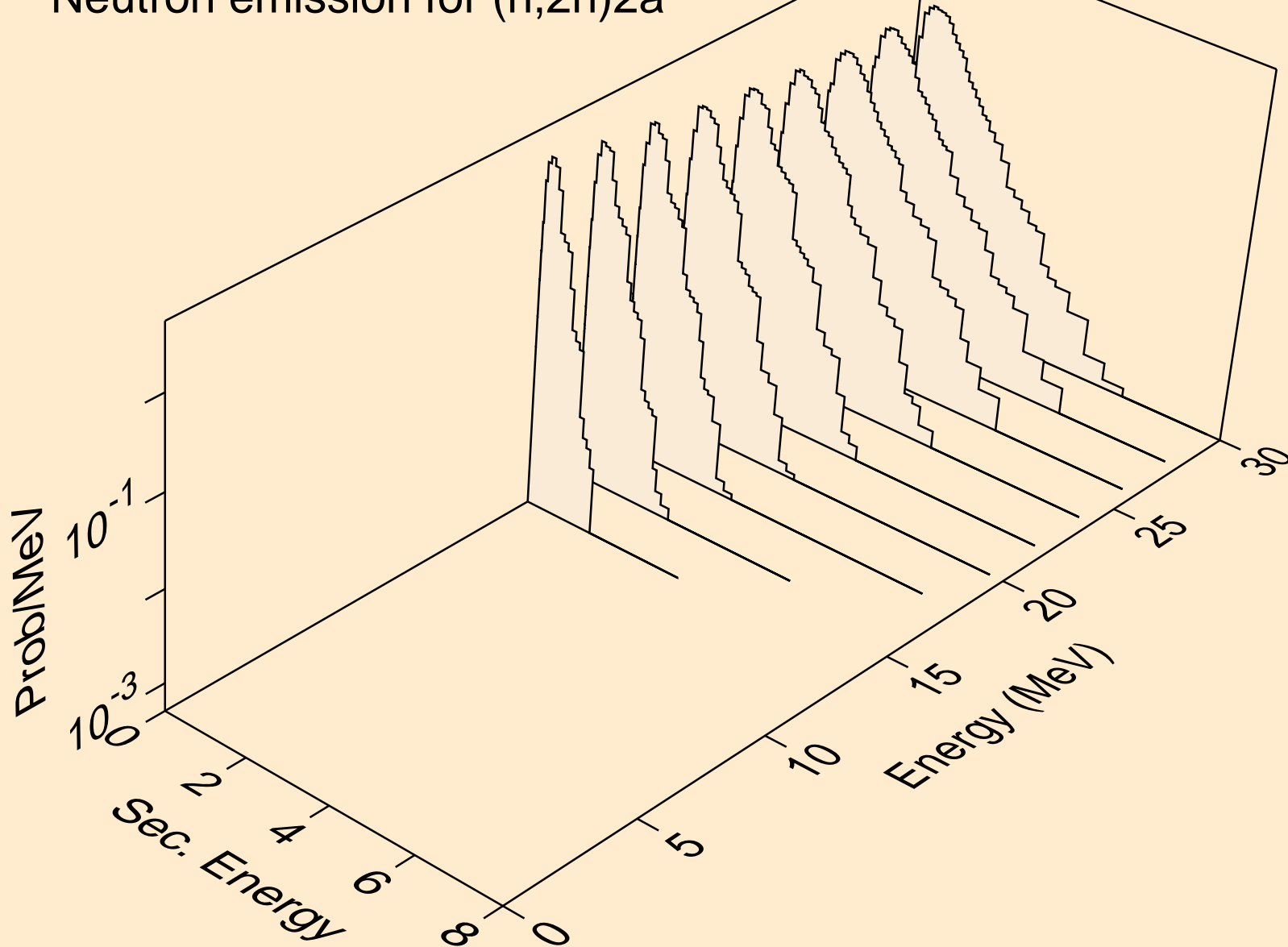

W171 NEUTRON ACER TENDL-2019 LIBRARY; T=293.16K  
Neutron emission for (n,n\*)d

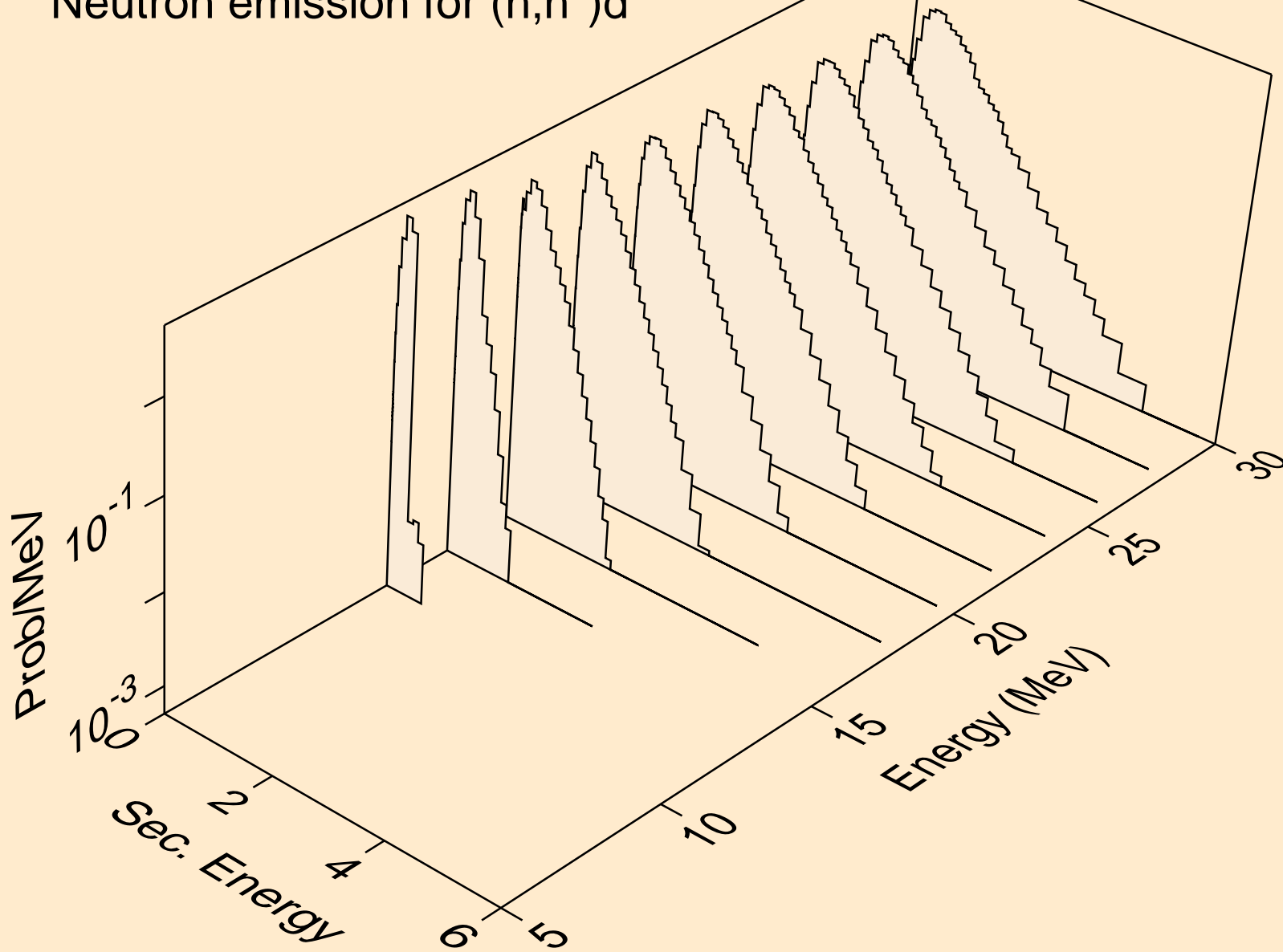

W171 NEUTRON ACER TENDL-2019 LIBRARY; T=293.16K  
Neutron emission for (n,n\*)t

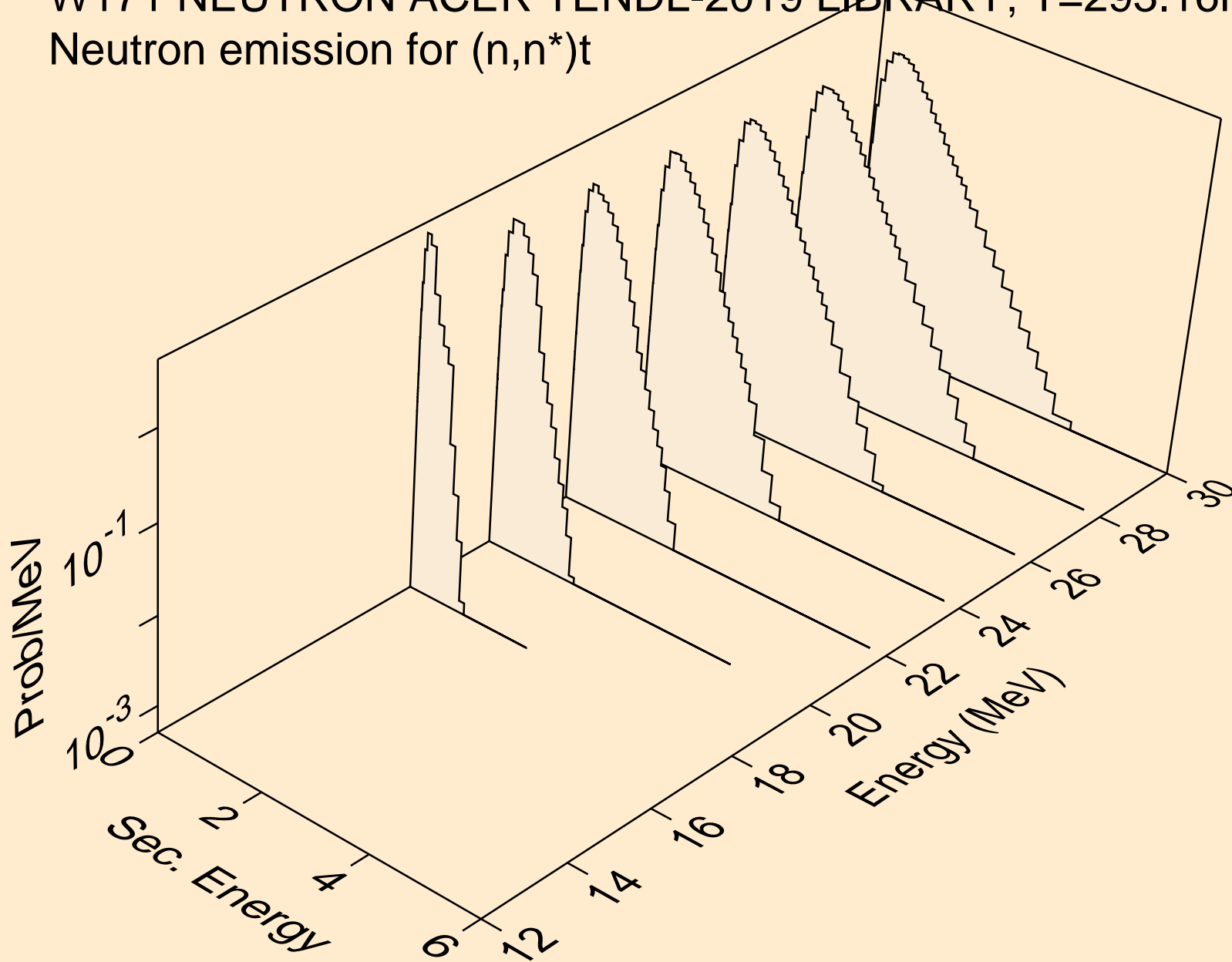

W171 NEUTRON ACER TENDL-2019 LIBRARY; T=293.16K  
Neutron emission for (n,n\*)he3

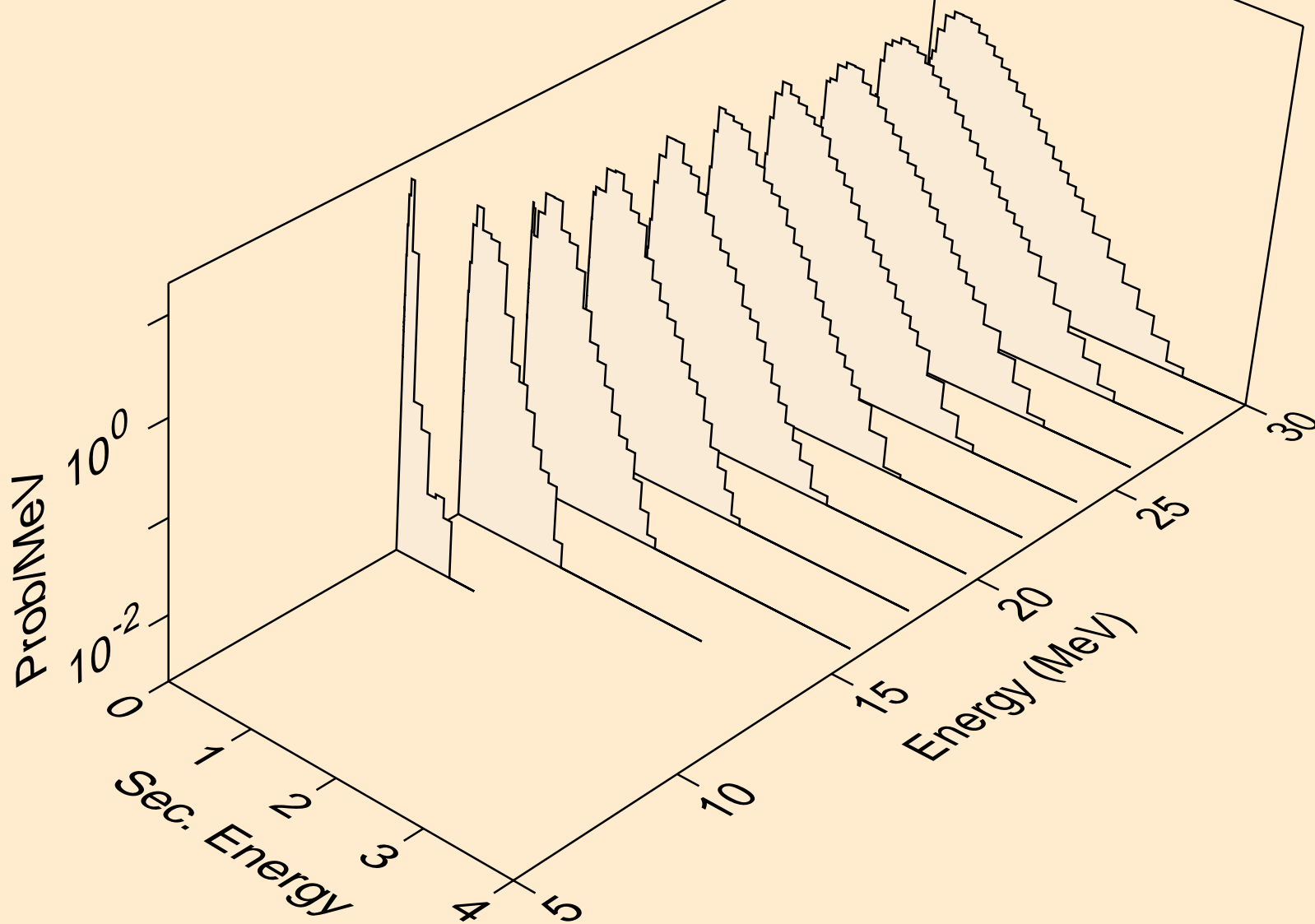

W171 NEUTRON ACER TENDL-2019 LIBRARY; T=293.16K  
Neutron emission for (n,4n)

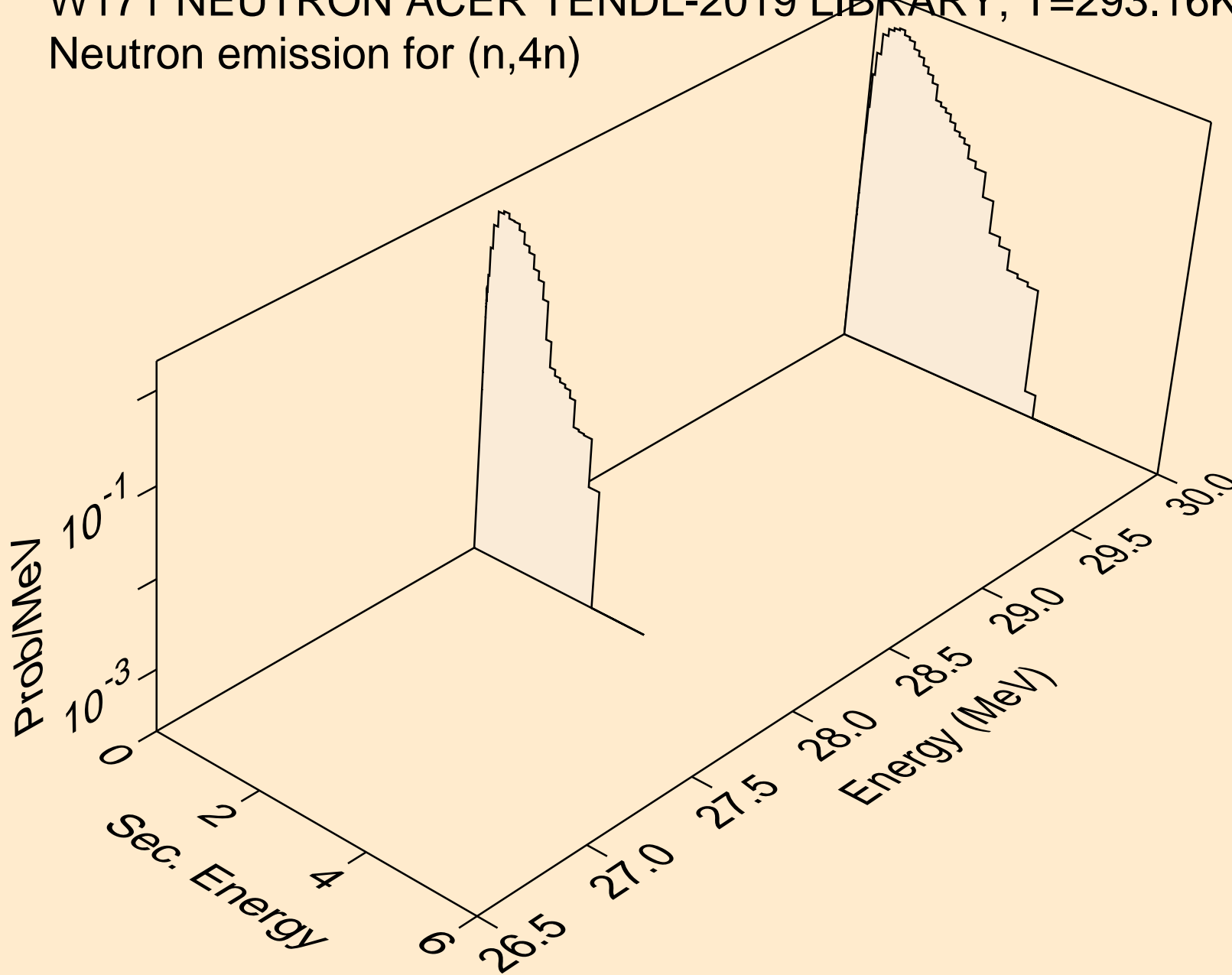

W171 NEUTRON ACER TENDL-2019 LIBRARY; T=293.16K  
Neutron emission for (n,2np)

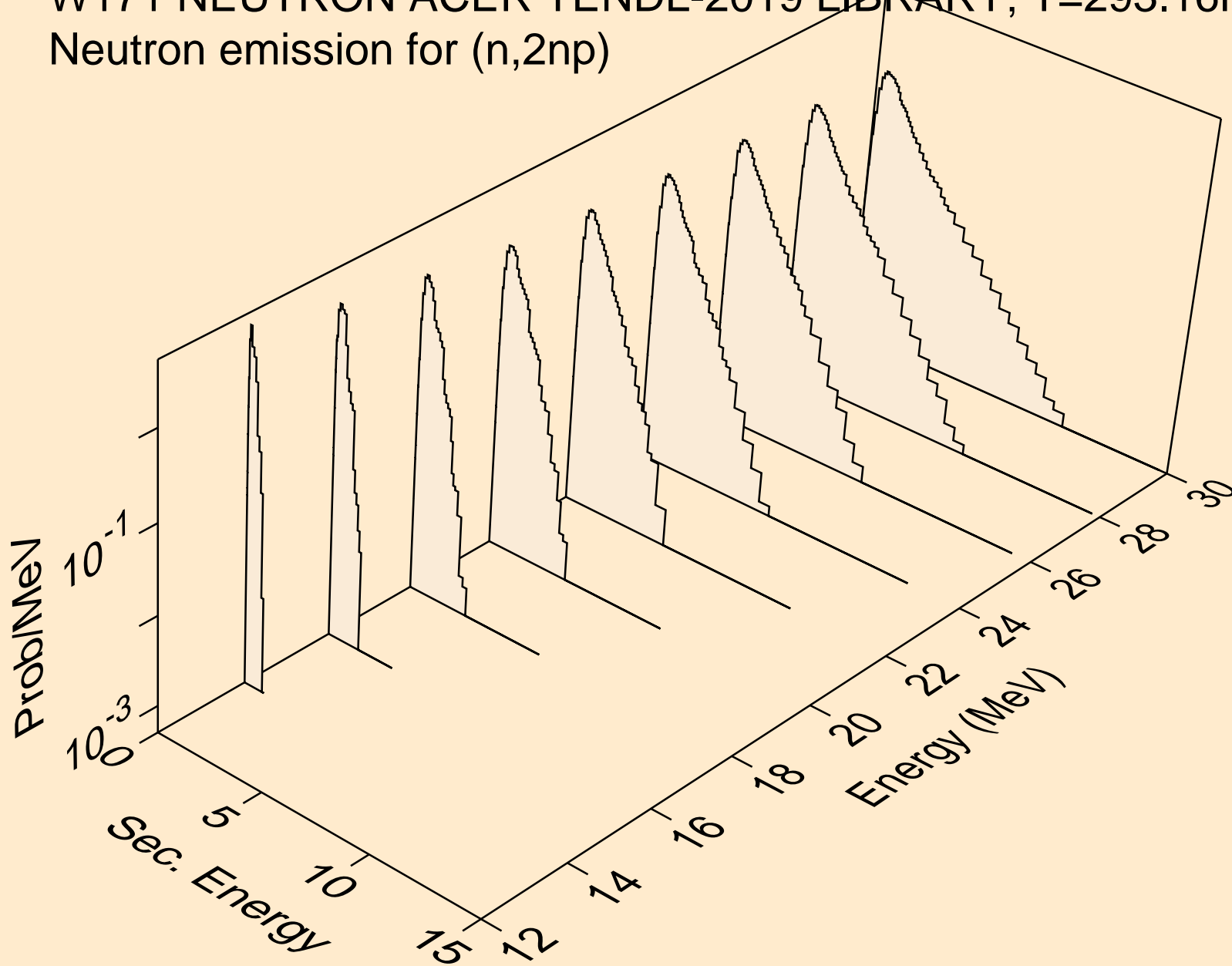

W171 NEUTRON ACER TENDL-2019 LIBRARY; T=293.16K  
Neutron emission for (n,3np)

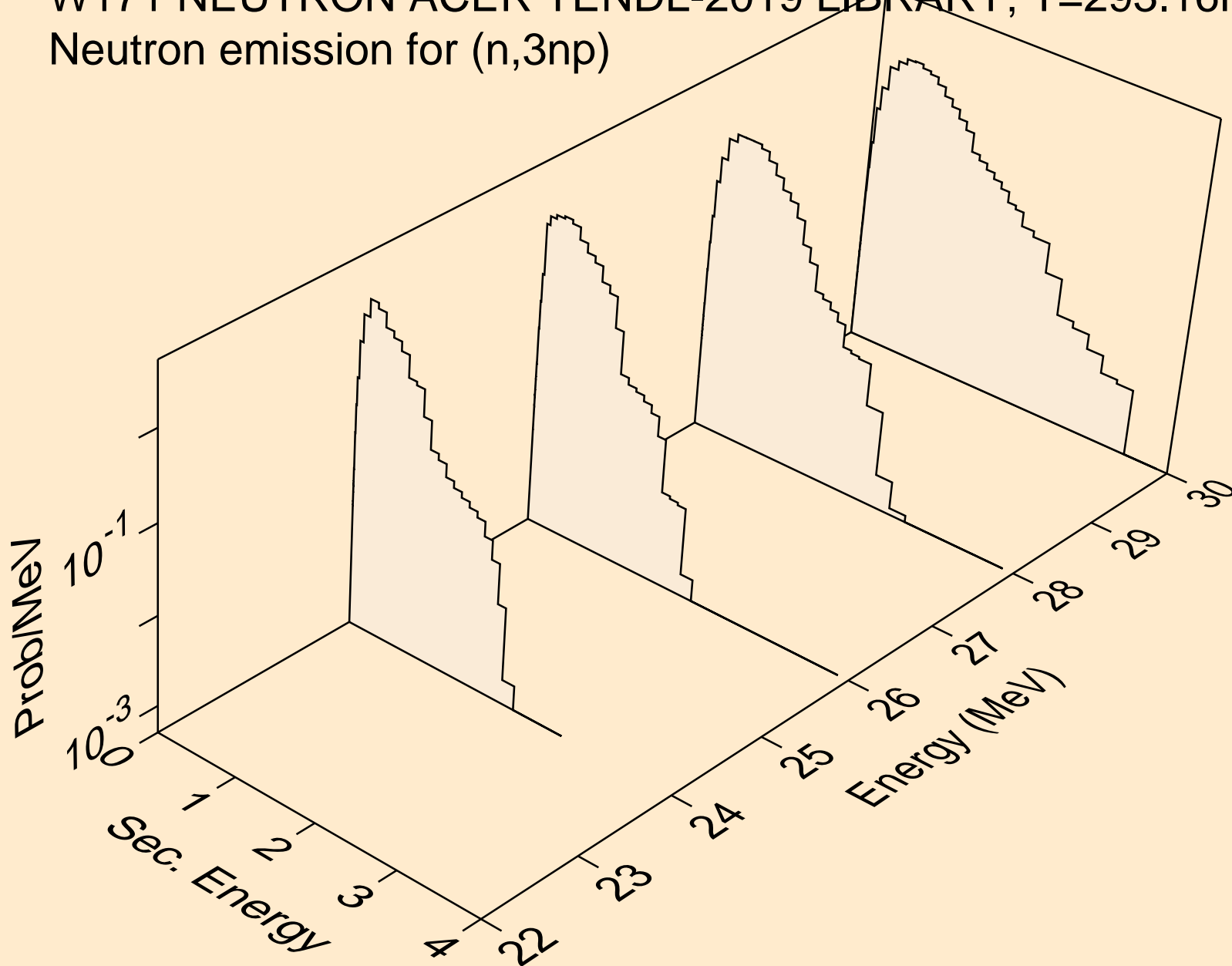

W171 NEUTRON ACER TENDL-2019 LIBRARY; T=293.16K  
Neutron emission for (n,2np)

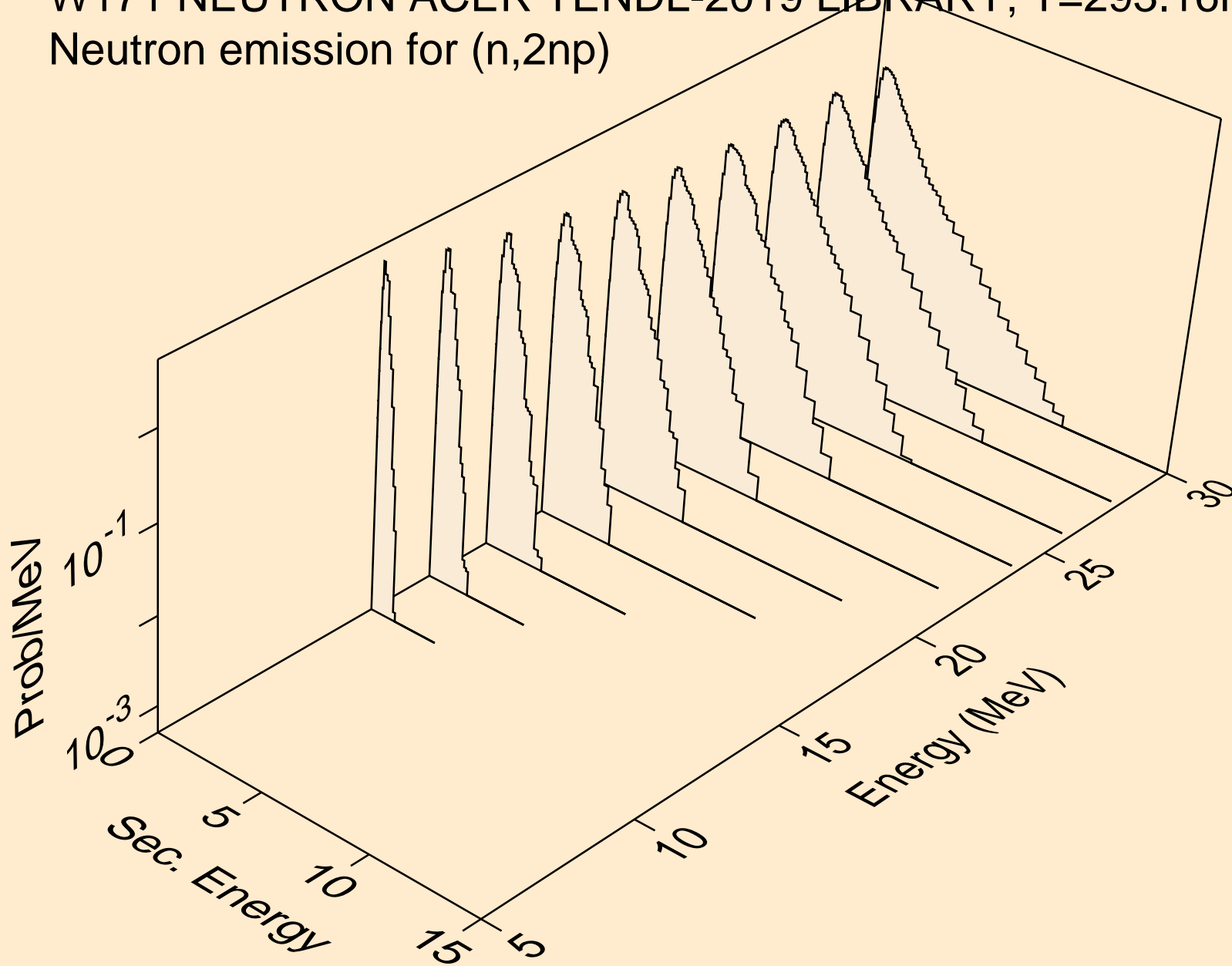



W171 NEUTRON ACER TENDL-2019 LIBRARY; T=293.16K  
Neutron emission for (n,npa)

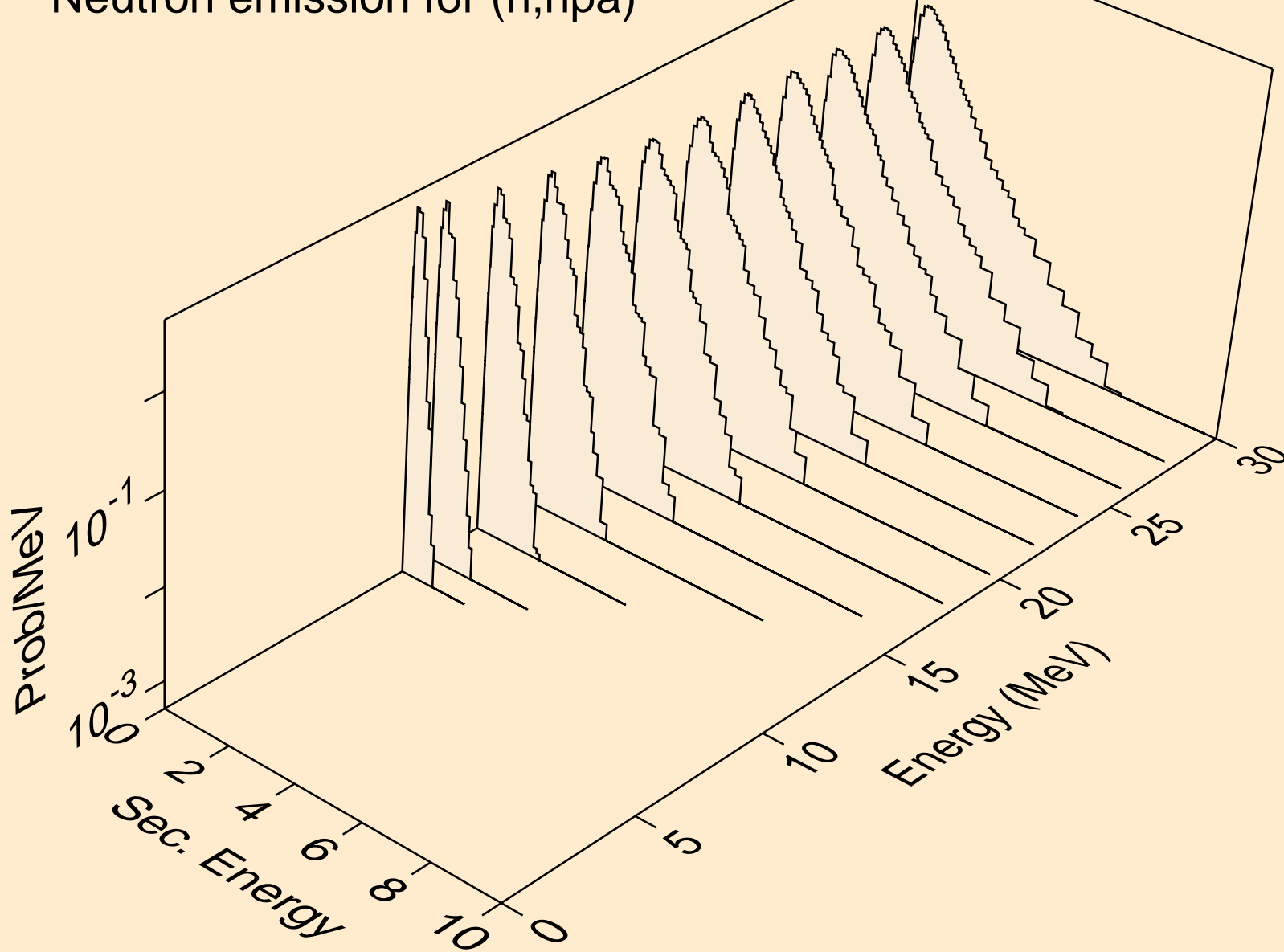

W171 NEUTRON ACER TENDL-2019 LIBRARY; T=293.16K  
Neutron emission for (n,n\*c)

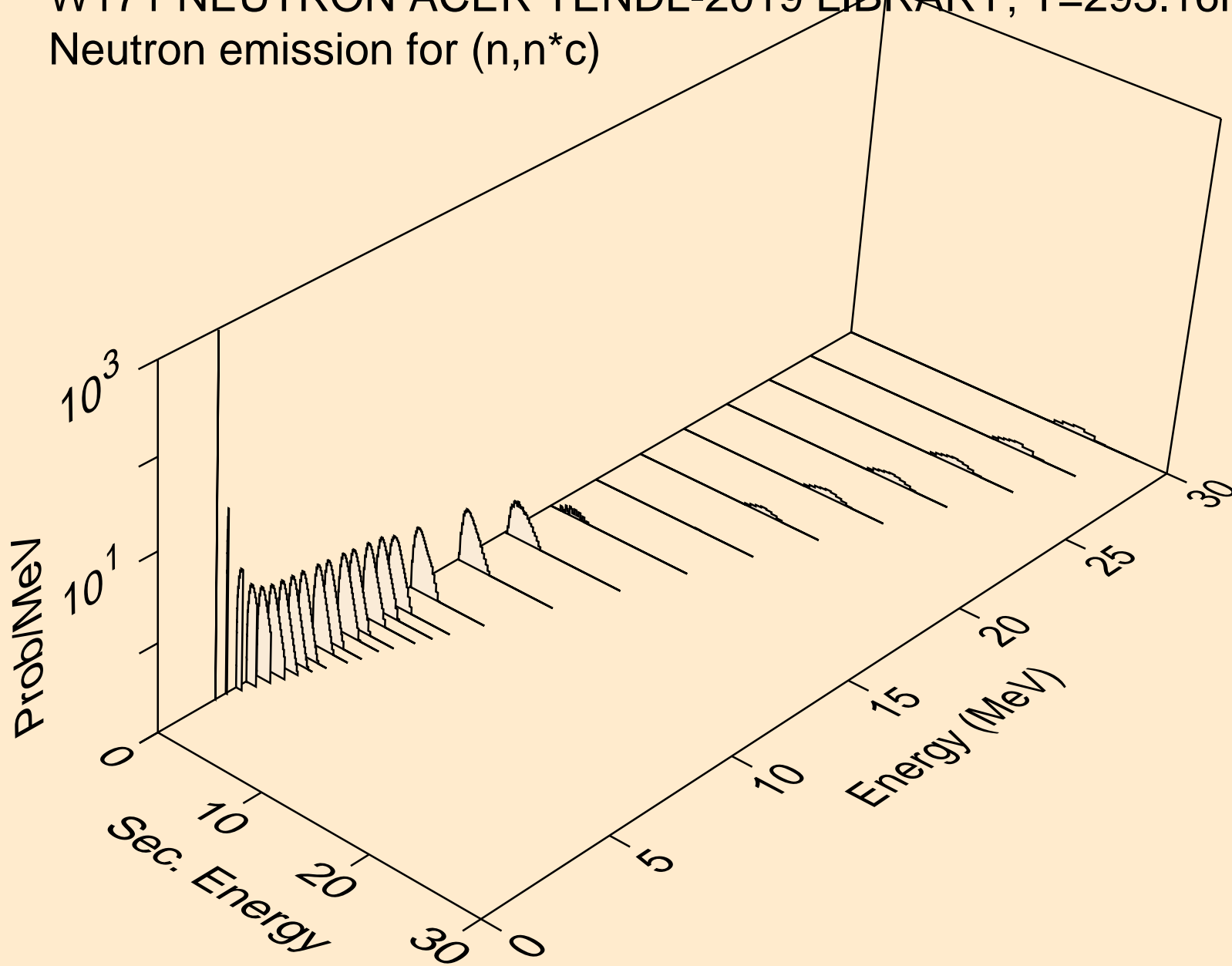

W171 NEUTRON ACER TENDL-2019 LIBRARY; T=293.16K  
Photon emission for (n,x)

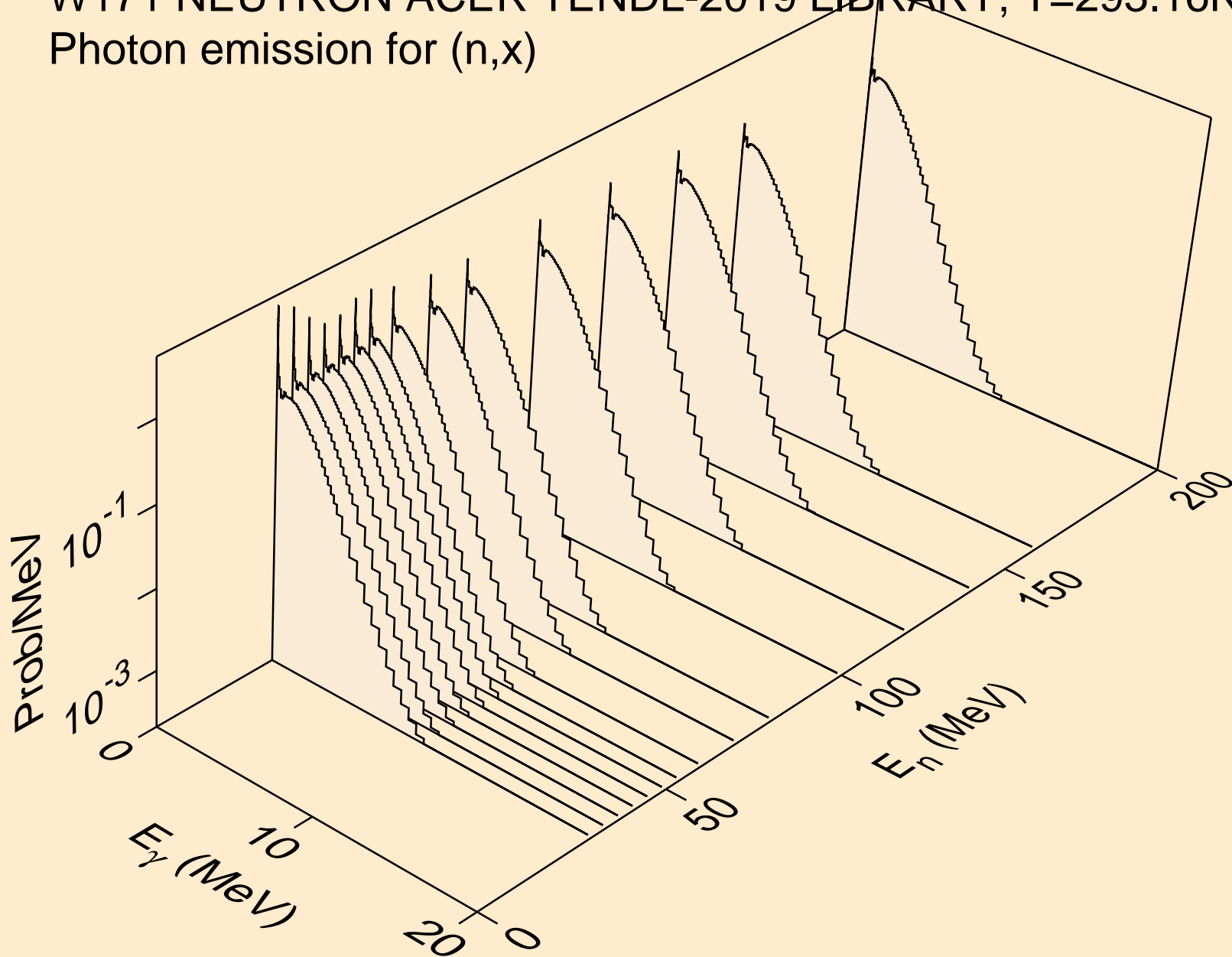

W171 NEUTRON ACER TENDL-2019 LIBRARY; T=293.16K  
Photon emission for (n,2nd)

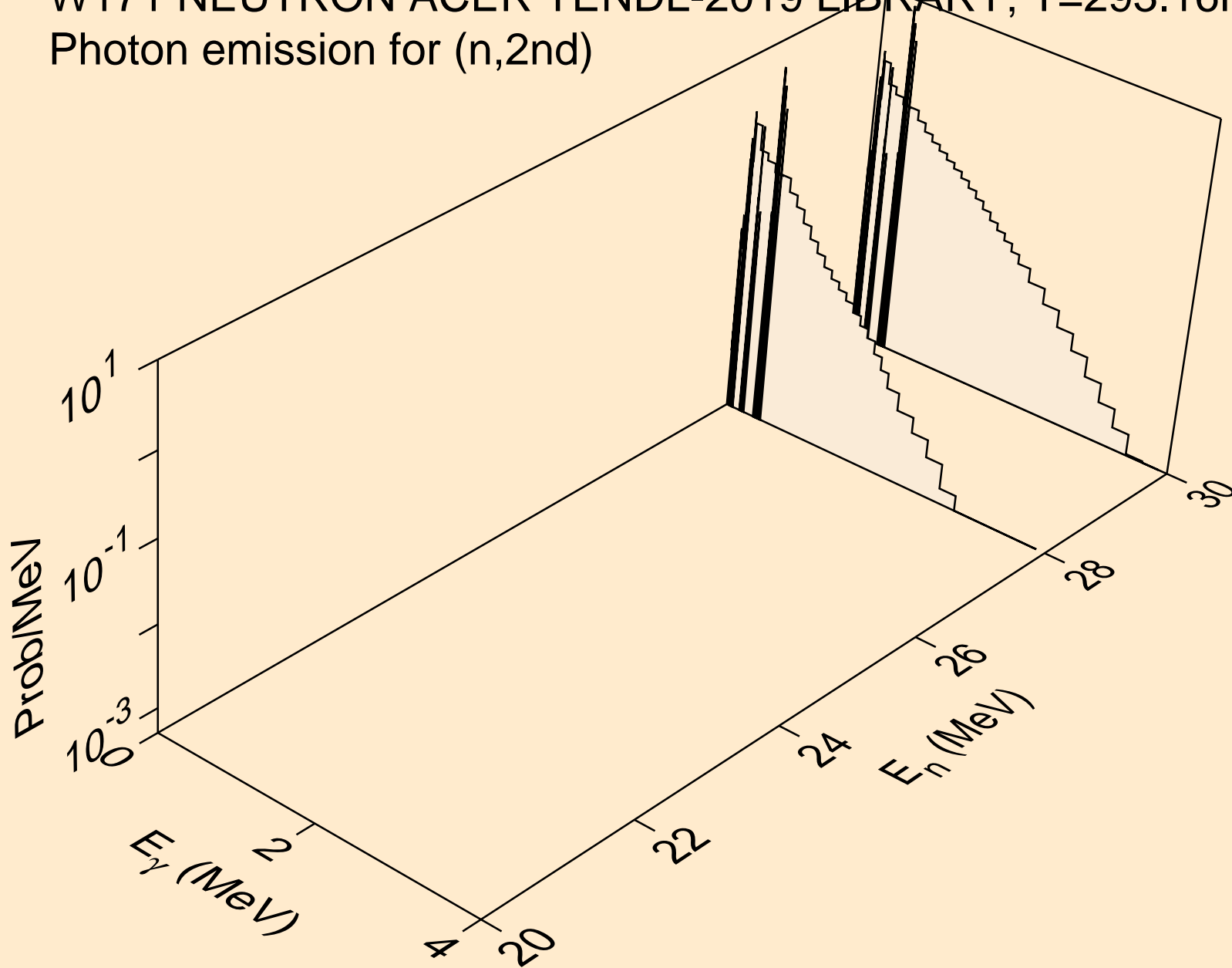

W171 NEUTRON ACER TENDL-2019 LIBRARY; T=293.16K  
Photon emission for (n,2n)

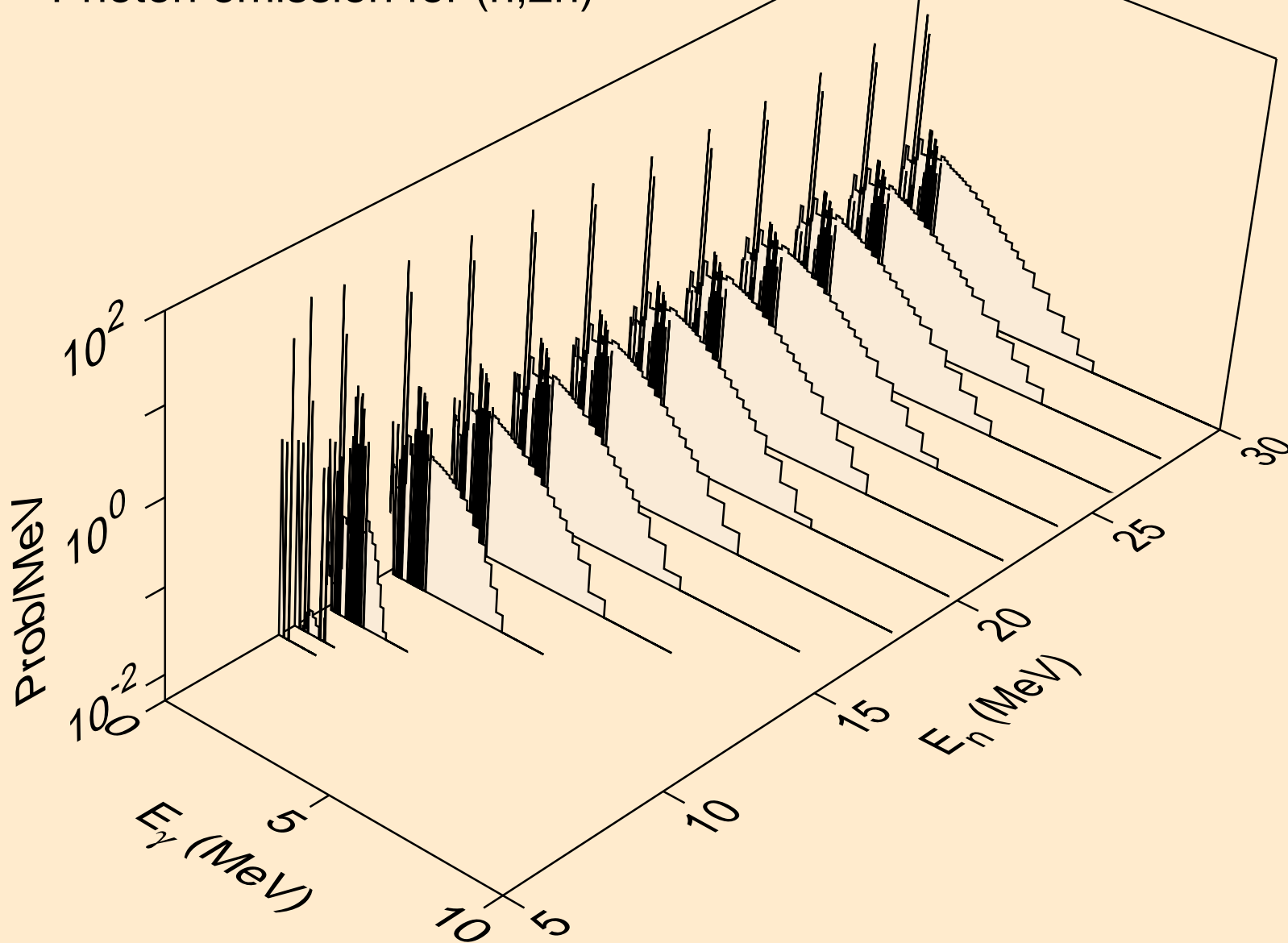

W171 NEUTRON ACER TENDL-2019 LIBRARY; T=293.16K  
Photon emission for (n,3n)

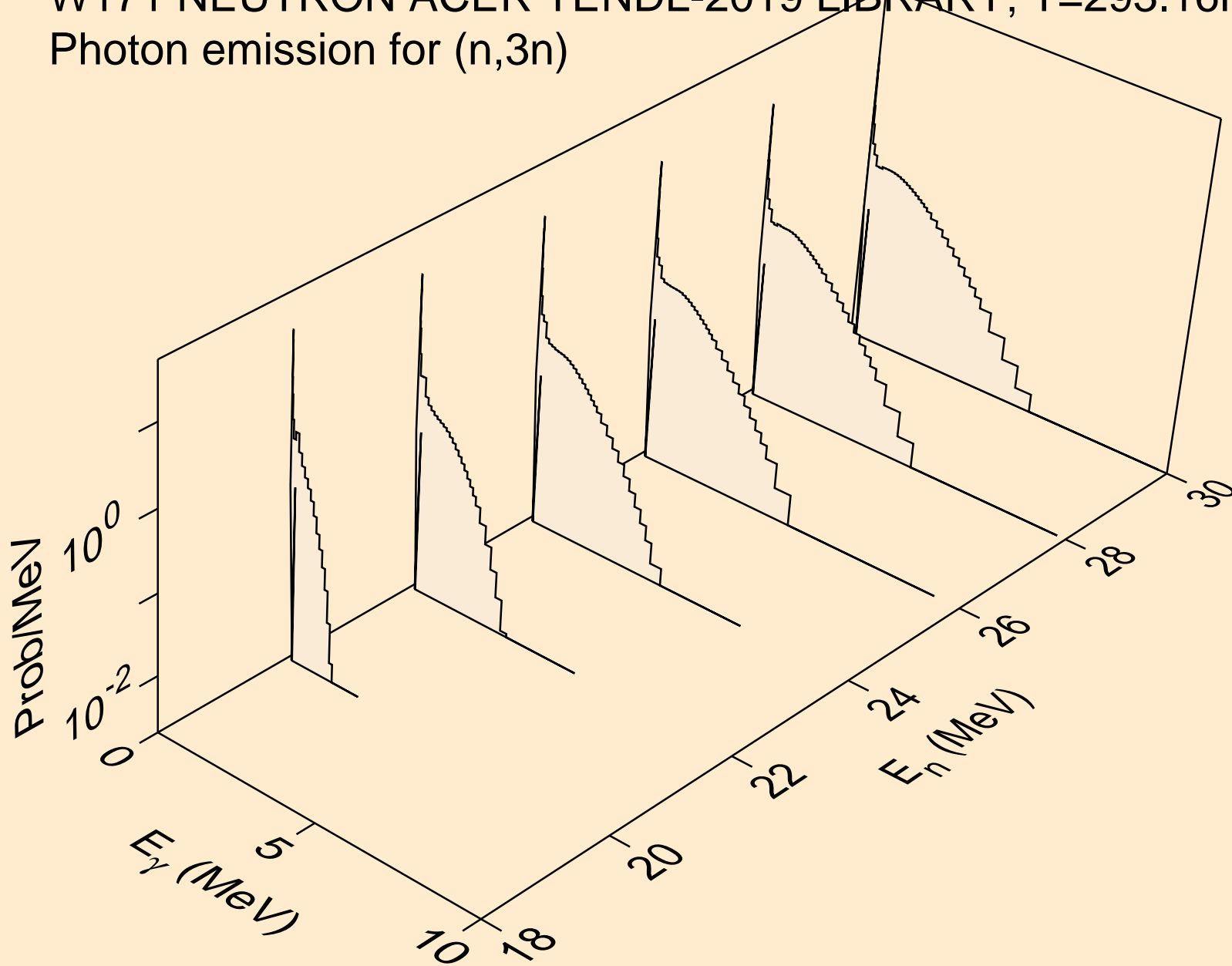

W171 NEUTRON ACER TENDL-2019 LIBRARY; T=293.16K  
Photon emission for (n,n\*)a

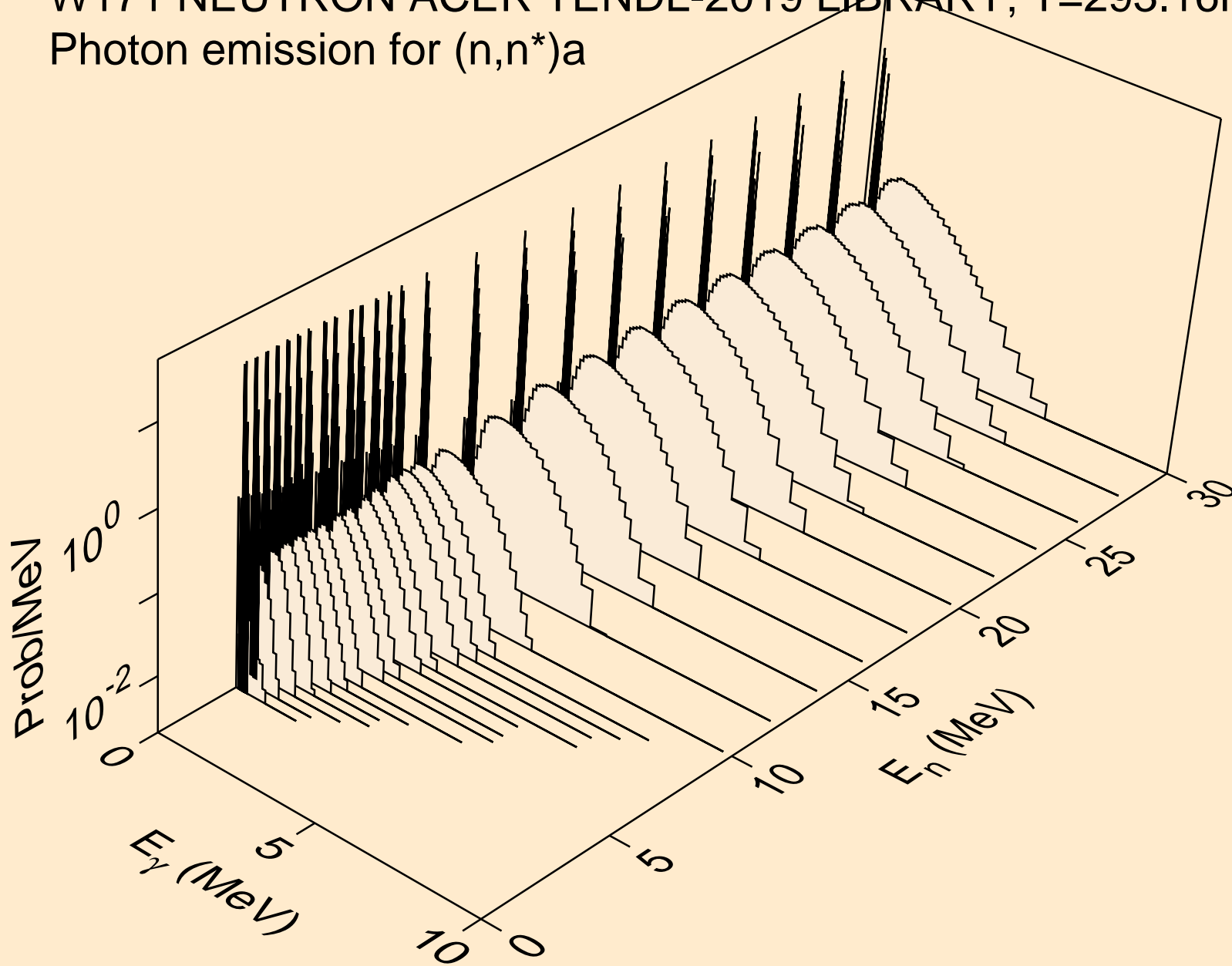

W171 NEUTRON ACER TENDL-2019 LIBRARY; T=293.16K  
Photon emission for (n,2n)a

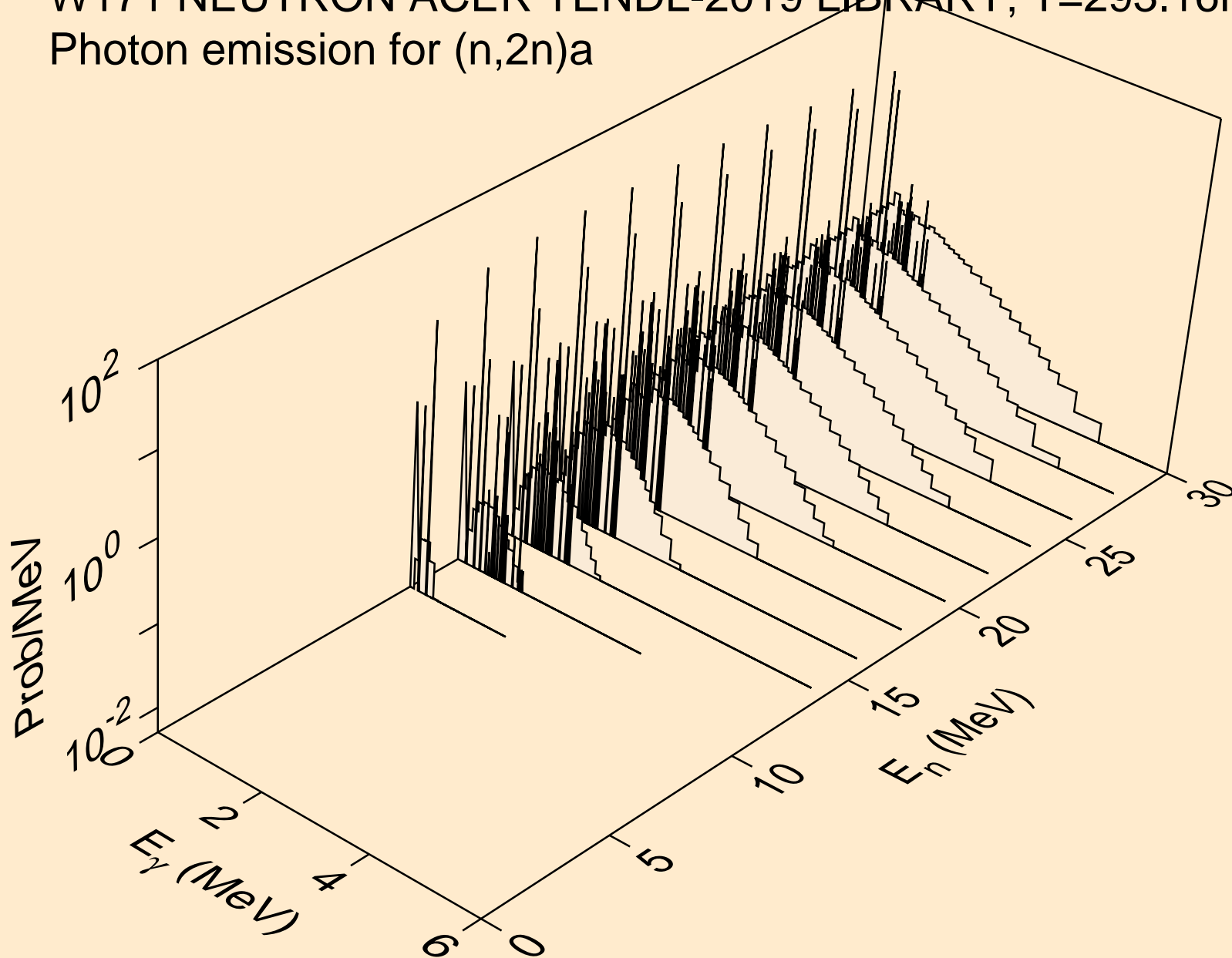



W171 NEUTRON ACER TENDL-2019 LIBRARY; T=293.16K  
Photon emission for (n,3n)a

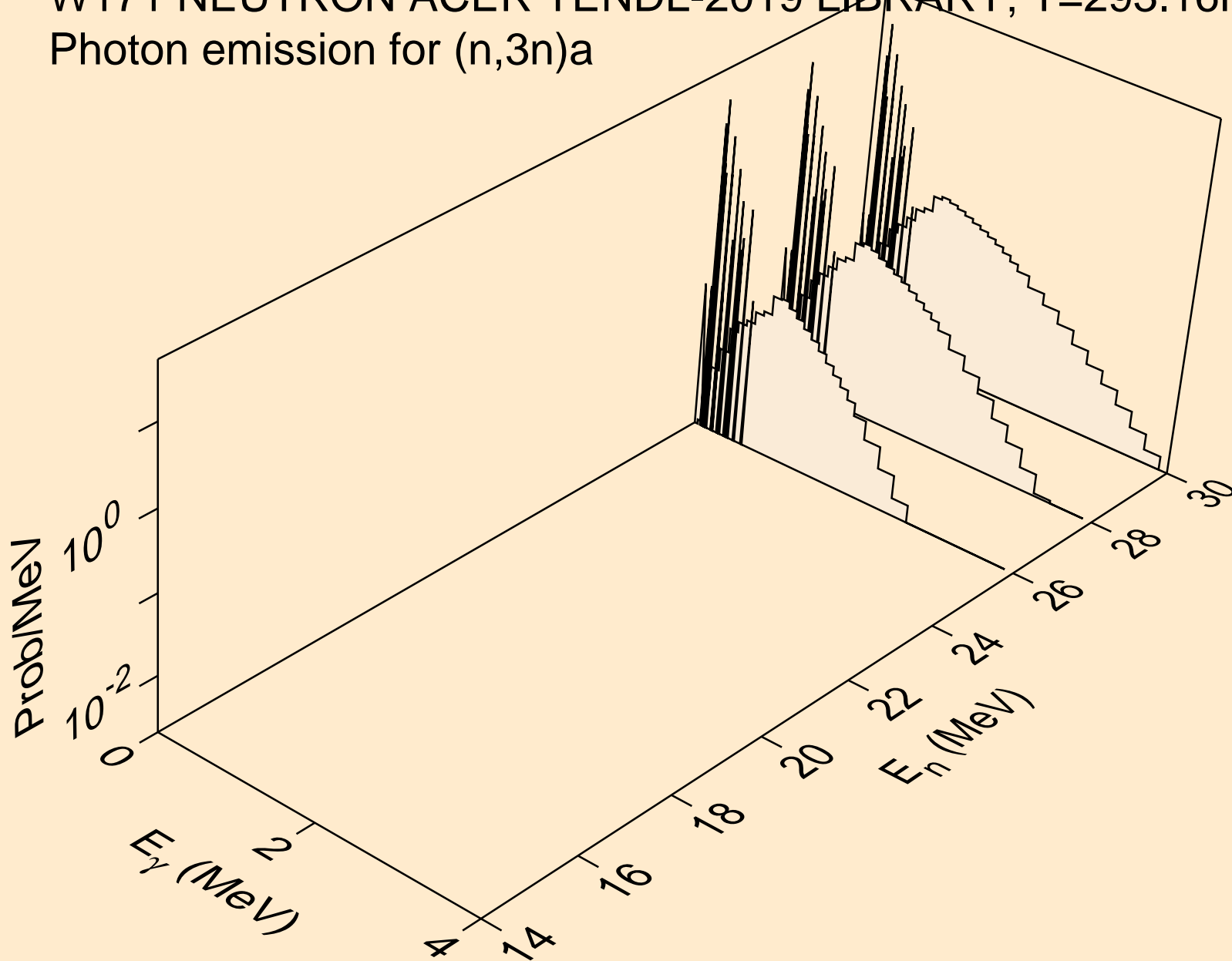

W171 NEUTRON ACER TENDL-2019 LIBRARY; T=293.16K  
Photon emission for (n,n\*)p

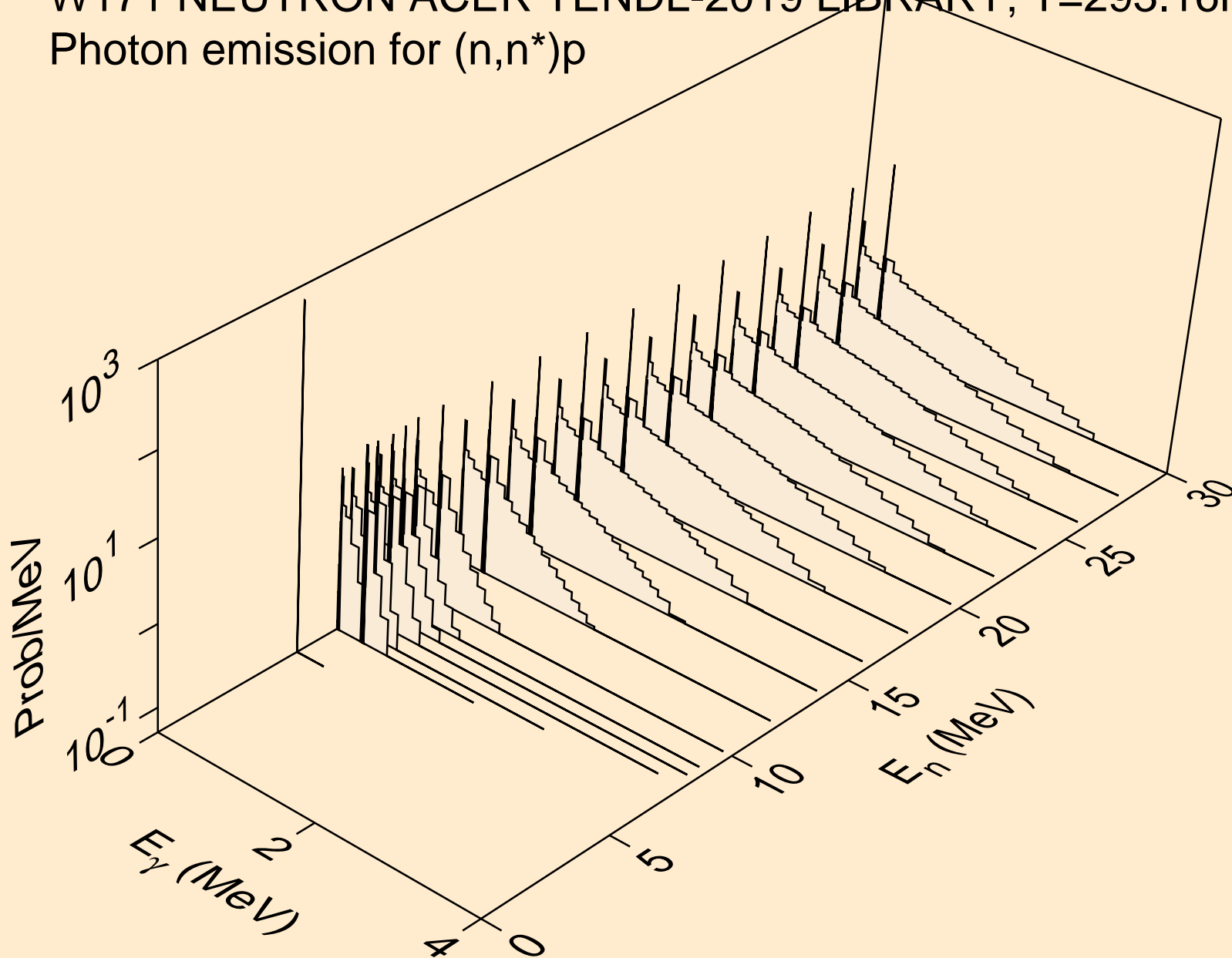

W171 NEUTRON ACER TENDL-2019 LIBRARY; T=293.16K  
Photon emission for (n,n\*)2a

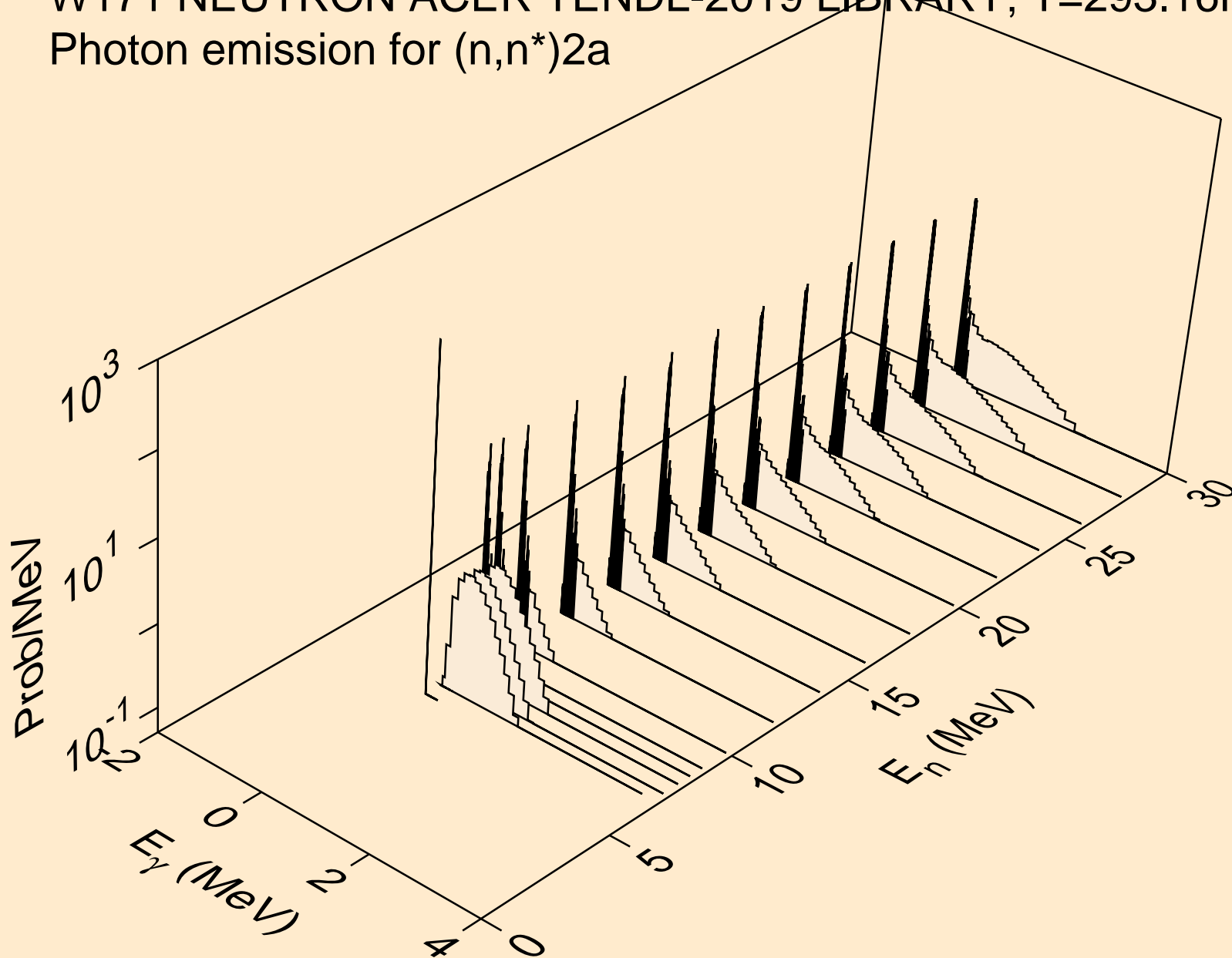

W171 NEUTRON ACER TENDL-2019 LIBRARY; T=293.16K  
Photon emission for (n,2n)2a

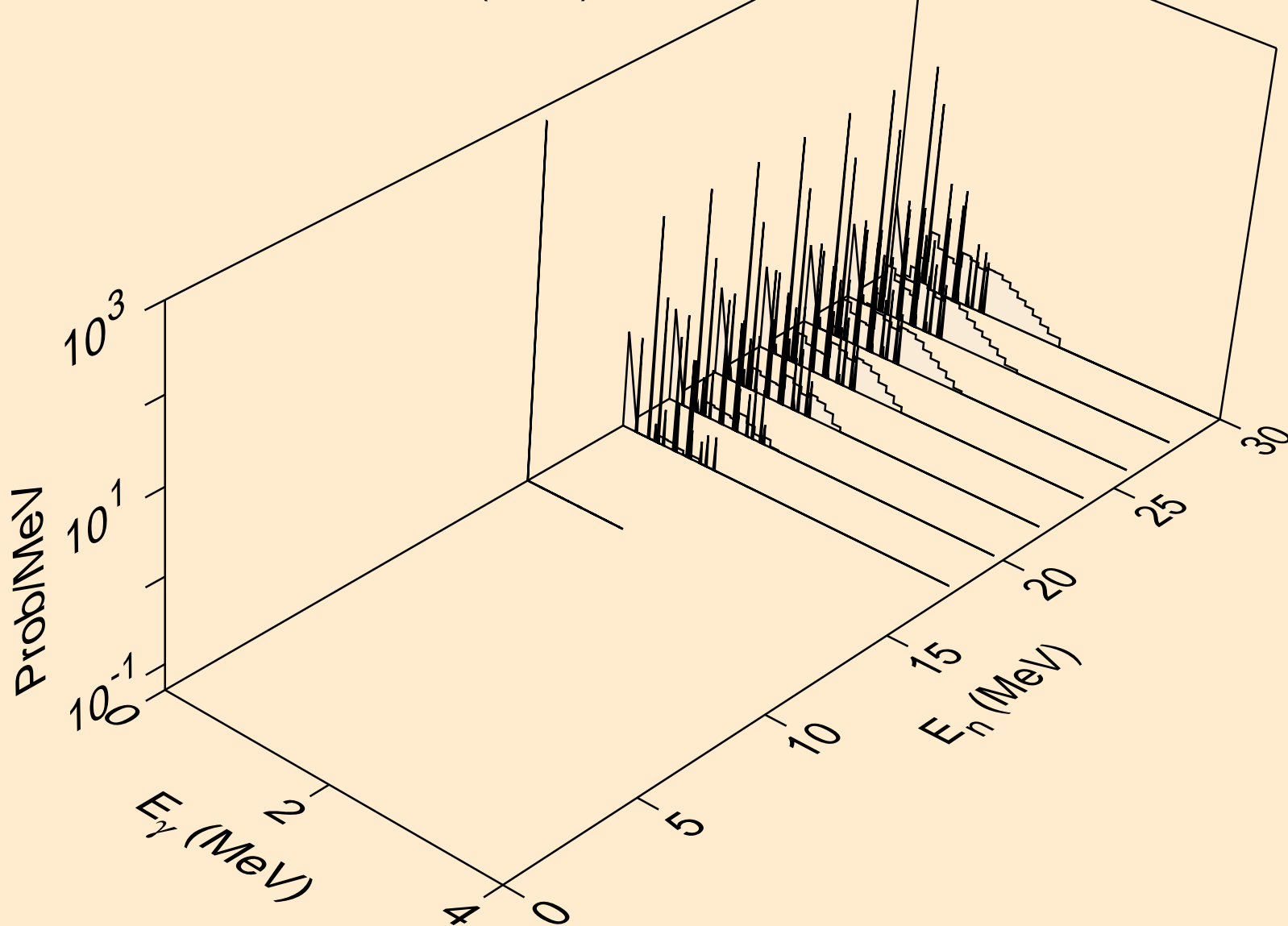

W171 NEUTRON ACER TENDL-2019 LIBRARY; T=293.16K  
Photon emission for (n,n\*)d

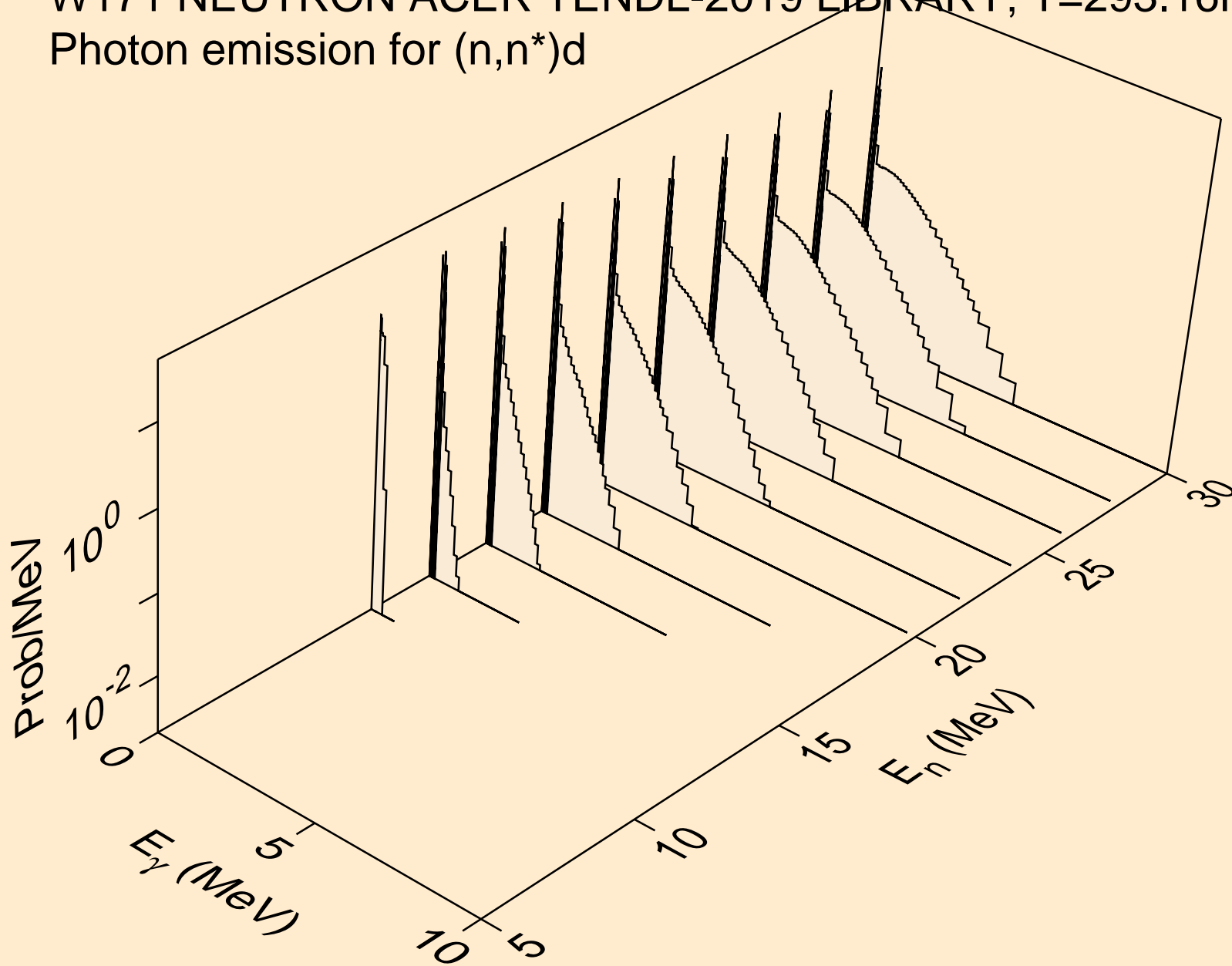

W171 NEUTRON ACER TENDL-2019 LIBRARY; T=293.16K  
Photon emission for (n,n\*)t

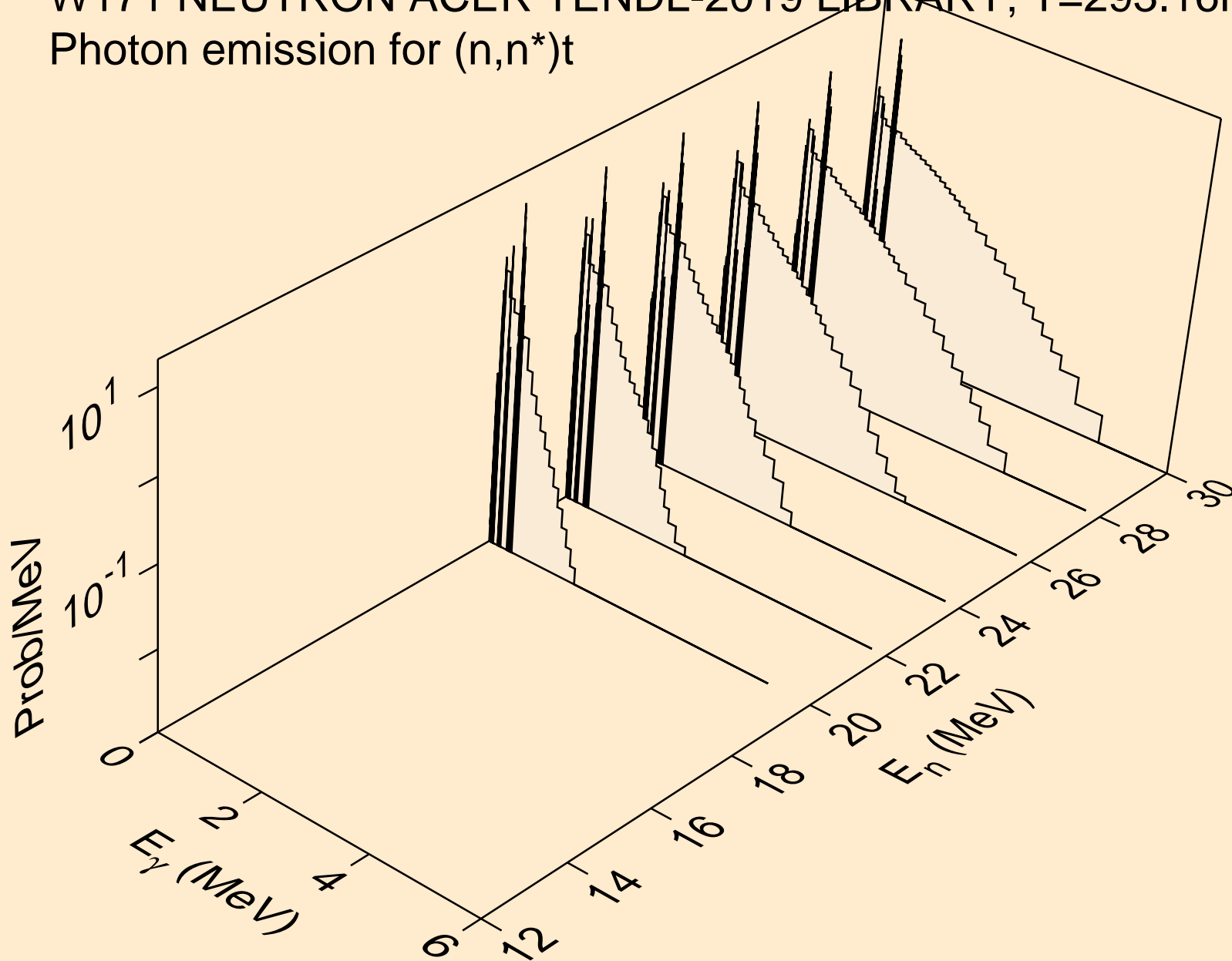

W171 NEUTRON ACER TENDL-2019 LIBRARY; T=293.16K  
Photon emission for (n,n\*)he3

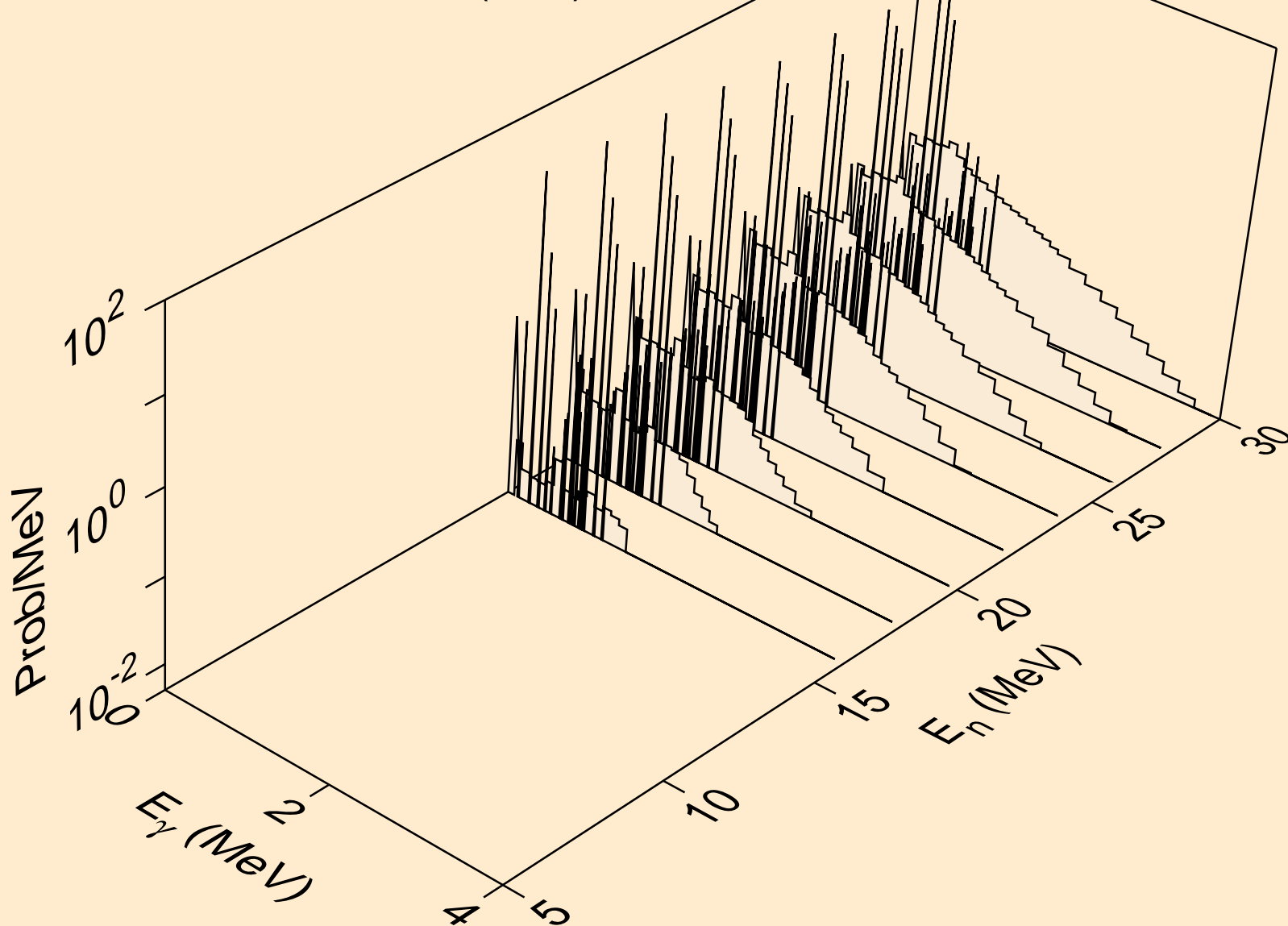

W171 NEUTRON ACER TENDL-2019 LIBRARY; T=293.16K  
Photon emission for (n,4n)

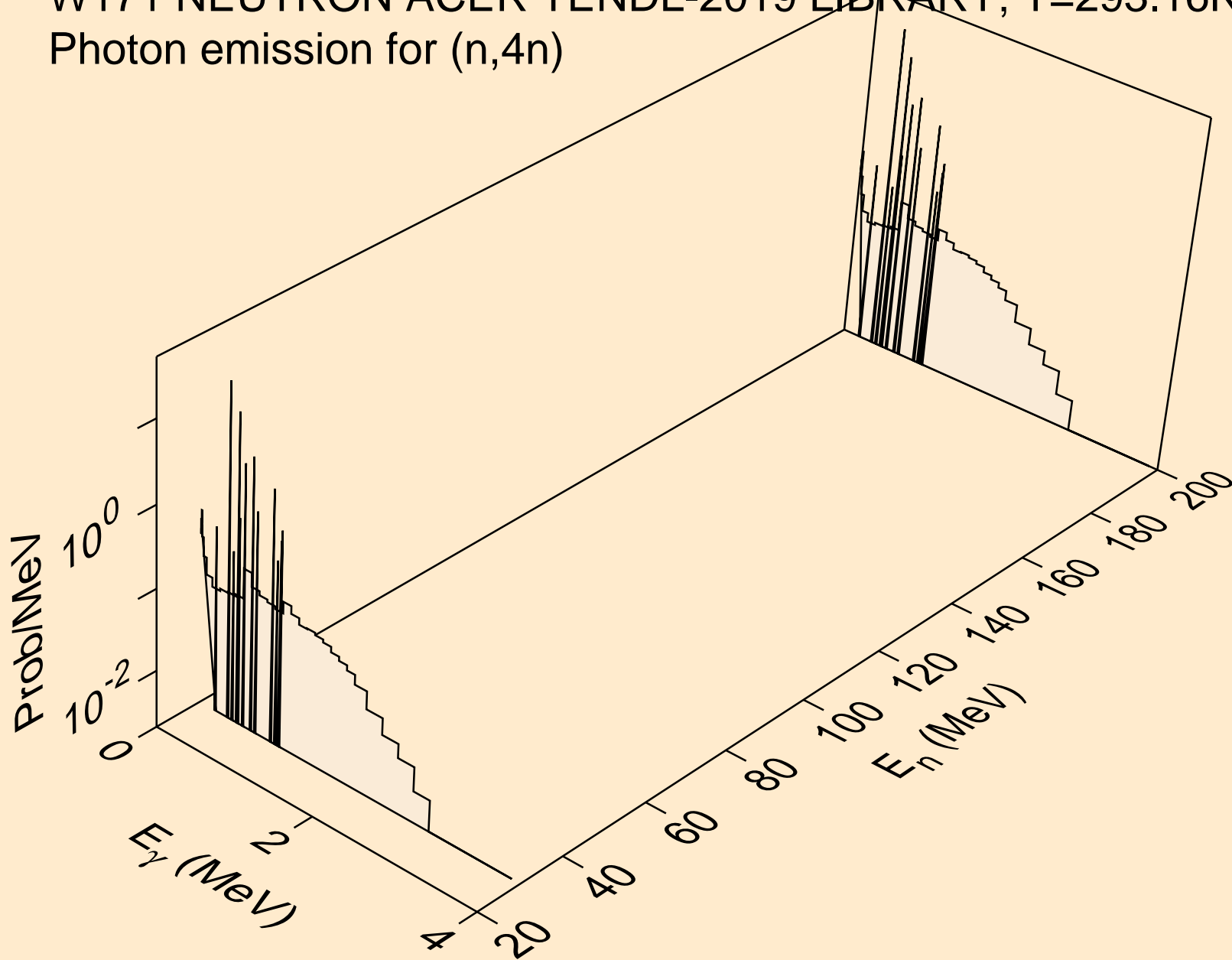



W171 NEUTRON ACER TENDL-2019 LIBRARY; T=293.16K  
Photon emission for (n,2np)

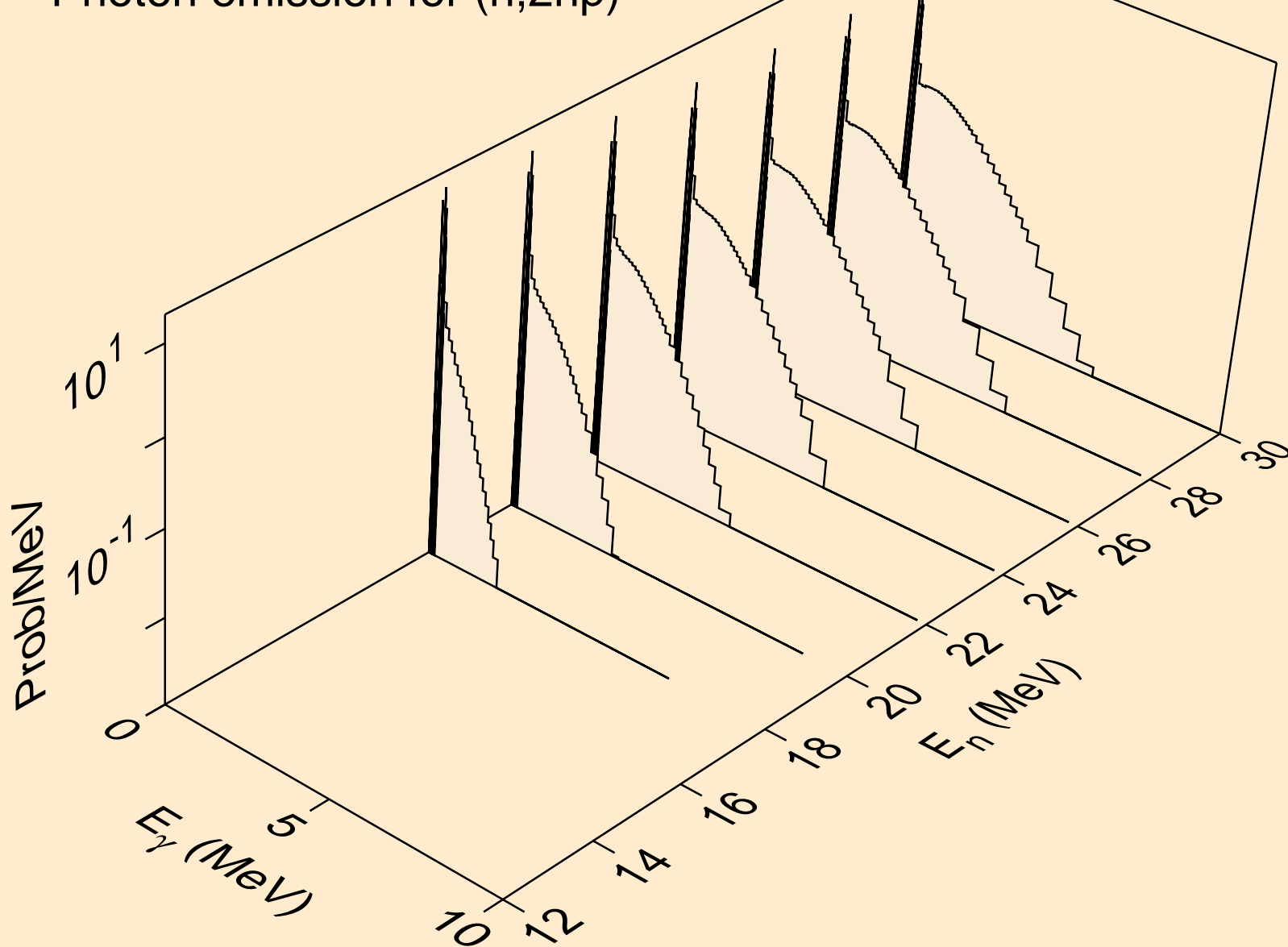

W171 NEUTRON ACER TENDL-2019 LIBRARY; T=293.16K  
Photon emission for (n,3np)

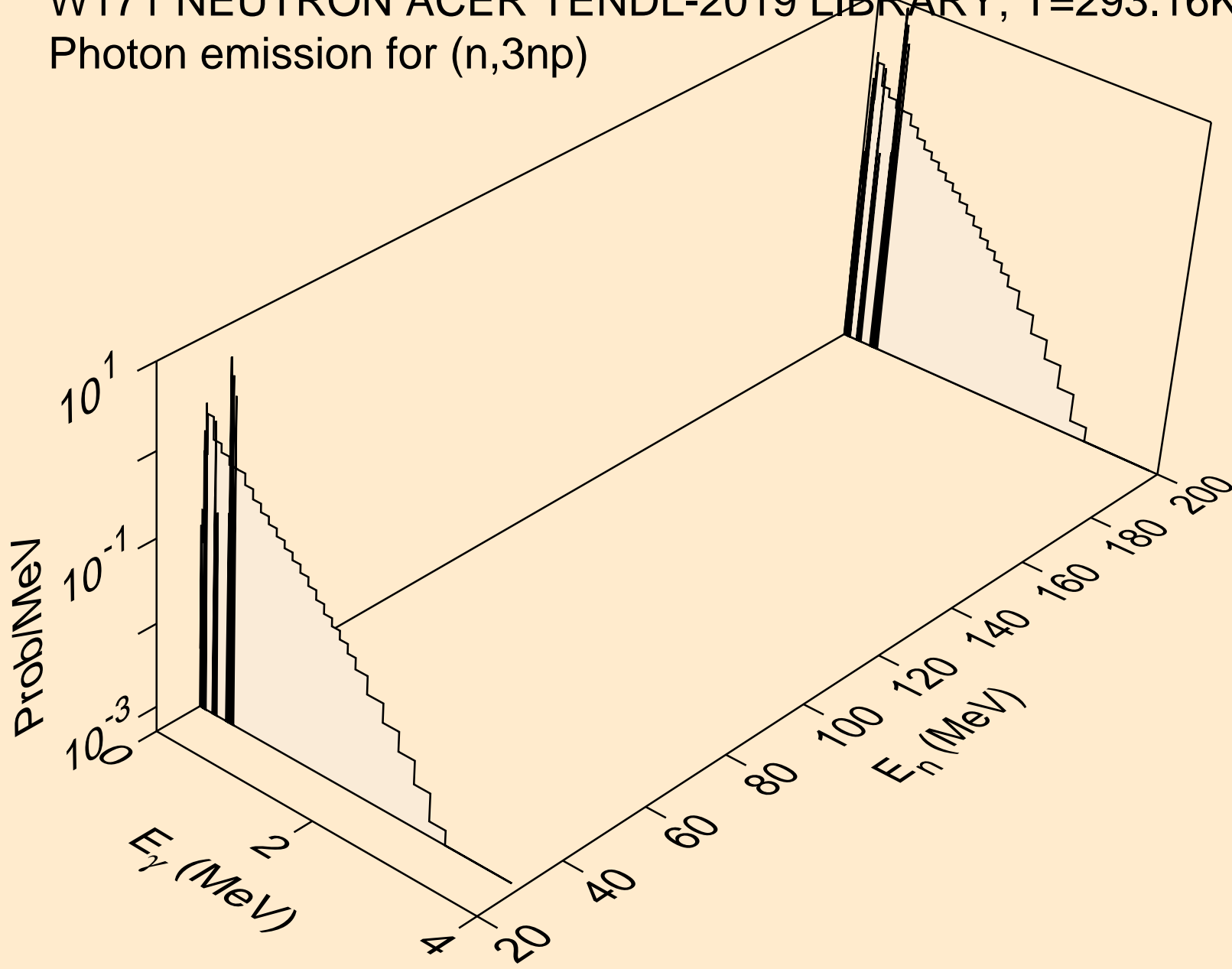

W171 NEUTRON ACER TENDL-2019 LIBRARY; T=293.16K  
Photon emission for (n,2np)

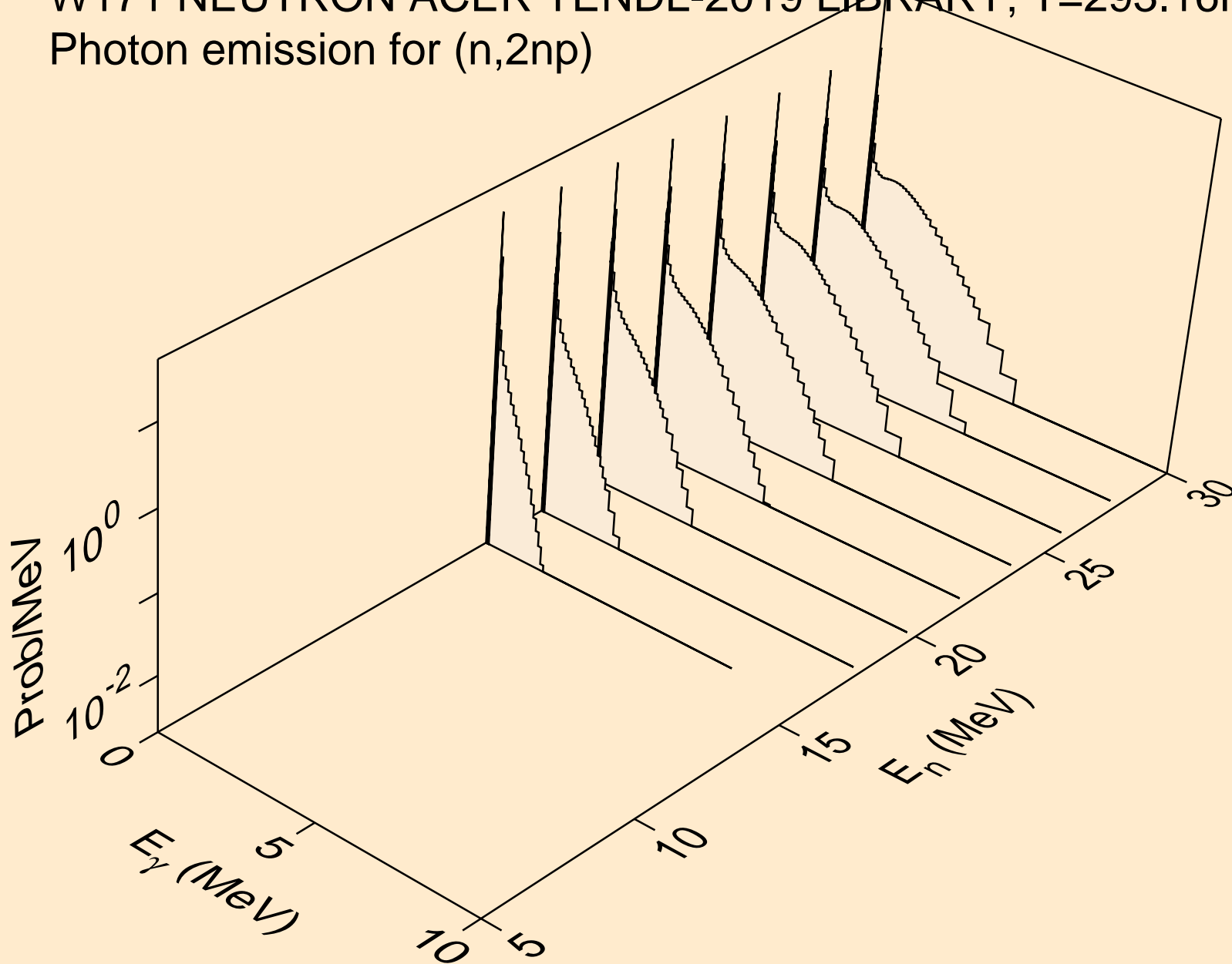

W171 NEUTRON ACER TENDL-2019 LIBRARY; T=293.16K  
Photon emission for (n,npa)

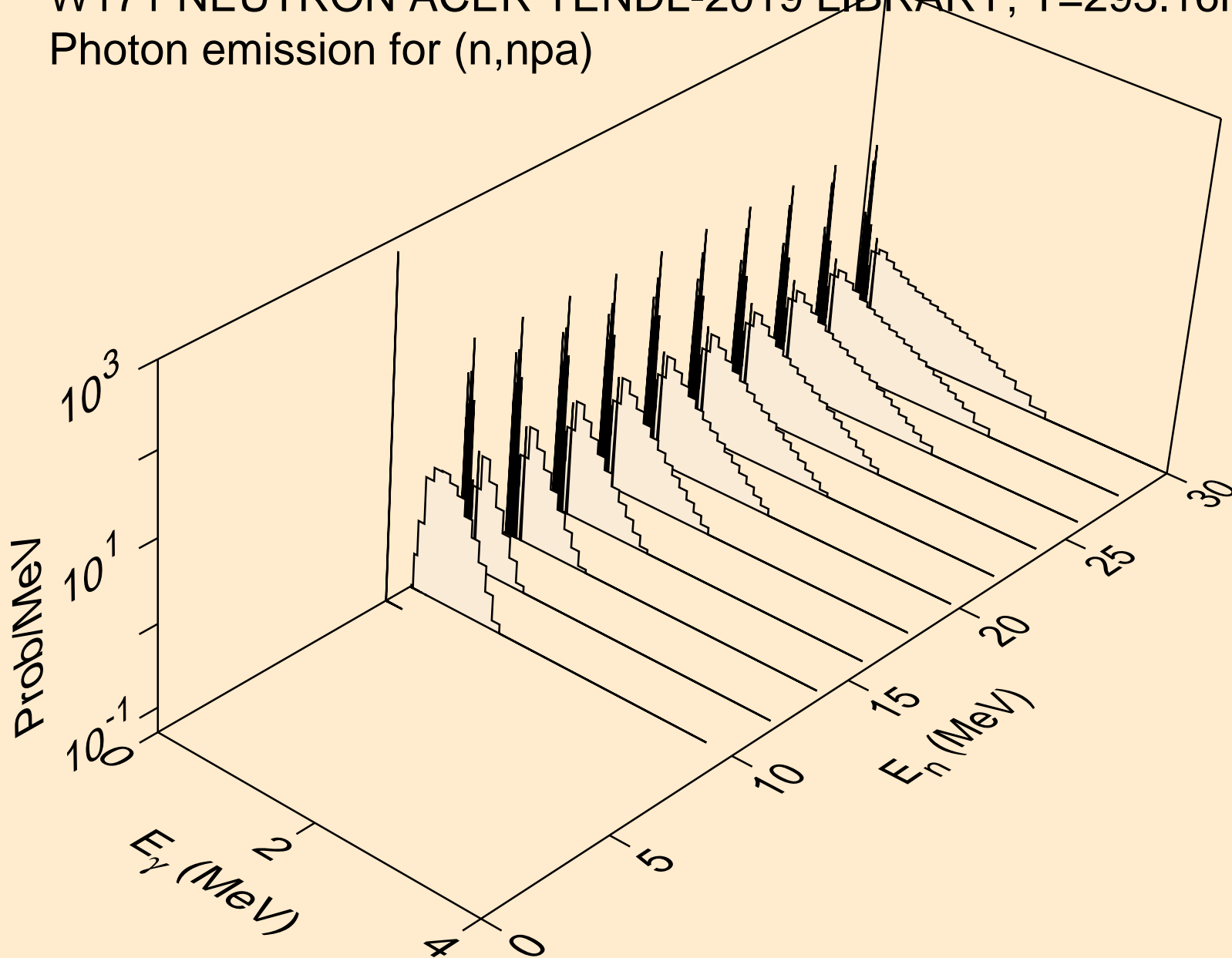

W171 NEUTRON ACER TENDL-2019 LIBRARY; T=293.16K  
Photon emission for (n,n\*c)

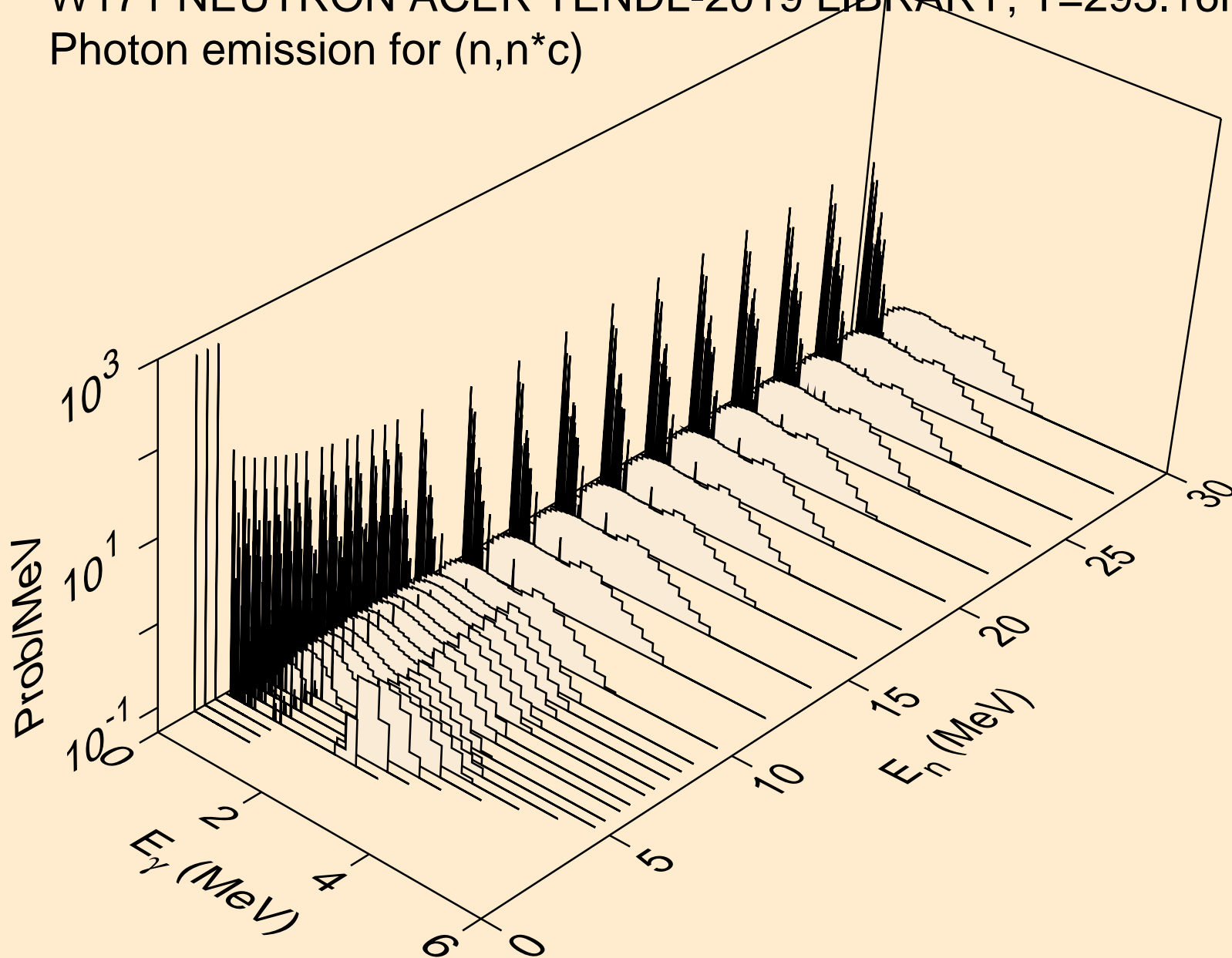

W171 NEUTRON ACER TENDL-2019 LIBRARY; T=293.16K  
Photon emission for (n,gma)

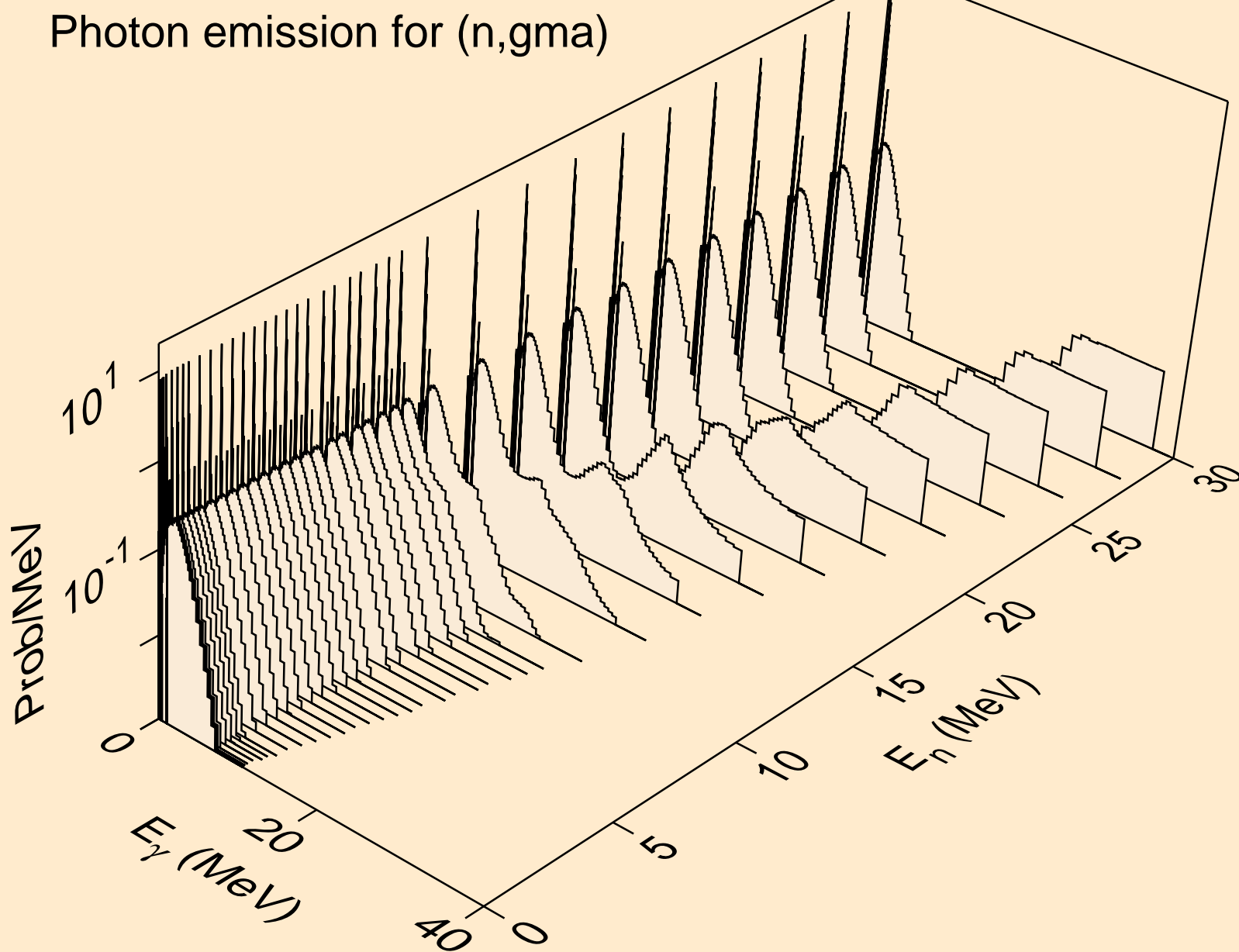

W171 NEUTRON ACER TENDL-2019 LIBRARY; T=293.16K  
Photon emission for (n,p)

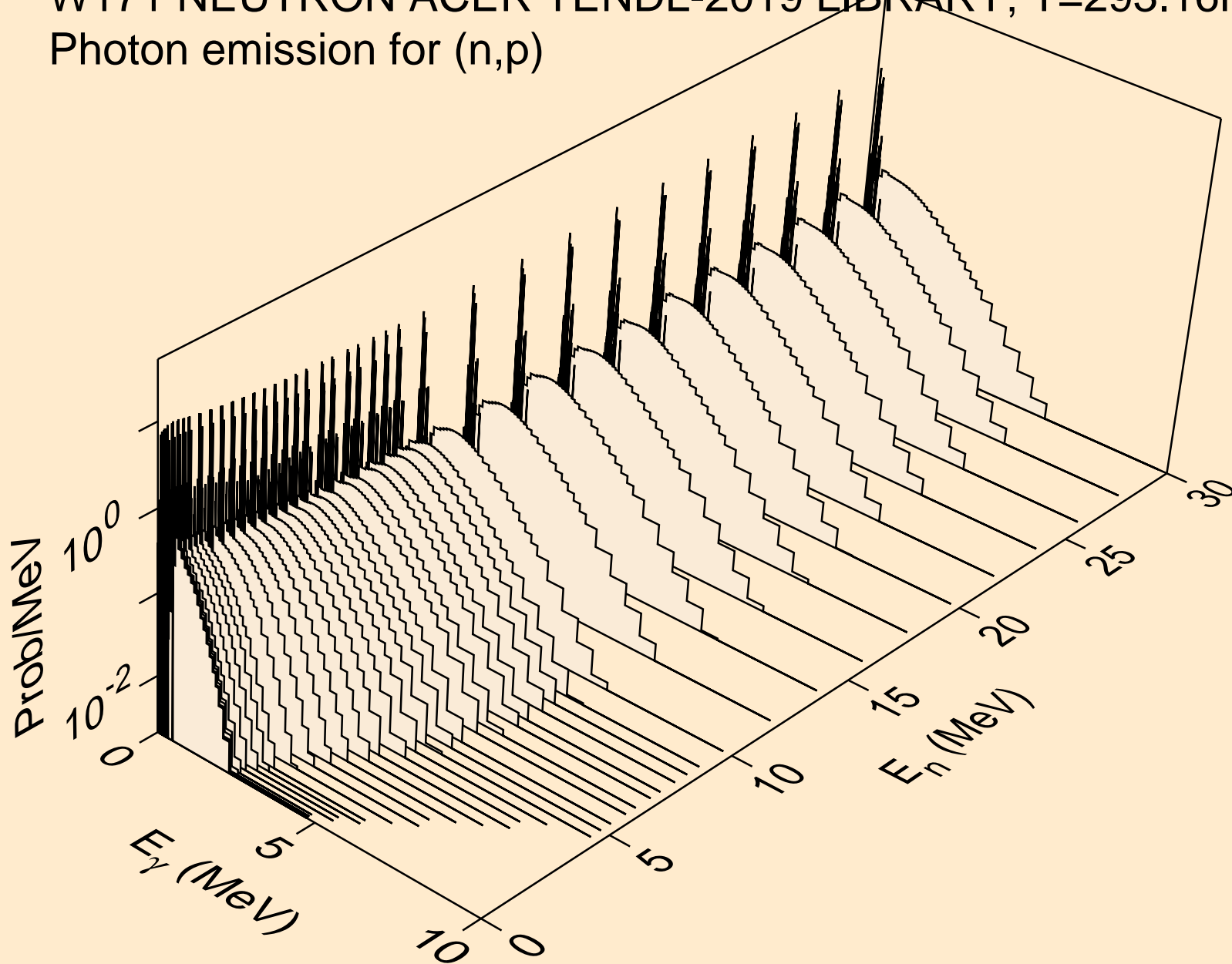

W171 NEUTRON ACER TENDL-2019 LIBRARY; T=293.16K  
Photon emission for (n,d)

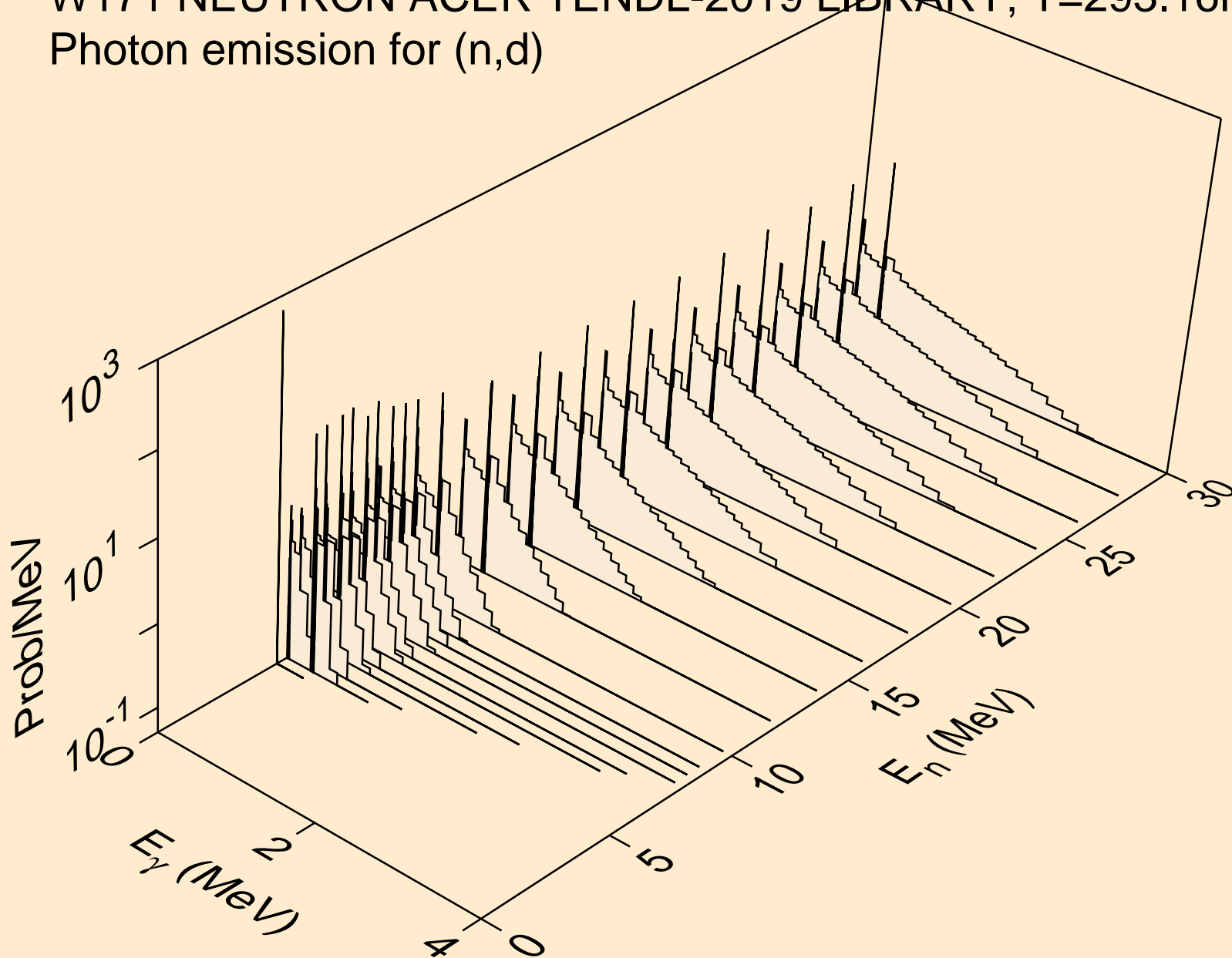



W171 NEUTRON ACER TENDL-2019 LIBRARY; T=293.16K  
Photon emission for (n,t)

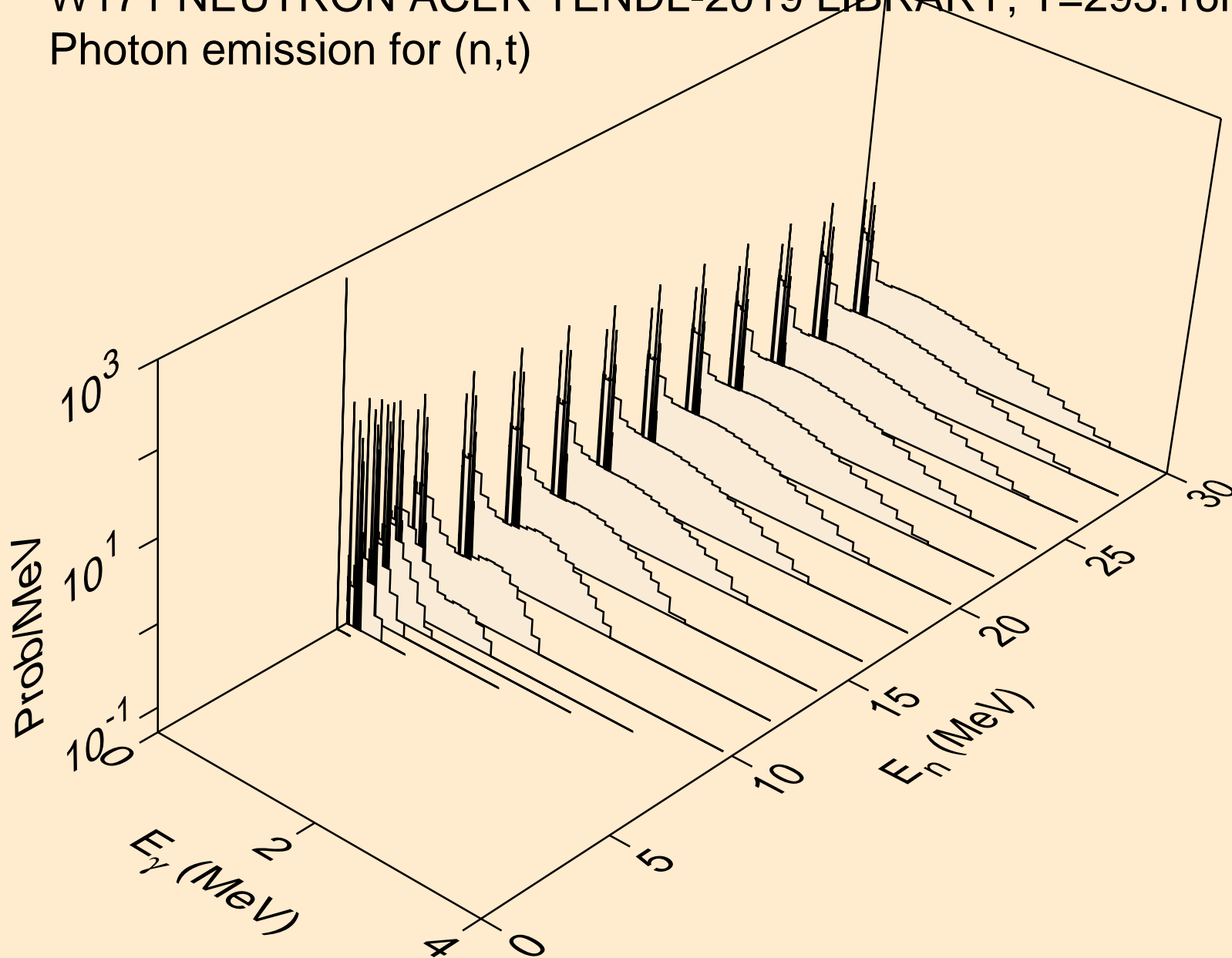

W171 NEUTRON ACER TENDL-2019 LIBRARY; T=293.16K  
Photon emission for (n,he3)

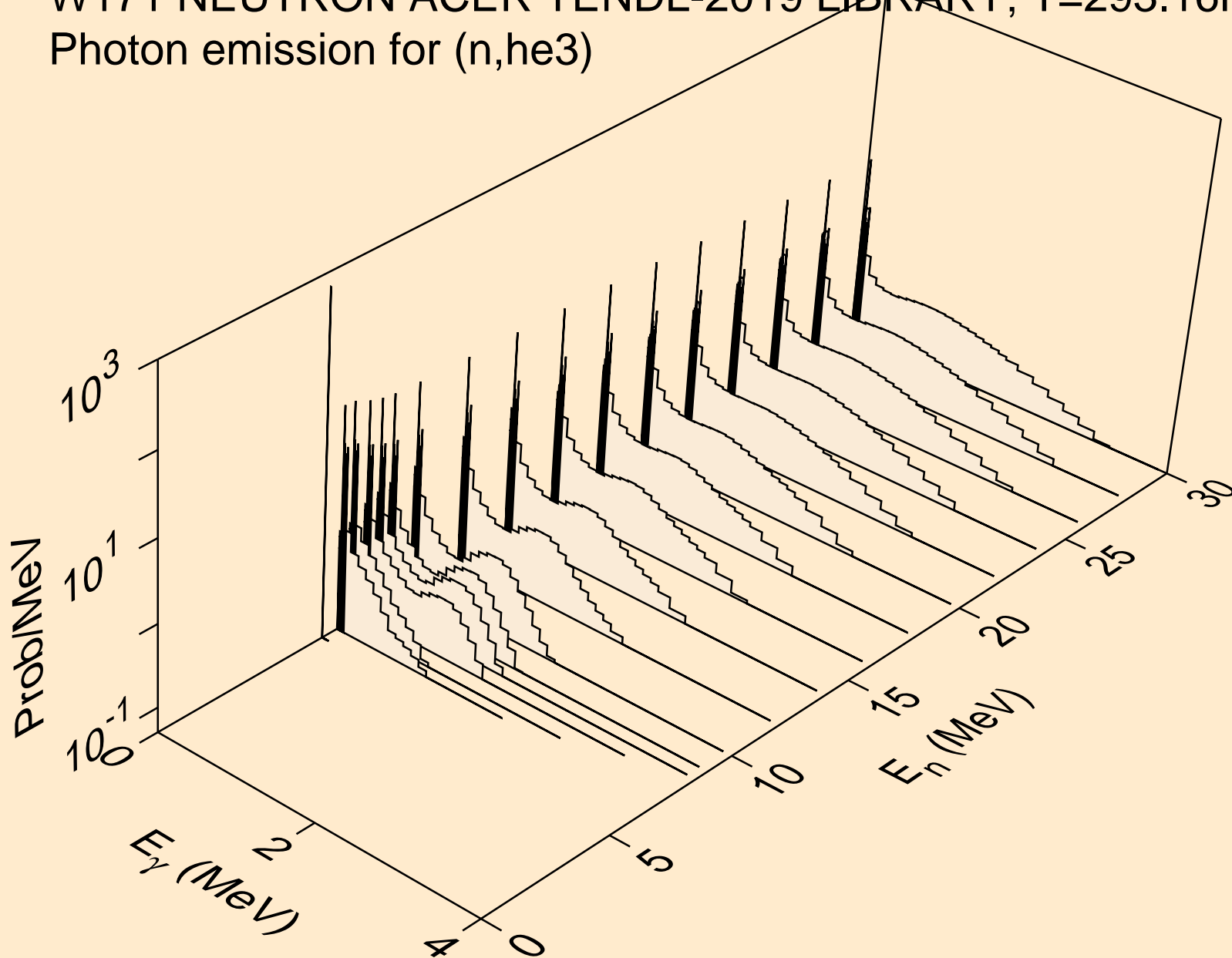

W171 NEUTRON ACER TENDL-2019 LIBRARY; T=293.16K  
Photon emission for (n,a)

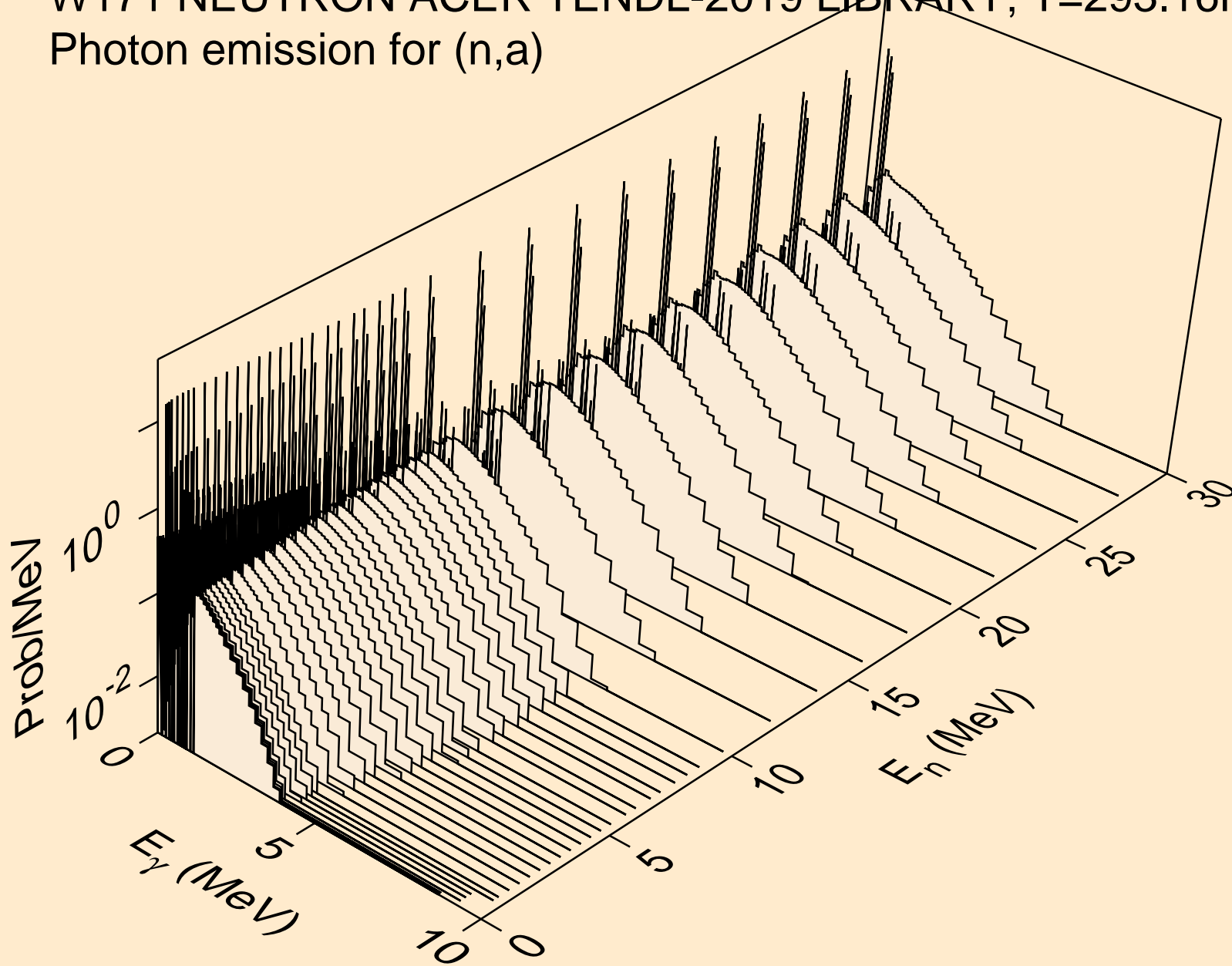

W171 NEUTRON ACER TENDL-2019 LIBRARY; T=293.16K  
Photon emission for (n,2a)

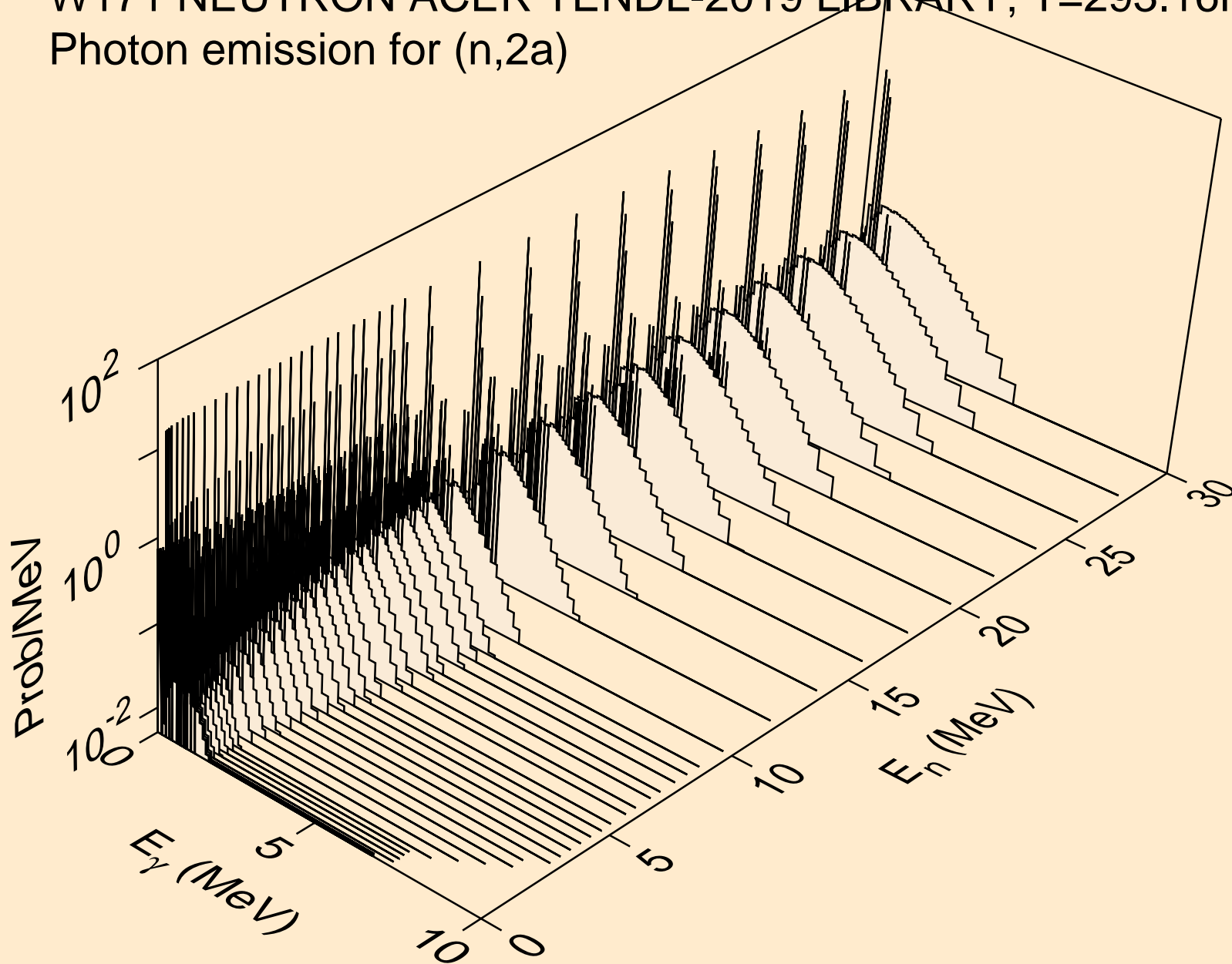

W171 NEUTRON ACER TENDL-2019 LIBRARY; T=293.16K  
Photon emission for (n,2p)

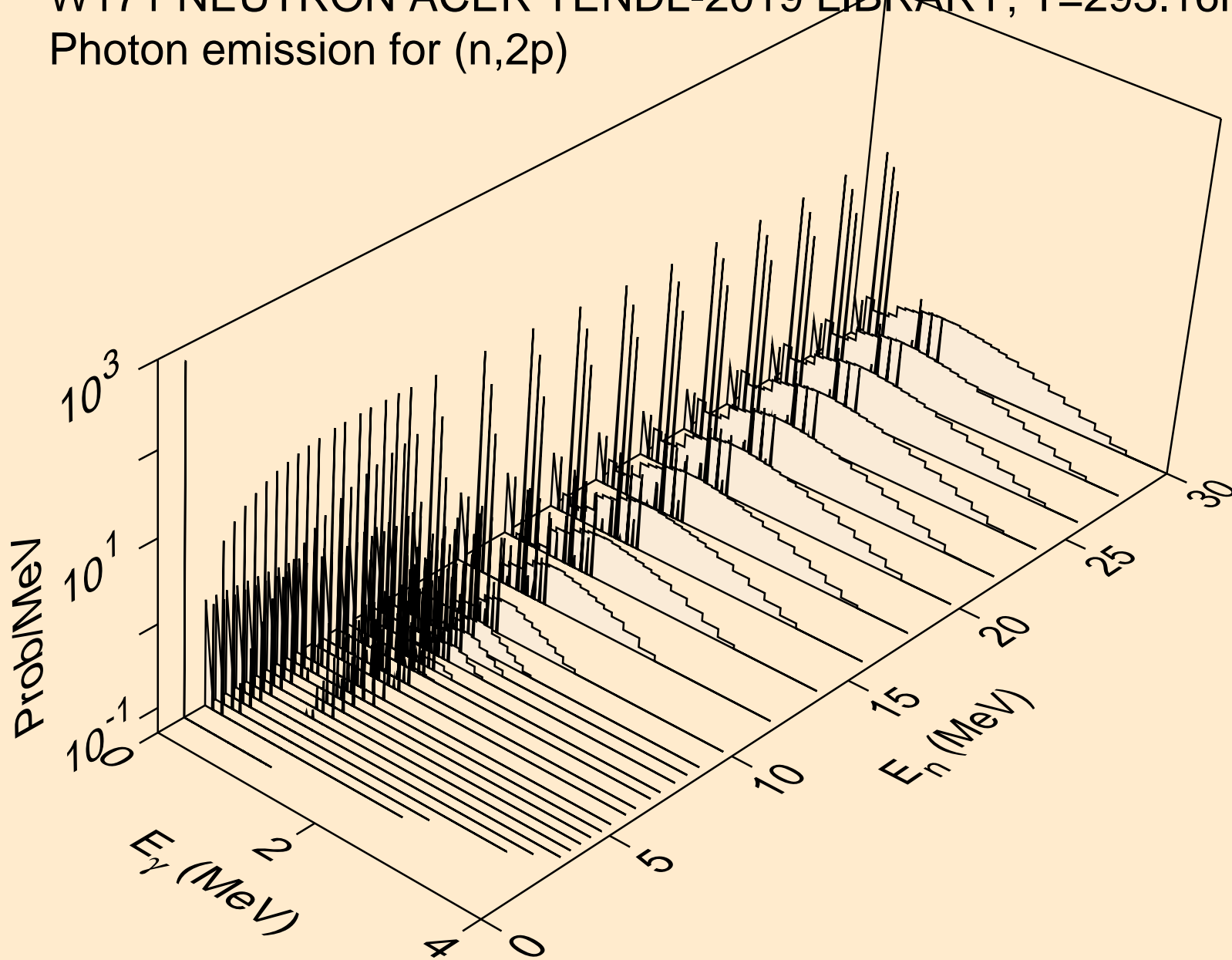

W171 NEUTRON ACER TENDL-2019 LIBRARY; T=293.16K  
Photon emission for (n,p $\alpha$ )

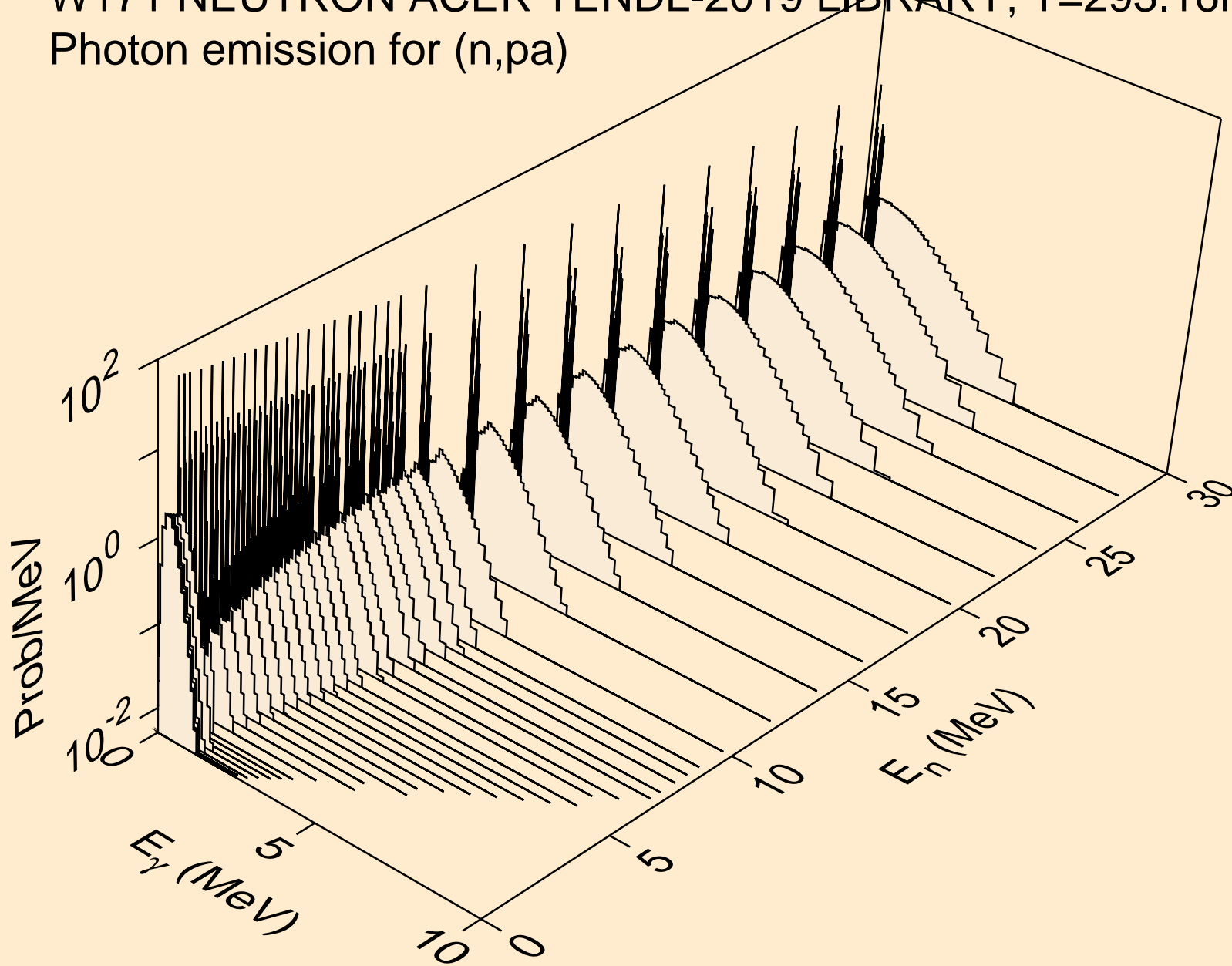

W171 NEUTRON ACER TENDL-2019 LIBRARY; T=293.16K  
Photon emission for (n,pd)

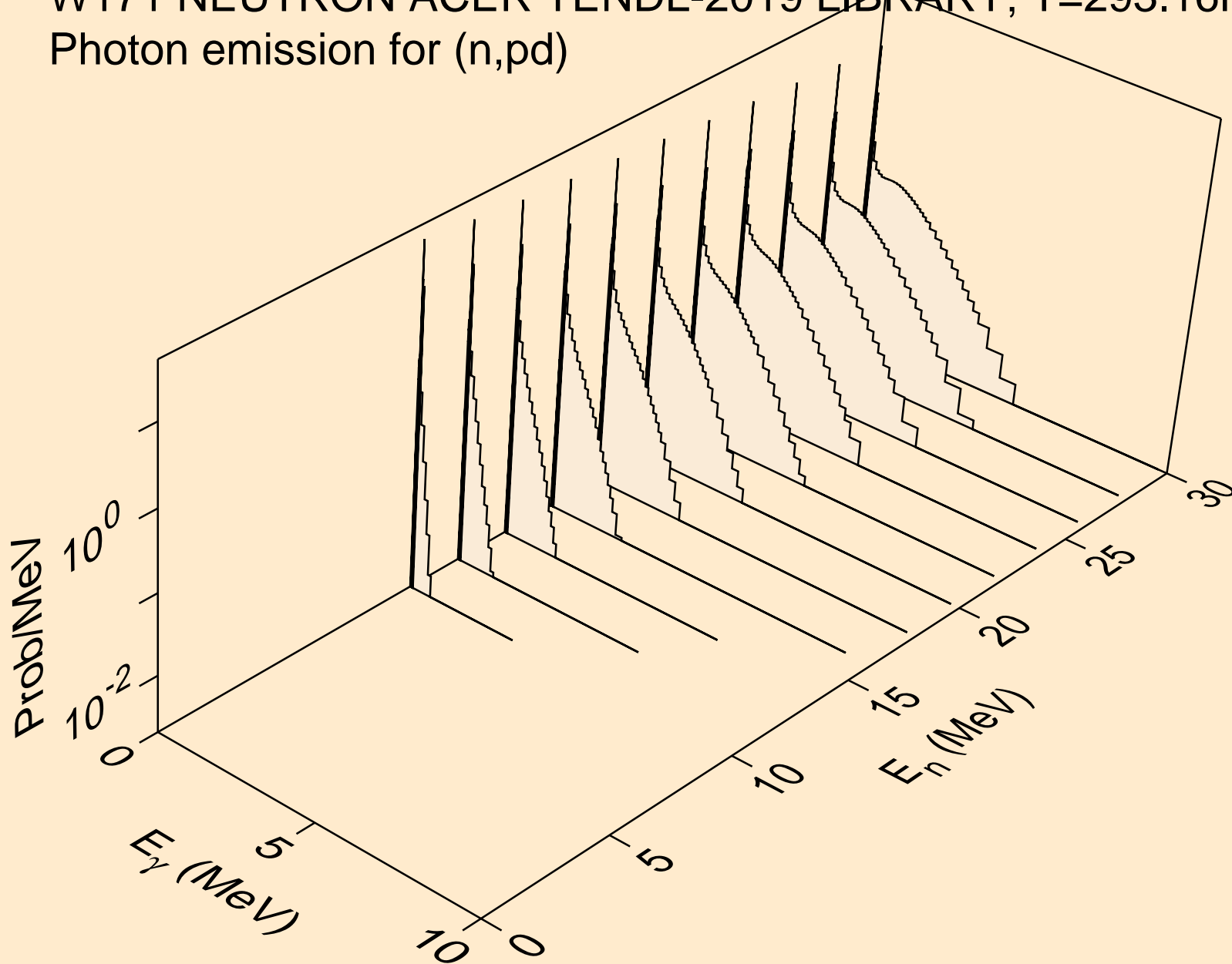

W171 NEUTRON ACER TENDL-2019 LIBRARY; T=293.16K  
Photon emission for (n,pt)

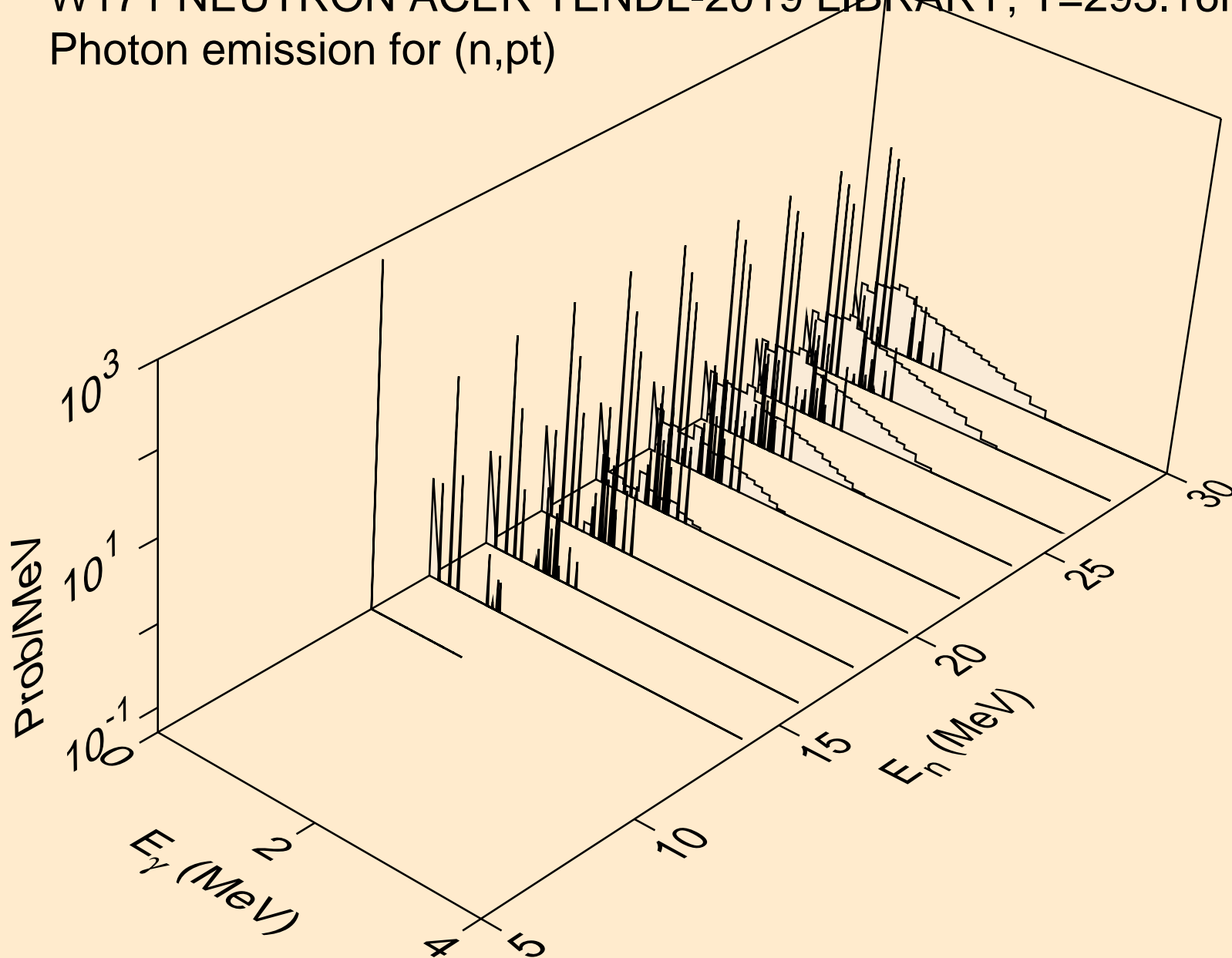



W171 NEUTRON ACER TENDL-2019 LIBRARY; T=293.16K  
Photon emission for (n,da)

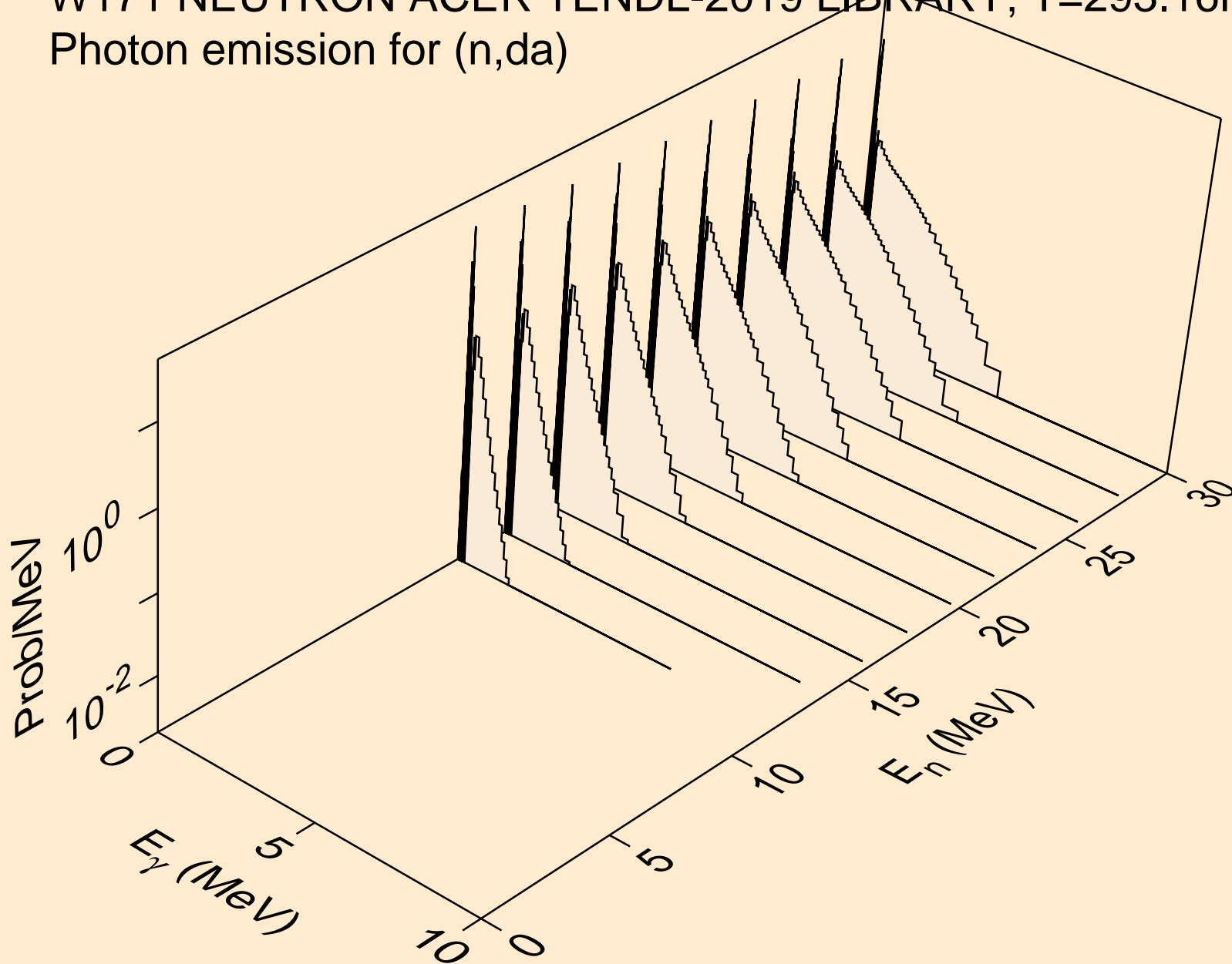

W171 NEUTRON ACER TENDL-2019 LIBRARY; T=293.16K  
thermal capture photon spectrum

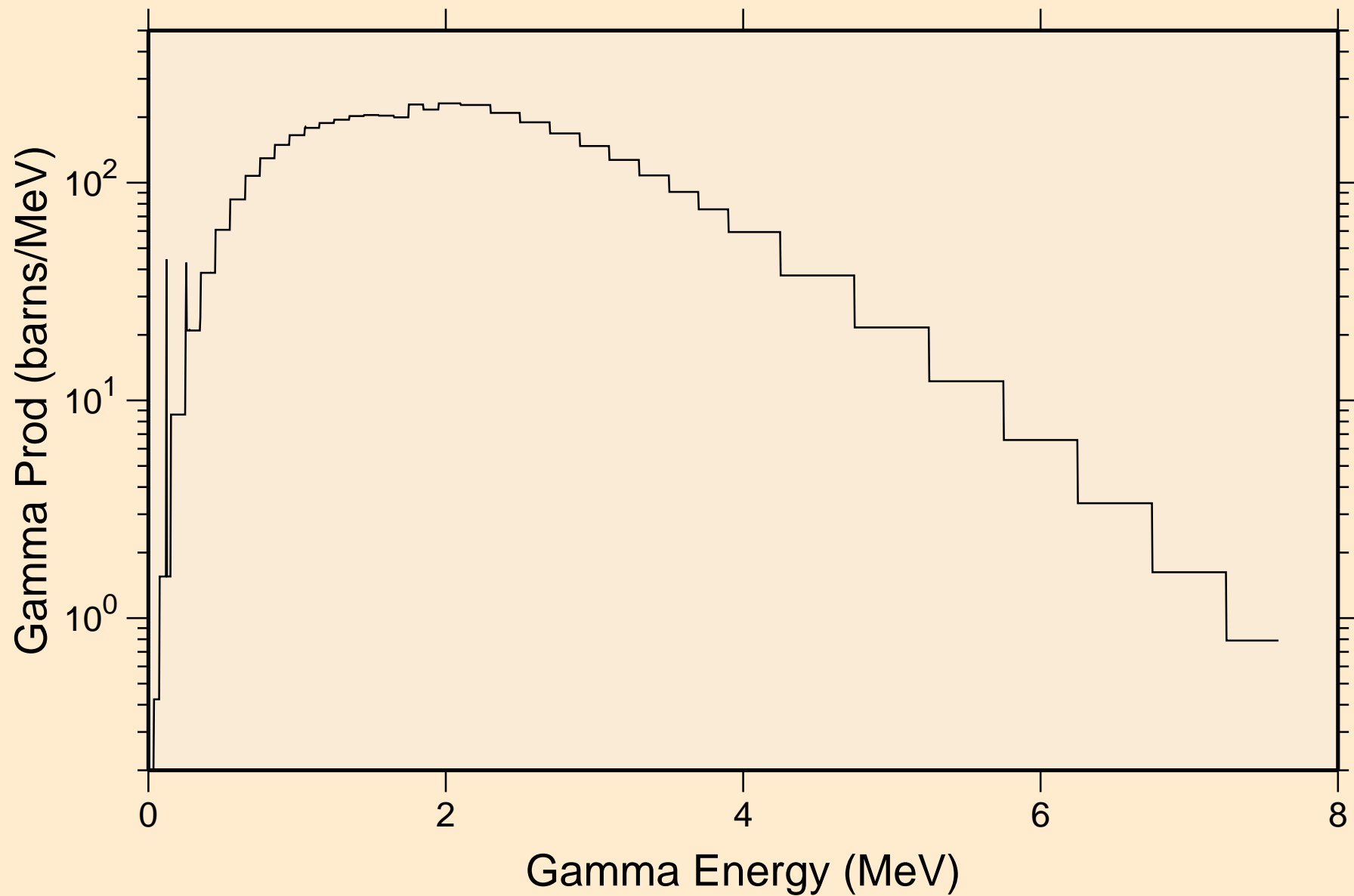

W171 NEUTRON ACER TENDL-2019 LIBRARY; T=293.16K  
14 MeV photon spectrum

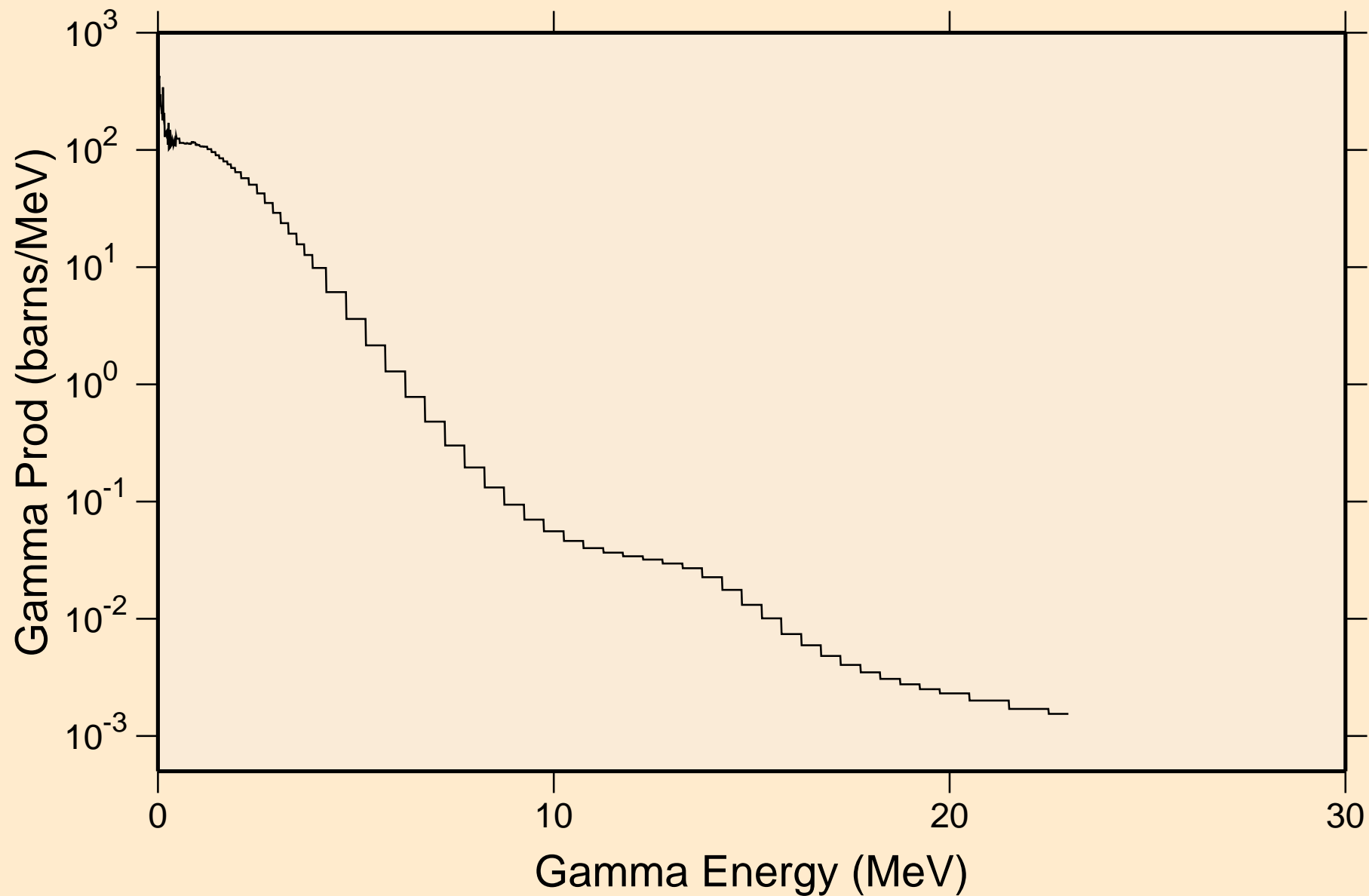

# W171 NEUTRON ACER TENDL-2019 LIBRARY; T=293.16K

## Particle heating contributions

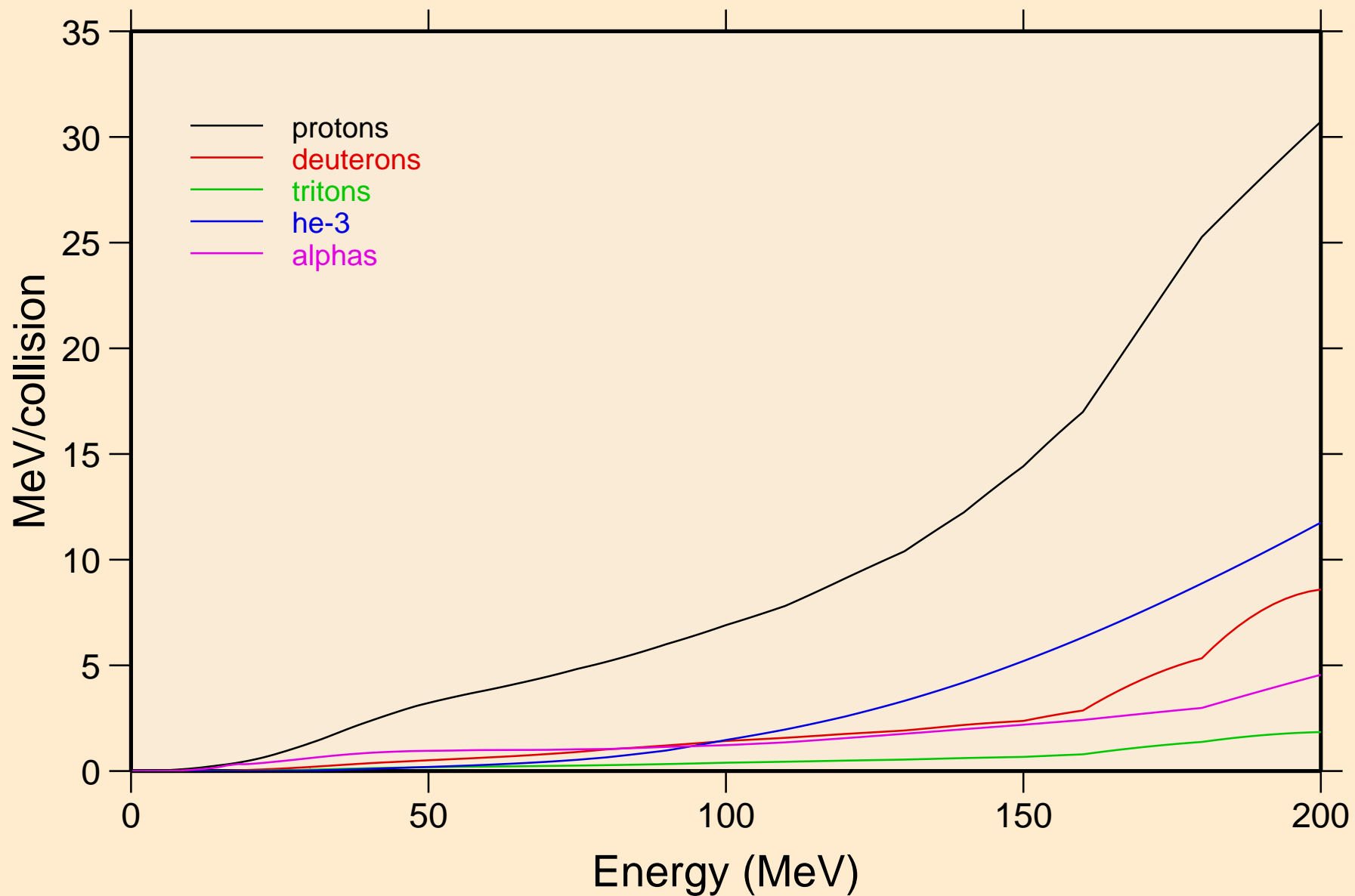

W171 NEUTRON ACER TENDL-2019 LIBRARY; T=293.16K  
Recoil Heating

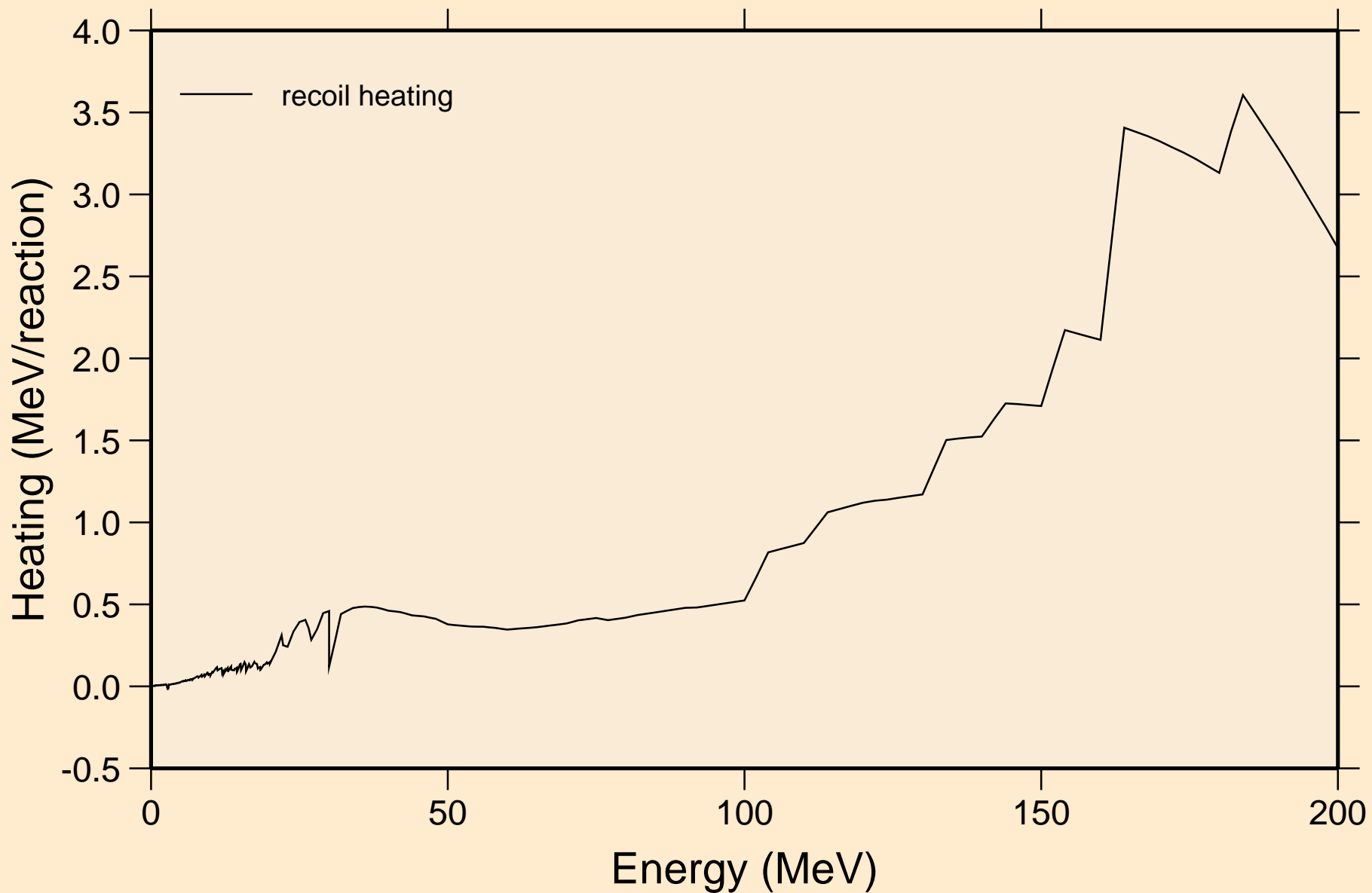

W171 NEUTRON ACER TENDL-2019 LIBRARY; T=293.16K  
Particle production cross sections

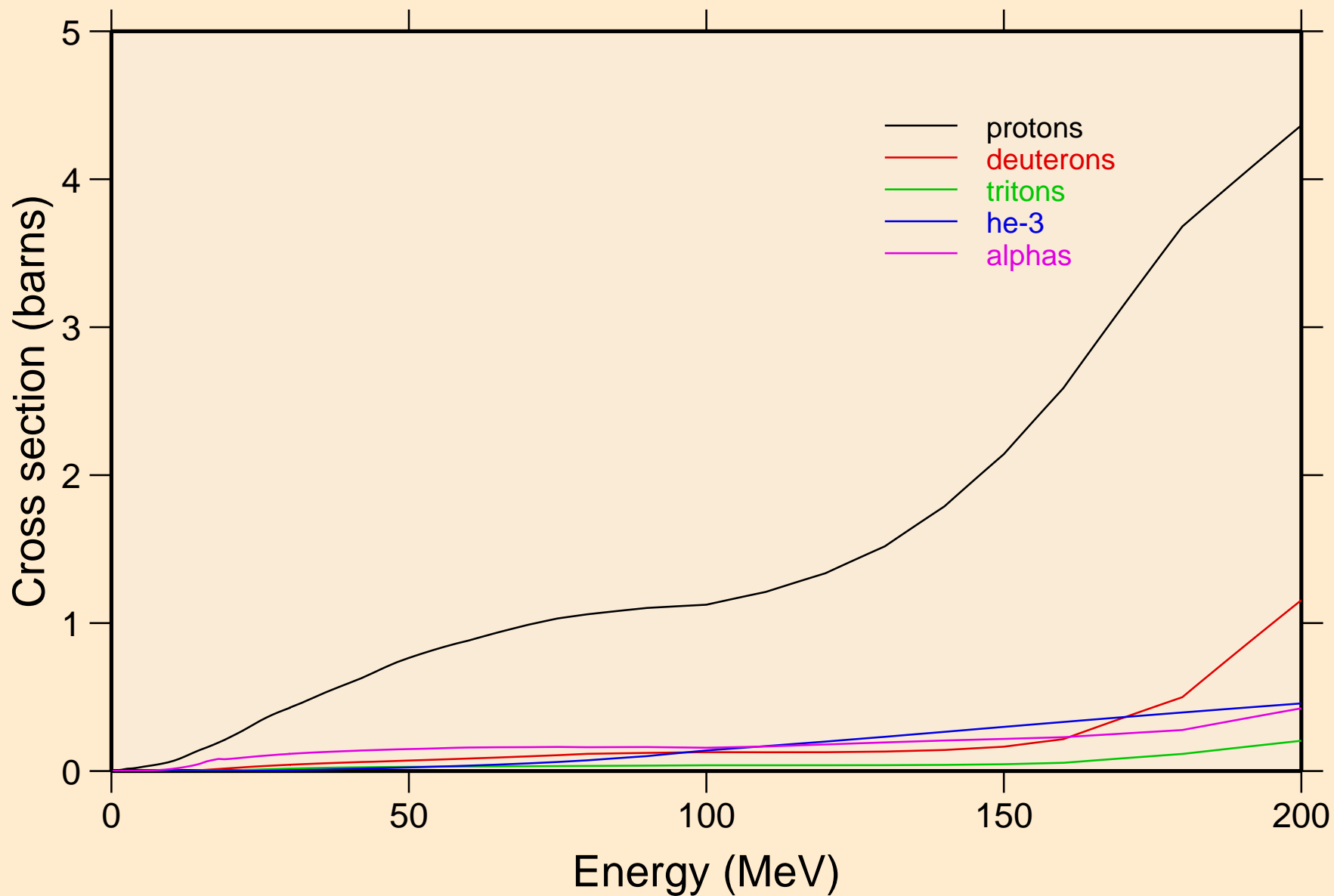

W171 NEUTRON ACER TENDL-2019 LIBRARY; T=293.16K  
protons from (n,x)

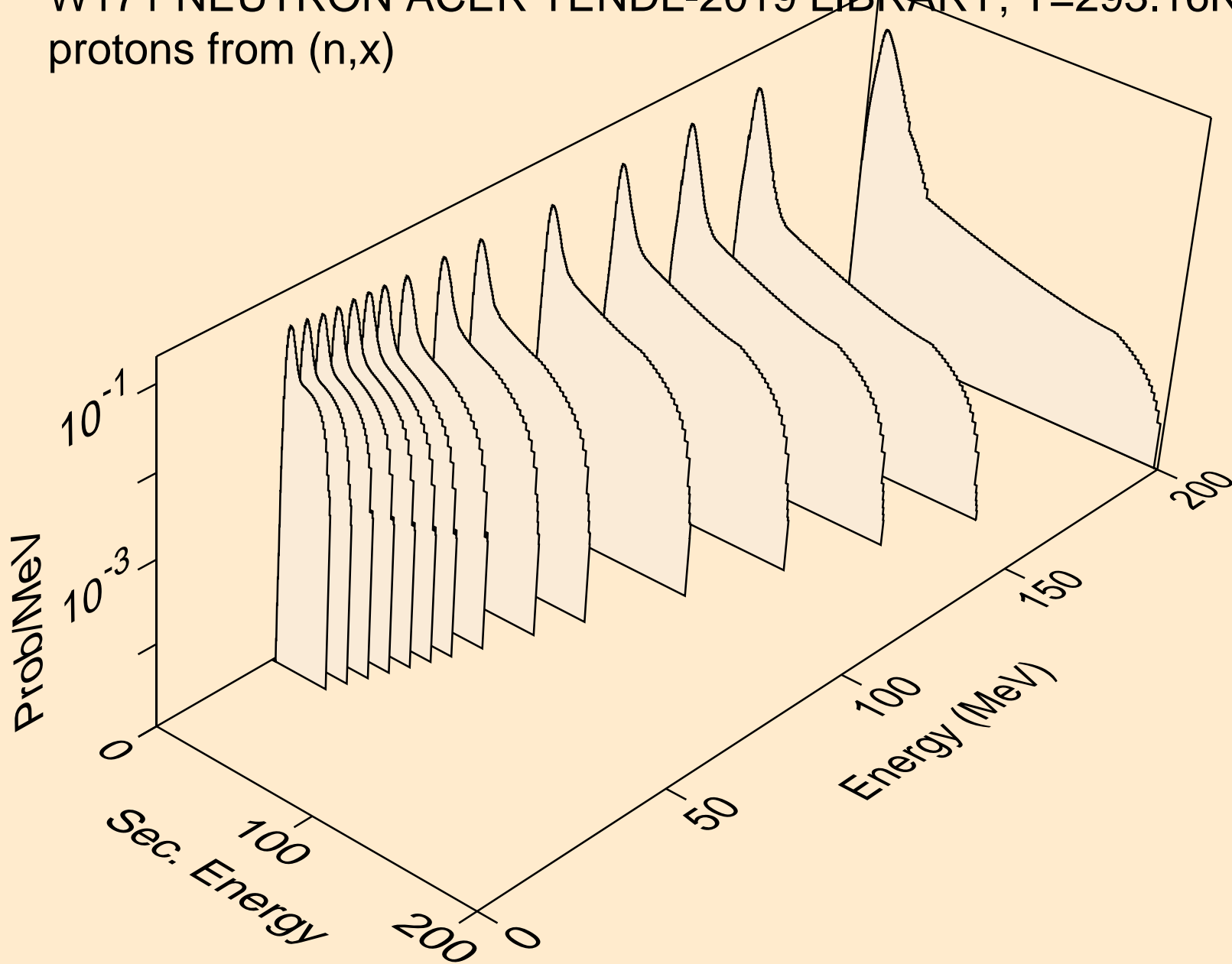

W171 NEUTRON ACER TENDL-2019 LIBRARY; T=293.16K  
protons from (n,n\*)p

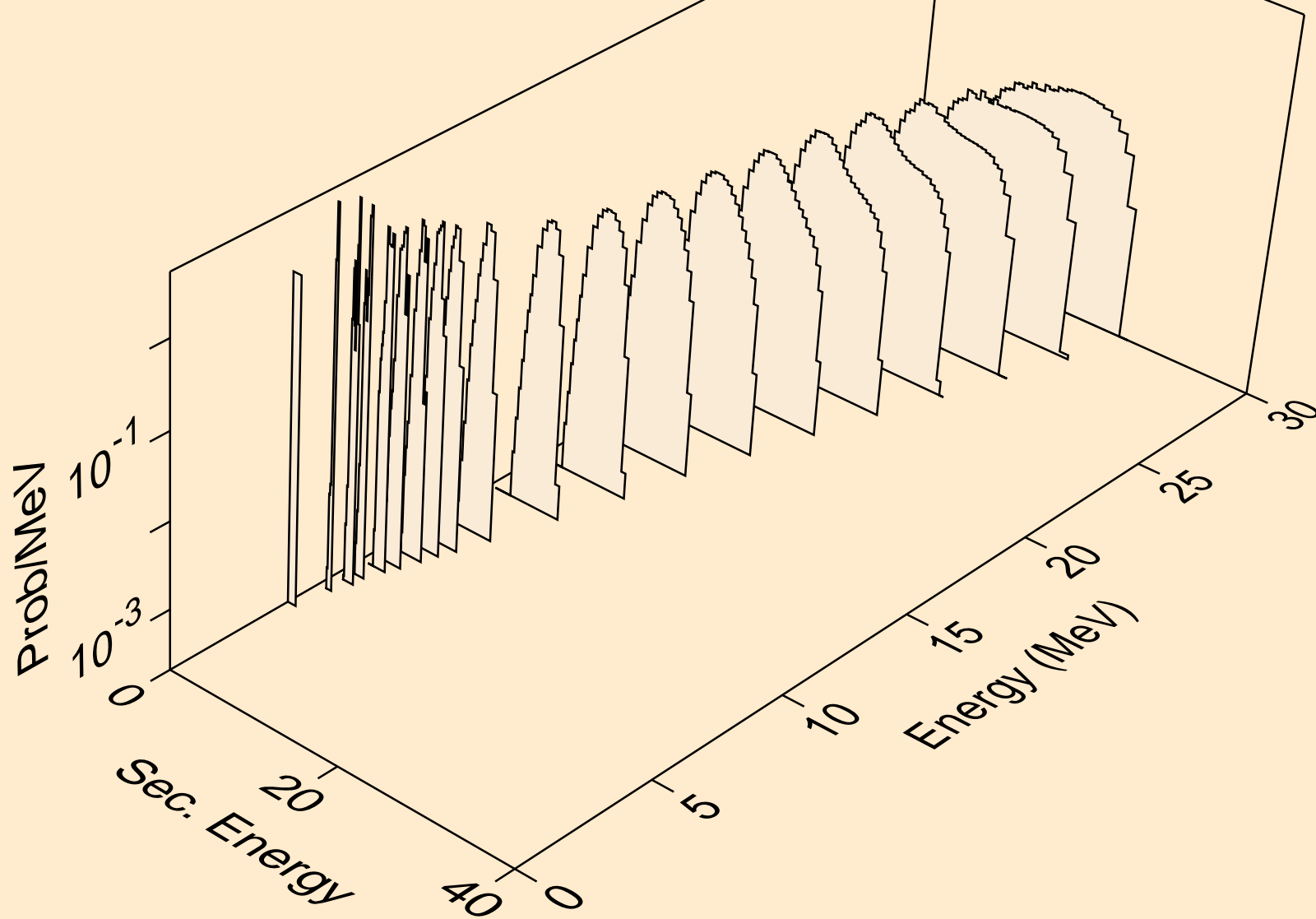



W171 NEUTRON ACER TENDL-2019 LIBRARY; T=293.16K  
protons from (n,2np)

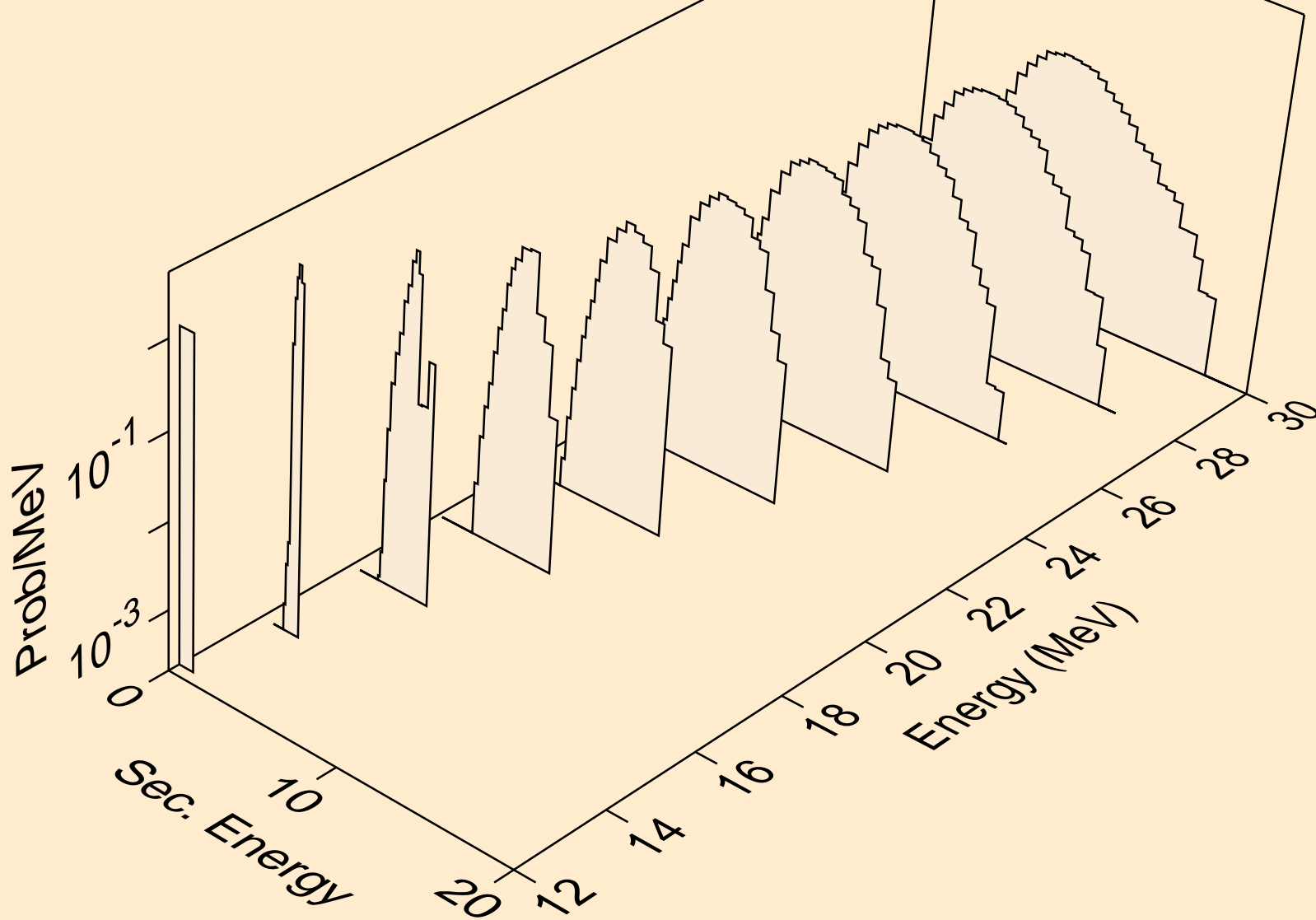

W171 NEUTRON ACER TENDL-2019 LIBRARY; T=293.16K  
protons from (n,3np)

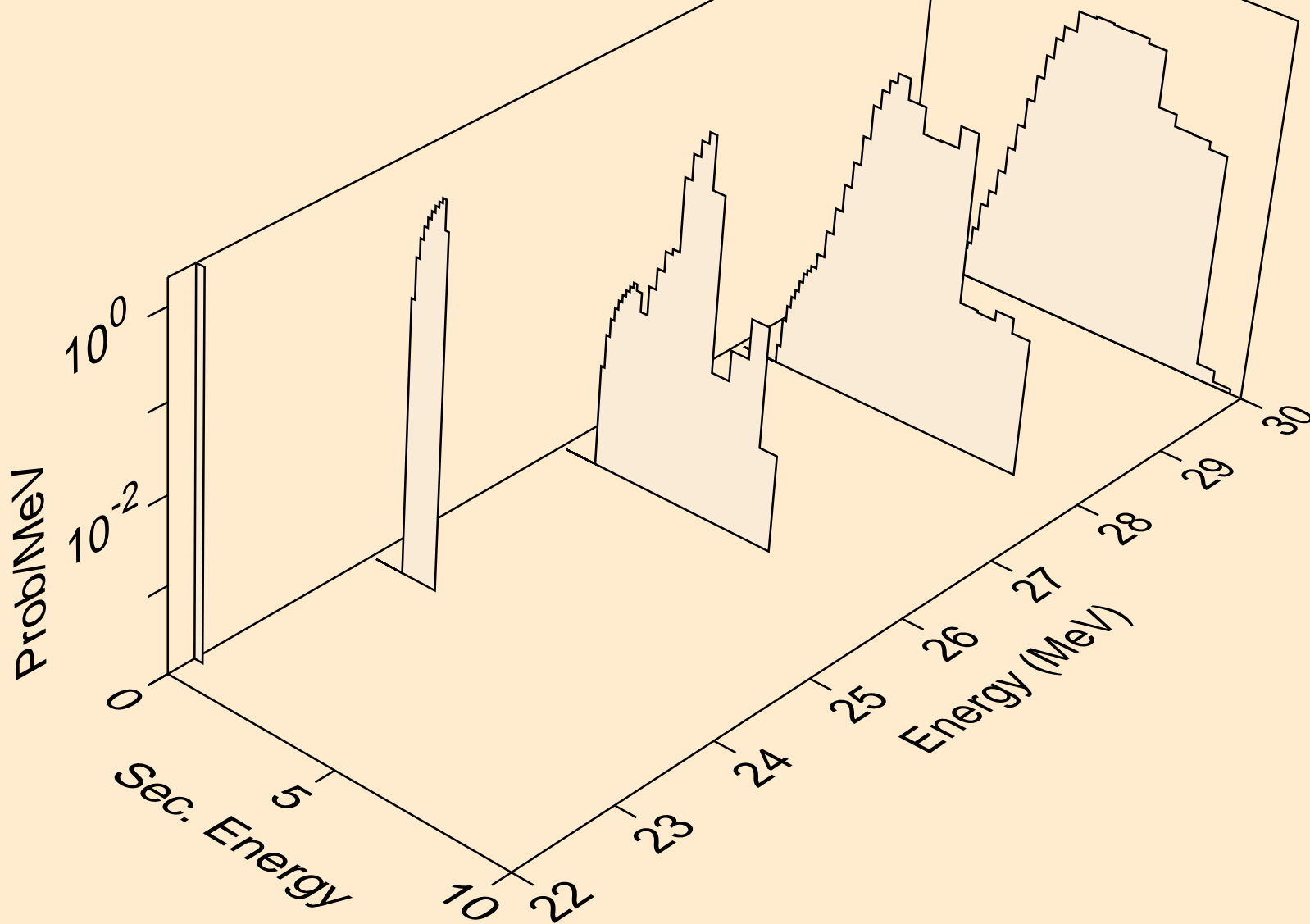

W171 NEUTRON ACER TENDL-2019 LIBRARY; T=293.16K  
protons from (n,2np)

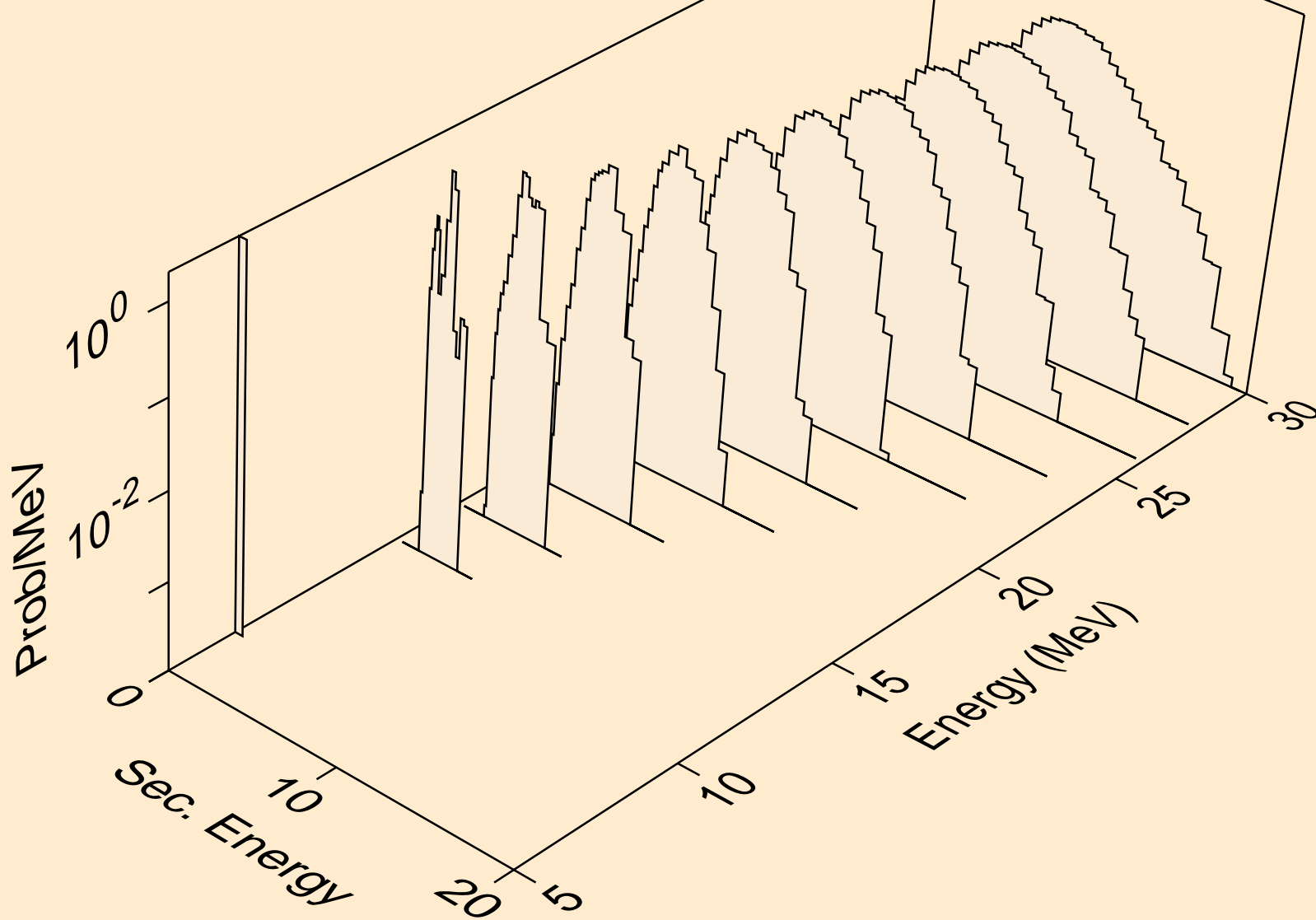

W171 NEUTRON ACER TENDL-2019 LIBRARY; T=293.16K  
protons from (n,npa)

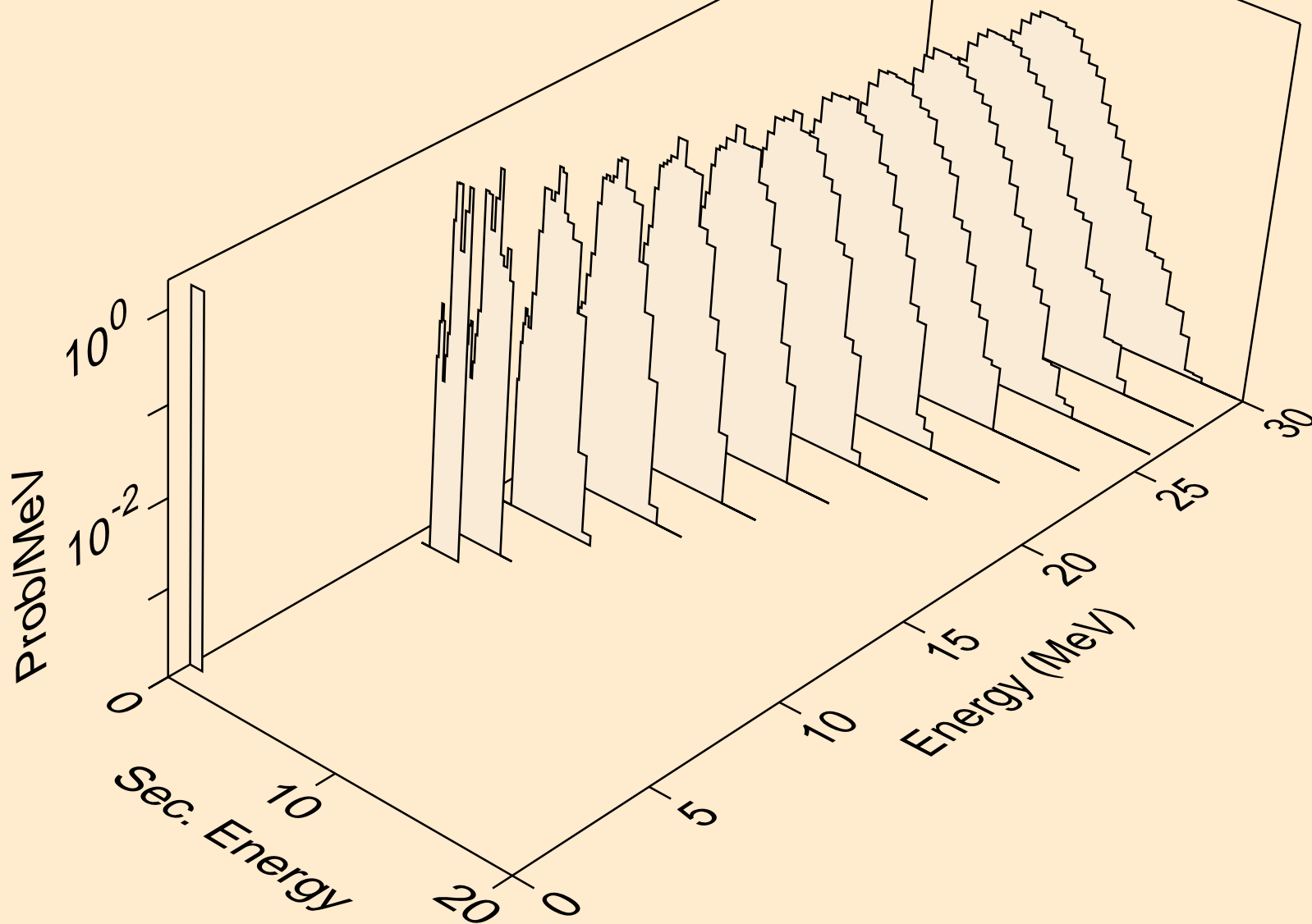

W171 NEUTRON ACER TENDL-2019 LIBRARY; T=293.16K  
protons from (n,p)

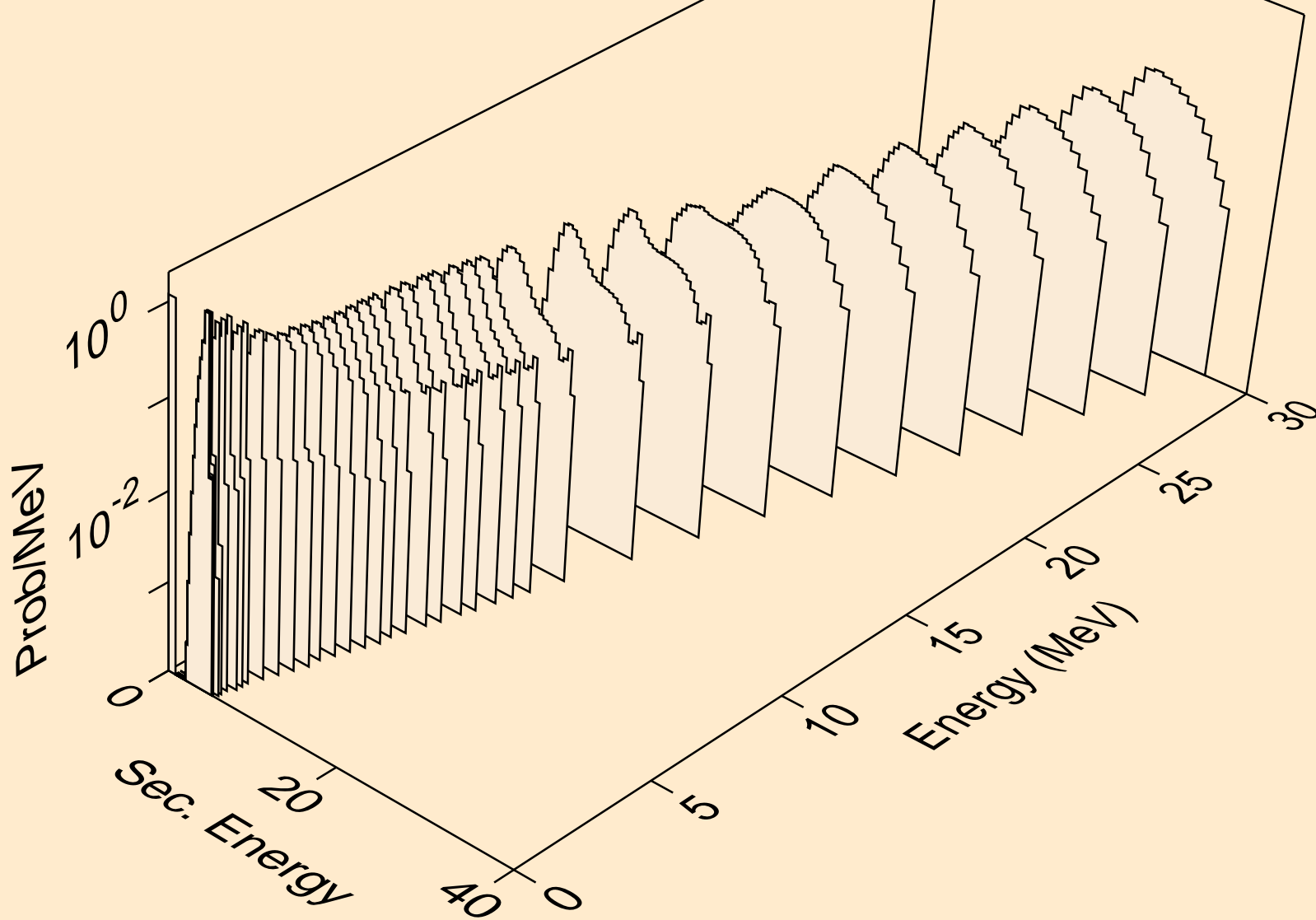

W171 NEUTRON ACER TENDL-2019 LIBRARY; T=293.16K  
protons from (n,2p)

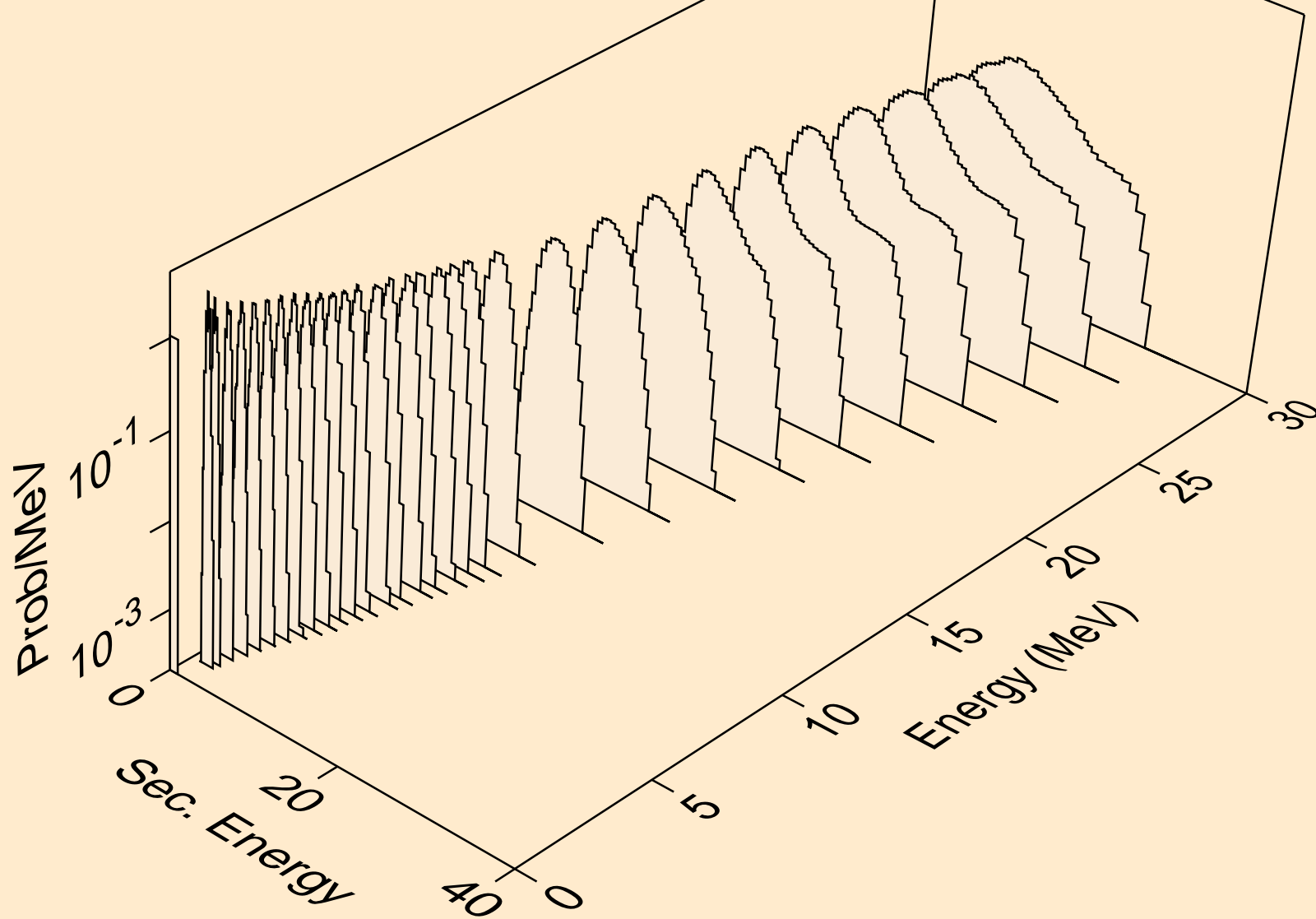

W171 NEUTRON ACER TENDL-2019 LIBRARY; T=293.16K  
protons from (n,p)

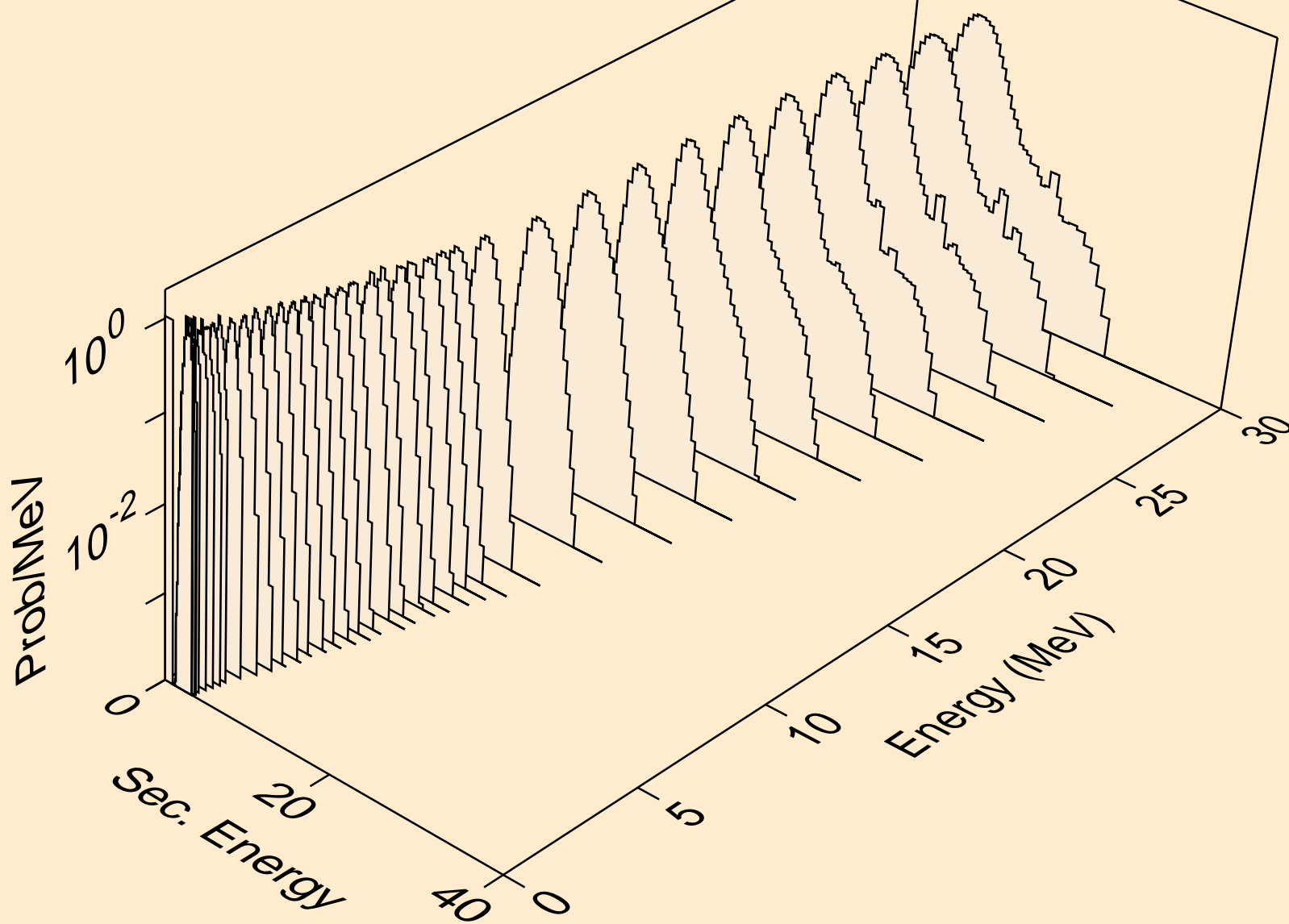

W171 NEUTRON ACER TENDL-2019 LIBRARY; T=293.16K  
protons from (n,pd)

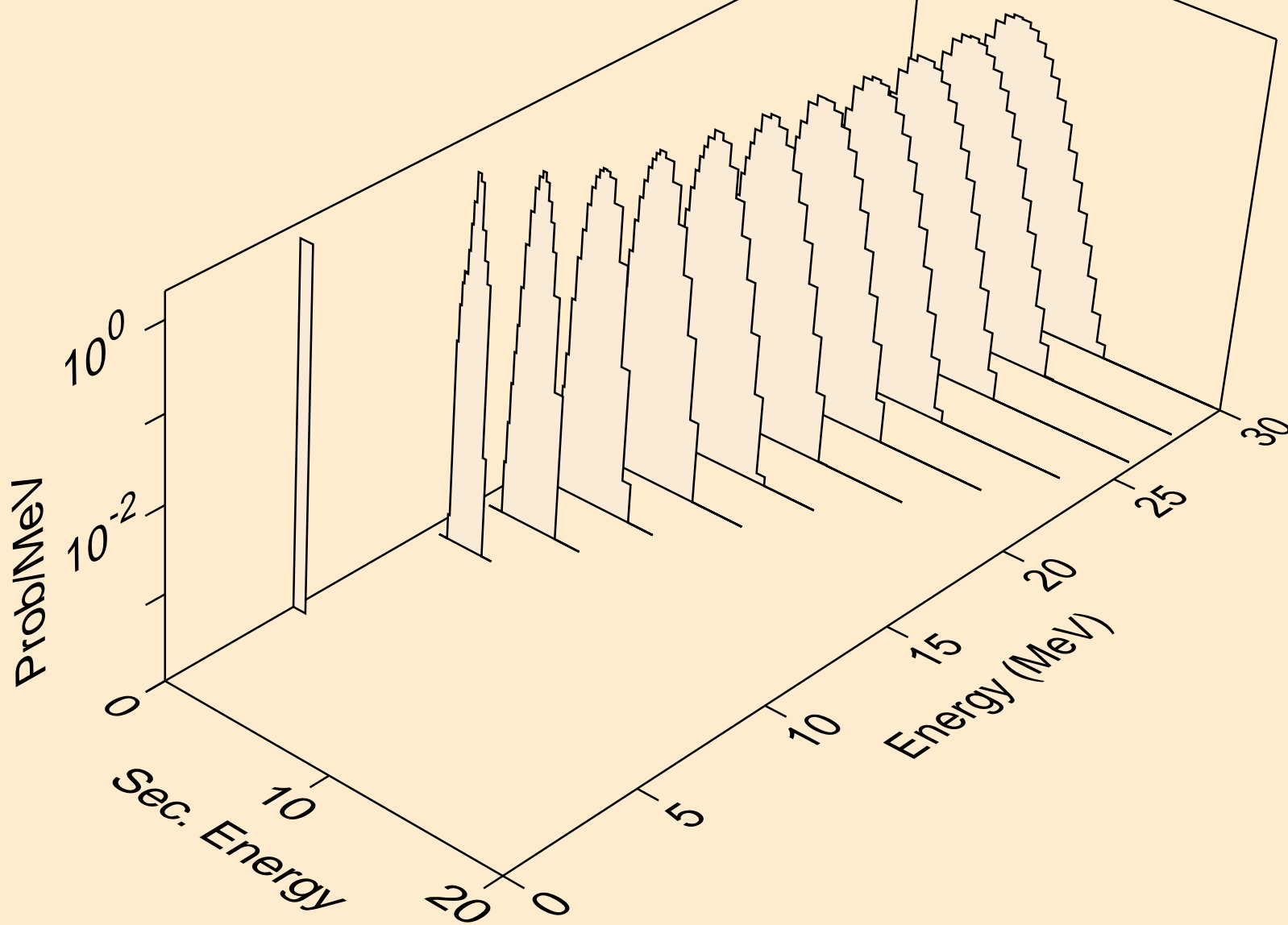



W171 NEUTRON ACER TENDL-2019 LIBRARY; T=293.16K  
protons from (n,pt)

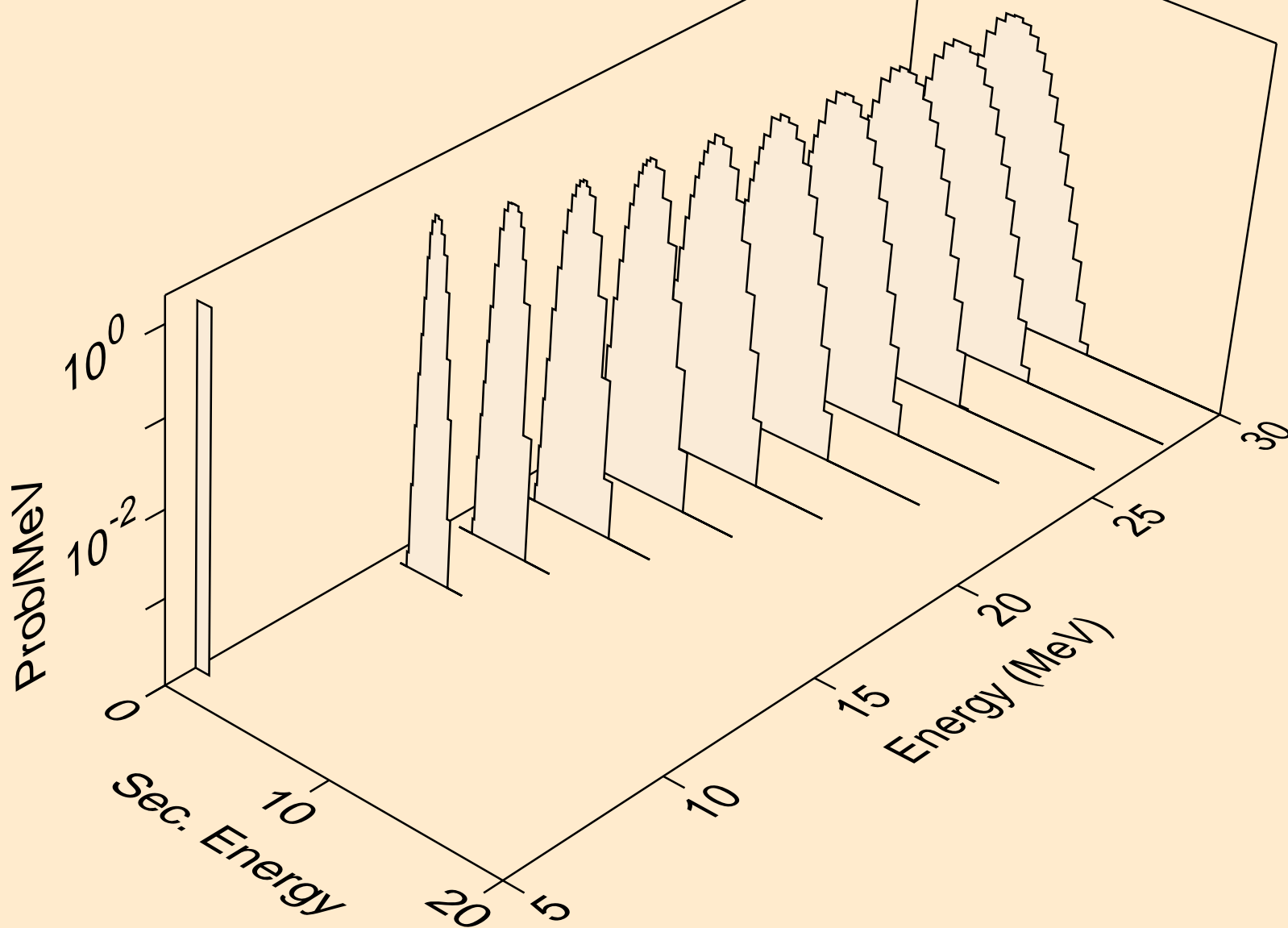

W171 NEUTRON ACER TENDL-2019 LIBRARY; T=293.16K  
deuterons from (n,x)

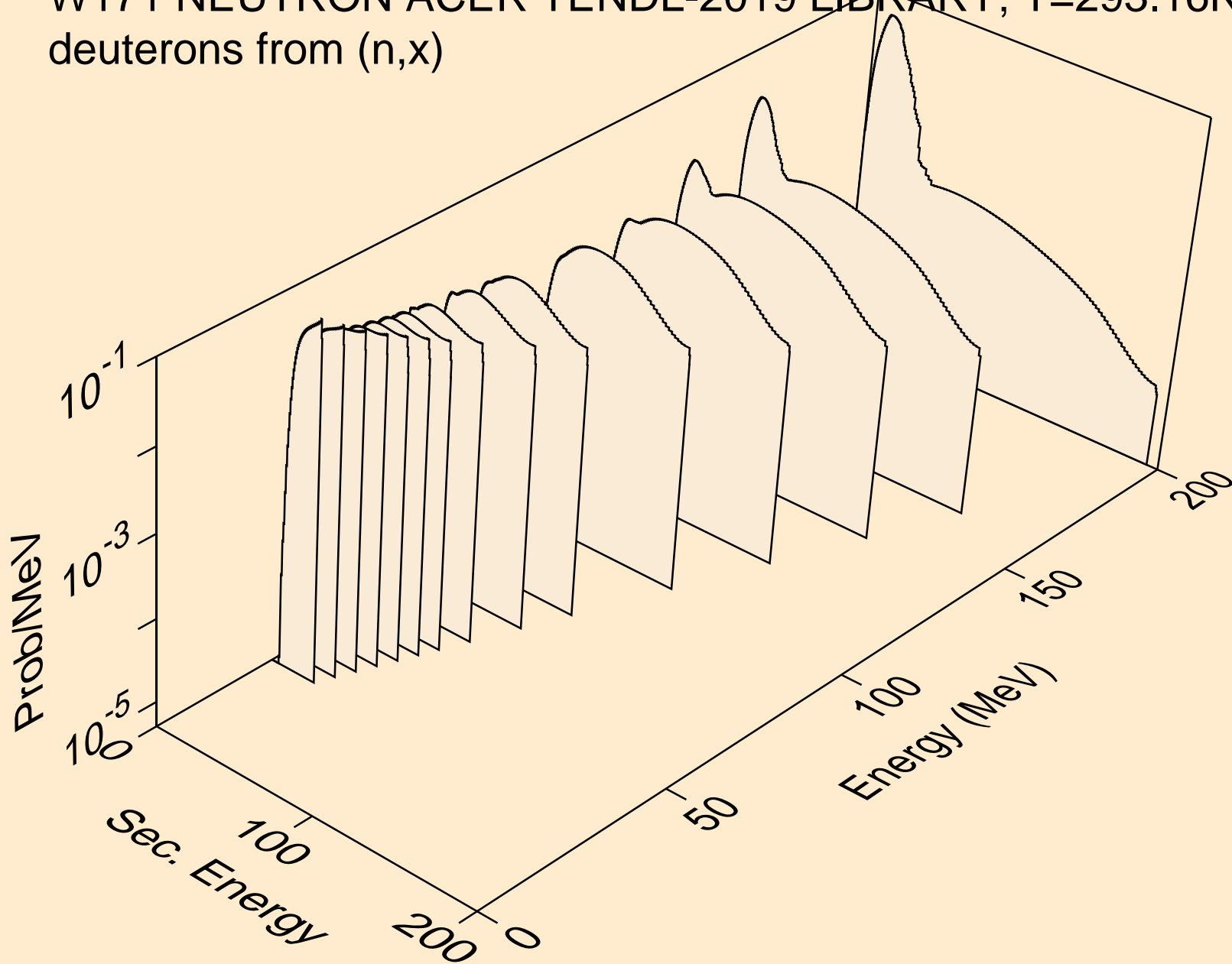

W171 NEUTRON ACER TENDL-2019 LIBRARY; T=293.16K  
deuterons from (n,2nd)

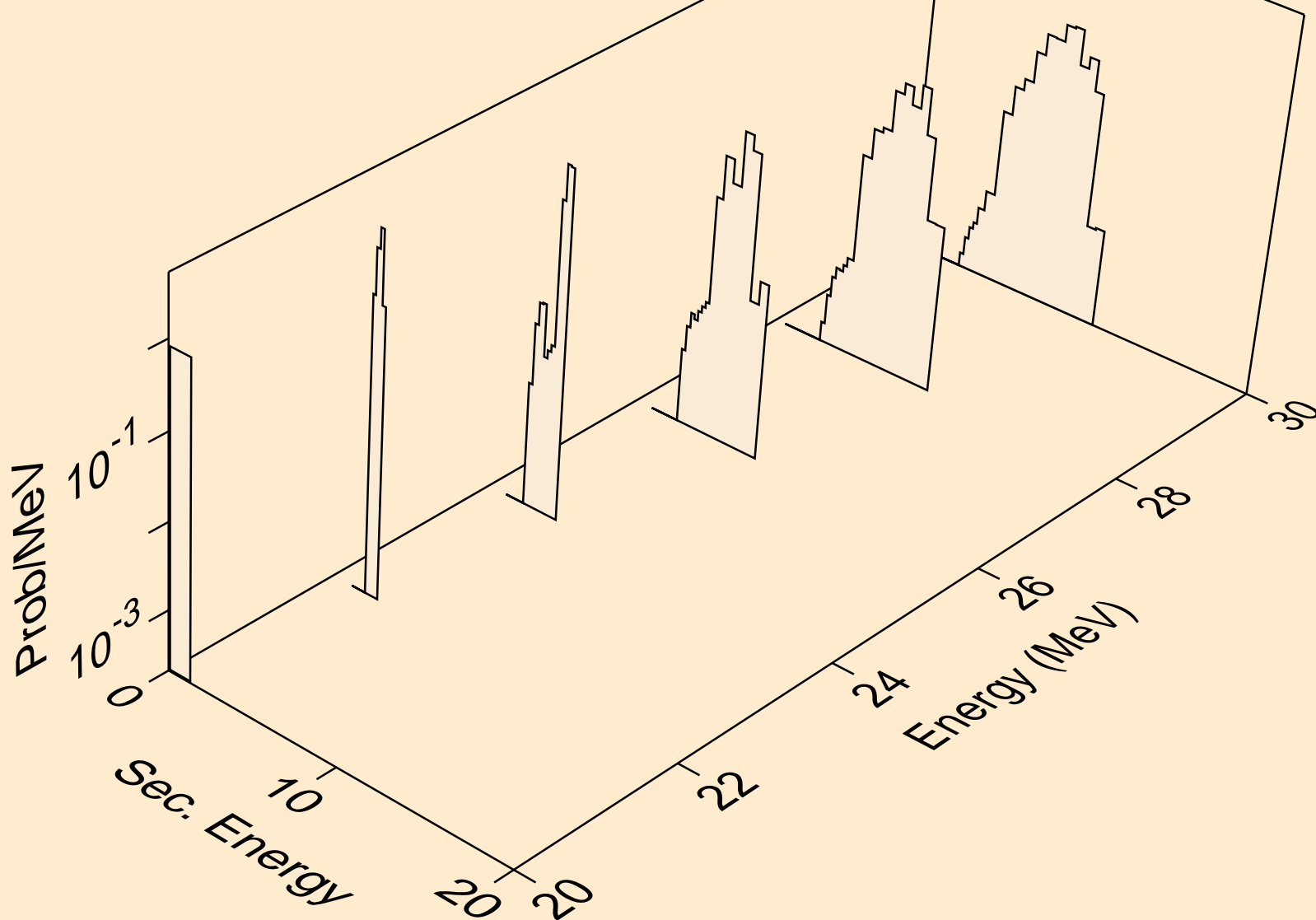

W171 NEUTRON ACER TENDL-2019 LIBRARY; T=293.16K  
deuterons from (n,n\*)d

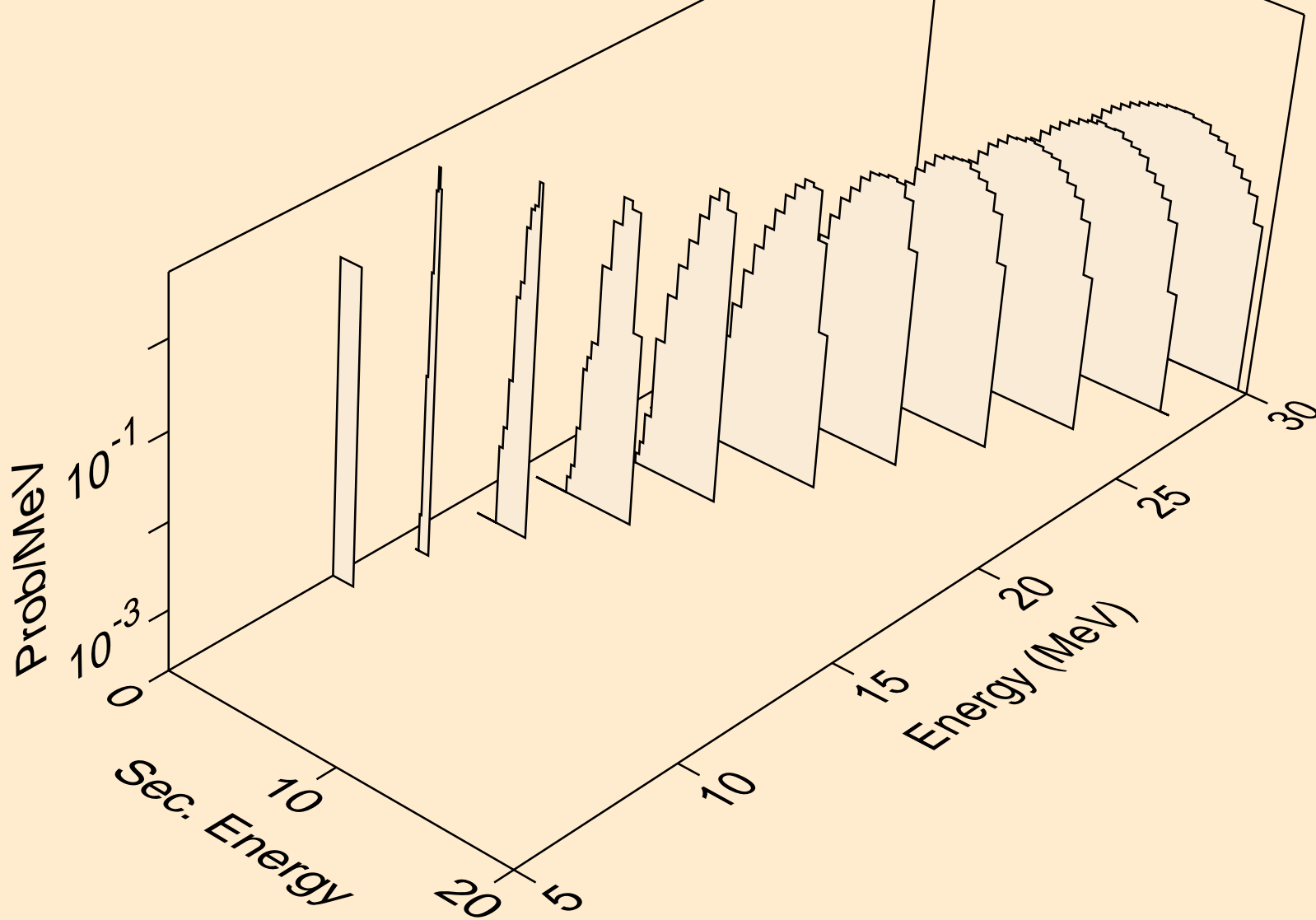

W171 NEUTRON ACER TENDL-2019 LIBRARY; T=293.16K  
deuterons from (n,d)

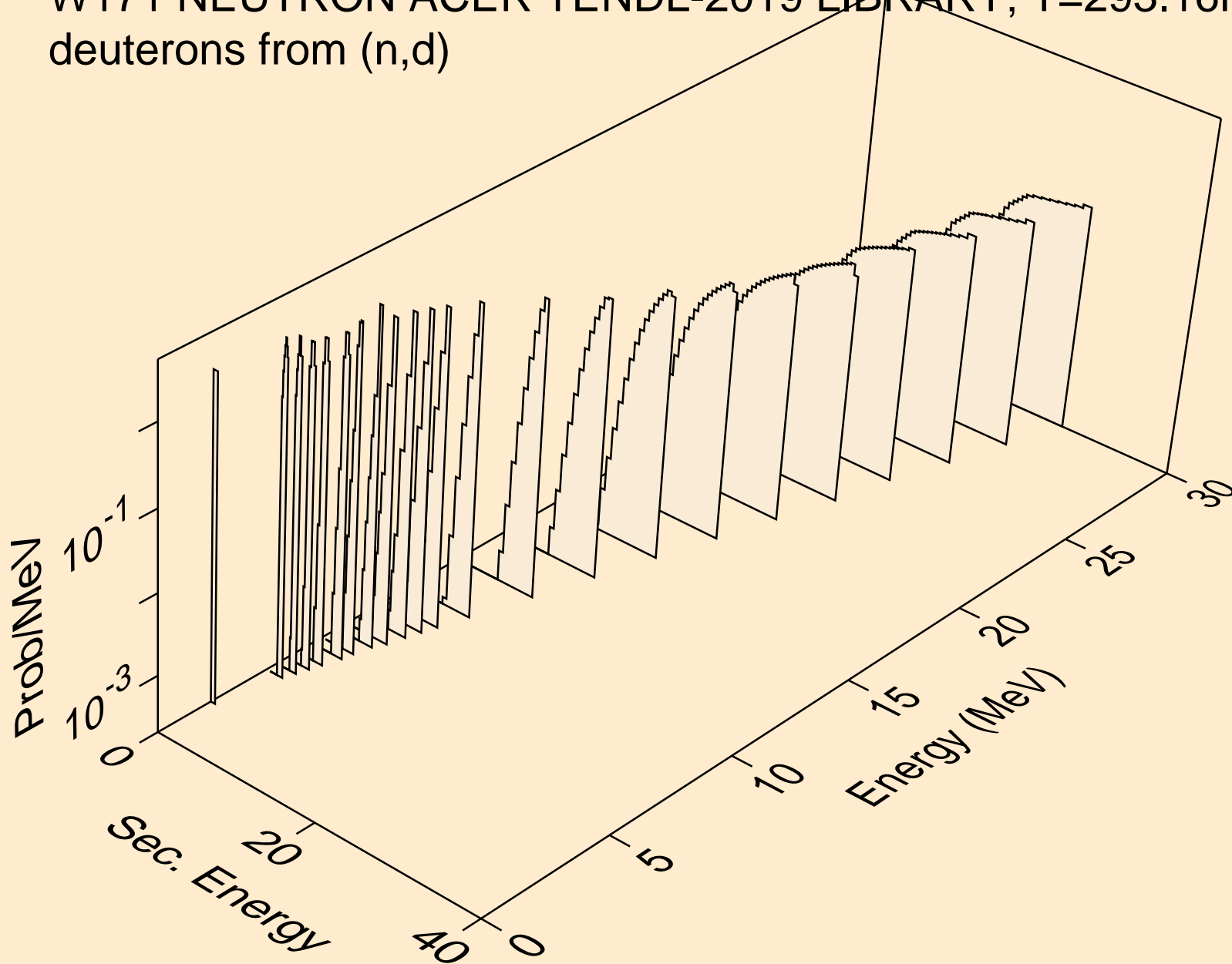

W171 NEUTRON ACER TENDL-2019 LIBRARY; T=293.16K  
deuterons from (n,pd)

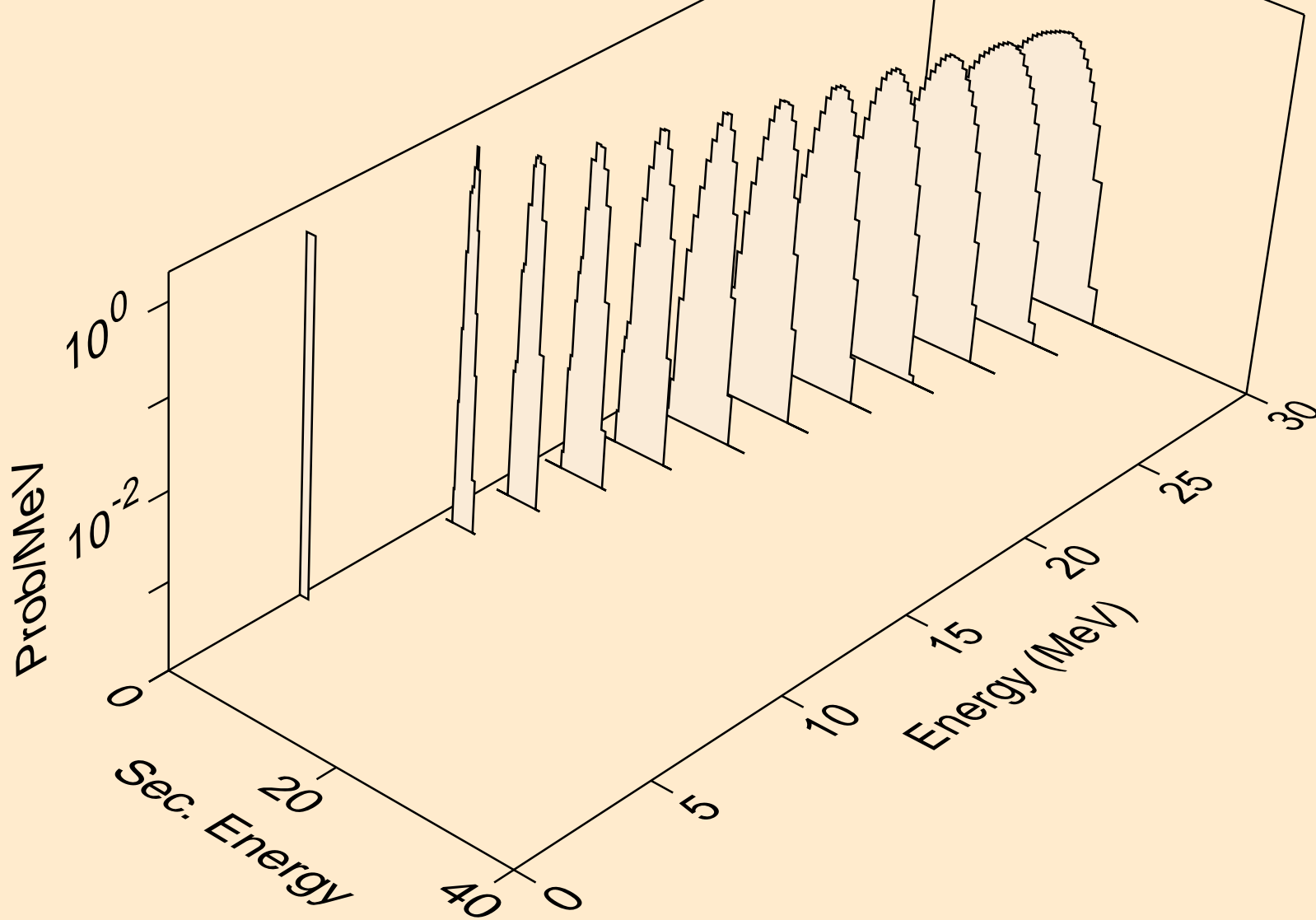

W171 NEUTRON ACER TENDL-2019 LIBRARY; T=293.16K  
deuterons from (n,da)

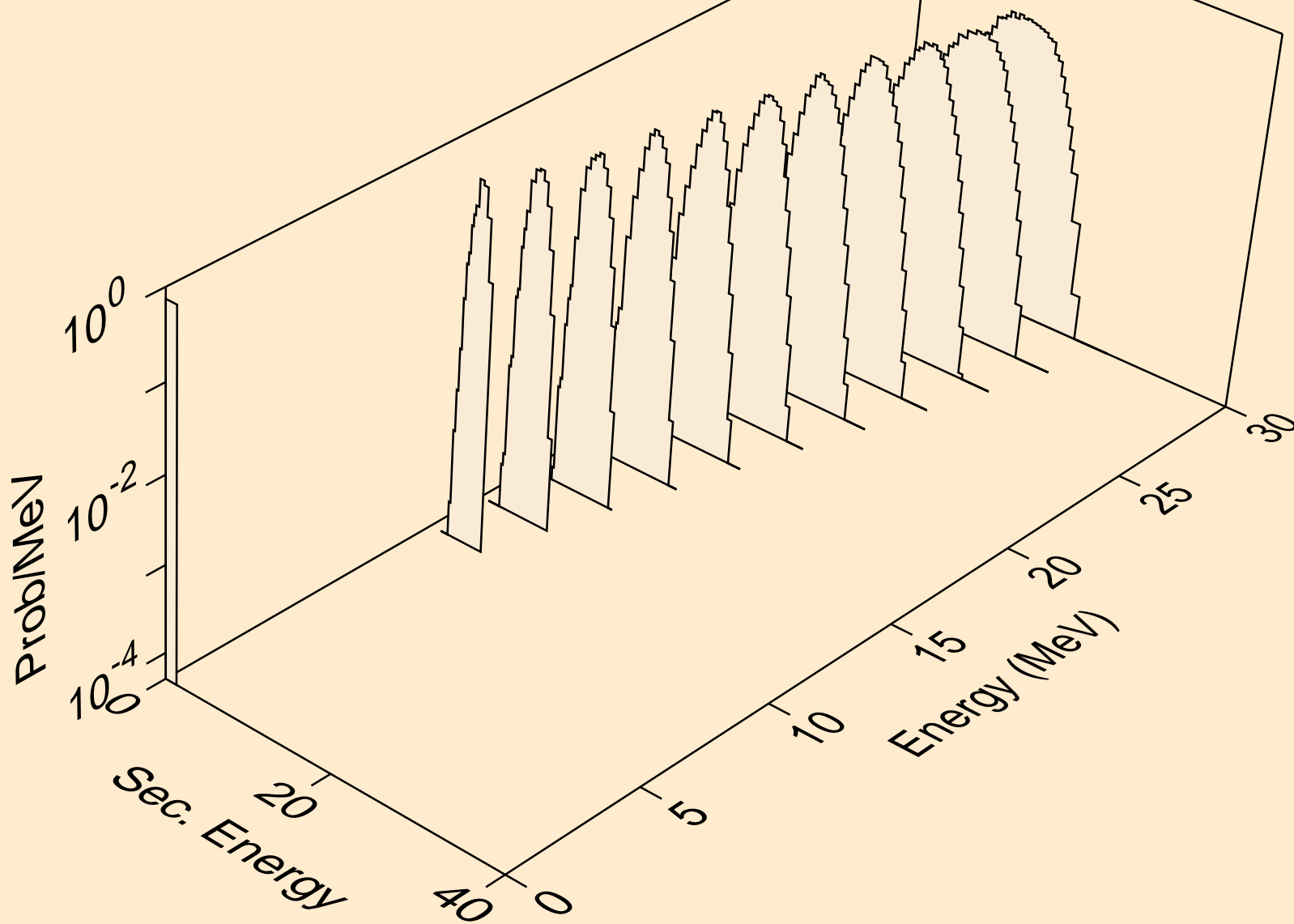

W171 NEUTRON ACER TENDL-2019 LIBRARY; T=293.16K  
tritons from (n,x)

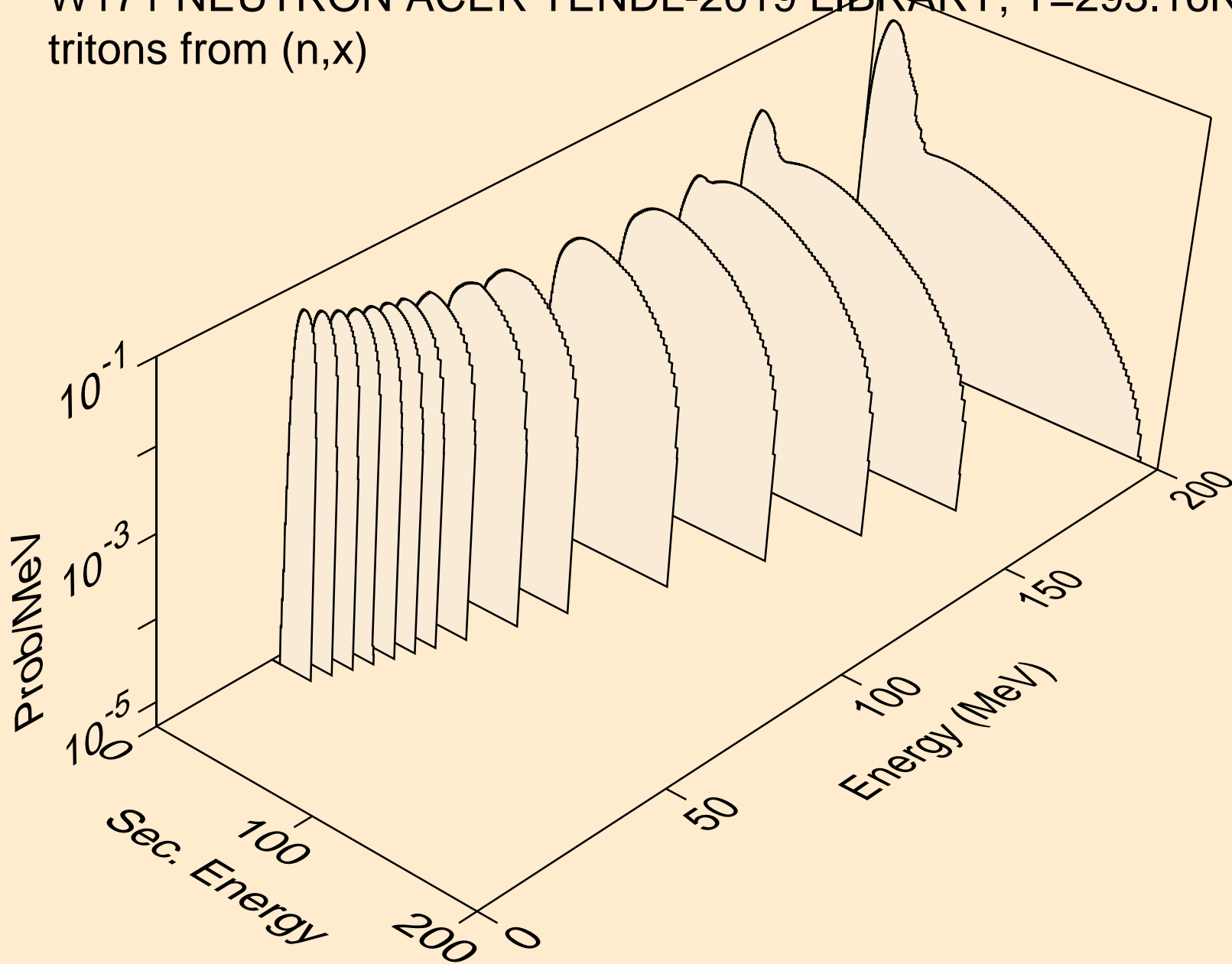



W171 NEUTRON ACER TENDL-2019 LIBRARY; T=293.16K  
tritons from (n,n\*)t

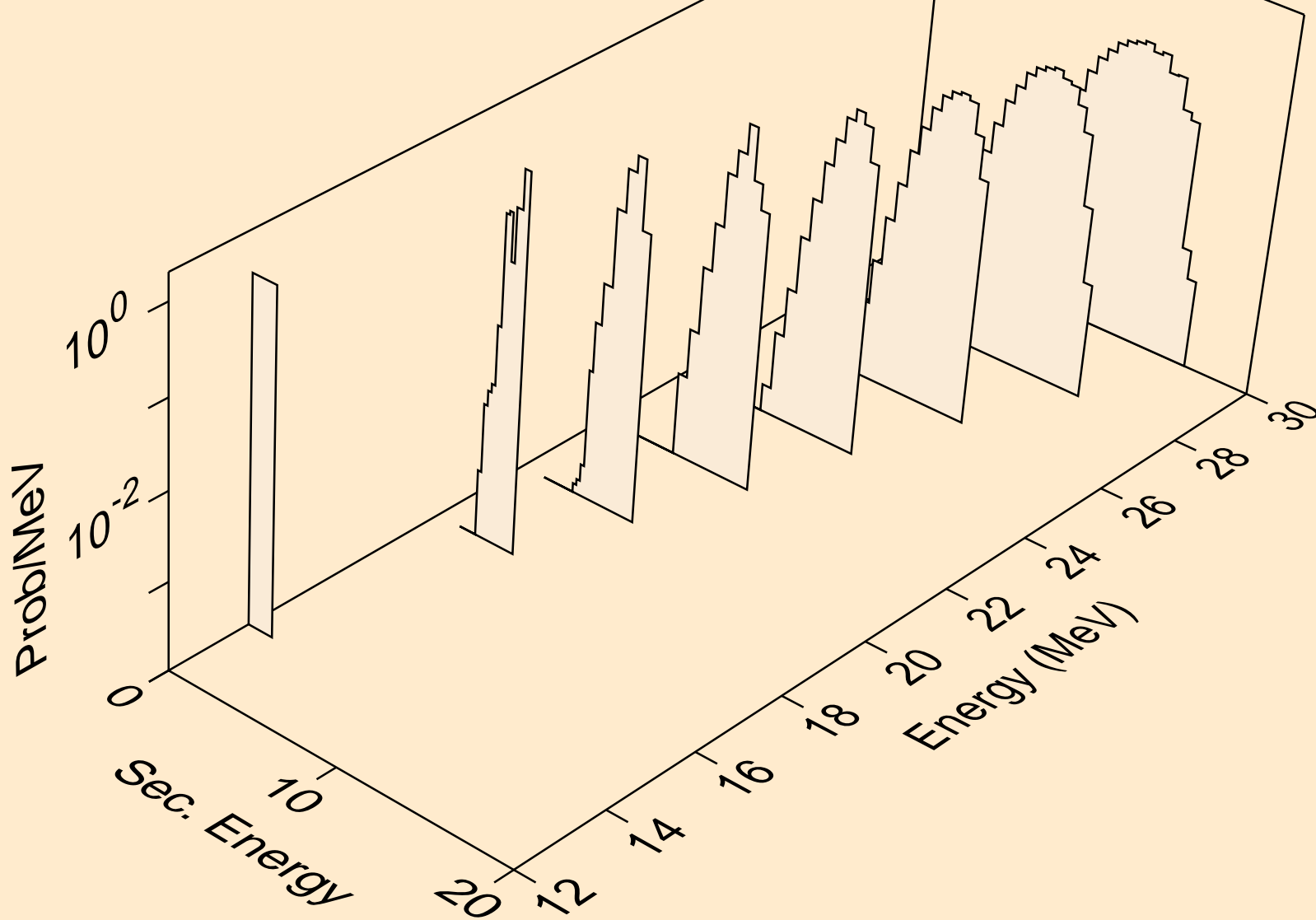

W171 NEUTRON ACER TENDL-2019 LIBRARY; T=293.16K  
tritons from (n,t)

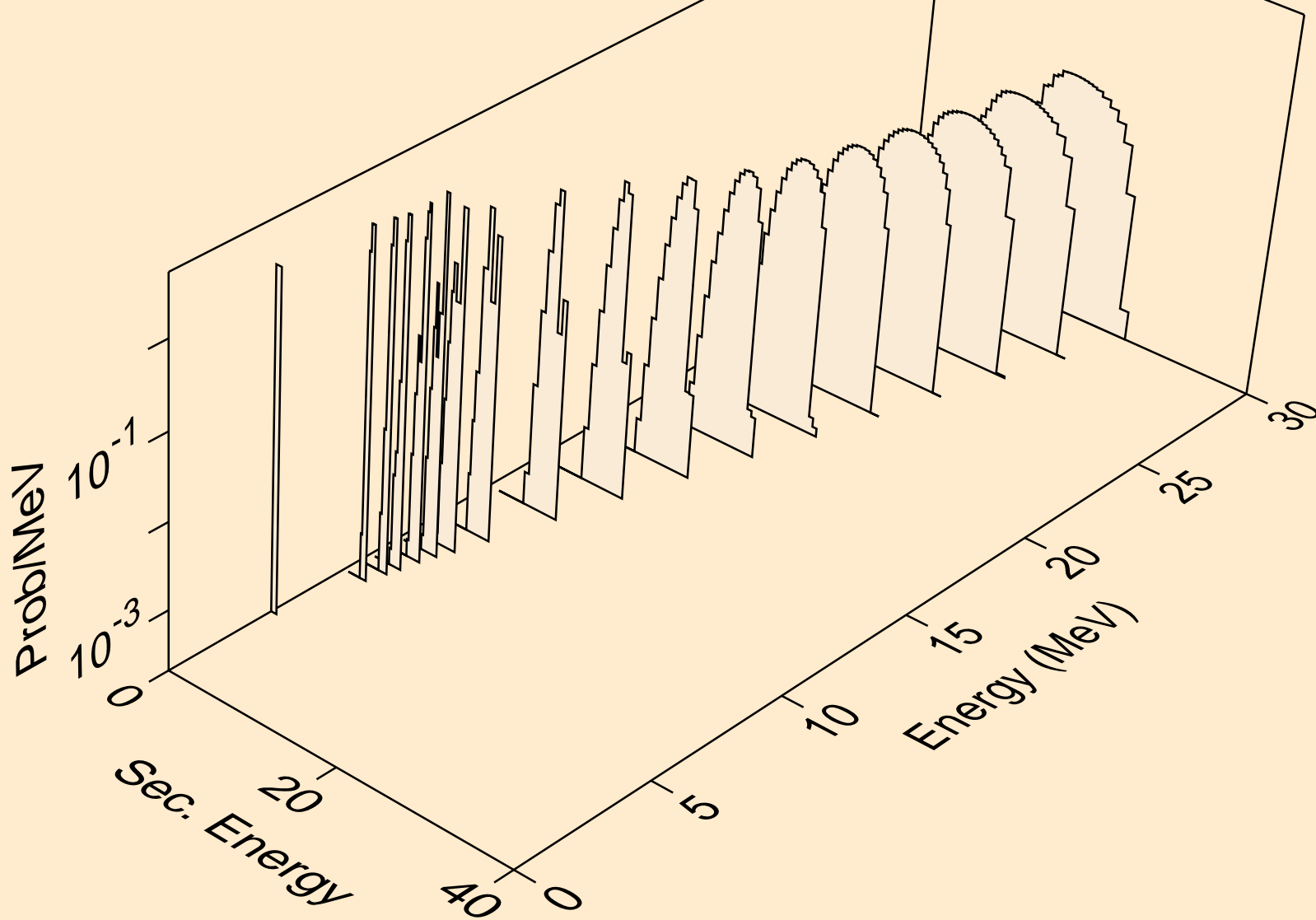

W171 NEUTRON ACER TENDL-2019 LIBRARY; T=293.16K  
tritons from (n,pt)

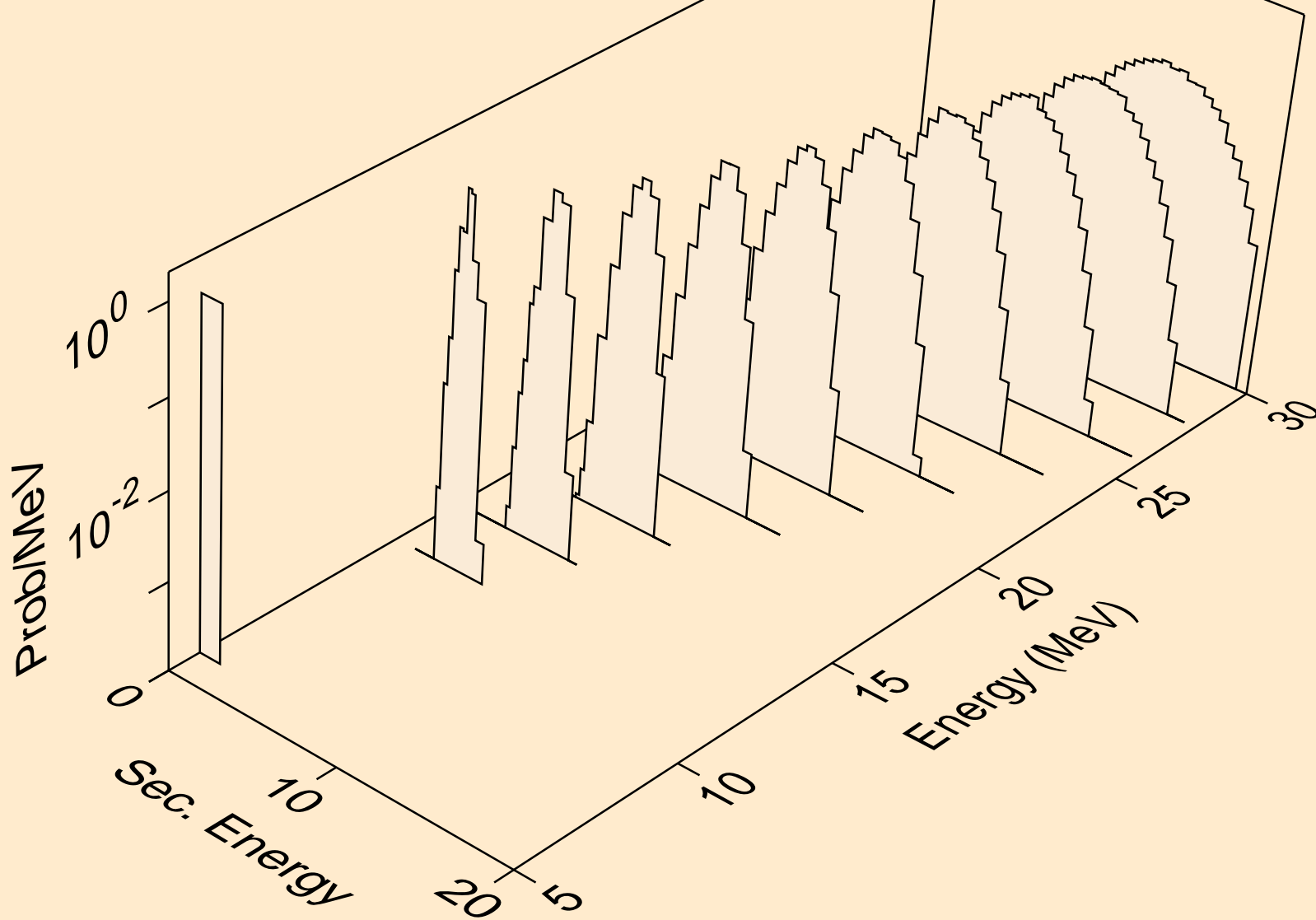

W171 NEUTRON ACER TENDL-2019 LIBRARY; T=293.16K  
he3s from (n,x)

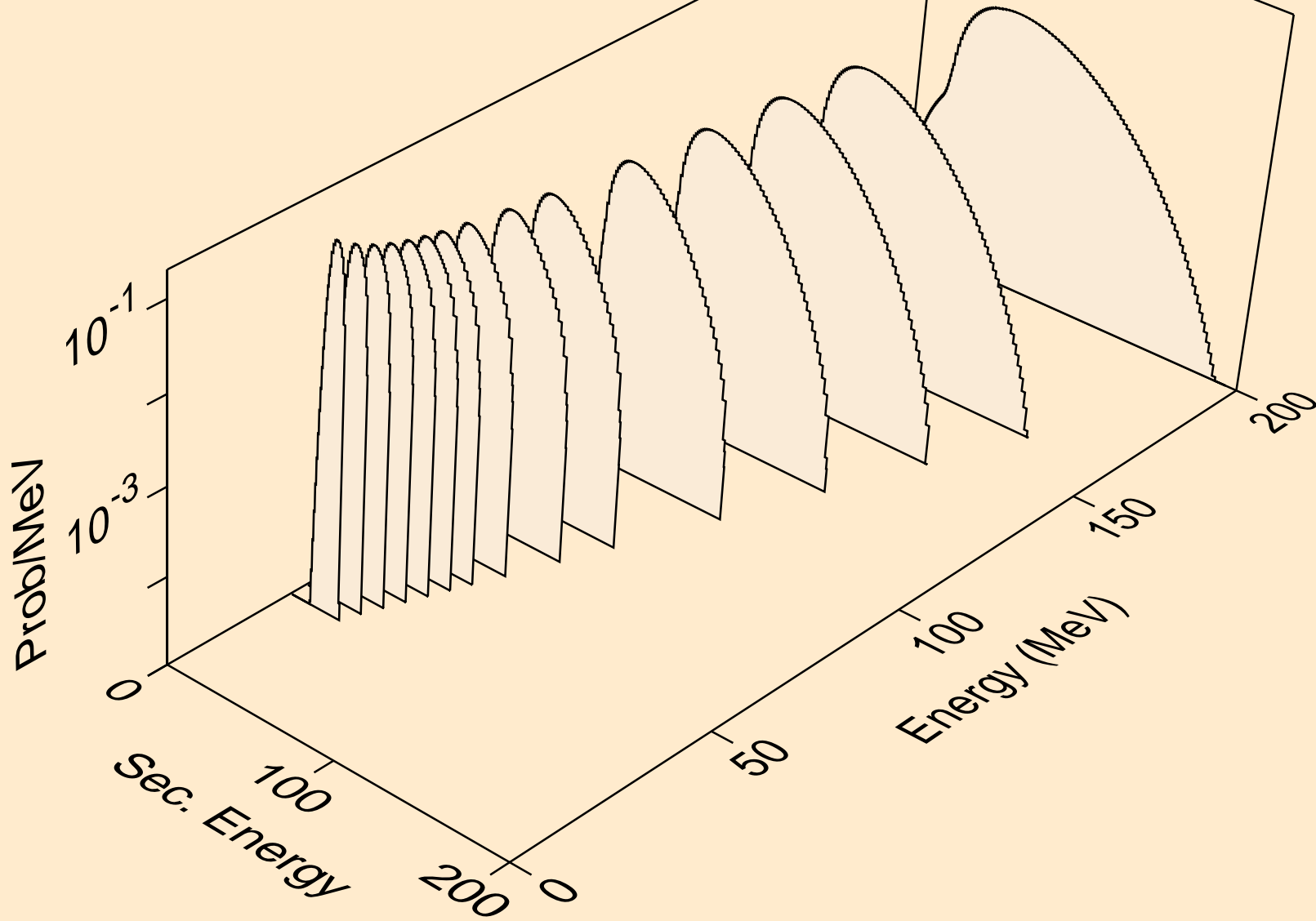

W171 NEUTRON ACER TENDL-2019 LIBRARY; T=293.16K  
he3s from (n,n\*)he3

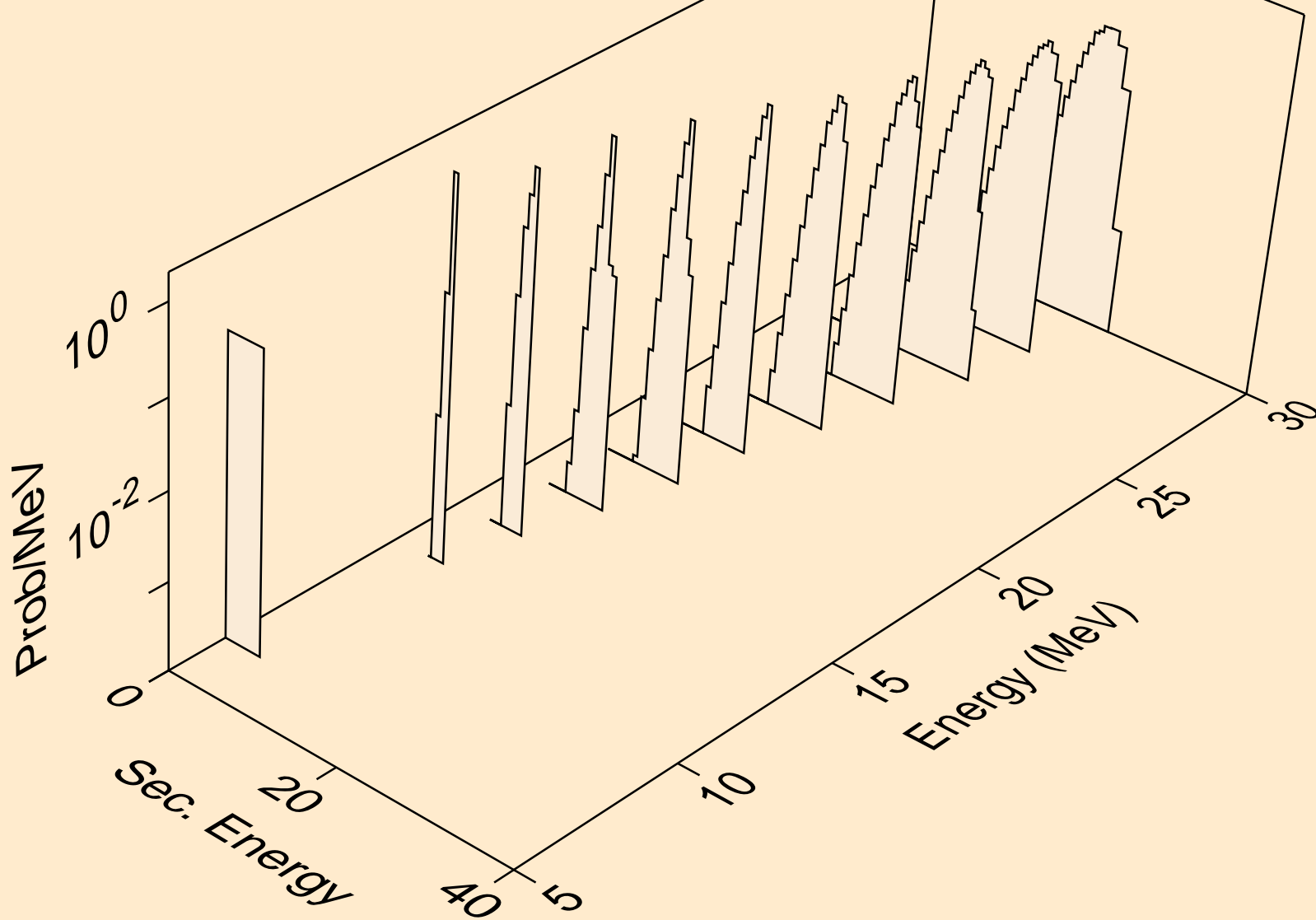

W171 NEUTRON ACER TENDL-2019 LIBRARY; T=293.16K  
he3s from (n,he3)

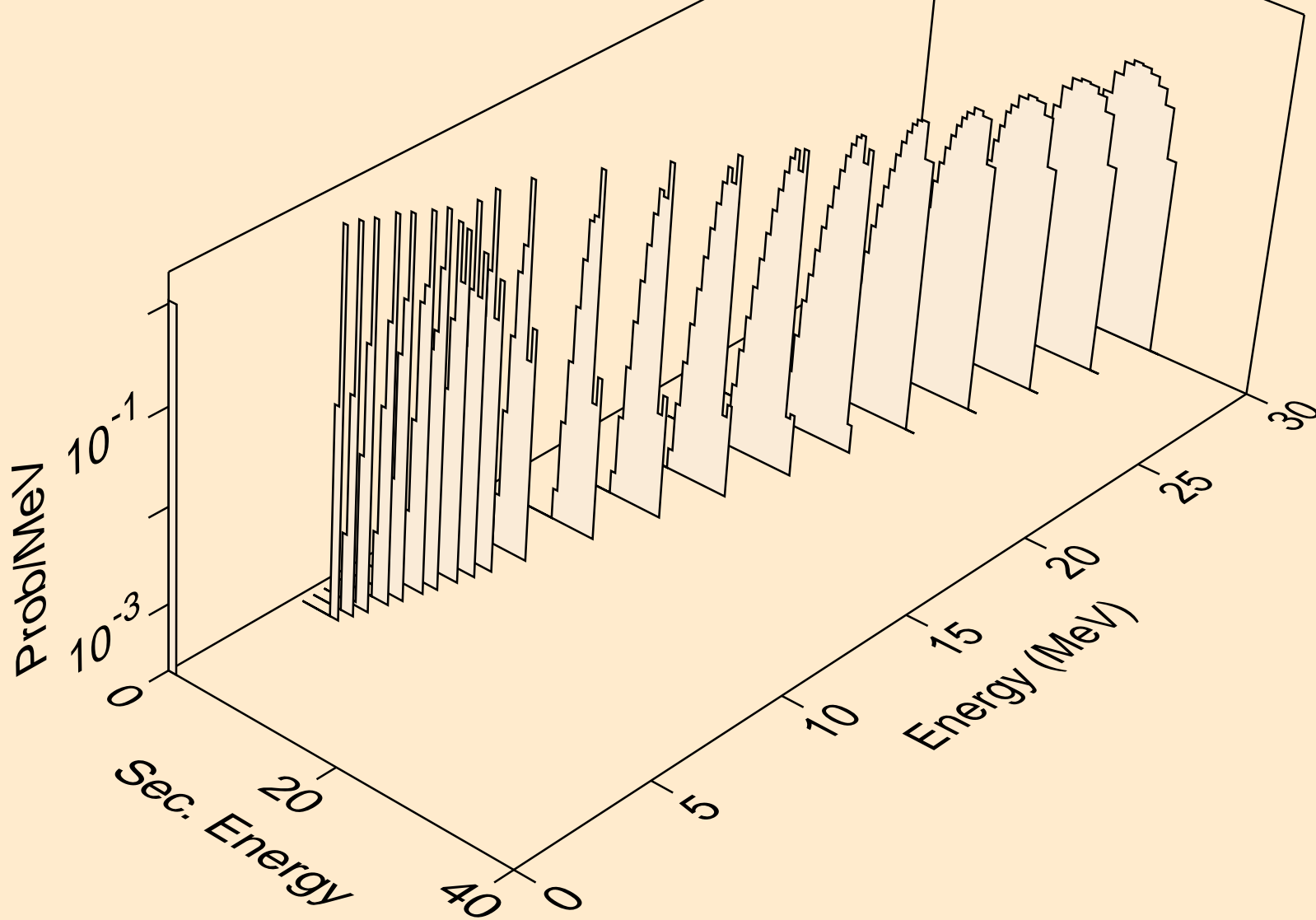

W171 NEUTRON ACER TENDL-2019 LIBRARY; T=293.16K  
alphas from (n,x)

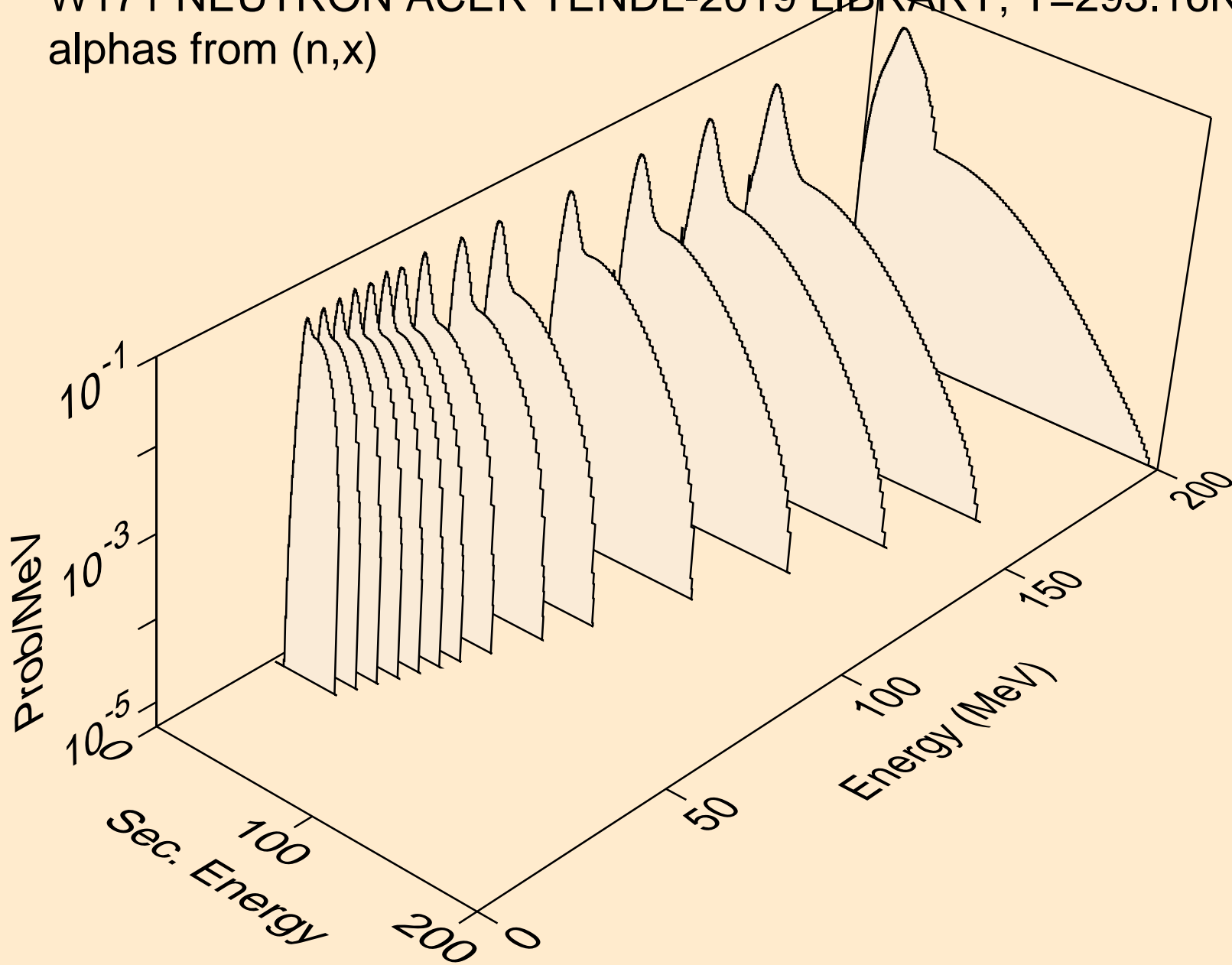

W171 NEUTRON ACER TENDL-2019 LIBRARY; T=293.16K  
alphas from (n,n\*)a

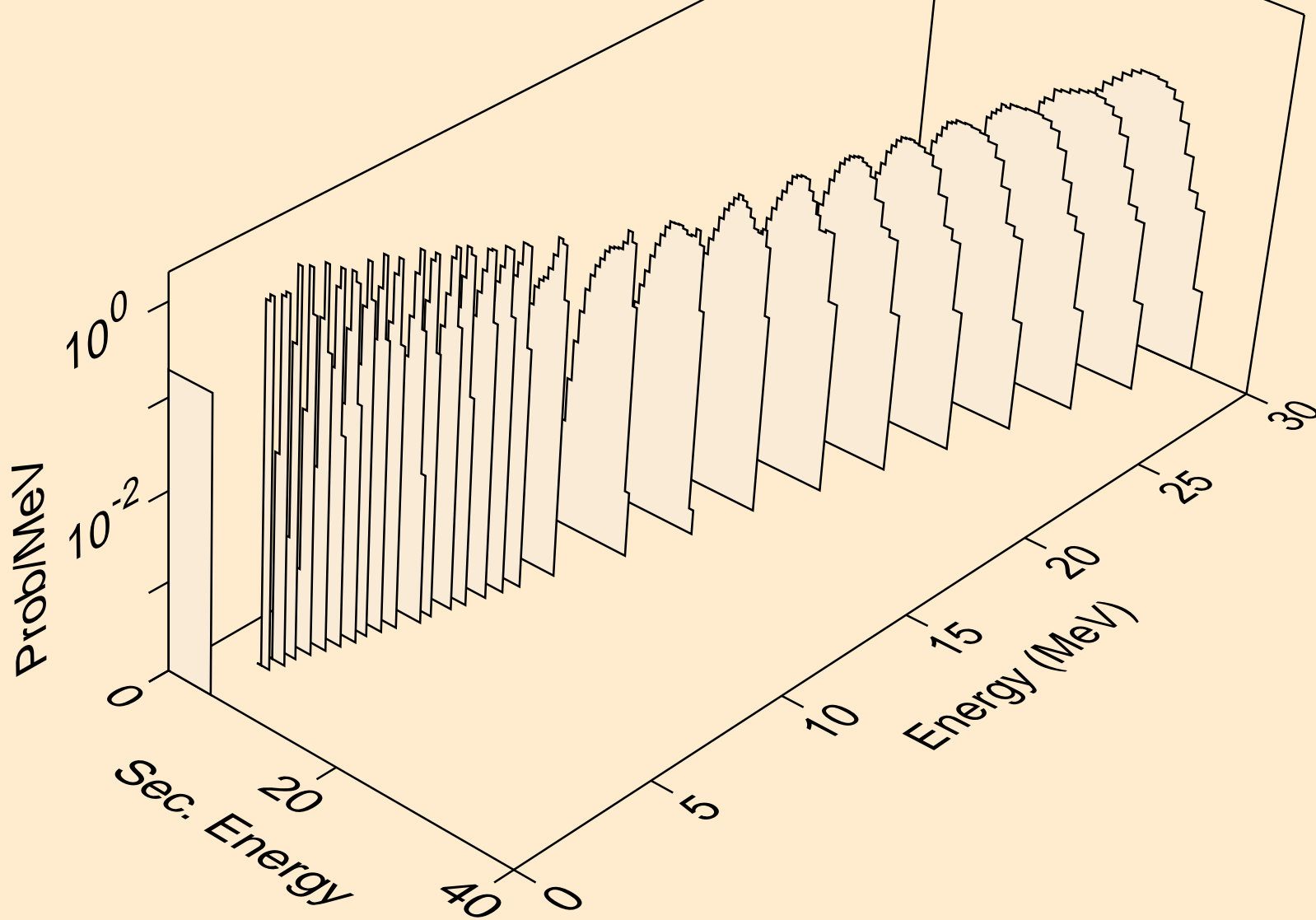



W171 NEUTRON ACER TENDL-2019 LIBRARY; T=293.16K  
alphas from (n,2n)a

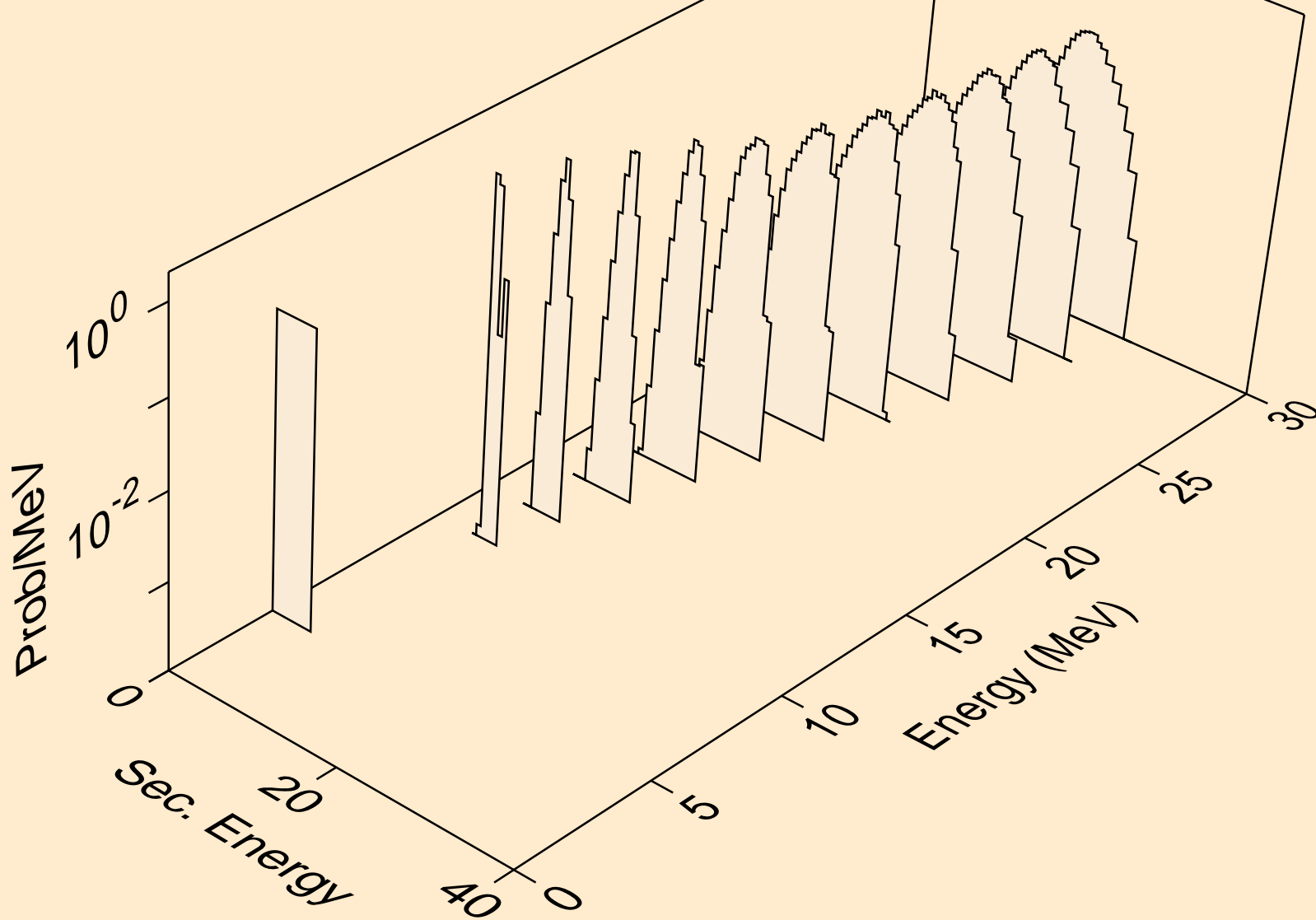

W171 NEUTRON ACER TENDL-2019 LIBRARY; T=293.16K  
alphas from (n,3n)a

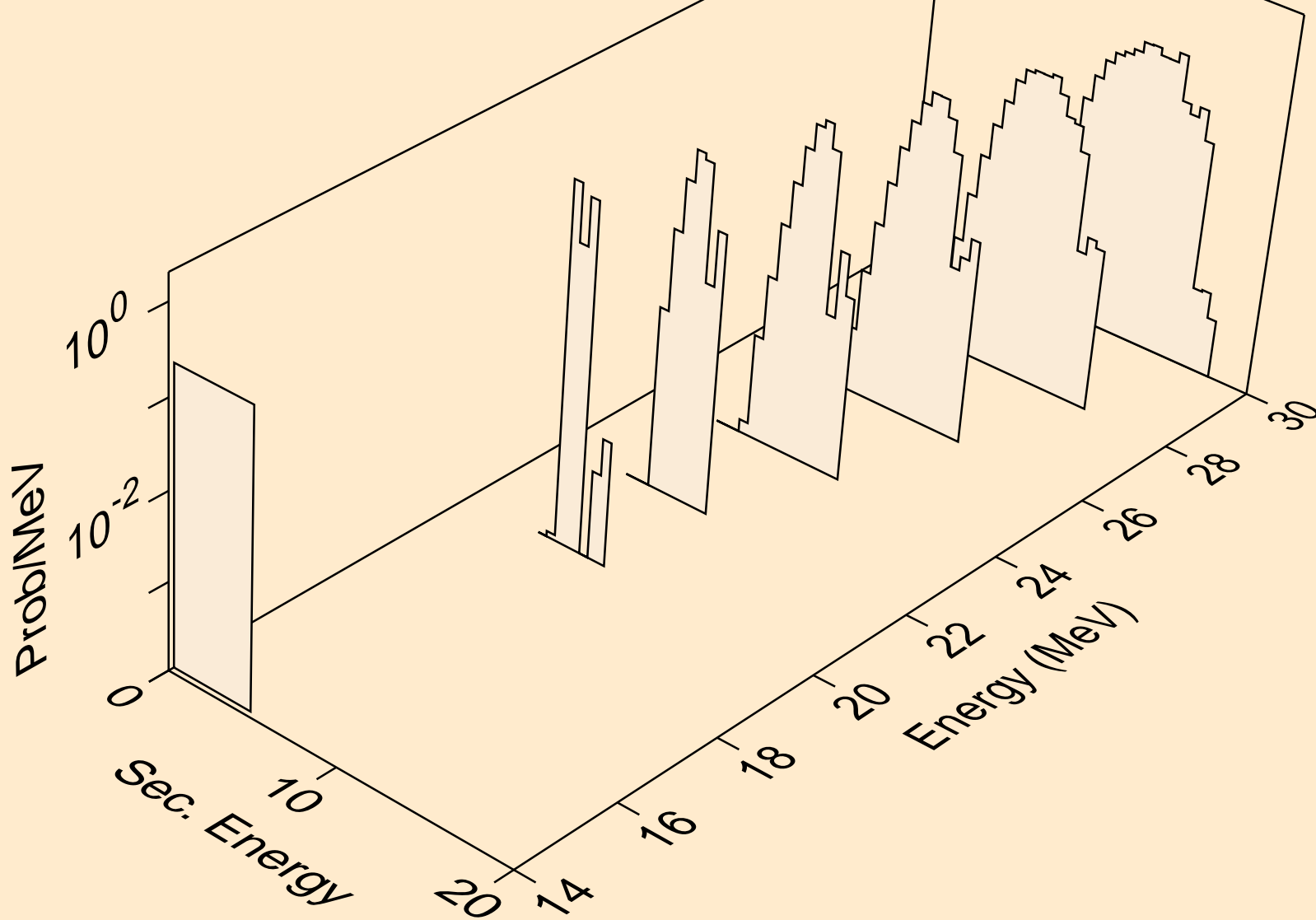

W171 NEUTRON ACER TENDL-2019 LIBRARY; T=293.16K  
alphas from (n,n\*)2a

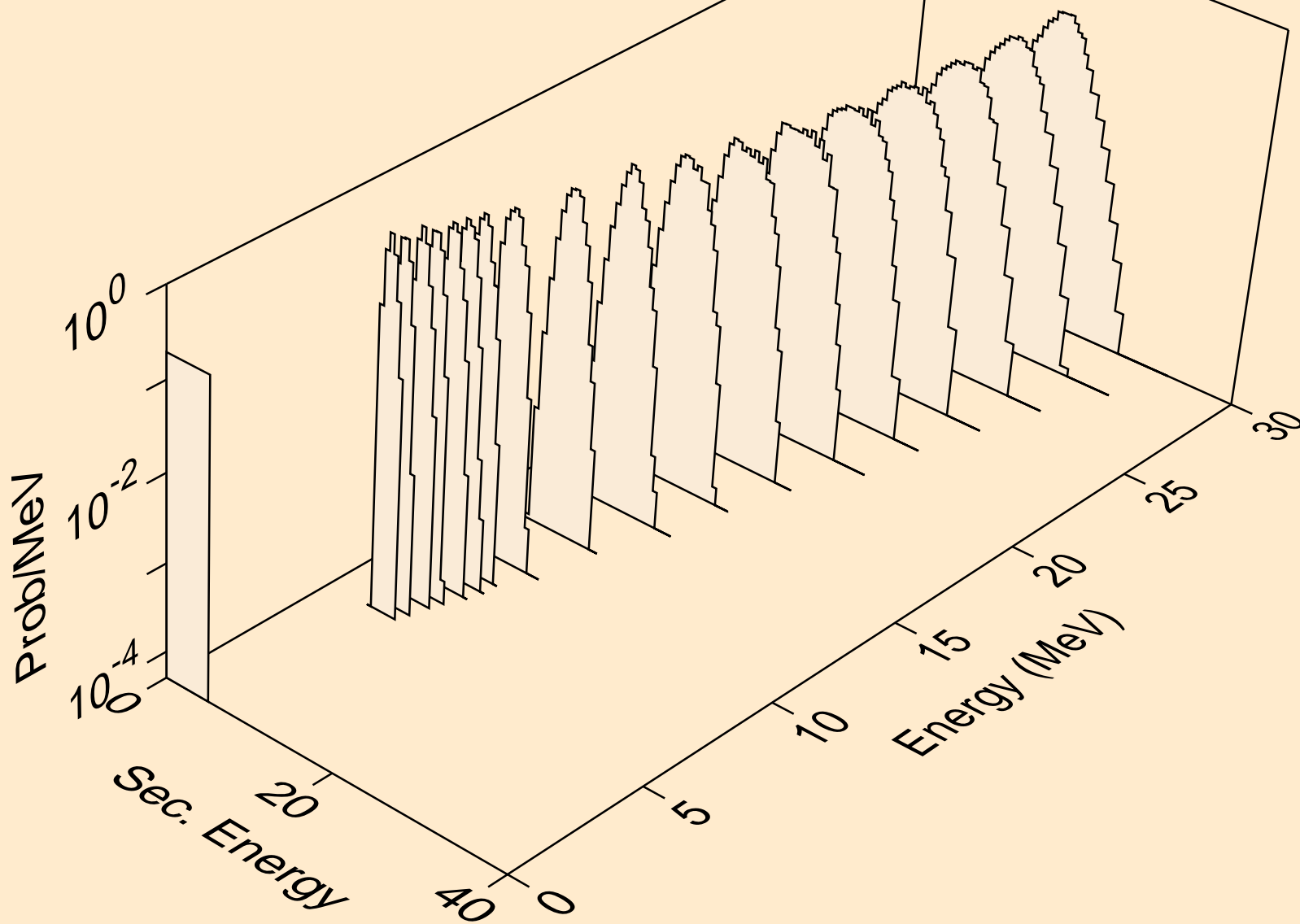

W171 NEUTRON ACER TENDL-2019 LIBRARY; T=293.16K  
alphas from (n,2n)2a

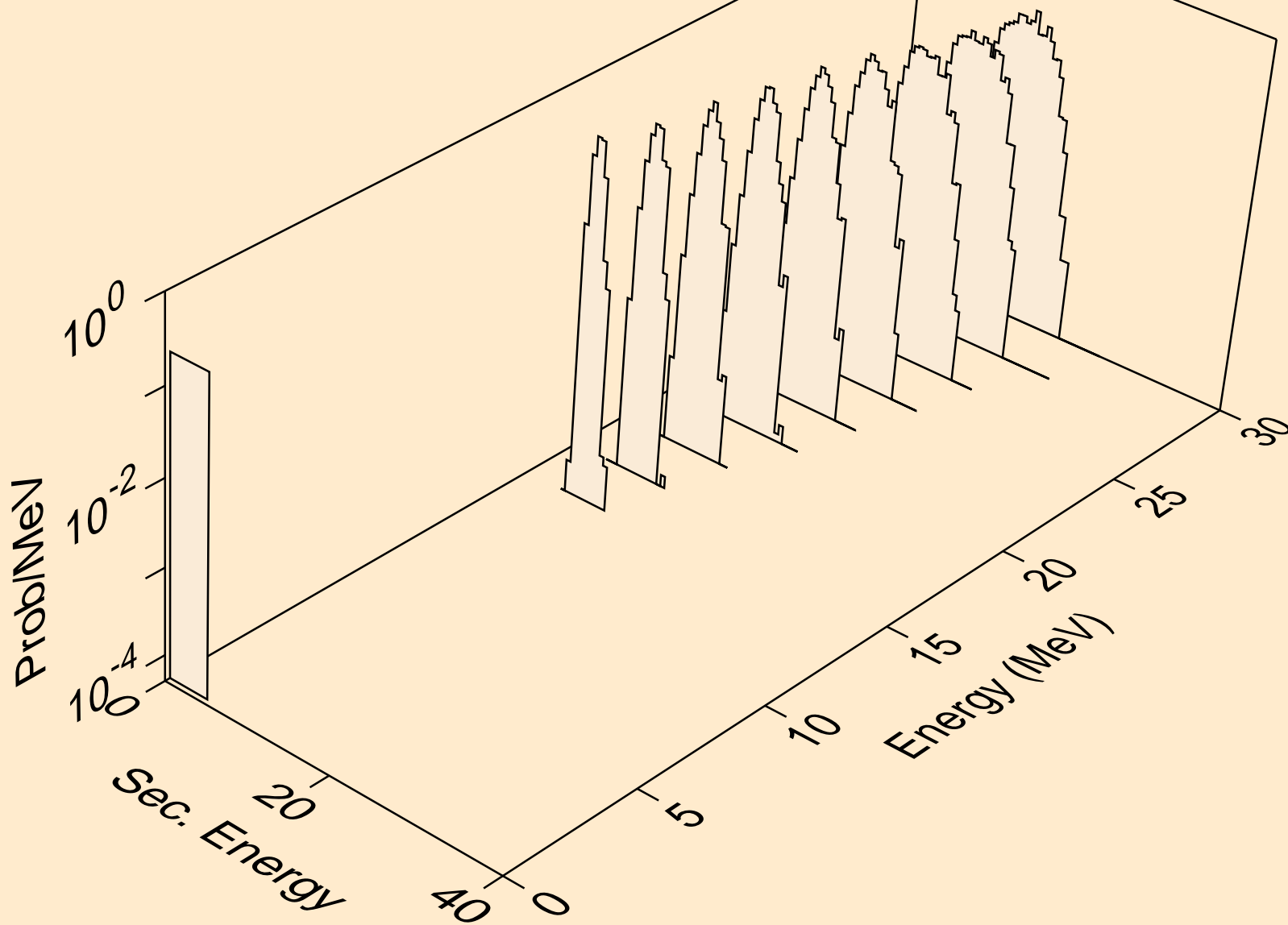

W171 NEUTRON ACER TENDL-2019 LIBRARY; T=293.16K  
alphas from (n,npa)

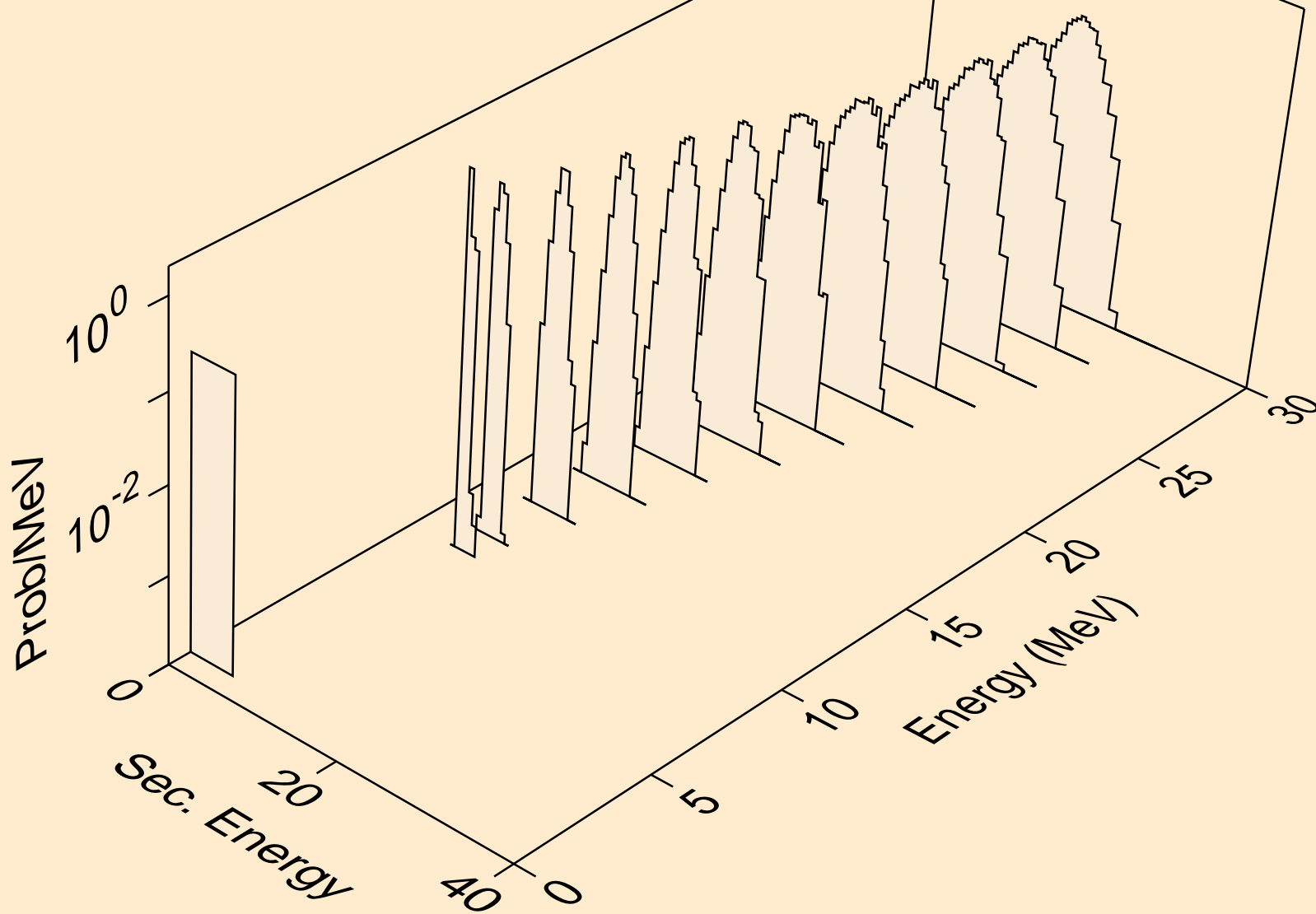

W171 NEUTRON ACER TENDL-2019 LIBRARY; T=293.16K  
alphas from (n,a)

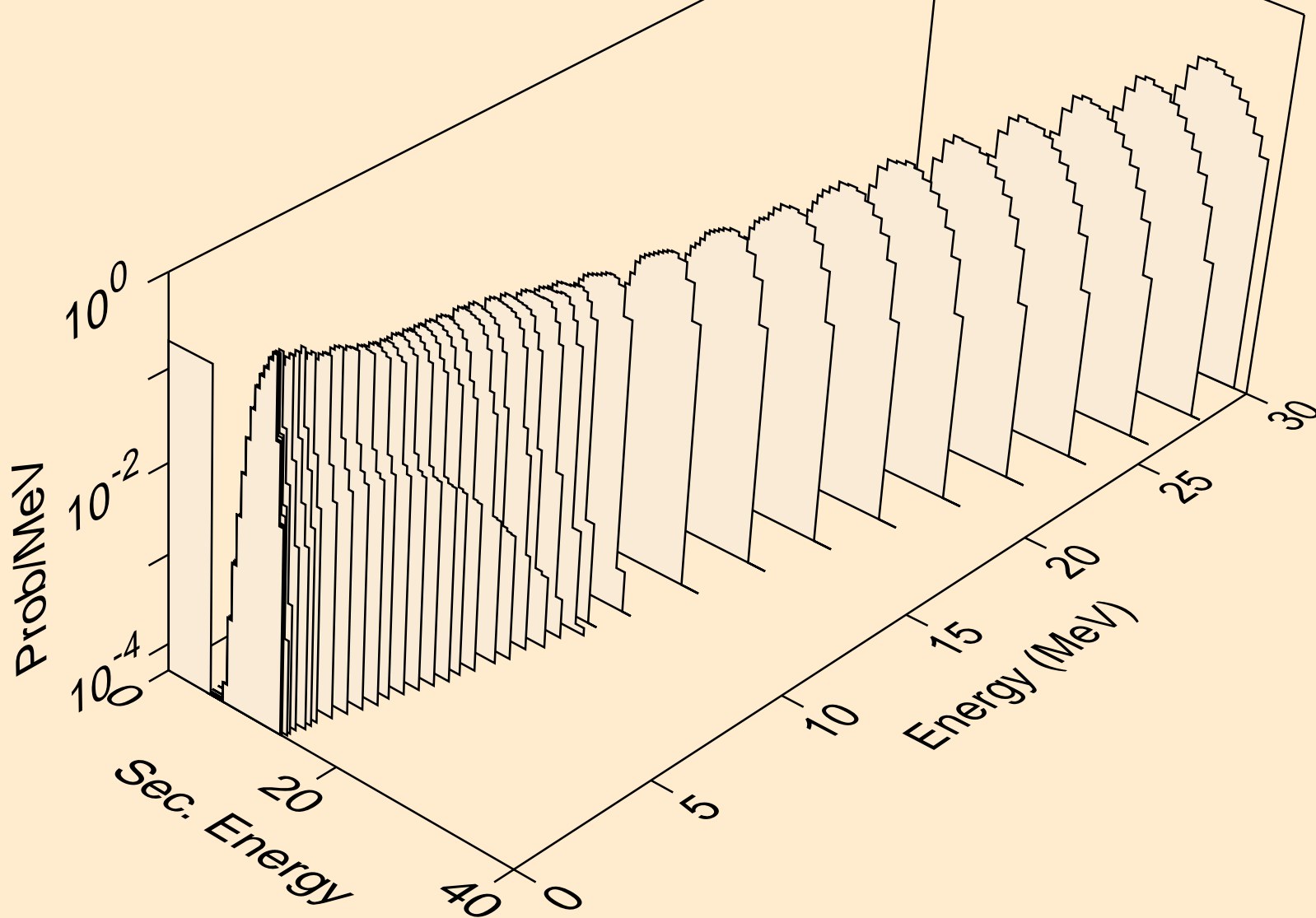

W171 NEUTRON ACER TENDL-2019 LIBRARY; T=293.16K  
alphas from (n,2a)

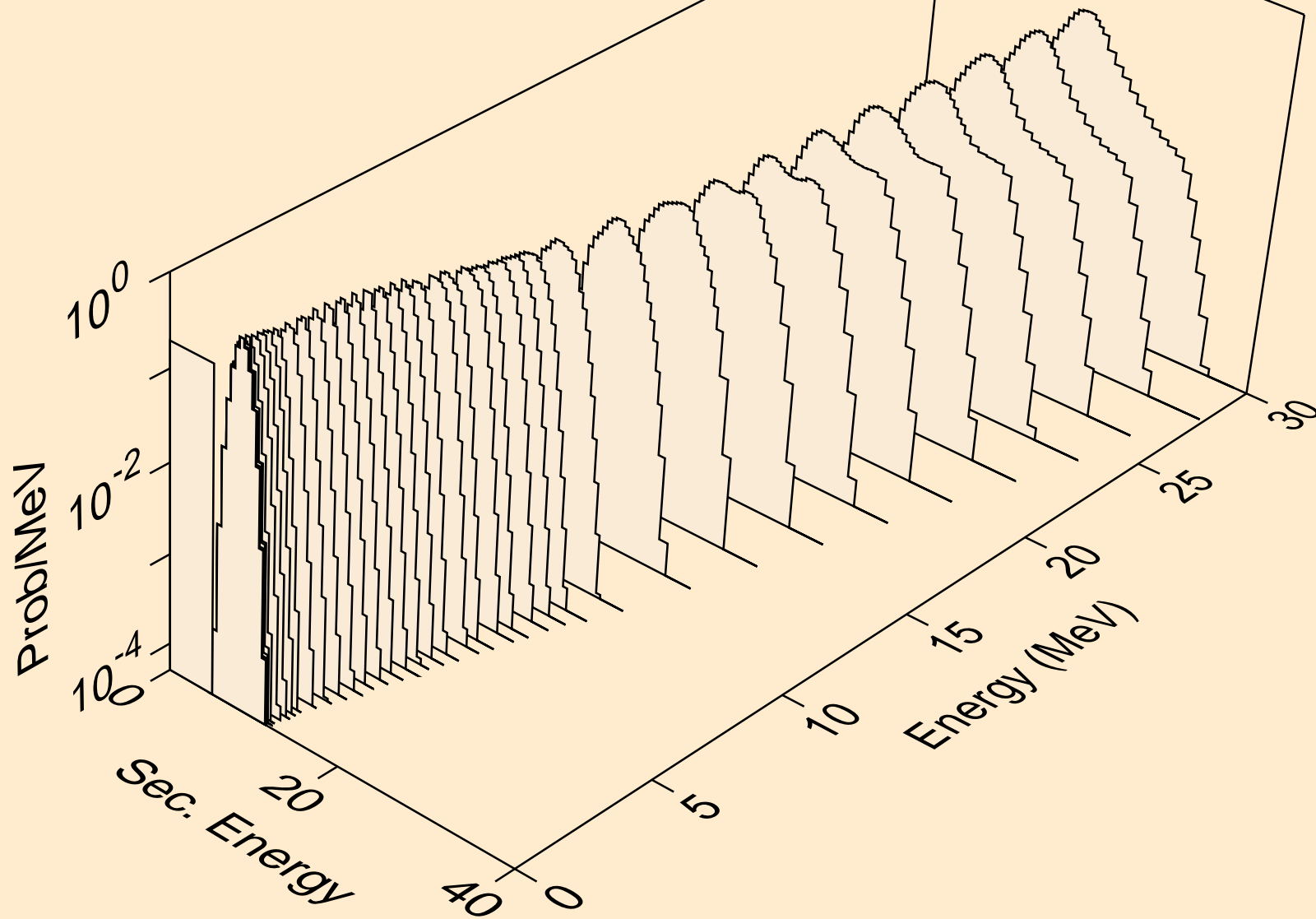

W171 NEUTRON ACER TENDL-2019 LIBRARY; T=293.16K  
alphas from (n,pa)

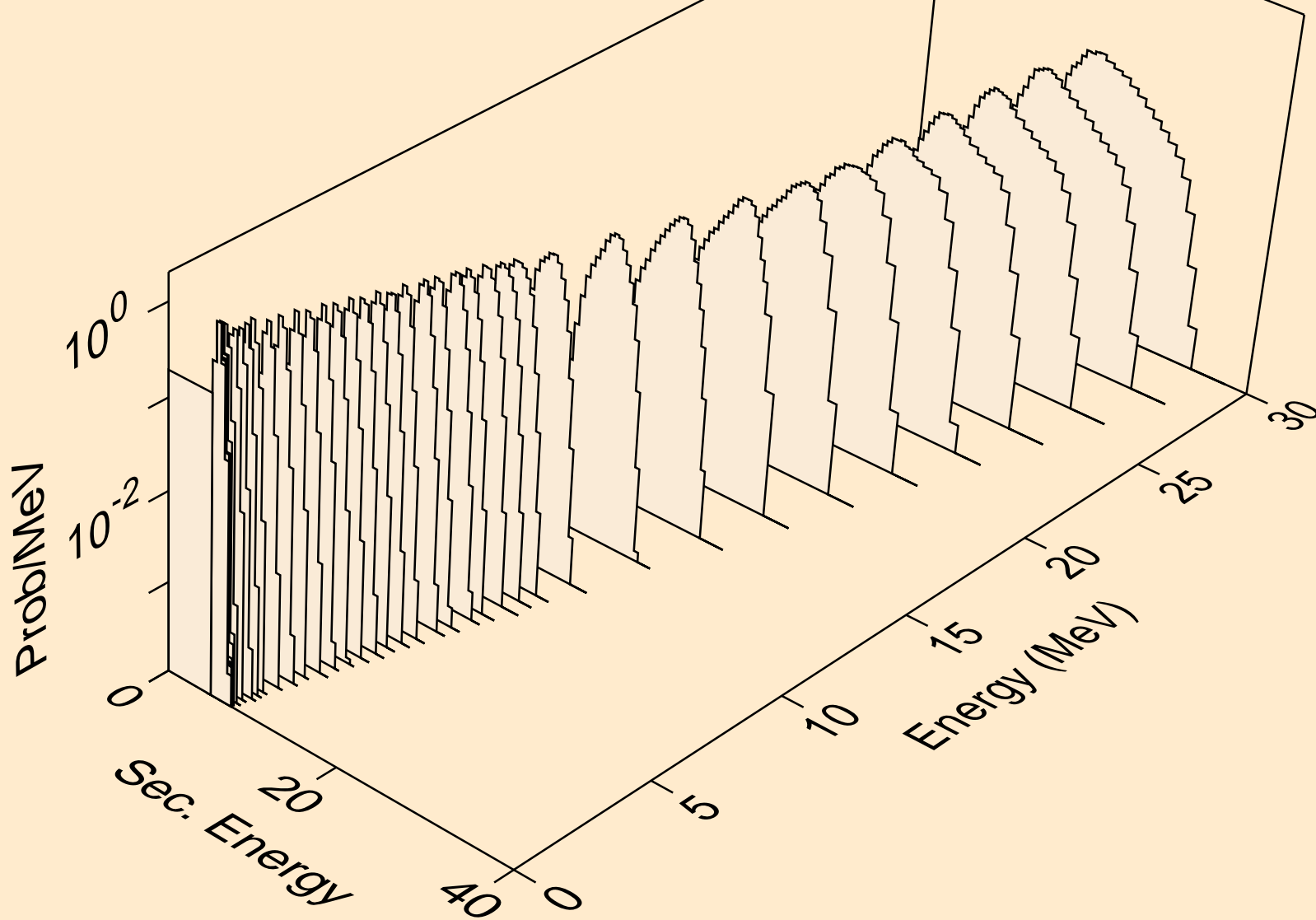



W171 NEUTRON ACER TENDL-2019 LIBRARY; T=293.16K  
alphas from (n,da)

