

W180 NEUTRON ACER TENDL-2019 LIBRARY; T=293.16K
Principal cross sections

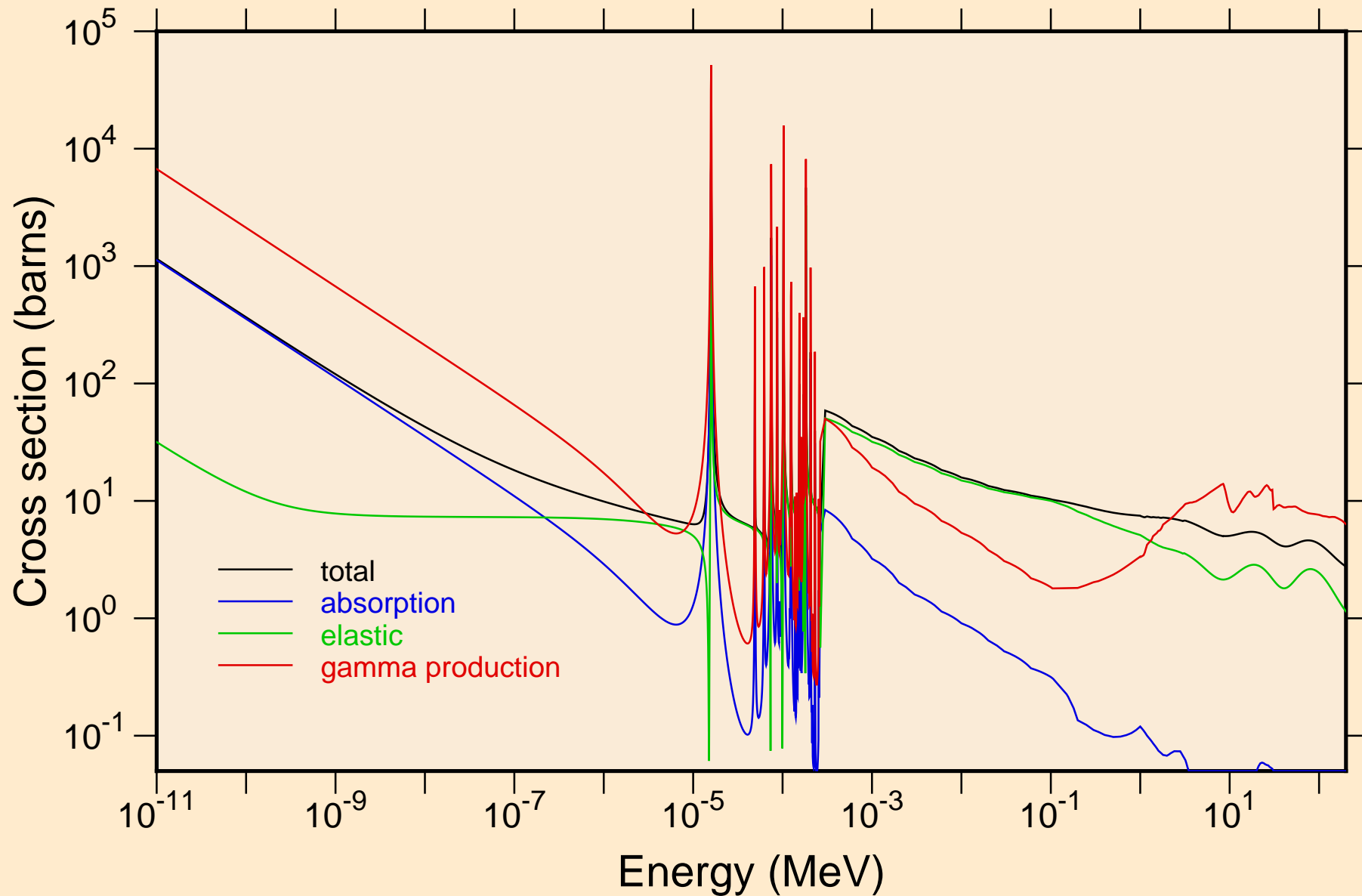

W180 NEUTRON ACER TENDL-2019 LIBRARY; T=293.16K
resonance total cross section

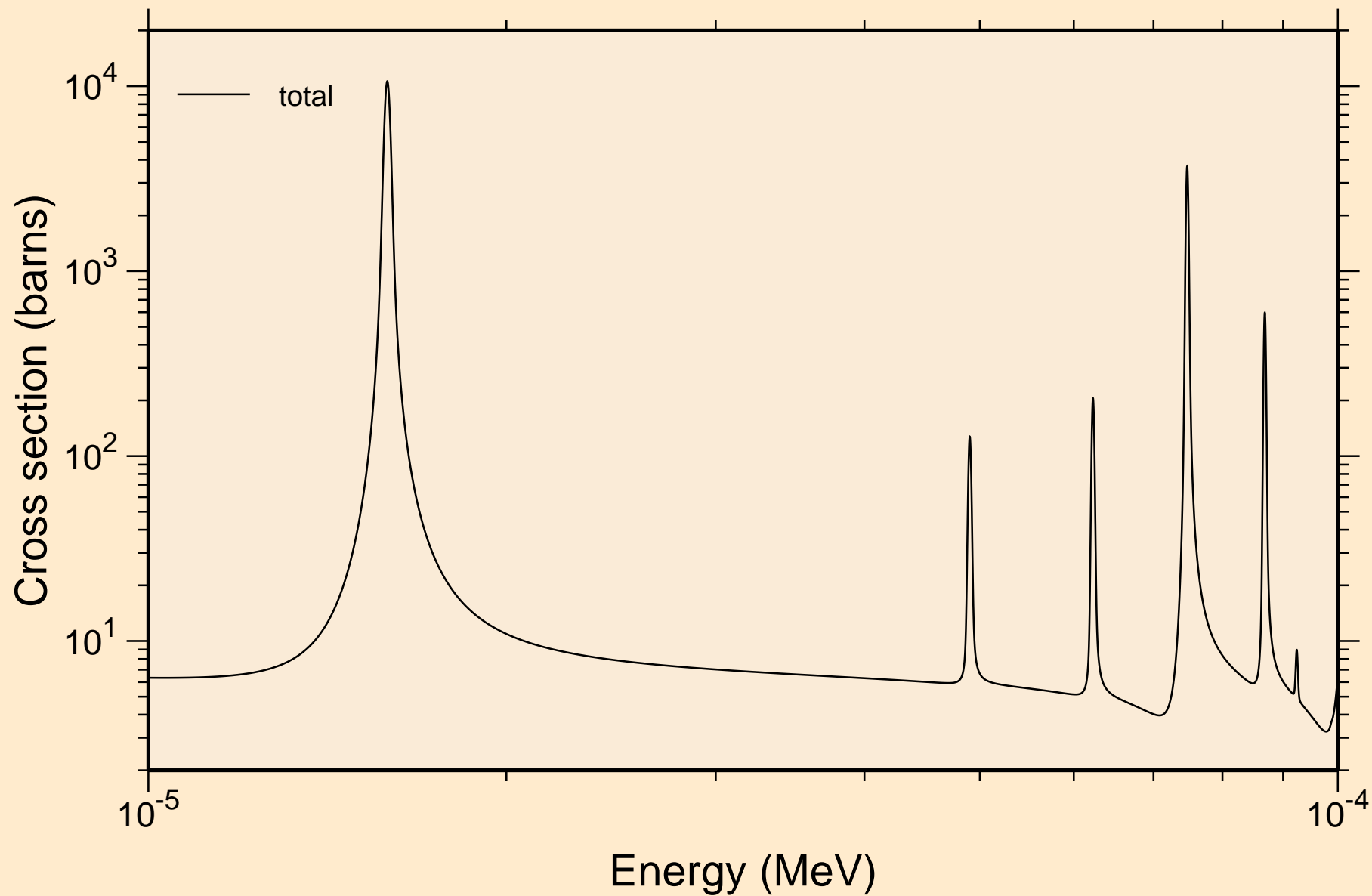

W180 NEUTRON ACER TENDL-2019 LIBRARY; T=293.16K
resonance total cross section

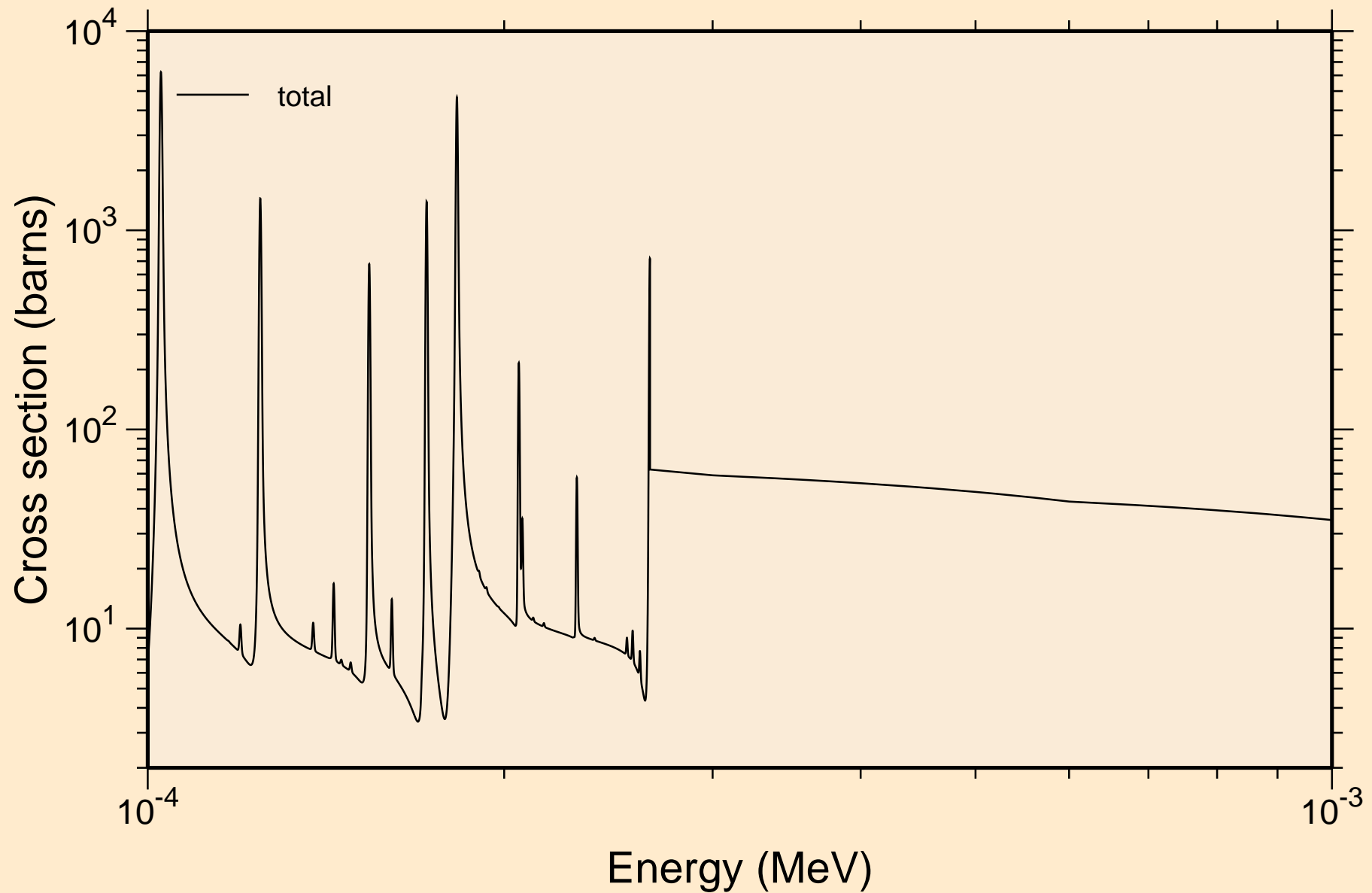

W180 NEUTRON ACER TENDL-2019 LIBRARY; T=293.16K
resonance total cross section

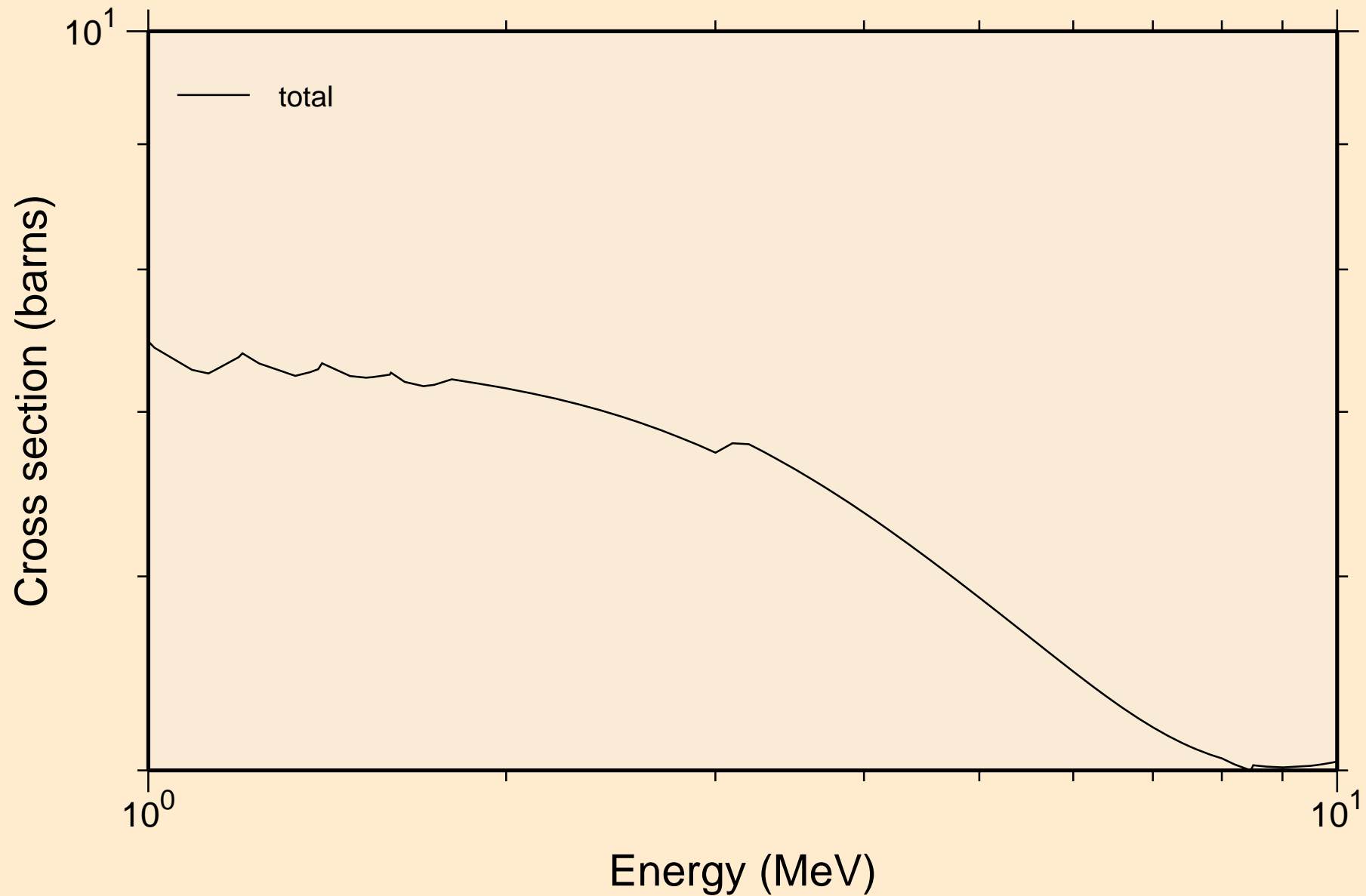

W180 NEUTRON ACER TENDL-2019 LIBRARY; T=293.16K
resonance absorption cross sections

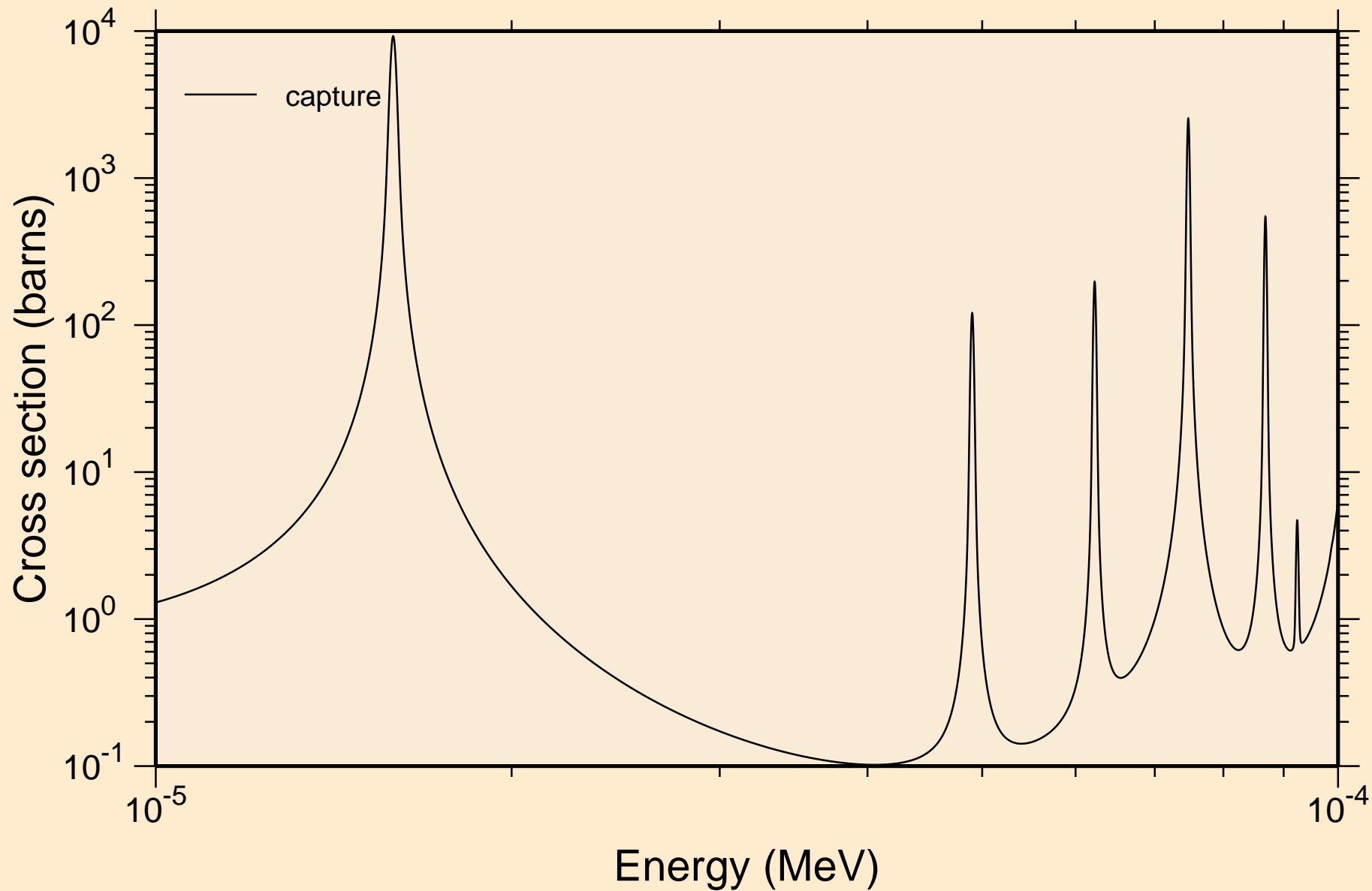

W180 NEUTRON ACER TENDL-2019 LIBRARY; T=293.16K
resonance absorption cross sections

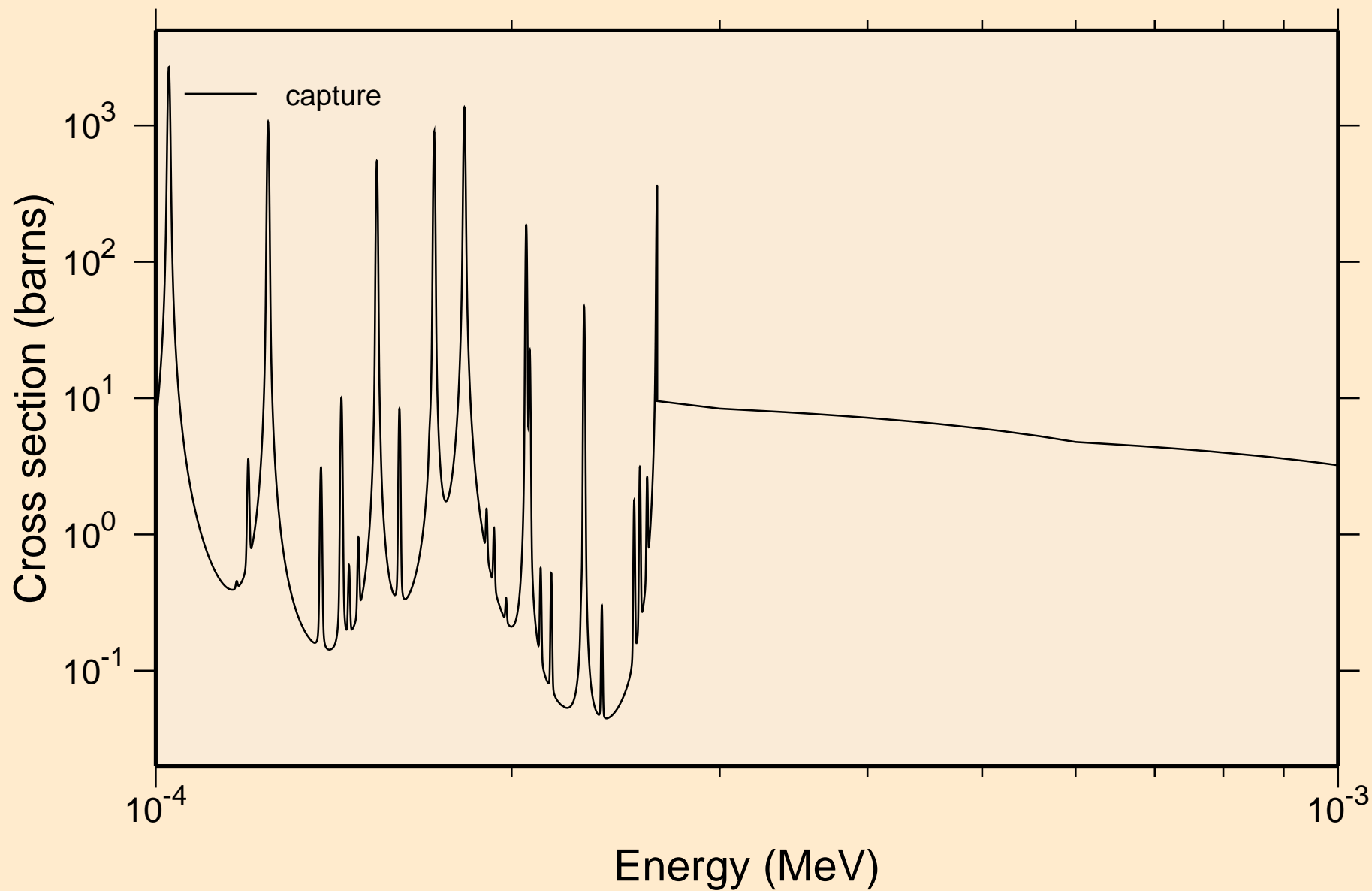

W180 NEUTRON ACER TENDL-2019 LIBRARY; T=293.16K
resonance absorption cross sections

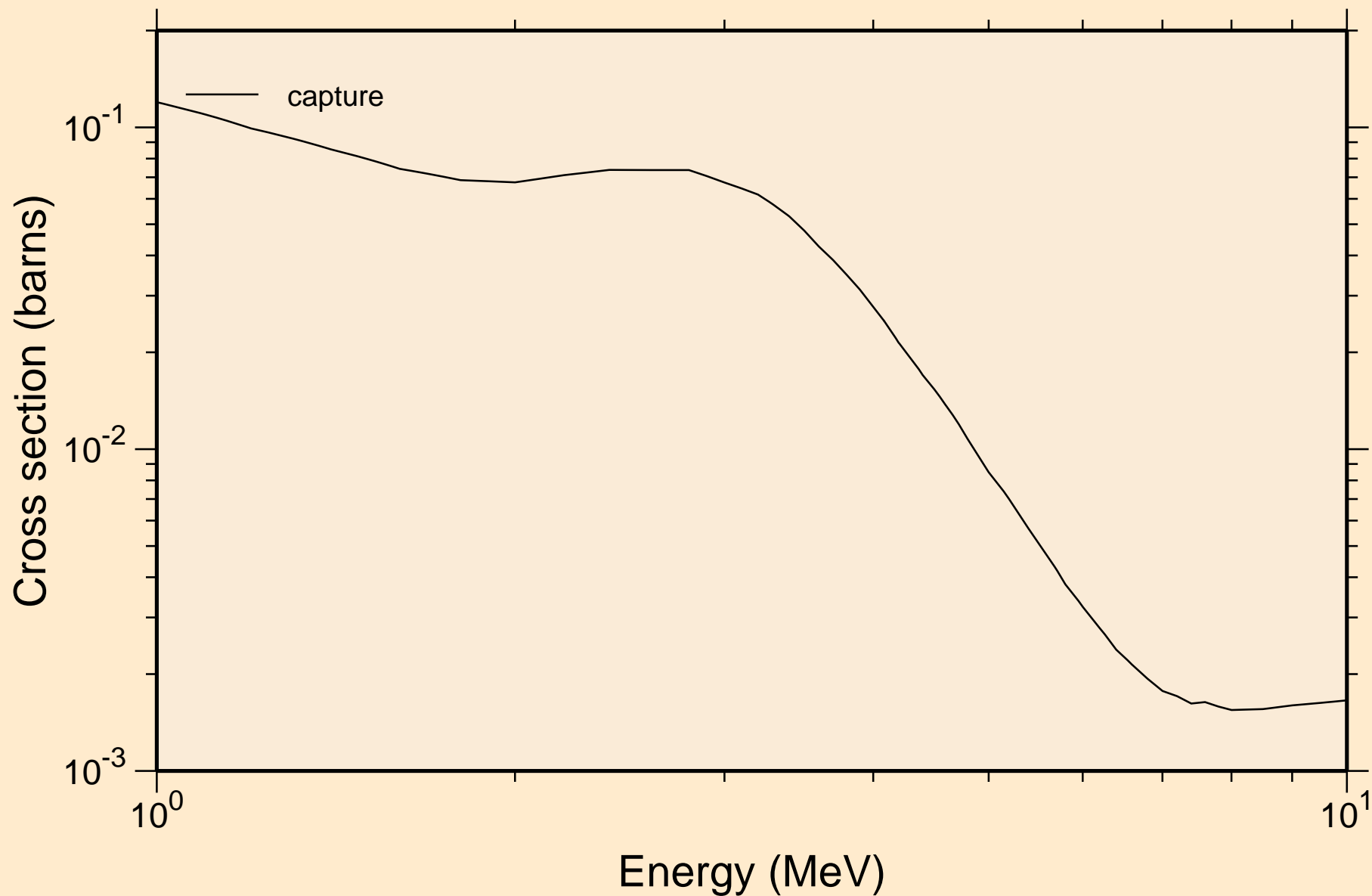

W180 NEUTRON ACER TENDL-2019 LIBRARY; T=293.16K
Heating

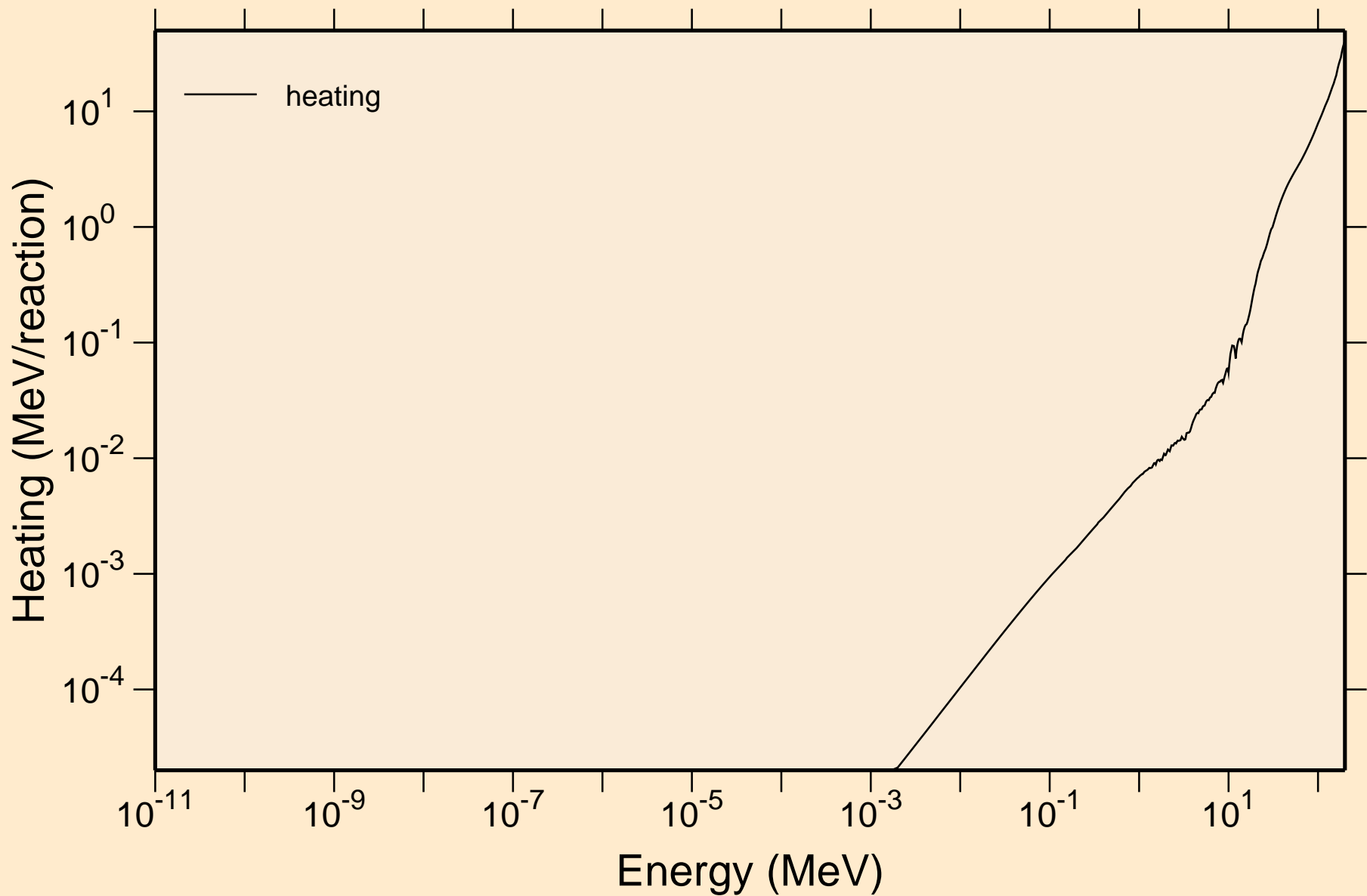

W180 NEUTRON ACER TENDL-2019 LIBRARY; T=293.16K Damage

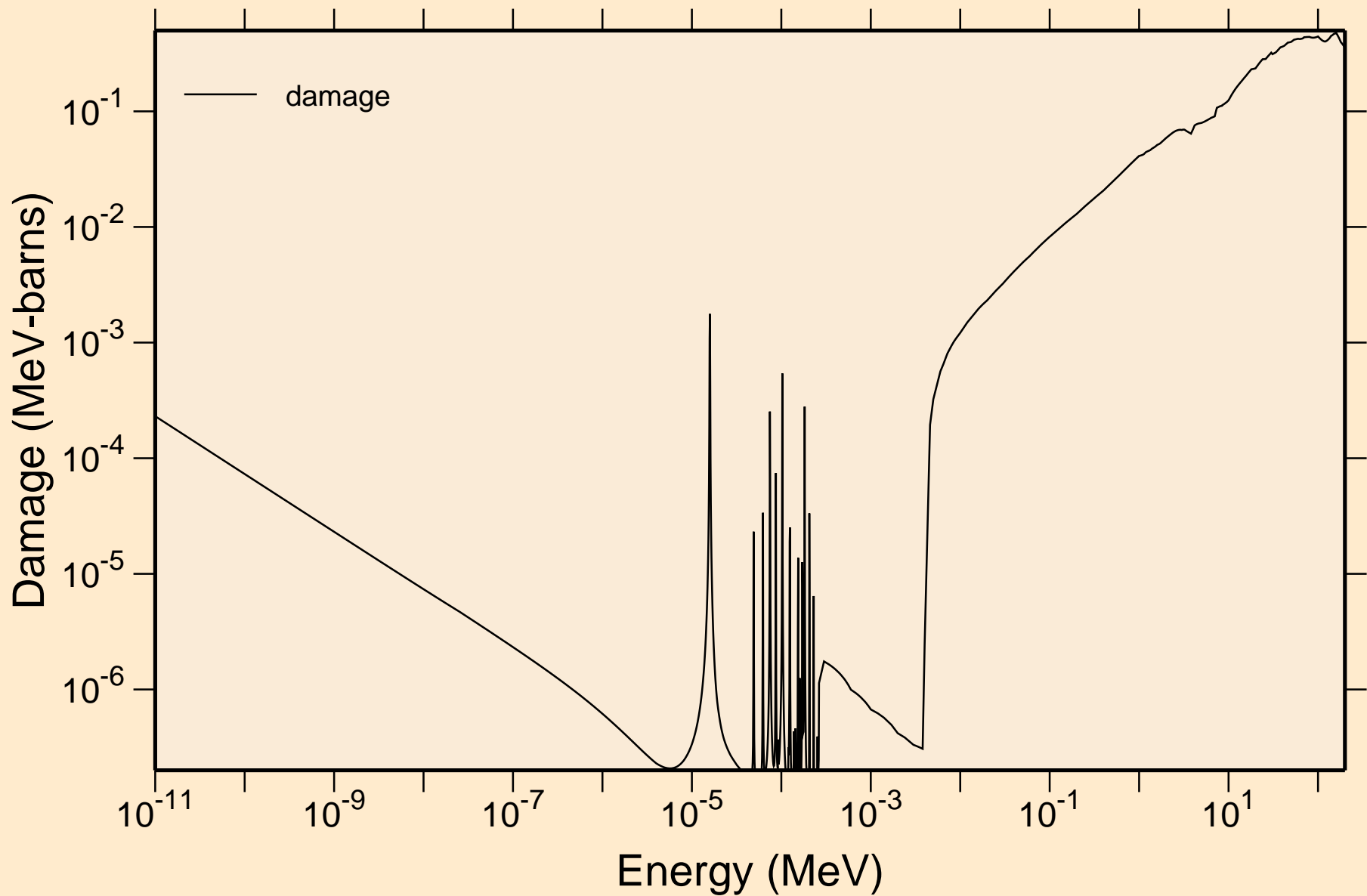

W180 NEUTRON ACER TENDL-2019 LIBRARY; T=293.16K
Non-threshold reactions

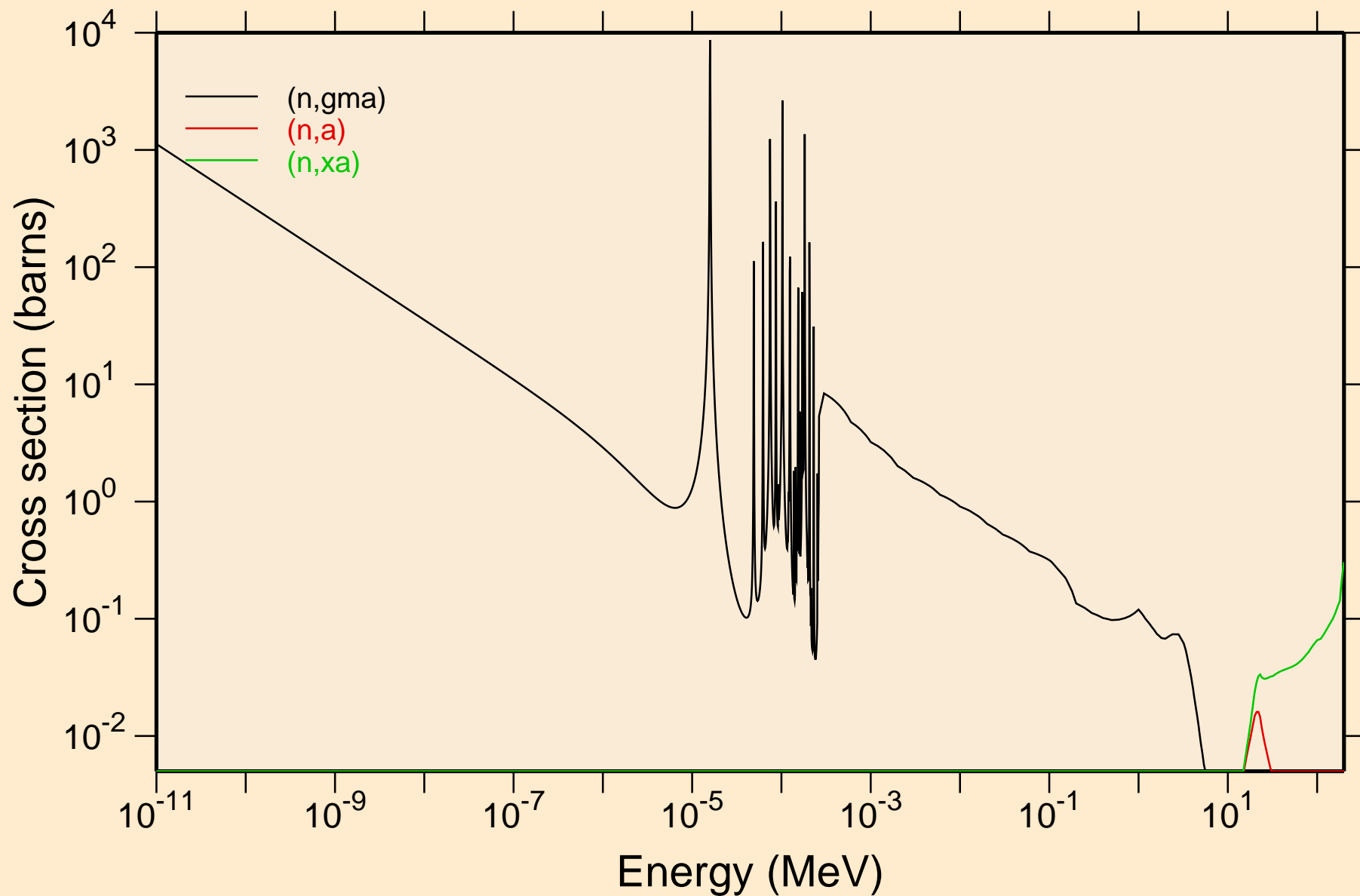

W180 NEUTRON ACER TENDL-2019 LIBRARY; T=293.16K
Principal cross sections

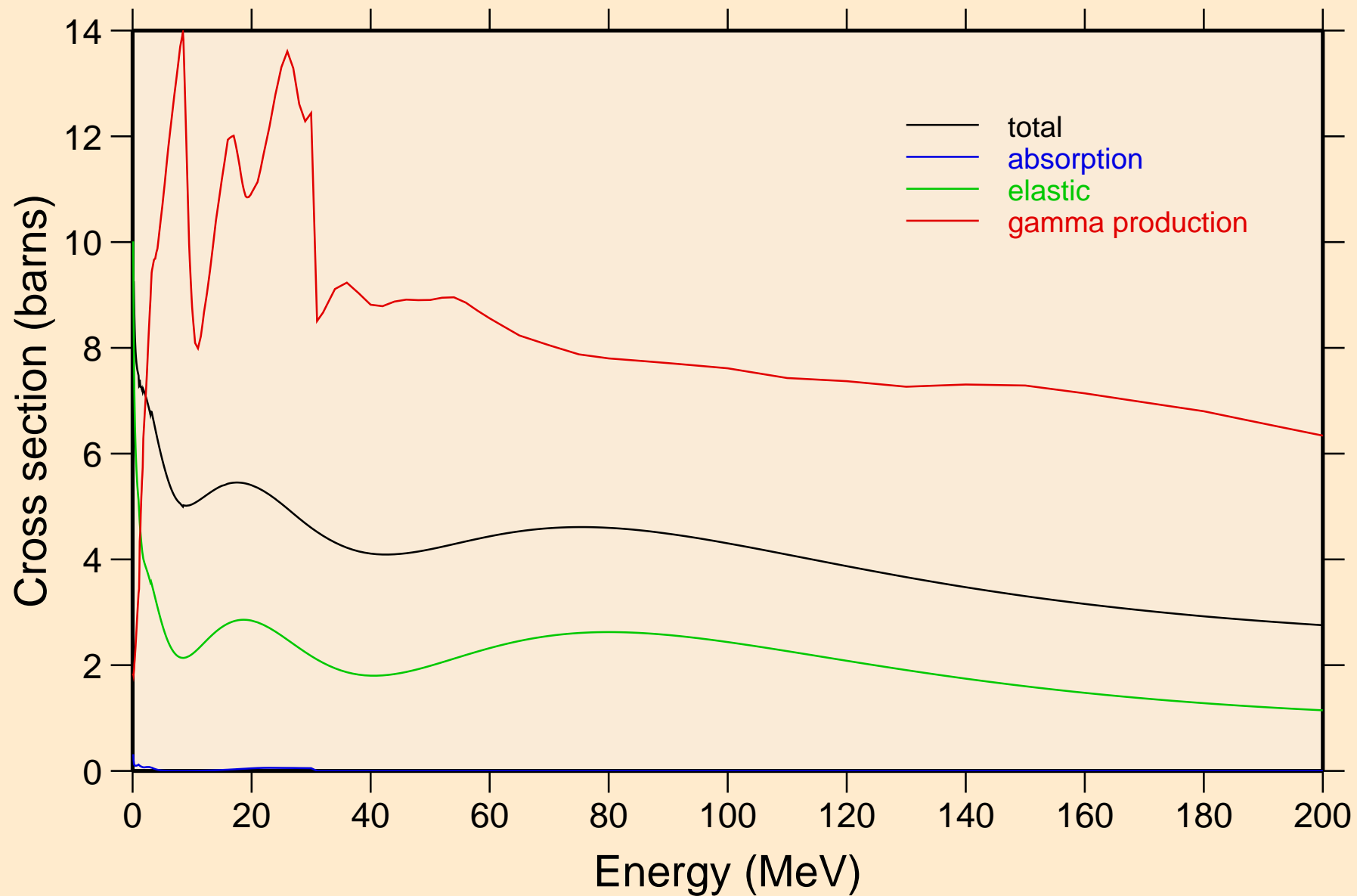

W180 NEUTRON ACER TENDL-2019 LIBRARY; T=293.16K
Heating

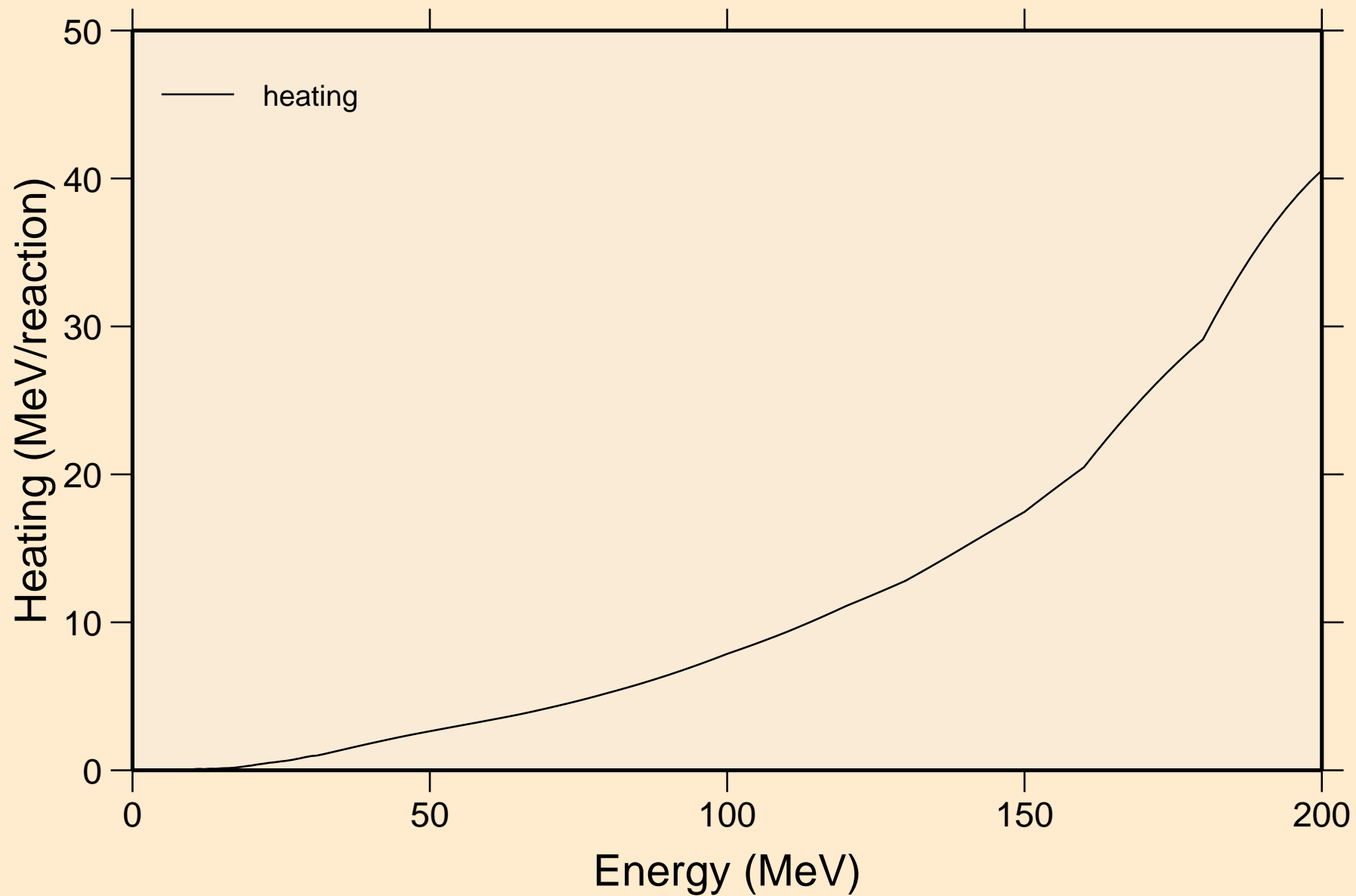

W180 NEUTRON ACER TENDL-2019 LIBRARY; T=293.16K
Damage

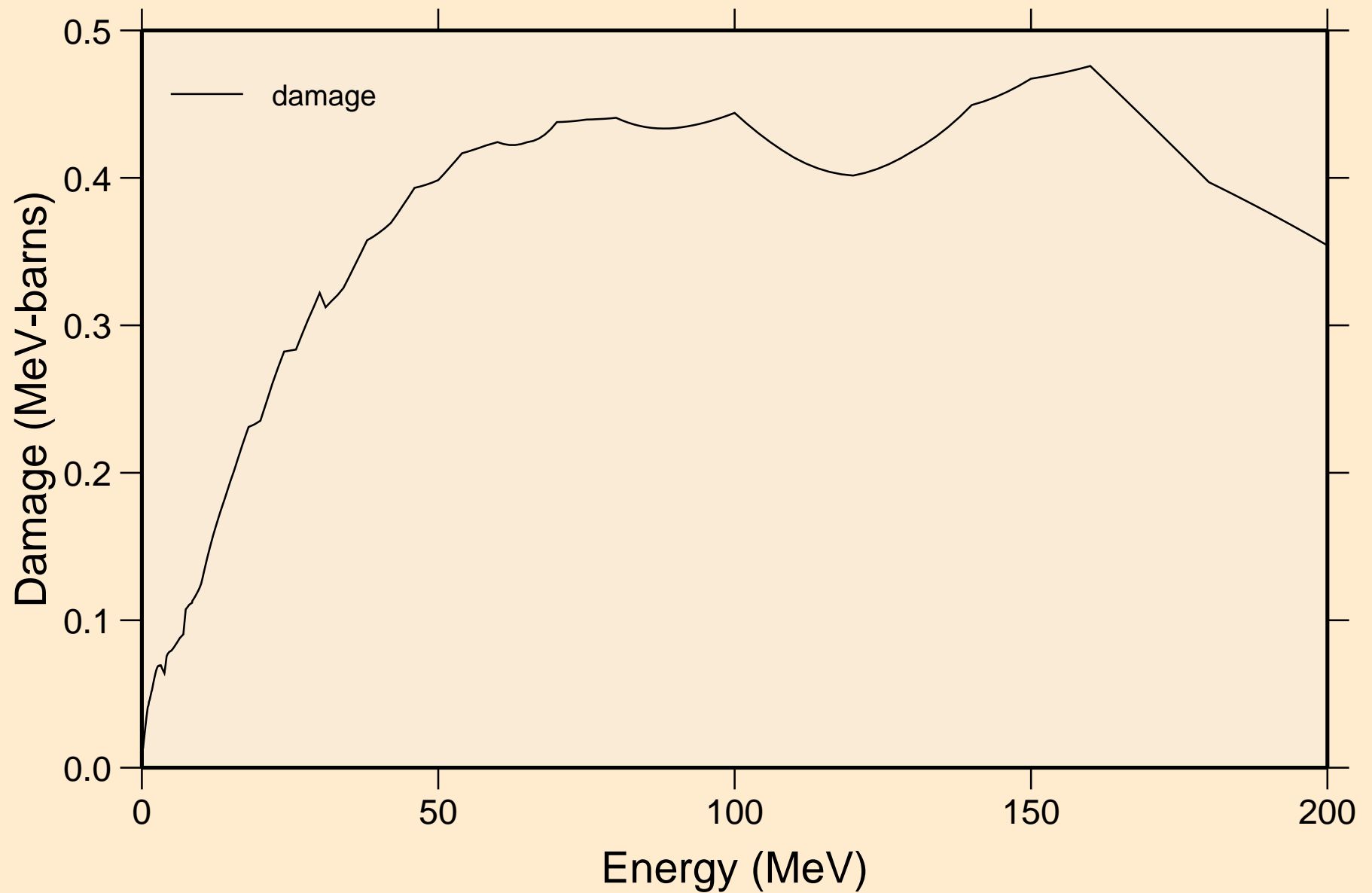

W180 NEUTRON ACER TENDL-2019 LIBRARY; T=293.16K
Non-threshold reactions

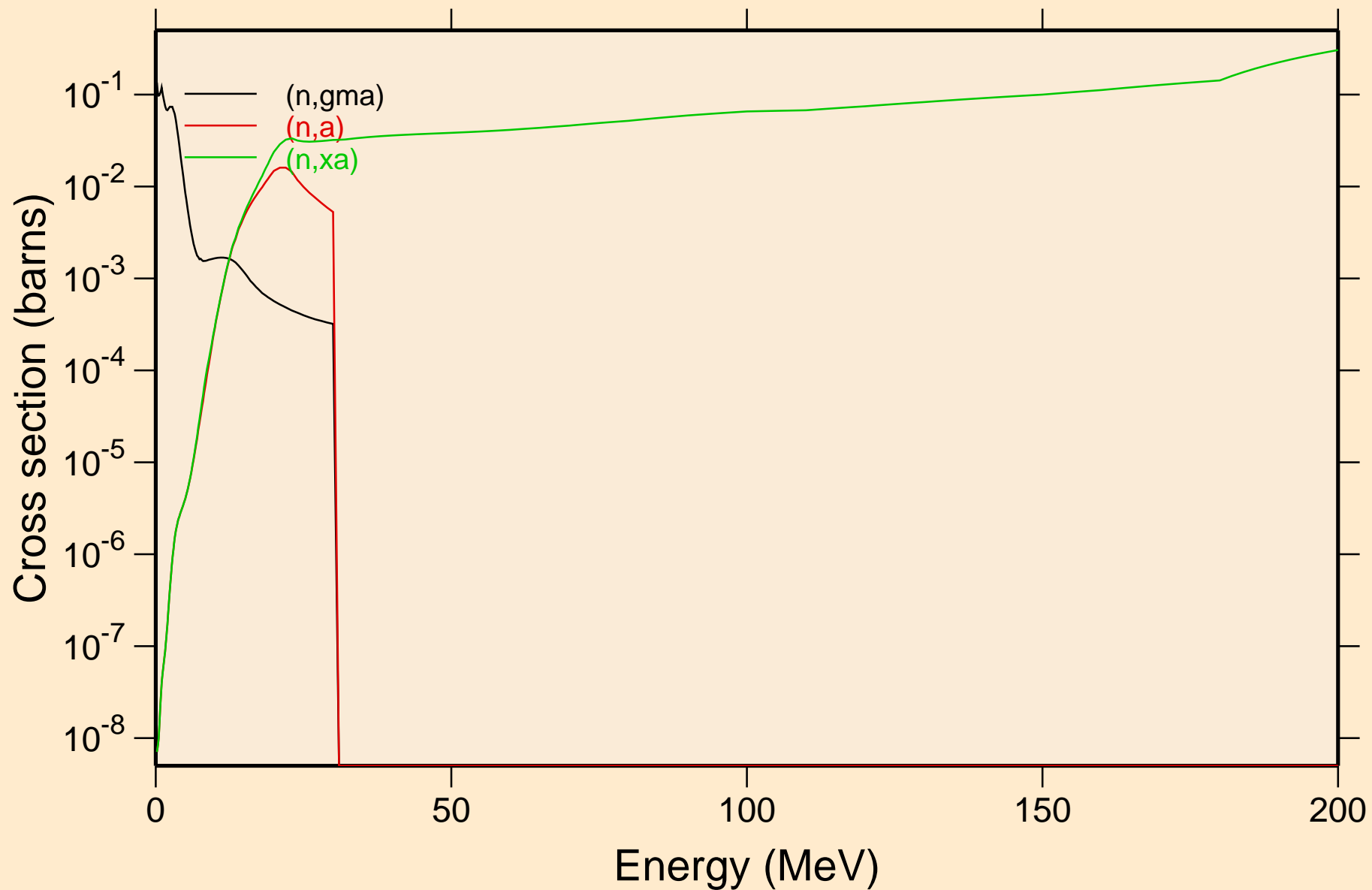

W180 NEUTRON ACER TENDL-2019 LIBRARY; T=293.16K
Inelastic levels

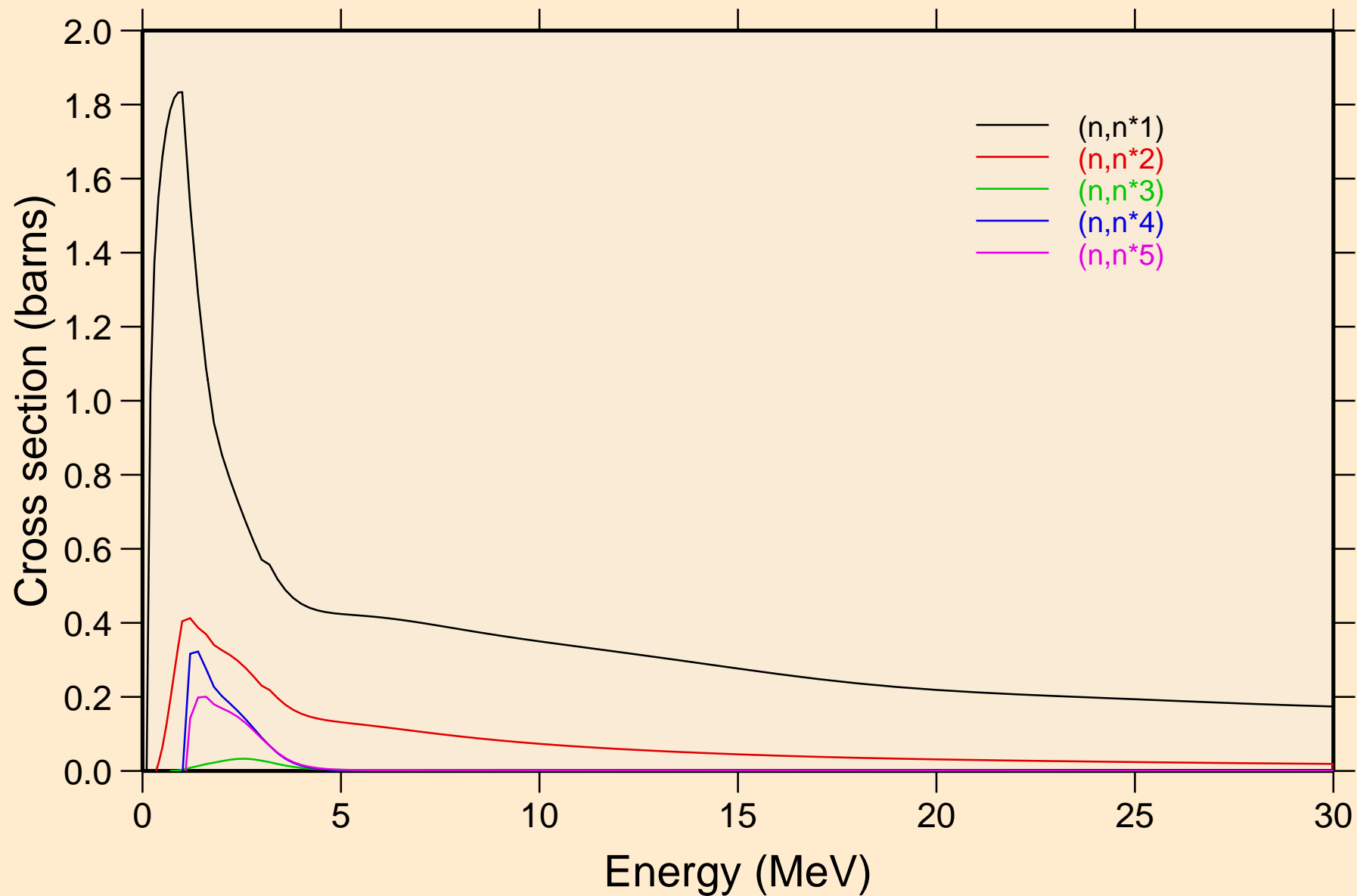

W180 NEUTRON ACER TENDL-2019 LIBRARY; T=293.16K
Inelastic levels

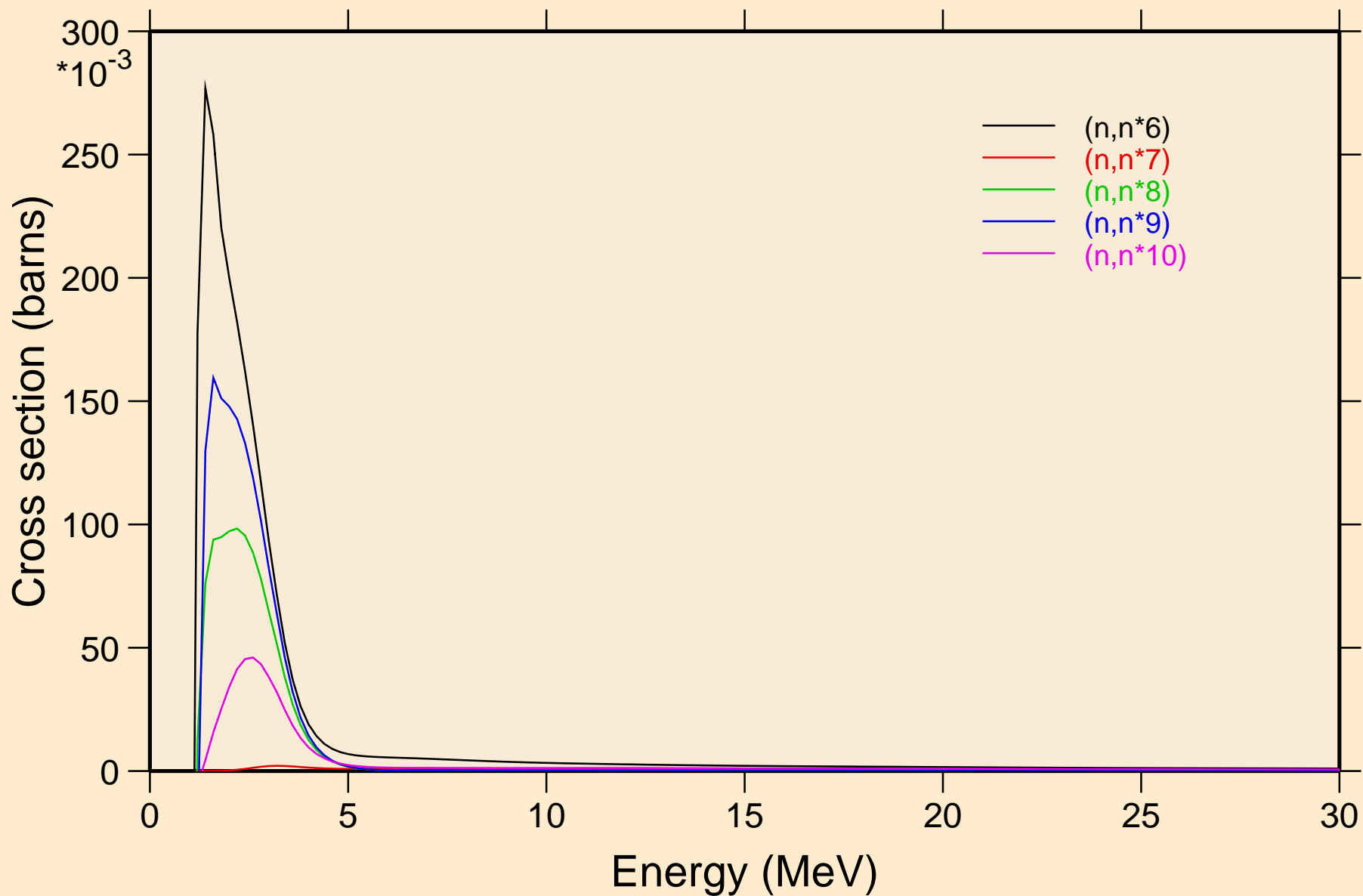

W180 NEUTRON ACER TENDL-2019 LIBRARY; T=293.16K
Inelastic levels

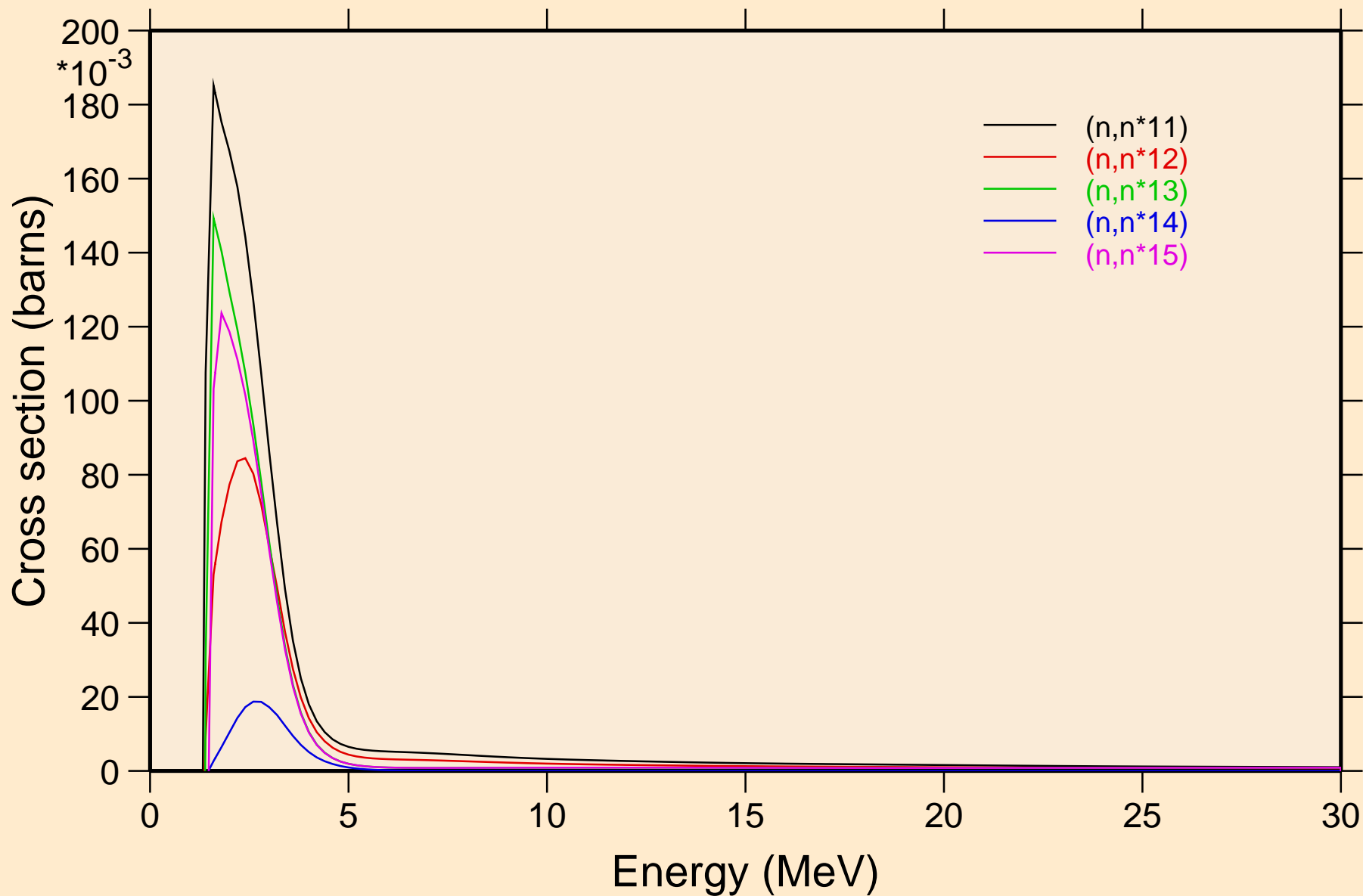

W180 NEUTRON ACER TENDL-2019 LIBRARY; T=293.16K
Inelastic levels

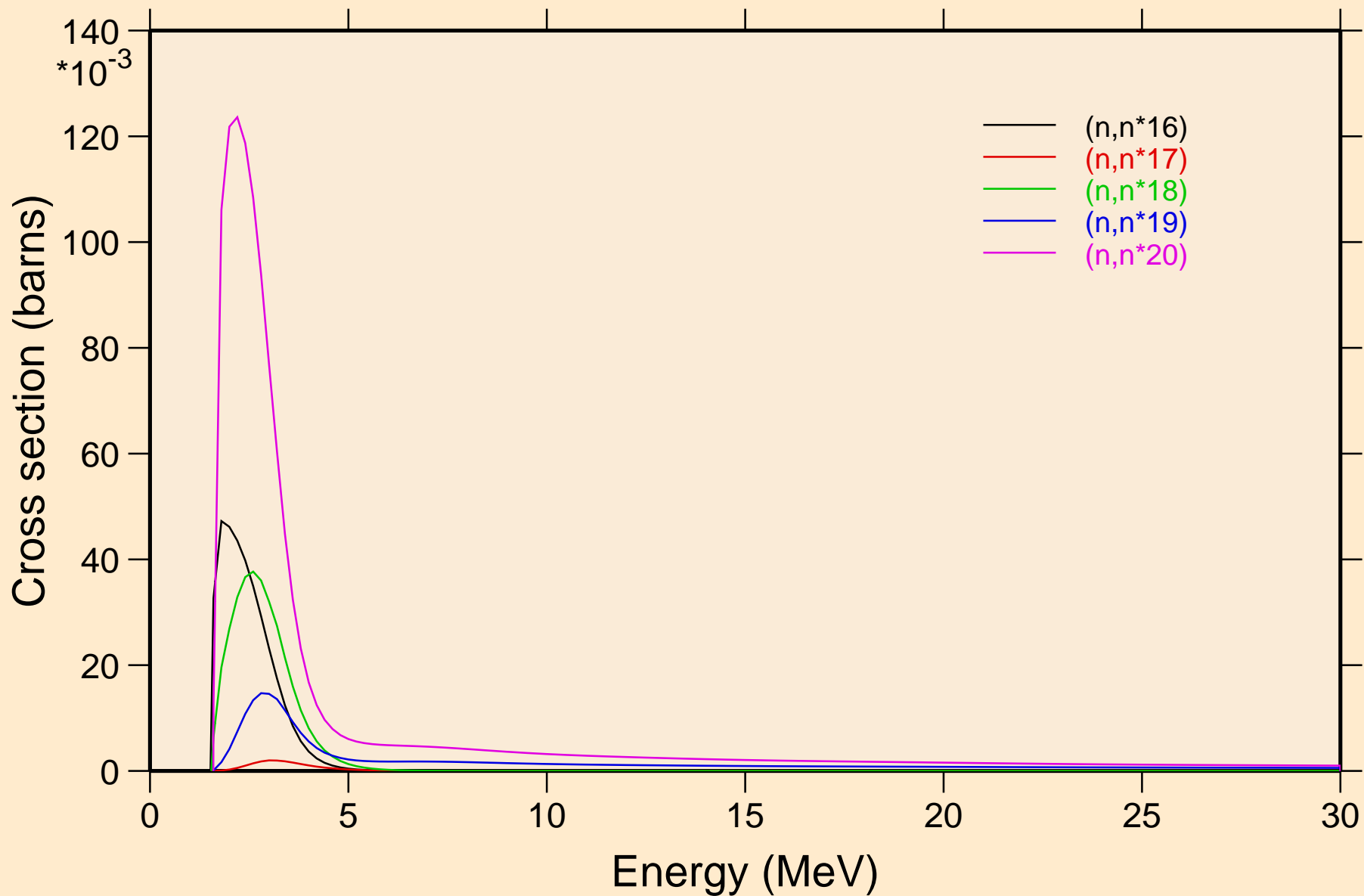

W180 NEUTRON ACER TENDL-2019 LIBRARY; T=293.16K
Inelastic levels

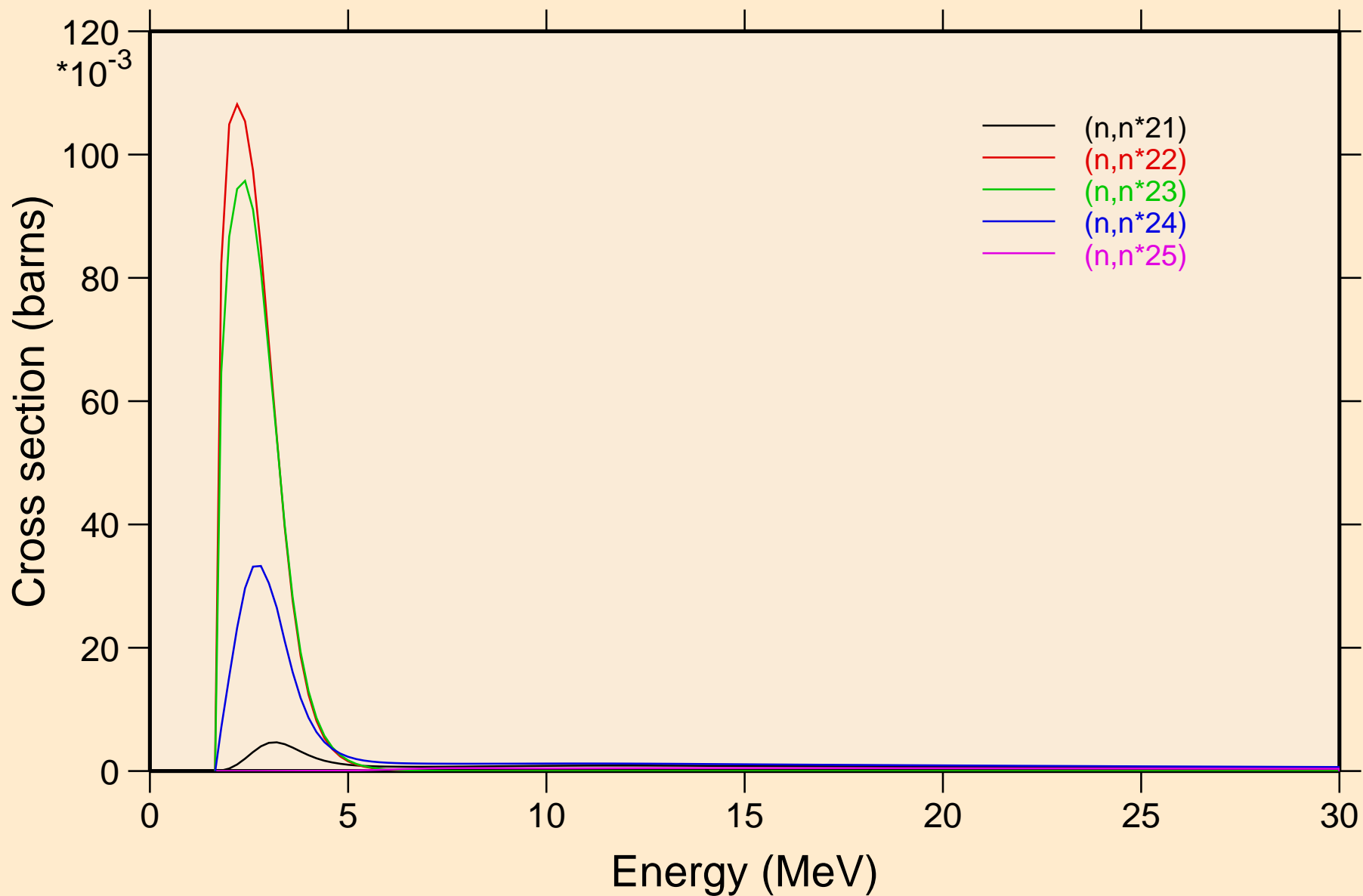

W180 NEUTRON ACER TENDL-2019 LIBRARY; T=293.16K
Inelastic levels

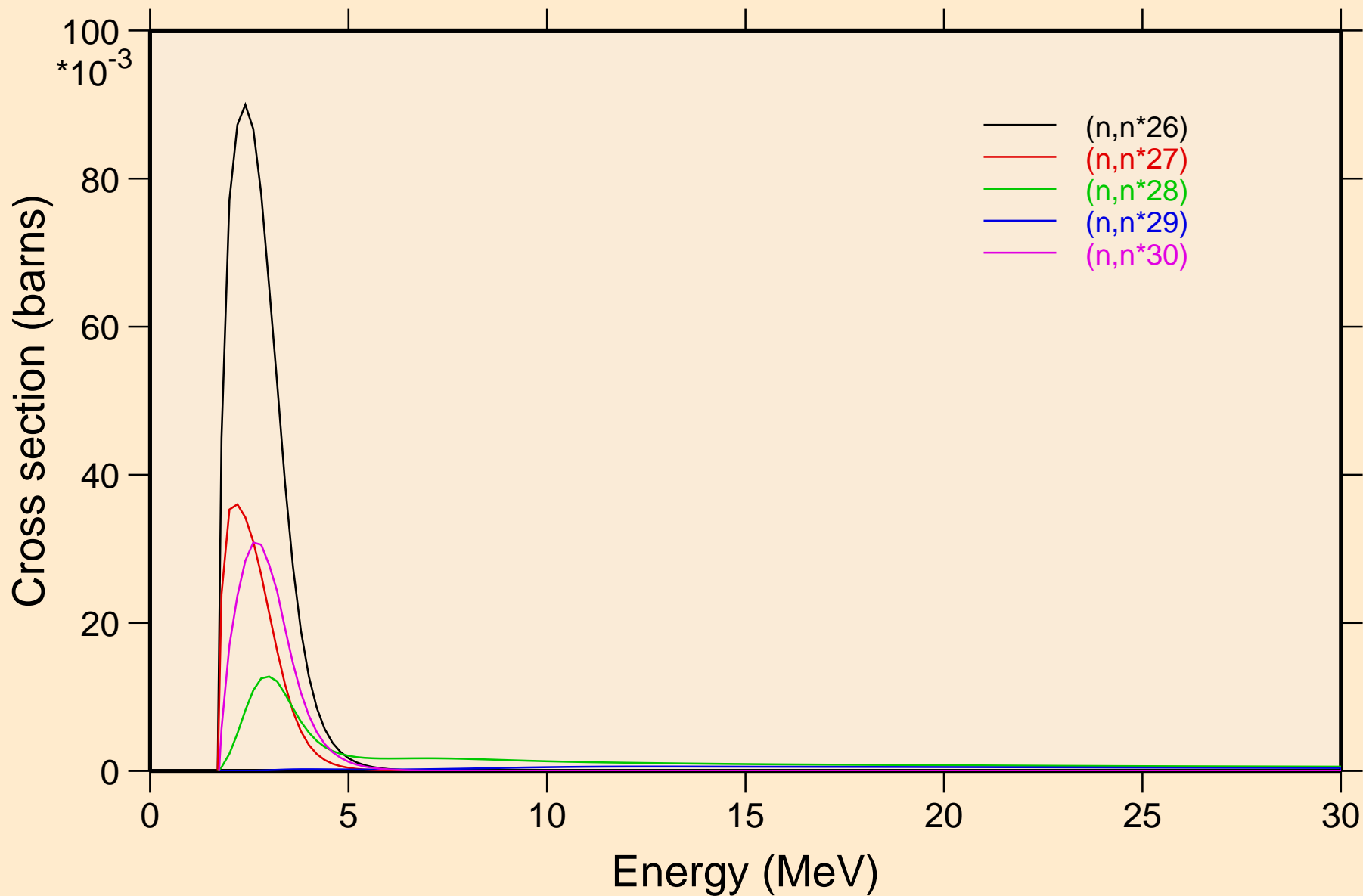

W180 NEUTRON ACER TENDL-2019 LIBRARY; T=293.16K
Threshold reactions

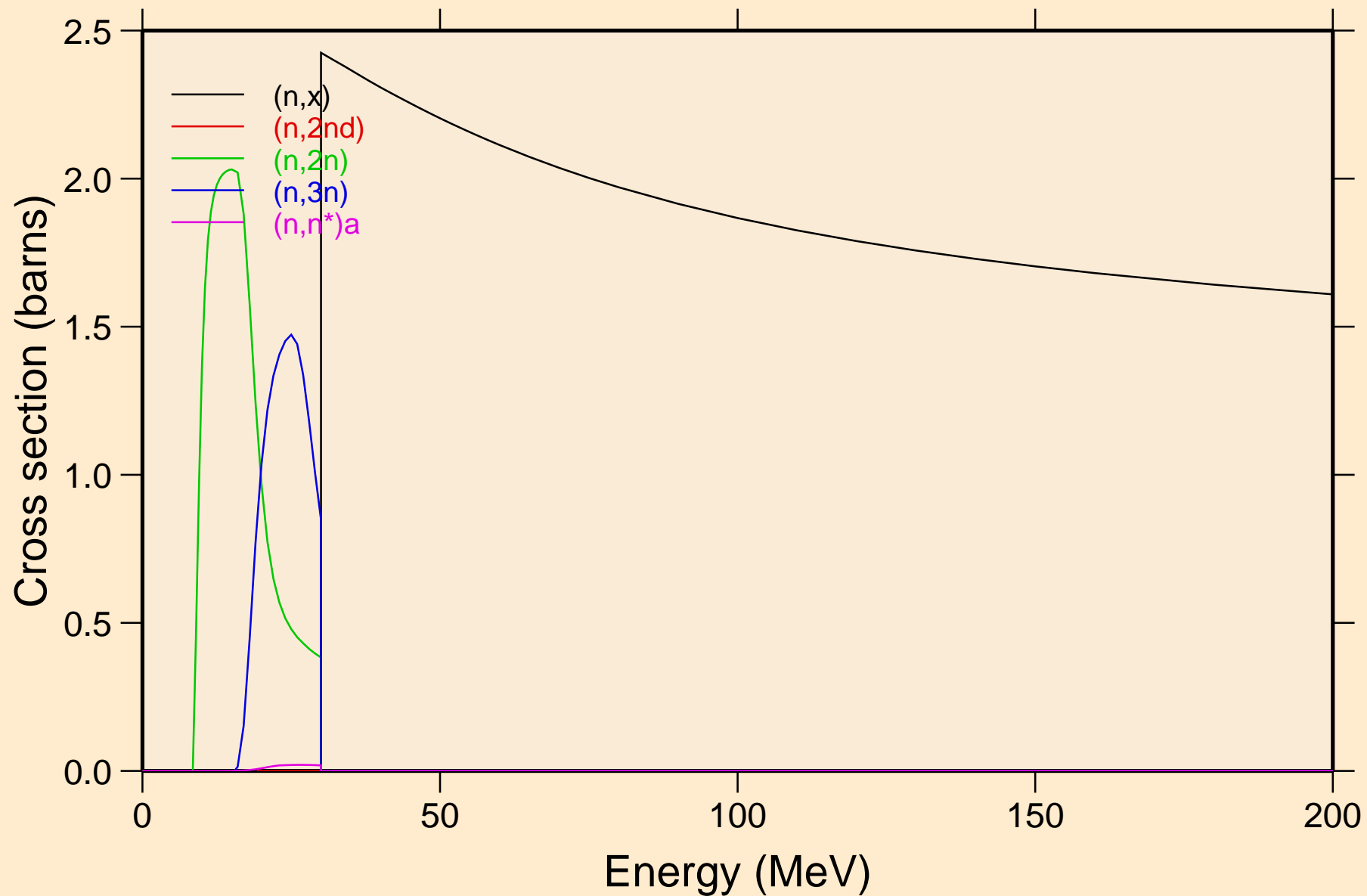

W180 NEUTRON ACER TENDL-2019 LIBRARY; T=293.16K
Threshold reactions

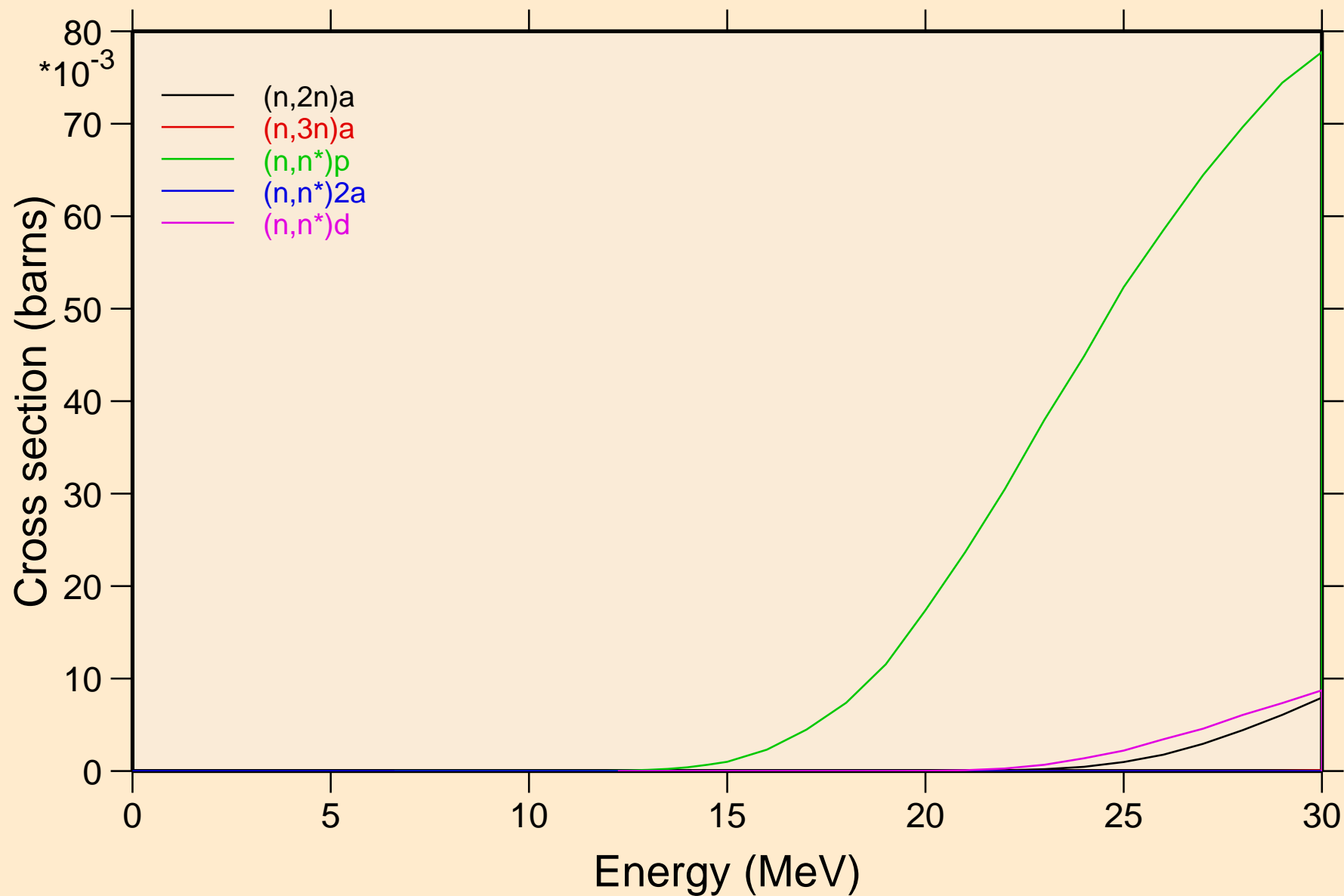

W180 NEUTRON ACER TENDL-2019 LIBRARY; T=293.16K
Threshold reactions

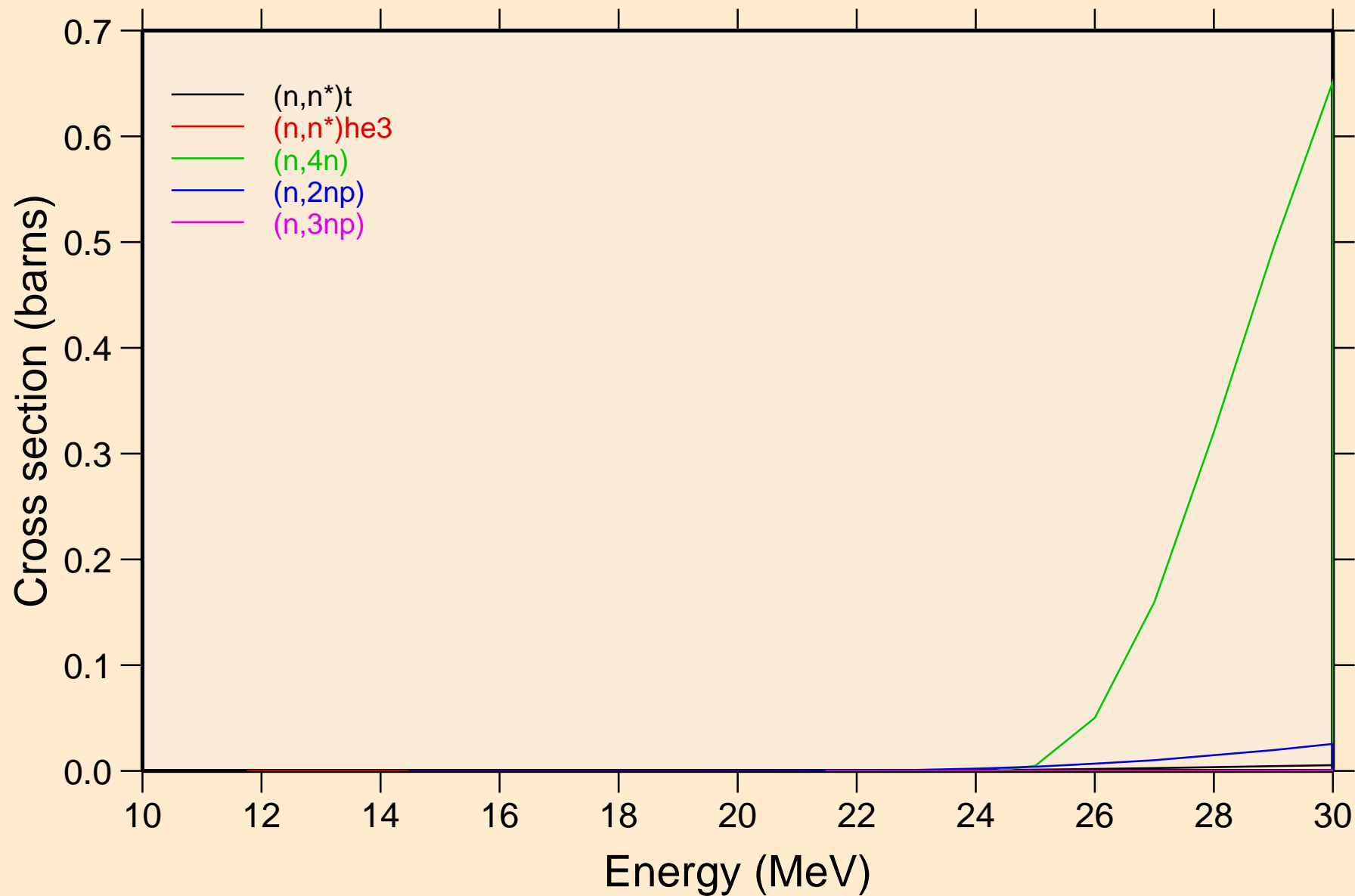

W180 NEUTRON ACER TENDL-2019 LIBRARY; T=293.16K
Threshold reactions

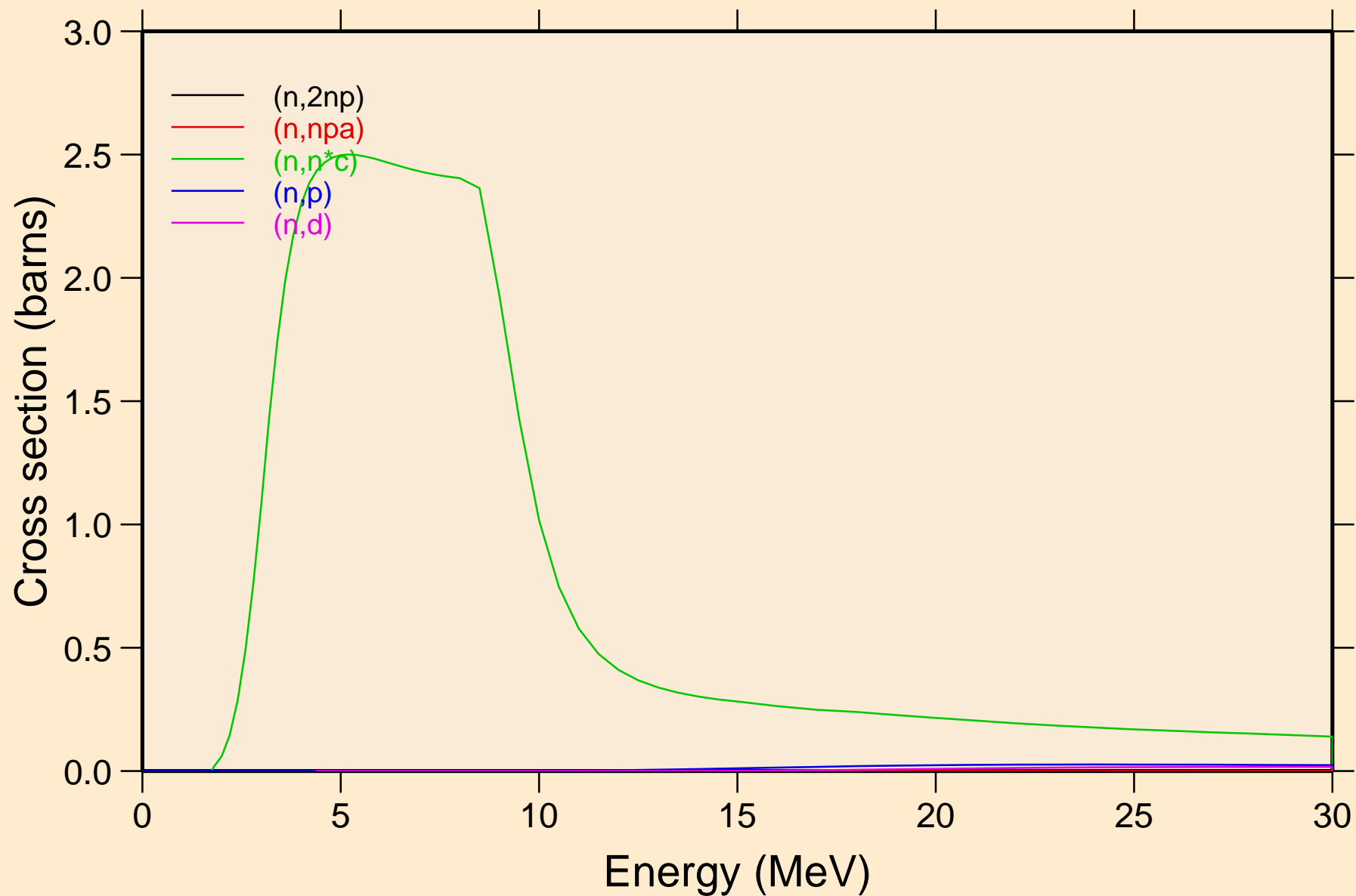

W180 NEUTRON ACER TENDL-2019 LIBRARY; T=293.16K
Threshold reactions

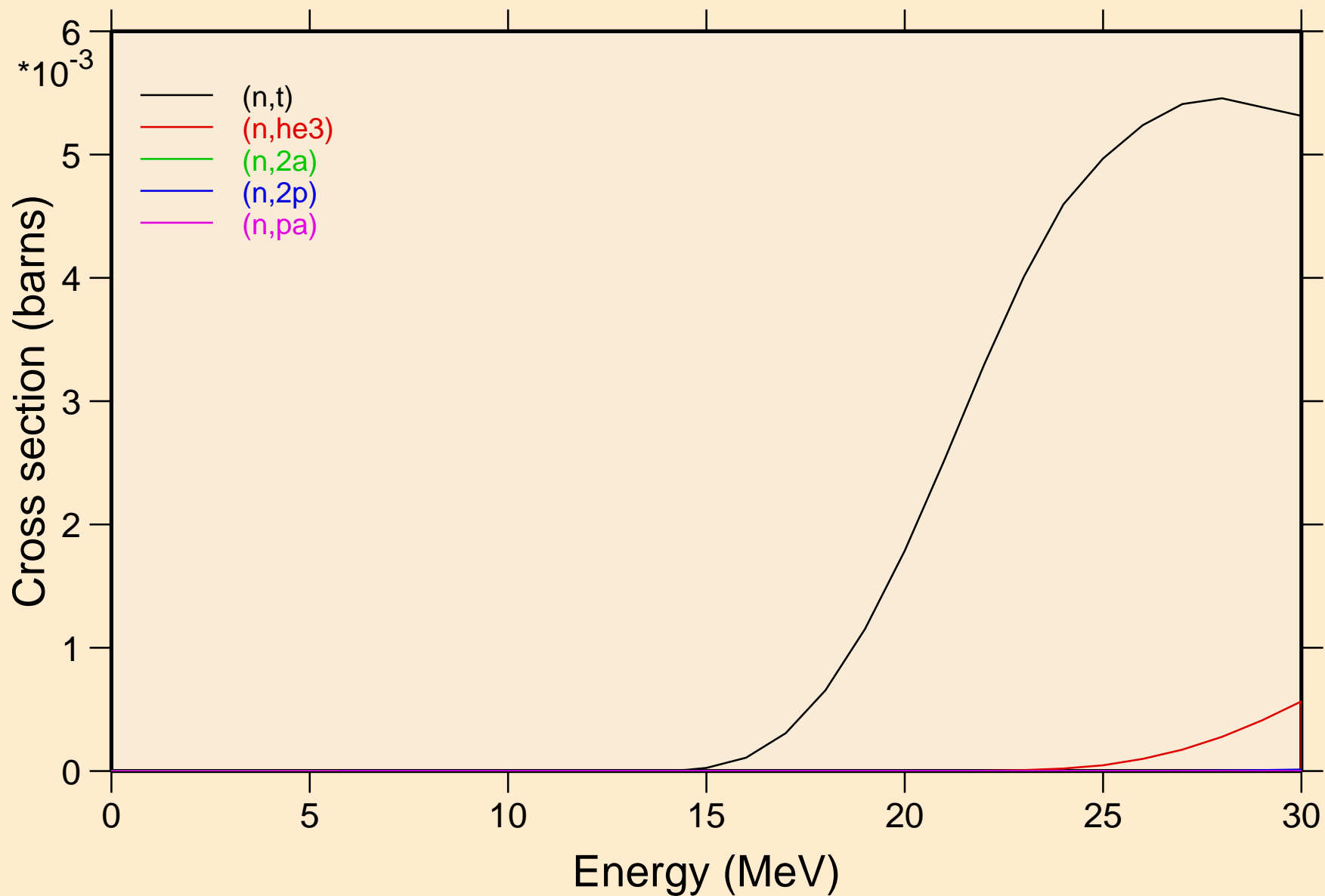

W180 NEUTRON ACER TENDL-2019 LIBRARY; T=293.16K
Threshold reactions

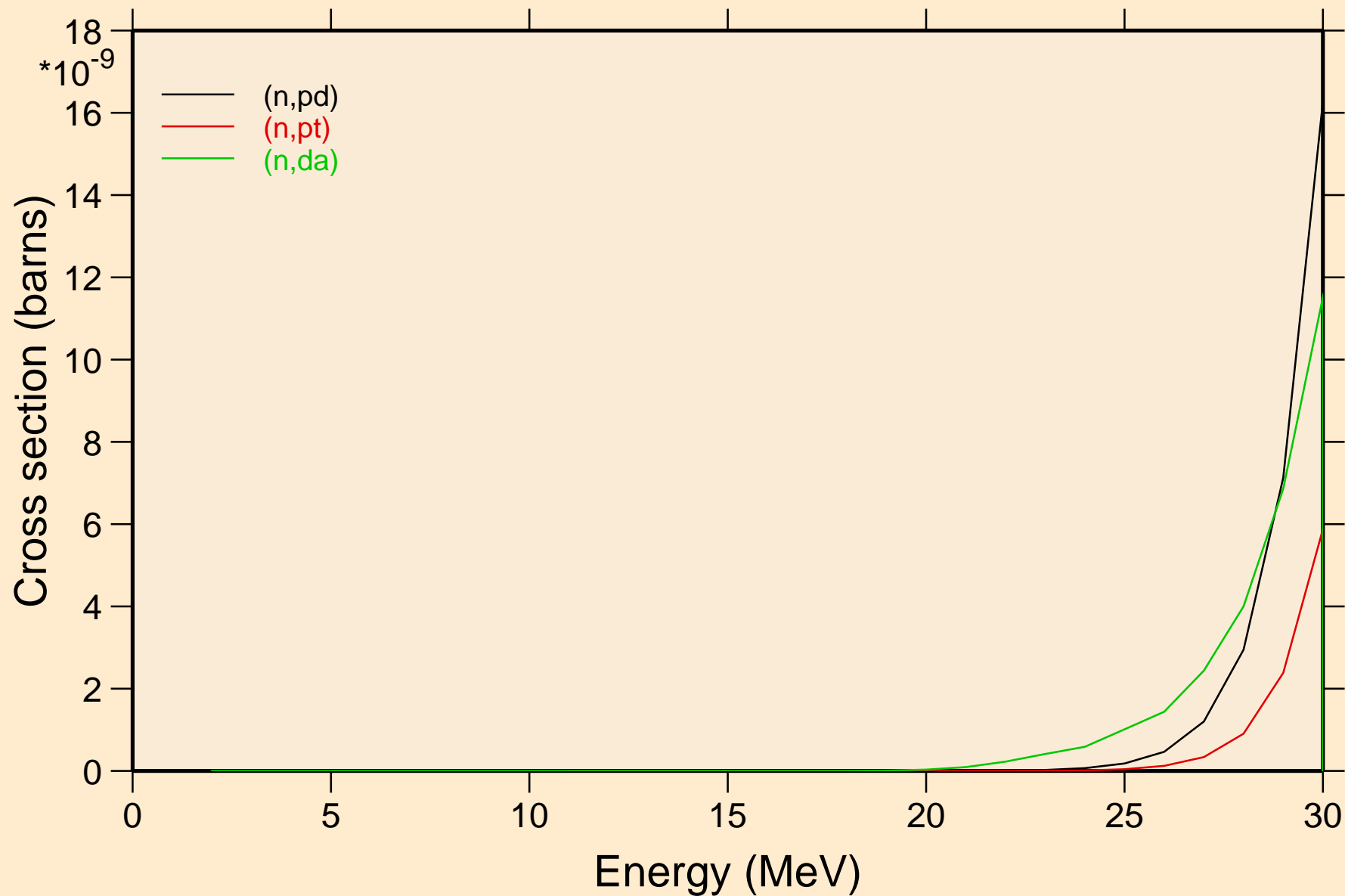

W180 NEUTRON ACER TENDL-2019 LIBRARY; T=293.16K
Threshold reactions

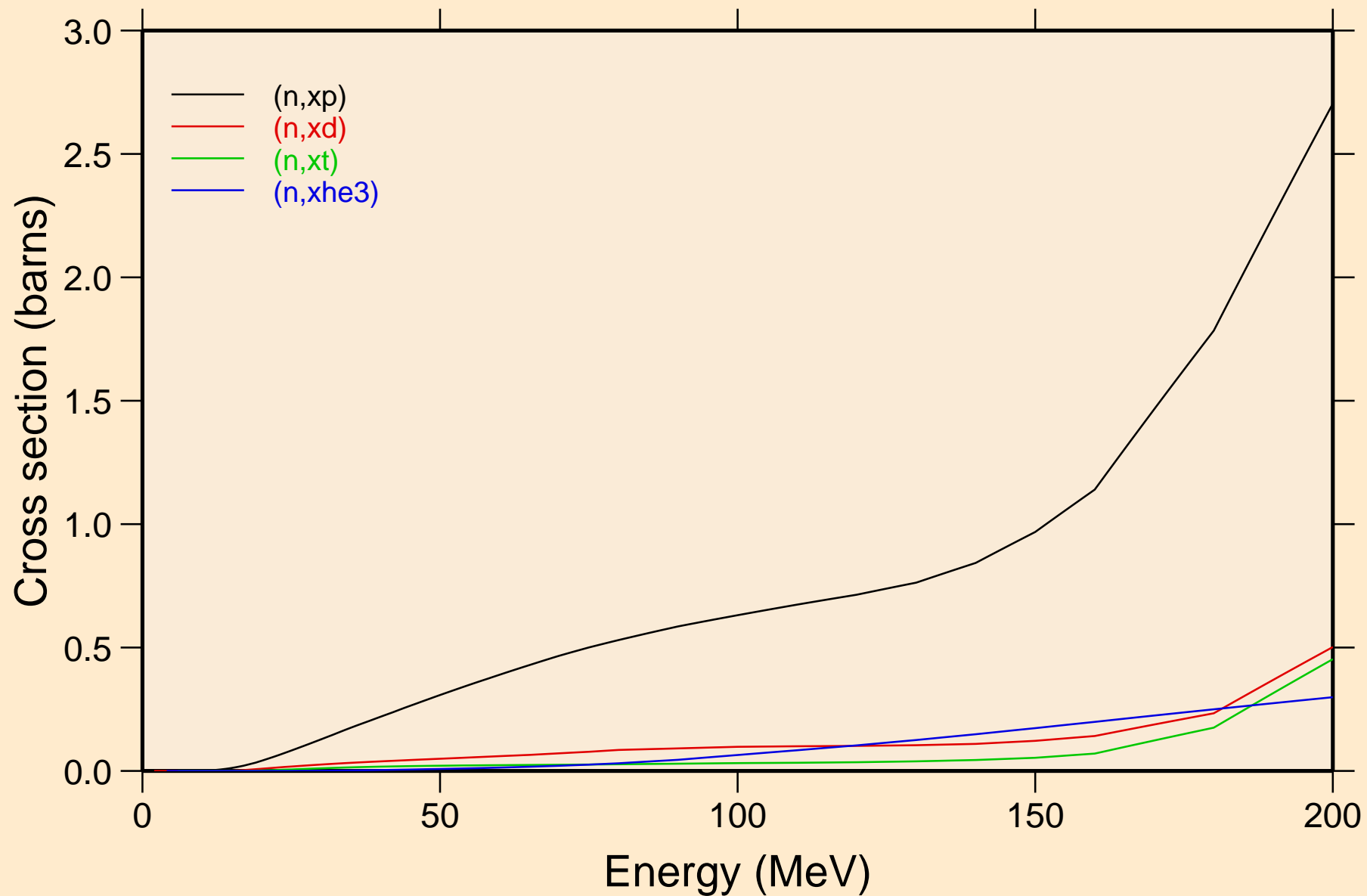

W180 NEUTRON ACER TENDL-2019 LIBRARY; T=293.16K
angular distribution for elastic

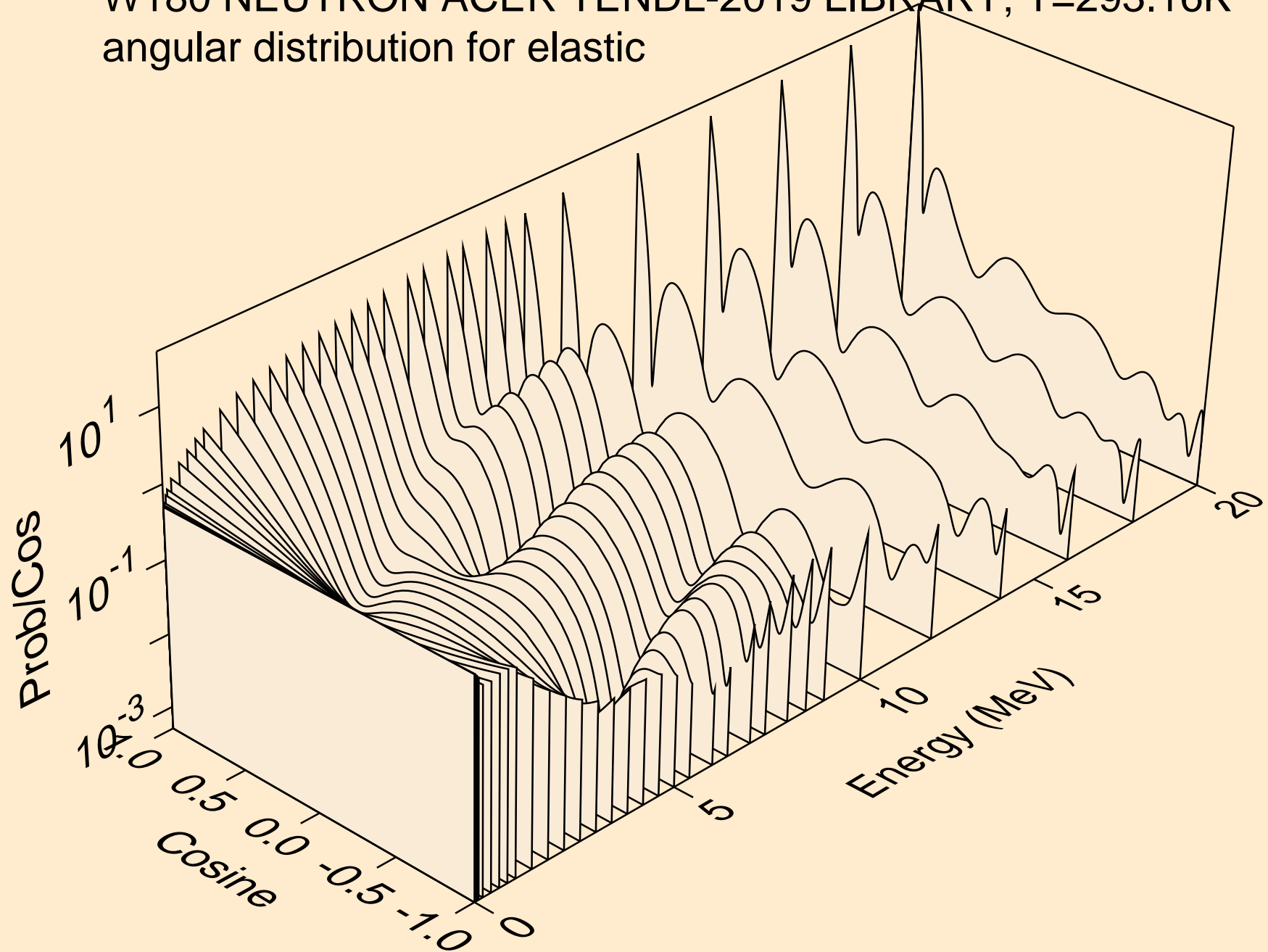

W180 NEUTRON ACER TENDL-2019 LIBRARY; T=293.16K
angular distribution for elastic

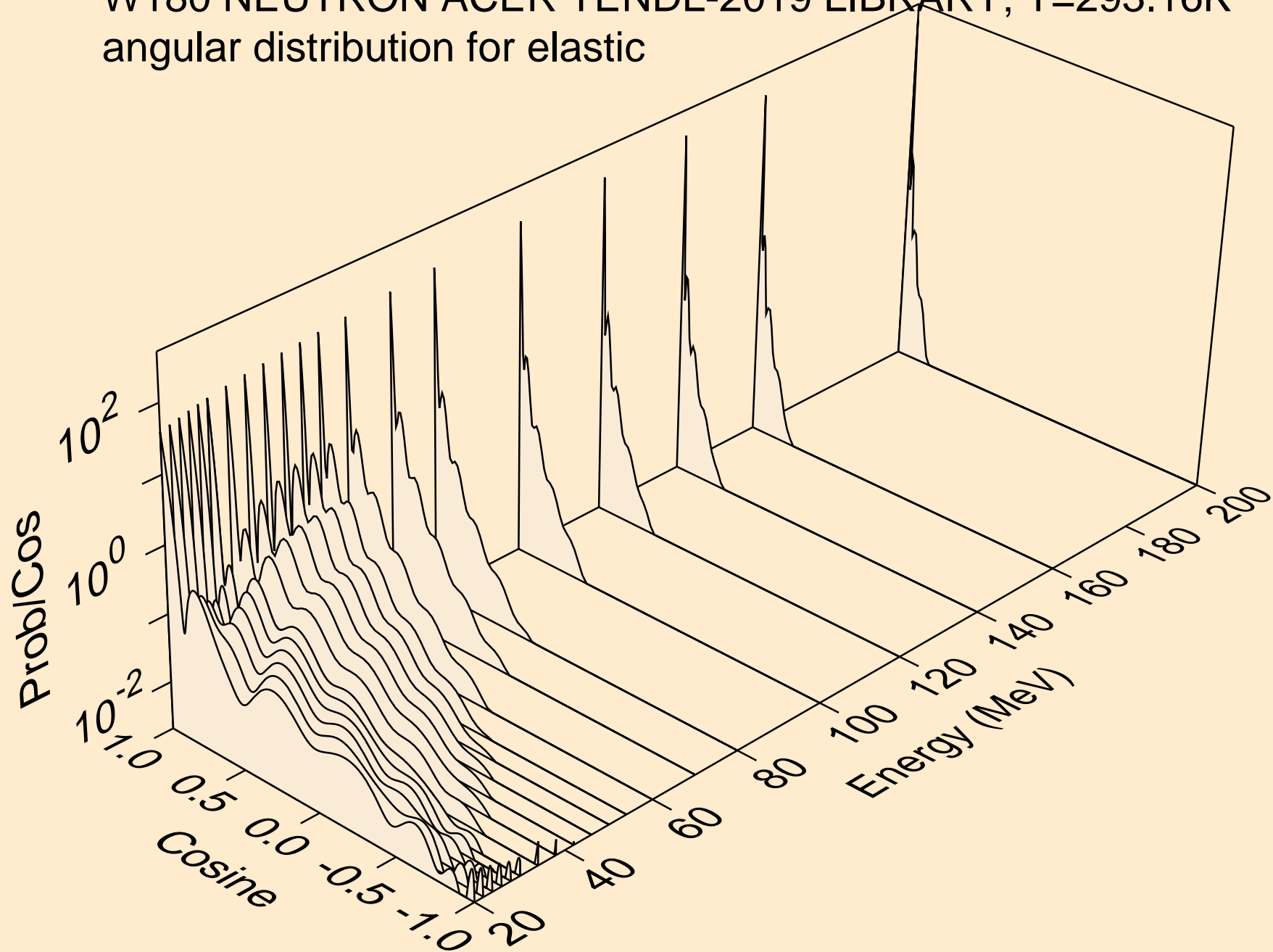

W180 NEUTRON ACER TENDL-2019 LIBRARY; T=293.16K
angular distribution for (n,n*1)

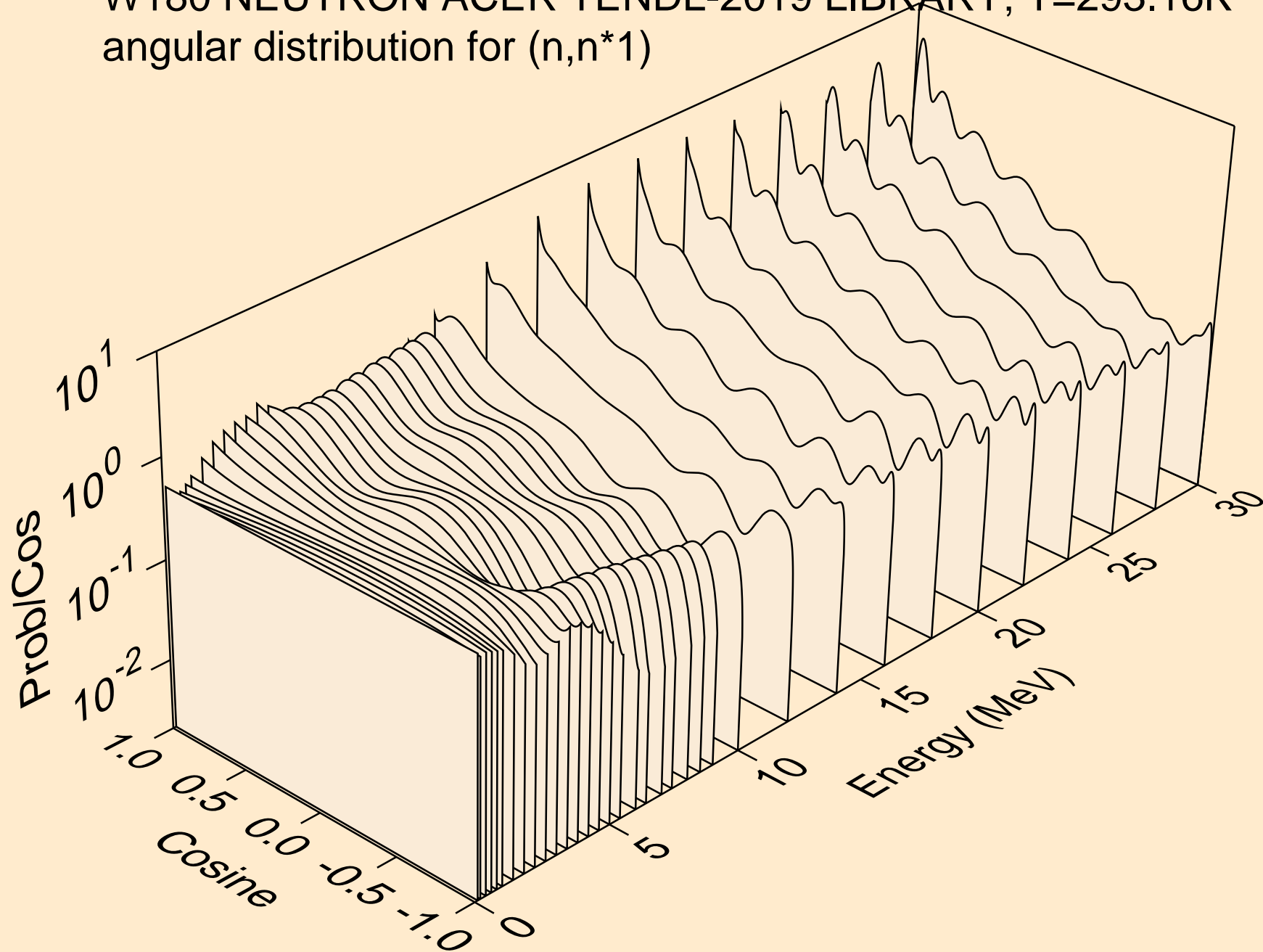

W180 NEUTRON ACER TENDL-2019 LIBRARY; T=293.16K
angular distribution for (n,n*2)

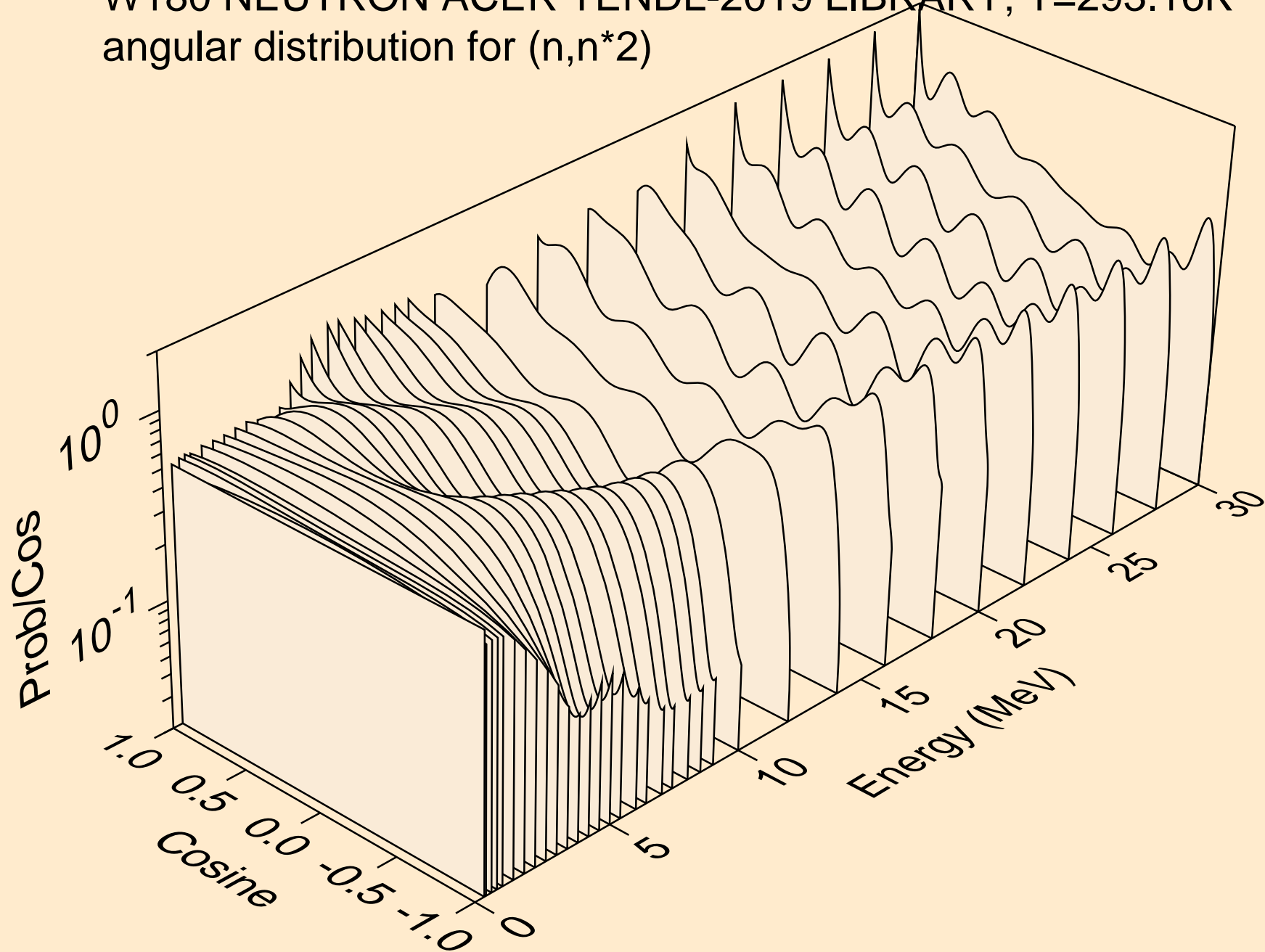

W180 NEUTRON ACER TENDL-2019 LIBRARY; T=293.16K
angular distribution for (n,n*3)

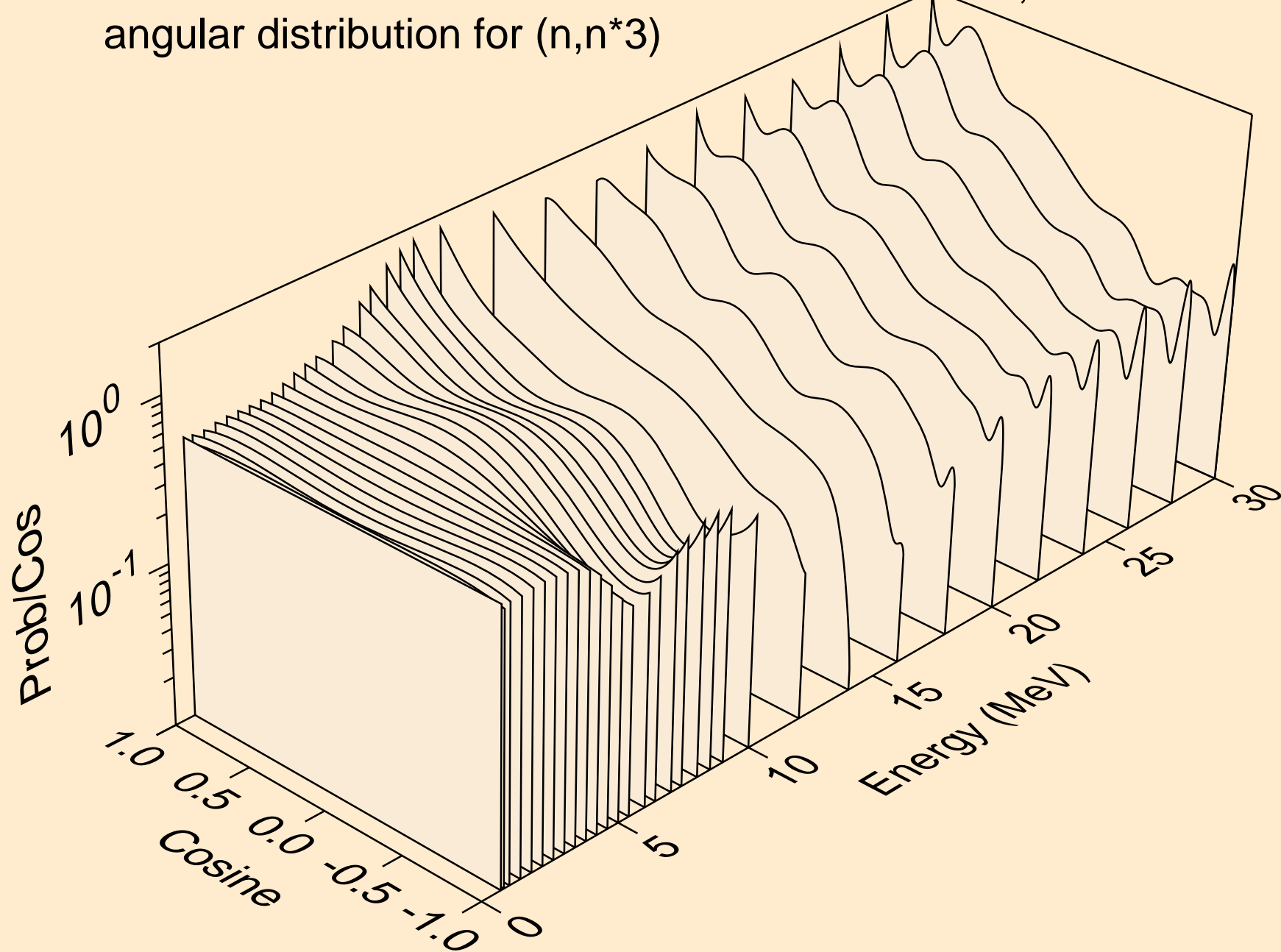

W180 NEUTRON ACER TENDL-2019 LIBRARY; T=293.16K
angular distribution for (n,n*4)

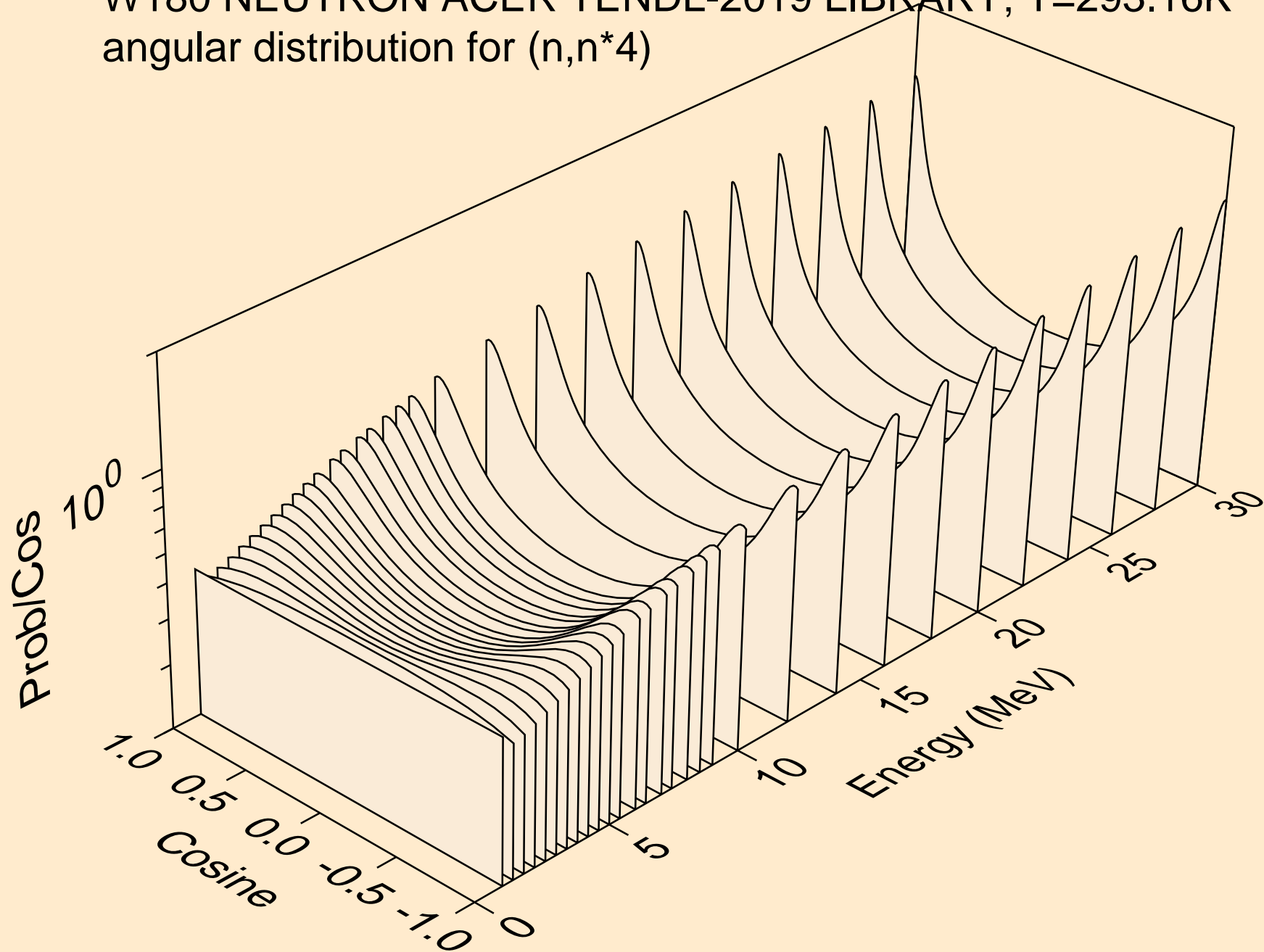

W180 NEUTRON ACER TENDL-2019 LIBRARY; T=293.16K
angular distribution for (n,n*5)

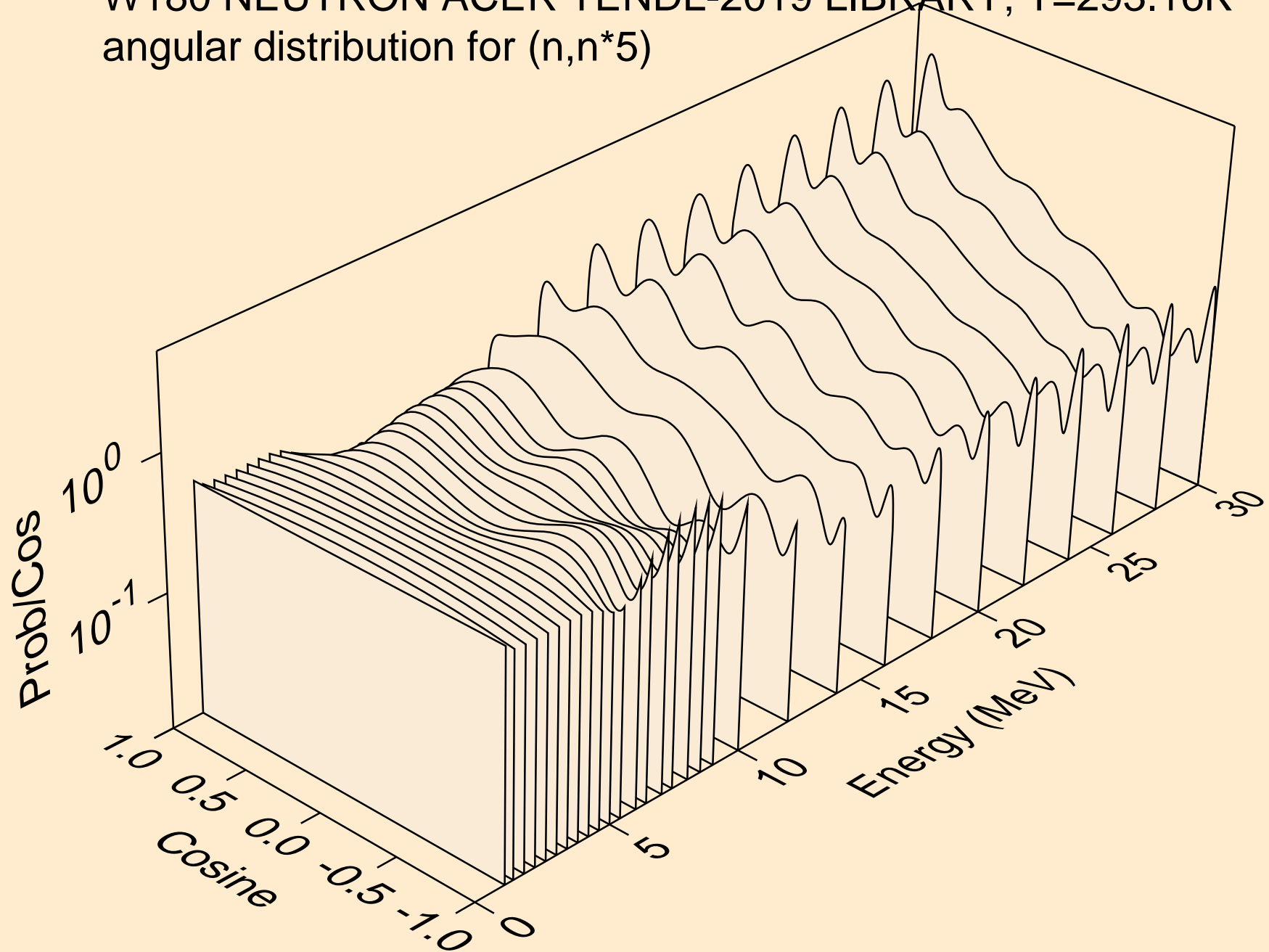

W180 NEUTRON ACER TENDL-2019 LIBRARY; T=293.16K
angular distribution for (n,n*6)

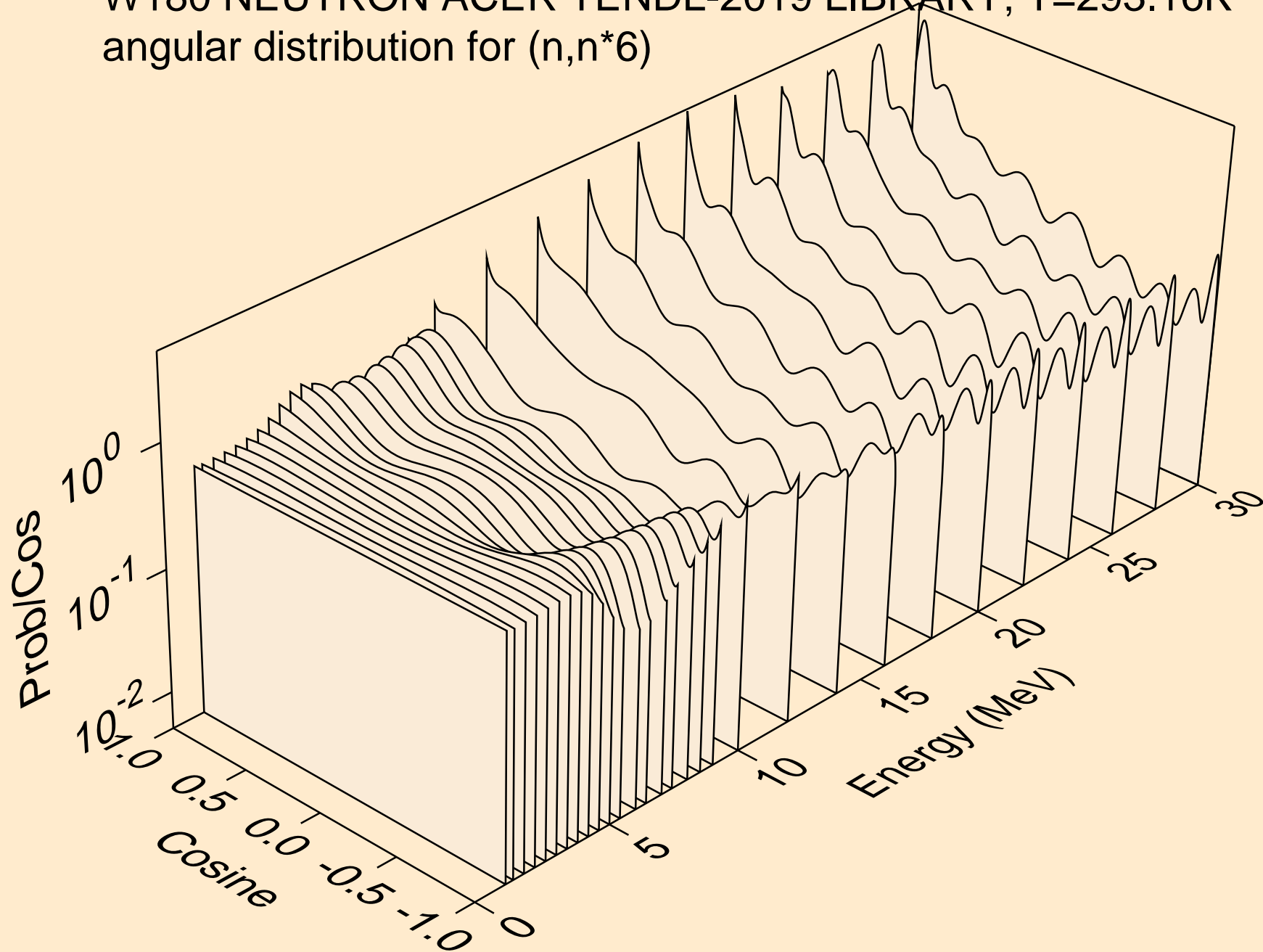

W180 NEUTRON ACER TENDL-2019 LIBRARY; T=293.16K
angular distribution for (n,n*7)

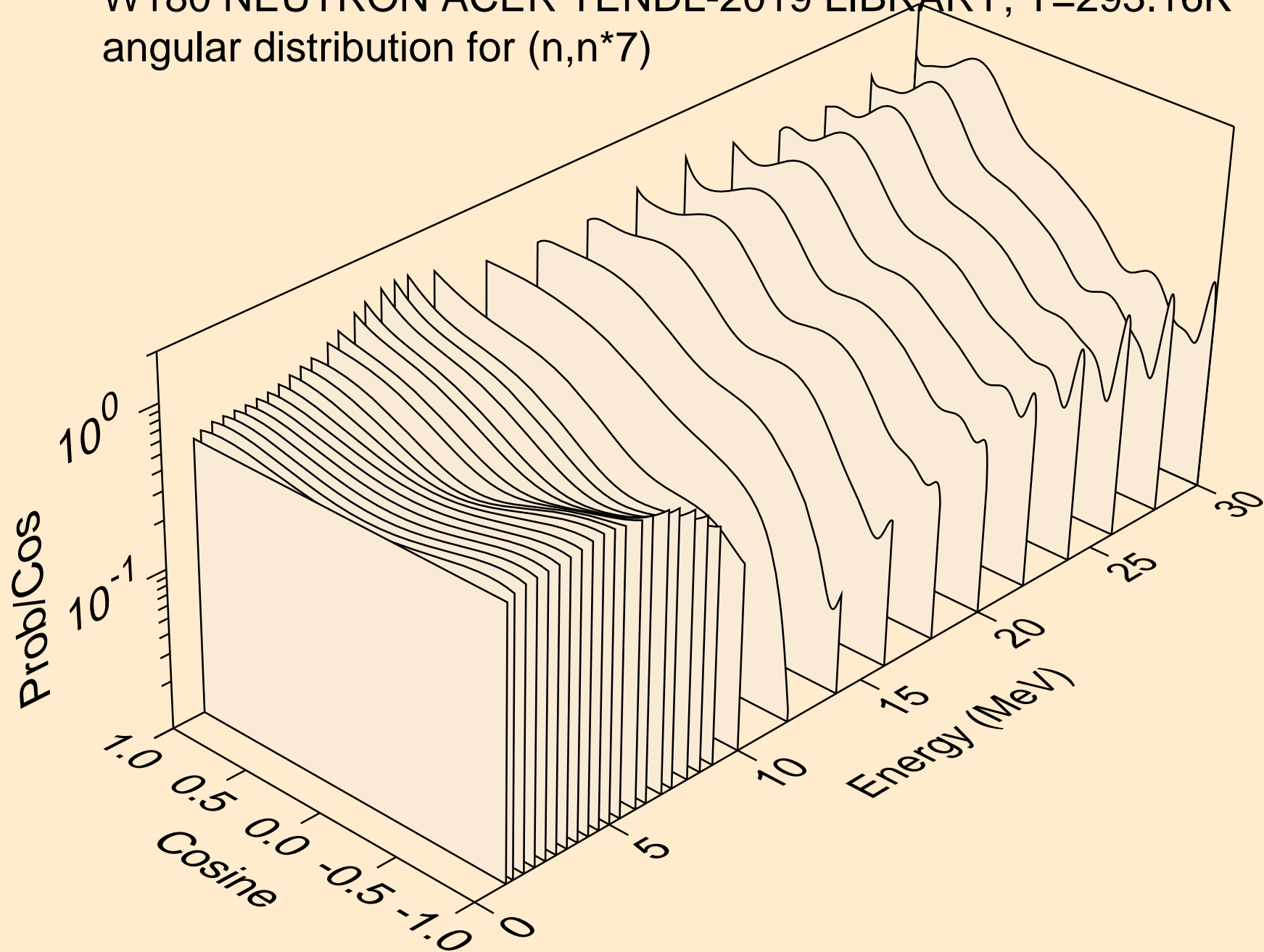

W180 NEUTRON ACER TENDL-2019 LIBRARY; T=293.16K
angular distribution for (n,n*8)

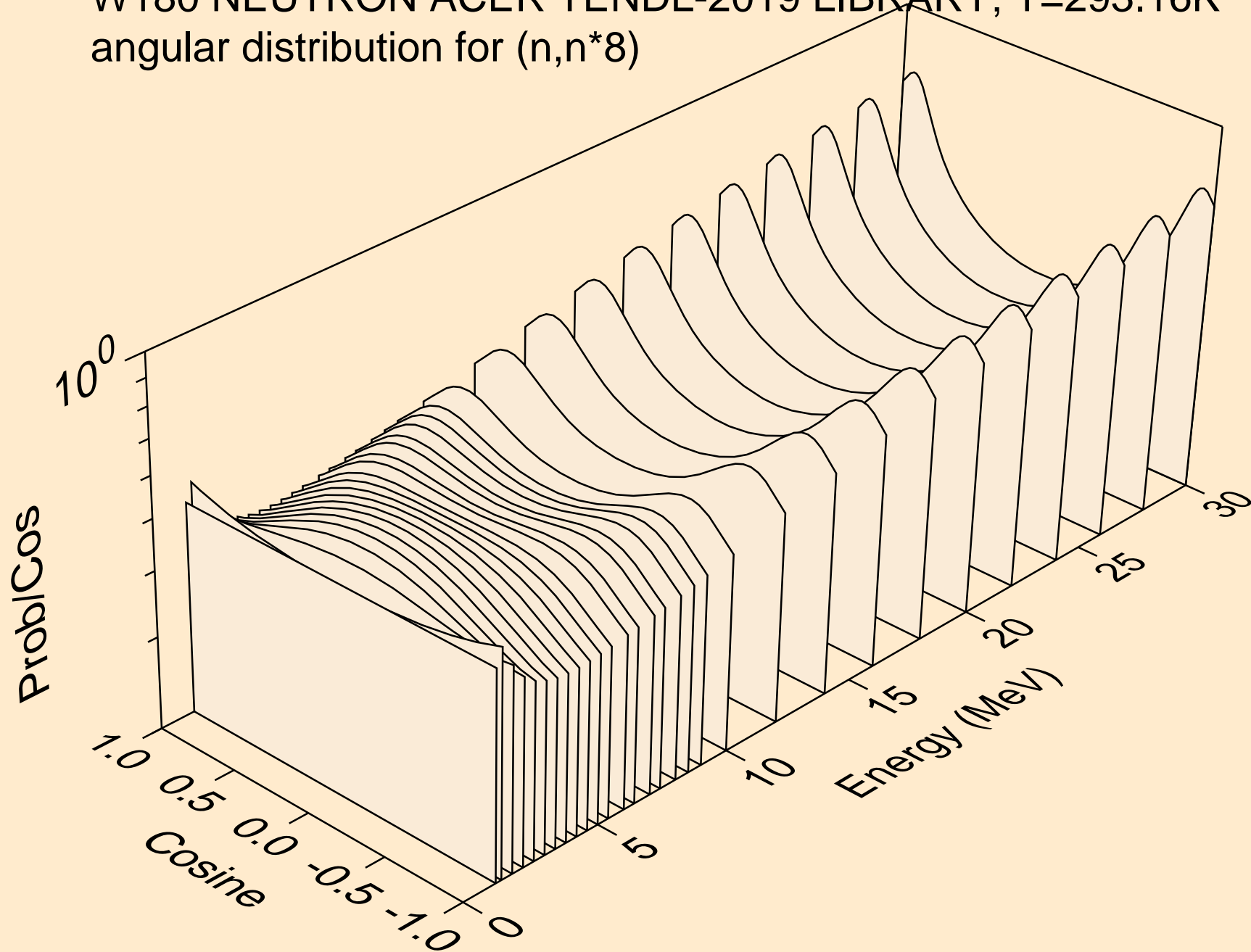

W180 NEUTRON ACER TENDL-2019 LIBRARY; T=293.16K
angular distribution for (n,n*9)

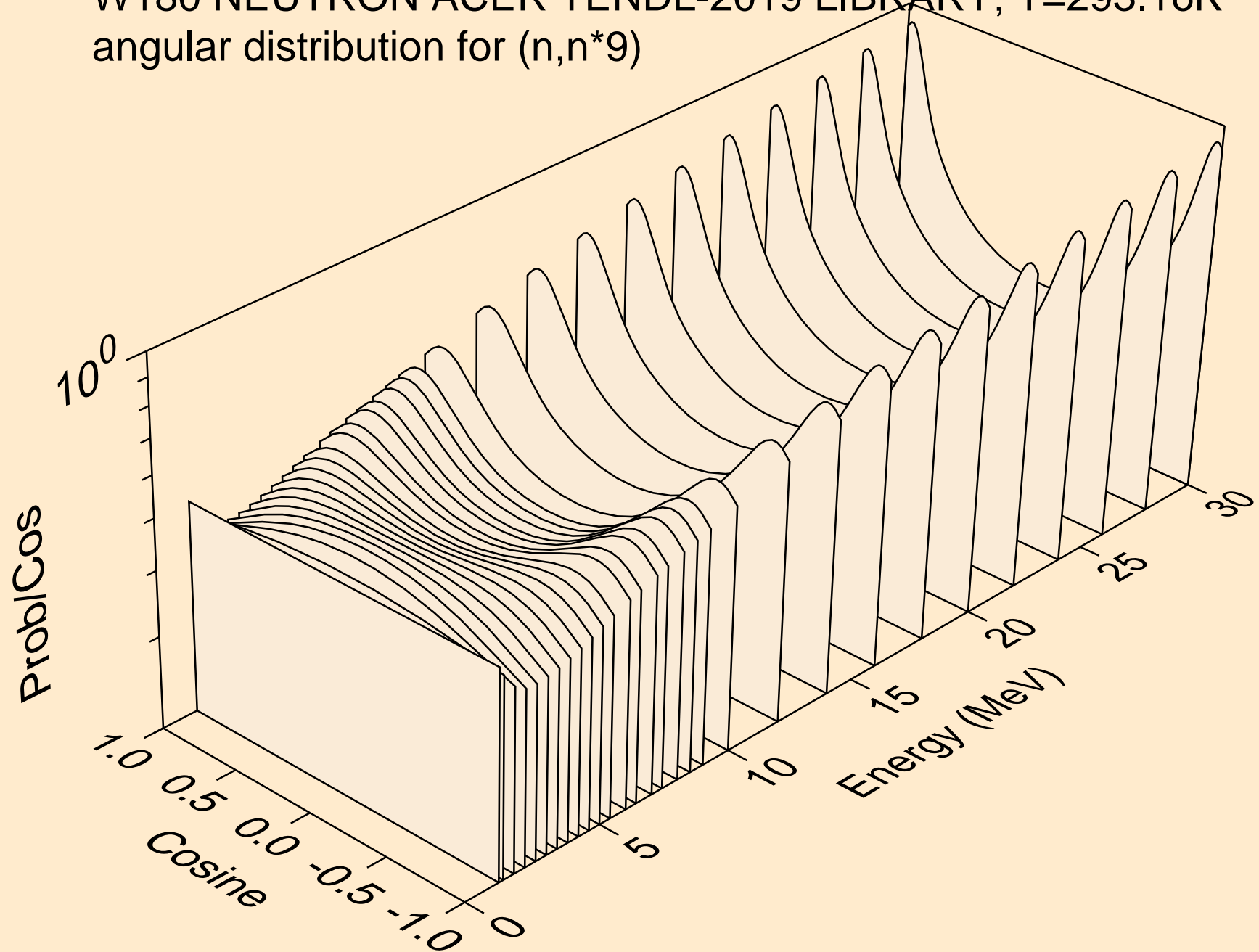

W180 NEUTRON ACER TENDL-2019 LIBRARY; T=293.16K
angular distribution for (n,n*10)

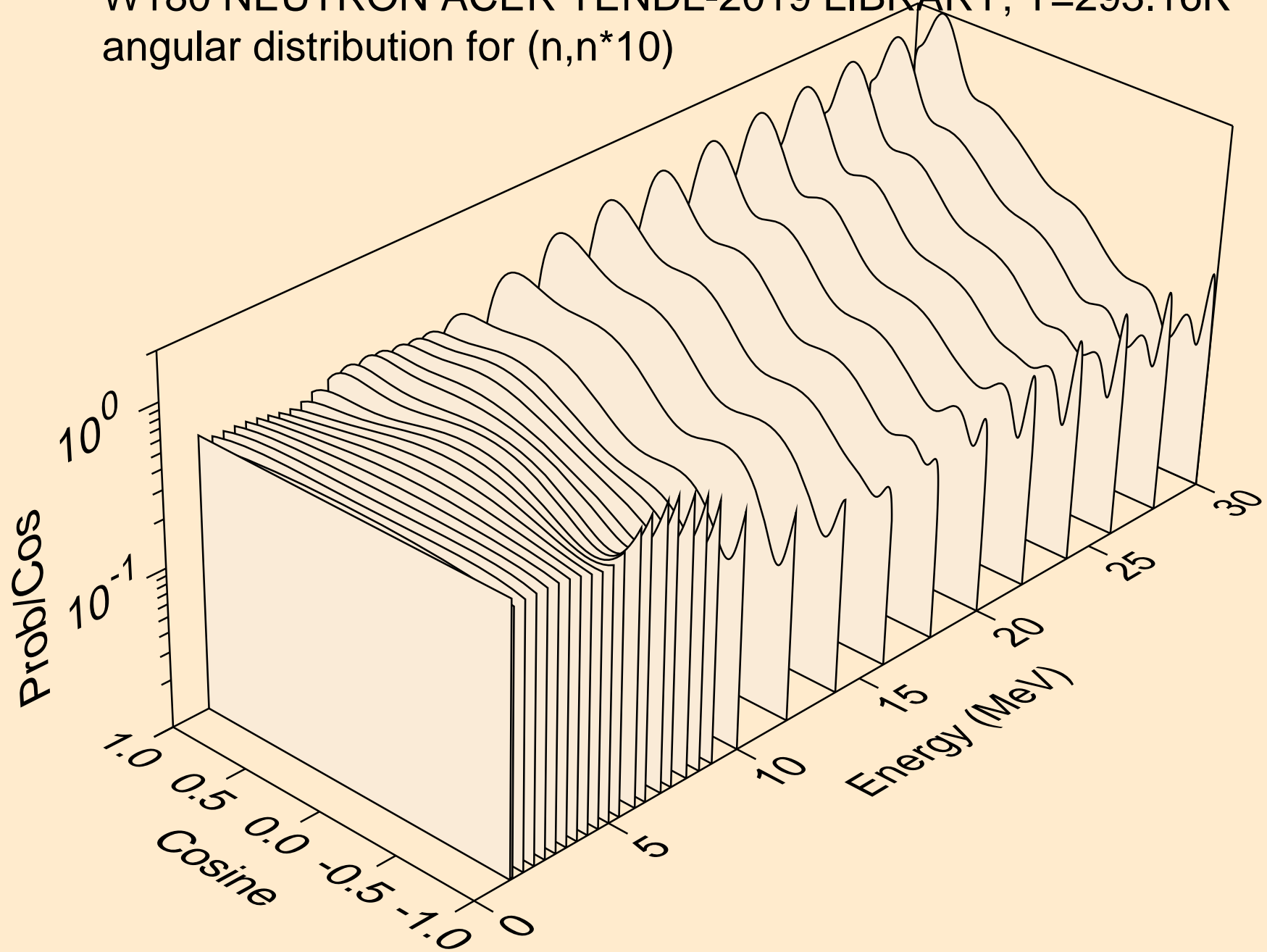

W180 NEUTRON ACER TENDL-2019 LIBRARY; T=293.16K
angular distribution for (n,n*11)

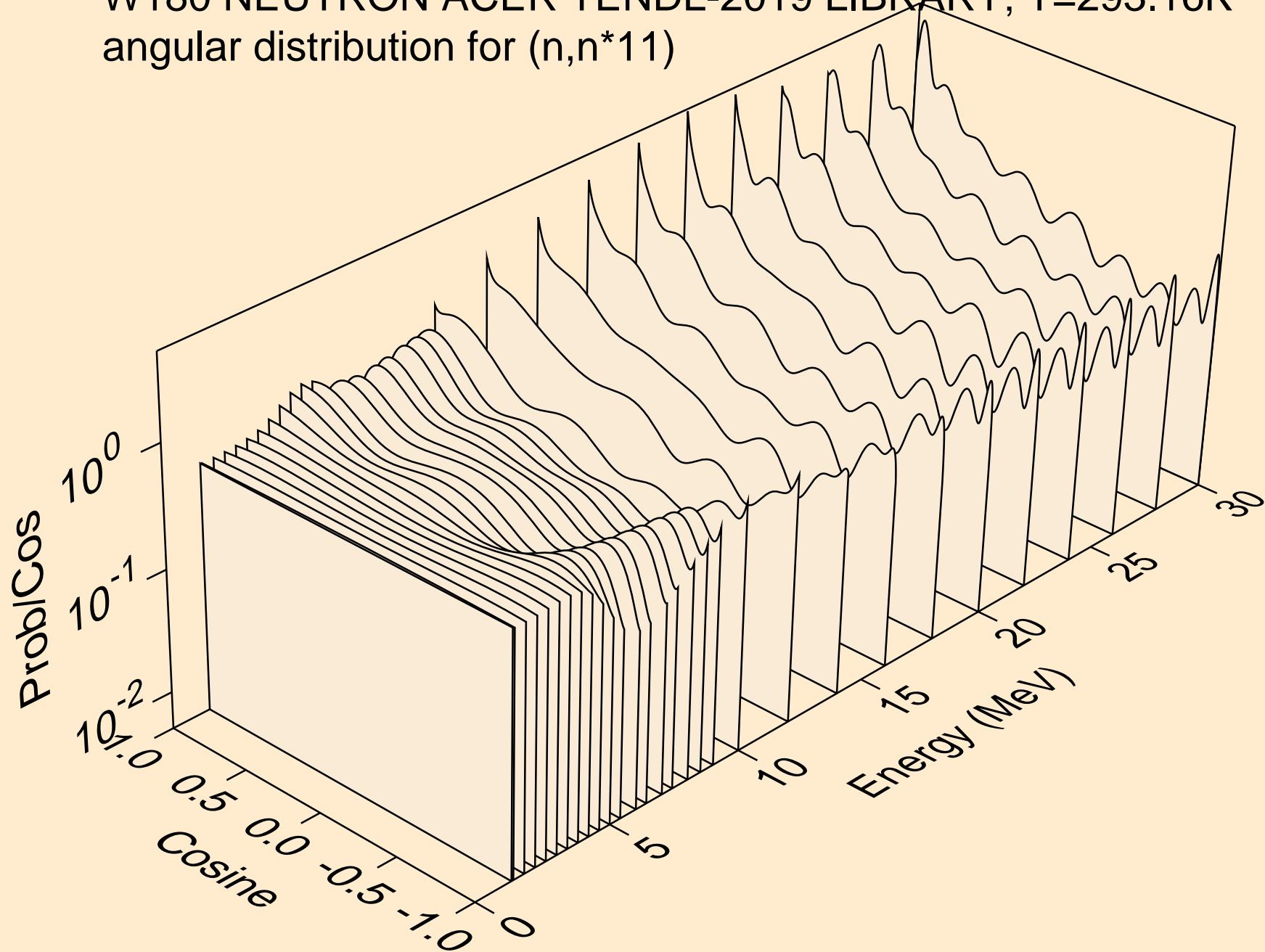

W180 NEUTRON ACER TENDL-2019 LIBRARY; T=293.16K
angular distribution for (n,n*12)

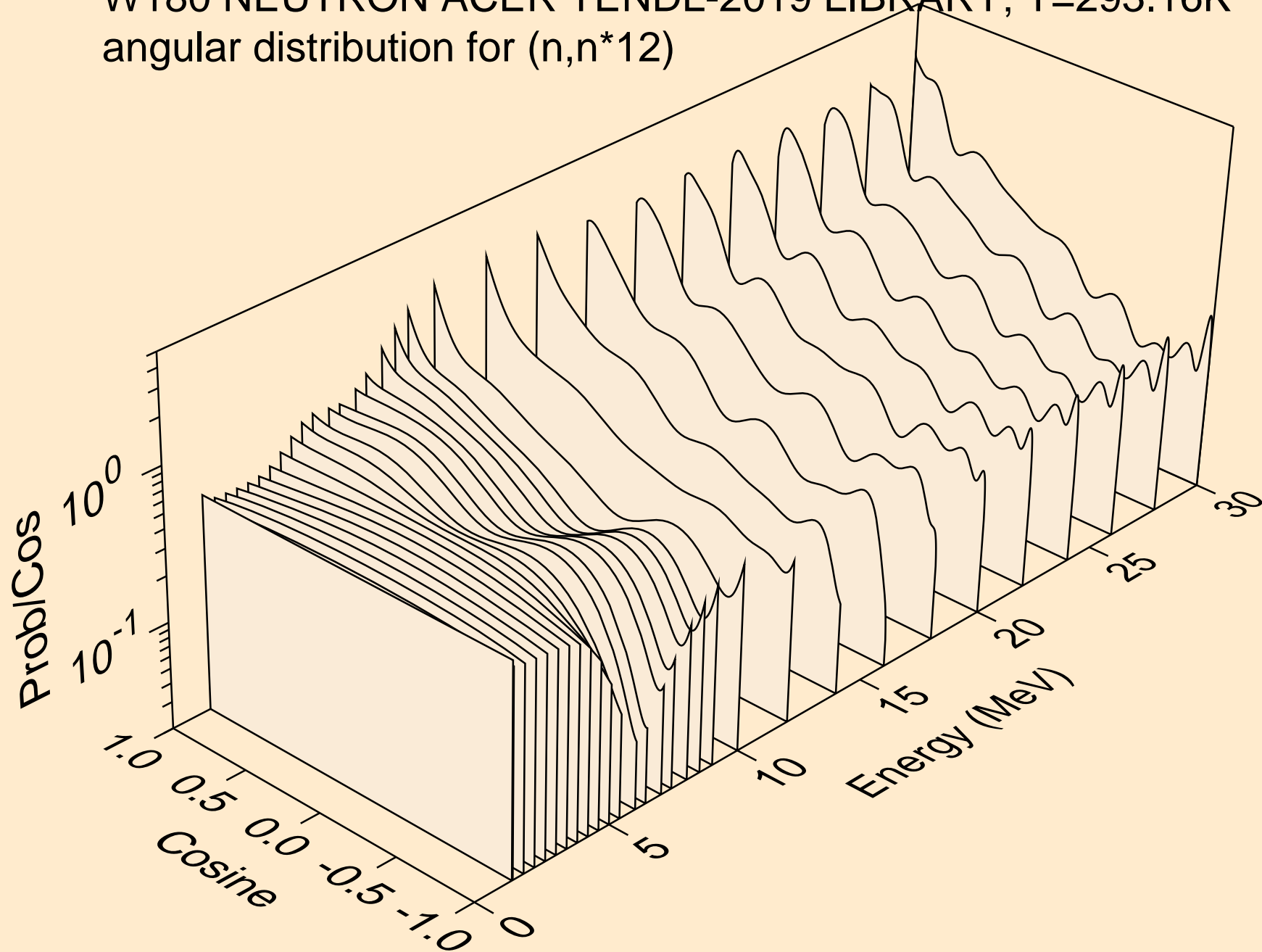

W180 NEUTRON ACER TENDL-2019 LIBRARY; T=293.16K
angular distribution for (n,n*13)

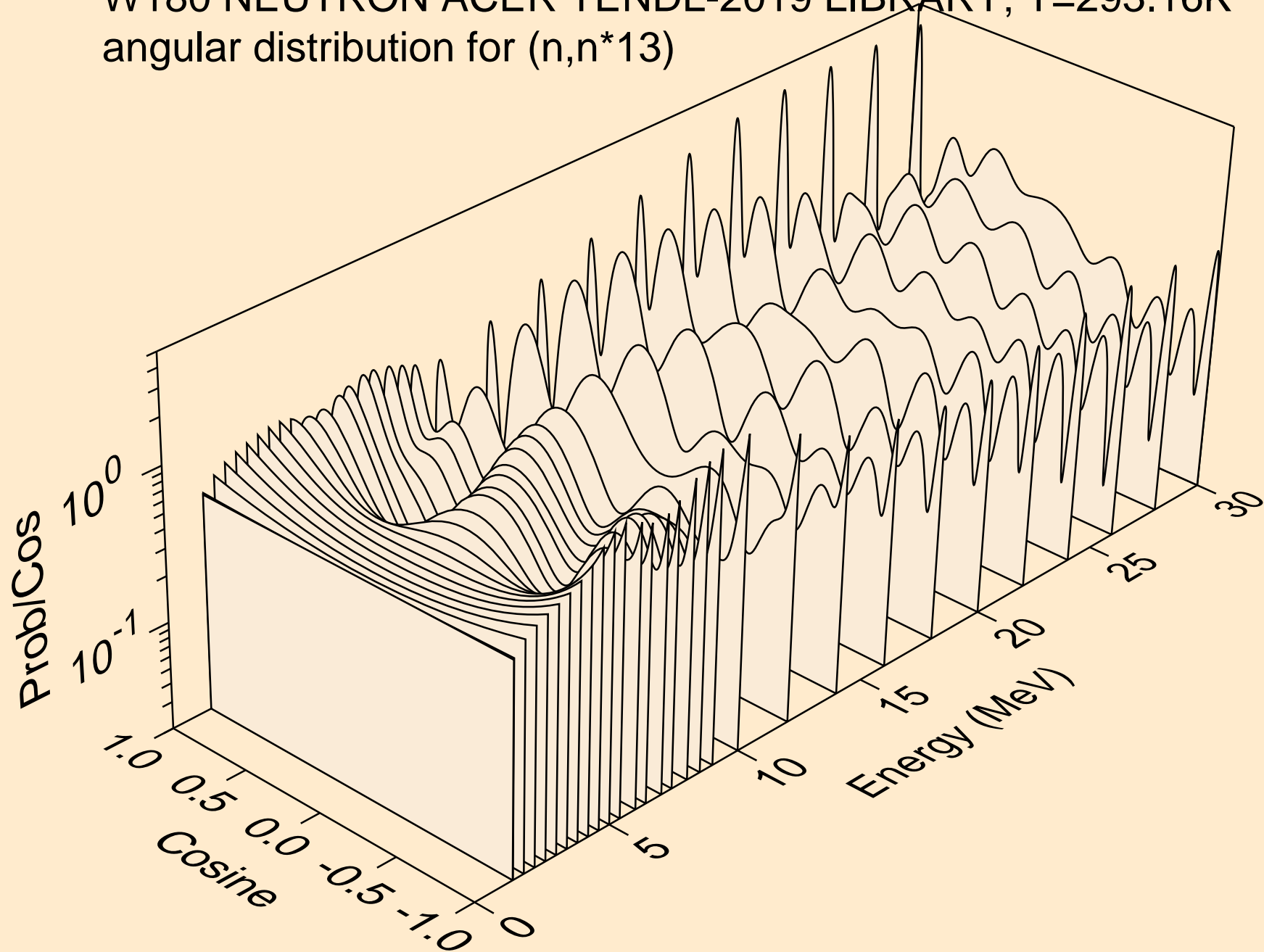

W180 NEUTRON ACER TENDL-2019 LIBRARY; T=293.16K
angular distribution for (n,n*14)

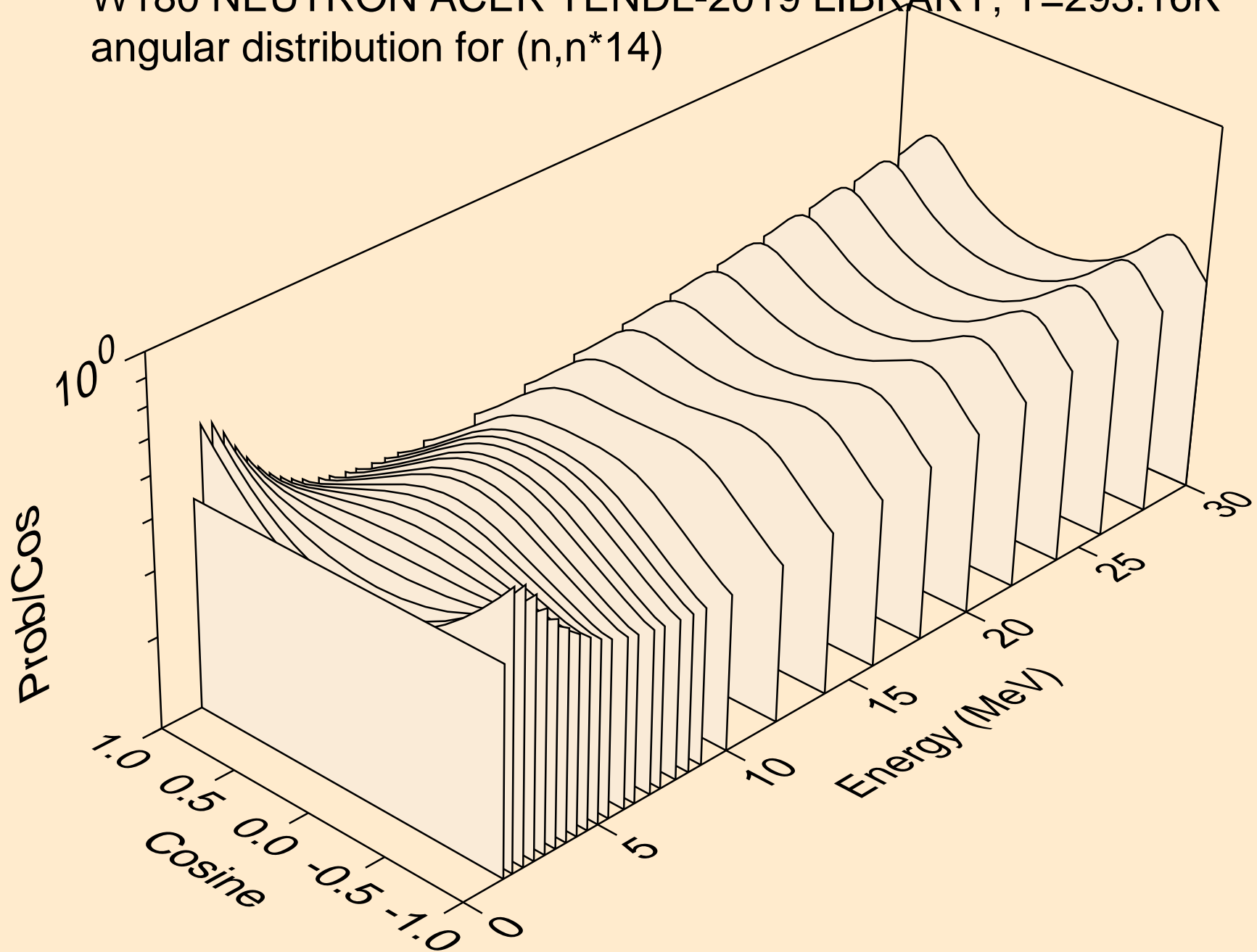

W180 NEUTRON ACER TENDL-2019 LIBRARY; T=293.16K
angular distribution for (n,n*15)

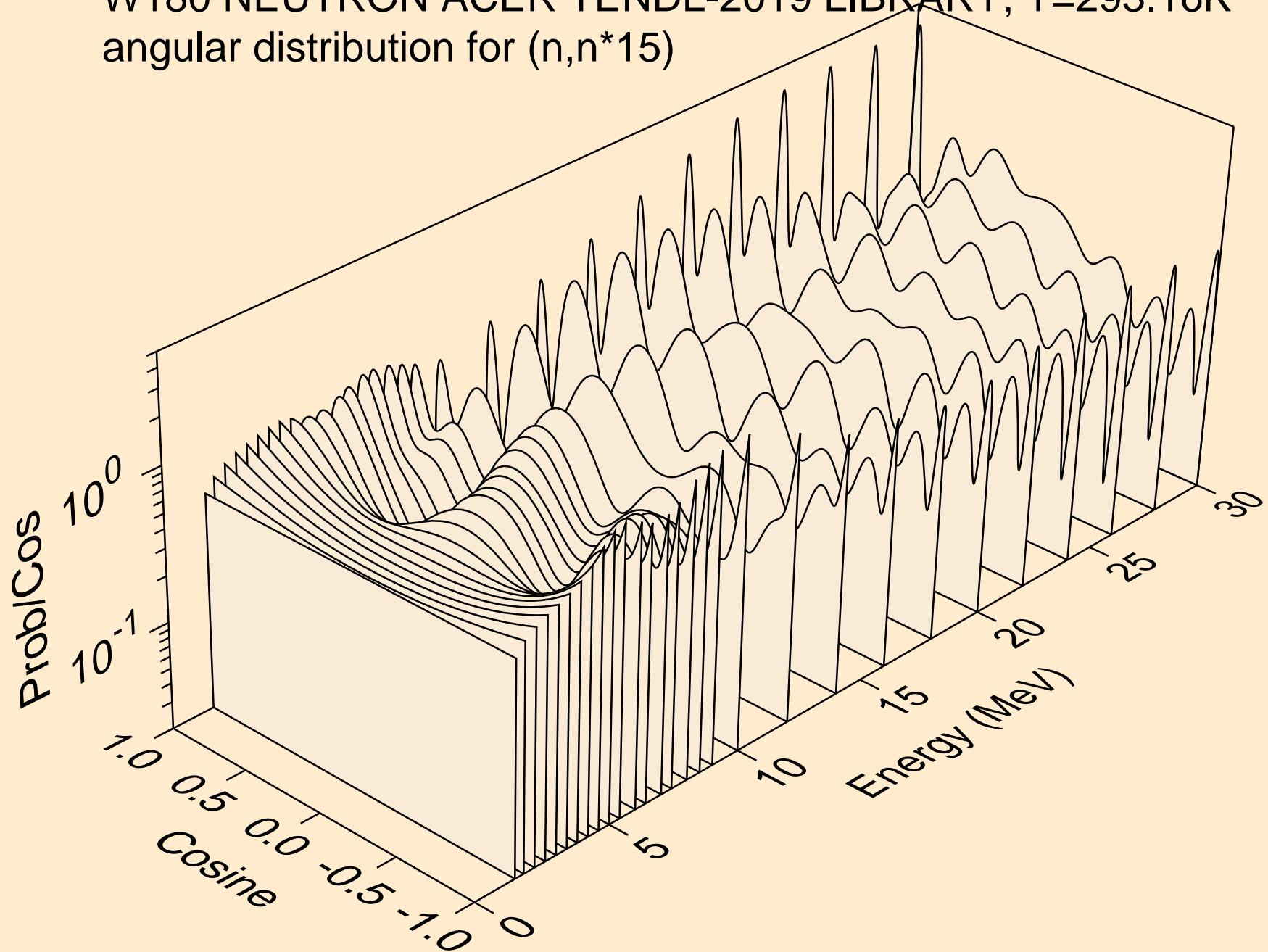

W180 NEUTRON ACER TENDL-2019 LIBRARY; T=293.16K
angular distribution for (n,n*16)

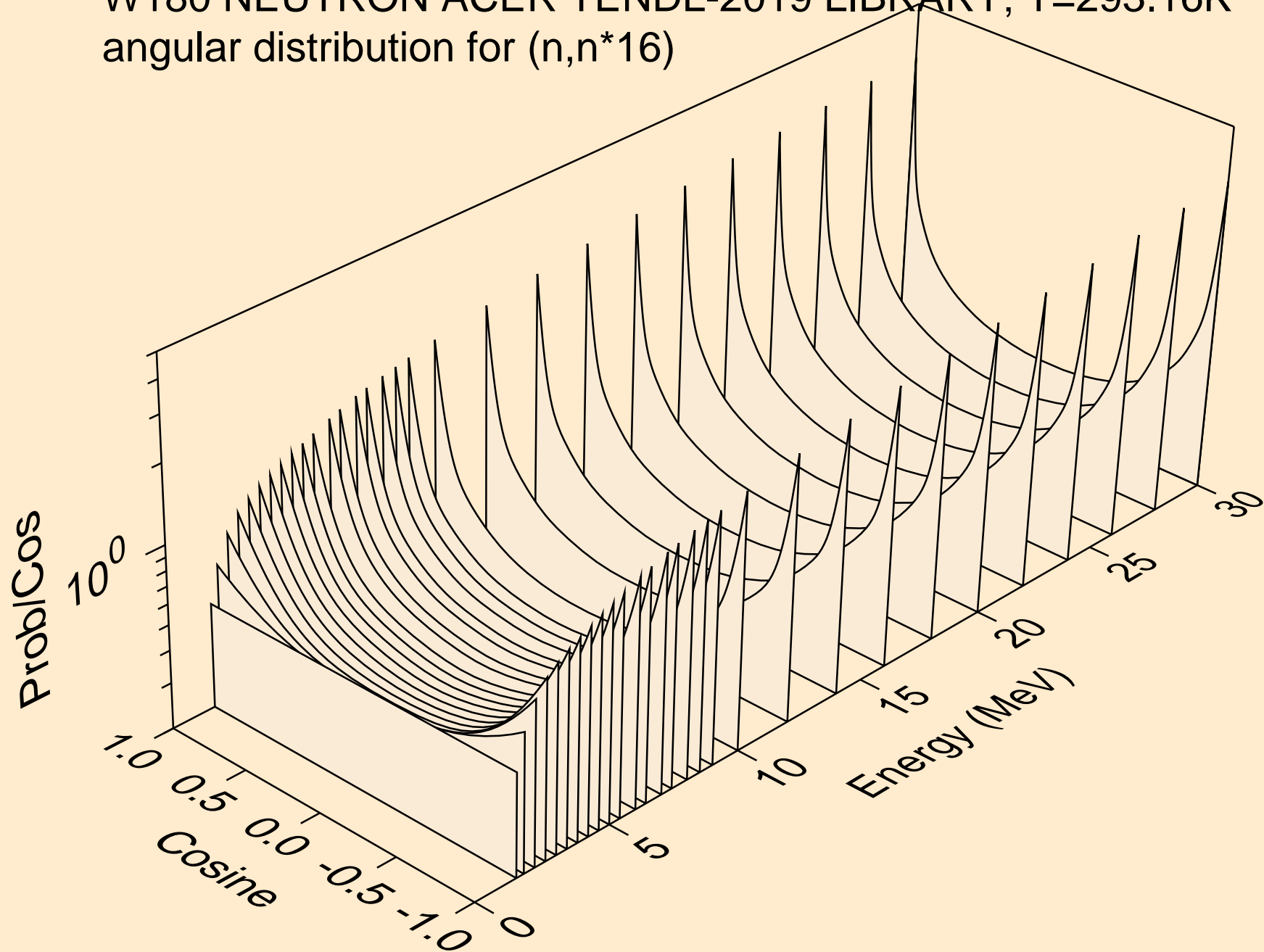

W180 NEUTRON ACER TENDL-2019 LIBRARY; T=293.16K
angular distribution for (n,n*17)

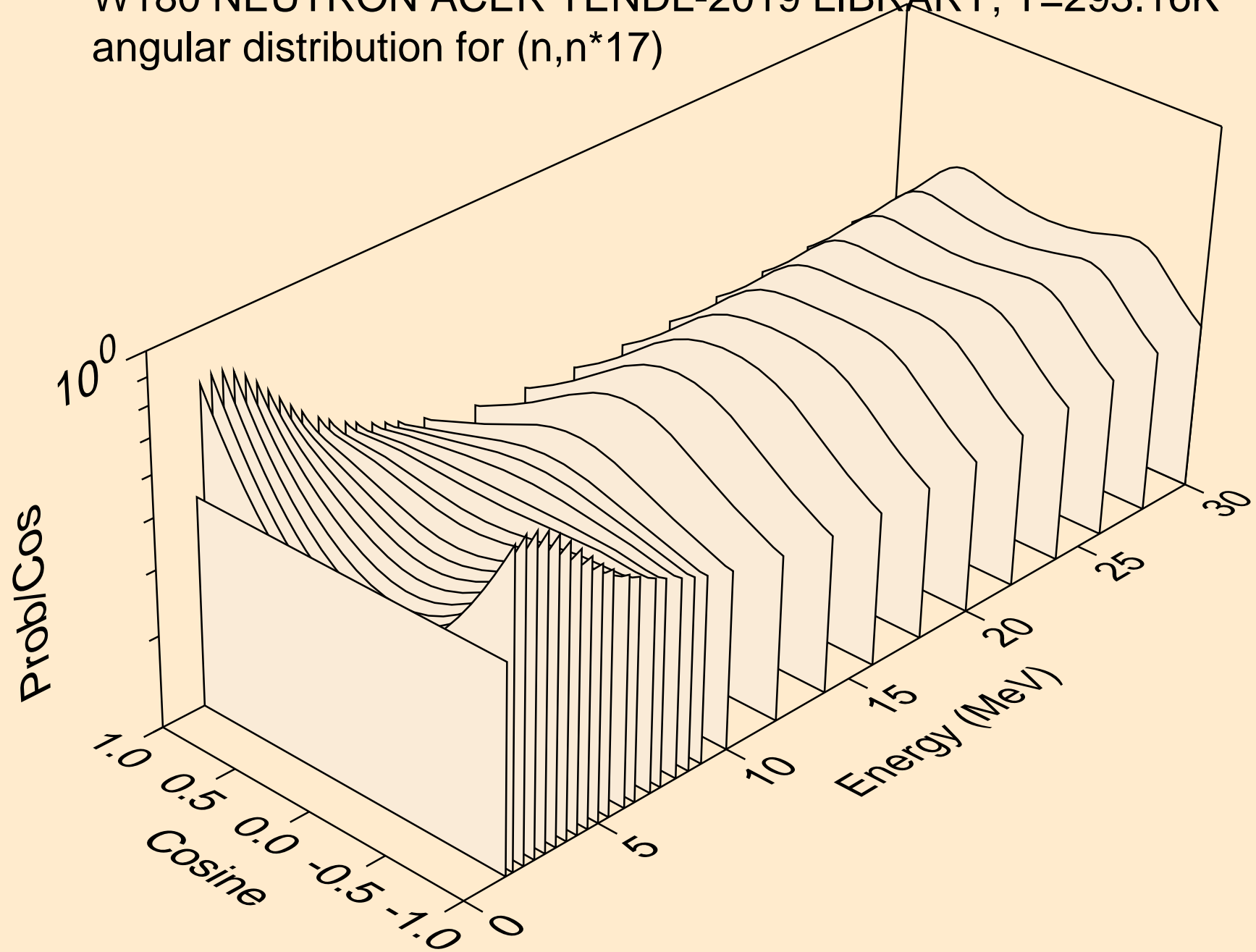

W180 NEUTRON ACER TENDL-2019 LIBRARY; T=293.16K
angular distribution for (n,n*18)

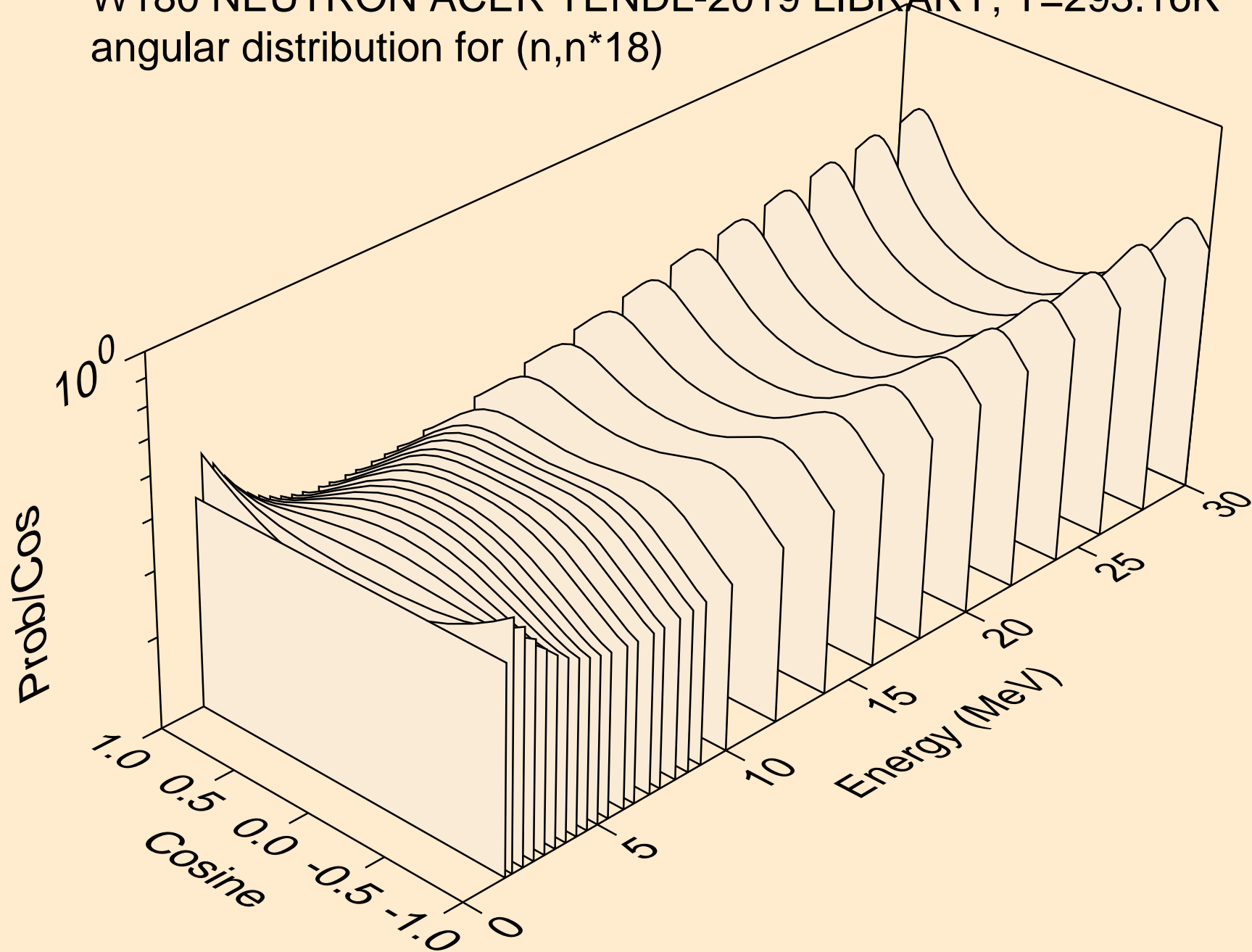

W180 NEUTRON ACER TENDL-2019 LIBRARY; T=293.16K
angular distribution for (n,n*19)

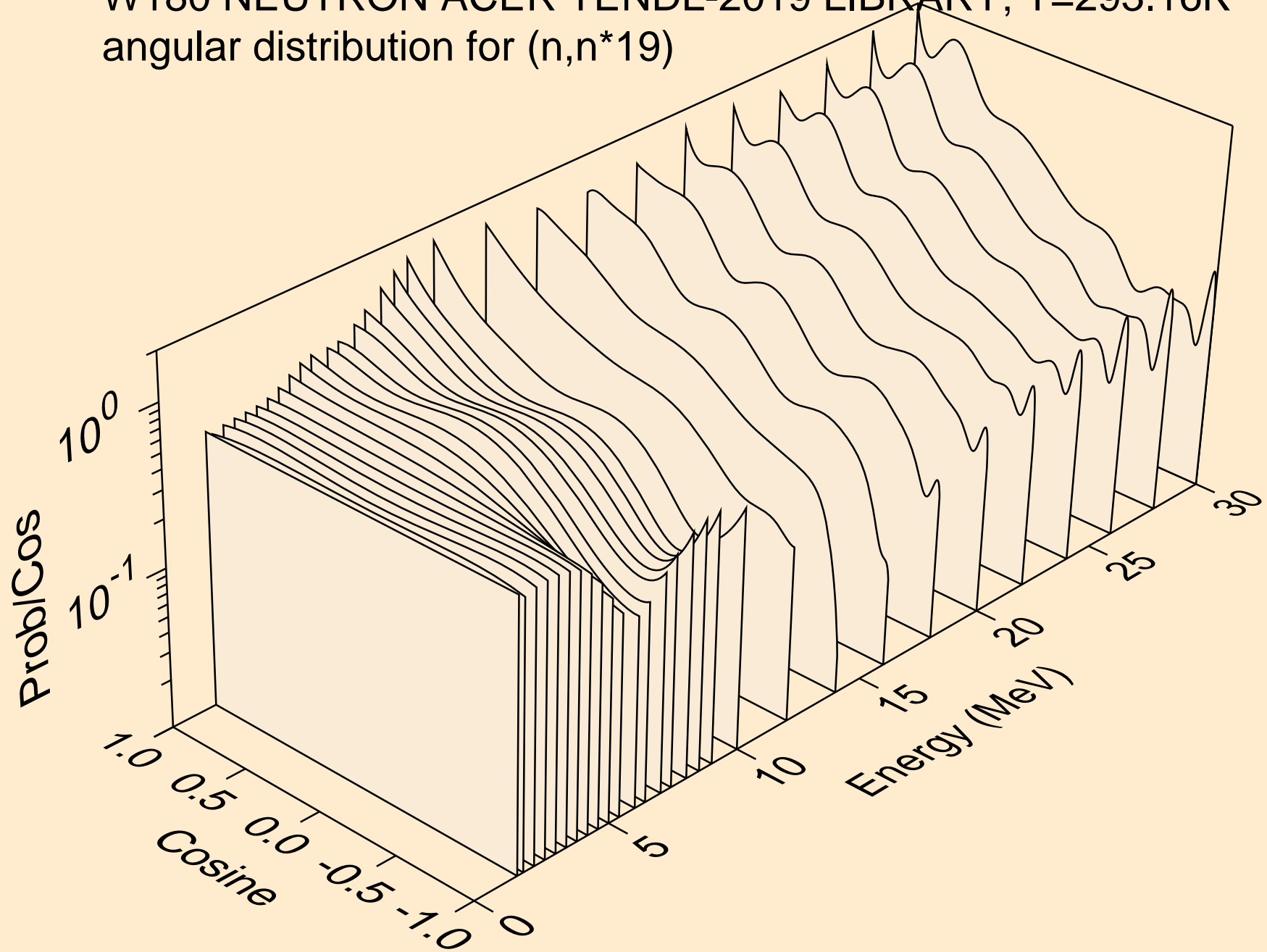

W180 NEUTRON ACER TENDL-2019 LIBRARY; T=293.16K
angular distribution for (n,n*20)

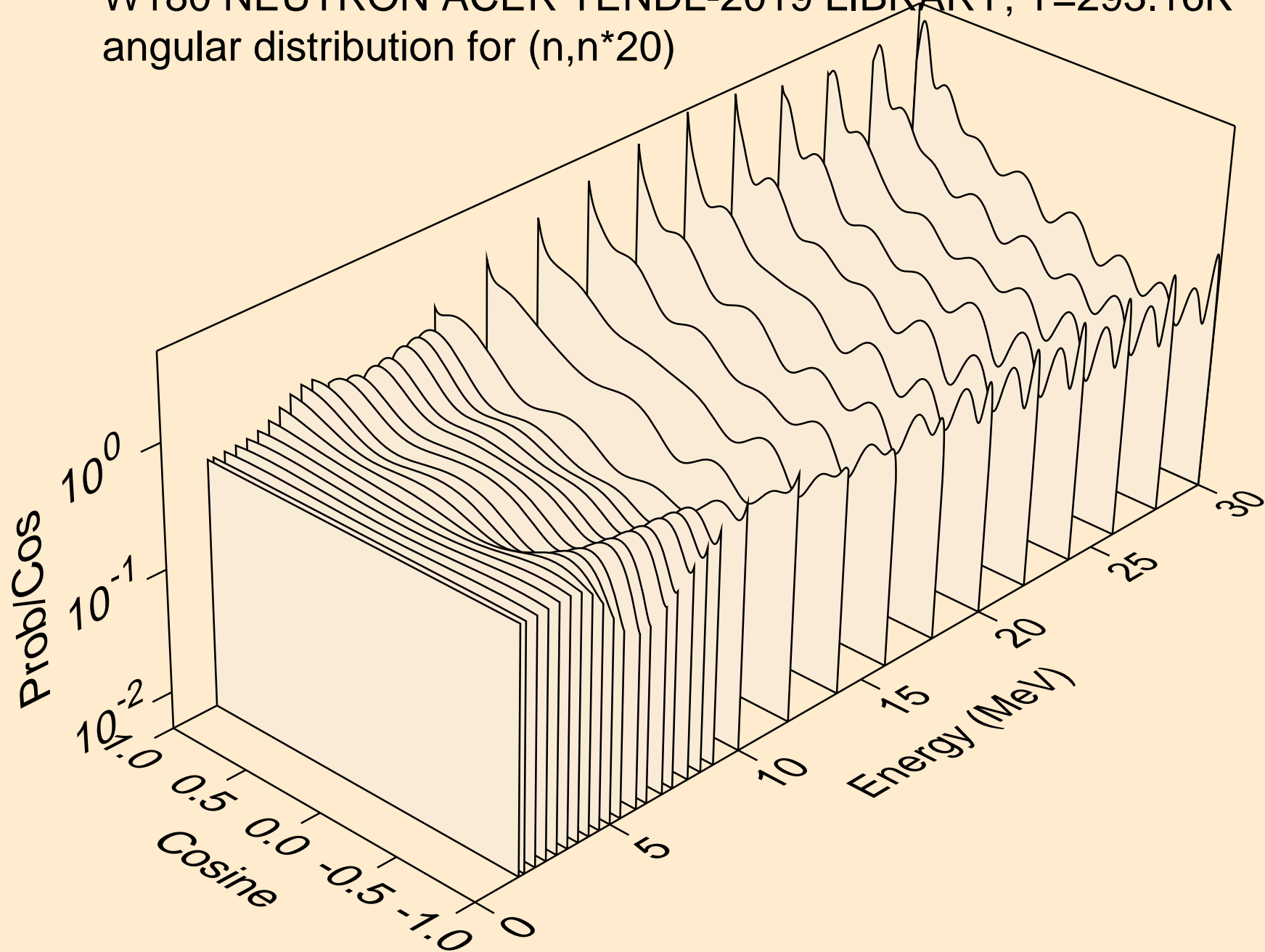

W180 NEUTRON ACER TENDL-2019 LIBRARY; T=293.16K
angular distribution for (n,n*21)

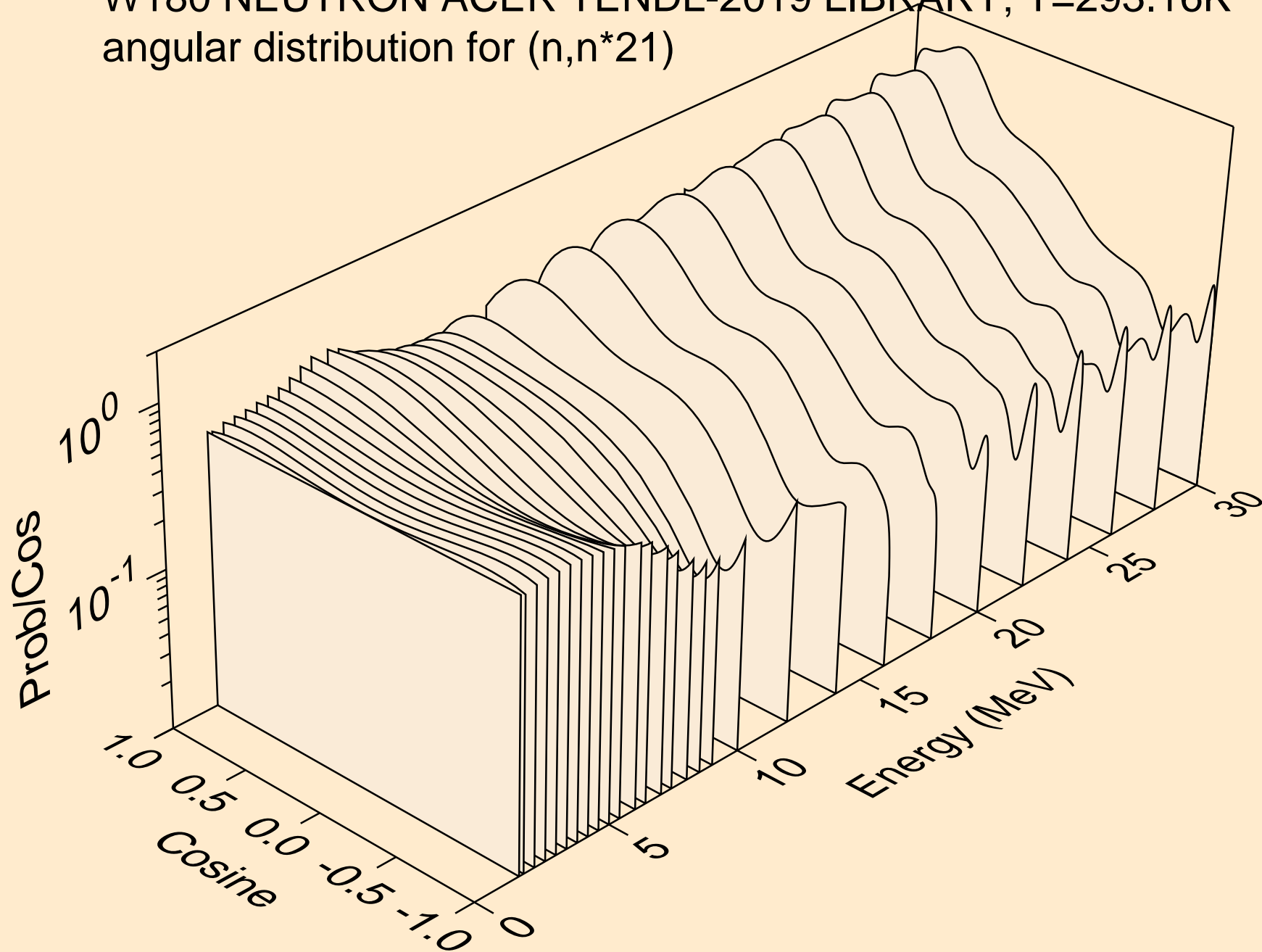

W180 NEUTRON ACER TENDL-2019 LIBRARY; T=293.16K
angular distribution for (n,n*22)

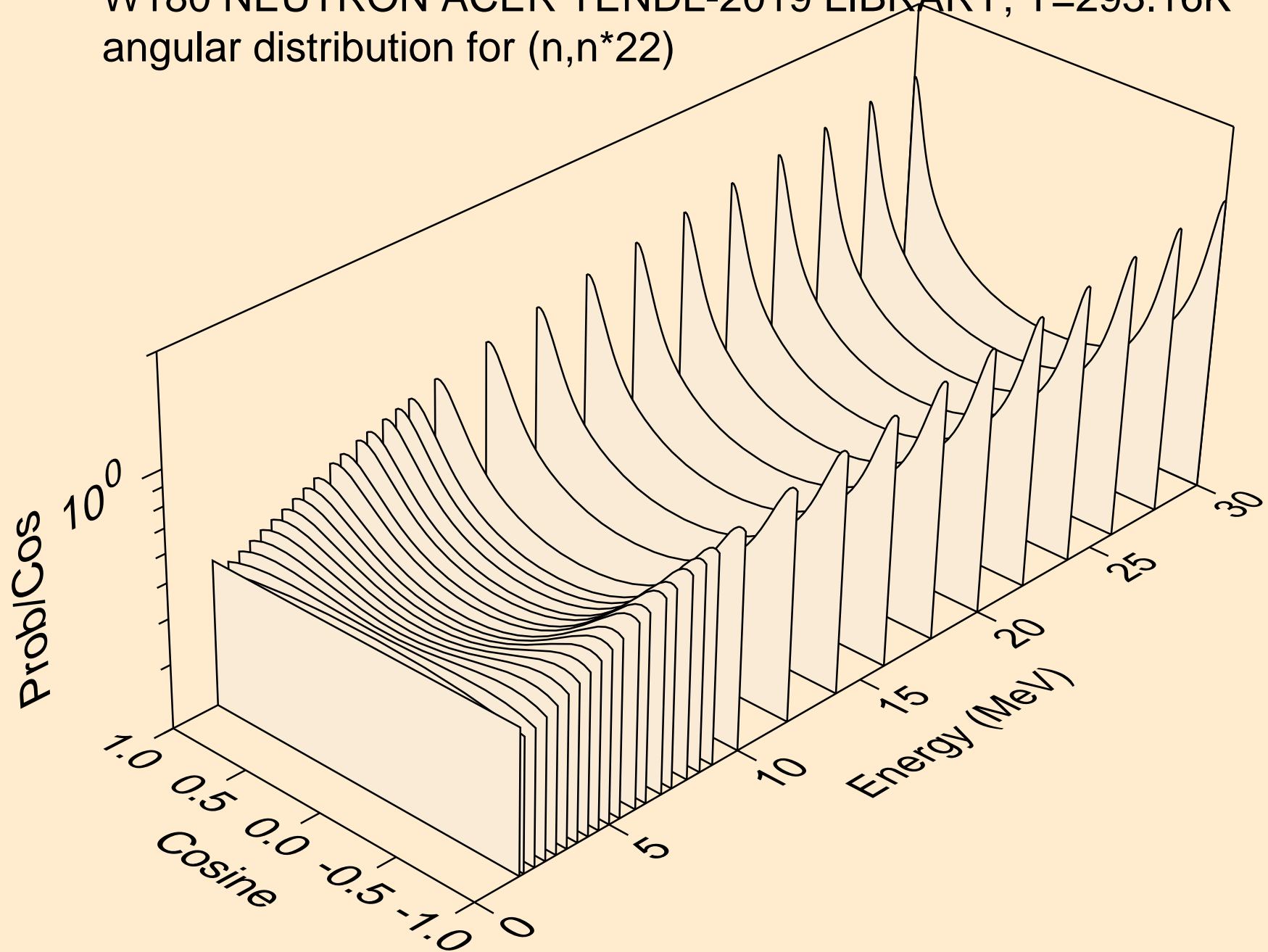

W180 NEUTRON ACER TENDL-2019 LIBRARY; T=293.16K
angular distribution for (n,n*23)

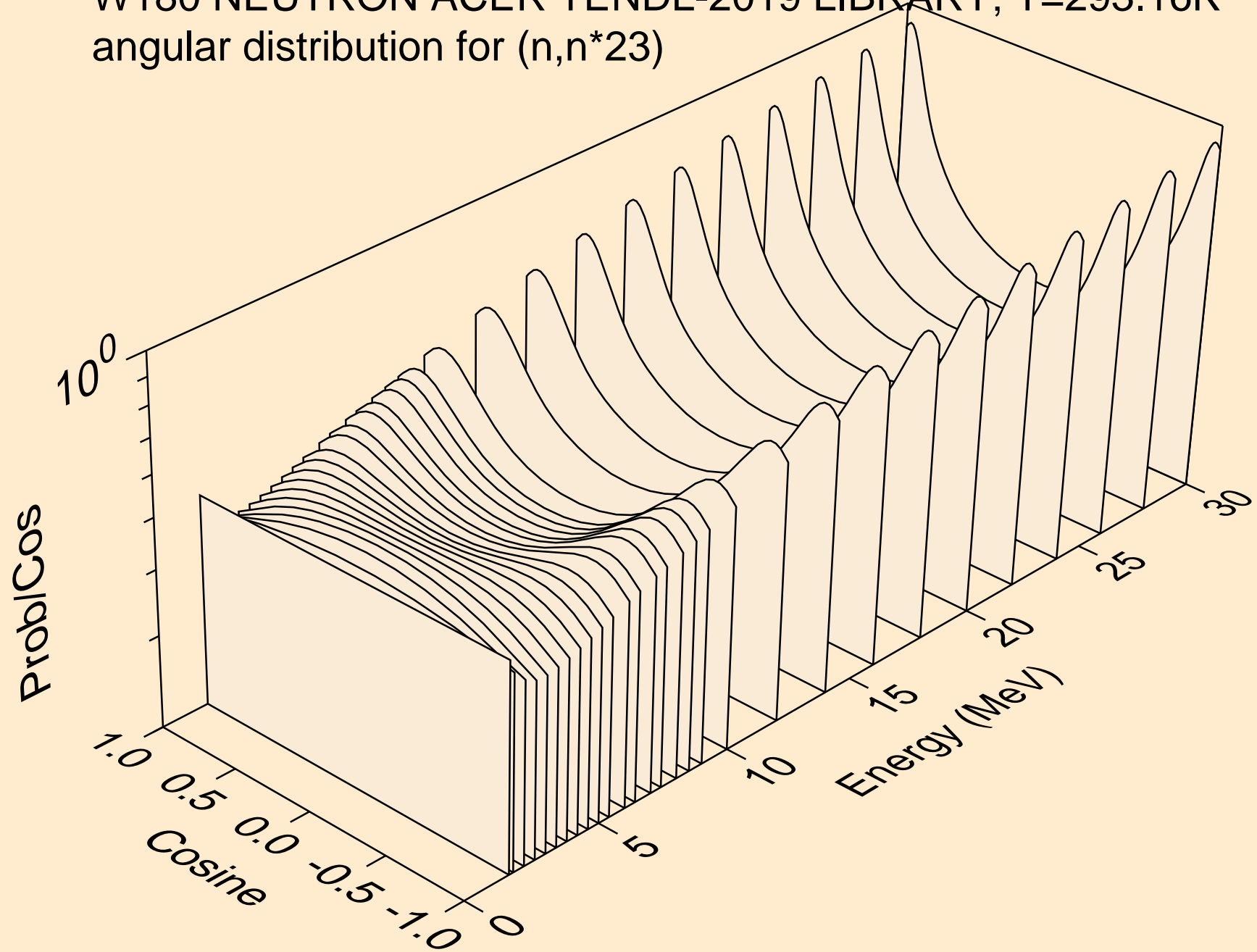

W180 NEUTRON ACER TENDL-2019 LIBRARY; T=293.16K
angular distribution for (n,n*24)

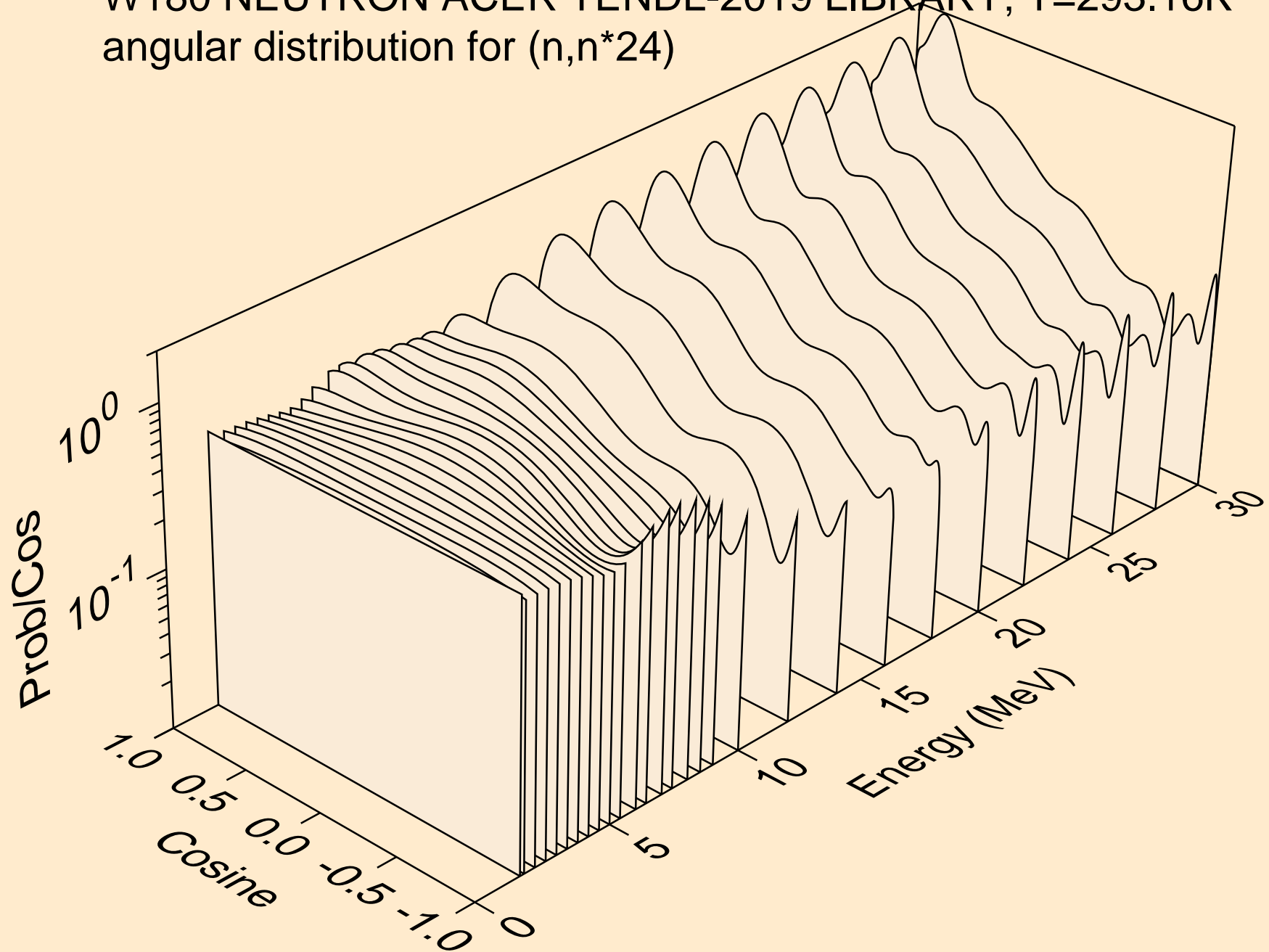

W180 NEUTRON ACER TENDL-2019 LIBRARY; T=293.16K
angular distribution for (n,n*25)

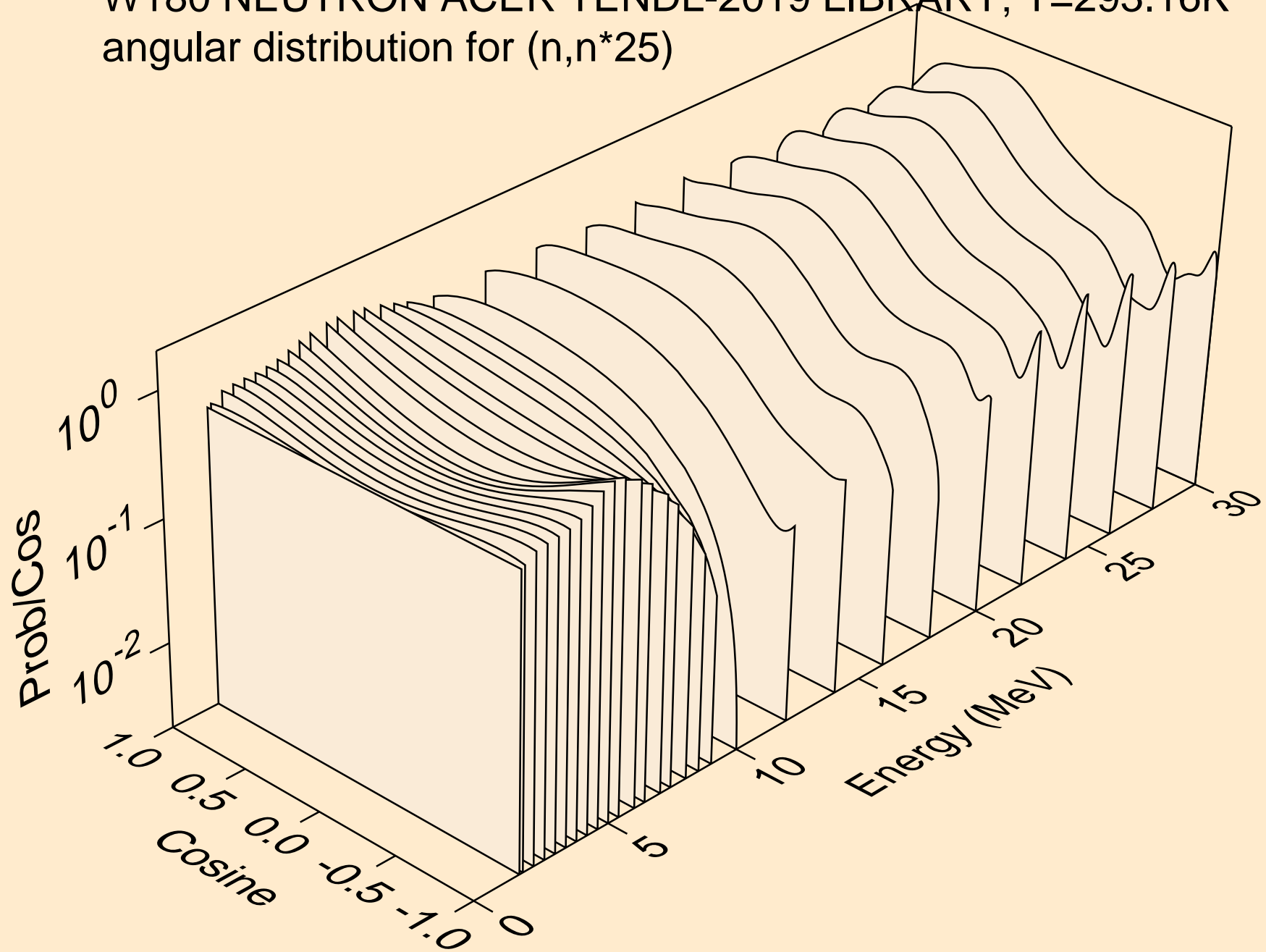

W180 NEUTRON ACER TENDL-2019 LIBRARY; T=293.16K
angular distribution for (n,n*26)

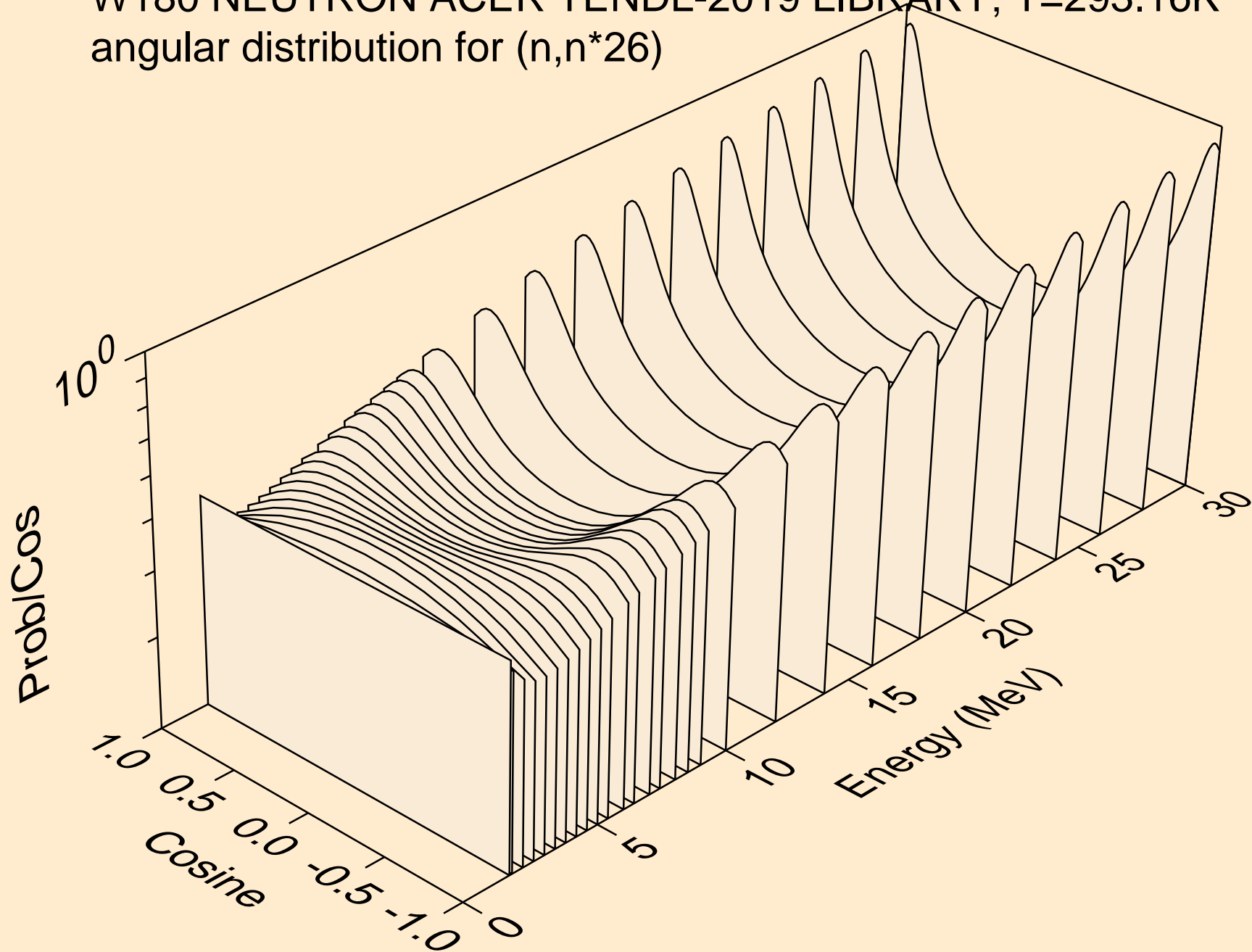

W180 NEUTRON ACER TENDL-2019 LIBRARY; T=293.16K
angular distribution for (n,n*27)

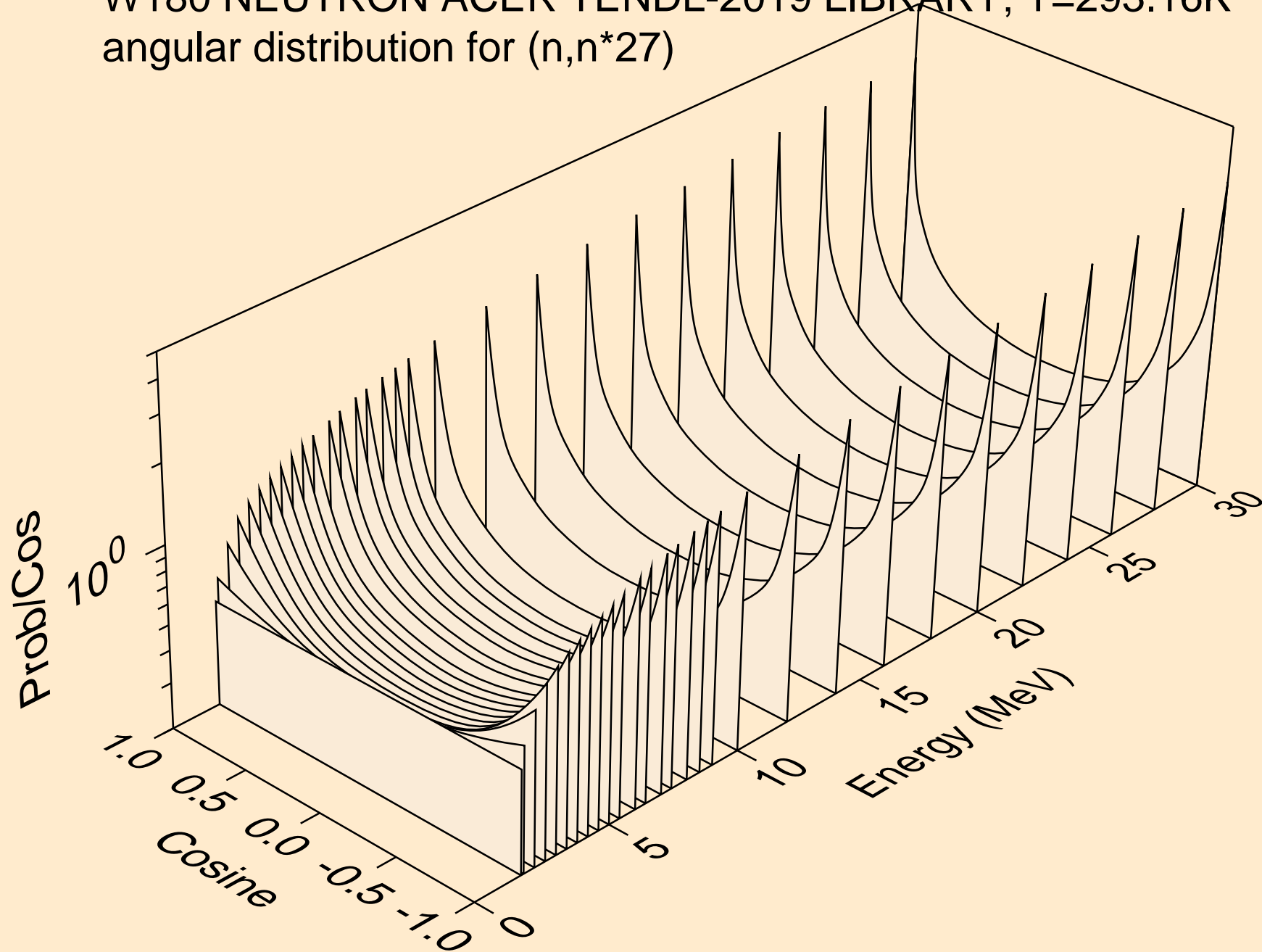

W180 NEUTRON ACER TENDL-2019 LIBRARY; T=293.16K
angular distribution for (n,n*28)

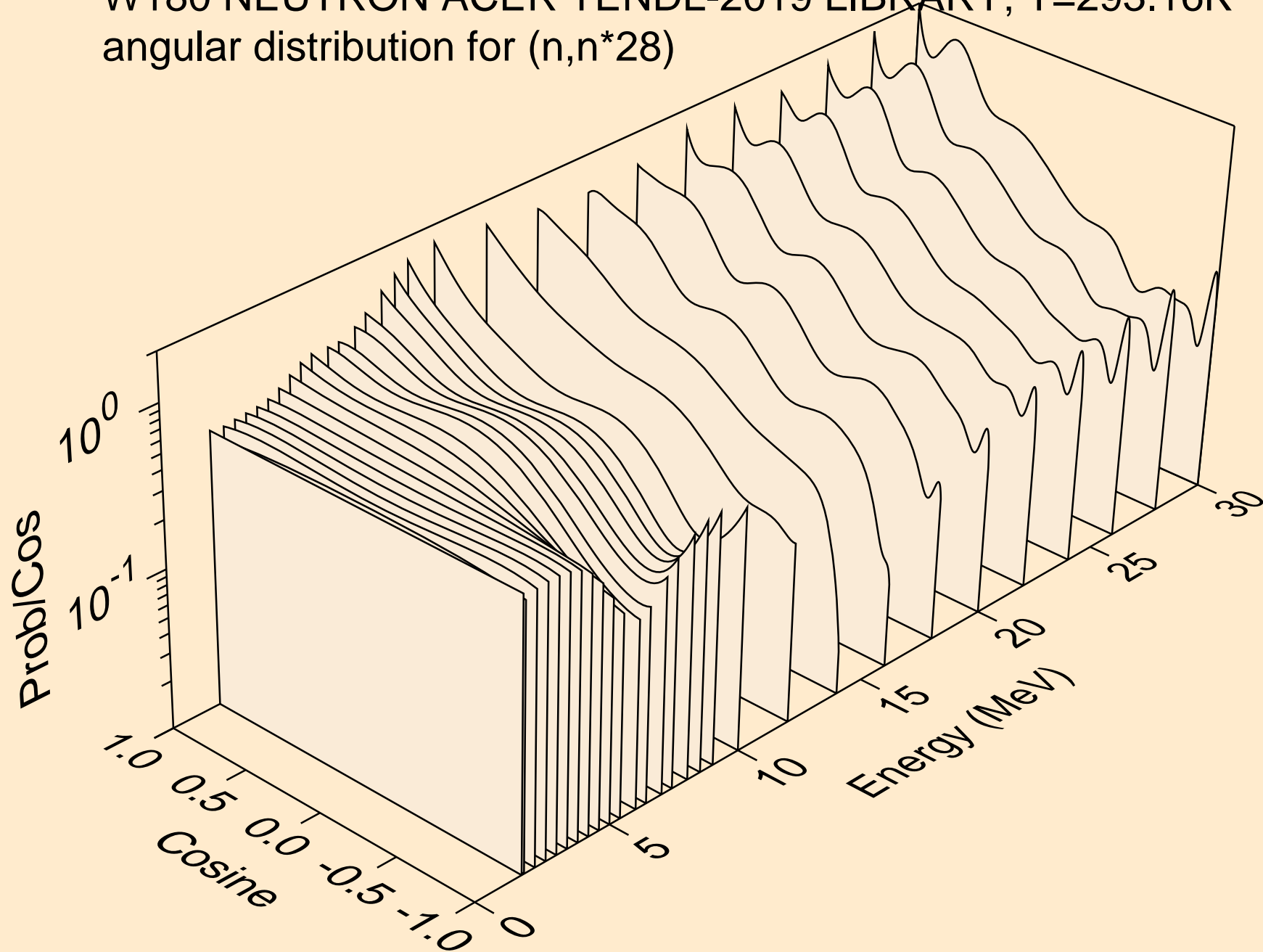

W180 NEUTRON ACER TENDL-2019 LIBRARY; T=293.16K
angular distribution for (n,n*29)

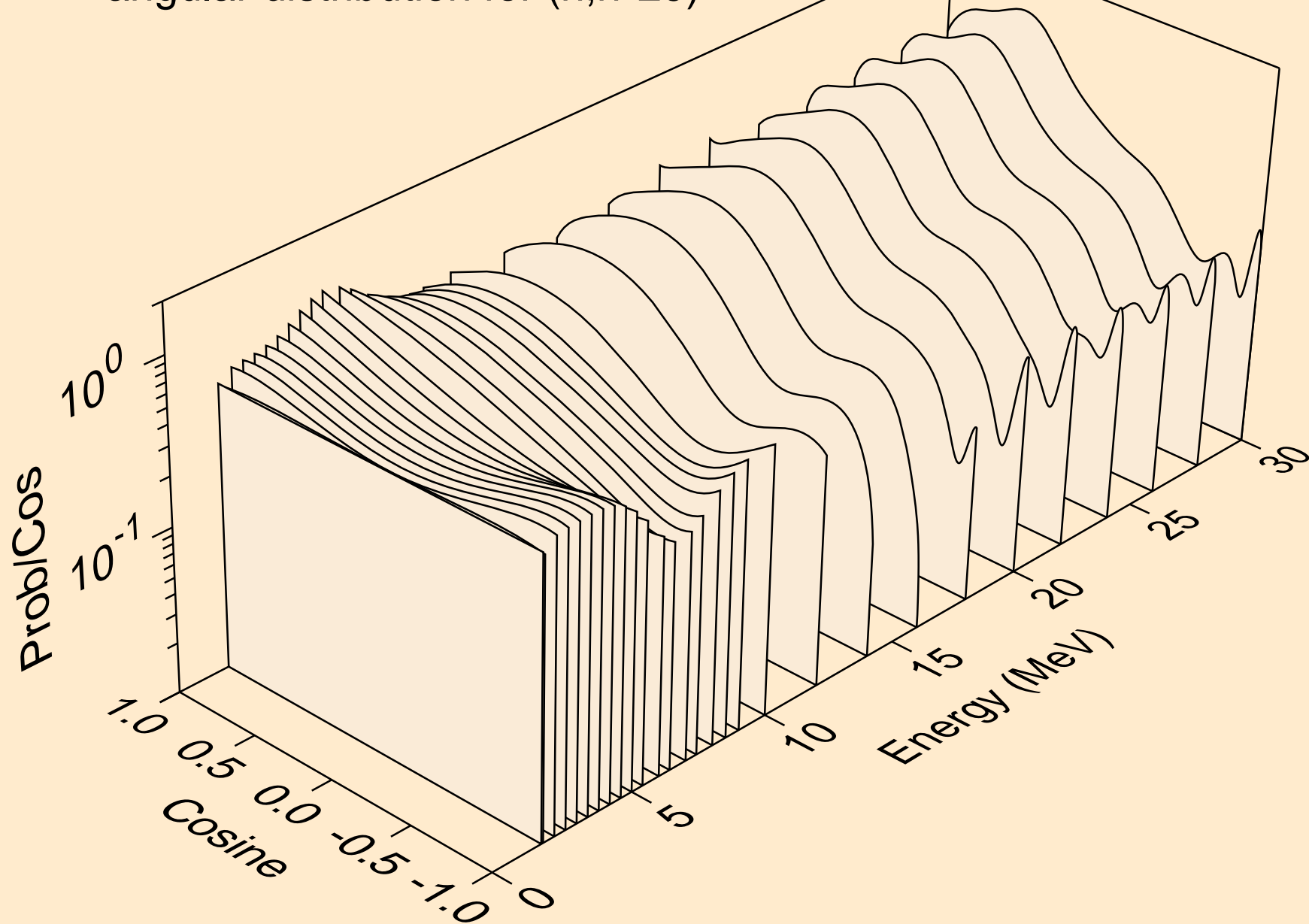

W180 NEUTRON ACER TENDL-2019 LIBRARY; T=293.16K
angular distribution for (n,n*30)

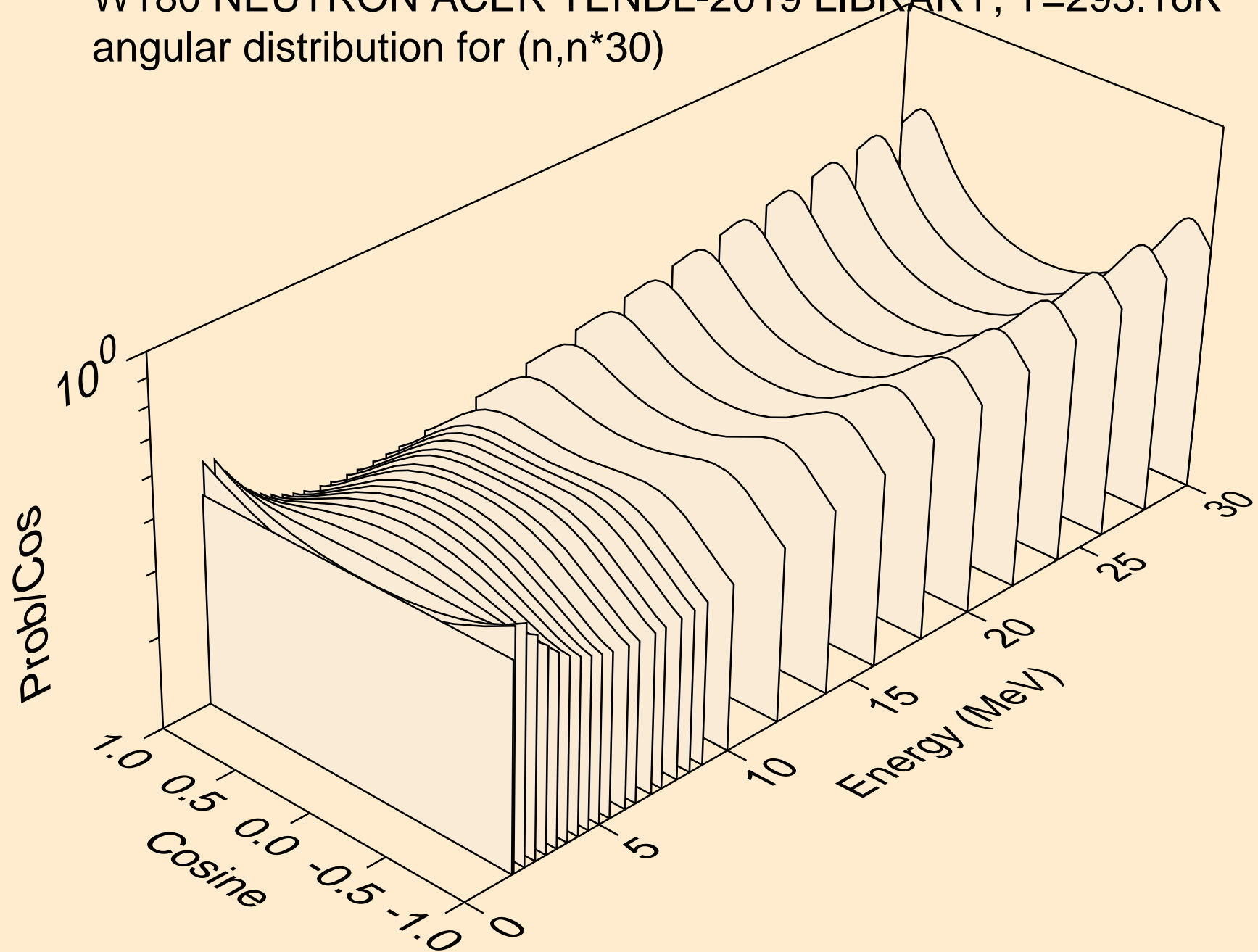

W180 NEUTRON ACER TENDL-2019 LIBRARY; T=293.16K
Neutron emission for (n,x)

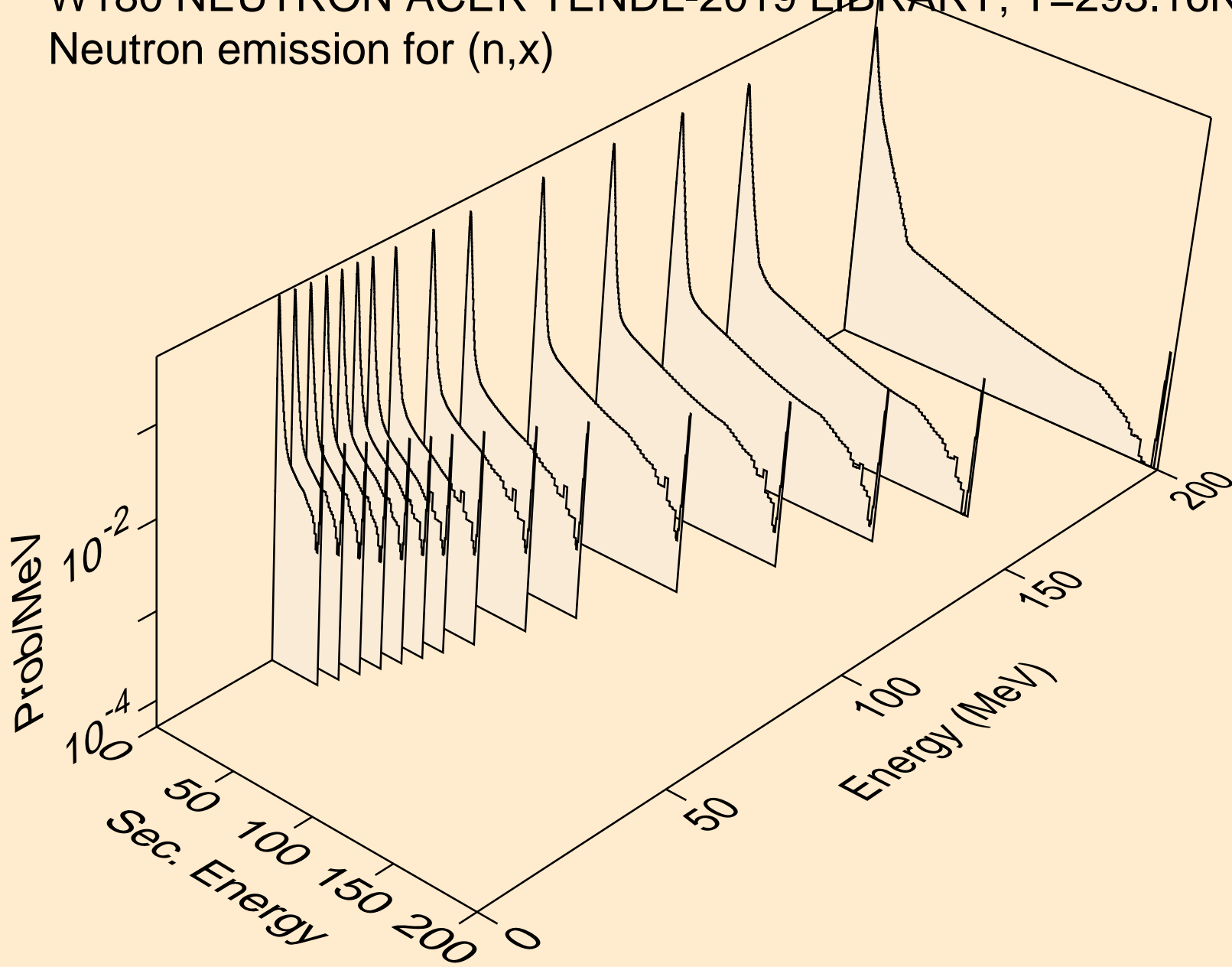

W180 NEUTRON ACER TENDL-2019 LIBRARY; T=293.16K
Neutron emission for (n,2nd)

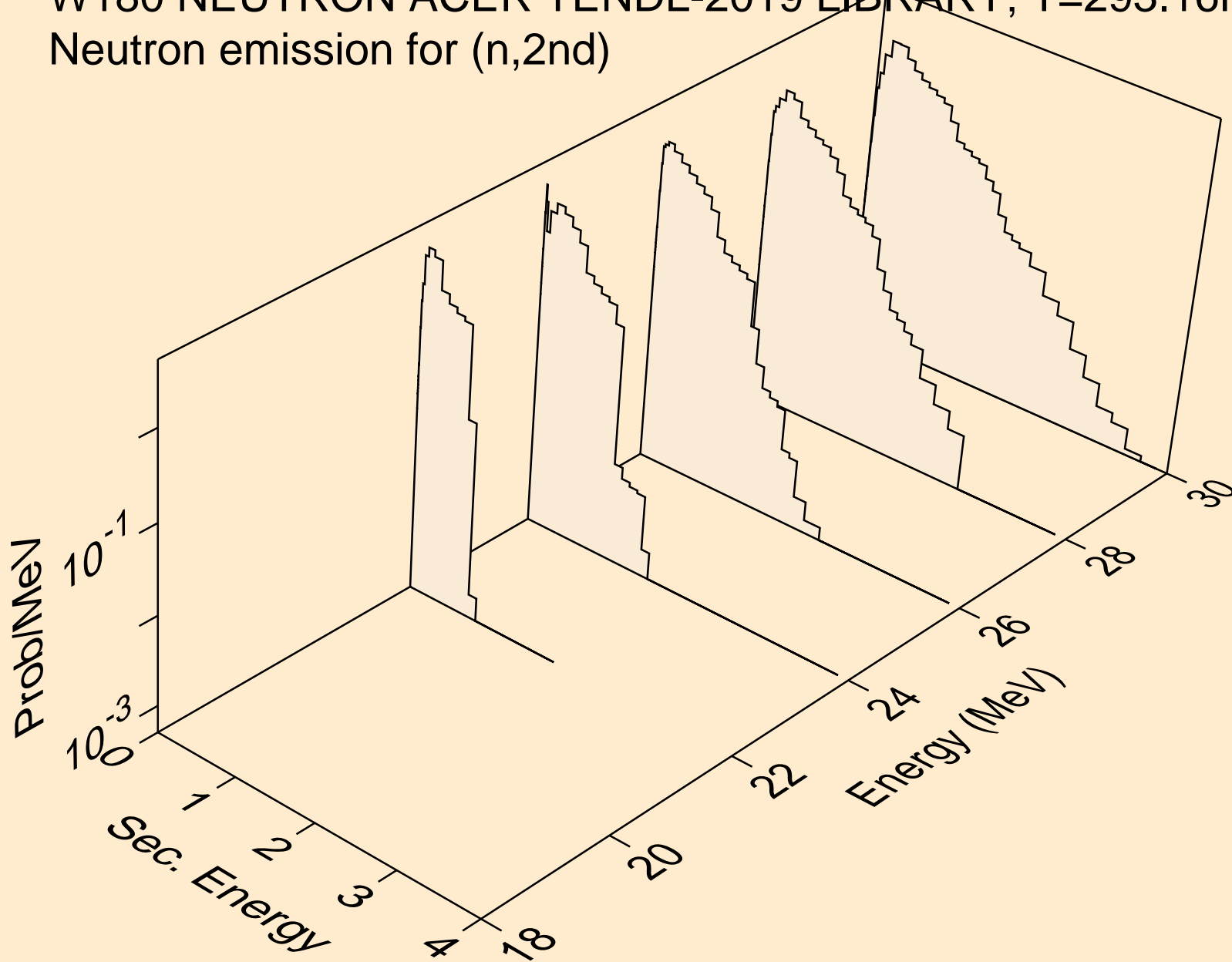

W180 NEUTRON ACER TENDL-2019 LIBRARY; T=293.16K
Neutron emission for (n,2n)

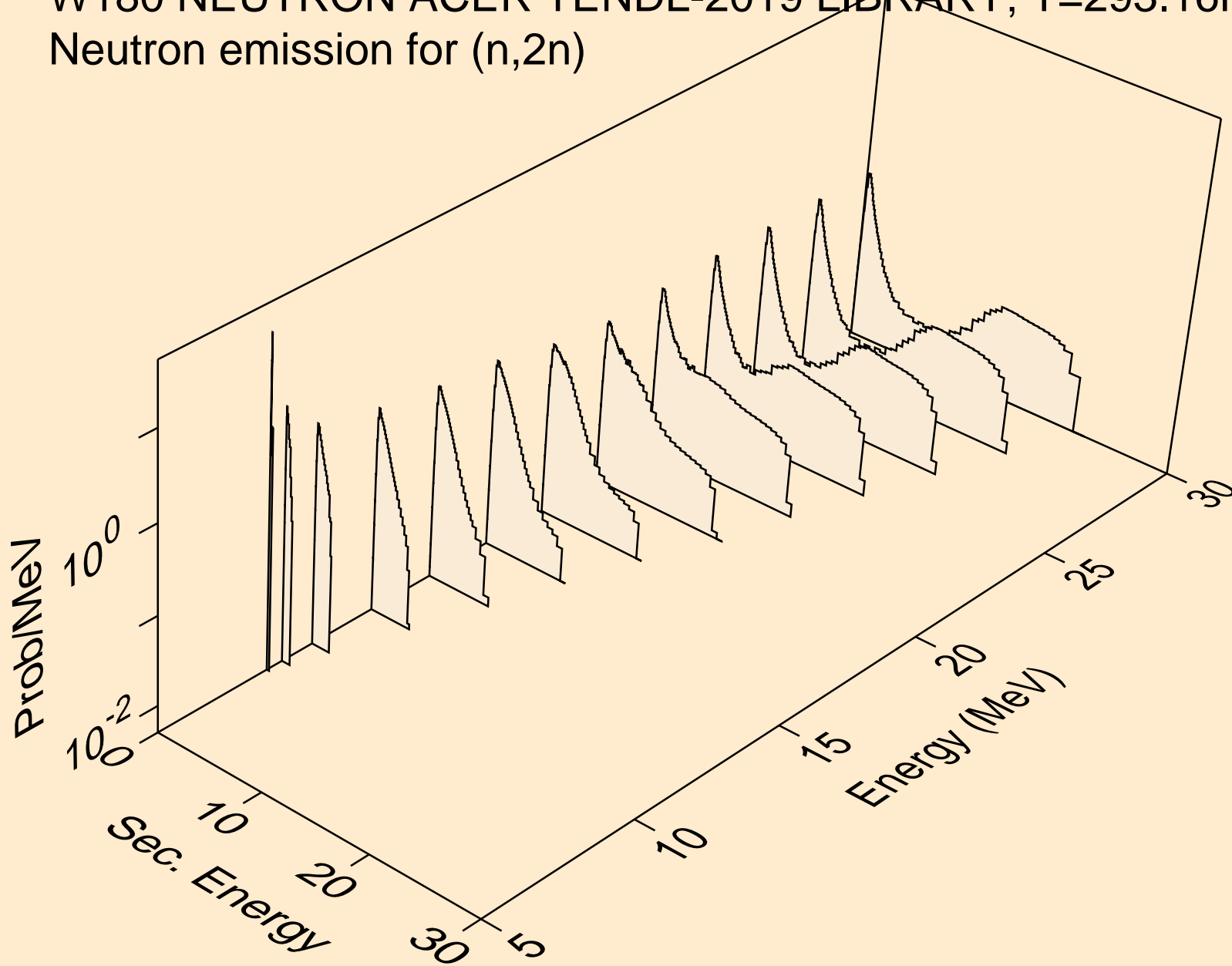

W180 NEUTRON ACER TENDL-2019 LIBRARY; T=293.16K
Neutron emission for (n,3n)

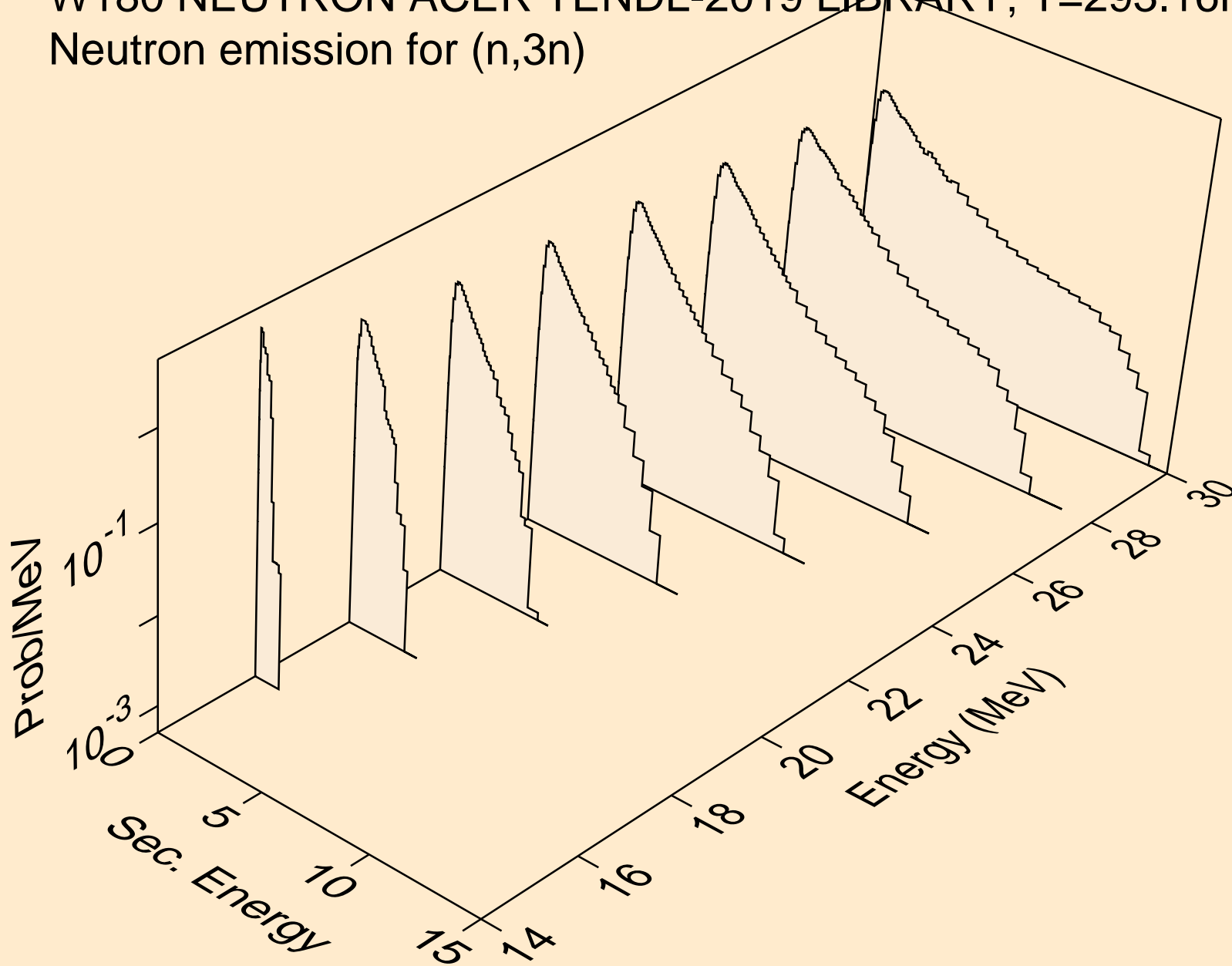

W180 NEUTRON ACER TENDL-2019 LIBRARY; T=293.16K
Neutron emission for (n,n*)a

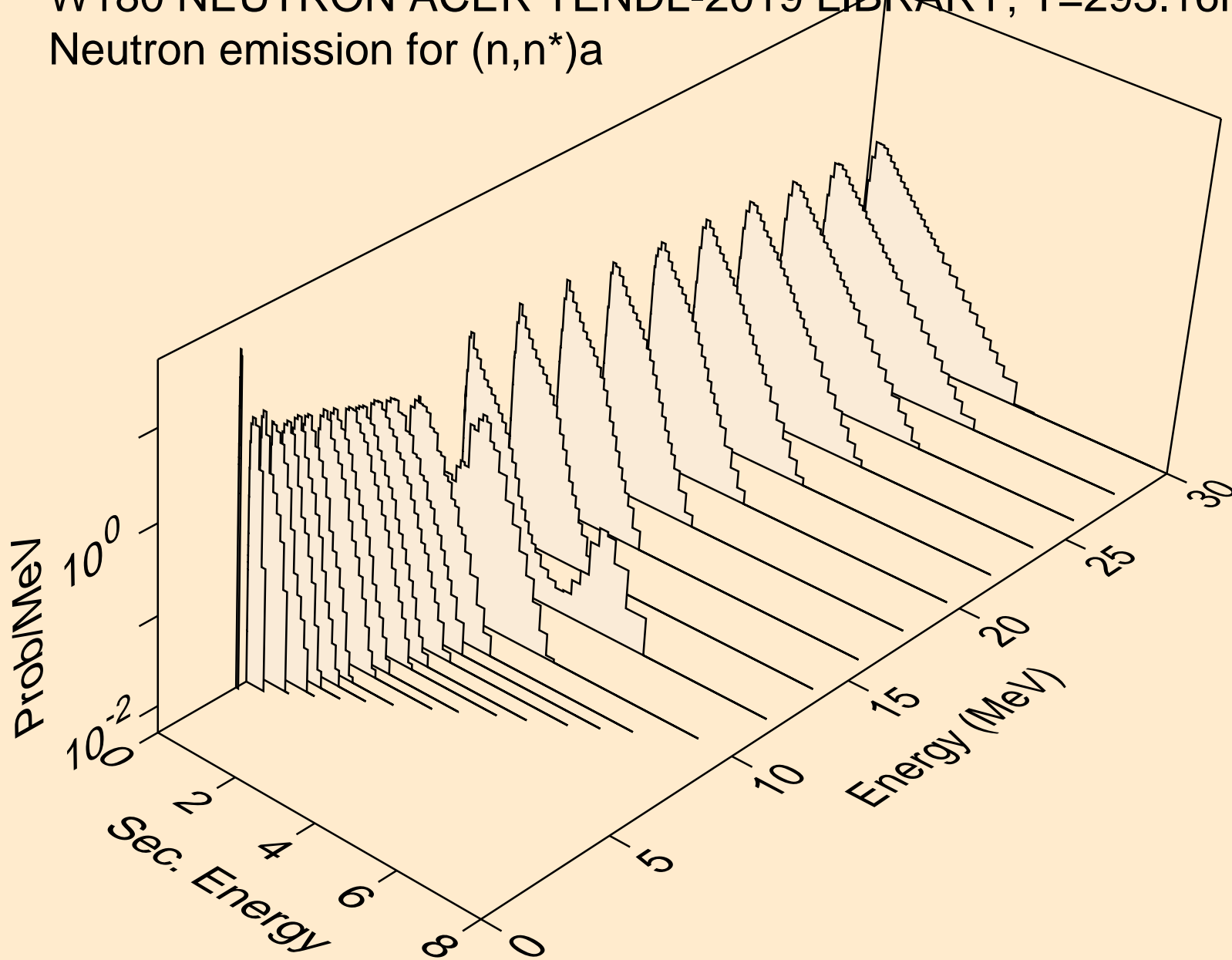

W180 NEUTRON ACER TENDL-2019 LIBRARY; T=293.16K
Neutron emission for (n,2n)a

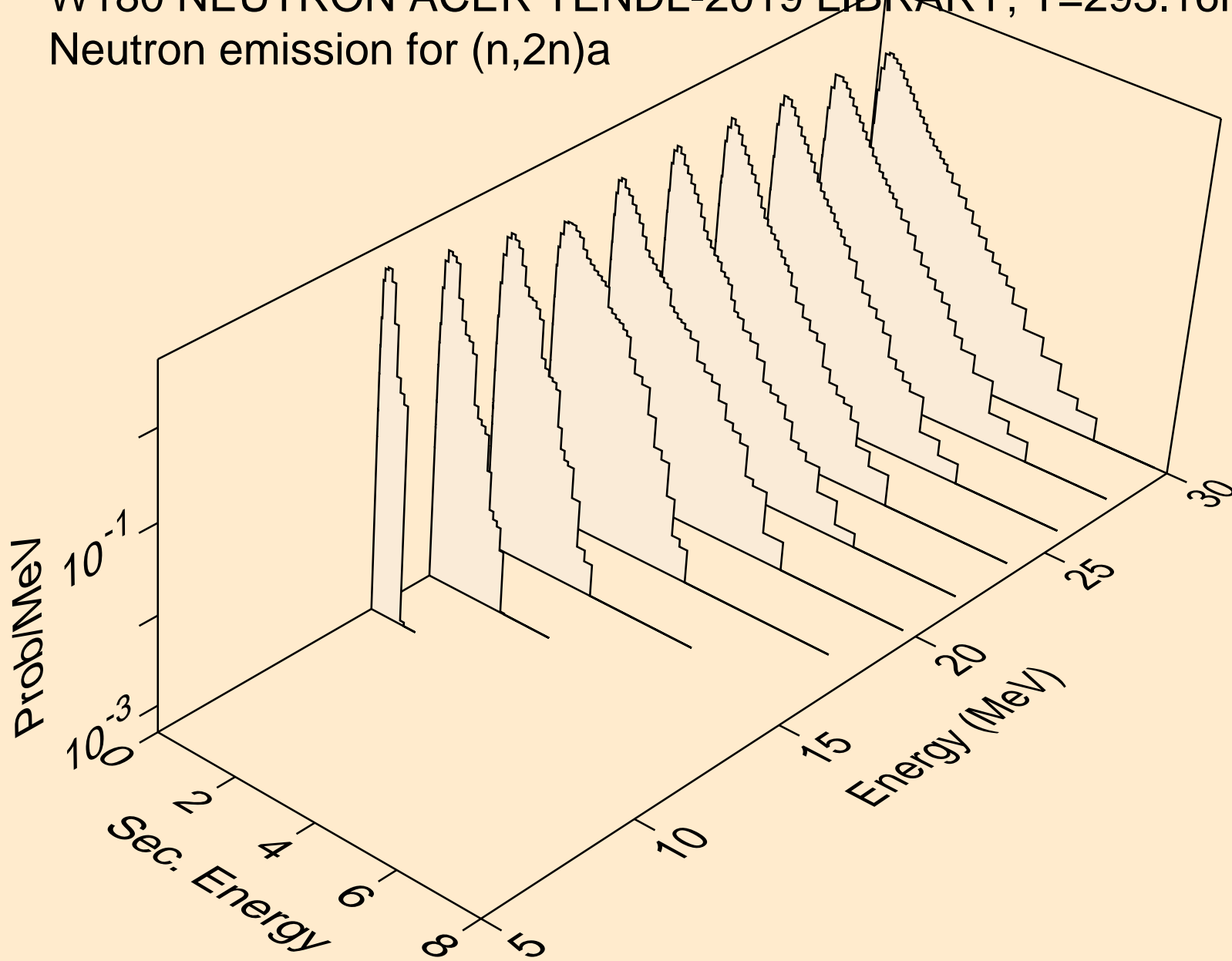

W180 NEUTRON ACER TENDL-2019 LIBRARY; T=293.16K
Neutron emission for (n,3n)a

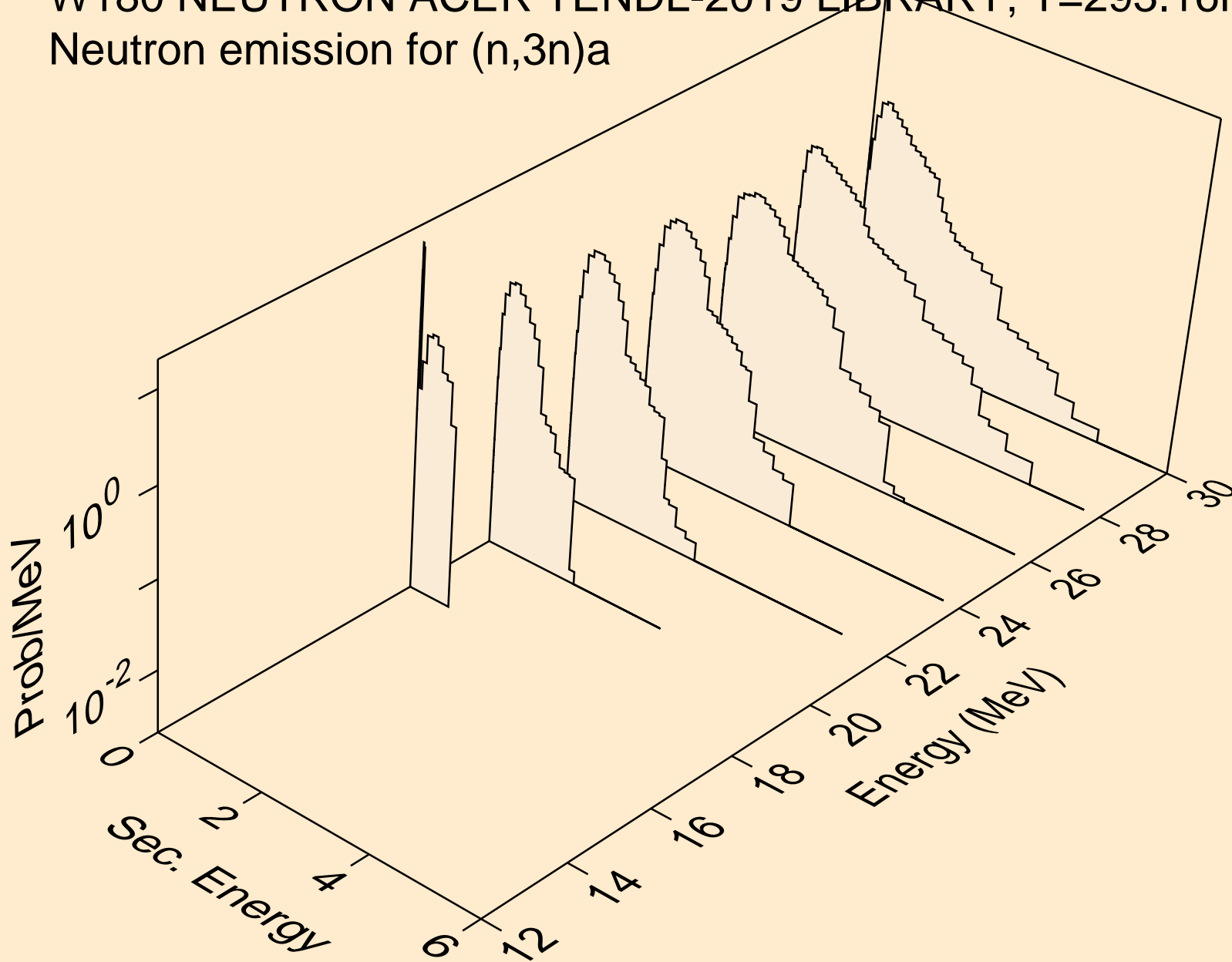

W180 NEUTRON ACER TENDL-2019 LIBRARY; T=293.16K
Neutron emission for (n,n*)p

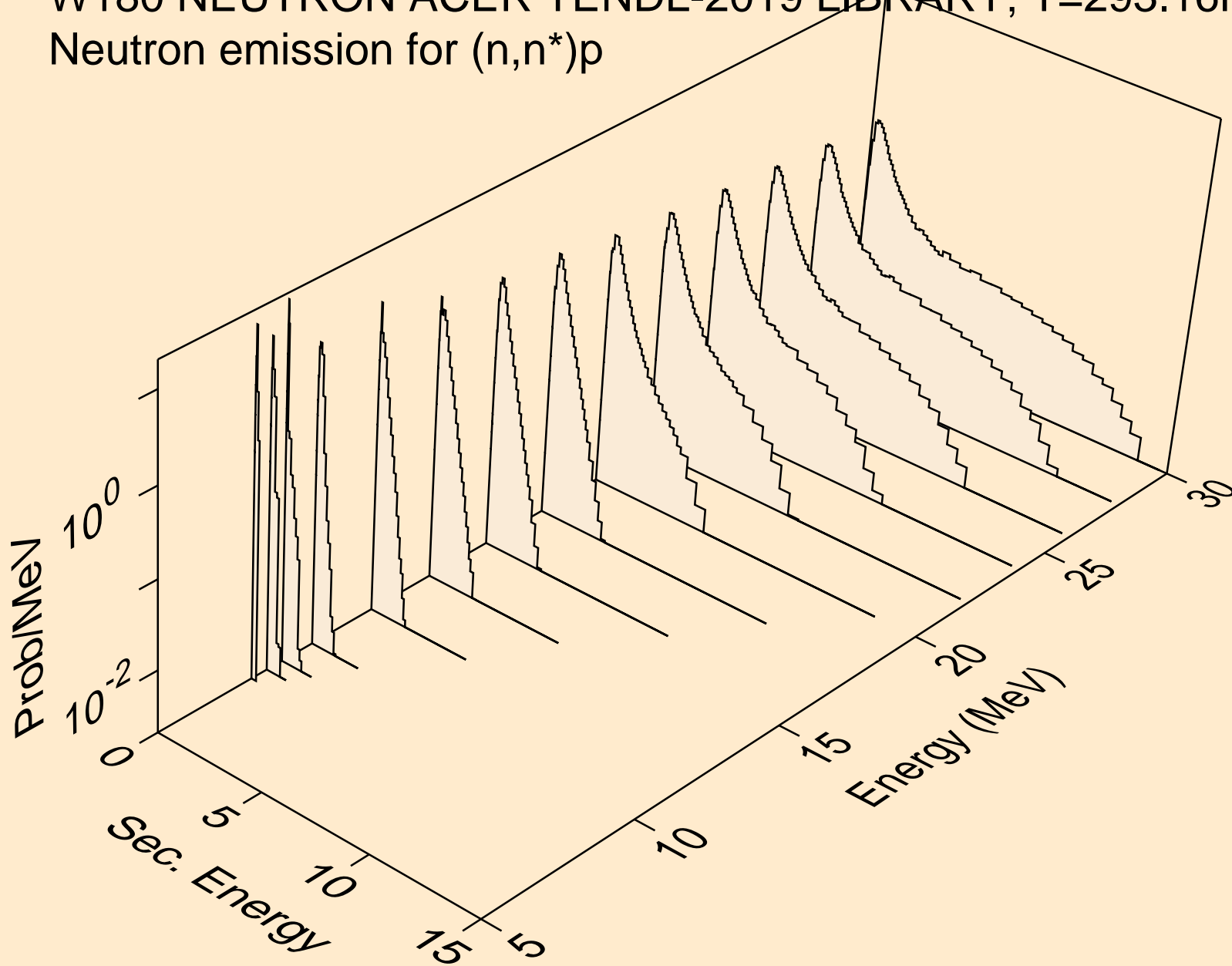

W180 NEUTRON ACER TENDL-2019 LIBRARY; T=293.16K
Neutron emission for (n,n*)2a

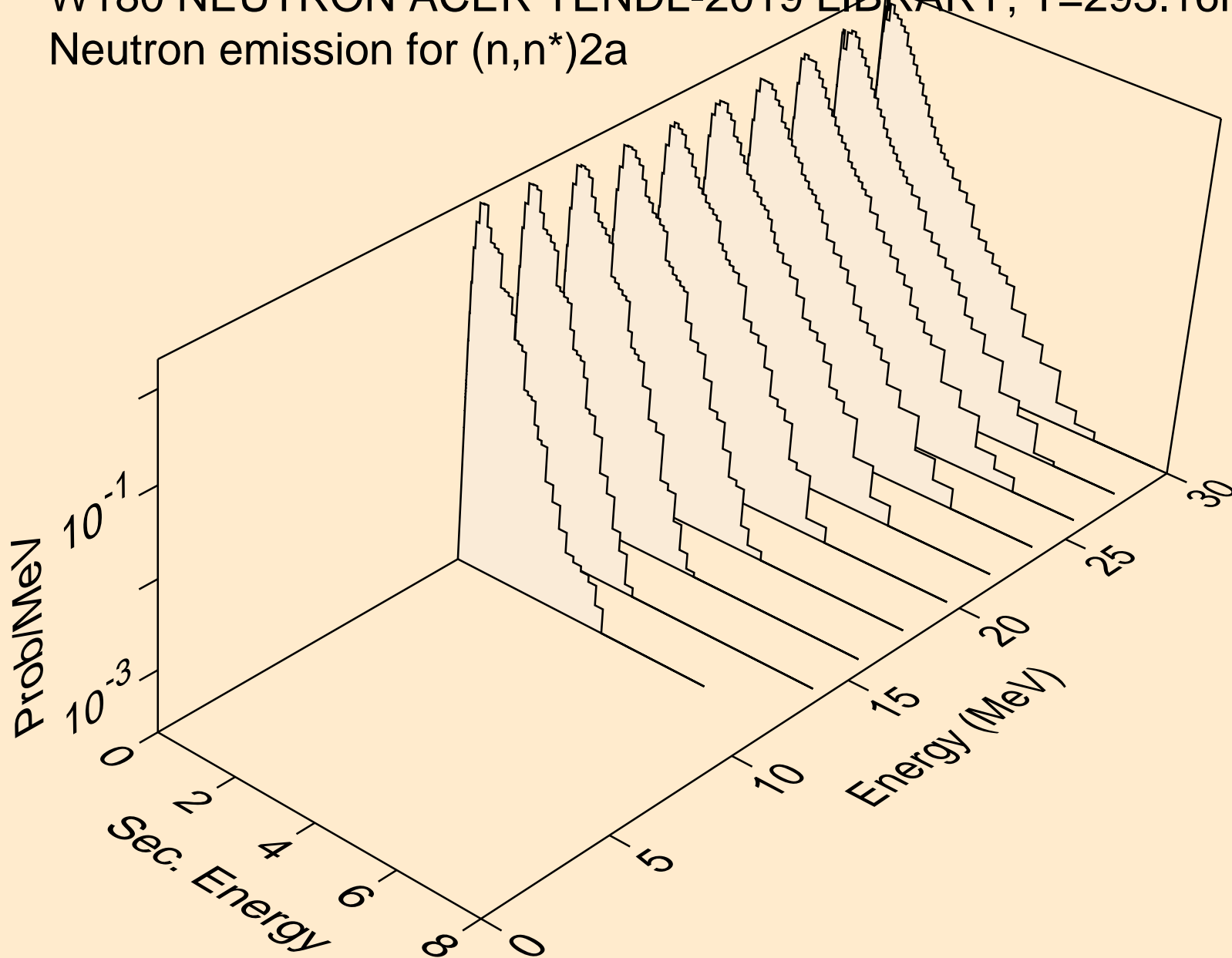

W180 NEUTRON ACER TENDL-2019 LIBRARY; T=293.16K
Neutron emission for (n,n*)d

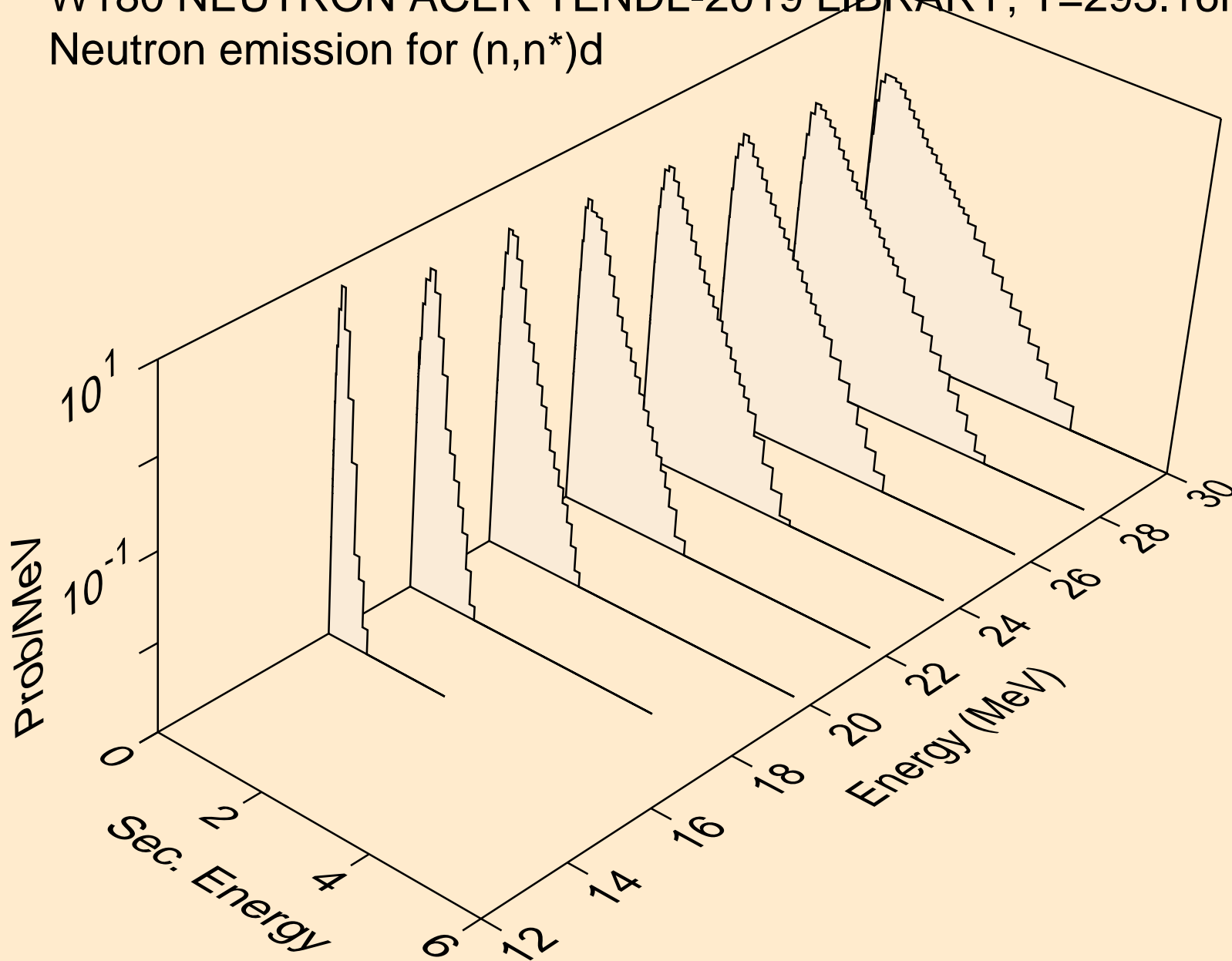

W180 NEUTRON ACER TENDL-2019 LIBRARY; T=293.16K
Neutron emission for (n,n*)t

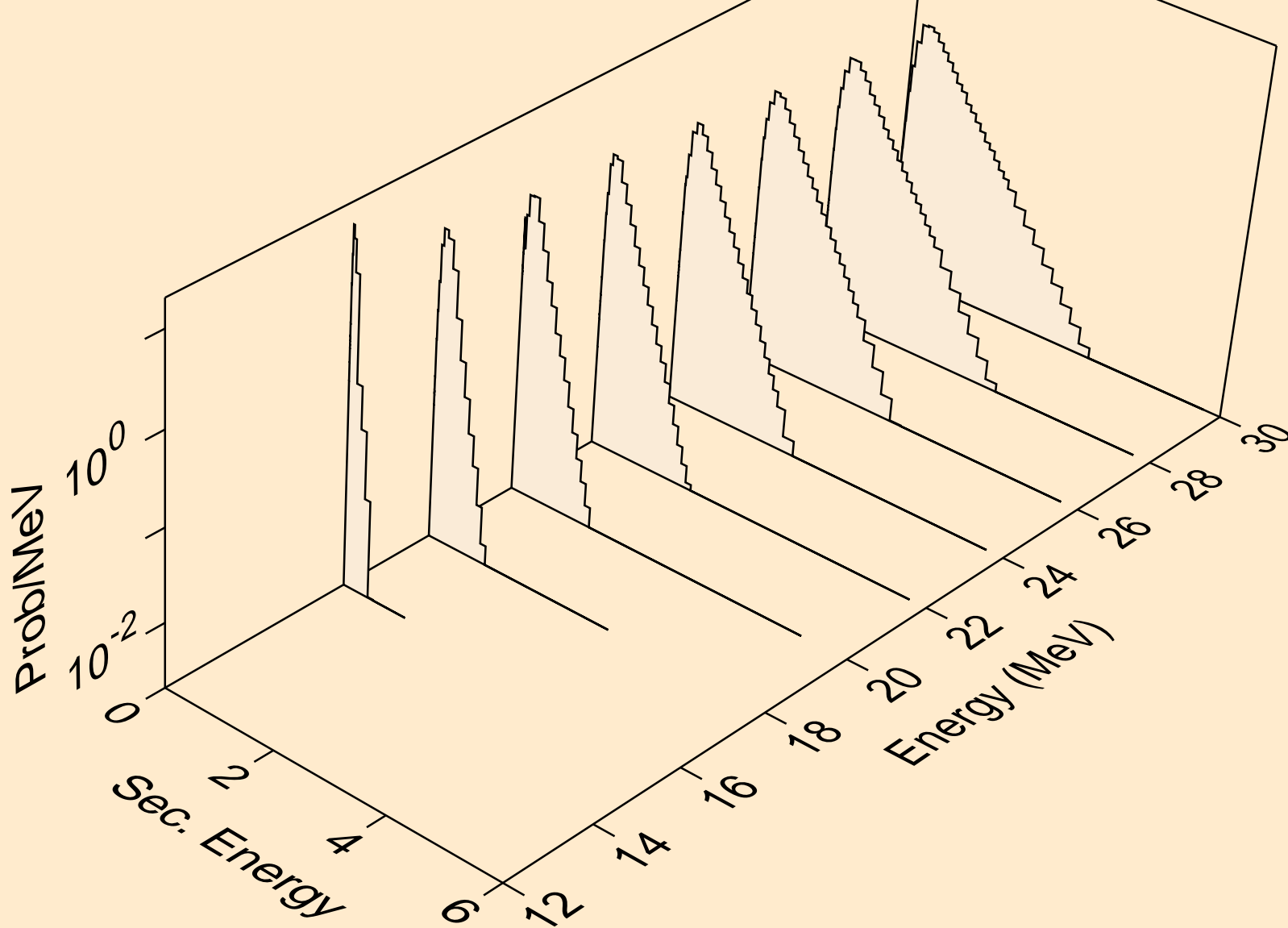

W180 NEUTRON ACER TENDL-2019 LIBRARY; T=293.16K
Neutron emission for (n,n*)he3

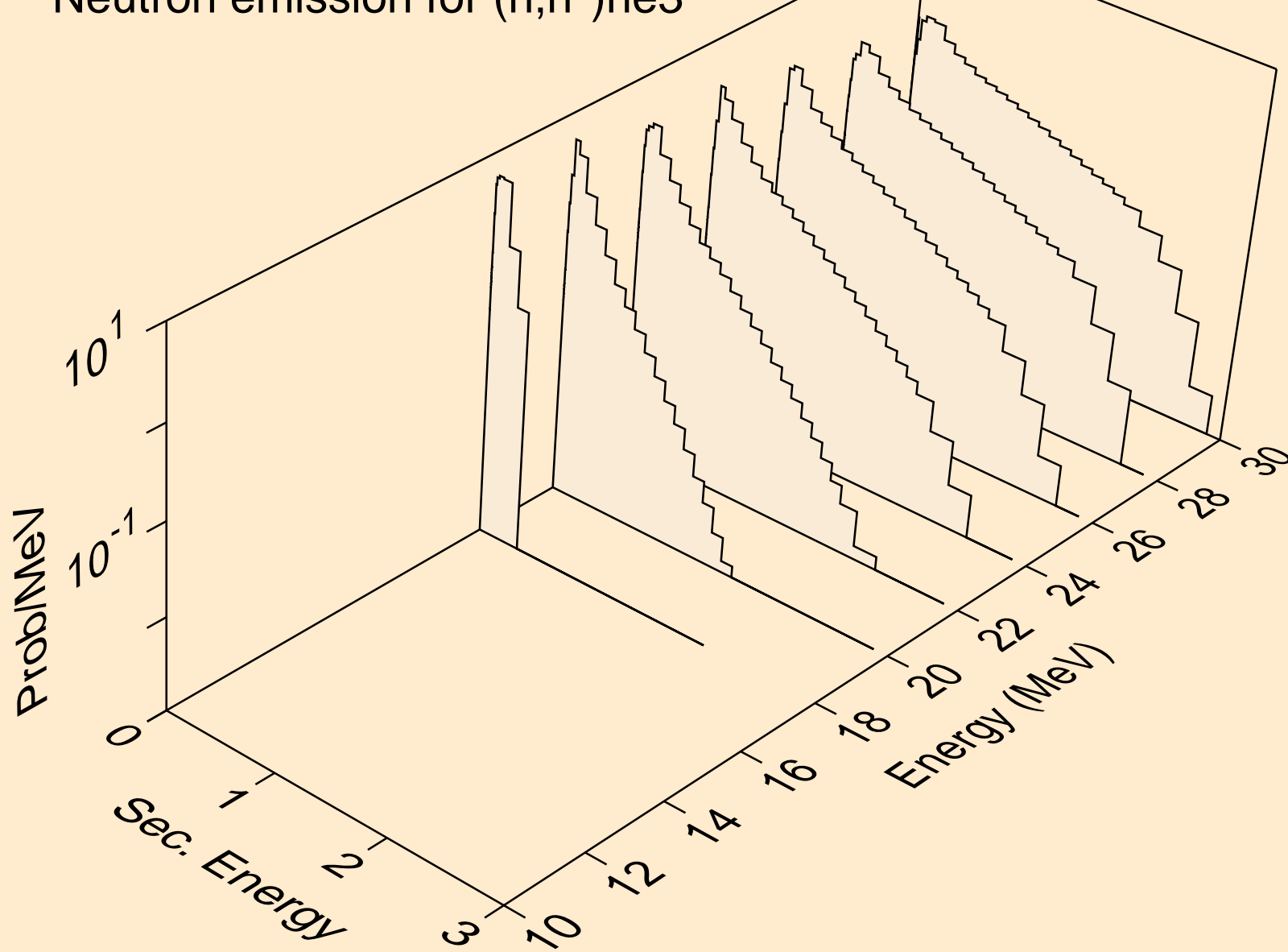

W180 NEUTRON ACER TENDL-2019 LIBRARY; T=293.16K
Neutron emission for (n,4n)

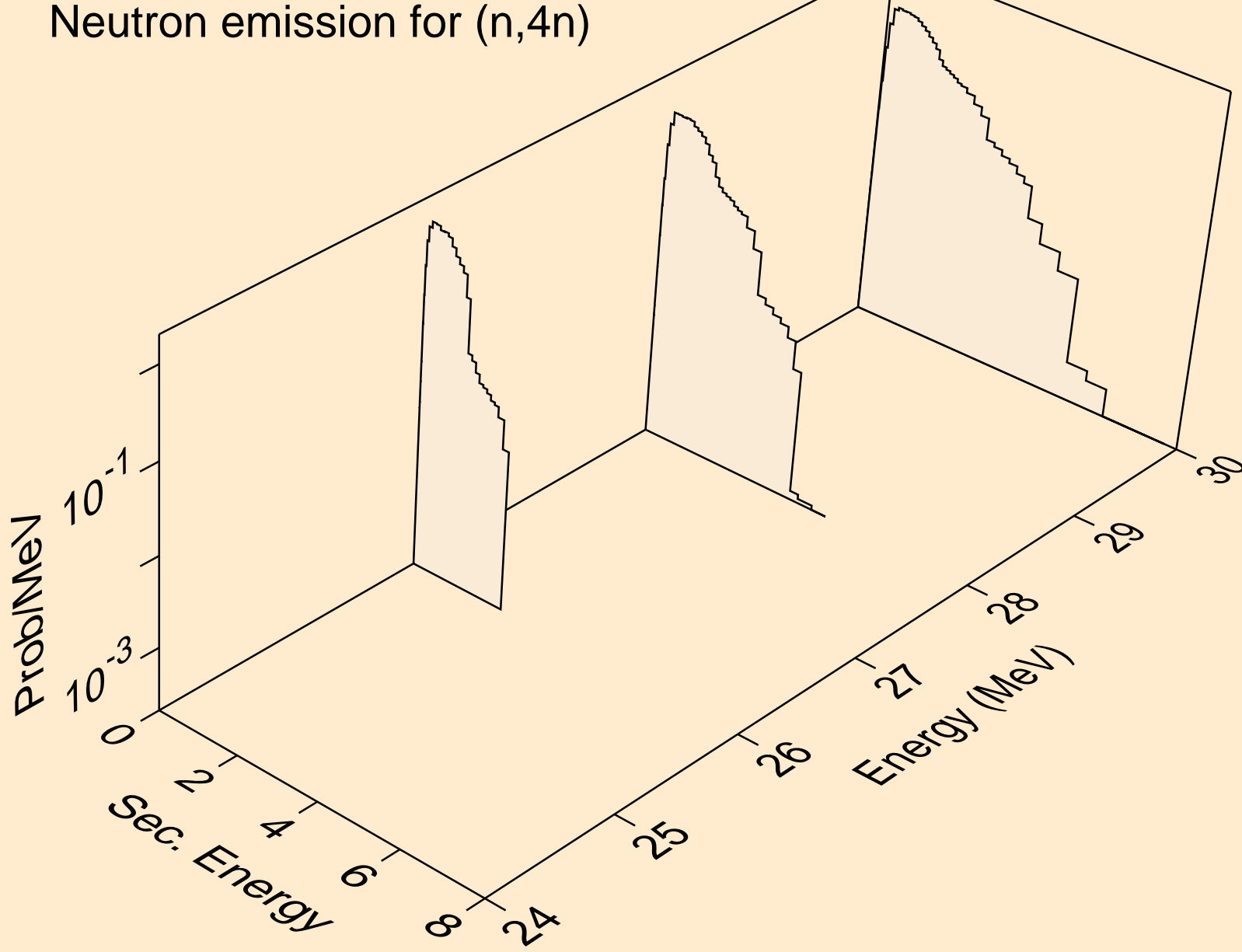

W180 NEUTRON ACER TENDL-2019 LIBRARY; T=293.16K
Neutron emission for (n,2np)

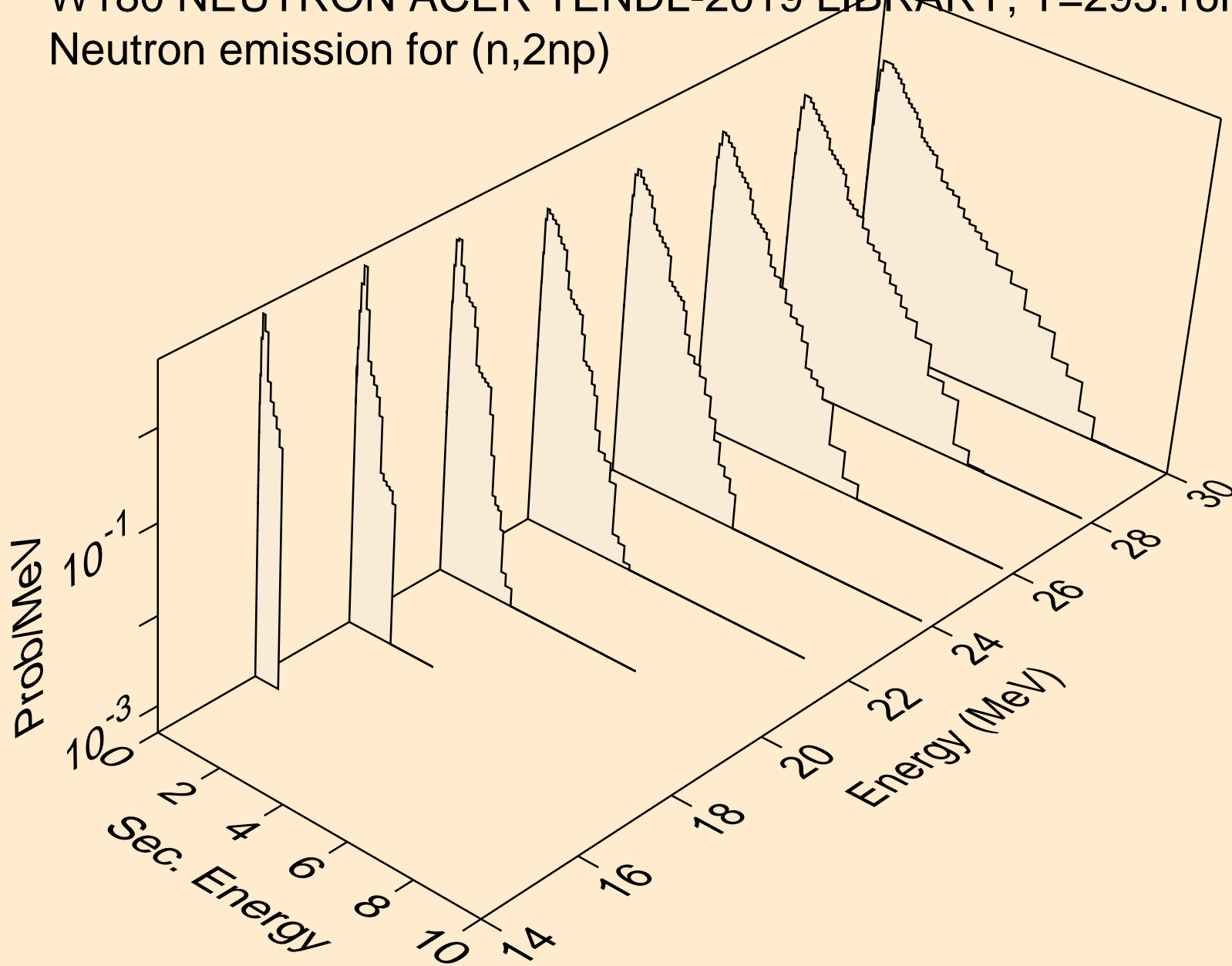

W180 NEUTRON ACER TENDL-2019 LIBRARY; T=293.16K
Neutron emission for (n,3np)

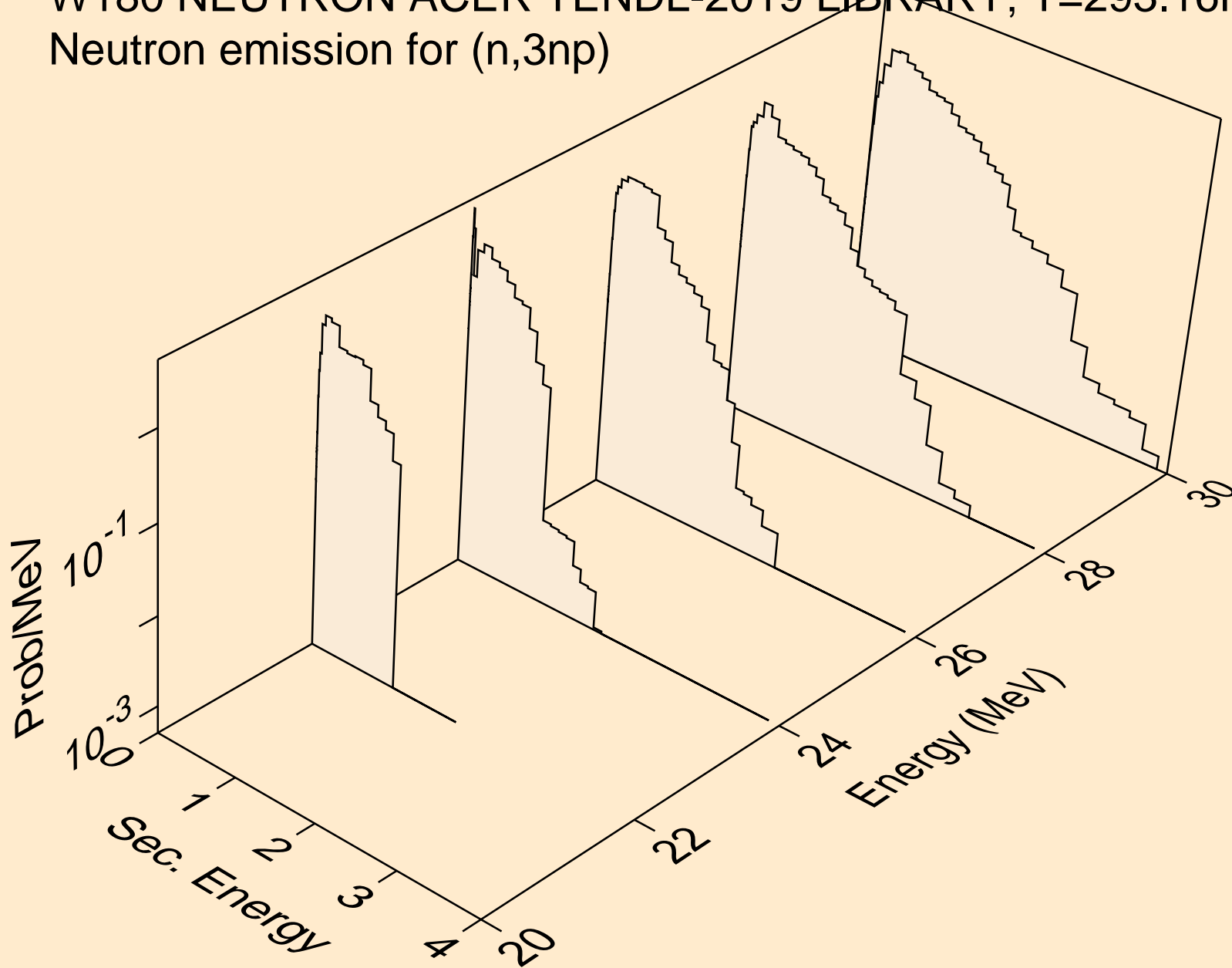

W180 NEUTRON ACER TENDL-2019 LIBRARY; T=293.16K
Neutron emission for (n,2np)

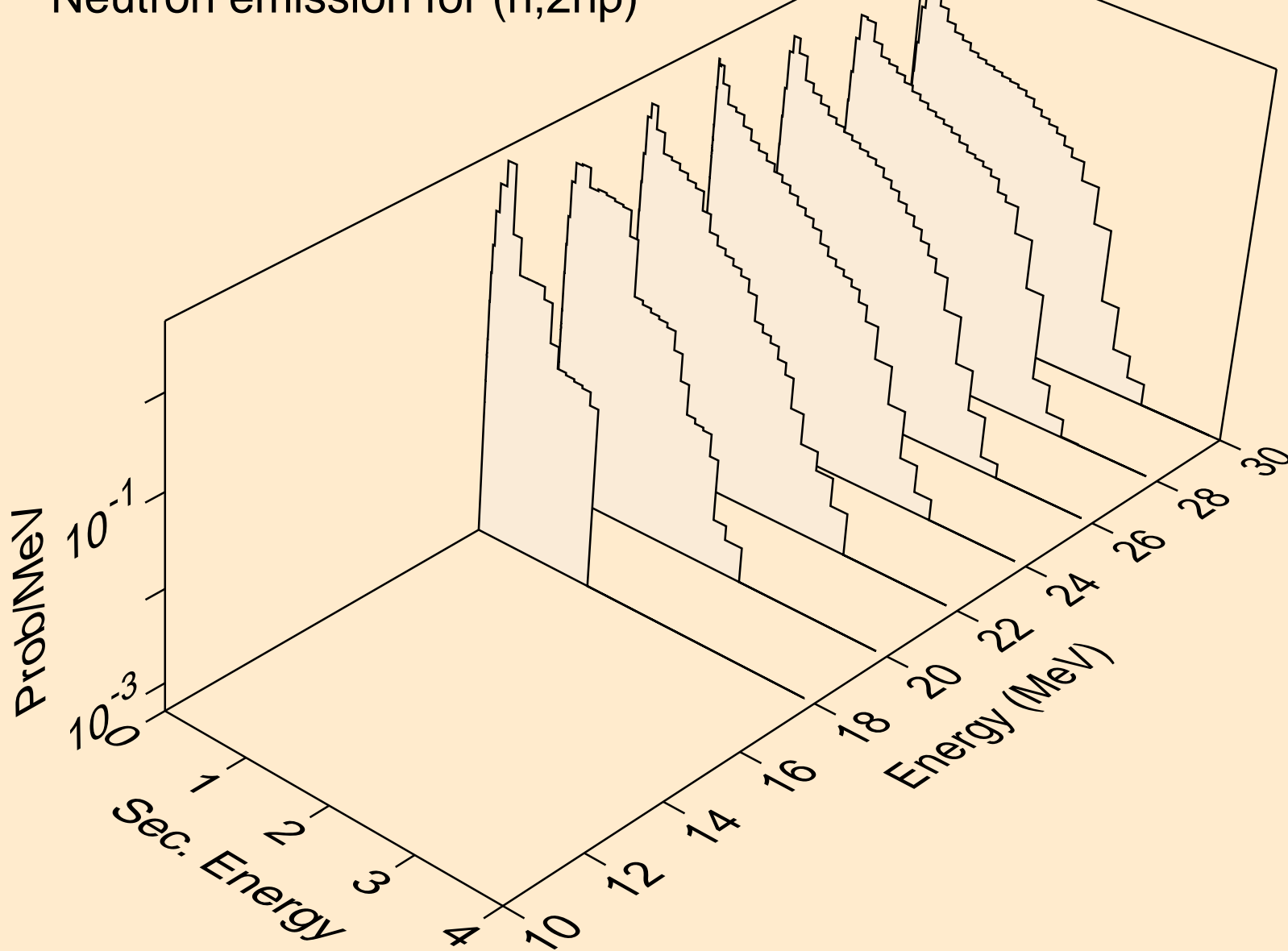

W180 NEUTRON ACER TENDL-2019 LIBRARY; T=293.16K
Neutron emission for (n,npa)

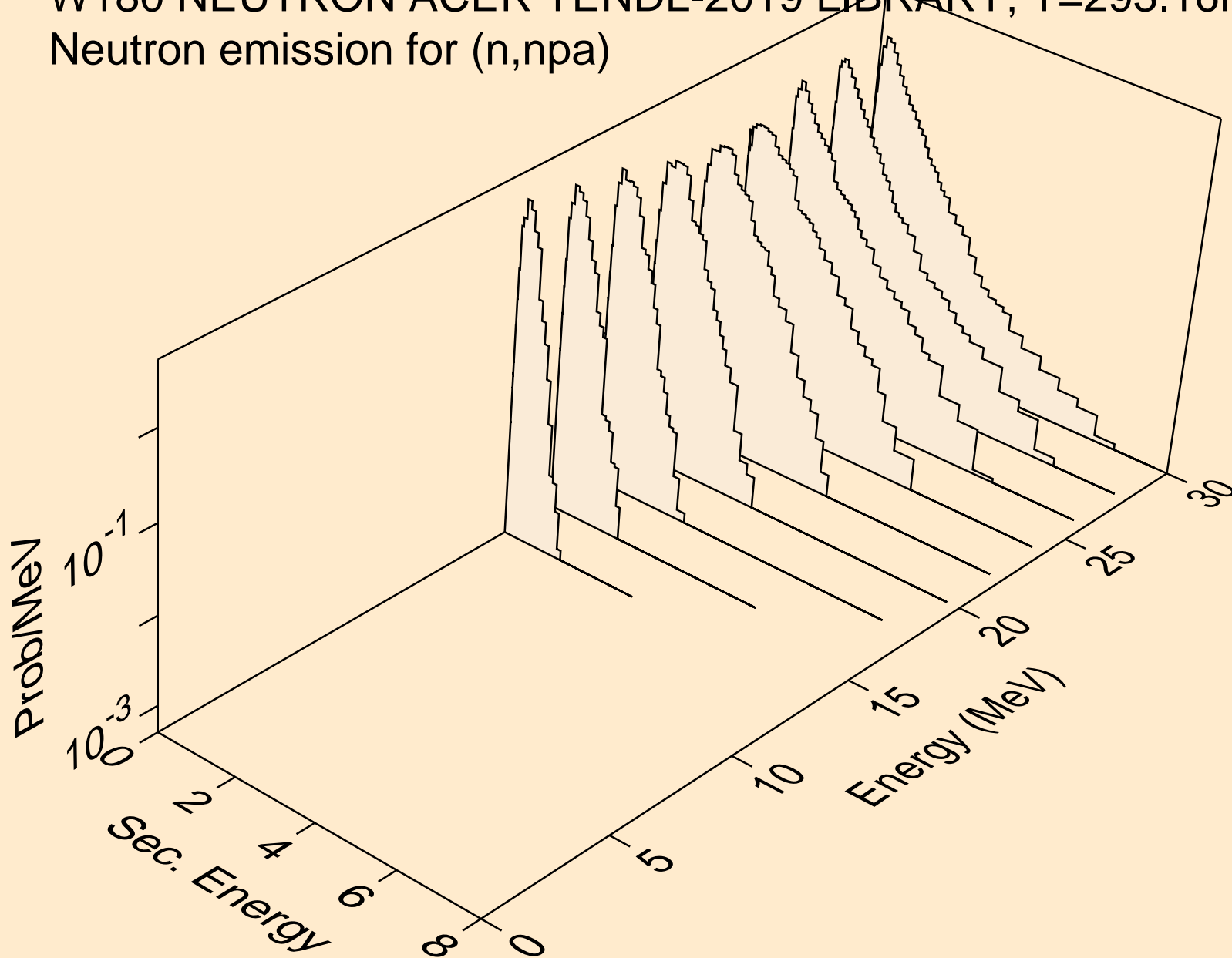

W180 NEUTRON ACER TENDL-2019 LIBRARY; T=293.16K
Neutron emission for (n,n*c)

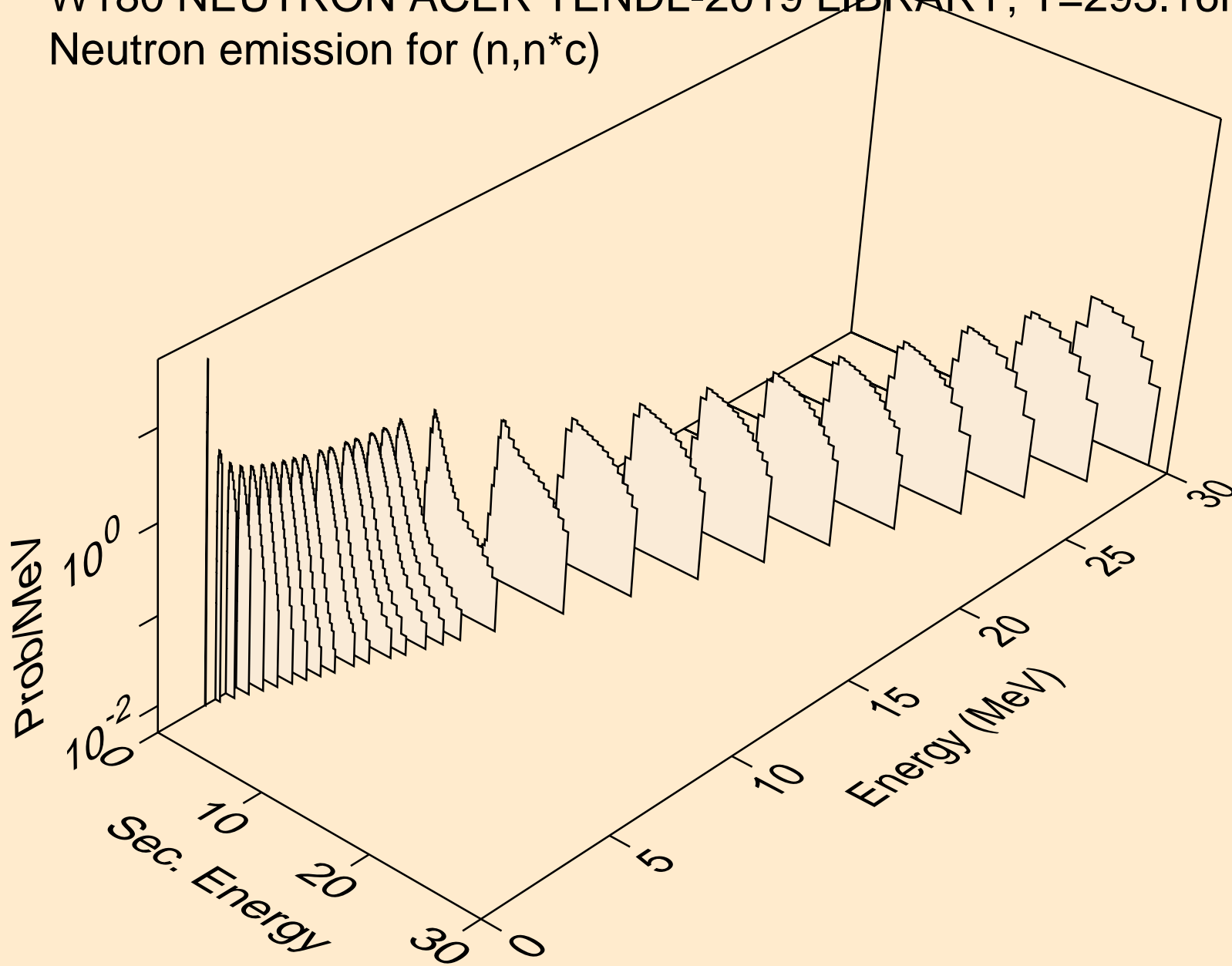

W180 NEUTRON ACER TENDL-2019 LIBRARY; T=293.16K
Photon emission for (n,x)

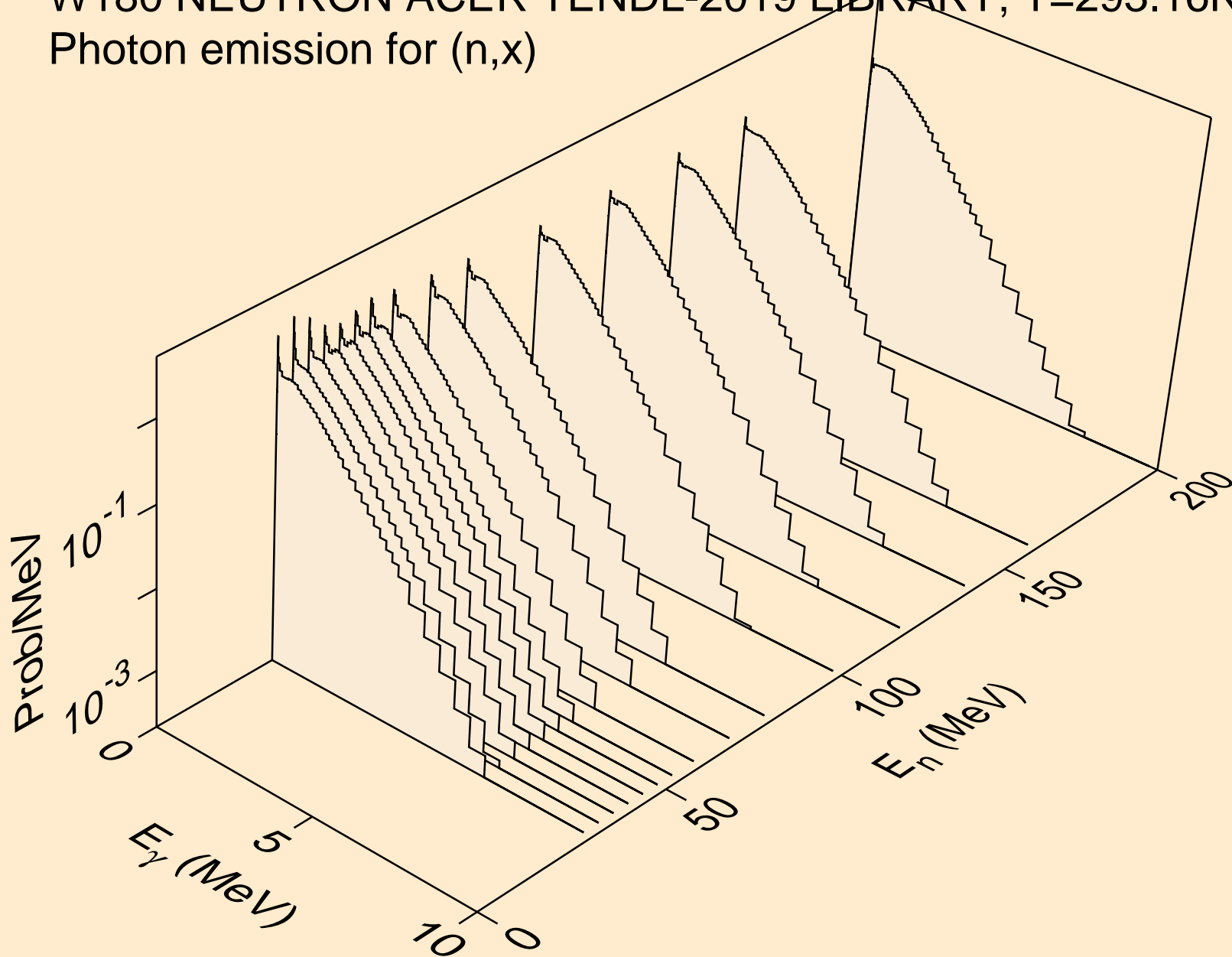

W180 NEUTRON ACER TENDL-2019 LIBRARY; T=293.16K
Photon emission for (n,2nd)

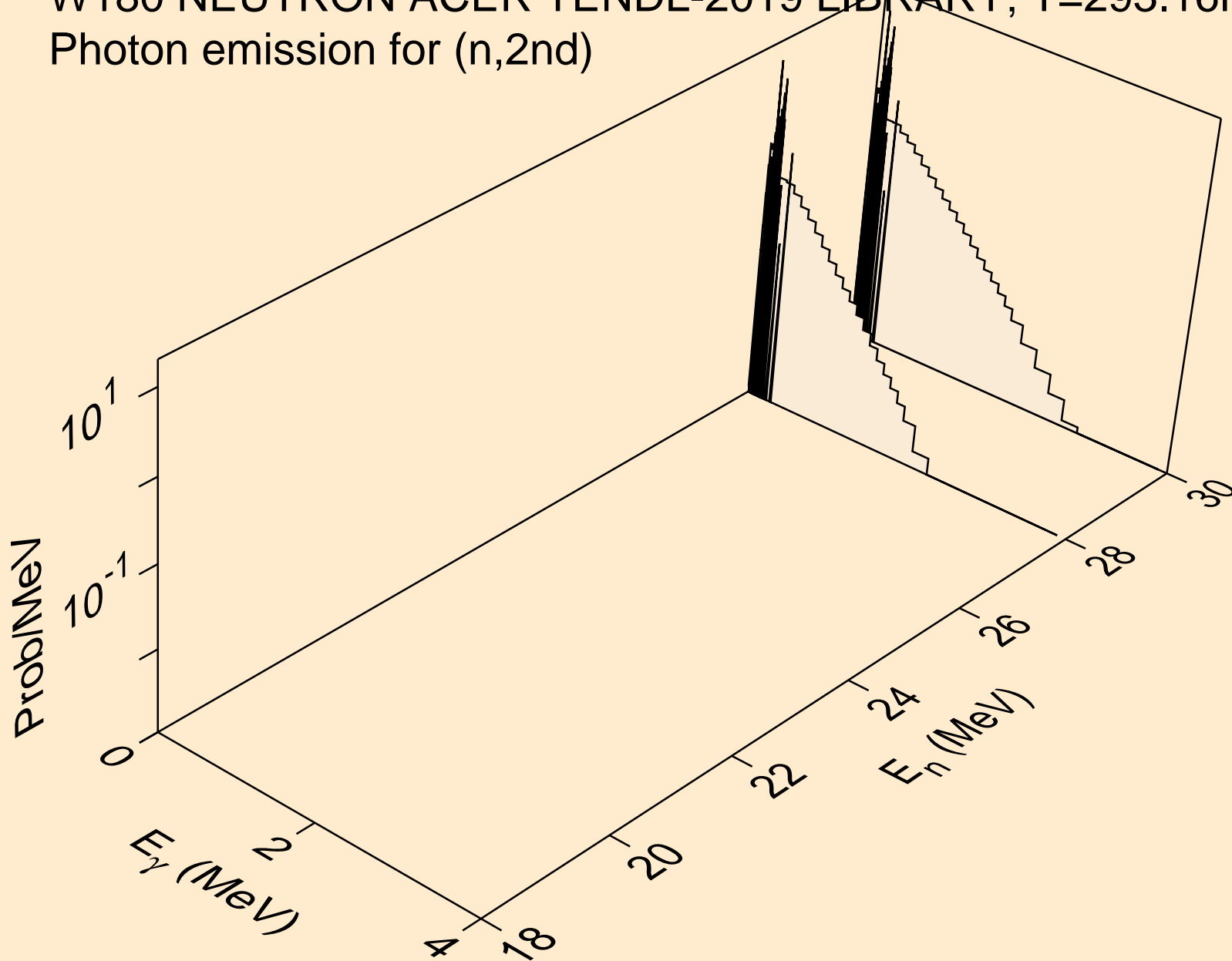

W180 NEUTRON ACER TENDL-2019 LIBRARY; T=293.16K
Photon emission for (n,2n)

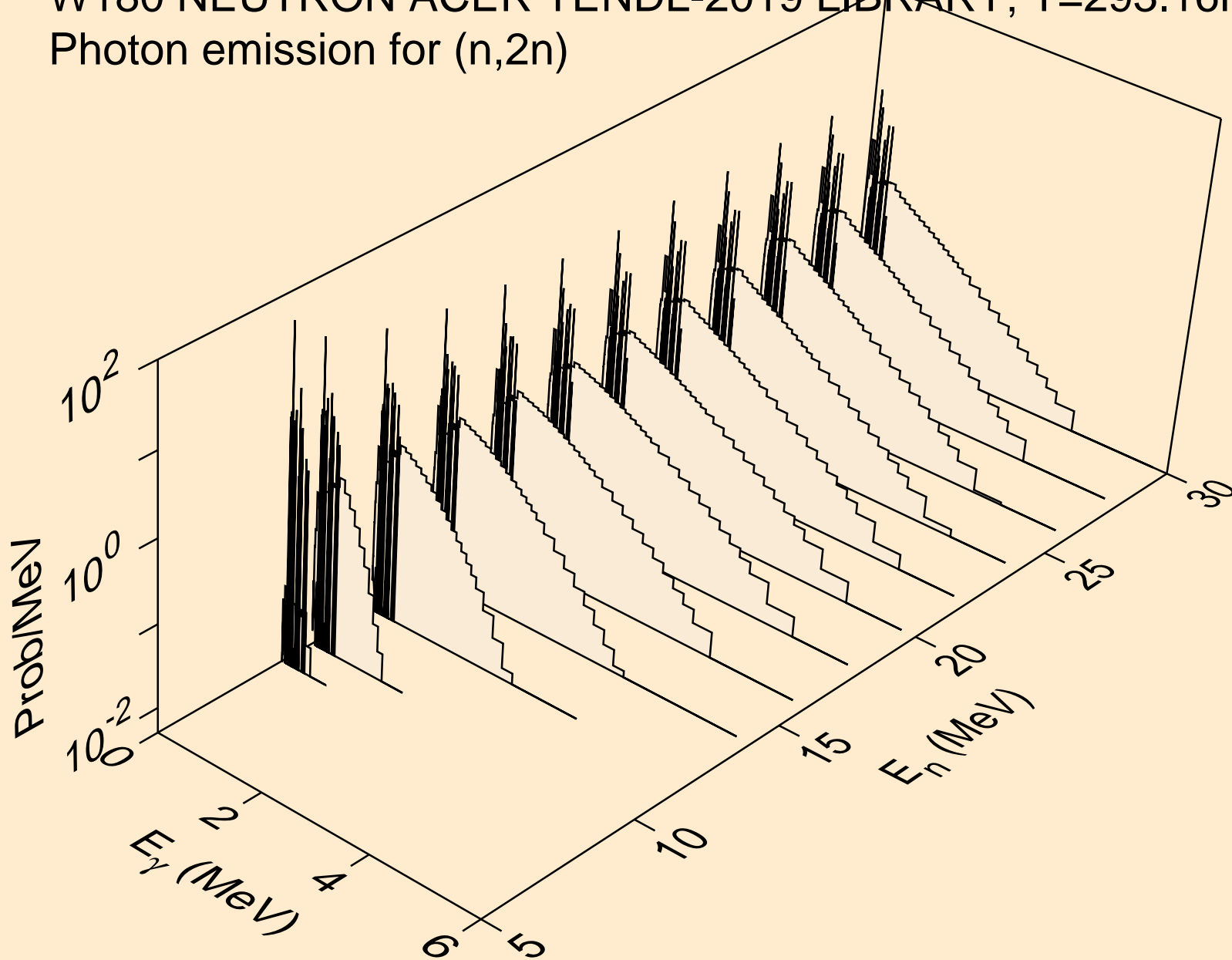

W180 NEUTRON ACER TENDL-2019 LIBRARY; T=293.16K
Photon emission for (n,3n)

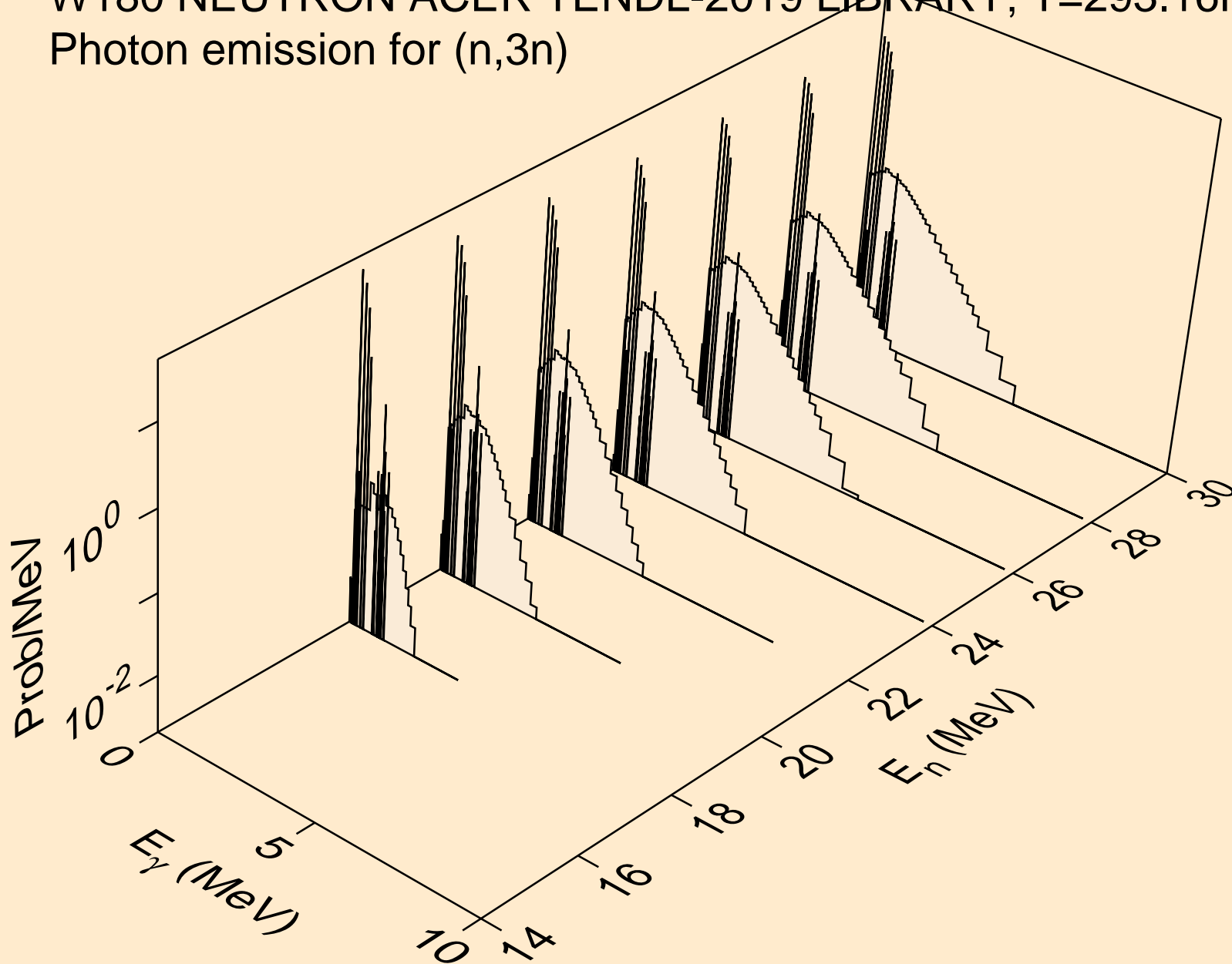

W180 NEUTRON ACER TENDL-2019 LIBRARY; T=293.16K
Photon emission for (n,n*)a

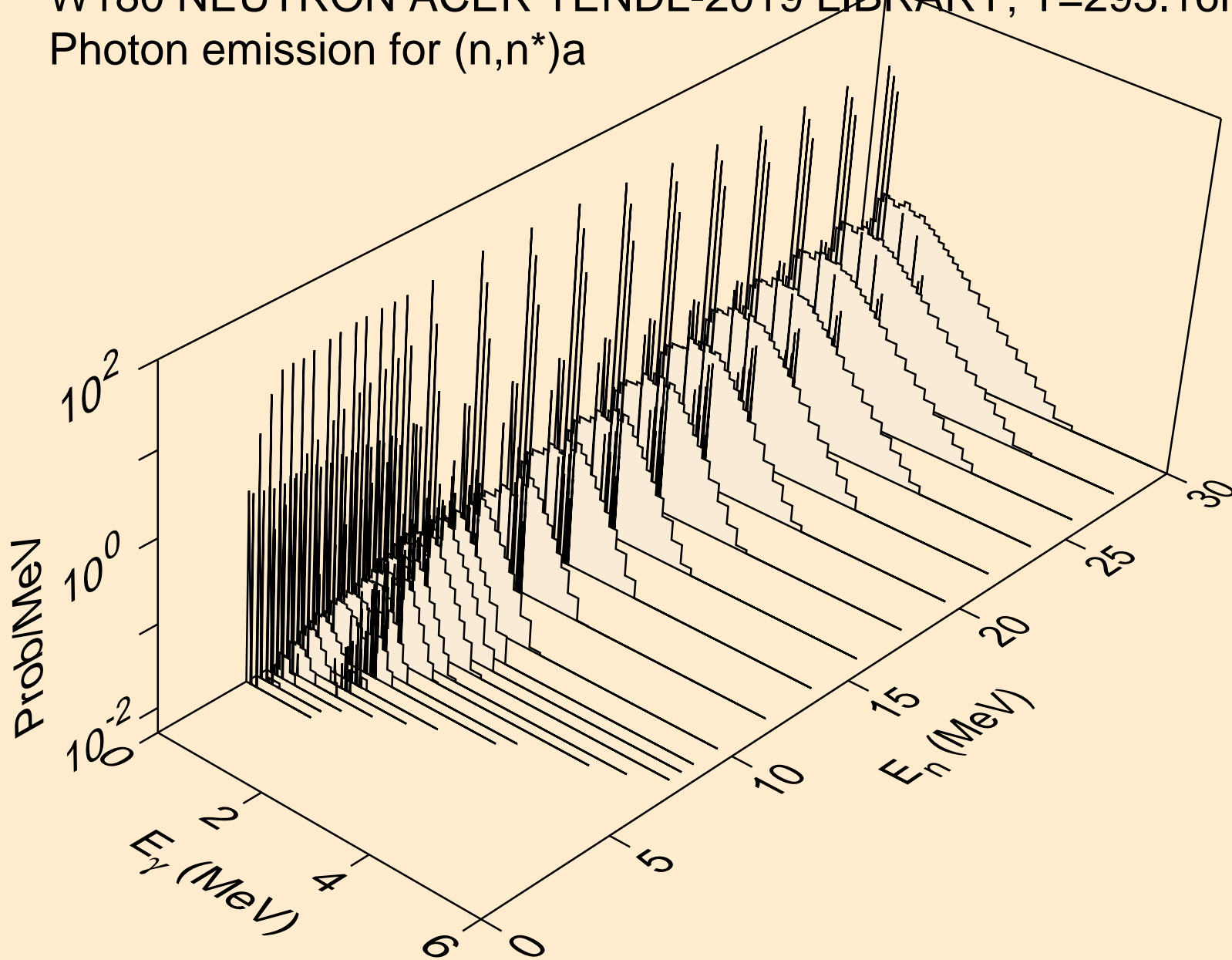

W180 NEUTRON ACER TENDL-2019 LIBRARY; T=293.16K
Photon emission for (n,2n)a

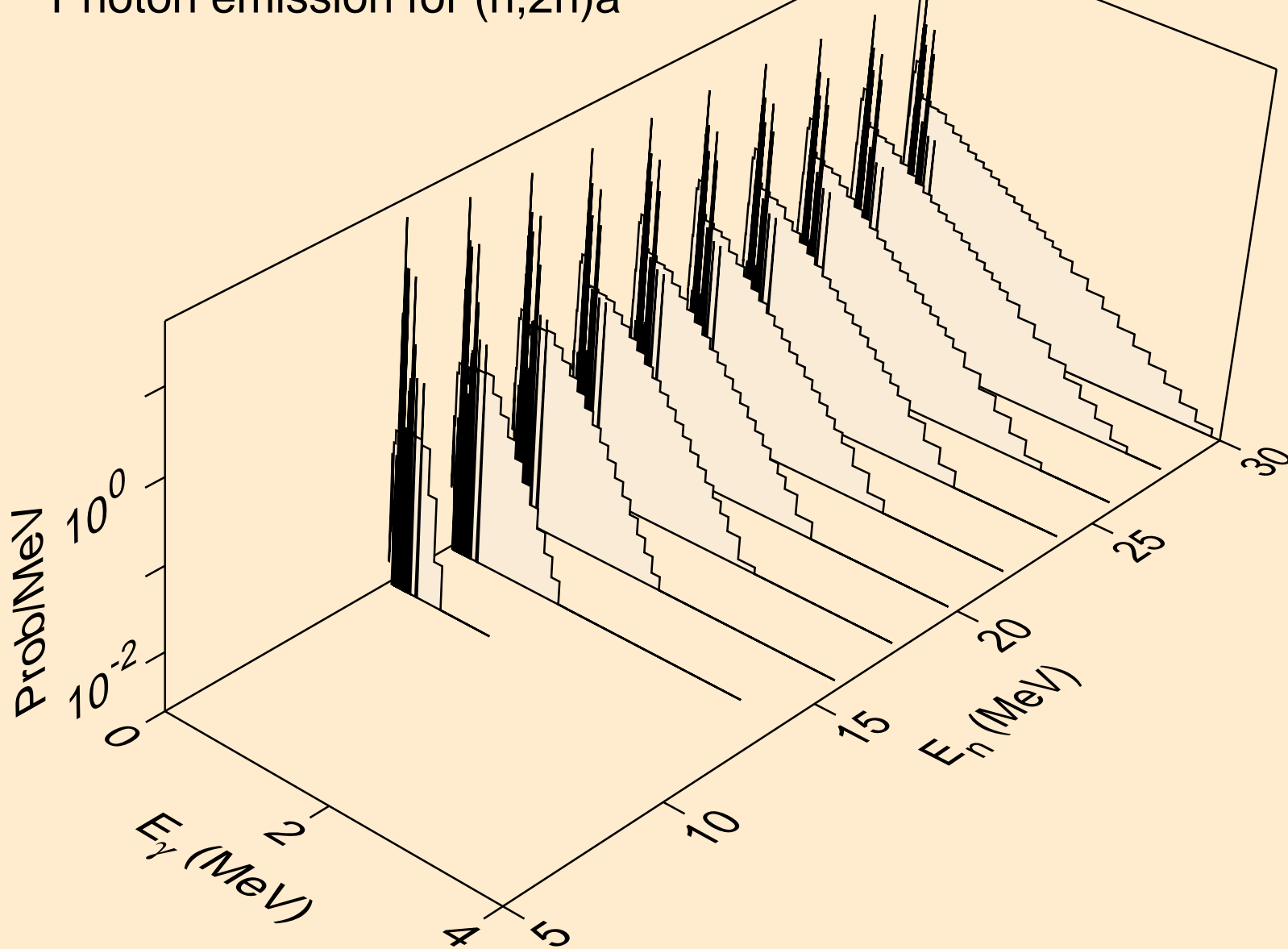

W180 NEUTRON ACER TENDL-2019 LIBRARY; T=293.16K
Photon emission for (n,3n)a

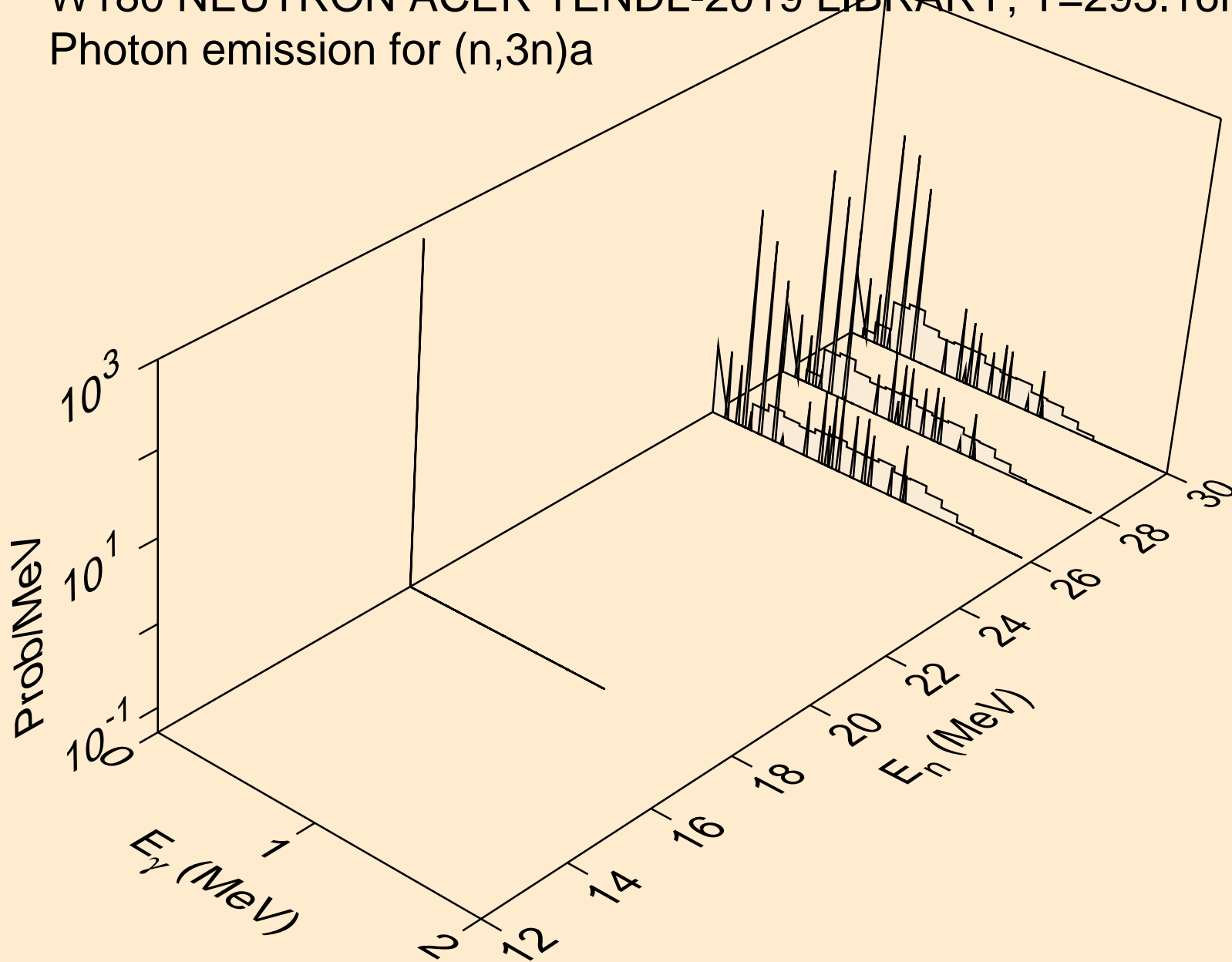

W180 NEUTRON ACER TENDL-2019 LIBRARY; T=293.16K
Photon emission for (n,n*)p

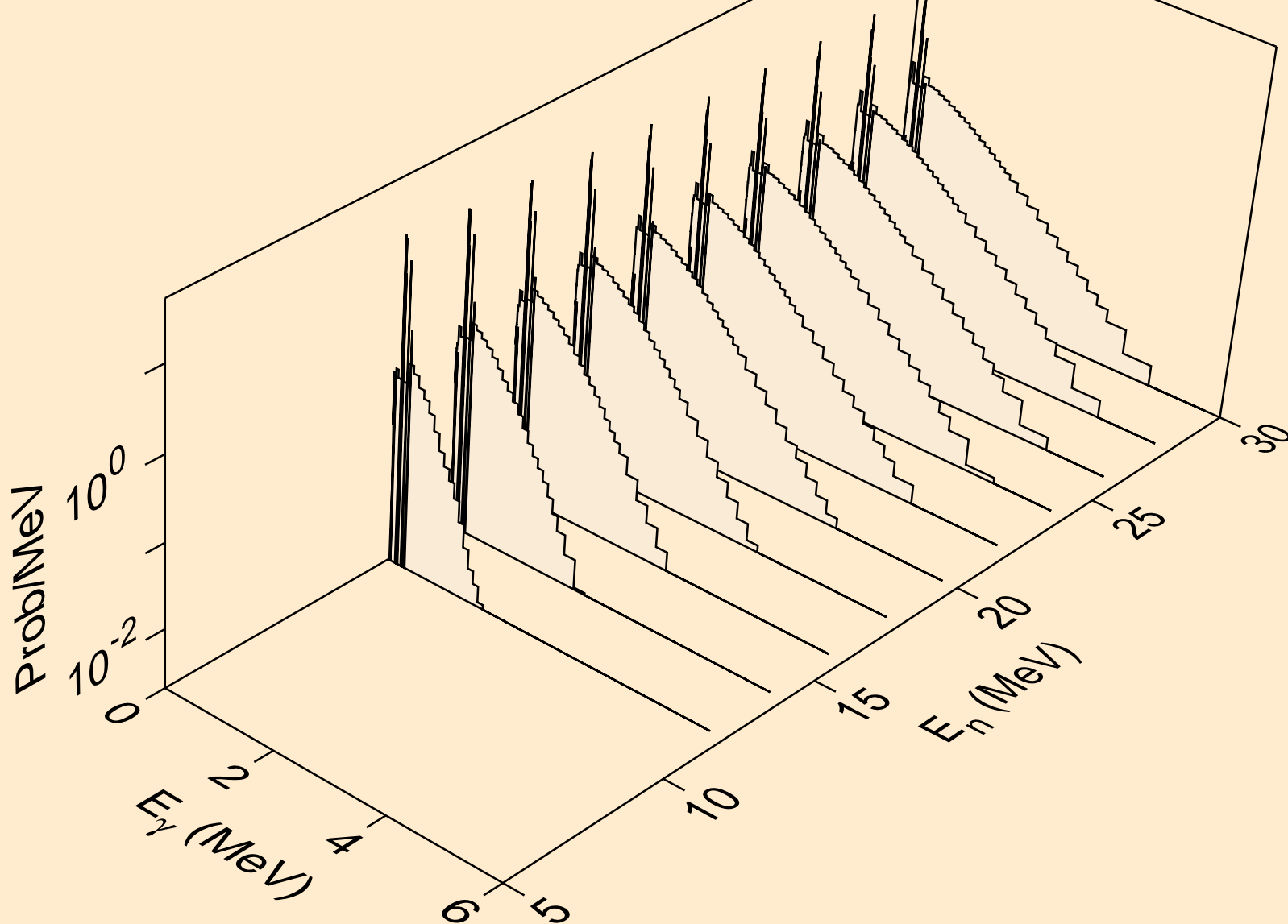

W180 NEUTRON ACER TENDL-2019 LIBRARY; T=293.16K
Photon emission for (n,n*)2a

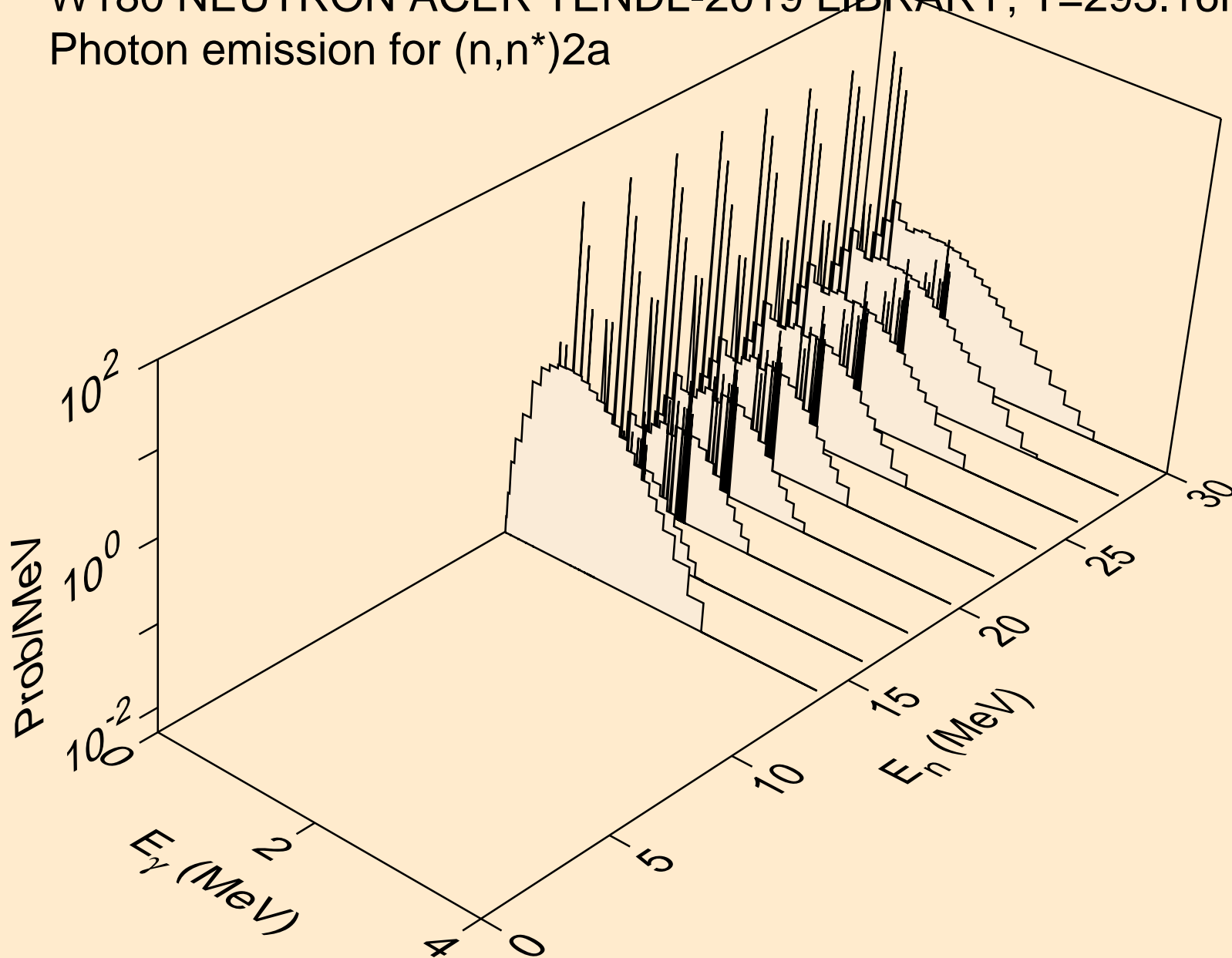

W180 NEUTRON ACER TENDL-2019 LIBRARY; T=293.16K
Photon emission for (n,n*)d

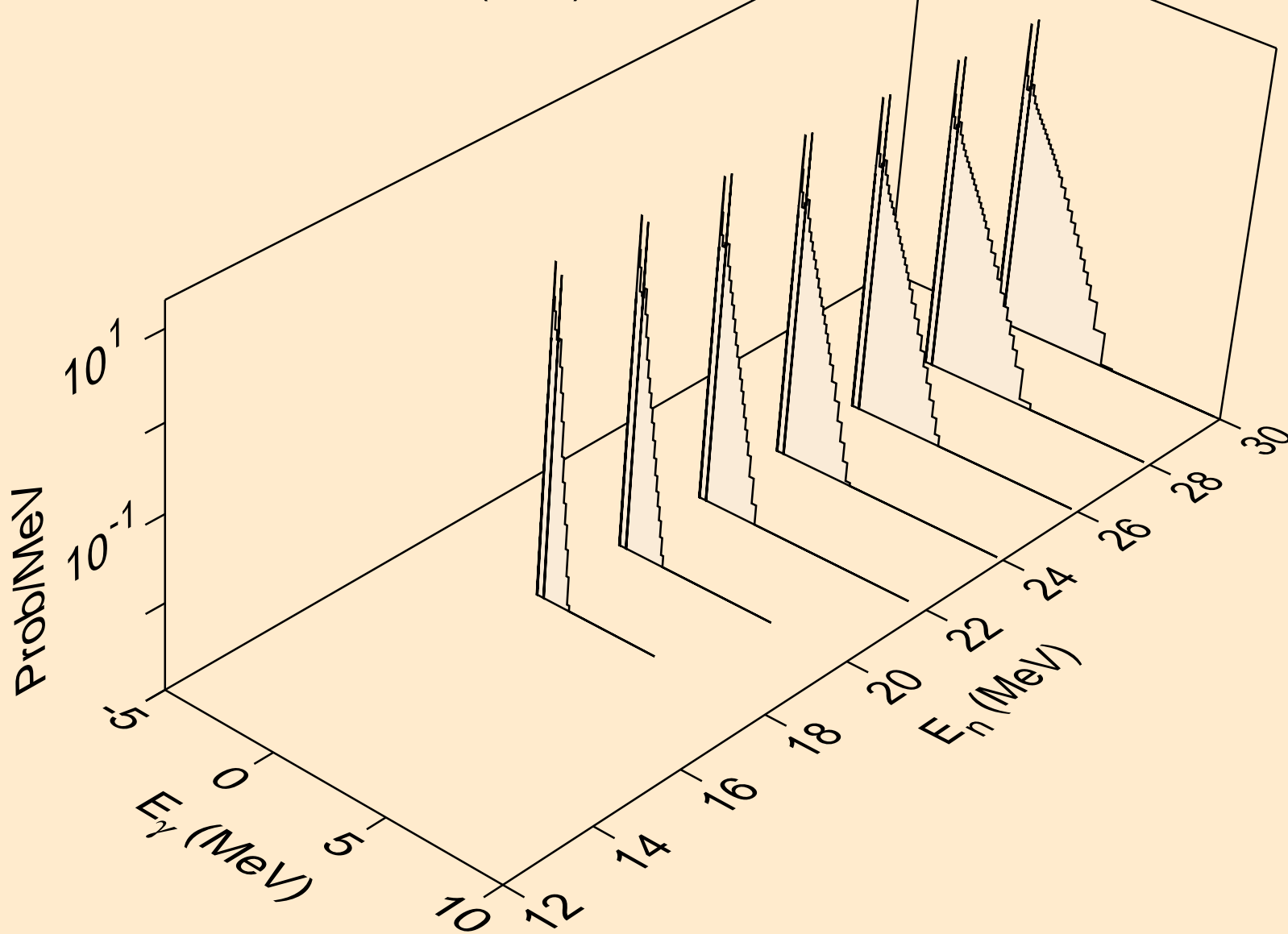

W180 NEUTRON ACER TENDL-2019 LIBRARY; T=293.16K
Photon emission for (n,n*)t

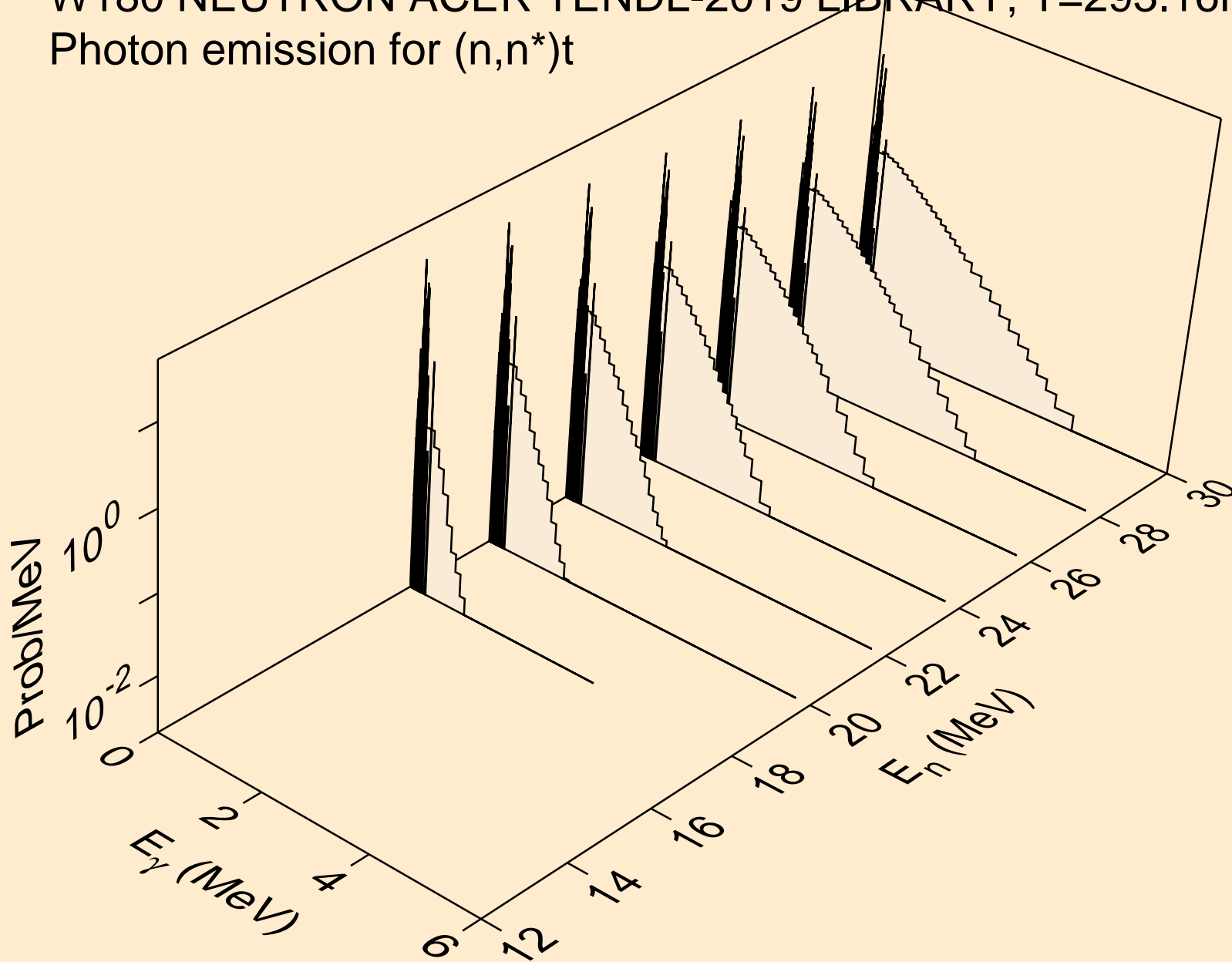

W180 NEUTRON ACER TENDL-2019 LIBRARY; T=293.16K
Photon emission for (n,n*)he3

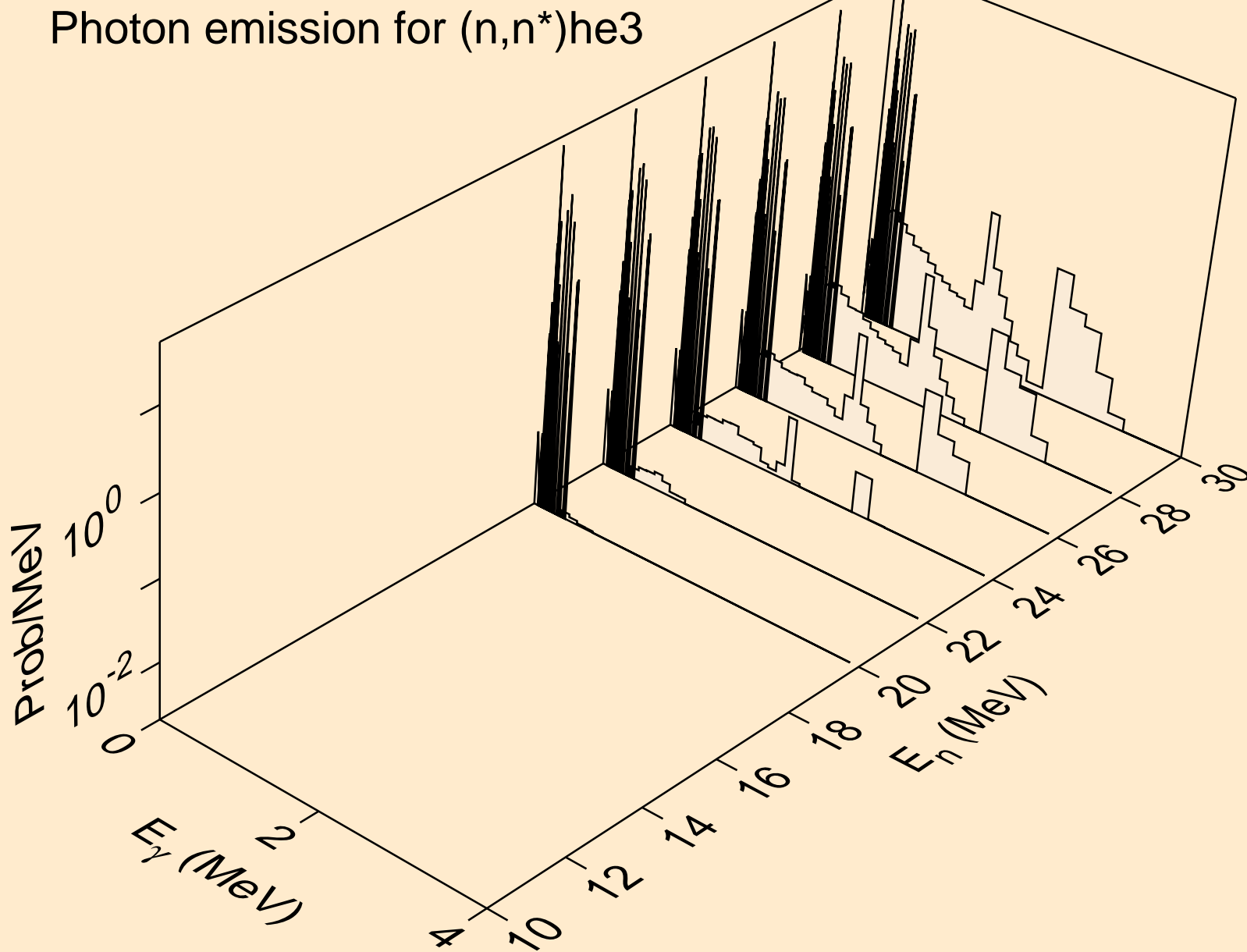

W180 NEUTRON ACER TENDL-2019 LIBRARY; T=293.16K
Photon emission for (n,4n)

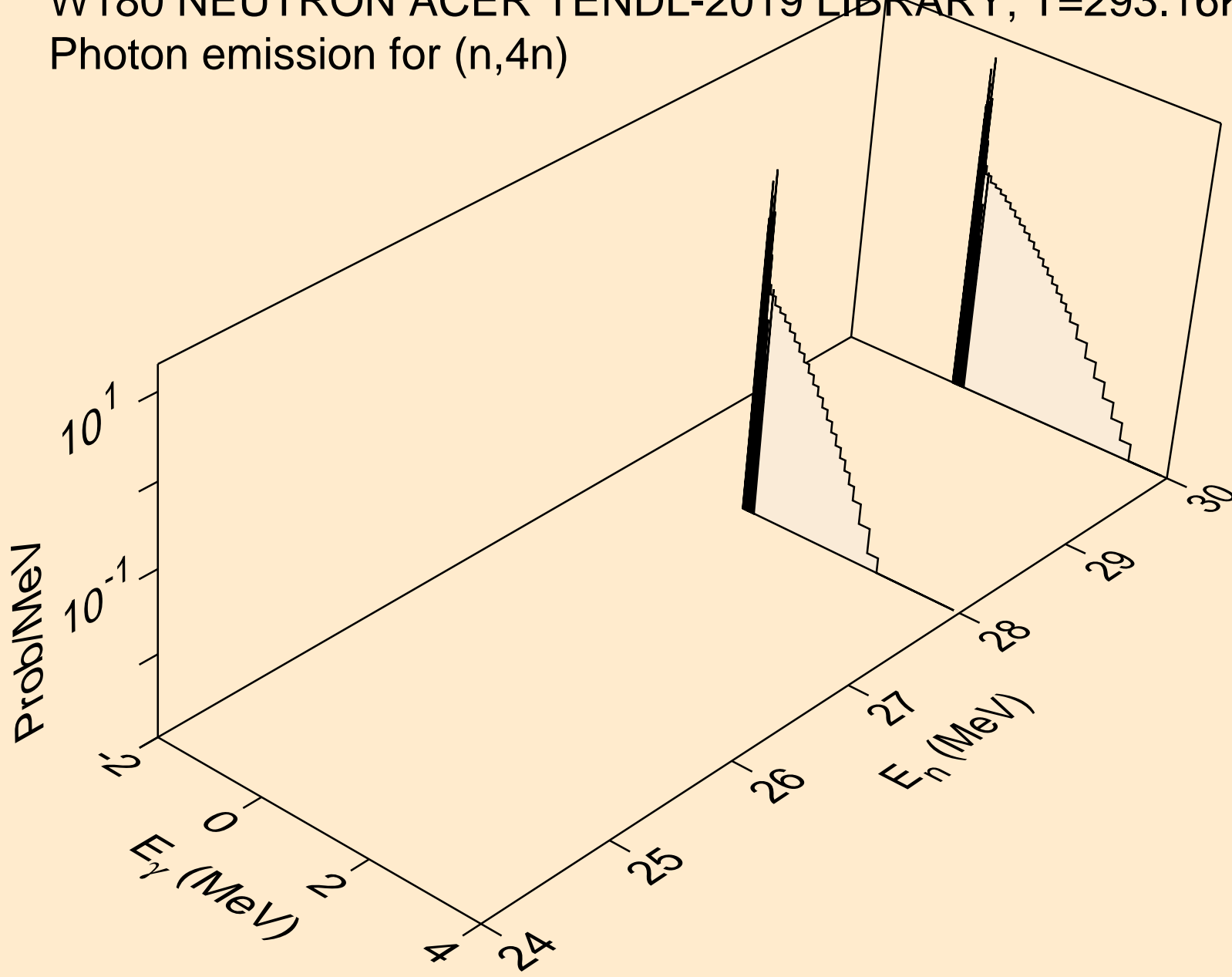

W180 NEUTRON ACER TENDL-2019 LIBRARY; T=293.16K
Photon emission for (n,2np)

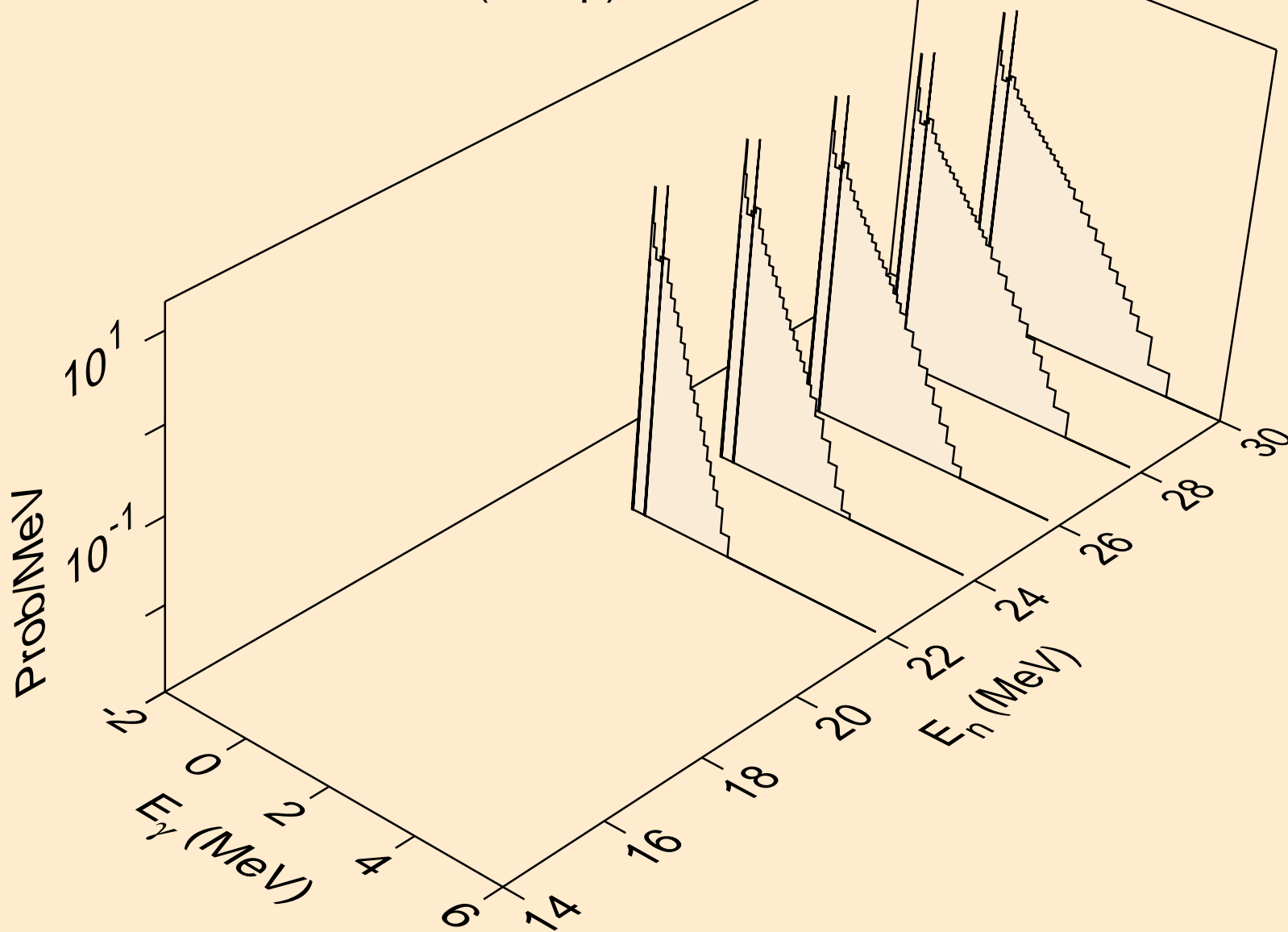

W180 NEUTRON ACER TENDL-2019 LIBRARY; T=293.16K
Photon emission for (n,3np)

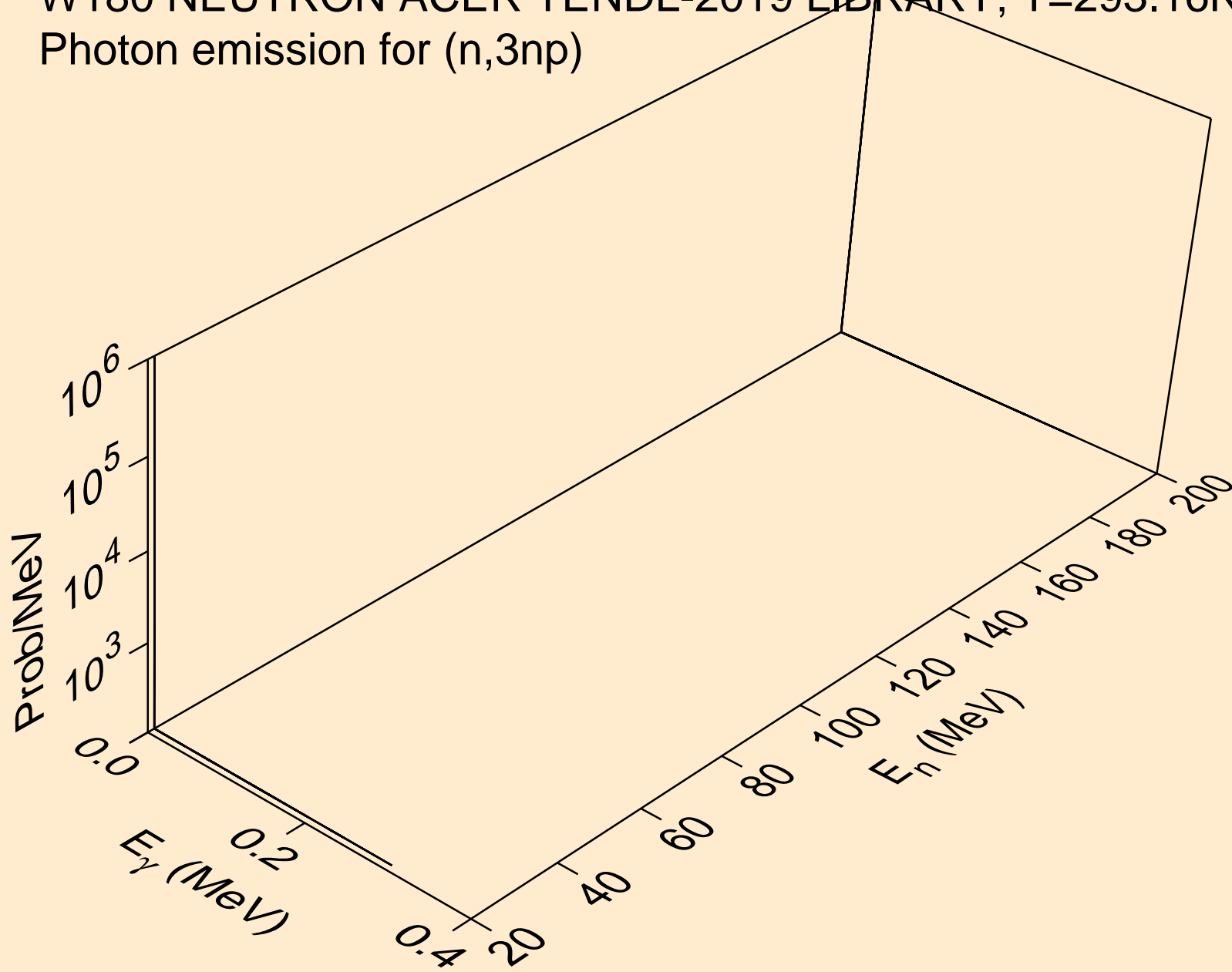

W180 NEUTRON ACER TENDL-2019 LIBRARY; T=293.16K
Photon emission for (n,2np)

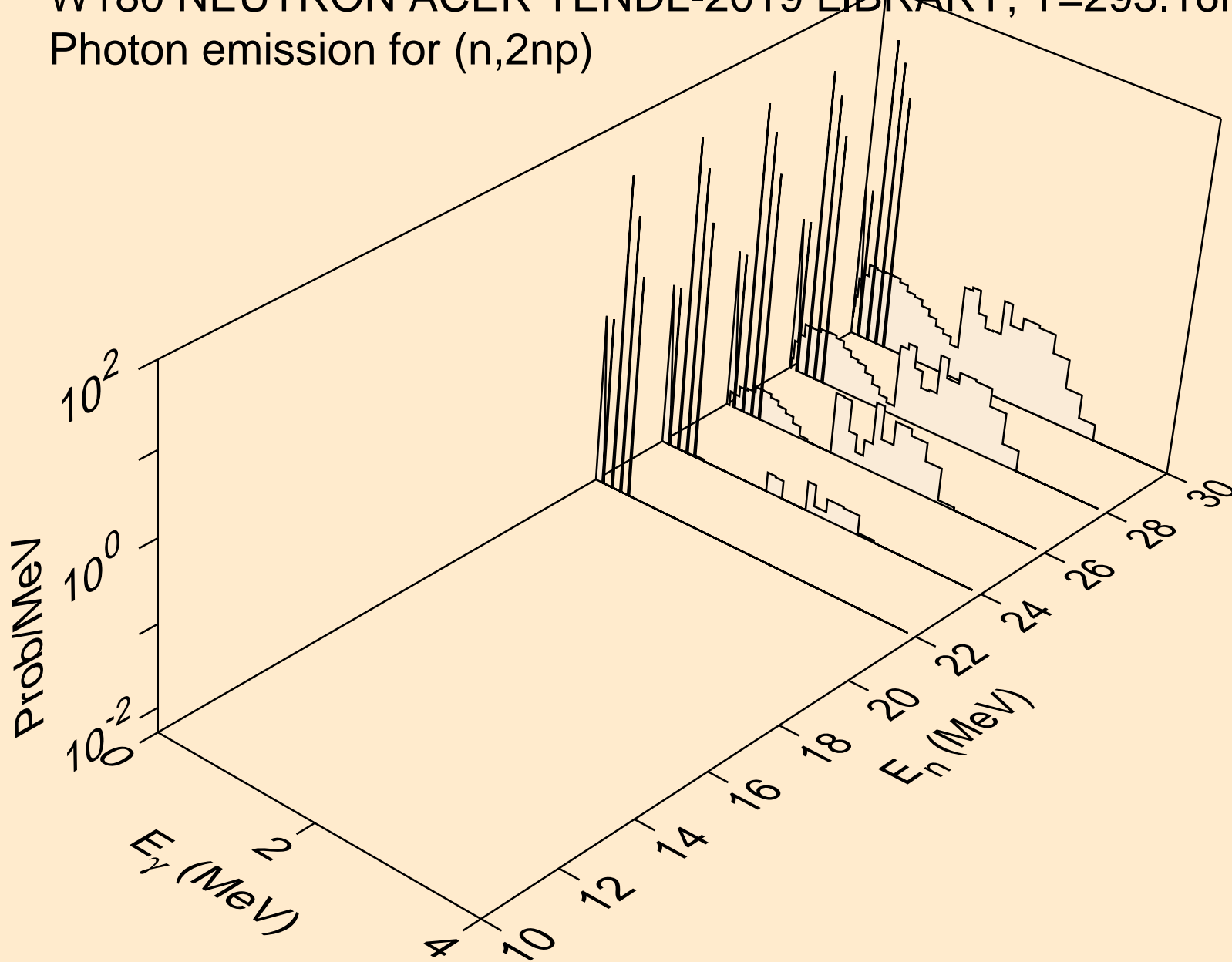

W180 NEUTRON ACER TENDL-2019 LIBRARY; T=293.16K
Photon emission for (n,npa)

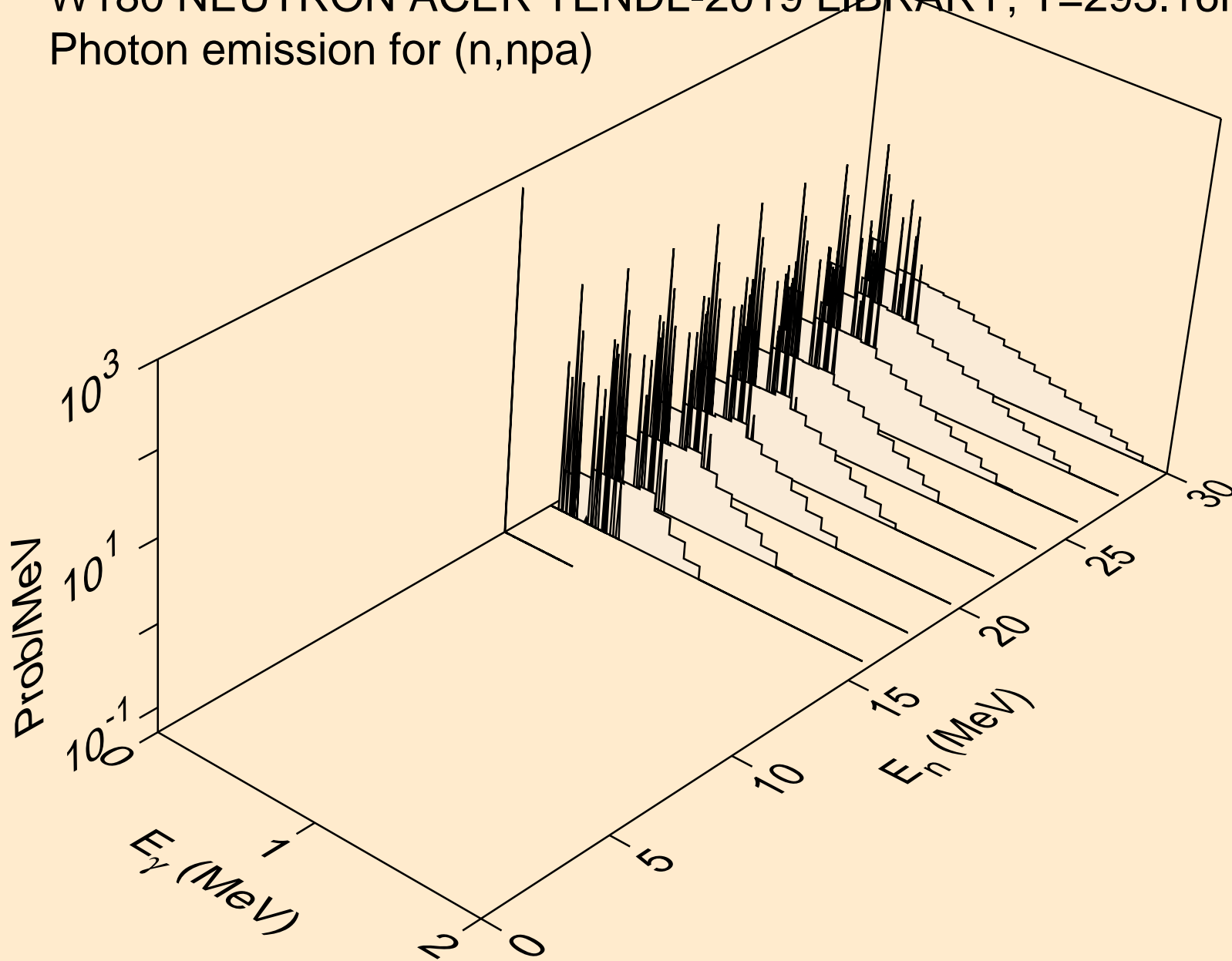

W180 NEUTRON ACER TENDL-2019 LIBRARY; T=293.16K
Photon emission for (n,n*c)

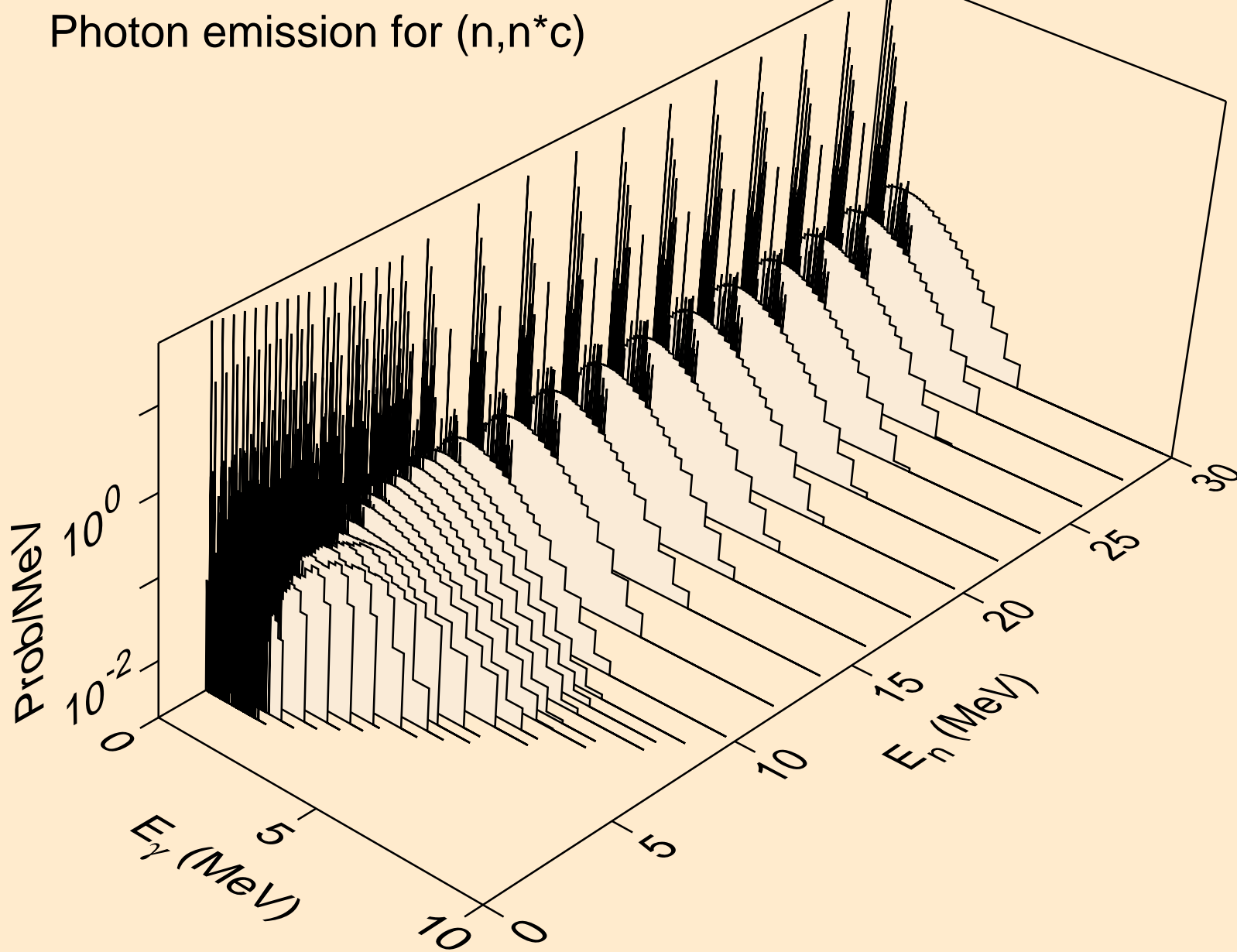

W180 NEUTRON ACER TENDL-2019 LIBRARY; T=293.16K
Photon emission for (n,gma)

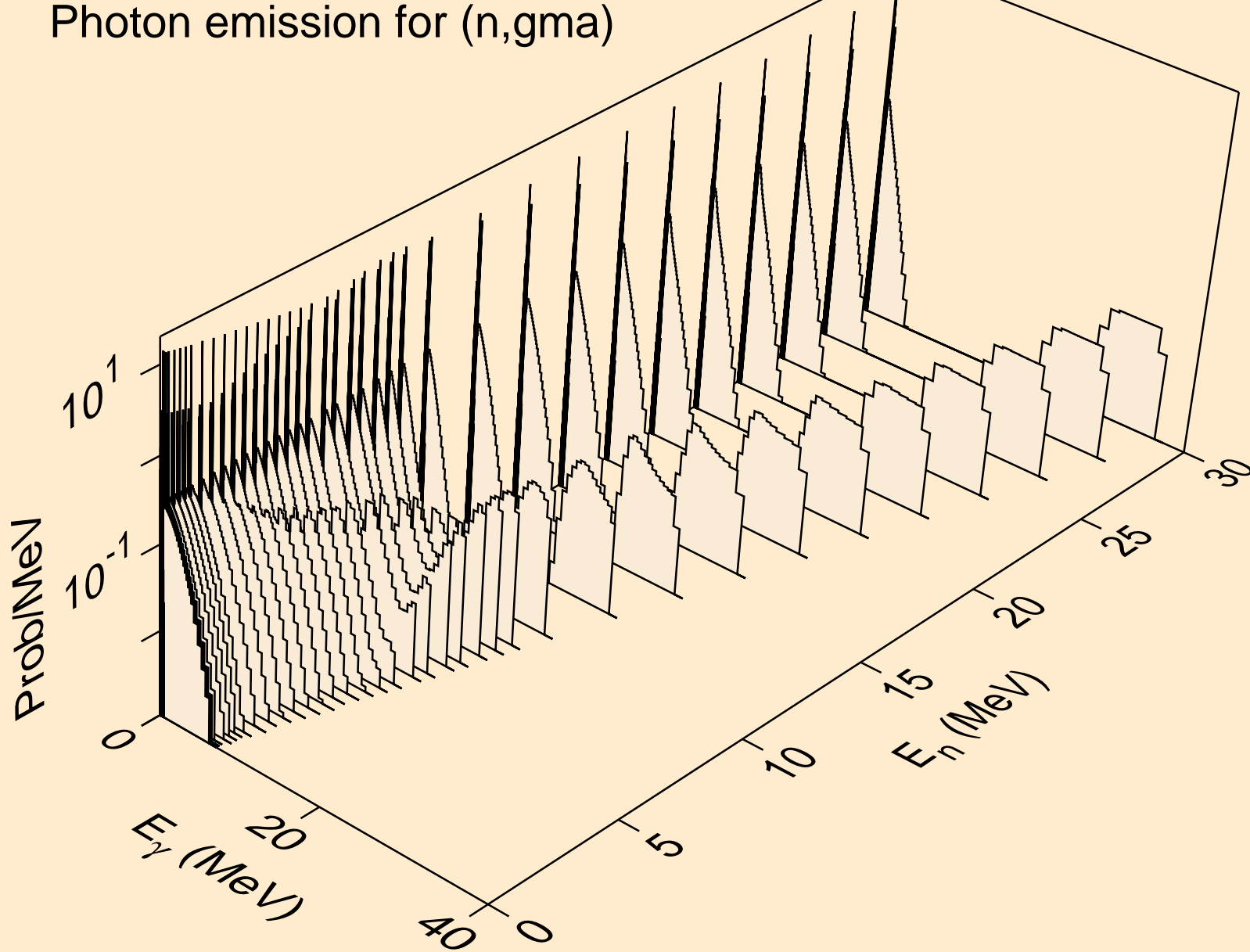

W180 NEUTRON ACER TENDL-2019 LIBRARY; T=293.16K
Photon emission for (n,p)

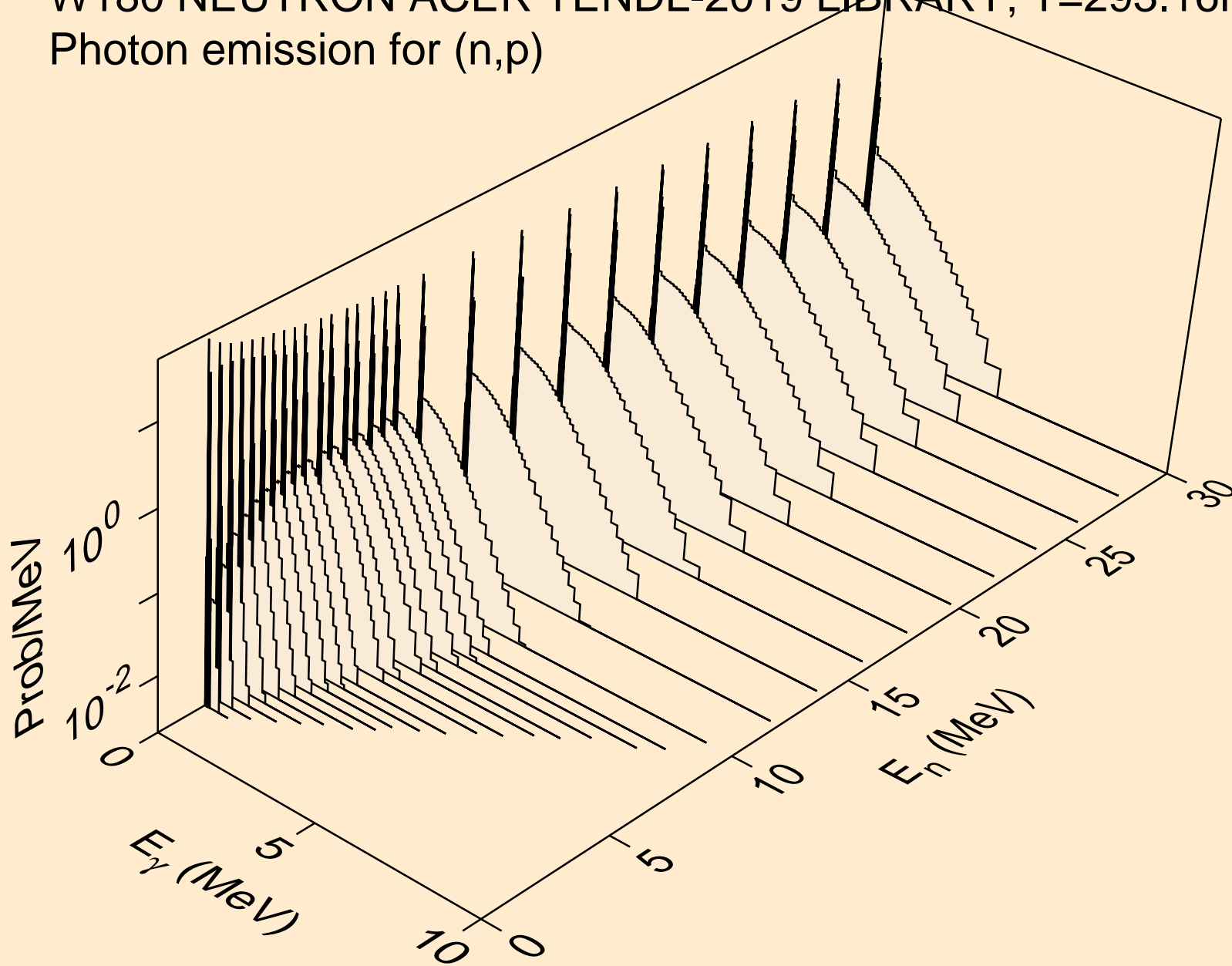

W180 NEUTRON ACER TENDL-2019 LIBRARY; T=293.16K
Photon emission for (n,d)

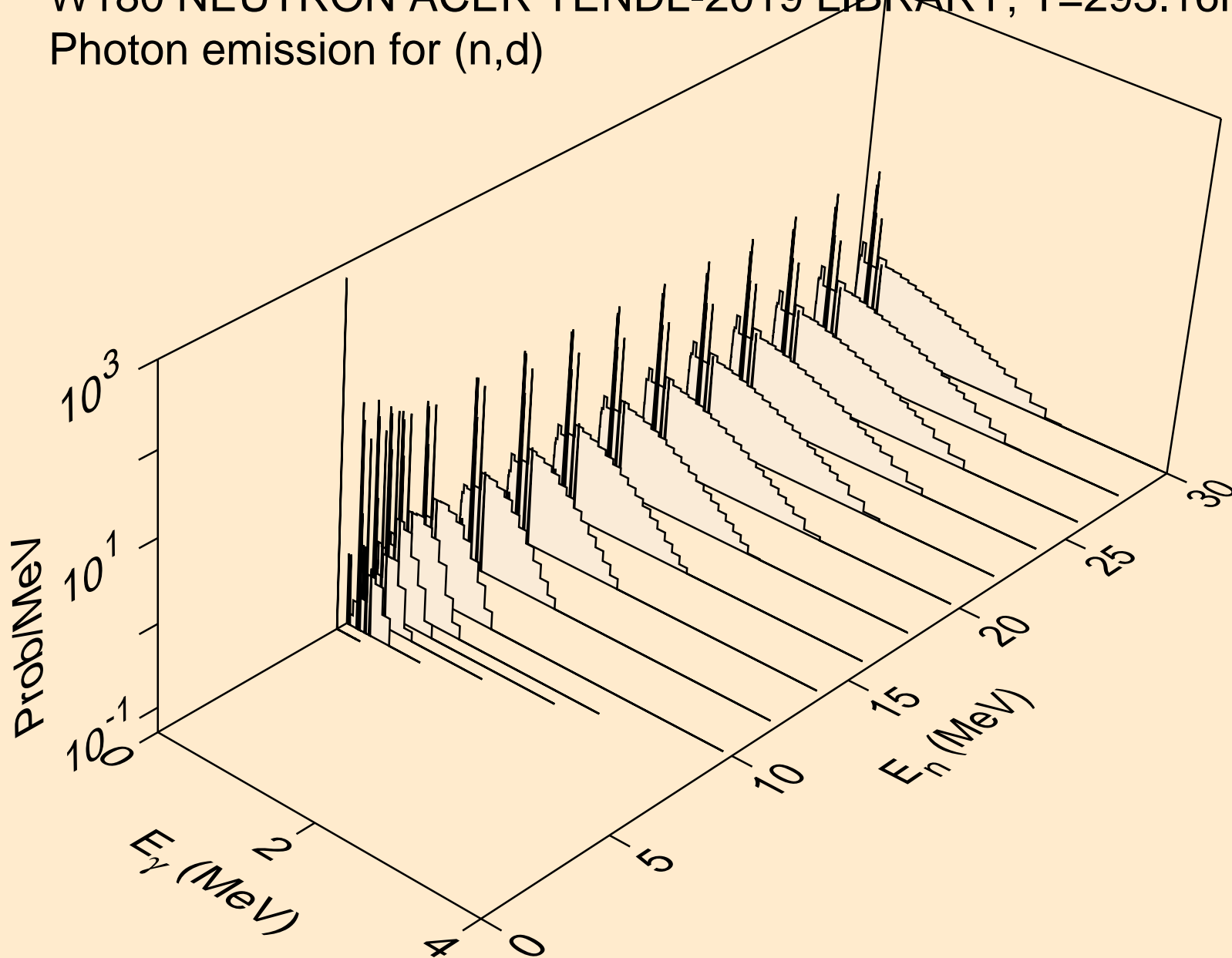

W180 NEUTRON ACER TENDL-2019 LIBRARY; T=293.16K
Photon emission for (n,t)

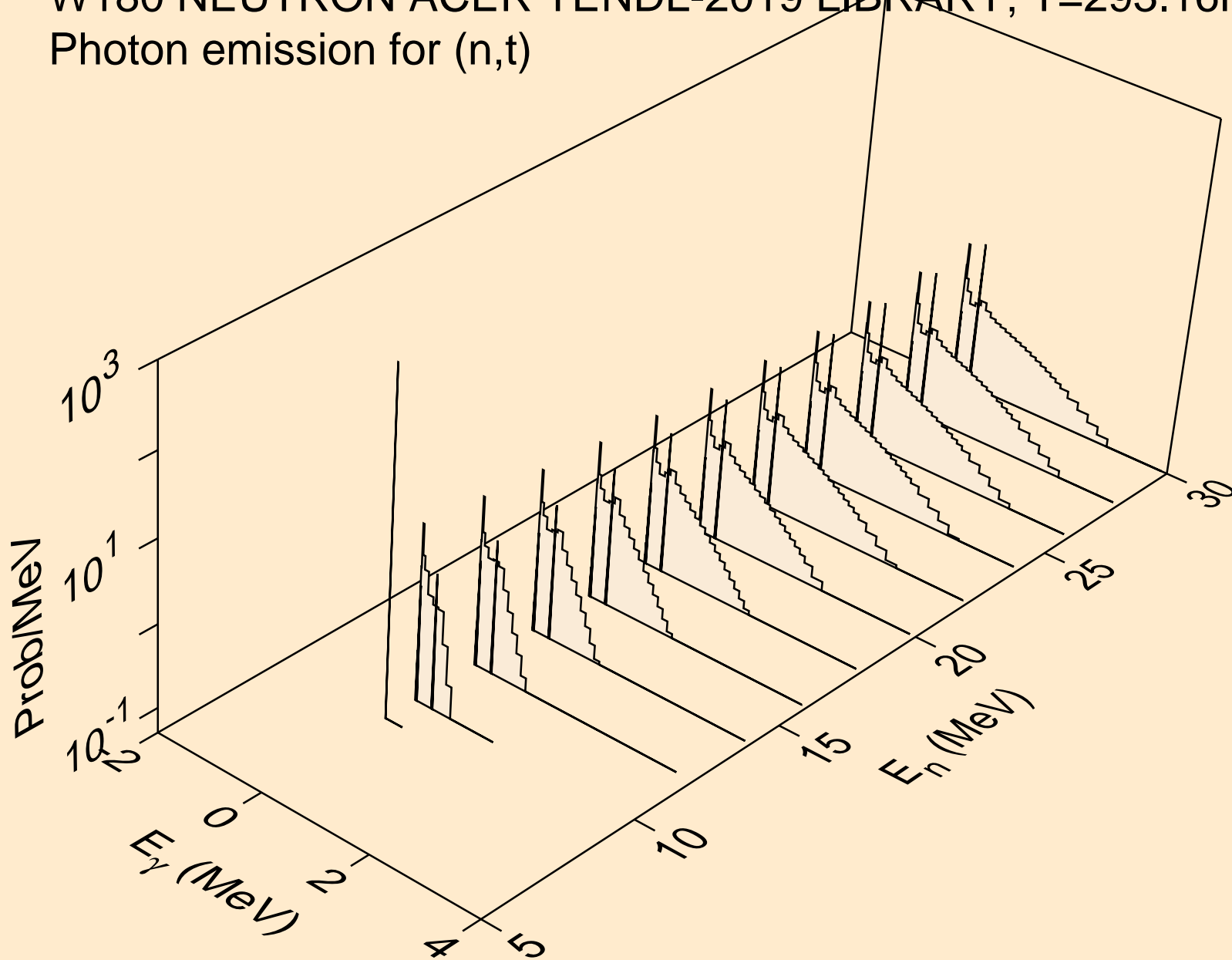

W180 NEUTRON ACER TENDL-2019 LIBRARY; T=293.16K
Photon emission for (n,he3)

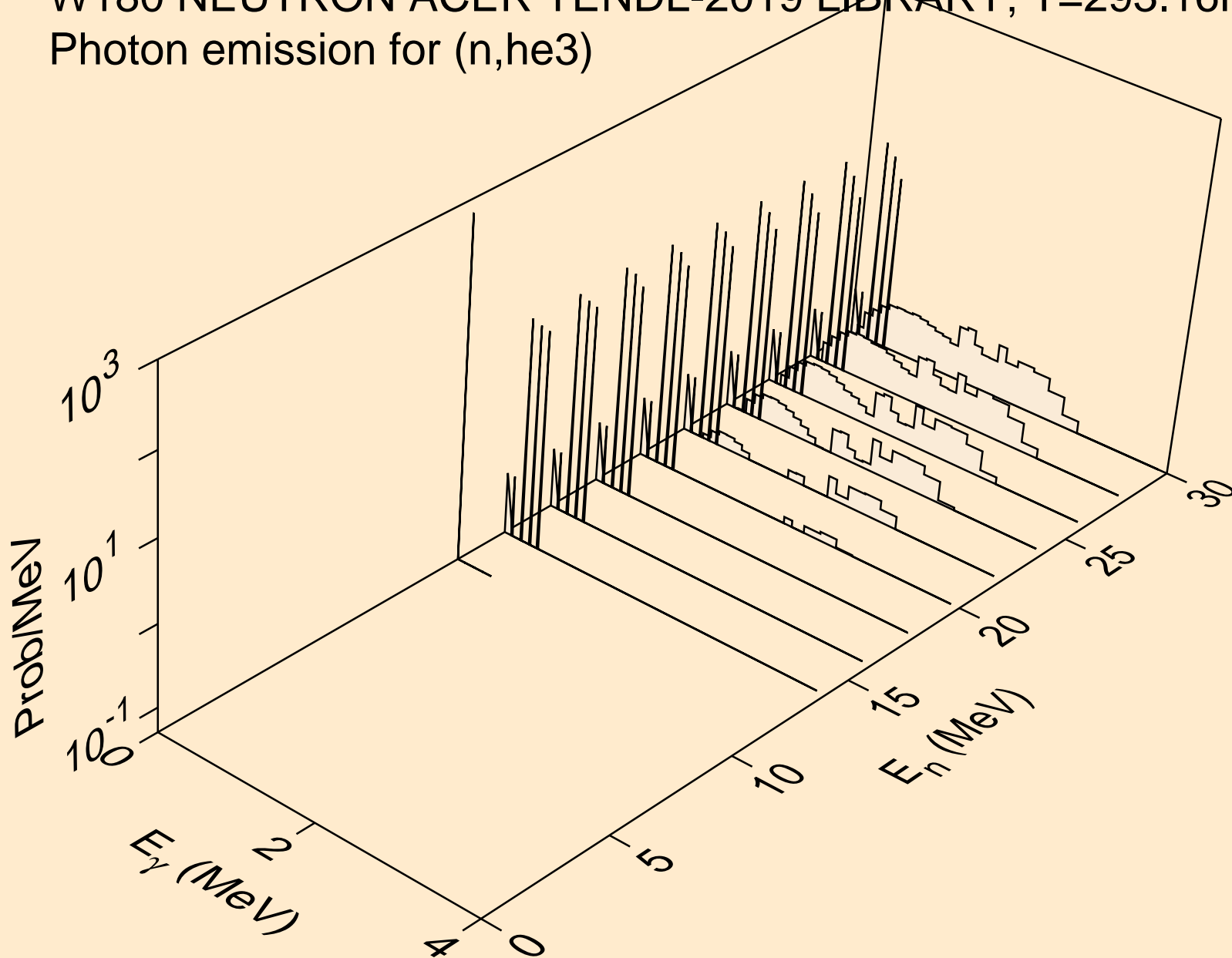

W180 NEUTRON ACER TENDL-2019 LIBRARY; T=293.16K
Photon emission for (n,a)

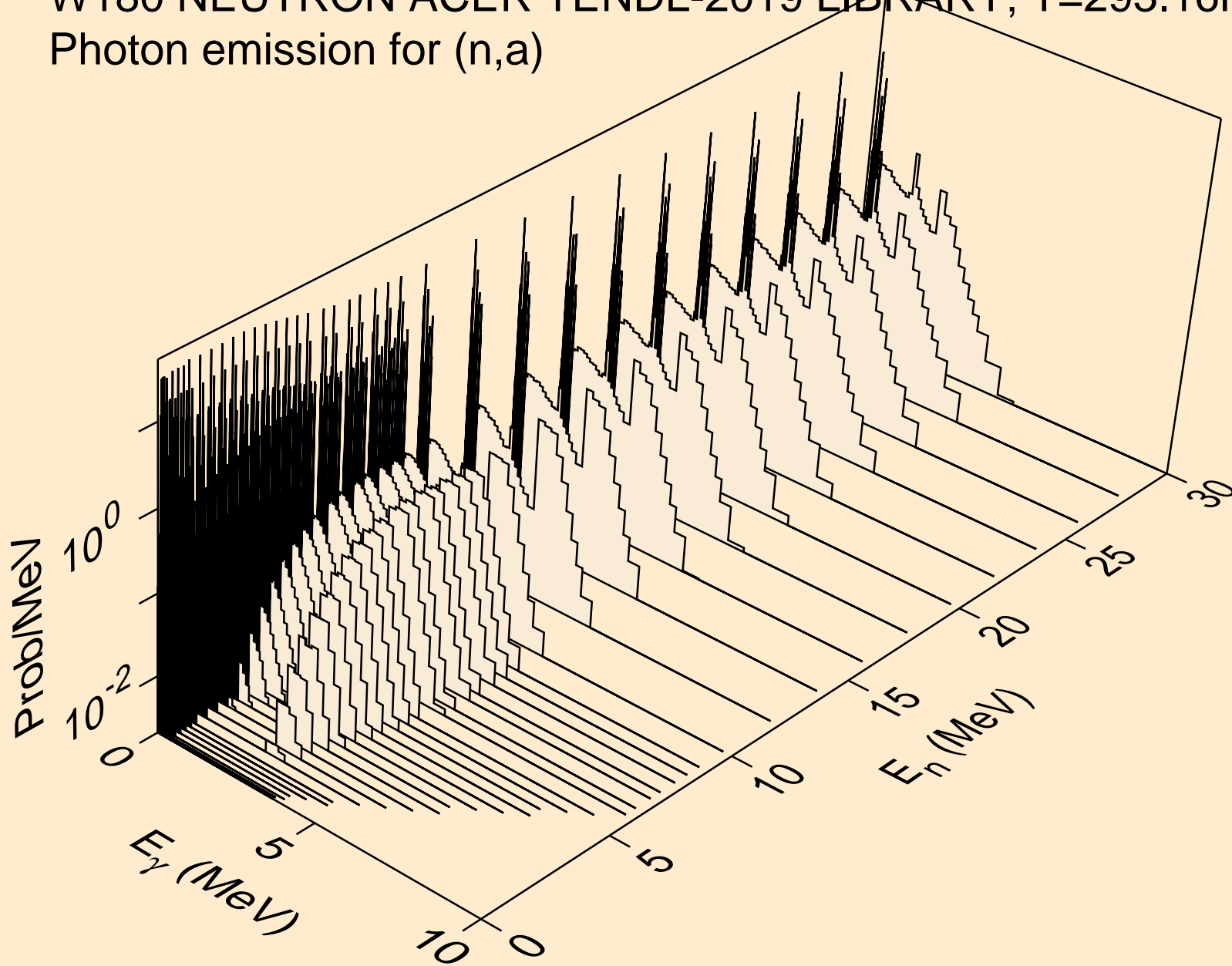

W180 NEUTRON ACER TENDL-2019 LIBRARY; T=293.16K
Photon emission for (n,2a)

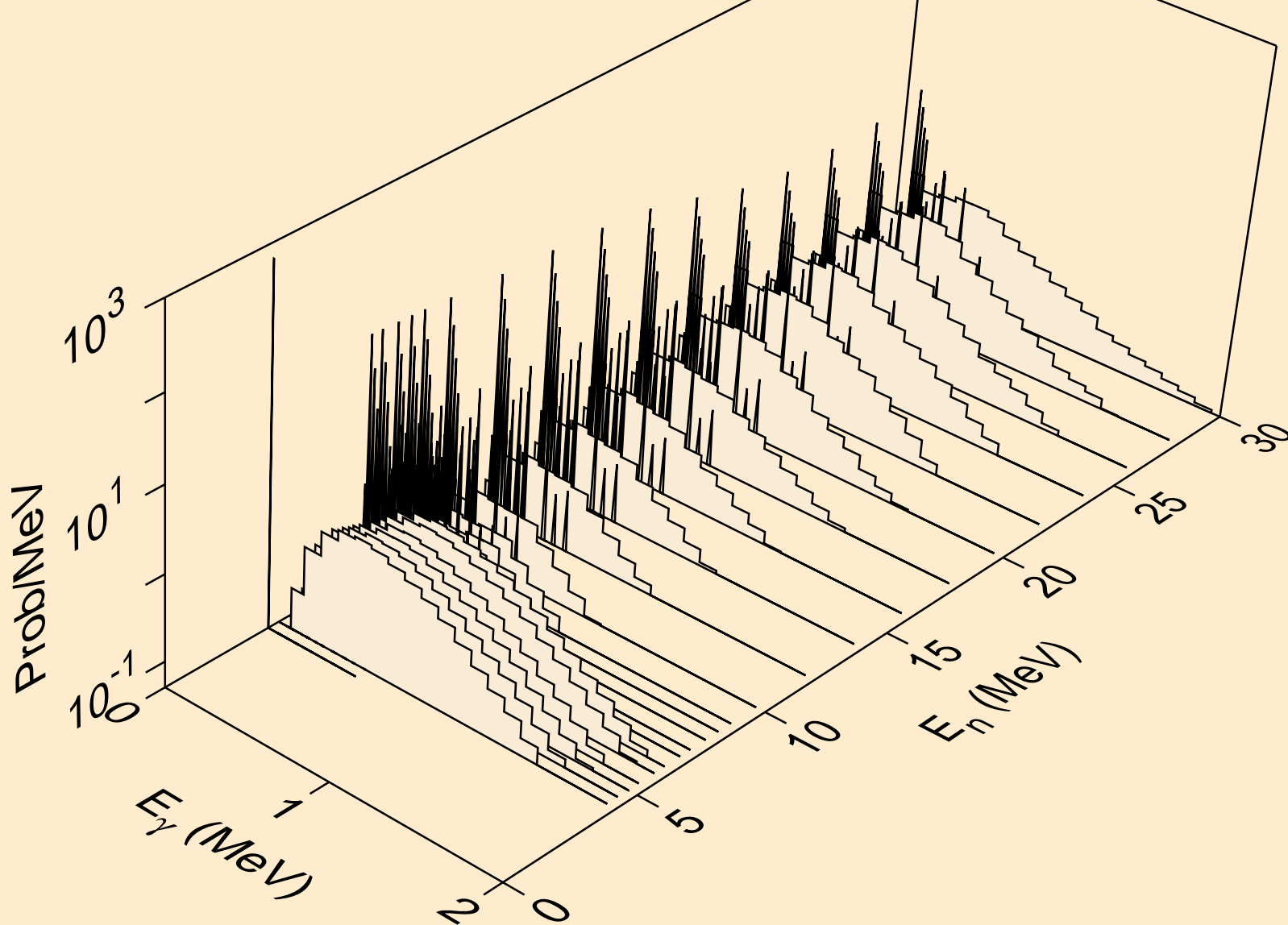

W180 NEUTRON ACER TENDL-2019 LIBRARY; T=293.16K
Photon emission for (n,2p)

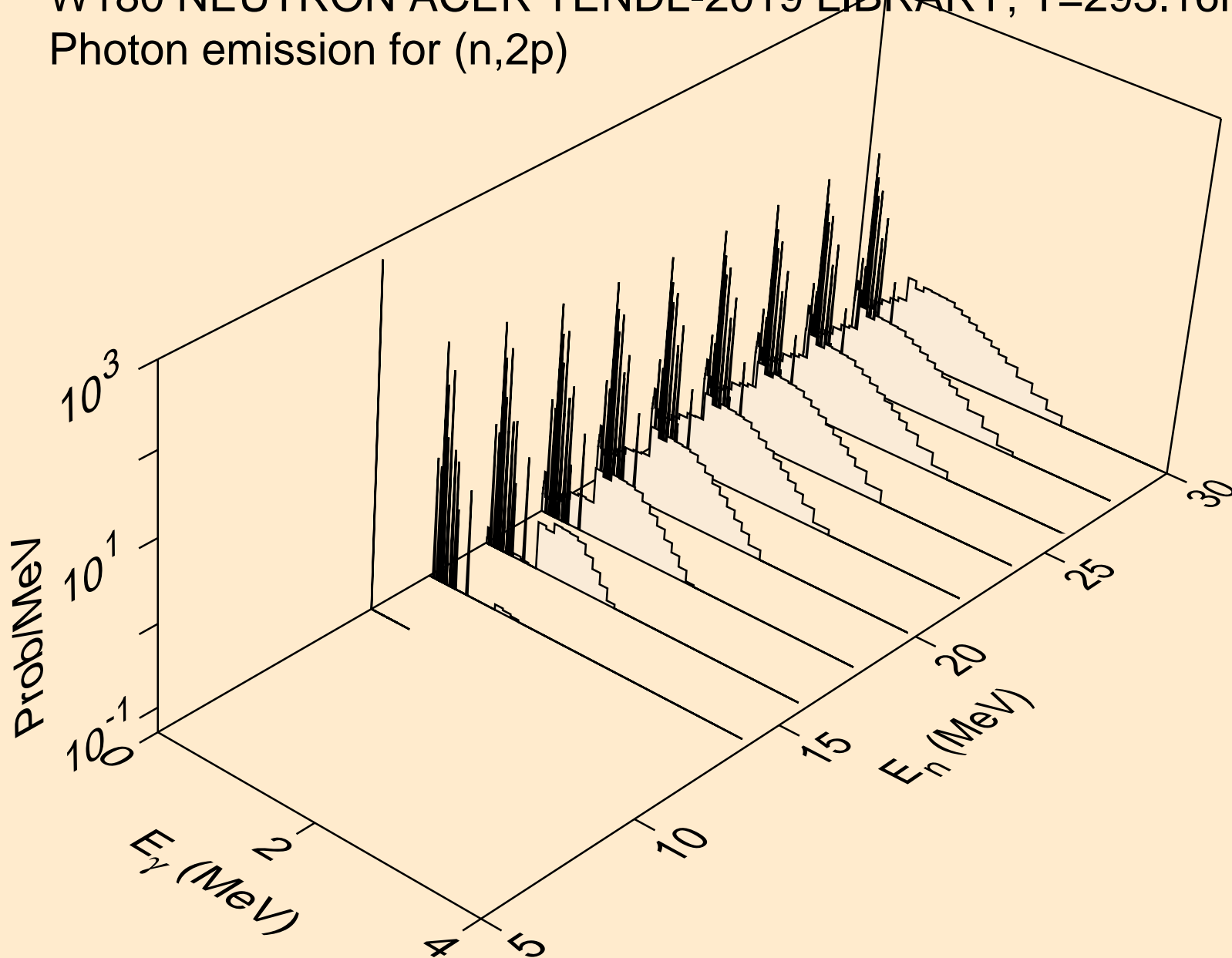

W180 NEUTRON ACER TENDL-2019 LIBRARY; T=293.16K
Photon emission for (n,p α)

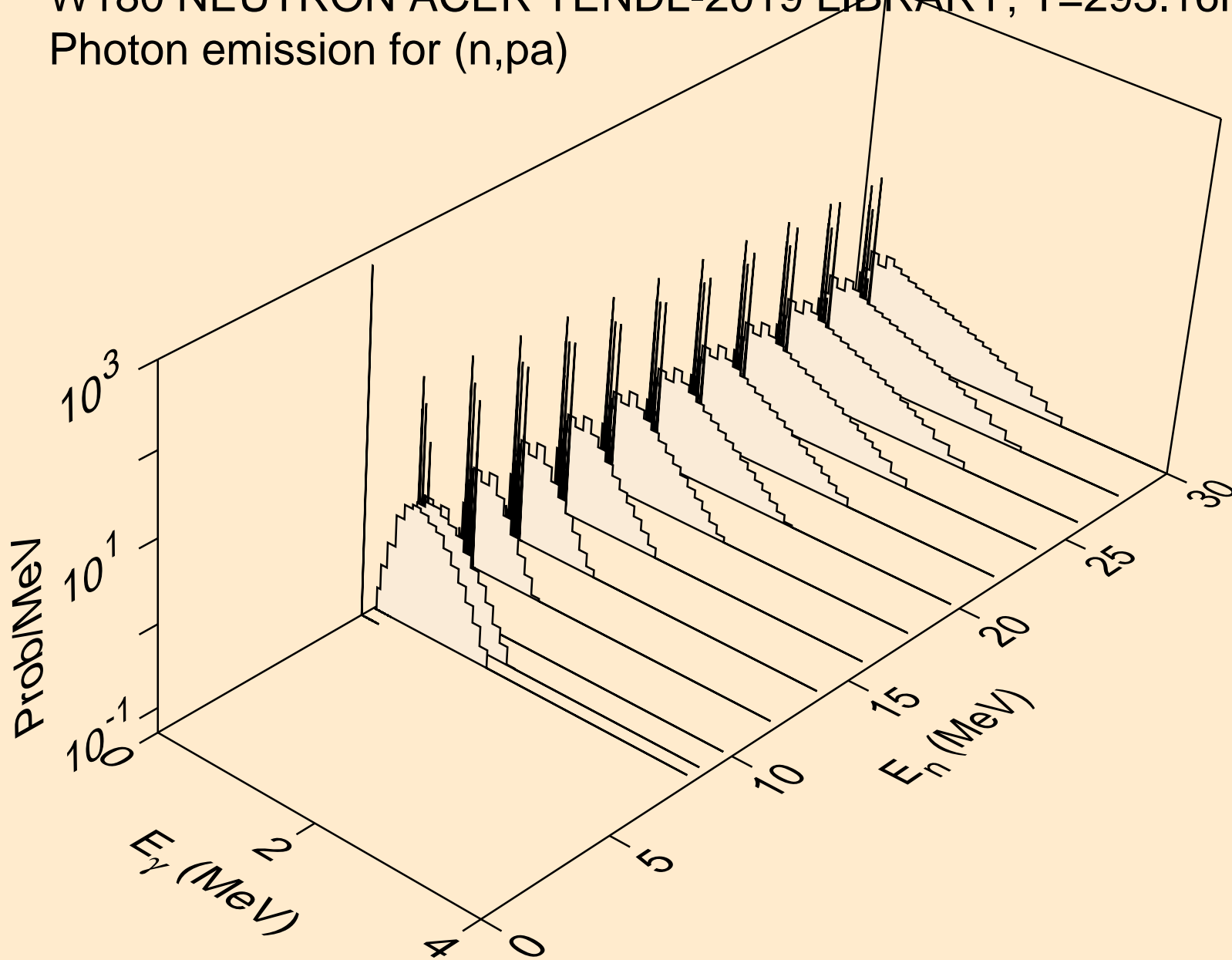

W180 NEUTRON ACER TENDL-2019 LIBRARY; T=293.16K
Photon emission for (n,pd)

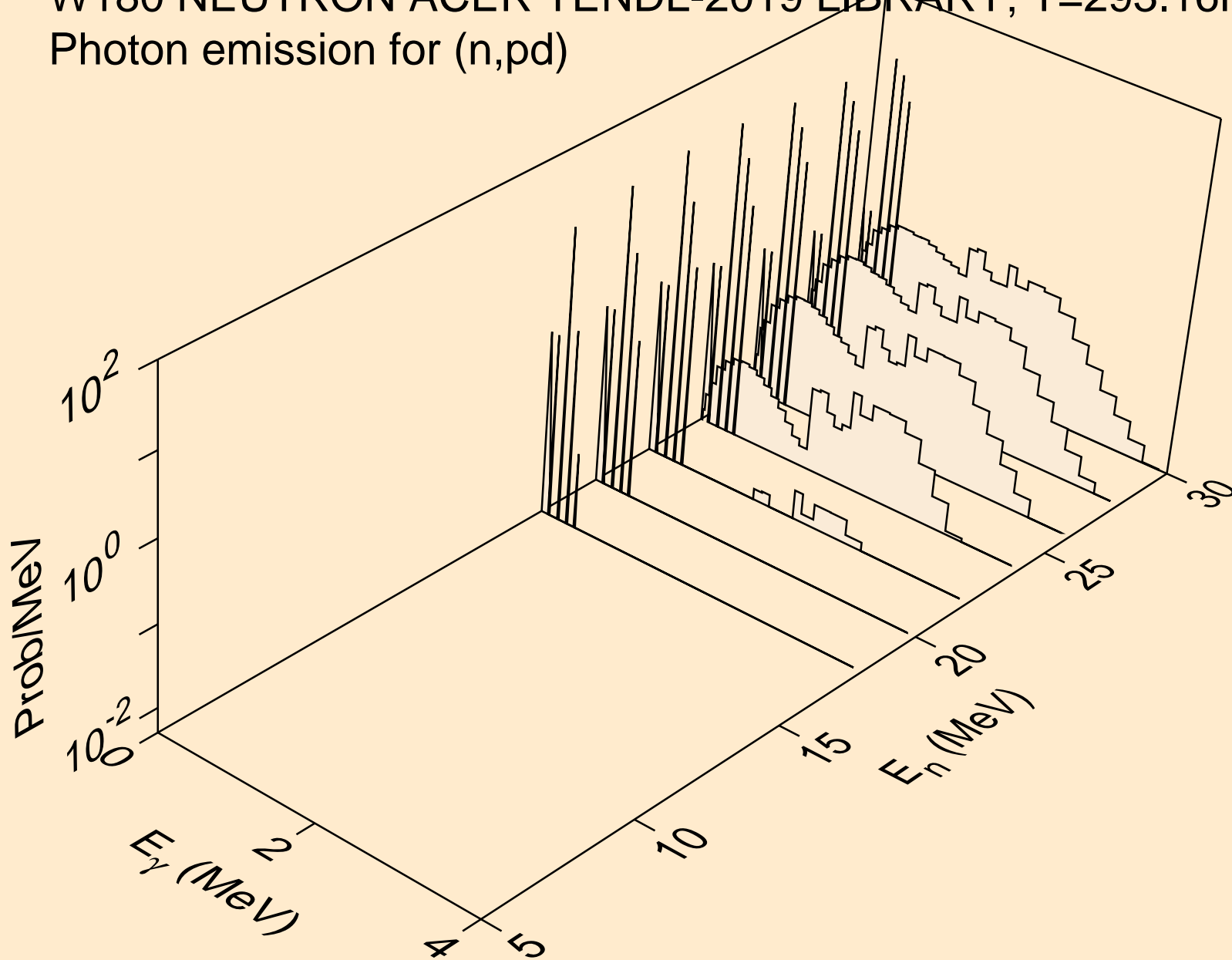

W180 NEUTRON ACER TENDL-2019 LIBRARY; T=293.16K
Photon emission for (n,pt)

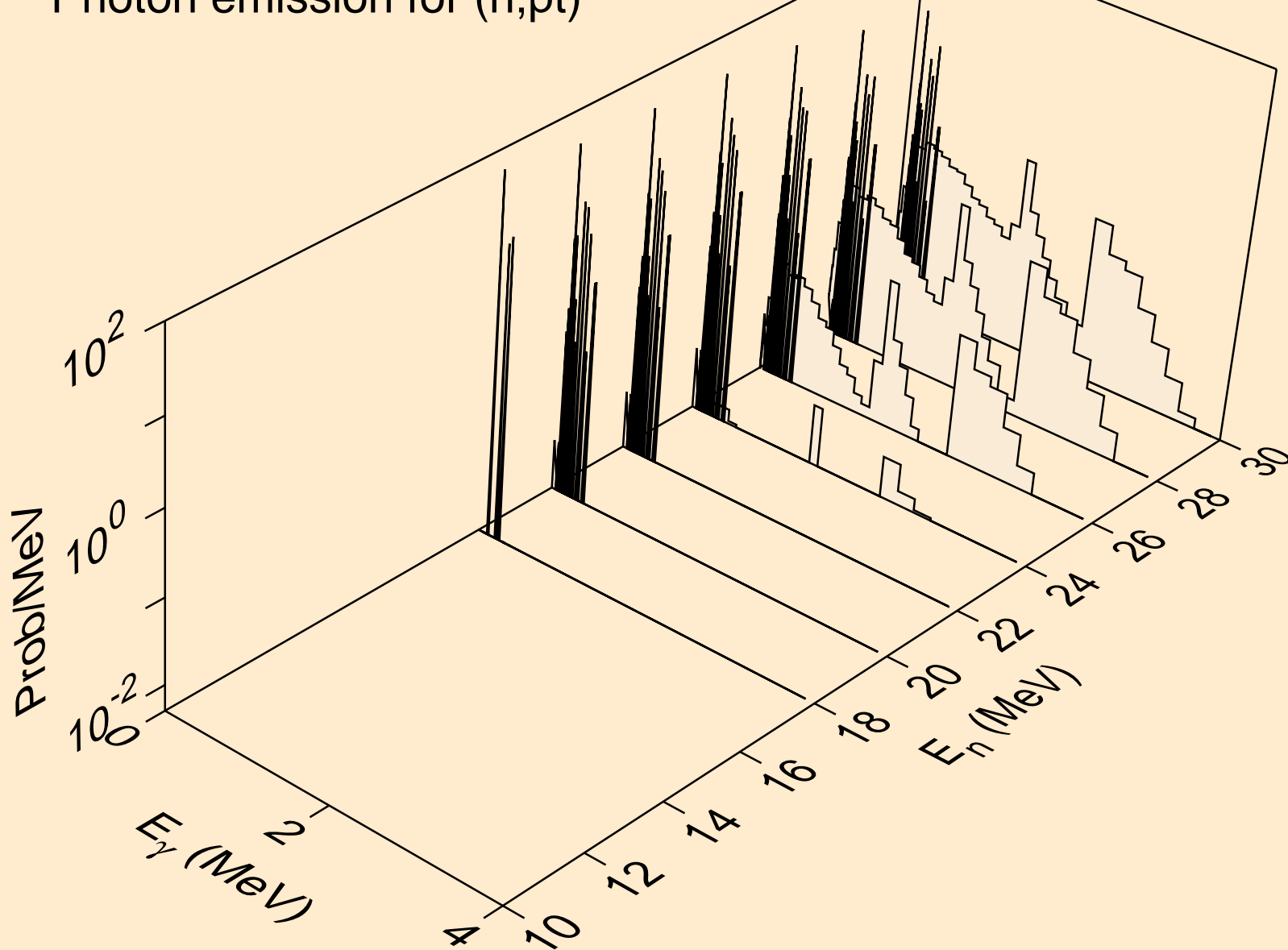

W180 NEUTRON ACER TENDL-2019 LIBRARY; T=293.16K
Photon emission for (n,da)

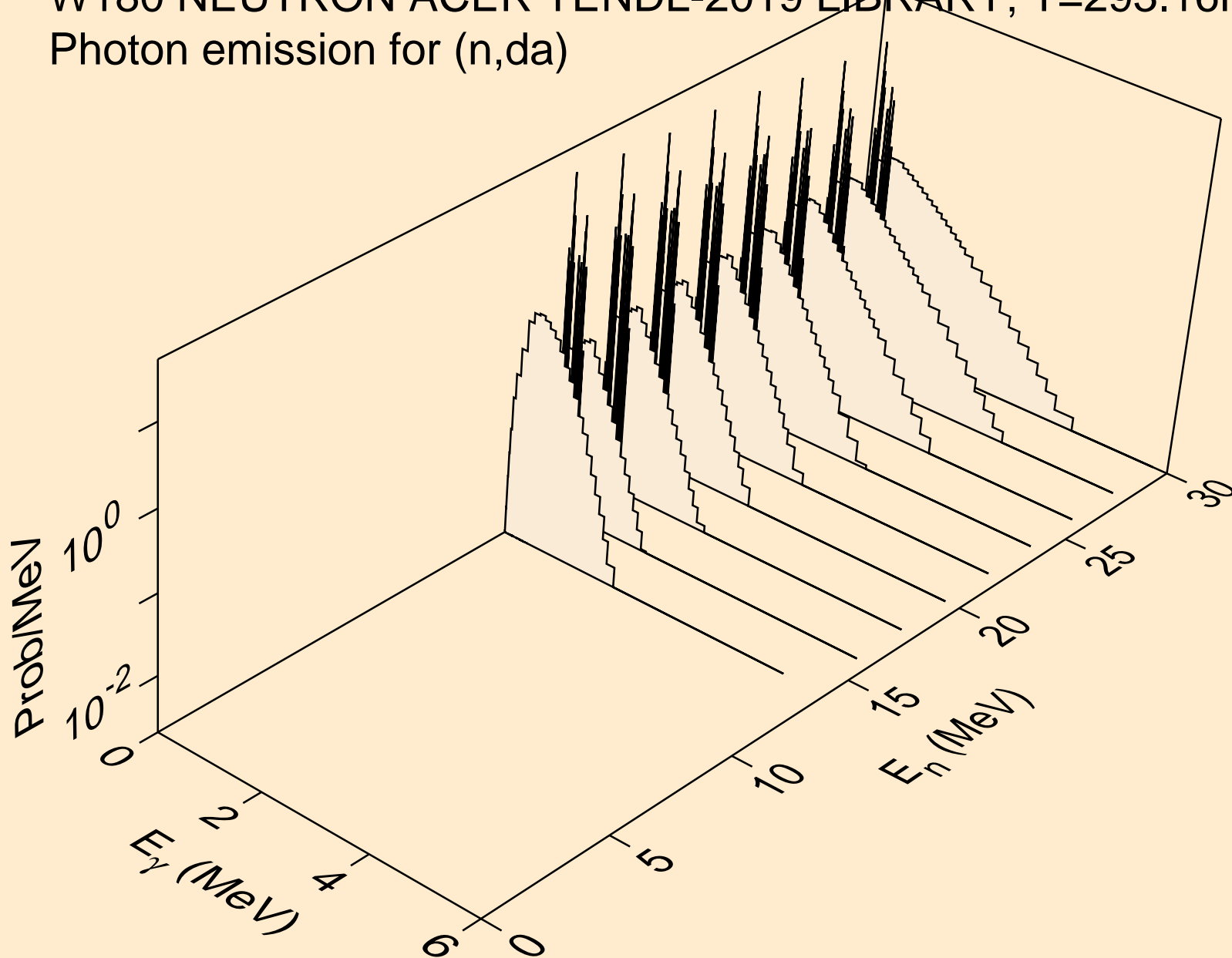

W180 NEUTRON ACER TENDL-2019 LIBRARY; T=293.16K
thermal capture photon spectrum

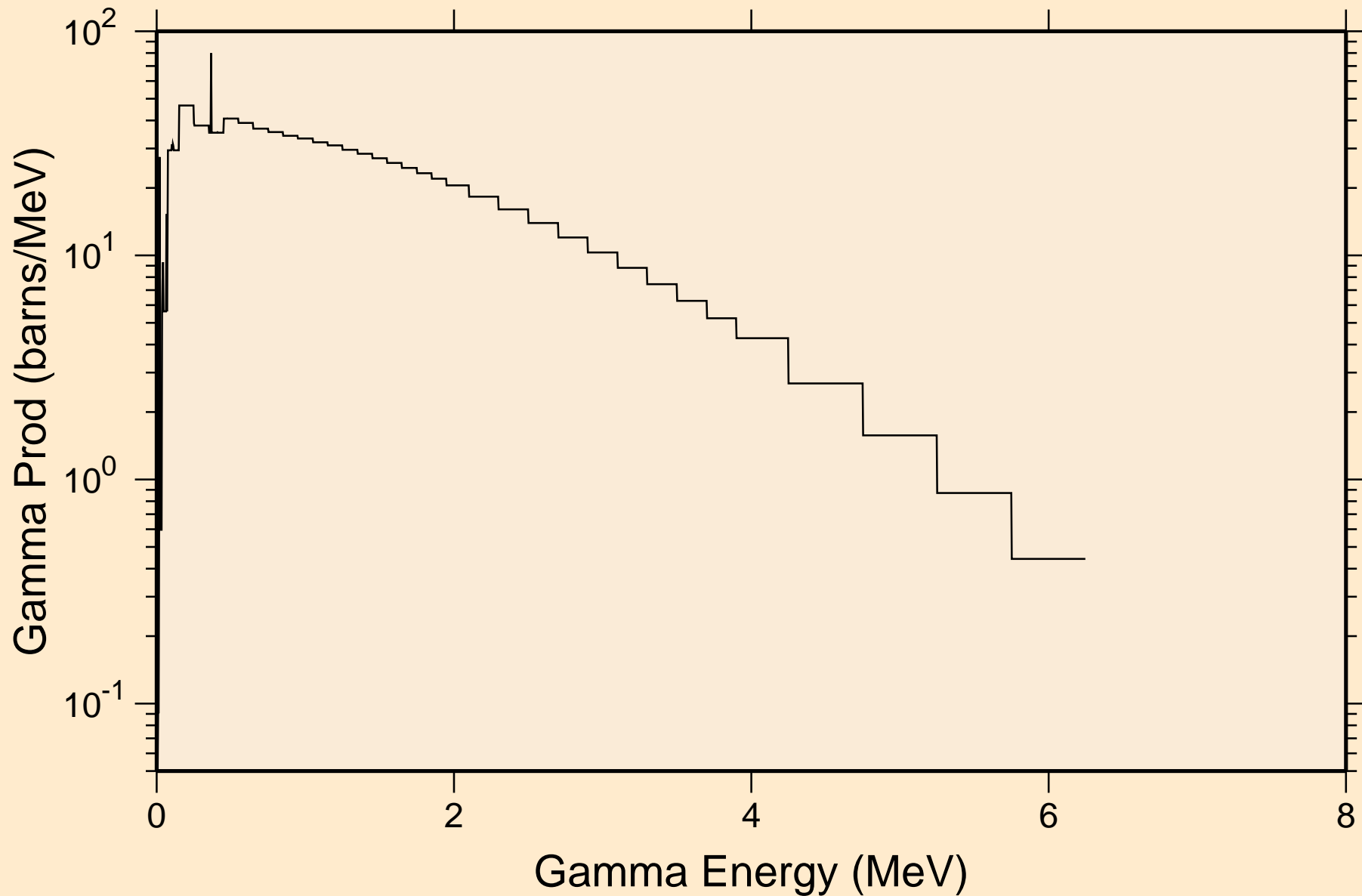

W180 NEUTRON ACER TENDL-2019 LIBRARY; T=293.16K
14 MeV photon spectrum

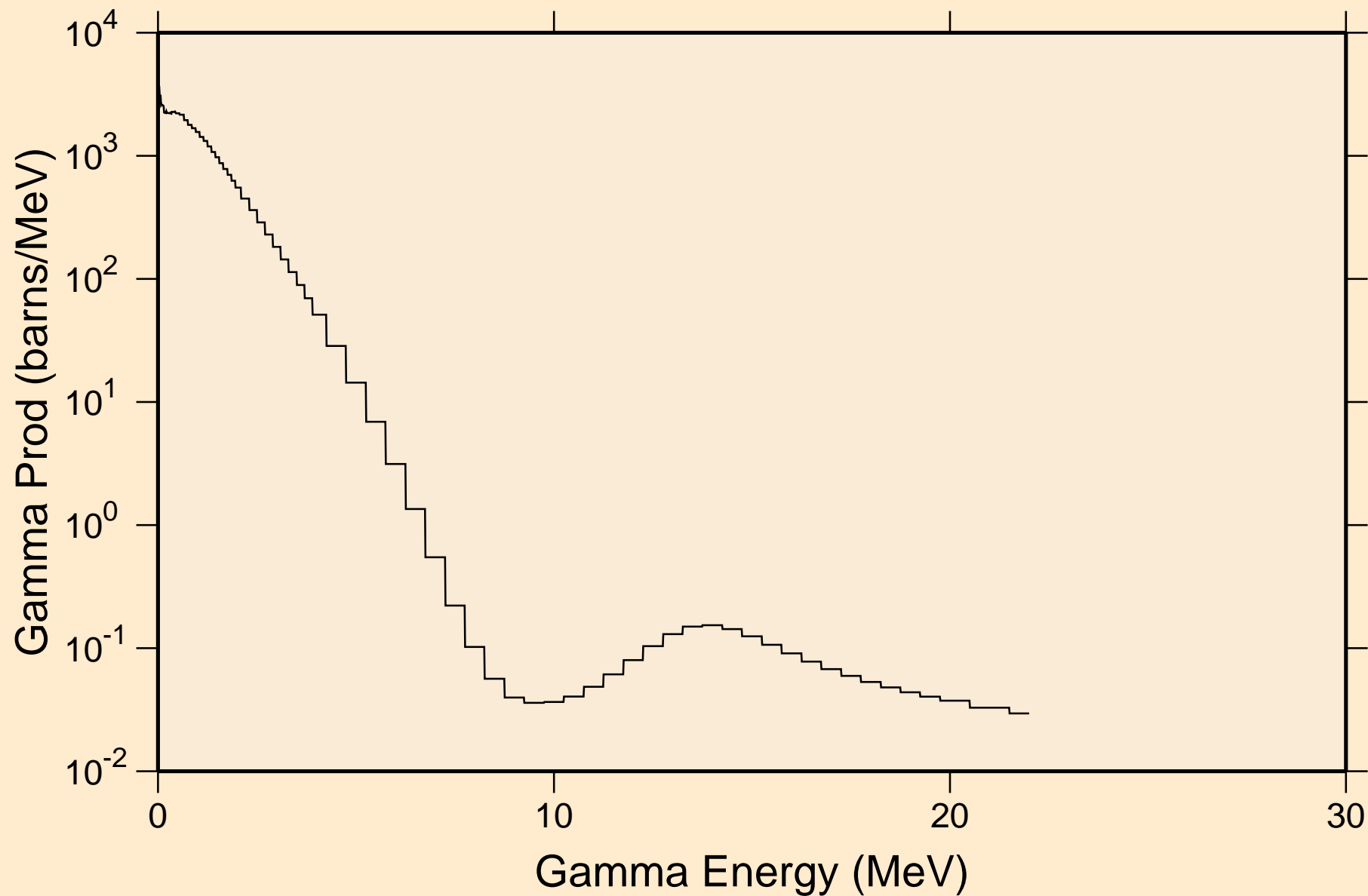

W180 NEUTRON ACER TENDL-2019 LIBRARY; T=293.16K
Particle heating contributions

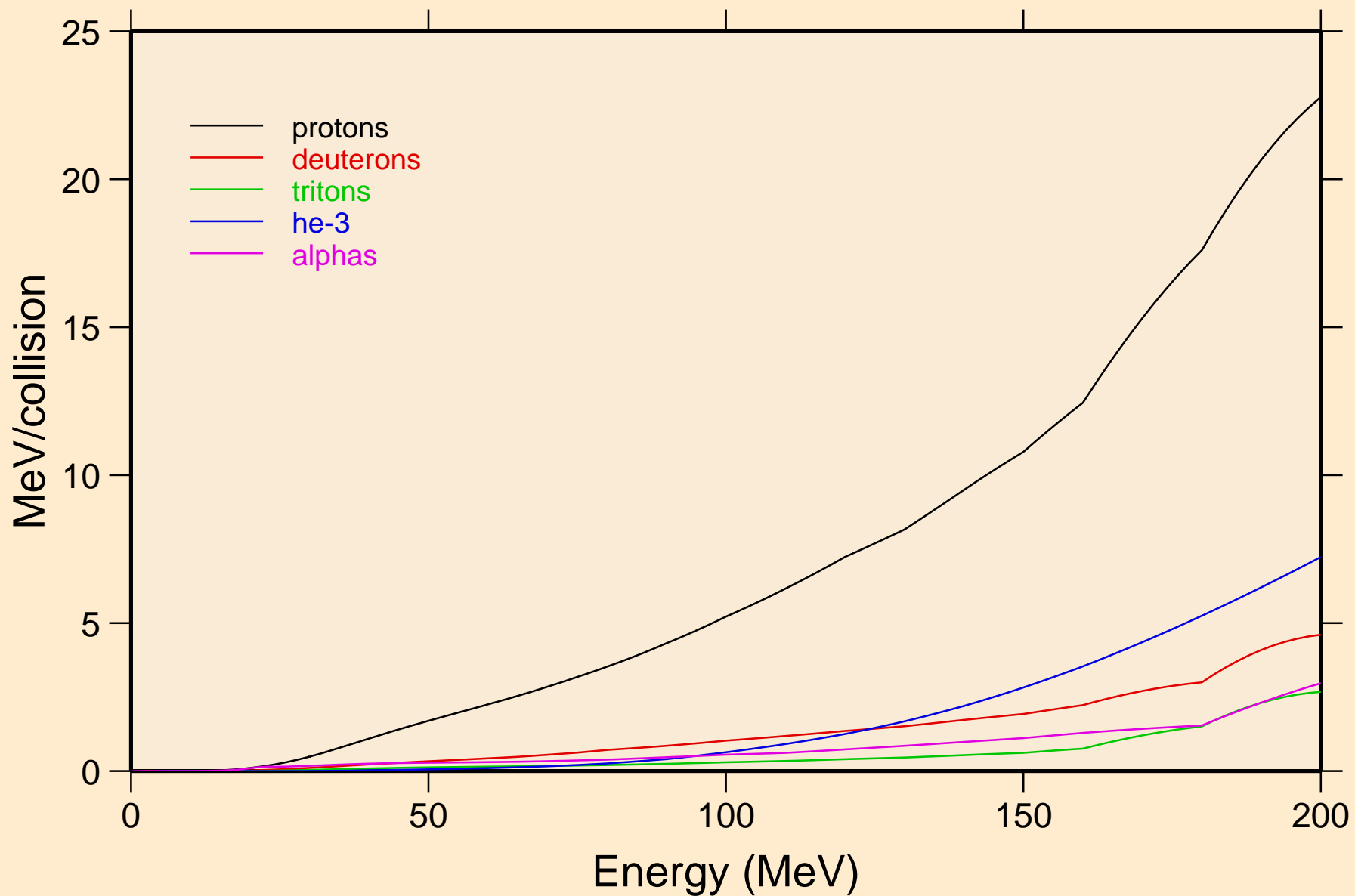

W180 NEUTRON ACER TENDL-2019 LIBRARY; T=293.16K
Recoil Heating

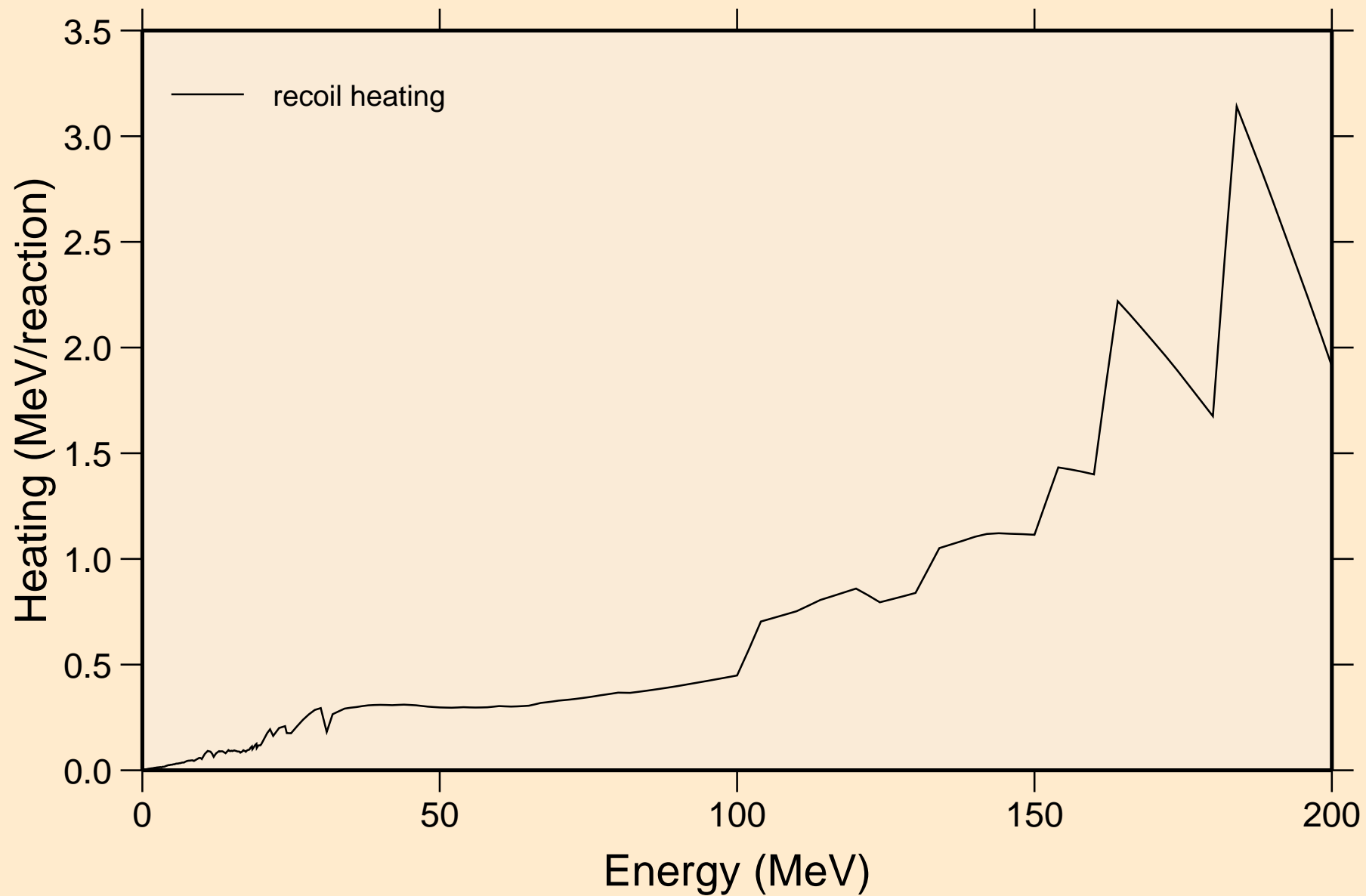

W180 NEUTRON ACER TENDL-2019 LIBRARY; T=293.16K
Particle production cross sections

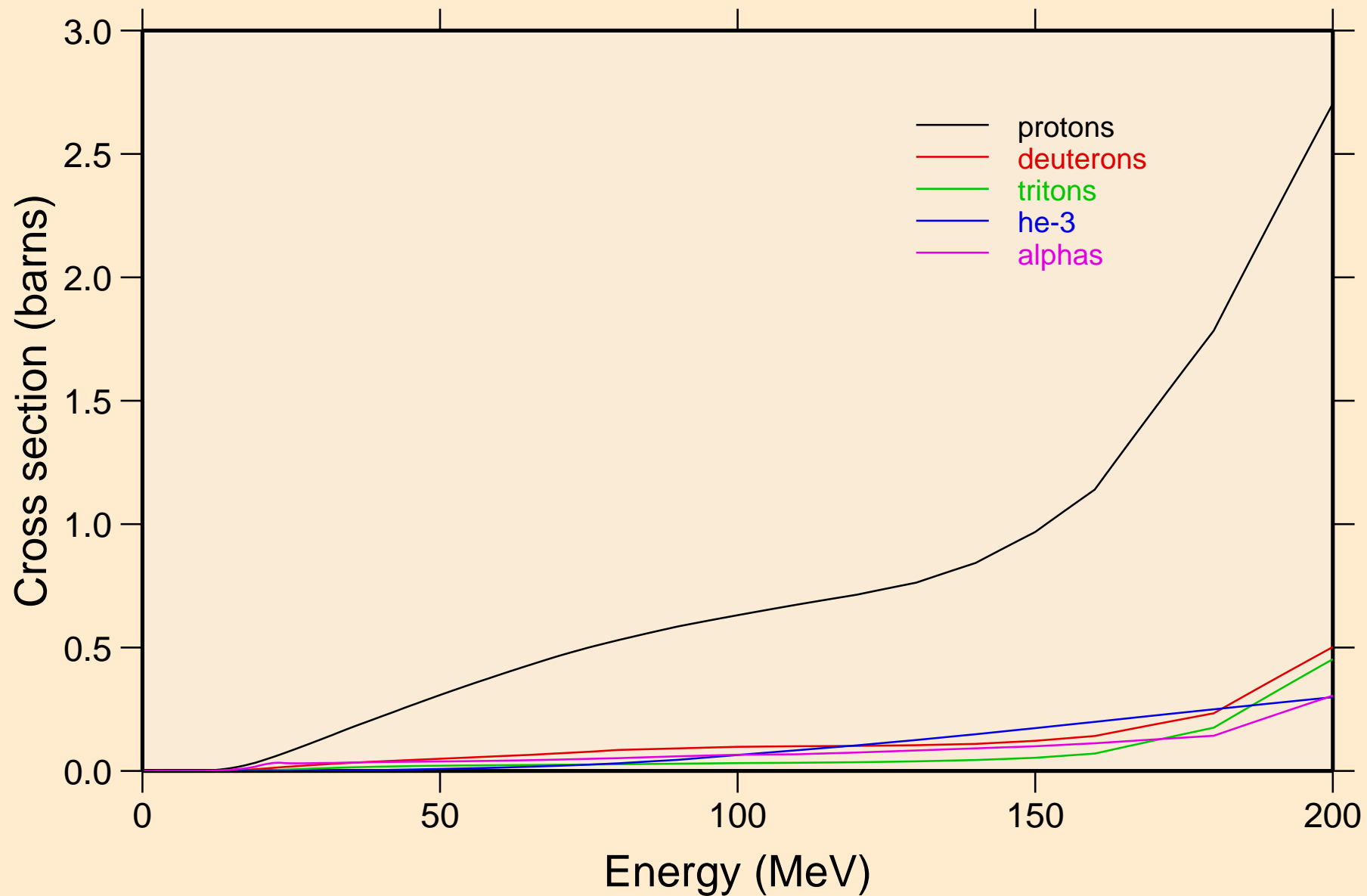

W180 NEUTRON ACER TENDL-2019 LIBRARY; T=293.16K
protons from (n,x)

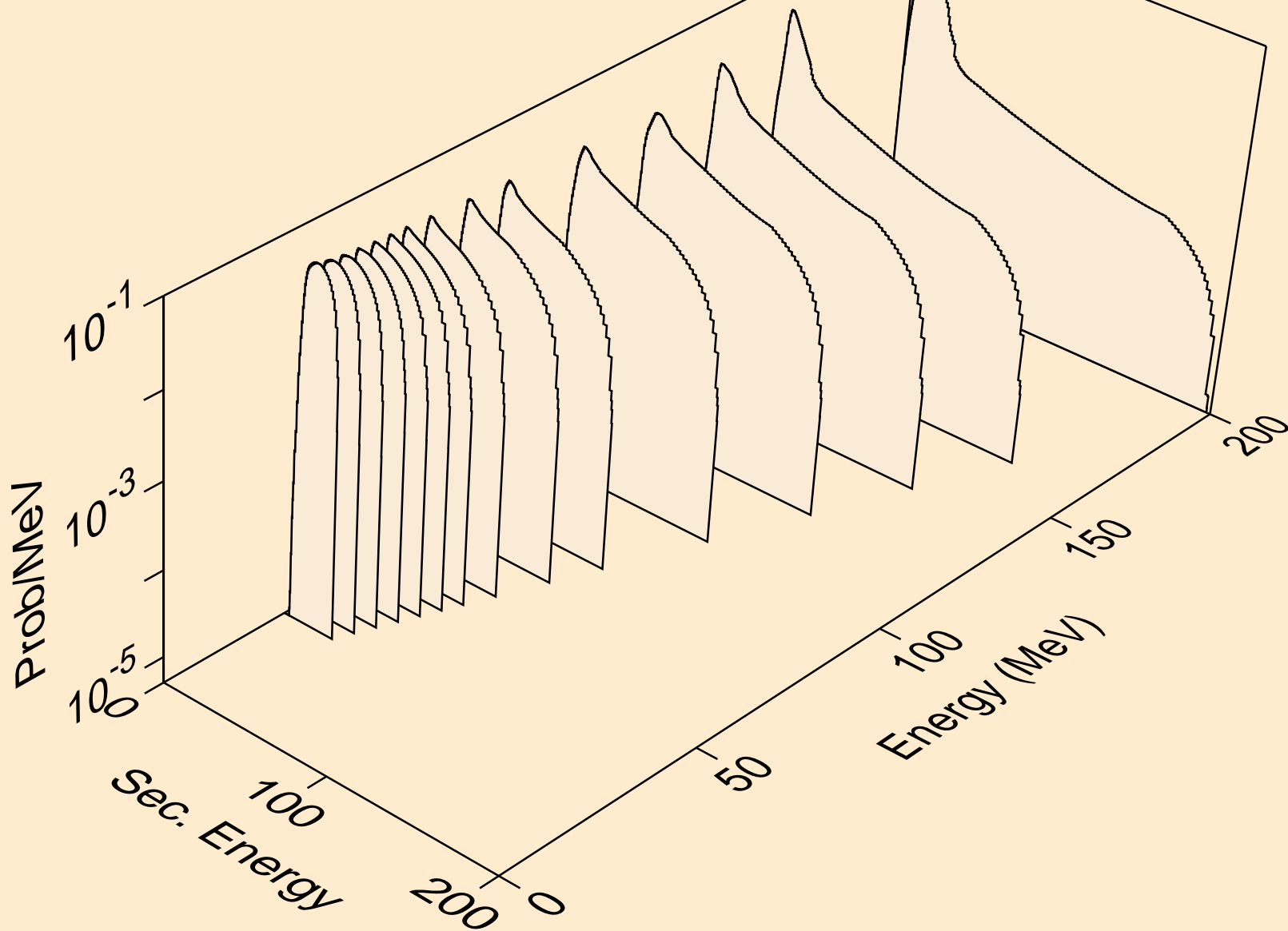

W180 NEUTRON ACER TENDL-2019 LIBRARY; T=293.16K
protons from (n,n*)p

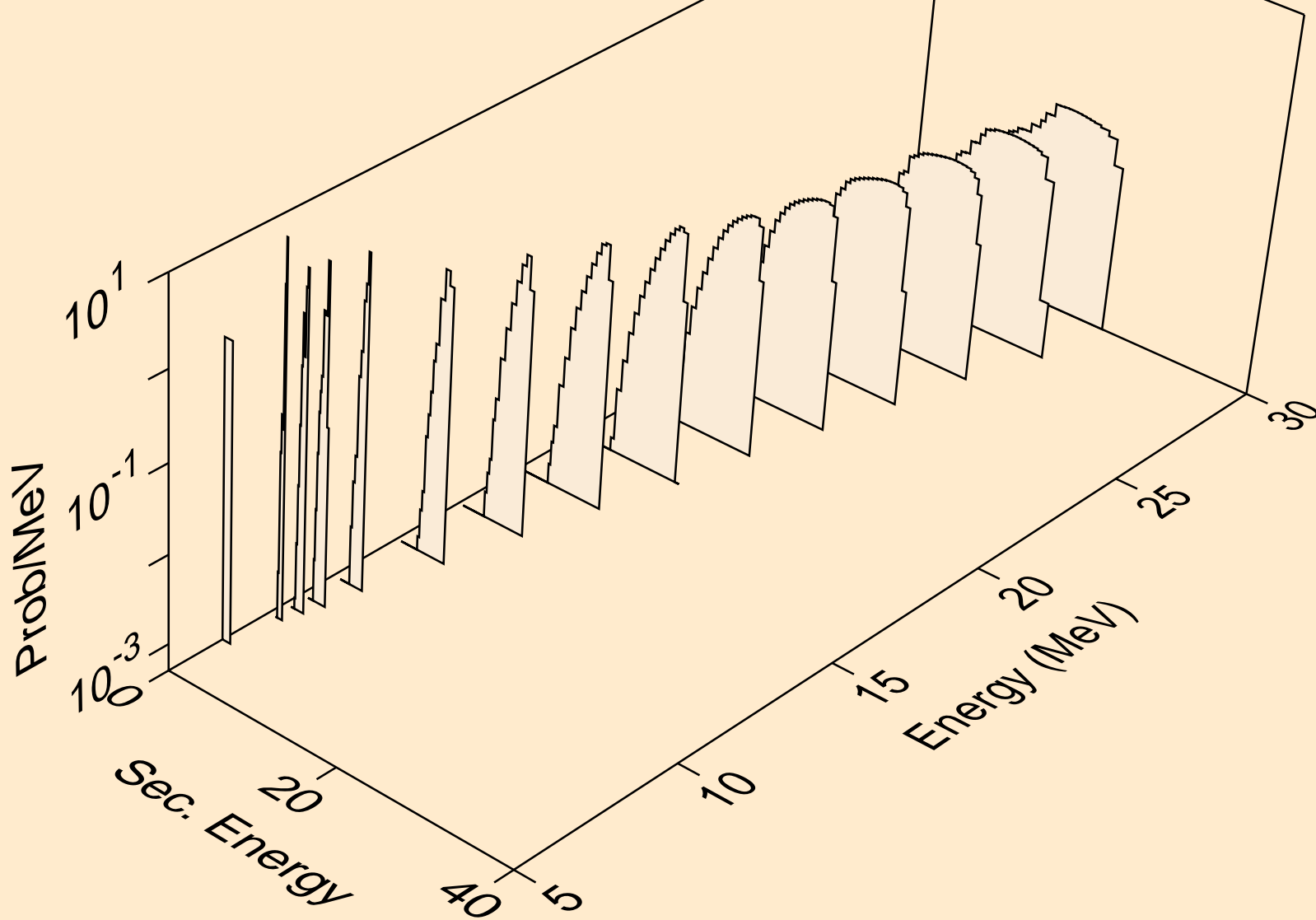

W180 NEUTRON ACER TENDL-2019 LIBRARY; T=293.16K
protons from (n,2np)

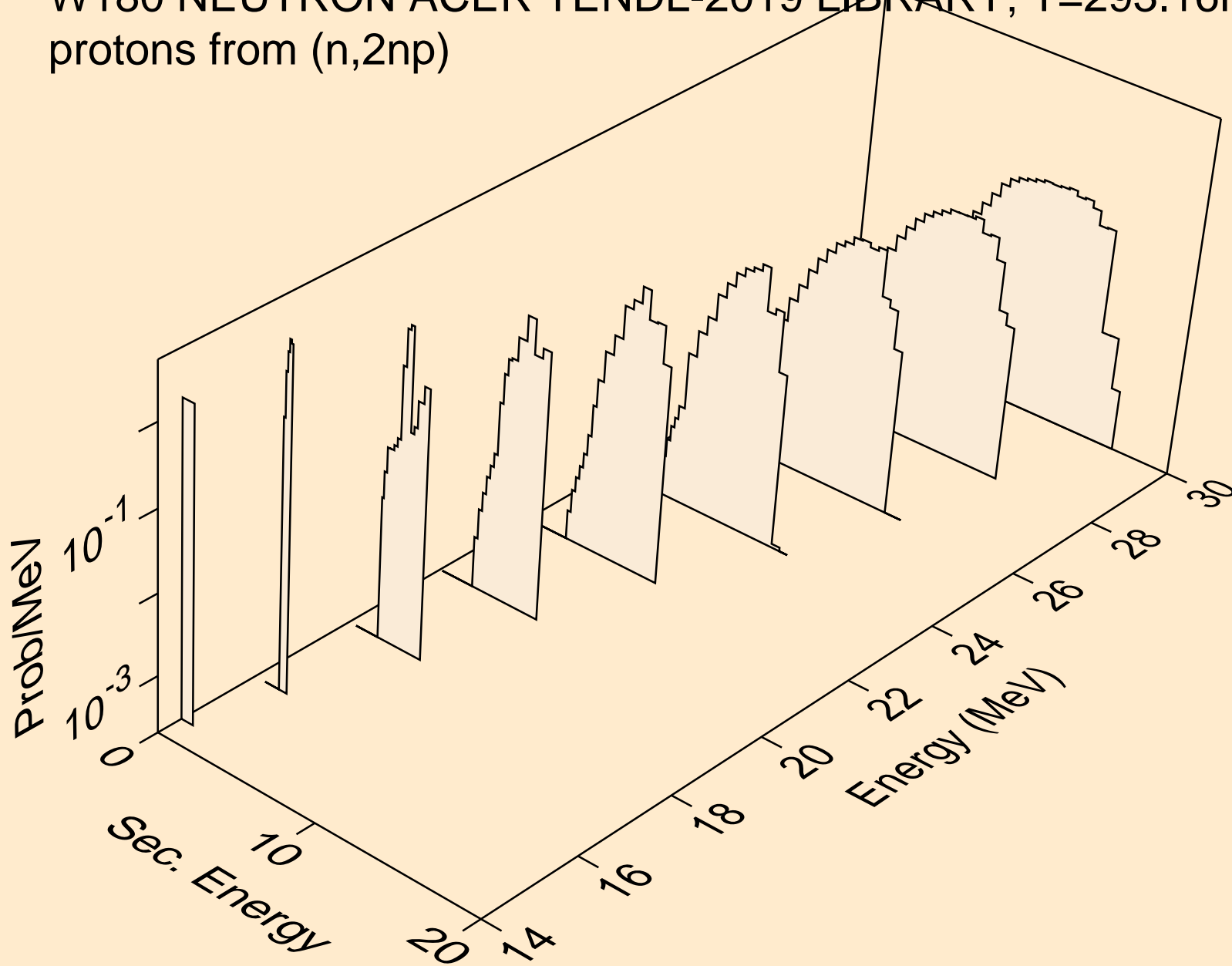

W180 NEUTRON ACER TENDL-2019 LIBRARY; T=293.16K
protons from (n,3np)

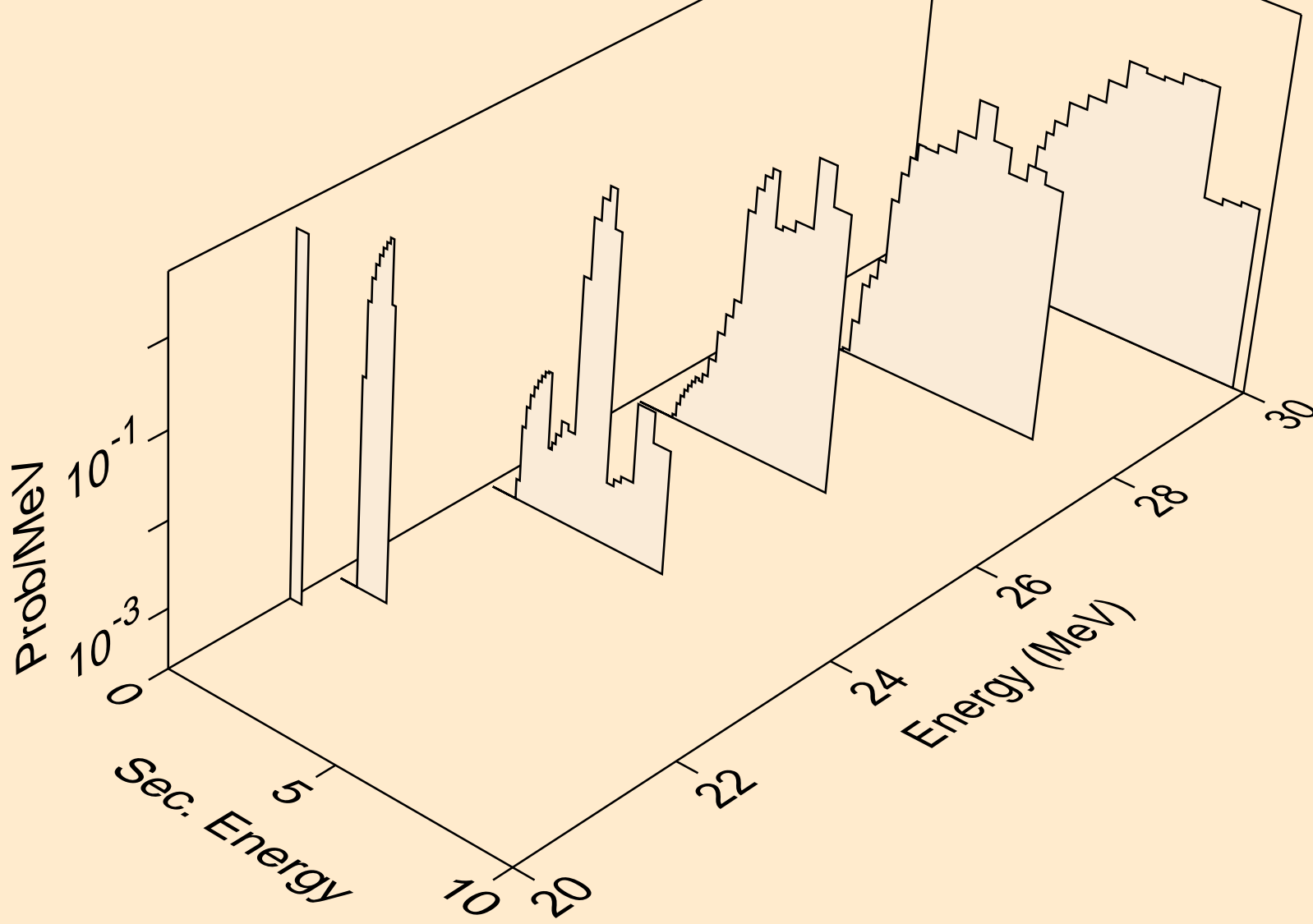

W180 NEUTRON ACER TENDL-2019 LIBRARY; T=293.16K
protons from (n,2np)

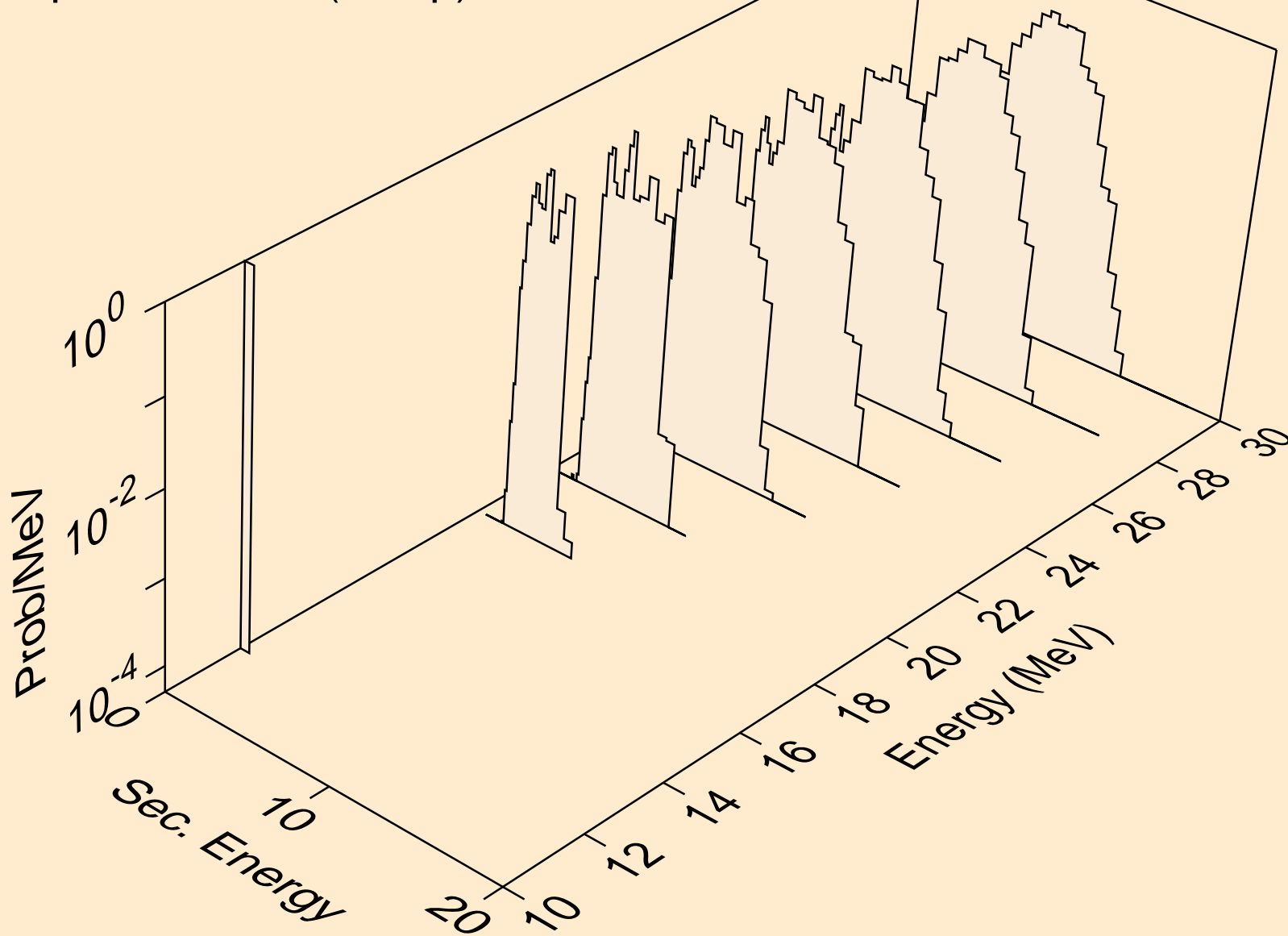

W180 NEUTRON ACER TENDL-2019 LIBRARY; T=293.16K
protons from (n,npa)

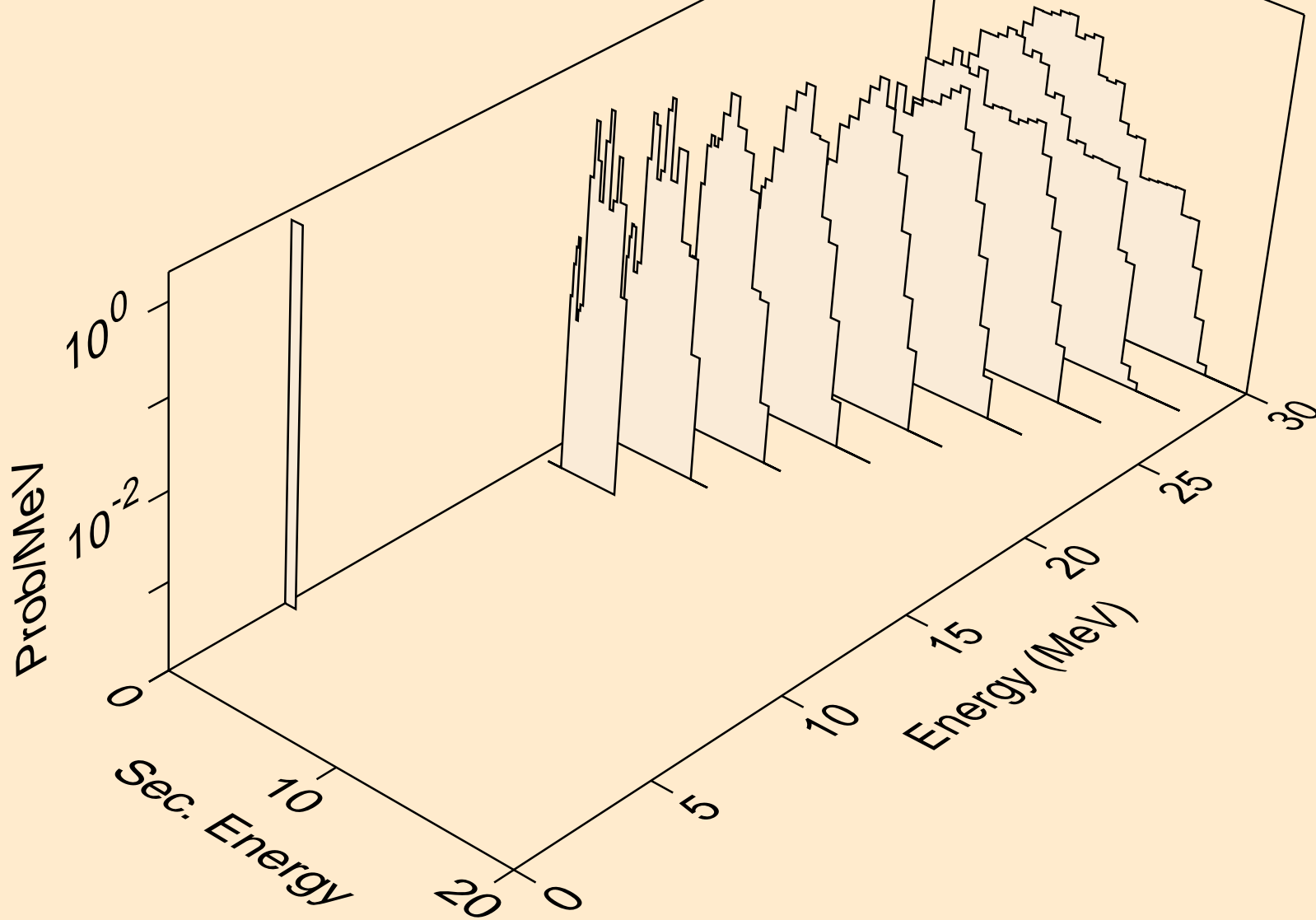

W180 NEUTRON ACER TENDL-2019 LIBRARY; T=293.16K
protons from (n,p)

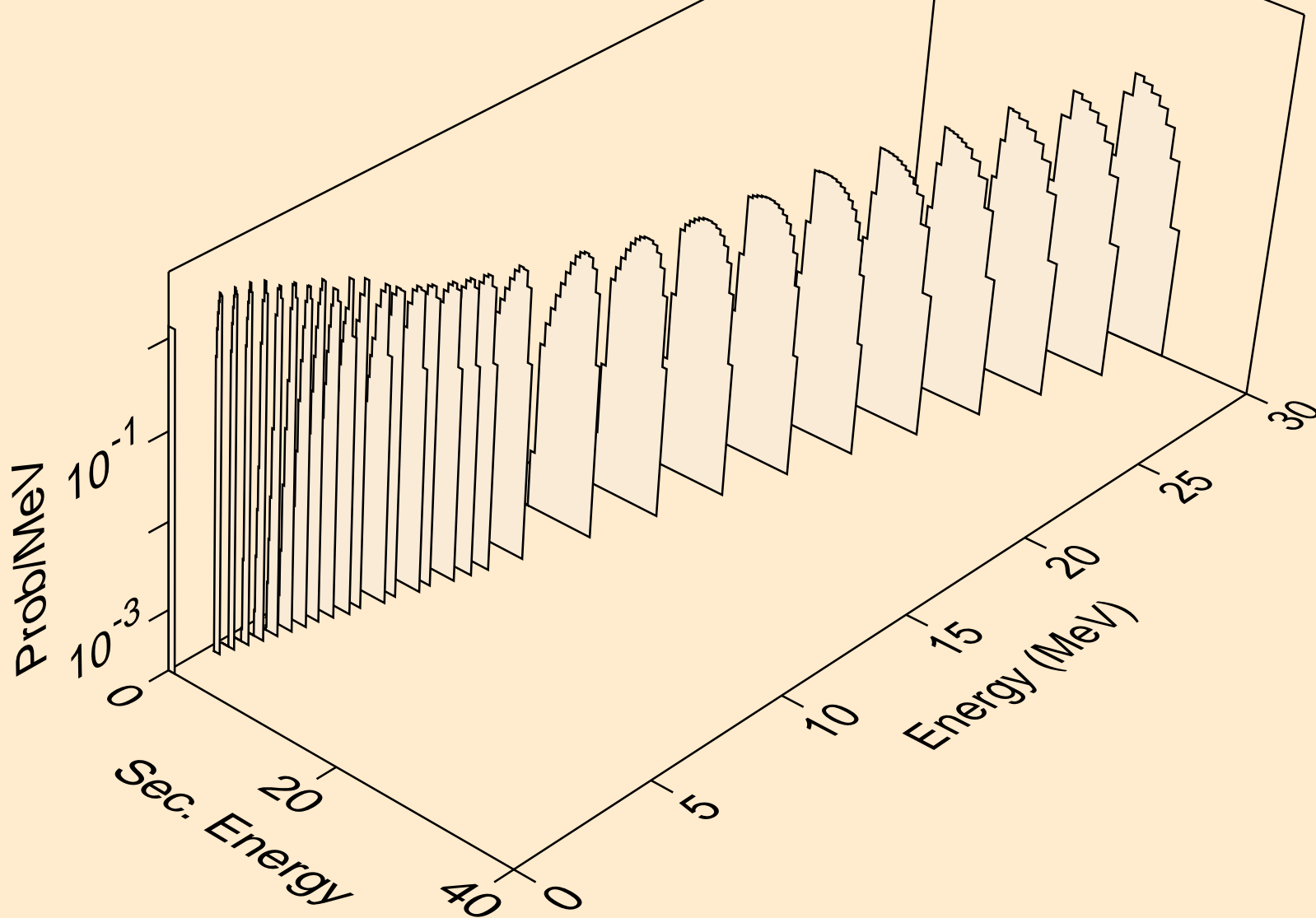

W180 NEUTRON ACER TENDL-2019 LIBRARY; T=293.16K
protons from (n,2p)

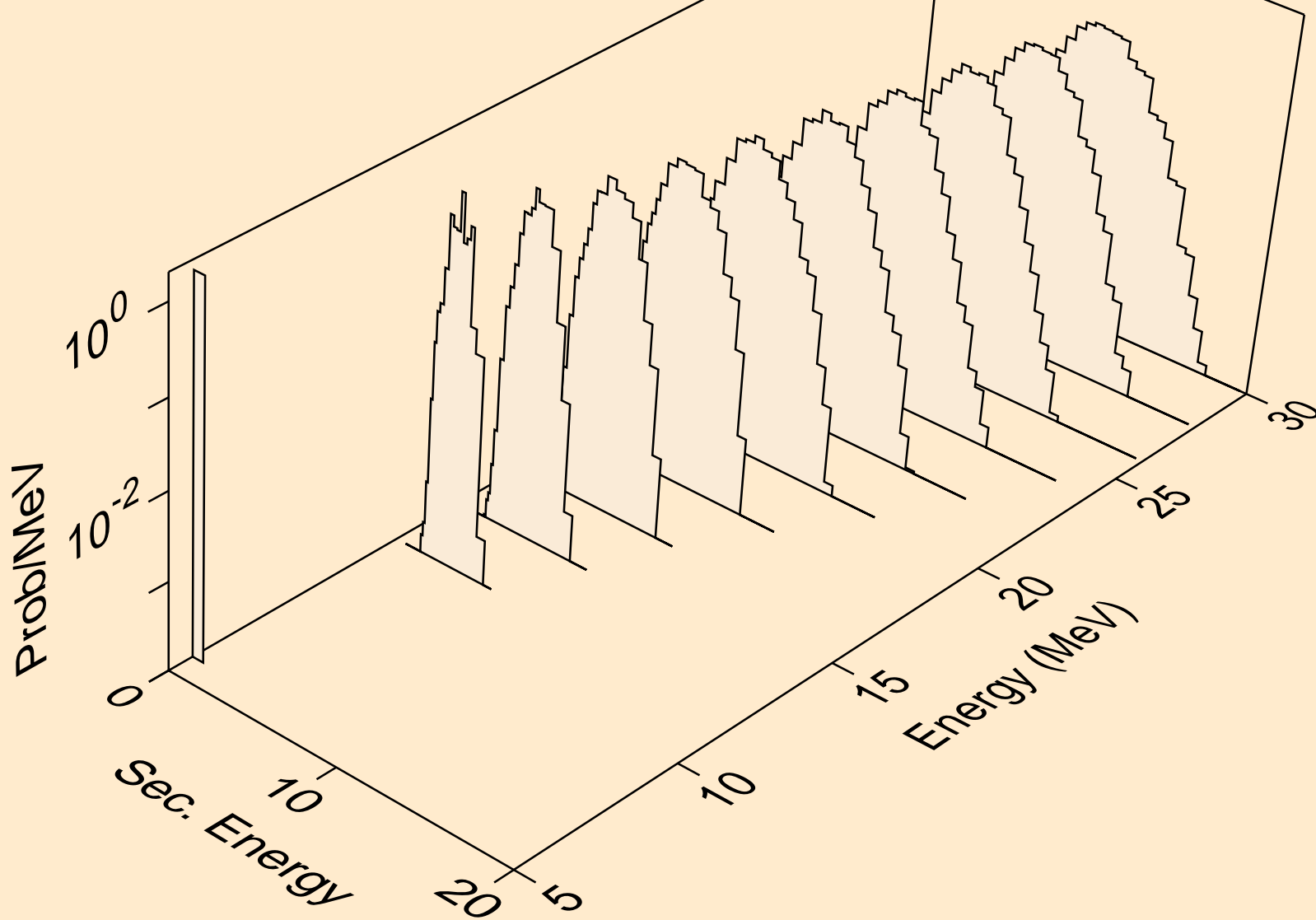

W180 NEUTRON ACER TENDL-2019 LIBRARY; T=293.16K
protons from (n,p)

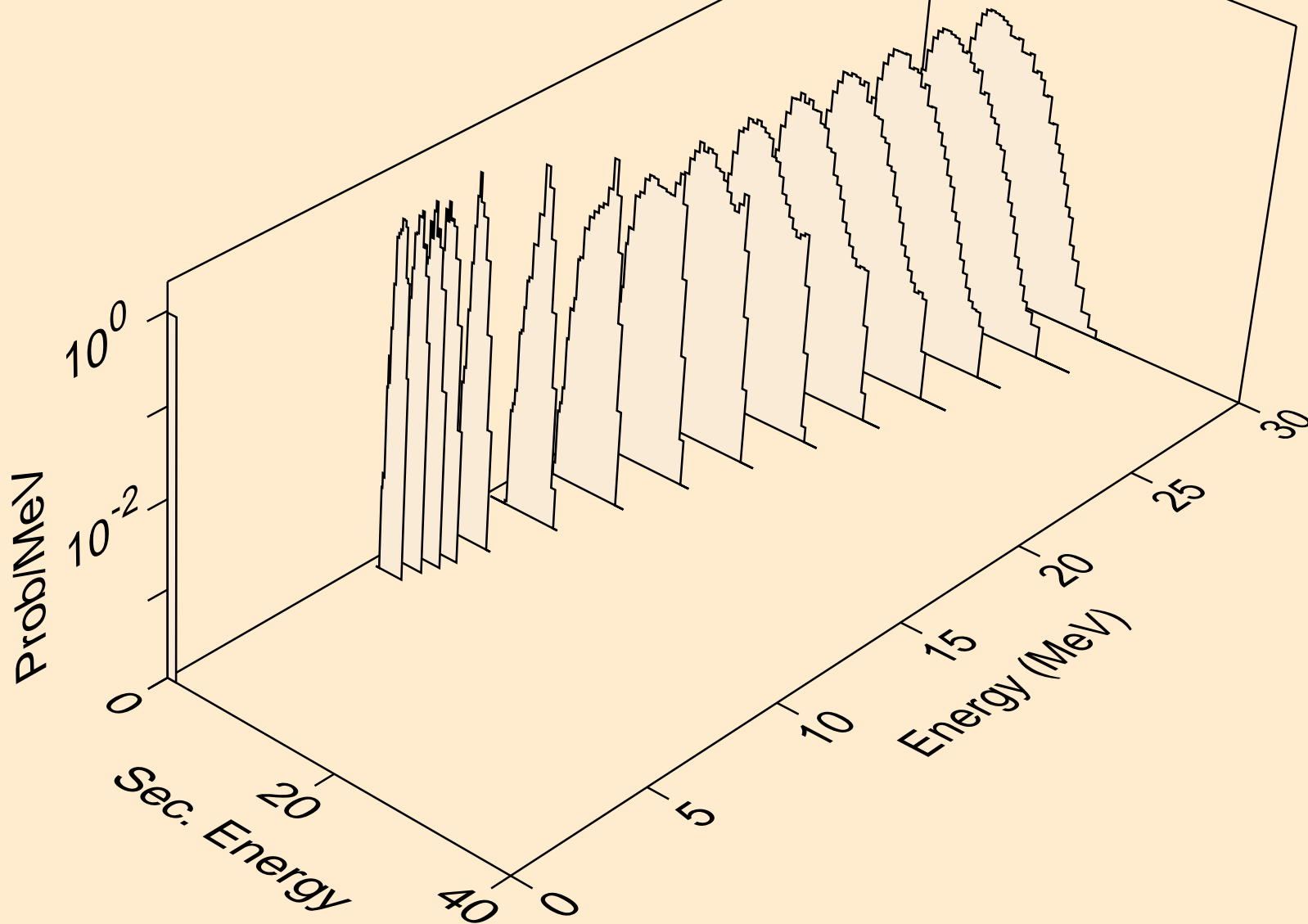

W180 NEUTRON ACER TENDL-2019 LIBRARY; T=293.16K
protons from (n,pd)

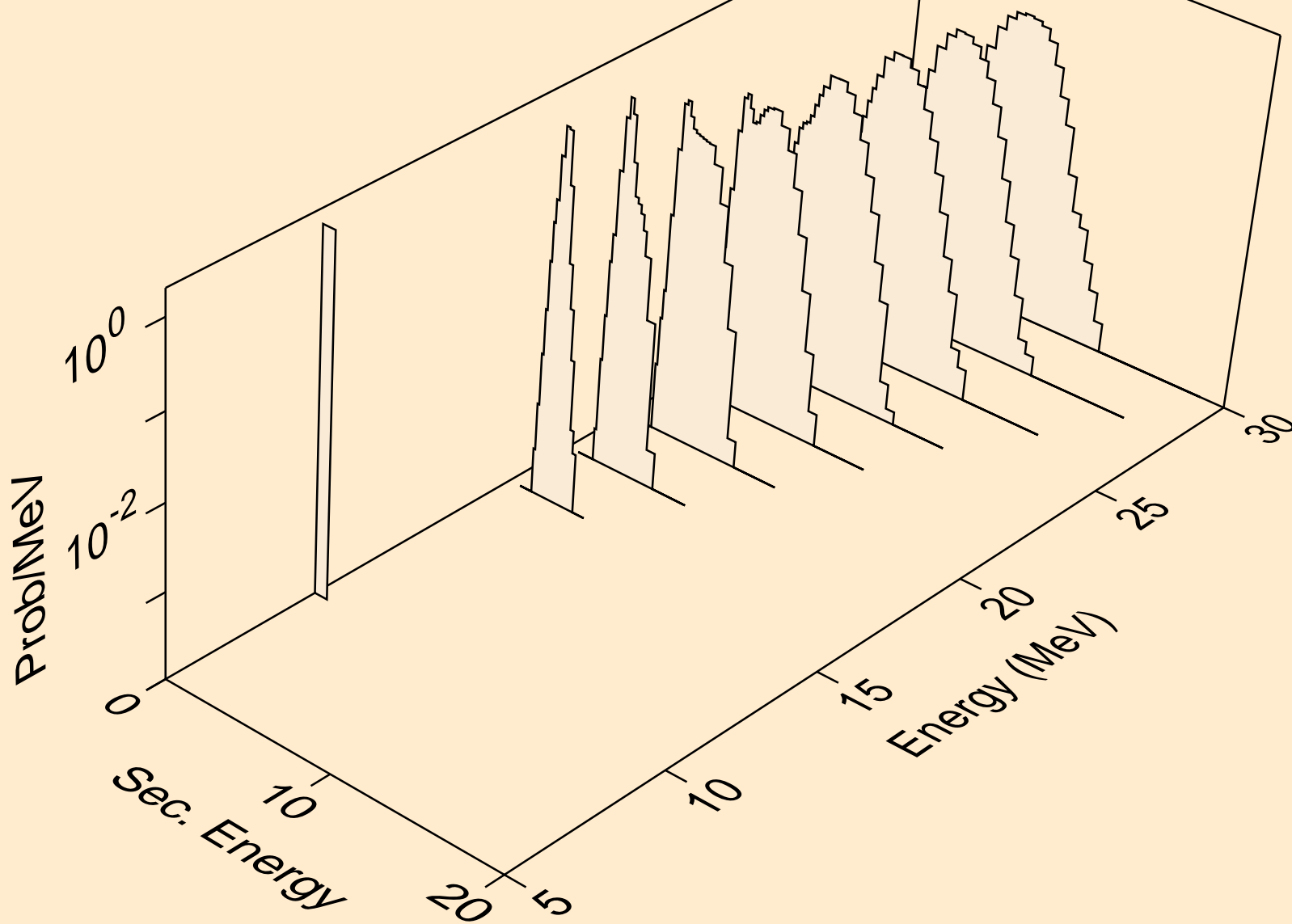

W180 NEUTRON ACER TENDL-2019 LIBRARY; T=293.16K
protons from (n,pt)

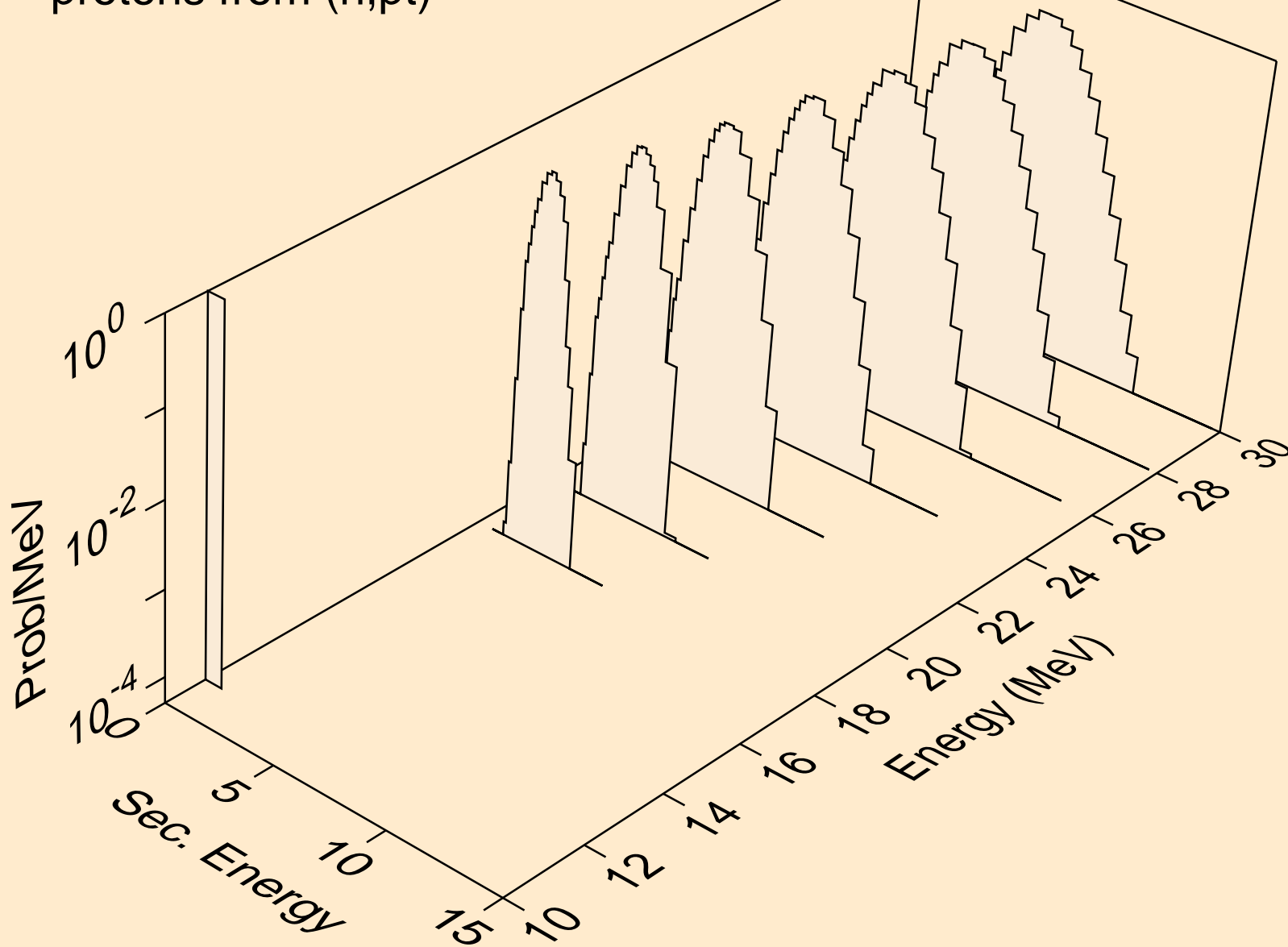

W180 NEUTRON ACER TENDL-2019 LIBRARY; T=293.16K
deuterons from (n,x)

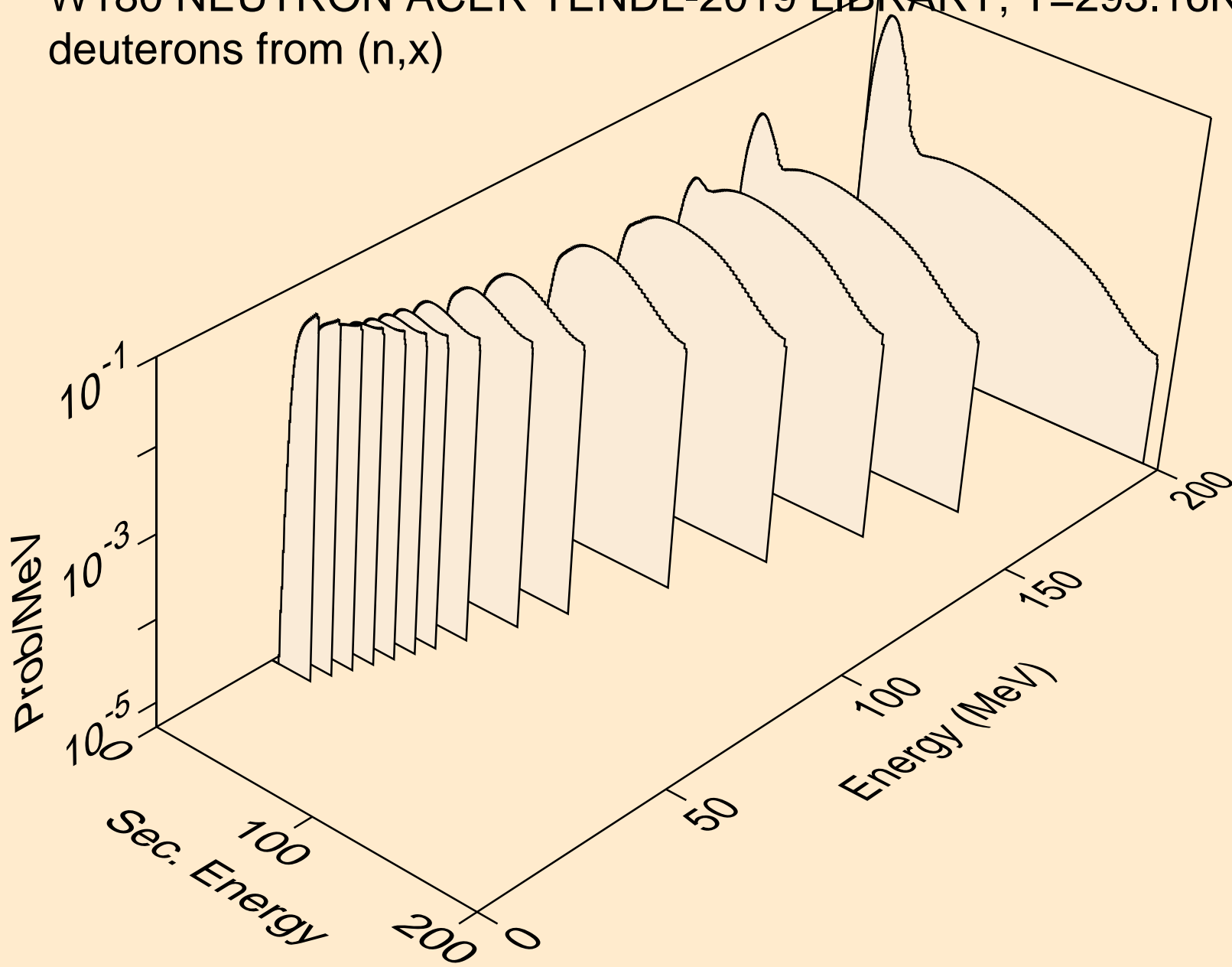

W180 NEUTRON ACER TENDL-2019 LIBRARY; T=293.16K
deuterons from (n,2nd)

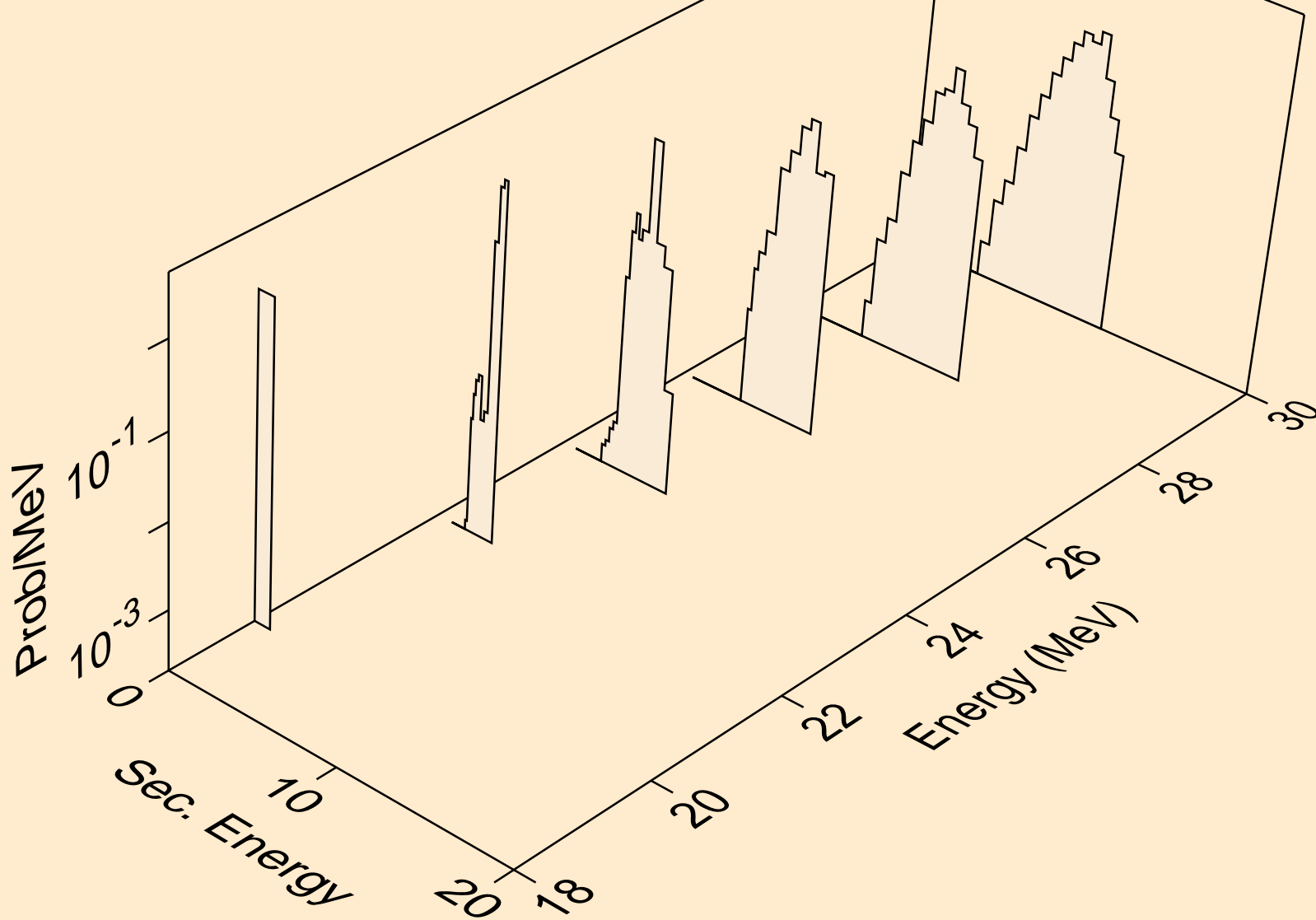

W180 NEUTRON ACER TENDL-2019 LIBRARY; T=293.16K
deuterons from (n,n*)d

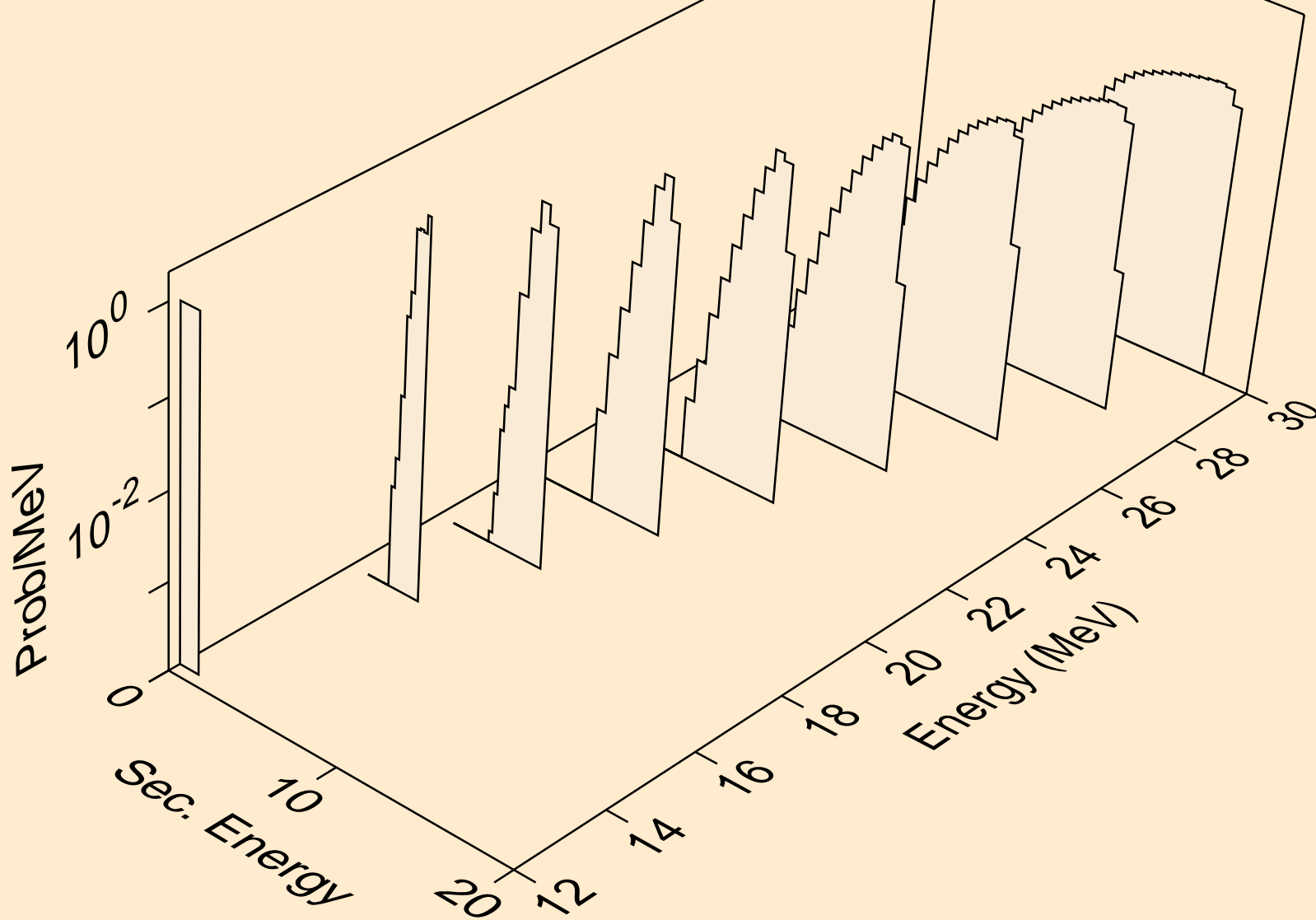

W180 NEUTRON ACER TENDL-2019 LIBRARY; T=293.16K
deuterons from (n,d)

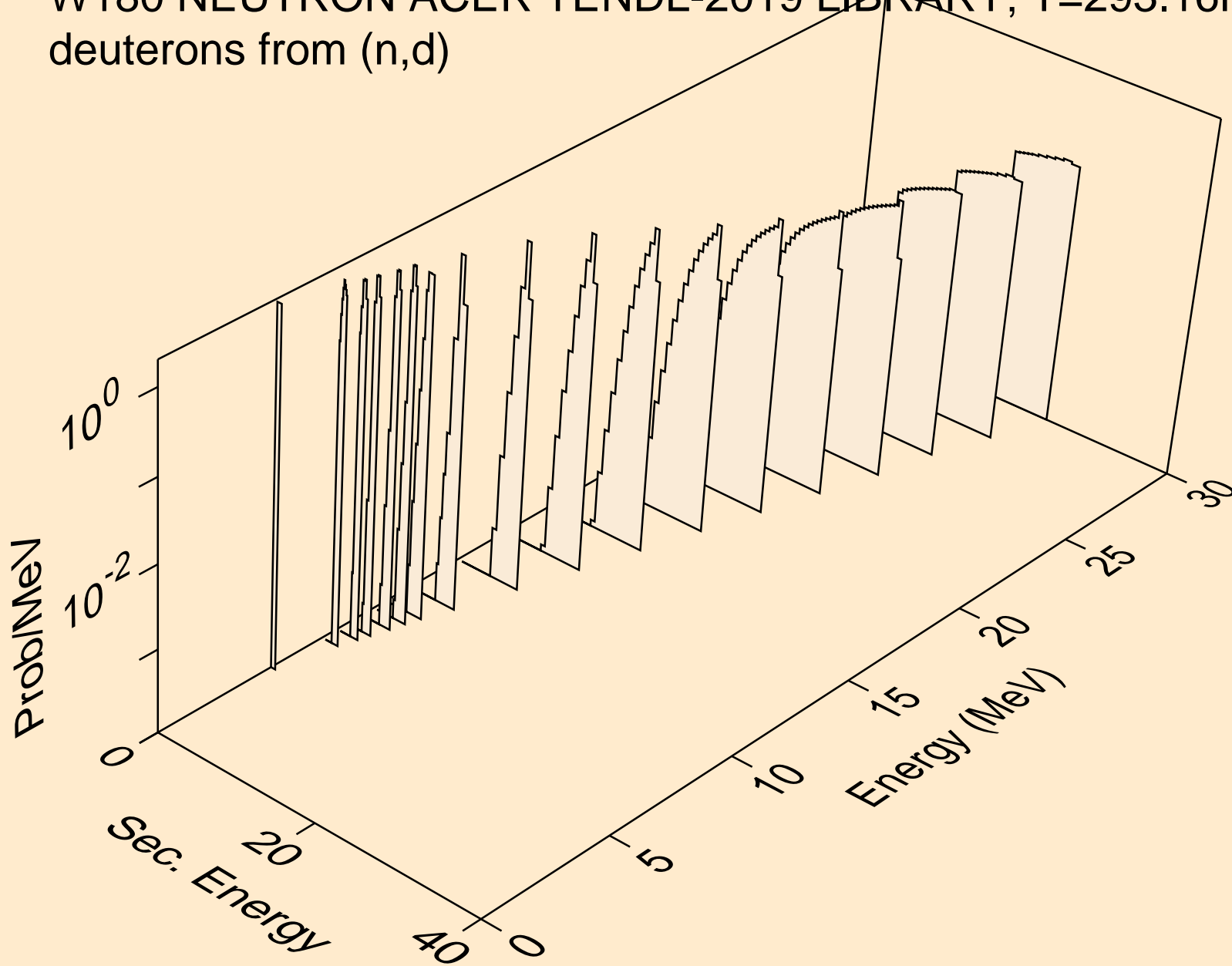

W180 NEUTRON ACER TENDL-2019 LIBRARY; T=293.16K
deuterons from (n,pd)

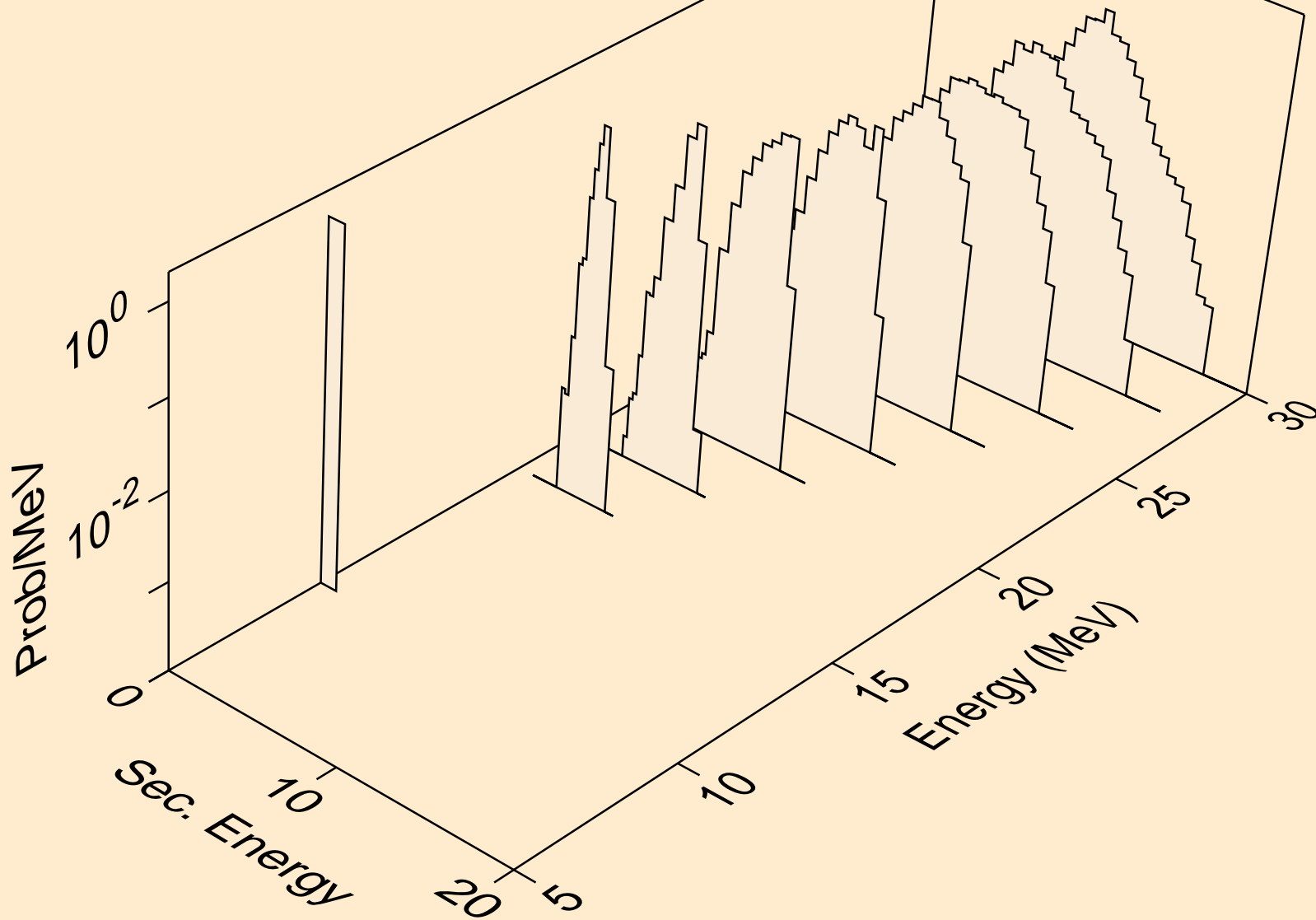

W180 NEUTRON ACER TENDL-2019 LIBRARY; T=293.16K
deuterons from (n,da)

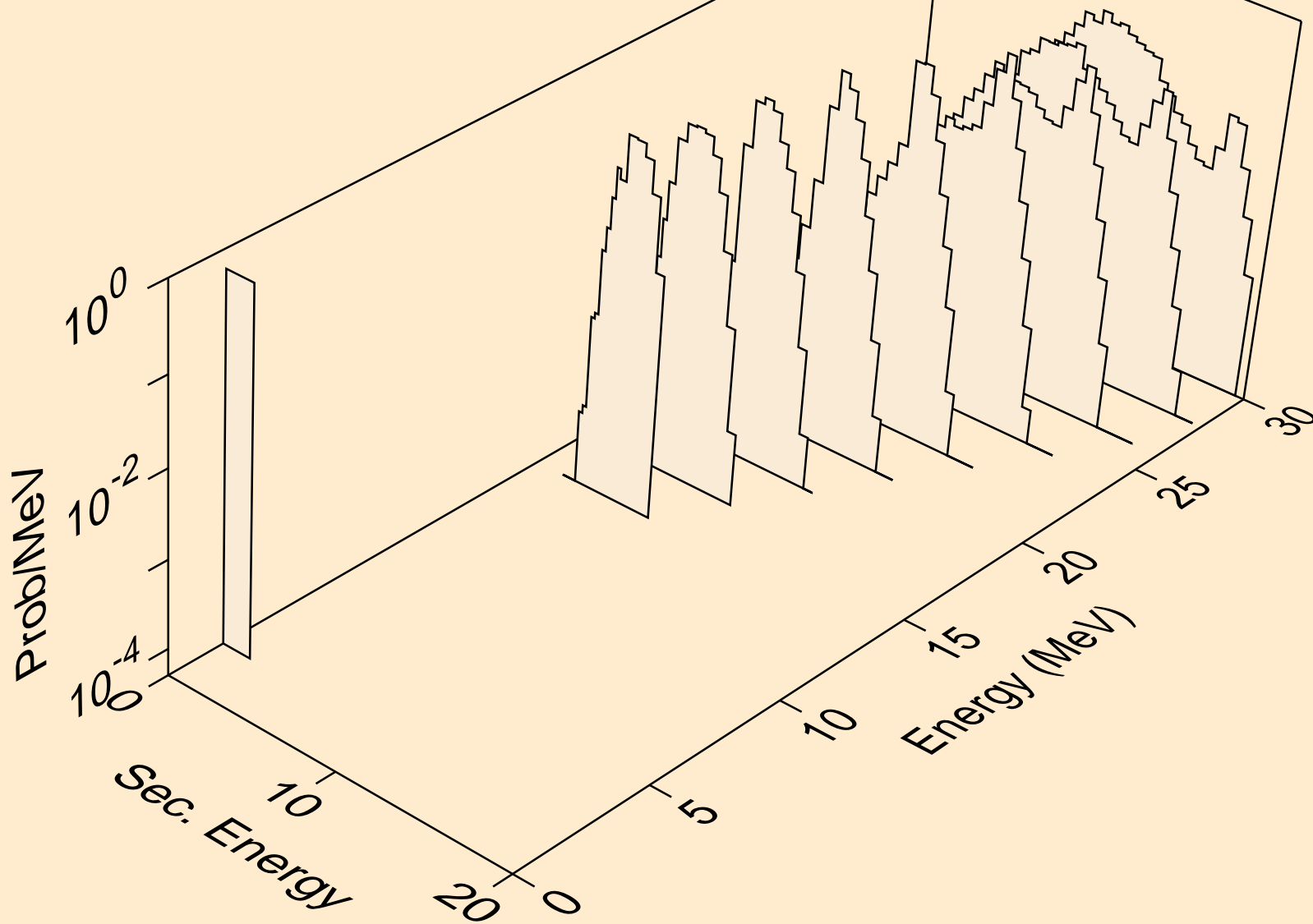

W180 NEUTRON ACER TENDL-2019 LIBRARY; T=293.16K
tritons from (n,x)

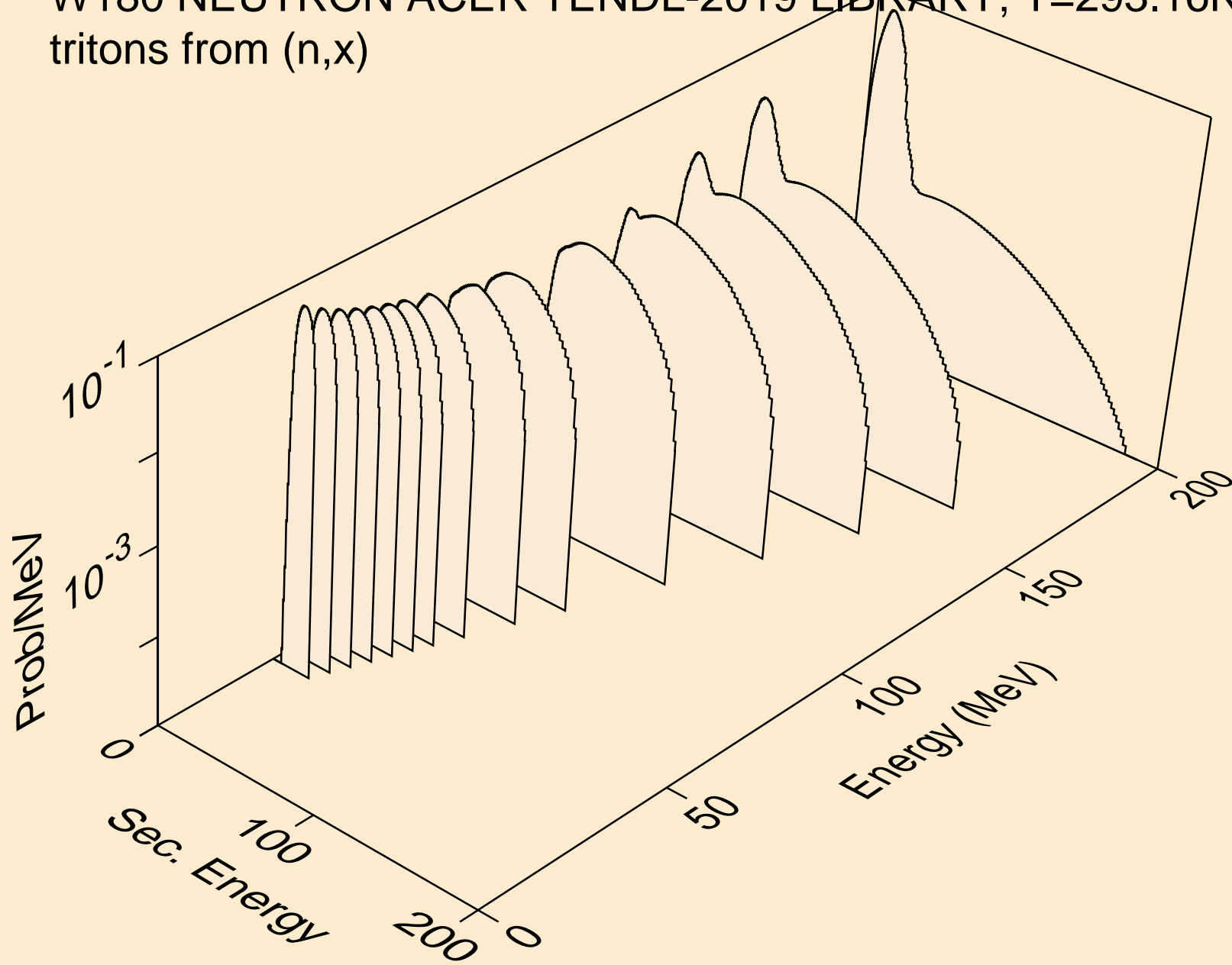

W180 NEUTRON ACER TENDL-2019 LIBRARY; T=293.16K
tritons from (n,n*)t

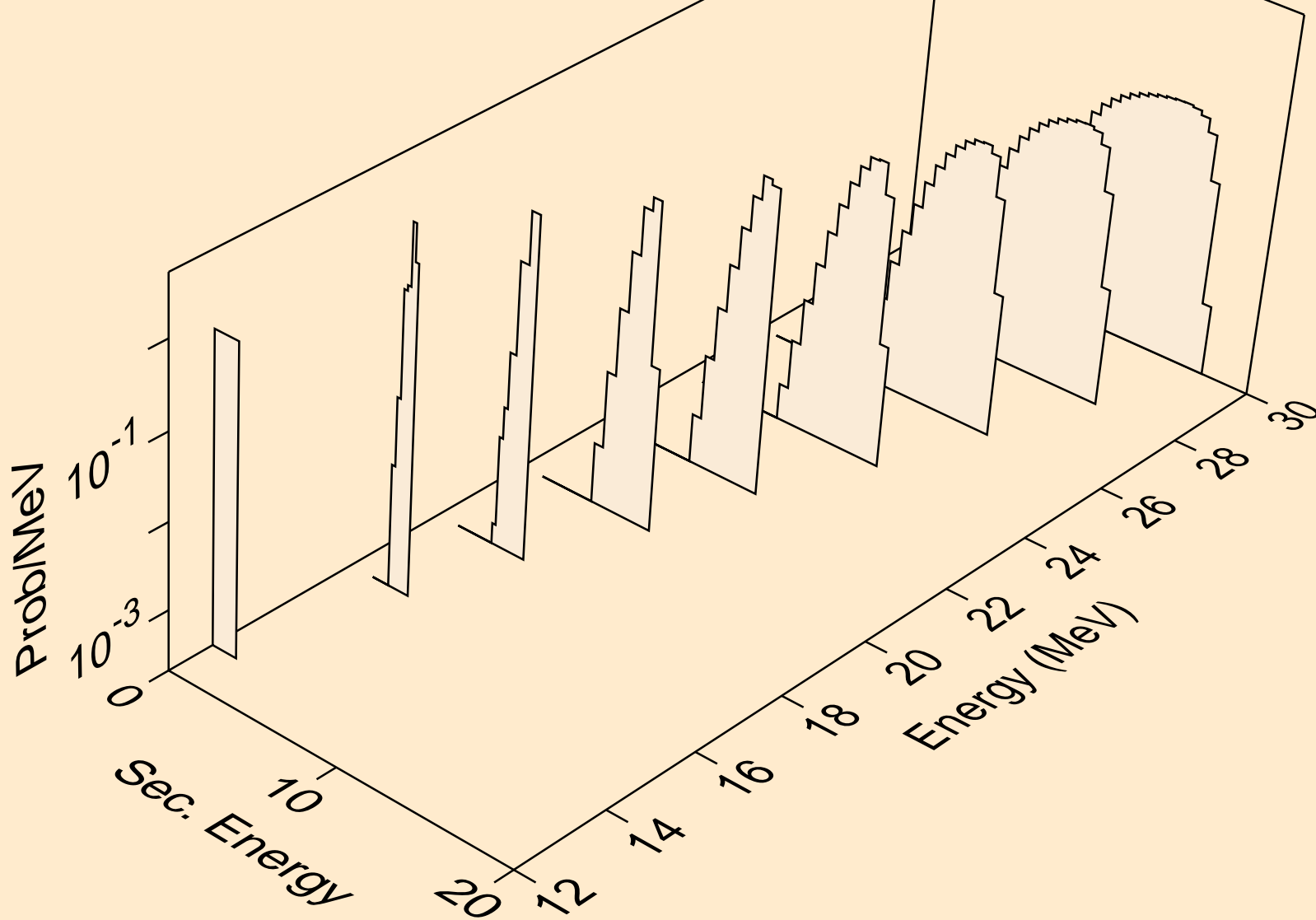

W180 NEUTRON ACER TENDL-2019 LIBRARY; T=293.16K
tritons from (n,t)

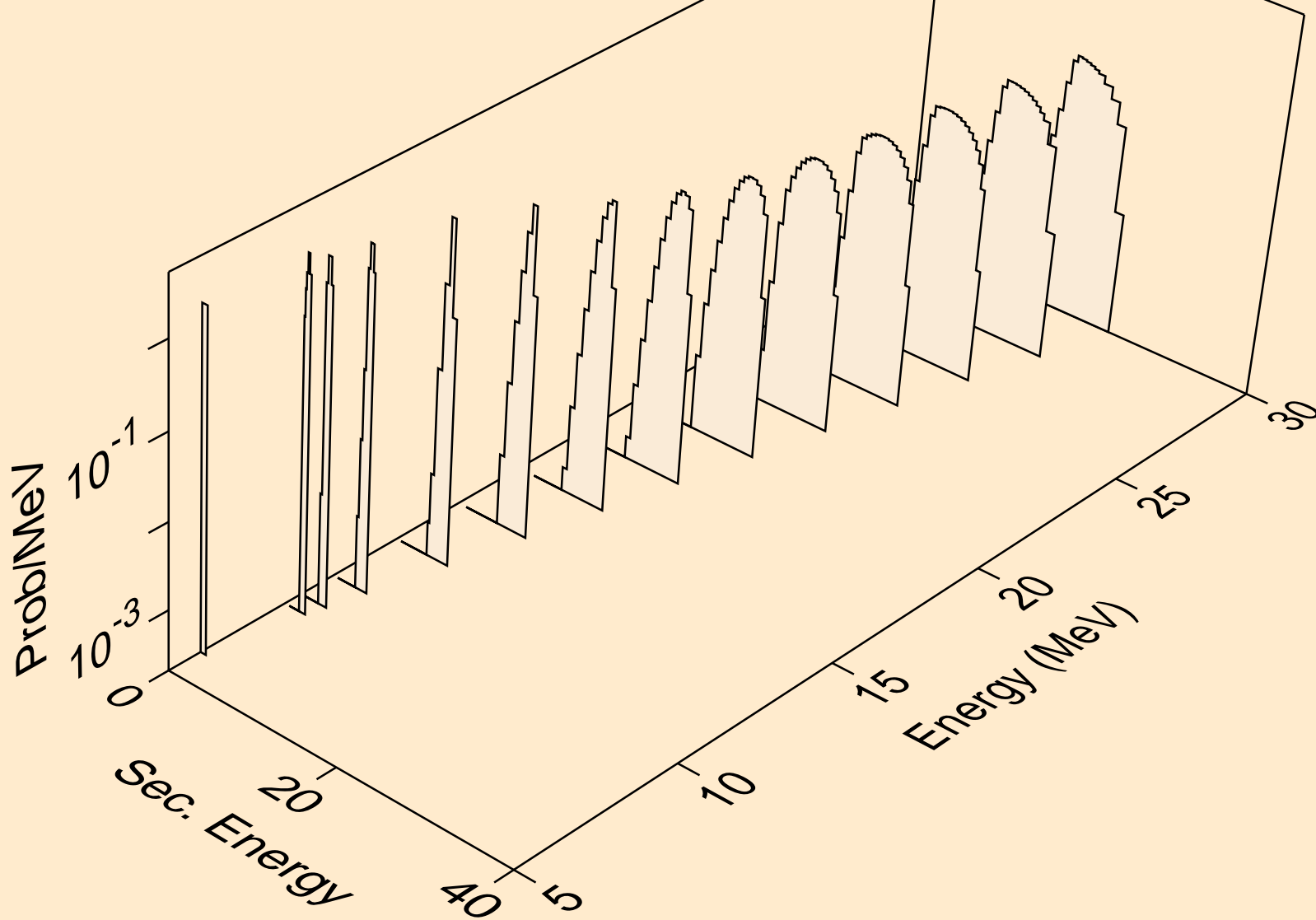

W180 NEUTRON ACER TENDL-2019 LIBRARY; T=293.16K
tritons from (n,pt)

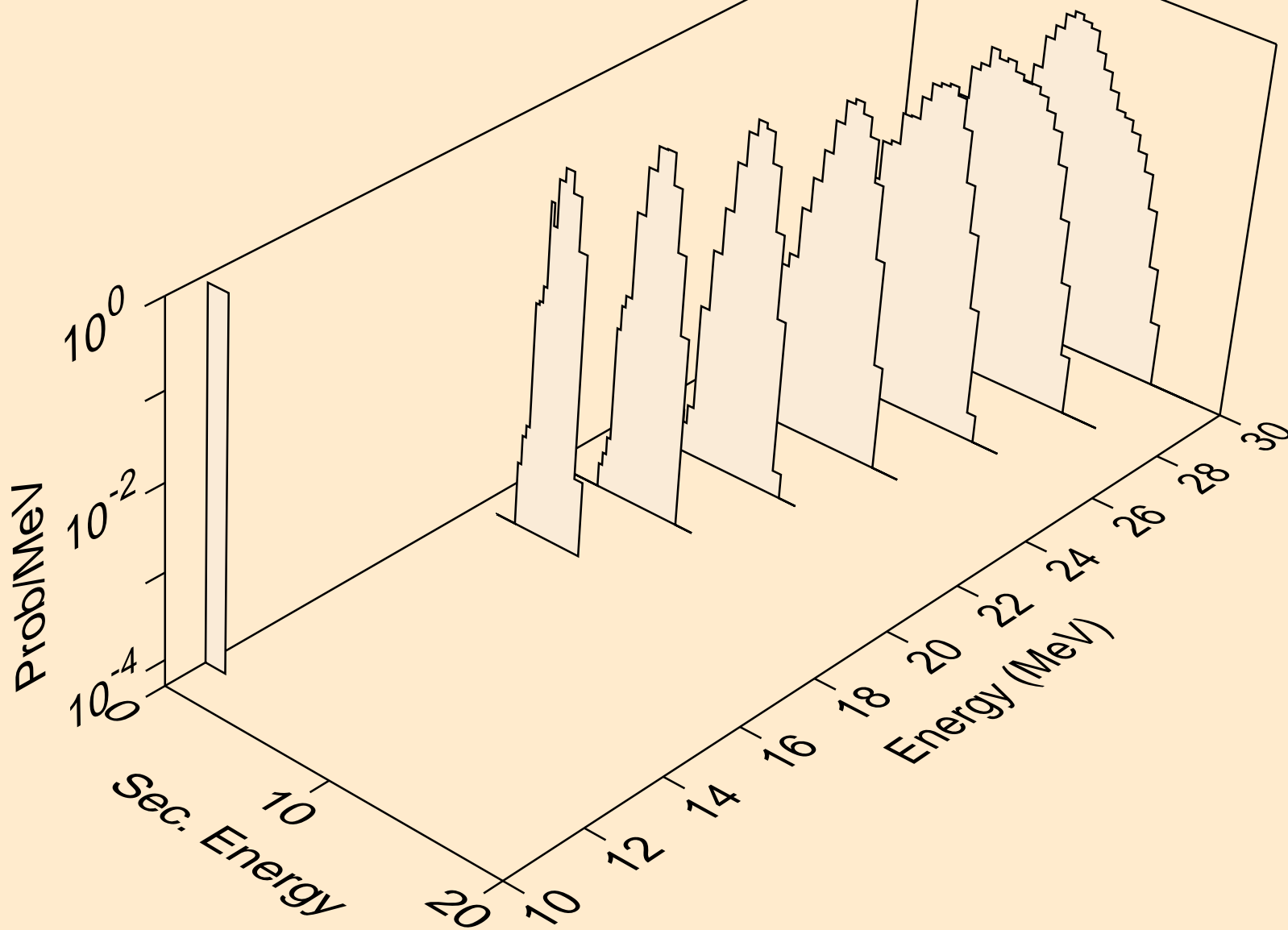

W180 NEUTRON ACER TENDL-2019 LIBRARY; T=293.16K
he3s from (n,x)

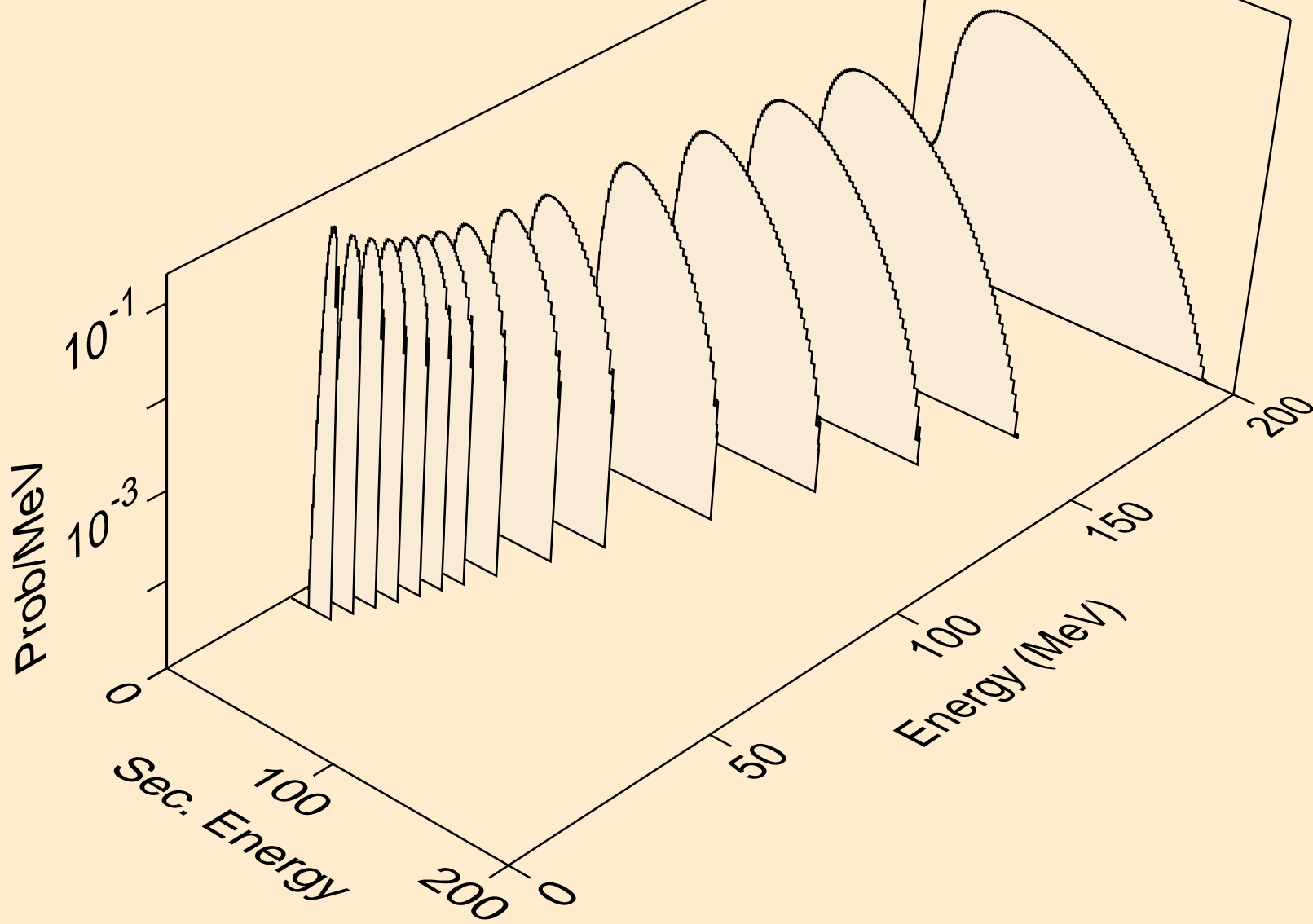

W180 NEUTRON ACER TENDL-2019 LIBRARY; T=293.16K
he3s from (n,n*)he3

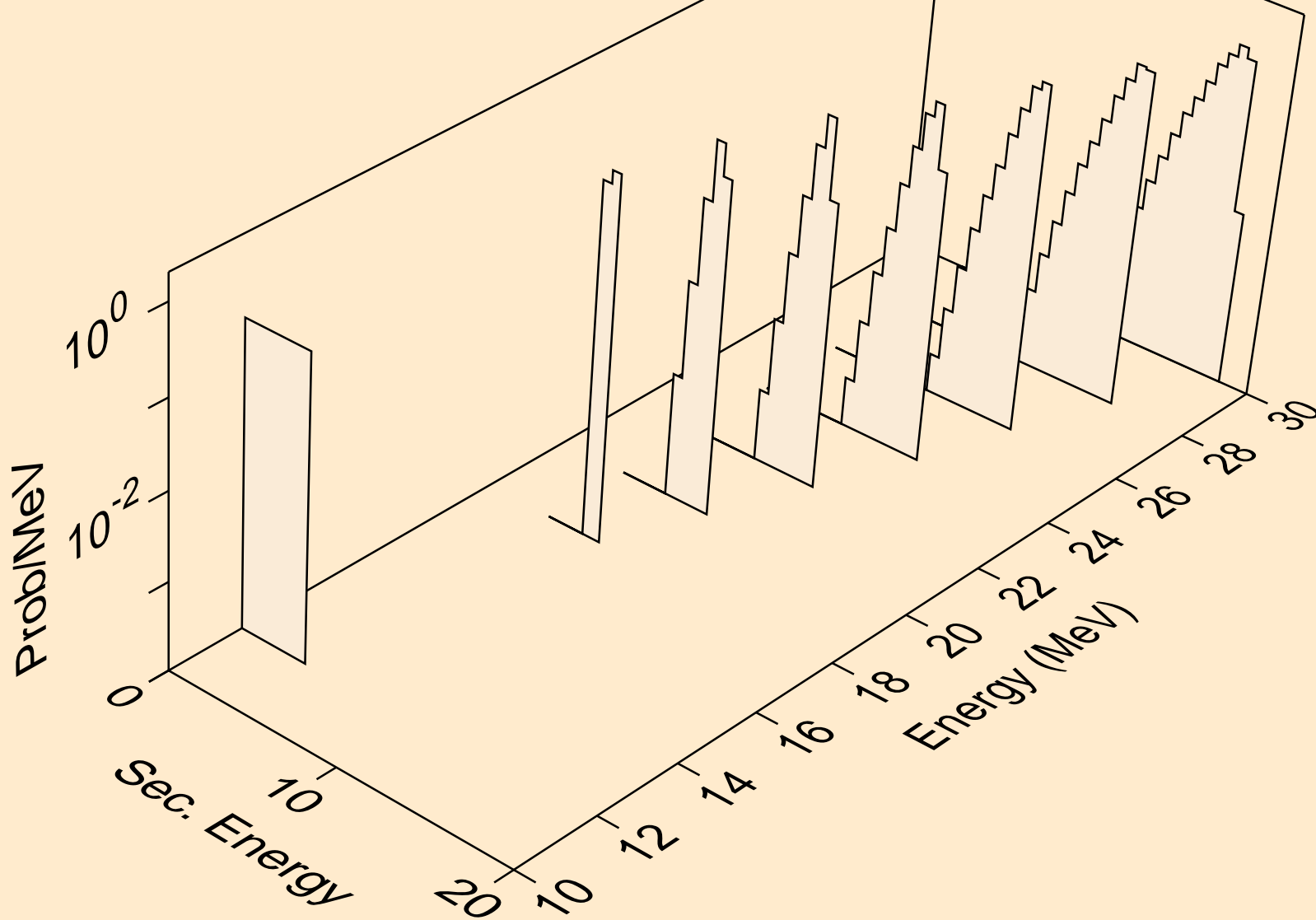

W180 NEUTRON ACER TENDL-2019 LIBRARY; T=293.16K
he3s from (n,he3)

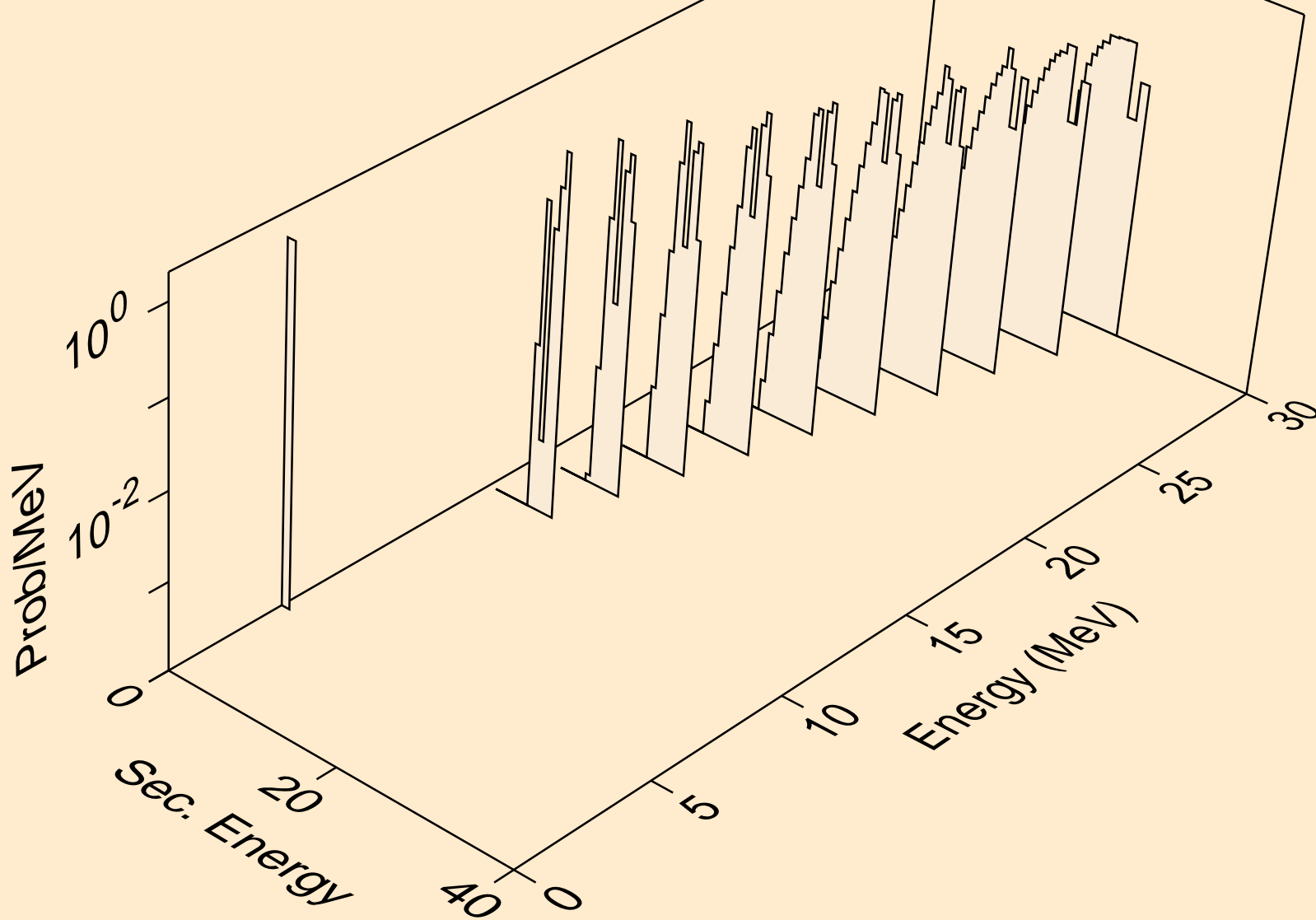

W180 NEUTRON ACER TENDL-2019 LIBRARY; T=293.16K
alphas from (n,x)

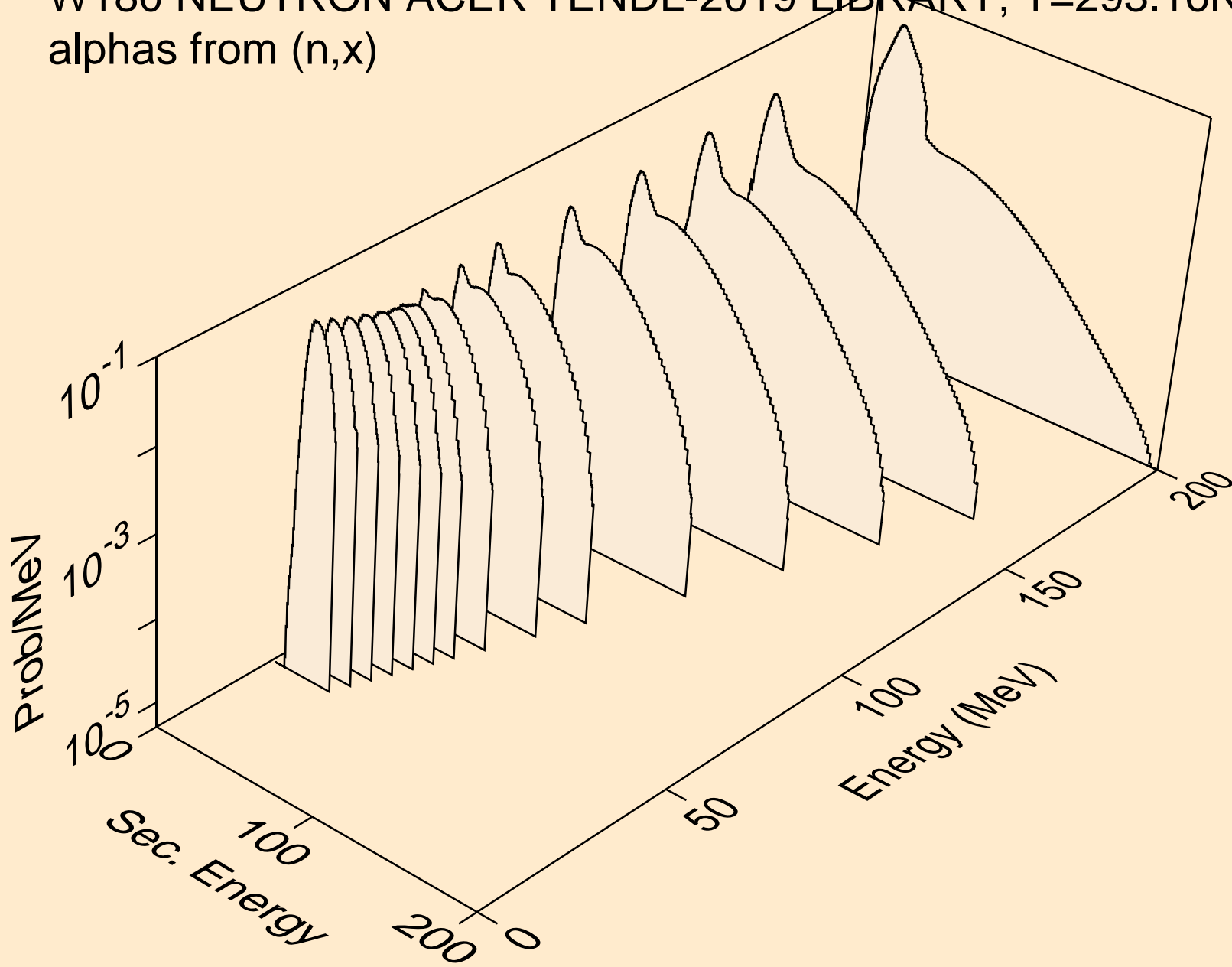

W180 NEUTRON ACER TENDL-2019 LIBRARY; T=293.16K
alphas from (n,n*)a

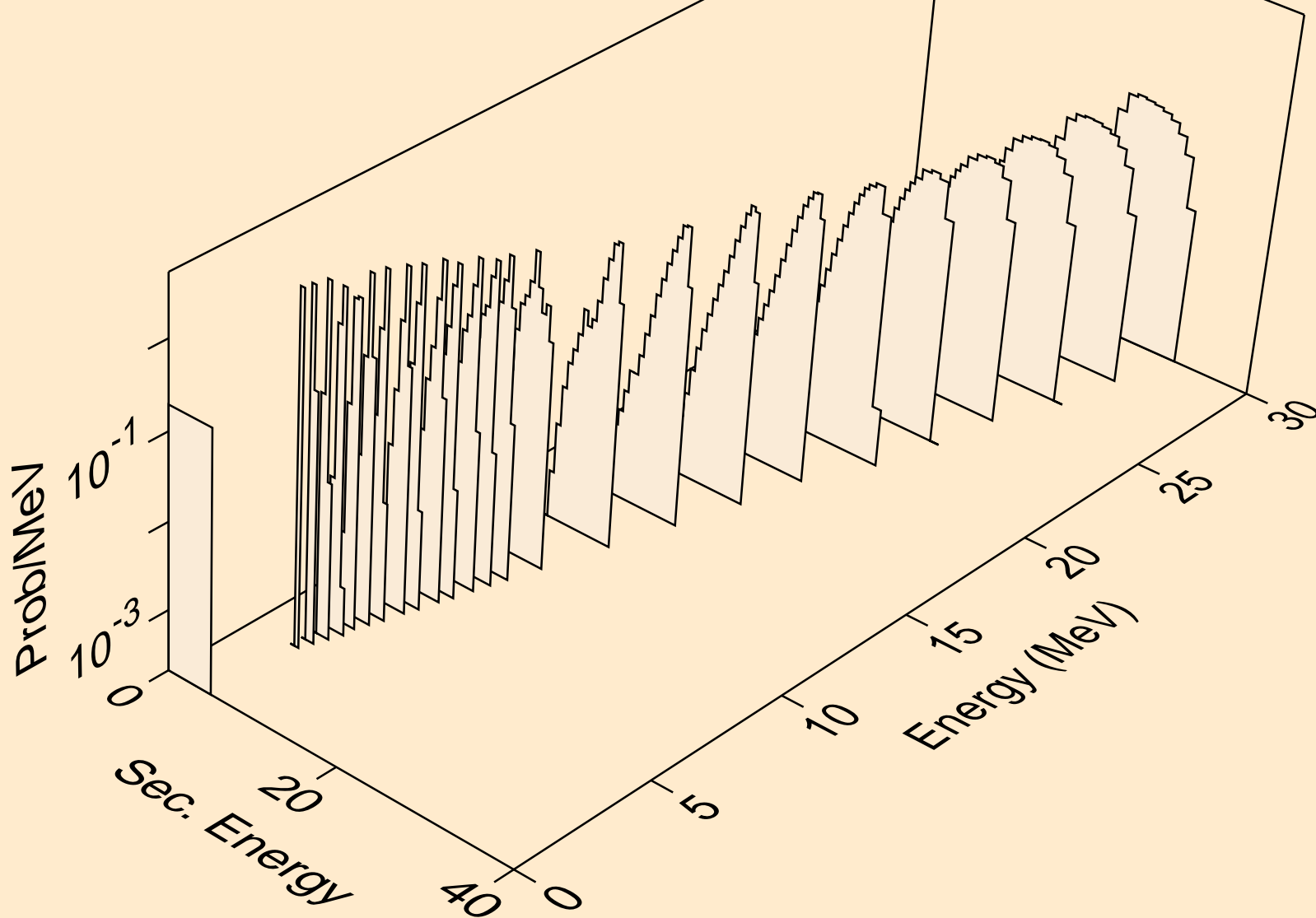

W180 NEUTRON ACER TENDL-2019 LIBRARY; T=293.16K
alphas from (n,2n)a

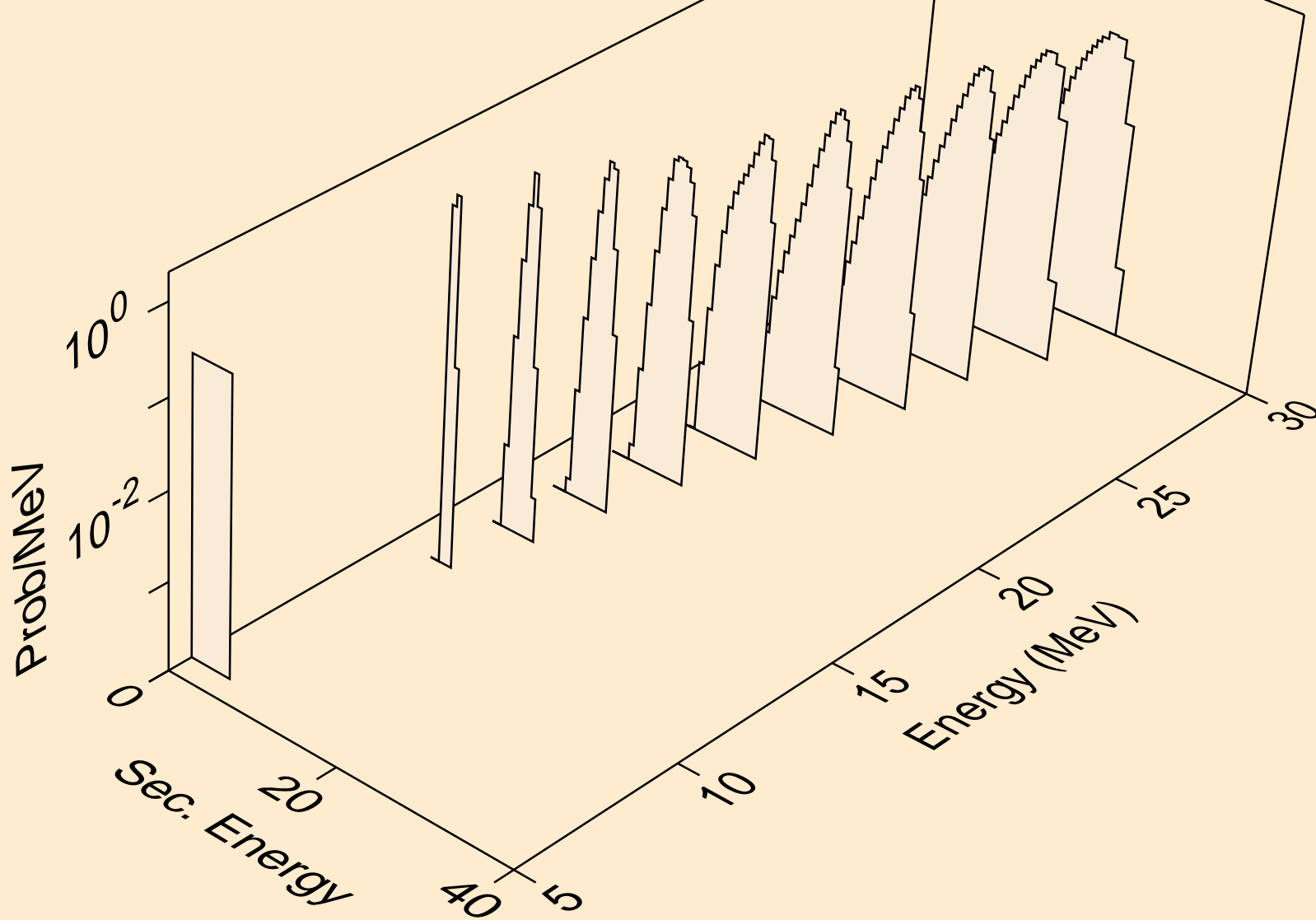

W180 NEUTRON ACER TENDL-2019 LIBRARY; T=293.16K
alphas from (n,3n)a

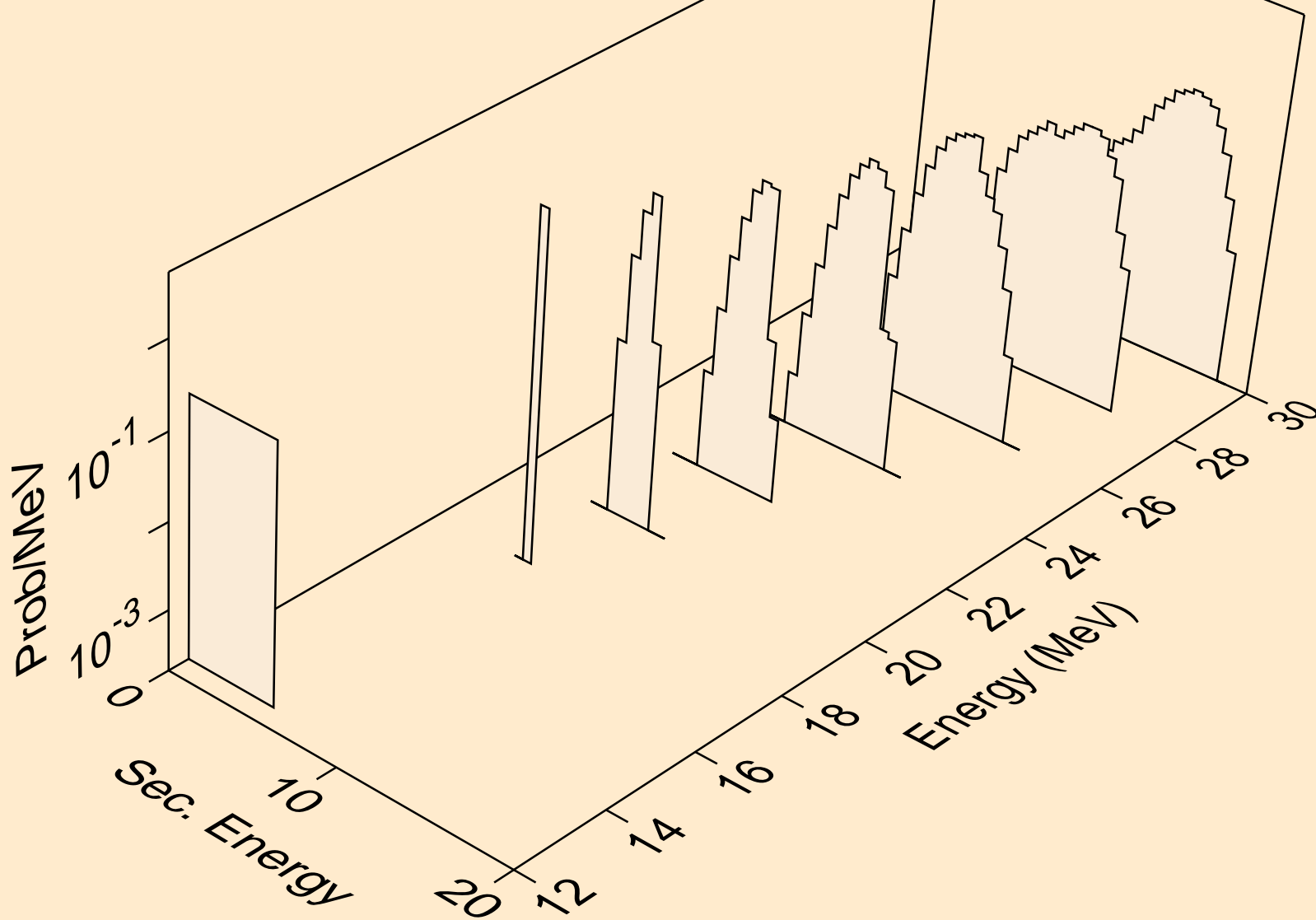

W180 NEUTRON ACER TENDL-2019 LIBRARY; T=293.16K
alphas from (n,n*)2a

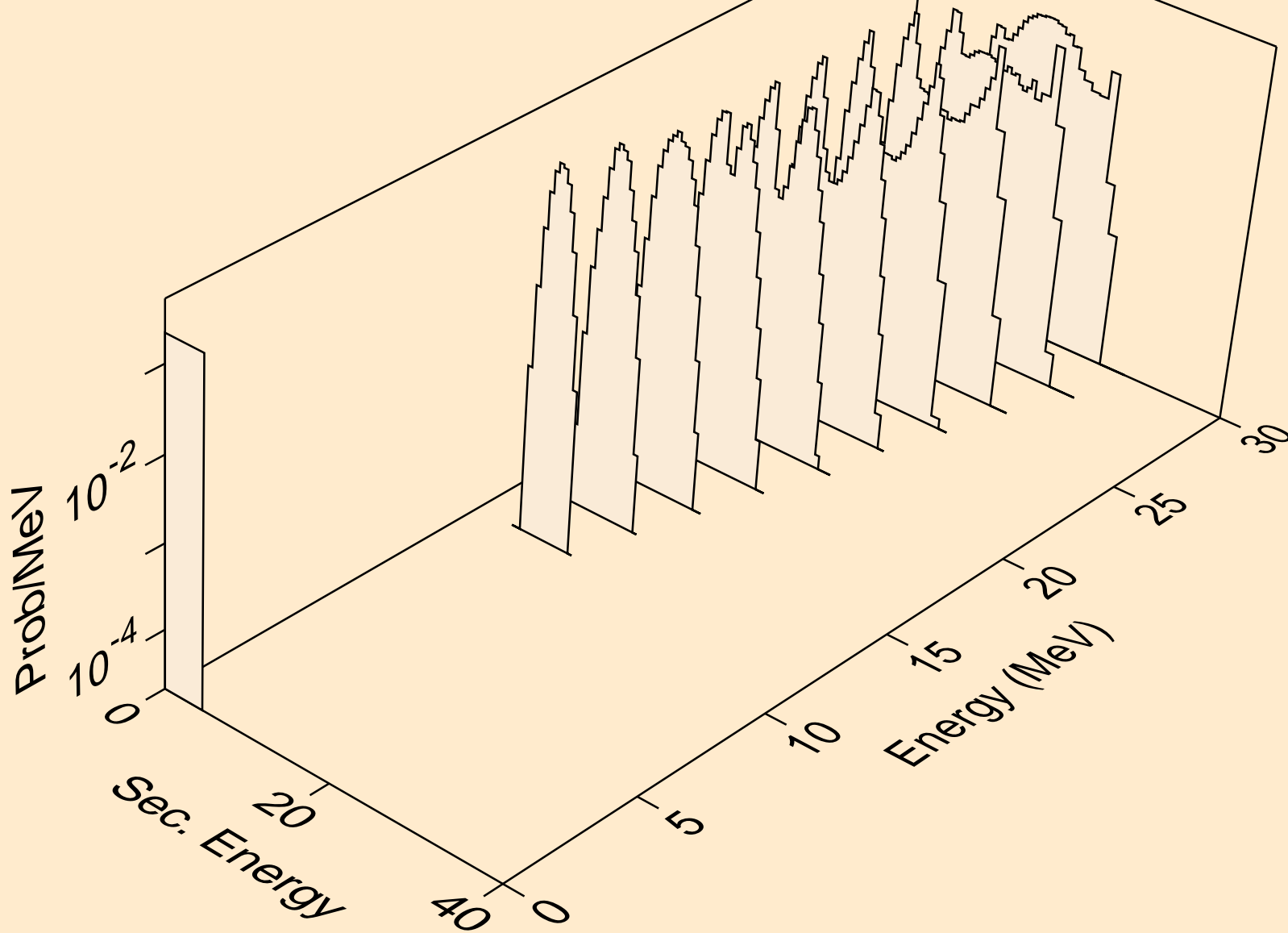

W180 NEUTRON ACER TENDL-2019 LIBRARY; T=293.16K
alphas from (n,npa)

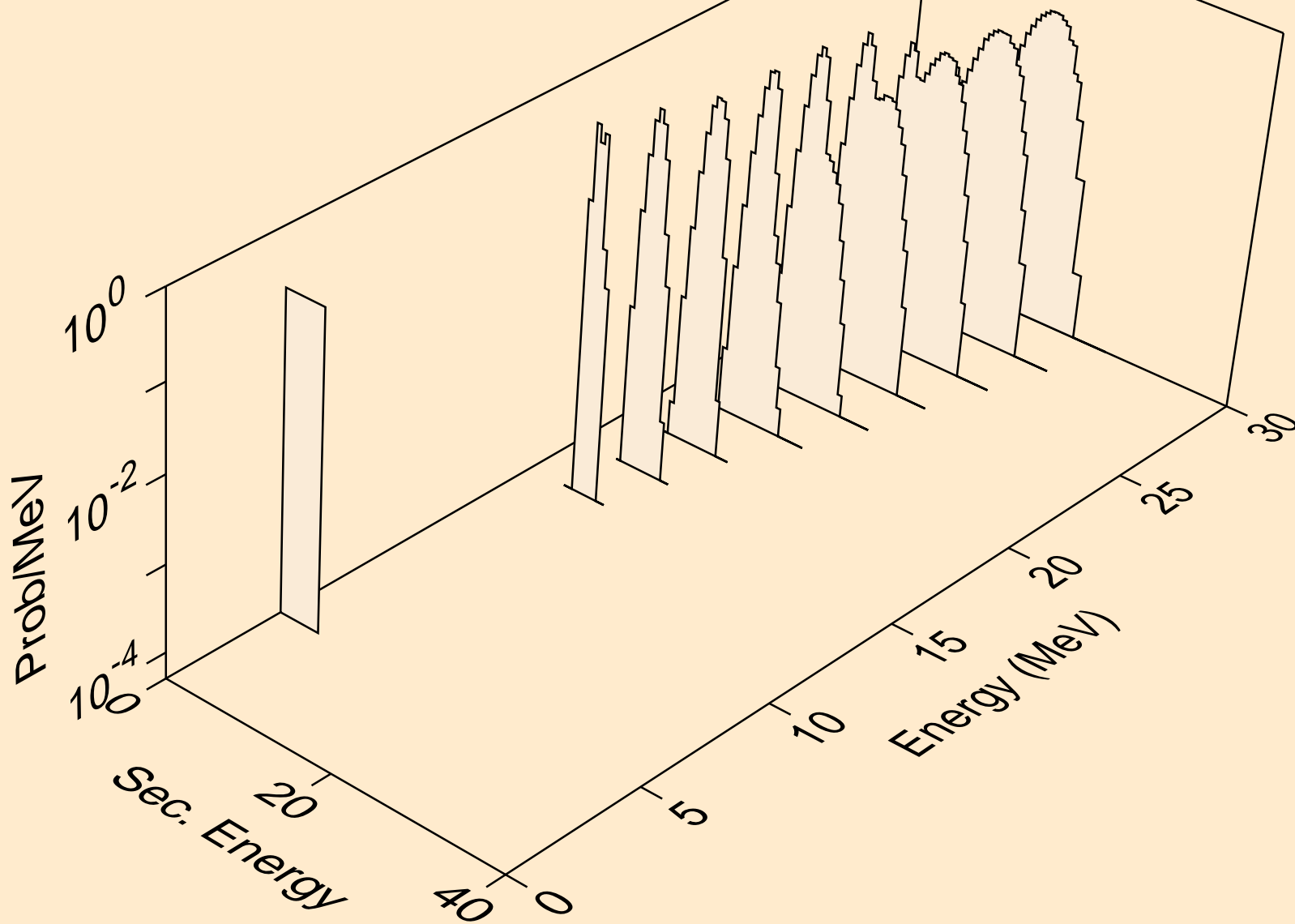

W180 NEUTRON ACER TENDL-2019 LIBRARY; T=293.16K
alphas from (n,a)

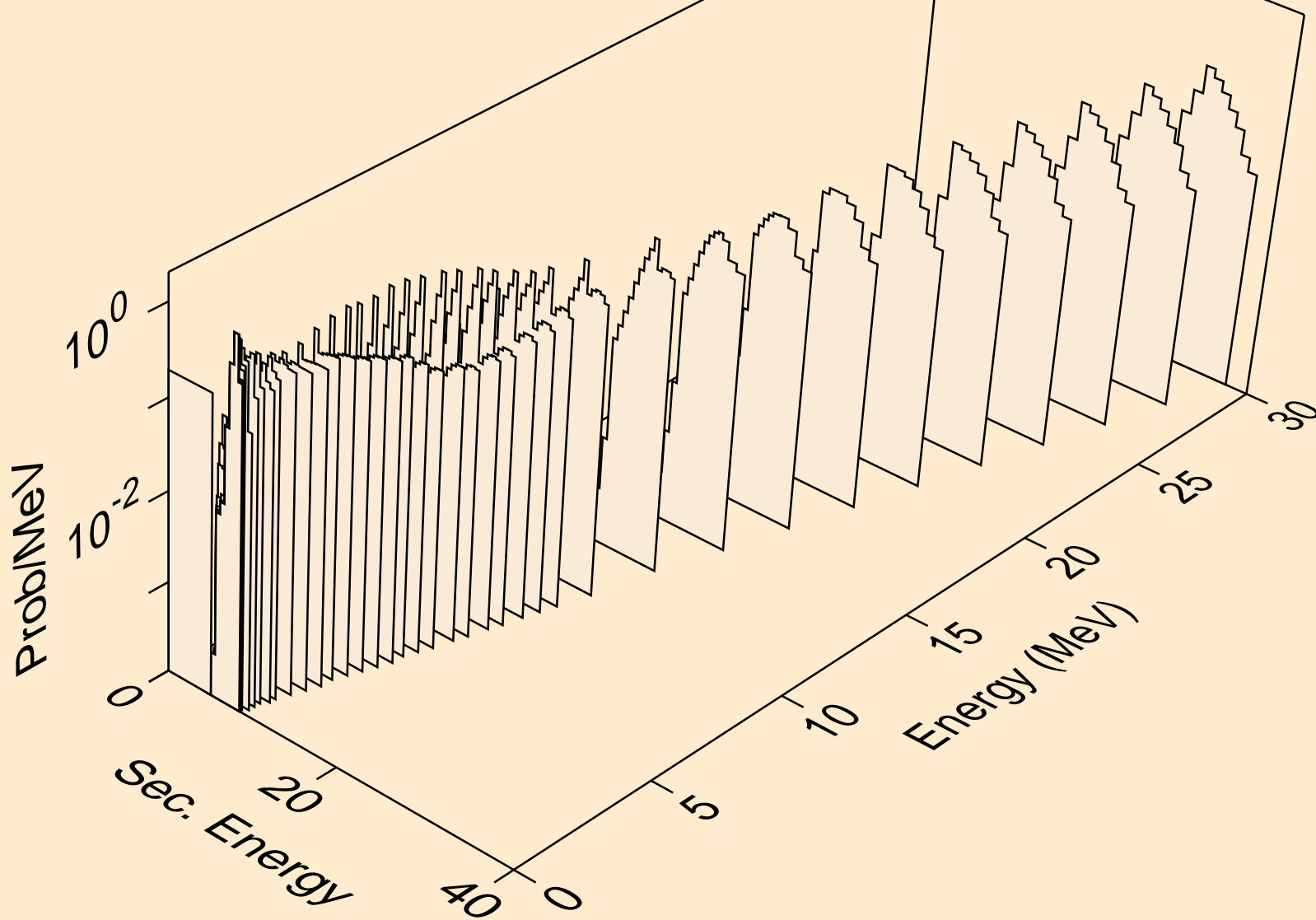

W180 NEUTRON ACER TENDL-2019 LIBRARY; T=293.16K
alphas from (n,2a)

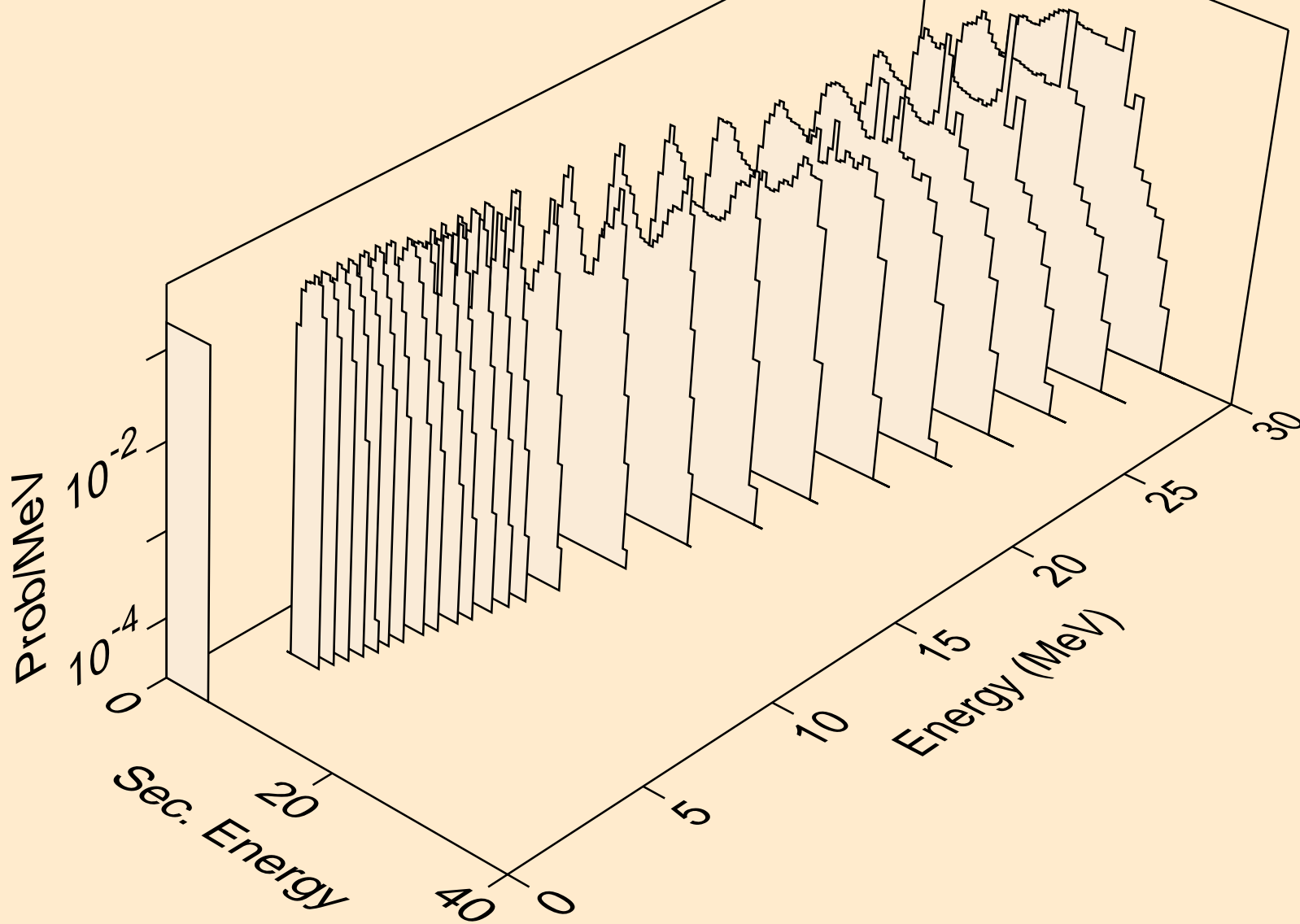

W180 NEUTRON ACER TENDL-2019 LIBRARY; T=293.16K
alphas from (n,pa)

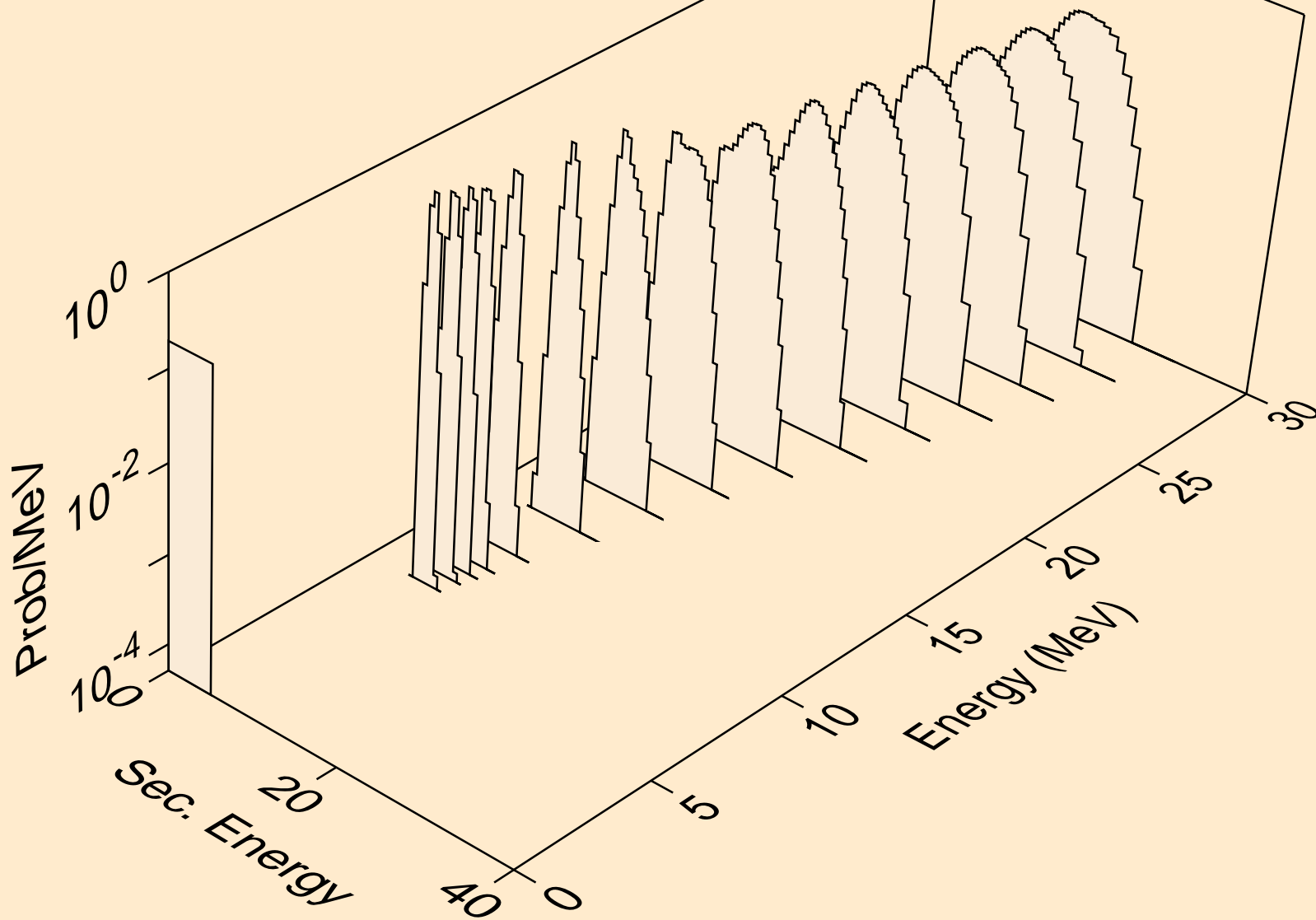

W180 NEUTRON ACER TENDL-2019 LIBRARY; T=293.16K
alphas from (n,da)

