

Y080M NEUTRON ACER TENDL-2019 LIBRARY; T=293.16K
Principal cross sections

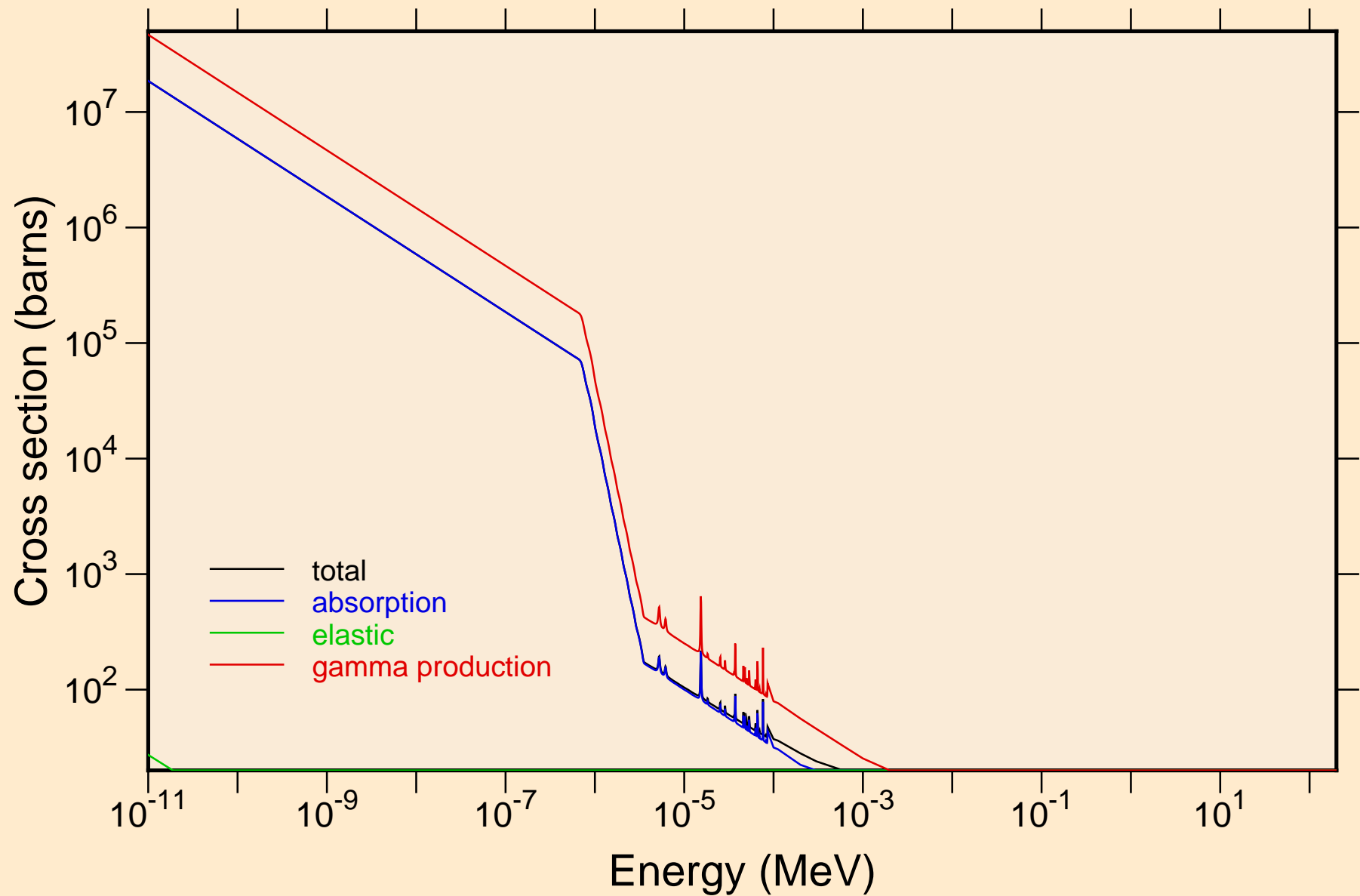

Y080M NEUTRON ACER TENDL-2019 LIBRARY; T=293.16K
resonance total cross section

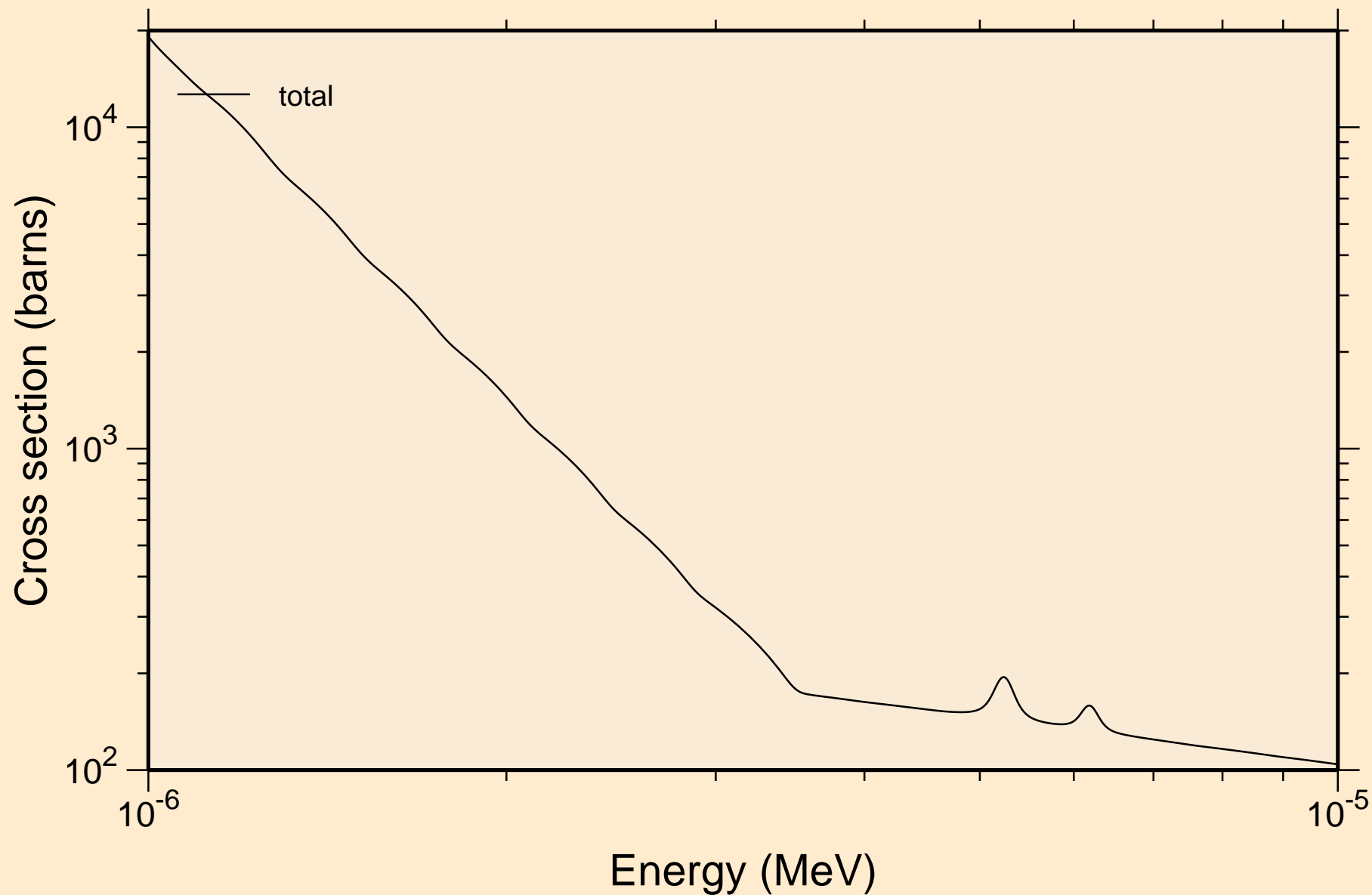

Y080M NEUTRON ACER TENDL-2019 LIBRARY; T=293.16K
resonance total cross section

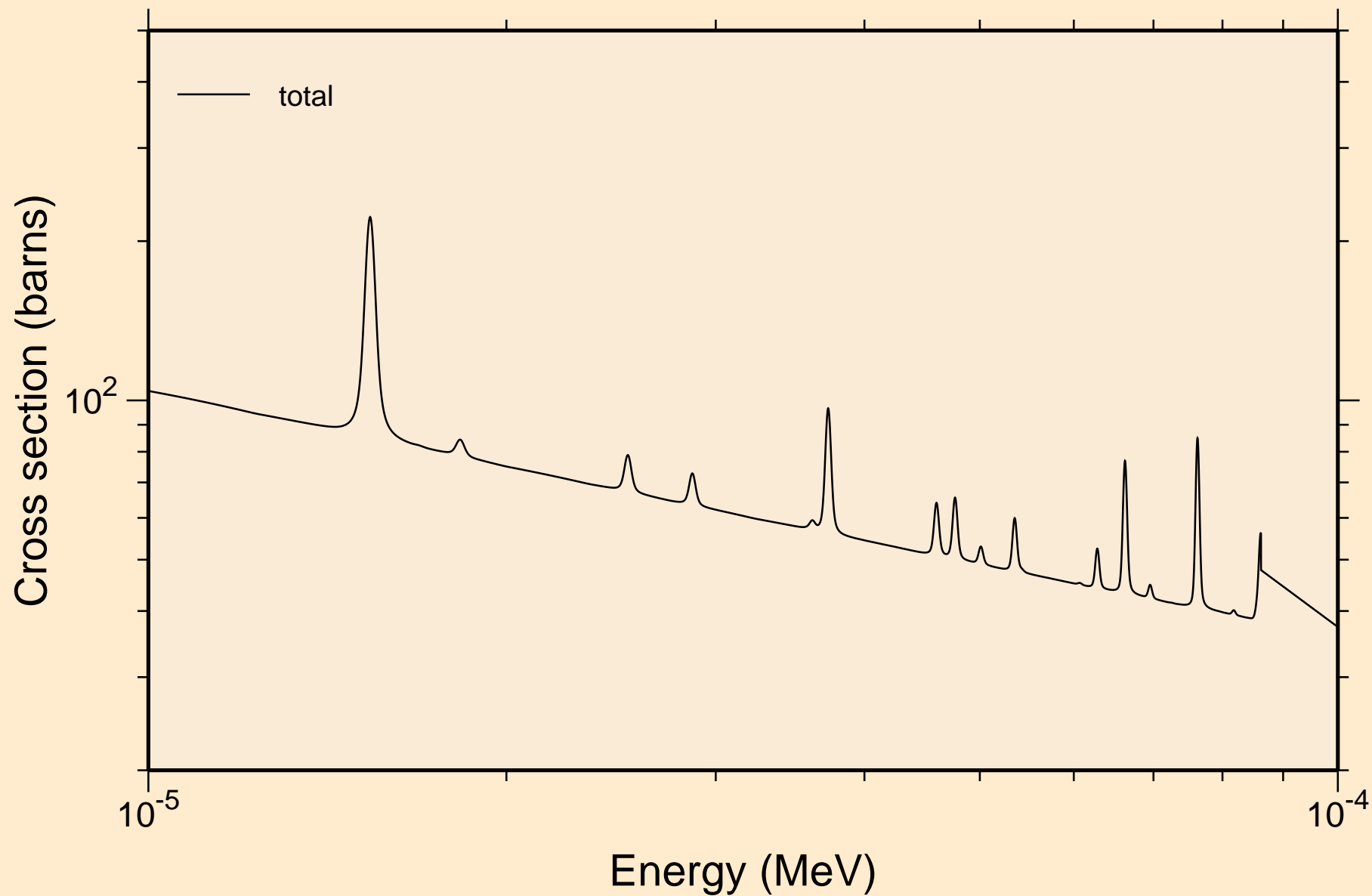

Y080M NEUTRON ACER TENDL-2019 LIBRARY; T=293.16K
resonance total cross section

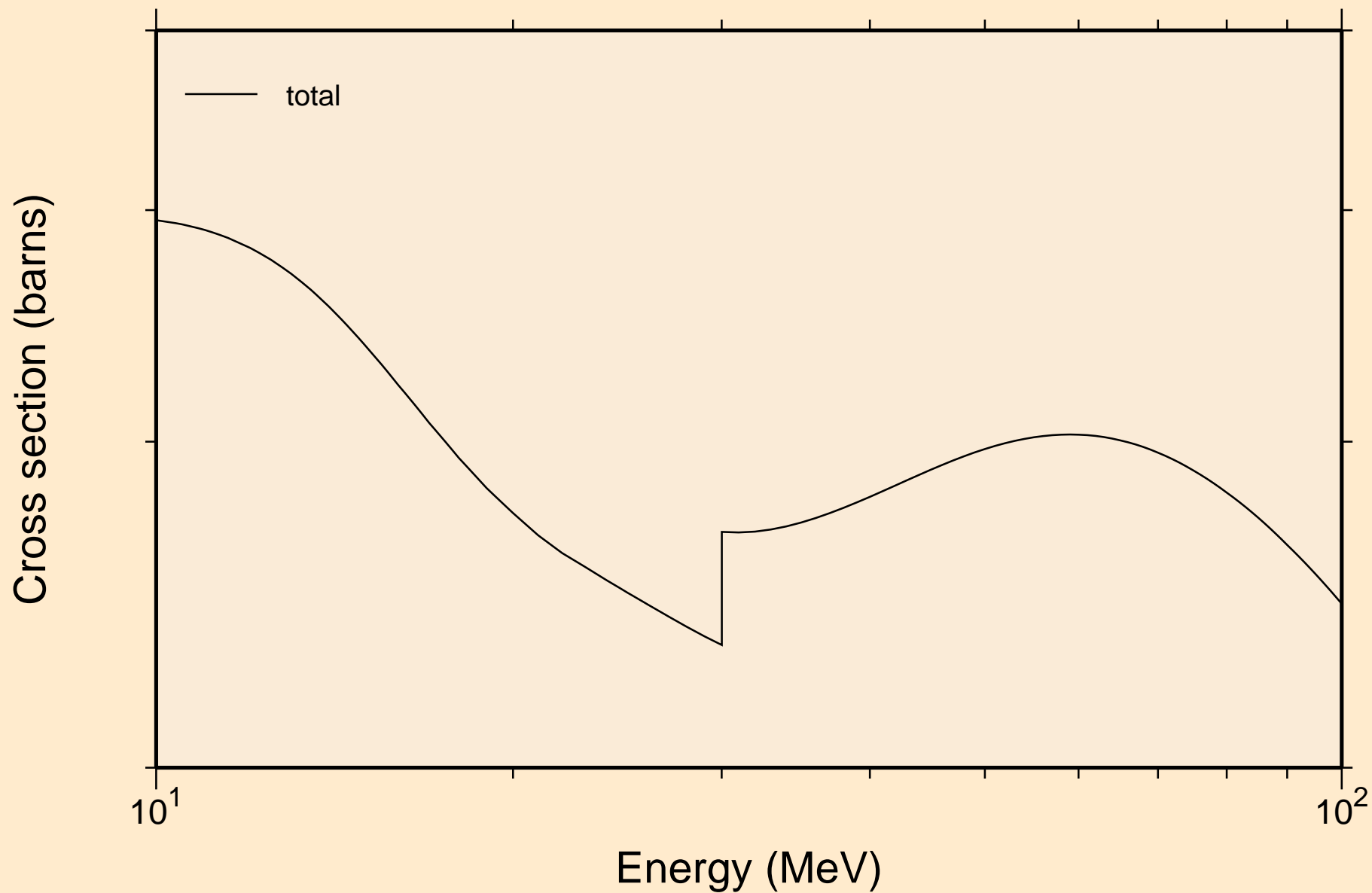

Y080M NEUTRON ACER TENDL-2019 LIBRARY; T=293.16K
resonance absorption cross sections

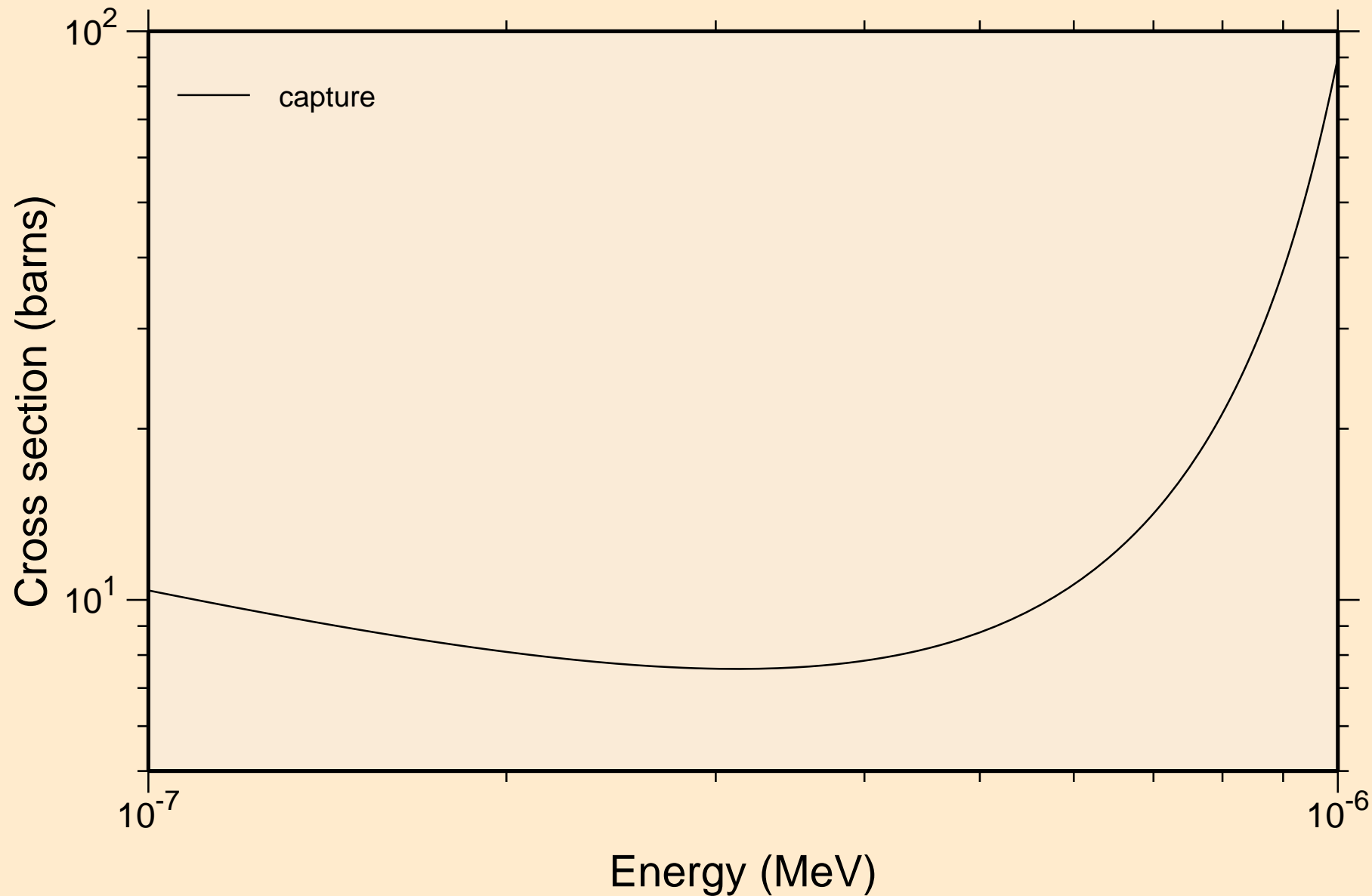

Y080M NEUTRON ACER TENDL-2019 LIBRARY; T=293.16K
resonance absorption cross sections

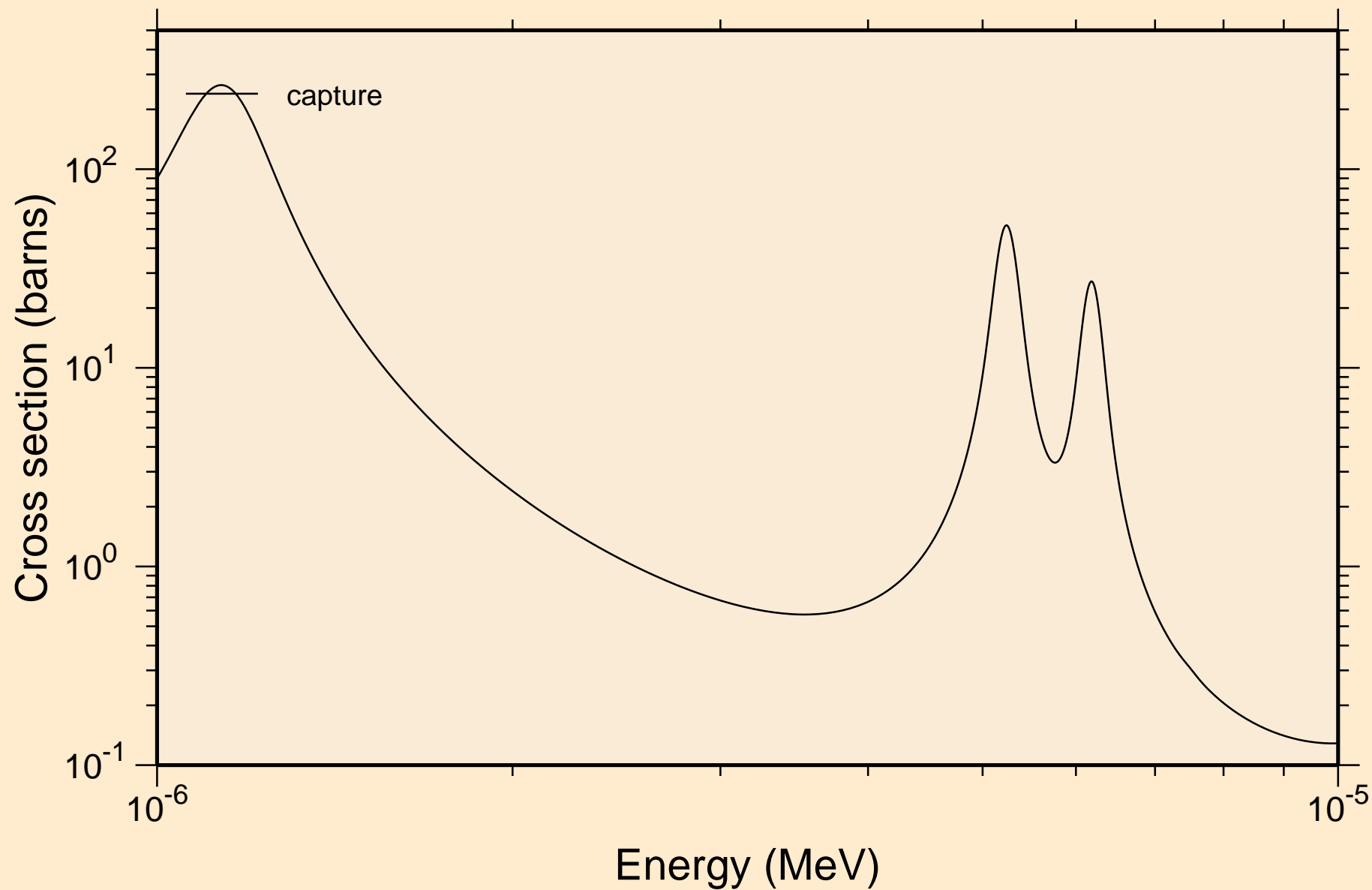

Y080M NEUTRON ACER TENDL-2019 LIBRARY; T=293.16K
resonance absorption cross sections

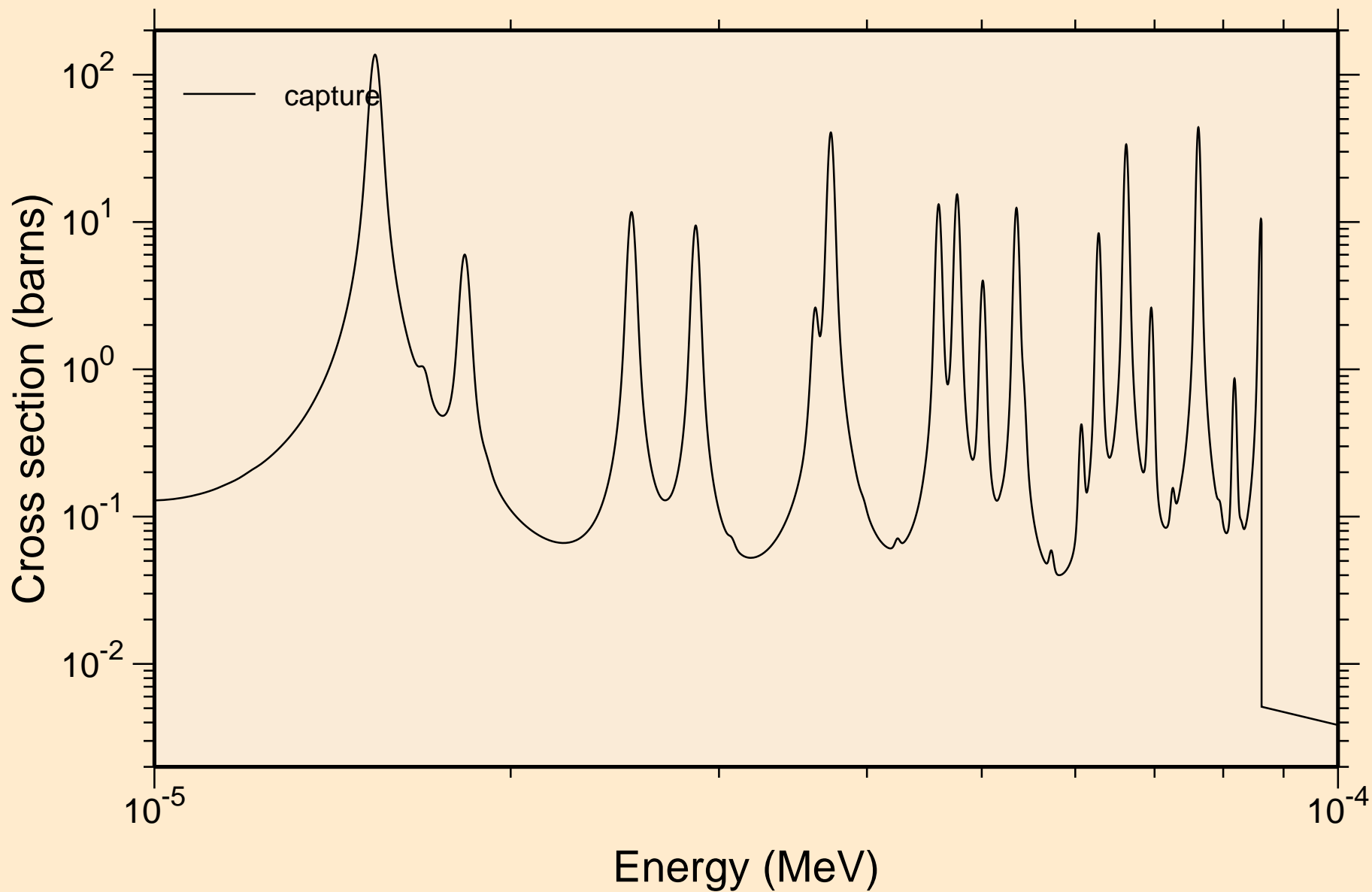

Y080M NEUTRON ACER TENDL-2019 LIBRARY; T=293.16K
resonance absorption cross sections

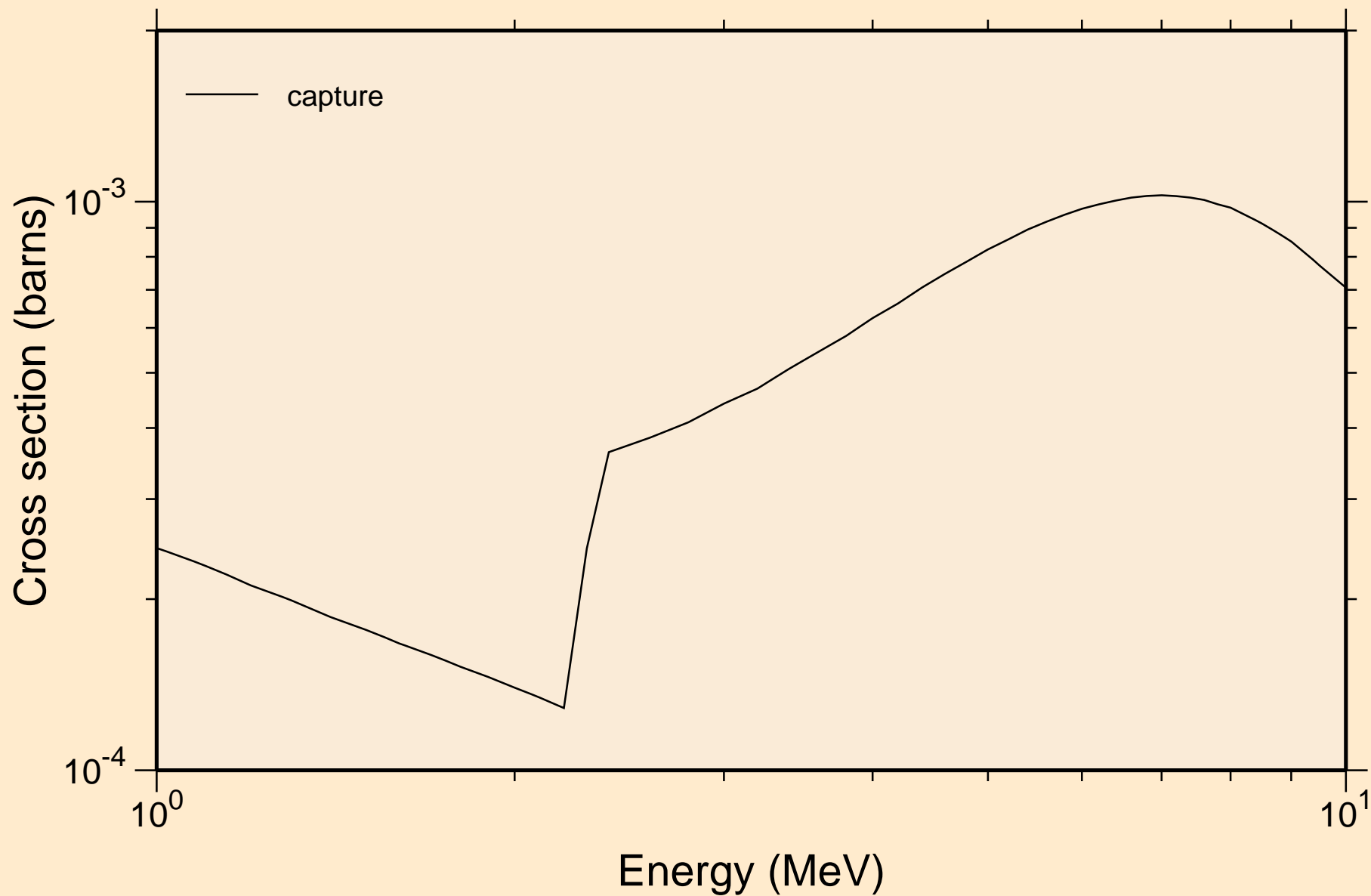

Y080M NEUTRON ACER TENDL-2019 LIBRARY; T=293.16K
Heating

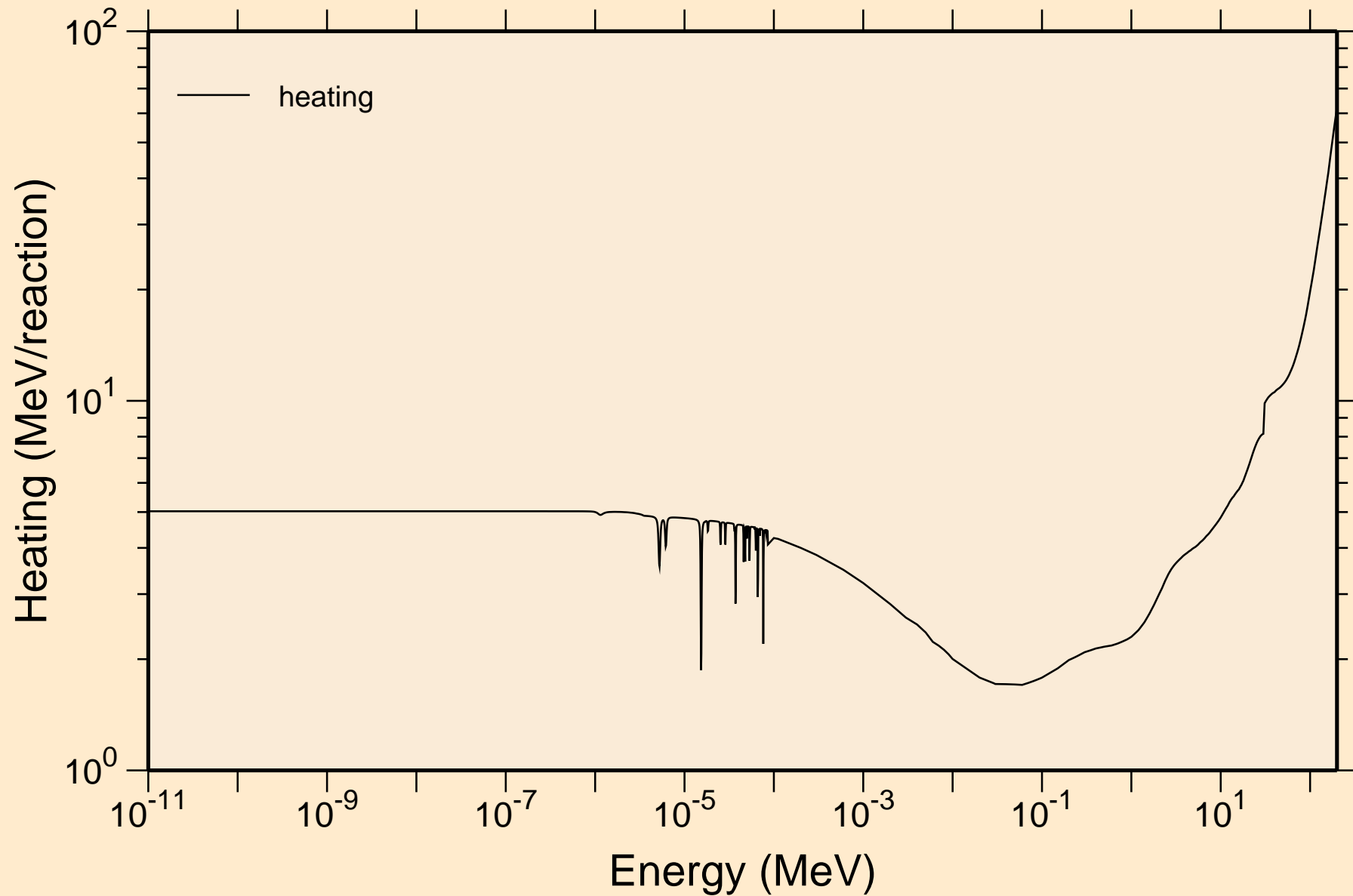

Y080M NEUTRON ACER TENDL-2019 LIBRARY; T=293.16K
Damage

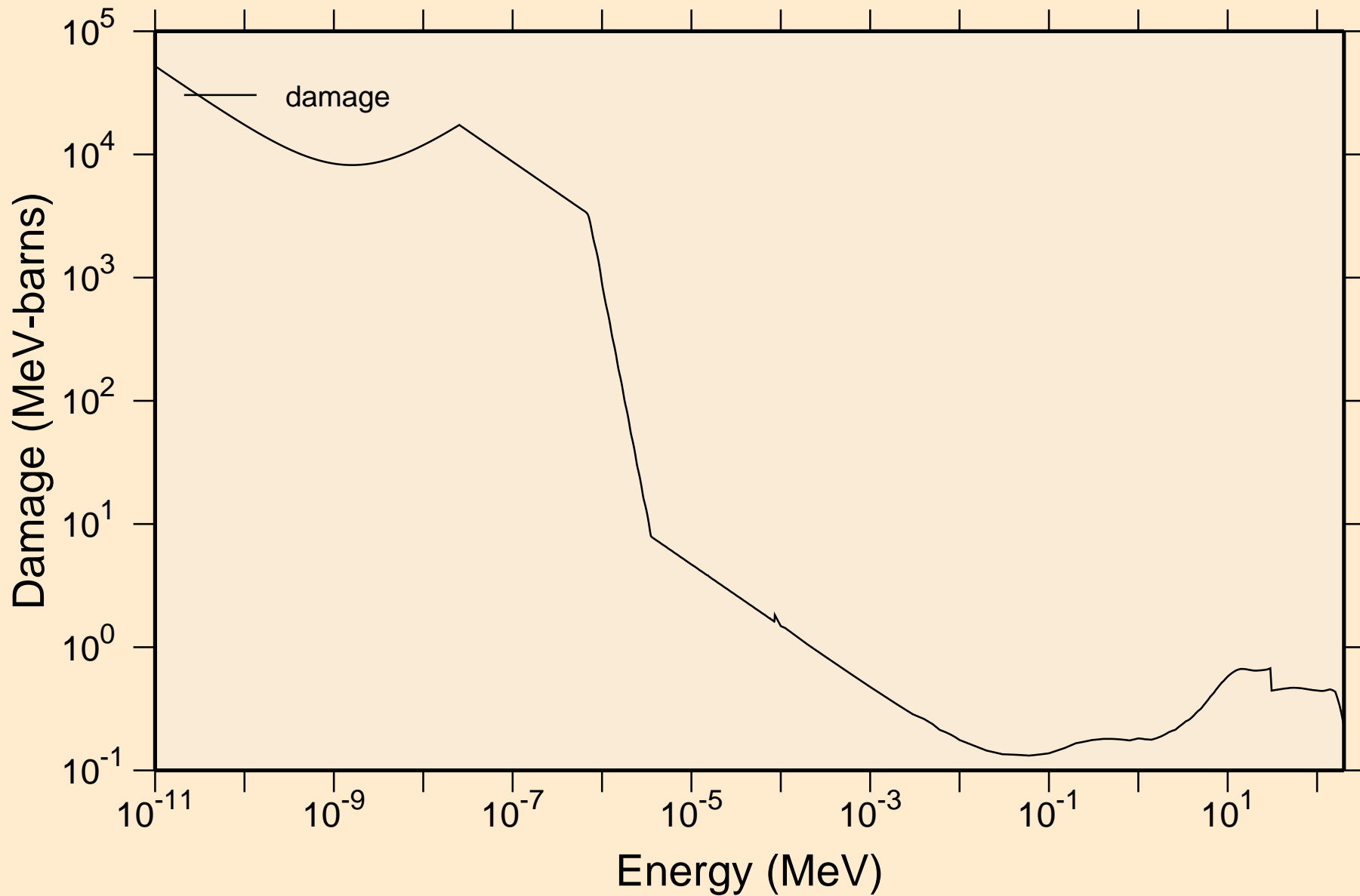

Y080M NEUTRON ACER TENDL-2019 LIBRARY; T=293.16K
Non-threshold reactions

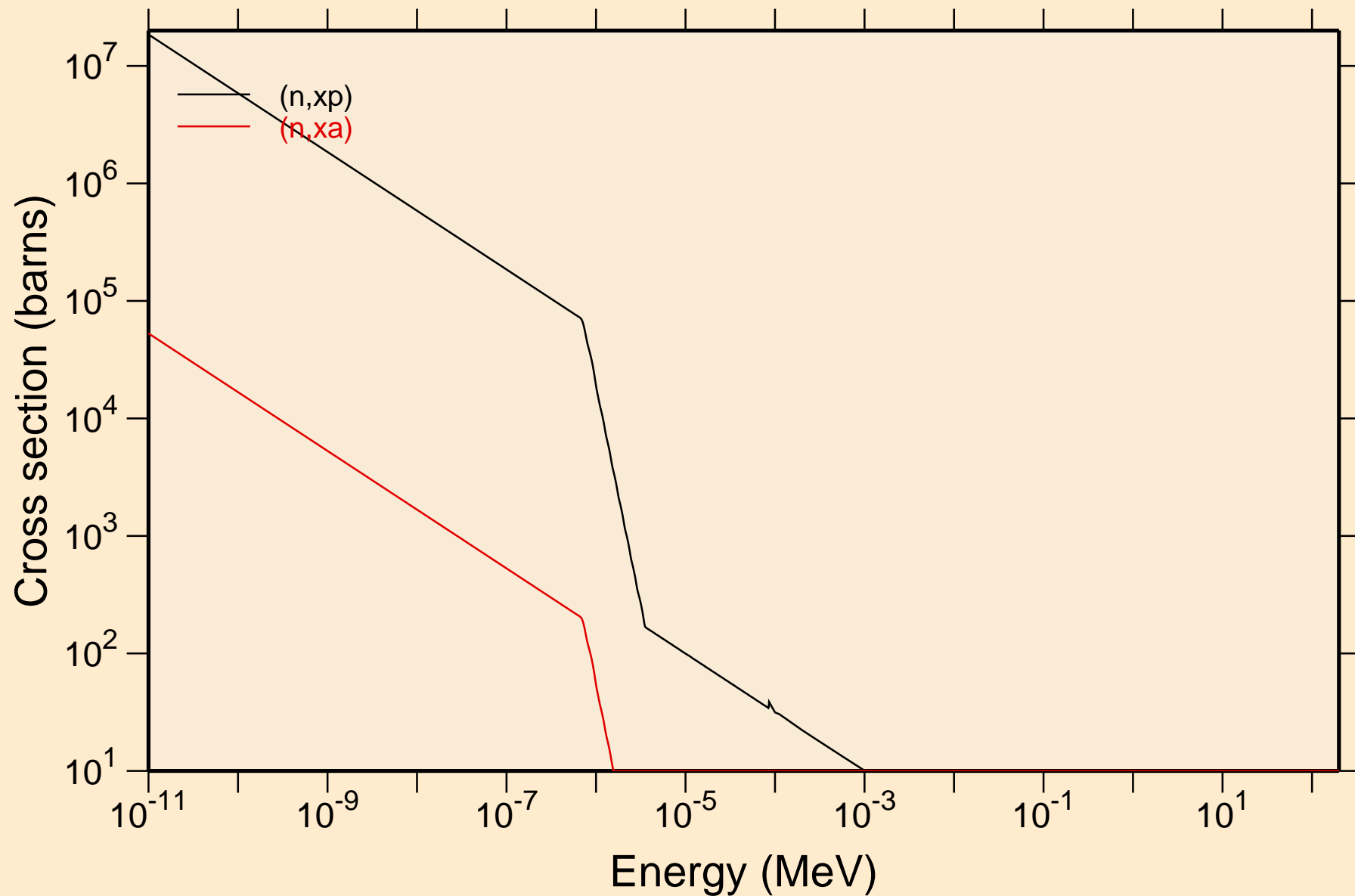

Y080M NEUTRON ACER TENDL-2019 LIBRARY; T=293.16K
Principal cross sections

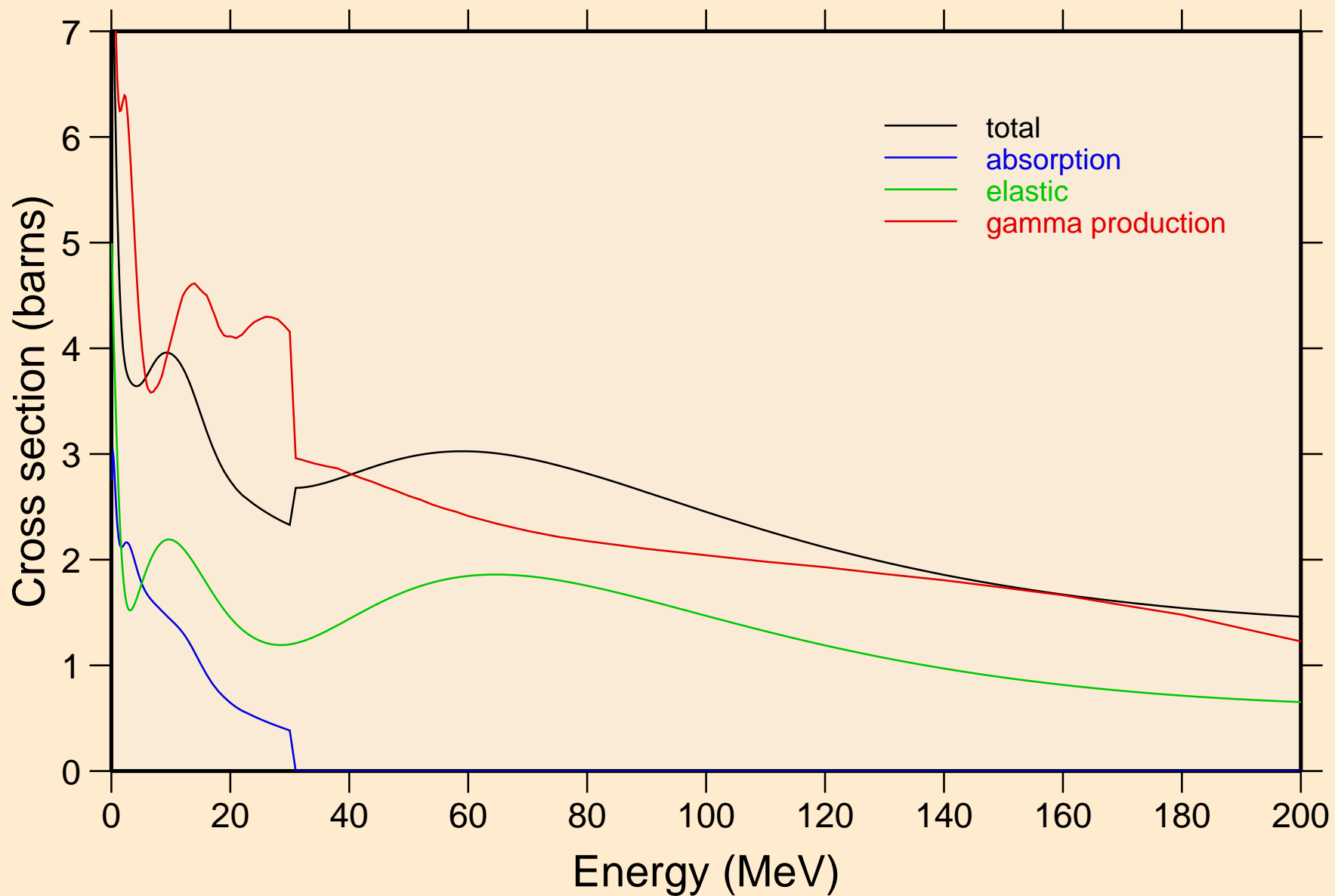

Y080M NEUTRON ACER TENDL-2019 LIBRARY; T=293.16K
Heating

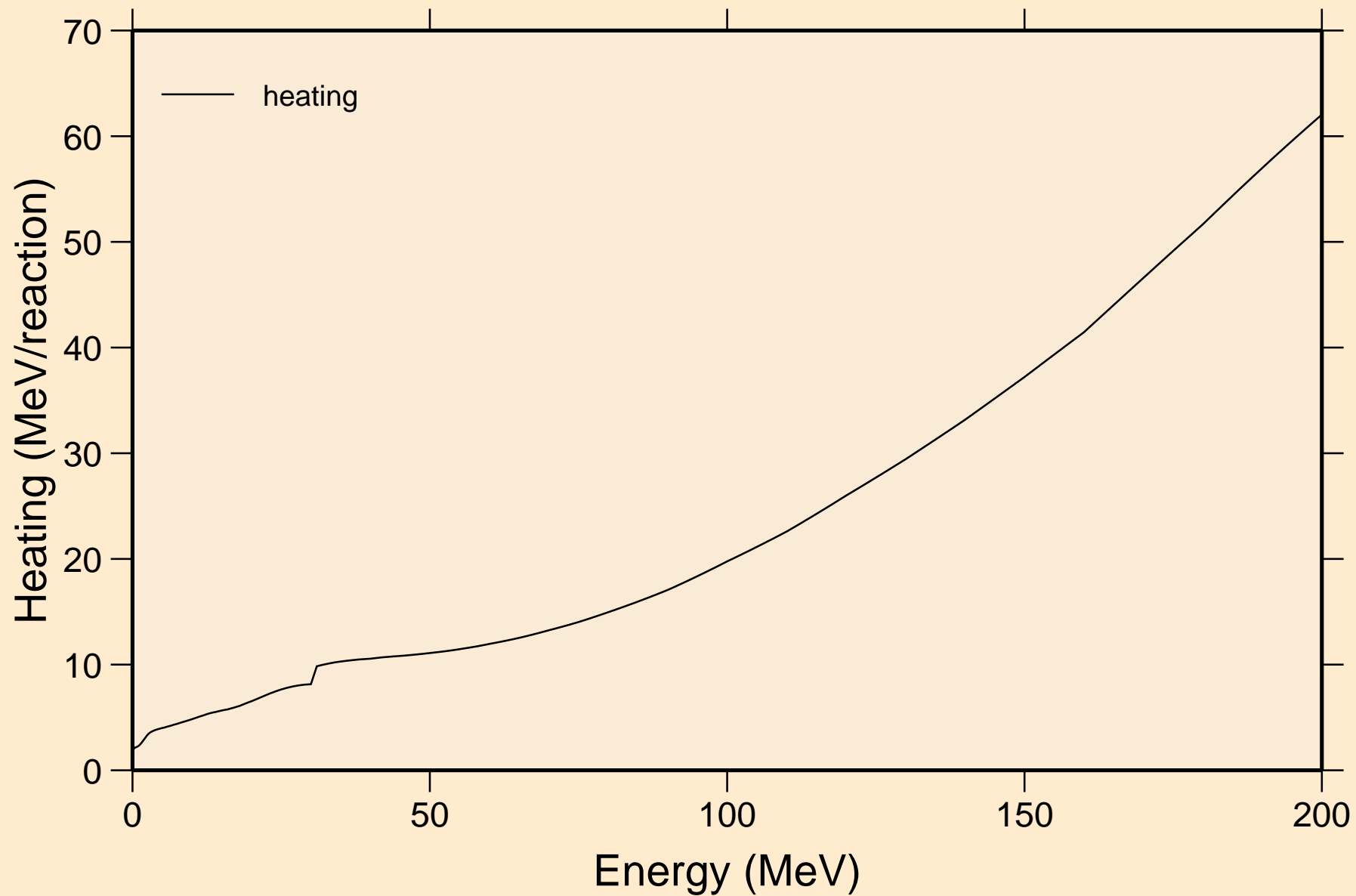

Y080M NEUTRON ACER TENDL-2019 LIBRARY; T=293.16K
Damage

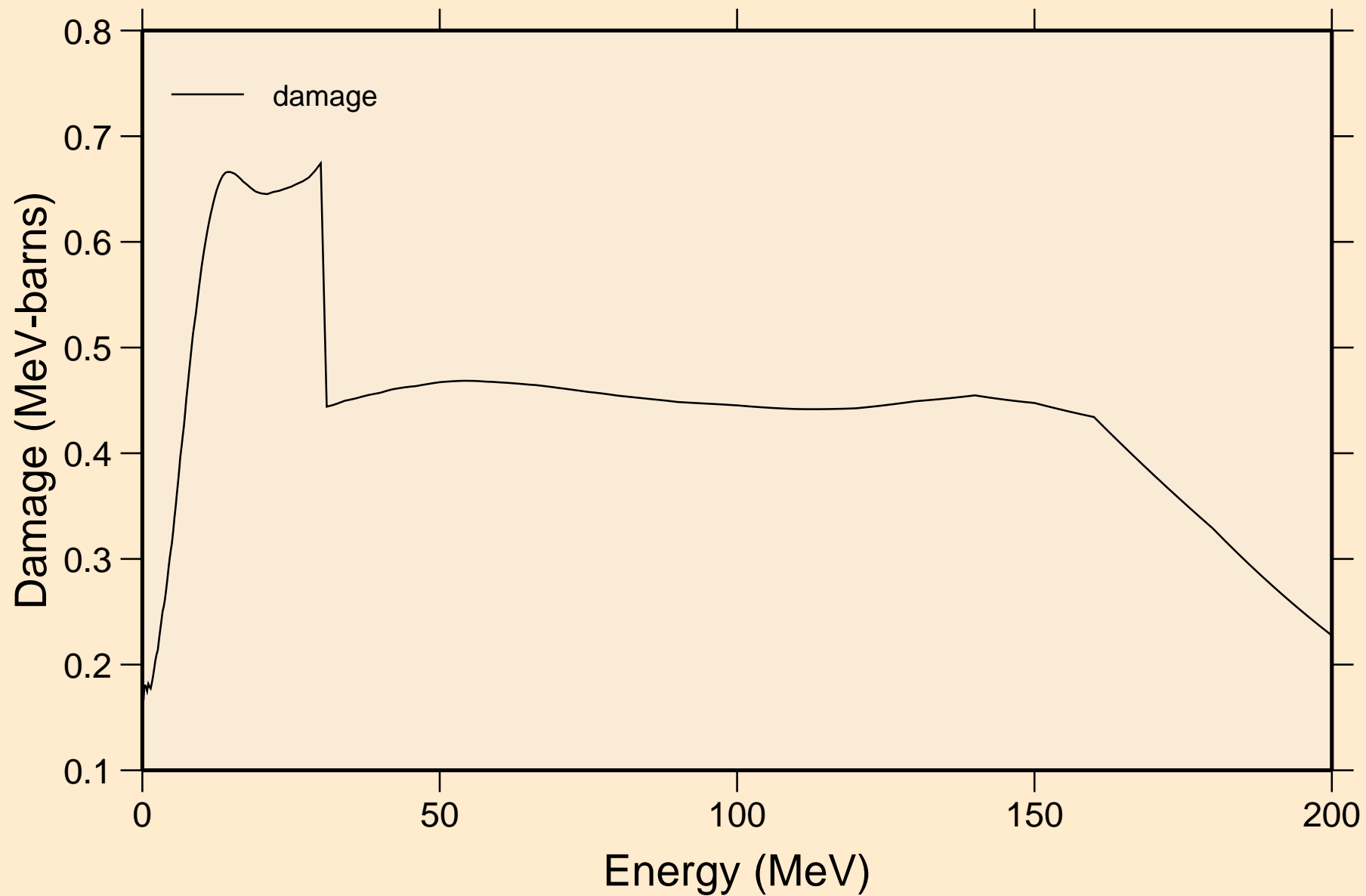

Y080M NEUTRON ACER TENDL-2019 LIBRARY; T=293.16K
Non-threshold reactions

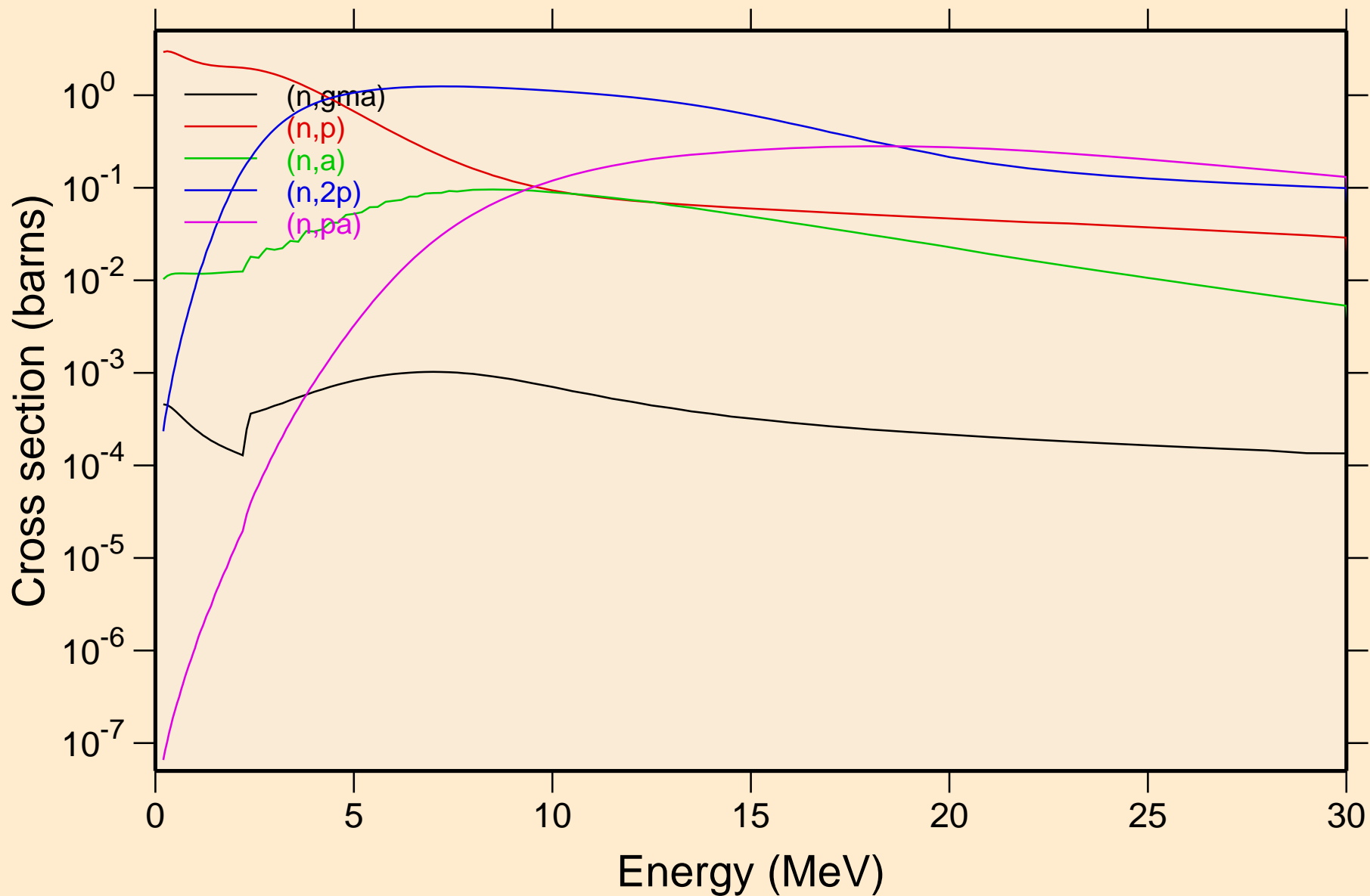

Y080M NEUTRON ACER TENDL-2019 LIBRARY; T=293.16K
Non-threshold reactions

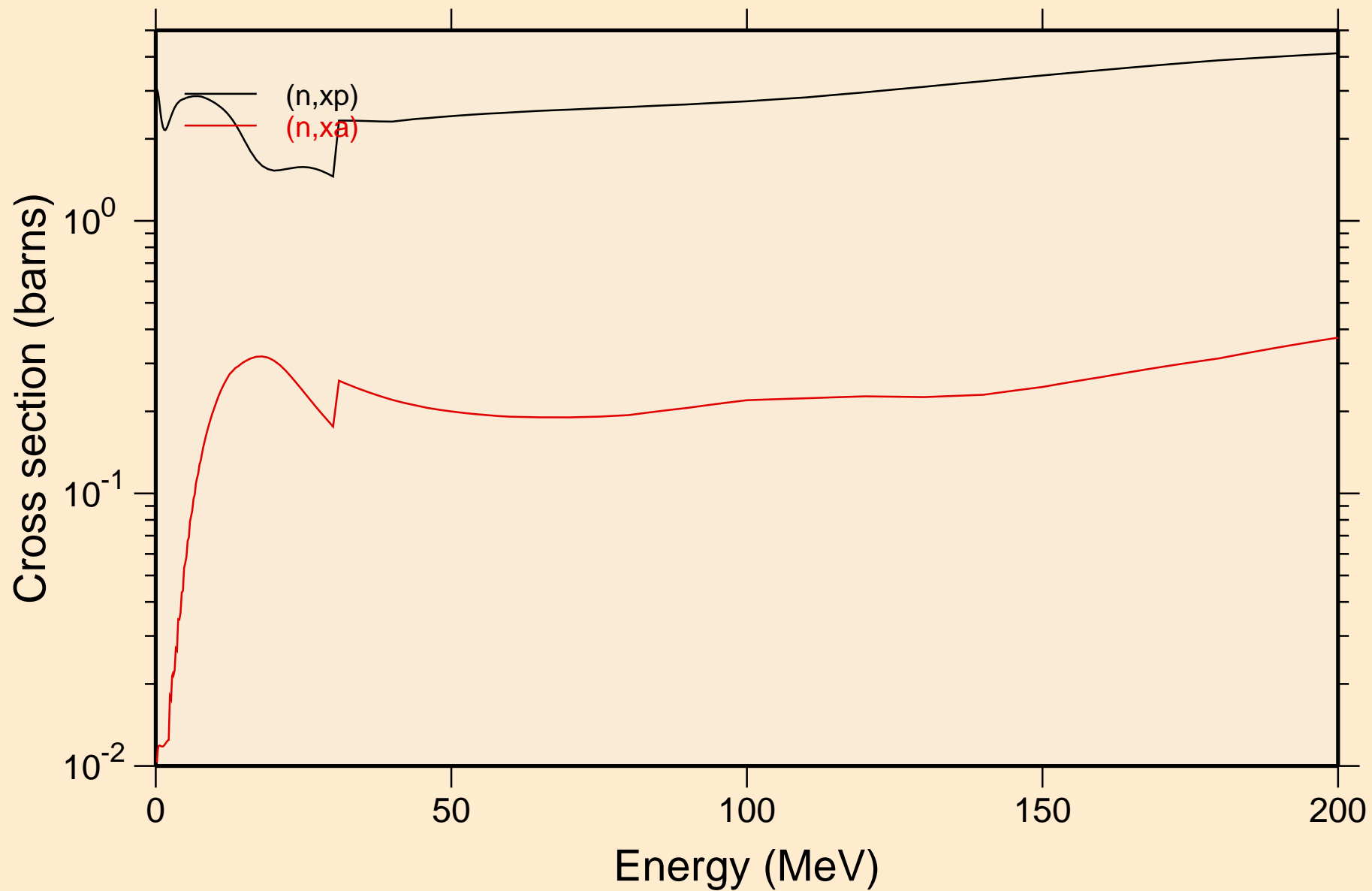

Y080M NEUTRON ACER TENDL-2019 LIBRARY; T=293.16K
Inelastic levels

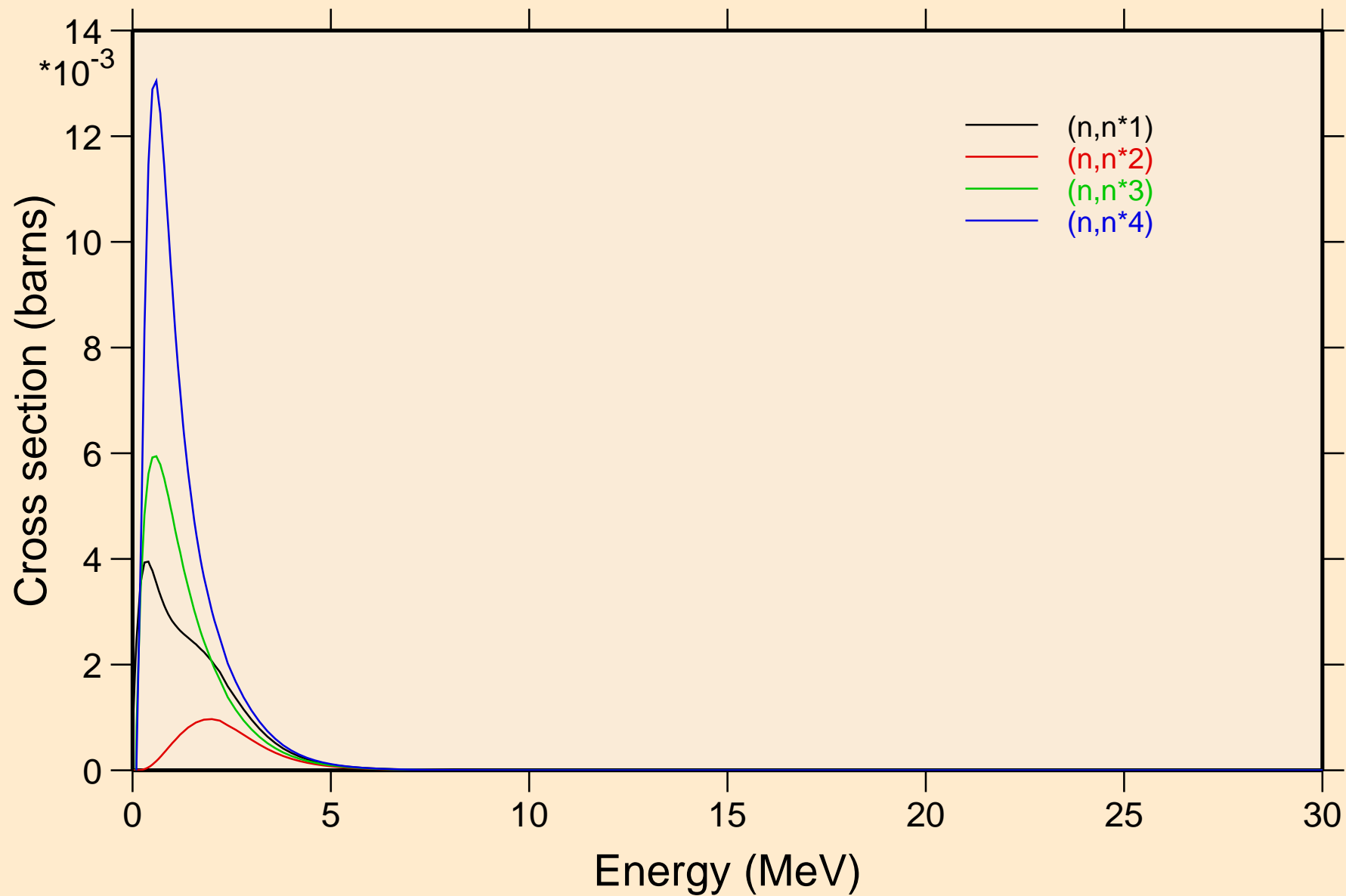

Y080M NEUTRON ACER TENDL-2019 LIBRARY; T=293.16K
Threshold reactions

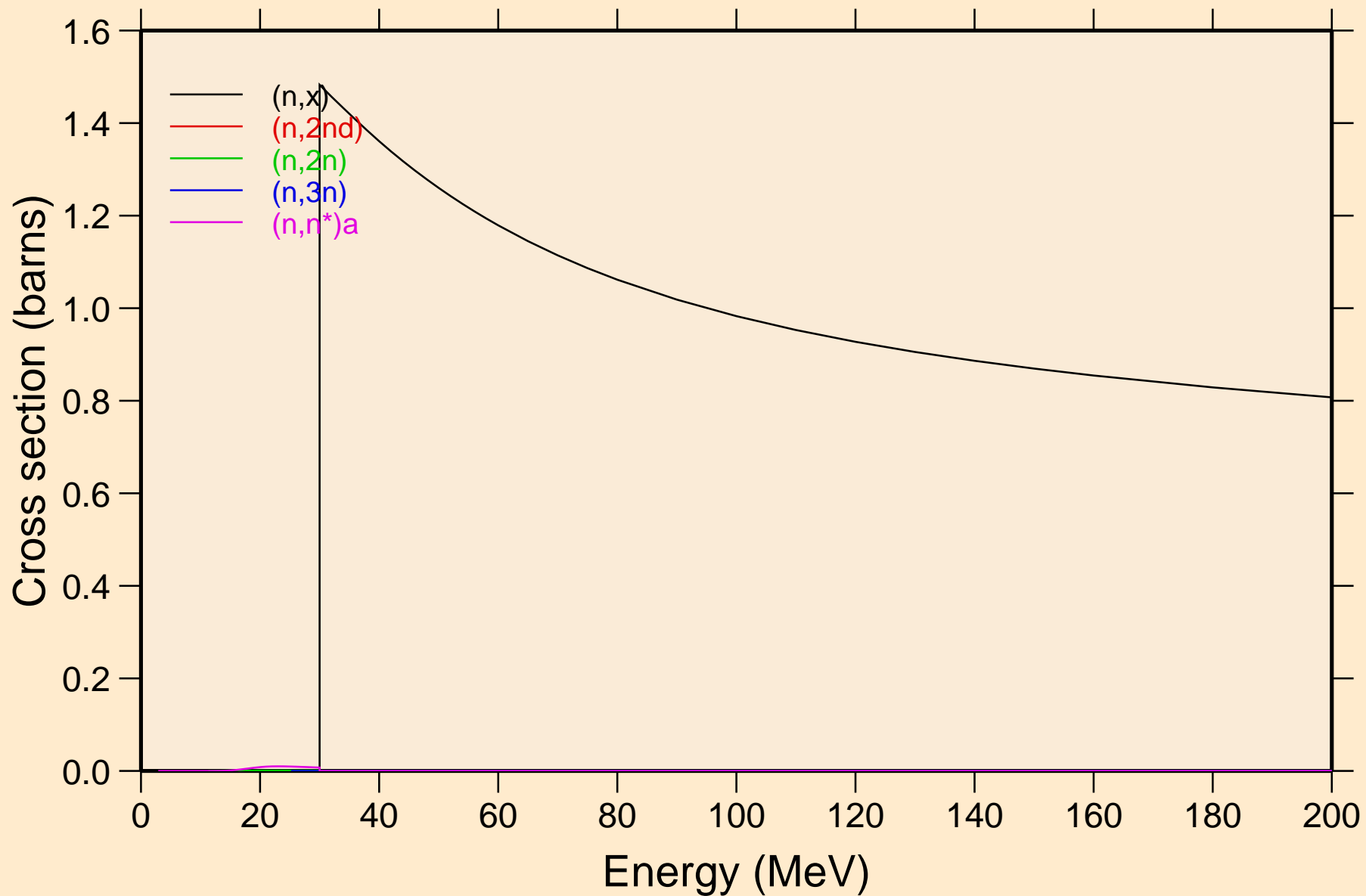

Y080M NEUTRON ACER TENDL-2019 LIBRARY; T=293.16K
Threshold reactions

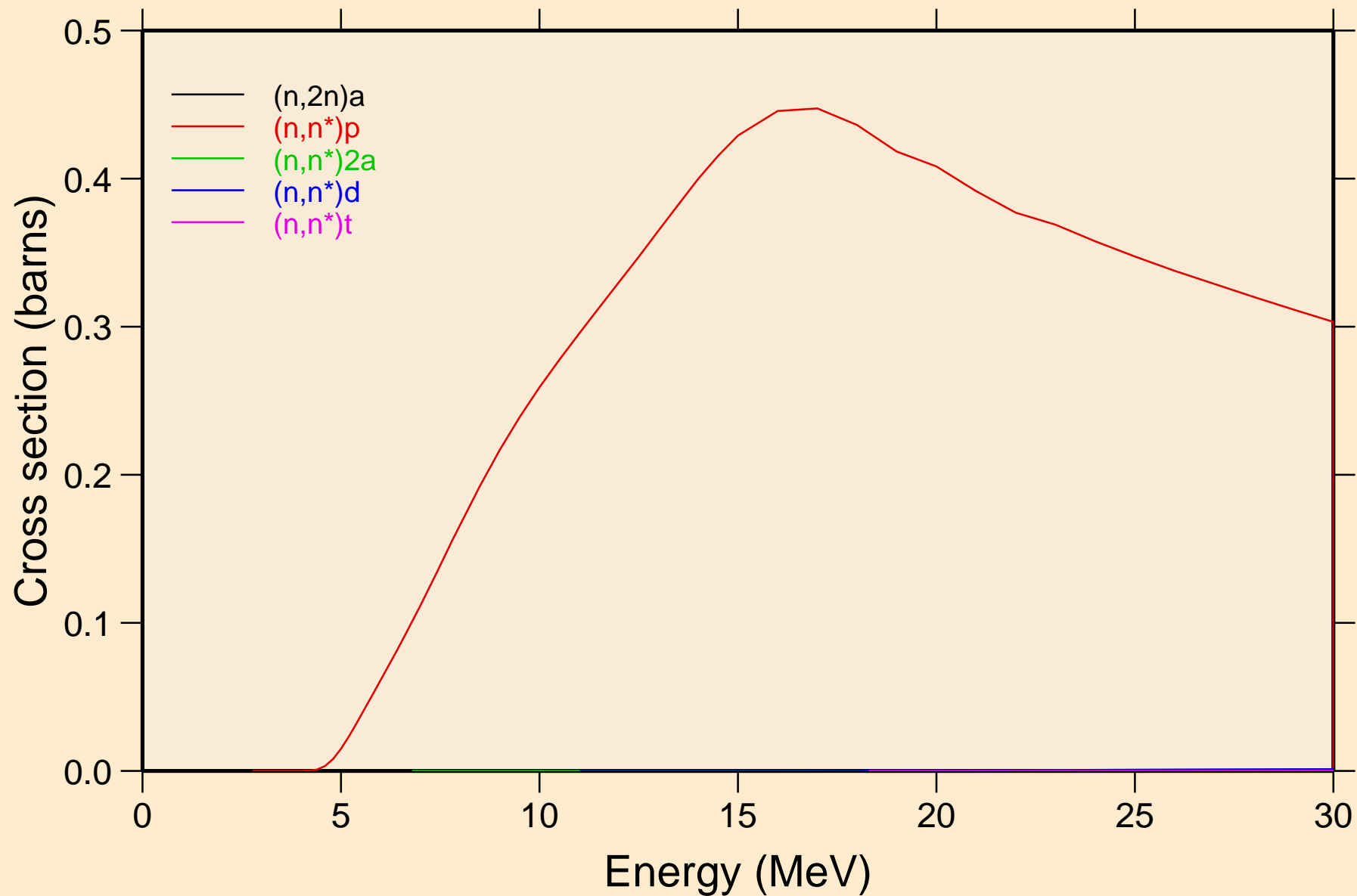

Y080M NEUTRON ACER TENDL-2019 LIBRARY; T=293.16K
Threshold reactions

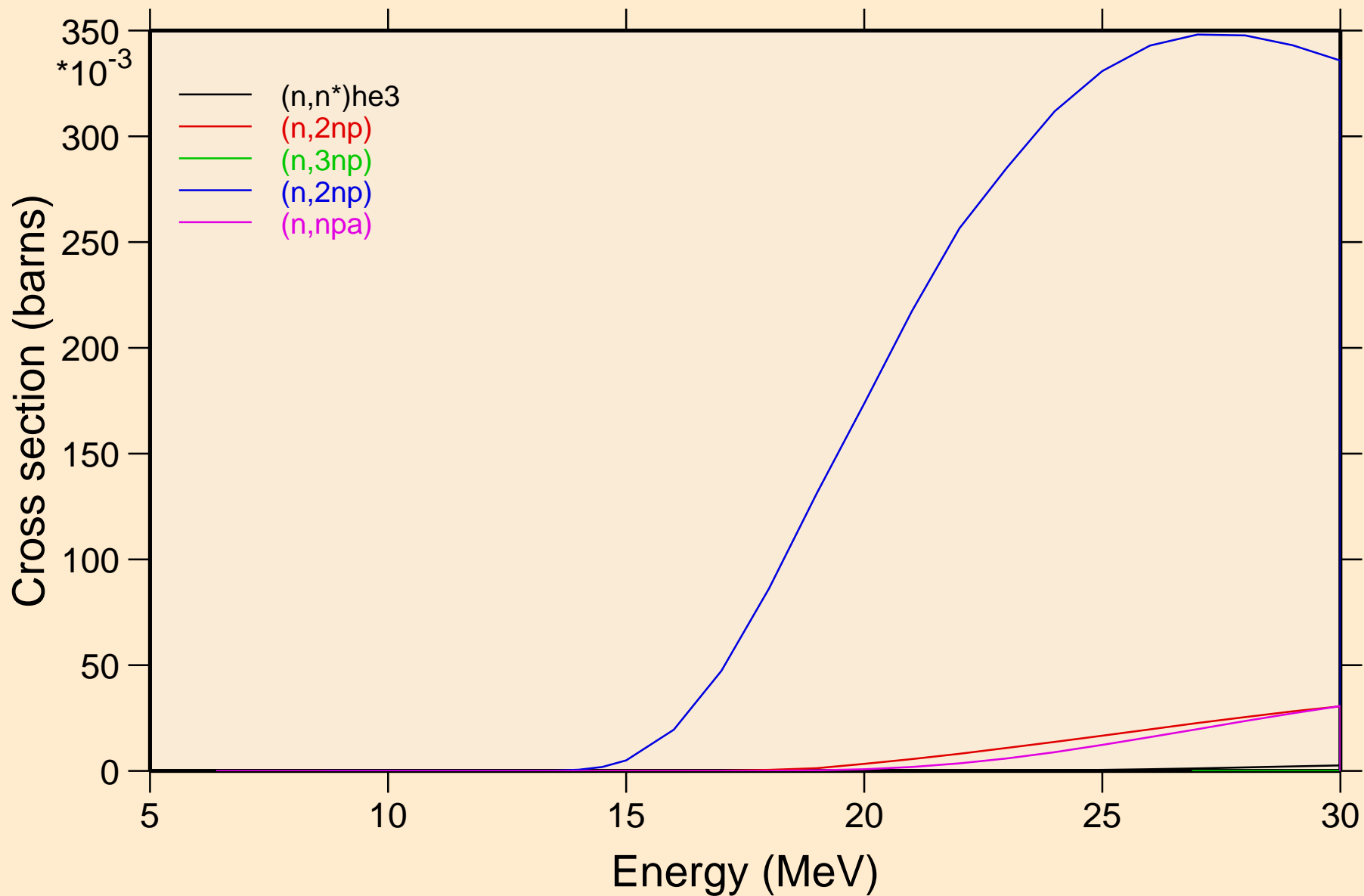

Y080M NEUTRON ACER TENDL-2019 LIBRARY; T=293.16K
Threshold reactions

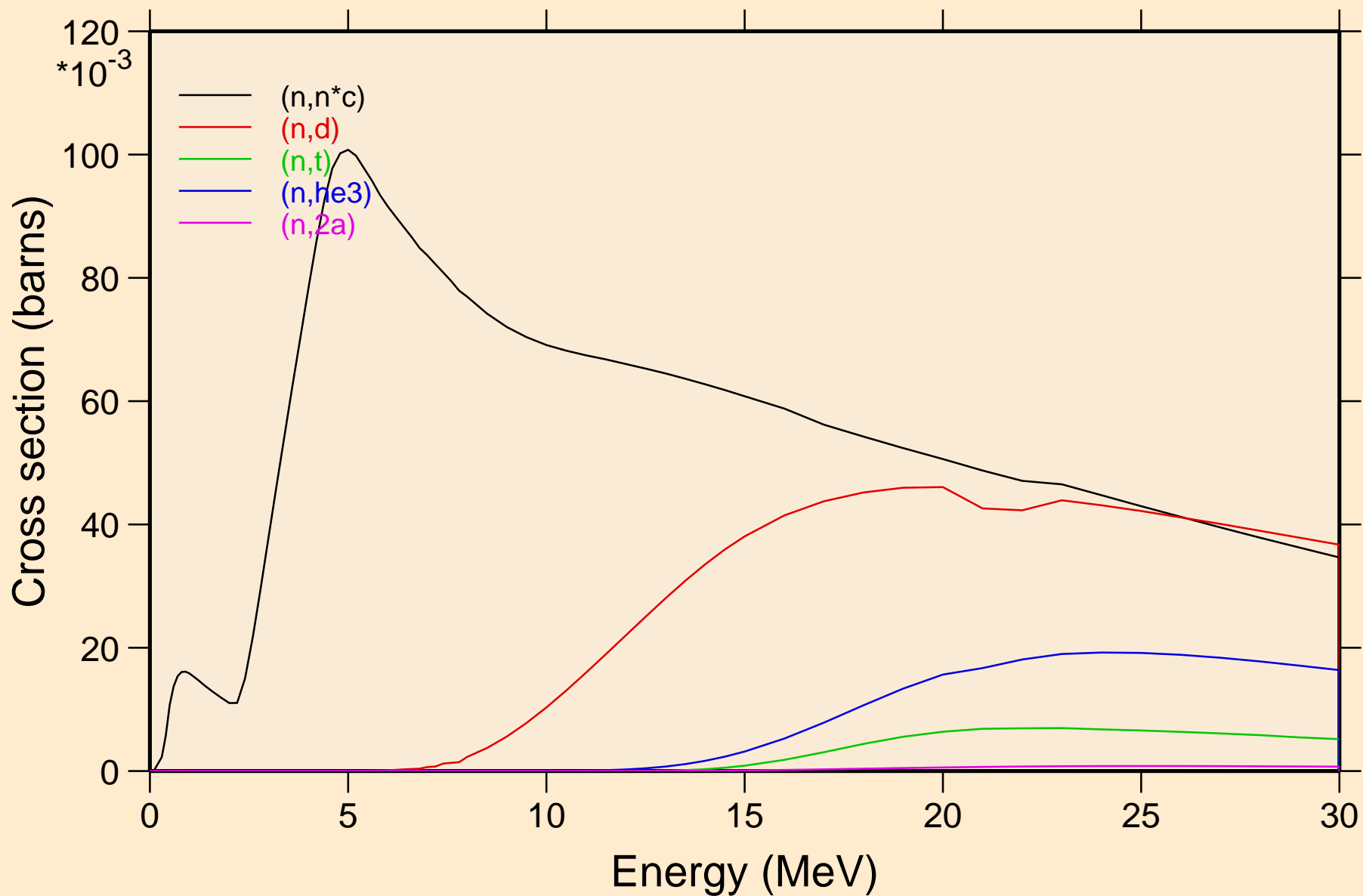

Y080M NEUTRON ACER TENDL-2019 LIBRARY; T=293.16K
Threshold reactions

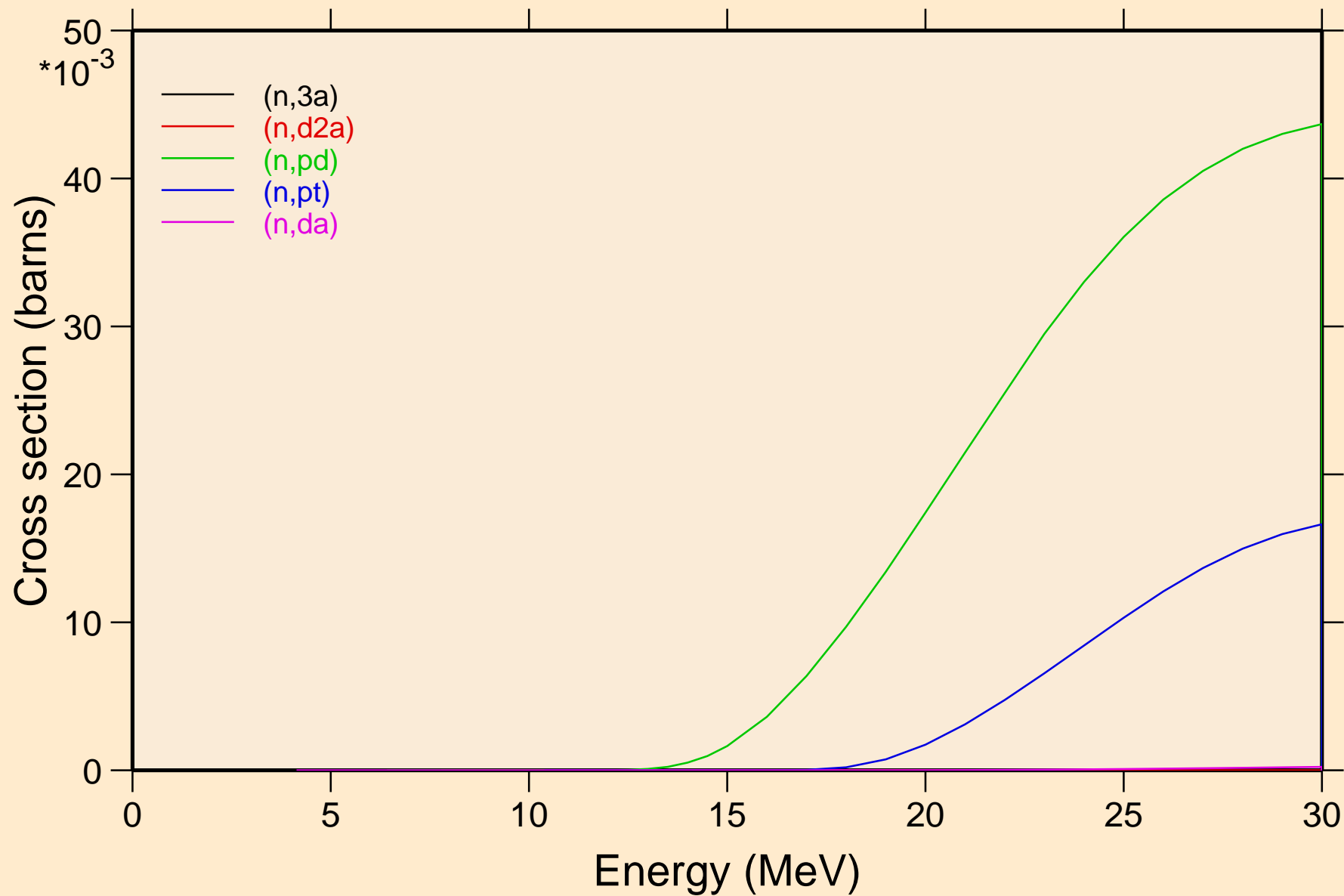

Y080M NEUTRON ACER TENDL-2019 LIBRARY; T=293.16K
Threshold reactions

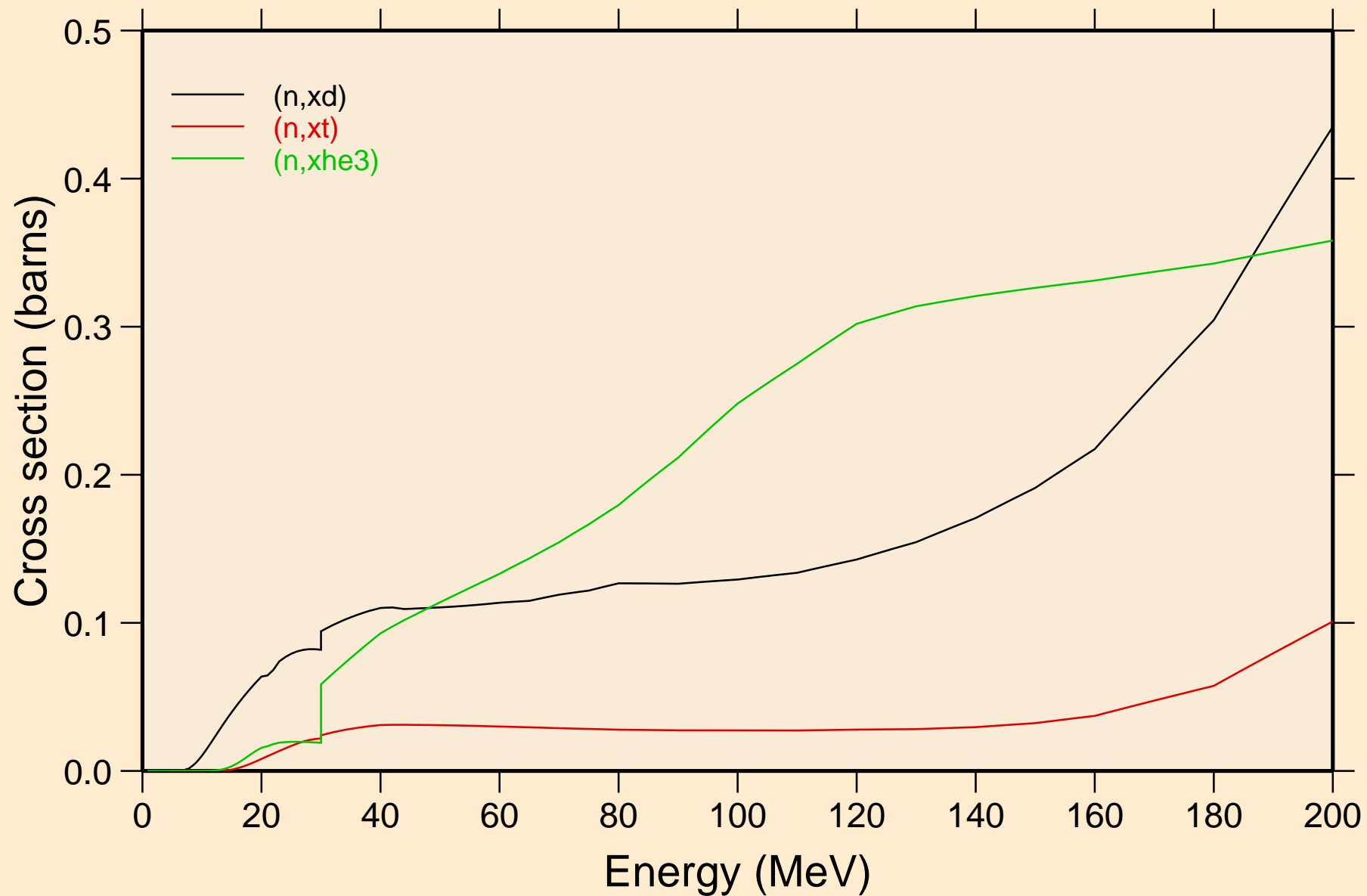

Y080M NEUTRON ACER TENDL-2019 LIBRARY; T=293.16K
angular distribution for elastic

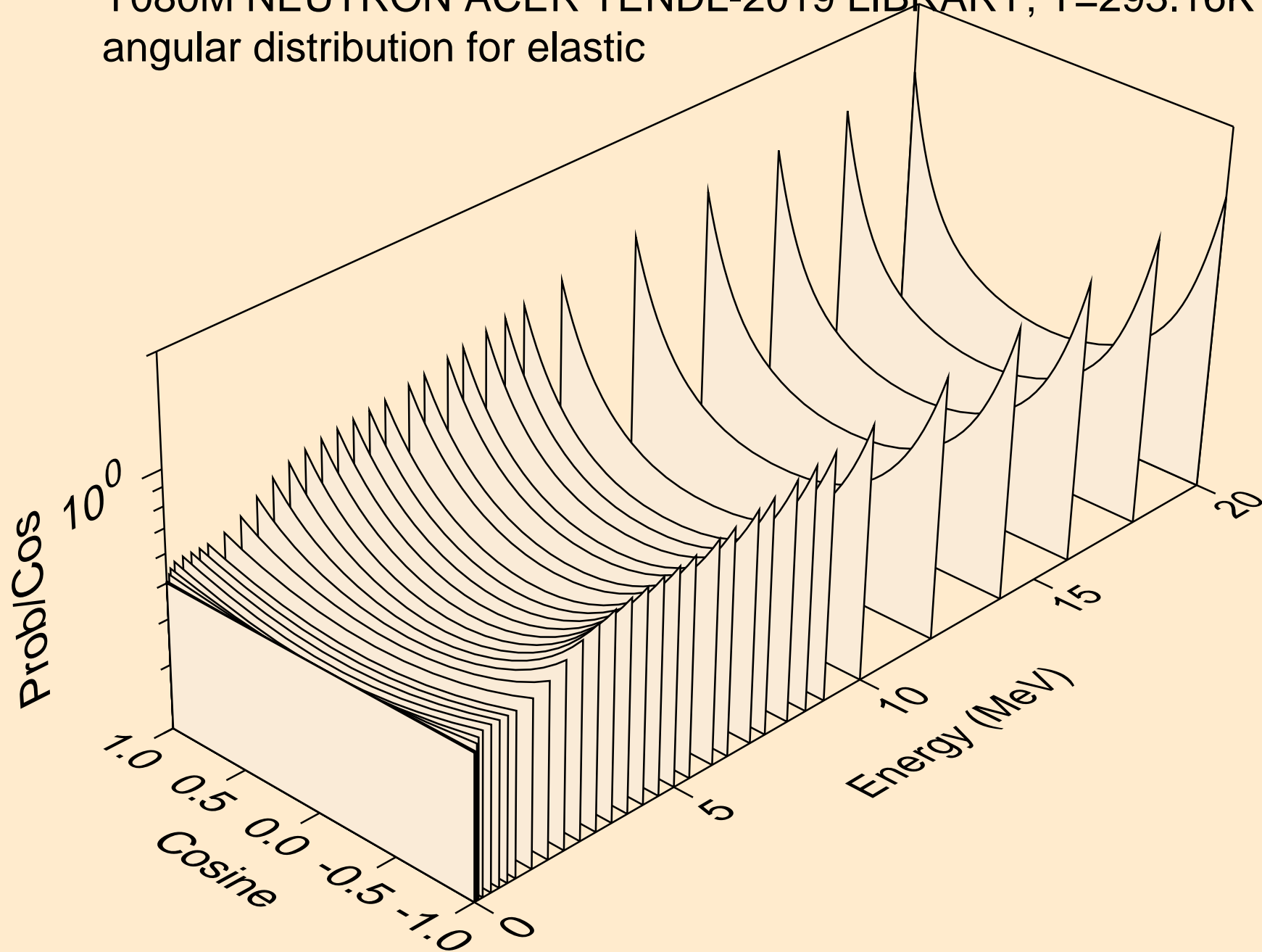

Y080M NEUTRON ACER TENDL-2019 LIBRARY; T=293.16K
angular distribution for elastic

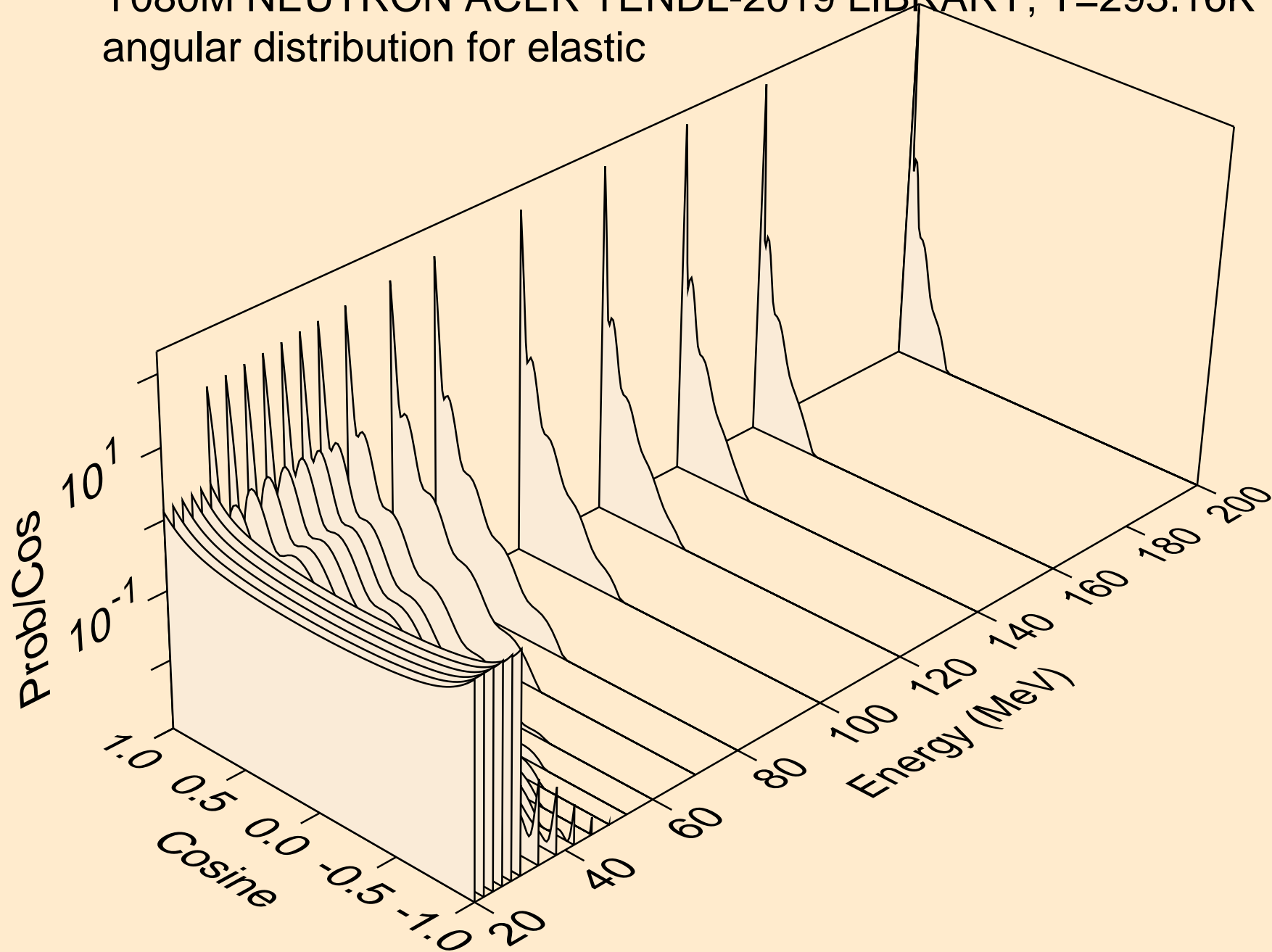

Y080M NEUTRON ACER TENDL-2019 LIBRARY; T=293.16K
angular distribution for (n,n*1)

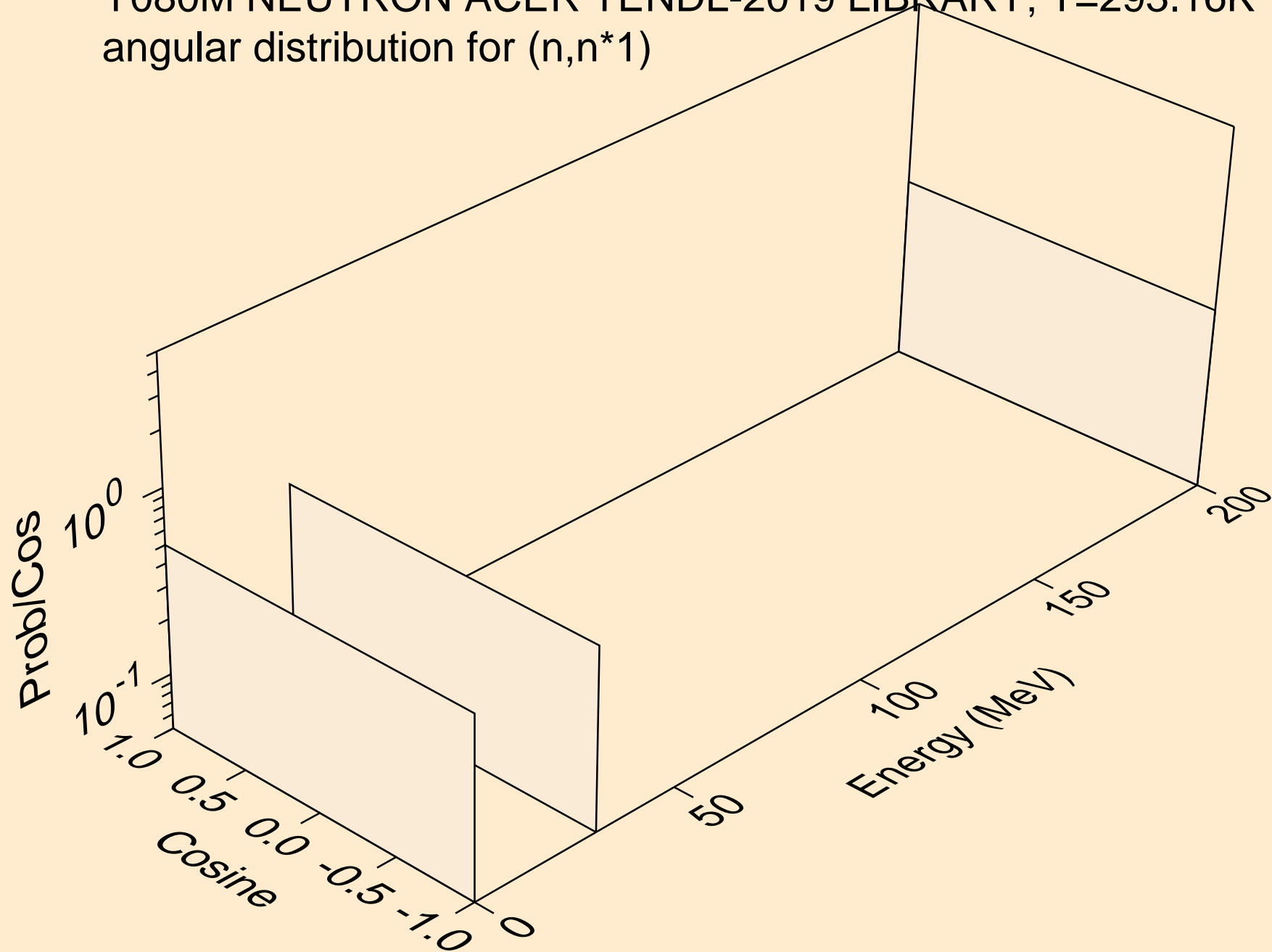

Y080M NEUTRON ACER TENDL-2019 LIBRARY; T=293.16K
angular distribution for (n,n*2)

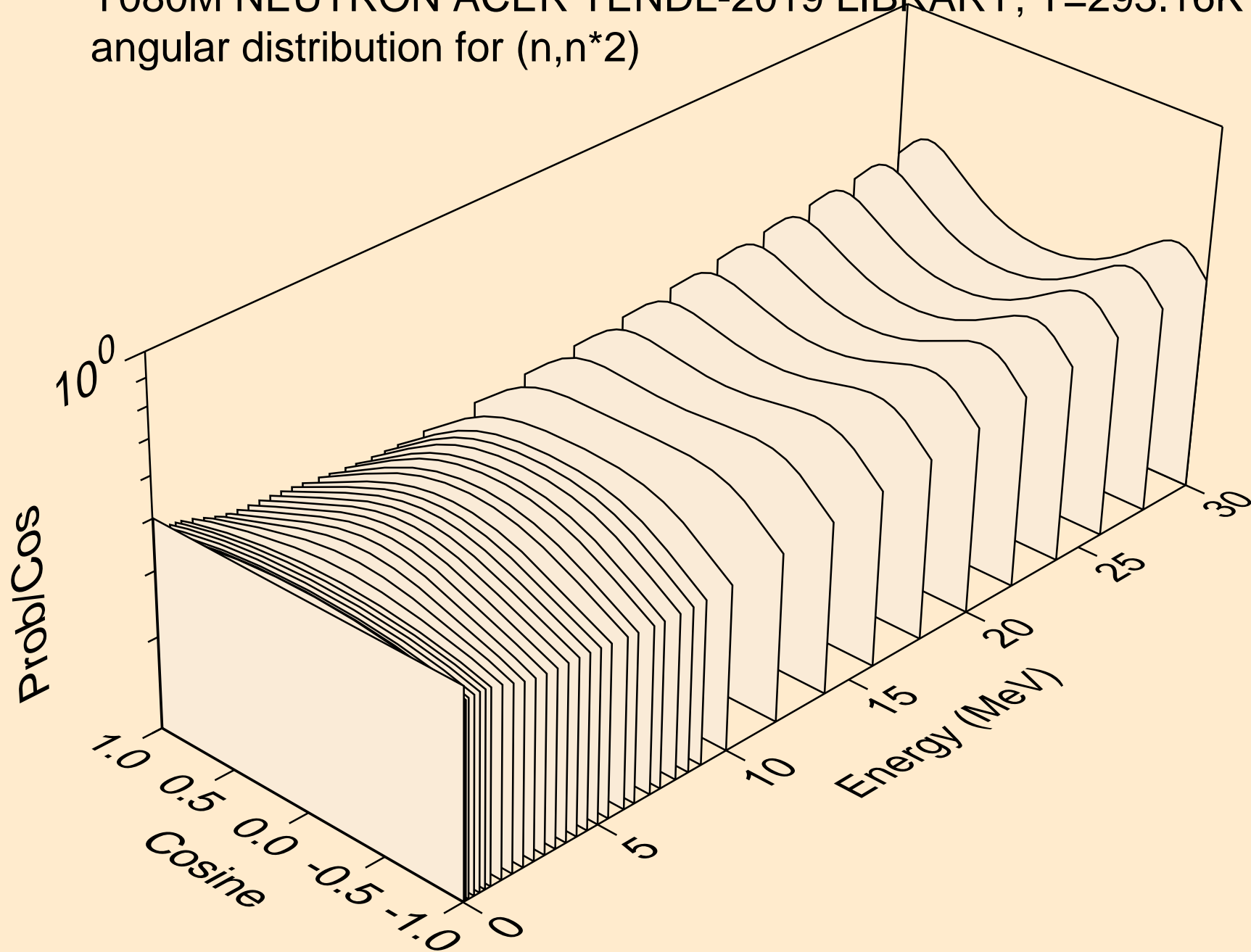

Y080M NEUTRON ACER TENDL-2019 LIBRARY; T=293.16K
angular distribution for (n,n*3)

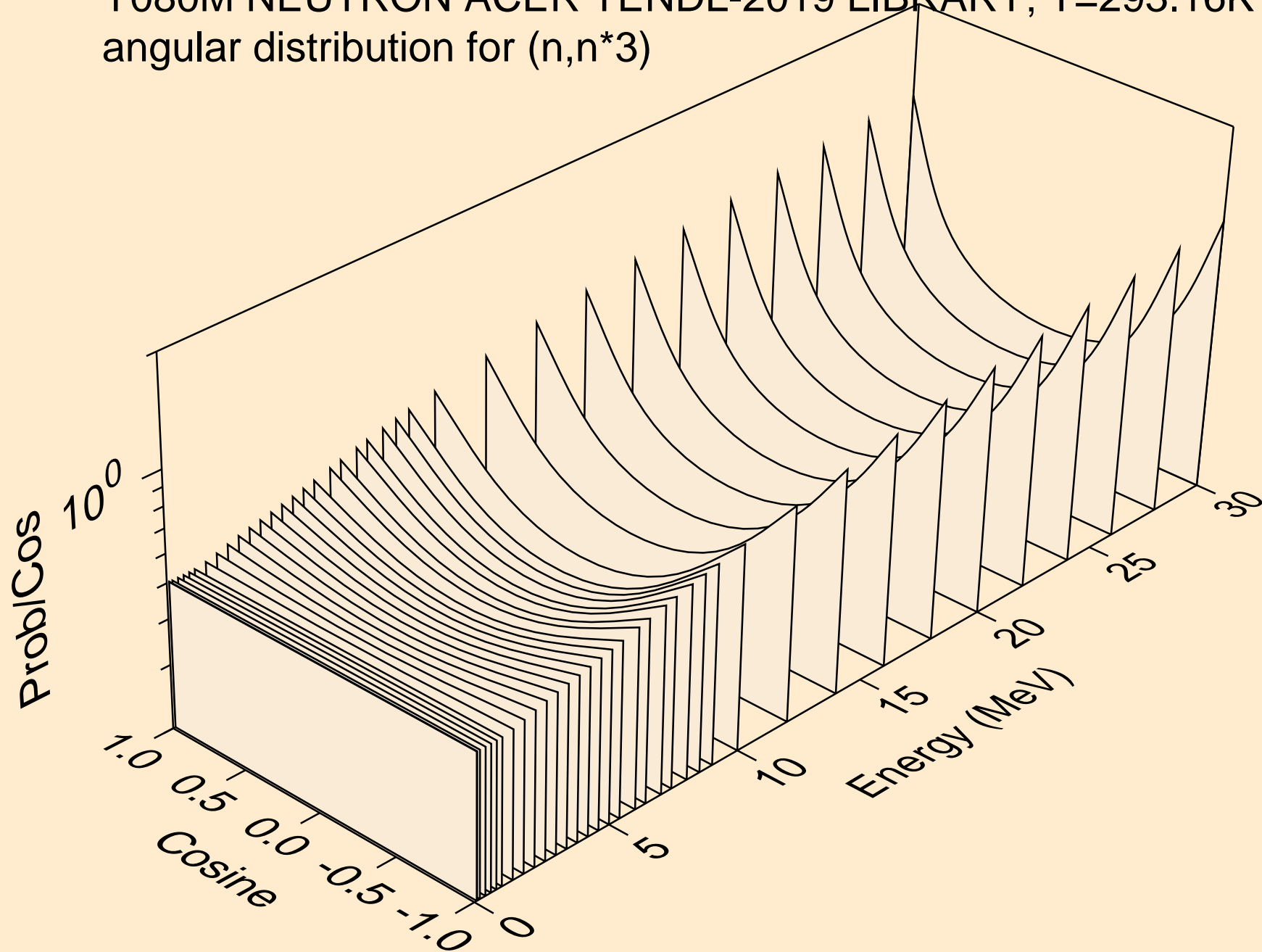

Y080M NEUTRON ACER TENDL-2019 LIBRARY; T=293.16K
angular distribution for (n,n*4)

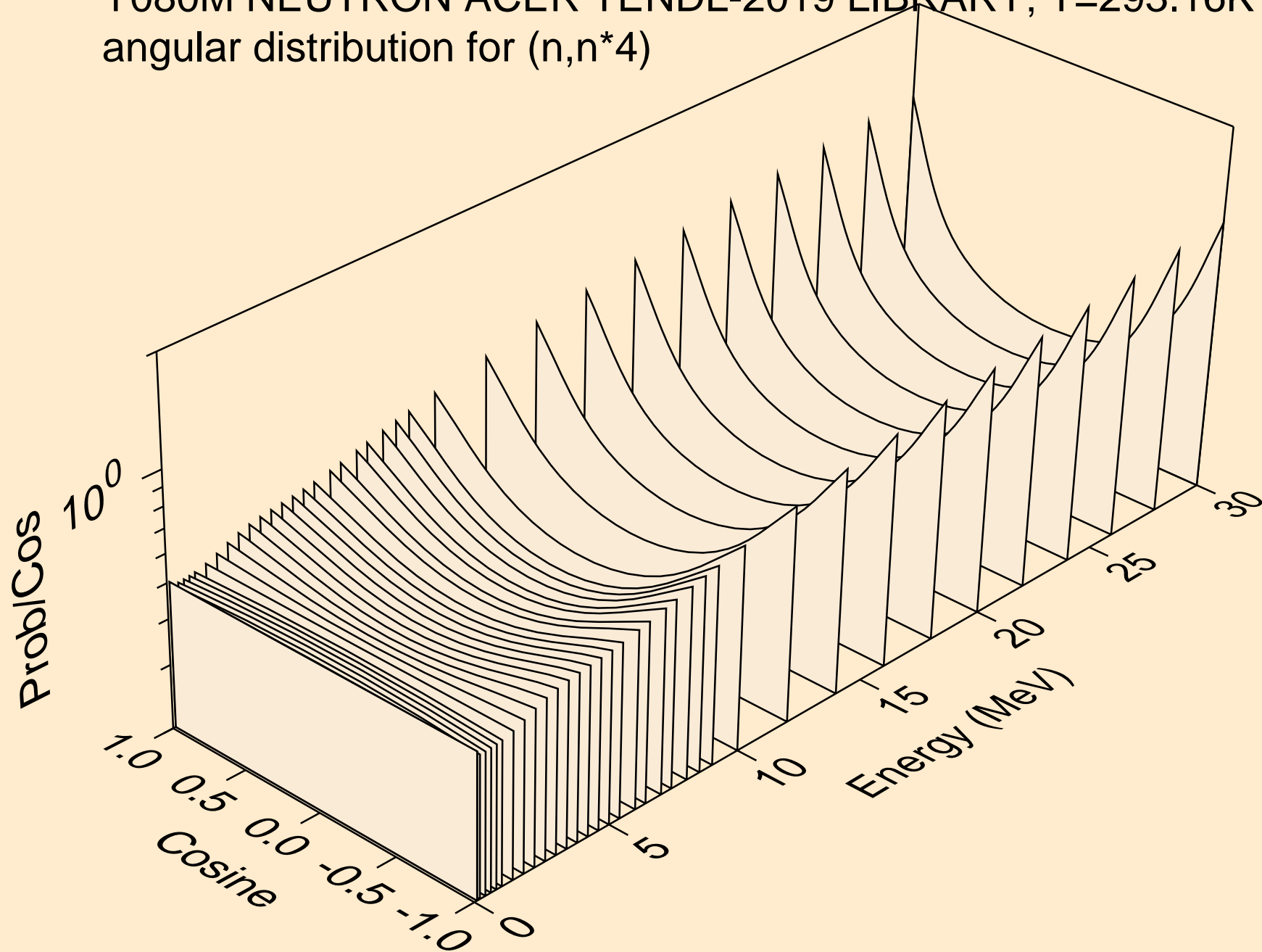

Y080M NEUTRON ACER TENDL-2019 LIBRARY; T=293.16K
Neutron emission for (n,x)

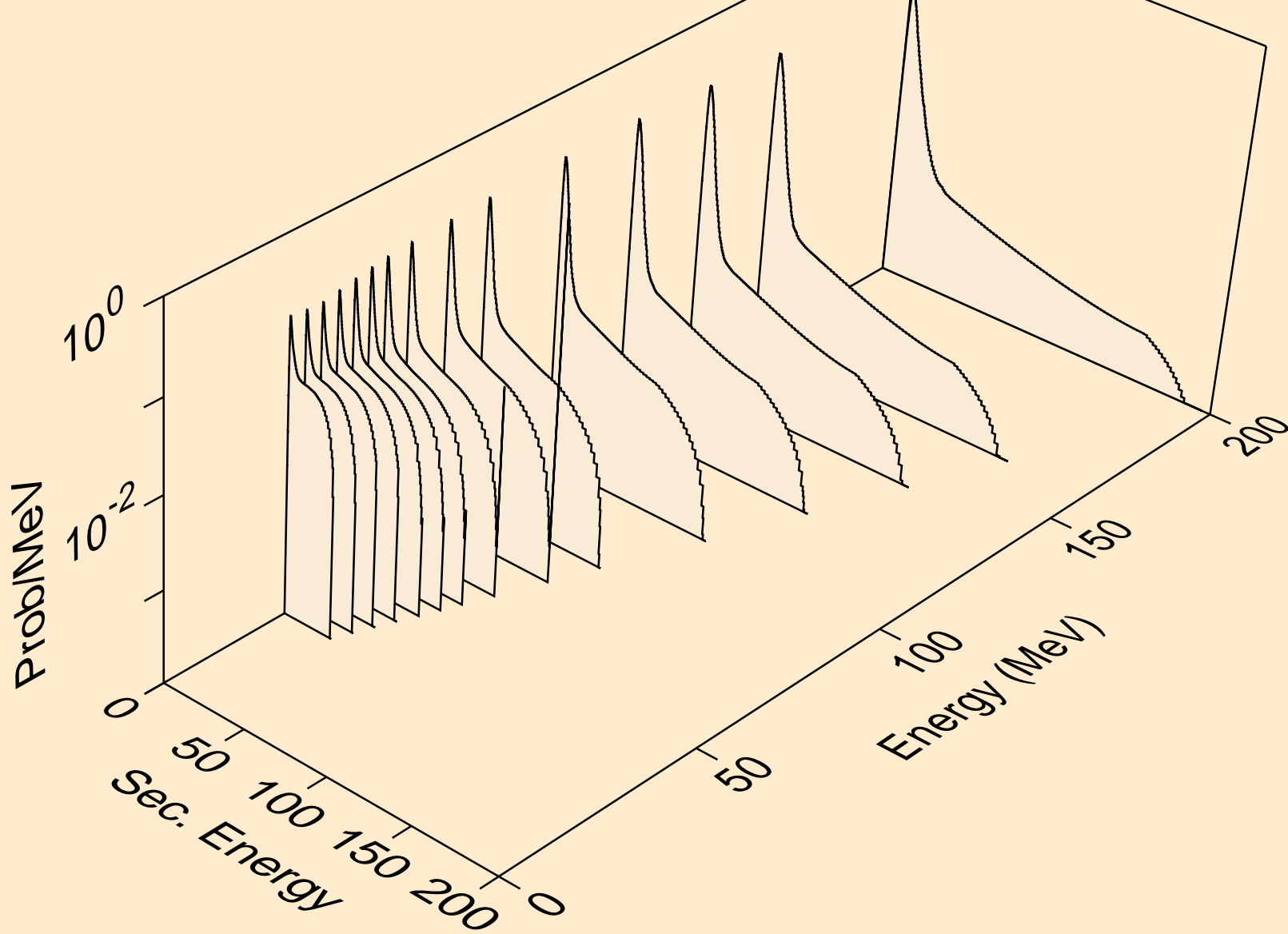

Y080M NEUTRON ACER TENDL-2019 LIBRARY; T=293.16K
Neutron emission for (n,2nd)

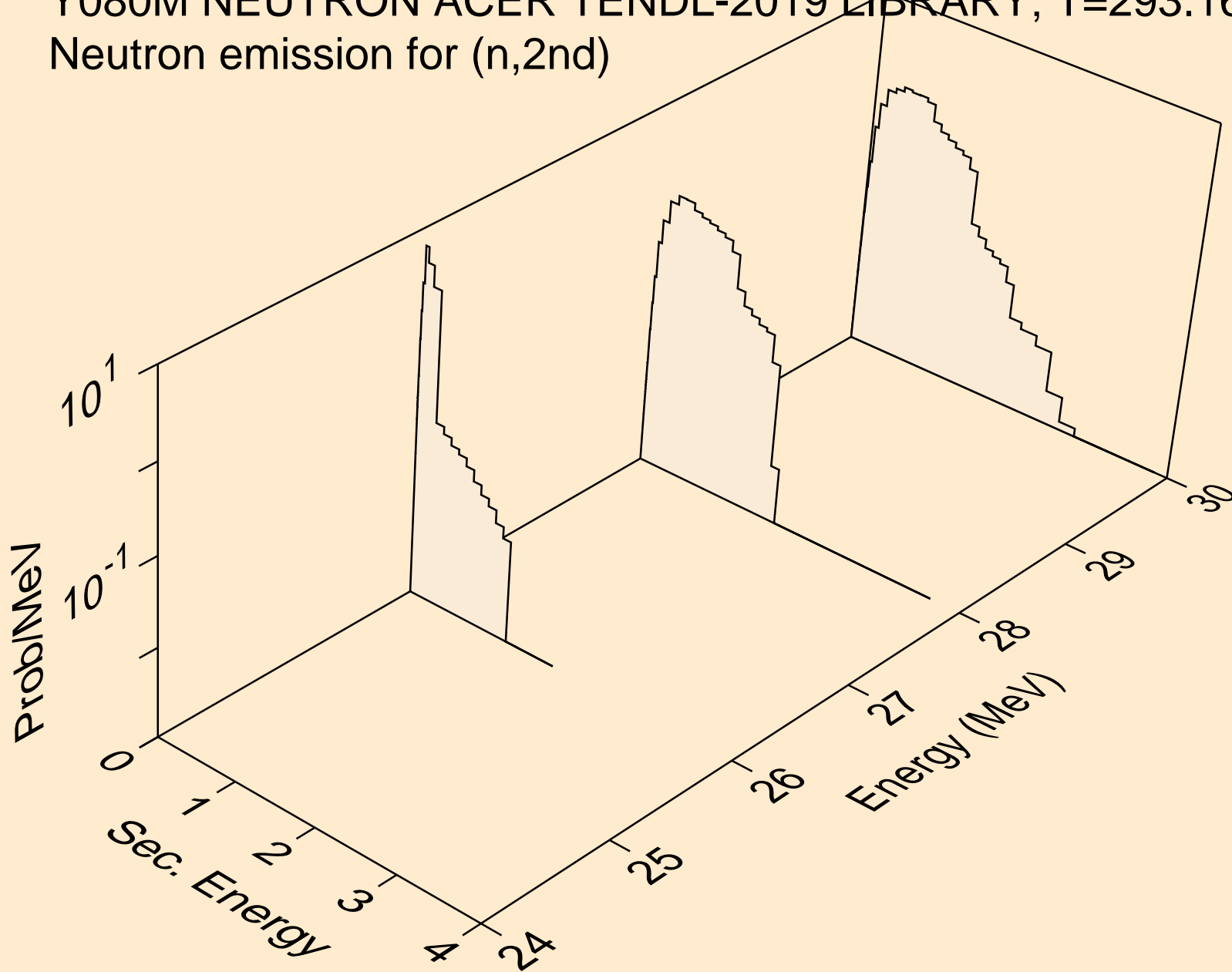

Y080M NEUTRON ACER TENDL-2019 LIBRARY; T=293.16K
Neutron emission for (n,2n)

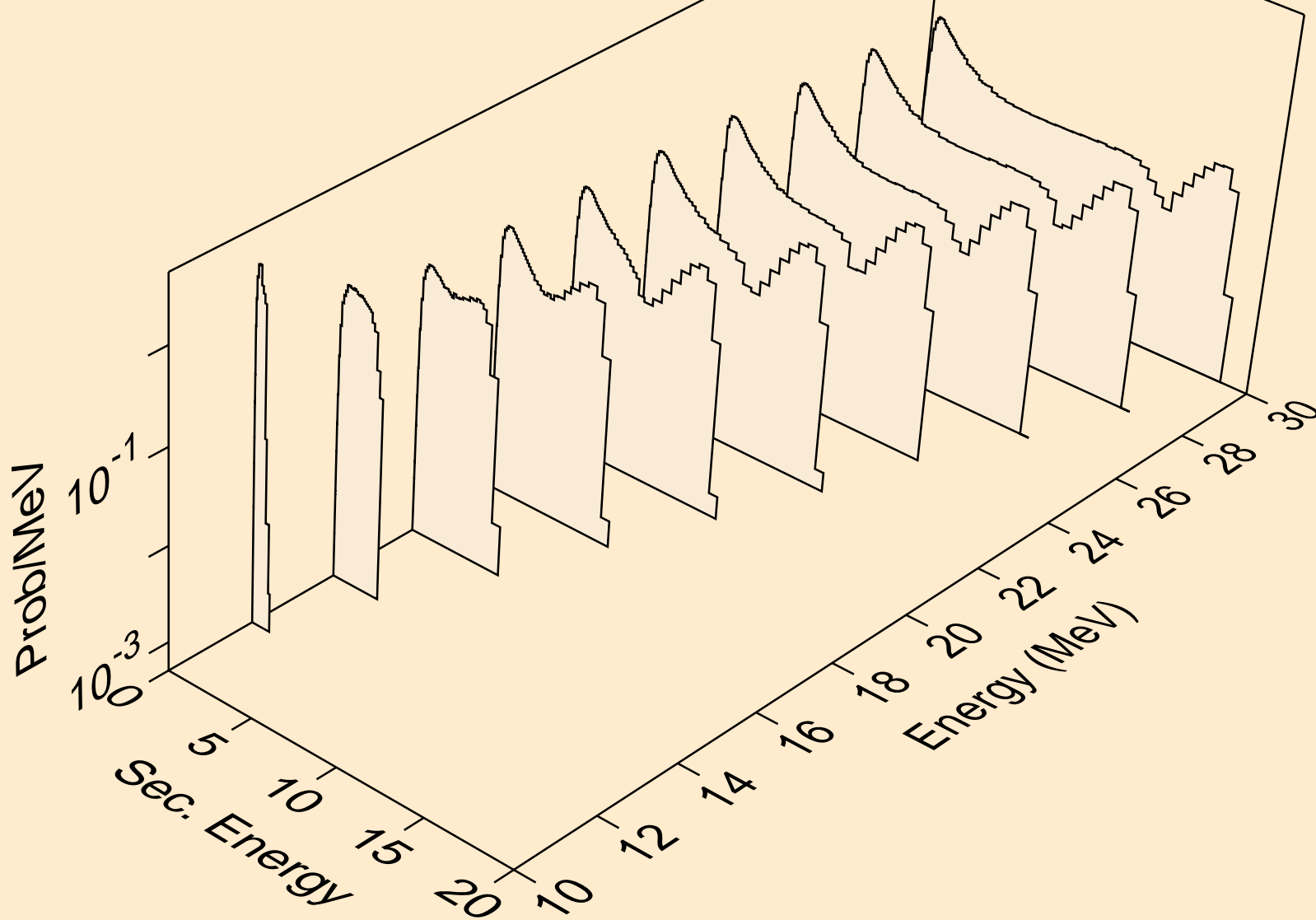

Y080M NEUTRON ACER TENDL-2019 LIBRARY; T=293.16K
Neutron emission for (n,3n)

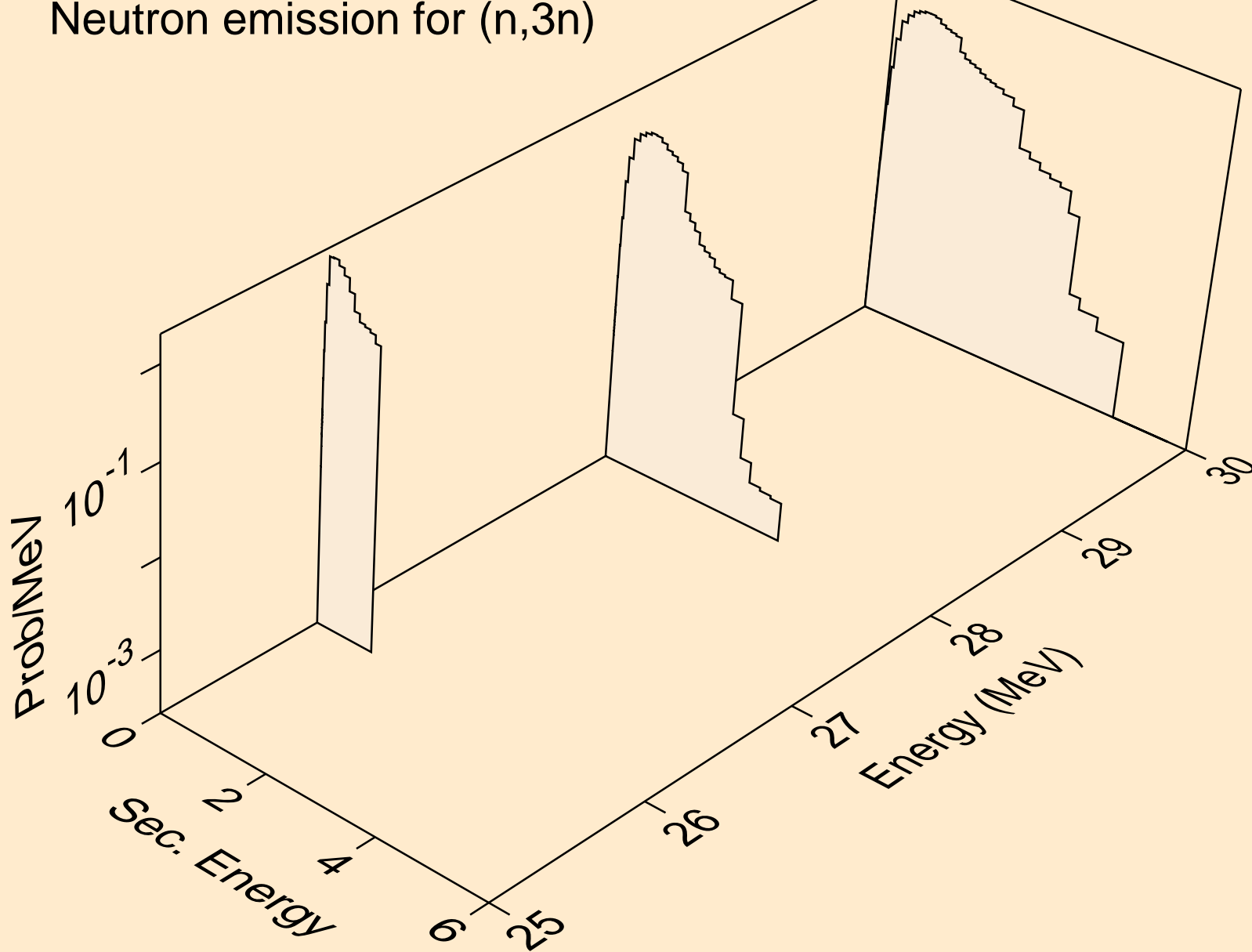

Y080M NEUTRON ACER TENDL-2019 LIBRARY; T=293.16K
Neutron emission for (n,n*)a

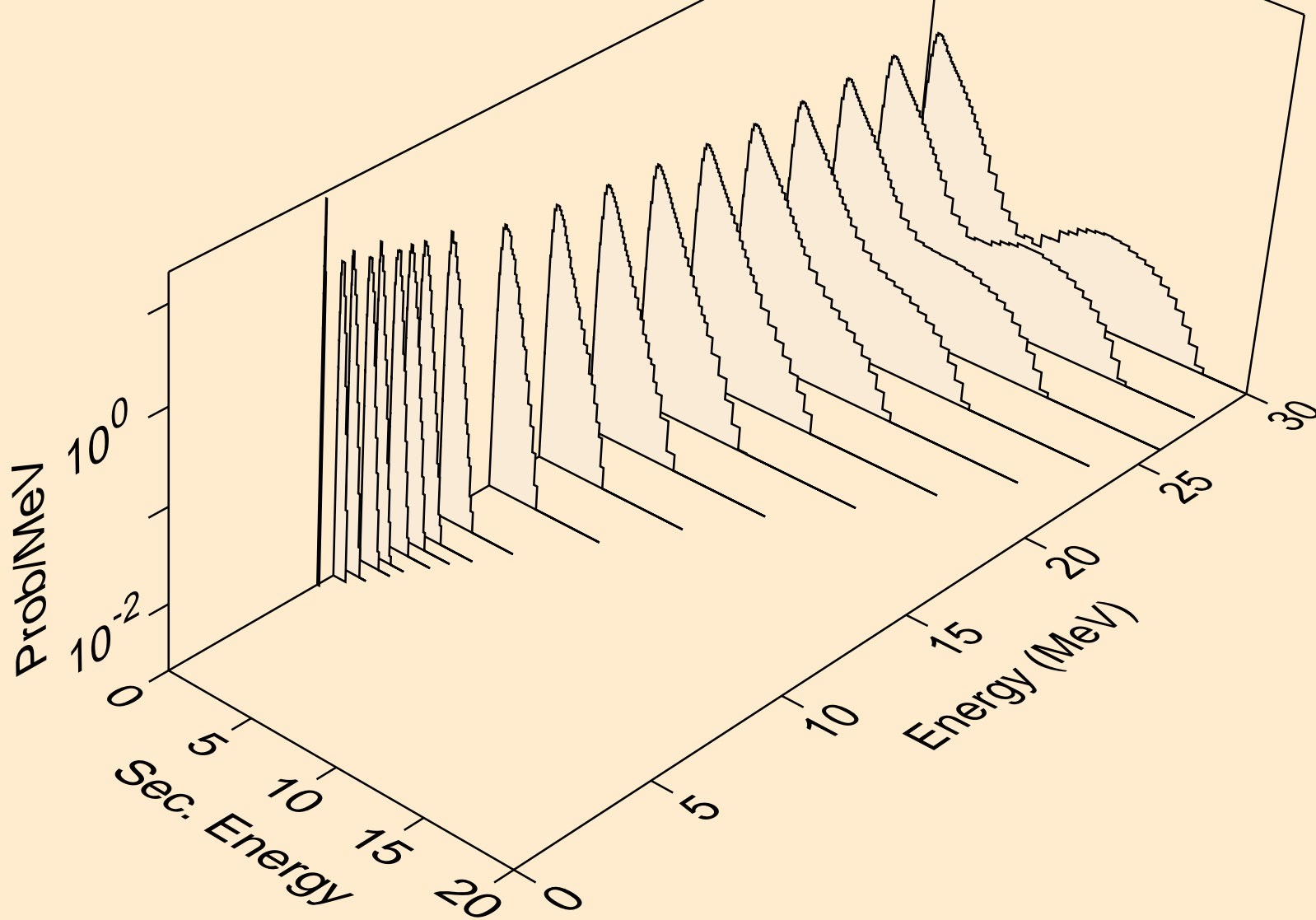

Y080M NEUTRON ACER TENDL-2019 LIBRARY; T=293.16K
Neutron emission for (n,2n)a

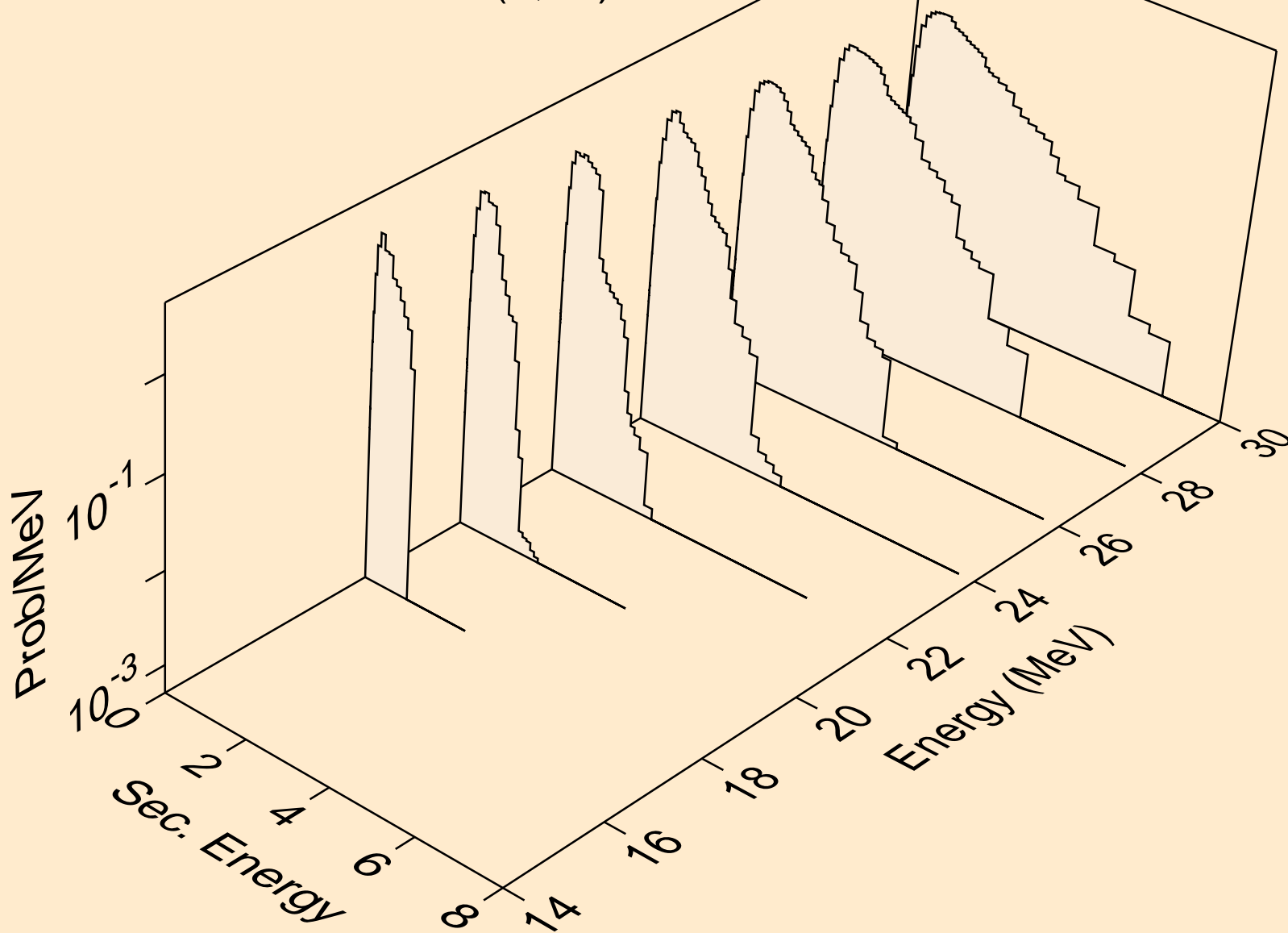

Y080M NEUTRON ACER TENDL-2019 LIBRARY; T=293.16K
Neutron emission for (n,n*)p

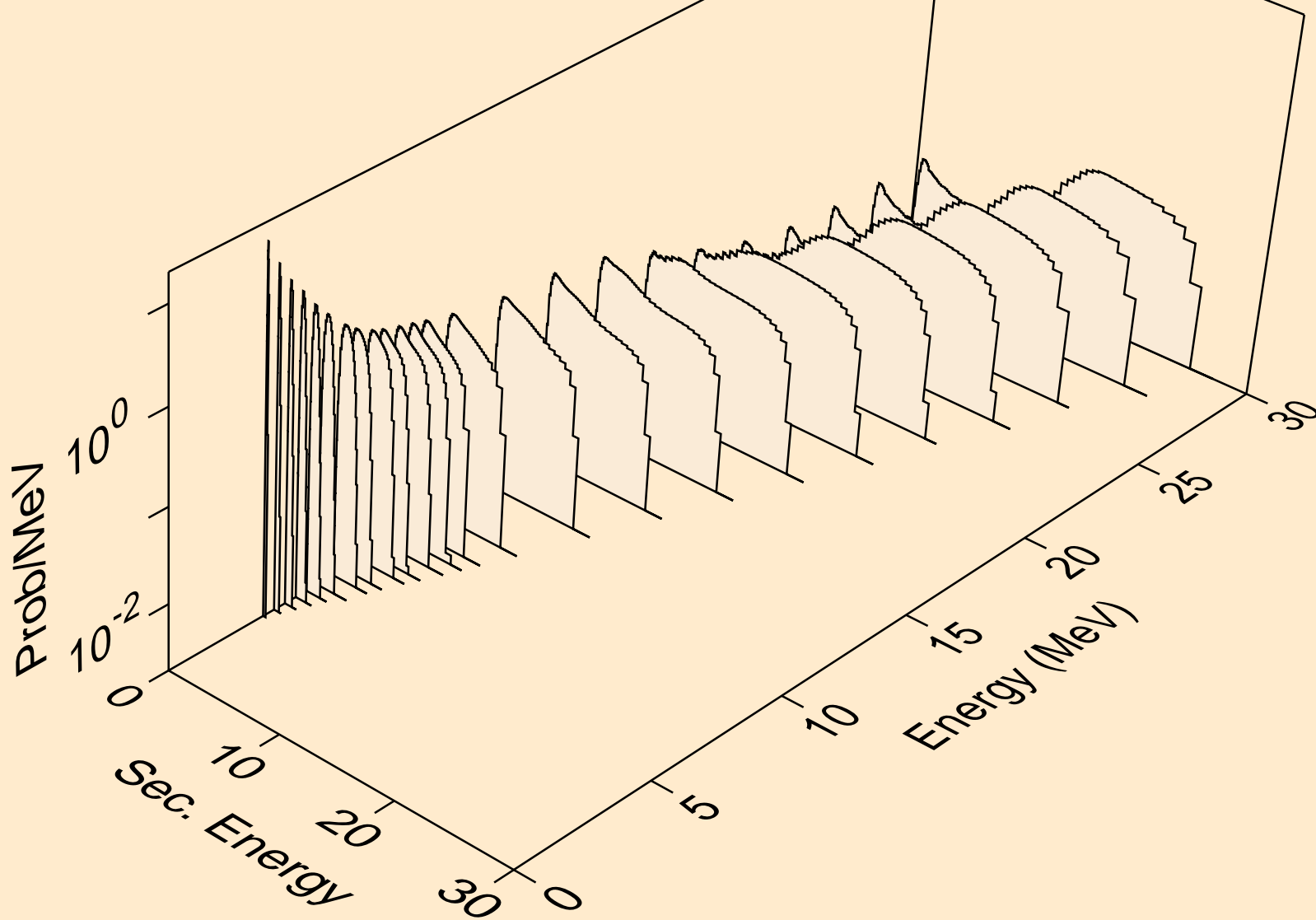

Y080M NEUTRON ACER TENDL-2019 LIBRARY; T=293.16K
Neutron emission for (n,n*)2a

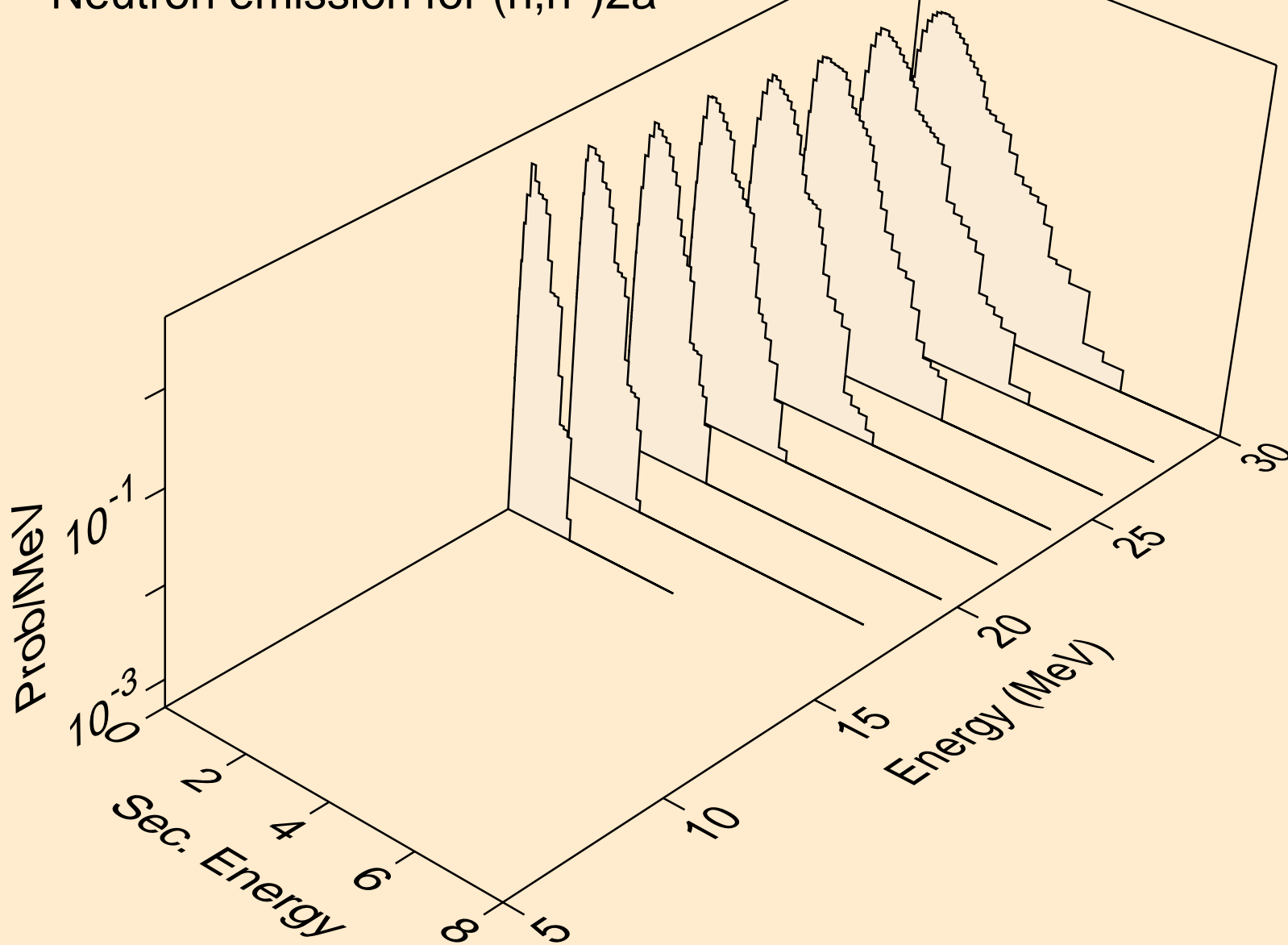

Y080M NEUTRON ACER TENDL-2019 LIBRARY; T=293.16K
Neutron emission for (n,n*)d

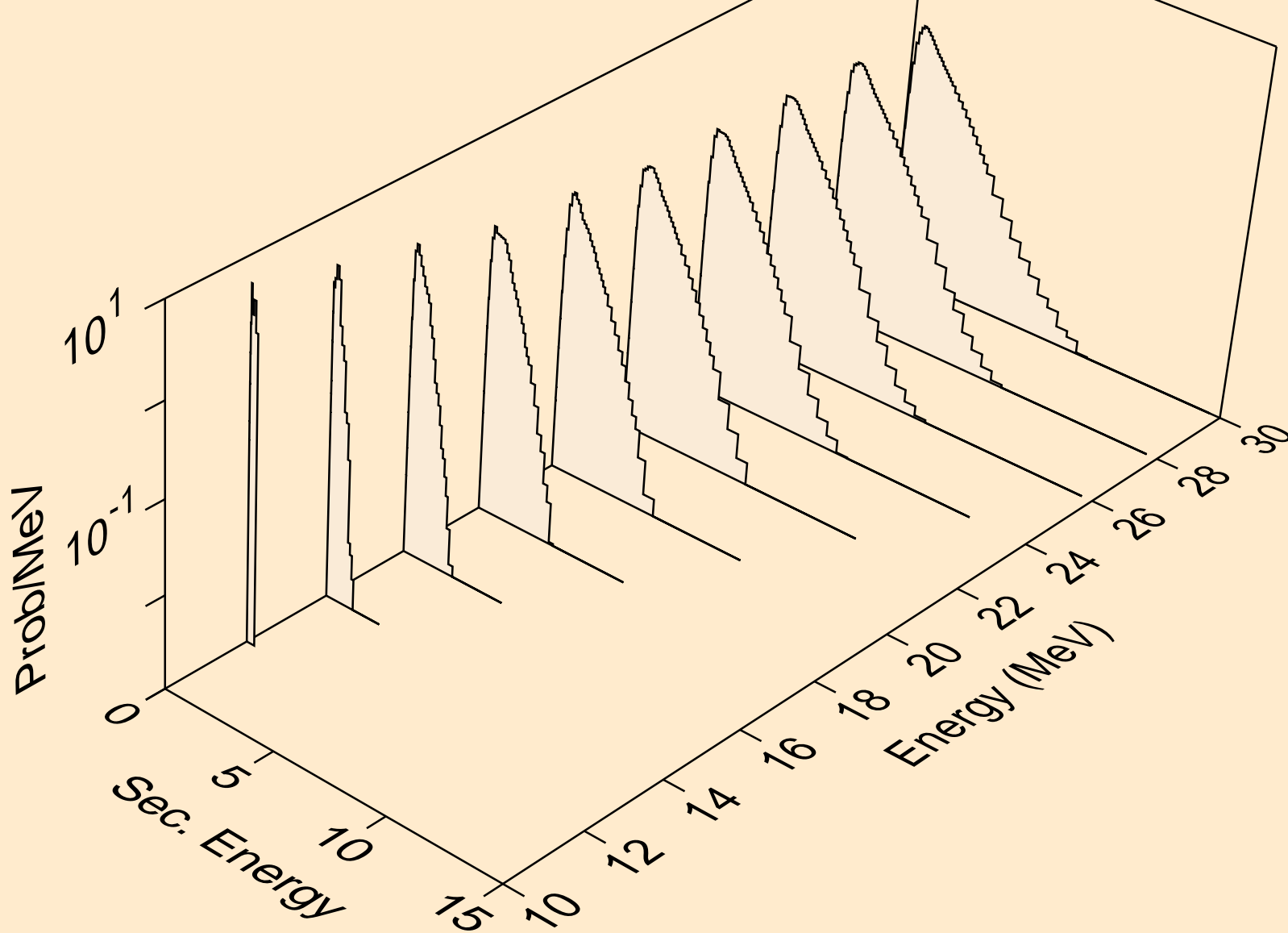

Y080M NEUTRON ACER TENDL-2019 LIBRARY; T=293.16K
Neutron emission for (n,n*)t

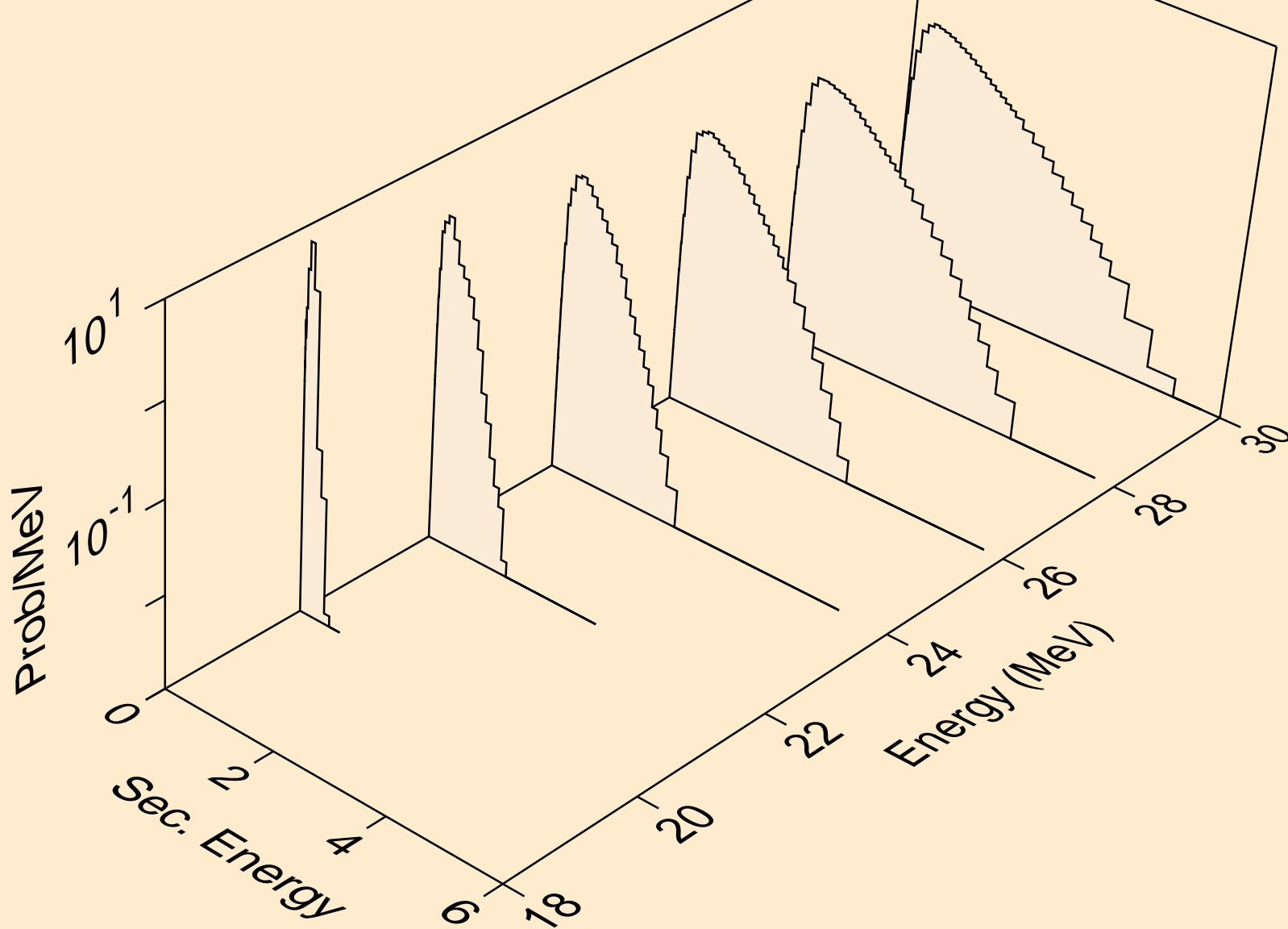

Y080M NEUTRON ACER TENDL-2019 LIBRARY; T=293.16K
Neutron emission for (n,n*)he3

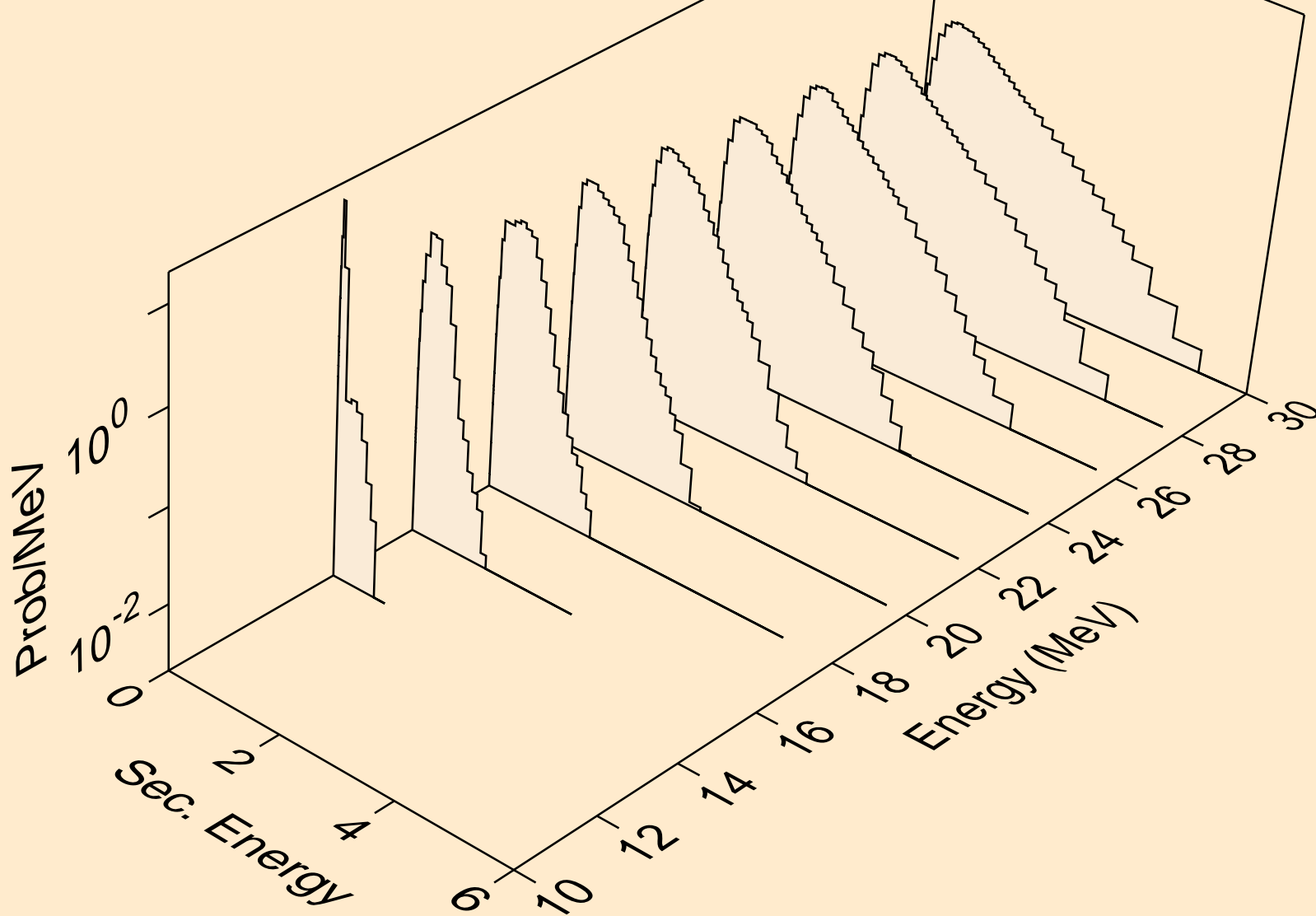

Y080M NEUTRON ACER TENDL-2019 LIBRARY; T=293.16K
Neutron emission for (n,2np)

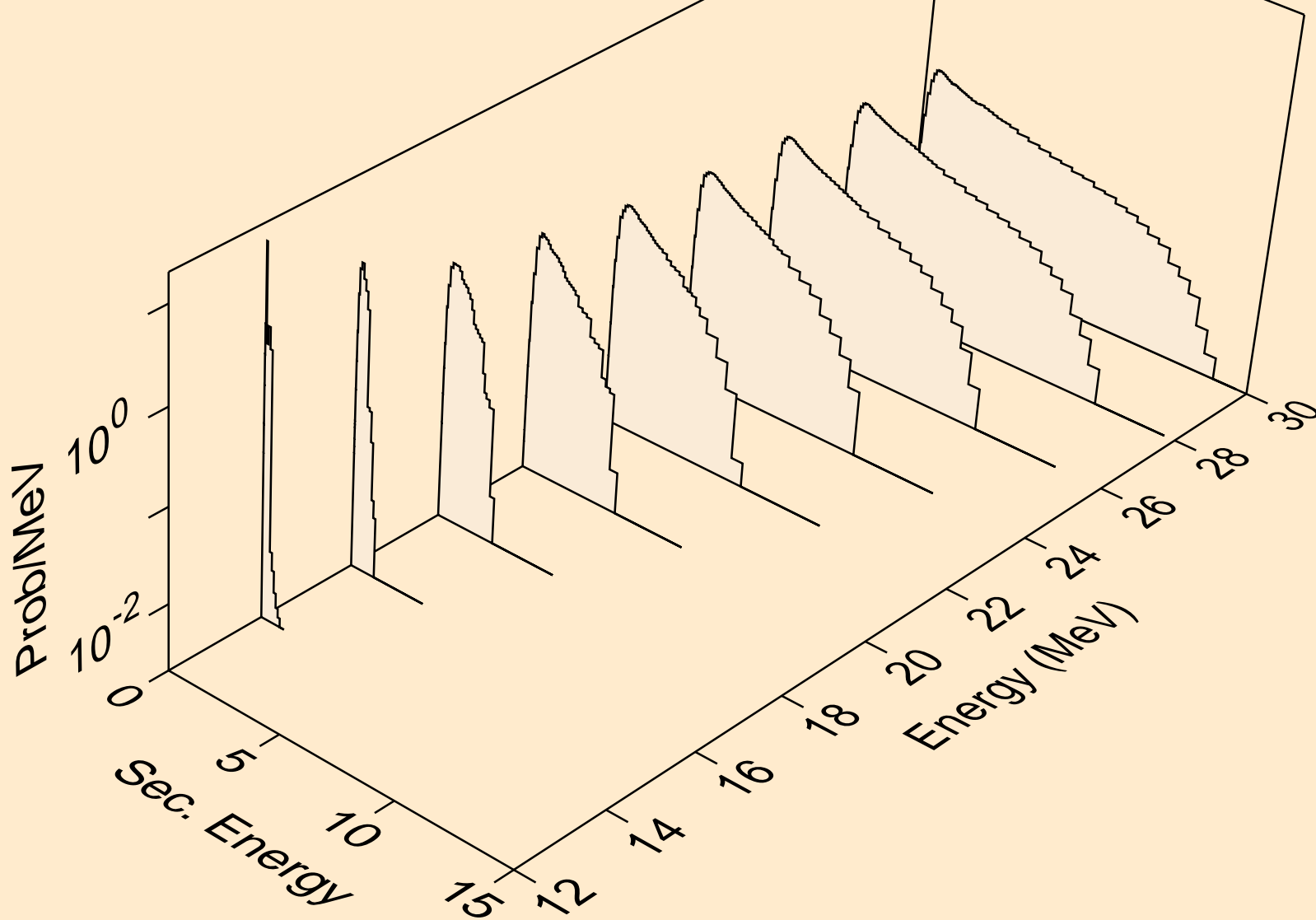

Y080M NEUTRON ACER TENDL-2019 LIBRARY; T=293.16K
Neutron emission for (n,3np)

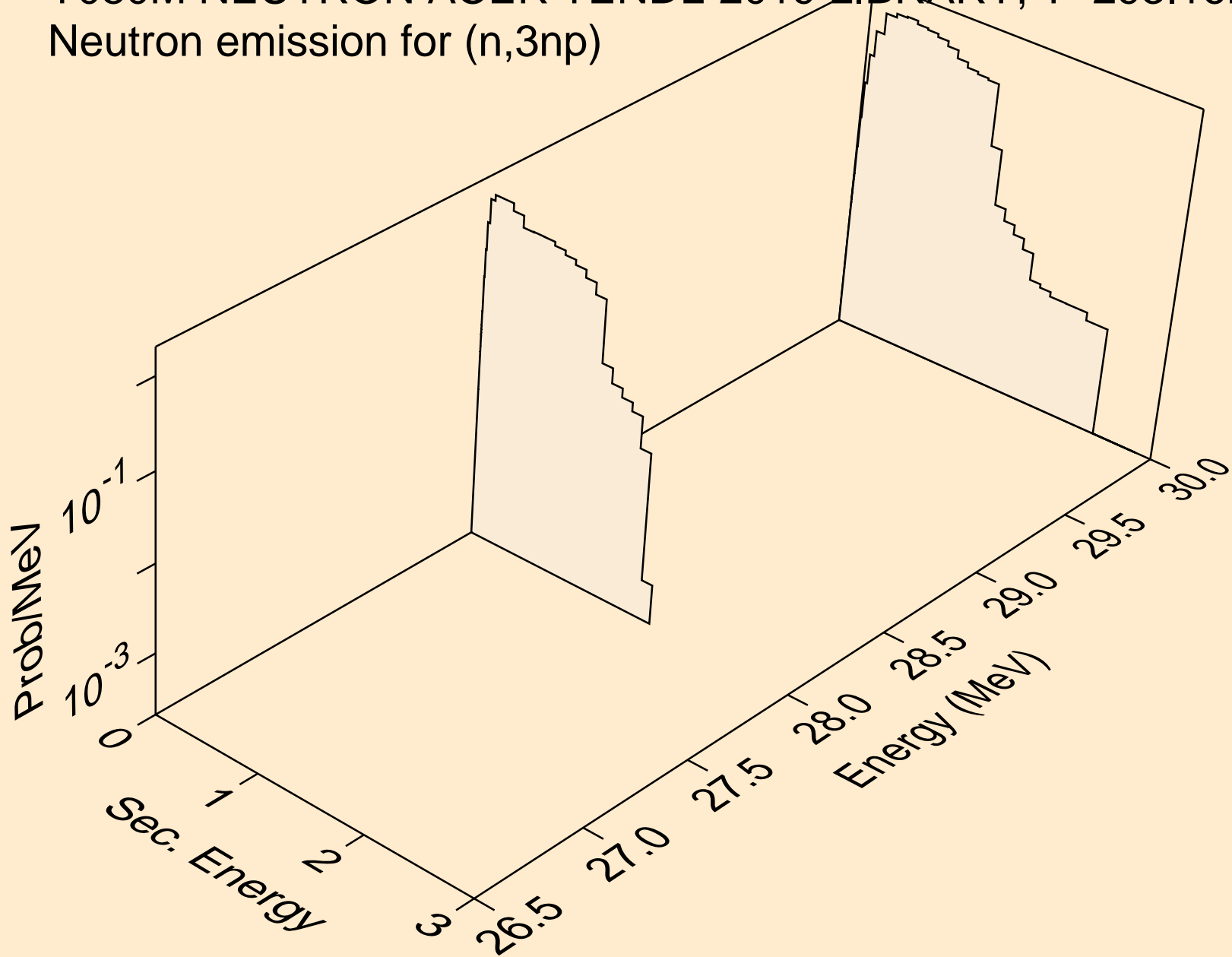

Y080M NEUTRON ACER TENDL-2019 LIBRARY; T=293.16K
Neutron emission for (n,2np)

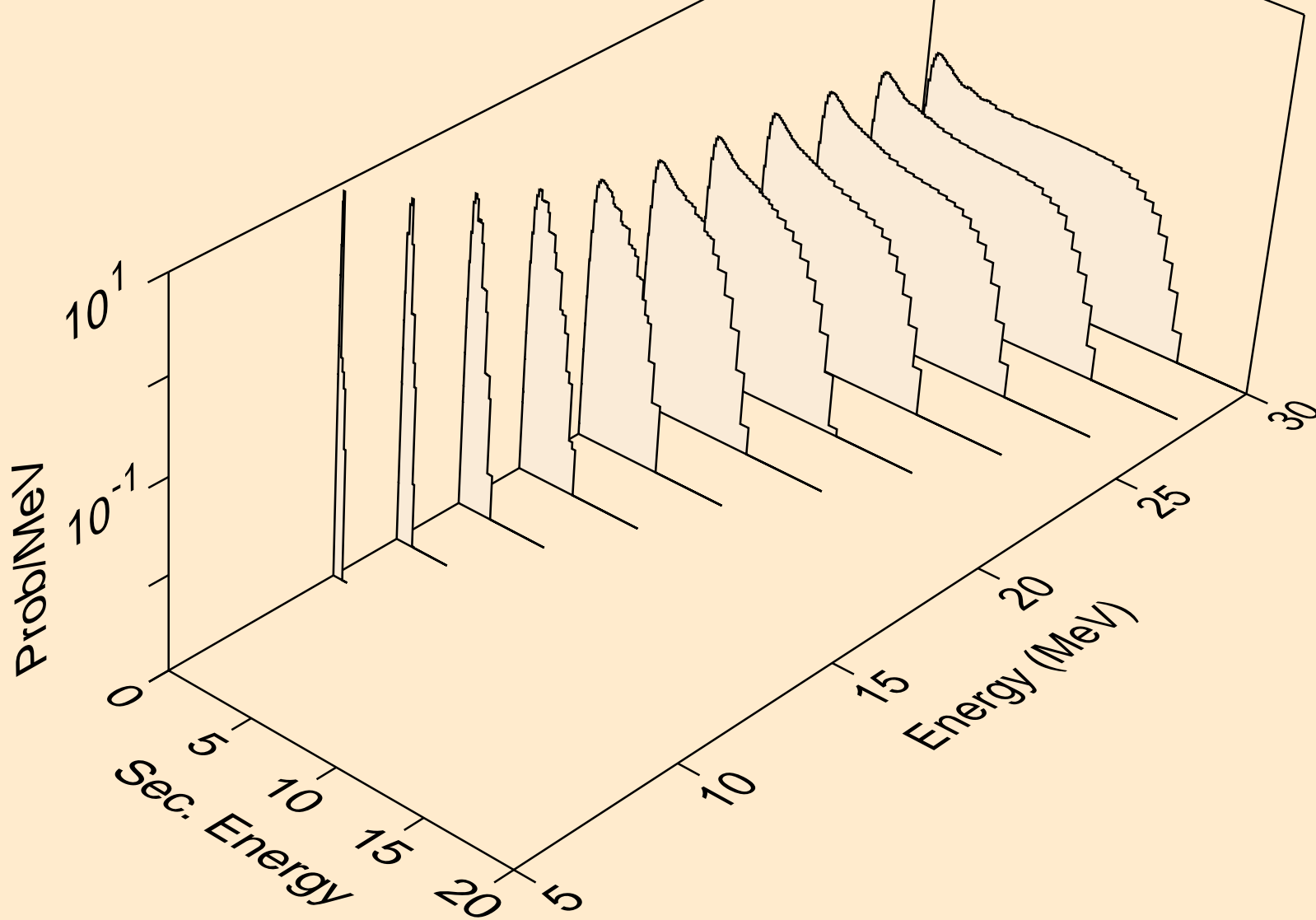

Y080M NEUTRON ACER TENDL-2019 LIBRARY; T=293.16K
Neutron emission for (n,npa)

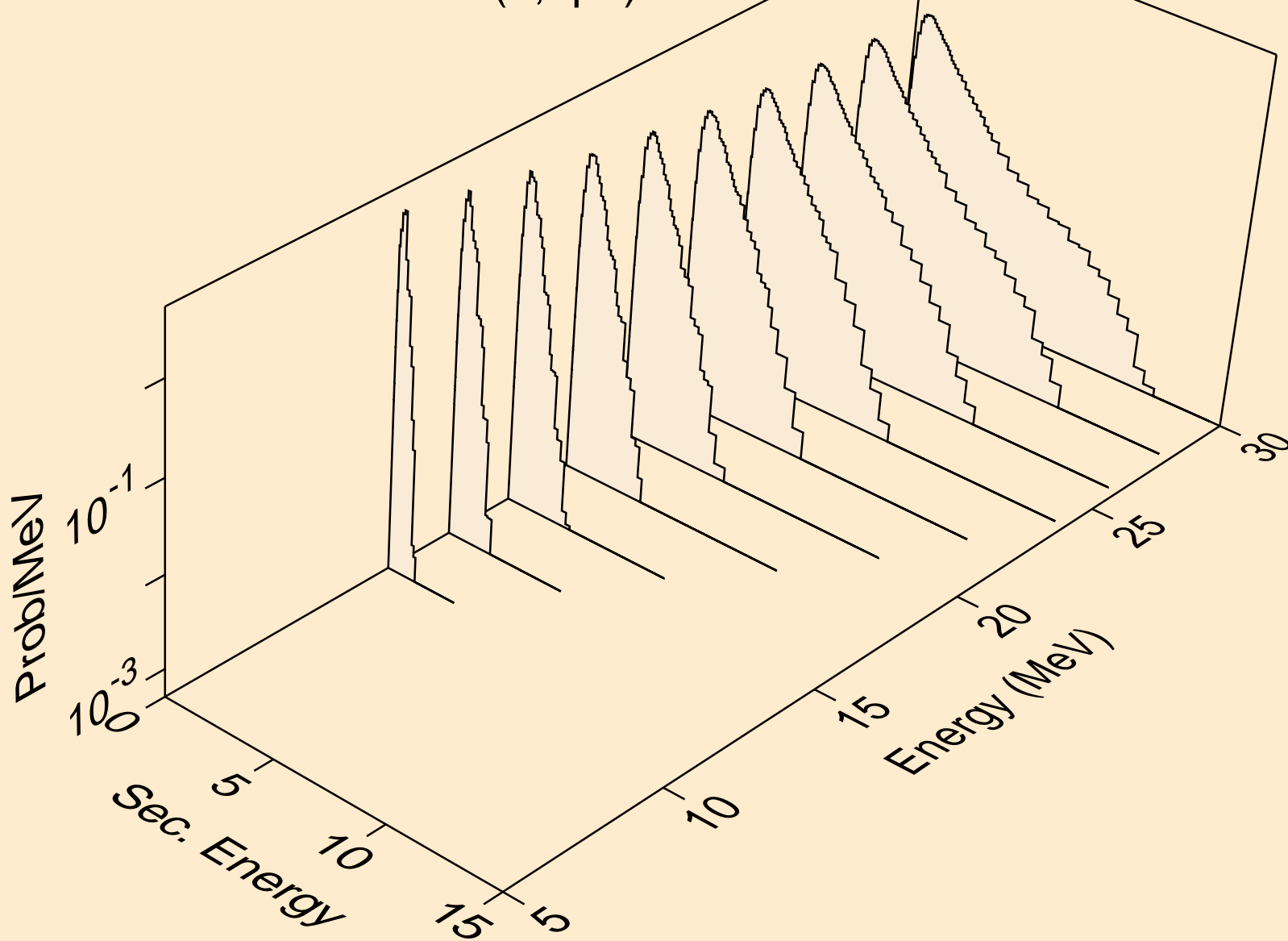

Y080M NEUTRON ACER TENDL-2019 LIBRARY; T=293.16K
Neutron emission for (n,n*c)

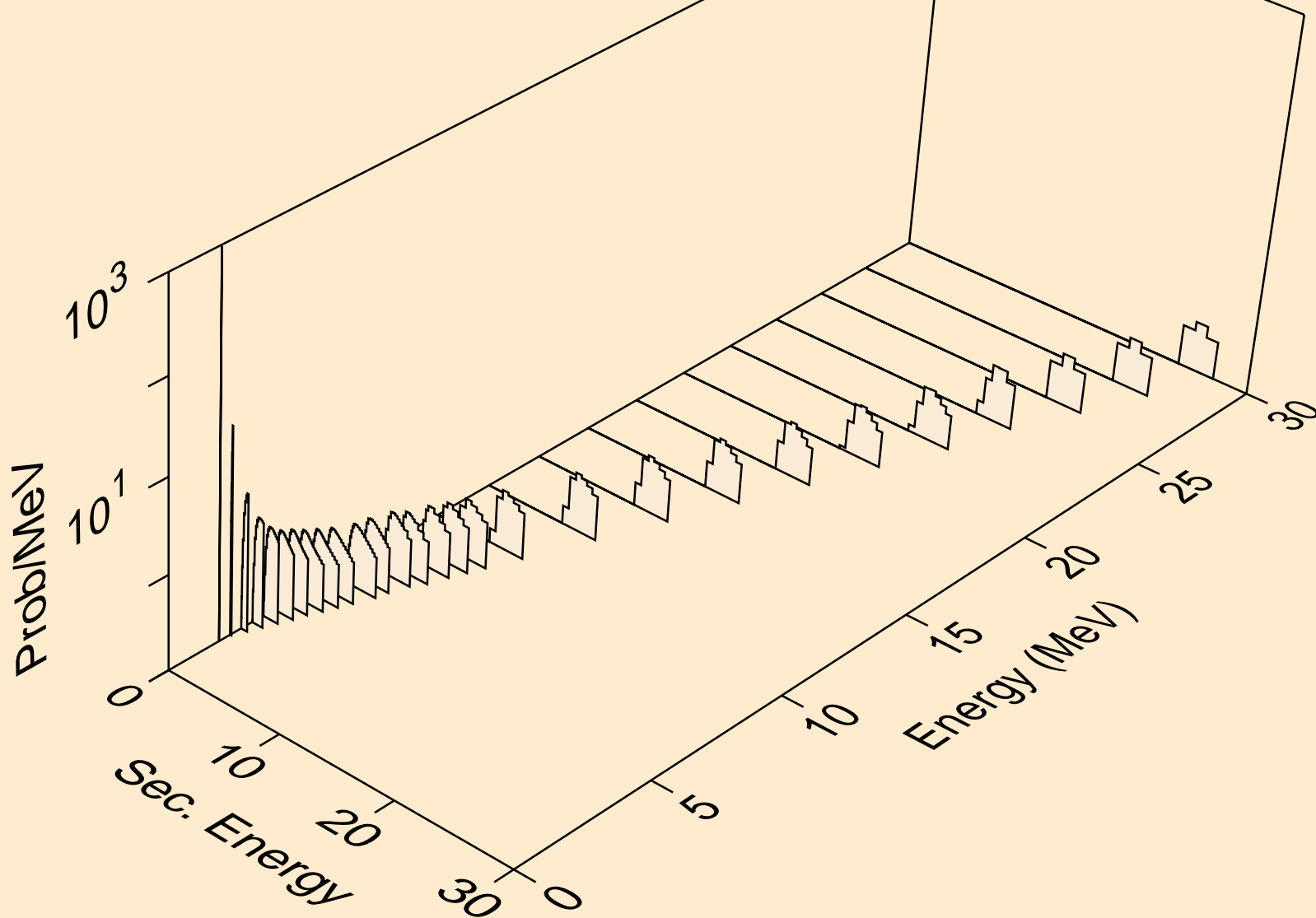

Y080M NEUTRON ACER TENDL-2019 LIBRARY; T=293.16K
Photon emission for (n,x)

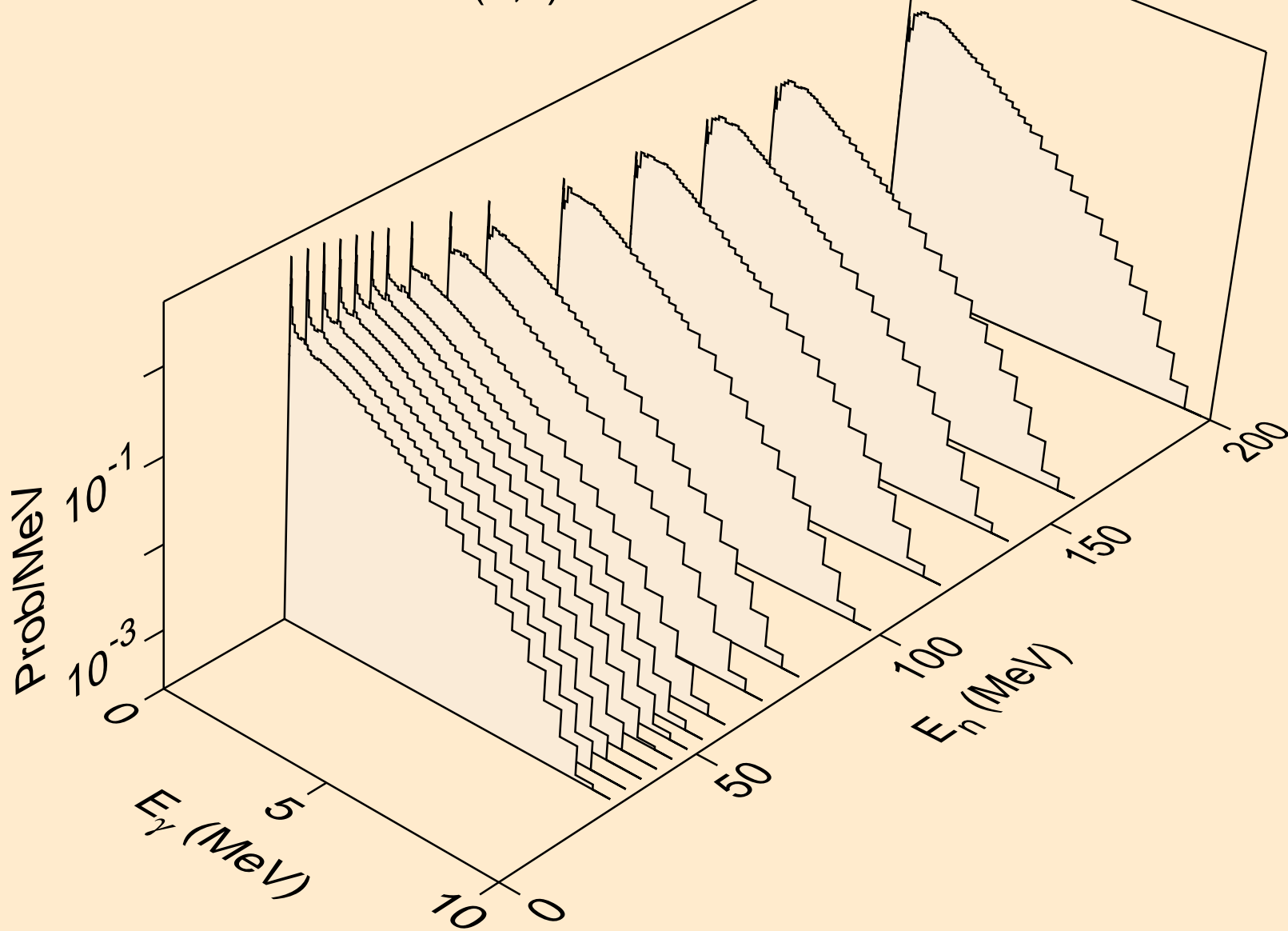

Y080M NEUTRON ACER TENDL-2019 LIBRARY; T=293.16K
Photon emission for (n,2nd)

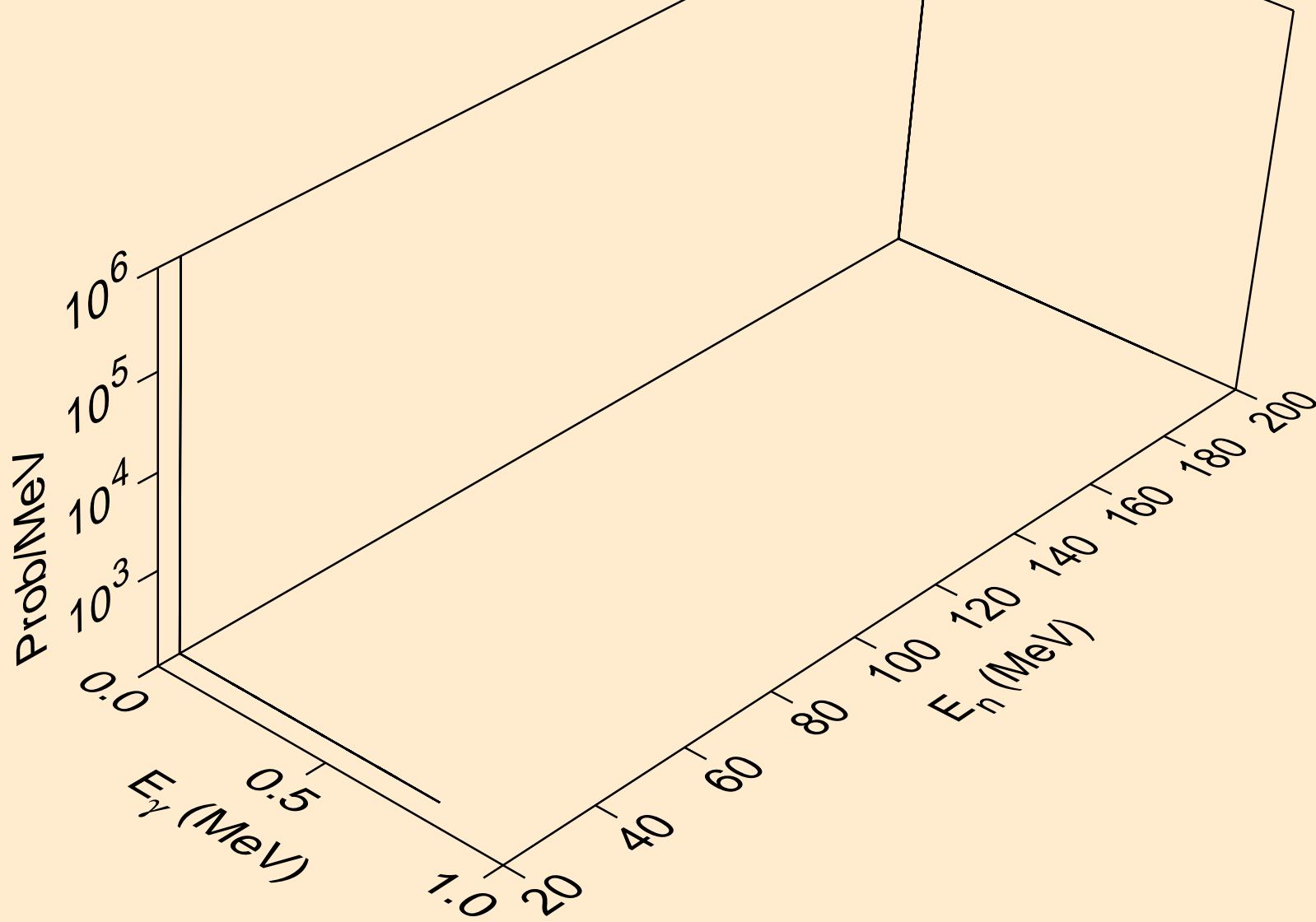

Y080M NEUTRON ACER TENDL-2019 LIBRARY; T=293.16K
Photon emission for (n,2n)

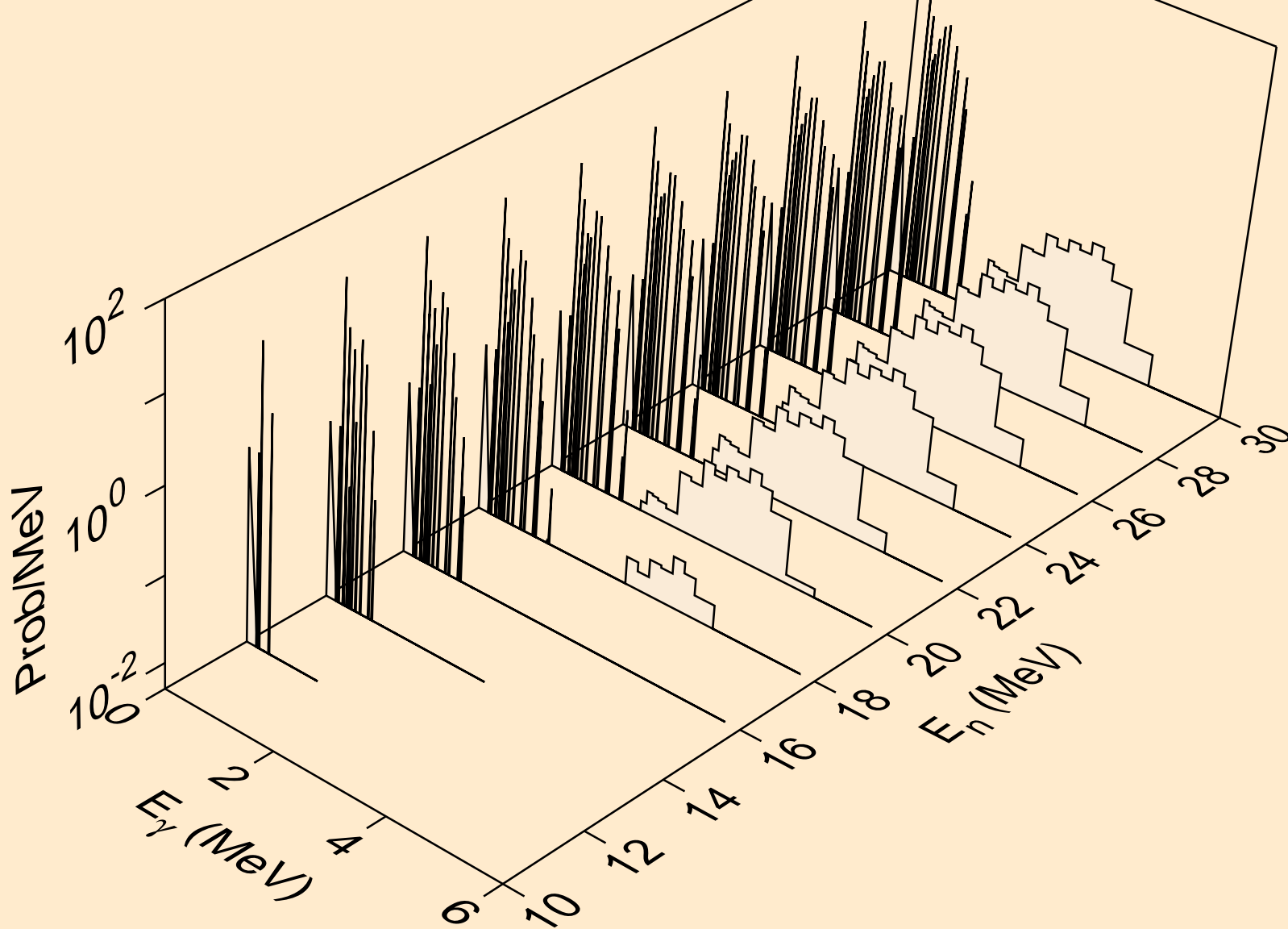

Y080M NEUTRON ACER TENDL-2019 LIBRARY; T=293.16K
Photon emission for (n,3n)

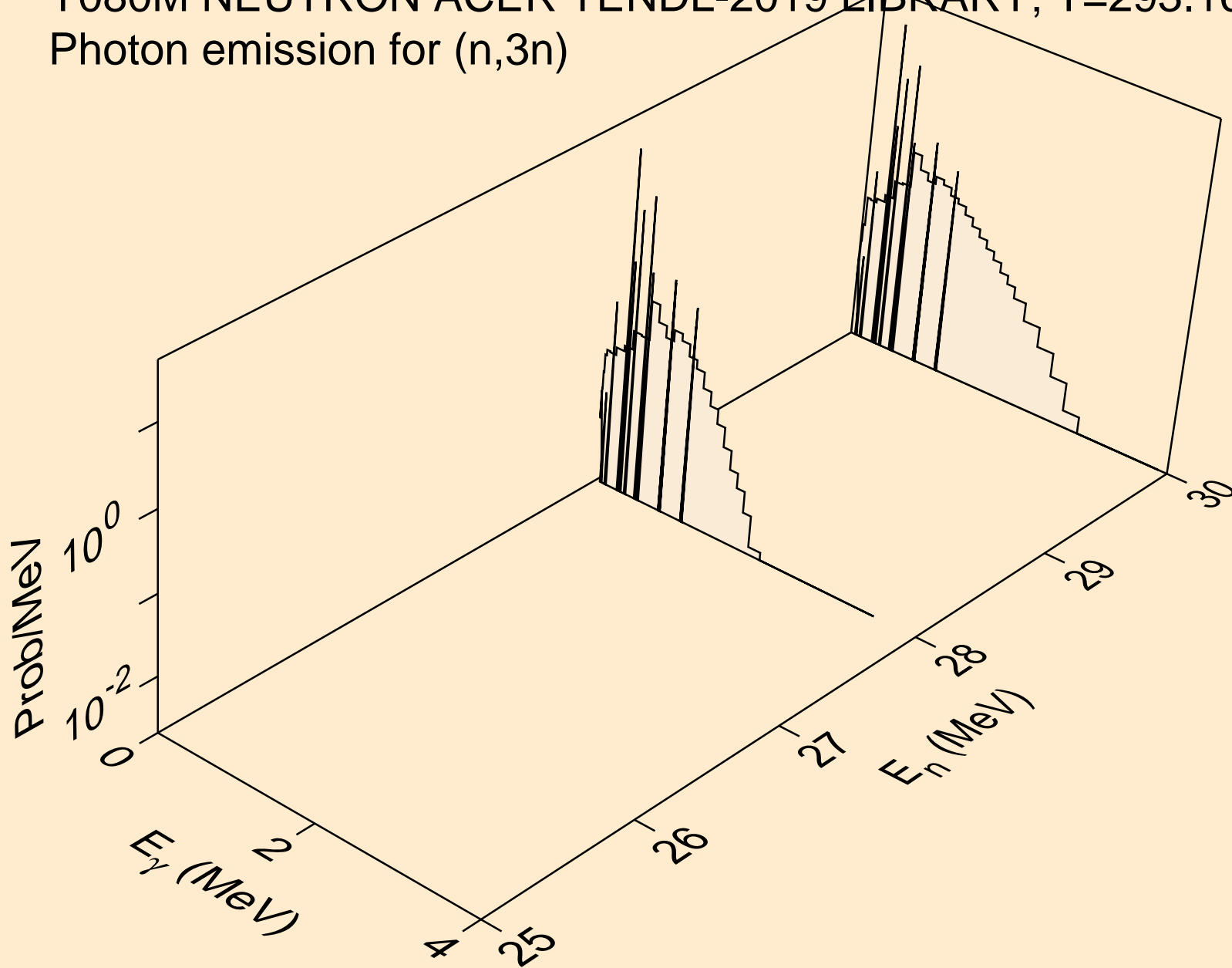

Y080M NEUTRON ACER TENDL-2019 LIBRARY; T=293.16K
Photon emission for (n,n*)a

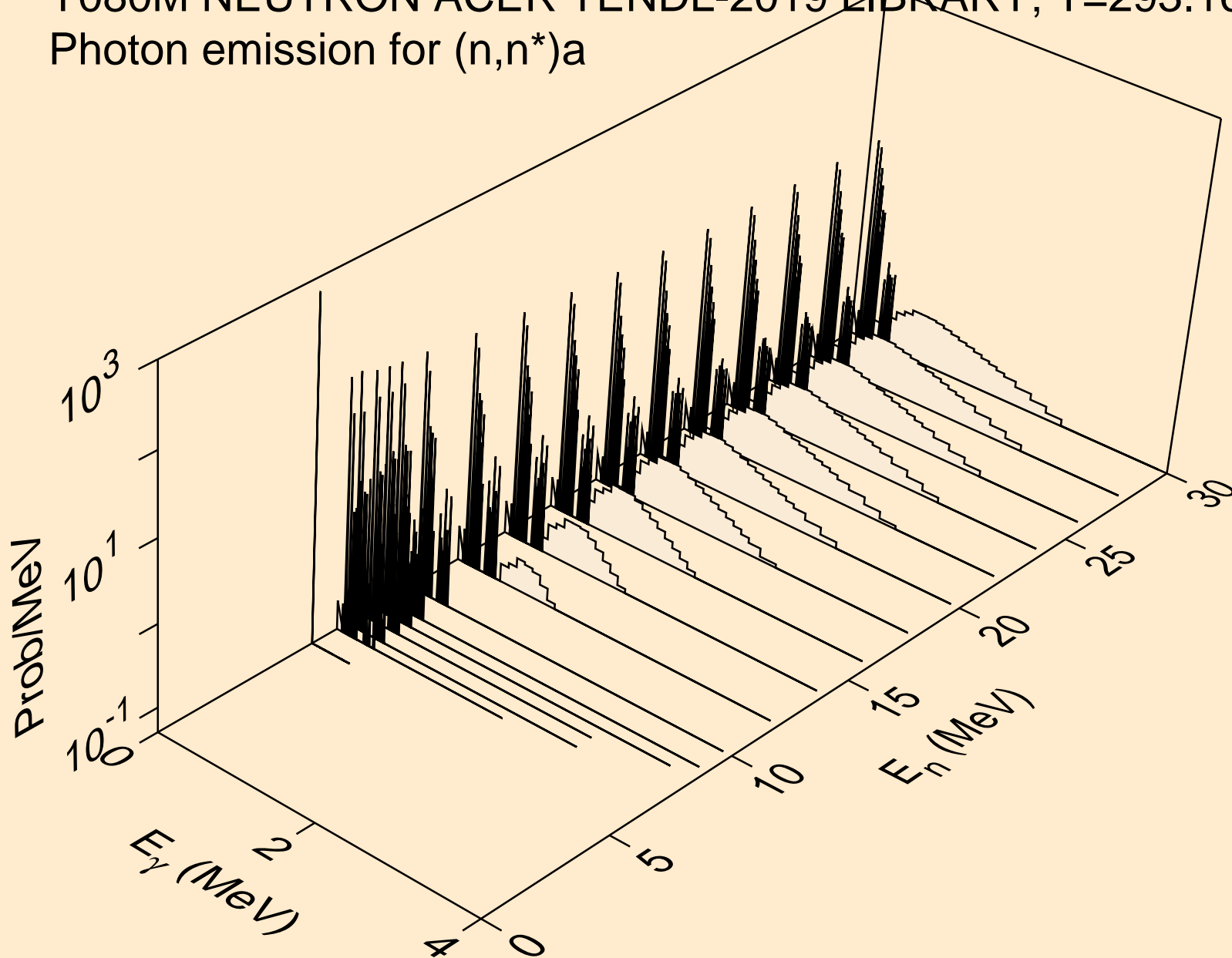

Y080M NEUTRON ACER TENDL-2019 LIBRARY; T=293.16K
Photon emission for (n,2n)a

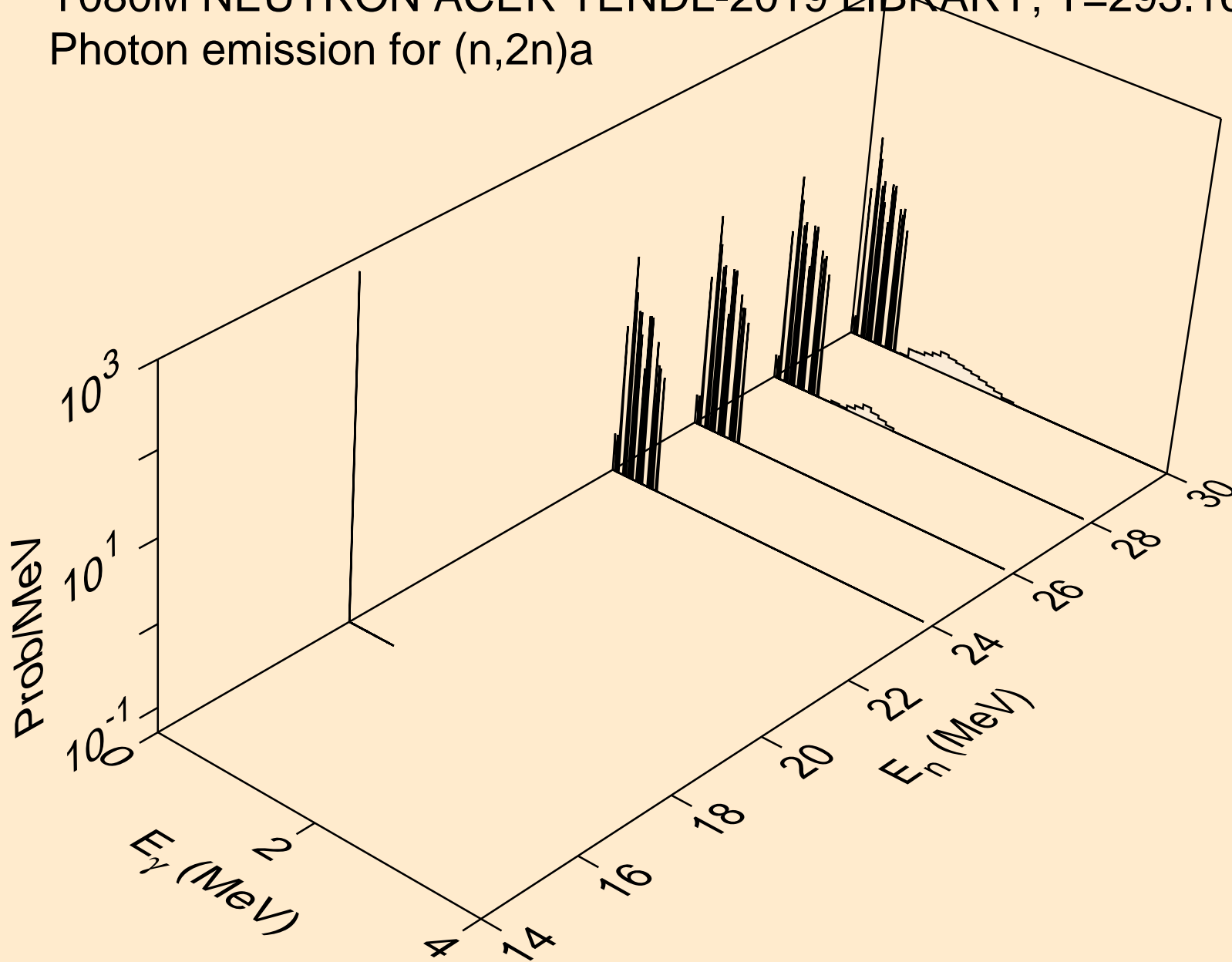

Y080M NEUTRON ACER TENDL-2019 LIBRARY; T=293.16K
Photon emission for (n,n*)p

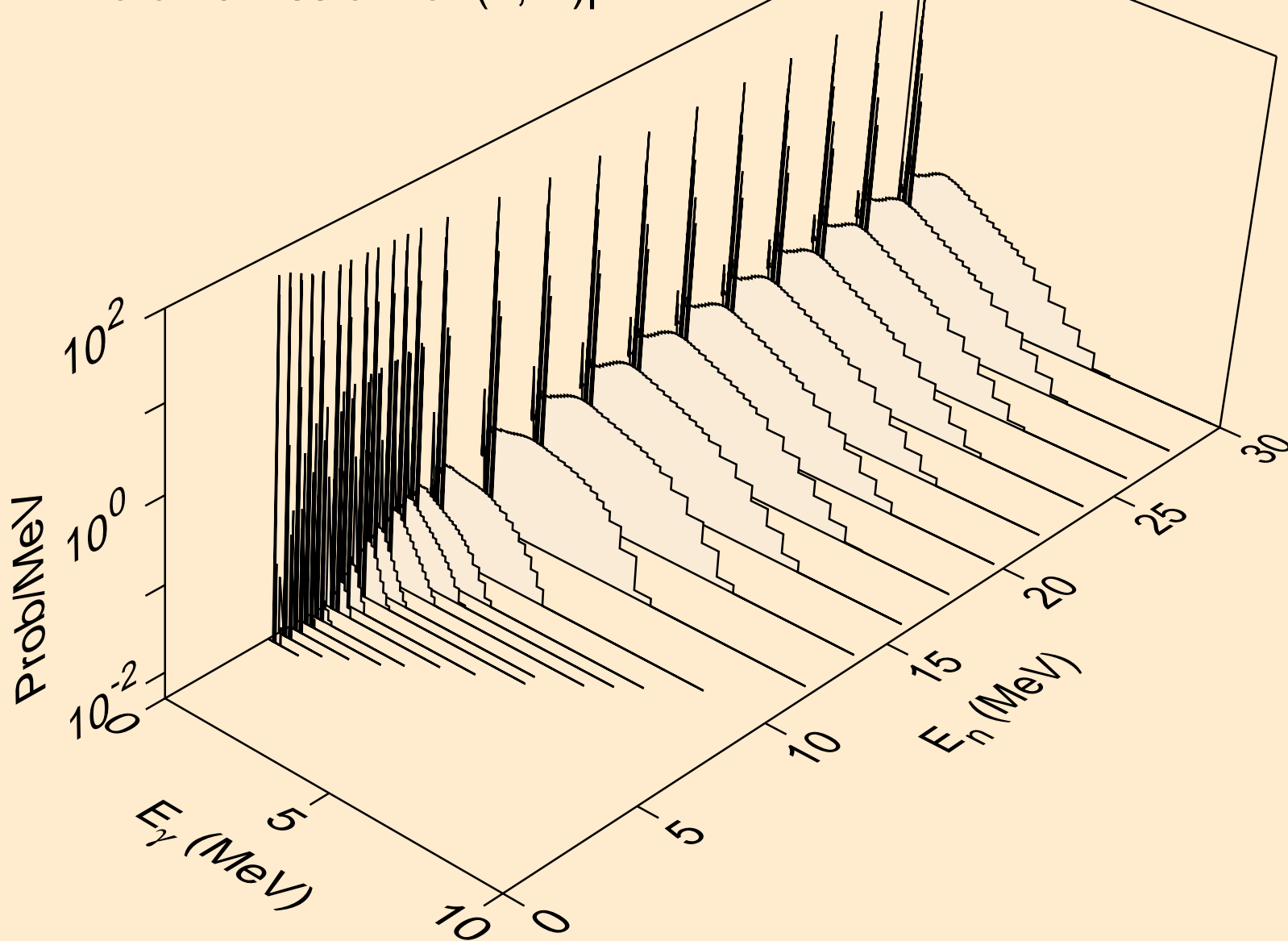

Y080M NEUTRON ACER TENDL-2019 LIBRARY; T=293.16K
Photon emission for (n,n*)2a

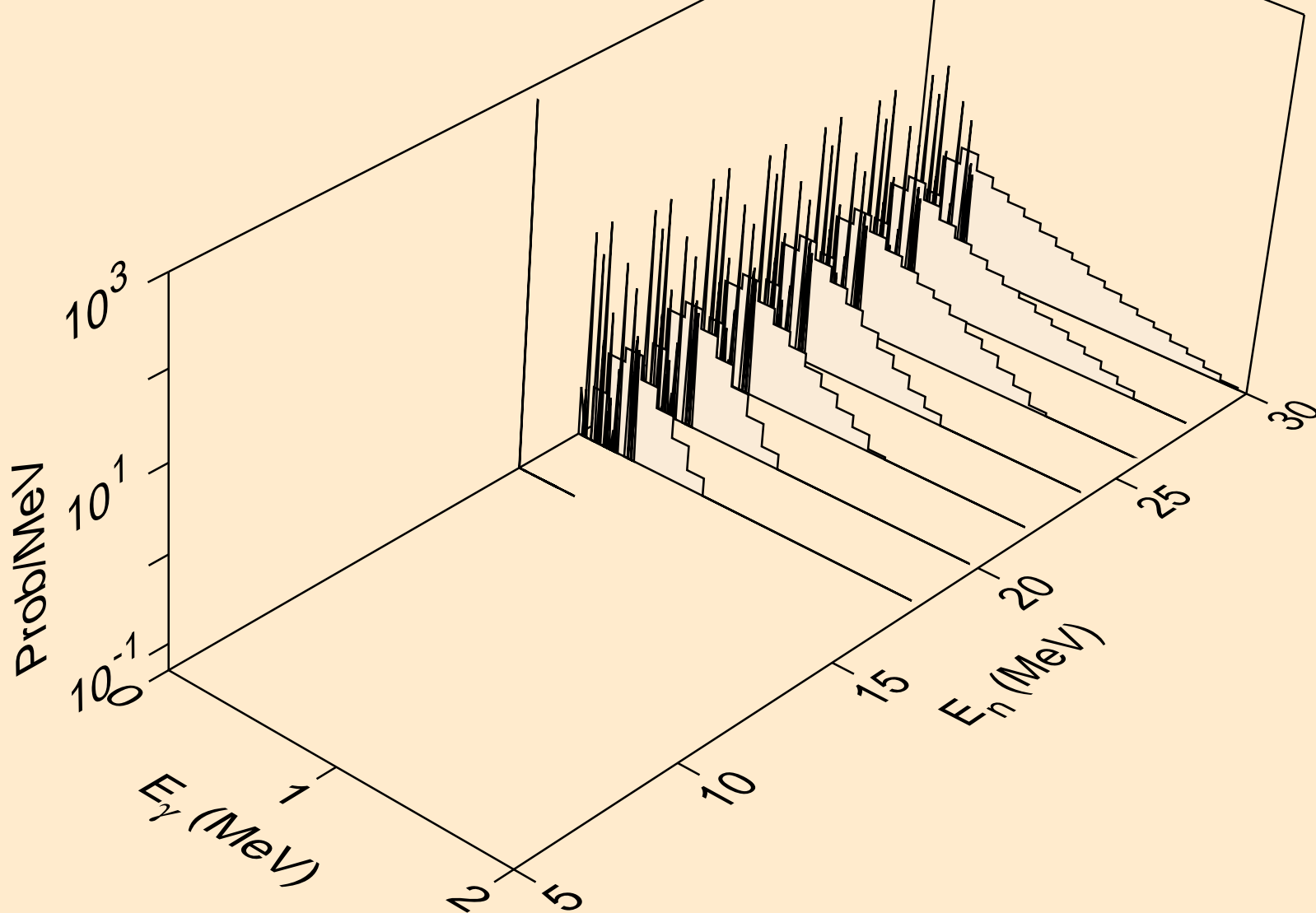

Y080M NEUTRON ACER TENDL-2019 LIBRARY; T=293.16K
Photon emission for (n,n*)d

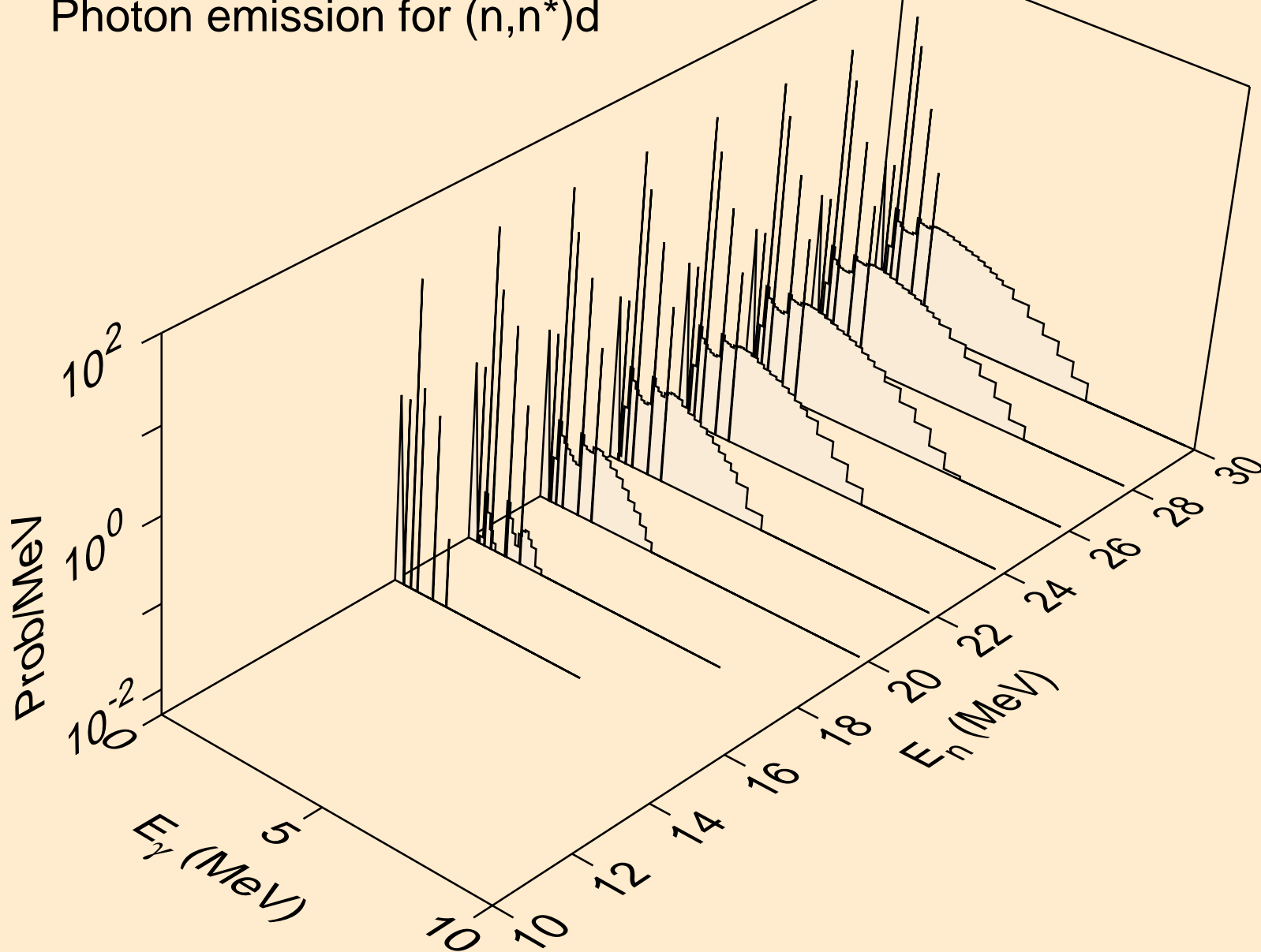

Y080M NEUTRON ACER TENDL-2019 LIBRARY; T=293.16K
Photon emission for (n,n*)t

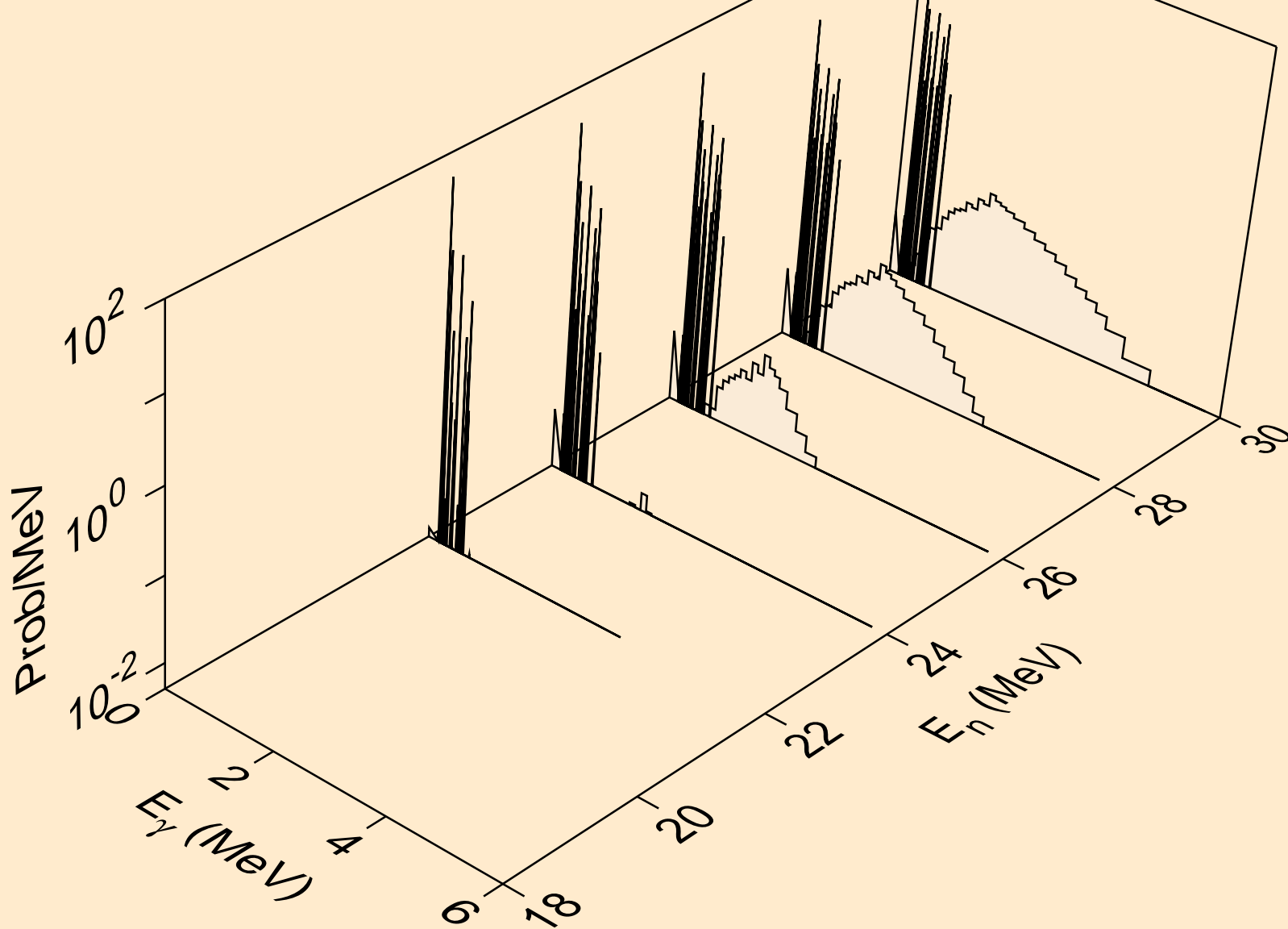

Y080M NEUTRON ACER TENDL-2019 LIBRARY; T=293.16K
Photon emission for (n,n*)he3

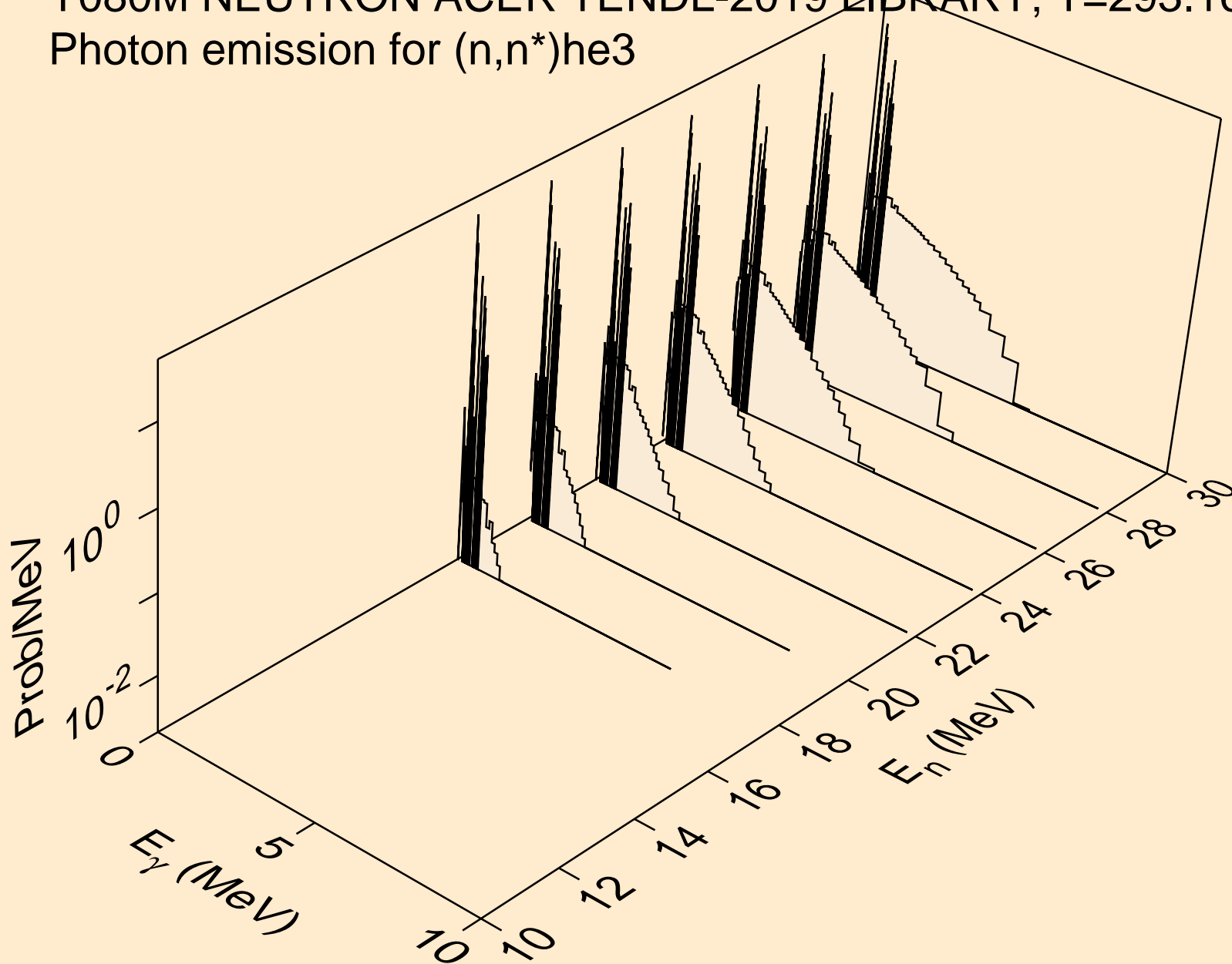

Y080M NEUTRON ACER TENDL-2019 LIBRARY; T=293.16K
Photon emission for (n,2np)

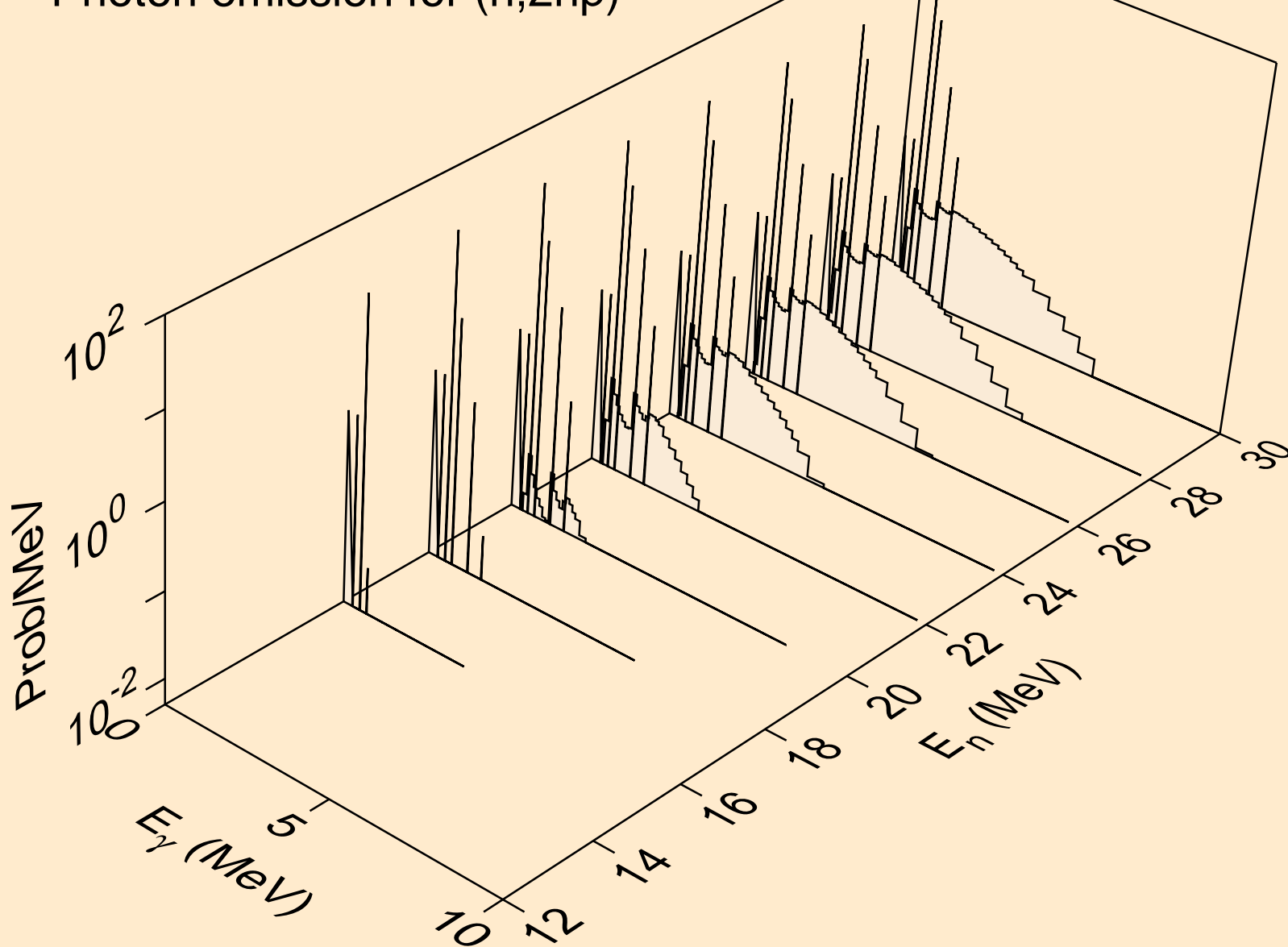

Y080M NEUTRON ACER TENDL-2019 LIBRARY; T=293.16K
Photon emission for (n,3np)

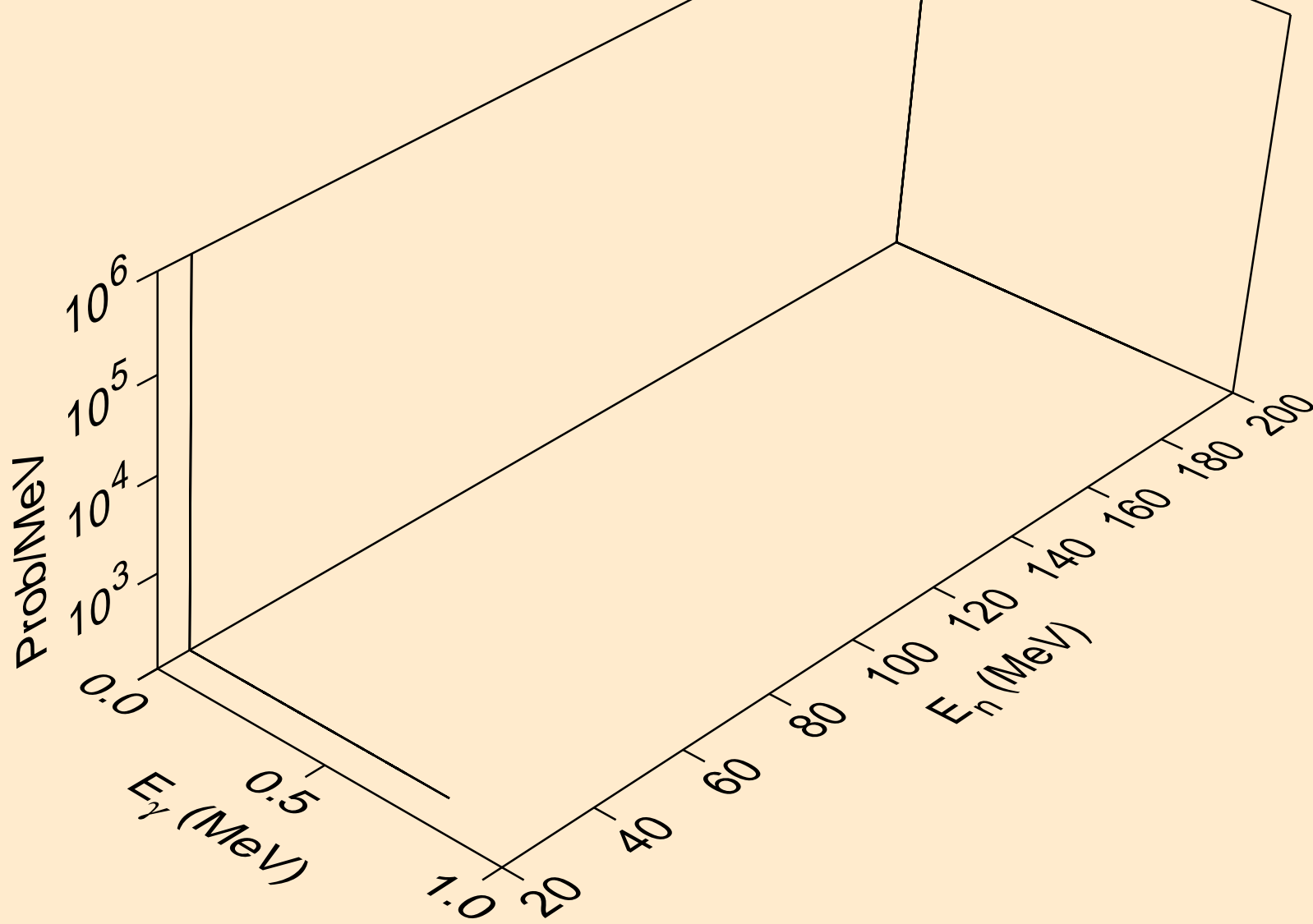

Y080M NEUTRON ACER TENDL-2019 LIBRARY; T=293.16K
Photon emission for (n,2np)

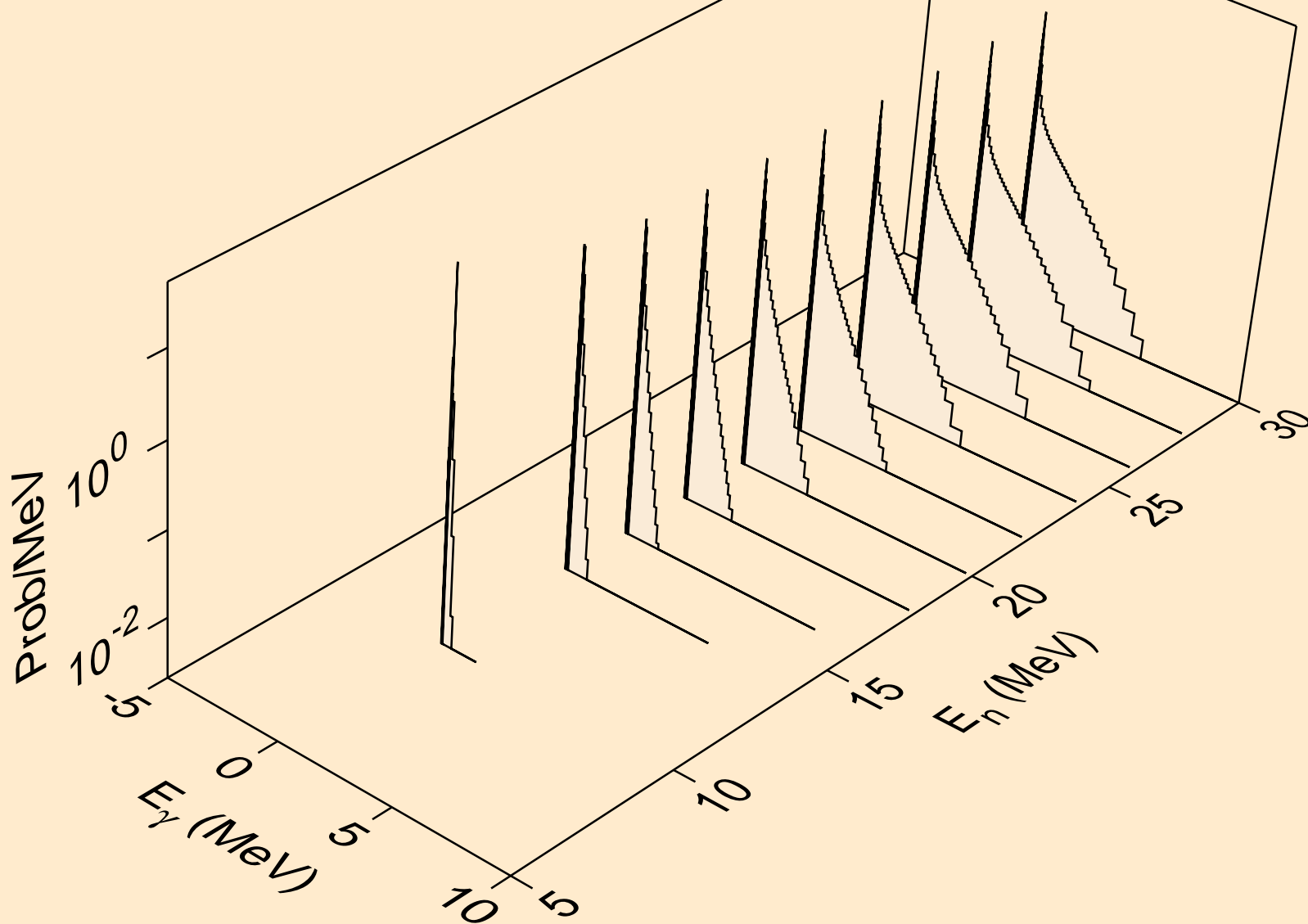

Y080M NEUTRON ACER TENDL-2019 LIBRARY; T=293.16K
Photon emission for (n,npa)

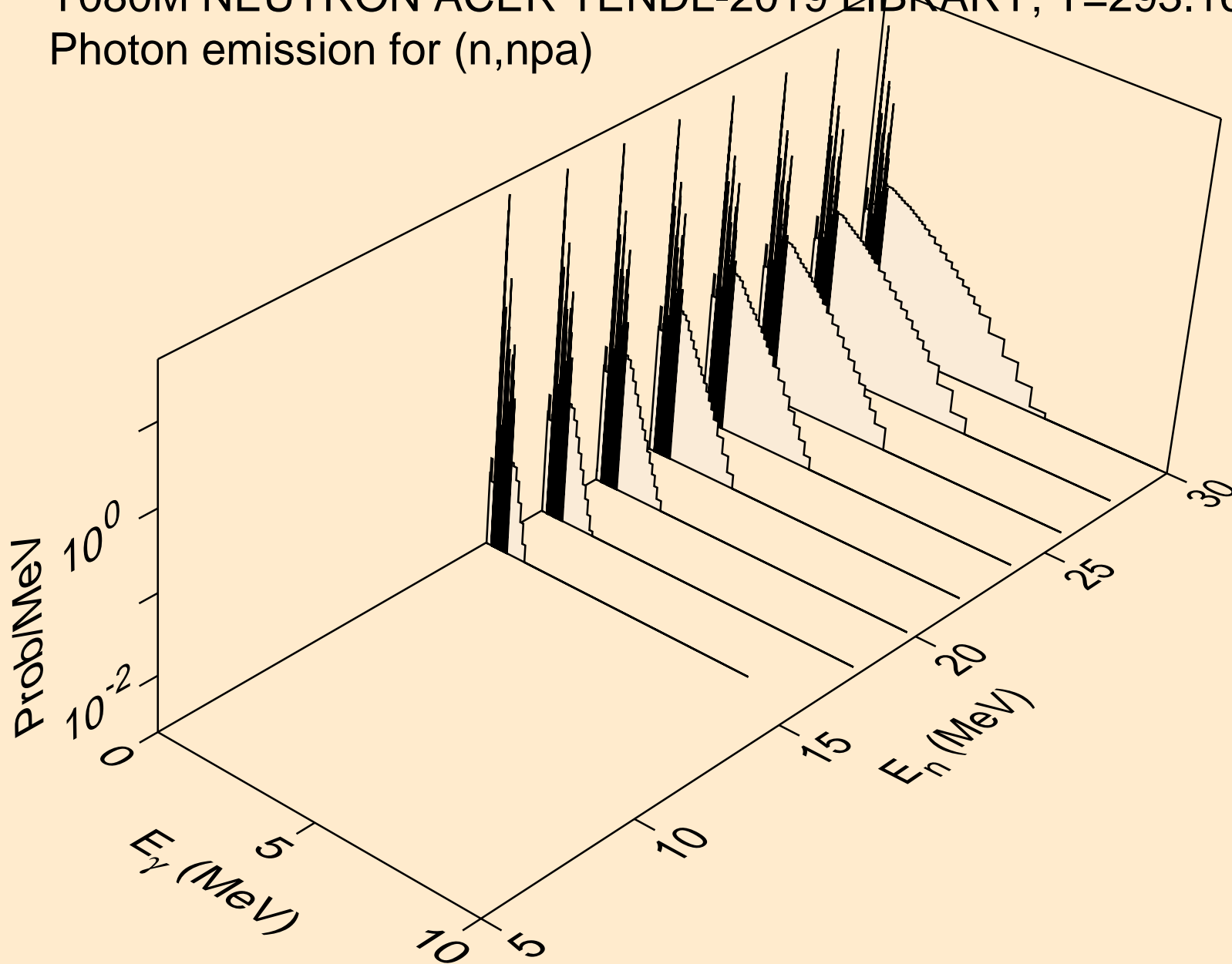

Y080M NEUTRON ACER TENDL-2019 LIBRARY; T=293.16K
Photon emission for (n,n*2)

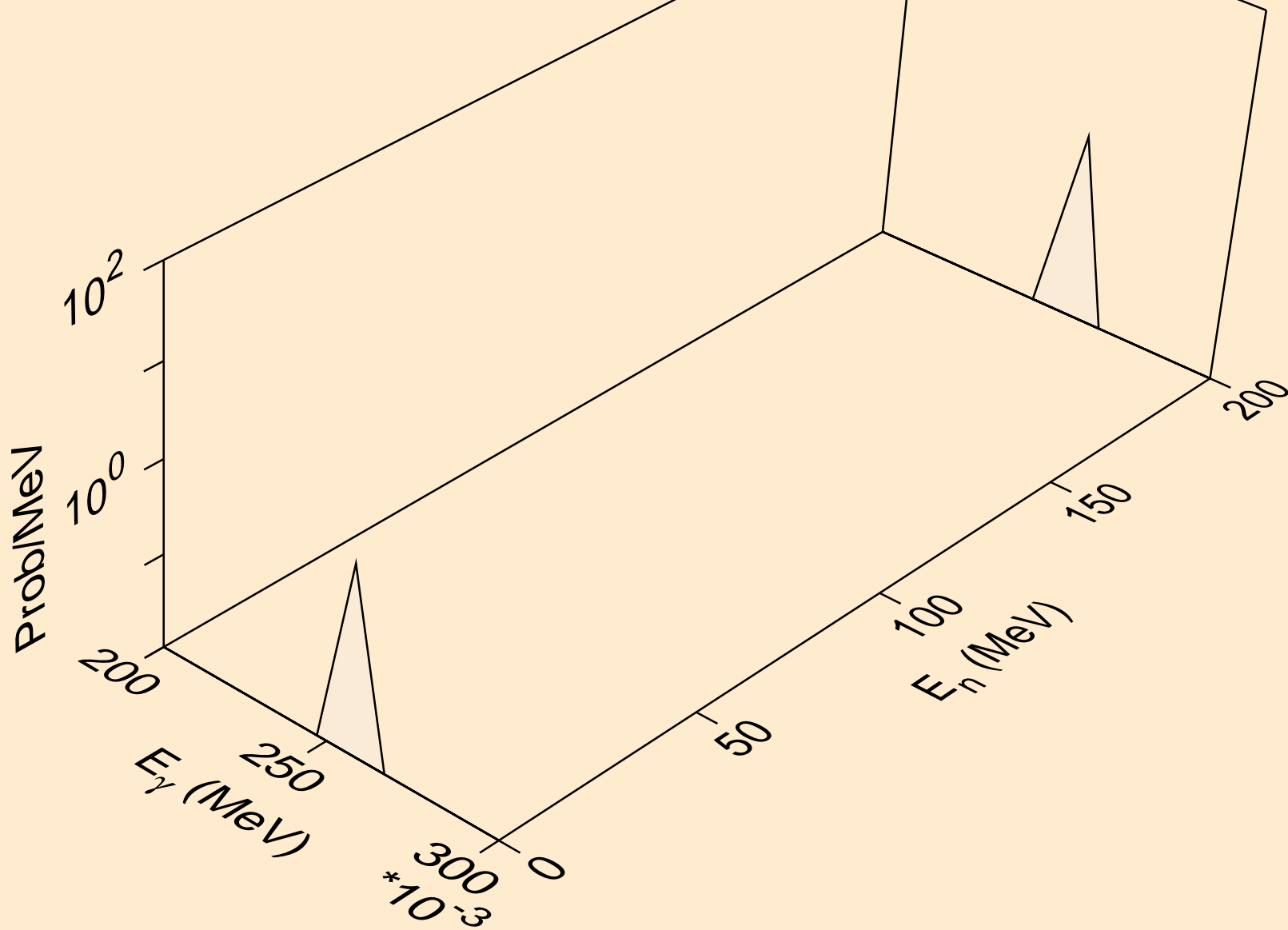

Y080M NEUTRON ACER TENDL-2019 LIBRARY; T=293.16K
Photon emission for (n,n*3)

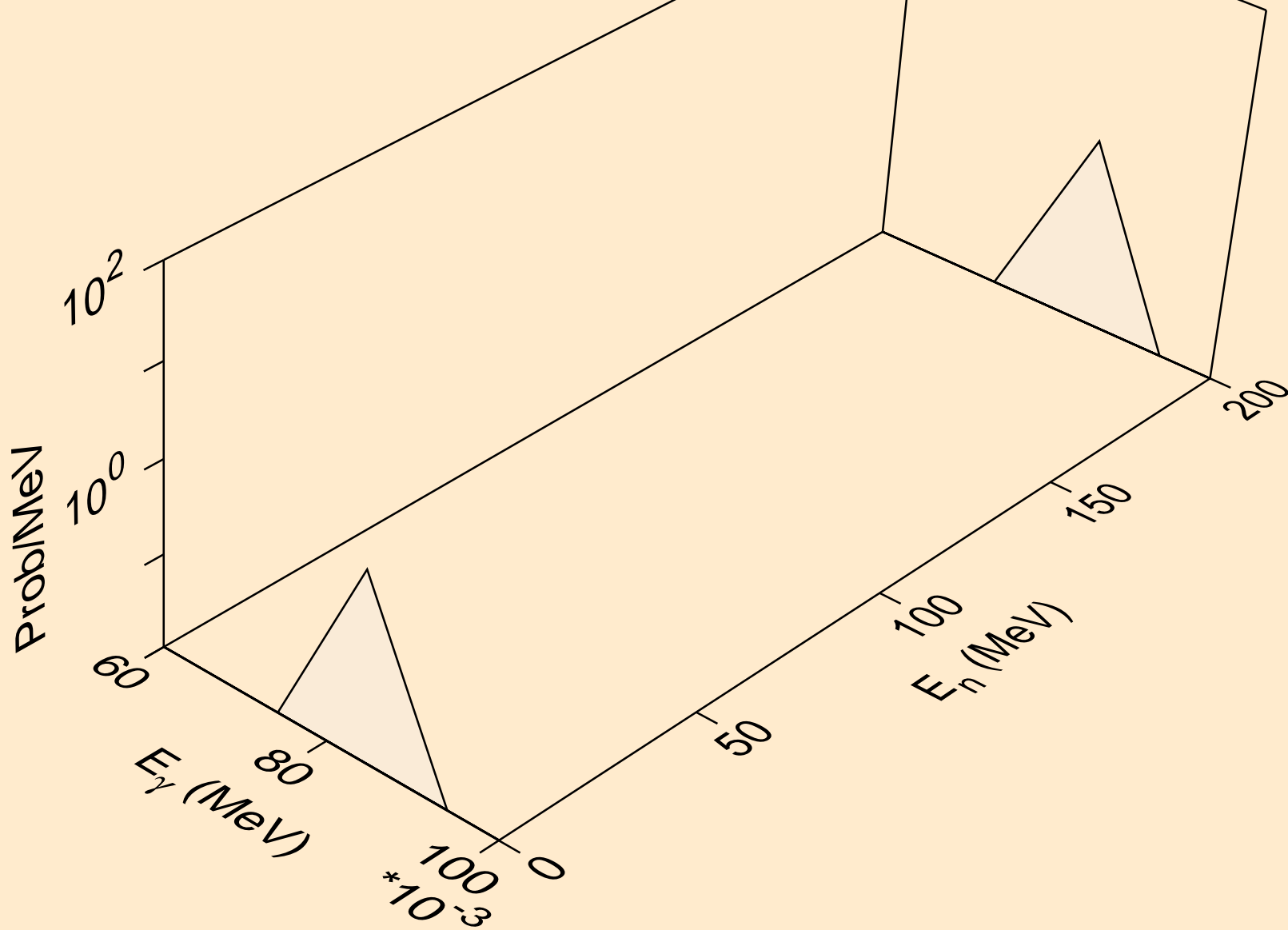

Y080M NEUTRON ACER TENDL-2019 LIBRARY; T=293.16K
Photon emission for (n,n*4)

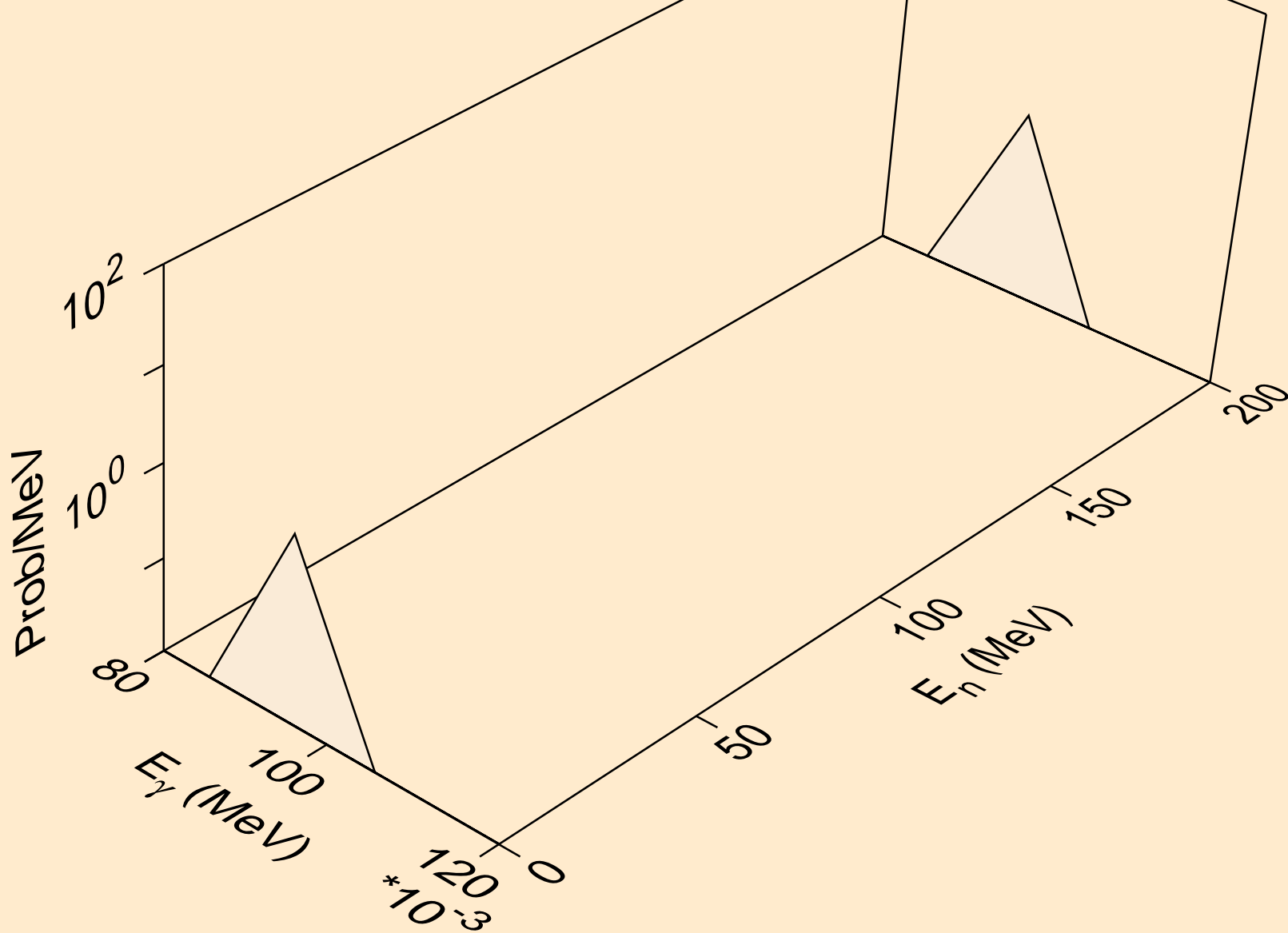

Y080M NEUTRON ACER TENDL-2019 LIBRARY; T=293.16K
Photon emission for (n,n*c)

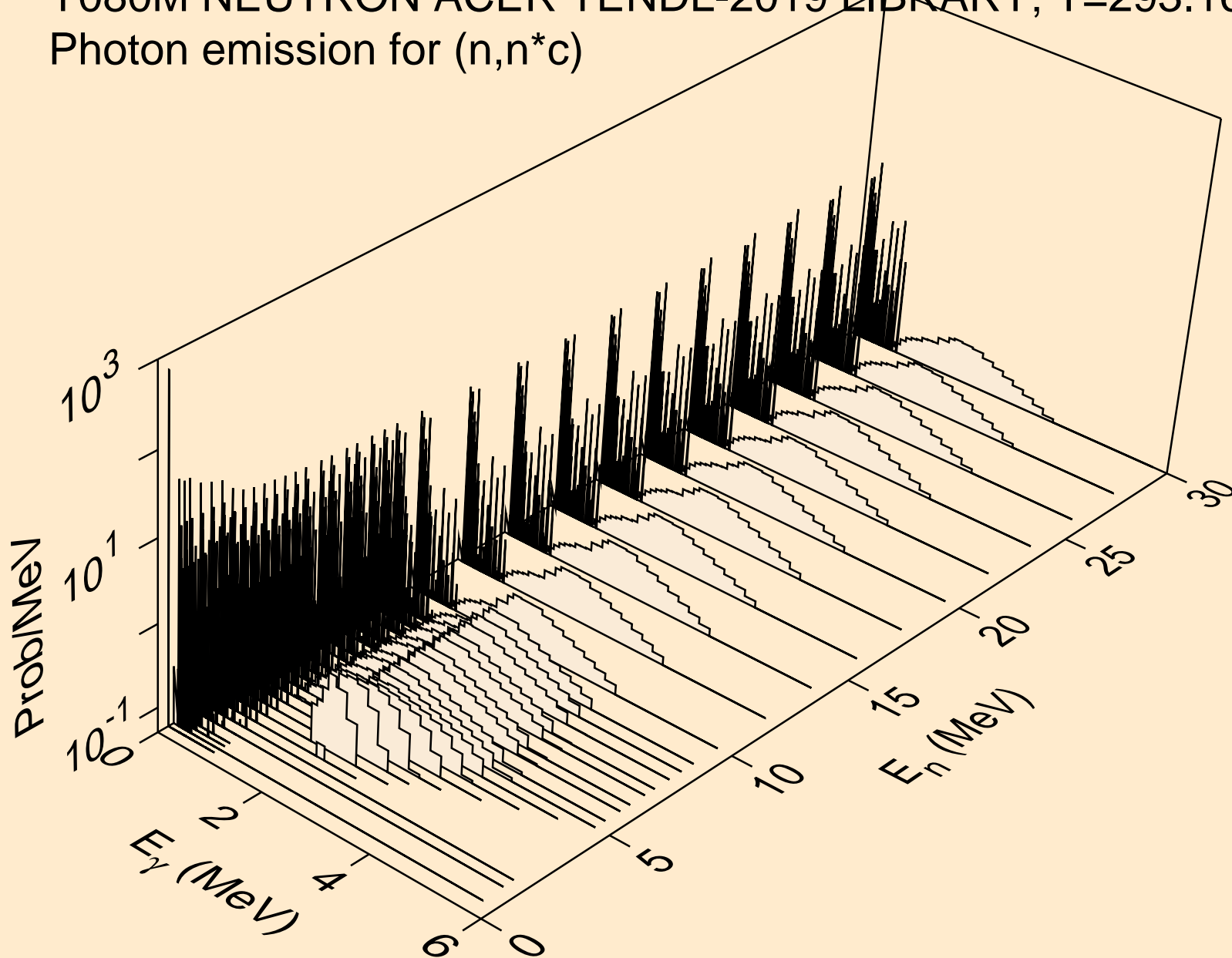

Y080M NEUTRON ACER TENDL-2019 LIBRARY; T=293.16K
Photon emission for (n,gma)

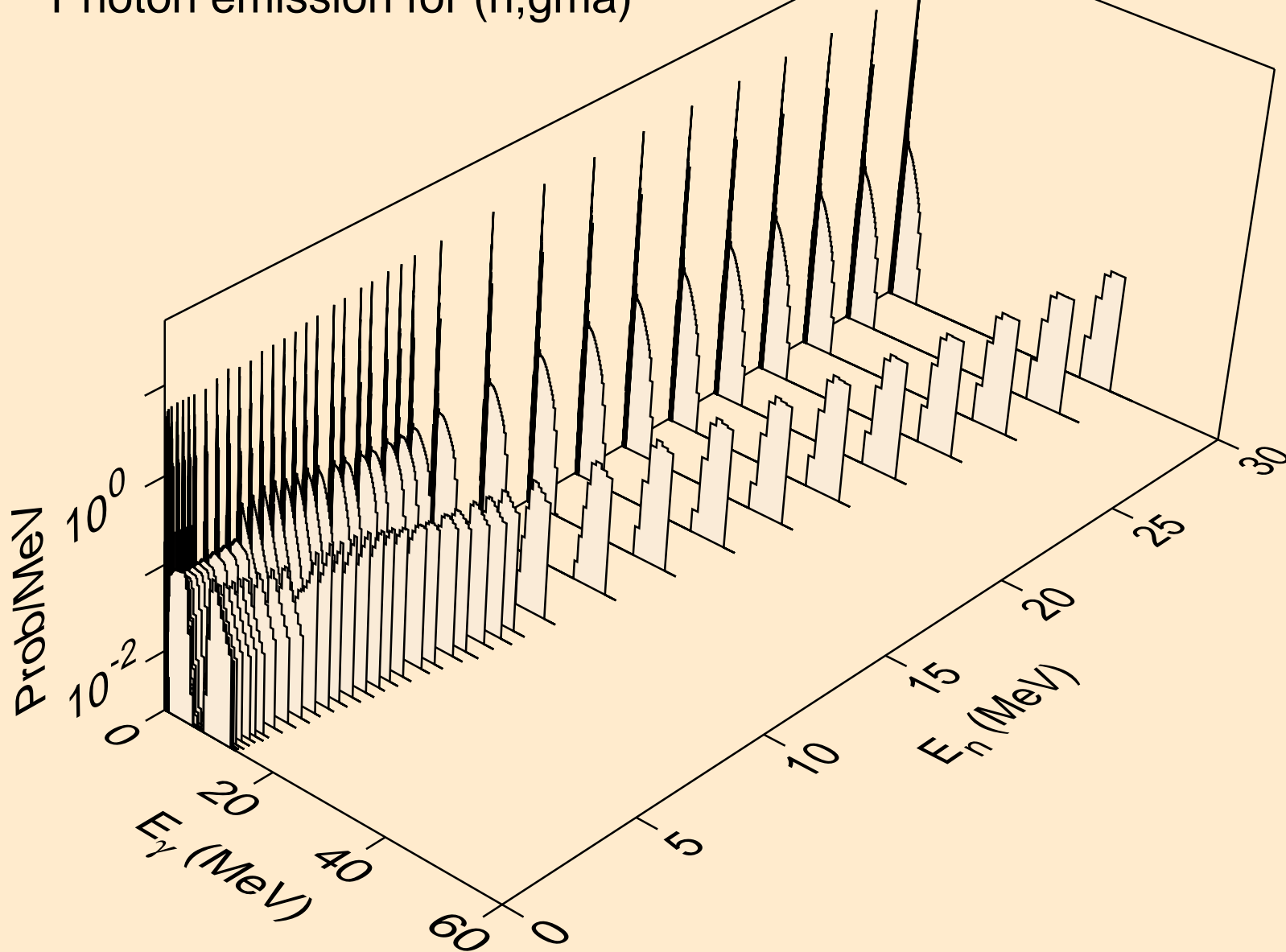

Y080M NEUTRON ACER TENDL-2019 LIBRARY; T=293.16K
Photon emission for (n,p)

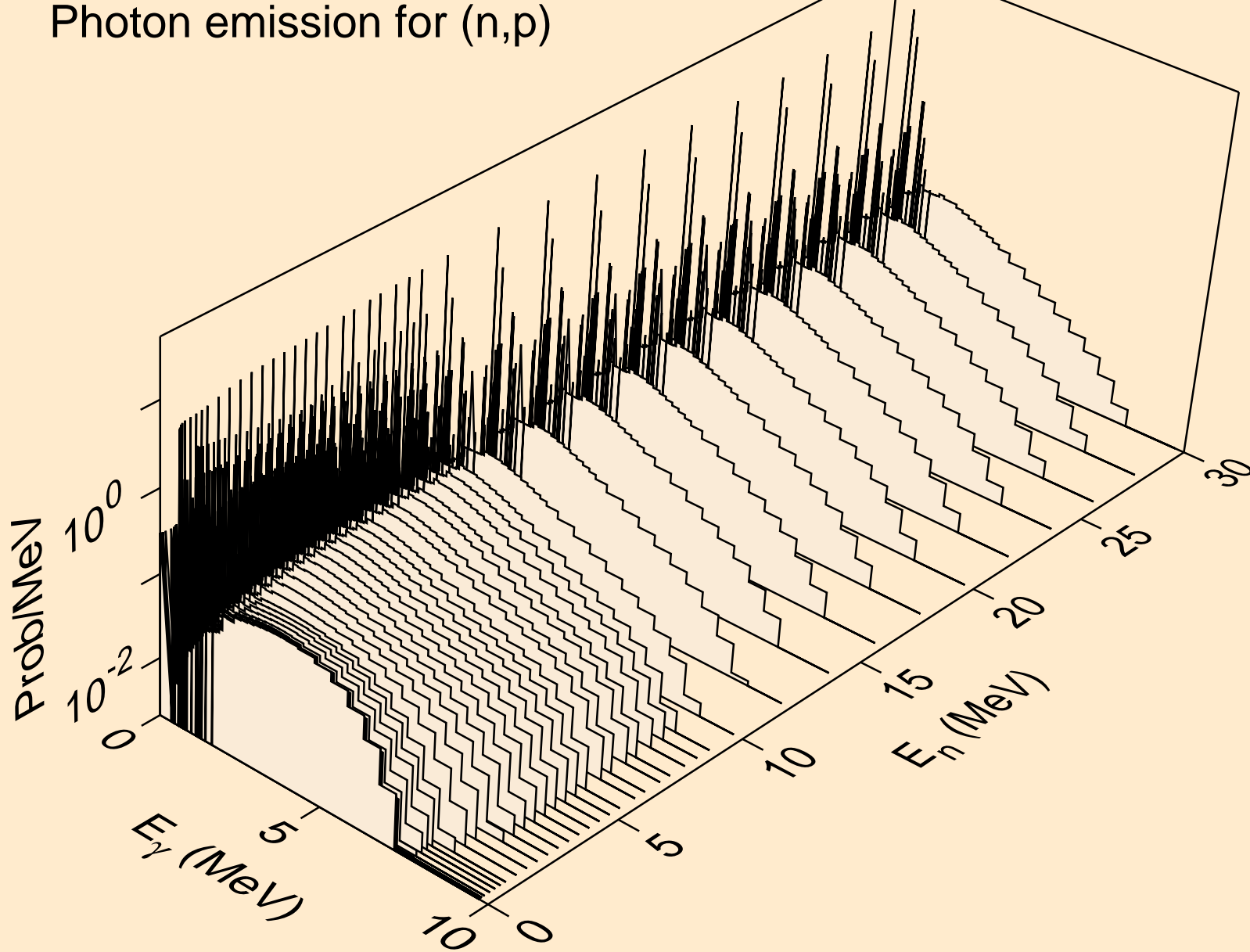

Y080M NEUTRON ACER TENDL-2019 LIBRARY; T=293.16K
Photon emission for (n,d)

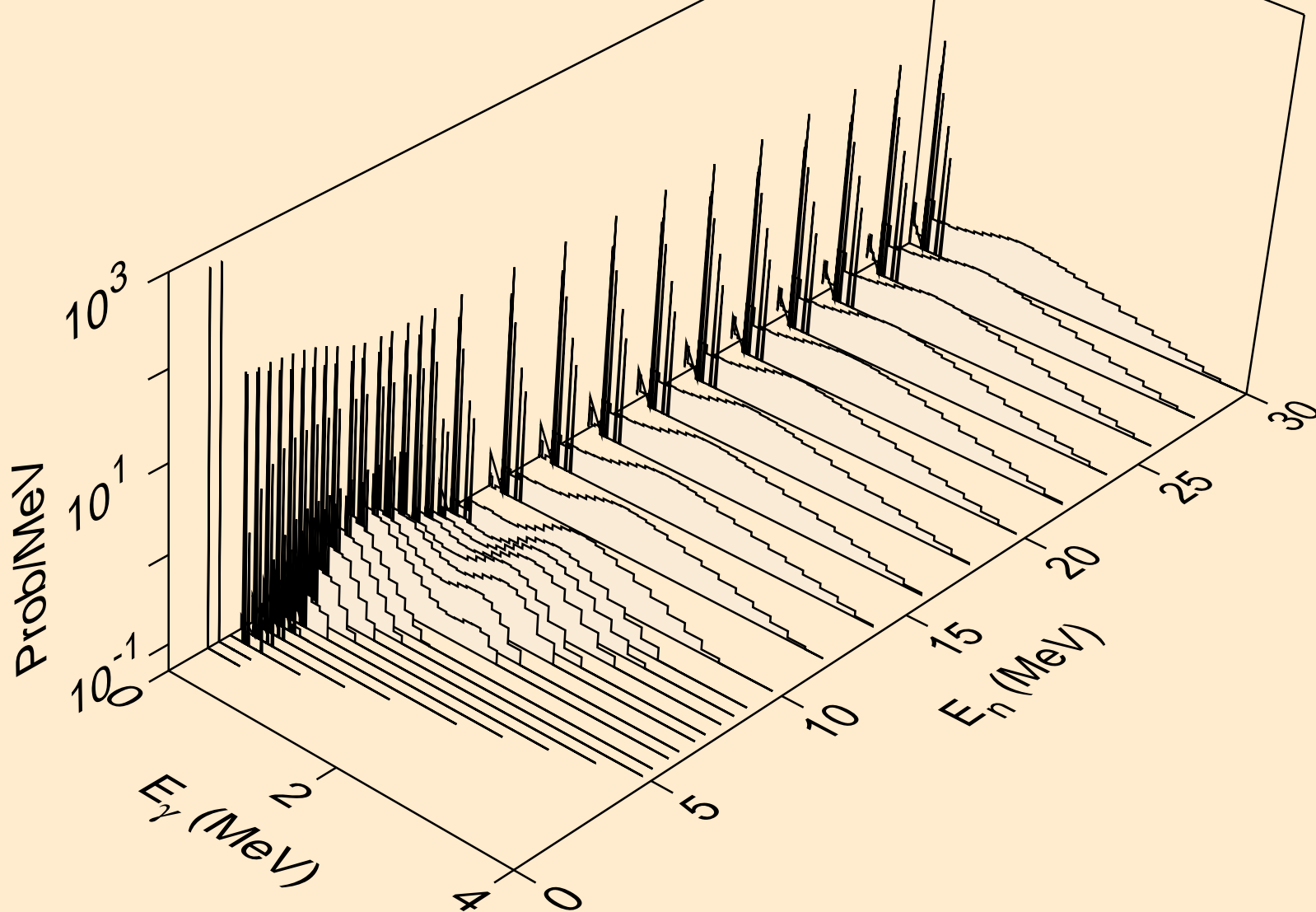

Y080M NEUTRON ACER TENDL-2019 LIBRARY; T=293.16K
Photon emission for (n,t)

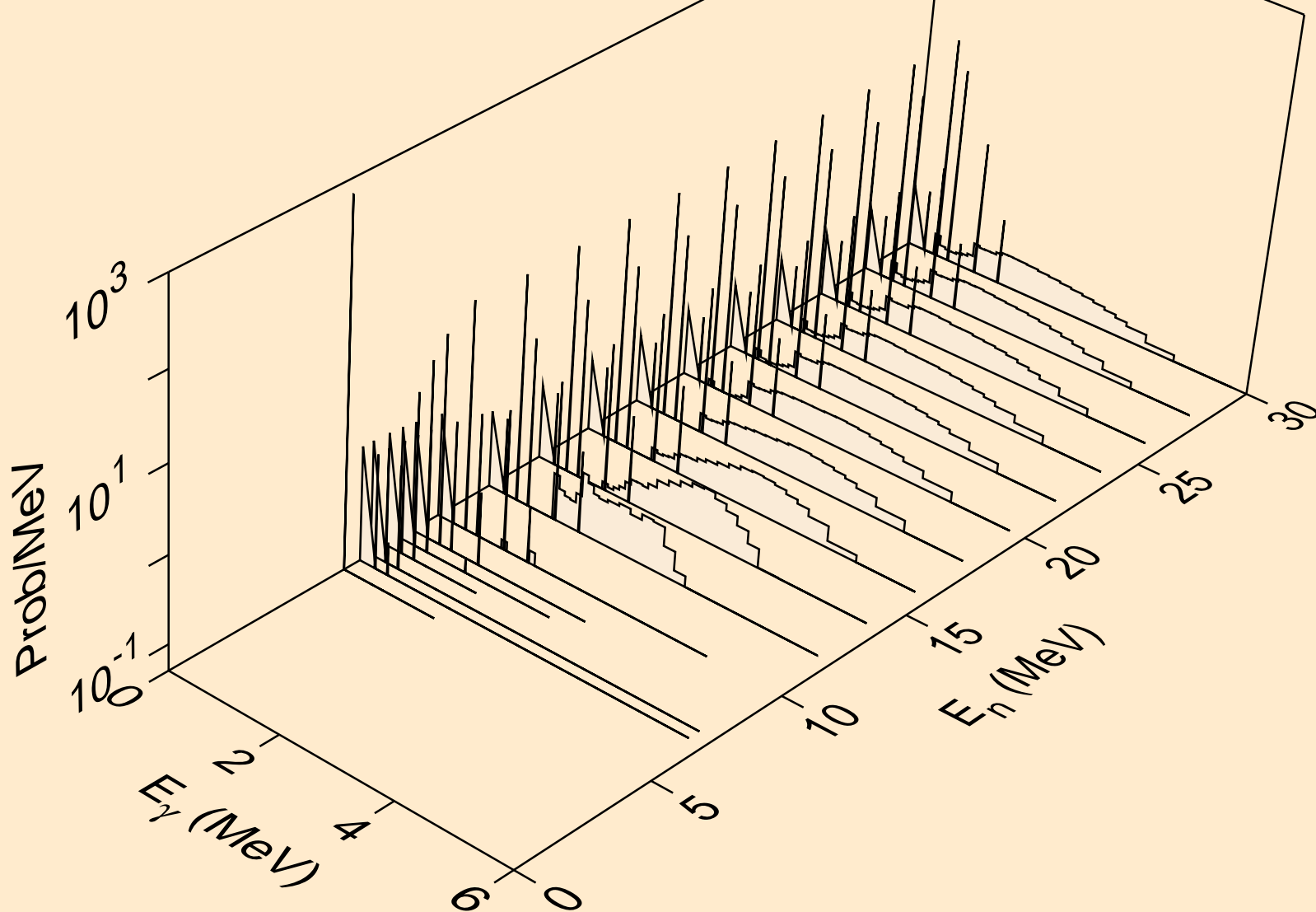

Y080M NEUTRON ACER TENDL-2019 LIBRARY; T=293.16K
Photon emission for (n,he3)

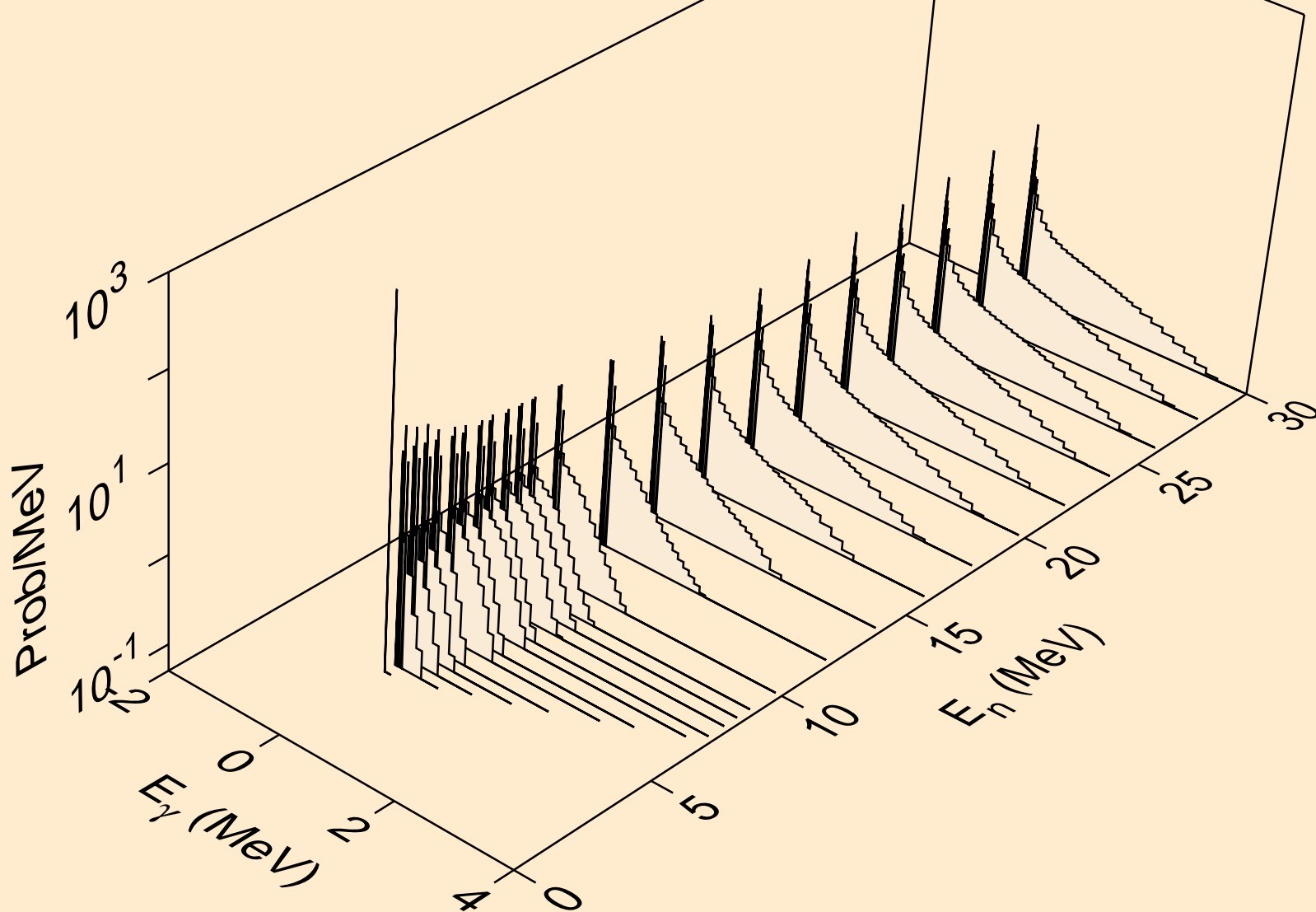

Y080M NEUTRON ACER TENDL-2019 LIBRARY; T=293.16K
Photon emission for (n,a)

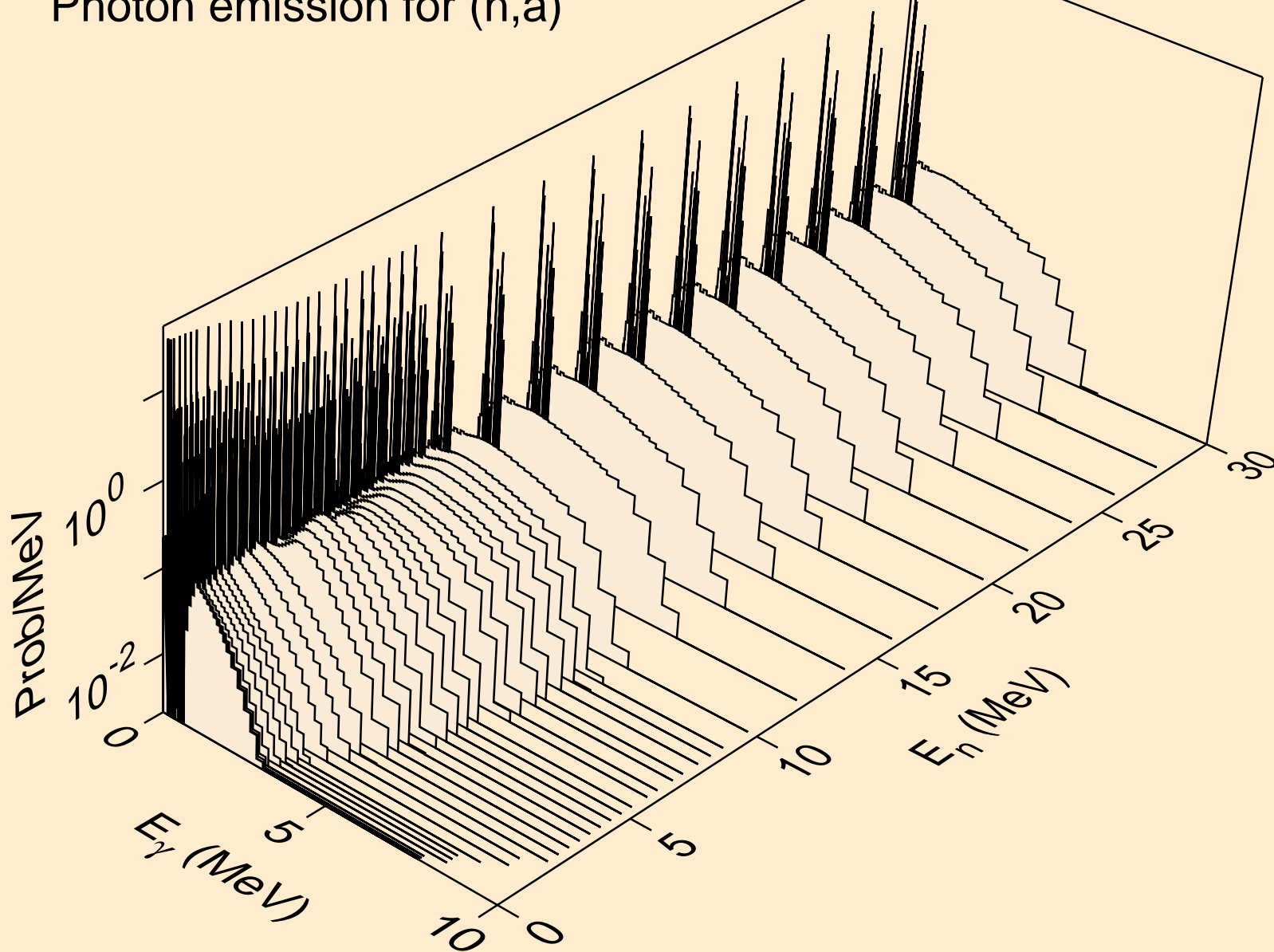

Y080M NEUTRON ACER TENDL-2019 LIBRARY; T=293.16K
Photon emission for (n,2a)

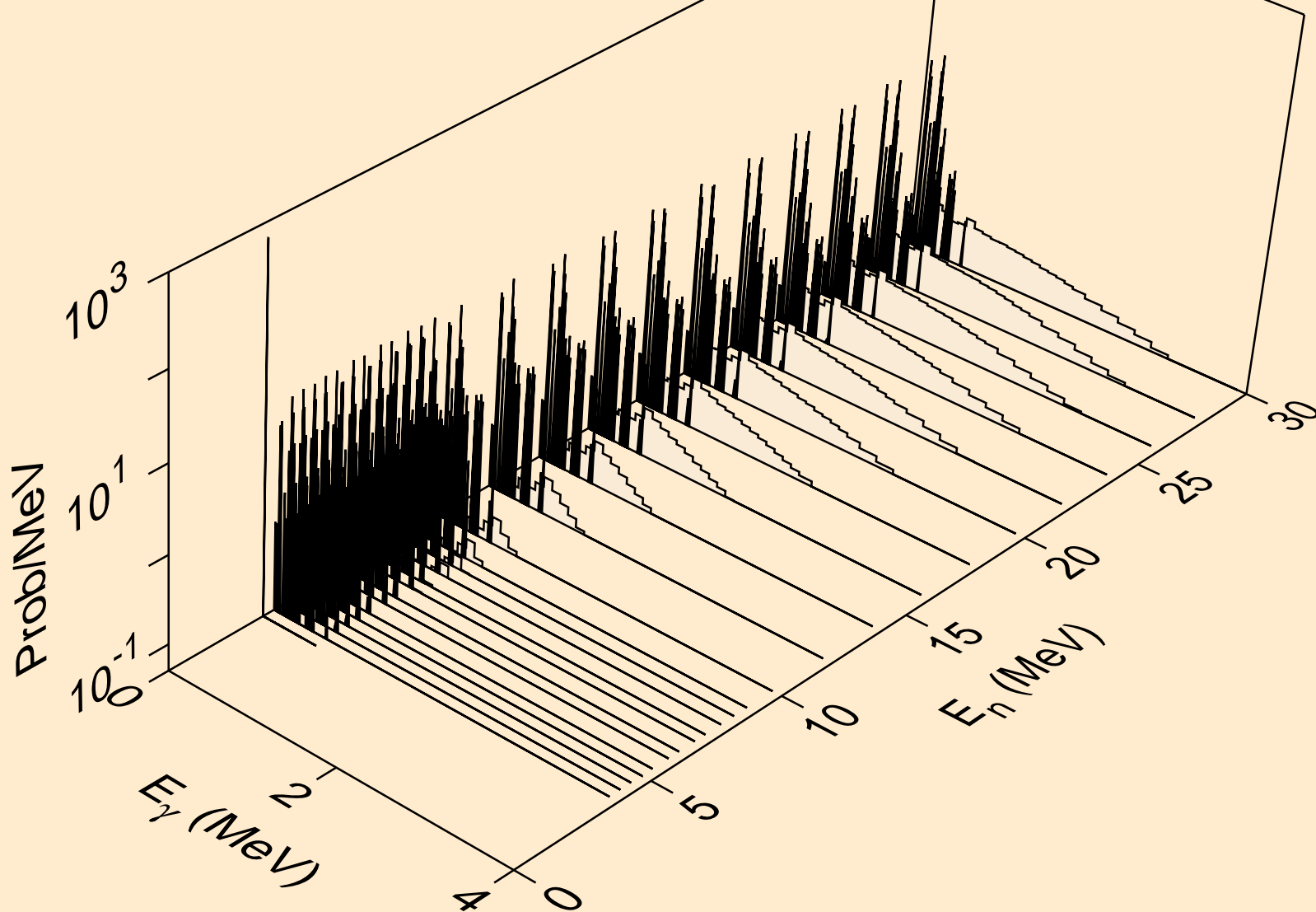

Y080M NEUTRON ACER TENDL-2019 LIBRARY; T=293.16K
Photon emission for (n,3a)

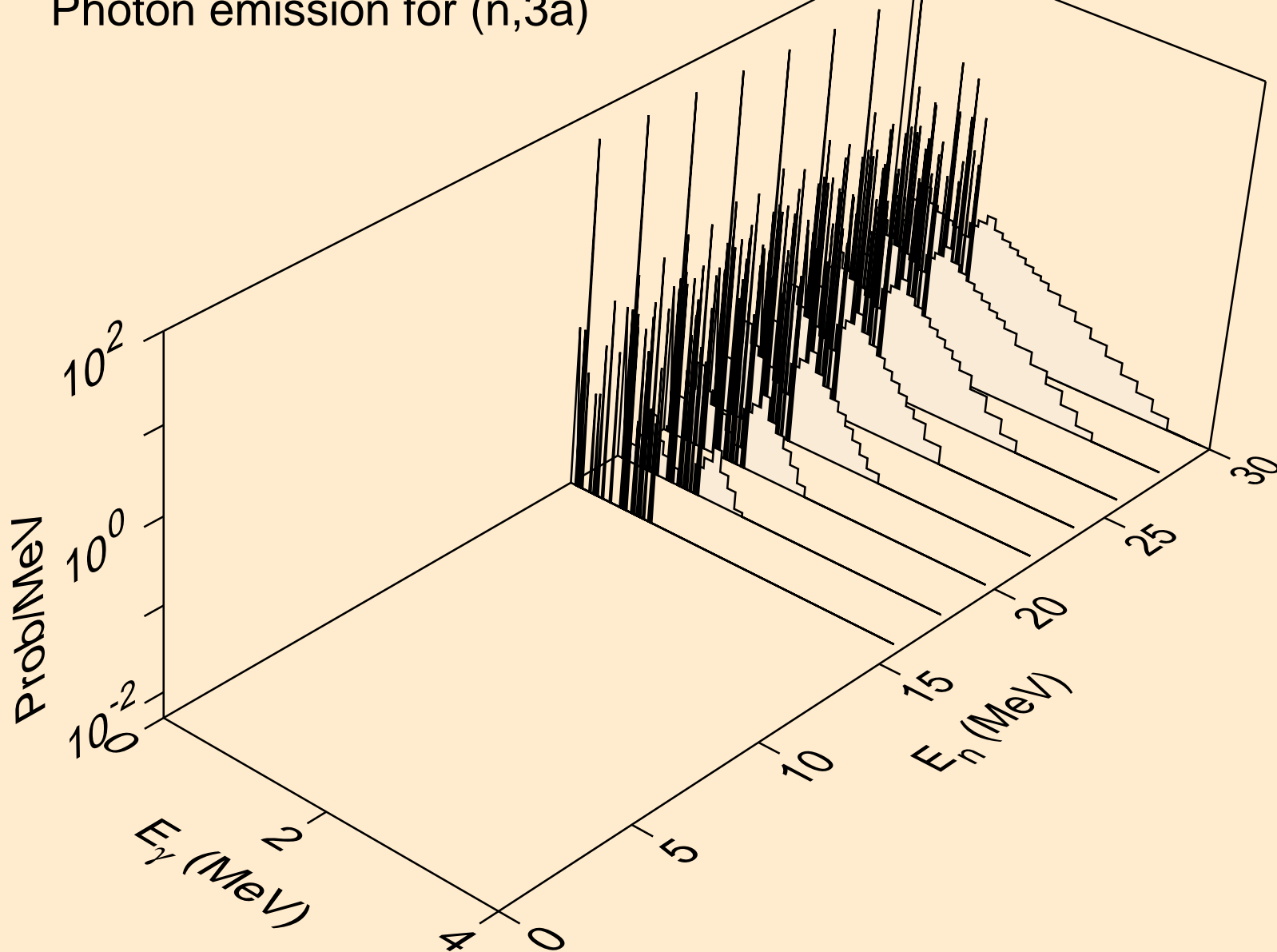

Y080M NEUTRON ACER TENDL-2019 LIBRARY; T=293.16K
Photon emission for (n,2p)

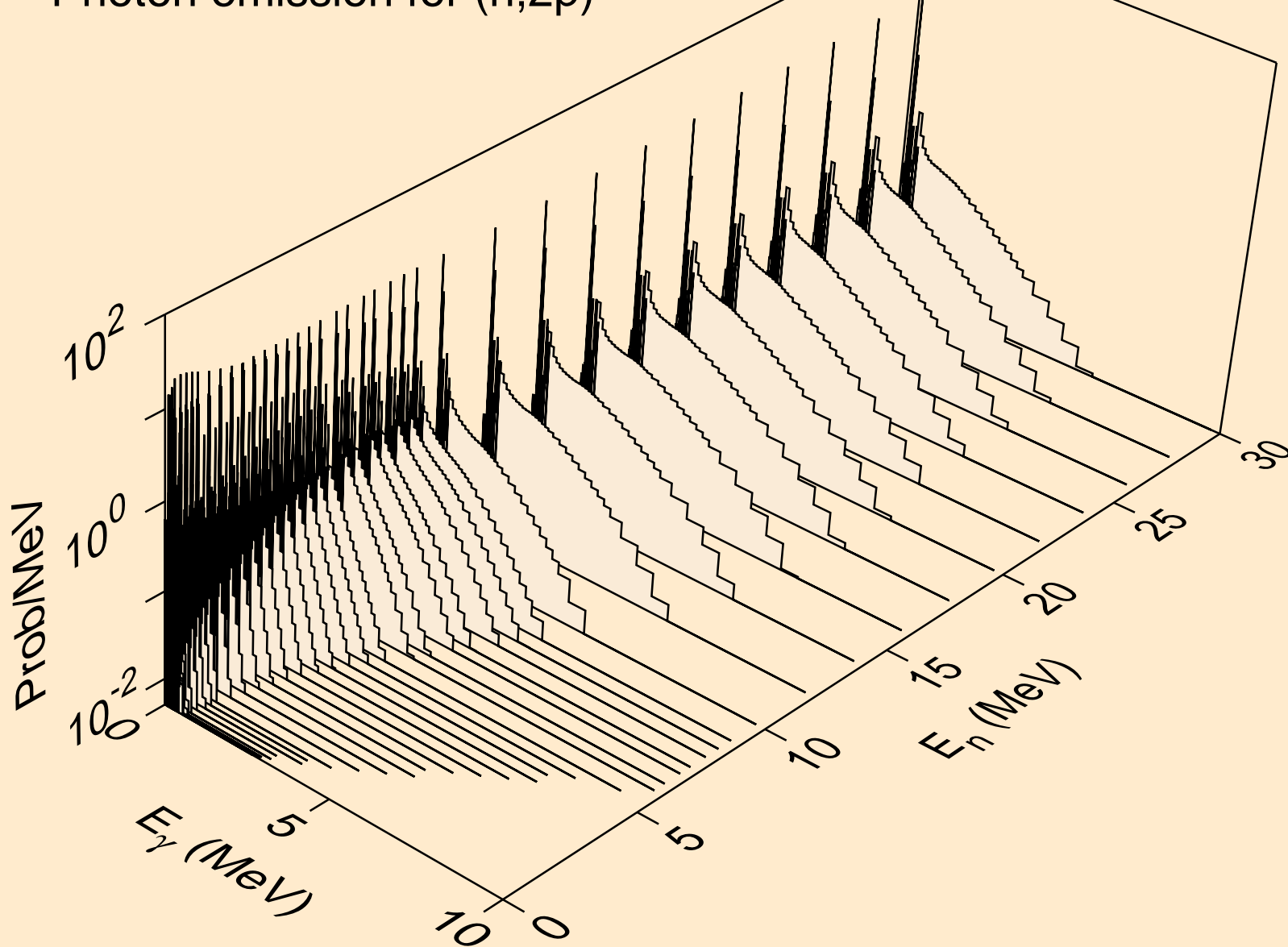

Y080M NEUTRON ACER TENDL-2019 LIBRARY; T=293.16K
Photon emission for (n,p)

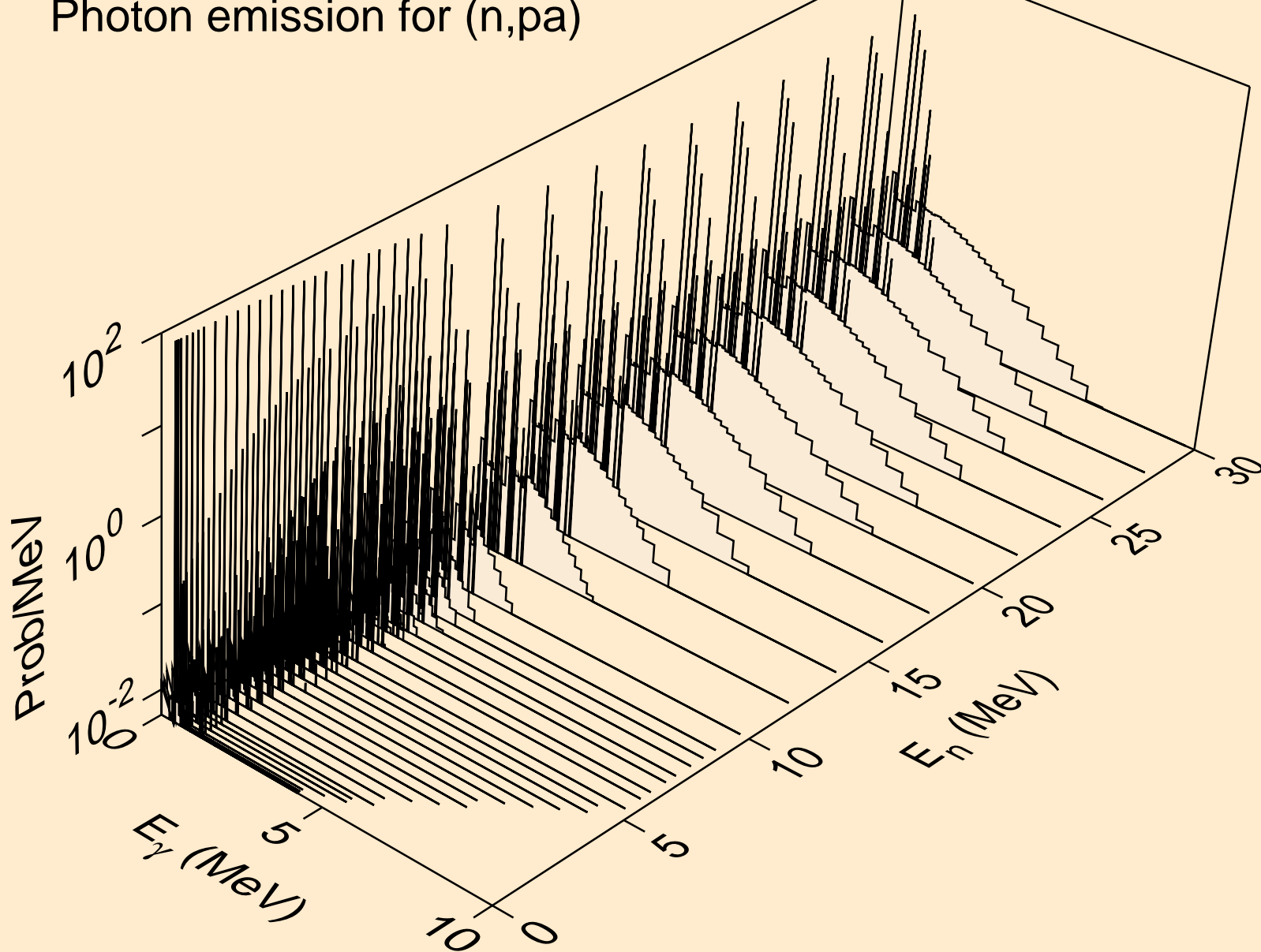

Y080M NEUTRON ACER TENDL-2019 LIBRARY; T=293.16K
Photon emission for (n,d2a)

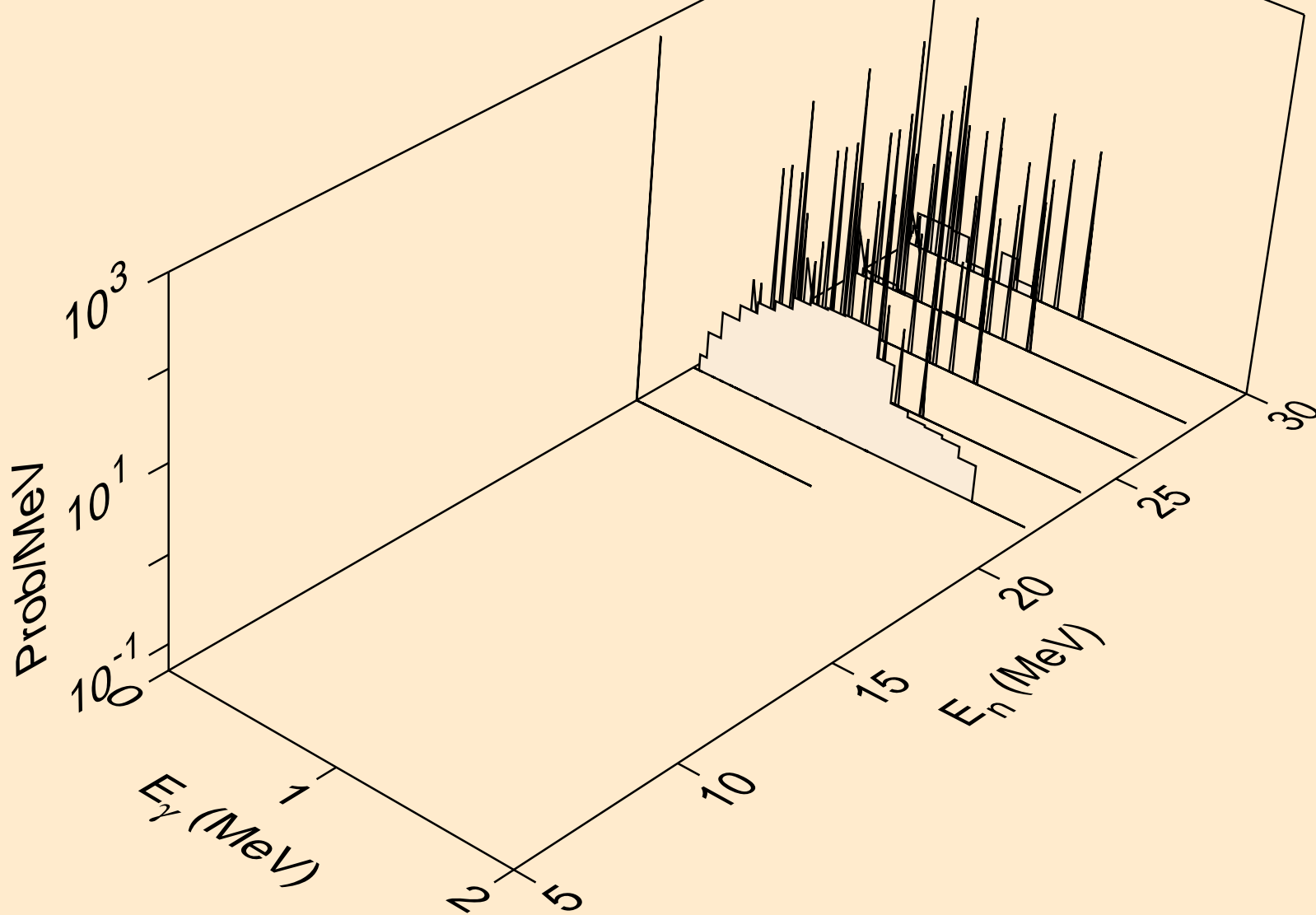

Y080M NEUTRON ACER TENDL-2019 LIBRARY; T=293.16K
Photon emission for (n,pd)

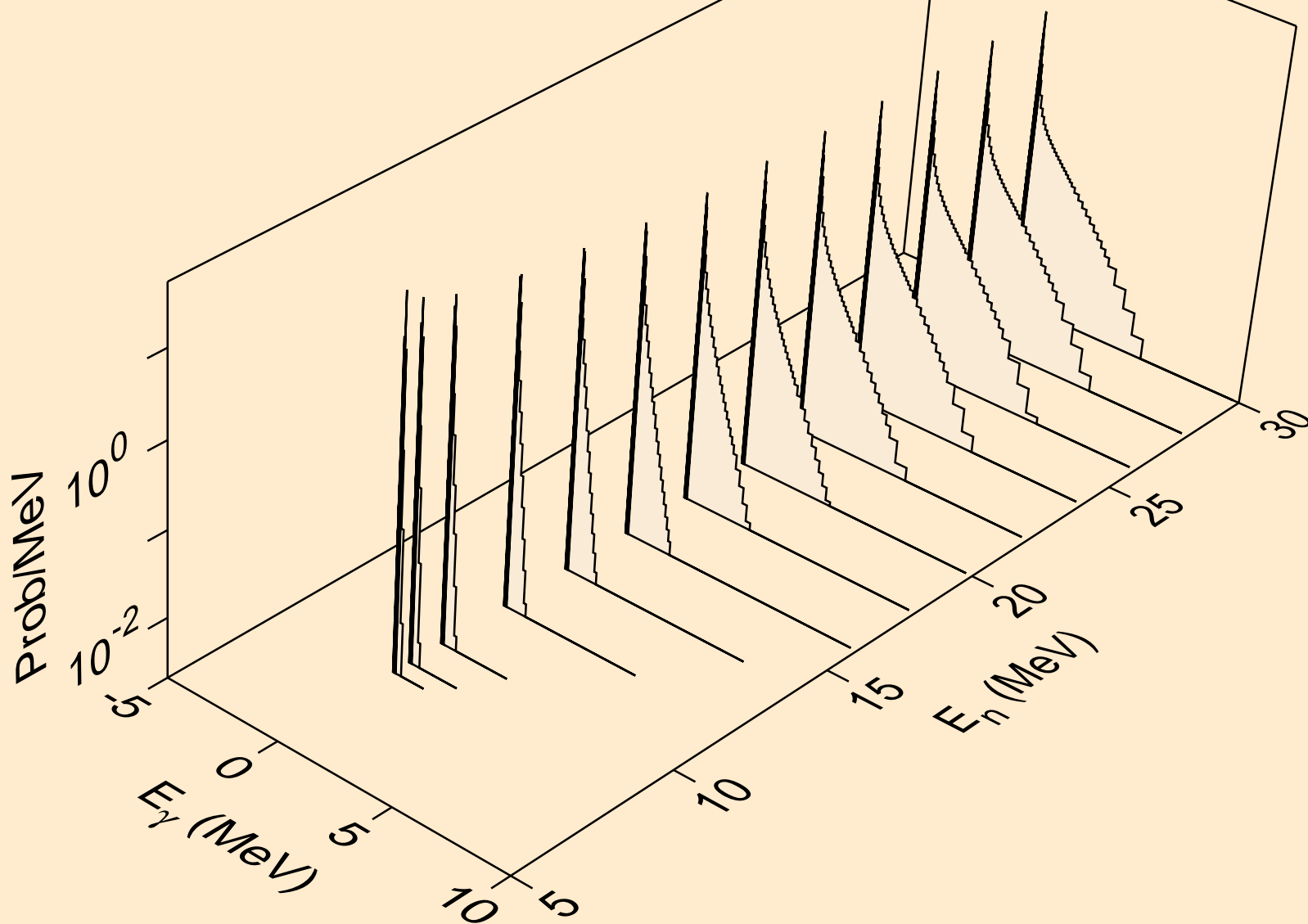

Y080M NEUTRON ACER TENDL-2019 LIBRARY; T=293.16K
Photon emission for (n,pt)

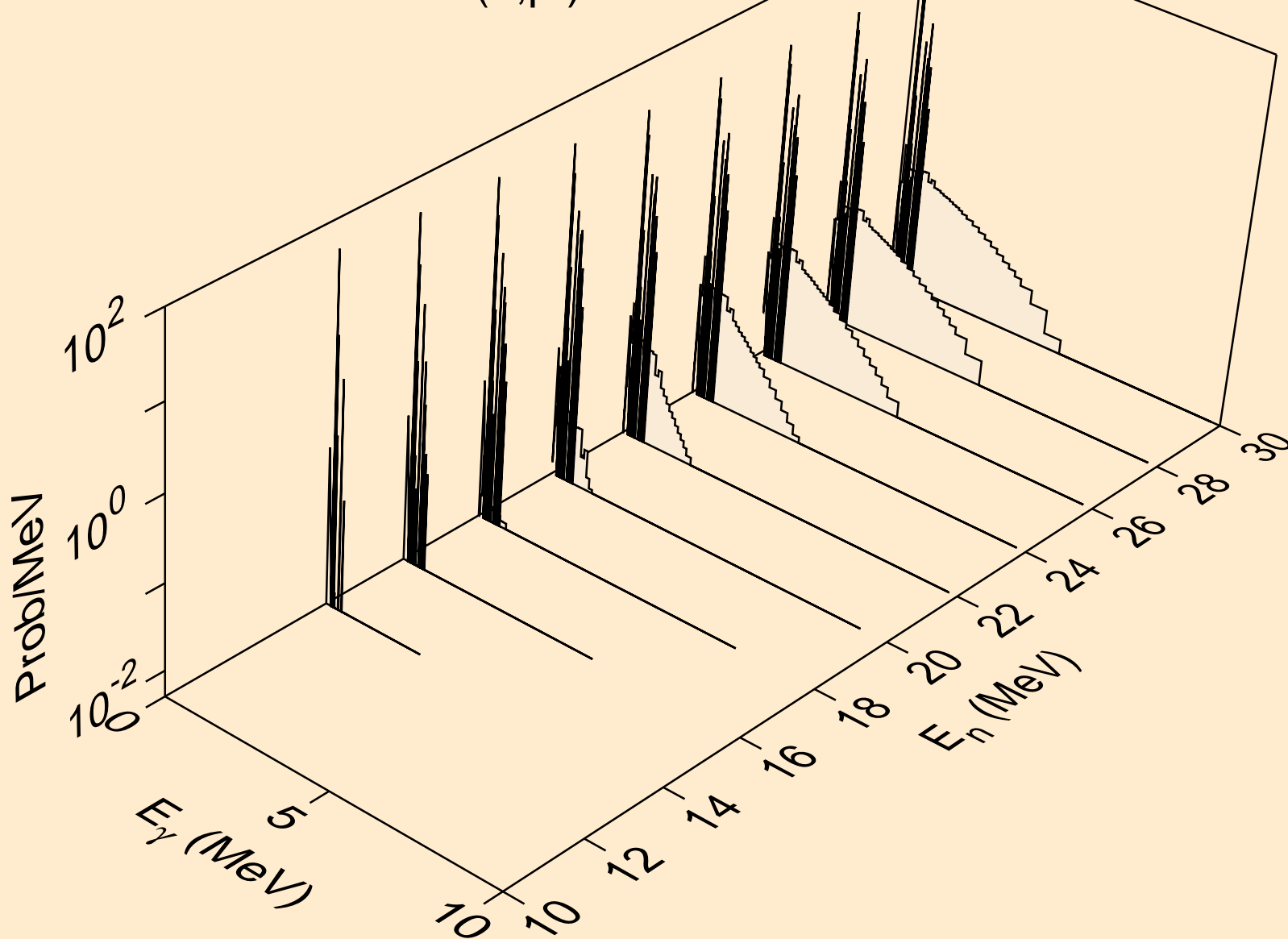

Y080M NEUTRON ACER TENDL-2019 LIBRARY; T=293.16K
Photon emission for (n,da)

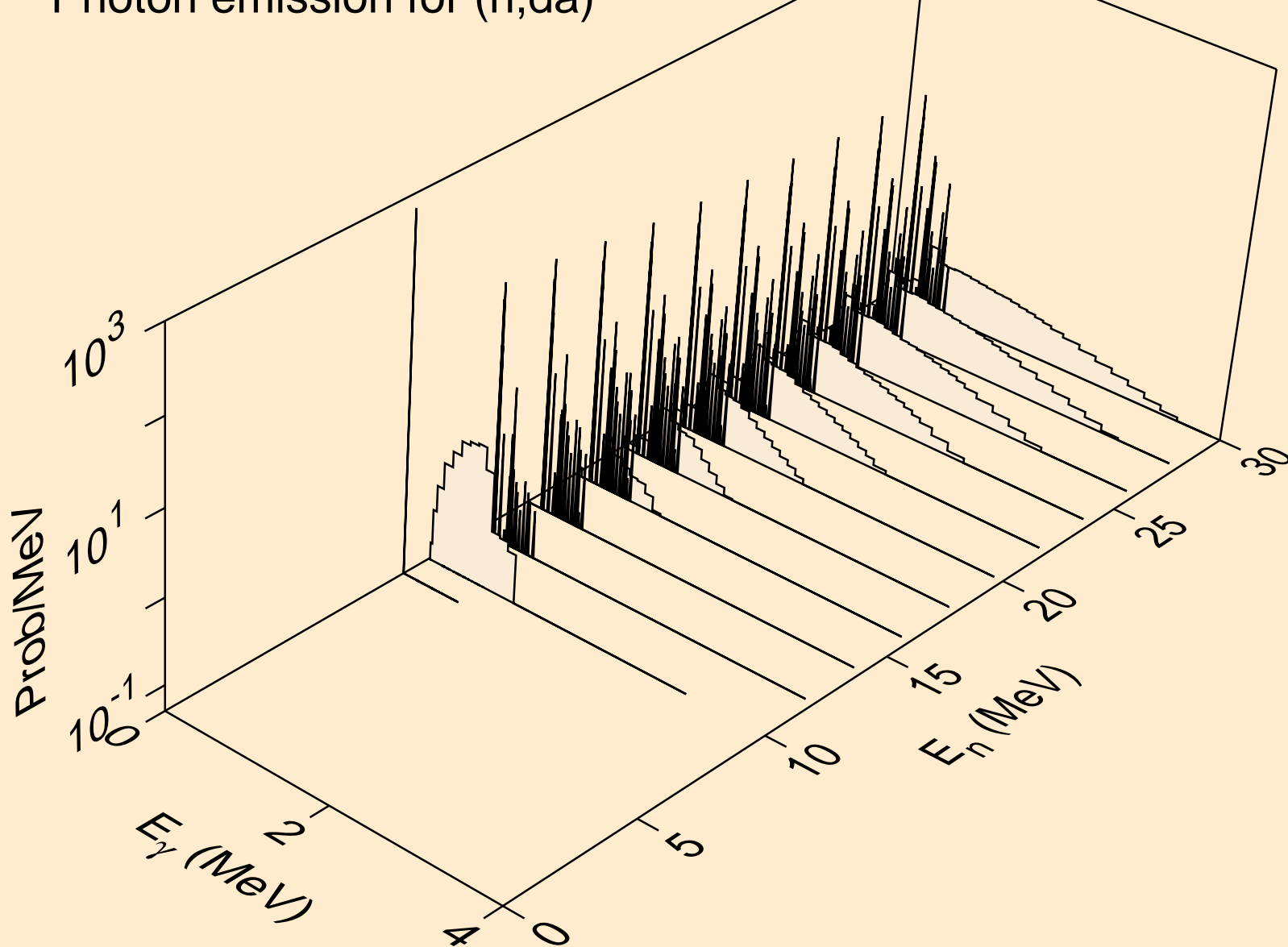

Y080M NEUTRON ACER TENDL-2019 LIBRARY; T=293.16K
thermal capture photon spectrum

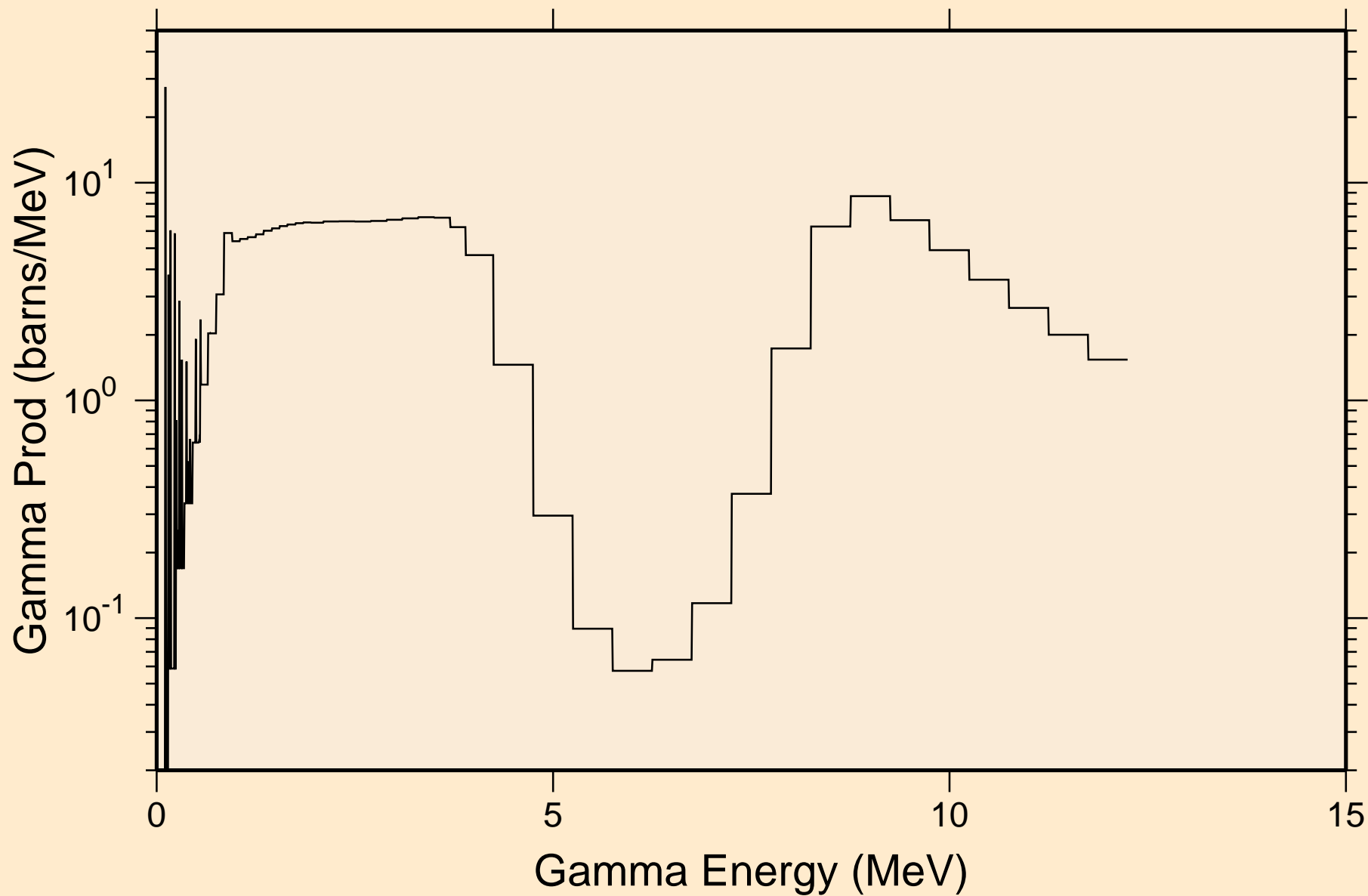

Y080M NEUTRON ACER TENDL-2019 LIBRARY; T=293.16K
14 MeV photon spectrum

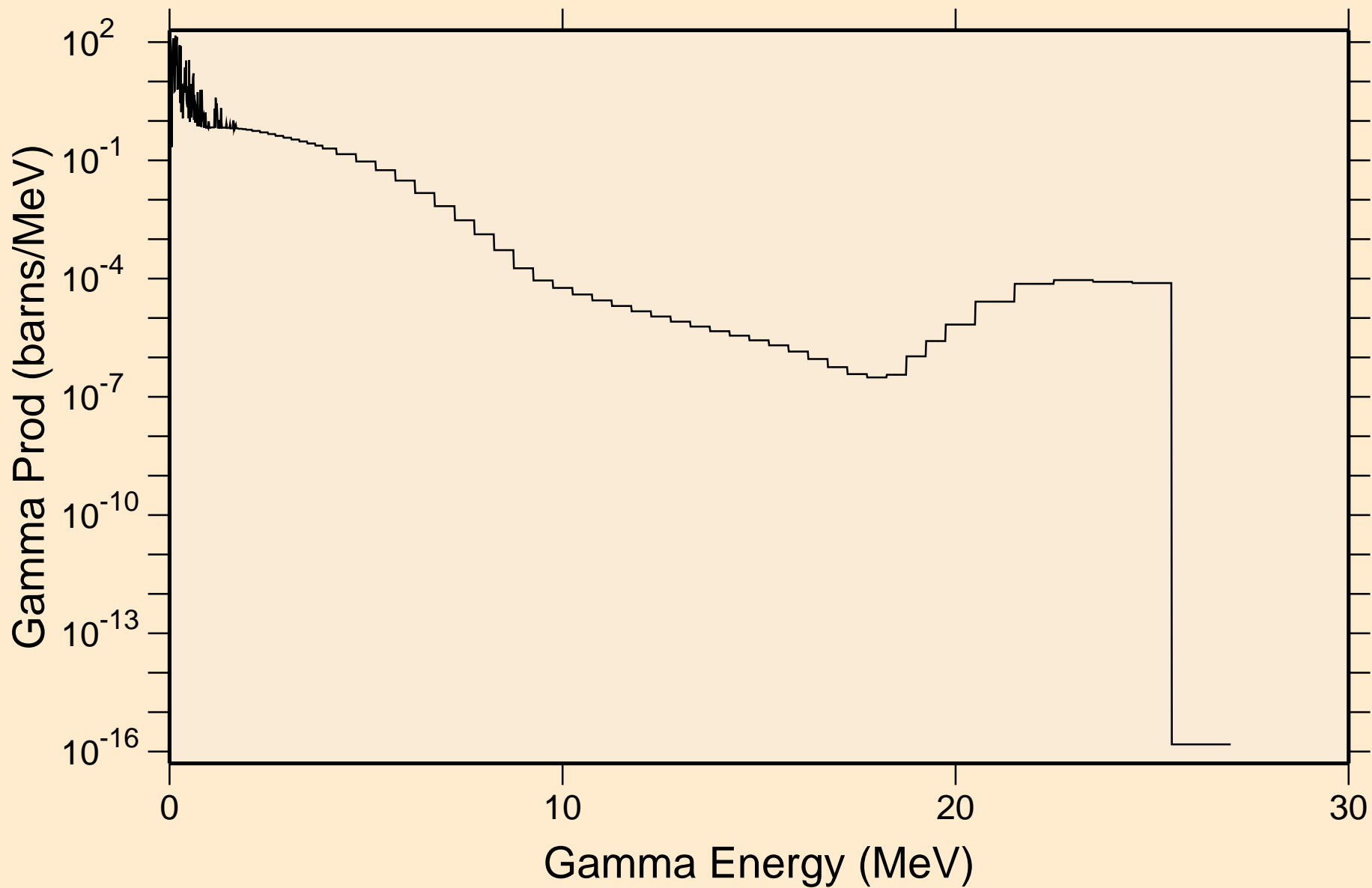

Y080M NEUTRON ACER TENDL-2019 LIBRARY; T=293.16K
Particle heating contributions

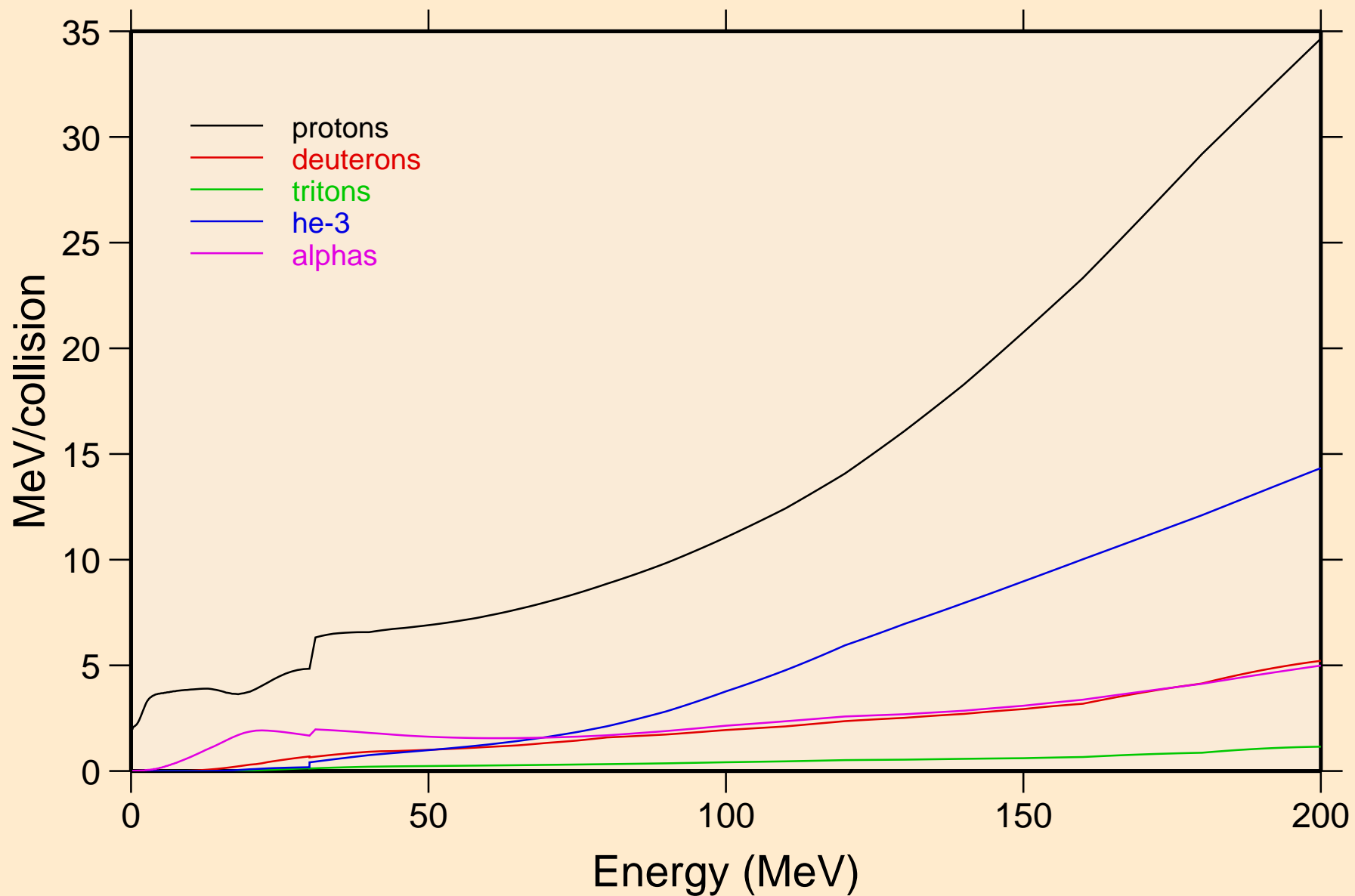

Y080M NEUTRON ACER TENDL-2019 LIBRARY; T=293.16K
Recoil Heating

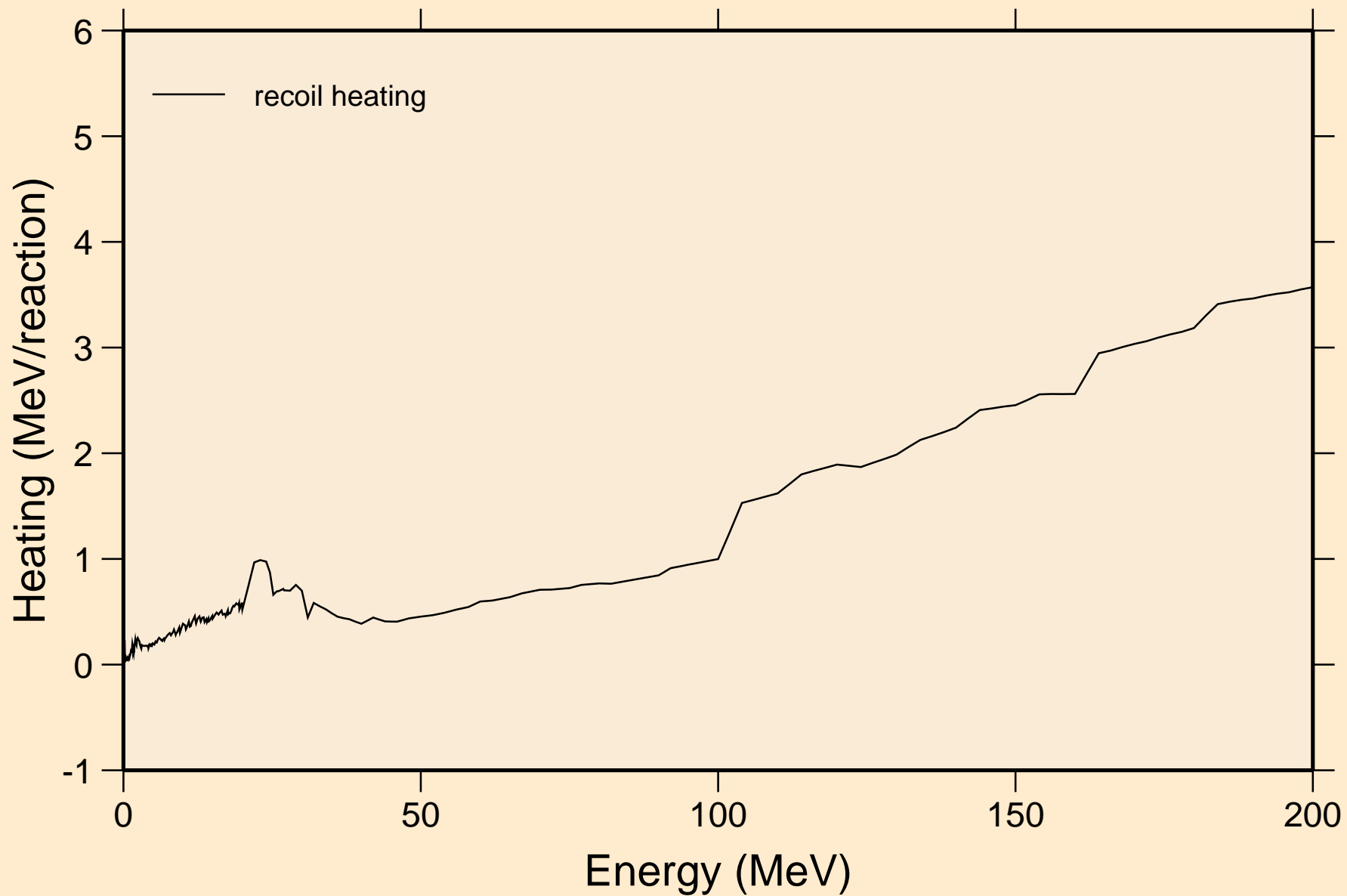

Y080M NEUTRON ACER TENDL-2019 LIBRARY; T=293.16K
Particle production cross sections

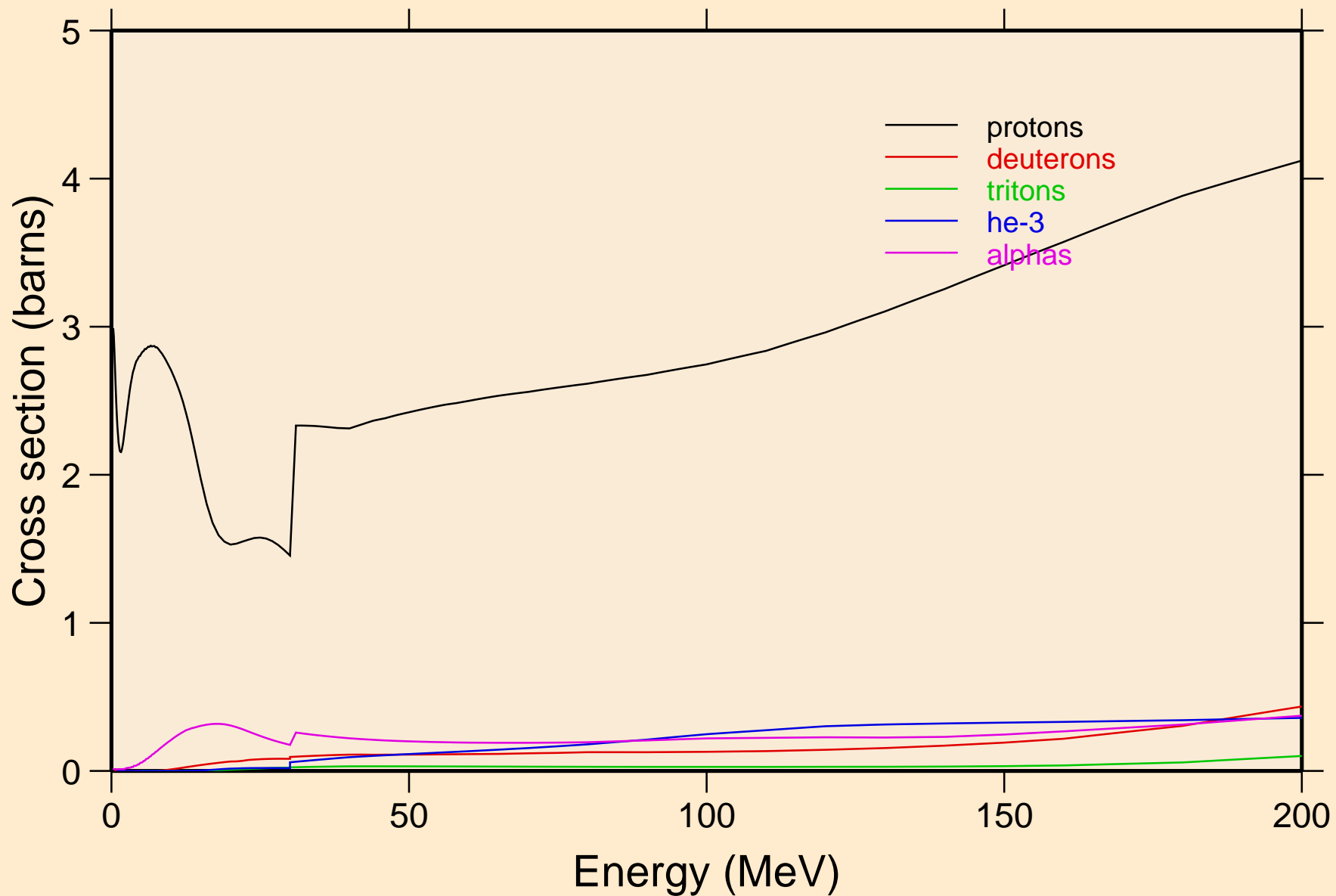

Y080M NEUTRON ACER TENDL-2019 LIBRARY; T=293.16K
protons from (n,x)

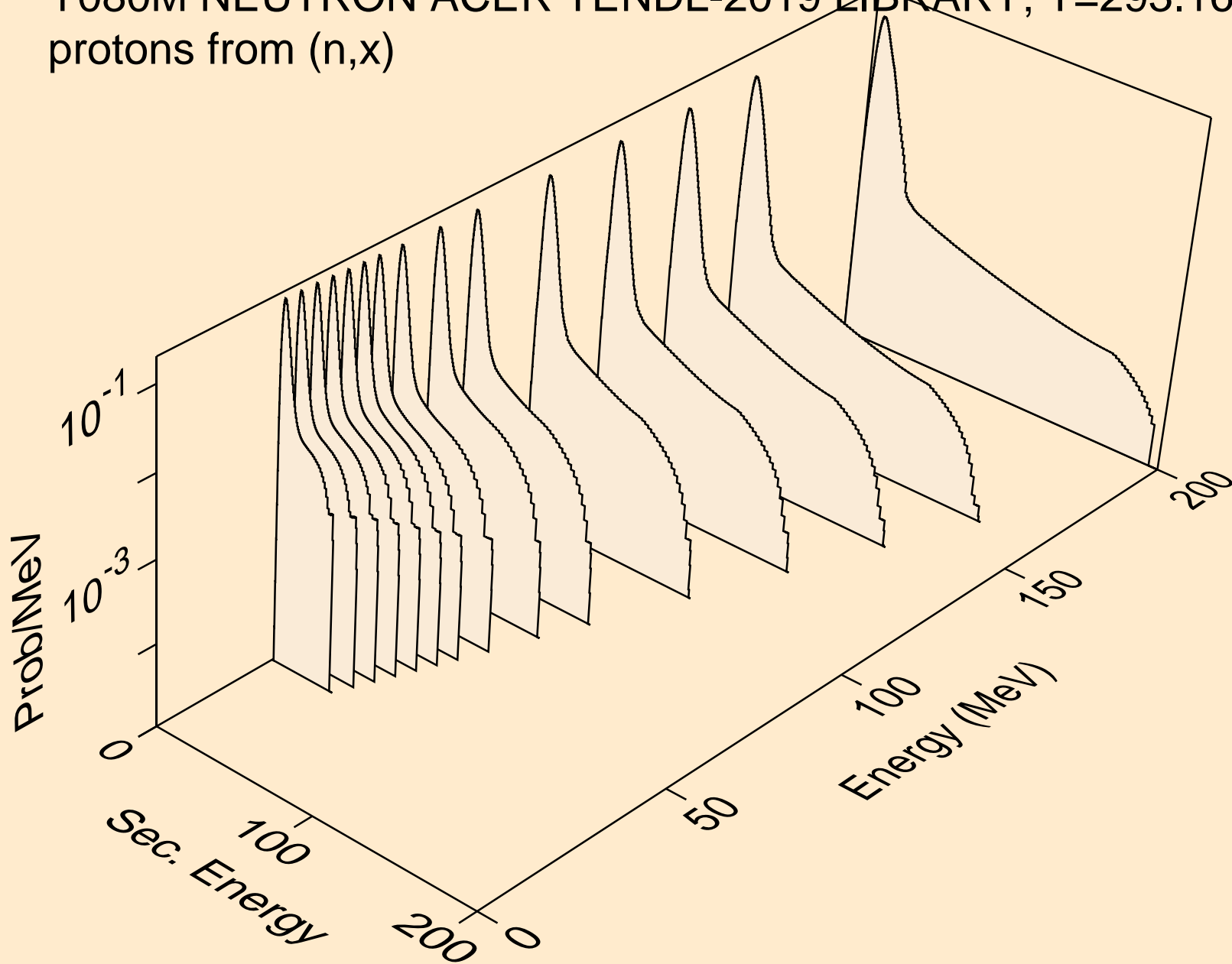

Y080M NEUTRON ACER TENDL-2019 LIBRARY; T=293.16K
protons from (n,n*)p

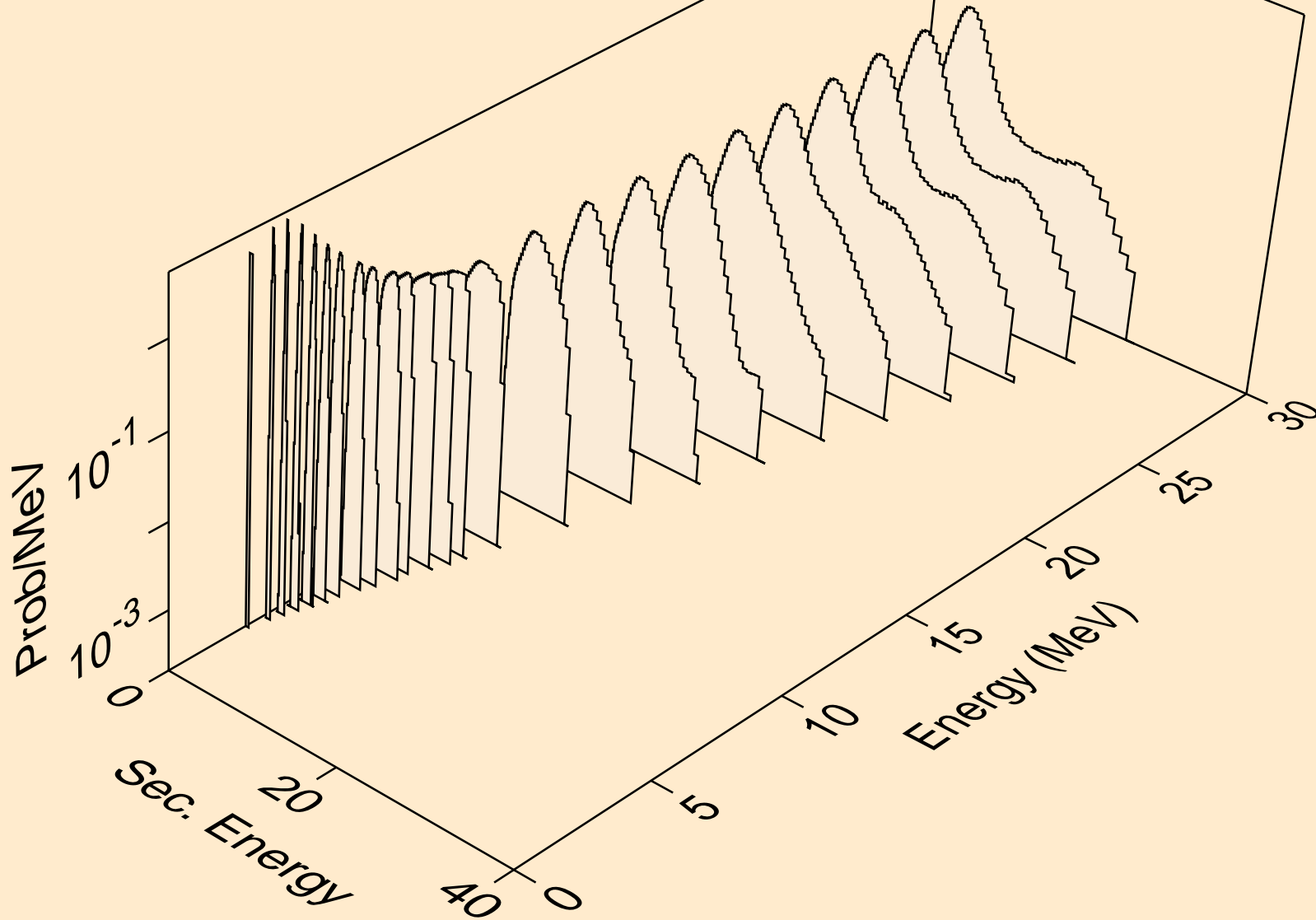

Y080M NEUTRON ACER TENDL-2019 LIBRARY; T=293.16K
protons from (n,2np)

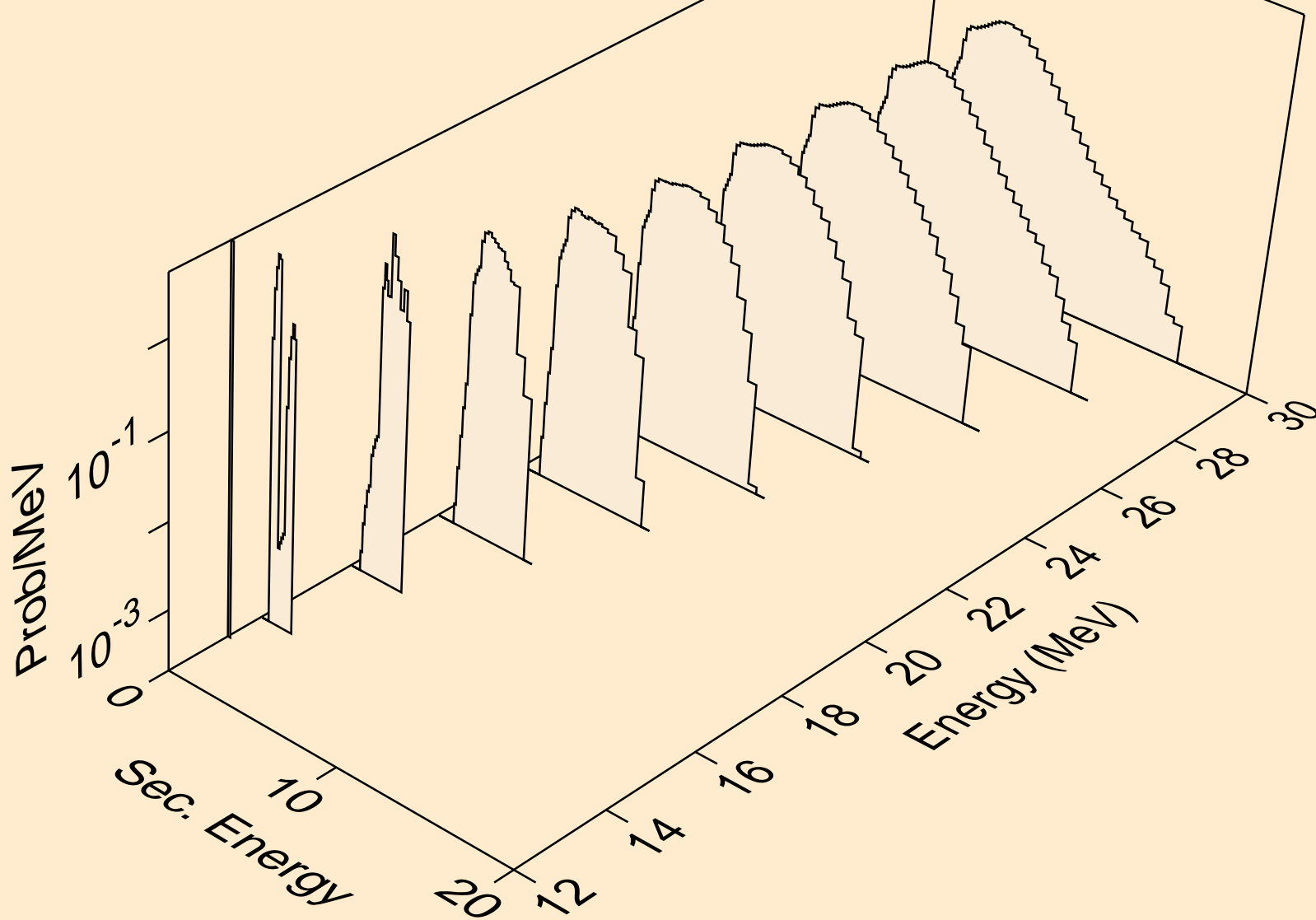

Y080M NEUTRON ACER TENDL-2019 LIBRARY; T=293.16K
protons from (n,3np)

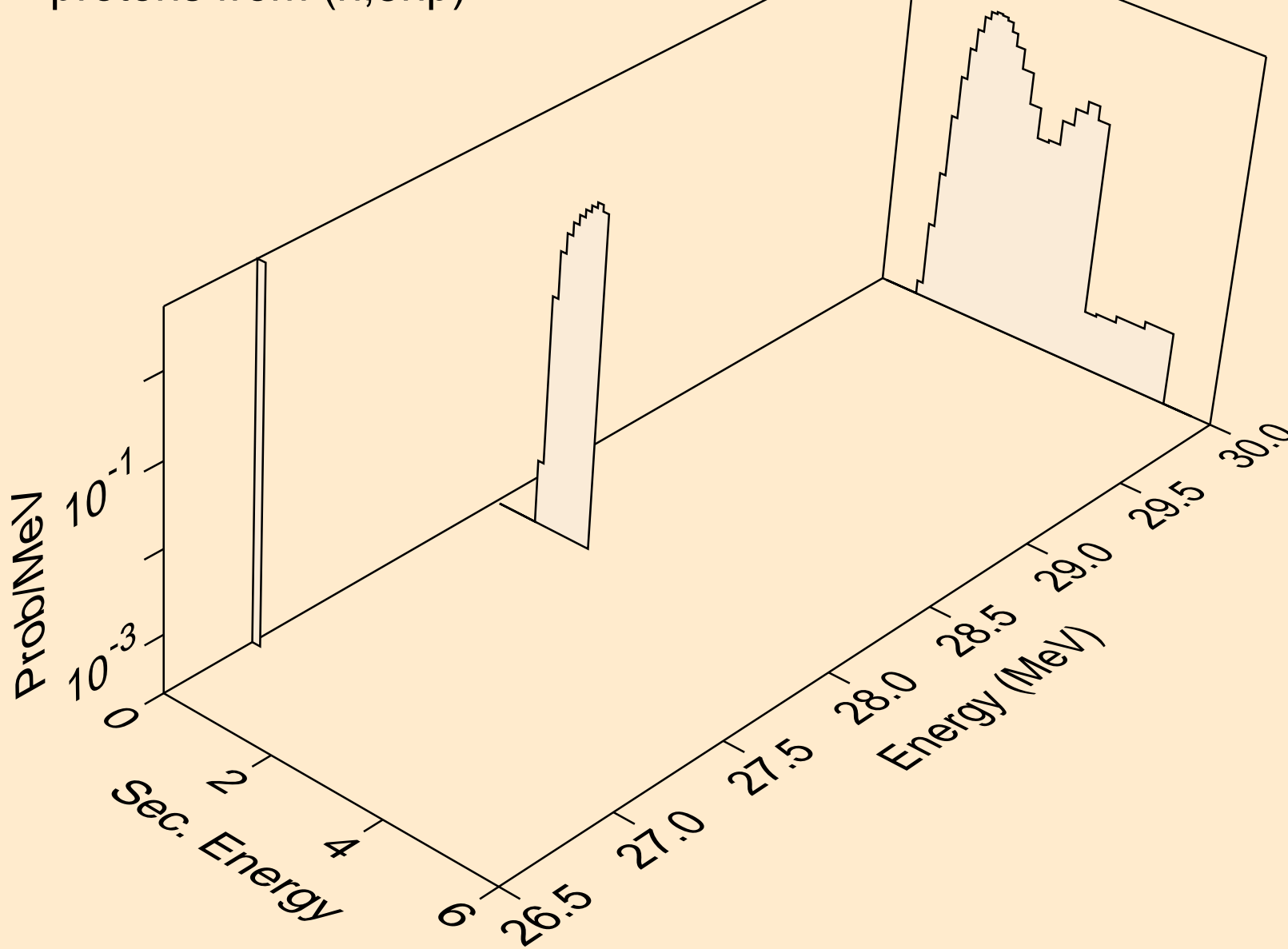

Y080M NEUTRON ACER TENDL-2019 LIBRARY; T=293.16K
protons from (n,2np)

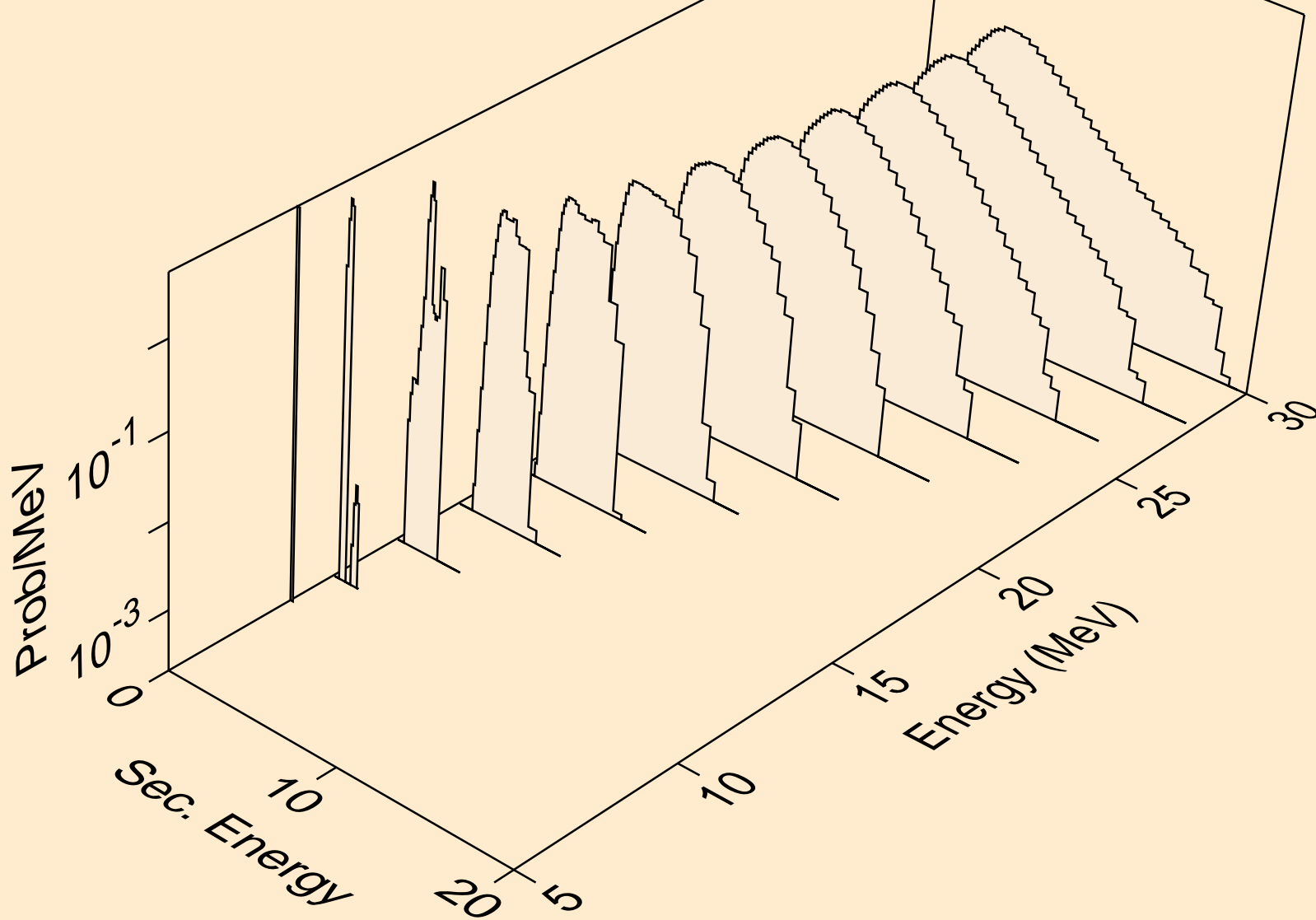

Y080M NEUTRON ACER TENDL-2019 LIBRARY; T=293.16K
protons from (n,npa)

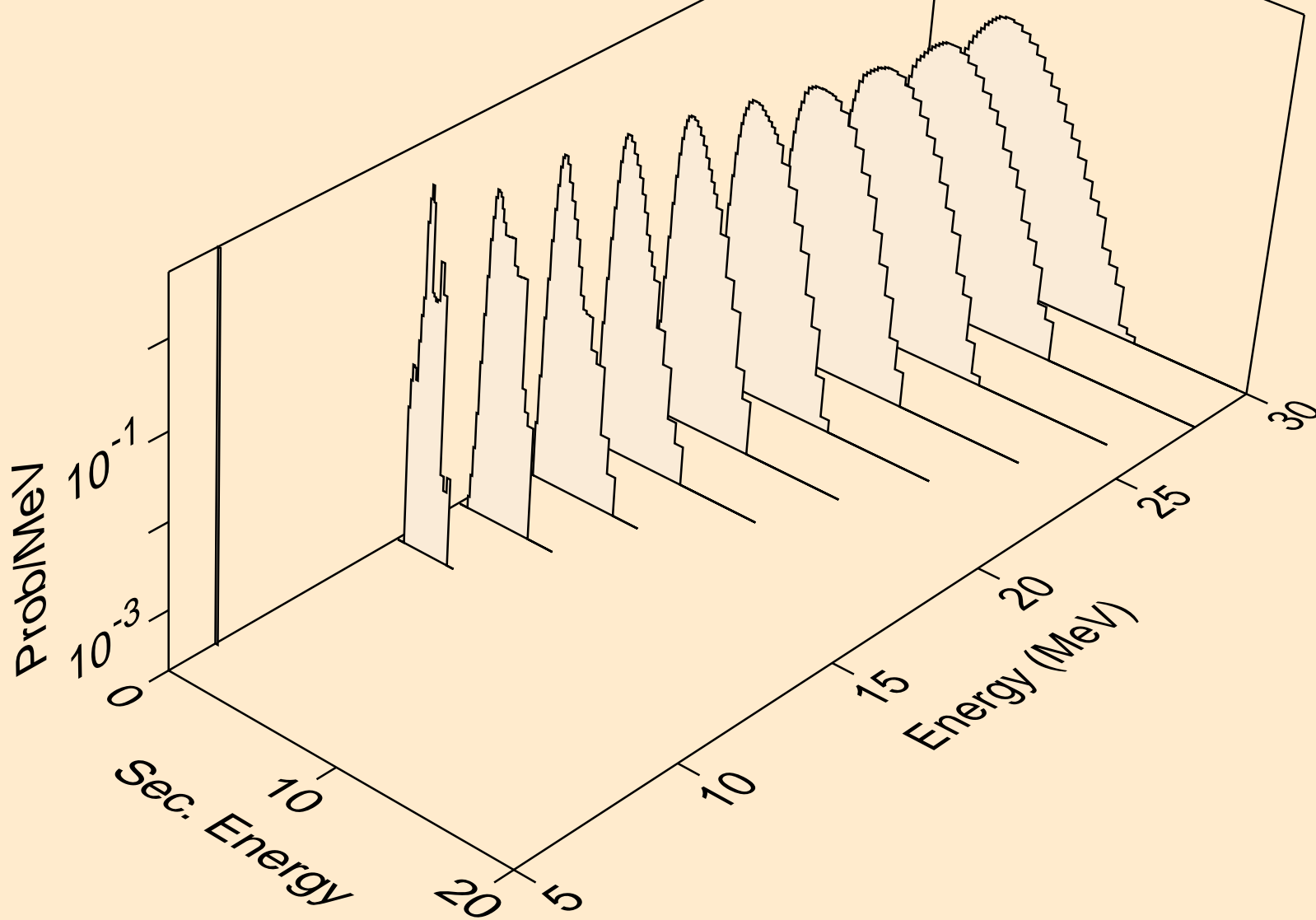

Y080M NEUTRON ACER TENDL-2019 LIBRARY; T=293.16K
protons from (n,p)

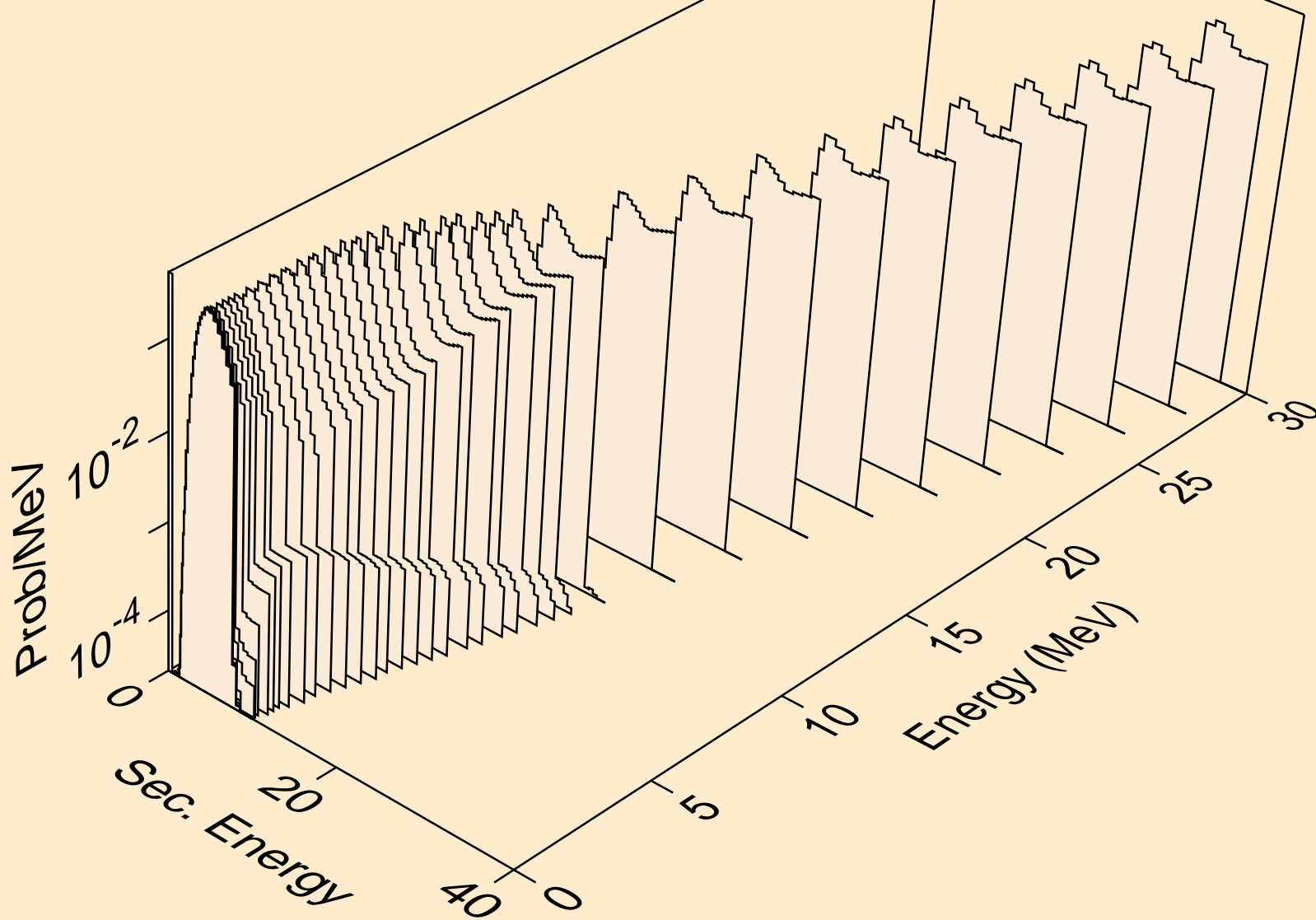

Y080M NEUTRON ACER TENDL-2019 LIBRARY; T=293.16K
protons from (n,2p)

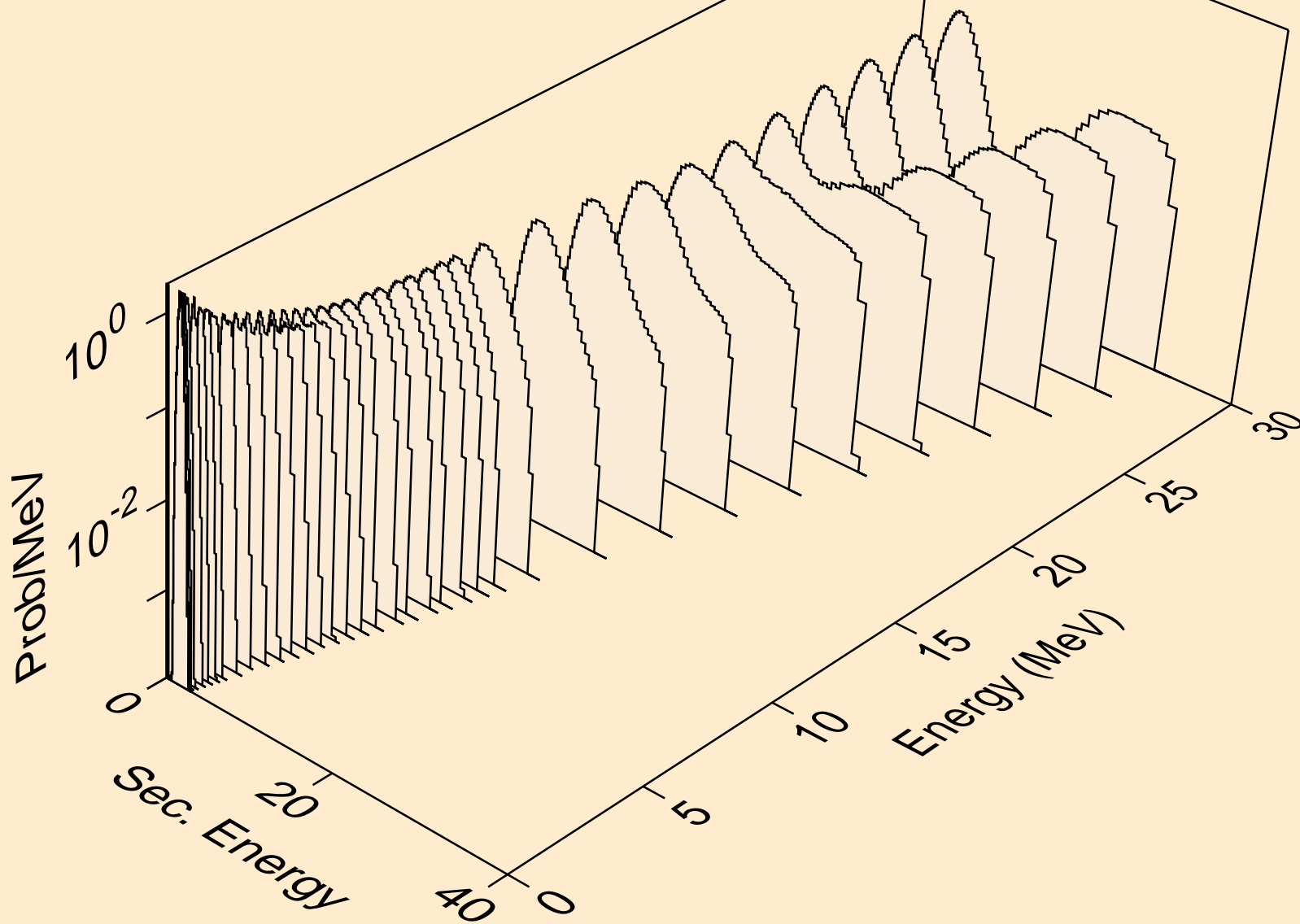

Y080M NEUTRON ACER TENDL-2019 LIBRARY; T=293.16K
protons from (n,p)

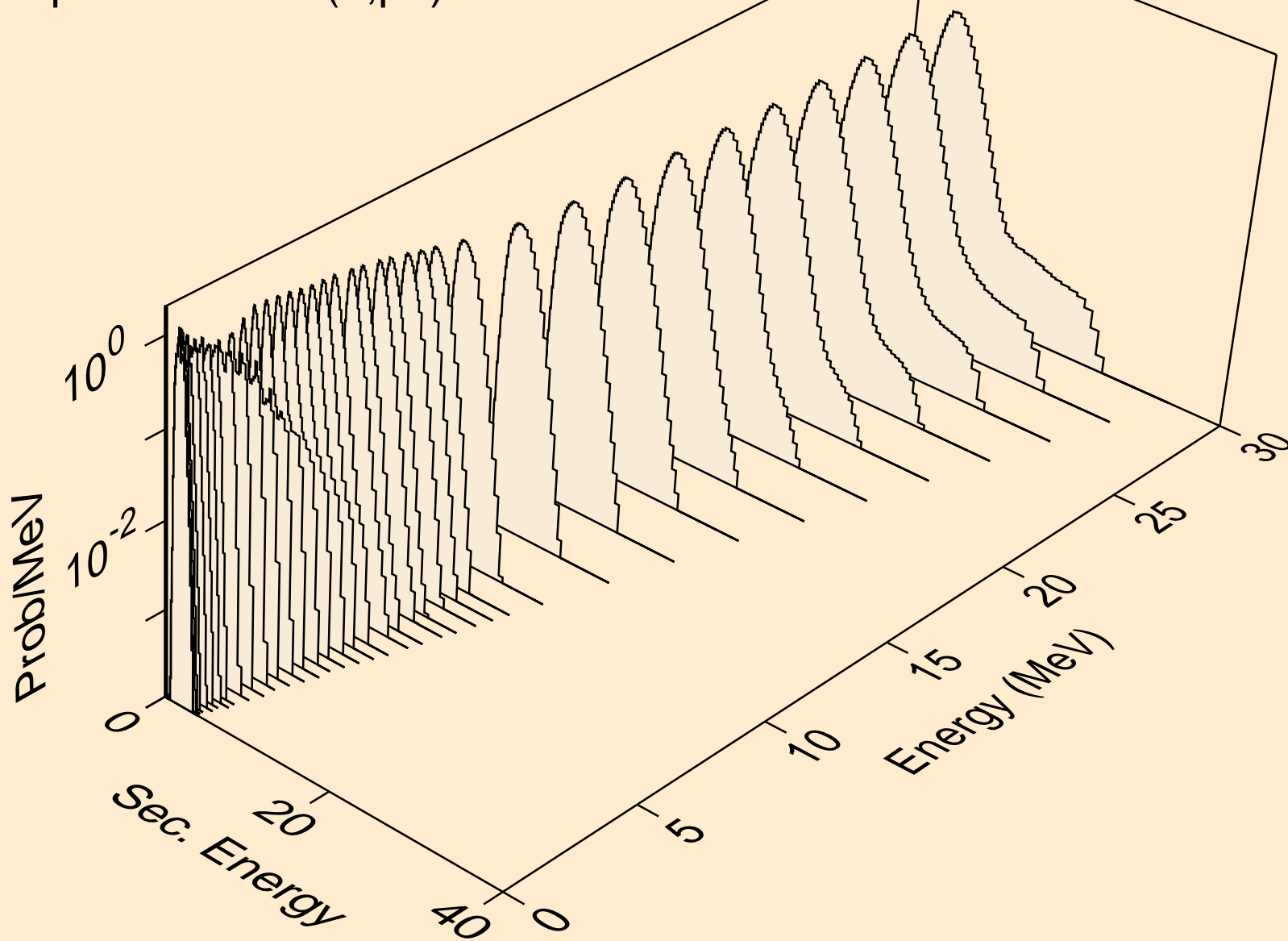

Y080M NEUTRON ACER TENDL-2019 LIBRARY; T=293.16K
protons from (n,pd)

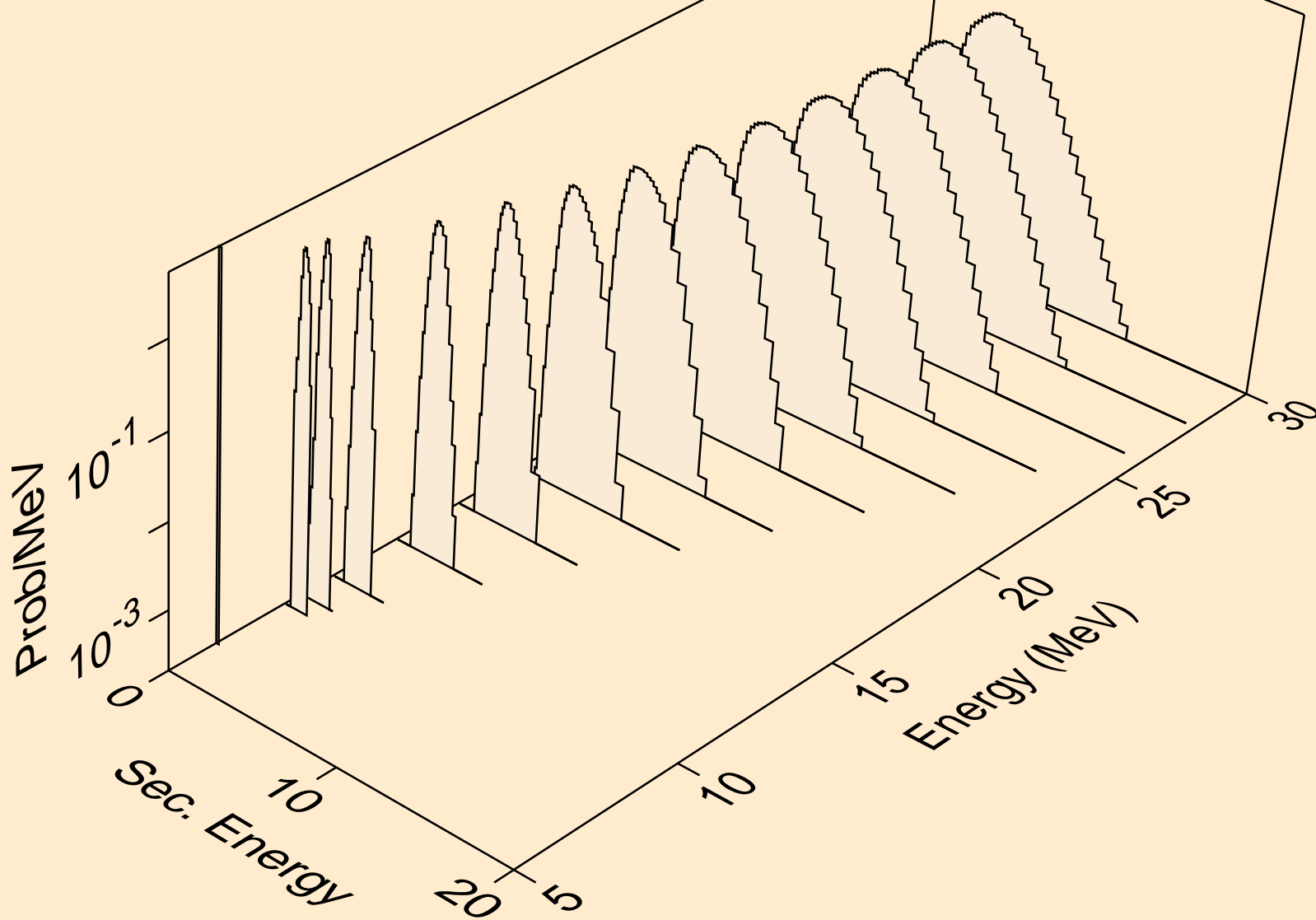

Y080M NEUTRON ACER TENDL-2019 LIBRARY; T=293.16K
protons from (n,pt)

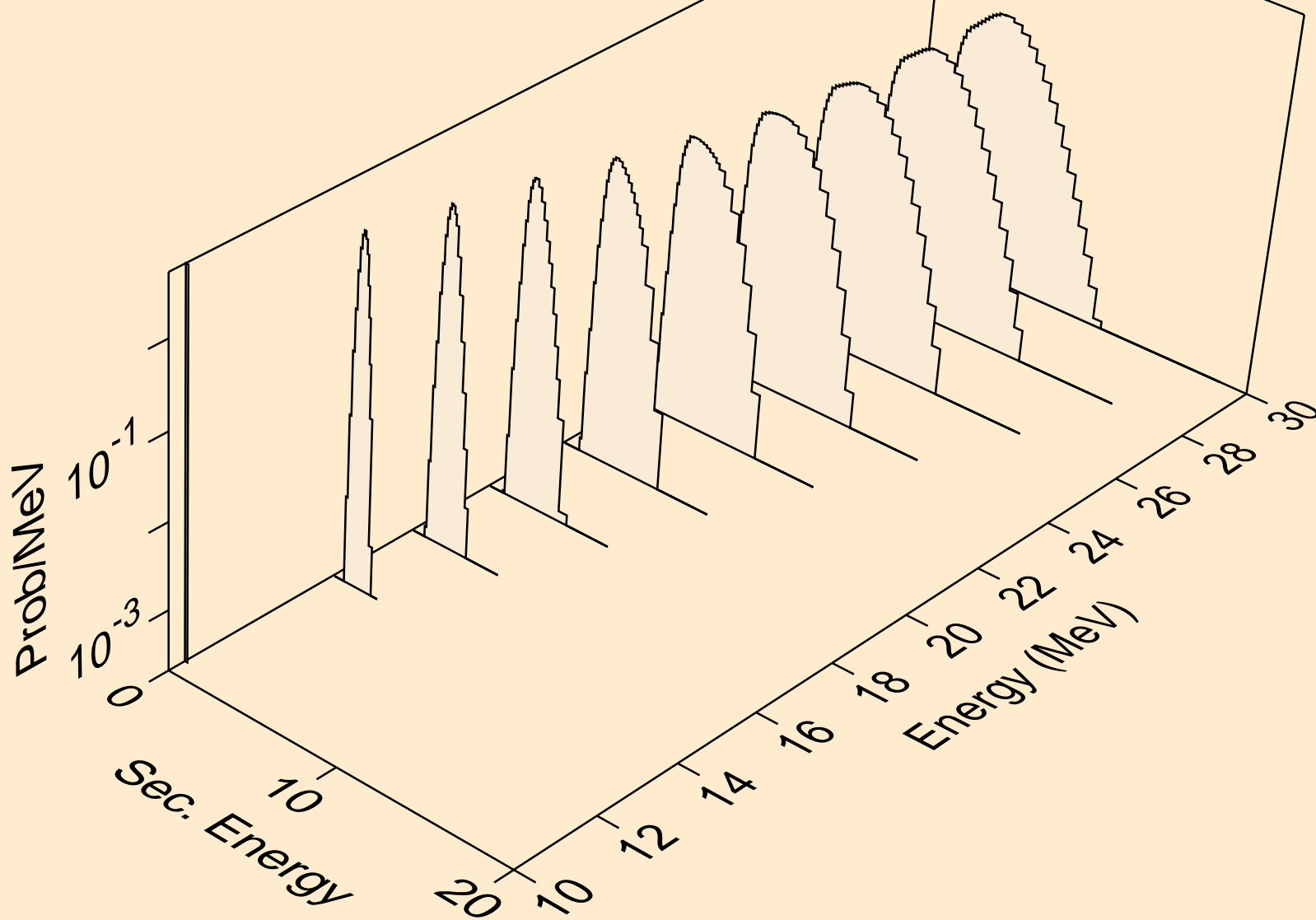

Y080M NEUTRON ACER TENDL-2019 LIBRARY; T=293.16K
deuterons from (n,x)

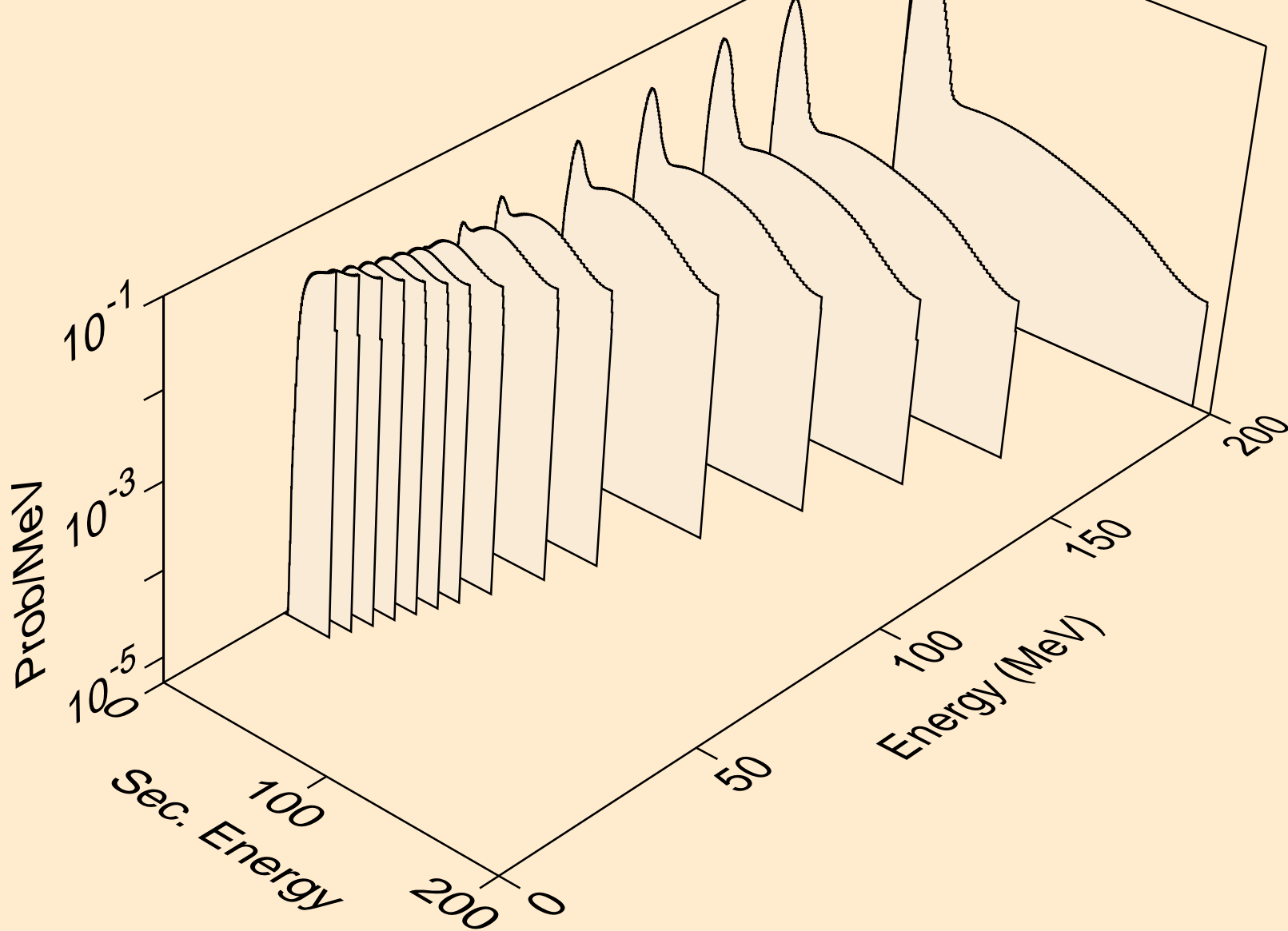

Y080M NEUTRON ACER TENDL-2019 LIBRARY; T=293.16K
deuterons from (n,2nd)

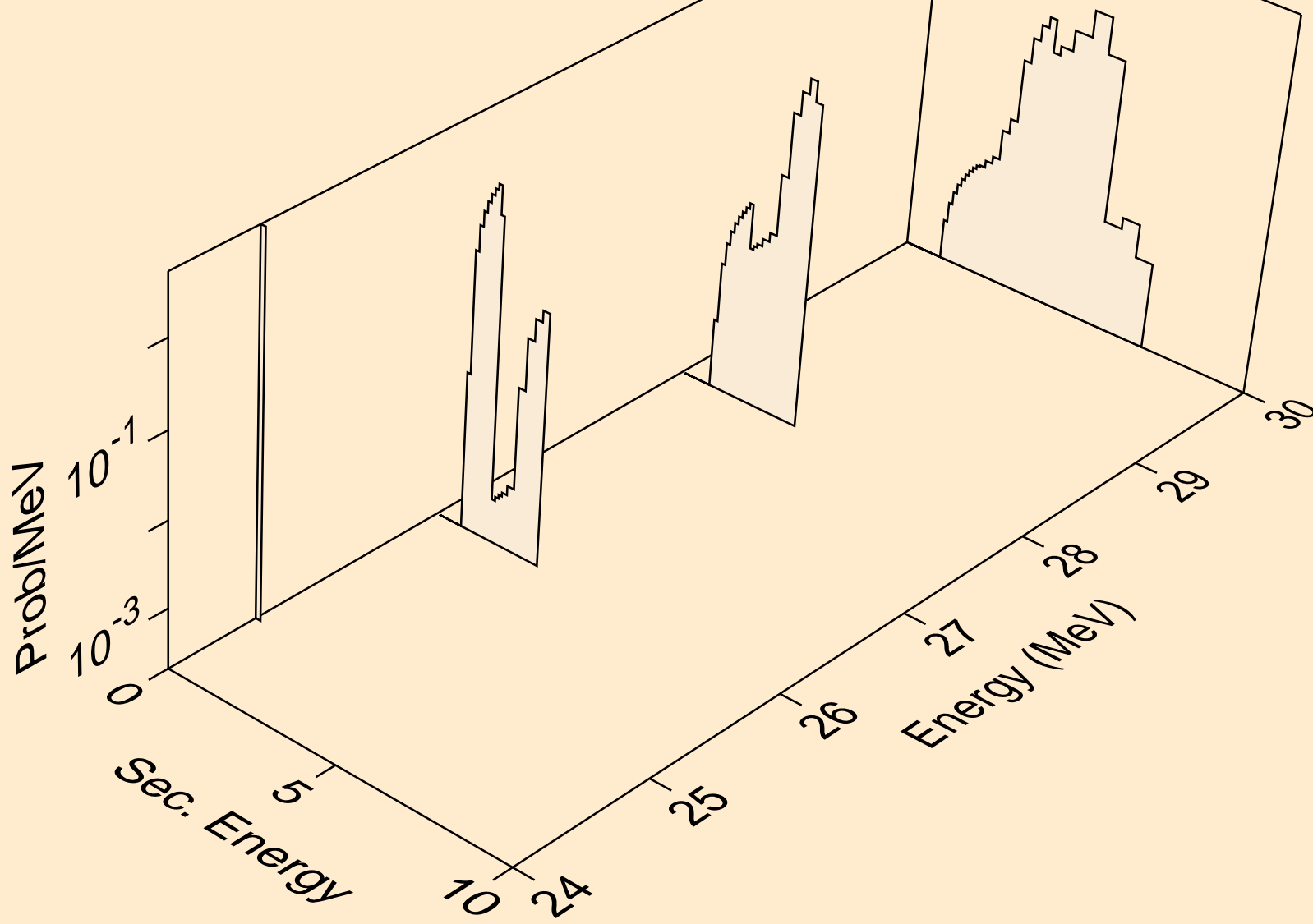

Y080M NEUTRON ACER TENDL-2019 LIBRARY; T=293.16K
deuterons from (n,n*)d

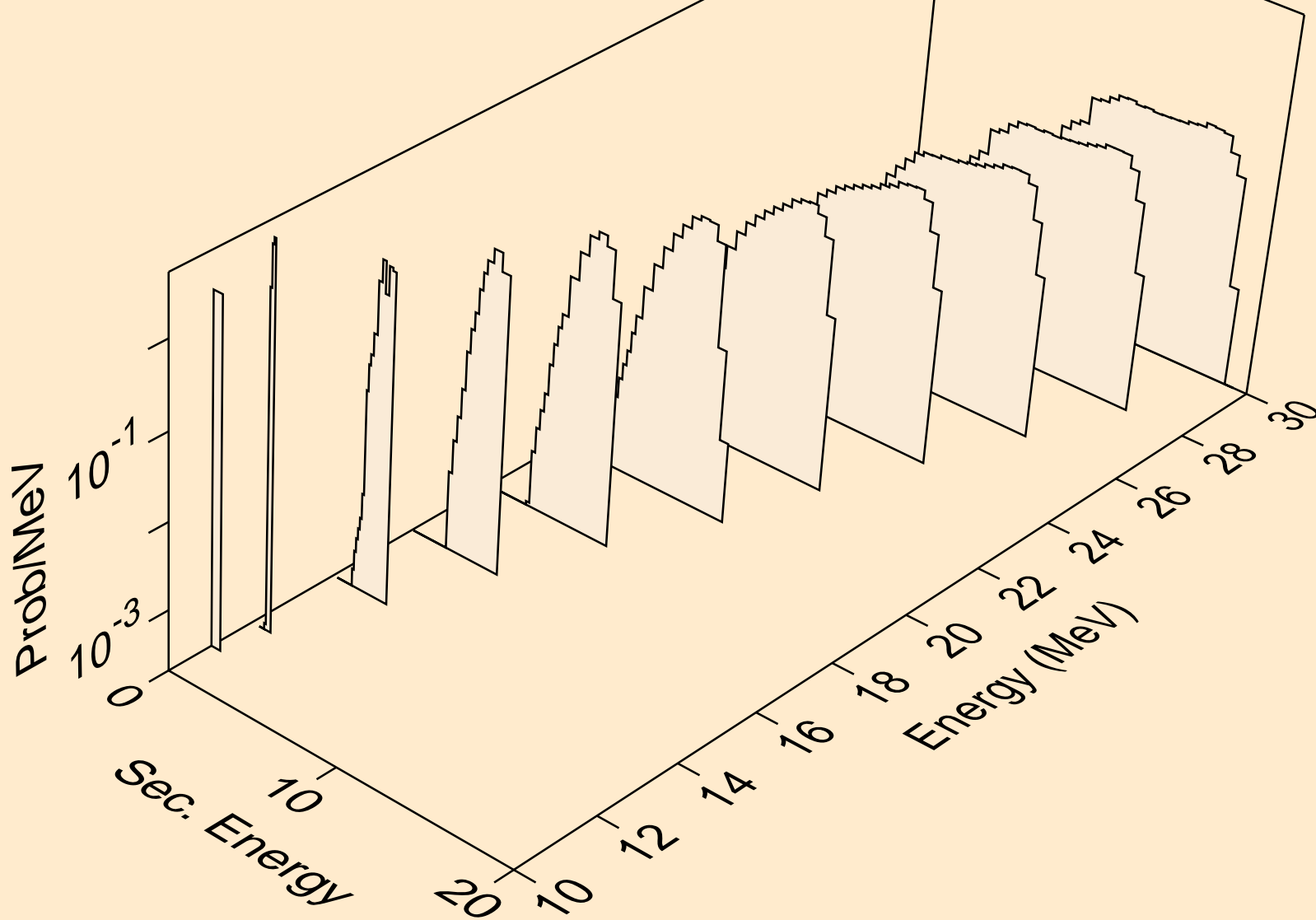

Y080M NEUTRON ACER TENDL-2019 LIBRARY; T=293.16K
deuterons from (n,d)

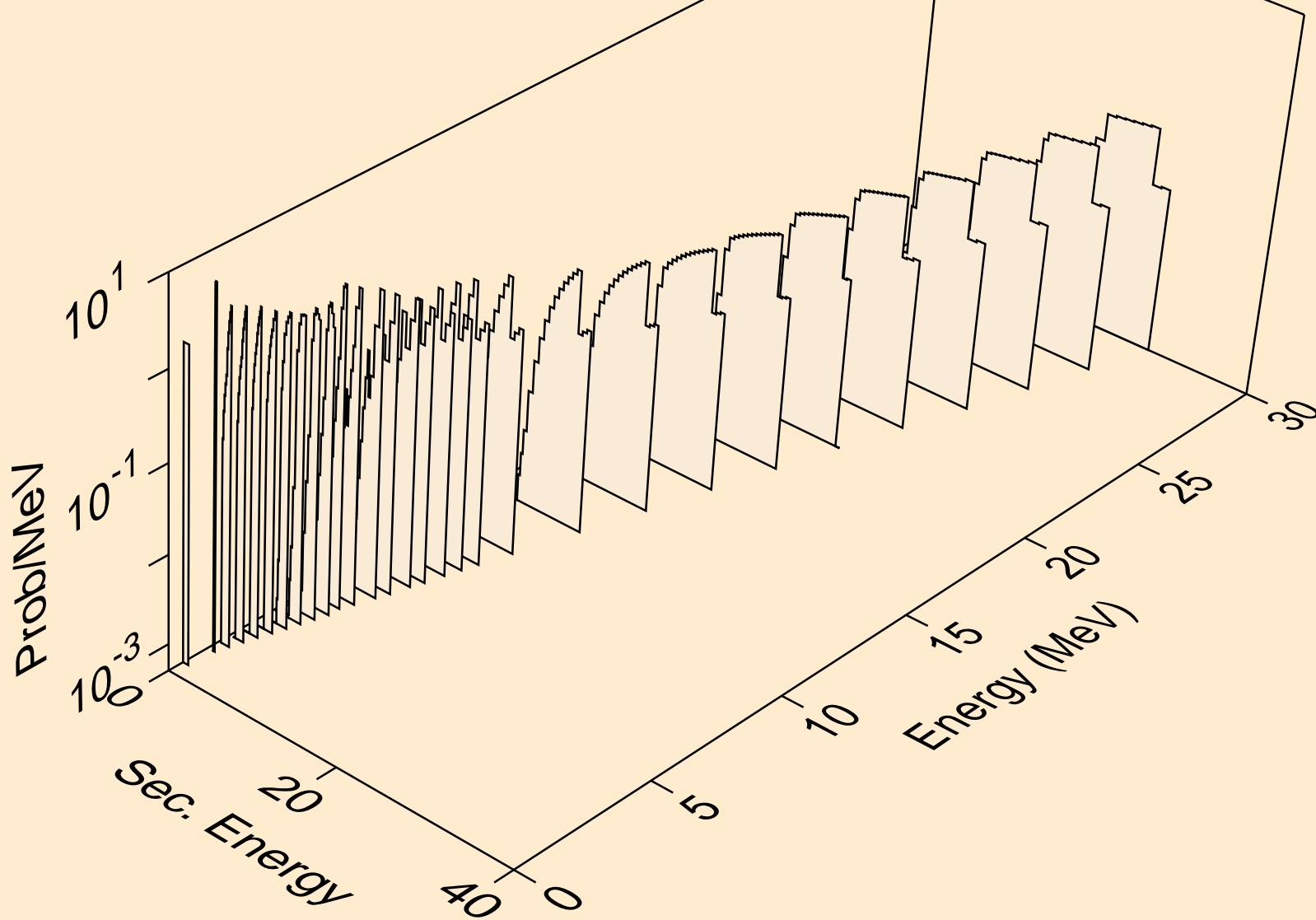

Y080M NEUTRON ACER TENDL-2019 LIBRARY; T=293.16K
deuterons from (n,d2a)

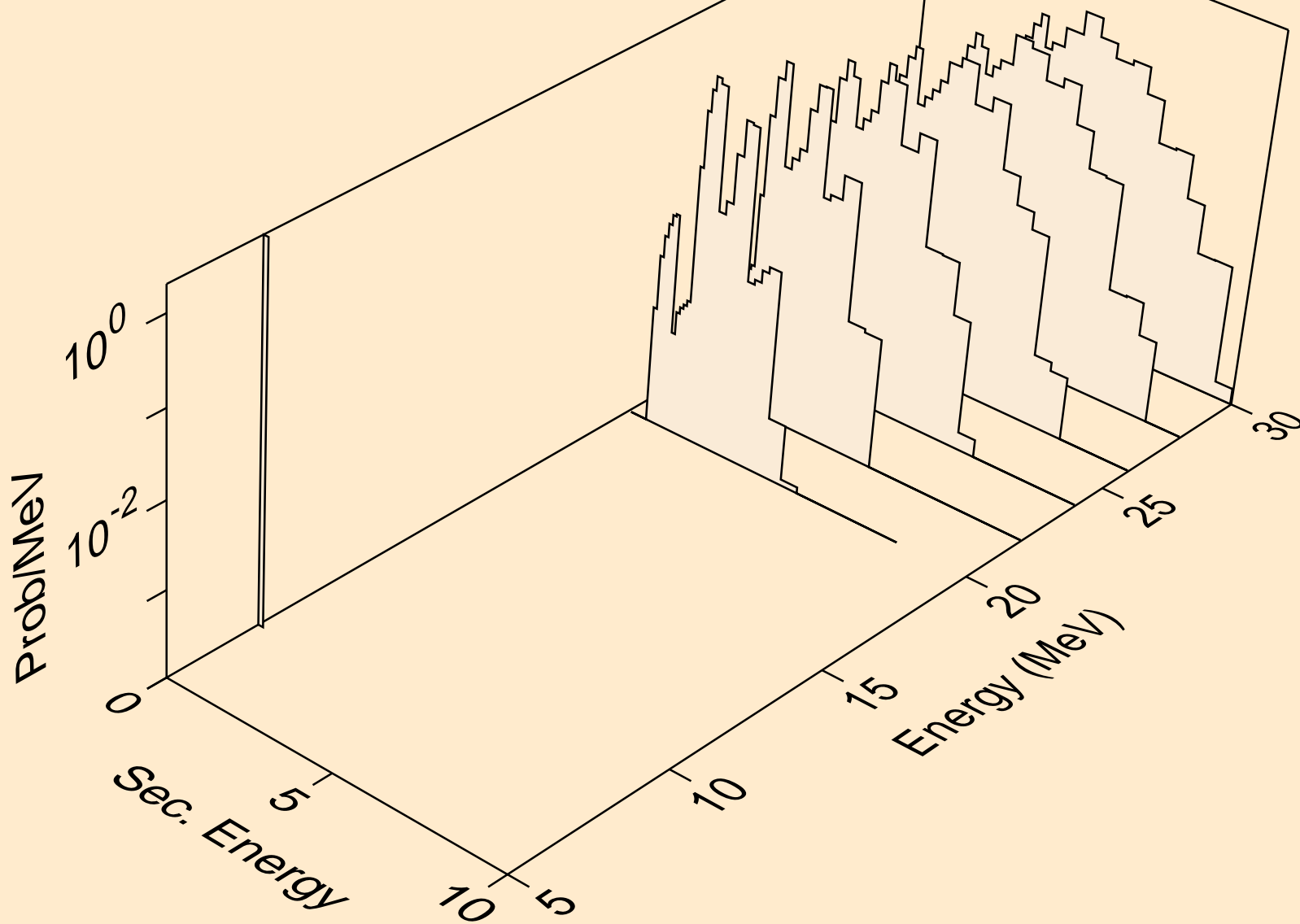

Y080M NEUTRON ACER TENDL-2019 LIBRARY; T=293.16K
deuterons from (n,pd)

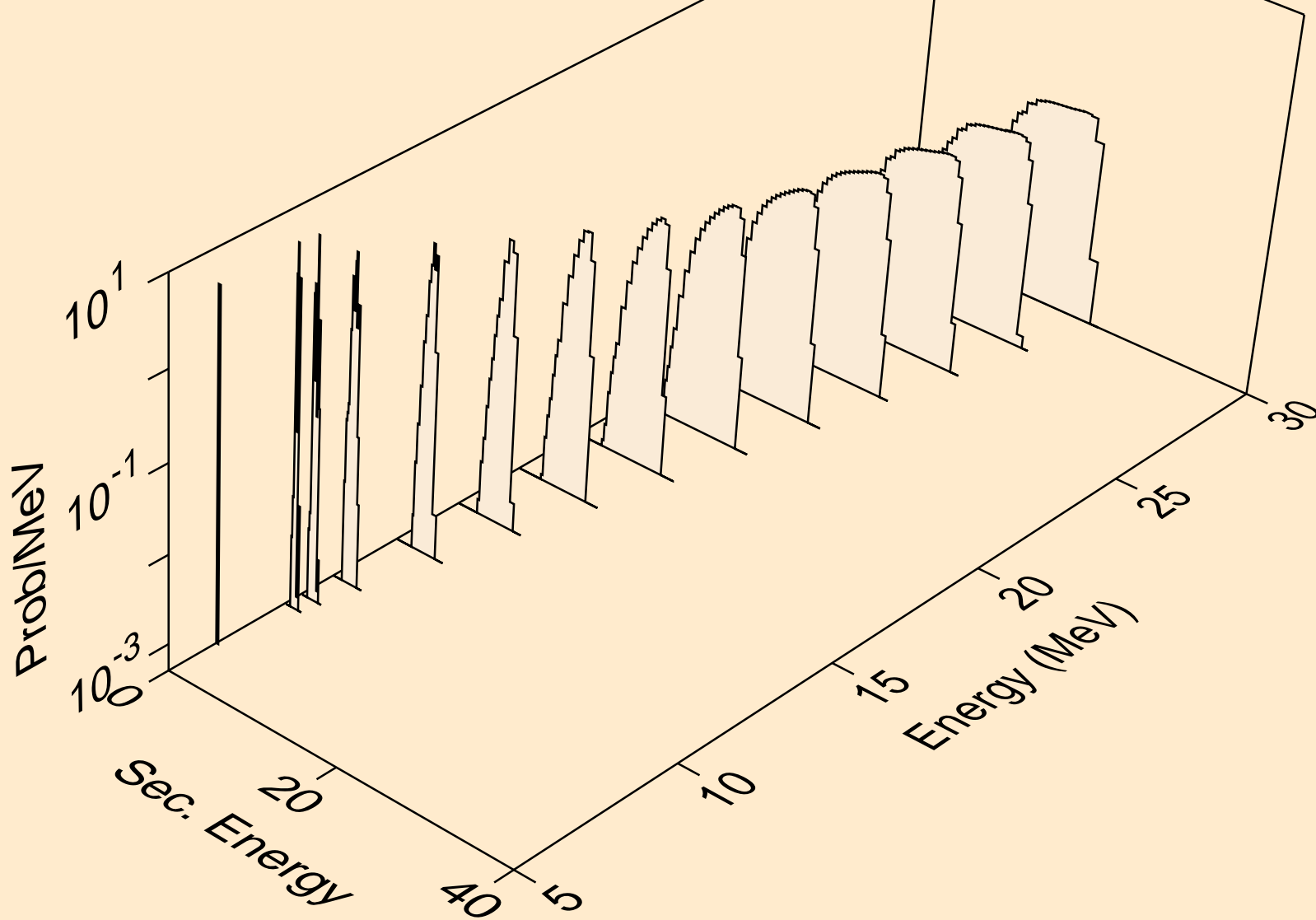

Y080M NEUTRON ACER TENDL-2019 LIBRARY; T=293.16K
deuterons from (n,da)

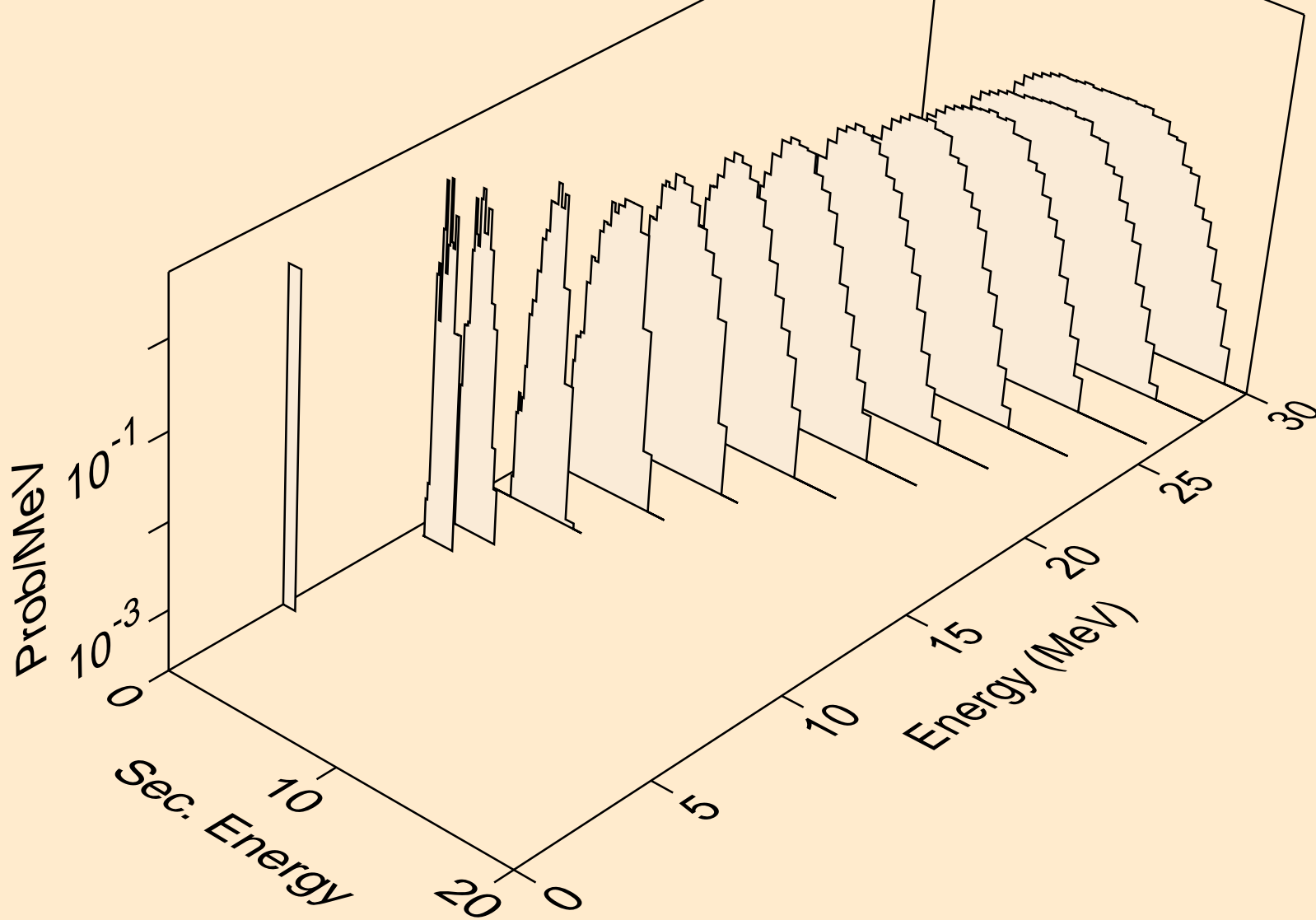

Y080M NEUTRON ACER TENDL-2019 LIBRARY; T=293.16K
tritons from (n,x)

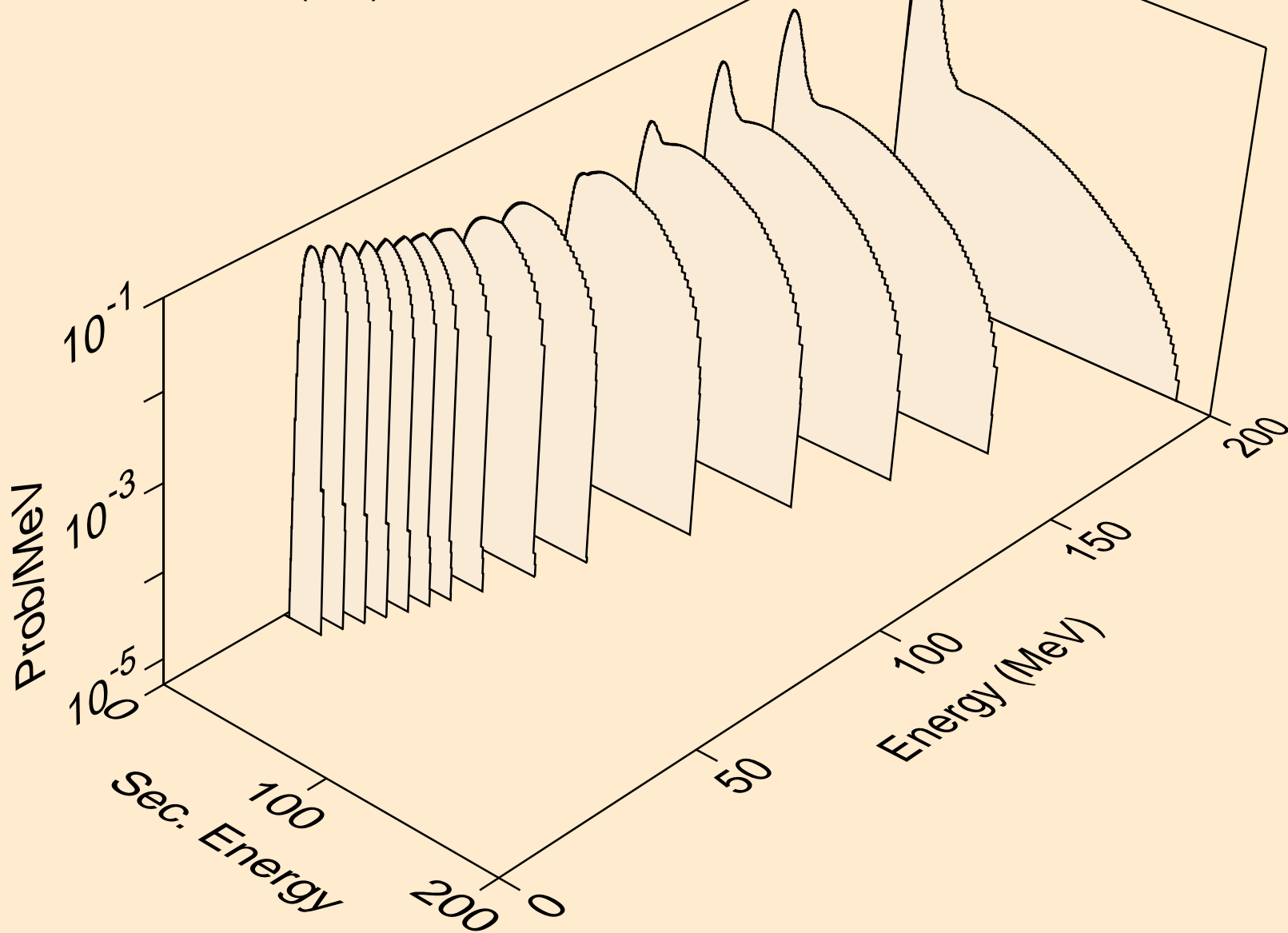

Y080M NEUTRON ACER TENDL-2019 LIBRARY; T=293.16K
tritons from (n,n*)t

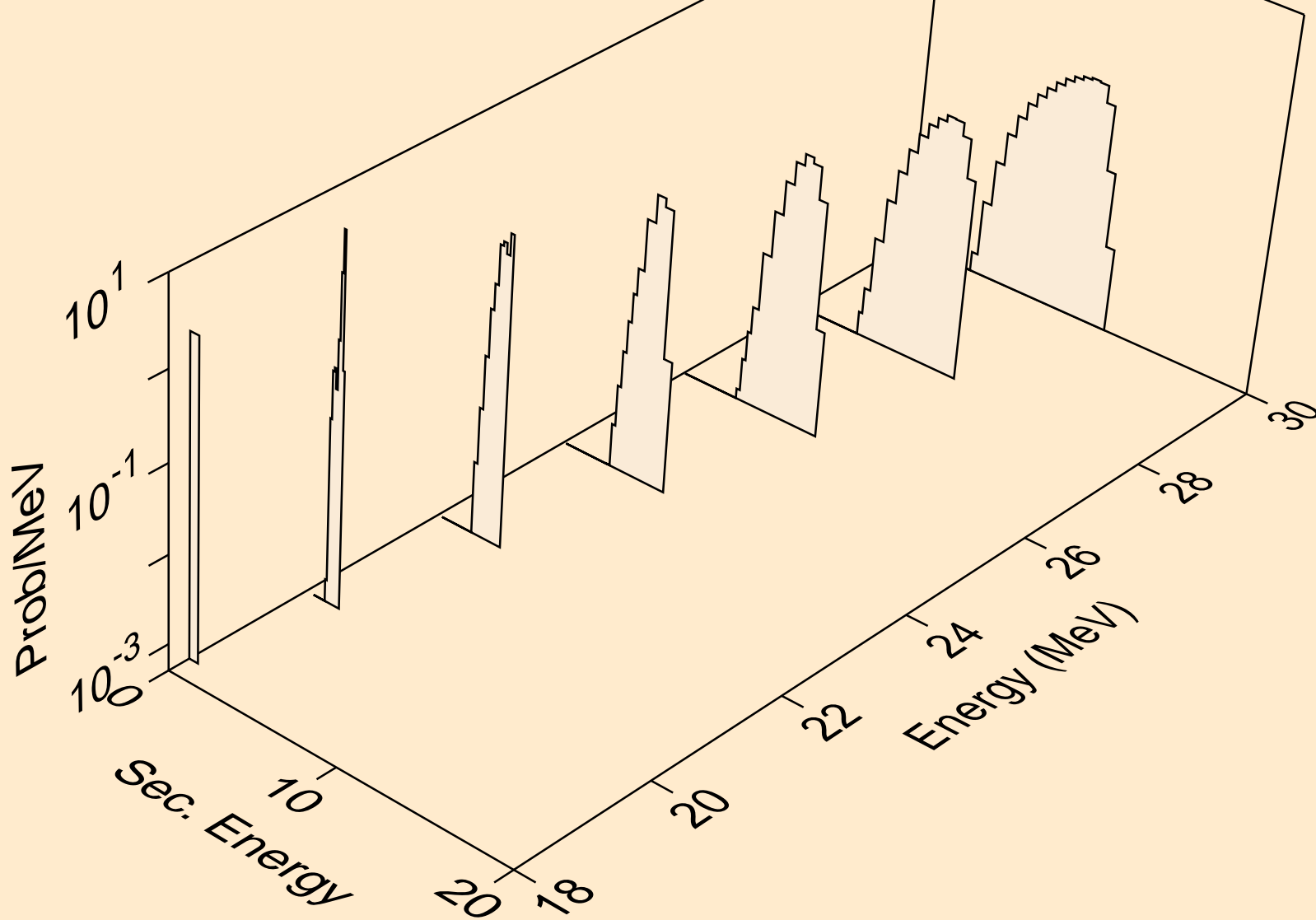

Y080M NEUTRON ACER TENDL-2019 LIBRARY; T=293.16K
tritons from (n,t)

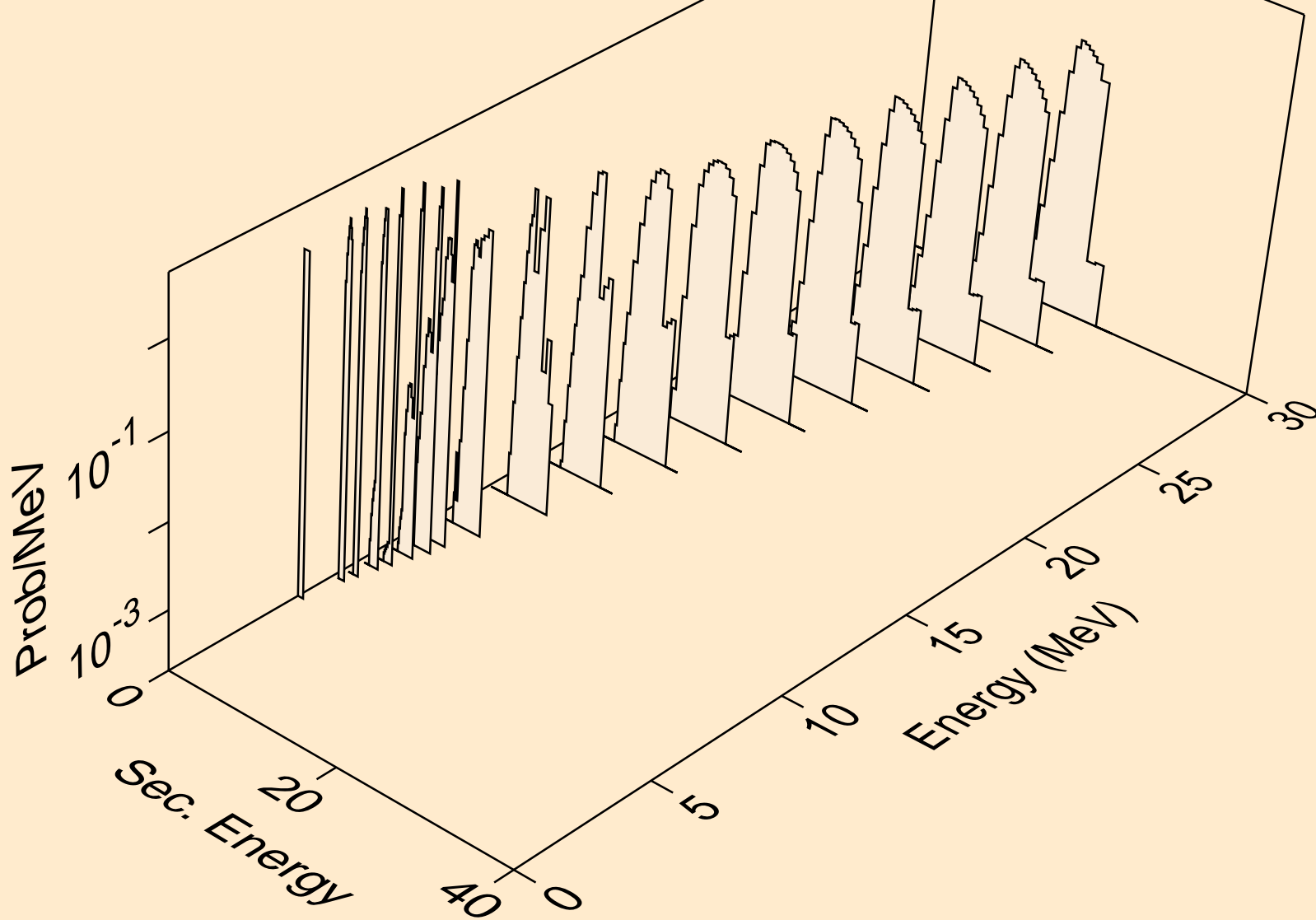

Y080M NEUTRON ACER TENDL-2019 LIBRARY; T=293.16K
tritons from (n,pt)

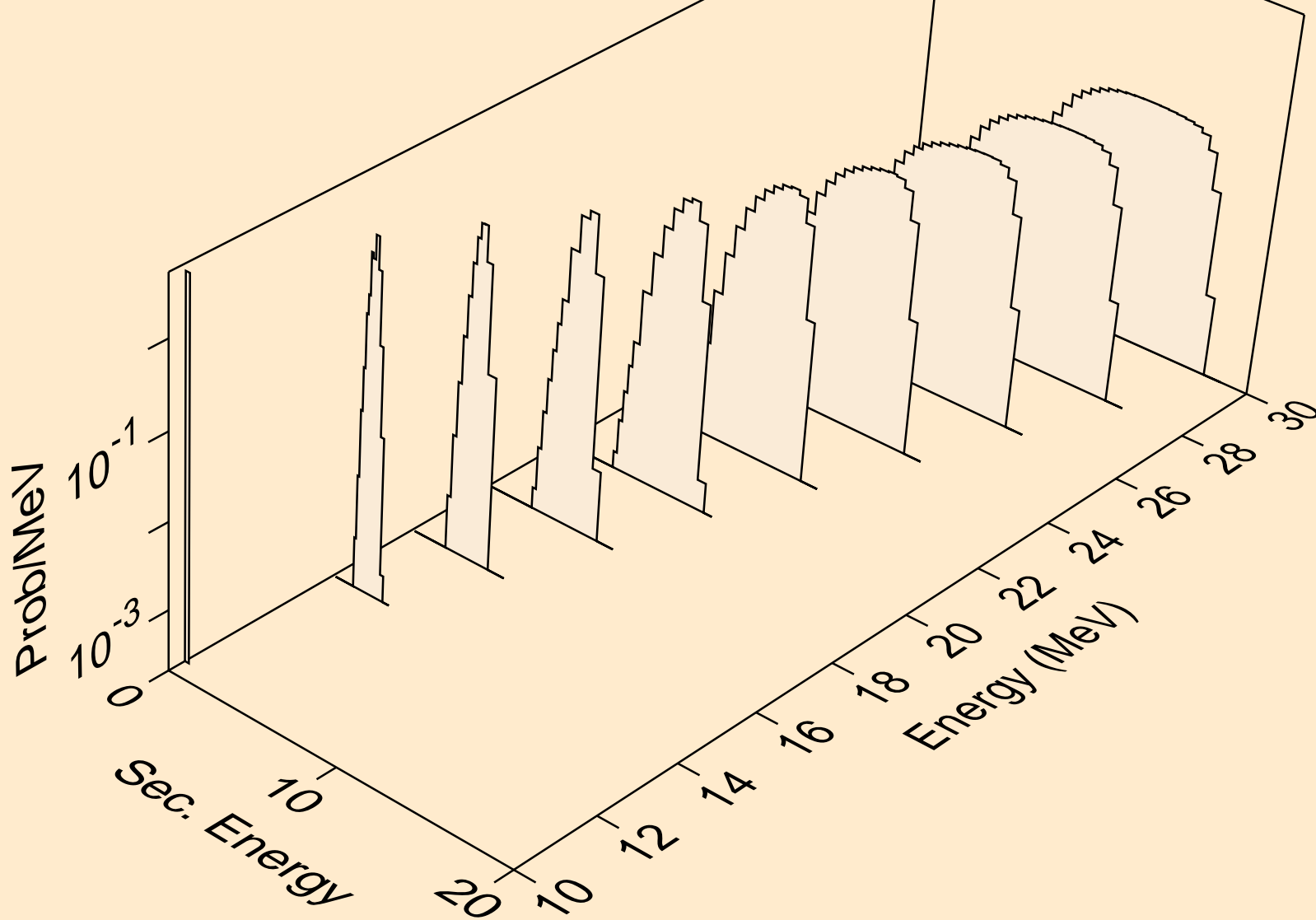

Y080M NEUTRON ACER TENDL-2019 LIBRARY; T=293.16K
he3s from (n,x)

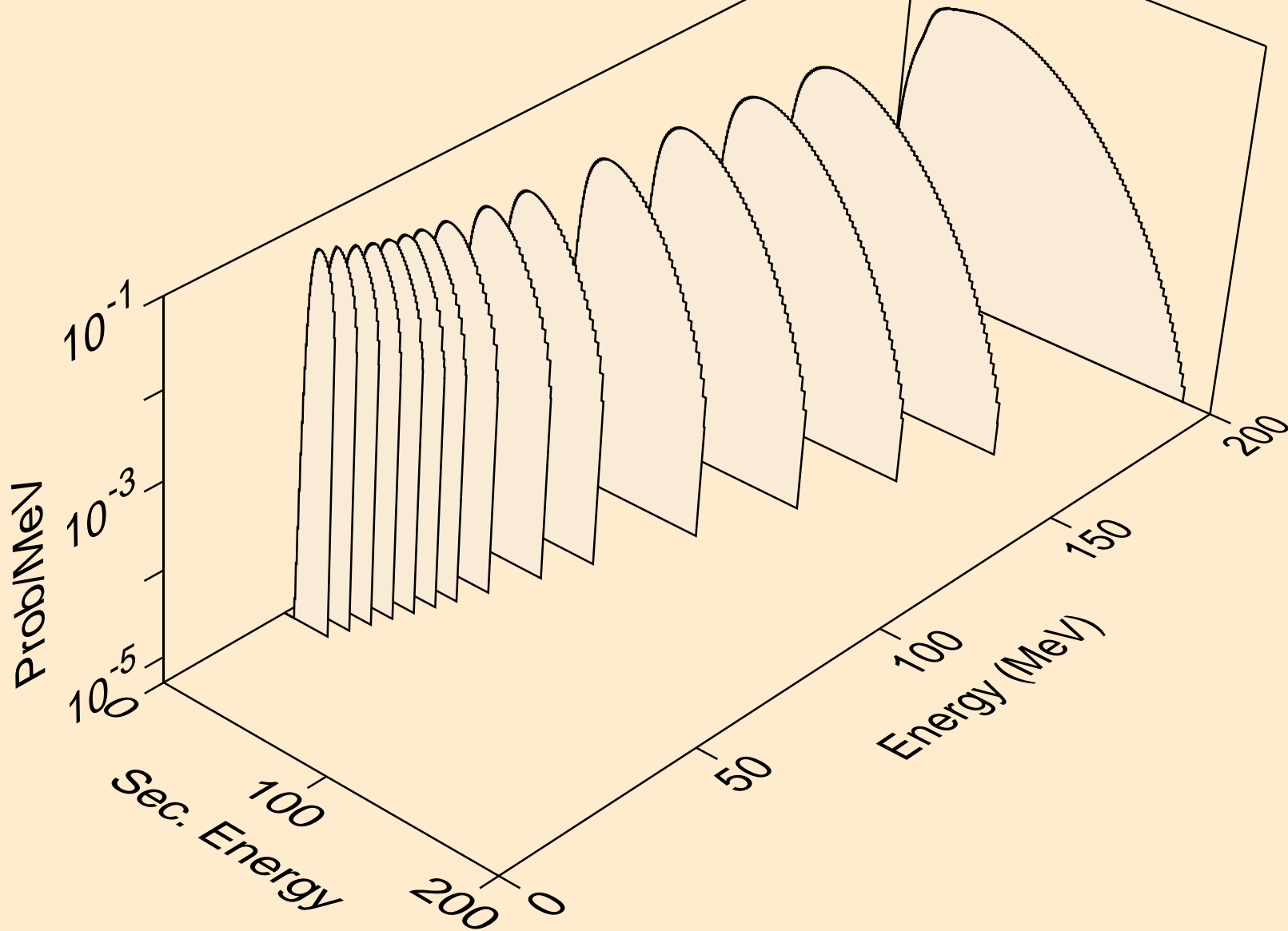

Y080M NEUTRON ACER TENDL-2019 LIBRARY; T=293.16K
he3s from (n,n*)he3

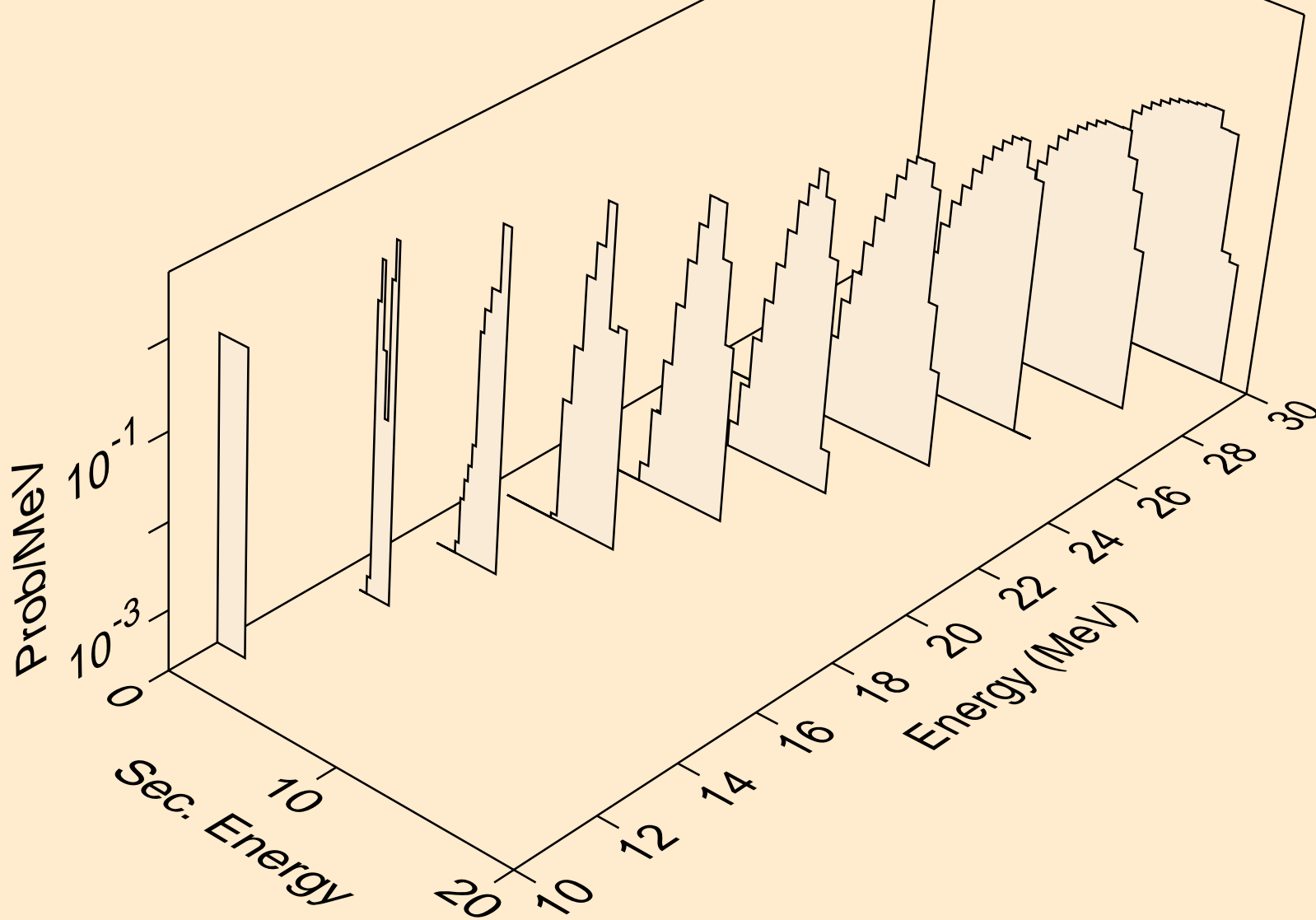

Y080M NEUTRON ACER TENDL-2019 LIBRARY; T=293.16K
he3s from (n,he3)

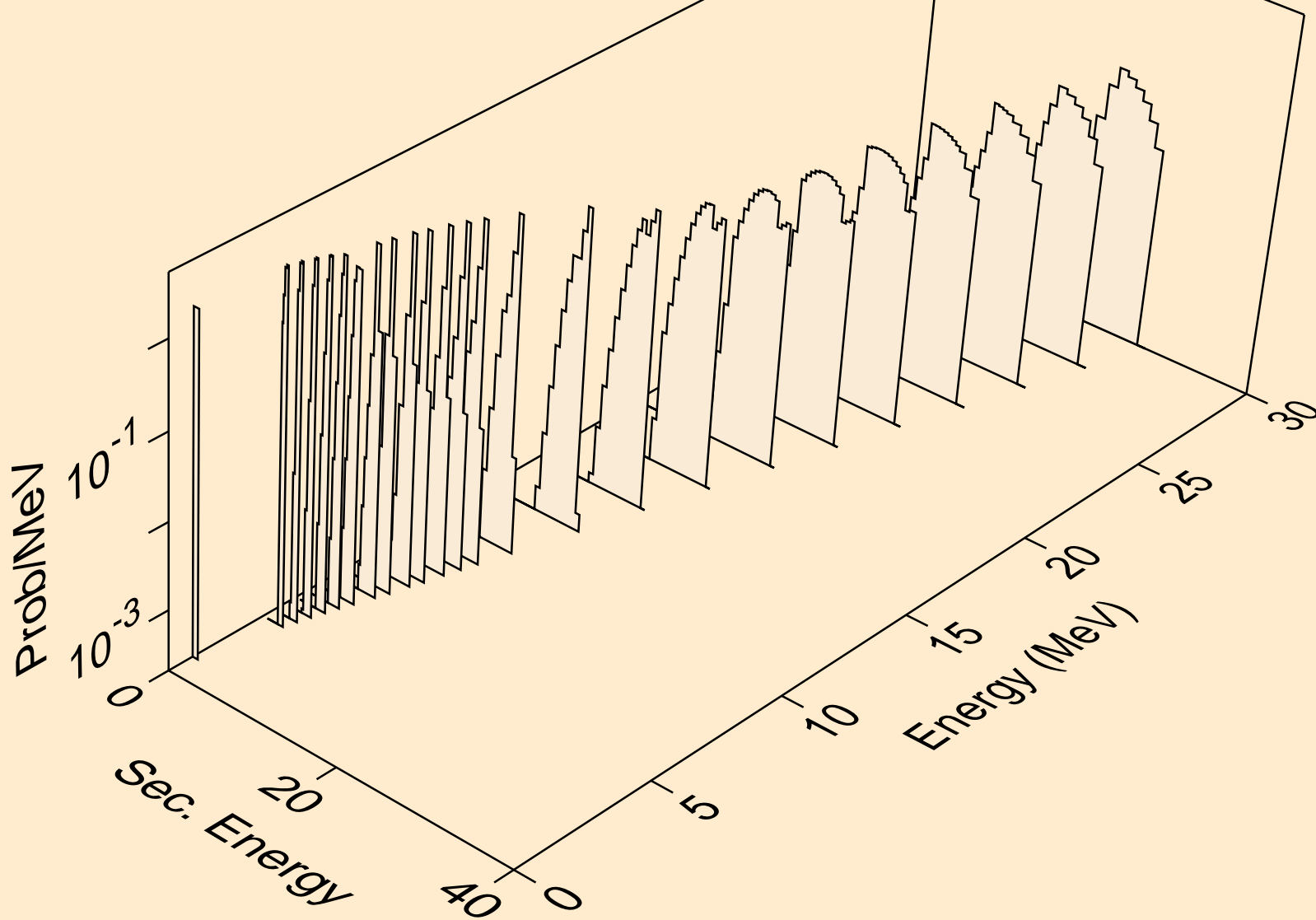

Y080M NEUTRON ACER TENDL-2019 LIBRARY; T=293.16K
alphas from (n,x)

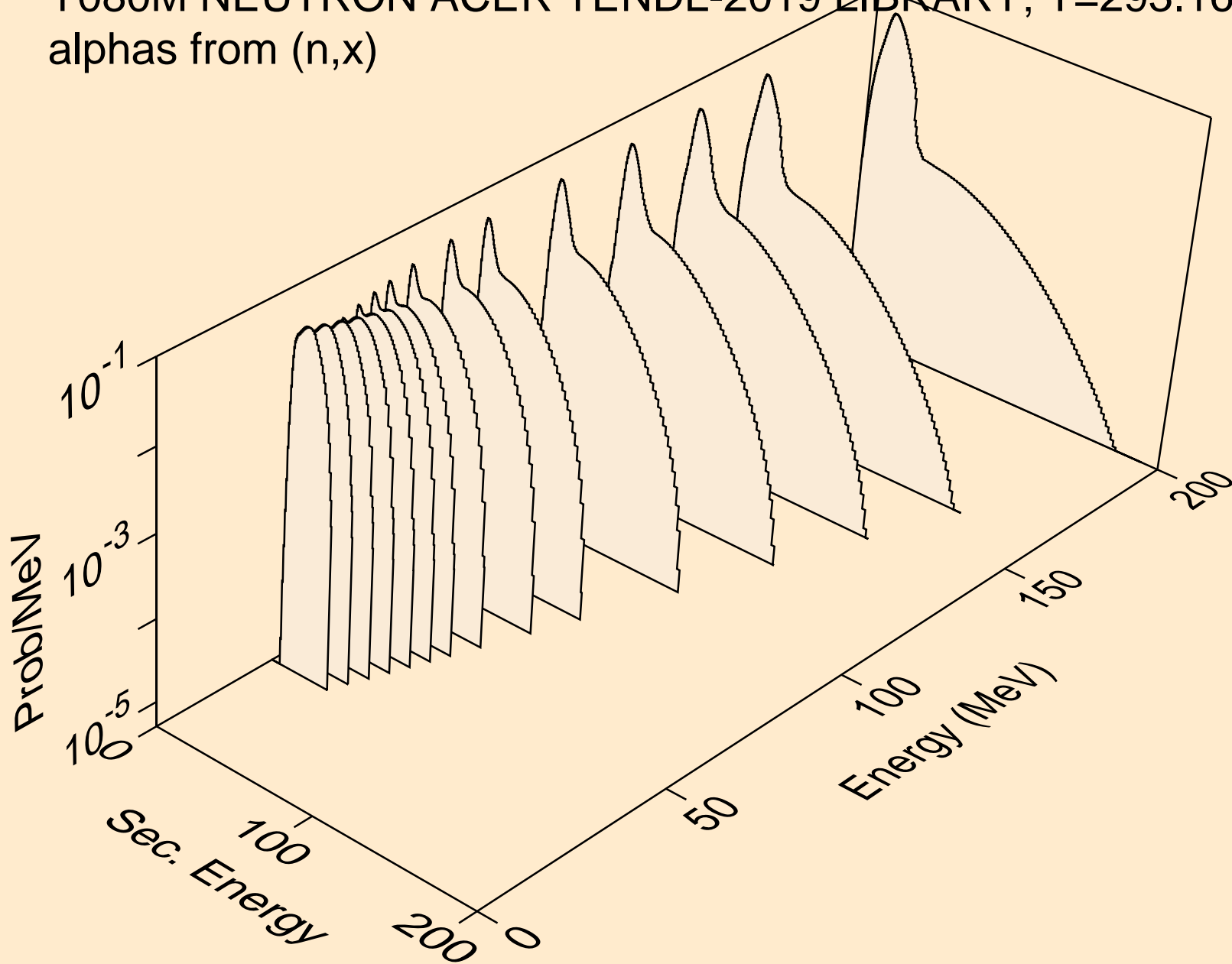

Y080M NEUTRON ACER TENDL-2019 LIBRARY; T=293.16K
alphas from (n,n*)a

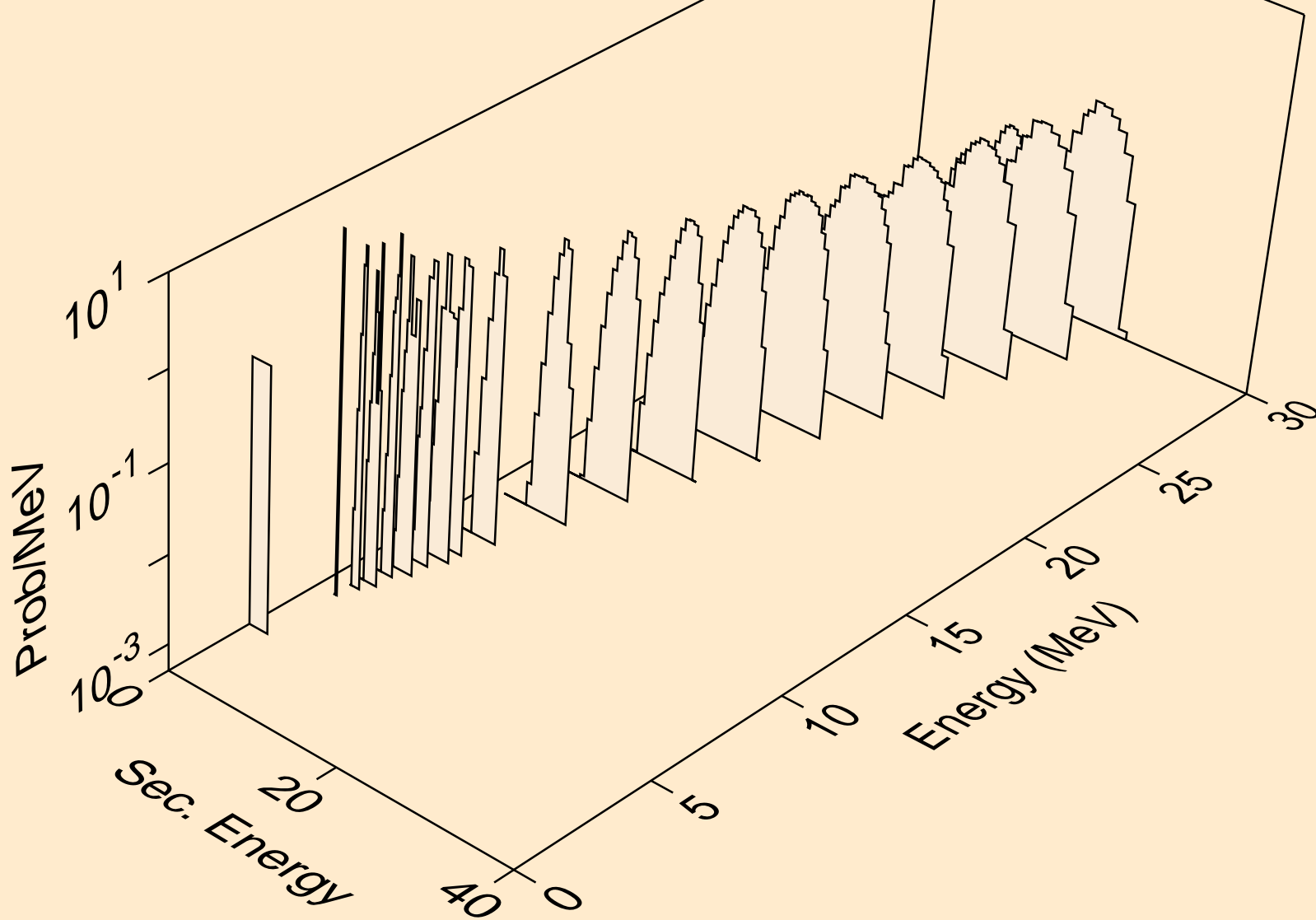

Y080M NEUTRON ACER TENDL-2019 LIBRARY; T=293.16K
alphas from (n,2n)a

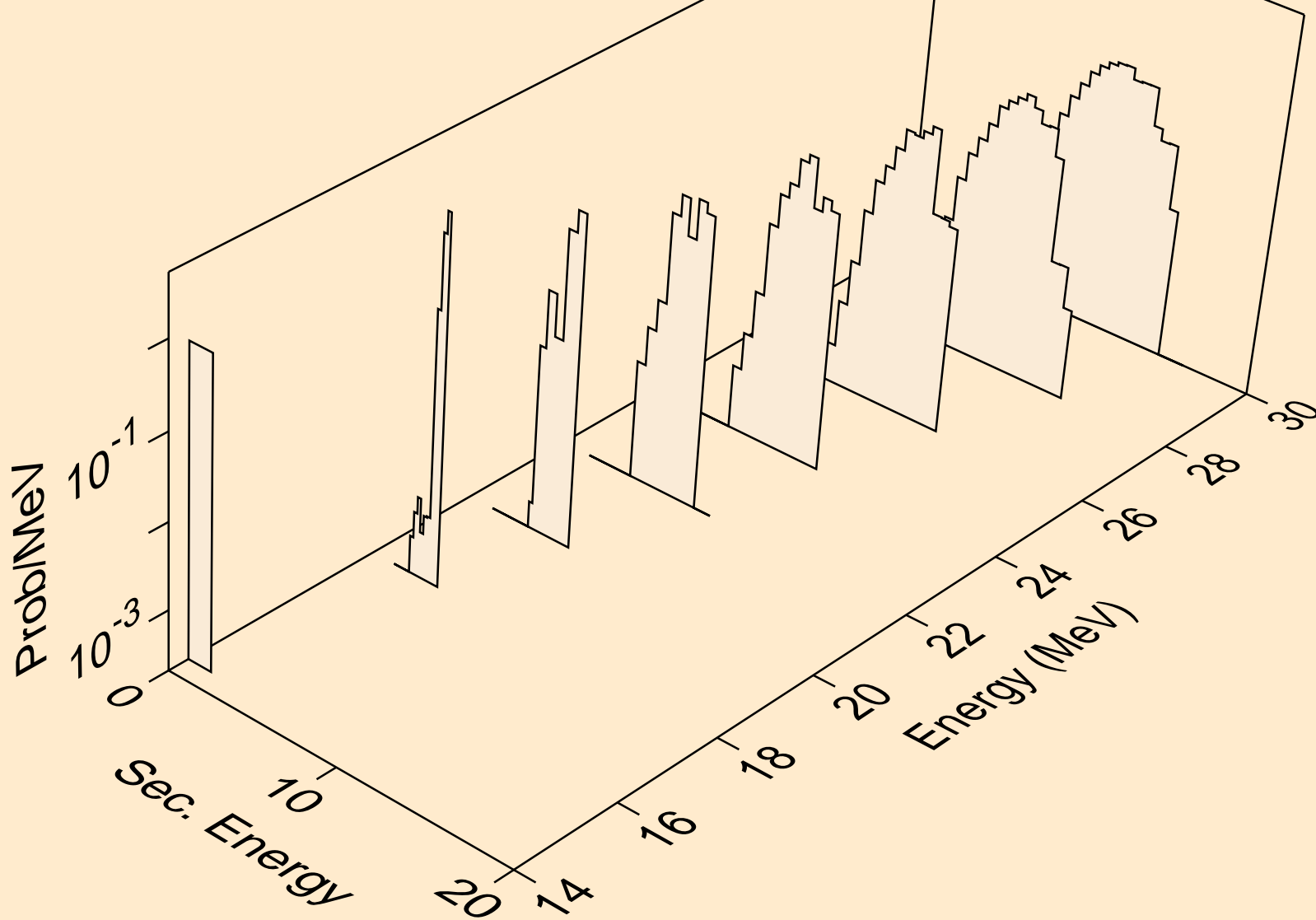

Y080M NEUTRON ACER TENDL-2019 LIBRARY; T=293.16K
alphas from (n,n*)2a

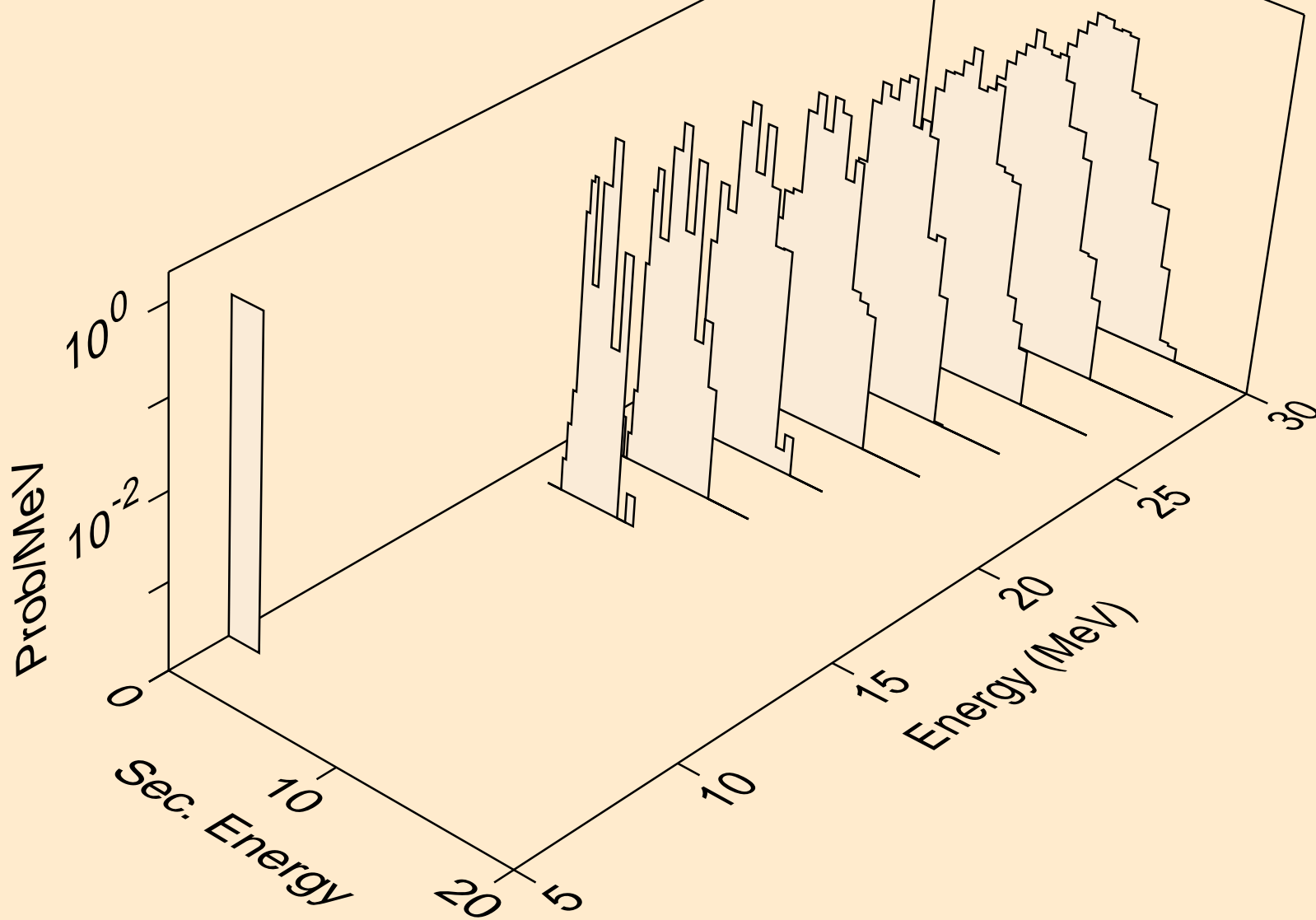

Y080M NEUTRON ACER TENDL-2019 LIBRARY; T=293.16K
alphas from (n,npa)

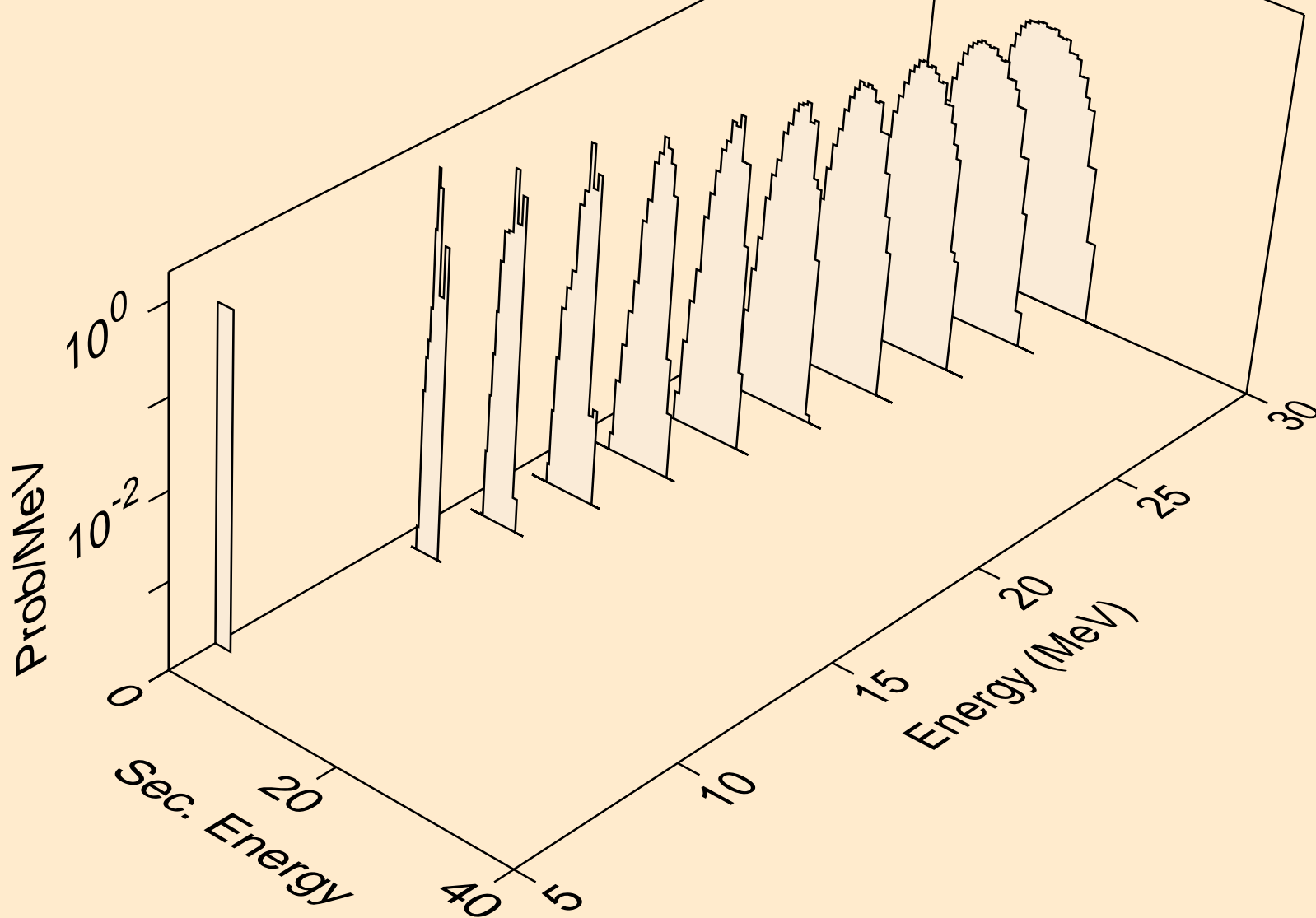

Y080M NEUTRON ACER TENDL-2019 LIBRARY; T=293.16K
alphas from (n,a)

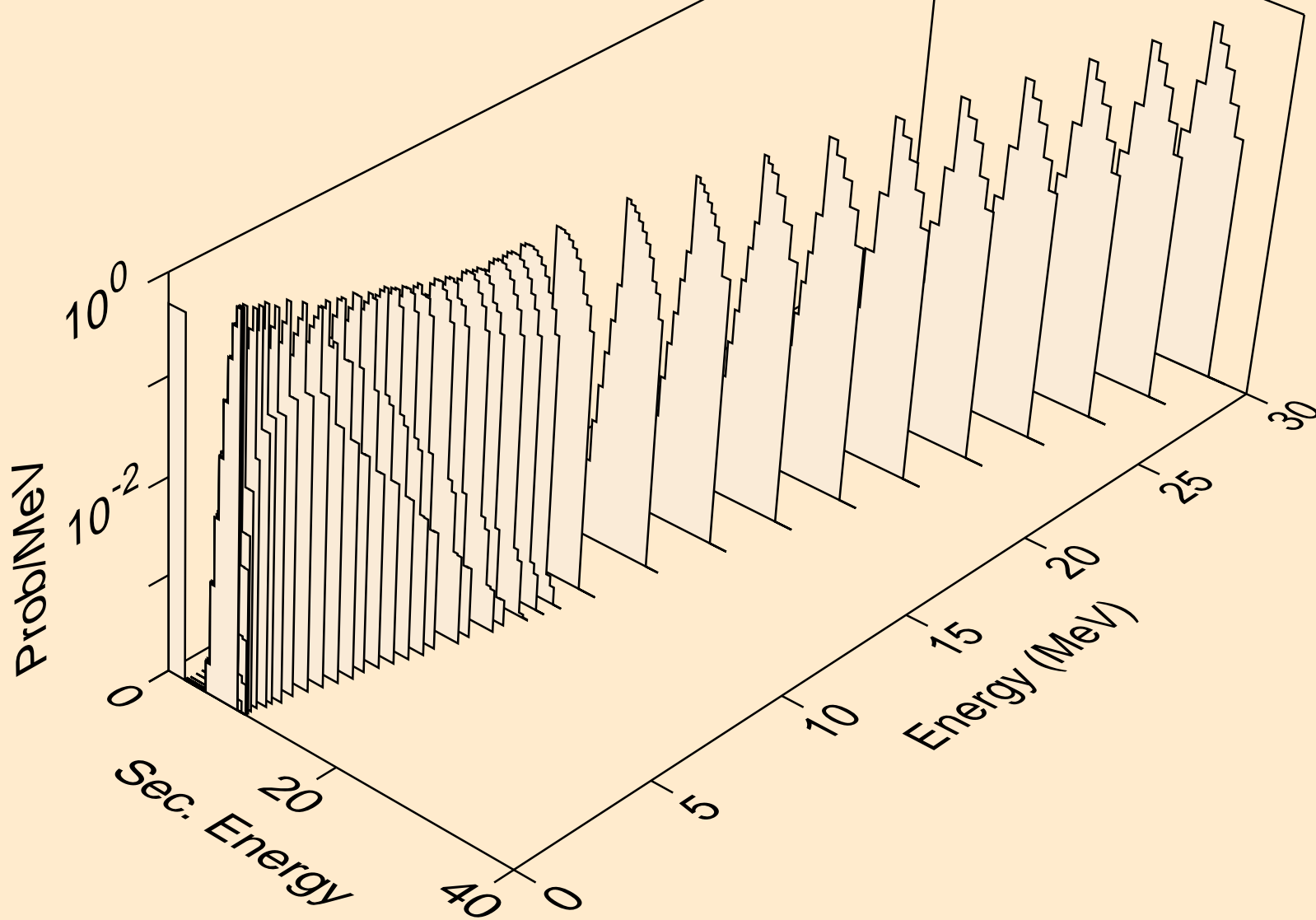

Y080M NEUTRON ACER TENDL-2019 LIBRARY; T=293.16K
alphas from (n,2a)

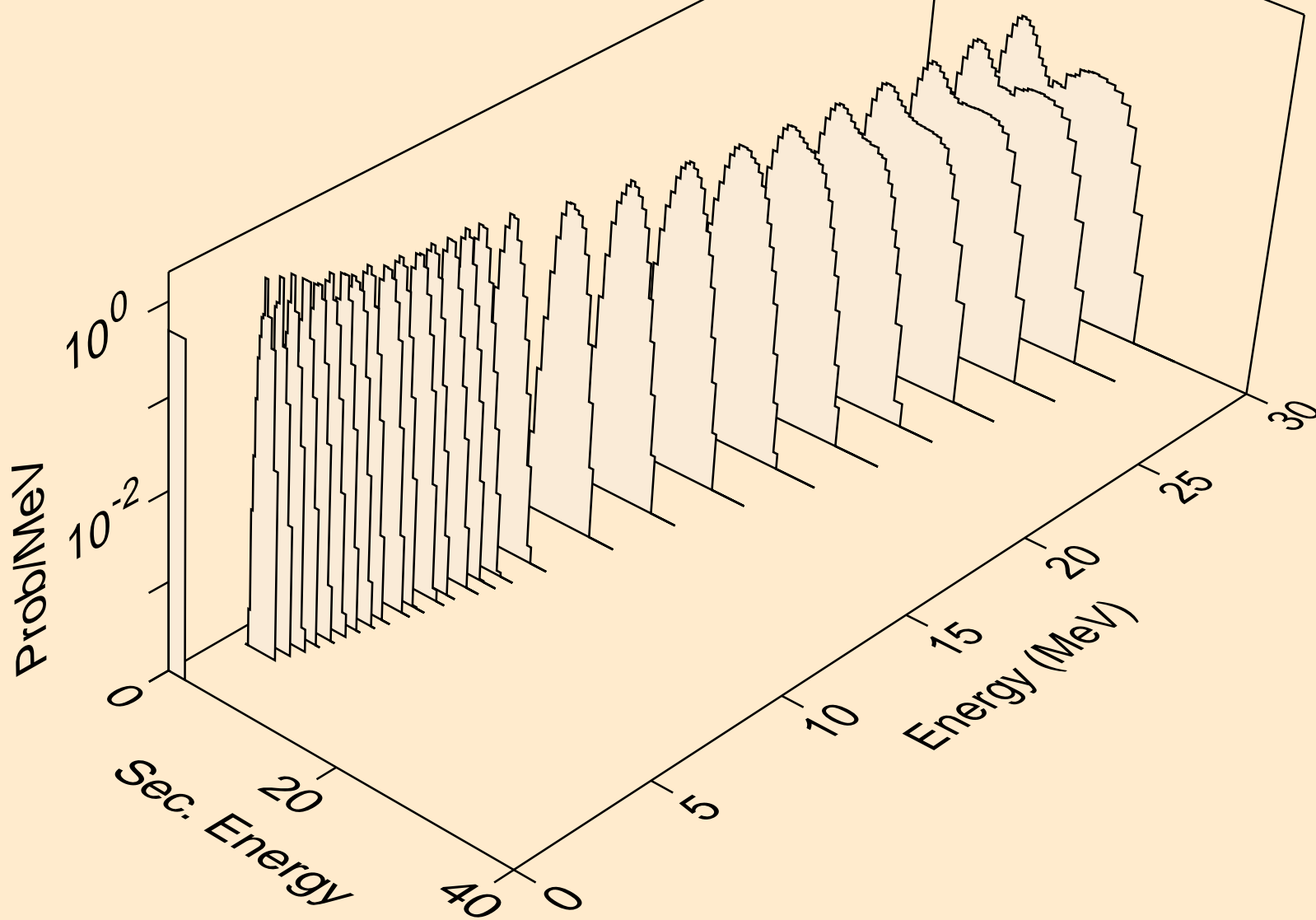

Y080M NEUTRON ACER TENDL-2019 LIBRARY; T=293.16K
alphas from (n,3a)

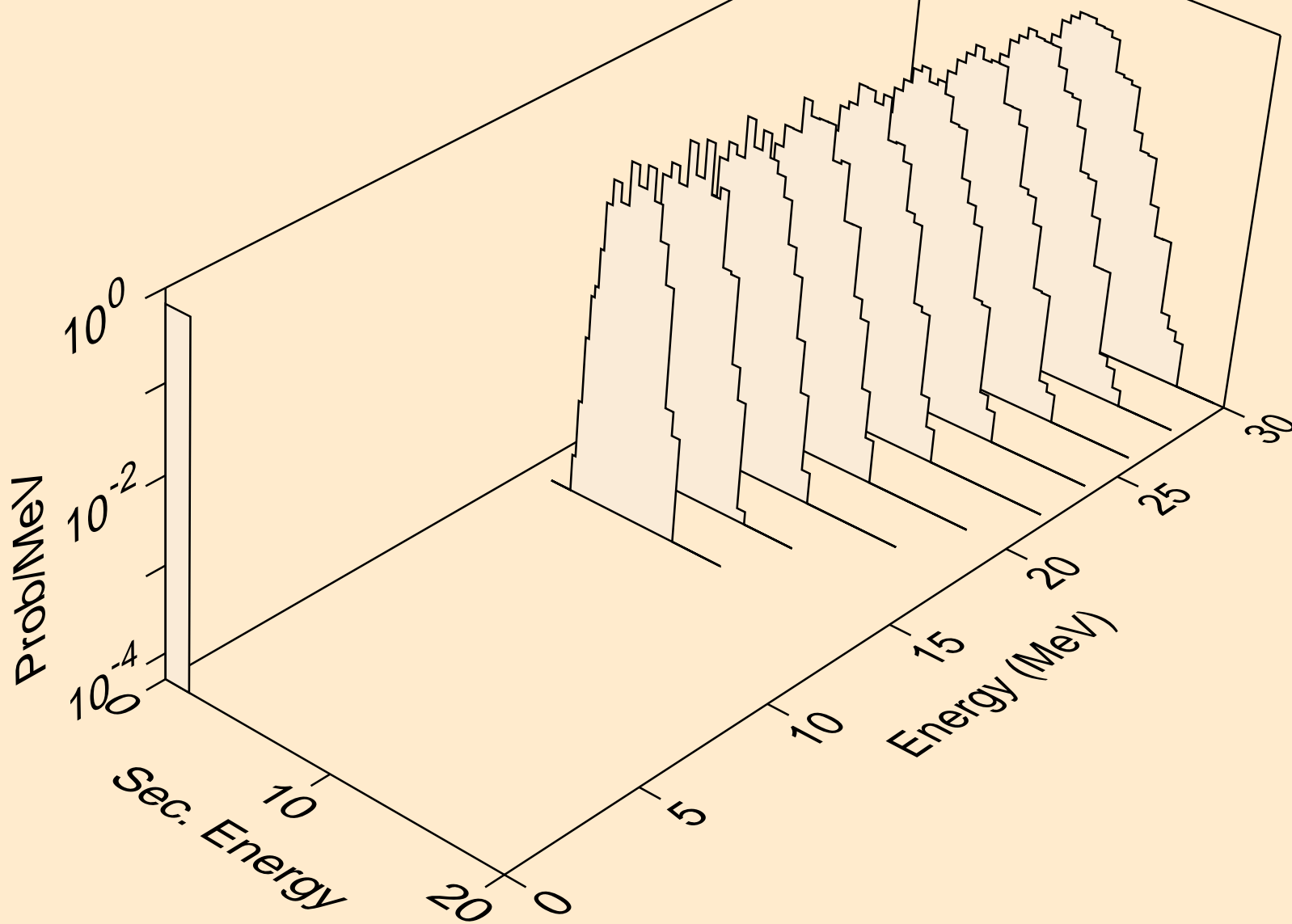

Y080M NEUTRON ACER TENDL-2019 LIBRARY; T=293.16K
alphas from (n,pa)

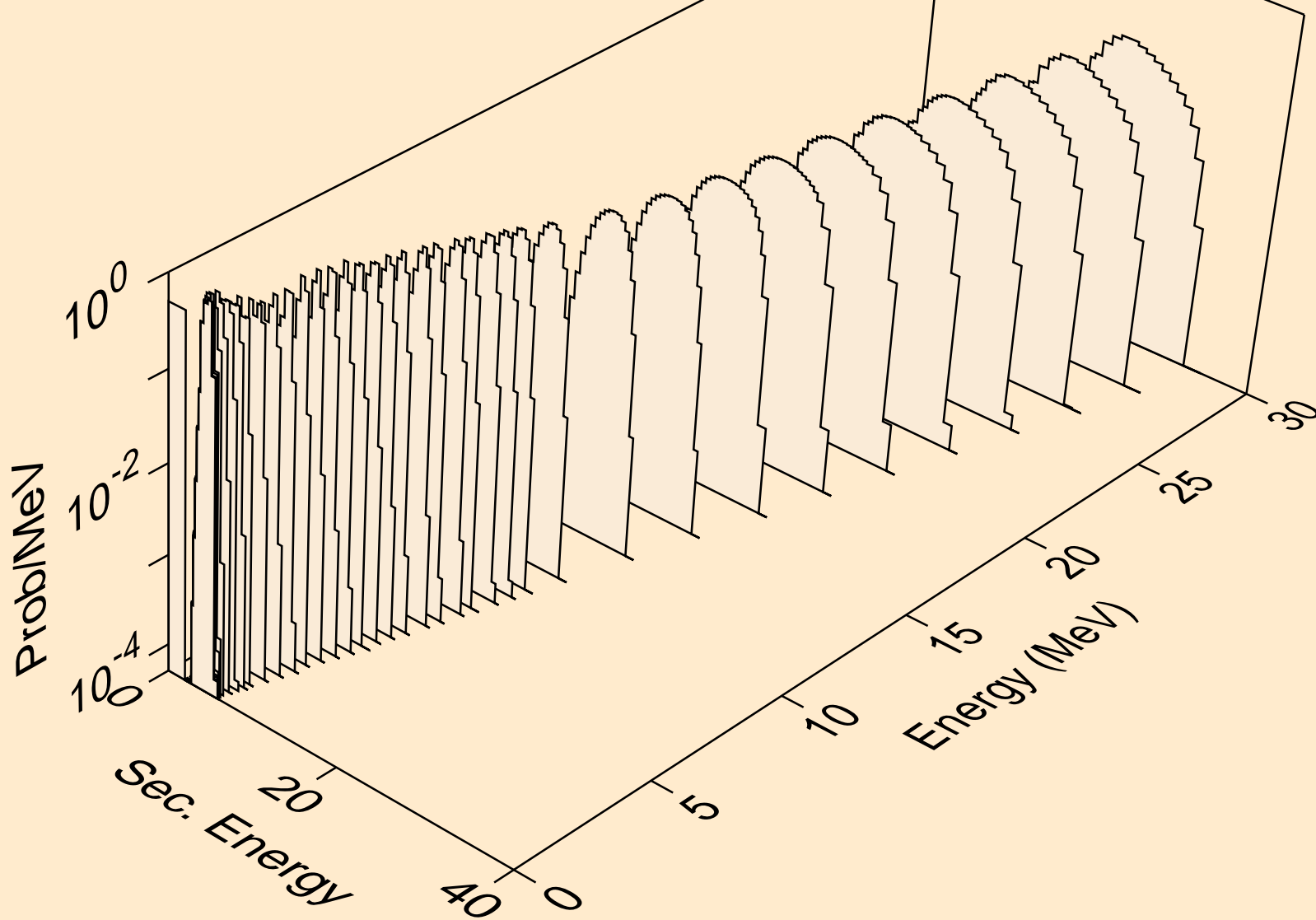

Y080M NEUTRON ACER TENDL-2019 LIBRARY; T=293.16K
alphas from (n,d2a)

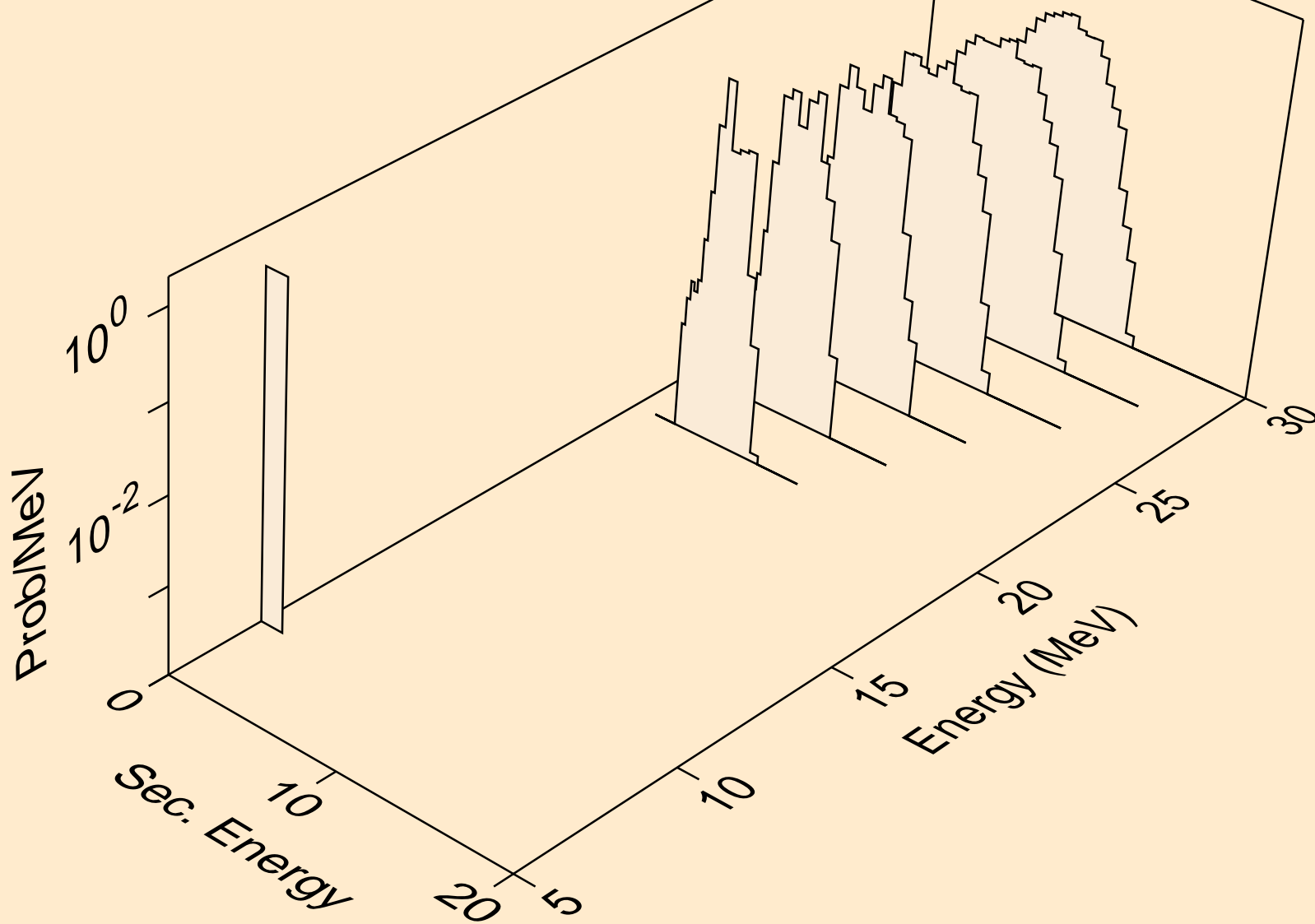

Y080M NEUTRON ACER TENDL-2019 LIBRARY; T=293.16K
alphas from (n,da)

