

Y083M NEUTRON ACER TENDL-2019 LIBRARY; T=293.16K  
Principal cross sections

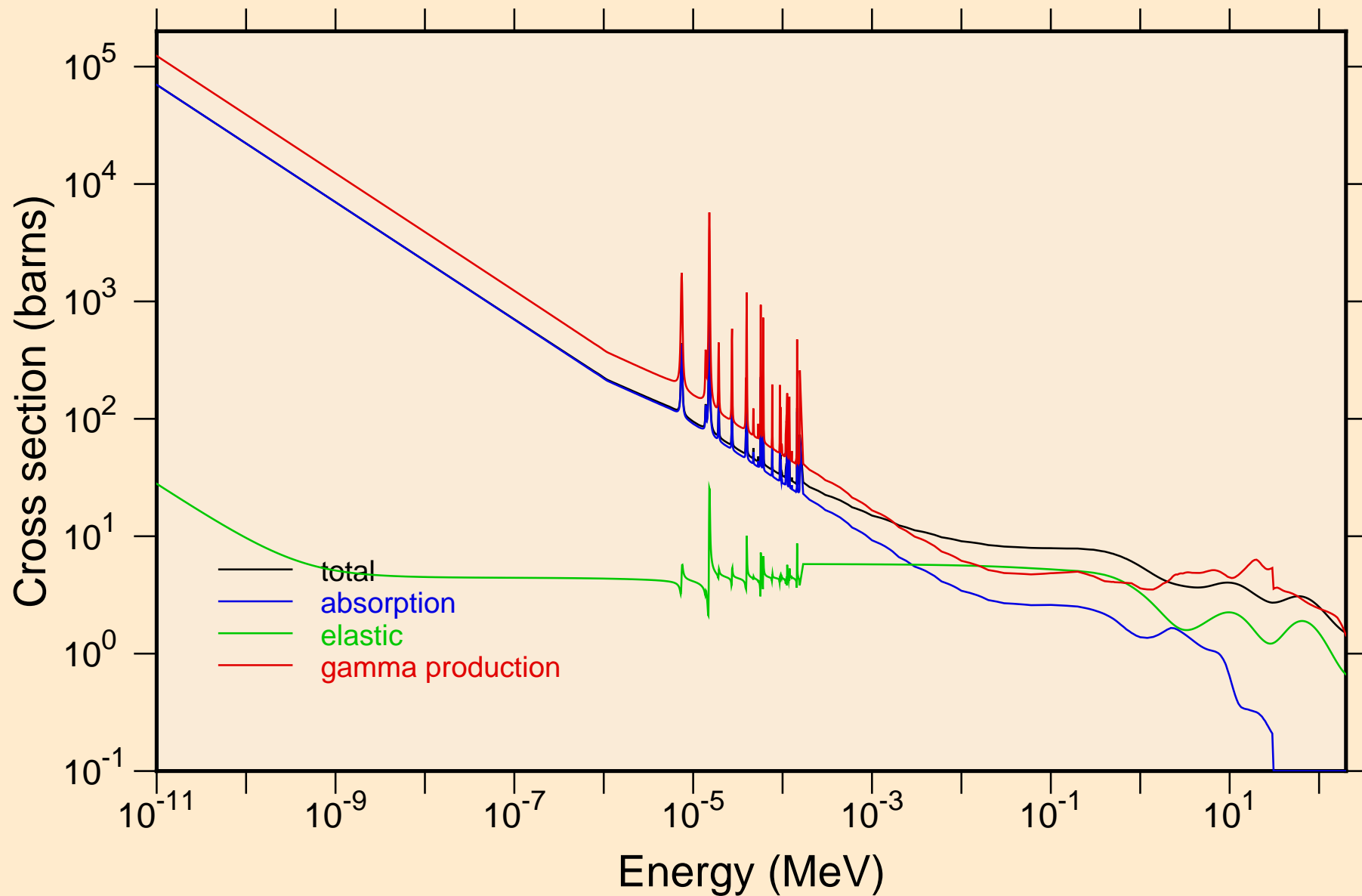

Y083M NEUTRON ACER TENDL-2019 LIBRARY; T=293.16K  
resonance total cross section

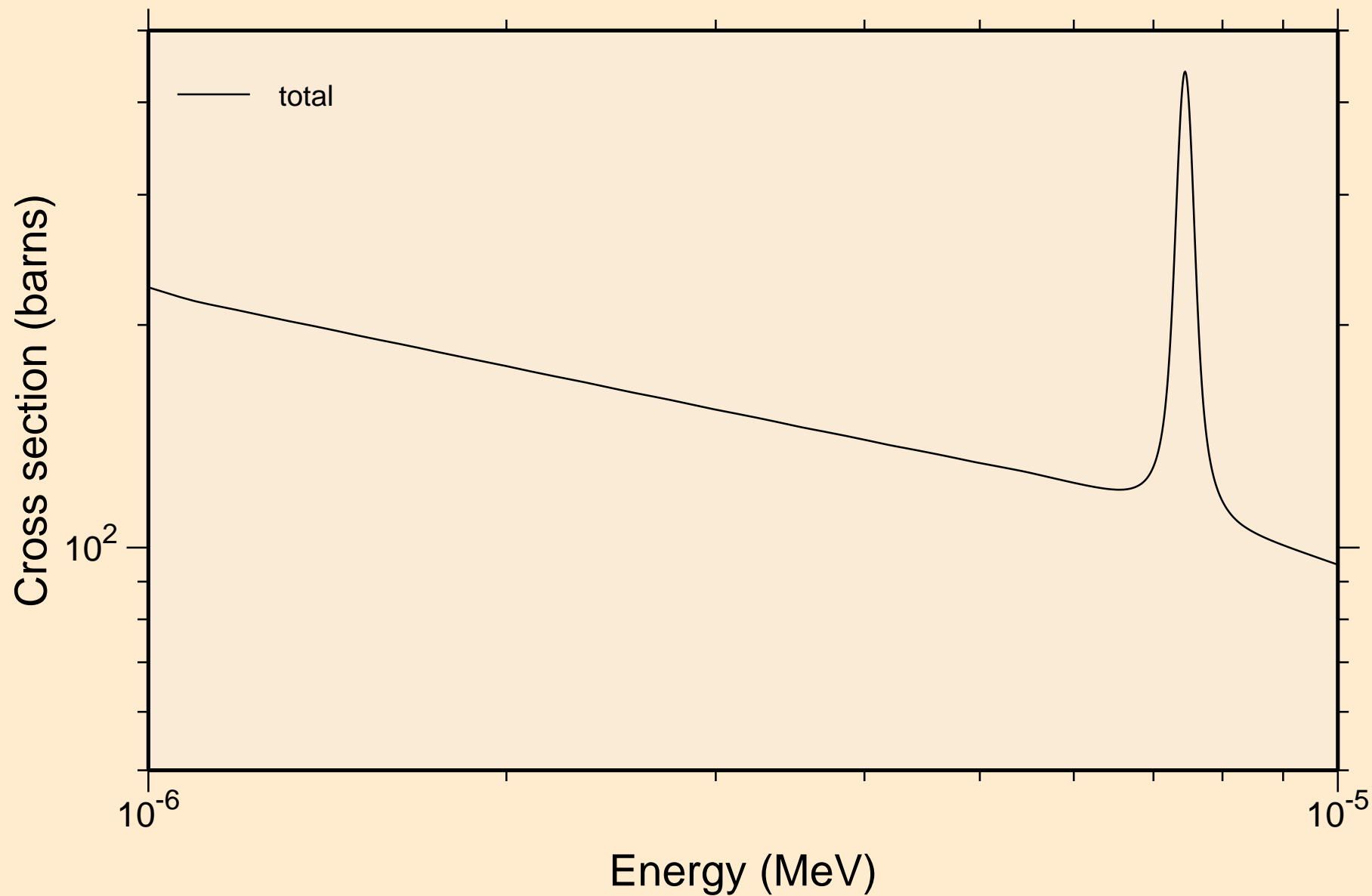

Y083M NEUTRON ACER TENDL-2019 LIBRARY; T=293.16K  
resonance total cross section

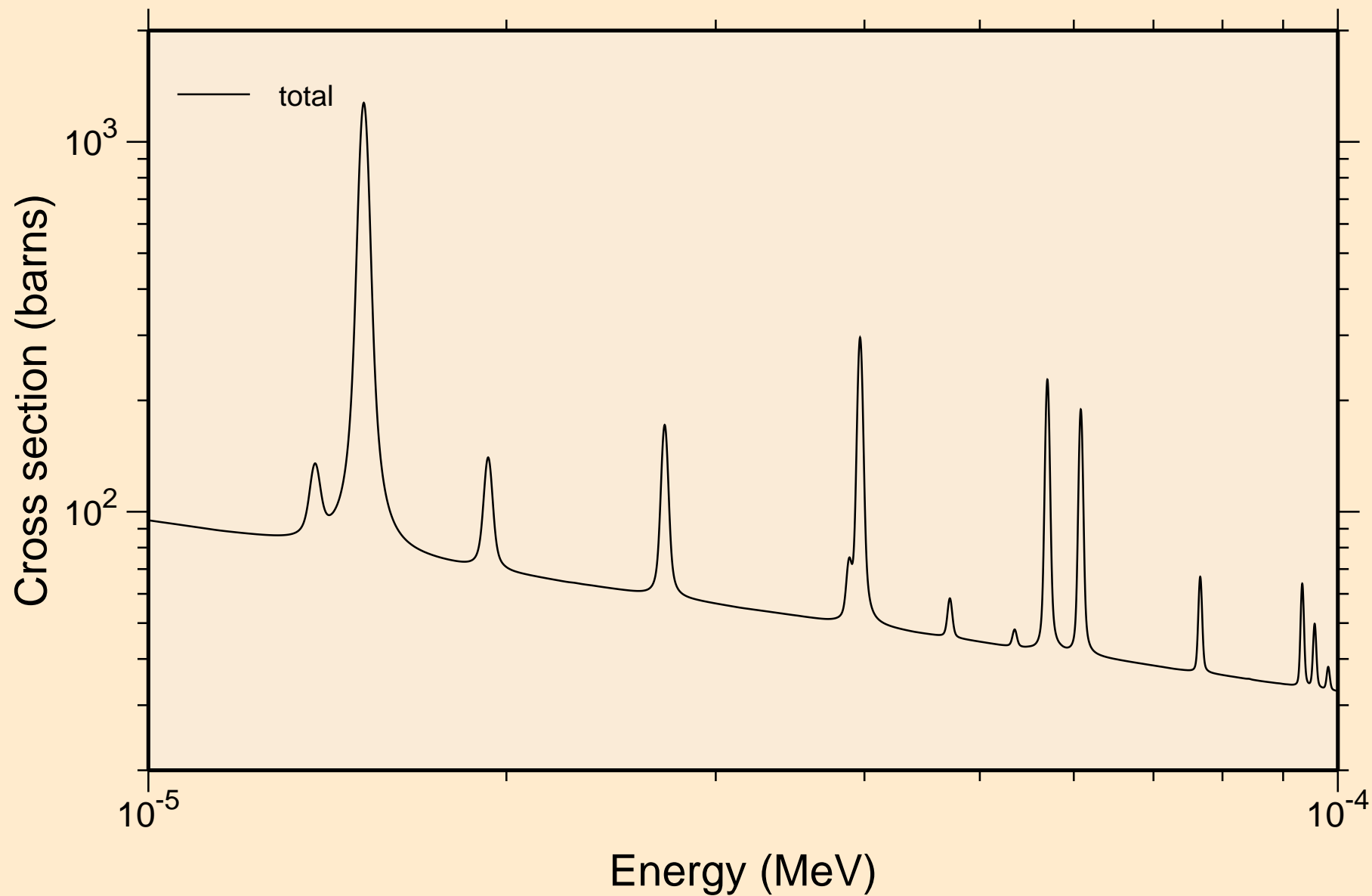

Y083M NEUTRON ACER TENDL-2019 LIBRARY; T=293.16K  
resonance total cross section

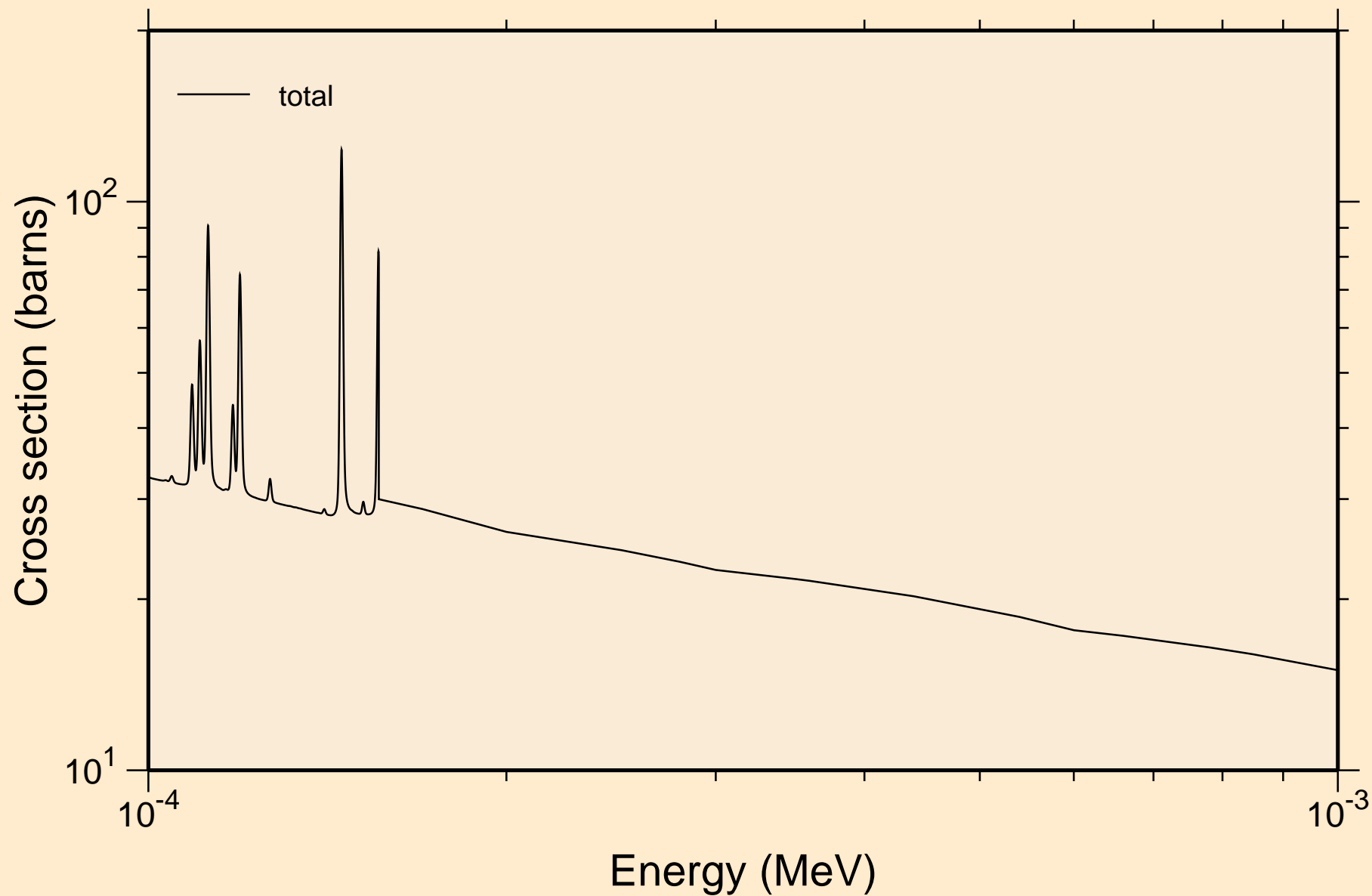

Y083M NEUTRON ACER TENDL-2019 LIBRARY; T=293.16K  
resonance total cross section

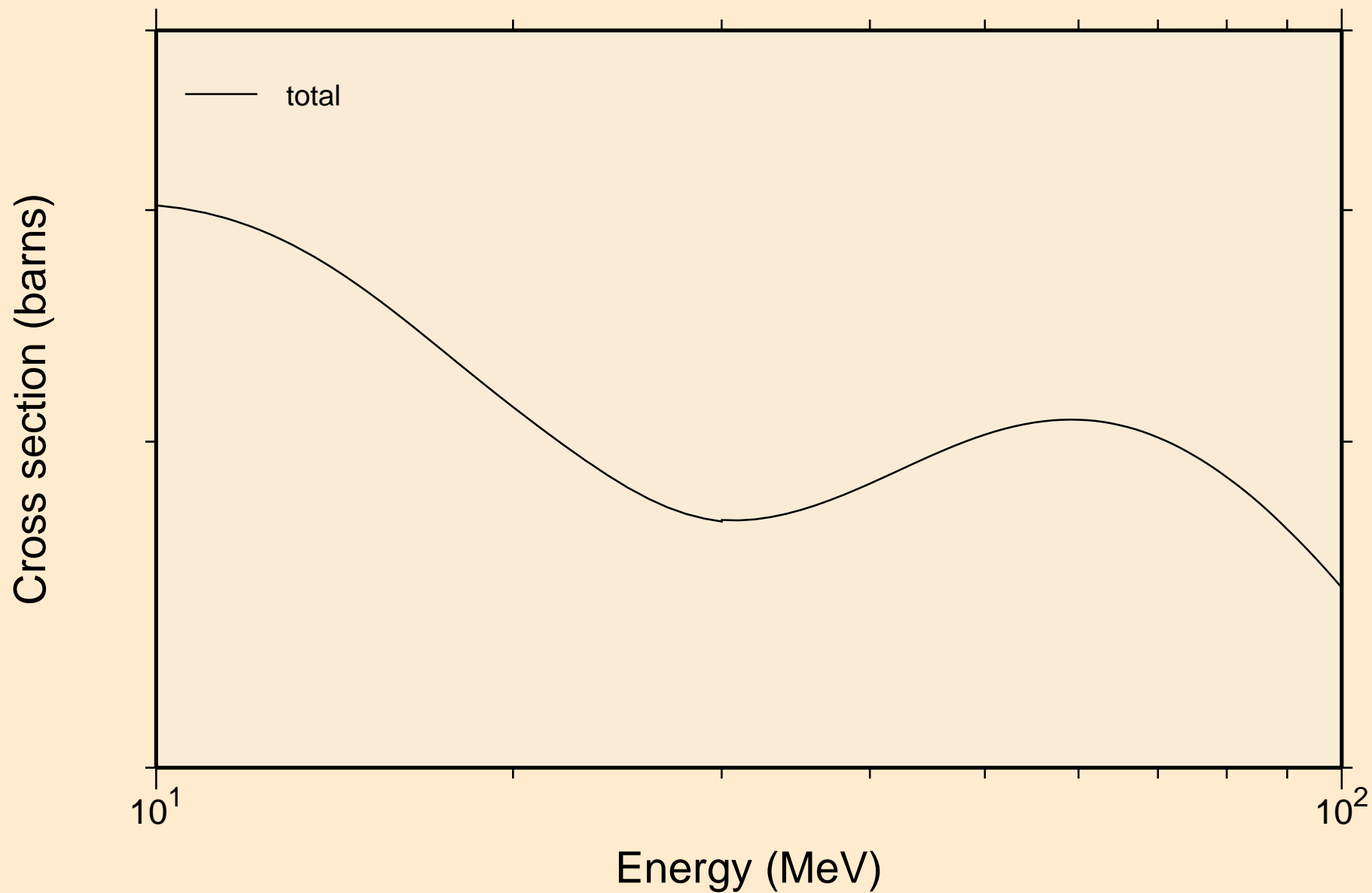

Y083M NEUTRON ACER TENDL-2019 LIBRARY; T=293.16K  
resonance absorption cross sections

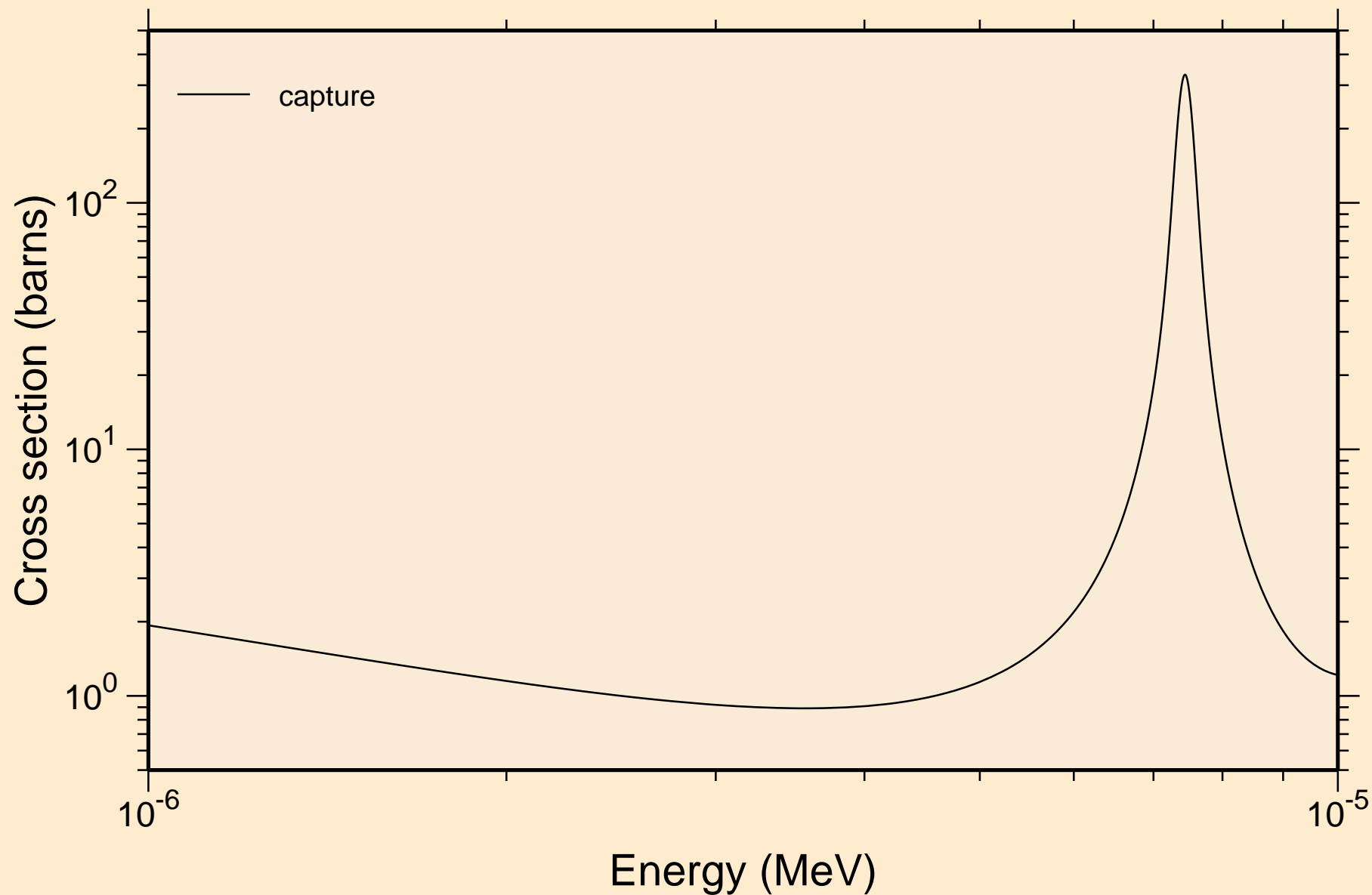

Y083M NEUTRON ACER TENDL-2019 LIBRARY; T=293.16K  
resonance absorption cross sections

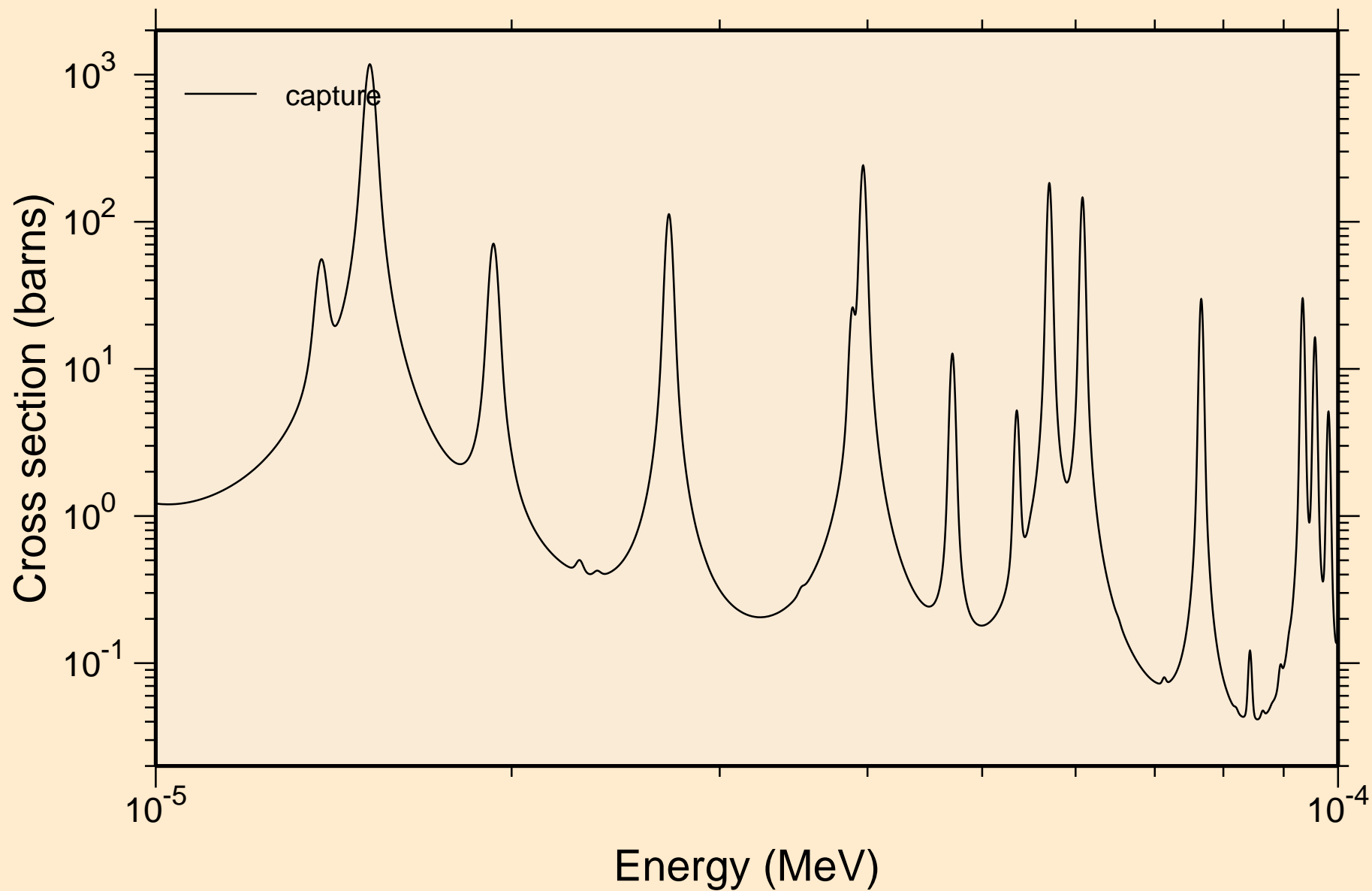

Y083M NEUTRON ACER TENDL-2019 LIBRARY; T=293.16K  
resonance absorption cross sections

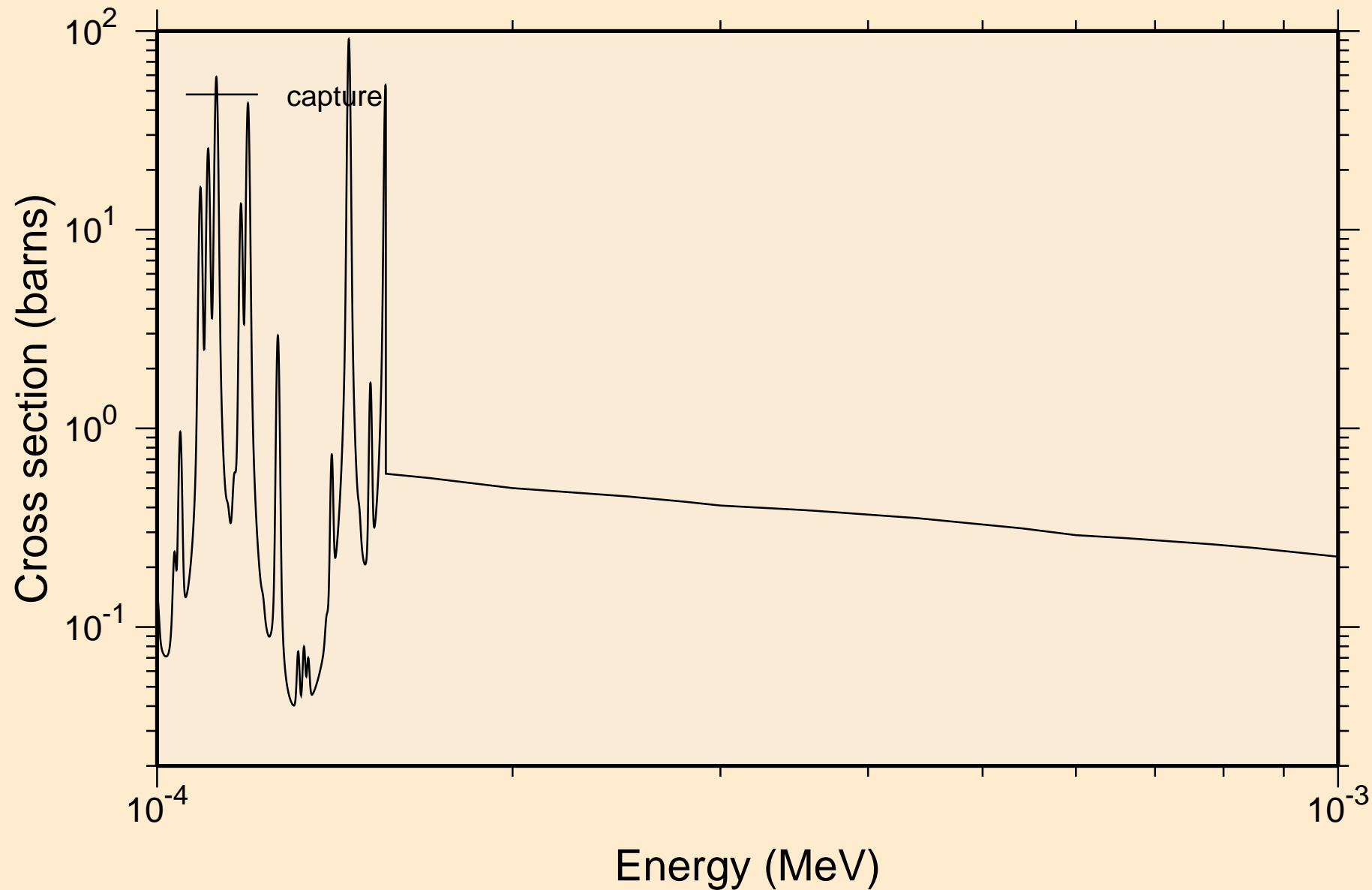



Y083M NEUTRON ACER TENDL-2019 LIBRARY; T=293.16K  
resonance absorption cross sections

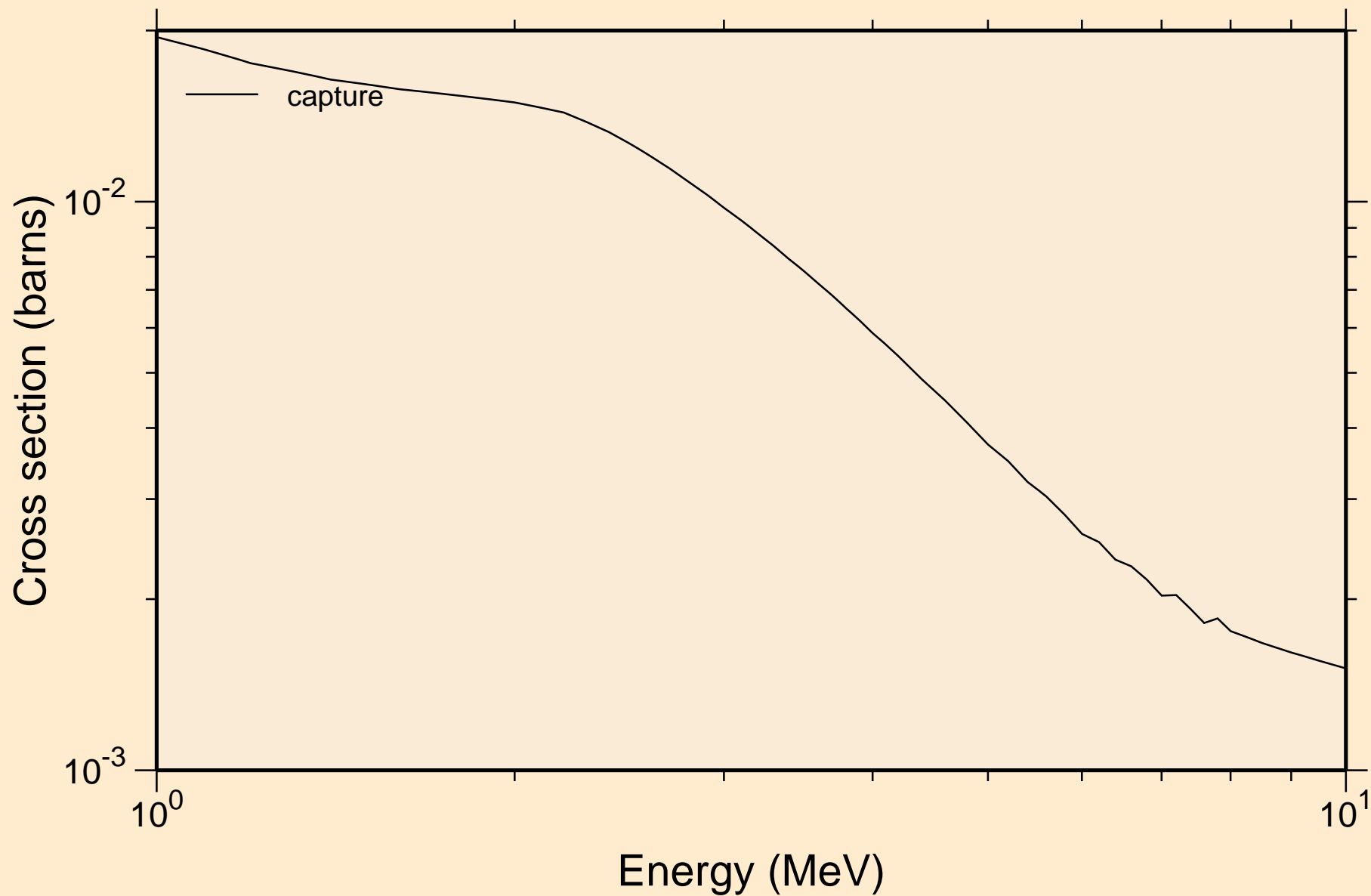

Y083M NEUTRON ACER TENDL-2019 LIBRARY; T=293.16K  
Heating

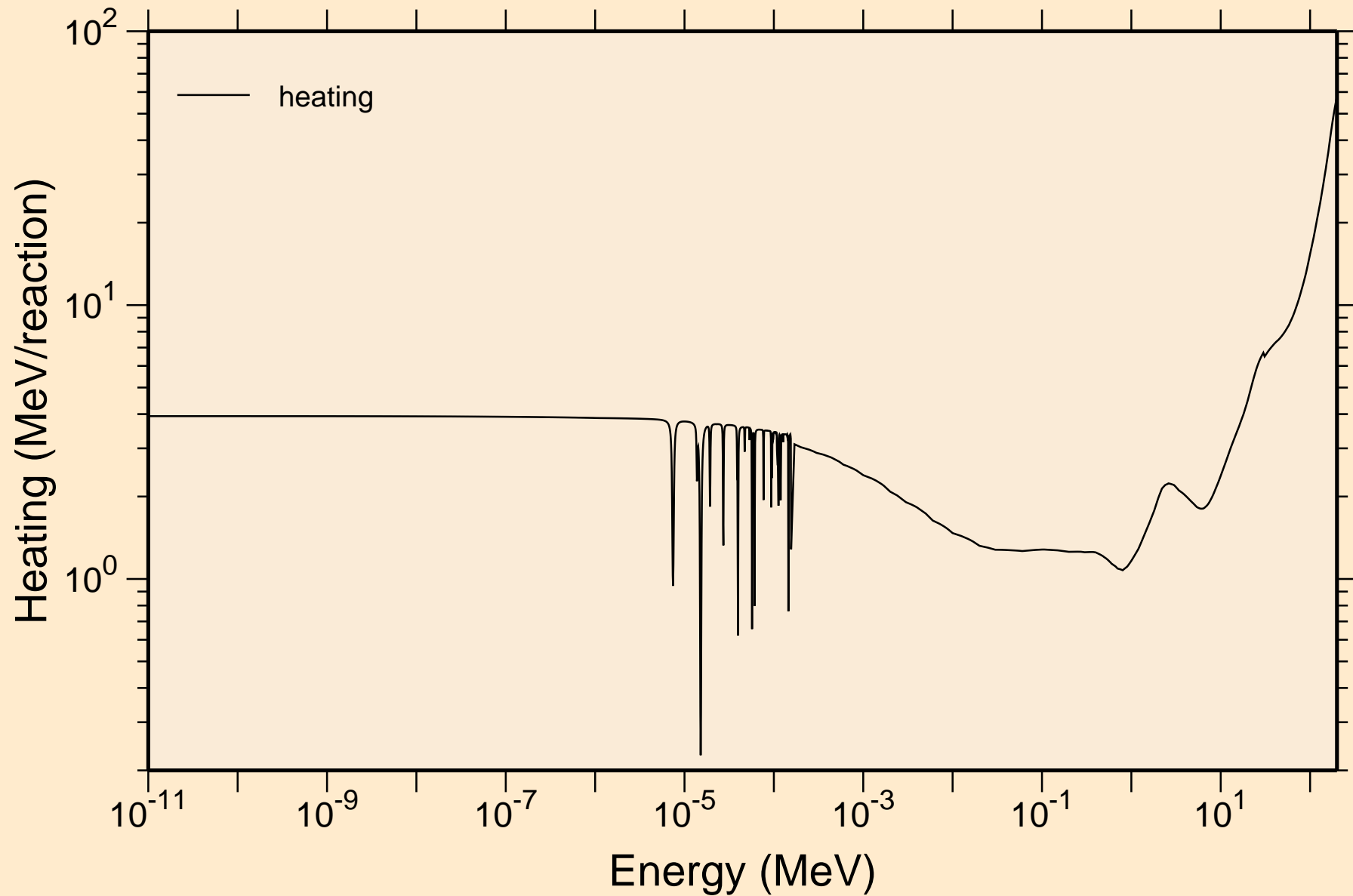

Y083M NEUTRON ACER TENDL-2019 LIBRARY; T=293.16K  
Damage

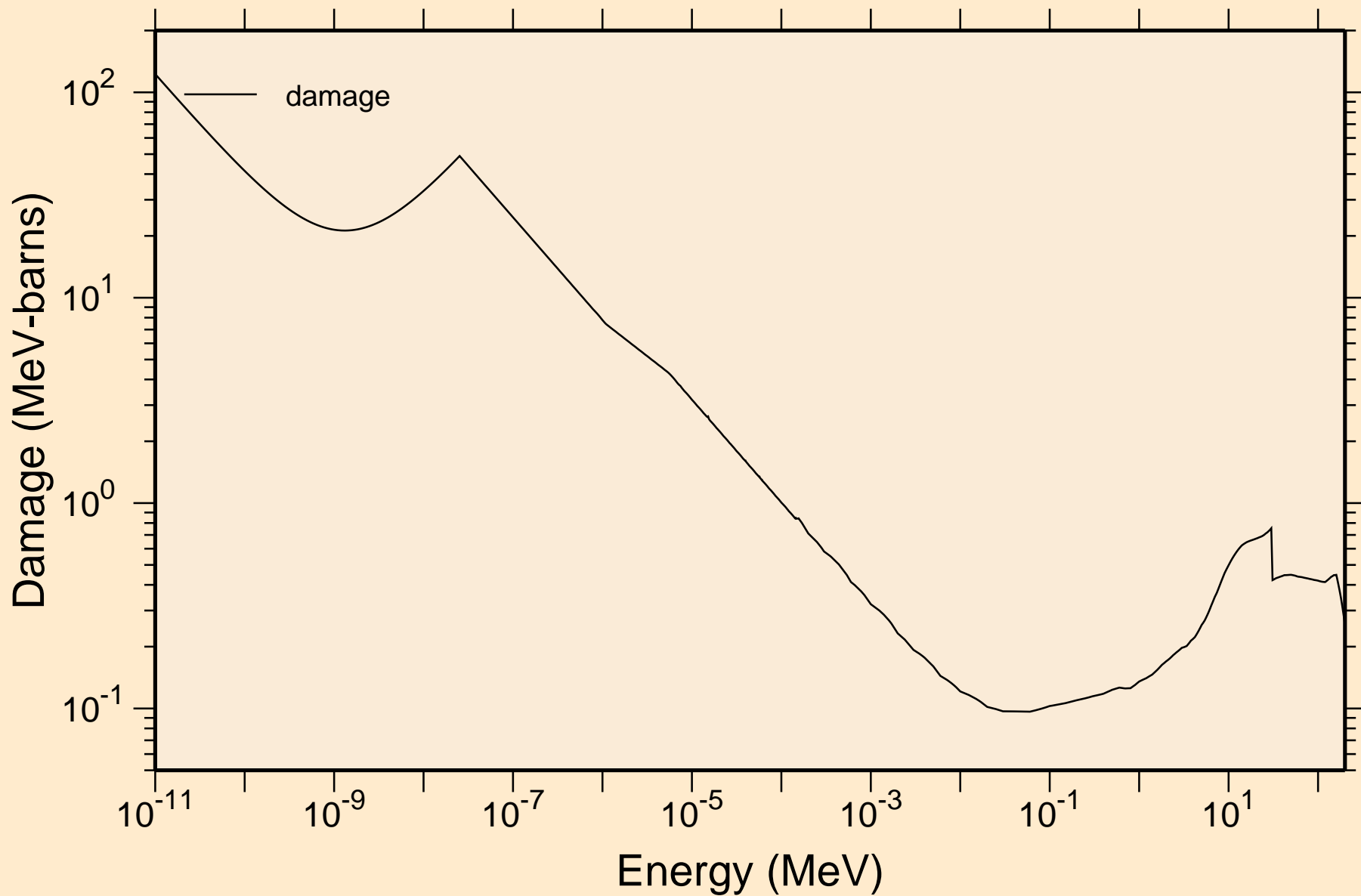

Y083M NEUTRON ACER TENDL-2019 LIBRARY; T=293.16K  
Non-threshold reactions

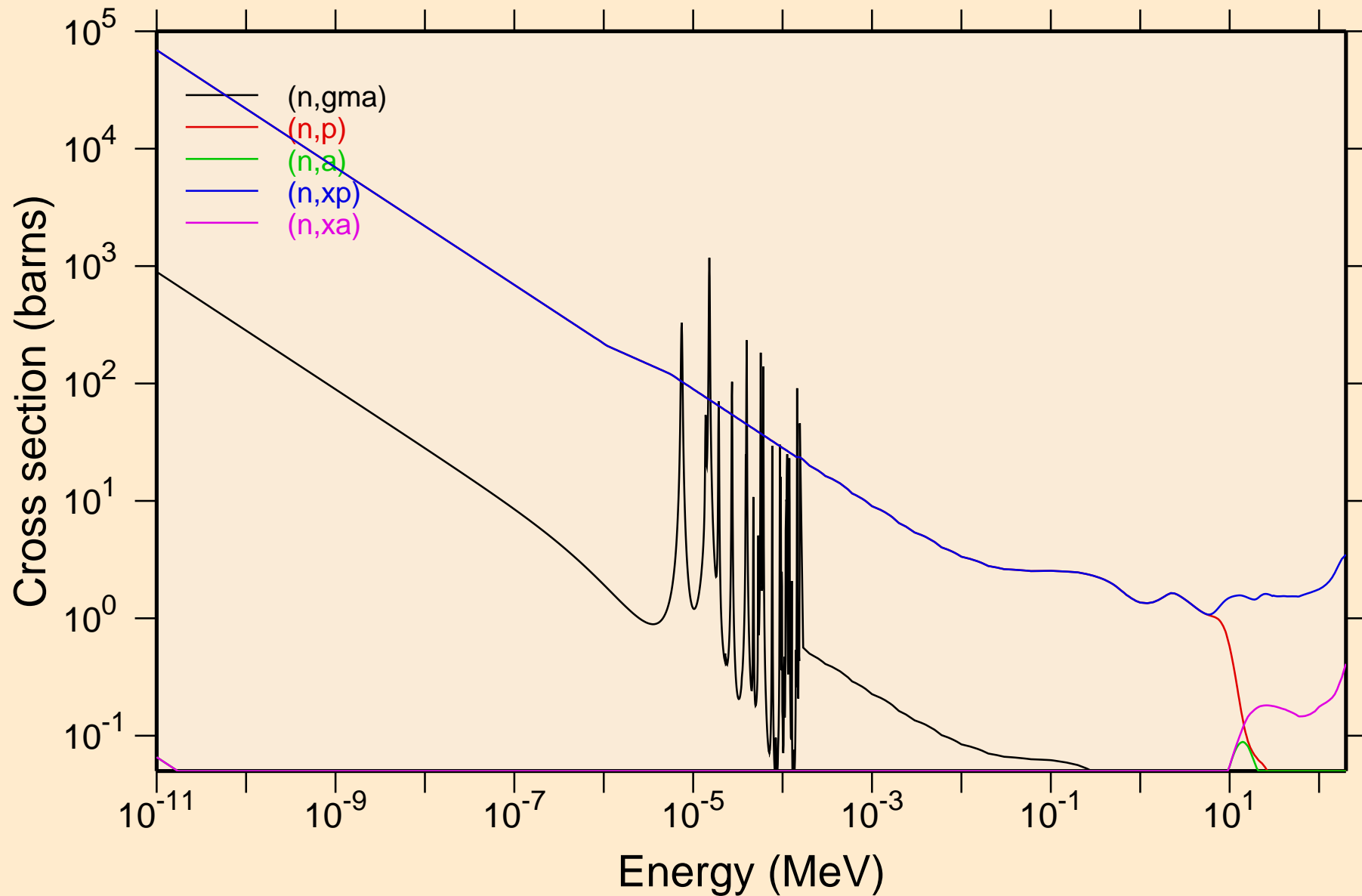

Y083M NEUTRON ACER TENDL-2019 LIBRARY; T=293.16K  
Principal cross sections

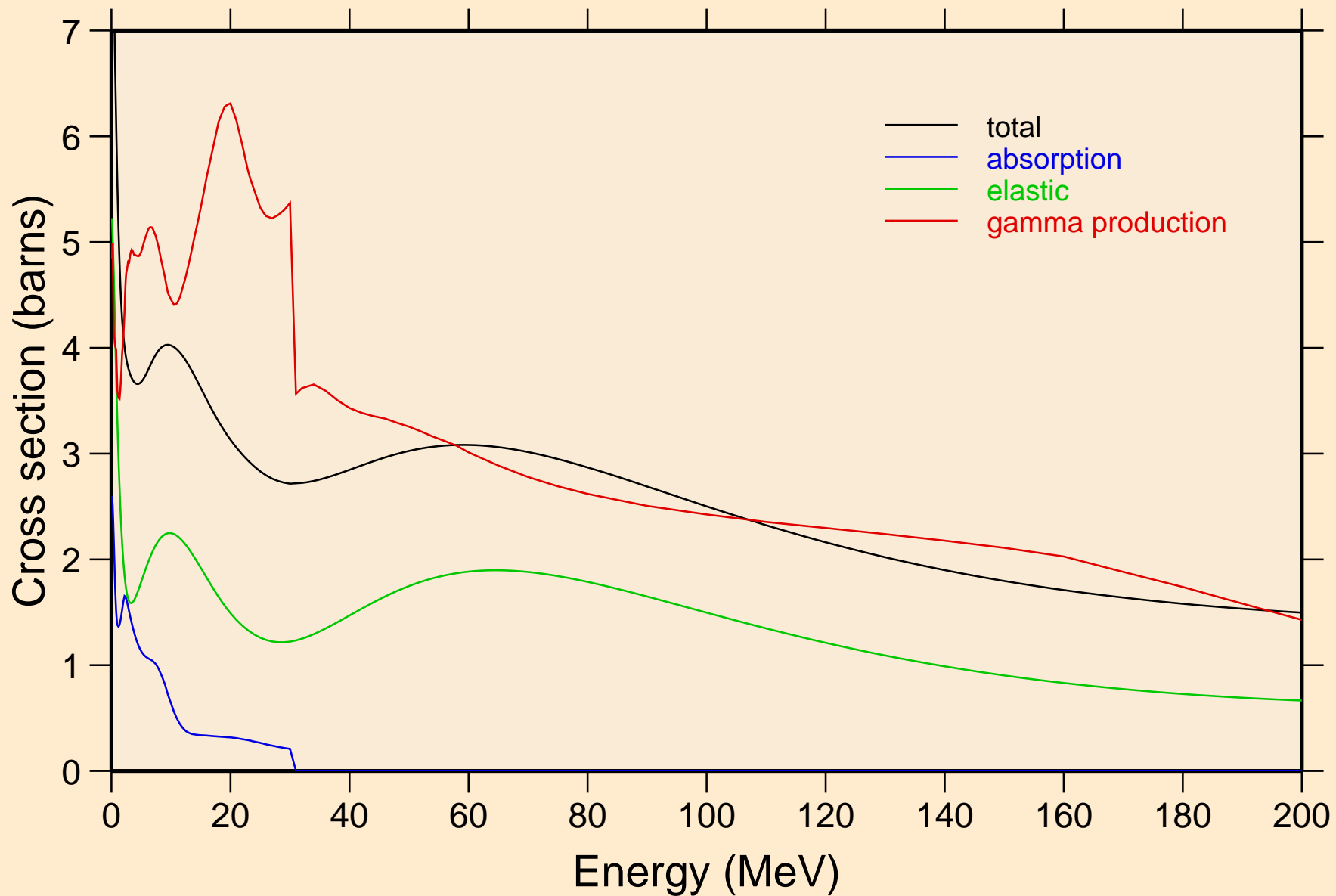

Y083M NEUTRON ACER TENDL-2019 LIBRARY; T=293.16K  
Heating

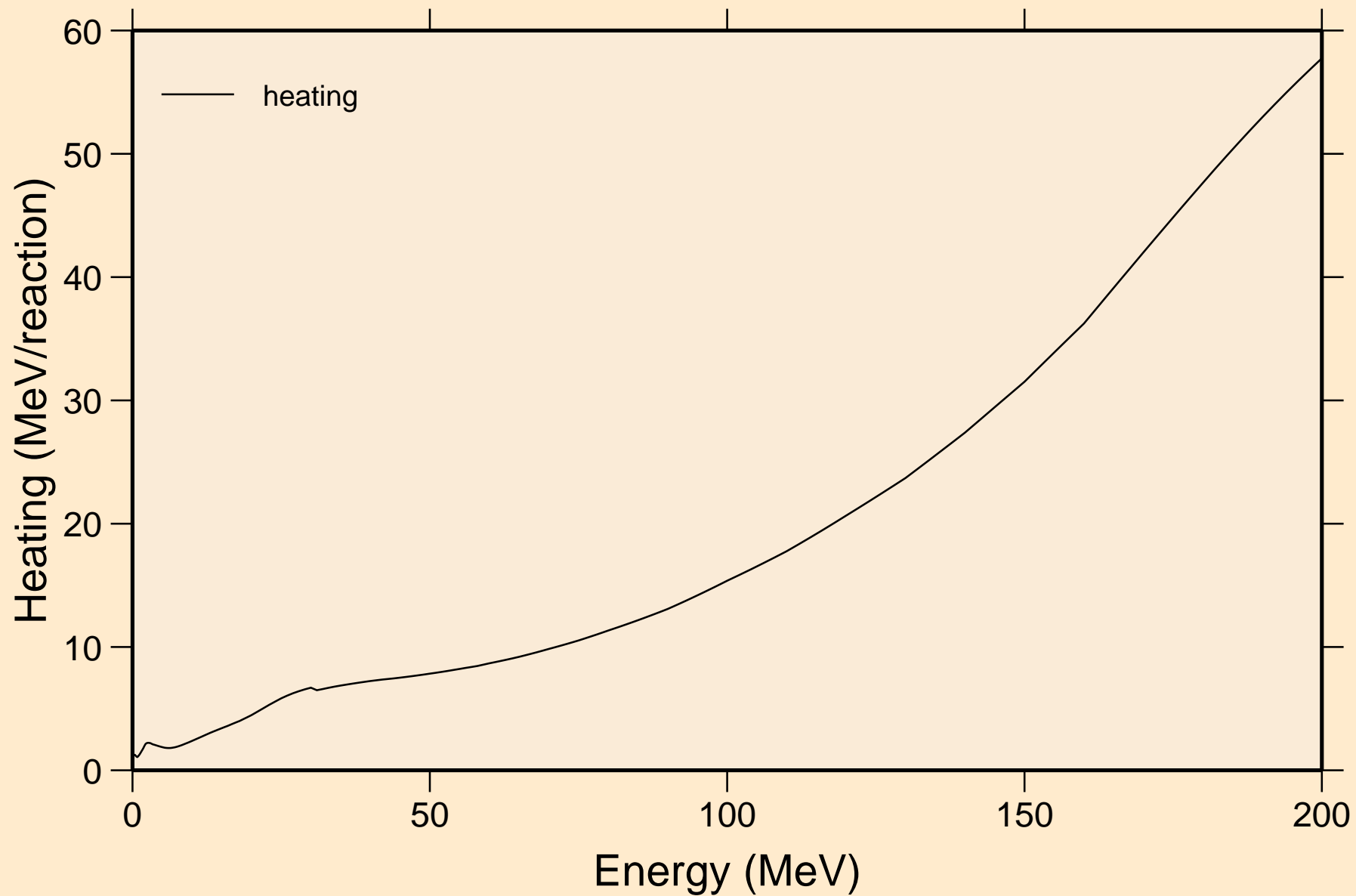

Y083M NEUTRON ACER TENDL-2019 LIBRARY; T=293.16K  
Damage

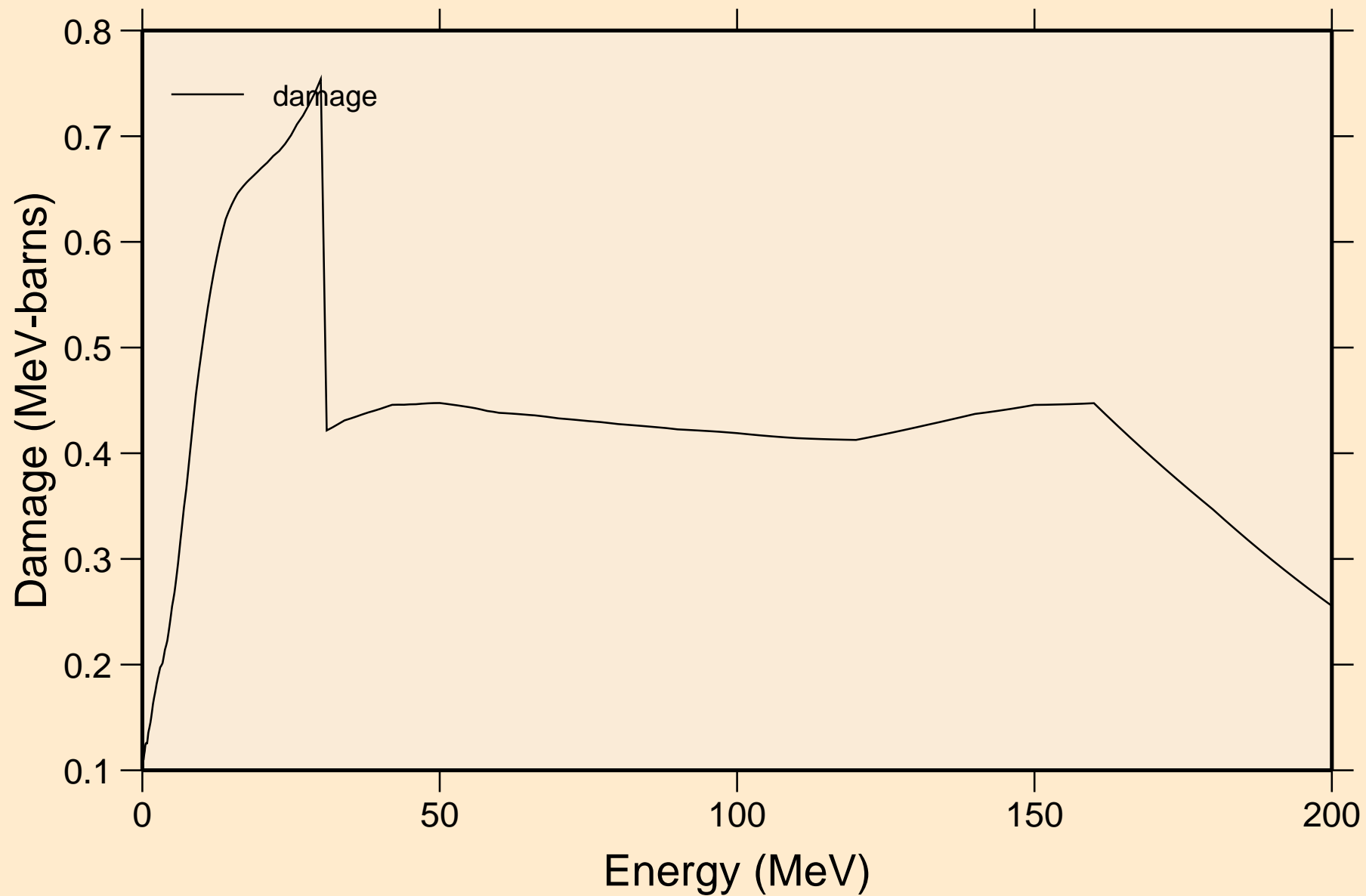

Y083M NEUTRON ACER TENDL-2019 LIBRARY; T=293.16K  
Non-threshold reactions

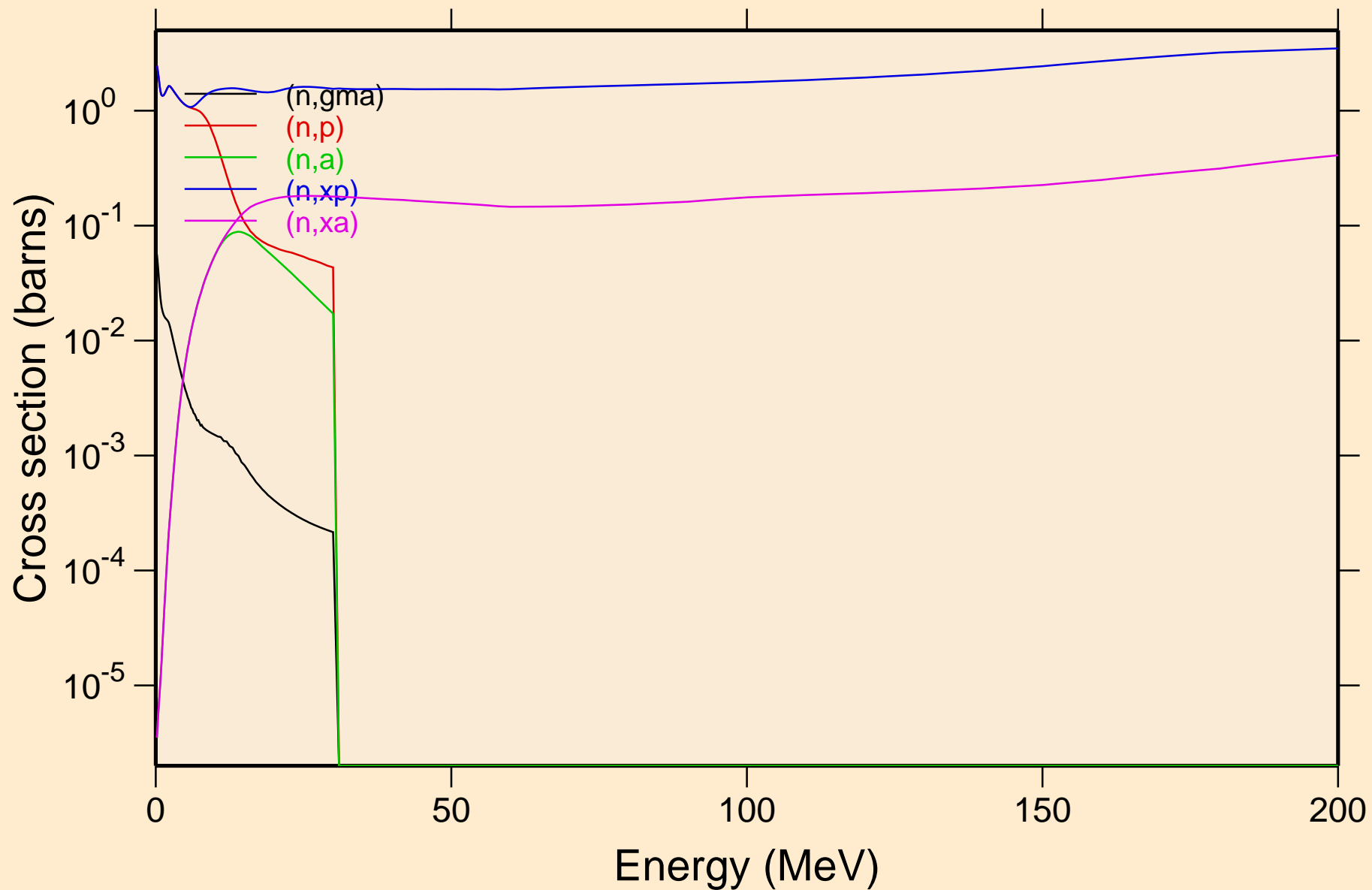



Y083M NEUTRON ACER TENDL-2019 LIBRARY; T=293.16K  
Inelastic levels

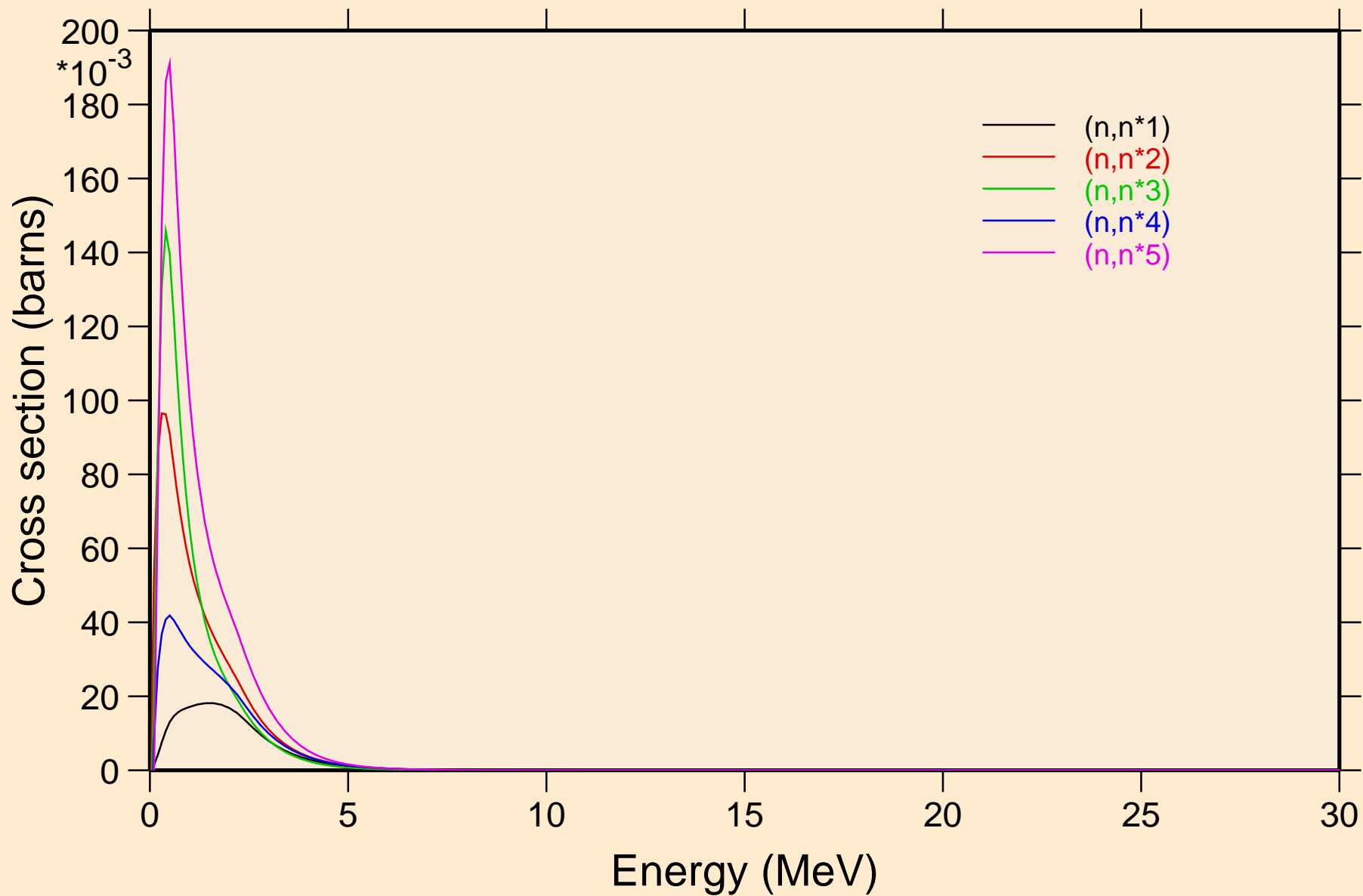

Y083M NEUTRON ACER TENDL-2019 LIBRARY; T=293.16K  
Inelastic levels

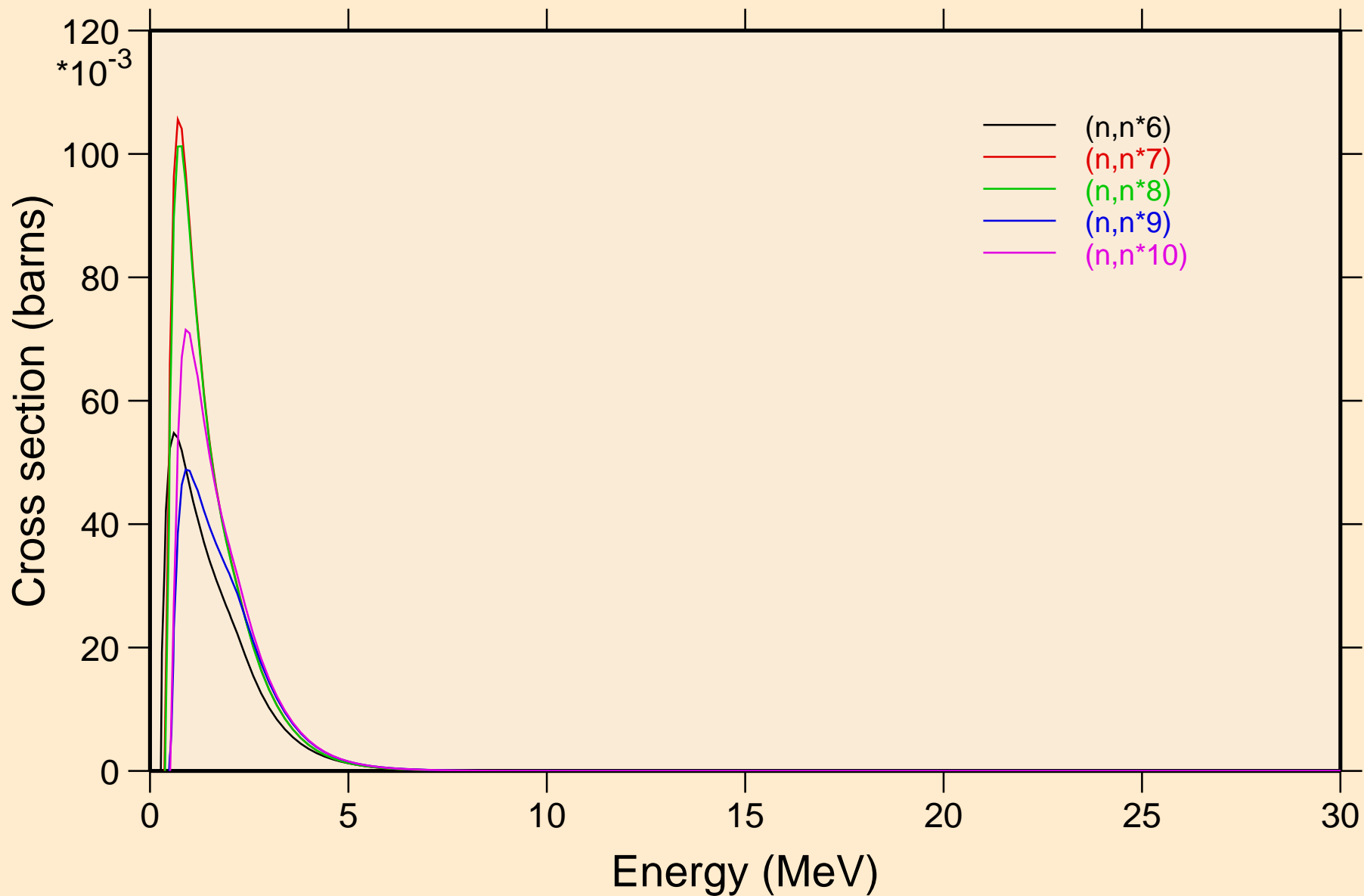

Y083M NEUTRON ACER TENDL-2019 LIBRARY; T=293.16K  
Inelastic levels

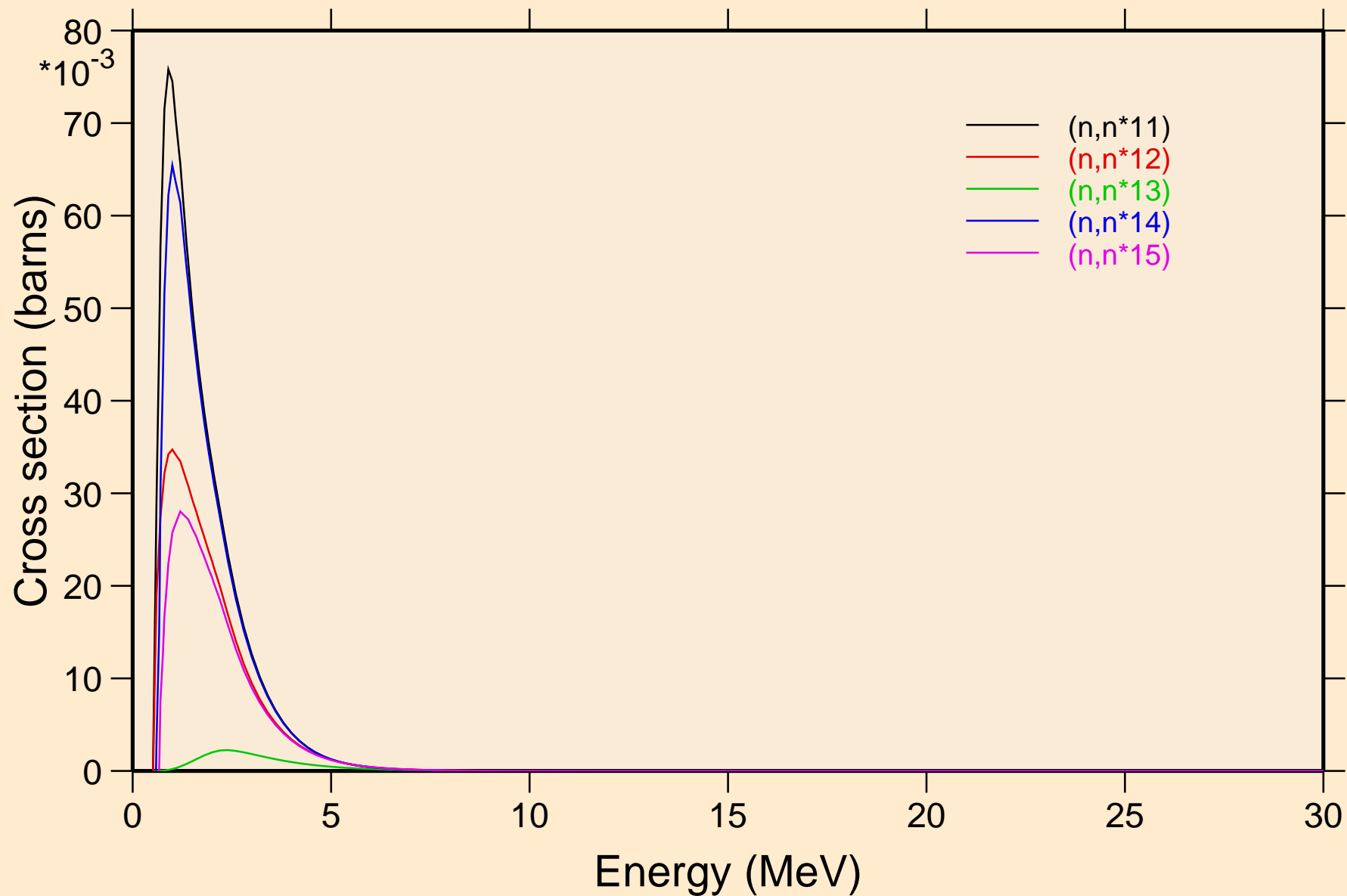

Y083M NEUTRON ACER TENDL-2019 LIBRARY; T=293.16K  
Inelastic levels

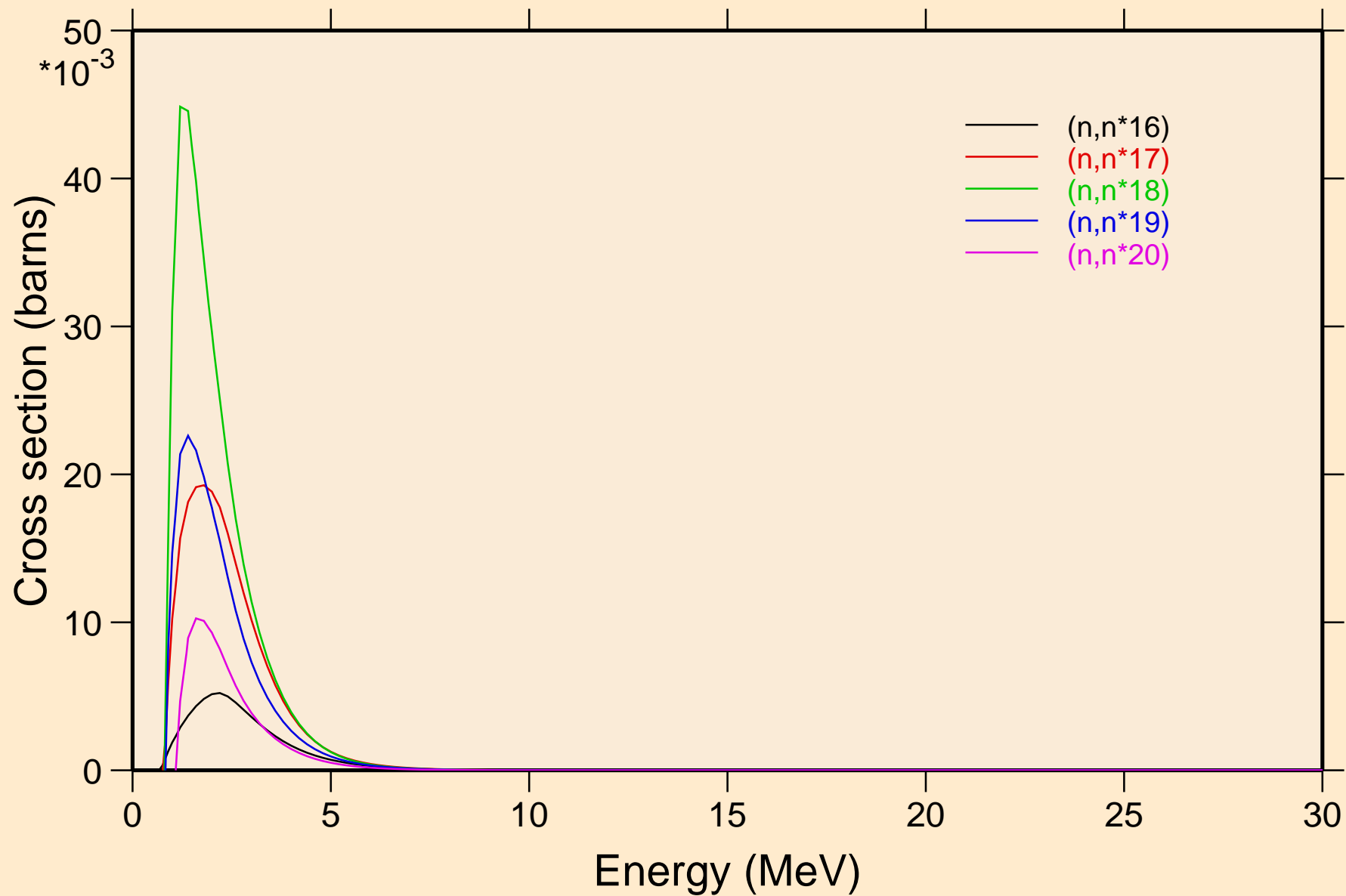

Y083M NEUTRON ACER TENDL-2019 LIBRARY; T=293.16K  
Inelastic levels

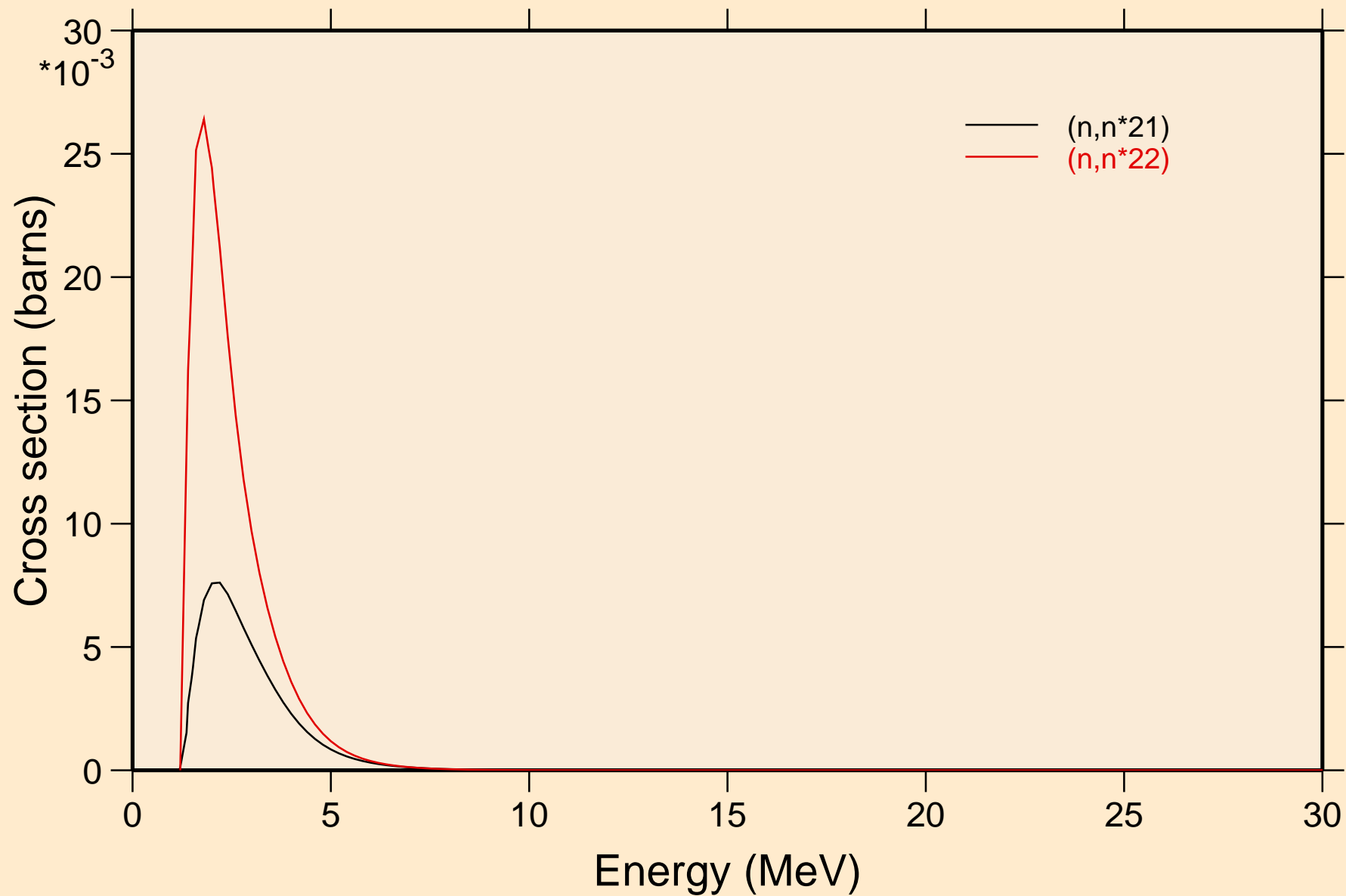

Y083M NEUTRON ACER TENDL-2019 LIBRARY; T=293.16K  
Threshold reactions

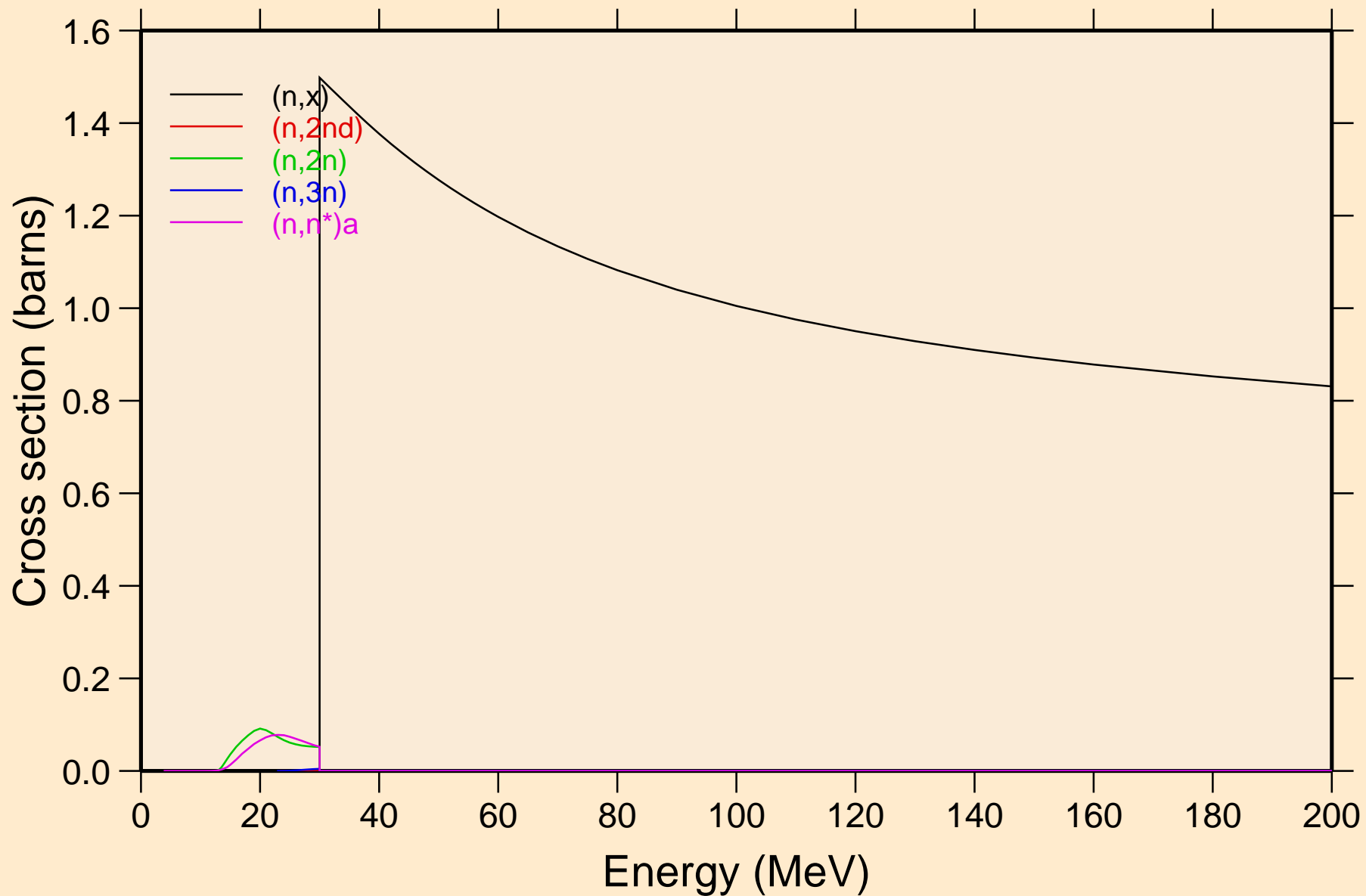

Y083M NEUTRON ACER TENDL-2019 LIBRARY; T=293.16K  
Threshold reactions

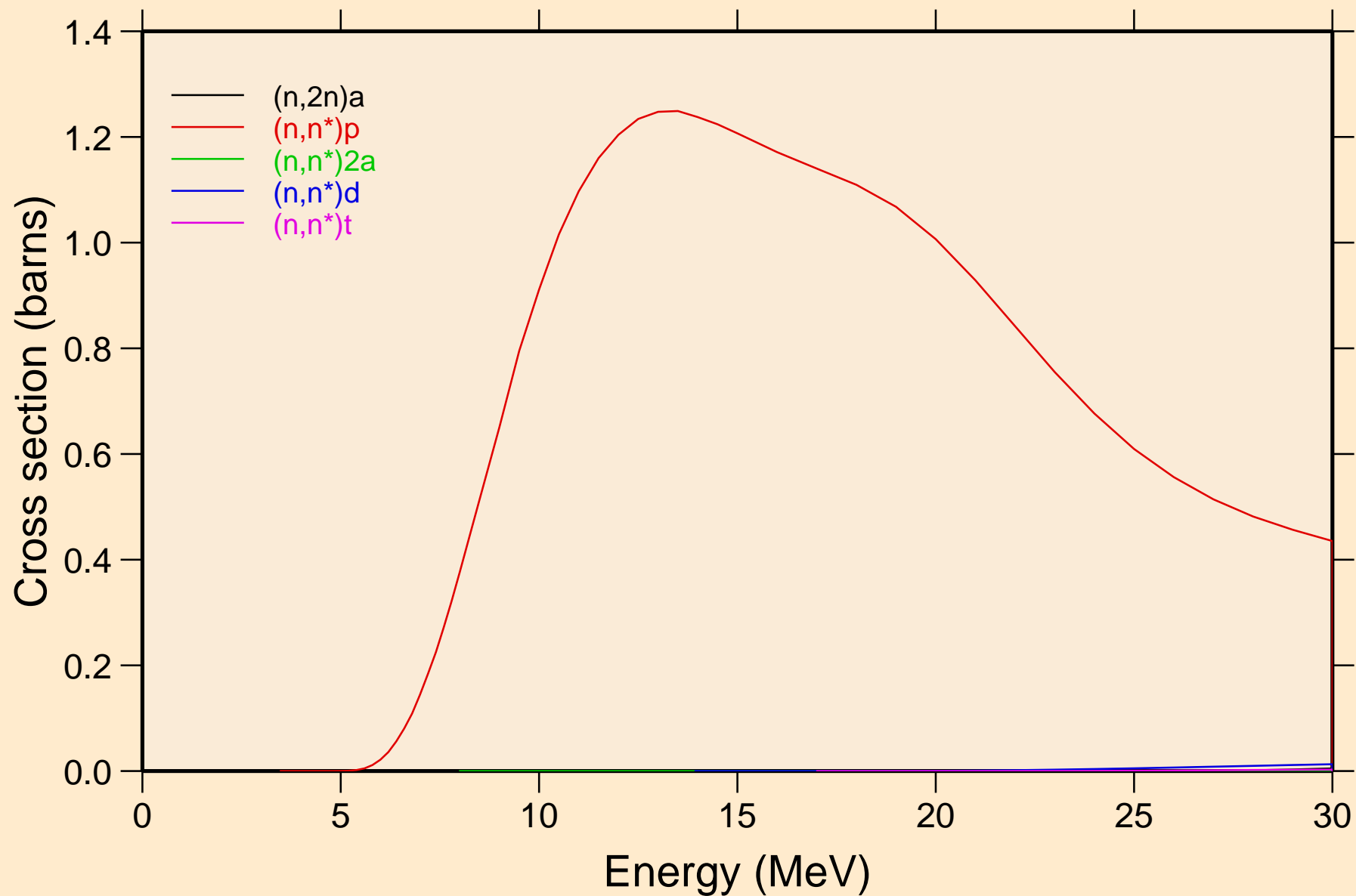

Y083M NEUTRON ACER TENDL-2019 LIBRARY; T=293.16K  
Threshold reactions

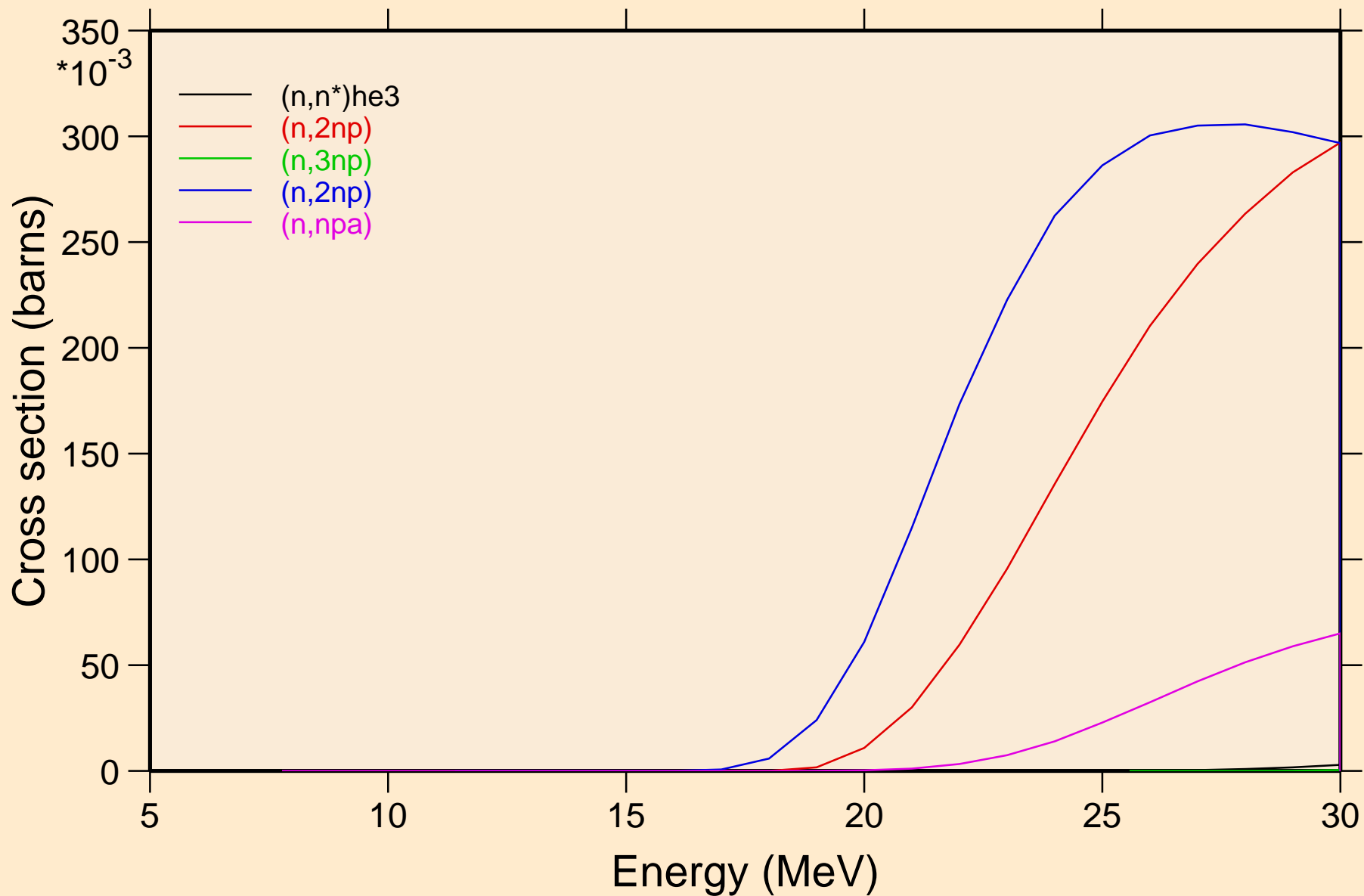



Y083M NEUTRON ACER TENDL-2019 LIBRARY; T=293.16K  
Threshold reactions

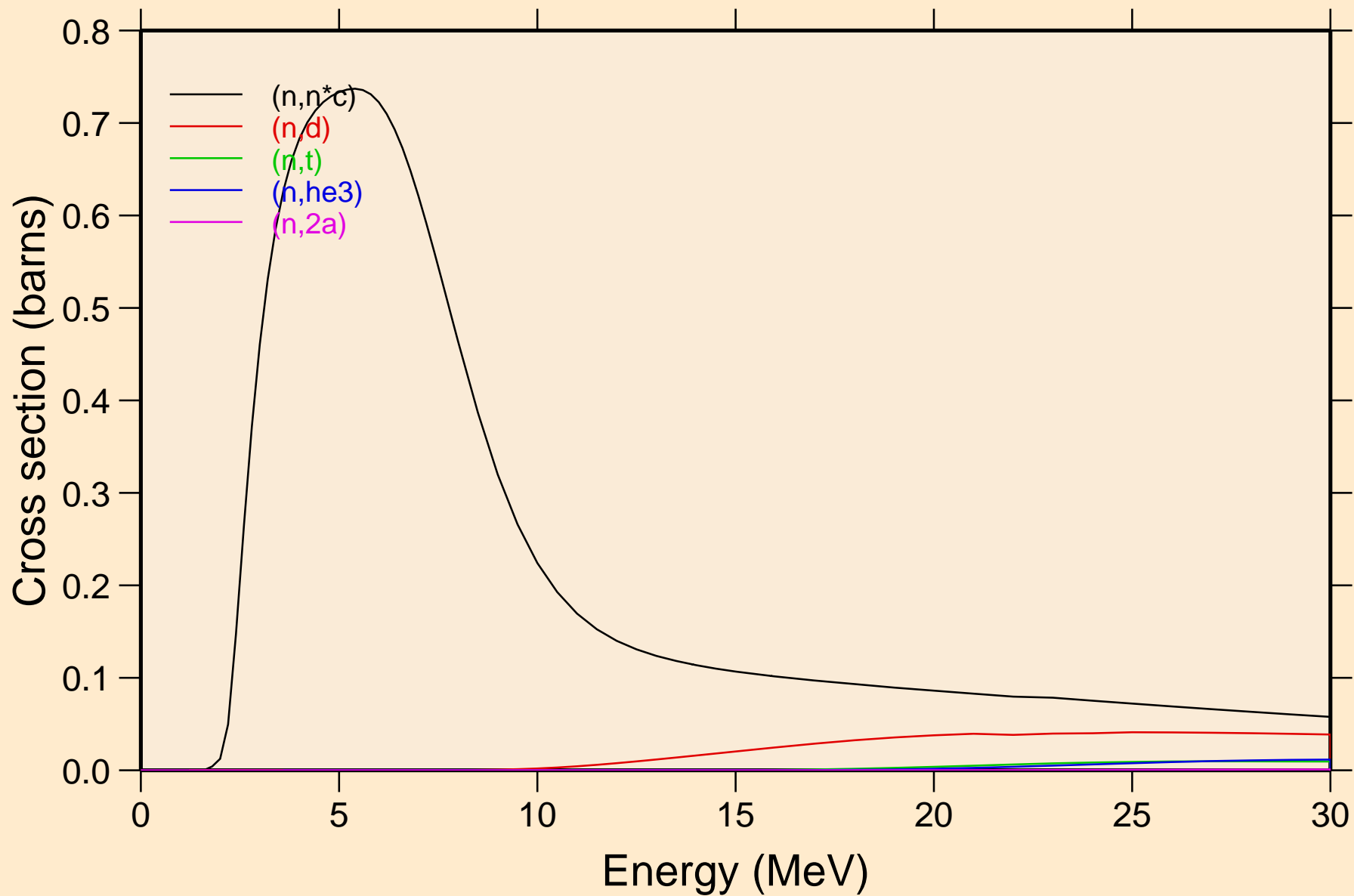

Y083M NEUTRON ACER TENDL-2019 LIBRARY; T=293.16K  
Threshold reactions

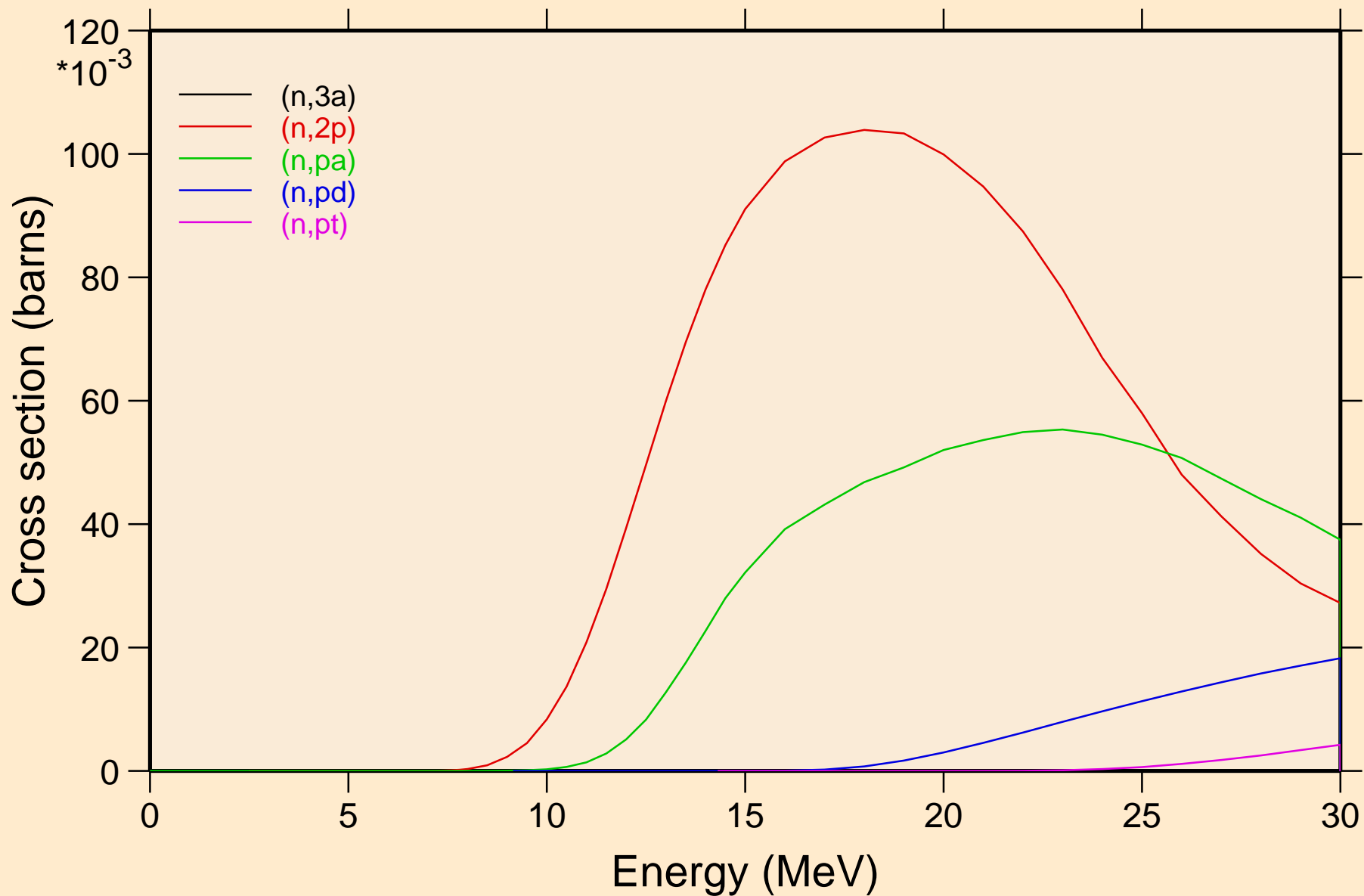

Y083M NEUTRON ACER TENDL-2019 LIBRARY; T=293.16K  
Threshold reactions

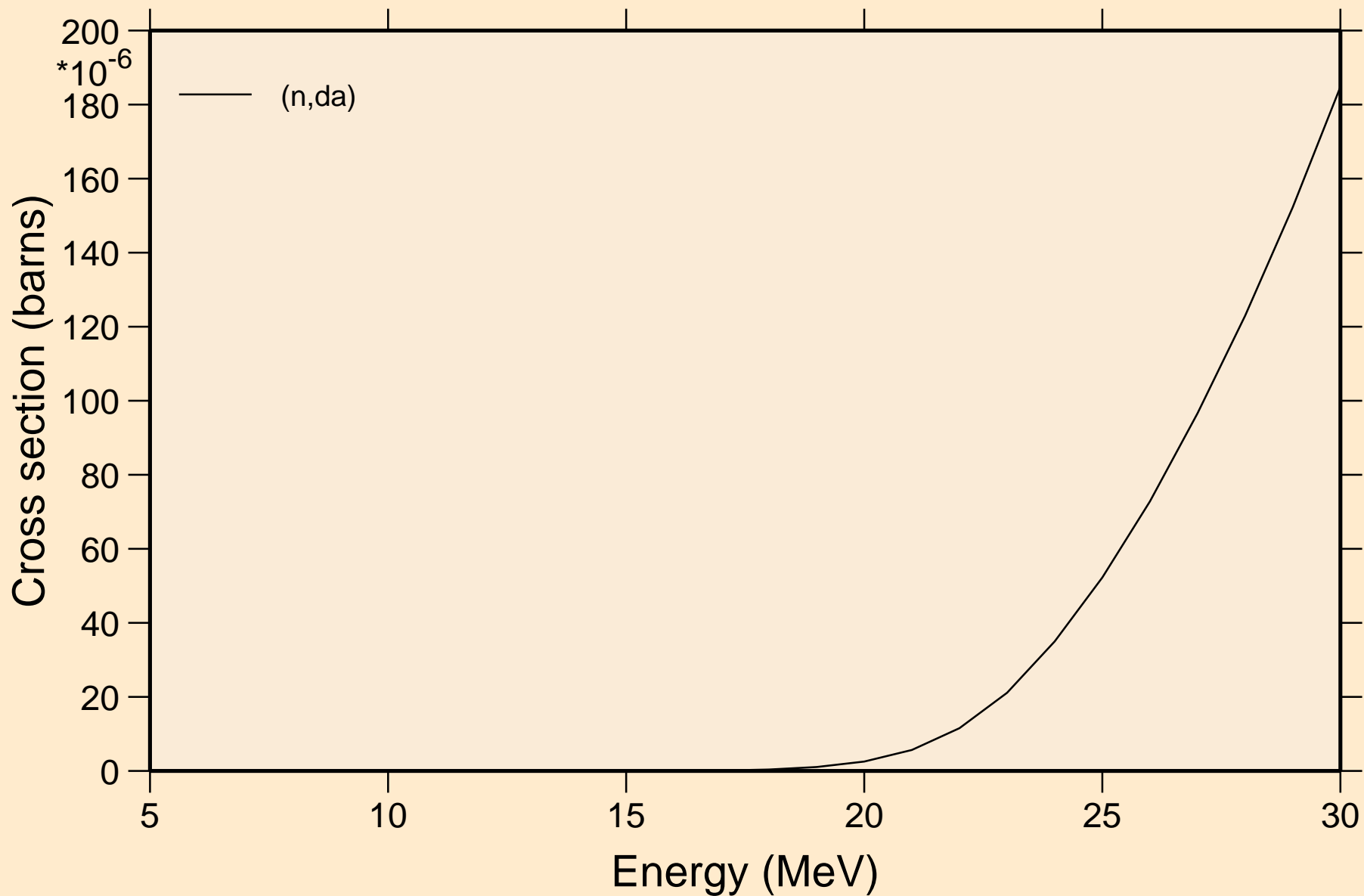

Y083M NEUTRON ACER TENDL-2019 LIBRARY; T=293.16K  
Threshold reactions

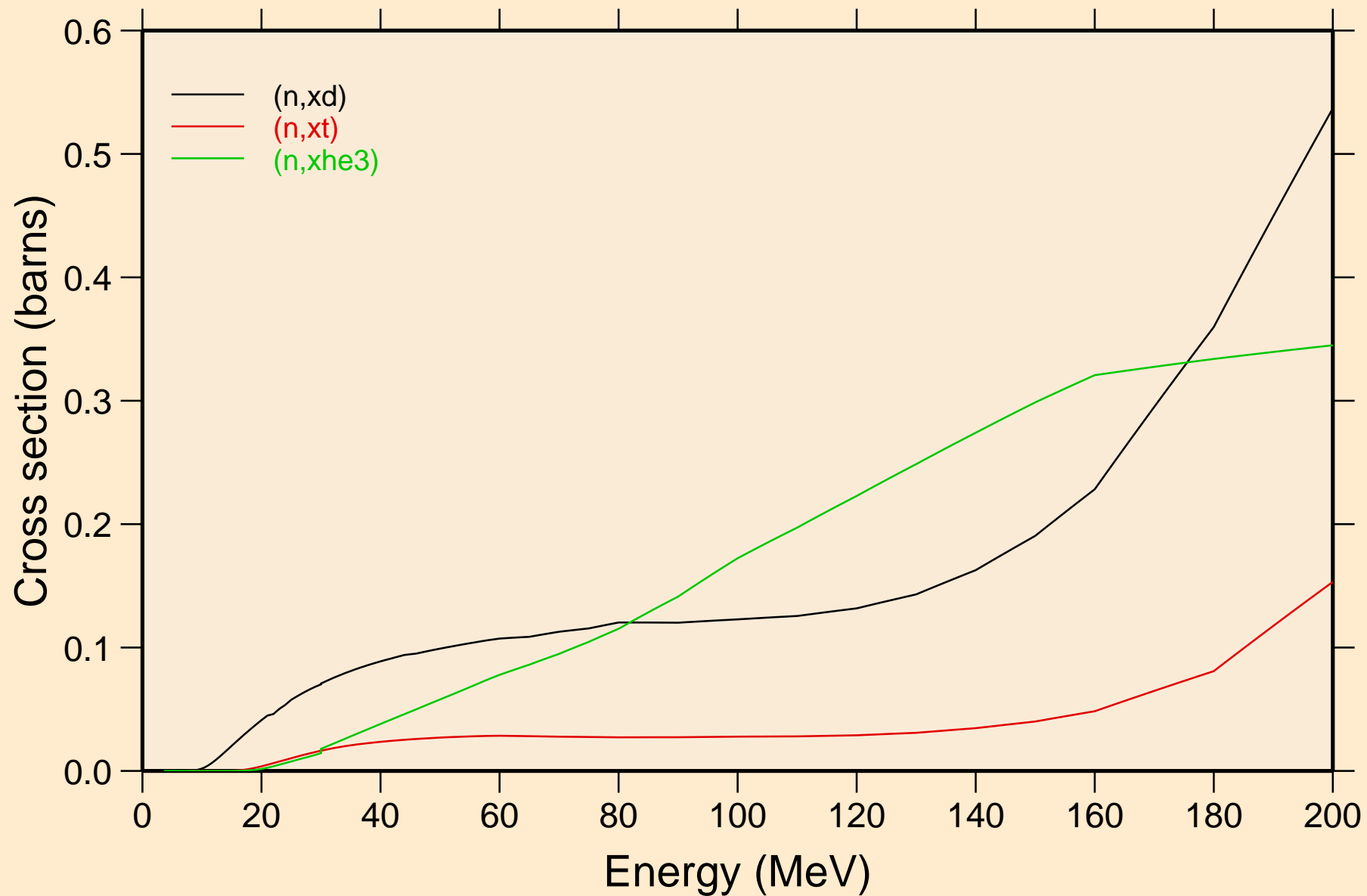

Y083M NEUTRON ACER TENDL-2019 LIBRARY; T=293.16K  
angular distribution for elastic

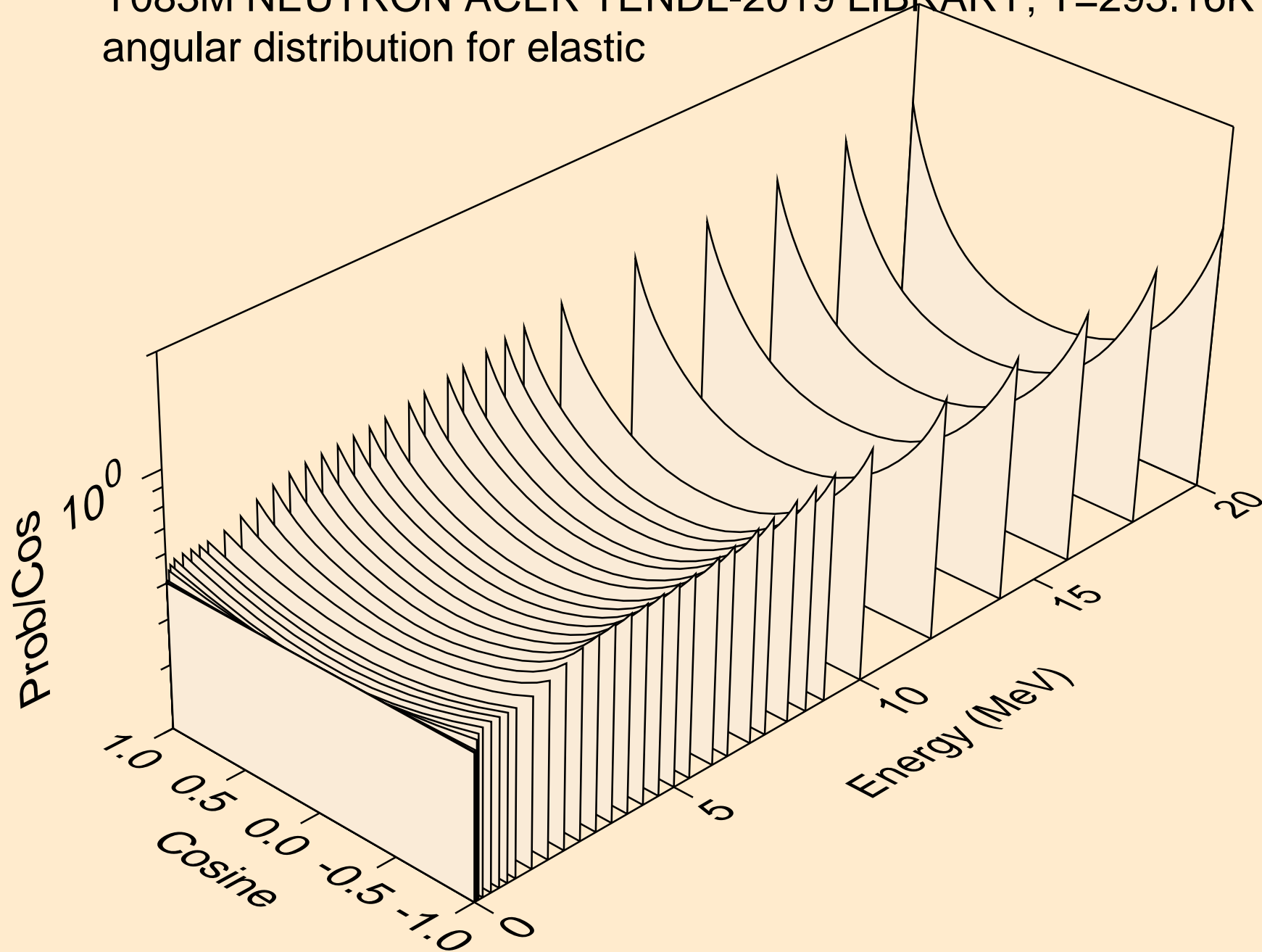

Y083M NEUTRON ACER TENDL-2019 LIBRARY; T=293.16K  
angular distribution for elastic

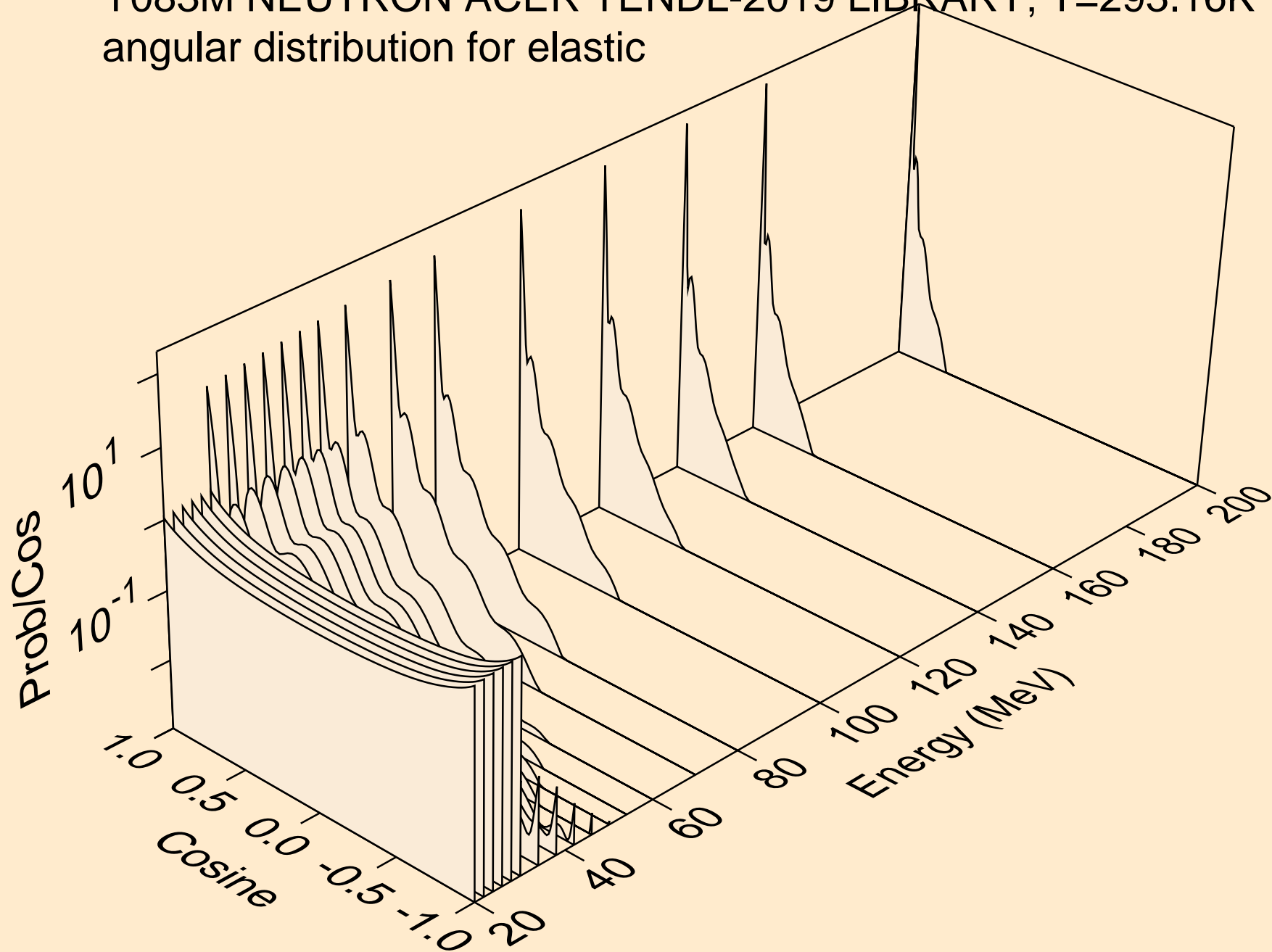

Y083M NEUTRON ACER TENDL-2019 LIBRARY; T=293.16K  
angular distribution for (n,n\*1)

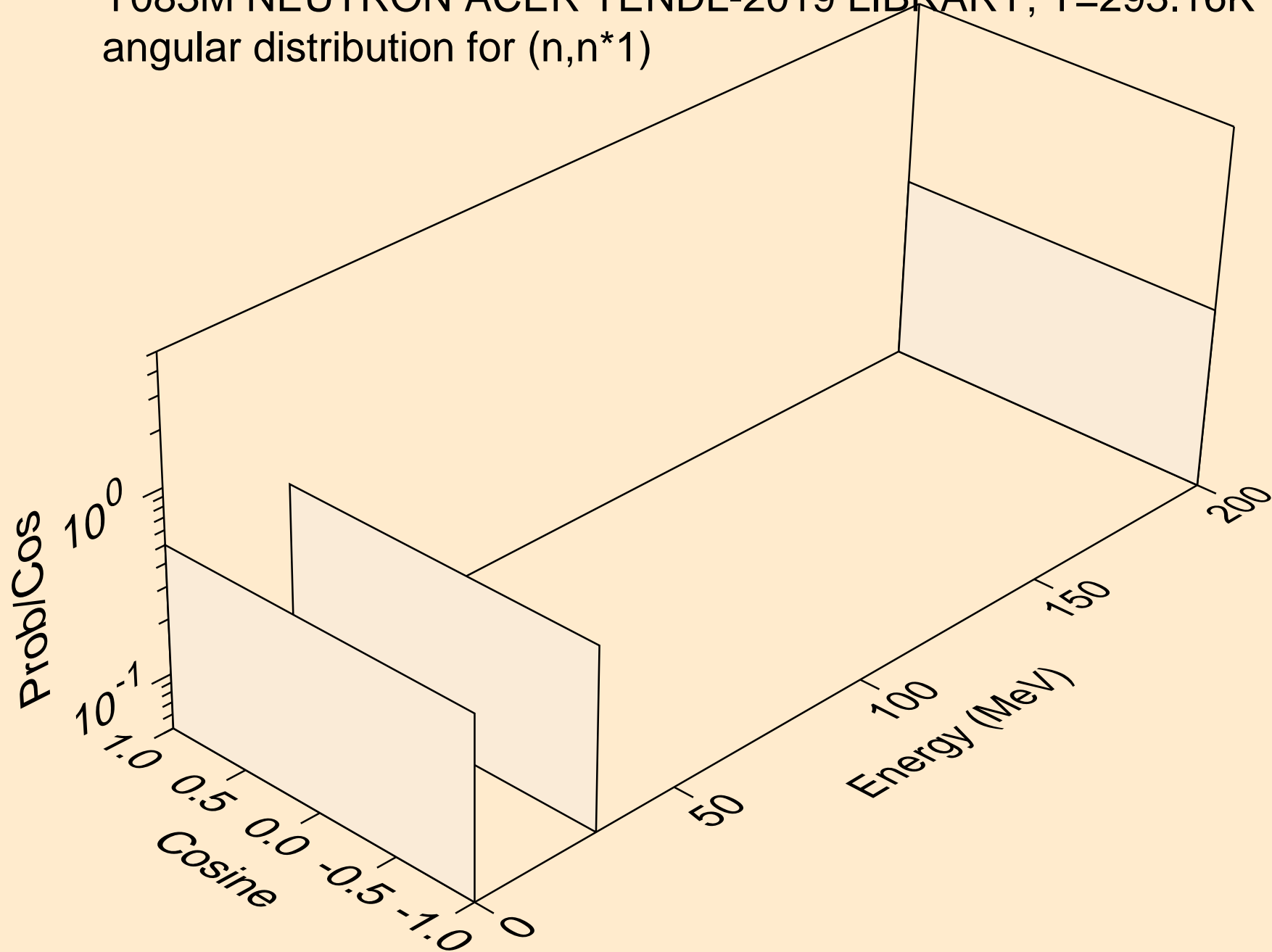

Y083M NEUTRON ACER TENDL-2019 LIBRARY; T=293.16K  
angular distribution for (n,n\*2)

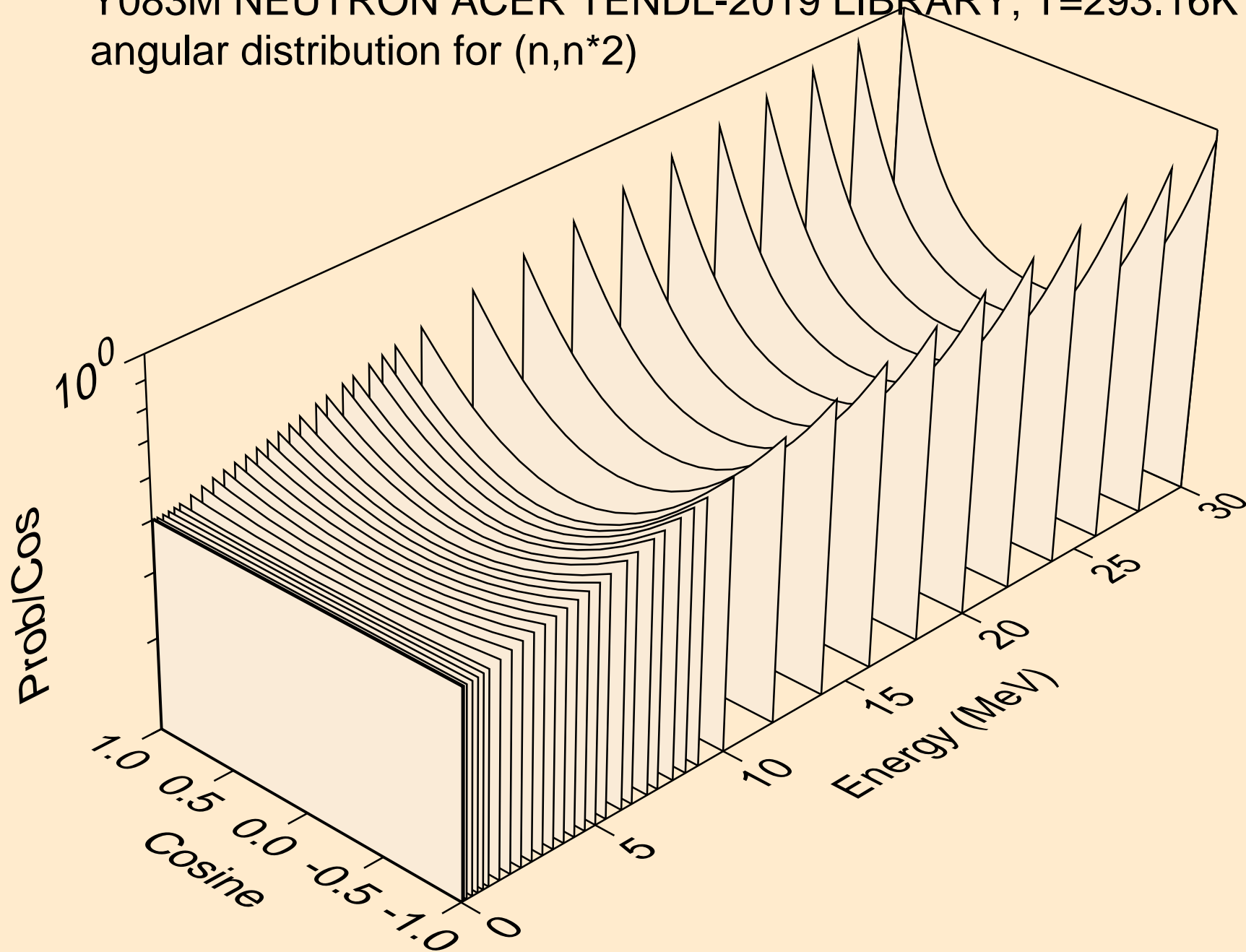



Y083M NEUTRON ACER TENDL-2019 LIBRARY; T=293.16K  
angular distribution for (n,n\*3)

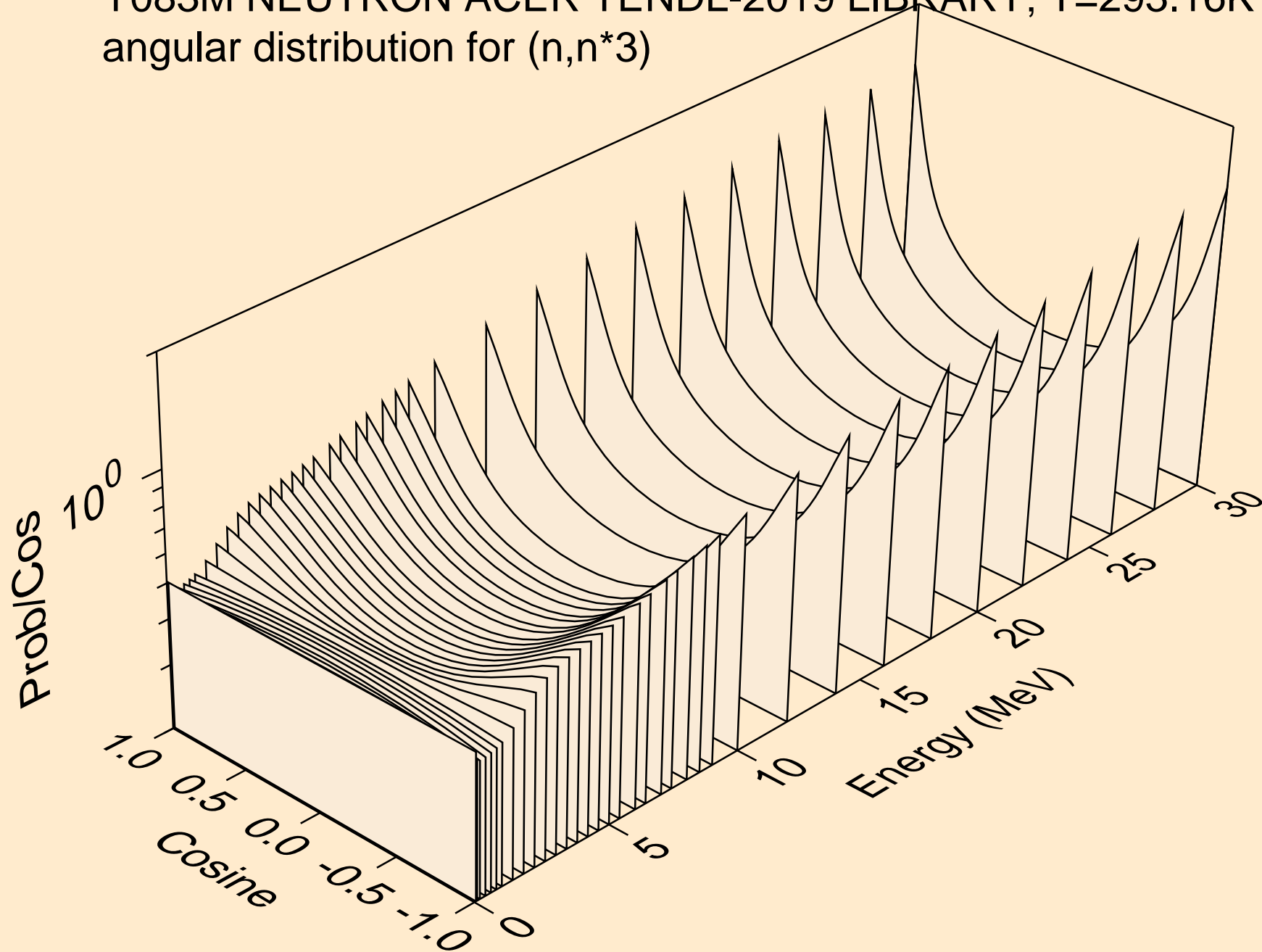

Y083M NEUTRON ACER TENDL-2019 LIBRARY; T=293.16K  
angular distribution for (n,n\*4)

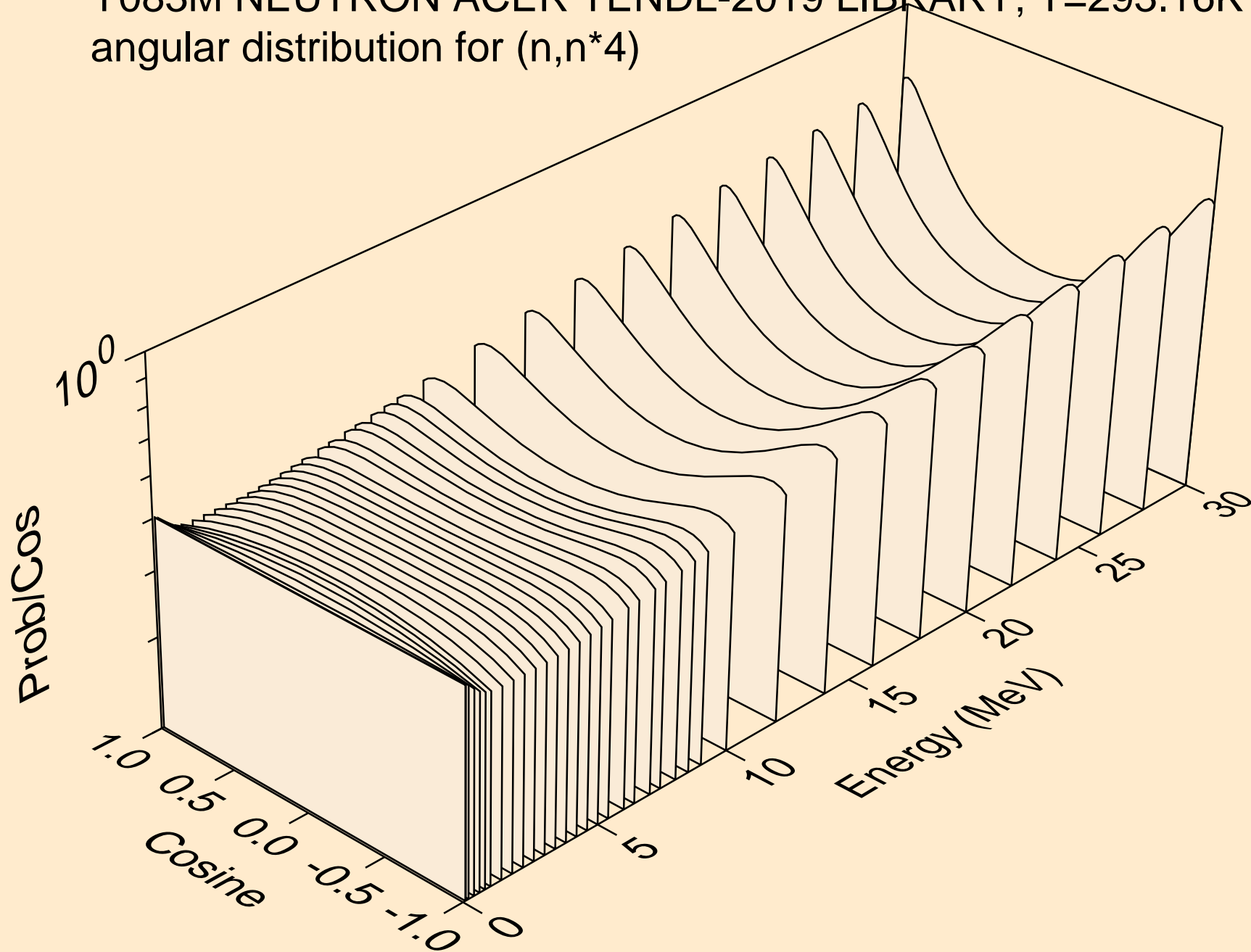

Y083M NEUTRON ACER TENDL-2019 LIBRARY; T=293.16K  
angular distribution for (n,n\*5)

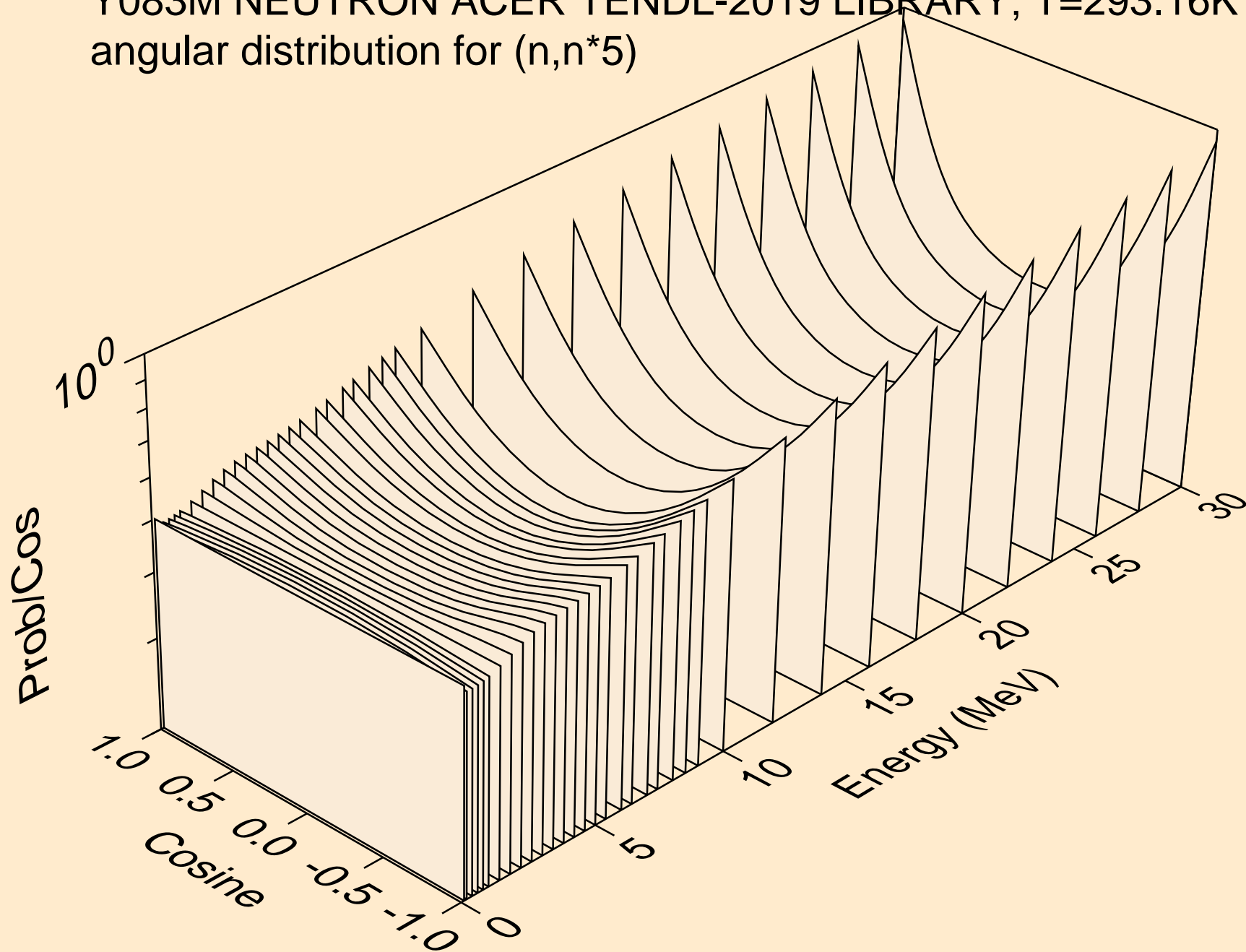

Y083M NEUTRON ACER TENDL-2019 LIBRARY; T=293.16K  
angular distribution for (n,n\*6)

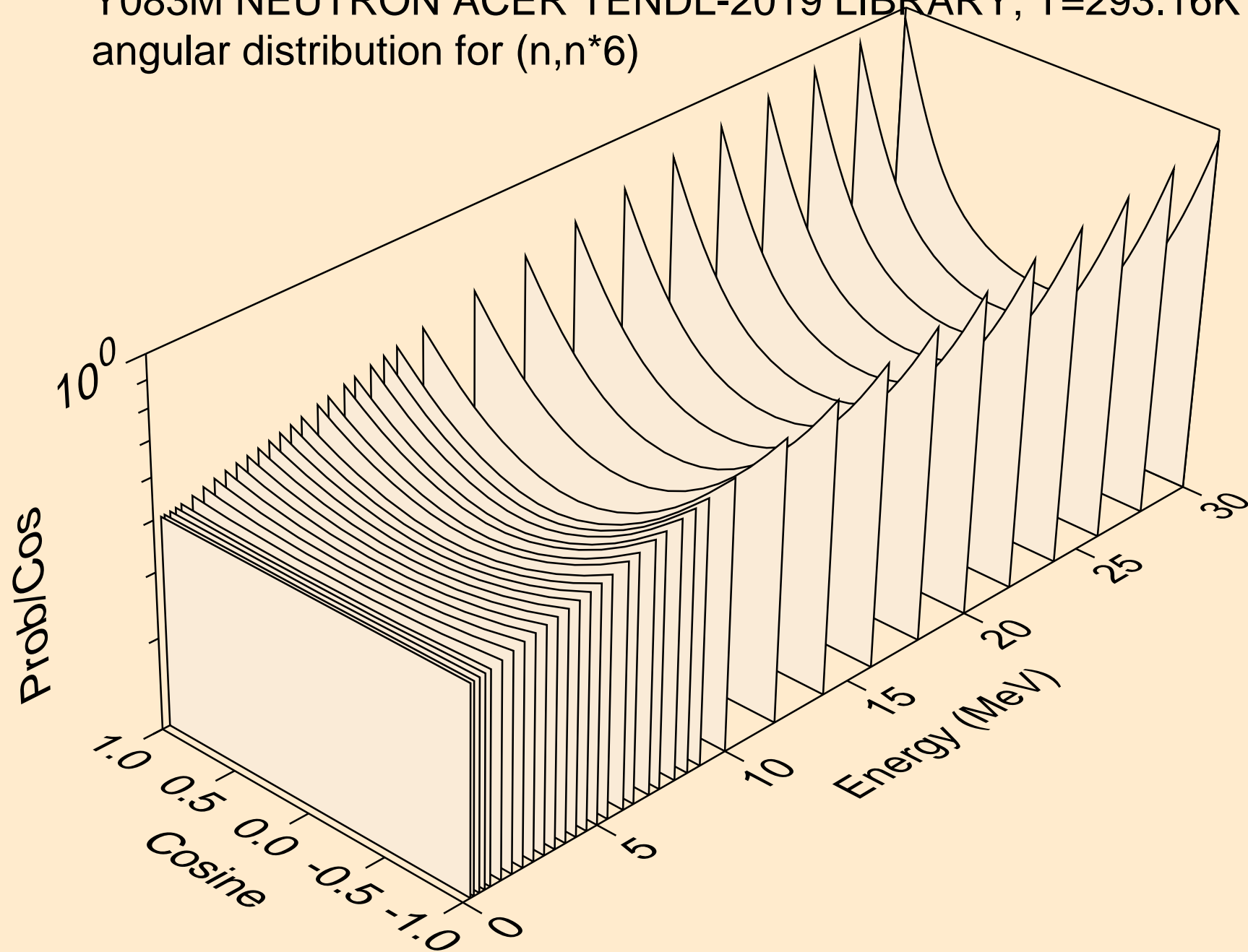

Y083M NEUTRON ACER TENDL-2019 LIBRARY; T=293.16K  
angular distribution for (n,n\*7)

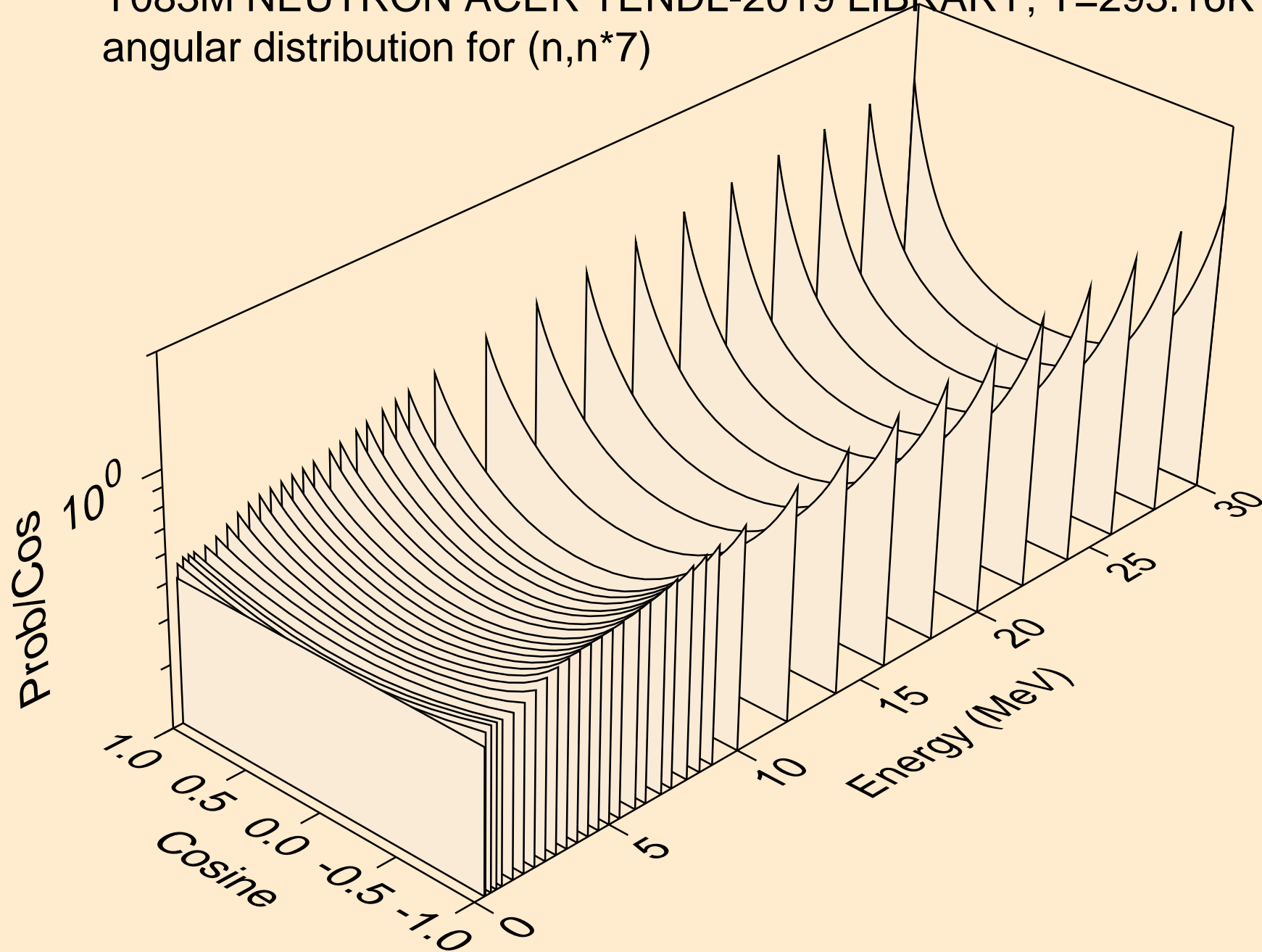

Y083M NEUTRON ACER TENDL-2019 LIBRARY; T=293.16K  
angular distribution for (n,n\*8)

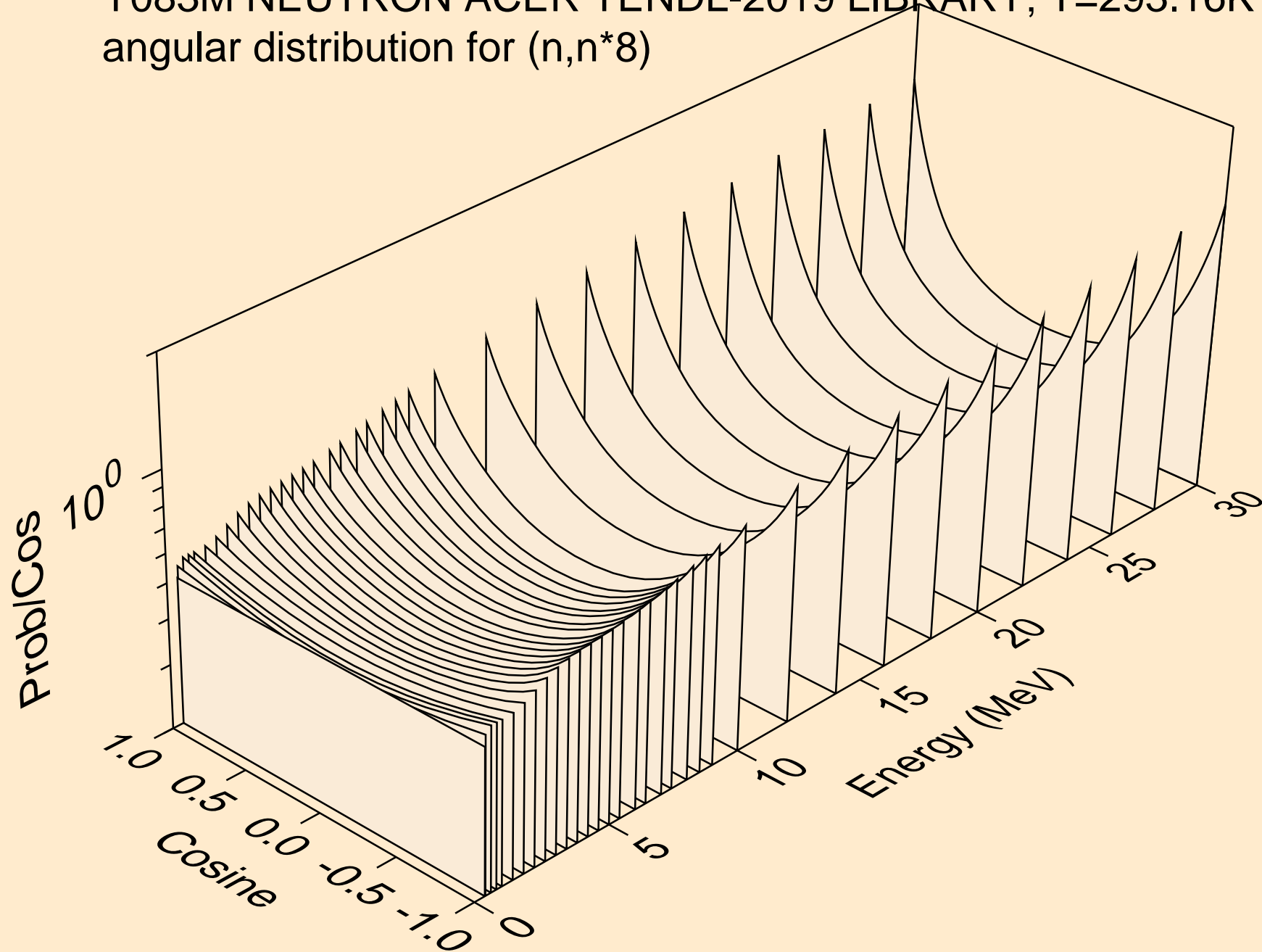

Y083M NEUTRON ACER TENDL-2019 LIBRARY; T=293.16K  
angular distribution for (n,n\*9)

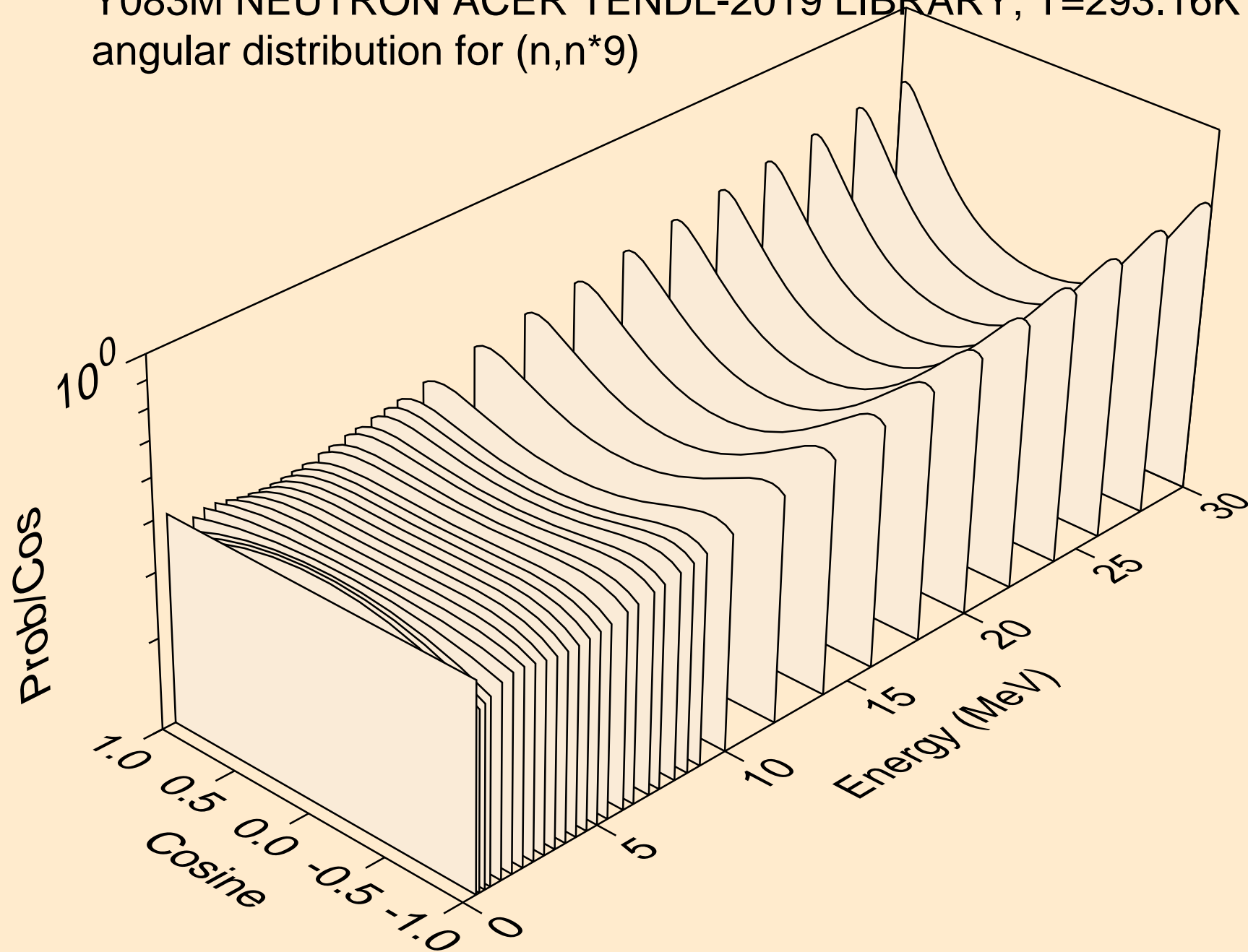

Y083M NEUTRON ACER TENDL-2019 LIBRARY; T=293.16K  
angular distribution for (n,n\*10)

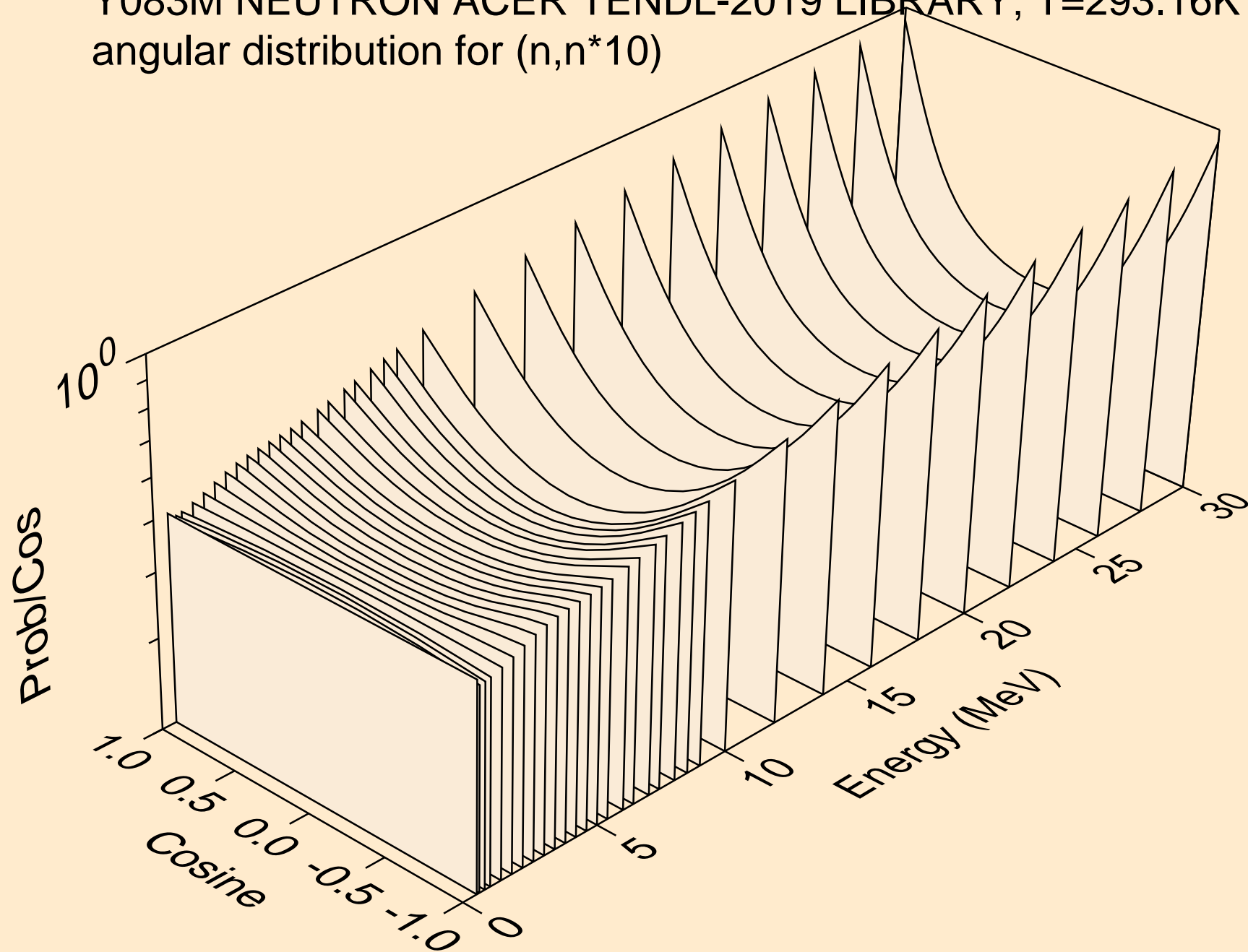



Y083M NEUTRON ACER TENDL-2019 LIBRARY; T=293.16K  
angular distribution for (n,n\*11)

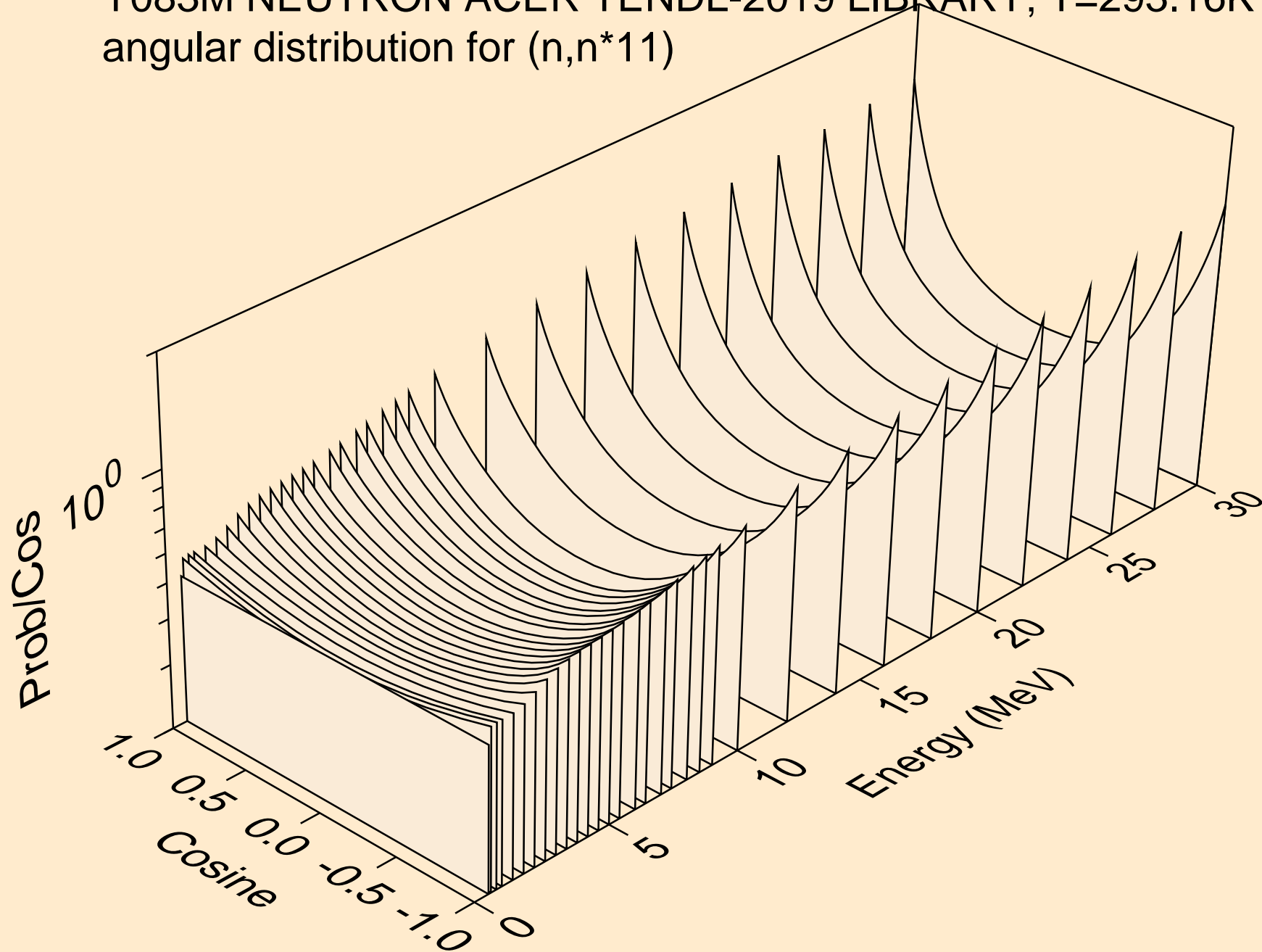

Y083M NEUTRON ACER TENDL-2019 LIBRARY; T=293.16K  
angular distribution for (n,n\*12)

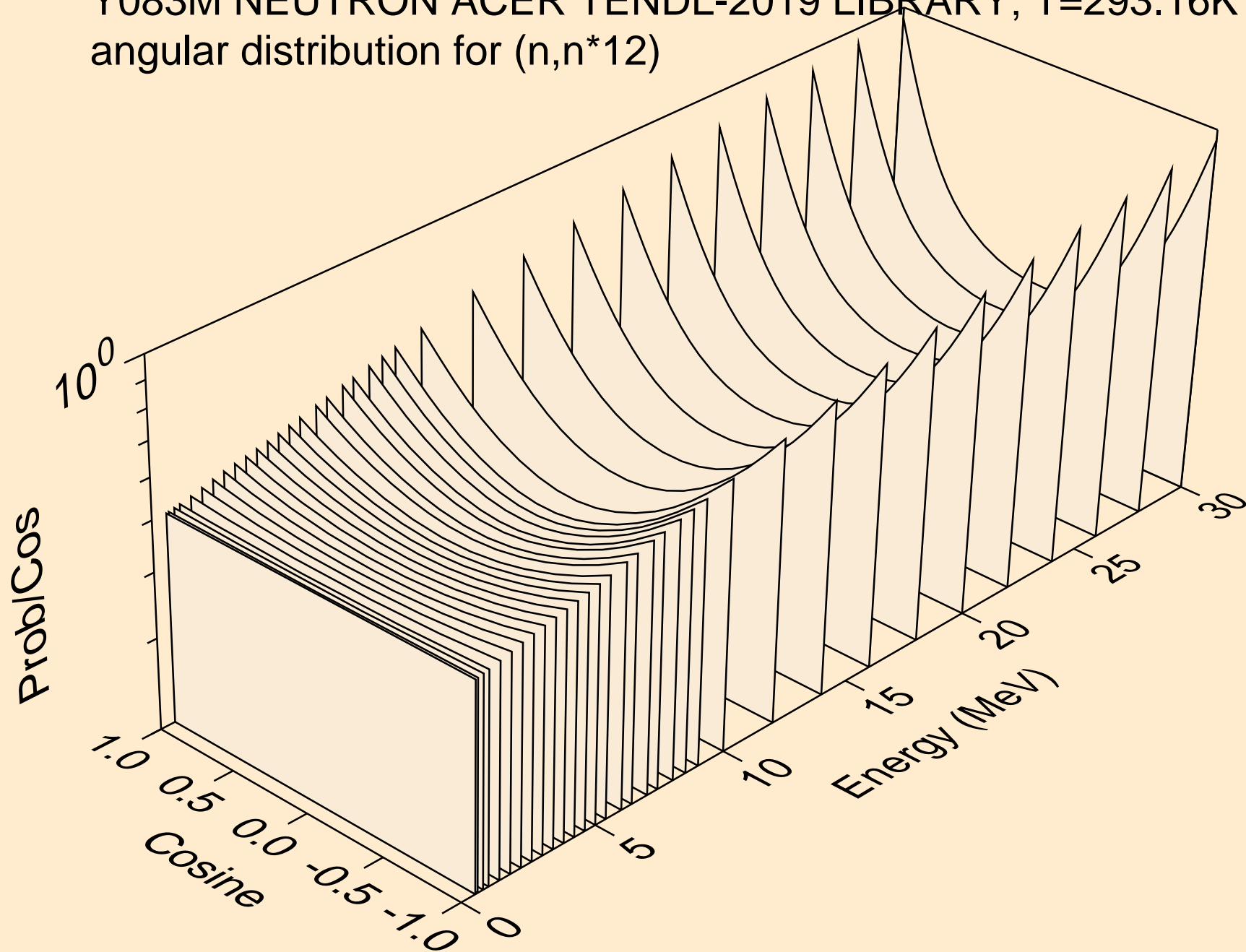

Y083M NEUTRON ACER TENDL-2019 LIBRARY; T=293.16K  
angular distribution for (n,n\*13)

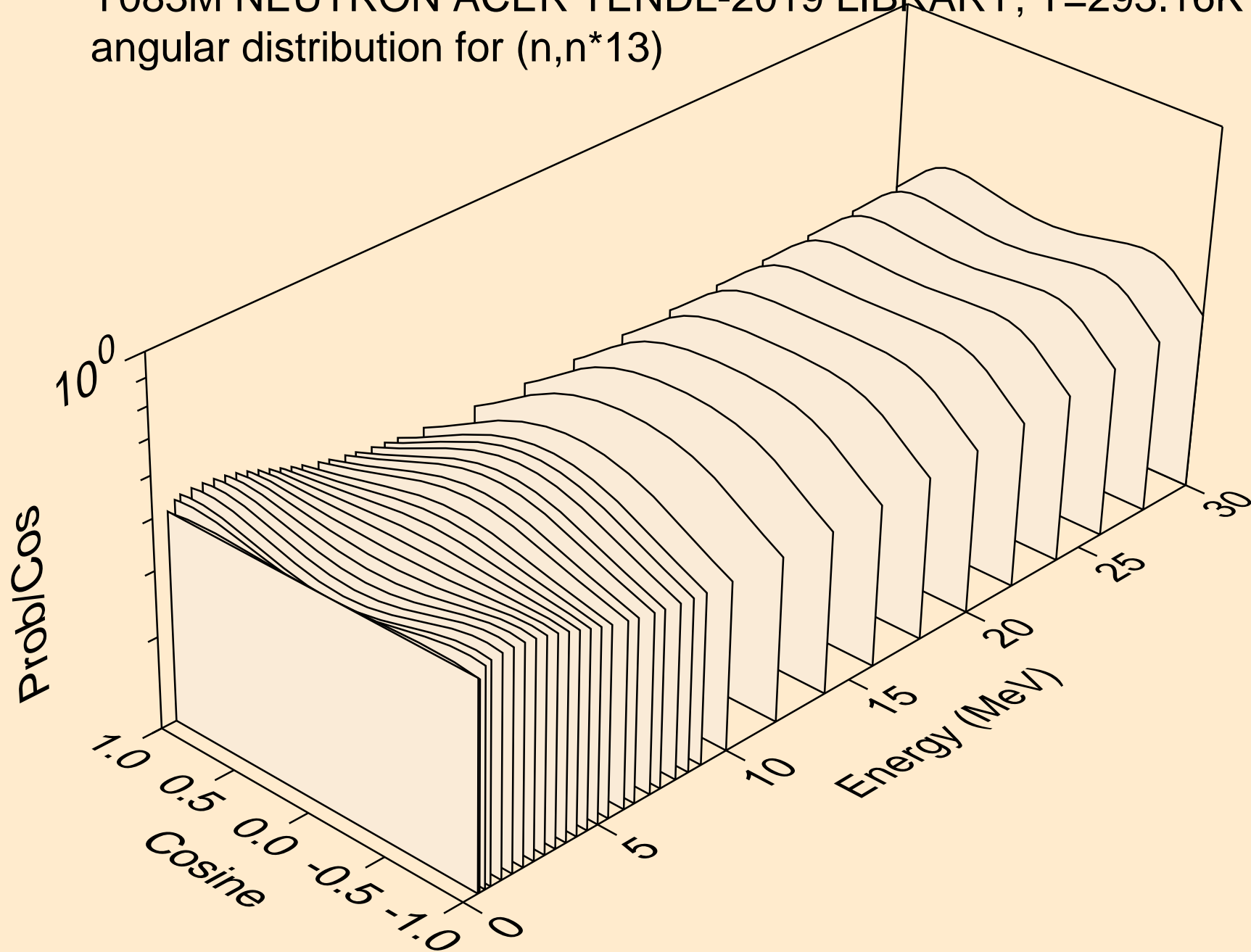

Y083M NEUTRON ACER TENDL-2019 LIBRARY; T=293.16K  
angular distribution for (n,n\*14)

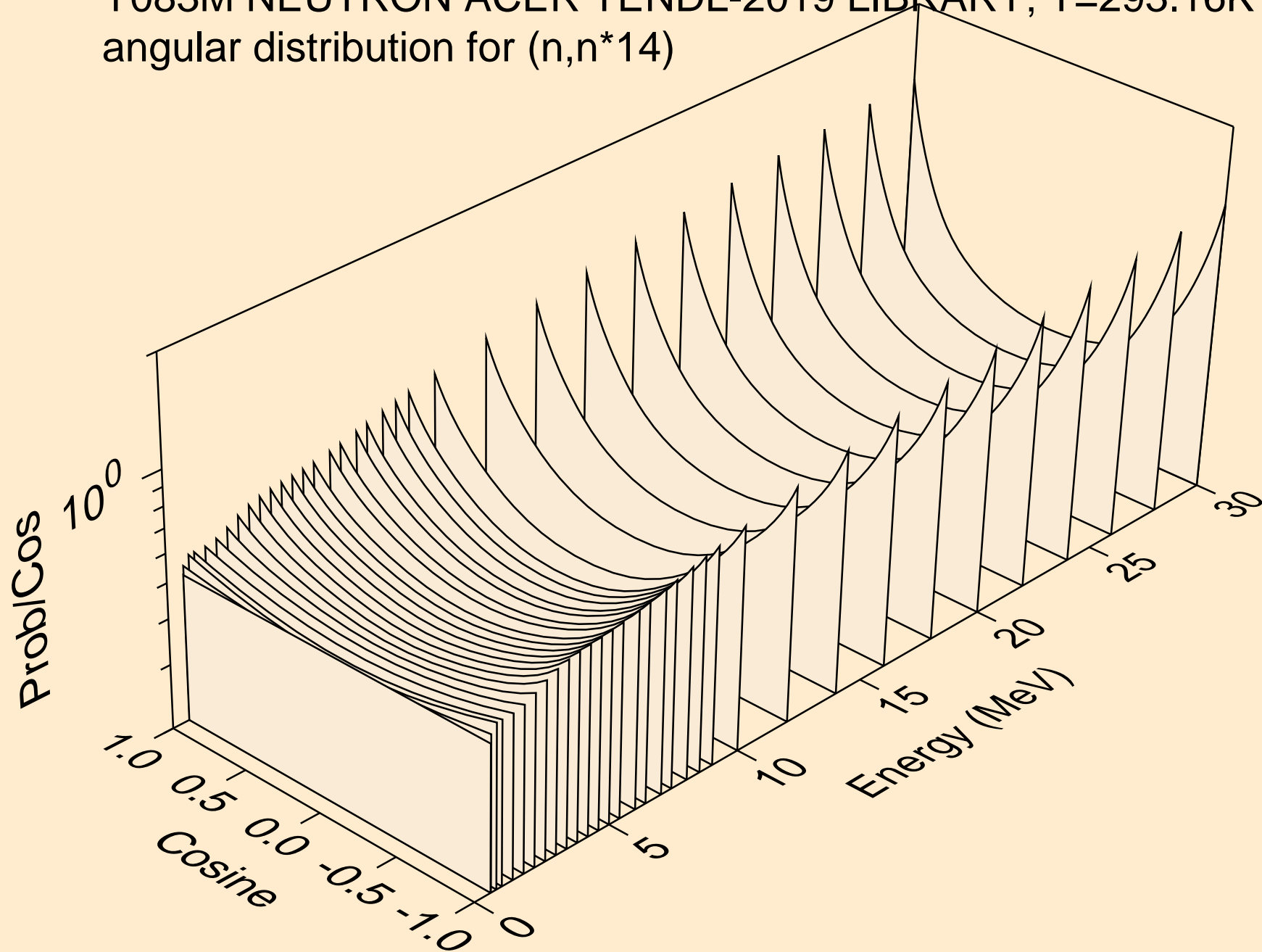

Y083M NEUTRON ACER TENDL-2019 LIBRARY; T=293.16K  
angular distribution for (n,n\*15)

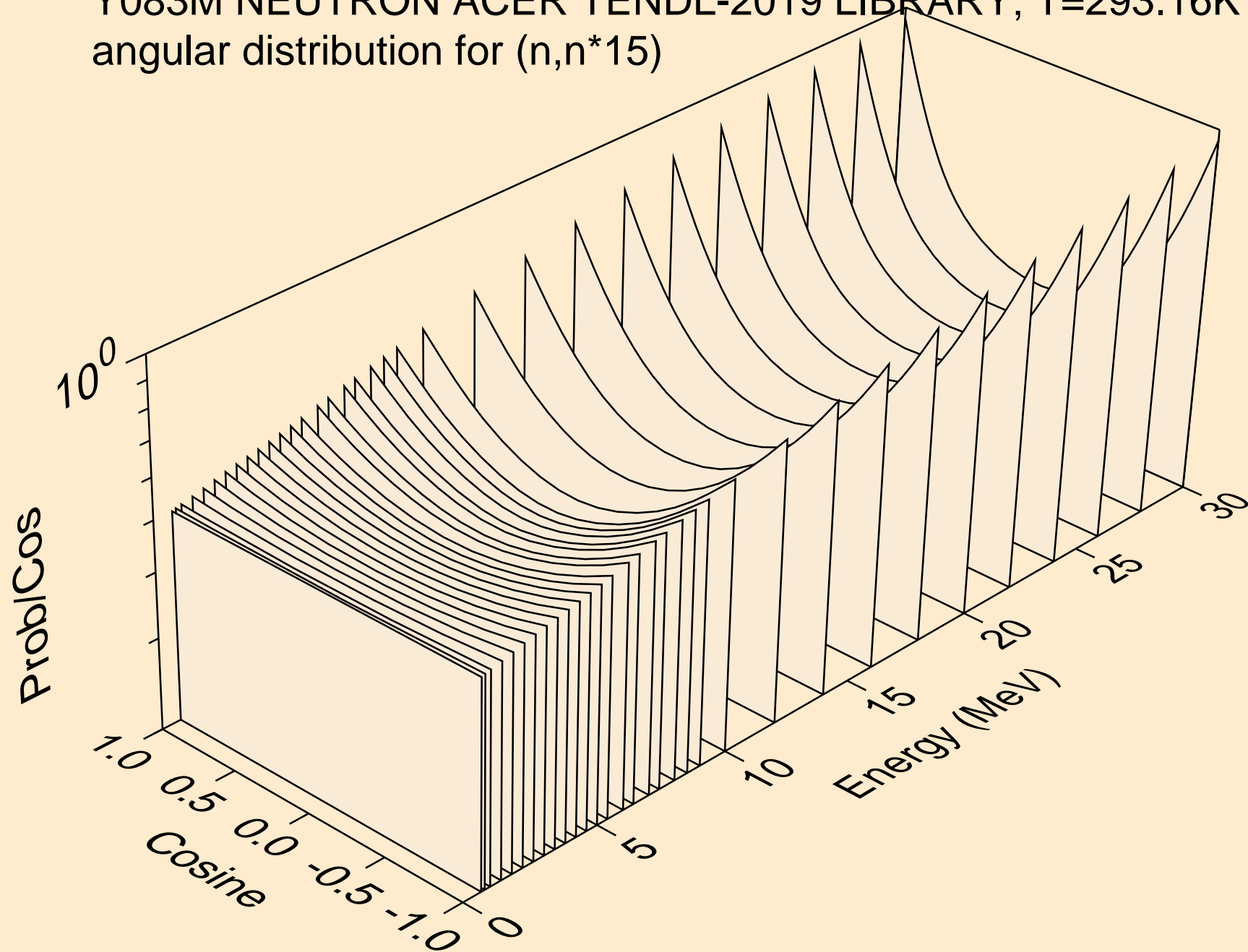

Y083M NEUTRON ACER TENDL-2019 LIBRARY; T=293.16K  
angular distribution for (n,n\*16)

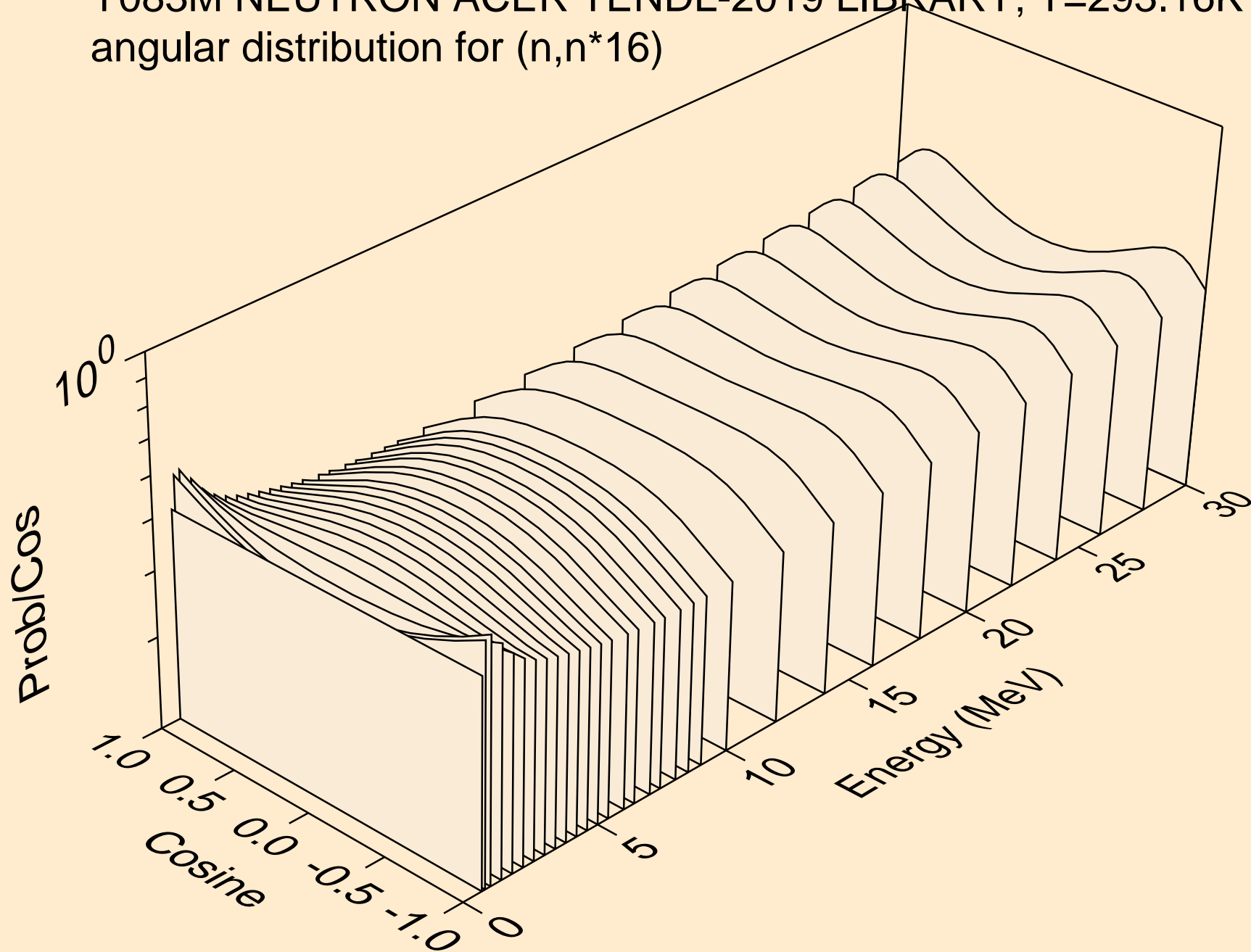

Y083M NEUTRON ACER TENDL-2019 LIBRARY; T=293.16K  
angular distribution for (n,n\*17)

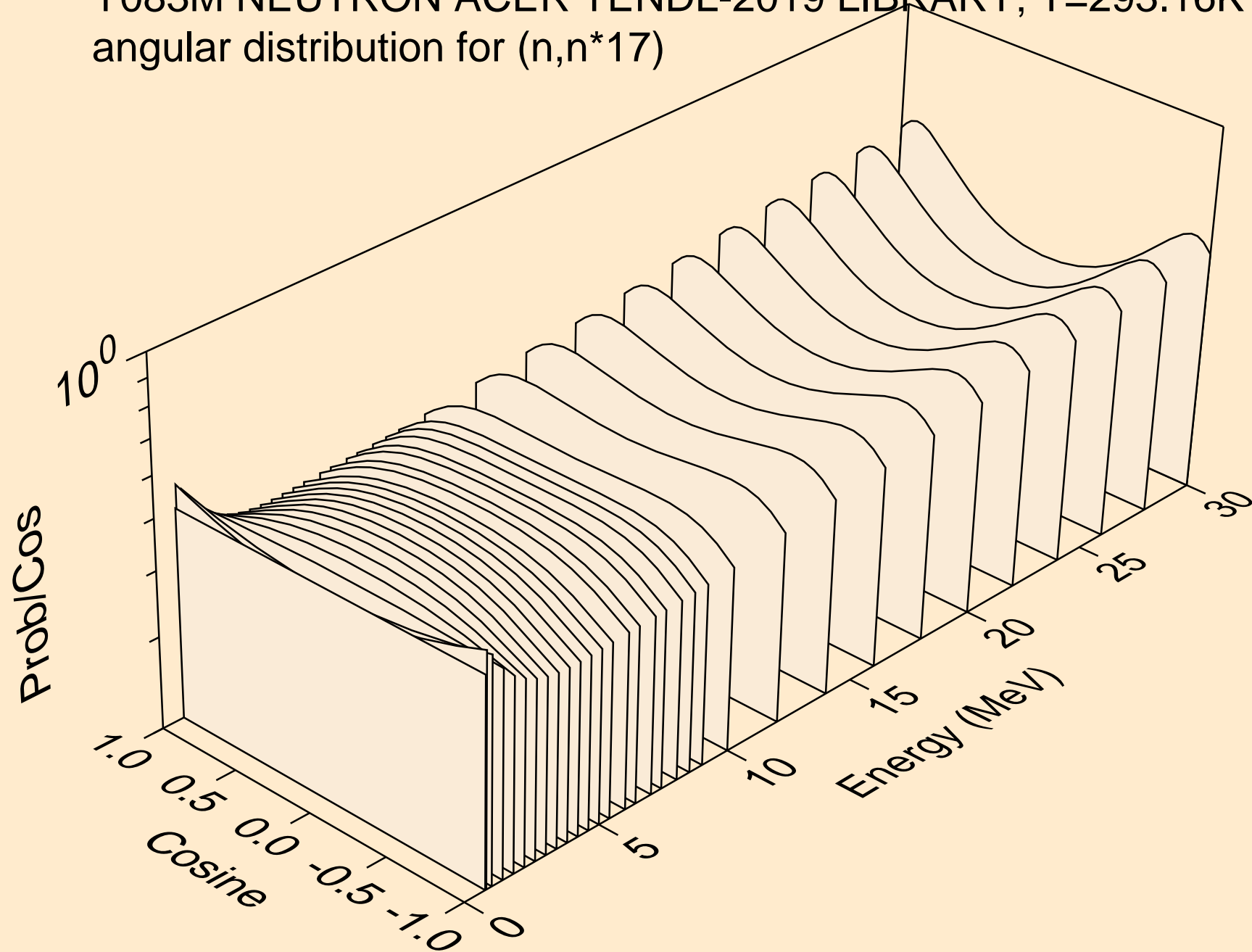

Y083M NEUTRON ACER TENDL-2019 LIBRARY; T=293.16K  
angular distribution for (n,n\*18)

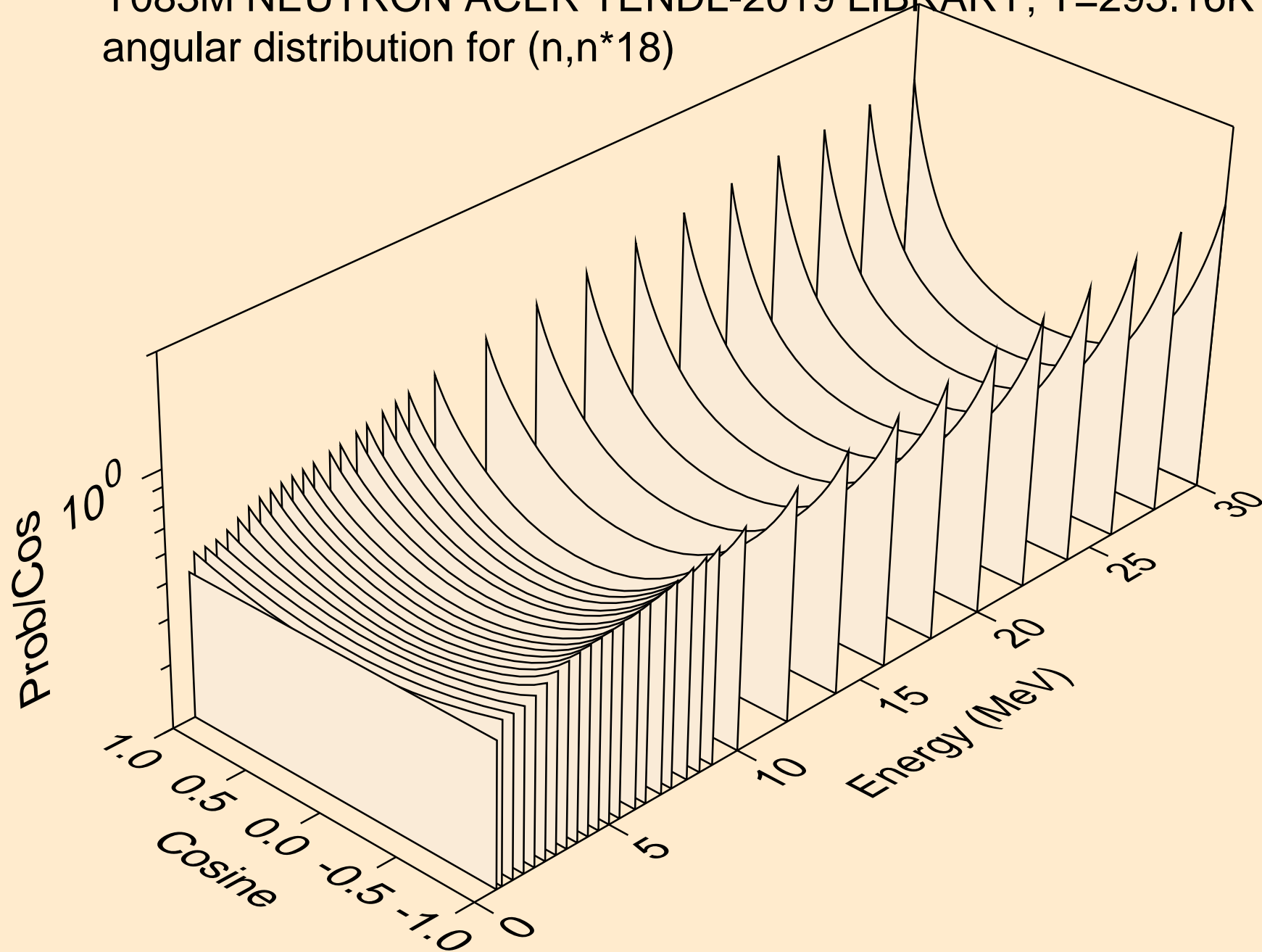



Y083M NEUTRON ACER TENDL-2019 LIBRARY; T=293.16K  
angular distribution for (n,n\*19)

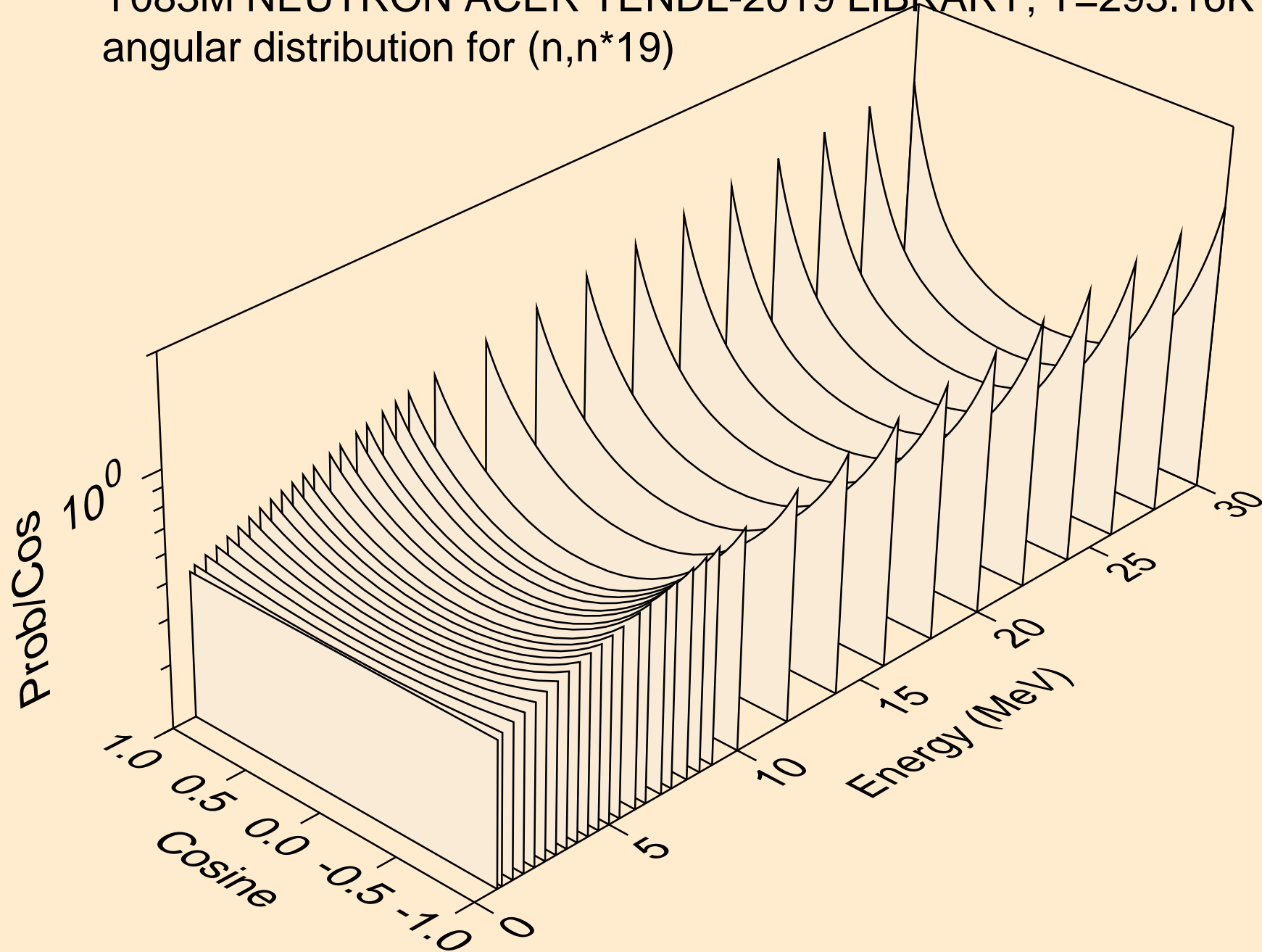

Y083M NEUTRON ACER TENDL-2019 LIBRARY; T=293.16K  
angular distribution for (n,n\*20)

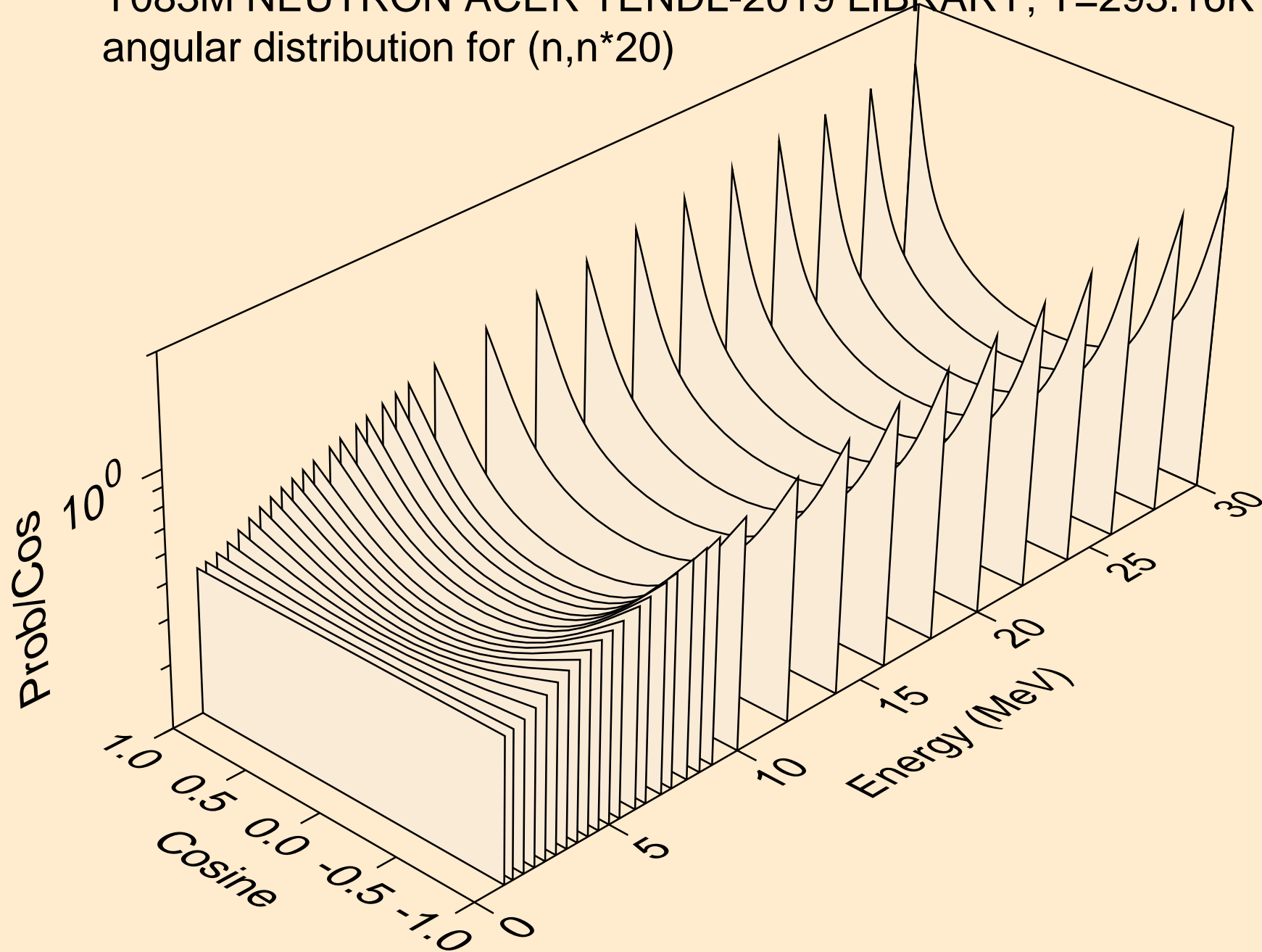

Y083M NEUTRON ACER TENDL-2019 LIBRARY; T=293.16K  
angular distribution for (n,n\*21)

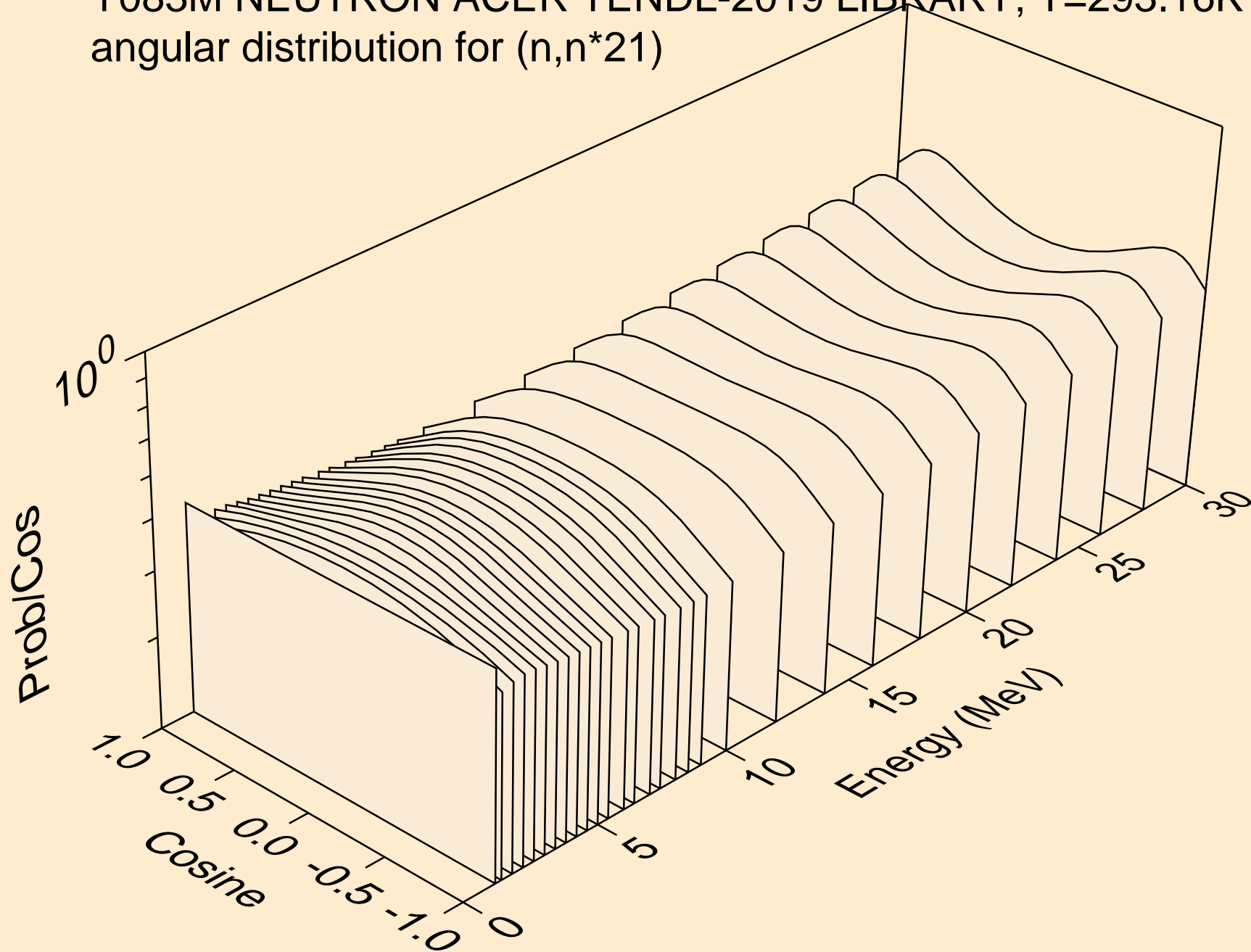

Y083M NEUTRON ACER TENDL-2019 LIBRARY; T=293.16K  
angular distribution for (n,n\*22)

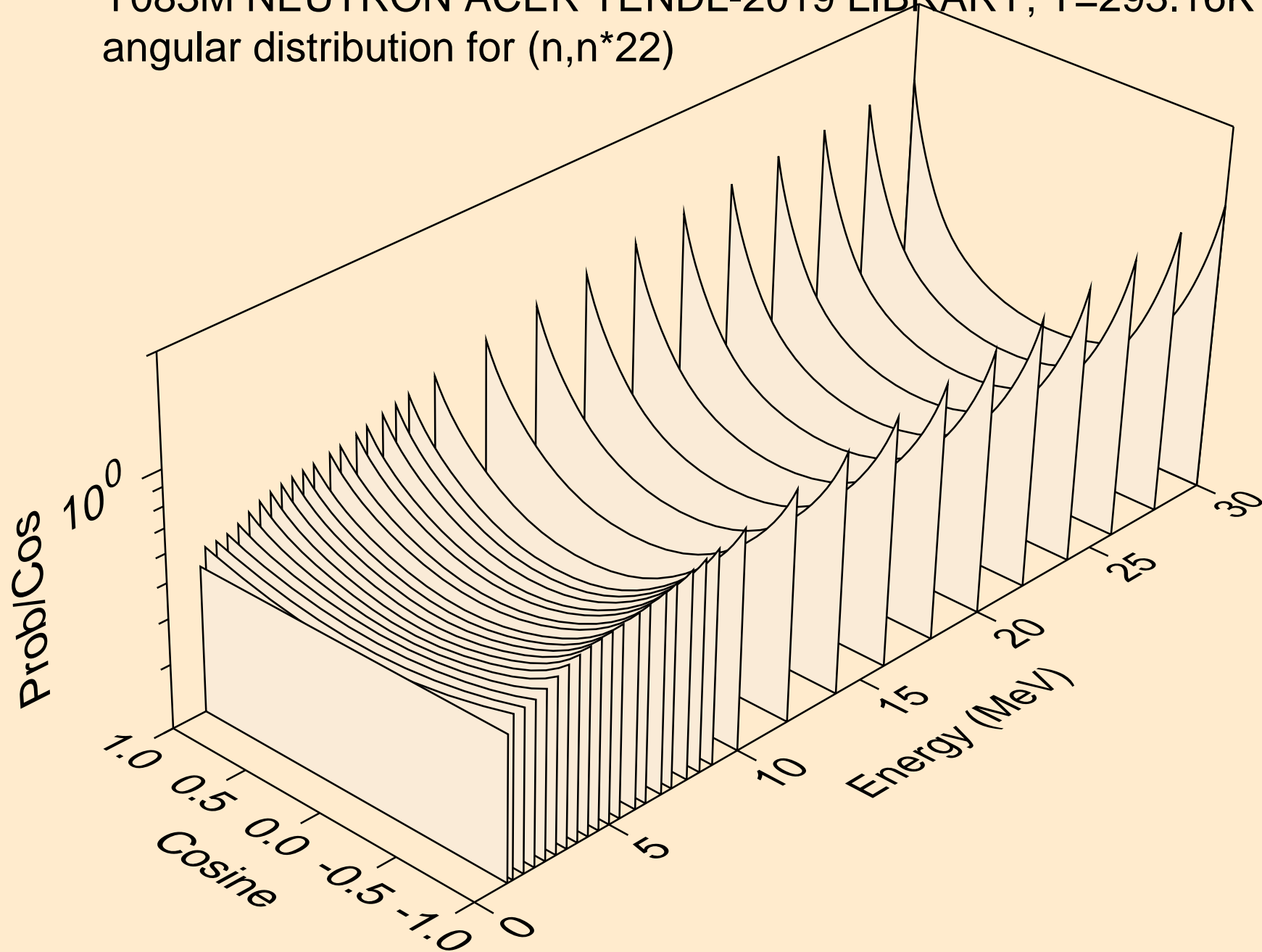

Y083M NEUTRON ACER TENDL-2019 LIBRARY; T=293.16K  
Neutron emission for (n,x)

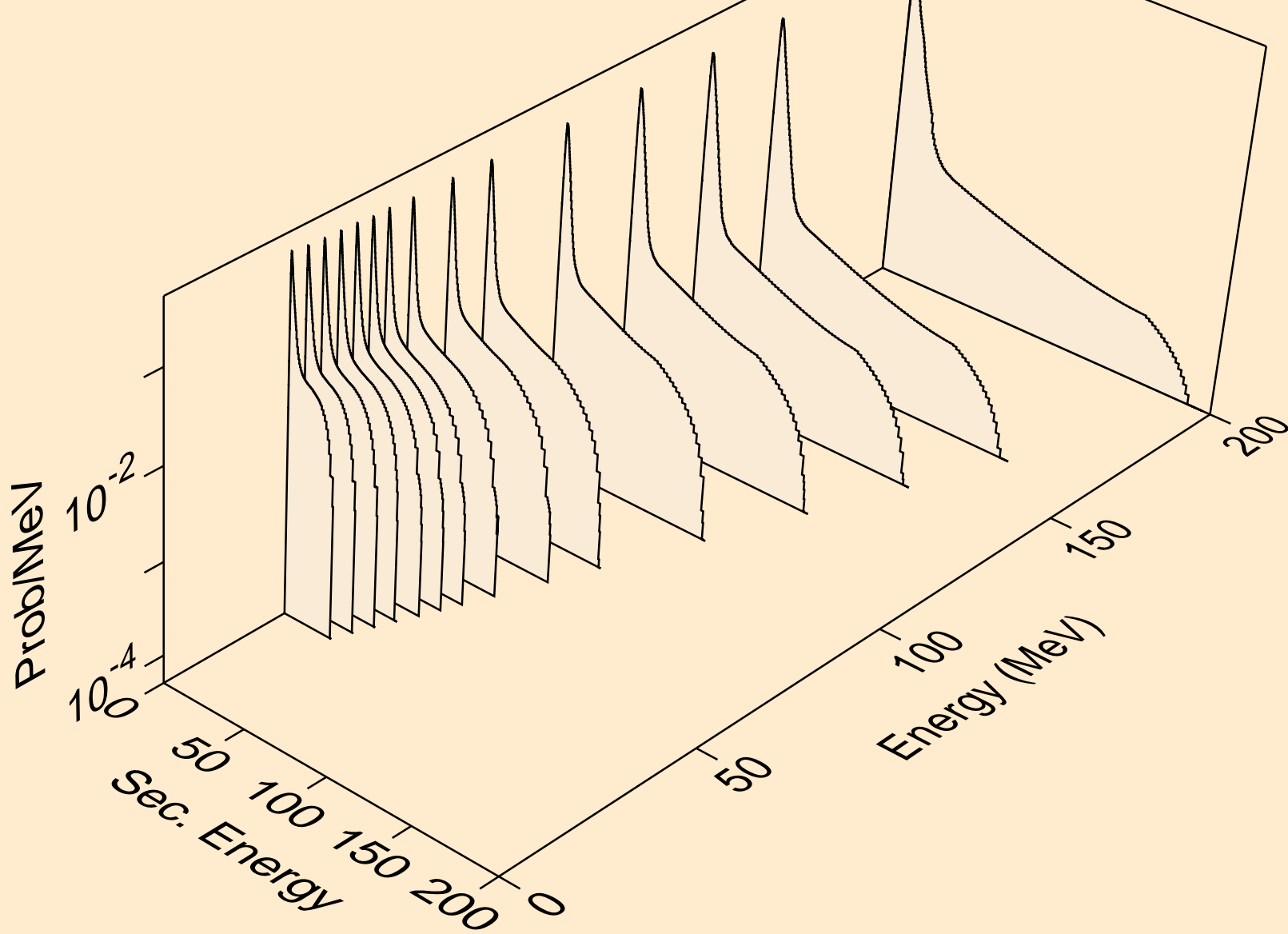

Y083M NEUTRON ACER TENDL-2019 LIBRARY; T=293.16K  
Neutron emission for (n,2nd)

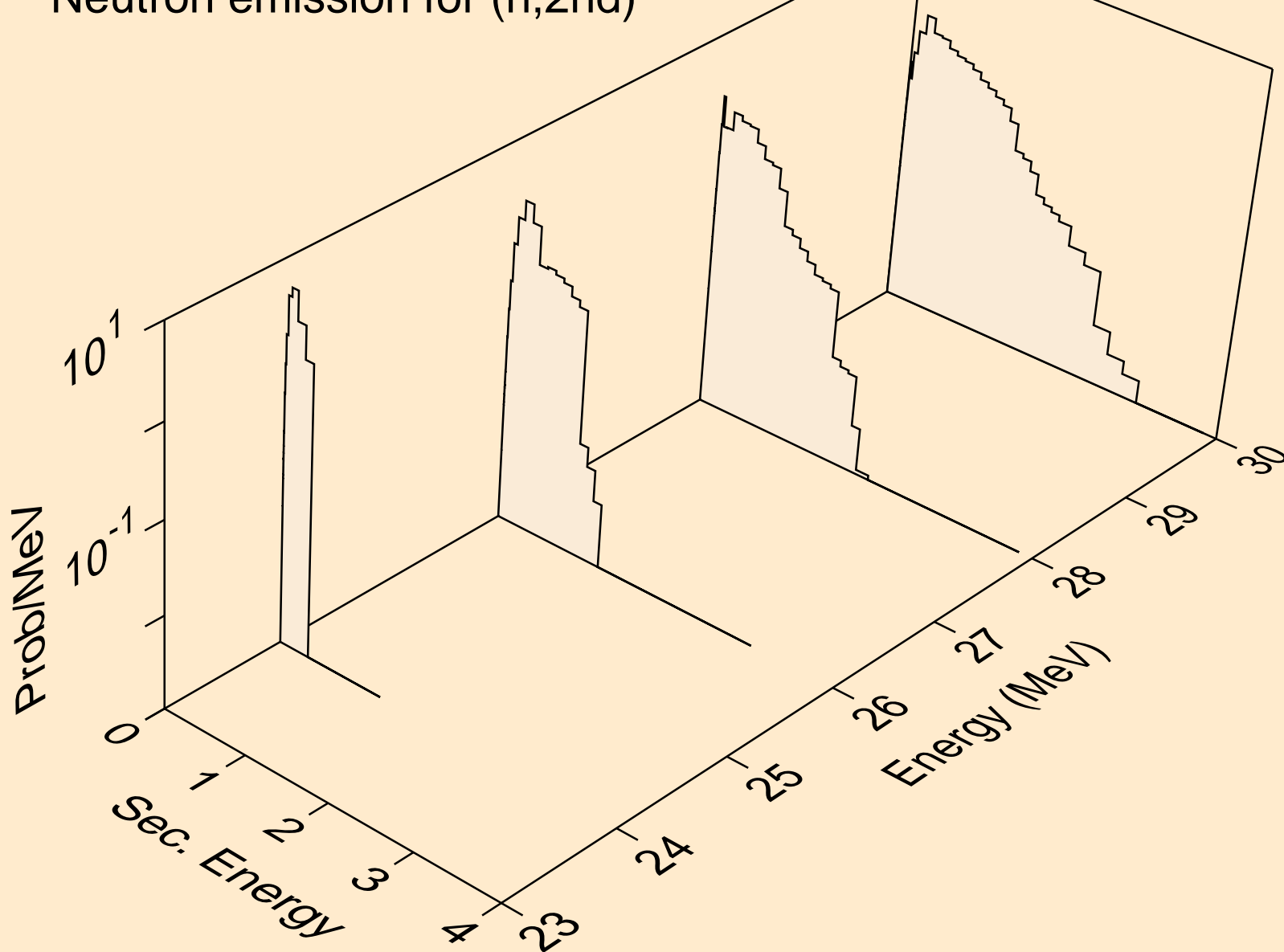

Y083M NEUTRON ACER TENDL-2019 LIBRARY; T=293.16K  
Neutron emission for (n,2n)

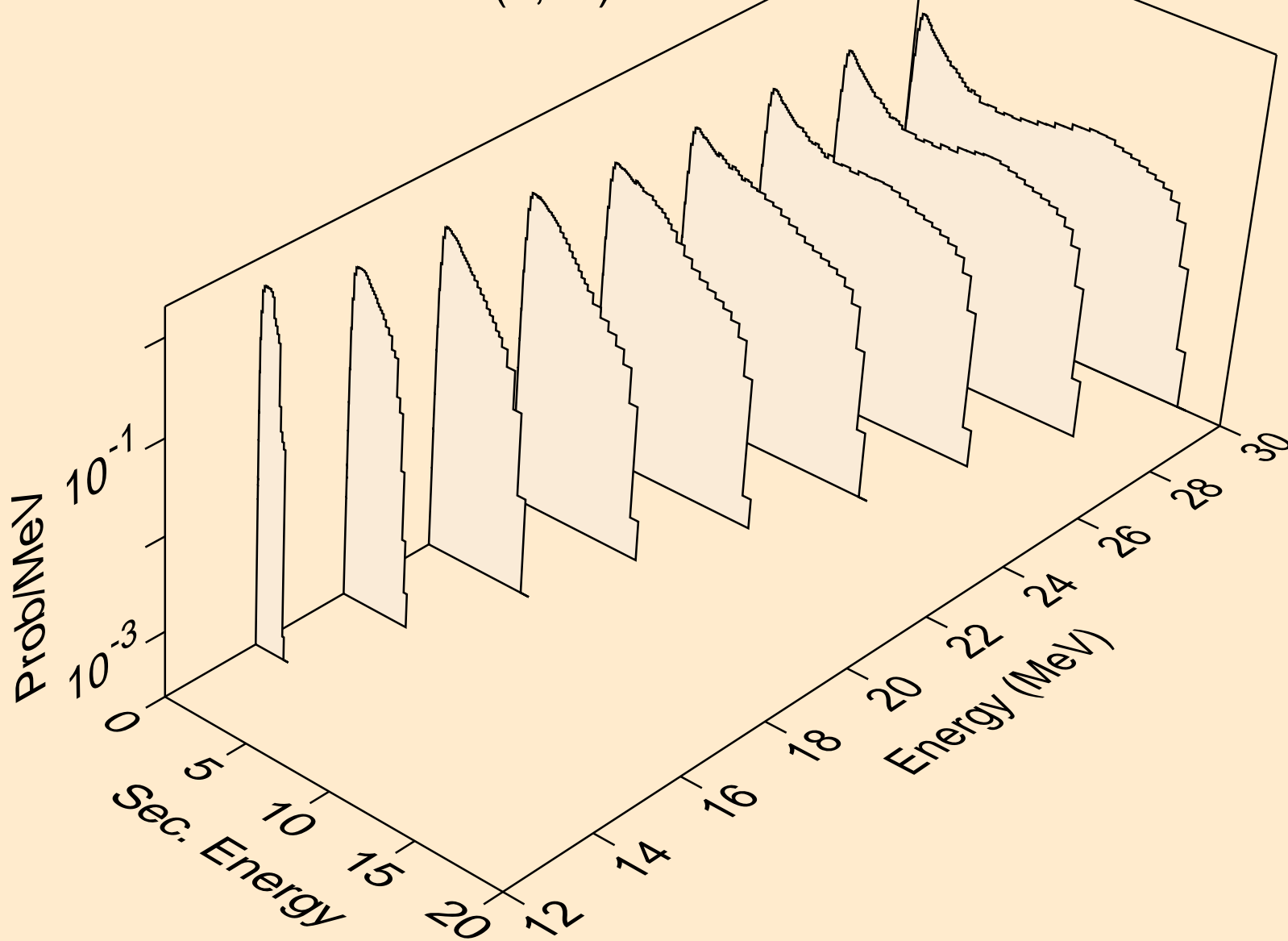

Y083M NEUTRON ACER TENDL-2019 LIBRARY; T=293.16K  
Neutron emission for (n,3n)

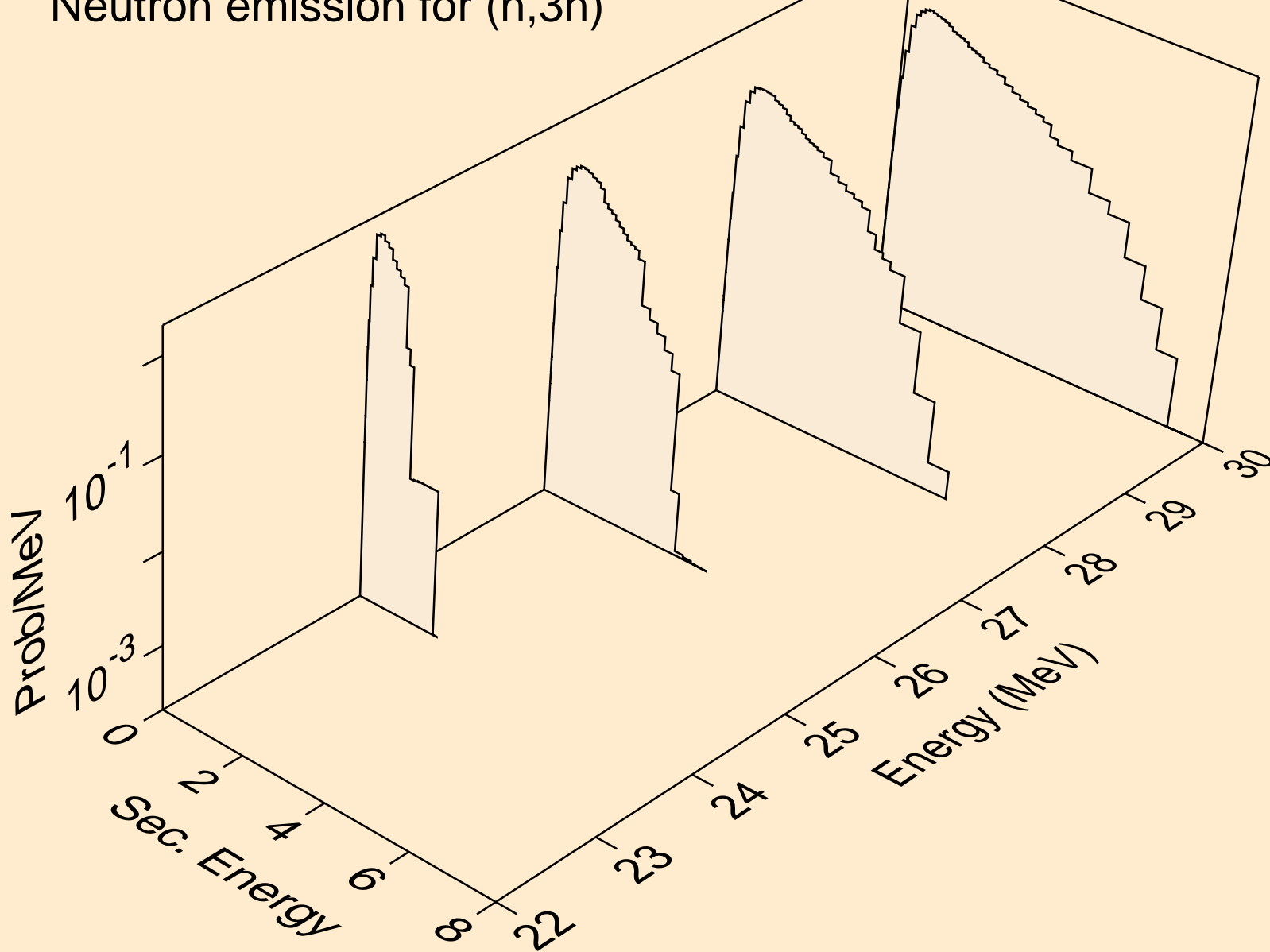



Y083M NEUTRON ACER TENDL-2019 LIBRARY; T=293.16K  
Neutron emission for (n,n\*)a

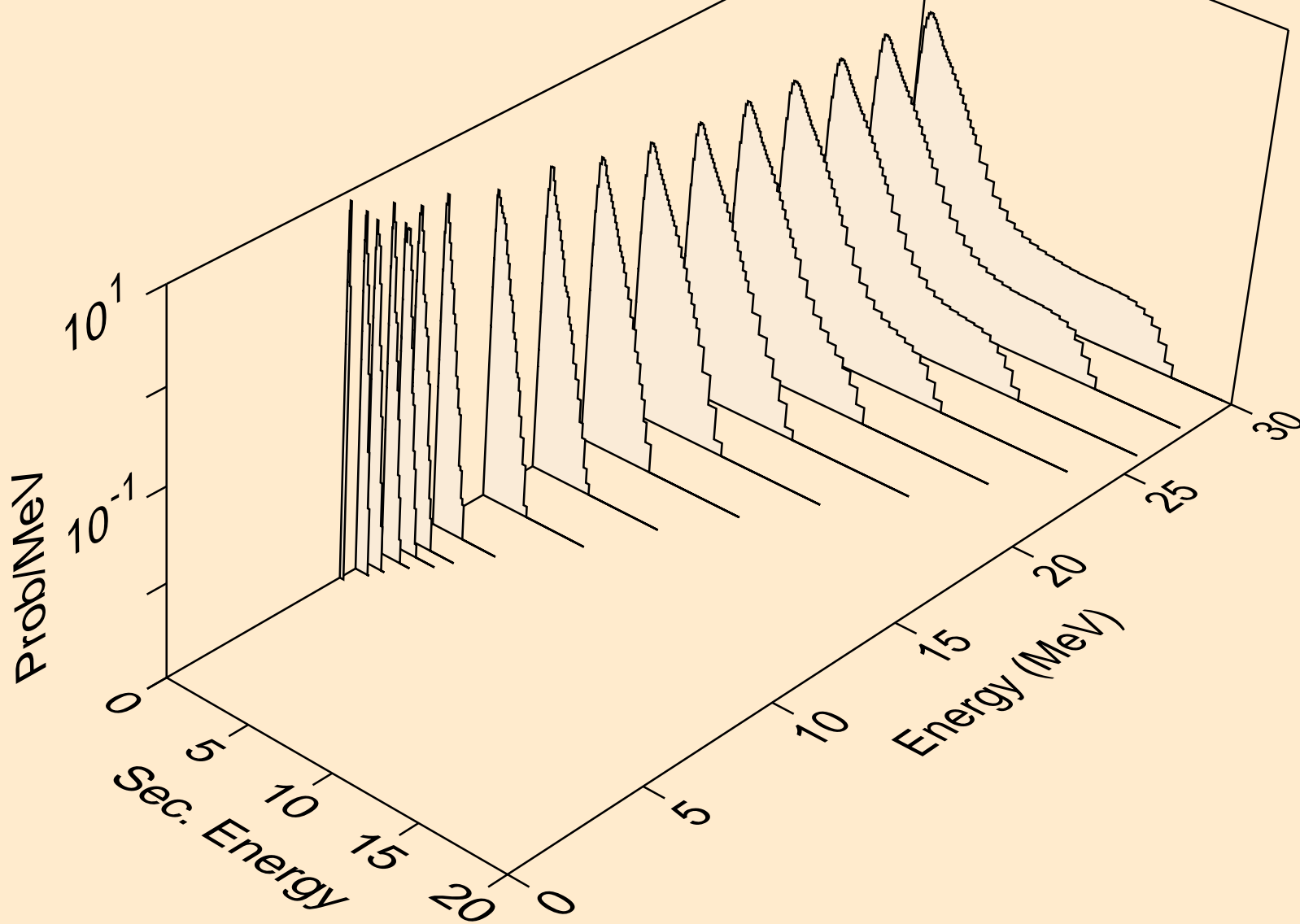

Y083M NEUTRON ACER TENDL-2019 LIBRARY; T=293.16K  
Neutron emission for (n,2n)a

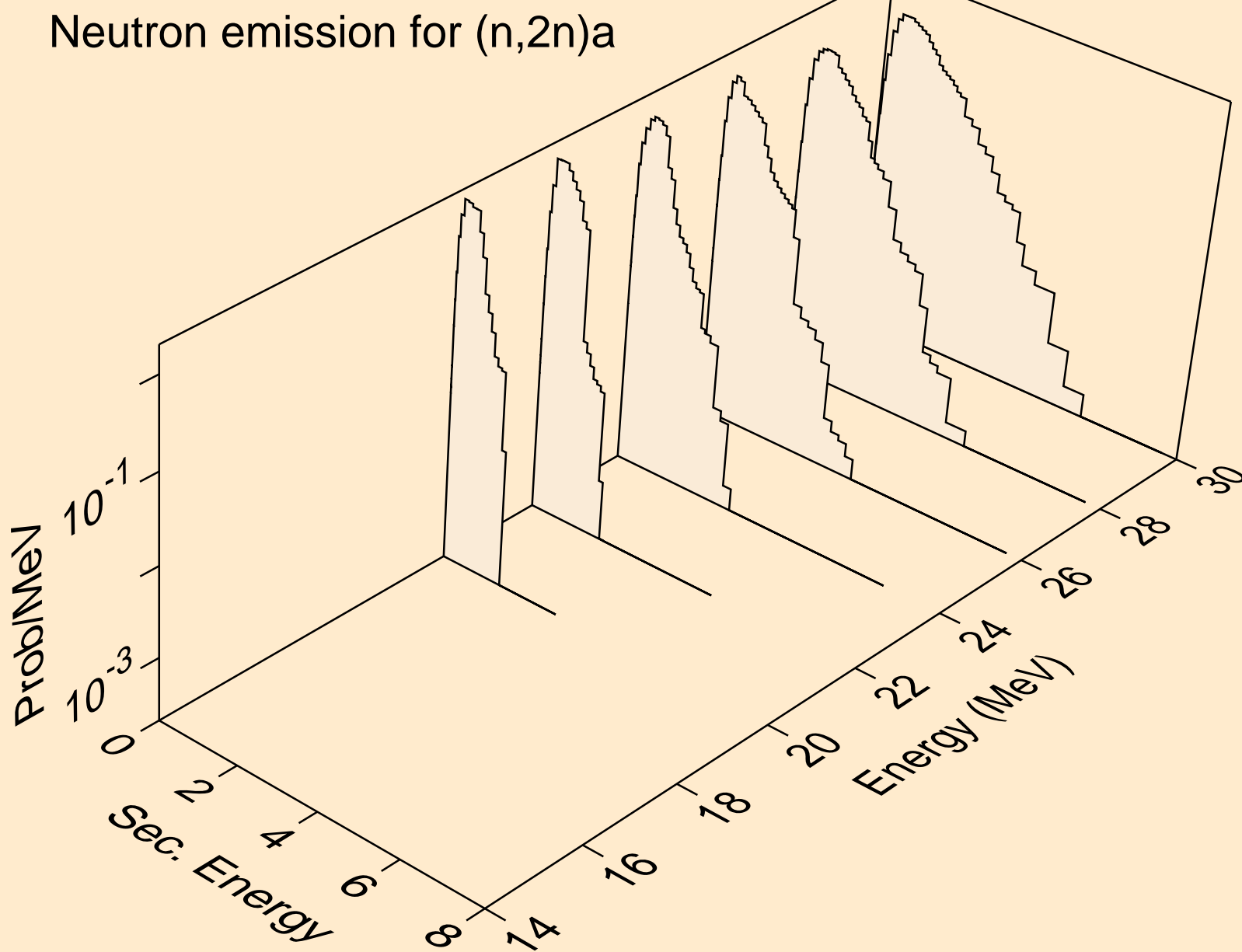

Y083M NEUTRON ACER TENDL-2019 LIBRARY; T=293.16K  
Neutron emission for (n,n\*)p

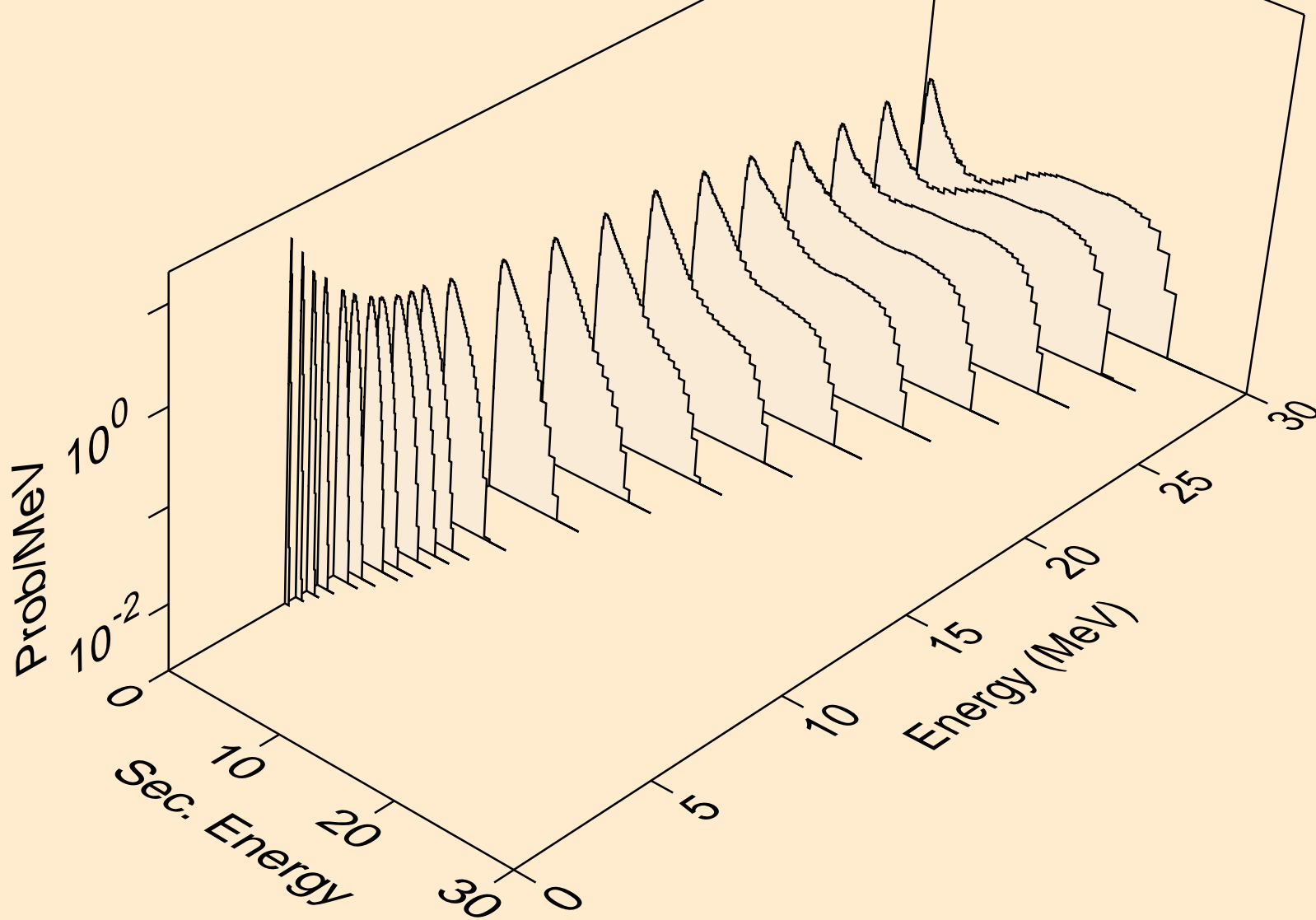

Y083M NEUTRON ACER TENDL-2019 LIBRARY; T=293.16K  
Neutron emission for (n,n\*)2a

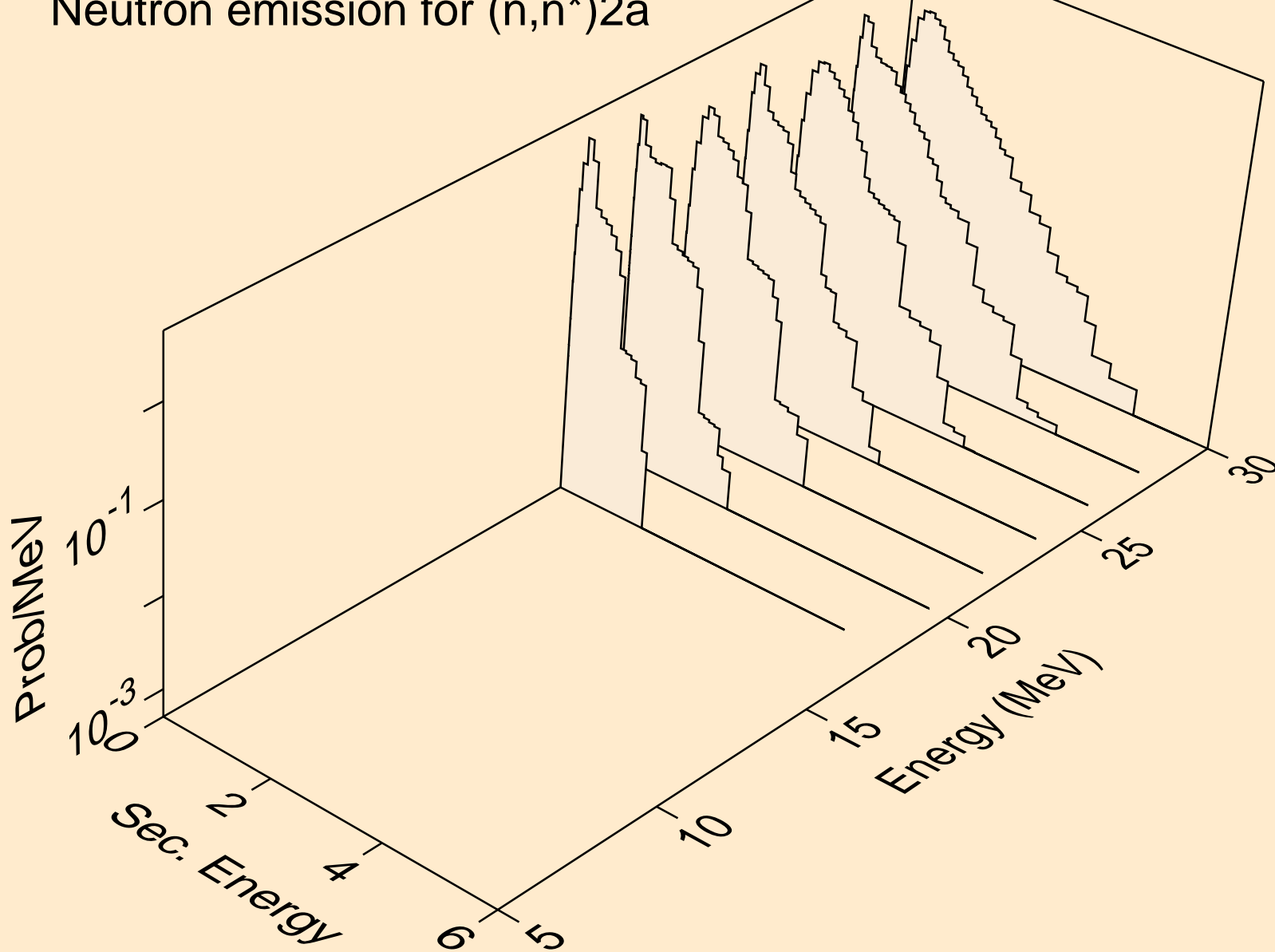

Y083M NEUTRON ACER TENDL-2019 LIBRARY; T=293.16K  
Neutron emission for (n,n\*)d

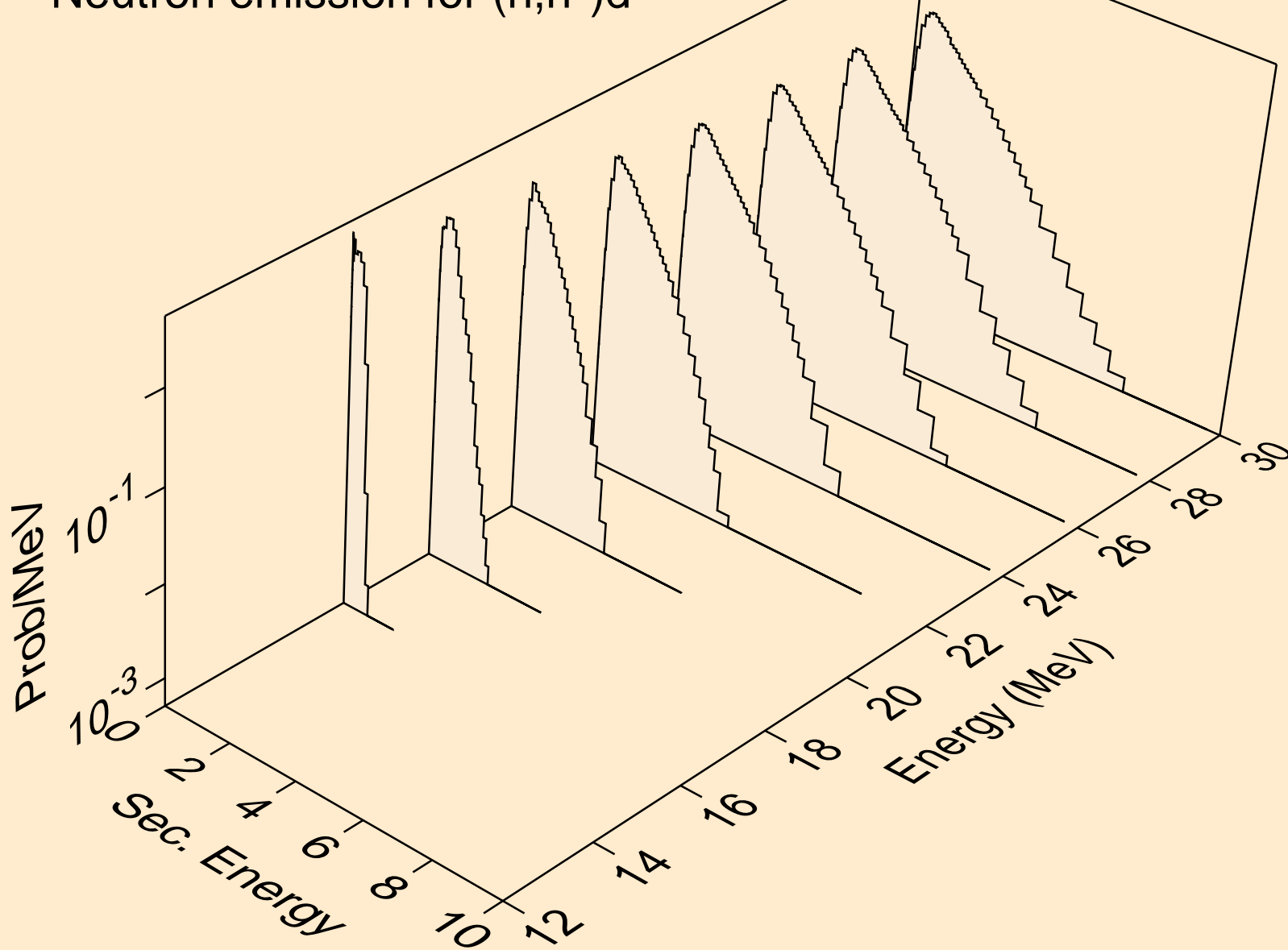

Y083M NEUTRON ACER TENDL-2019 LIBRARY; T=293.16K  
Neutron emission for (n,n\*)t

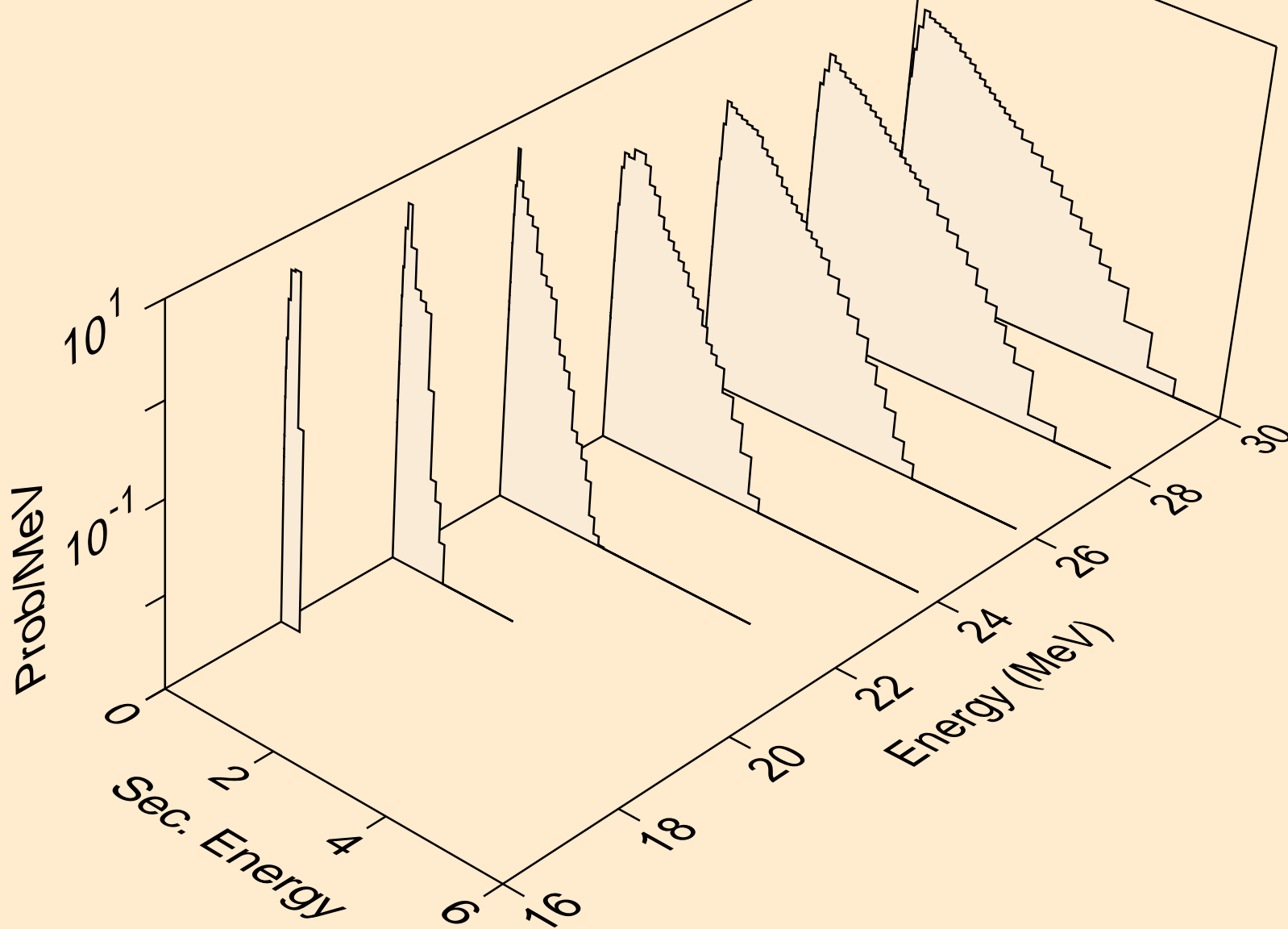

Y083M NEUTRON ACER TENDL-2019 LIBRARY; T=293.16K  
Neutron emission for (n,n\*)he3

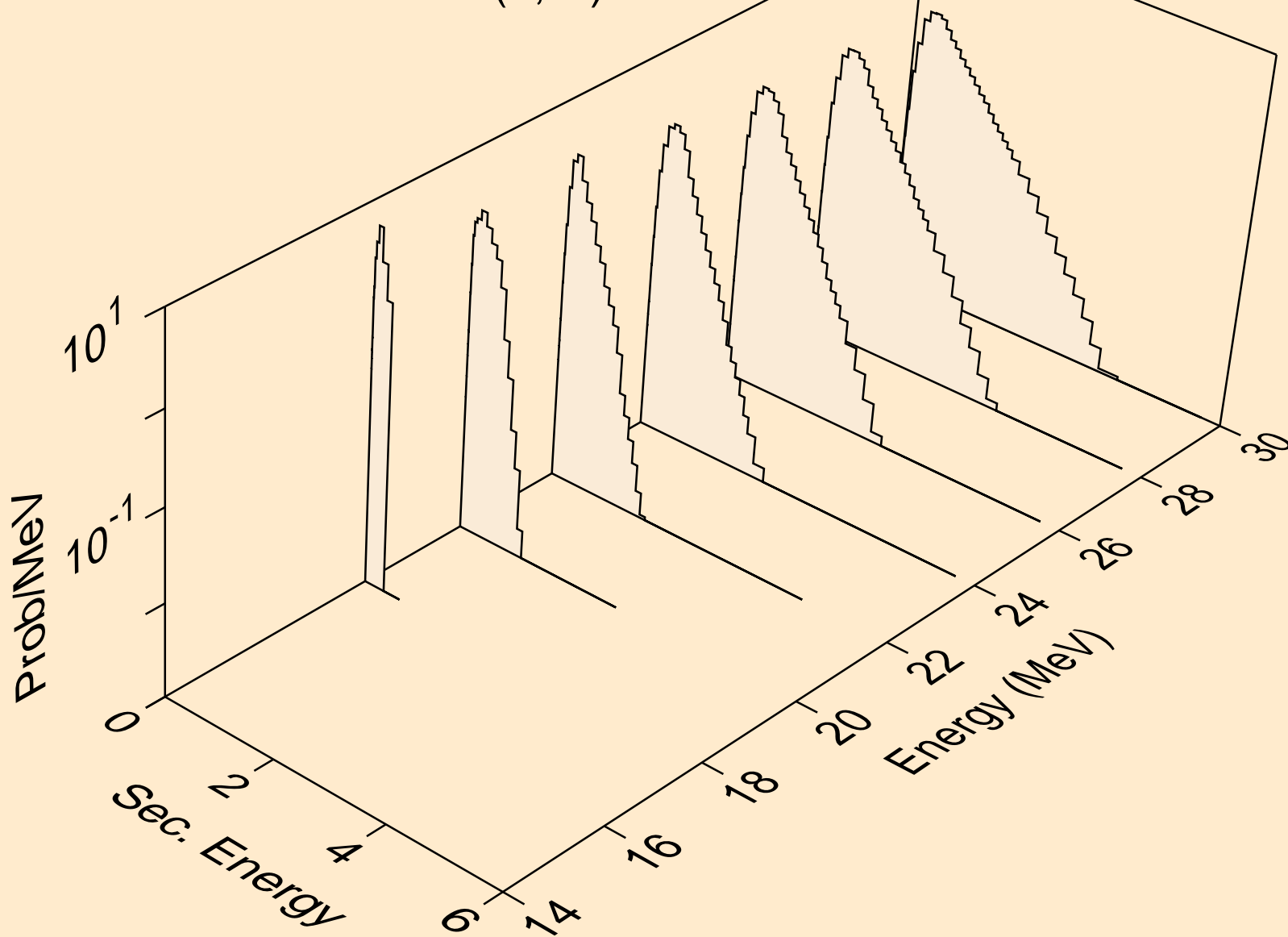

Y083M NEUTRON ACER TENDL-2019 LIBRARY; T=293.16K  
Neutron emission for (n,2np)

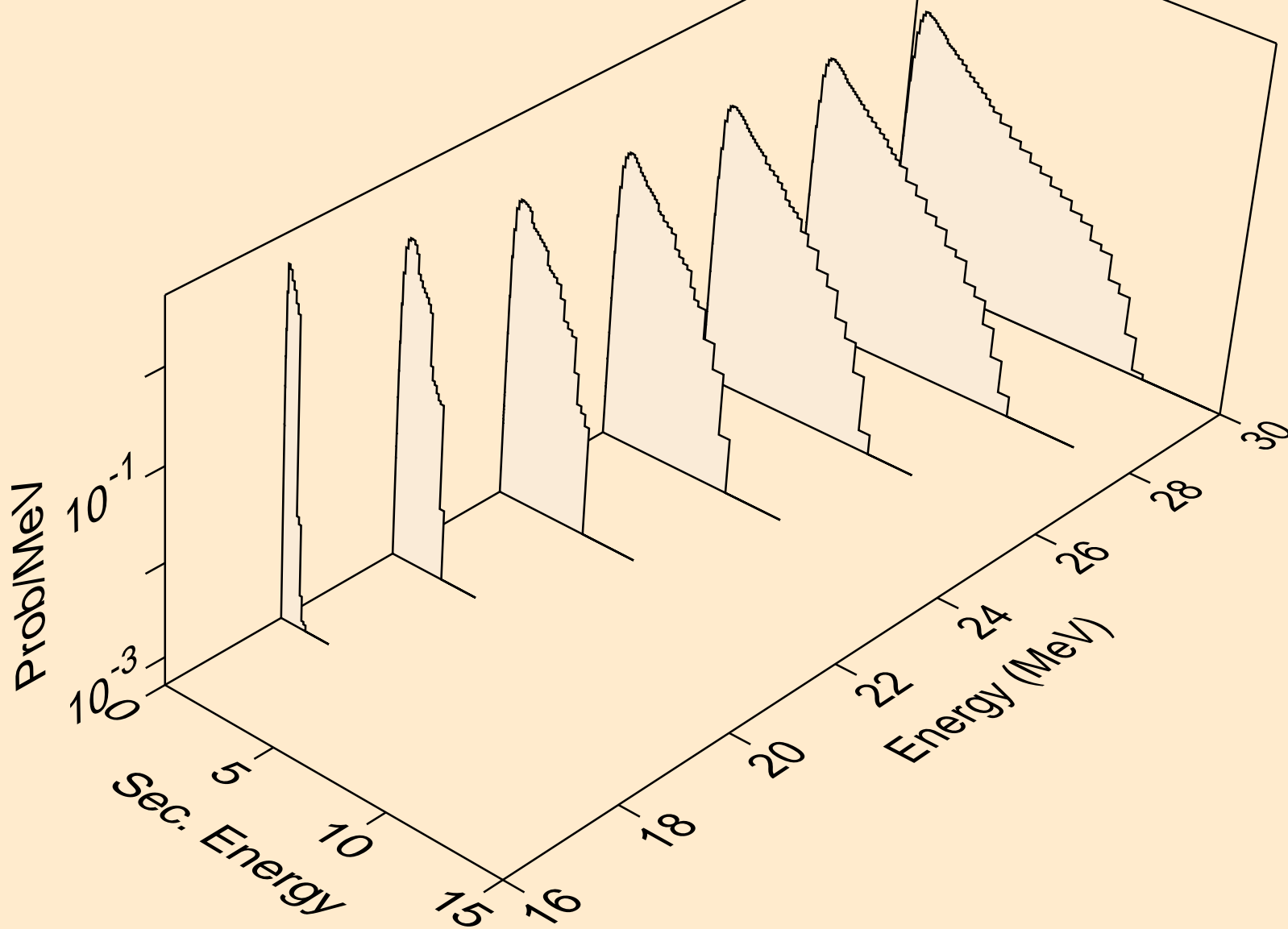



Y083M NEUTRON ACER TENDL-2019 LIBRARY; T=293.16K  
Neutron emission for (n,3np)

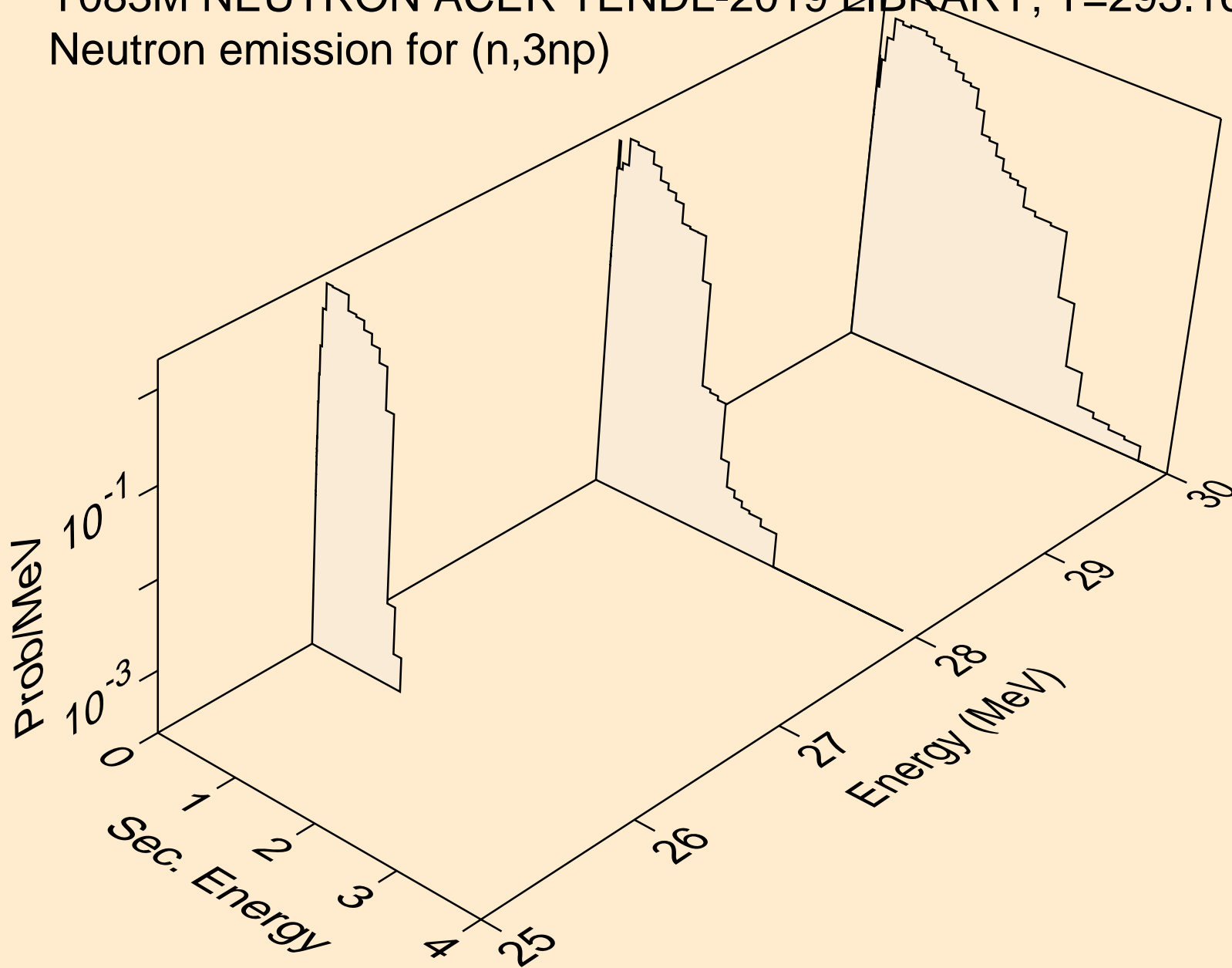

Y083M NEUTRON ACER TENDL-2019 LIBRARY; T=293.16K  
Neutron emission for (n,2np)

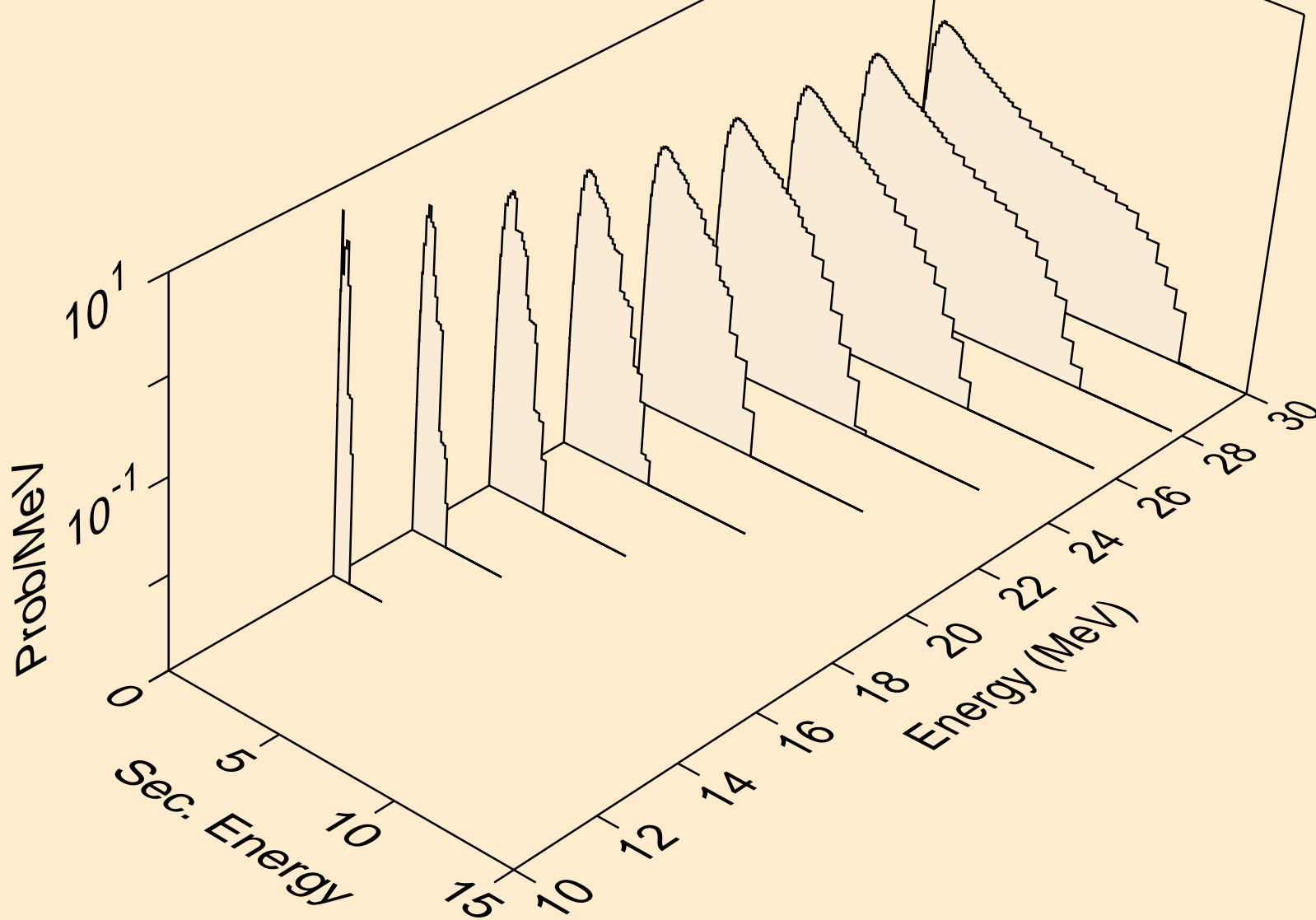

Y083M NEUTRON ACER TENDL-2019 LIBRARY; T=293.16K  
Neutron emission for (n,npa)

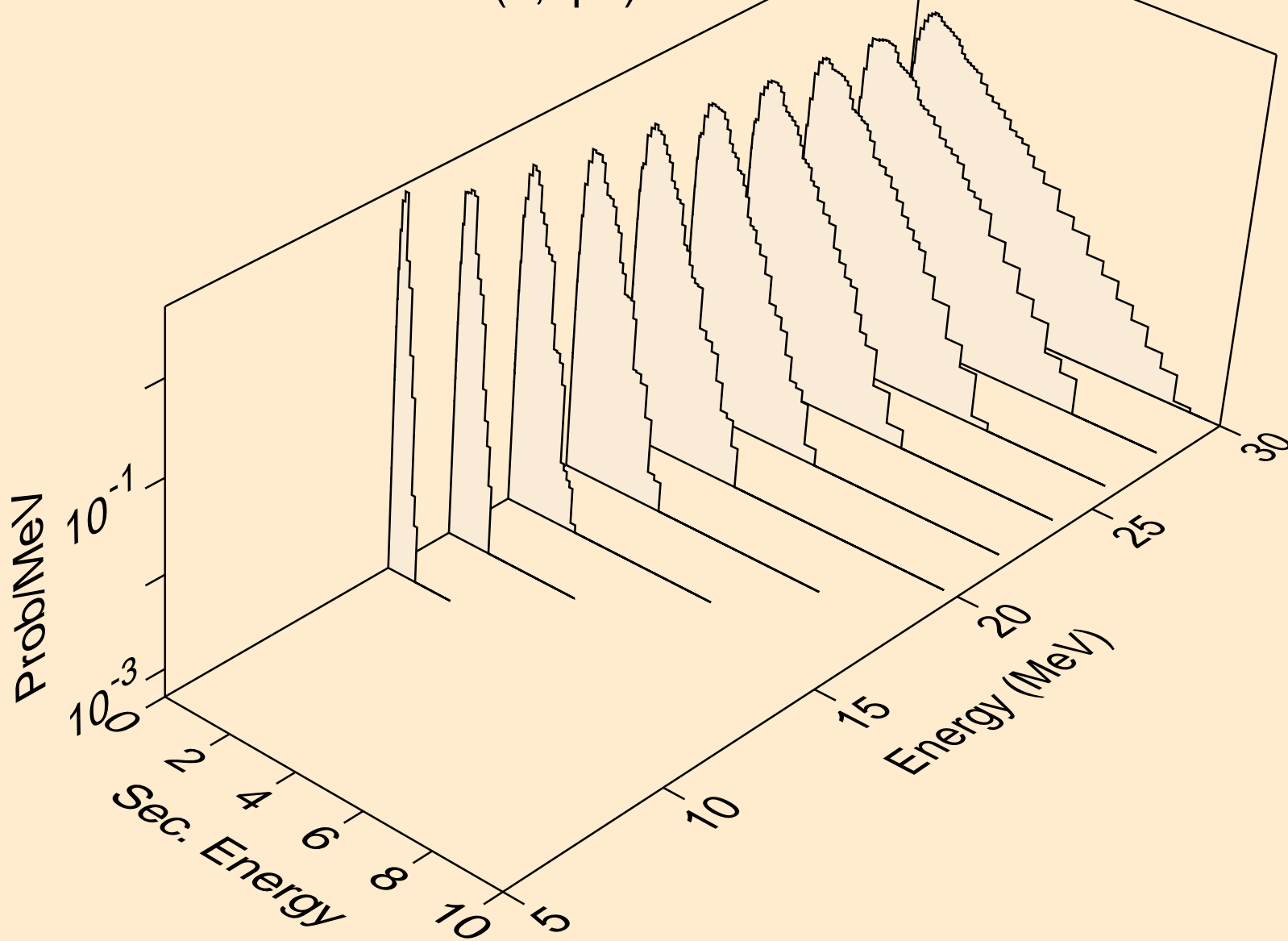

Y083M NEUTRON ACER TENDL-2019 LIBRARY; T=293.16K  
Neutron emission for (n,n\*c)

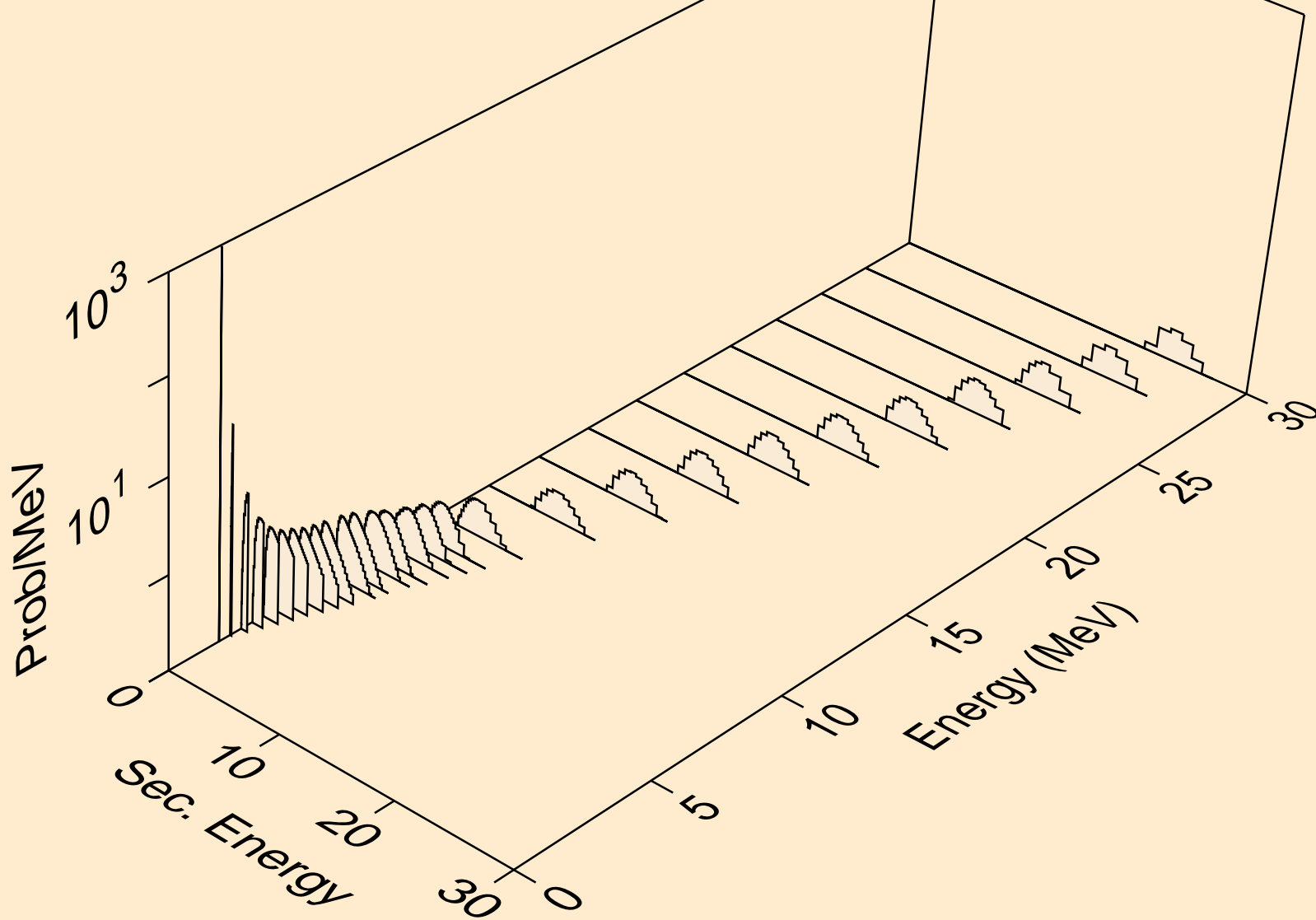

Y083M NEUTRON ACER TENDL-2019 LIBRARY; T=293.16K  
Photon emission for (n,x)

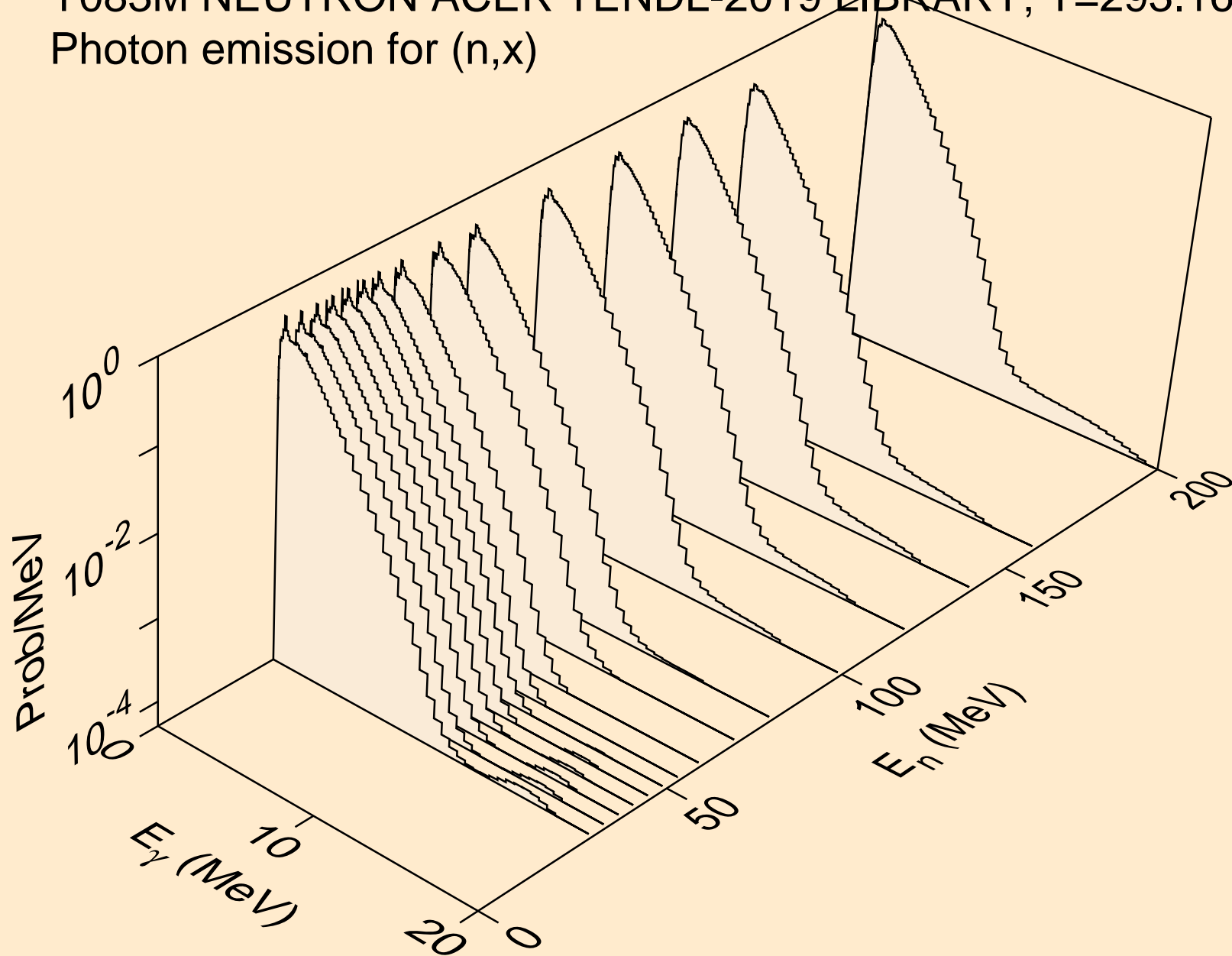

Y083M NEUTRON ACER TENDL-2019 LIBRARY; T=293.16K  
Photon emission for (n,2nd)

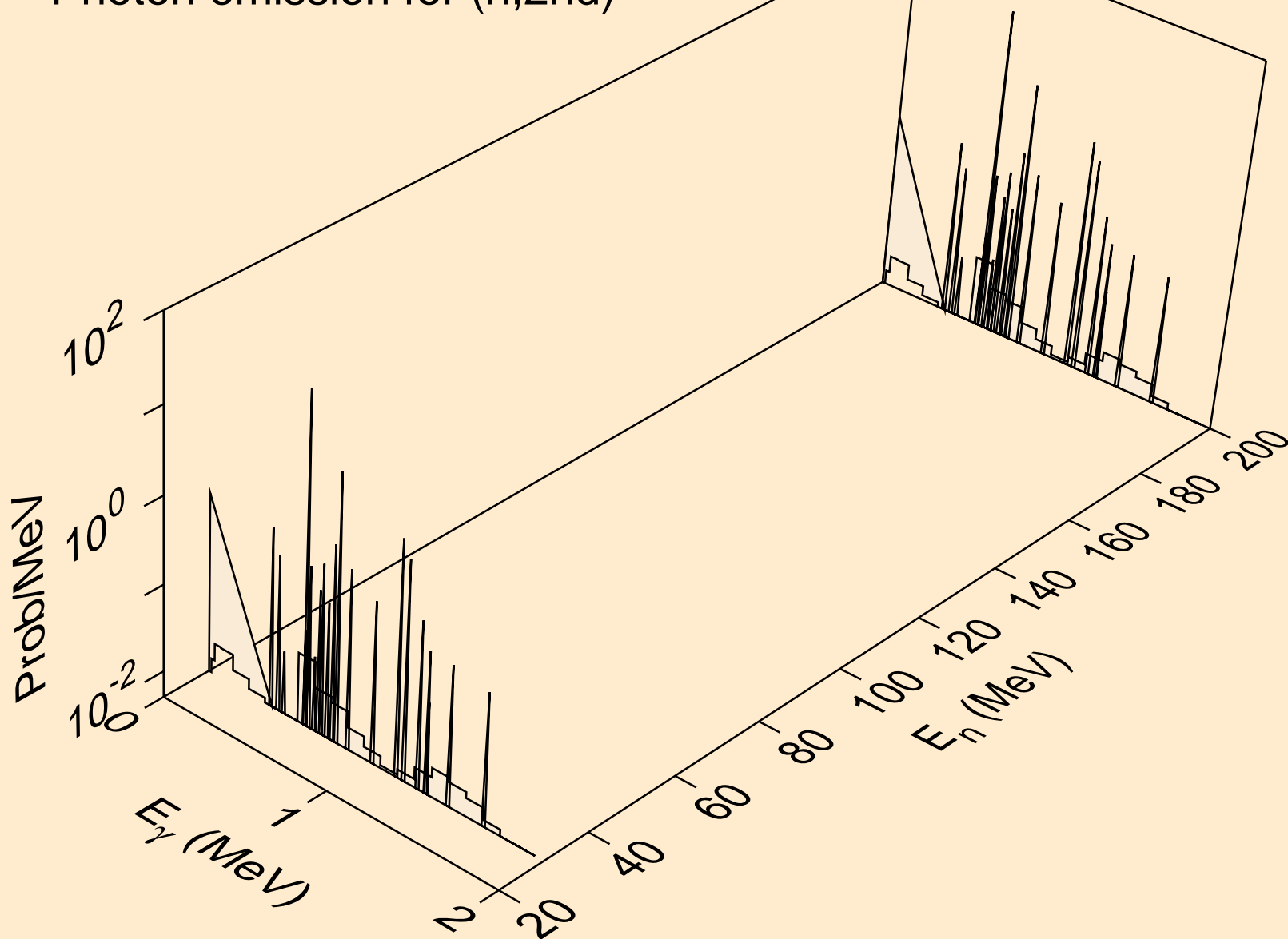

Y083M NEUTRON ACER TENDL-2019 LIBRARY; T=293.16K  
Photon emission for (n,2n)

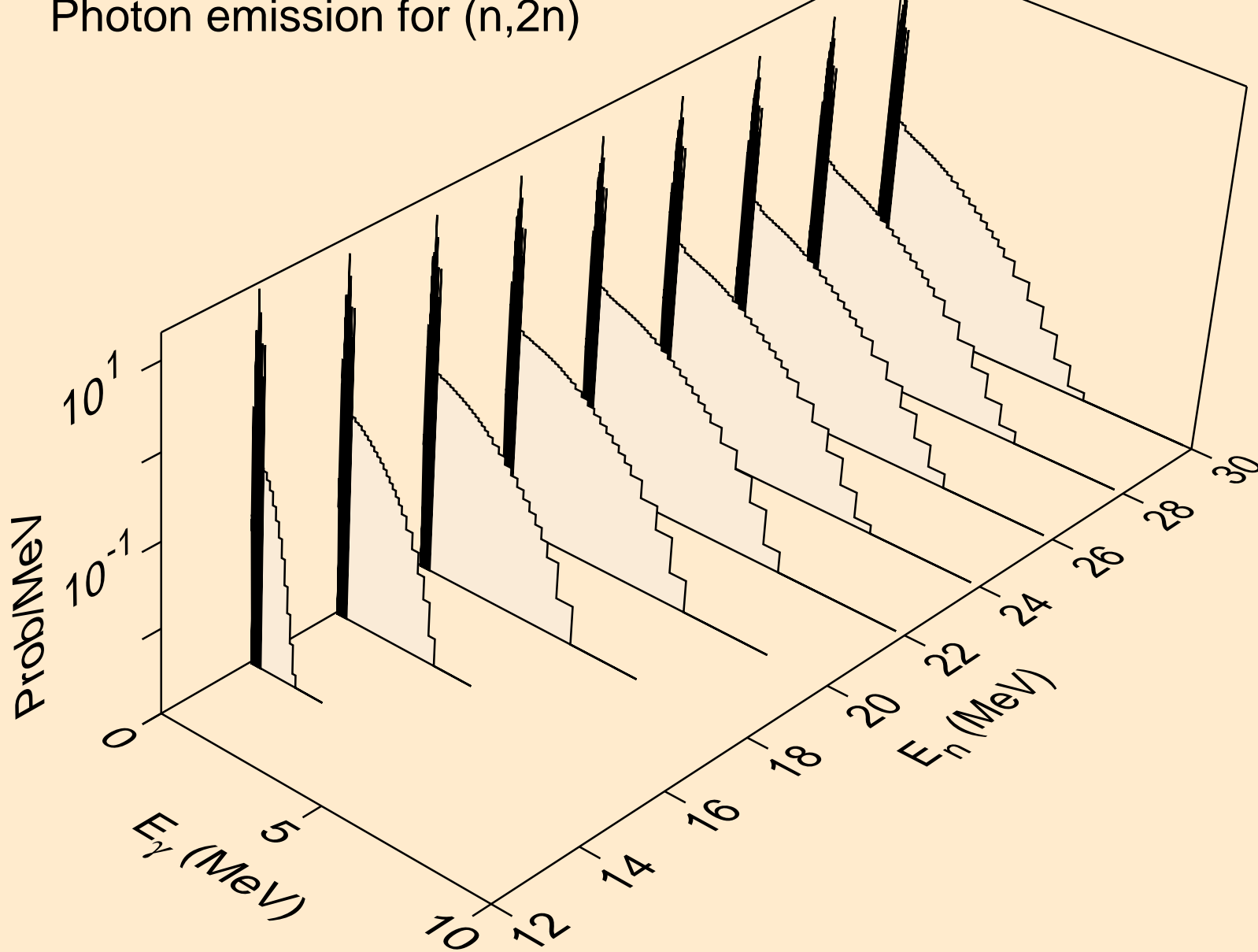

Y083M NEUTRON ACER TENDL-2019 LIBRARY; T=293.16K  
Photon emission for (n,3n)

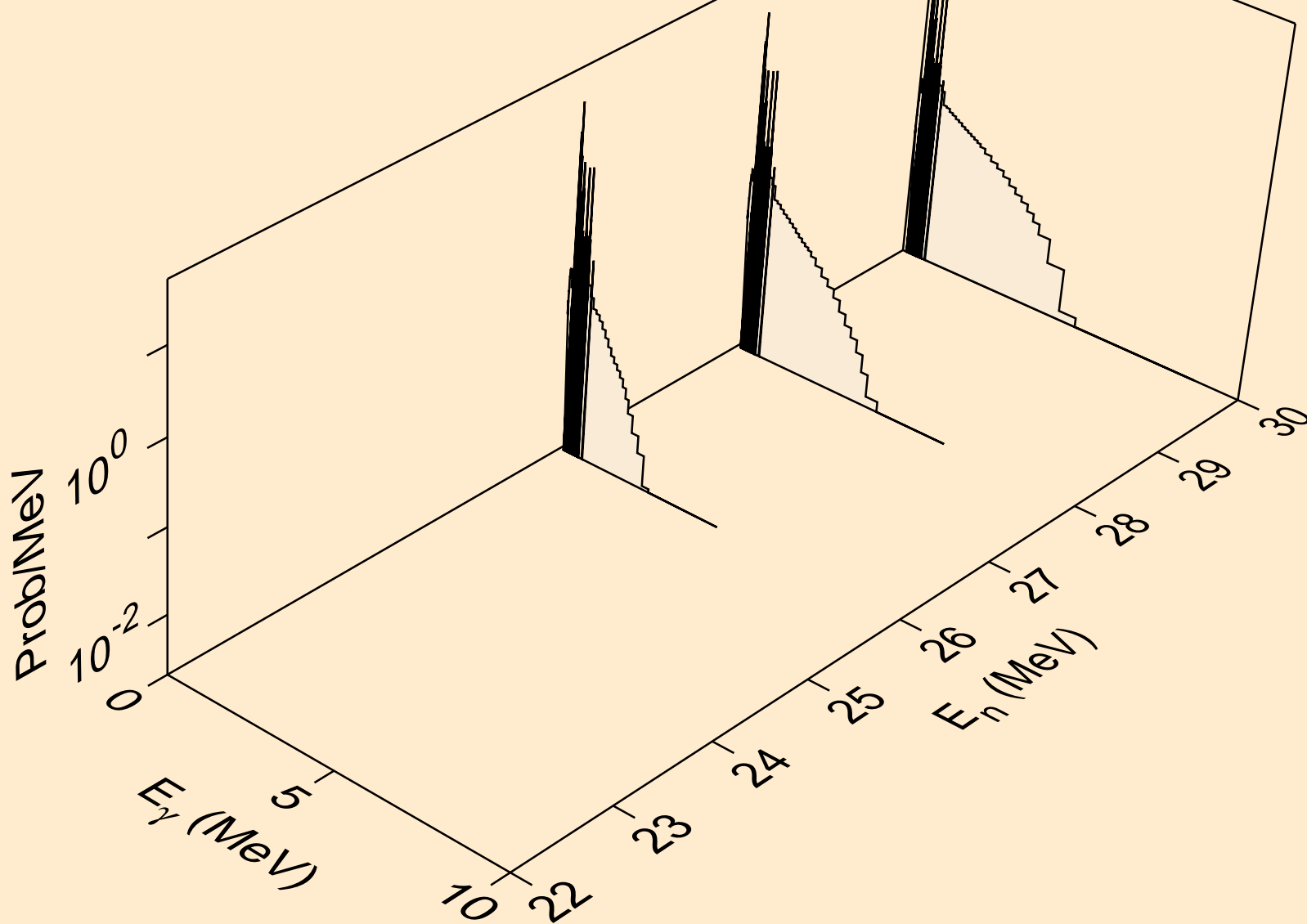



Y083M NEUTRON ACER TENDL-2019 LIBRARY; T=293.16K  
Photon emission for (n,n\*)a

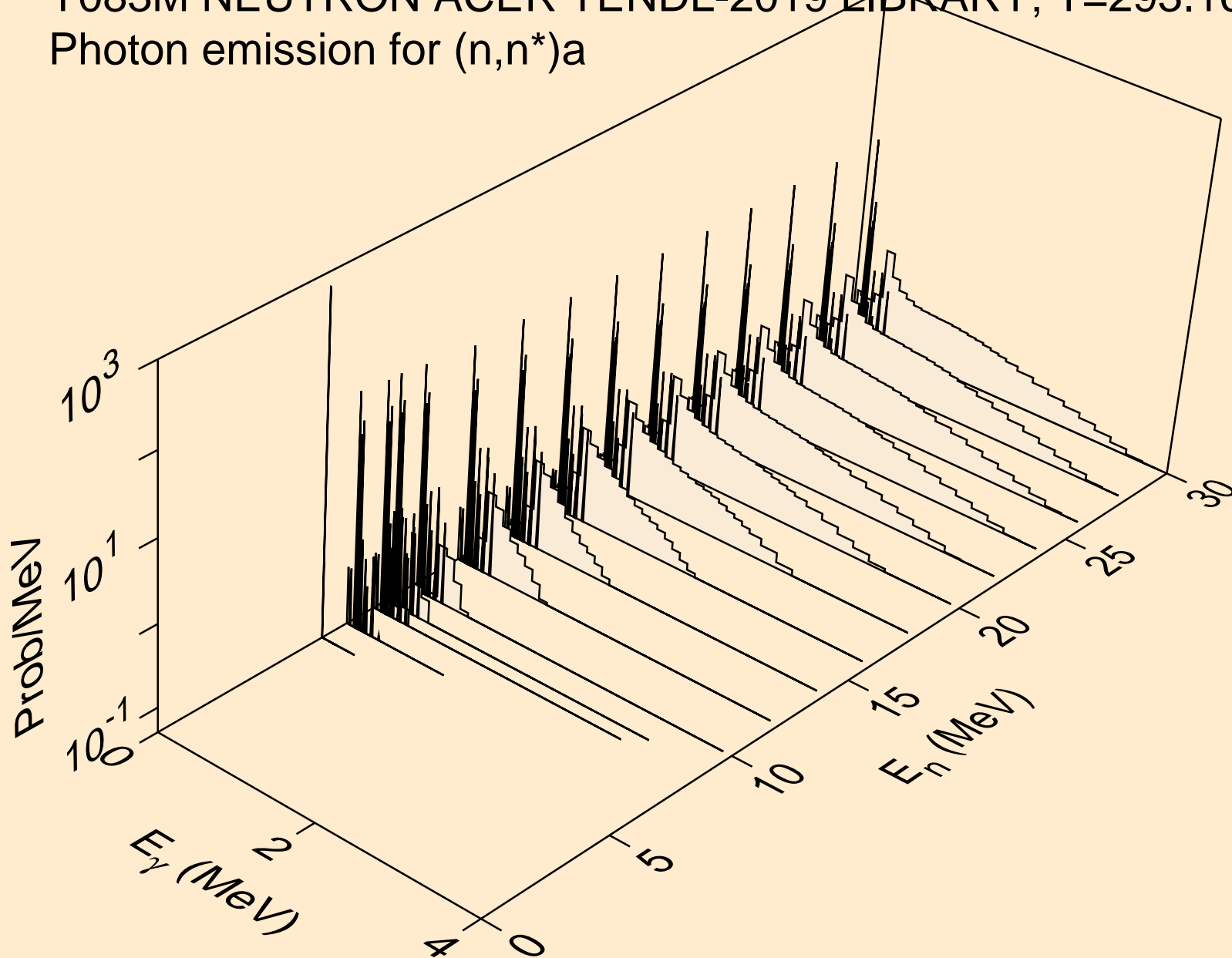

Y083M NEUTRON ACER TENDL-2019 LIBRARY; T=293.16K  
Photon emission for (n,2n)a

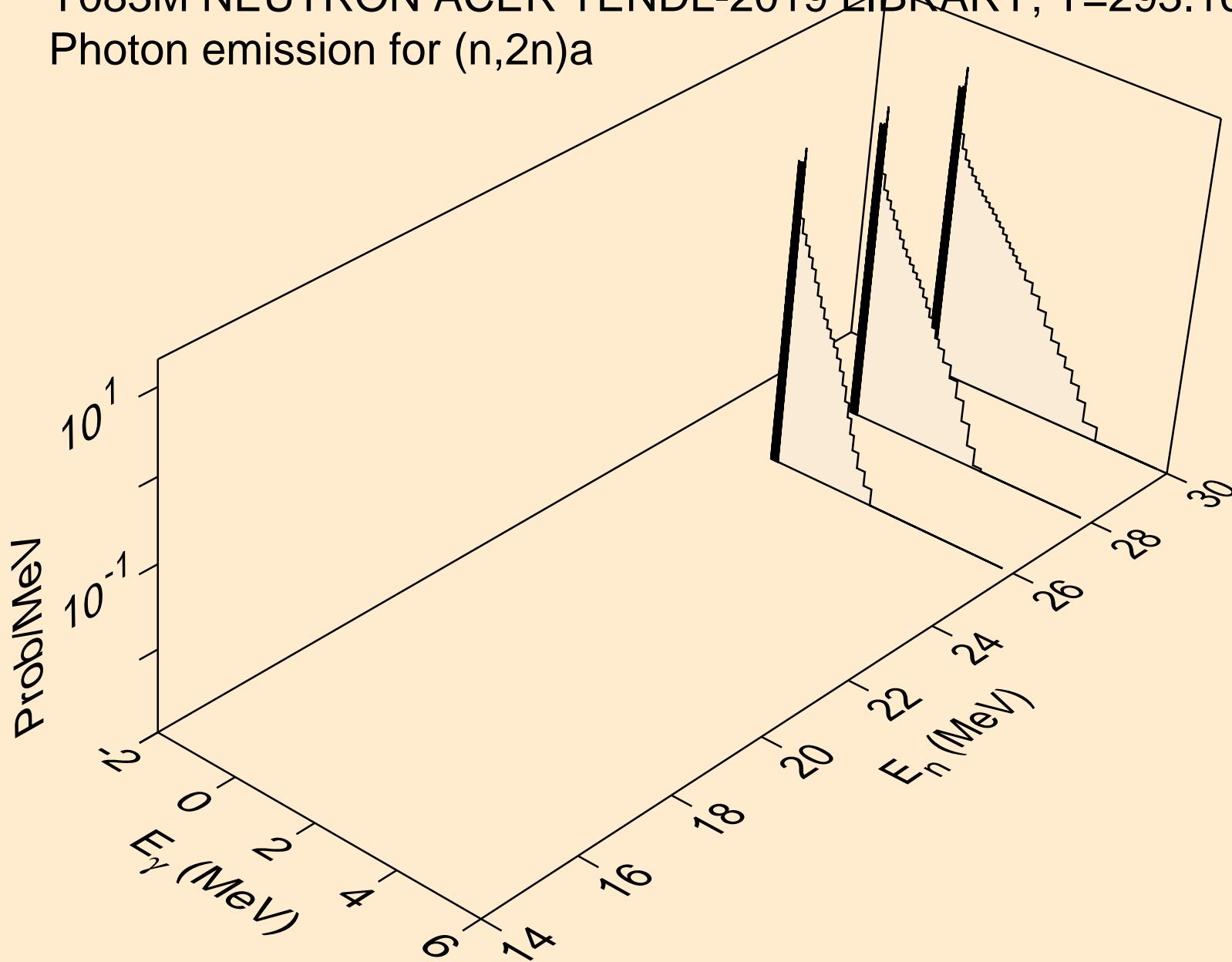

Y083M NEUTRON ACER TENDL-2019 LIBRARY; T=293.16K  
Photon emission for (n,n\*)p

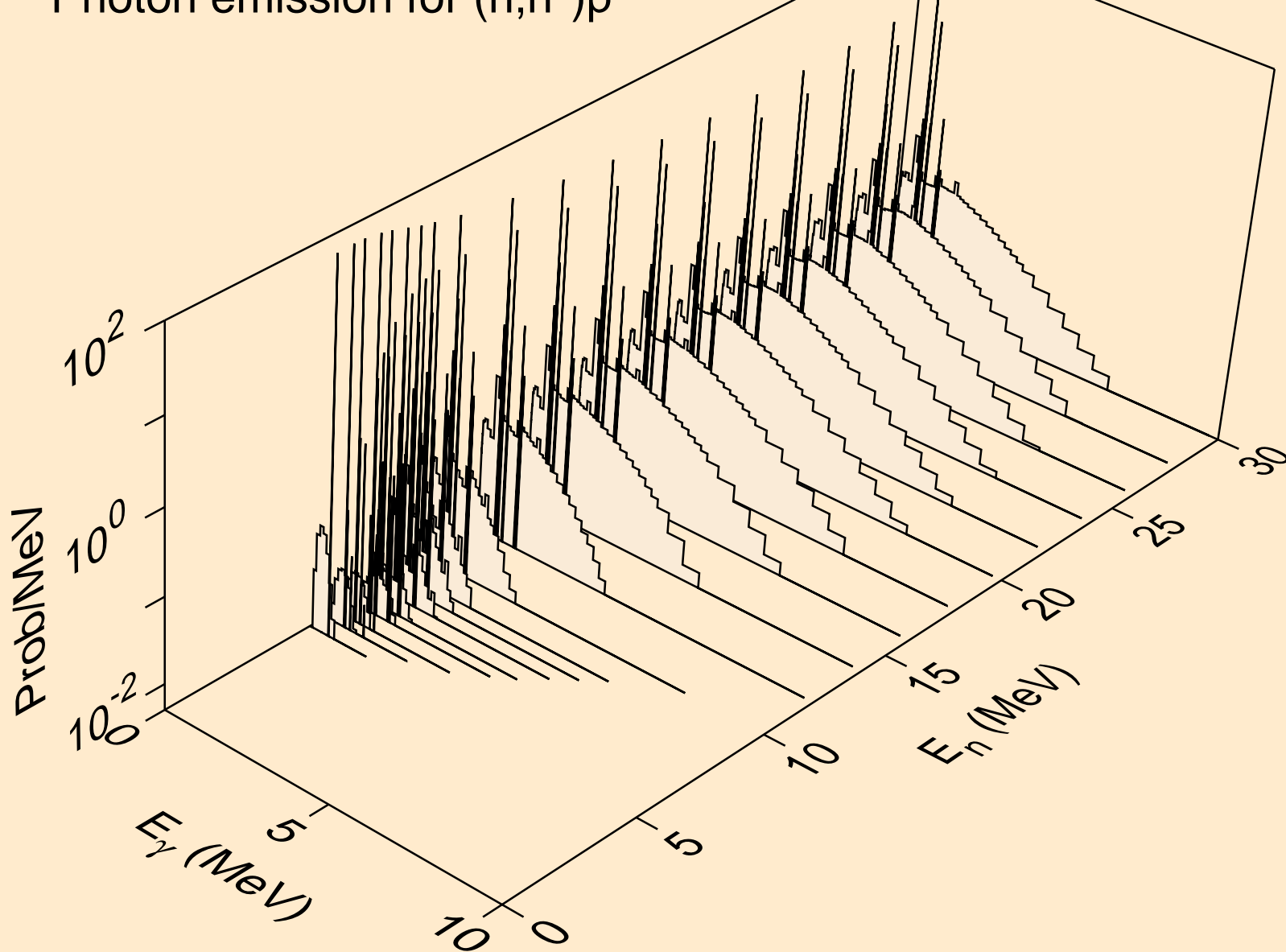

Y083M NEUTRON ACER TENDL-2019 LIBRARY; T=293.16K  
Photon emission for (n,n\*)2a

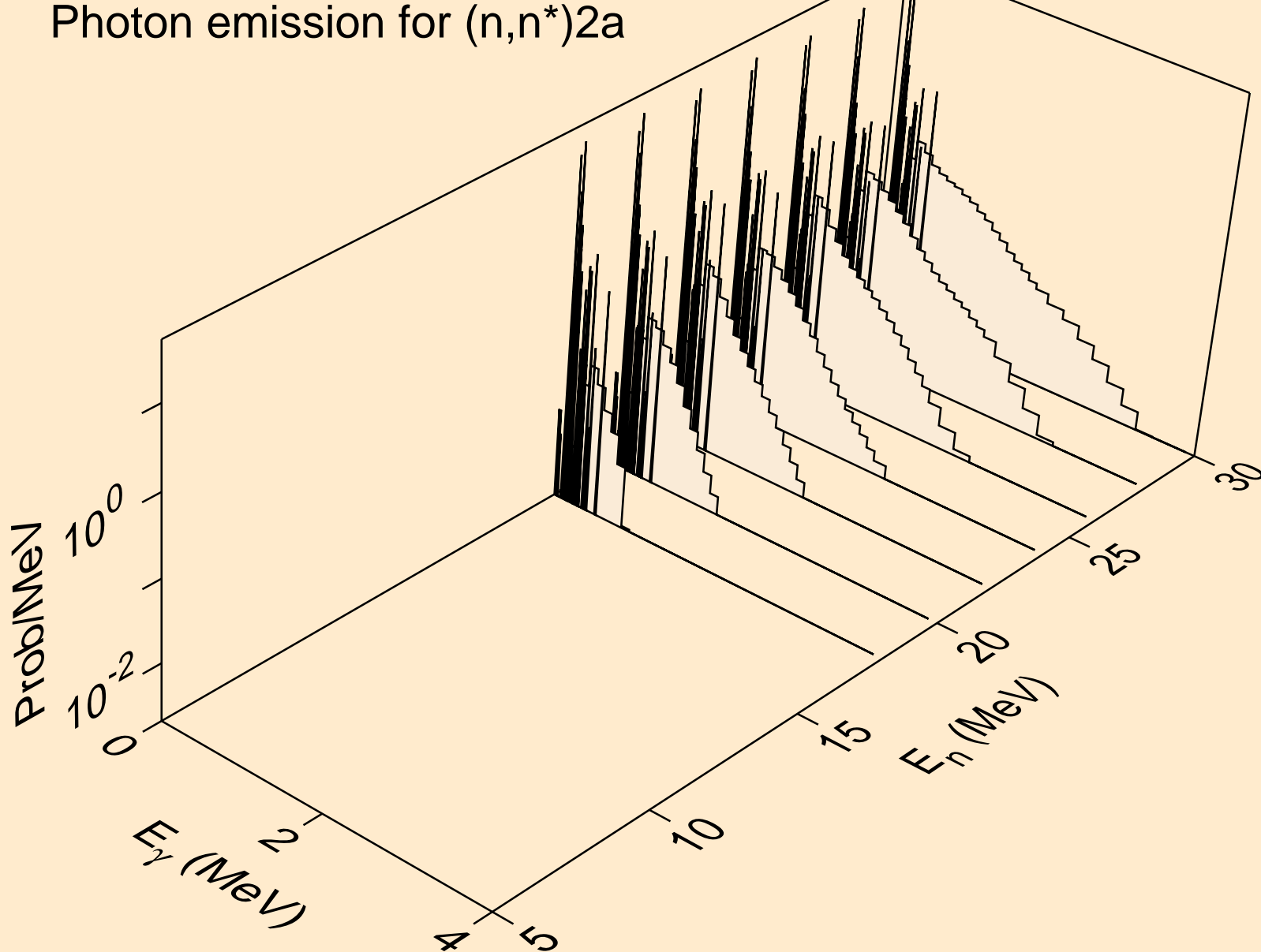

Y083M NEUTRON ACER TENDL-2019 LIBRARY; T=293.16K  
Photon emission for (n,n\*)d

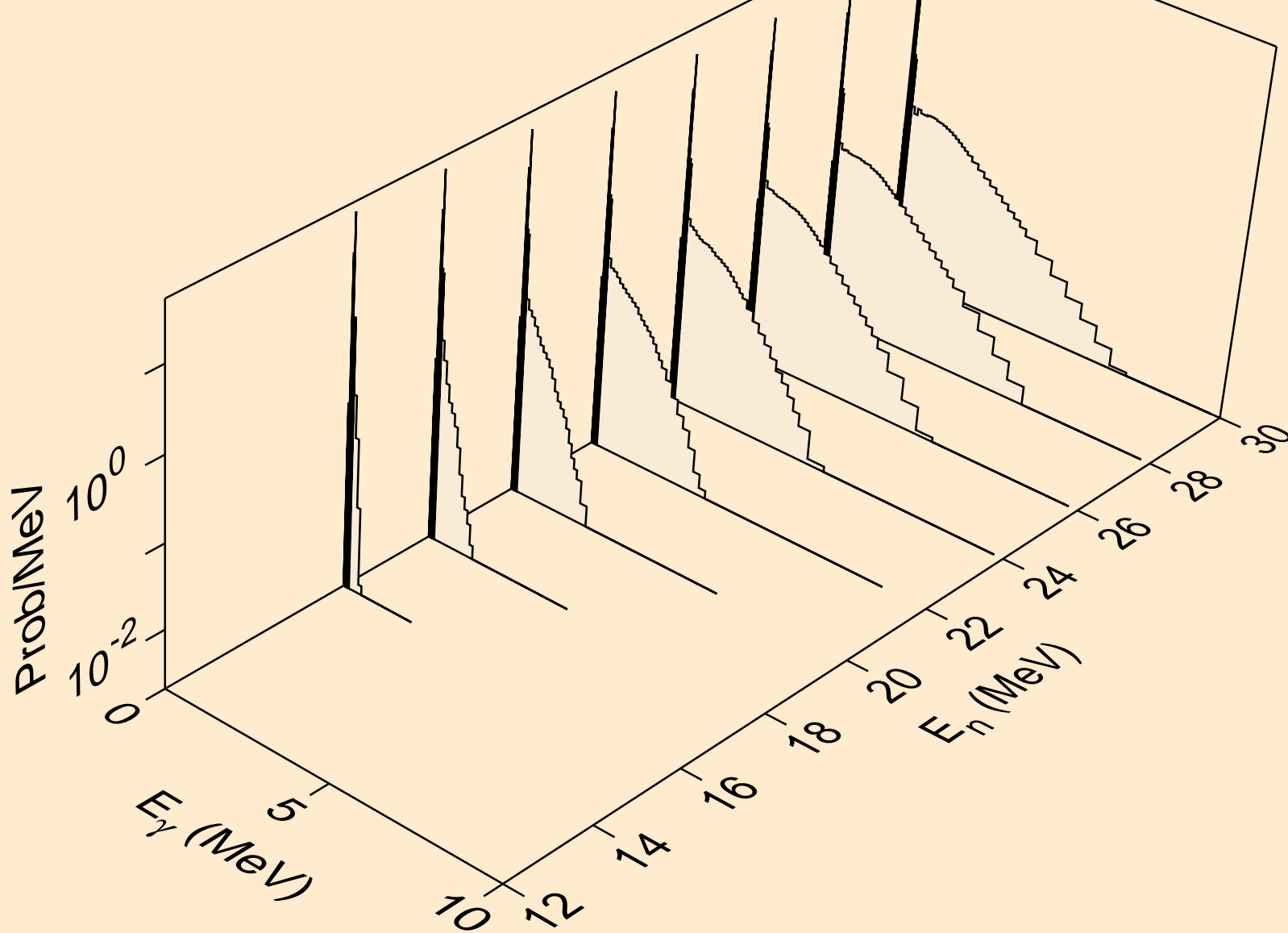

Y083M NEUTRON ACER TENDL-2019 LIBRARY; T=293.16K  
Photon emission for (n,n\*)t

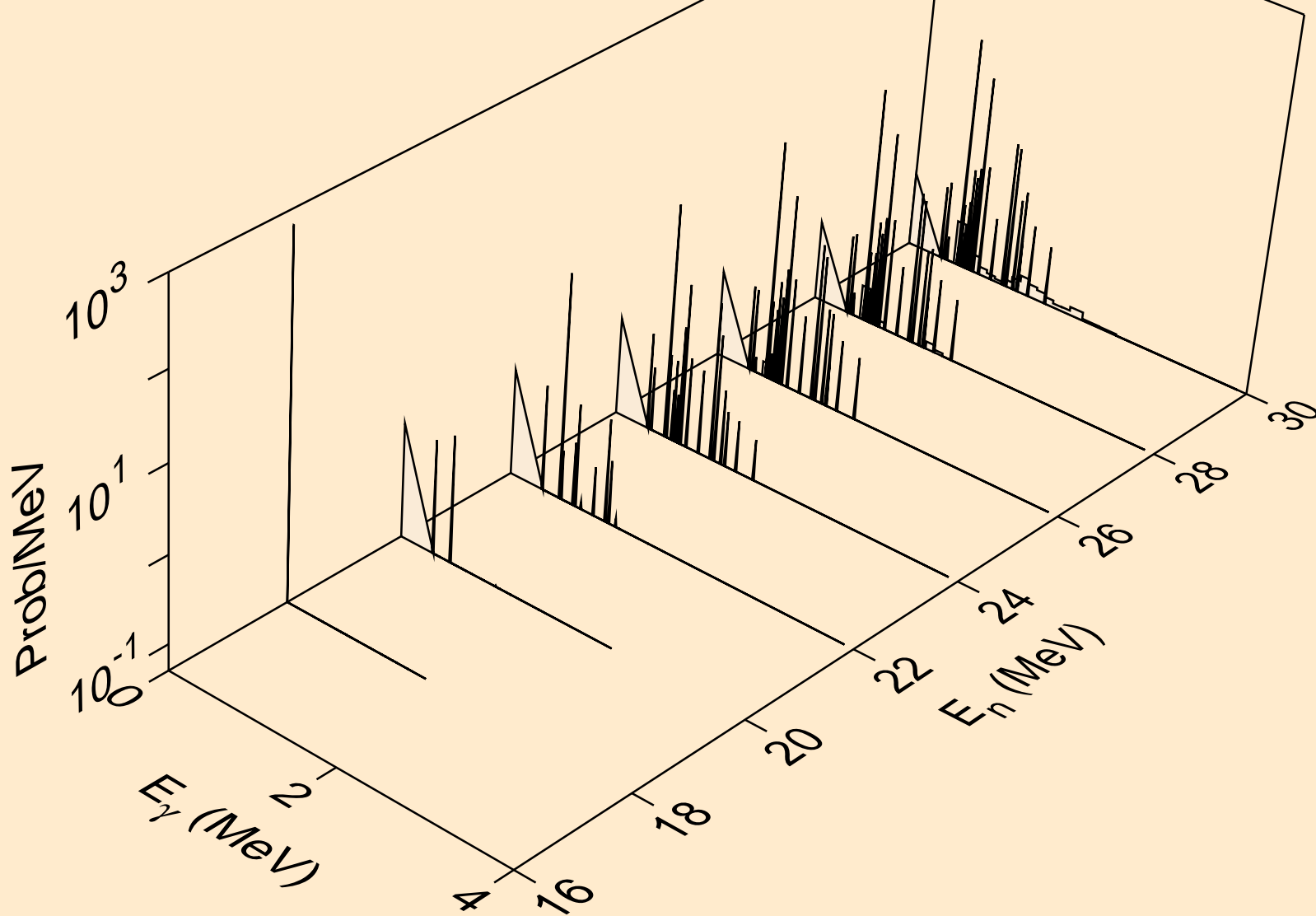

Y083M NEUTRON ACER TENDL-2019 LIBRARY; T=293.16K  
Photon emission for (n,n\*)he3

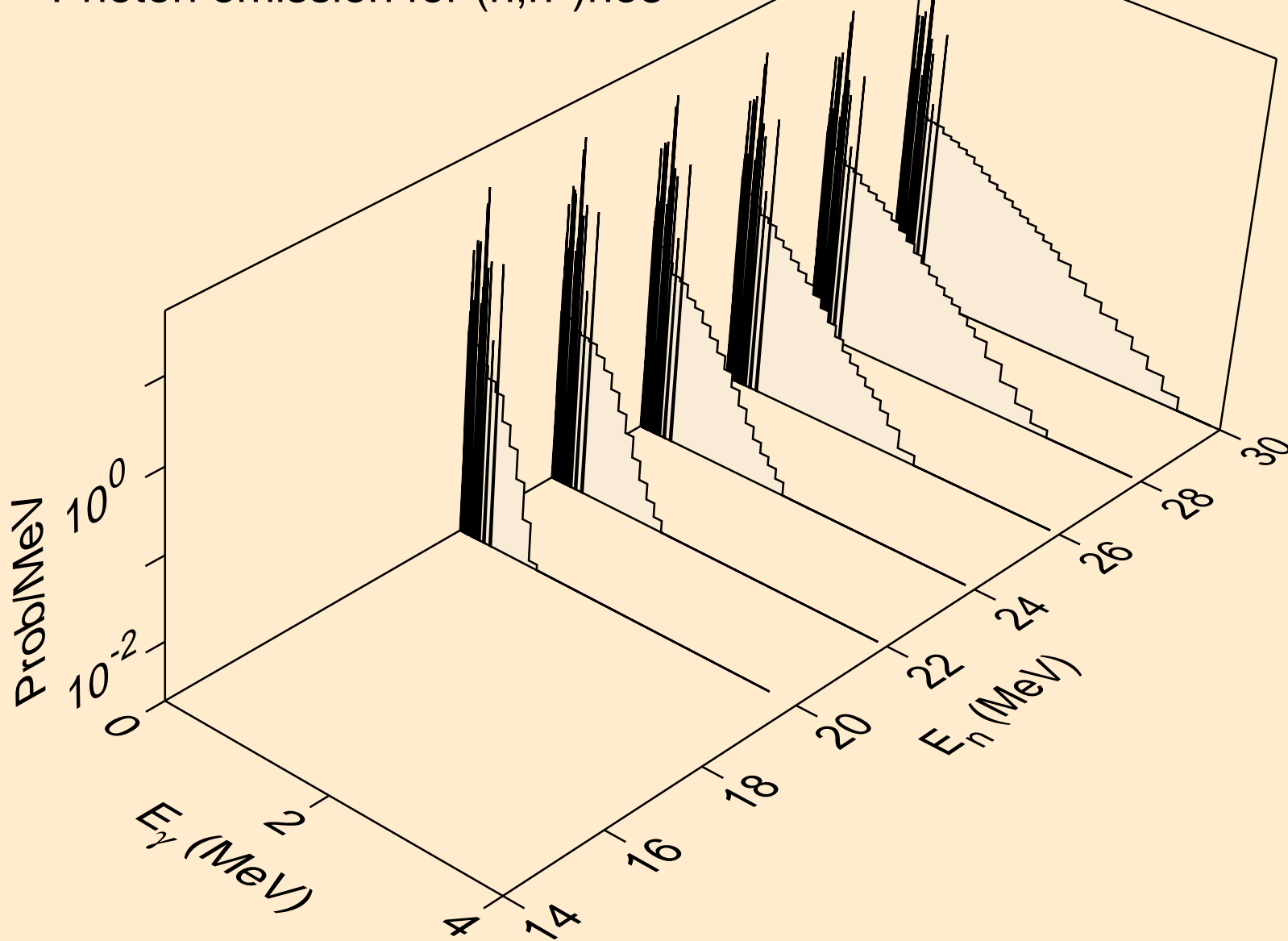

Y083M NEUTRON ACER TENDL-2019 LIBRARY; T=293.16K  
Photon emission for (n,2np)

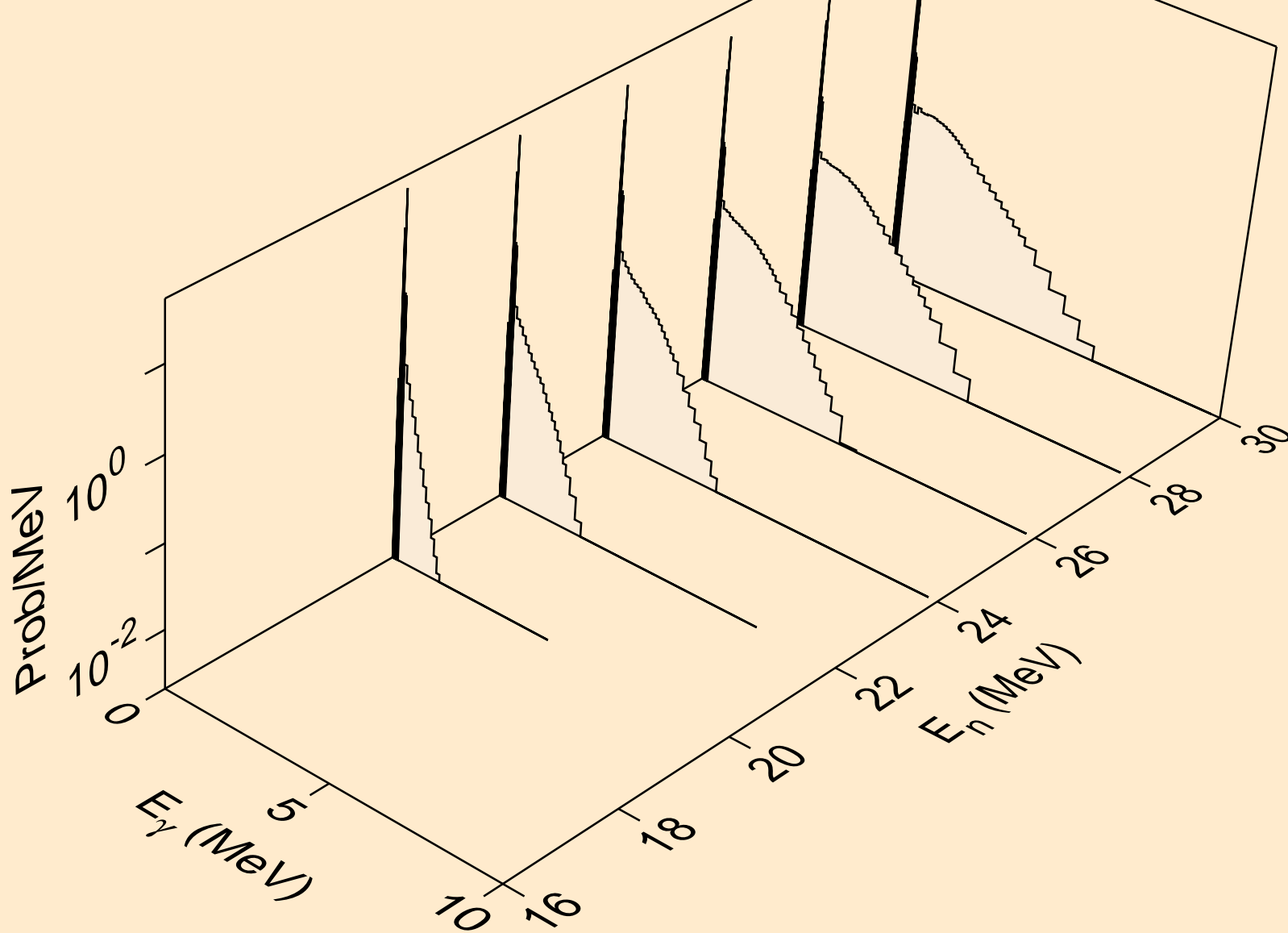



Y083M NEUTRON ACER TENDL-2019 LIBRARY; T=293.16K  
Photon emission for (n,3np)

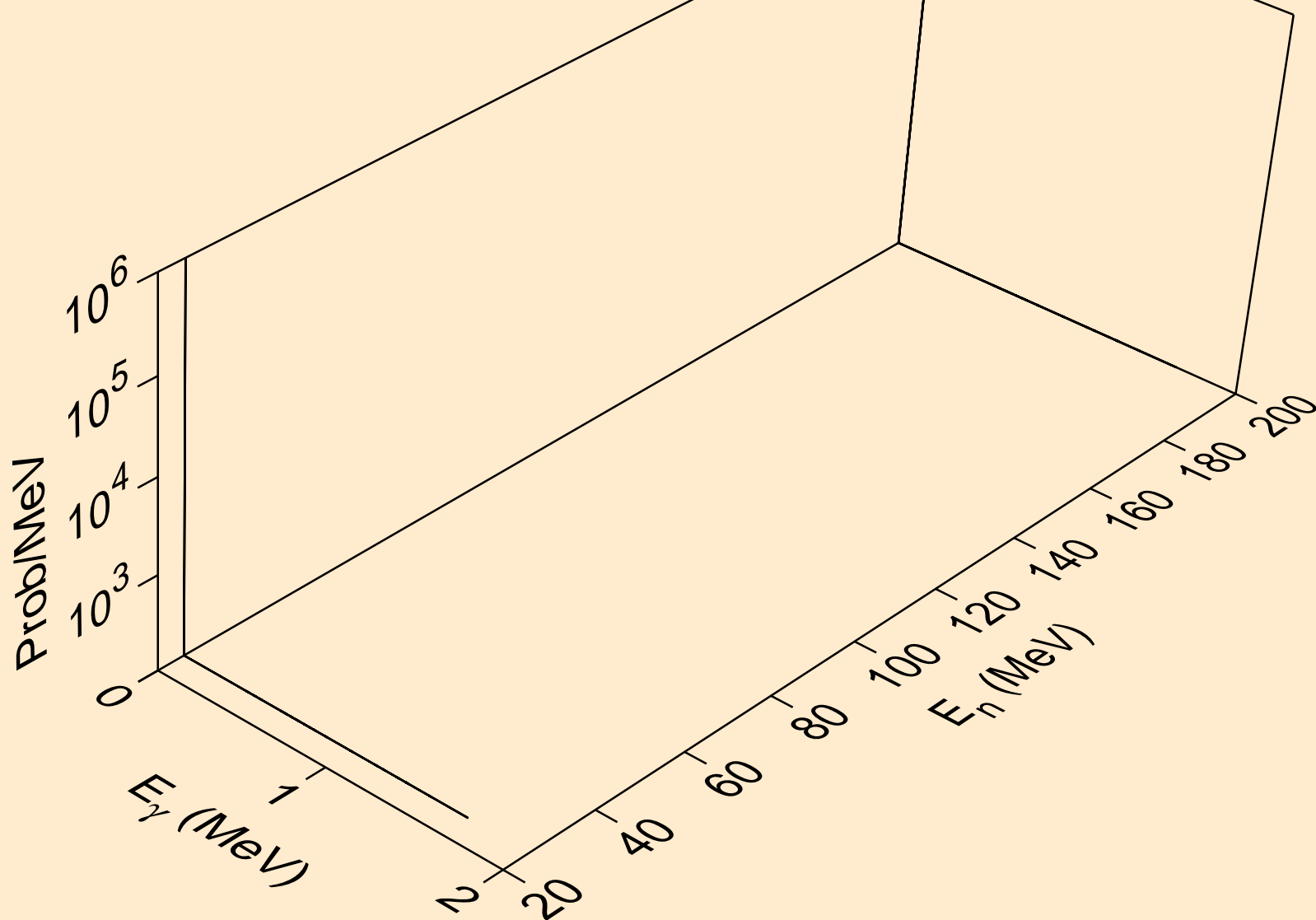

Y083M NEUTRON ACER TENDL-2019 LIBRARY; T=293.16K  
Photon emission for (n,2np)

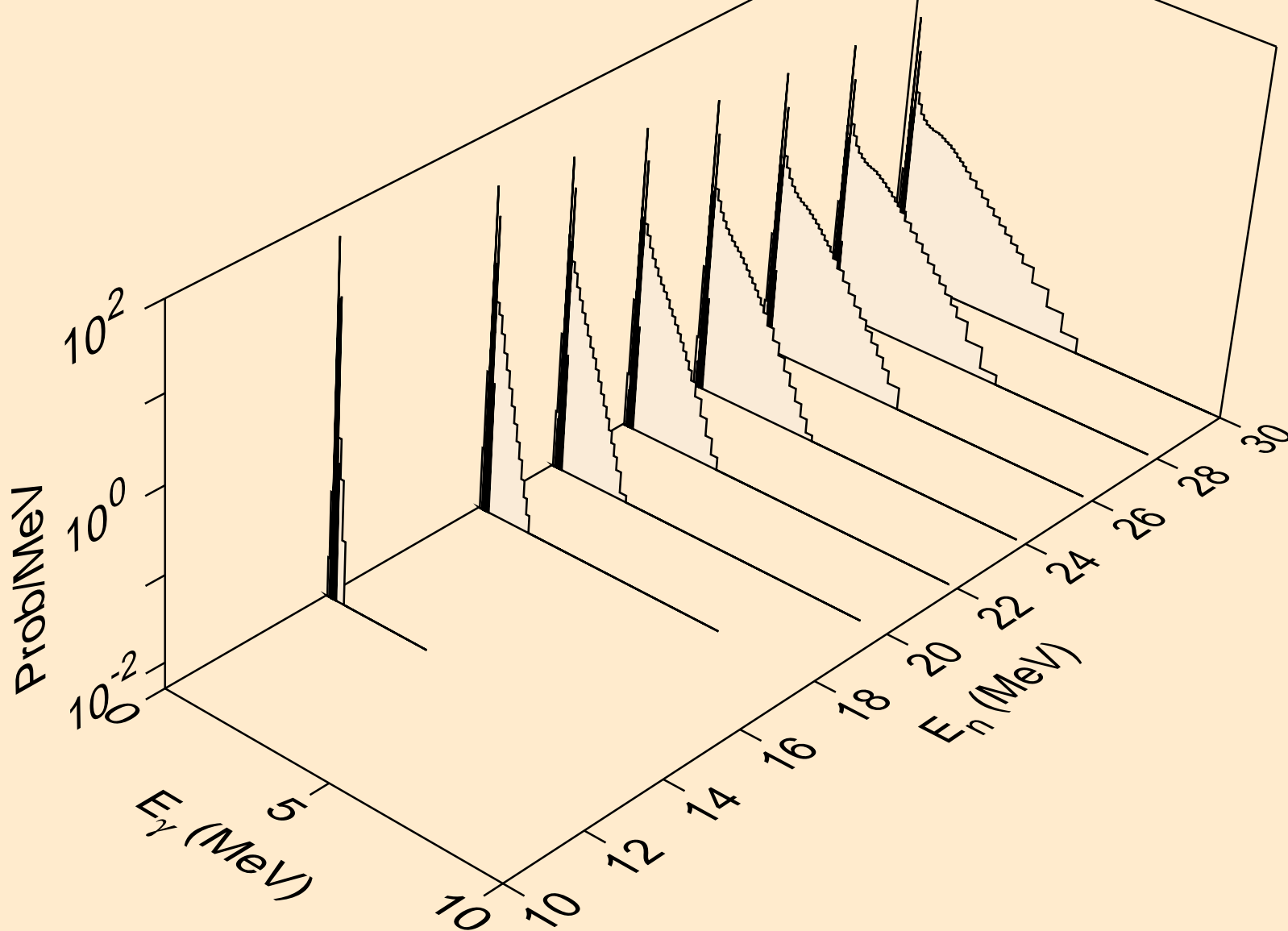

Y083M NEUTRON ACER TENDL-2019 LIBRARY; T=293.16K  
Photon emission for (n,npa)

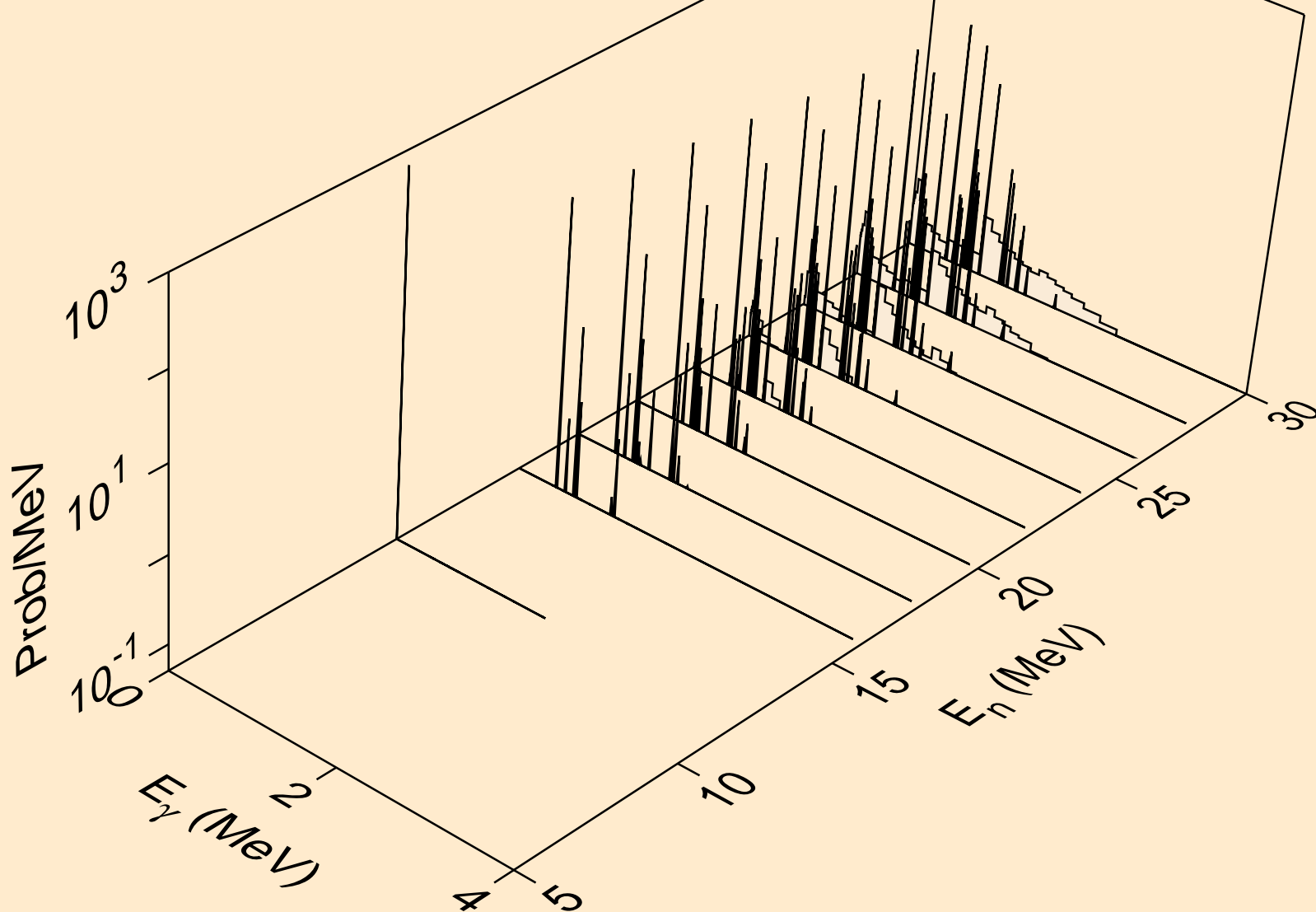

Y083M NEUTRON ACER TENDL-2019 LIBRARY; T=293.16K  
Photon emission for (n,n\*2)

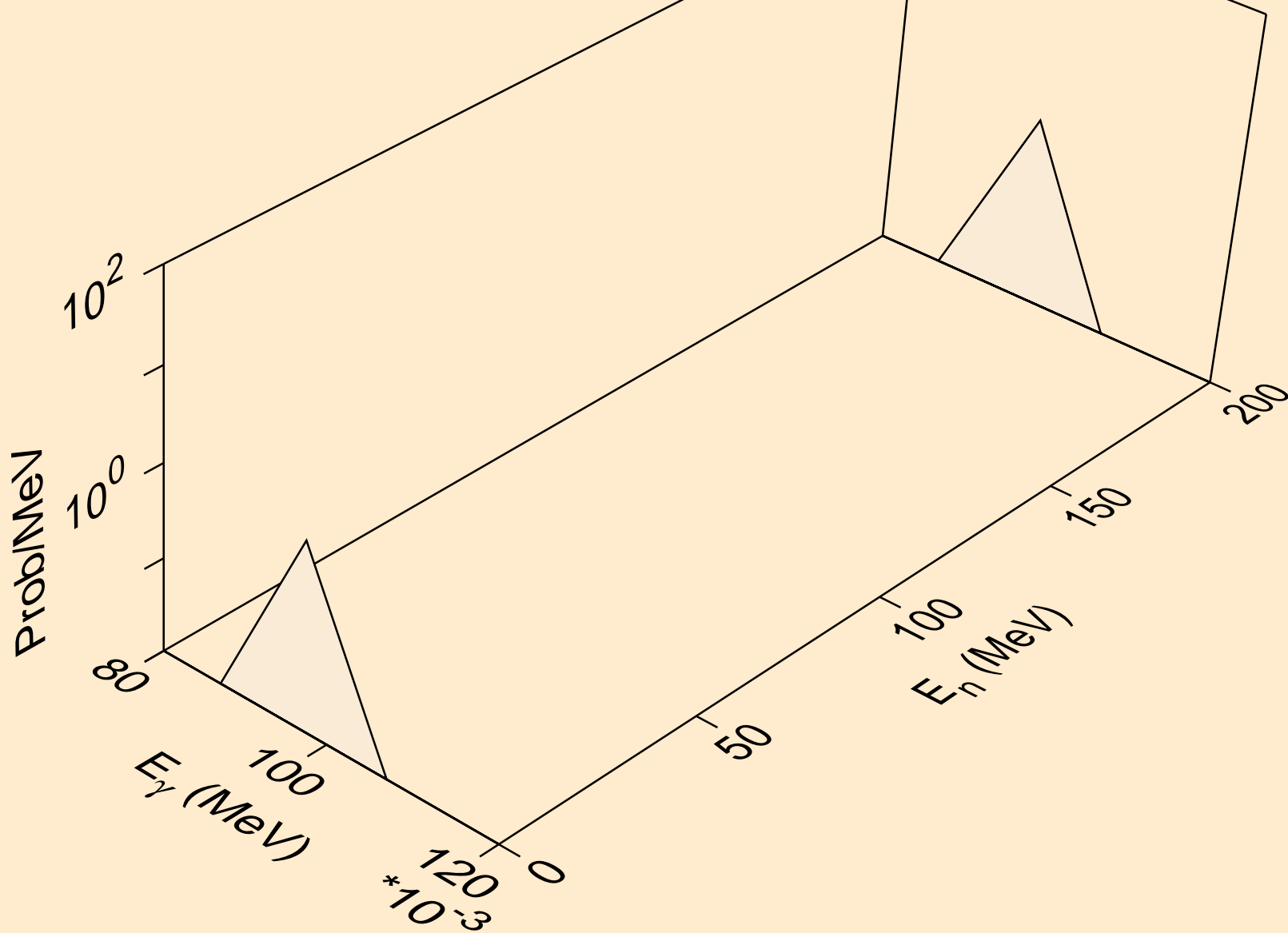

Y083M NEUTRON ACER TENDL-2019 LIBRARY; T=293.16K  
Photon emission for (n,n\*3)

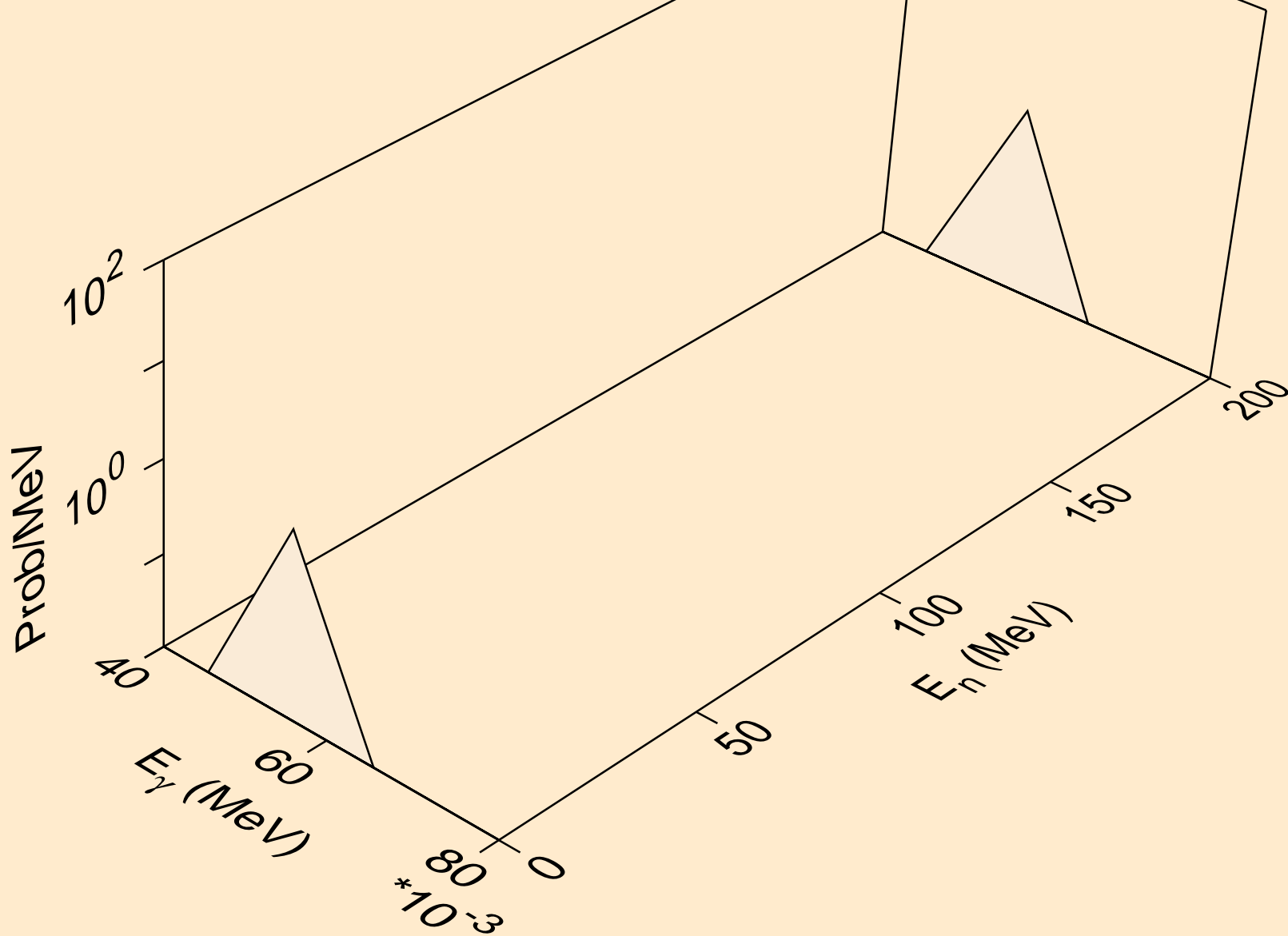

Y083M NEUTRON ACER TENDL-2019 LIBRARY; T=293.16K  
Photon emission for (n,n\*4)

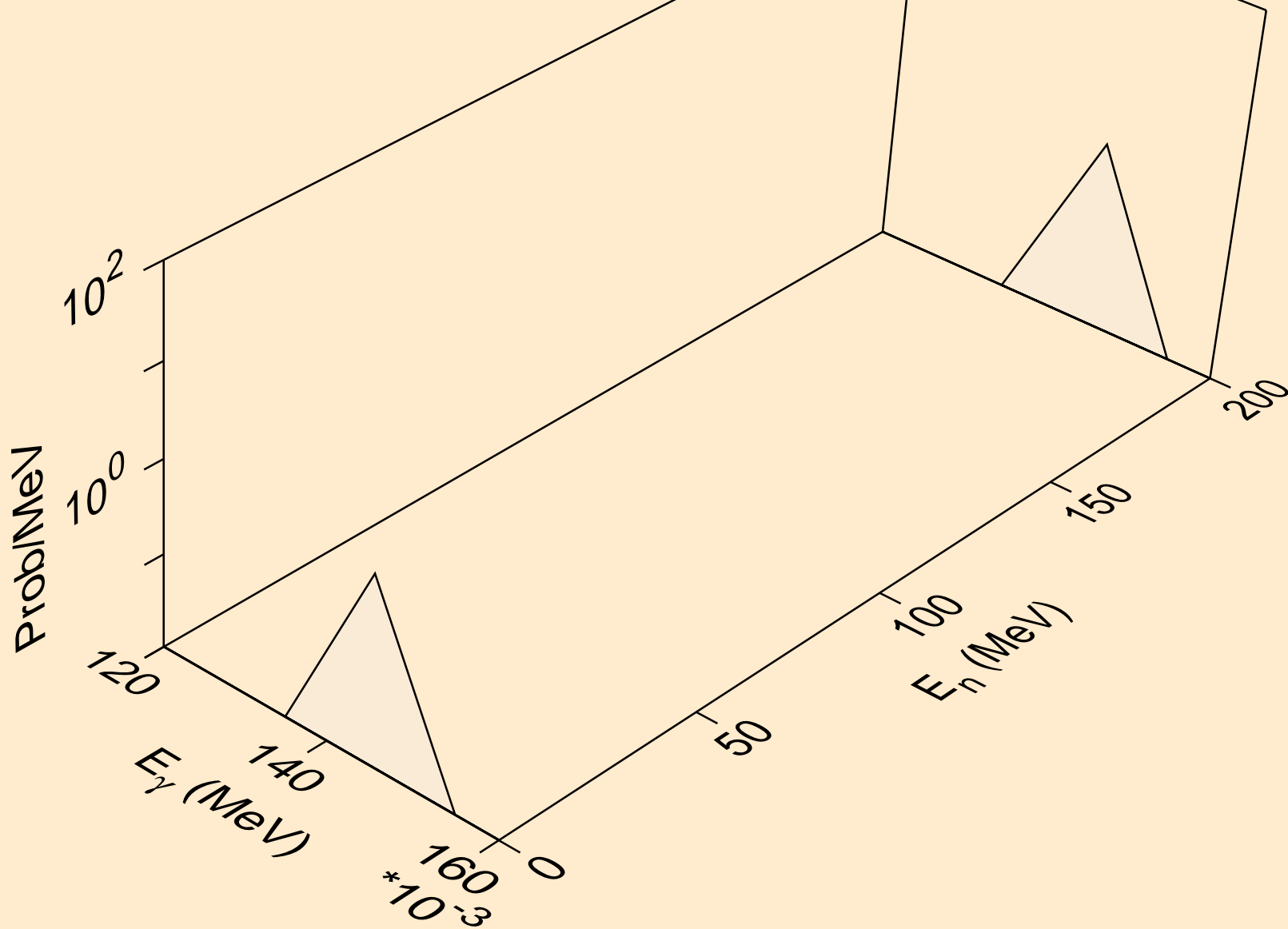

Y083M NEUTRON ACER TENDL-2019 LIBRARY; T=293.16K  
Photon emission for (n,n\*5)

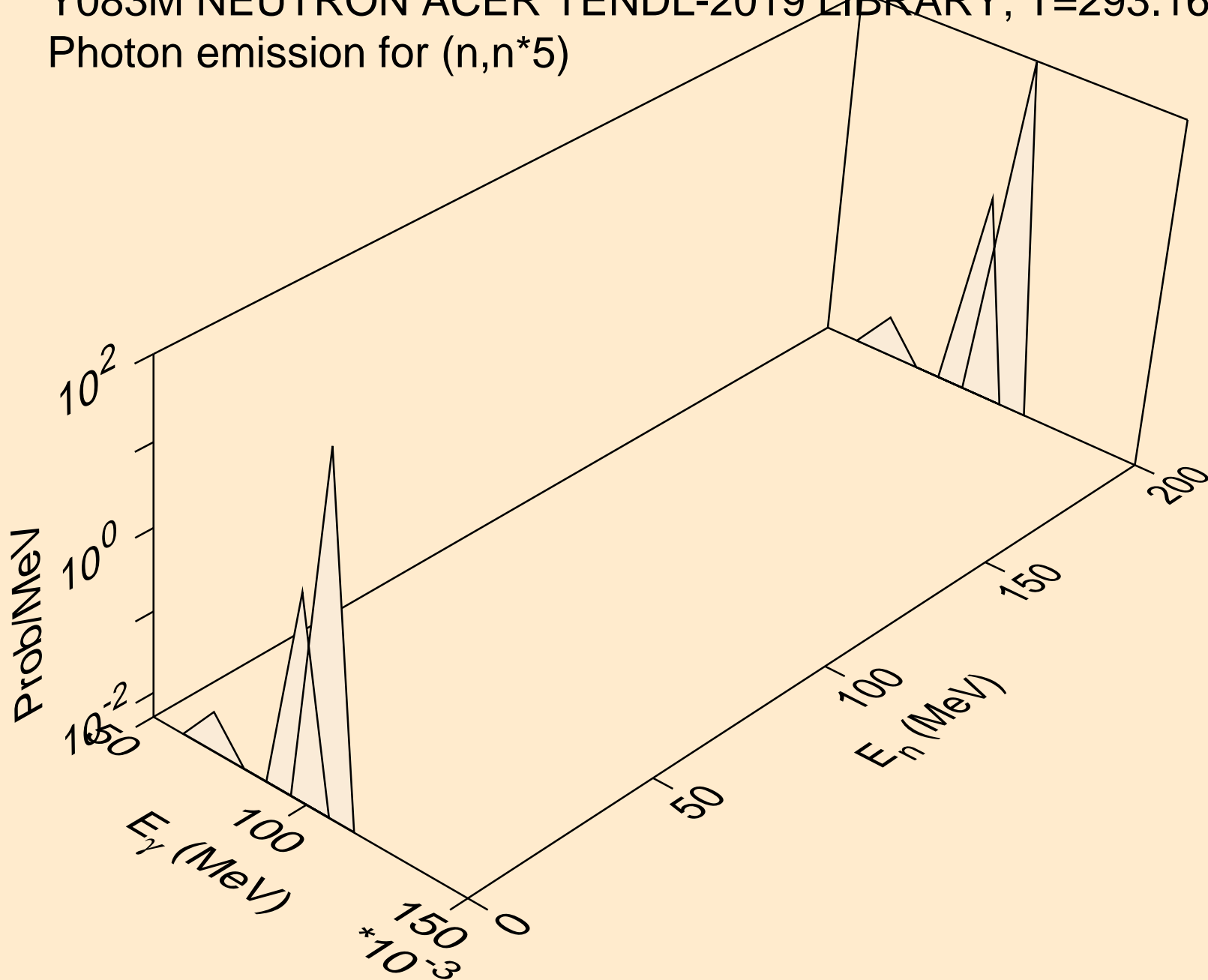

Y083M NEUTRON ACER TENDL-2019 LIBRARY; T=293.16K  
Photon emission for (n,n\*6)

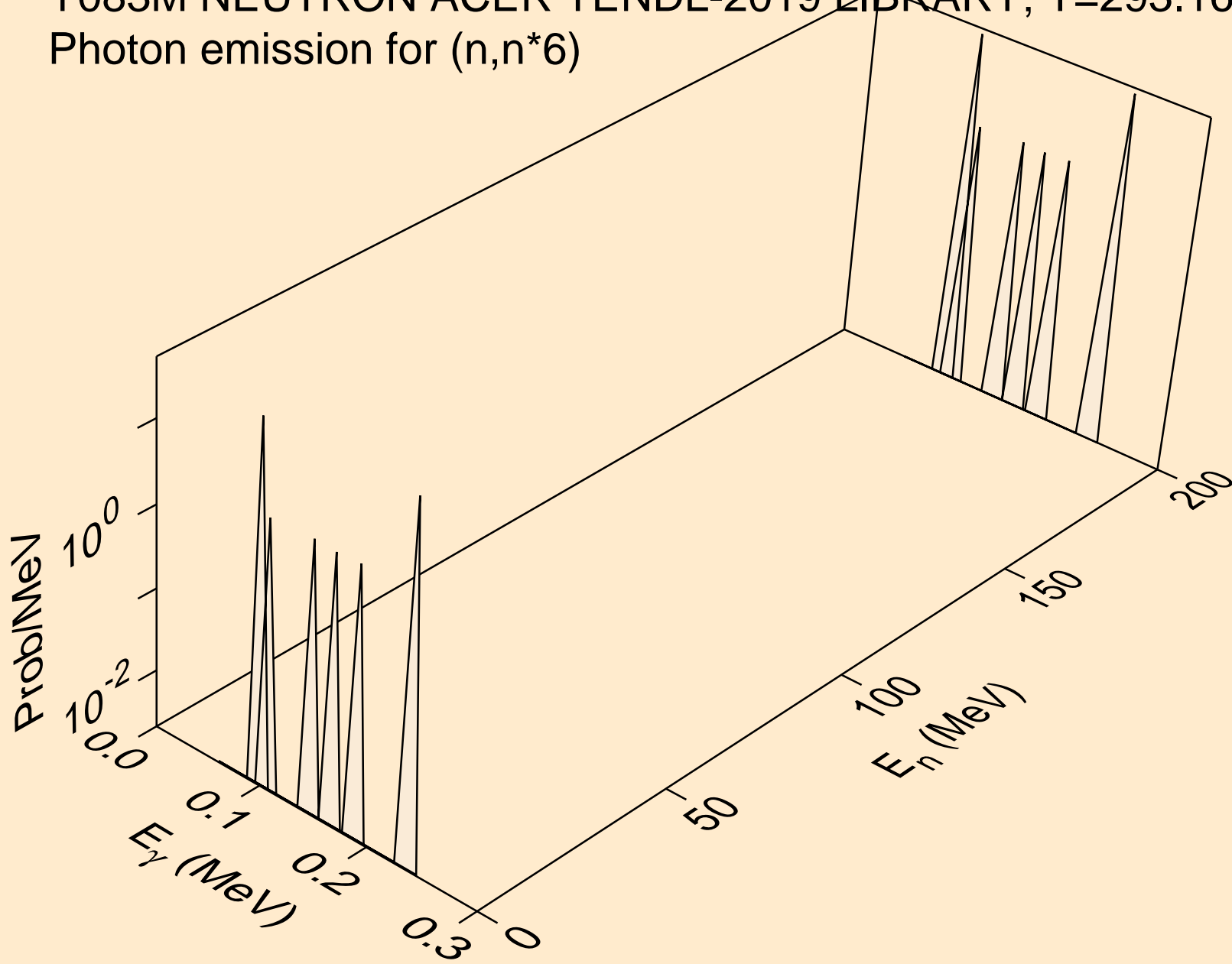



Y083M NEUTRON ACER TENDL-2019 LIBRARY; T=293.16K  
Photon emission for (n,n\*7)

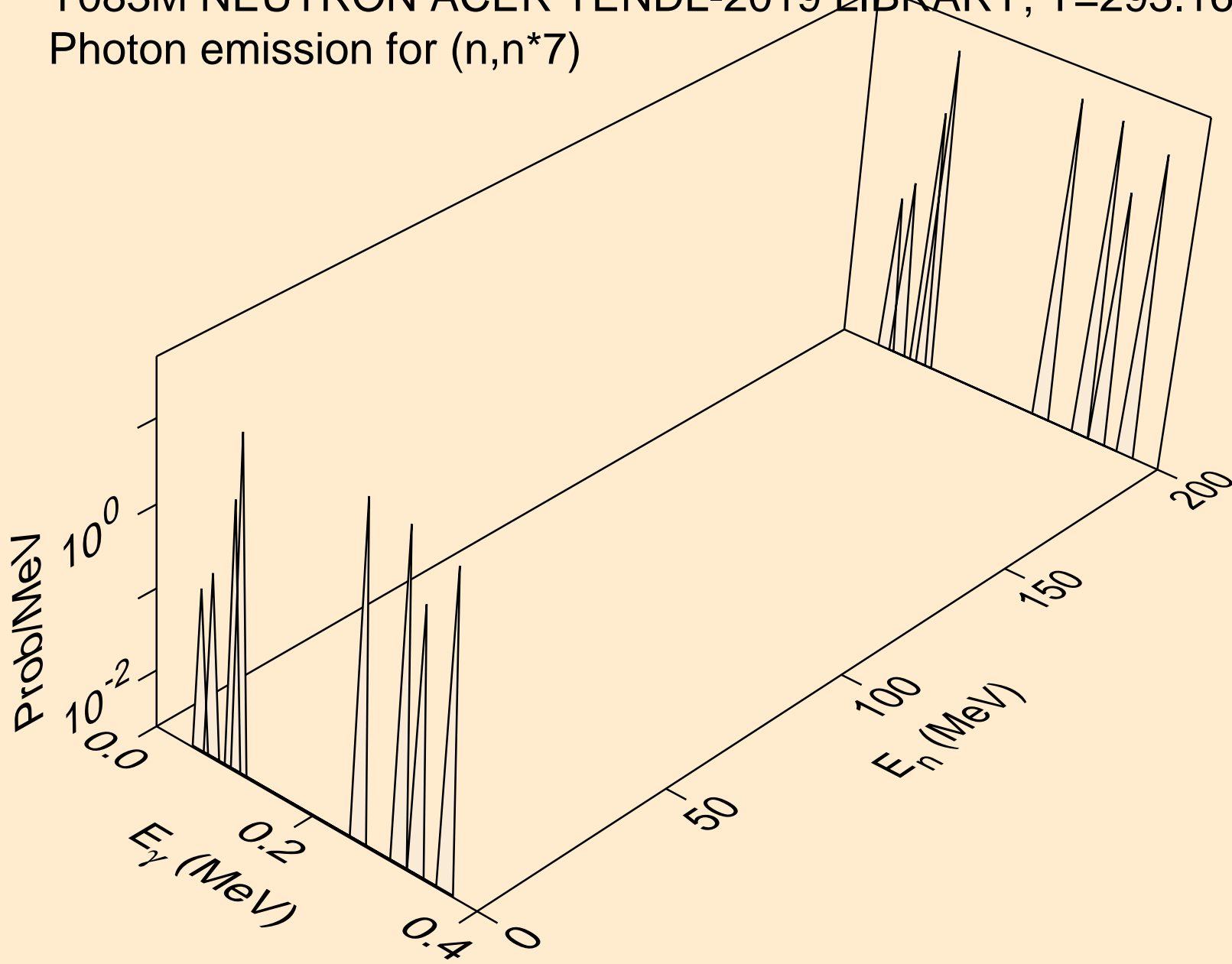

Y083M NEUTRON ACER TENDL-2019 LIBRARY; T=293.16K  
Photon emission for (n,n\*8)

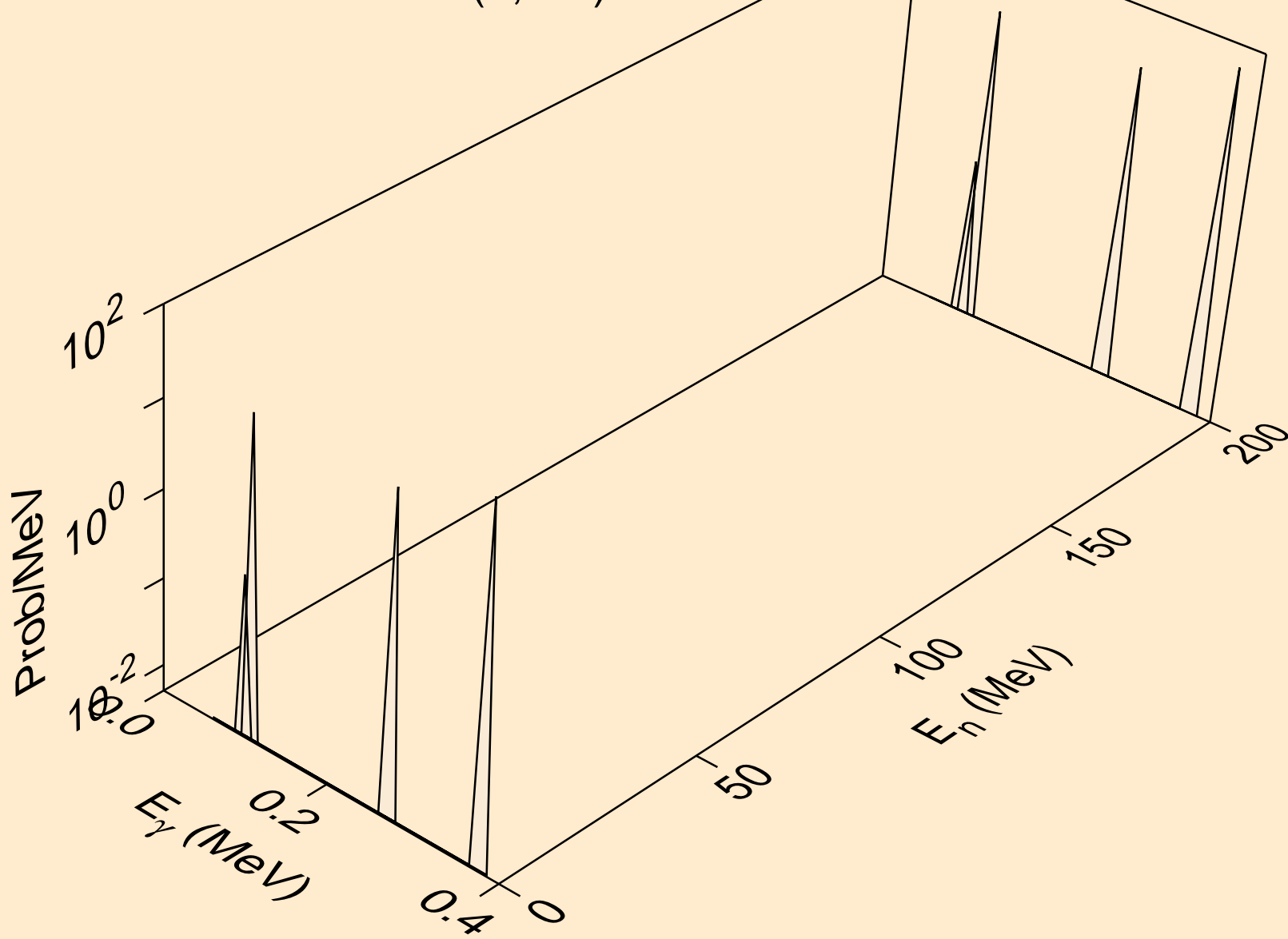

Y083M NEUTRON ACER TENDL-2019 LIBRARY; T=293.16K  
Photon emission for (n,n\*9)

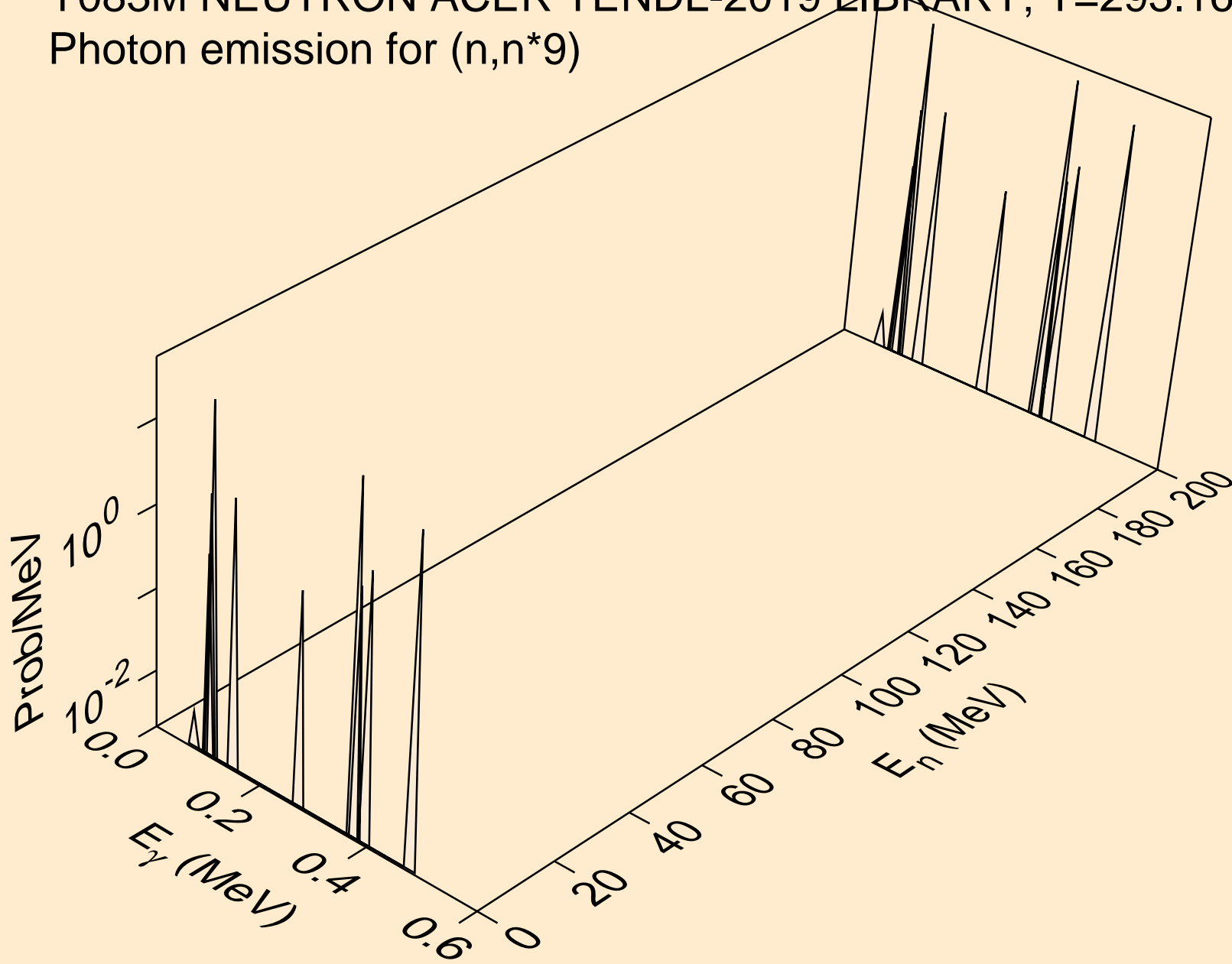

Y083M NEUTRON ACER TENDL-2019 LIBRARY; T=293.16K  
Photon emission for (n,n\*10)

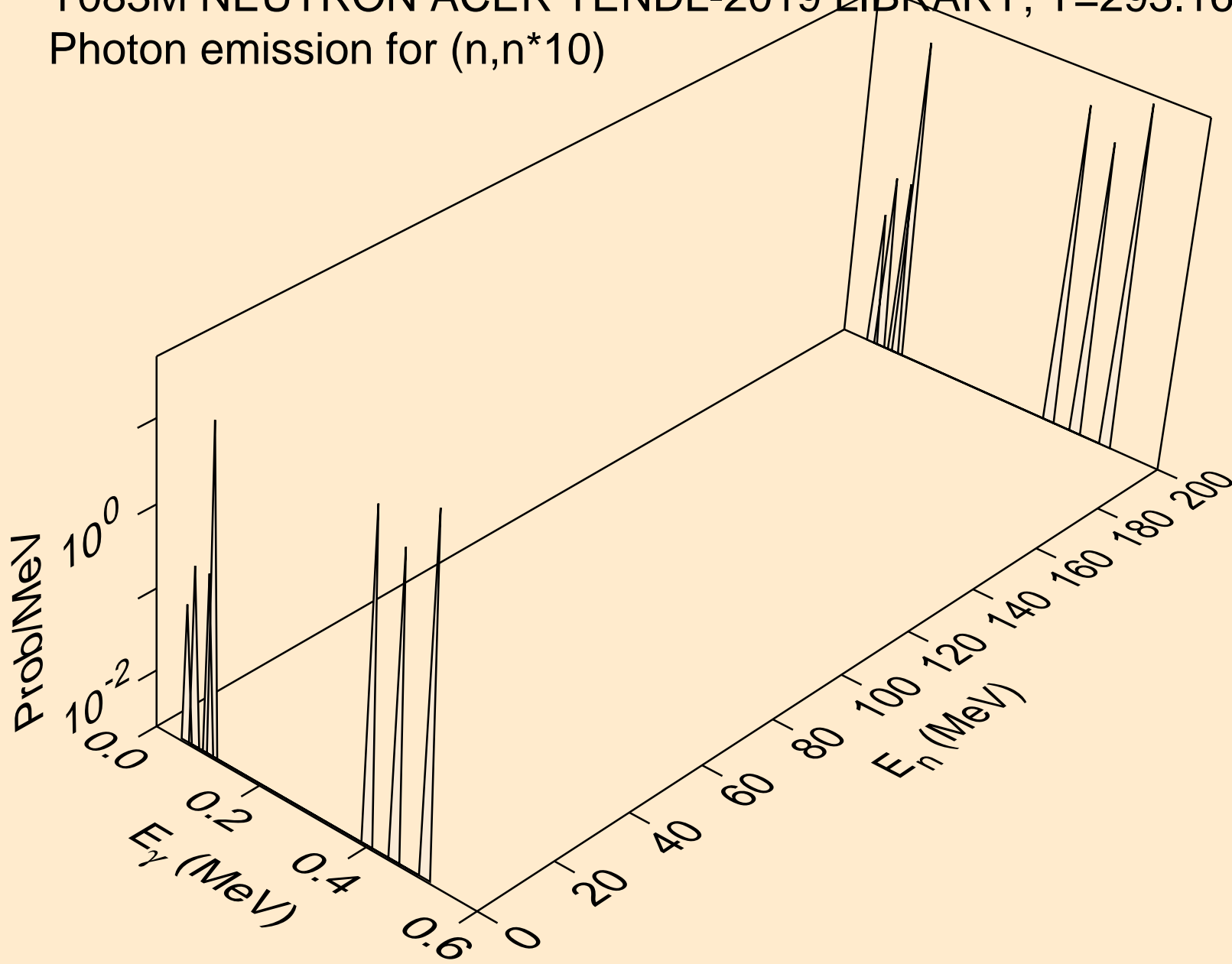

Y083M NEUTRON ACER TENDL-2019 LIBRARY; T=293.16K  
Photon emission for (n,n\*11)

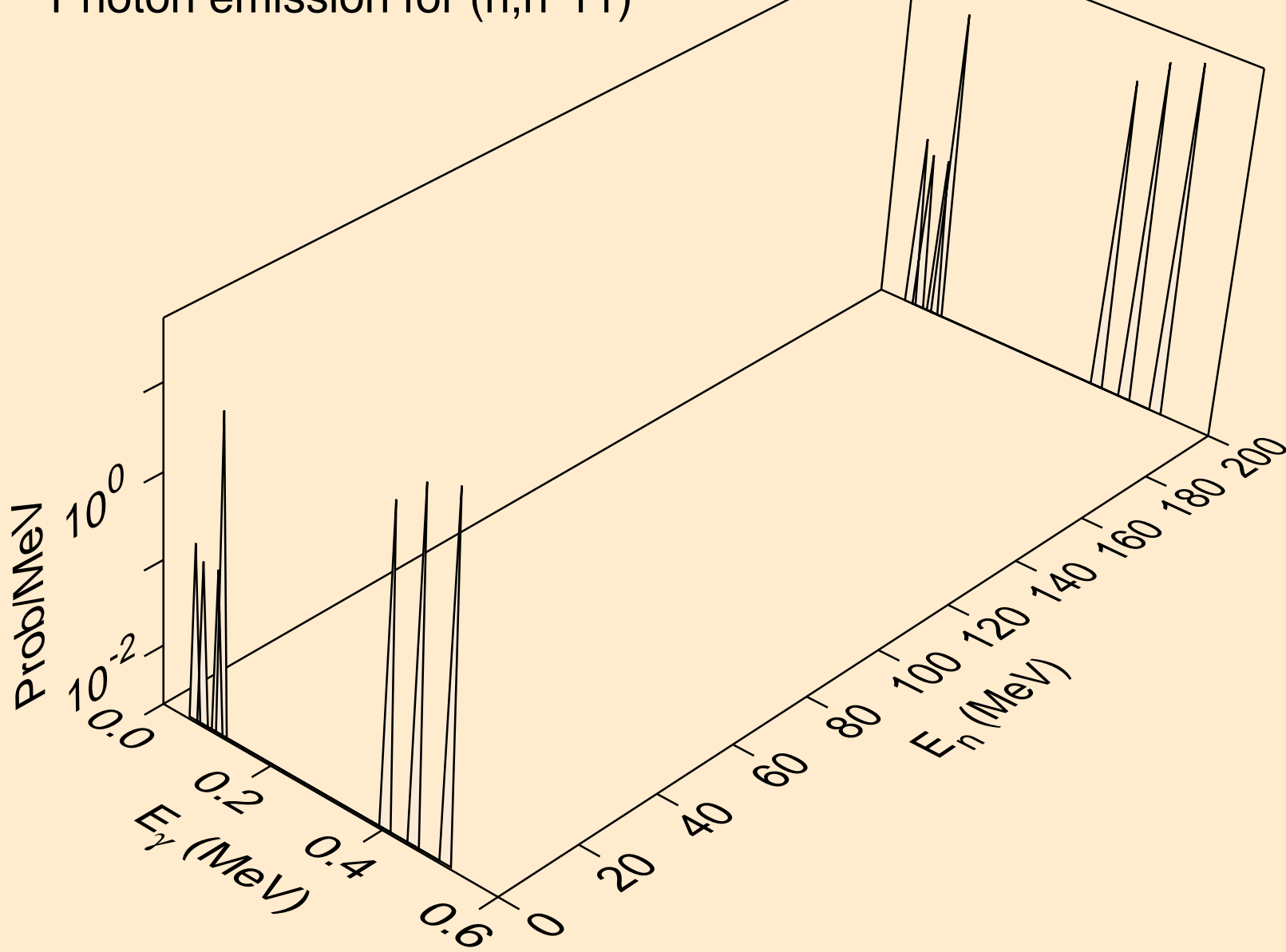

Y083M NEUTRON ACER TENDL-2019 LIBRARY; T=293.16K  
Photon emission for (n,n\*12)

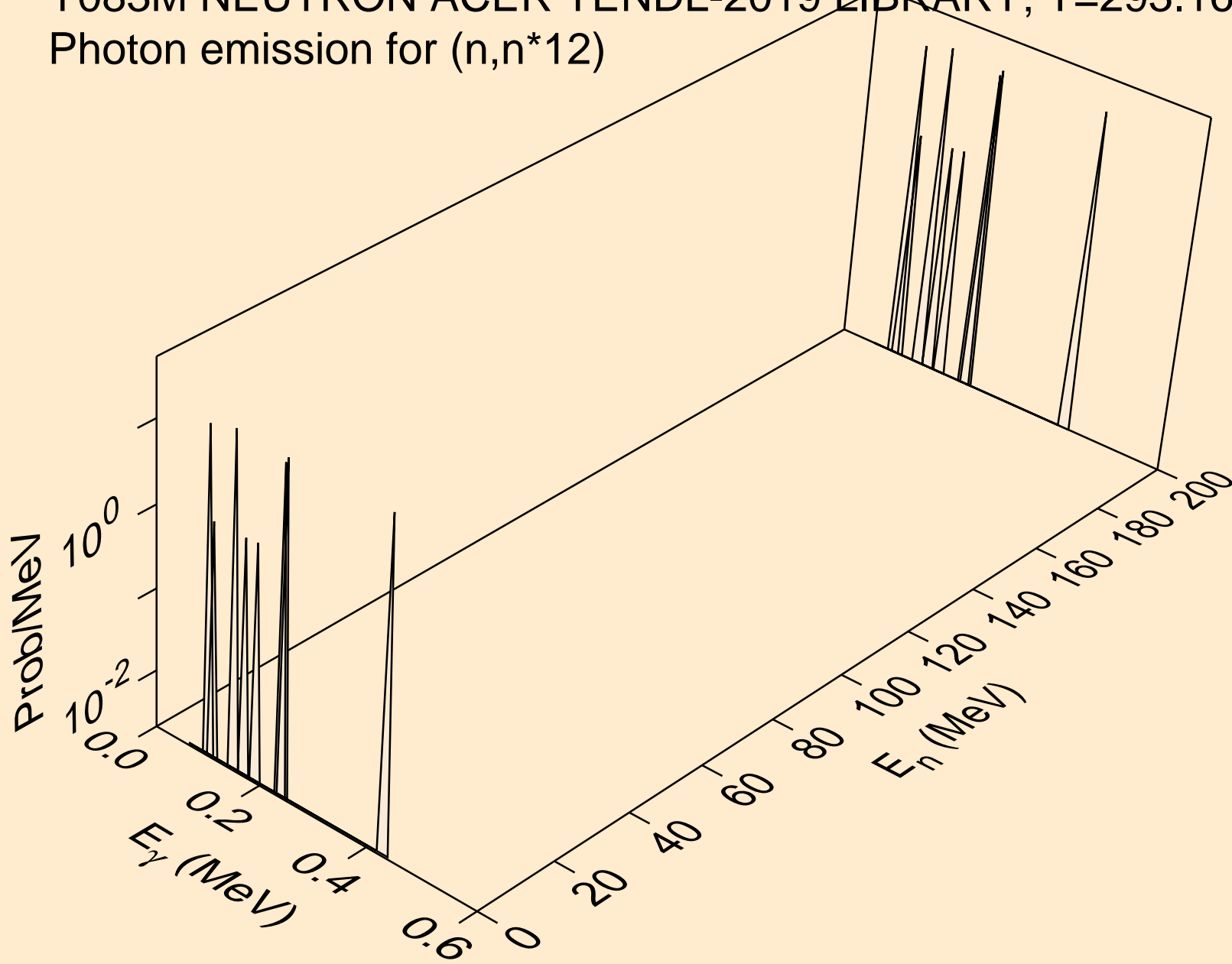

Y083M NEUTRON ACER TENDL-2019 LIBRARY; T=293.16K  
Photon emission for (n,n\*13)

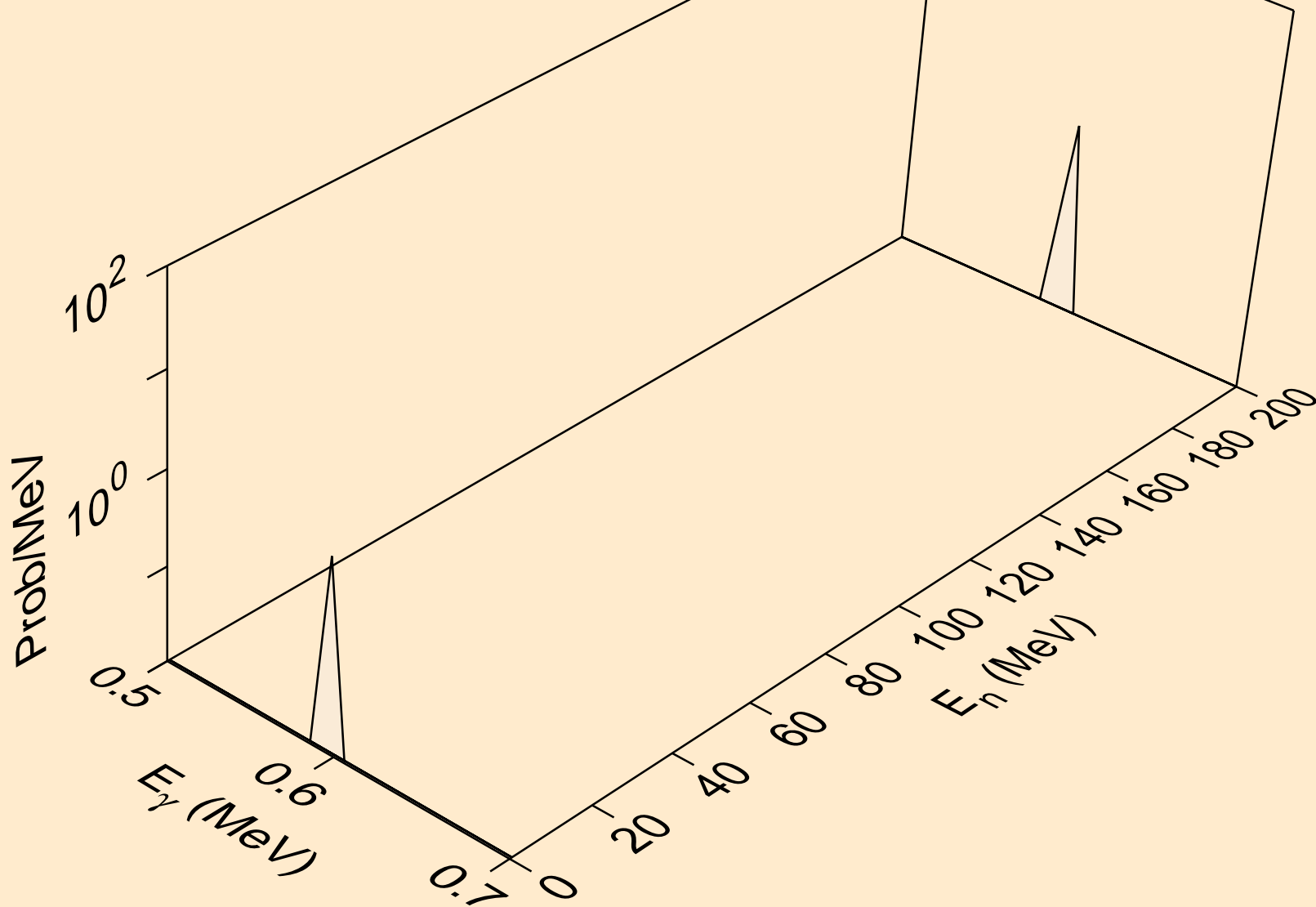

Y083M NEUTRON ACER TENDL-2019 LIBRARY; T=293.16K  
Photon emission for (n,n\*14)

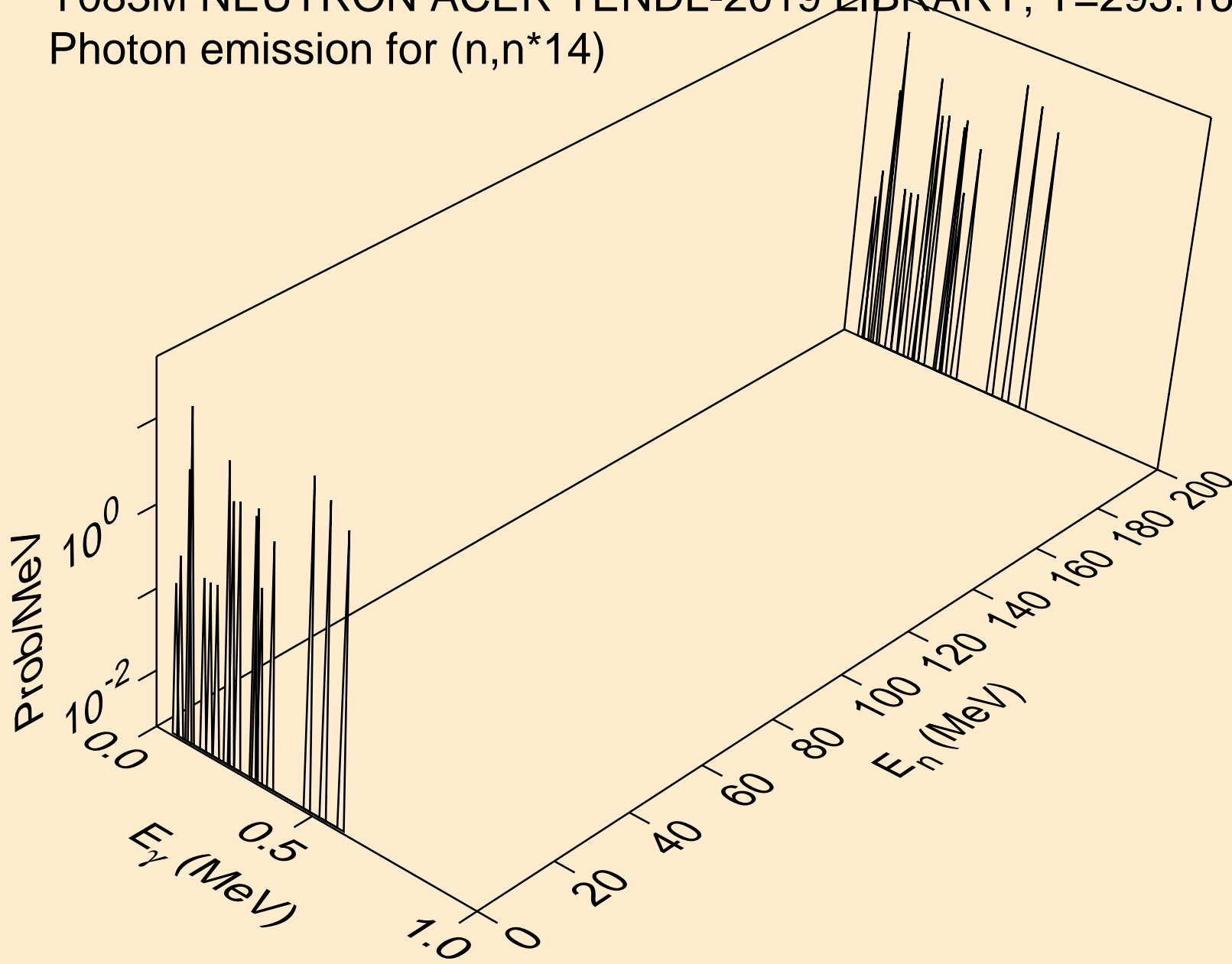



Y083M NEUTRON ACER TENDL-2019 LIBRARY; T=293.16K  
Photon emission for (n,n\*15)

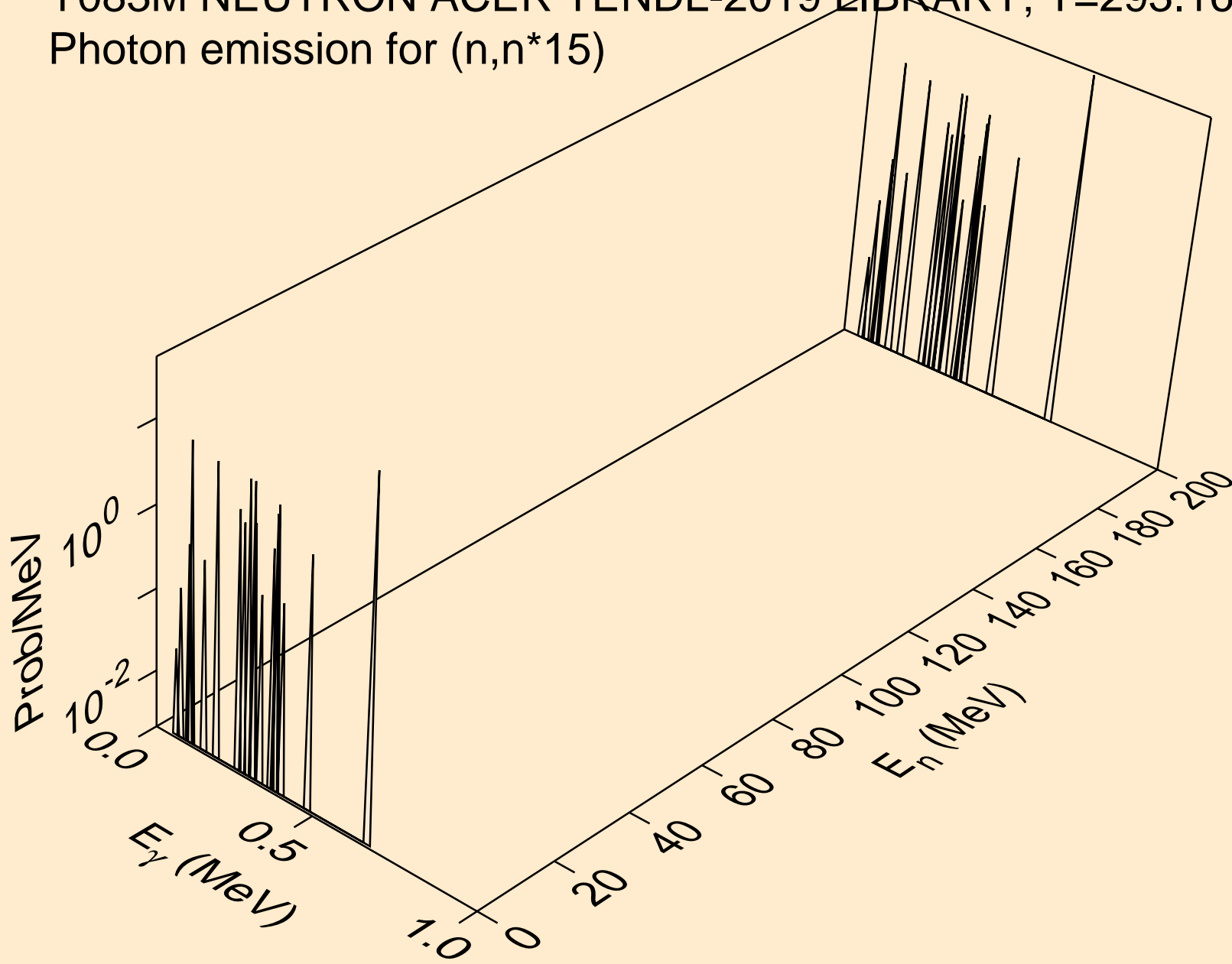

Y083M NEUTRON ACER TENDL-2019 LIBRARY; T=293.16K  
Photon emission for (n,n\*16)

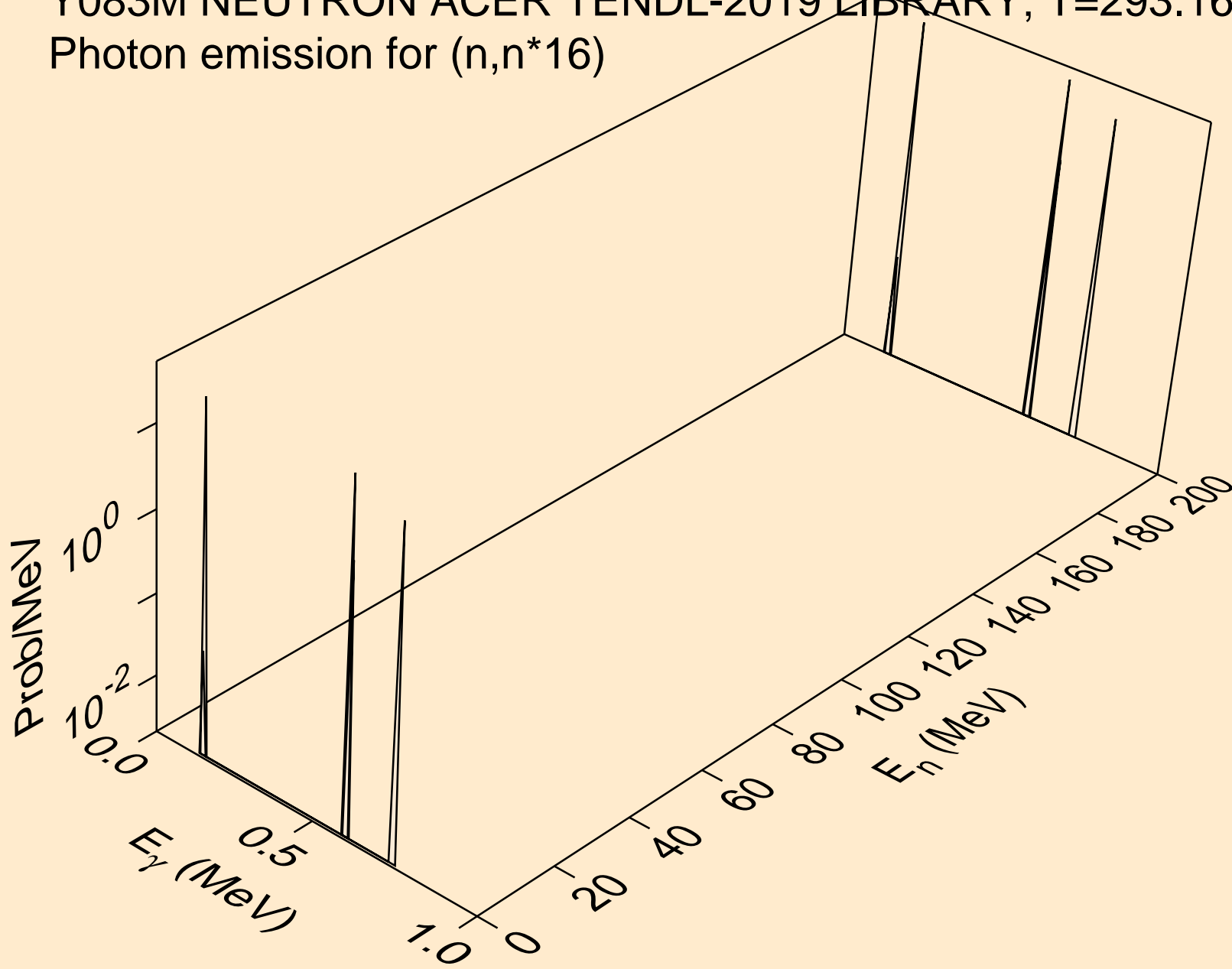

Y083M NEUTRON ACER TENDL-2019 LIBRARY; T=293.16K  
Photon emission for (n,n\*17)

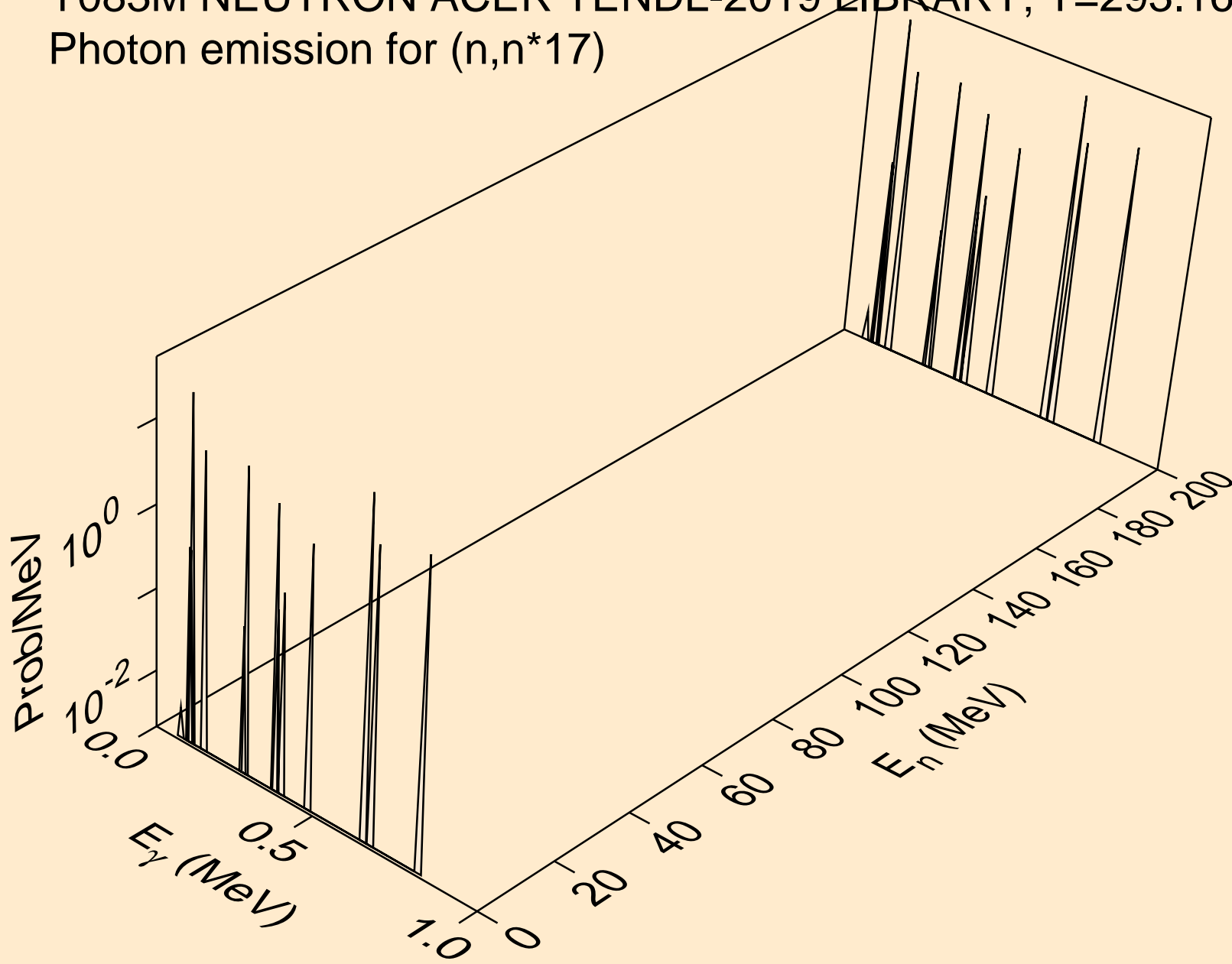

Y083M NEUTRON ACER TENDL-2019 LIBRARY; T=293.16K  
Photon emission for (n,n\*18)

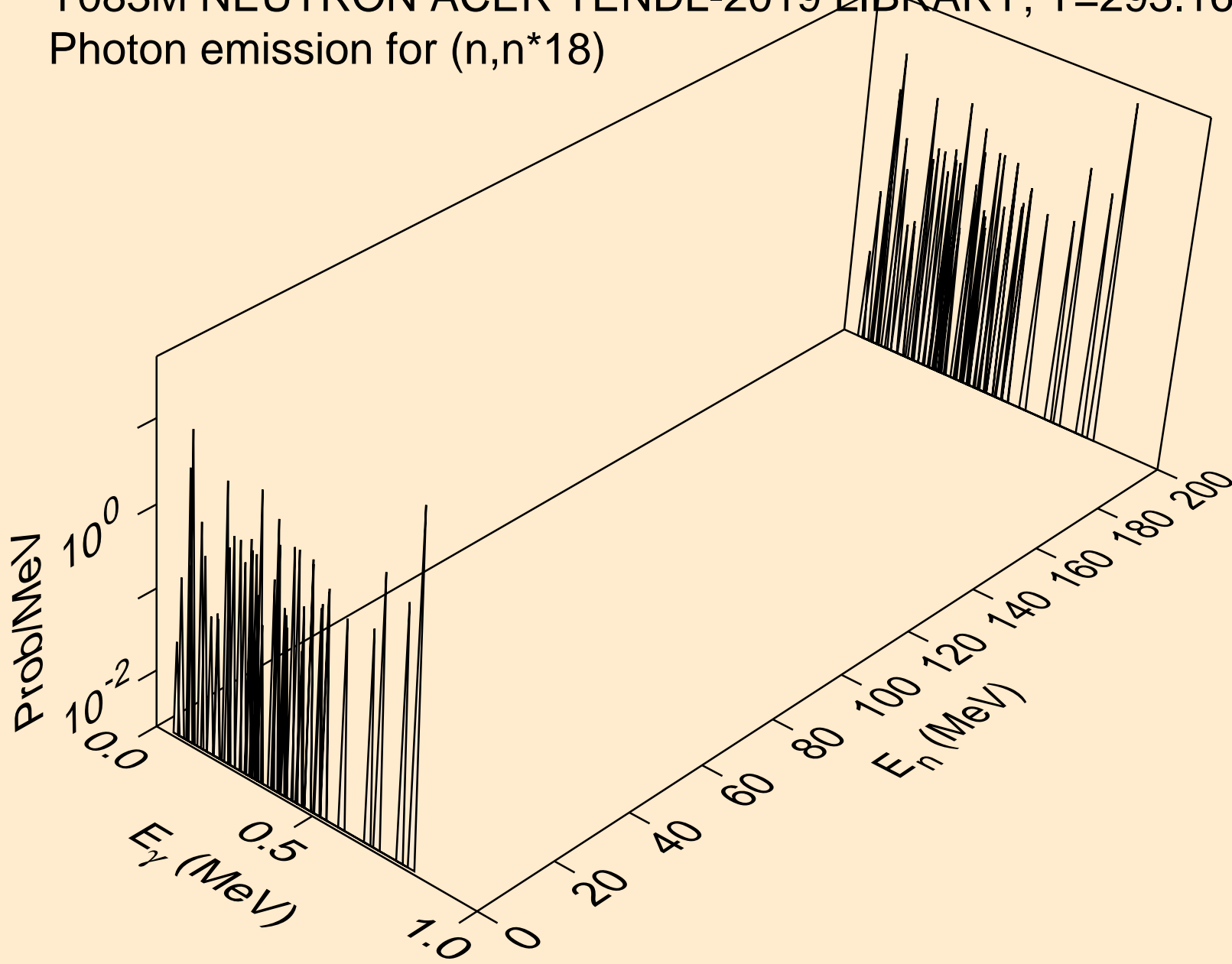

Y083M NEUTRON ACER TENDL-2019 LIBRARY; T=293.16K  
Photon emission for (n,n\*19)

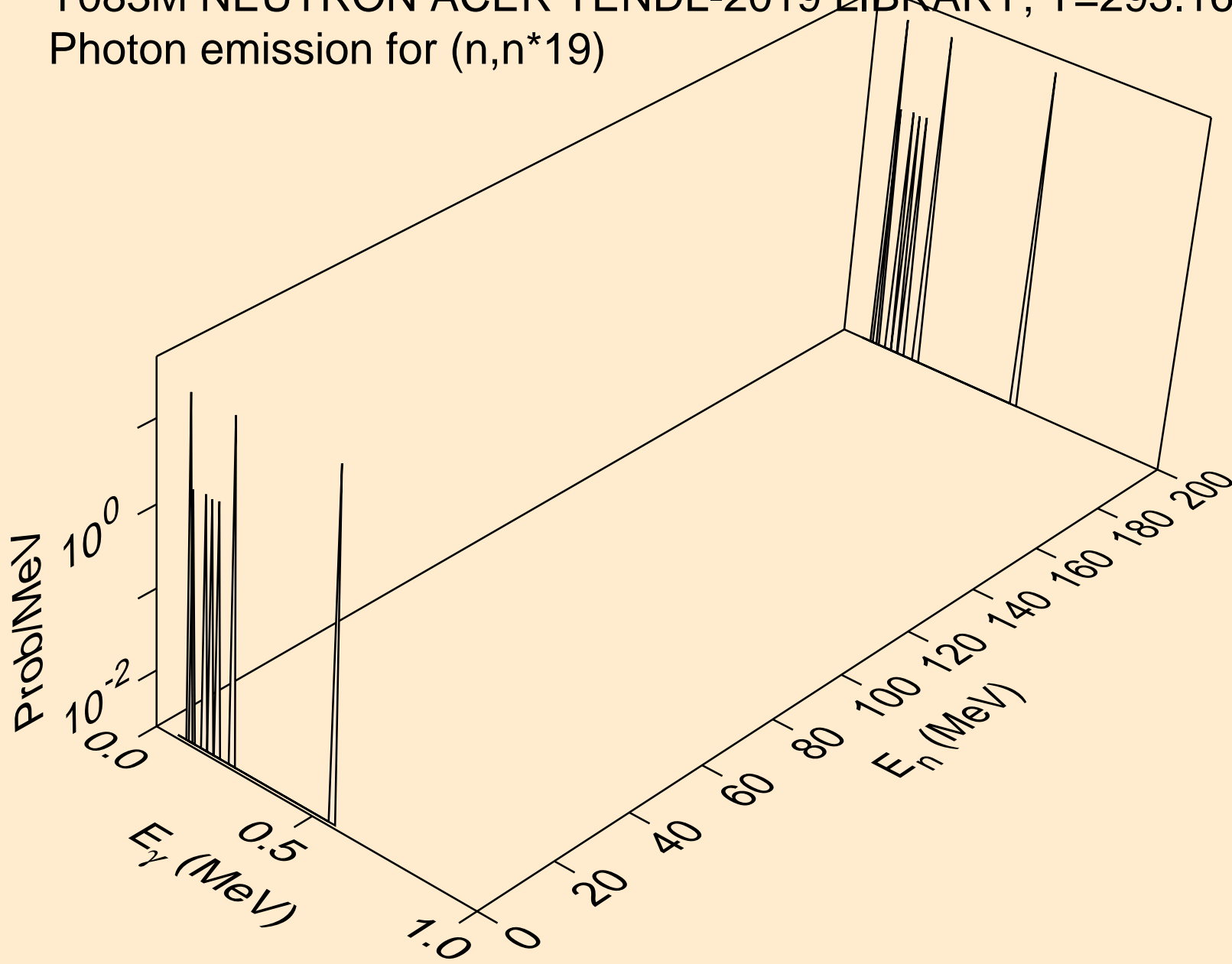

Y083M NEUTRON ACER TENDL-2019 LIBRARY; T=293.16K  
Photon emission for (n,n\*20)

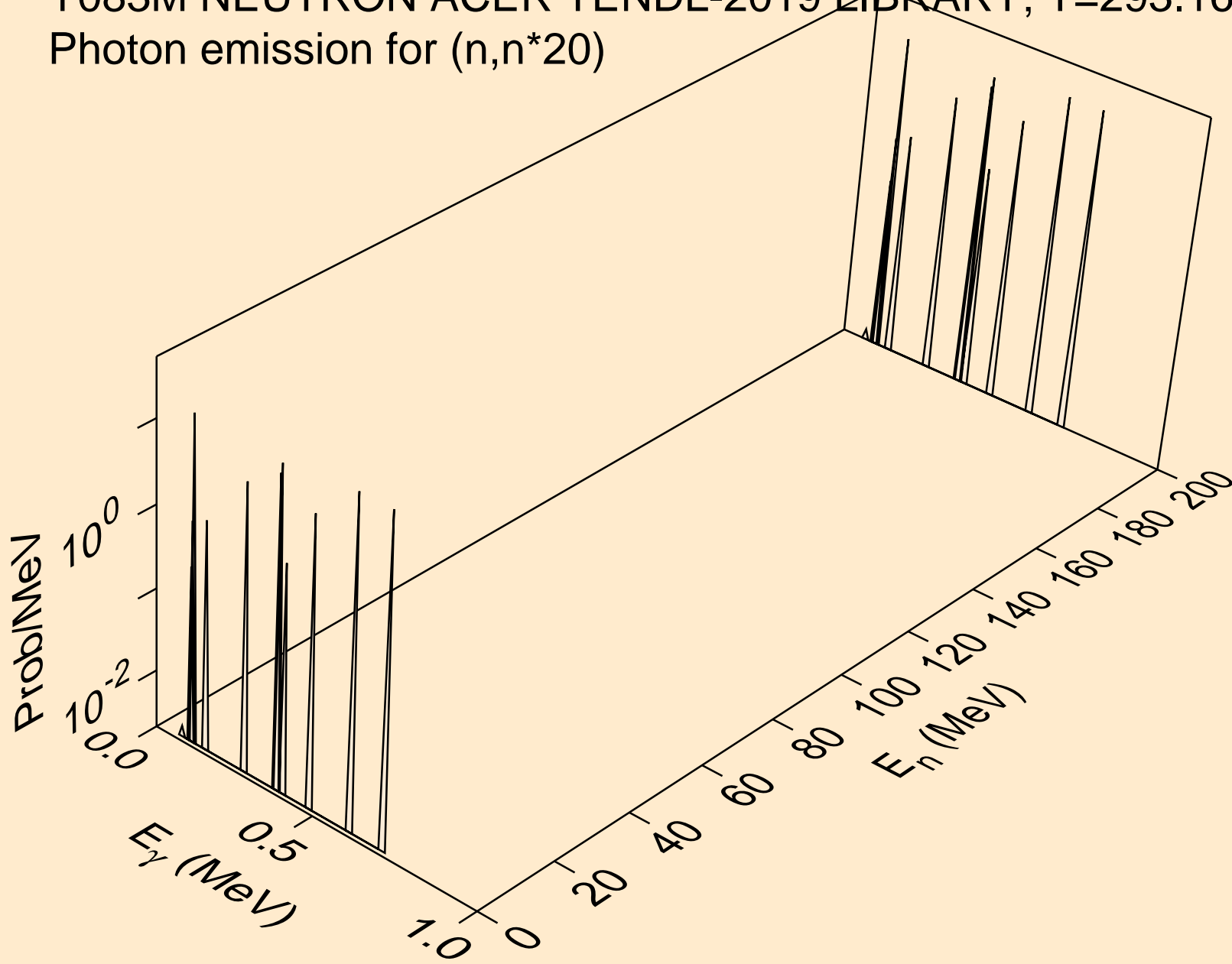

Y083M NEUTRON ACER TENDL-2019 LIBRARY; T=293.16K  
Photon emission for (n,n\*21)

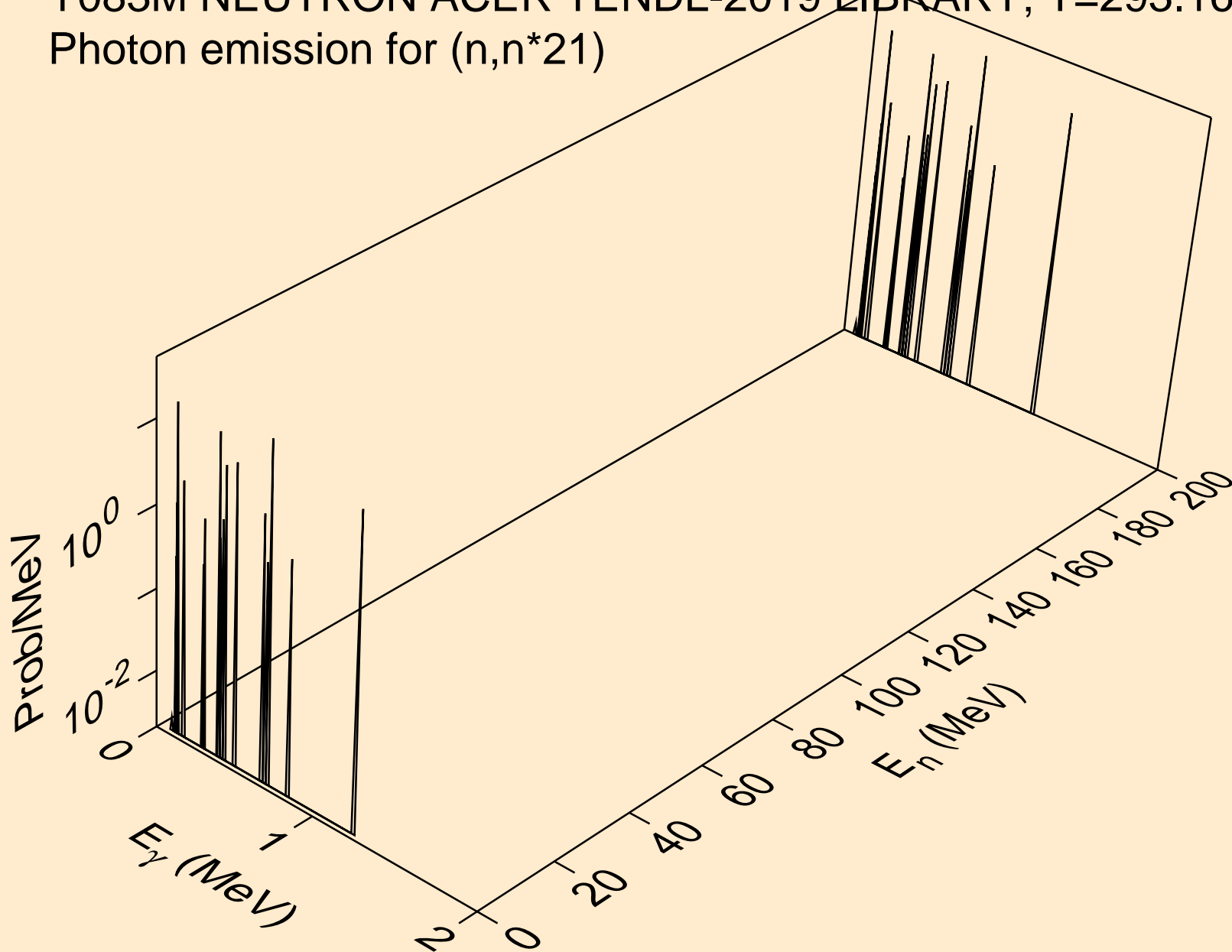

Y083M NEUTRON ACER TENDL-2019 LIBRARY; T=293.16K  
Photon emission for (n,n\*22)

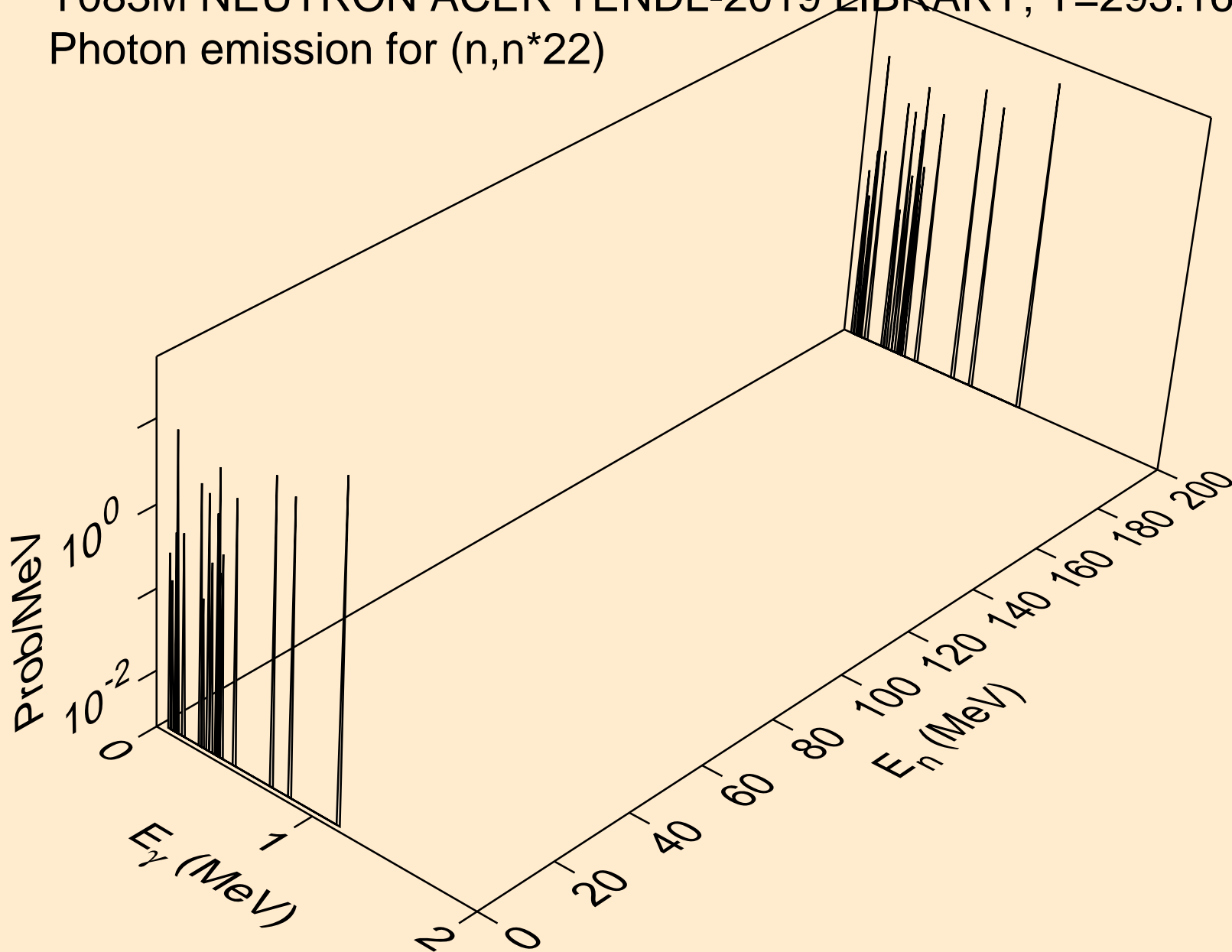



Y083M NEUTRON ACER TENDL-2019 LIBRARY; T=293.16K  
Photon emission for (n,n\*c)

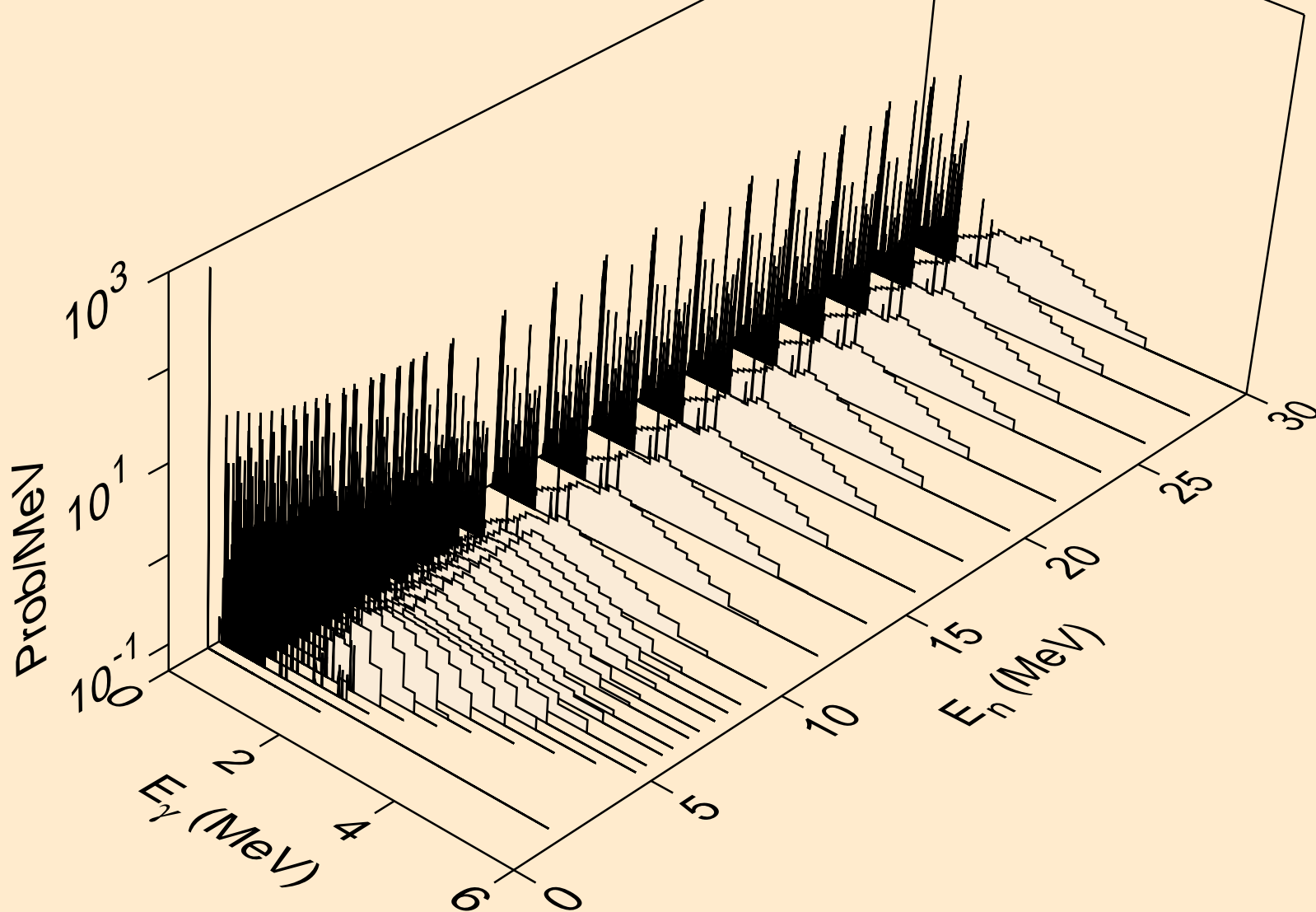

Y083M NEUTRON ACER TENDL-2019 LIBRARY; T=293.16K  
Photon emission for (n,gma)

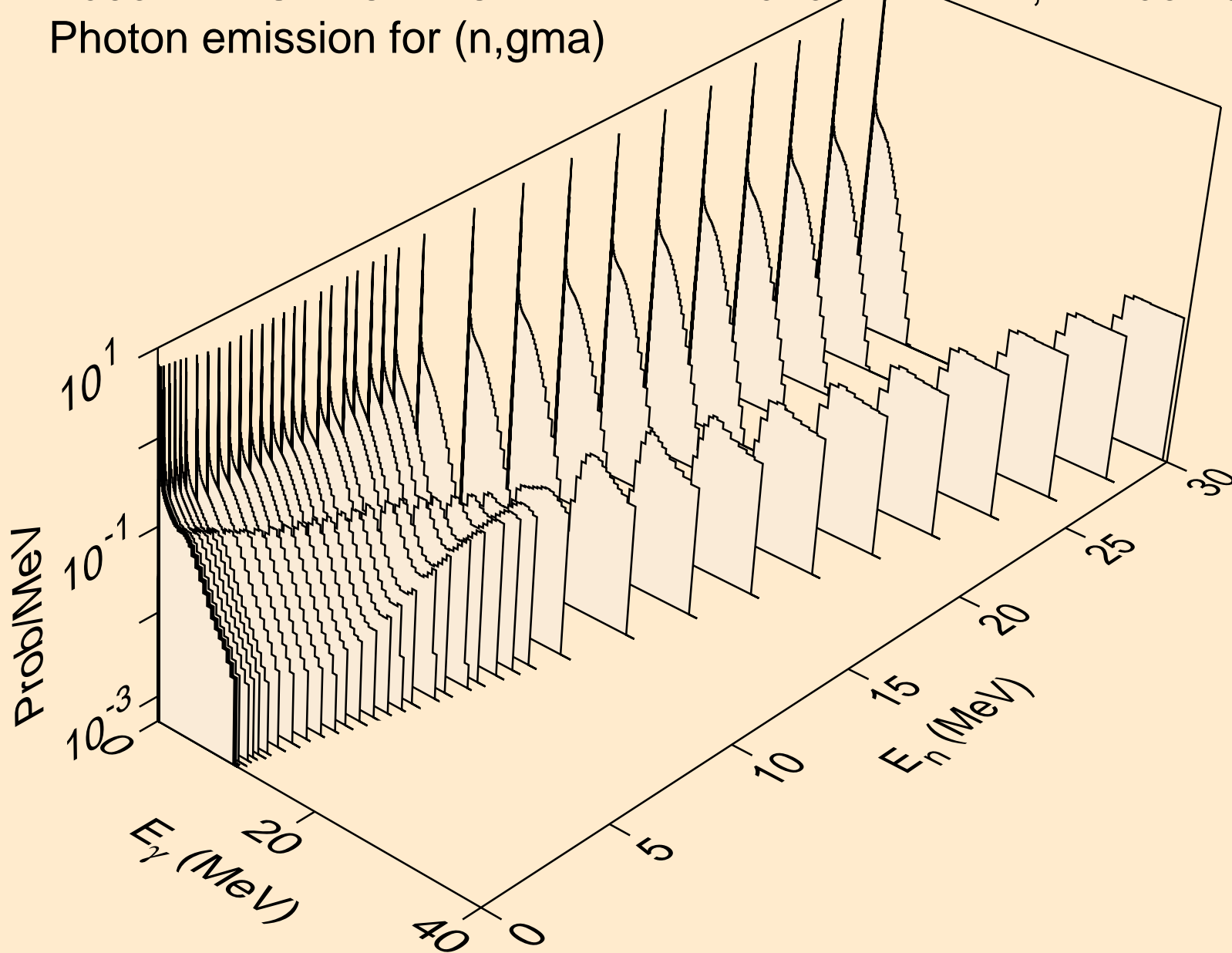

Y083M NEUTRON ACER TENDL-2019 LIBRARY; T=293.16K  
Photon emission for (n,p)

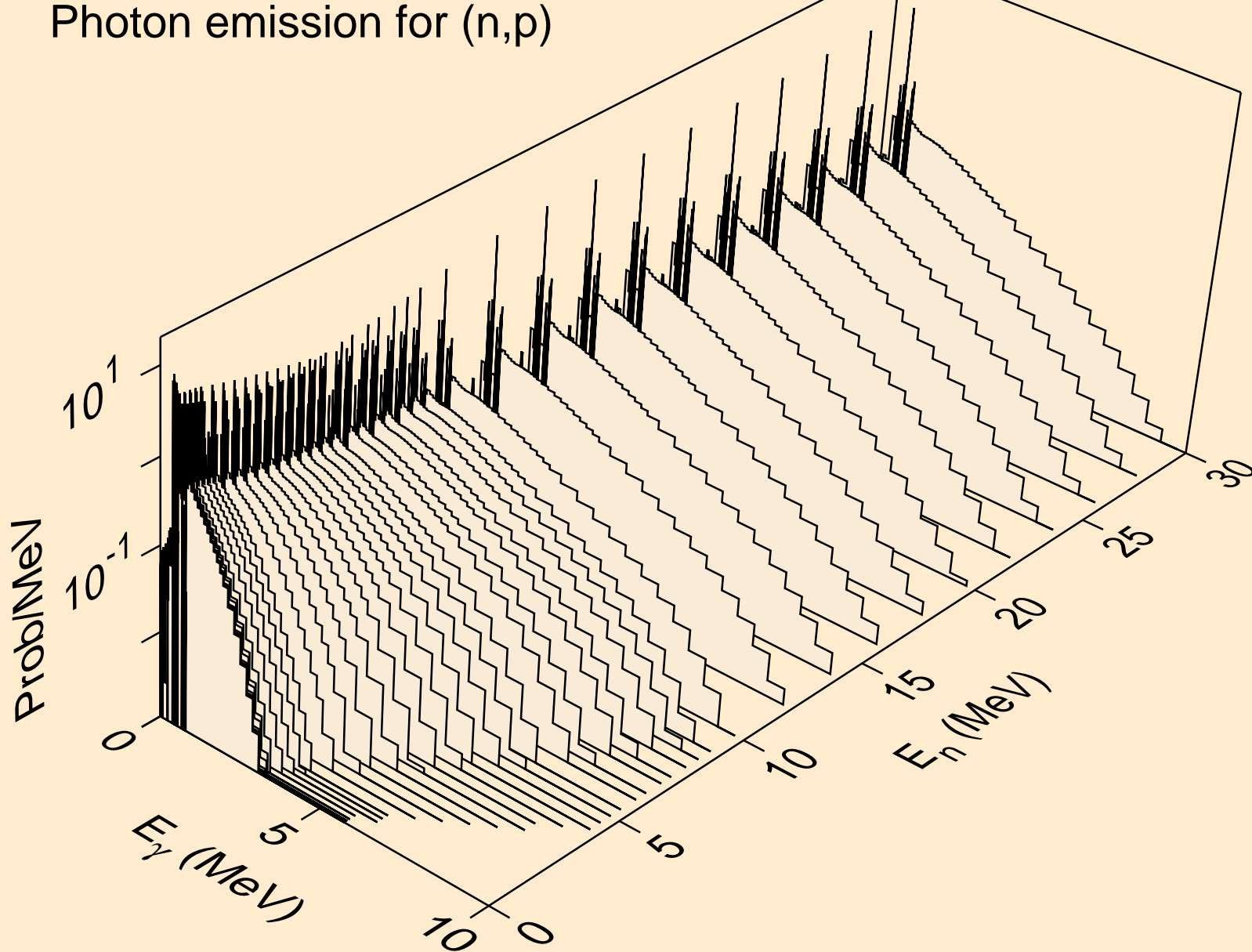

Y083M NEUTRON ACER TENDL-2019 LIBRARY; T=293.16K  
Photon emission for (n,d)

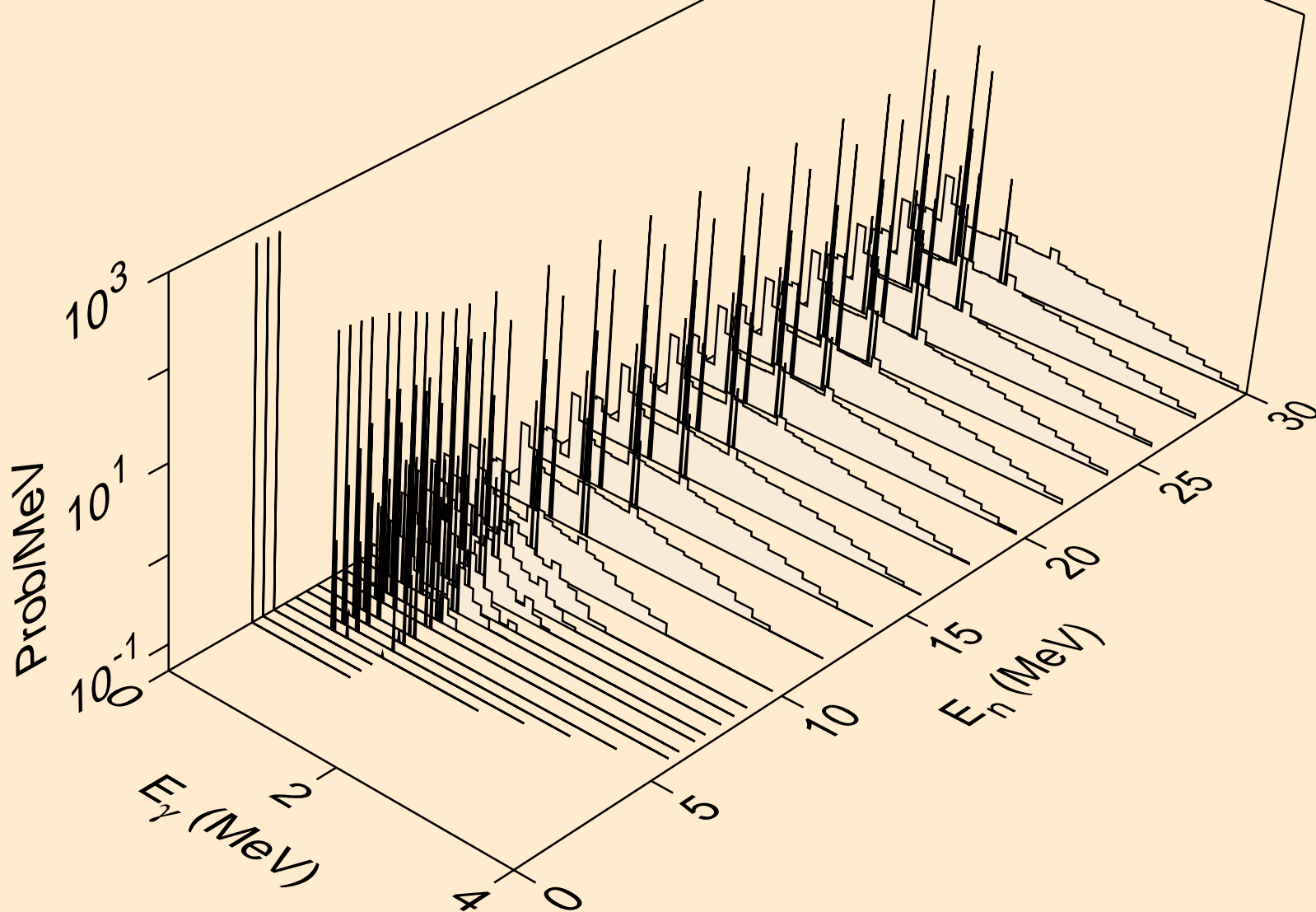

Y083M NEUTRON ACER TENDL-2019 LIBRARY; T=293.16K  
Photon emission for (n,t)

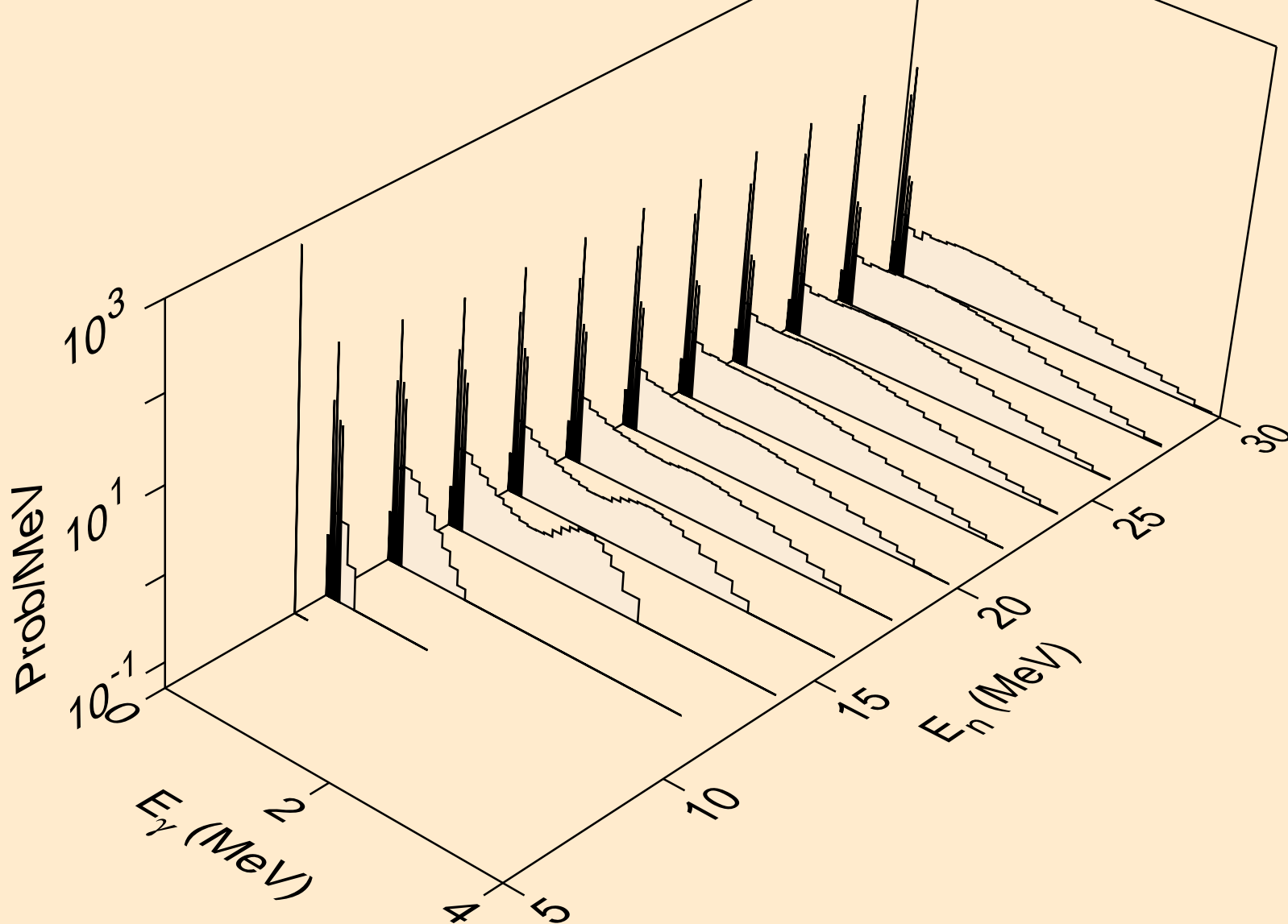

Y083M NEUTRON ACER TENDL-2019 LIBRARY; T=293.16K  
Photon emission for (n,he3)

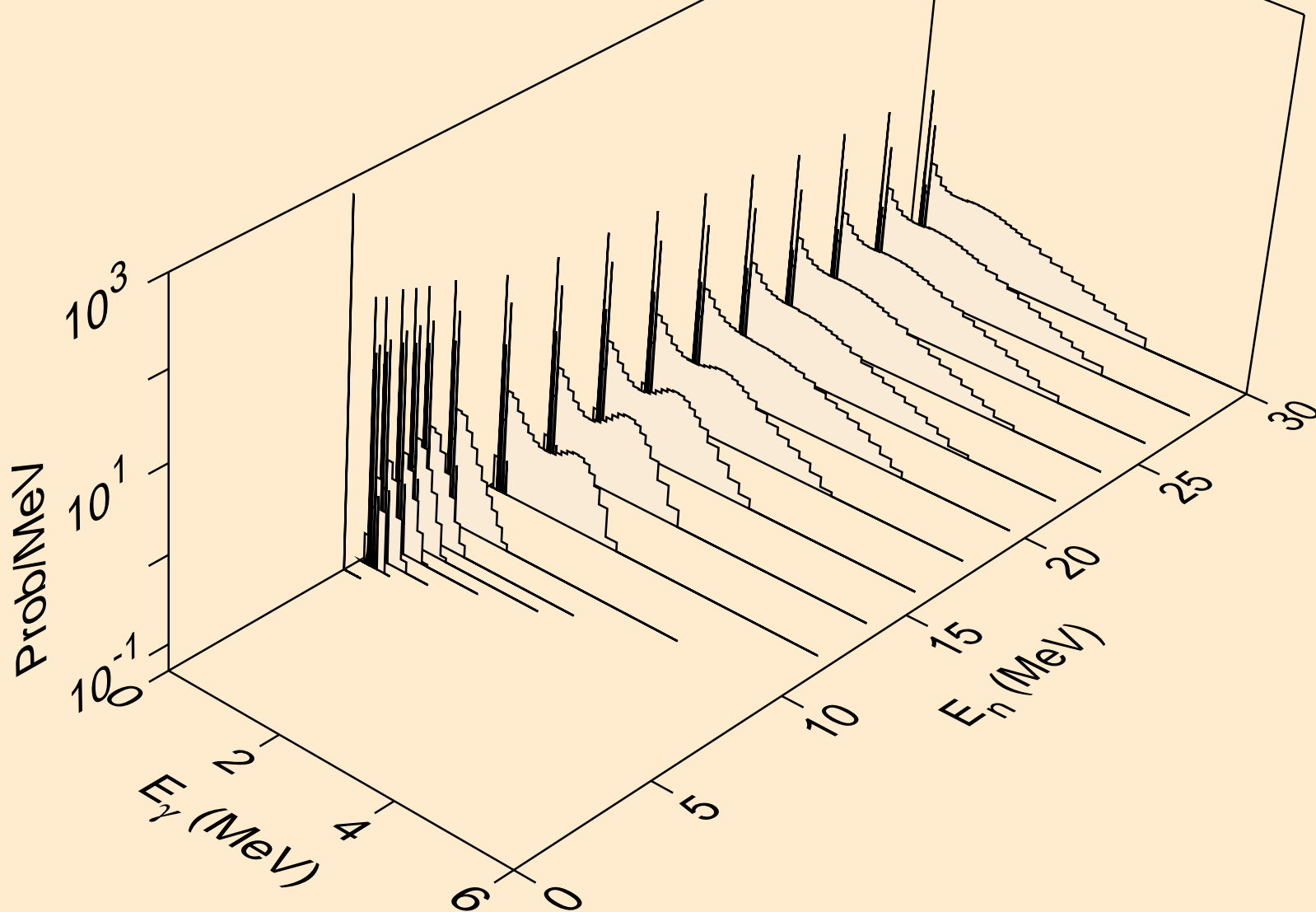

Y083M NEUTRON ACER TENDL-2019 LIBRARY; T=293.16K  
Photon emission for (n,a)

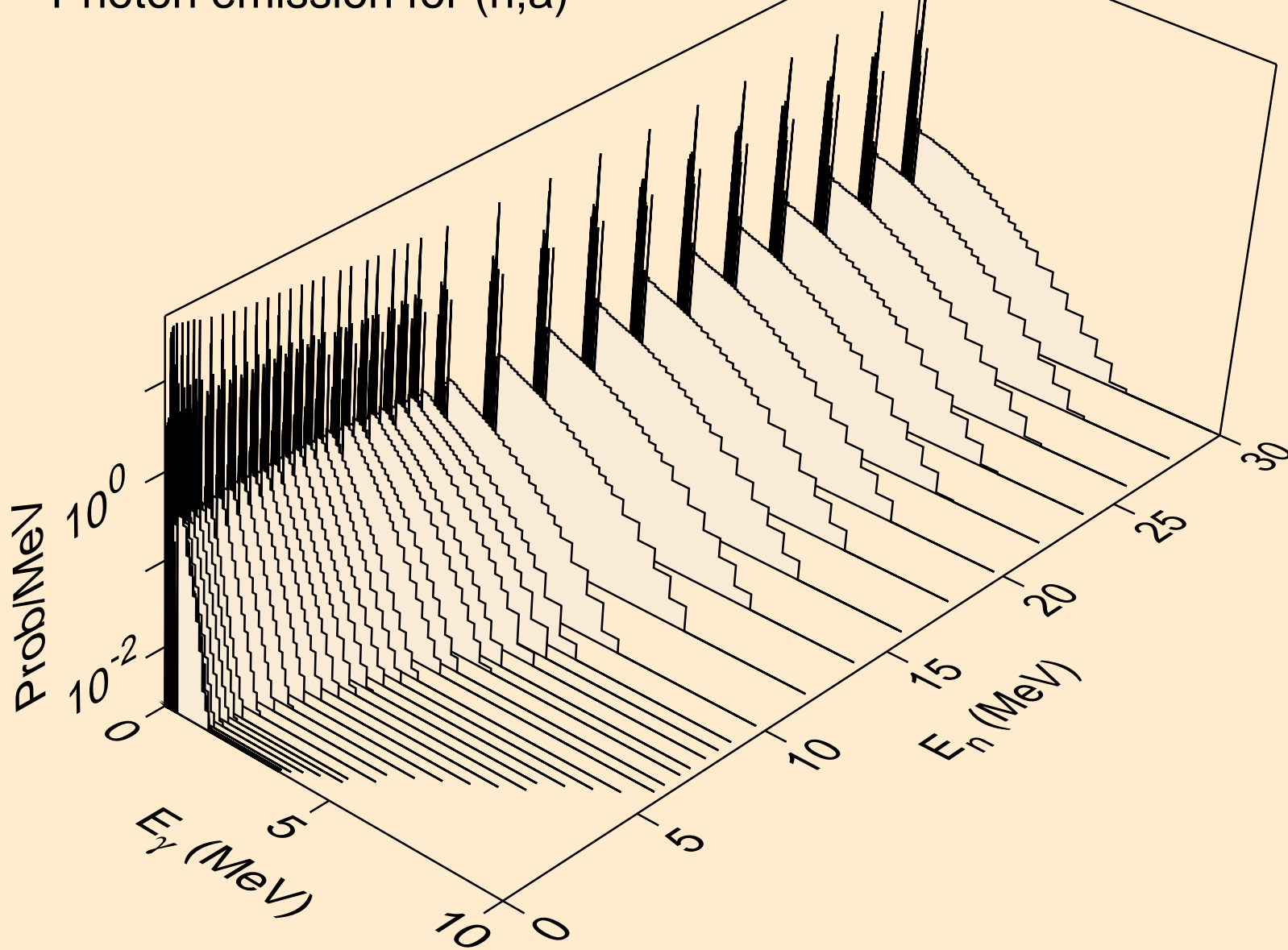

Y083M NEUTRON ACER TENDL-2019 LIBRARY; T=293.16K  
Photon emission for (n,2a)

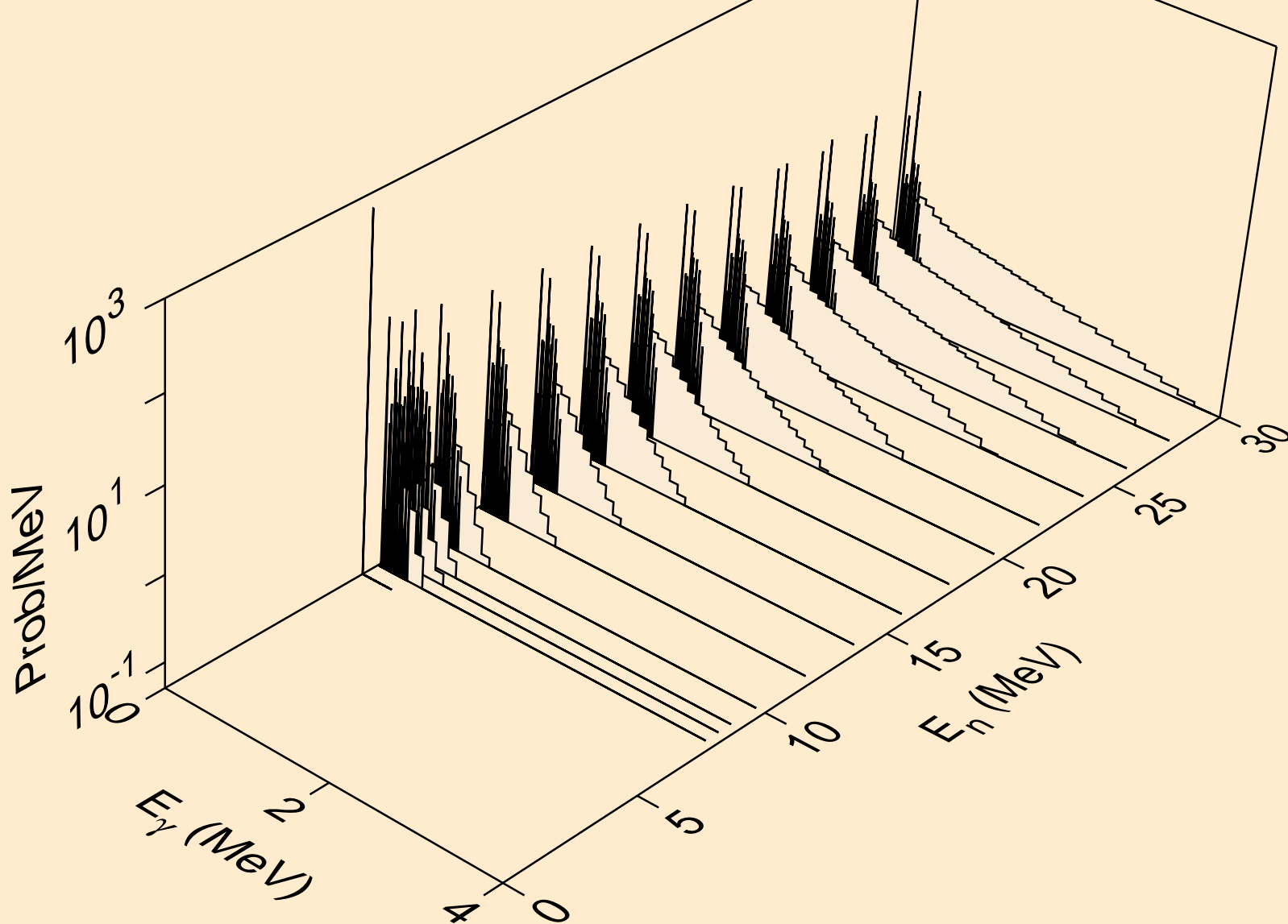



Y083M NEUTRON ACER TENDL-2019 LIBRARY; T=293.16K  
Photon emission for (n,3a)

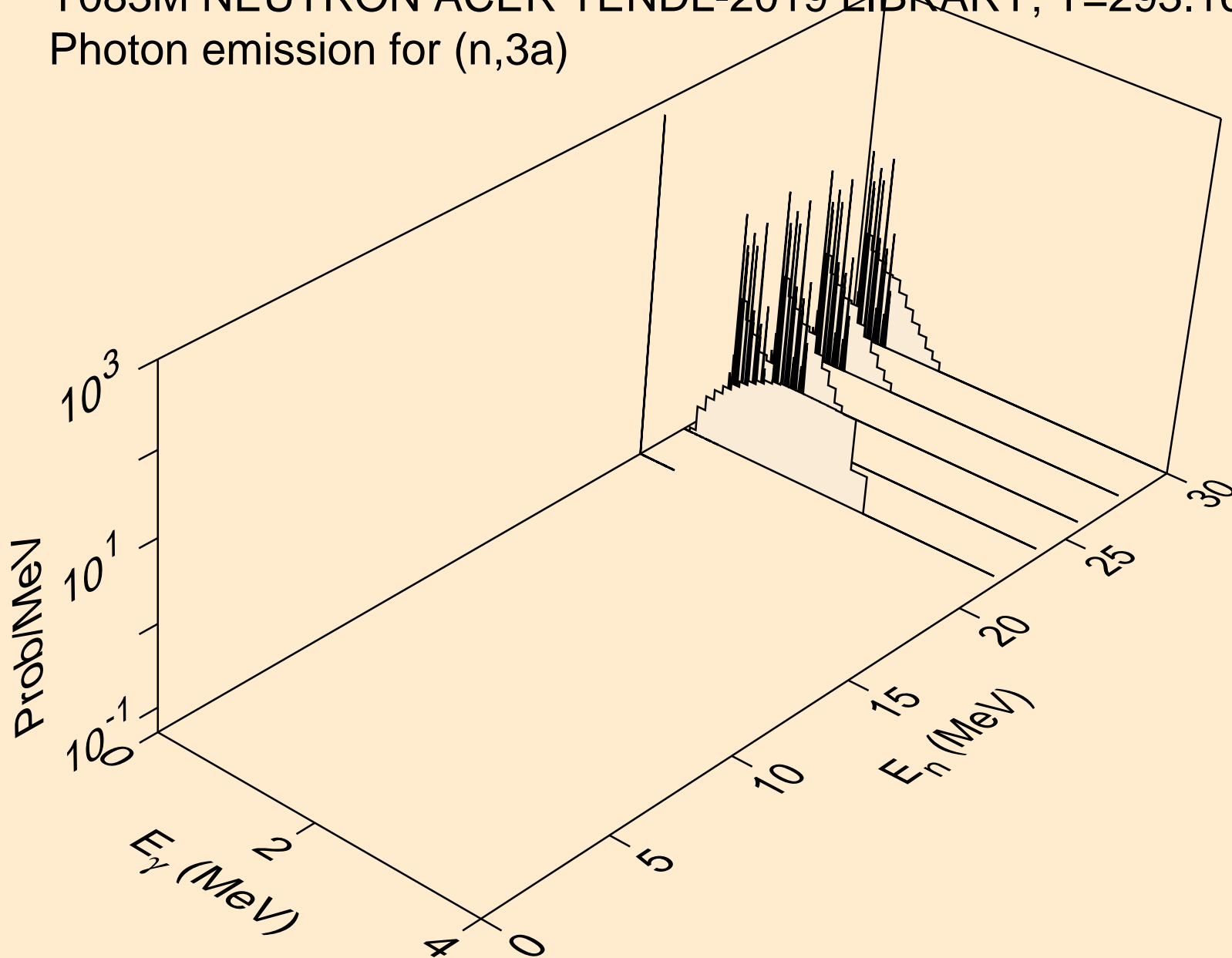

Y083M NEUTRON ACER TENDL-2019 LIBRARY; T=293.16K  
Photon emission for (n,2p)

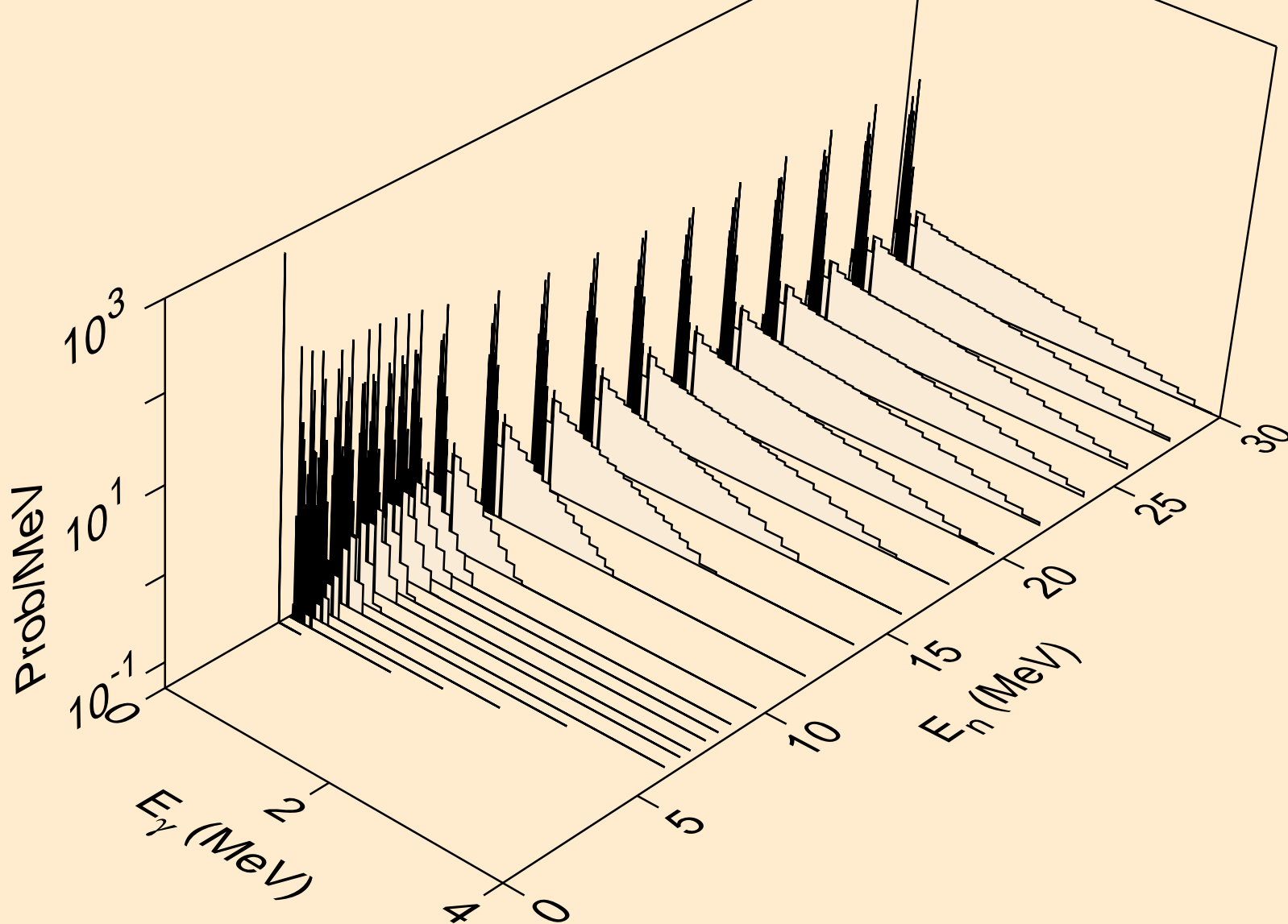

Y083M NEUTRON ACER TENDL-2019 LIBRARY; T=293.16K  
Photon emission for (n,p $\alpha$ )

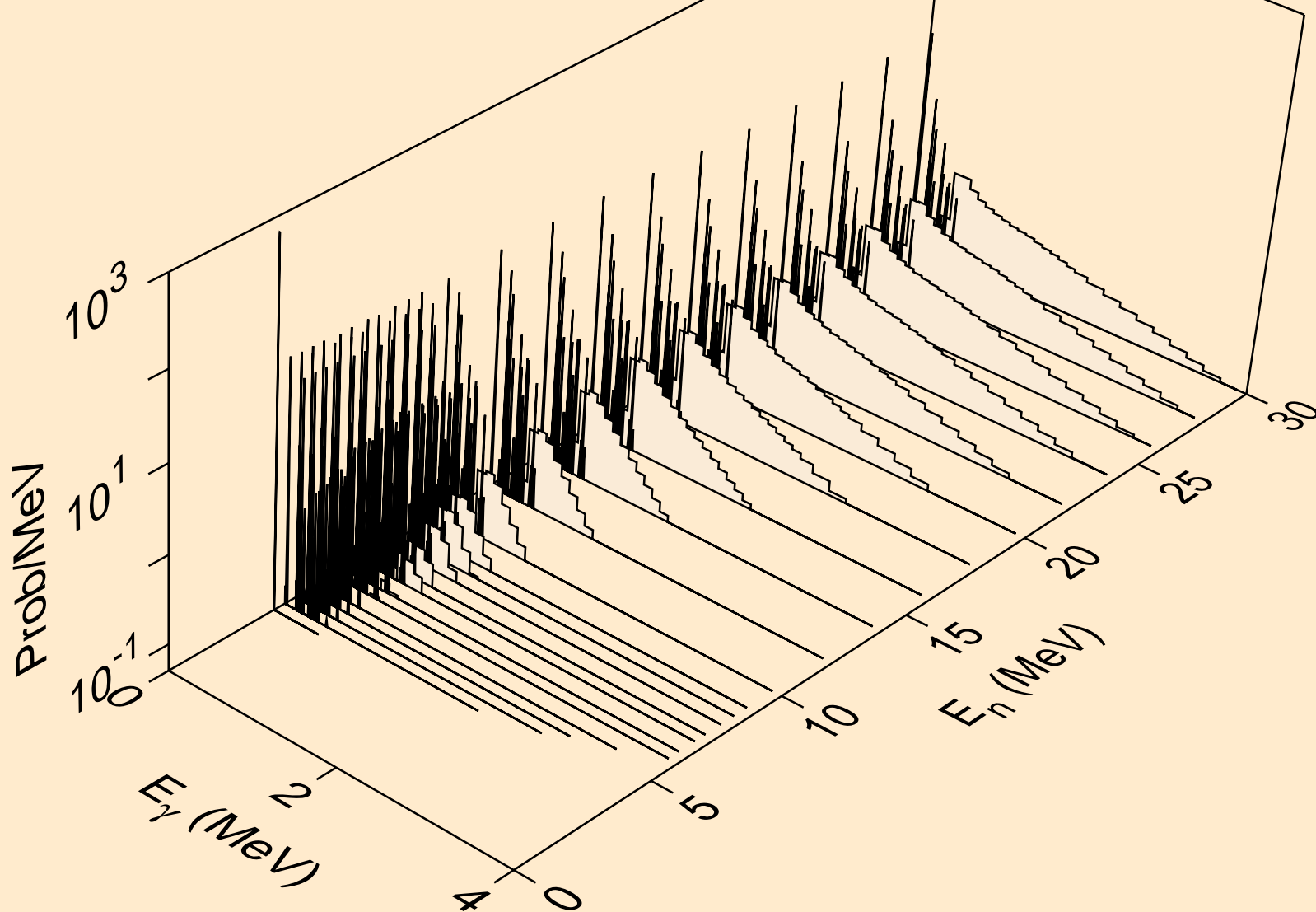

Y083M NEUTRON ACER TENDL-2019 LIBRARY; T=293.16K  
Photon emission for (n,pd)

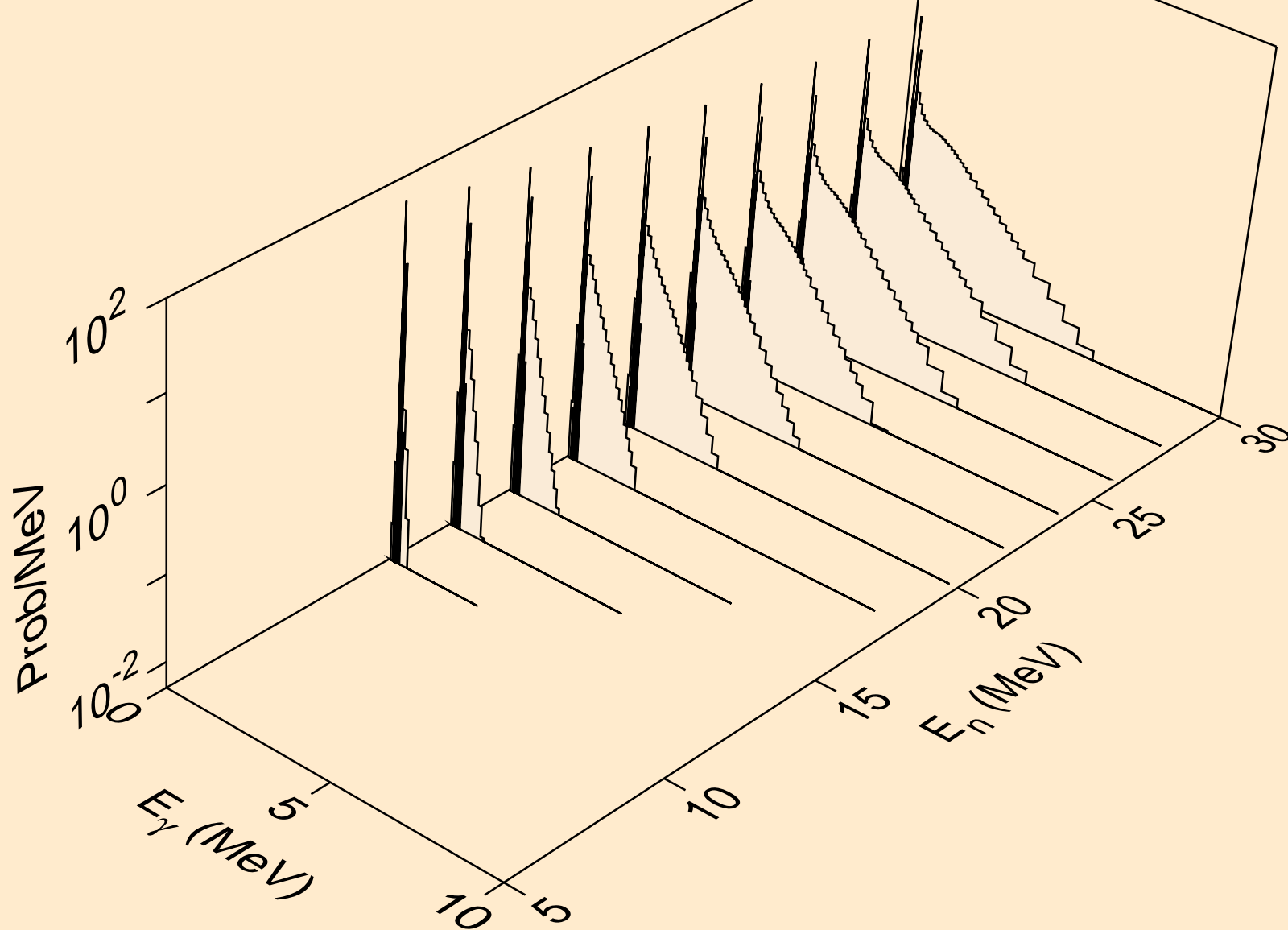

Y083M NEUTRON ACER TENDL-2019 LIBRARY; T=293.16K  
Photon emission for (n,pt)

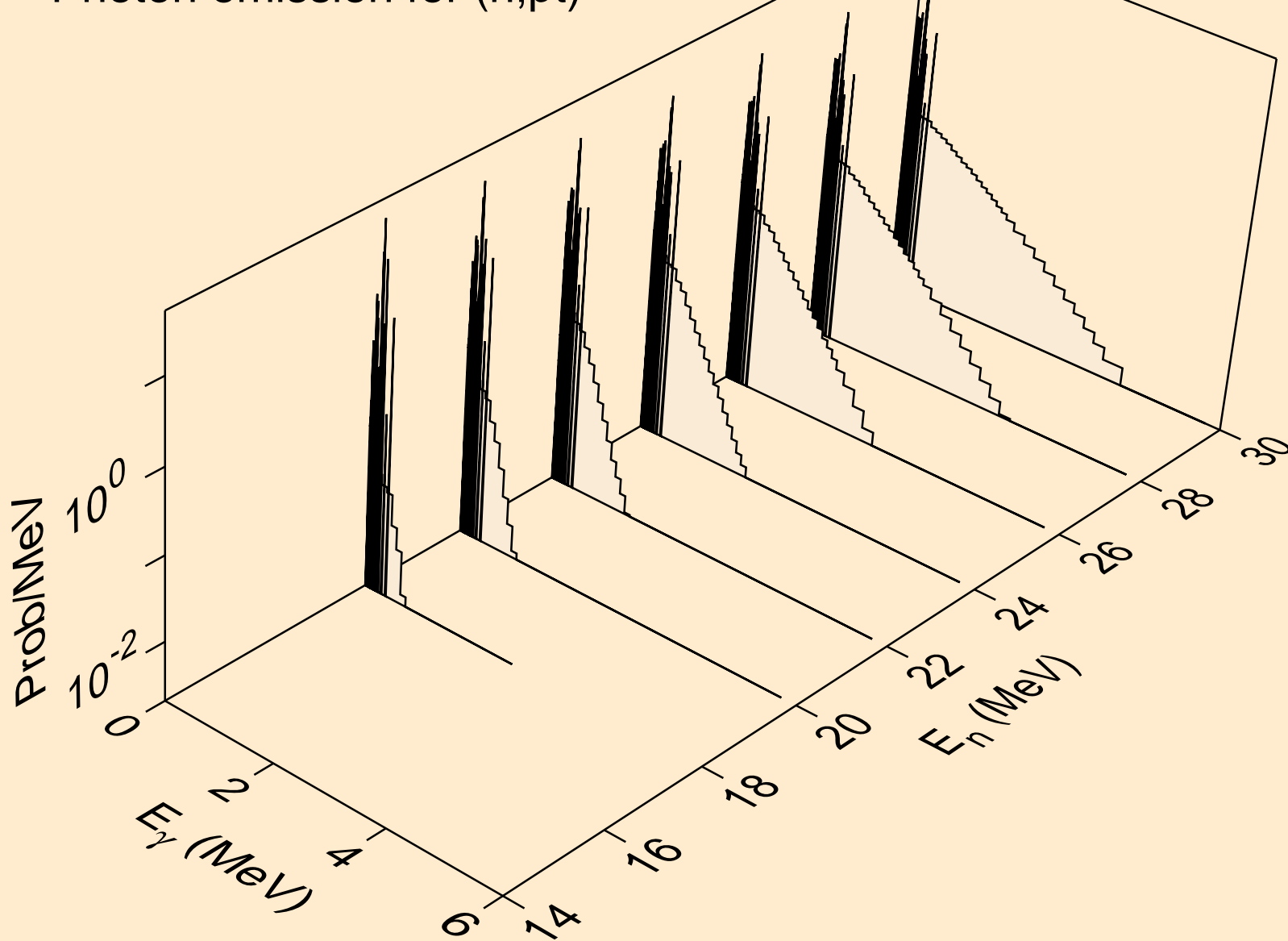

Y083M NEUTRON ACER TENDL-2019 LIBRARY; T=293.16K  
Photon emission for (n,da)

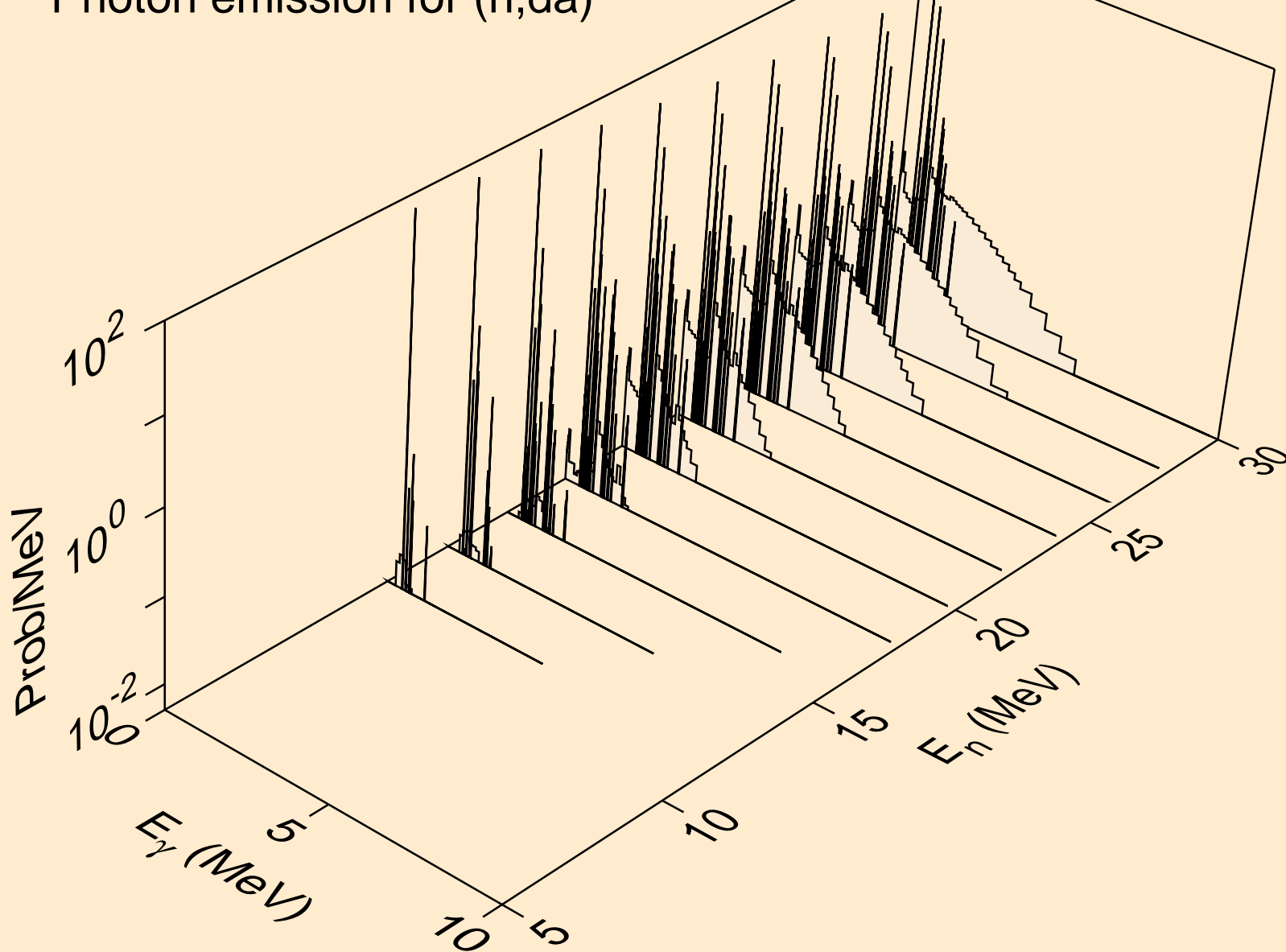

Y083M NEUTRON ACER TENDL-2019 LIBRARY; T=293.16K  
thermal capture photon spectrum

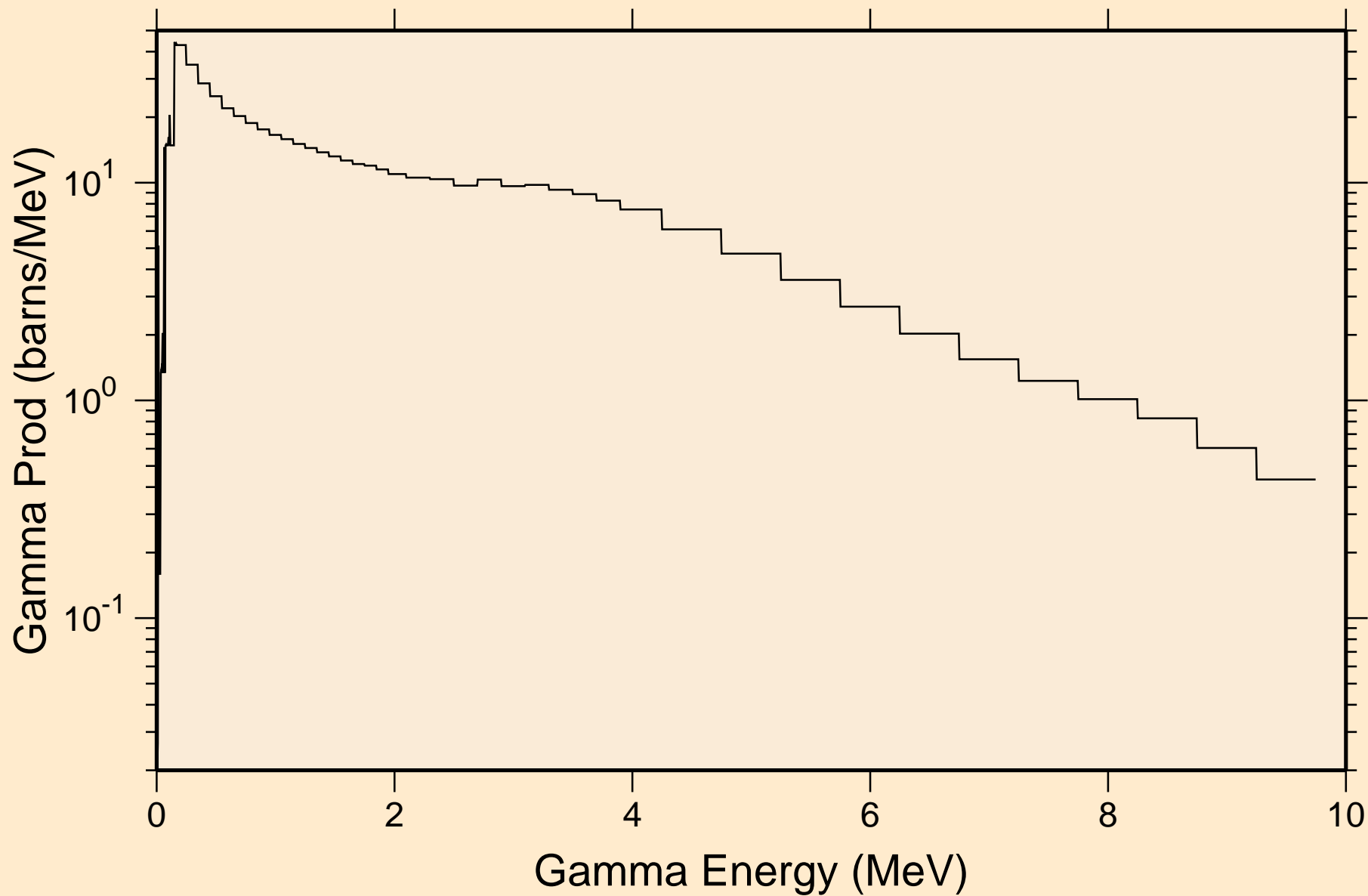

Y083M NEUTRON ACER TENDL-2019 LIBRARY; T=293.16K  
14 MeV photon spectrum

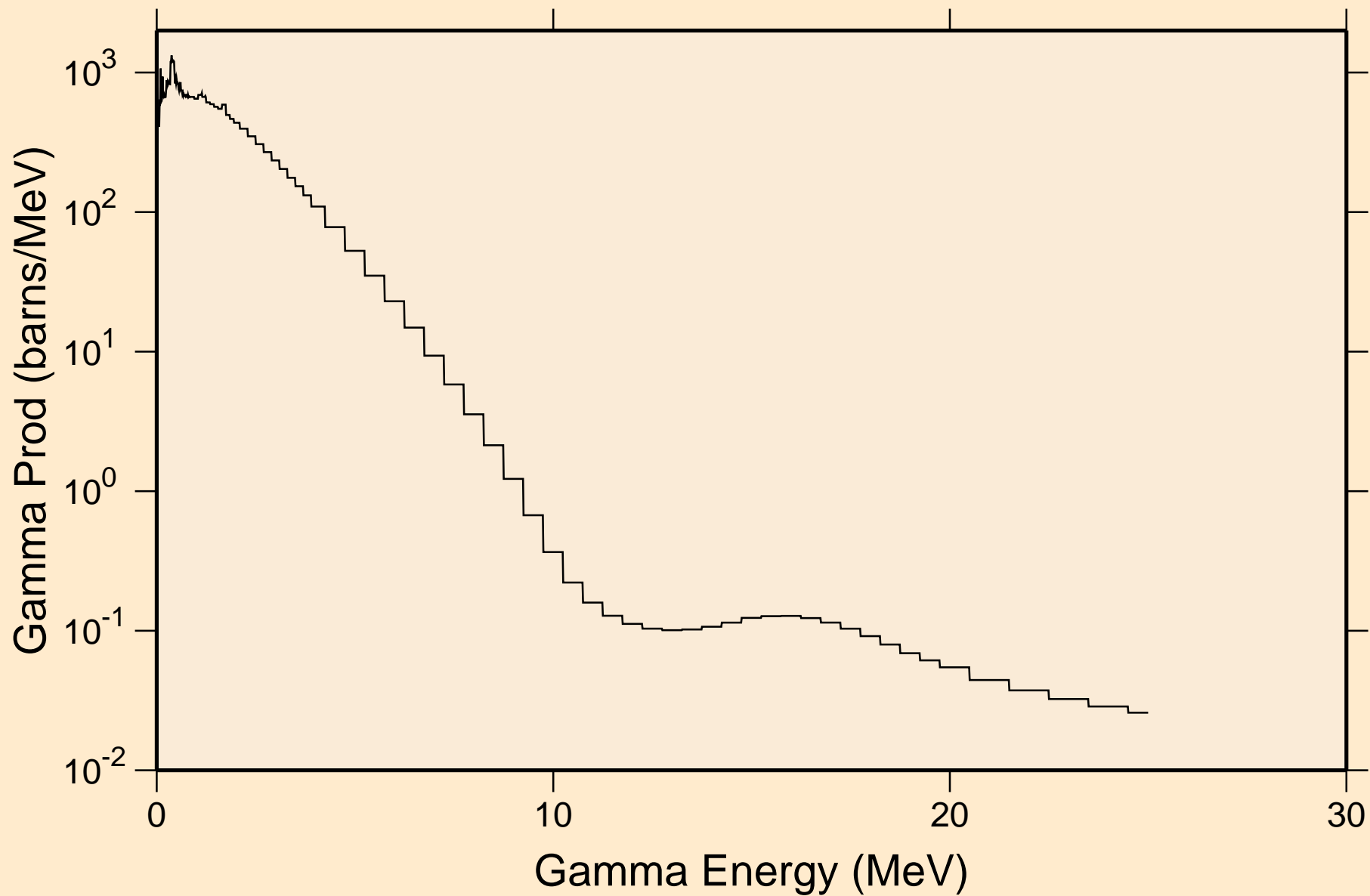



Y083M NEUTRON ACER TENDL-2019 LIBRARY; T=293.16K  
Particle heating contributions

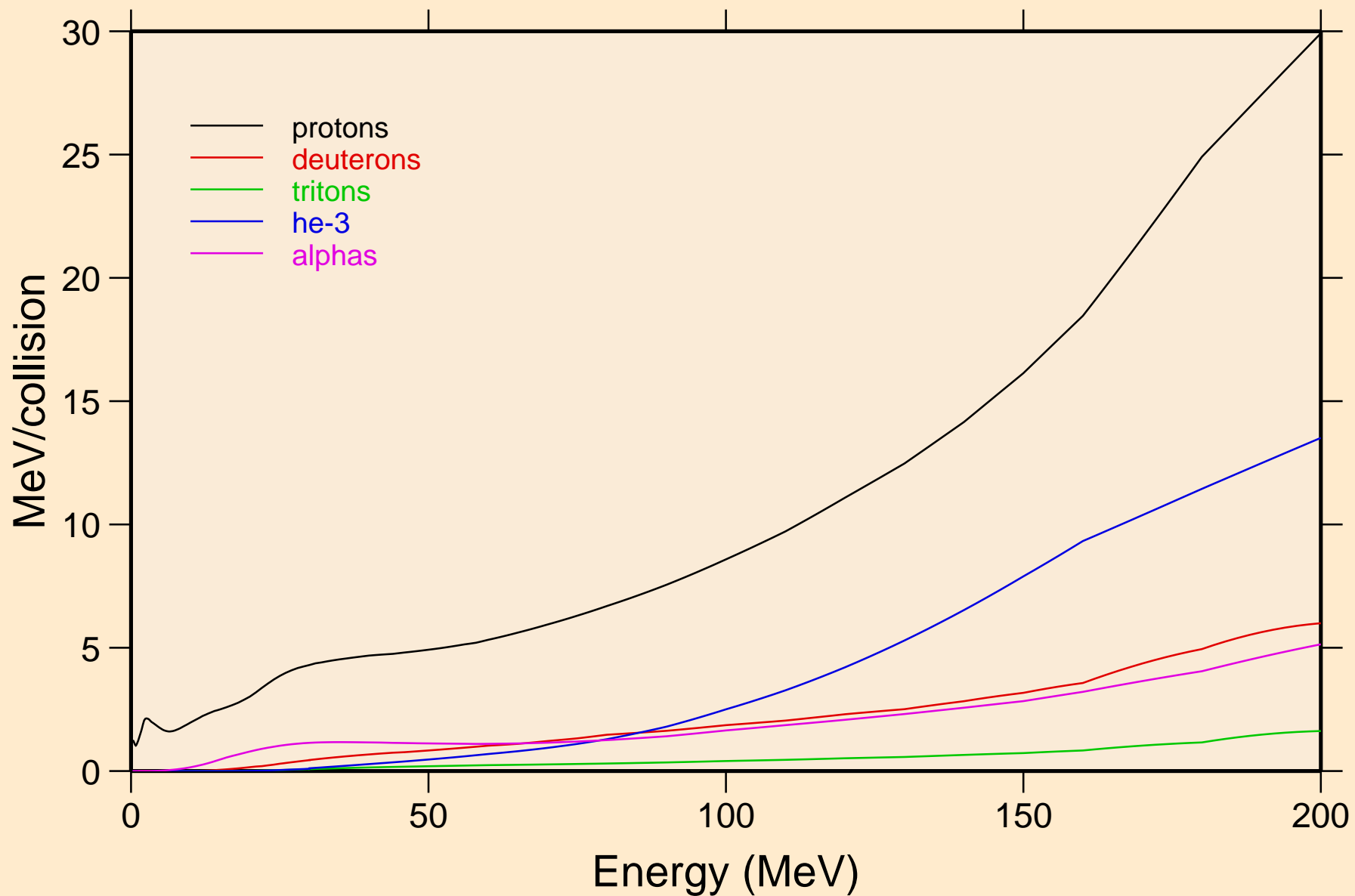

Y083M NEUTRON ACER TENDL-2019 LIBRARY; T=293.16K  
Recoil Heating

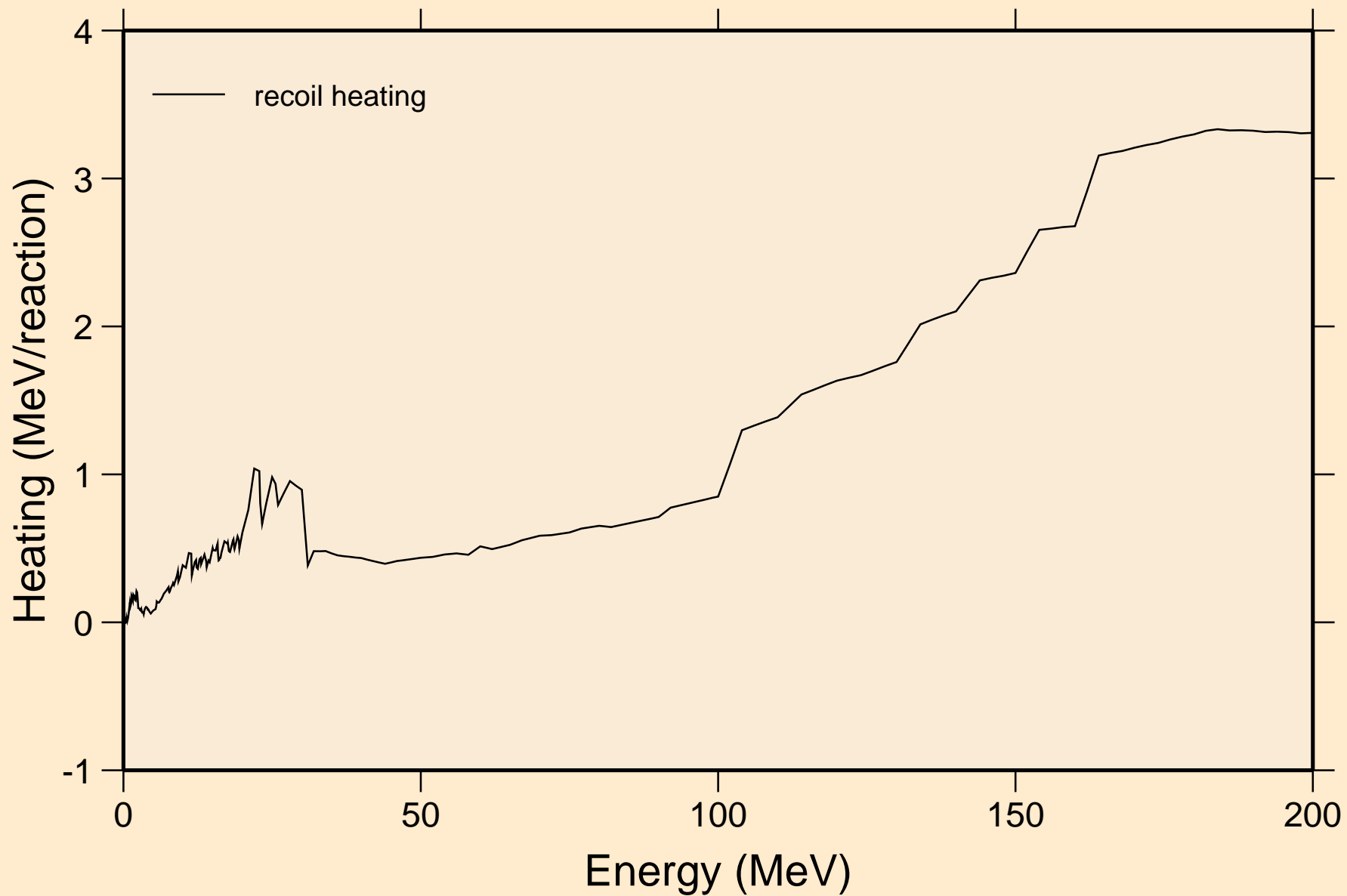

Y083M NEUTRON ACER TENDL-2019 LIBRARY; T=293.16K  
Particle production cross sections

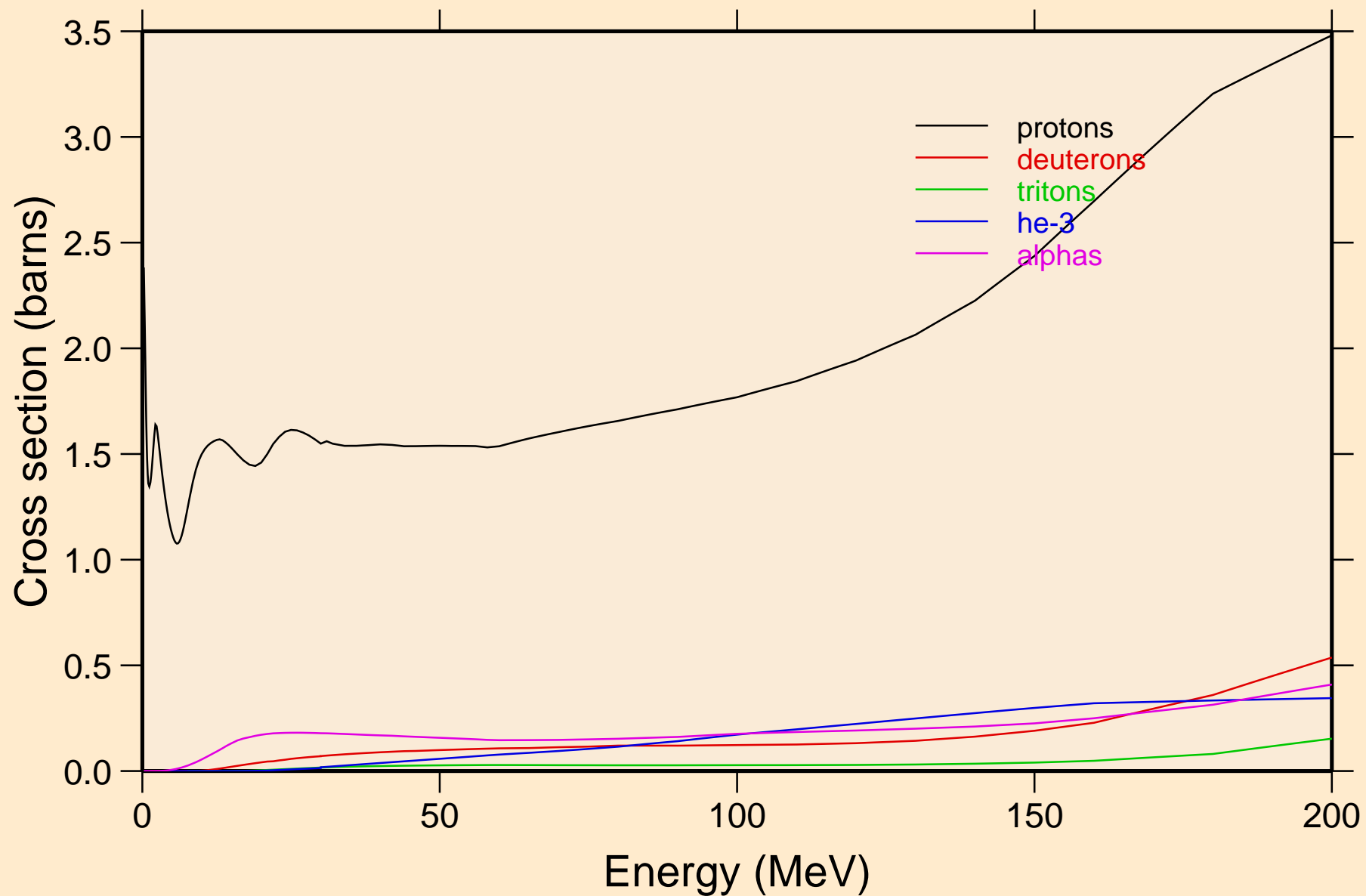

Y083M NEUTRON ACER TENDL-2019 LIBRARY; T=293.16K  
protons from (n,x)

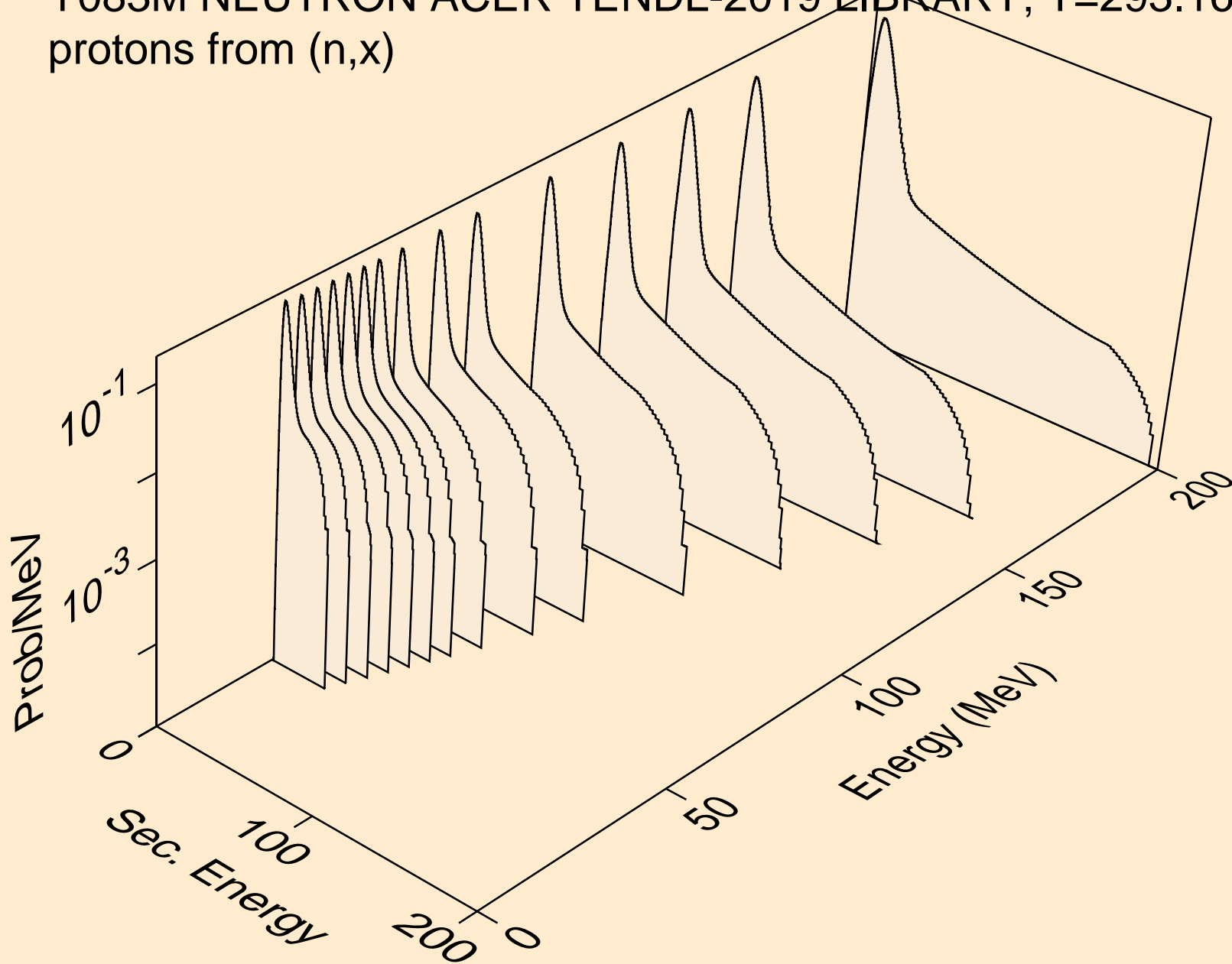

Y083M NEUTRON ACER TENDL-2019 LIBRARY; T=293.16K  
protons from (n,n\*)p

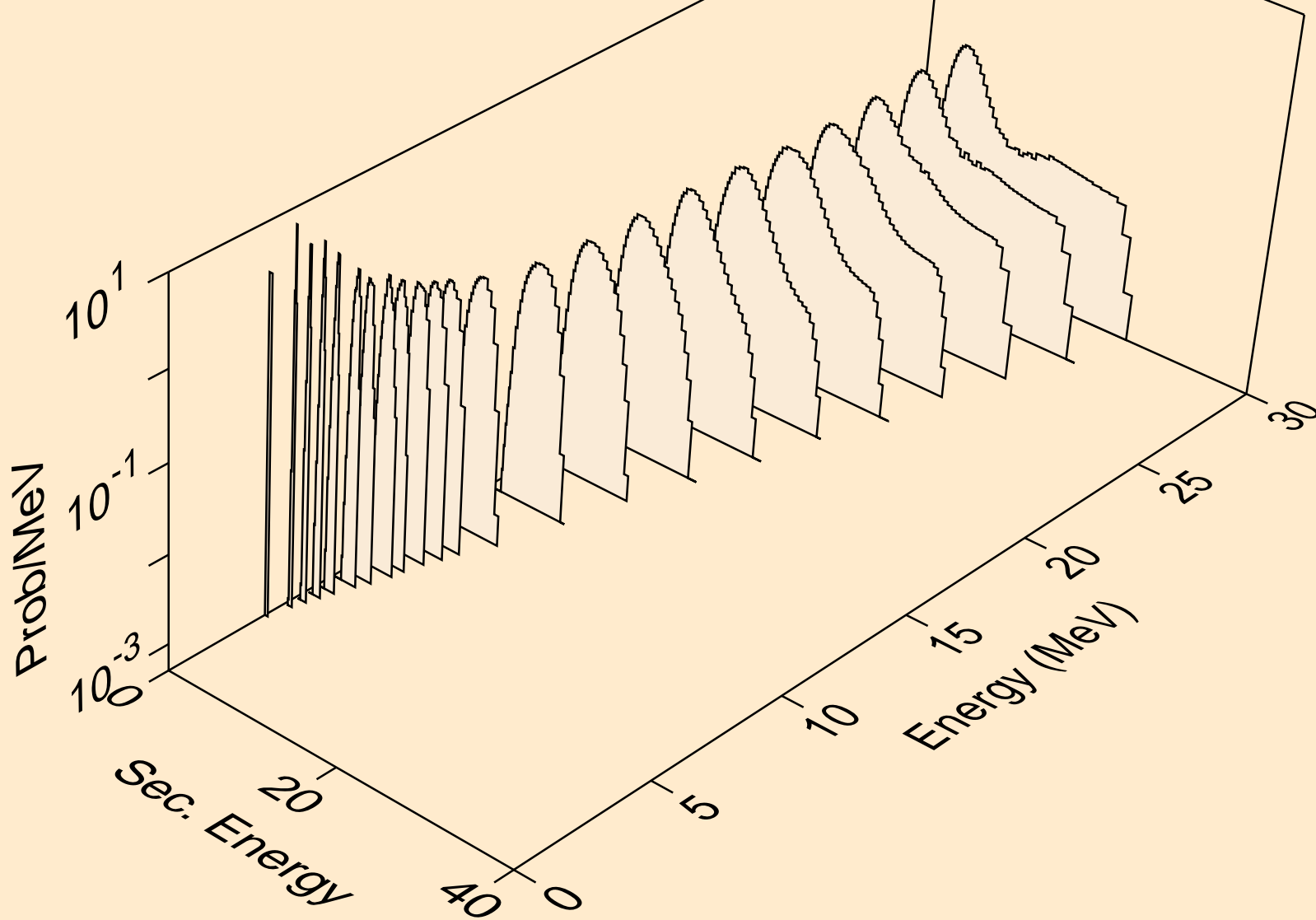

Y083M NEUTRON ACER TENDL-2019 LIBRARY; T=293.16K  
protons from (n,2np)

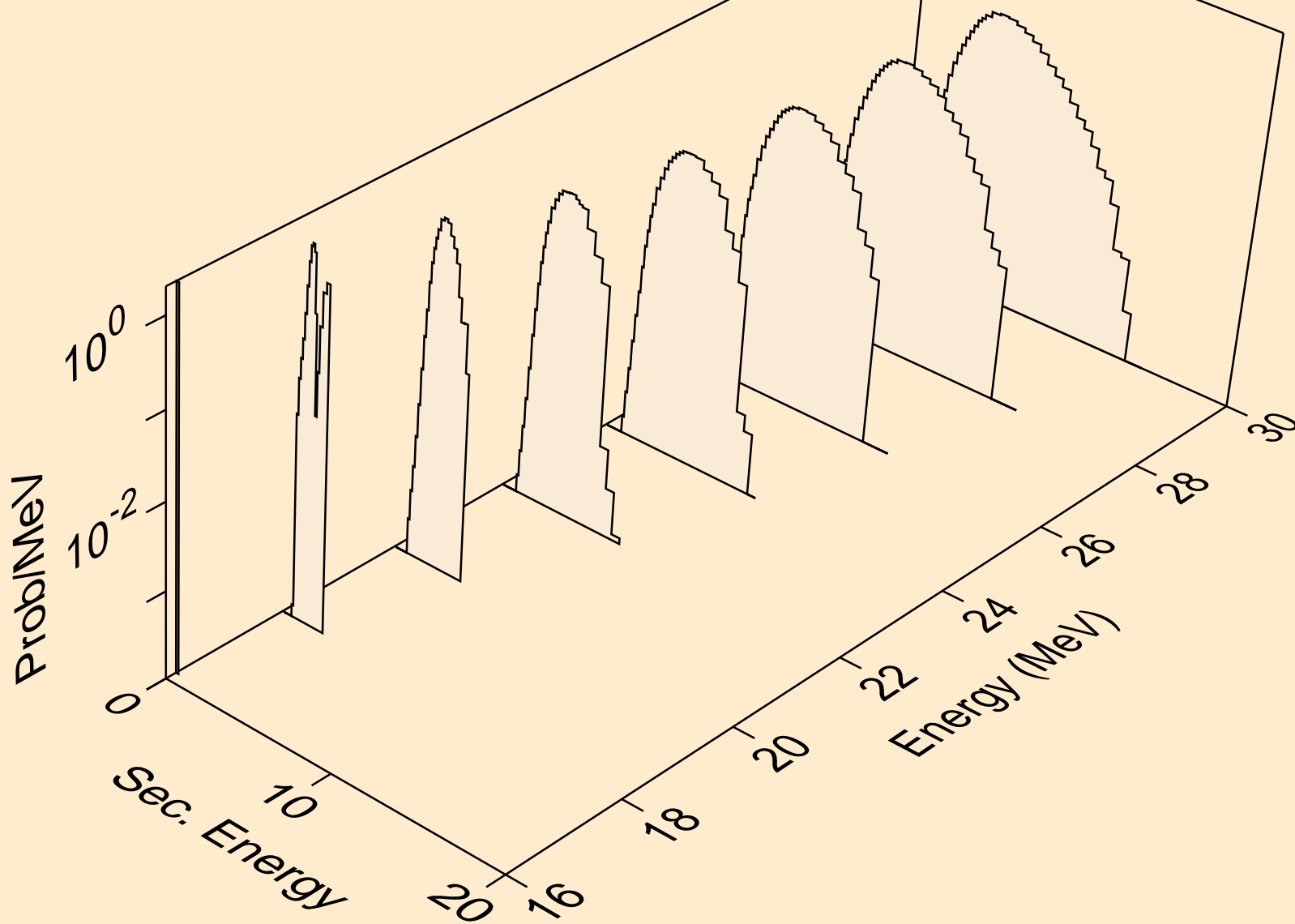

Y083M NEUTRON ACER TENDL-2019 LIBRARY; T=293.16K  
protons from (n,3np)

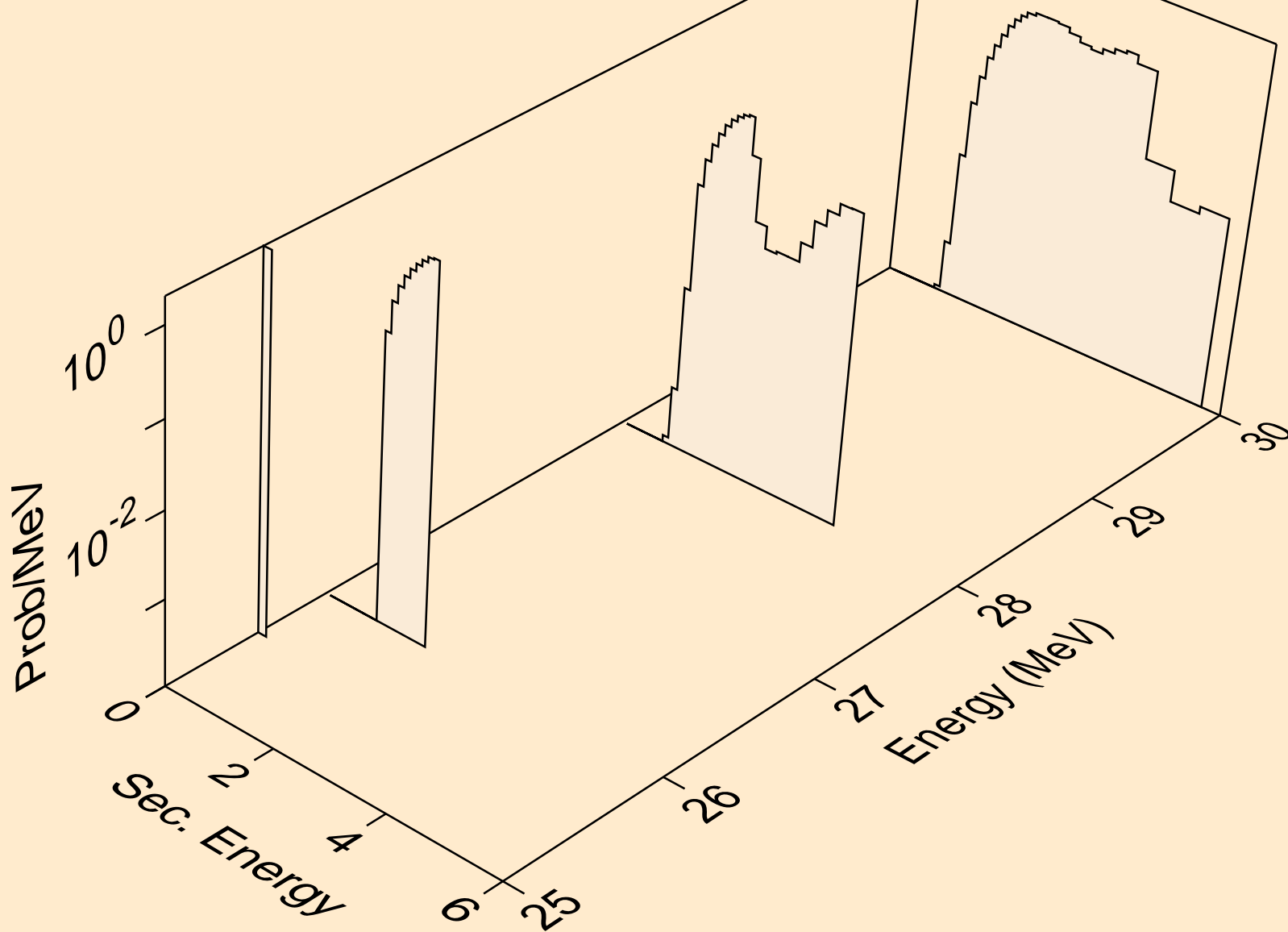

Y083M NEUTRON ACER TENDL-2019 LIBRARY; T=293.16K  
protons from (n,2np)

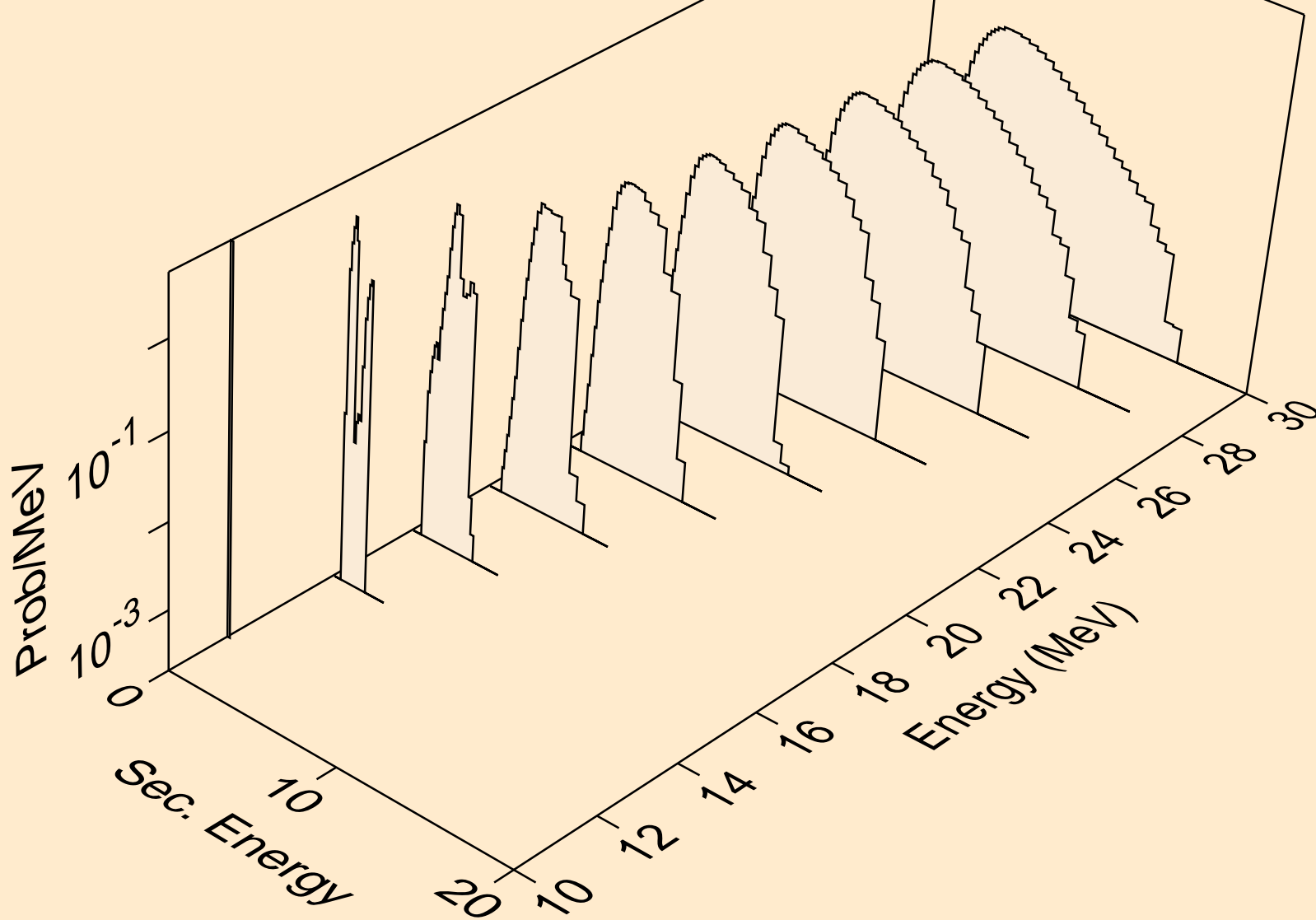



Y083M NEUTRON ACER TENDL-2019 LIBRARY; T=293.16K  
protons from (n,npa)

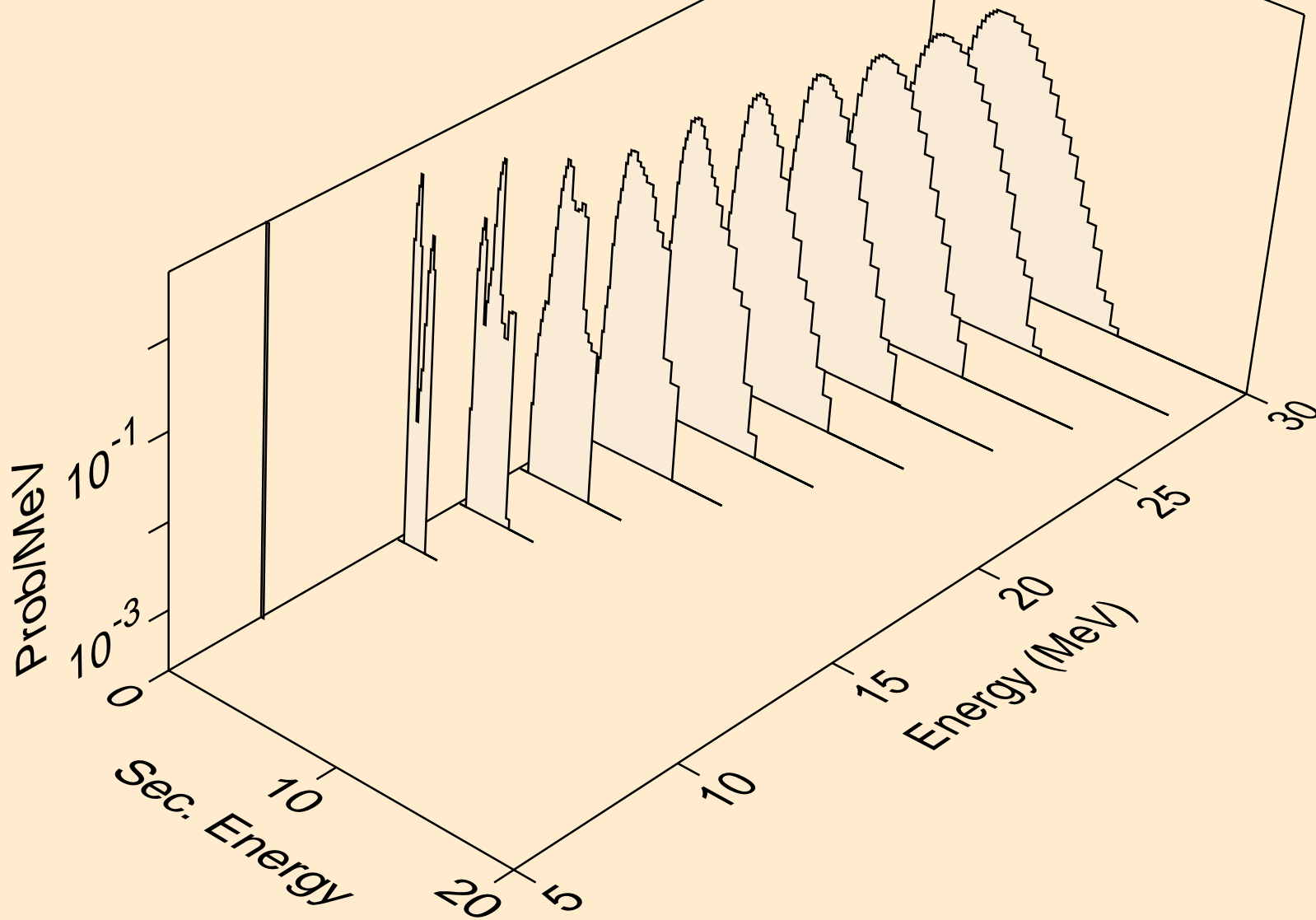

Y083M NEUTRON ACER TENDL-2019 LIBRARY; T=293.16K  
protons from (n,p)

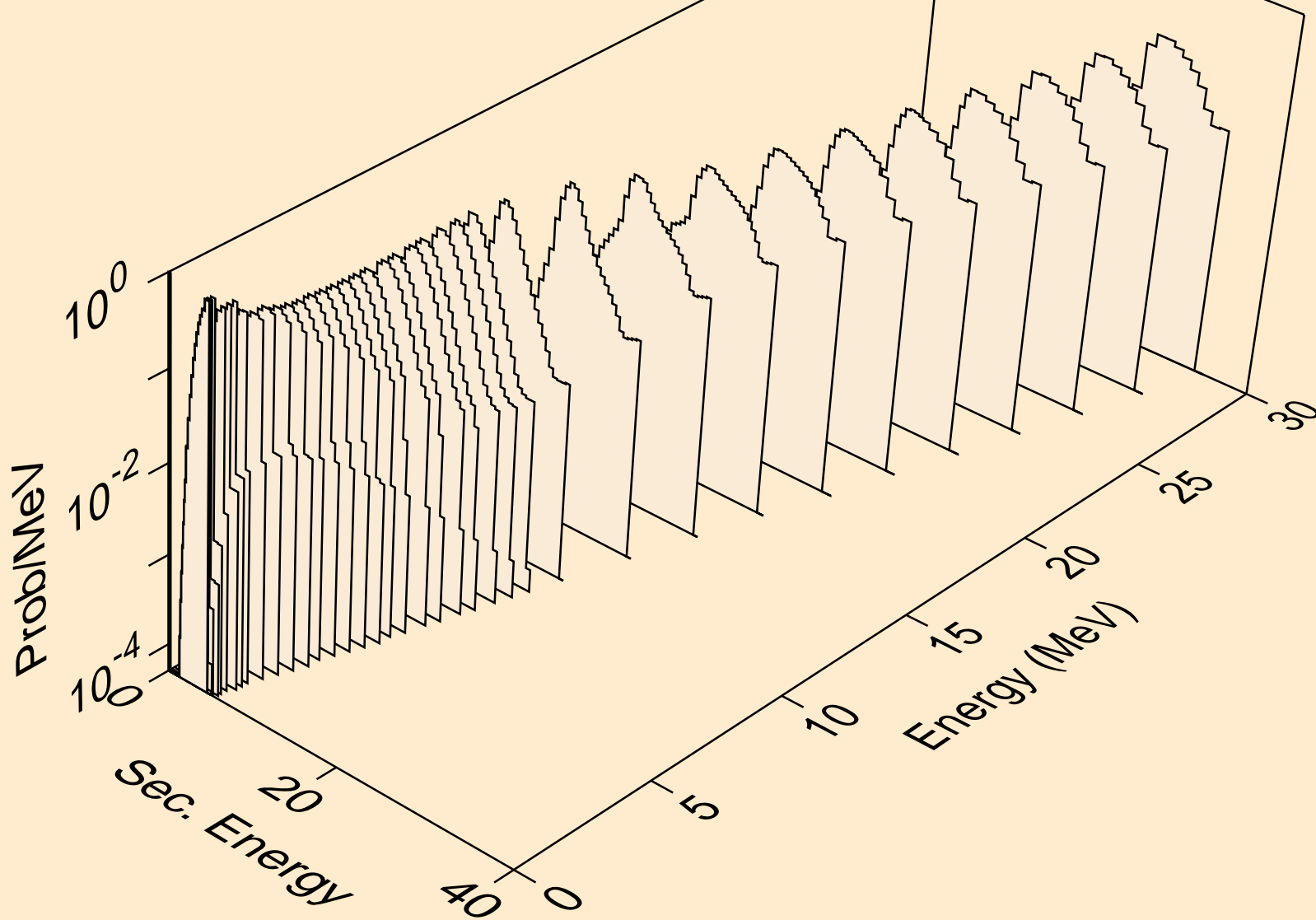

Y083M NEUTRON ACER TENDL-2019 LIBRARY; T=293.16K  
protons from (n,2p)

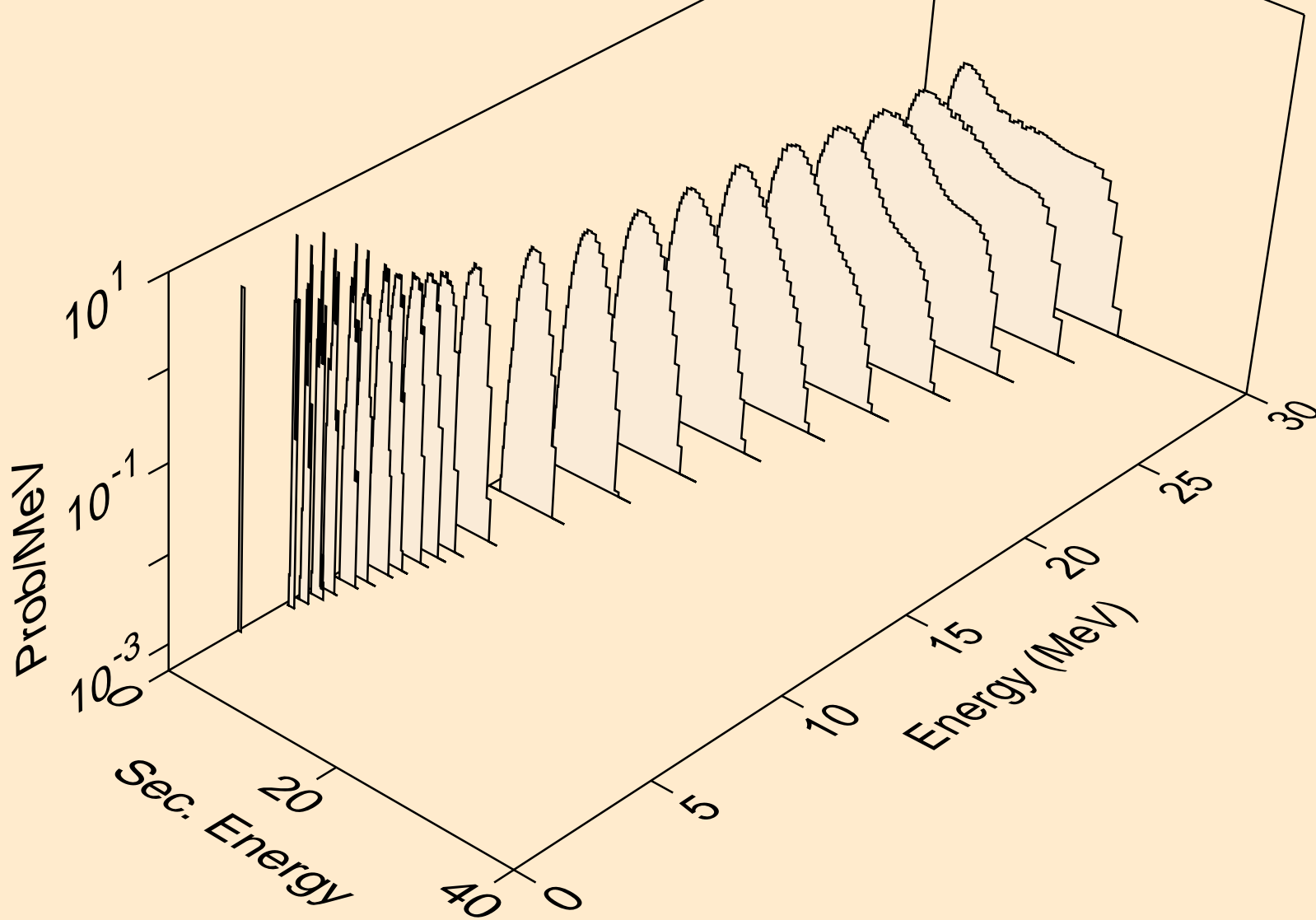

Y083M NEUTRON ACER TENDL-2019 LIBRARY; T=293.16K  
protons from (n,p)

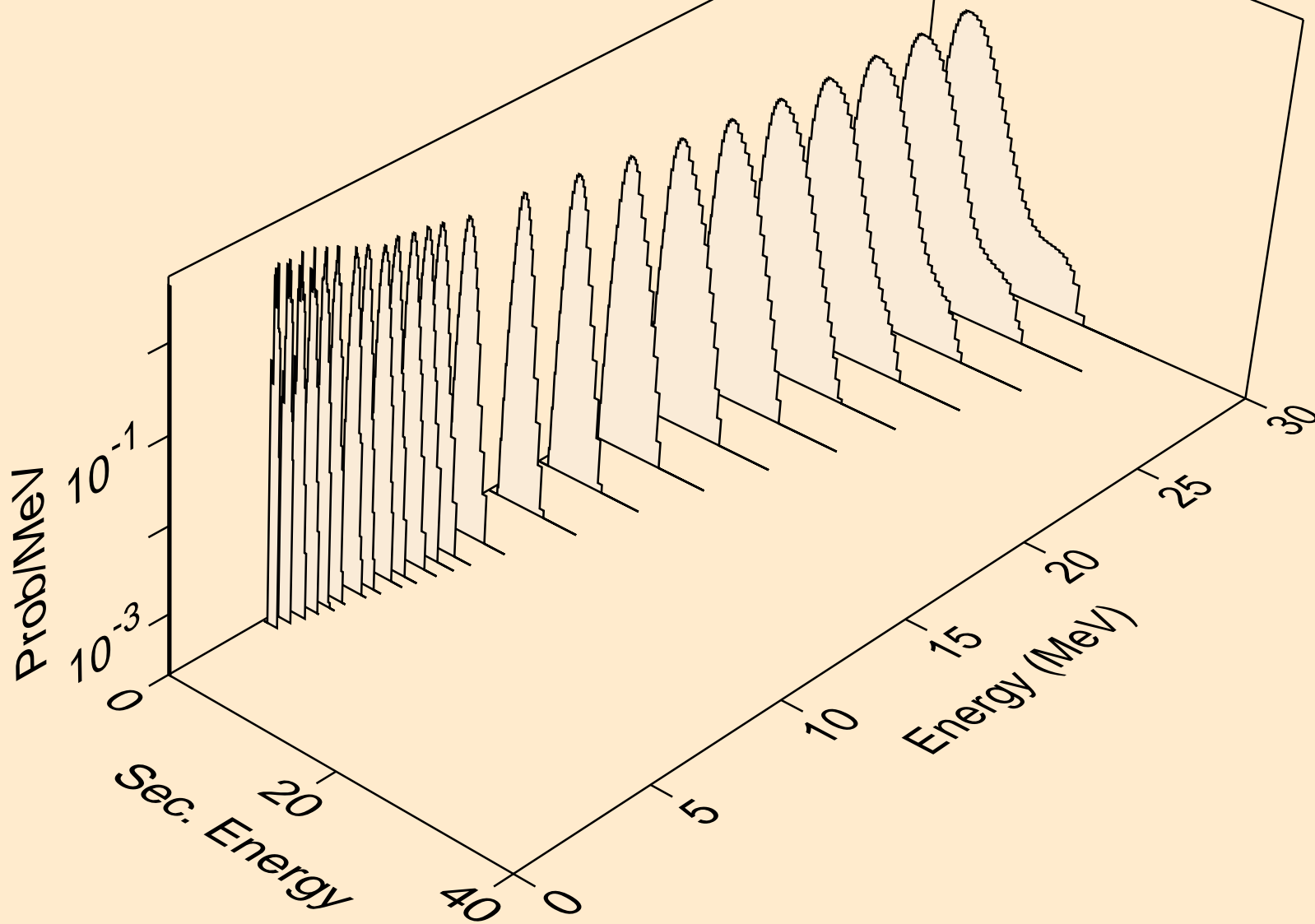

Y083M NEUTRON ACER TENDL-2019 LIBRARY; T=293.16K  
protons from (n,pd)

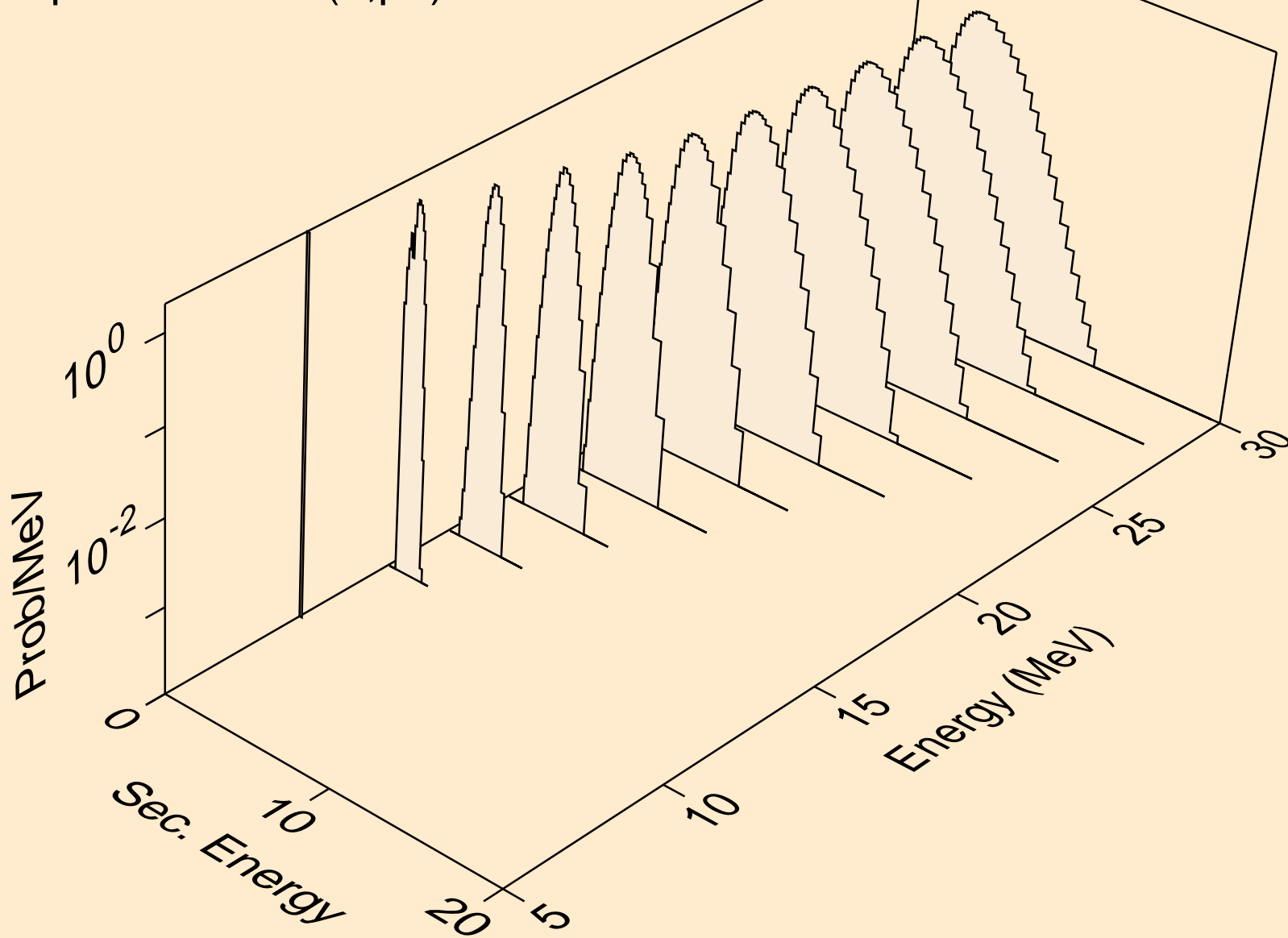

Y083M NEUTRON ACER TENDL-2019 LIBRARY; T=293.16K  
protons from (n,pt)

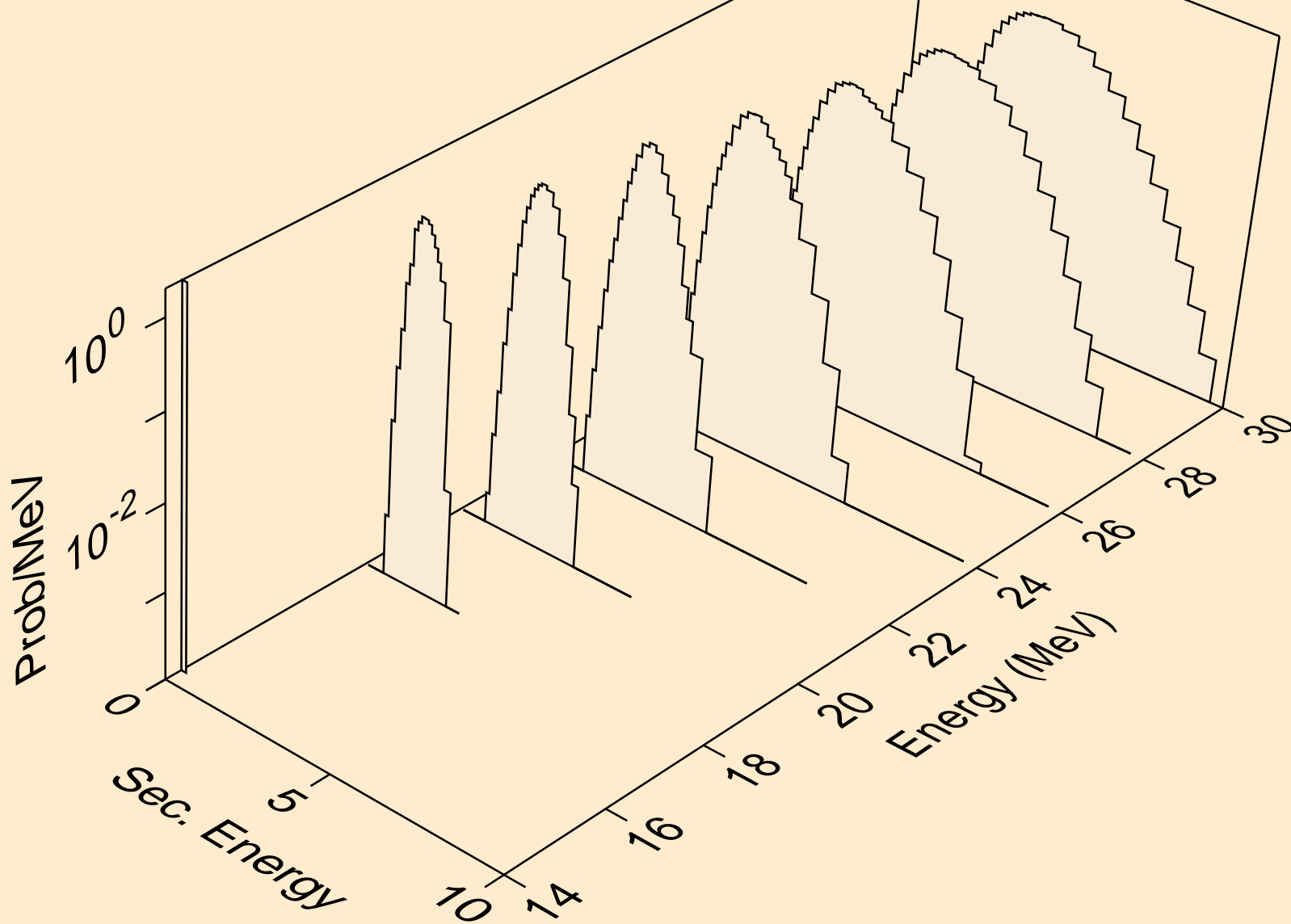

Y083M NEUTRON ACER TENDL-2019 LIBRARY; T=293.16K  
deuterons from (n,x)

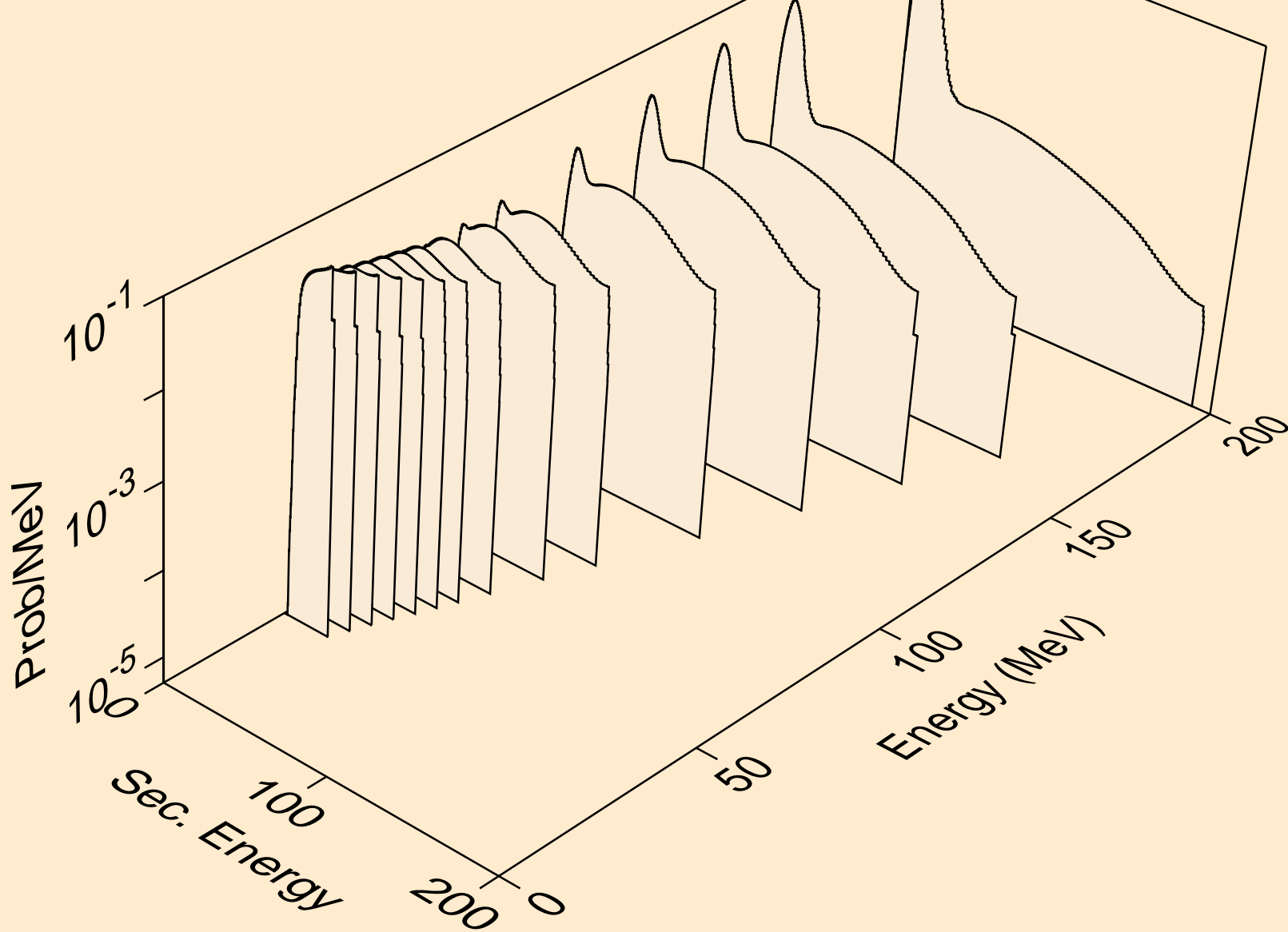

Y083M NEUTRON ACER TENDL-2019 LIBRARY; T=293.16K  
deuterons from (n,2nd)

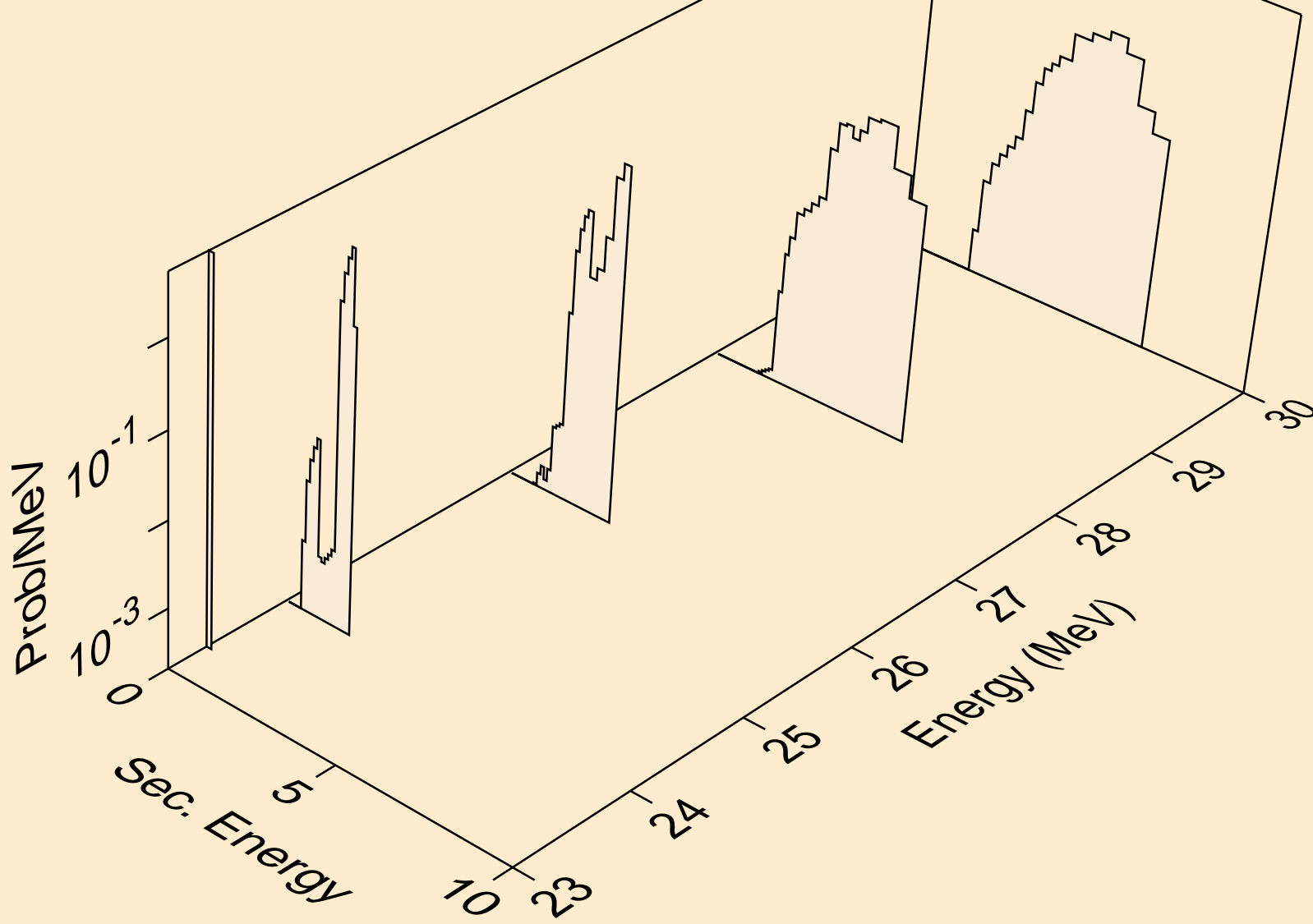



Y083M NEUTRON ACER TENDL-2019 LIBRARY; T=293.16K  
deuterons from (n,n\*)d

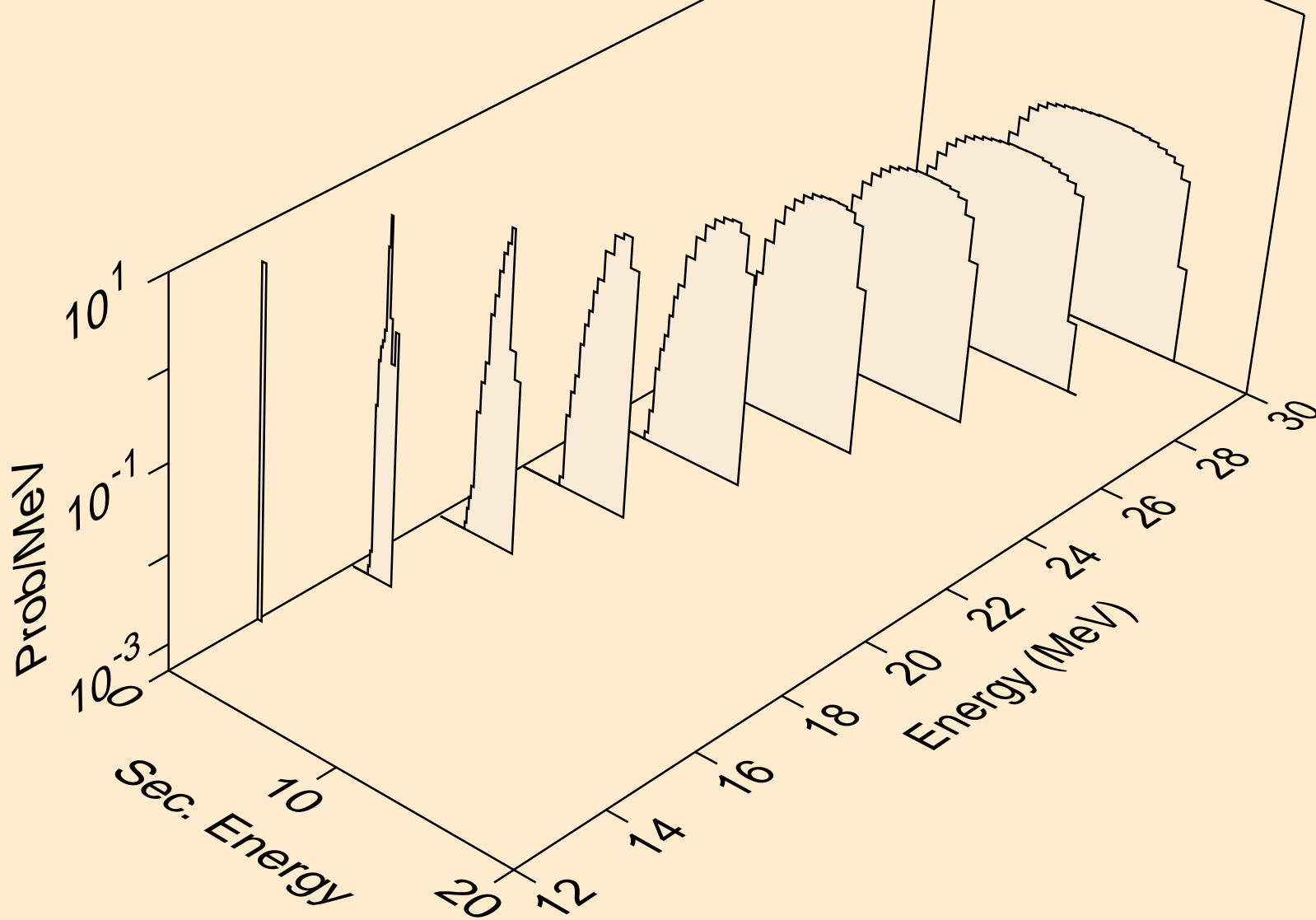

Y083M NEUTRON ACER TENDL-2019 LIBRARY; T=293.16K  
deuterons from (n,d)

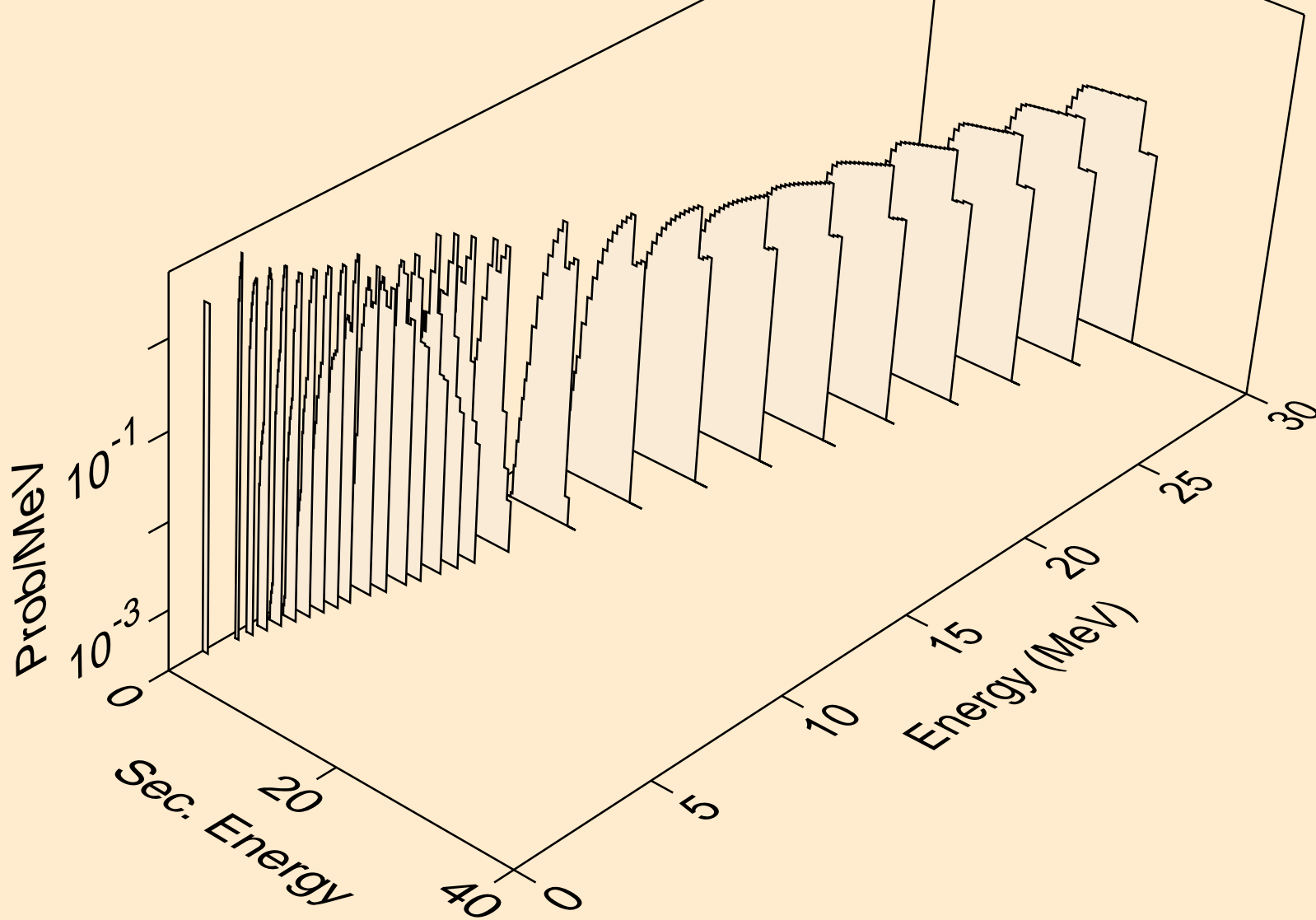

Y083M NEUTRON ACER TENDL-2019 LIBRARY; T=293.16K  
deuterons from (n,pd)

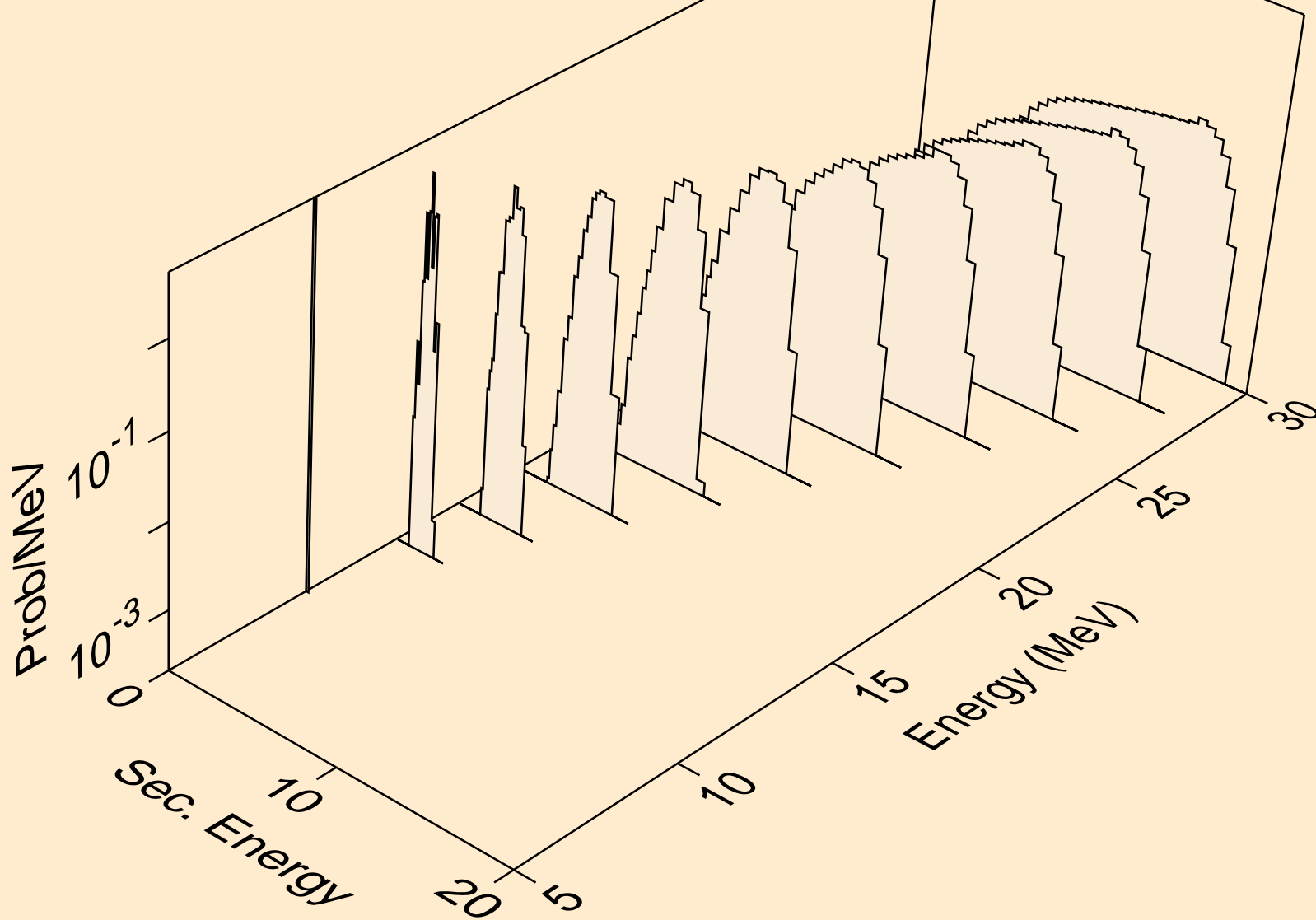

Y083M NEUTRON ACER TENDL-2019 LIBRARY; T=293.16K  
deuterons from (n,da)

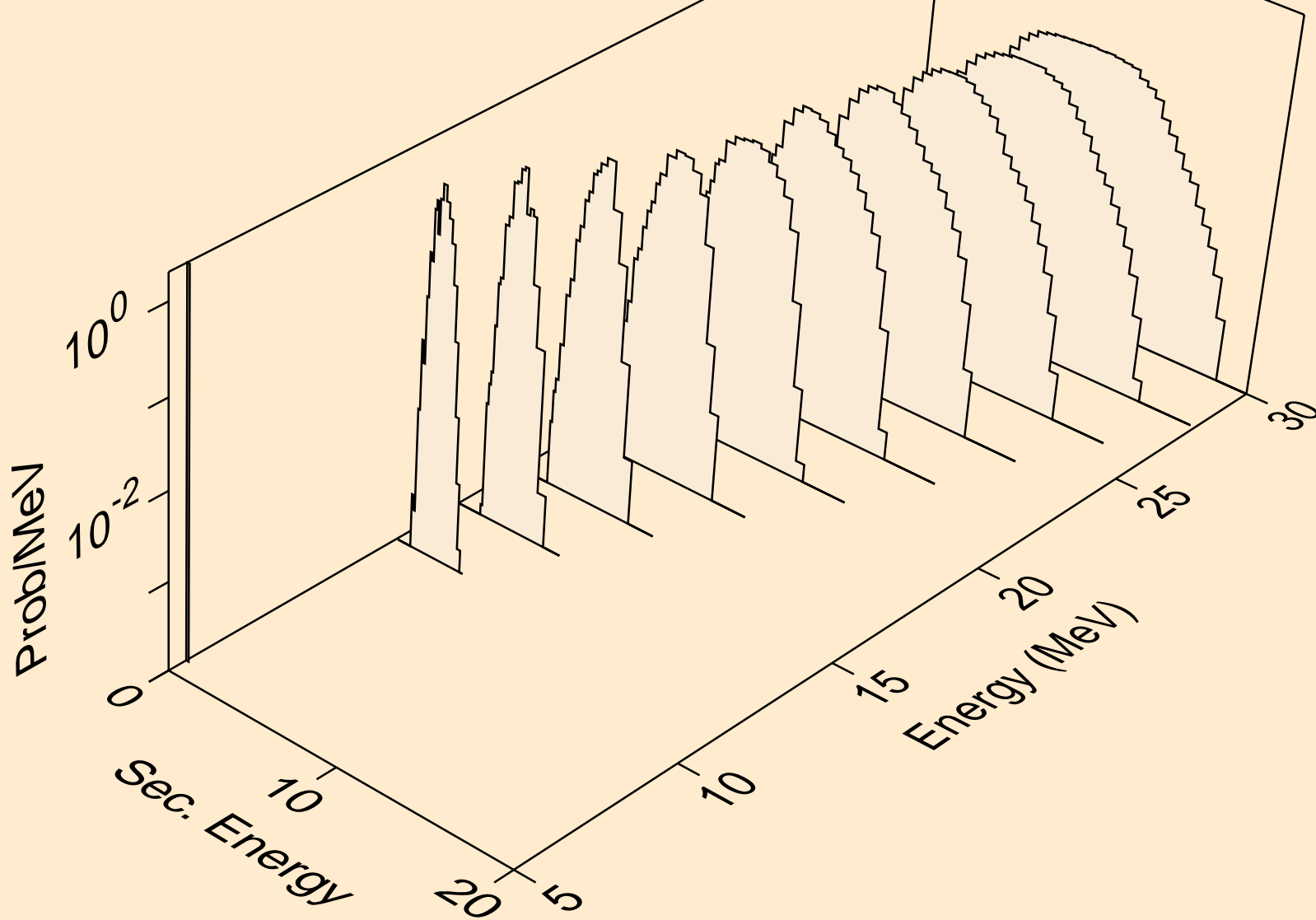

Y083M NEUTRON ACER TENDL-2019 LIBRARY; T=293.16K  
tritons from (n,x)

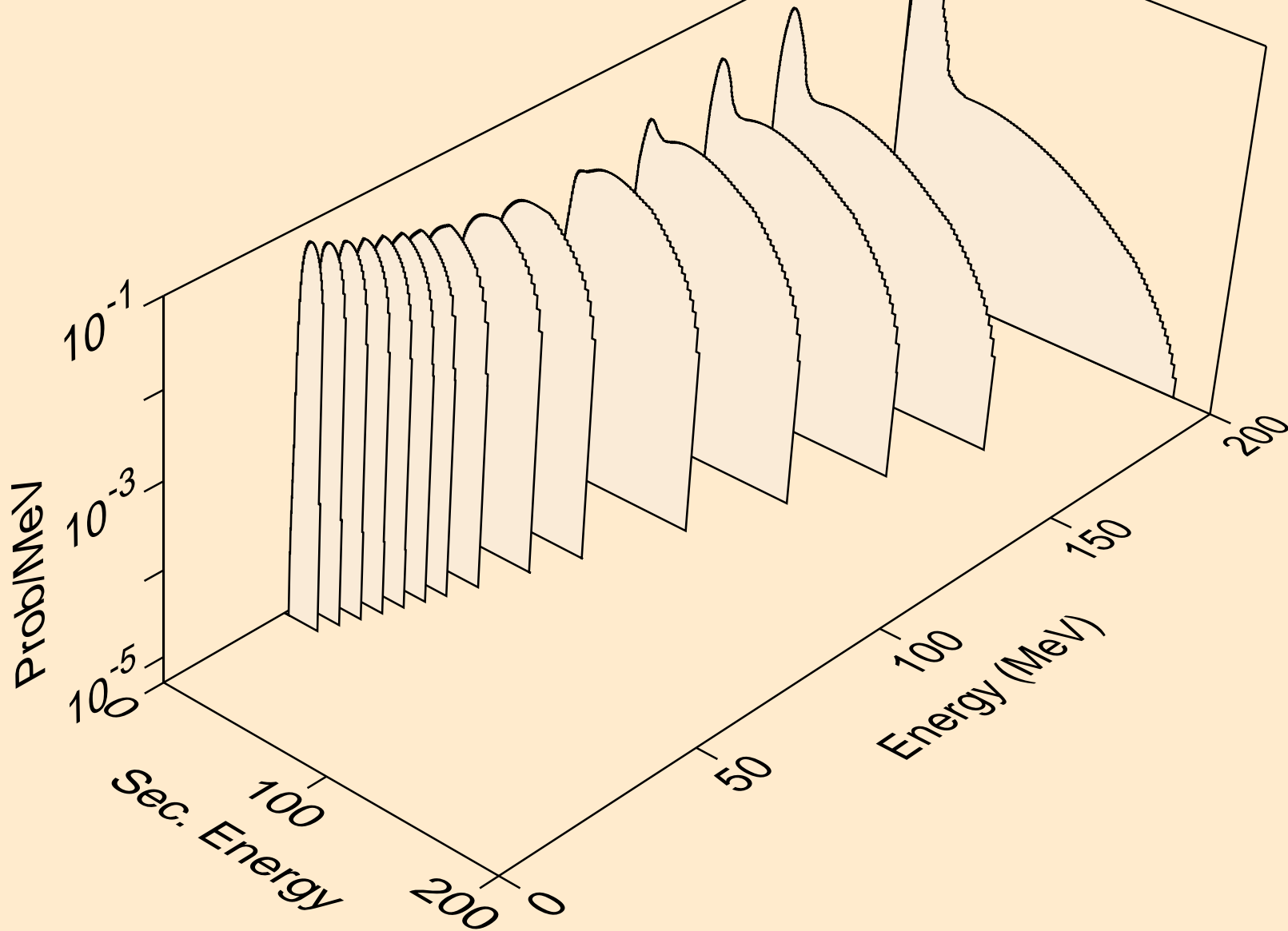

Y083M NEUTRON ACER TENDL-2019 LIBRARY; T=293.16K  
tritons from (n,n\*)t

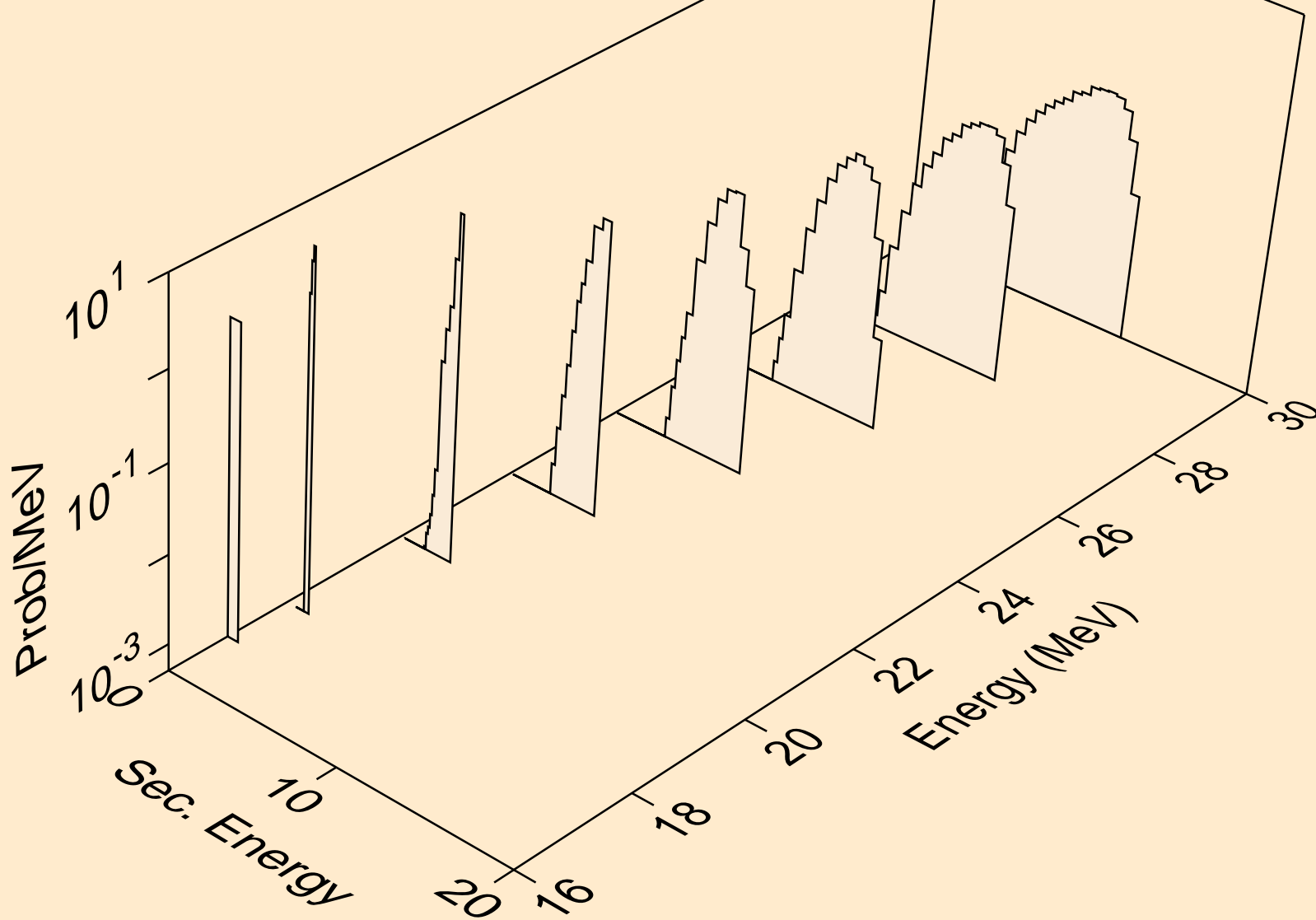

Y083M NEUTRON ACER TENDL-2019 LIBRARY; T=293.16K  
tritons from (n,t)

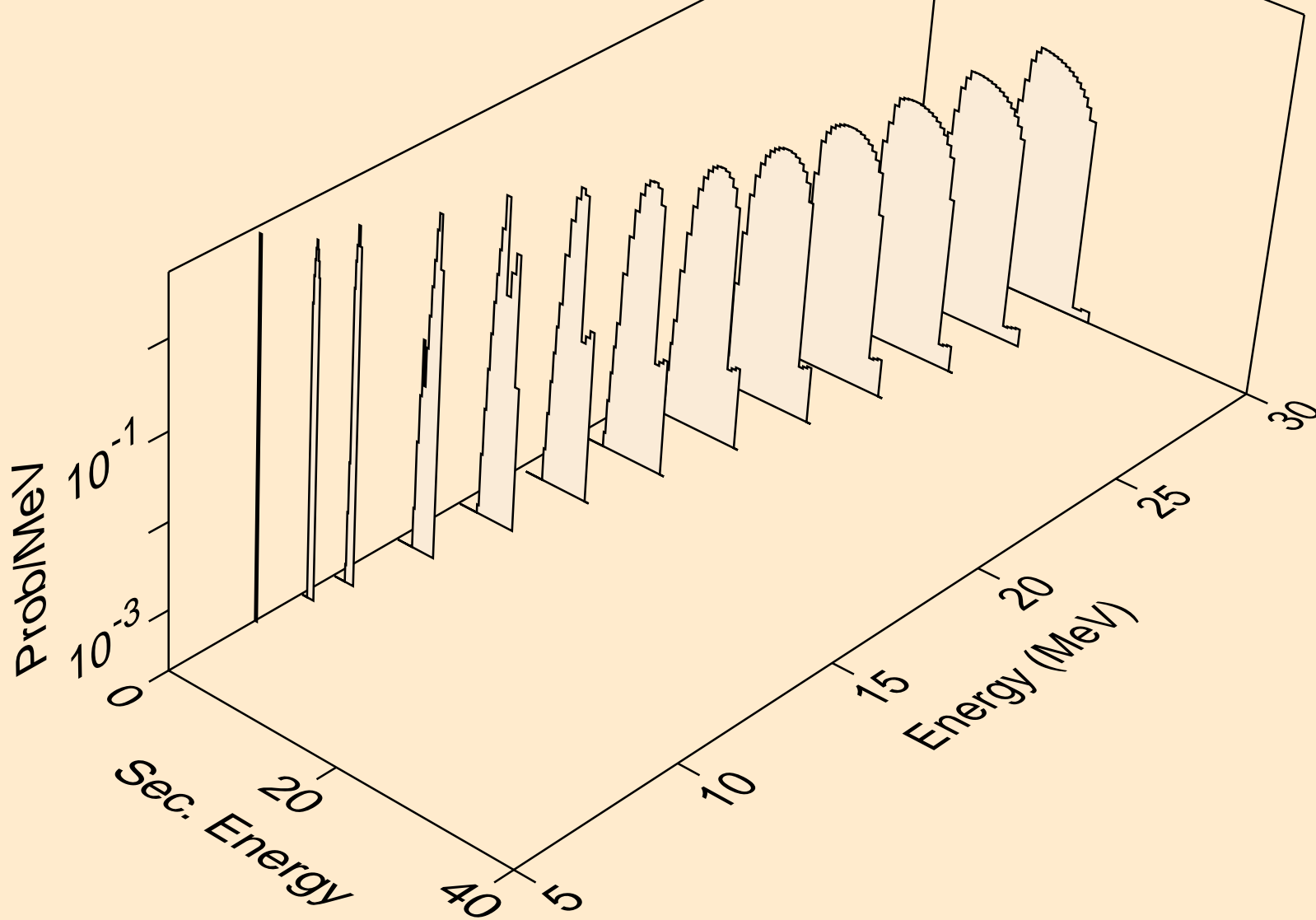

Y083M NEUTRON ACER TENDL-2019 LIBRARY; T=293.16K  
tritons from (n,pt)

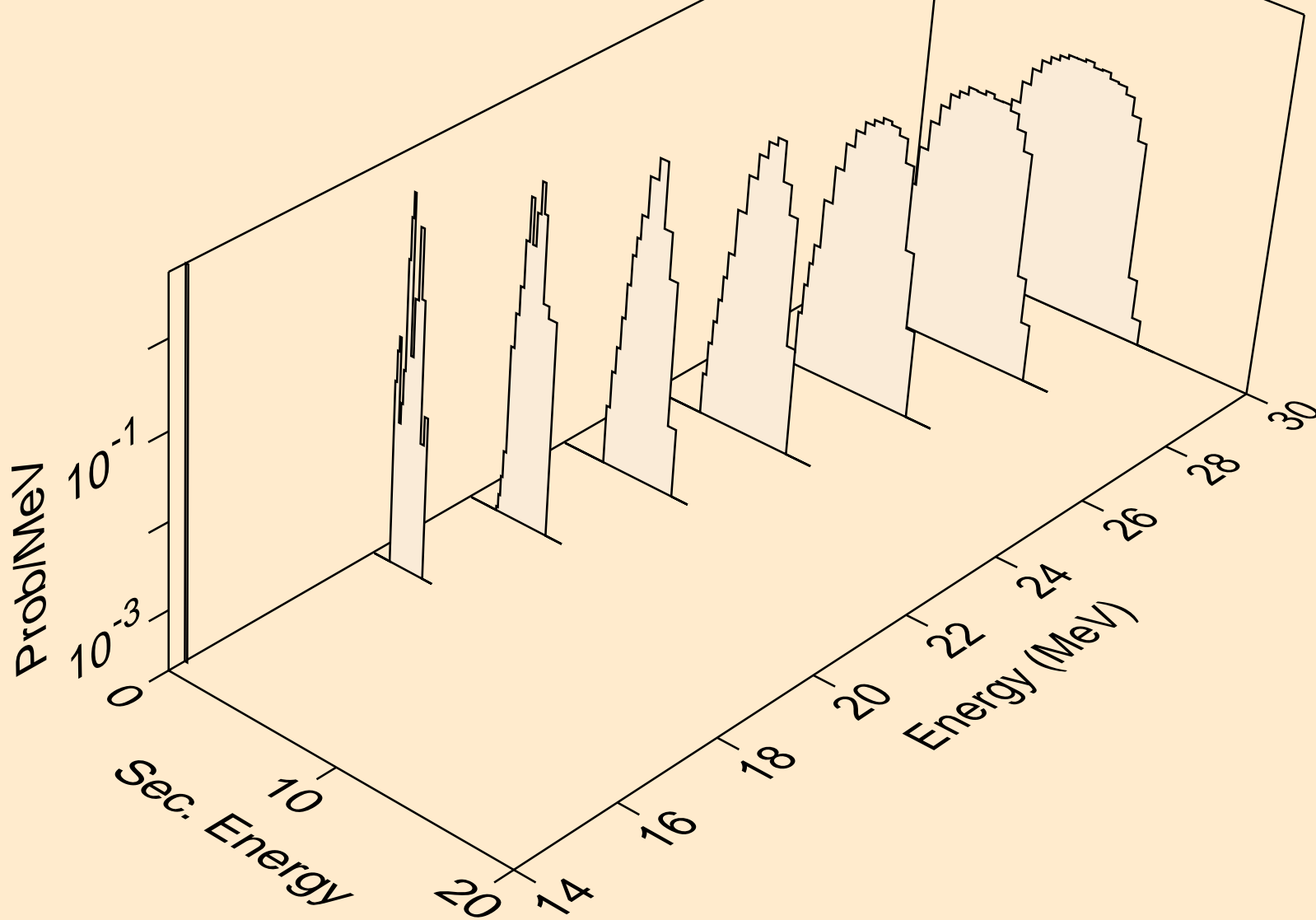



Y083M NEUTRON ACER TENDL-2019 LIBRARY; T=293.16K  
he3s from (n,x)

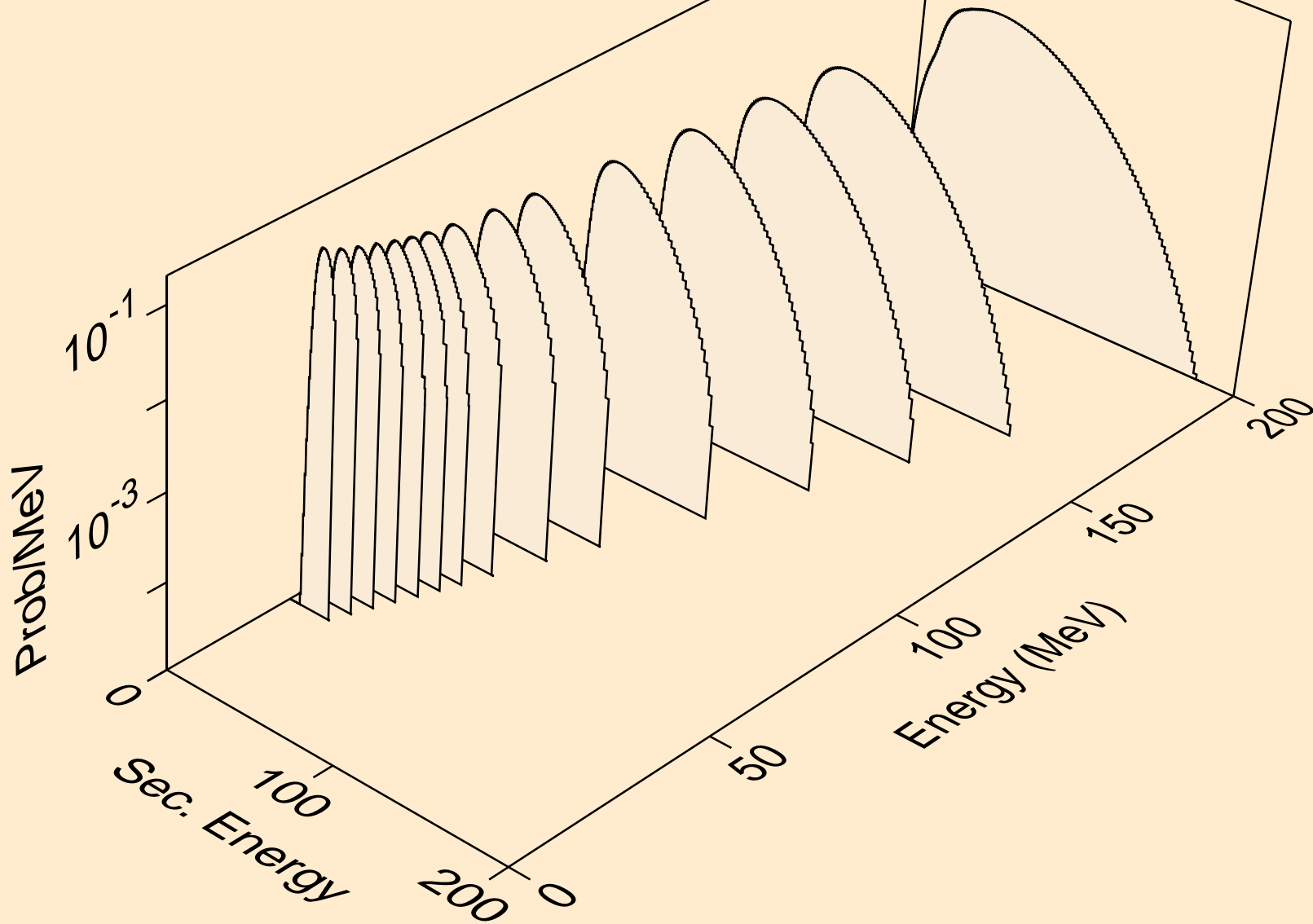

Y083M NEUTRON ACER TENDL-2019 LIBRARY; T=293.16K  
he3s from (n,n\*)he3

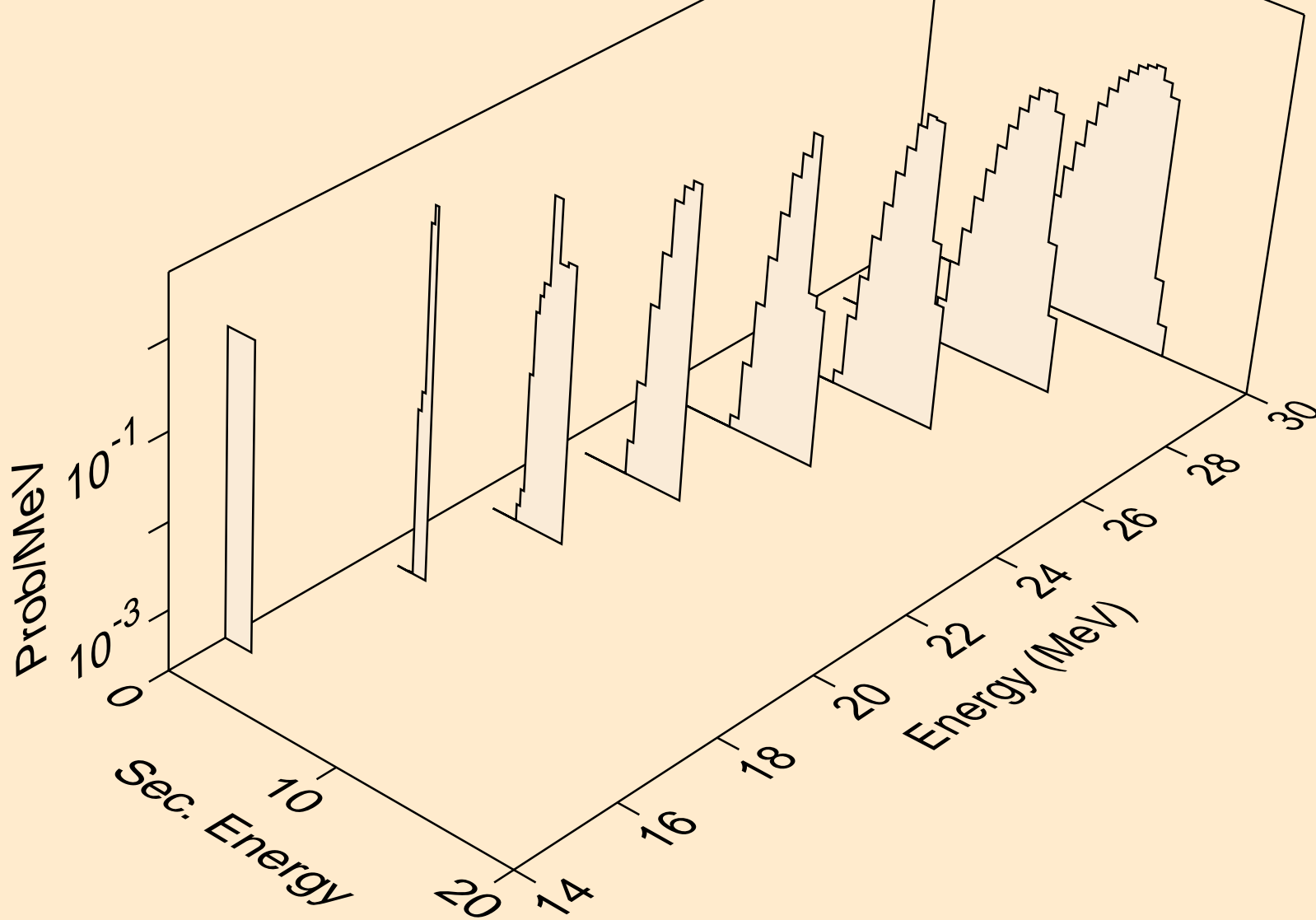

Y083M NEUTRON ACER TENDL-2019 LIBRARY; T=293.16K  
he3s from (n,he3)

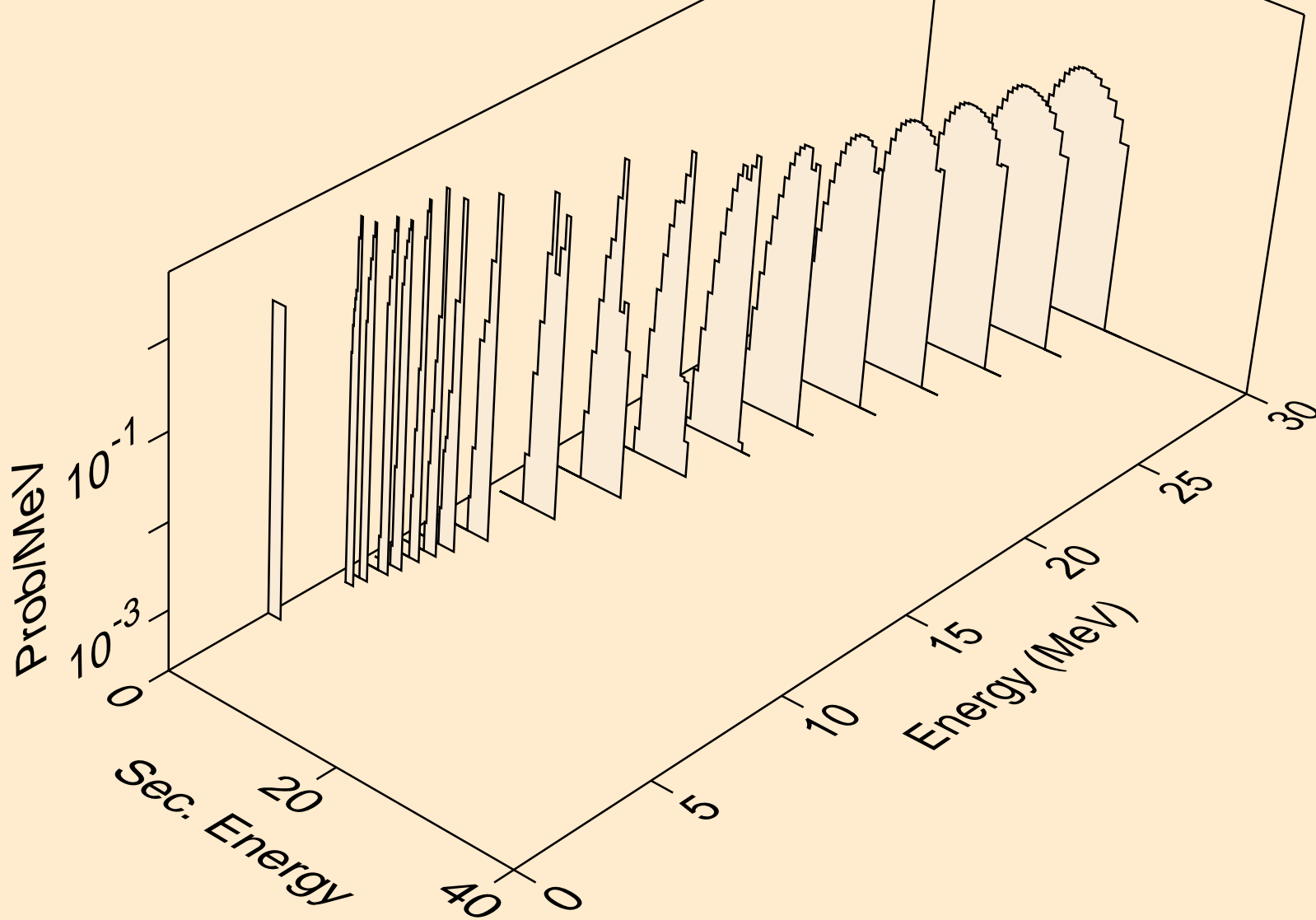

Y083M NEUTRON ACER TENDL-2019 LIBRARY; T=293.16K  
alphas from (n,x)

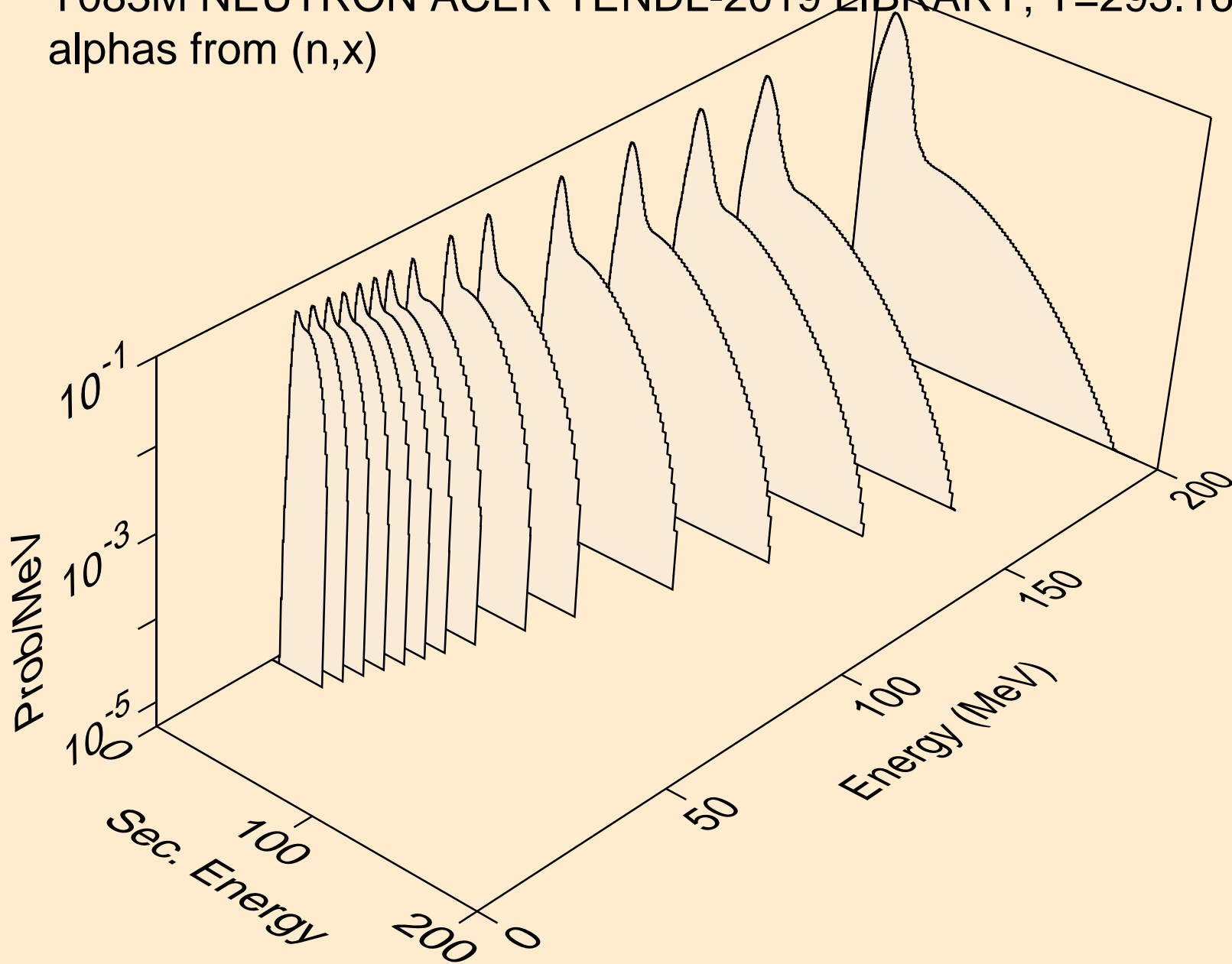

Y083M NEUTRON ACER TENDL-2019 LIBRARY; T=293.16K  
alphas from (n,n\*)a

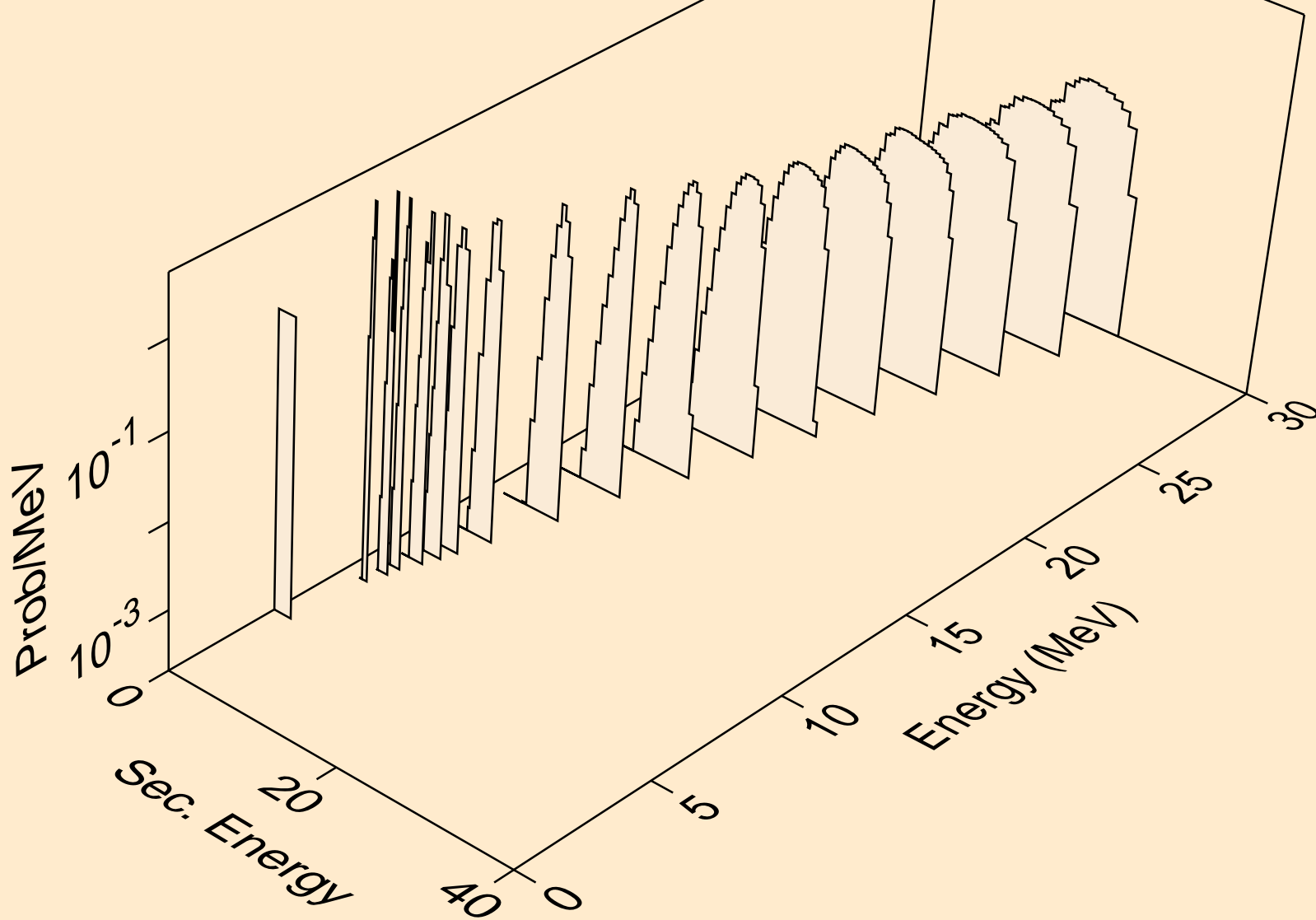

Y083M NEUTRON ACER TENDL-2019 LIBRARY; T=293.16K  
alphas from (n,2n)a

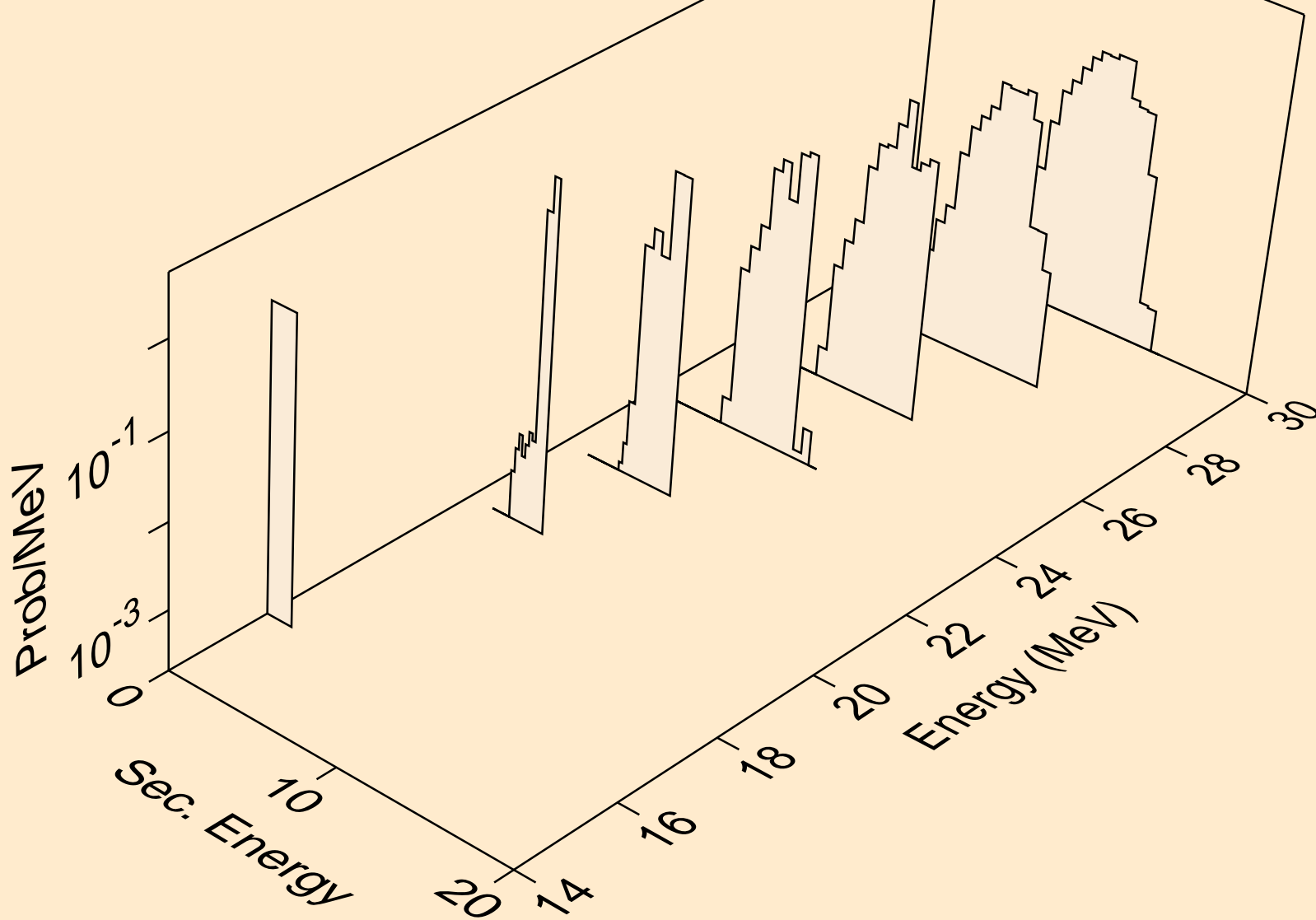

Y083M NEUTRON ACER TENDL-2019 LIBRARY; T=293.16K  
alphas from (n,n\*)2a

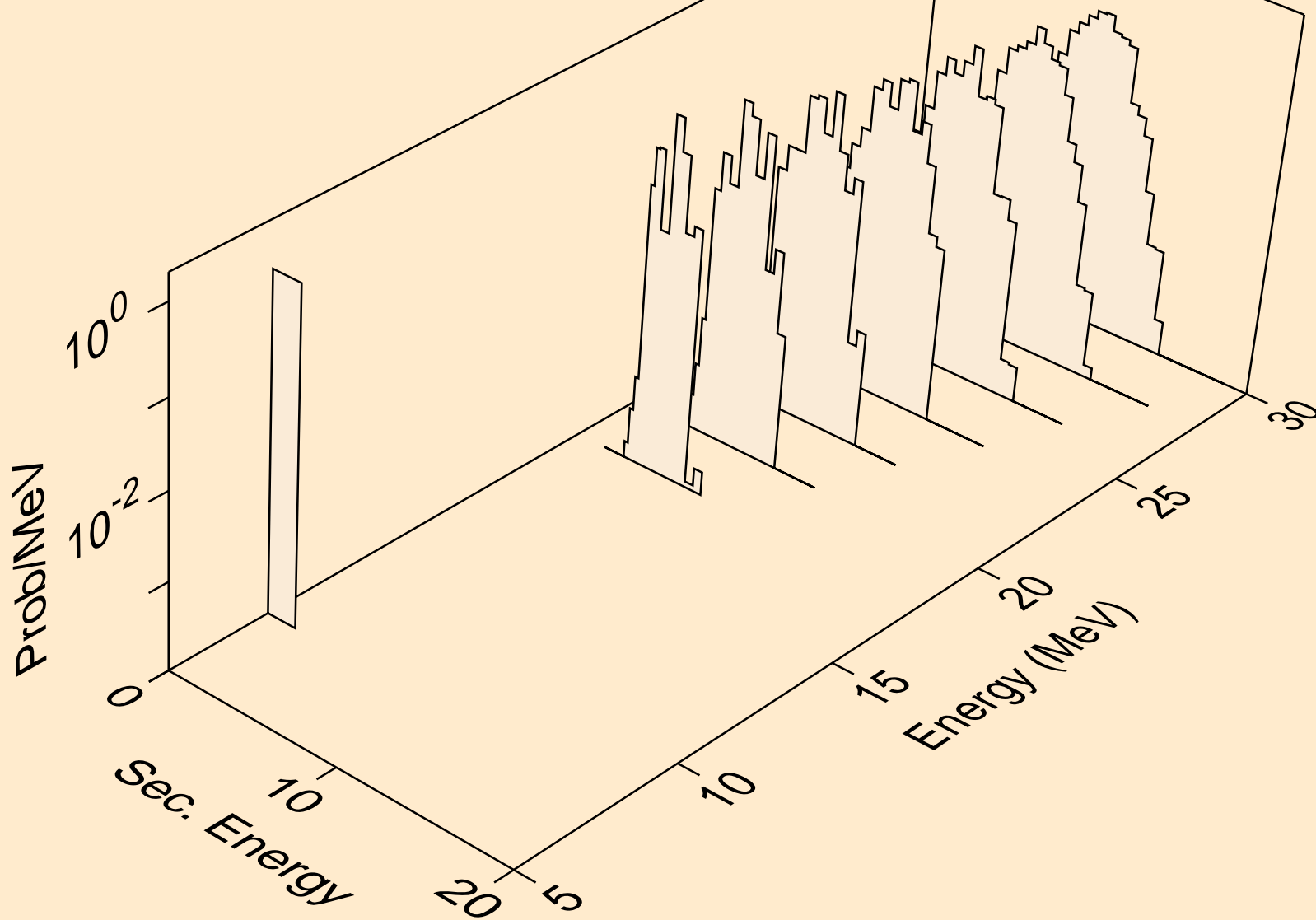

Y083M NEUTRON ACER TENDL-2019 LIBRARY; T=293.16K  
alphas from (n,npa)

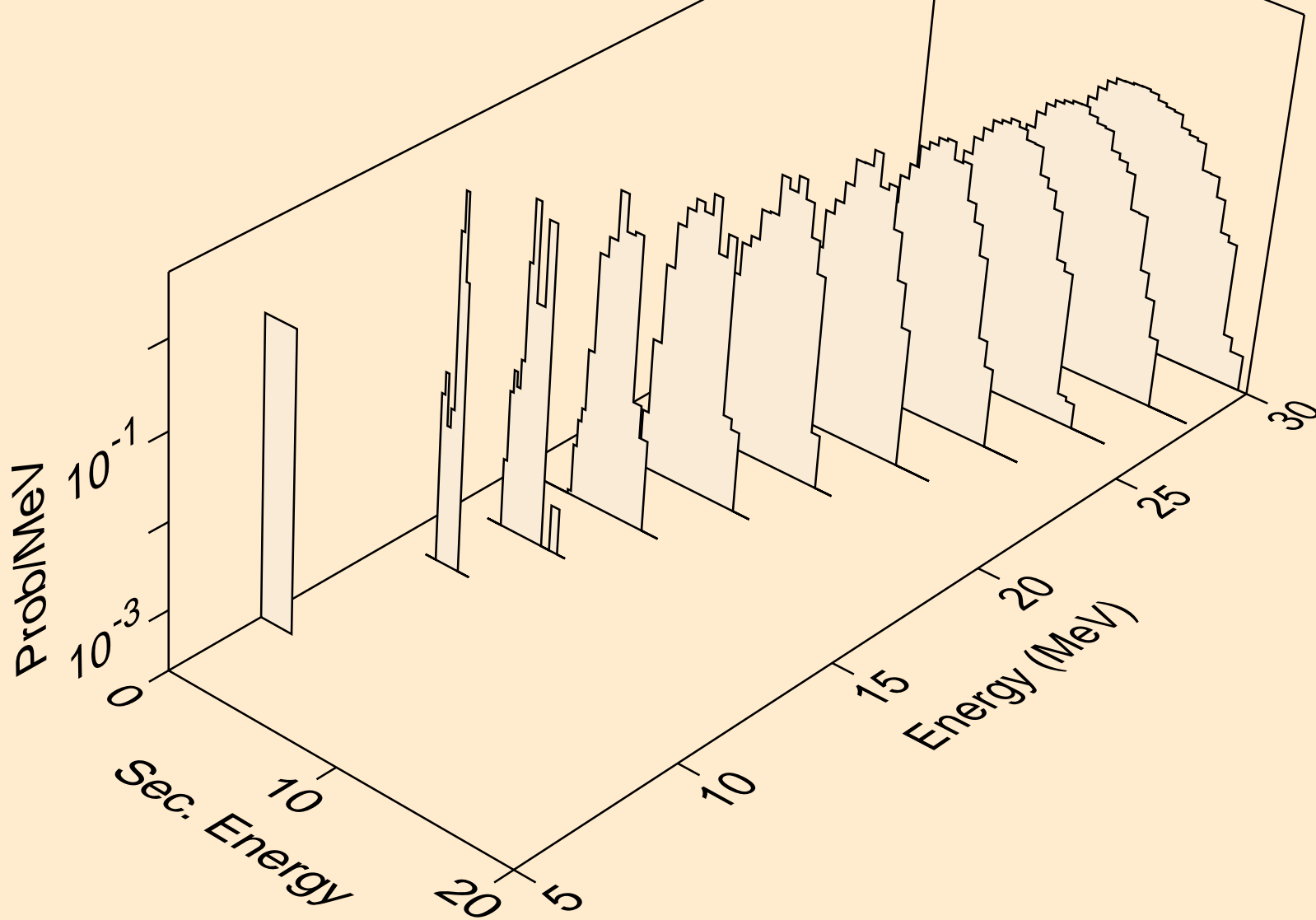



Y083M NEUTRON ACER TENDL-2019 LIBRARY; T=293.16K  
alphas from (n,a)

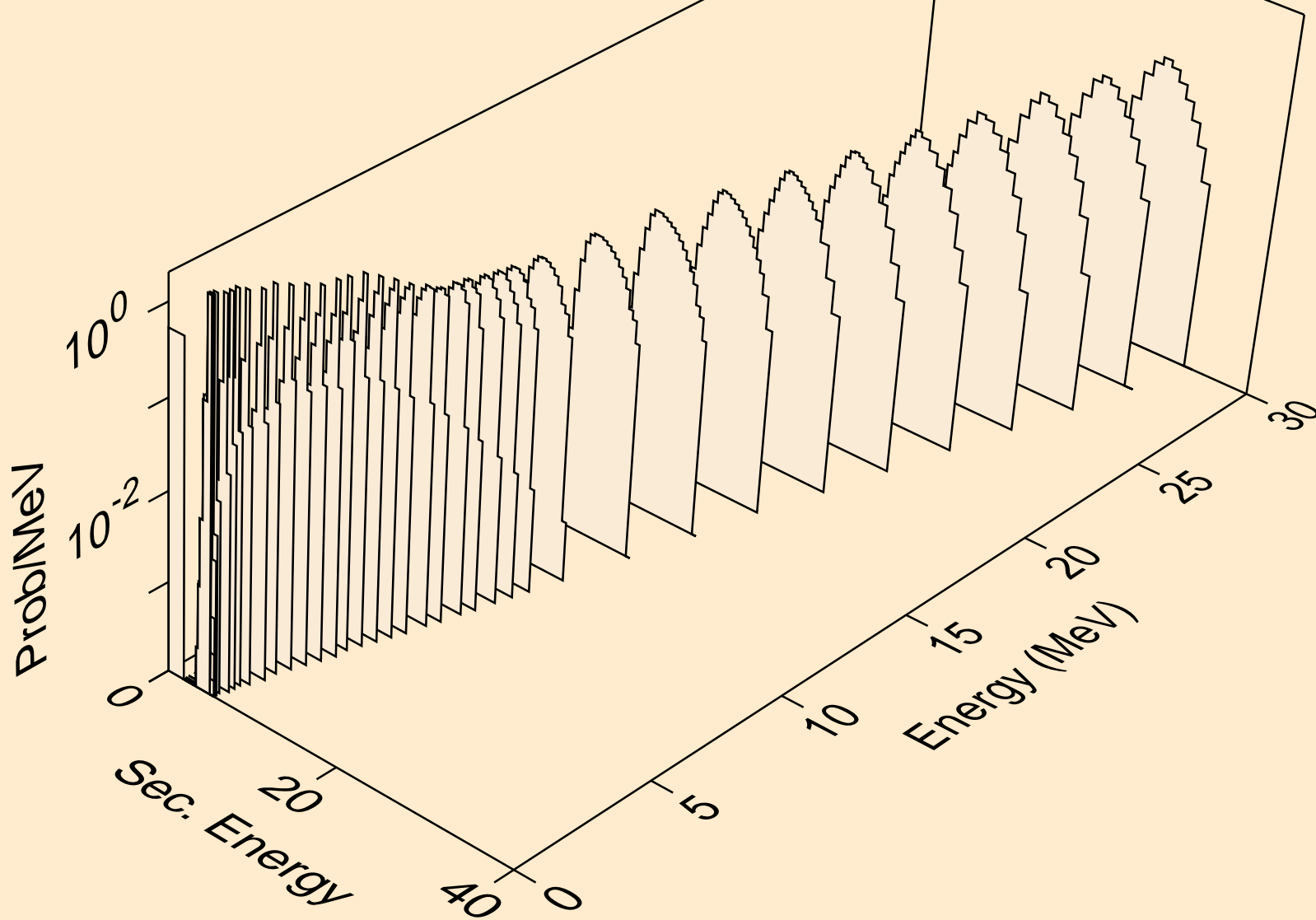

Y083M NEUTRON ACER TENDL-2019 LIBRARY; T=293.16K  
alphas from (n,2a)

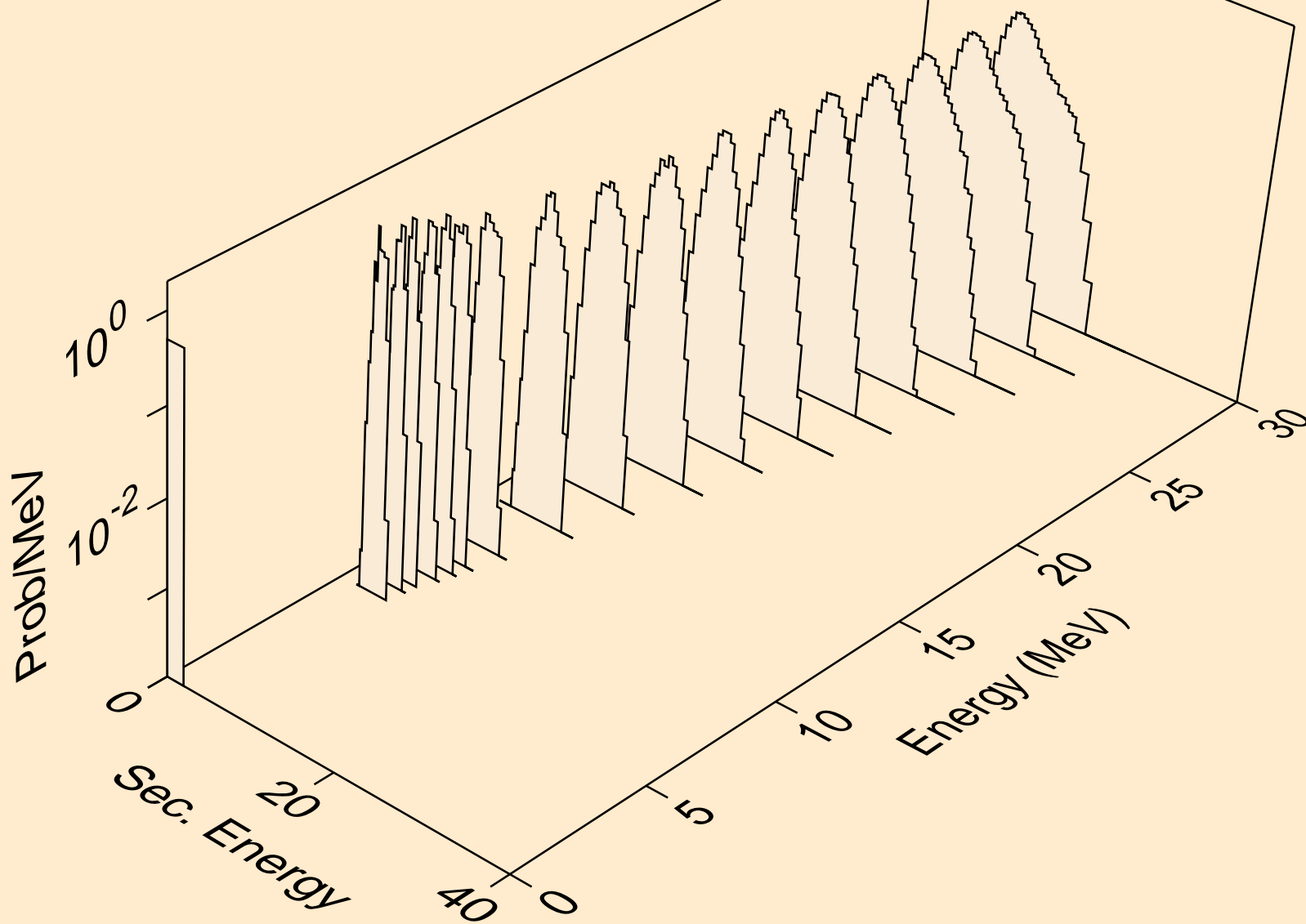

Y083M NEUTRON ACER TENDL-2019 LIBRARY; T=293.16K  
alphas from (n,3a)

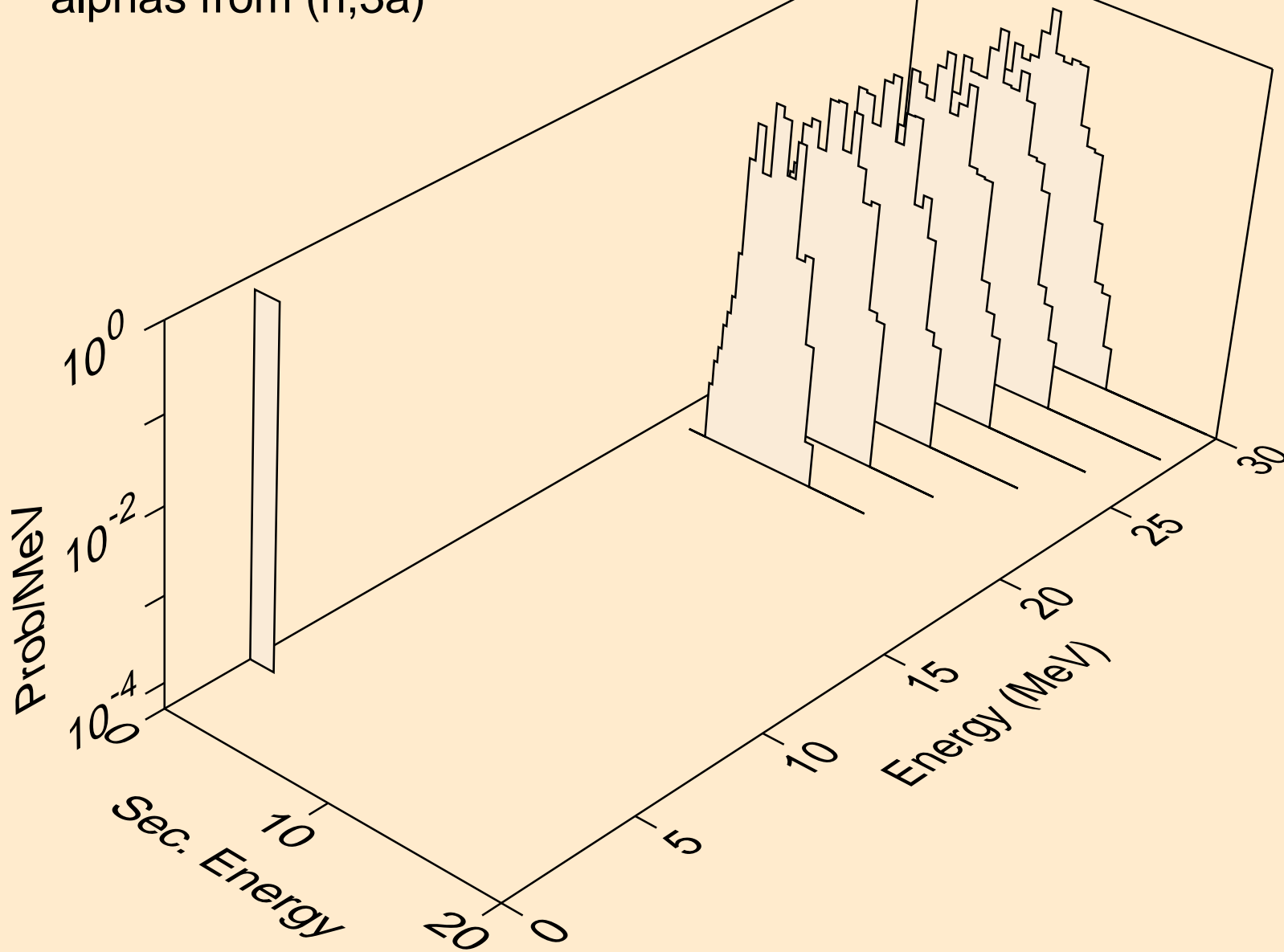

Y083M NEUTRON ACER TENDL-2019 LIBRARY; T=293.16K  
alphas from (n,pa)

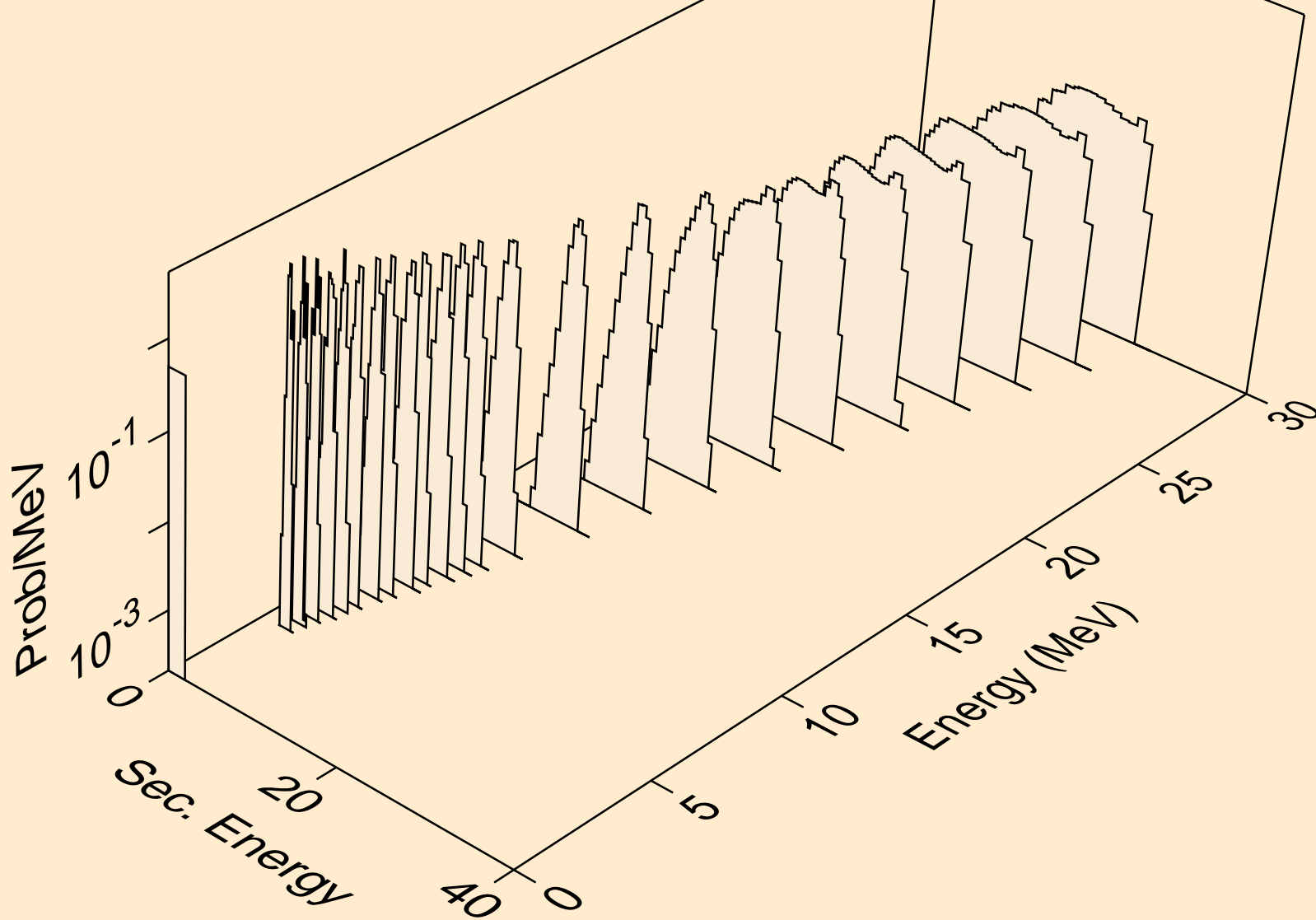

Y083M NEUTRON ACER TENDL-2019 LIBRARY; T=293.16K  
alphas from (n,da)

