

Program EVALPLOT
(Version 2018-1)

by

Dermott E. Cullen
(Present Contact Information)

Dermott E. Cullen
1466 Hudson Way
Livermore, CA 94550
U.S.A.

Tele: 925-443-1911

E.Mail:redcullen1@comcast.net
Web:redcullen1.net/HOMEPAGE.NEW

Press Mouse Button to Start

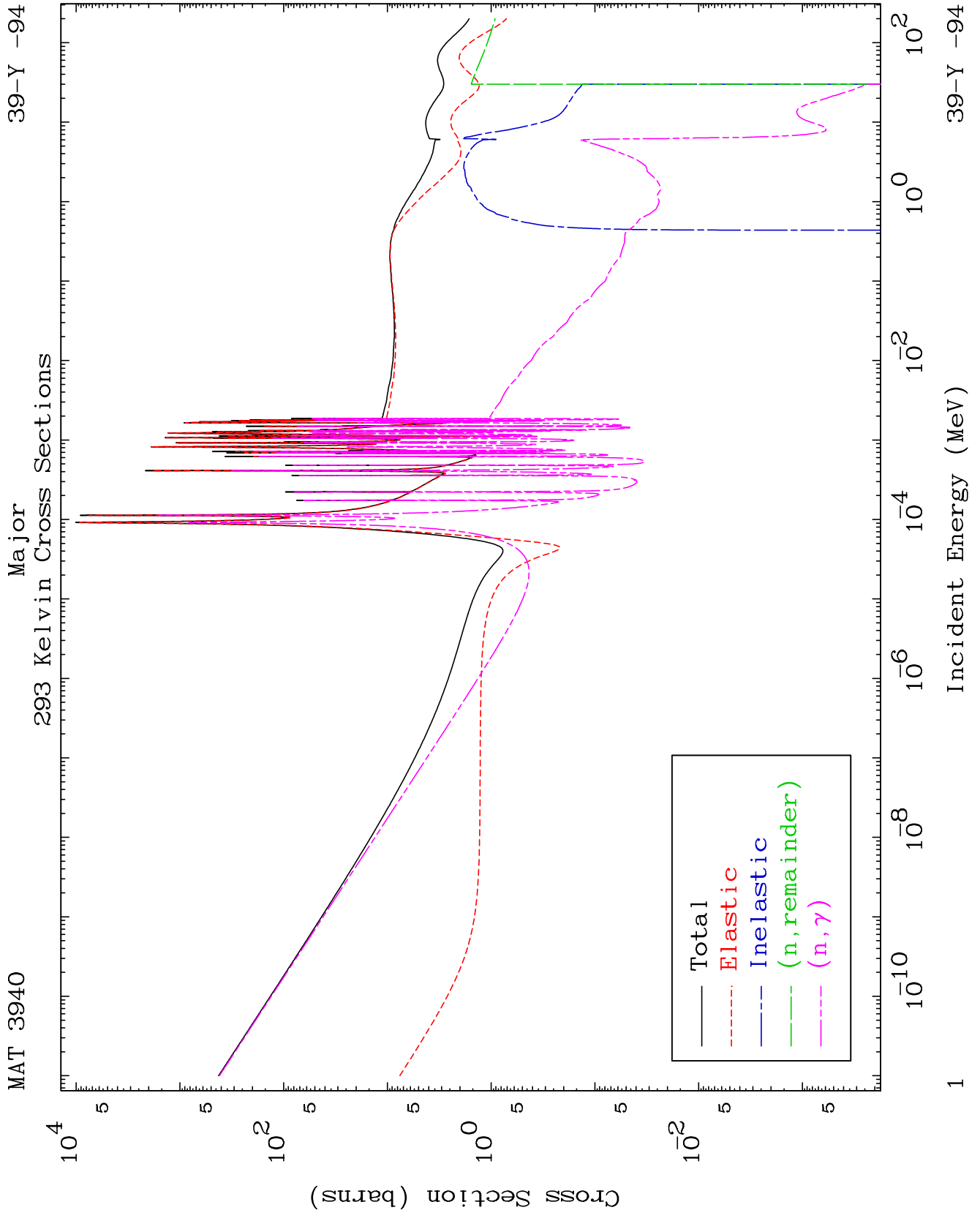

MAT 3940

Neutron Production 293 Kelvin Cross Sections

39-Y -94

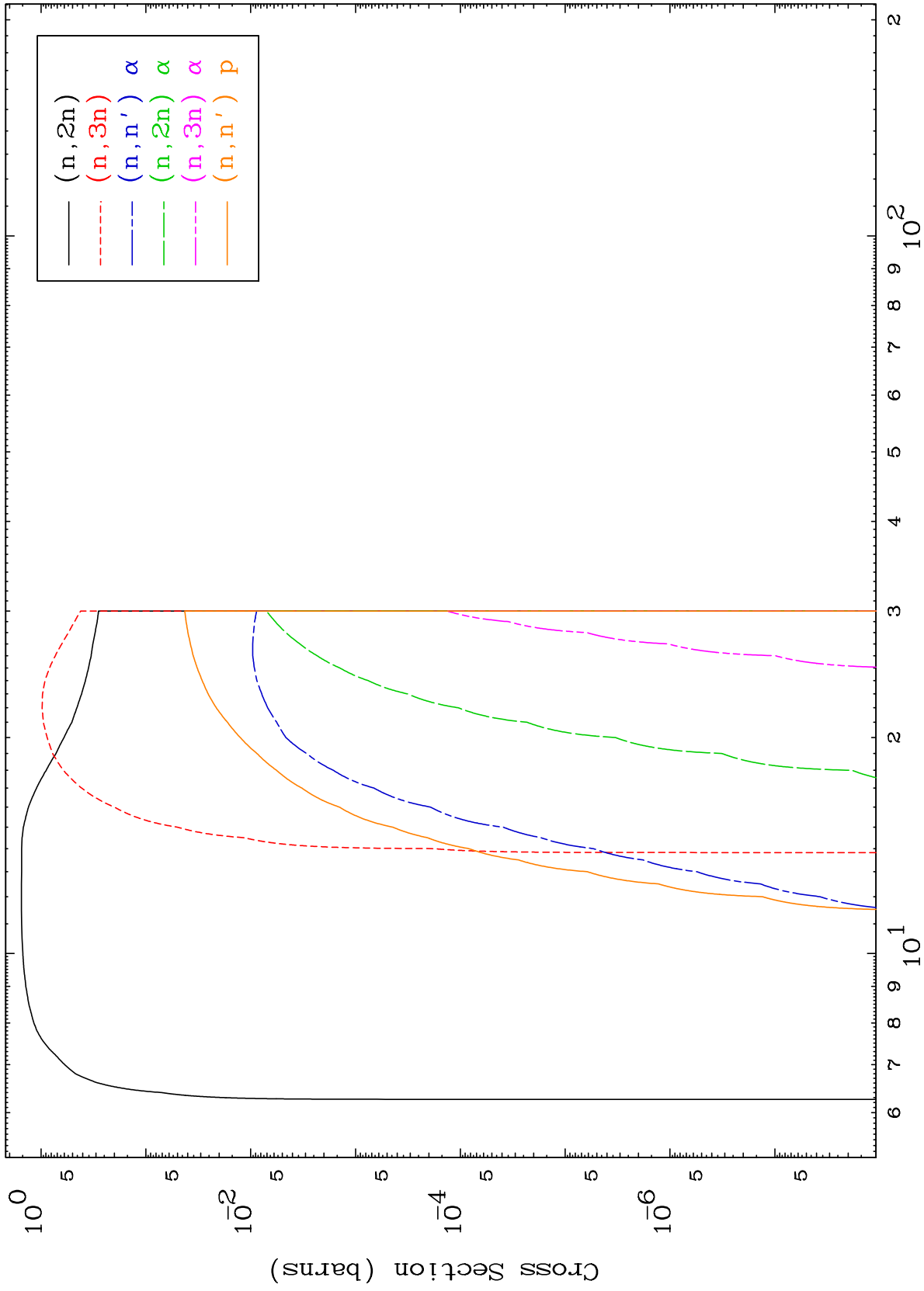

2

Incident Energy (MeV)

39-Y -94

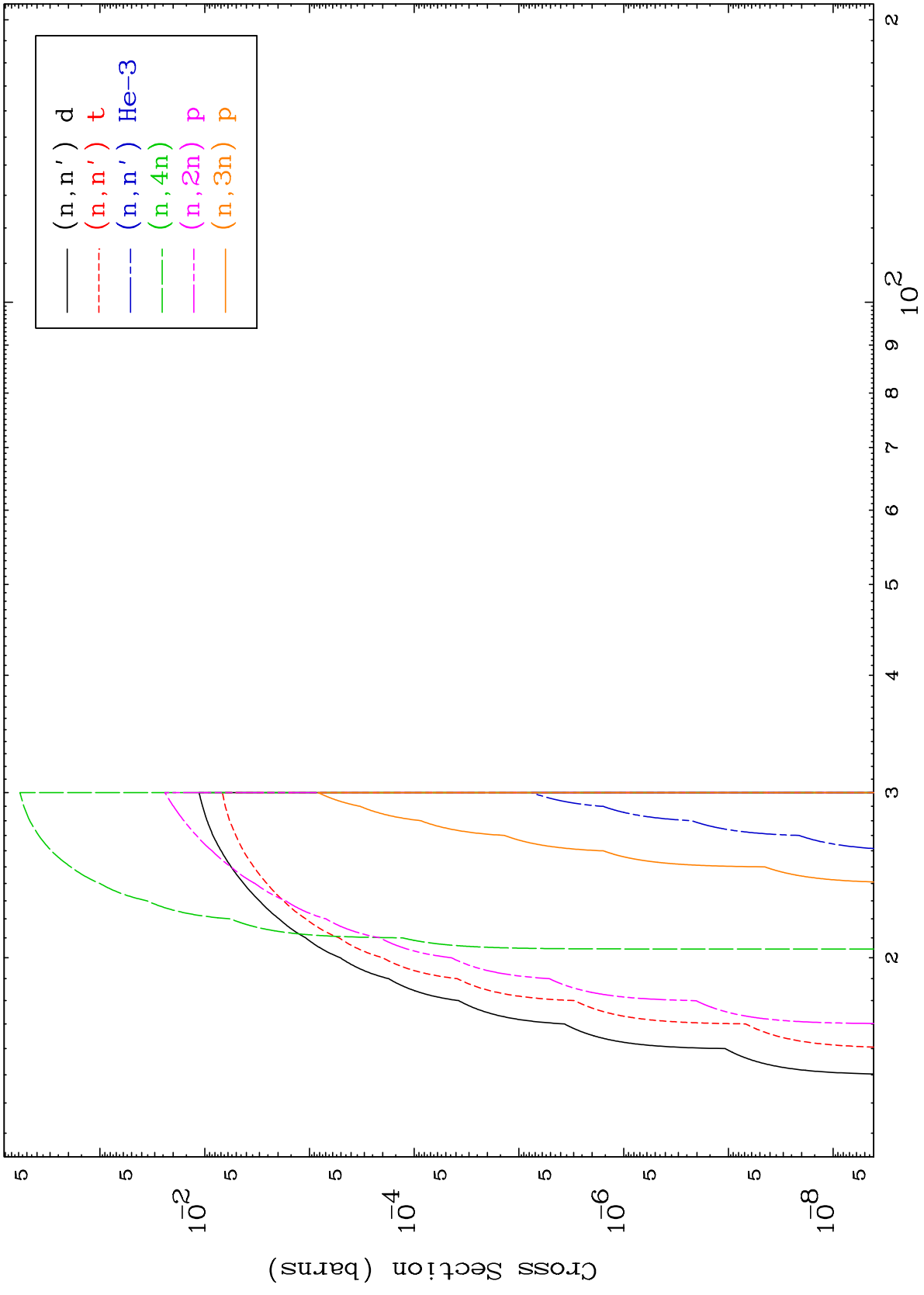

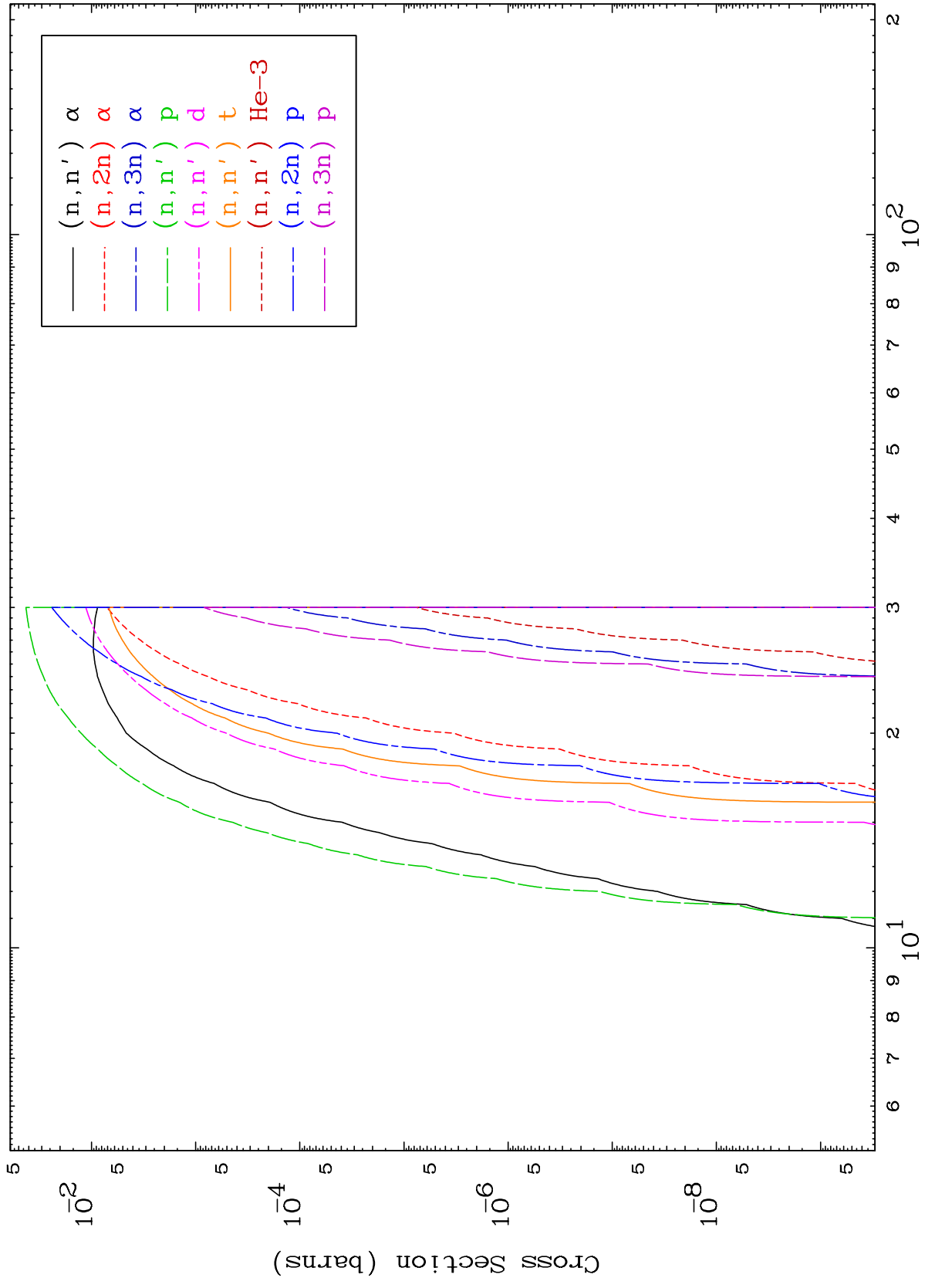

MAT 3940

Charged Particle
293 Kelvin Cross Sections

39-Y -94

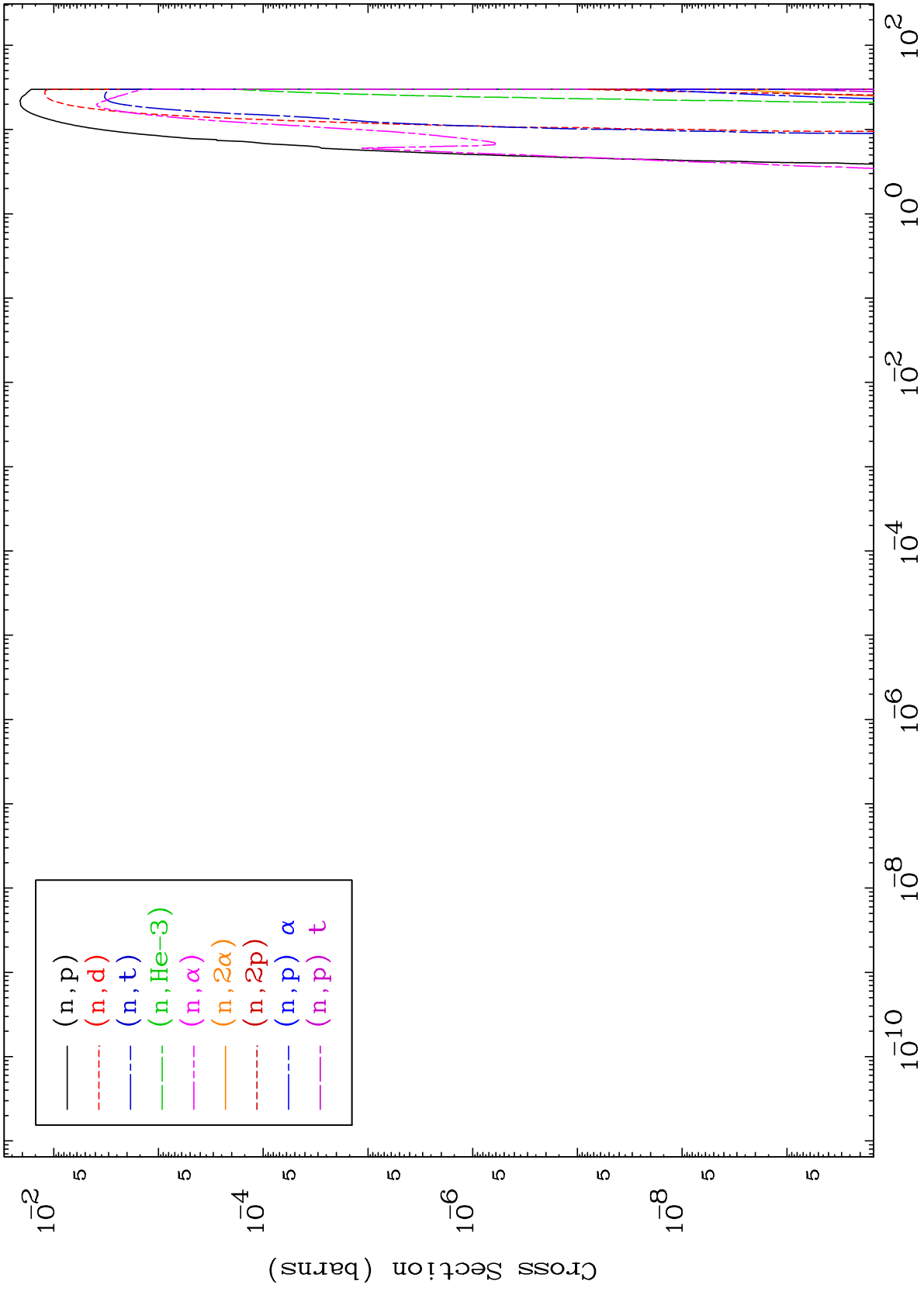

MAT 3940

Particle Production
293 Kelvin Cross Sections

39-Y -94

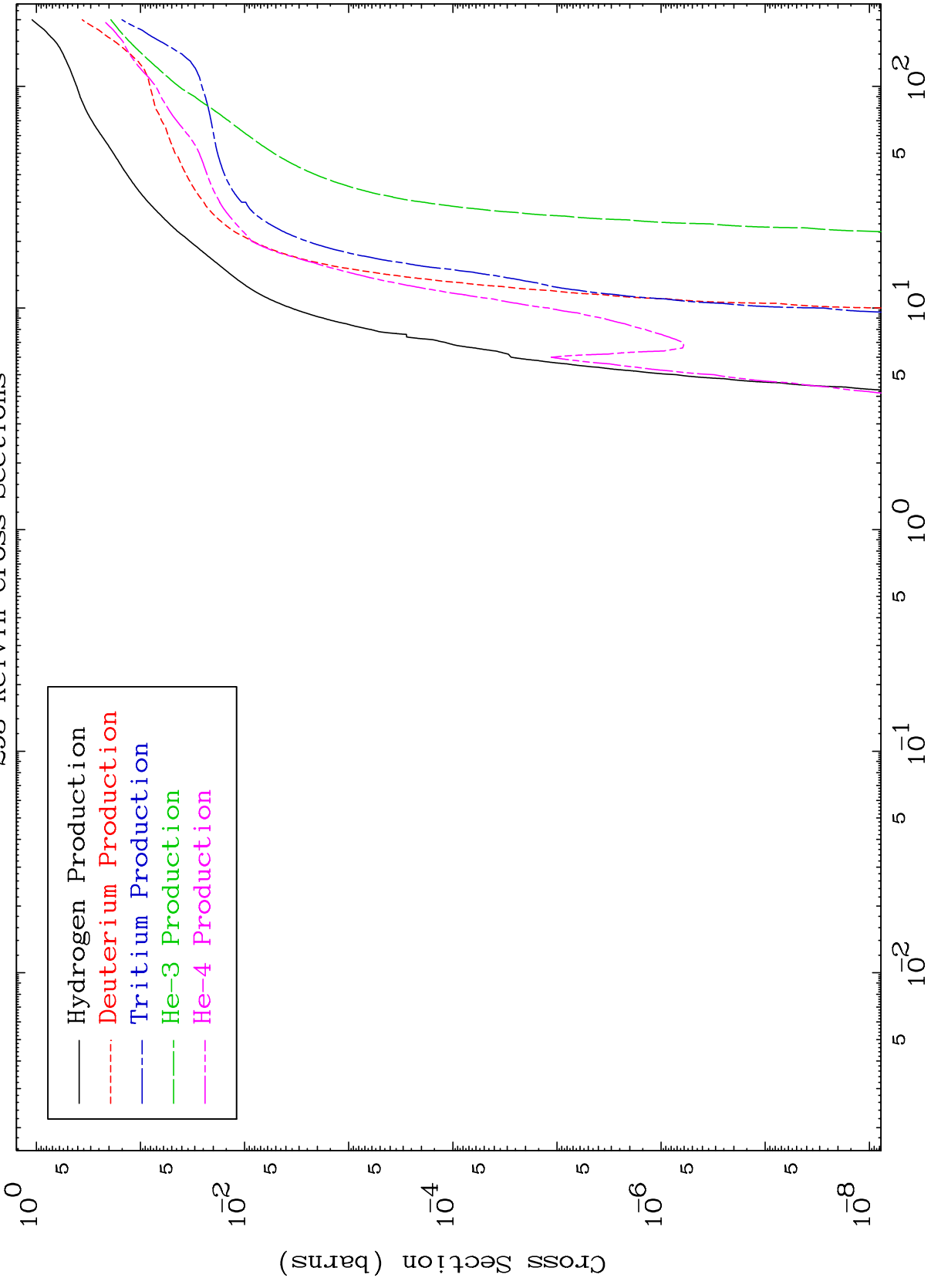

6

Incident Energy (MeV)

39-Y -94

MAT 3940

(n,n') Level

39-Y -94

293 Kelvin Cross Sections

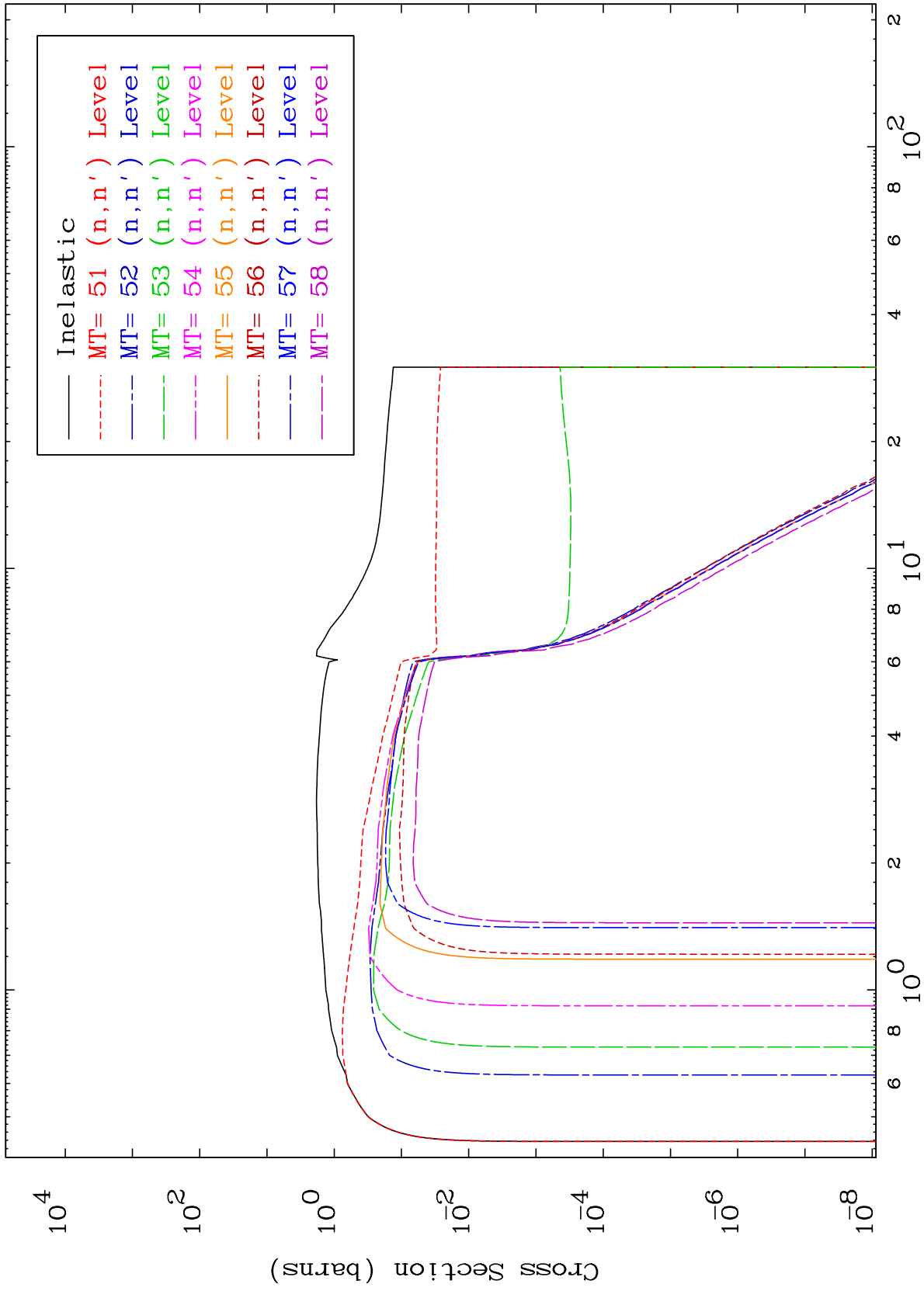

7

Incident Energy (MeV)

39-Y -94

MAT 3940

(n,n') Level
293 Kelvin Cross Sections

39-Y -94

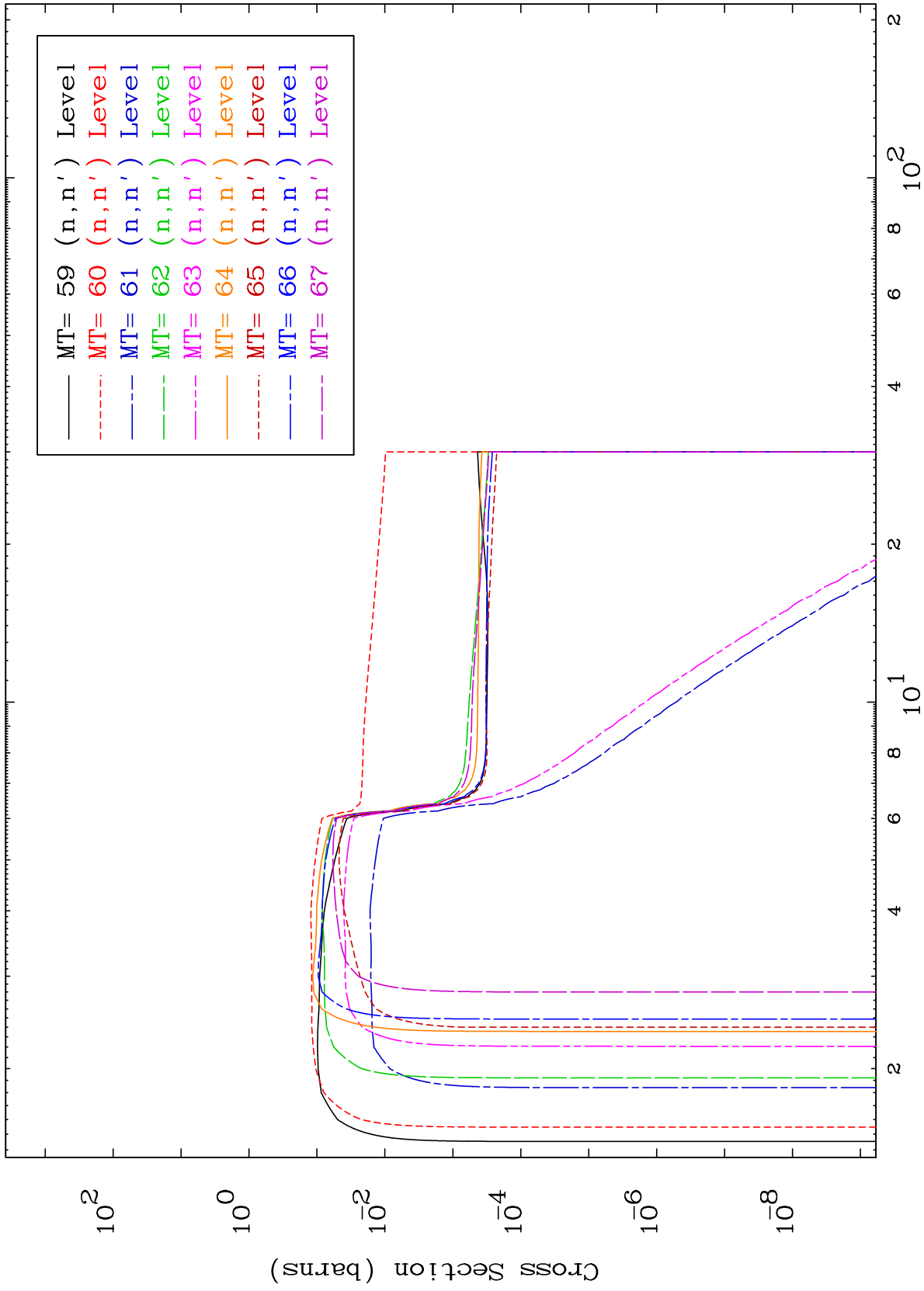

8

Incident Energy (MeV)

39-Y -94

MAT 3940

(n,n') Level

293 Kelvin Cross Sections

39-Y -94

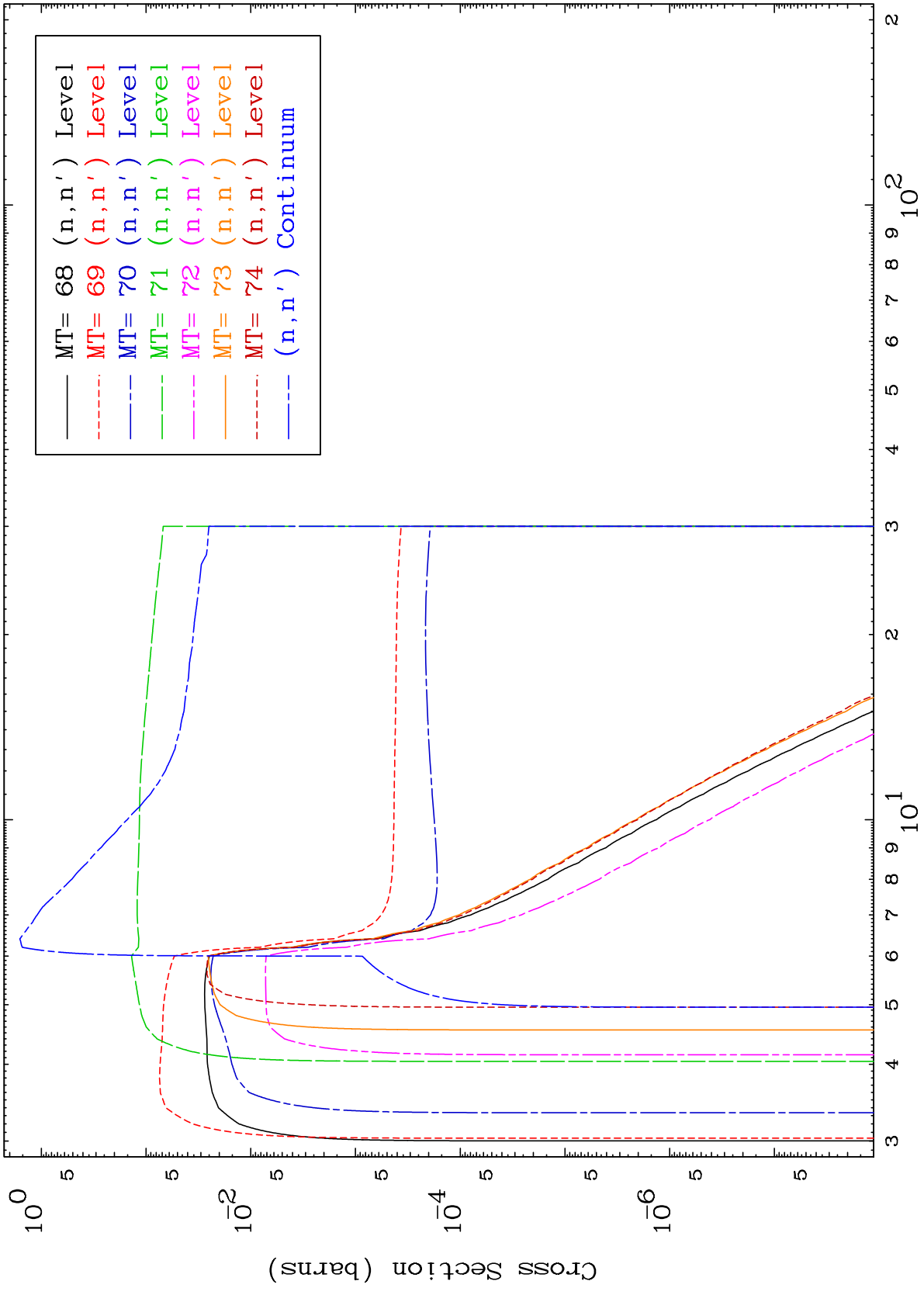

9

Incident Energy (MeV)

39-Y -94

MAT 3940

(n,p) Levels
293 Kelvin Cross Sections

39-Y -94

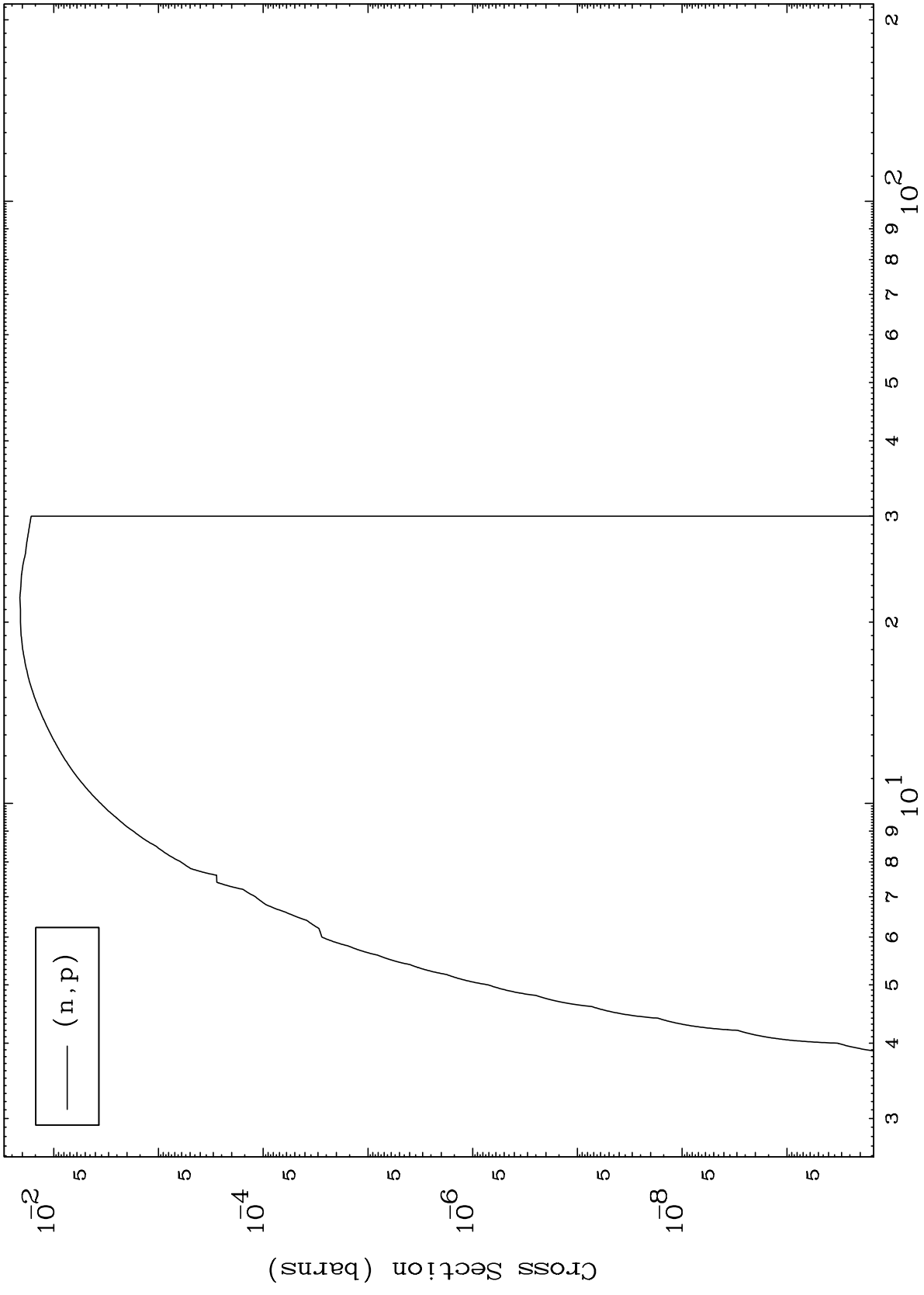

10

Incident Energy (MeV)

39-Y -94

MAT 3940

39-Y -94

(n,d) Levels
293 Kelvin Cross Sections

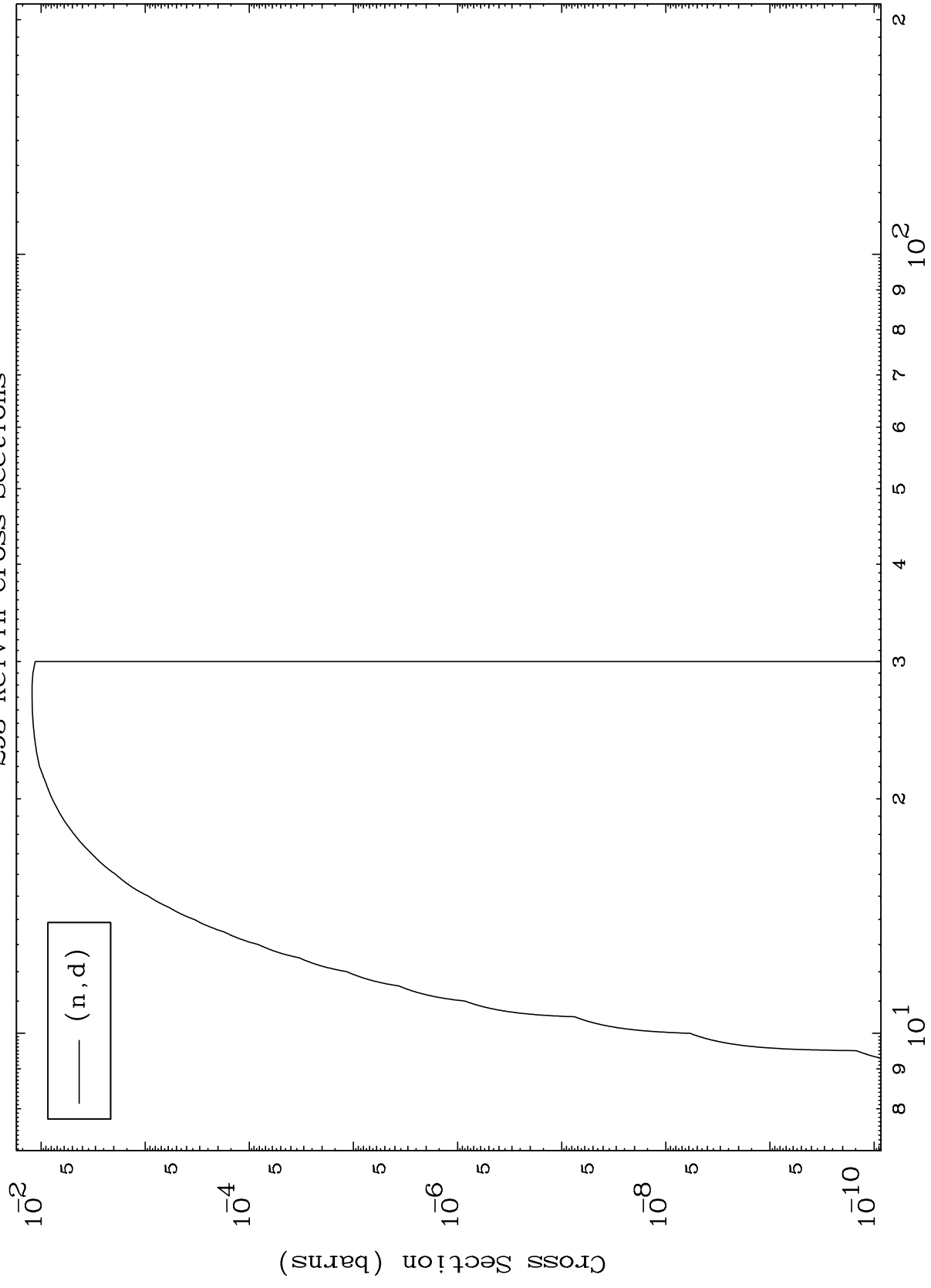

11

Incident Energy (MeV)

39-Y -94

MAT 3940

(n,t) Levels
293 Kelvin Cross Sections

39-Y -94

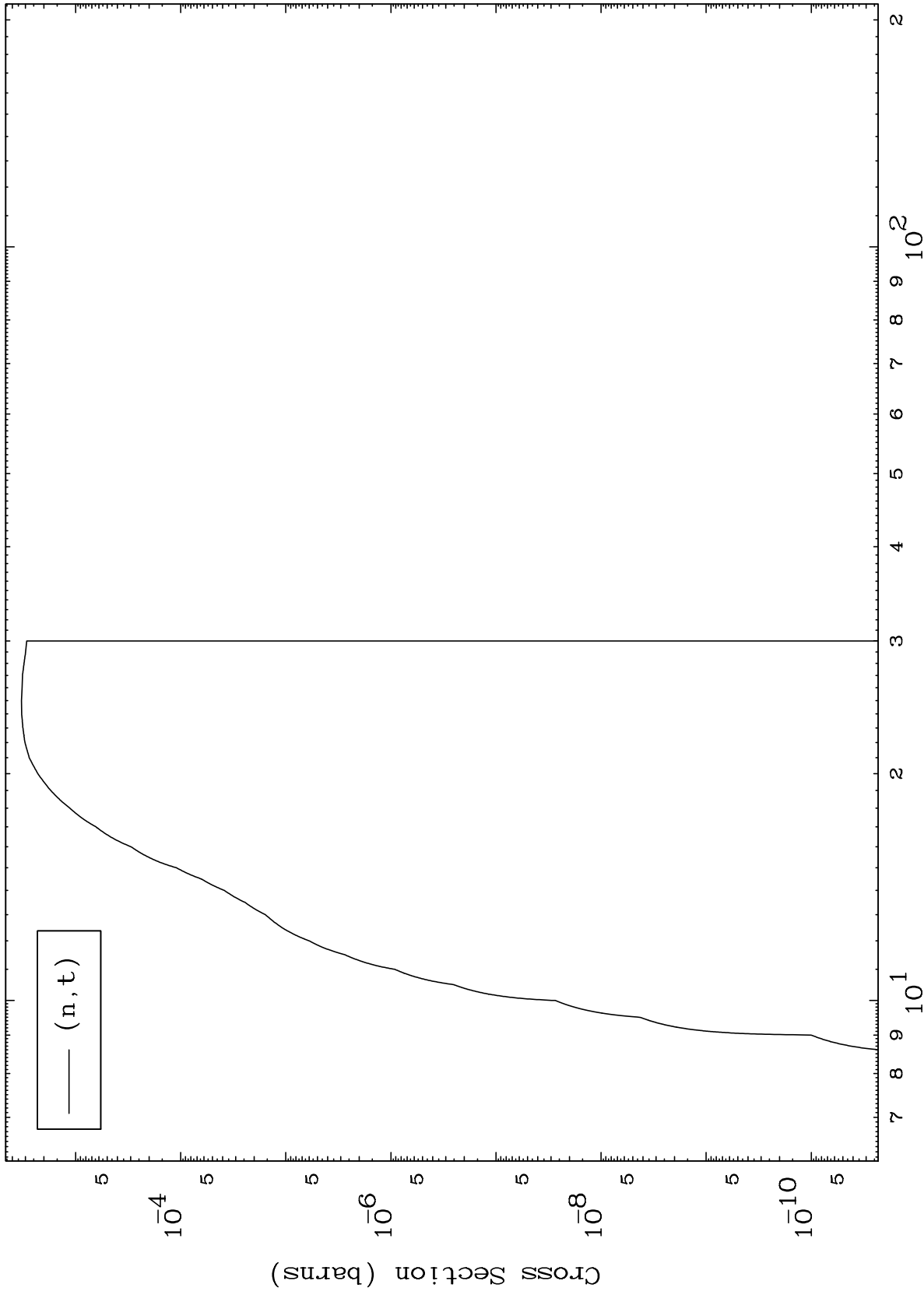

12

Incident Energy (MeV)

39-Y -94

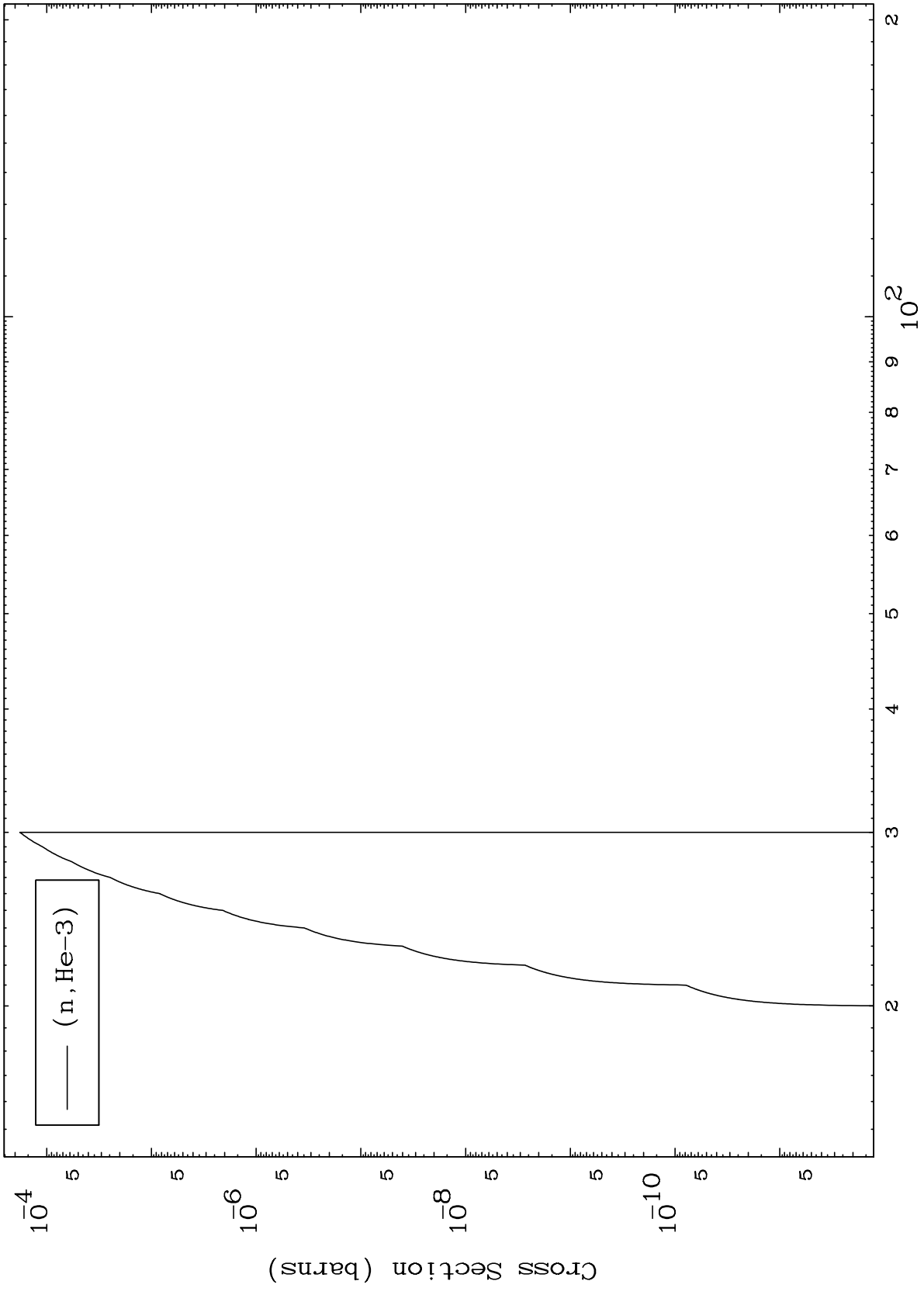

MAT 3940

(n,α) Levels
293 Kelvin Cross Sections

39-Y -94

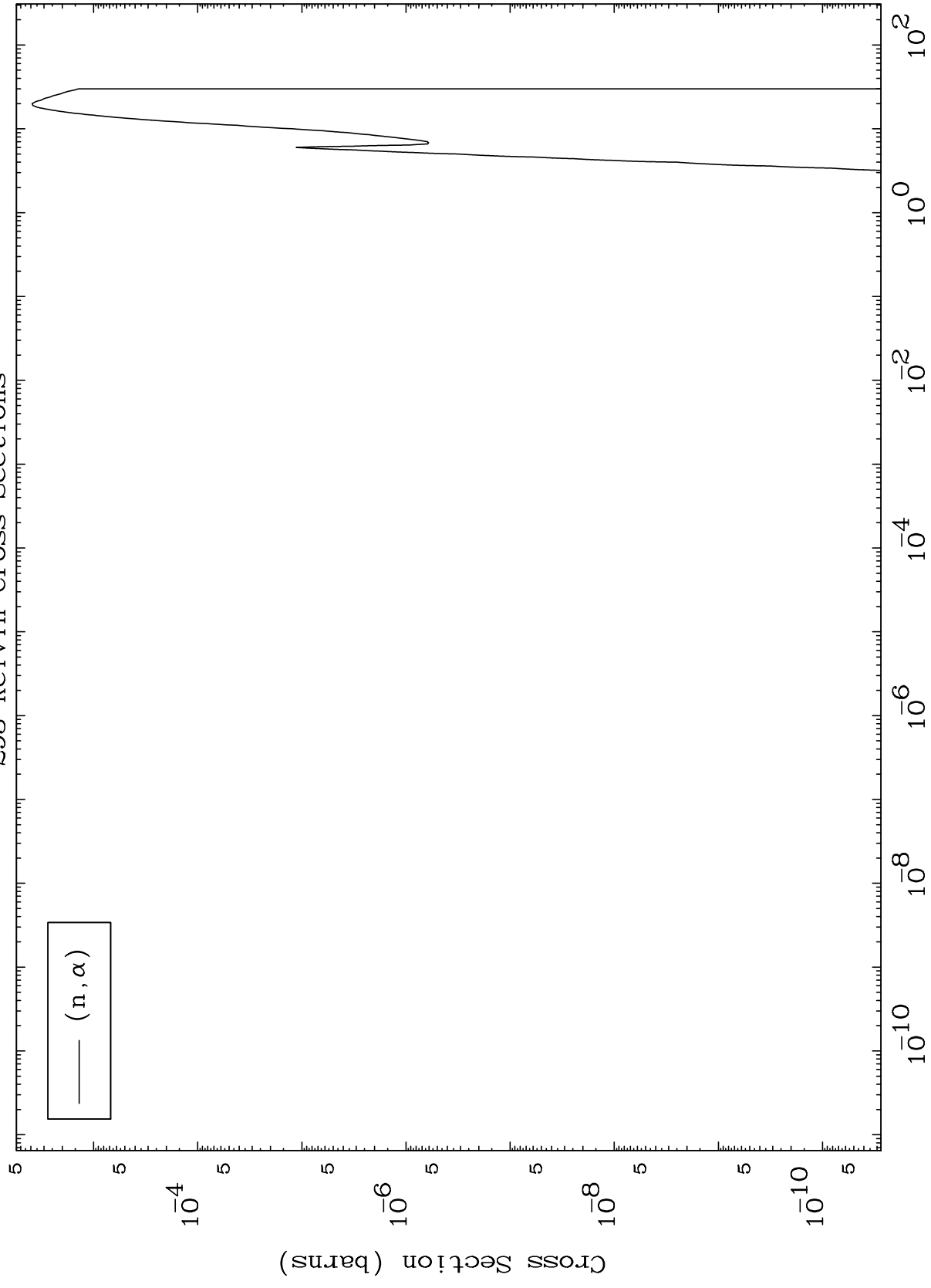

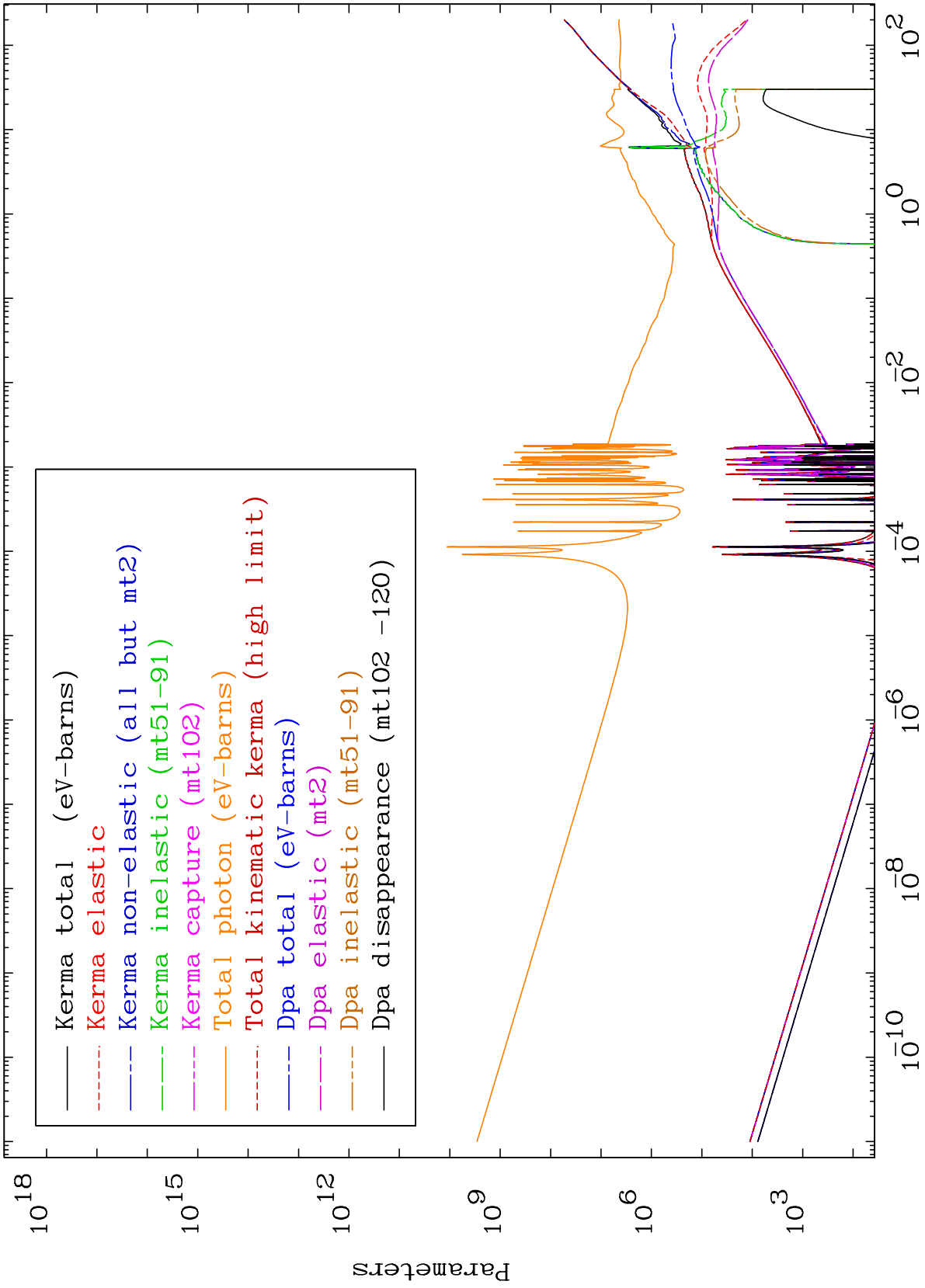

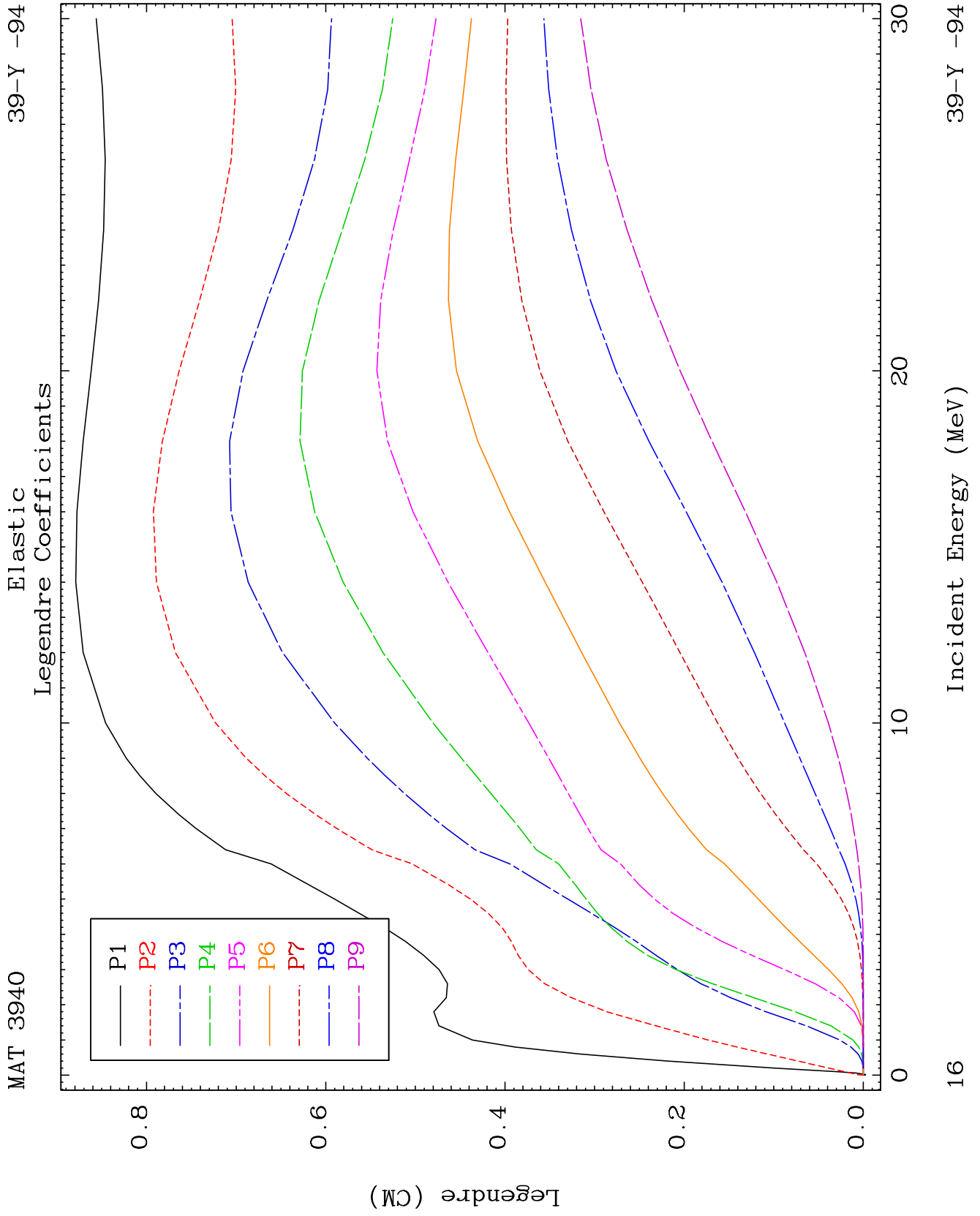

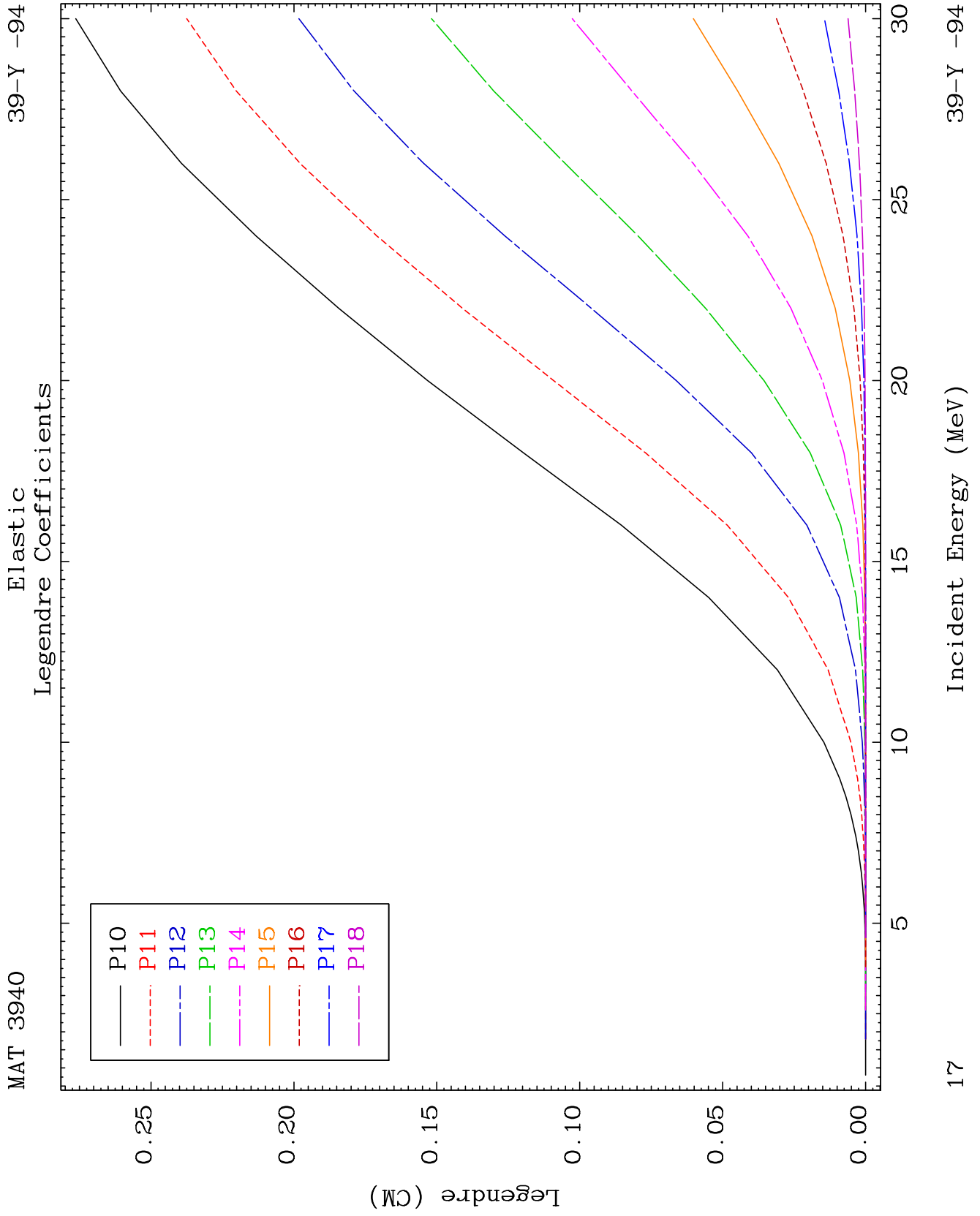

MAT 3940

Elastic Legendre Coefficients

39-Y -94

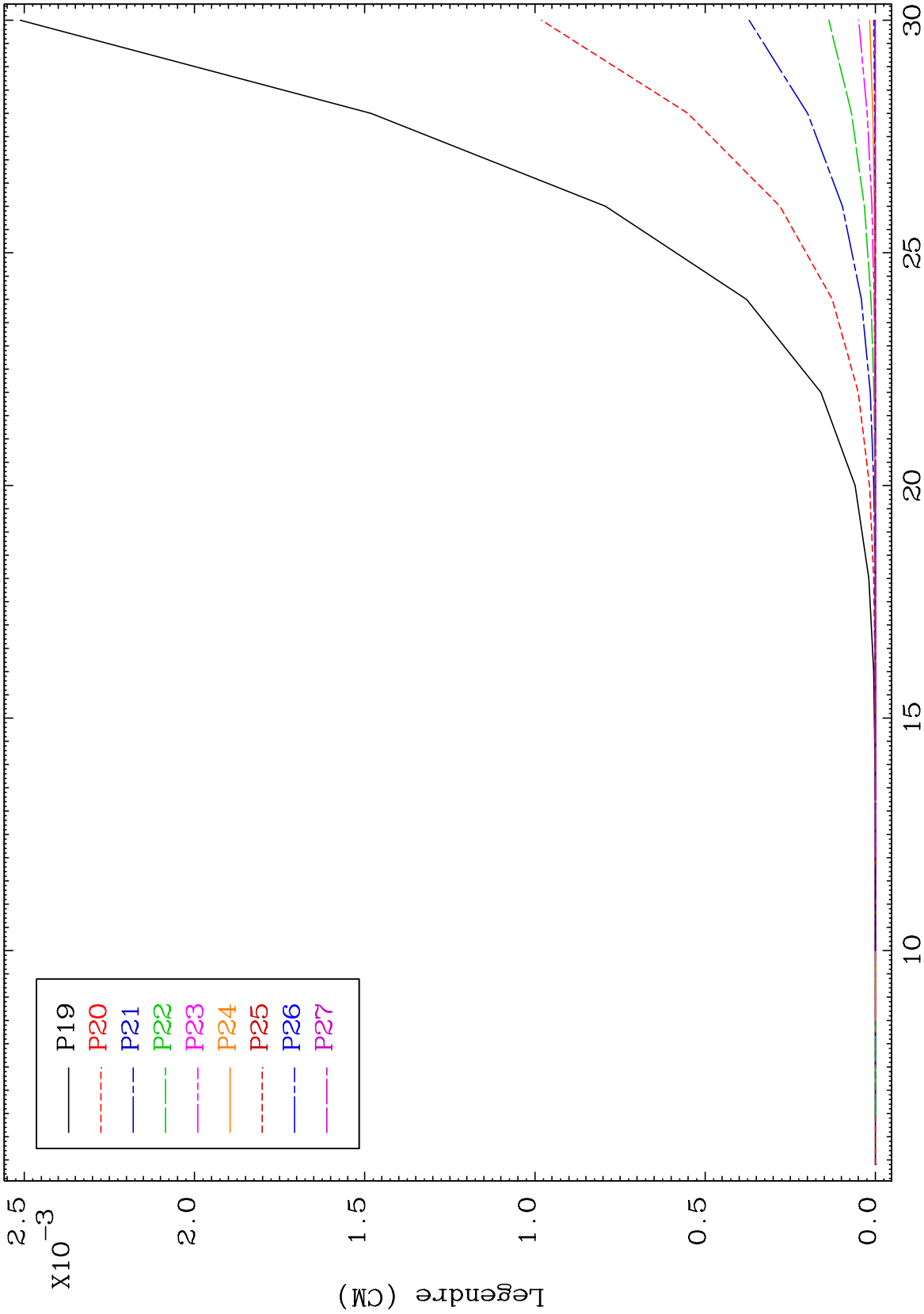

18

Incident Energy (MeV)

39-Y -94

MAT 3940

Elastic Legendre Coefficients

39-Y -94

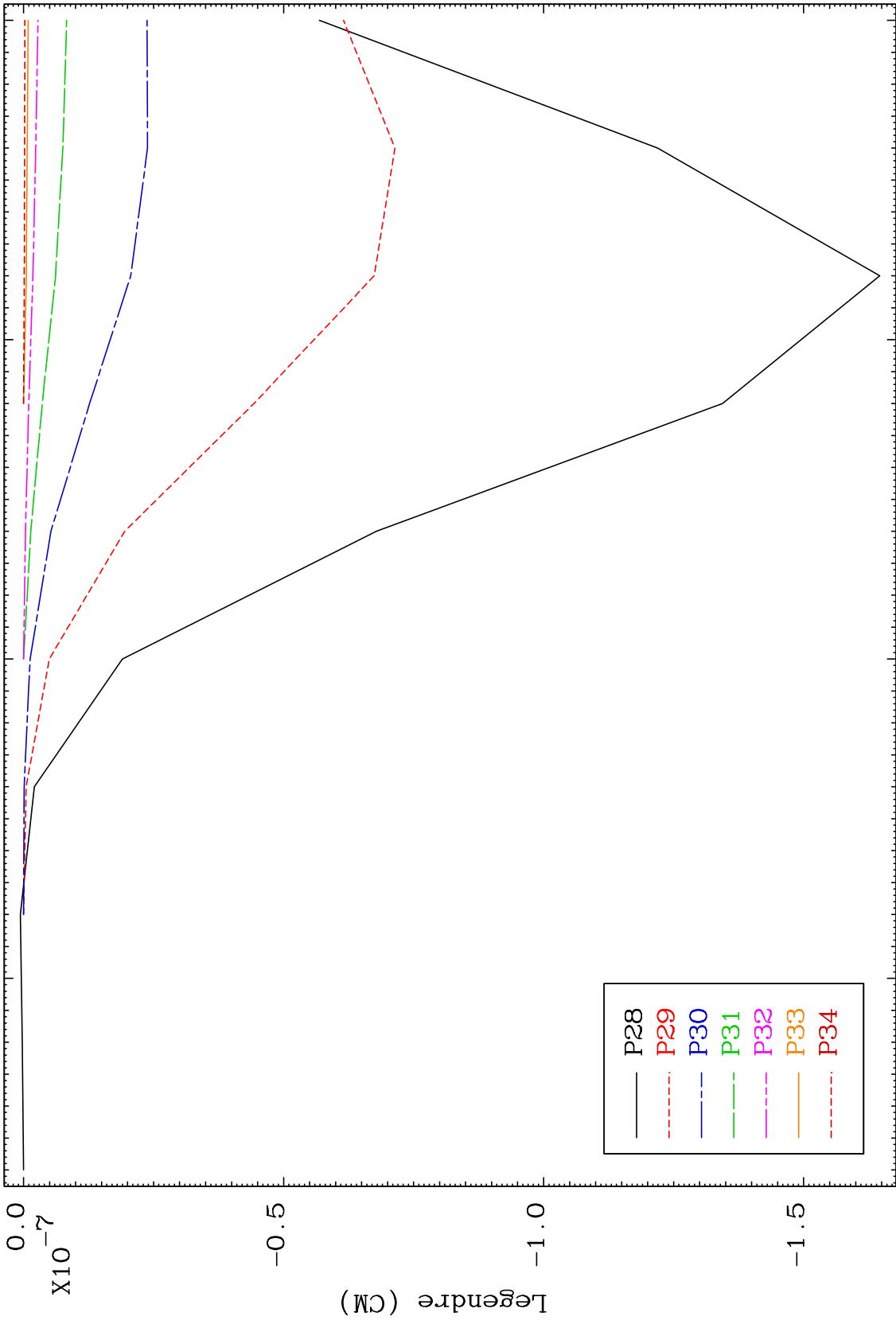

0.0
X10⁻⁷

-0.5

-1.0

-1.5

Legendre (CM)

15

20

25

30

19

Incident Energy (MeV)

39-Y -94

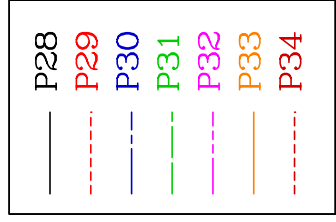

MAT 3940 MT= 51 (n,n') Level Legendre Coefficients 39-Y -94

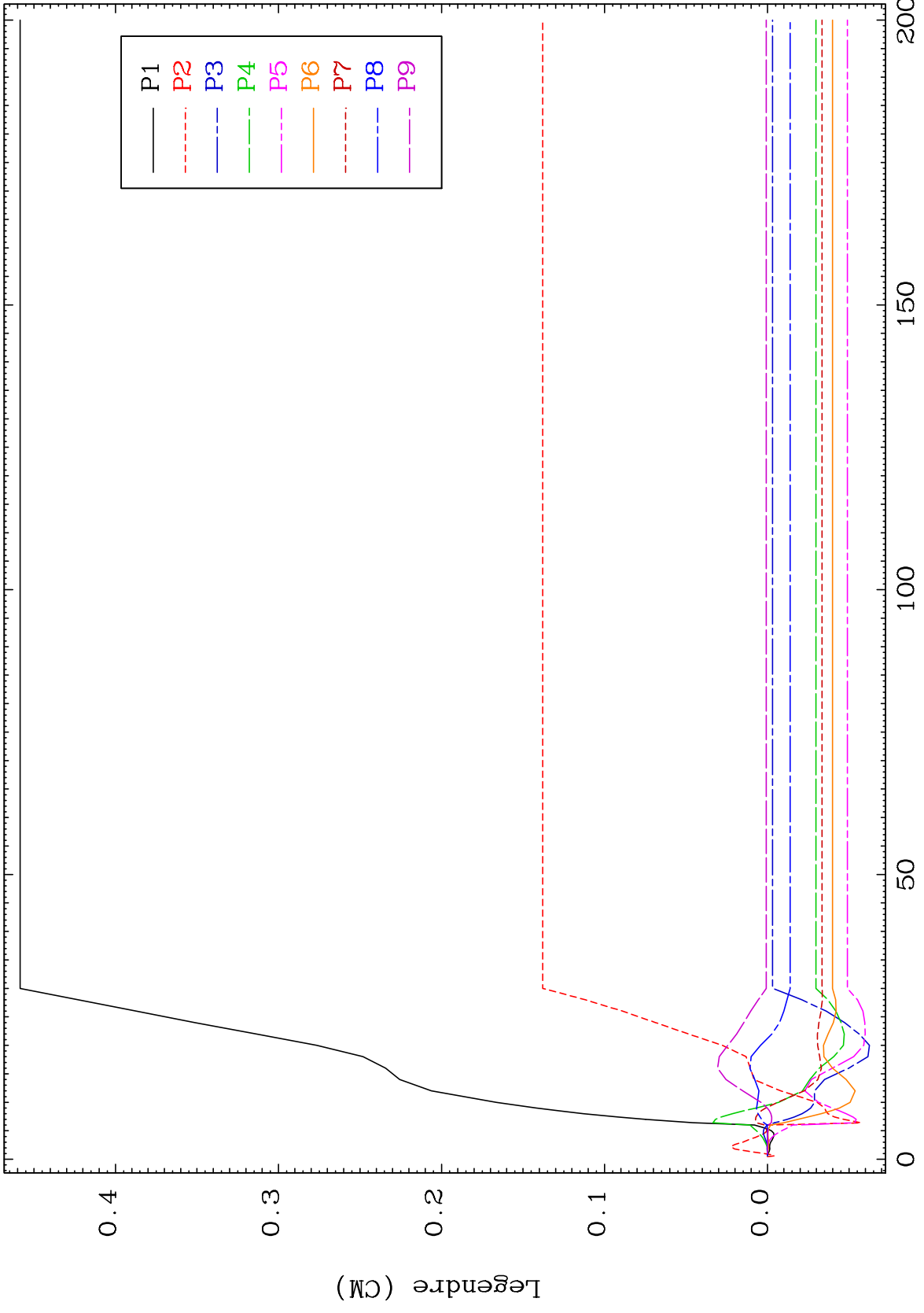

39-Y -94

MAT 3940

MT= 51 (n,n') Level
Legendre Coefficients

39-Y -94

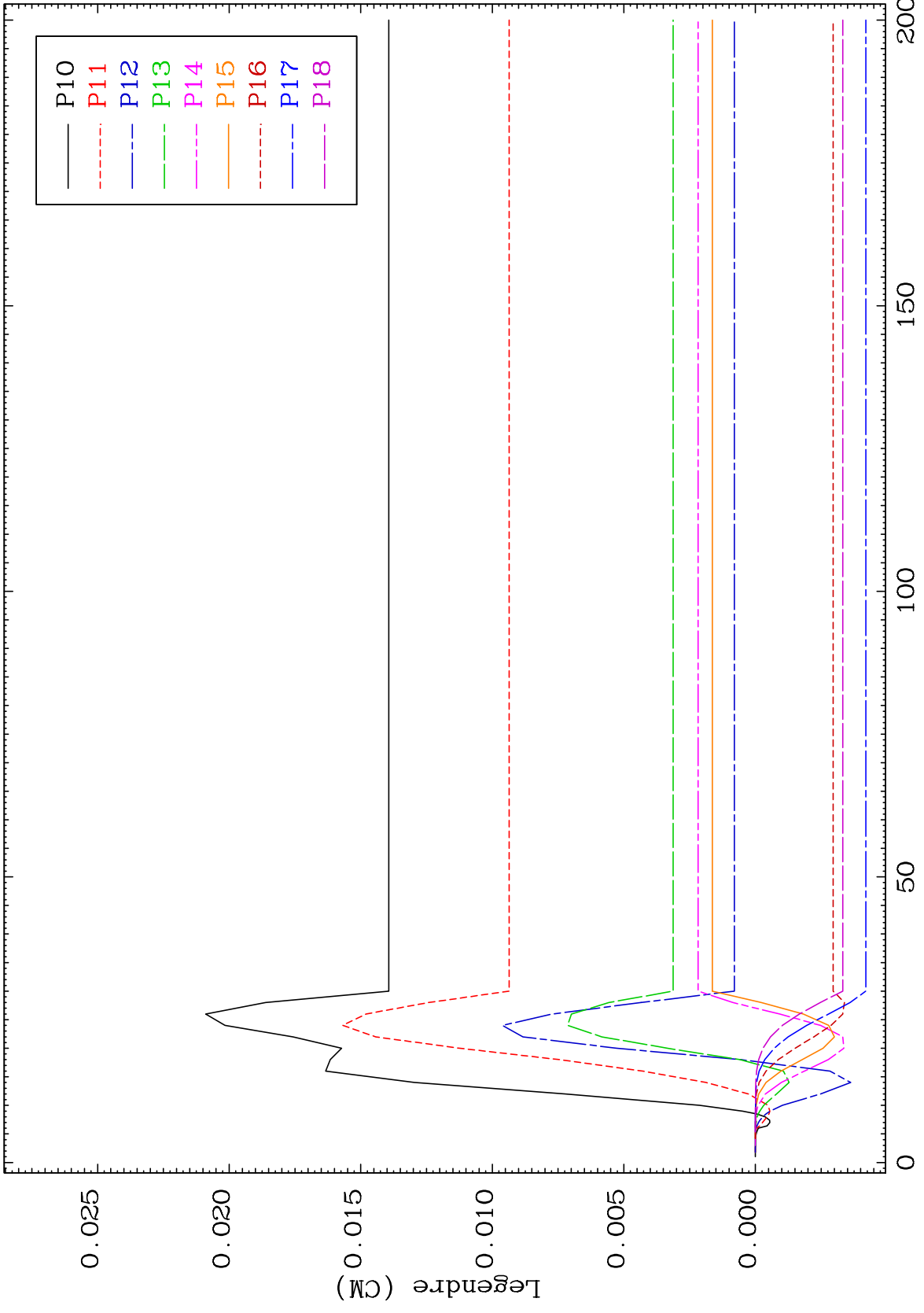

21

Incident Energy (MeV)

39-Y -94

MAT 3940

MT= 51 (n,n') Level
Legendre Coefficients

39-Y -94

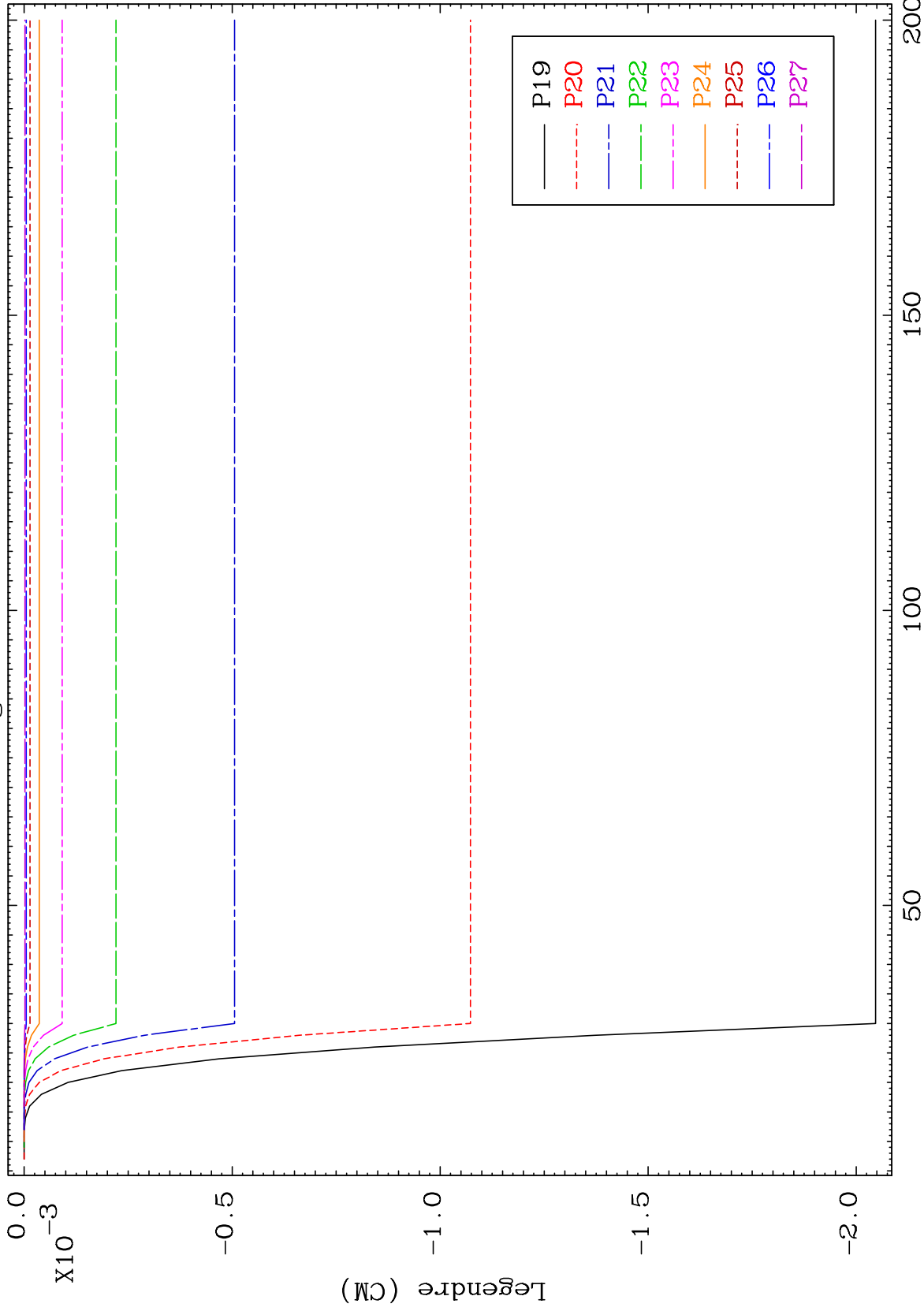

22

Incident Energy (MeV)

39-Y -94

MAT 3940 MT= 51 (n,n') Level Legendre Coefficients 39-Y -94

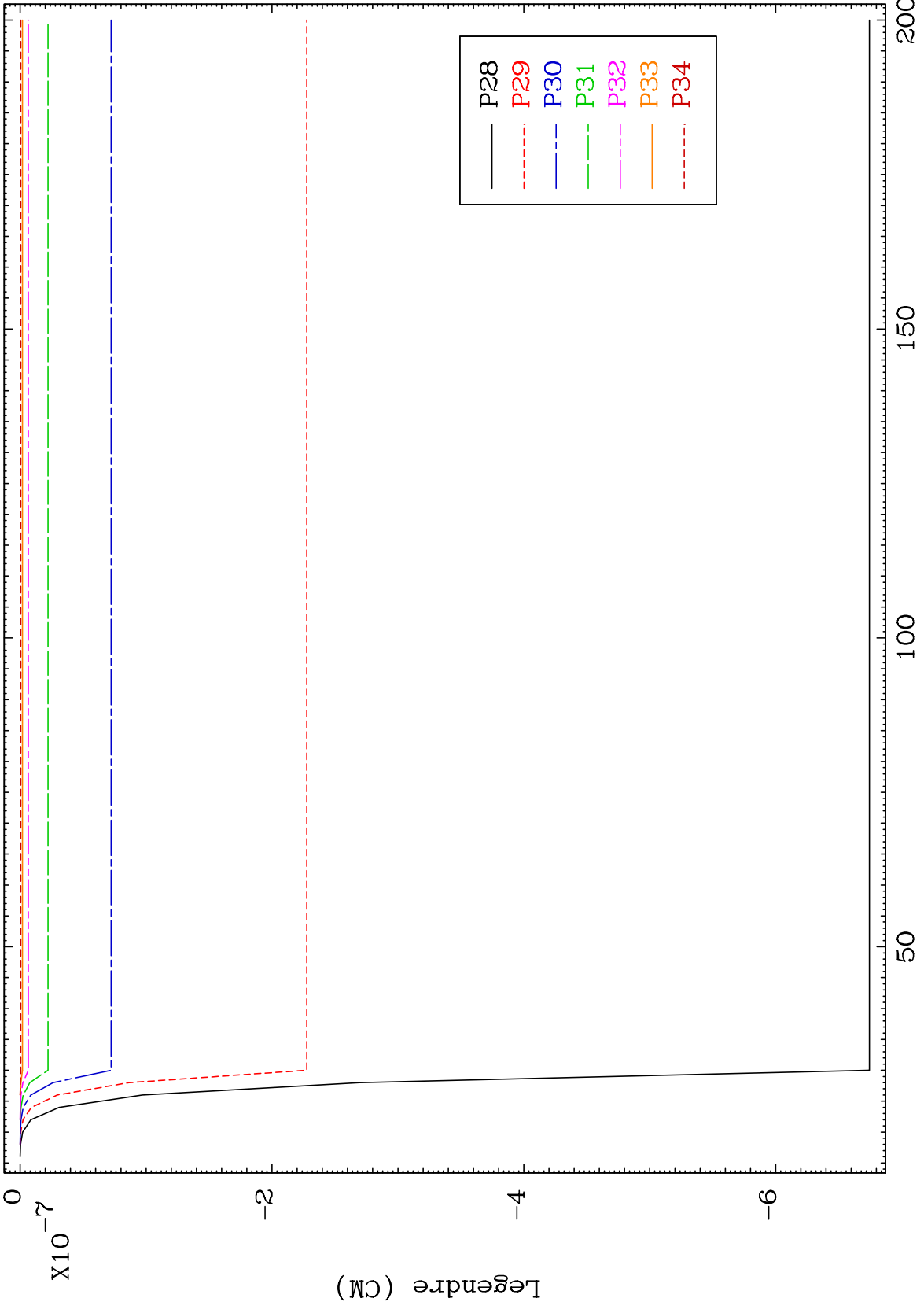

23 39-Y -94

MAT 3940 MT= 52 (n,n') Level Legendre Coefficients 39-Y -94

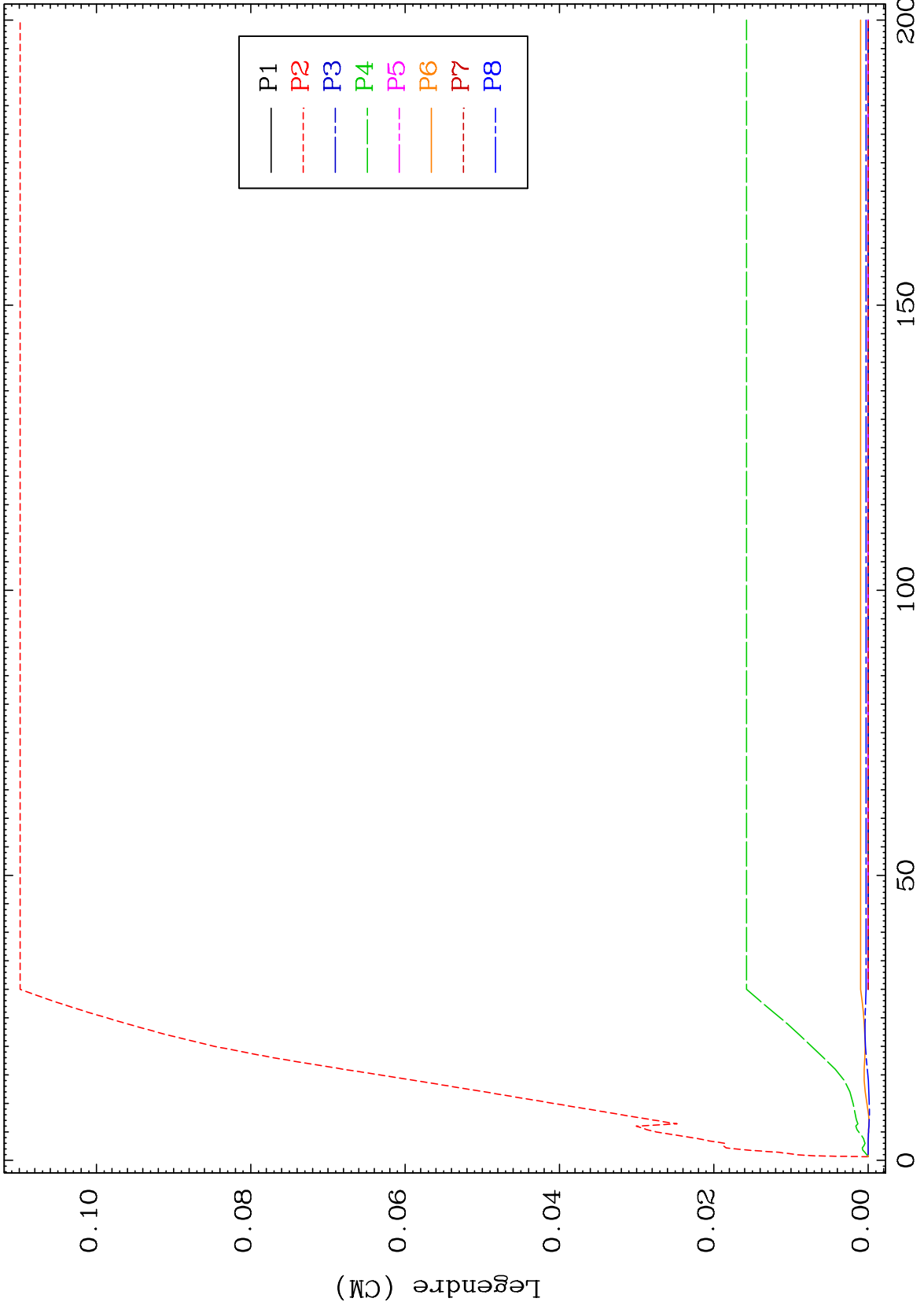

Incident Energy (MeV) 39-Y -94

MAT 3940 MT= 52 (n,n') Level Legendre Coefficients 39-Y -94

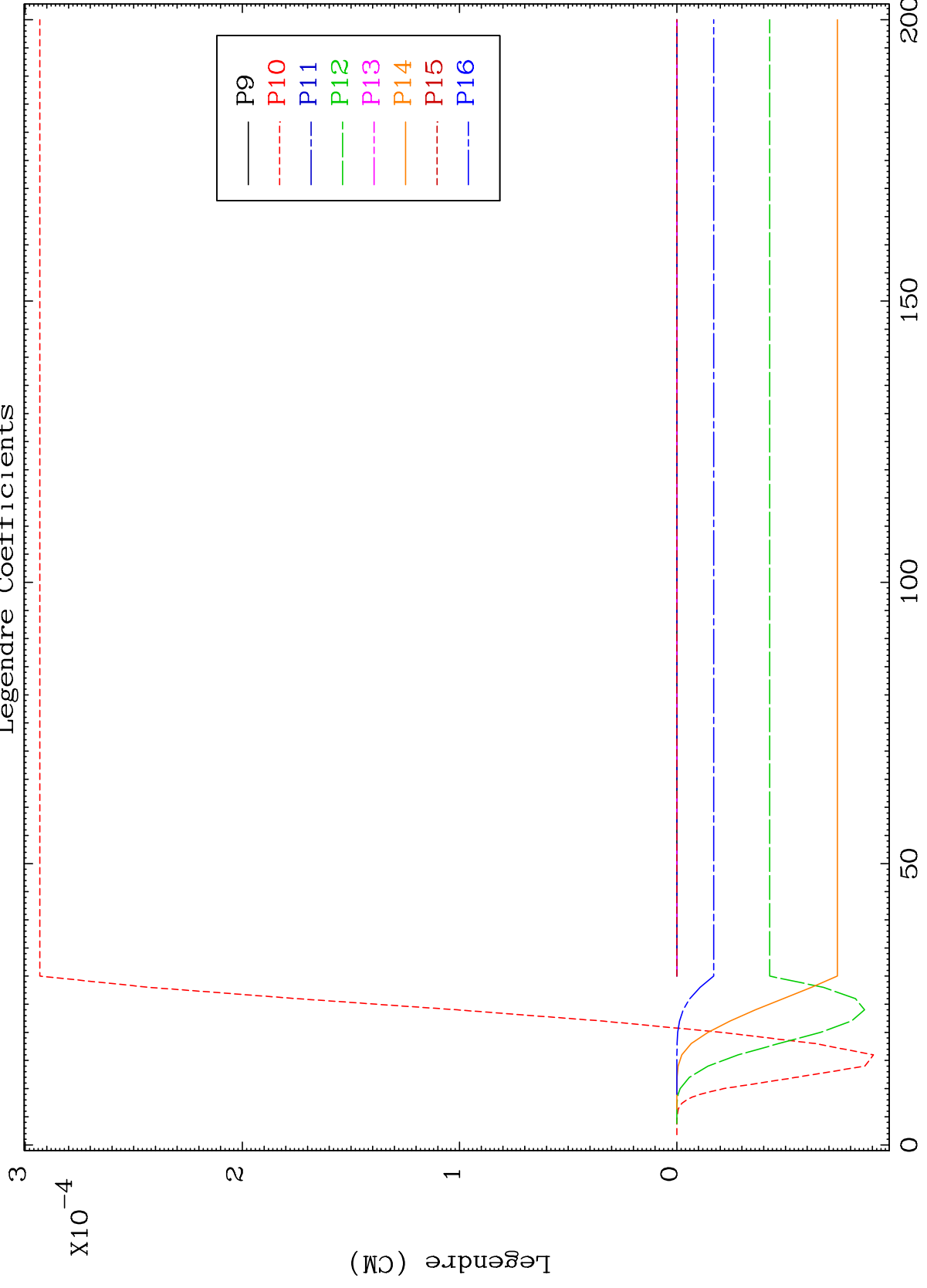

Incident Energy (MeV) 39-Y -94

MAT 3940

MT= 52 (n,n') Level
Legendre Coefficients

39-Y -94

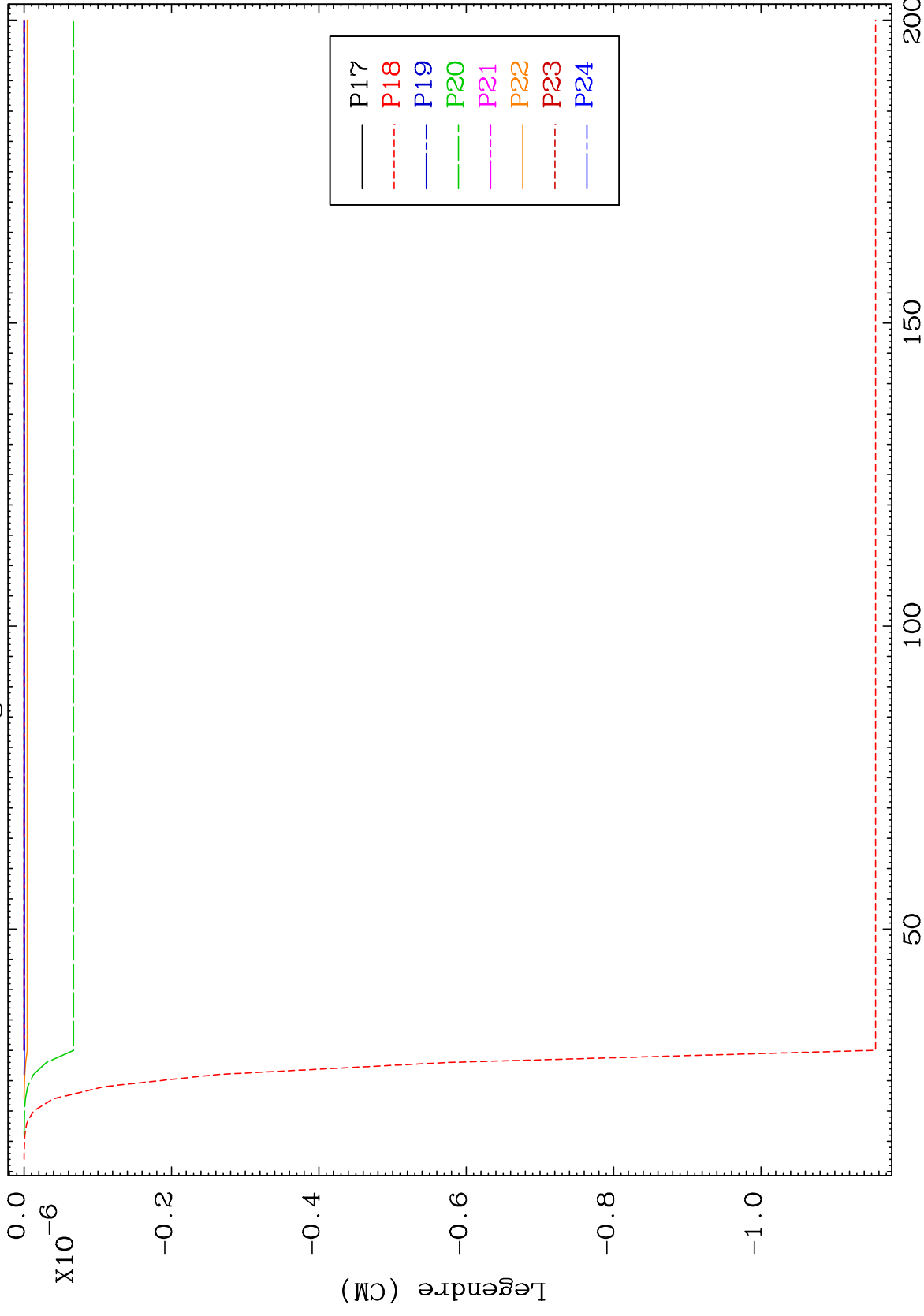

39-Y -94

Incident Energy (MeV)

26

MAT 3940

MT= 53 (n,n') Level
Legendre Coefficients

39-Y -94

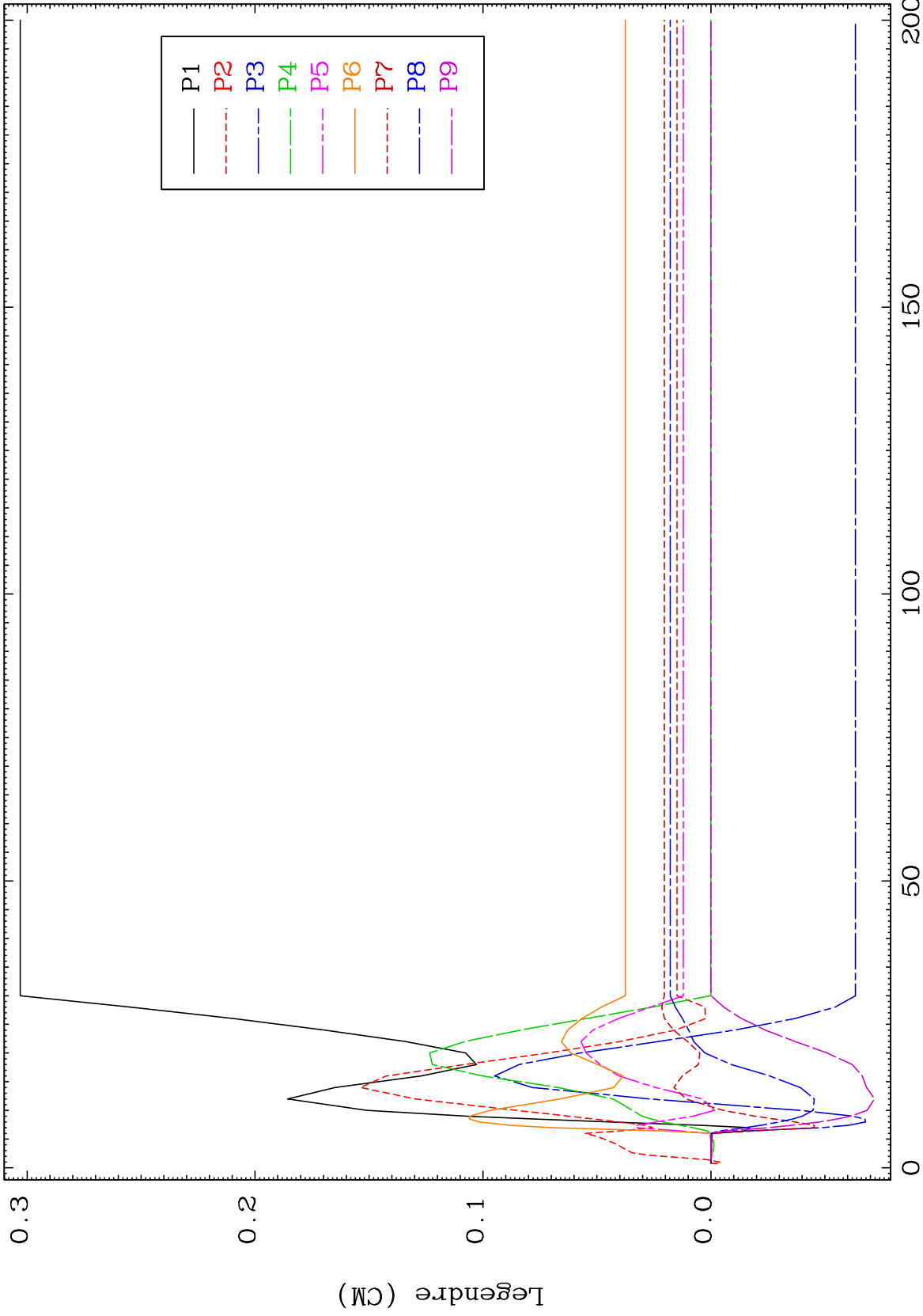

27

Incident Energy (MeV)

39-Y -94

MAT 3940

MT= 53 (n,n') Level
Legendre Coefficients

39-Y -94

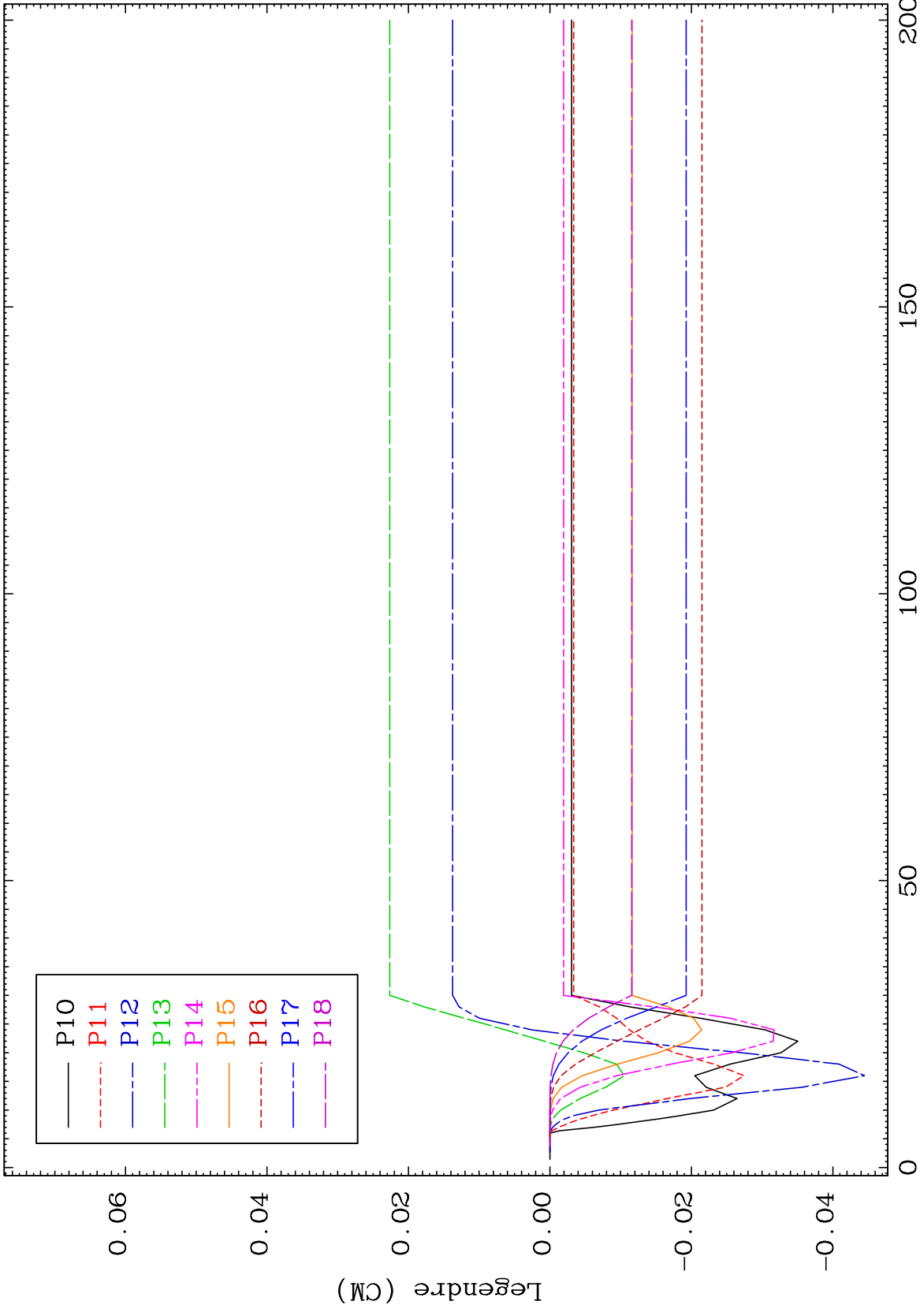

28

Incident Energy (MeV)

39-Y -94

MAT 3940 MT= 53 (n,n') Level Legendre Coefficients 39-Y -94

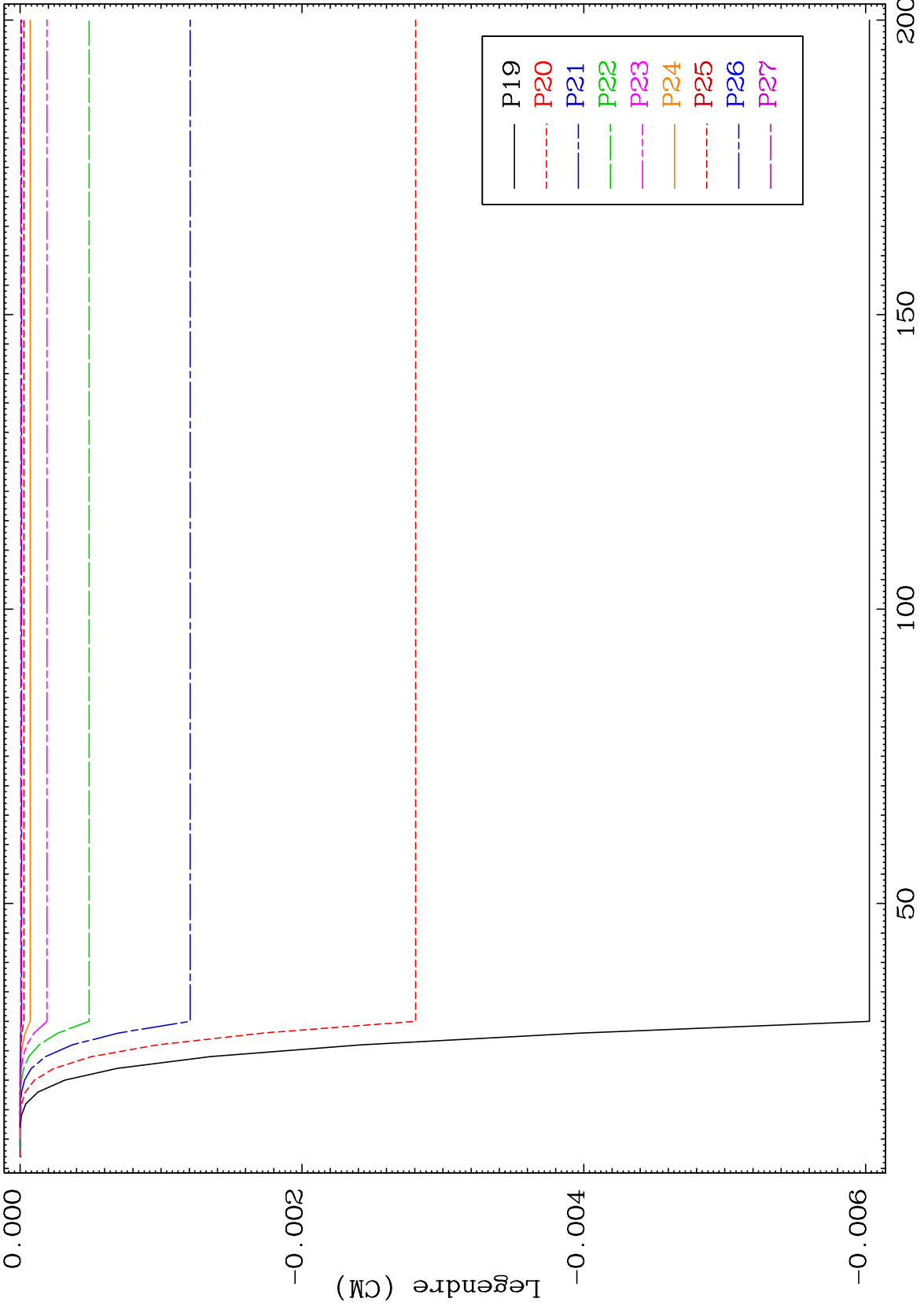

MAT 3940 MT= 53 (n,n') Level Legendre Coefficients 39-Y -94

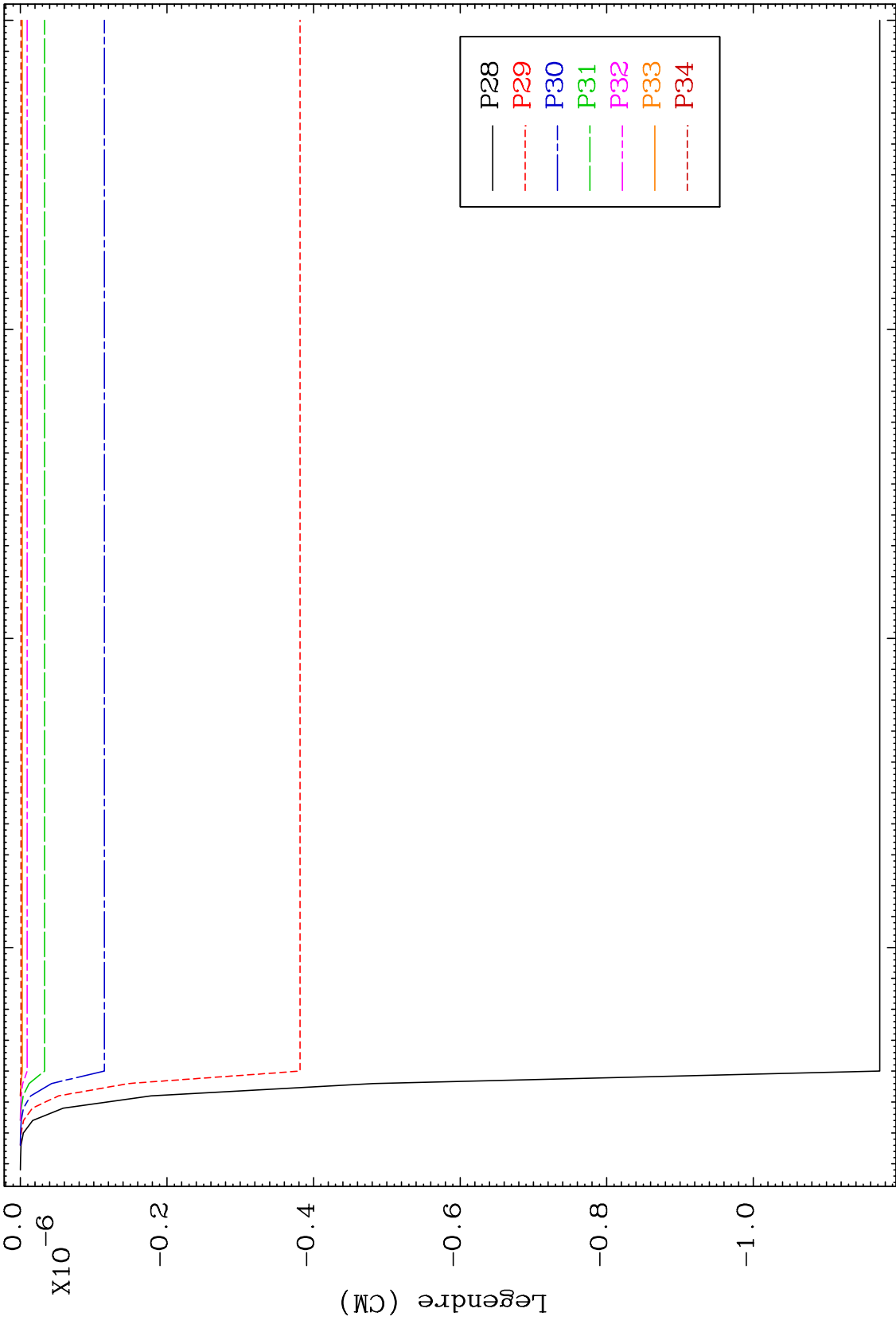

30 Incident Energy (MeV) 150 200 39-Y -94

MAT 3940 MT= 54 (n,n') Level Legendre Coefficients 39-Y -94

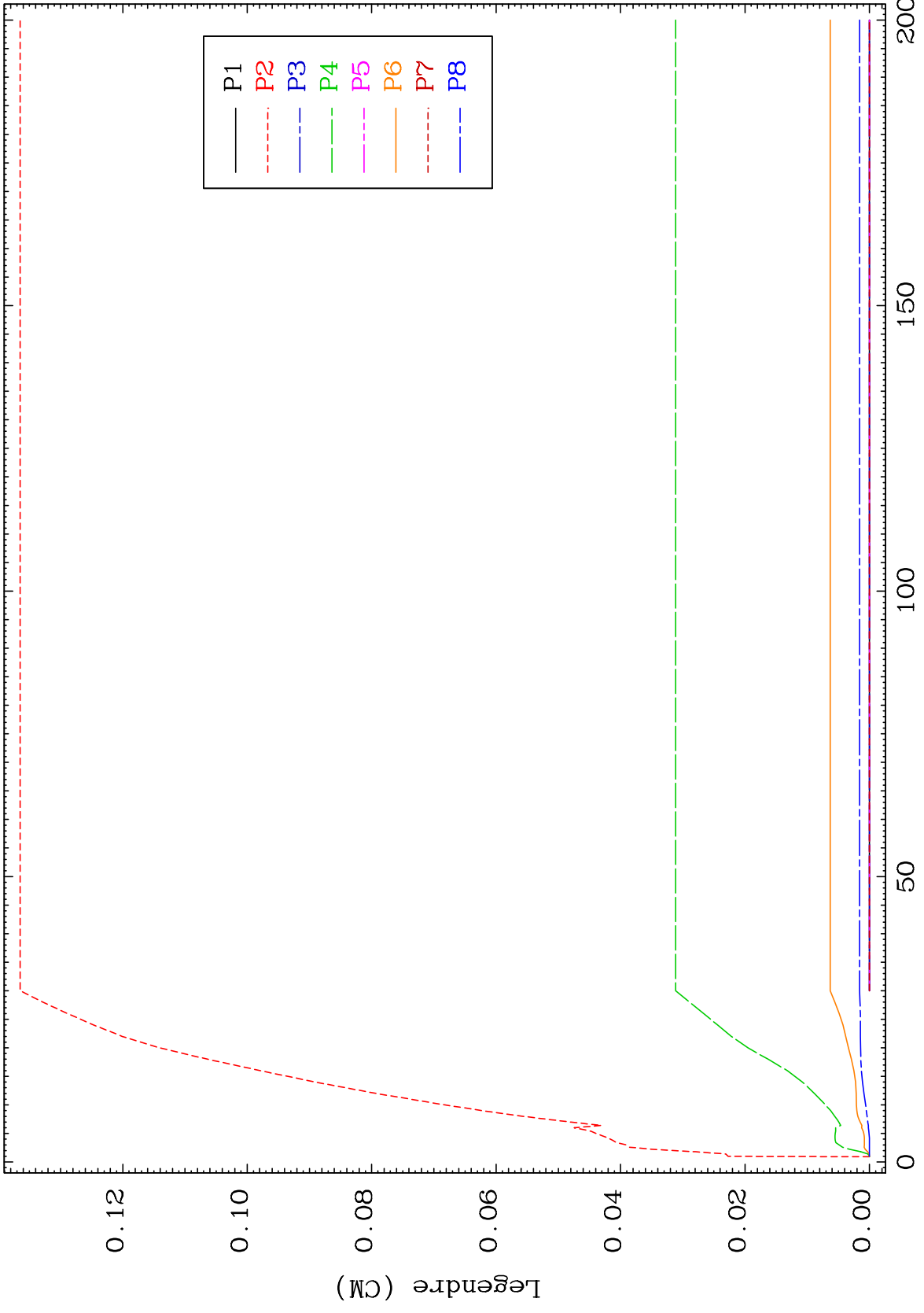

31 39-Y -94

MAT 3940 MT= 54 (n,n') Level Legendre Coefficients 39-Y -94

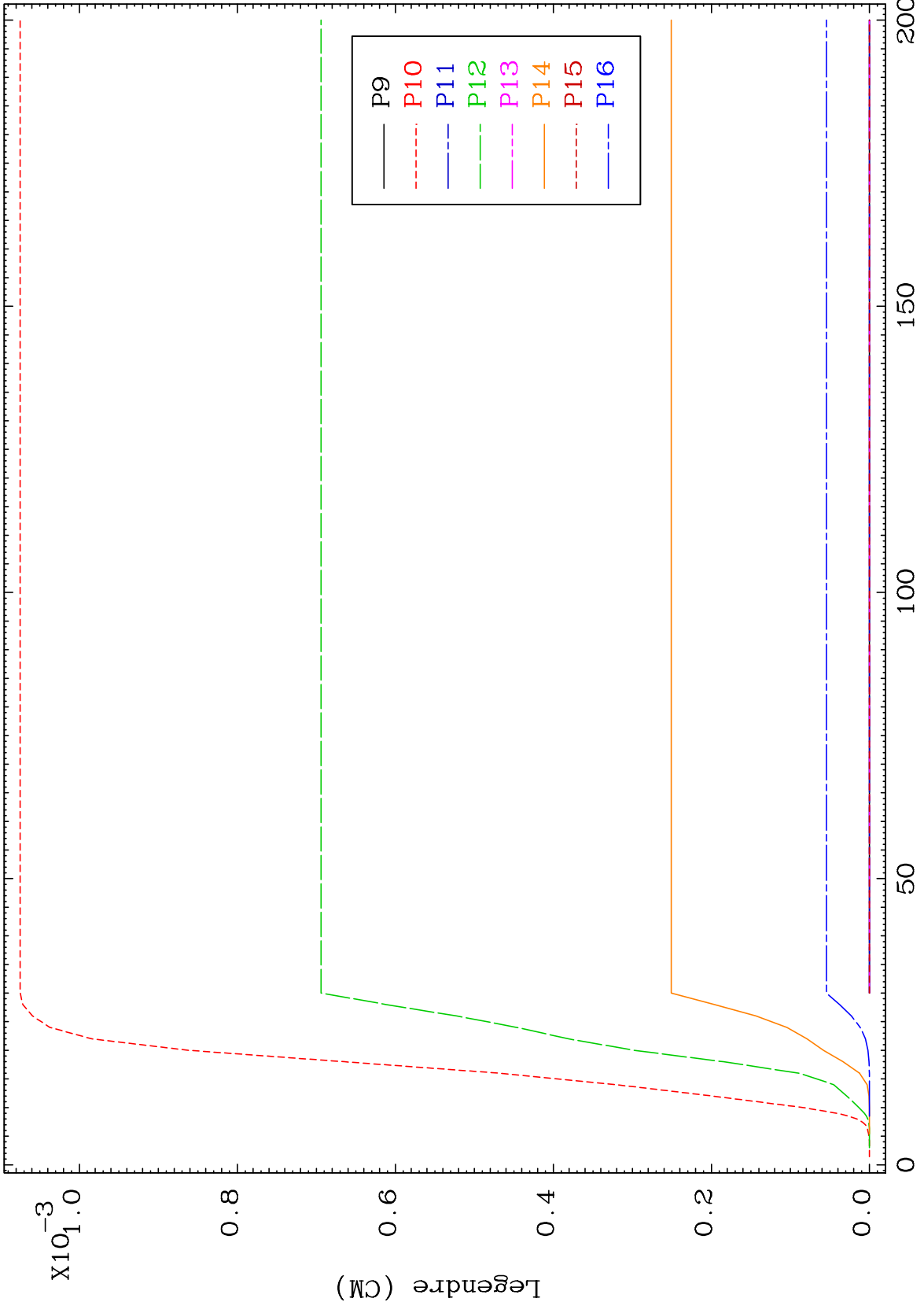

32 39-Y -94

MAT 3940 MT= 54 (n,n') Level Legendre Coefficients 39-Y -94

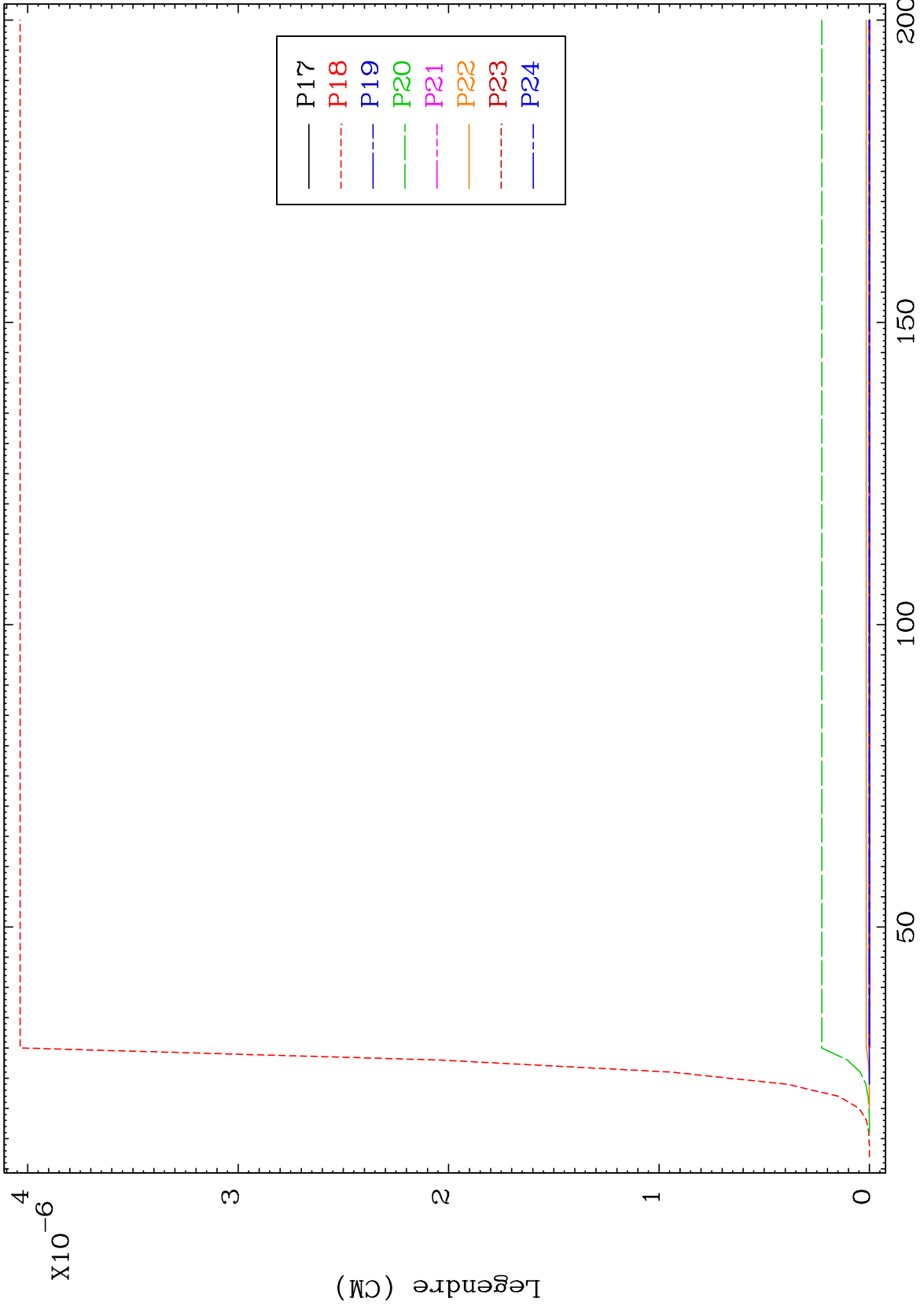

33 Incident Energy (MeV) 39-Y -94

MAT 3940 MT= 55 (n,n') Level Legendre Coefficients 39-Y -94

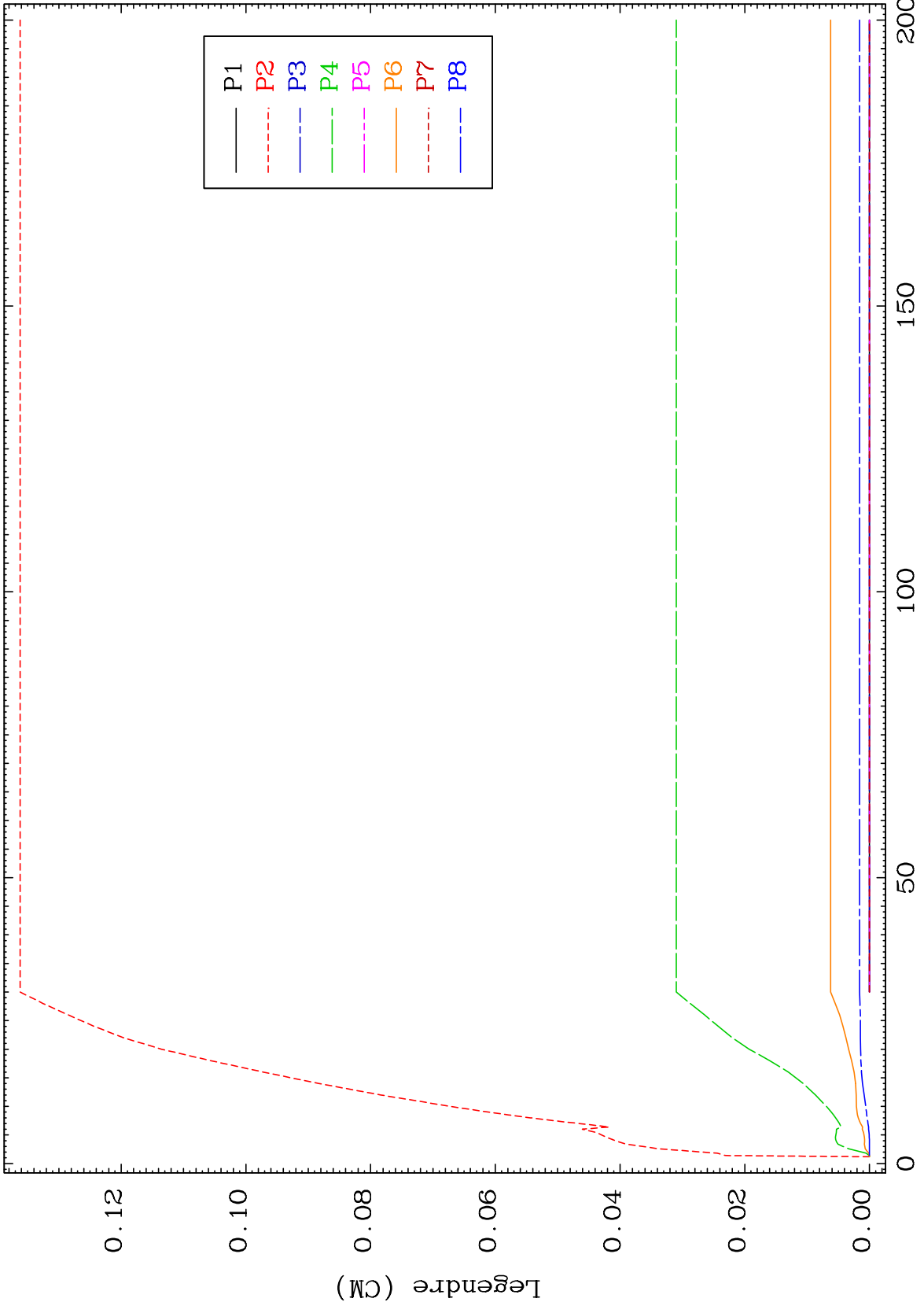

34 39-Y -94

MAT 3940 MT= 55 (n,n') Level Legendre Coefficients 39-Y -94

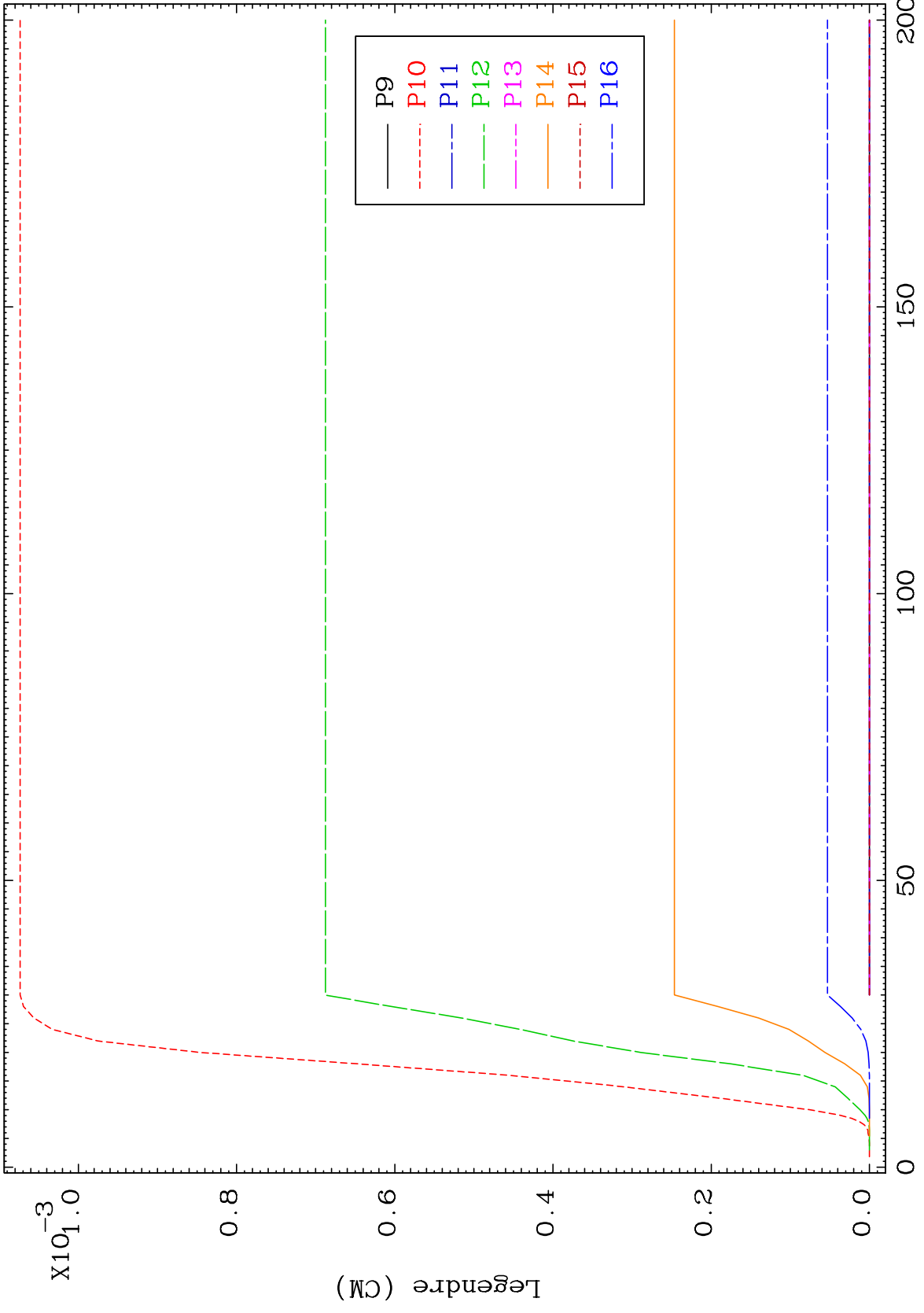

35 Incident Energy (MeV) 39-Y -94

MAT 3940 MT= 55 (n,n') Level Legendre Coefficients 39-Y -94

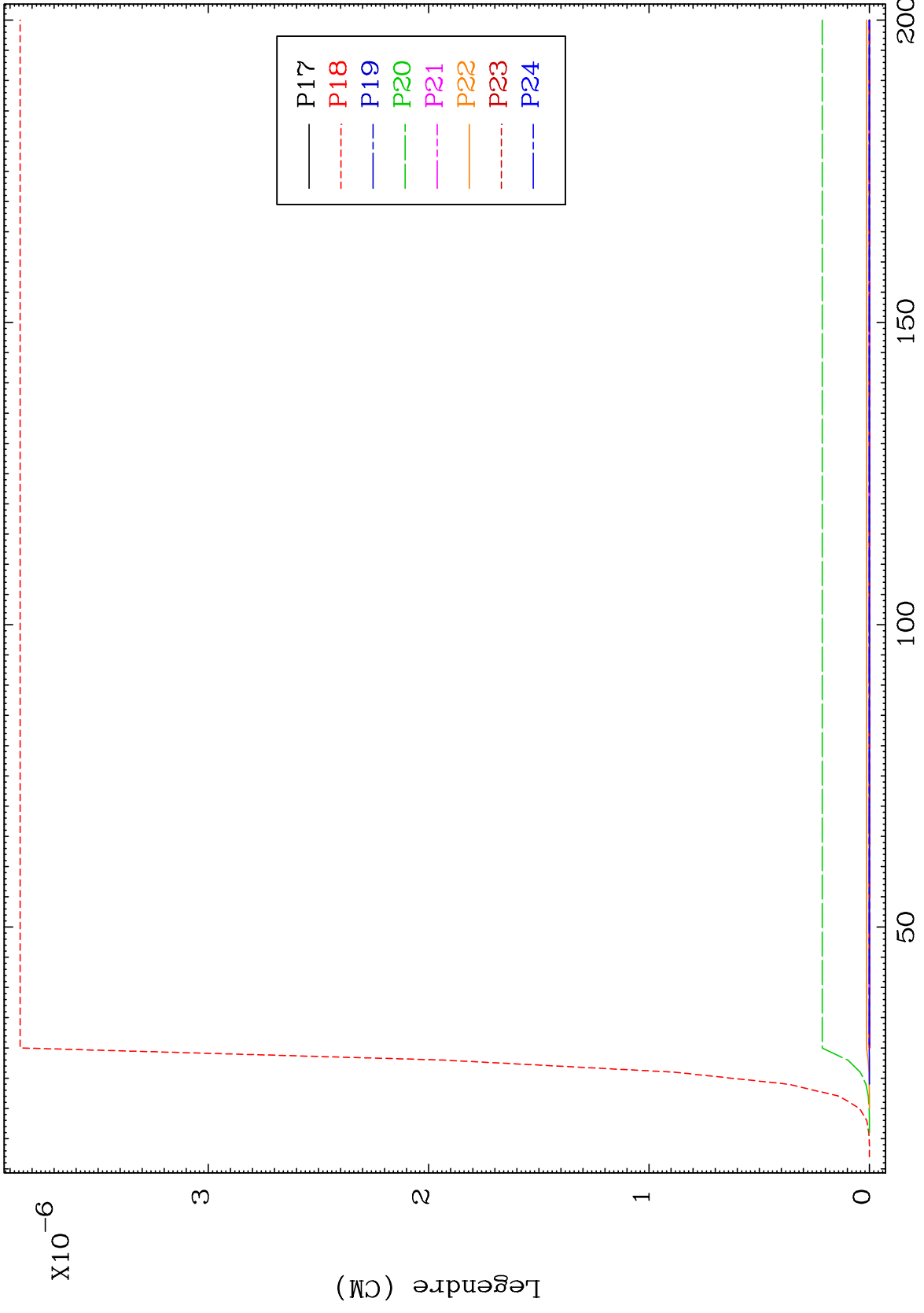

36 50 100 150 200 39-Y -94

MAT 3940 MT= 56 (n,n') Level Legendre Coefficients 39-Y -94

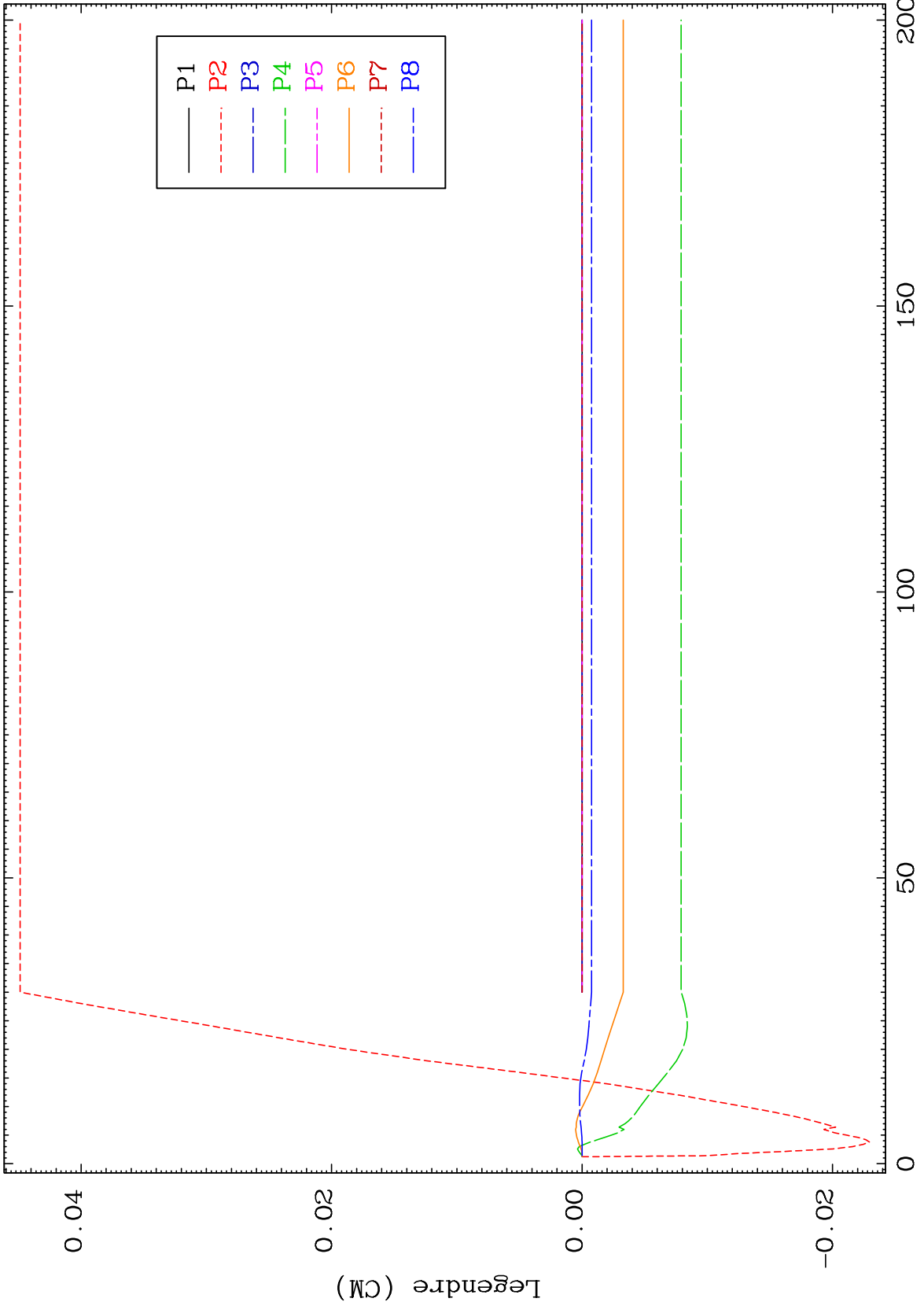

37 Incident Energy (MeV) 39-Y -94

MAT 3940

MT= 56 (n,n') Level
Legendre Coefficients

39-Y -94

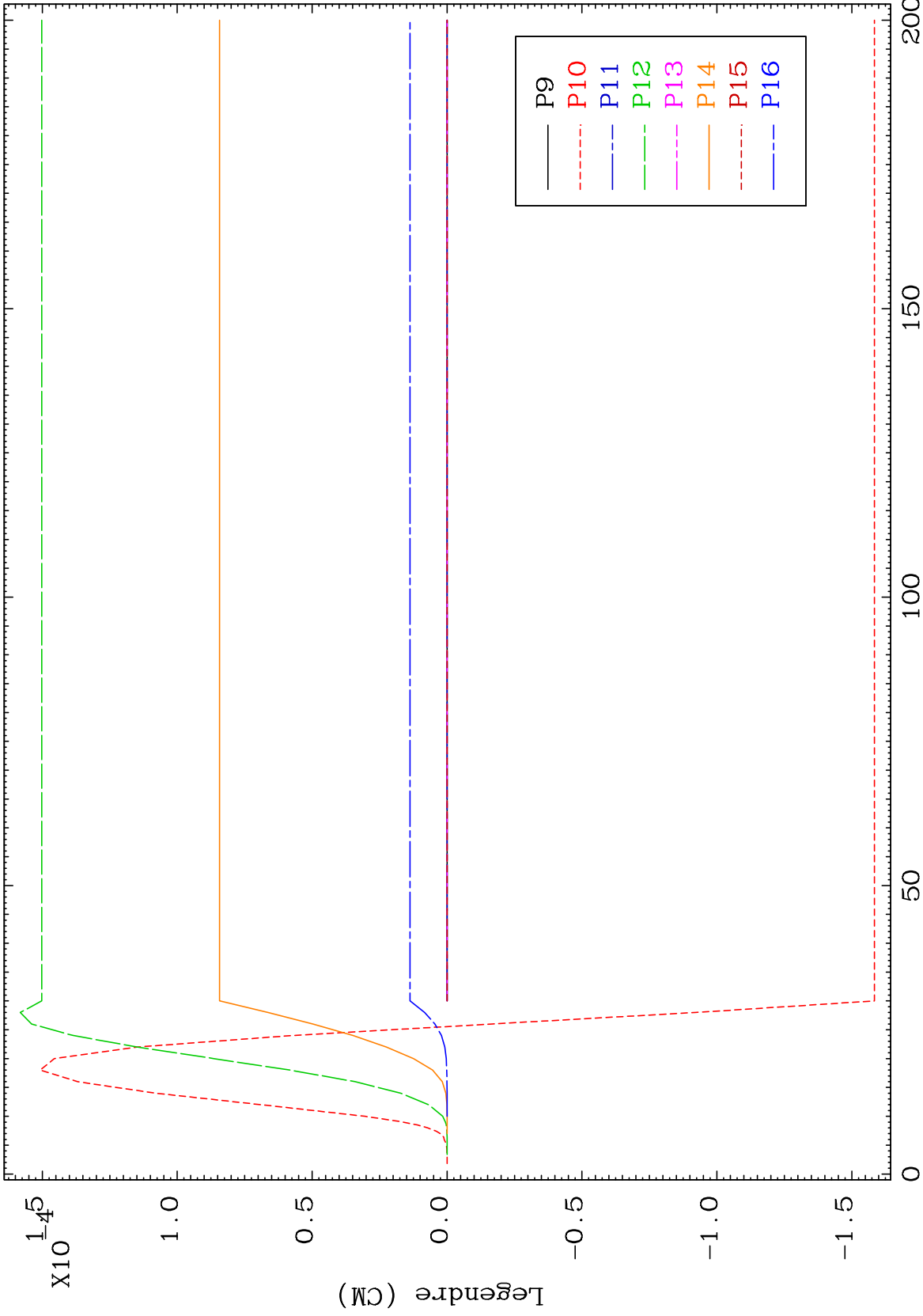

38

Incident Energy (MeV)

39-Y -94

MAT 3940 MT= 56 (n,n') Level Legendre Coefficients 39-Y -94

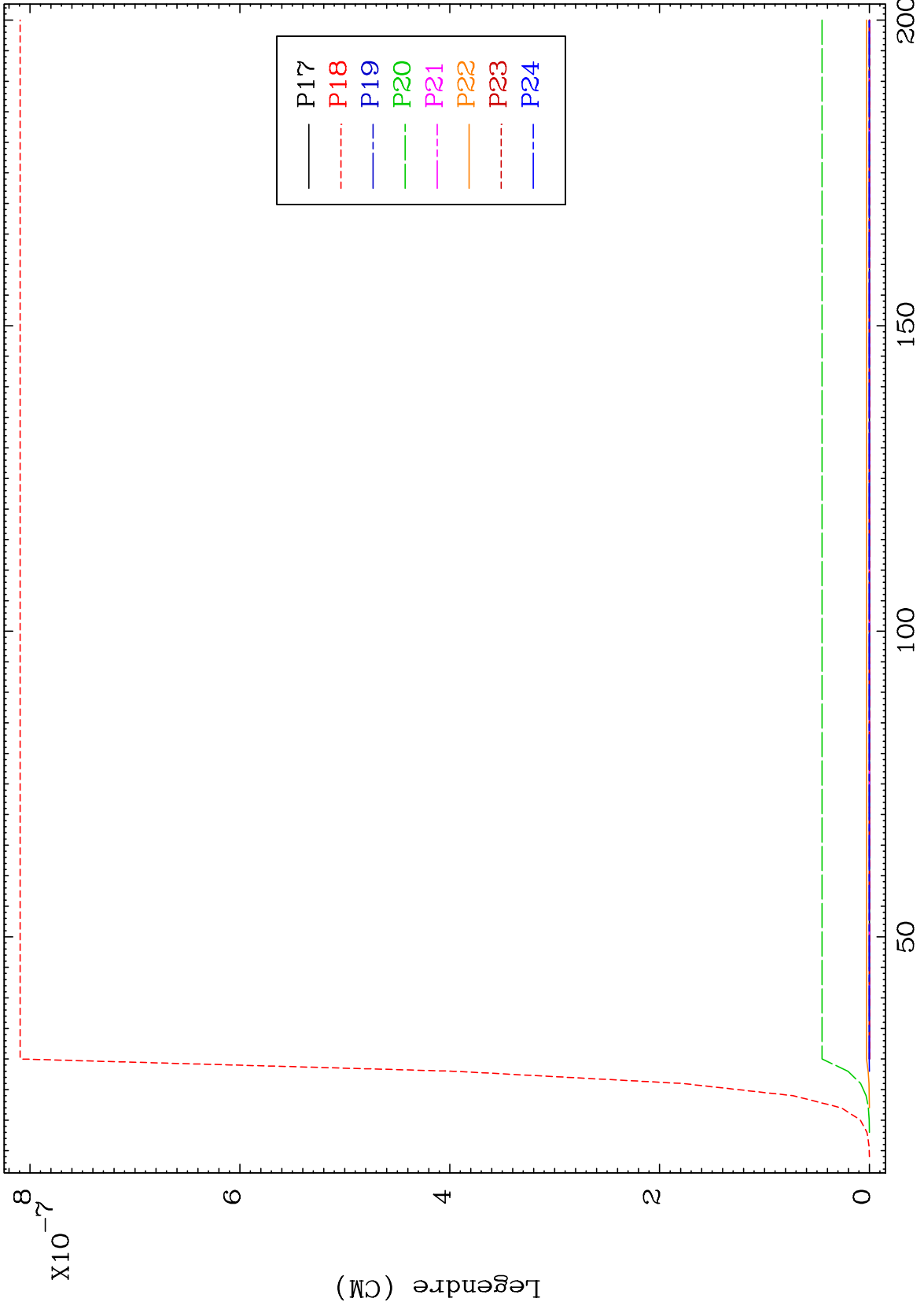

39 39-Y -94

MAT 3940 MT= 57 (n,n') Level Legendre Coefficients 39-Y -94

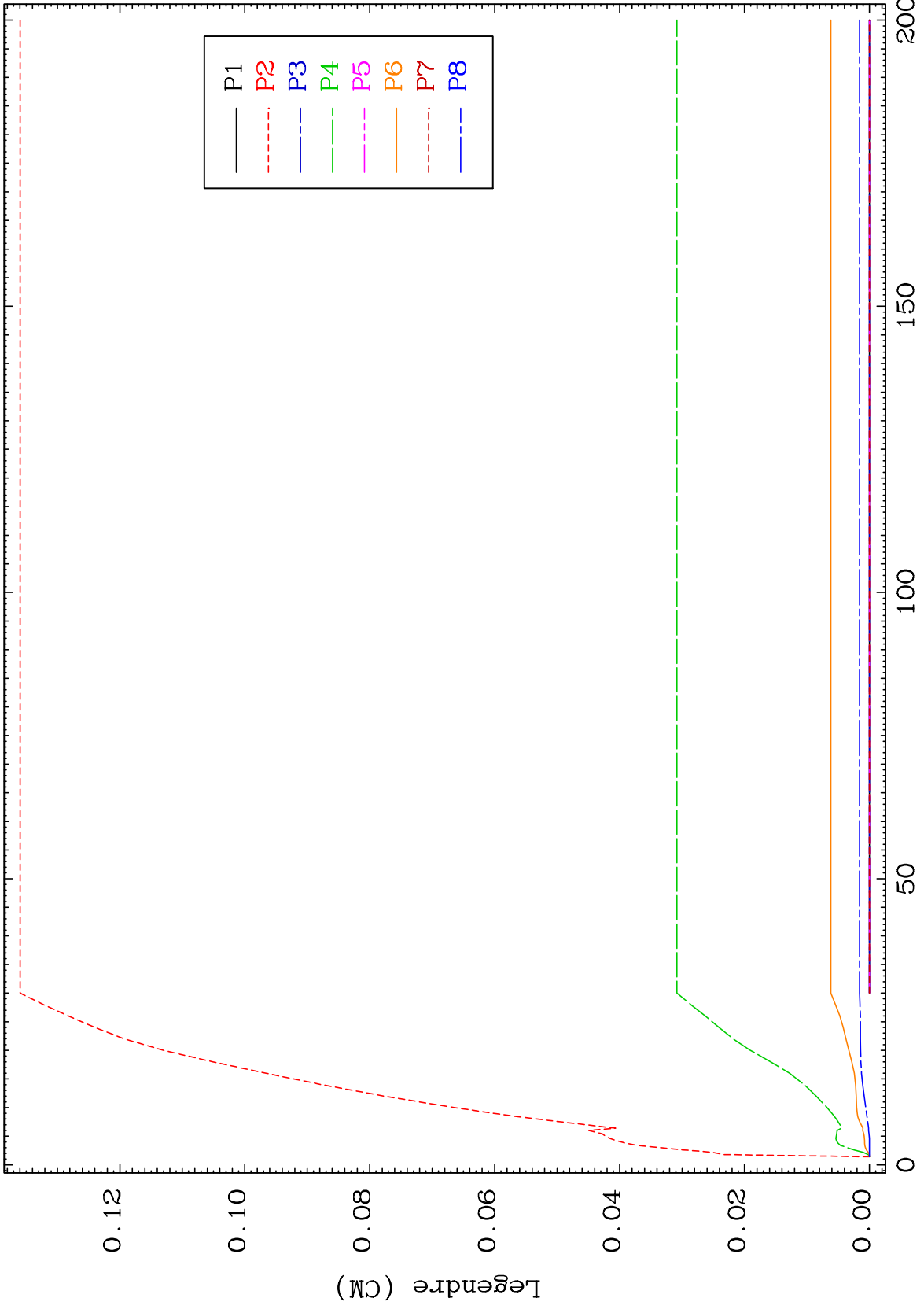

39-Y -94

MAT 3940 MT= 57 (n,n') Level Legendre Coefficients 39-Y -94

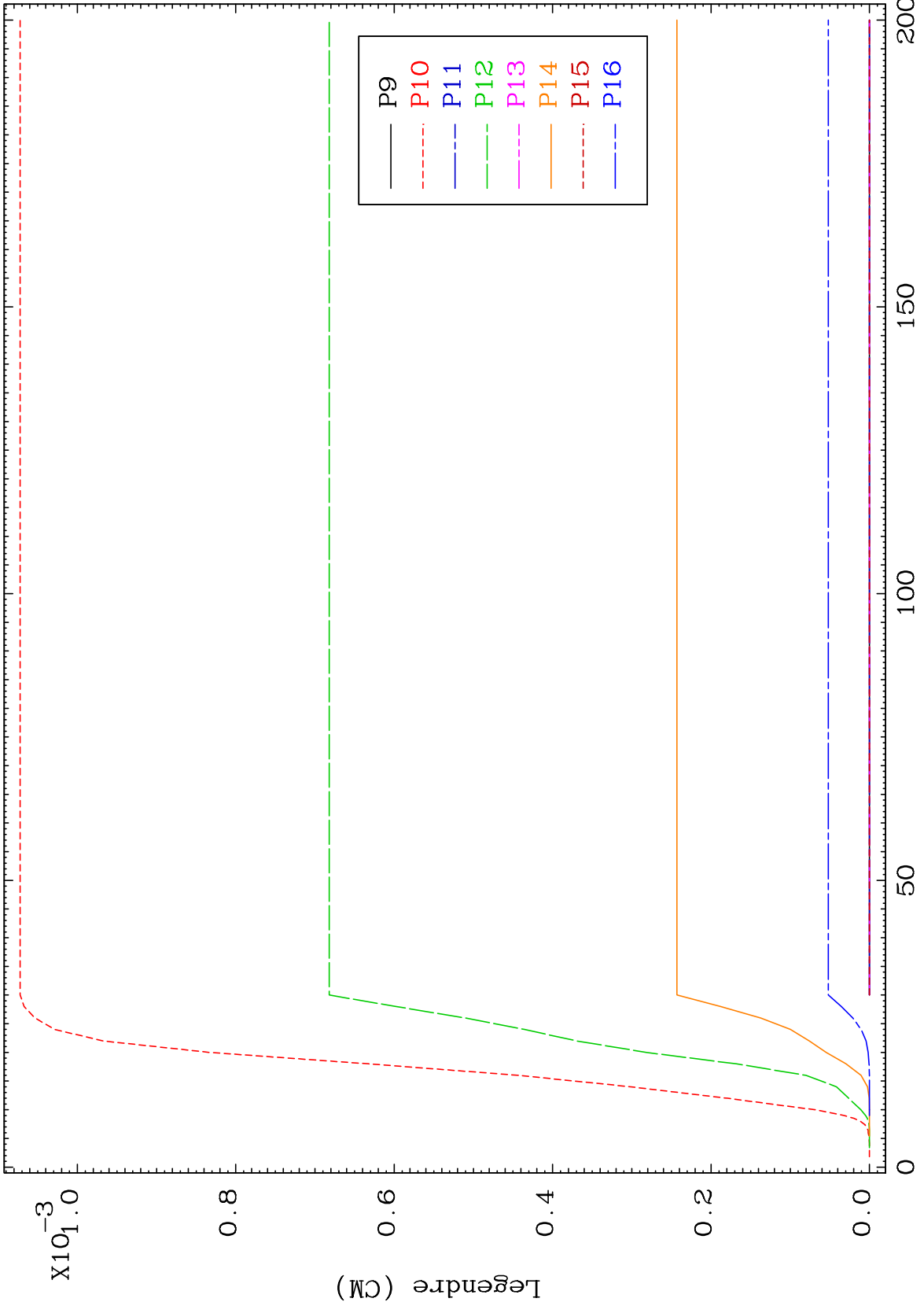

41 39-Y -94

MAT 3940 MT= 57 (n,n') Level Legendre Coefficients 39-Y -94

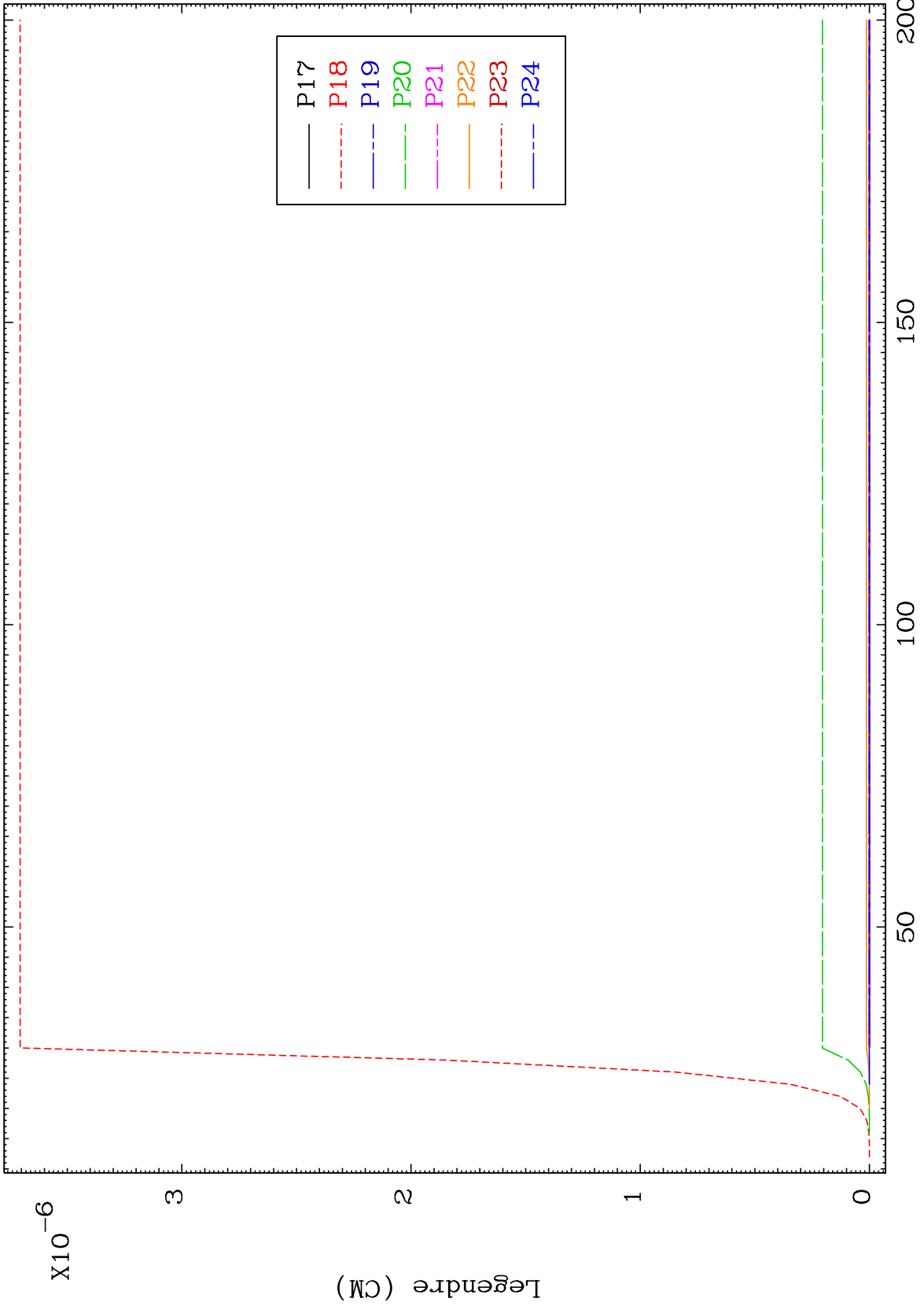

42 Incident Energy (MeV) 39-Y -94

MAT 3940 MT= 58 (n,n') Level Legendre Coefficients 39-Y -94

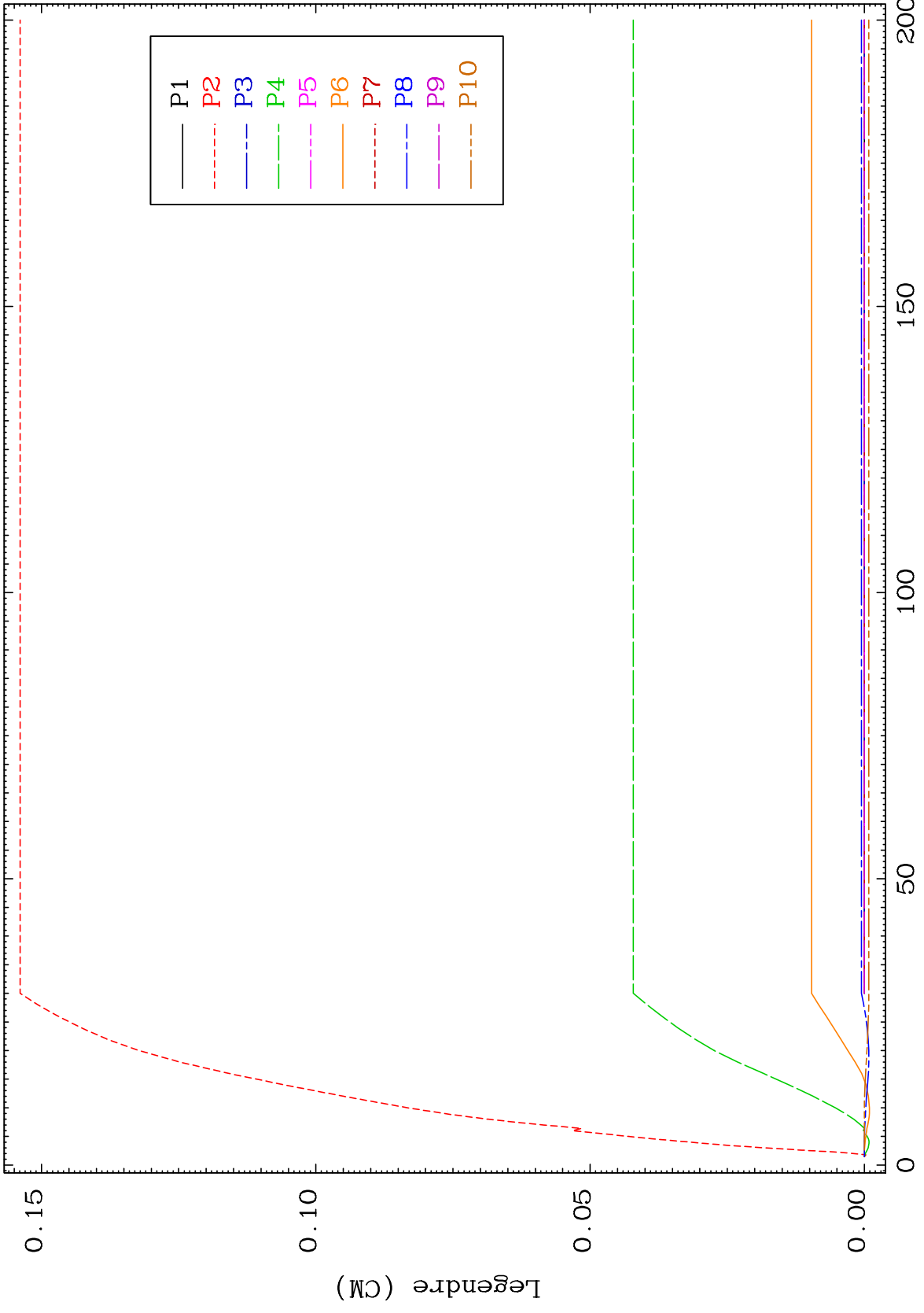

43 39-Y -94

MAT 3940 MT= 58 (n,n') Level Legendre Coefficients 39-Y -94

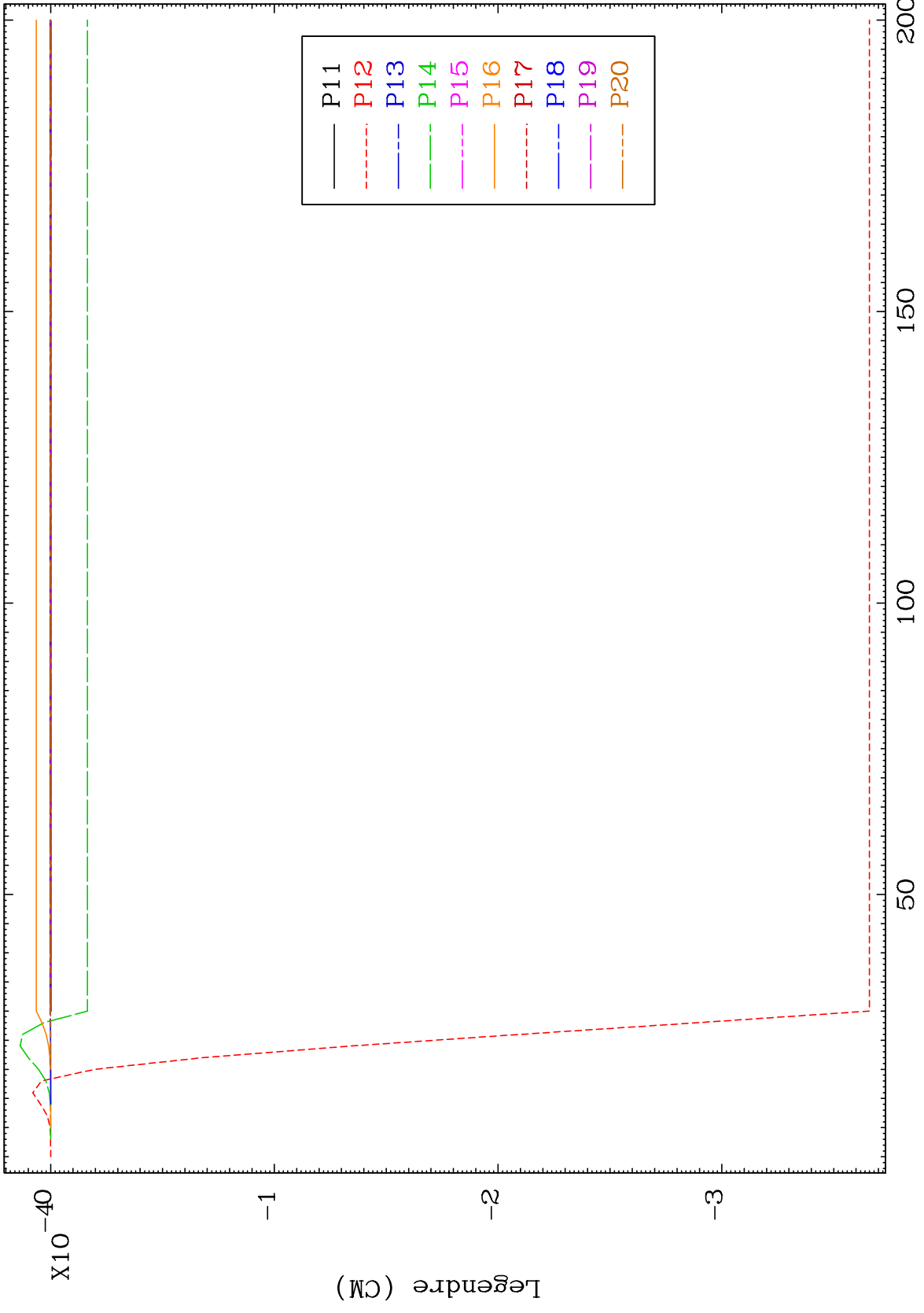

MAT 3940 MT= 59 (n,n') Level Legendre Coefficients

39-Y -94

39-Y -94

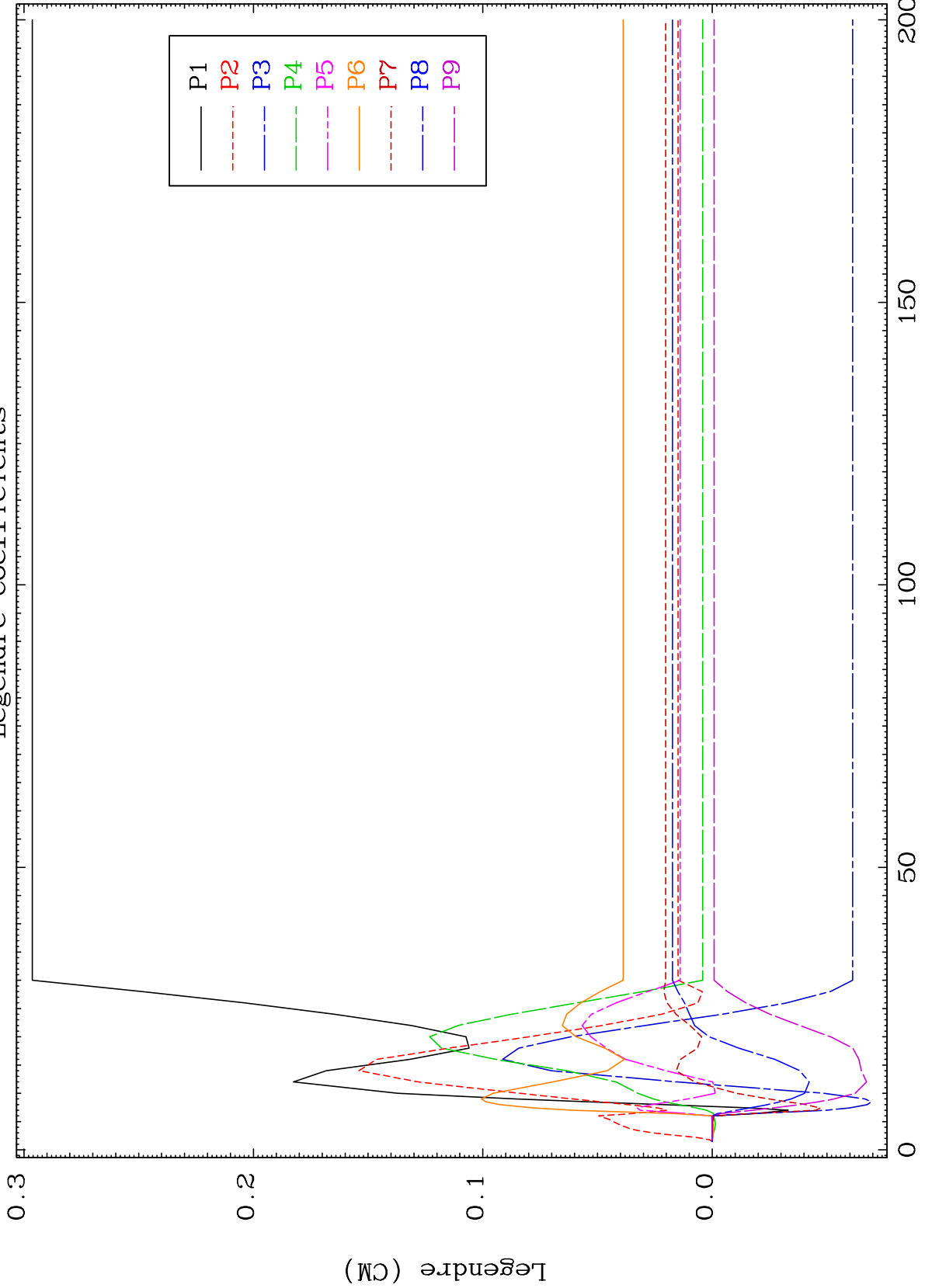

MAT 3940

MT= 59 (n,n') Level
Legendre Coefficients

39-Y -94

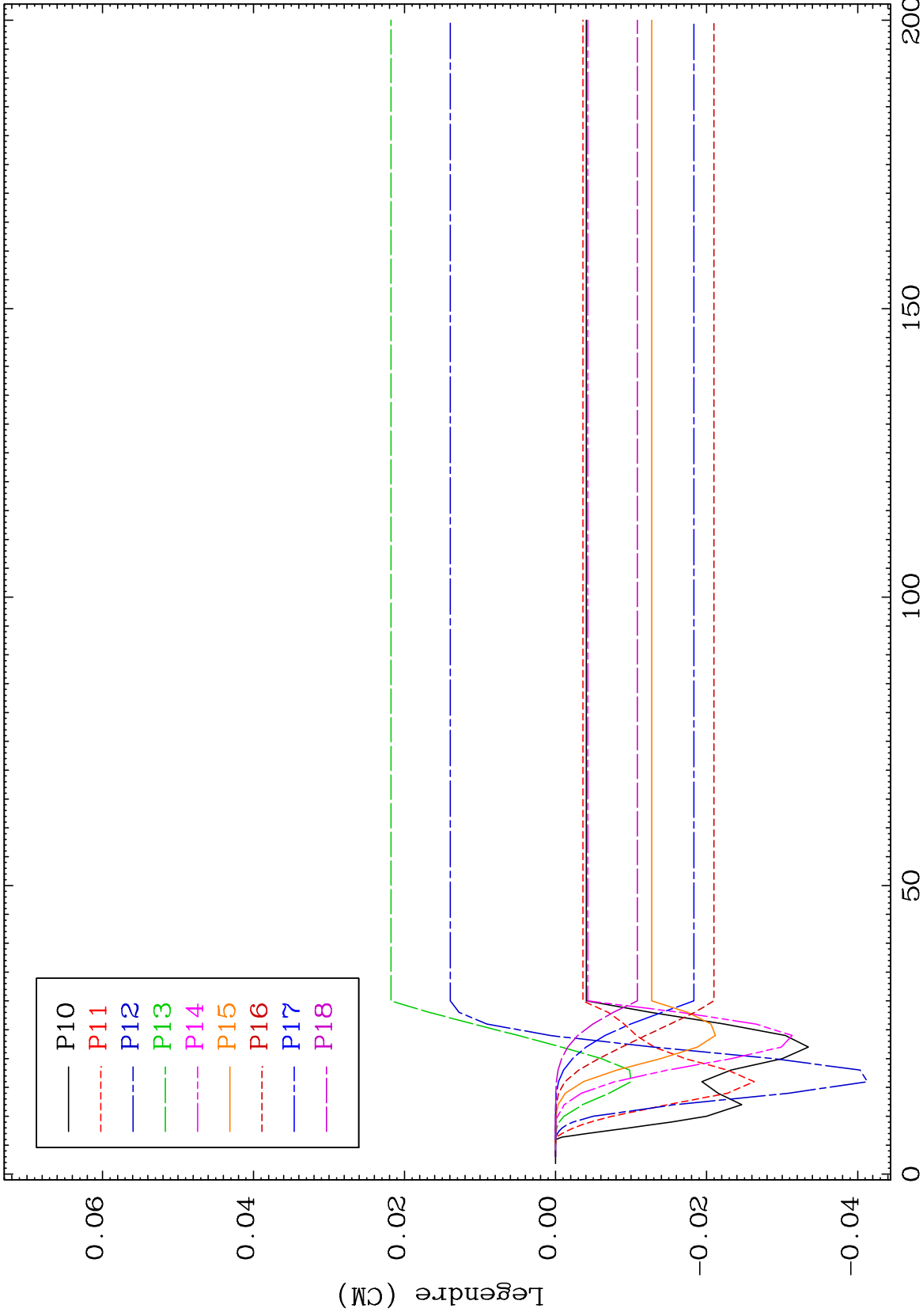

46

Incident Energy (MeV)

39-Y -94

MAT 3940 MT= 59 (n,n') Level Legendre Coefficients 39-Y -94

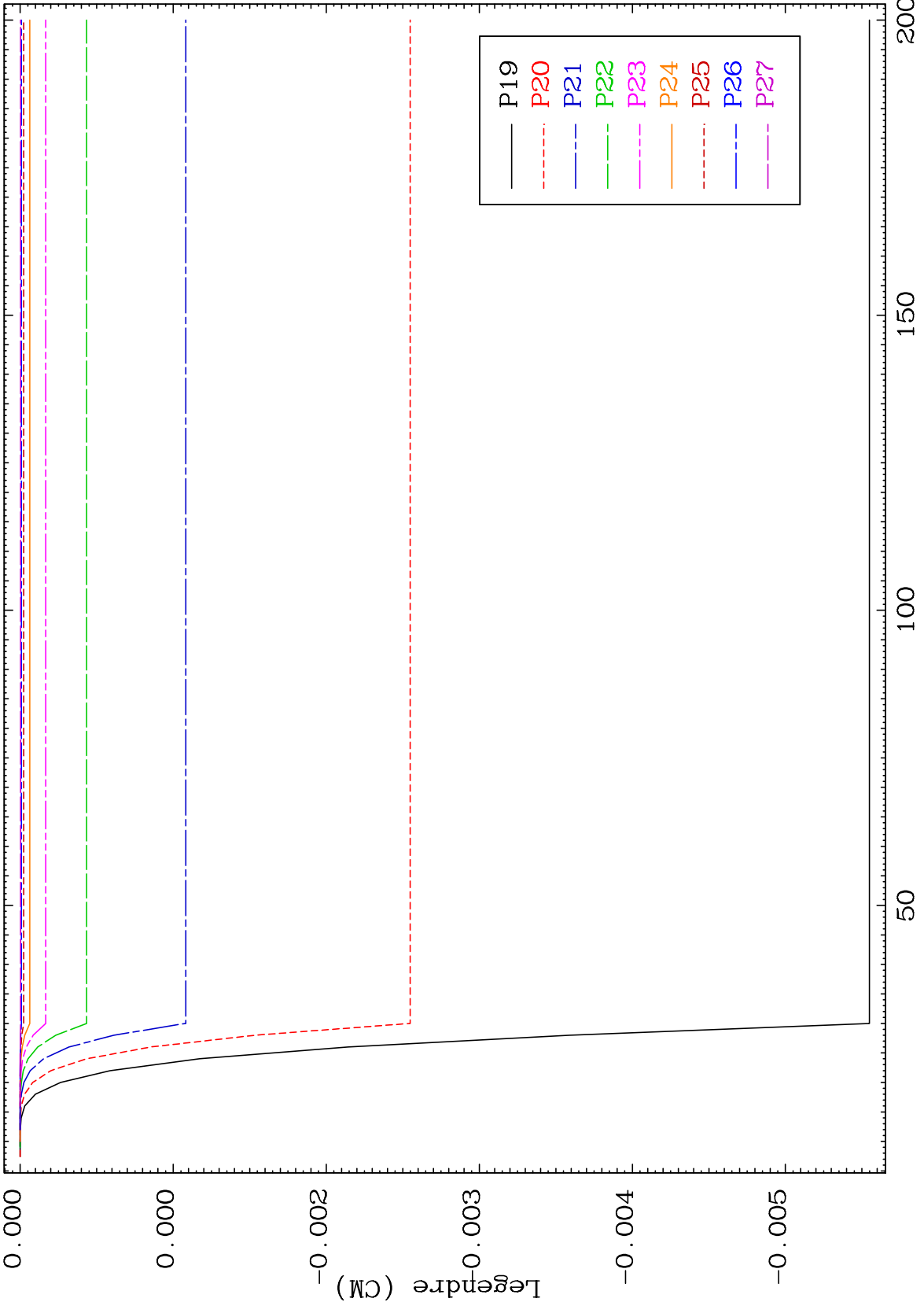

47 Incident Energy (MeV) 39-Y -94

MAT 3940 MT= 59 (n,n') Level Legendre Coefficients 39-Y -94

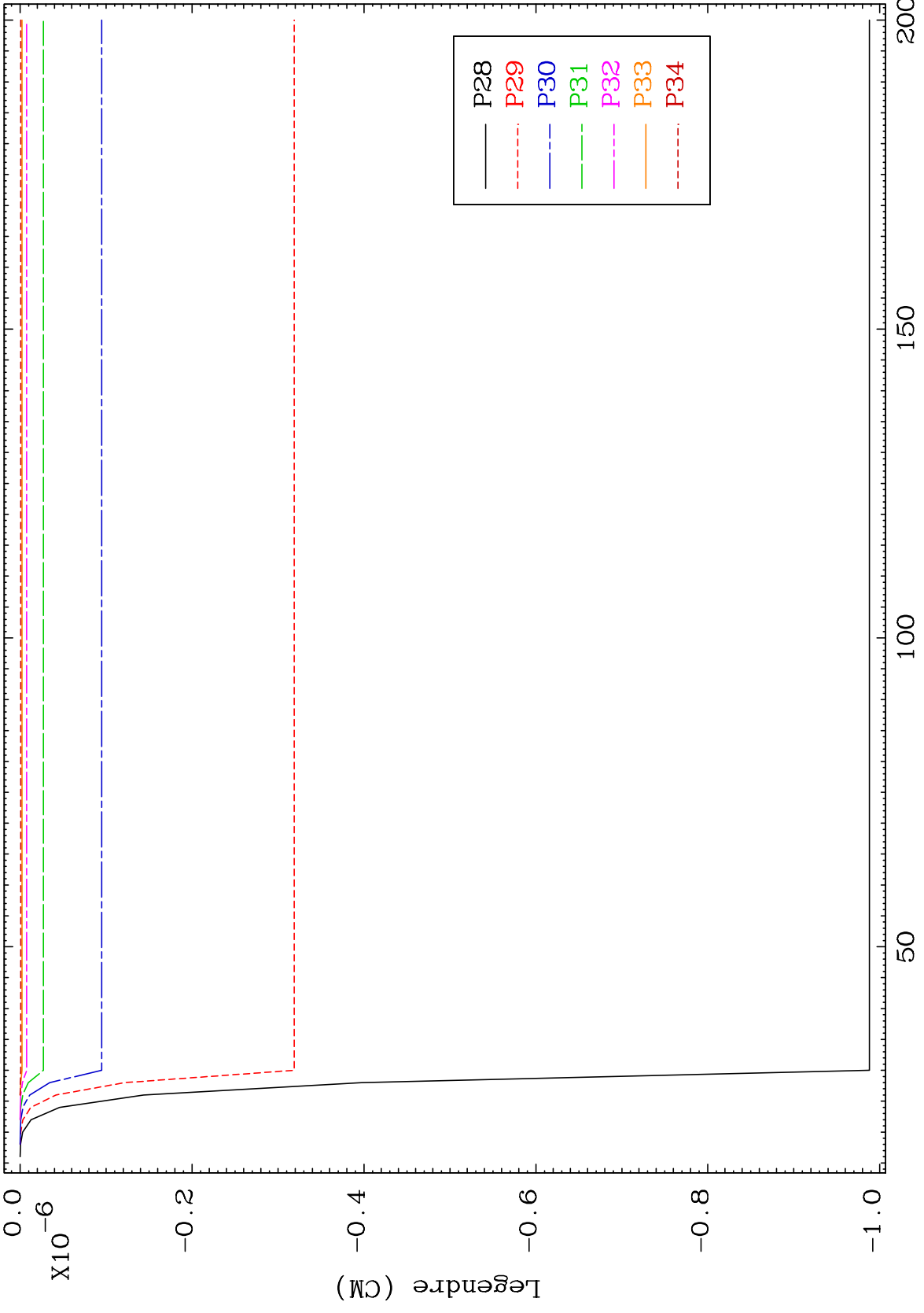

48 Incident Energy (MeV) 39-Y -94

MAT 3940 MT= 60 (n,n') Level Legendre Coefficients 39-Y -94

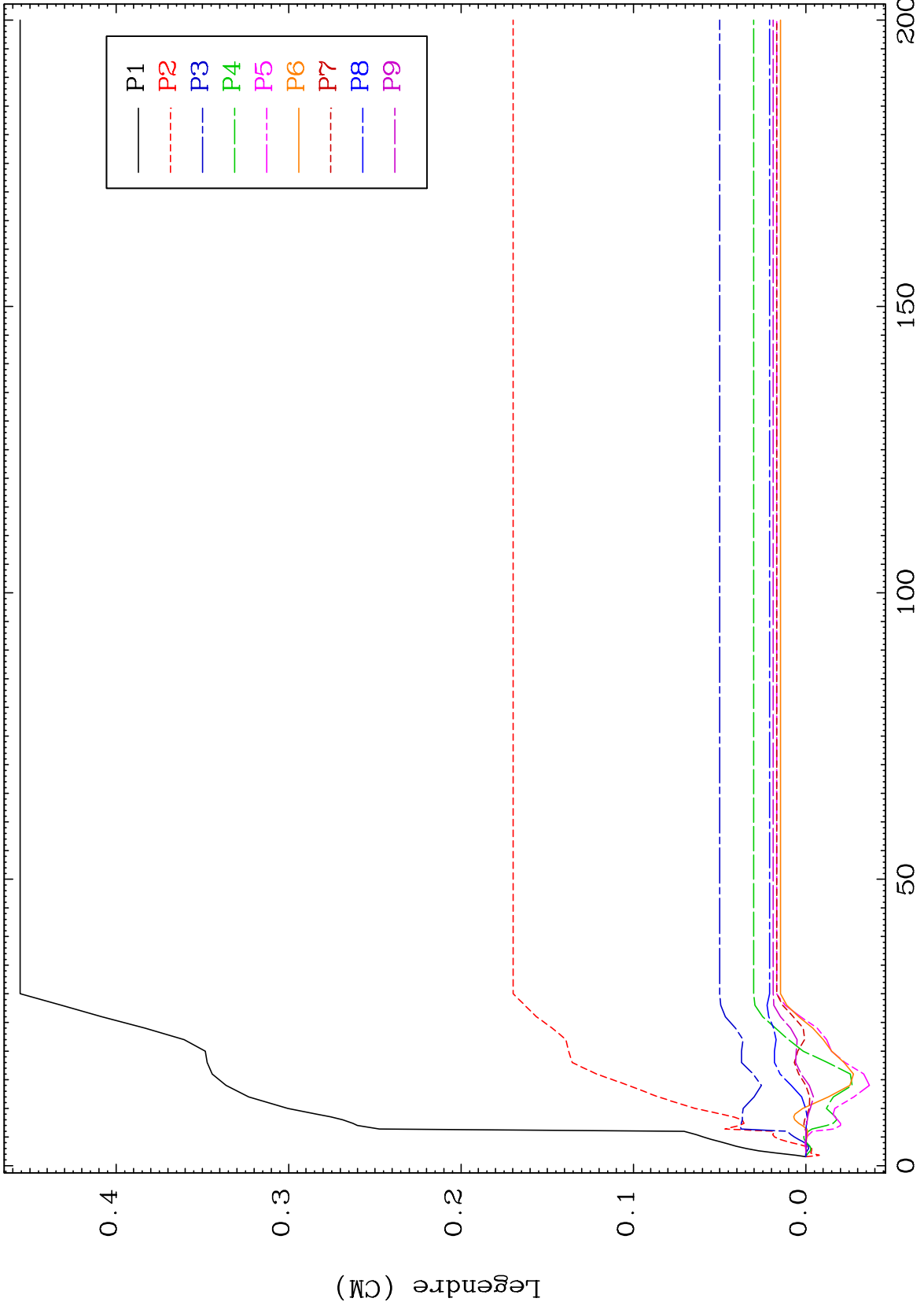

49 Incident Energy (MeV) 39-Y -94

MAT 3940

MT= 60 (n,n') Level
Legendre Coefficients

39-Y -94

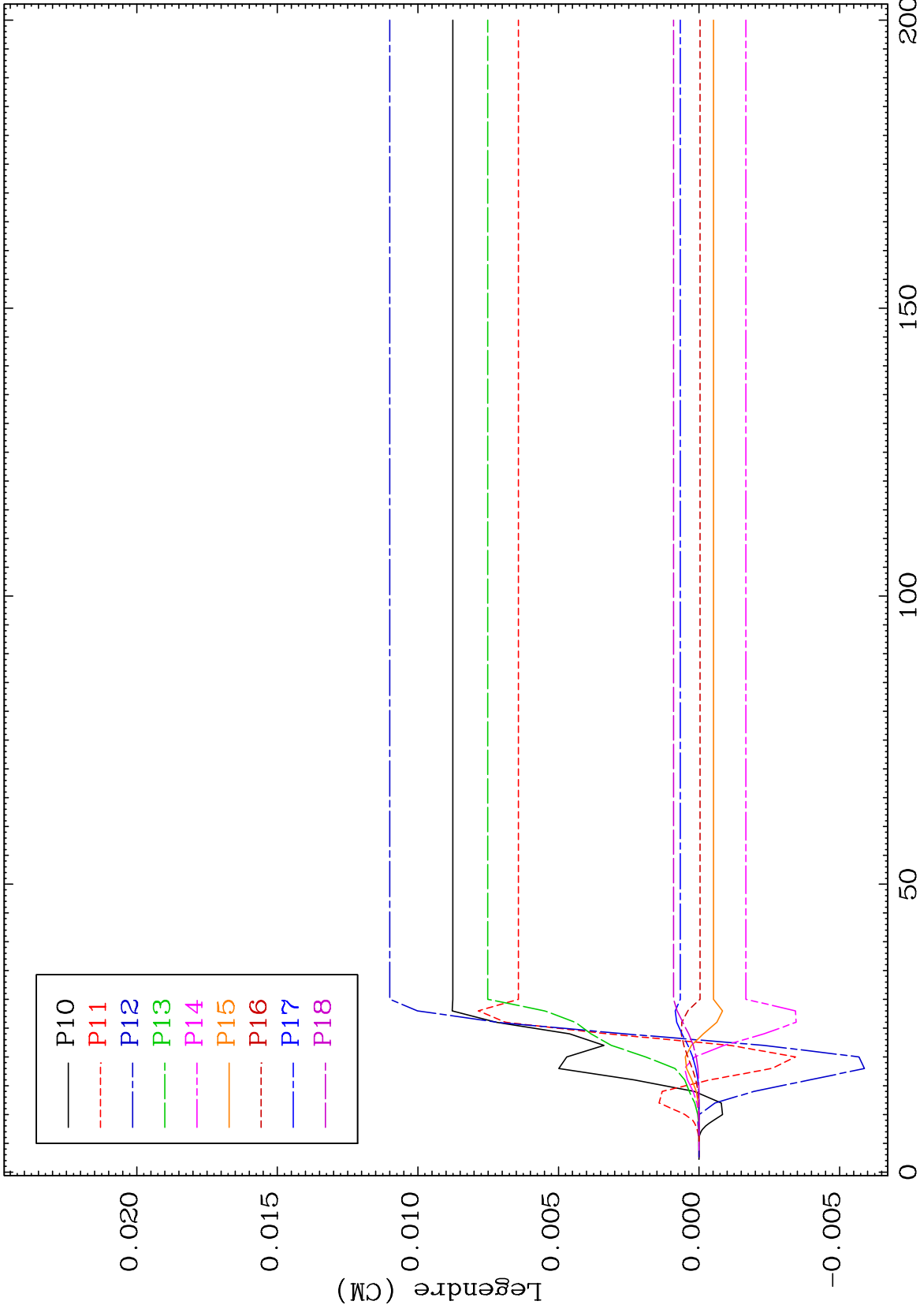

50

Incident Energy (MeV)

39-Y -94

MAT 3940

MT= 60 (n,n') Level
Legendre Coefficients

39-Y -94

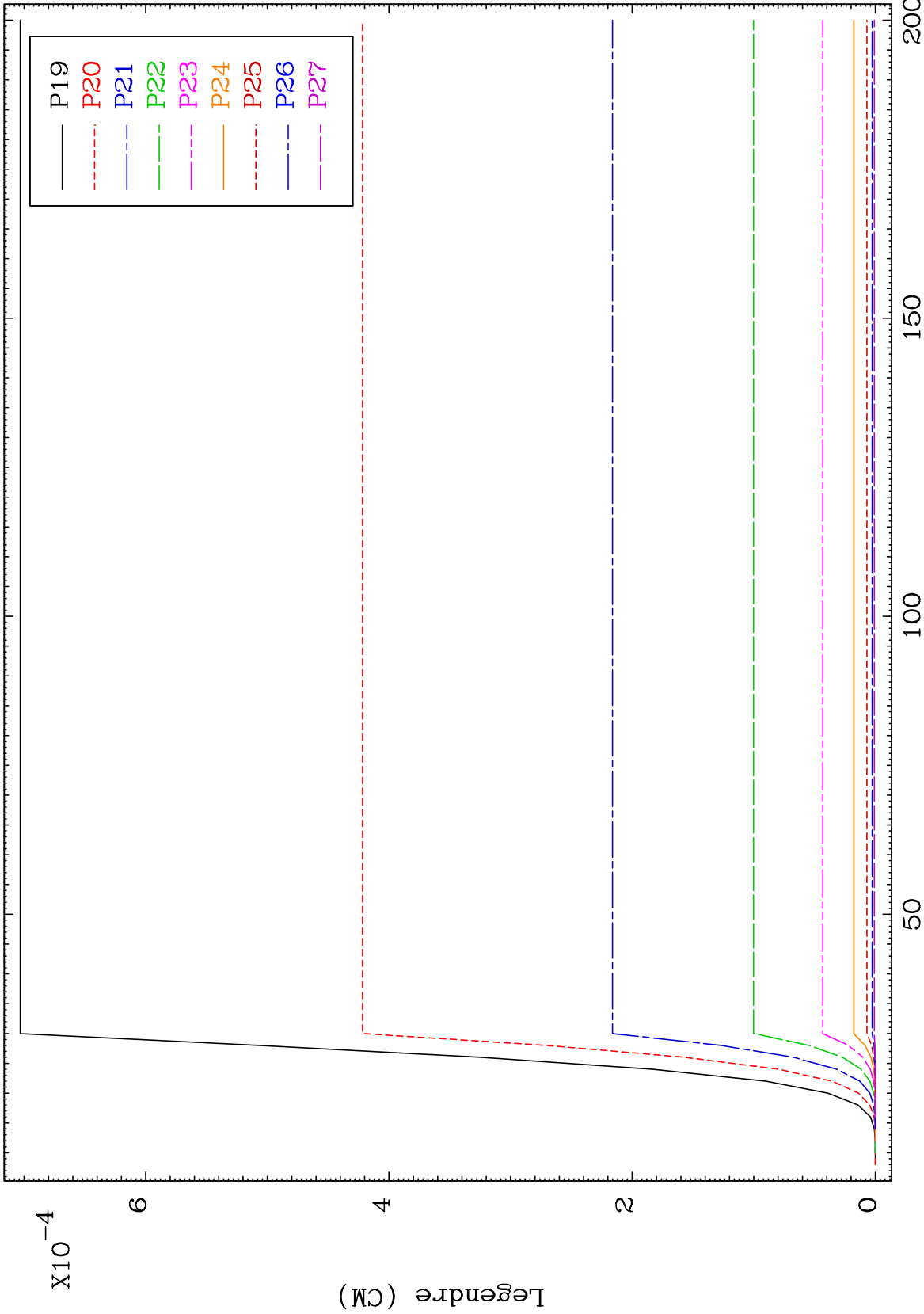

51

Incident Energy (MeV)

39-Y -94

MAT 3940

MT= 60 (n,n') Level
Legendre Coefficients

39-Y -94

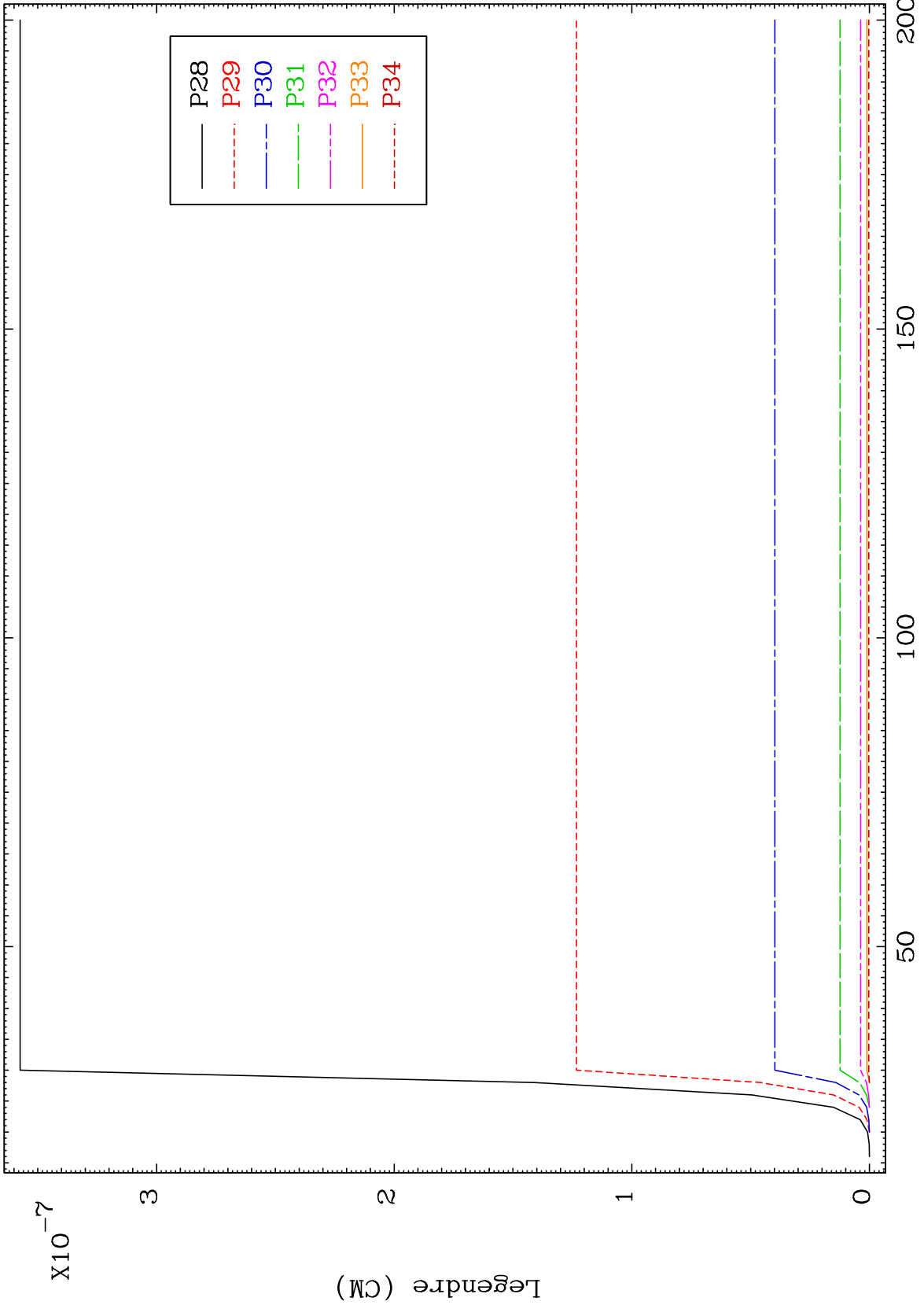

52

Incident Energy (MeV)

39-Y -94

MAT 3940 MT= 61 (n,n') Level Legendre Coefficients 39-Y -94

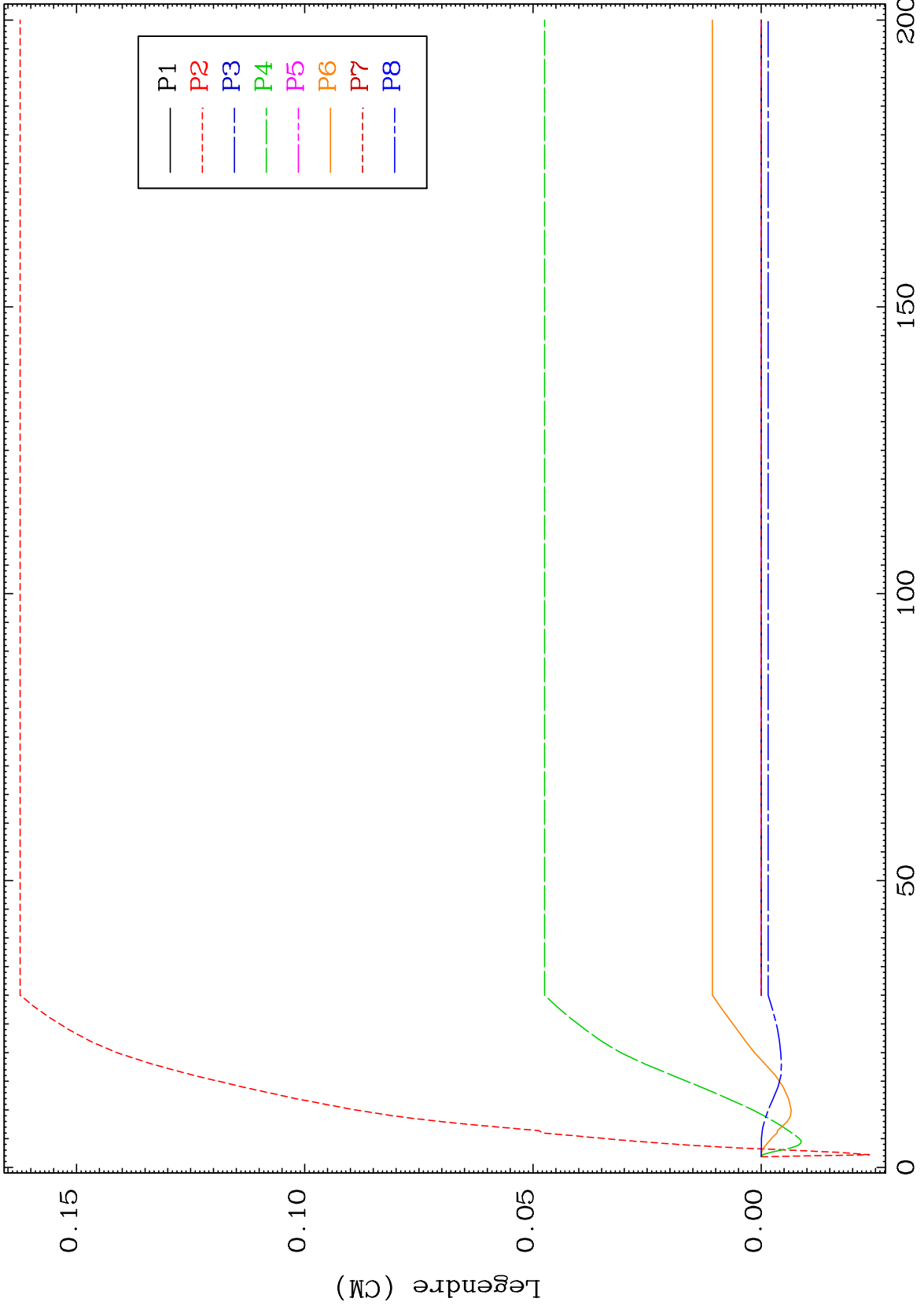

53 39-Y -94

MAT 3940 MT= 61 (n,n') Level Legendre Coefficients 39-Y -94

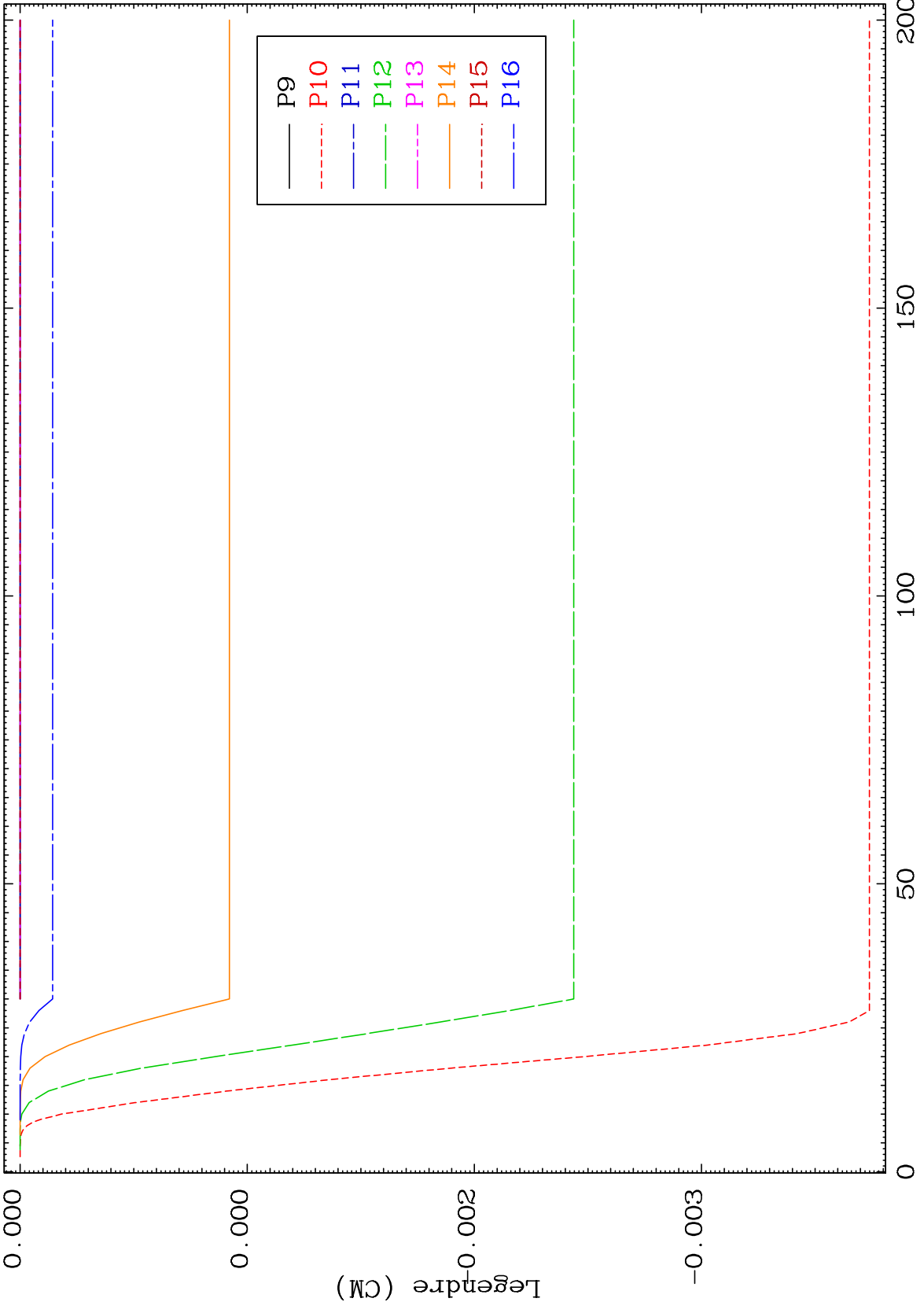

54 39-Y -94

MAT 3940 MT= 61 (n,n') Level Legendre Coefficients 39-Y -94

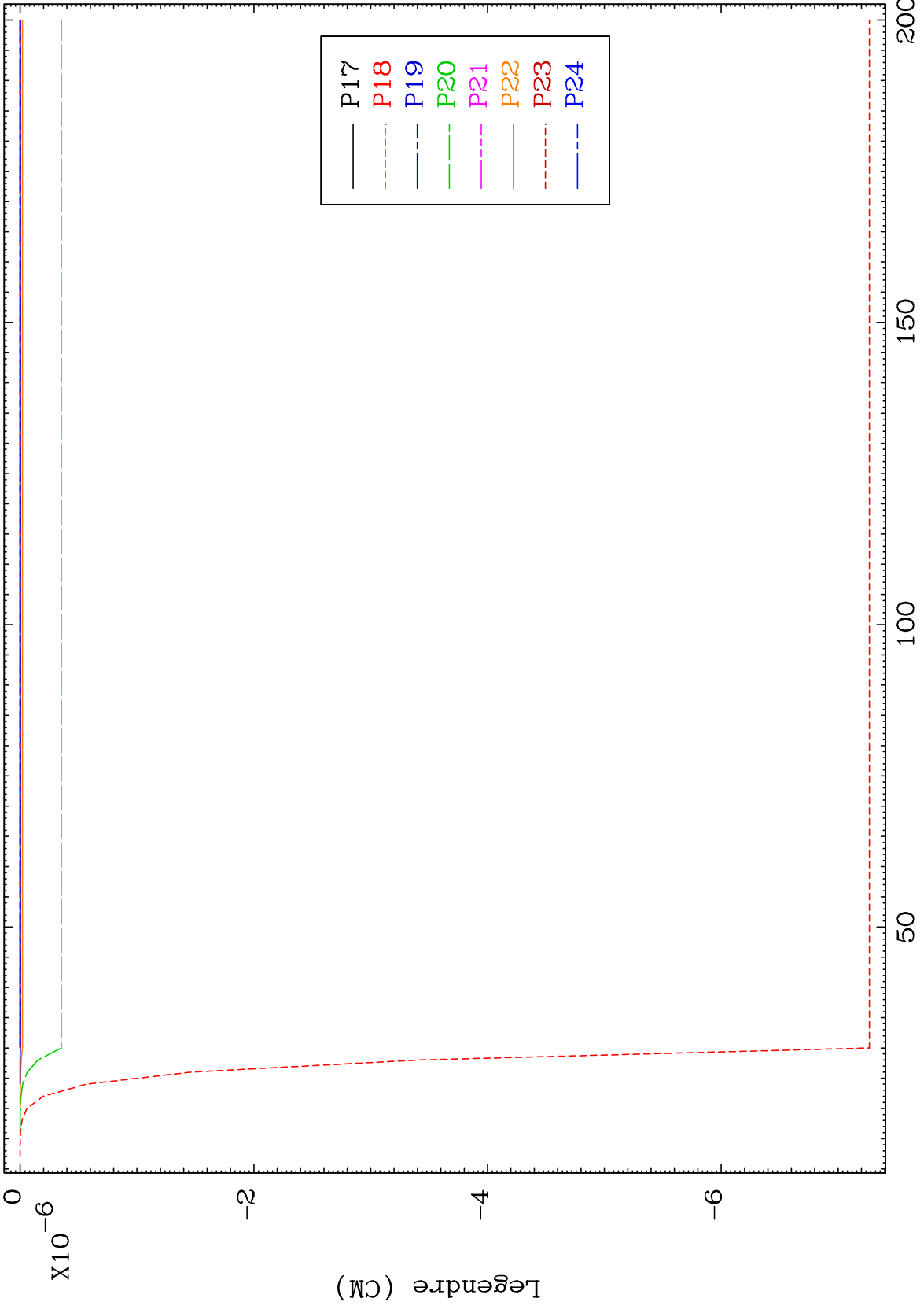

55 100 150 200 39-Y -94

MAT 3940

MT= 62 (n,n') Level
Legendre Coefficients

39-Y -94

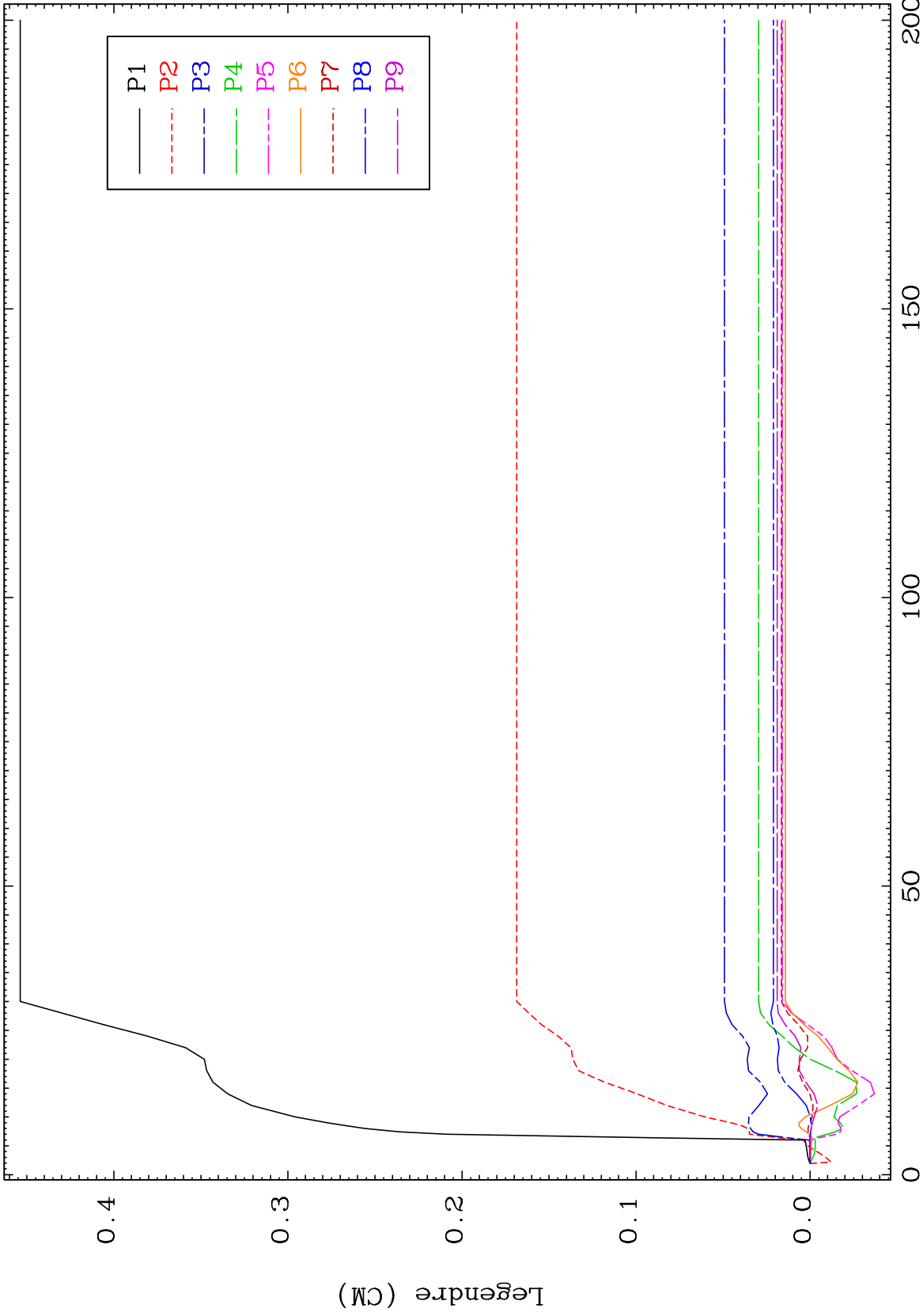

56

Incident Energy (MeV)

39-Y -94

MAT 3940

MT= 62 (n,n') Level
Legendre Coefficients

39-Y -94

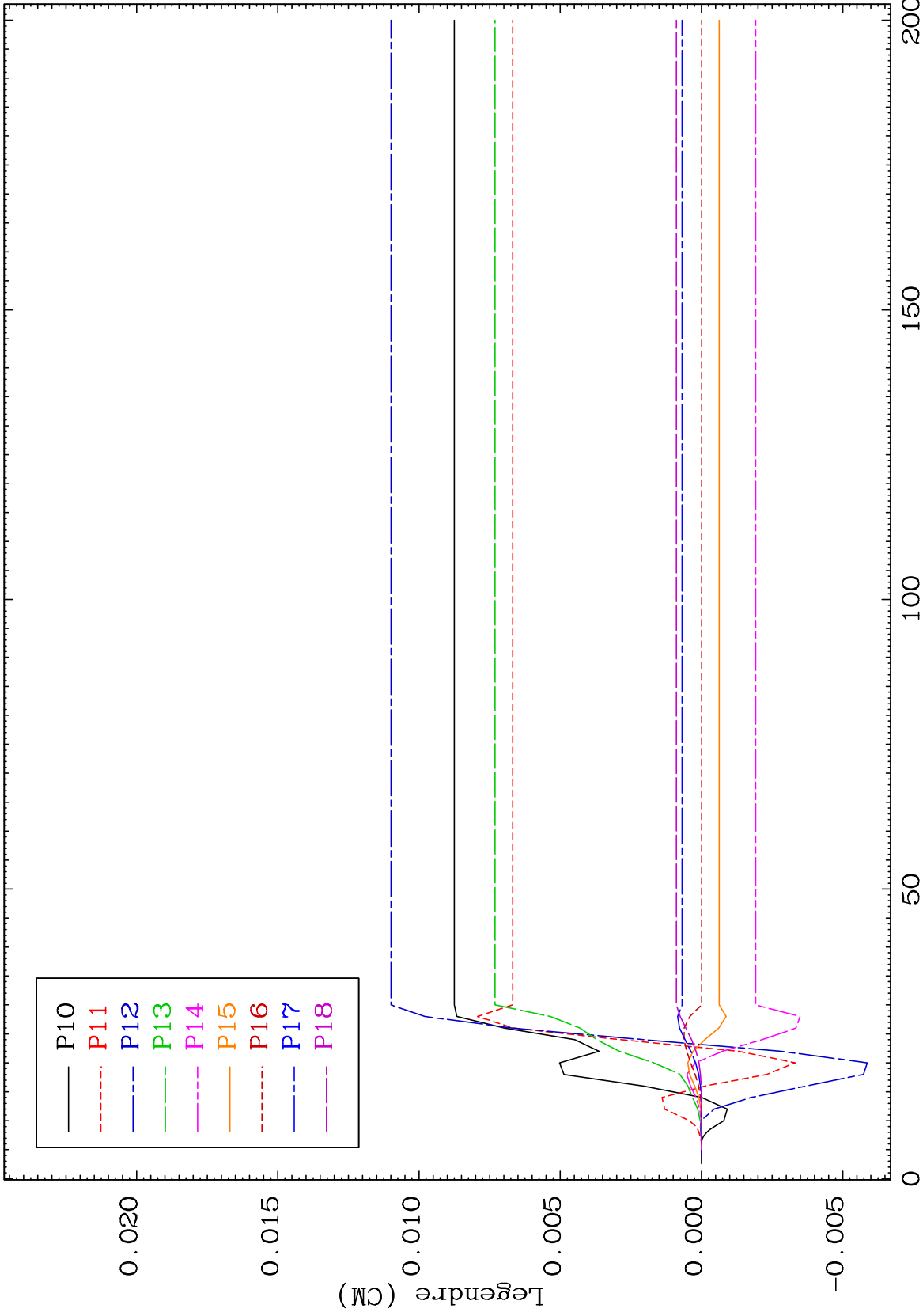

57

Incident Energy (MeV)

39-Y -94

MAT 3940 MT= 62 (n,n') Level Legendre Coefficients 39-Y -94

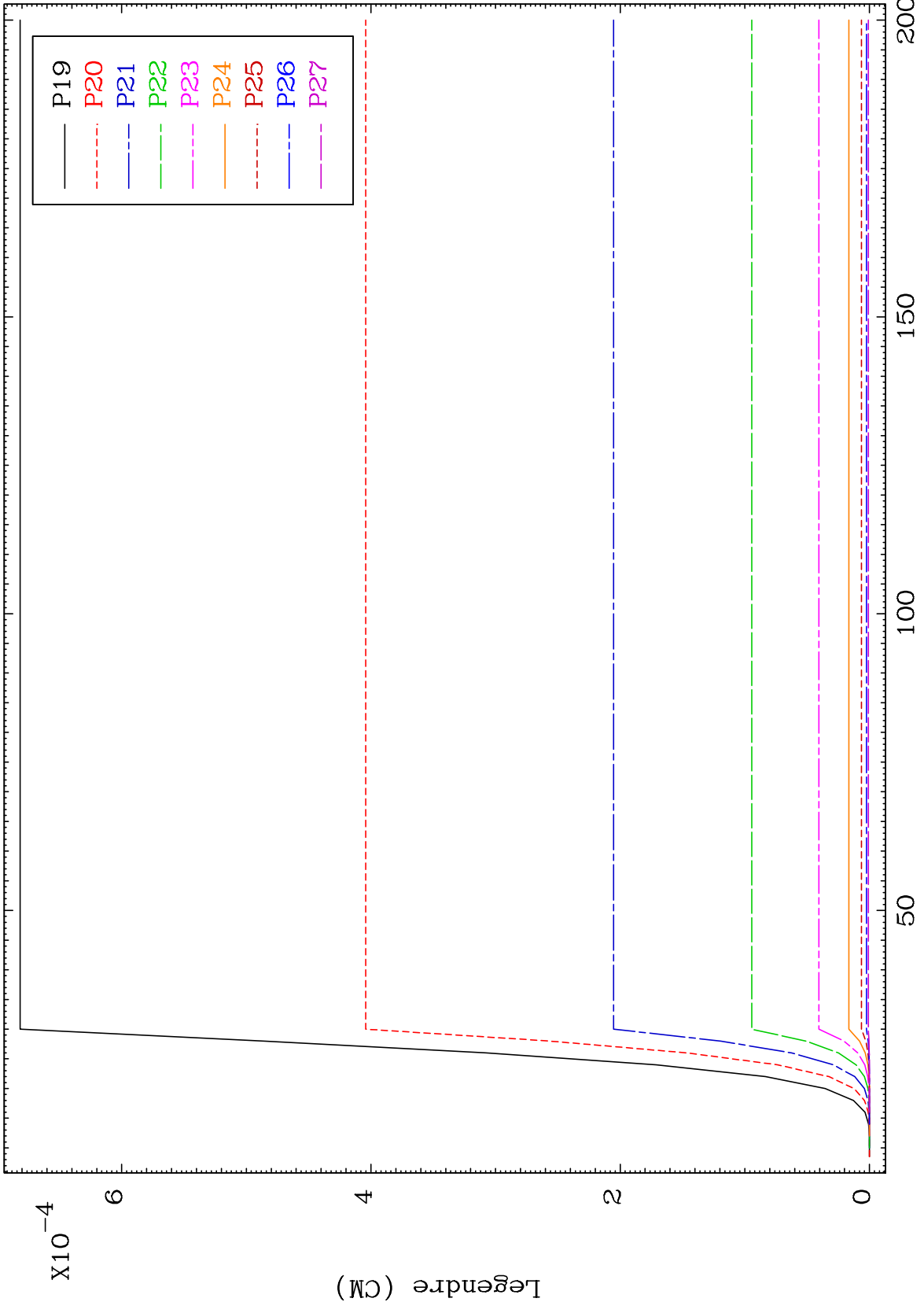

58 Incident Energy (MeV) 39-Y -94

MAT 3940

MT= 62 (n,n') Level
Legendre Coefficients

39-Y -94

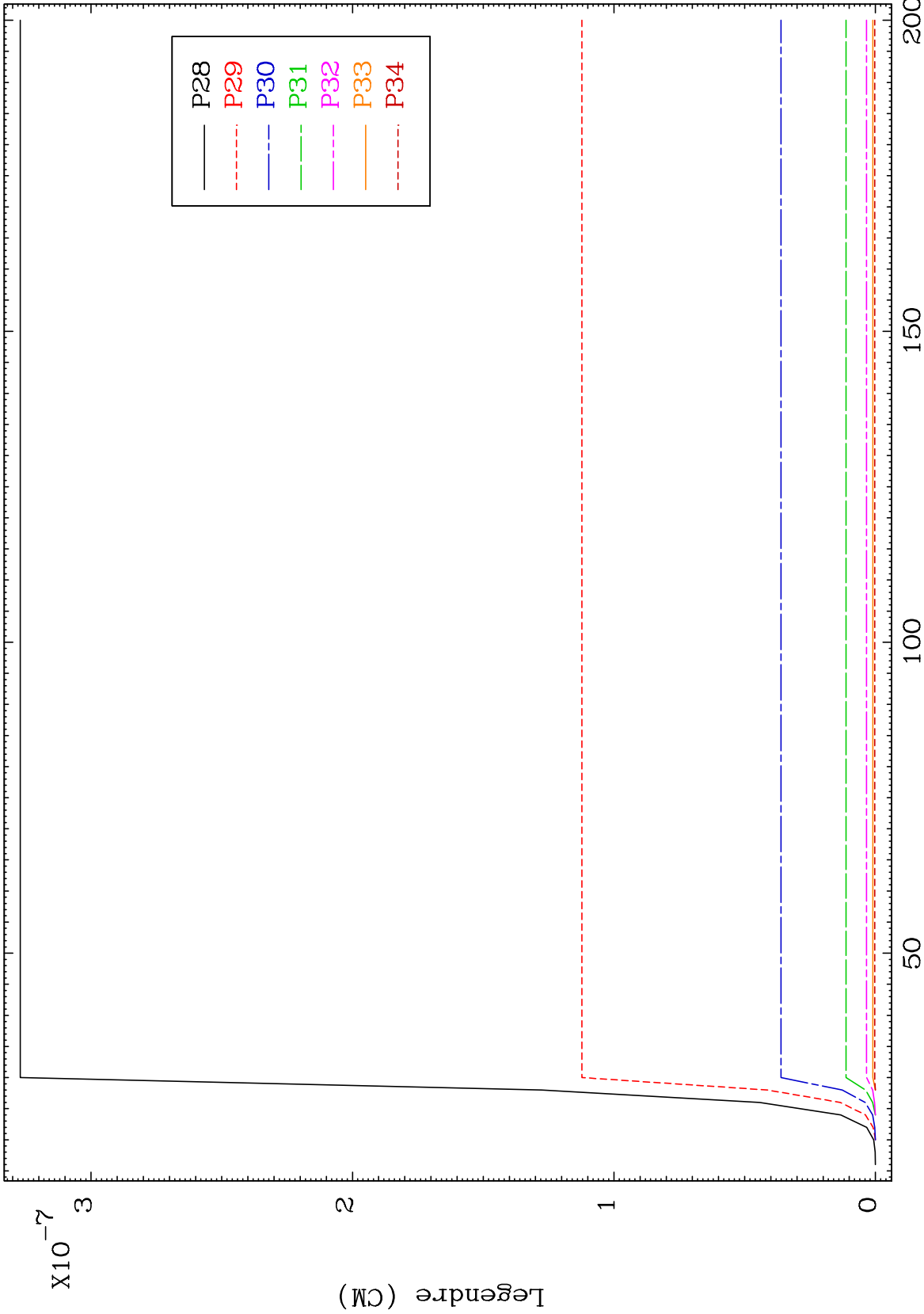

59

Incident Energy (MeV)

39-Y -94

MAT 3940 MT= 63 (n,n') Level Legendre Coefficients 39-Y -94

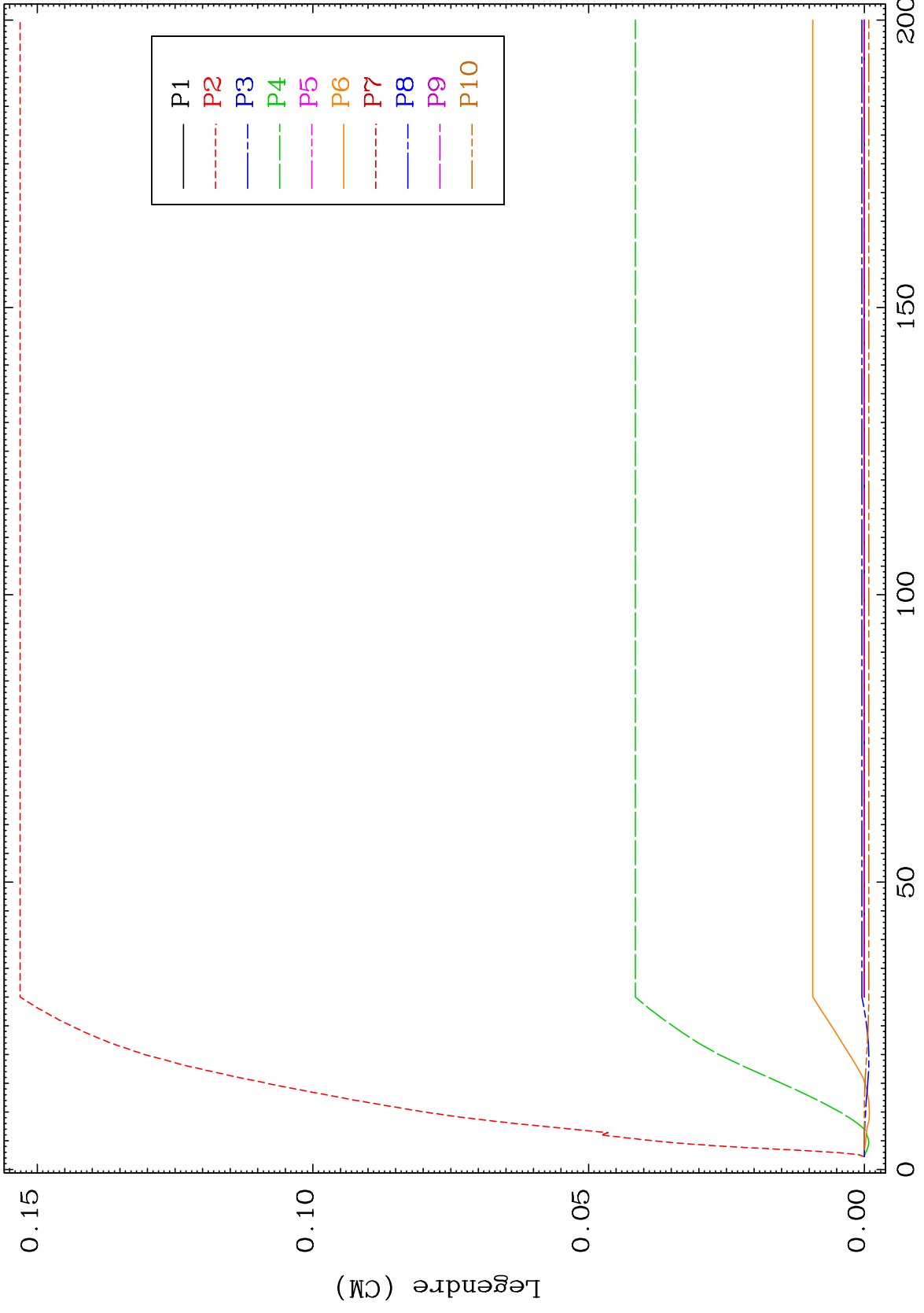

Incident Energy (MeV) 39-Y -94

MAT 3940 MT= 63 (n,n') Level Legendre Coefficients 39-Y -94

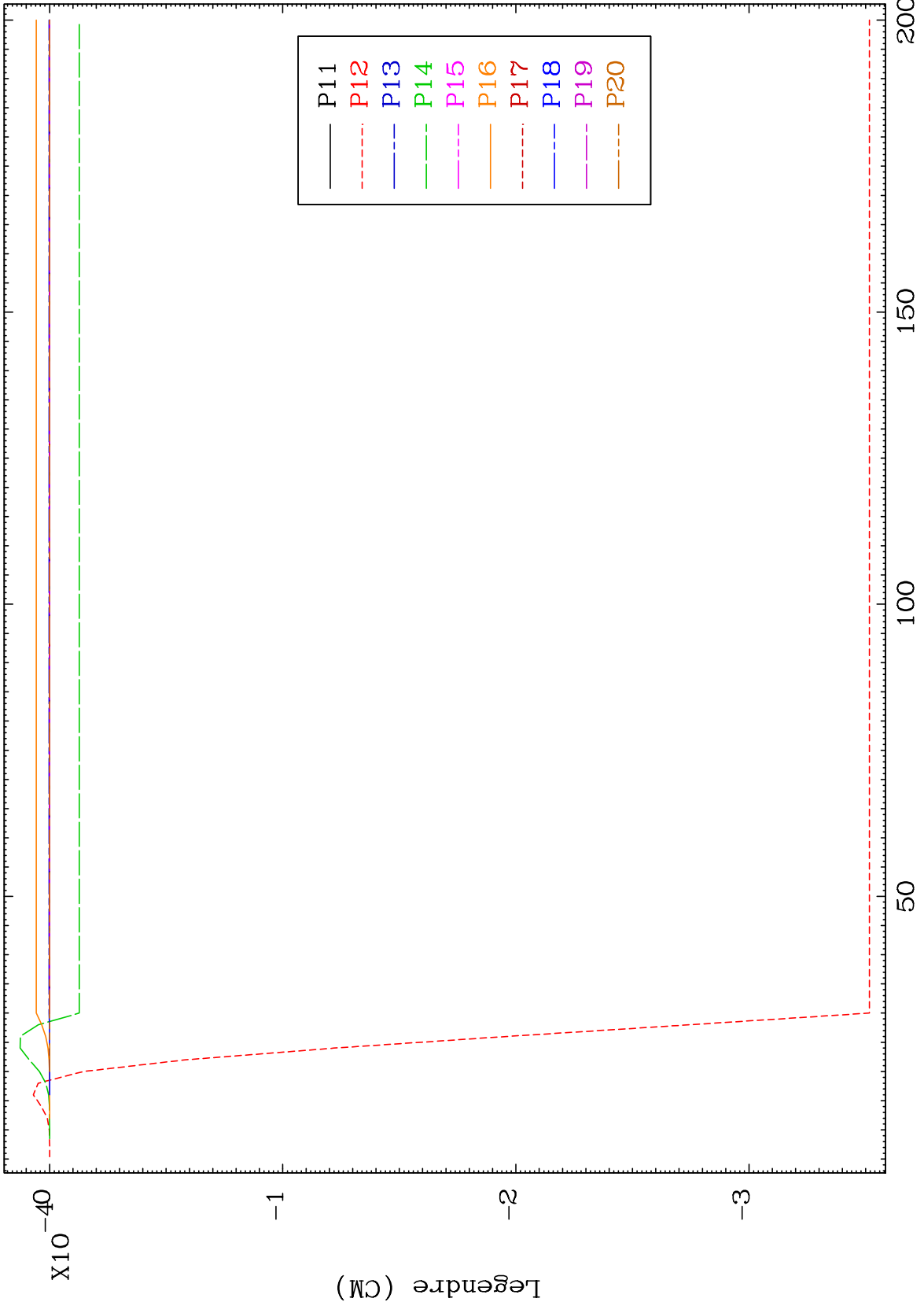

61 39-Y -94

MAT 3940

MT= 64 (n,n') Level
Legendre Coefficients

39-Y -94



62

Incident Energy (MeV)

39-Y -94

MAT 3940

MT= 64 (n,n') Level
Legendre Coefficients

39-Y -94

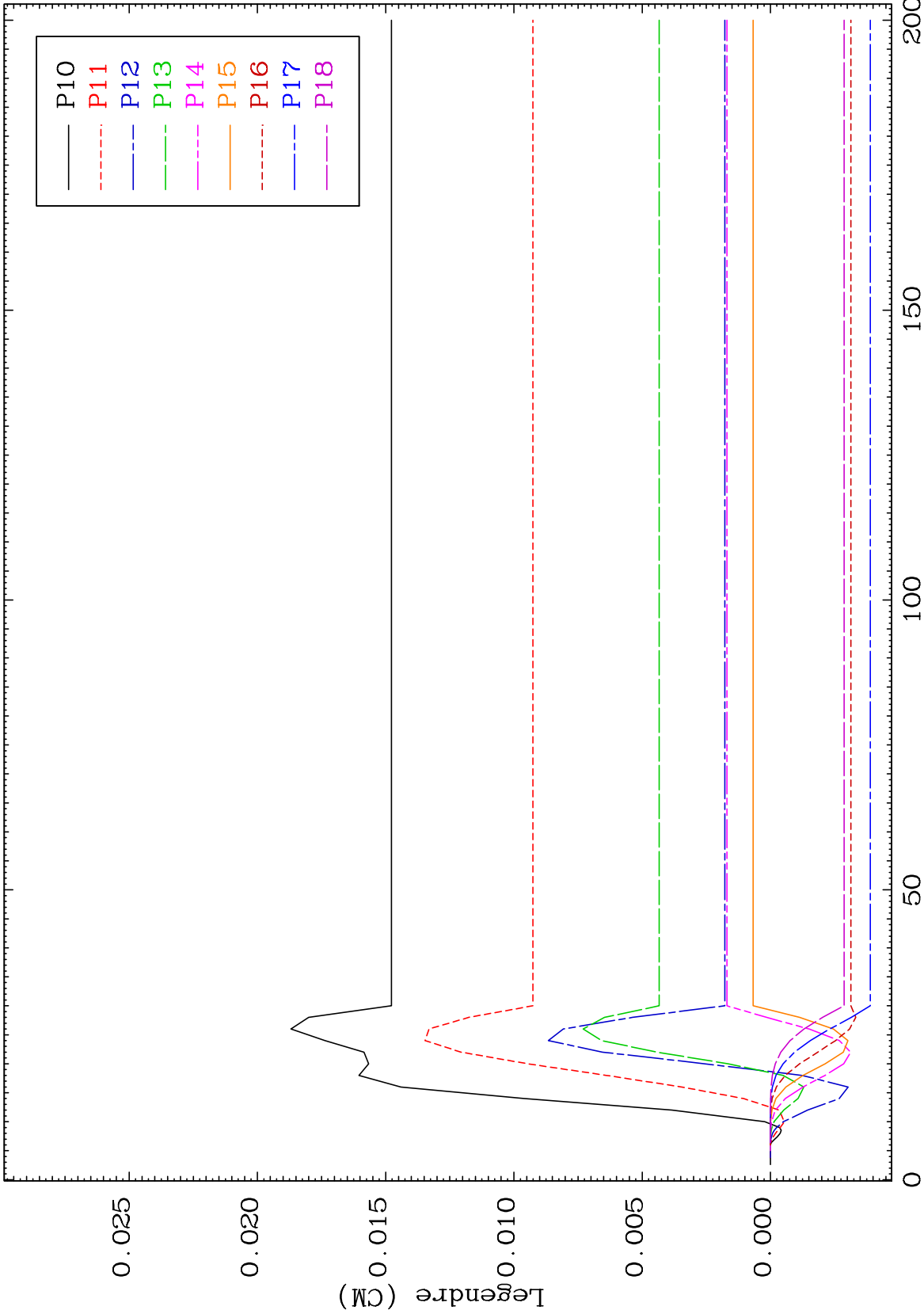

63

Incident Energy (MeV)

39-Y -94

MAT 3940 MT= 64 (n,n') Level Legendre Coefficients 39-Y -94

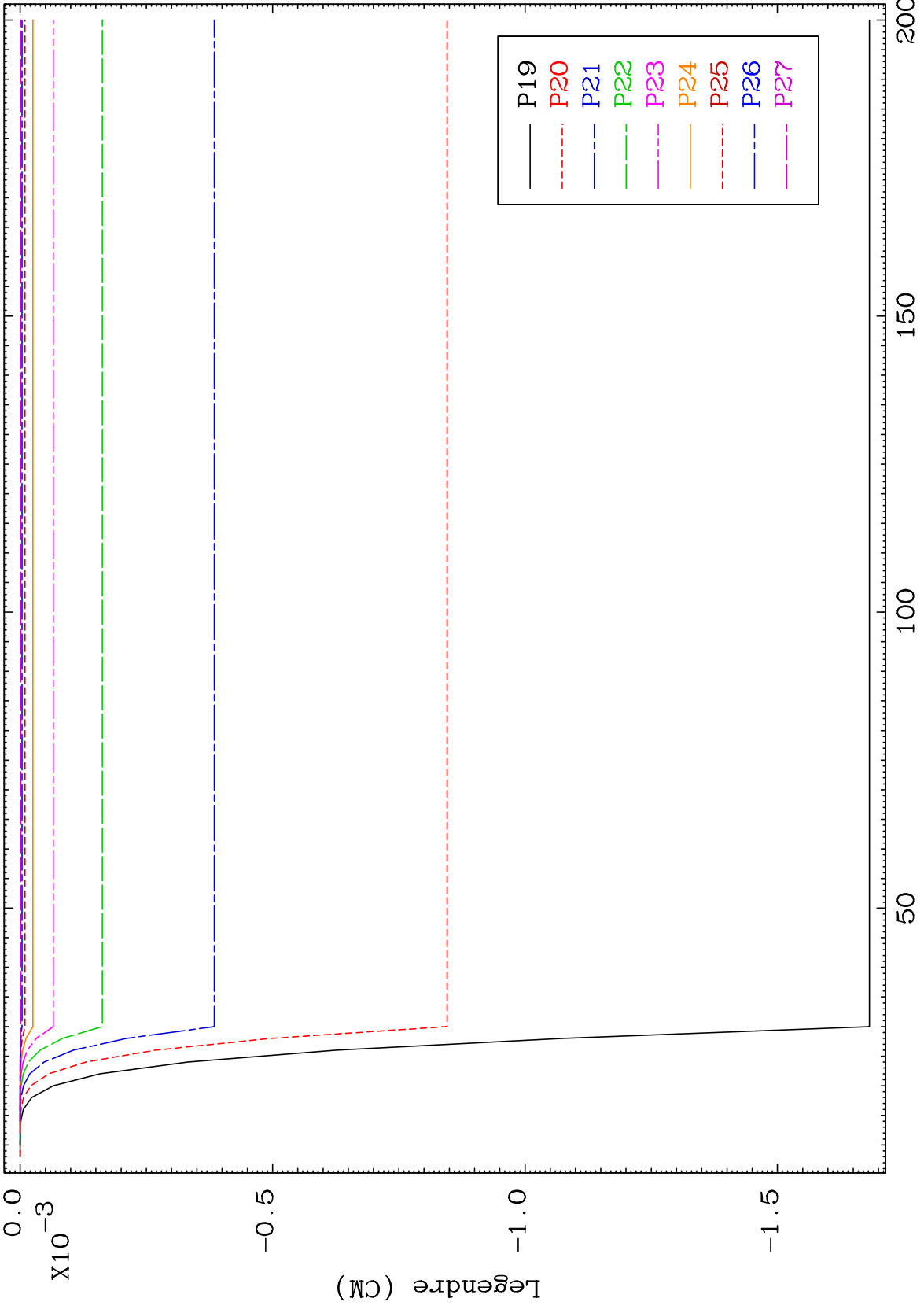

64 39-Y -94

MAT 3940 MT= 64 (n,n') Level Legendre Coefficients 39-Y -94

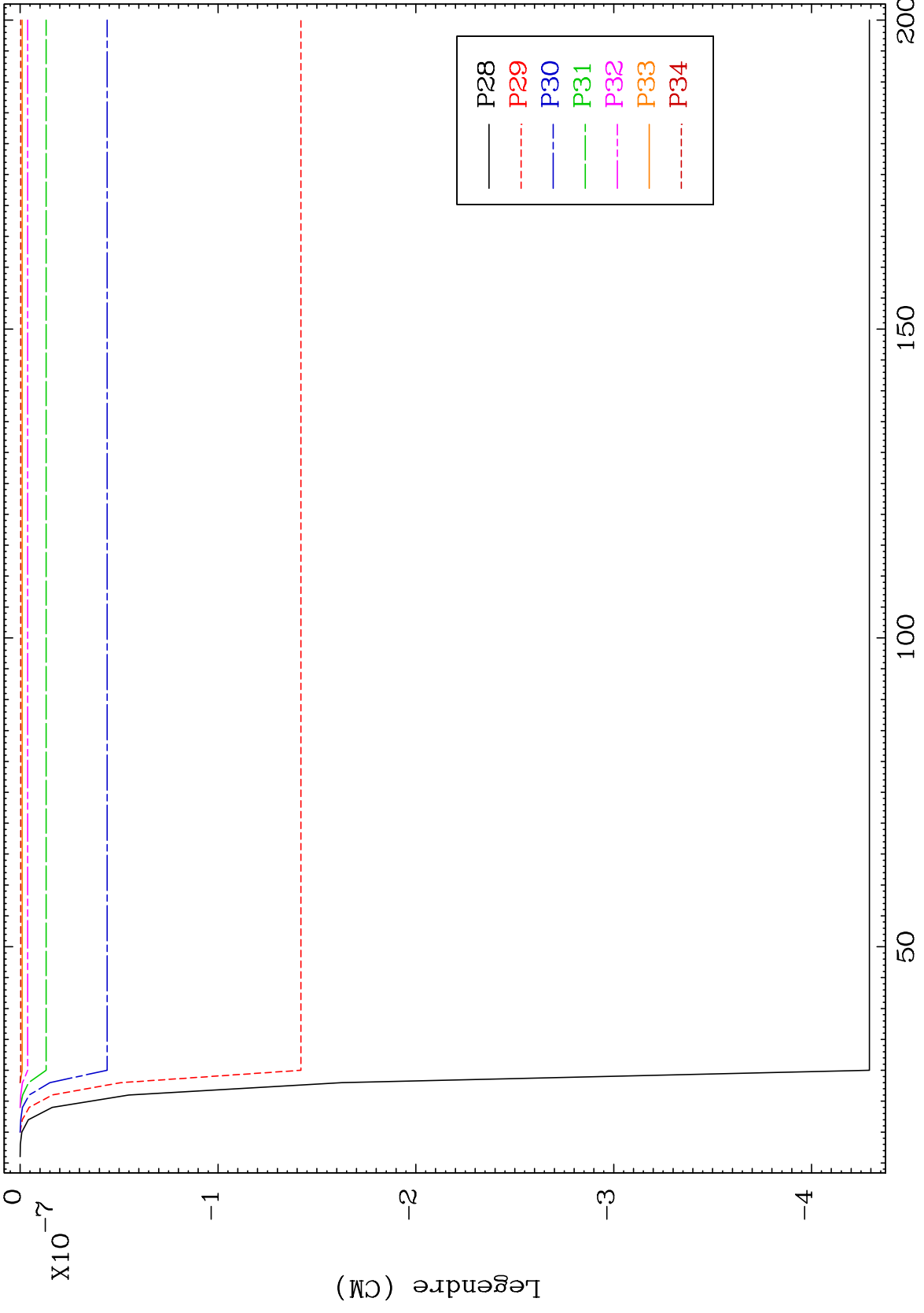

65 Incident Energy (MeV) 39-Y -94

MAT 3940 MT= 65 (n,n') Level Legendre Coefficients 39-Y -94

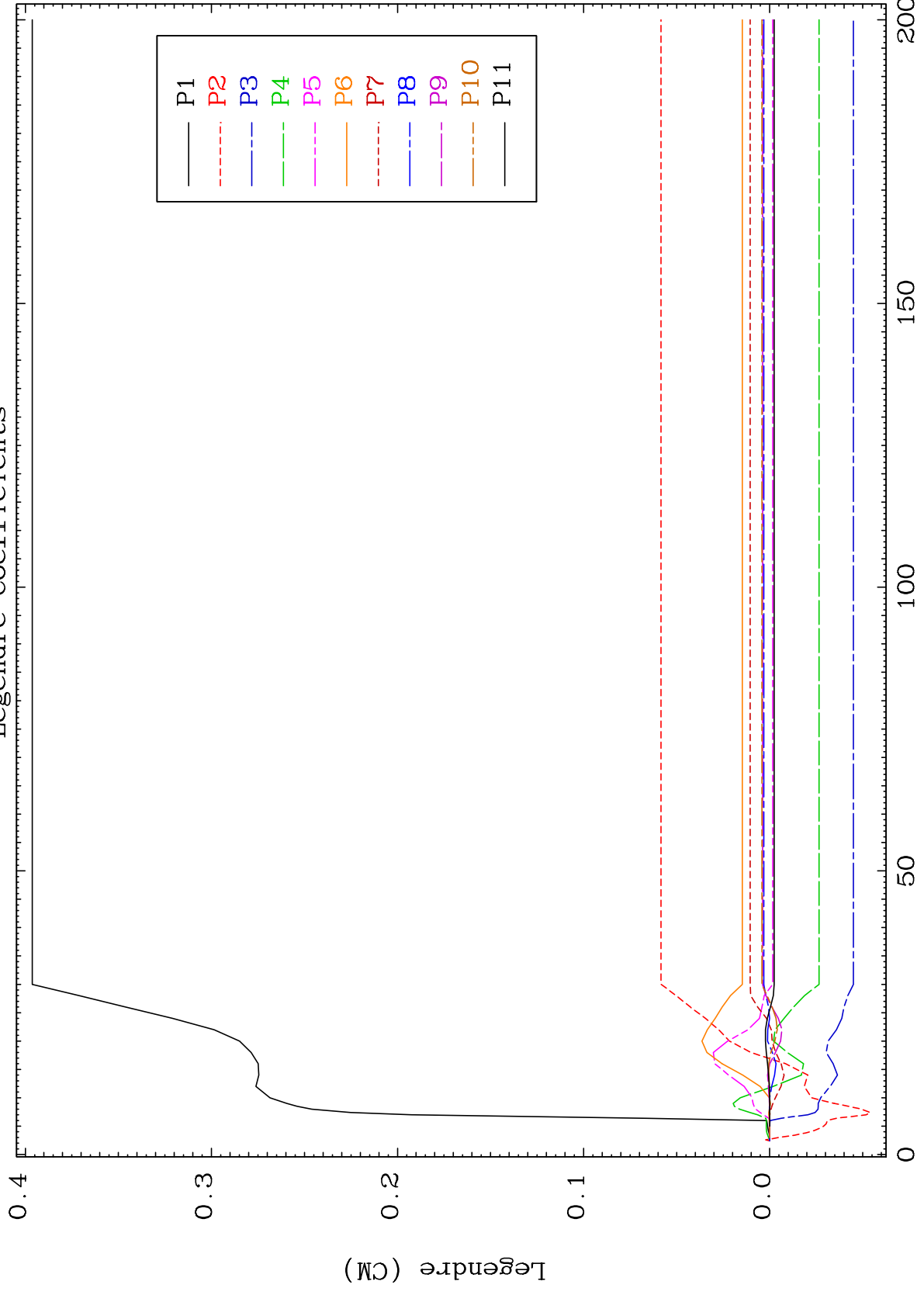

66 39-Y -94

MAT 3940 MT= 65 (n,n') Level Legendre Coefficients 39-Y -94

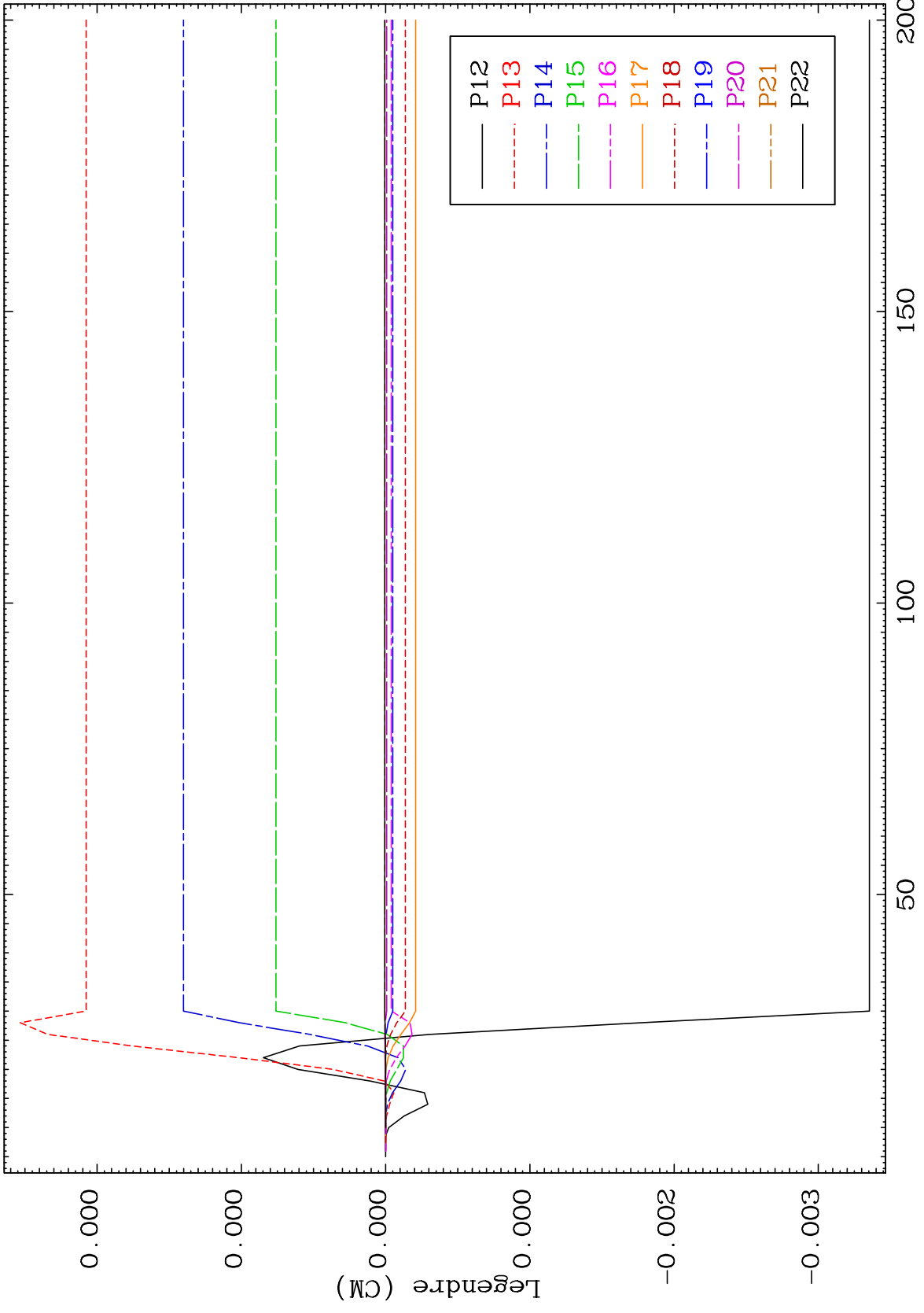

67 39-Y -94

MAT 3940

MT= 65 (n,n') Level
Legendre Coefficients

39-Y -94

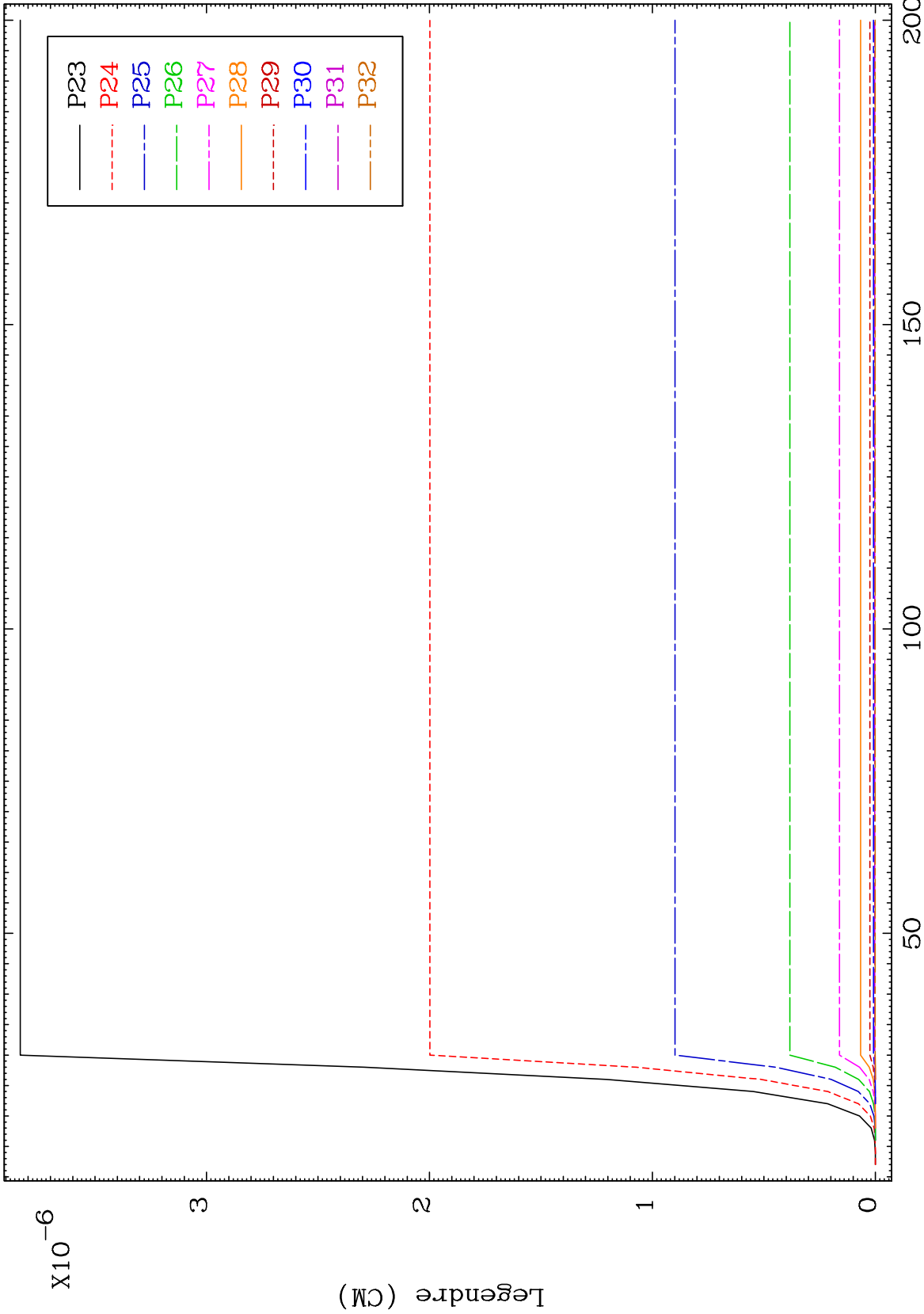

68

Incident Energy (MeV)

39-Y -94

MAT 3940

MT= 66 (n,n') Level
Legendre Coefficients

39-Y -94

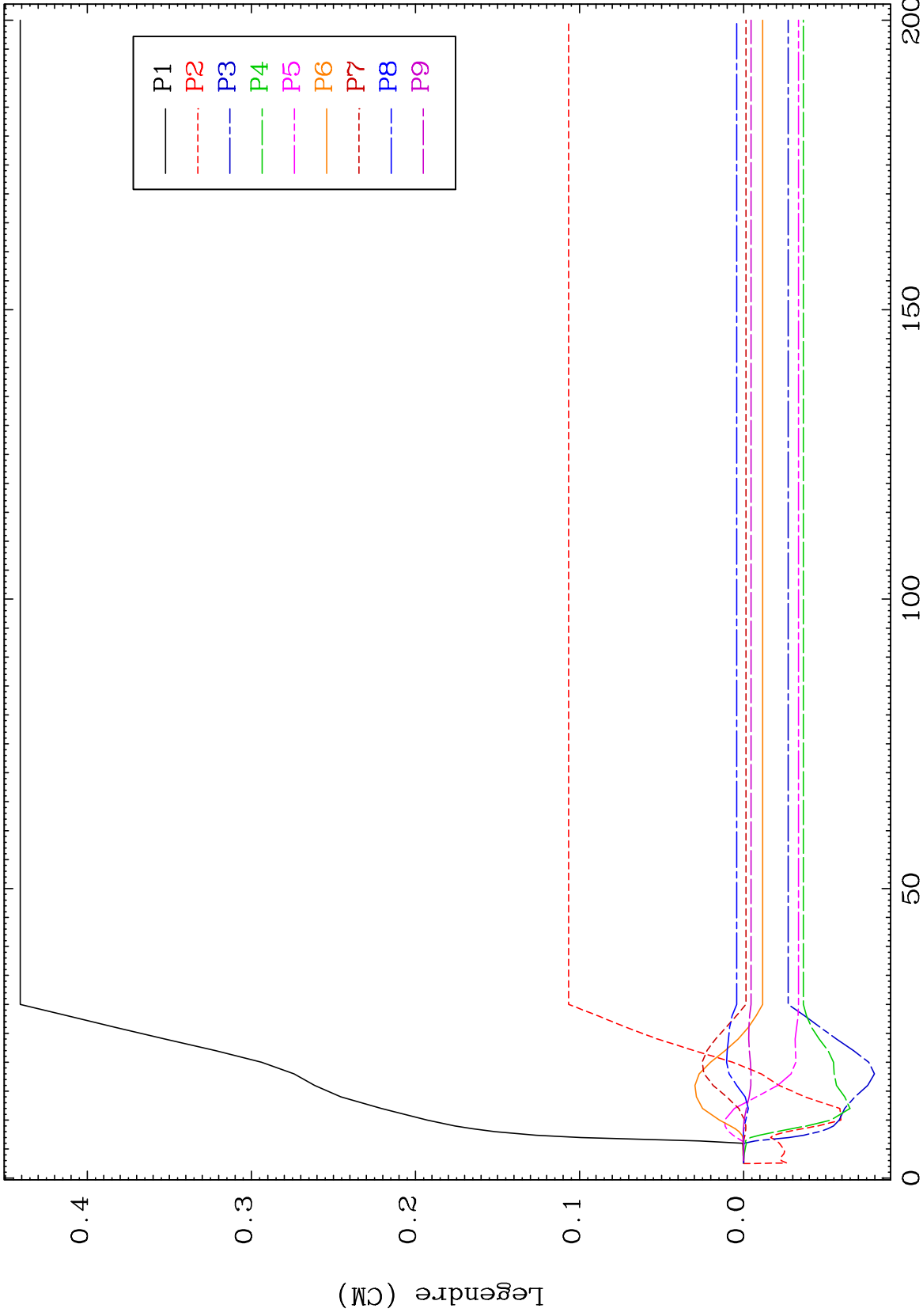

69

Incident Energy (MeV)

39-Y -94

MAT 3940 MT= 66 (n,n') Level Legendre Coefficients 39-Y -94

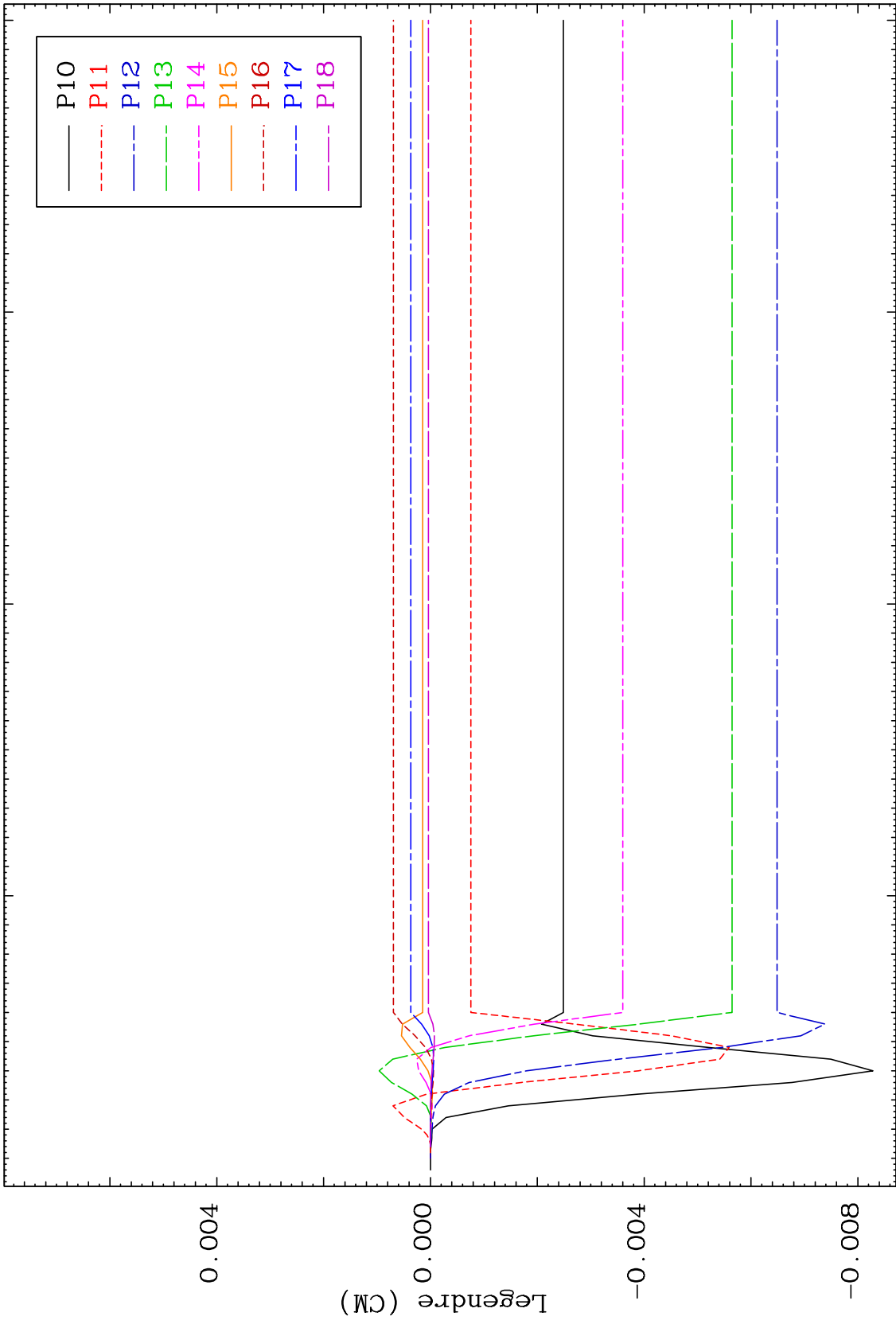

70 150 200 39-Y -94

MAT 3940

MT= 66 (n,n') Level
Legendre Coefficients

39-Y -94

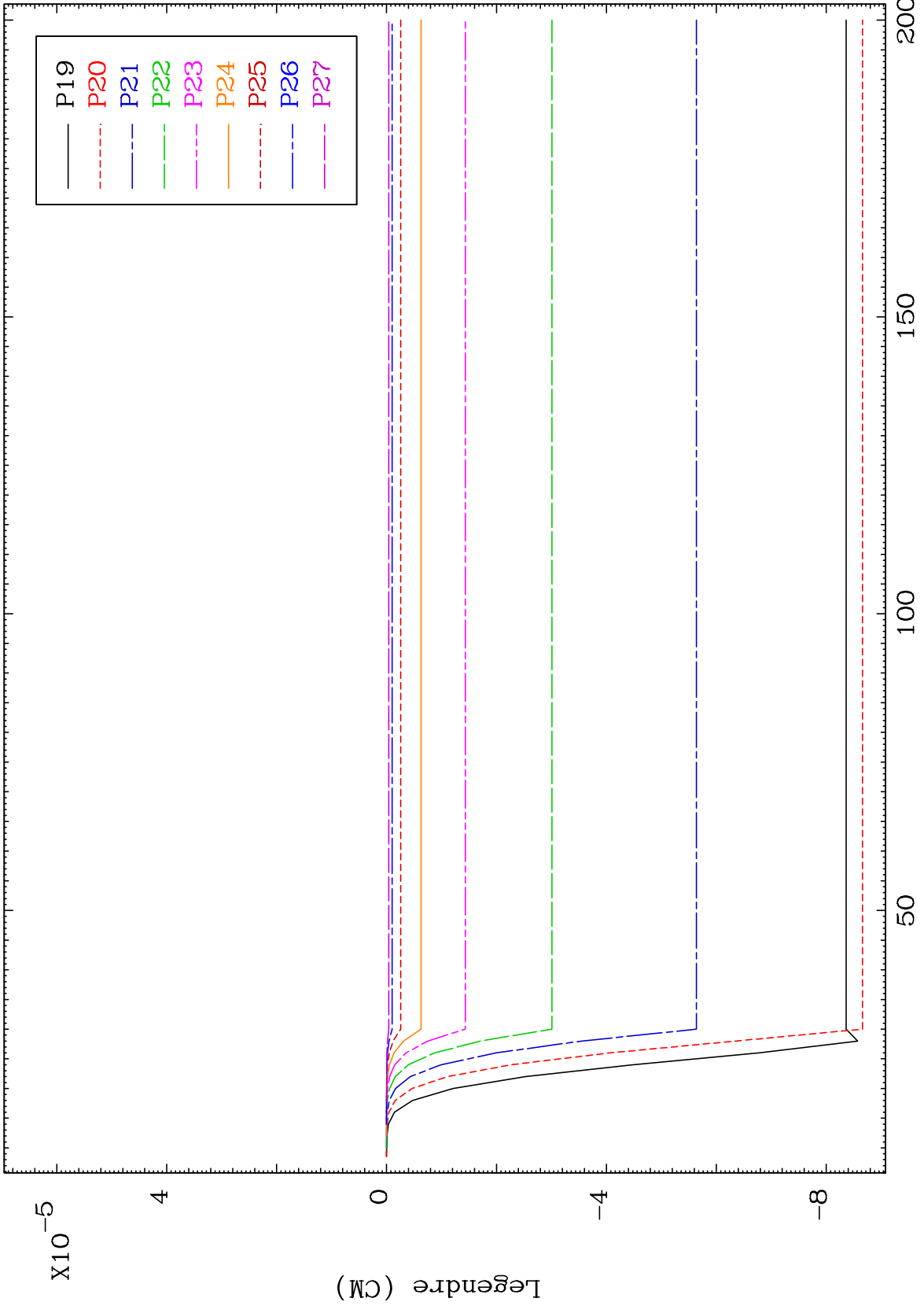

71

Incident Energy (MeV)

39-Y -94

MAT 3940 MT= 66 (n,n') Level Legendre Coefficients 39-Y -94

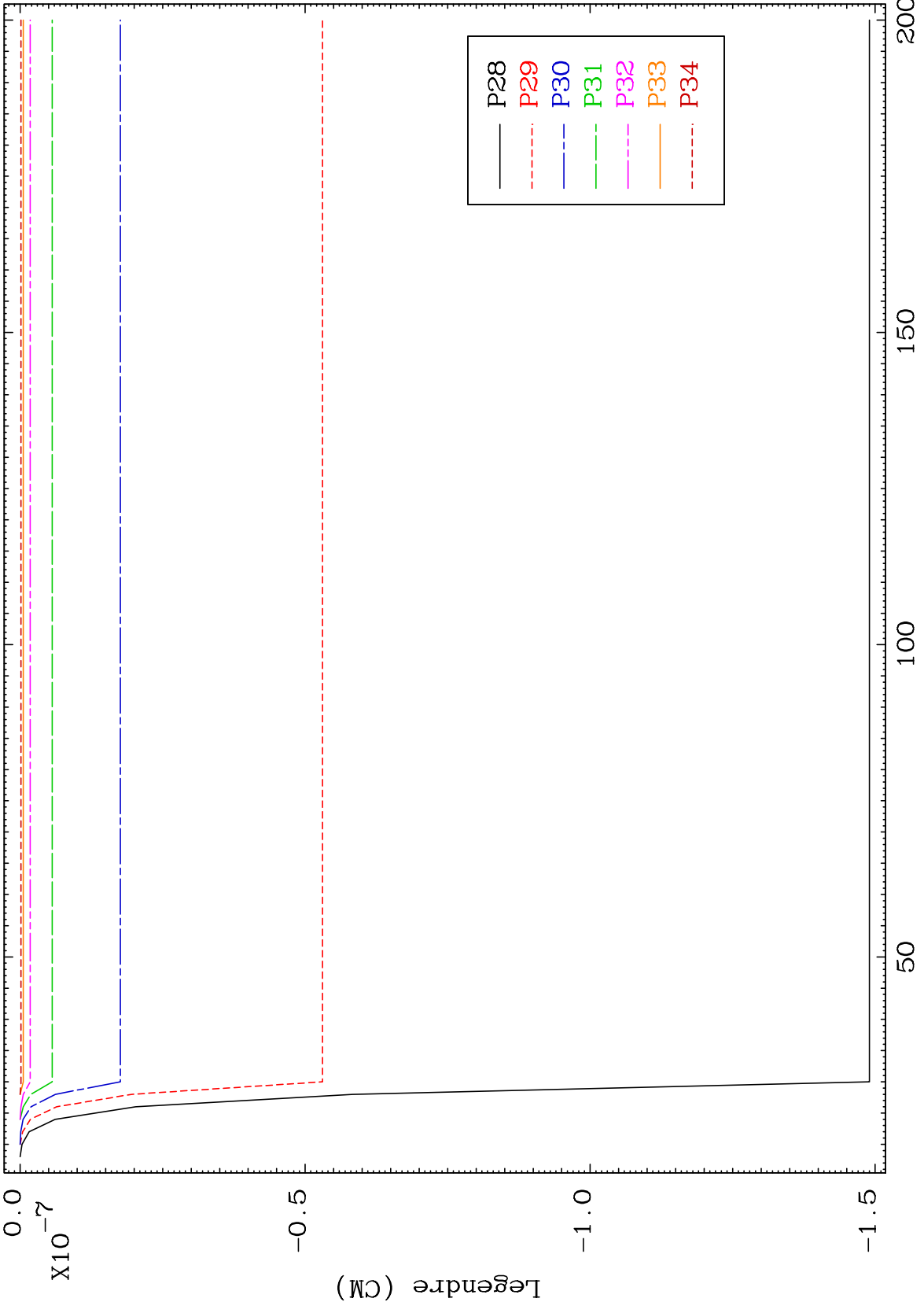

72 39-Y -94

MAT 3940

MT= 67 (n,n') Level
Legendre Coefficients

39-Y -94

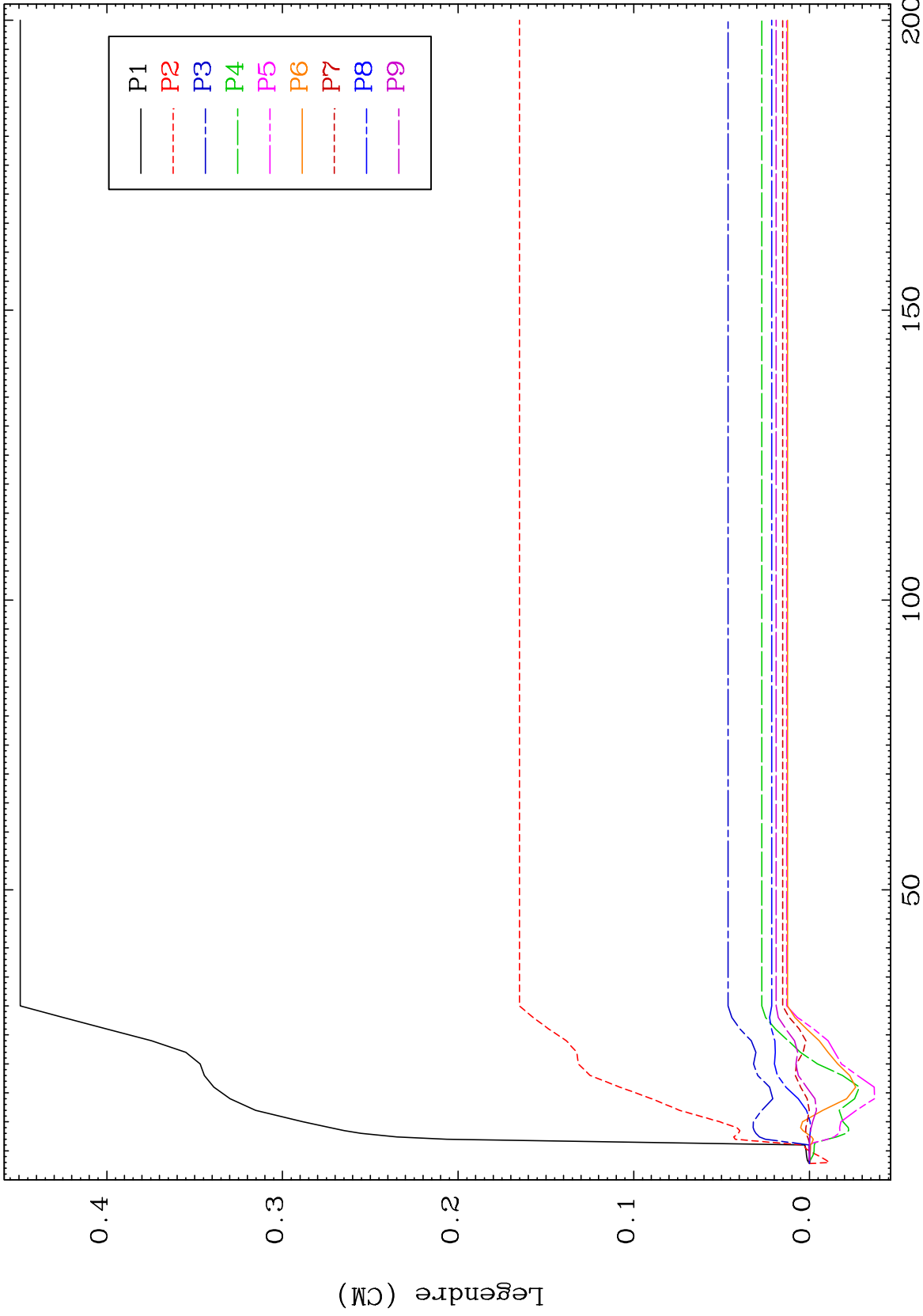

73

Incident Energy (MeV)

39-Y -94

MAT 3940

MT= 67 (n,n') Level
Legendre Coefficients

39-Y -94

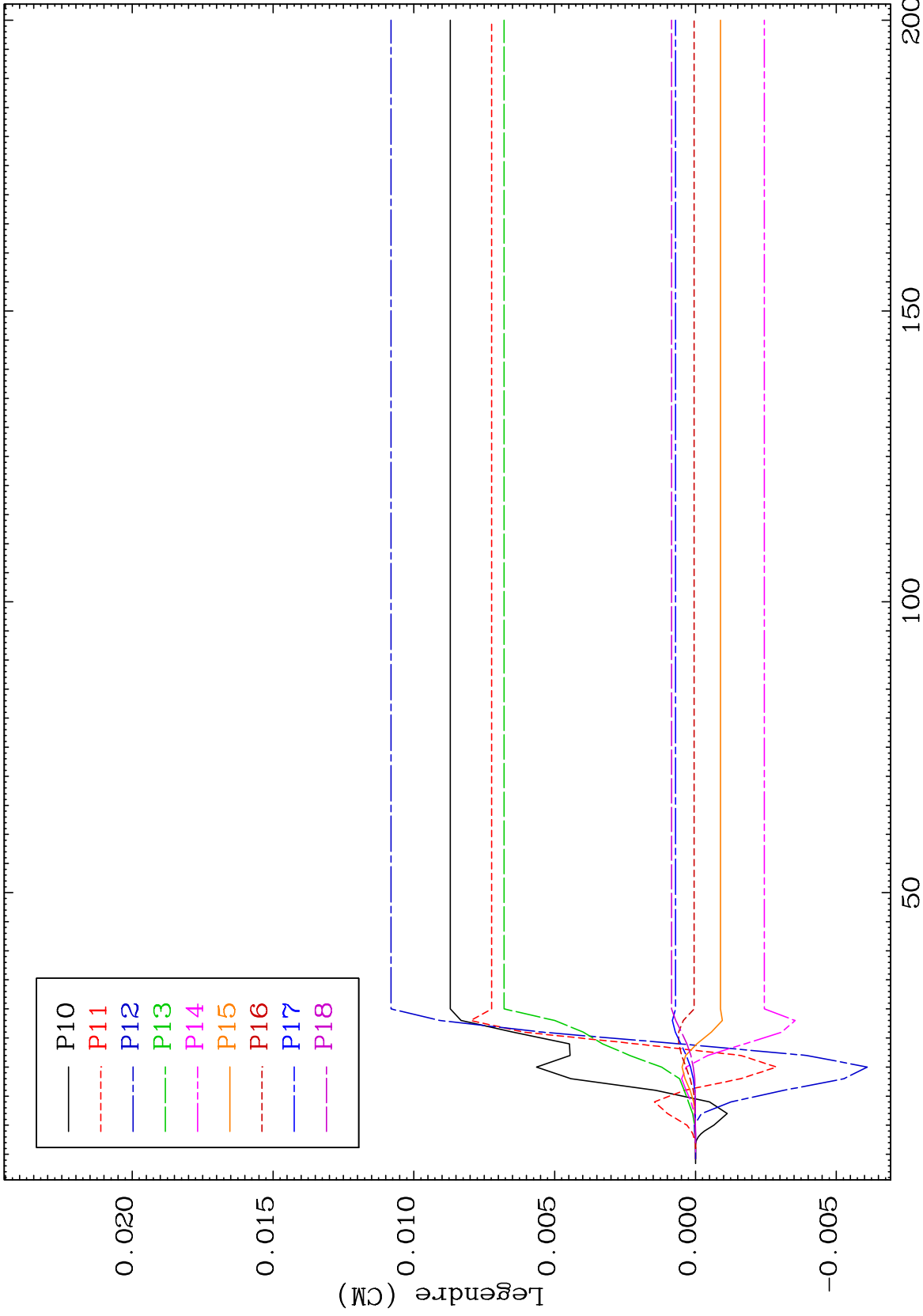

74

Incident Energy (MeV)

39-Y -94

MAT 3940

MT= 67 (n,n') Level
Legendre Coefficients

39-Y -94

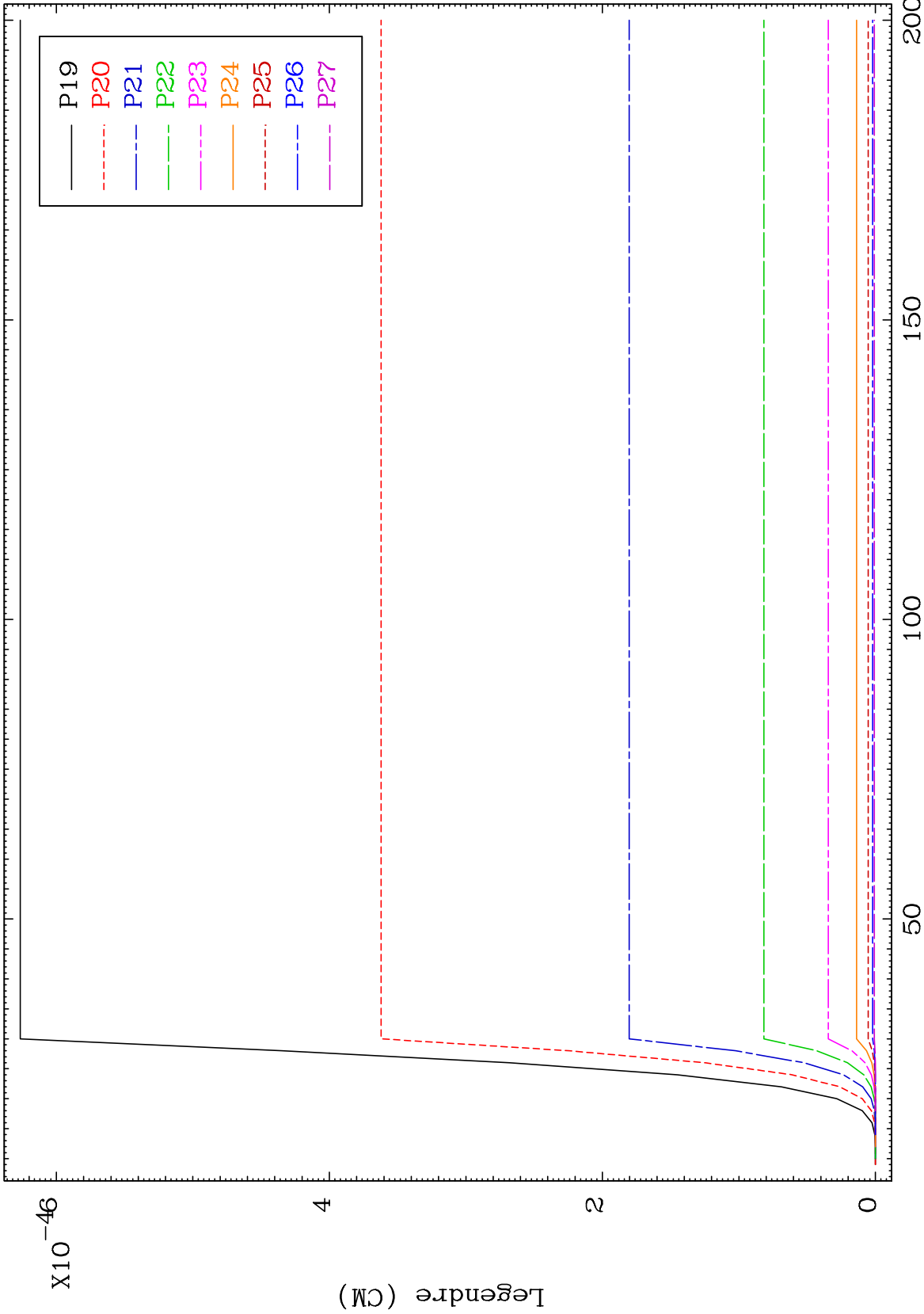

75

Incident Energy (MeV)

39-Y -94

MAT 3940

MT= 67 (n,n') Level
Legendre Coefficients

39-Y -94

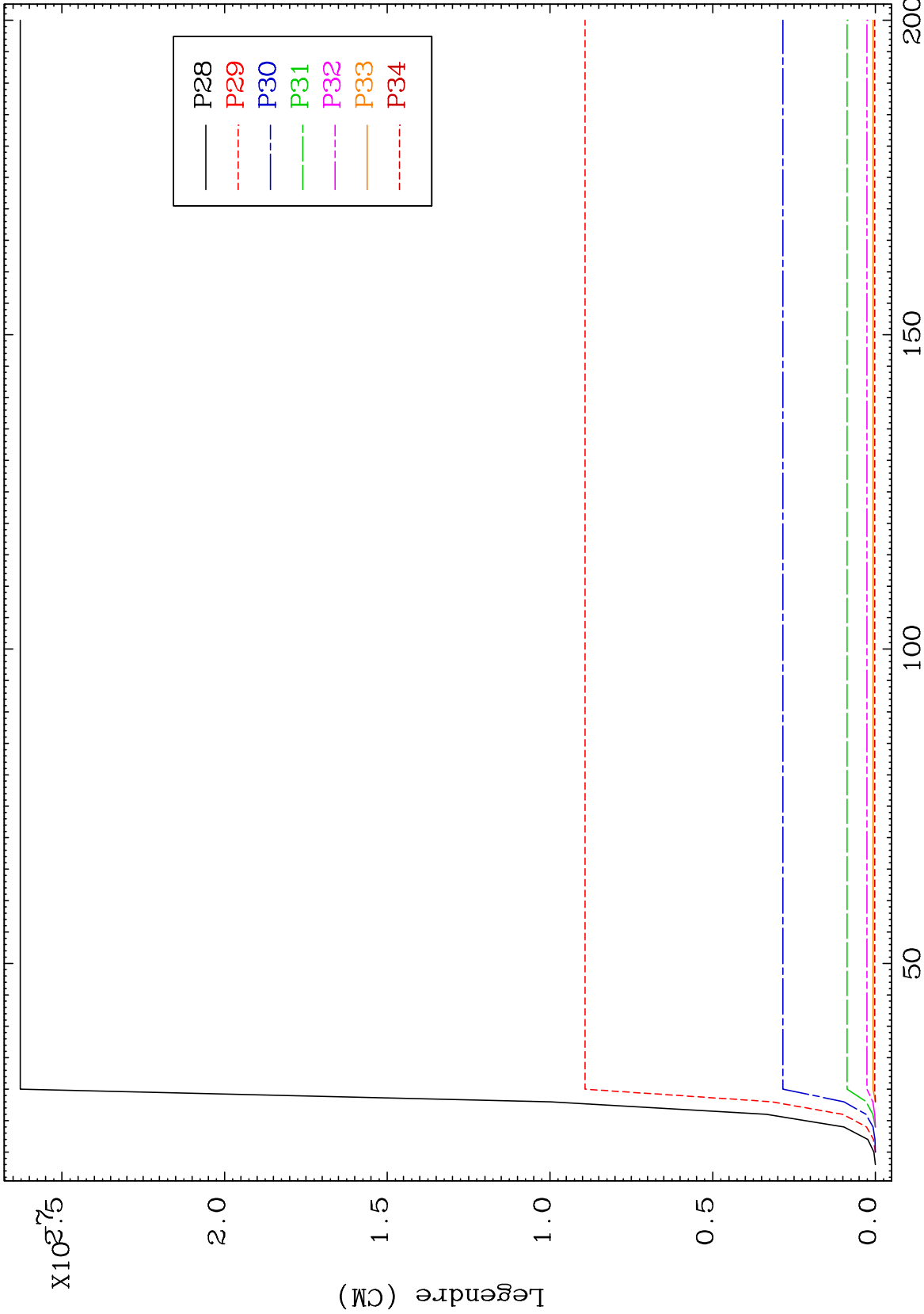

76

Incident Energy (MeV)

39-Y -94

MAT 3940 MT= 68 (n,n') Level Legendre Coefficients 39-Y -94

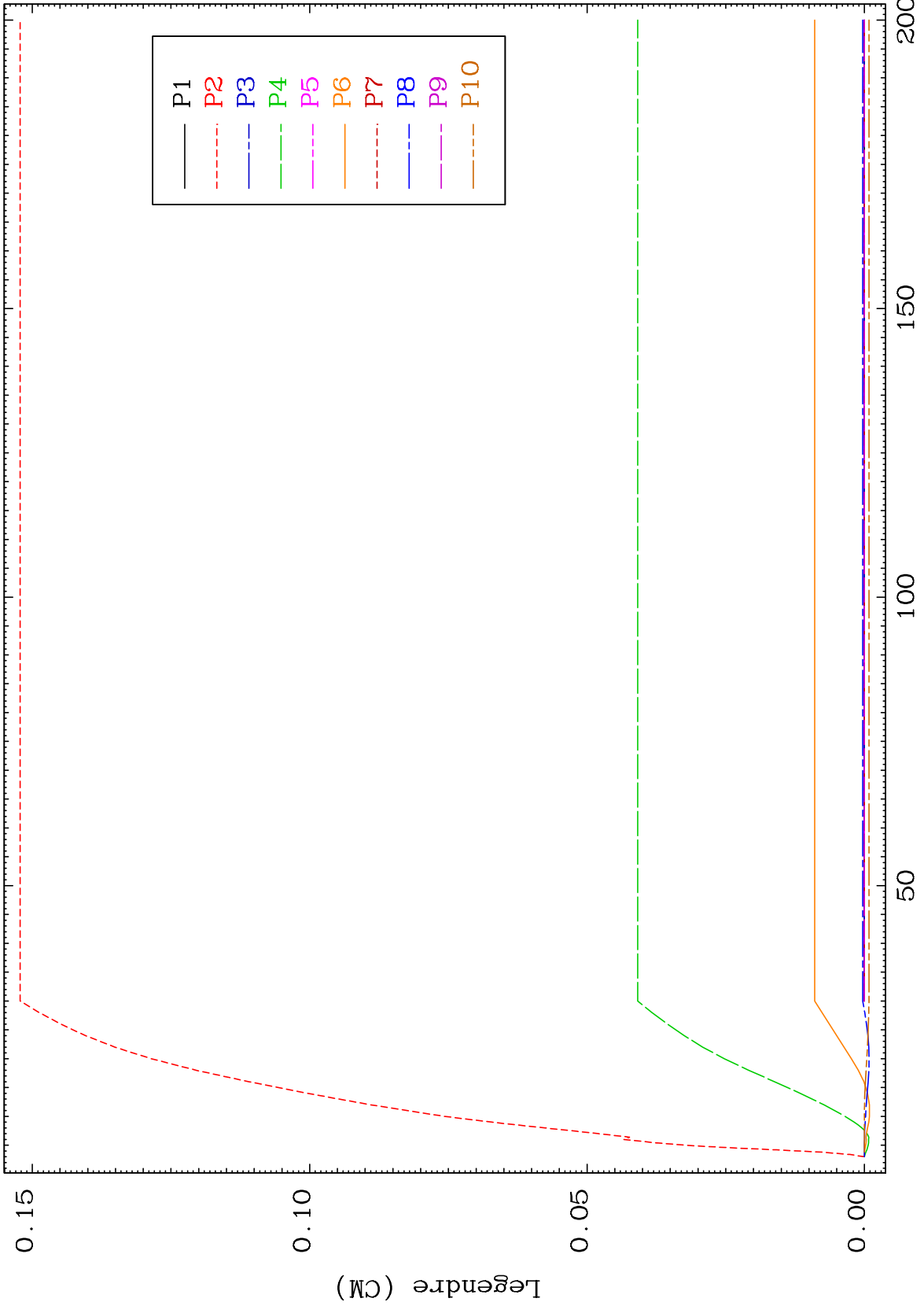

77 39-Y -94

MAT 3940 MT= 68 (n,n') Level Legendre Coefficients 39-Y -94

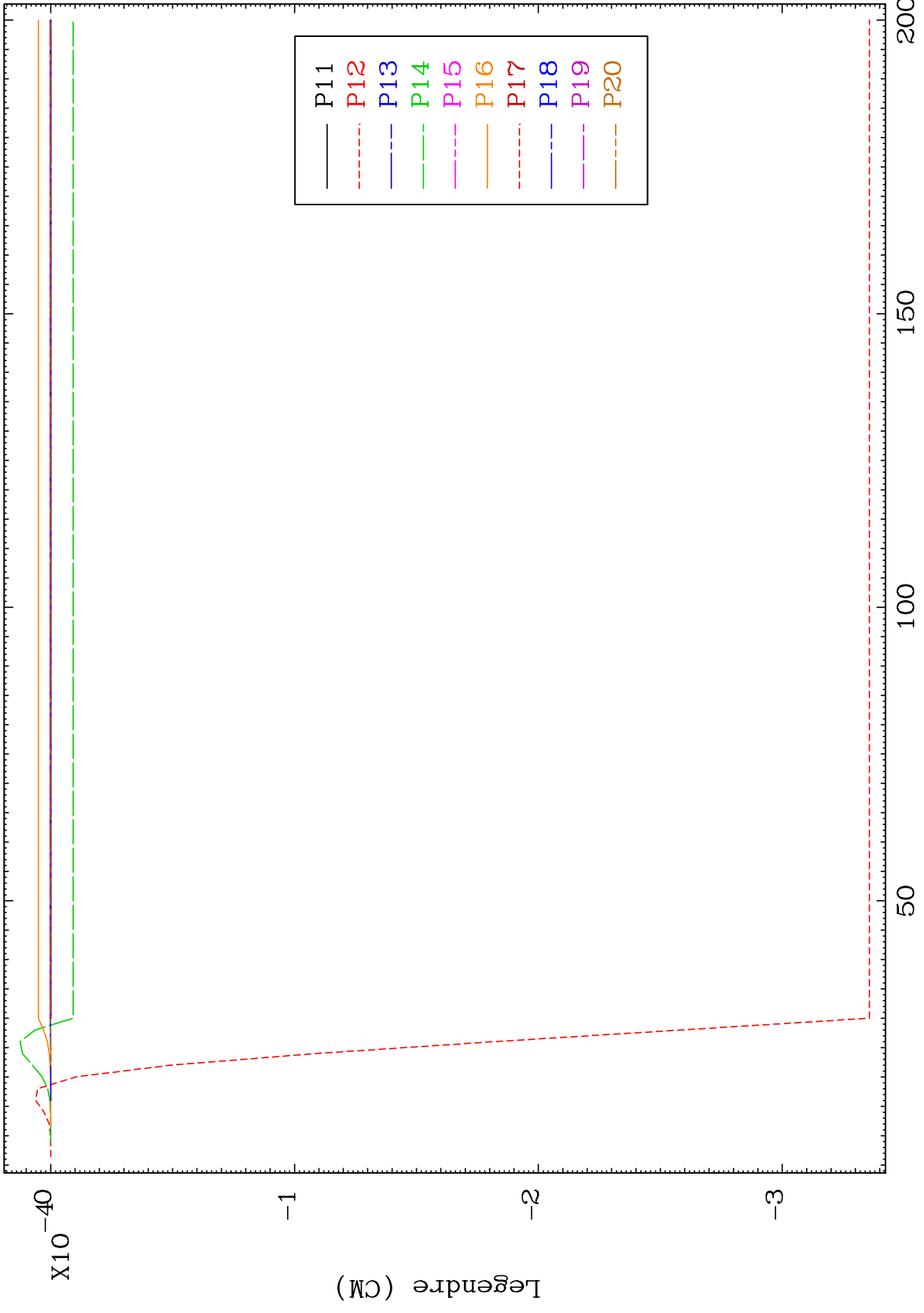

78 39-Y -94

MAT 3940 MT= 69 (n,n') Level Legendre Coefficients 39-Y -94

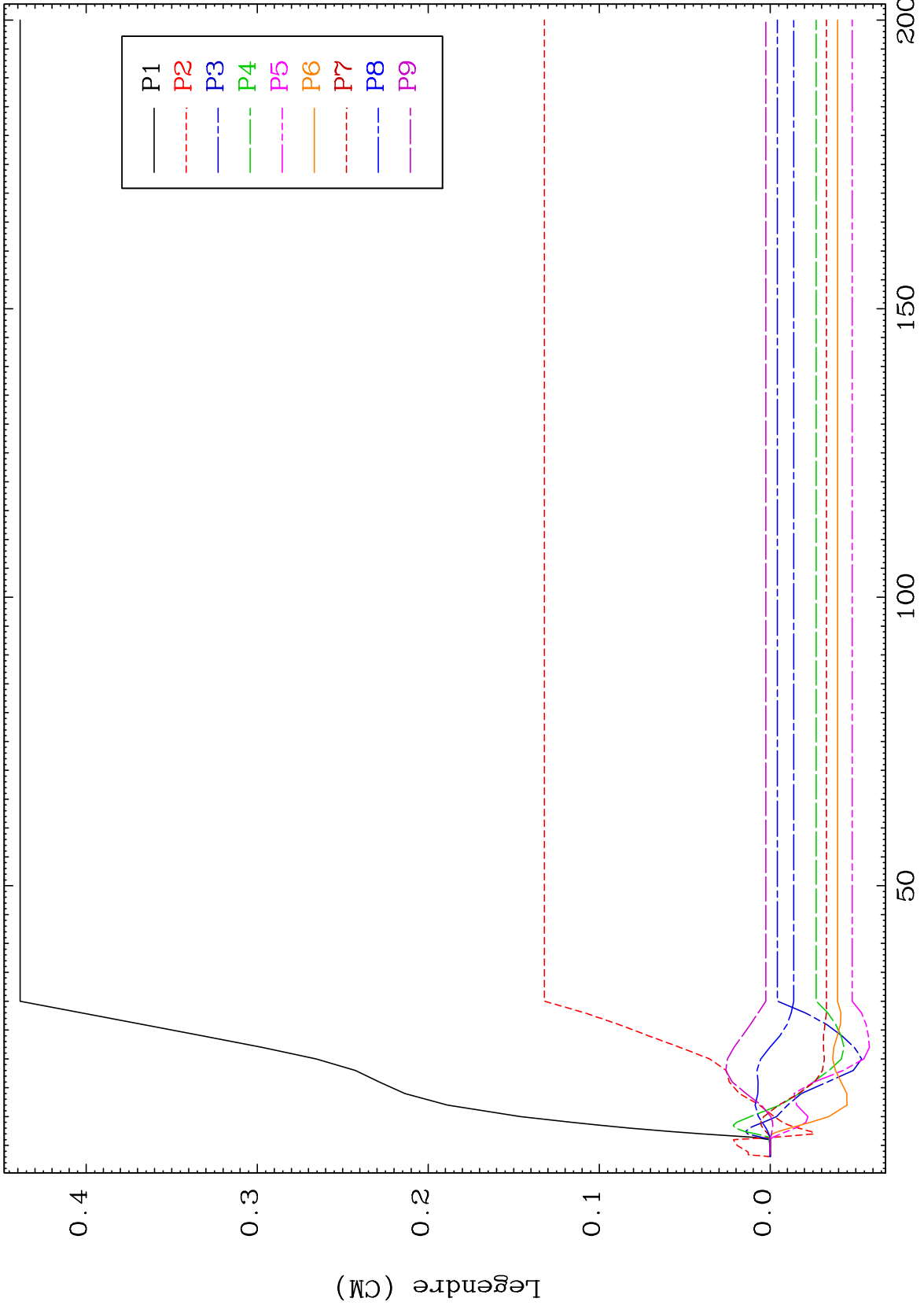

79 39-Y -94

MAT 3940

MT= 69 (n,n') Level
Legendre Coefficients

39-Y -94

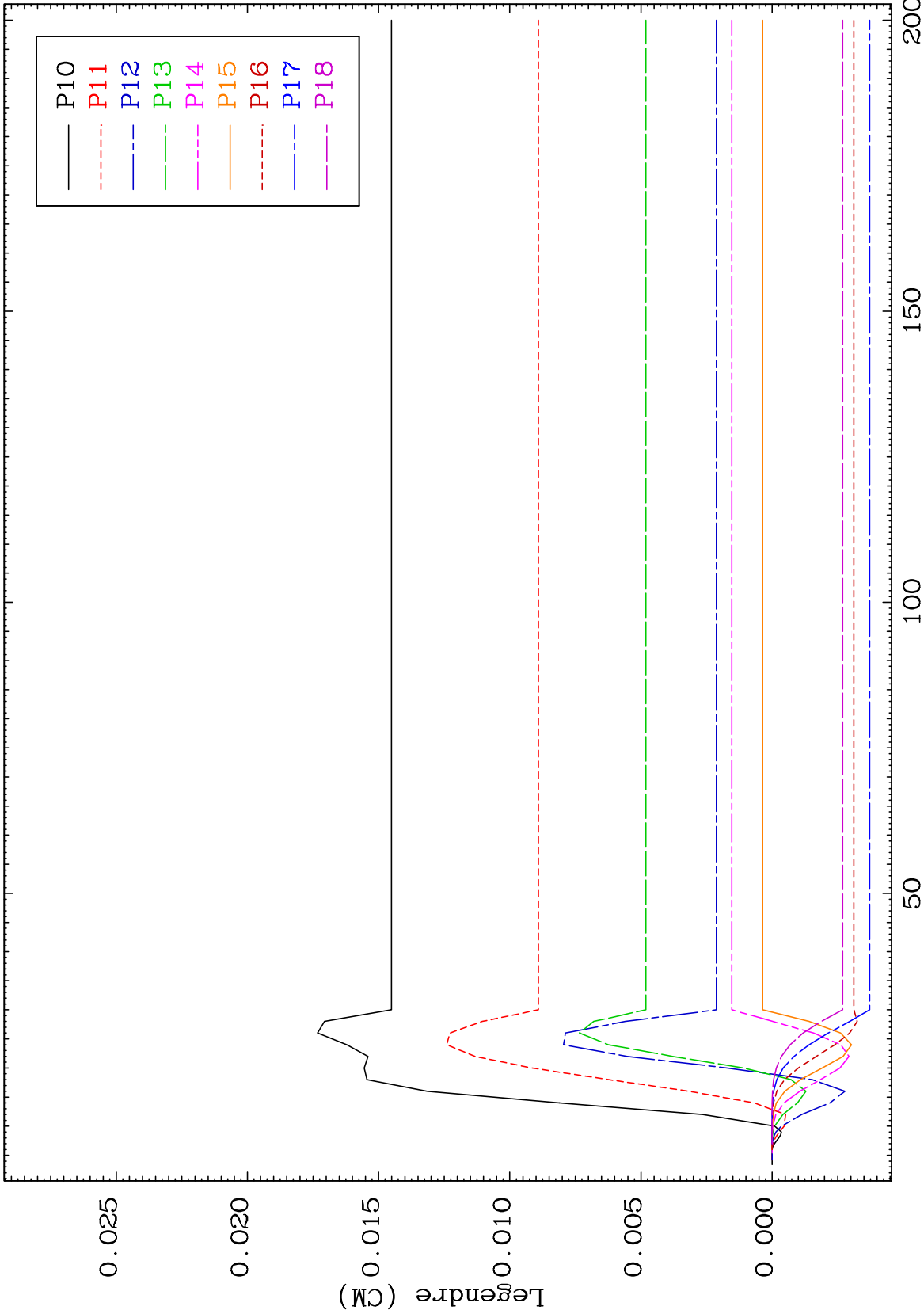

80

Incident Energy (MeV)

39-Y -94

MAT 3940 MT= 69 (n,n') Level Legendre Coefficients 39-Y -94

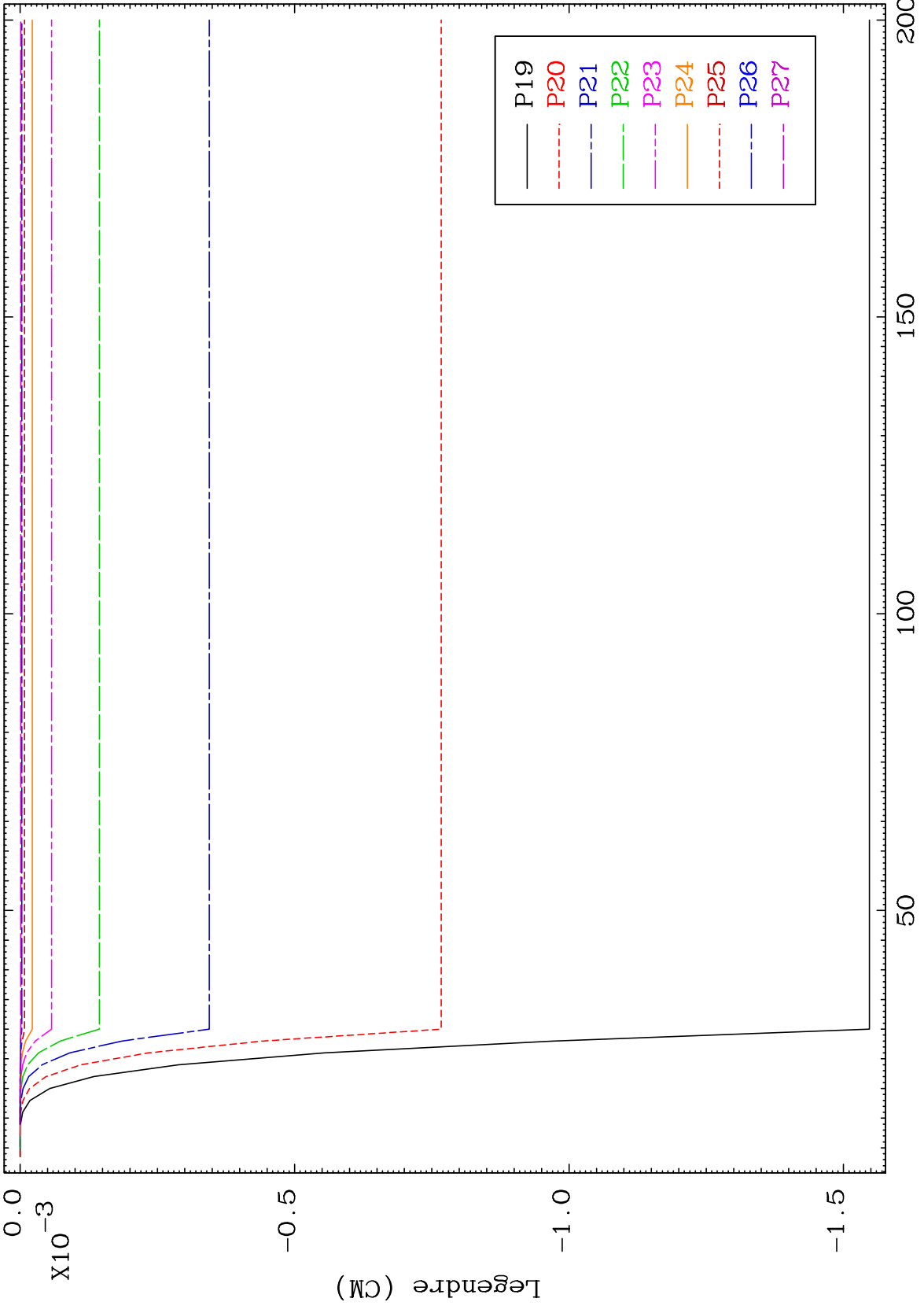

81 Incident Energy (MeV) 39-Y -94

MAT 3940 MT= 69 (n,n') Level Legendre Coefficients 39-Y -94

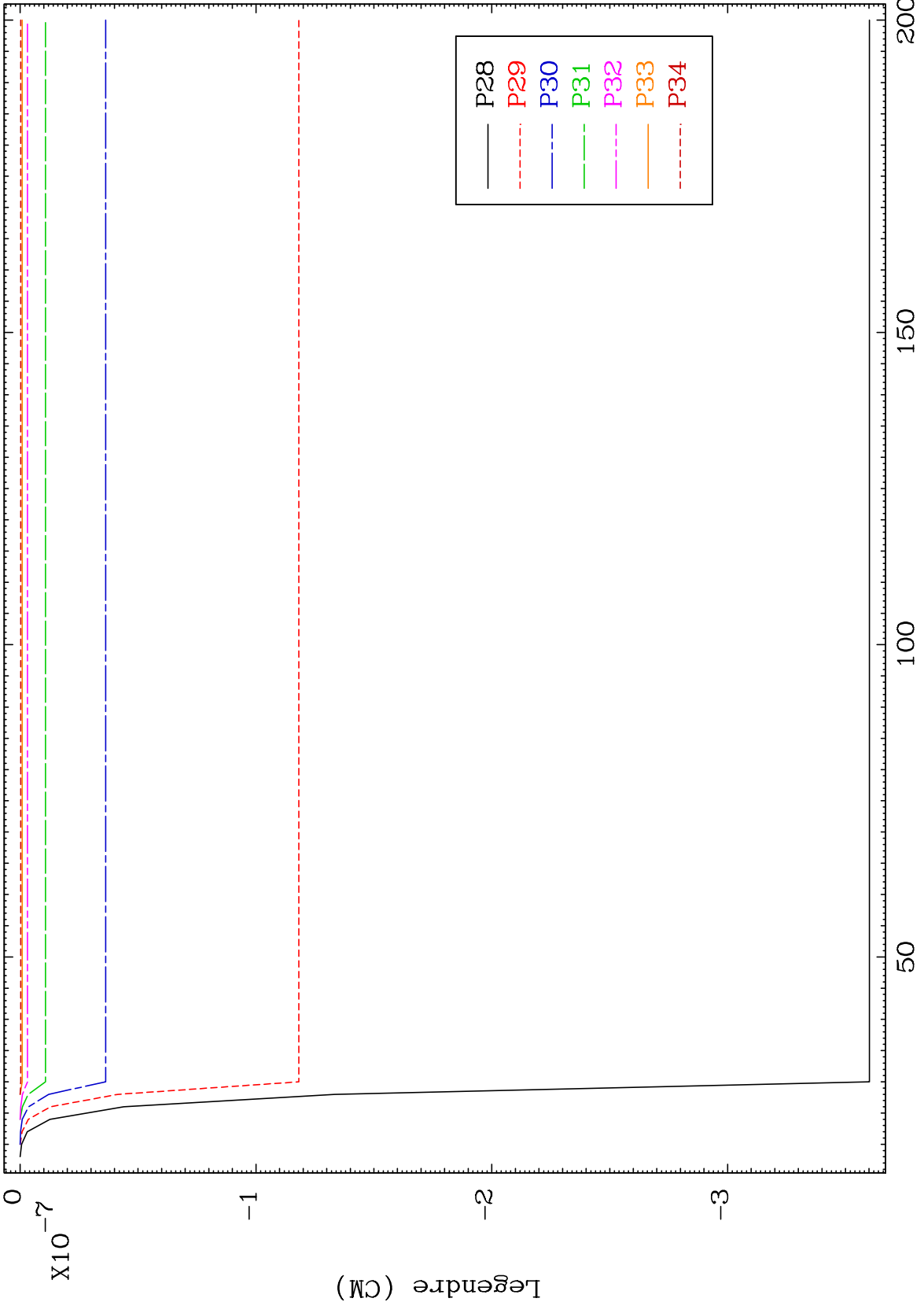

82 39-Y -94

MAT 3940 MT= 70 (n,n') Level Legendre Coefficients 39-Y -94

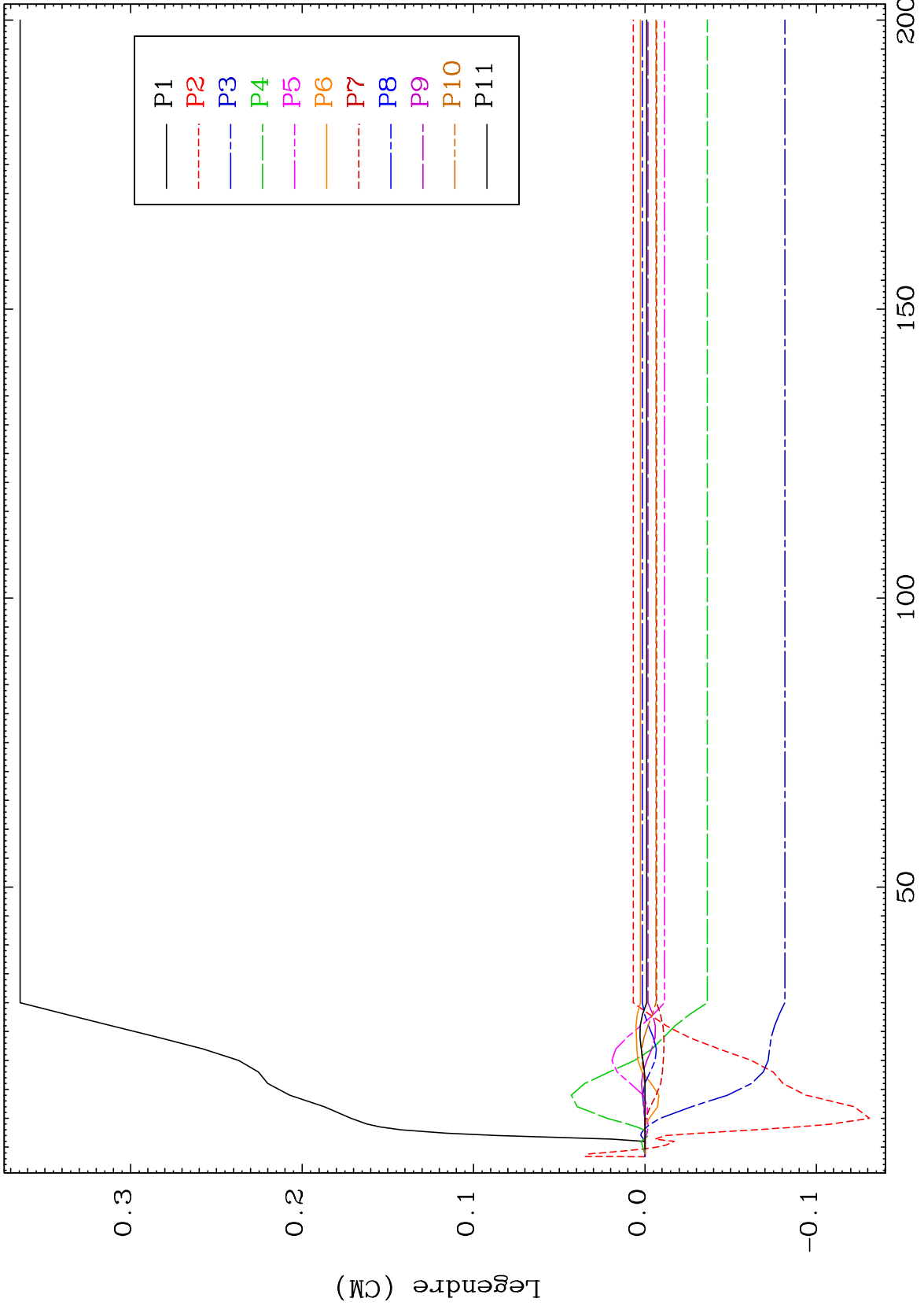

83 39-Y -94

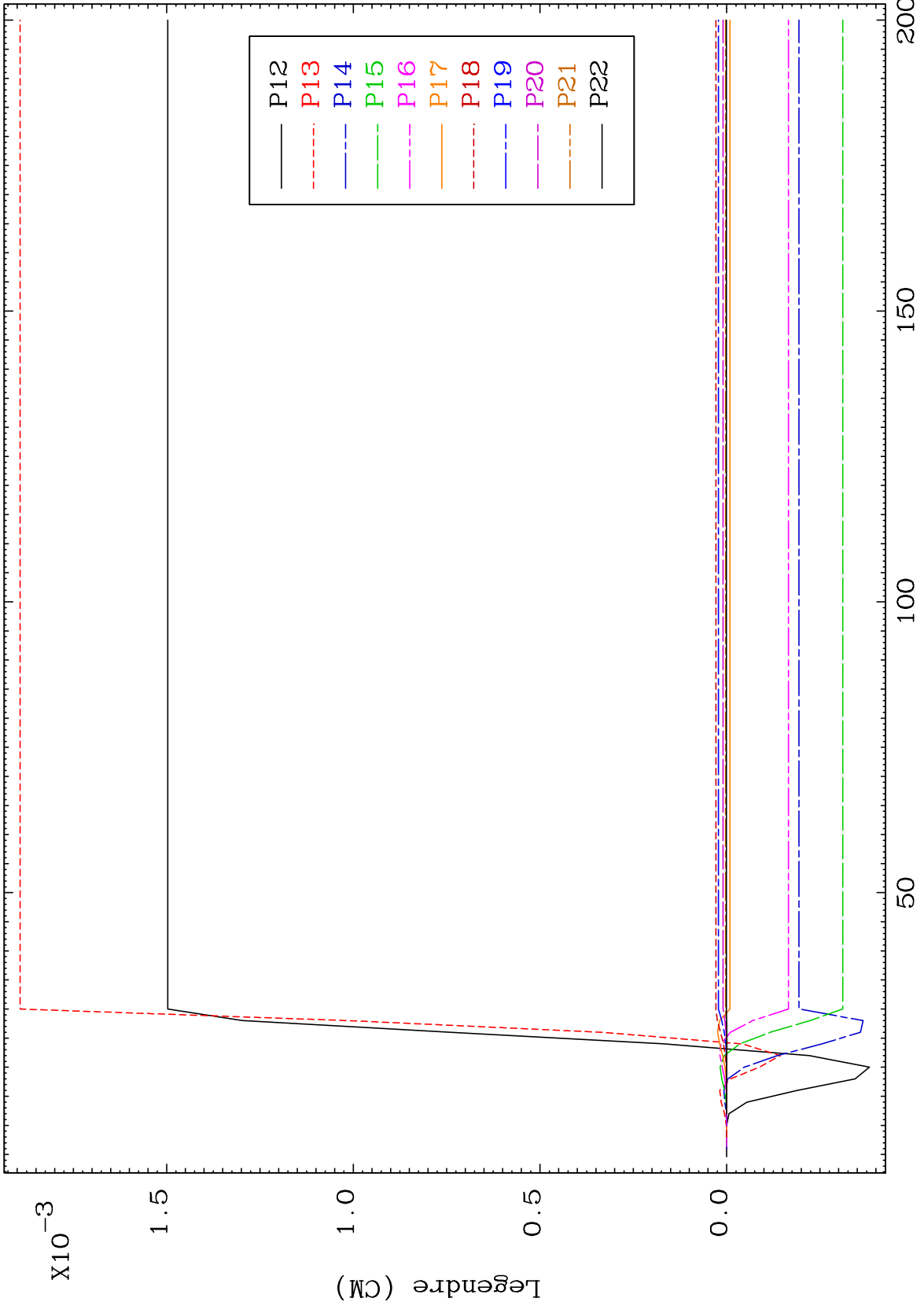

MAT 3940 MT= 70 (n,n') Level Legendre Coefficients 39-Y -94

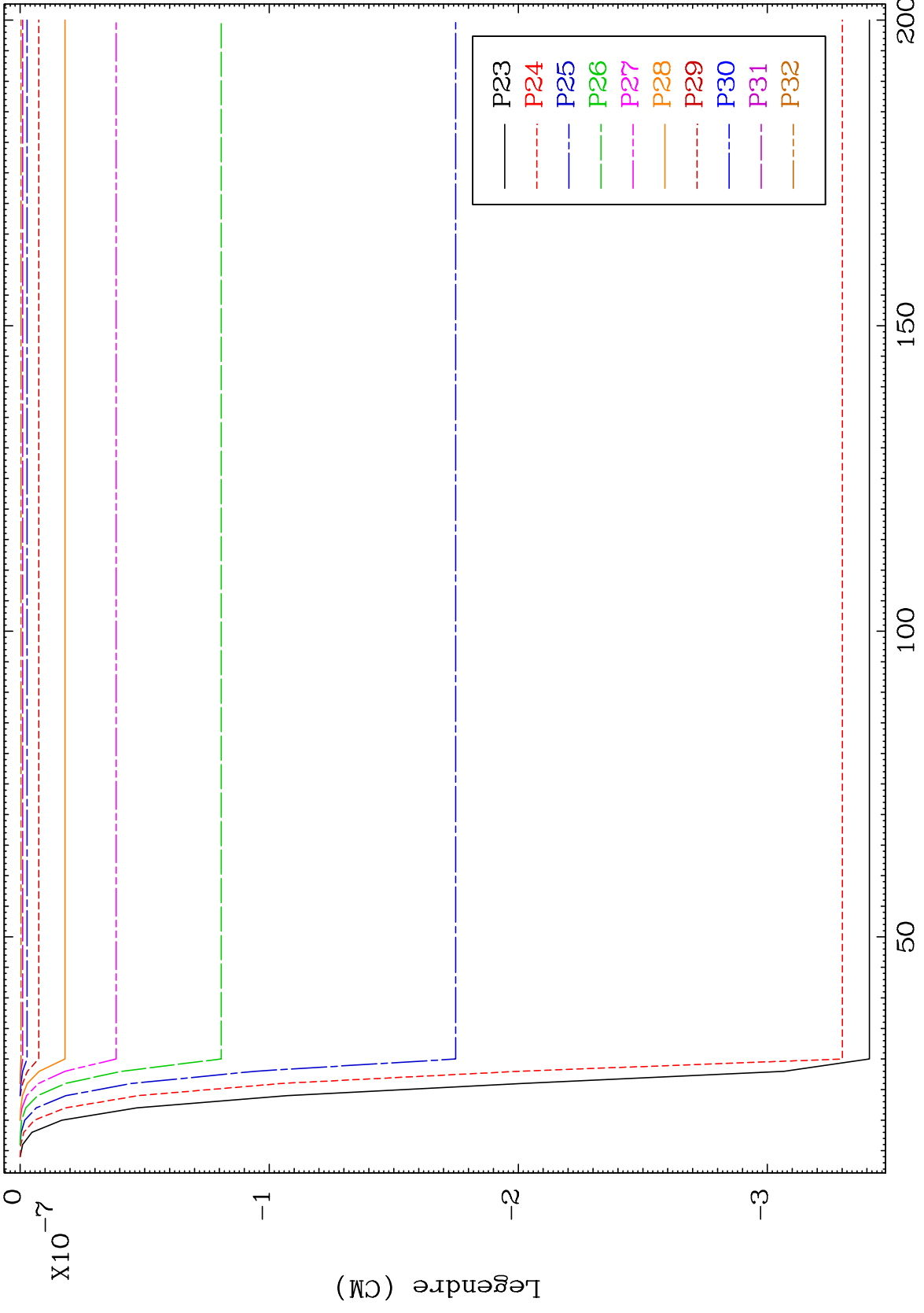

85 Incident Energy (MeV) 39-Y -94

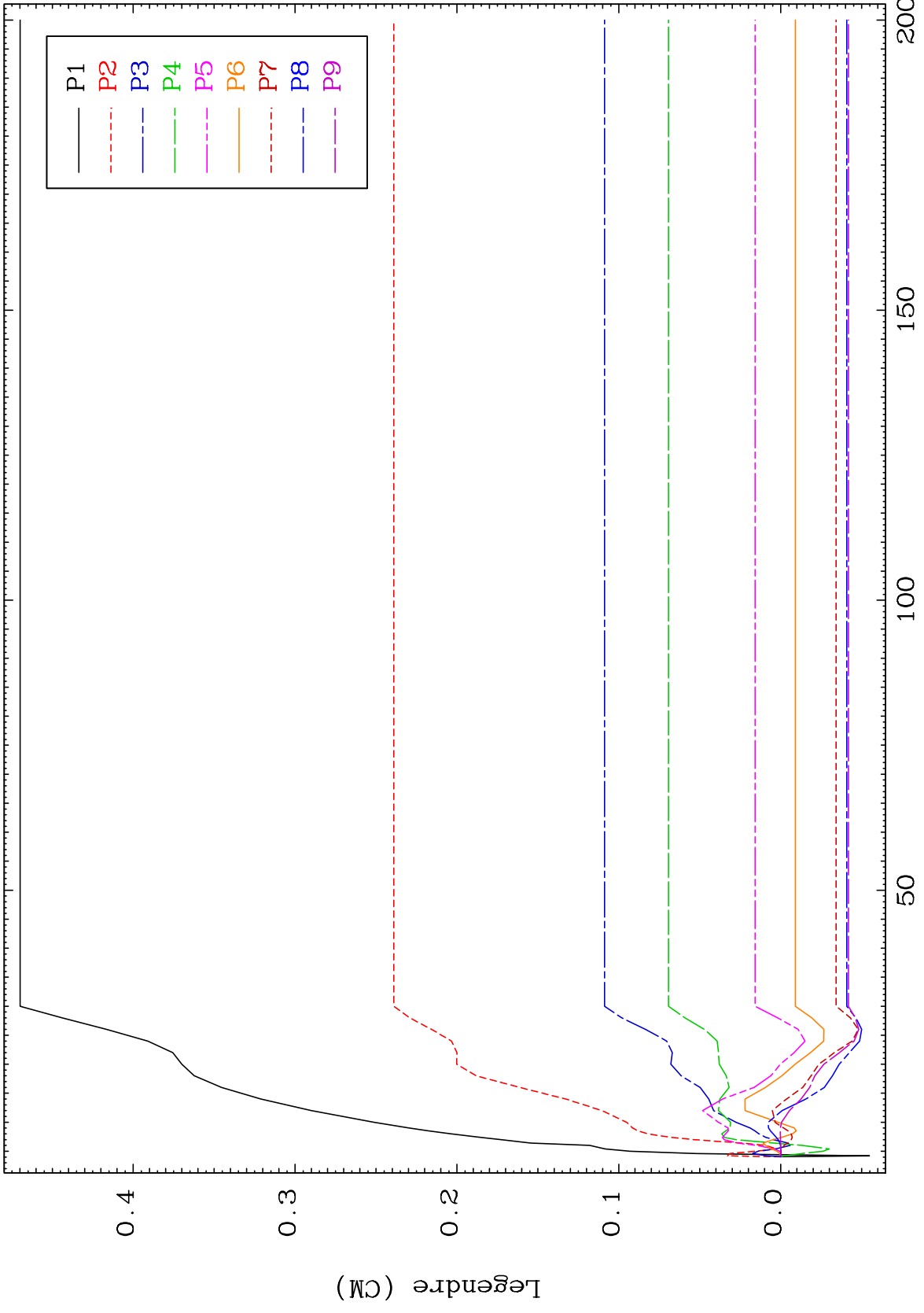

MAT 3940

MT= 71 (n,n') Level
Legendre Coefficients

39-Y -94

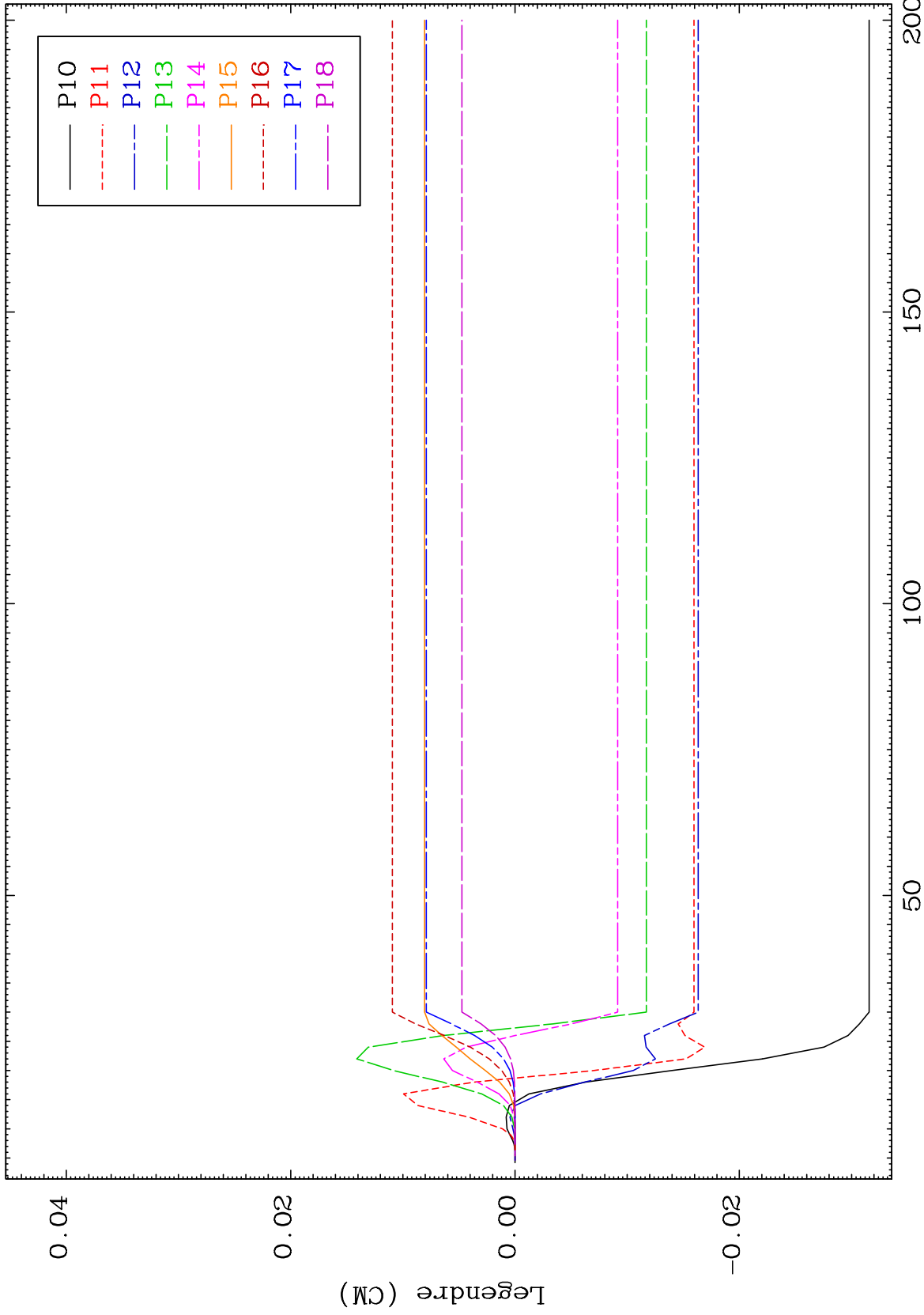

87

Incident Energy (MeV)

39-Y -94

MAT 3940

MT= 71 (n,n') Level
Legendre Coefficients

39-Y -94

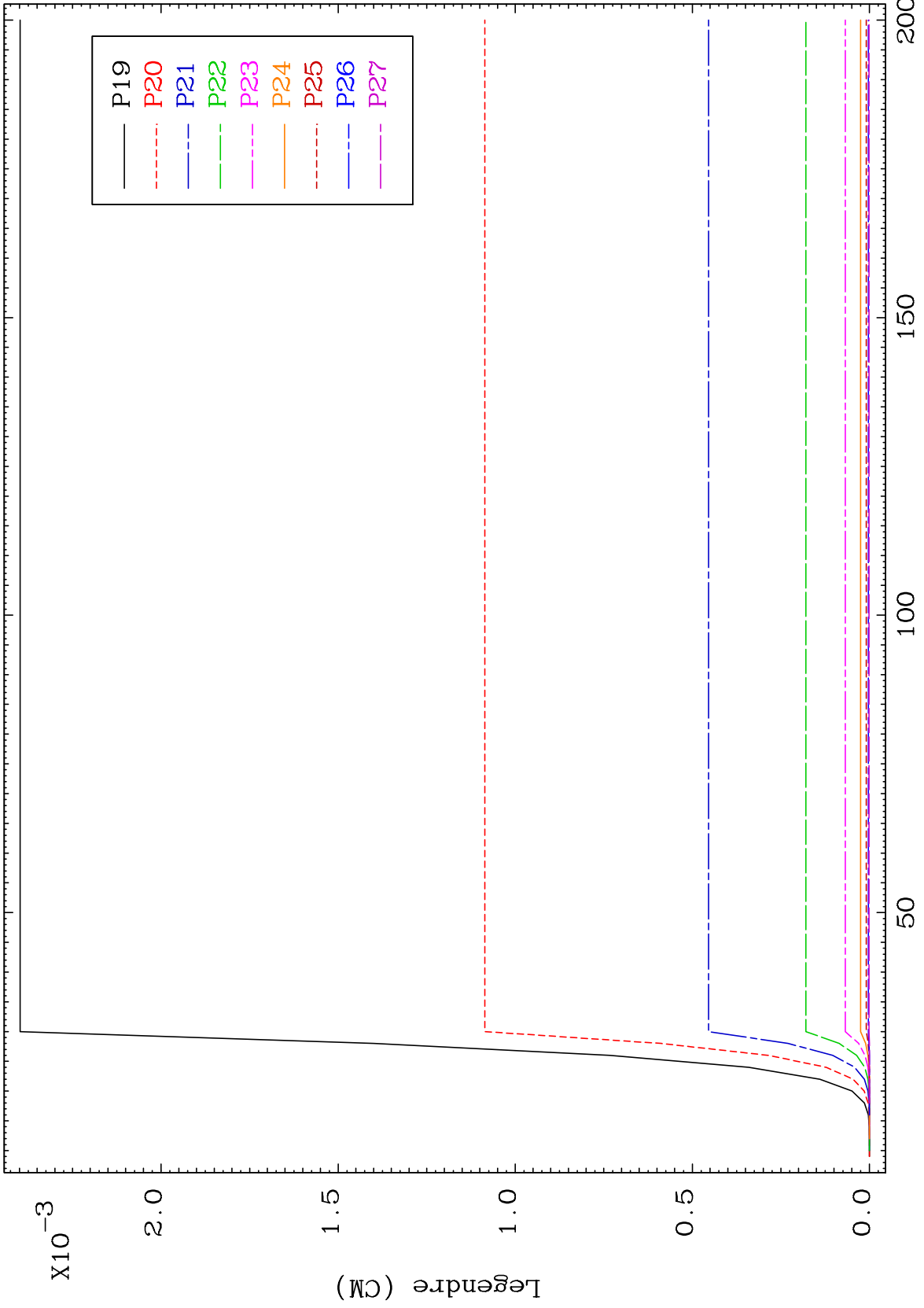

88

Incident Energy (MeV)

39-Y -94

MAT 3940

MT= 71 (n,n') Level
Legendre Coefficients

39-Y -94

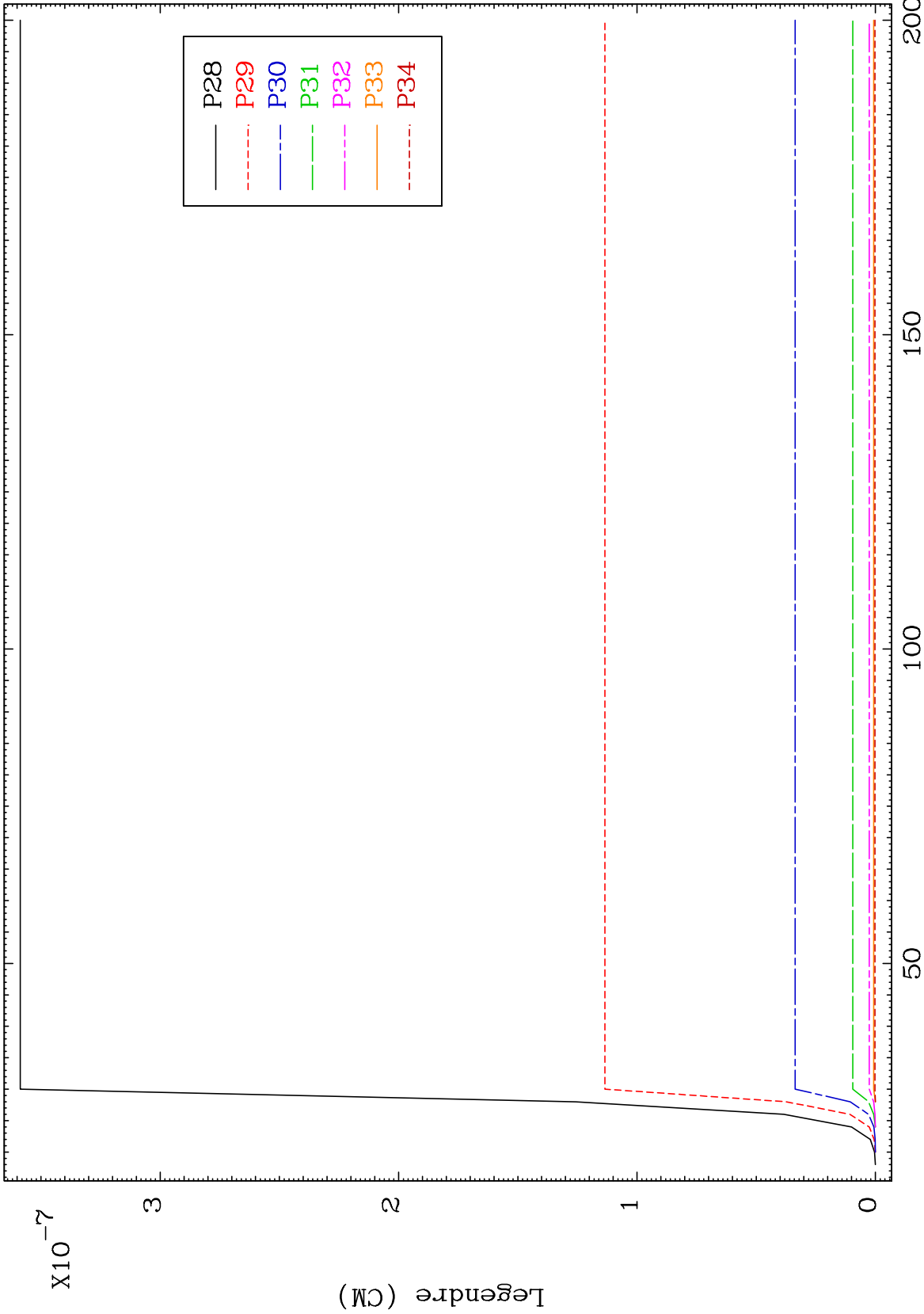

89

Incident Energy (MeV)

39-Y -94

MAT 3940 MT= 72 (n,n') Level Legendre Coefficients 39-Y -94

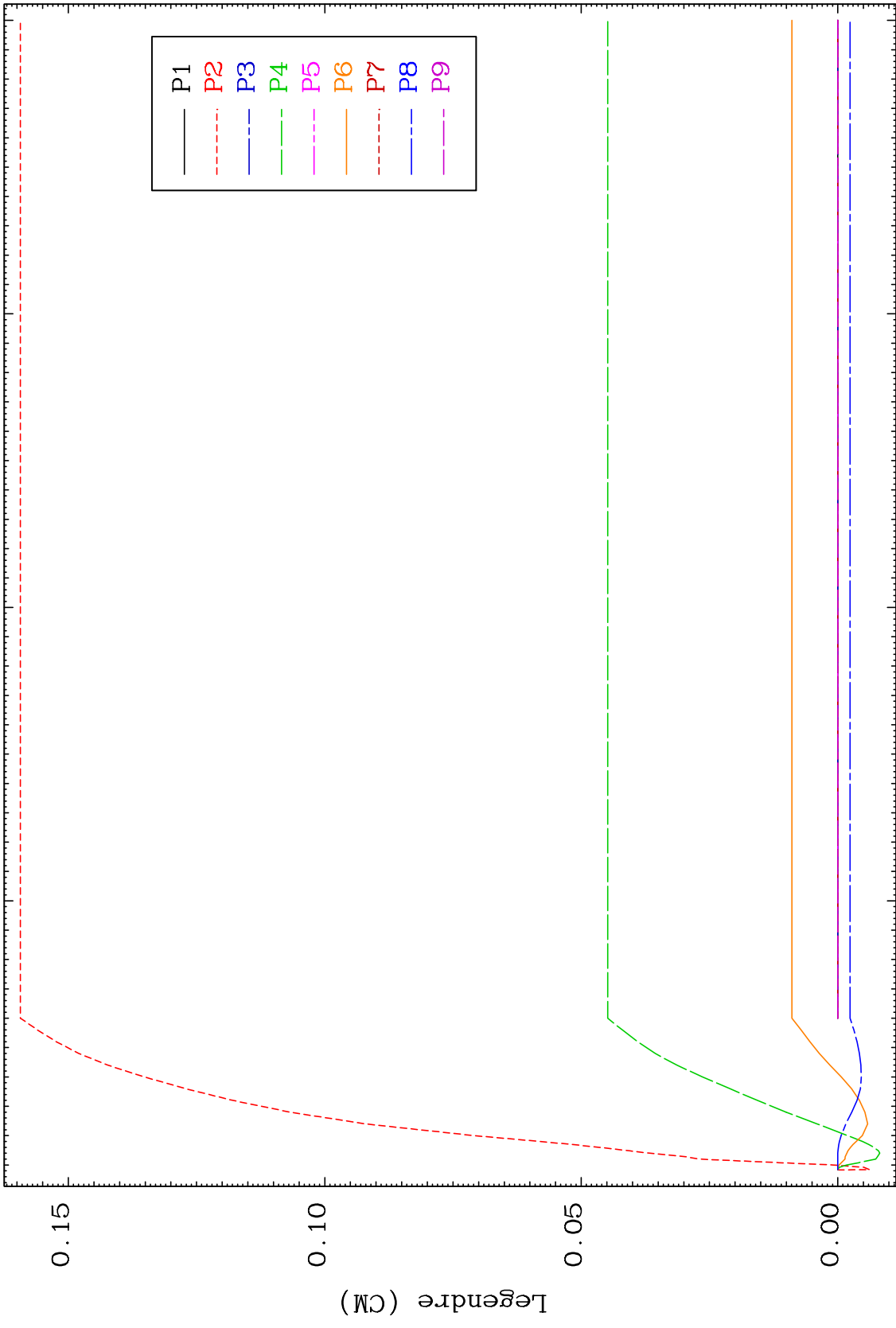

Incident Energy (MeV) 39-Y -94

MAT 3940 MT= 72 (n,n') Level Legendre Coefficients

39-Y -94

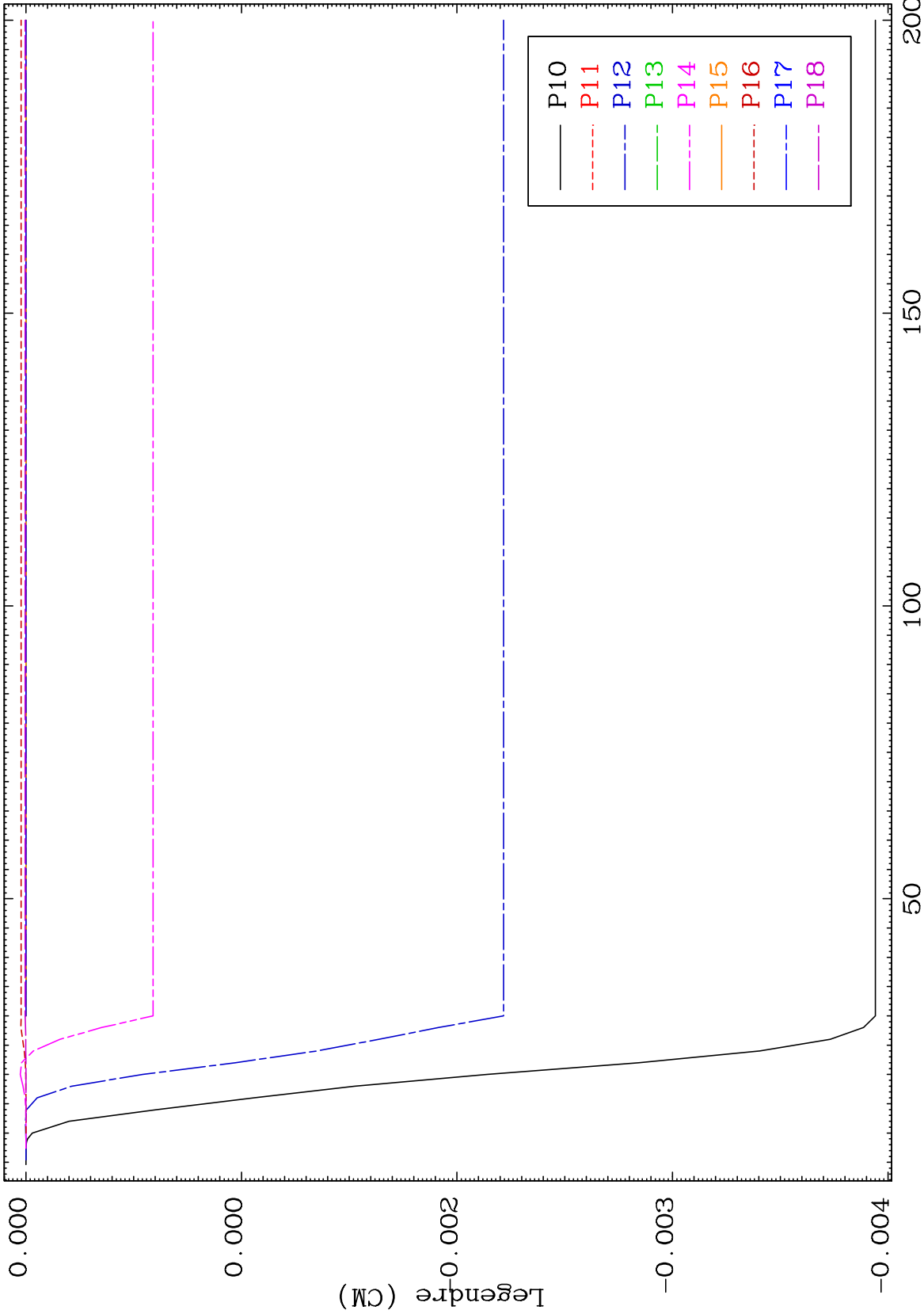

39-Y -94

Incident Energy (MeV)

MAT 3940 MT= 72 (n,n') Level Legendre Coefficients 39-Y -94

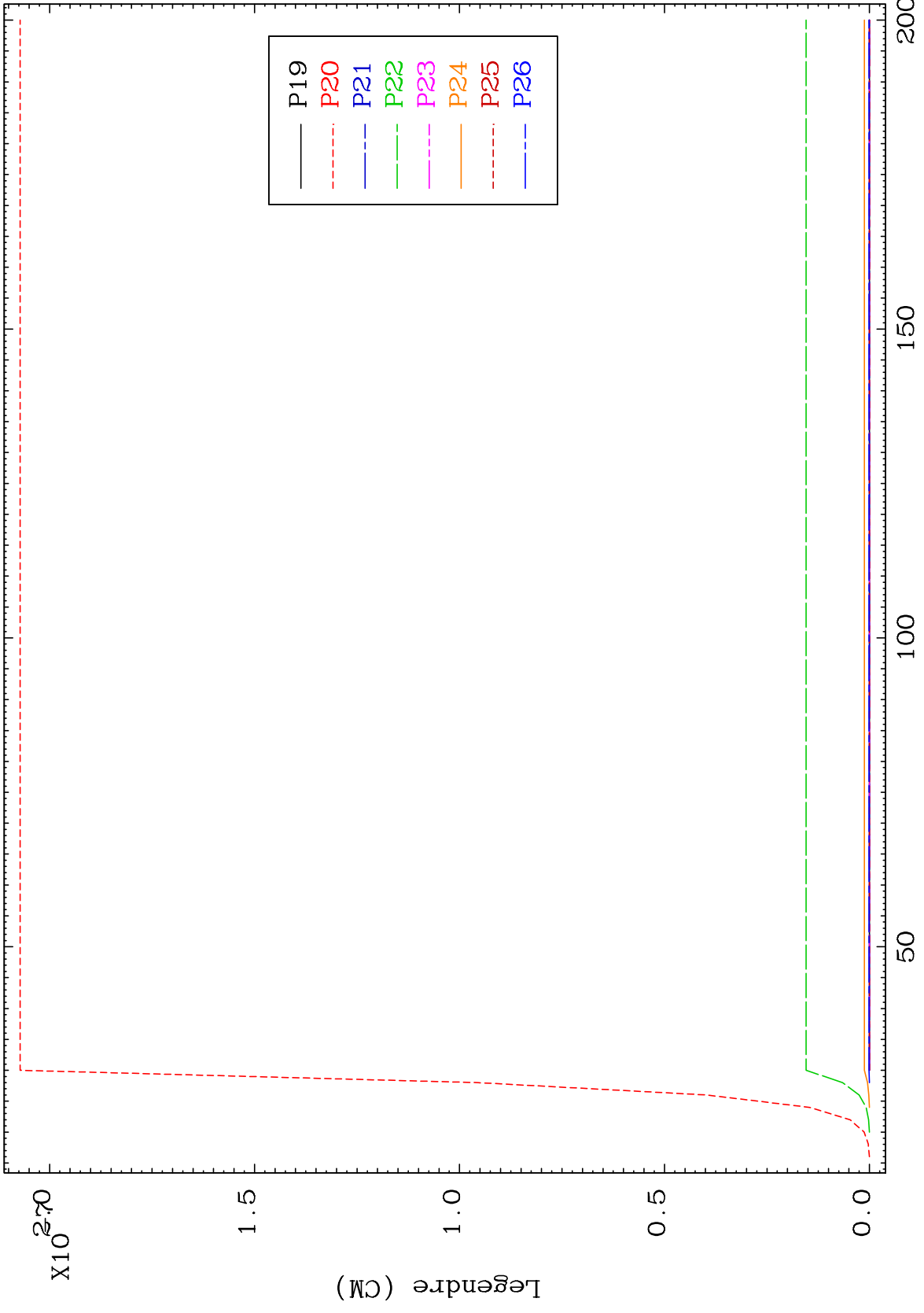

92 39-Y -94

MAT 3940 MT= 73 (n,n') Level Legendre Coefficients 39-Y -94

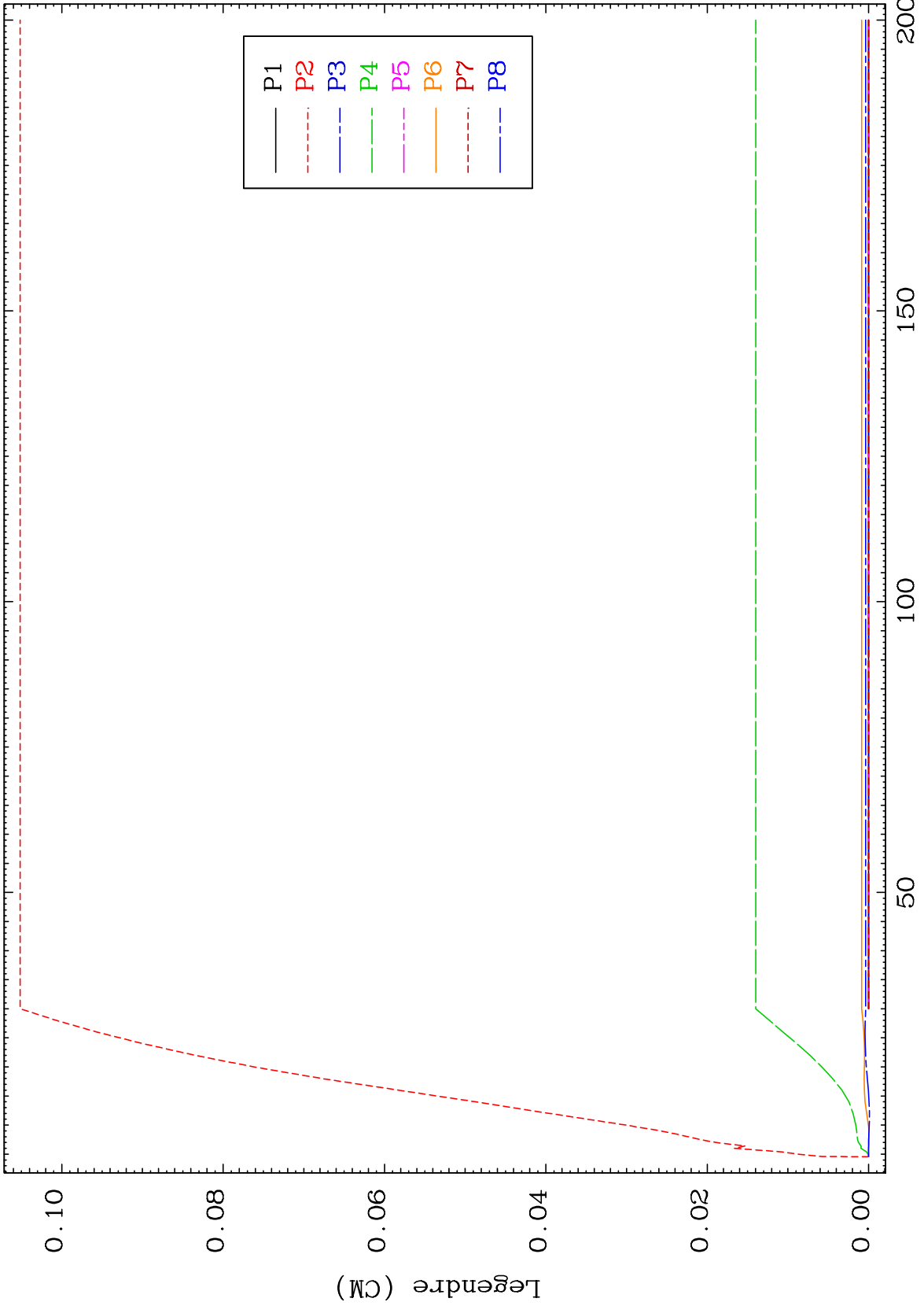

93 39-Y -94

MAT 3940 MT= 73 (n,n') Level Legendre Coefficients 39-Y -94

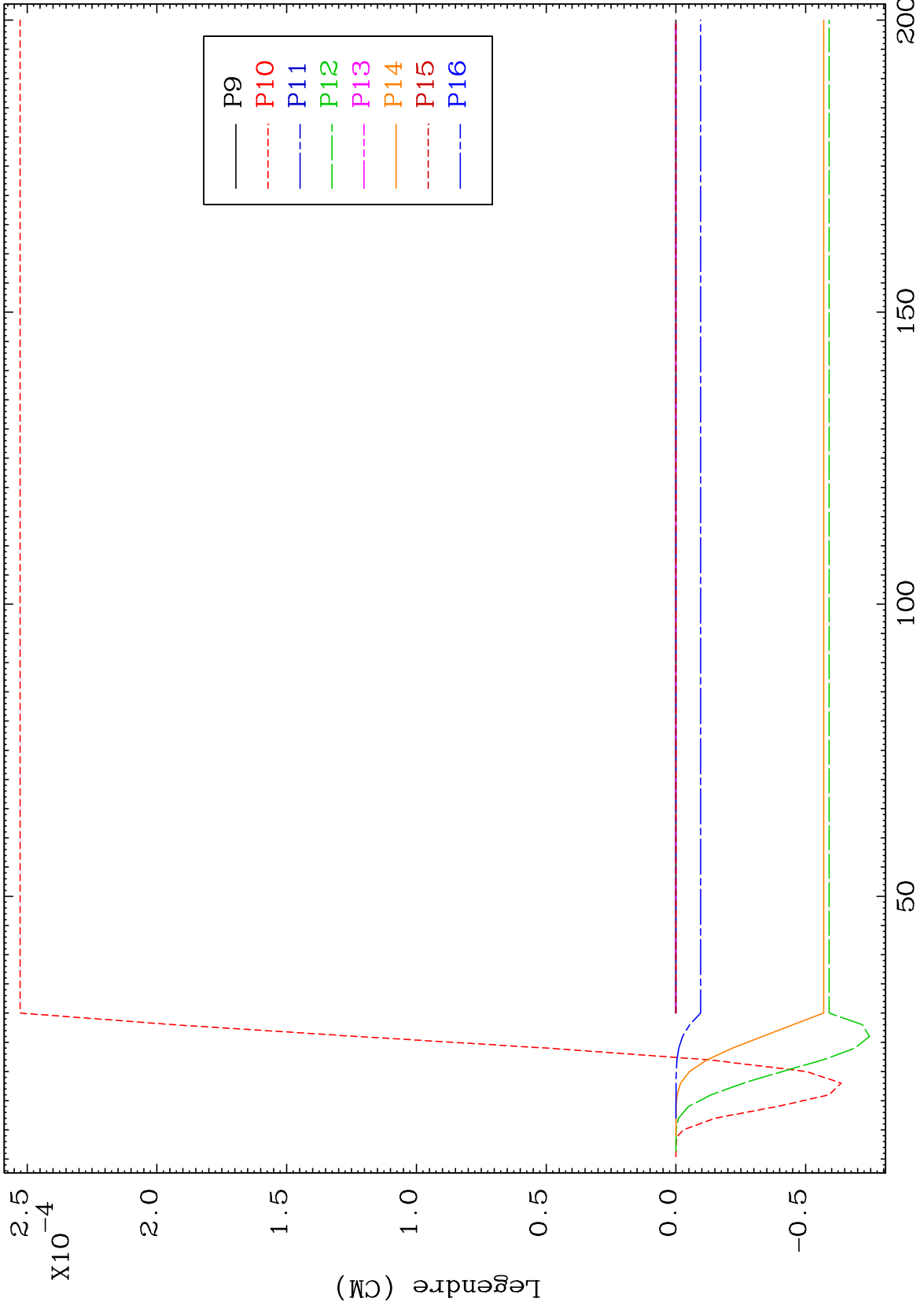

94 Incident Energy (MeV) 39-Y -94

MAT 3940 MT= 73 (n,n') Level Legendre Coefficients 39-Y -94

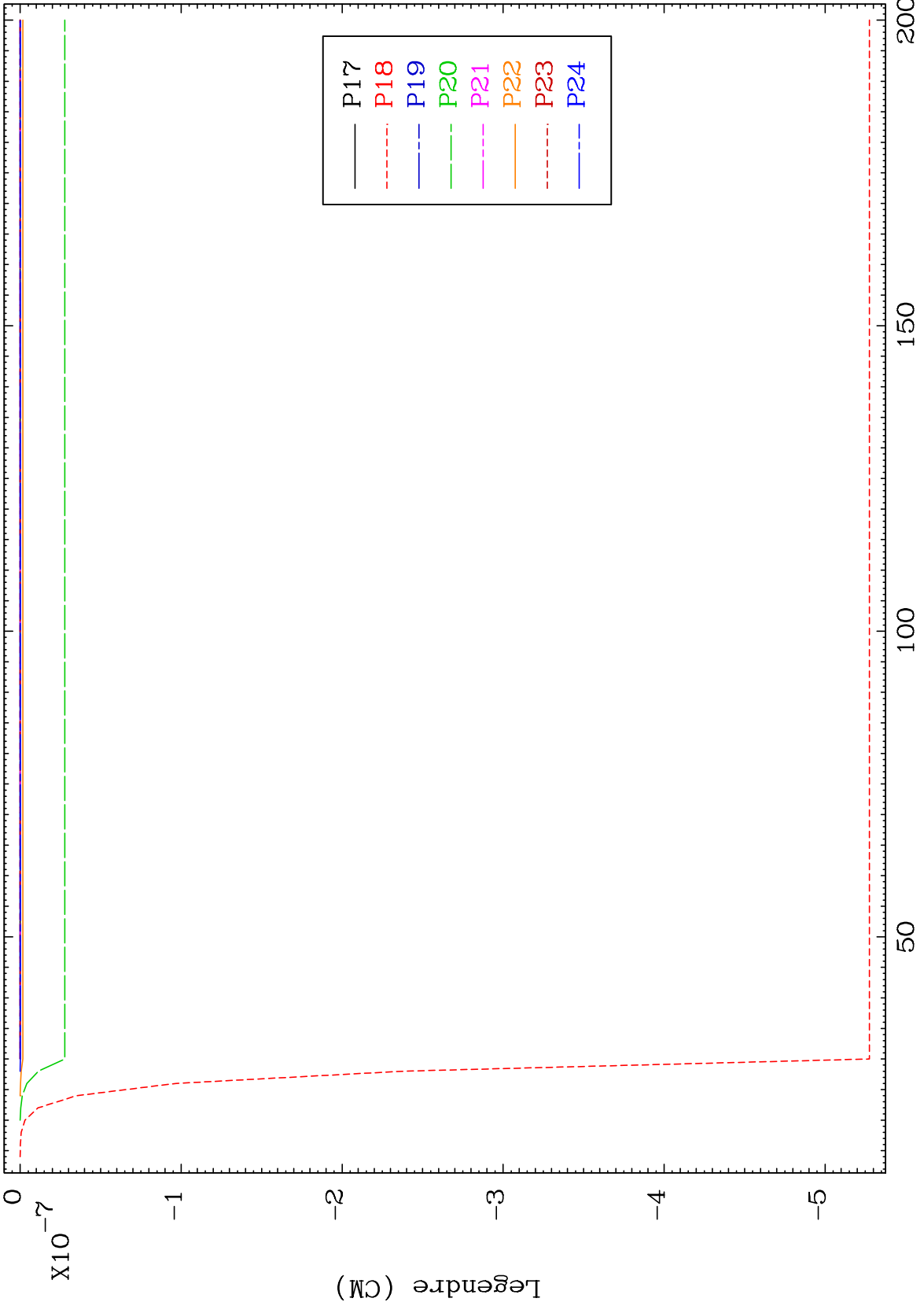

95 39-Y -94

MAT 3940 MT= 74 (n,n') Level Legendre Coefficients 39-Y -94

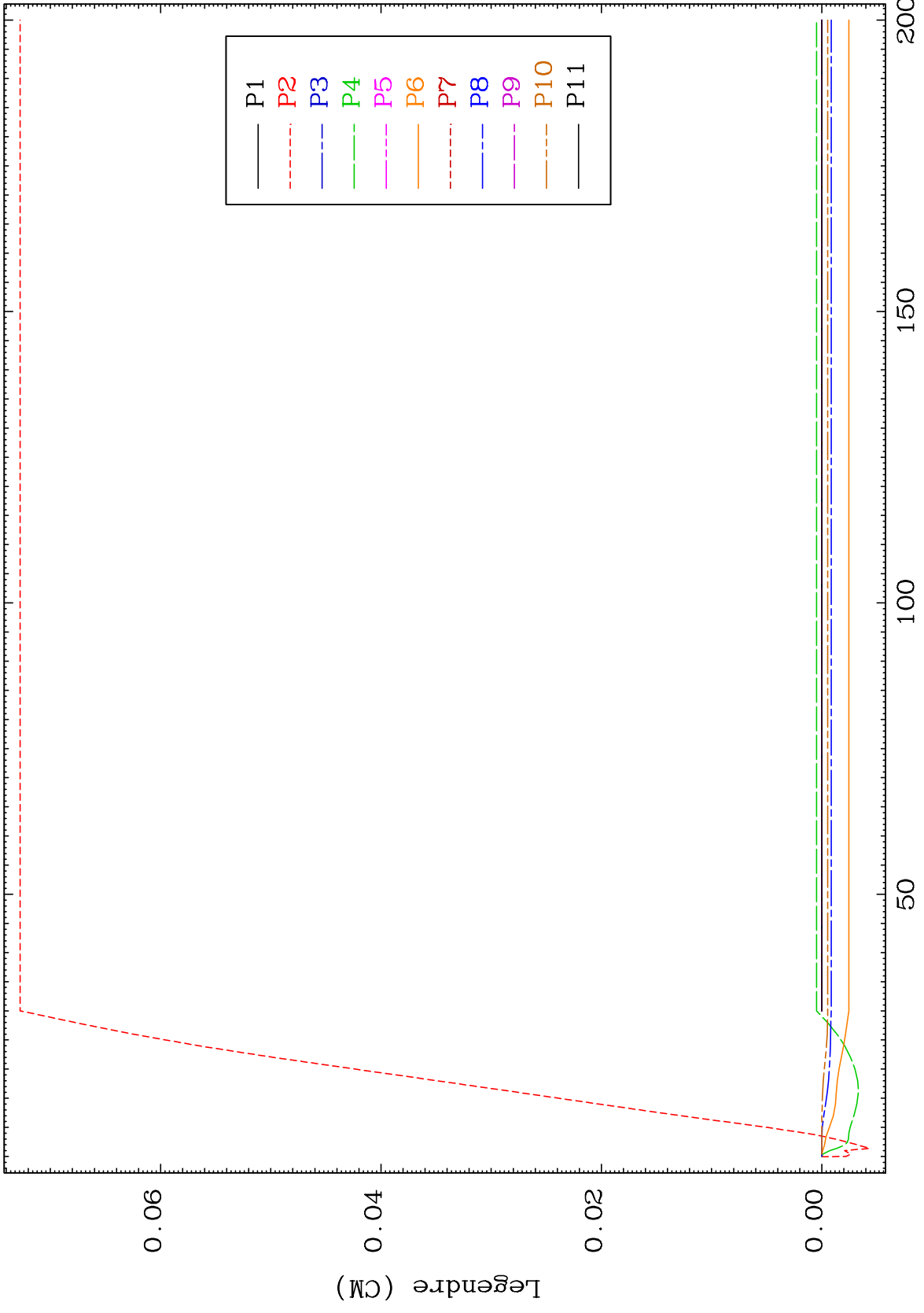

96 39-Y -94

MAT 3940 MT= 74 (n,n') Level Legendre Coefficients 39-Y -94

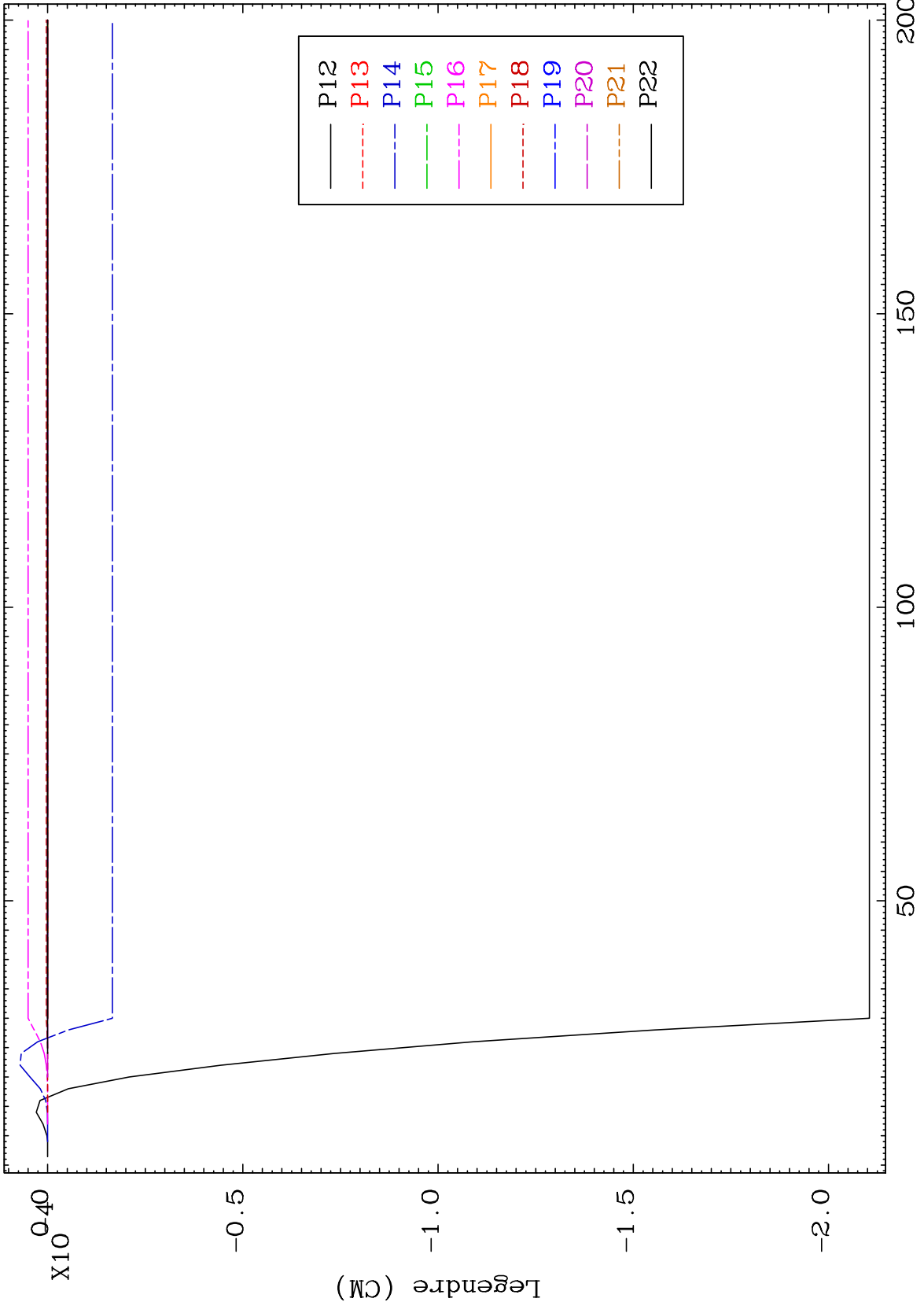

97 39-Y -94

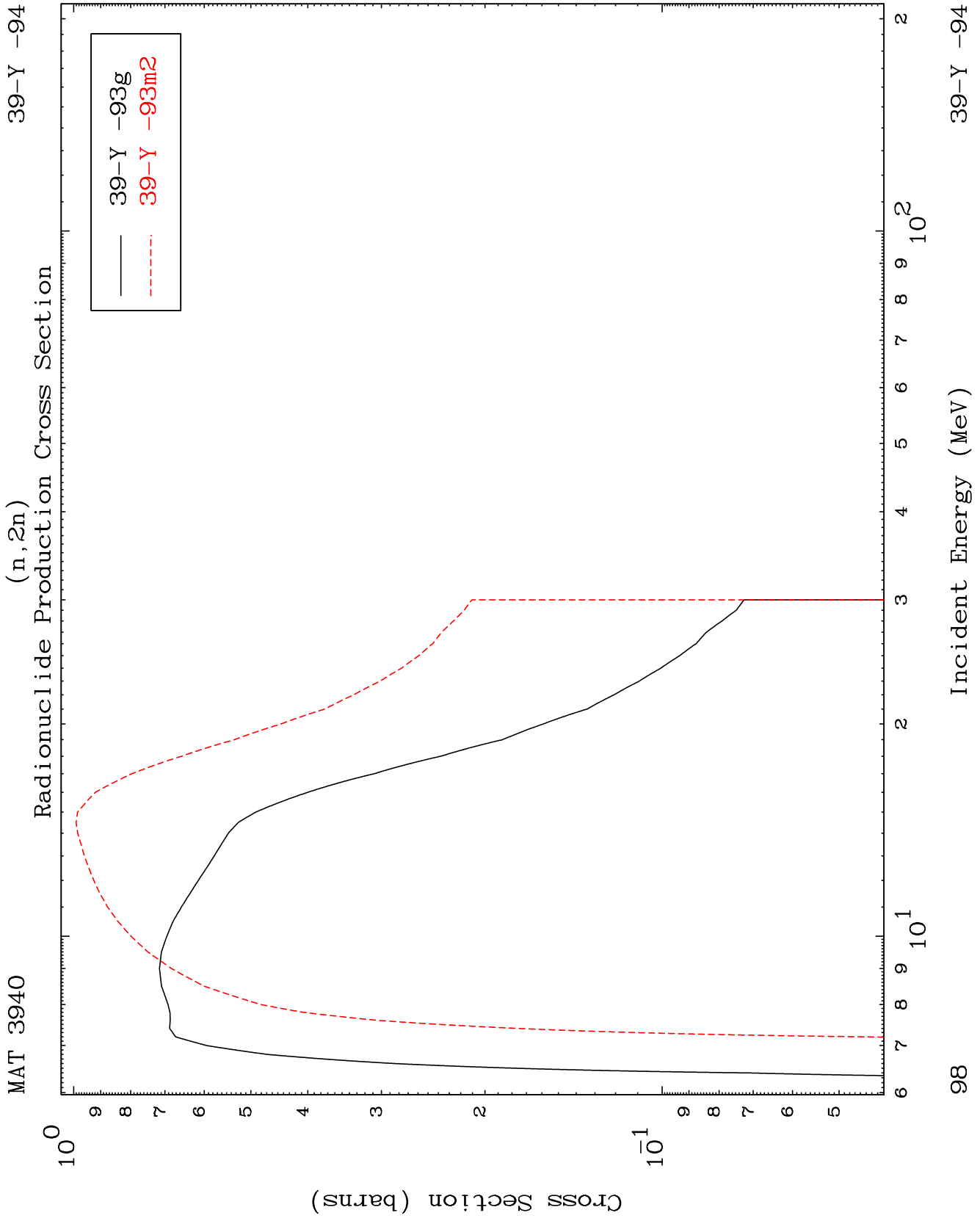

MAT 3940

(n,n') α

39-Y -94

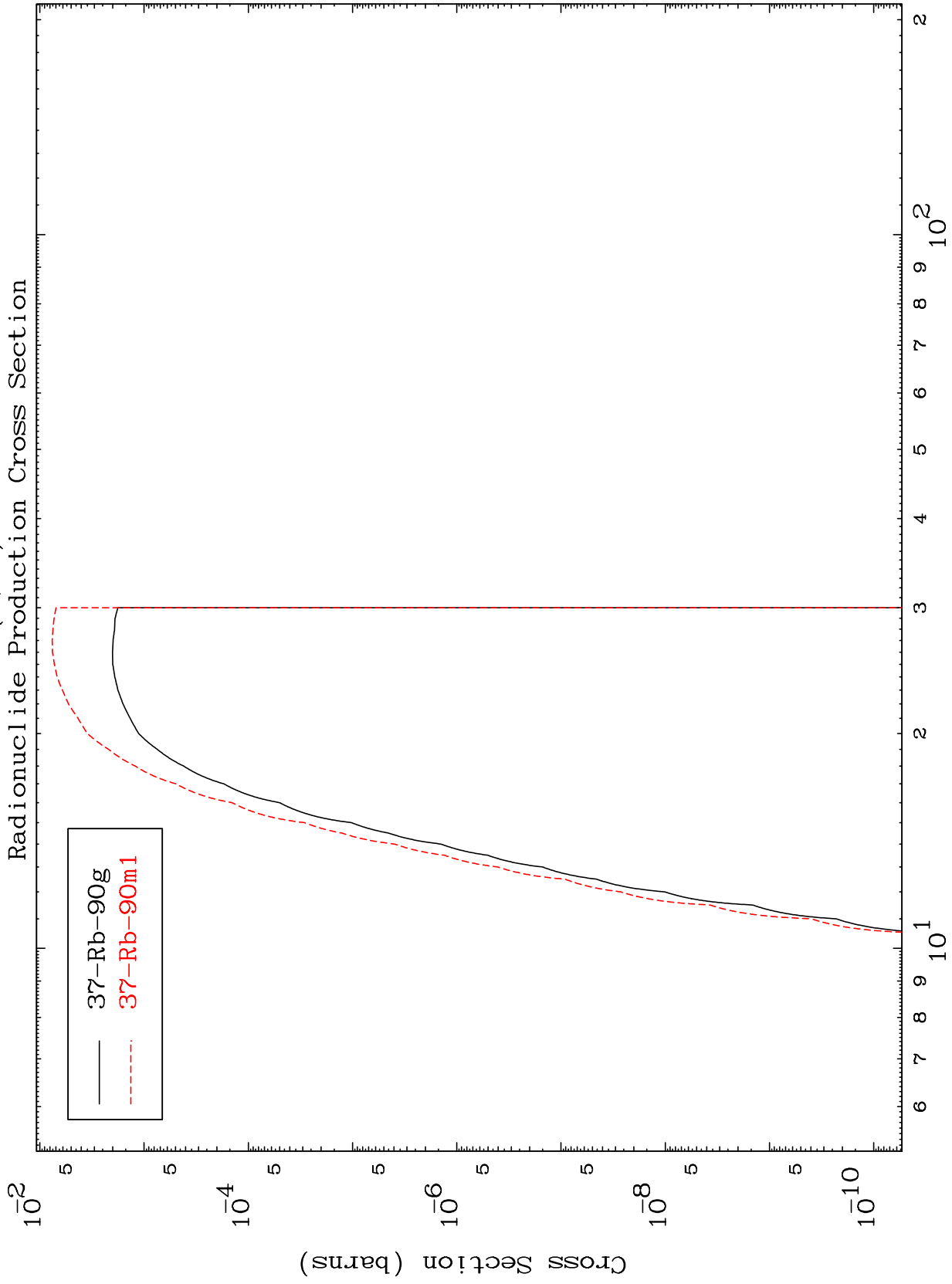

39-Y -94

Incident Energy (MeV)

99

MAT 3940 (n,4n) 39-Y -94

Radionuclide Production Cross Section

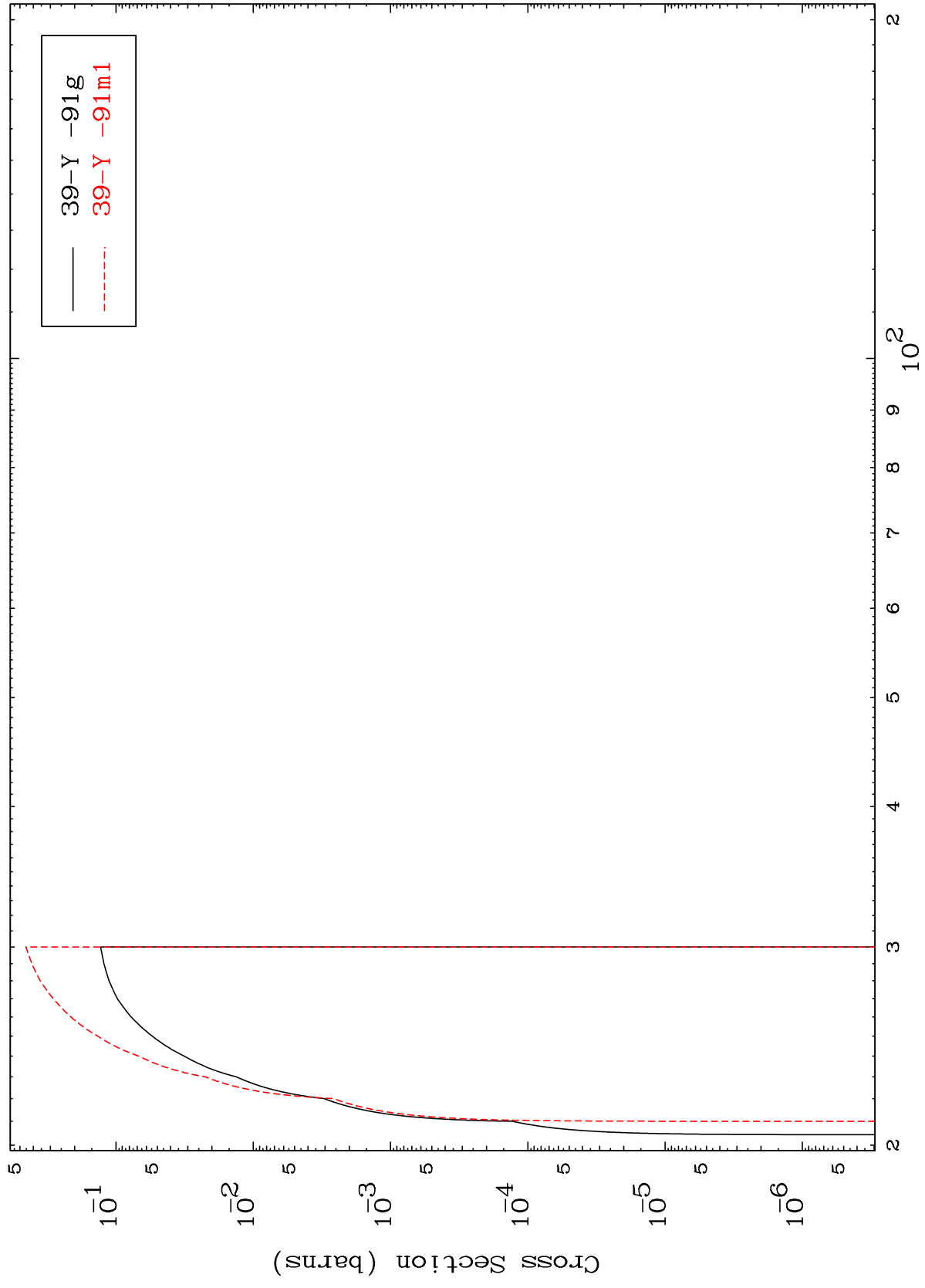

100 10² Incident Energy (MeV) 39-Y -94