

Y095 NEUTRON ACER TENDL-2019 LIBRARY; T=293.16K
Principal cross sections

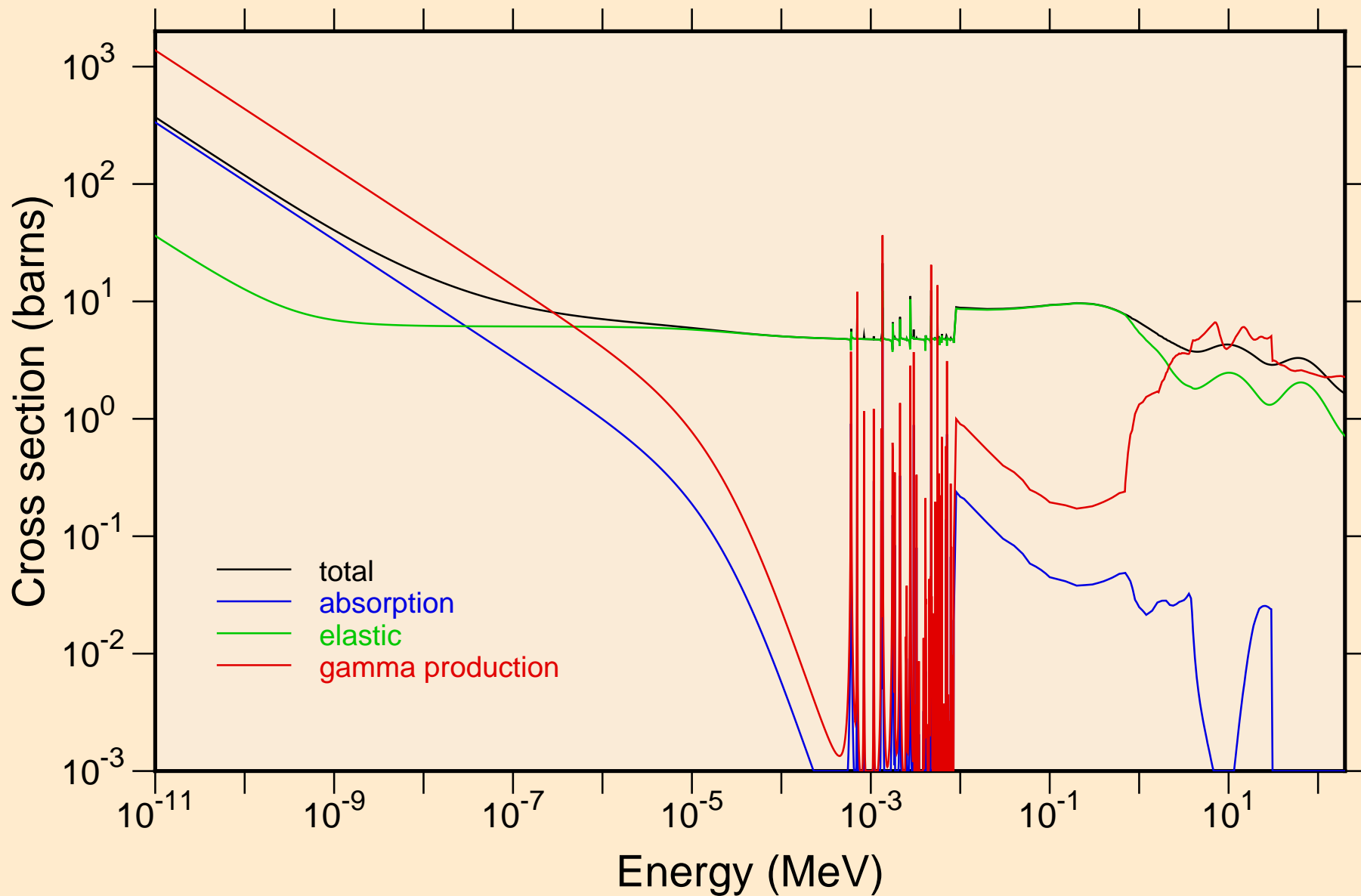

Y095 NEUTRON ACER TENDL-2019 LIBRARY; T=293.16K
resonance total cross section

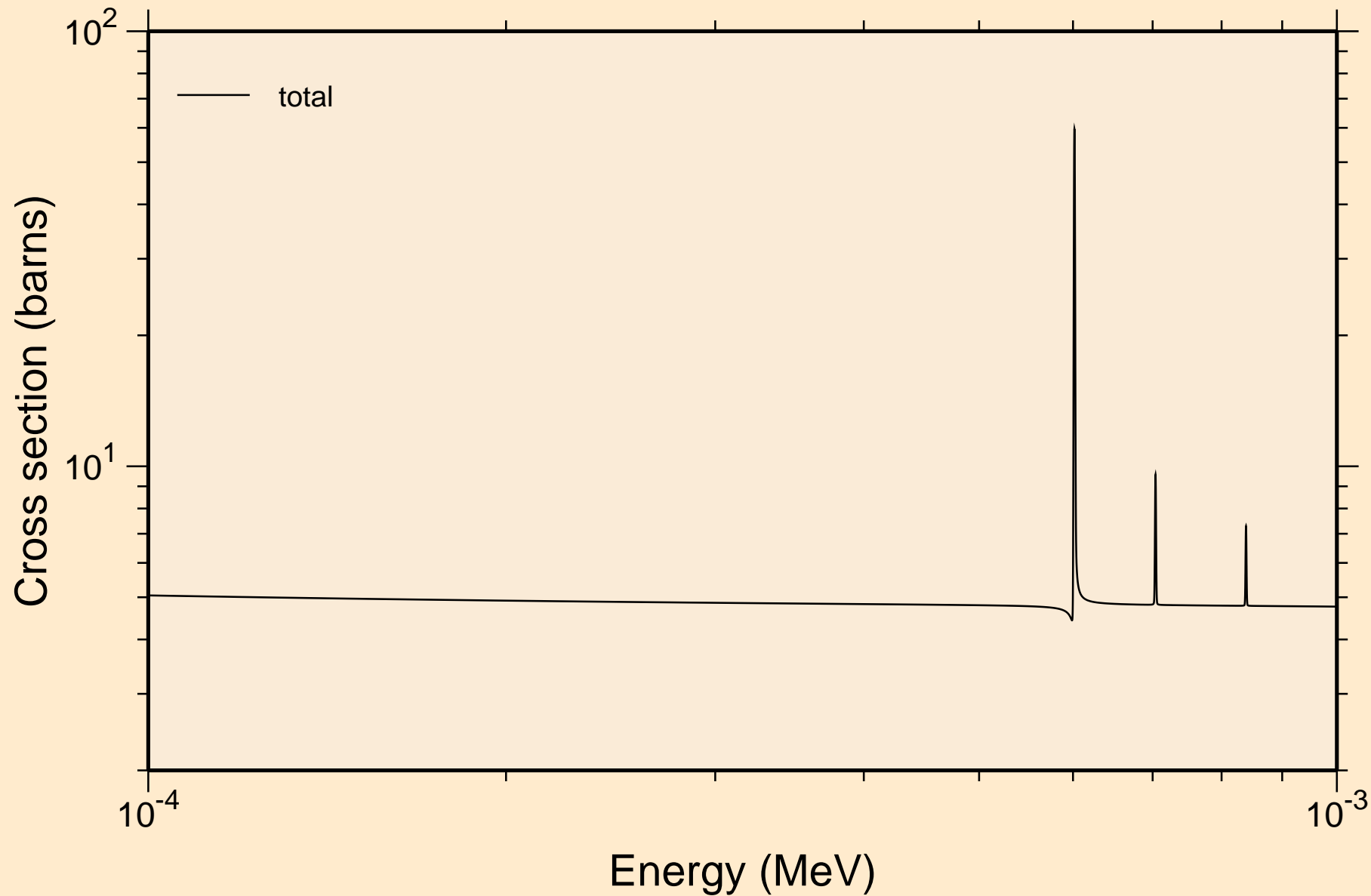

Y095 NEUTRON ACER TENDL-2019 LIBRARY; T=293.16K
resonance total cross section

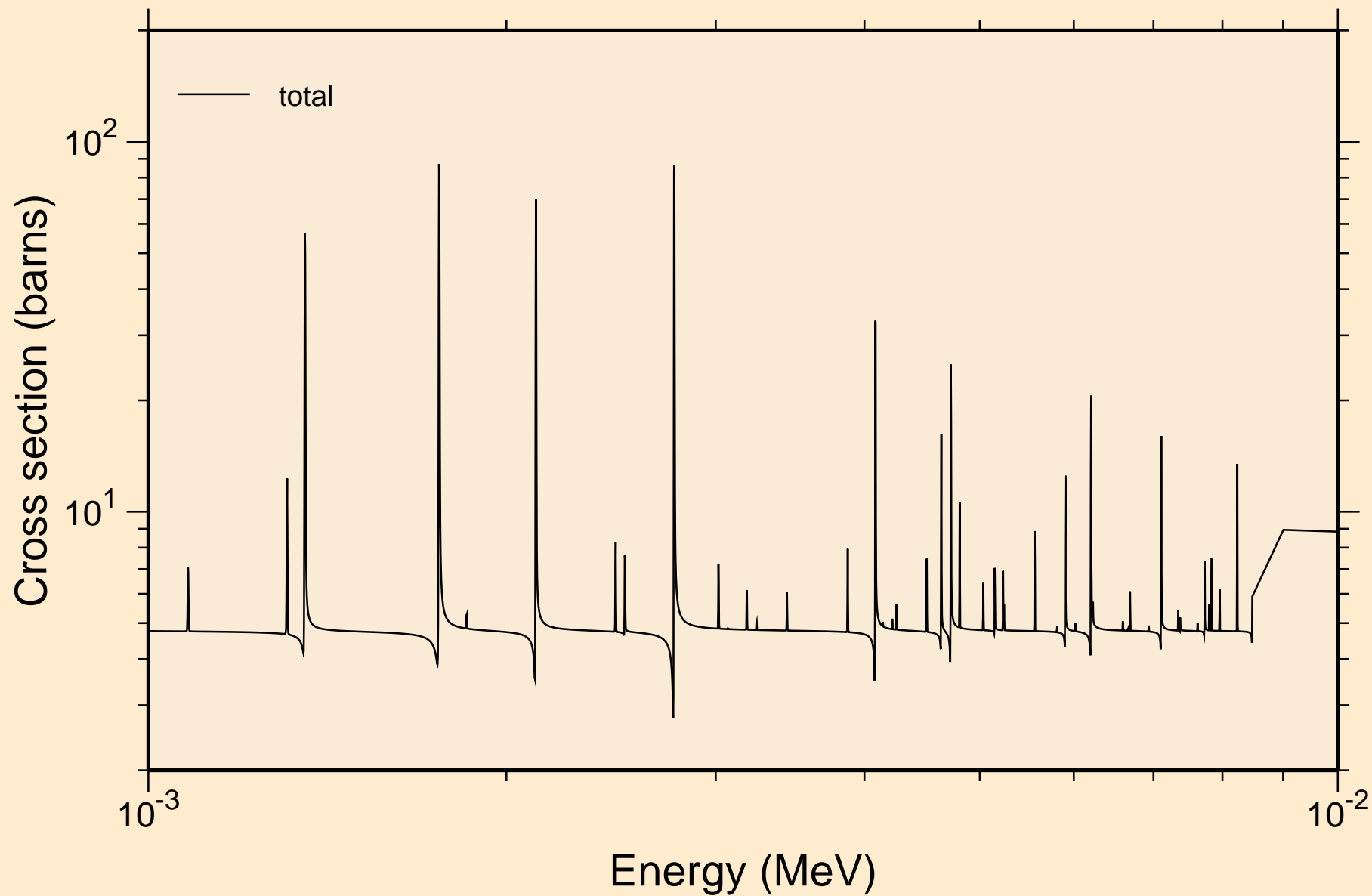

Y095 NEUTRON ACER TENDL-2019 LIBRARY; T=293.16K
resonance total cross section

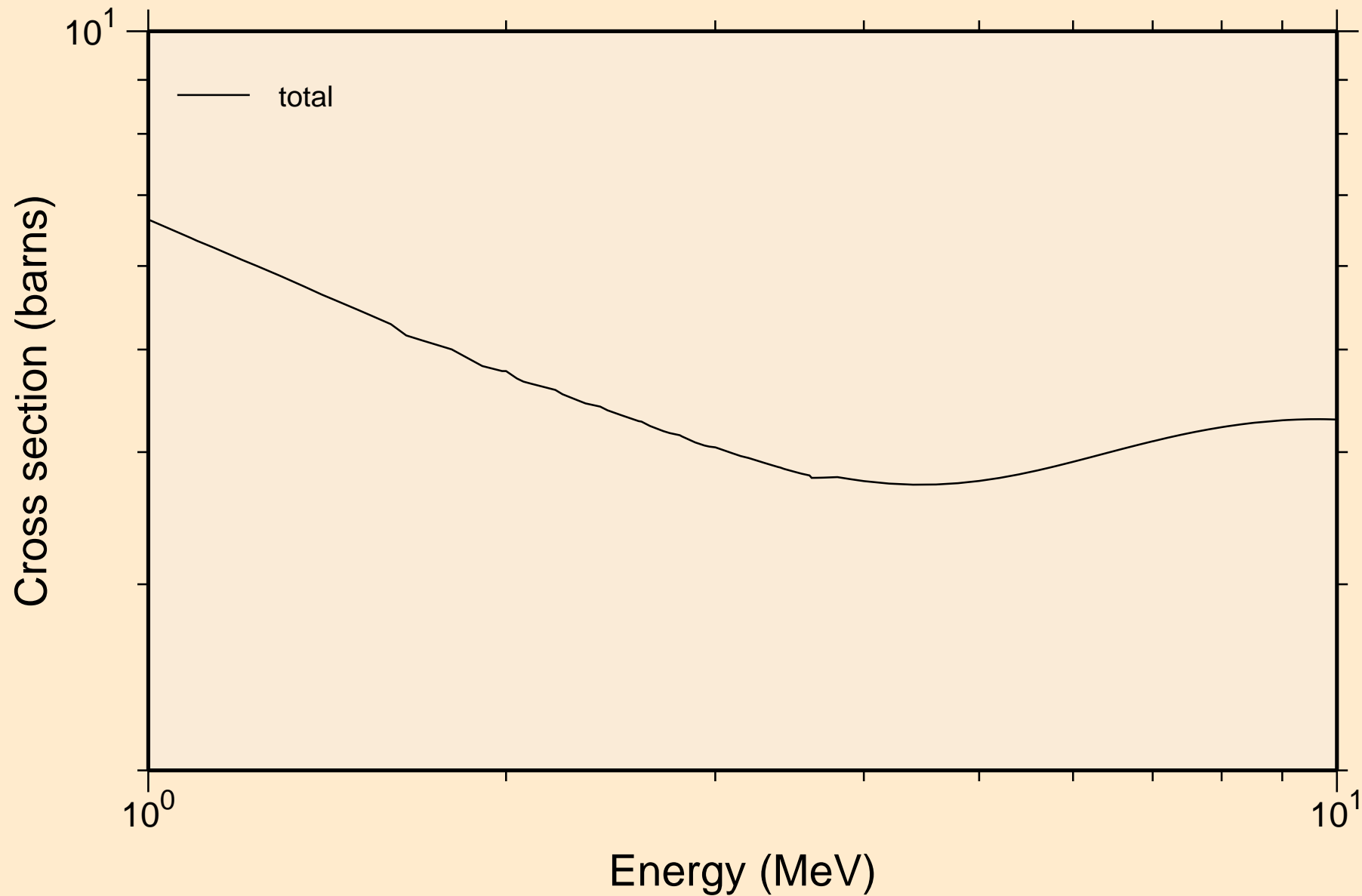

Y095 NEUTRON ACER TENDL-2019 LIBRARY; T=293.16K
resonance absorption cross sections

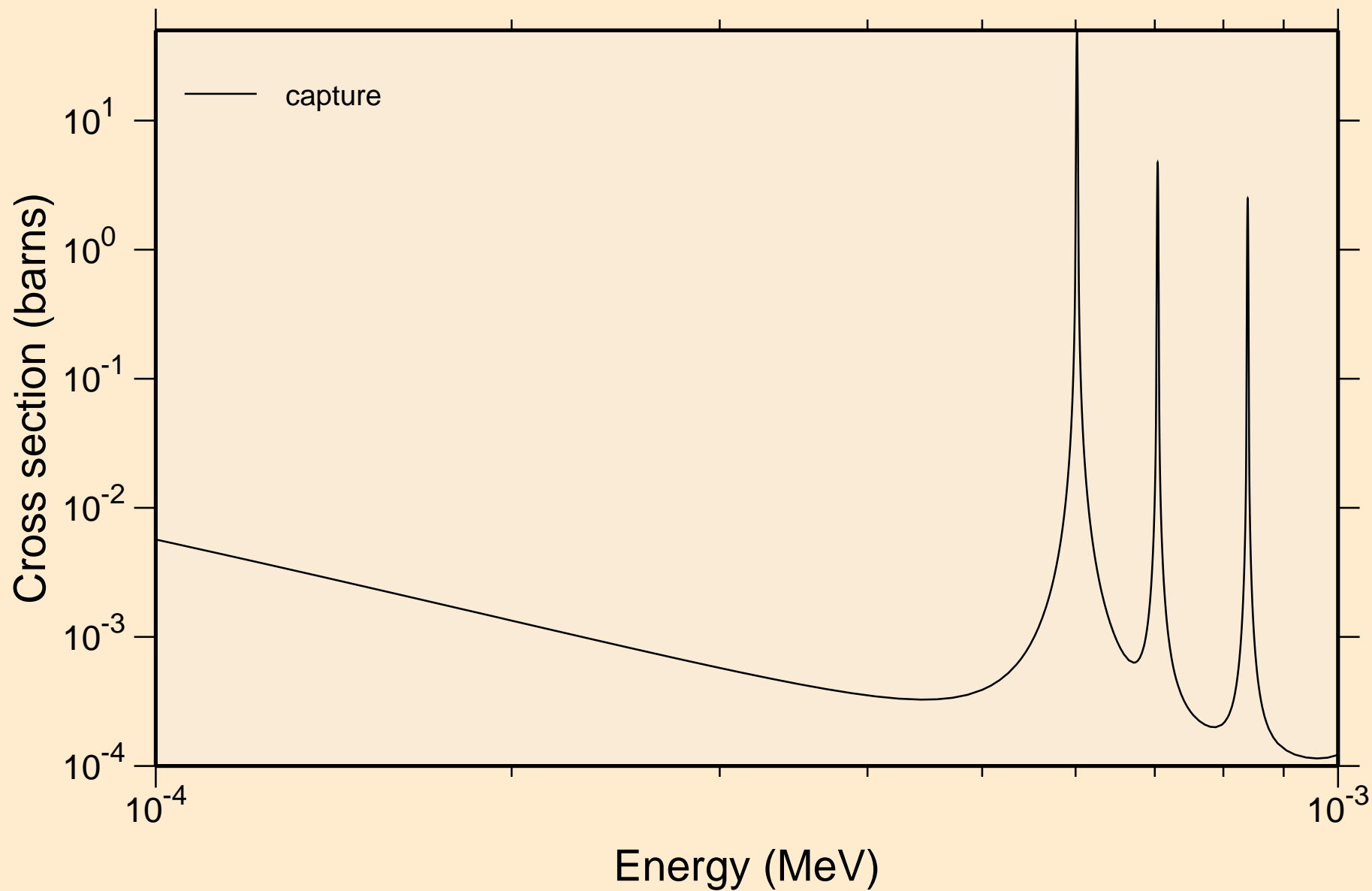

Y095 NEUTRON ACER TENDL-2019 LIBRARY; T=293.16K
resonance absorption cross sections

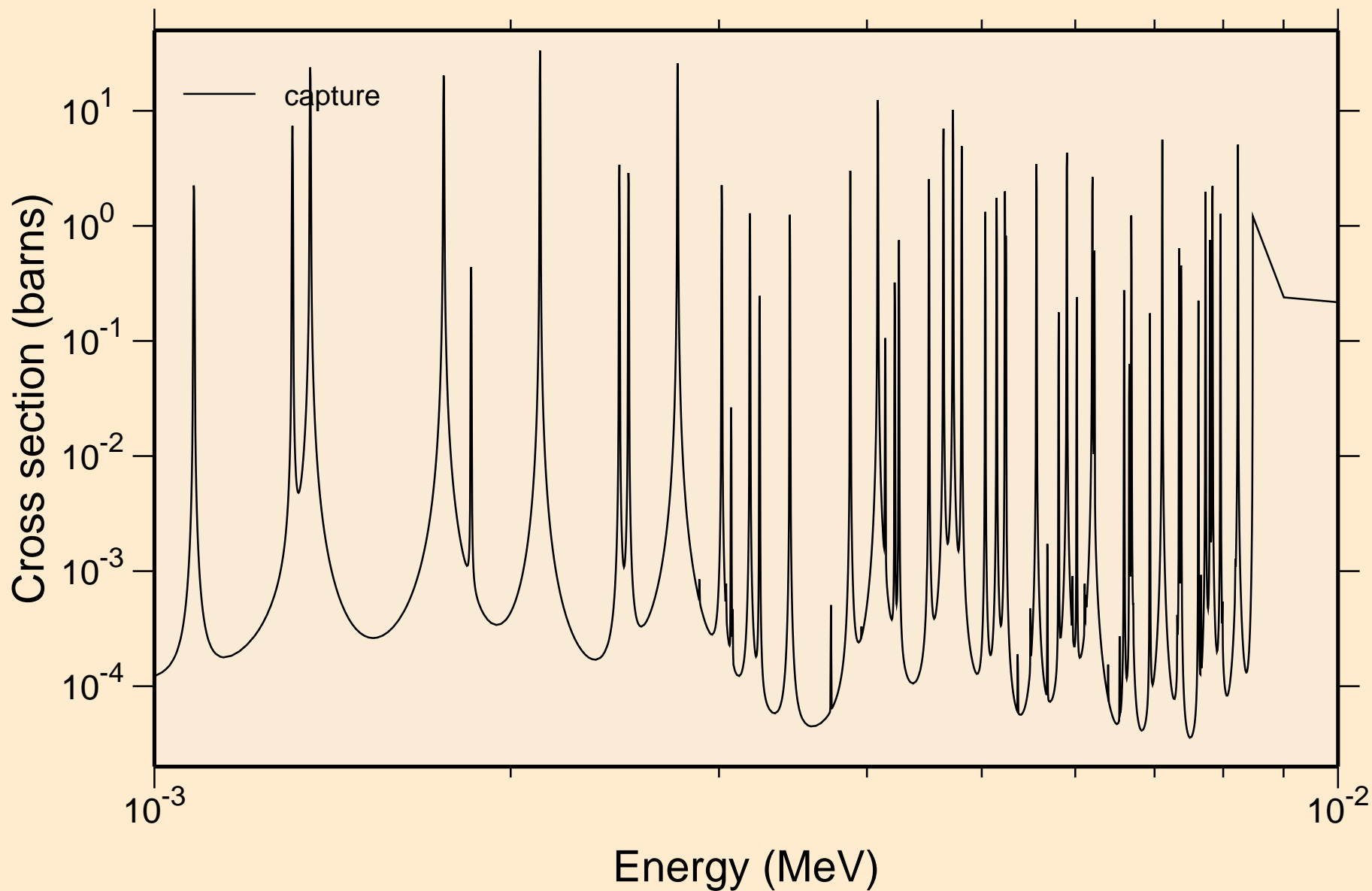

Y095 NEUTRON ACER TENDL-2019 LIBRARY; T=293.16K
resonance absorption cross sections

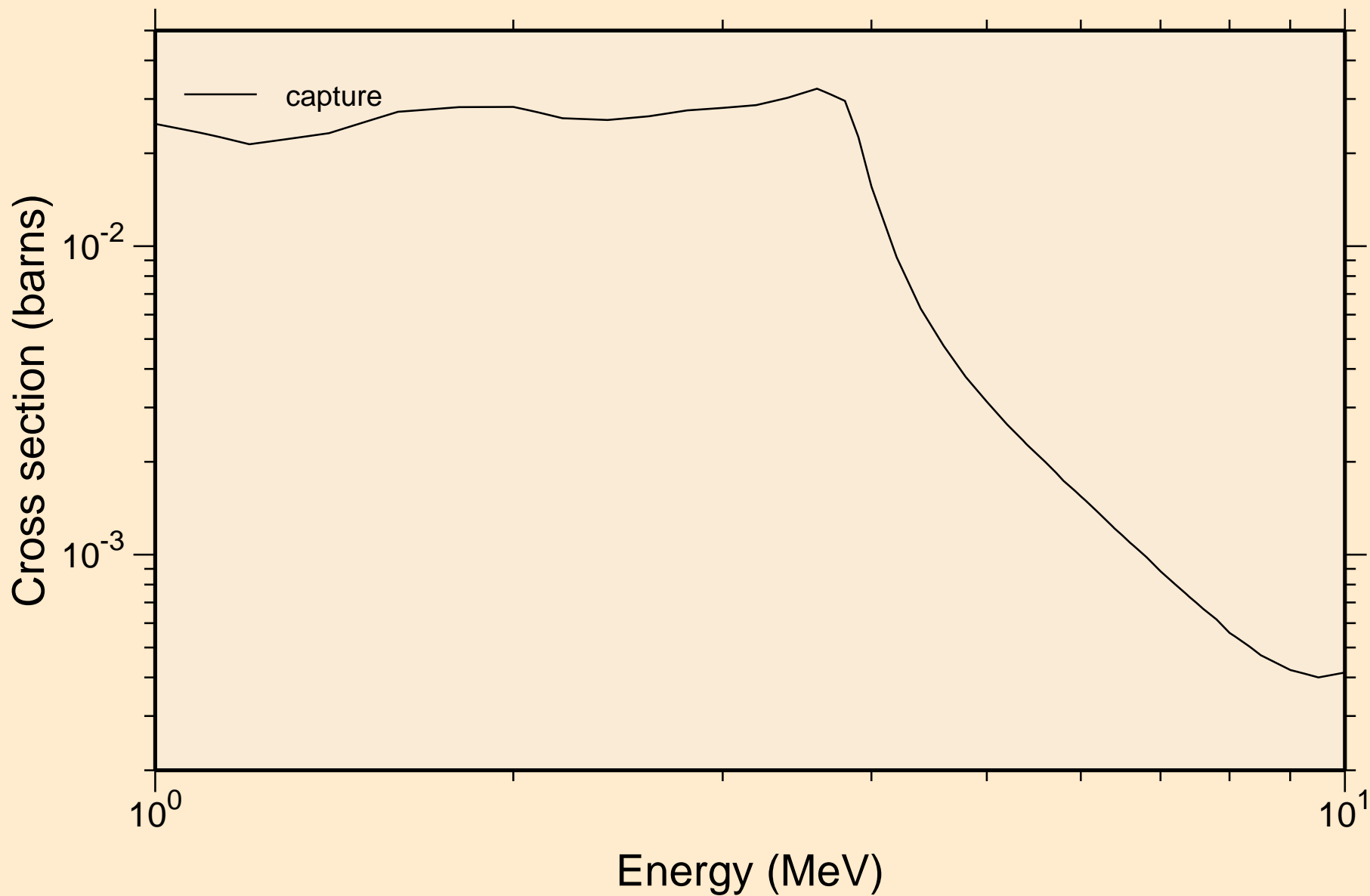

Y095 NEUTRON ACER TENDL-2019 LIBRARY; T=293.16K
Heating

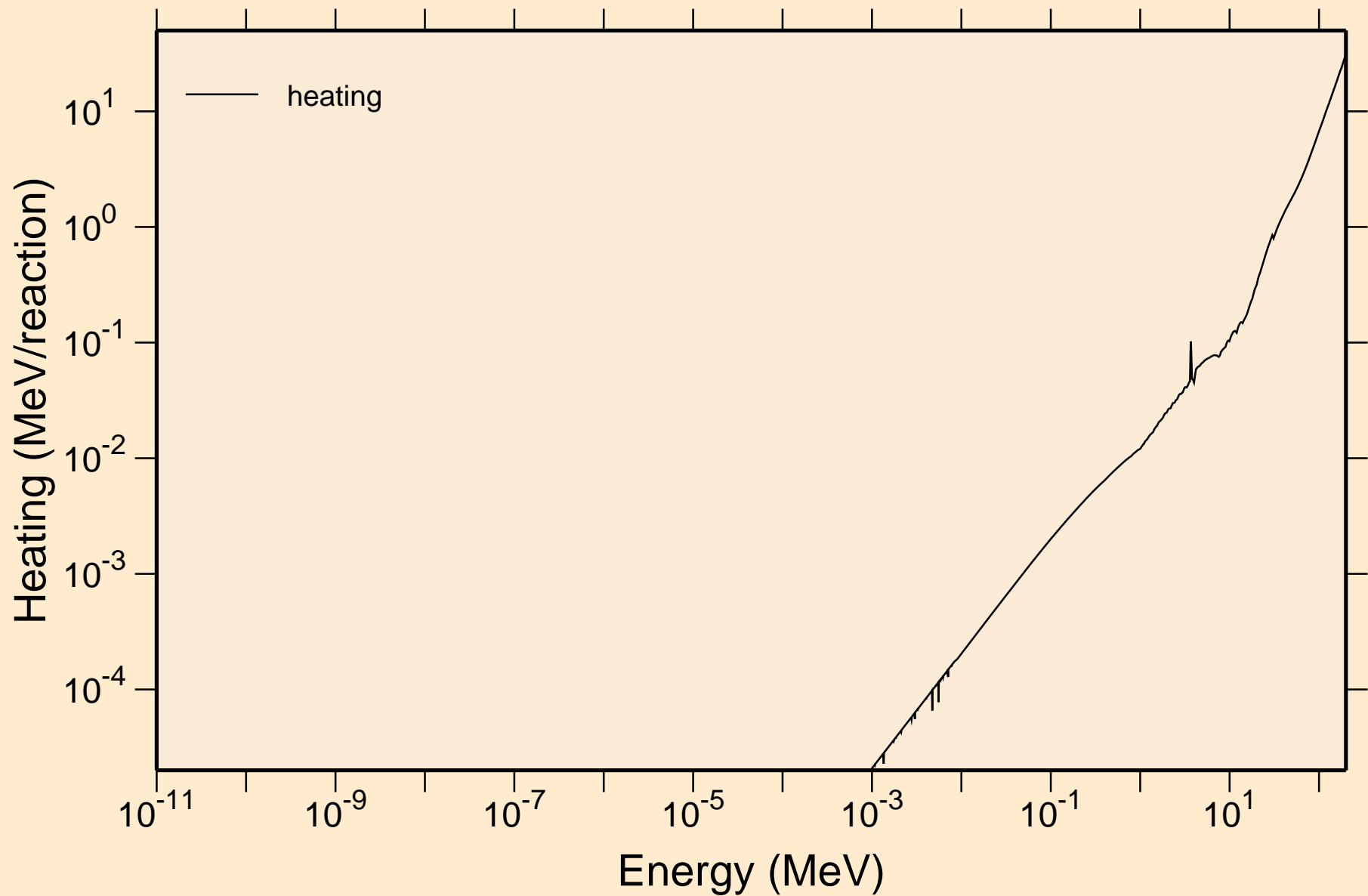

Y095 NEUTRON ACER TENDL-2019 LIBRARY; T=293.16K
Damage

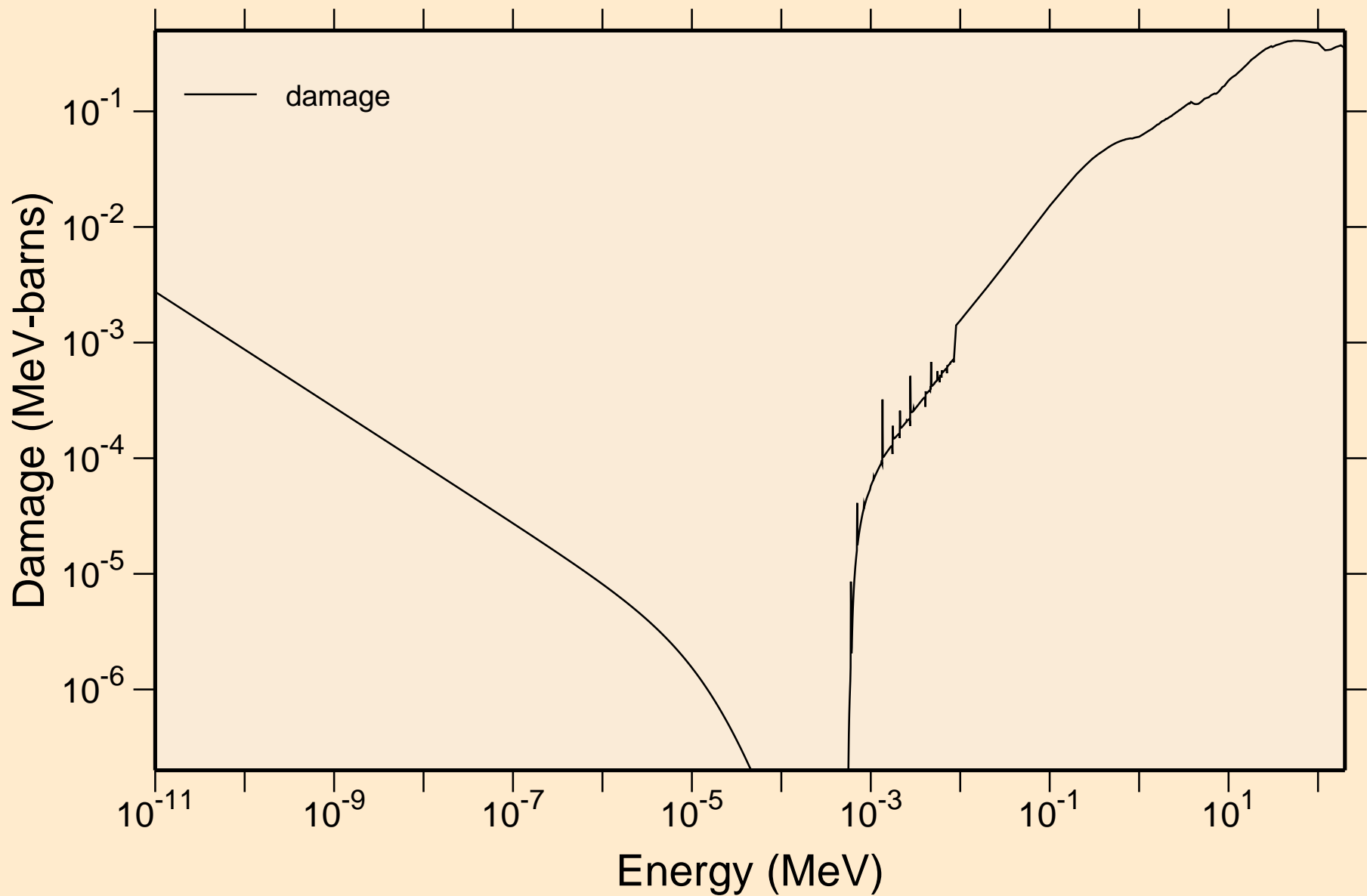

Y095 NEUTRON ACER TENDL-2019 LIBRARY; T=293.16K
Non-threshold reactions

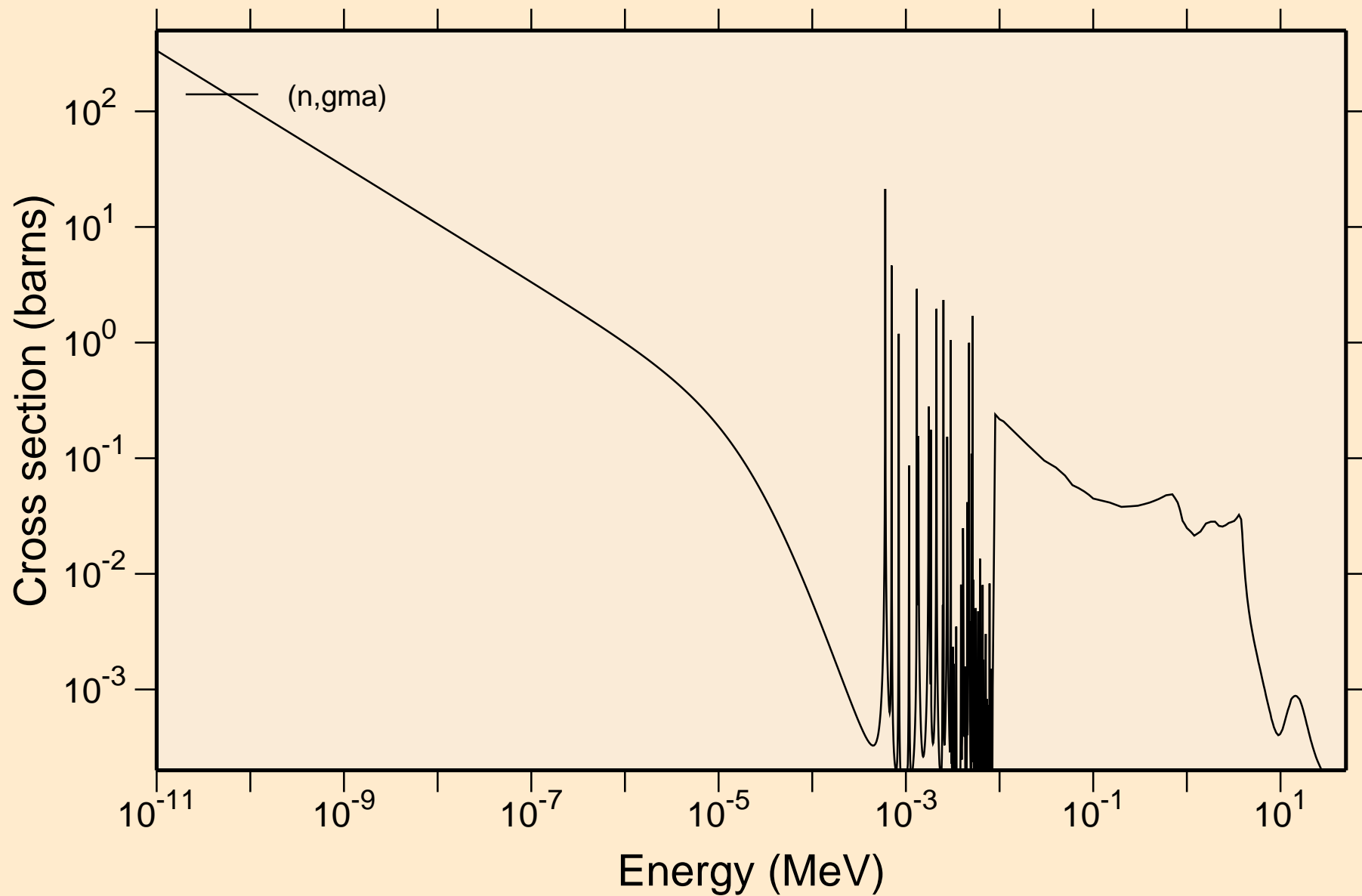

Y095 NEUTRON ACER TENDL-2019 LIBRARY; T=293.16K
Principal cross sections

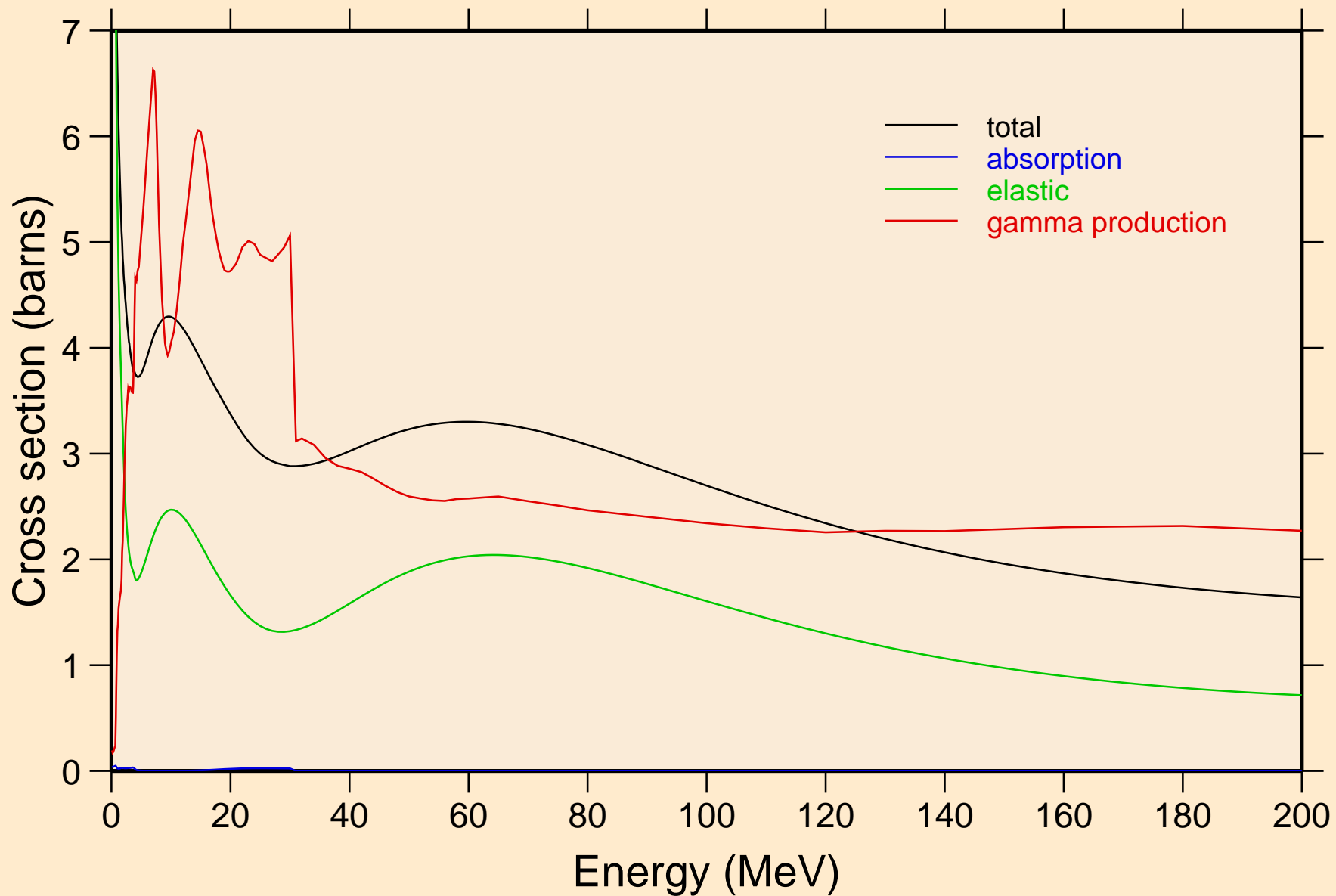

Y095 NEUTRON ACER TENDL-2019 LIBRARY; T=293.16K
Heating

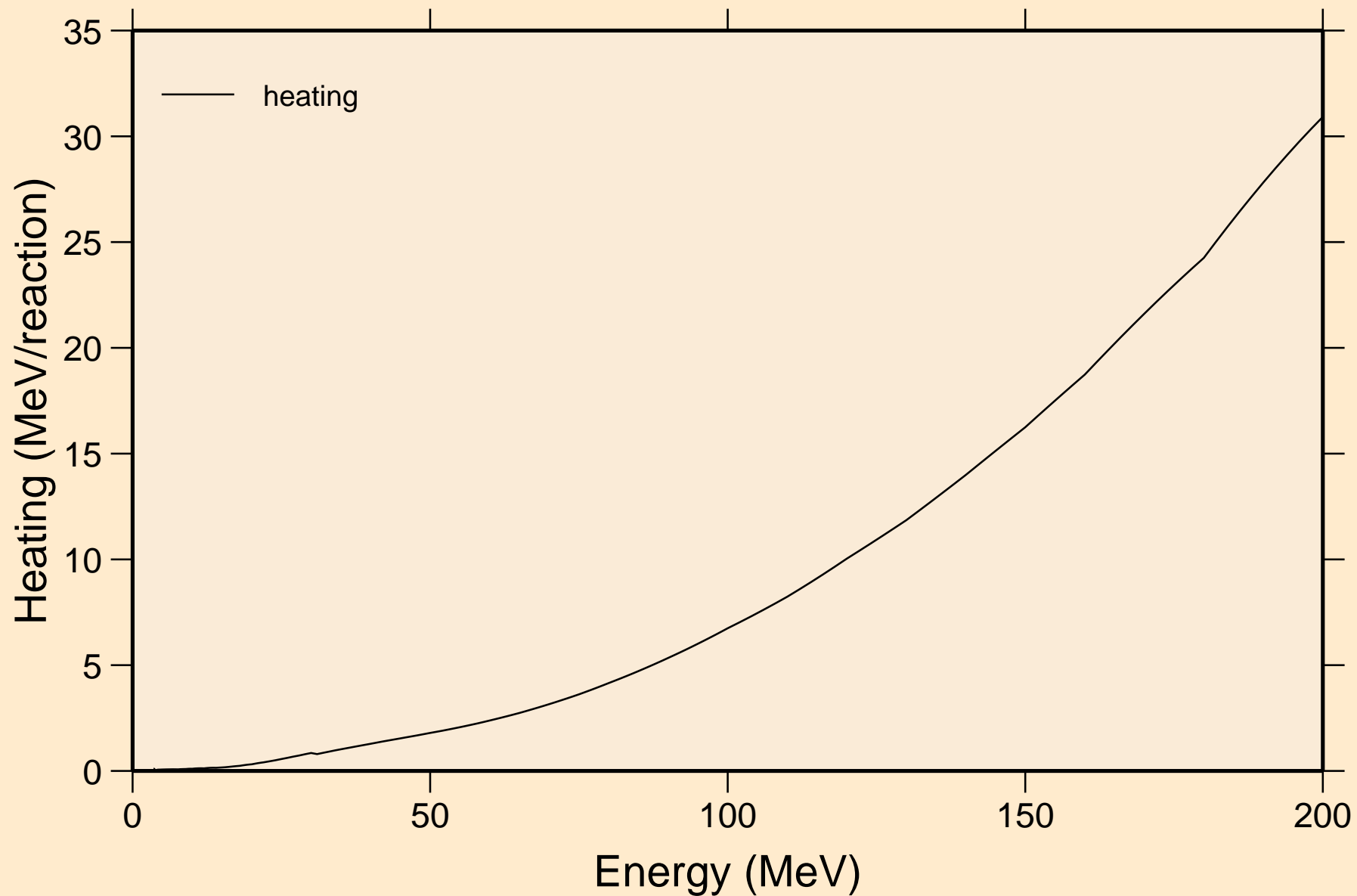

Y095 NEUTRON ACER TENDL-2019 LIBRARY; T=293.16K
Damage

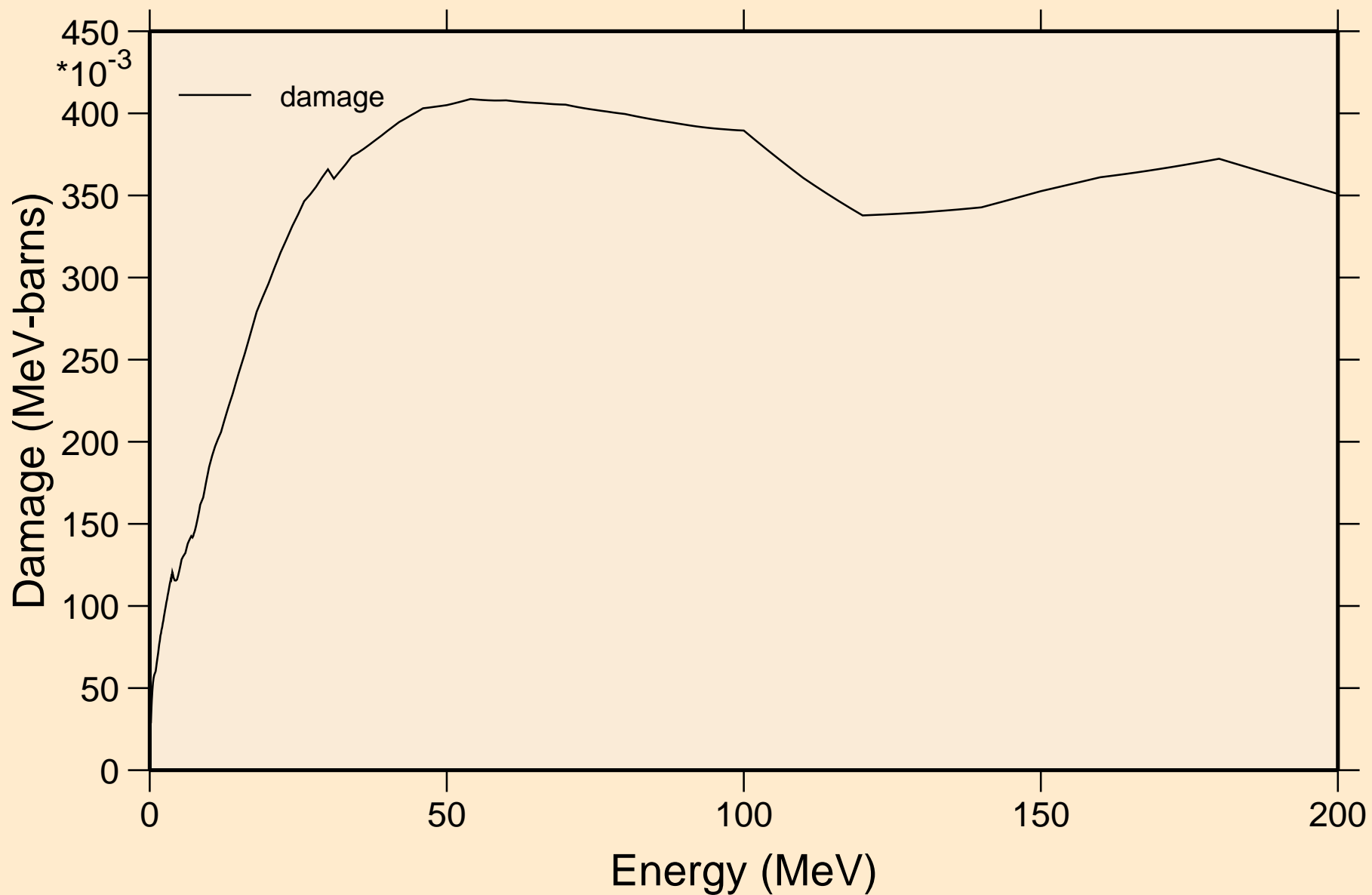

Y095 NEUTRON ACER TENDL-2019 LIBRARY; T=293.16K
Non-threshold reactions

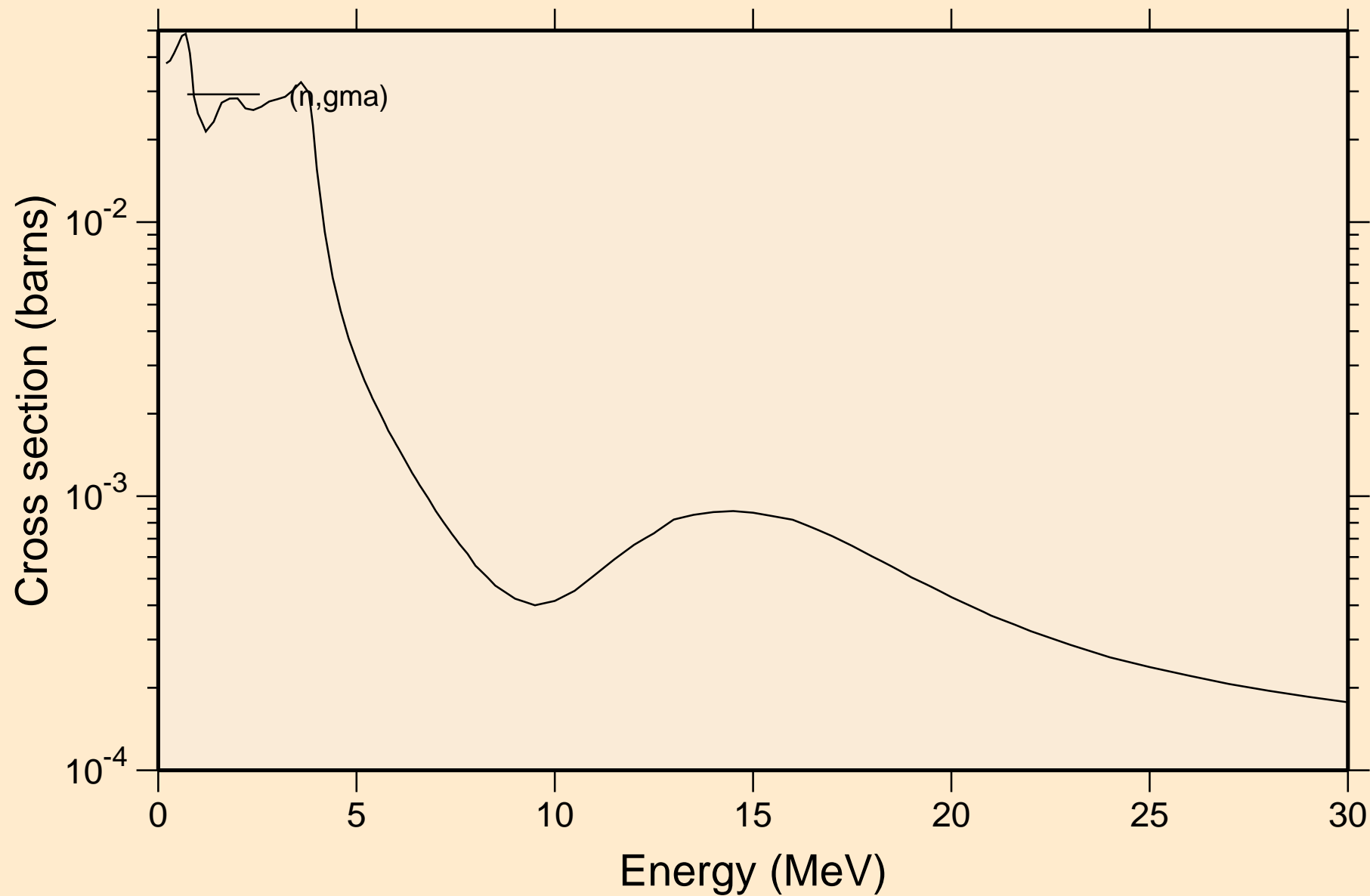

Y095 NEUTRON ACER TENDL-2019 LIBRARY; T=293.16K
Inelastic levels

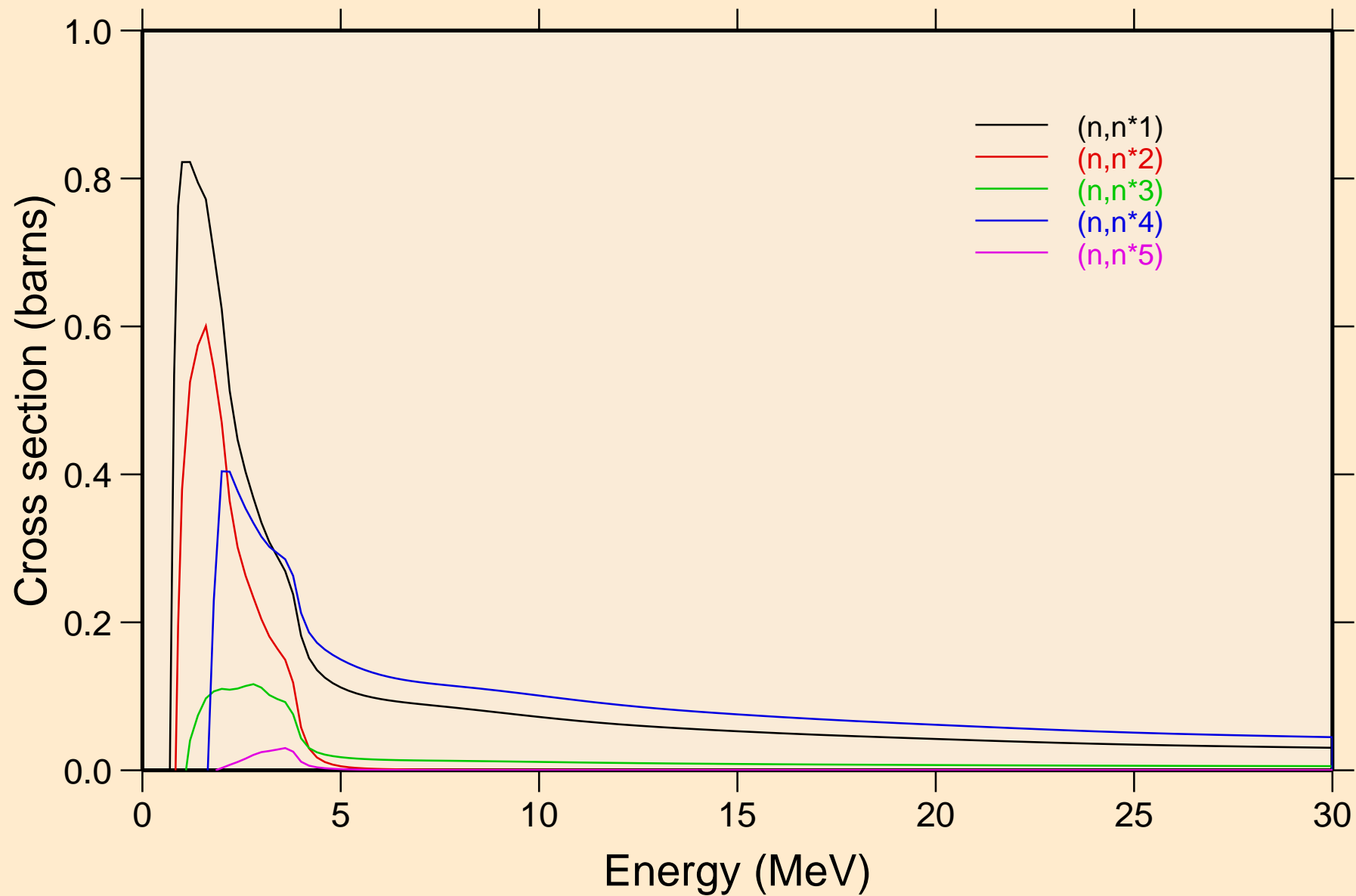

Y095 NEUTRON ACER TENDL-2019 LIBRARY; T=293.16K
Inelastic levels

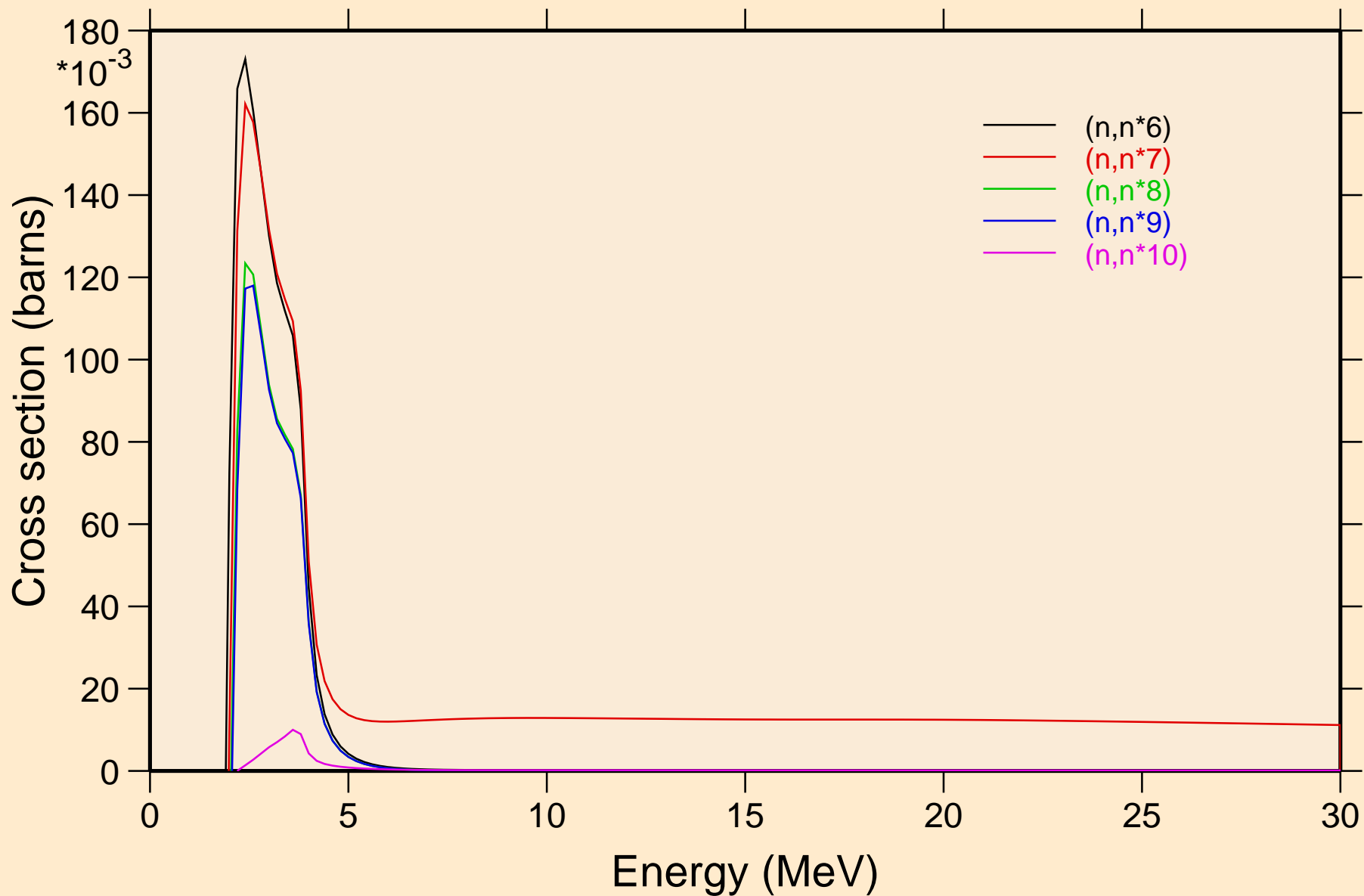

Y095 NEUTRON ACER TENDL-2019 LIBRARY; T=293.16K
Inelastic levels

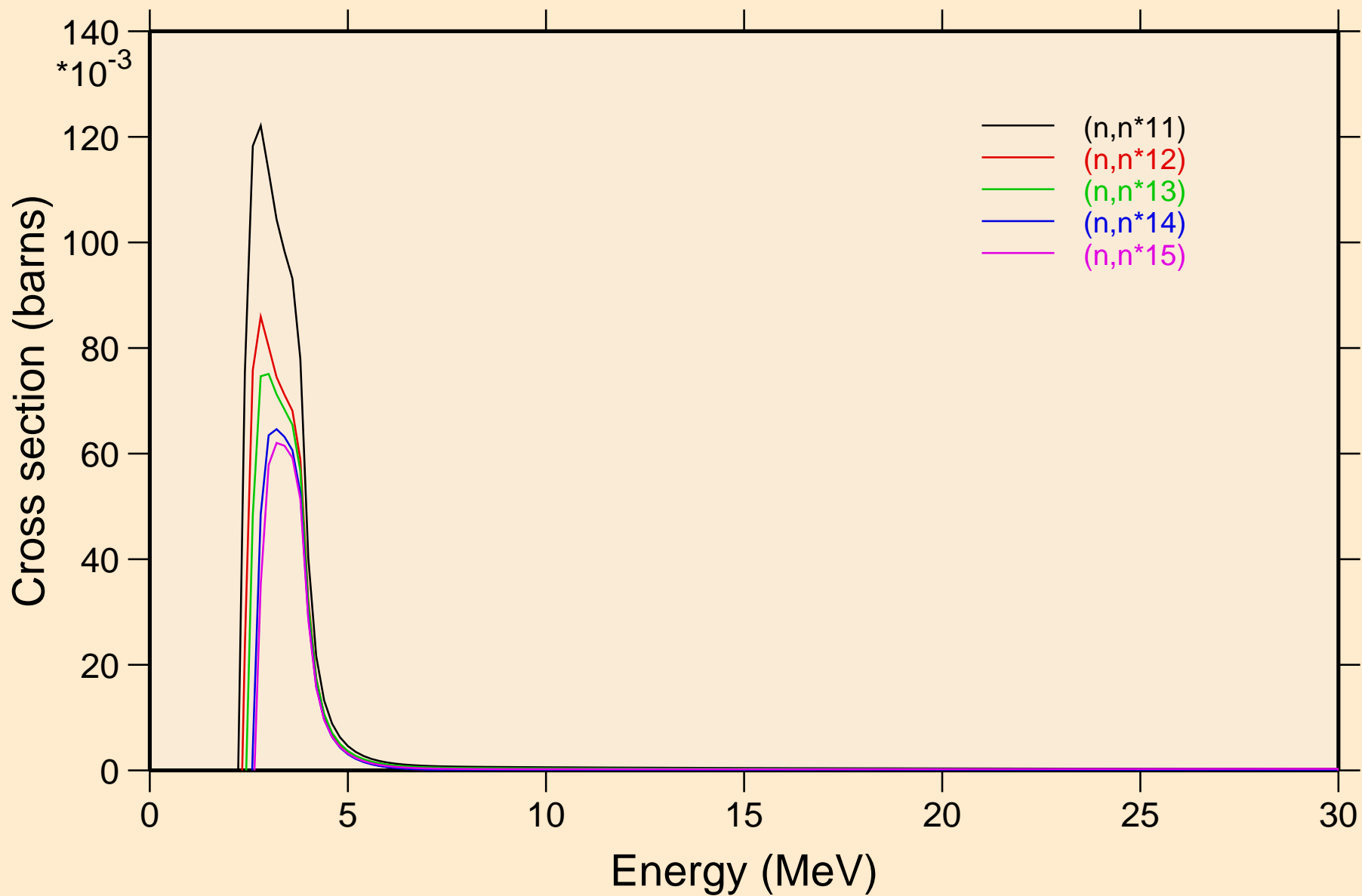

Y095 NEUTRON ACER TENDL-2019 LIBRARY; T=293.16K
Inelastic levels

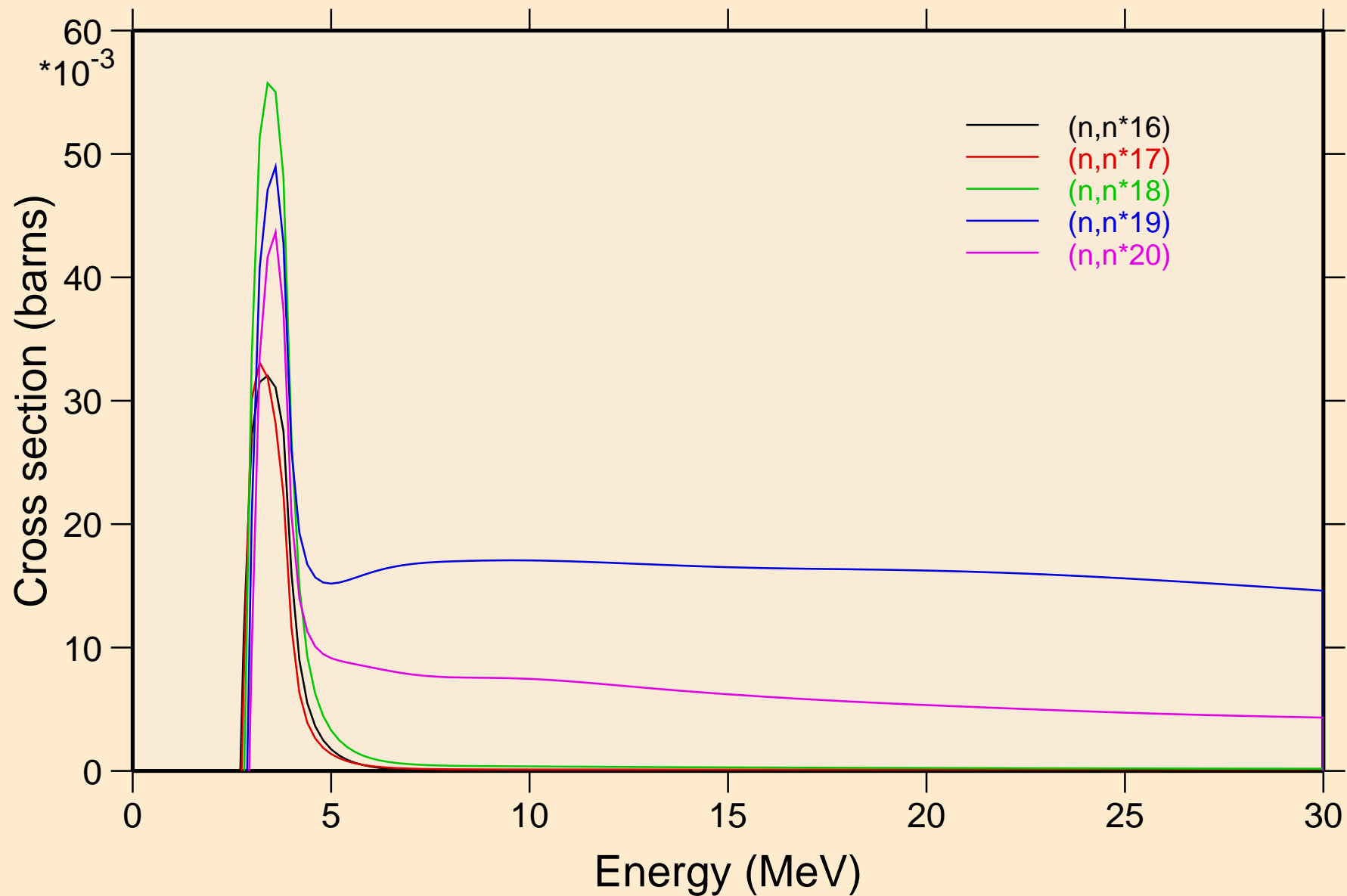

Y095 NEUTRON ACER TENDL-2019 LIBRARY; T=293.16K
Inelastic levels

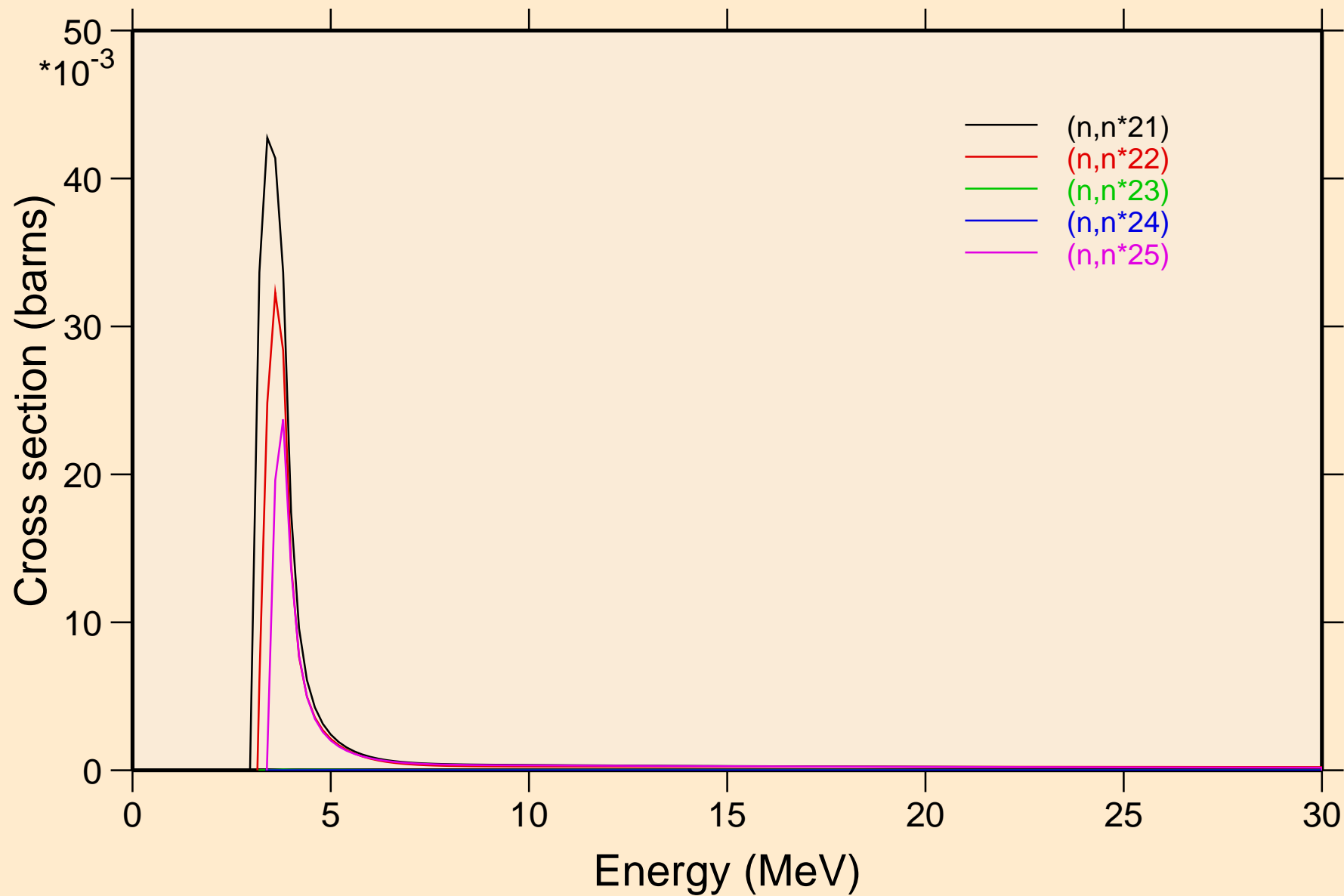

Y095 NEUTRON ACER TENDL-2019 LIBRARY; T=293.16K
Inelastic levels

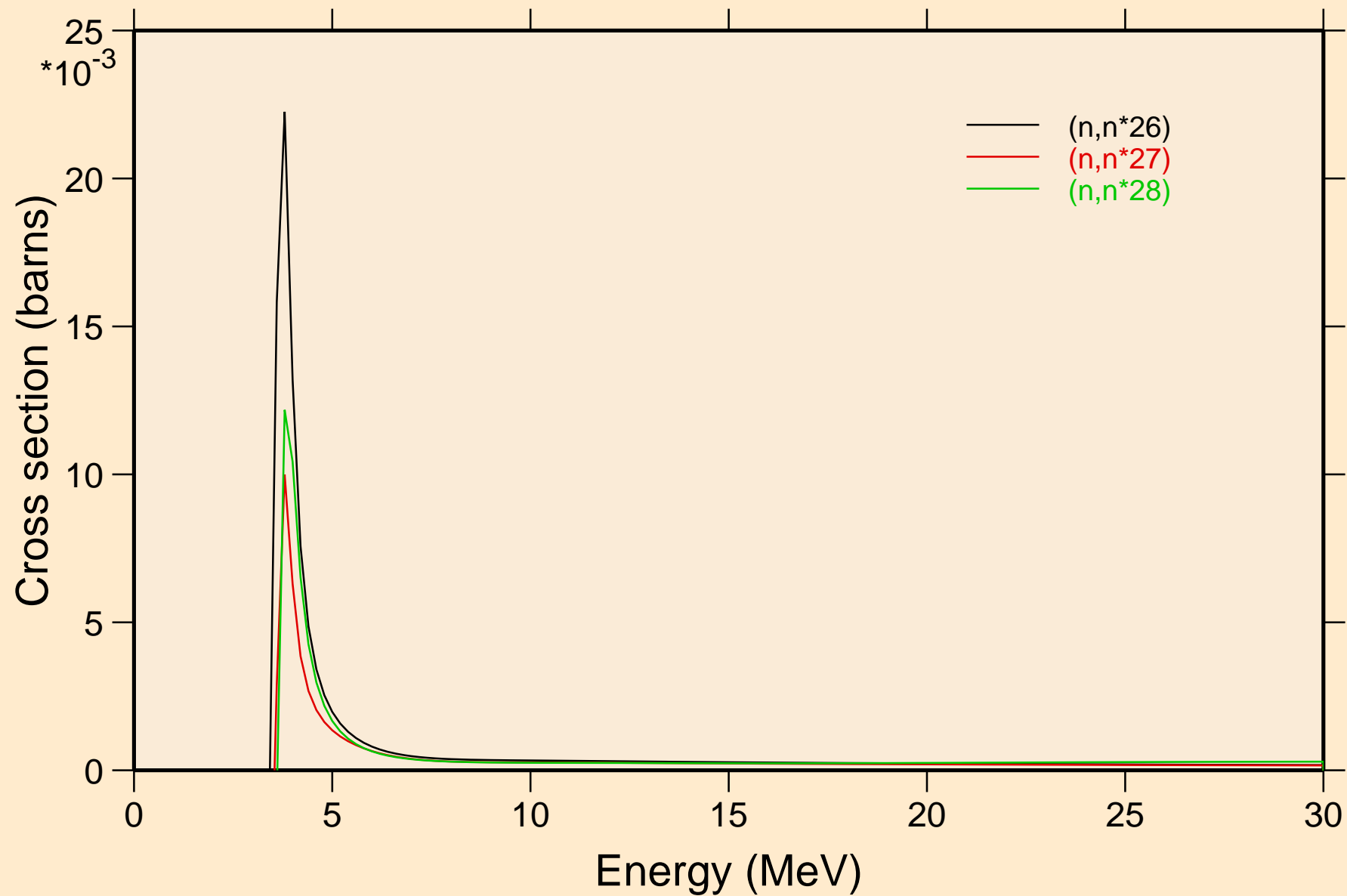

Y095 NEUTRON ACER TENDL-2019 LIBRARY; T=293.16K
Threshold reactions

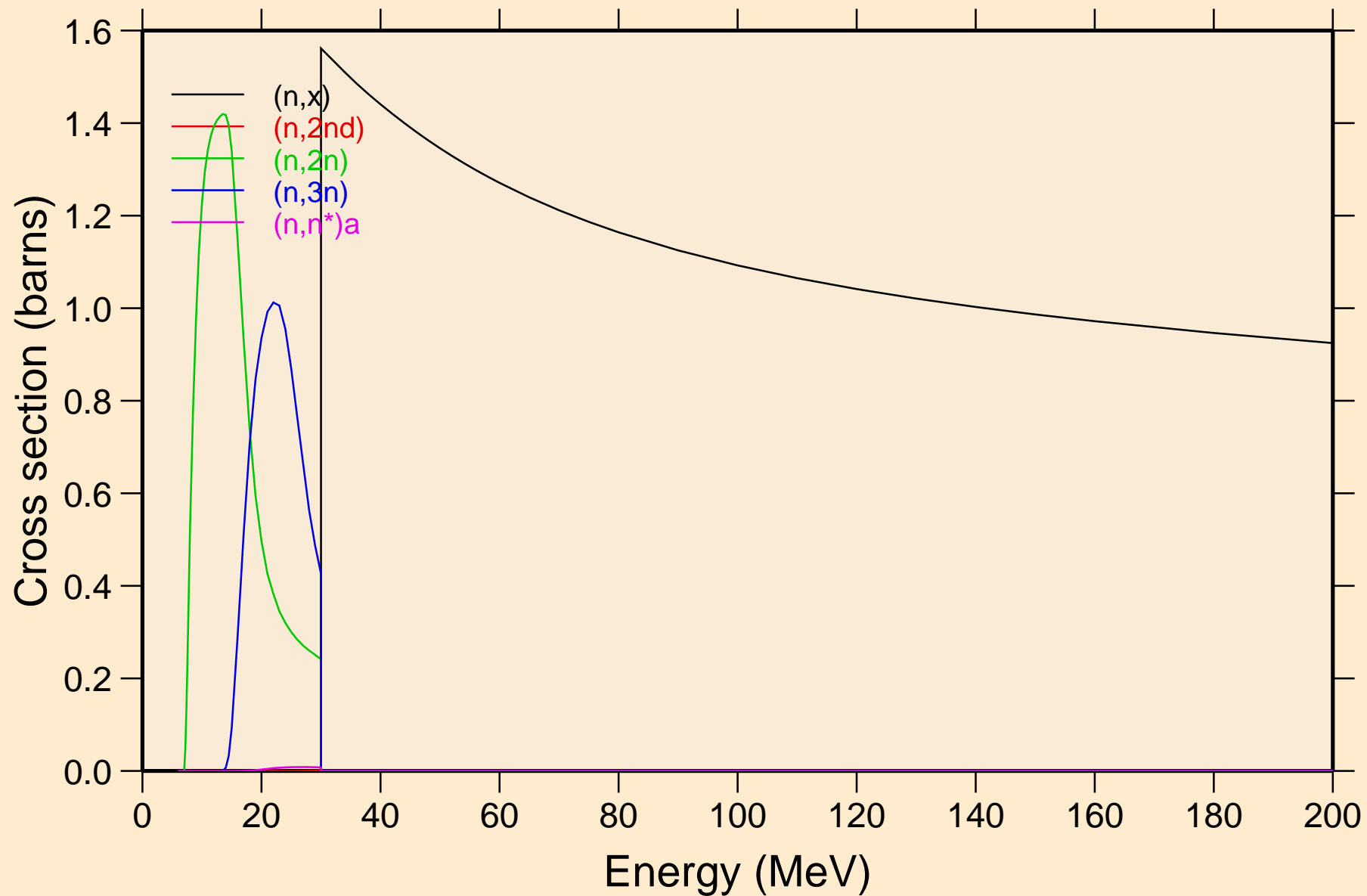

Y095 NEUTRON ACER TENDL-2019 LIBRARY; T=293.16K
Threshold reactions

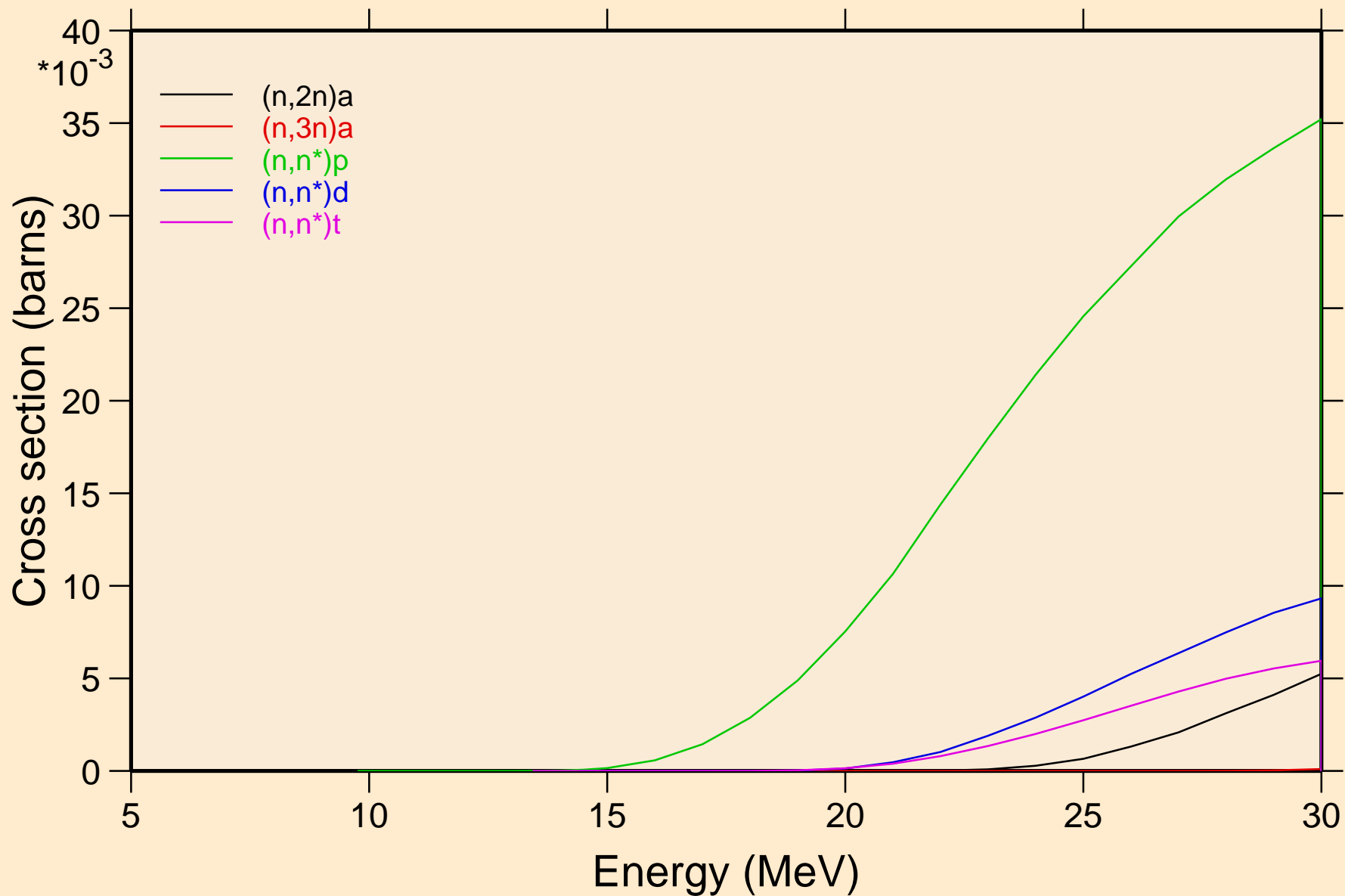

Y095 NEUTRON ACER TENDL-2019 LIBRARY; T=293.16K
Threshold reactions

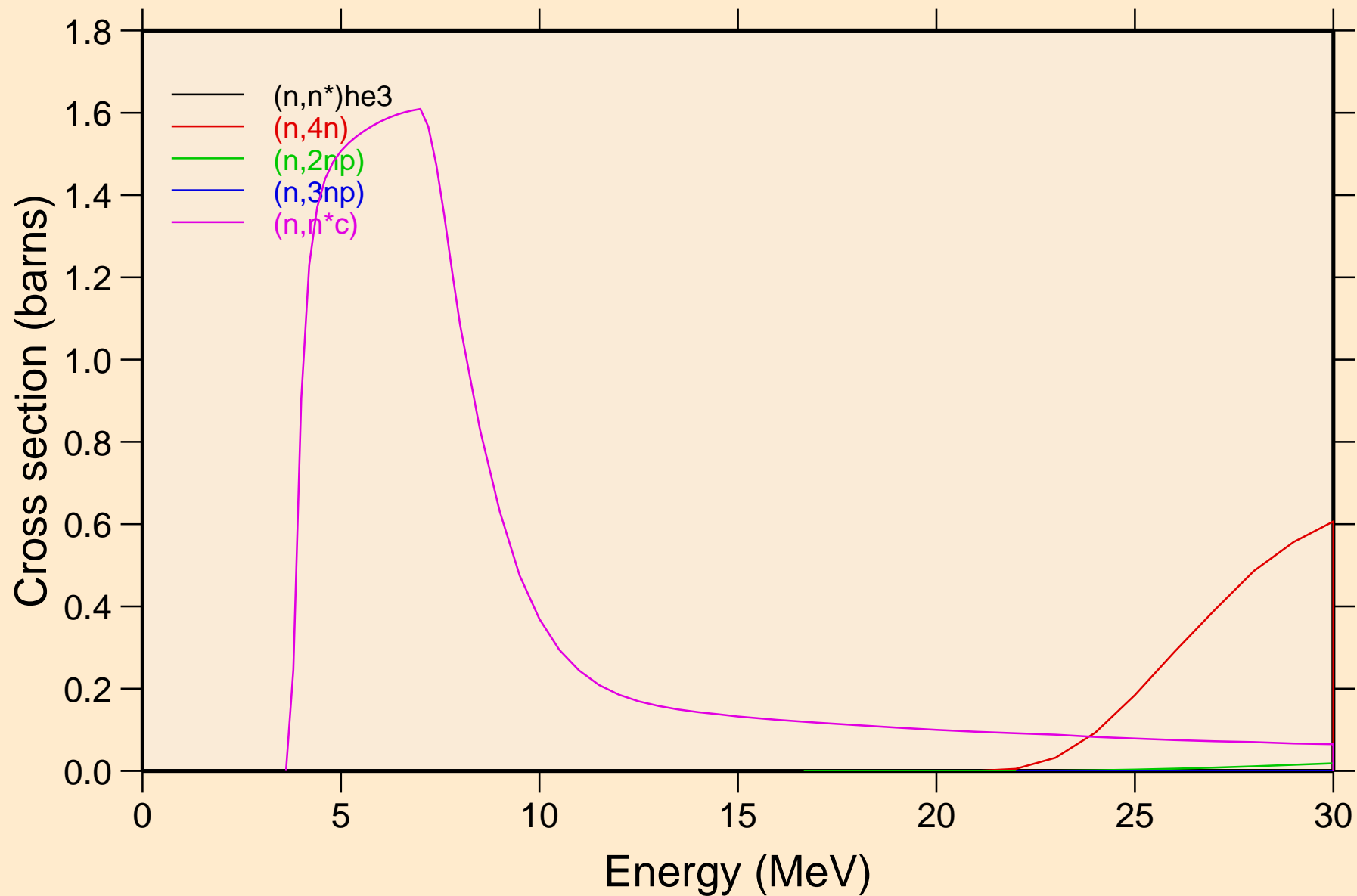

Y095 NEUTRON ACER TENDL-2019 LIBRARY; T=293.16K
Threshold reactions

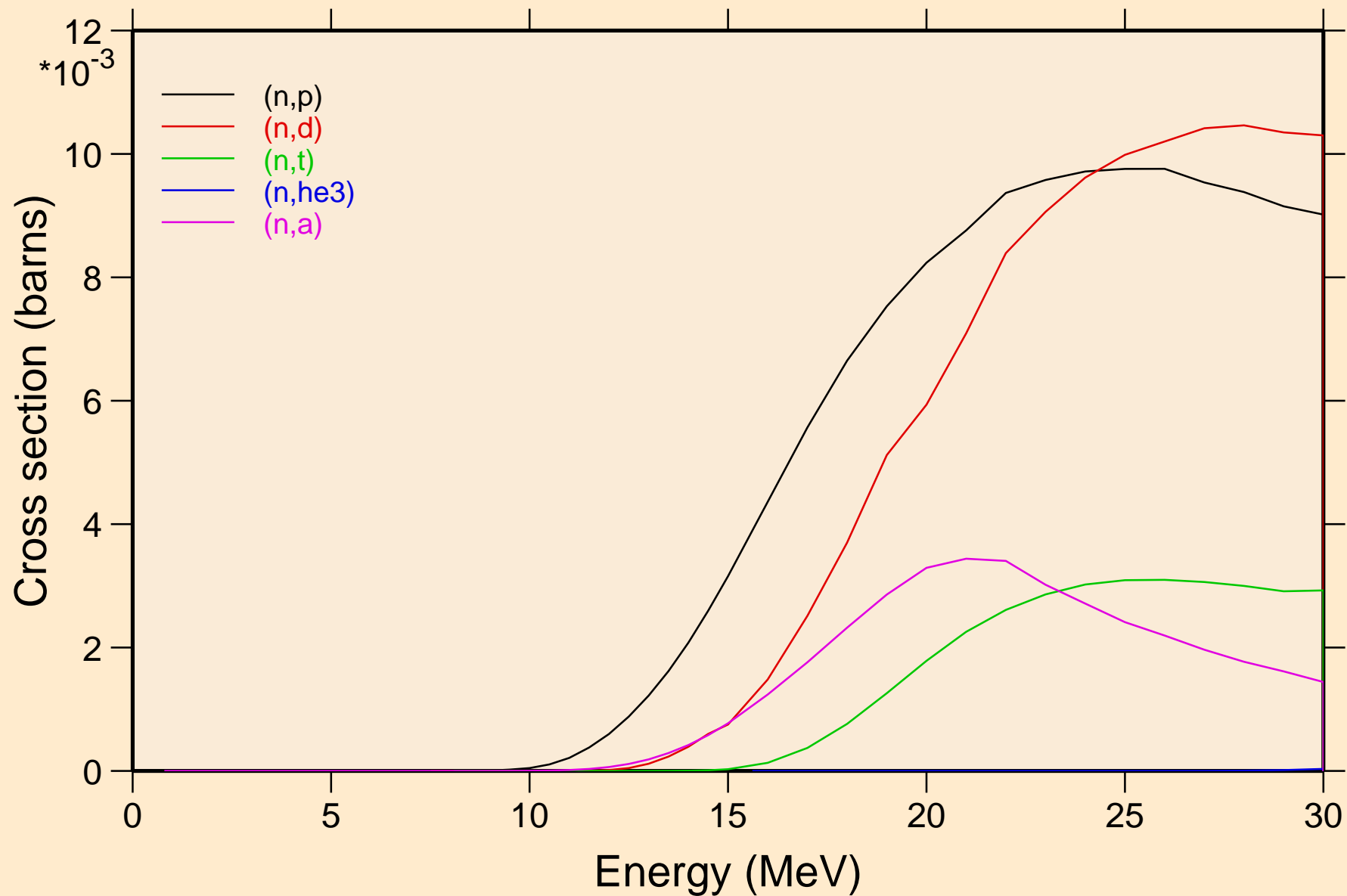

Y095 NEUTRON ACER TENDL-2019 LIBRARY; T=293.16K
Threshold reactions

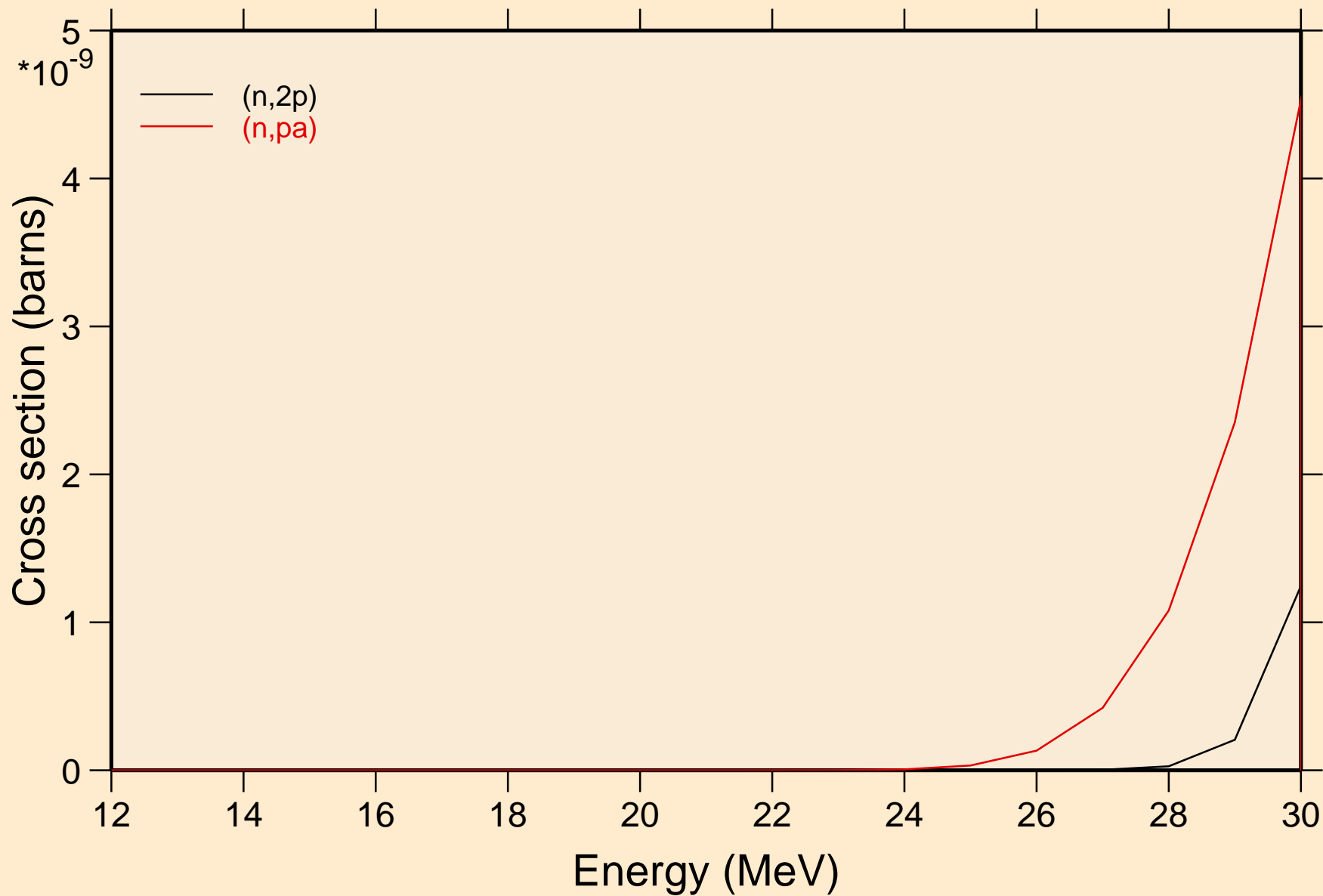

Y095 NEUTRON ACER TENDL-2019 LIBRARY; T=293.16K
Threshold reactions

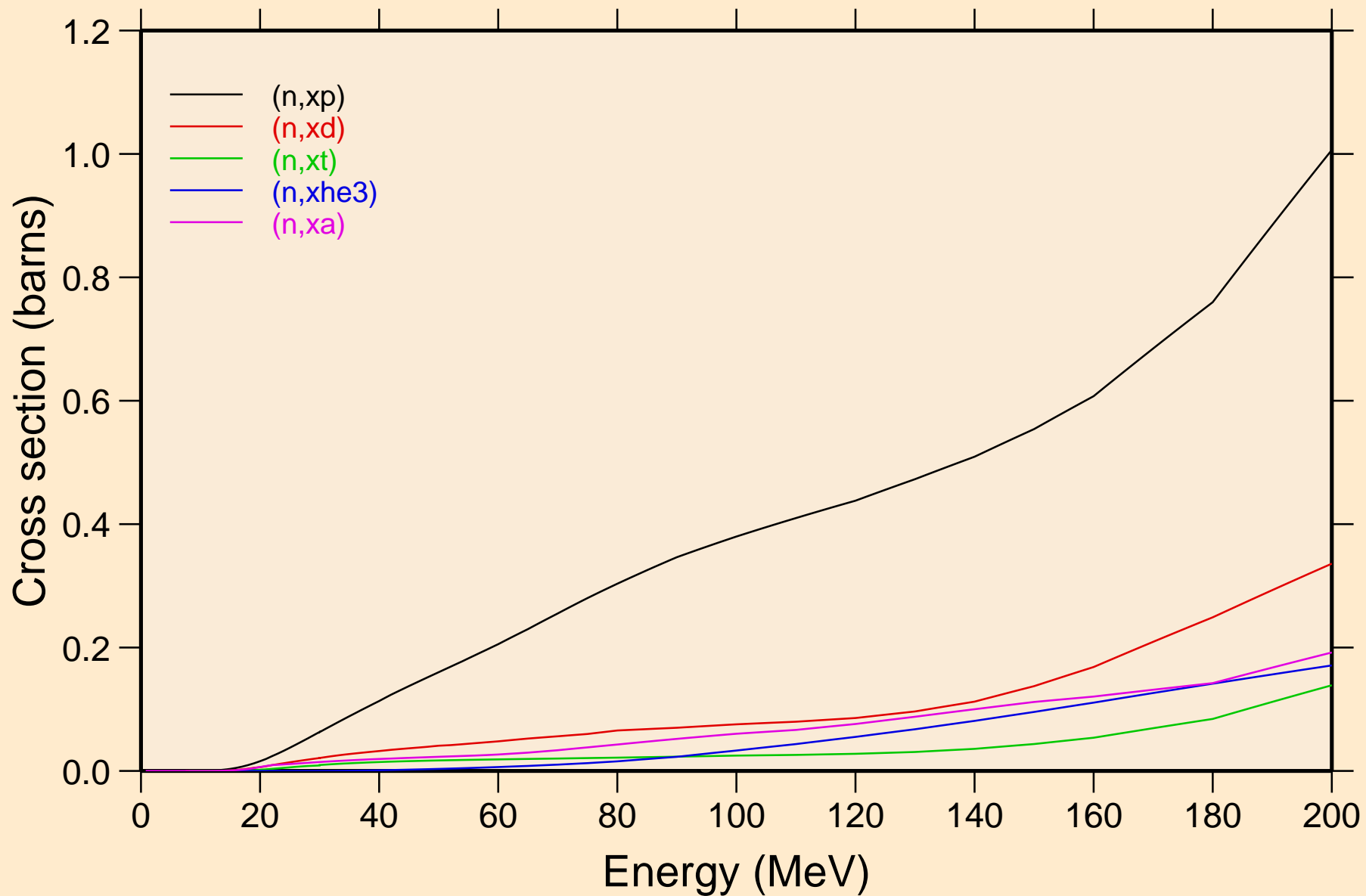

Y095 NEUTRON ACER TENDL-2019 LIBRARY; T=293.16K
angular distribution for elastic

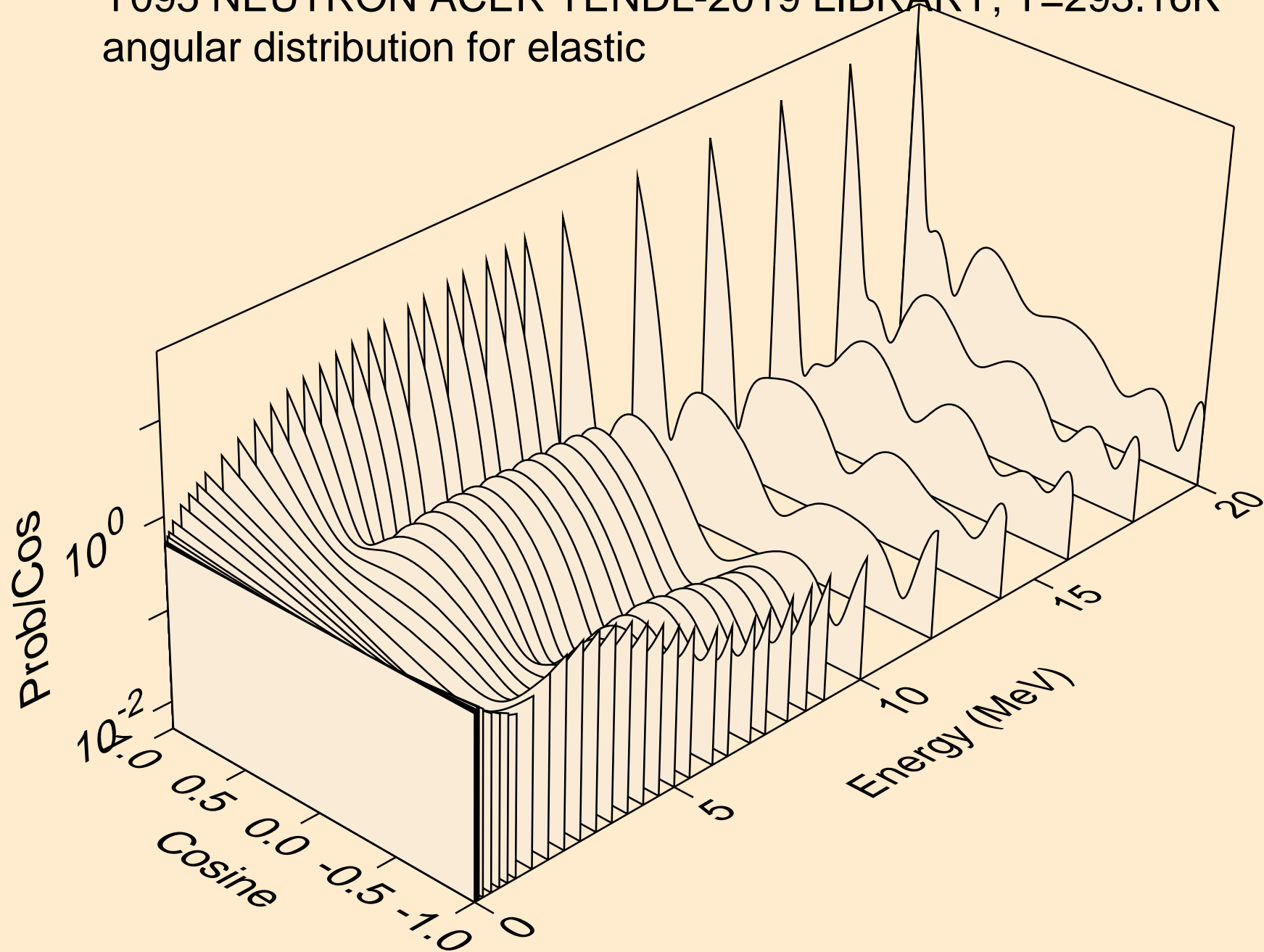

Y095 NEUTRON ACER TENDL-2019 LIBRARY; T=293.16K
angular distribution for elastic

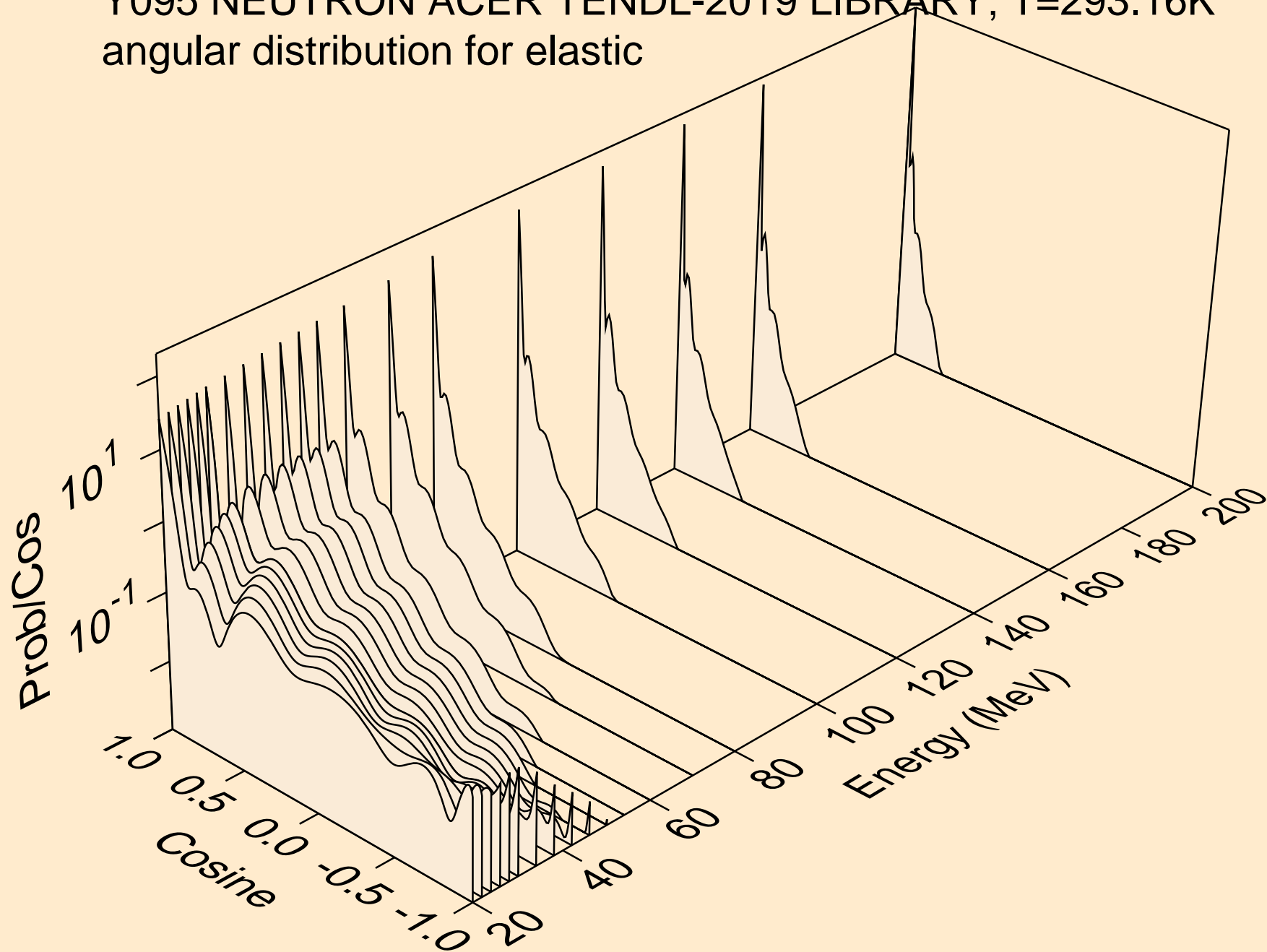

Y095 NEUTRON ACER TENDL-2019 LIBRARY; T=293.16K
angular distribution for (n,n*1)

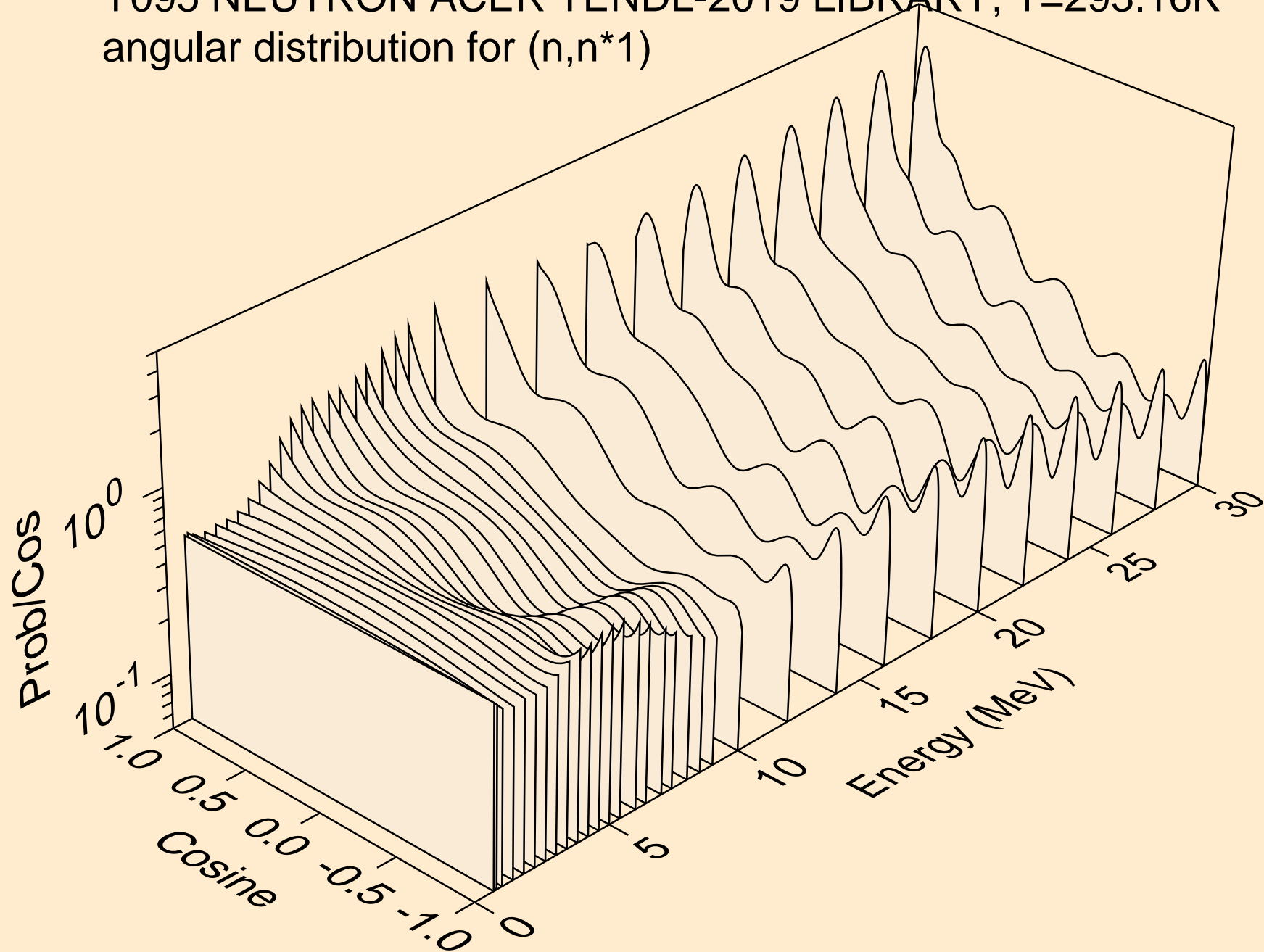

Y095 NEUTRON ACER TENDL-2019 LIBRARY; T=293.16K
angular distribution for (n,n*2)

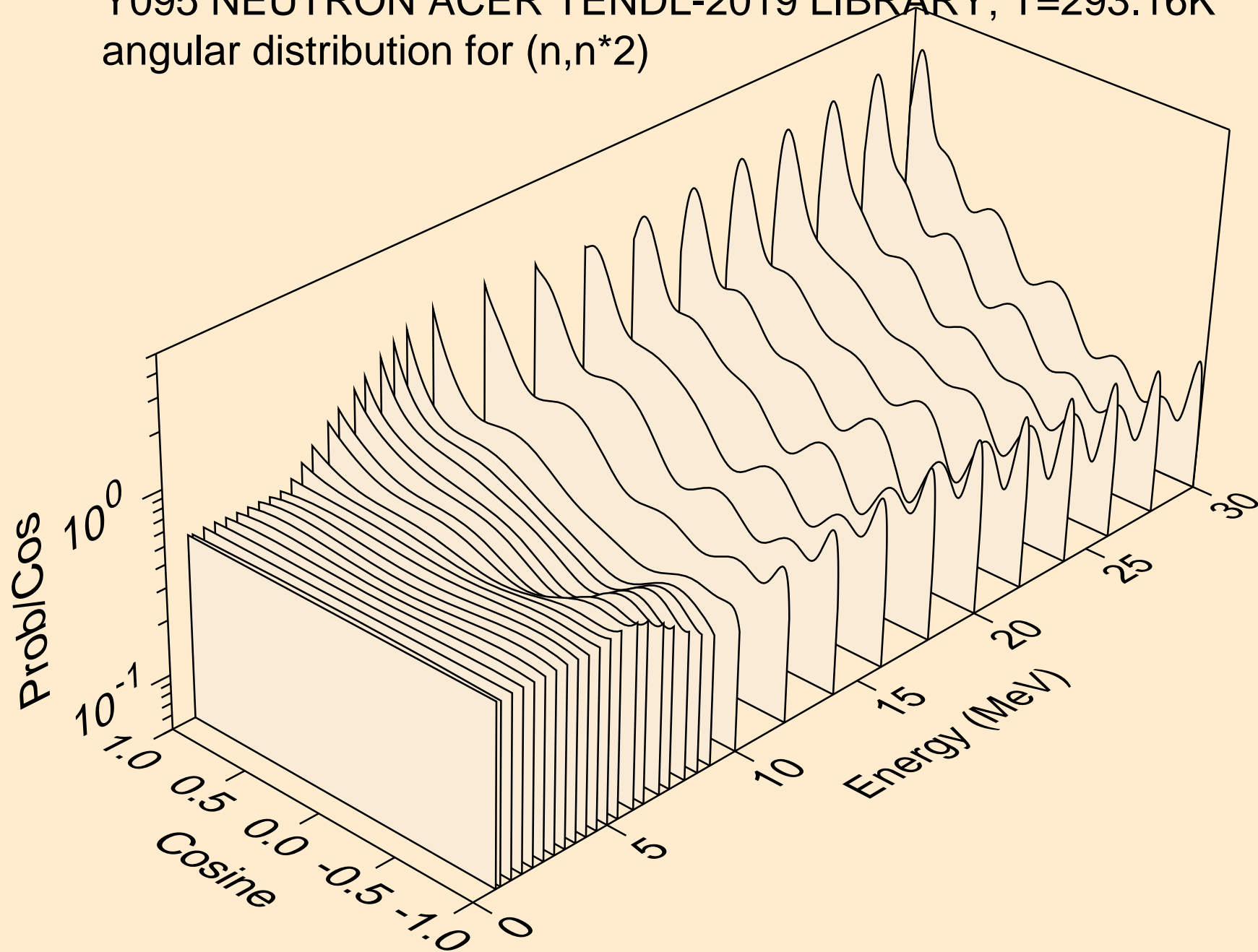

Y095 NEUTRON ACER TENDL-2019 LIBRARY; T=293.16K
angular distribution for (n,n*3)

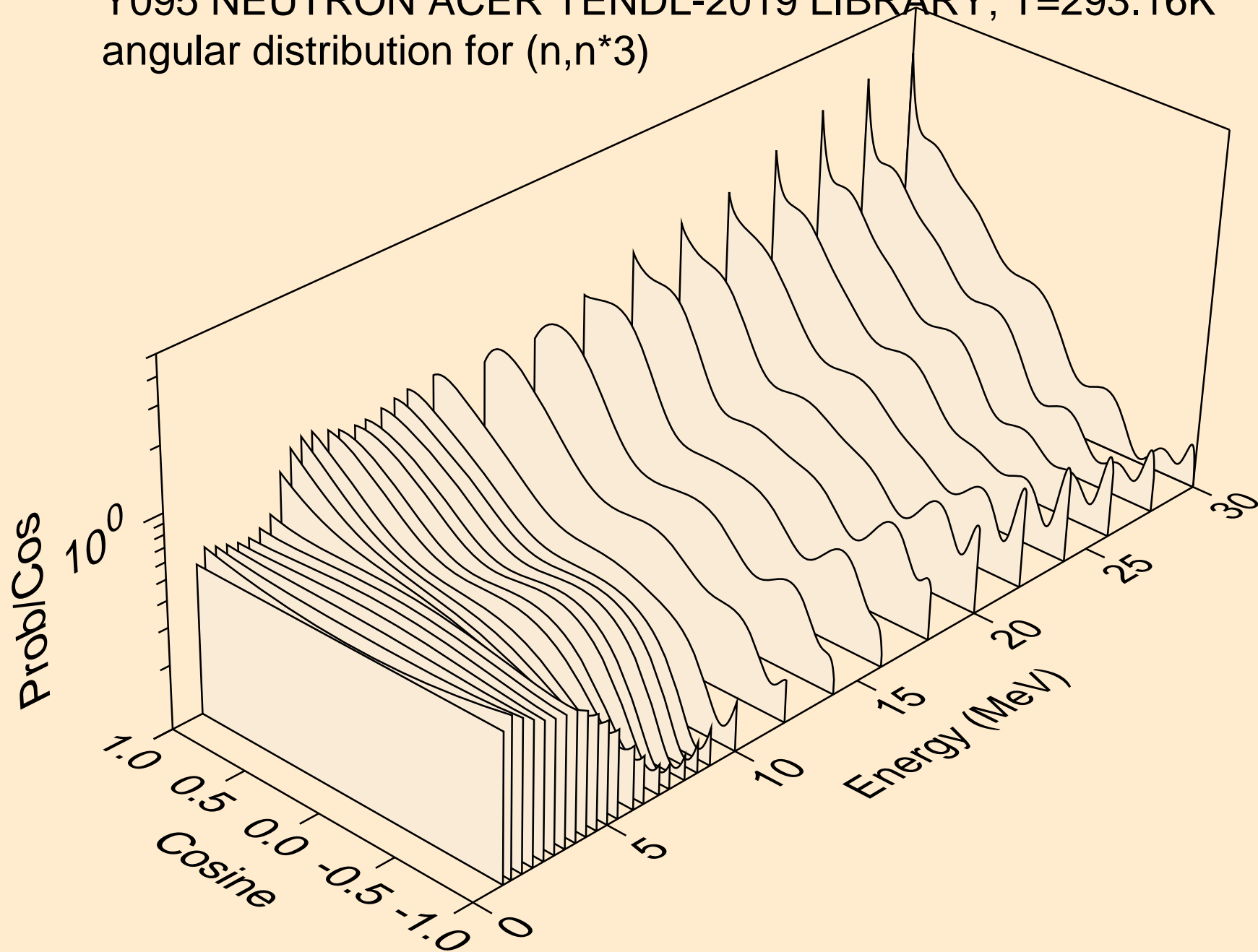

Y095 NEUTRON ACER TENDL-2019 LIBRARY; T=293.16K
angular distribution for (n,n*4)

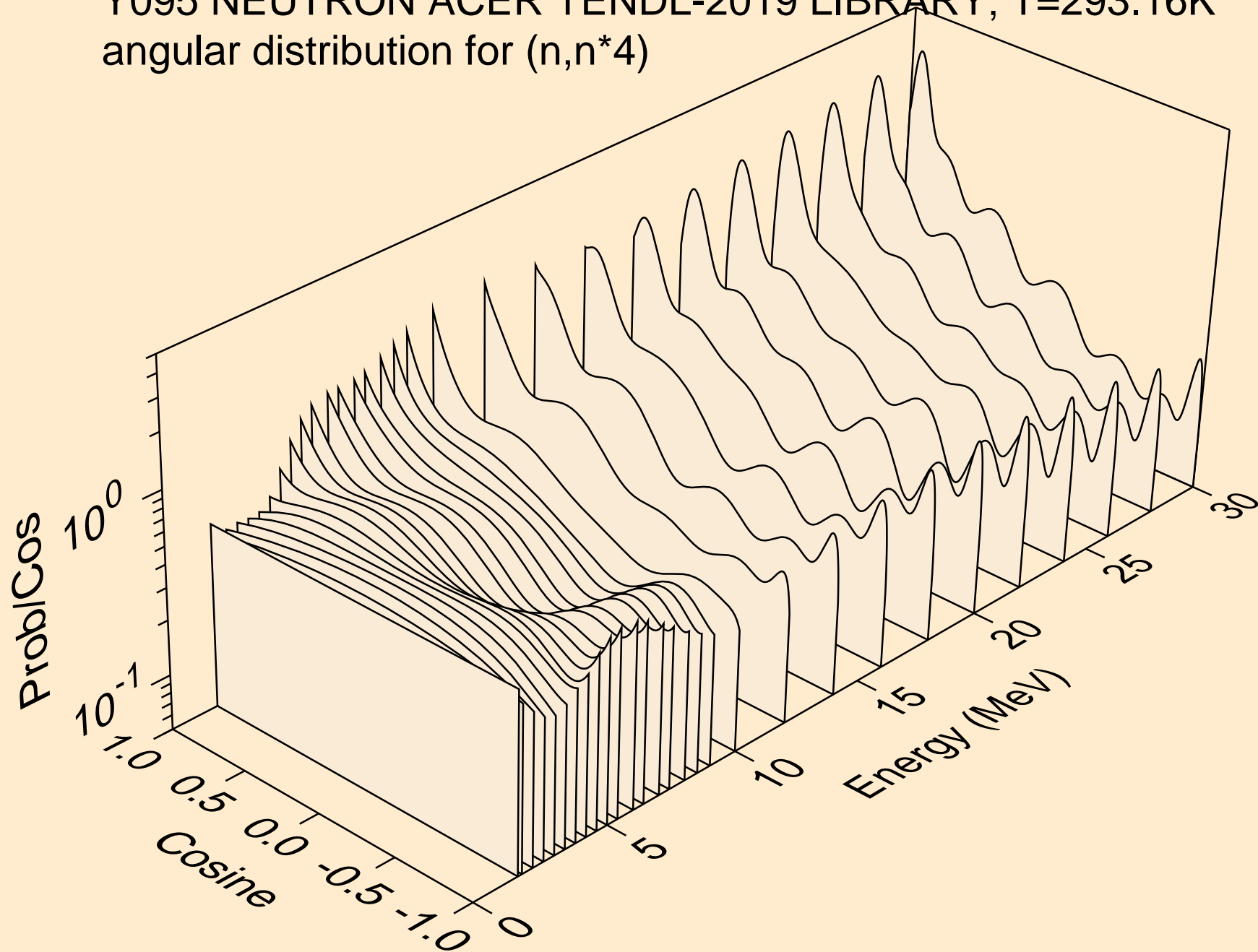

Y095 NEUTRON ACER TENDL-2019 LIBRARY; T=293.16K
angular distribution for (n,n*5)

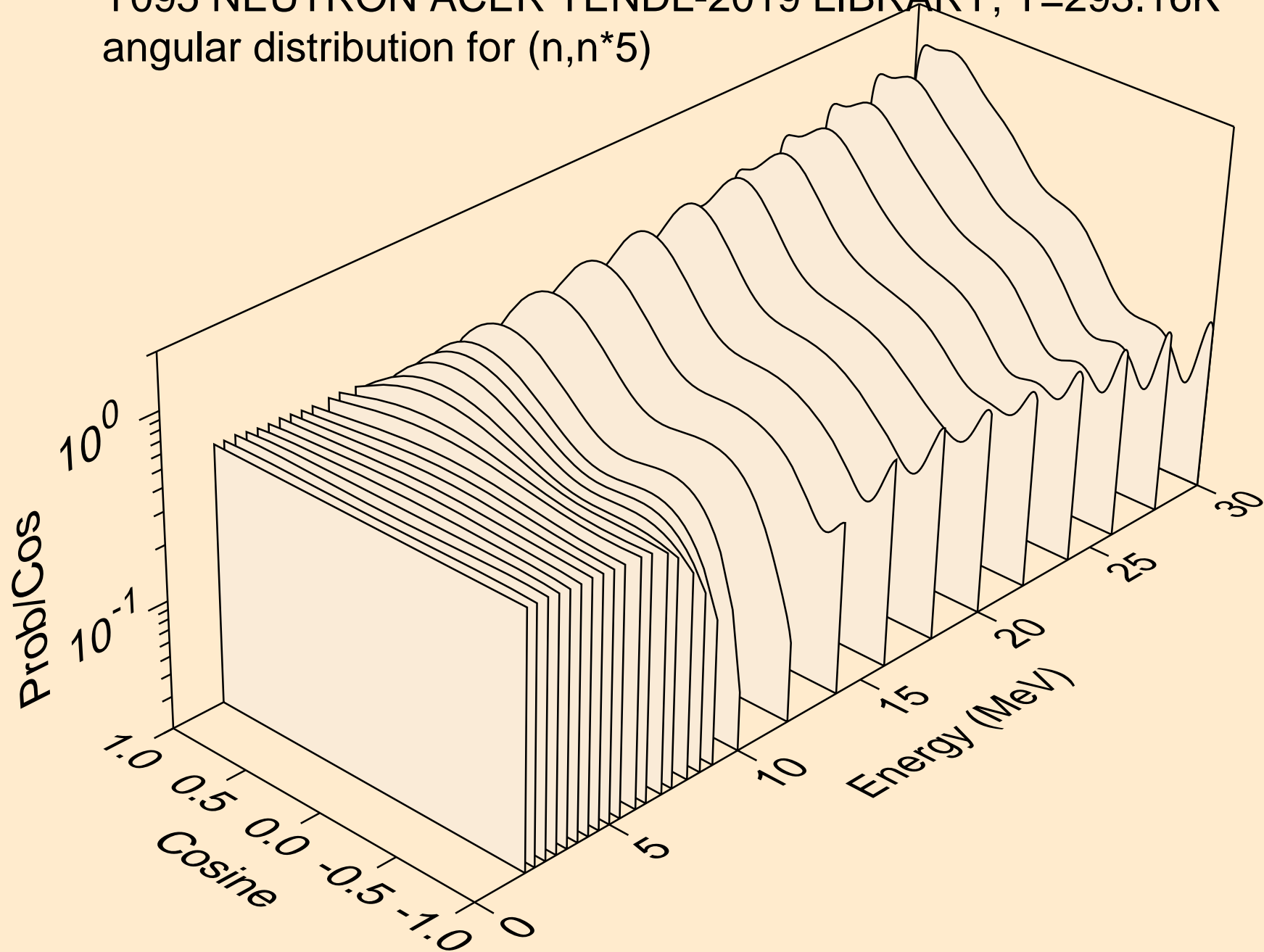

Y095 NEUTRON ACER TENDL-2019 LIBRARY; T=293.16K
angular distribution for (n,n*6)

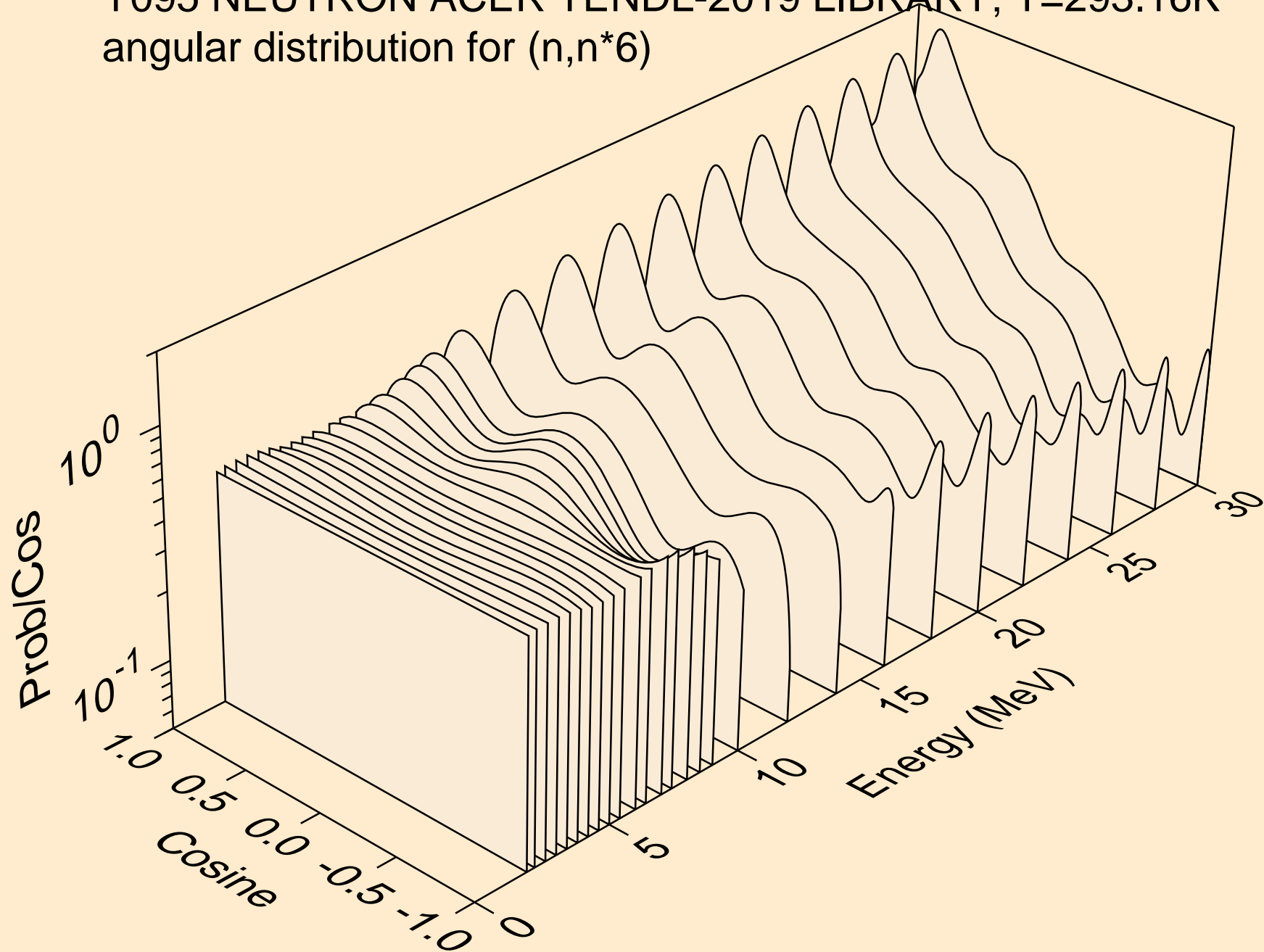

Y095 NEUTRON ACER TENDL-2019 LIBRARY; T=293.16K
angular distribution for (n,n*7)

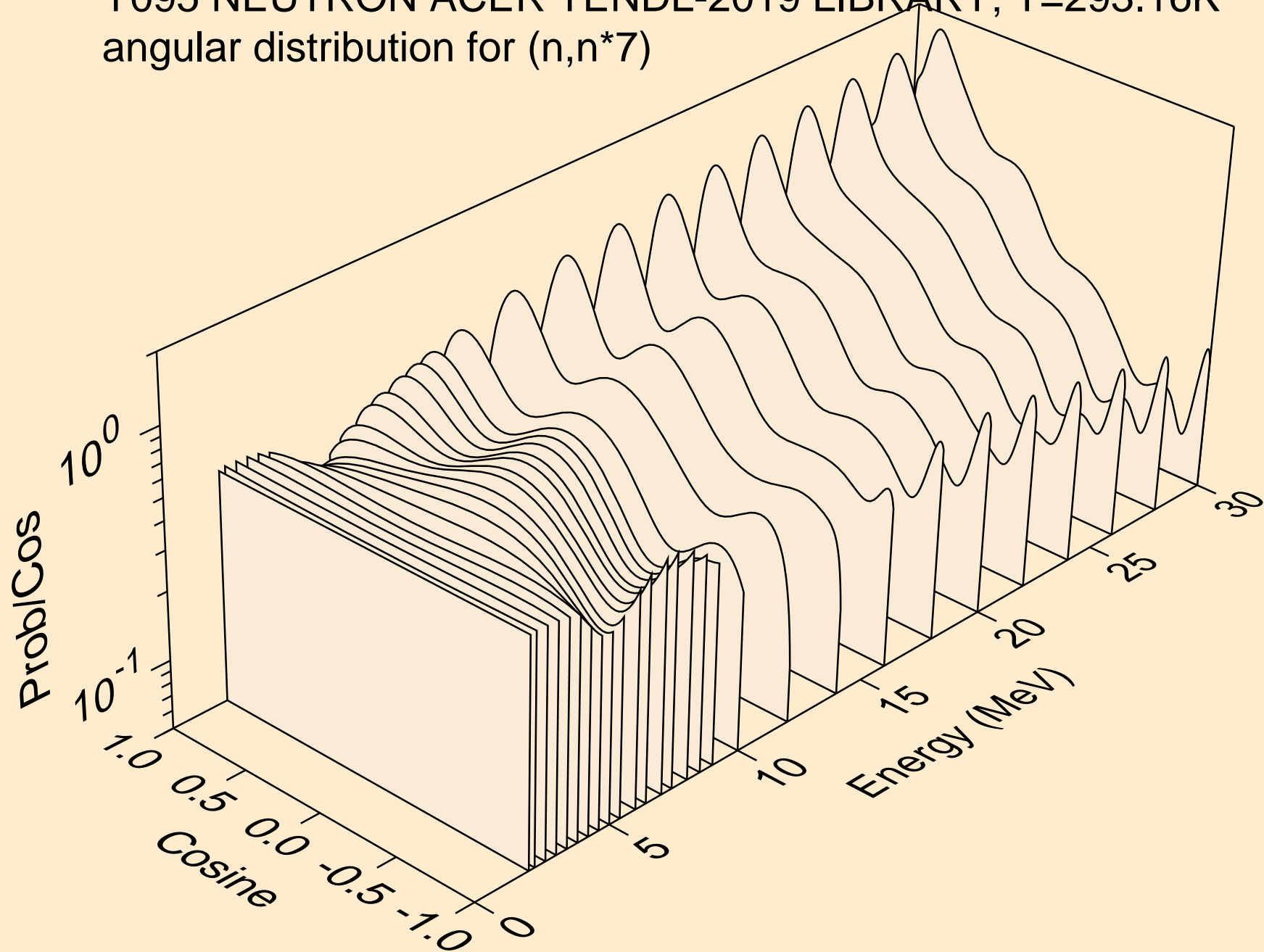

Y095 NEUTRON ACER TENDL-2019 LIBRARY; T=293.16K
angular distribution for (n,n*8)

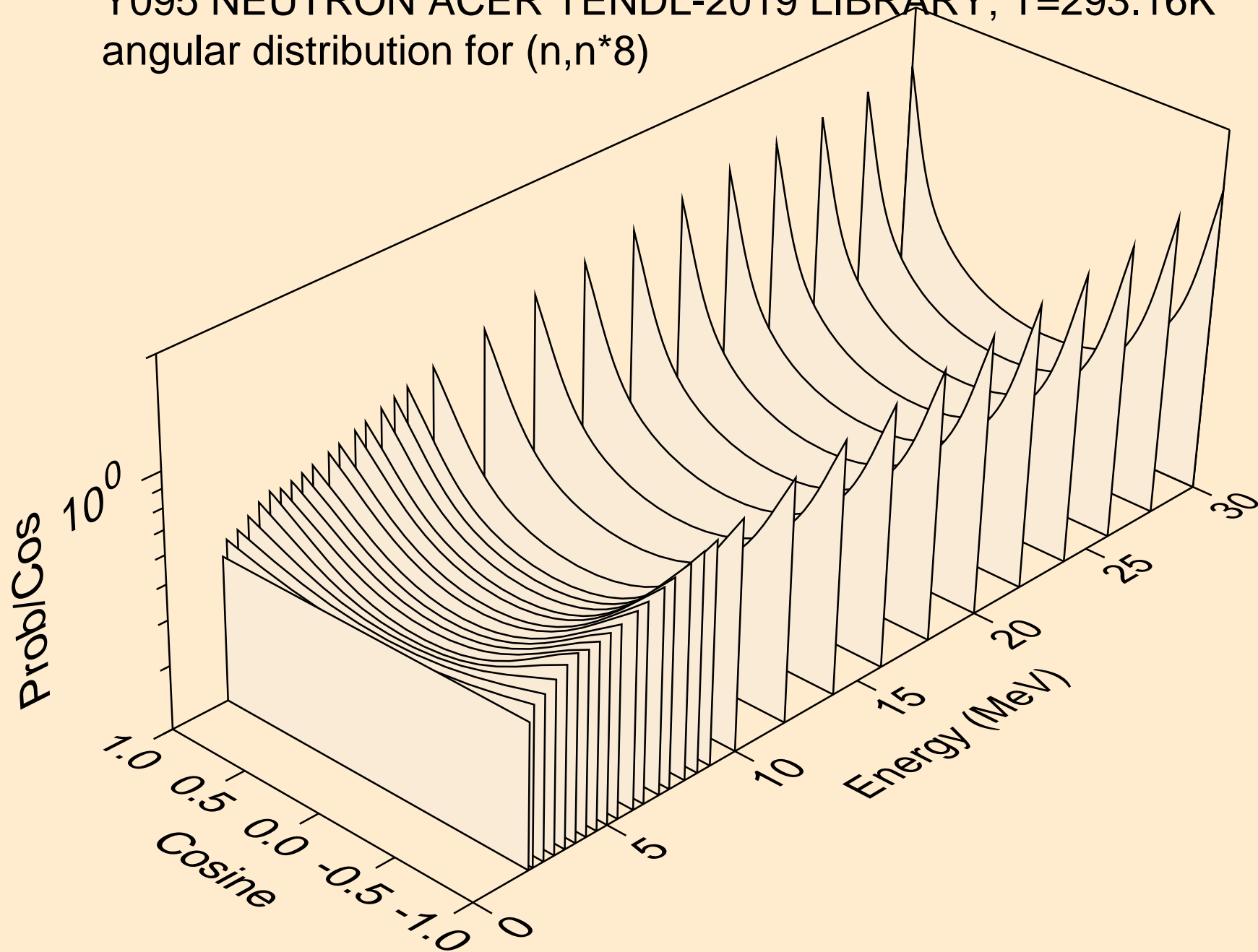

Y095 NEUTRON ACER TENDL-2019 LIBRARY; T=293.16K
angular distribution for (n,n*9)

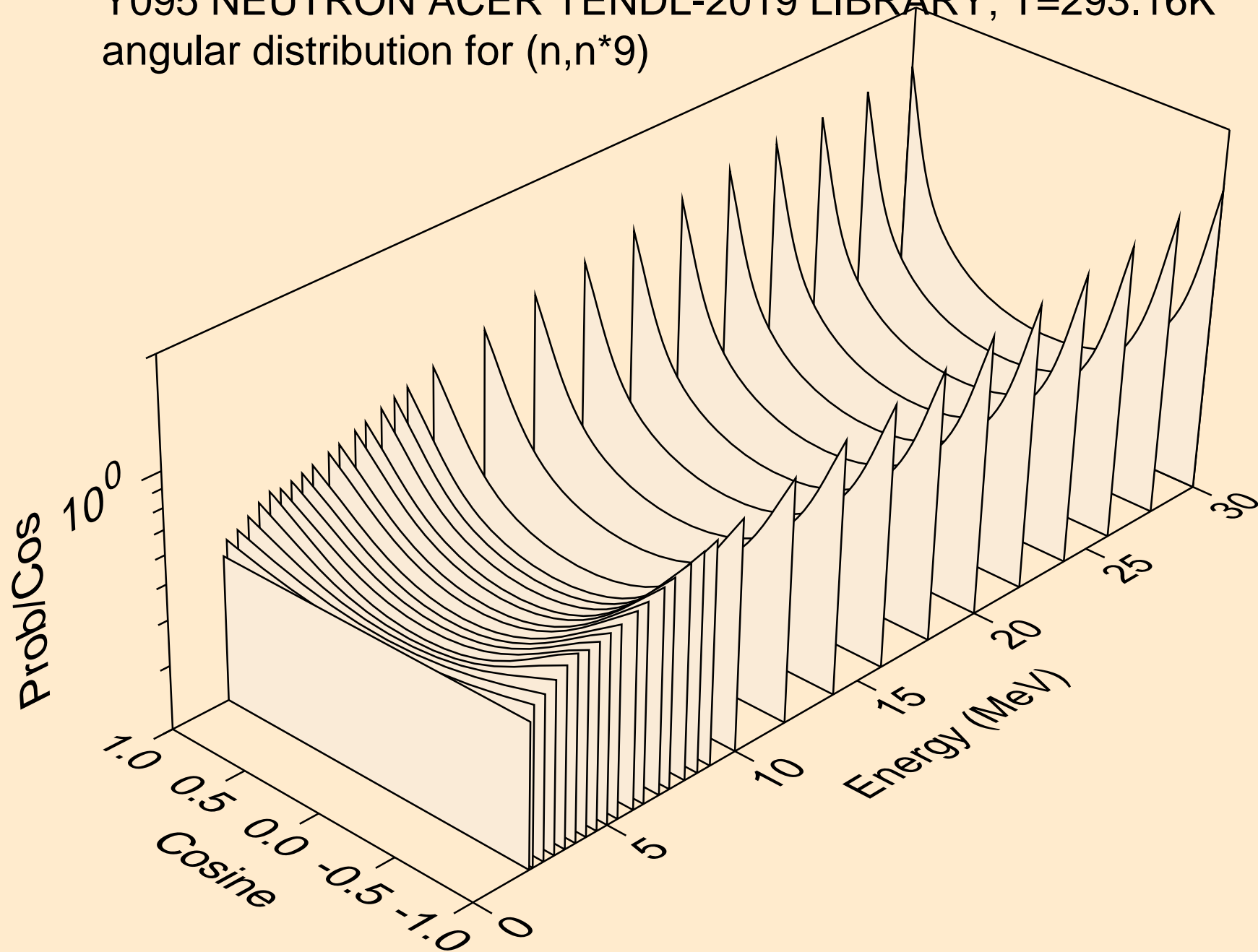

Y095 NEUTRON ACER TENDL-2019 LIBRARY; T=293.16K
angular distribution for (n,n*10)

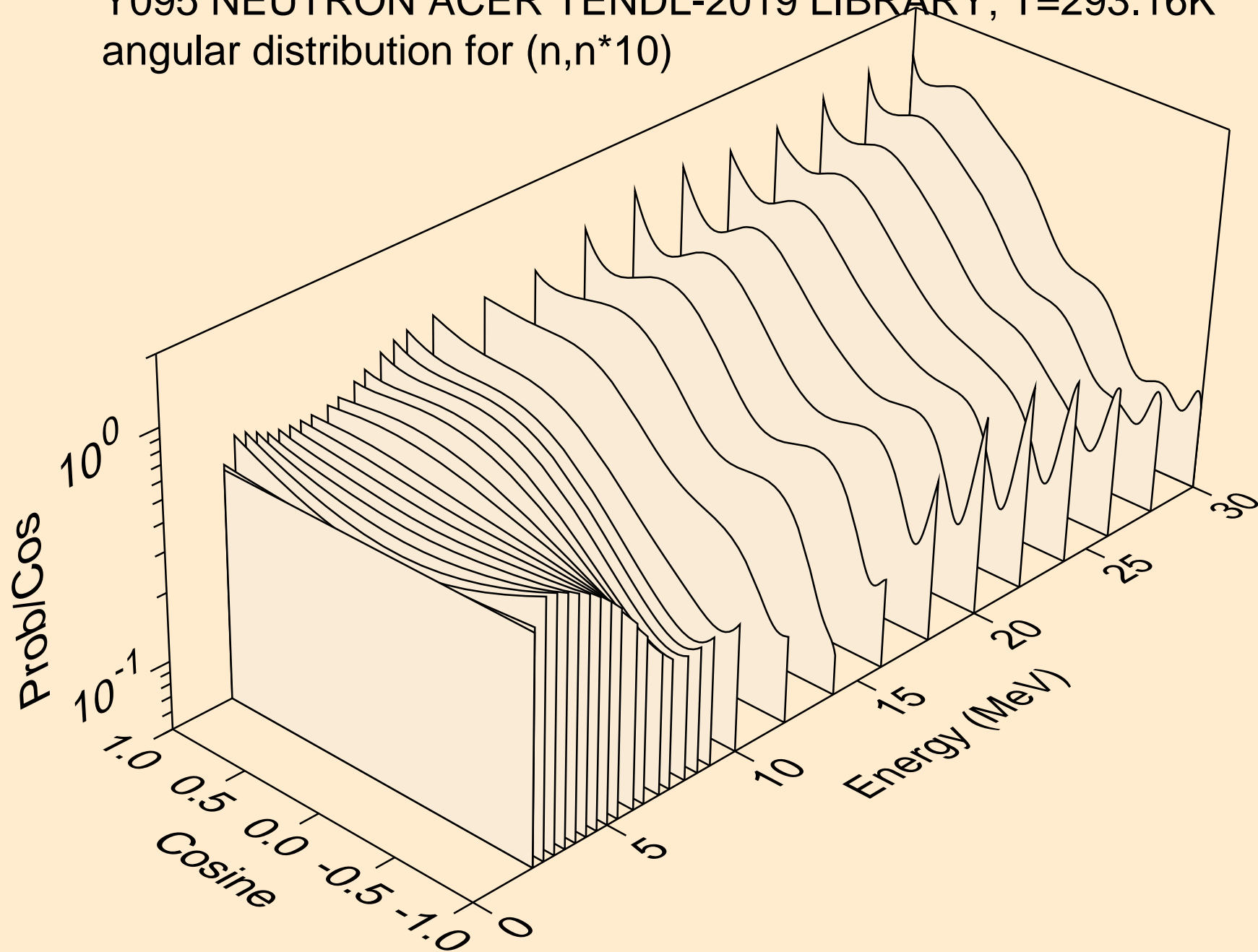

Y095 NEUTRON ACER TENDL-2019 LIBRARY; T=293.16K
angular distribution for (n,n*11)

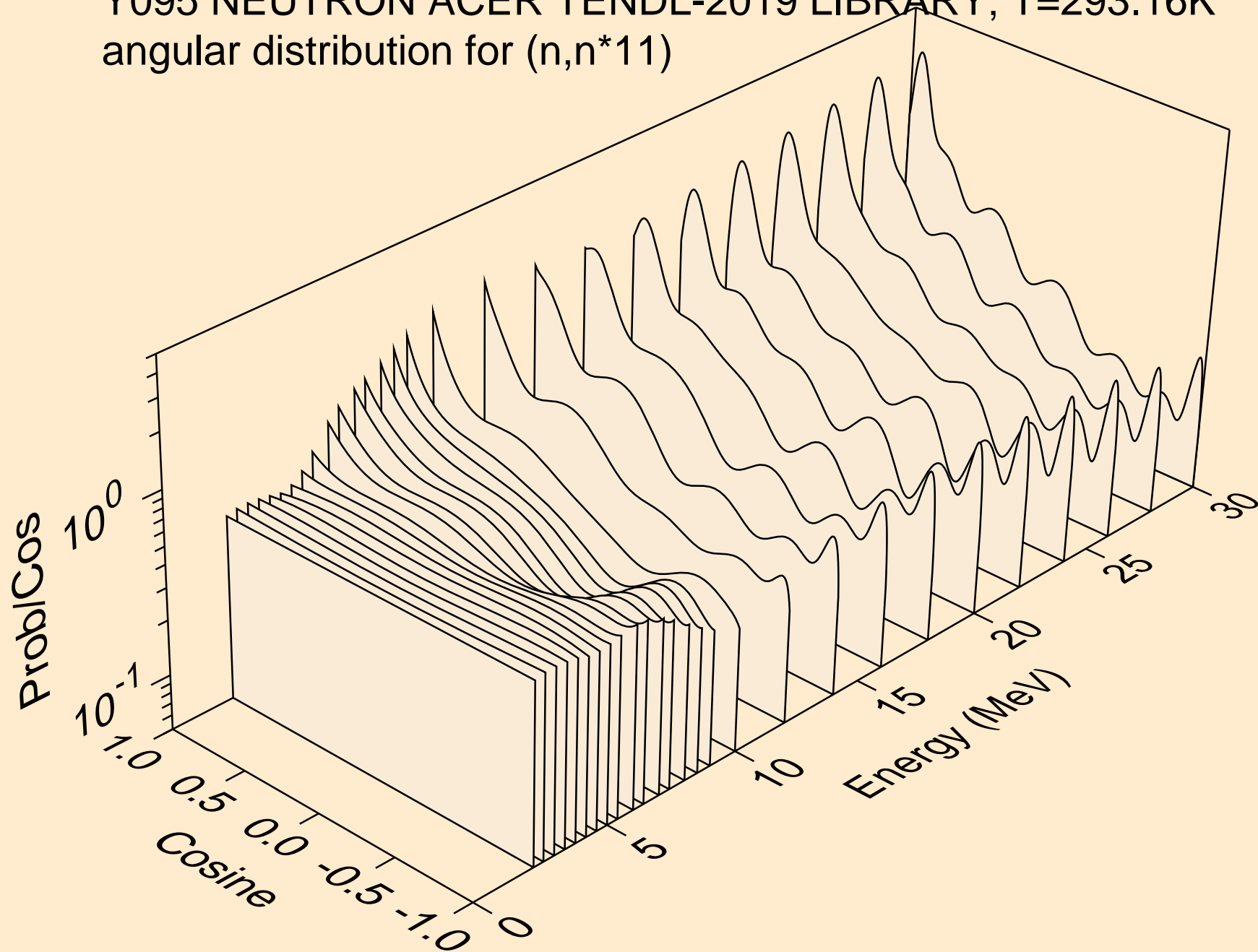

Y095 NEUTRON ACER TENDL-2019 LIBRARY; T=293.16K
angular distribution for (n,n*12)

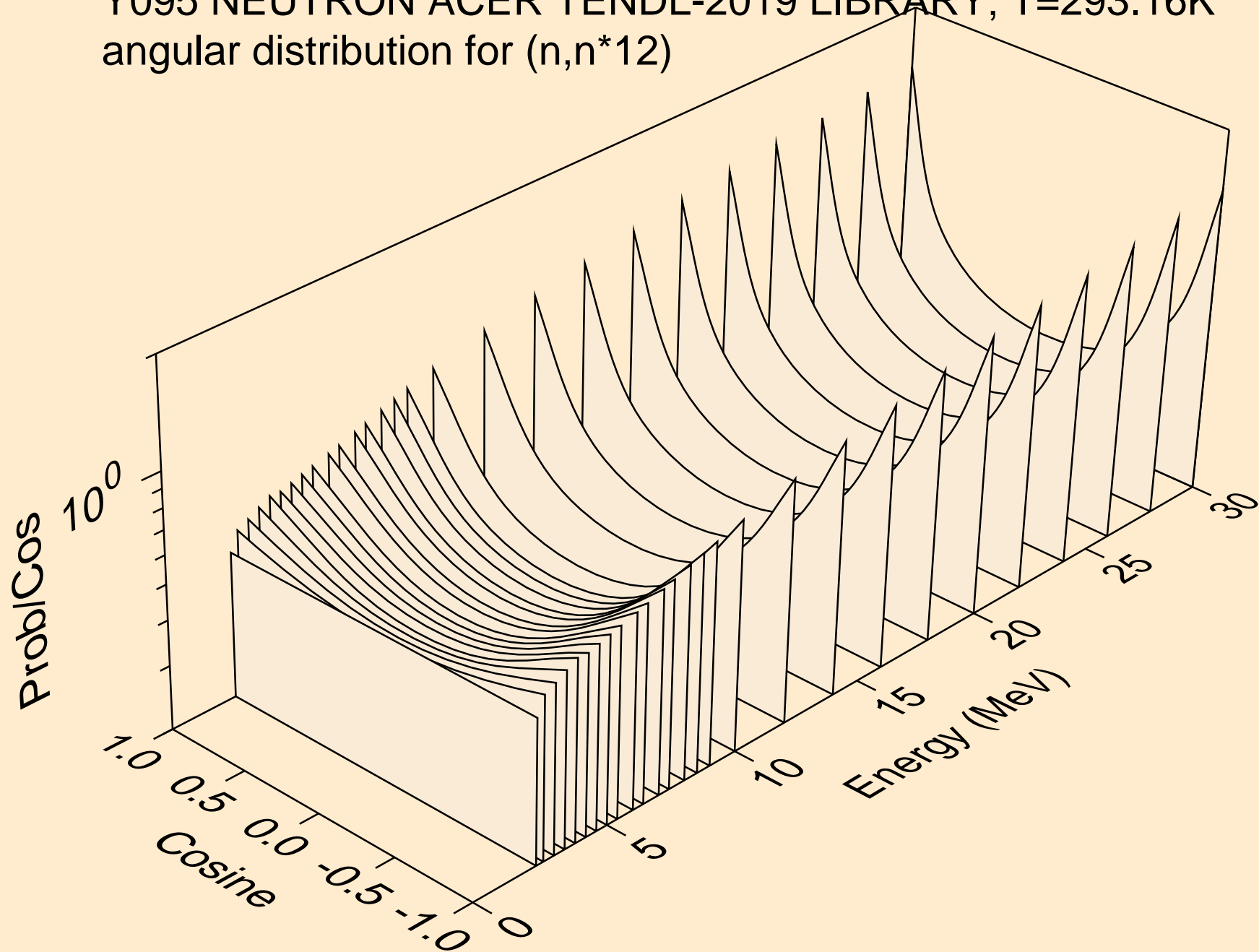

Y095 NEUTRON ACER TENDL-2019 LIBRARY; T=293.16K
angular distribution for (n,n*13)

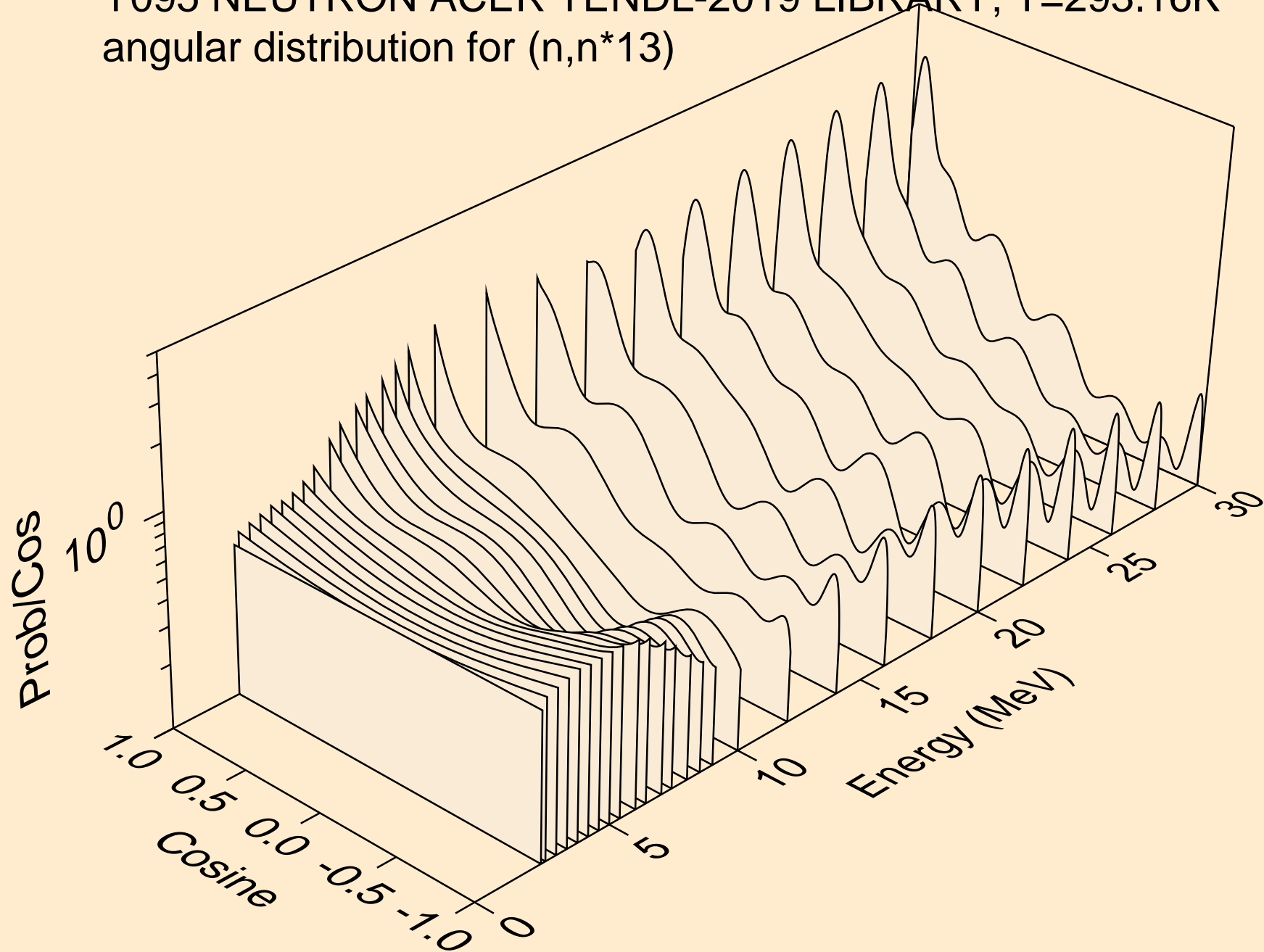

Y095 NEUTRON ACER TENDL-2019 LIBRARY; T=293.16K
angular distribution for (n,n*14)

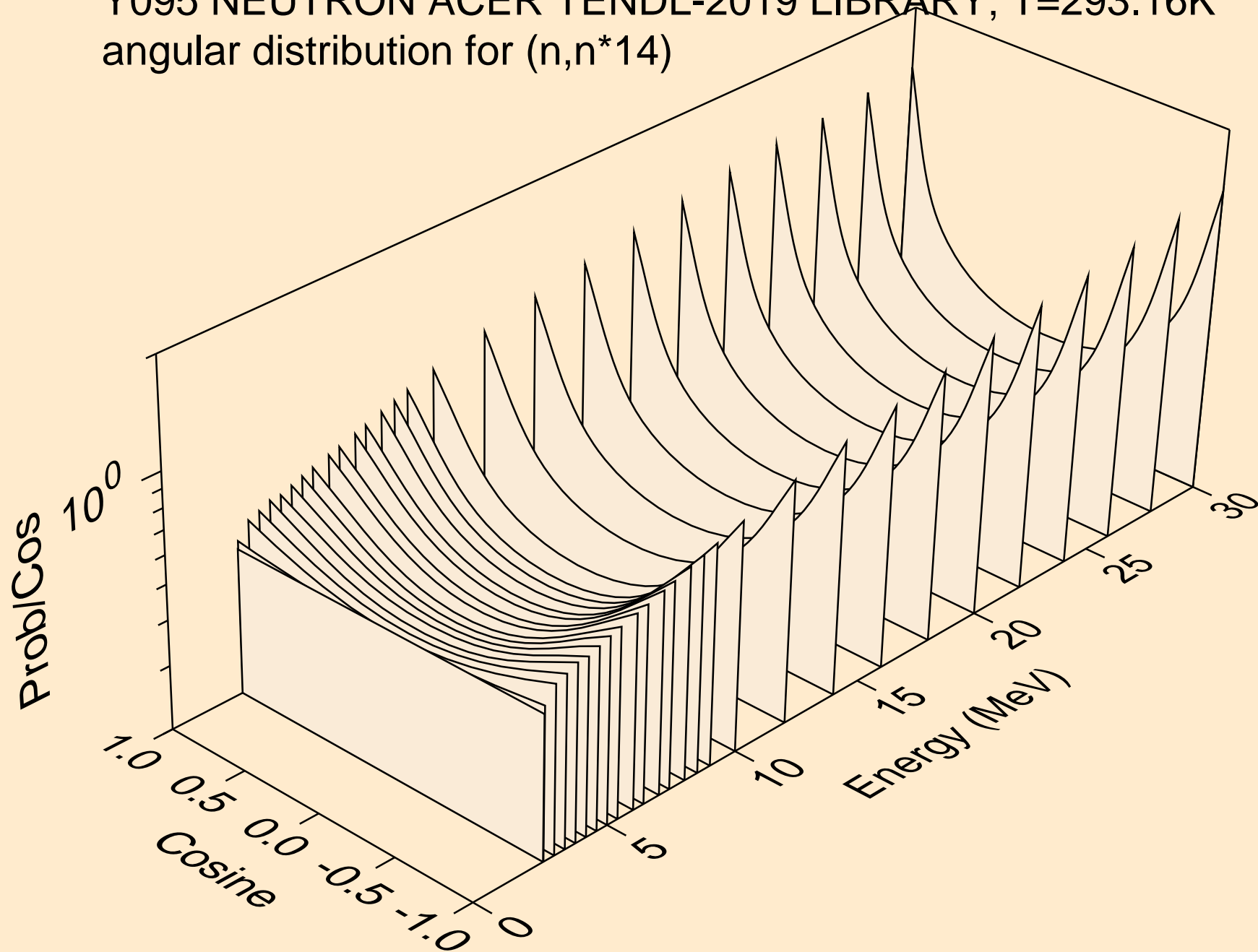

Y095 NEUTRON ACER TENDL-2019 LIBRARY; T=293.16K
angular distribution for (n,n*15)

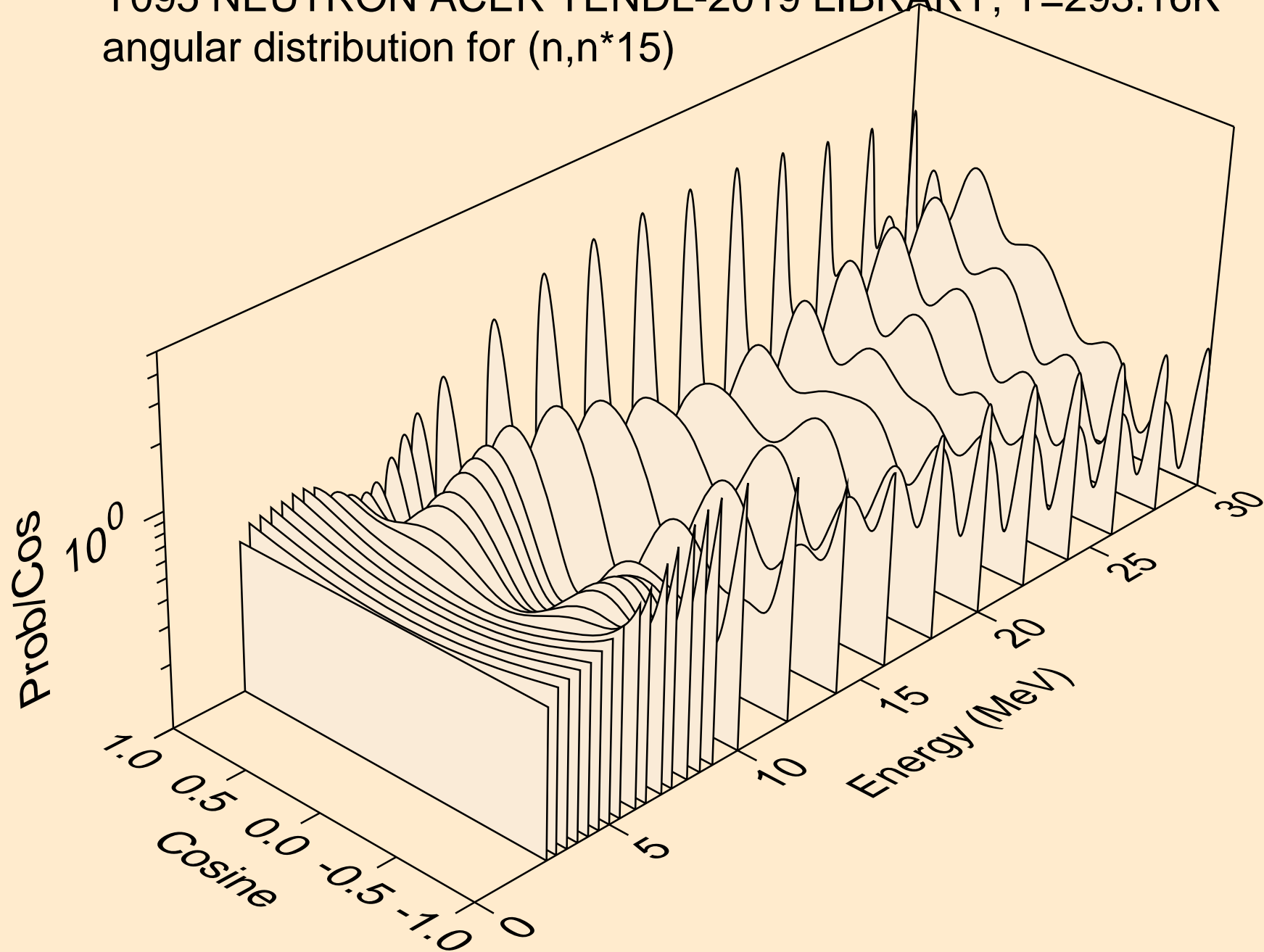

Y095 NEUTRON ACER TENDL-2019 LIBRARY; T=293.16K
angular distribution for (n,n*16)

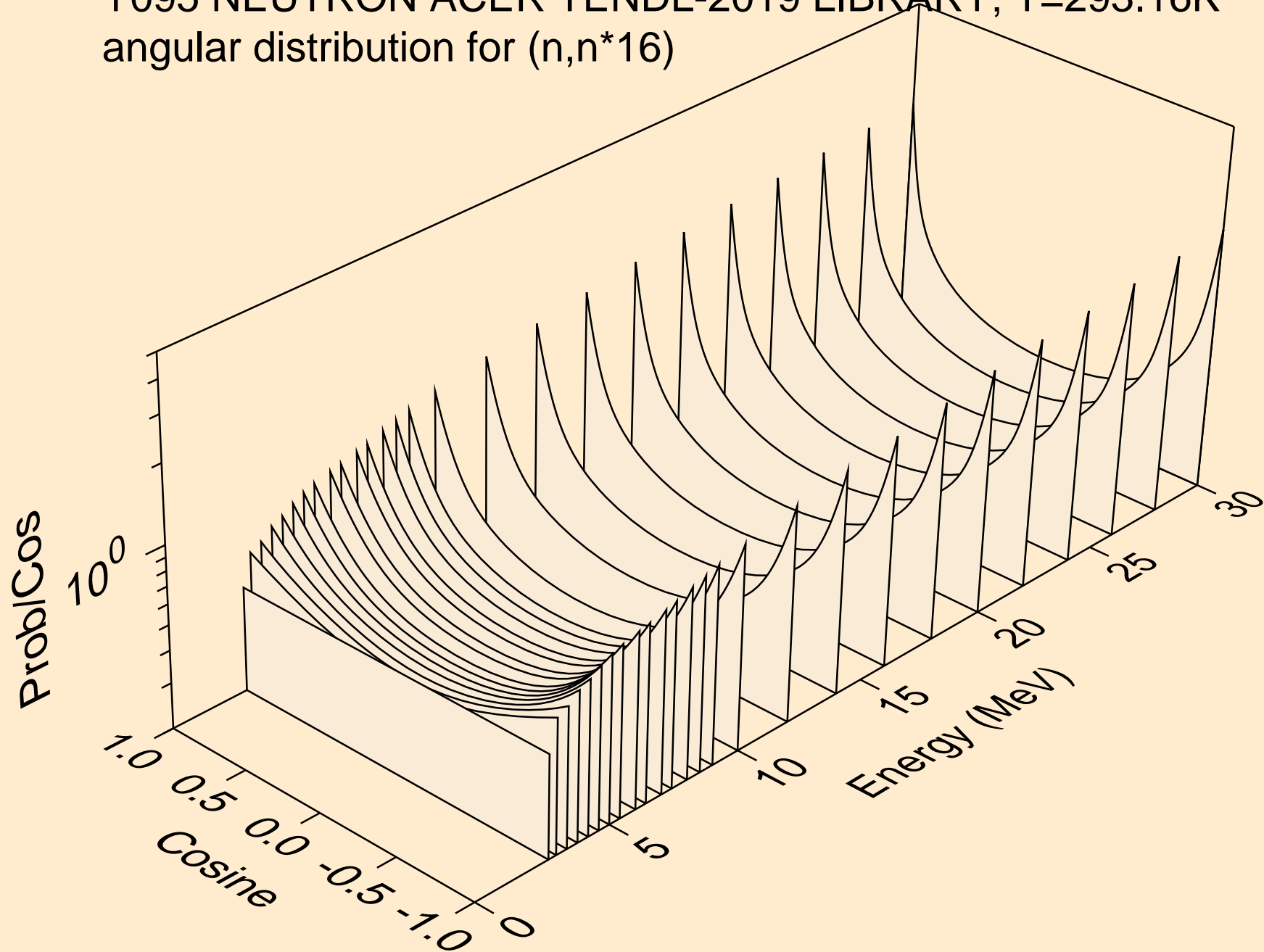

Y095 NEUTRON ACER TENDL-2019 LIBRARY; T=293.16K
angular distribution for (n,n*17)

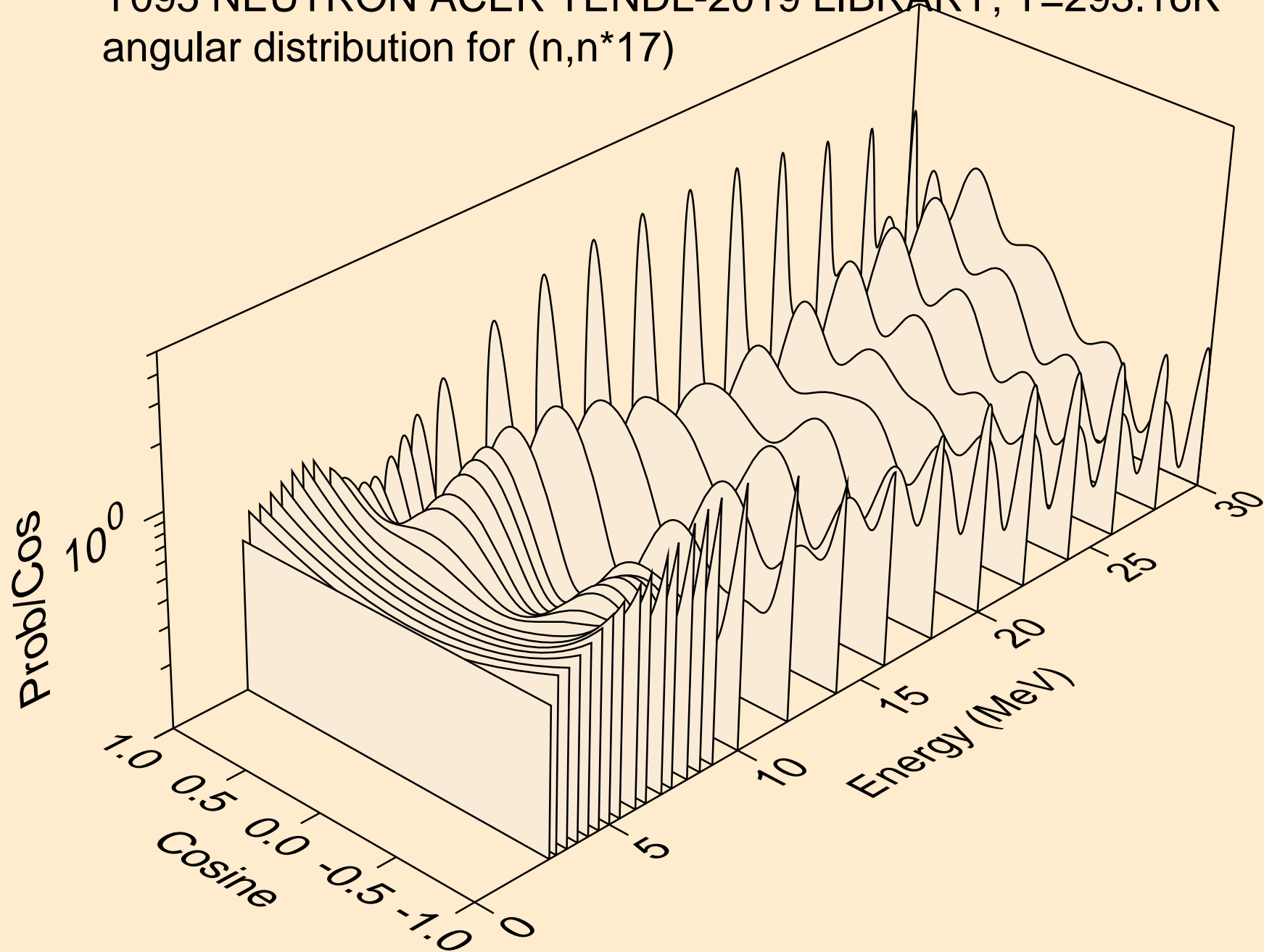

Y095 NEUTRON ACER TENDL-2019 LIBRARY; T=293.16K
angular distribution for (n,n*18)

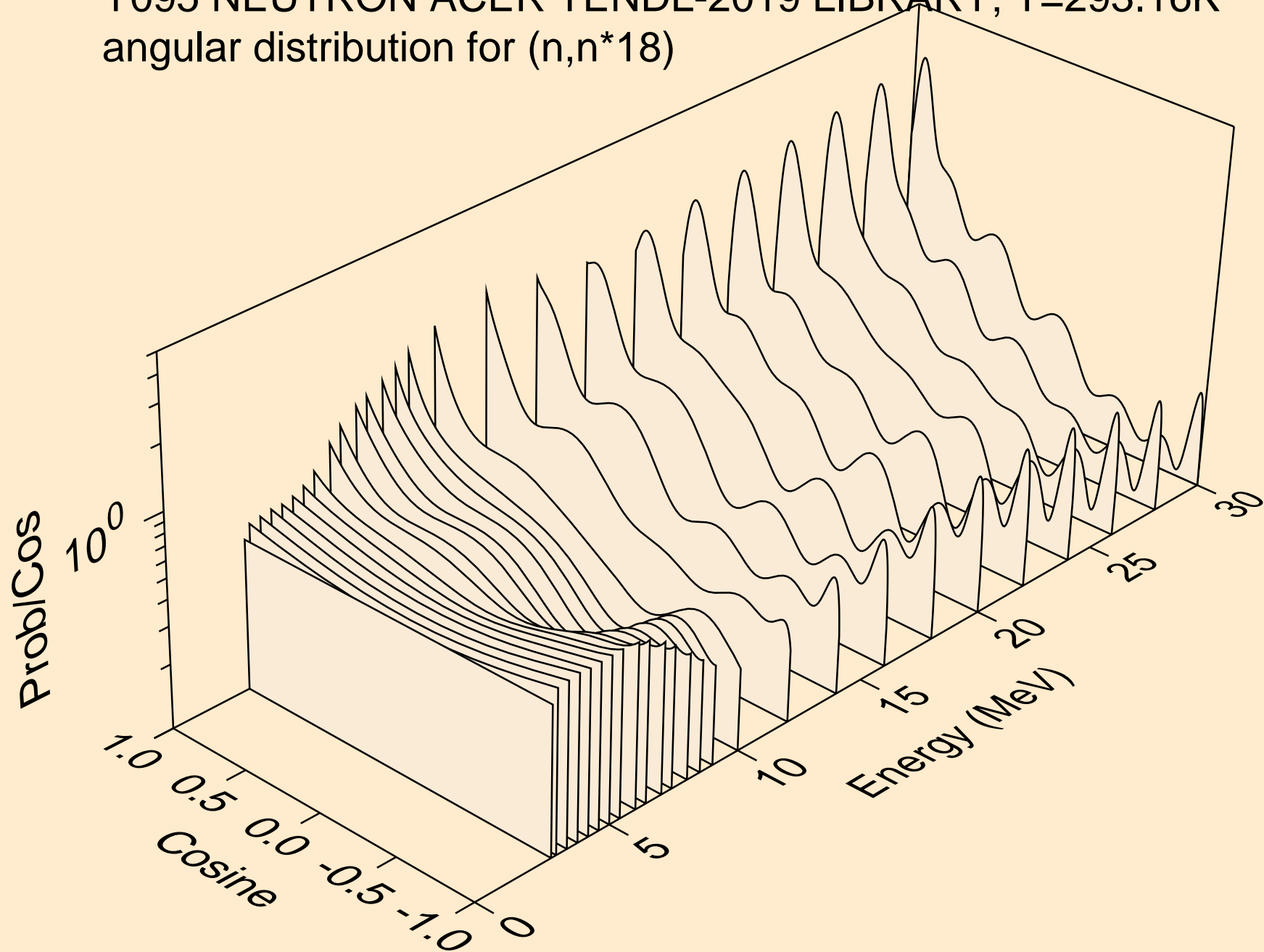

Y095 NEUTRON ACER TENDL-2019 LIBRARY; T=293.16K
angular distribution for (n,n*19)

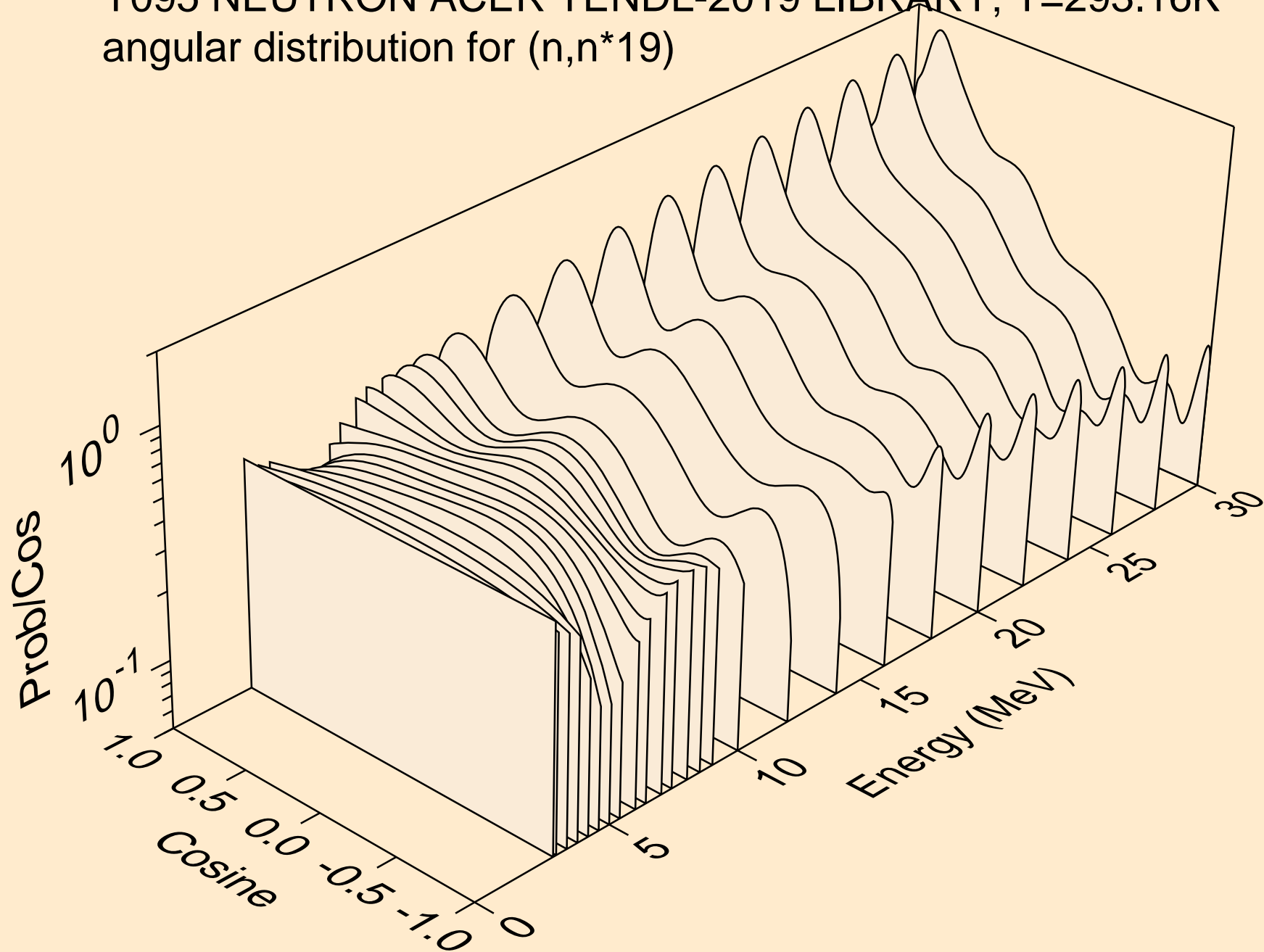

Y095 NEUTRON ACER TENDL-2019 LIBRARY; T=293.16K
angular distribution for (n,n*20)

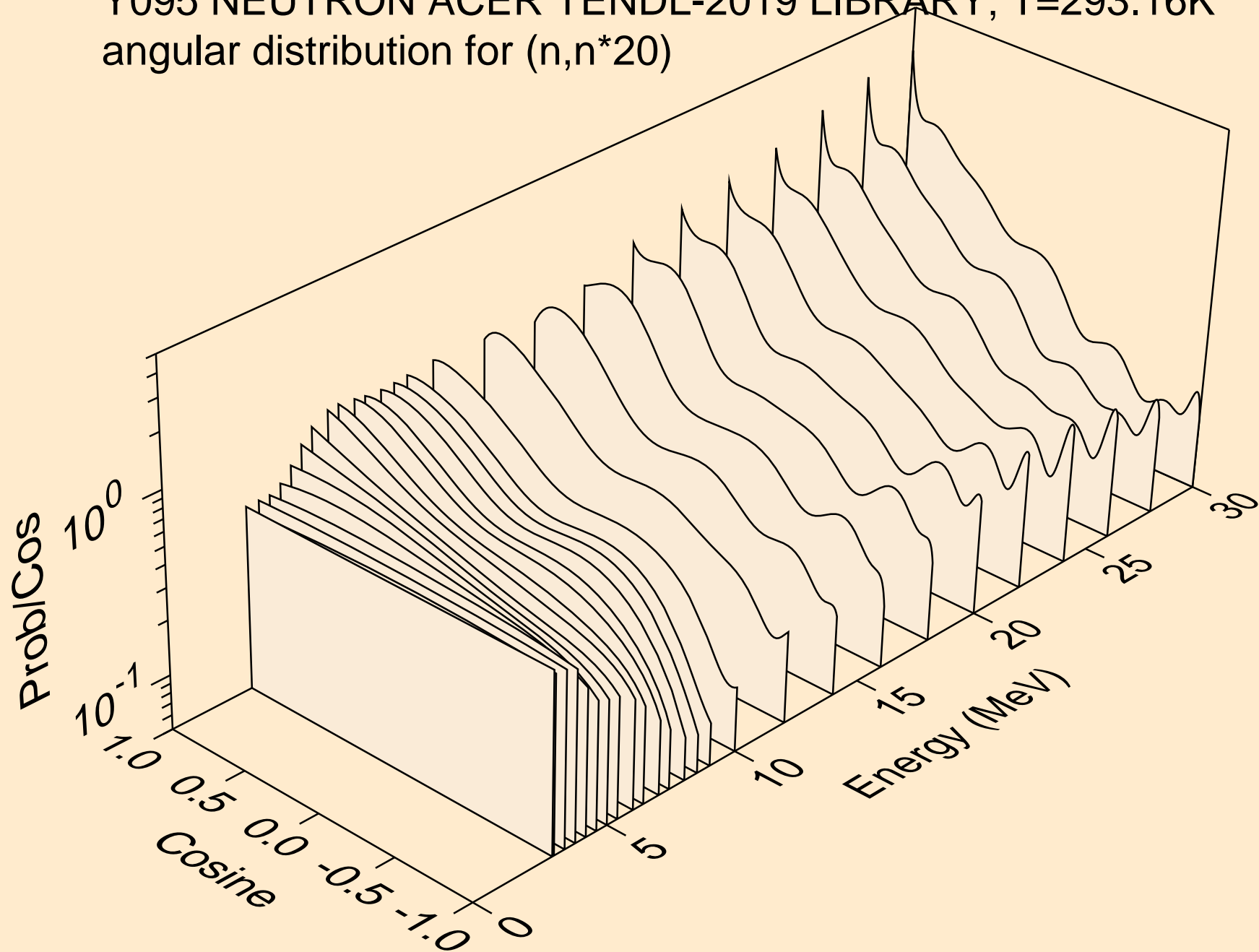

Y095 NEUTRON ACER TENDL-2019 LIBRARY; T=293.16K
angular distribution for (n,n*21)

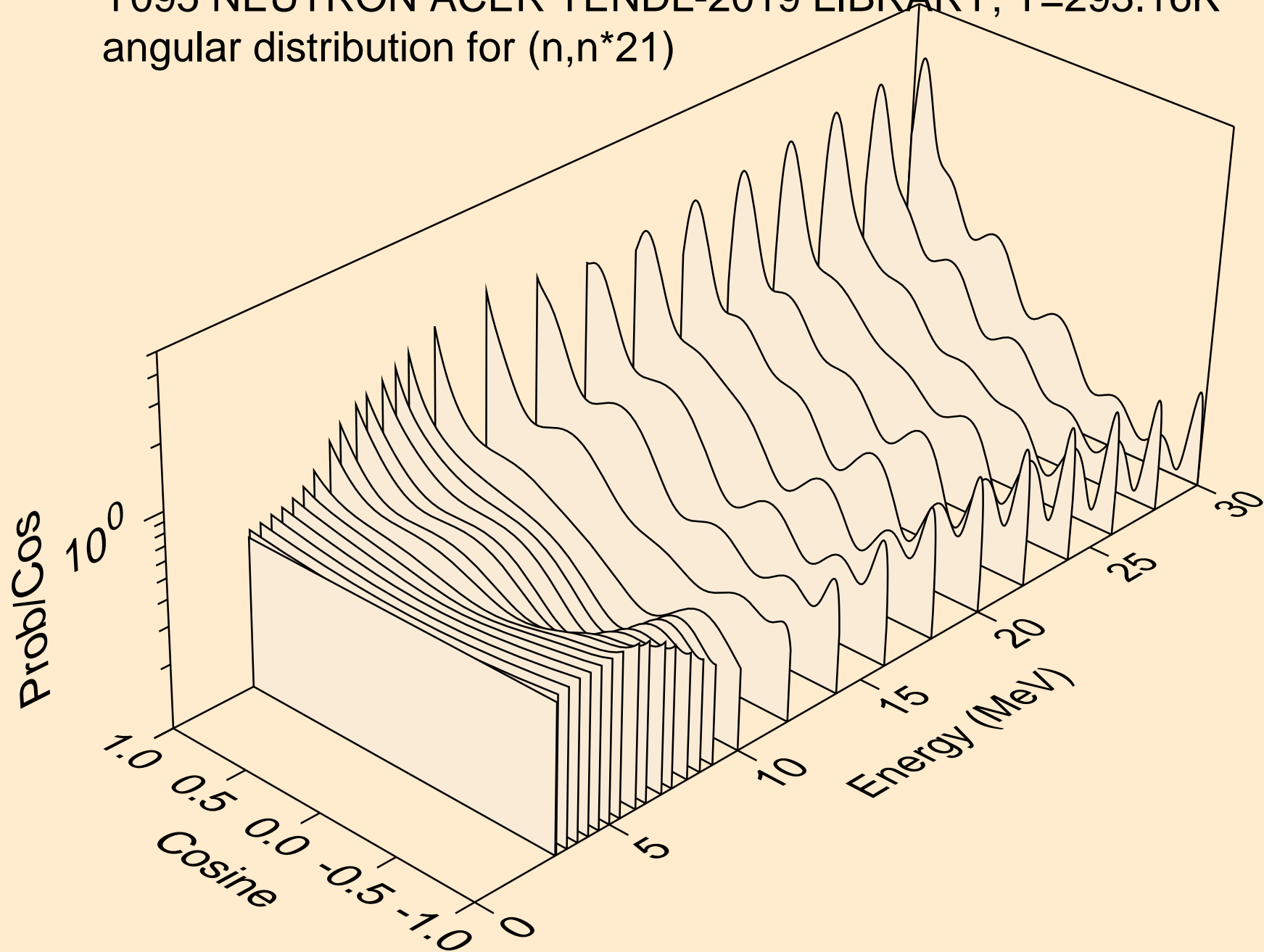

Y095 NEUTRON ACER TENDL-2019 LIBRARY; T=293.16K
angular distribution for (n,n*22)

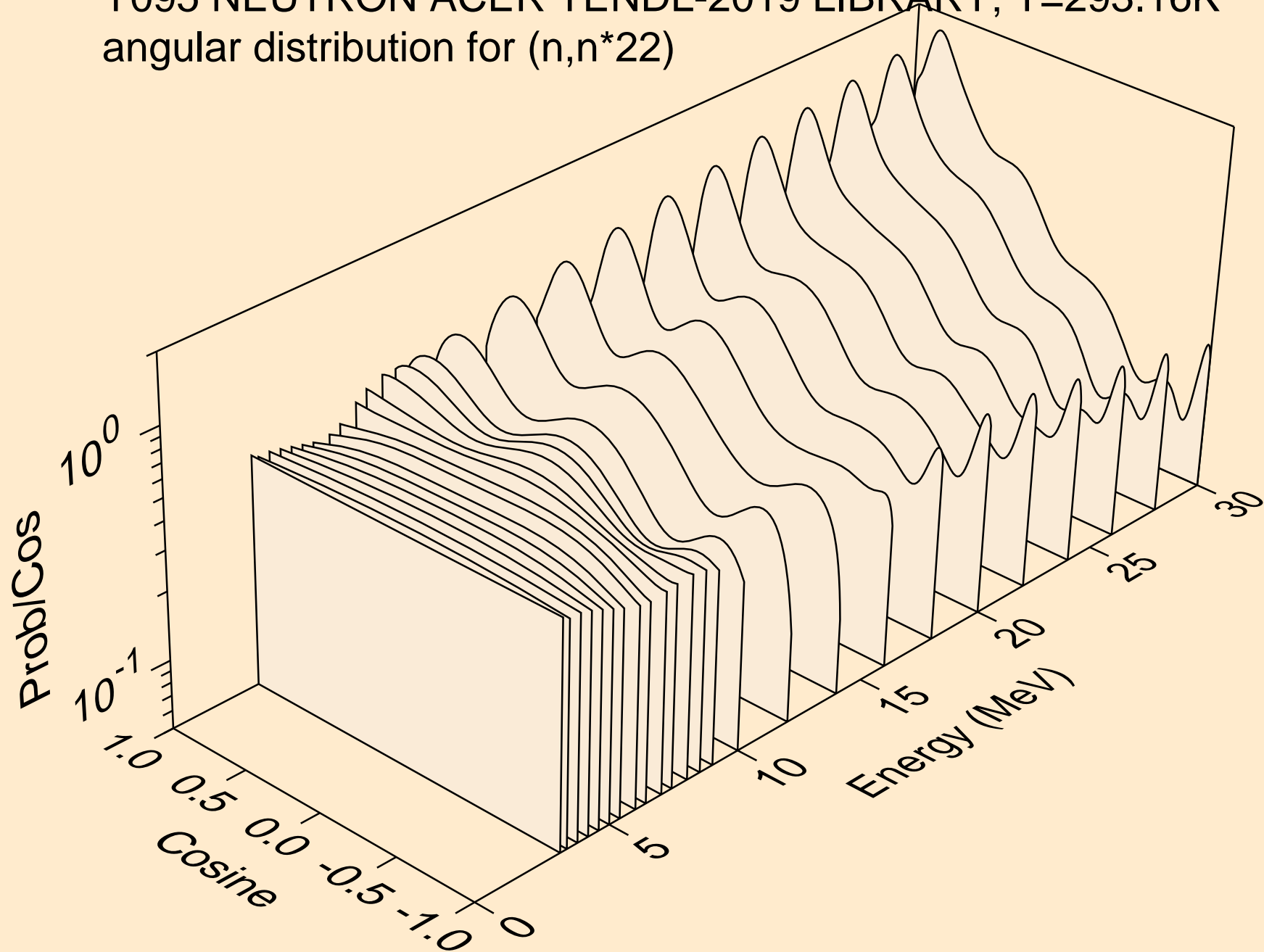

Y095 NEUTRON ACER TENDL-2019 LIBRARY; T=293.16K
angular distribution for (n,n*23)

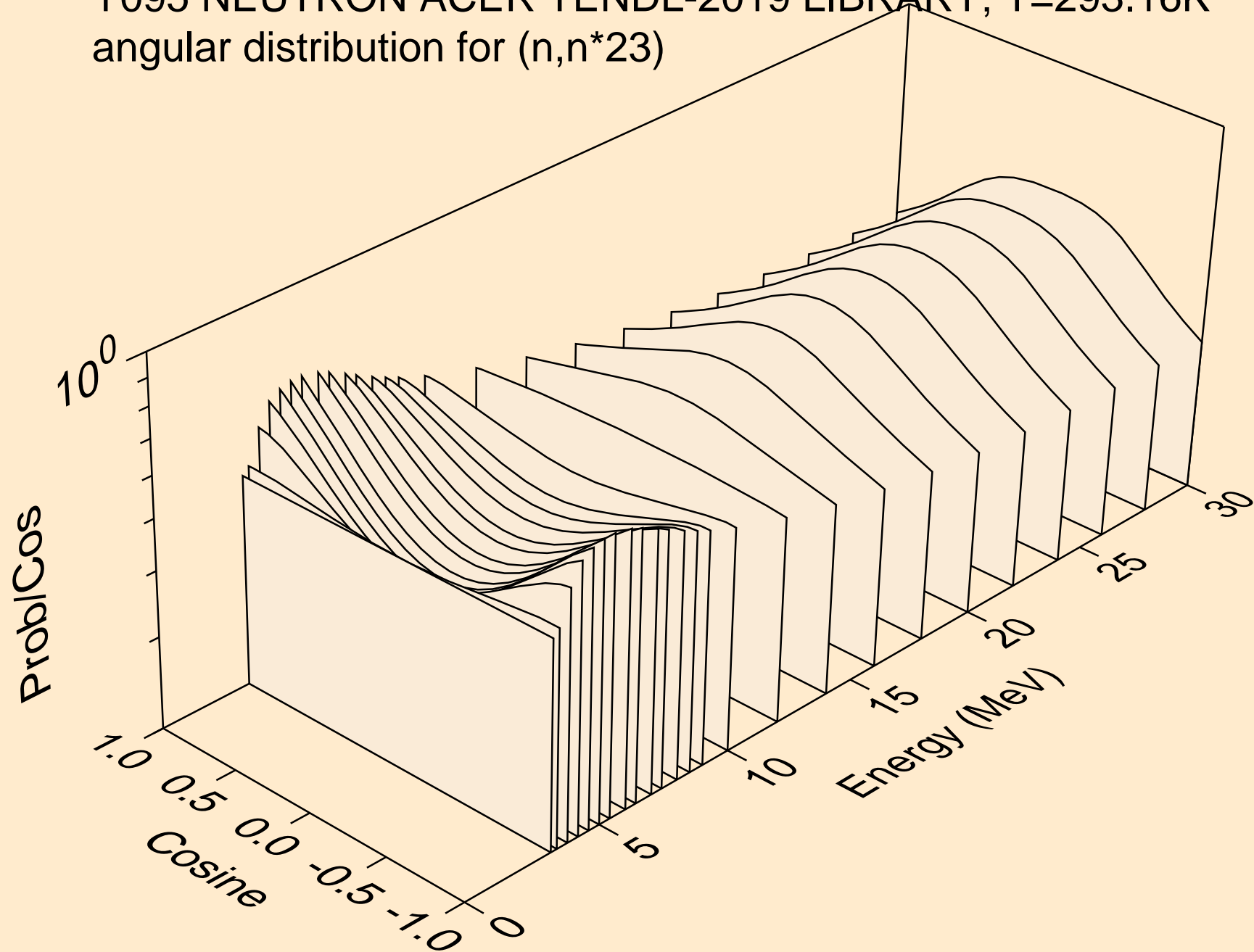

Y095 NEUTRON ACER TENDL-2019 LIBRARY; T=293.16K
angular distribution for (n,n*24)

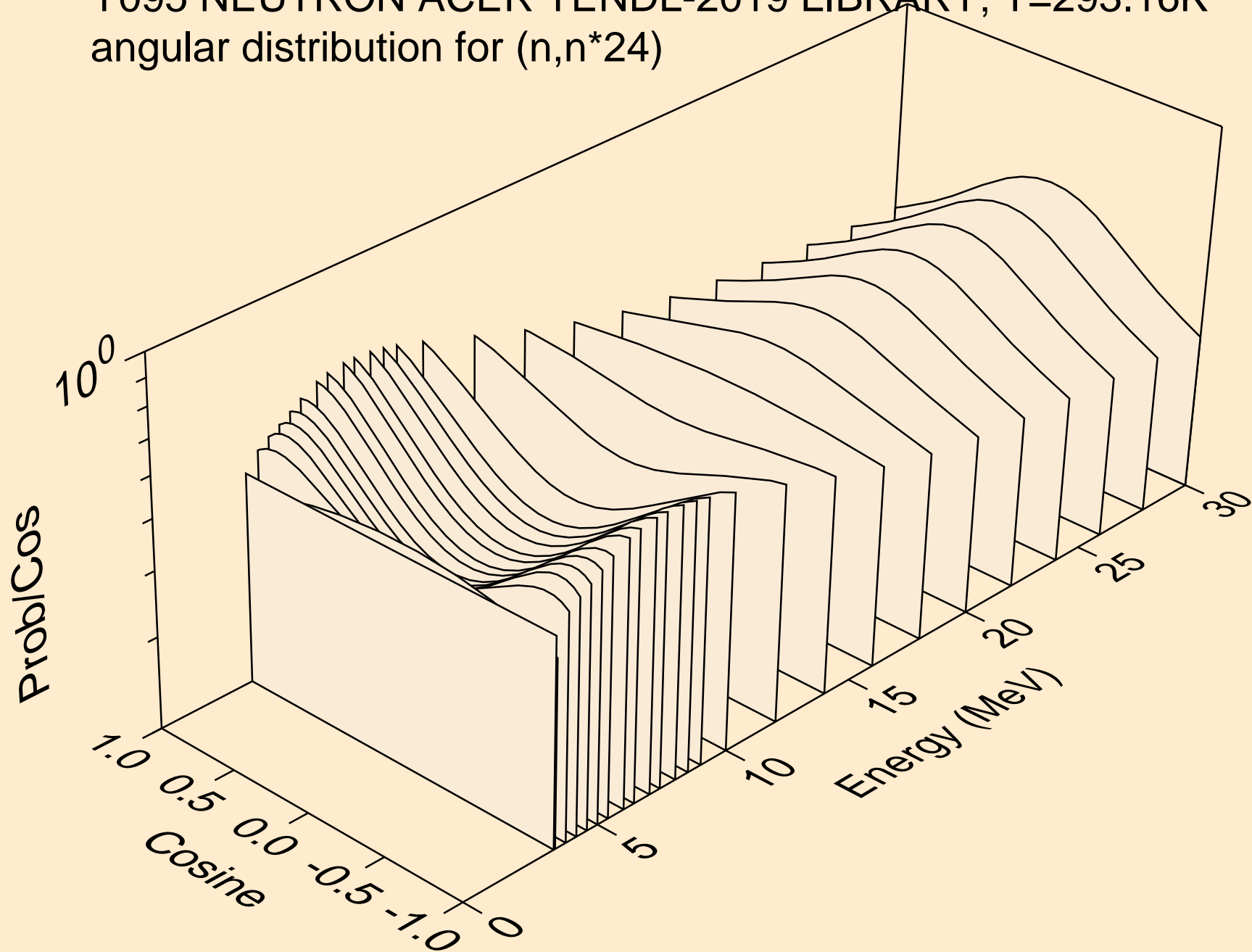

Y095 NEUTRON ACER TENDL-2019 LIBRARY; T=293.16K
angular distribution for (n,n*25)

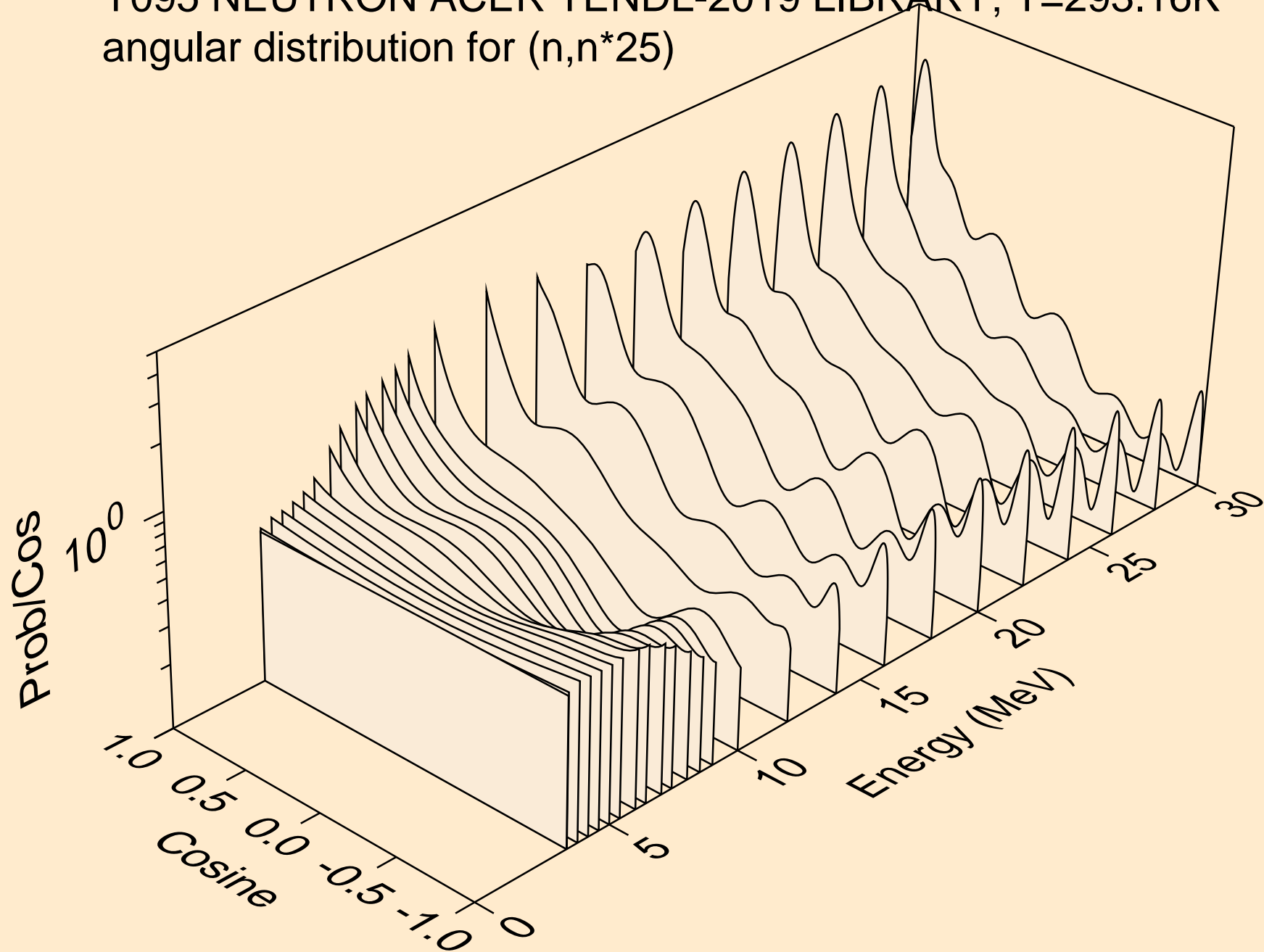

Y095 NEUTRON ACER TENDL-2019 LIBRARY; T=293.16K
angular distribution for (n,n*26)

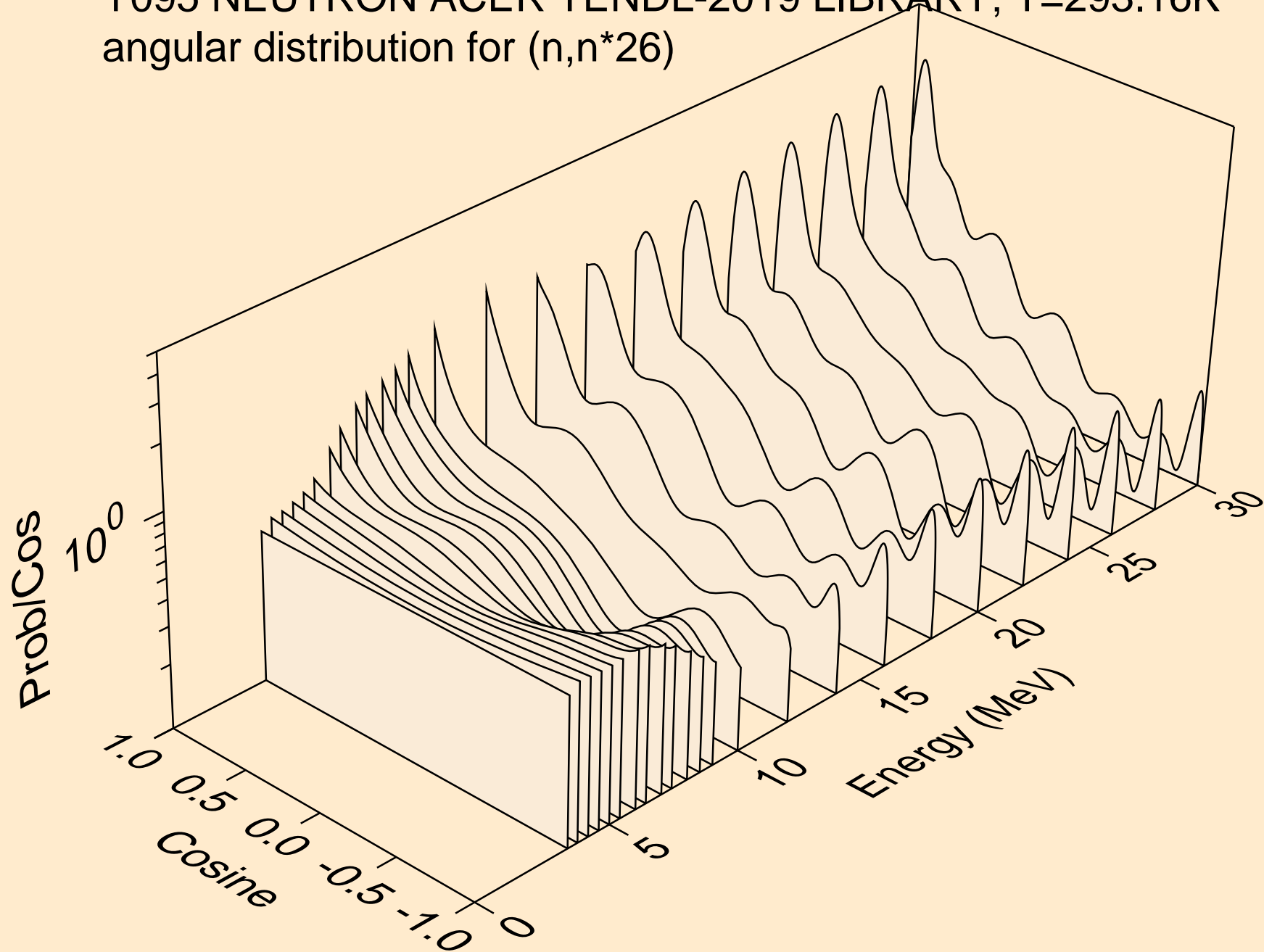

Y095 NEUTRON ACER TENDL-2019 LIBRARY; T=293.16K
angular distribution for (n,n*27)

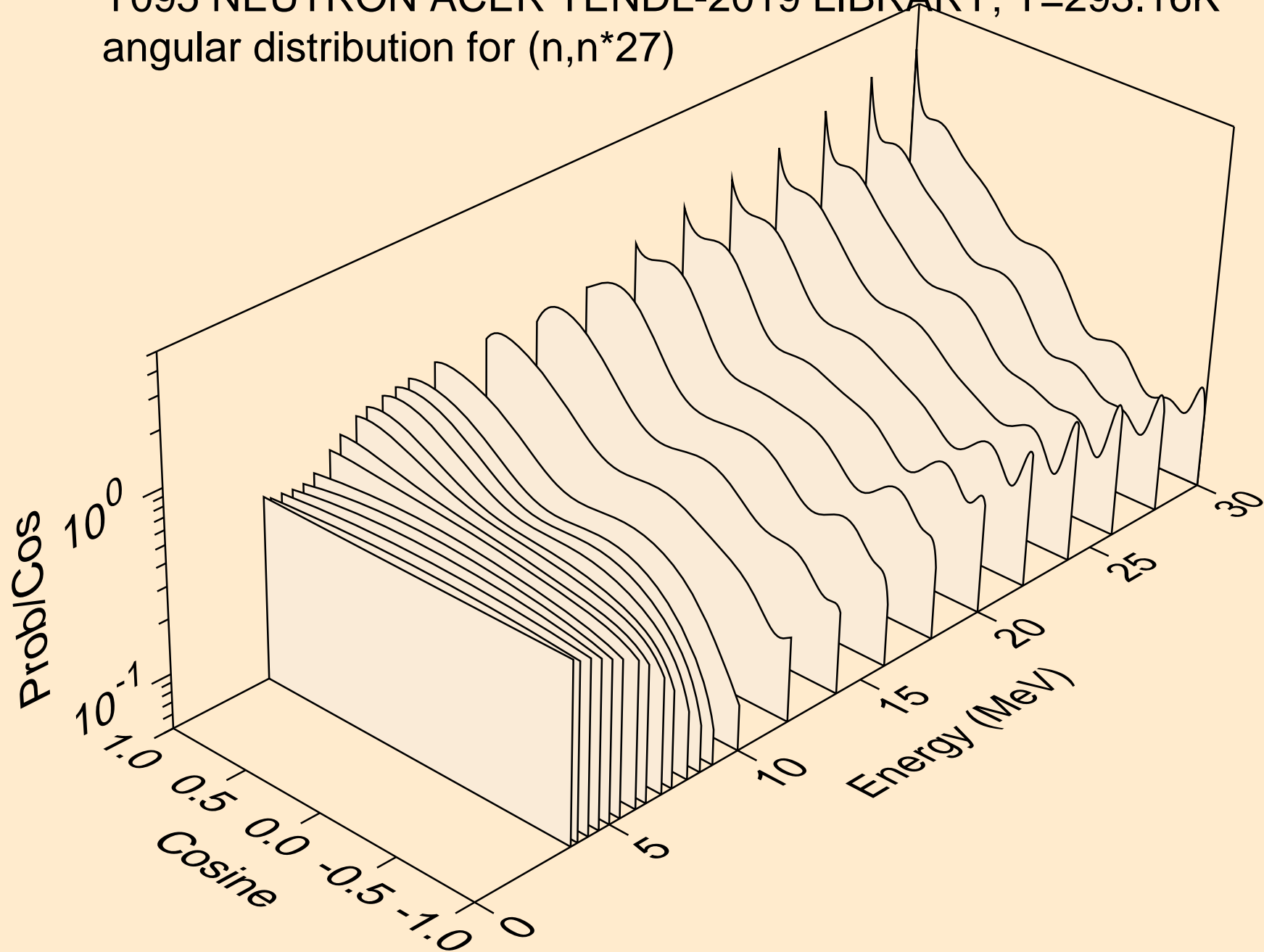

Y095 NEUTRON ACER TENDL-2019 LIBRARY; T=293.16K
angular distribution for (n,n*28)

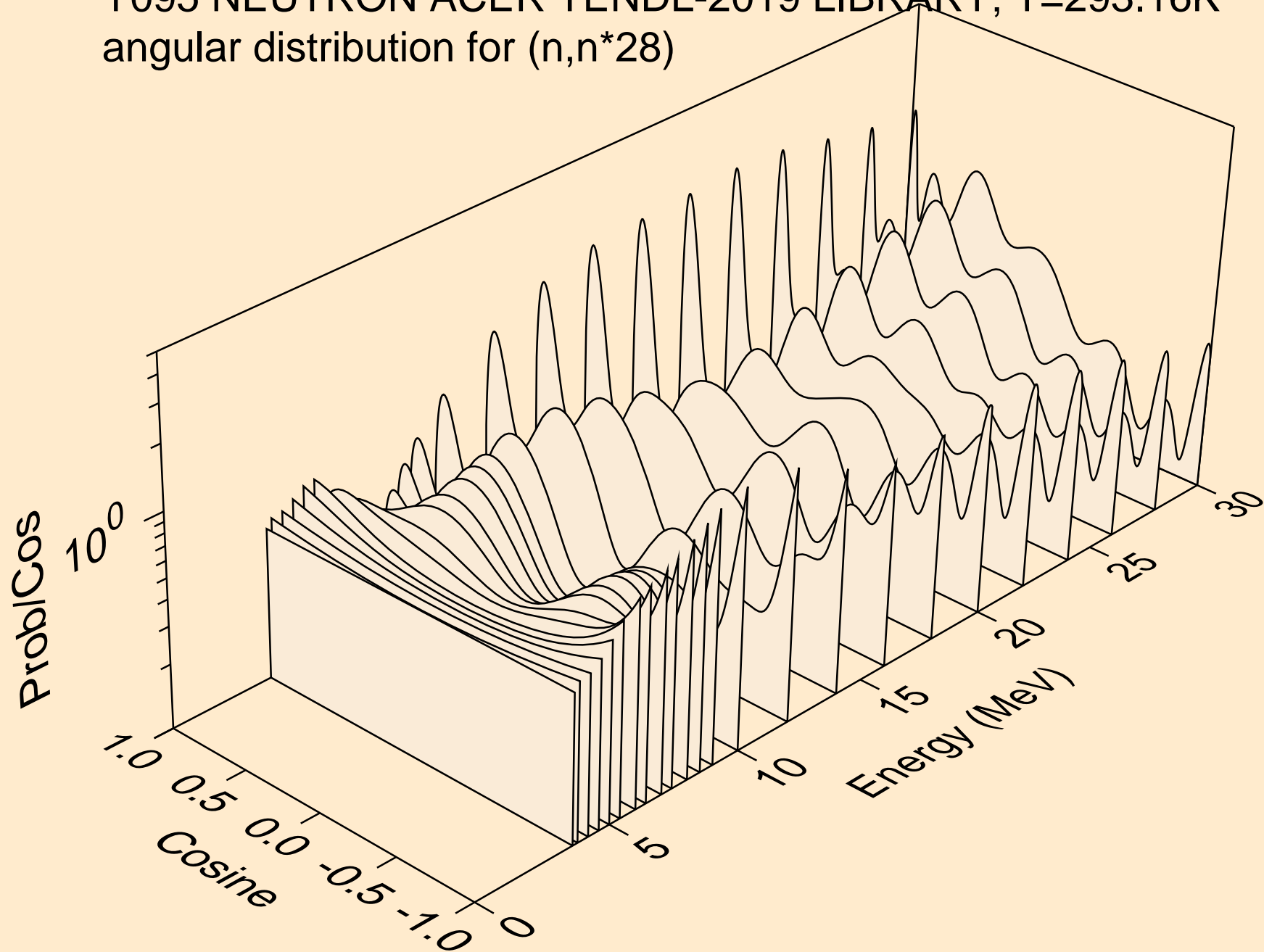

Y095 NEUTRON ACER TENDL-2019 LIBRARY; T=293.16K
Neutron emission for (n,x)

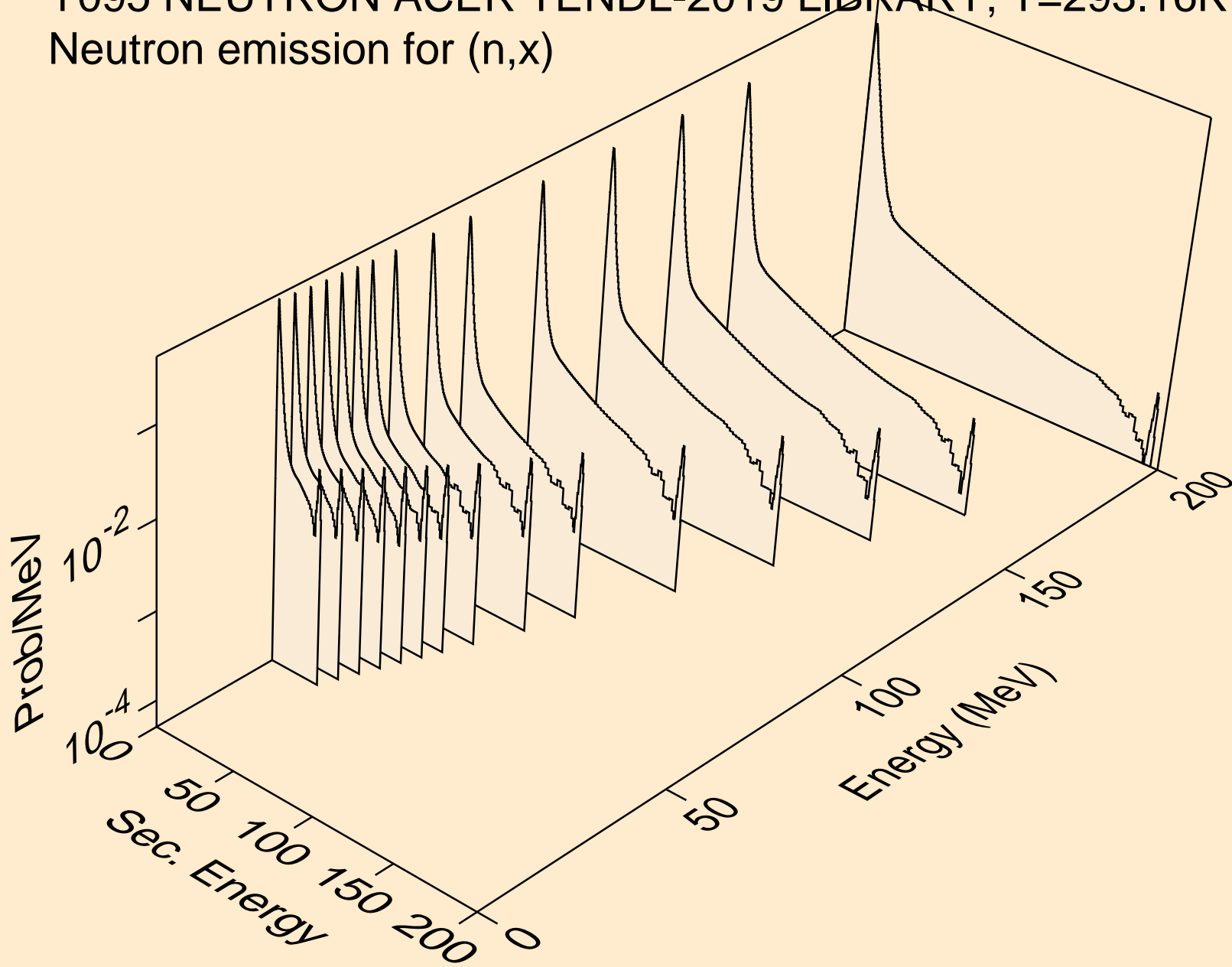

Y095 NEUTRON ACER TENDL-2019 LIBRARY; T=293.16K
Neutron emission for (n,2nd)

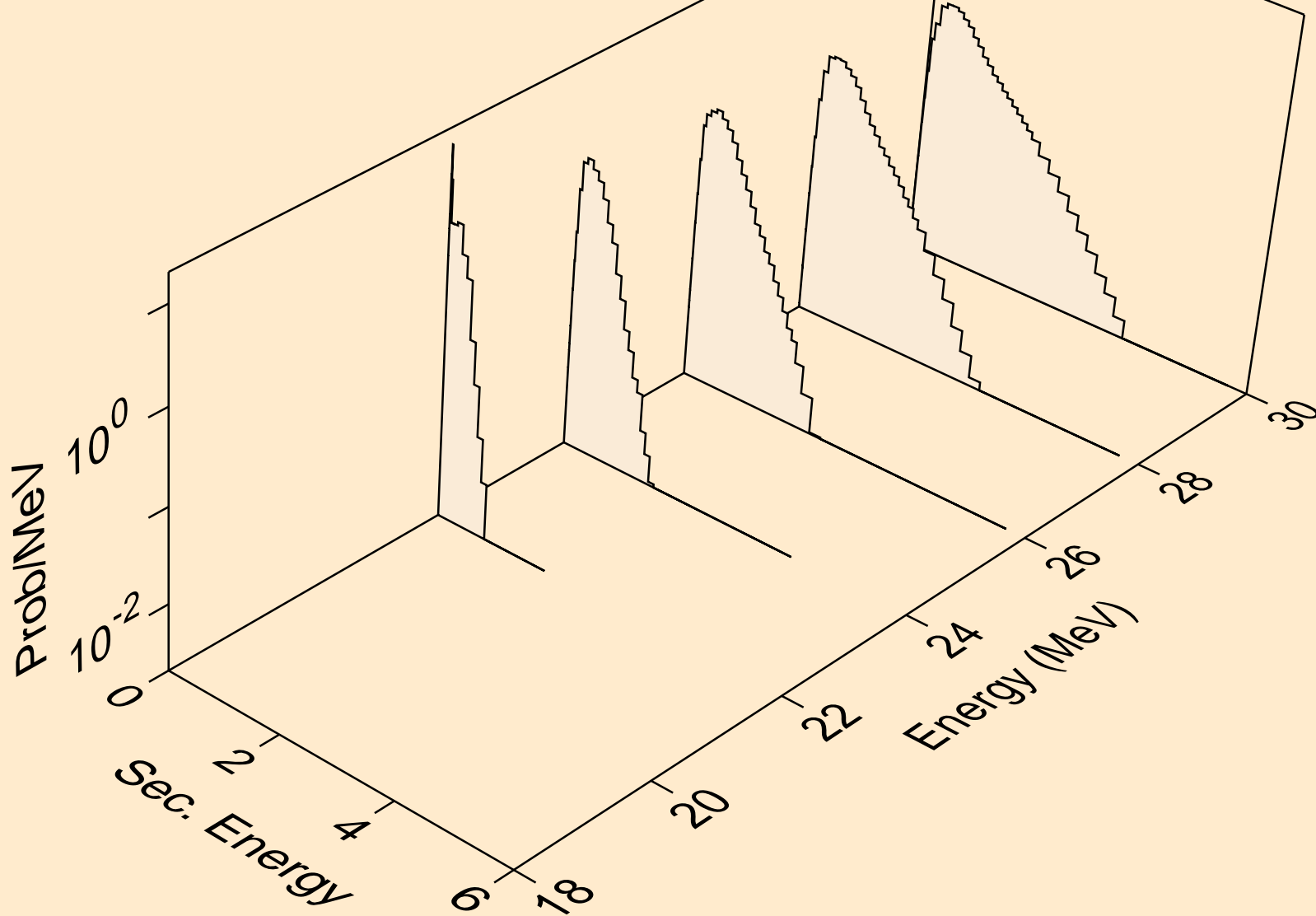

Y095 NEUTRON ACER TENDL-2019 LIBRARY; T=293.16K
Neutron emission for (n,2n)

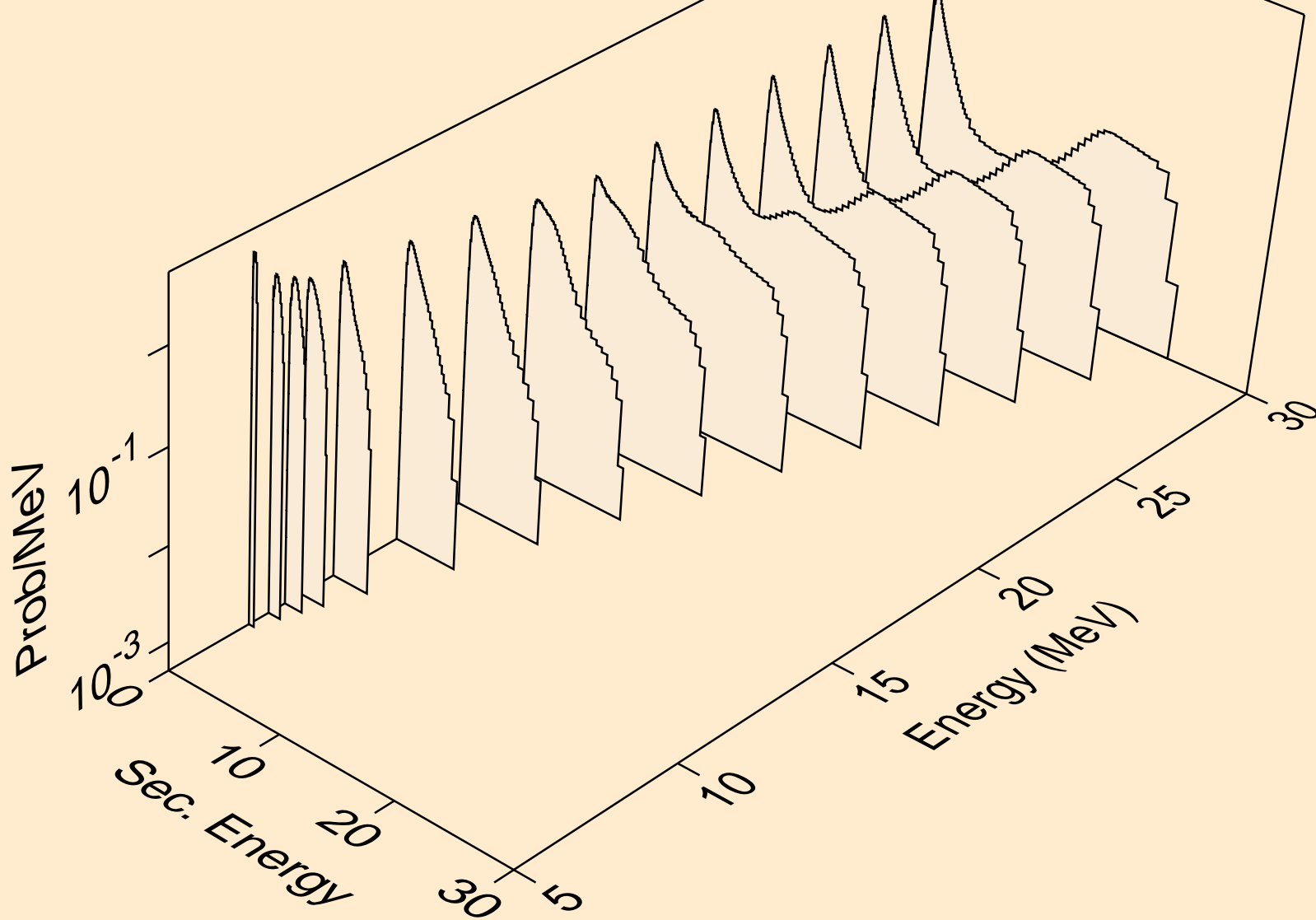

Y095 NEUTRON ACER TENDL-2019 LIBRARY; T=293.16K
Neutron emission for (n,3n)

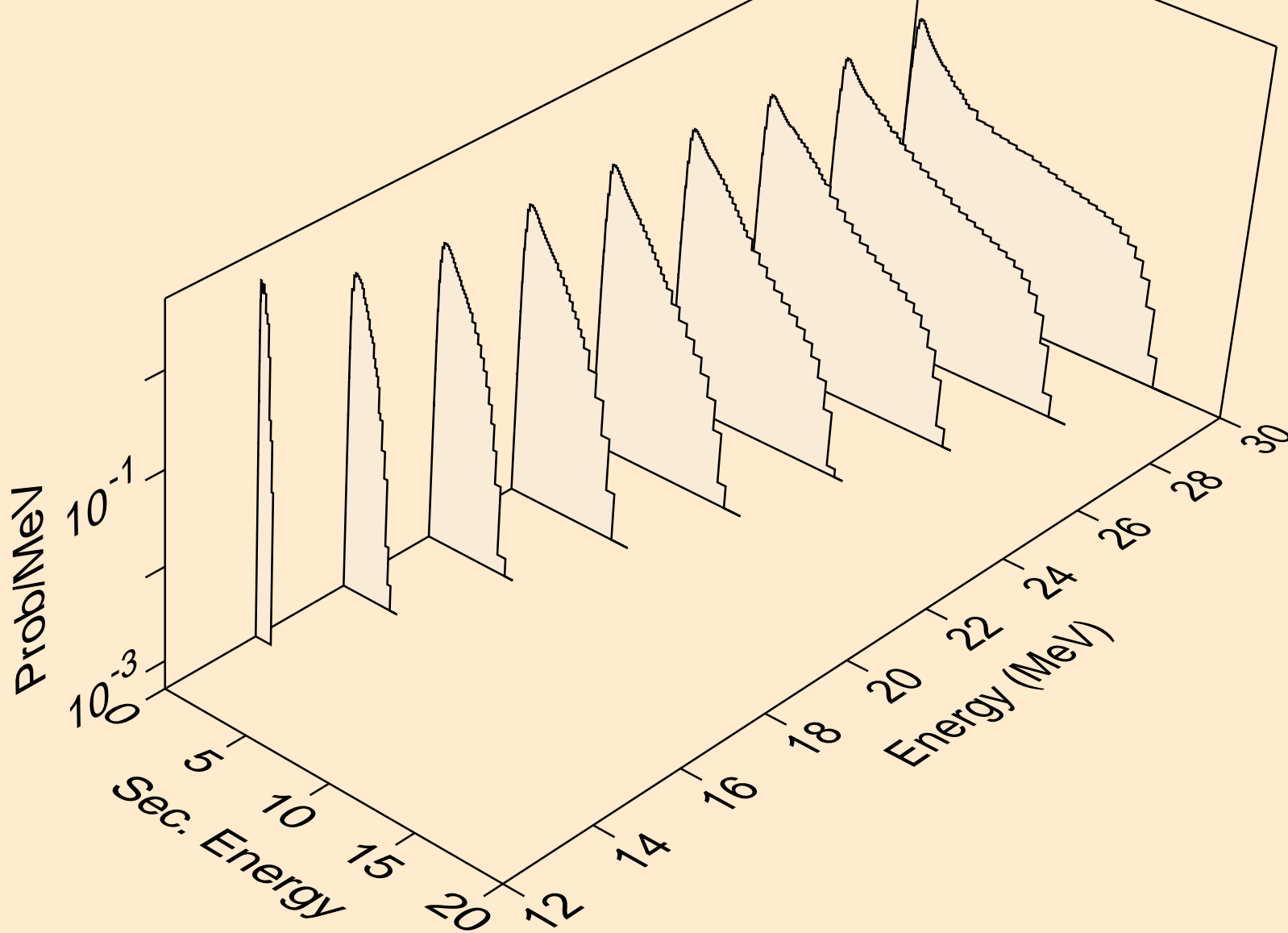

Y095 NEUTRON ACER TENDL-2019 LIBRARY; T=293.16K
Neutron emission for (n,n*)a

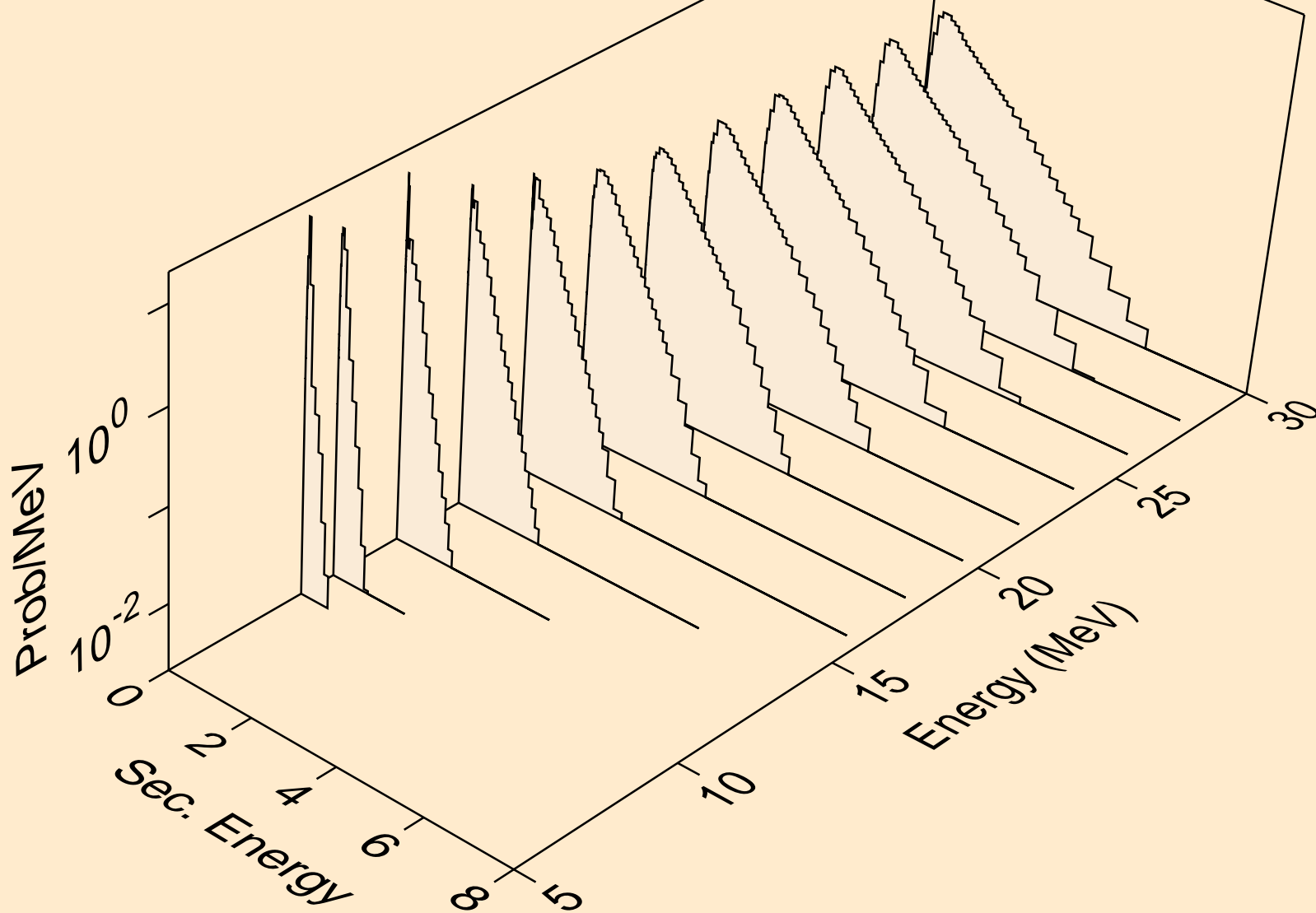

Y095 NEUTRON ACER TENDL-2019 LIBRARY; T=293.16K
Neutron emission for (n,2n)a

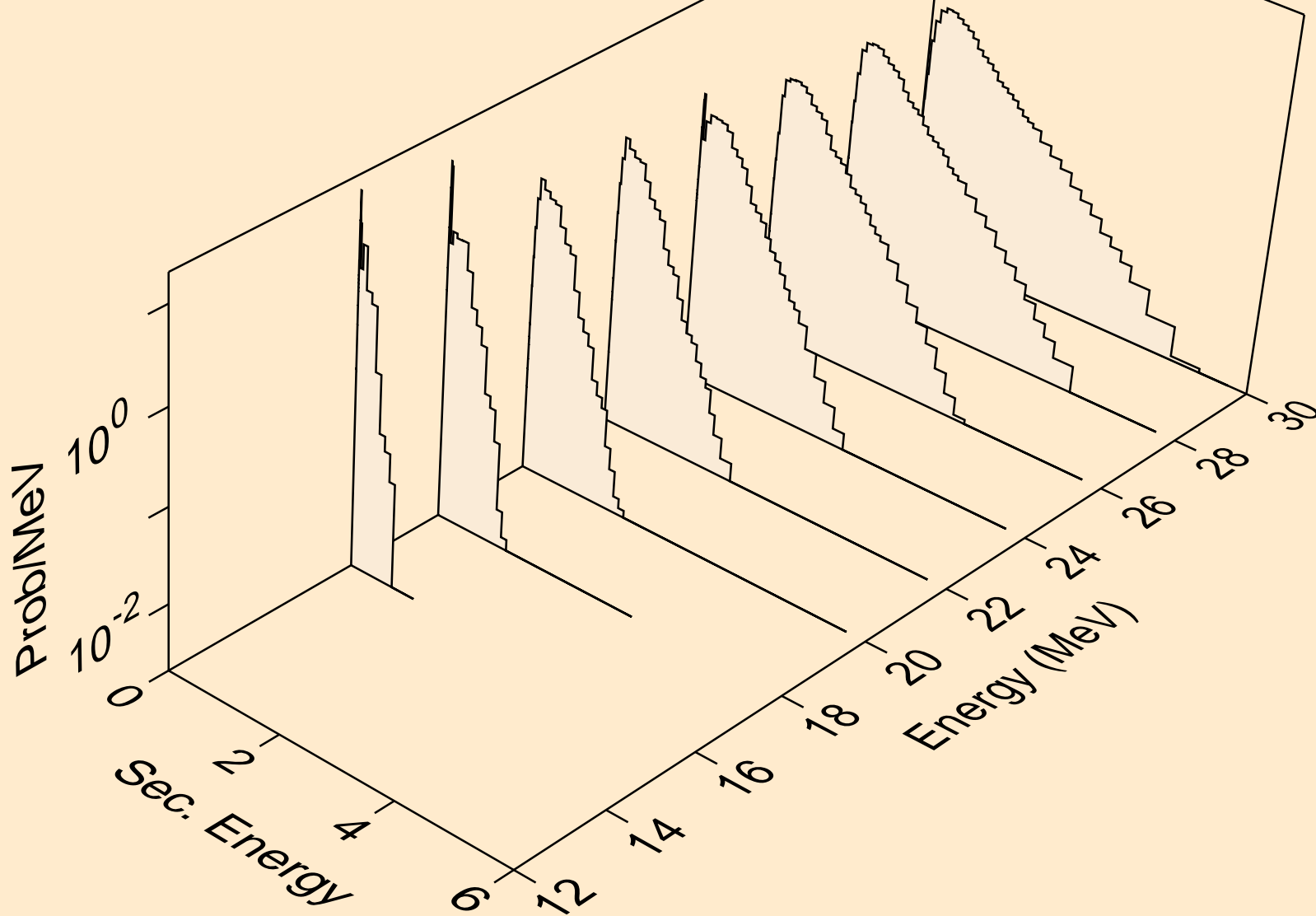

Y095 NEUTRON ACER TENDL-2019 LIBRARY; T=293.16K
Neutron emission for (n,3n)a

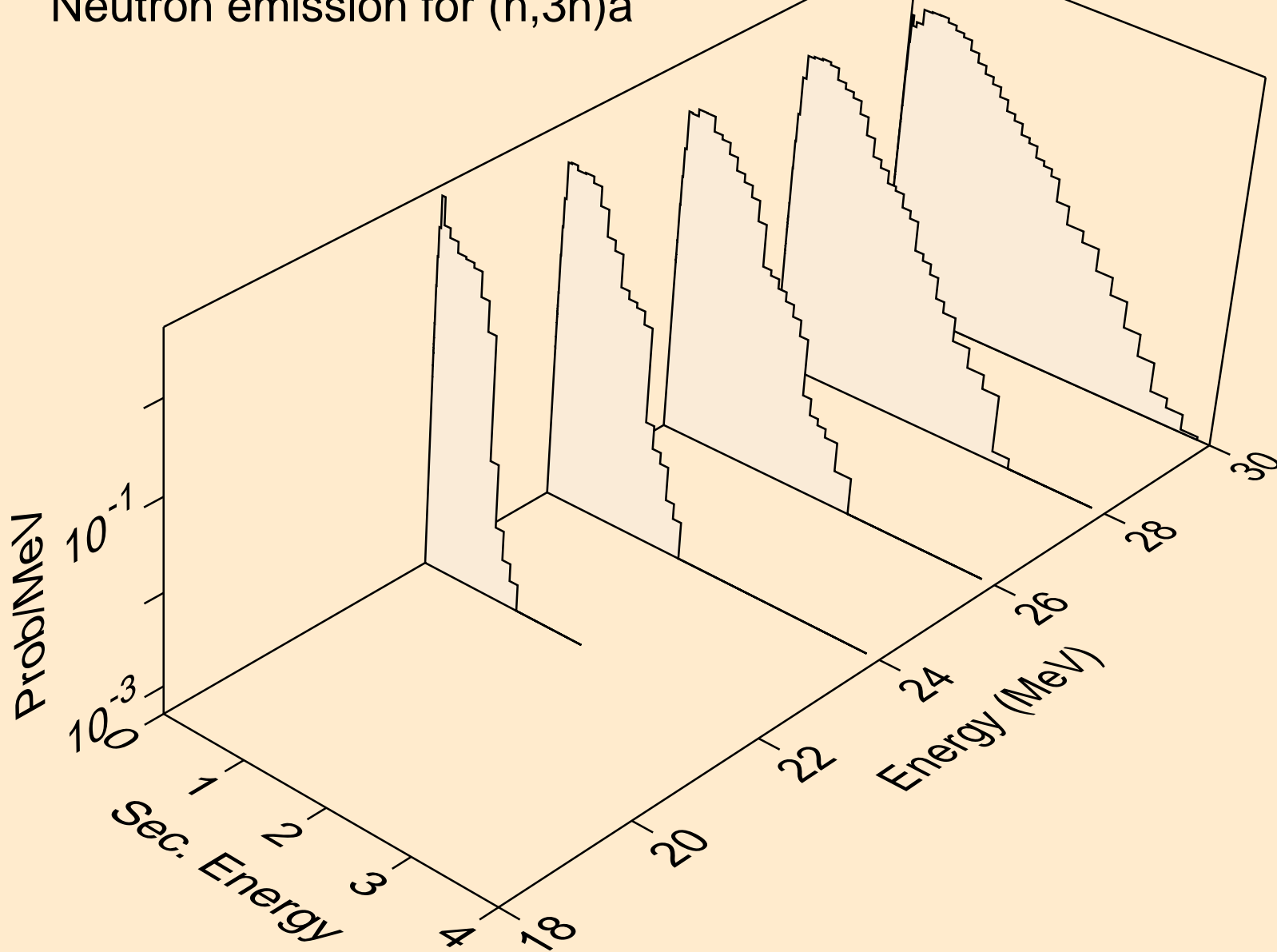

Y095 NEUTRON ACER TENDL-2019 LIBRARY; T=293.16K
Neutron emission for (n,n*)p

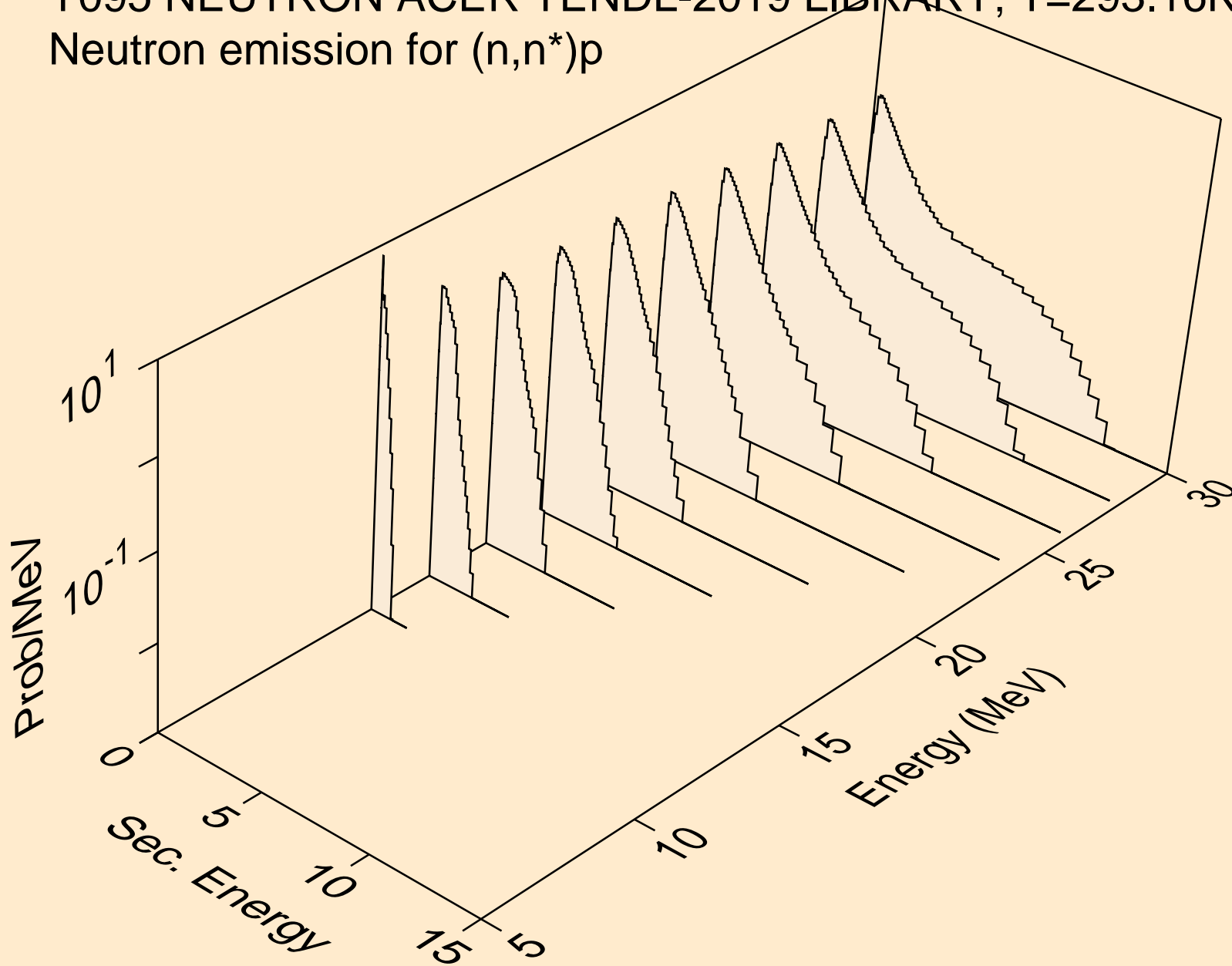

Y095 NEUTRON ACER TENDL-2019 LIBRARY; T=293.16K
Neutron emission for (n,n*)d

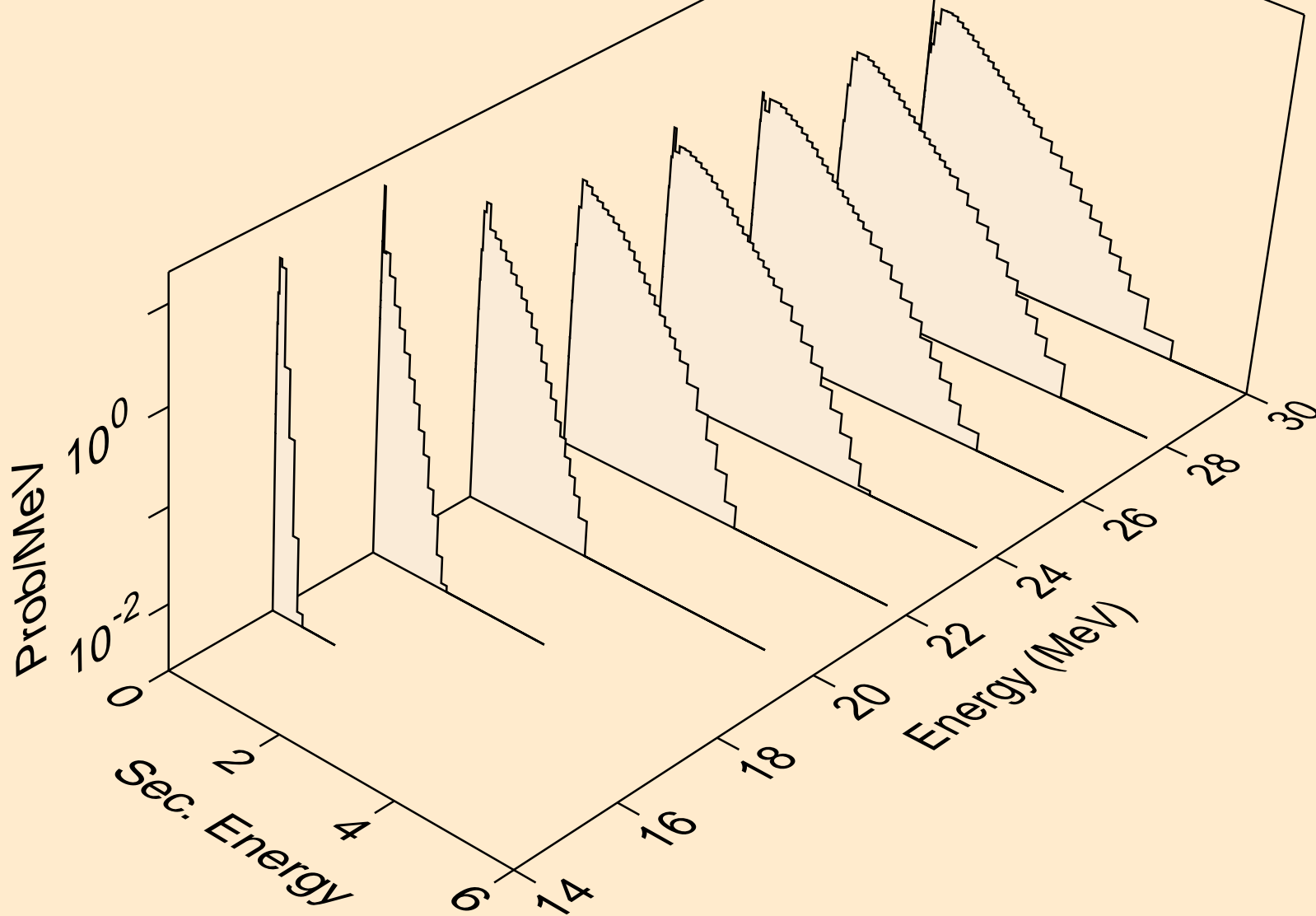

Y095 NEUTRON ACER TENDL-2019 LIBRARY; T=293.16K
Neutron emission for (n,n*)t

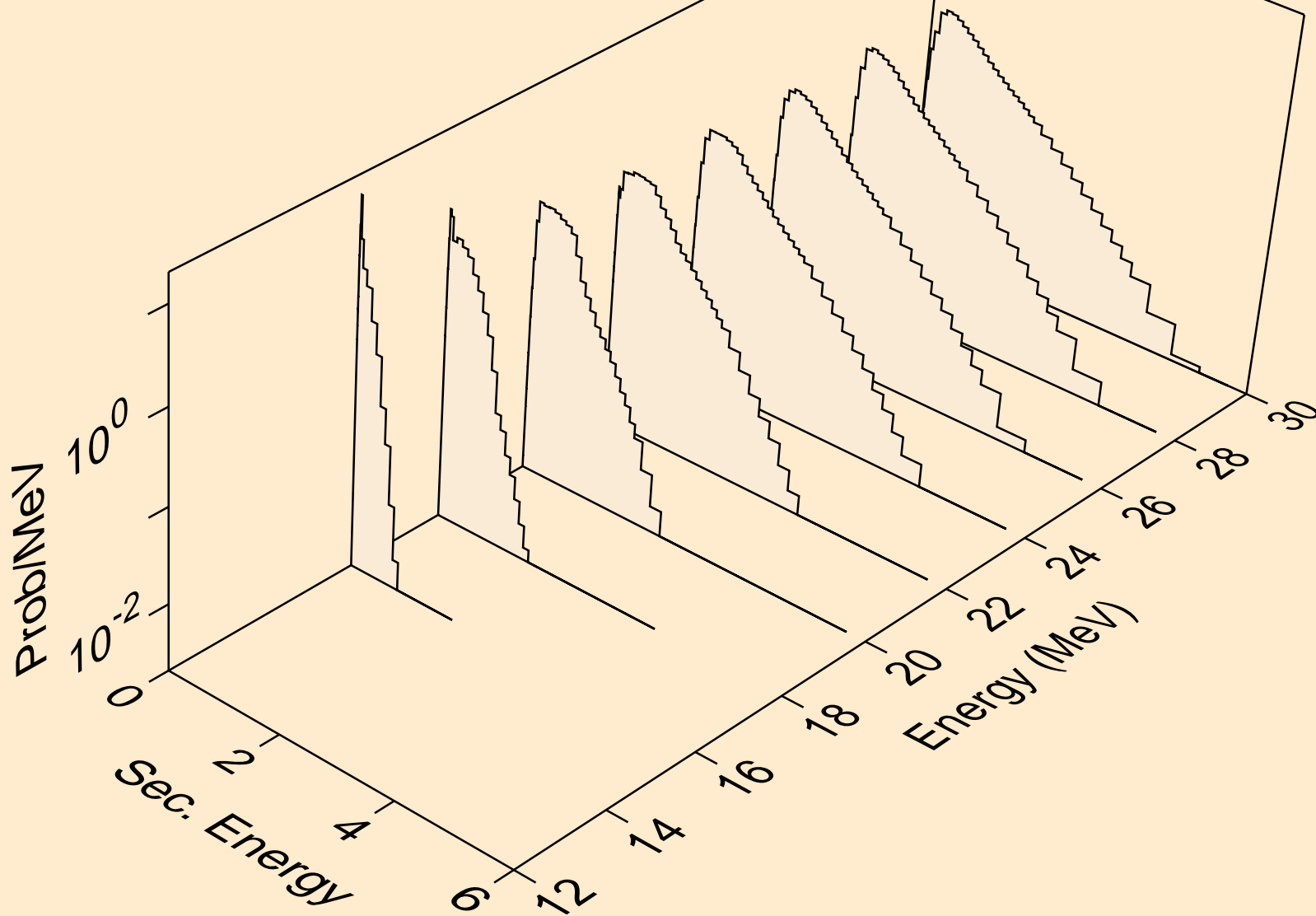

Y095 NEUTRON ACER TENDL-2019 LIBRARY; T=293.16K
Neutron emission for (n,n*)he3

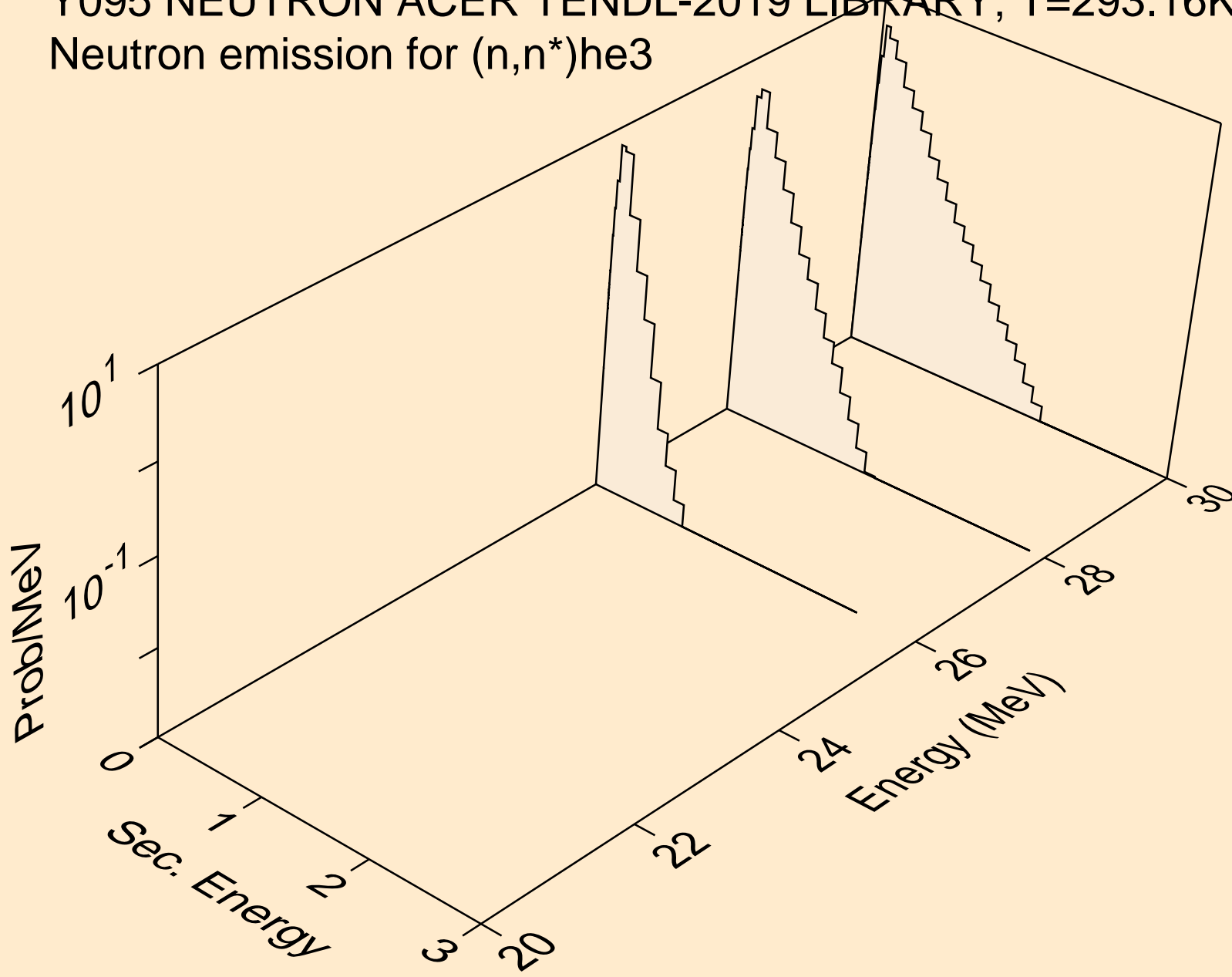

Y095 NEUTRON ACER TENDL-2019 LIBRARY; T=293.16K
Neutron emission for (n,4n)

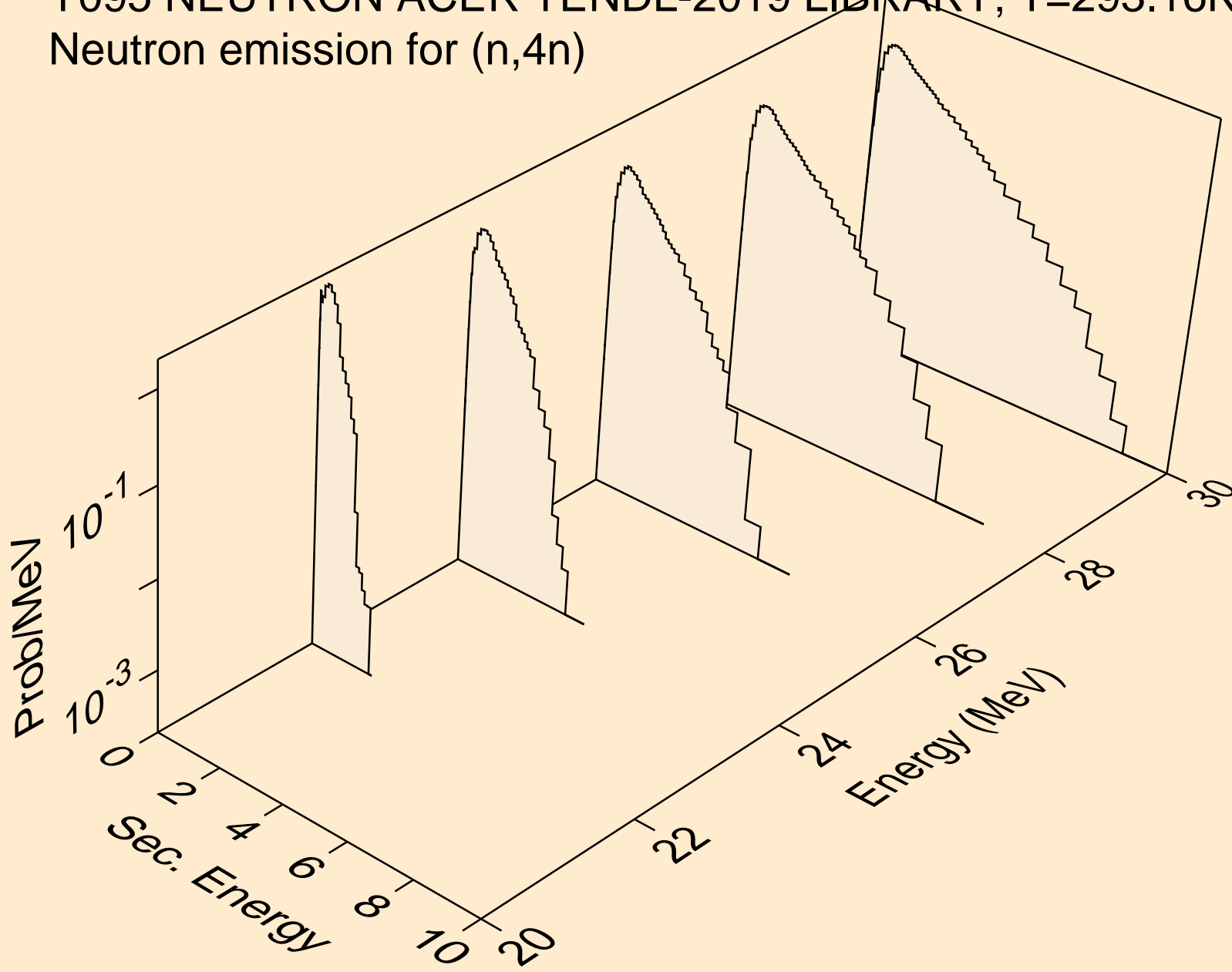

Y095 NEUTRON ACER TENDL-2019 LIBRARY; T=293.16K
Neutron emission for (n,2np)

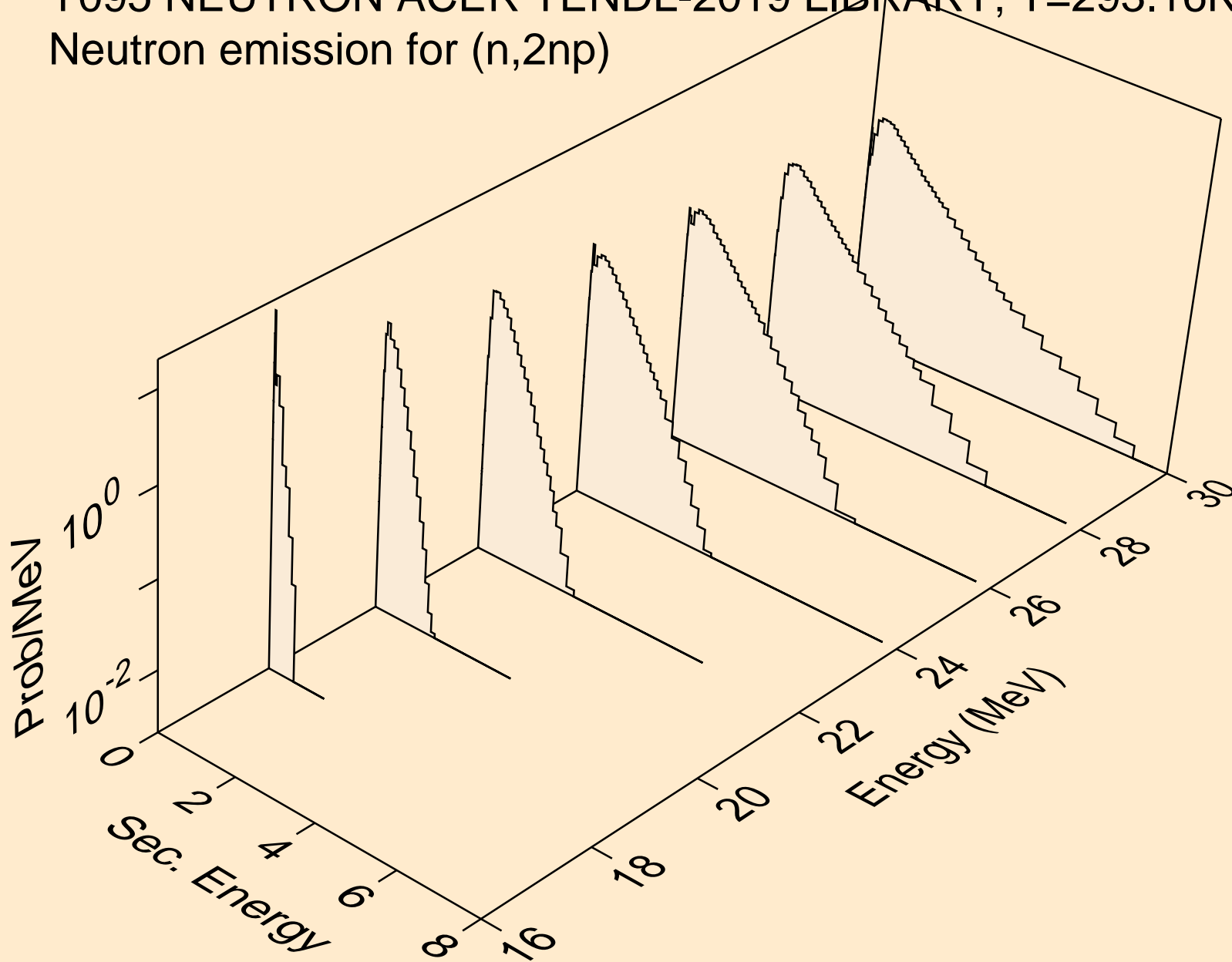

Y095 NEUTRON ACER TENDL-2019 LIBRARY; T=293.16K
Neutron emission for (n,3np)

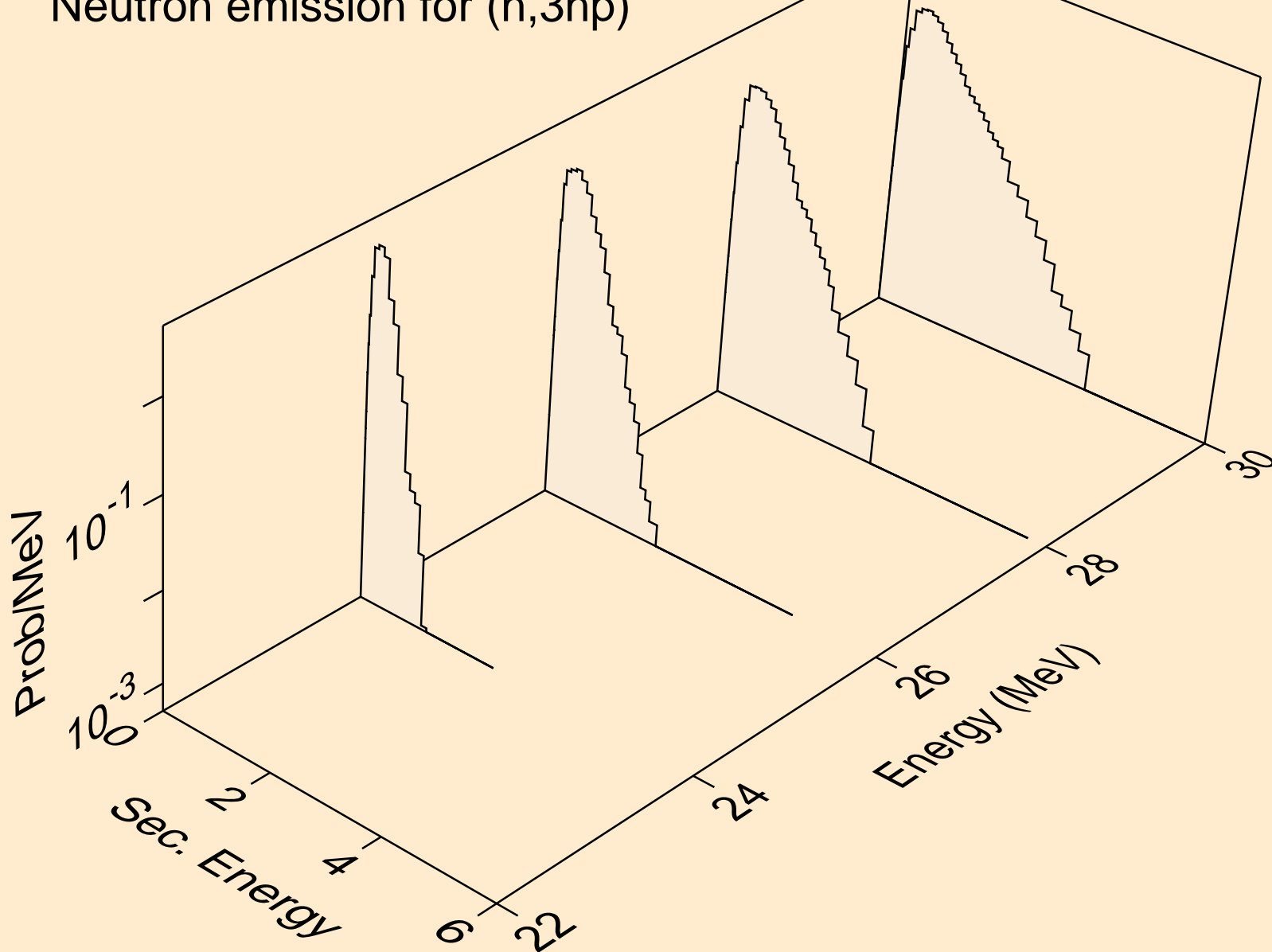

Y095 NEUTRON ACER TENDL-2019 LIBRARY; T=293.16K
Neutron emission for (n,n*c)

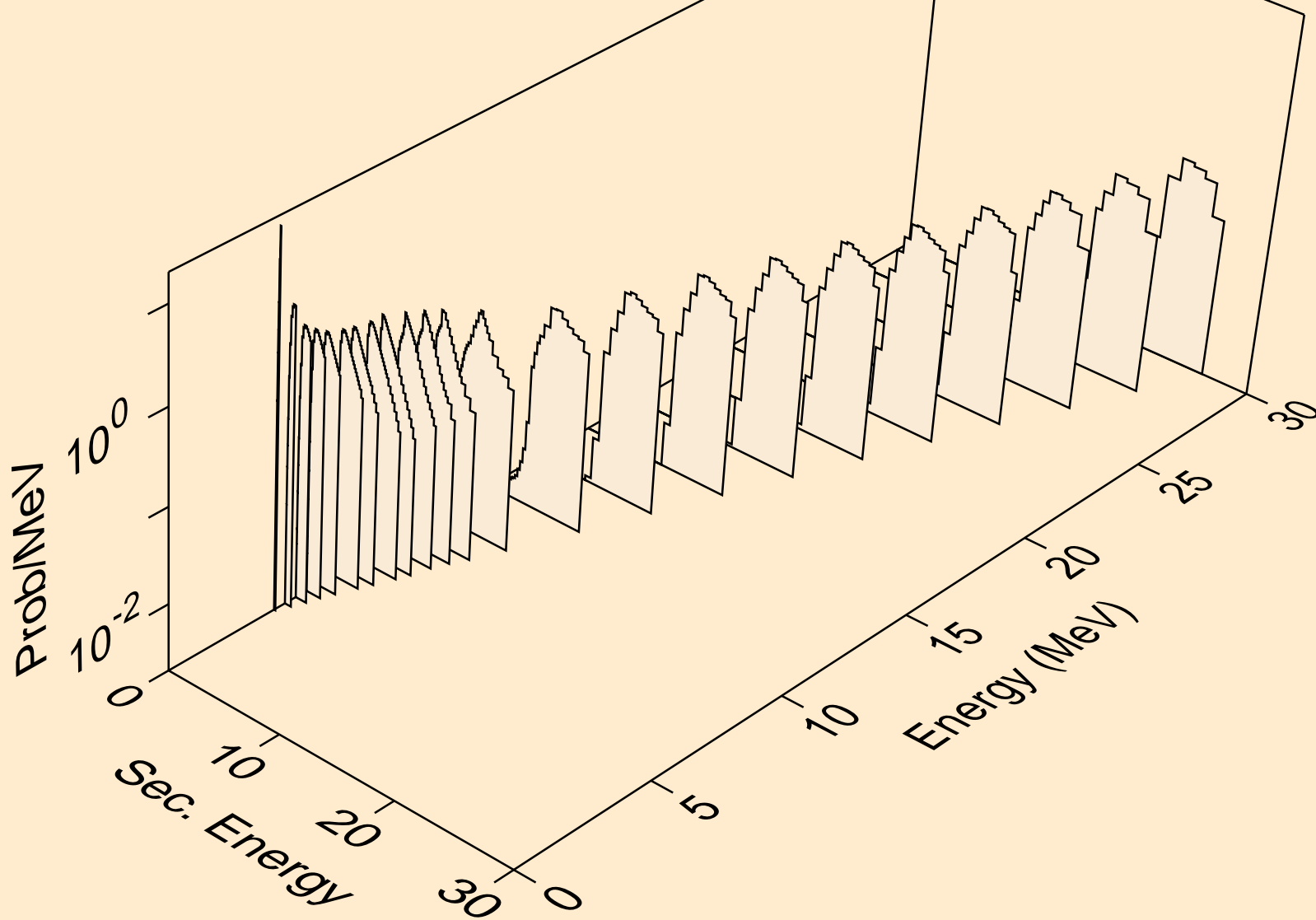

Y095 NEUTRON ACER TENDL-2019 LIBRARY; T=293.16K
Photon emission for (n,x)

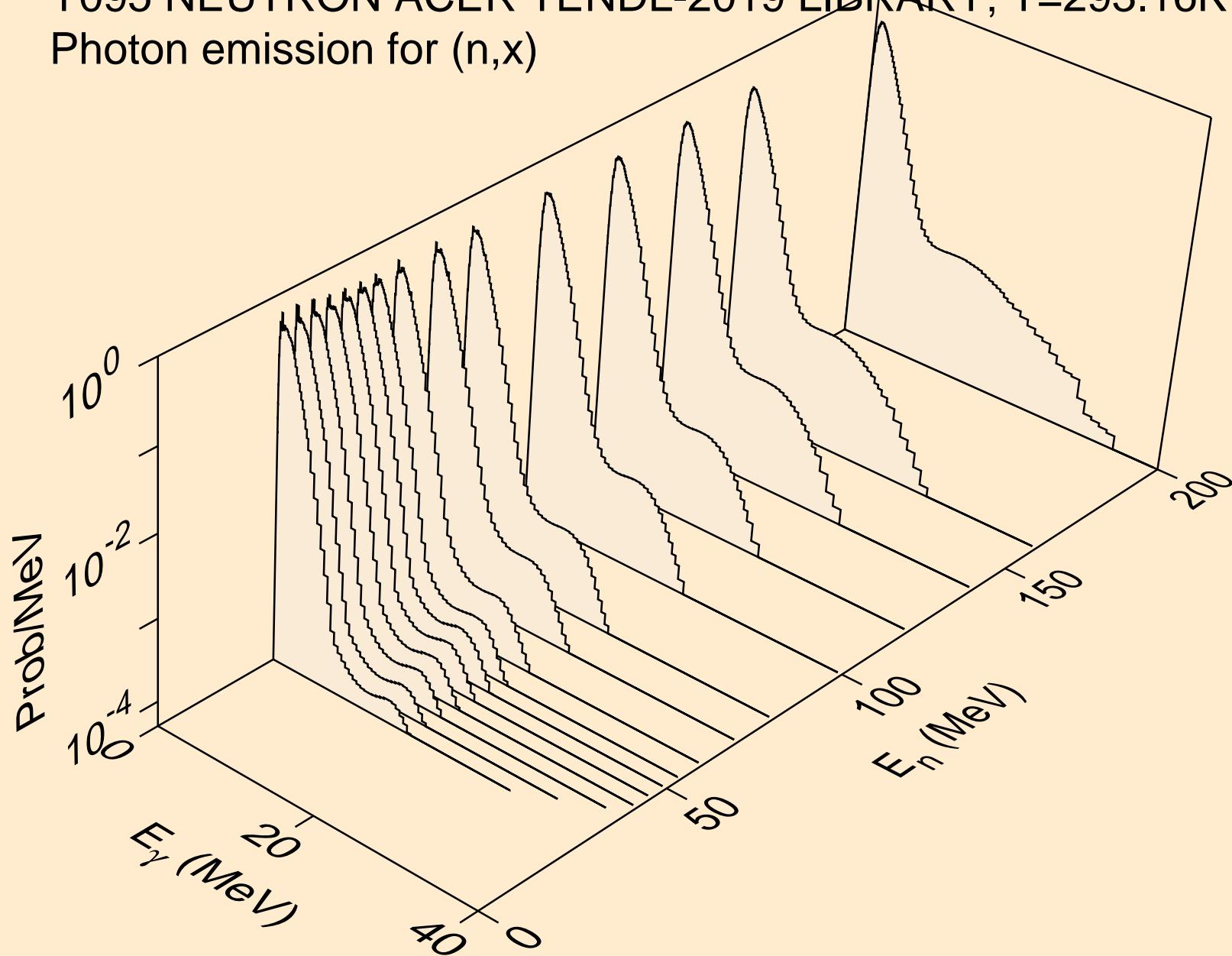

Y095 NEUTRON ACER TENDL-2019 LIBRARY; T=293.16K
Photon emission for (n,2nd)

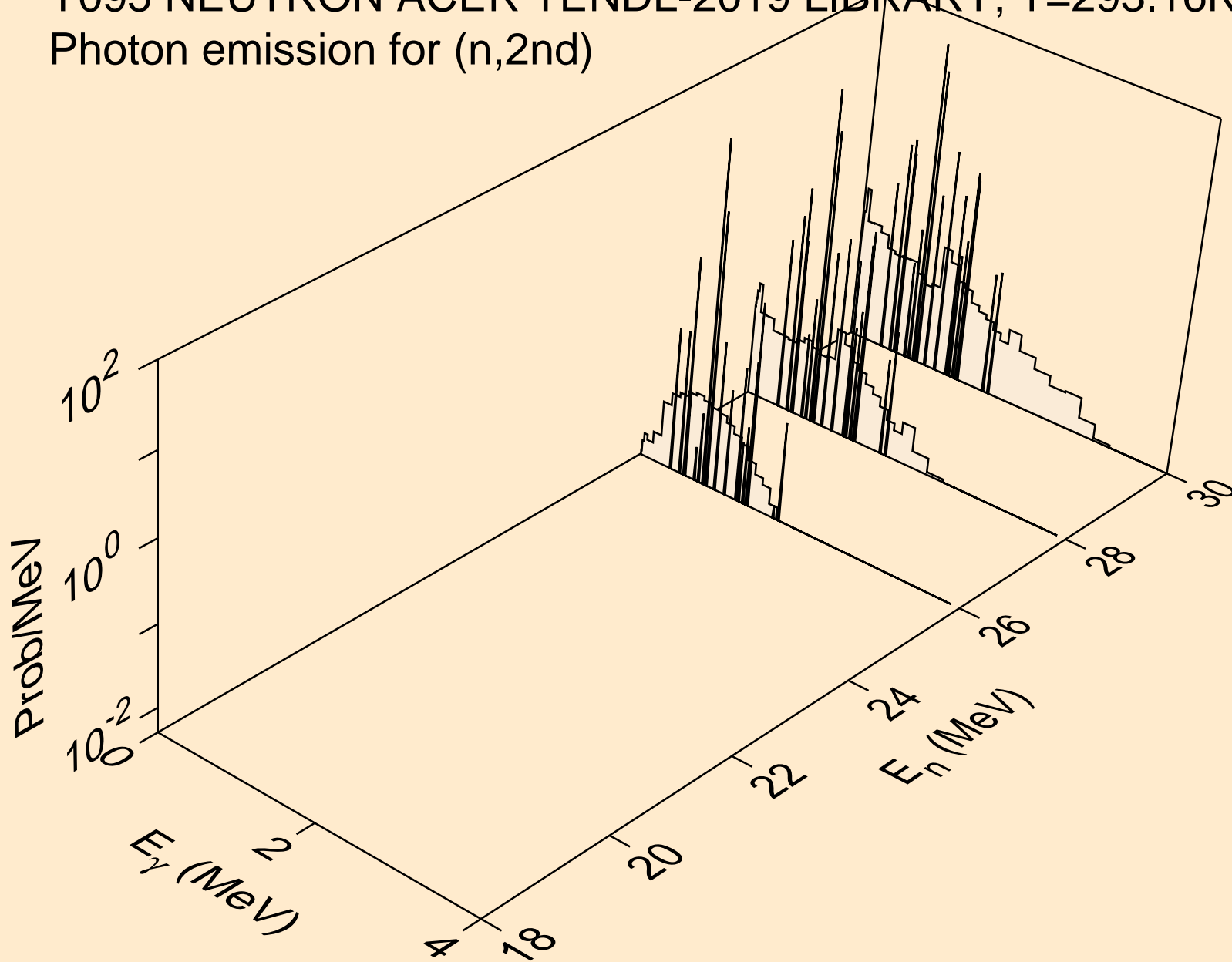

Y095 NEUTRON ACER TENDL-2019 LIBRARY; T=293.16K
Photon emission for (n,2n)

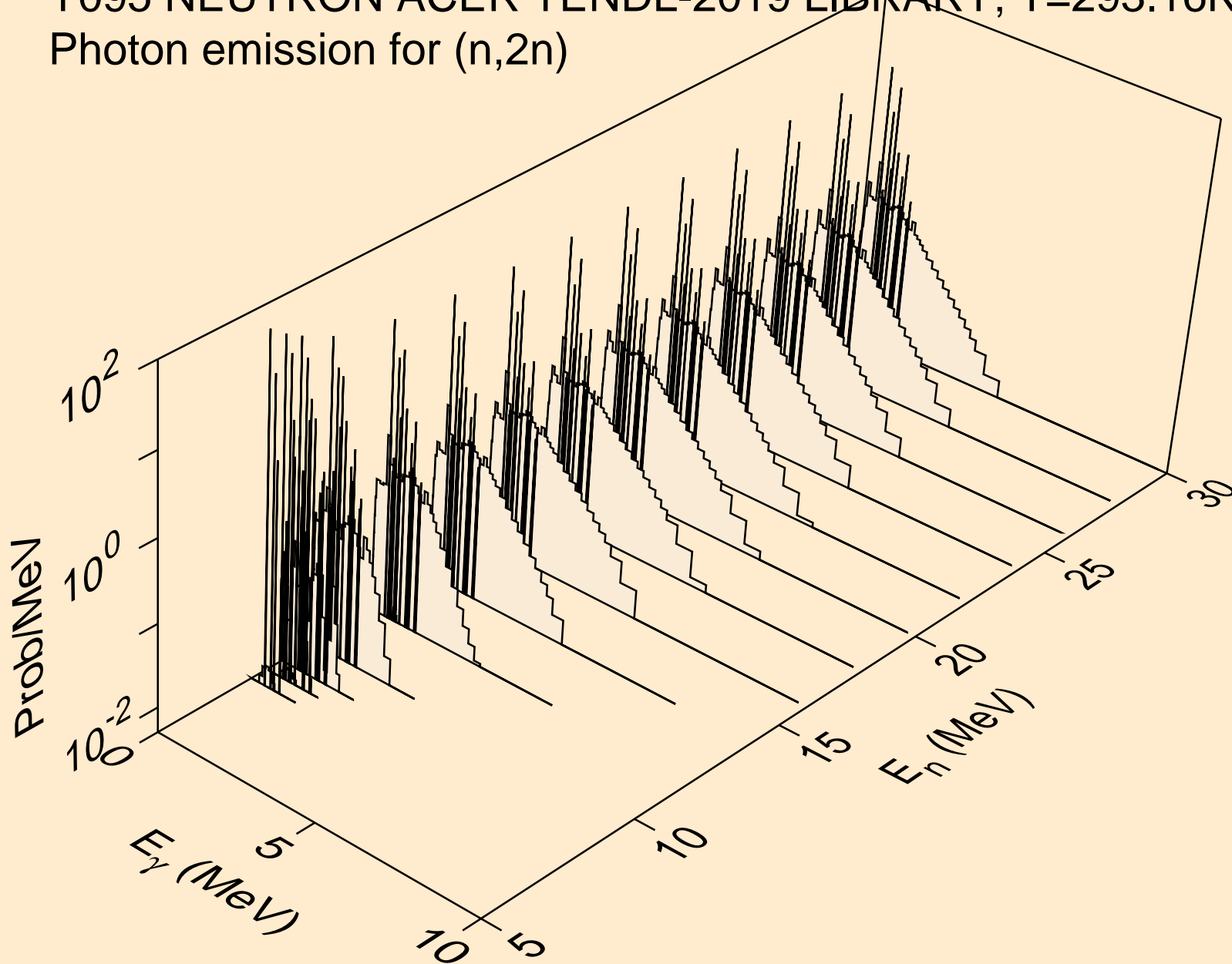

Y095 NEUTRON ACER TENDL-2019 LIBRARY; T=293.16K
Photon emission for (n,3n)

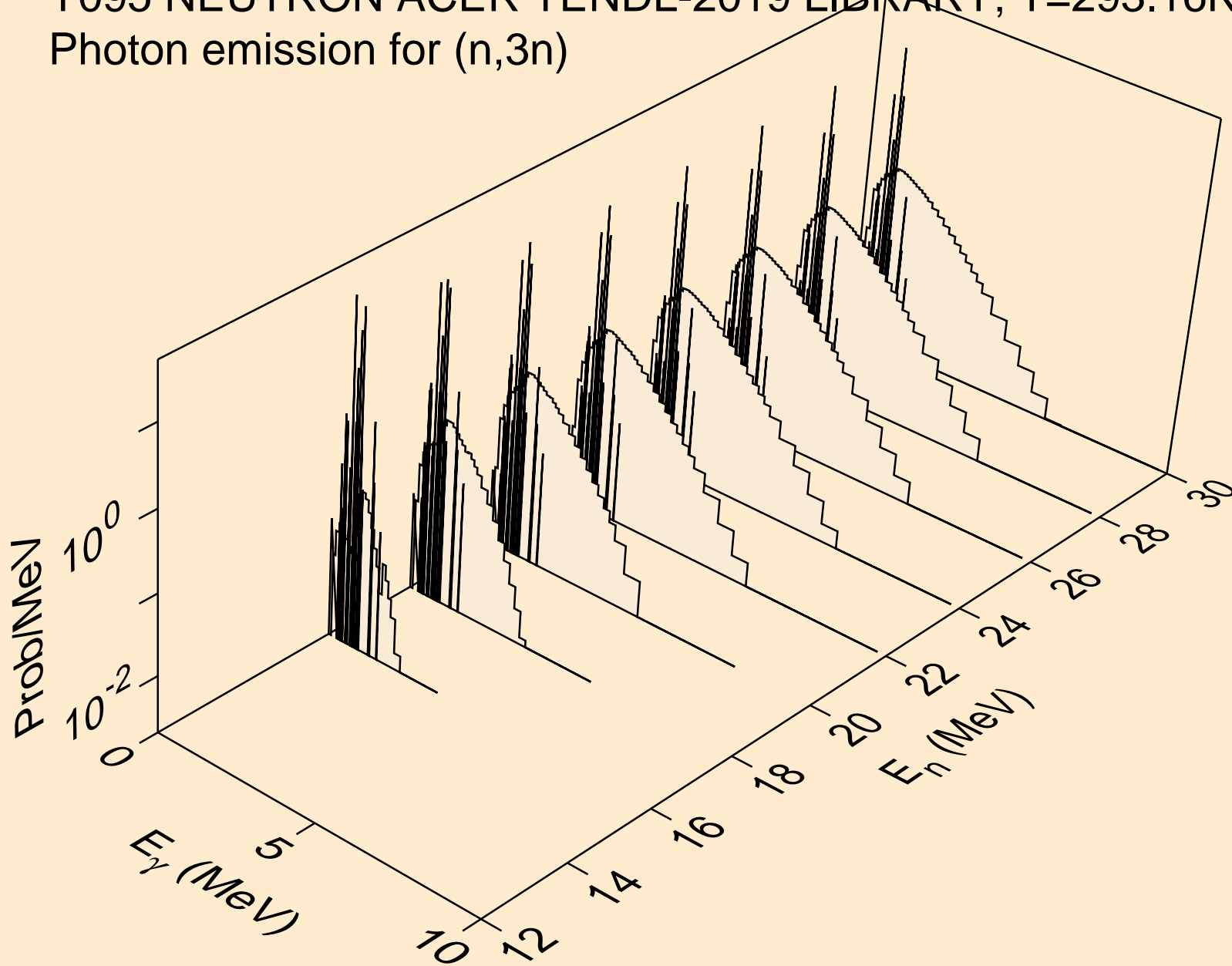

Y095 NEUTRON ACER TENDL-2019 LIBRARY; T=293.16K
Photon emission for (n,n*)a

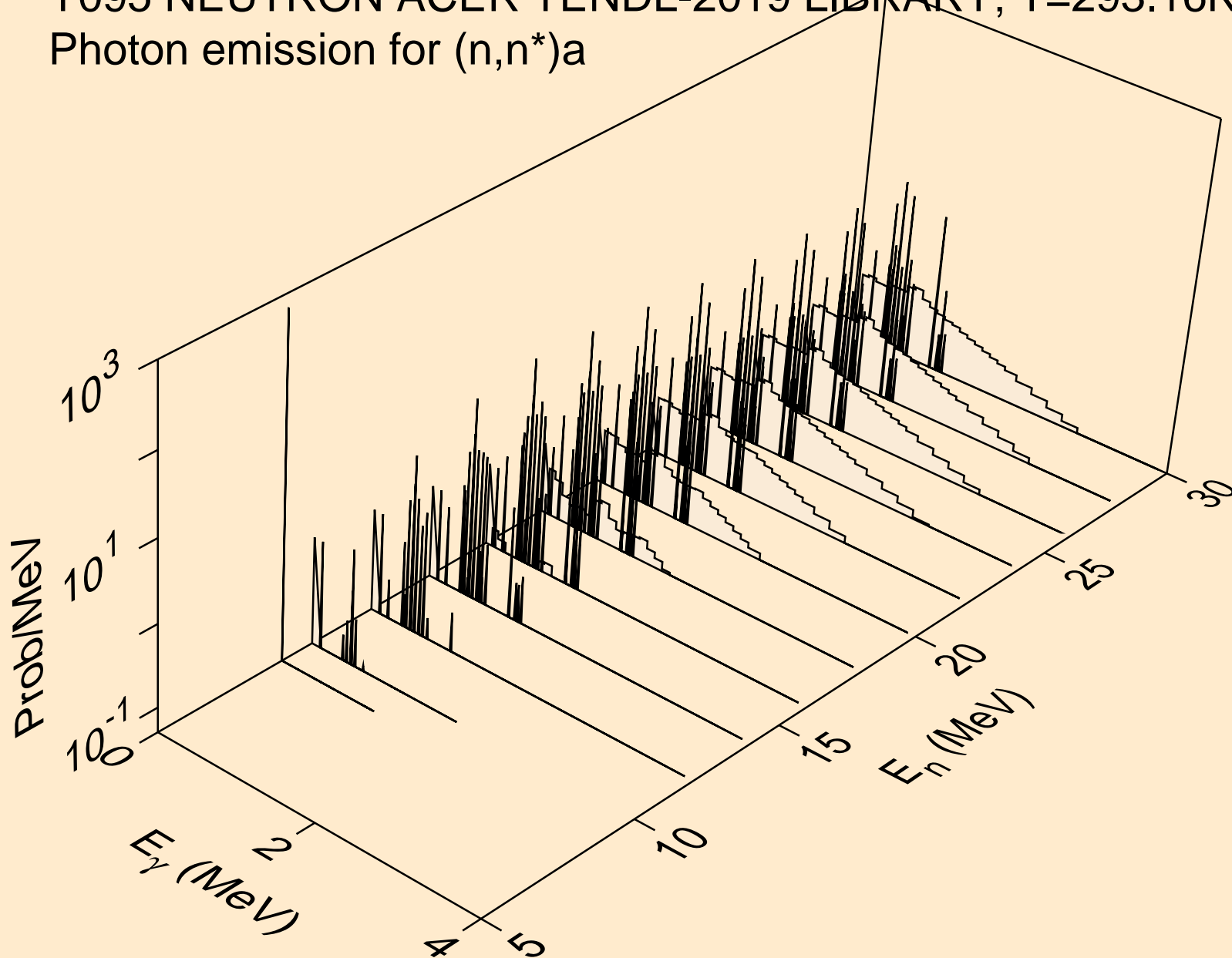

Y095 NEUTRON ACER TENDL-2019 LIBRARY; T=293.16K
Photon emission for (n,2n)a

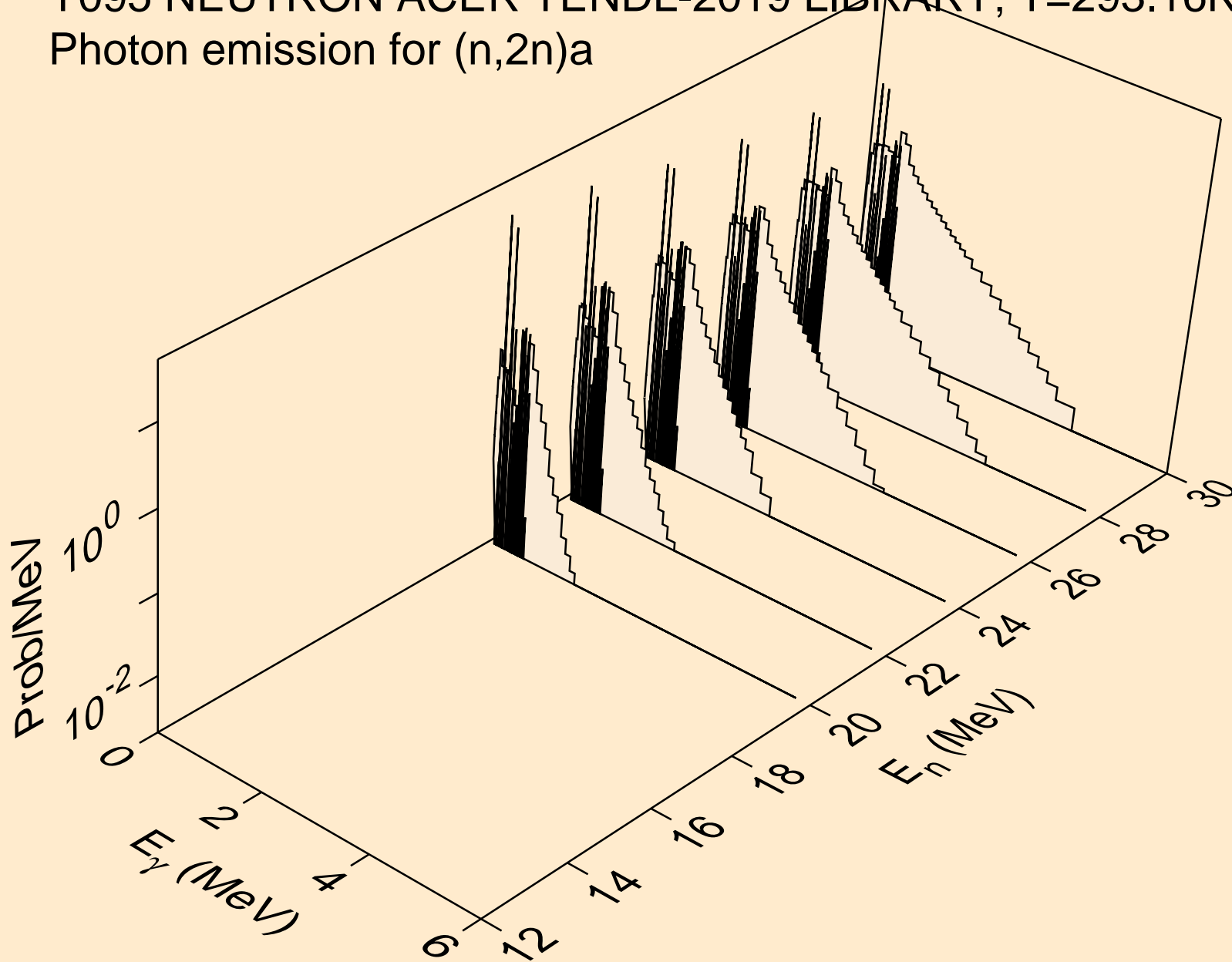

Y095 NEUTRON ACER TENDL-2019 LIBRARY; T=293.16K
Photon emission for (n,3n)a

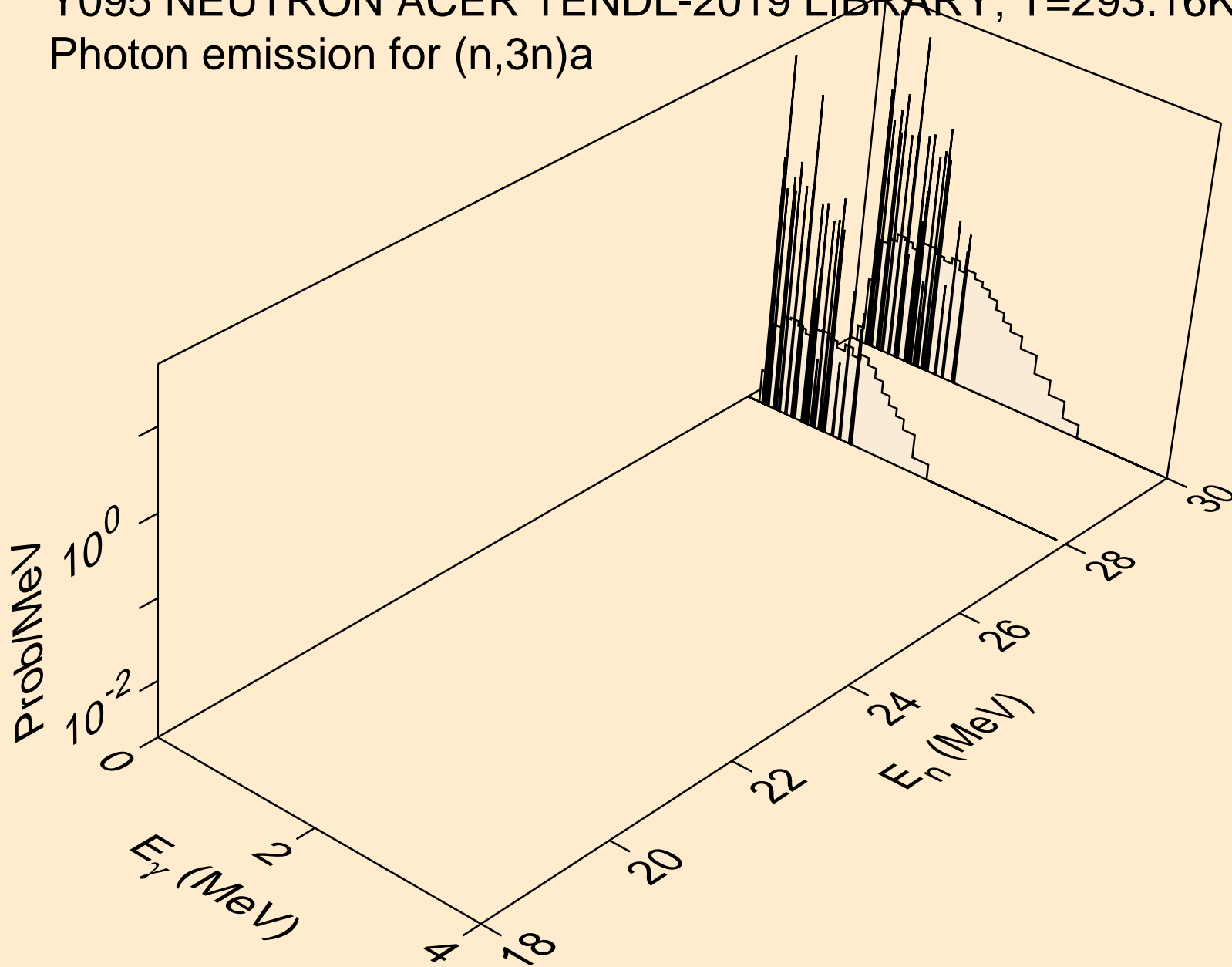

Y095 NEUTRON ACER TENDL-2019 LIBRARY; T=293.16K
Photon emission for (n,n*)p

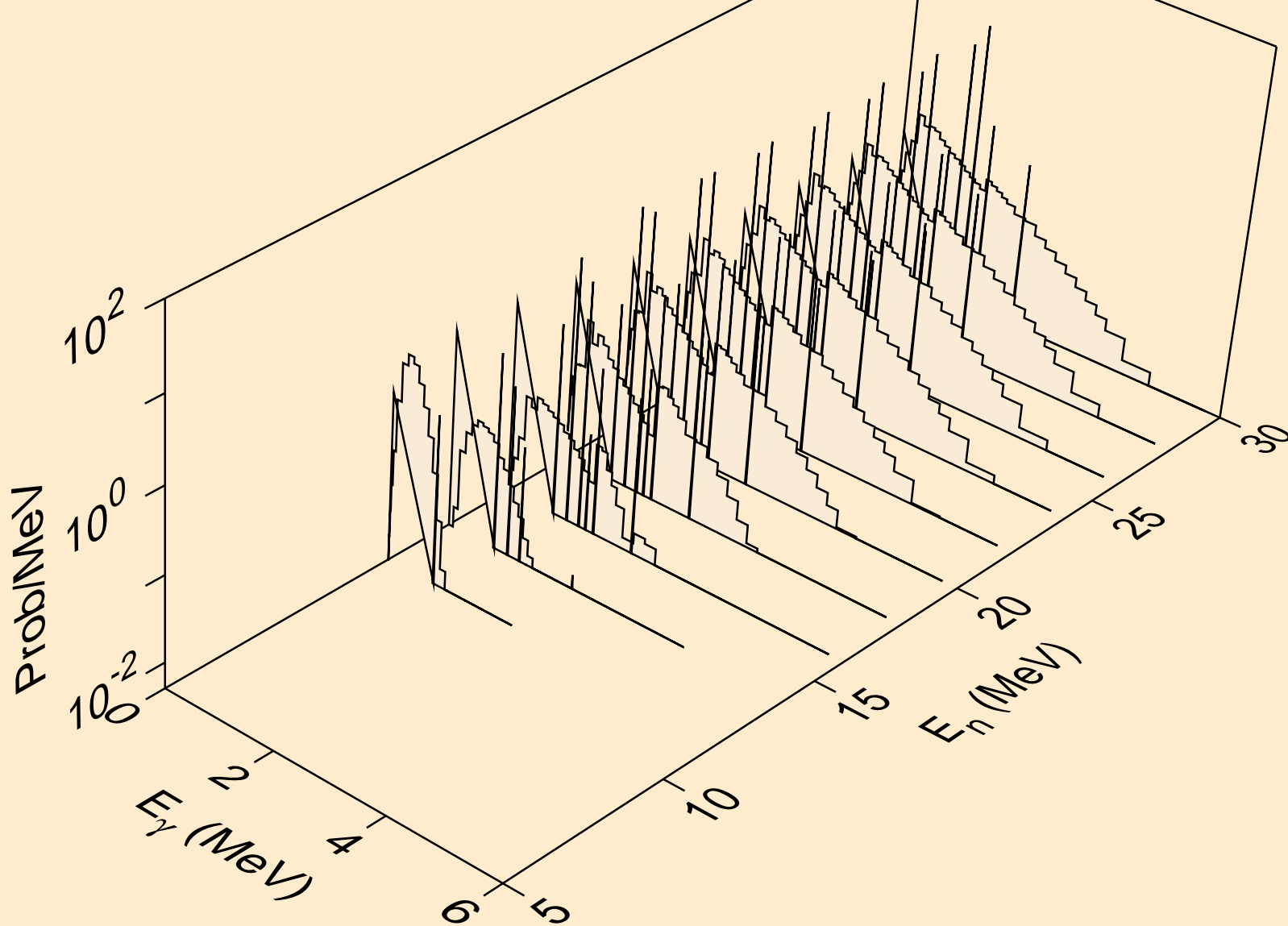

Y095 NEUTRON ACER TENDL-2019 LIBRARY; T=293.16K
Photon emission for (n,n*)d

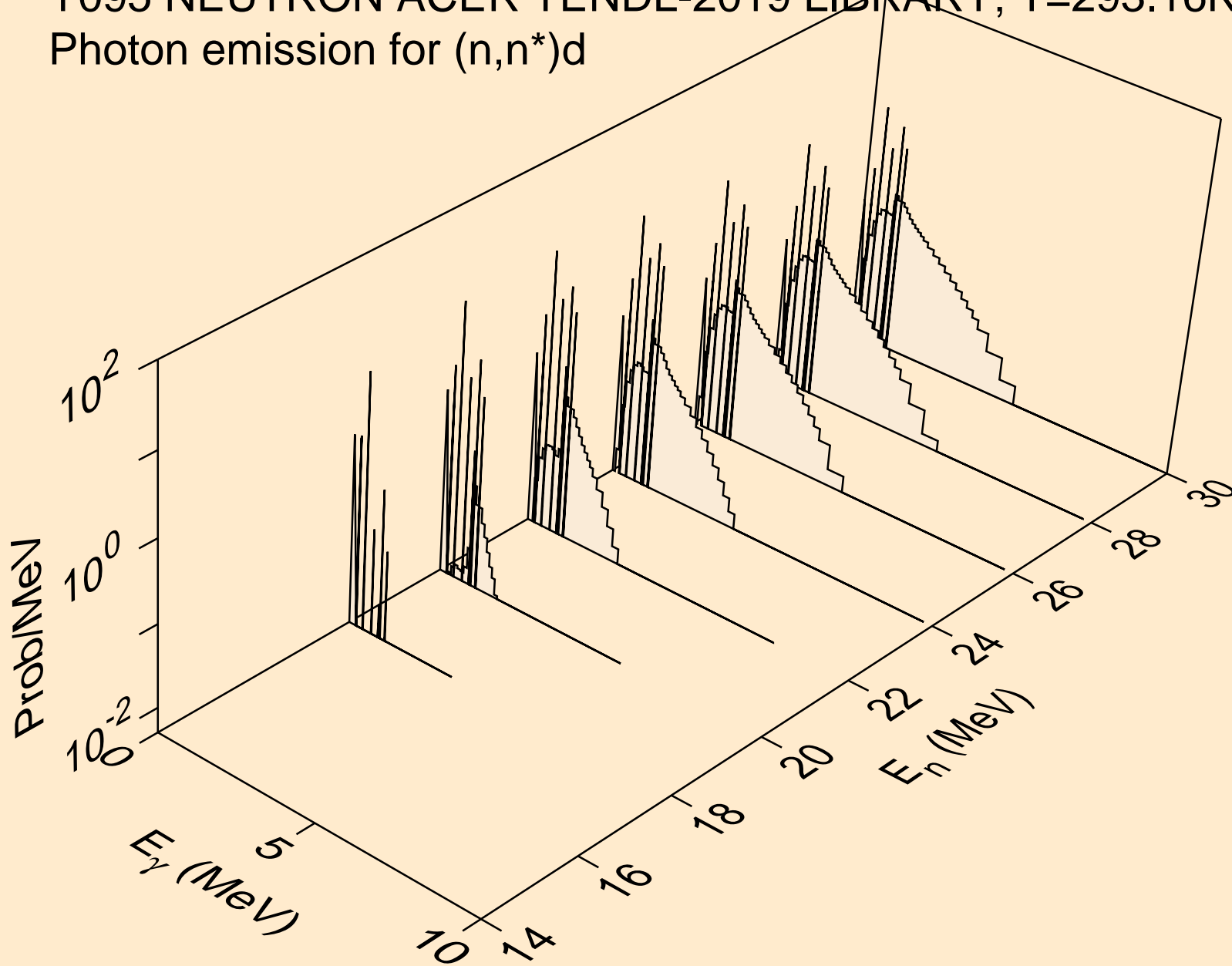

Y095 NEUTRON ACER TENDL-2019 LIBRARY; T=293.16K
Photon emission for (n,n*)t

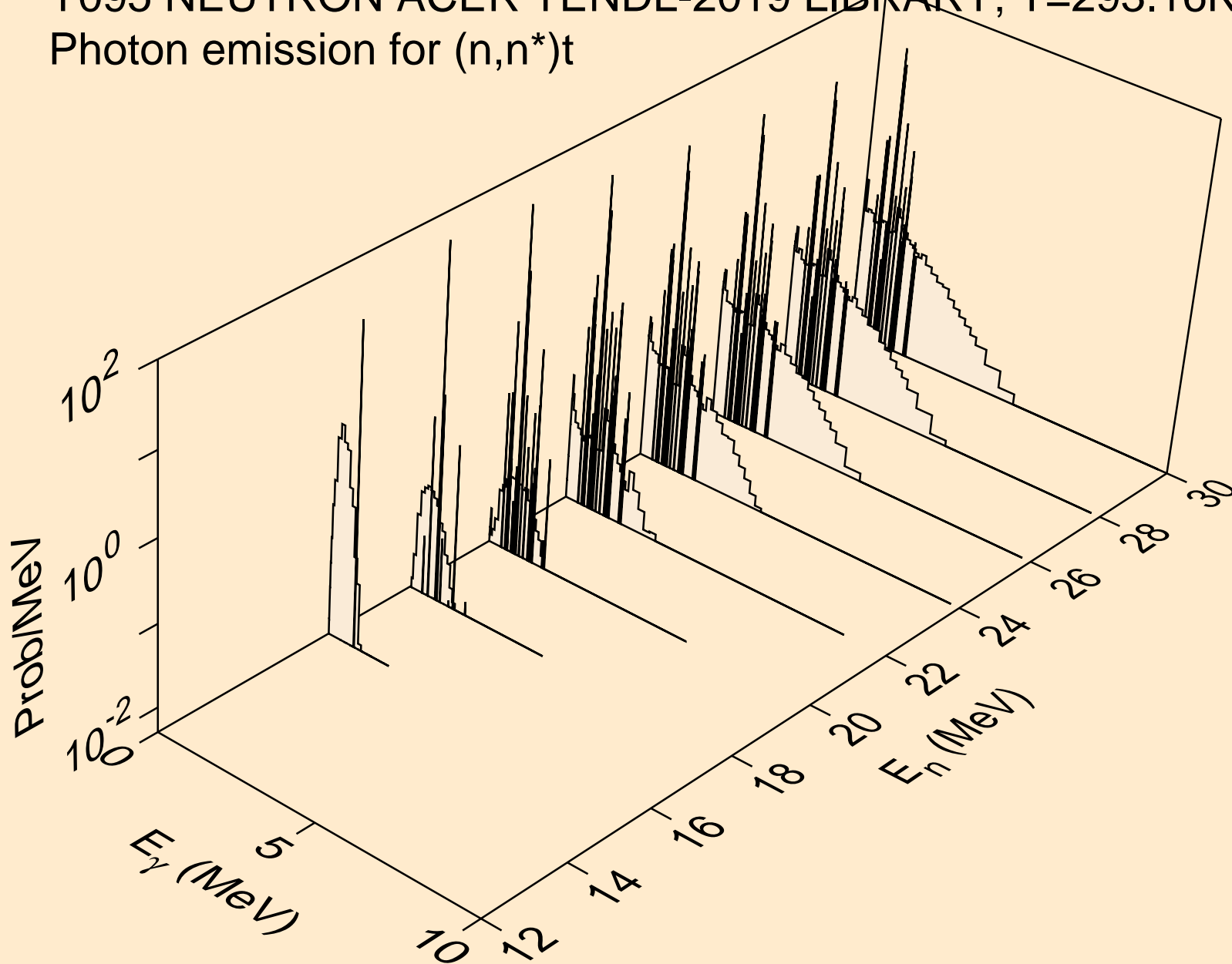

Y095 NEUTRON ACER TENDL-2019 LIBRARY; T=293.16K
Photon emission for (n,n*)he3

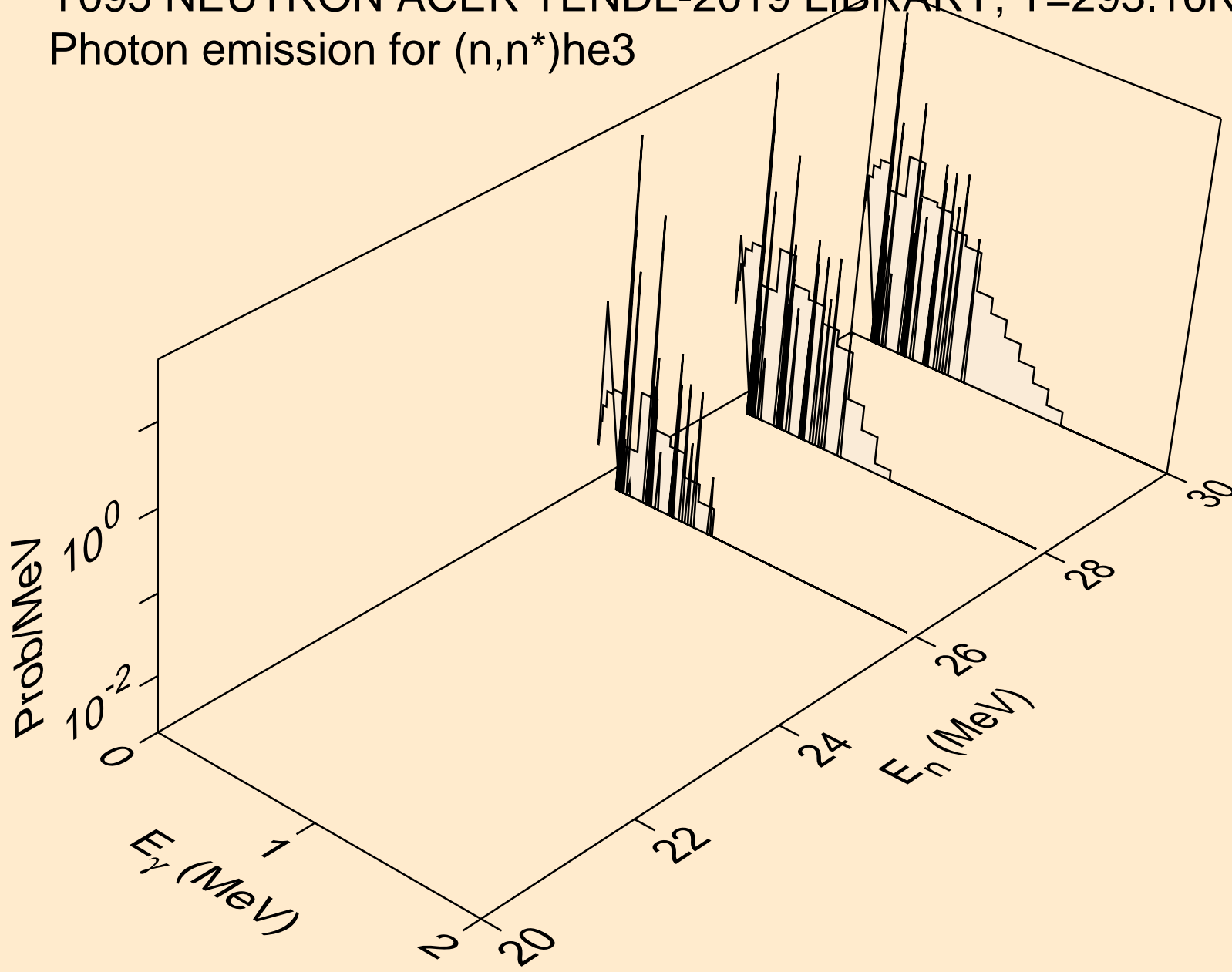

Y095 NEUTRON ACER TENDL-2019 LIBRARY; T=293.16K
Photon emission for (n,4n)

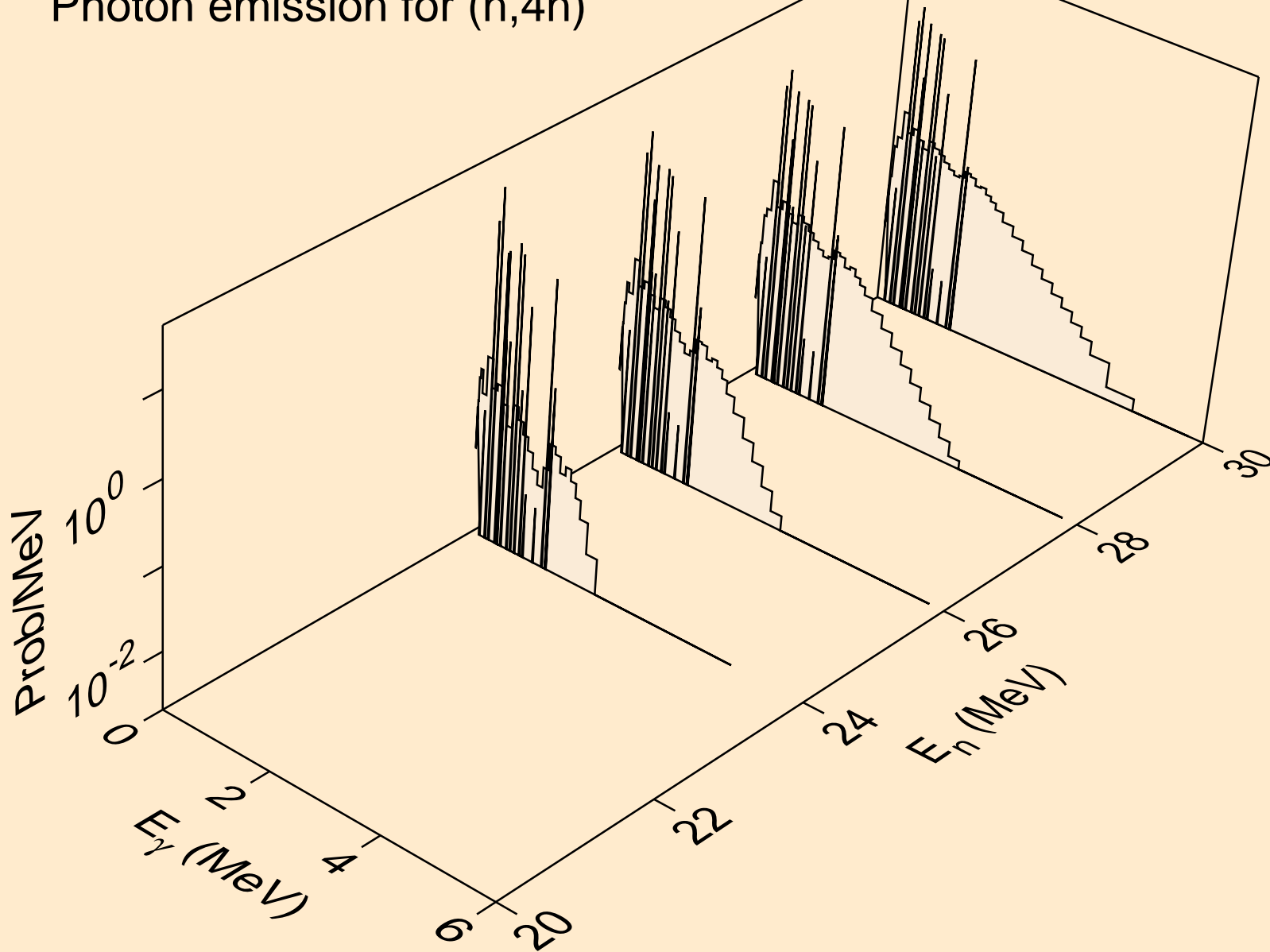

Y095 NEUTRON ACER TENDL-2019 LIBRARY; T=293.16K
Photon emission for (n,2np)

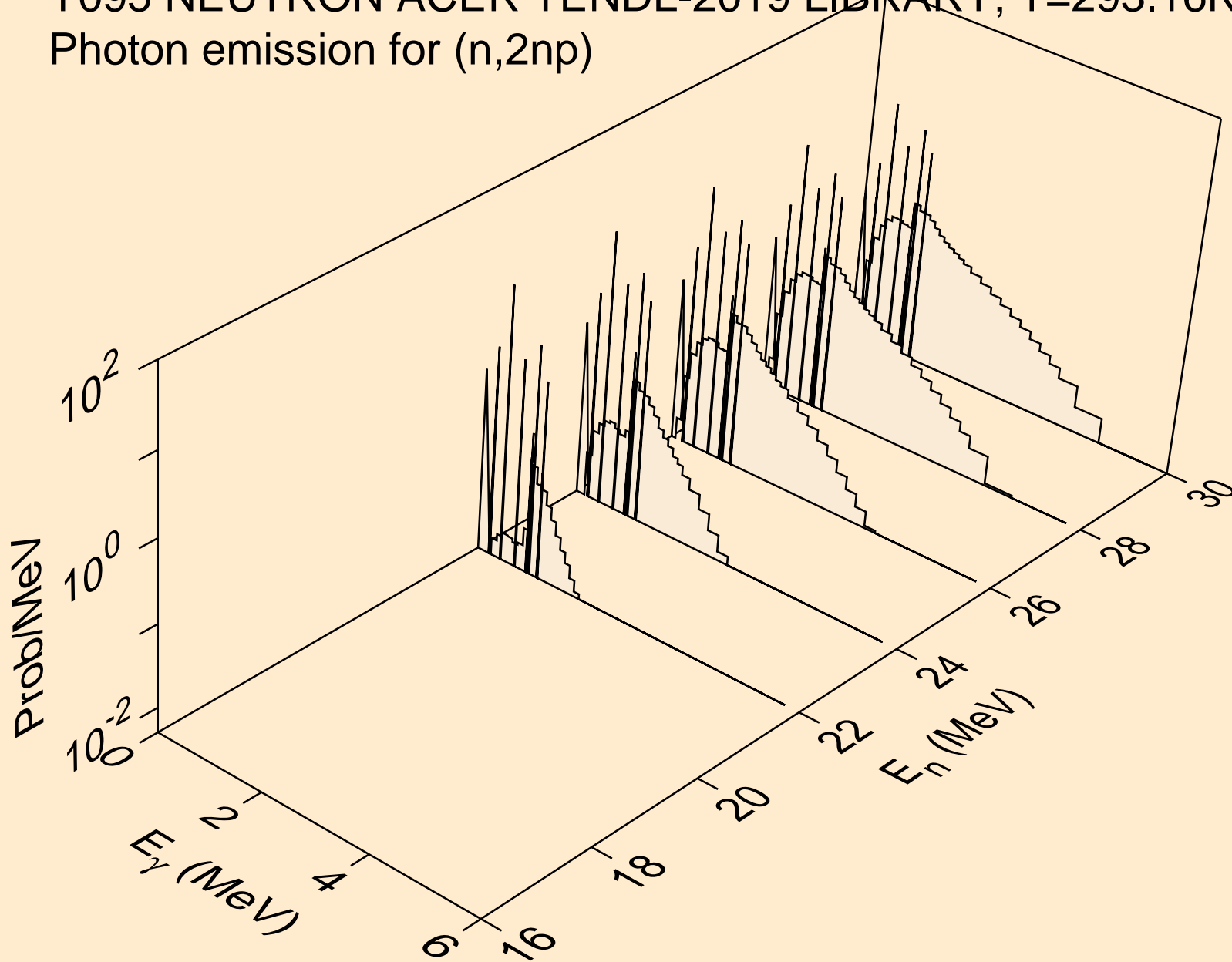

Y095 NEUTRON ACER TENDL-2019 LIBRARY; T=293.16K
Photon emission for (n,3np)

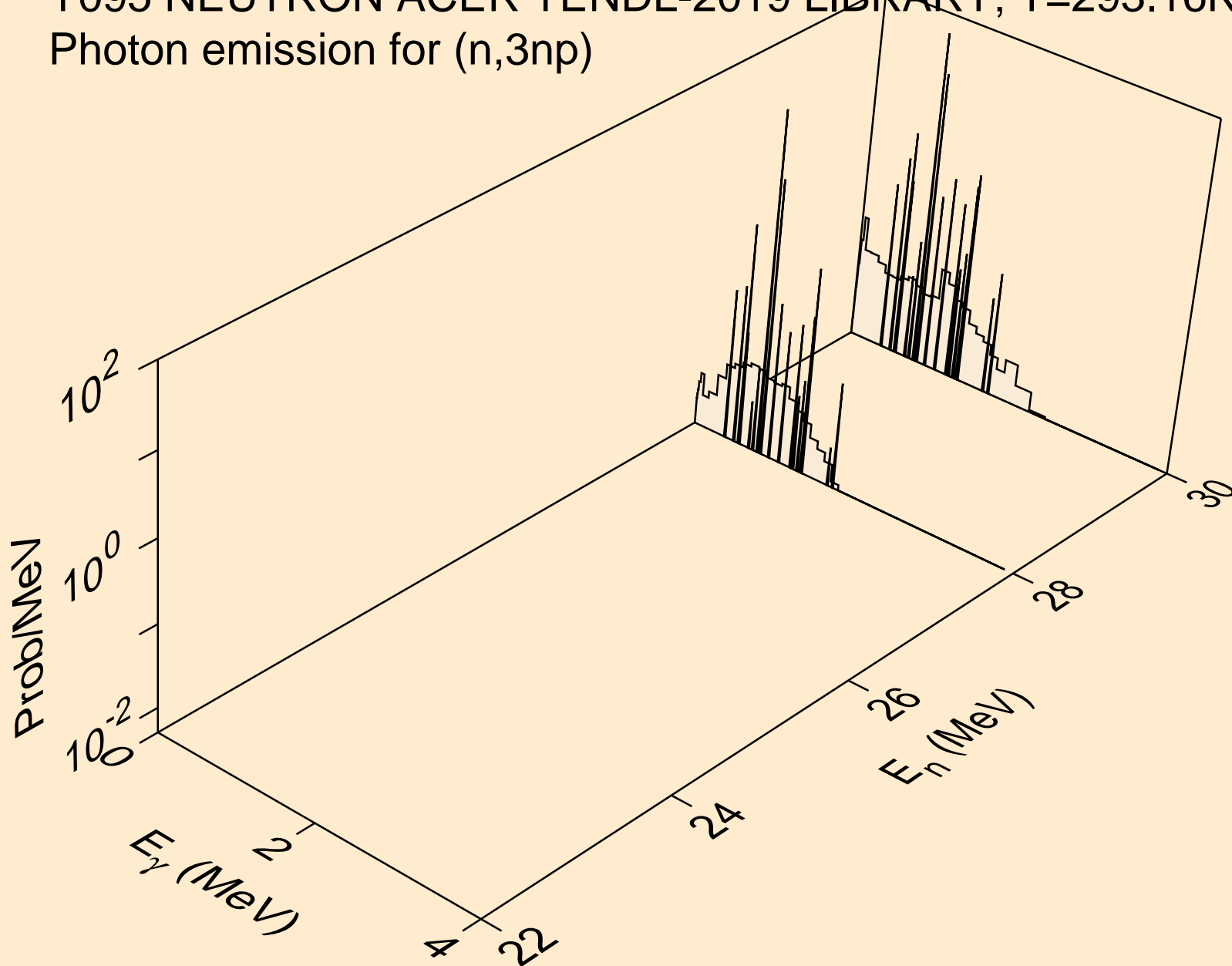

Y095 NEUTRON ACER TENDL-2019 LIBRARY; T=293.16K
Photon emission for (n,n*c)

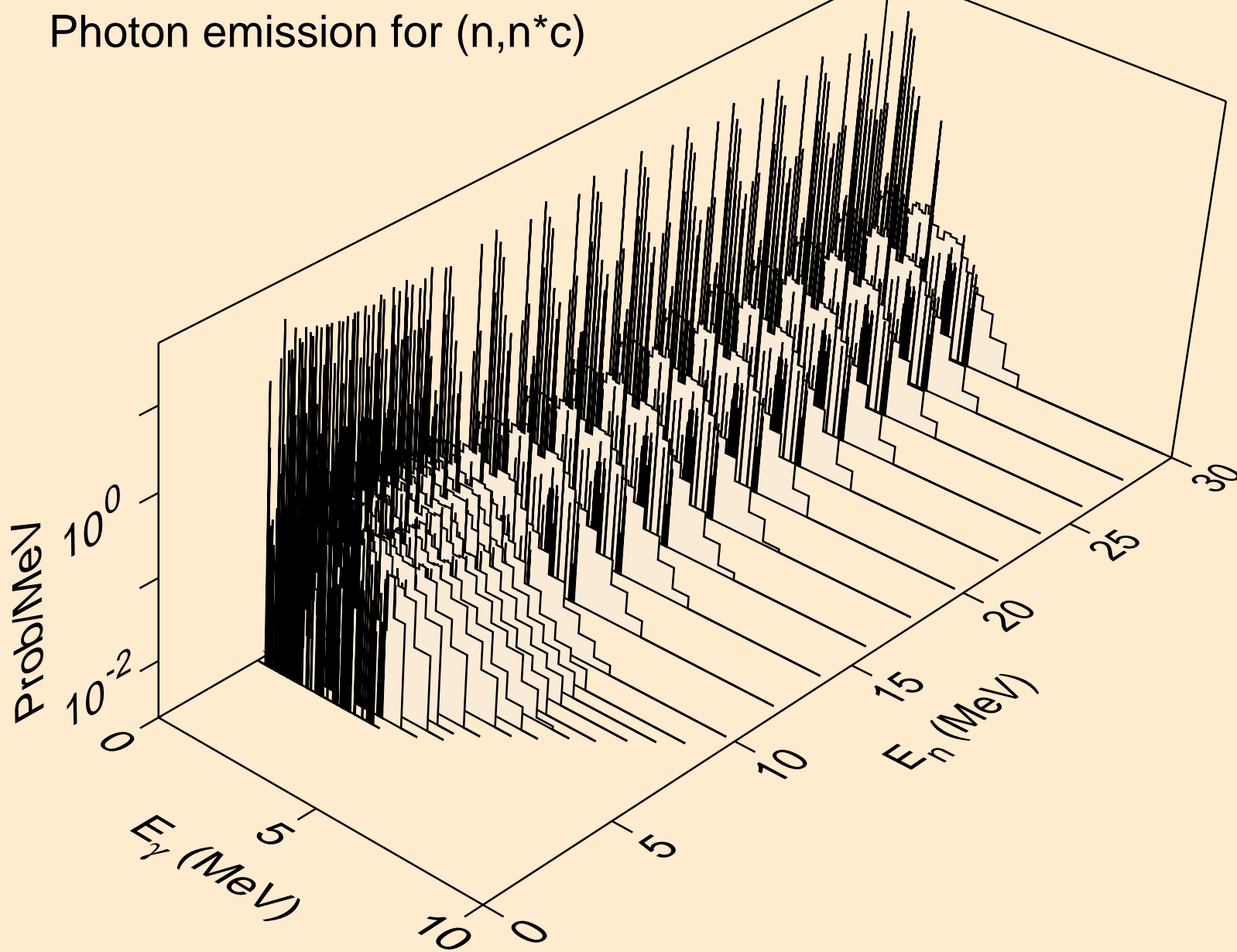

Y095 NEUTRON ACER TENDL-2019 LIBRARY; T=293.16K
Photon emission for (n,gma)

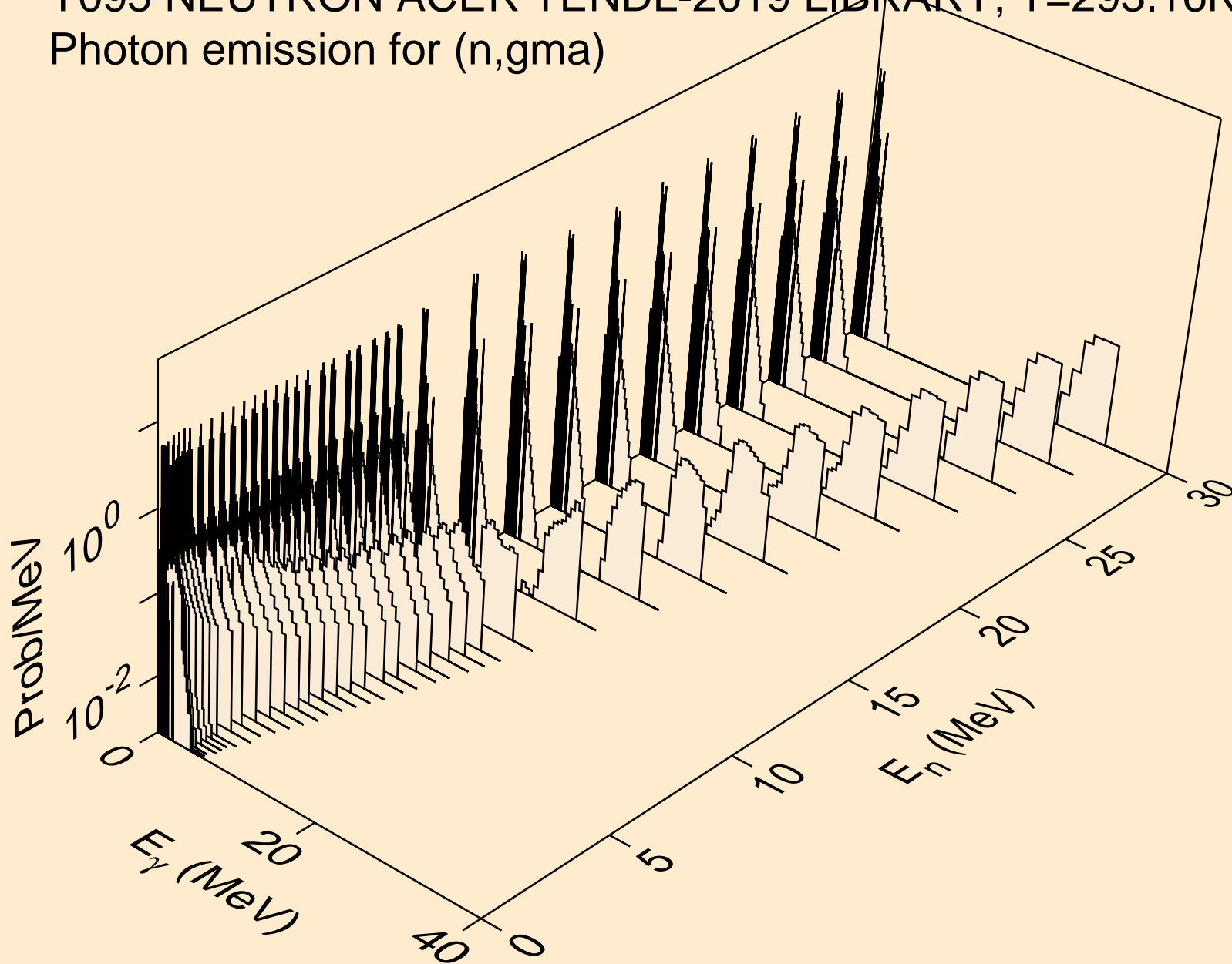

Y095 NEUTRON ACER TENDL-2019 LIBRARY; T=293.16K
Photon emission for (n,p)

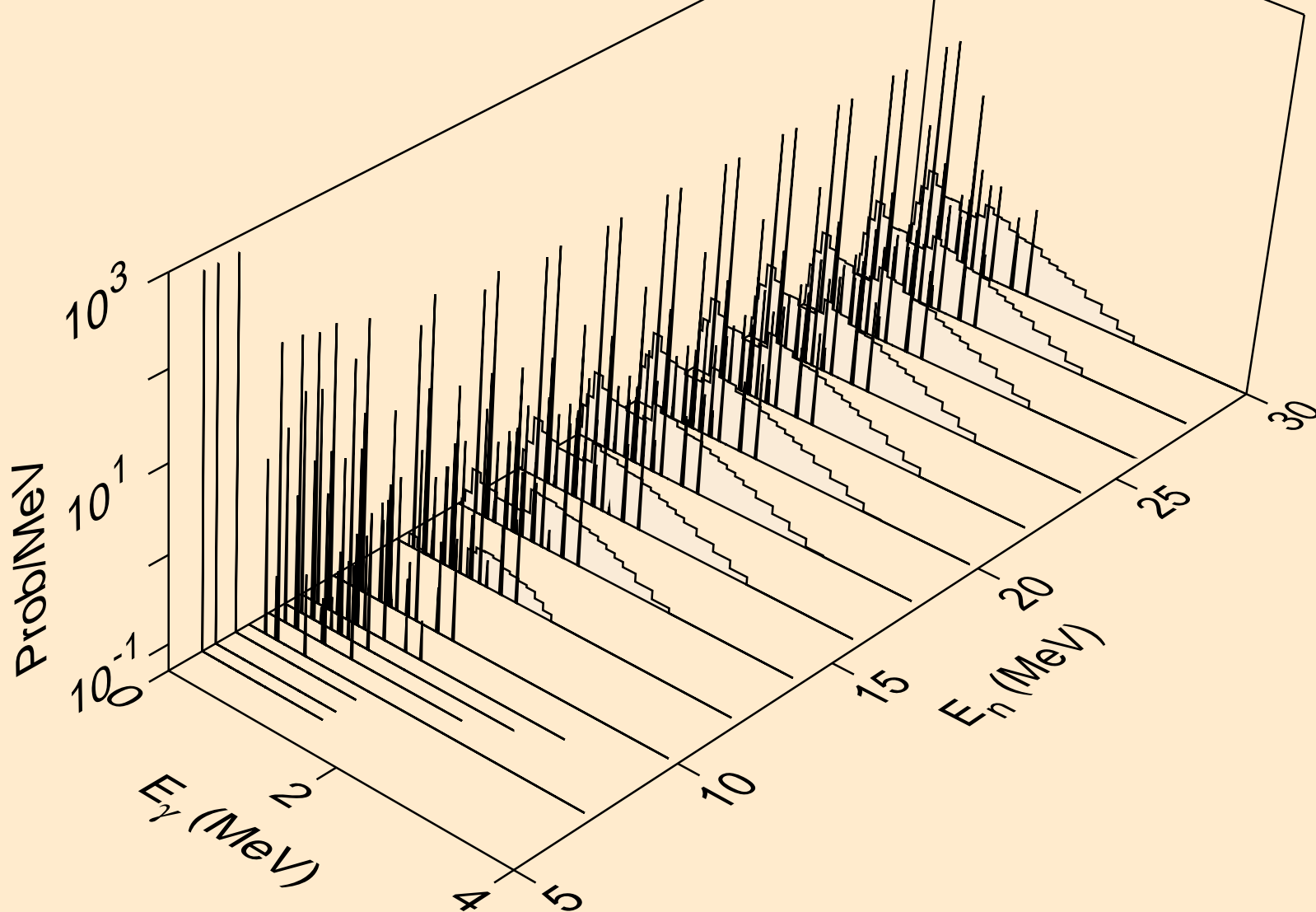

Y095 NEUTRON ACER TENDL-2019 LIBRARY; T=293.16K
Photon emission for (n,d)

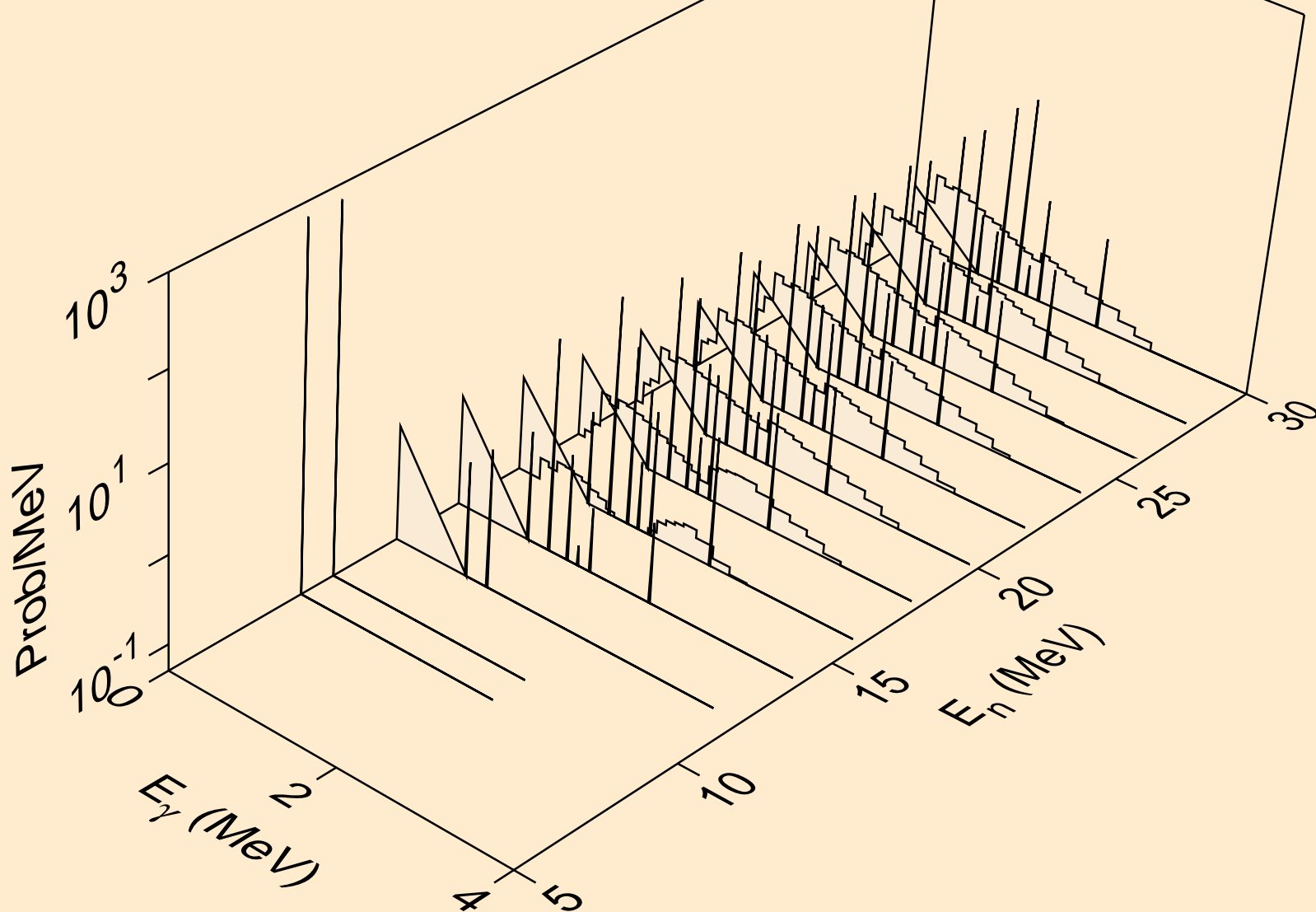

Y095 NEUTRON ACER TENDL-2019 LIBRARY; T=293.16K
Photon emission for (n,t)

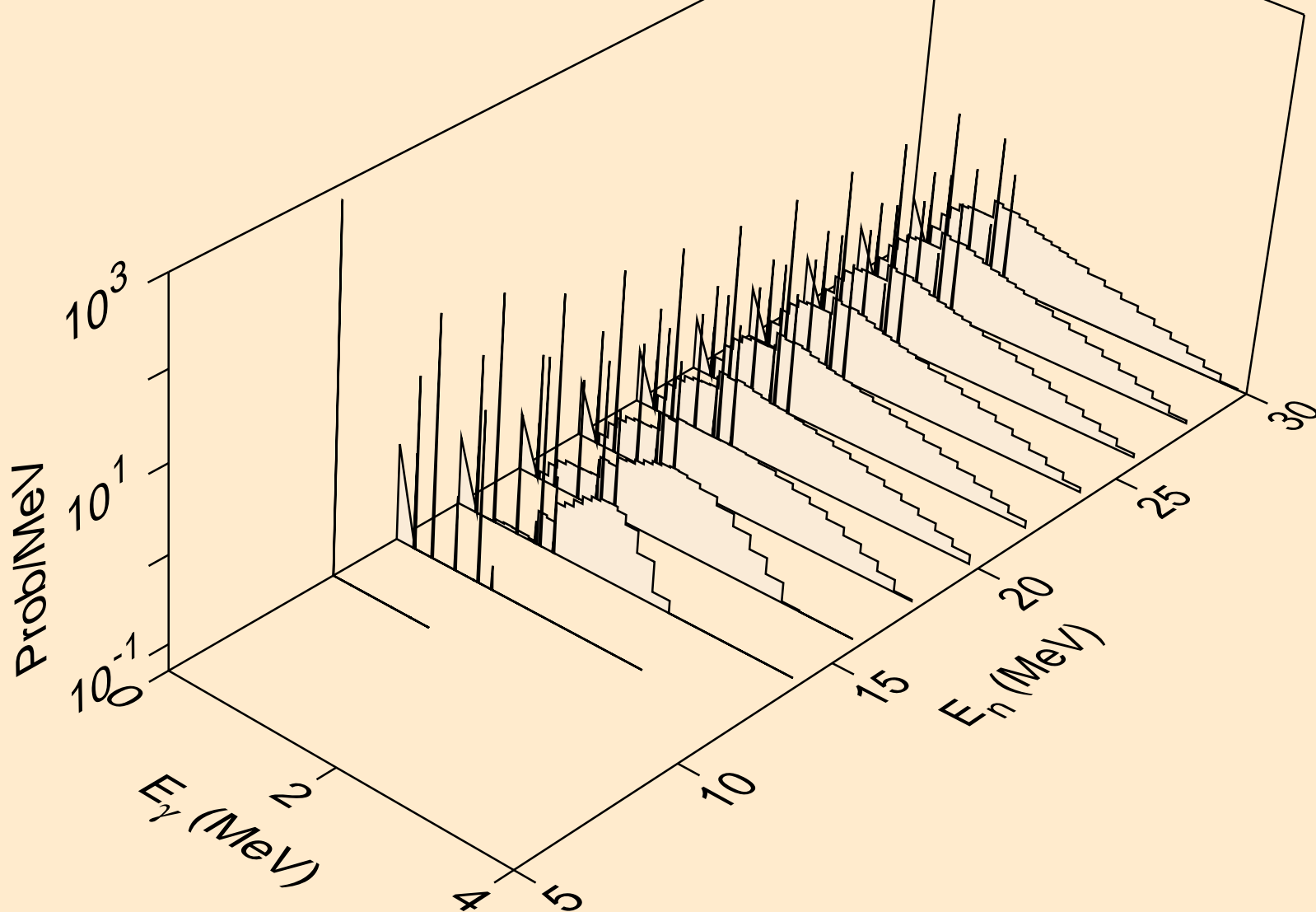

Y095 NEUTRON ACER TENDL-2019 LIBRARY; T=293.16K
Photon emission for (n,he3)

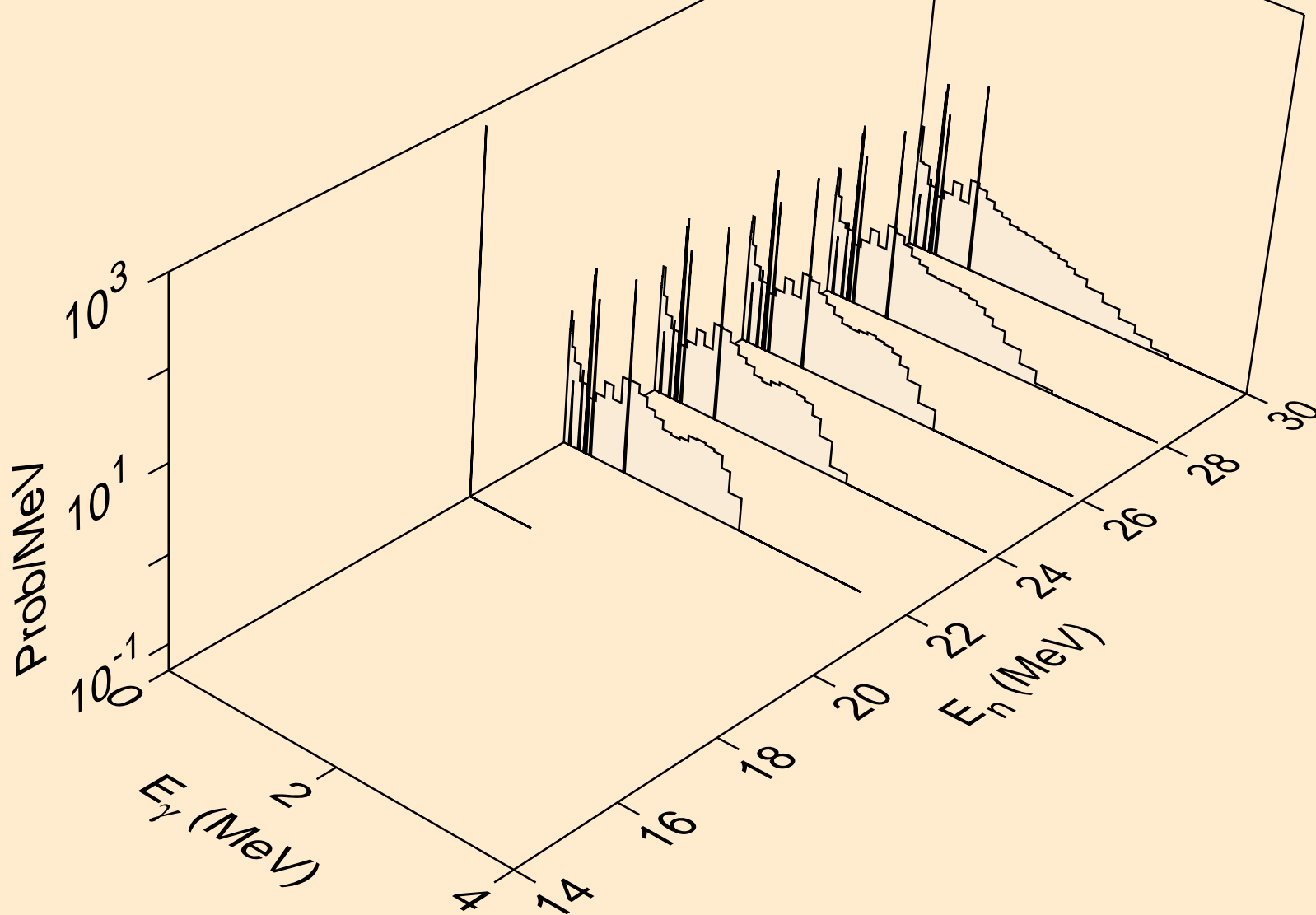

Y095 NEUTRON ACER TENDL-2019 LIBRARY; T=293.16K
Photon emission for (n,a)

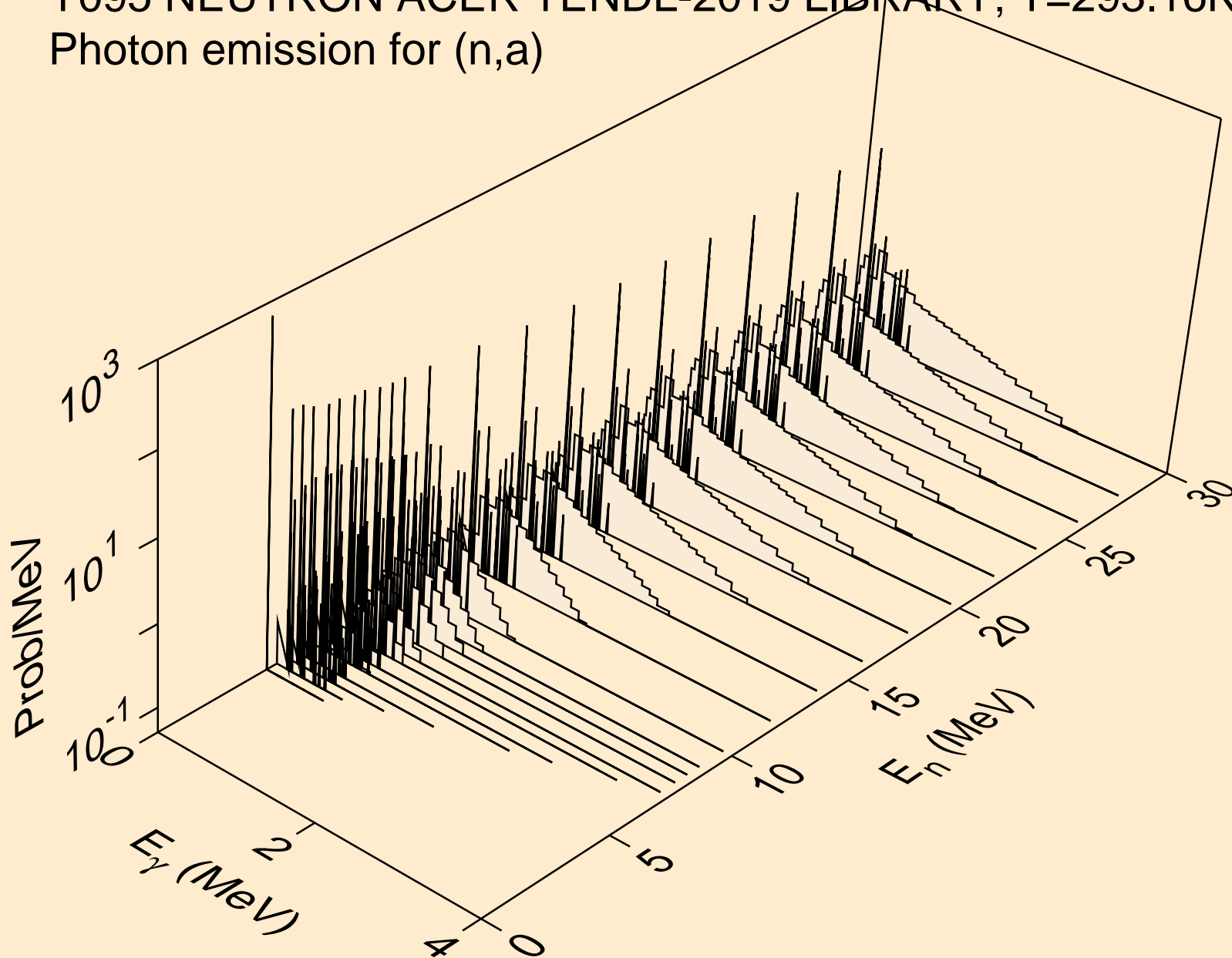

Y095 NEUTRON ACER TENDL-2019 LIBRARY; T=293.16K
Photon emission for (n,2p)

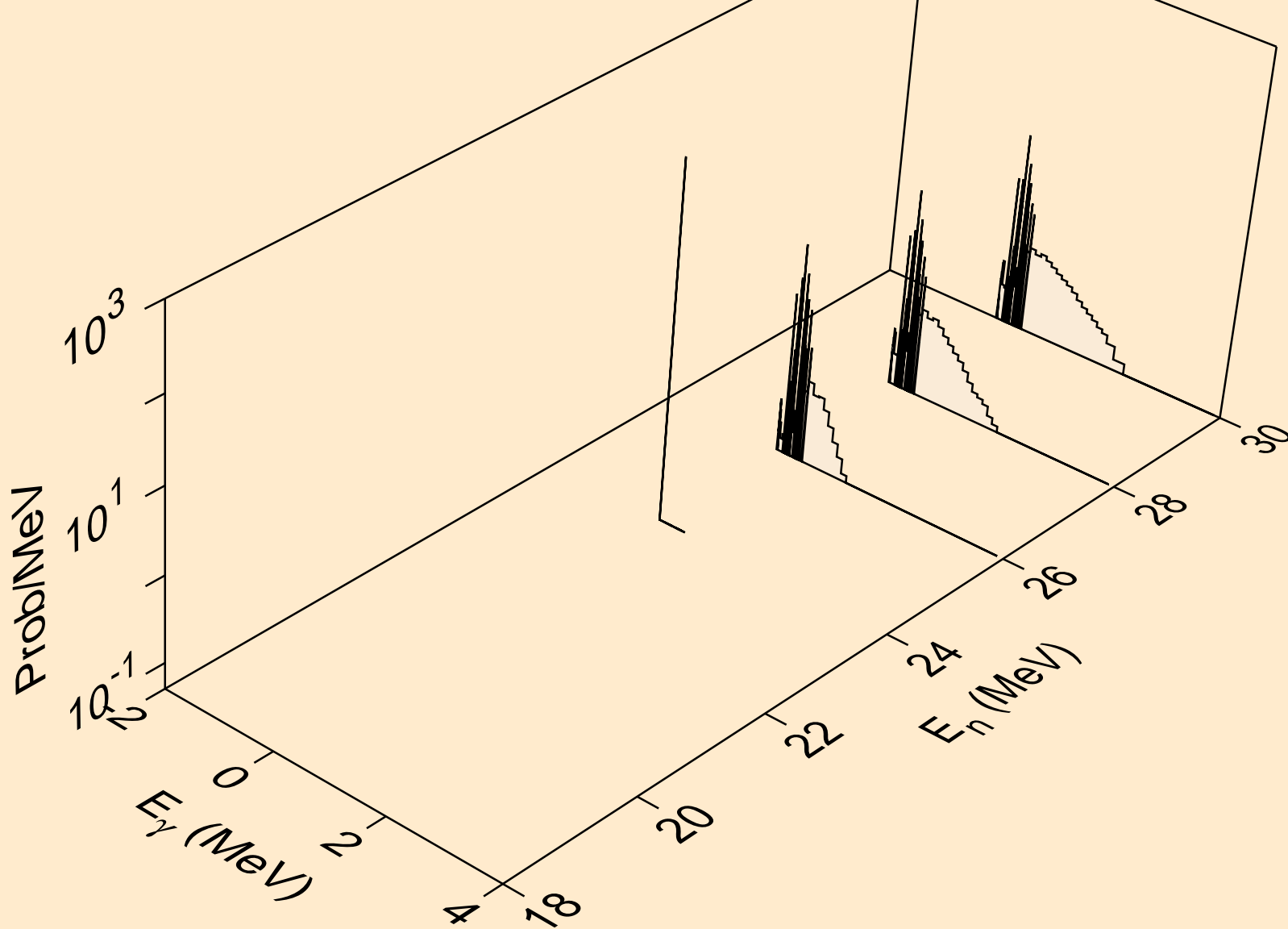

Y095 NEUTRON ACER TENDL-2019 LIBRARY; T=293.16K
Photon emission for (n,p)

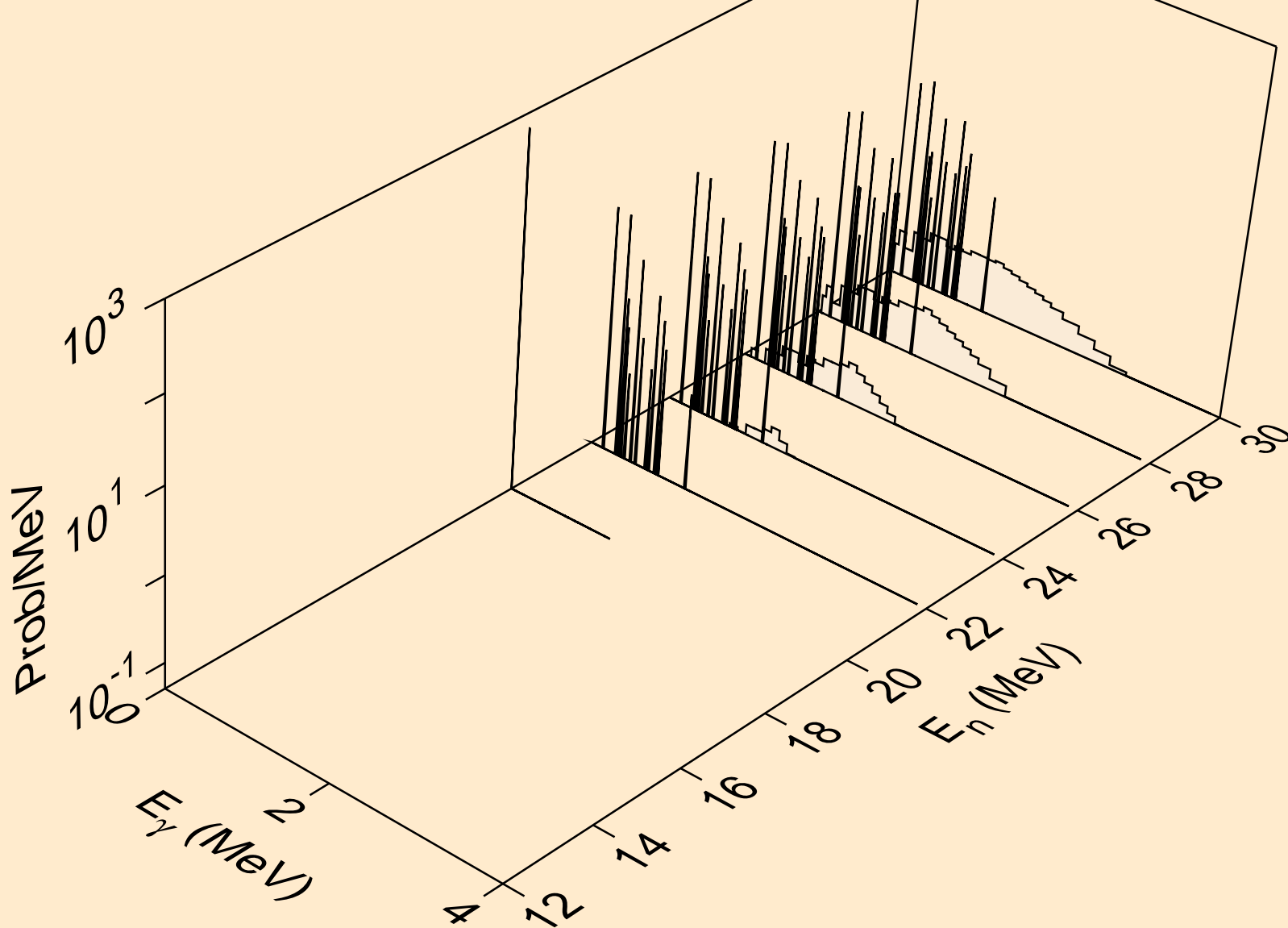

Y095 NEUTRON ACER TENDL-2019 LIBRARY; T=293.16K
thermal capture photon spectrum

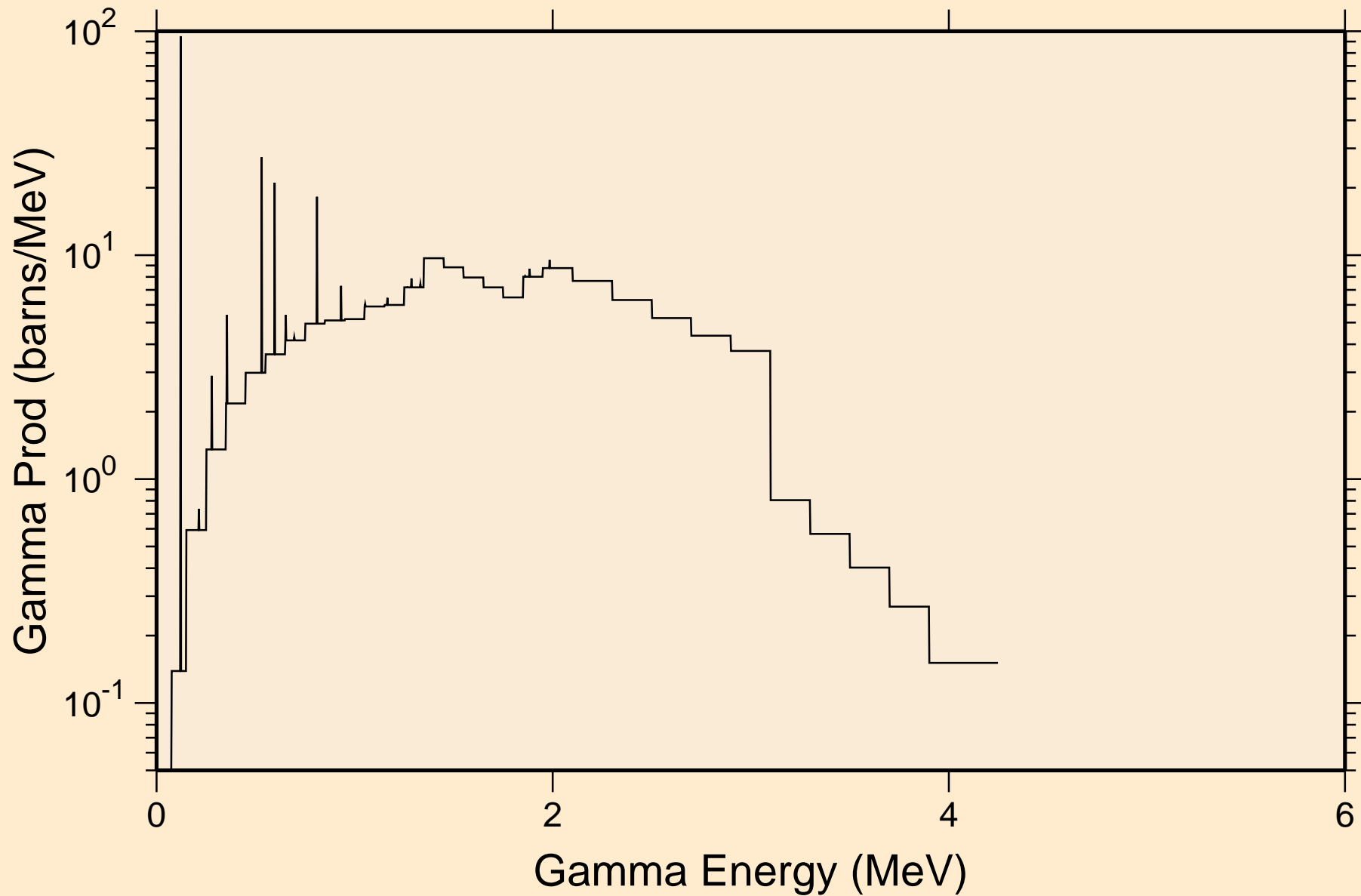

Y095 NEUTRON ACER TENDL-2019 LIBRARY; T=293.16K
14 MeV photon spectrum

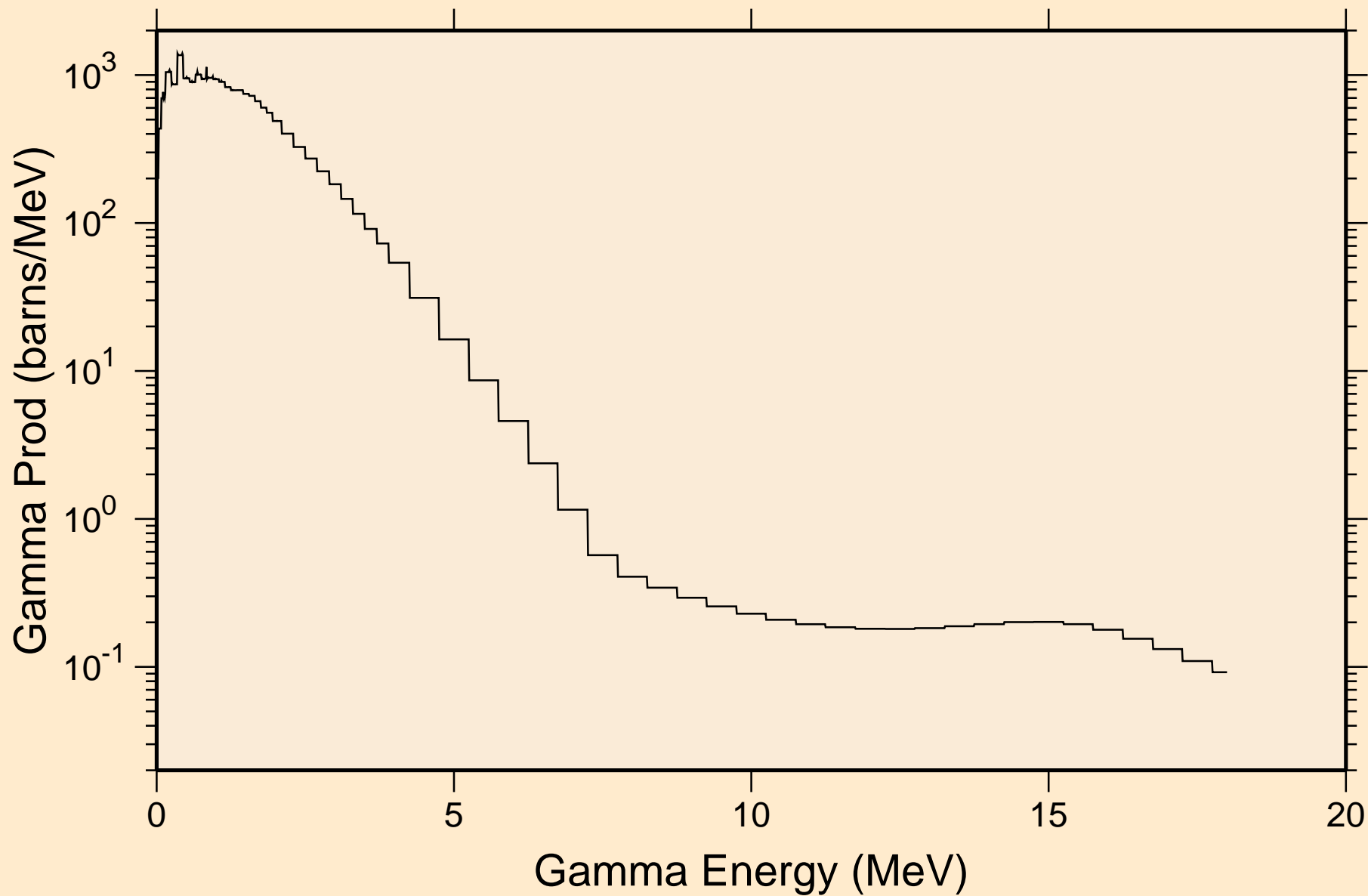

Y095 NEUTRON ACER TENDL-2019 LIBRARY; T=293.16K
Particle heating contributions

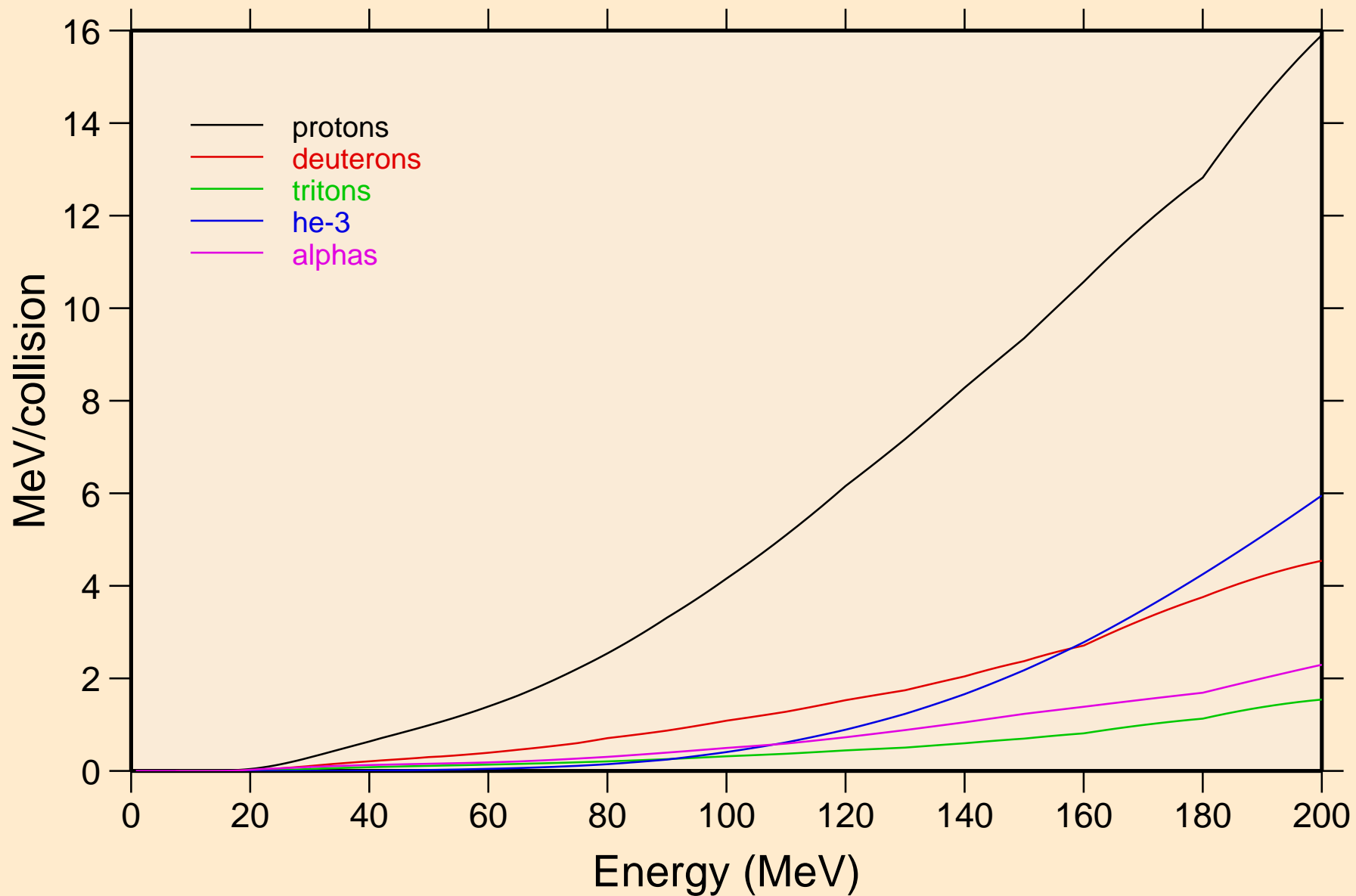

Y095 NEUTRON ACER TENDL-2019 LIBRARY; T=293.16K
Recoil Heating

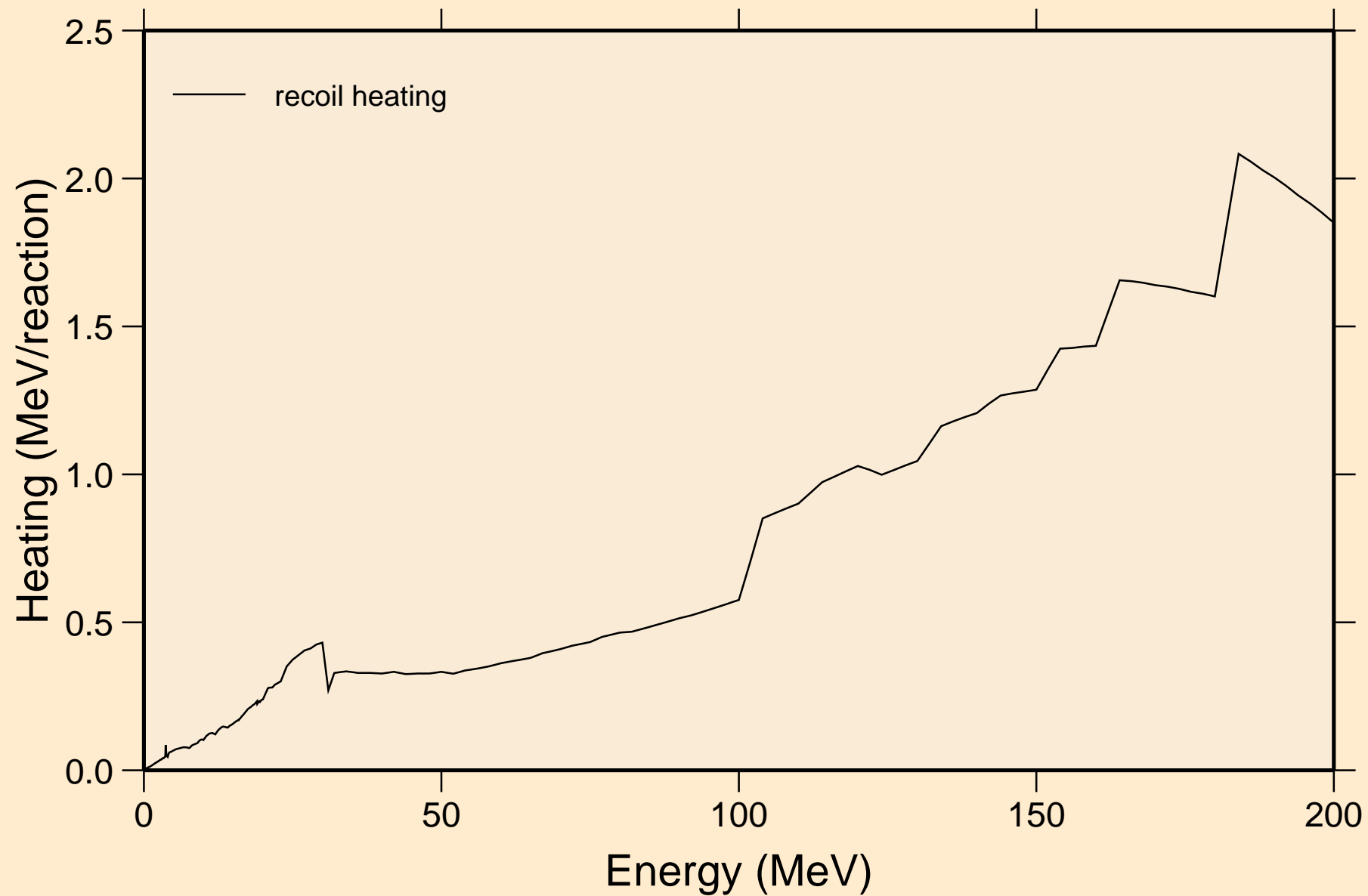

Y095 NEUTRON ACER TENDL-2019 LIBRARY; T=293.16K
Particle production cross sections

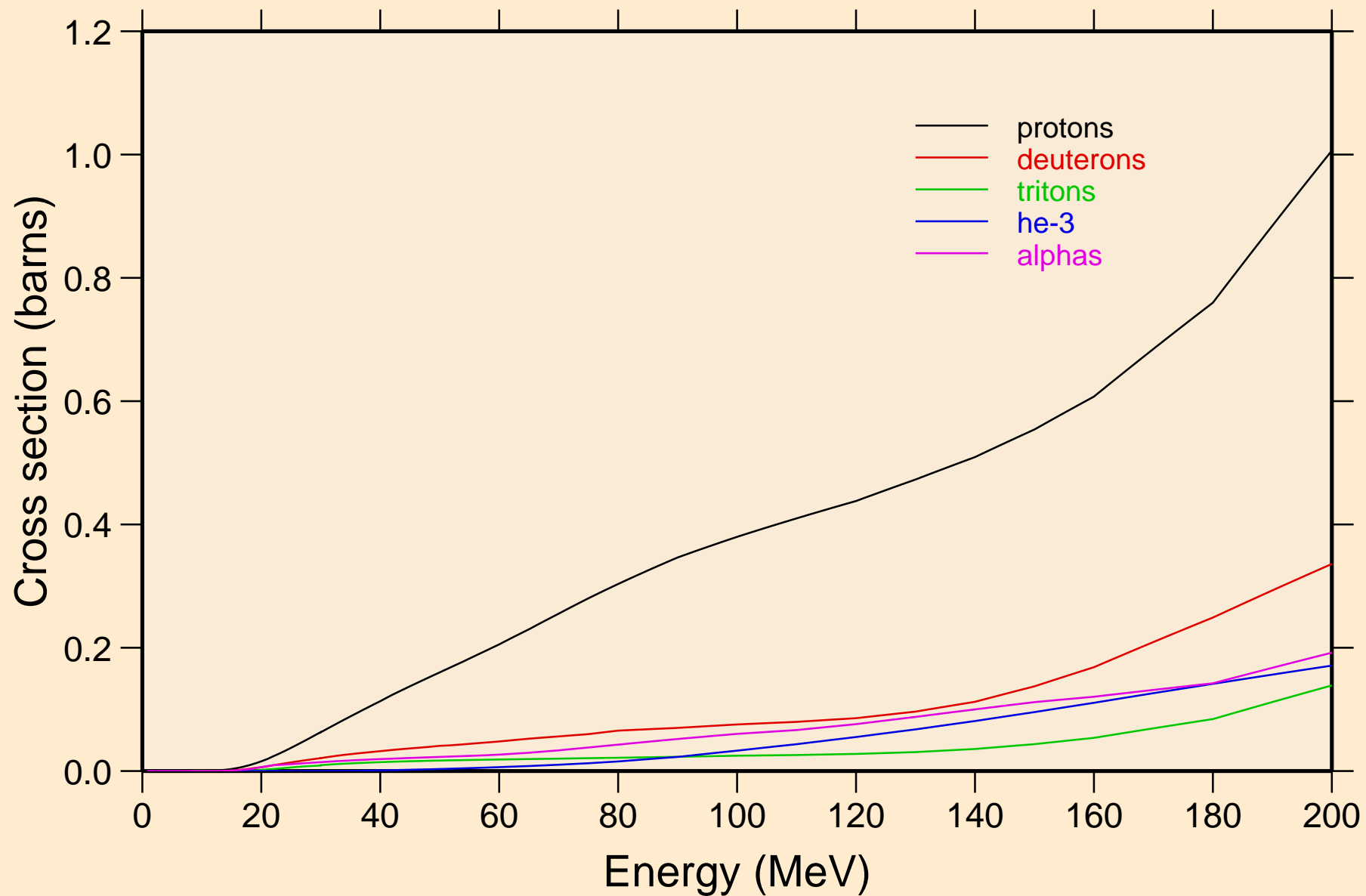

Y095 NEUTRON ACER TENDL-2019 LIBRARY; T=293.16K
protons from (n,x)

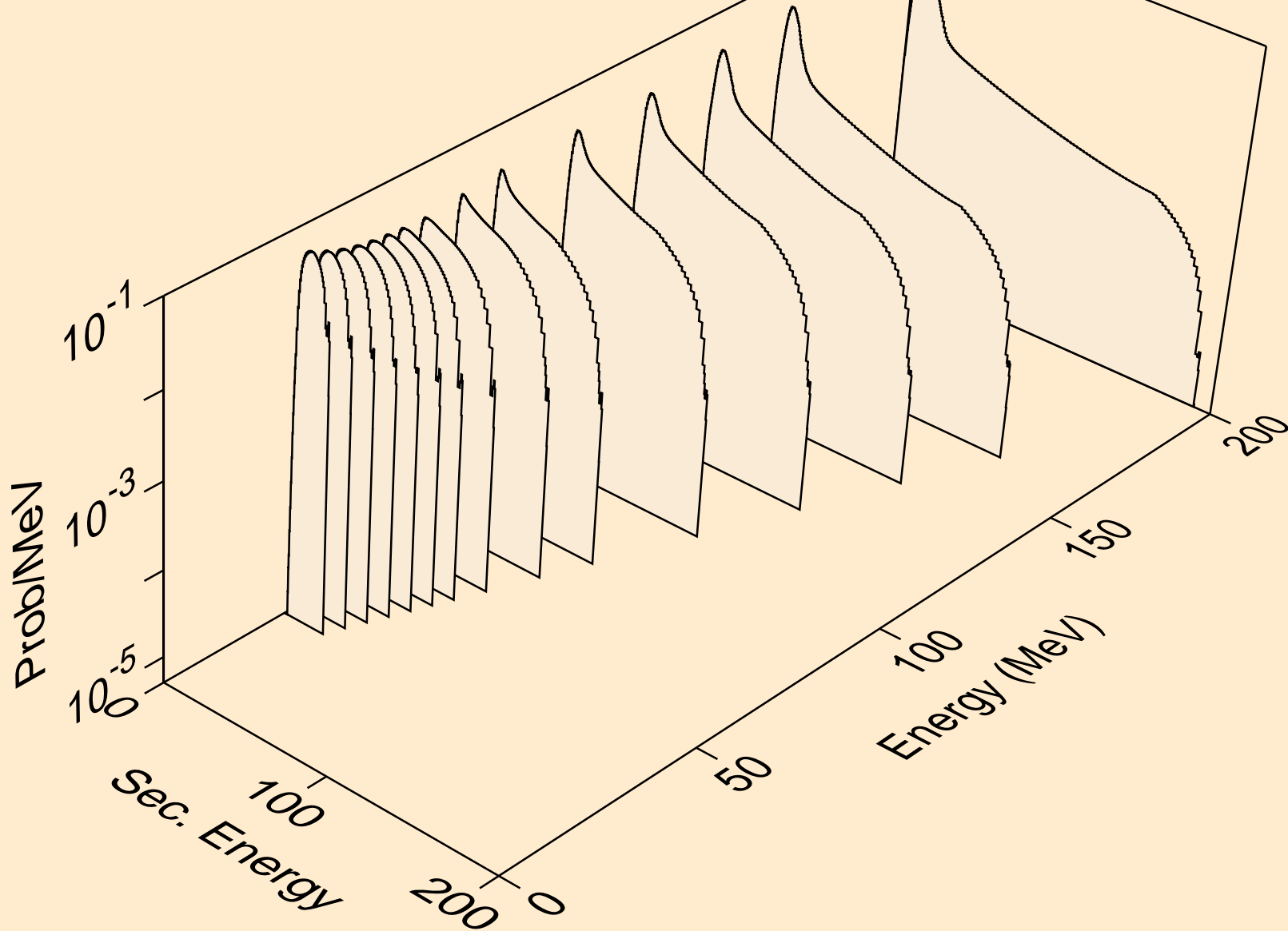

Y095 NEUTRON ACER TENDL-2019 LIBRARY; T=293.16K
protons from (n,n*)p

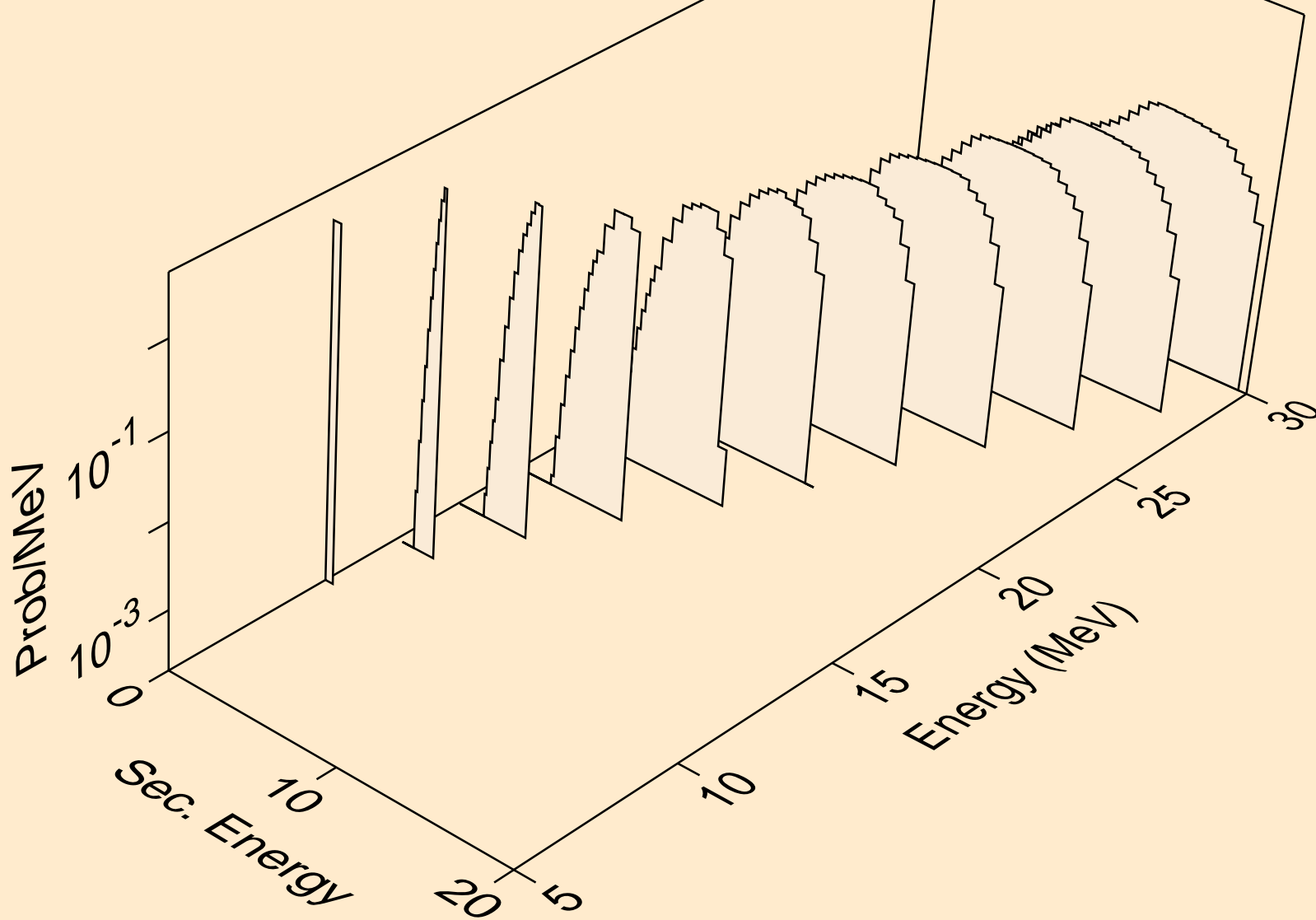

Y095 NEUTRON ACER TENDL-2019 LIBRARY; T=293.16K
protons from (n,2np)

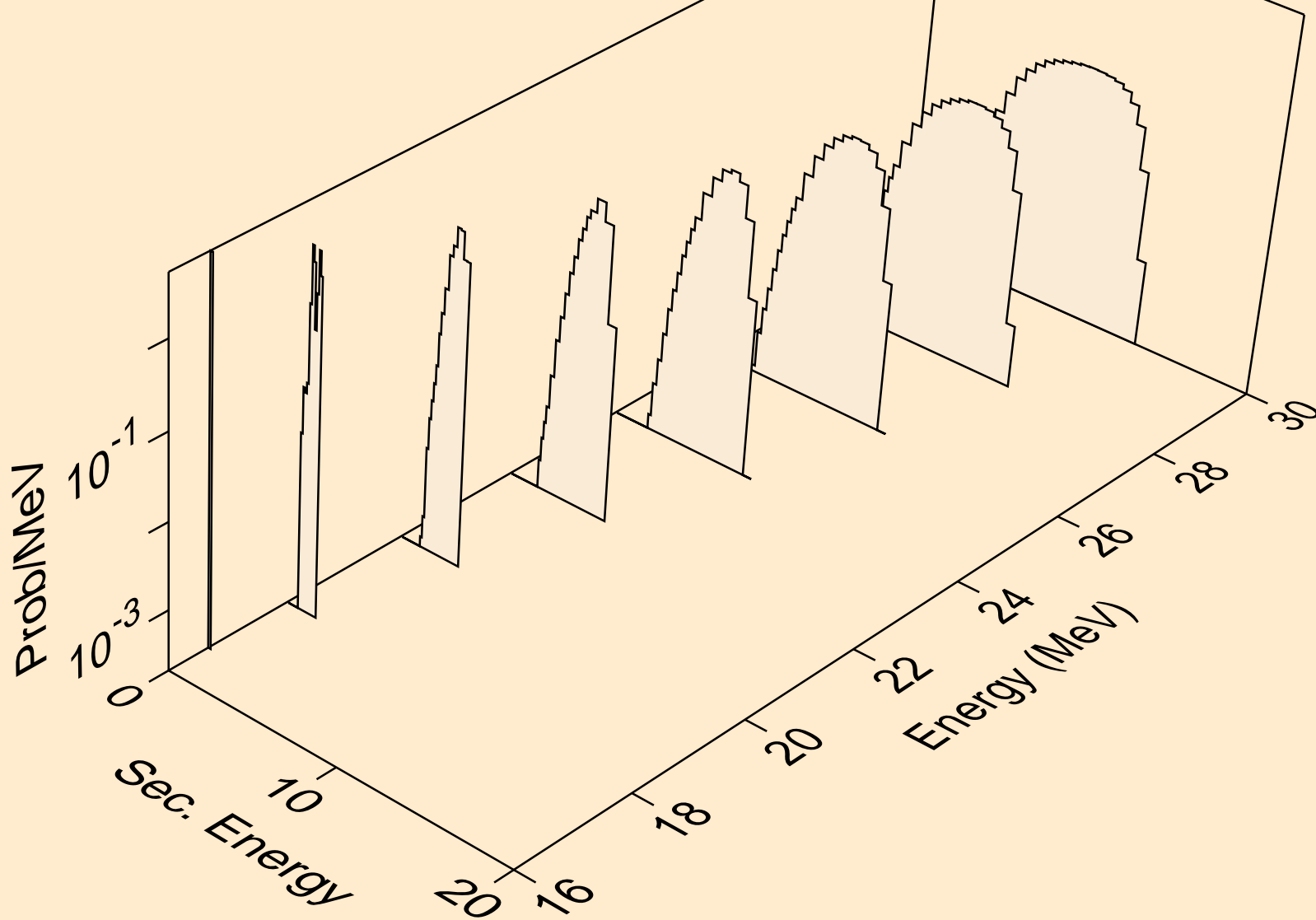

Y095 NEUTRON ACER TENDL-2019 LIBRARY; T=293.16K
protons from (n,3np)

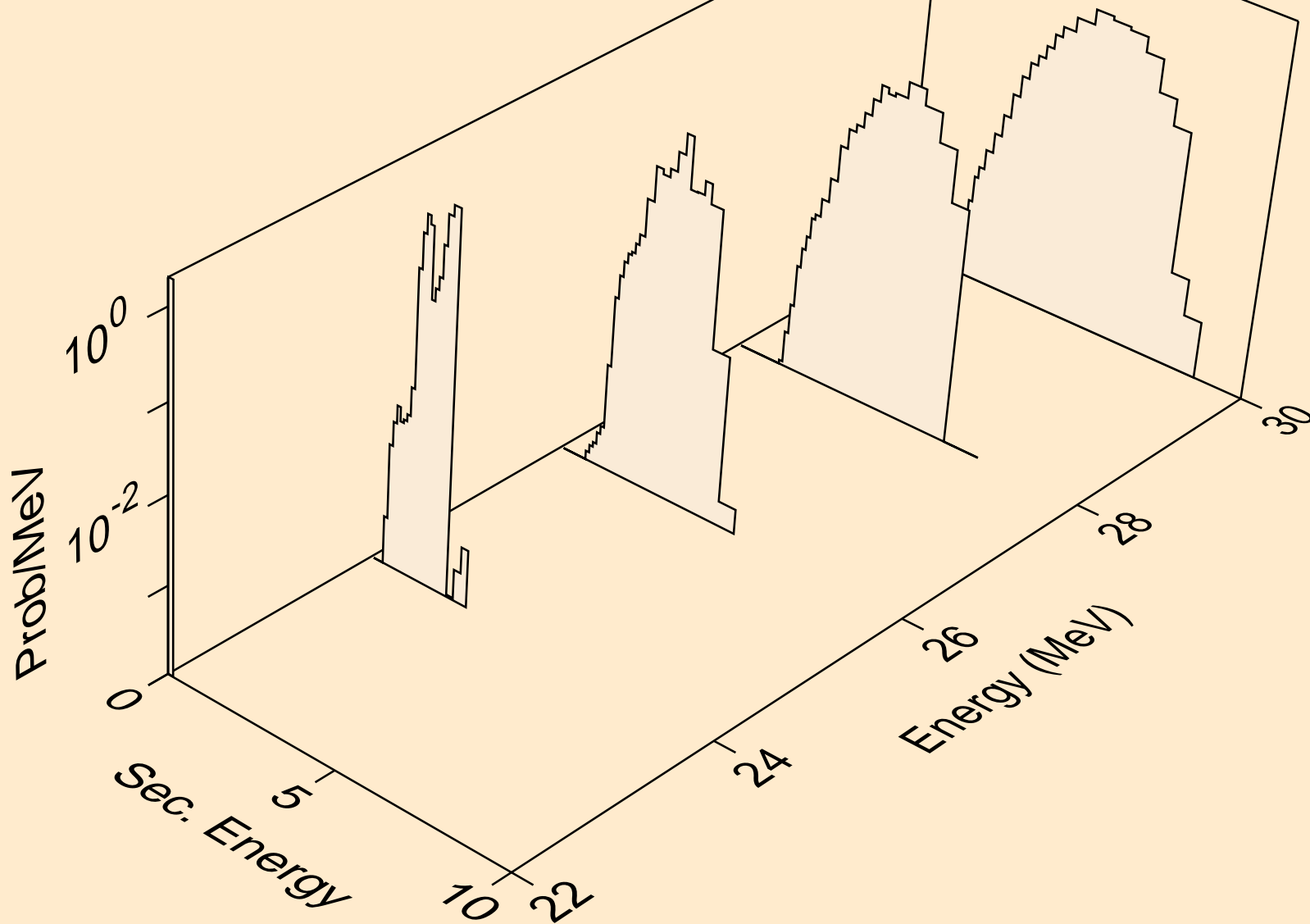

Y095 NEUTRON ACER TENDL-2019 LIBRARY; T=293.16K
protons from (n,p)

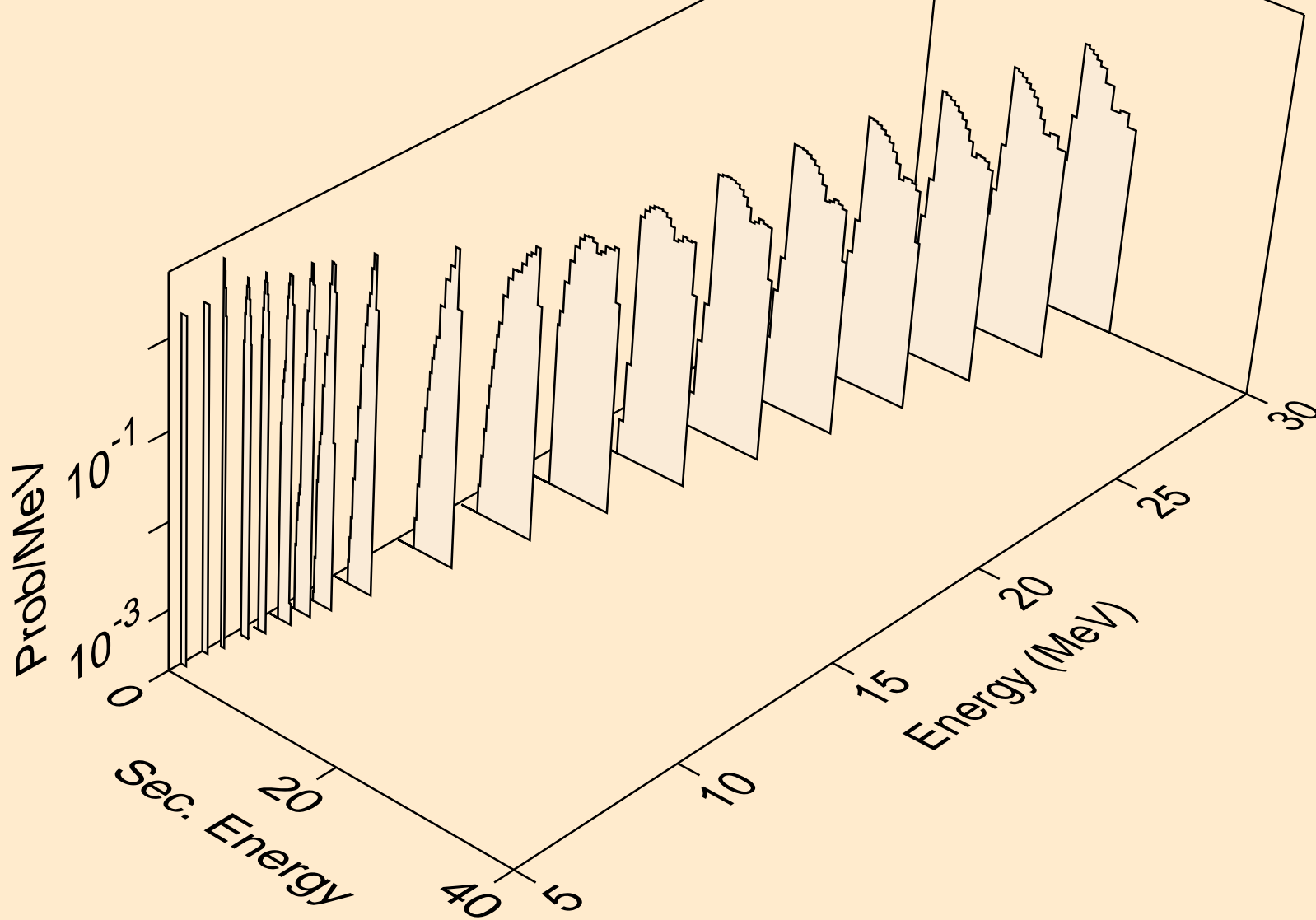

Y095 NEUTRON ACER TENDL-2019 LIBRARY; T=293.16K
protons from (n,2p)

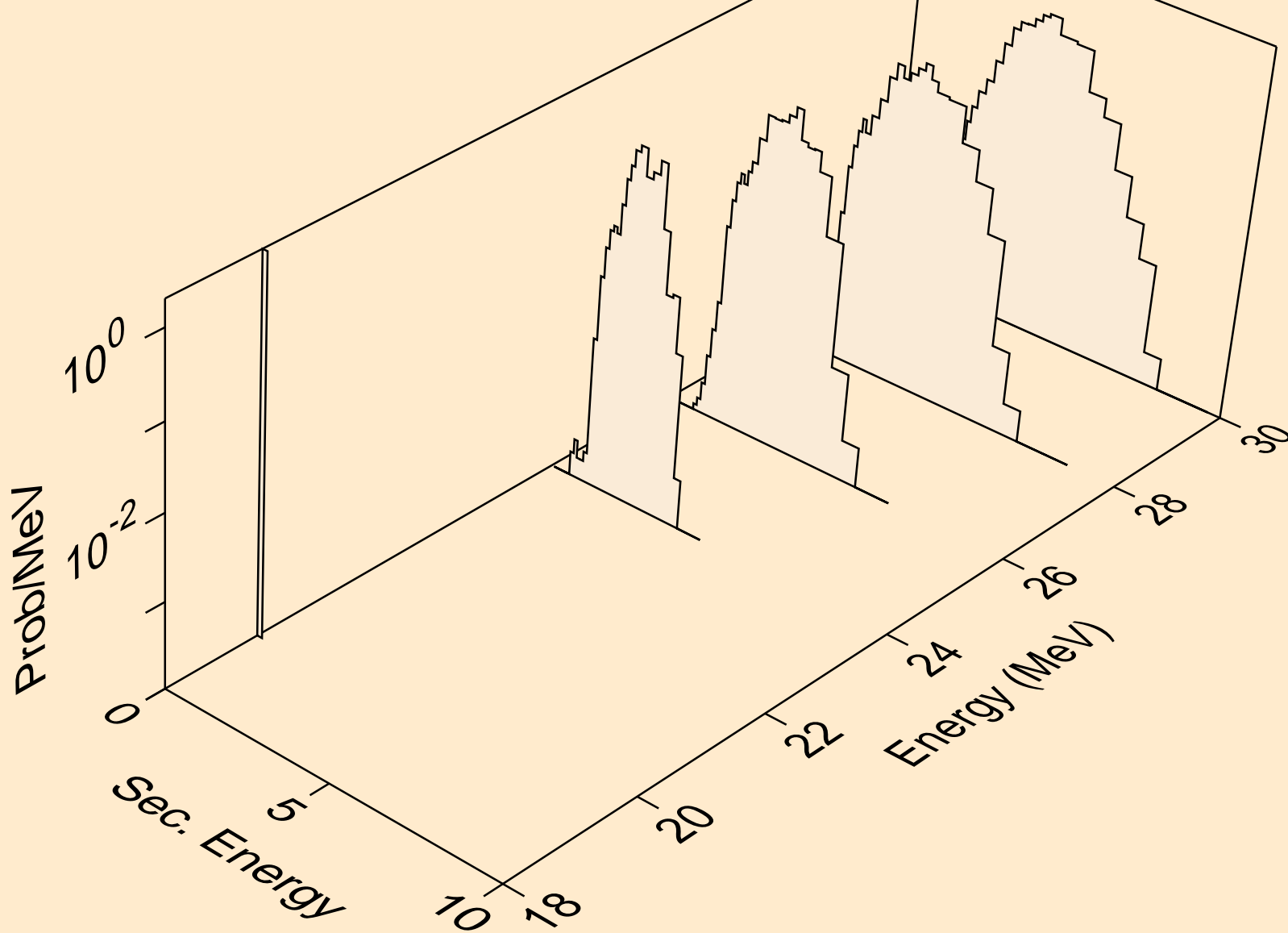

Y095 NEUTRON ACER TENDL-2019 LIBRARY; T=293.16K
protons from (n,p)

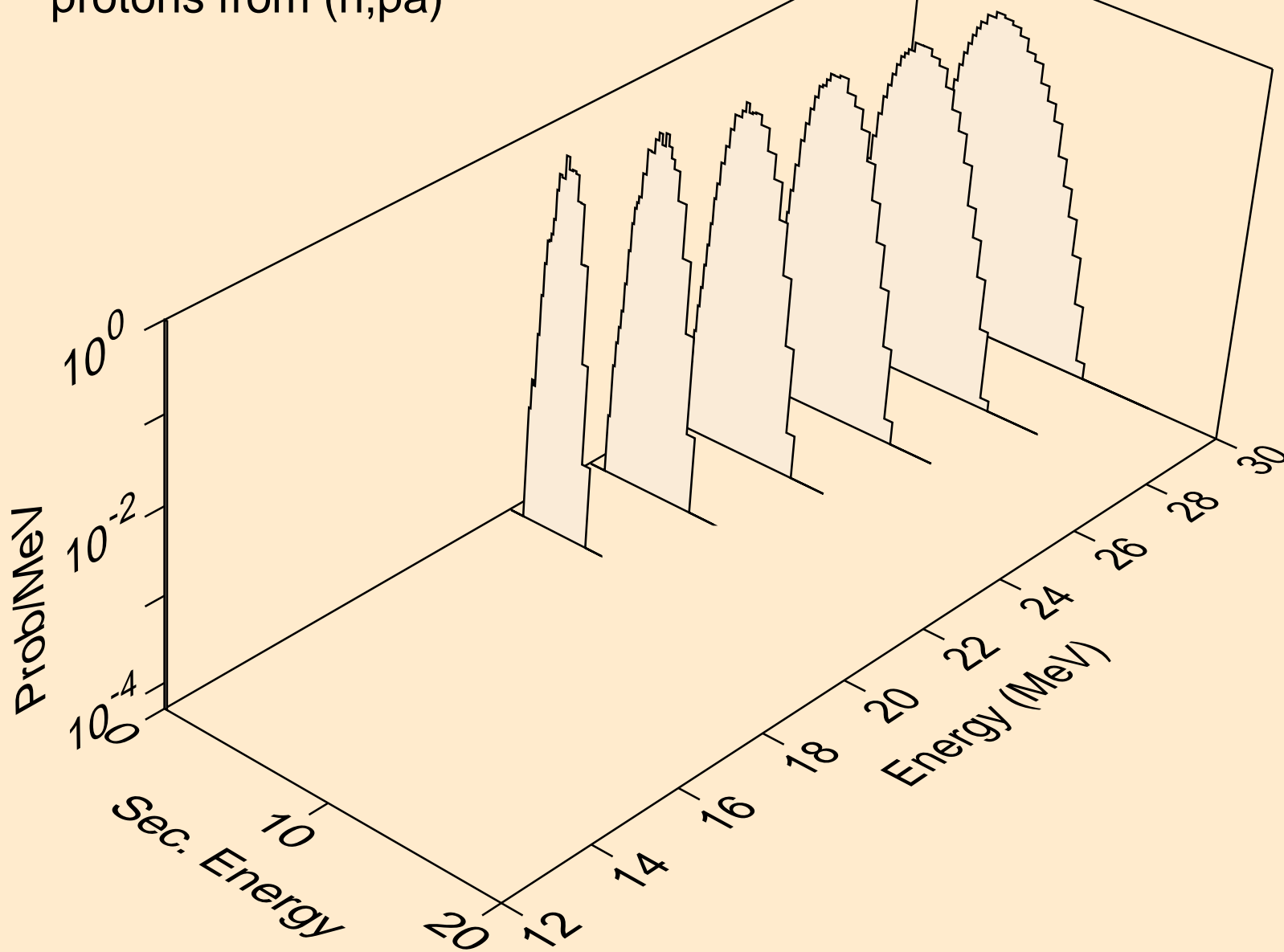

Y095 NEUTRON ACER TENDL-2019 LIBRARY; T=293.16K
deuterons from (n,x)

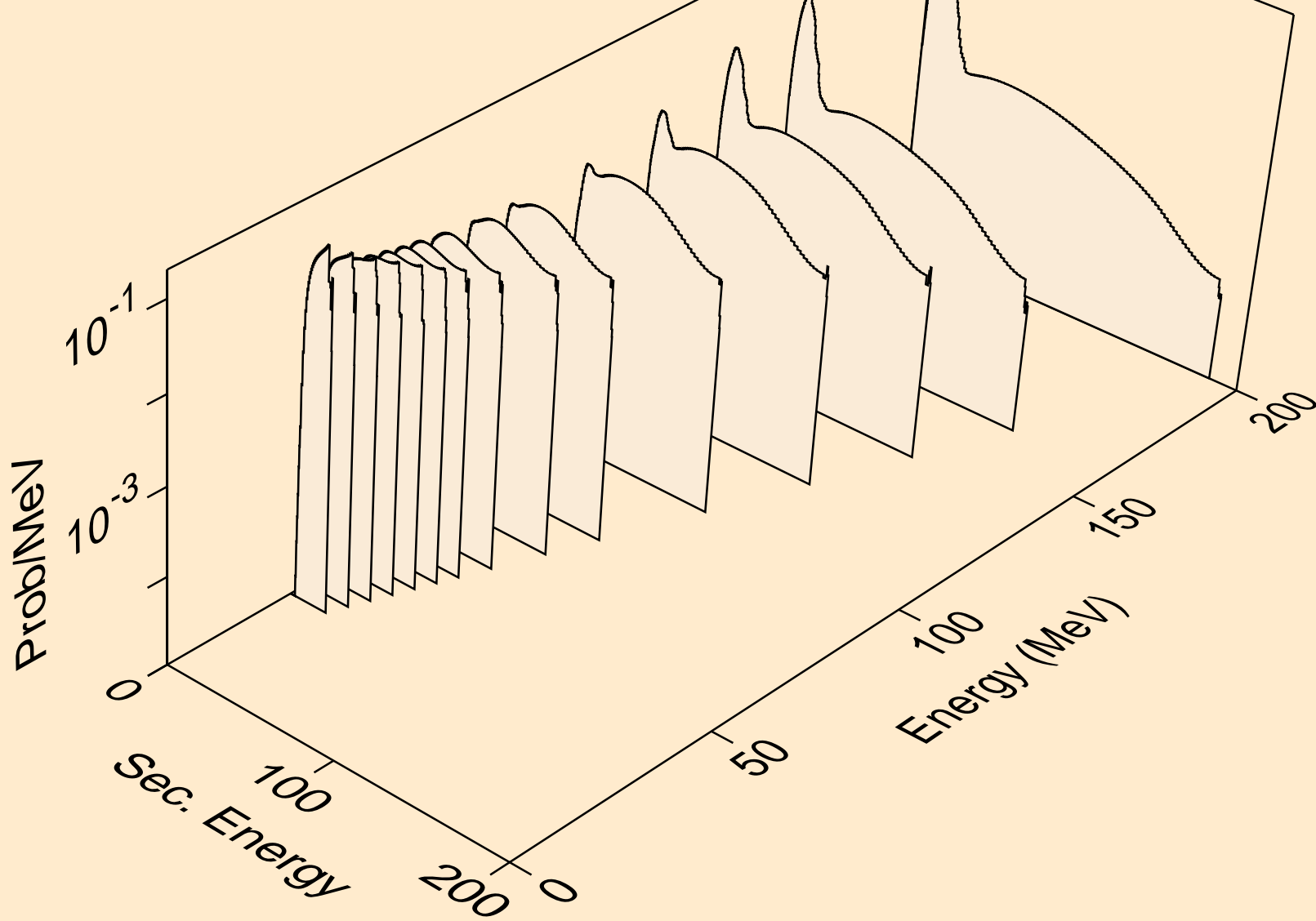

Y095 NEUTRON ACER TENDL-2019 LIBRARY; T=293.16K
deuterons from (n,2nd)

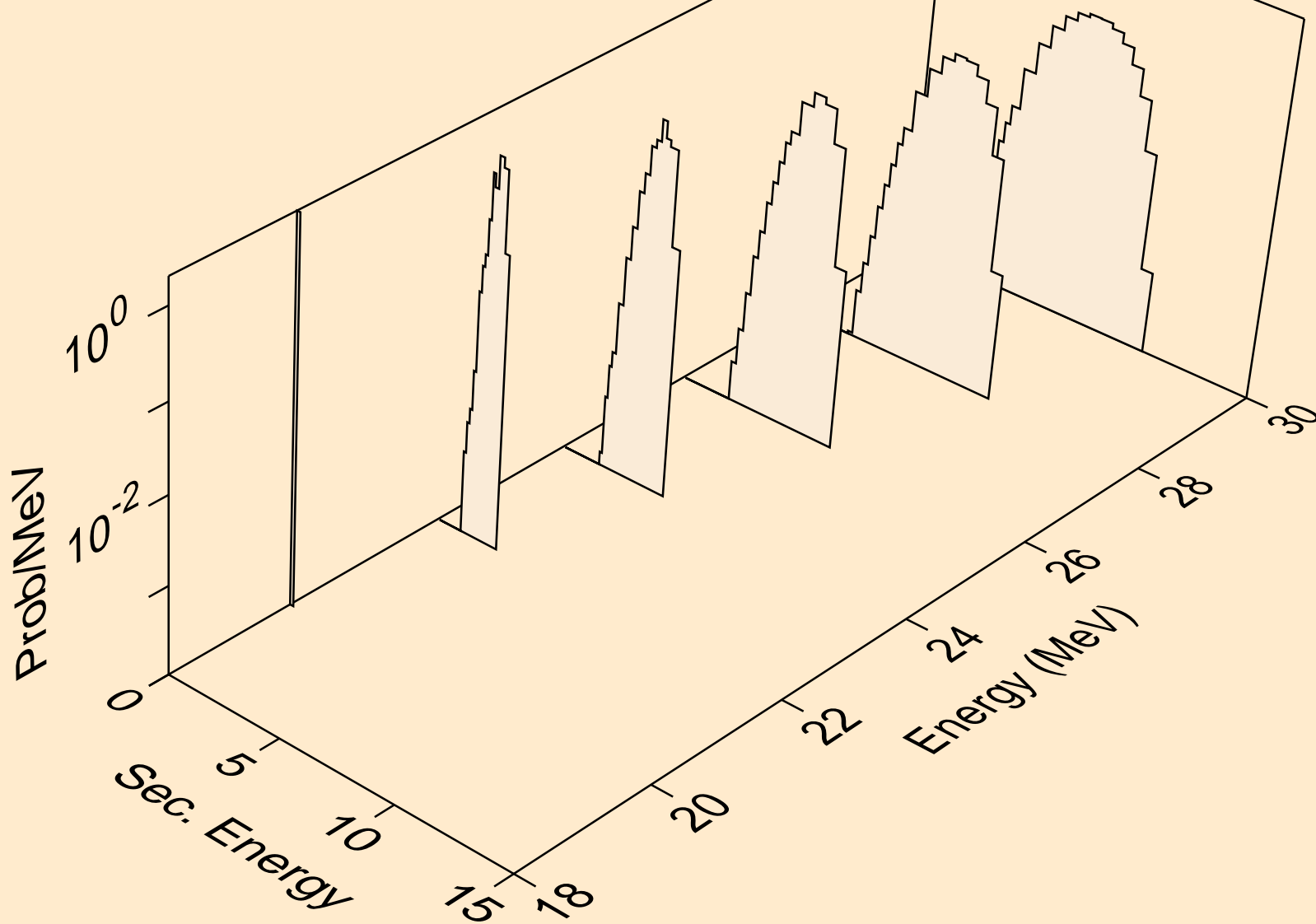

Y095 NEUTRON ACER TENDL-2019 LIBRARY; T=293.16K
deuterons from (n,n*)d

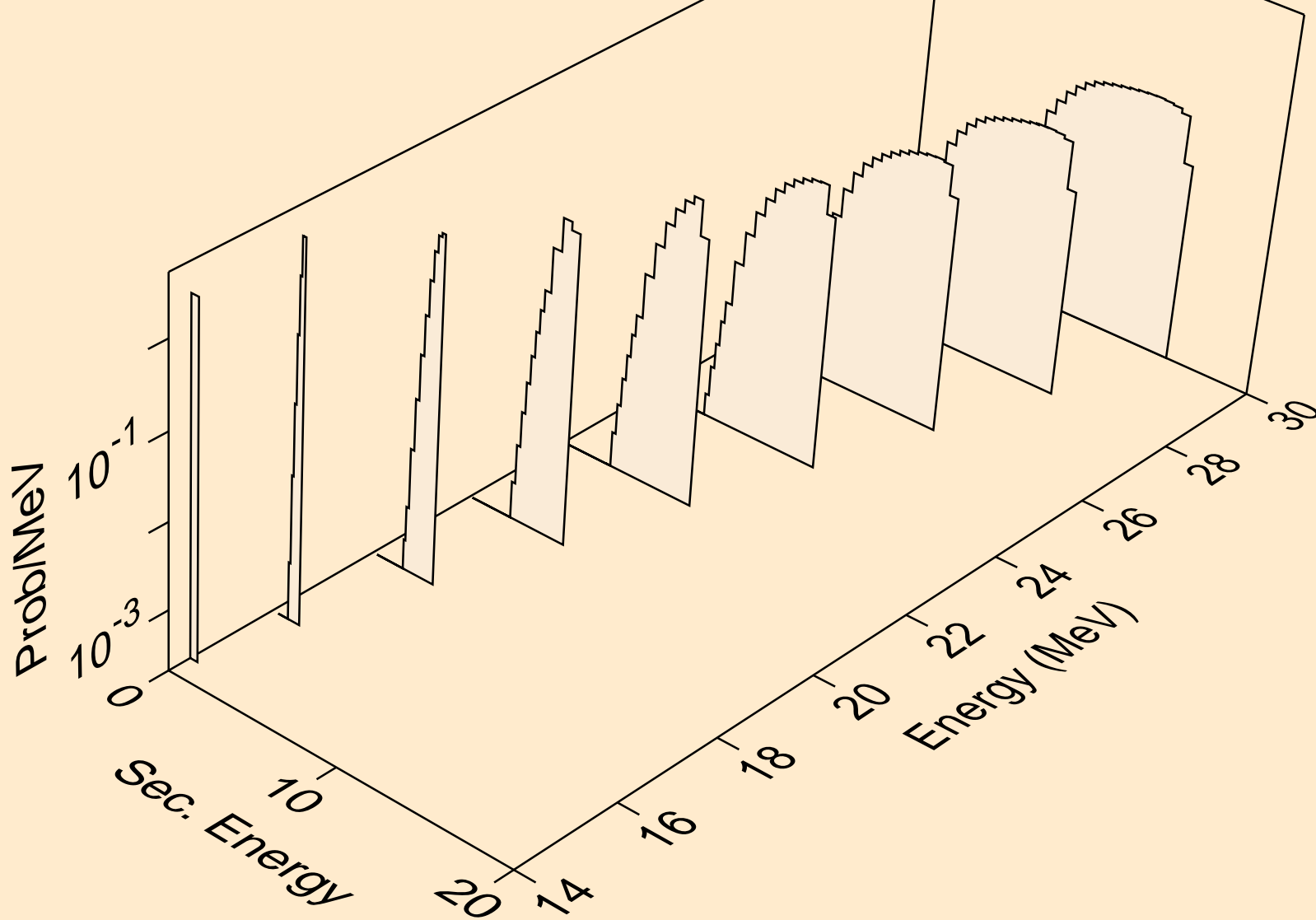

Y095 NEUTRON ACER TENDL-2019 LIBRARY; T=293.16K
deuterons from (n,d)

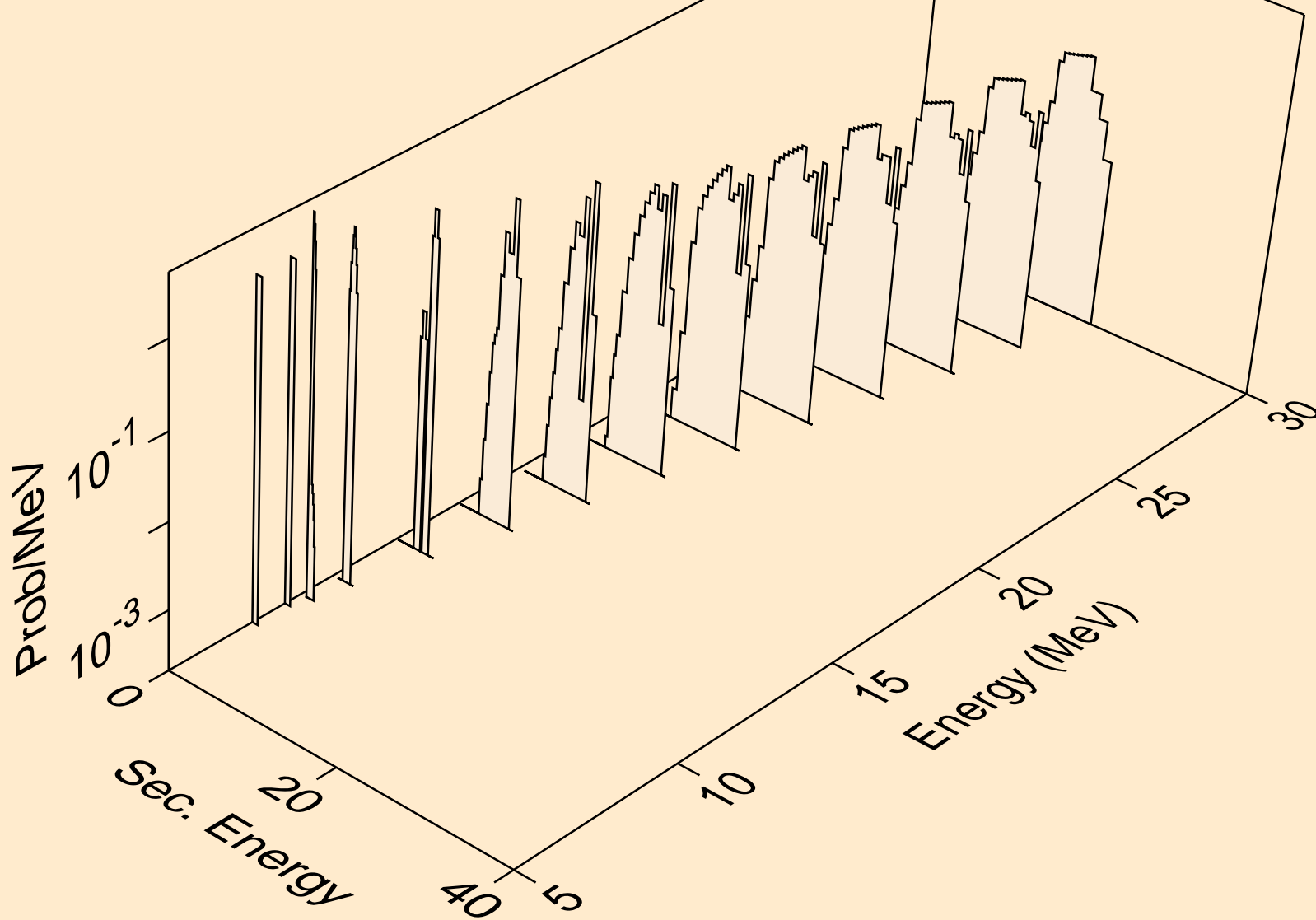

Y095 NEUTRON ACER TENDL-2019 LIBRARY; T=293.16K
tritons from (n,x)

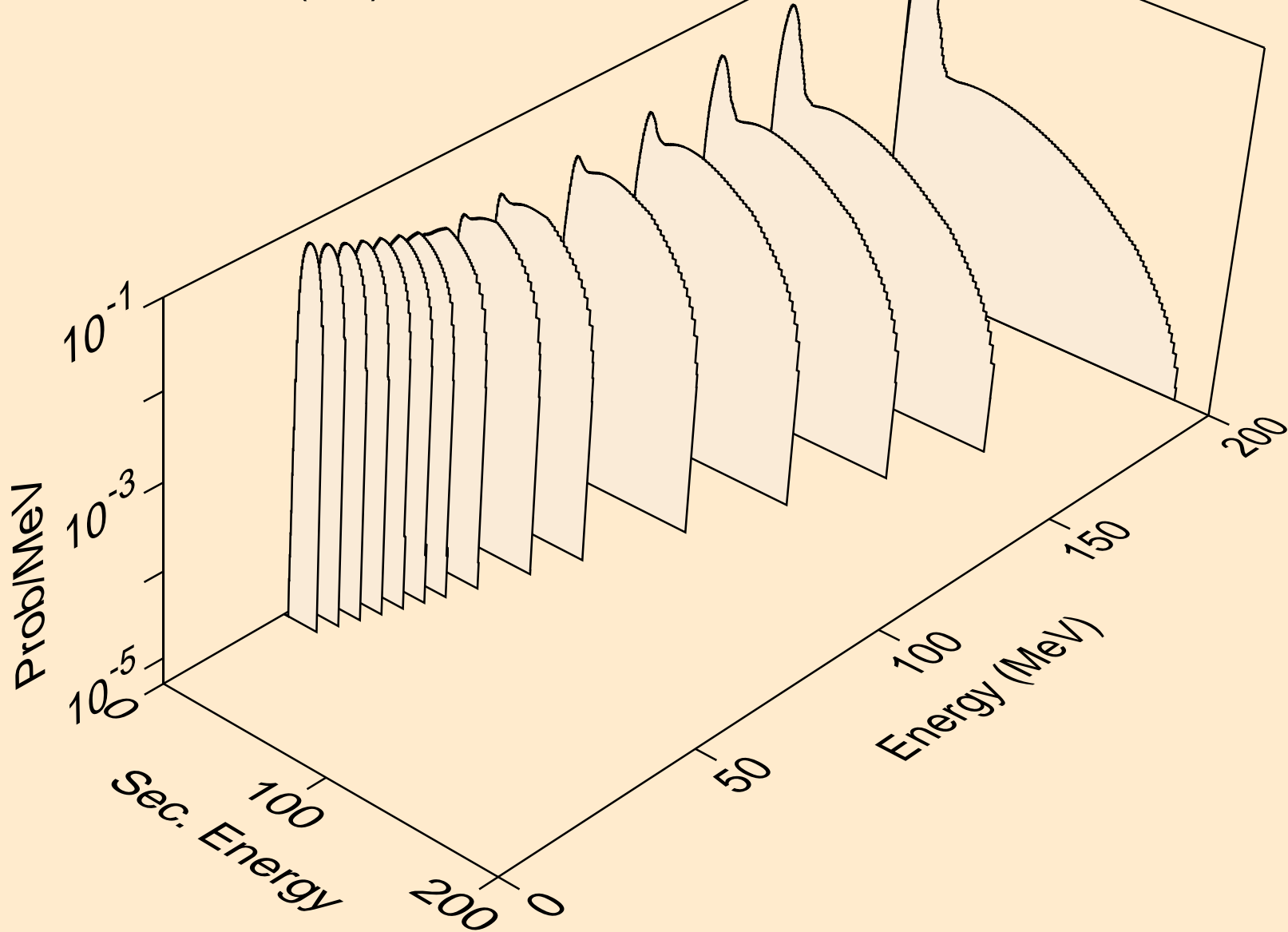

Y095 NEUTRON ACER TENDL-2019 LIBRARY; T=293.16K
tritons from (n,n*)t

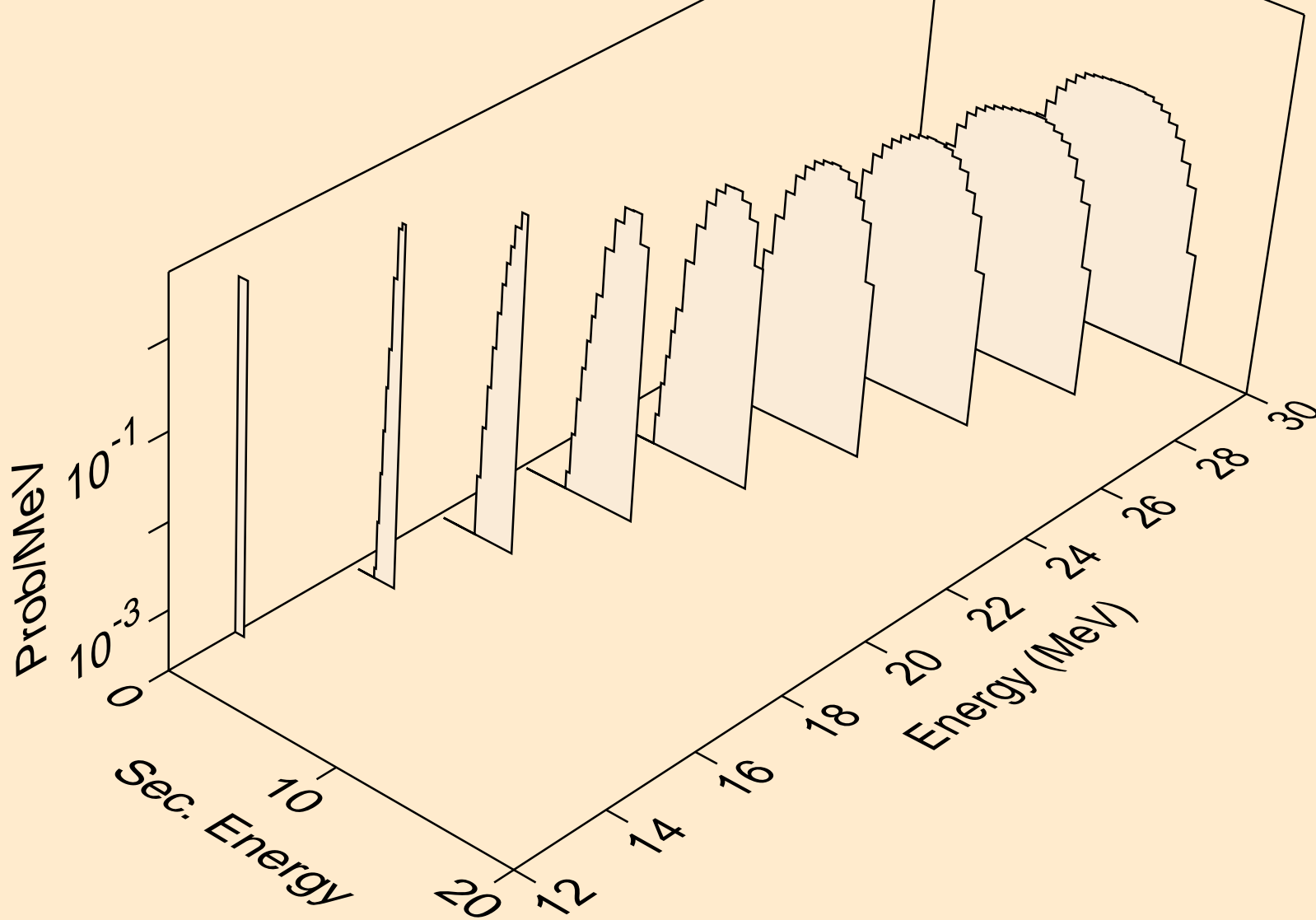

Y095 NEUTRON ACER TENDL-2019 LIBRARY; T=293.16K
tritons from (n,t)

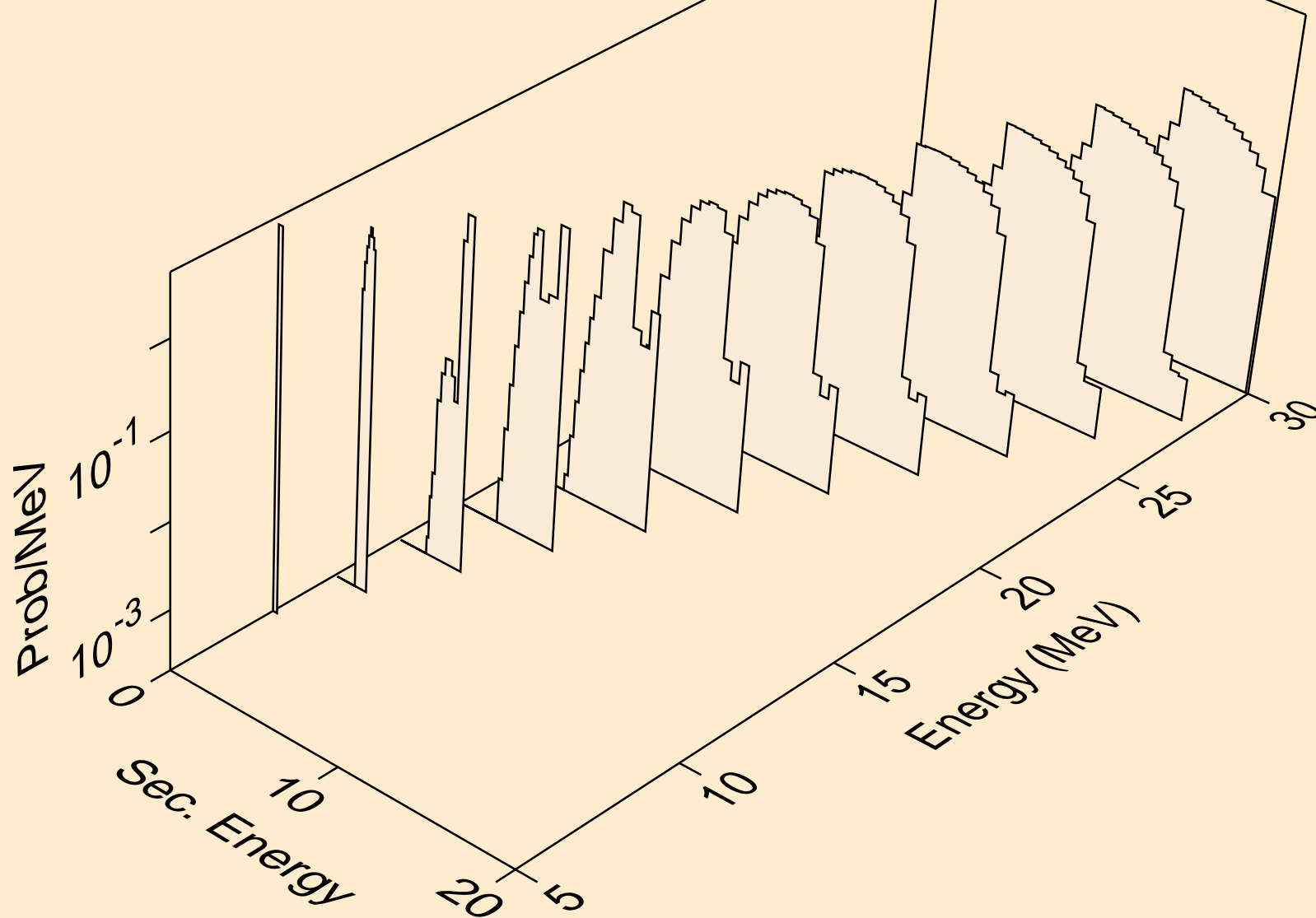

Y095 NEUTRON ACER TENDL-2019 LIBRARY; T=293.16K
he3s from (n,x)

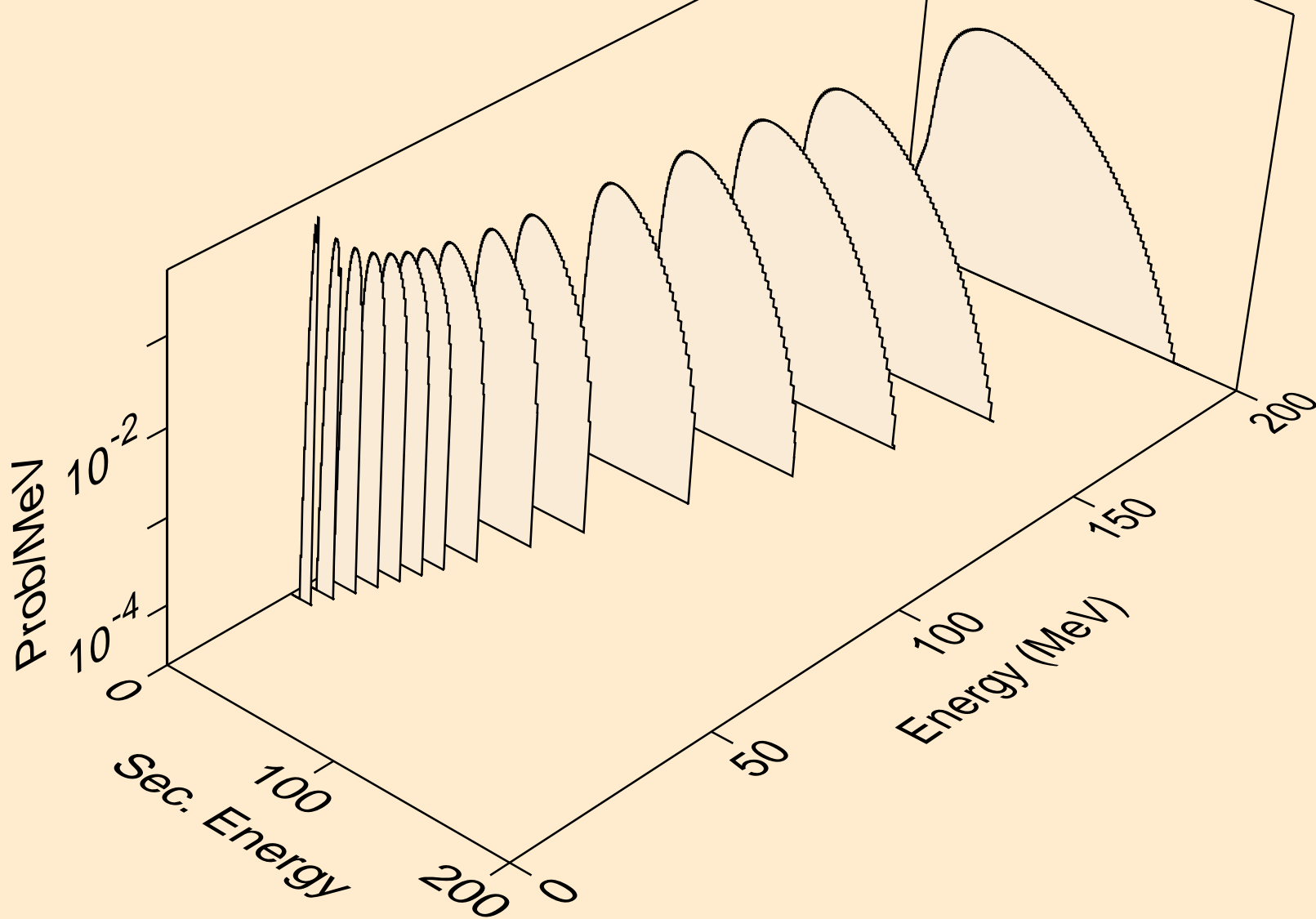

Y095 NEUTRON ACER TENDL-2019 LIBRARY; T=293.16K
he3s from (n,n*)he3

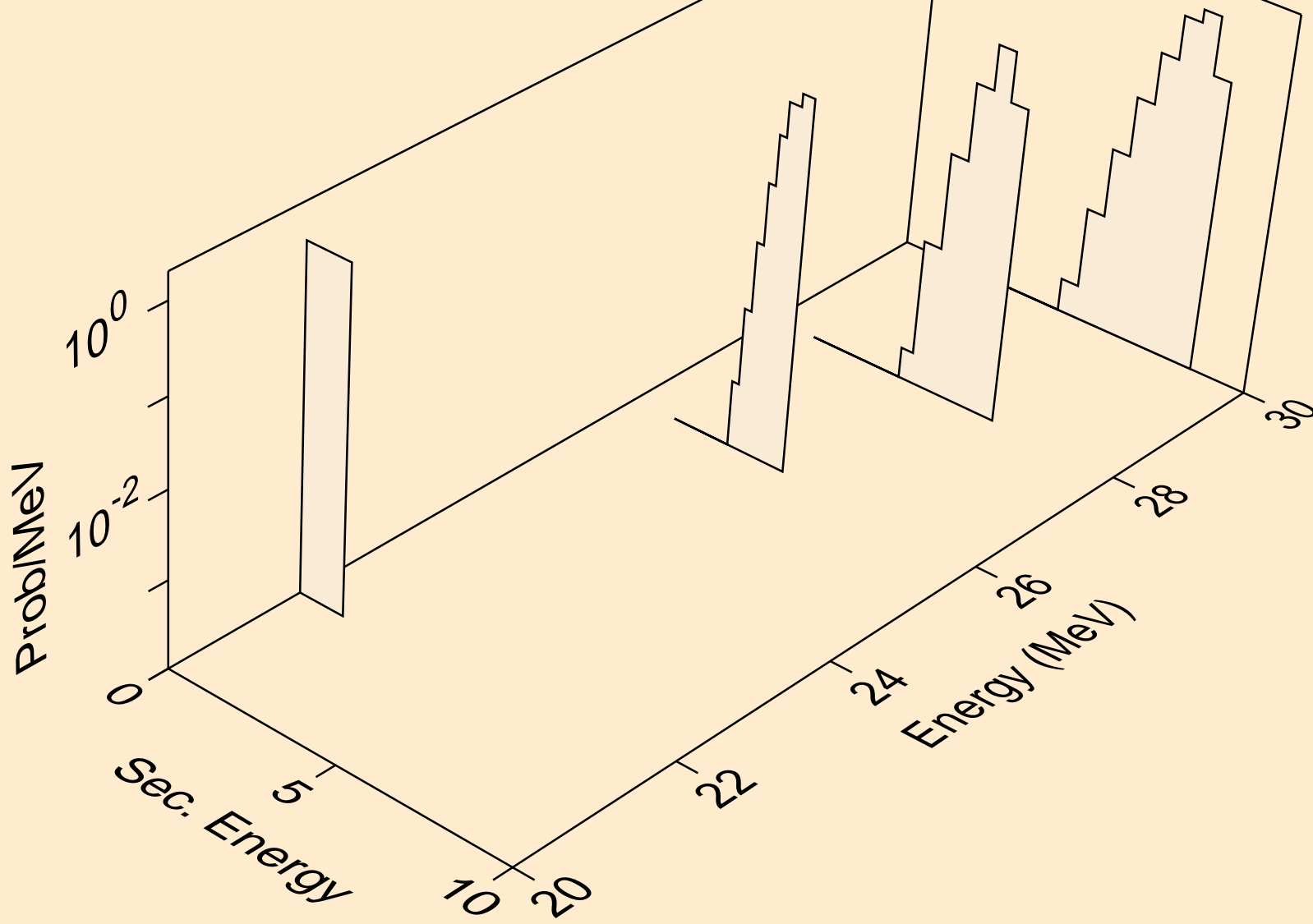

Y095 NEUTRON ACER TENDL-2019 LIBRARY; T=293.16K
he3s from (n,he3)

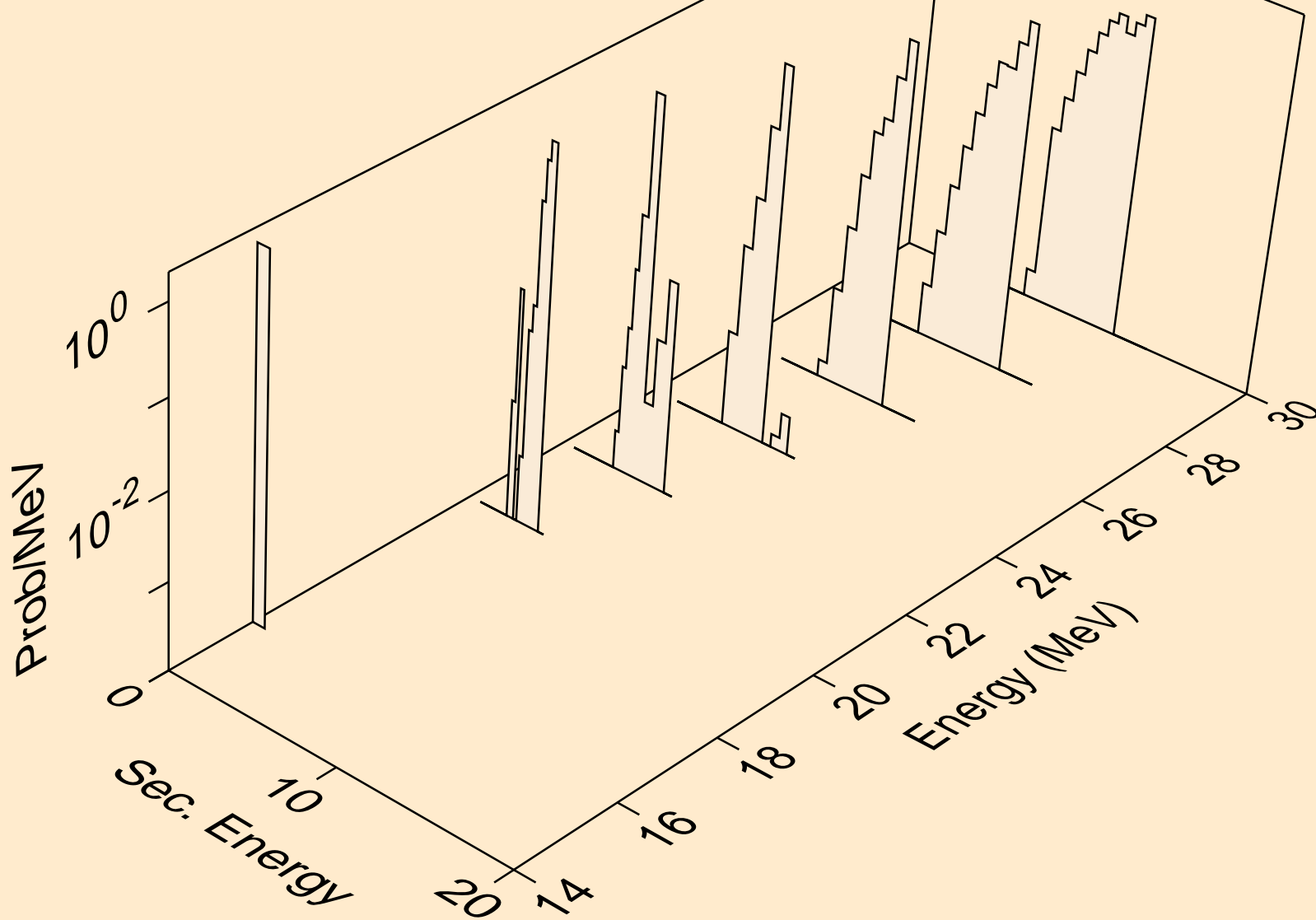

Y095 NEUTRON ACER TENDL-2019 LIBRARY; T=293.16K
alphas from (n,x)

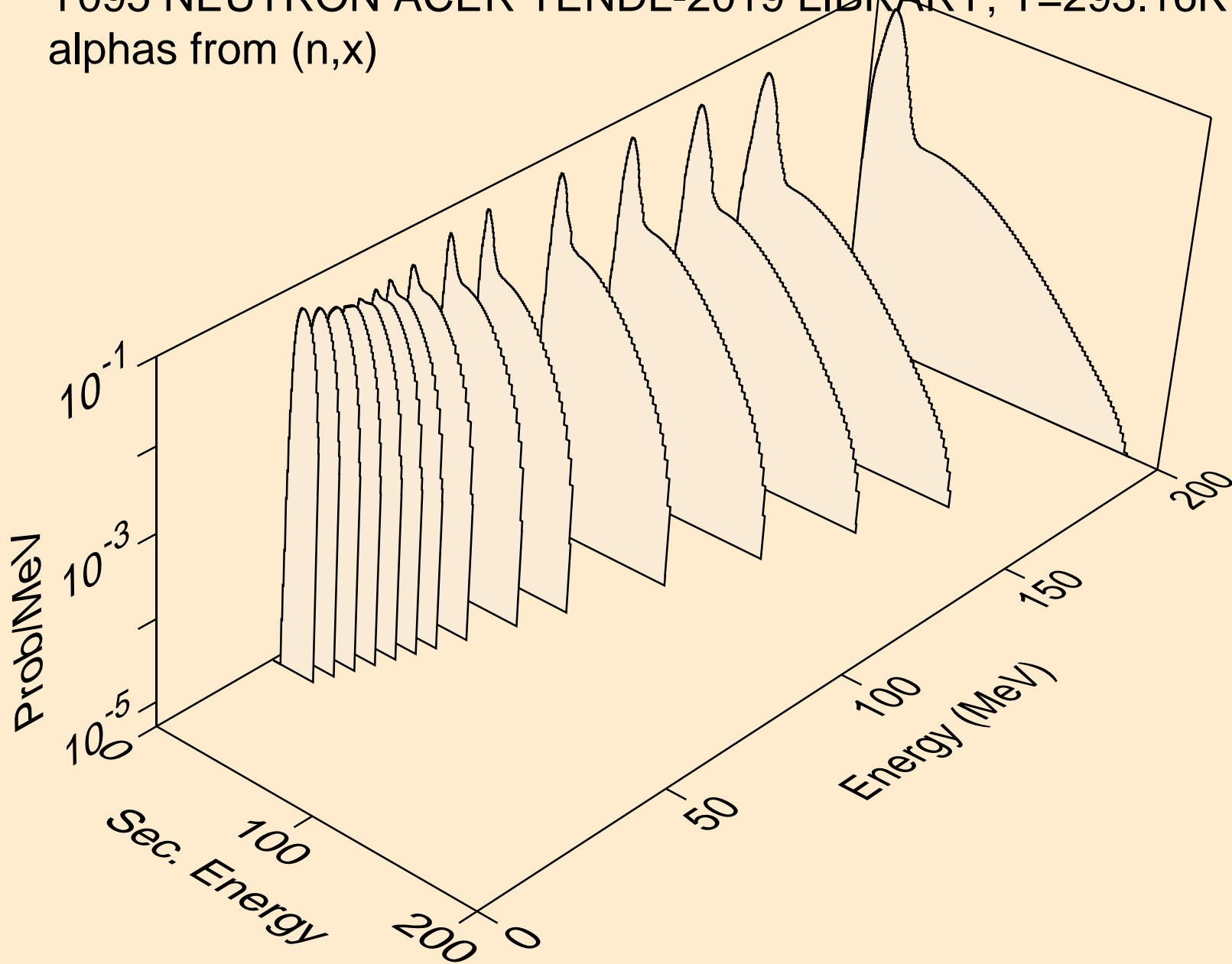

Y095 NEUTRON ACER TENDL-2019 LIBRARY; T=293.16K
alphas from (n,n*)a

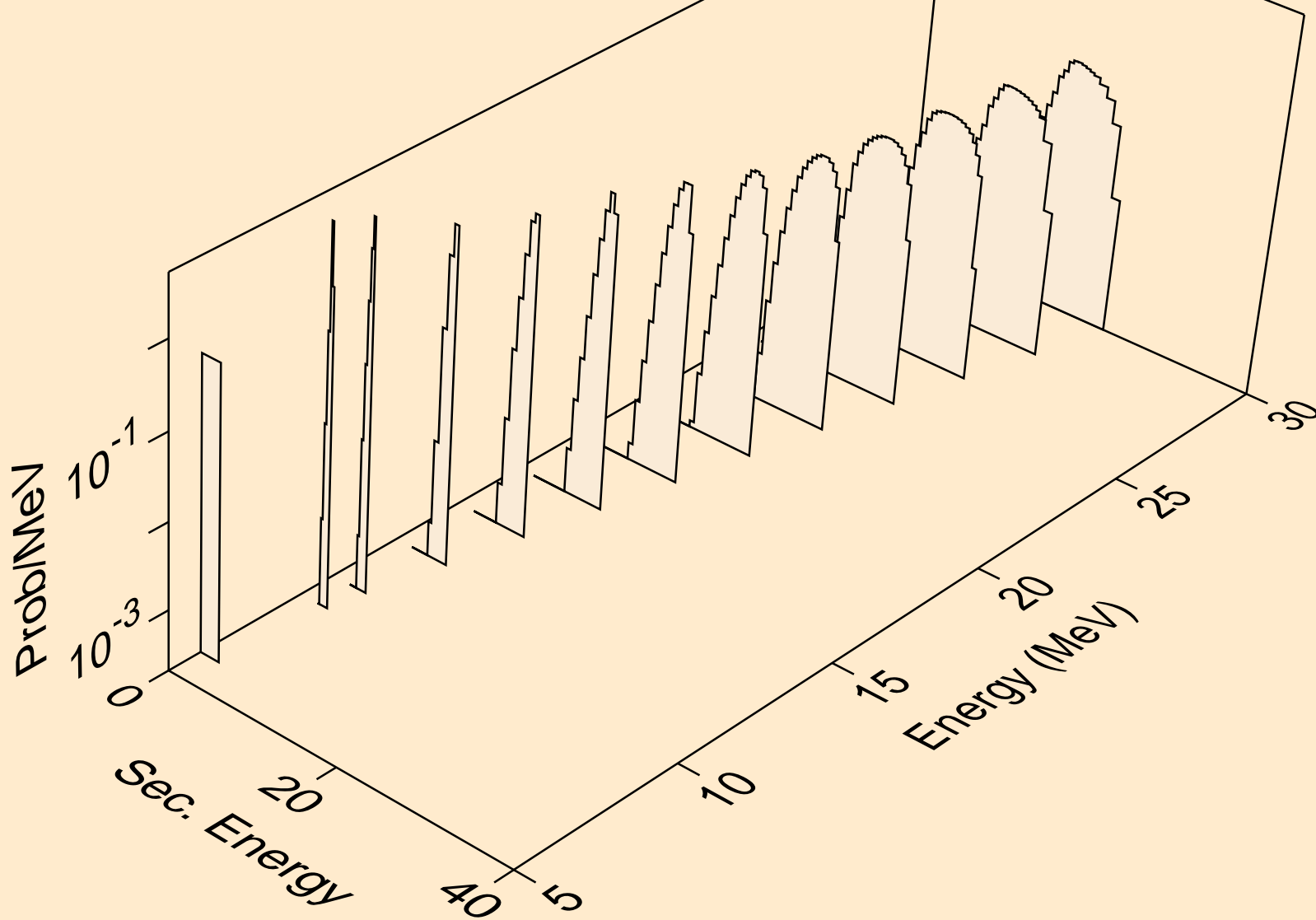

Y095 NEUTRON ACER TENDL-2019 LIBRARY; T=293.16K
alphas from (n,2n)a

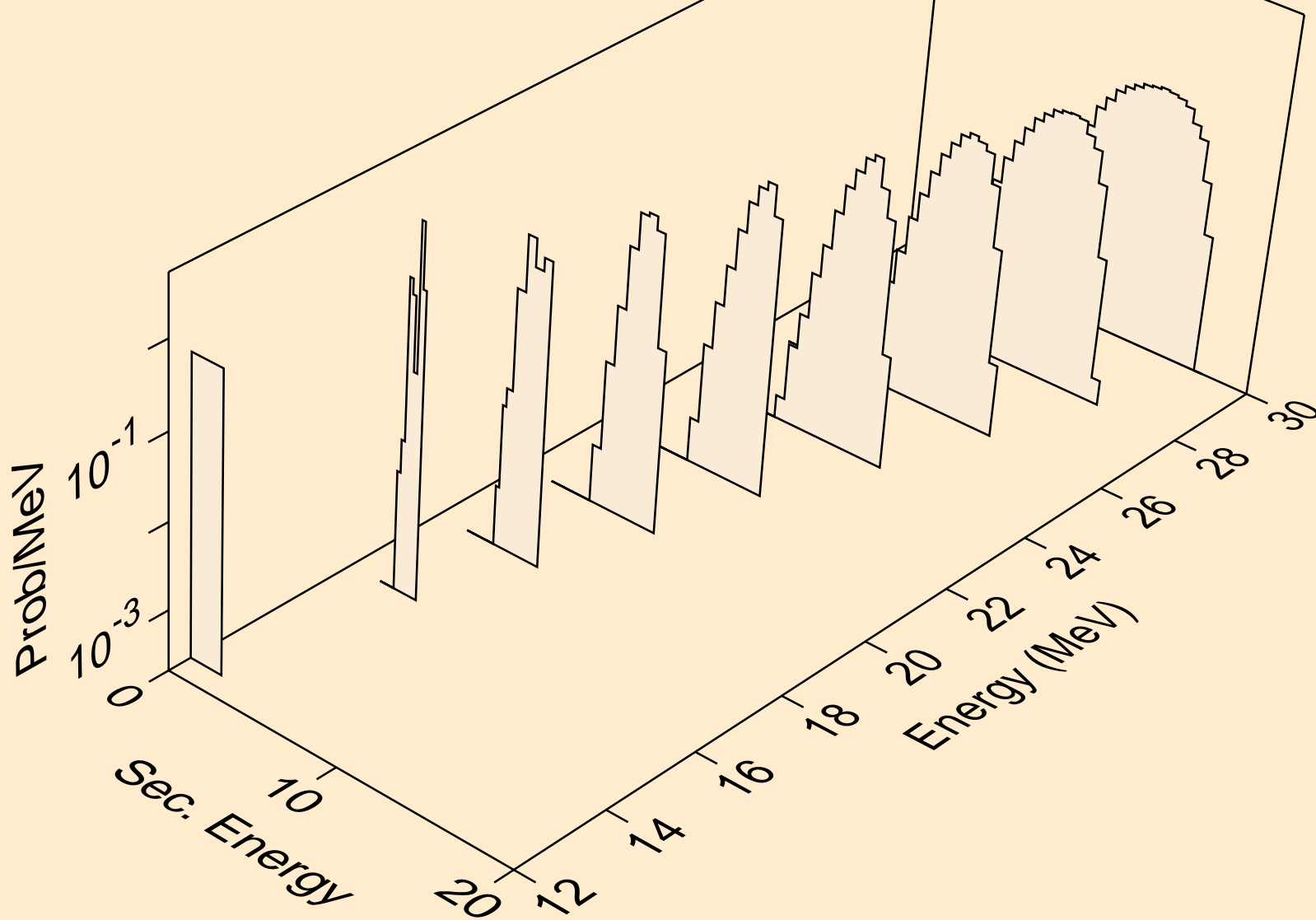

Y095 NEUTRON ACER TENDL-2019 LIBRARY; T=293.16K
alphas from (n,3n)a

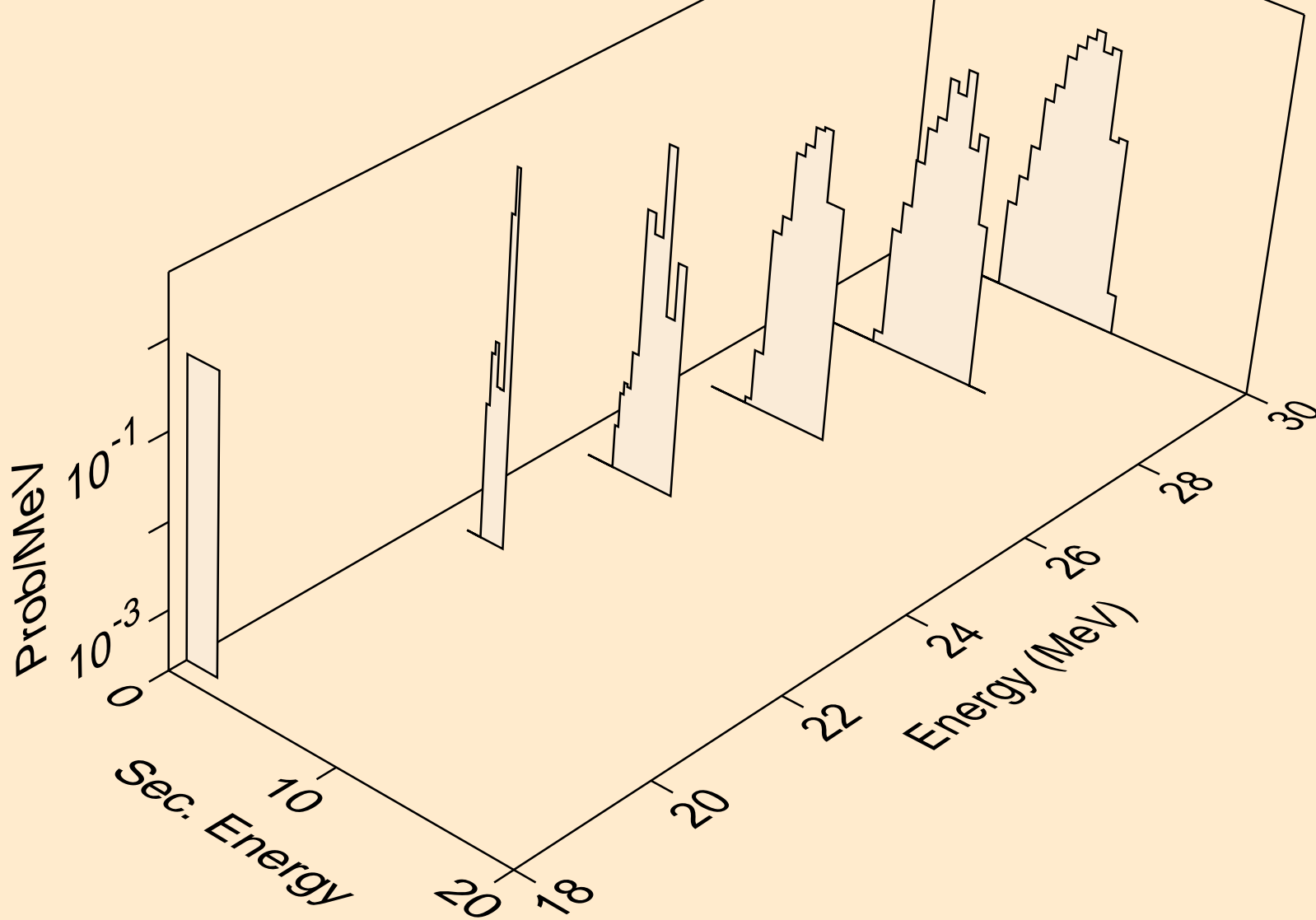

Y095 NEUTRON ACER TENDL-2019 LIBRARY; T=293.16K
alphas from (n,a)

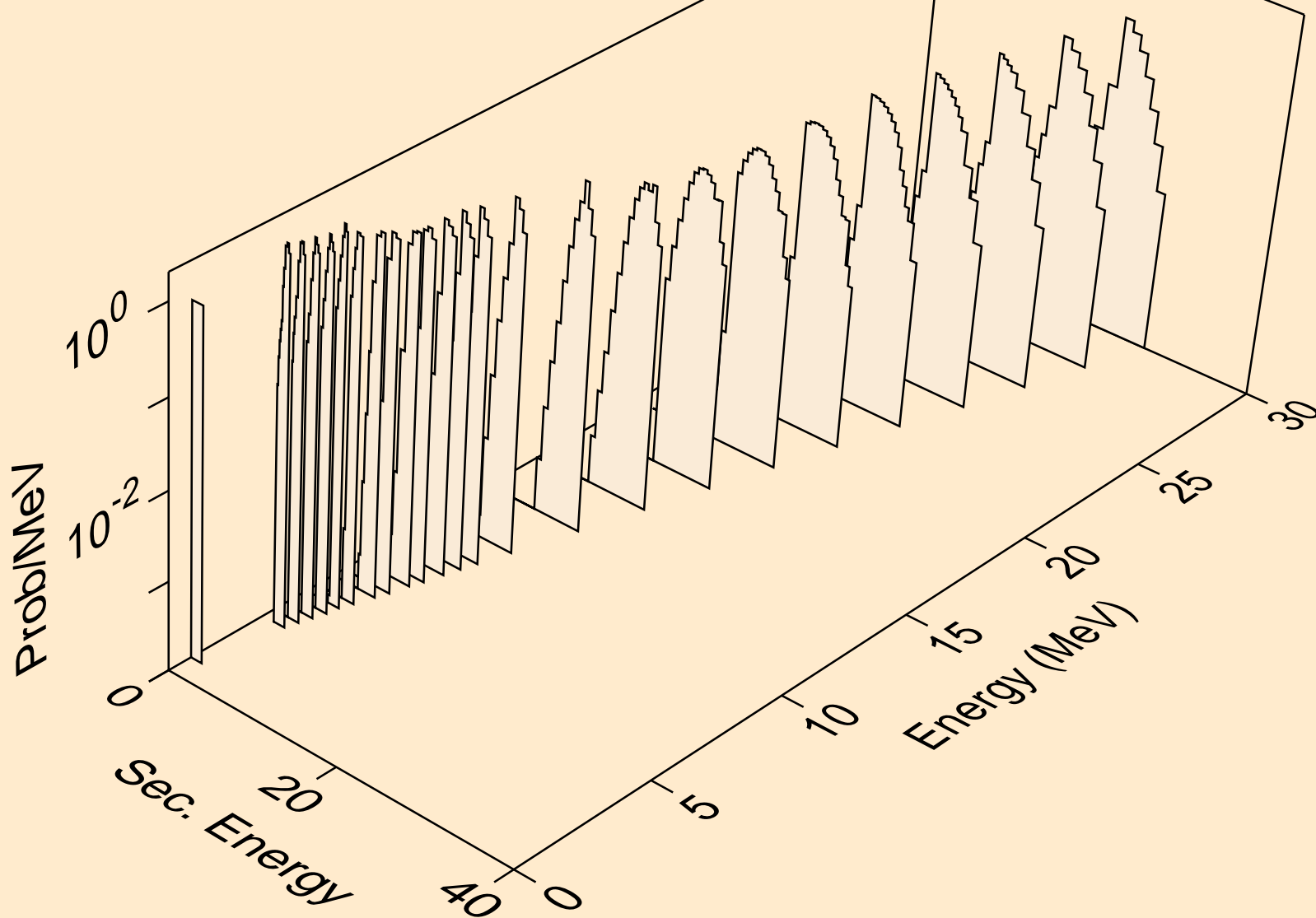

Y095 NEUTRON ACER TENDL-2019 LIBRARY; T=293.16K
alphas from (n,pa)

