

Y096 NEUTRON ACER TENDL-2019 LIBRARY; T=293.16K
Principal cross sections

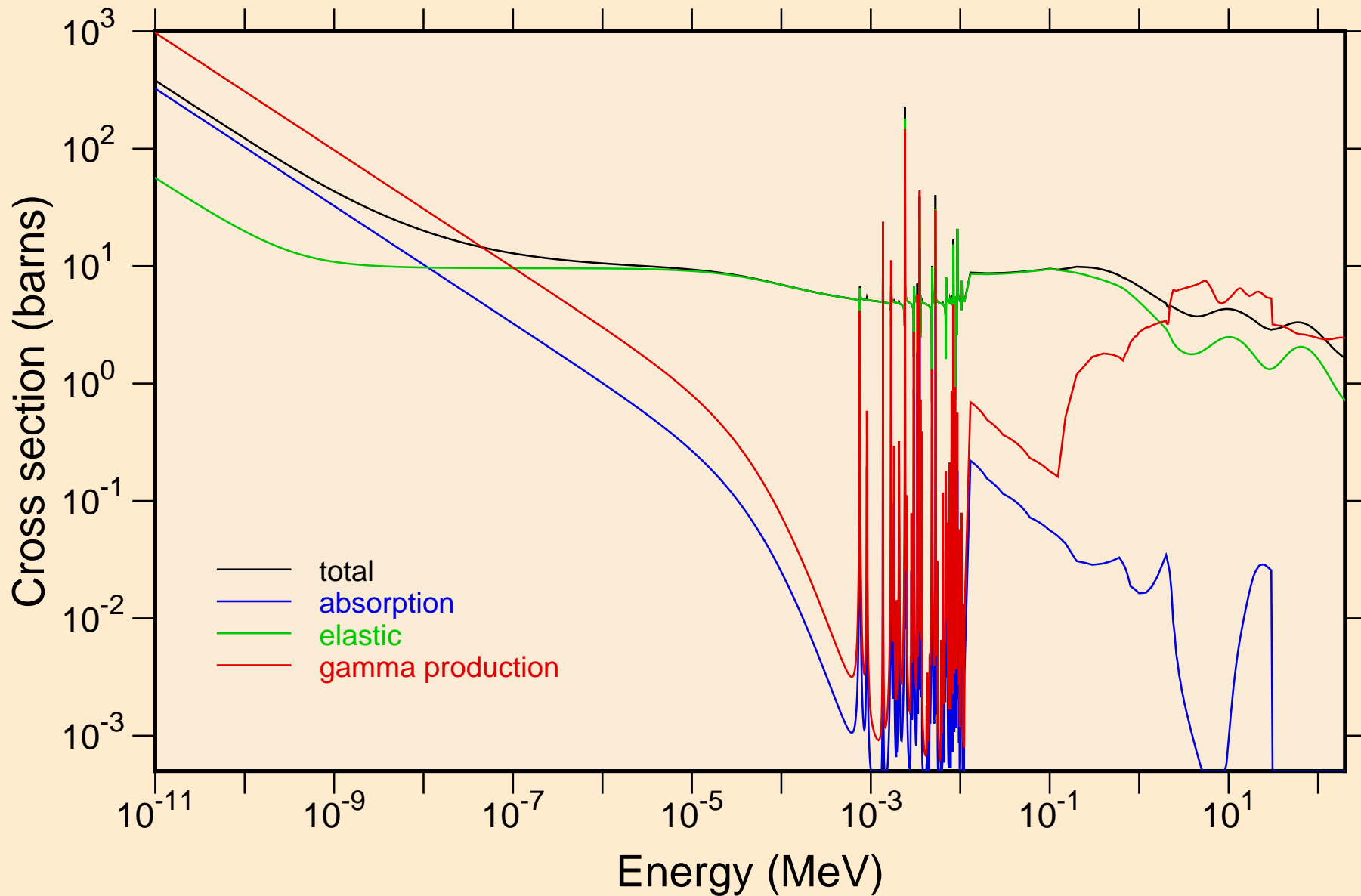

Y096 NEUTRON ACER TENDL-2019 LIBRARY; T=293.16K
resonance total cross section

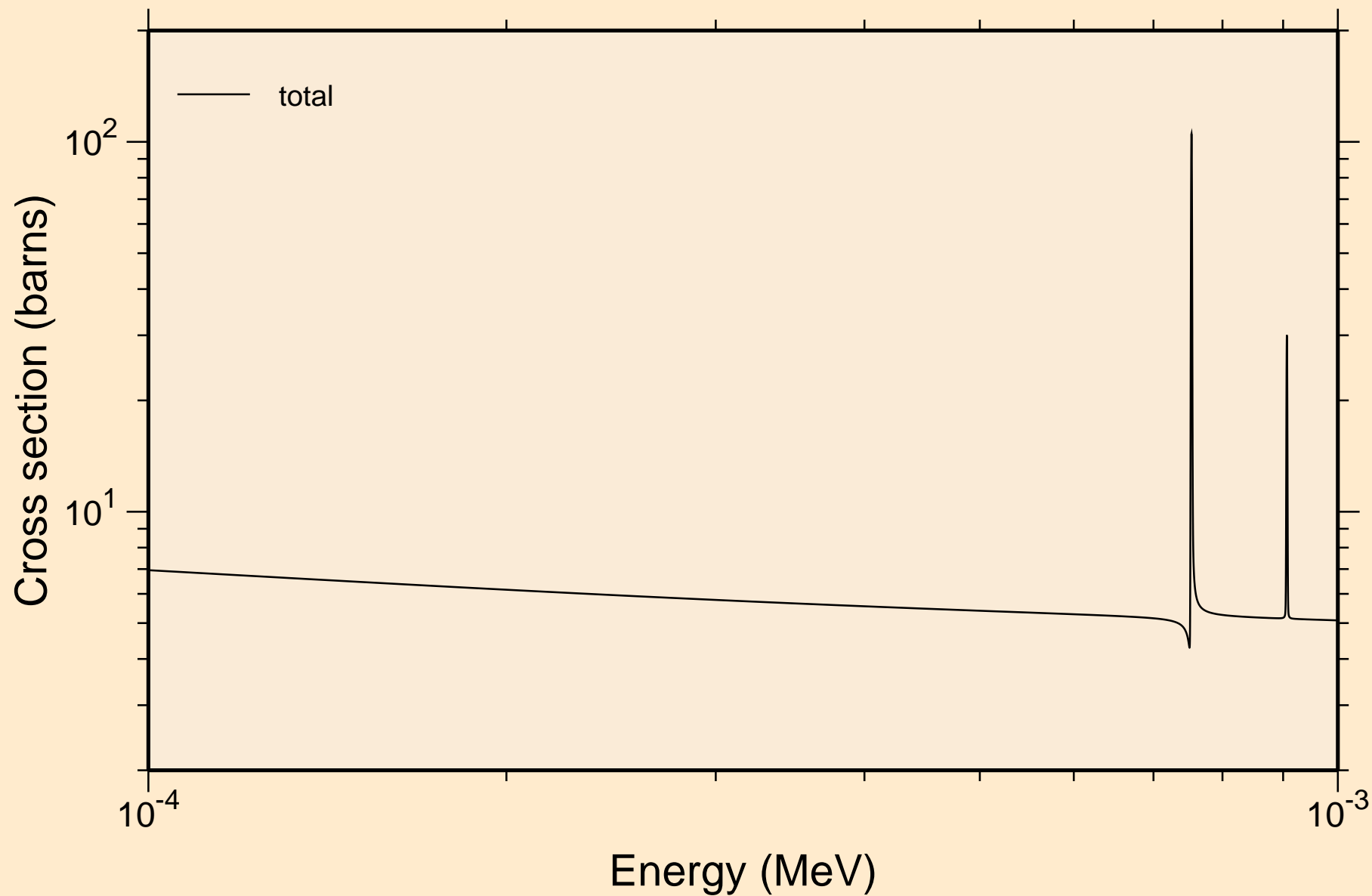

Y096 NEUTRON ACER TENDL-2019 LIBRARY; T=293.16K
resonance total cross section

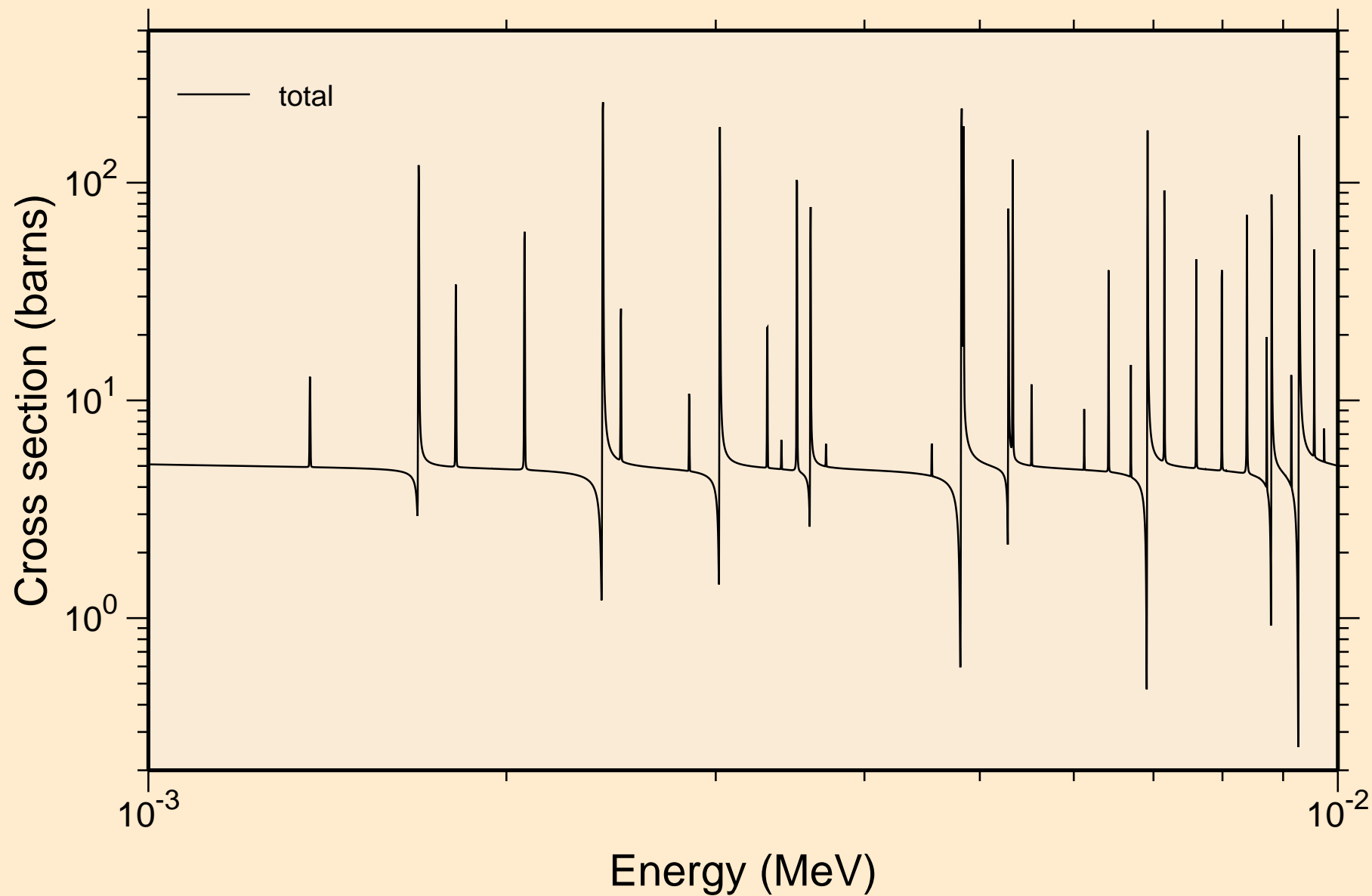

Y096 NEUTRON ACER TENDL-2019 LIBRARY; T=293.16K
resonance total cross section

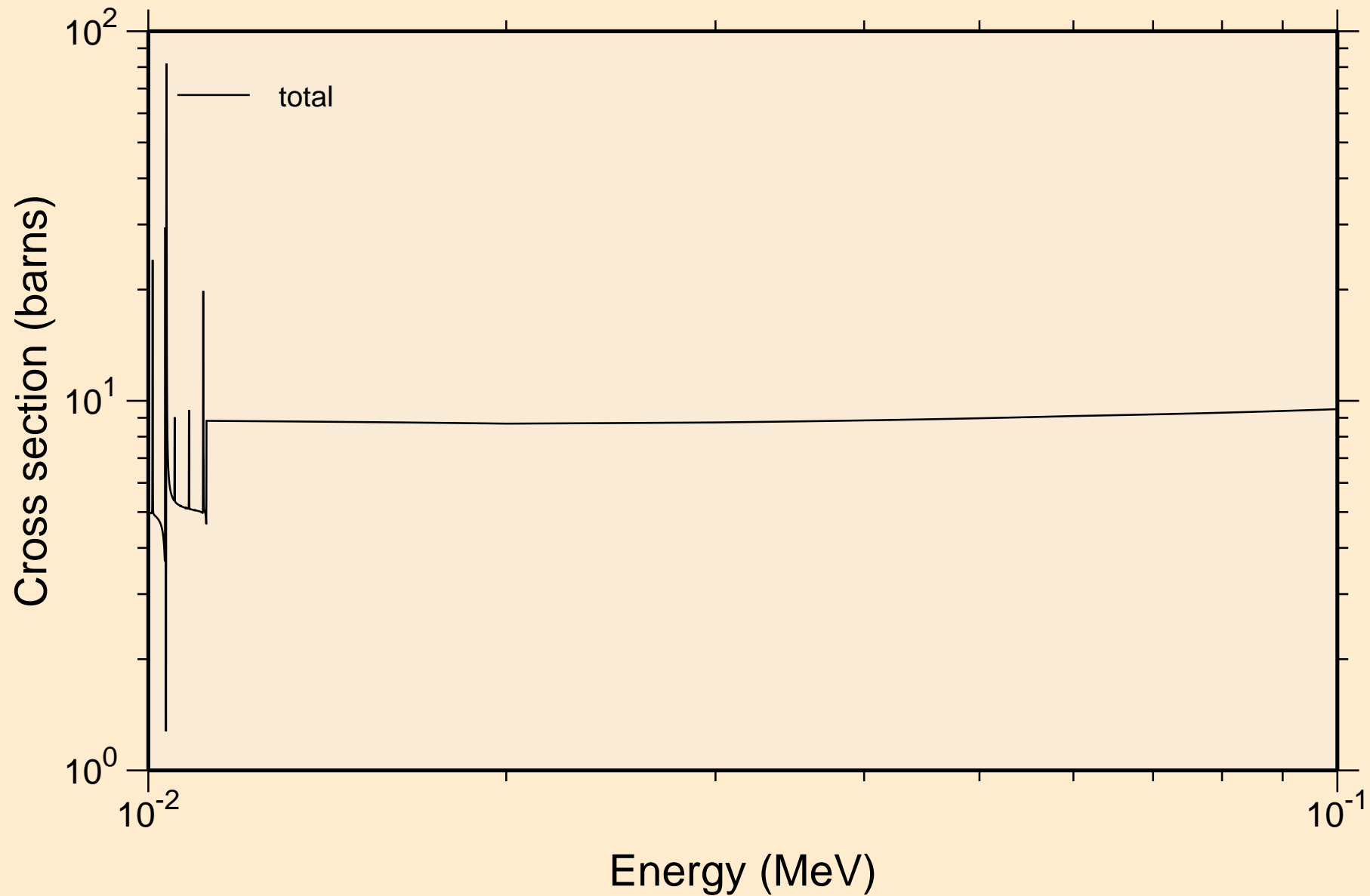

Y096 NEUTRON ACER TENDL-2019 LIBRARY; T=293.16K
resonance total cross section

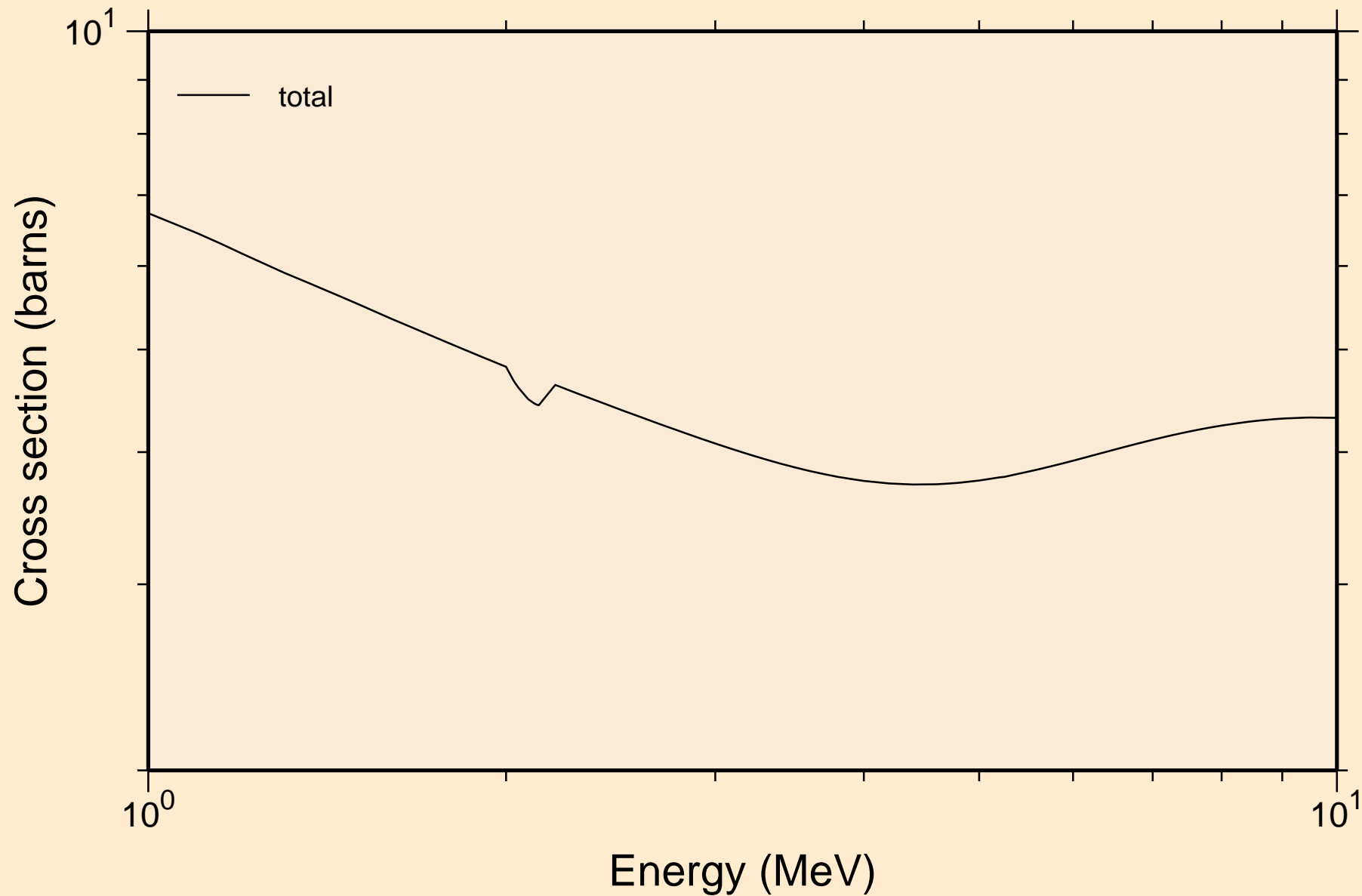

Y096 NEUTRON ACER TENDL-2019 LIBRARY; T=293.16K
resonance absorption cross sections

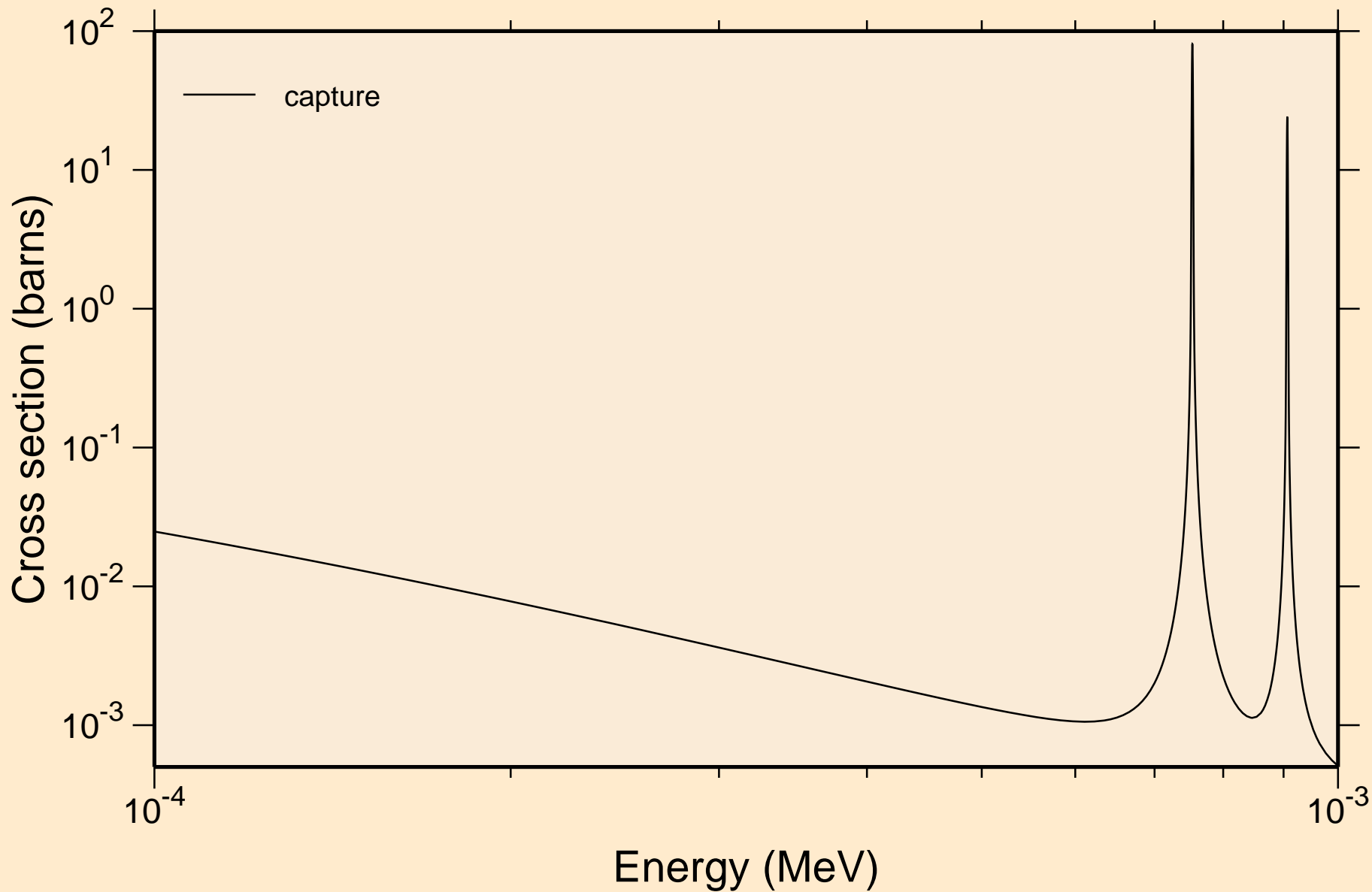

Y096 NEUTRON ACER TENDL-2019 LIBRARY; T=293.16K
resonance absorption cross sections

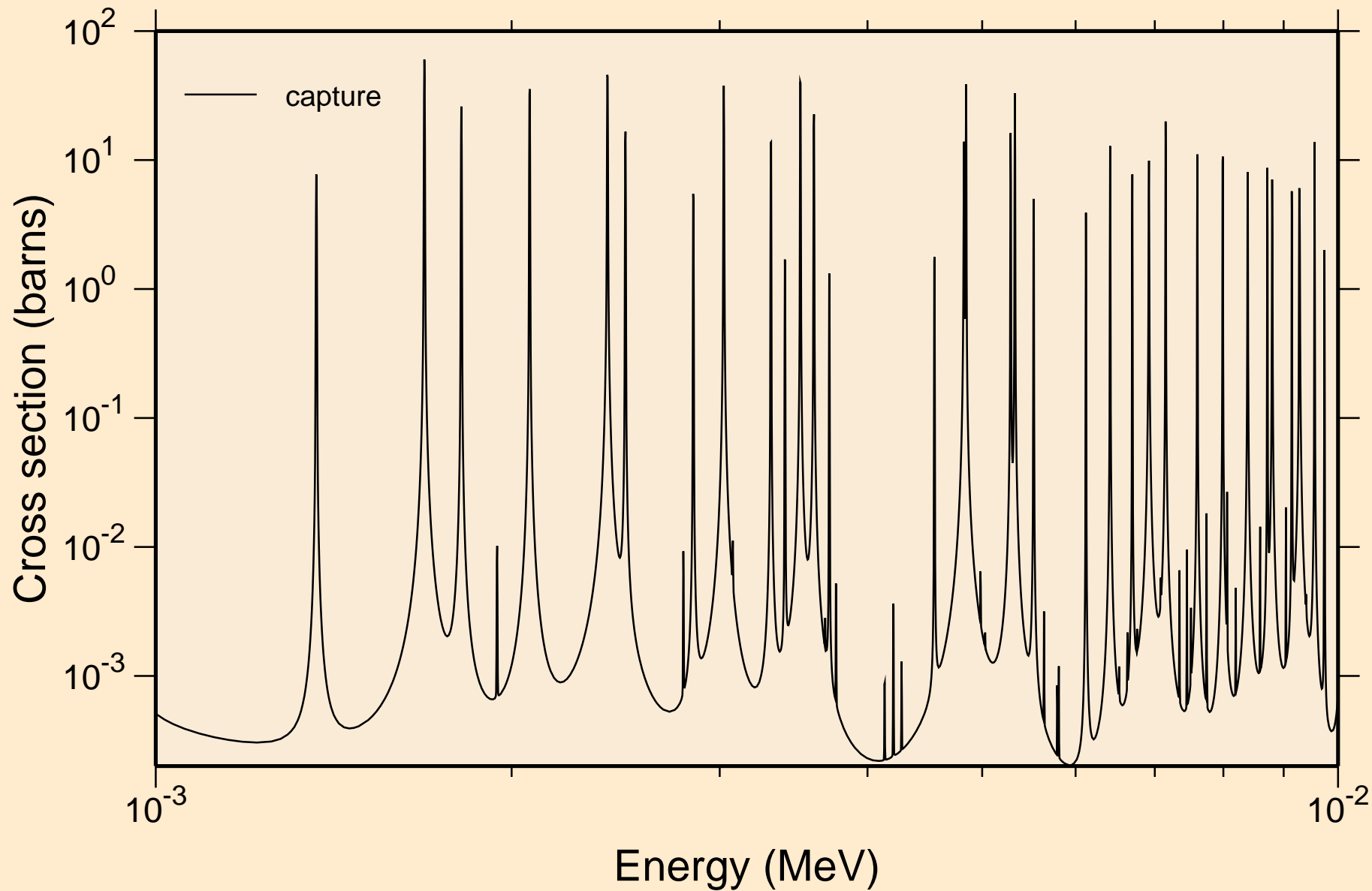

Y096 NEUTRON ACER TENDL-2019 LIBRARY; T=293.16K
resonance absorption cross sections

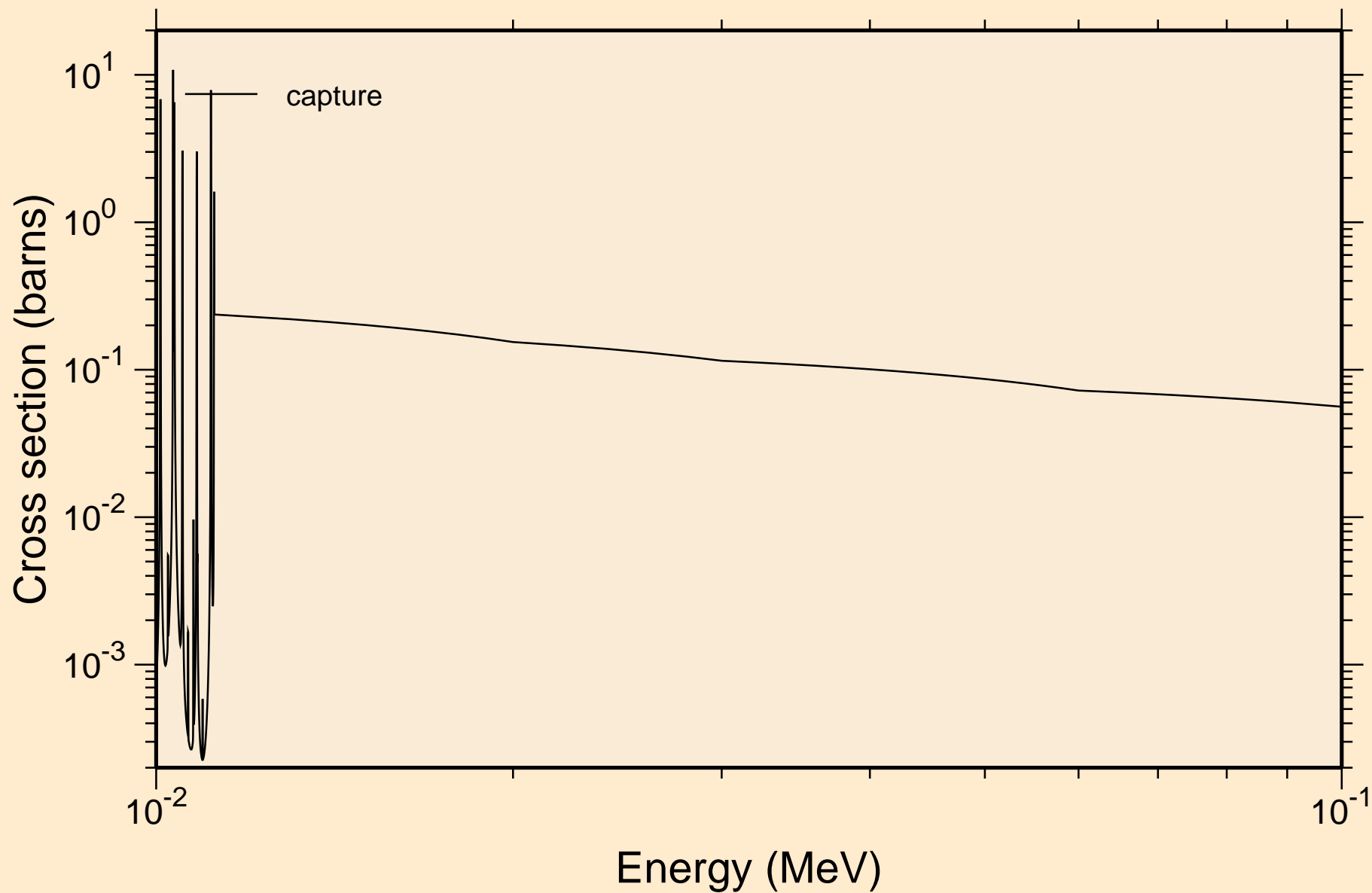

Y096 NEUTRON ACER TENDL-2019 LIBRARY; T=293.16K
resonance absorption cross sections

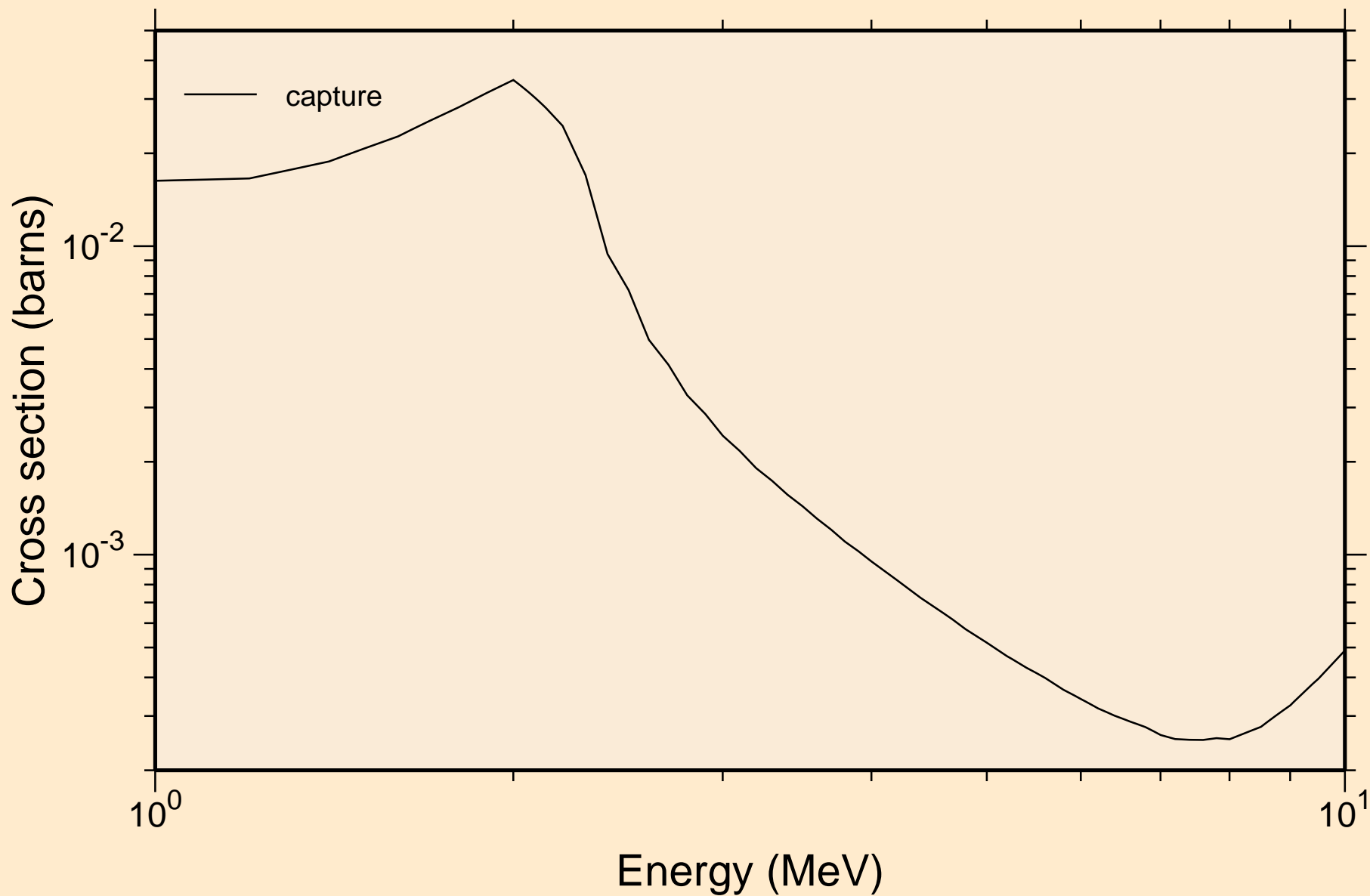

Y096 NEUTRON ACER TENDL-2019 LIBRARY; T=293.16K
Heating

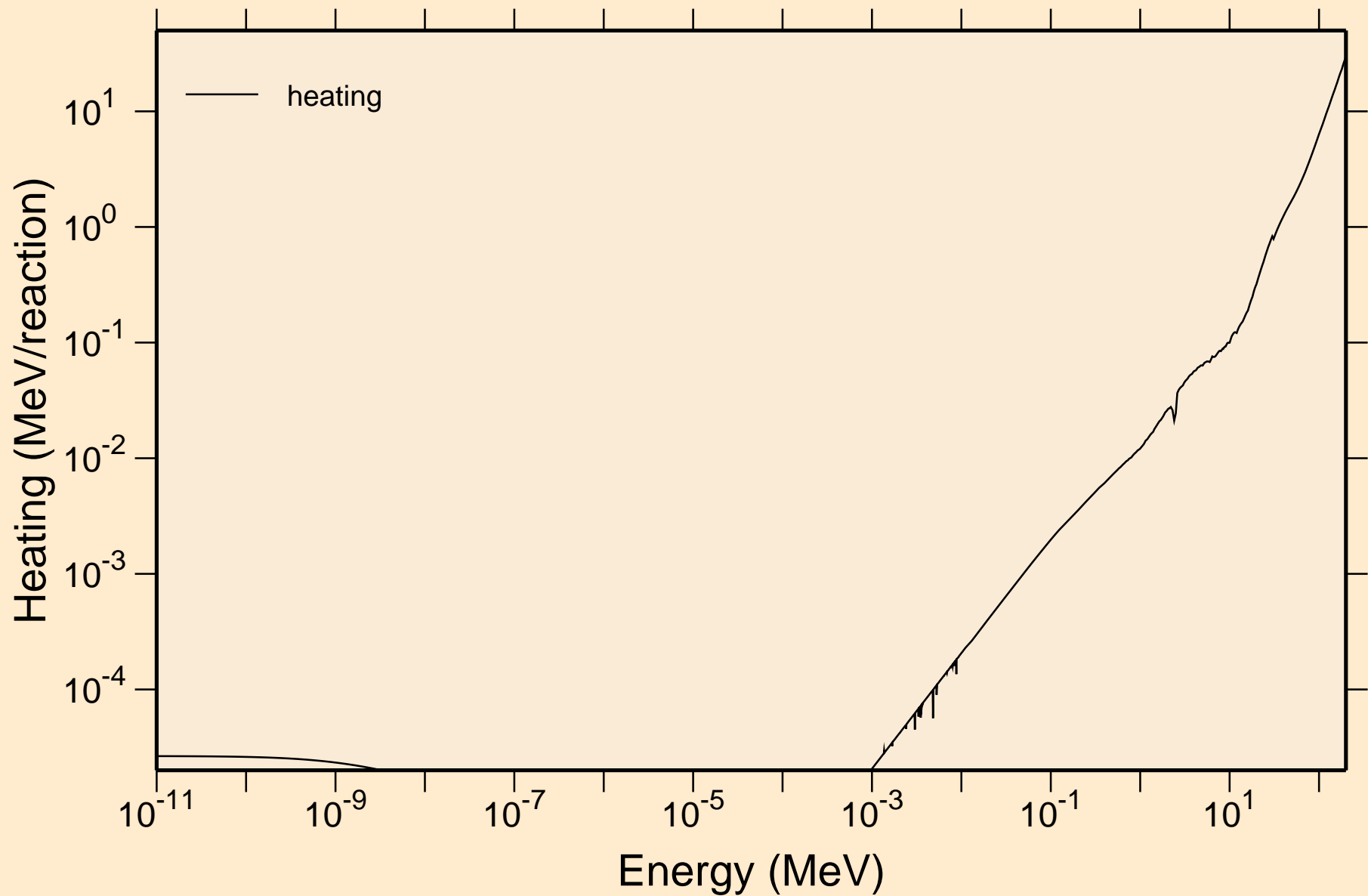

Y096 NEUTRON ACER TENDL-2019 LIBRARY; T=293.16K
Damage

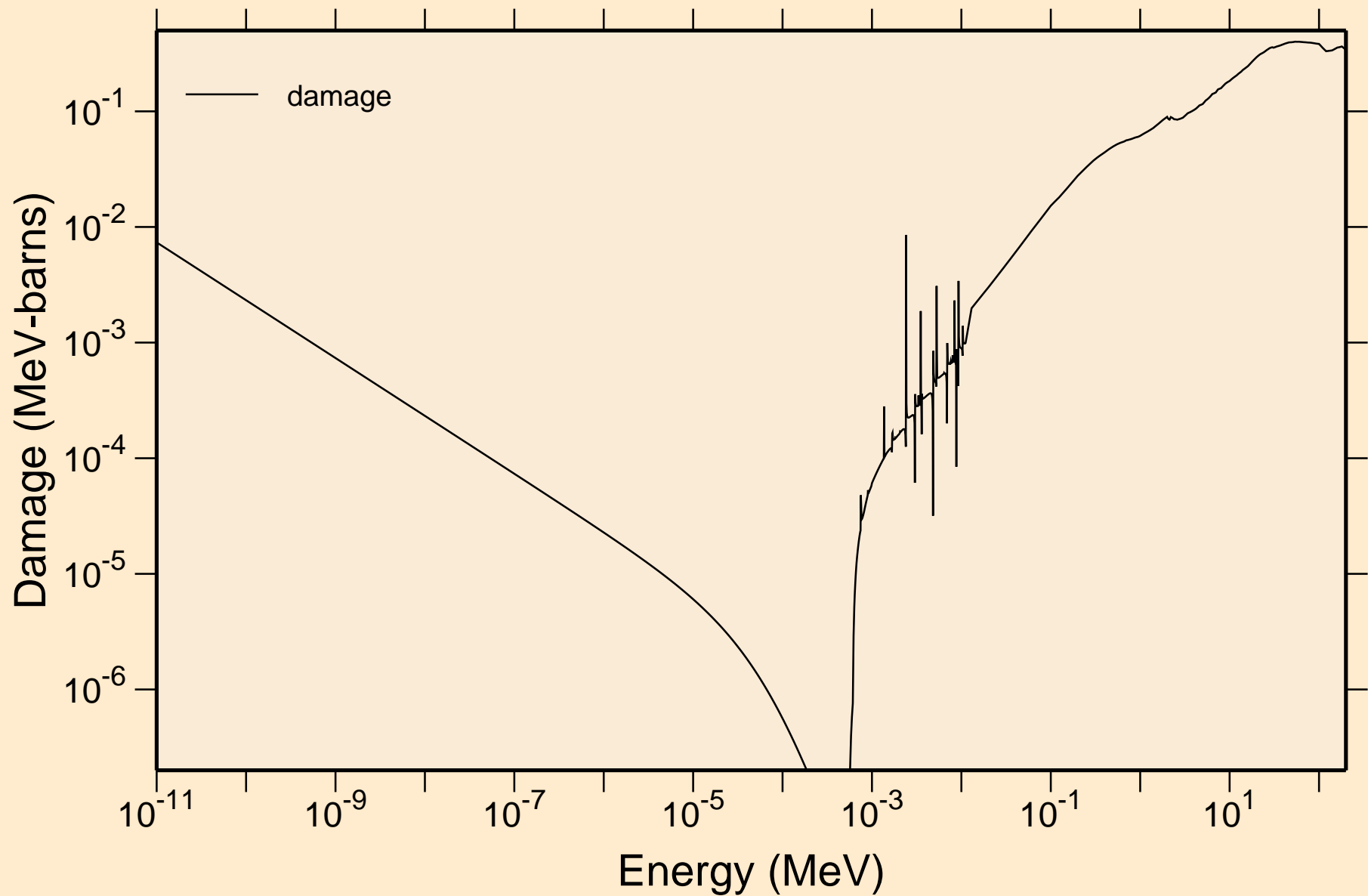

Y096 NEUTRON ACER TENDL-2019 LIBRARY; T=293.16K
Non-threshold reactions

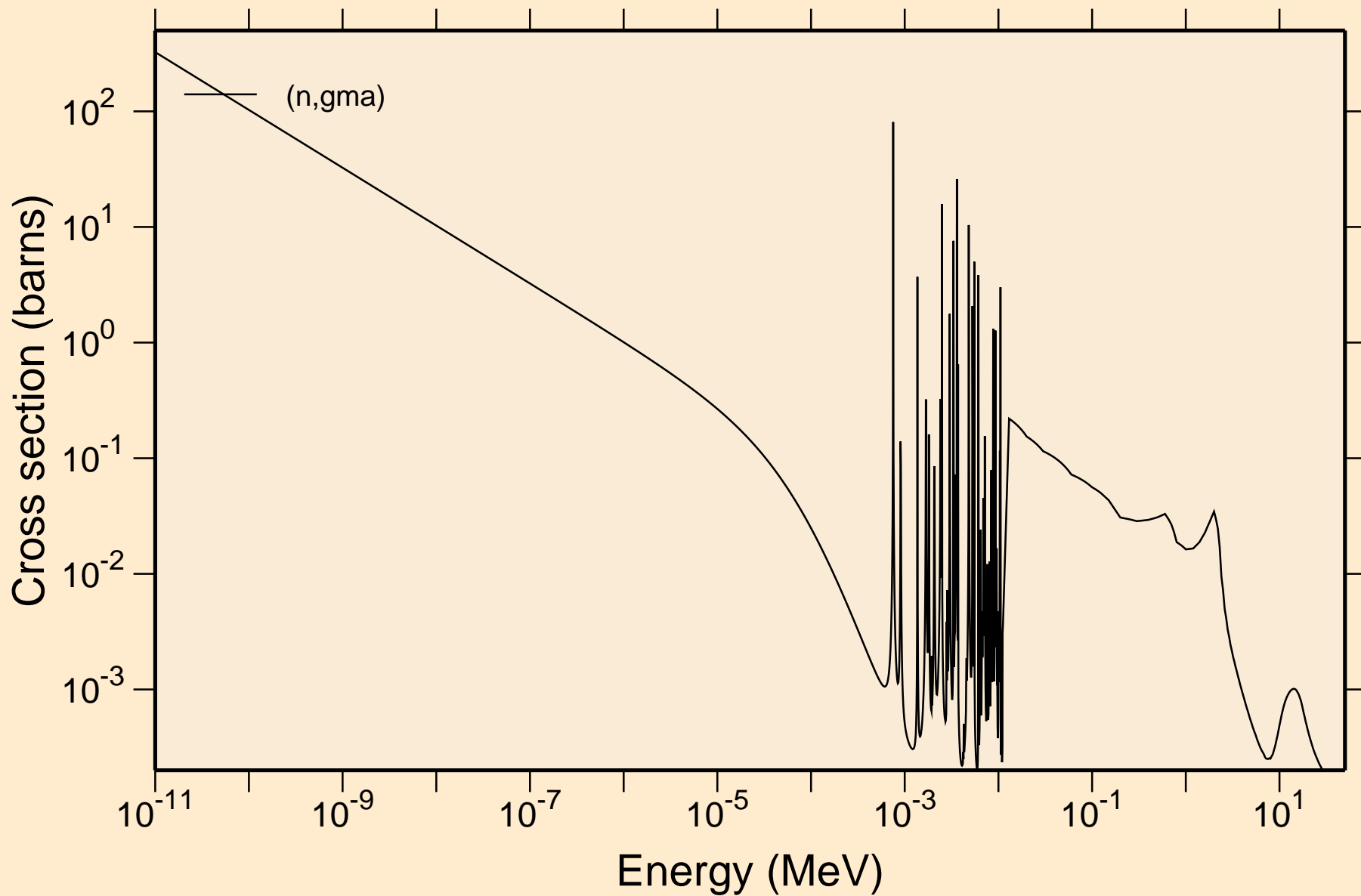

Y096 NEUTRON ACER TENDL-2019 LIBRARY; T=293.16K
Principal cross sections

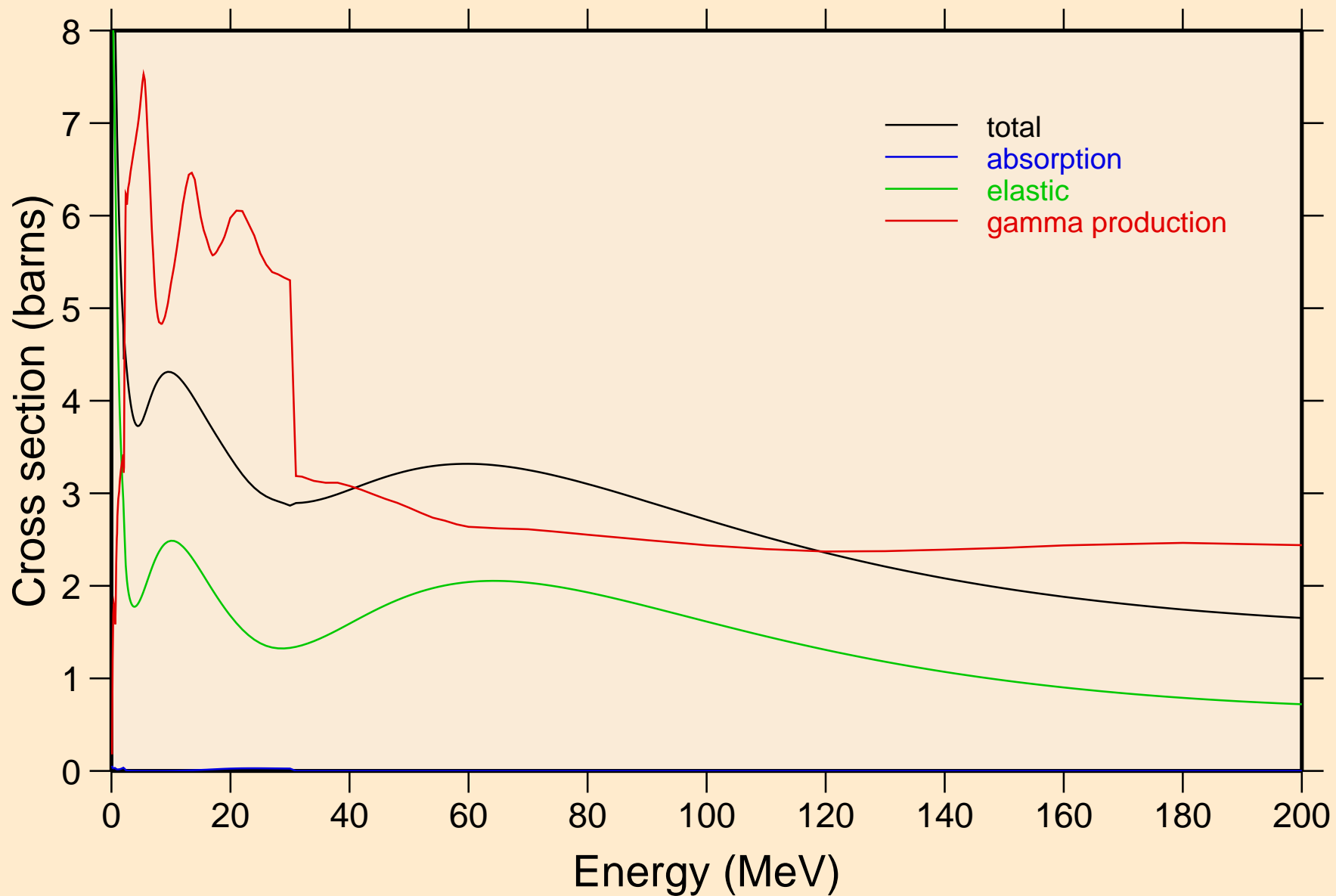

Y096 NEUTRON ACER TENDL-2019 LIBRARY; T=293.16K
Heating

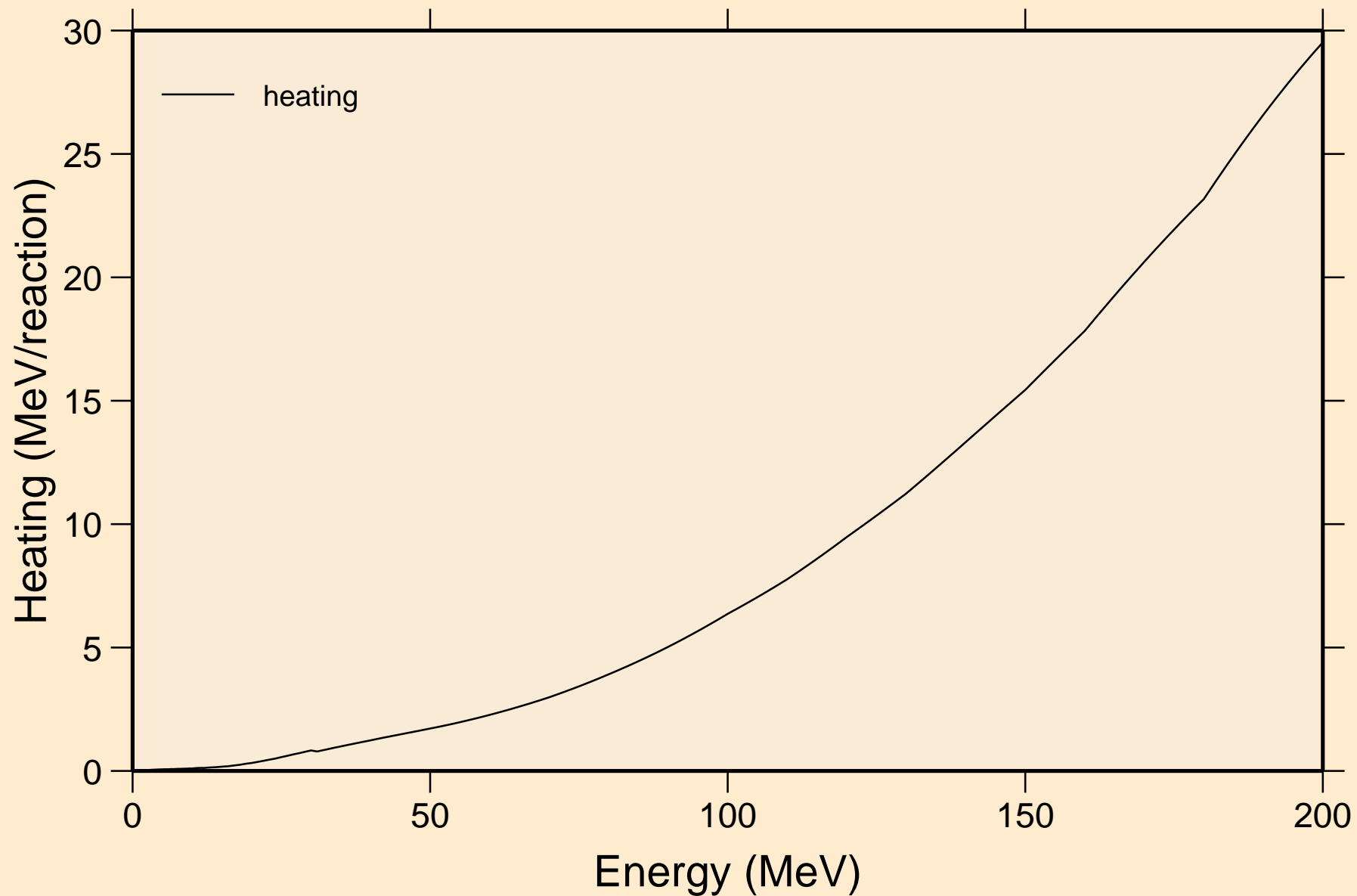

Y096 NEUTRON ACER TENDL-2019 LIBRARY; T=293.16K
Damage

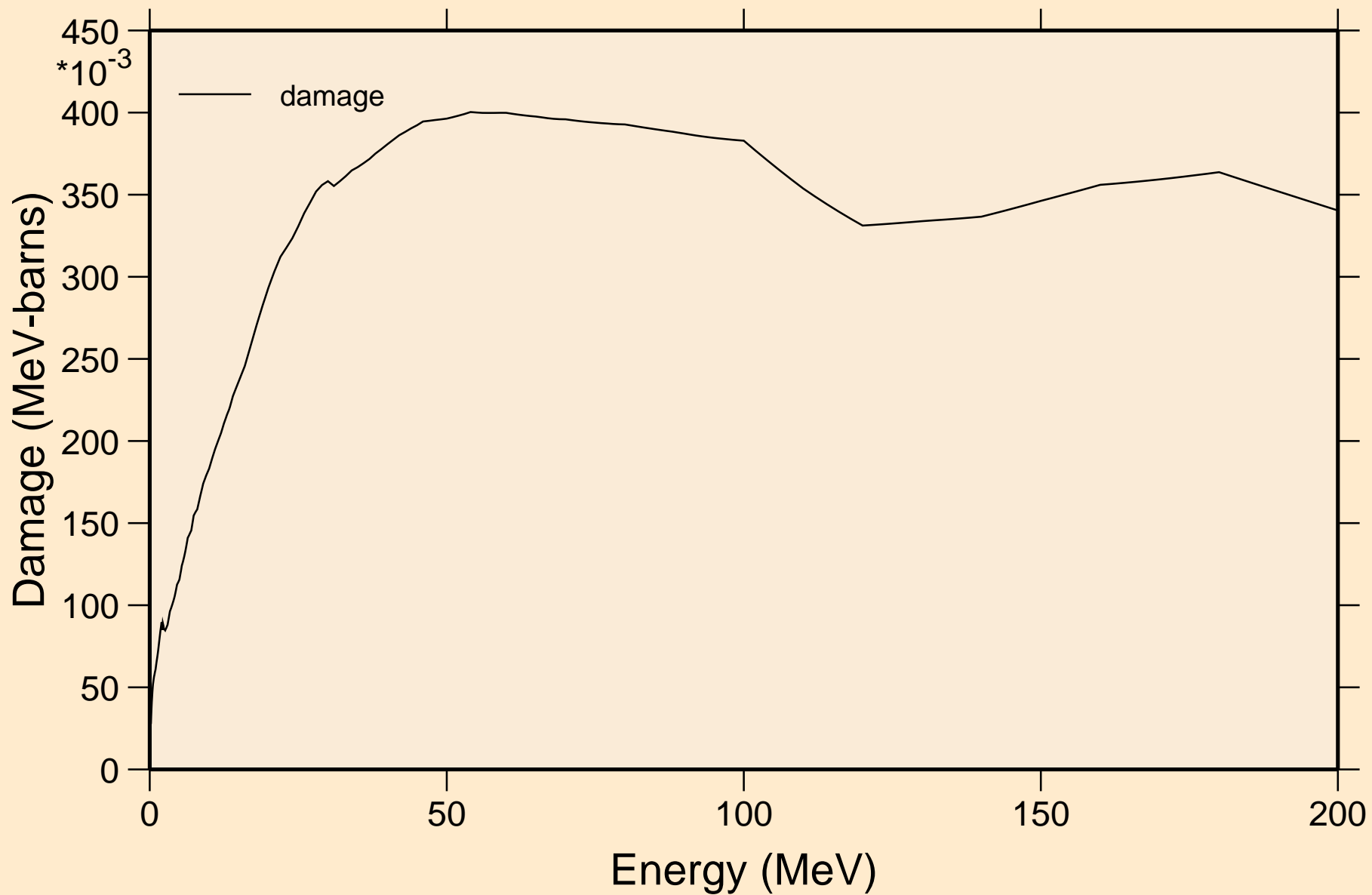

Y096 NEUTRON ACER TENDL-2019 LIBRARY; T=293.16K
Non-threshold reactions

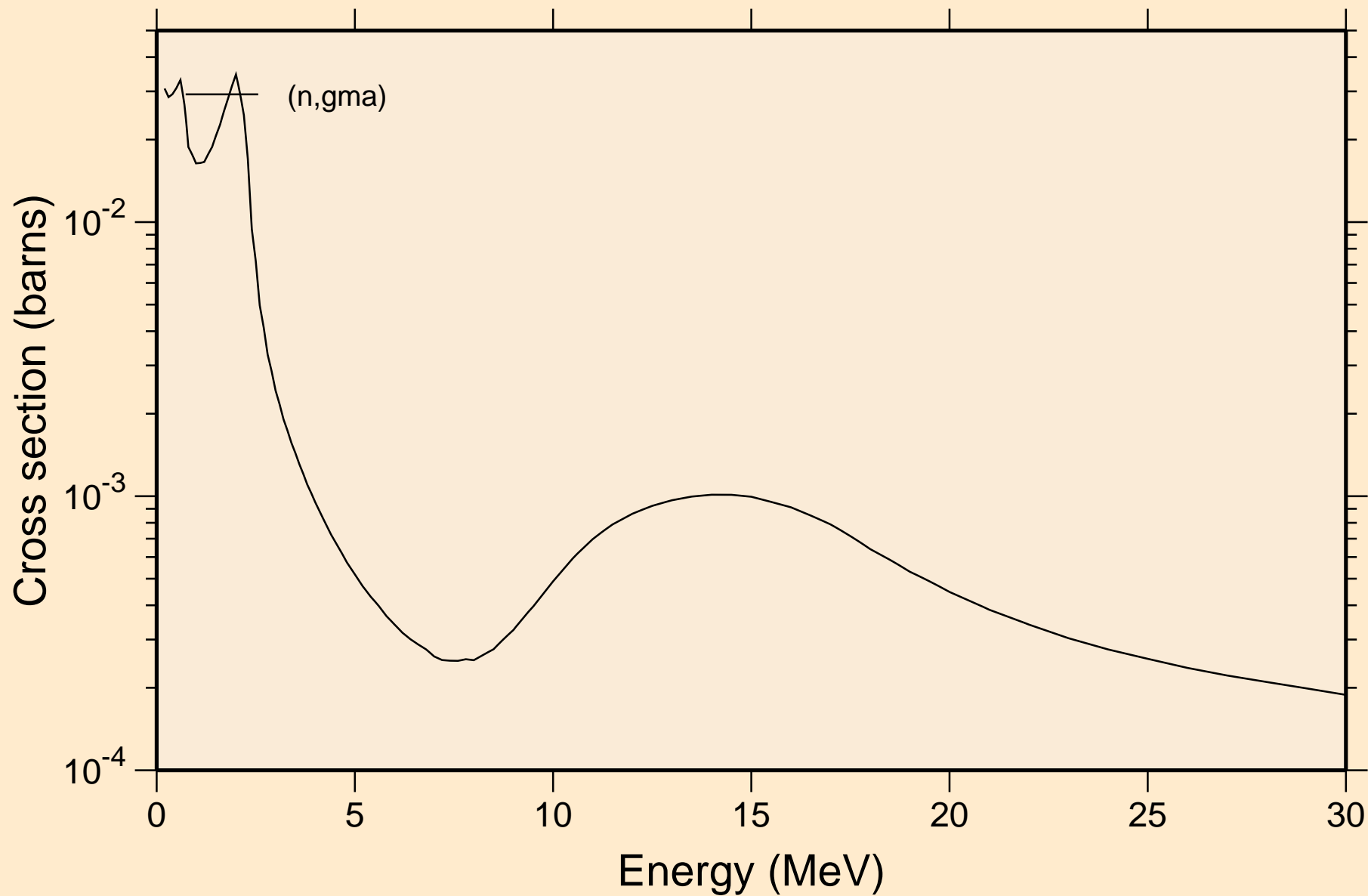

Y096 NEUTRON ACER TENDL-2019 LIBRARY; T=293.16K
Inelastic levels

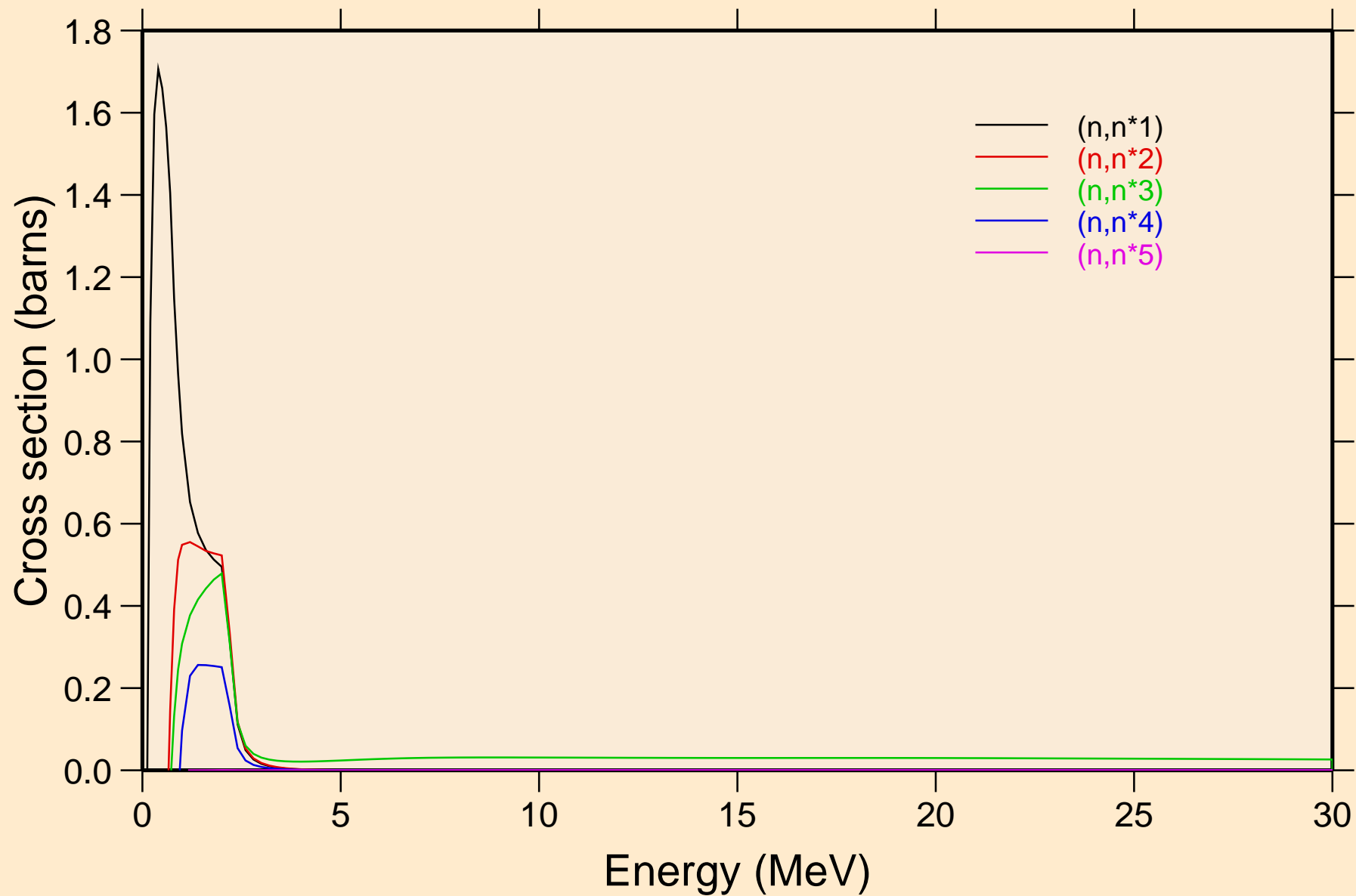

Y096 NEUTRON ACER TENDL-2019 LIBRARY; T=293.16K
Inelastic levels

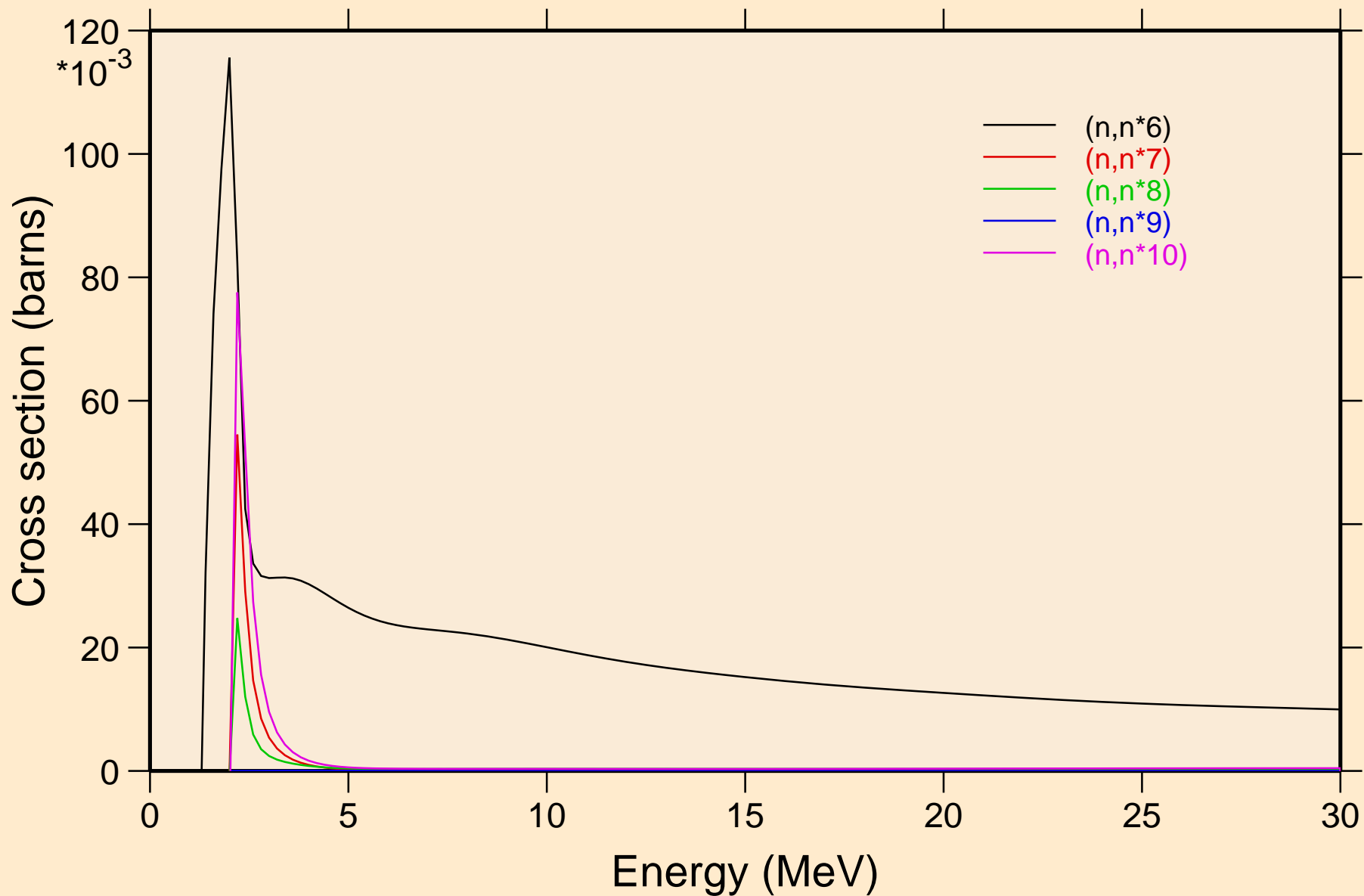

Y096 NEUTRON ACER TENDL-2019 LIBRARY; T=293.16K
Inelastic levels

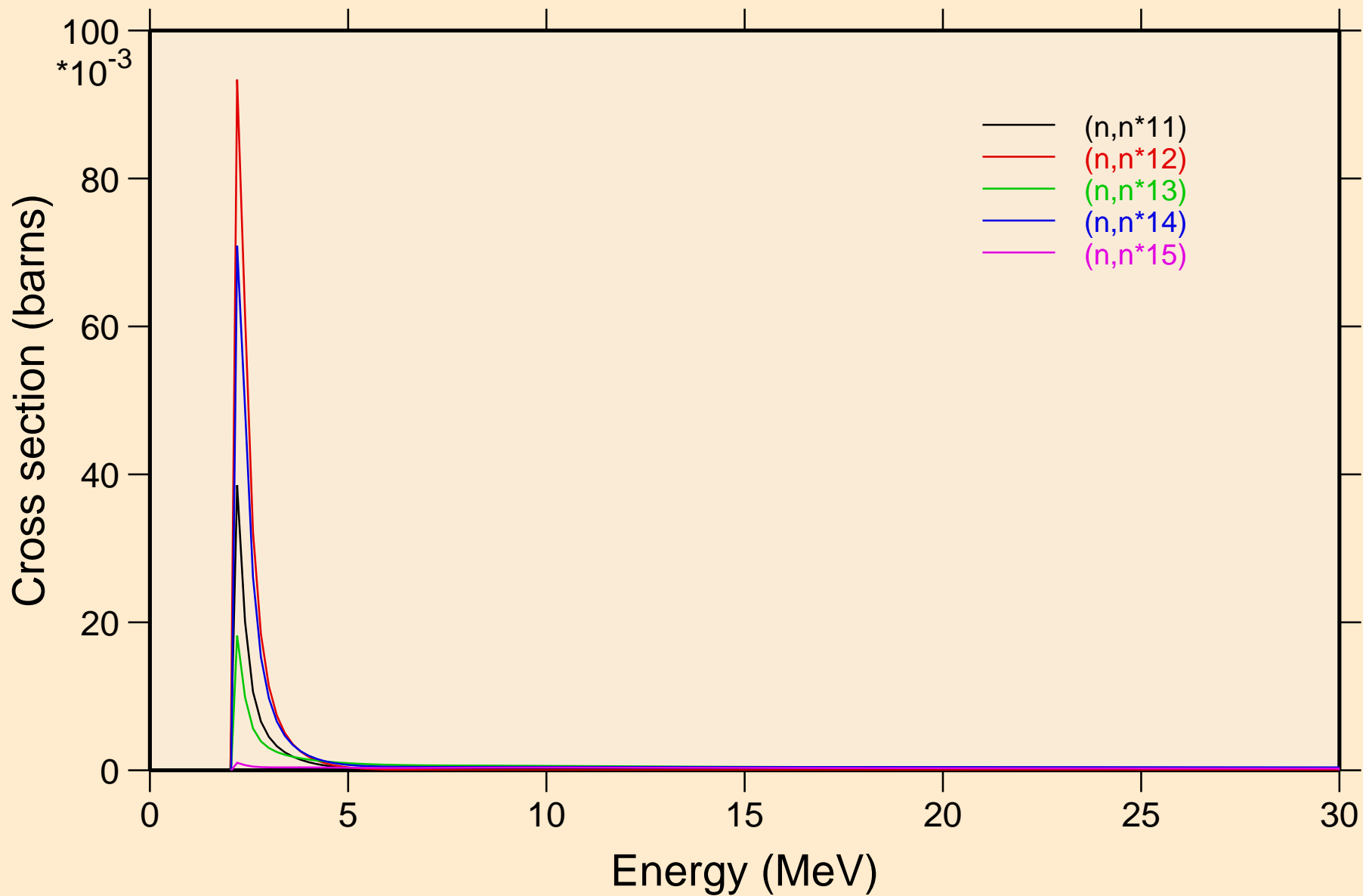

Y096 NEUTRON ACER TENDL-2019 LIBRARY; T=293.16K
Inelastic levels

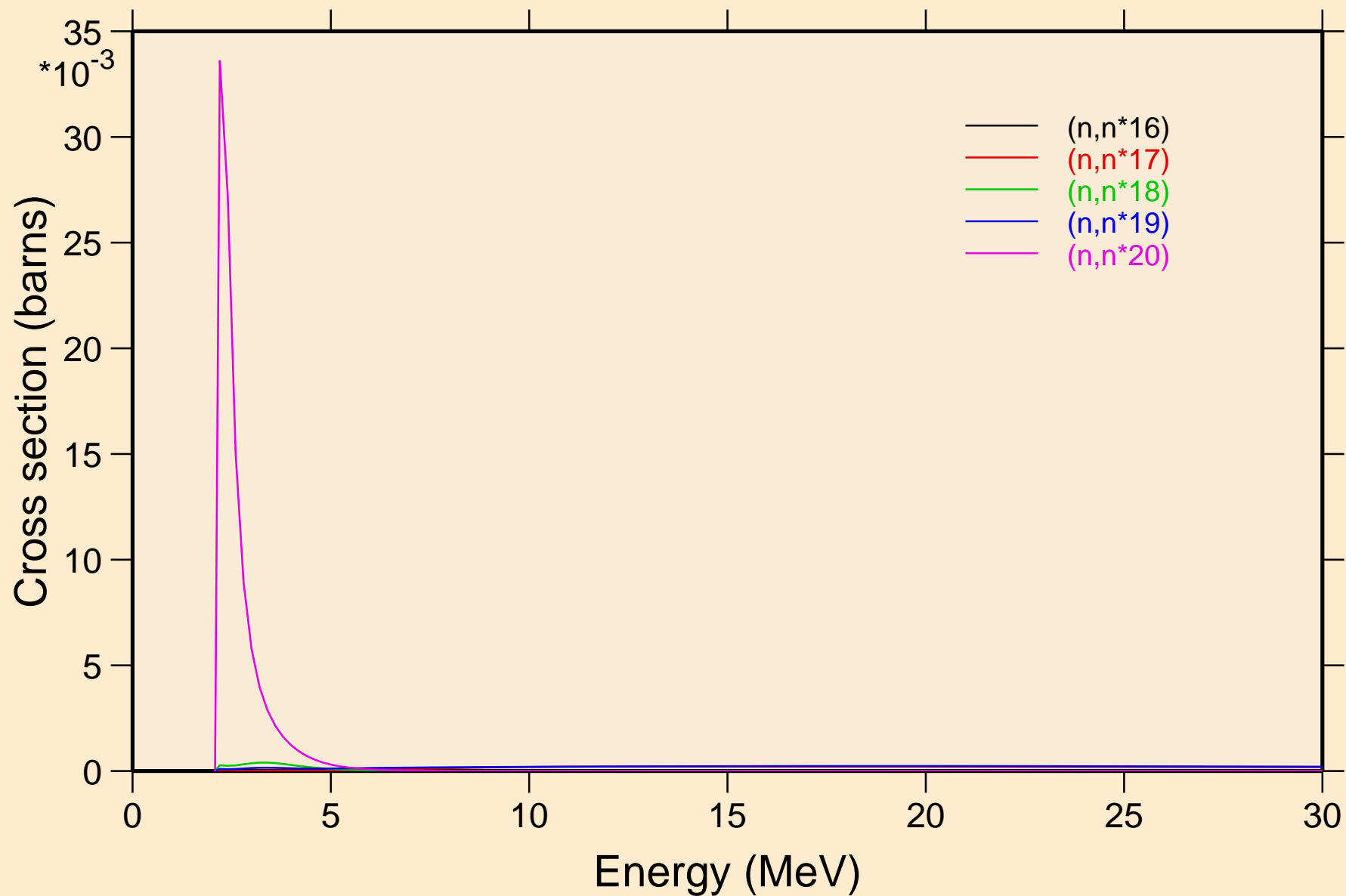

Y096 NEUTRON ACER TENDL-2019 LIBRARY; T=293.16K
Inelastic levels

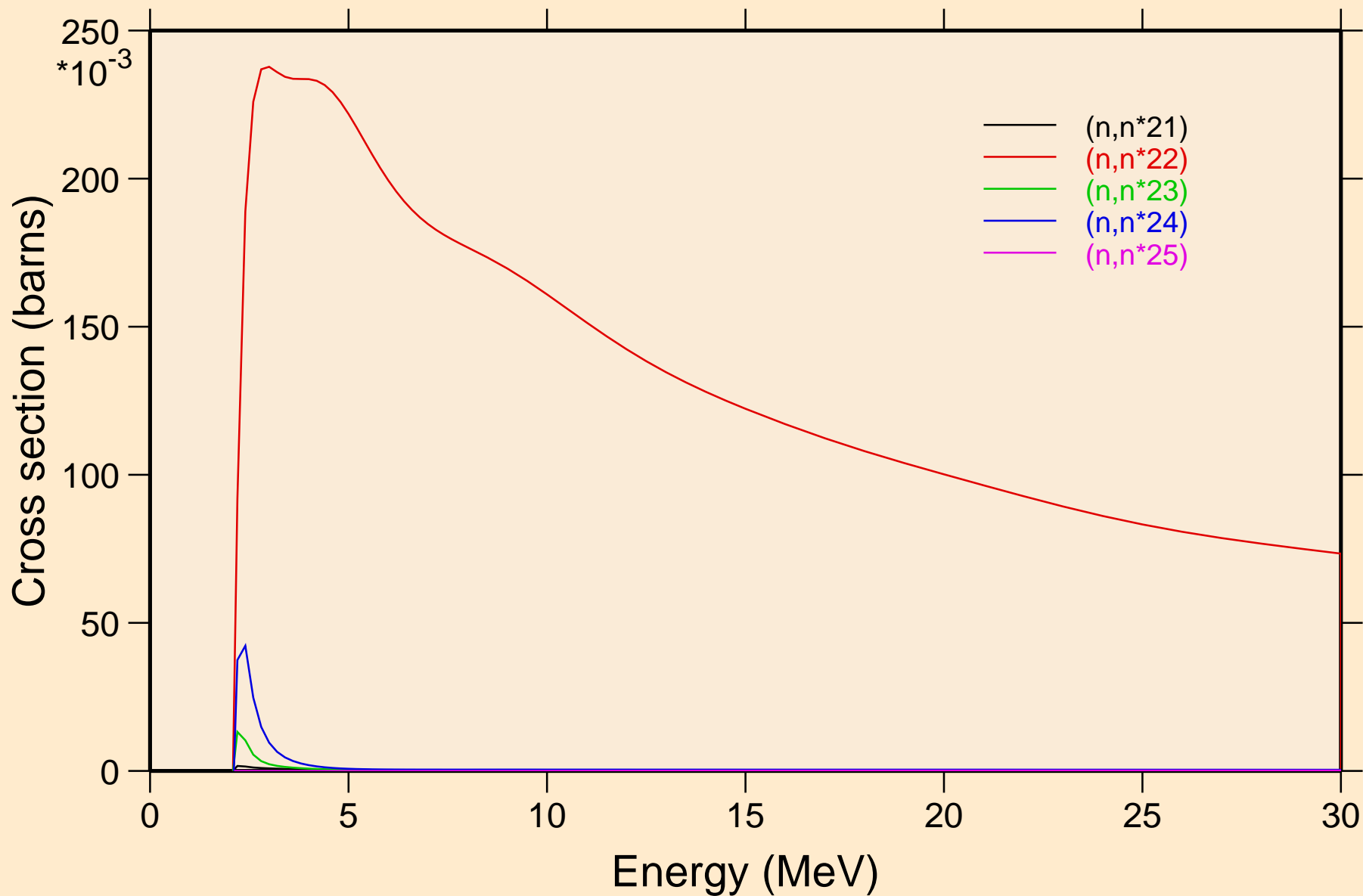

Y096 NEUTRON ACER TENDL-2019 LIBRARY; T=293.16K
Inelastic levels

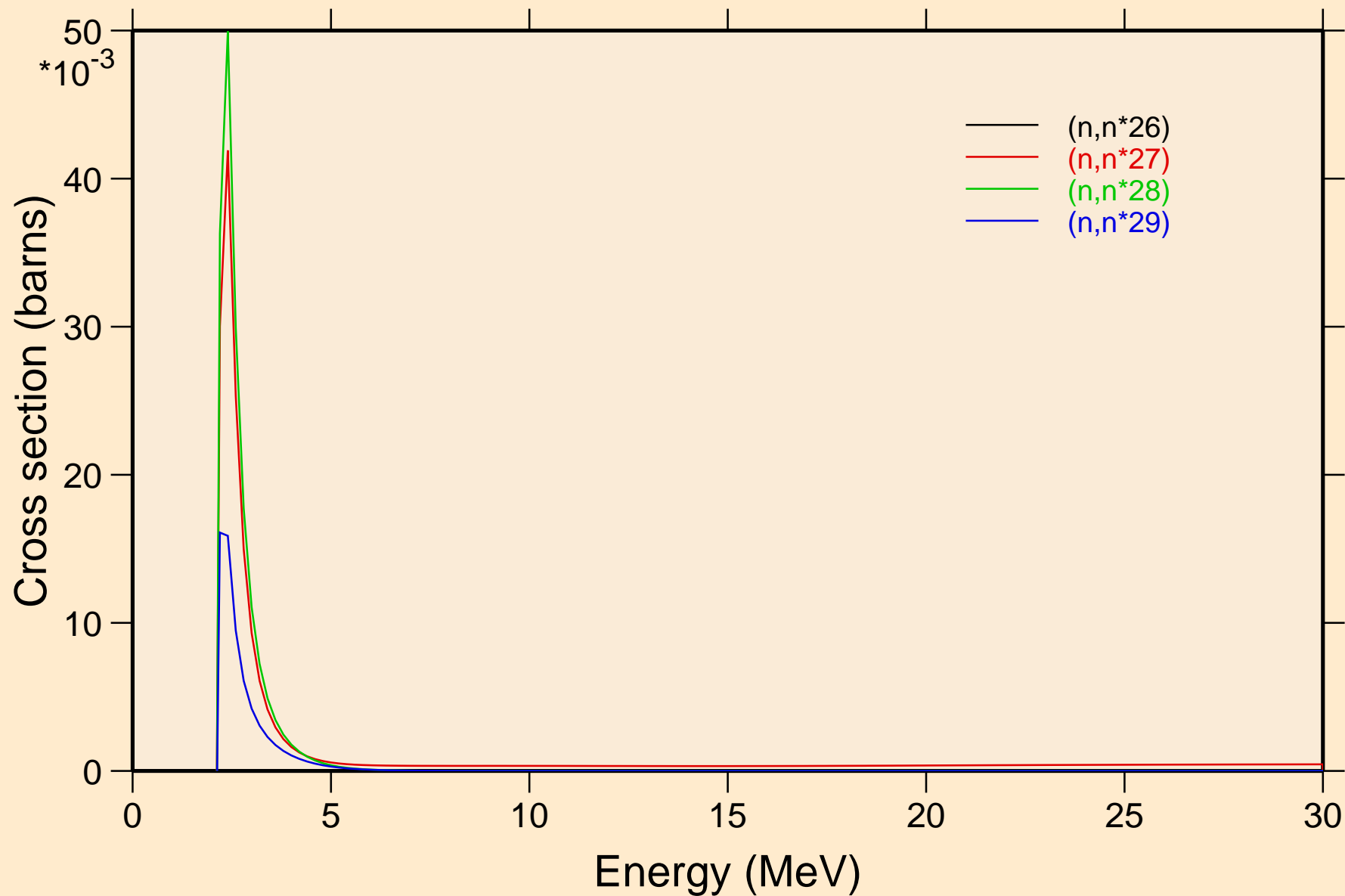

Y096 NEUTRON ACER TENDL-2019 LIBRARY; T=293.16K
Threshold reactions

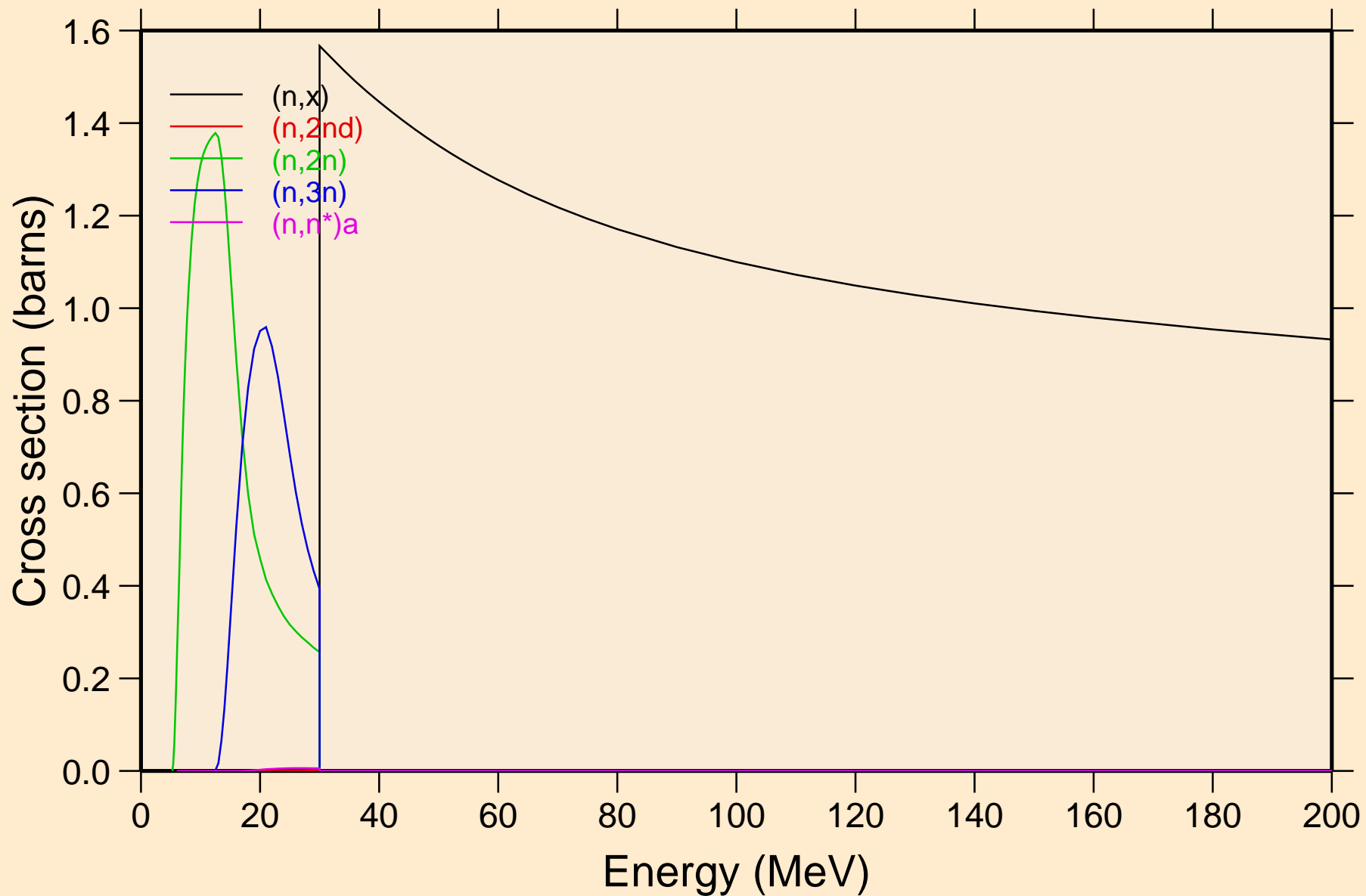

Y096 NEUTRON ACER TENDL-2019 LIBRARY; T=293.16K
Threshold reactions

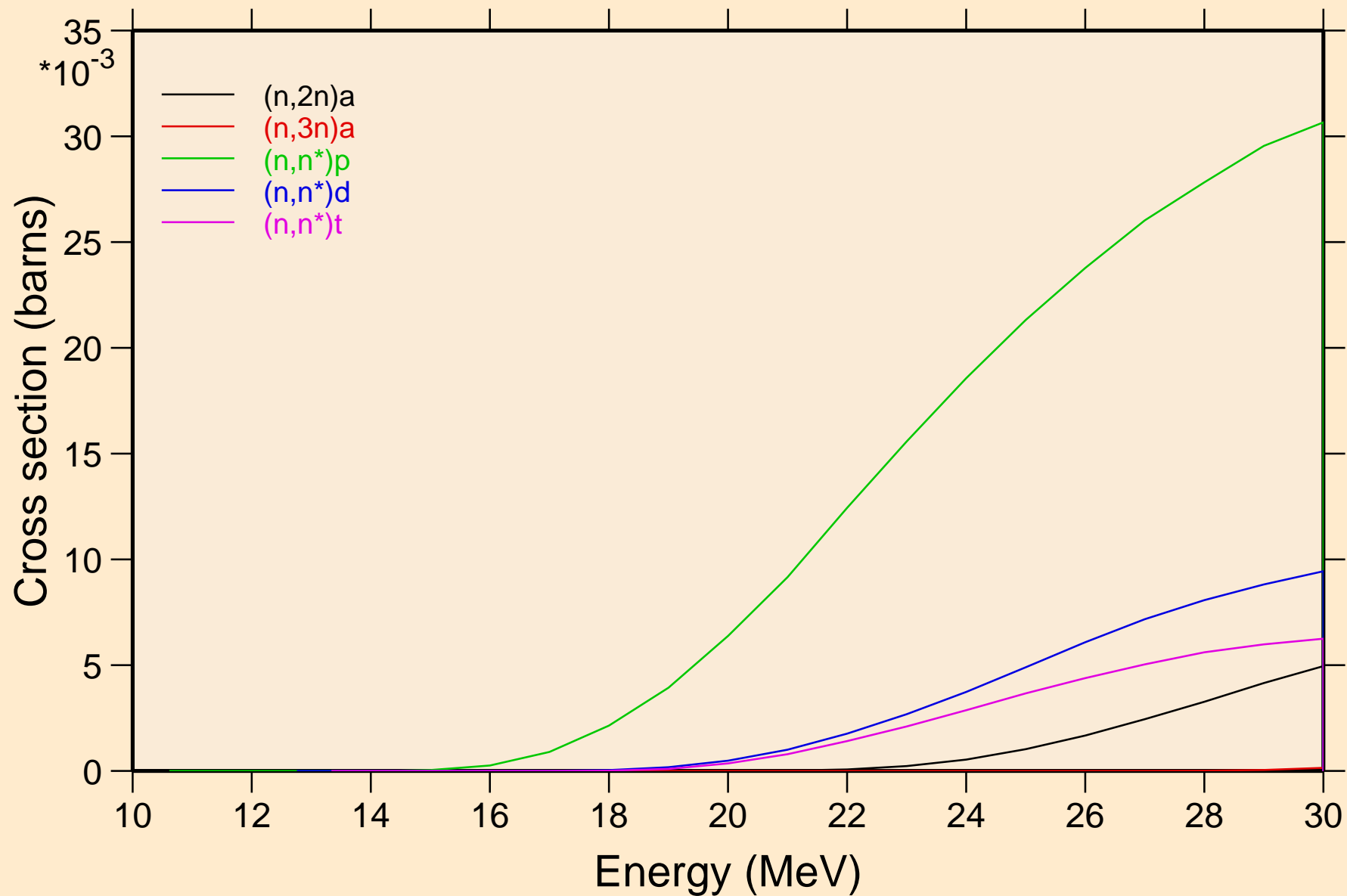

Y096 NEUTRON ACER TENDL-2019 LIBRARY; T=293.16K
Threshold reactions

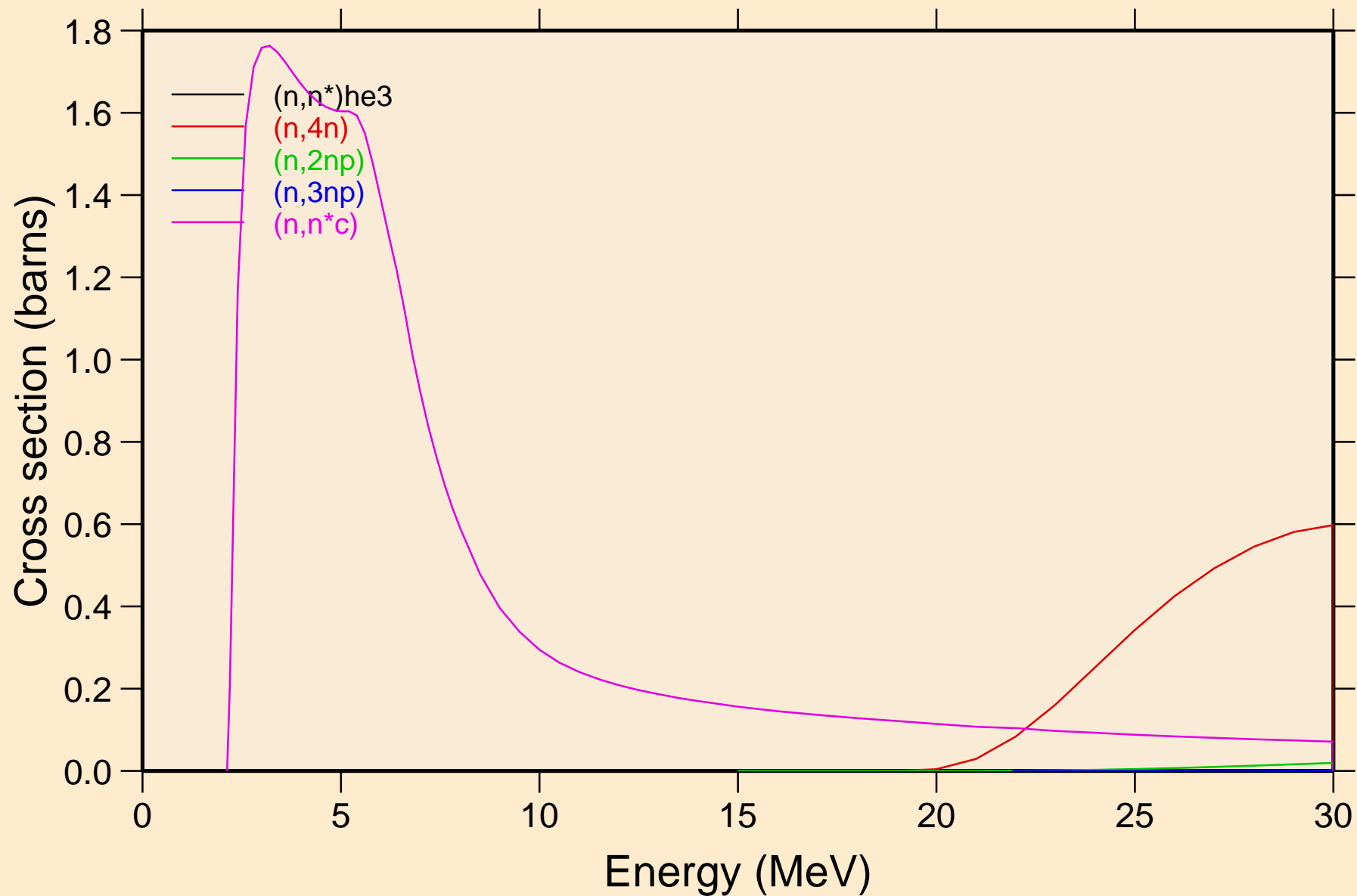

Y096 NEUTRON ACER TENDL-2019 LIBRARY; T=293.16K
Threshold reactions

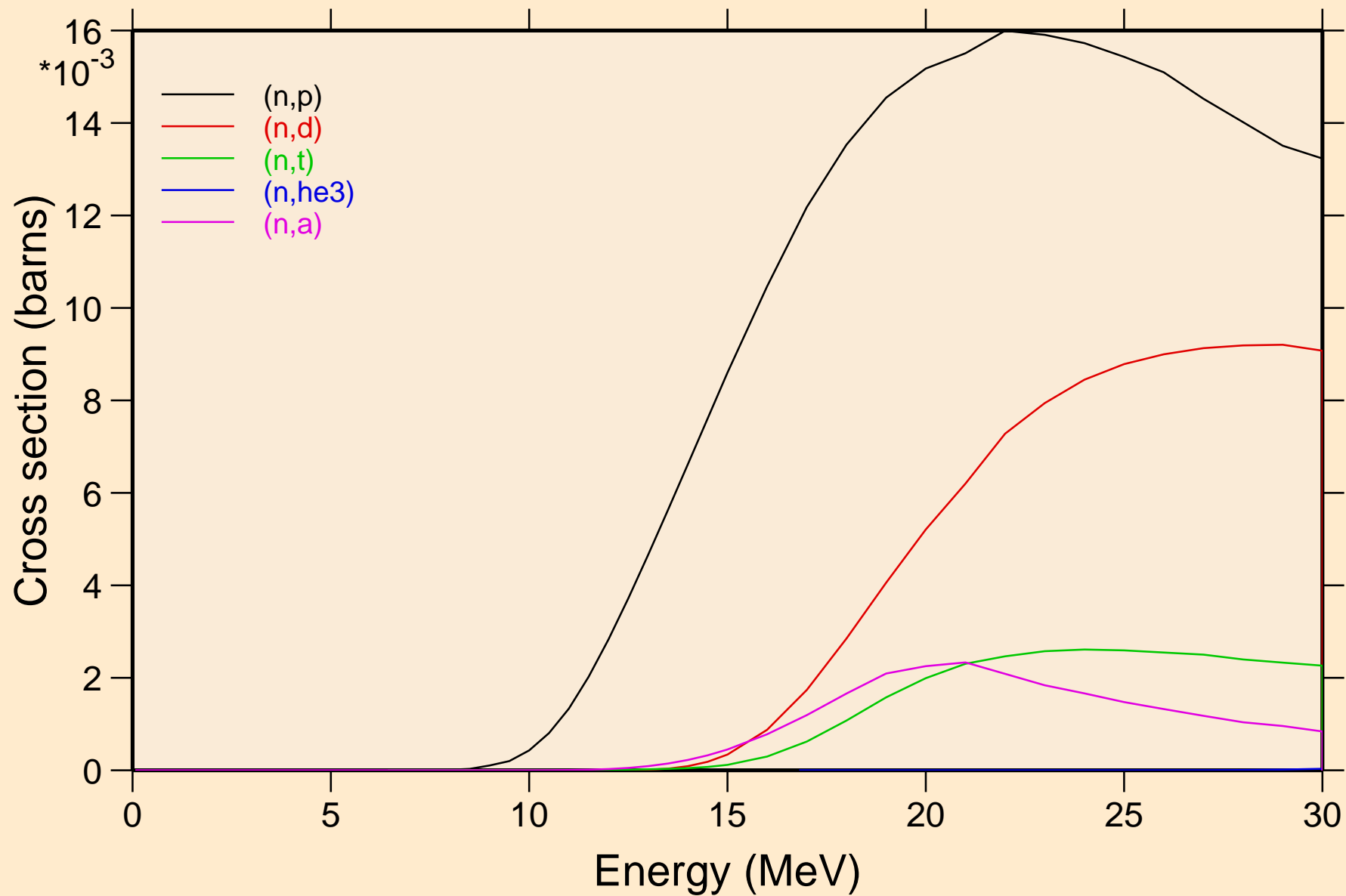

Y096 NEUTRON ACER TENDL-2019 LIBRARY; T=293.16K
Threshold reactions

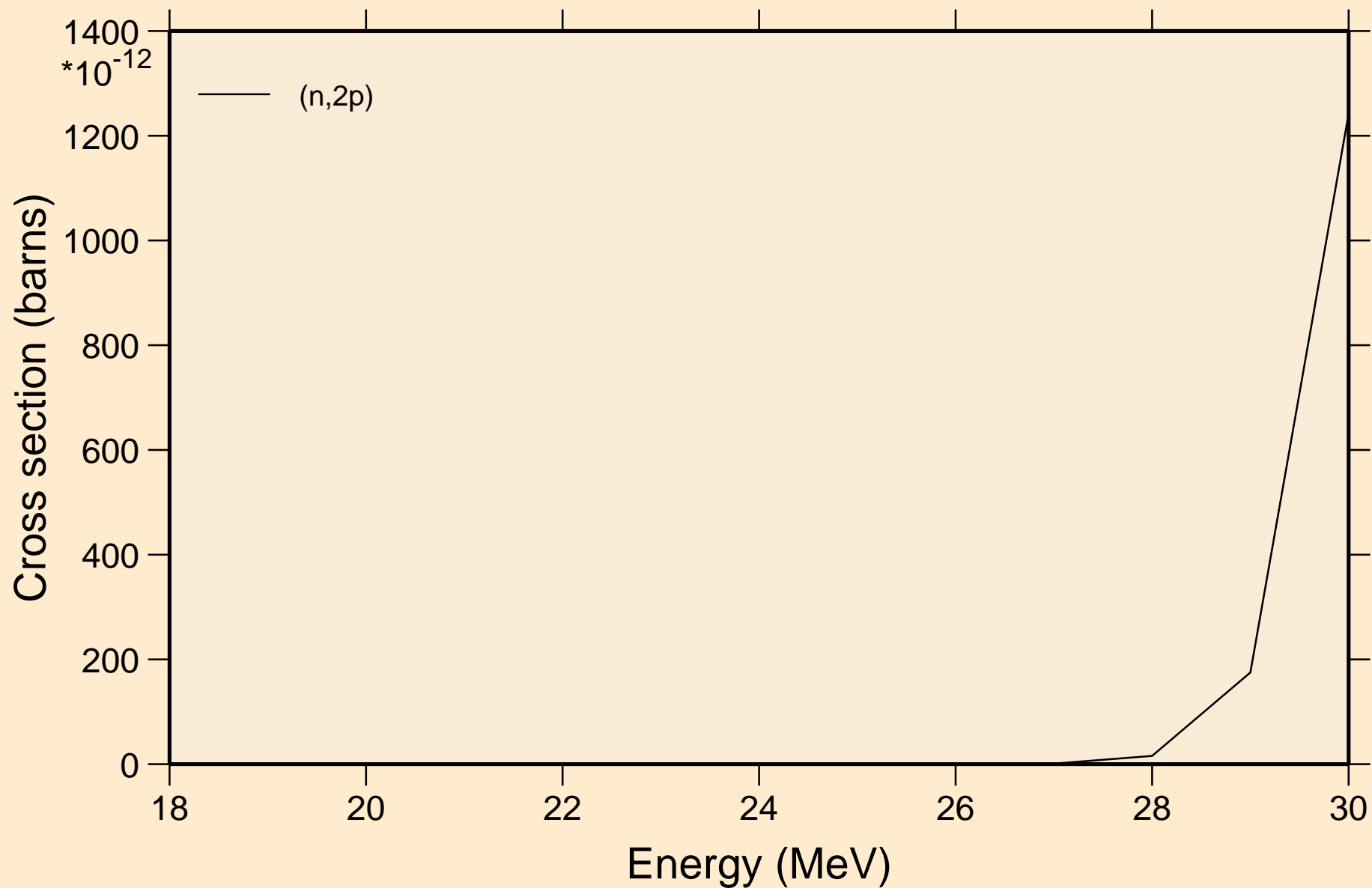

Y096 NEUTRON ACER TENDL-2019 LIBRARY; T=293.16K
Threshold reactions

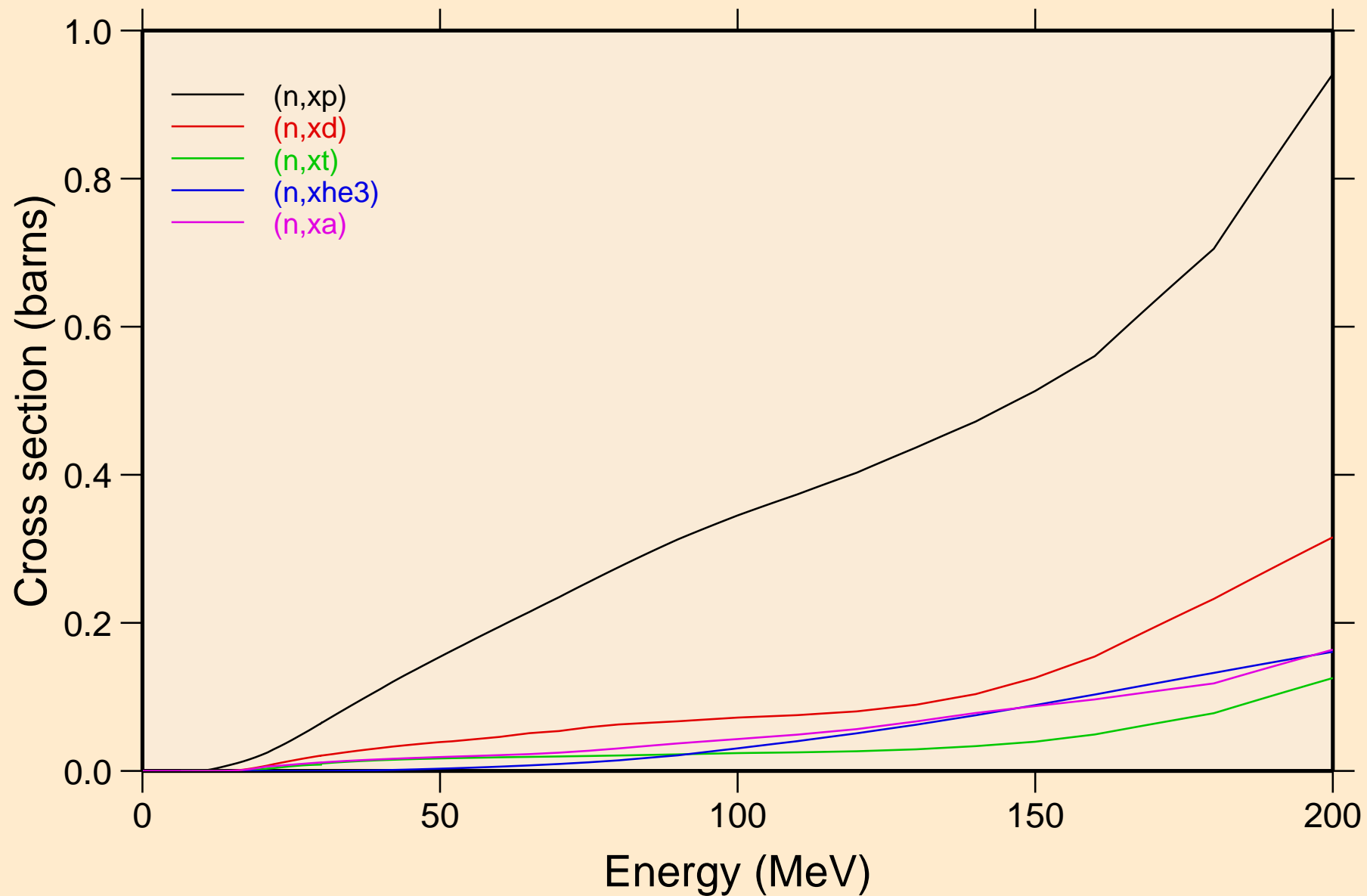

Y096 NEUTRON ACER TENDL-2019 LIBRARY; T=293.16K
angular distribution for elastic

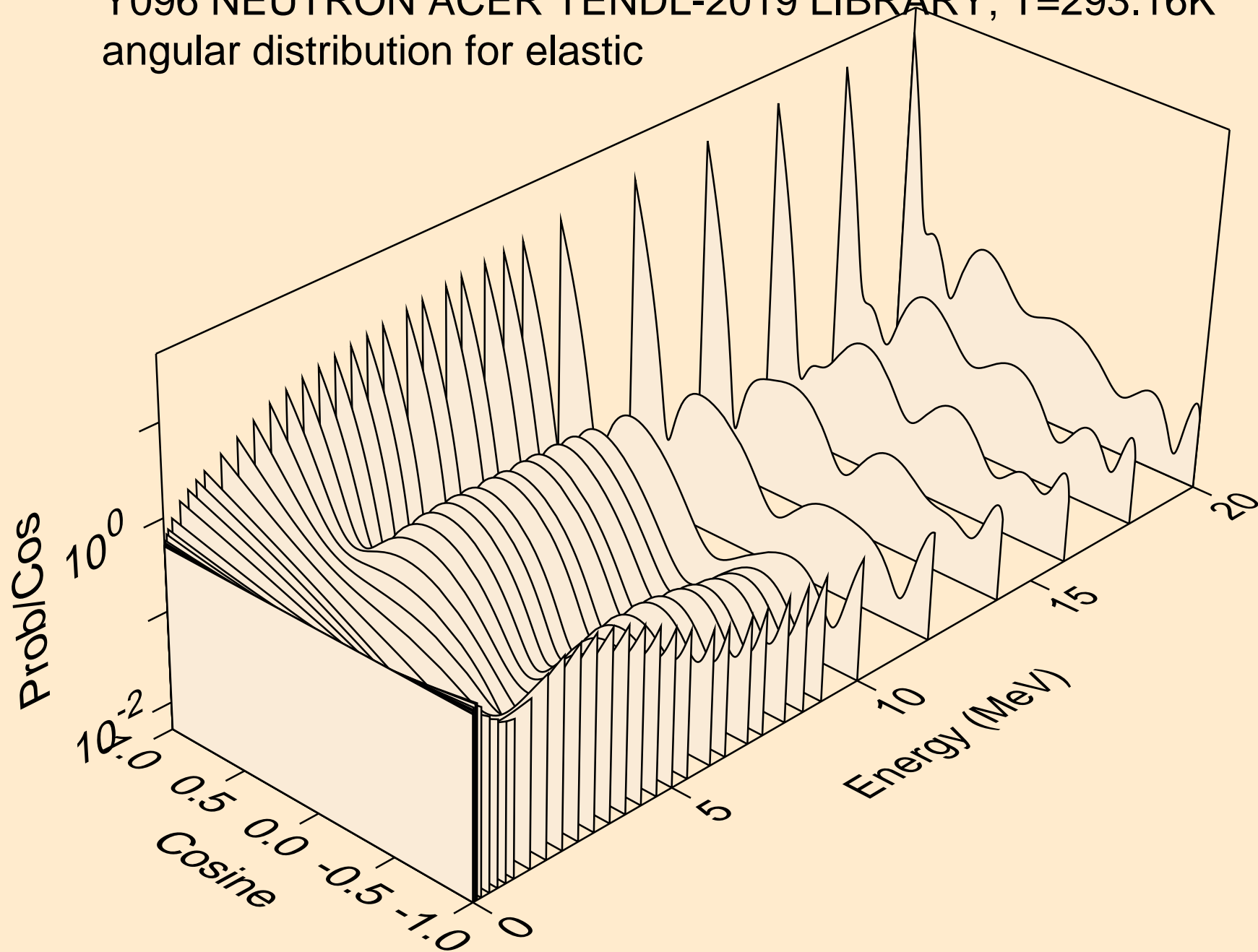

Y096 NEUTRON ACER TENDL-2019 LIBRARY; T=293.16K
angular distribution for elastic

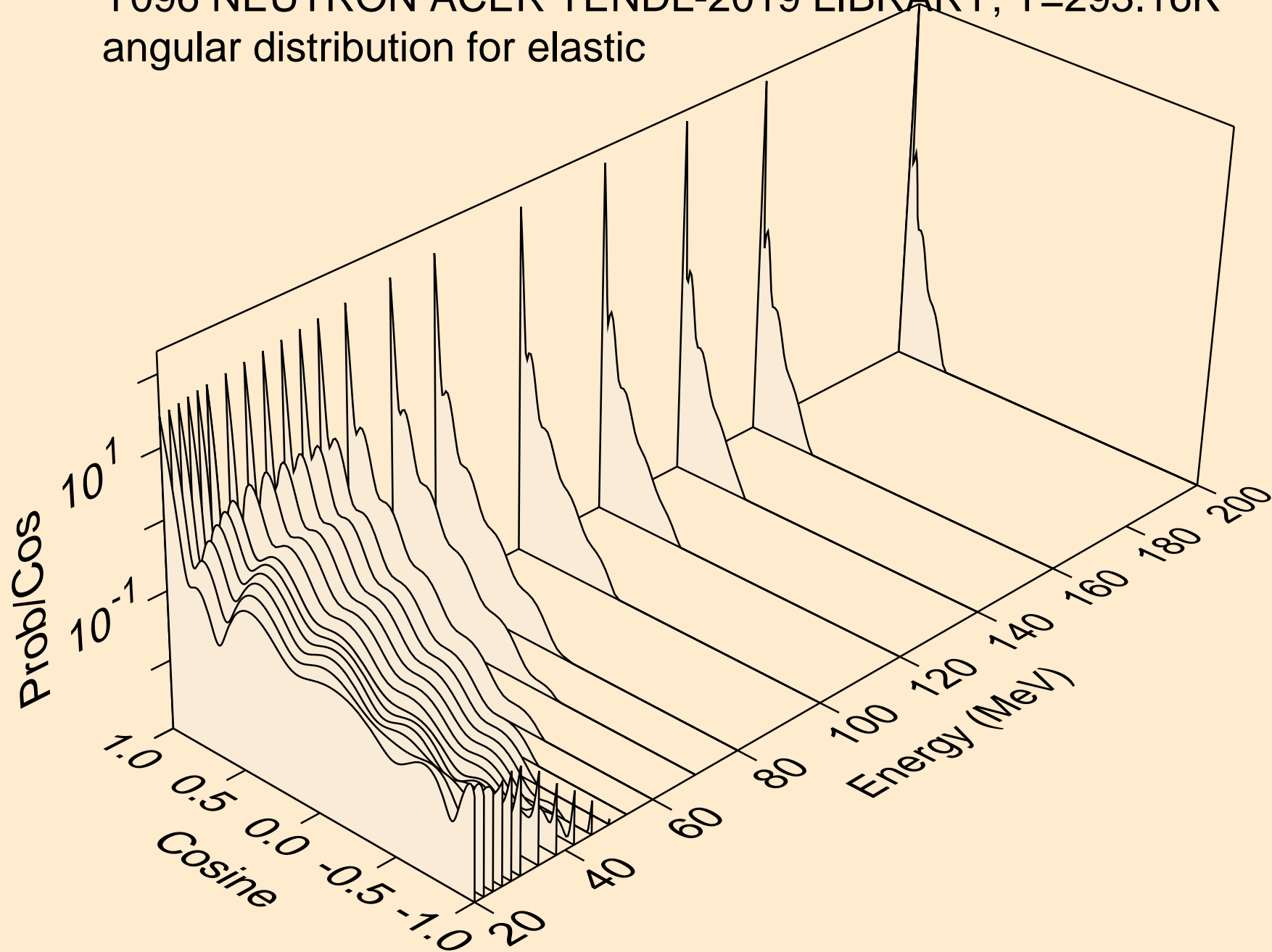

Y096 NEUTRON ACER TENDL-2019 LIBRARY; T=293.16K
angular distribution for (n,n*1)

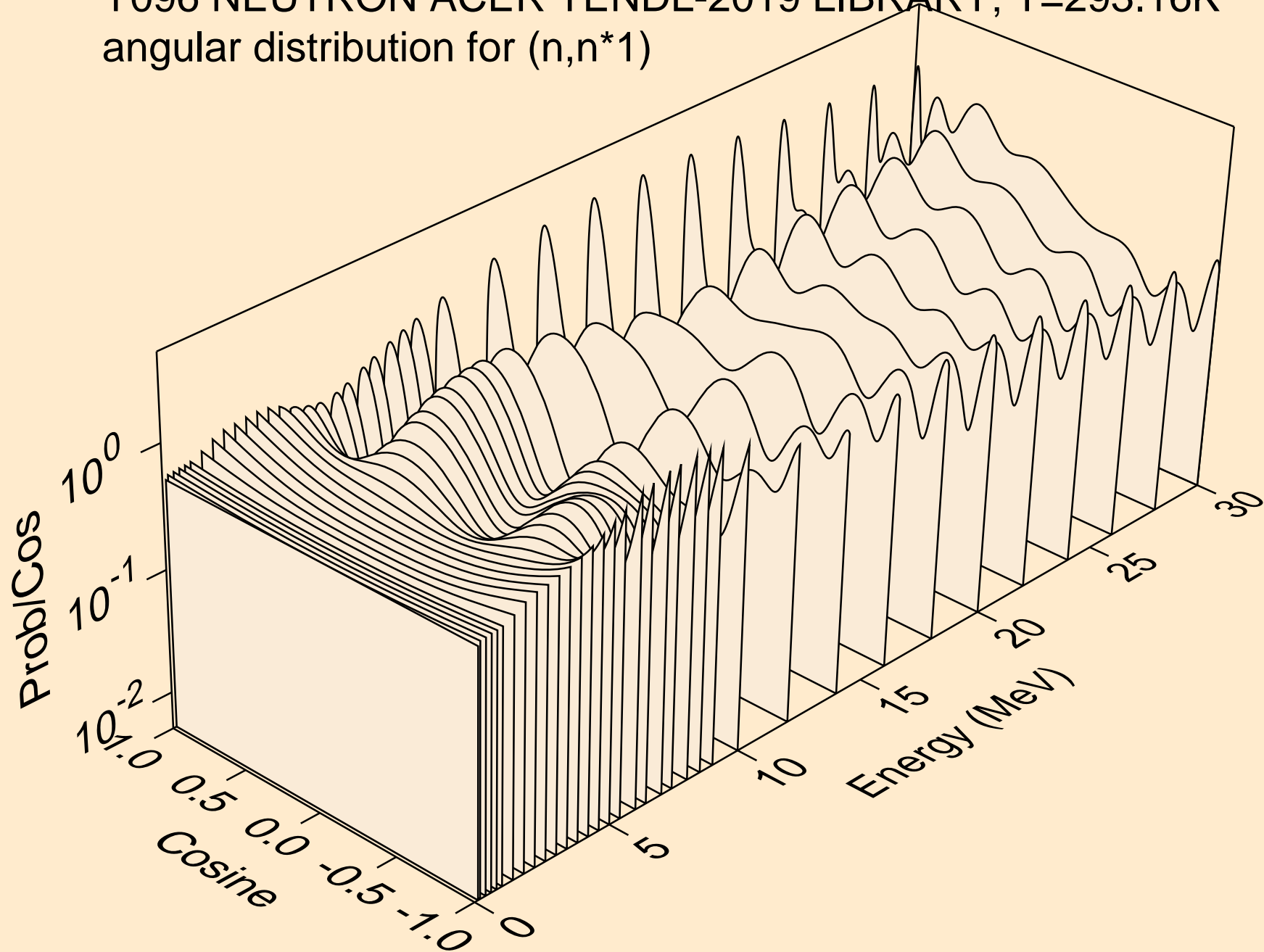

Y096 NEUTRON ACER TENDL-2019 LIBRARY; T=293.16K
angular distribution for (n,n*2)

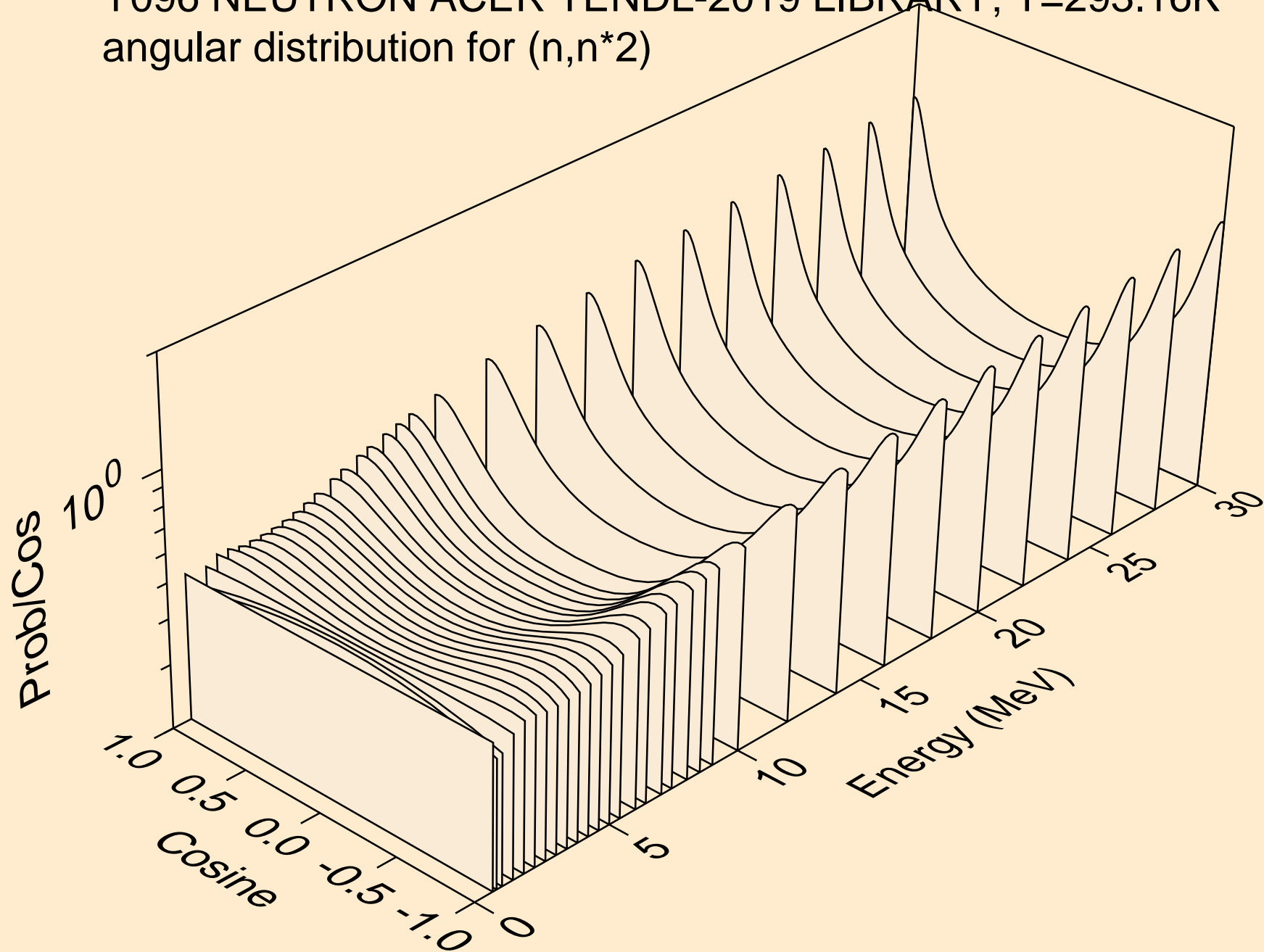

Y096 NEUTRON ACER TENDL-2019 LIBRARY; T=293.16K
angular distribution for (n,n*3)

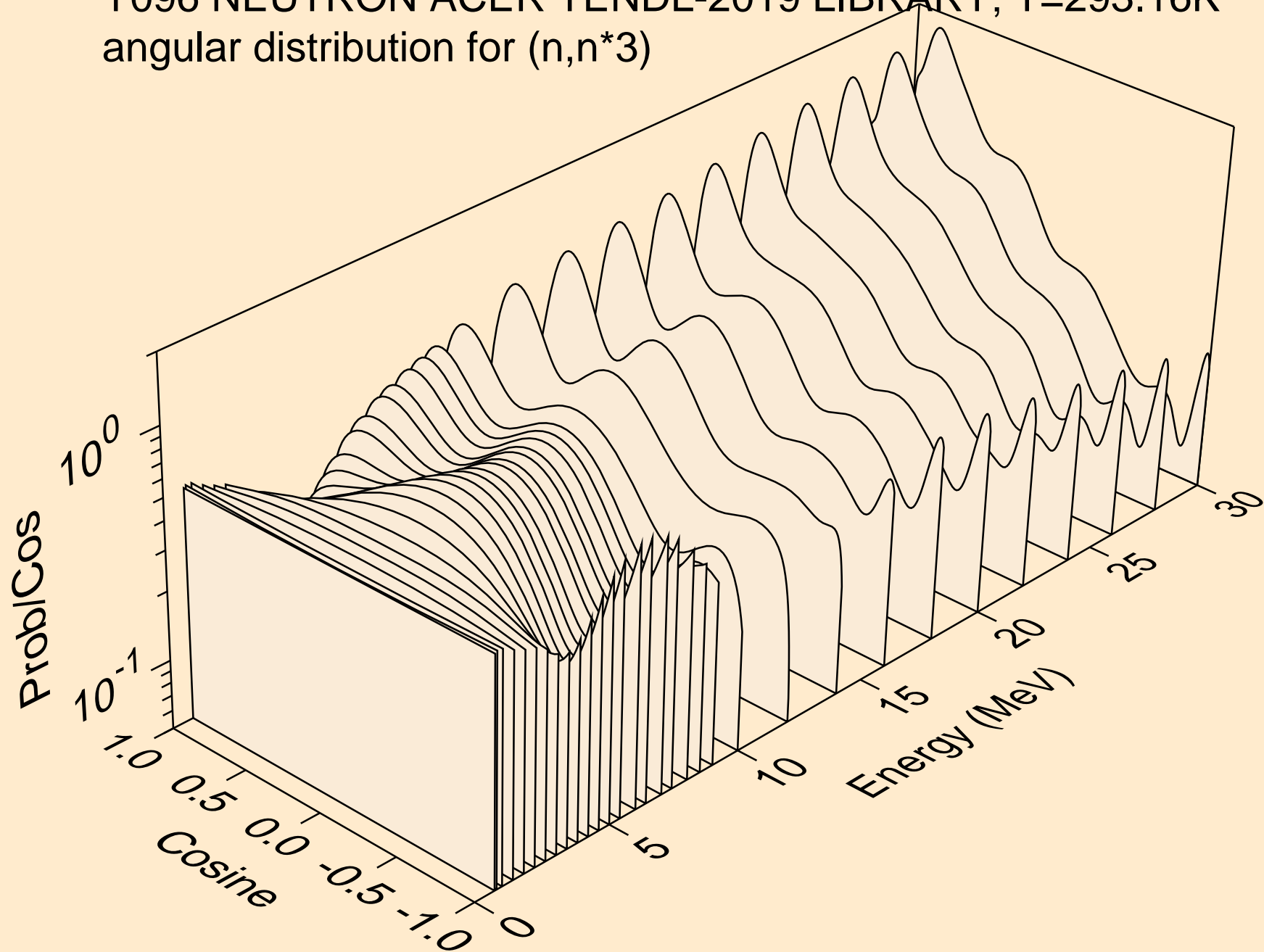

Y096 NEUTRON ACER TENDL-2019 LIBRARY; T=293.16K
angular distribution for (n,n*4)

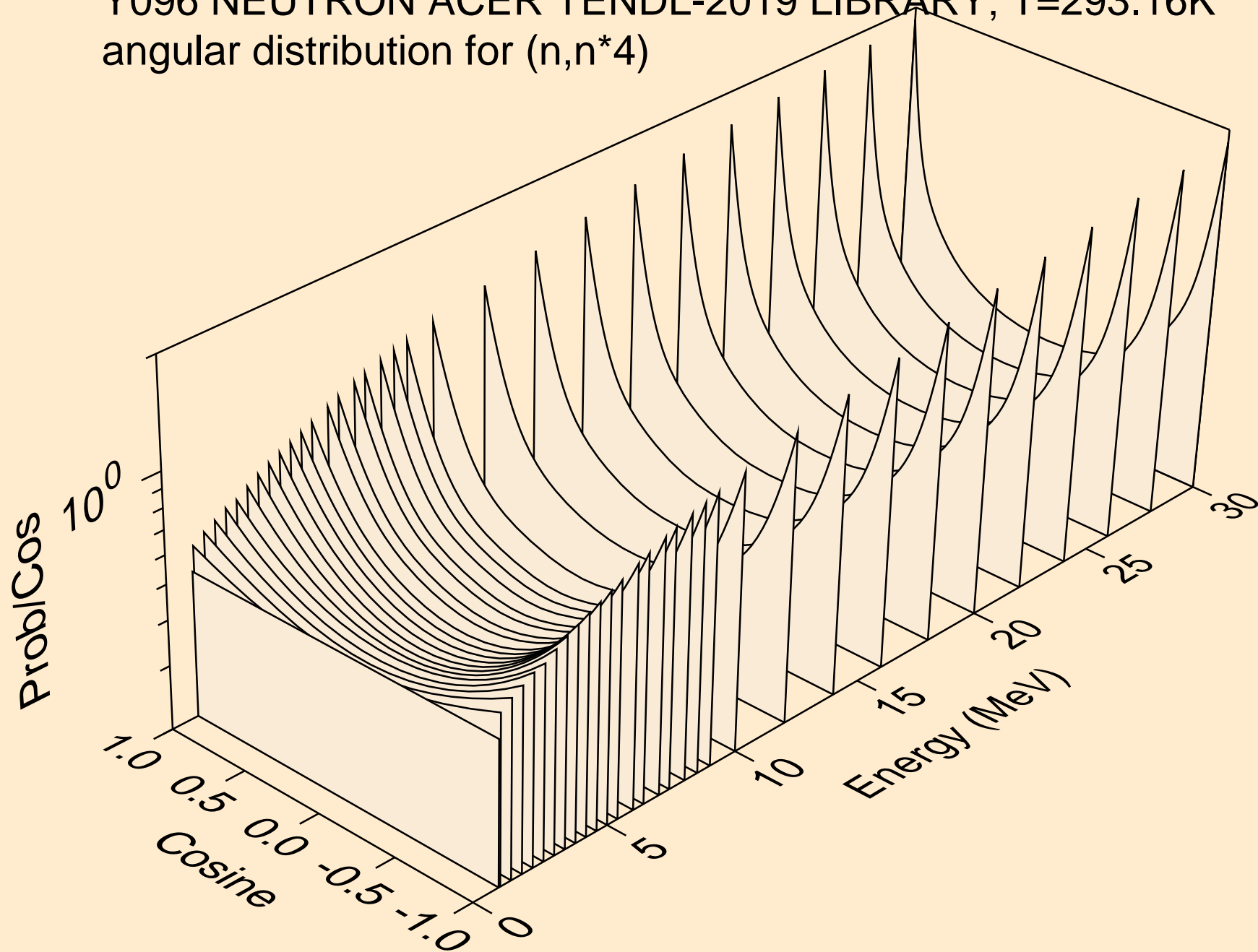

Y096 NEUTRON ACER TENDL-2019 LIBRARY; T=293.16K
angular distribution for (n,n*5)

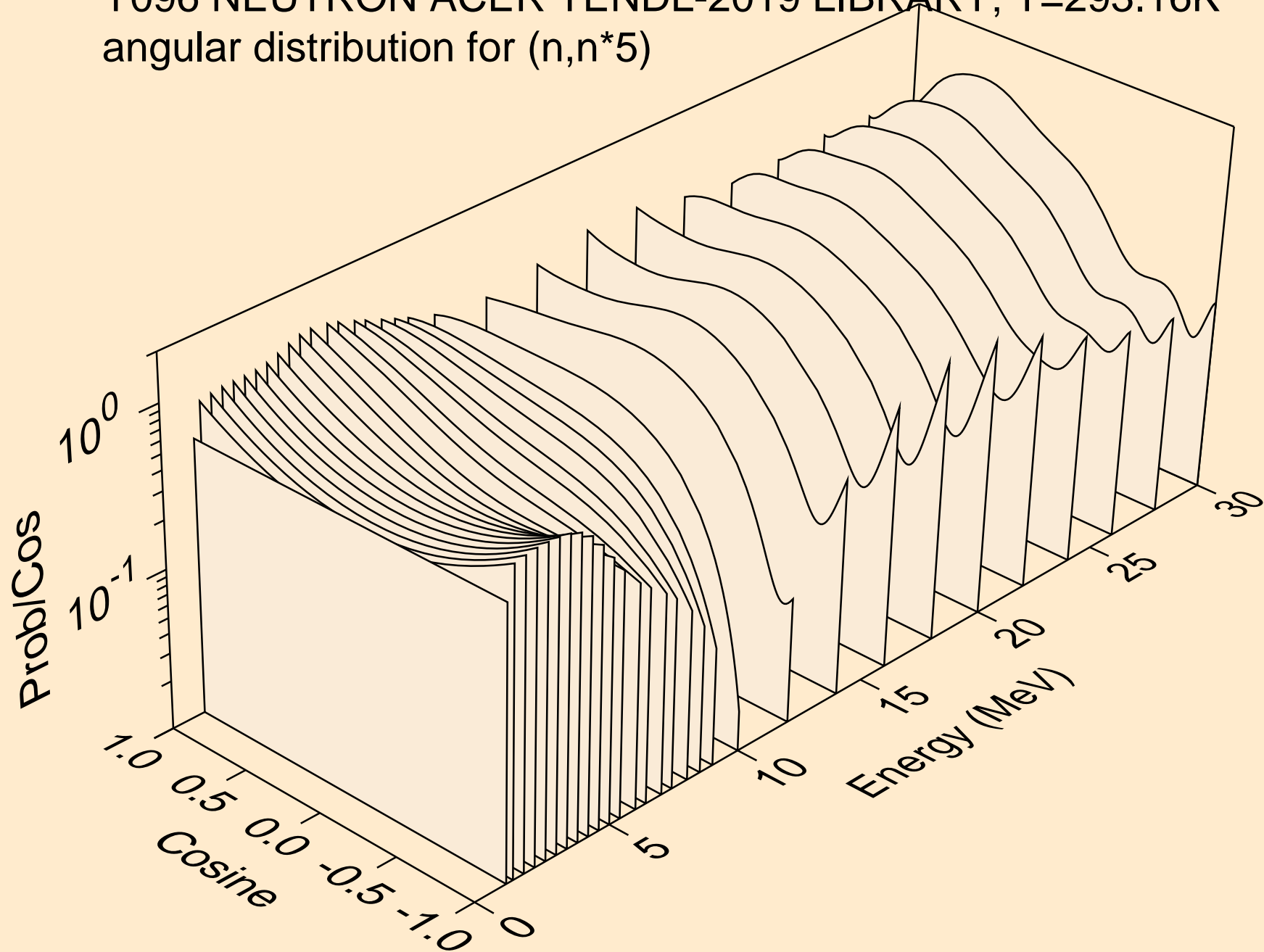

Y096 NEUTRON ACER TENDL-2019 LIBRARY; T=293.16K
angular distribution for (n,n*6)

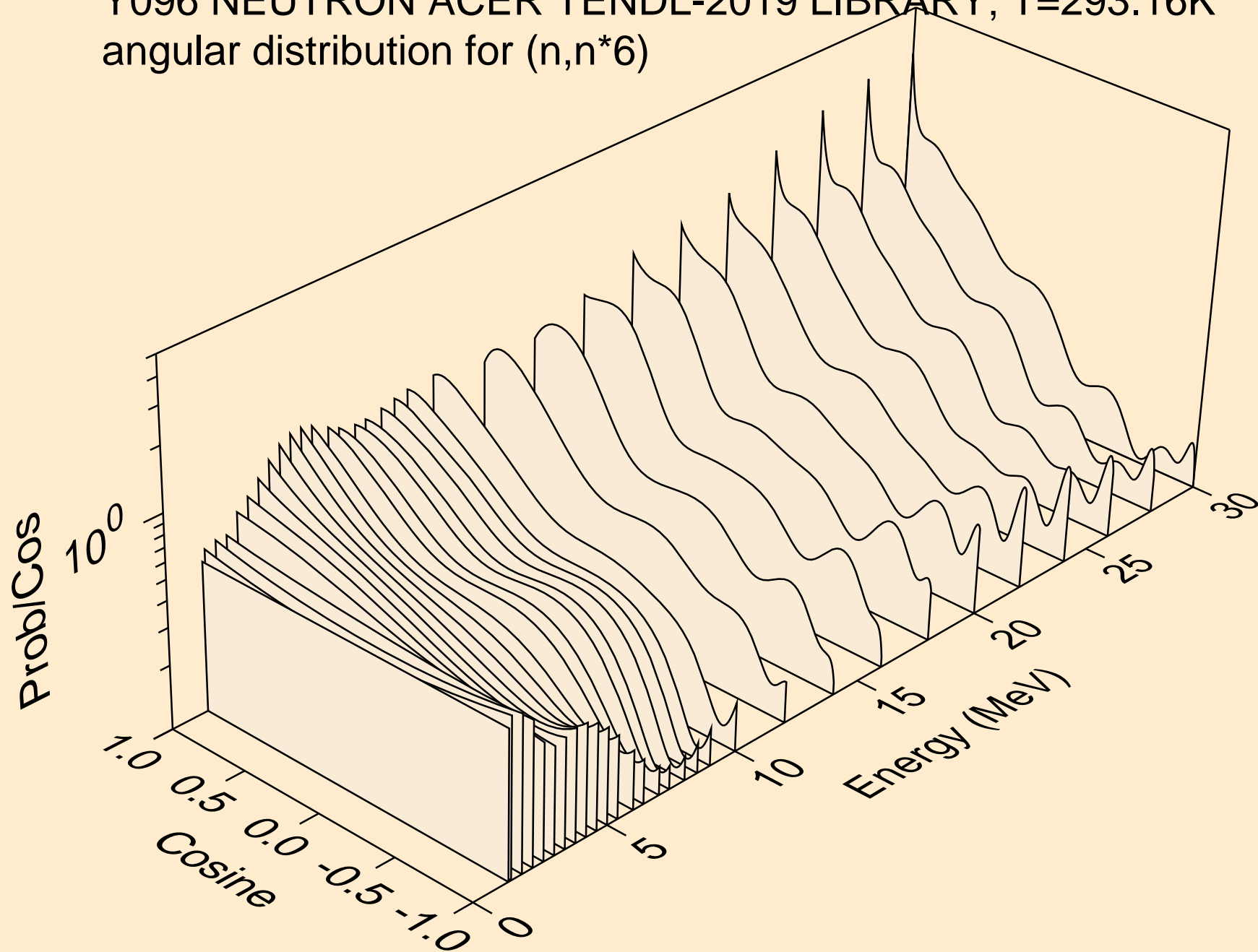

Y096 NEUTRON ACER TENDL-2019 LIBRARY; T=293.16K
angular distribution for (n,n*7)

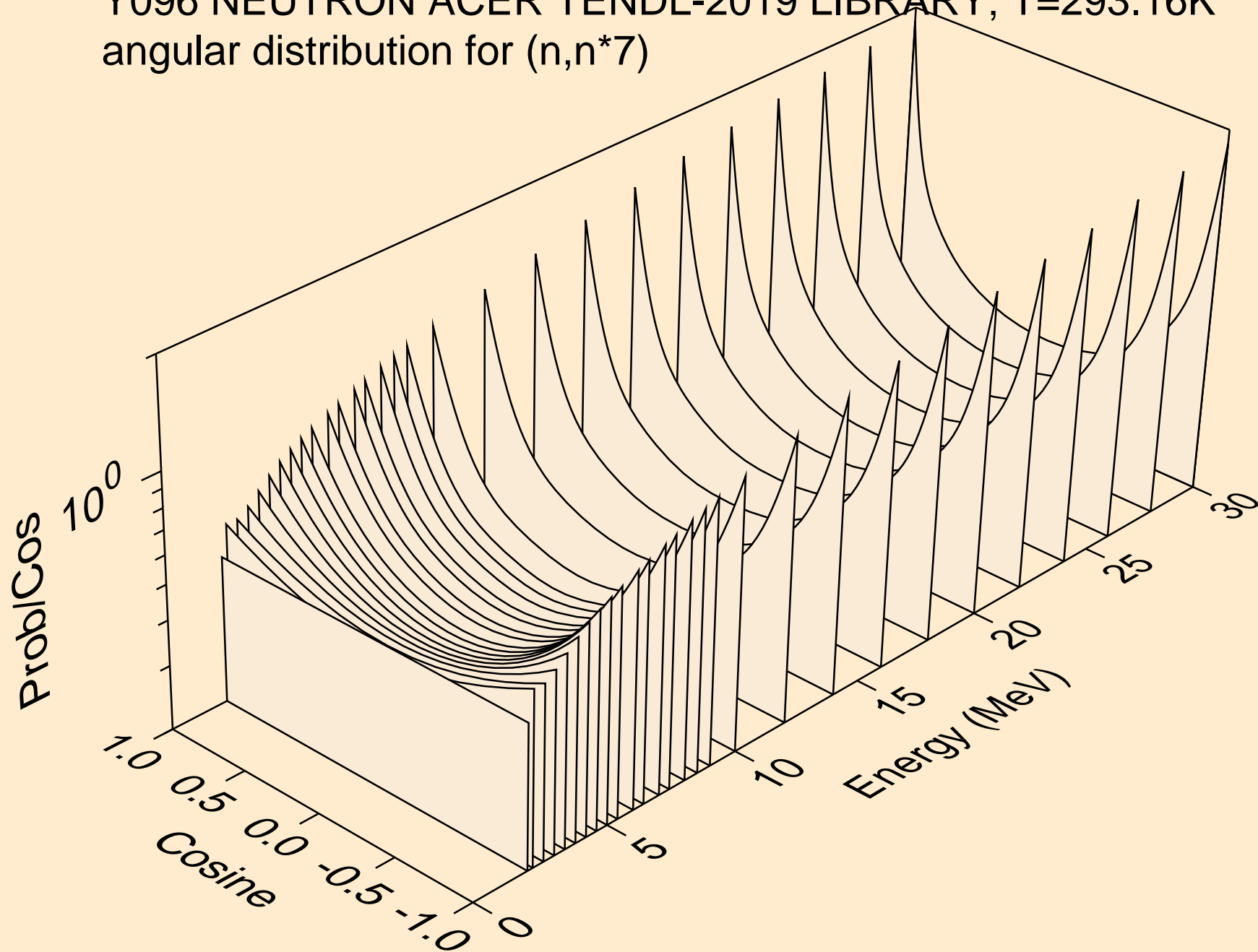

Y096 NEUTRON ACER TENDL-2019 LIBRARY; T=293.16K
angular distribution for (n,n*8)

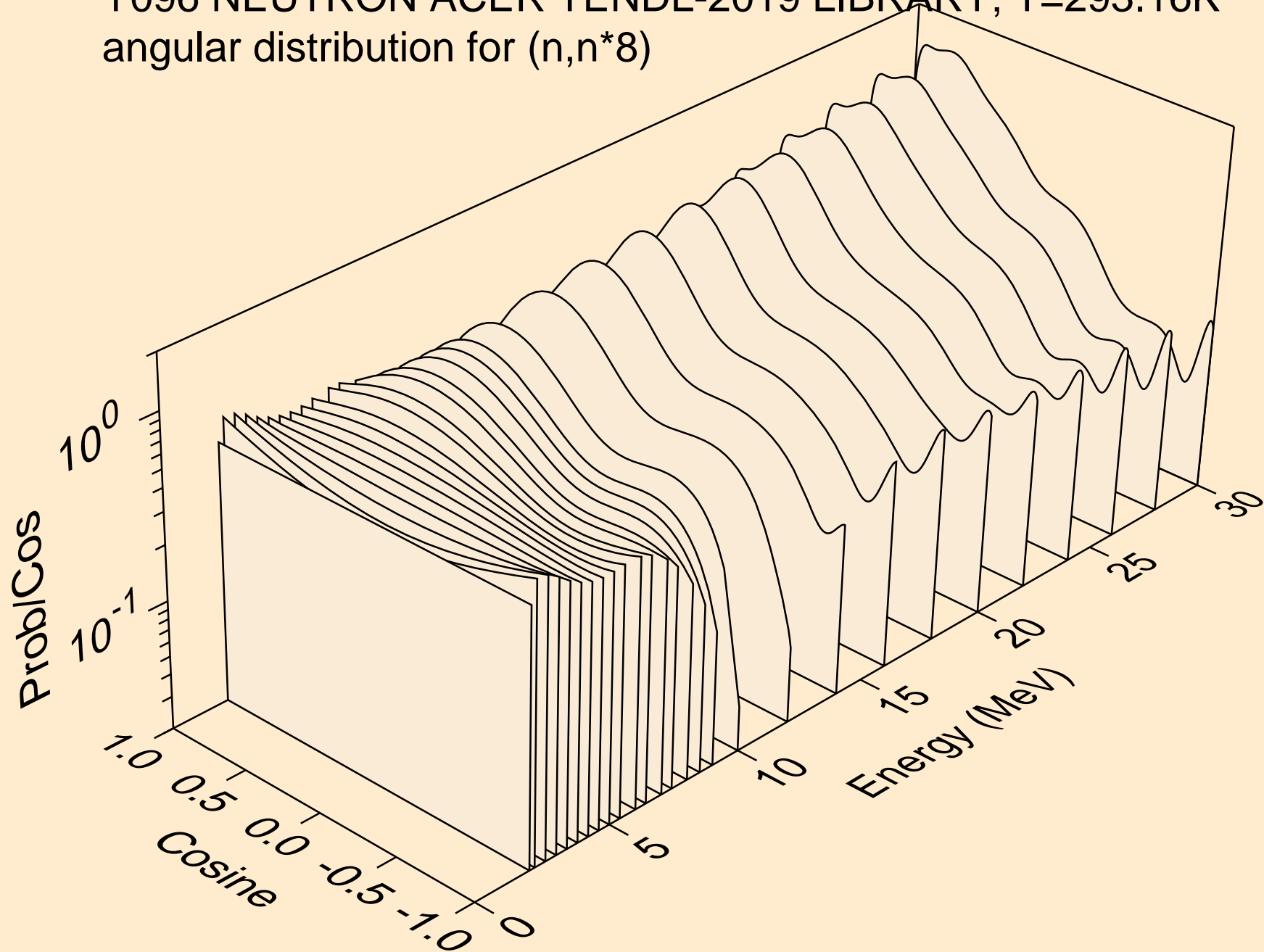

Y096 NEUTRON ACER TENDL-2019 LIBRARY; T=293.16K
angular distribution for (n,n*9)

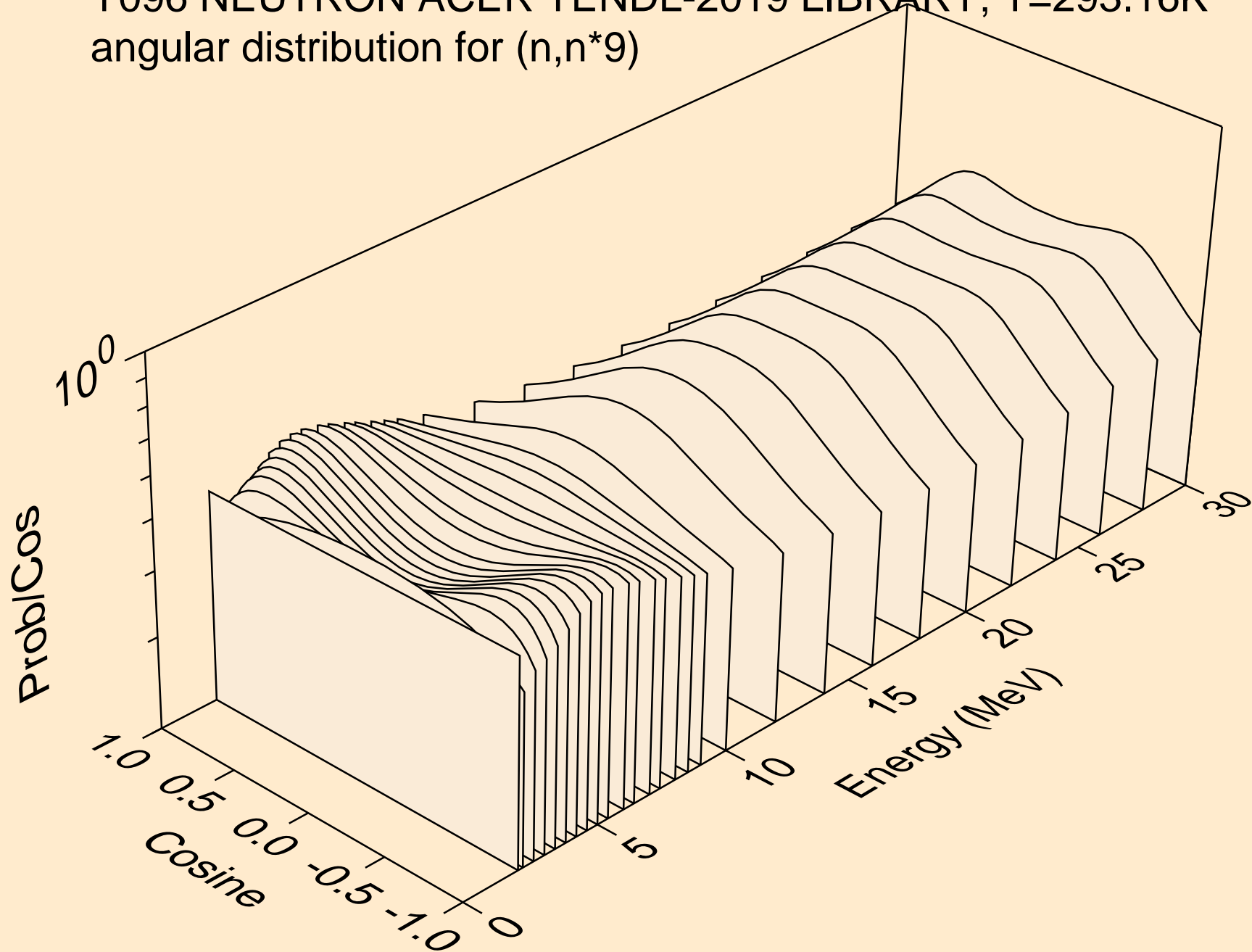

Y096 NEUTRON ACER TENDL-2019 LIBRARY; T=293.16K
angular distribution for (n,n*10)

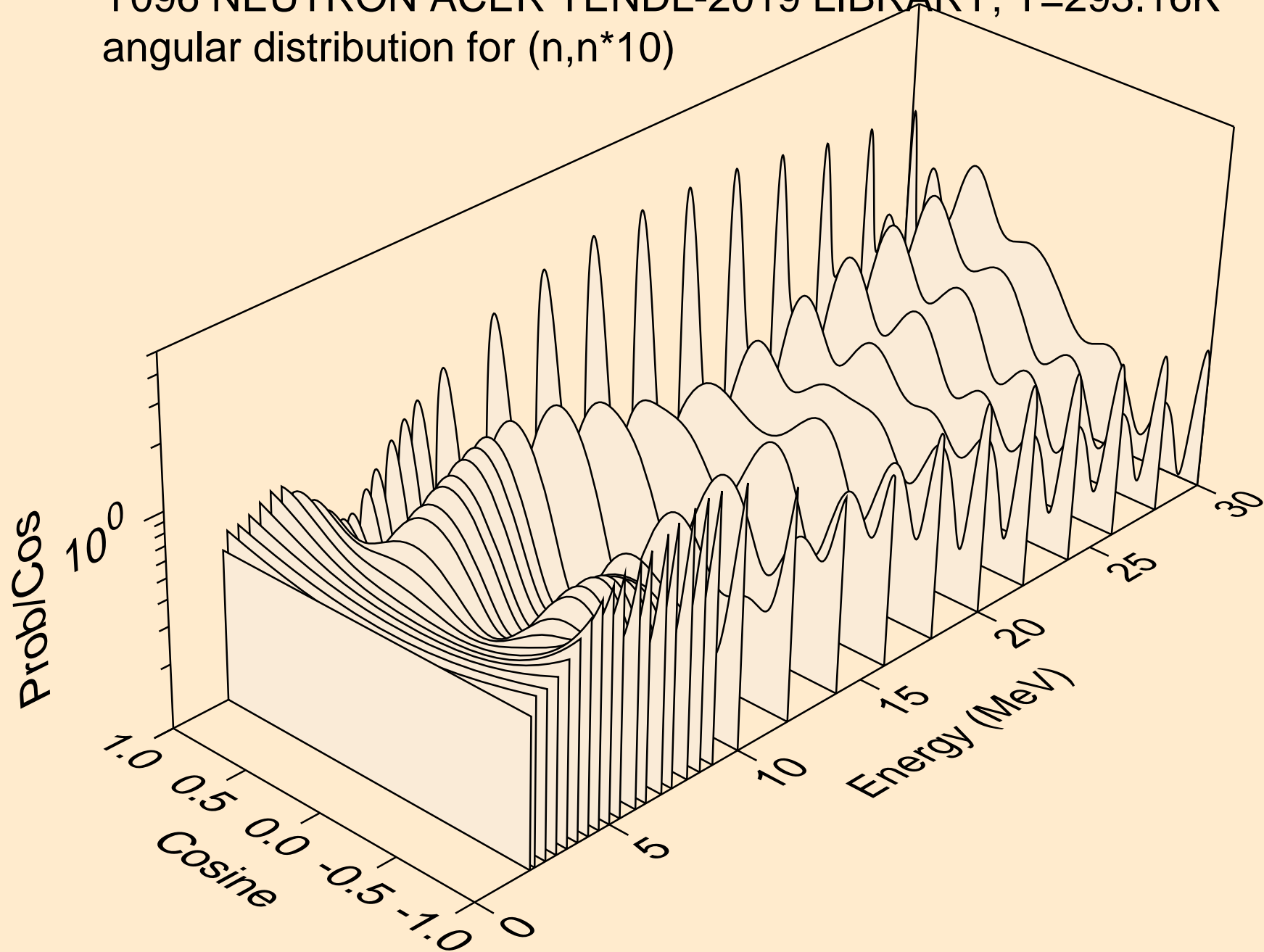

Y096 NEUTRON ACER TENDL-2019 LIBRARY; T=293.16K
angular distribution for (n,n*11)

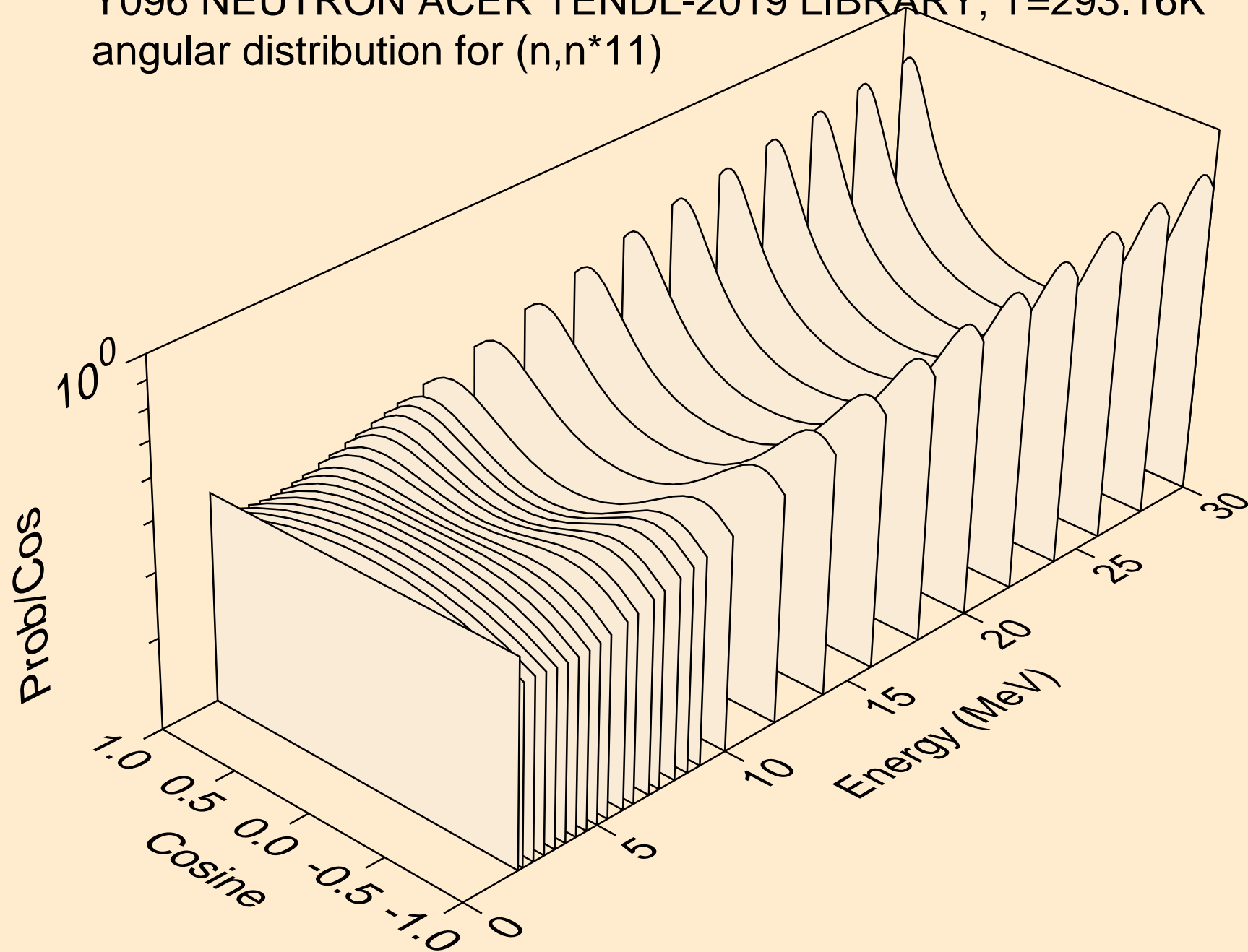

Y096 NEUTRON ACER TENDL-2019 LIBRARY; T=293.16K
angular distribution for (n,n*12)

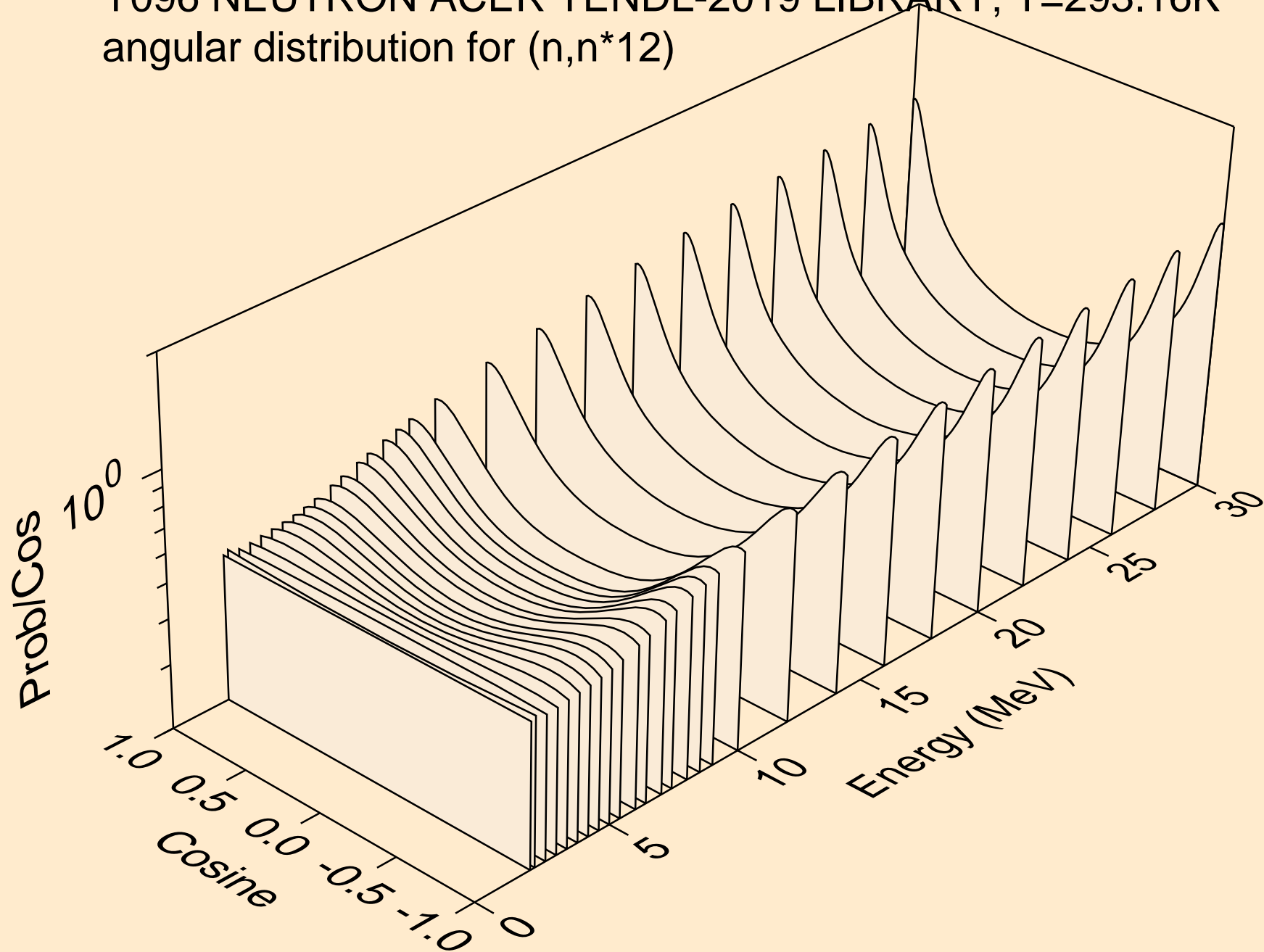

Y096 NEUTRON ACER TENDL-2019 LIBRARY; T=293.16K
angular distribution for (n,n*13)

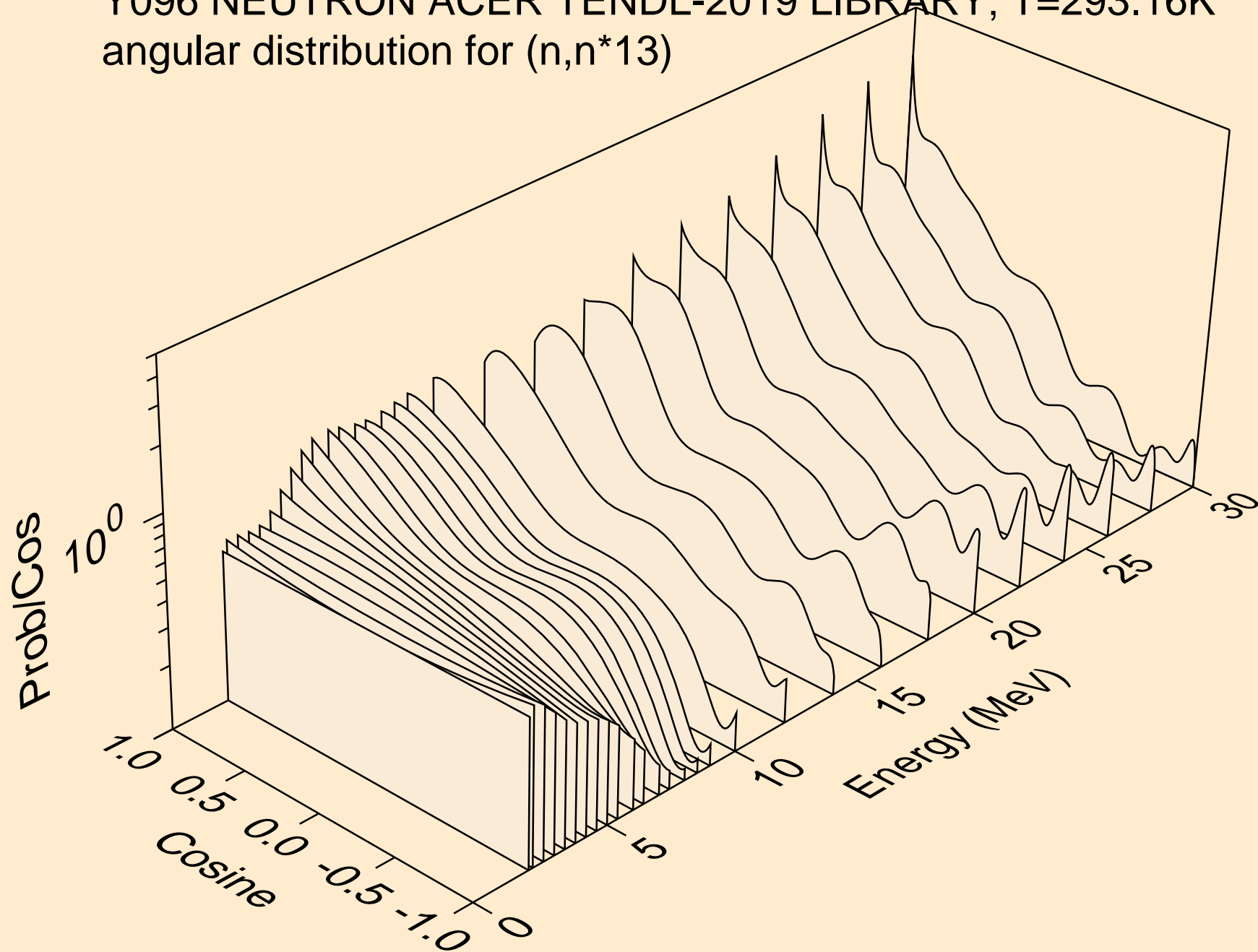

Y096 NEUTRON ACER TENDL-2019 LIBRARY; T=293.16K
angular distribution for (n,n*14)

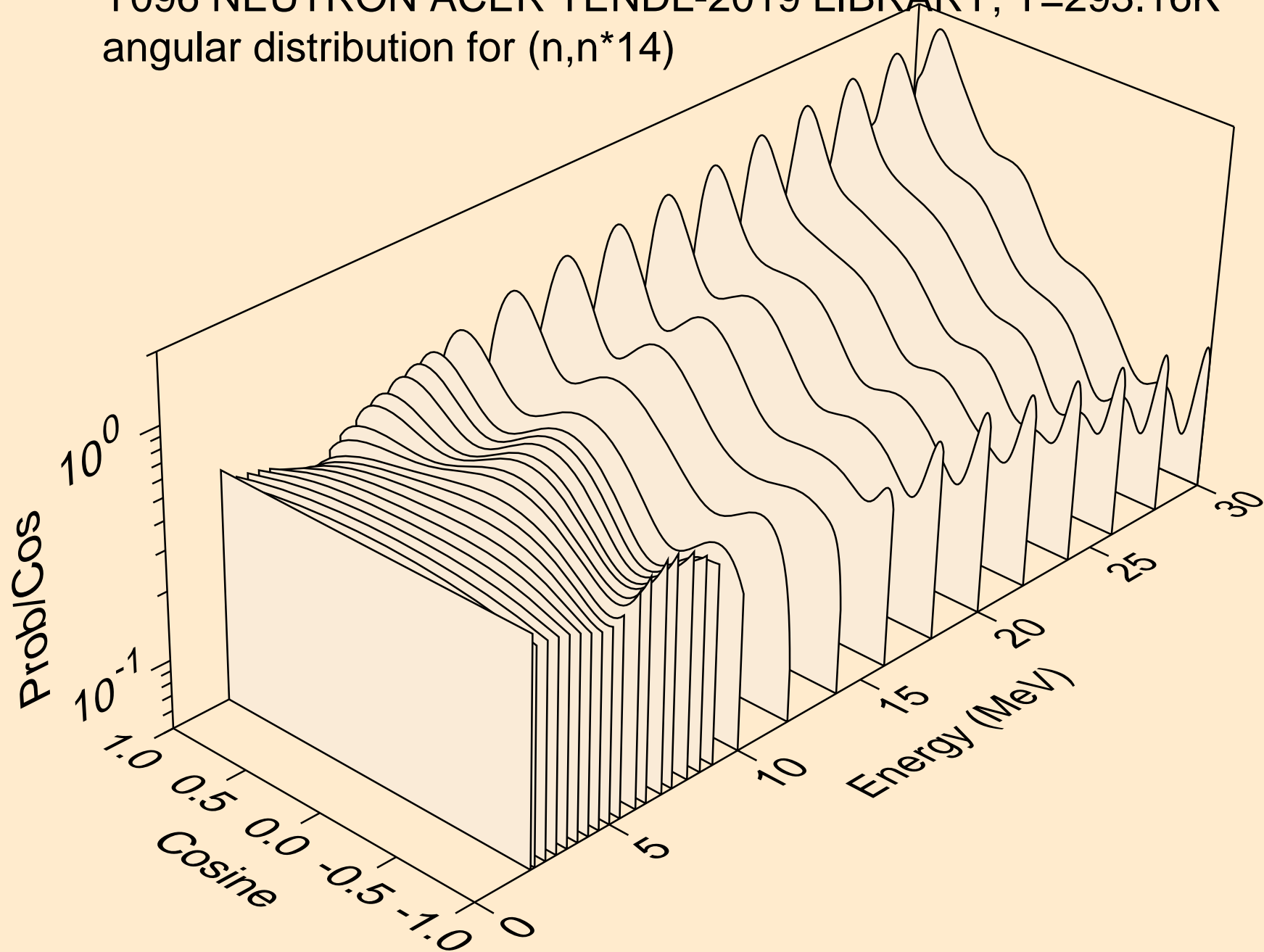

Y096 NEUTRON ACER TENDL-2019 LIBRARY; T=293.16K
angular distribution for (n,n*15)

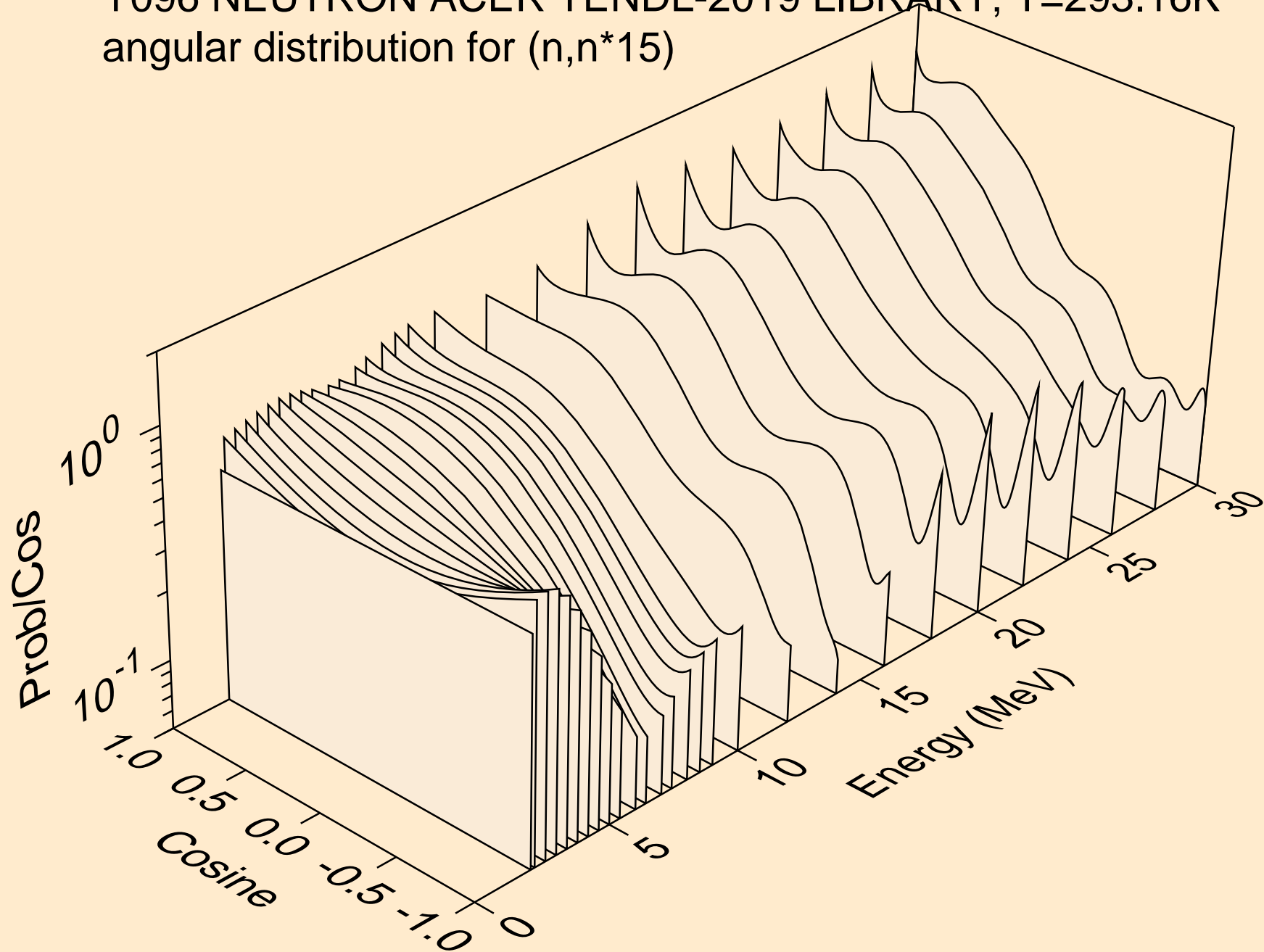

Y096 NEUTRON ACER TENDL-2019 LIBRARY; T=293.16K
angular distribution for (n,n*16)

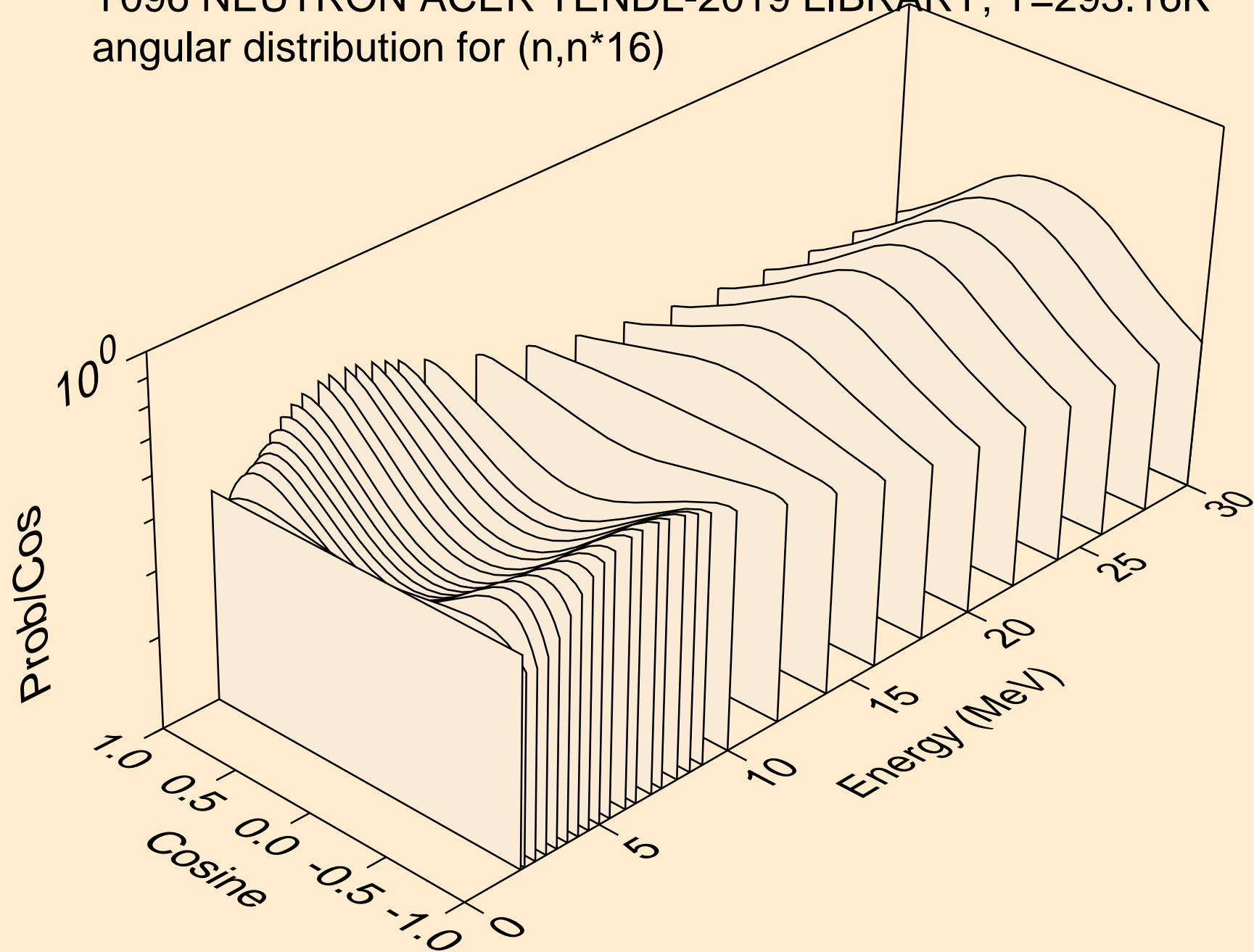

Y096 NEUTRON ACER TENDL-2019 LIBRARY; T=293.16K
angular distribution for (n,n*17)

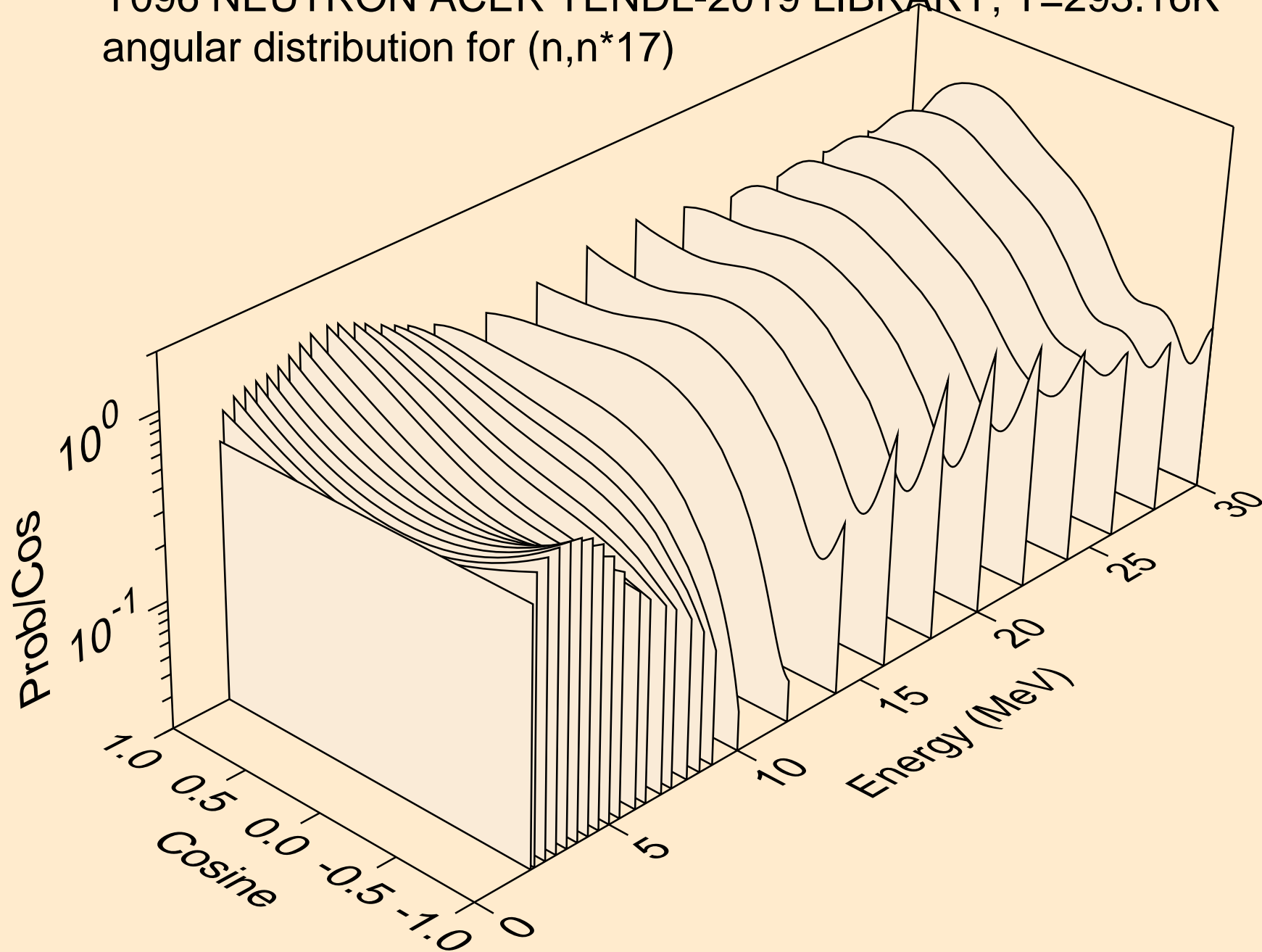

Y096 NEUTRON ACER TENDL-2019 LIBRARY; T=293.16K
angular distribution for (n,n*18)

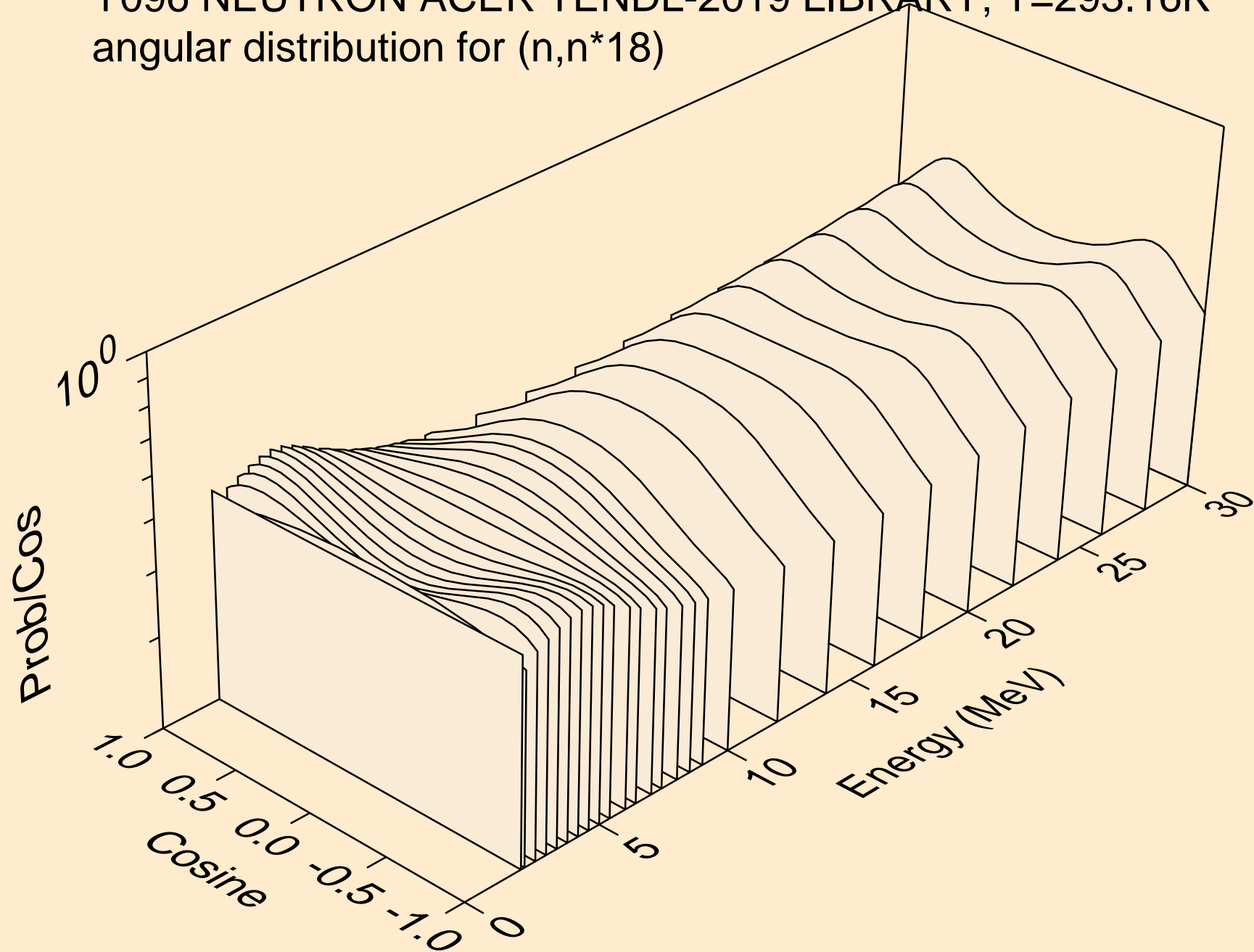

Y096 NEUTRON ACER TENDL-2019 LIBRARY; T=293.16K
angular distribution for (n,n*19)

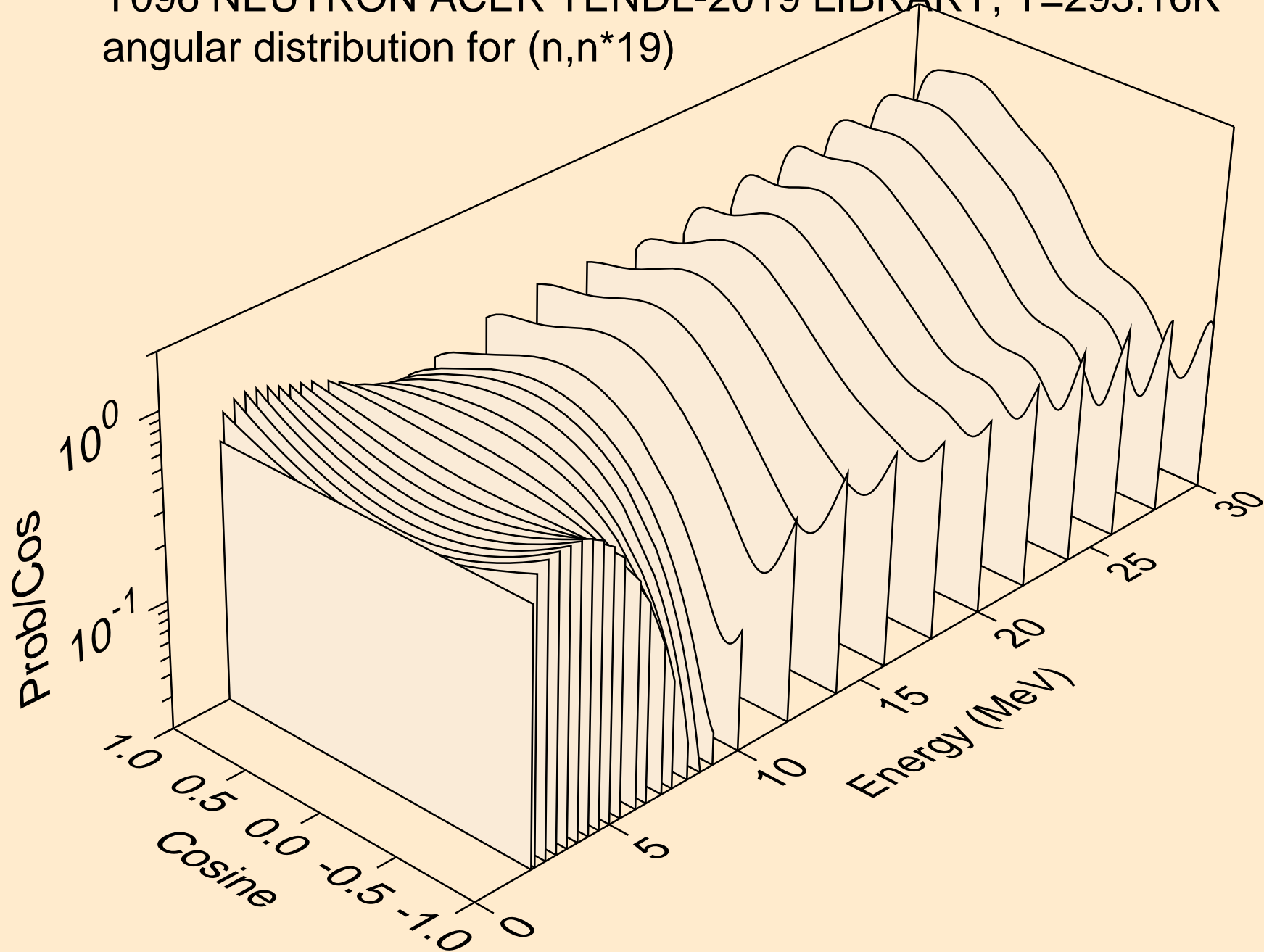

Y096 NEUTRON ACER TENDL-2019 LIBRARY; T=293.16K
angular distribution for (n,n*20)

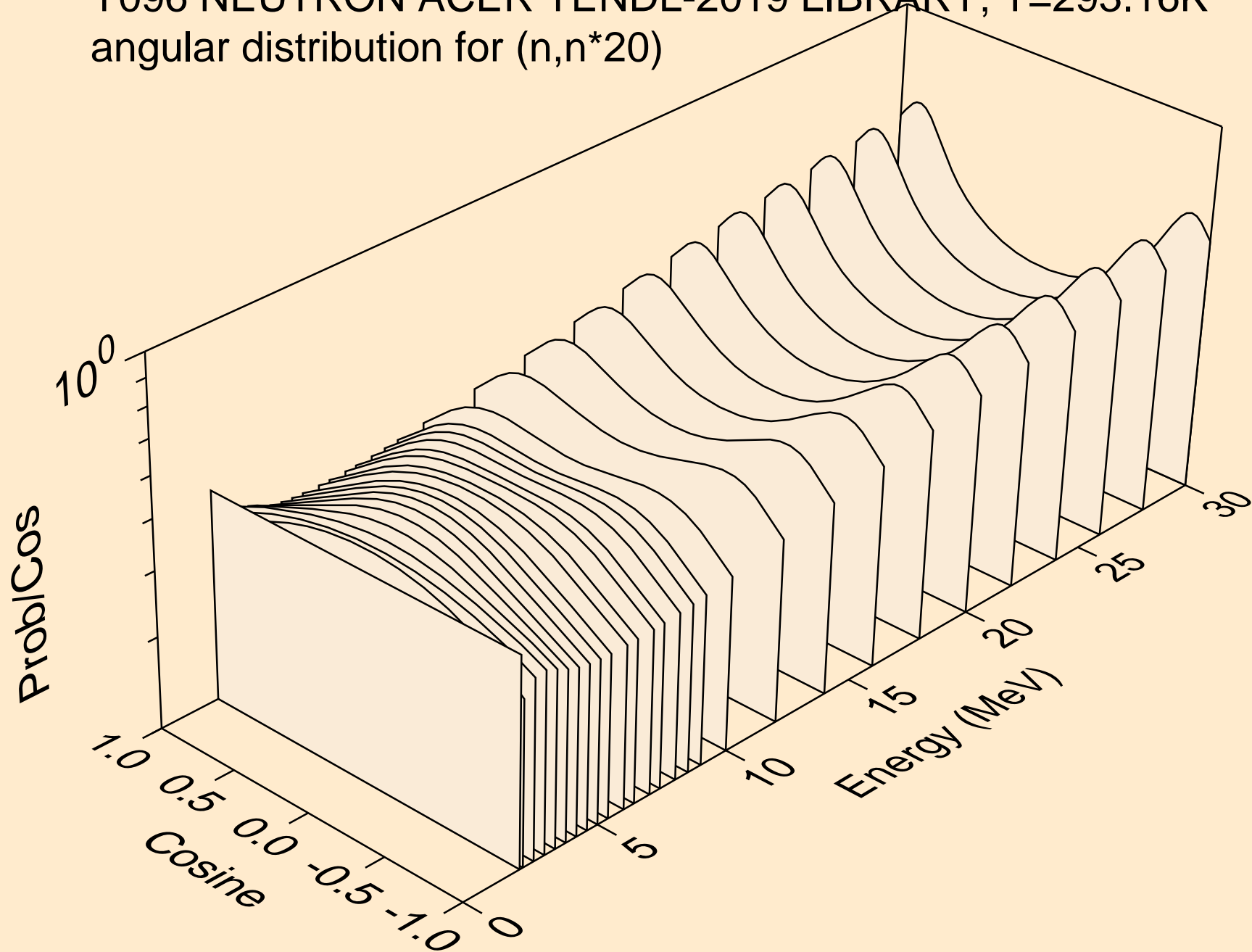

Y096 NEUTRON ACER TENDL-2019 LIBRARY; T=293.16K
angular distribution for (n,n*21)

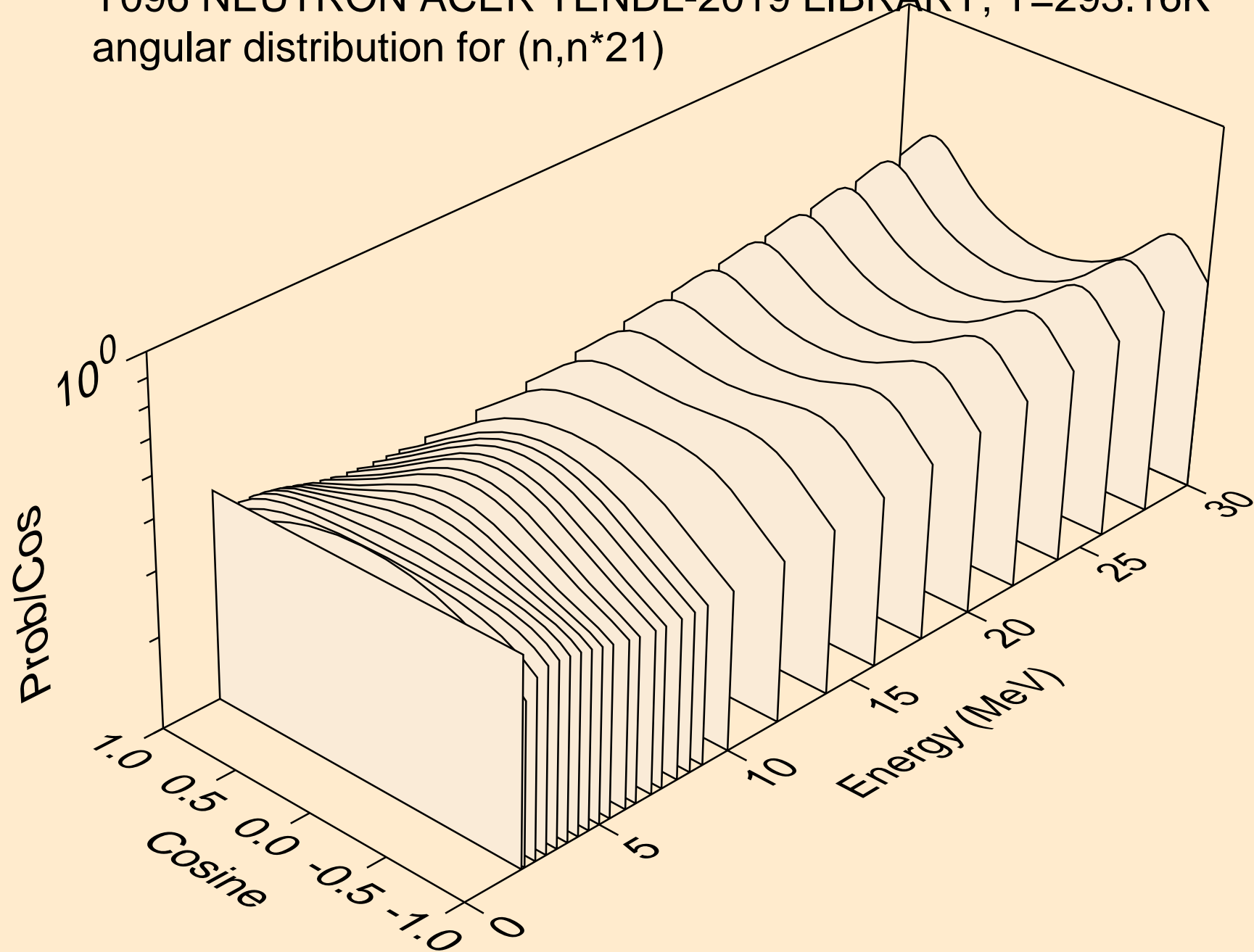

Y096 NEUTRON ACER TENDL-2019 LIBRARY; T=293.16K
angular distribution for (n,n*22)

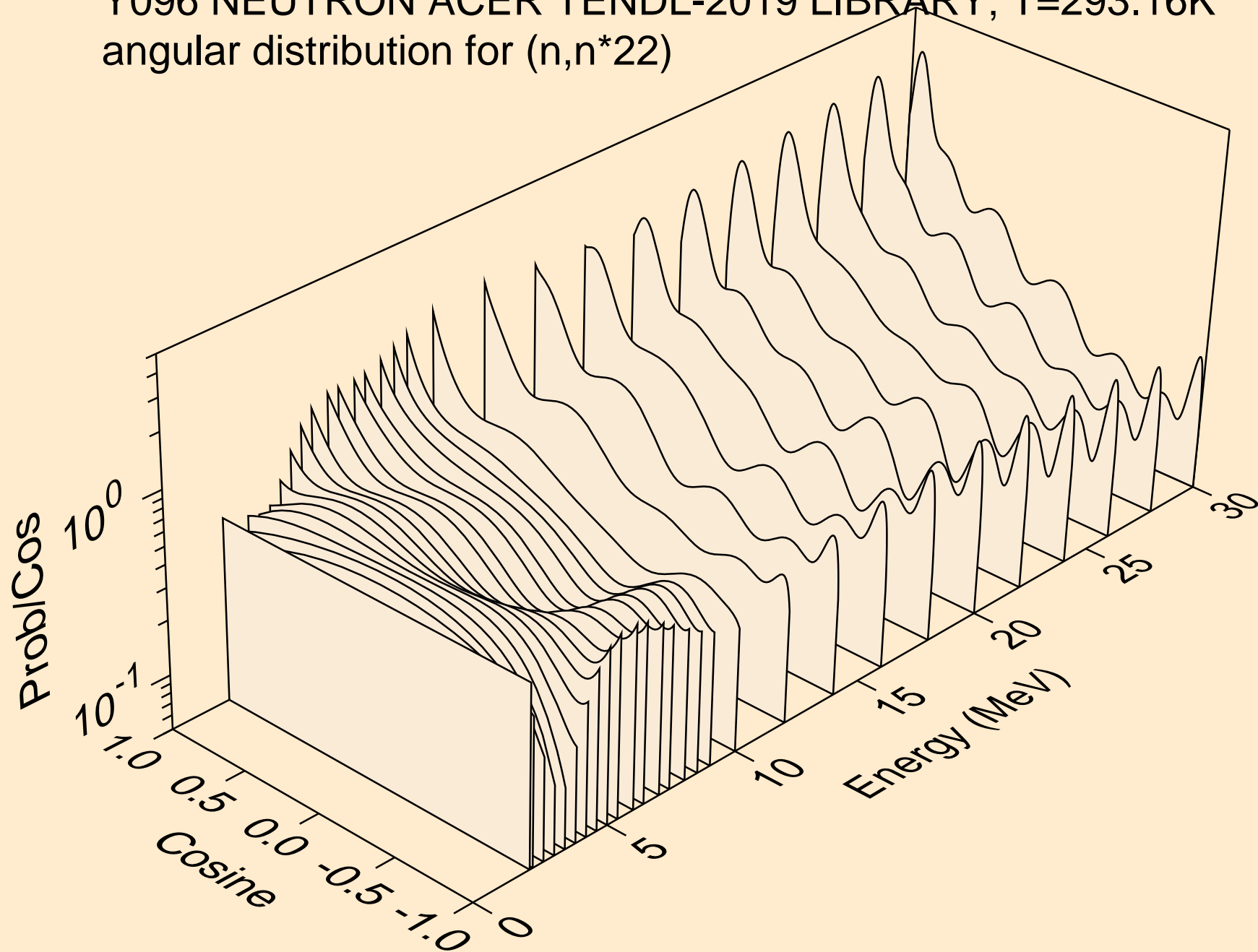

Y096 NEUTRON ACER TENDL-2019 LIBRARY; T=293.16K
angular distribution for (n,n*23)

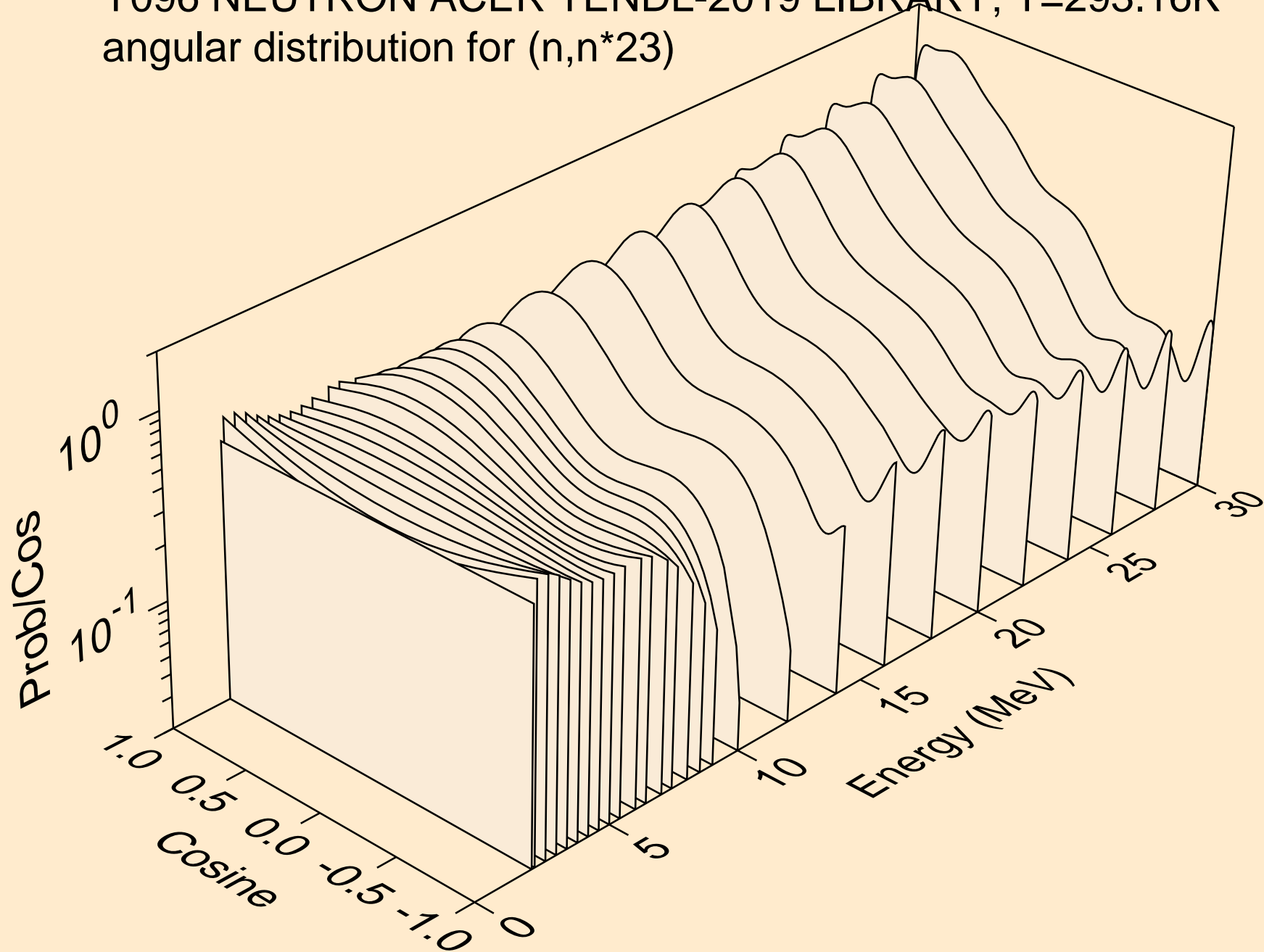

Y096 NEUTRON ACER TENDL-2019 LIBRARY; T=293.16K
angular distribution for (n,n*24)

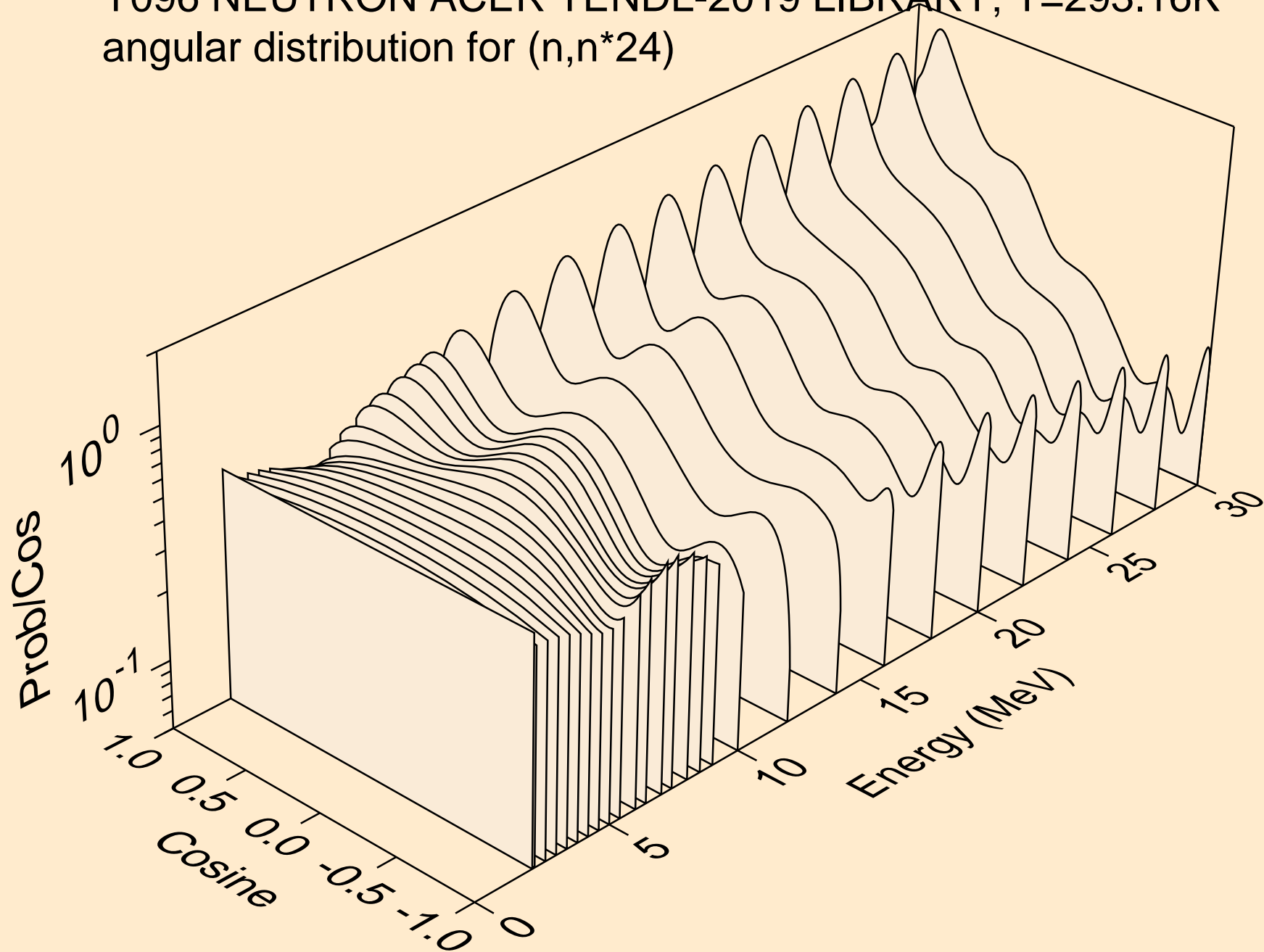

Y096 NEUTRON ACER TENDL-2019 LIBRARY; T=293.16K
angular distribution for (n,n*25)

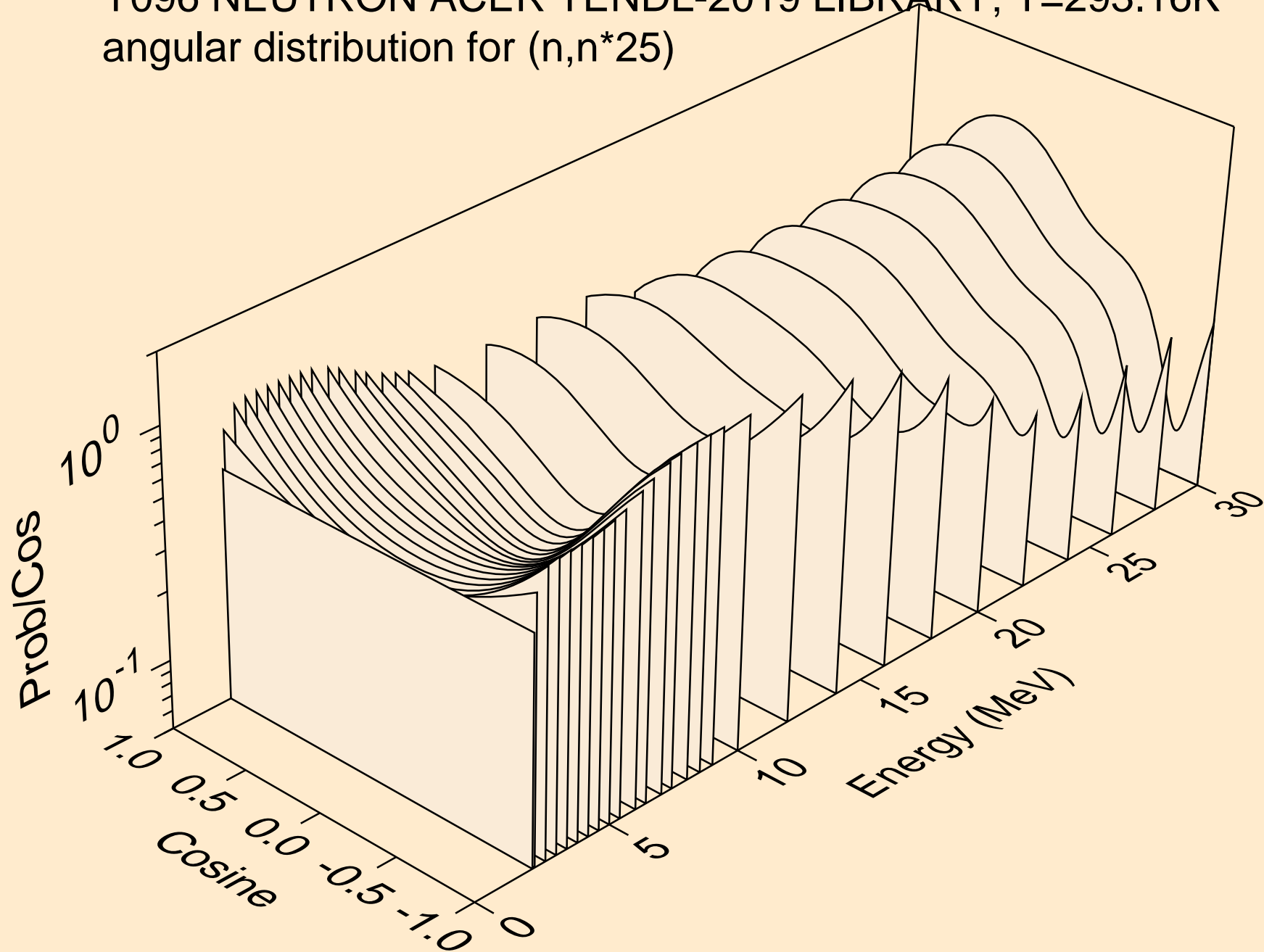

Y096 NEUTRON ACER TENDL-2019 LIBRARY; T=293.16K
angular distribution for (n,n*26)

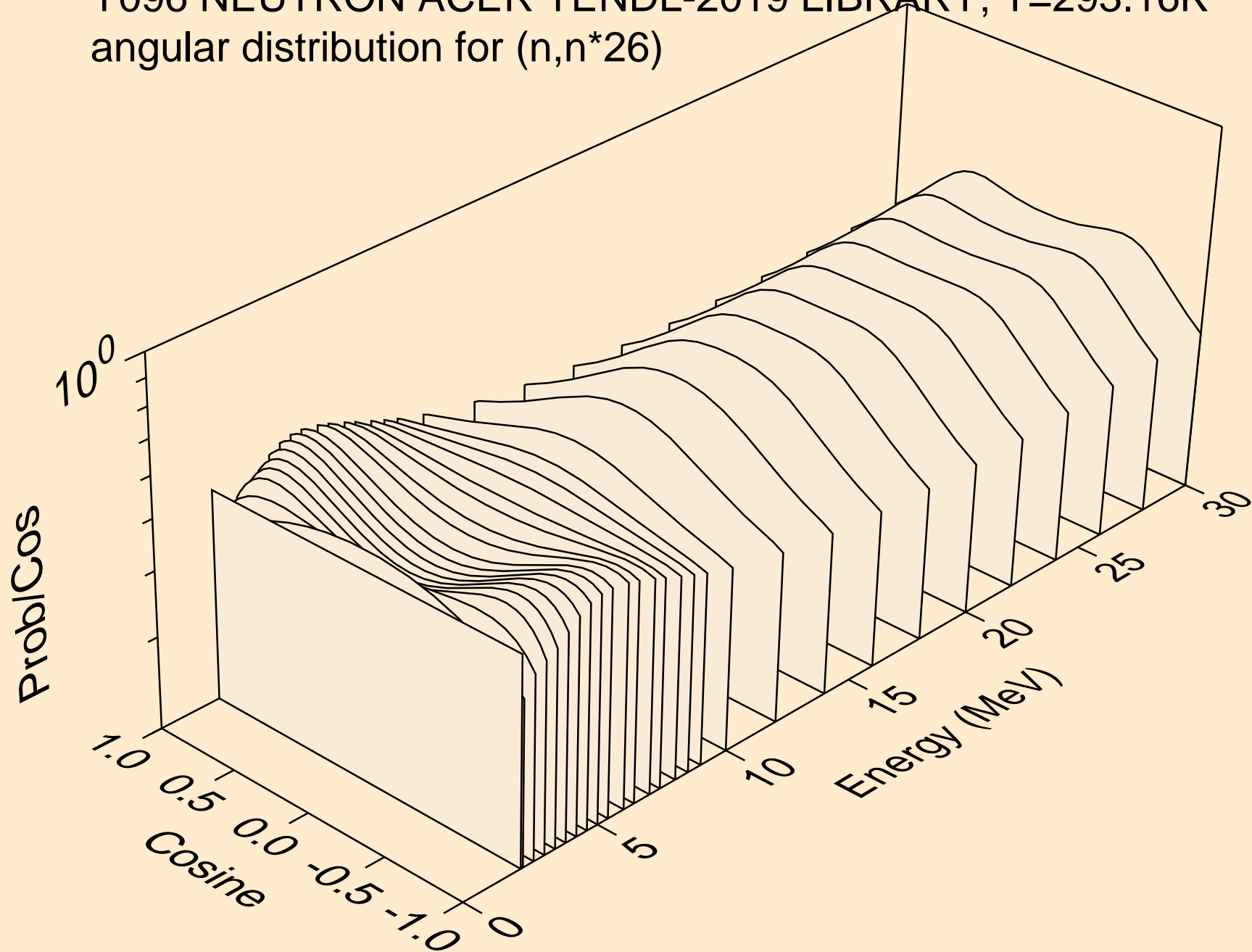

Y096 NEUTRON ACER TENDL-2019 LIBRARY; T=293.16K
angular distribution for (n,n*27)

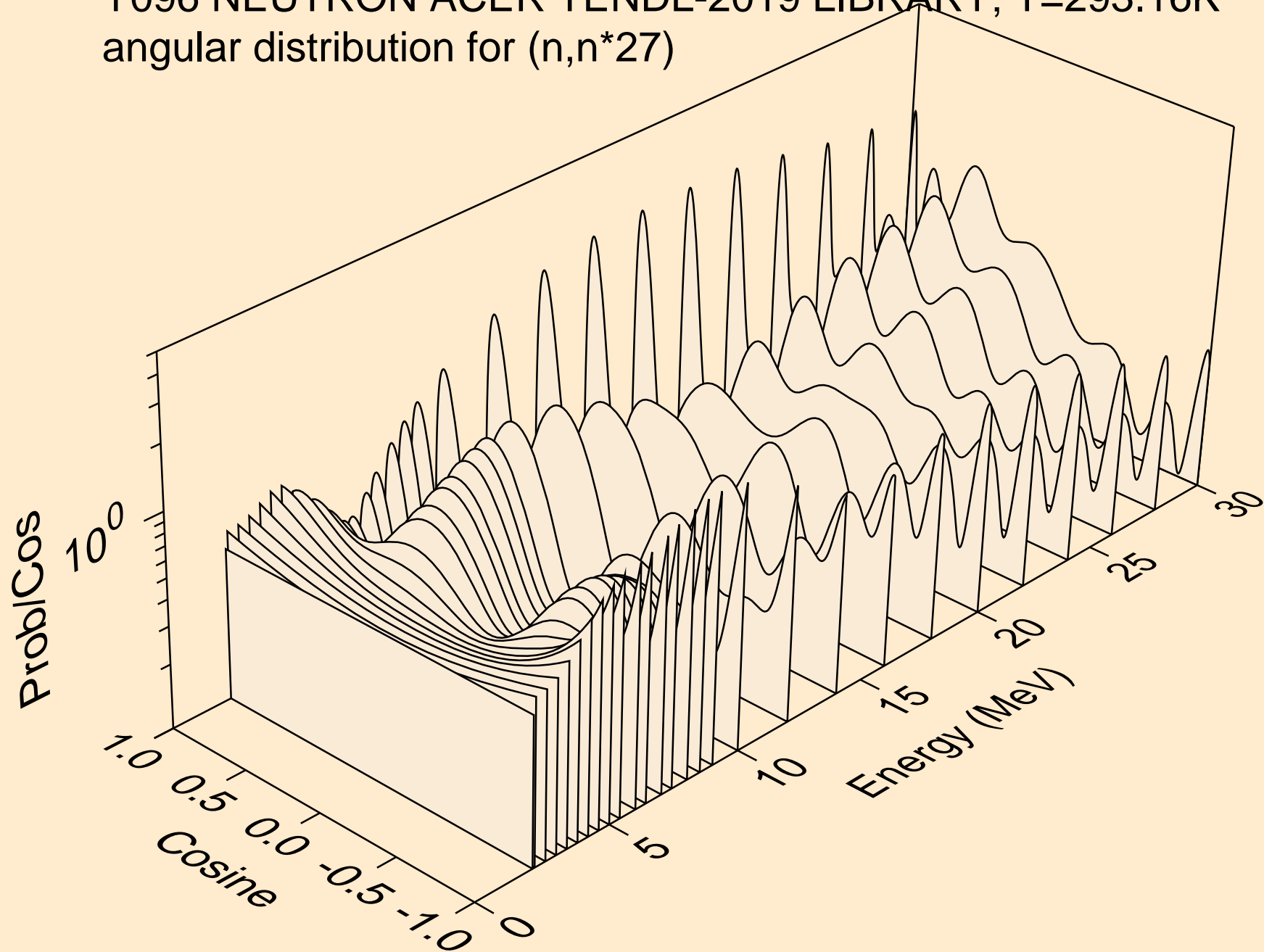

Y096 NEUTRON ACER TENDL-2019 LIBRARY; T=293.16K
angular distribution for (n,n*28)

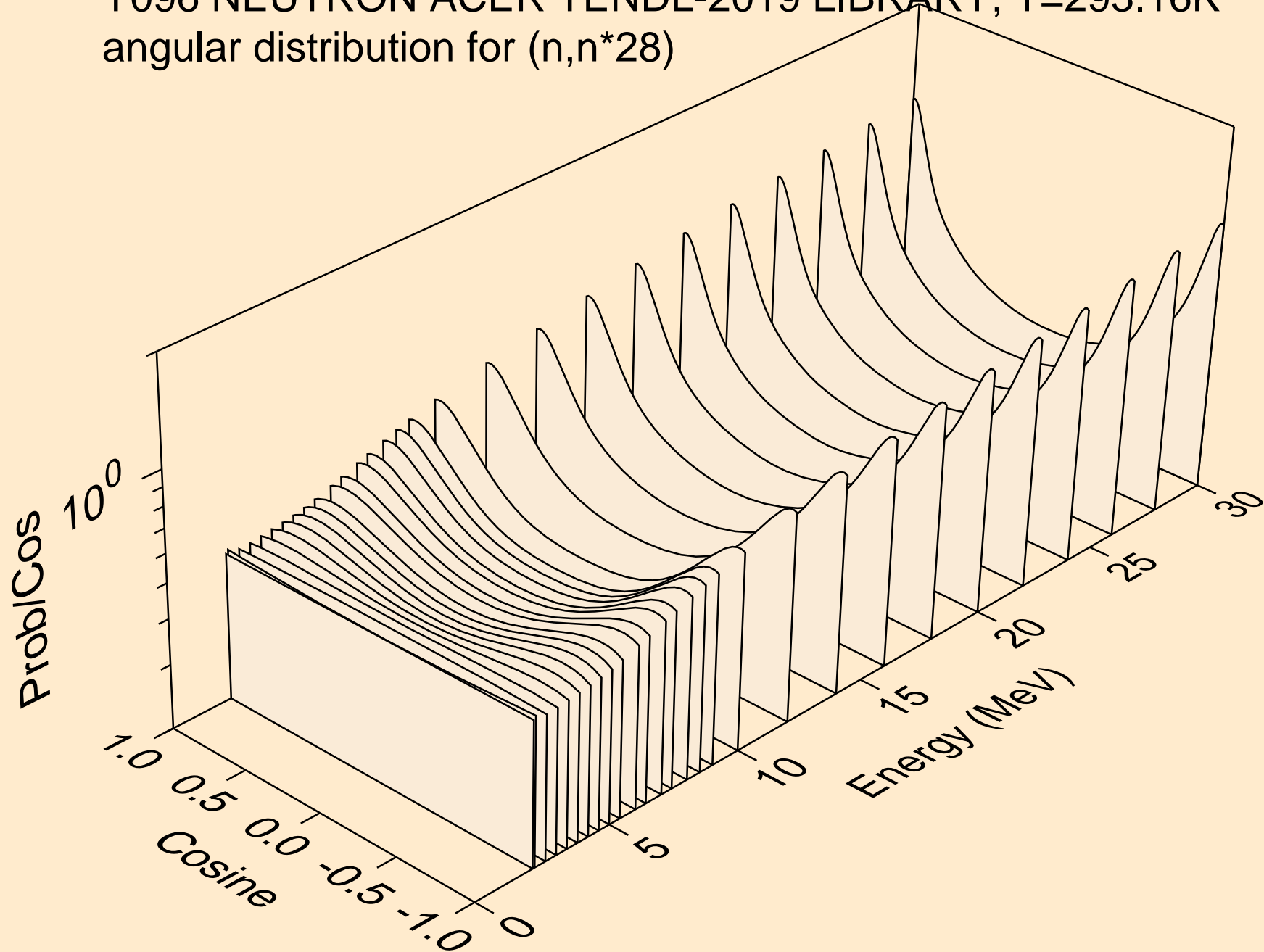

Y096 NEUTRON ACER TENDL-2019 LIBRARY; T=293.16K
angular distribution for (n,n*29)

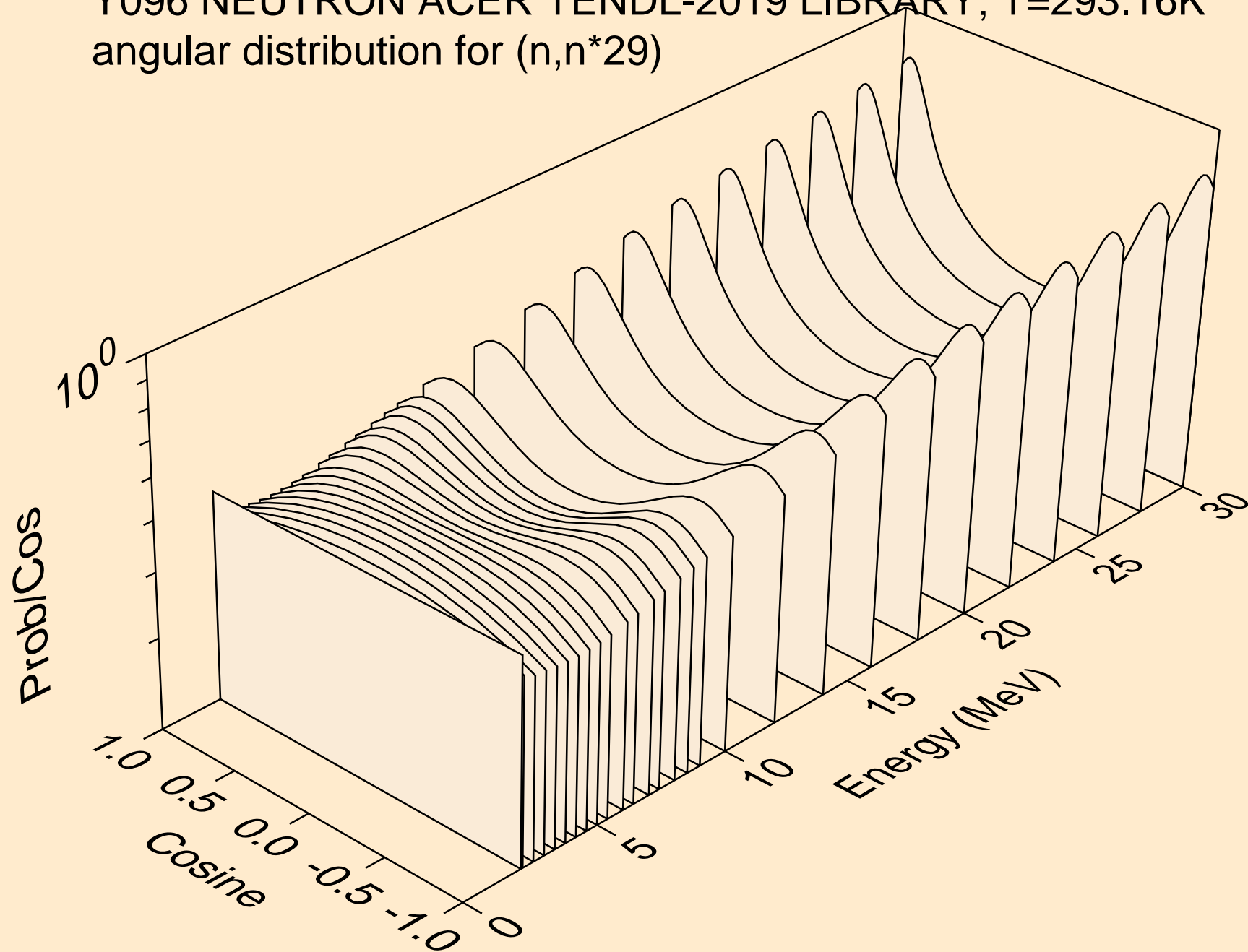

Y096 NEUTRON ACER TENDL-2019 LIBRARY; T=293.16K
Neutron emission for (n,x)

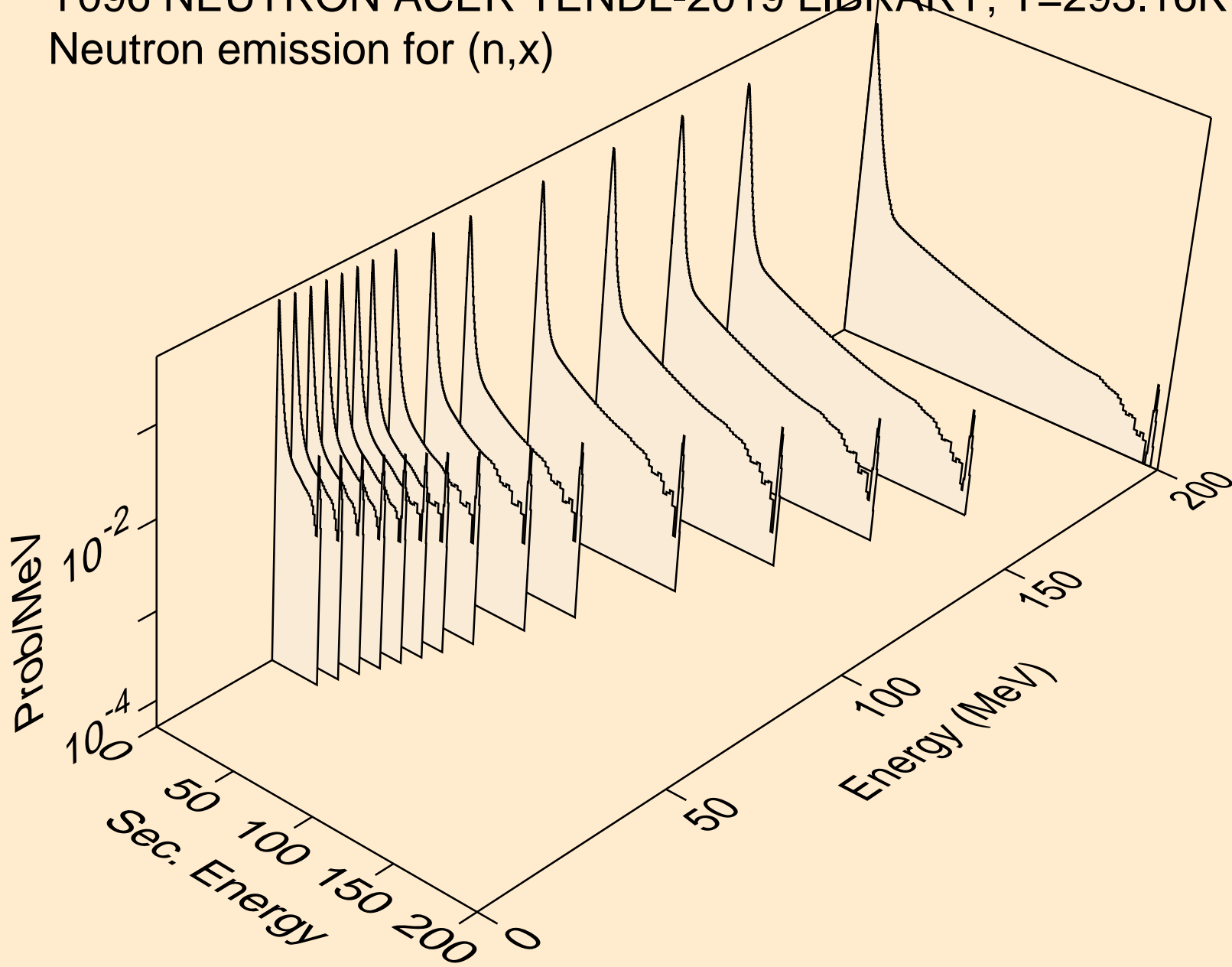

Y096 NEUTRON ACER TENDL-2019 LIBRARY; T=293.16K
Neutron emission for (n,2nd)

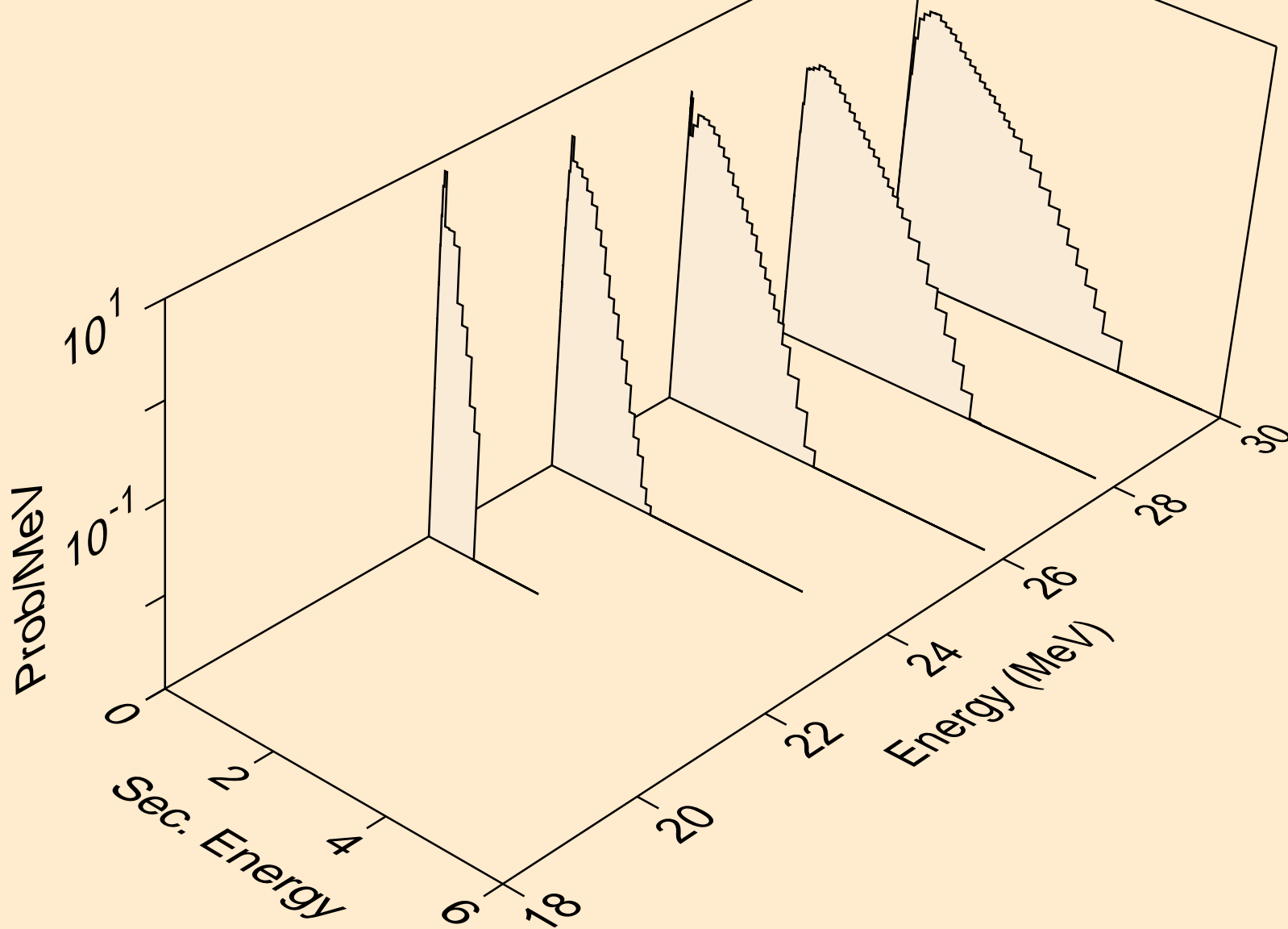

Y096 NEUTRON ACER TENDL-2019 LIBRARY; T=293.16K
Neutron emission for (n,2n)

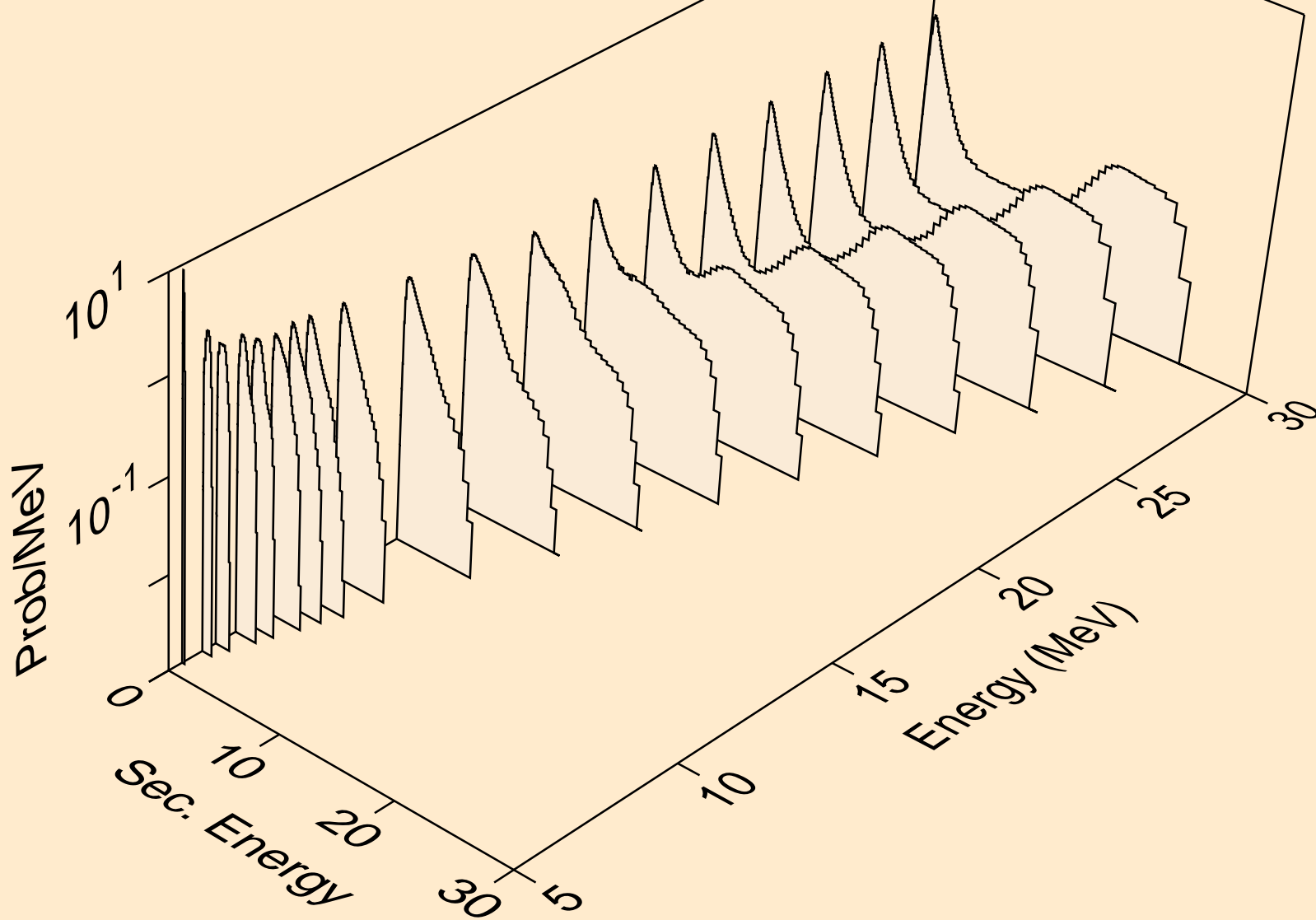

Y096 NEUTRON ACER TENDL-2019 LIBRARY; T=293.16K
Neutron emission for (n,3n)

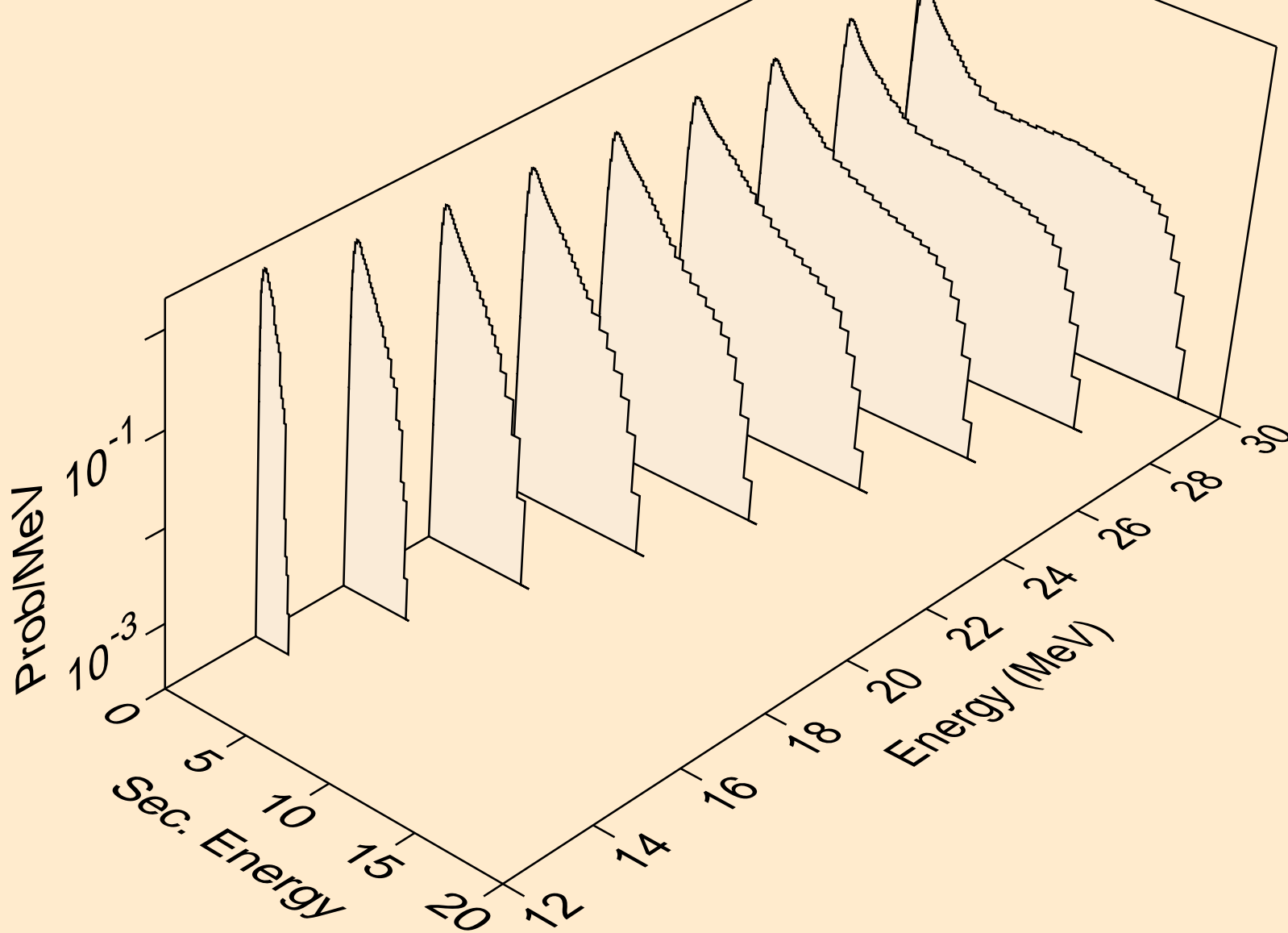

Y096 NEUTRON ACER TENDL-2019 LIBRARY; T=293.16K
Neutron emission for (n,n*)a

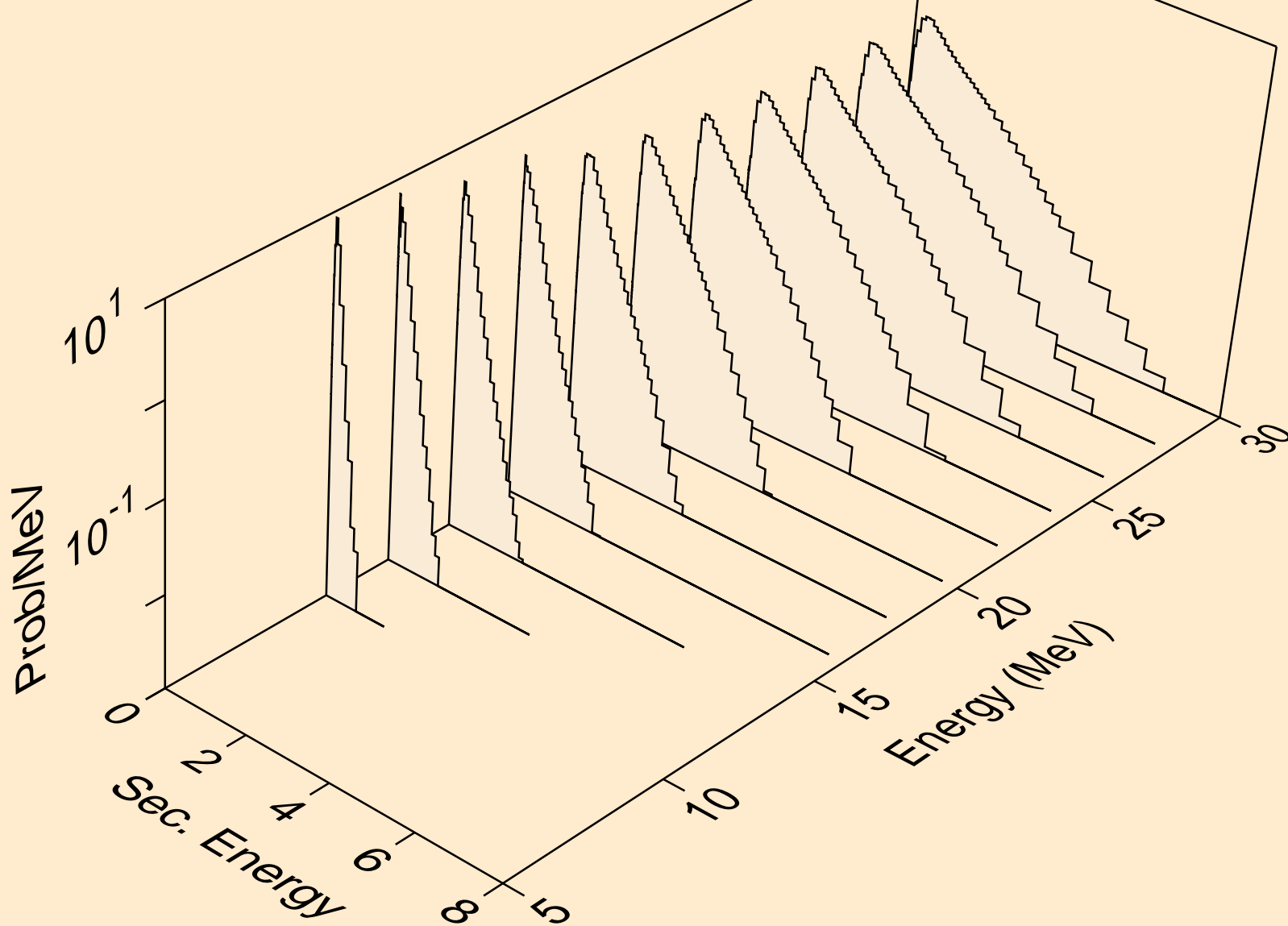

Y096 NEUTRON ACER TENDL-2019 LIBRARY; T=293.16K
Neutron emission for (n,2n)a

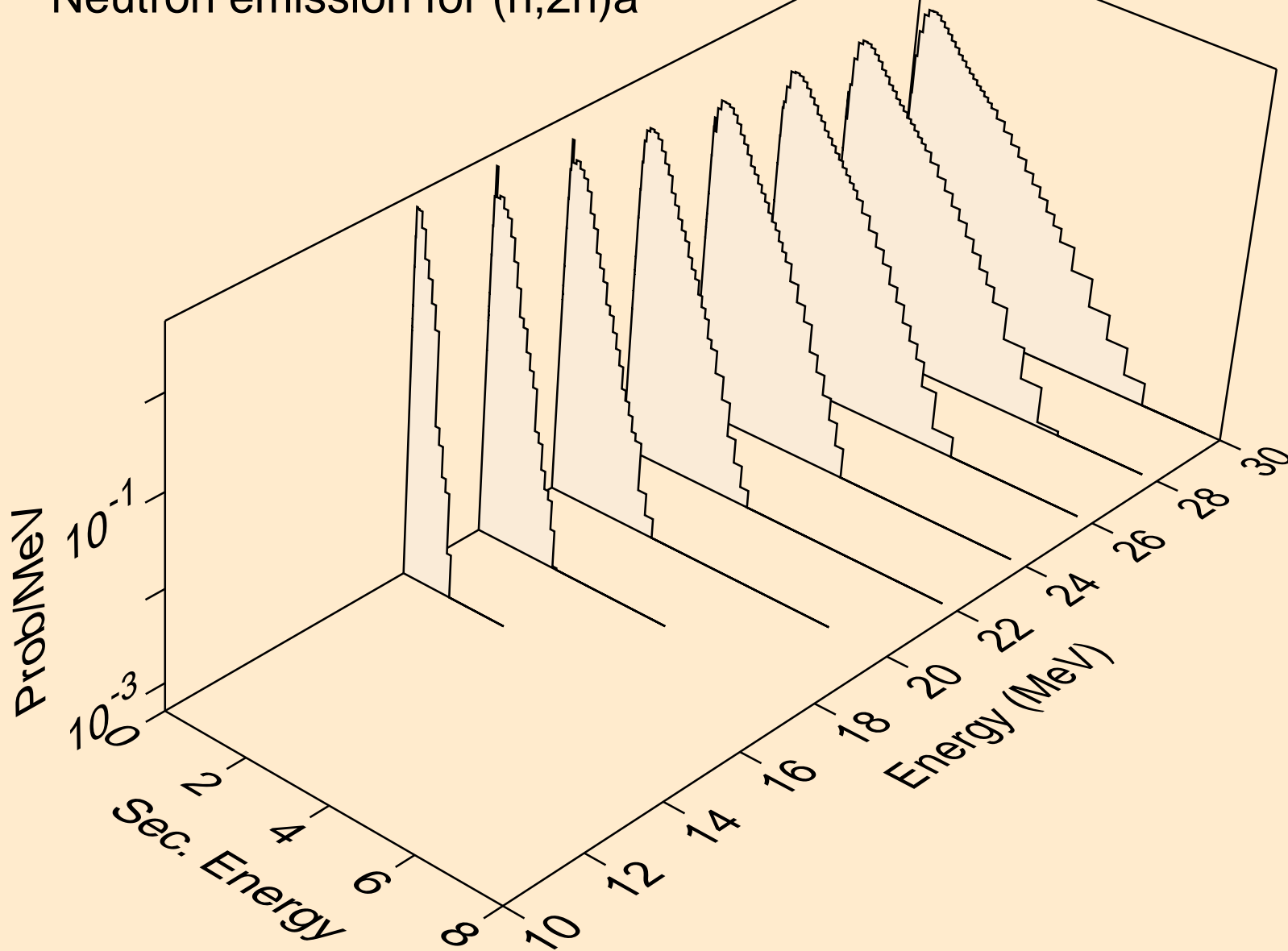

Y096 NEUTRON ACER TENDL-2019 LIBRARY; T=293.16K
Neutron emission for (n,3n)a

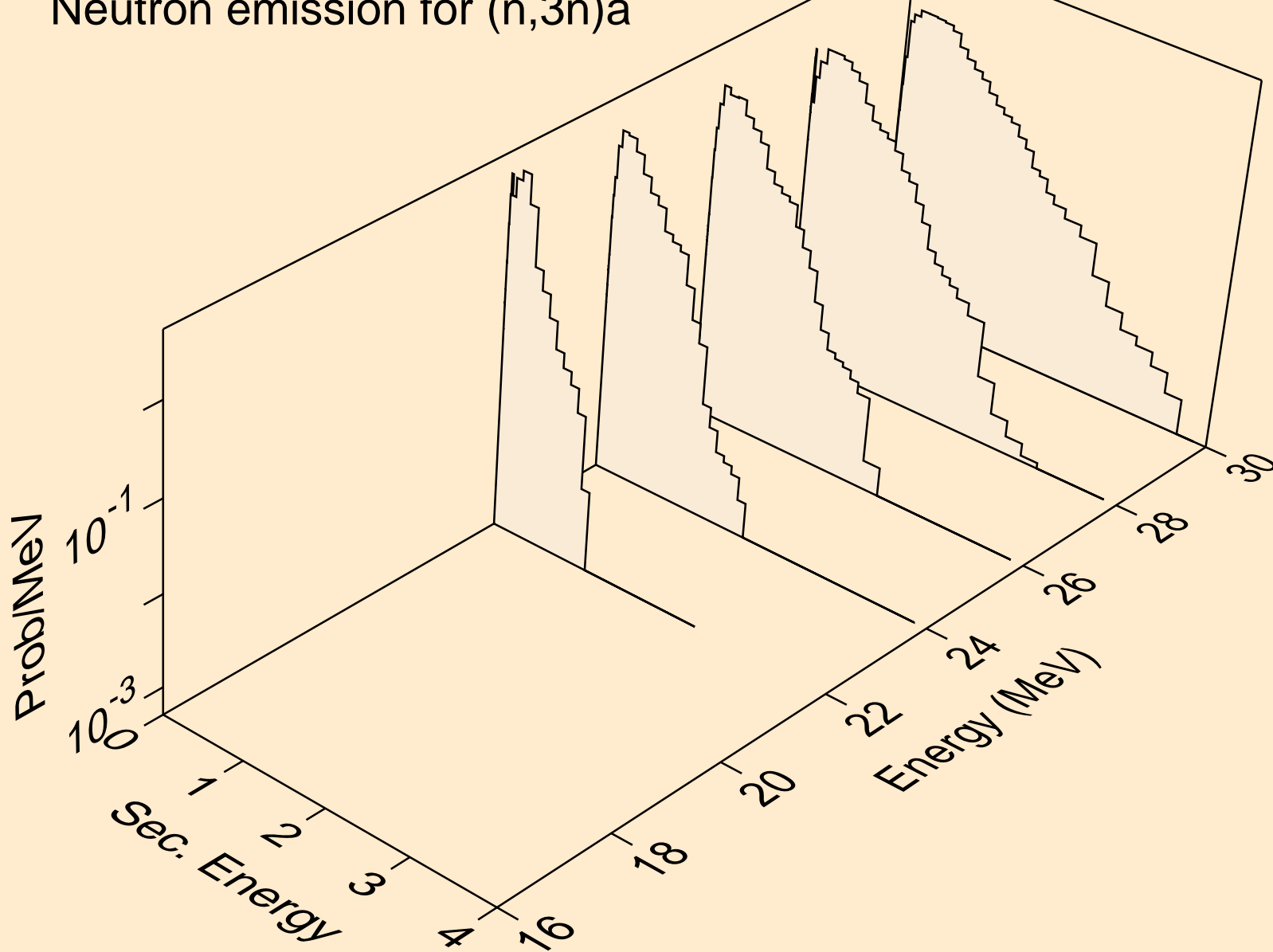

Y096 NEUTRON ACER TENDL-2019 LIBRARY; T=293.16K
Neutron emission for (n,n*)p

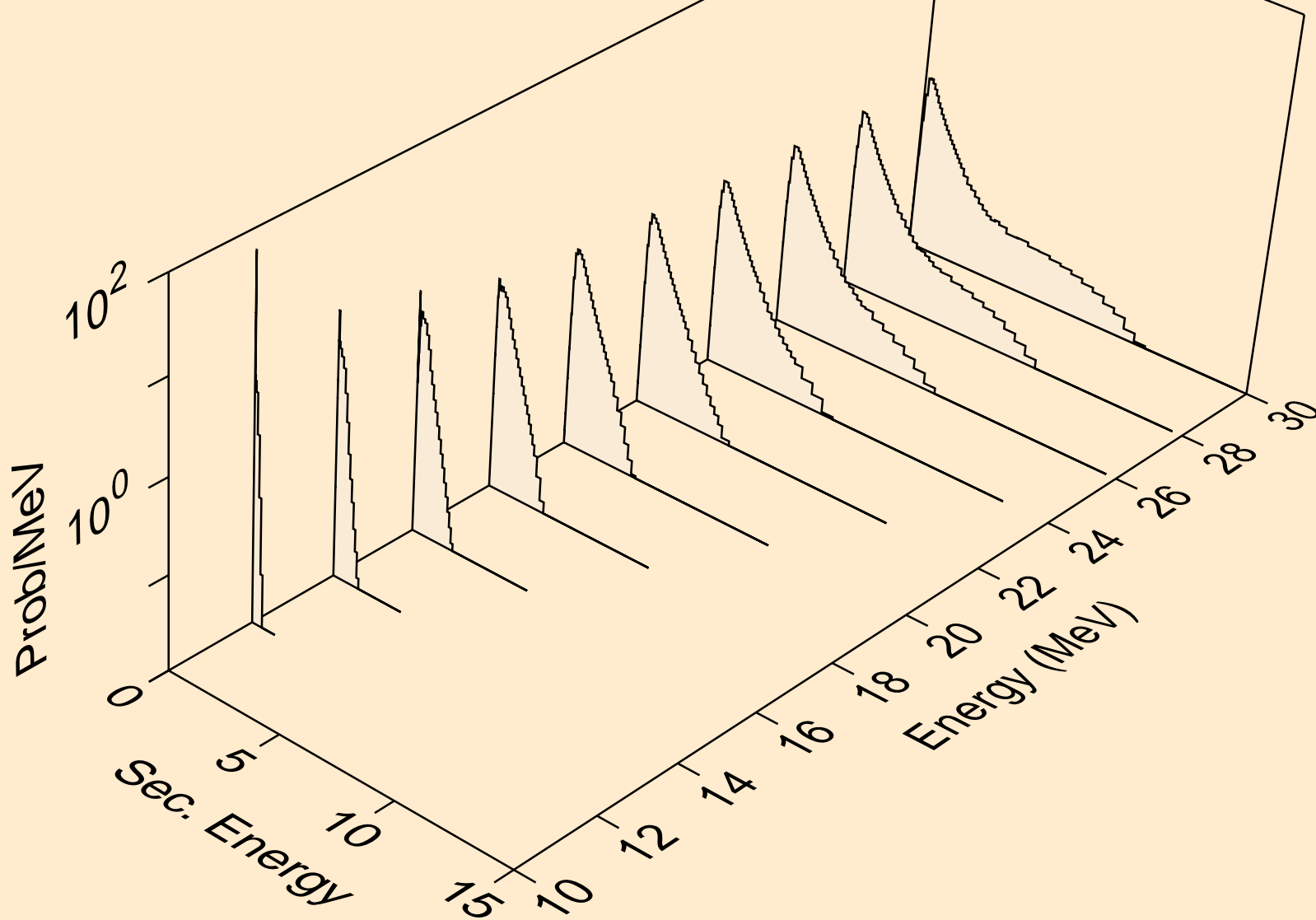

Y096 NEUTRON ACER TENDL-2019 LIBRARY; T=293.16K
Neutron emission for (n,n*)d

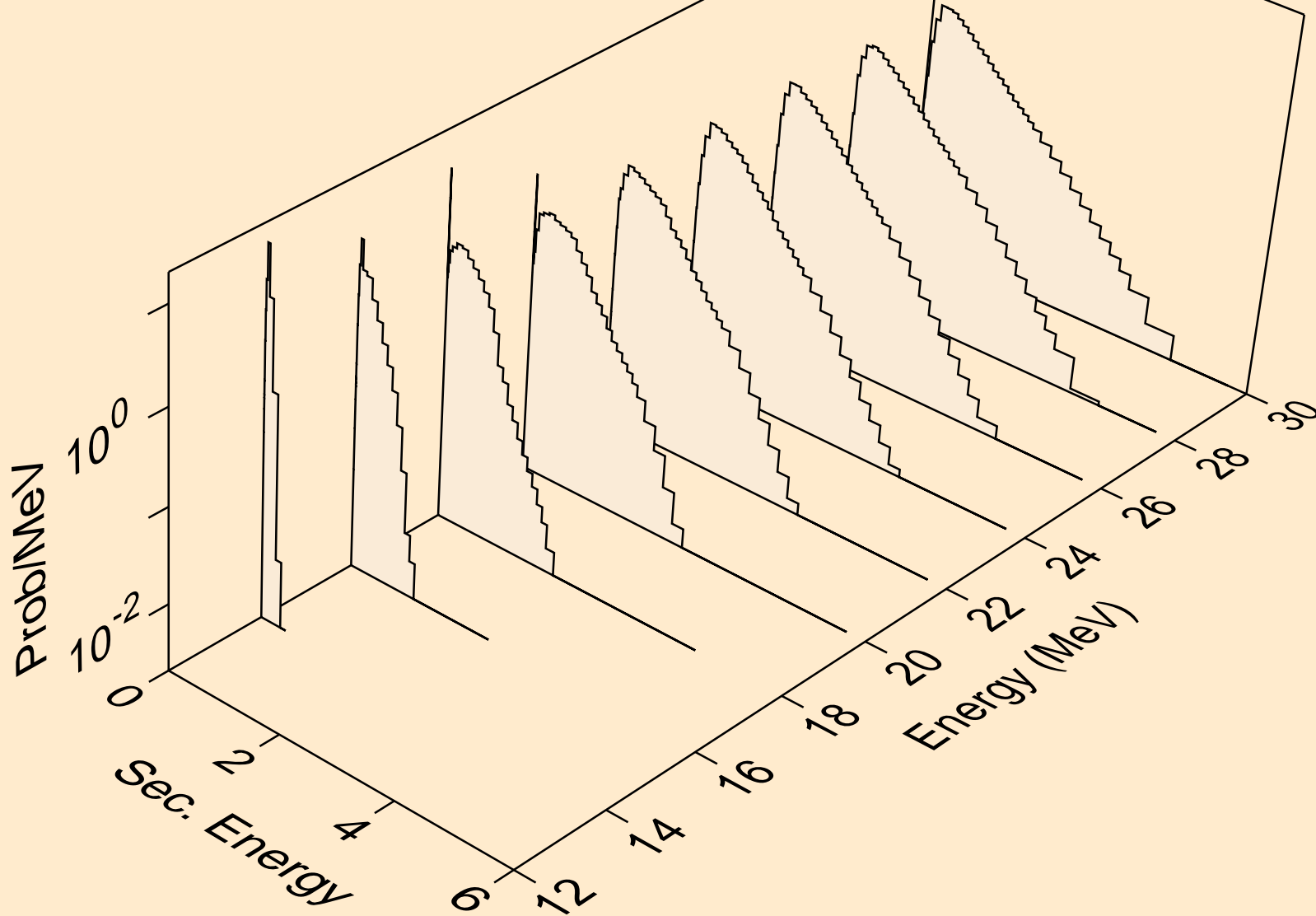

Y096 NEUTRON ACER TENDL-2019 LIBRARY; T=293.16K
Neutron emission for (n,n*)t

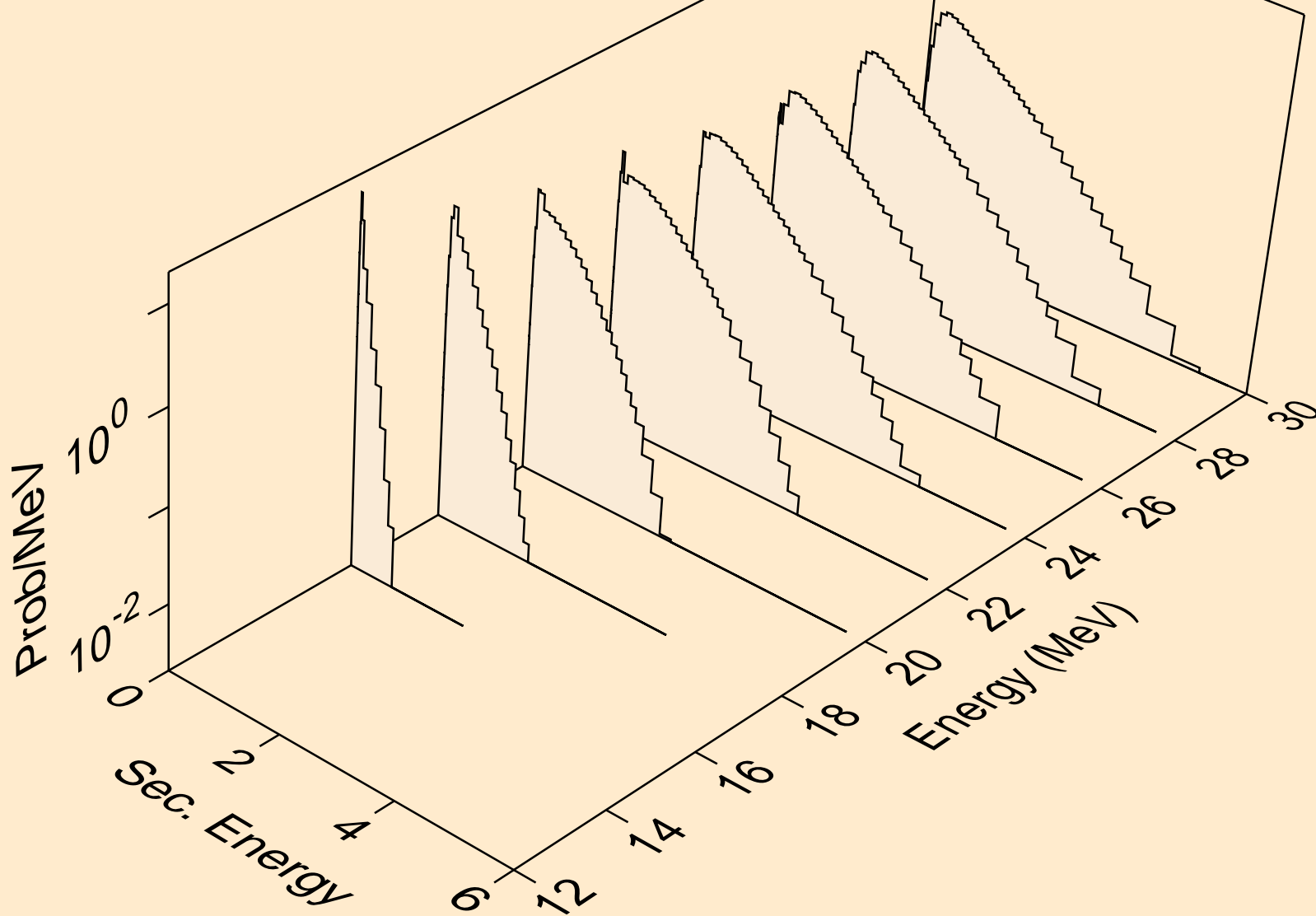

Y096 NEUTRON ACER TENDL-2019 LIBRARY; T=293.16K
Neutron emission for (n,n*)he3

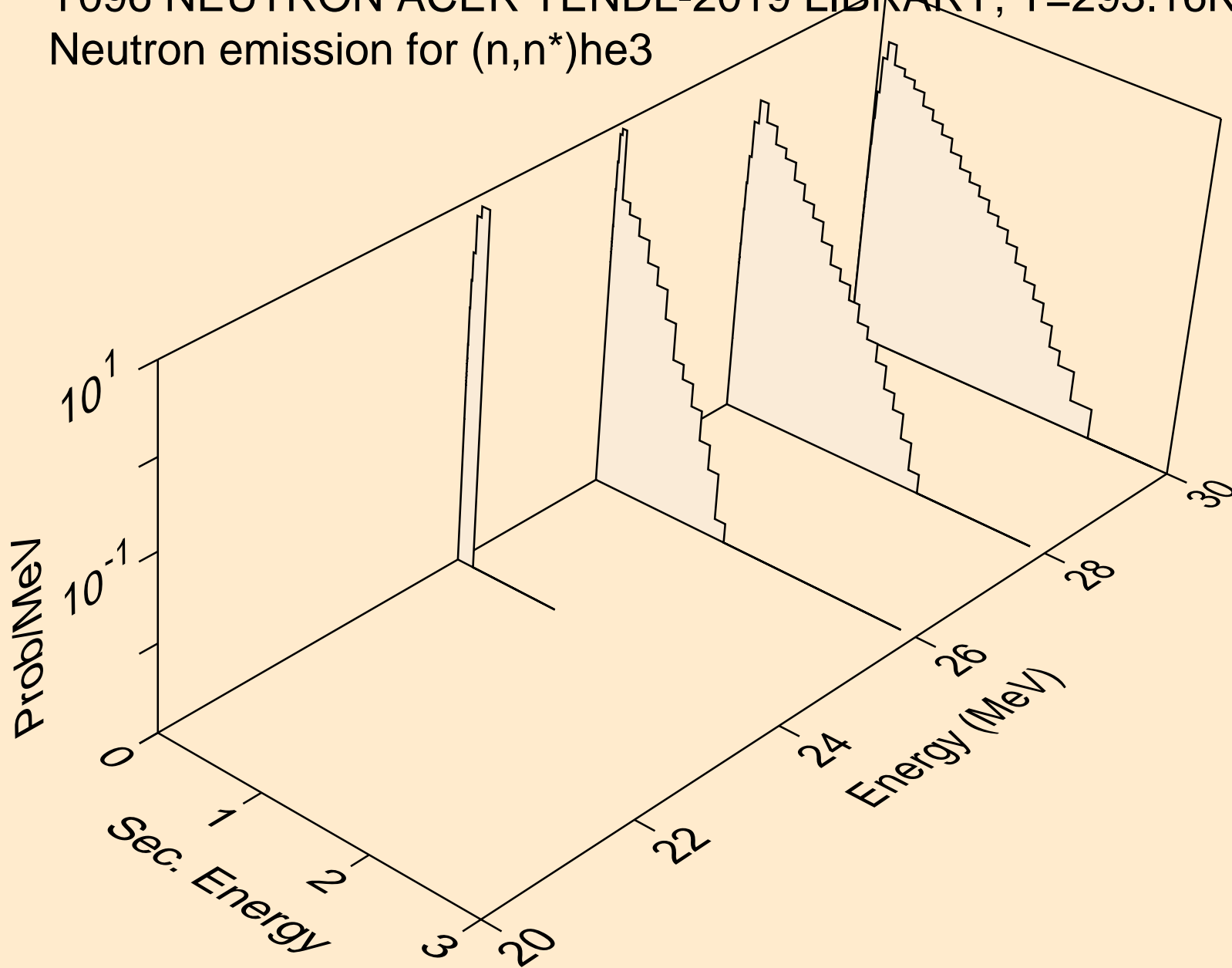

Y096 NEUTRON ACER TENDL-2019 LIBRARY; T=293.16K
Neutron emission for (n,4n)

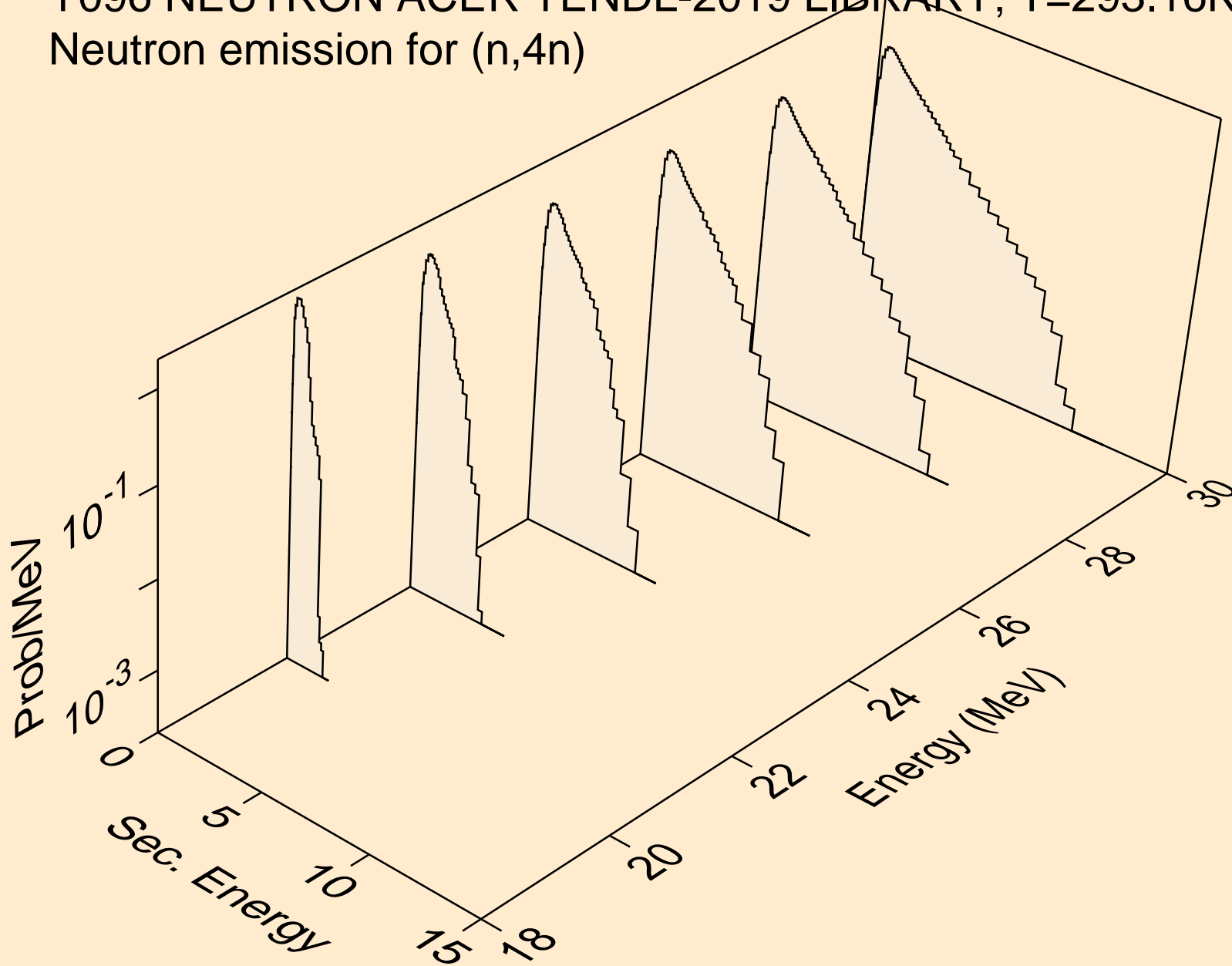

Y096 NEUTRON ACER TENDL-2019 LIBRARY; T=293.16K
Neutron emission for (n,2np)

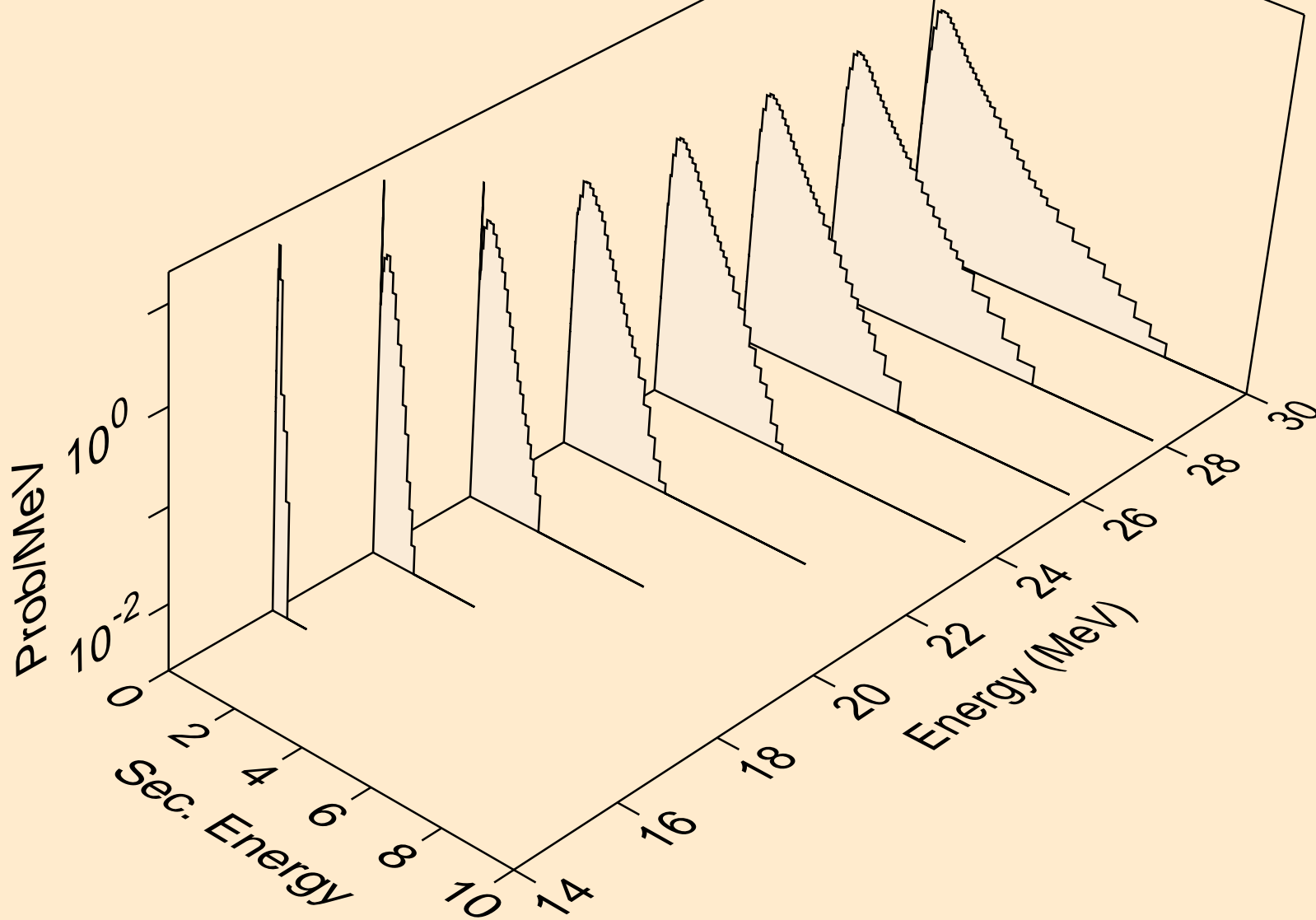

Y096 NEUTRON ACER TENDL-2019 LIBRARY; T=293.16K
Neutron emission for (n,3np)

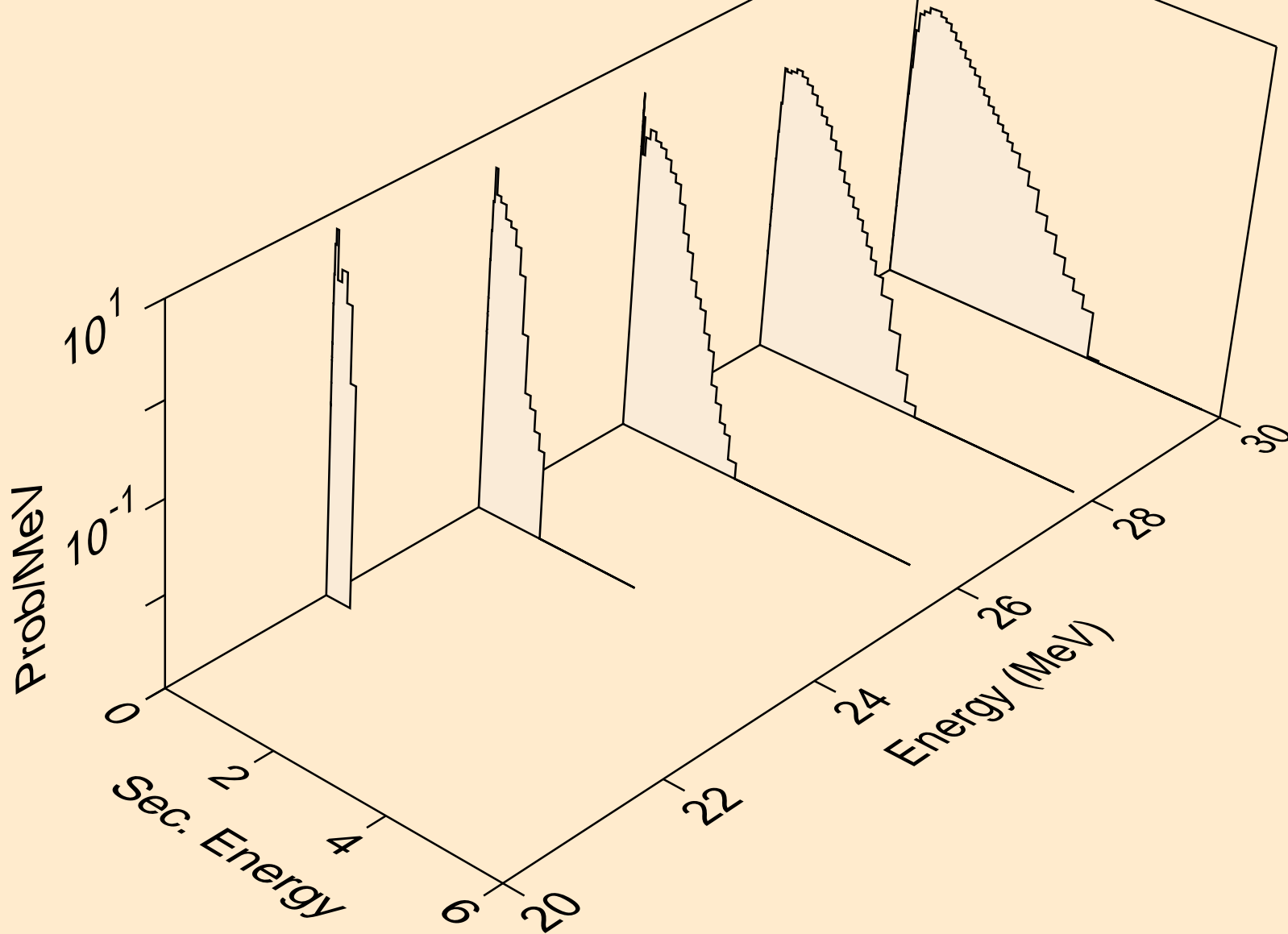

Y096 NEUTRON ACER TENDL-2019 LIBRARY; T=293.16K
Neutron emission for (n,n*c)

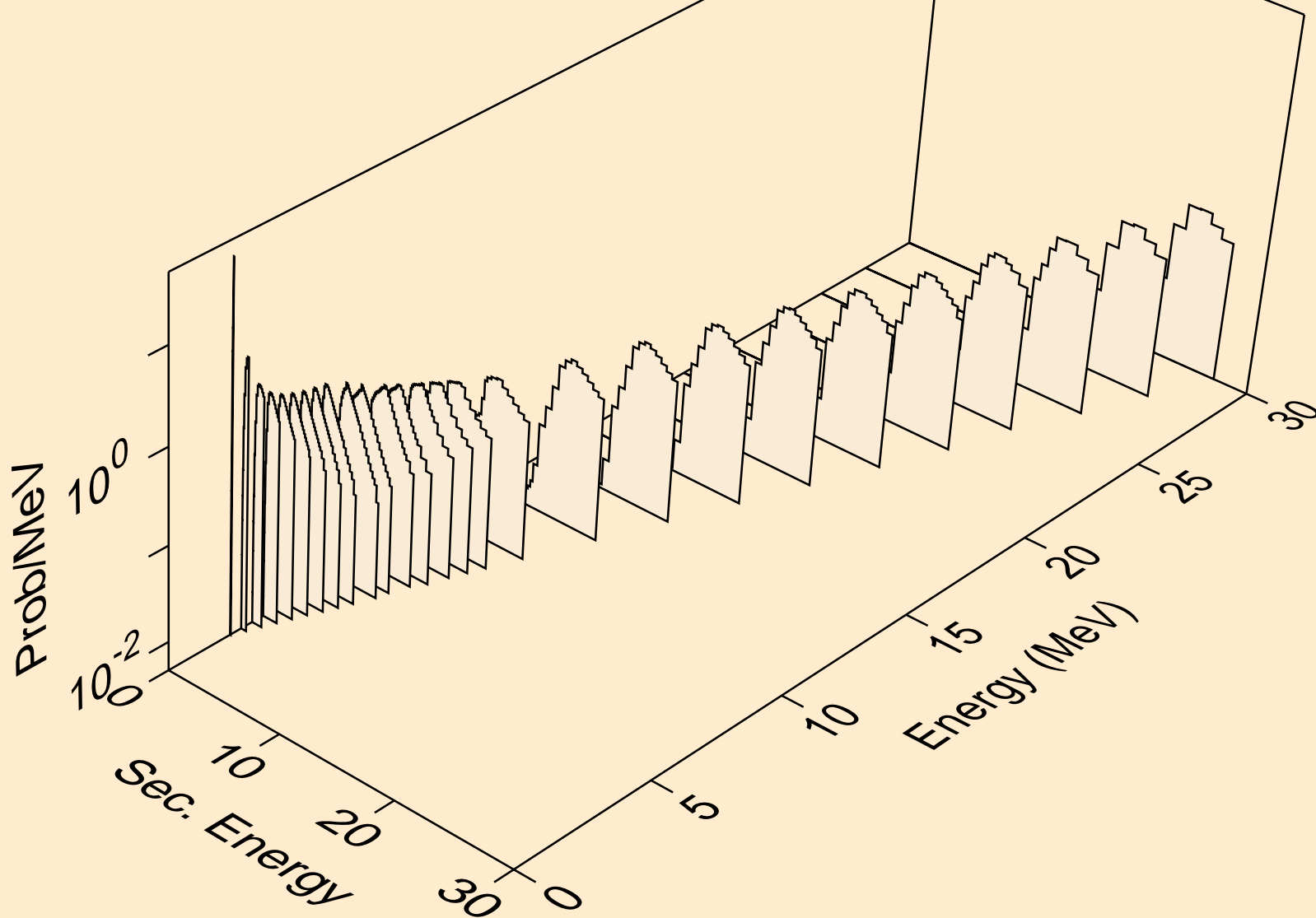

Y096 NEUTRON ACER TENDL-2019 LIBRARY; T=293.16K
Photon emission for (n,x)

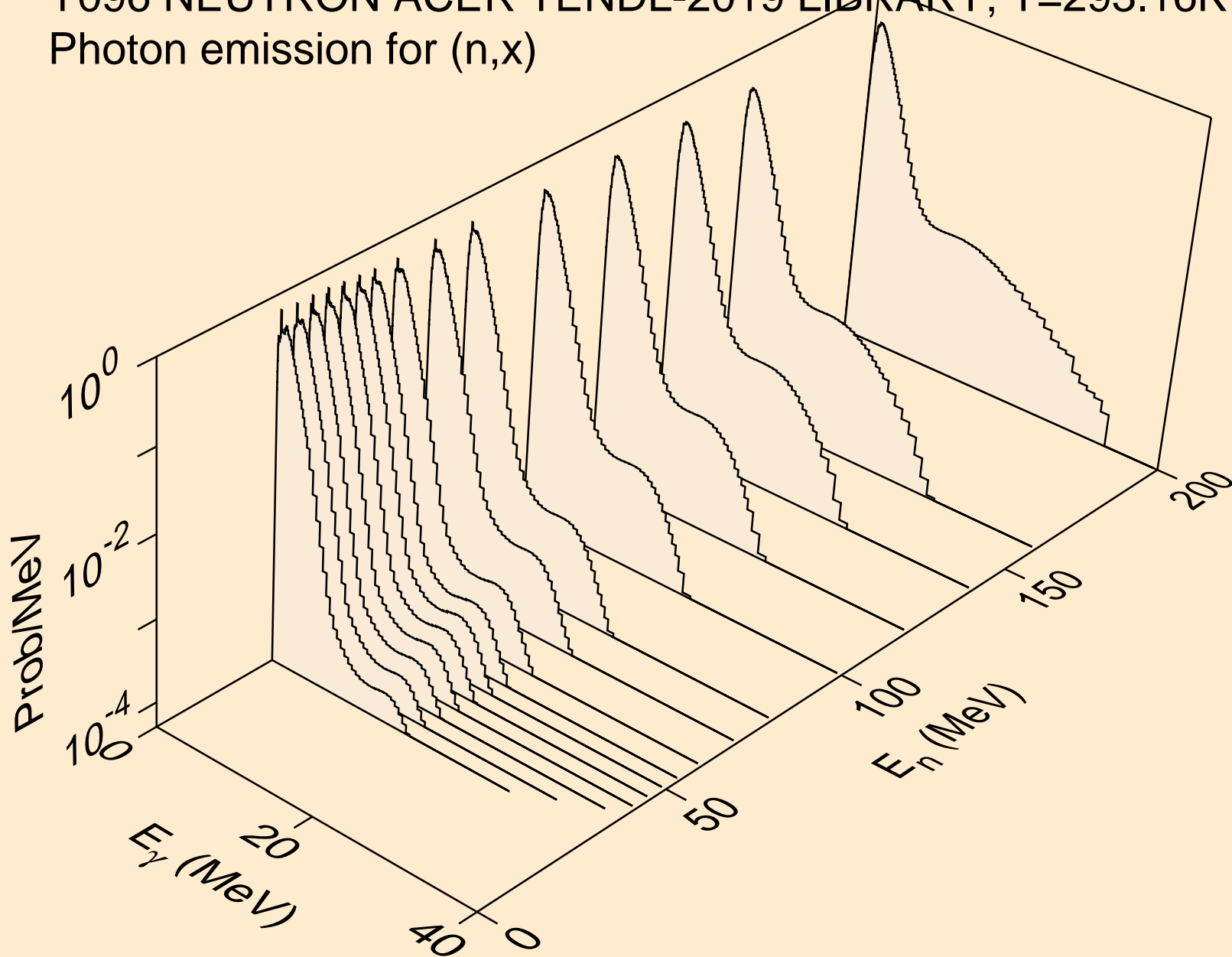

Y096 NEUTRON ACER TENDL-2019 LIBRARY; T=293.16K
Photon emission for (n,2nd)

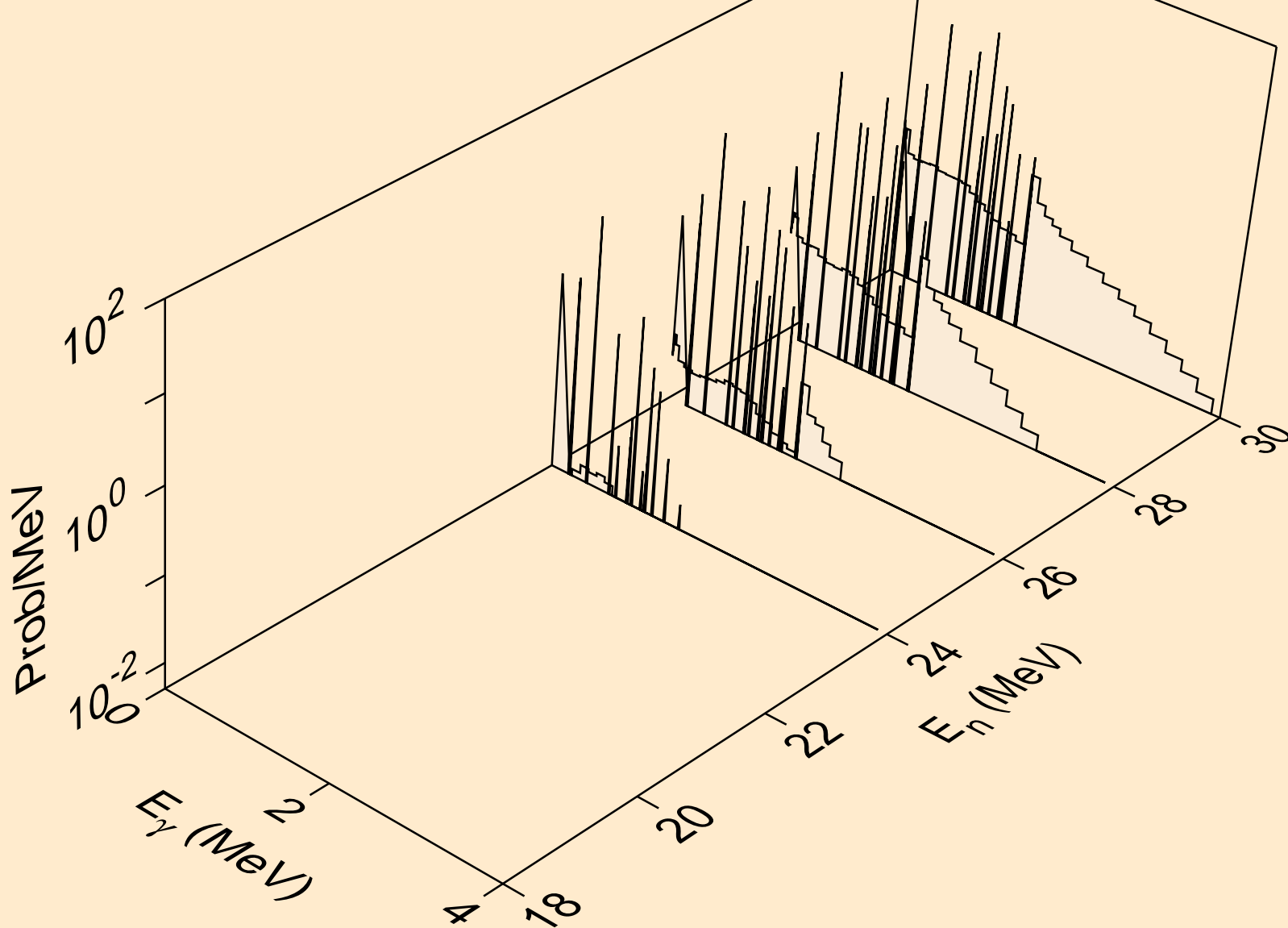

Y096 NEUTRON ACER TENDL-2019 LIBRARY; T=293.16K
Photon emission for (n,2n)

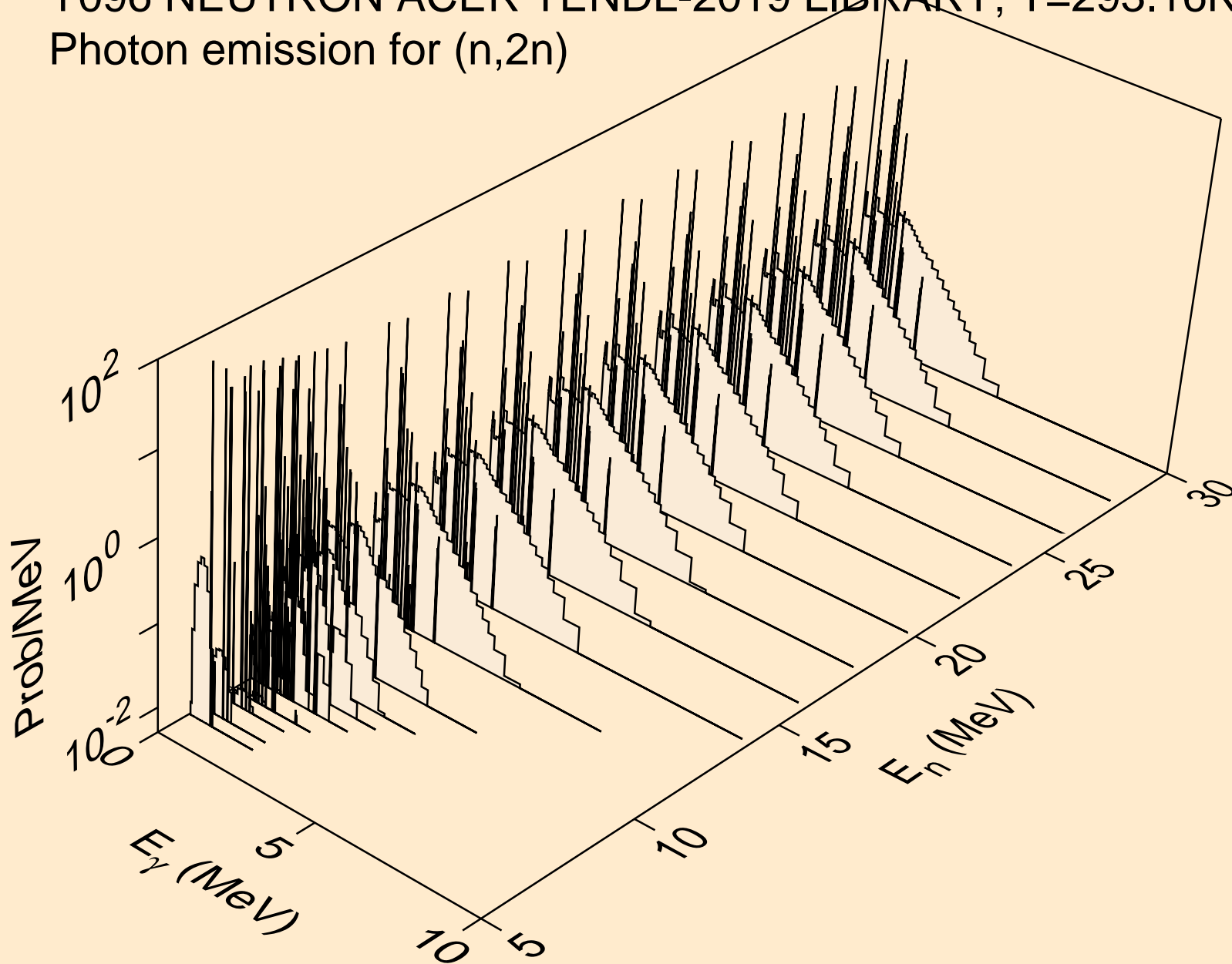

Y096 NEUTRON ACER TENDL-2019 LIBRARY; T=293.16K
Photon emission for (n,3n)

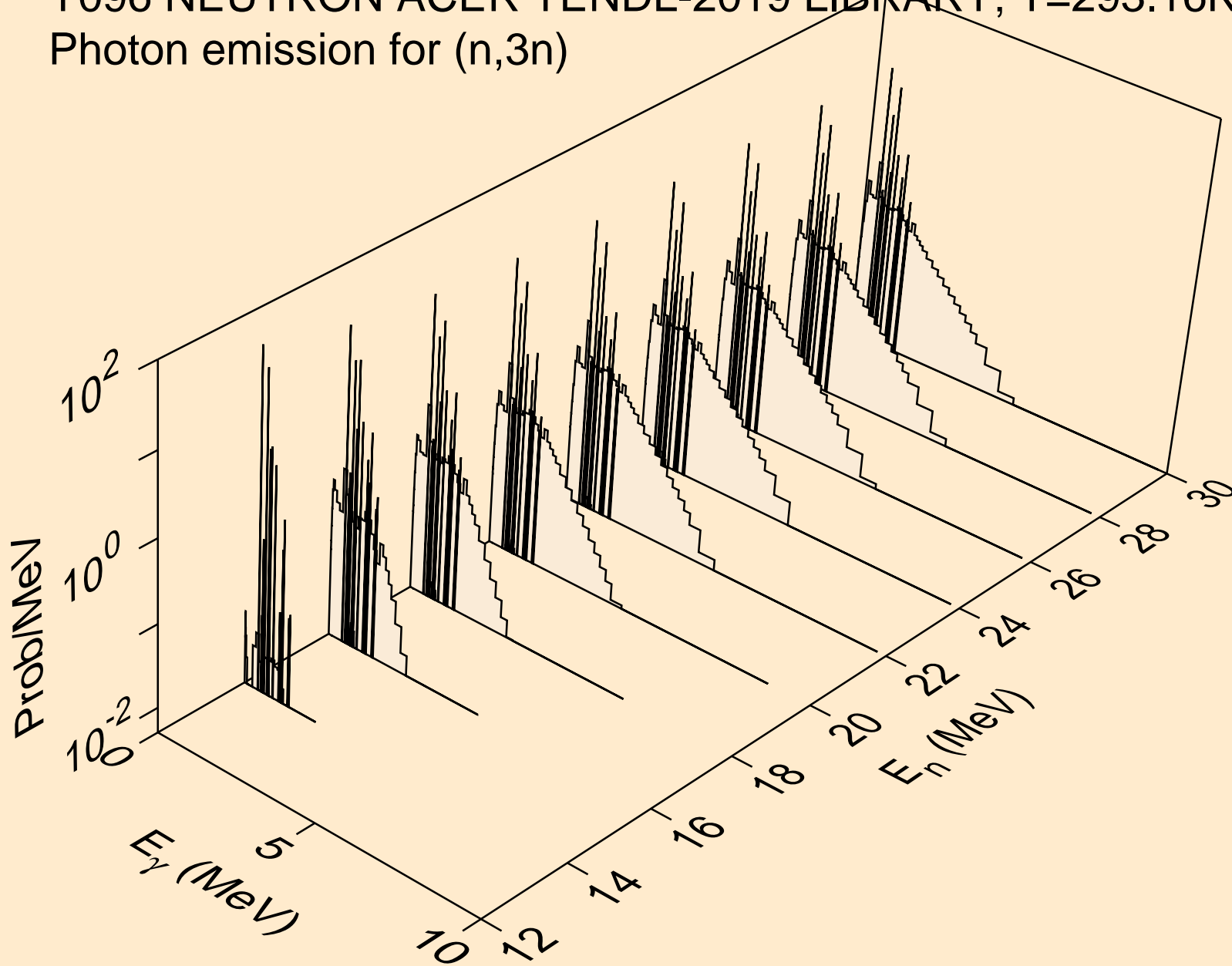

Y096 NEUTRON ACER TENDL-2019 LIBRARY; T=293.16K
Photon emission for (n,n*)a

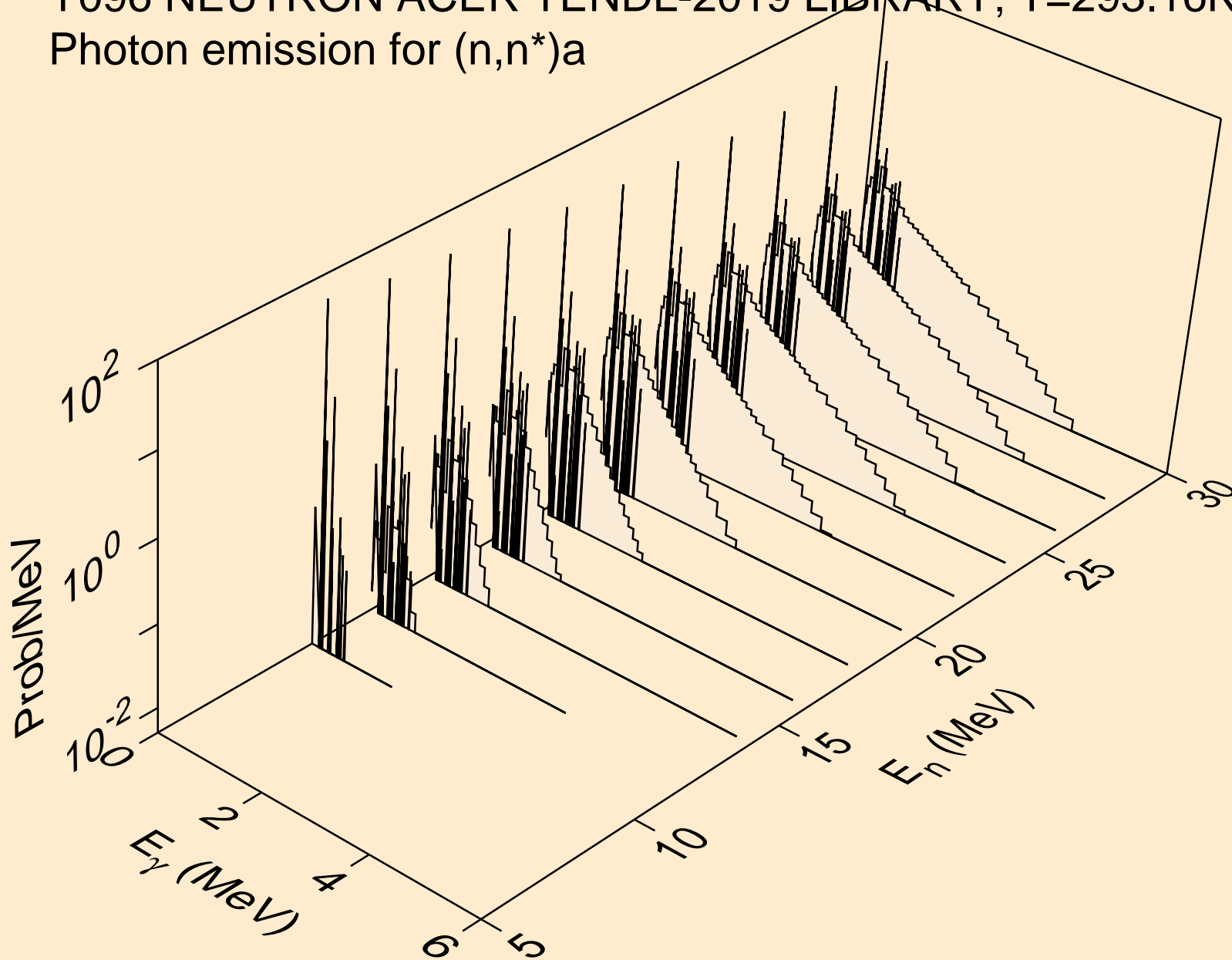

Y096 NEUTRON ACER TENDL-2019 LIBRARY; T=293.16K
Photon emission for (n,2n) α

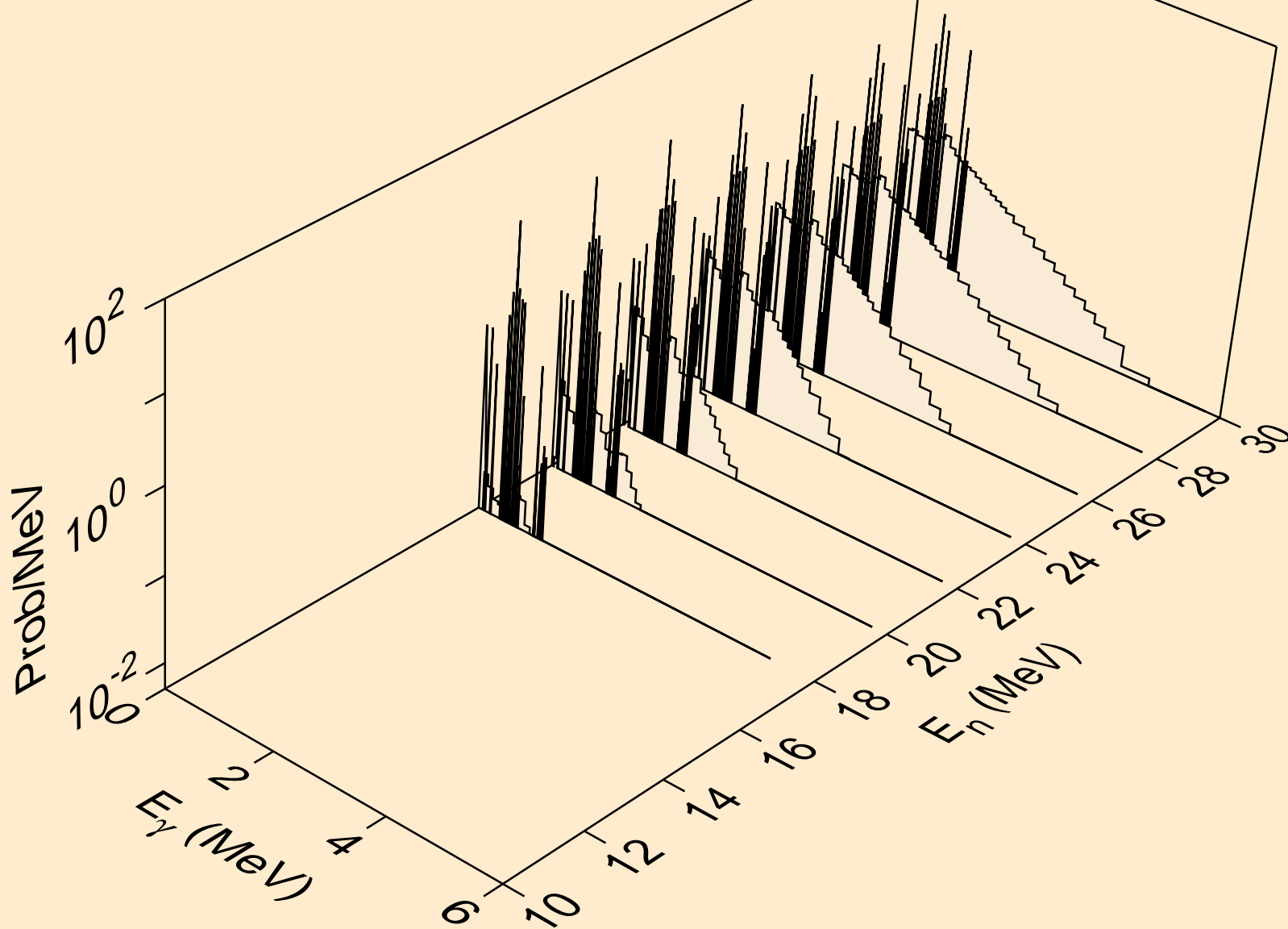

Y096 NEUTRON ACER TENDL-2019 LIBRARY; T=293.16K
Photon emission for (n,3n)a

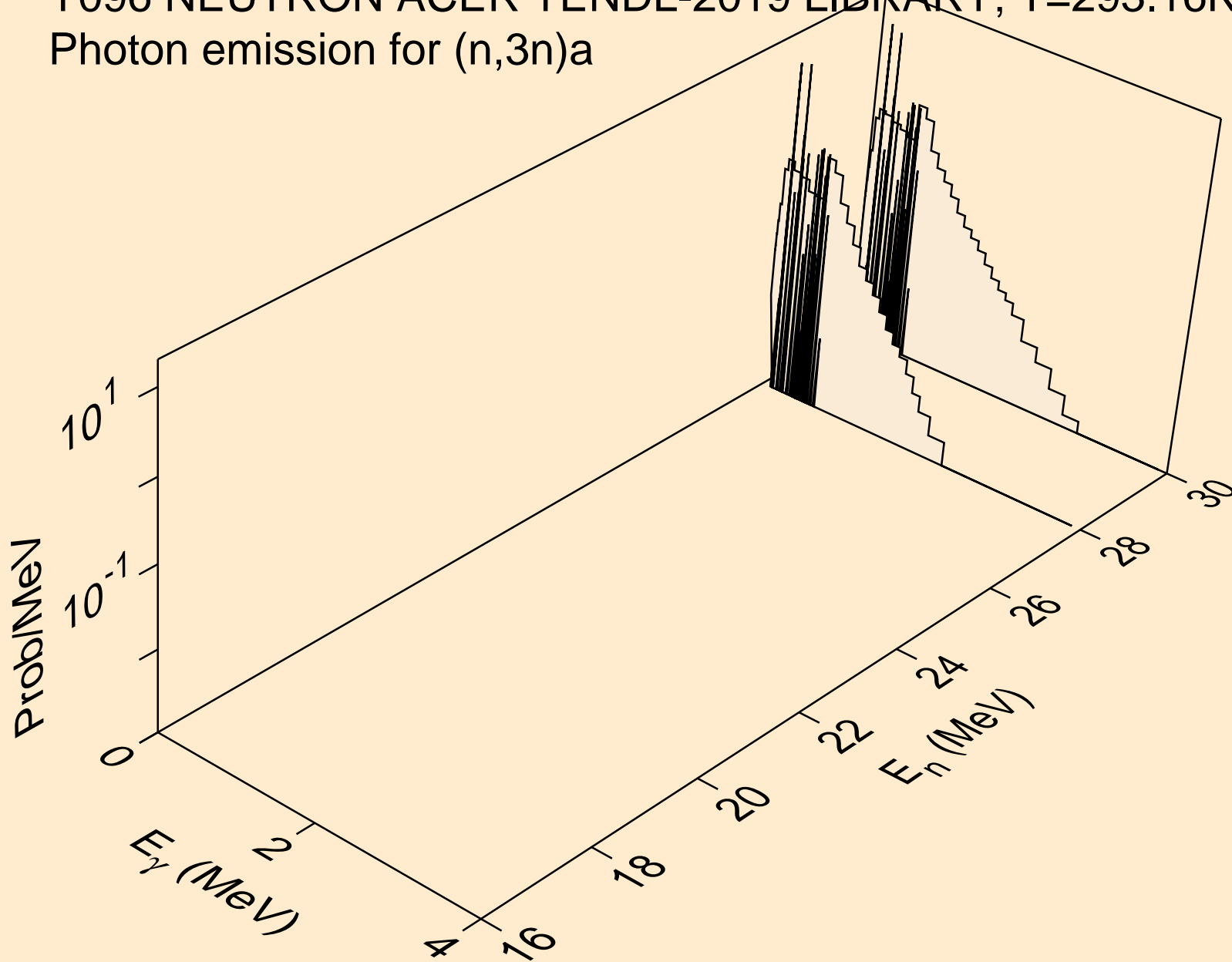

Y096 NEUTRON ACER TENDL-2019 LIBRARY; T=293.16K
Photon emission for (n,n*)p

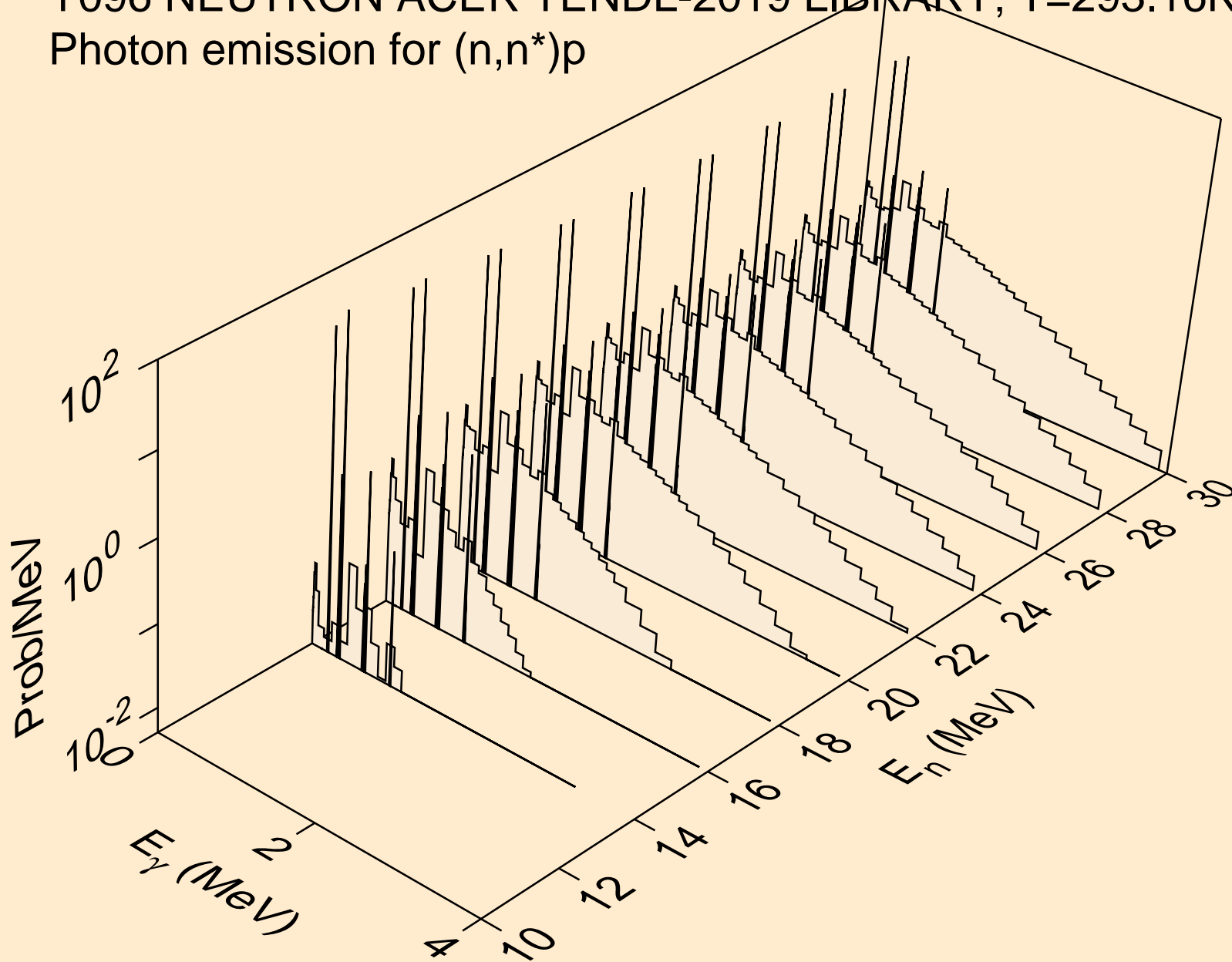

Y096 NEUTRON ACER TENDL-2019 LIBRARY; T=293.16K
Photon emission for (n,n*)d

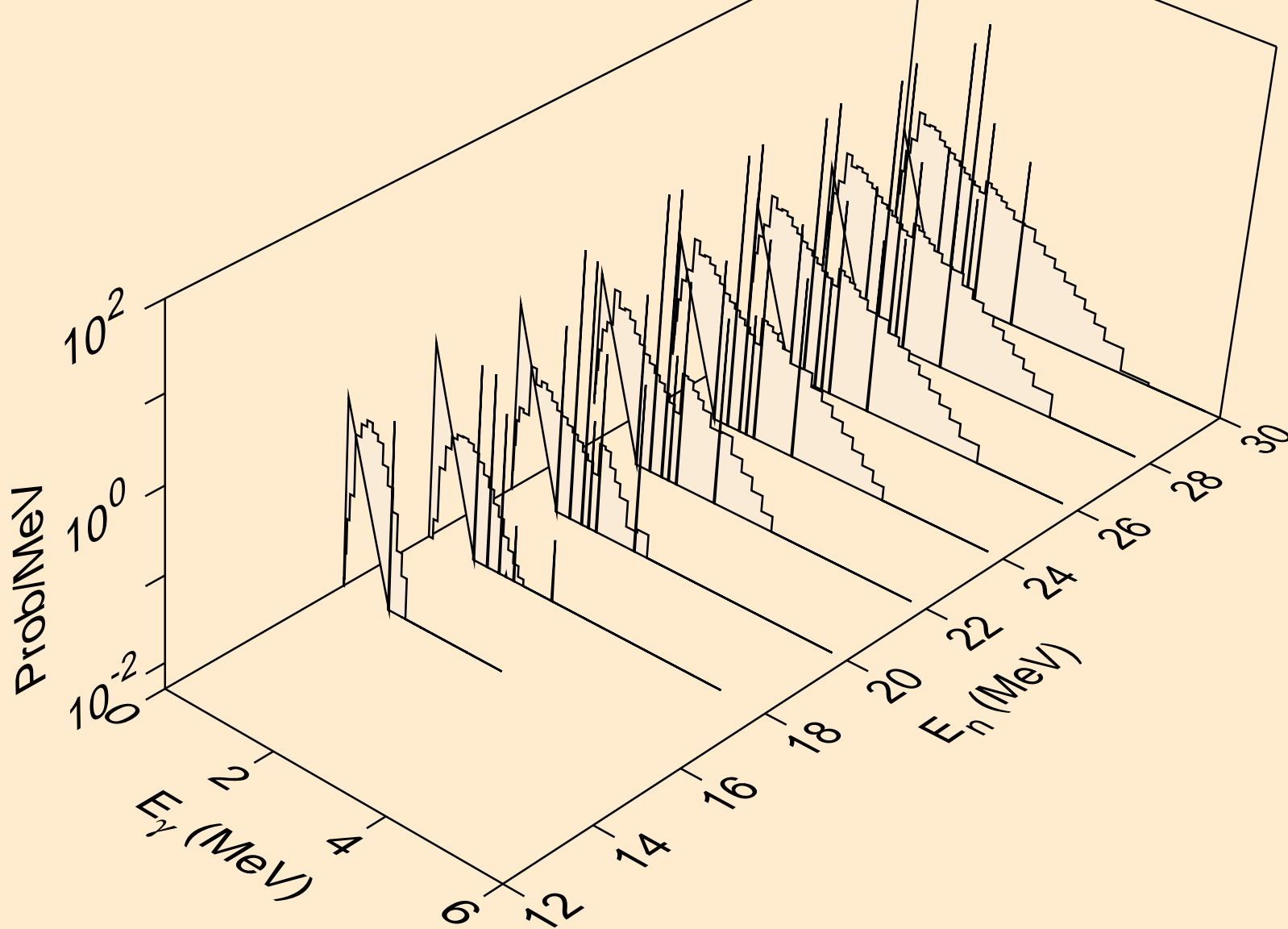

Y096 NEUTRON ACER TENDL-2019 LIBRARY; T=293.16K
Photon emission for (n,n*)t

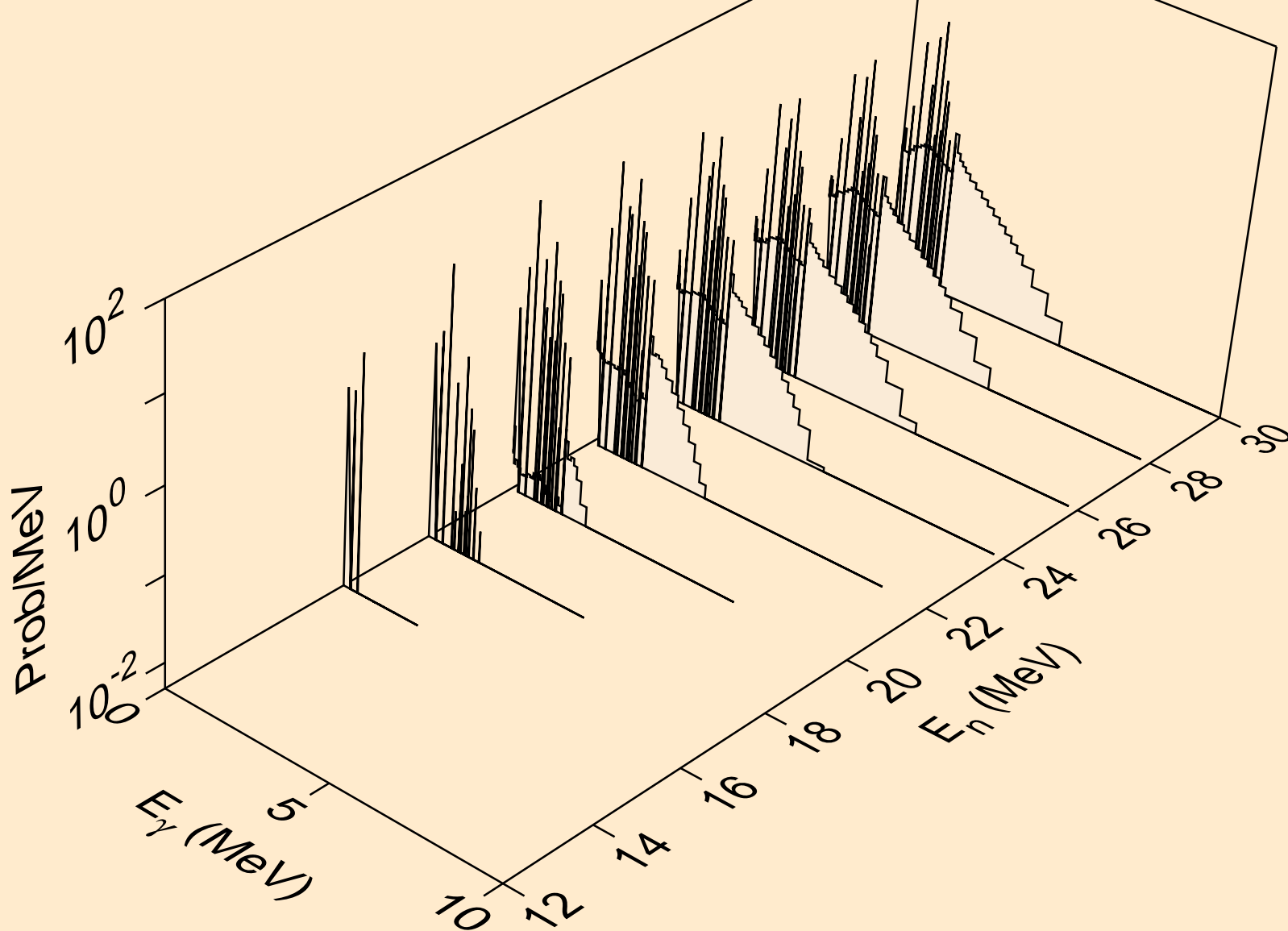

Y096 NEUTRON ACER TENDL-2019 LIBRARY; T=293.16K
Photon emission for (n,n*)he3

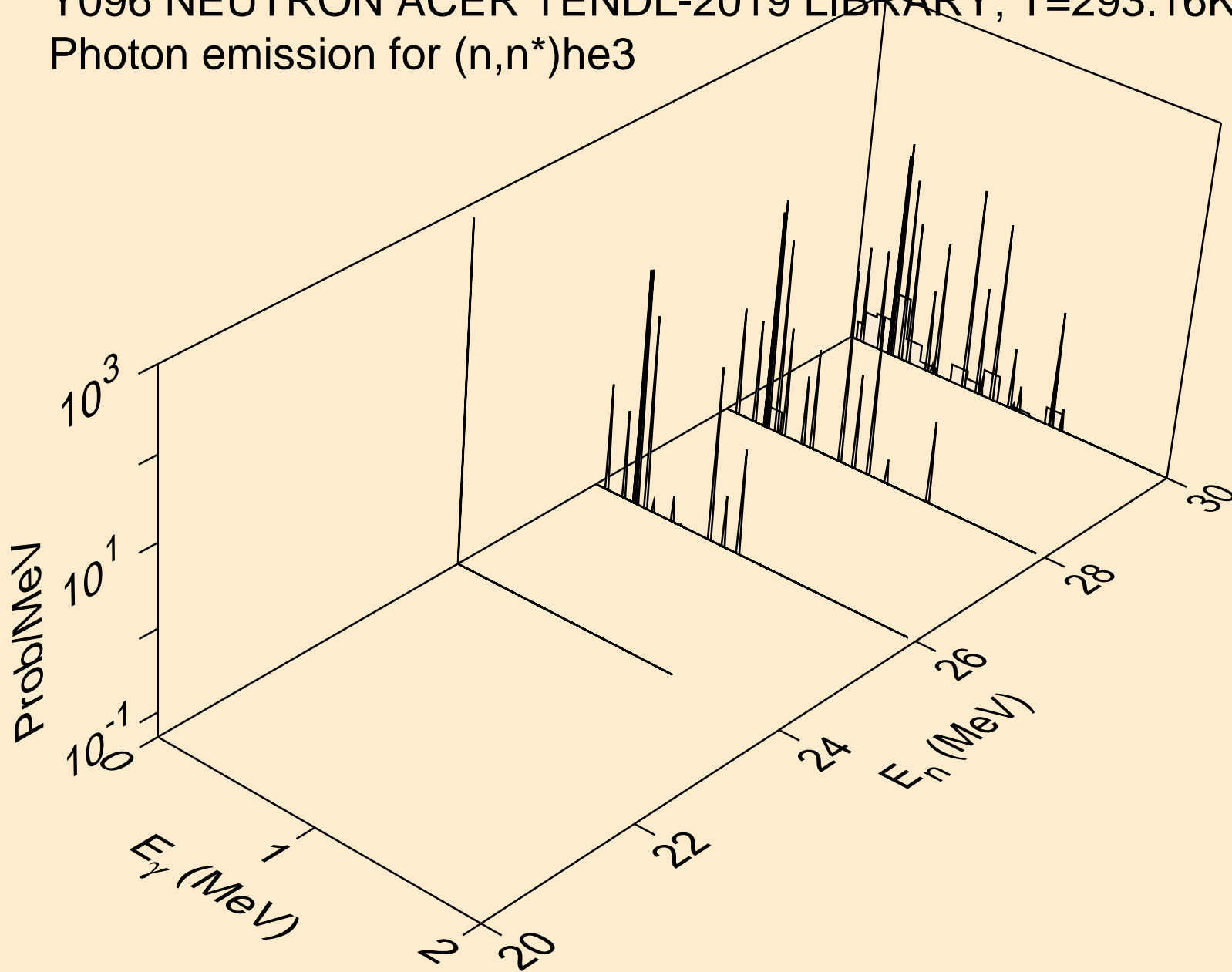

Y096 NEUTRON ACER TENDL-2019 LIBRARY; T=293.16K
Photon emission for (n,4n)

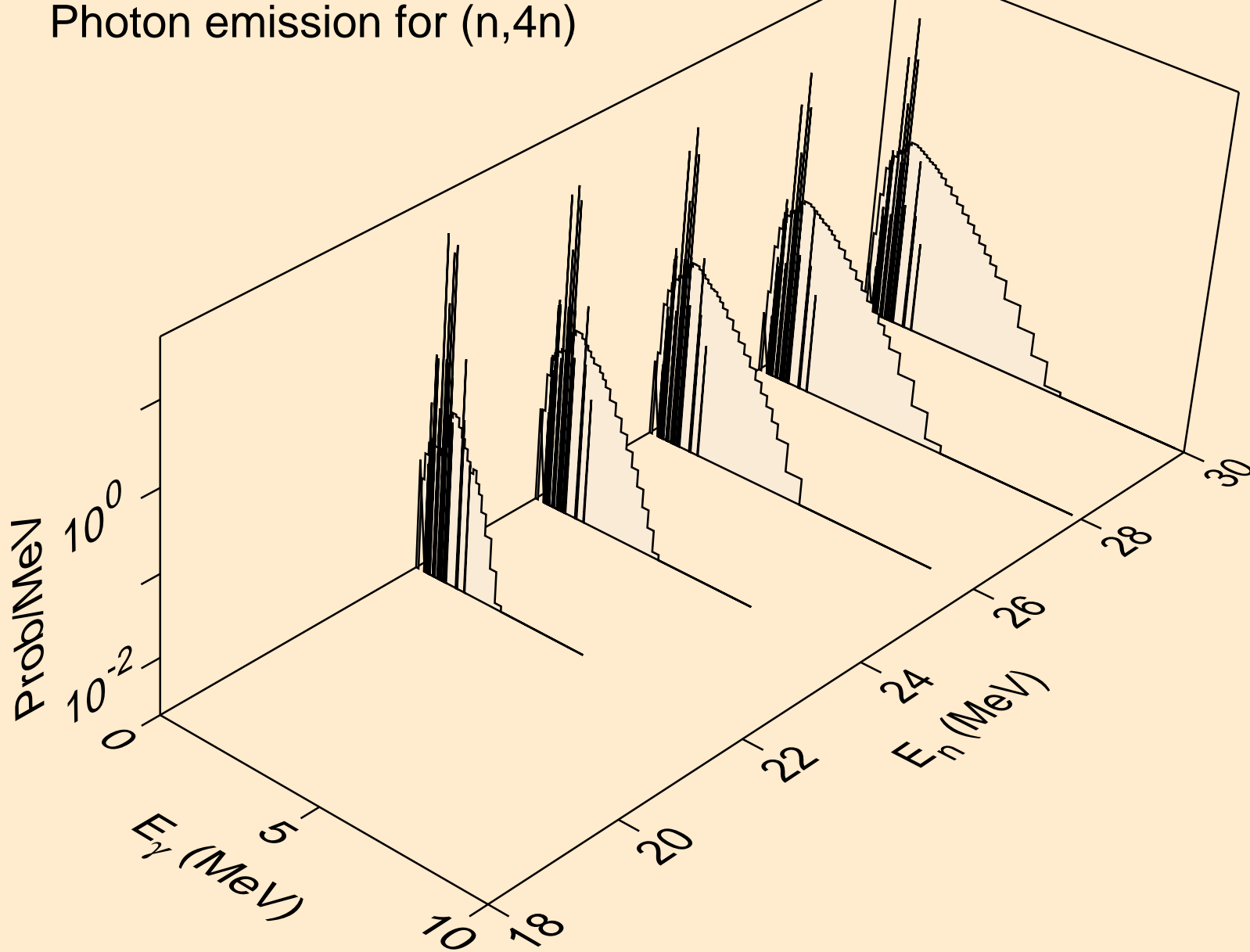

Y096 NEUTRON ACER TENDL-2019 LIBRARY; T=293.16K
Photon emission for (n,2np)

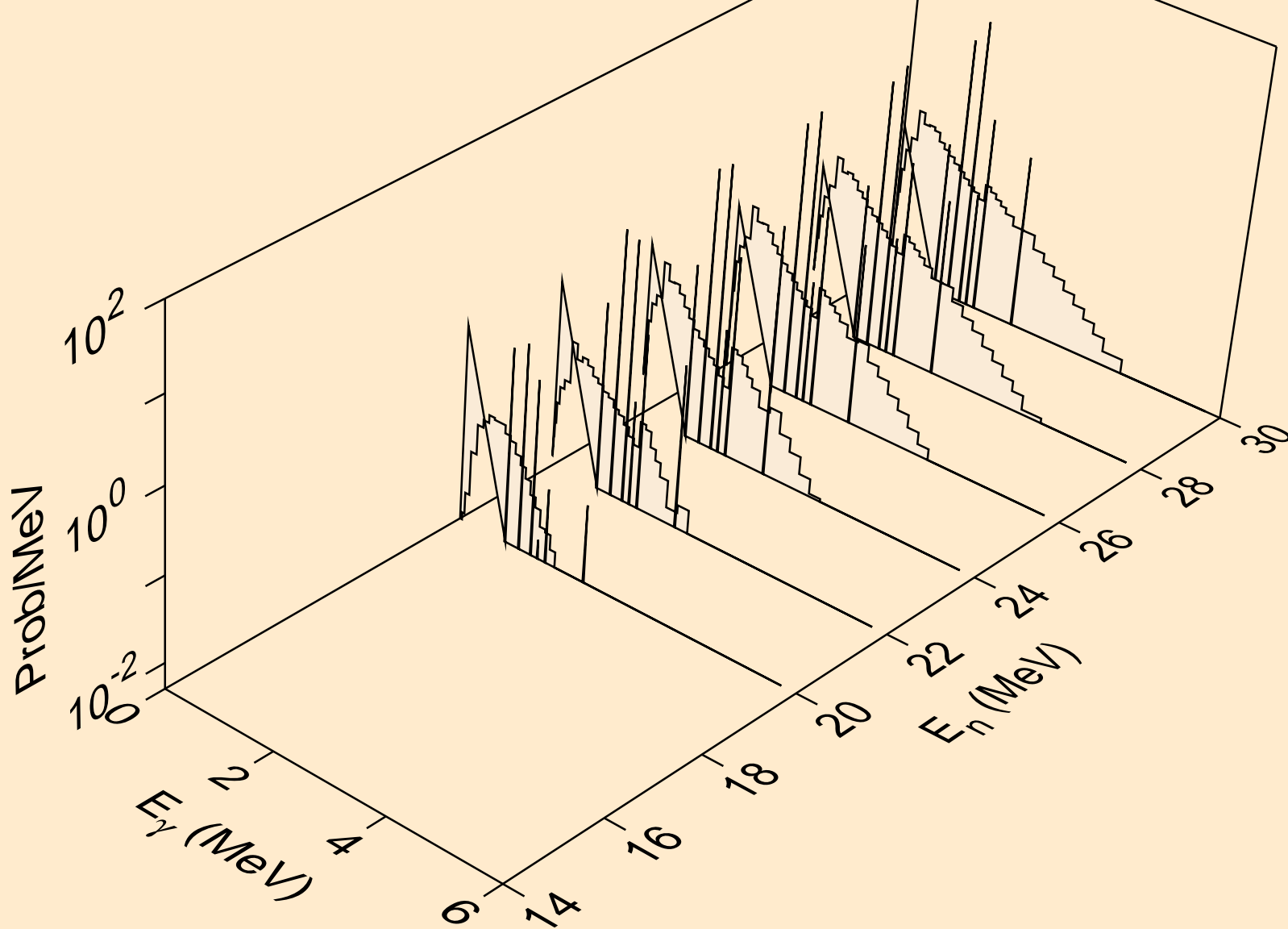

Y096 NEUTRON ACER TENDL-2019 LIBRARY; T=293.16K
Photon emission for (n,3np)

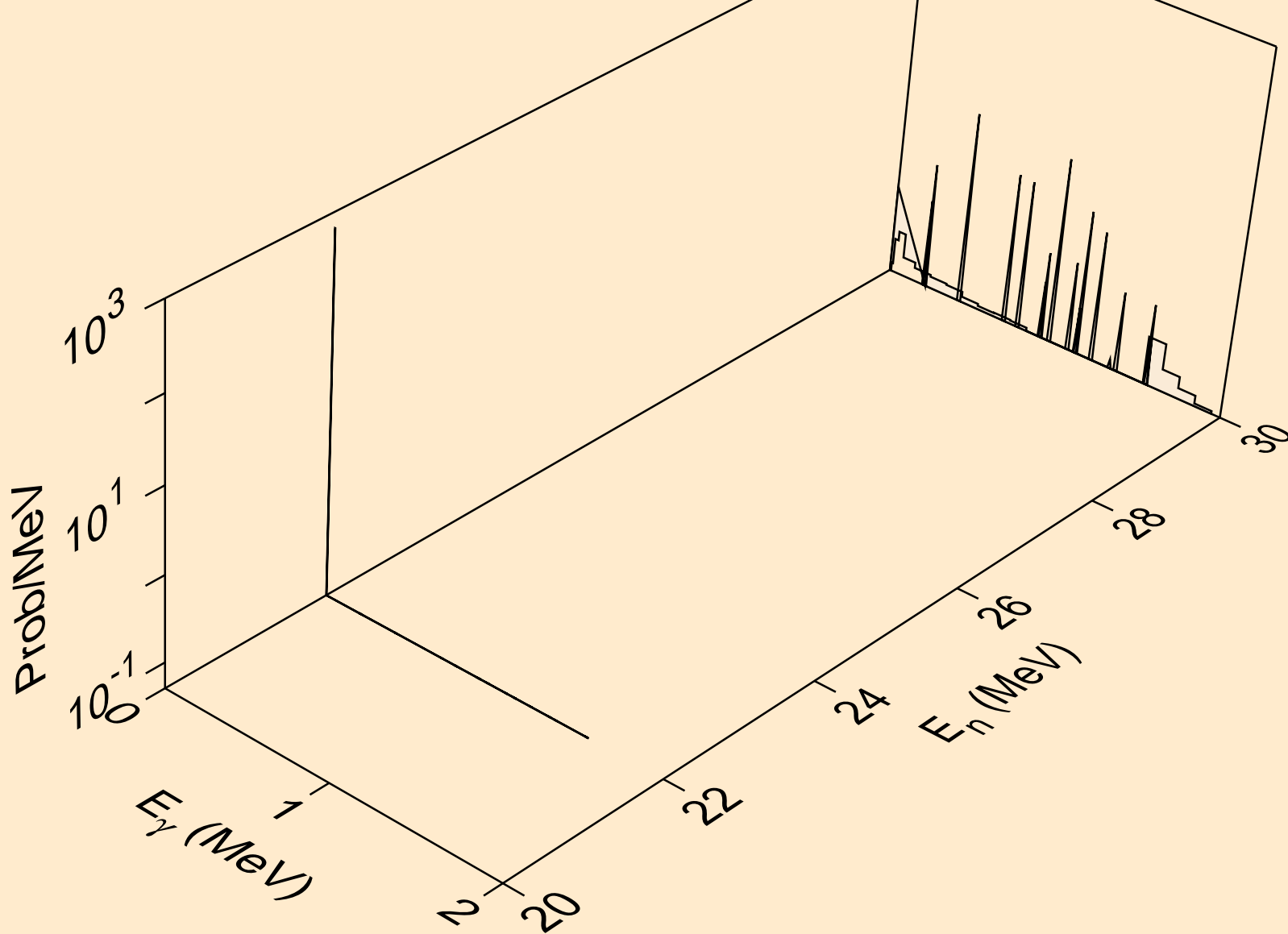

Y096 NEUTRON ACER TENDL-2019 LIBRARY; T=293.16K
Photon emission for (n,n*c)

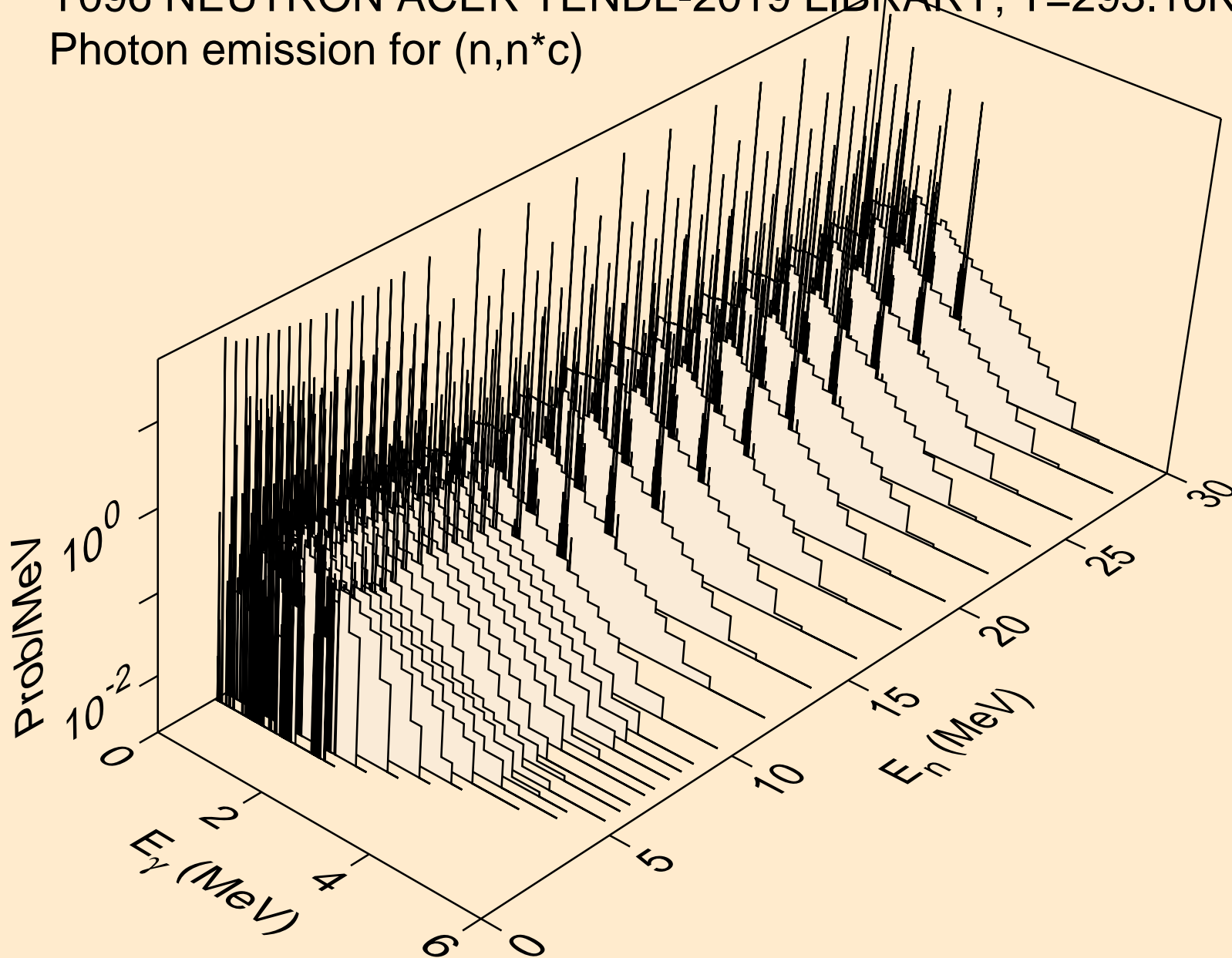

Y096 NEUTRON ACER TENDL-2019 LIBRARY; T=293.16K
Photon emission for (n,gma)

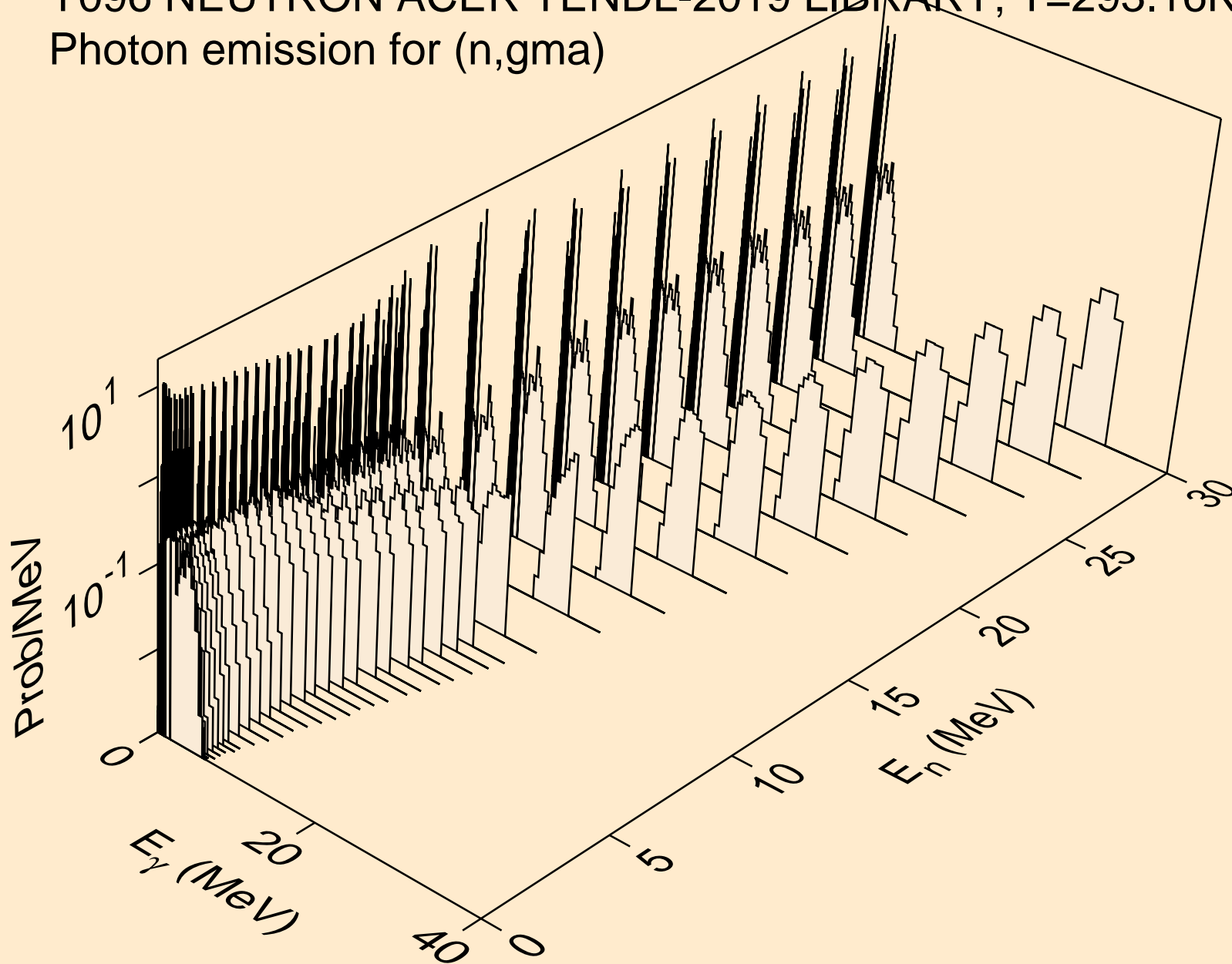

Y096 NEUTRON ACER TENDL-2019 LIBRARY; T=293.16K
Photon emission for (n,p)

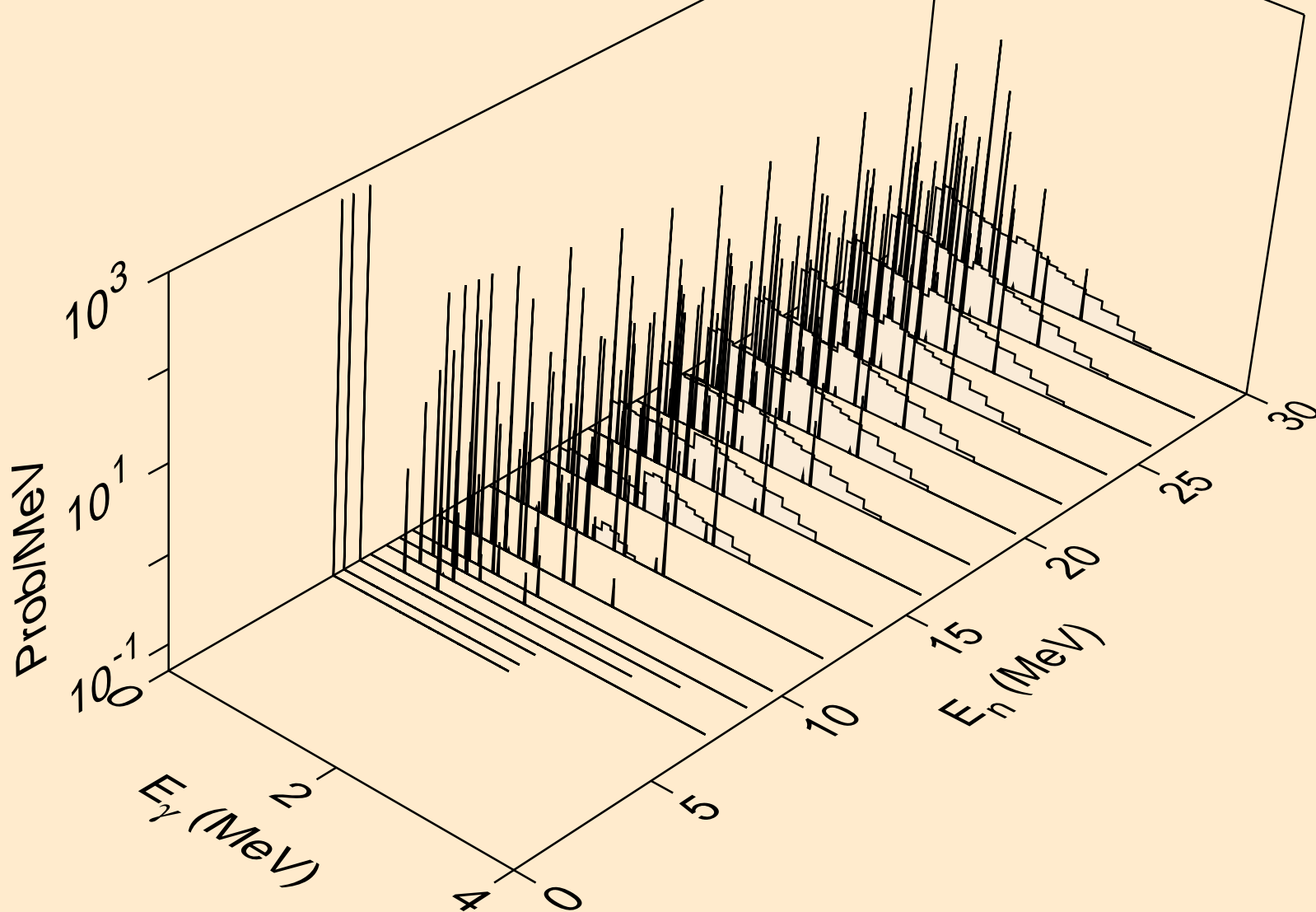

Y096 NEUTRON ACER TENDL-2019 LIBRARY; T=293.16K
Photon emission for (n,d)

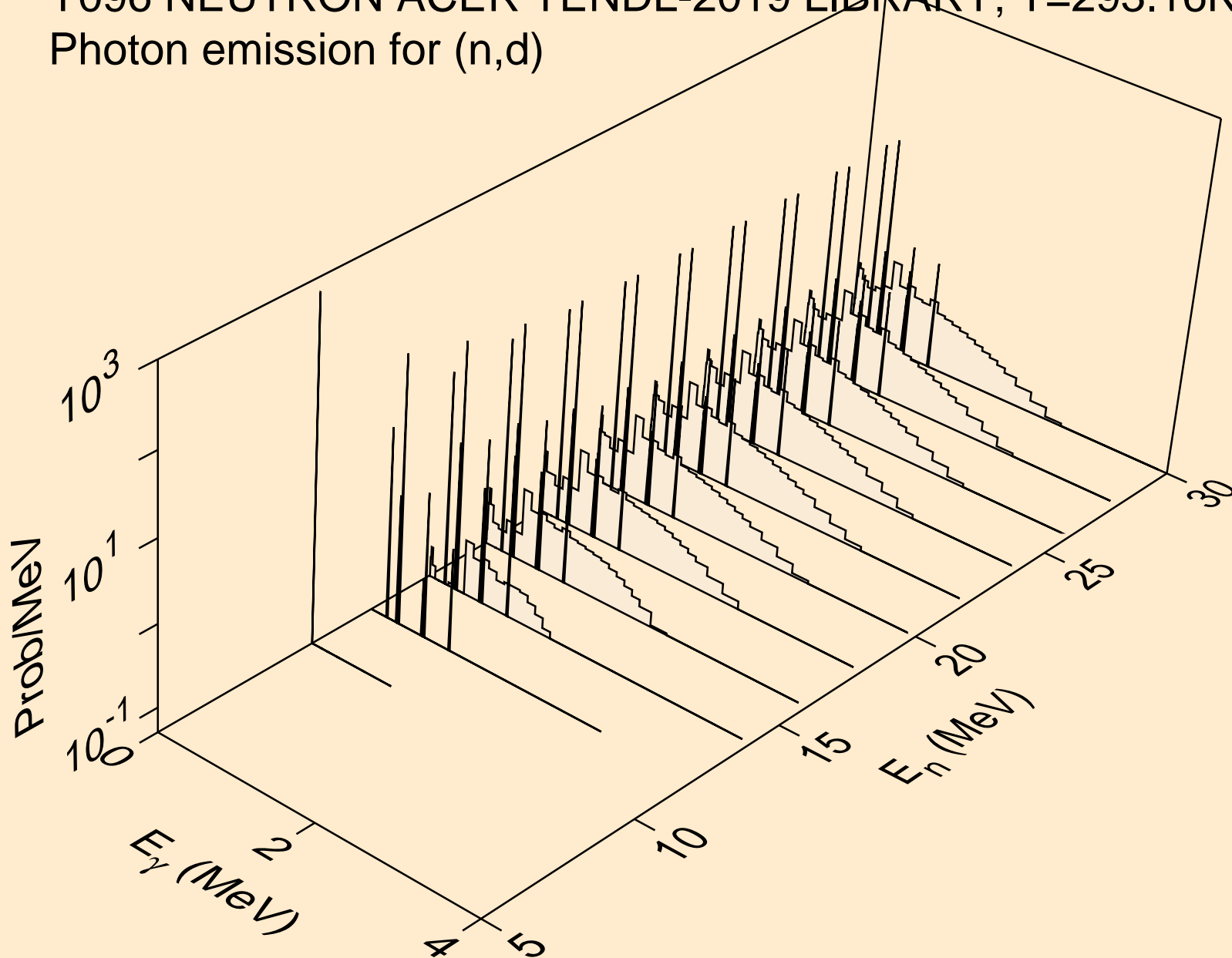

Y096 NEUTRON ACER TENDL-2019 LIBRARY; T=293.16K
Photon emission for (n,t)

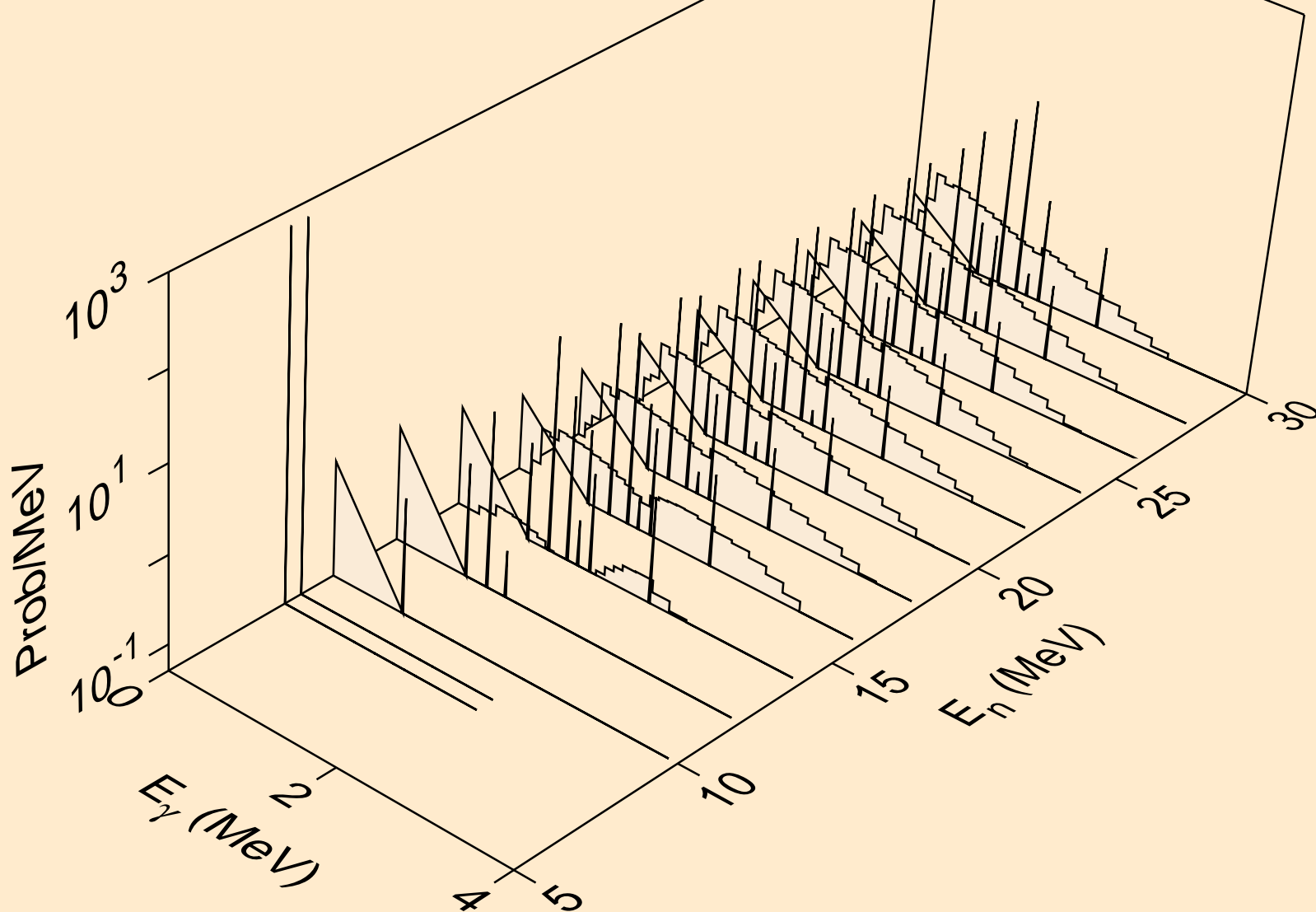

Y096 NEUTRON ACER TENDL-2019 LIBRARY; T=293.16K
Photon emission for (n,he3)

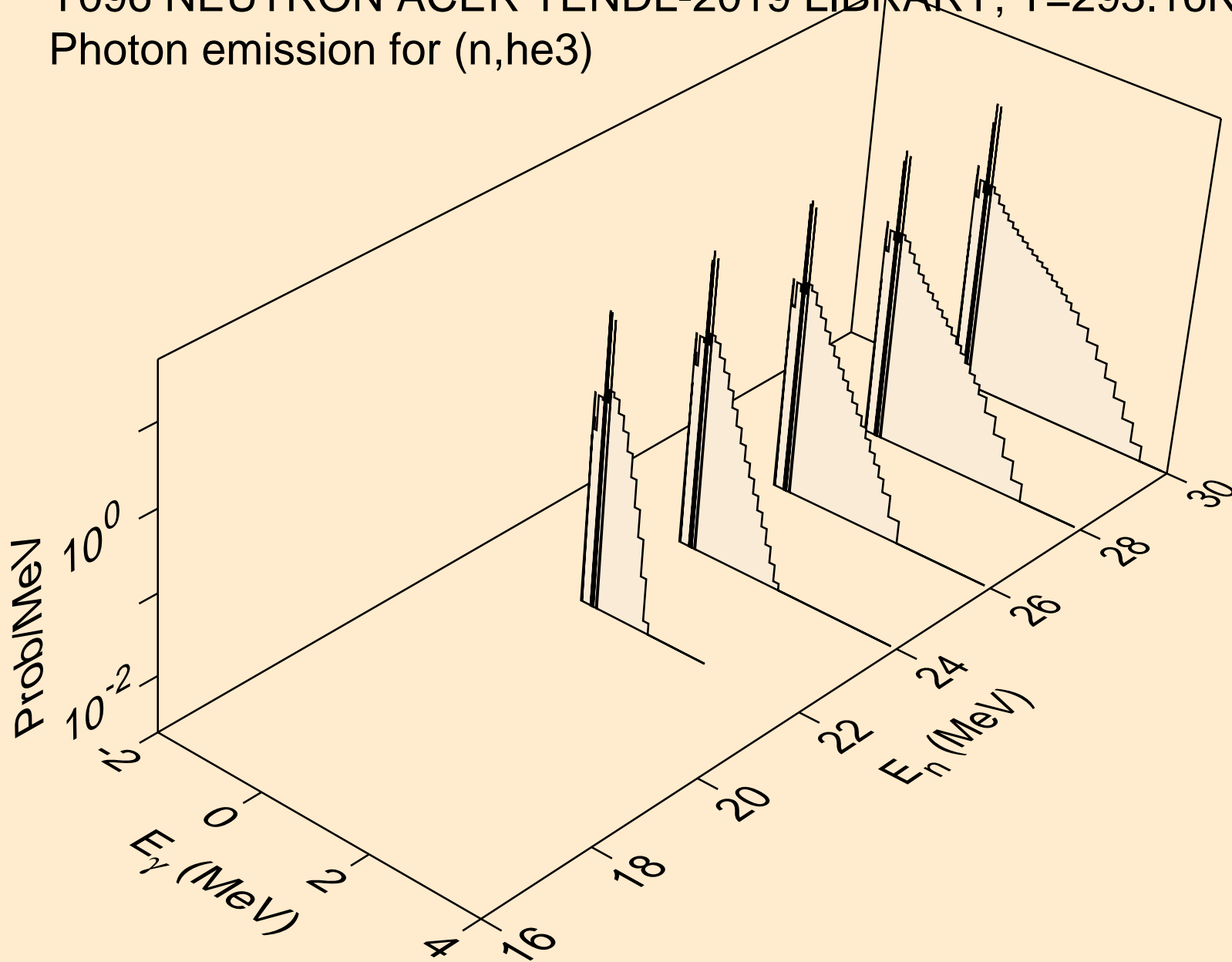

Y096 NEUTRON ACER TENDL-2019 LIBRARY; T=293.16K
Photon emission for (n,a)

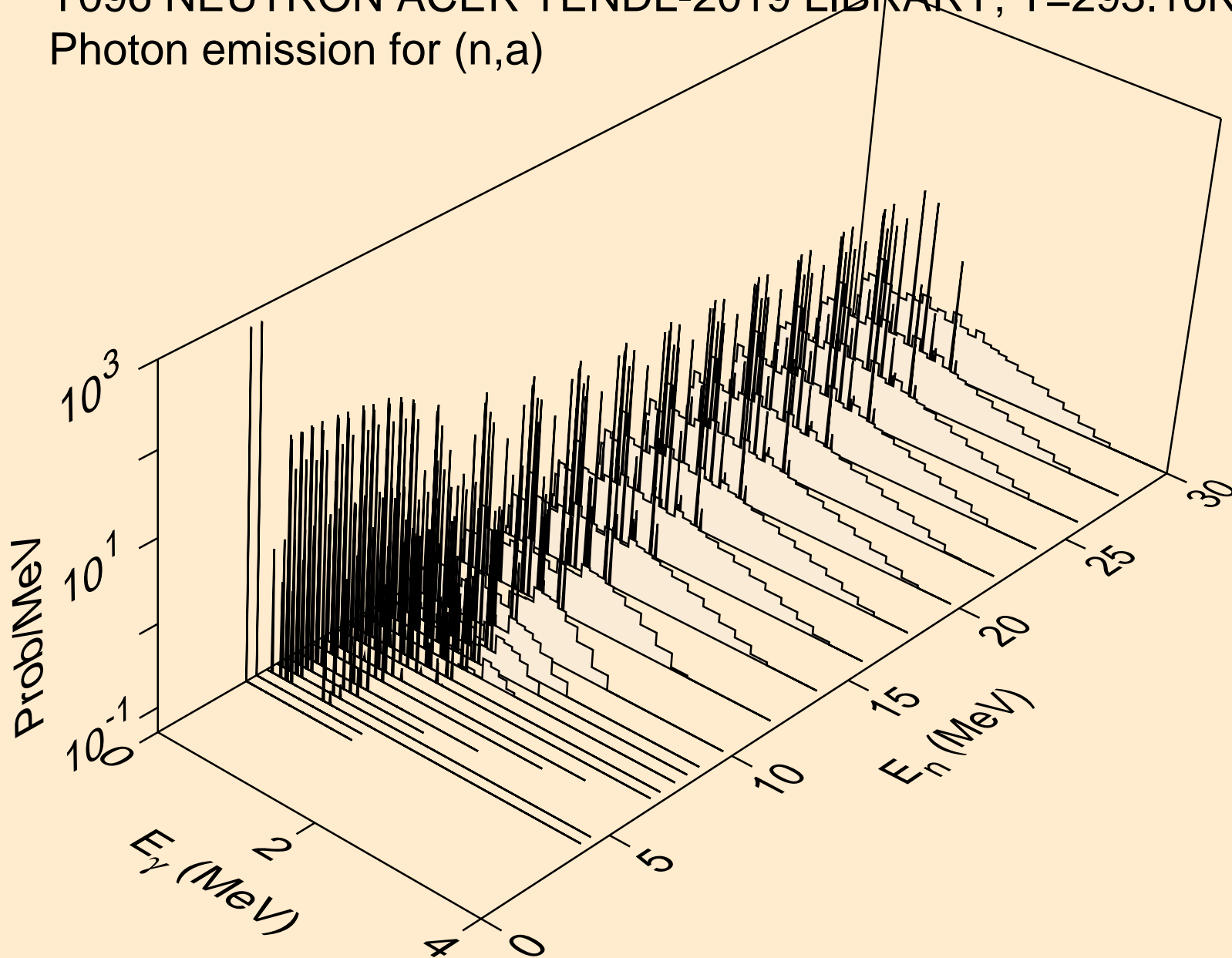

Y096 NEUTRON ACER TENDL-2019 LIBRARY; T=293.16K
Photon emission for (n,2p)

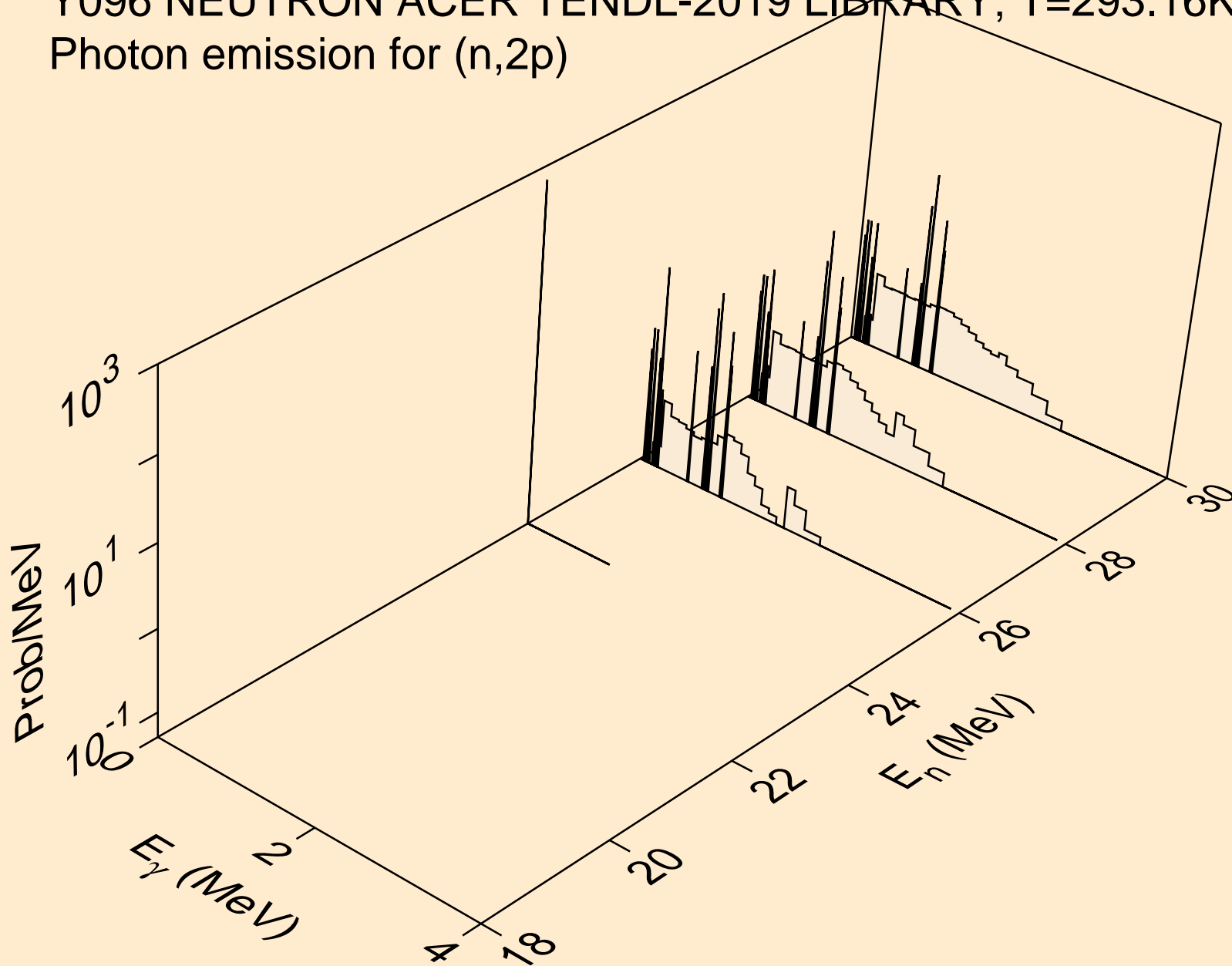

Y096 NEUTRON ACER TENDL-2019 LIBRARY; T=293.16K
thermal capture photon spectrum

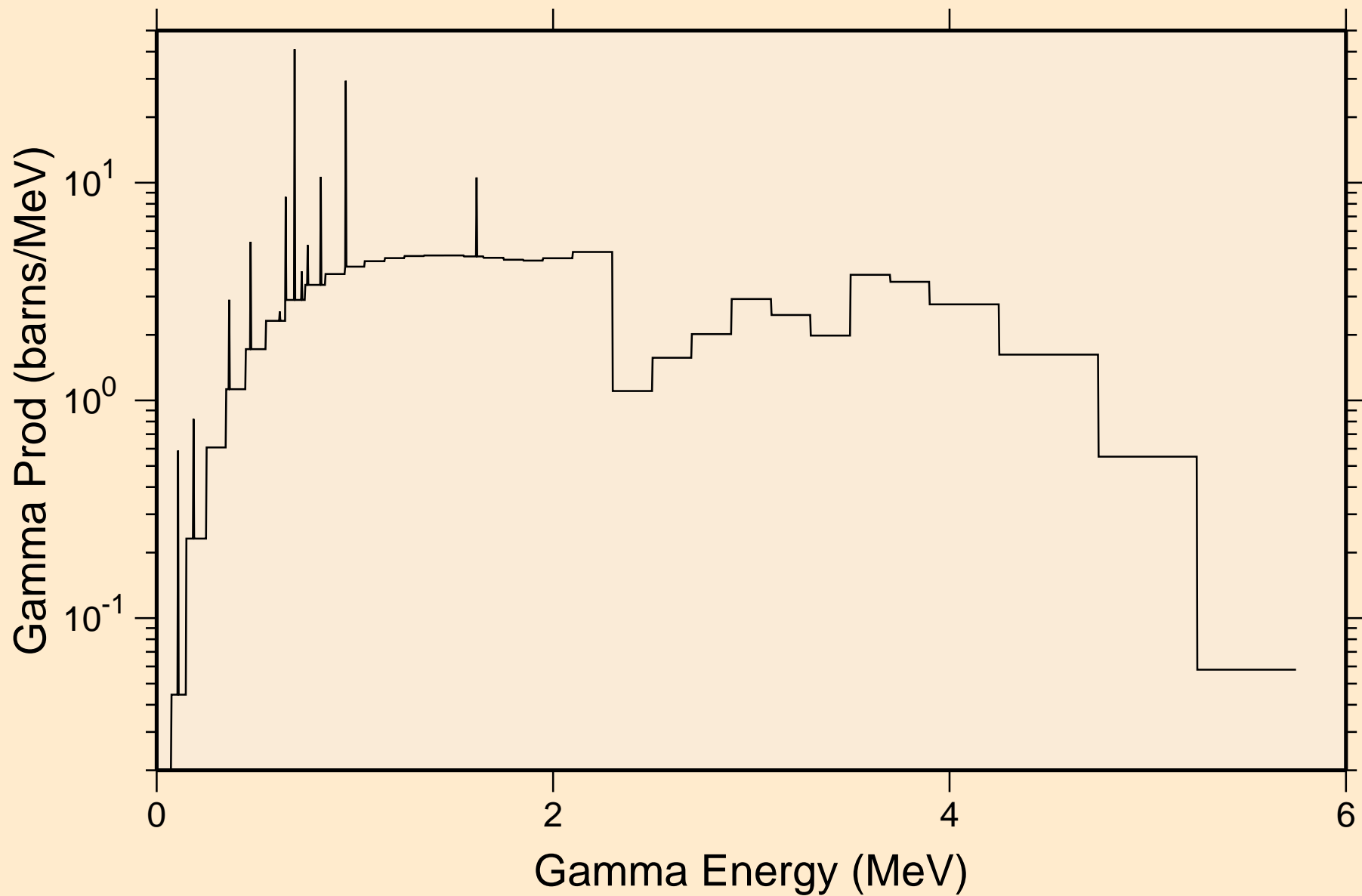

Y096 NEUTRON ACER TENDL-2019 LIBRARY; T=293.16K
14 MeV photon spectrum

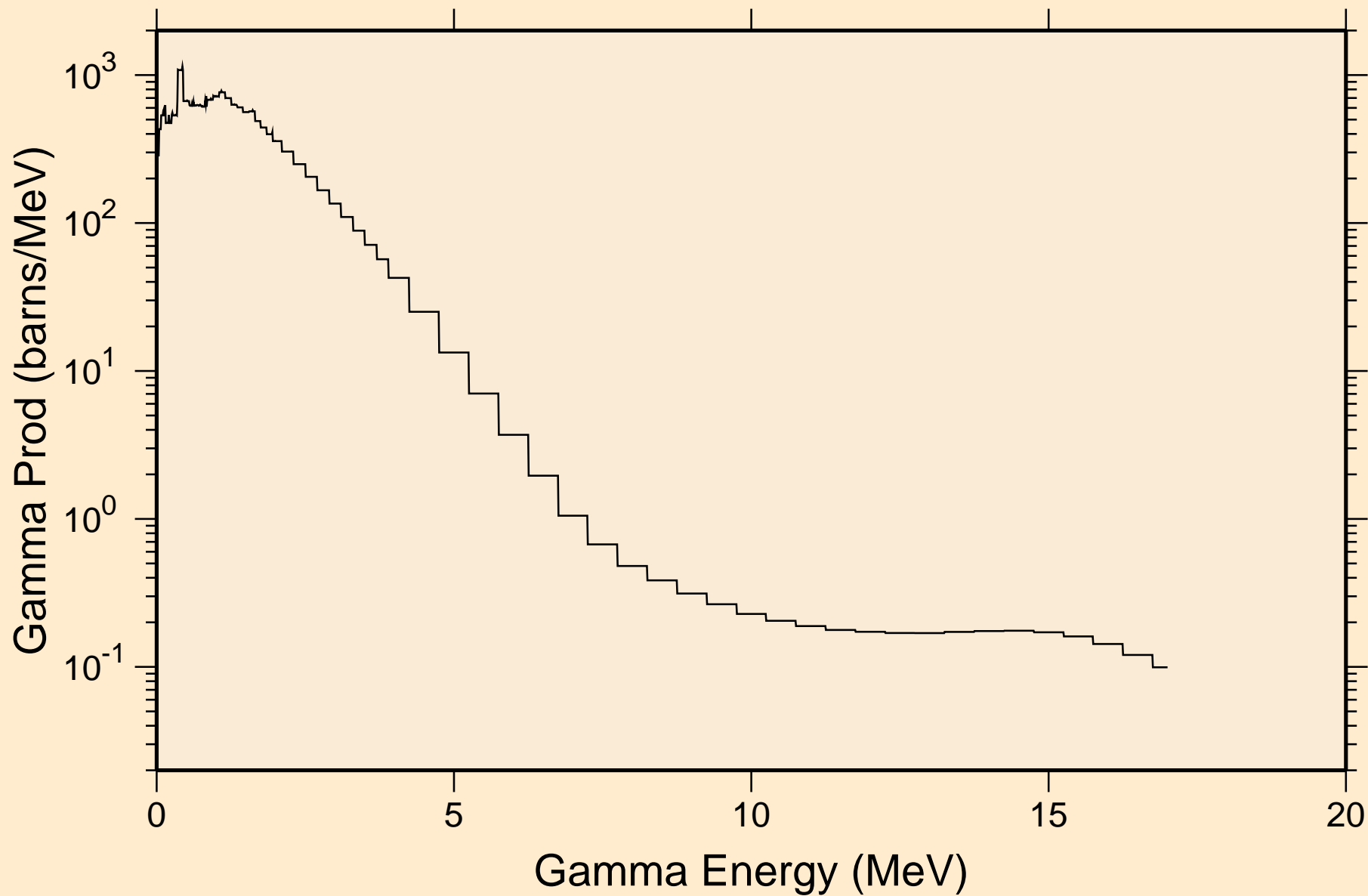

Y096 NEUTRON ACER TENDL-2019 LIBRARY; T=293.16K
Particle heating contributions

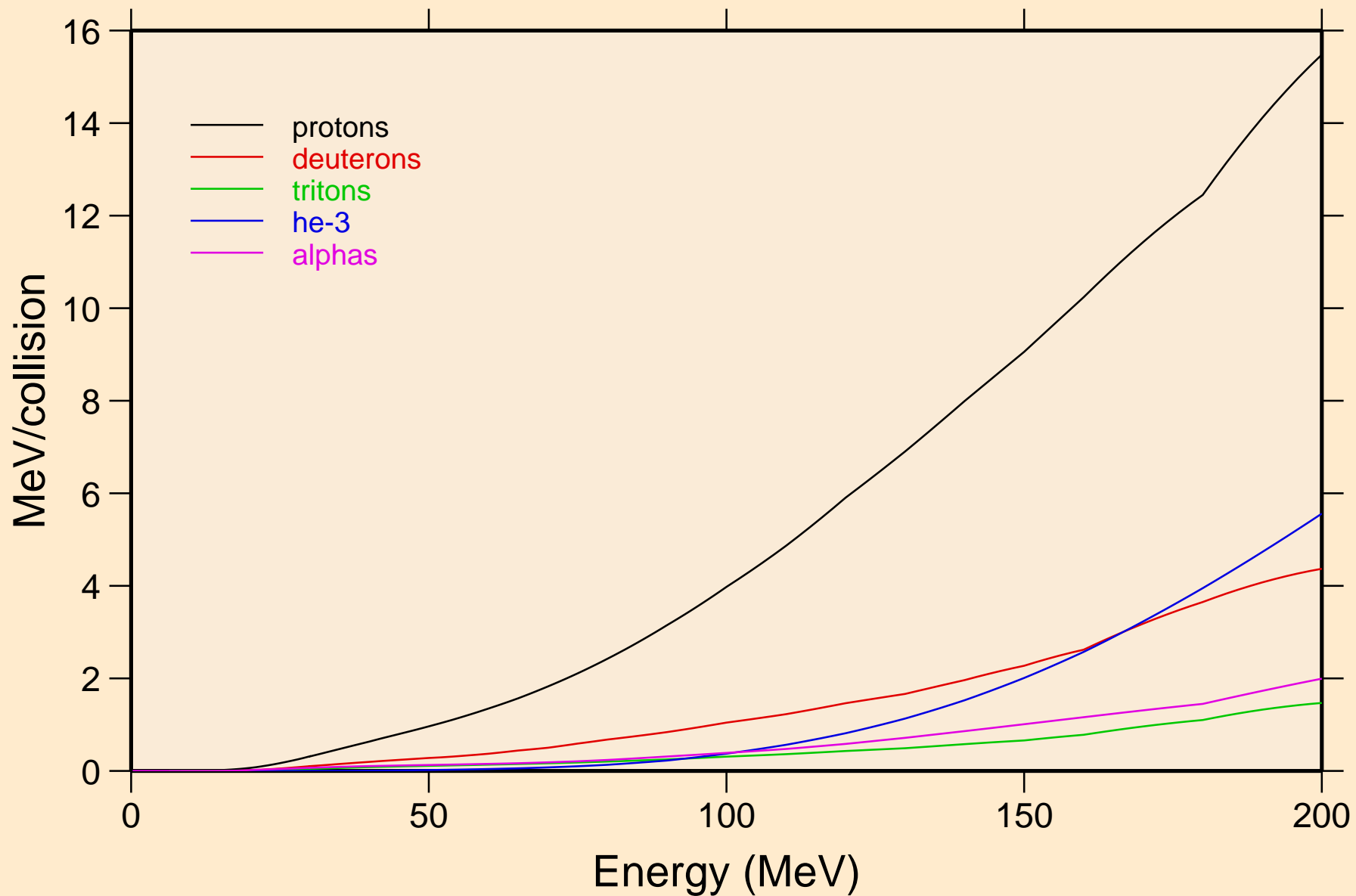

Y096 NEUTRON ACER TENDL-2019 LIBRARY; T=293.16K
Recoil Heating

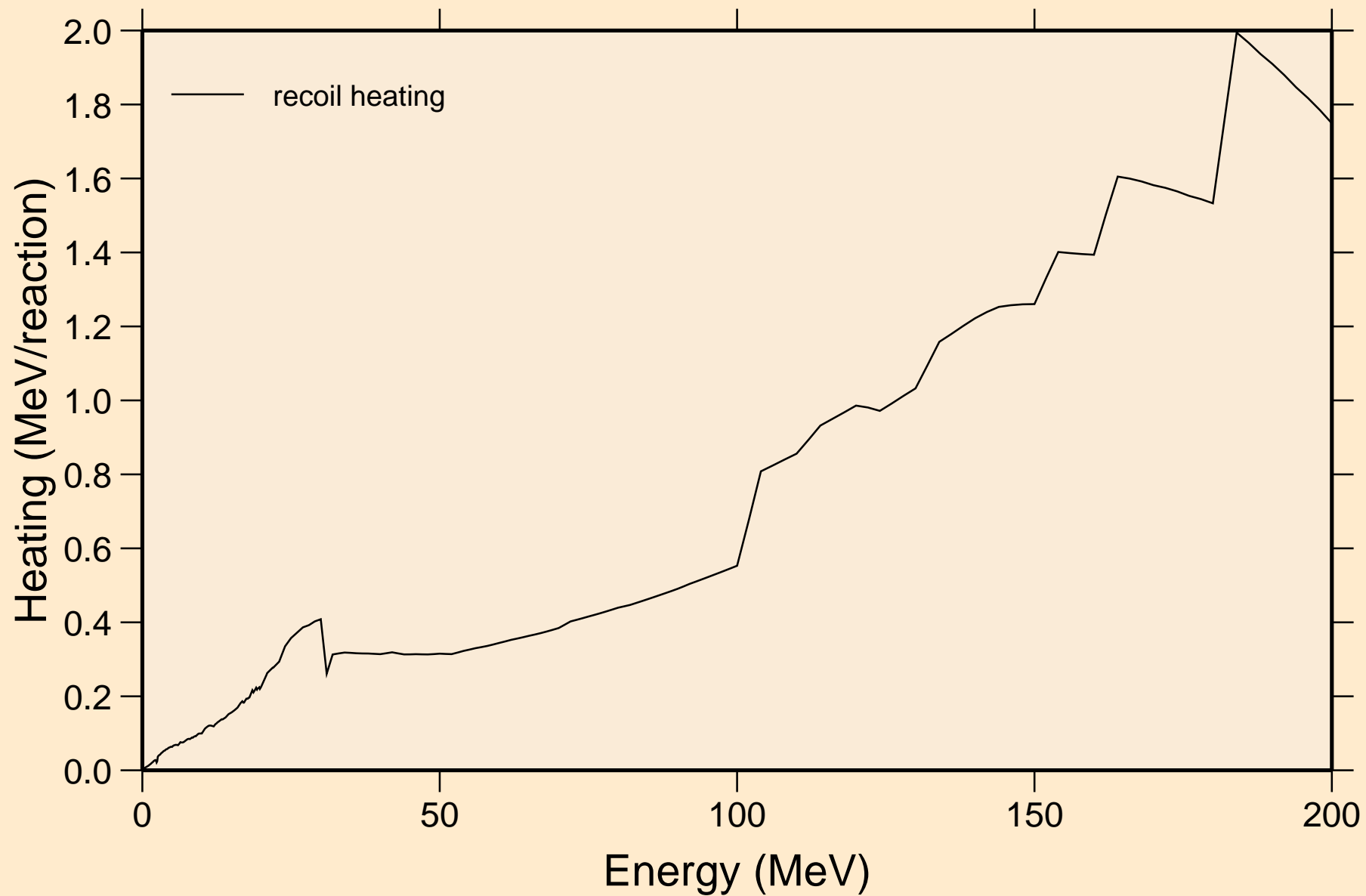

Y096 NEUTRON ACER TENDL-2019 LIBRARY; T=293.16K
Particle production cross sections

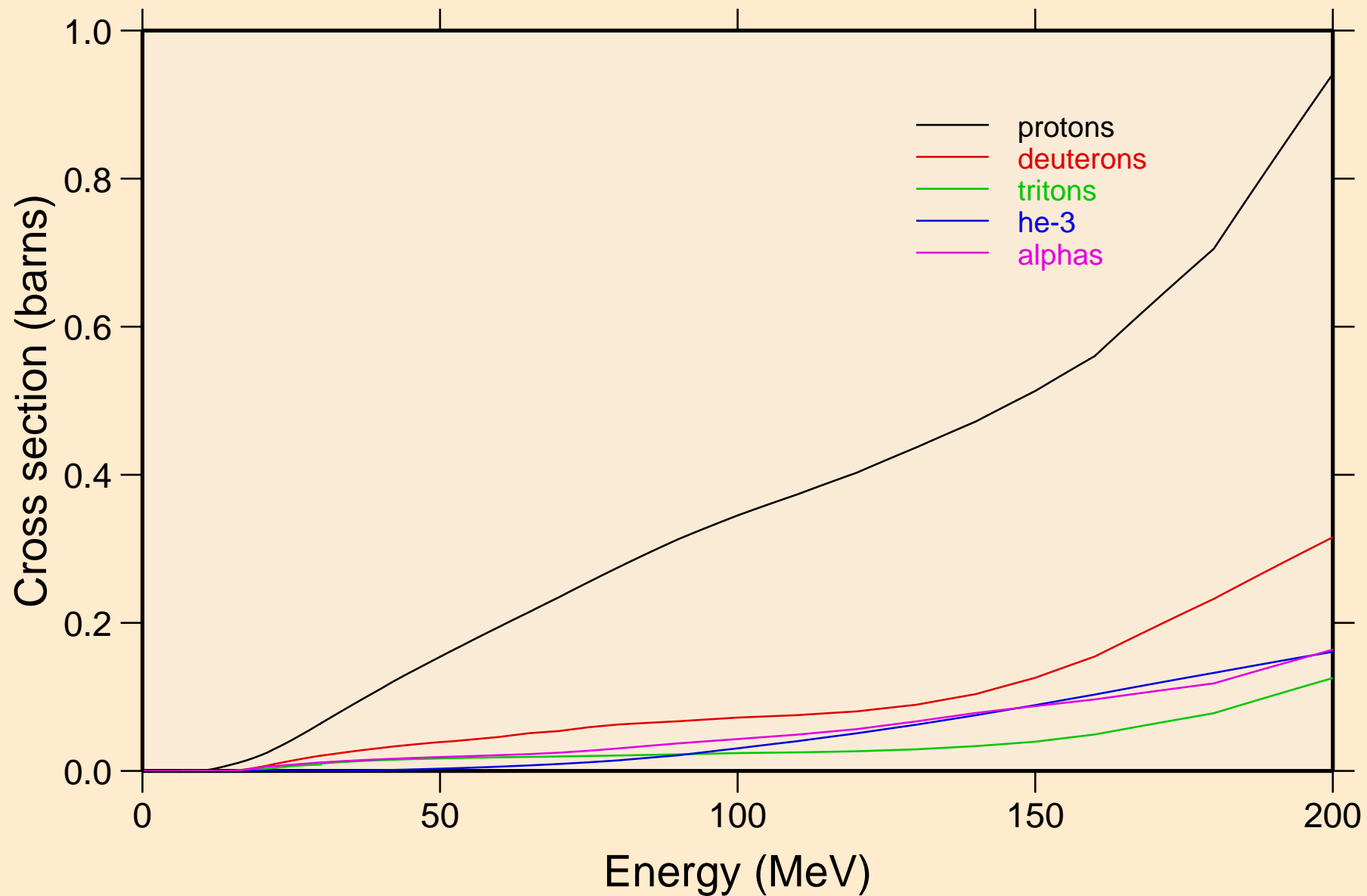

Y096 NEUTRON ACER TENDL-2019 LIBRARY; T=293.16K
protons from (n,x)

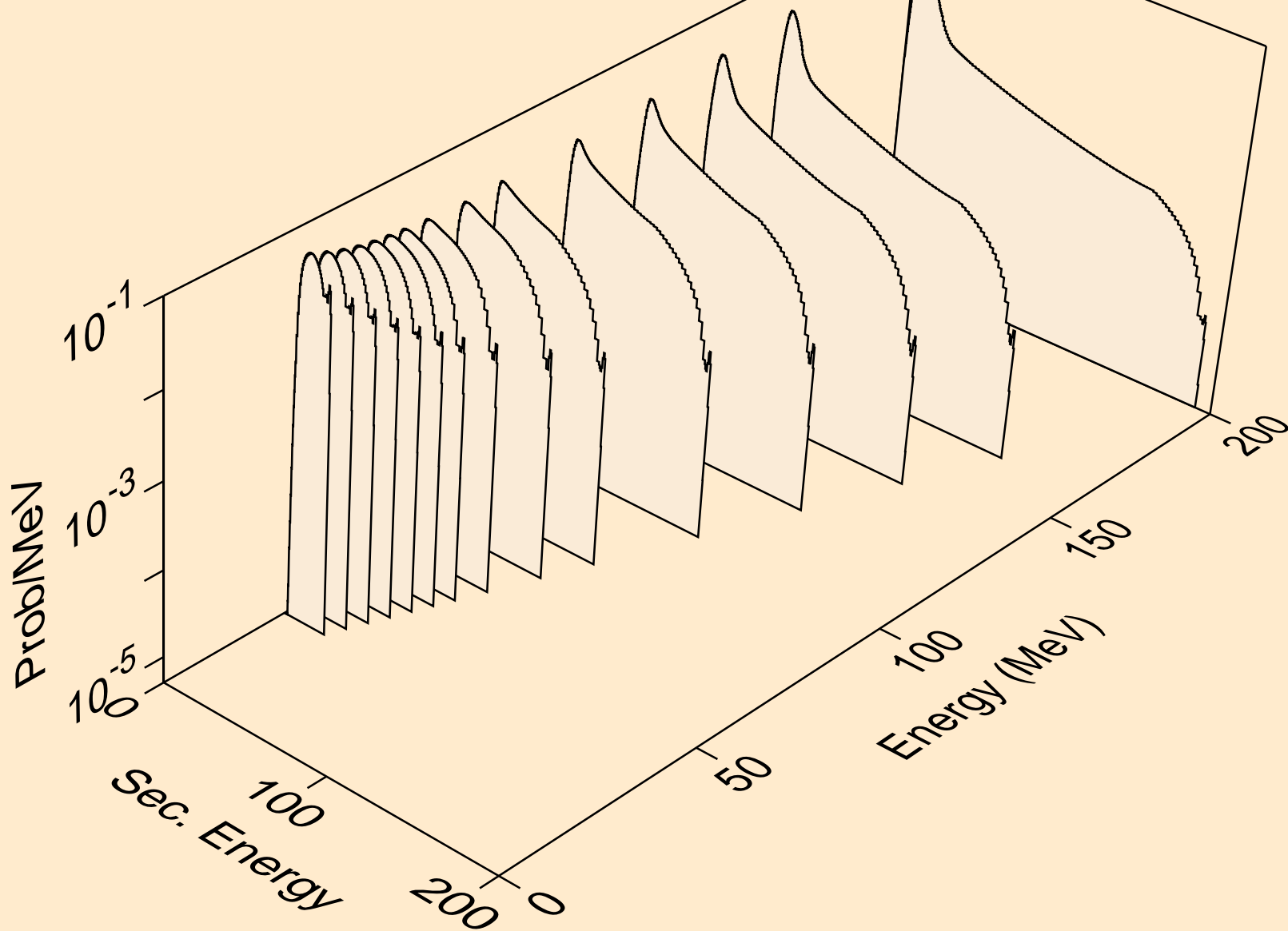

Y096 NEUTRON ACER TENDL-2019 LIBRARY; T=293.16K
protons from (n,n*)p

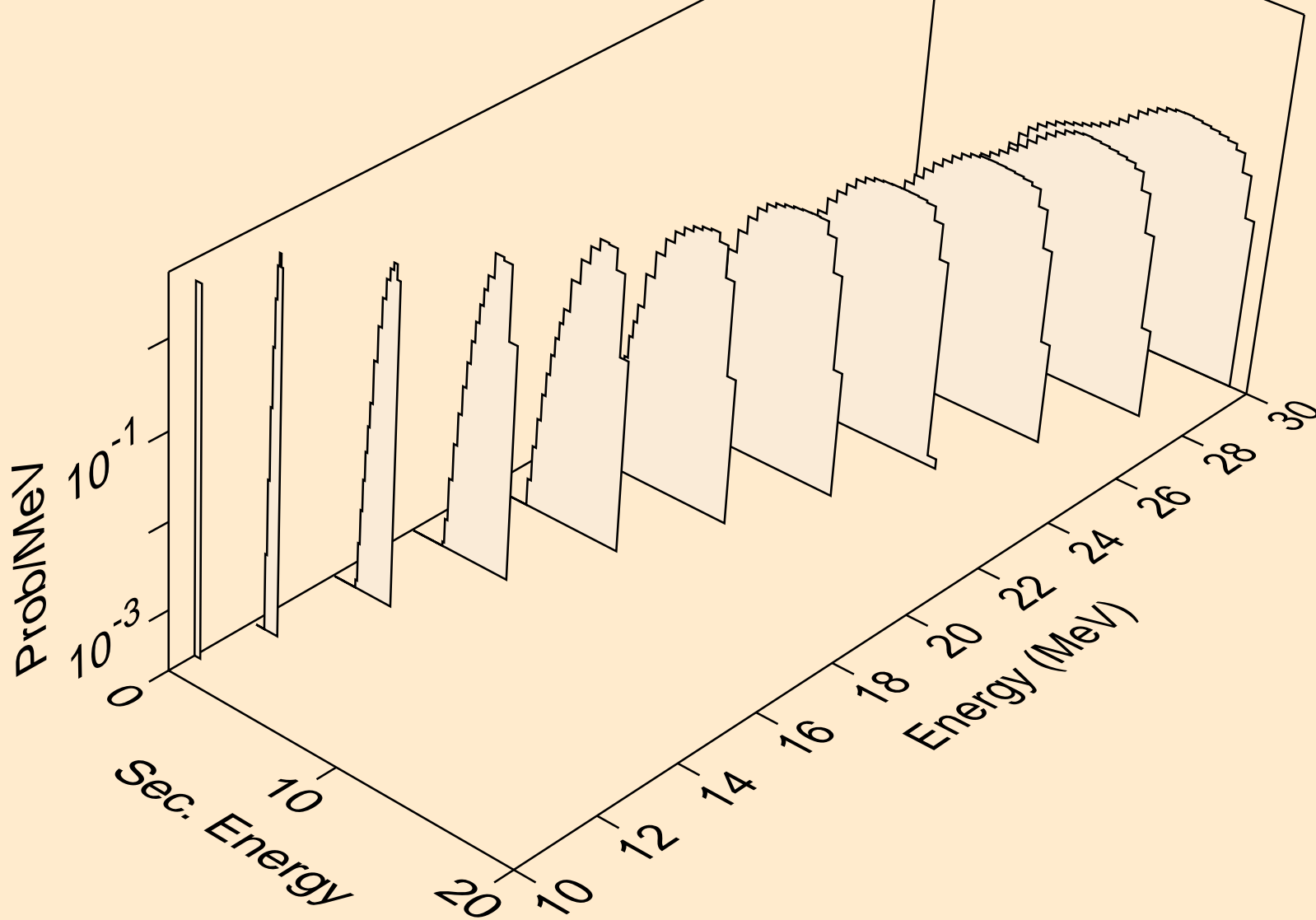

Y096 NEUTRON ACER TENDL-2019 LIBRARY; T=293.16K
protons from (n,2np)

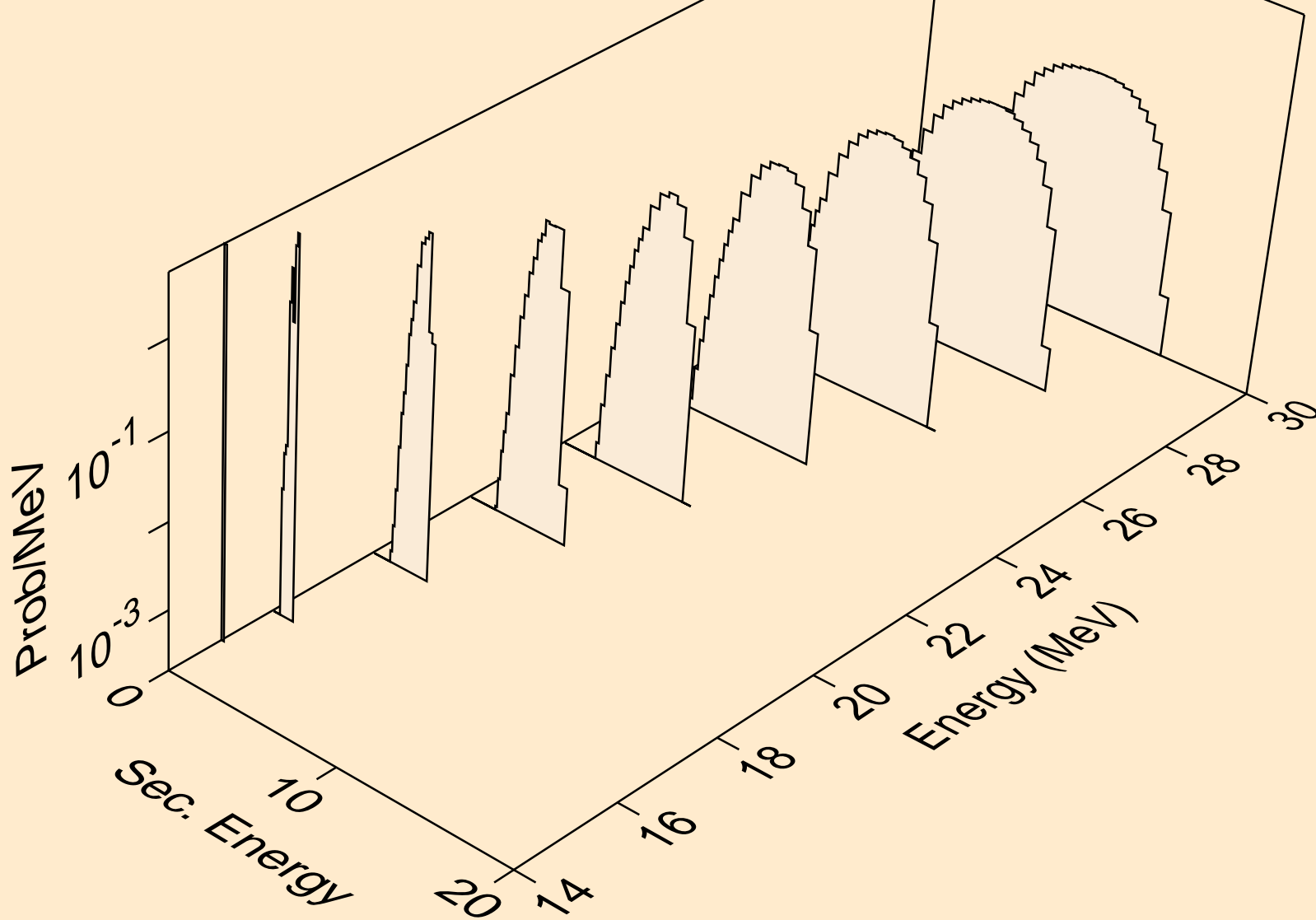

Y096 NEUTRON ACER TENDL-2019 LIBRARY; T=293.16K
protons from (n,3np)

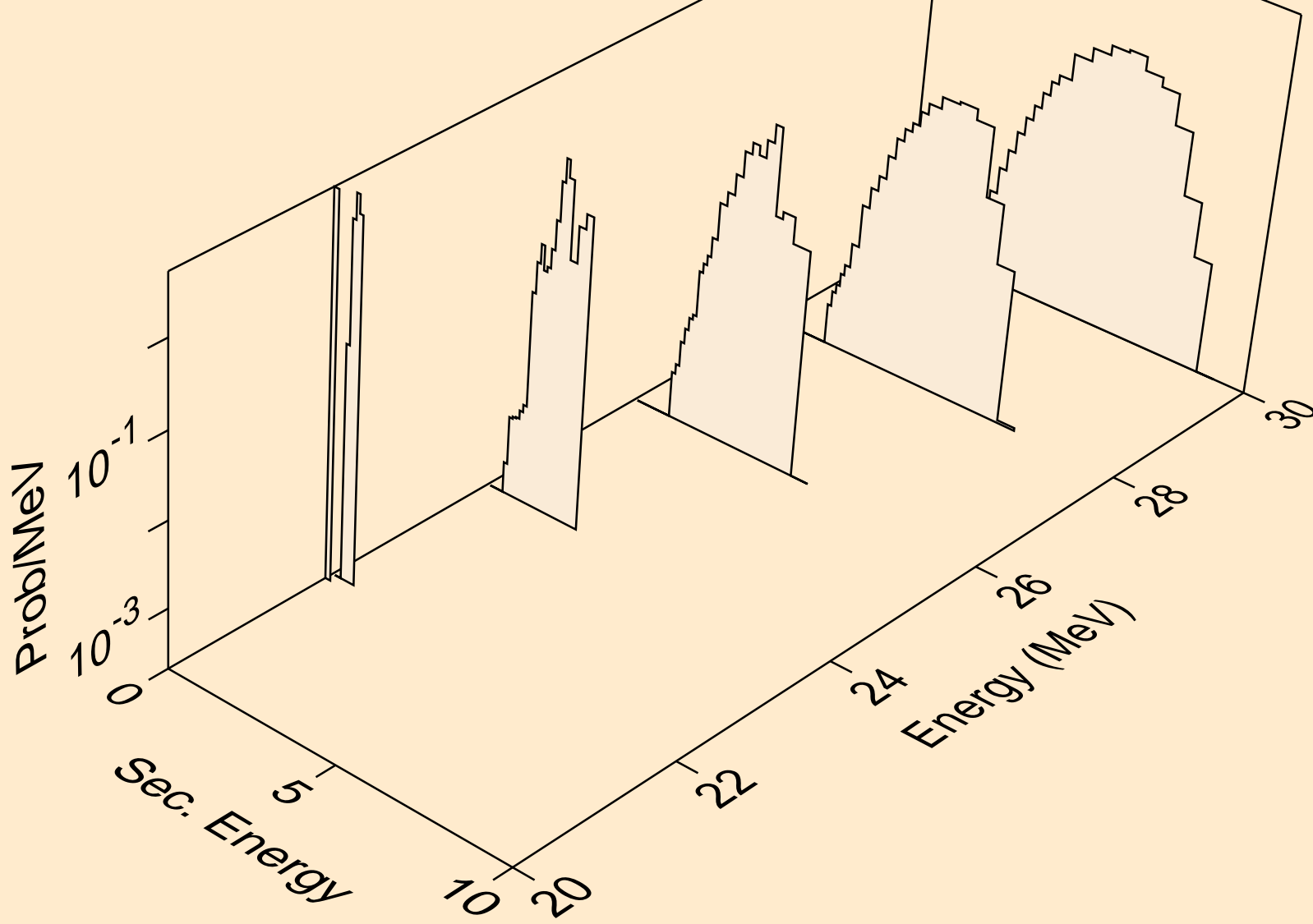

Y096 NEUTRON ACER TENDL-2019 LIBRARY; T=293.16K
protons from (n,p)

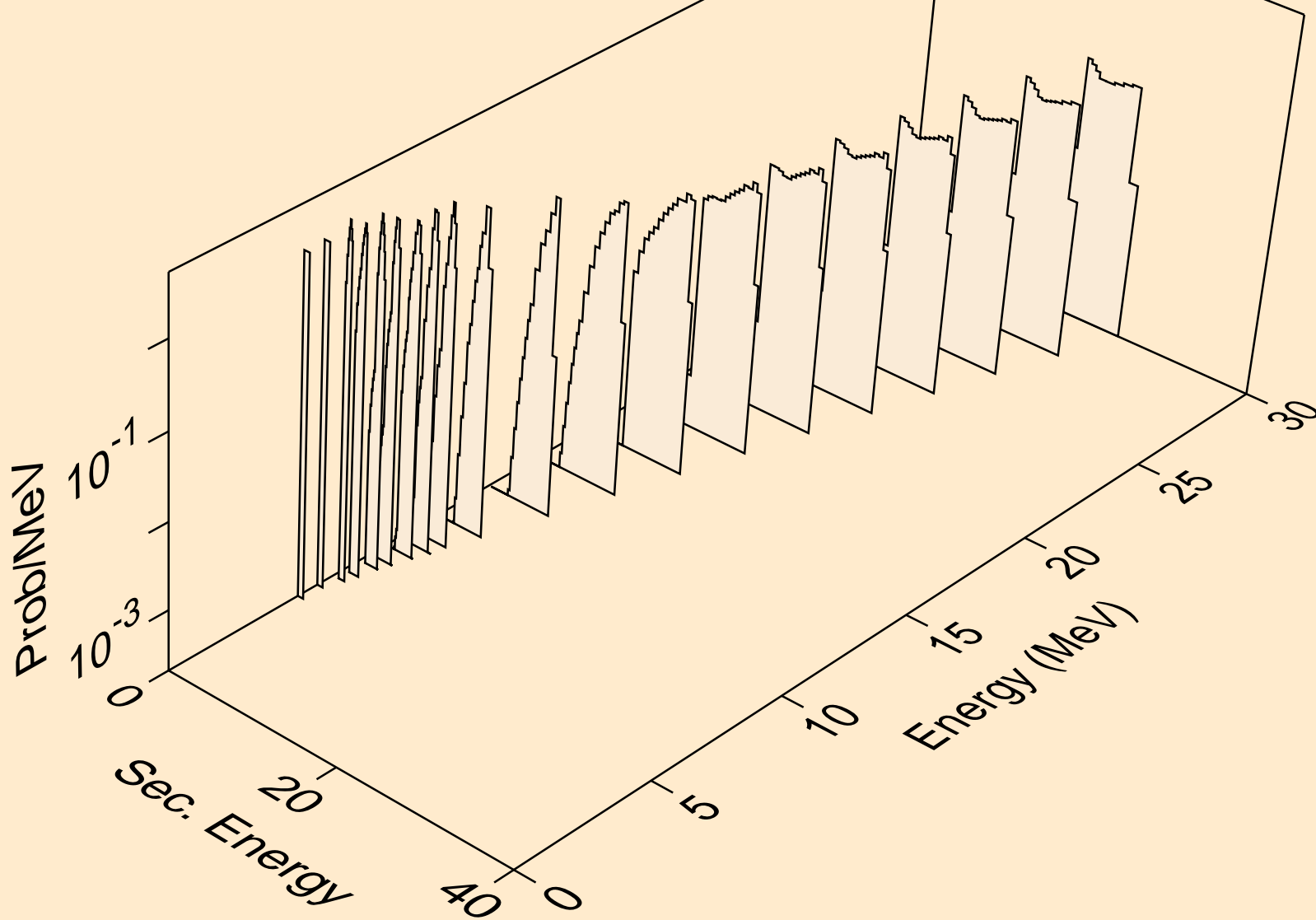

Y096 NEUTRON ACER TENDL-2019 LIBRARY; T=293.16K
protons from (n,2p)

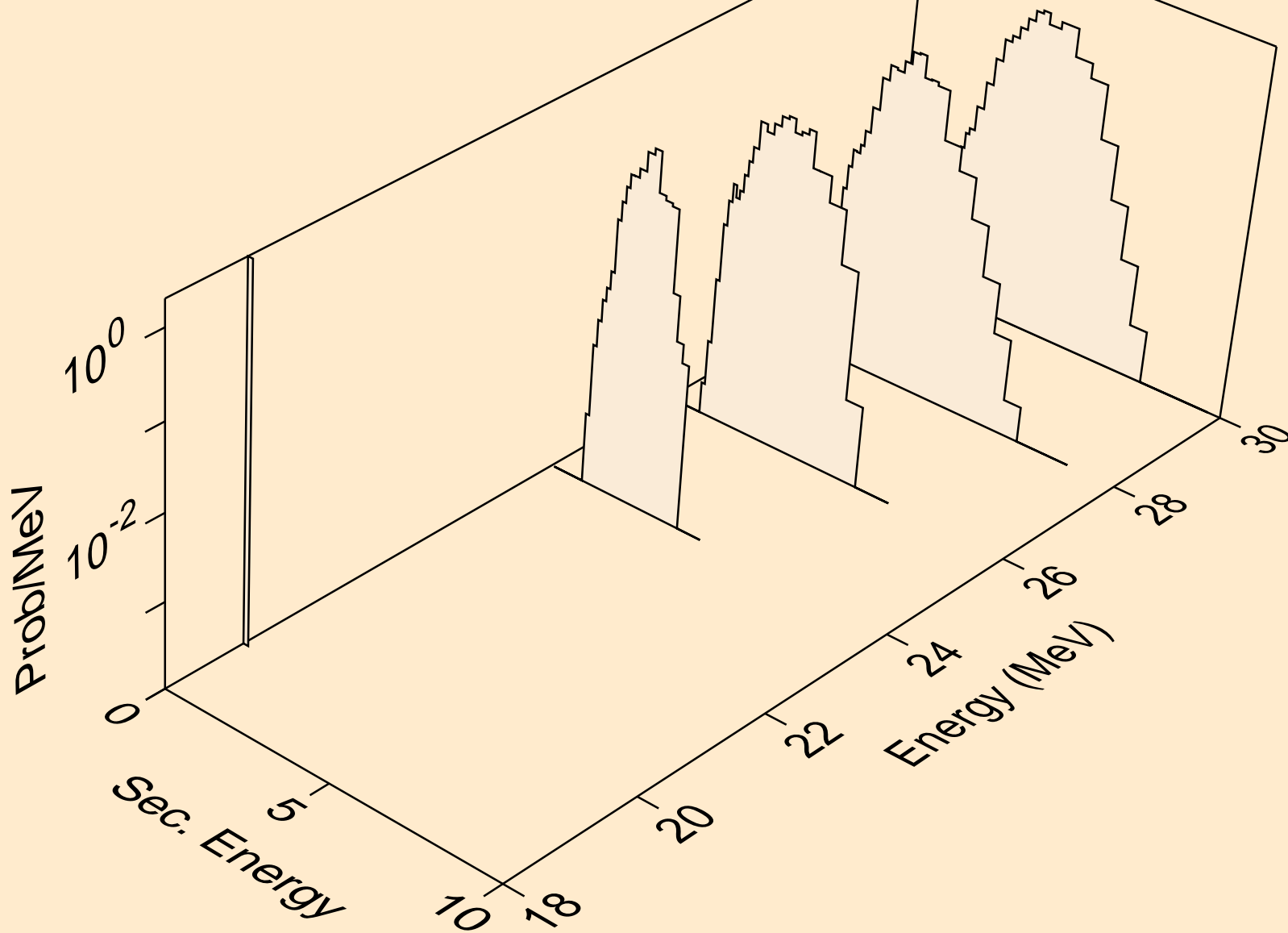

Y096 NEUTRON ACER TENDL-2019 LIBRARY; T=293.16K
deuterons from (n,x)

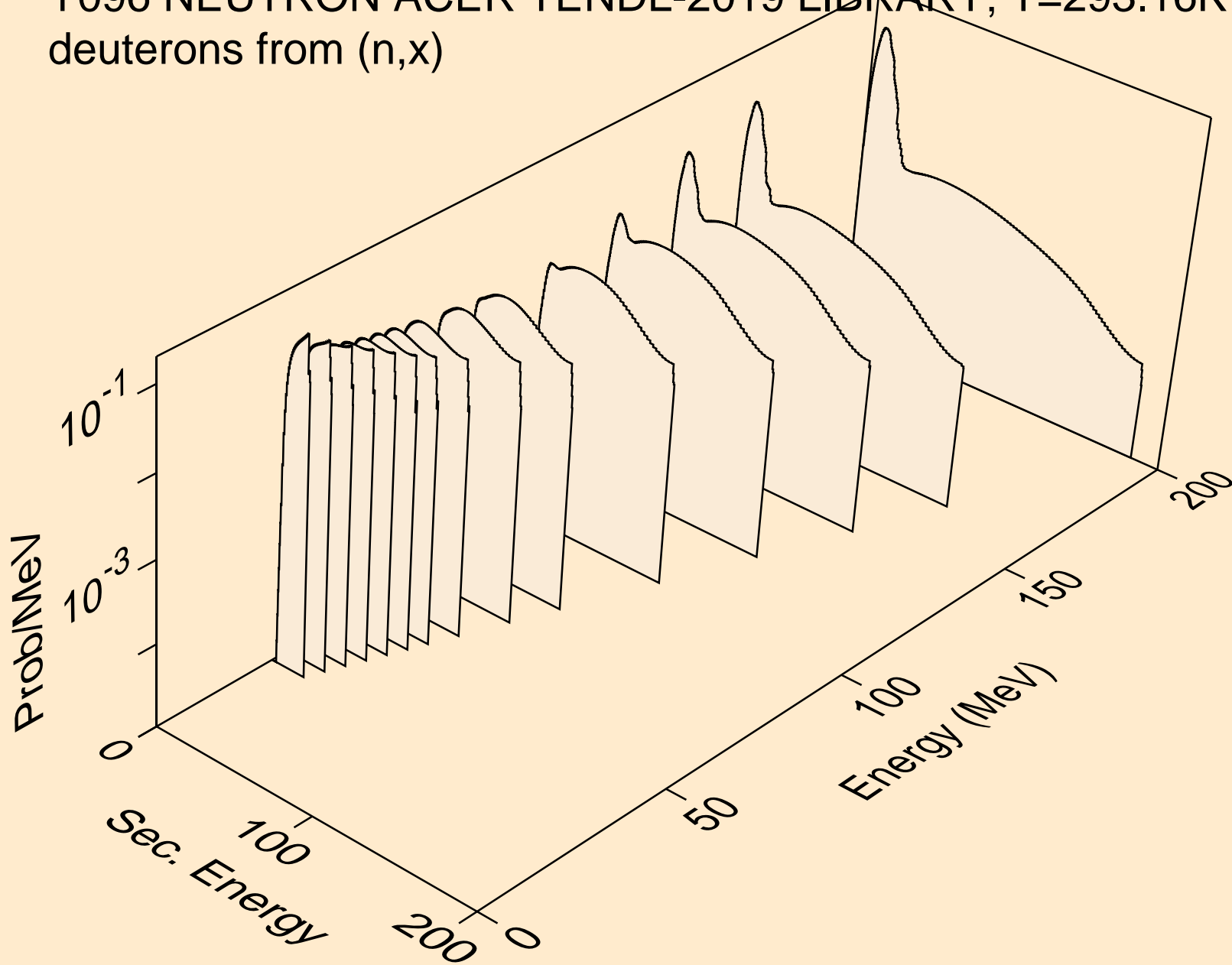

Y096 NEUTRON ACER TENDL-2019 LIBRARY; T=293.16K
deuterons from (n,2nd)

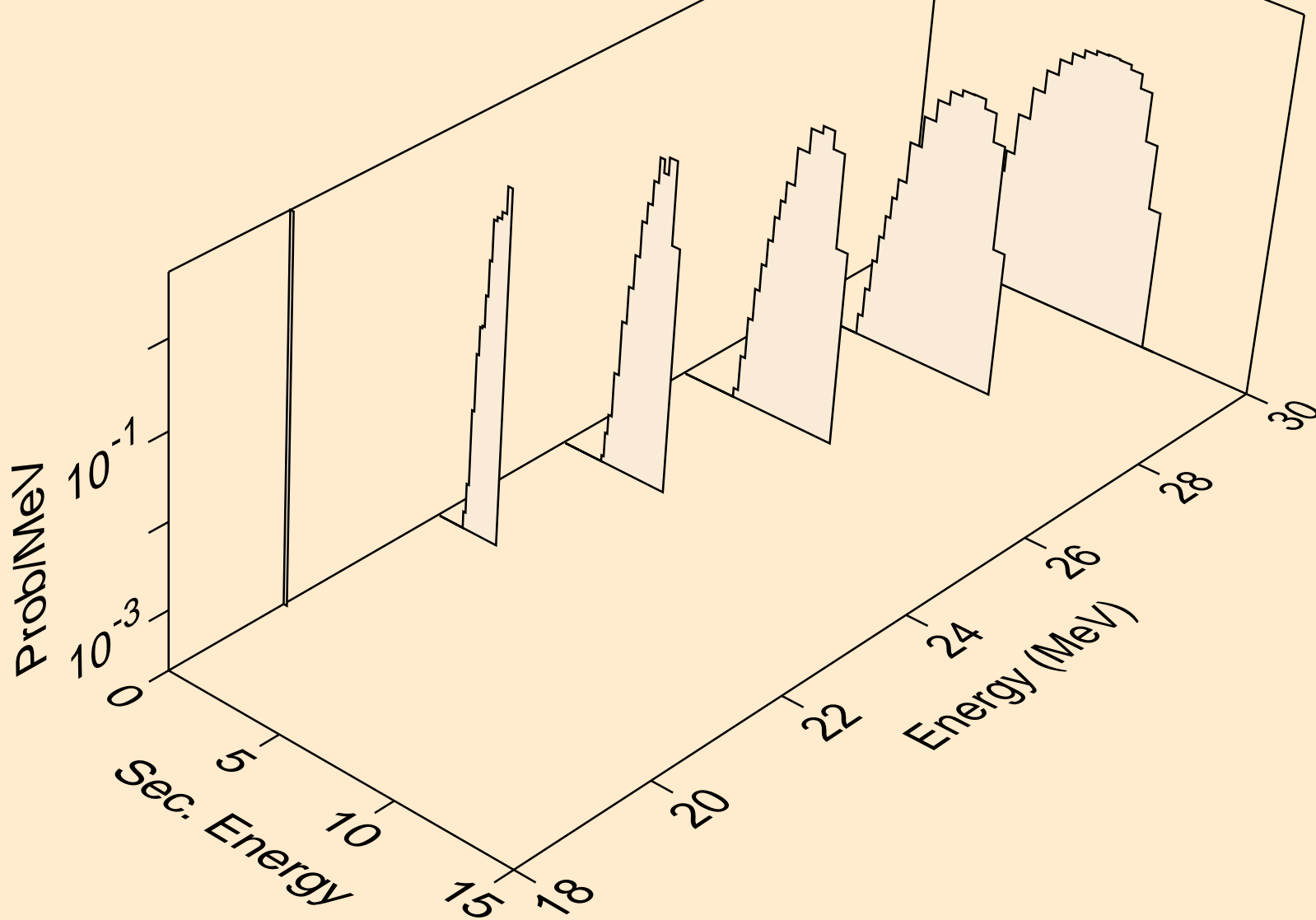

Y096 NEUTRON ACER TENDL-2019 LIBRARY; T=293.16K
deuterons from (n,n*)d

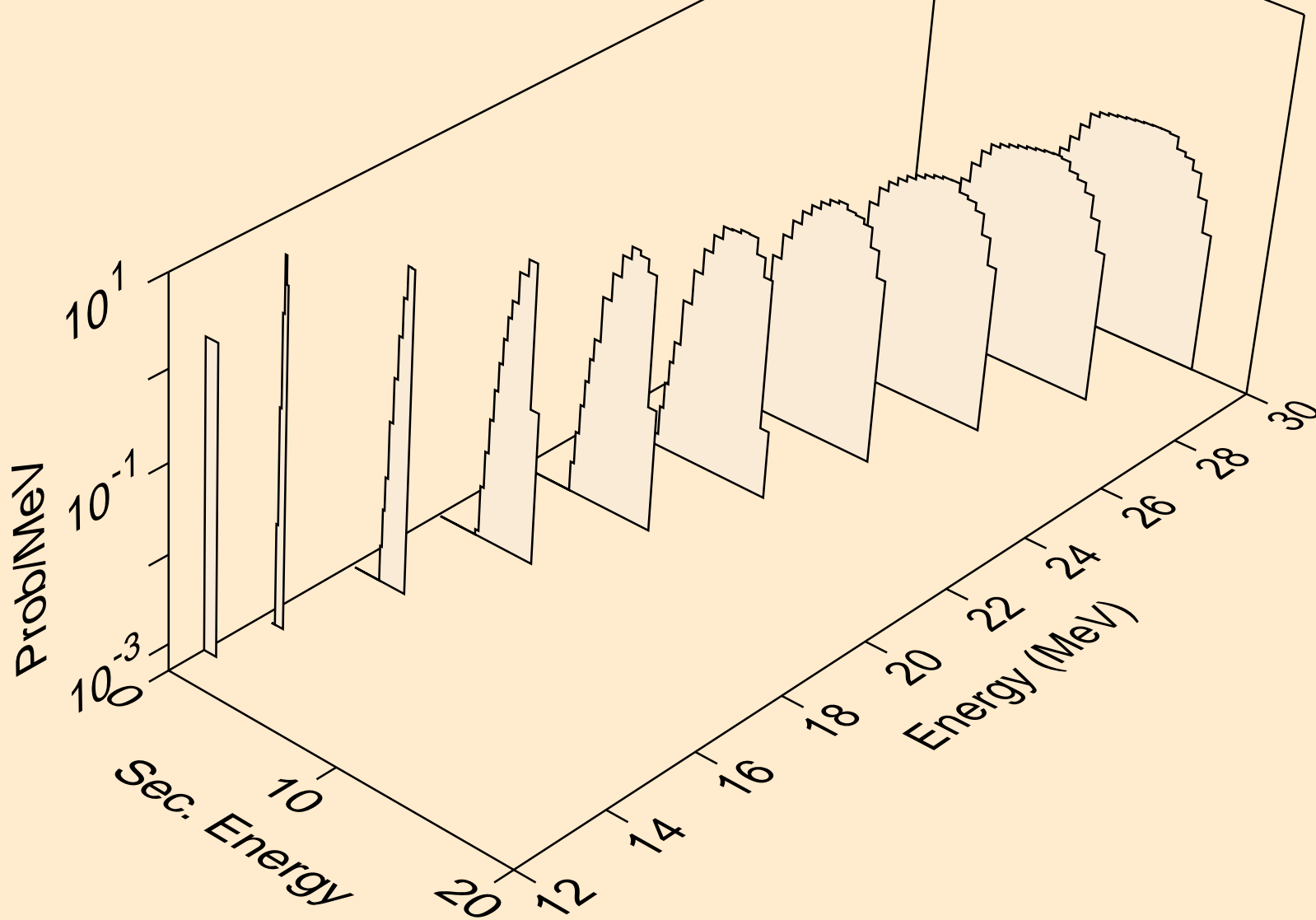

Y096 NEUTRON ACER TENDL-2019 LIBRARY; T=293.16K
deuterons from (n,d)

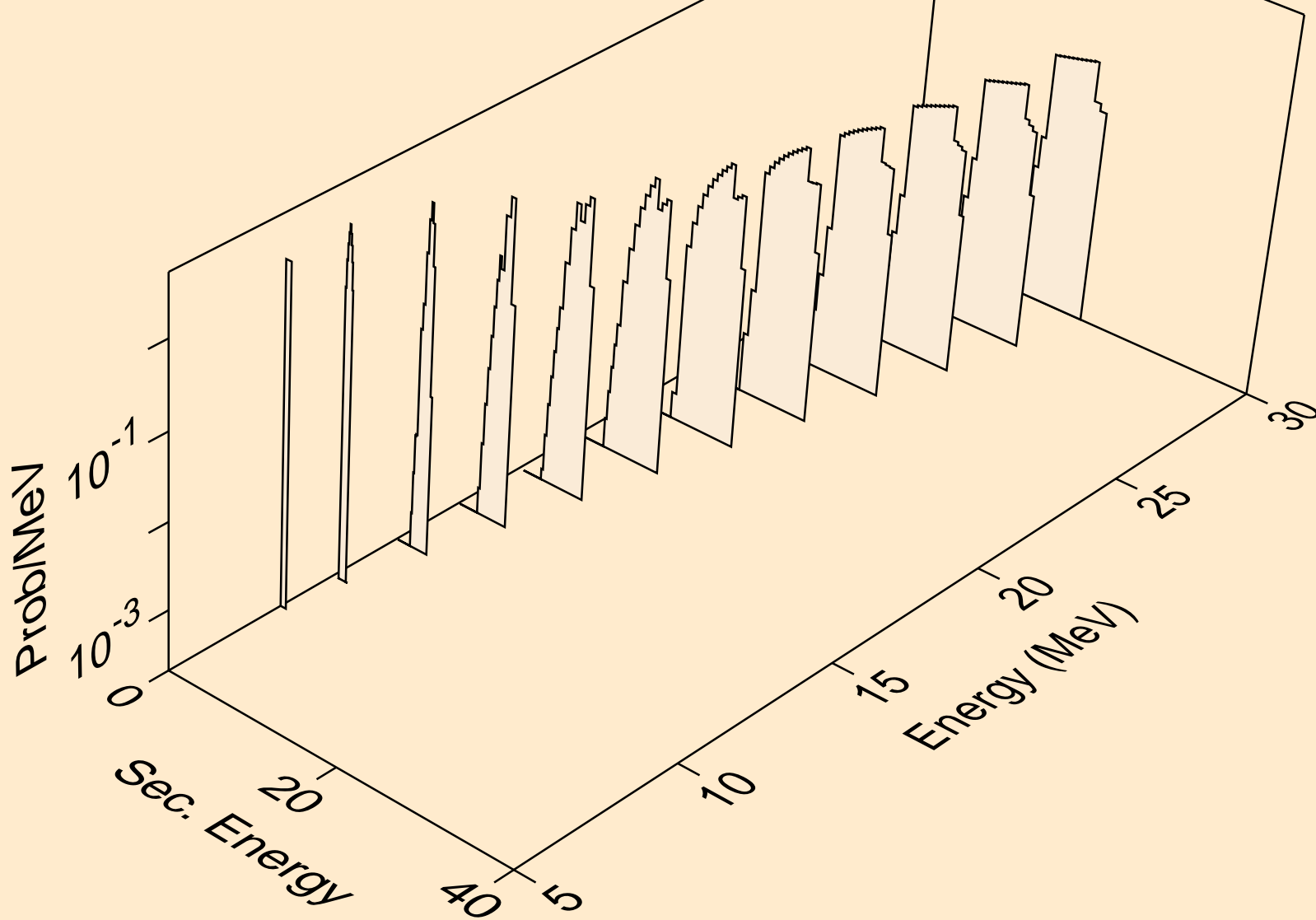

Y096 NEUTRON ACER TENDL-2019 LIBRARY; T=293.16K
tritons from (n,x)

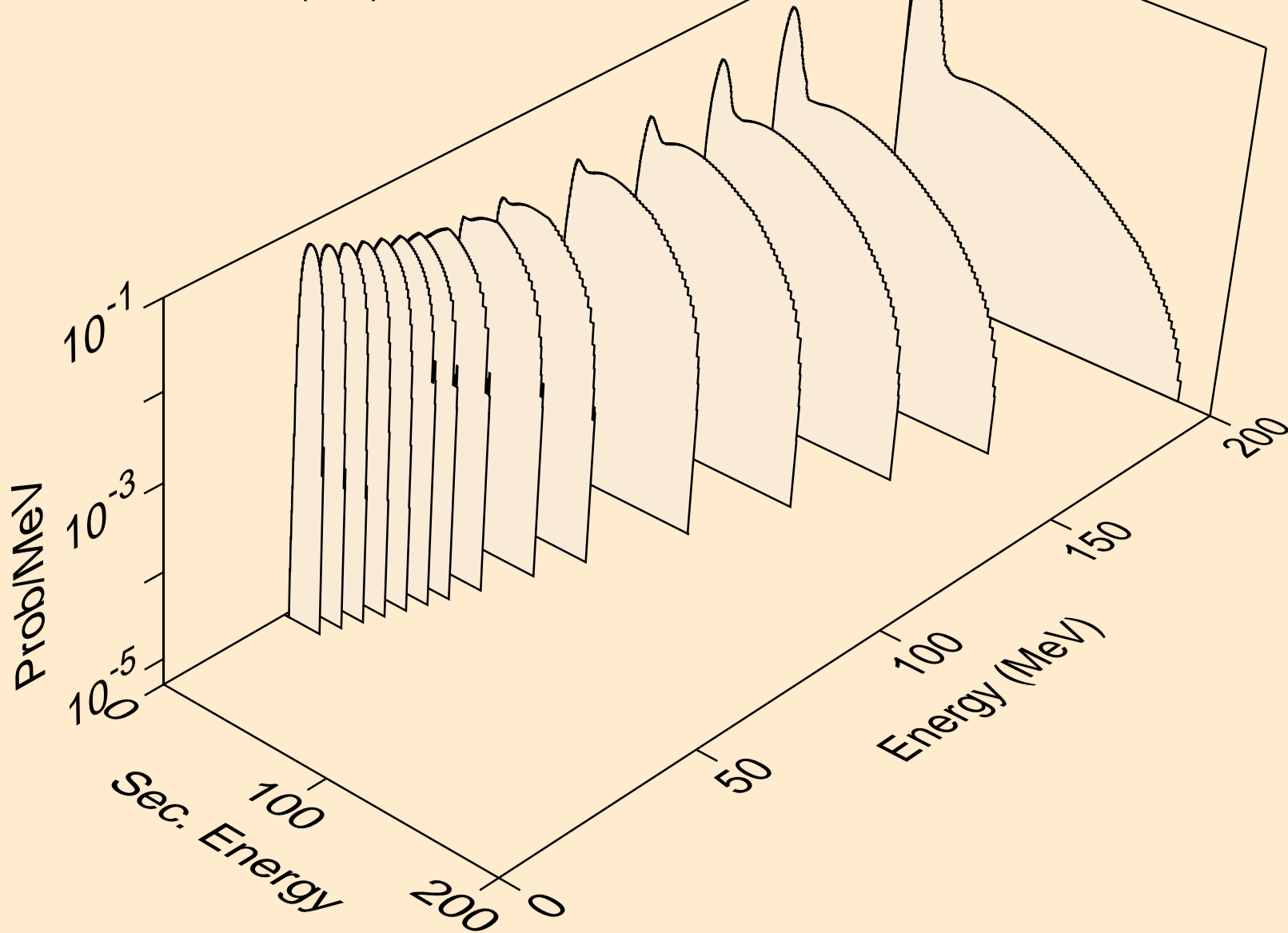

Y096 NEUTRON ACER TENDL-2019 LIBRARY; T=293.16K
tritons from (n,n*)t

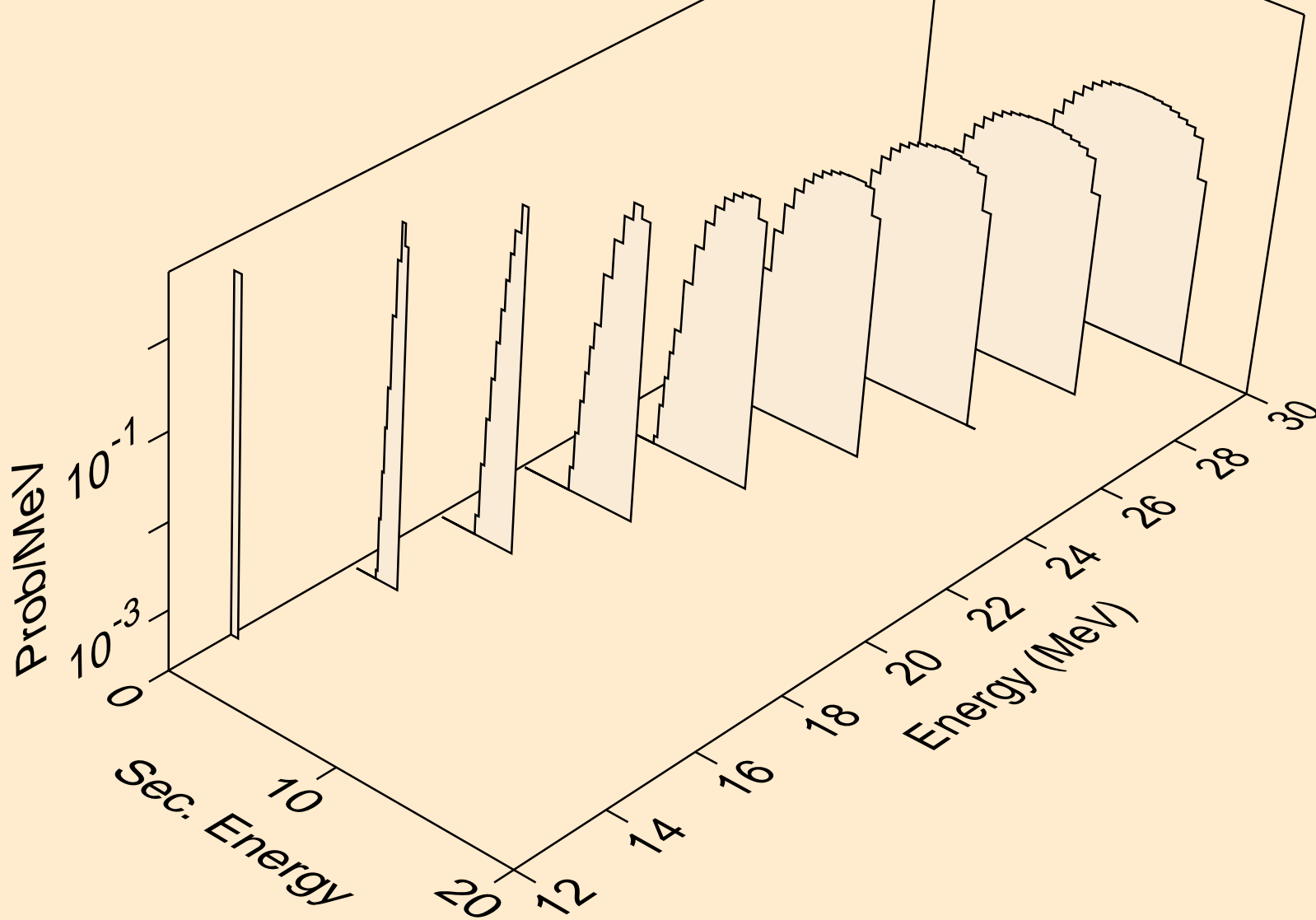

Y096 NEUTRON ACER TENDL-2019 LIBRARY; T=293.16K
tritons from (n,t)

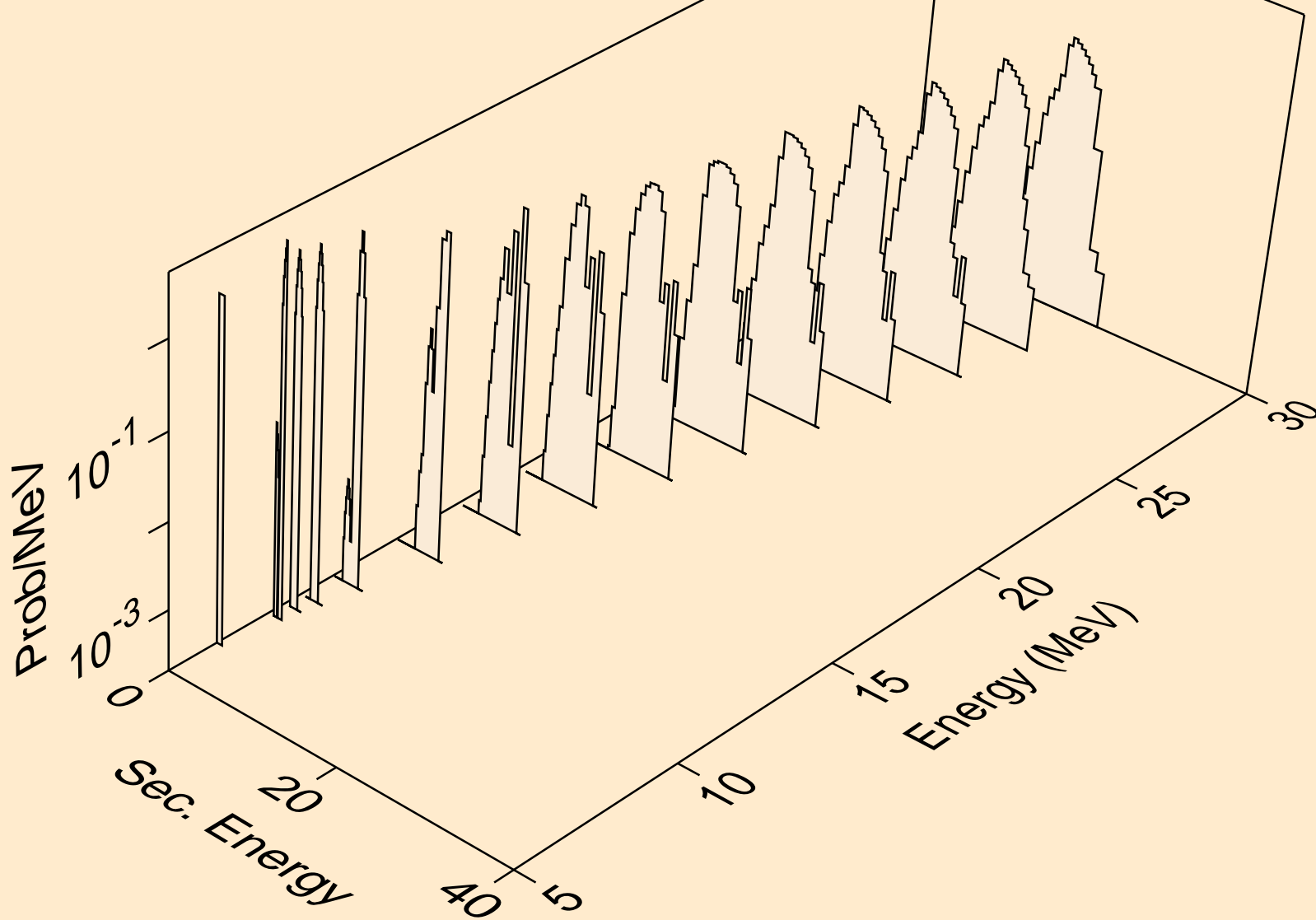

Y096 NEUTRON ACER TENDL-2019 LIBRARY; T=293.16K
he3s from (n,x)

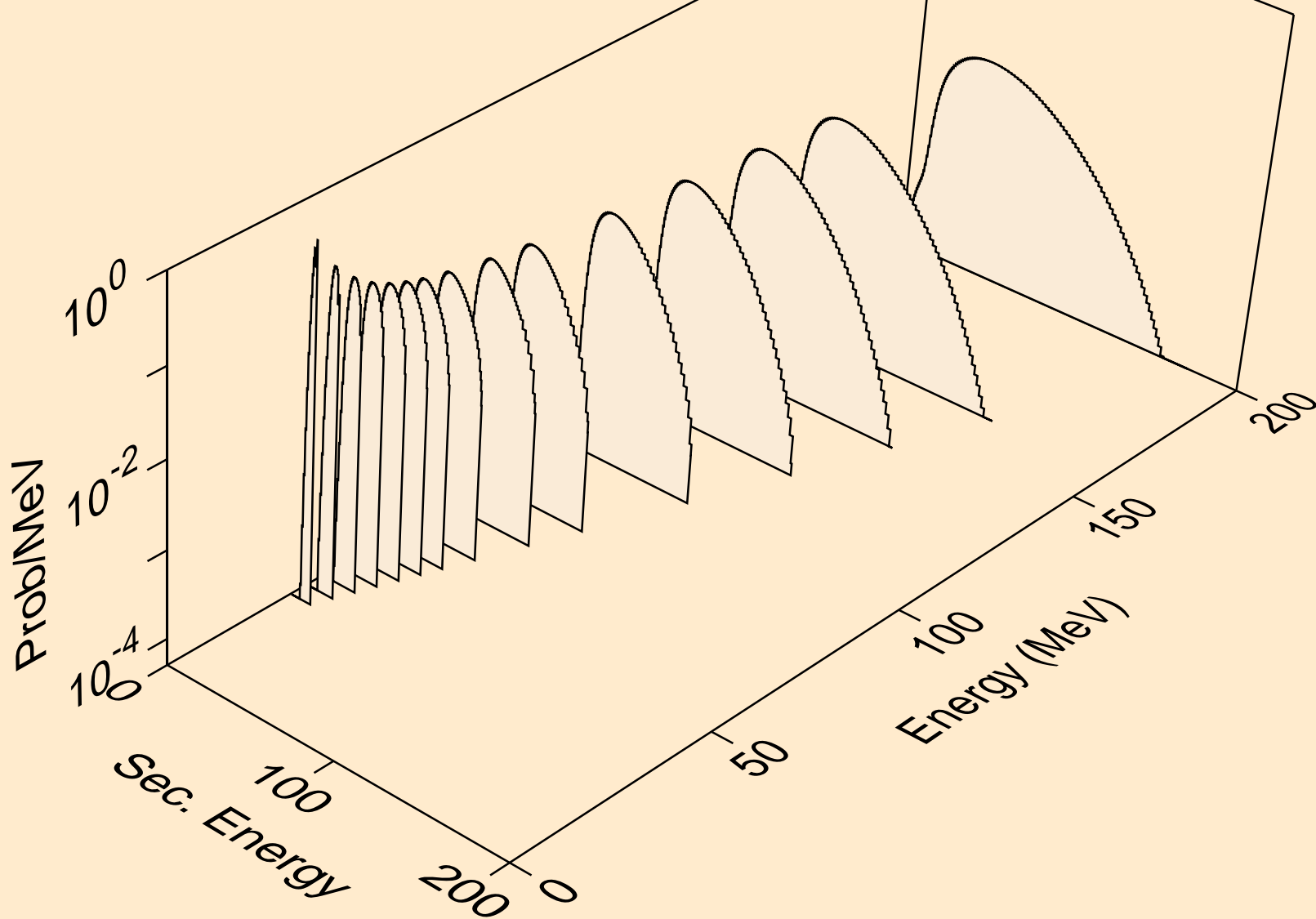

Y096 NEUTRON ACER TENDL-2019 LIBRARY; T=293.16K
he3s from (n,n*)he3

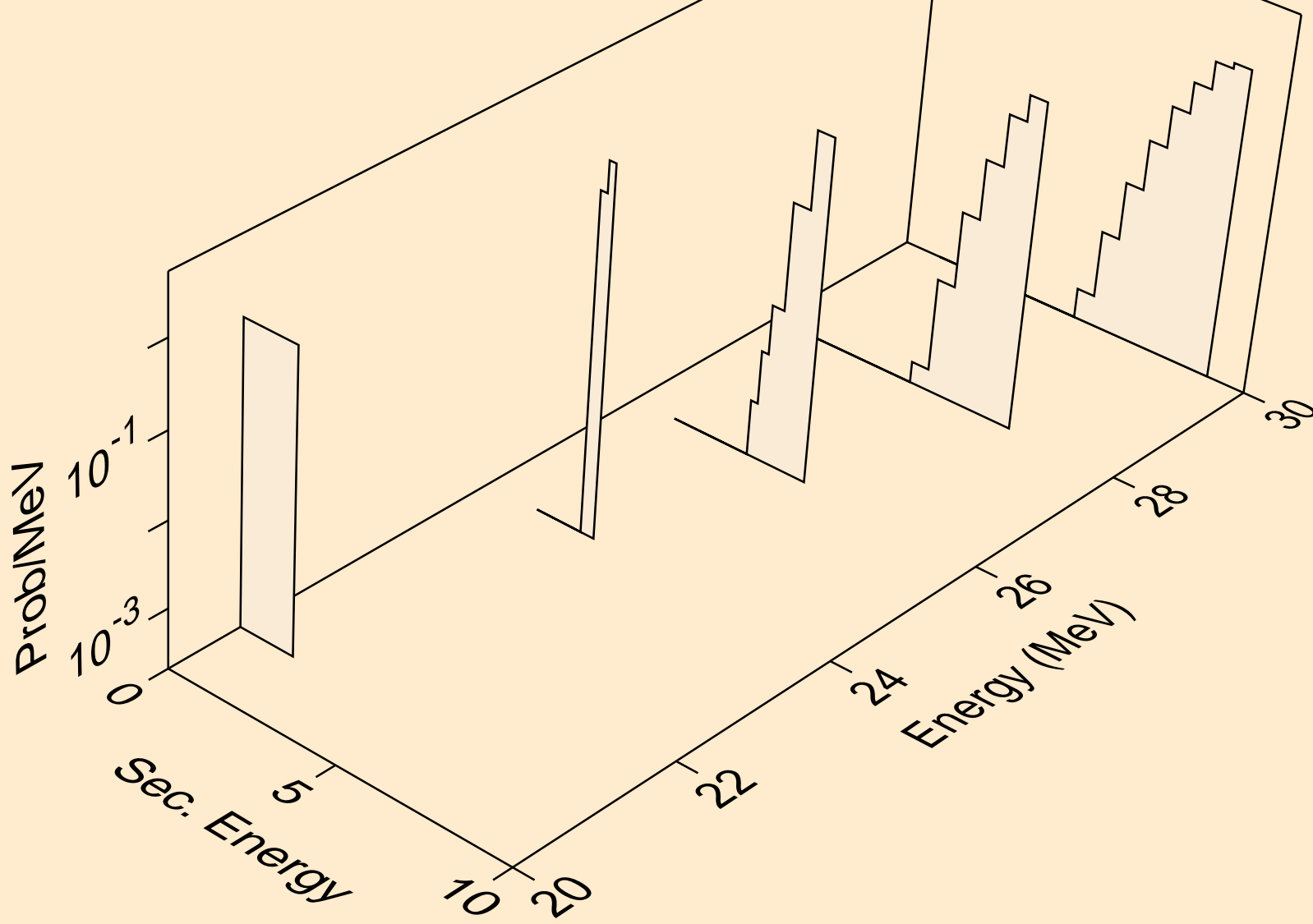

Y096 NEUTRON ACER TENDL-2019 LIBRARY; T=293.16K
he3s from (n,he3)

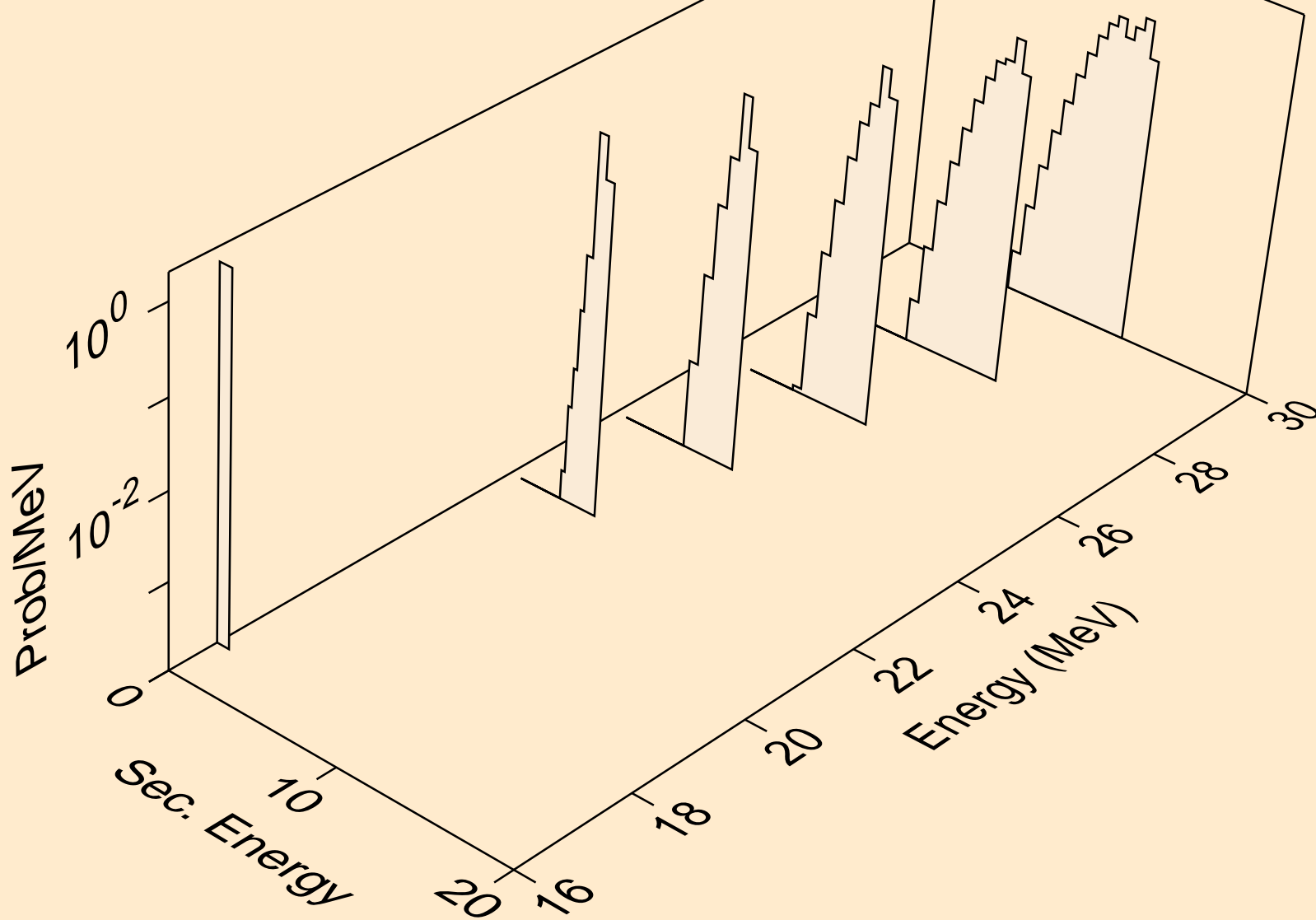

Y096 NEUTRON ACER TENDL-2019 LIBRARY; T=293.16K
alphas from (n,x)

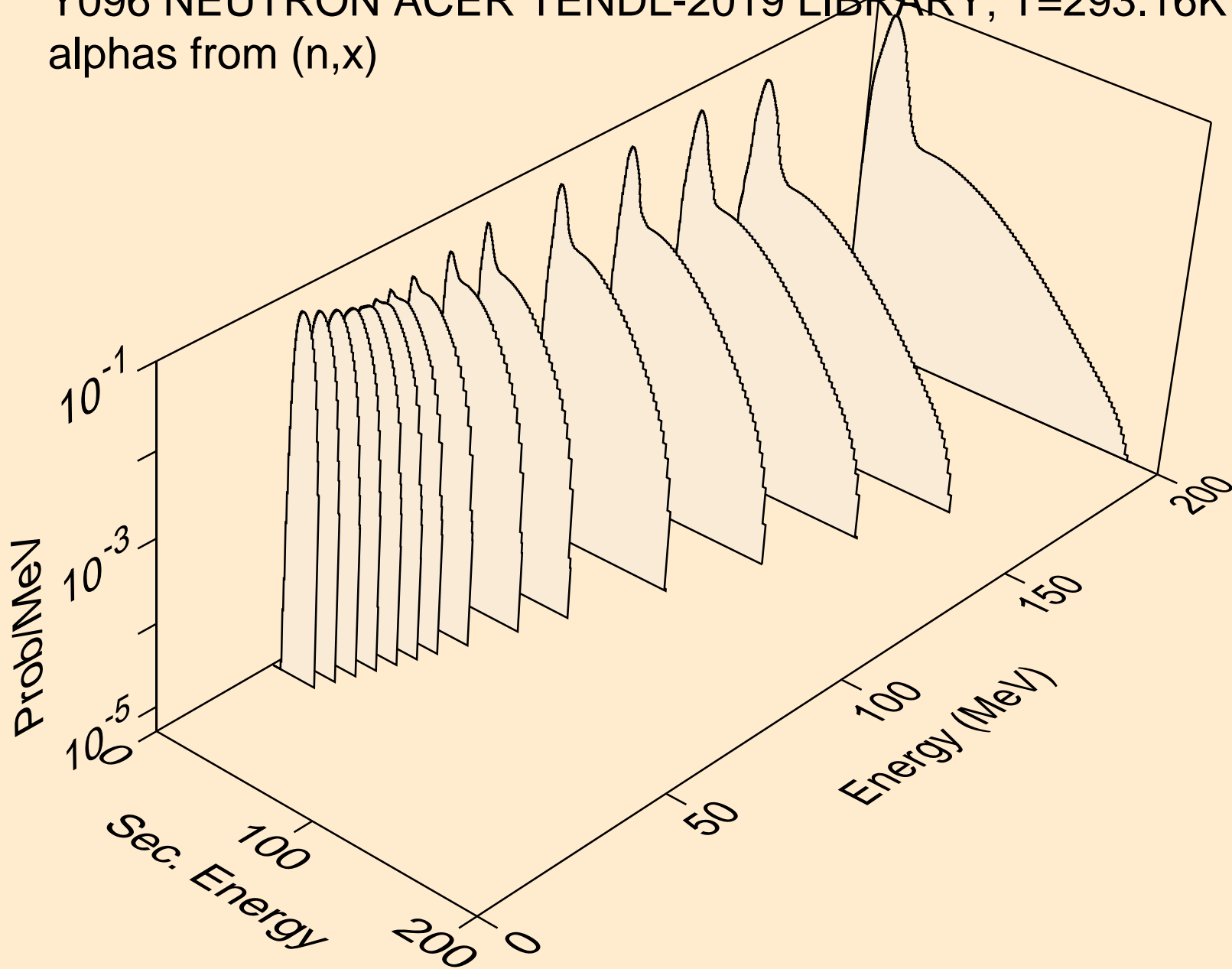

Y096 NEUTRON ACER TENDL-2019 LIBRARY; T=293.16K
alphas from (n,n*)a

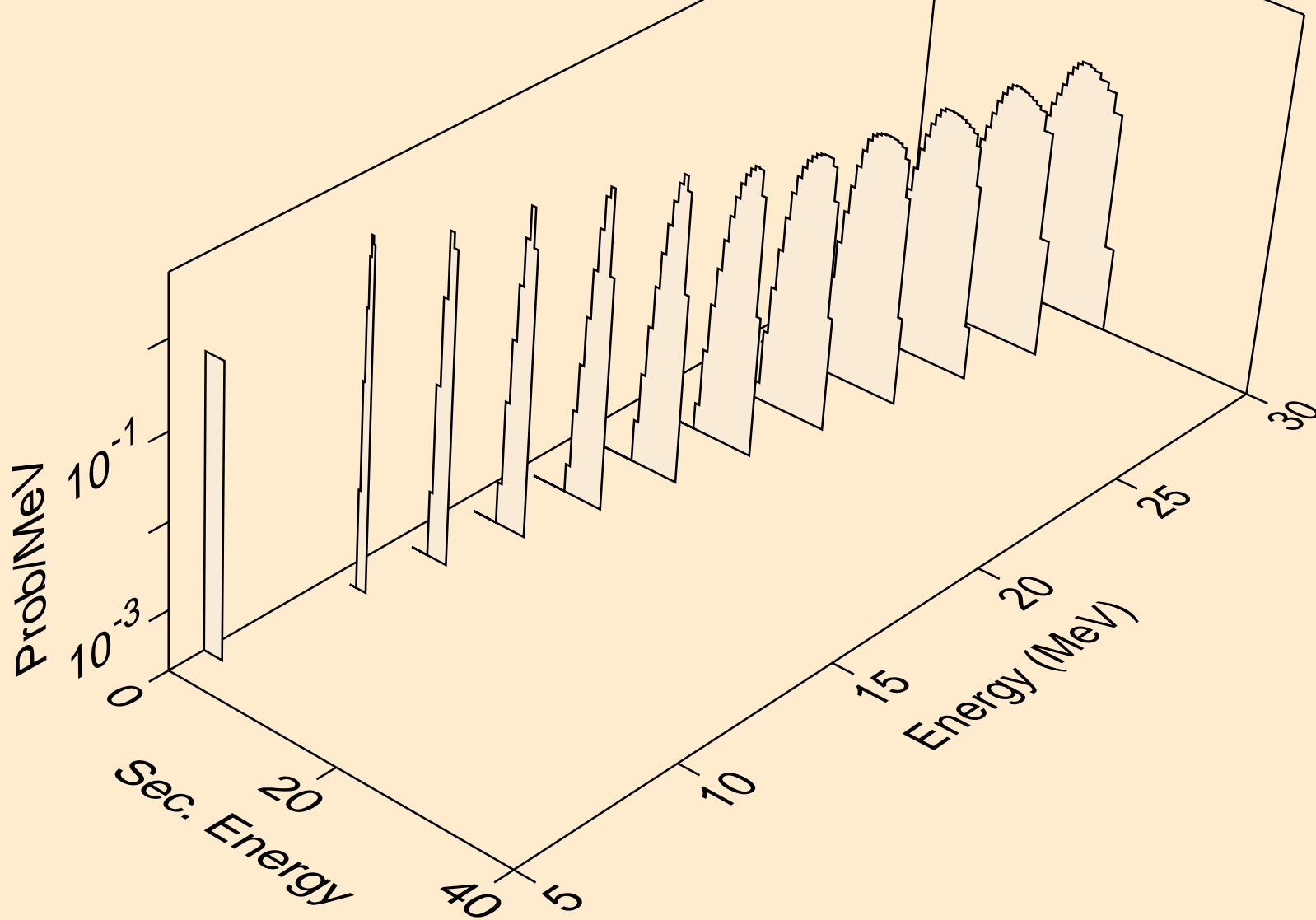

Y096 NEUTRON ACER TENDL-2019 LIBRARY; T=293.16K
alphas from (n,2n)a

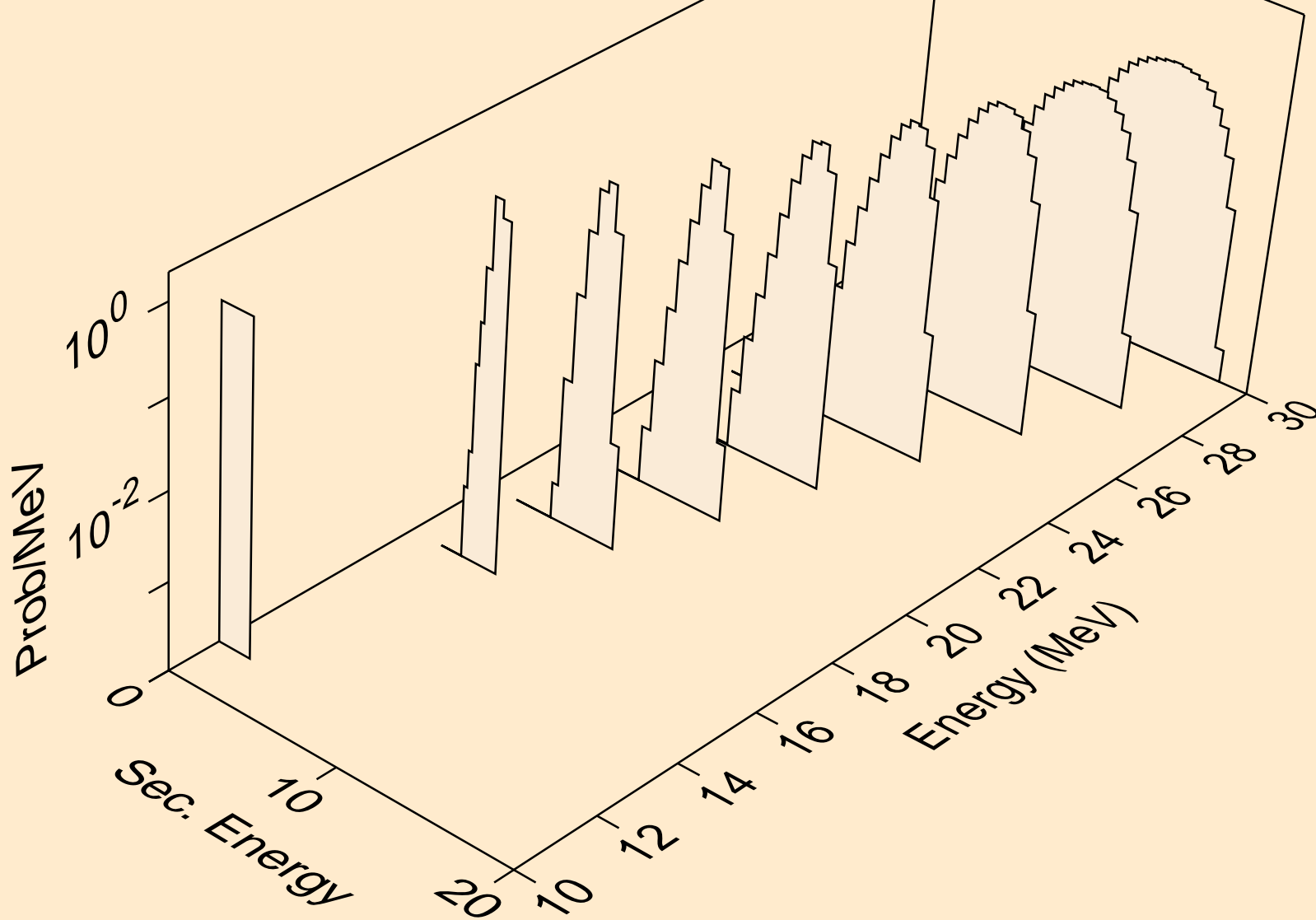

Y096 NEUTRON ACER TENDL-2019 LIBRARY; T=293.16K
alphas from (n,3n)a

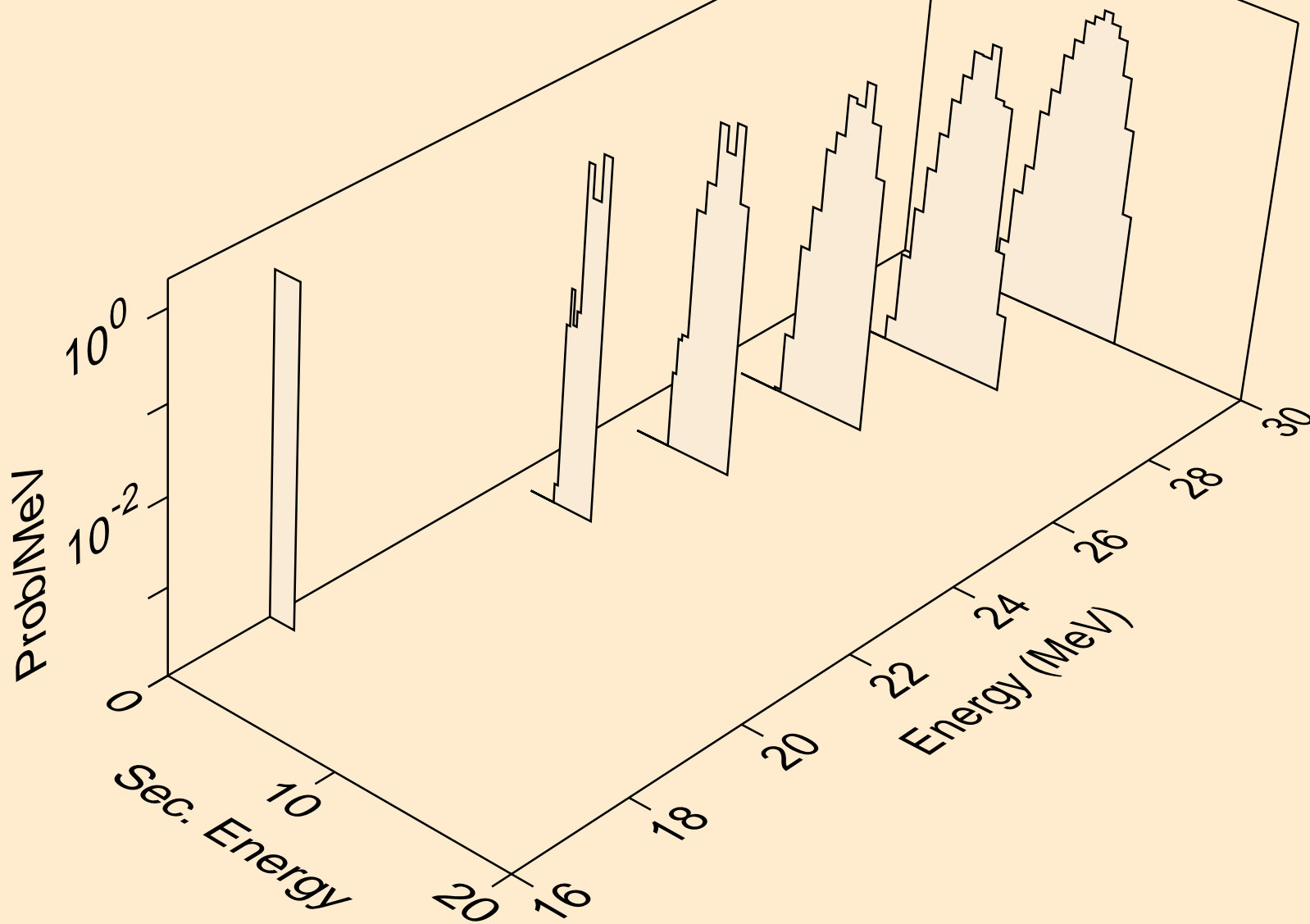

Y096 NEUTRON ACER TENDL-2019 LIBRARY; T=293.16K
alphas from (n,a)

