

ZN070 NEUTRON ACER TENDL-2019 LIBRARY; T=293.16K
Principal cross sections

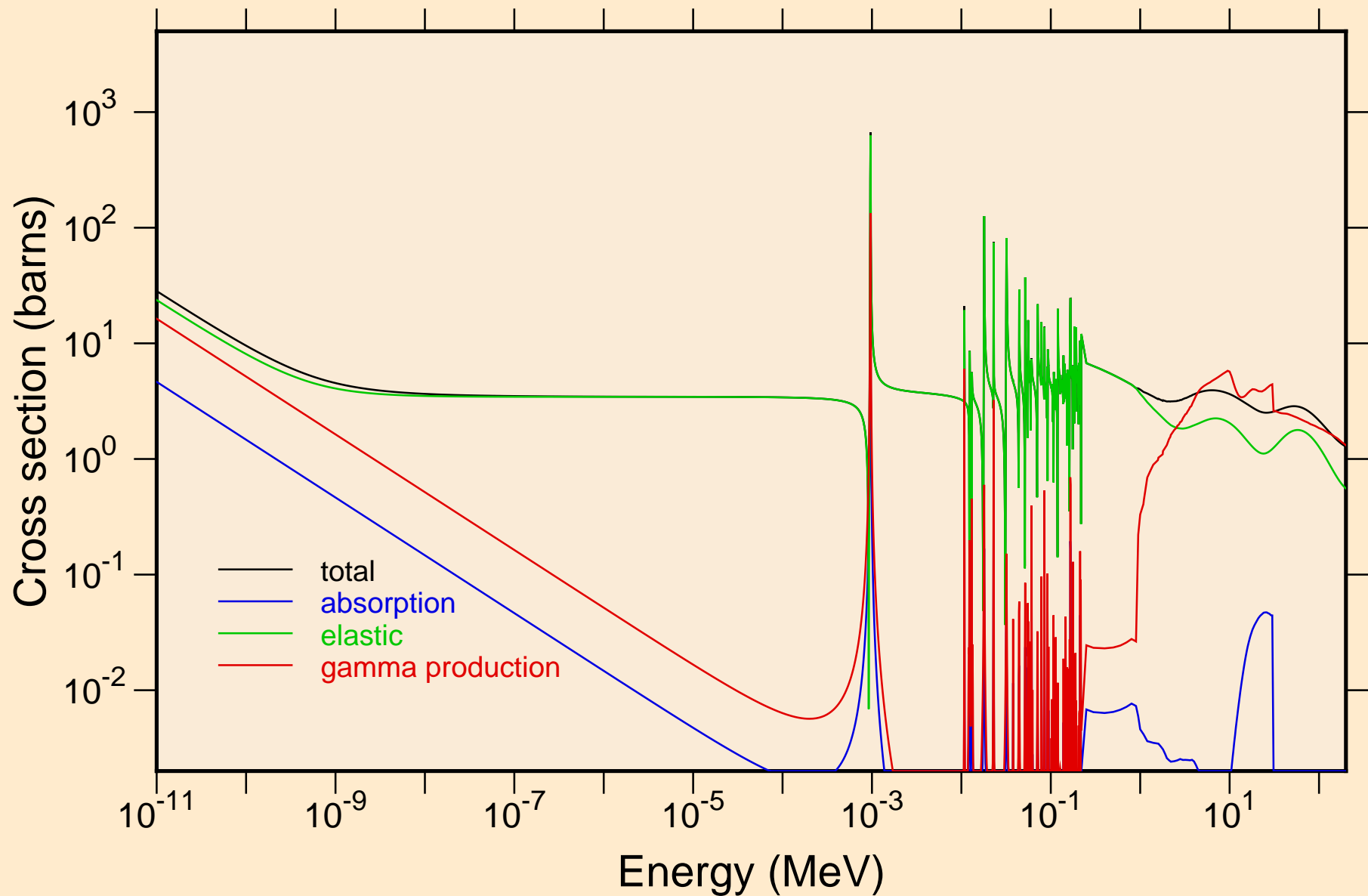

ZN070 NEUTRON ACER TENDL-2019 LIBRARY; T=293.16K
resonance total cross section

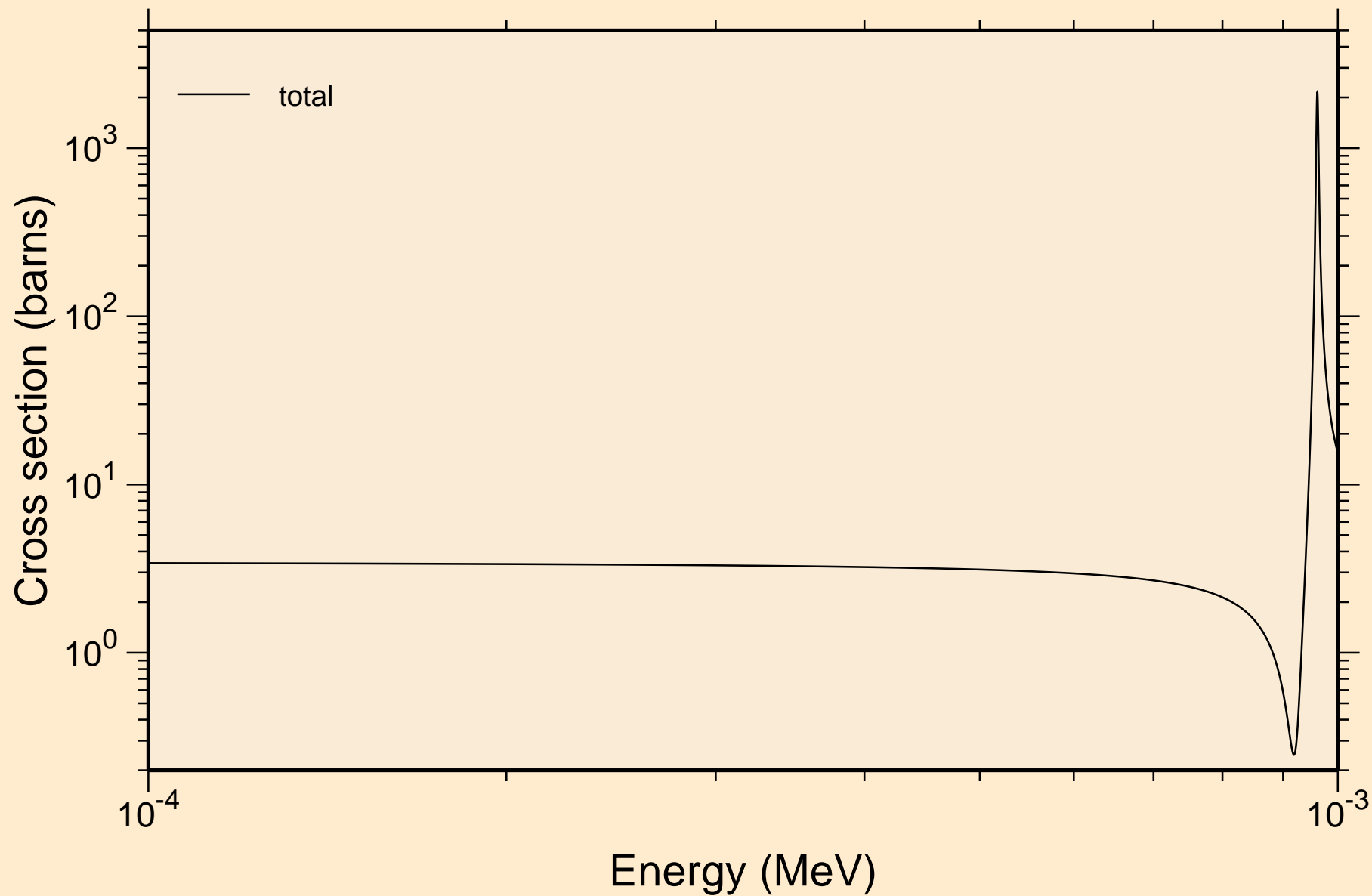

ZN070 NEUTRON ACER TENDL-2019 LIBRARY; T=293.16K
resonance total cross section

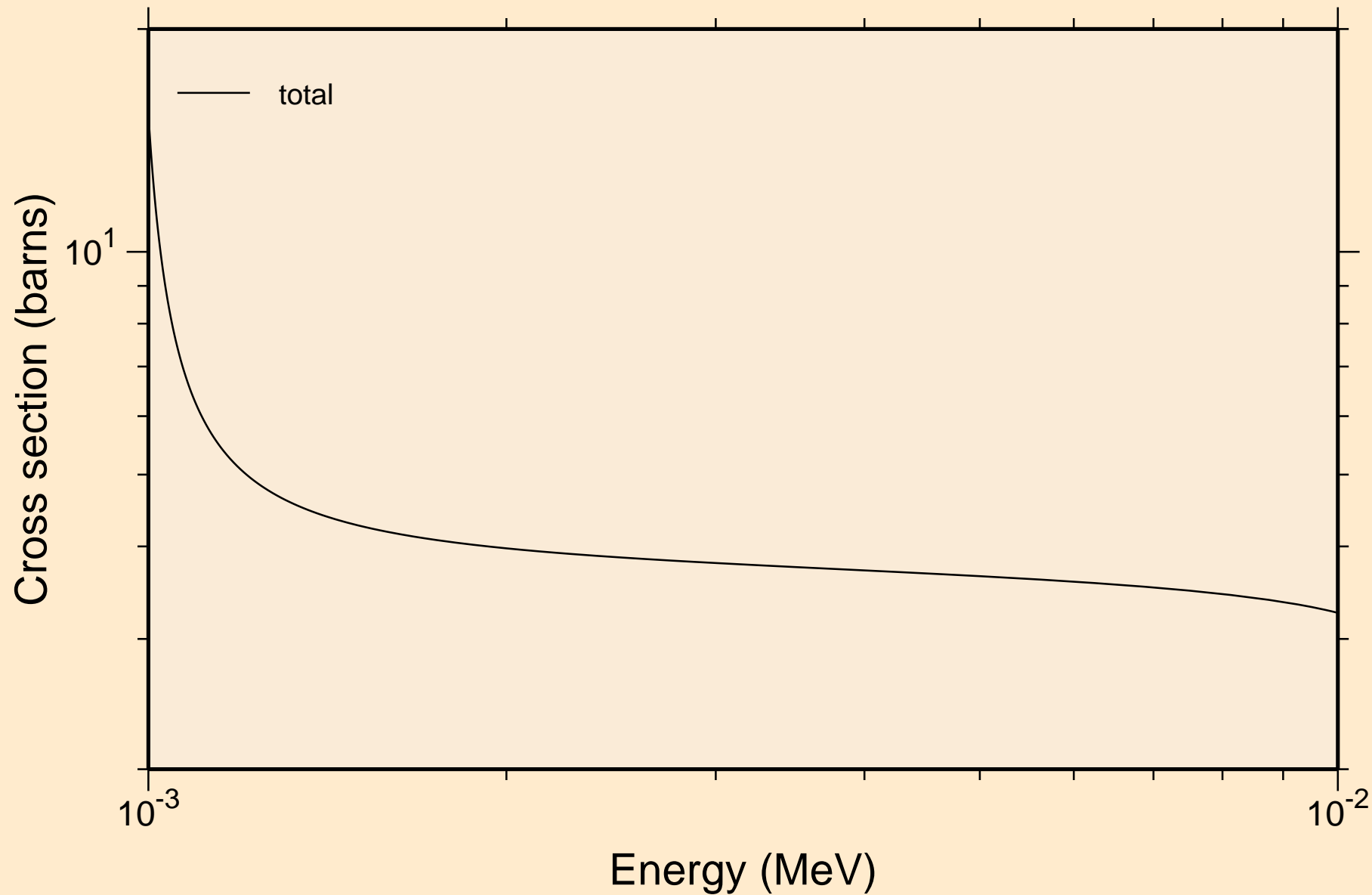

ZN070 NEUTRON ACER TENDL-2019 LIBRARY; T=293.16K
resonance total cross section

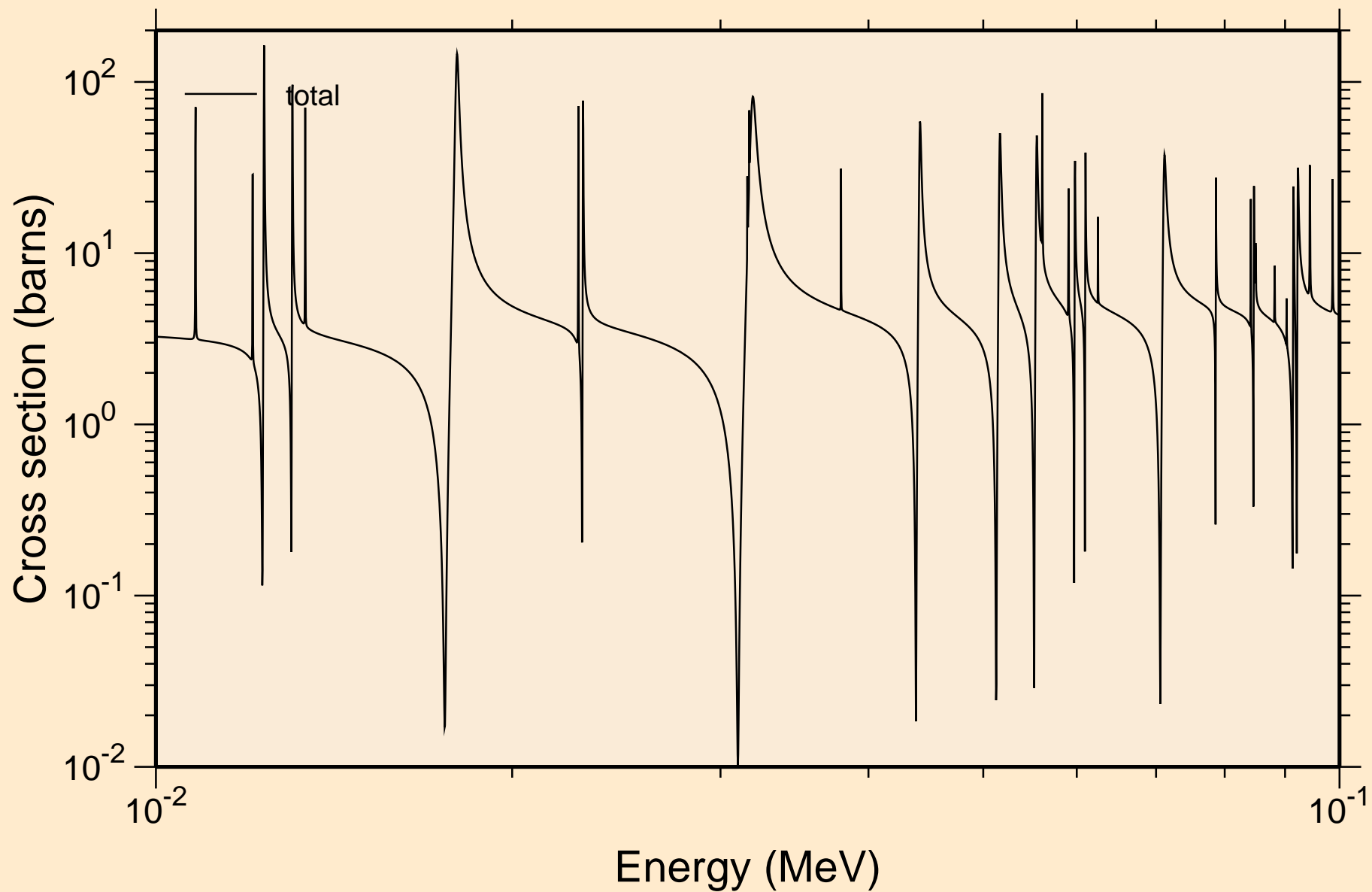

ZN070 NEUTRON ACER TENDL-2019 LIBRARY; T=293.16K
resonance total cross section

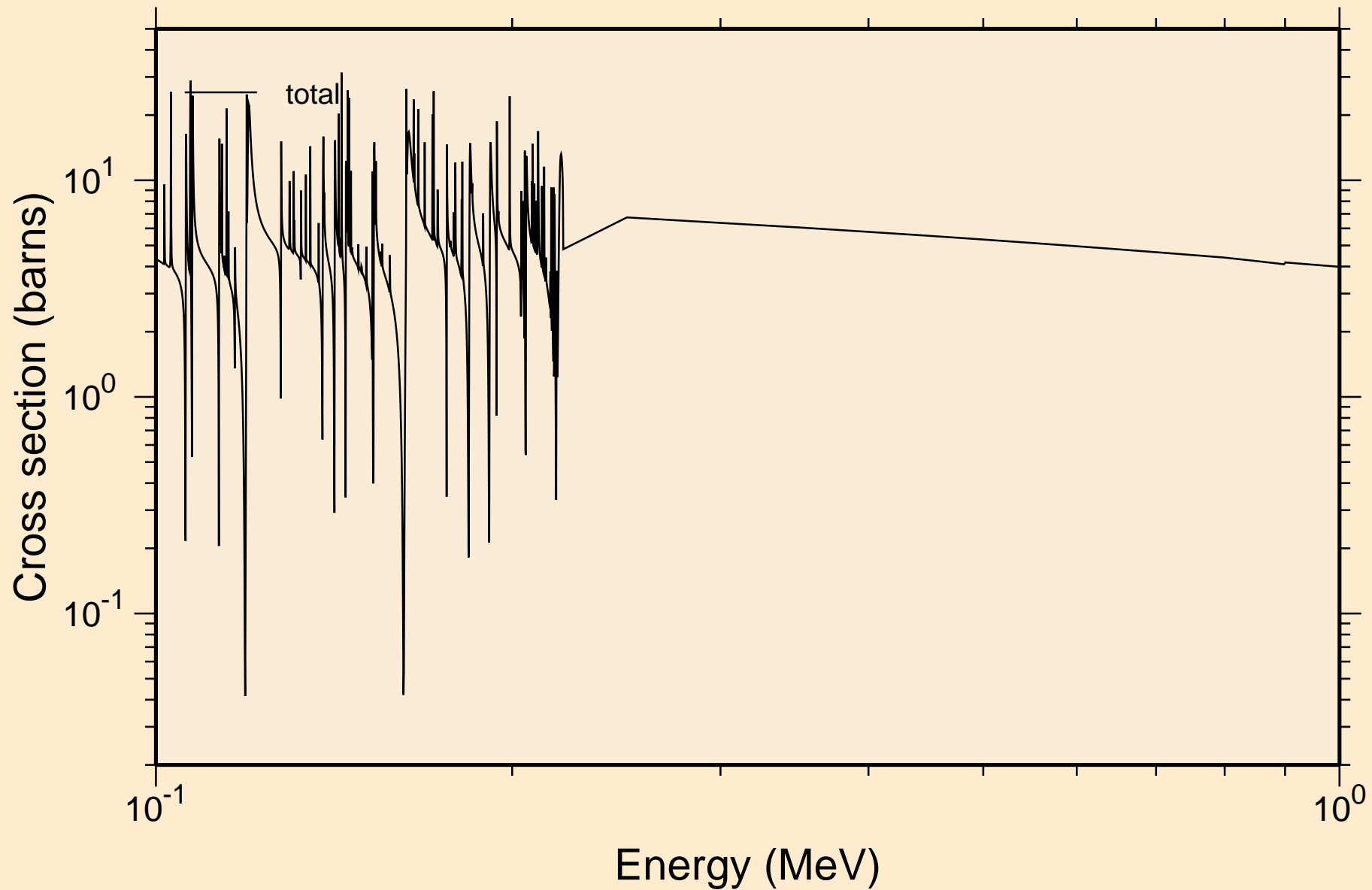

ZN070 NEUTRON ACER TENDL-2019 LIBRARY; T=293.16K
resonance total cross section

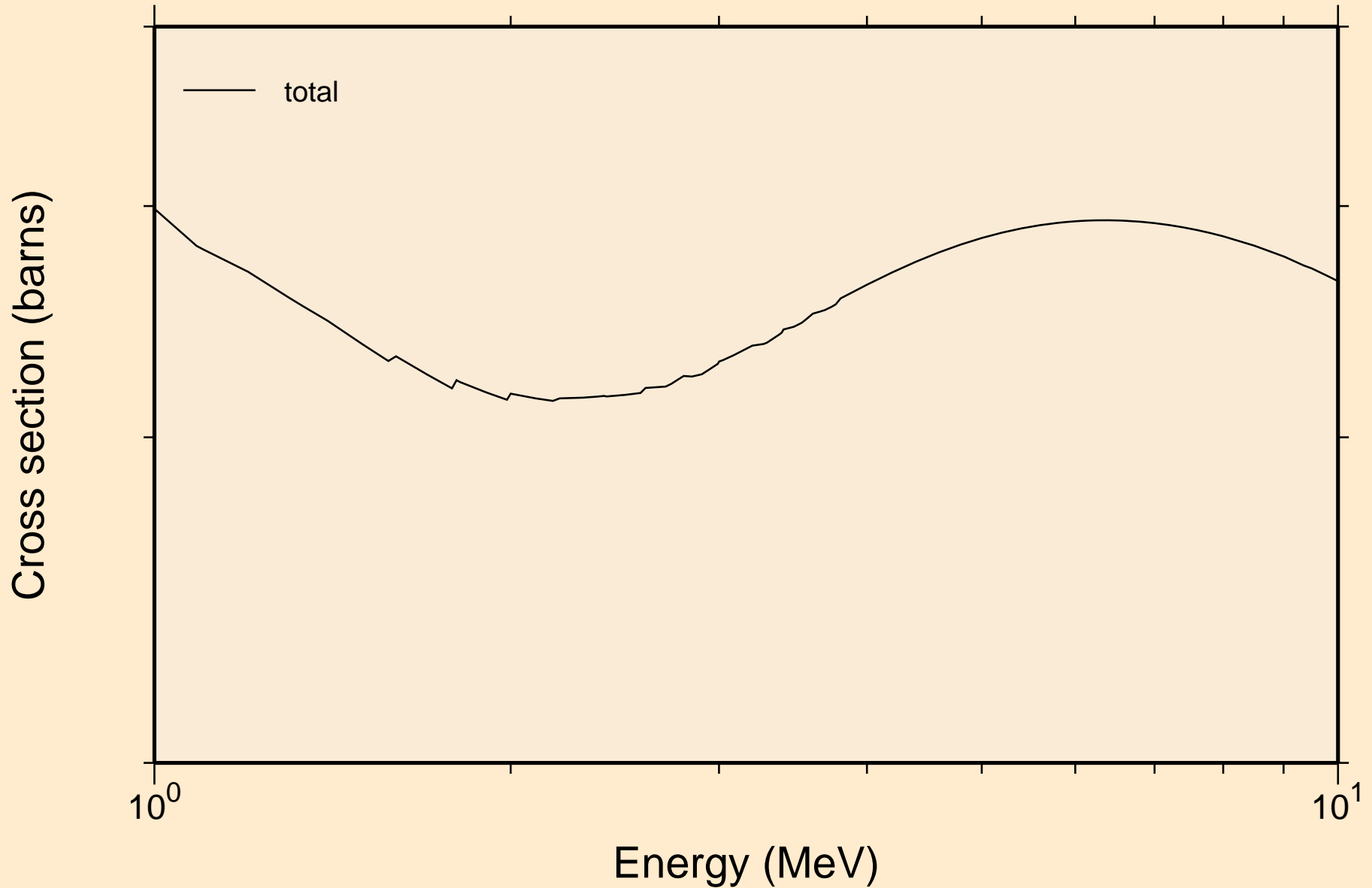

ZN070 NEUTRON ACER TENDL-2019 LIBRARY; T=293.16K
resonance absorption cross sections

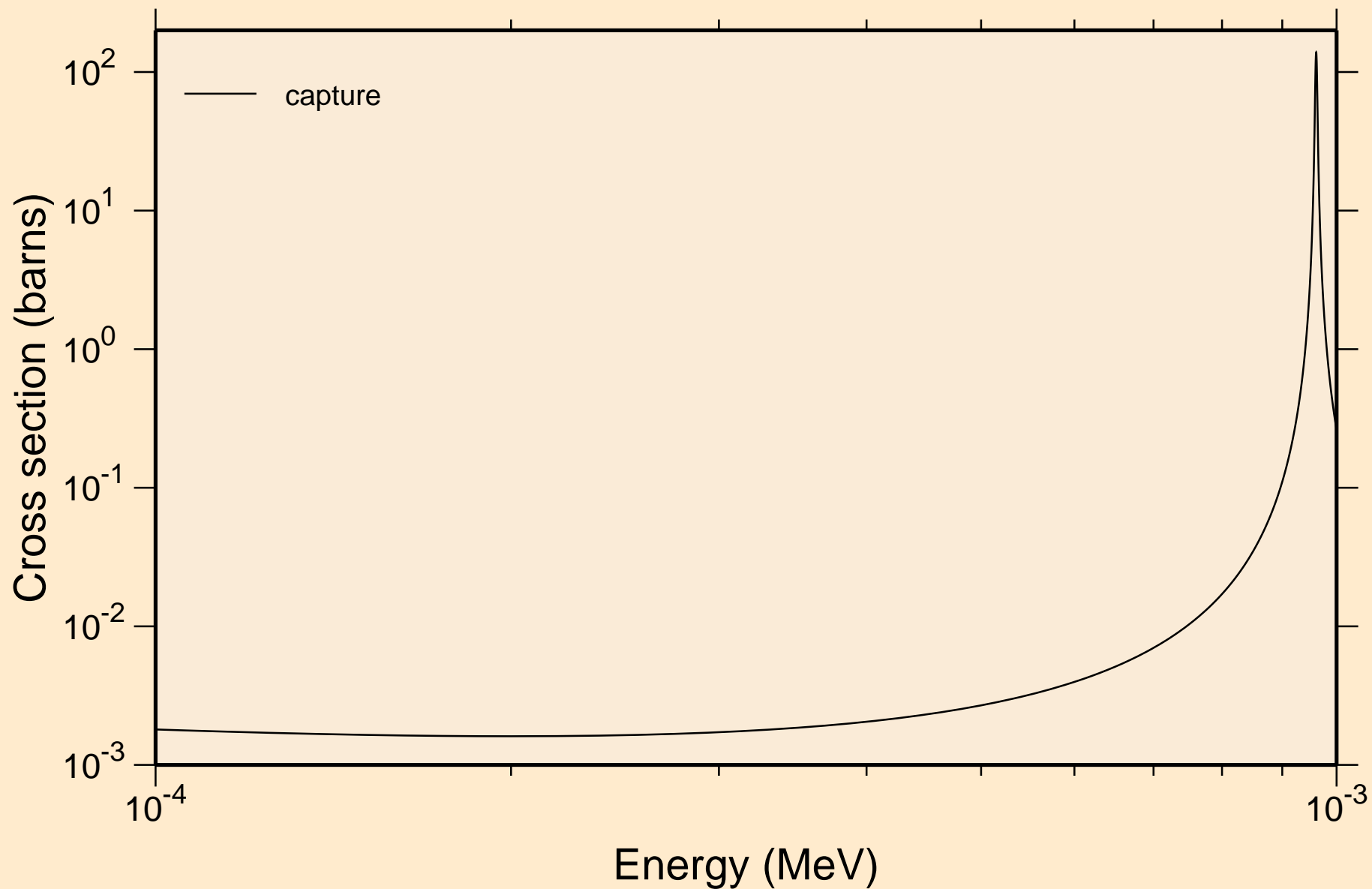

ZN070 NEUTRON ACER TENDL-2019 LIBRARY; T=293.16K
resonance absorption cross sections

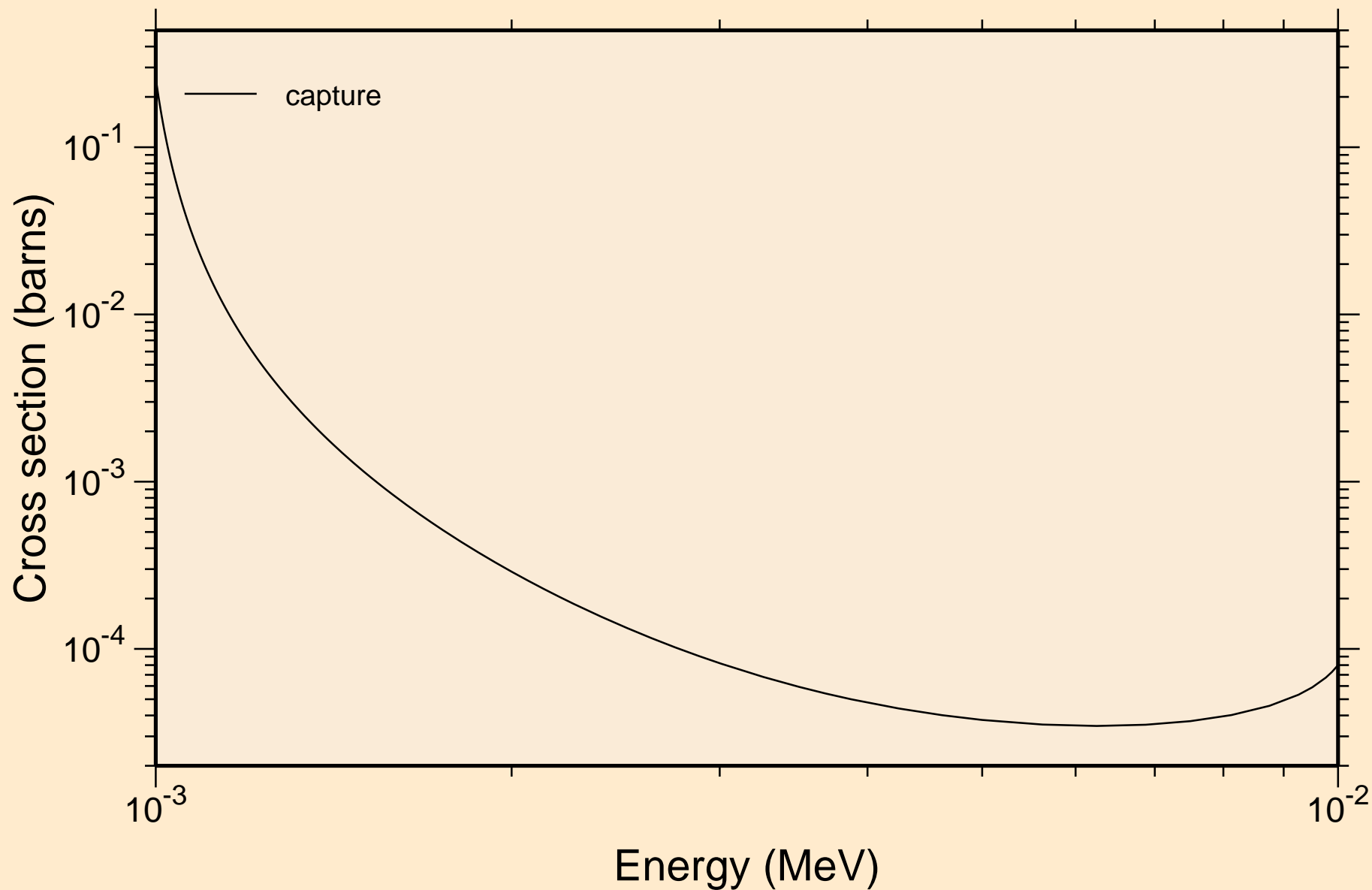

ZN070 NEUTRON ACER TENDL-2019 LIBRARY; T=293.16K
resonance absorption cross sections

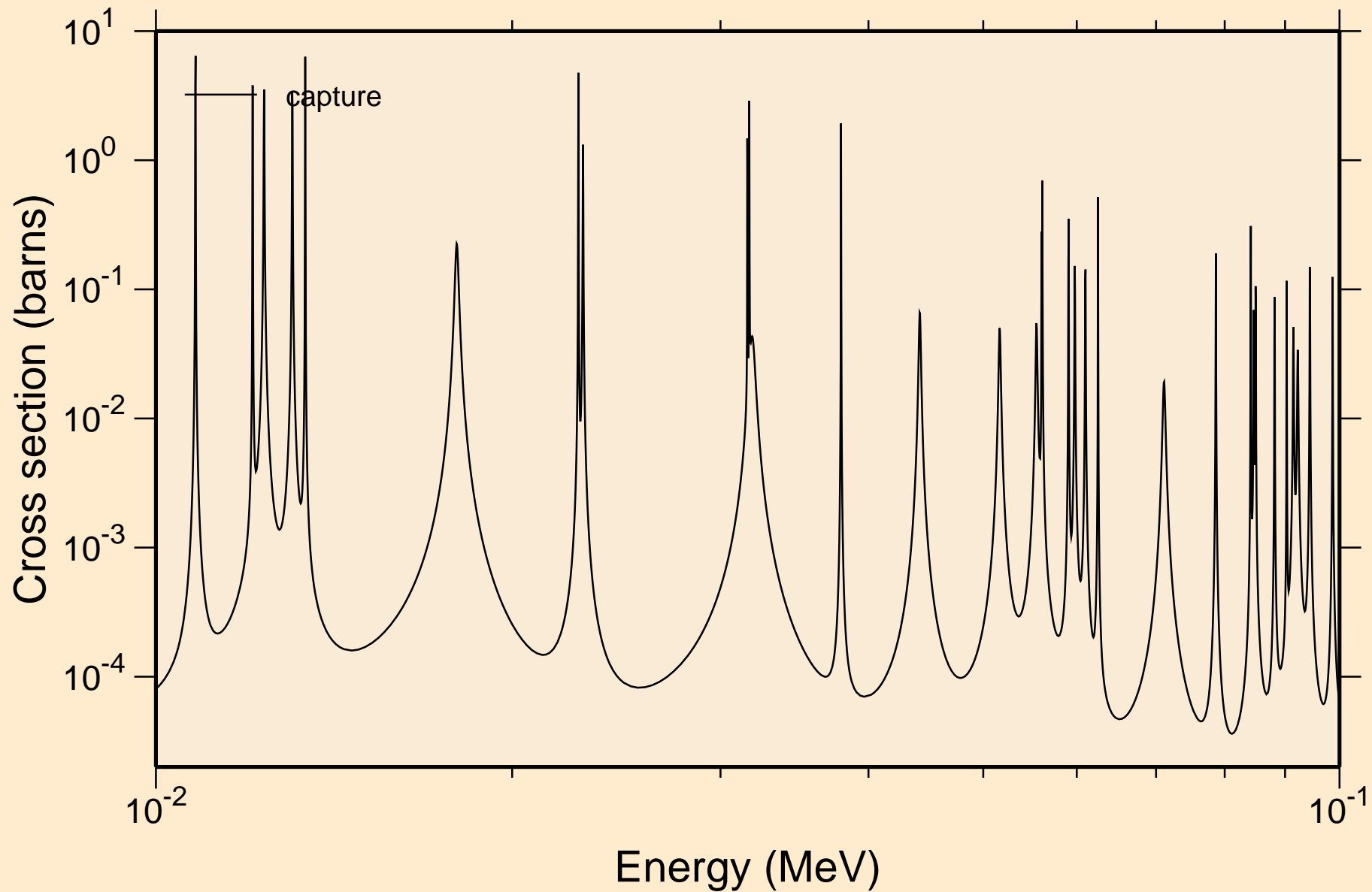

ZN070 NEUTRON ACER TENDL-2019 LIBRARY; T=293.16K
resonance absorption cross sections

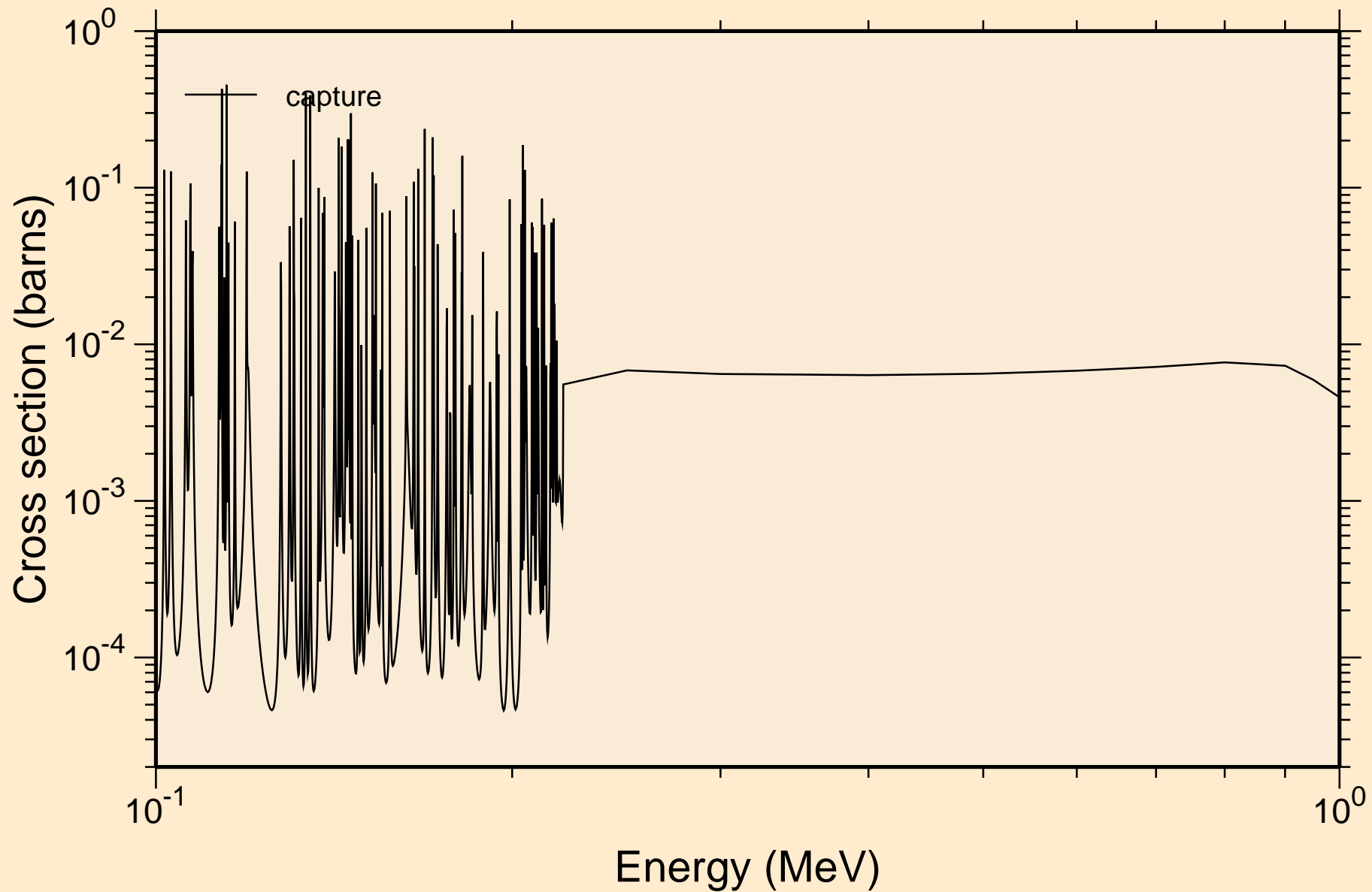

ZN070 NEUTRON ACER TENDL-2019 LIBRARY; T=293.16K
resonance absorption cross sections

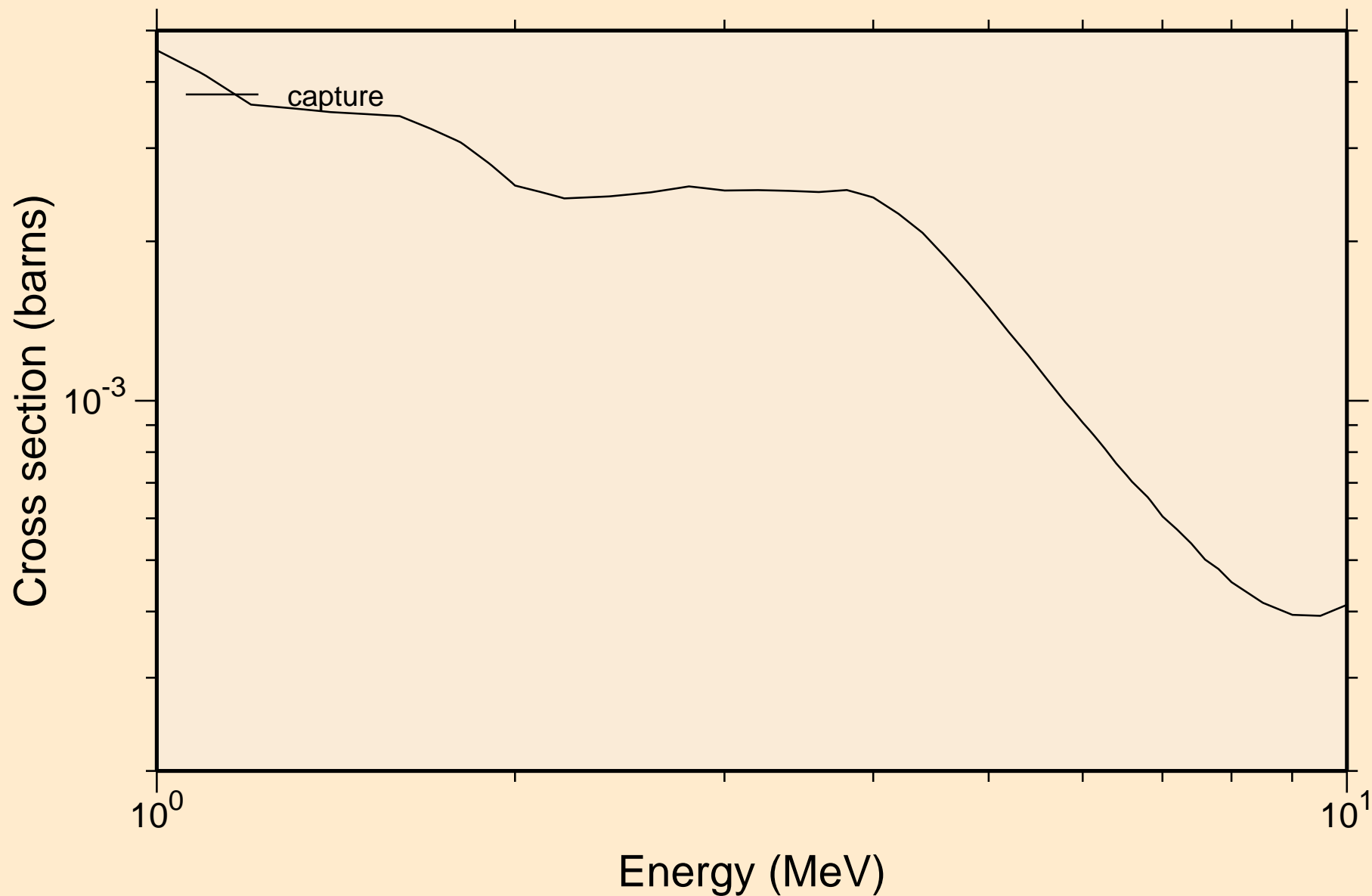

ZN070 NEUTRON ACER TENDL-2019 LIBRARY; T=293.16K
Heating

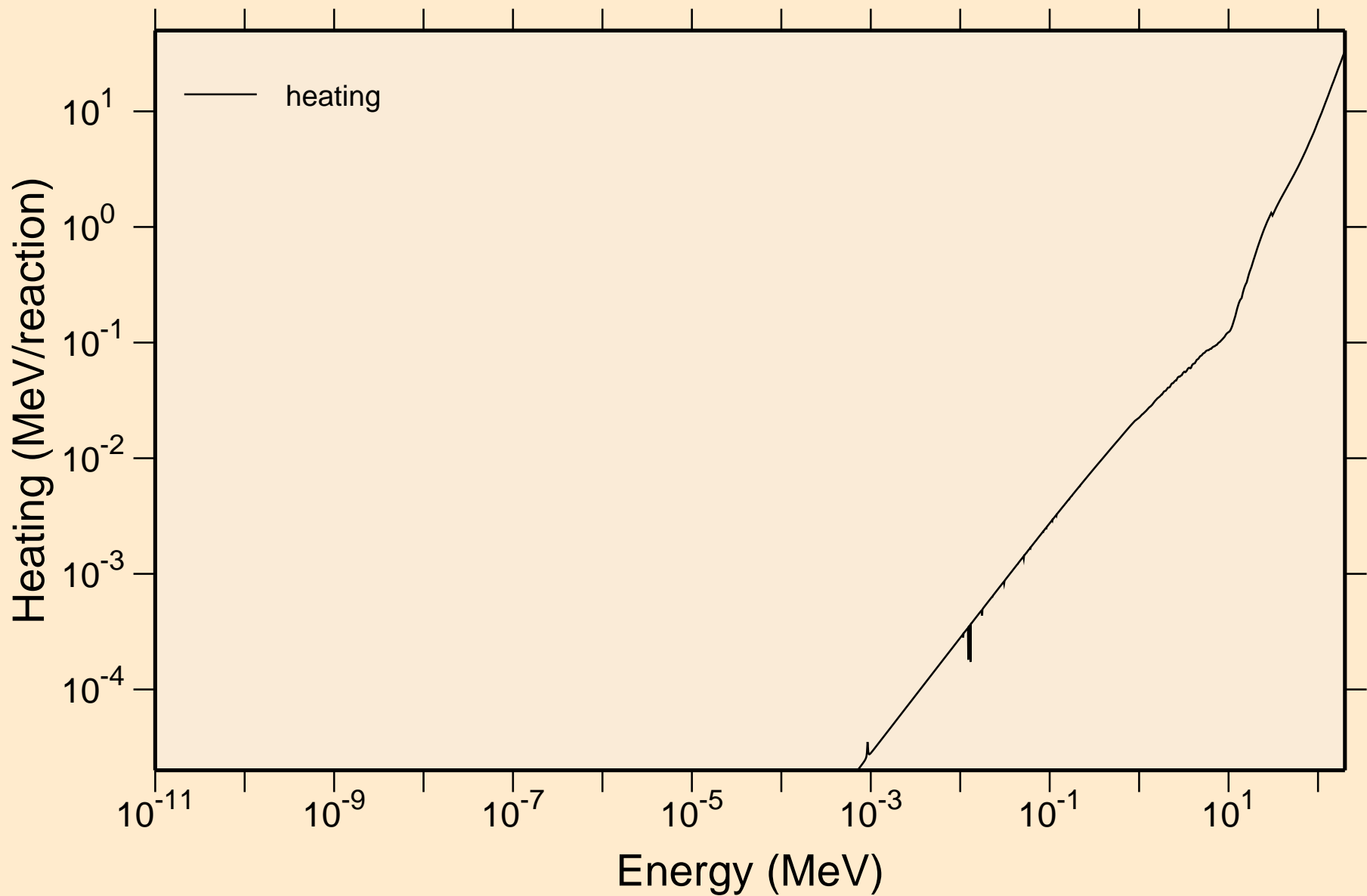

ZN070 NEUTRON ACER TENDL-2019 LIBRARY; T=293.16K
Damage

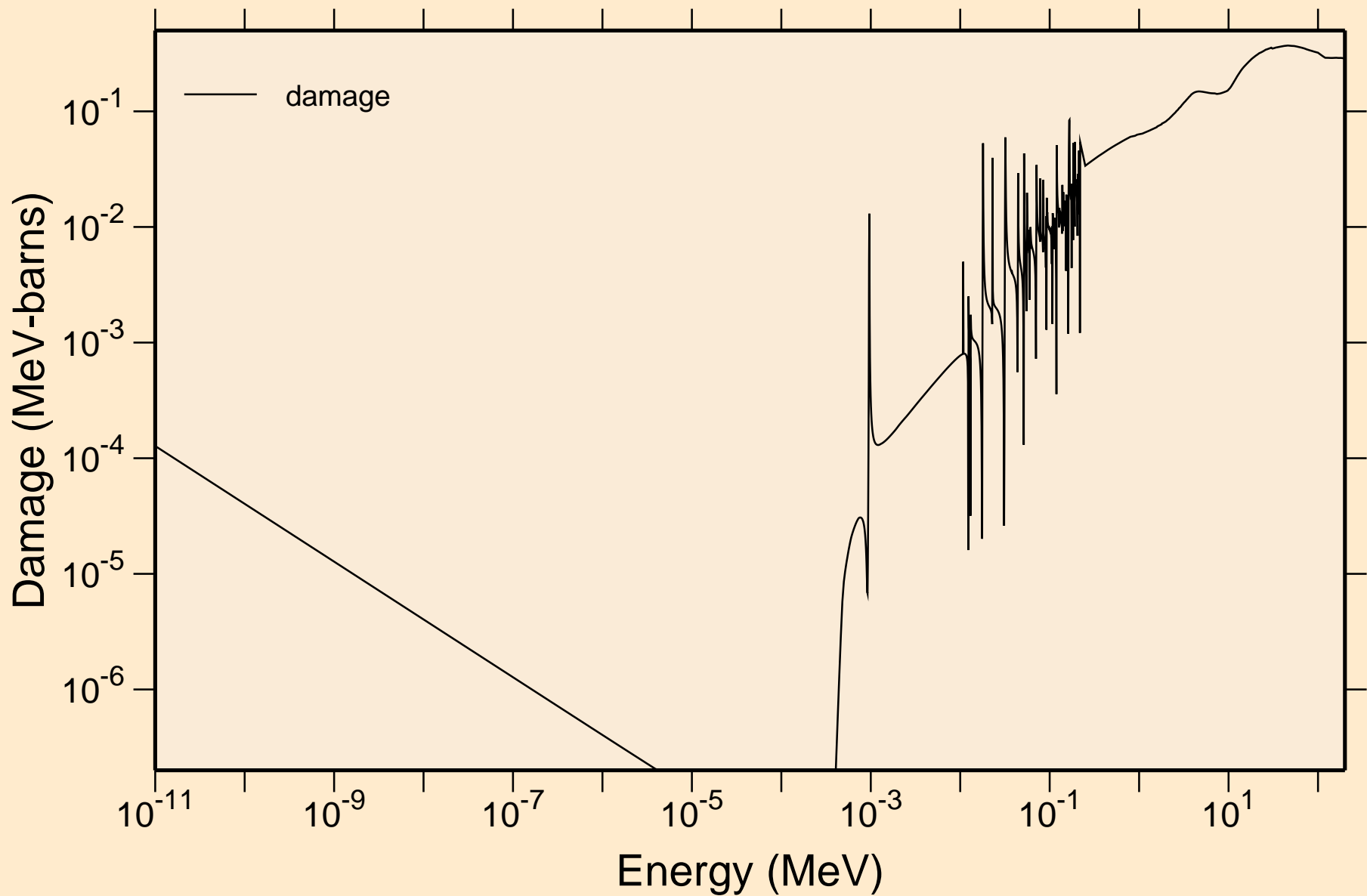

ZN070 NEUTRON ACER TENDL-2019 LIBRARY; T=293.16K
Non-threshold reactions

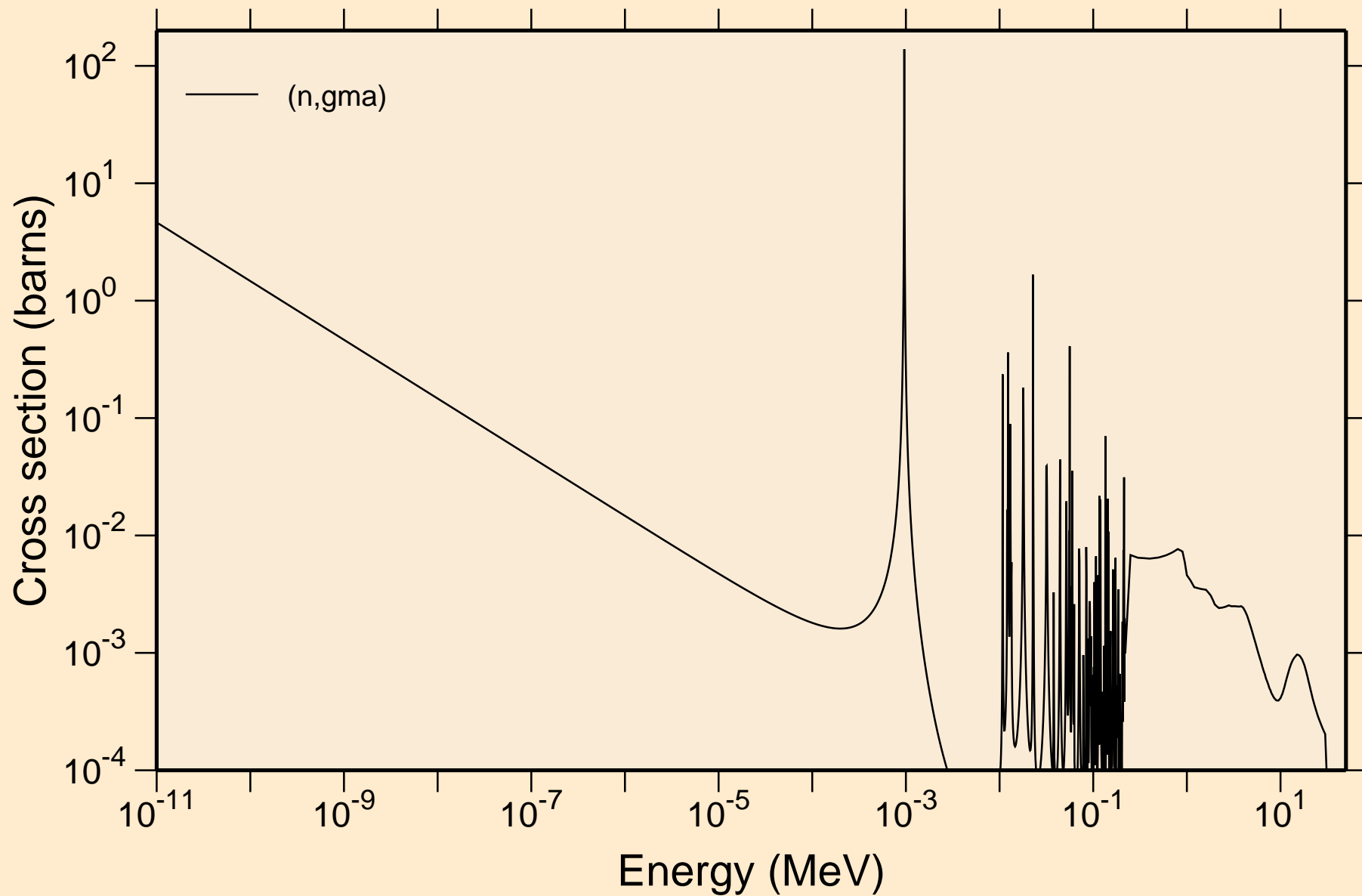

ZN070 NEUTRON ACER TENDL-2019 LIBRARY; T=293.16K
Principal cross sections

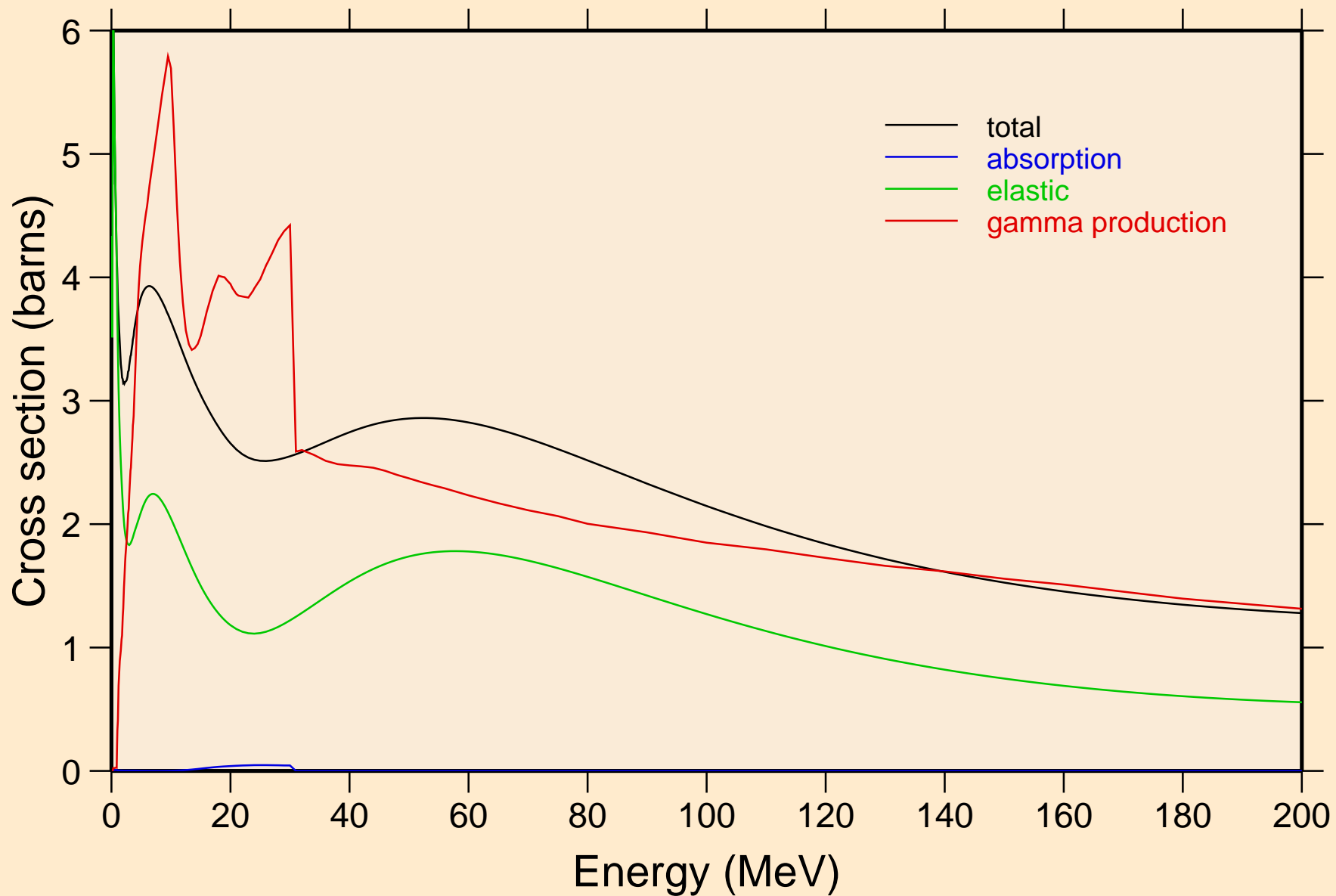

ZN070 NEUTRON ACER TENDL-2019 LIBRARY; T=293.16K
Heating

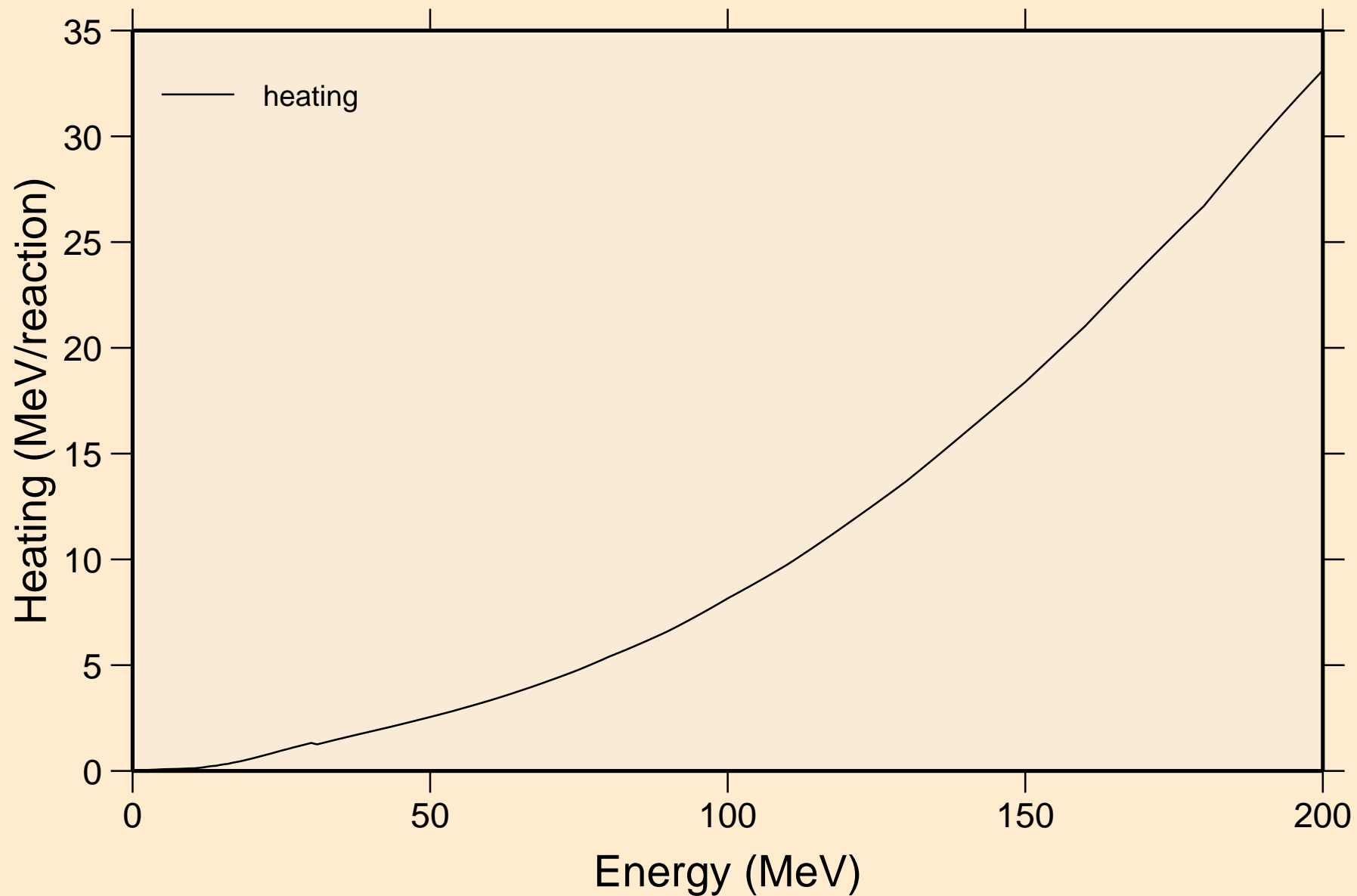

ZN070 NEUTRON ACER TENDL-2019 LIBRARY; T=293.16K
Damage

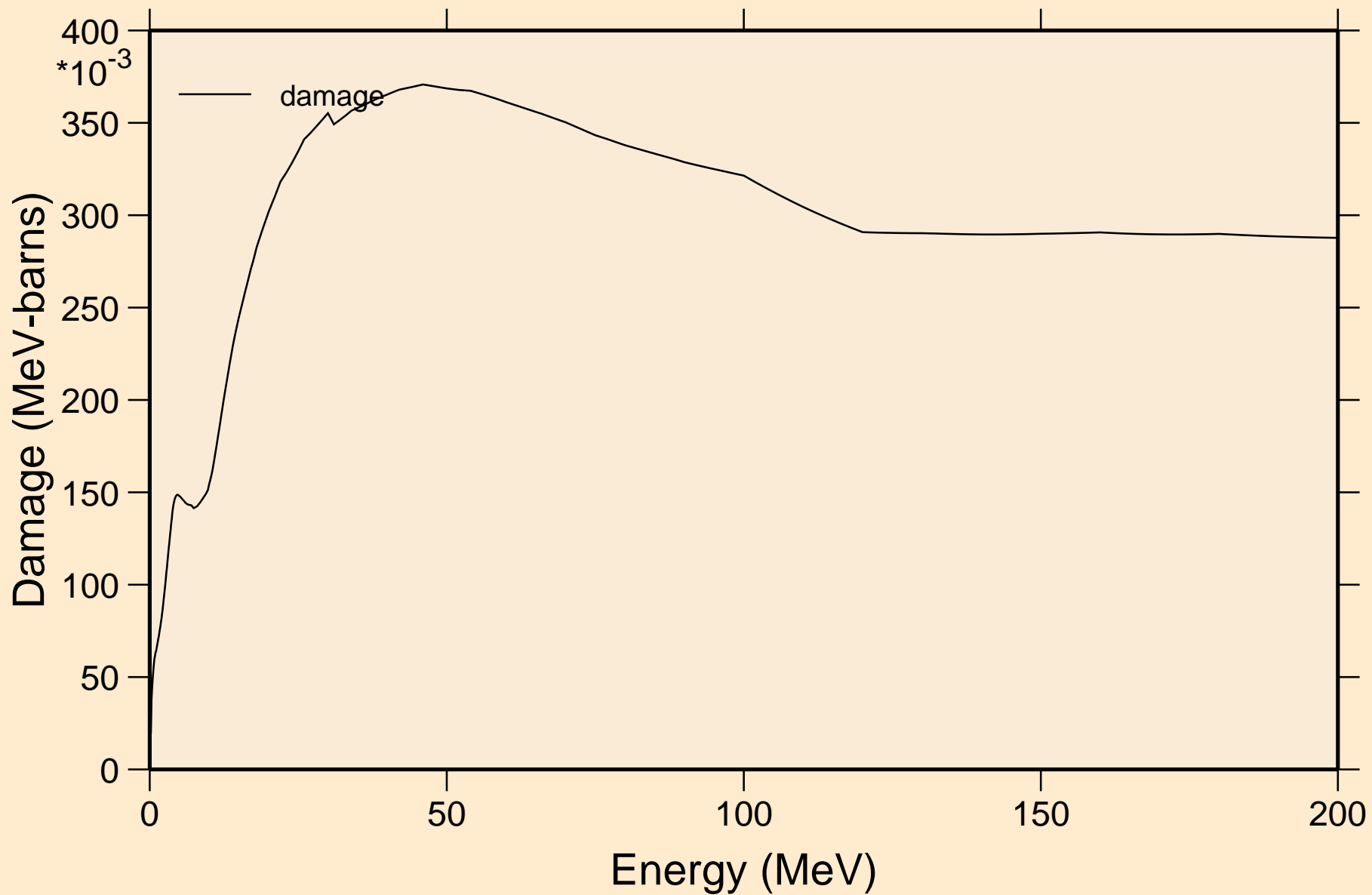

ZN070 NEUTRON ACER TENDL-2019 LIBRARY; T=293.16K
Non-threshold reactions

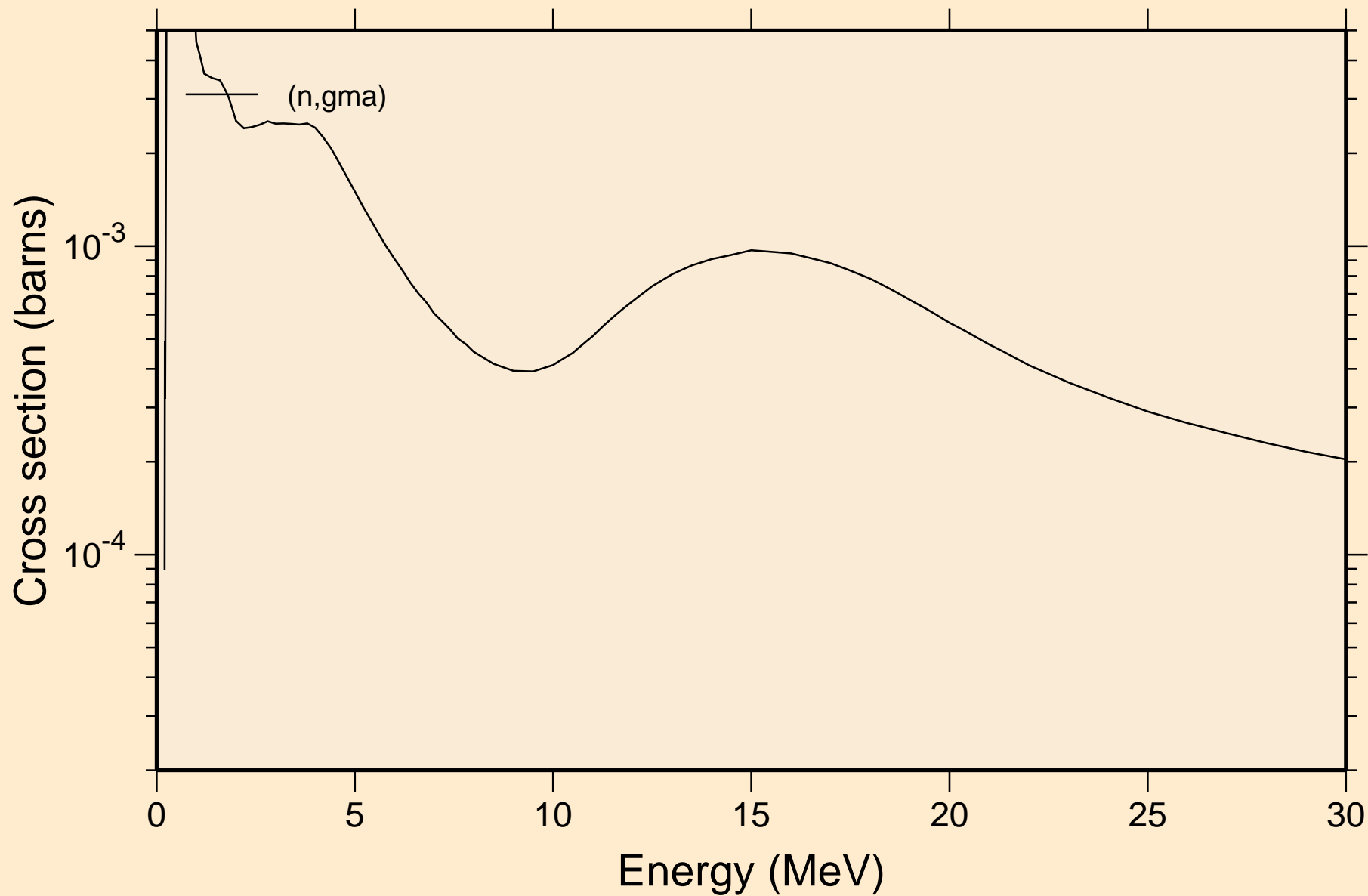

ZN070 NEUTRON ACER TENDL-2019 LIBRARY; T=293.16K
Inelastic levels

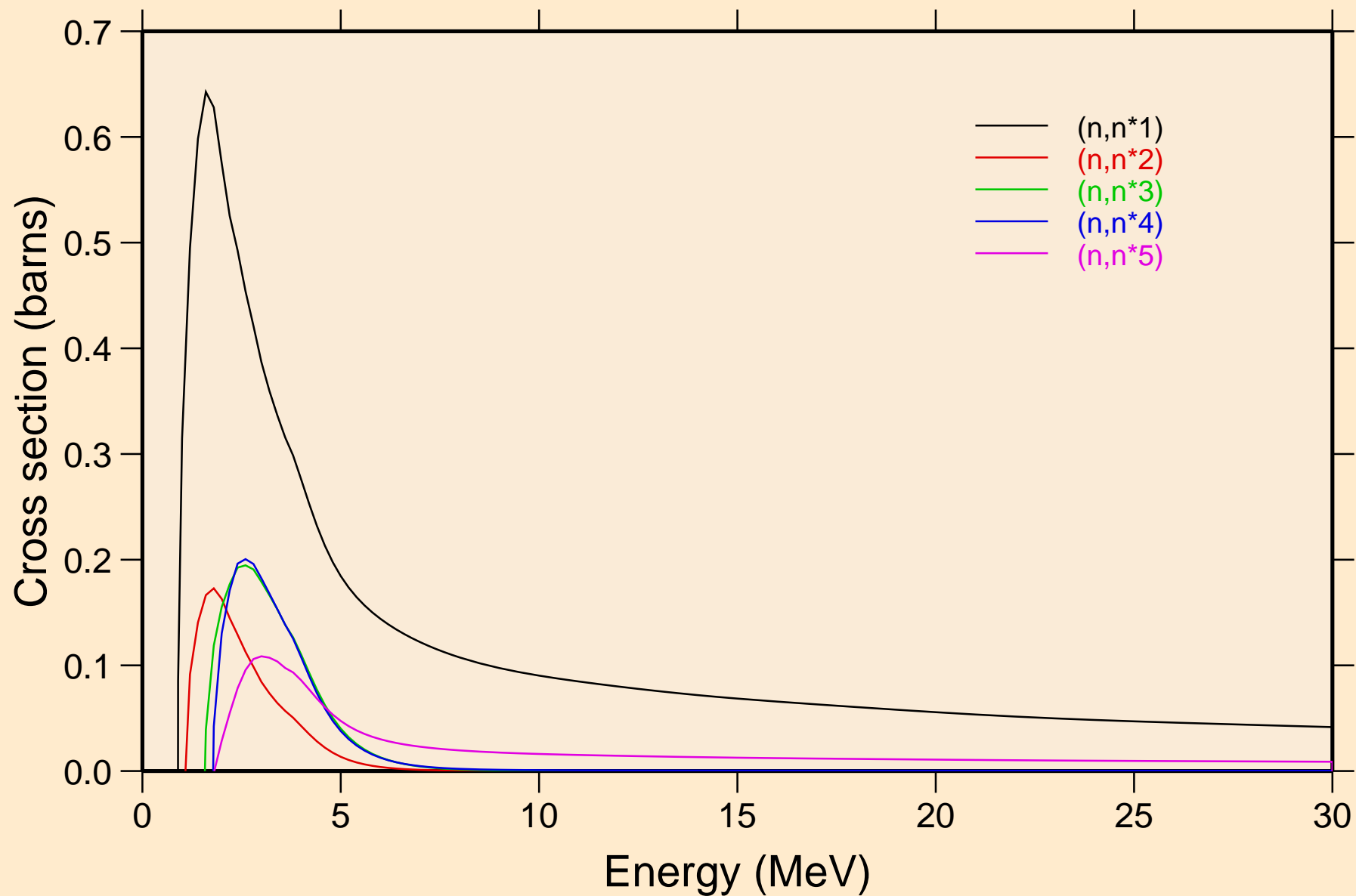

ZN070 NEUTRON ACER TENDL-2019 LIBRARY; T=293.16K
Inelastic levels

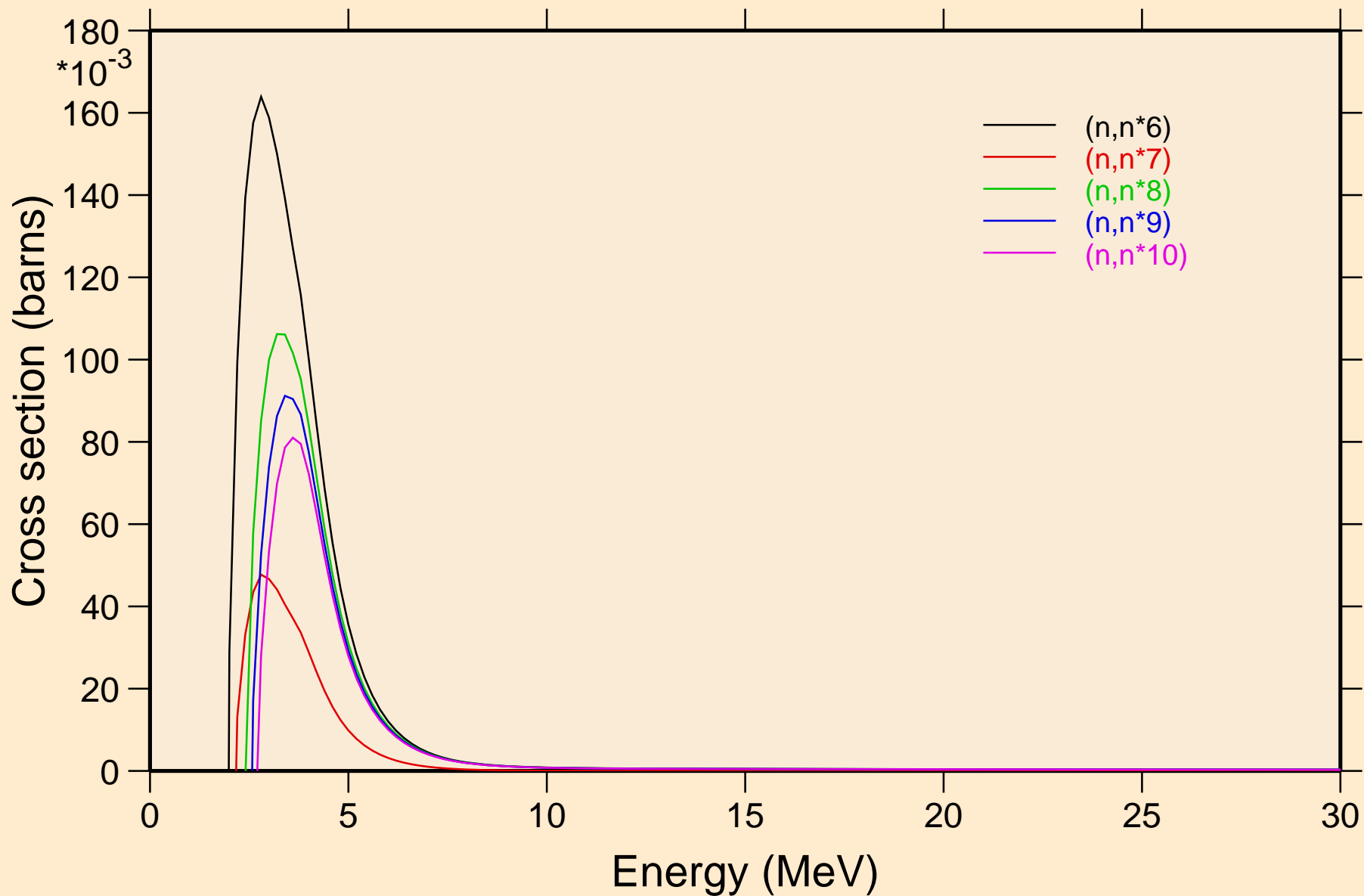

ZN070 NEUTRON ACER TENDL-2019 LIBRARY; T=293.16K
Inelastic levels

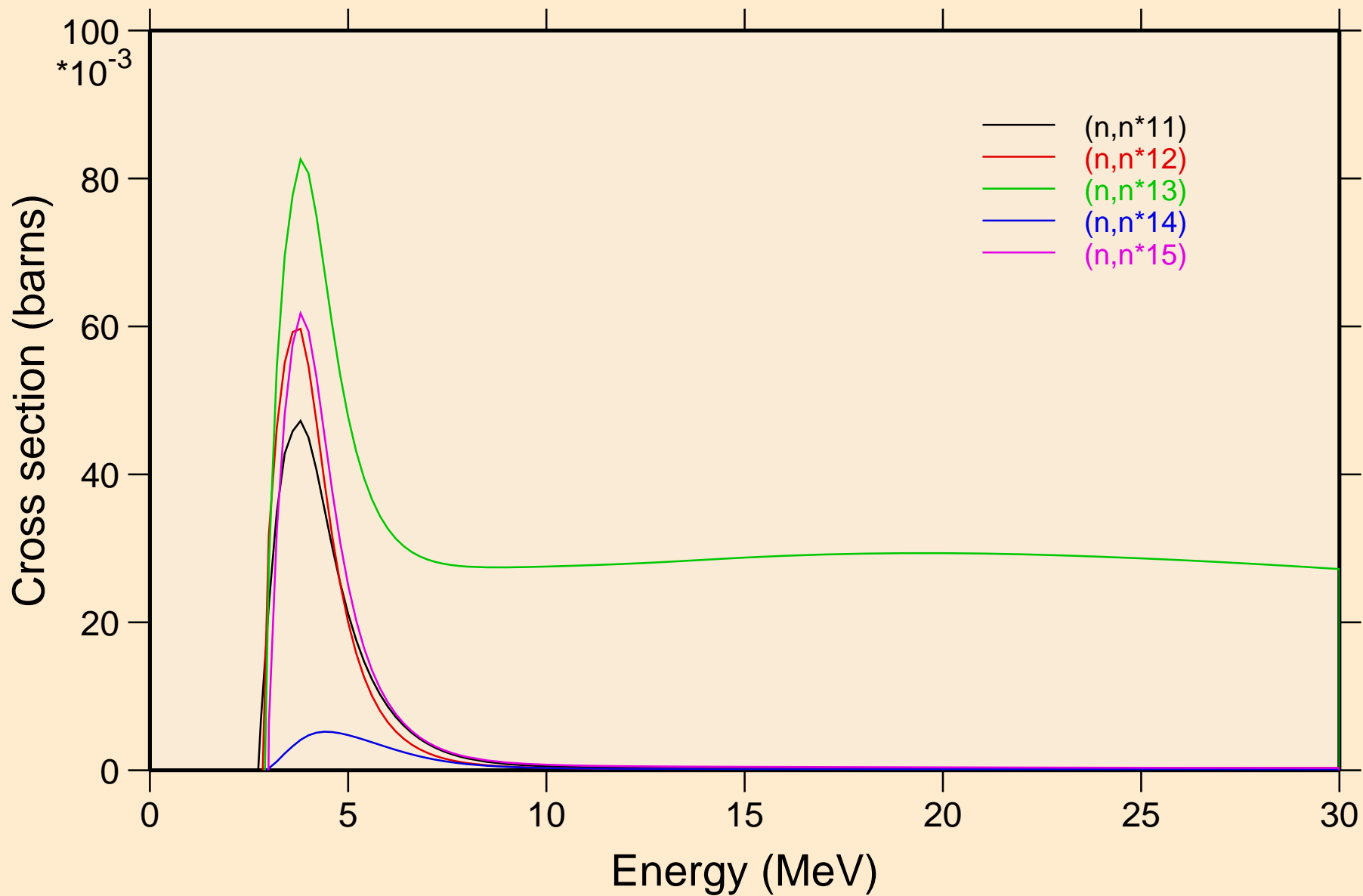

ZN070 NEUTRON ACER TENDL-2019 LIBRARY; T=293.16K
Inelastic levels

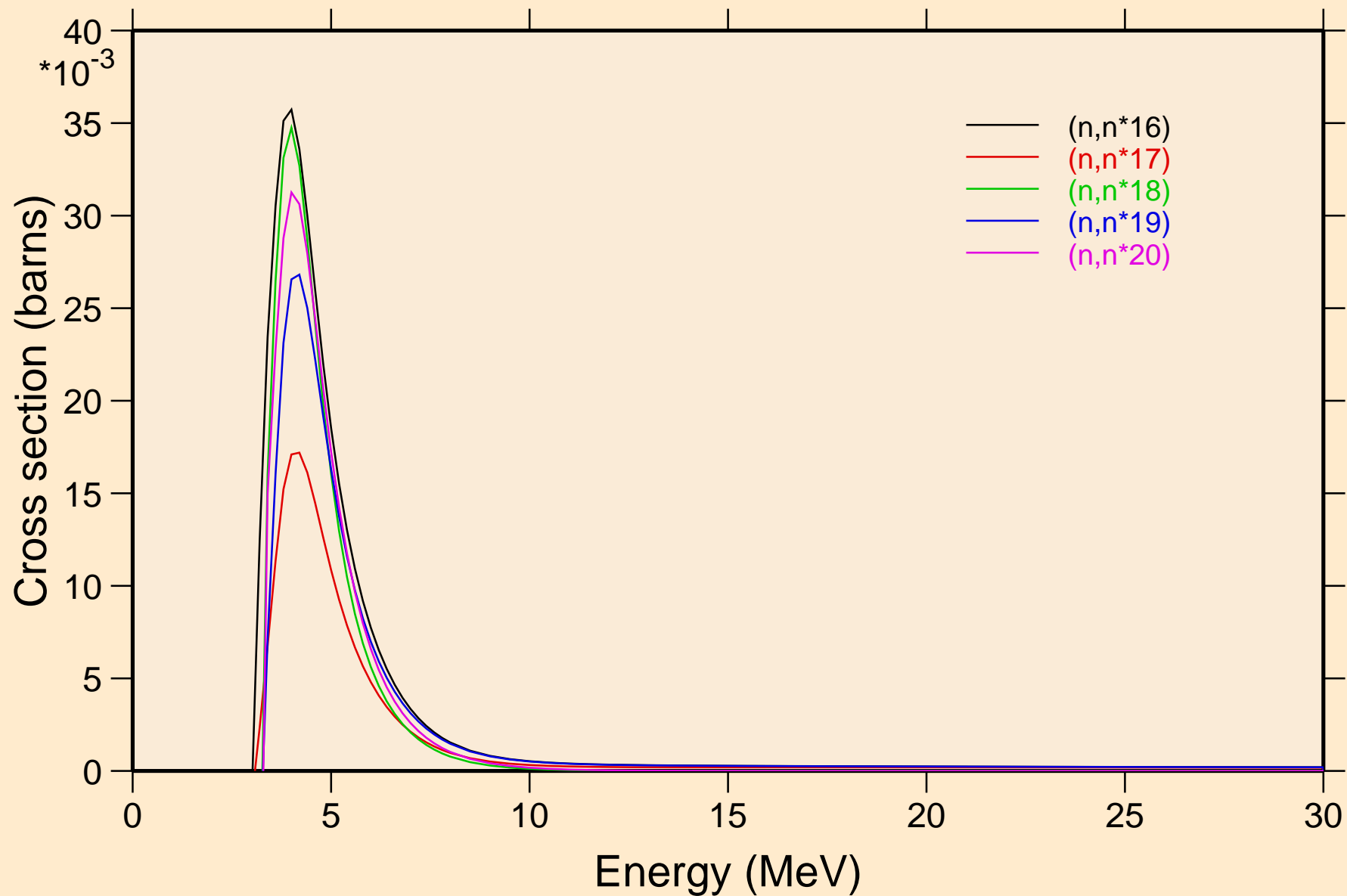

ZN070 NEUTRON ACER TENDL-2019 LIBRARY; T=293.16K
Inelastic levels

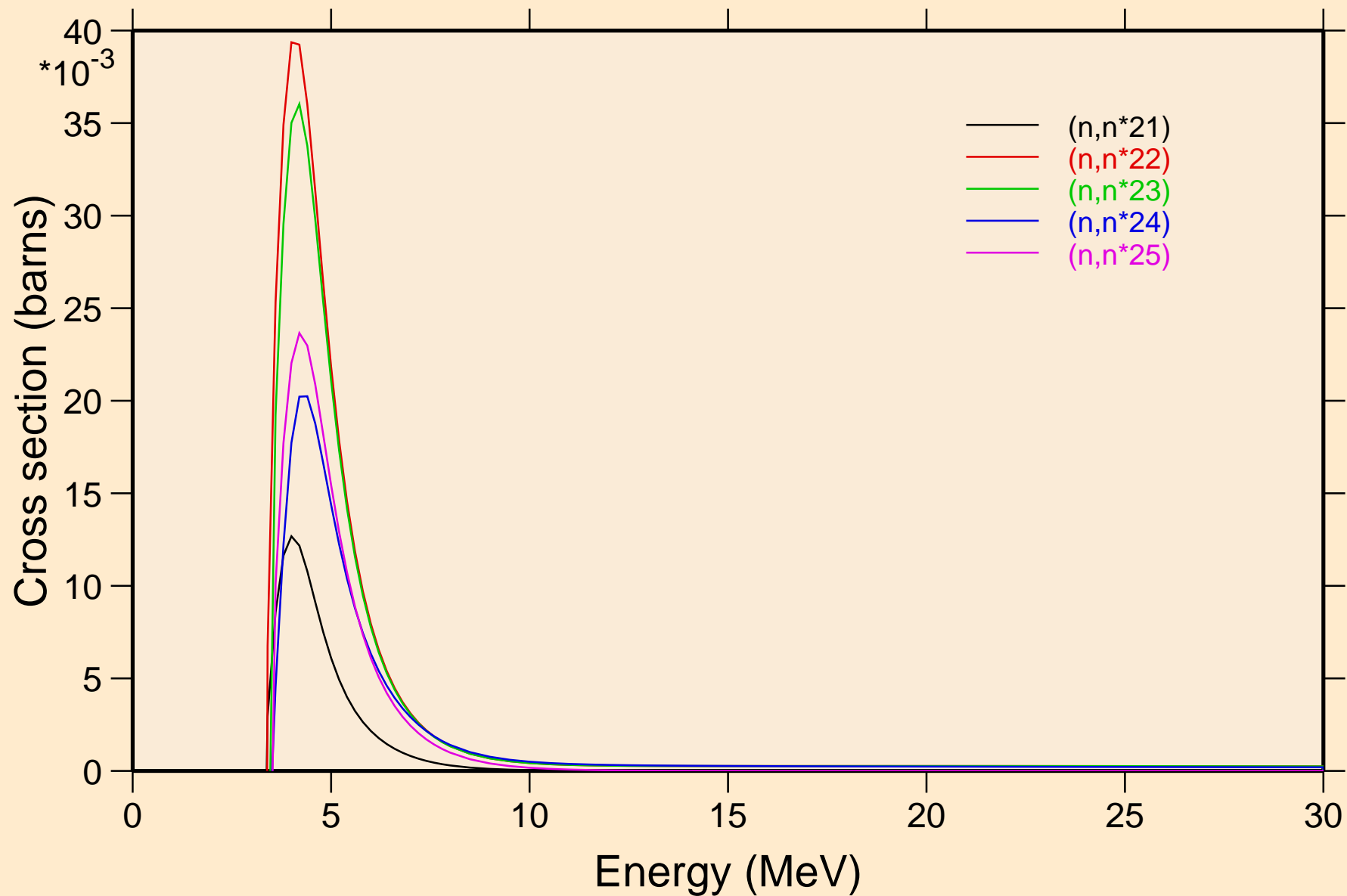

ZN070 NEUTRON ACER TENDL-2019 LIBRARY; T=293.16K
Inelastic levels

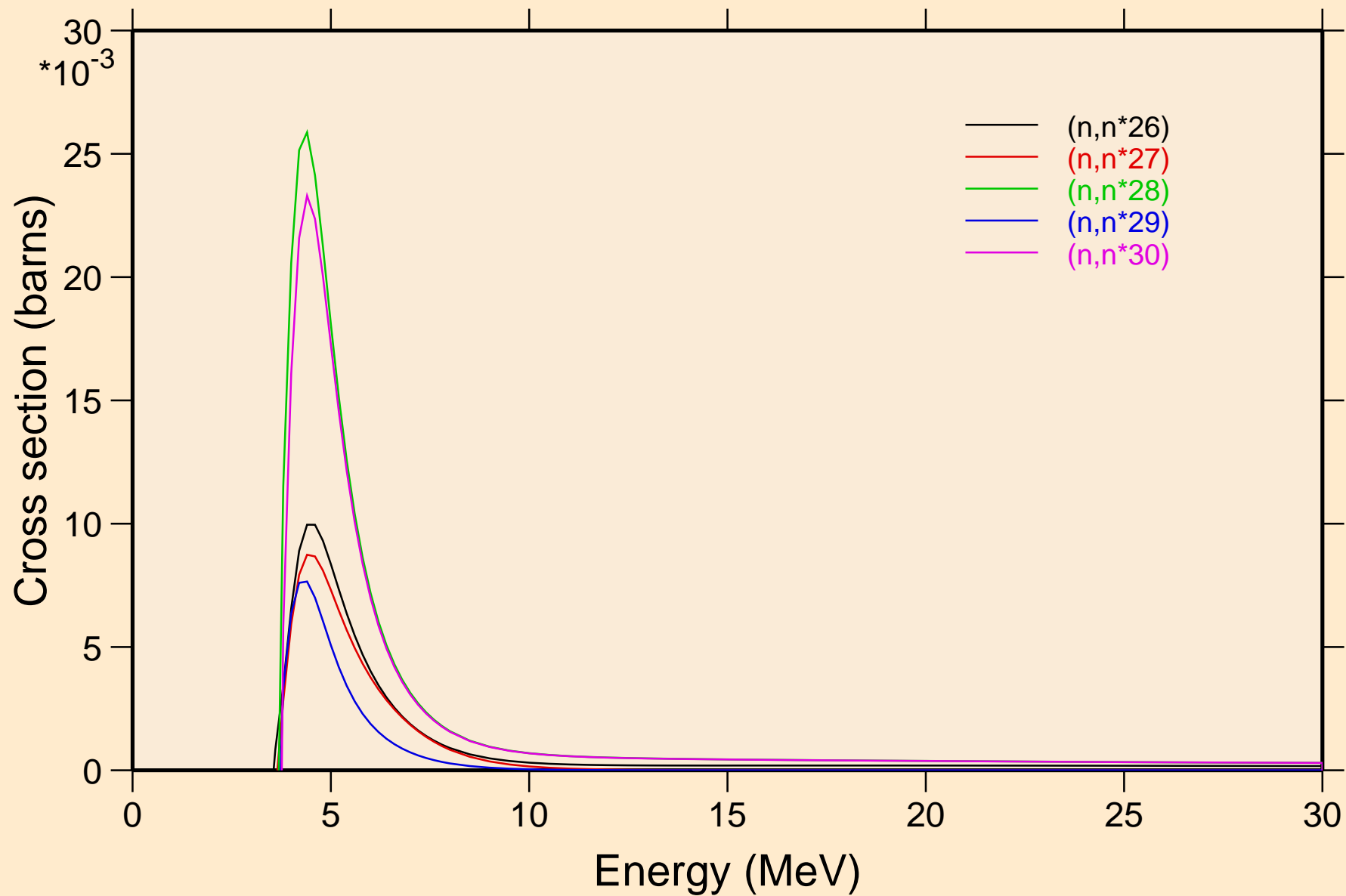

ZN070 NEUTRON ACER TENDL-2019 LIBRARY; T=293.16K
Threshold reactions

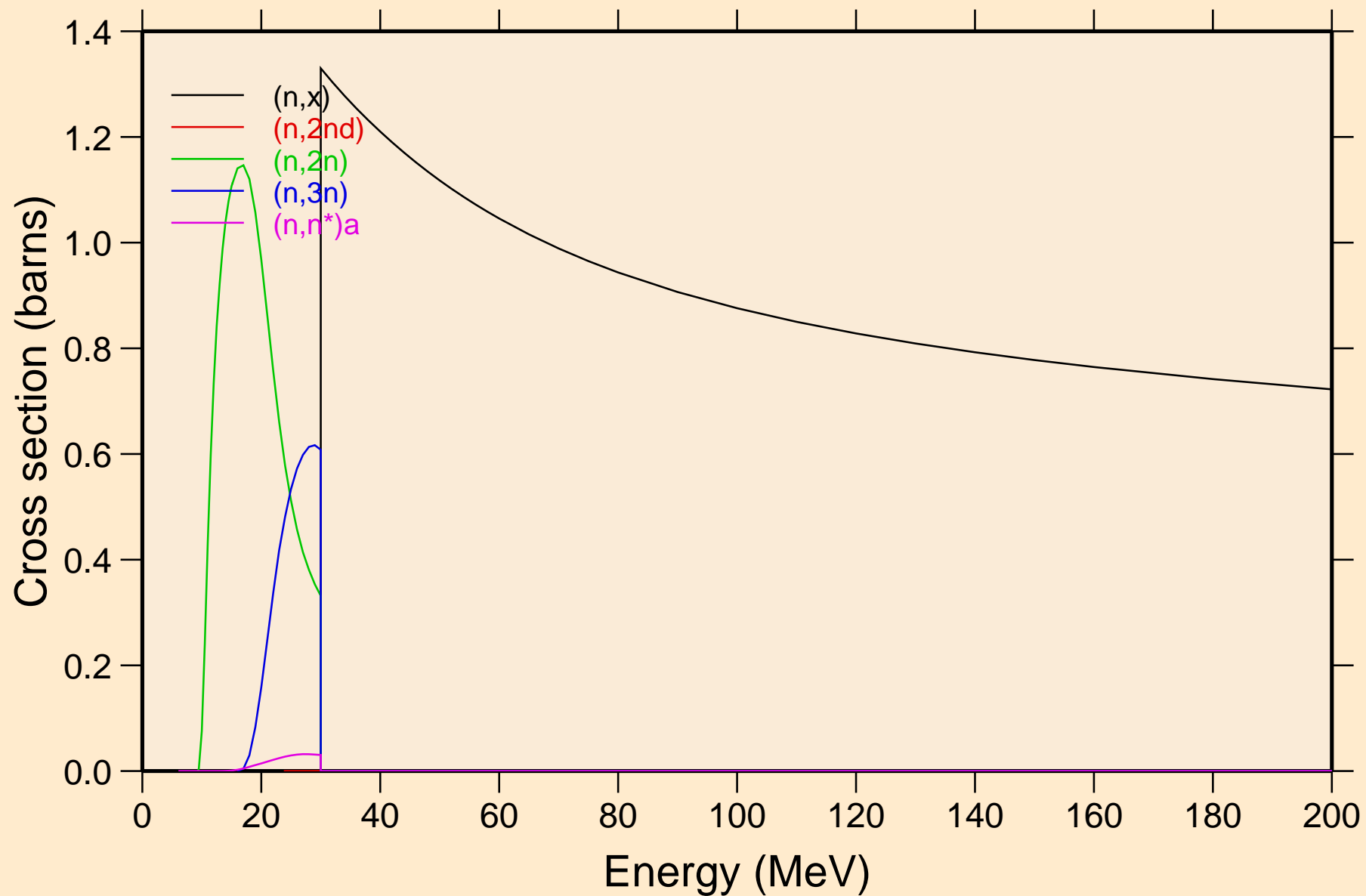

ZN070 NEUTRON ACER TENDL-2019 LIBRARY; T=293.16K

Threshold reactions

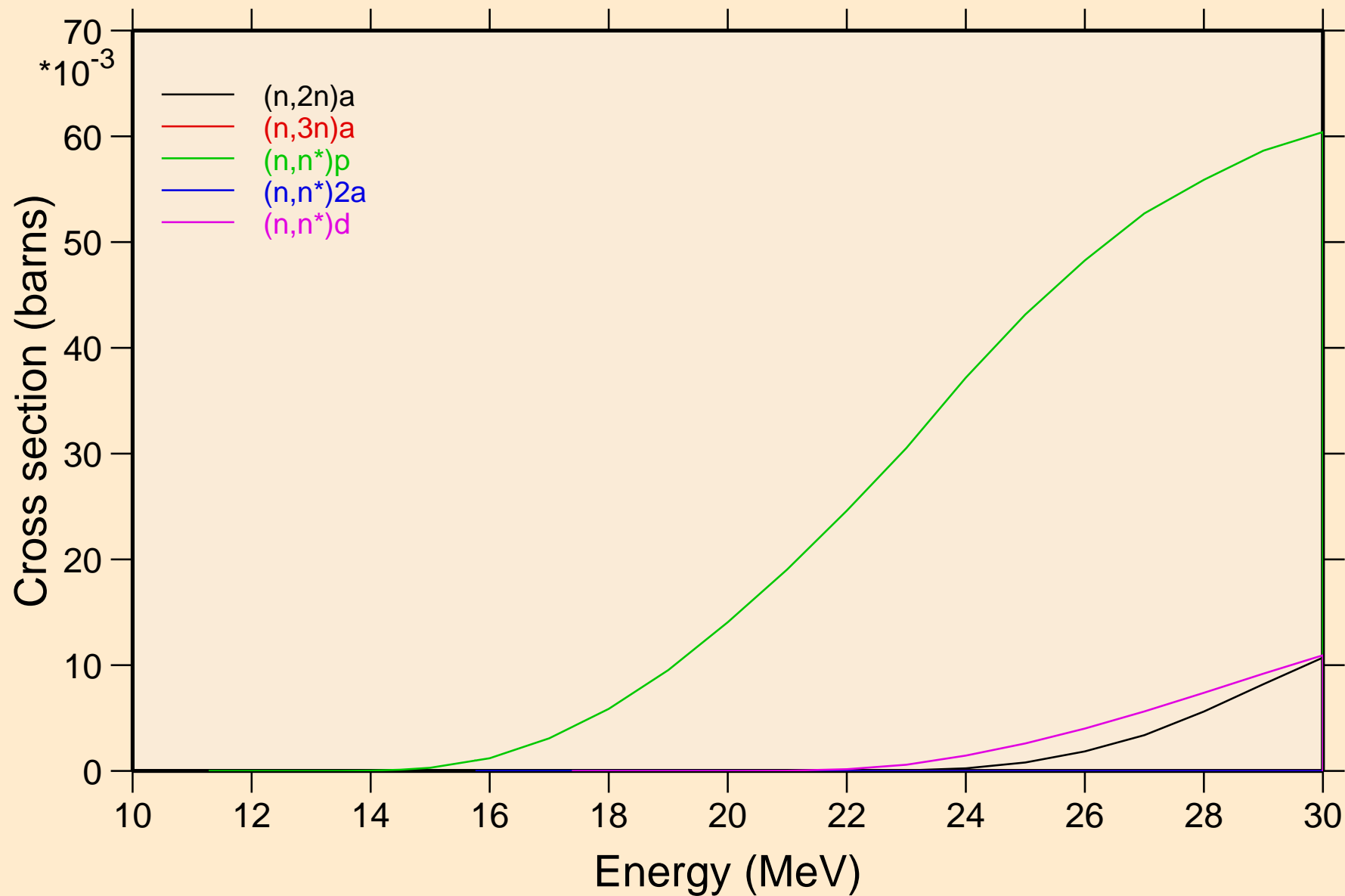

ZN070 NEUTRON ACER TENDL-2019 LIBRARY; T=293.16K
Threshold reactions

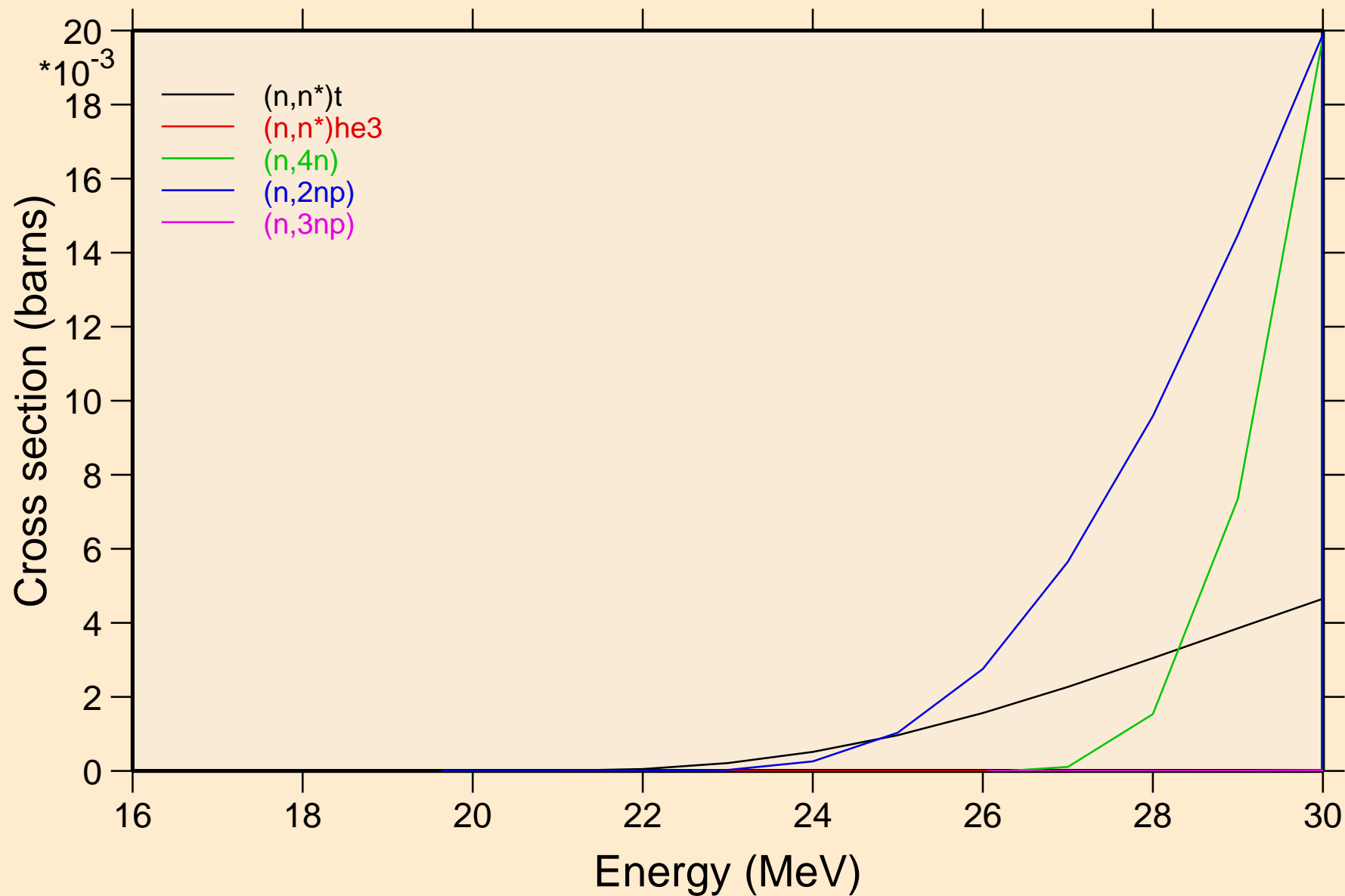

ZN070 NEUTRON ACER TENDL-2019 LIBRARY; T=293.16K
Threshold reactions

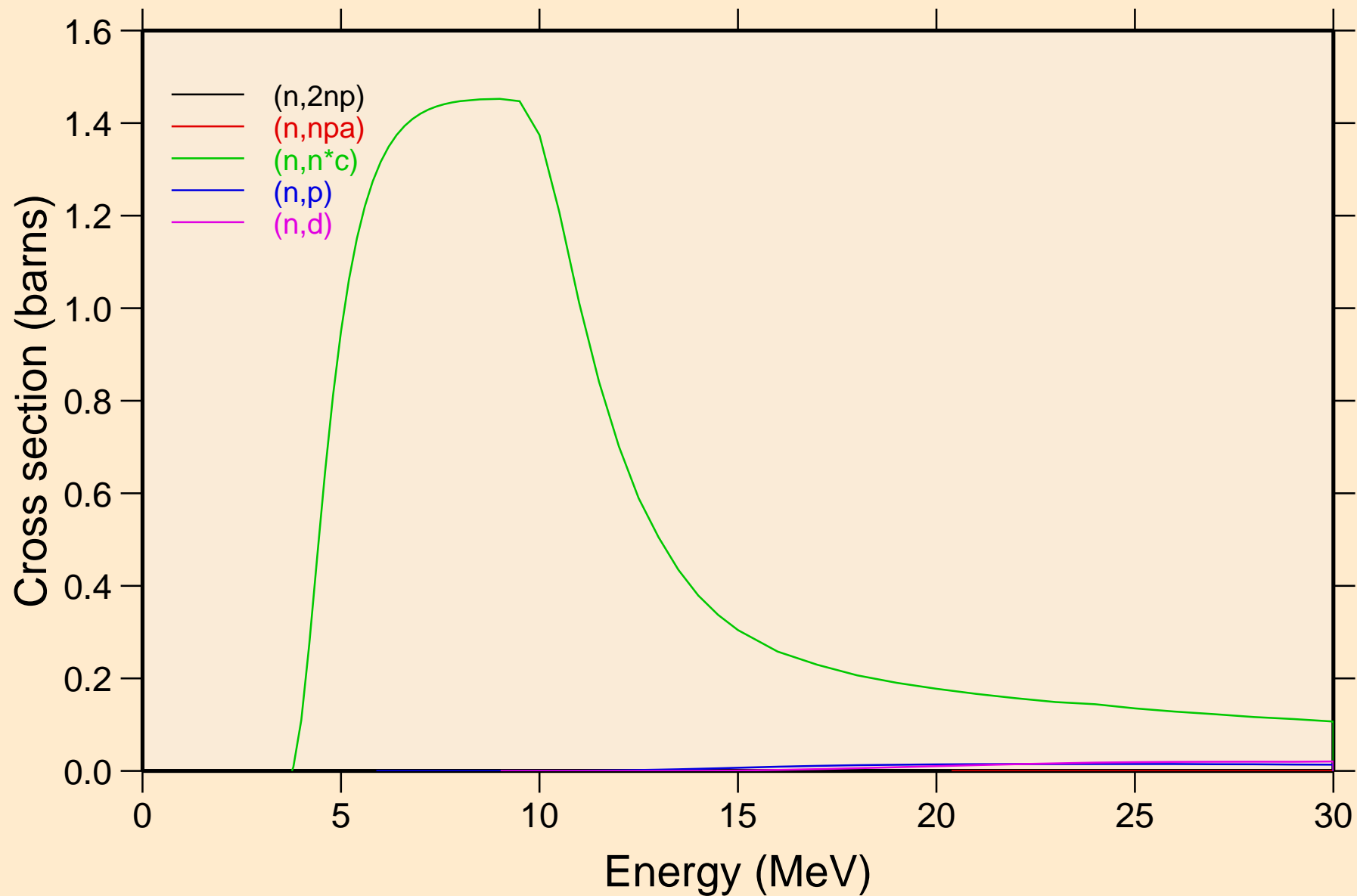

ZN070 NEUTRON ACER TENDL-2019 LIBRARY; T=293.16K
Threshold reactions

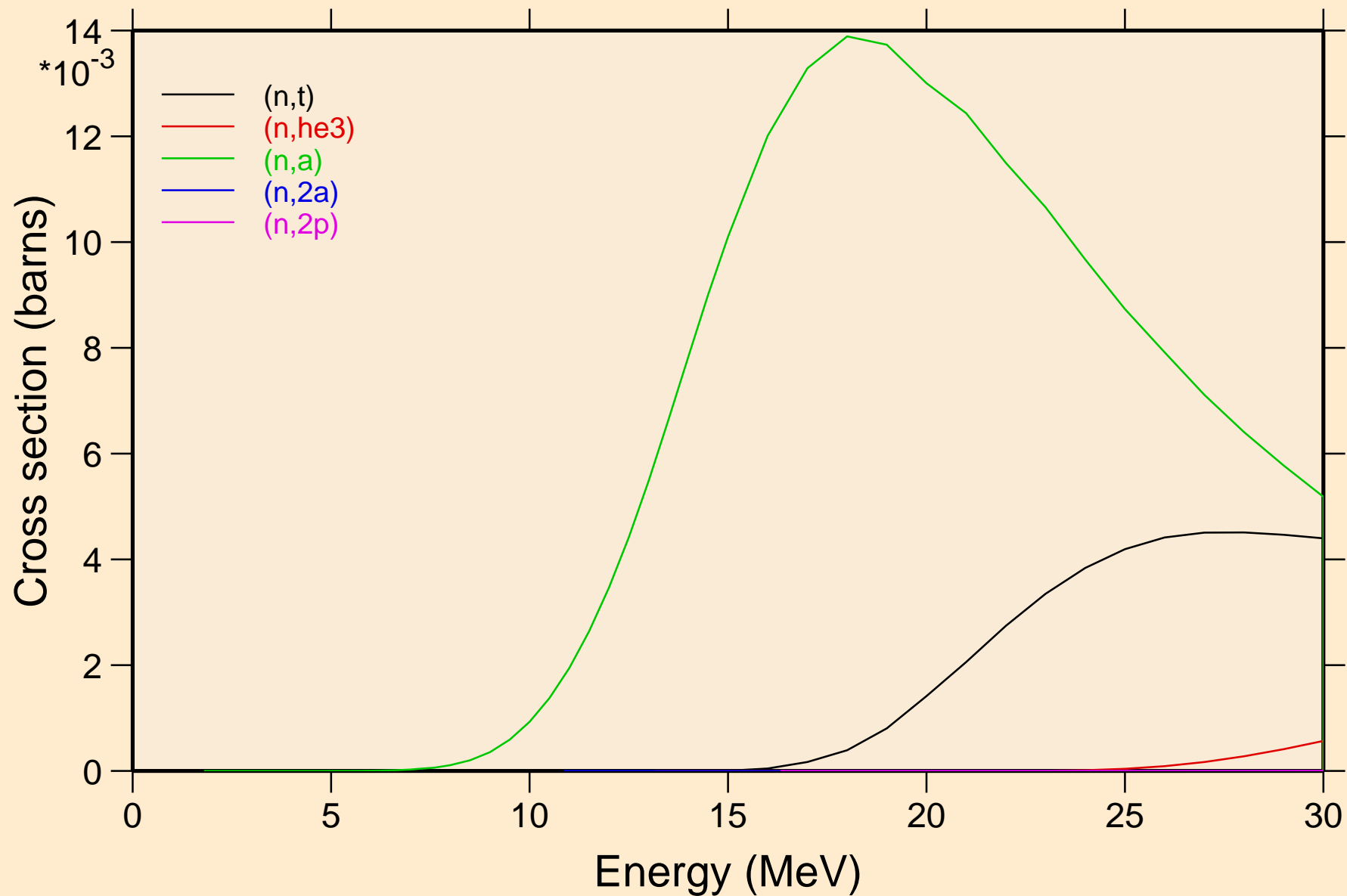

ZN070 NEUTRON ACER TENDL-2019 LIBRARY; T=293.16K

Threshold reactions

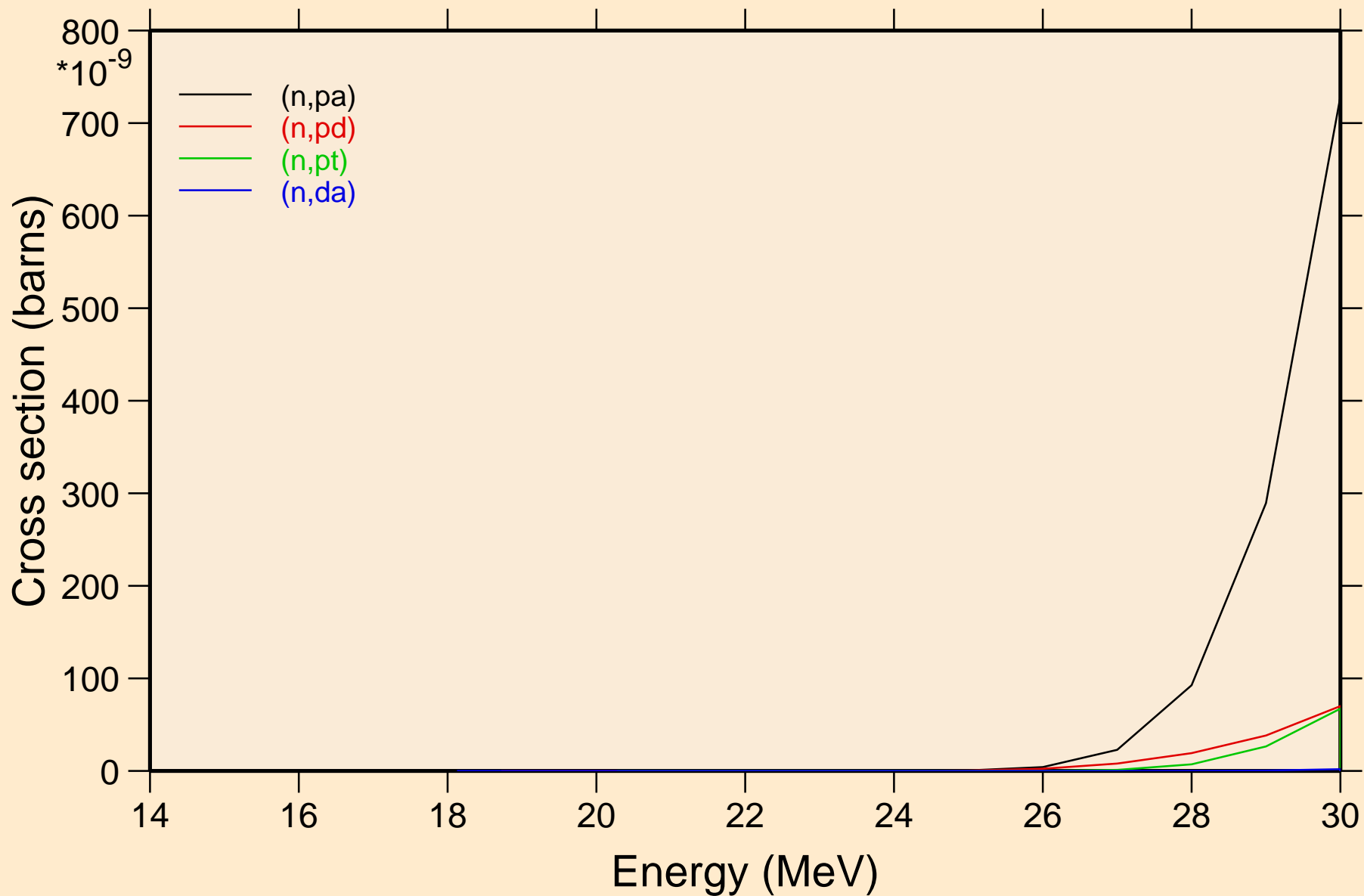

ZN070 NEUTRON ACER TENDL-2019 LIBRARY; T=293.16K
Threshold reactions

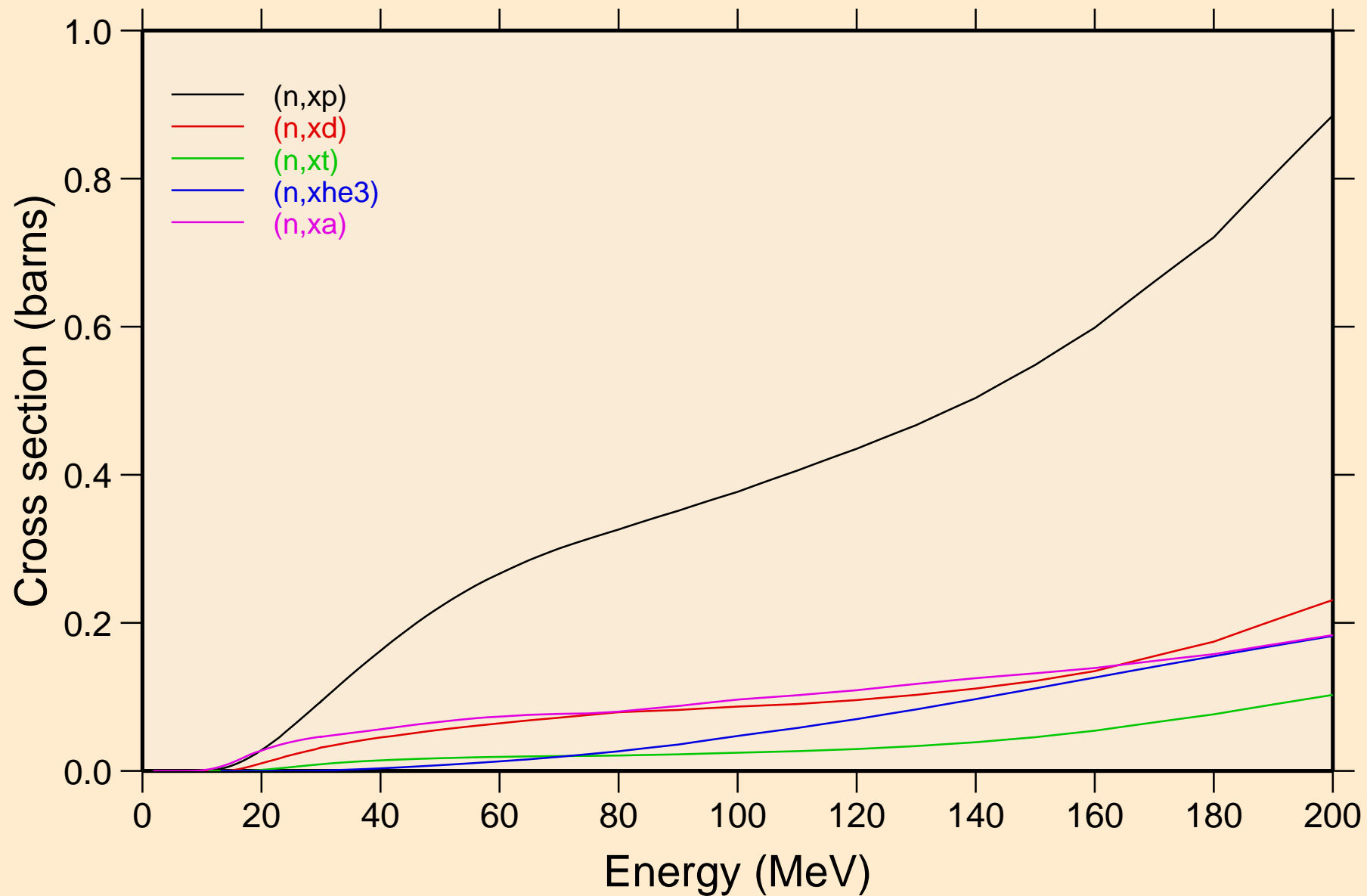

ZN070 NEUTRON ACER TENDL-2019 LIBRARY; T=293.16K
angular distribution for elastic

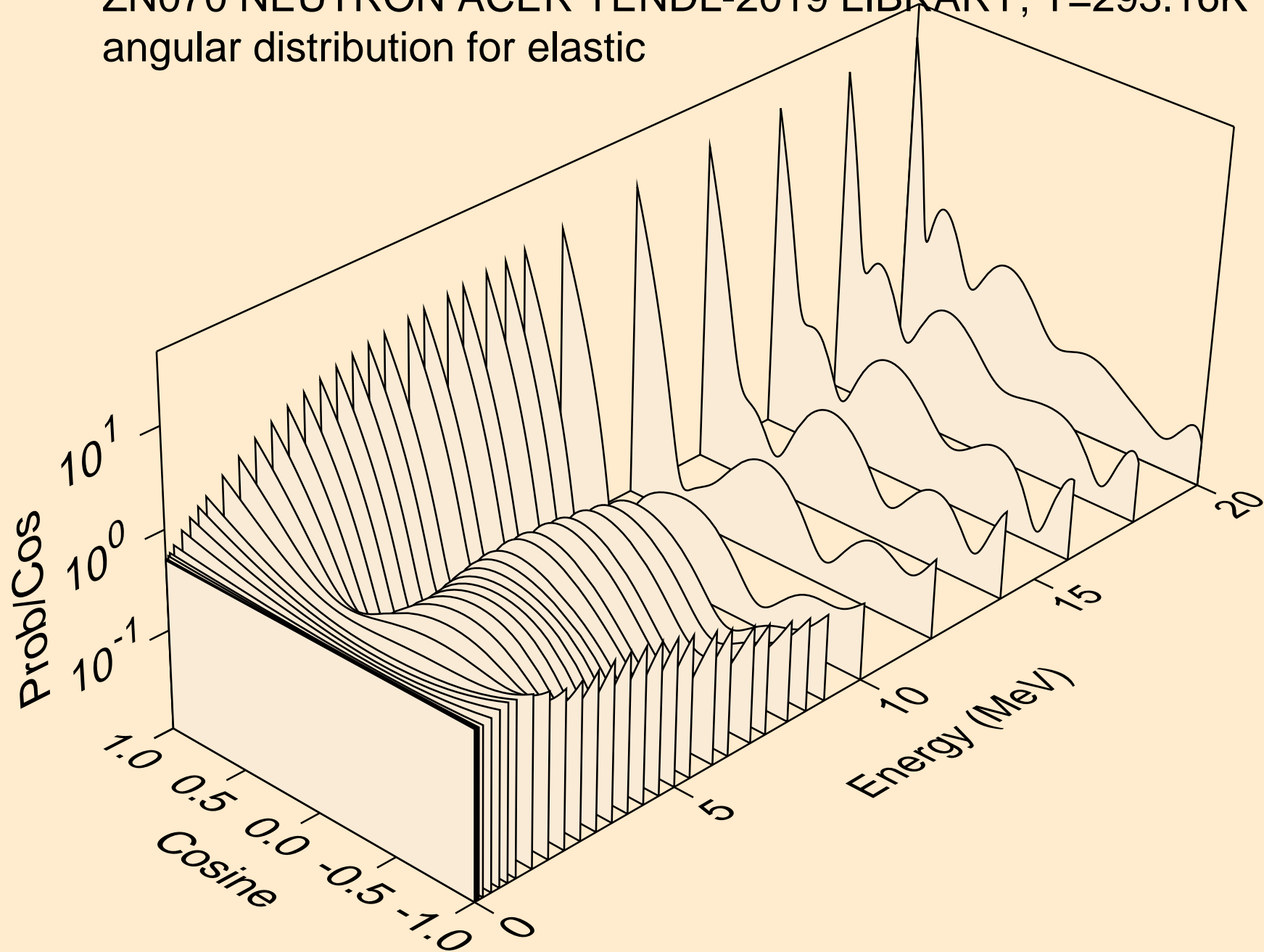

ZN070 NEUTRON ACER TENDL-2019 LIBRARY; T=293.16K
angular distribution for elastic

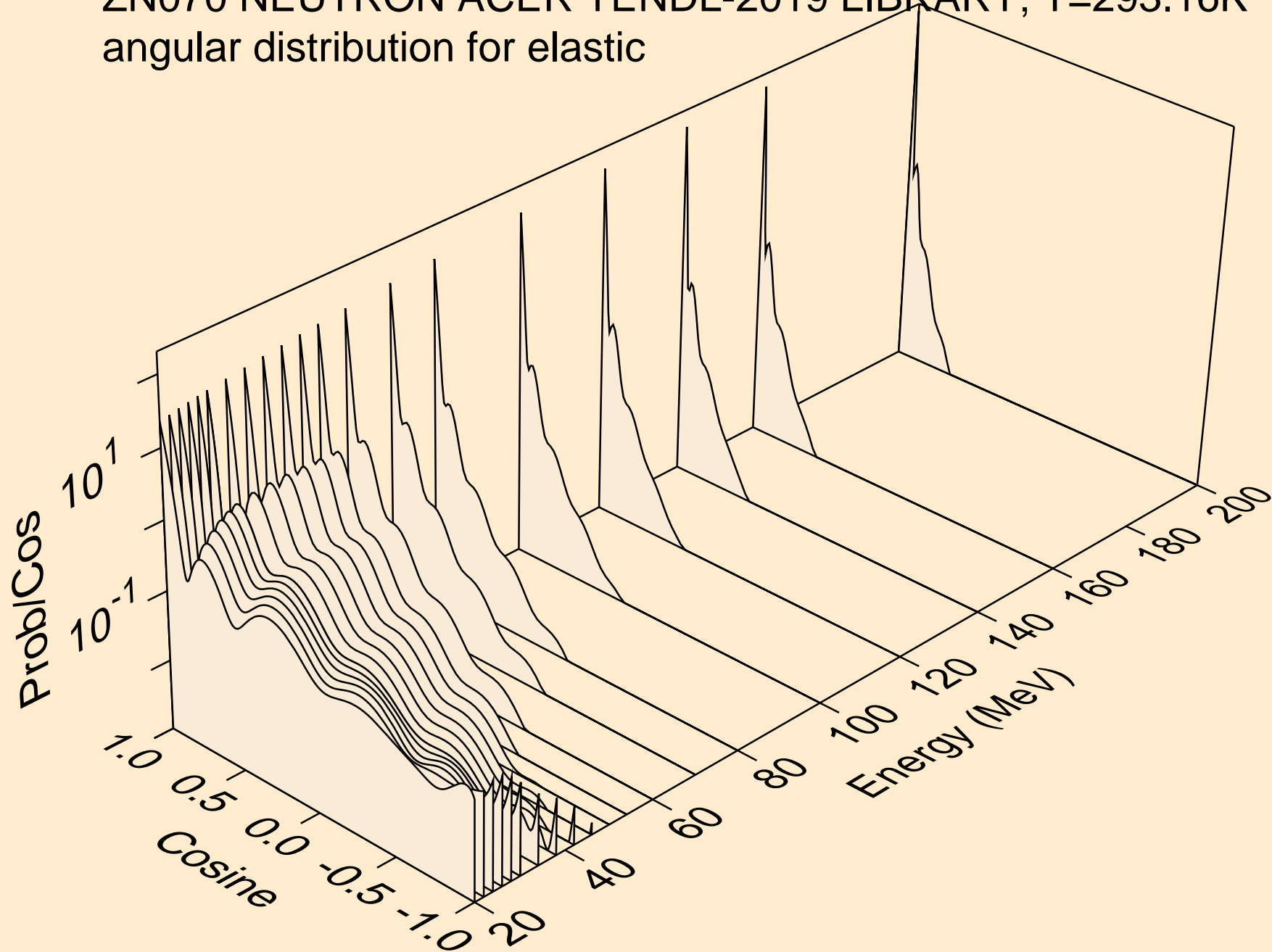

ZN070 NEUTRON ACER TENDL-2019 LIBRARY; T=293.16K
angular distribution for (n,n*1)

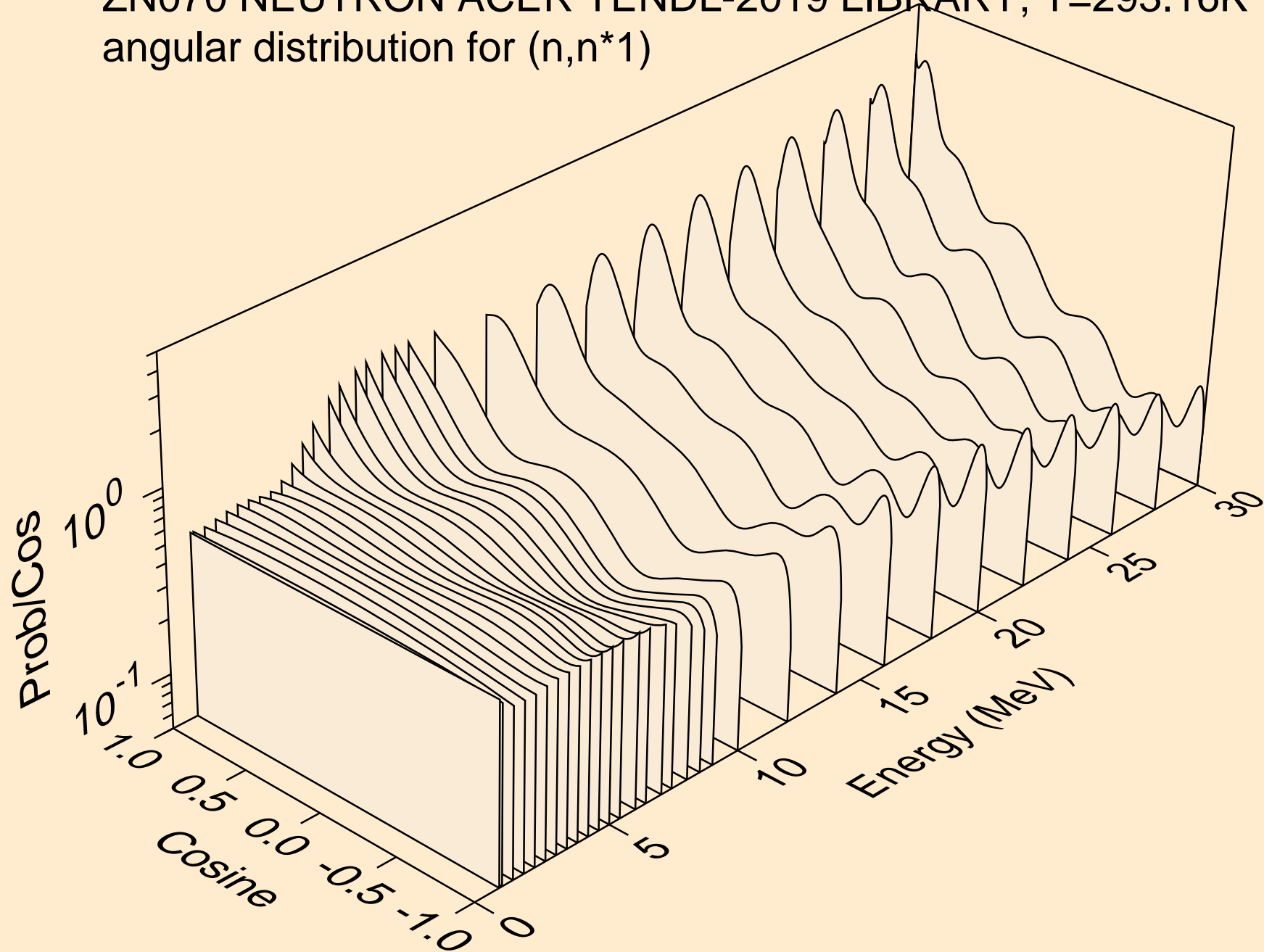

ZN070 NEUTRON ACER TENDL-2019 LIBRARY; T=293.16K
angular distribution for (n,n*2)

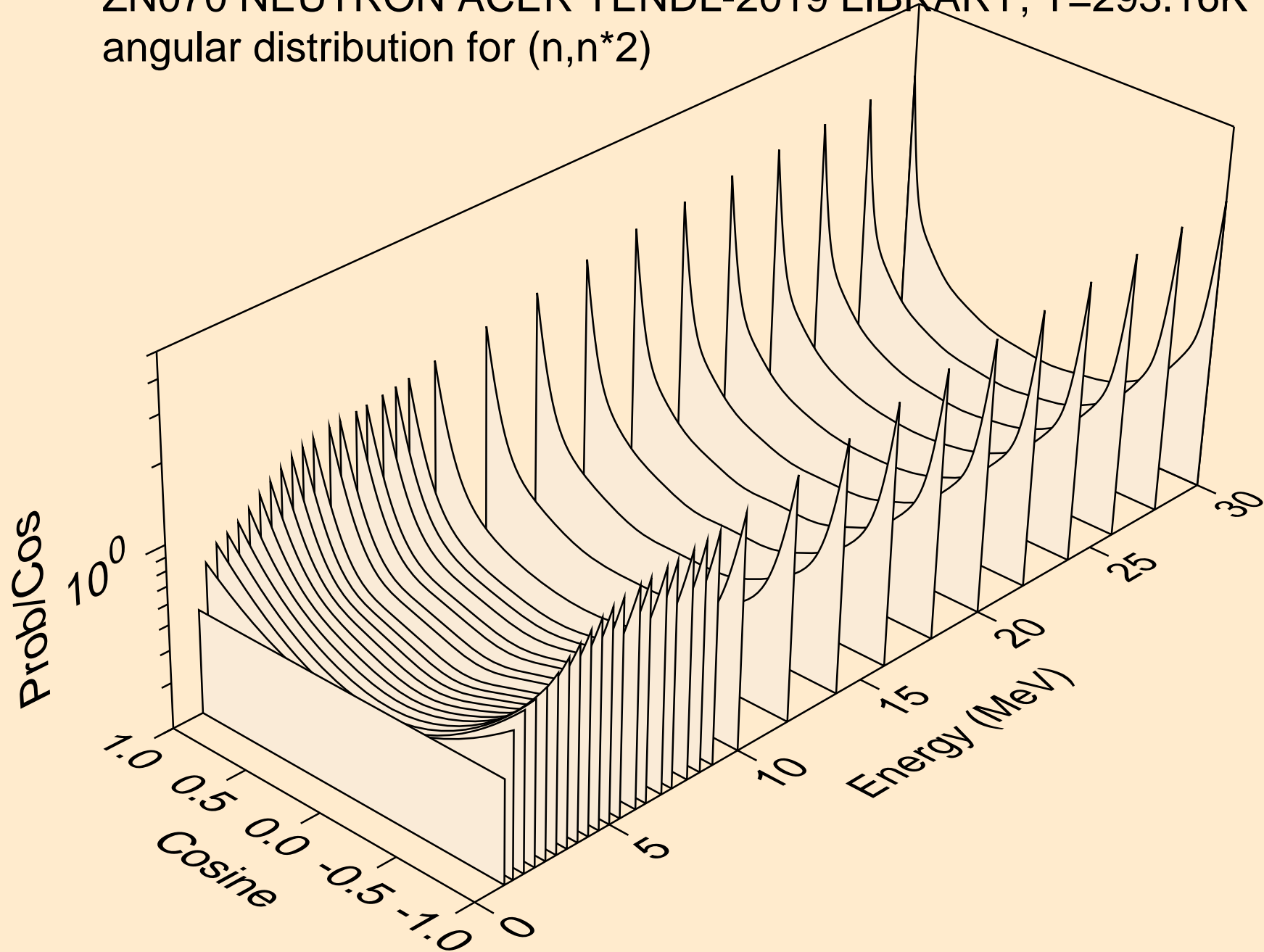

ZN070 NEUTRON ACER TENDL-2019 LIBRARY; T=293.16K
angular distribution for (n,n*3)

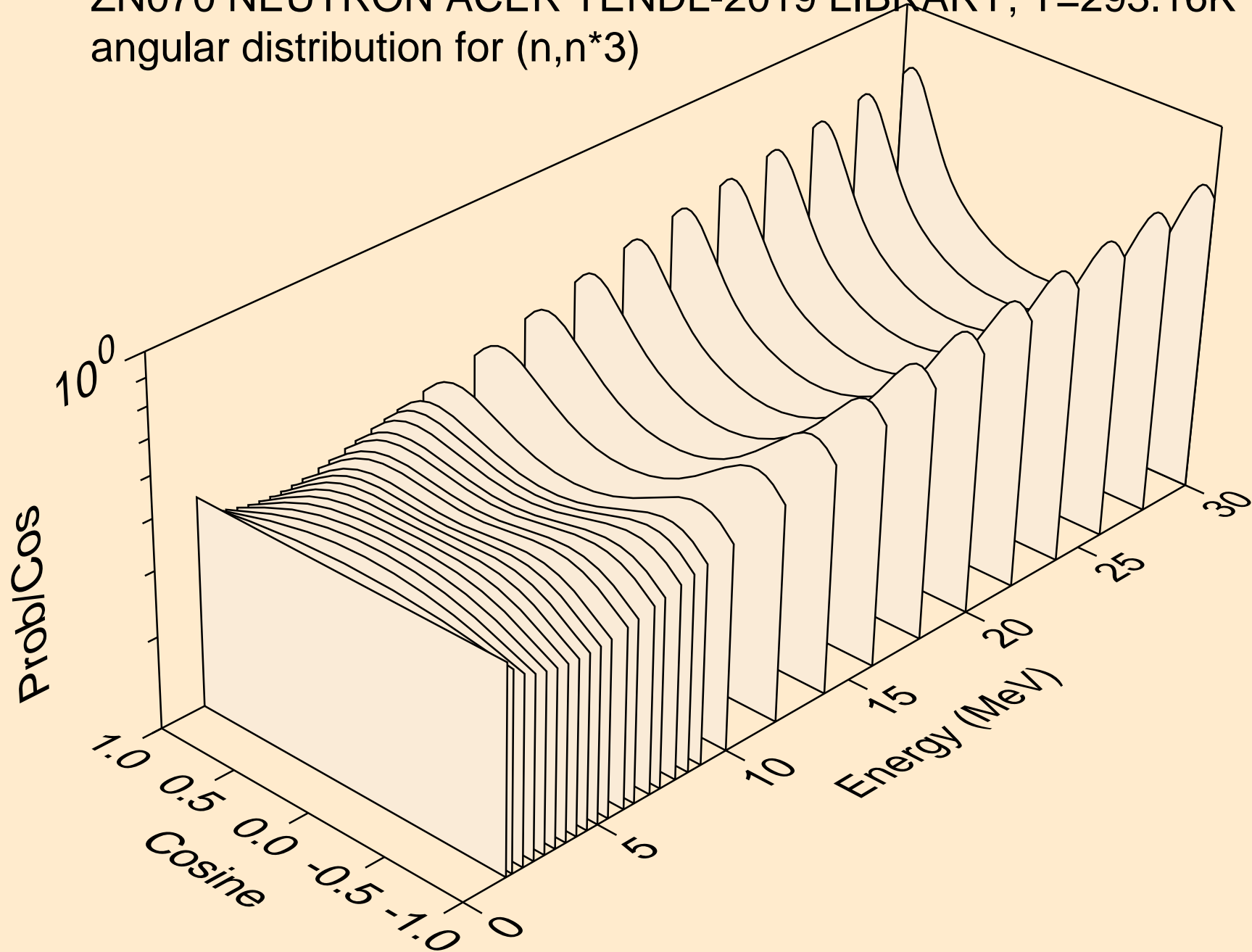

ZN070 NEUTRON ACER TENDL-2019 LIBRARY; T=293.16K
angular distribution for (n,n*4)

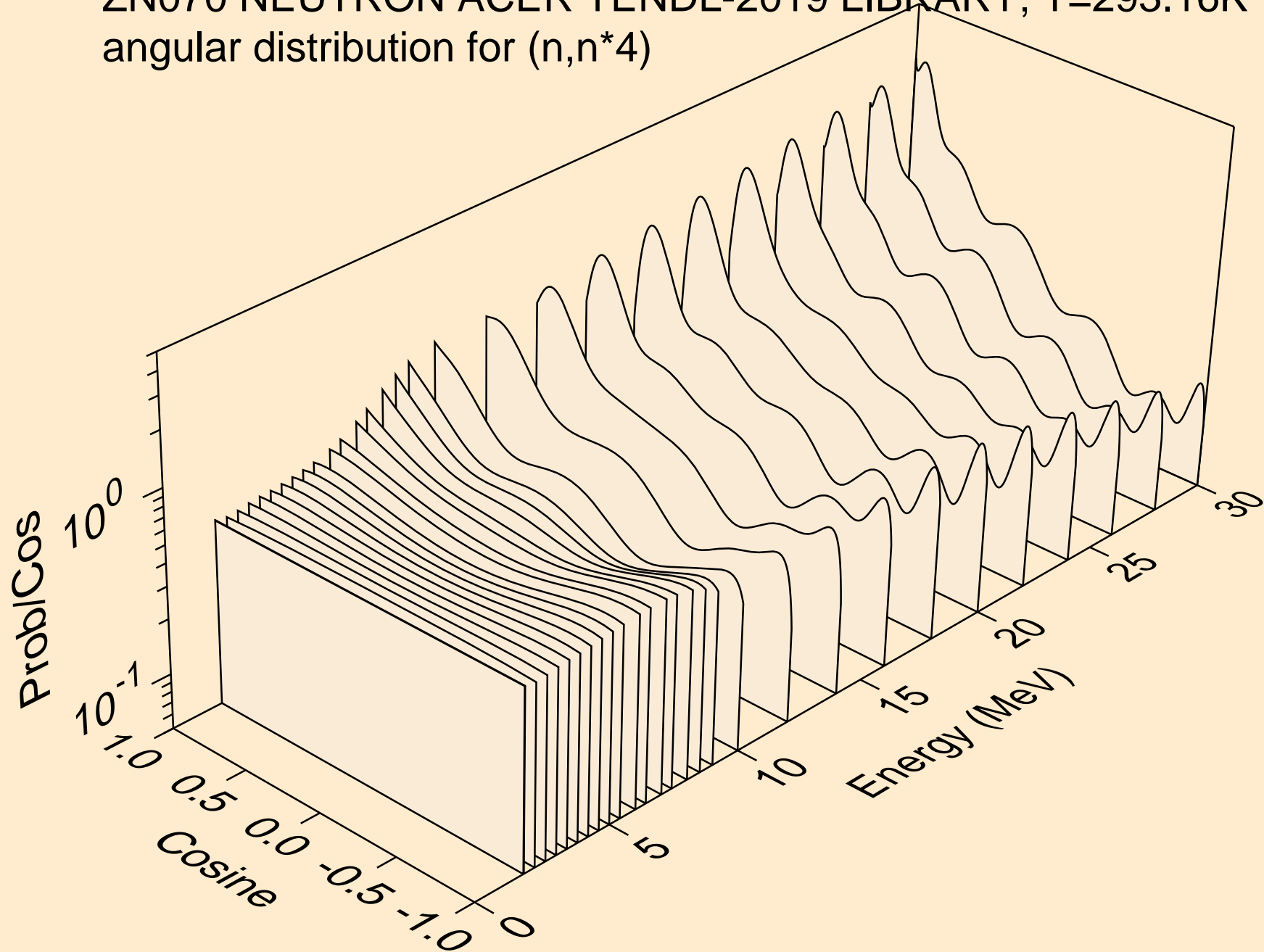

ZN070 NEUTRON ACER TENDL-2019 LIBRARY; T=293.16K
angular distribution for (n,n*5)

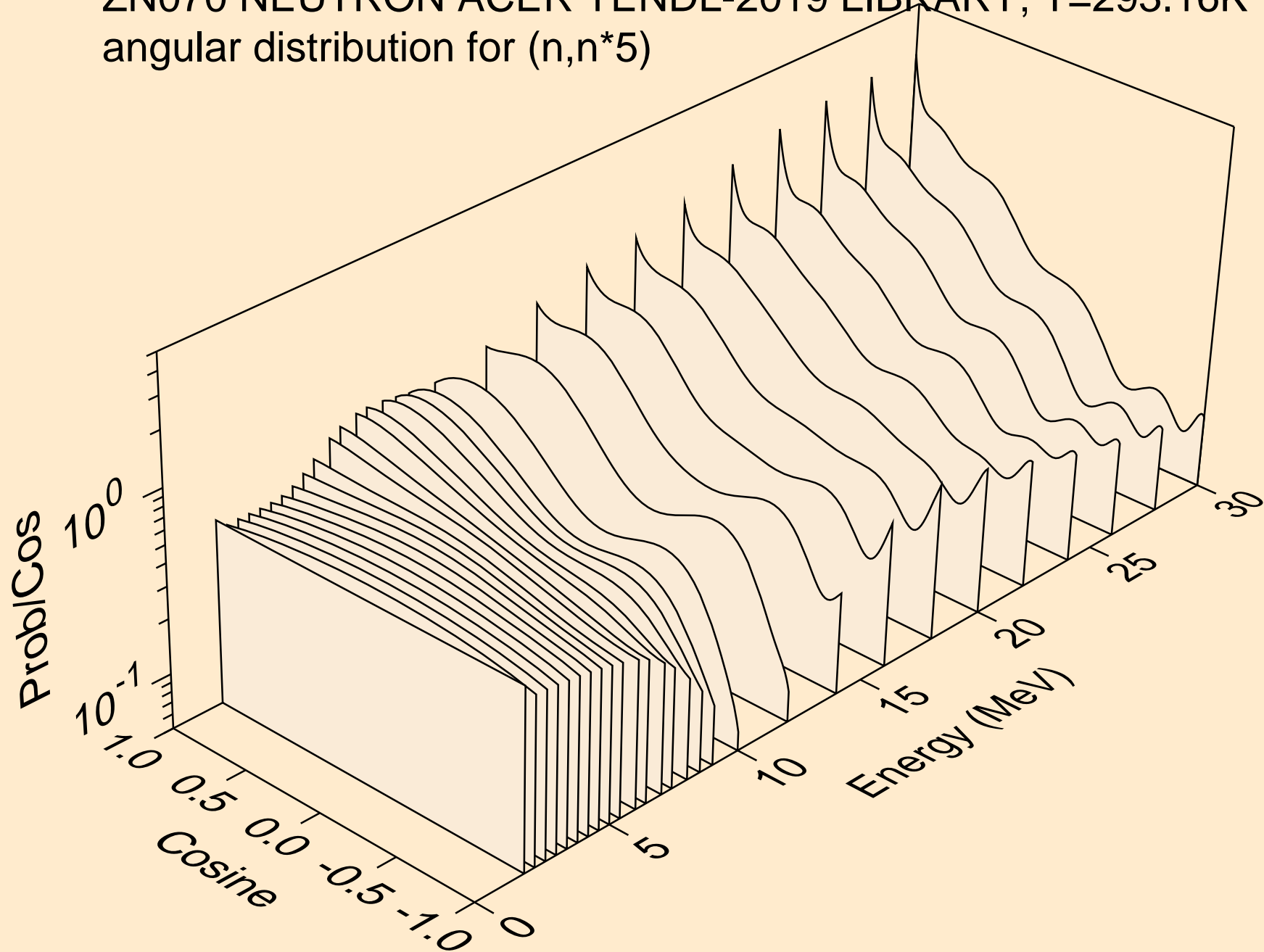

ZN070 NEUTRON ACER TENDL-2019 LIBRARY; T=293.16K
angular distribution for (n,n*6)

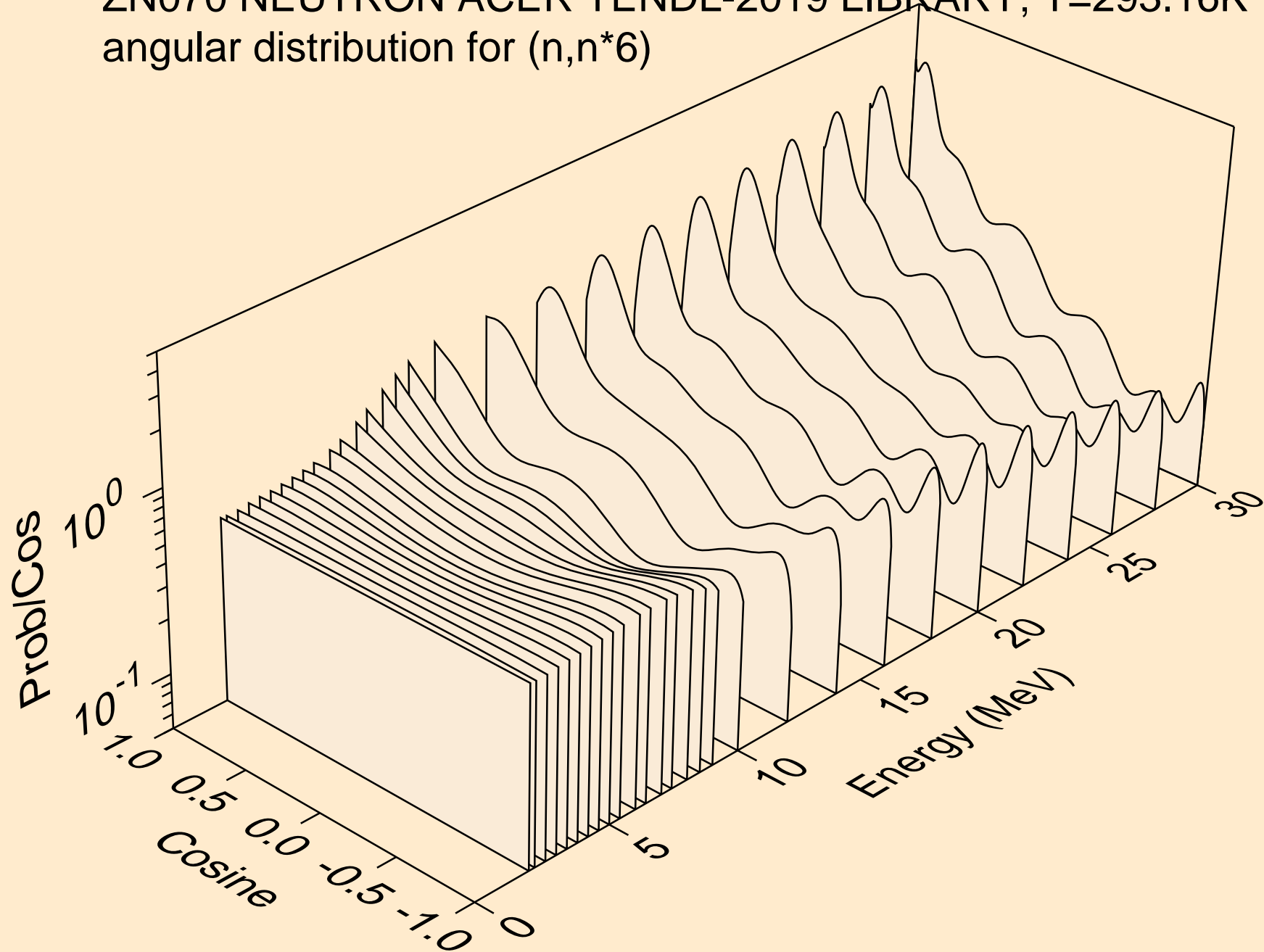

ZN070 NEUTRON ACER TENDL-2019 LIBRARY; T=293.16K
angular distribution for (n,n*7)

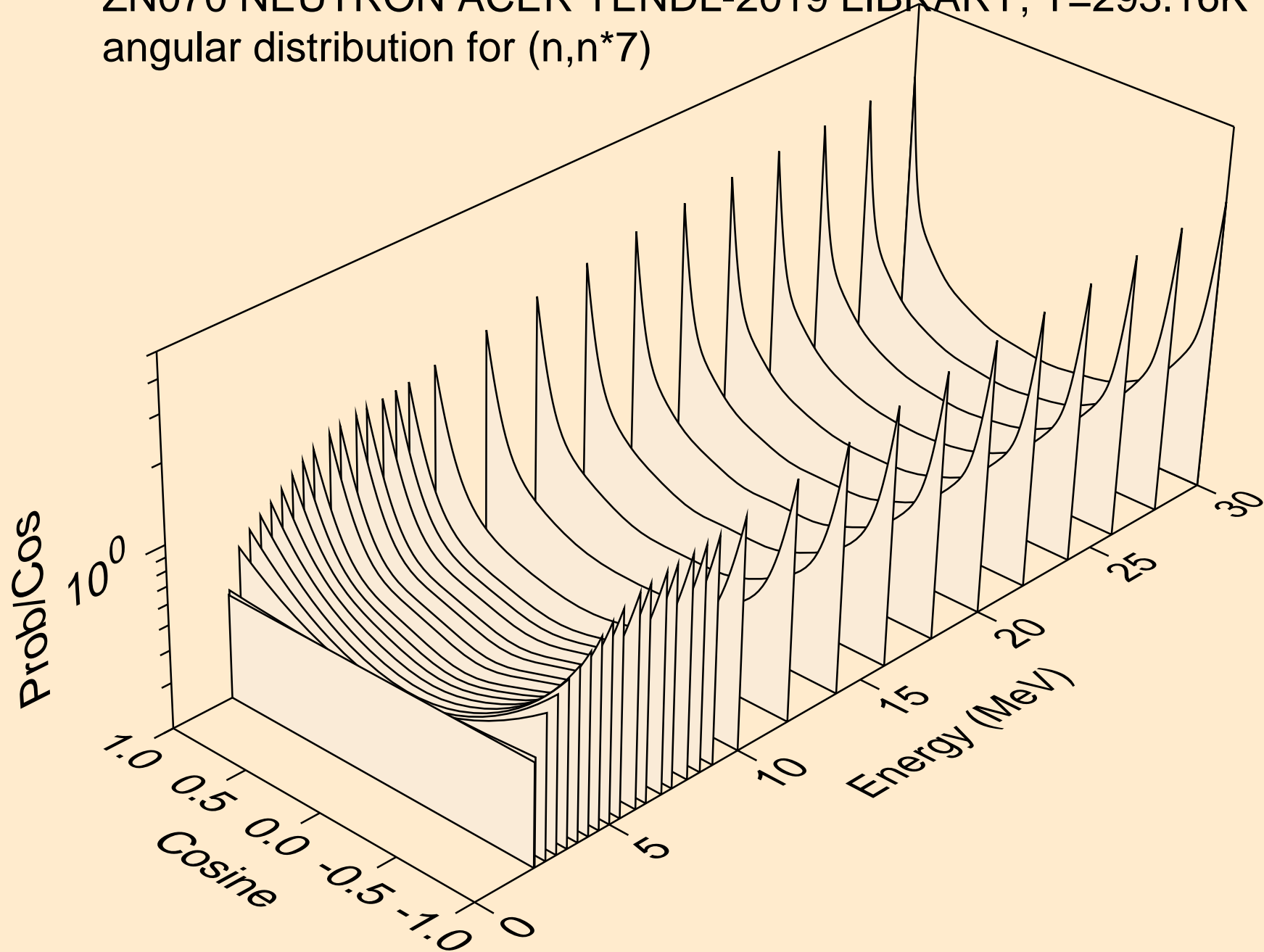

ZN070 NEUTRON ACER TENDL-2019 LIBRARY; T=293.16K
angular distribution for (n,n*8)

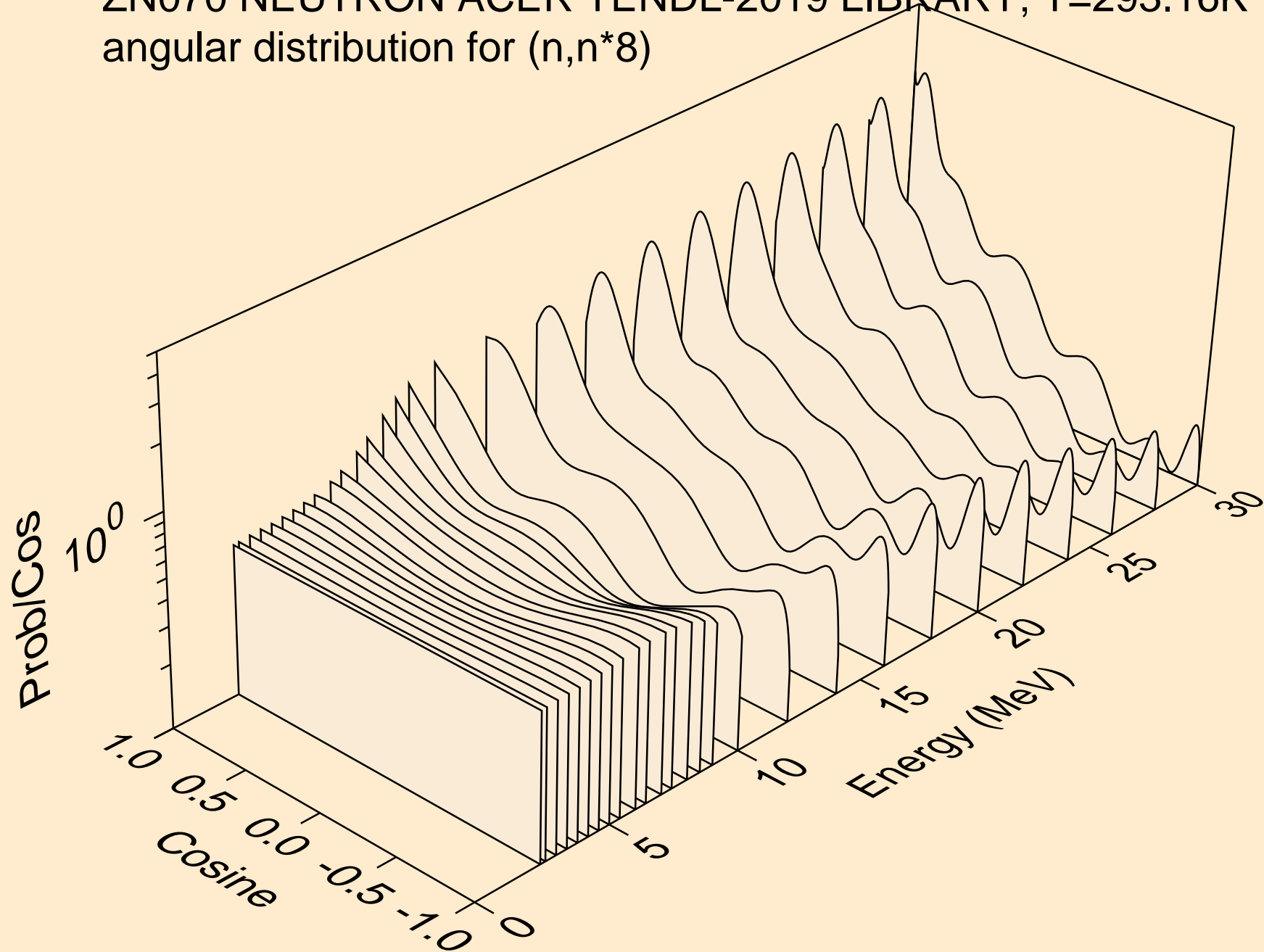

ZN070 NEUTRON ACER TENDL-2019 LIBRARY; T=293.16K
angular distribution for (n,n*9)

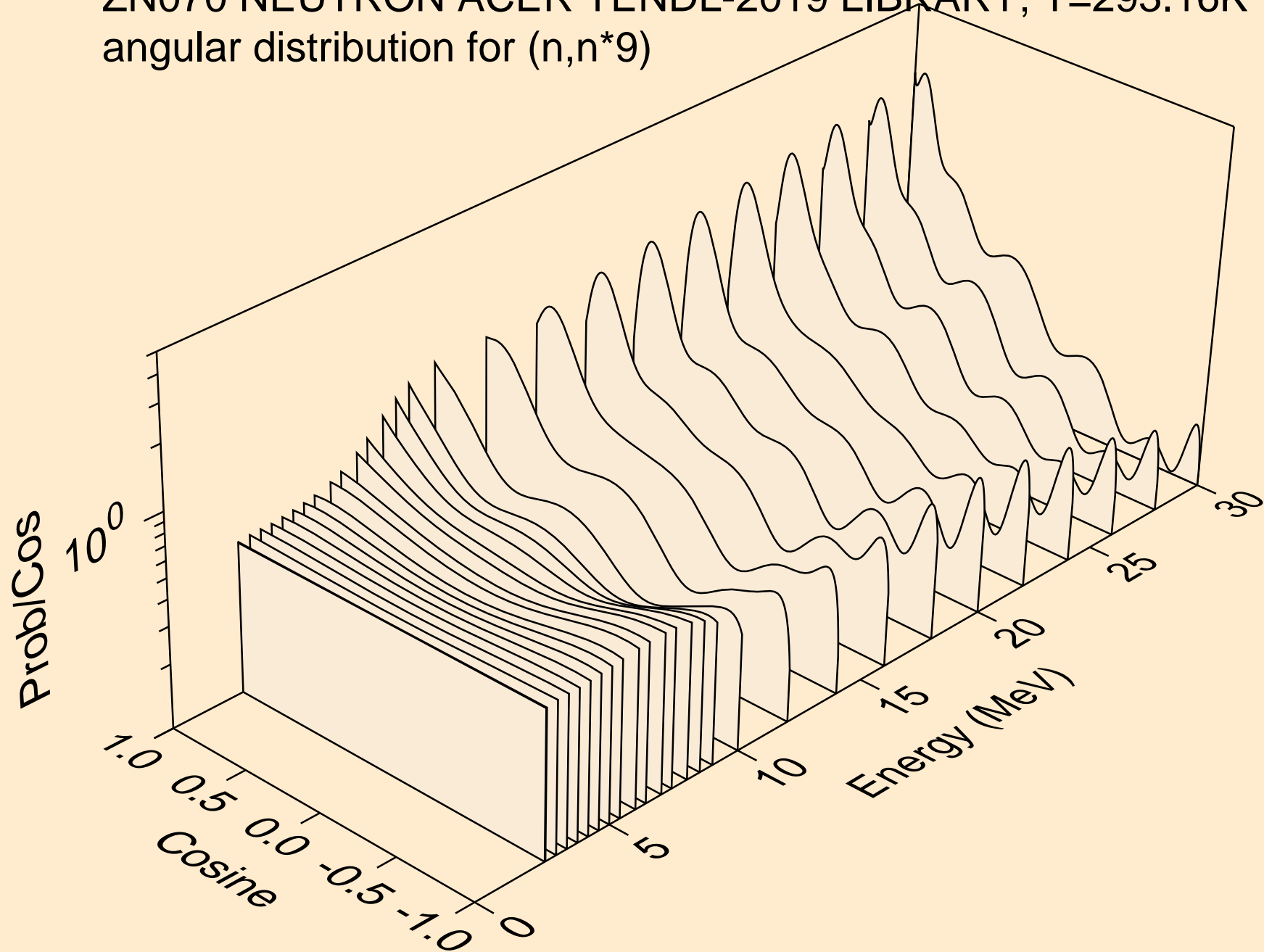

ZN070 NEUTRON ACER TENDL-2019 LIBRARY; T=293.16K
angular distribution for (n,n*10)

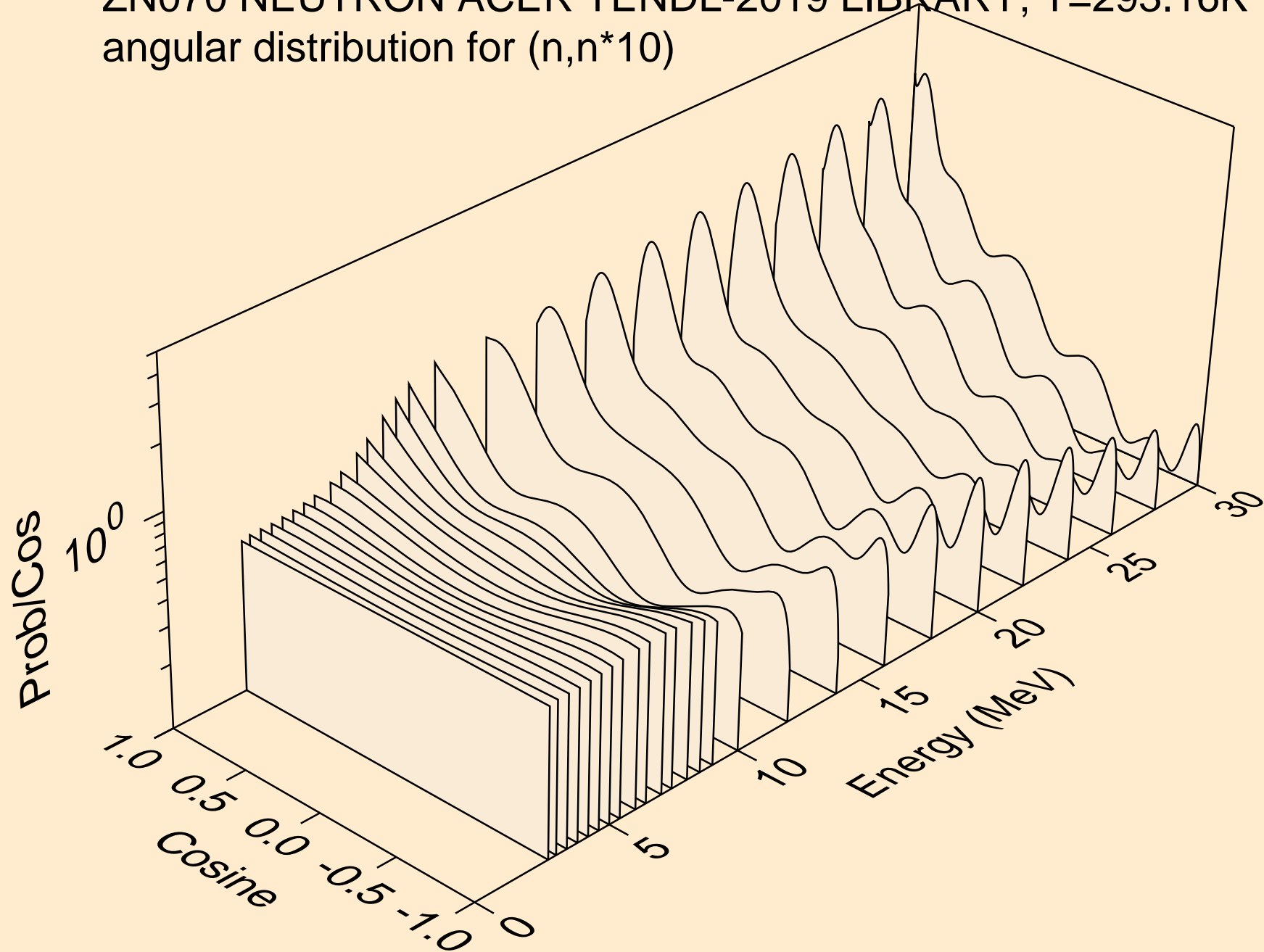

ZN070 NEUTRON ACER TENDL-2019 LIBRARY; T=293.16K
angular distribution for (n,n*11)

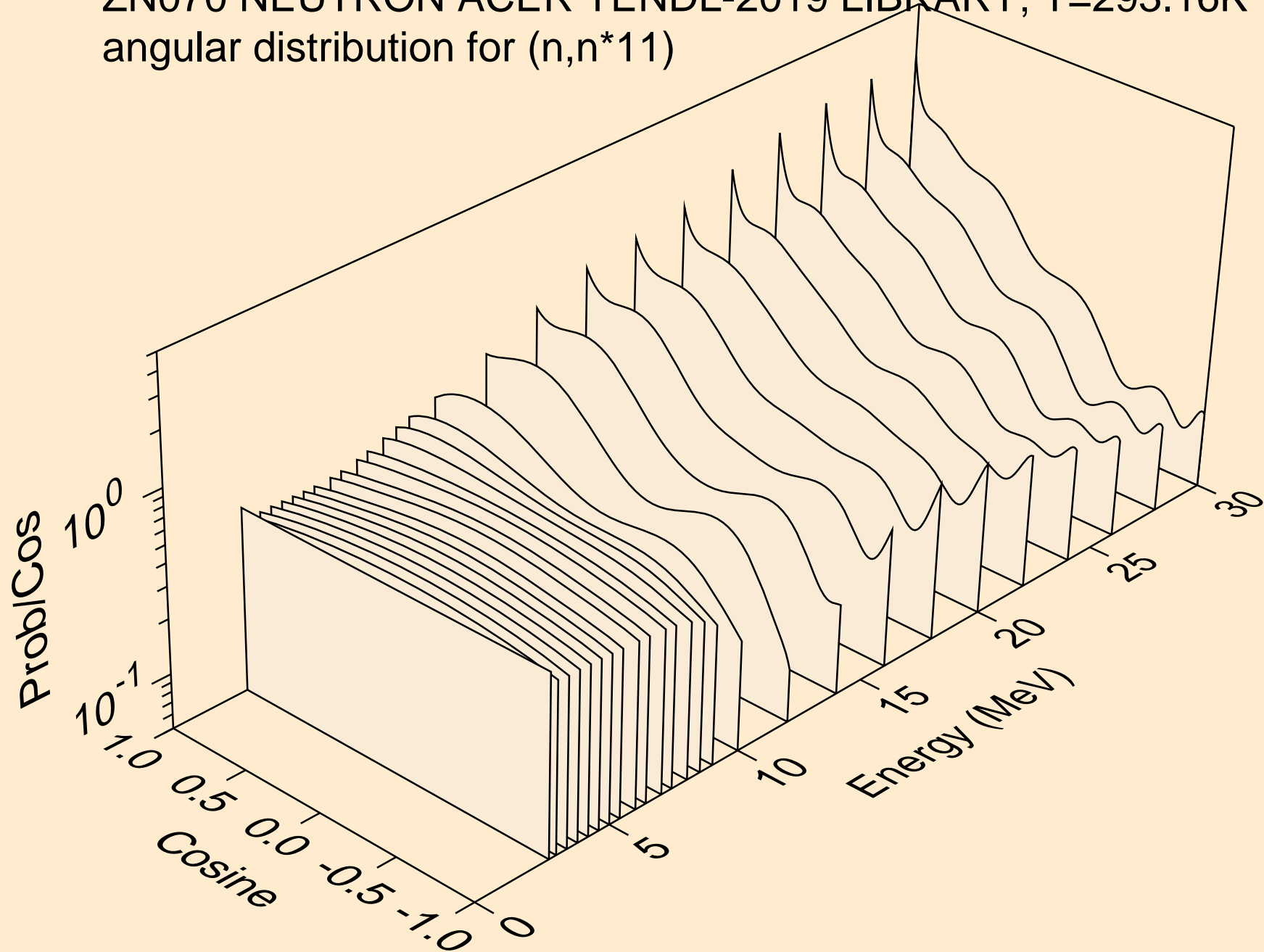

ZN070 NEUTRON ACER TENDL-2019 LIBRARY; T=293.16K
angular distribution for (n,n*12)

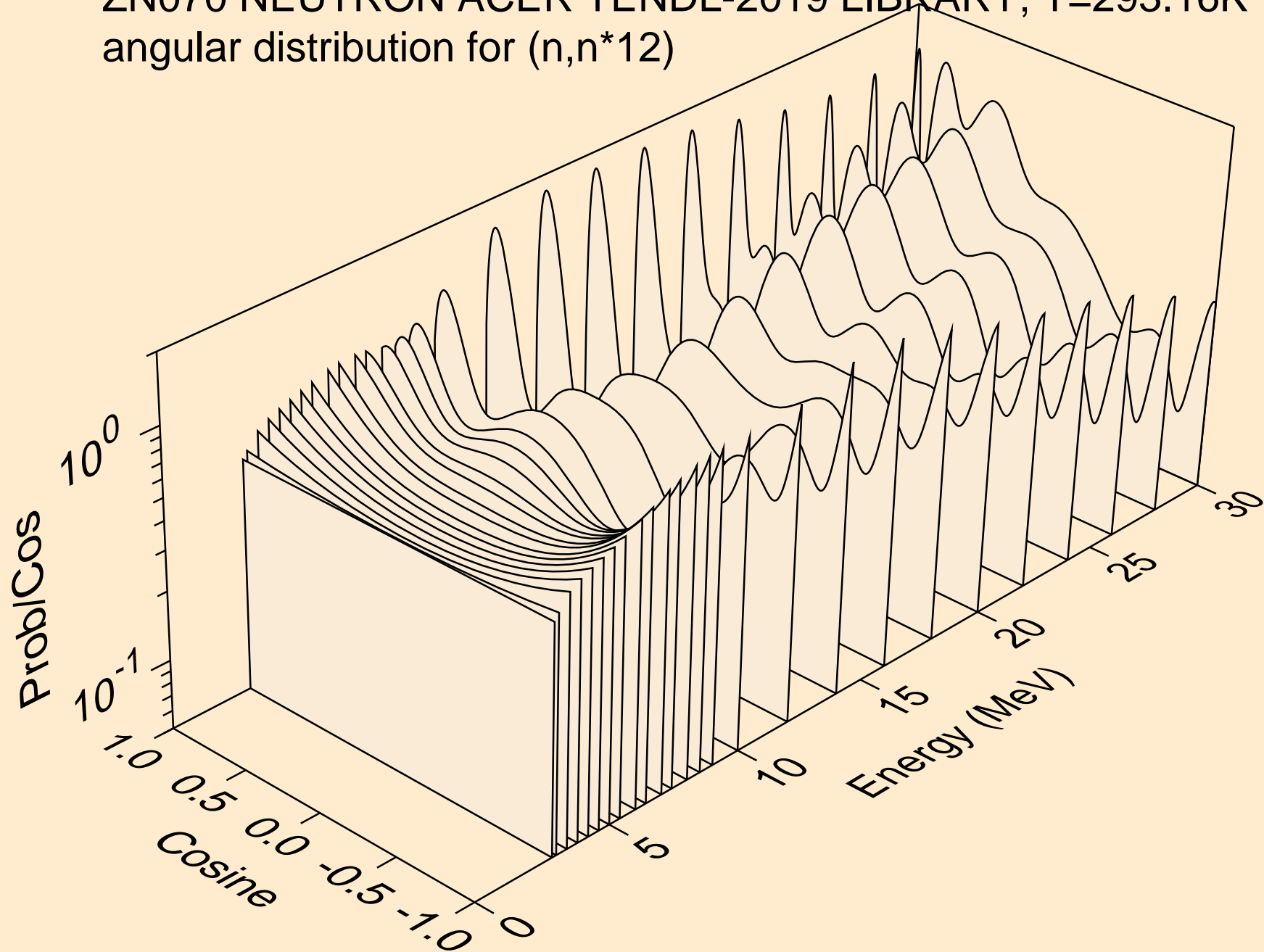

ZN070 NEUTRON ACER TENDL-2019 LIBRARY; T=293.16K
angular distribution for (n,n*13)

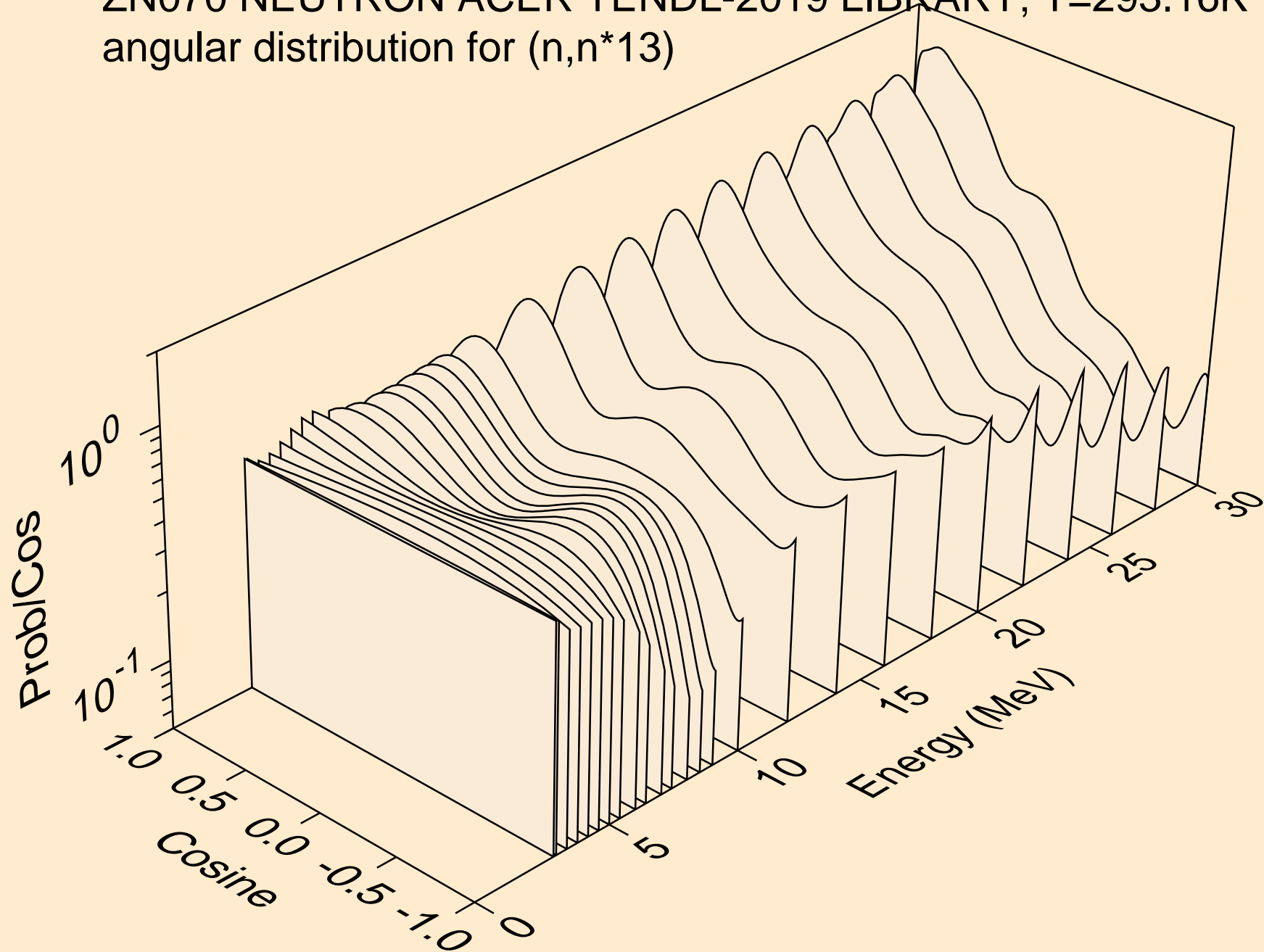

ZN070 NEUTRON ACER TENDL-2019 LIBRARY; T=293.16K
angular distribution for (n,n*14)

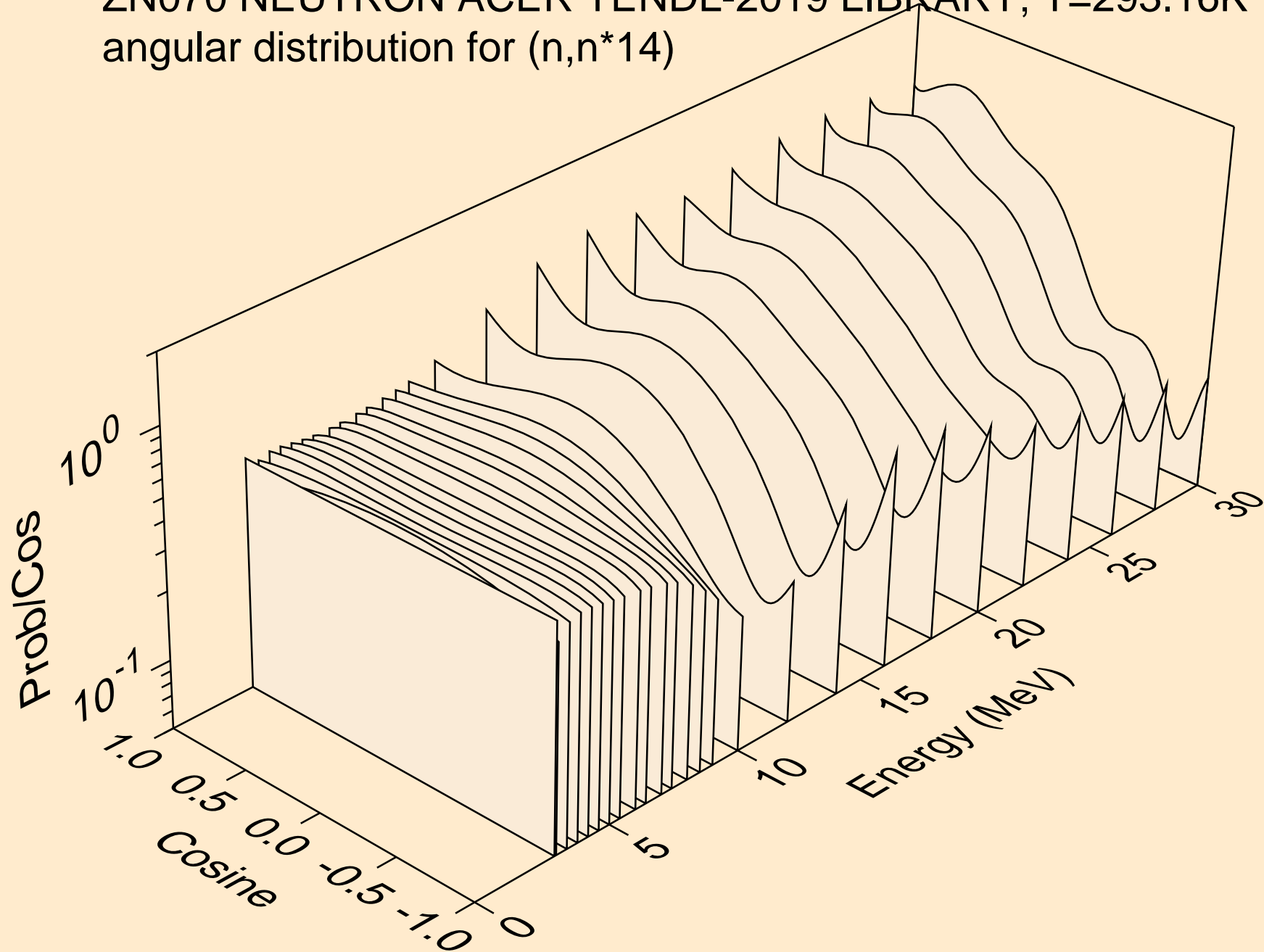

ZN070 NEUTRON ACER TENDL-2019 LIBRARY; T=293.16K
angular distribution for (n,n*15)

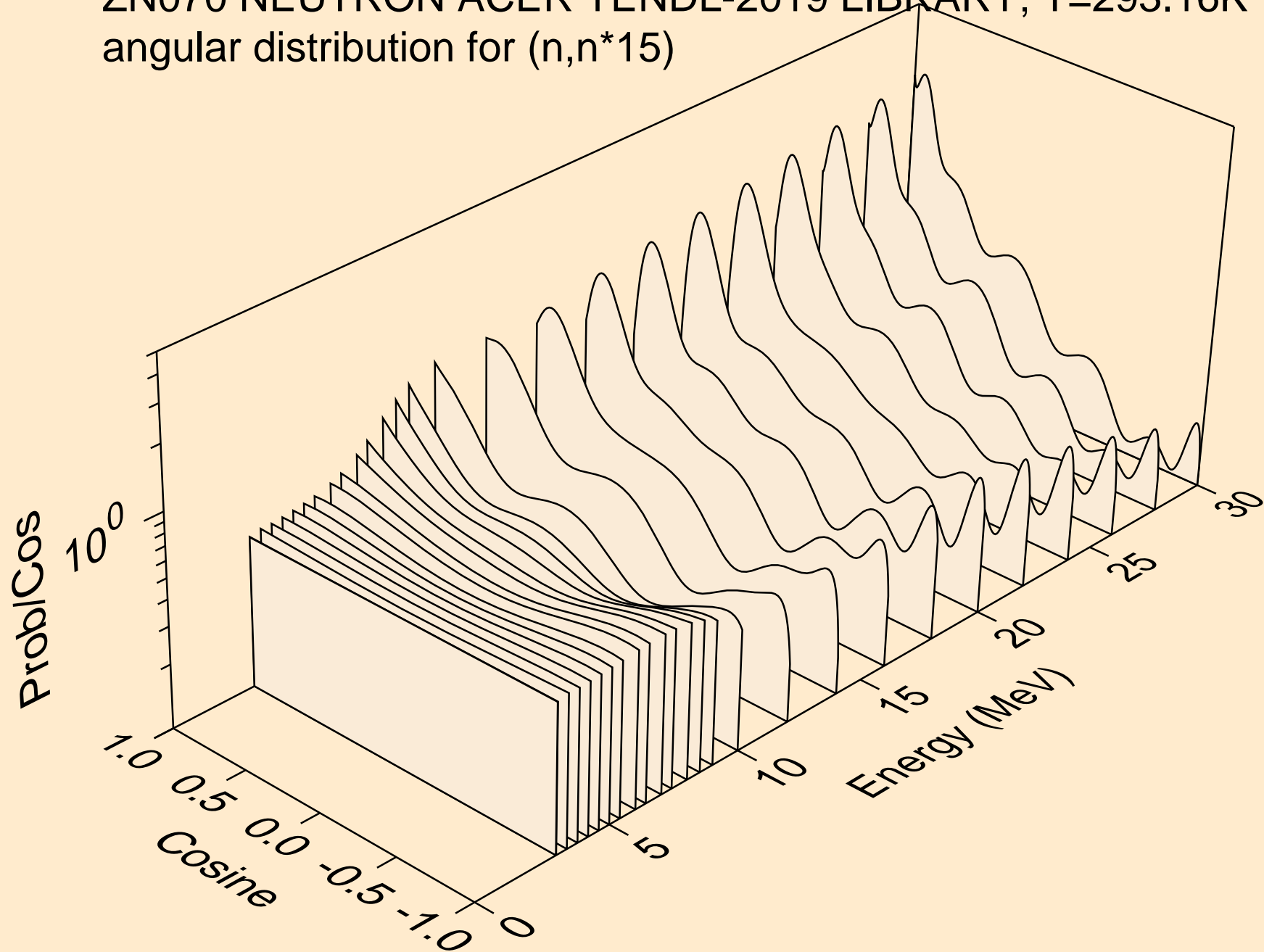

ZN070 NEUTRON ACER TENDL-2019 LIBRARY; T=293.16K
angular distribution for (n,n*16)

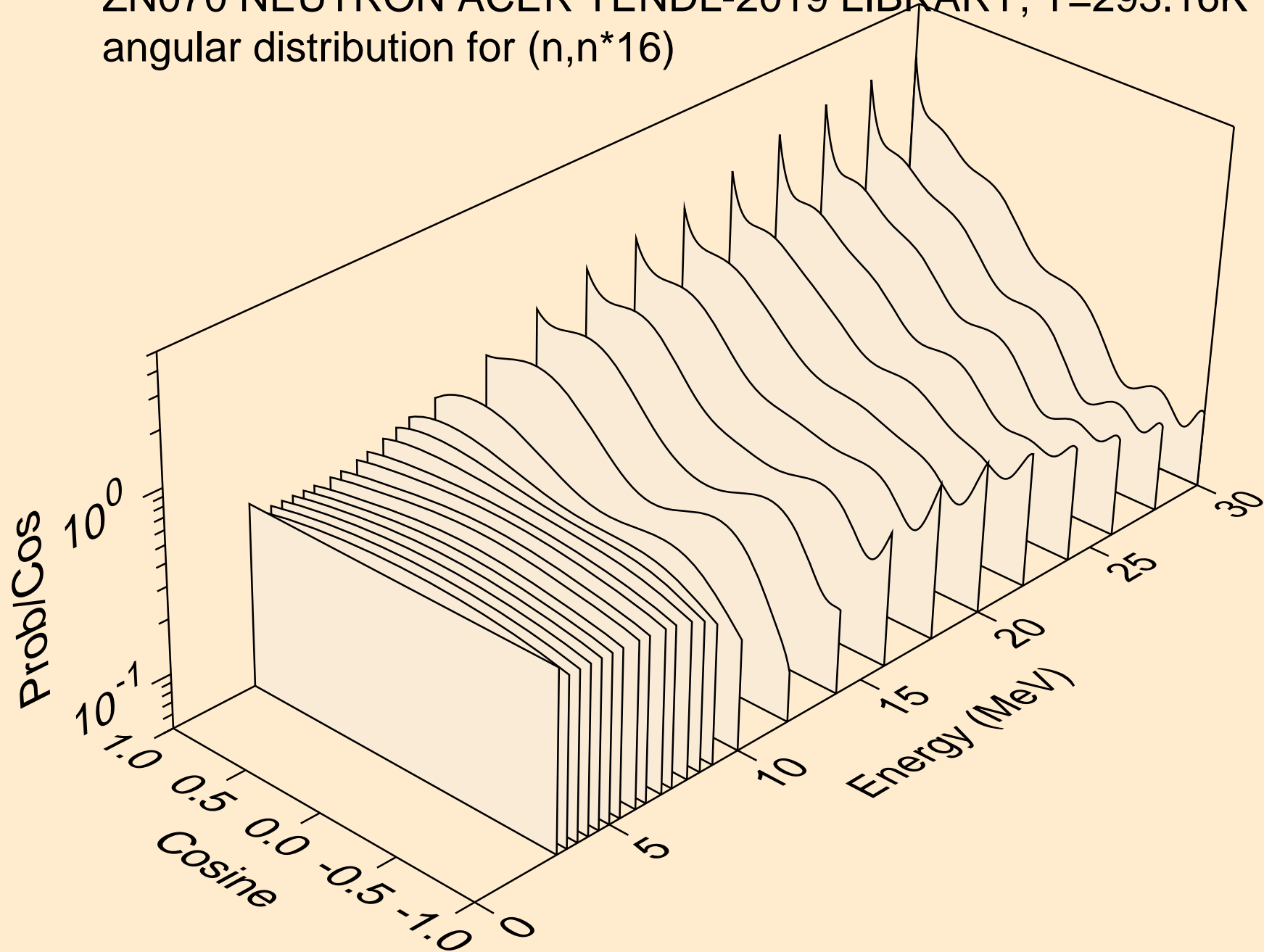

ZN070 NEUTRON ACER TENDL-2019 LIBRARY; T=293.16K
angular distribution for (n,n*17)

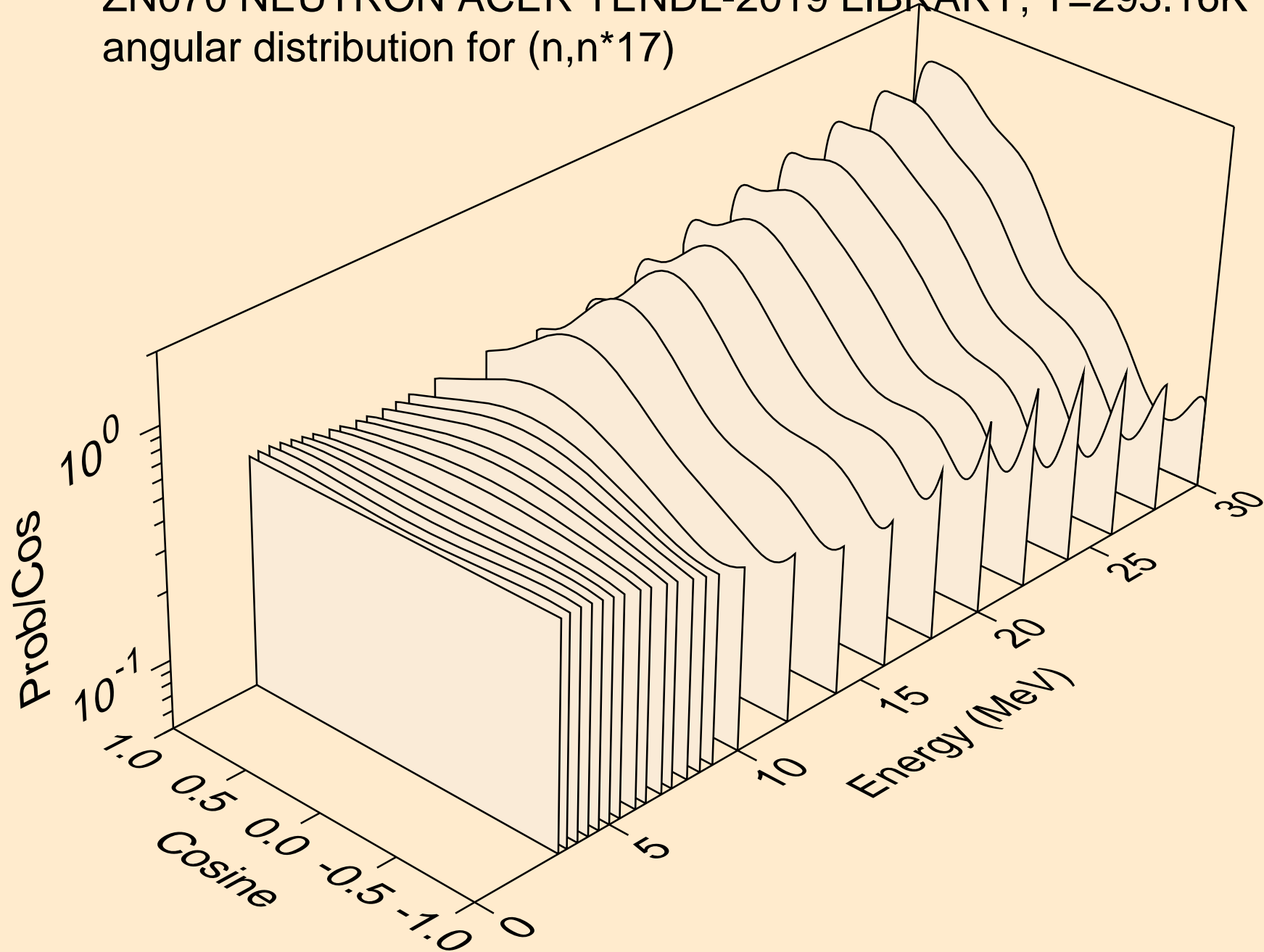

ZN070 NEUTRON ACER TENDL-2019 LIBRARY; T=293.16K
angular distribution for (n,n*18)

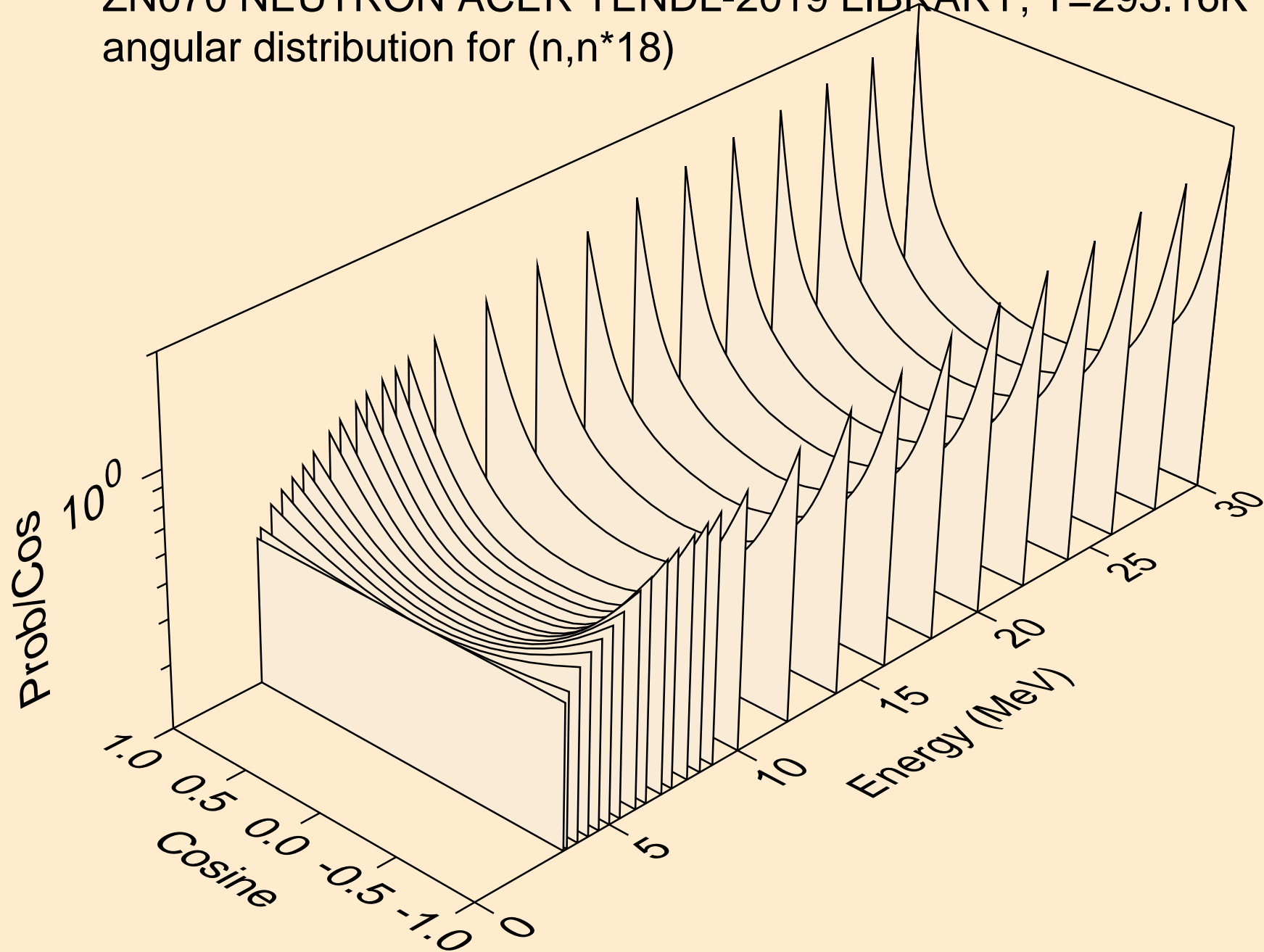

ZN070 NEUTRON ACER TENDL-2019 LIBRARY; T=293.16K
angular distribution for (n,n*19)

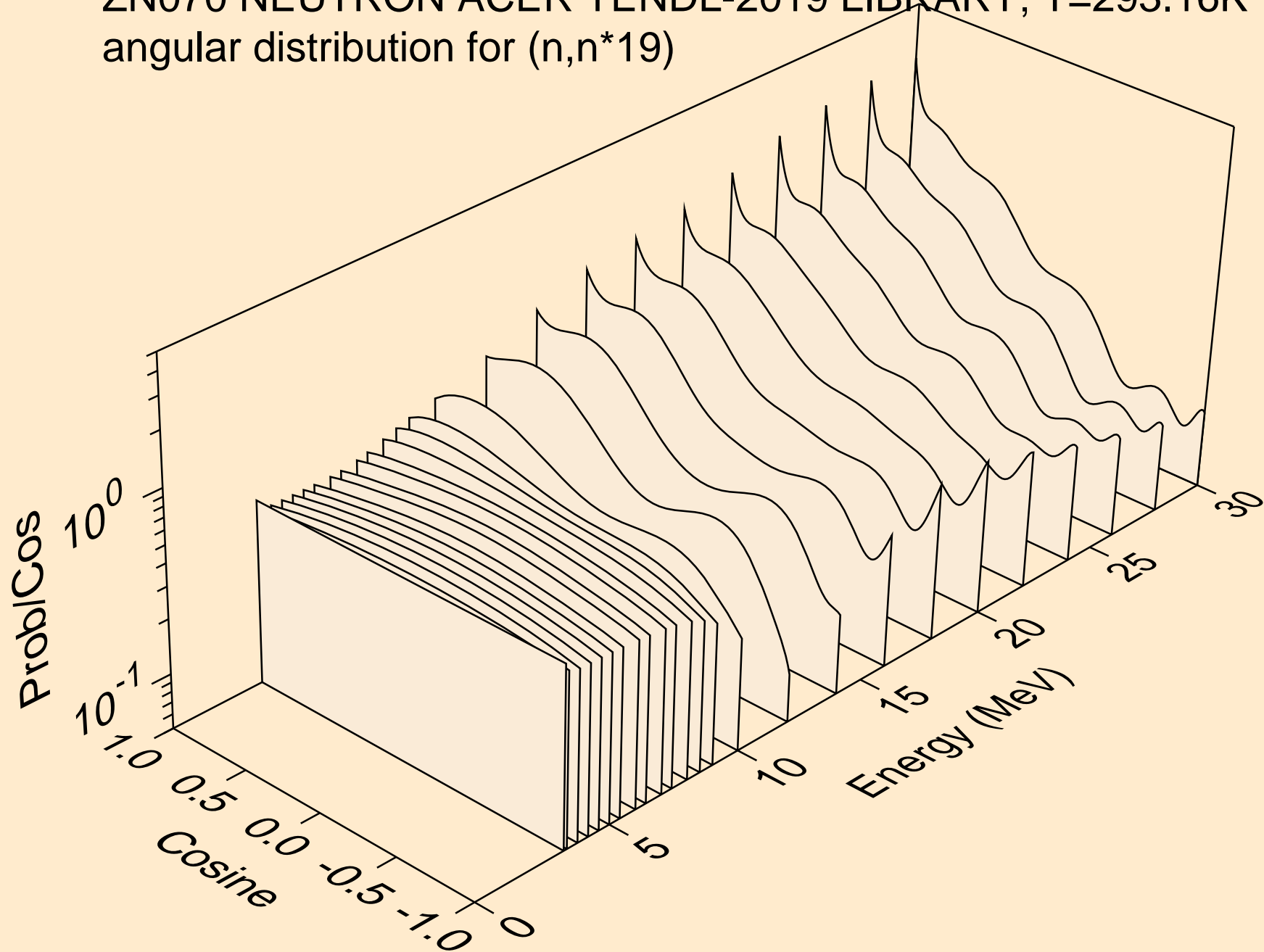

ZN070 NEUTRON ACER TENDL-2019 LIBRARY; T=293.16K
angular distribution for (n,n*20)

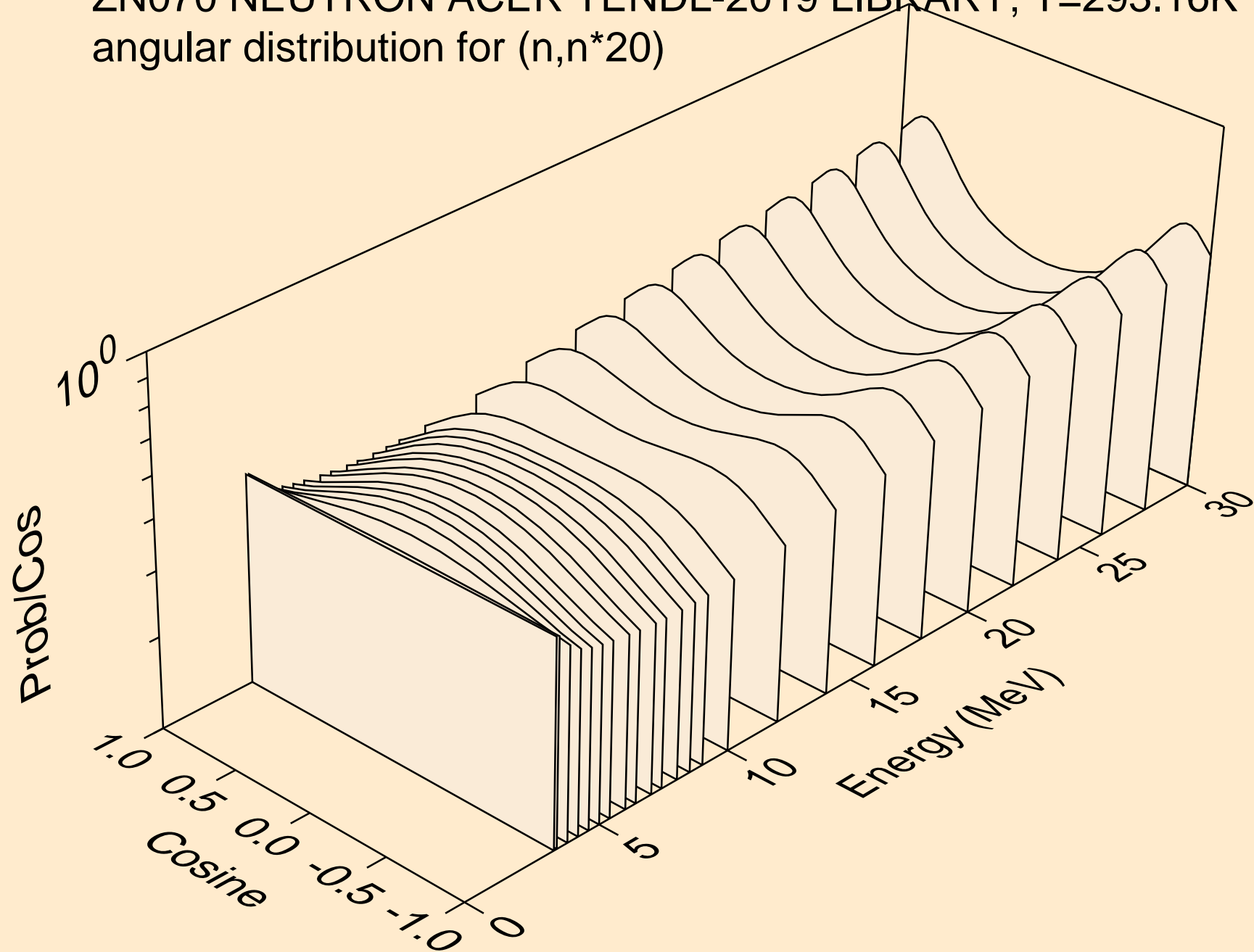

ZN070 NEUTRON ACER TENDL-2019 LIBRARY; T=293.16K
angular distribution for (n,n*21)

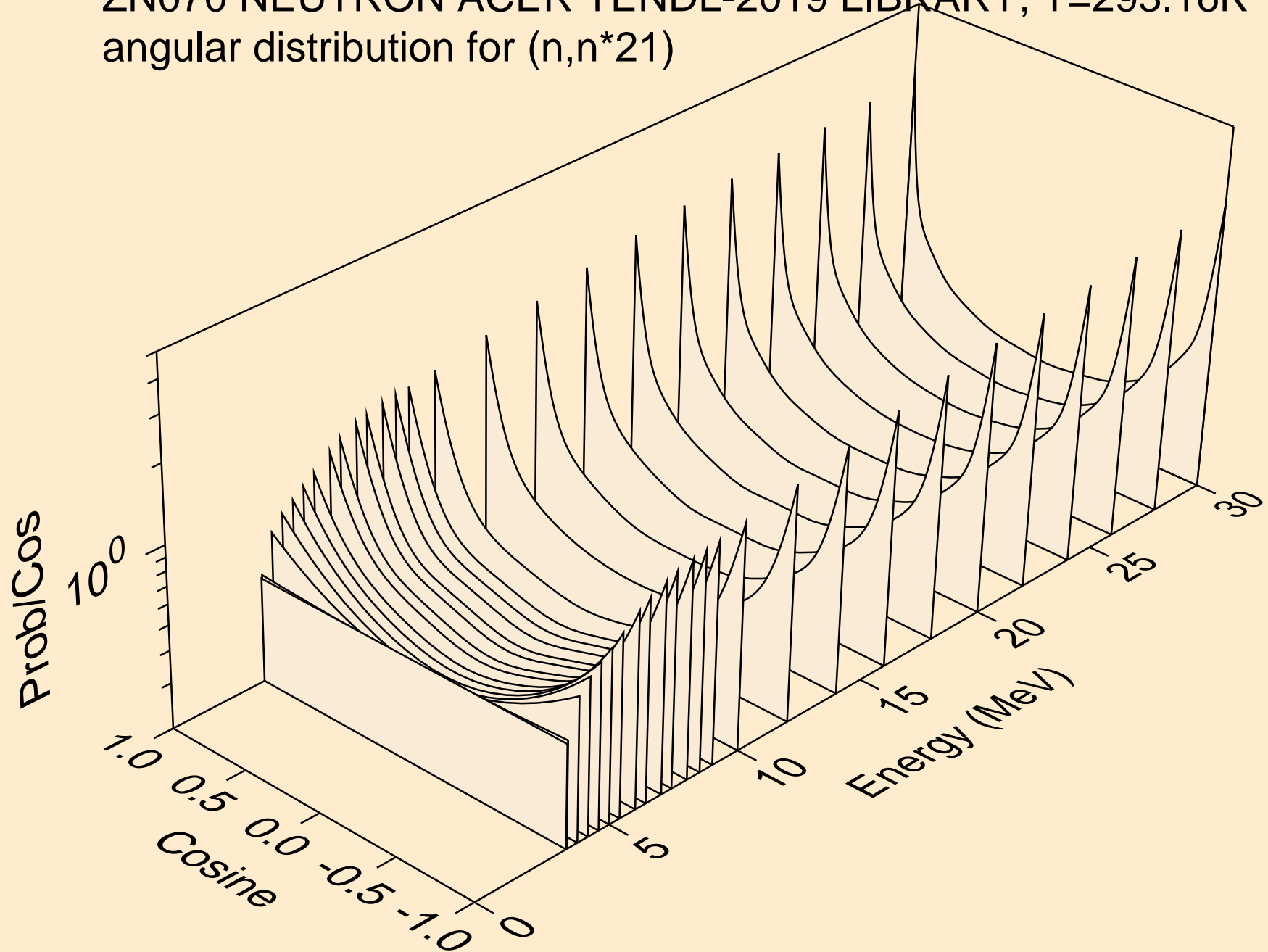

ZN070 NEUTRON ACER TENDL-2019 LIBRARY; T=293.16K
angular distribution for (n,n*22)

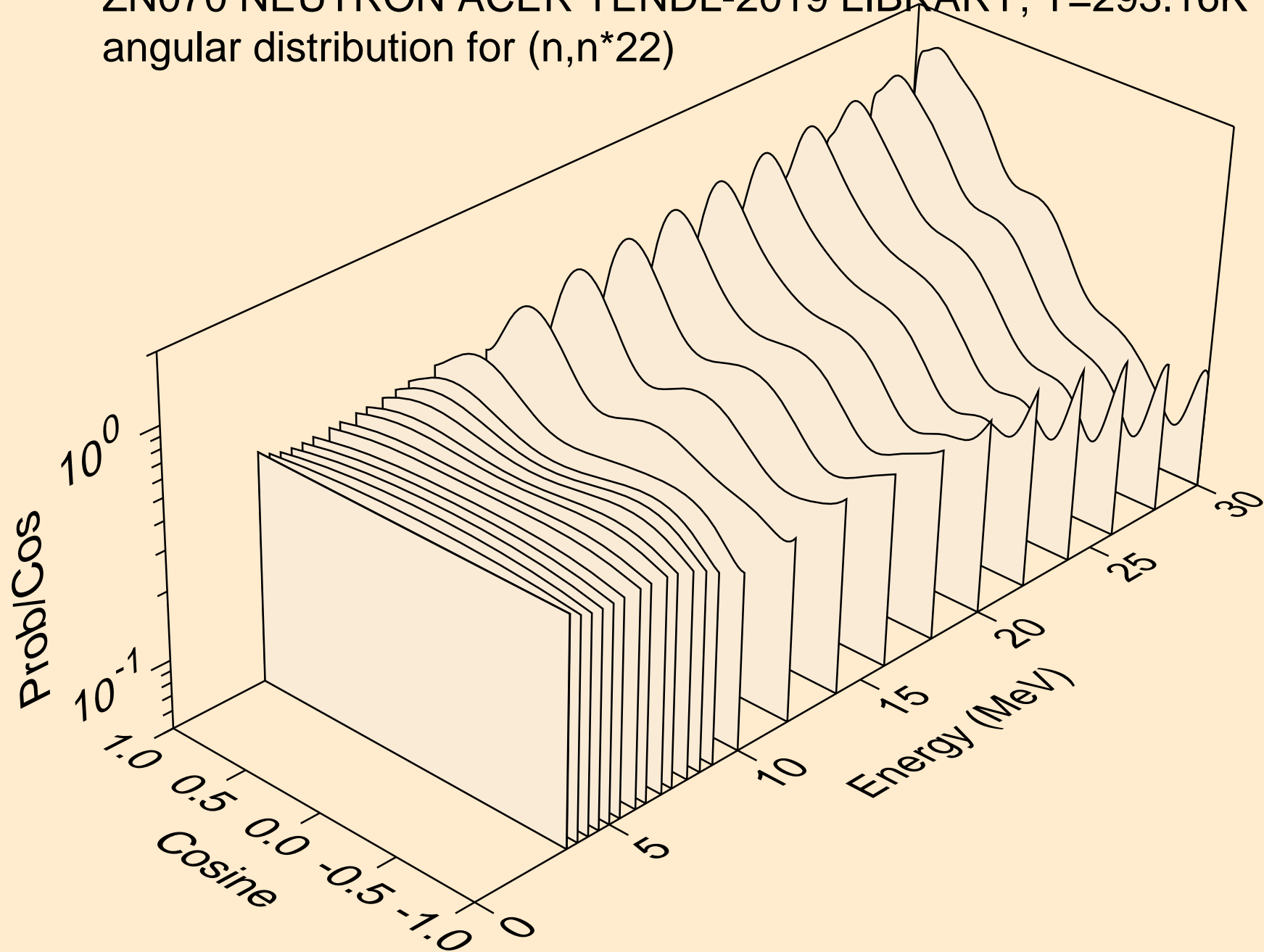

ZN070 NEUTRON ACER TENDL-2019 LIBRARY; T=293.16K
angular distribution for (n,n*23)

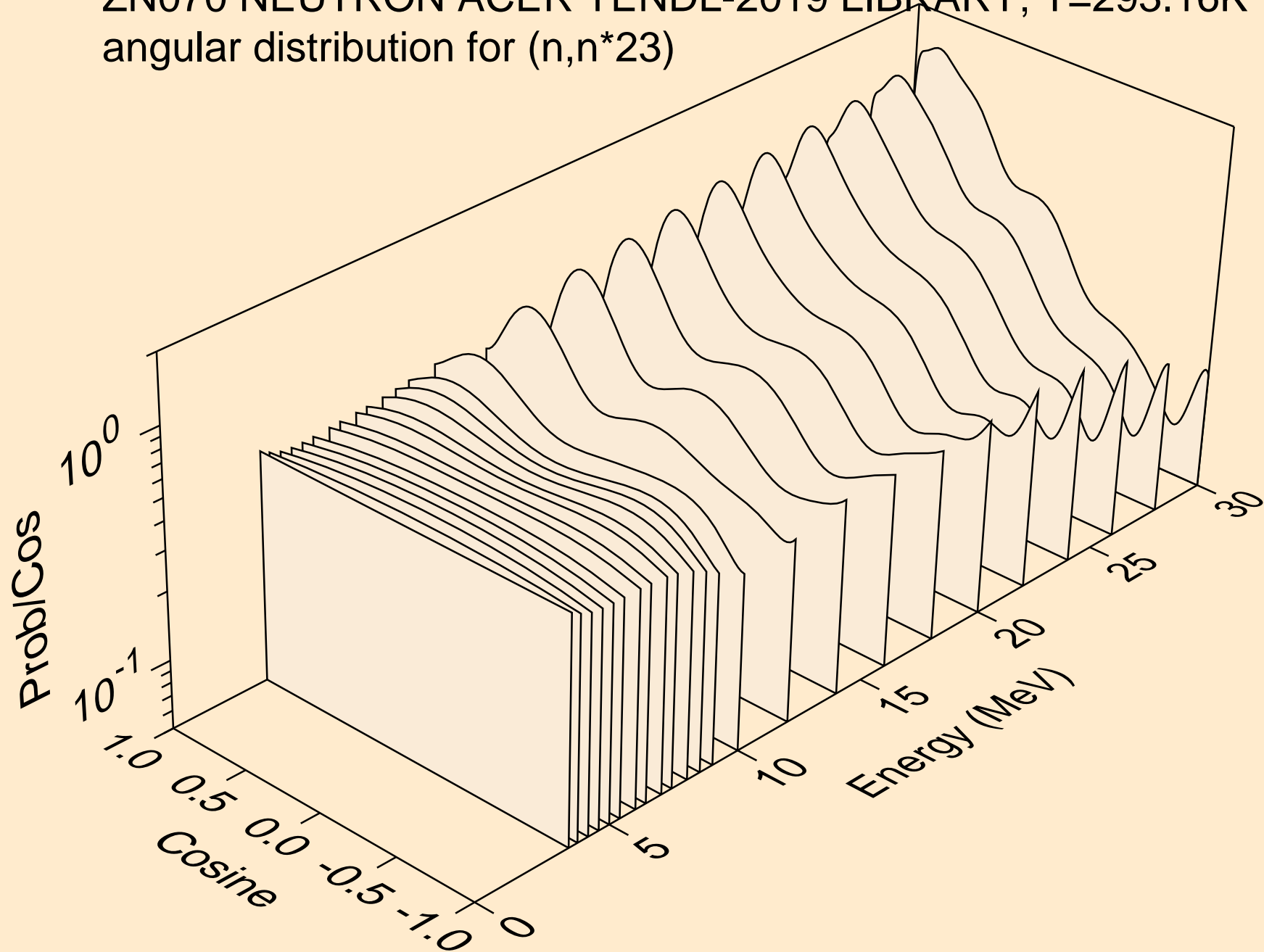

ZN070 NEUTRON ACER TENDL-2019 LIBRARY; T=293.16K
angular distribution for (n,n*24)

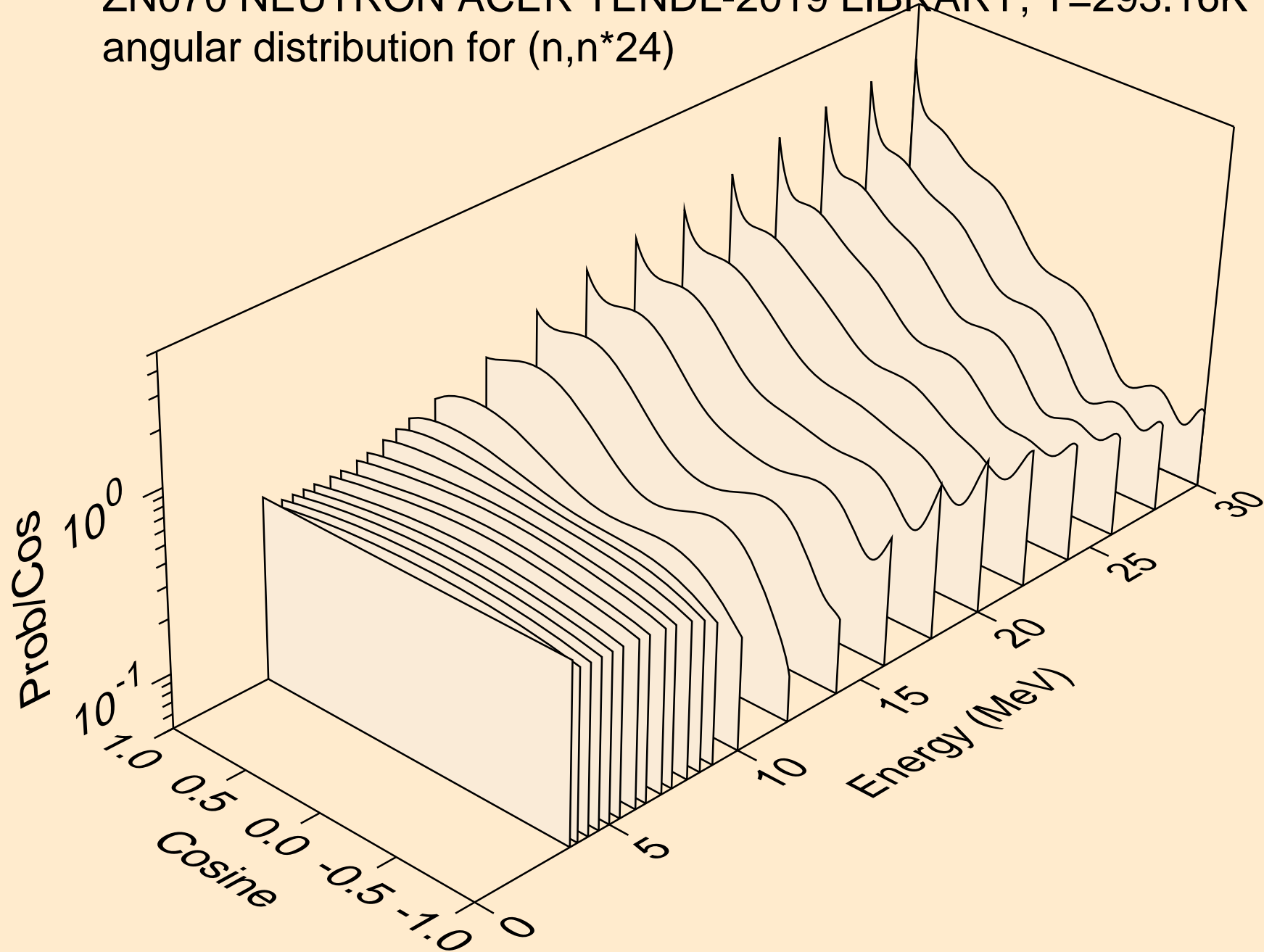

ZN070 NEUTRON ACER TENDL-2019 LIBRARY; T=293.16K
angular distribution for (n,n*25)

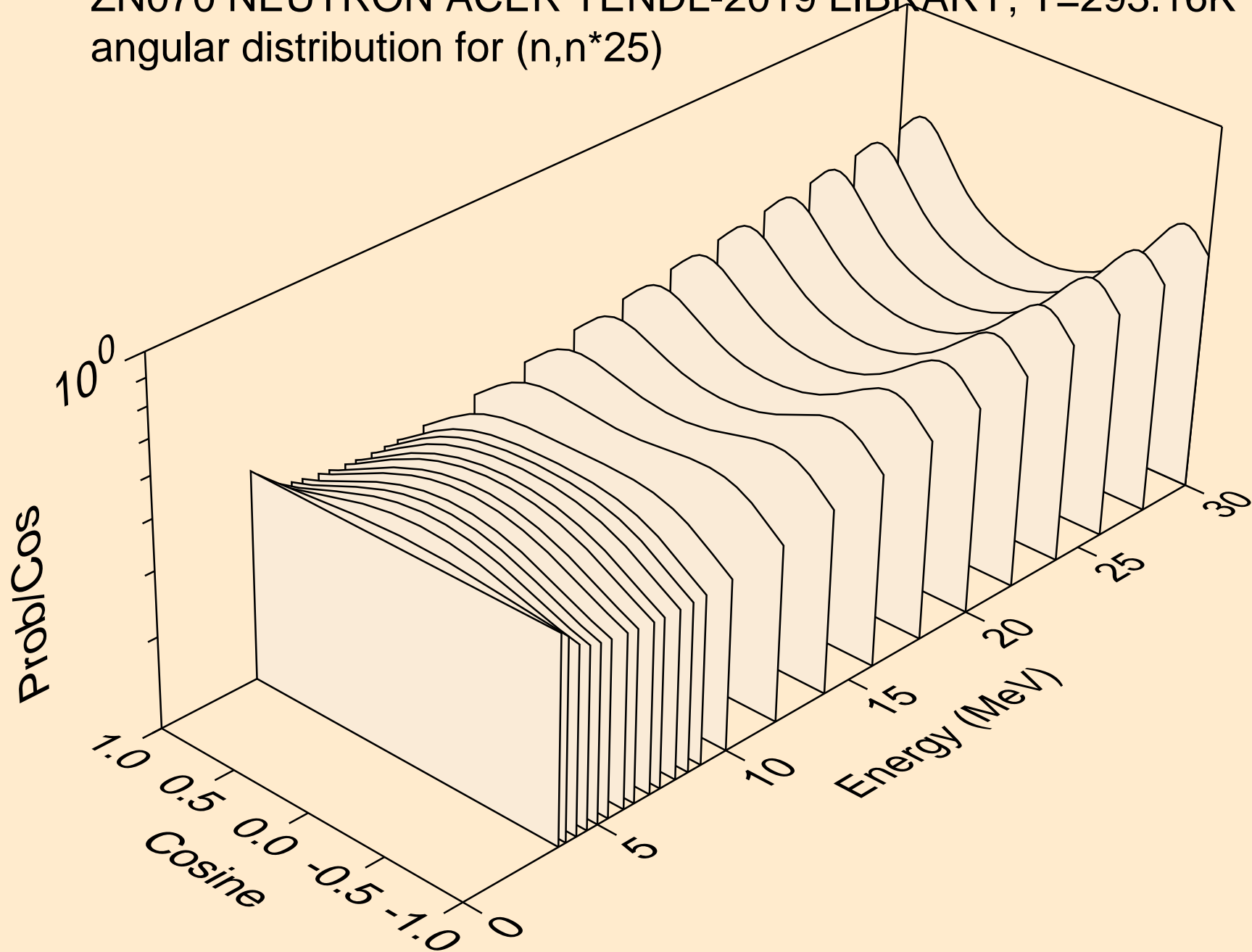

ZN070 NEUTRON ACER TENDL-2019 LIBRARY; T=293.16K
angular distribution for (n,n*26)

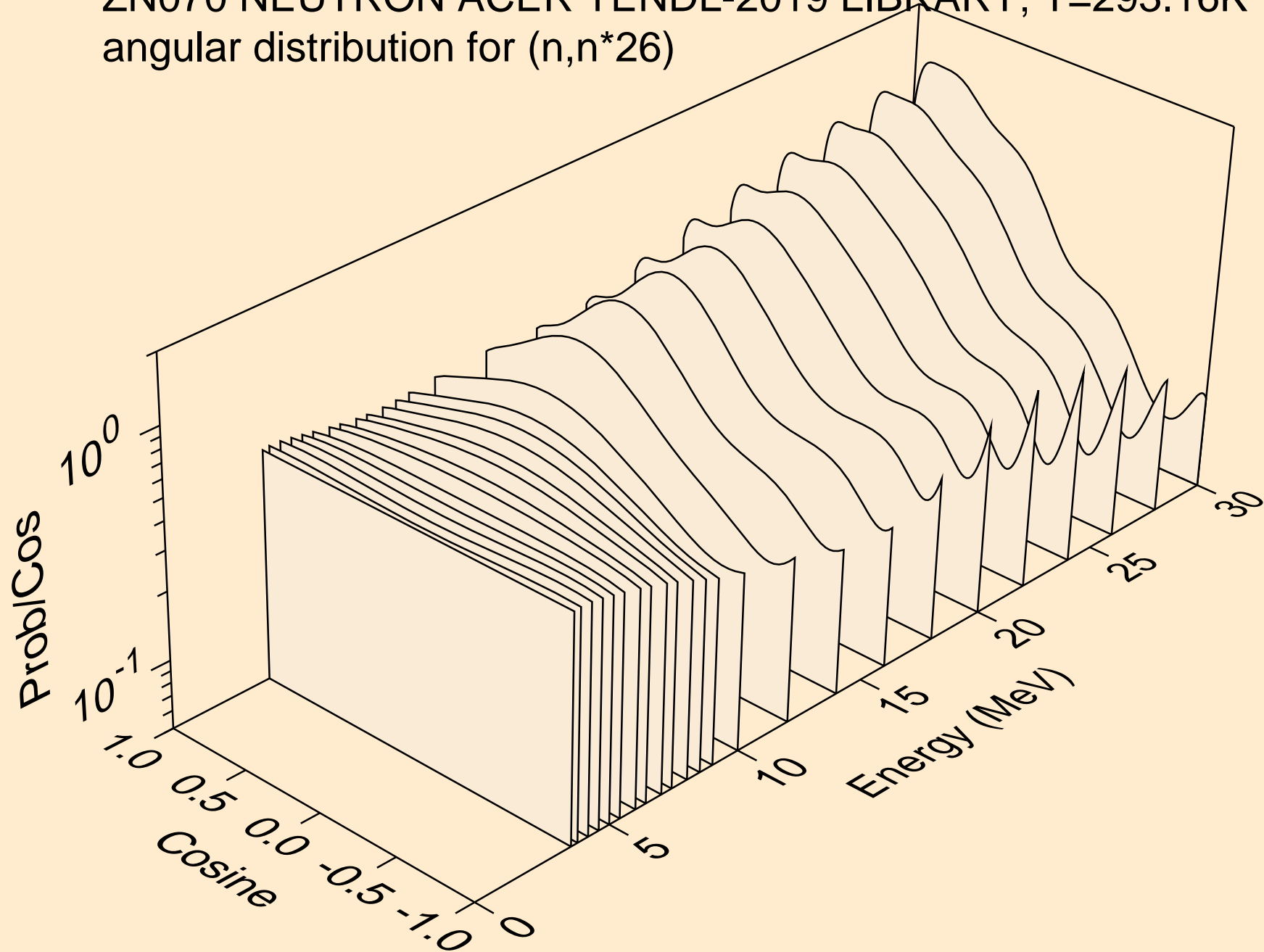

ZN070 NEUTRON ACER TENDL-2019 LIBRARY; T=293.16K
angular distribution for (n,n*27)

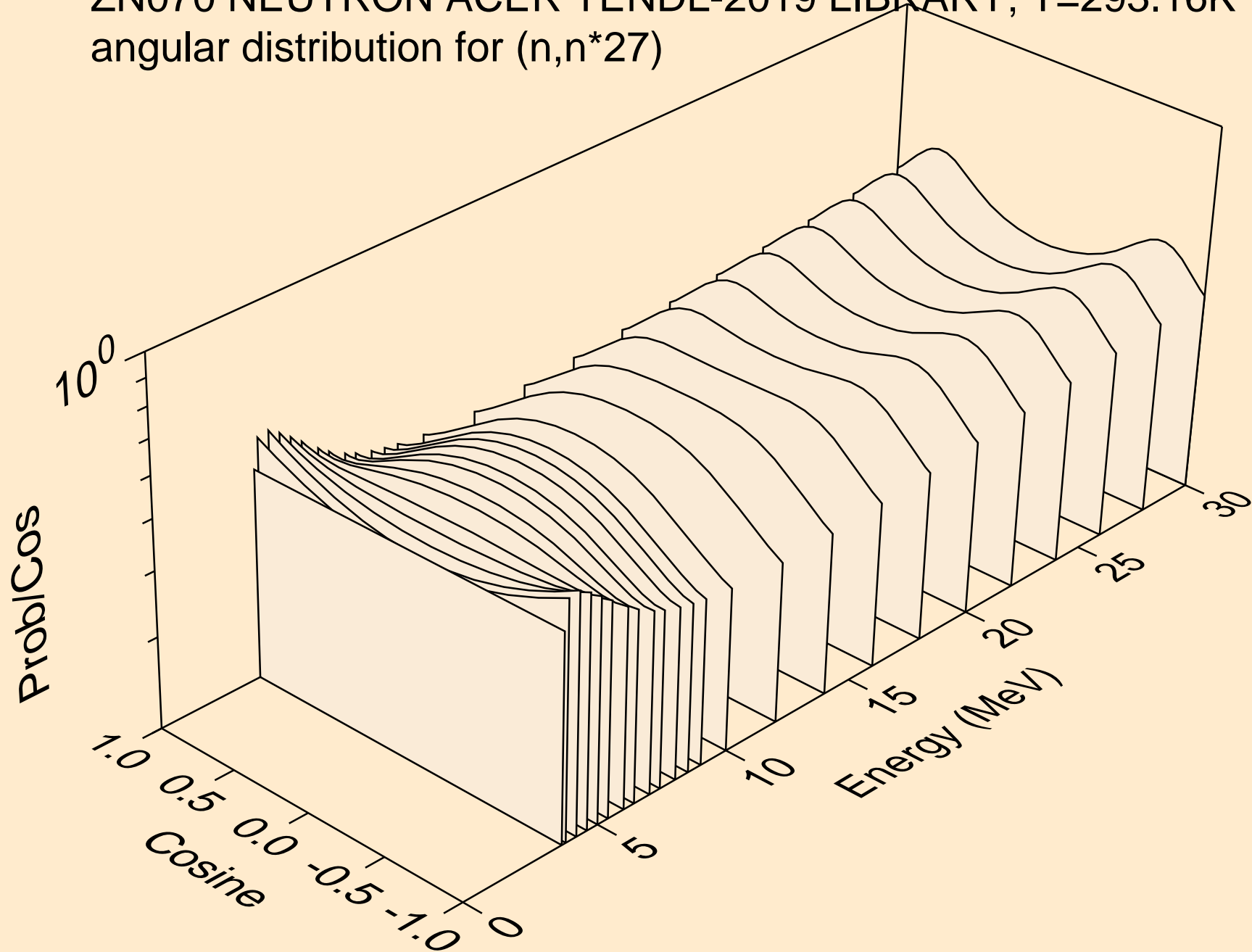

ZN070 NEUTRON ACER TENDL-2019 LIBRARY; T=293.16K
angular distribution for (n,n*28)

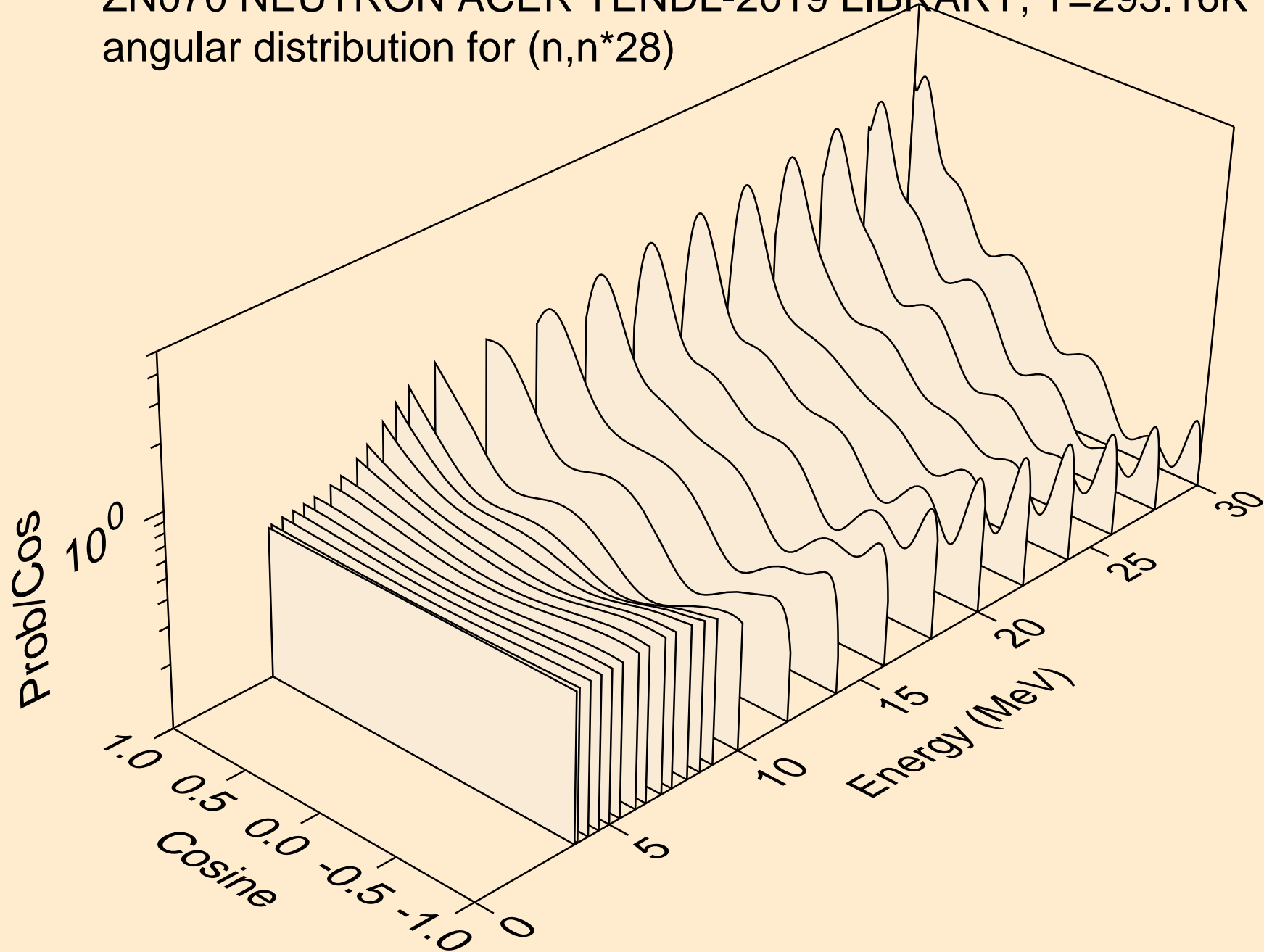

ZN070 NEUTRON ACER TENDL-2019 LIBRARY; T=293.16K
angular distribution for (n,n*29)

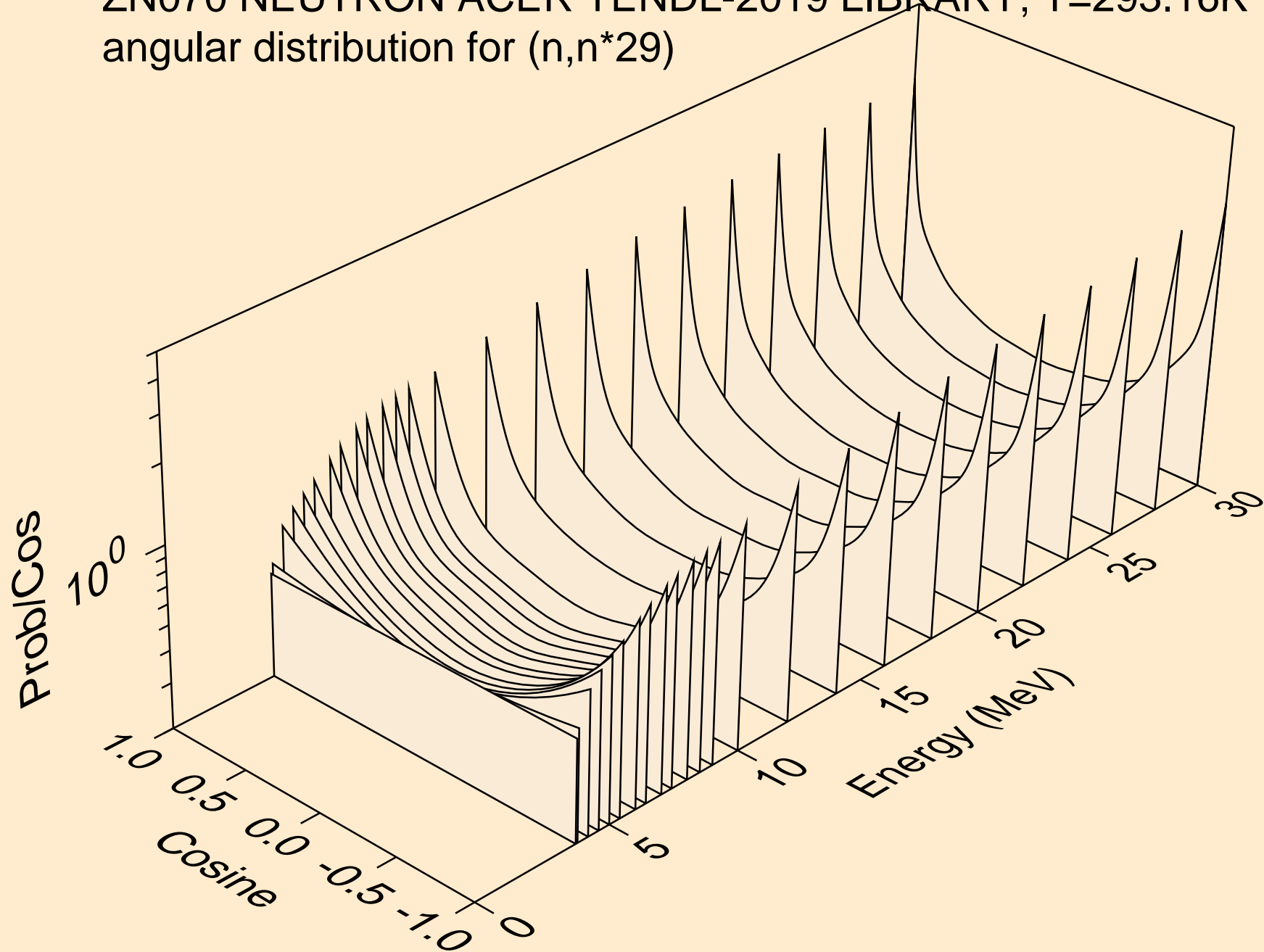

ZN070 NEUTRON ACER TENDL-2019 LIBRARY; T=293.16K
angular distribution for (n,n*30)

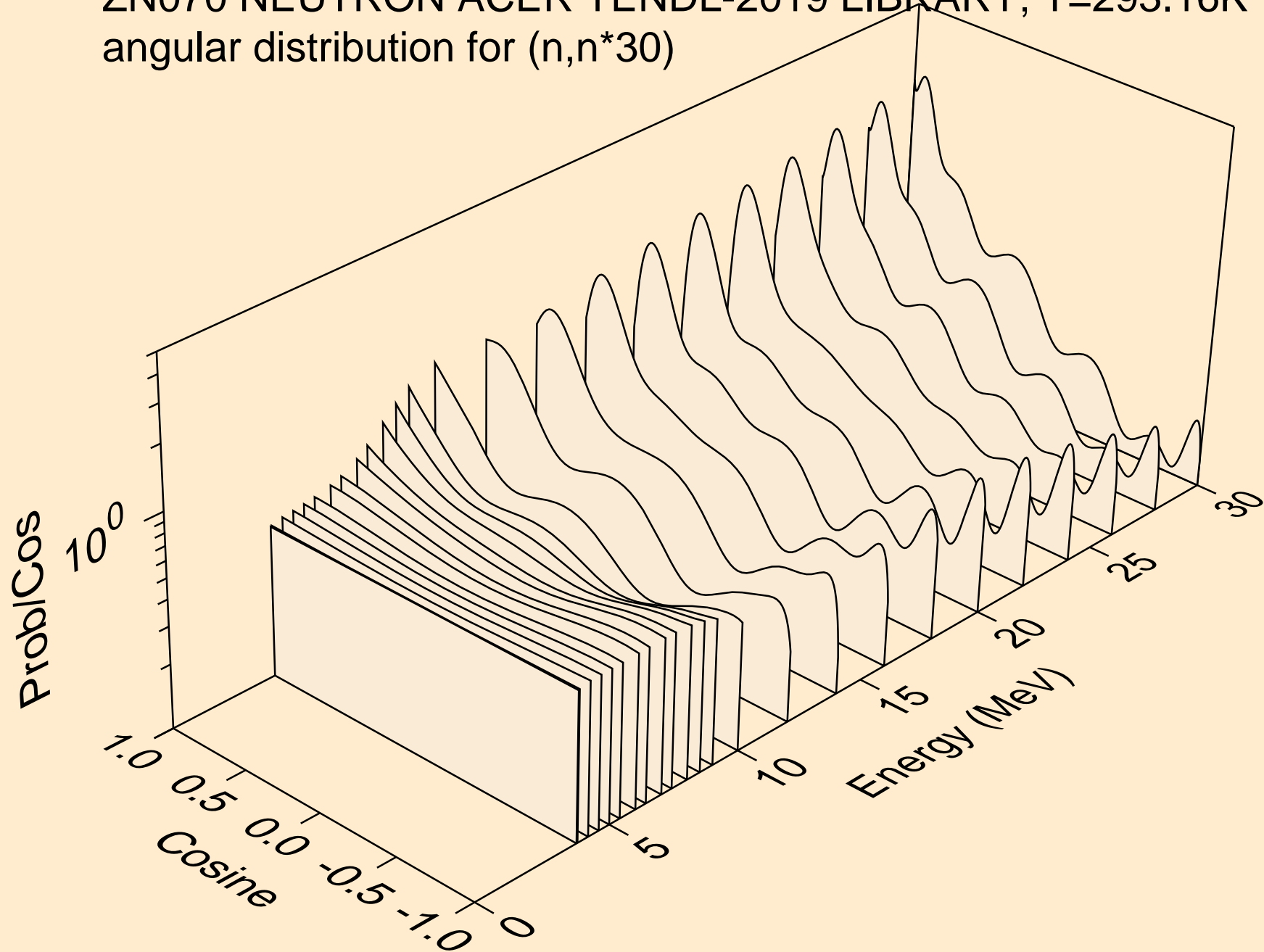

ZN070 NEUTRON ACER TENDL-2019 LIBRARY; T=293.16K
Neutron emission for (n,x)

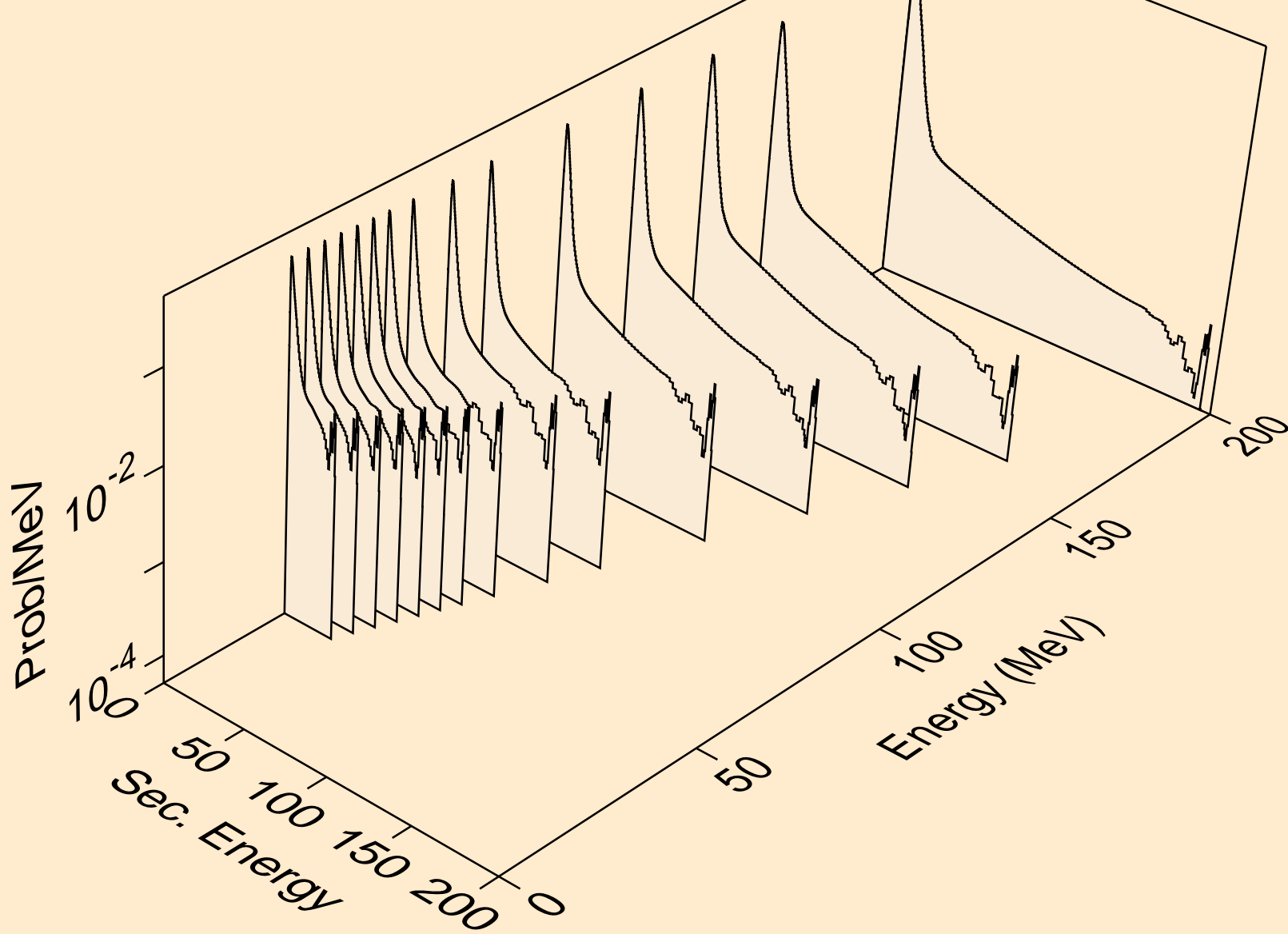

ZN070 NEUTRON ACER TENDL-2019 LIBRARY; T=293.16K
Neutron emission for (n,2nd)

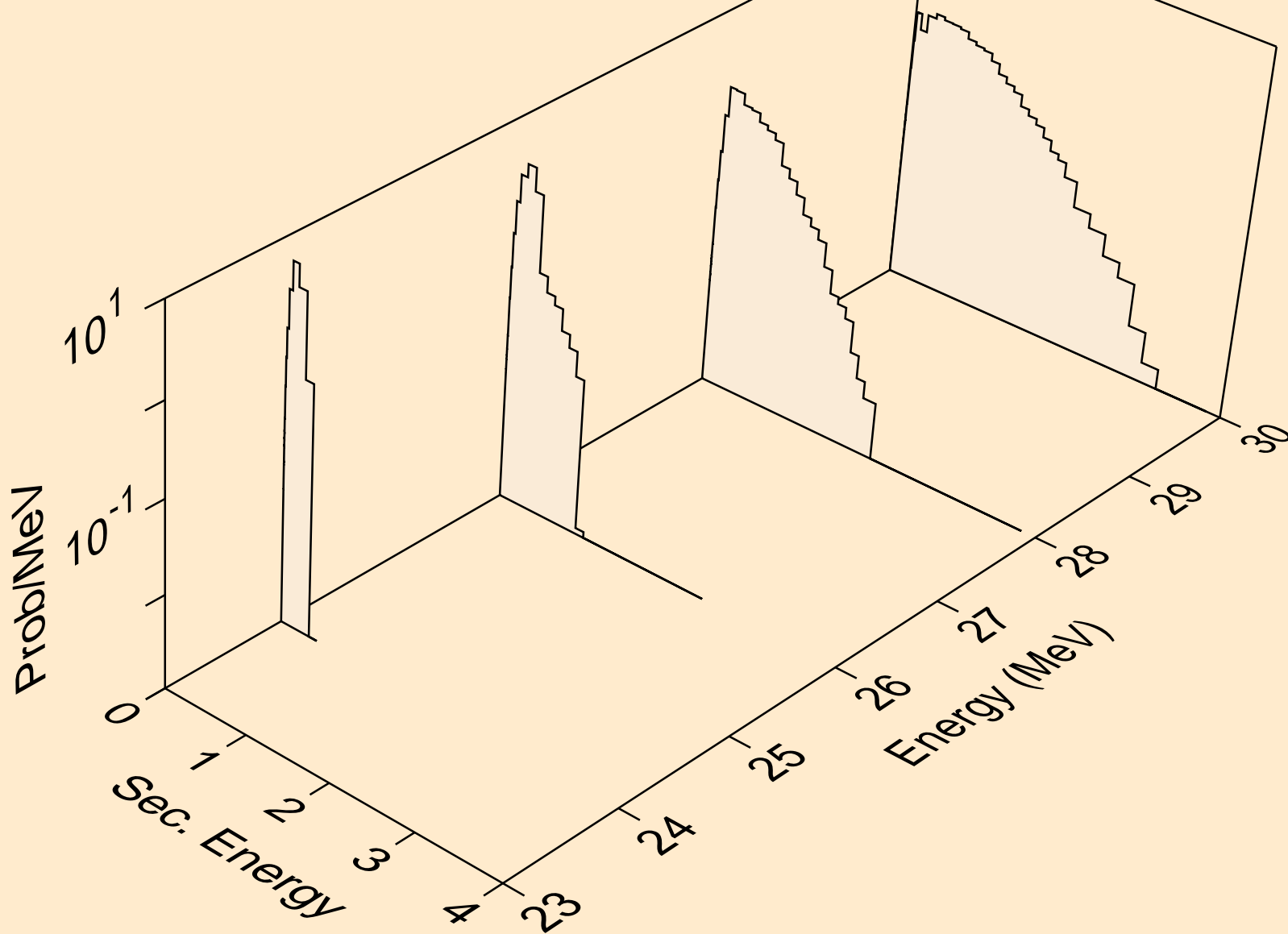

ZN070 NEUTRON ACER TENDL-2019 LIBRARY; T=293.16K
Neutron emission for (n,2n)

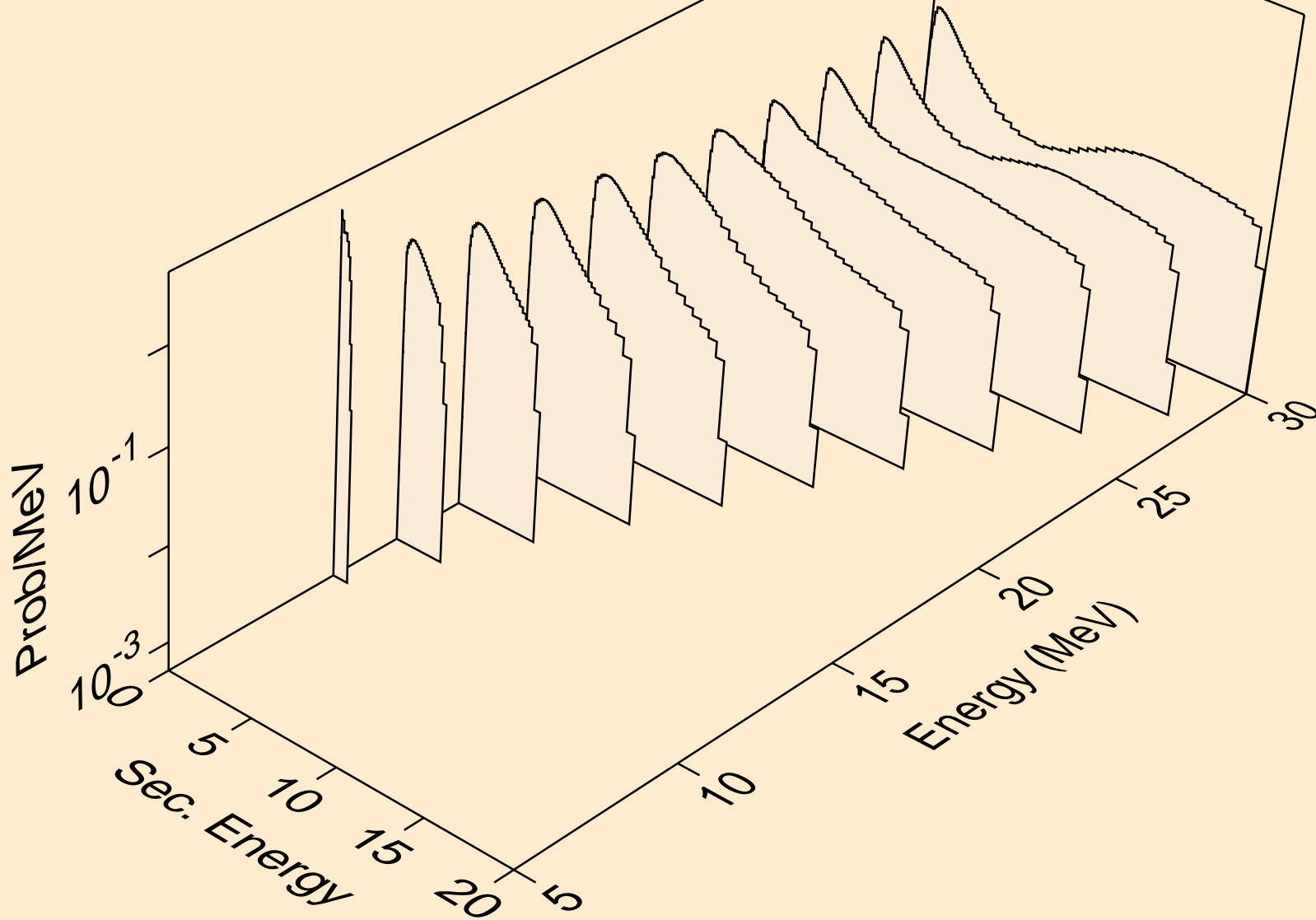

ZN070 NEUTRON ACER TENDL-2019 LIBRARY; T=293.16K
Neutron emission for (n,3n)

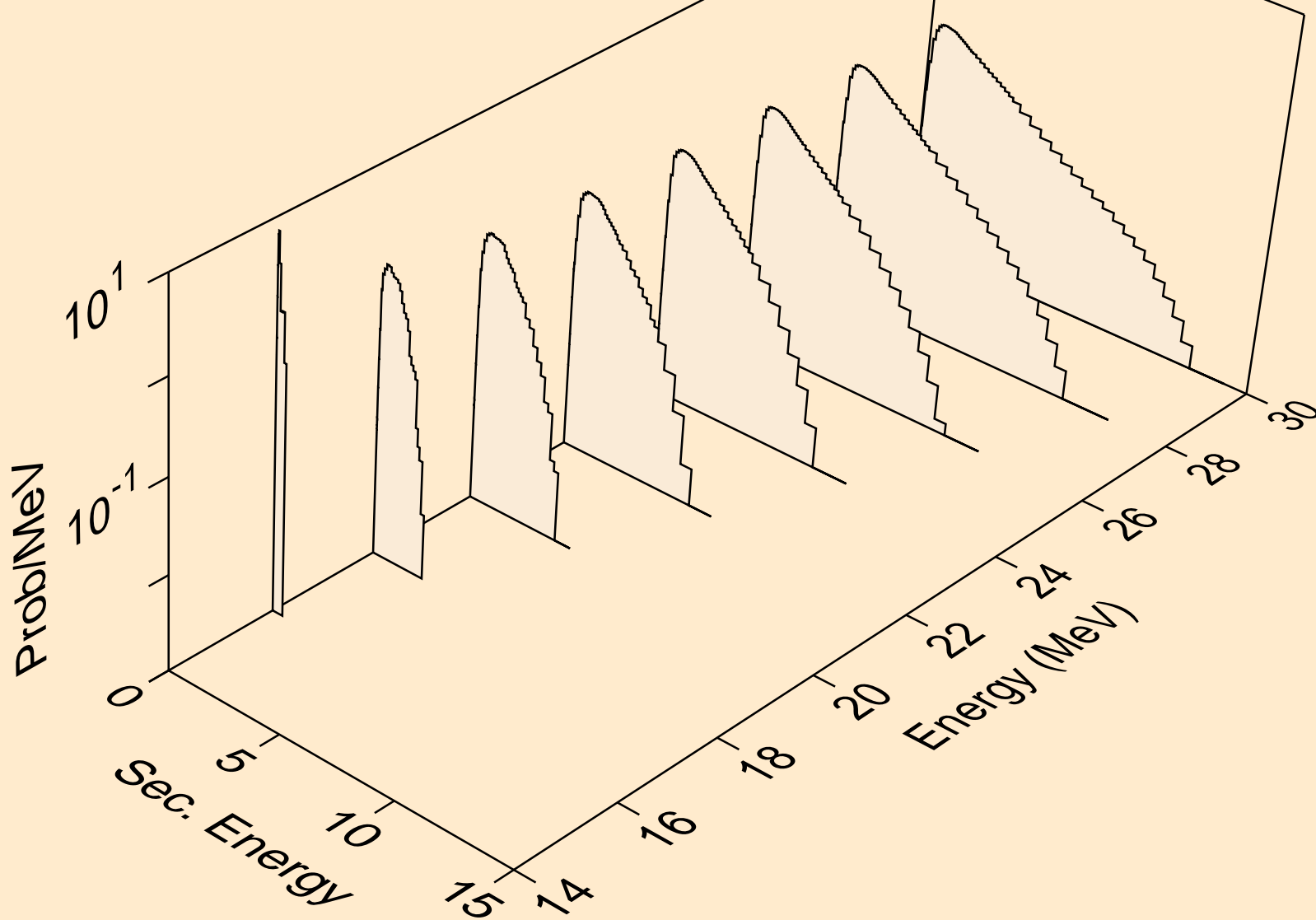

ZN070 NEUTRON ACER TENDL-2019 LIBRARY; T=293.16K
Neutron emission for (n,n*)a

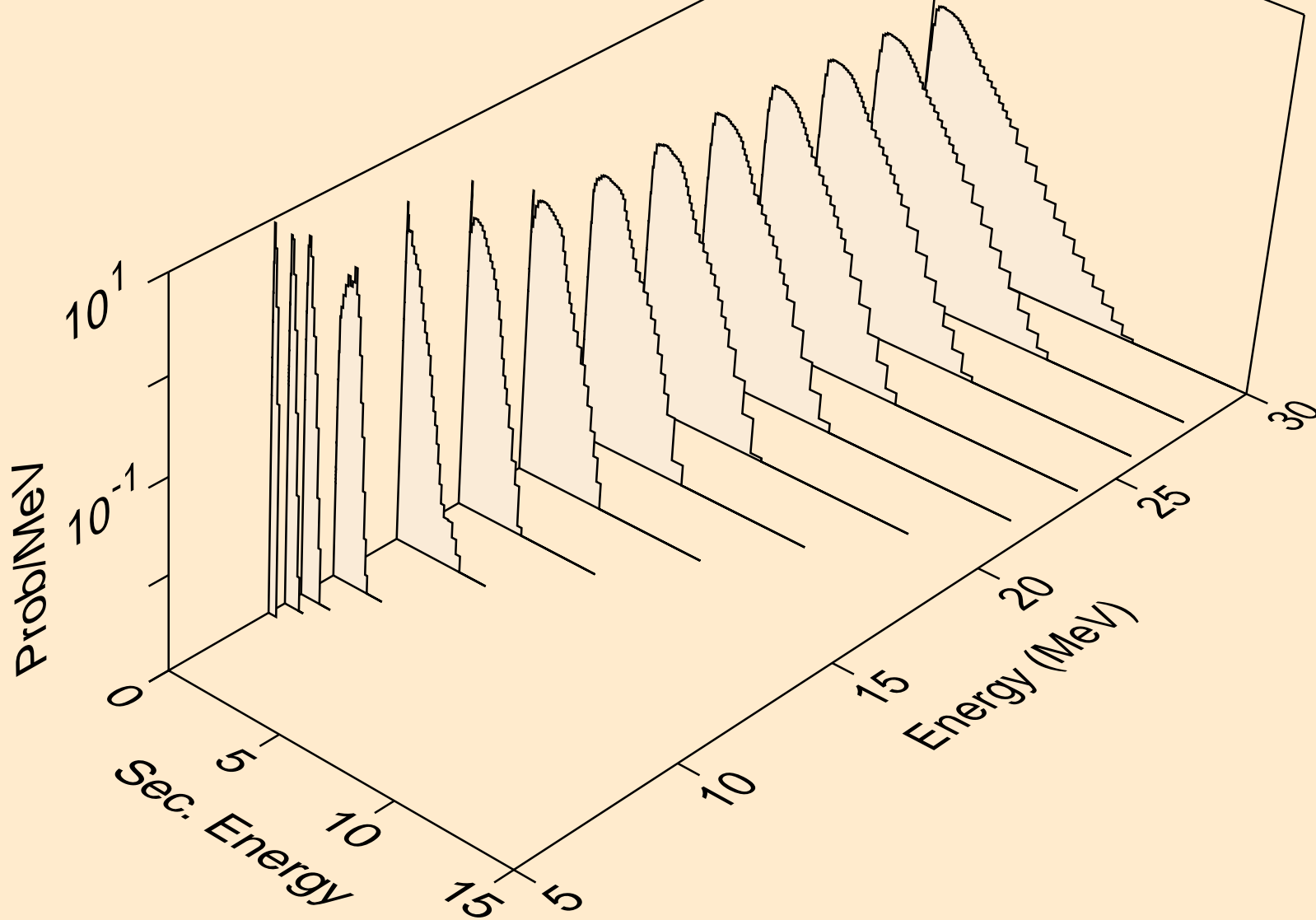

ZN070 NEUTRON ACER TENDL-2019 LIBRARY; T=293.16K
Neutron emission for (n,2n)_a

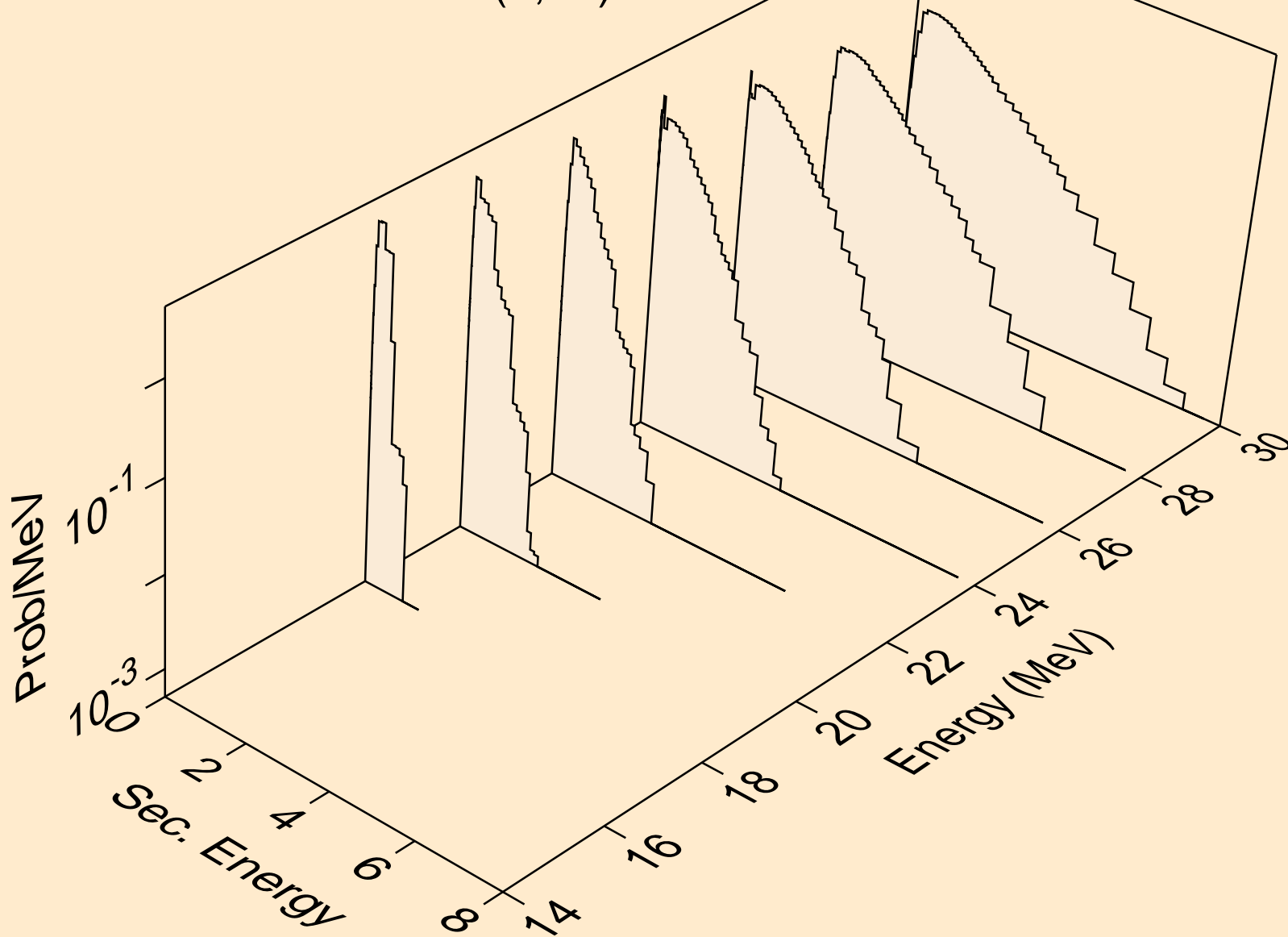

ZN070 NEUTRON ACER TENDL-2019 LIBRARY; T=293.16K
Neutron emission for (n,3n)a

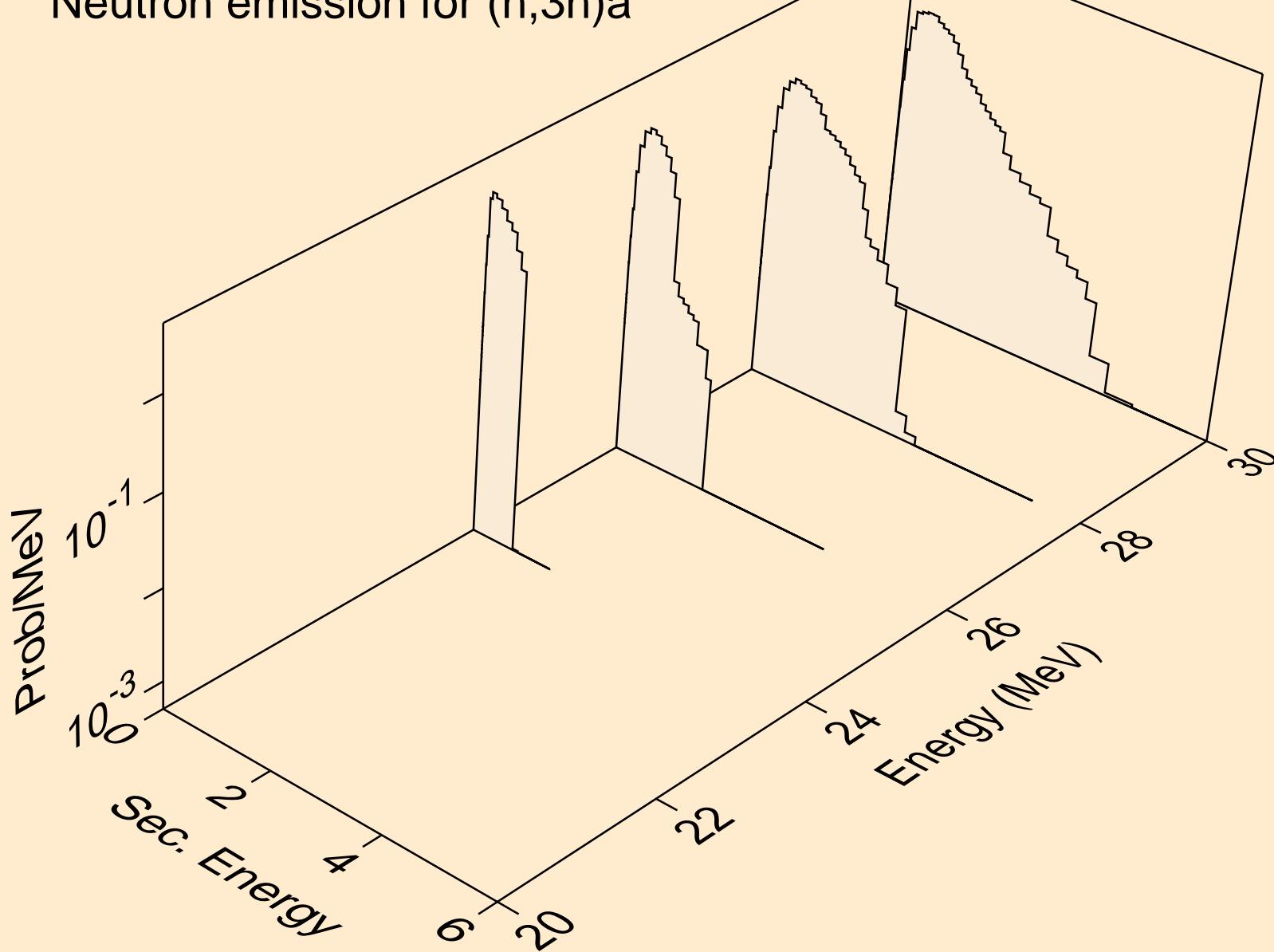

ZN070 NEUTRON ACER TENDL-2019 LIBRARY; T=293.16K
Neutron emission for (n,n*)p

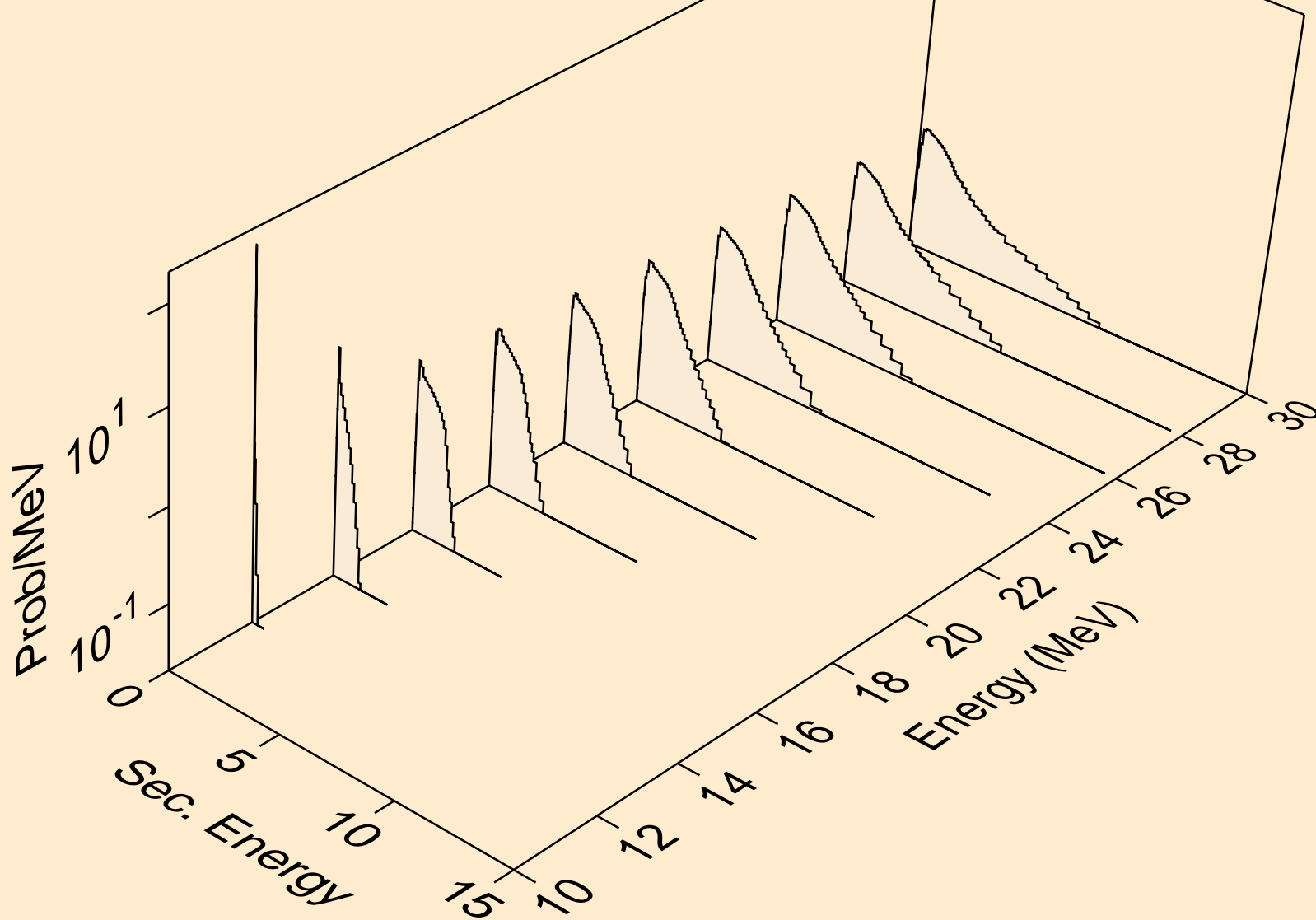

ZN070 NEUTRON ACER TENDL-2019 LIBRARY; T=293.16K
Neutron emission for (n,n*)2a

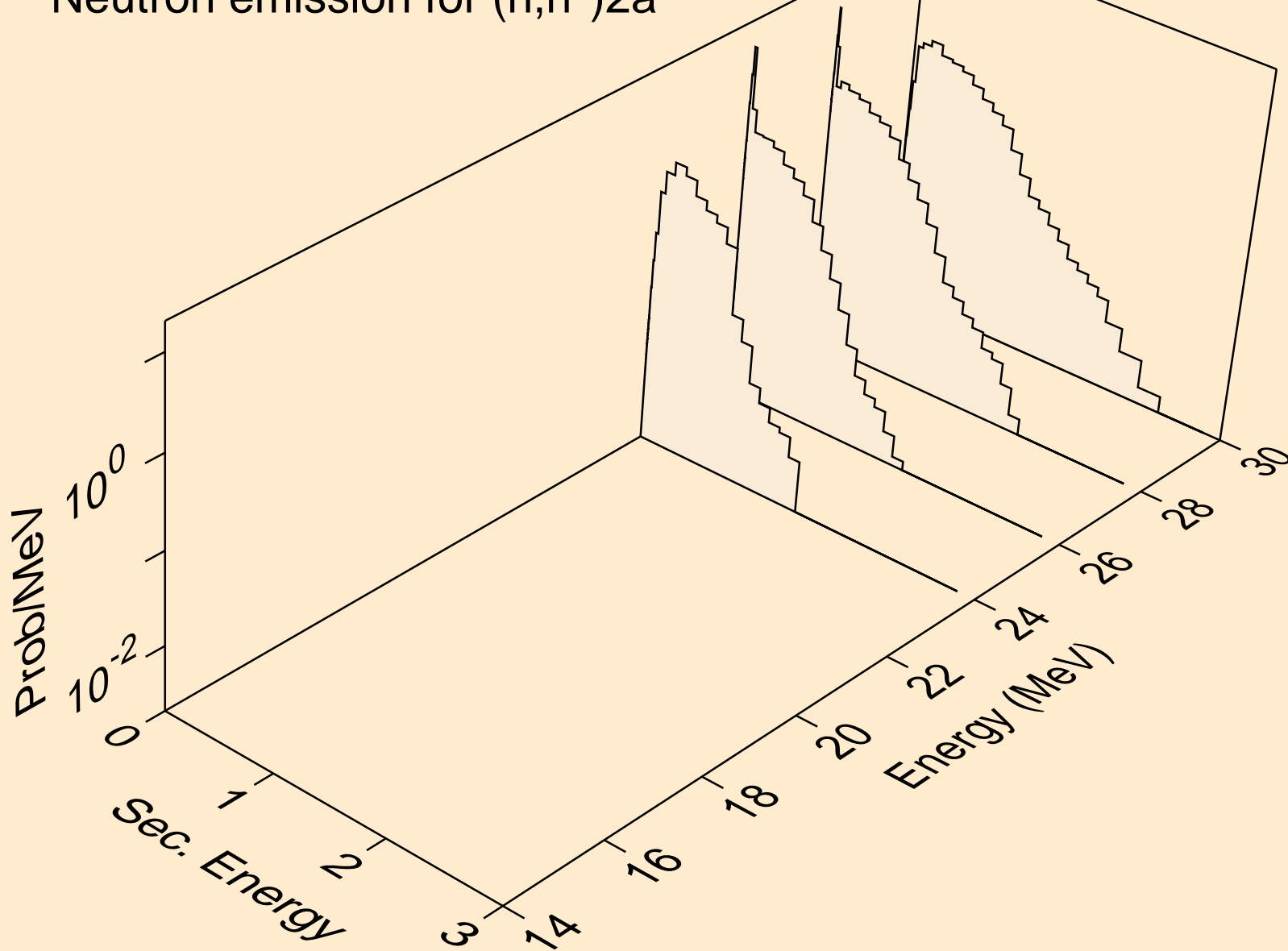

ZN070 NEUTRON ACER TENDL-2019 LIBRARY; T=293.16K
Neutron emission for (n,n*)d

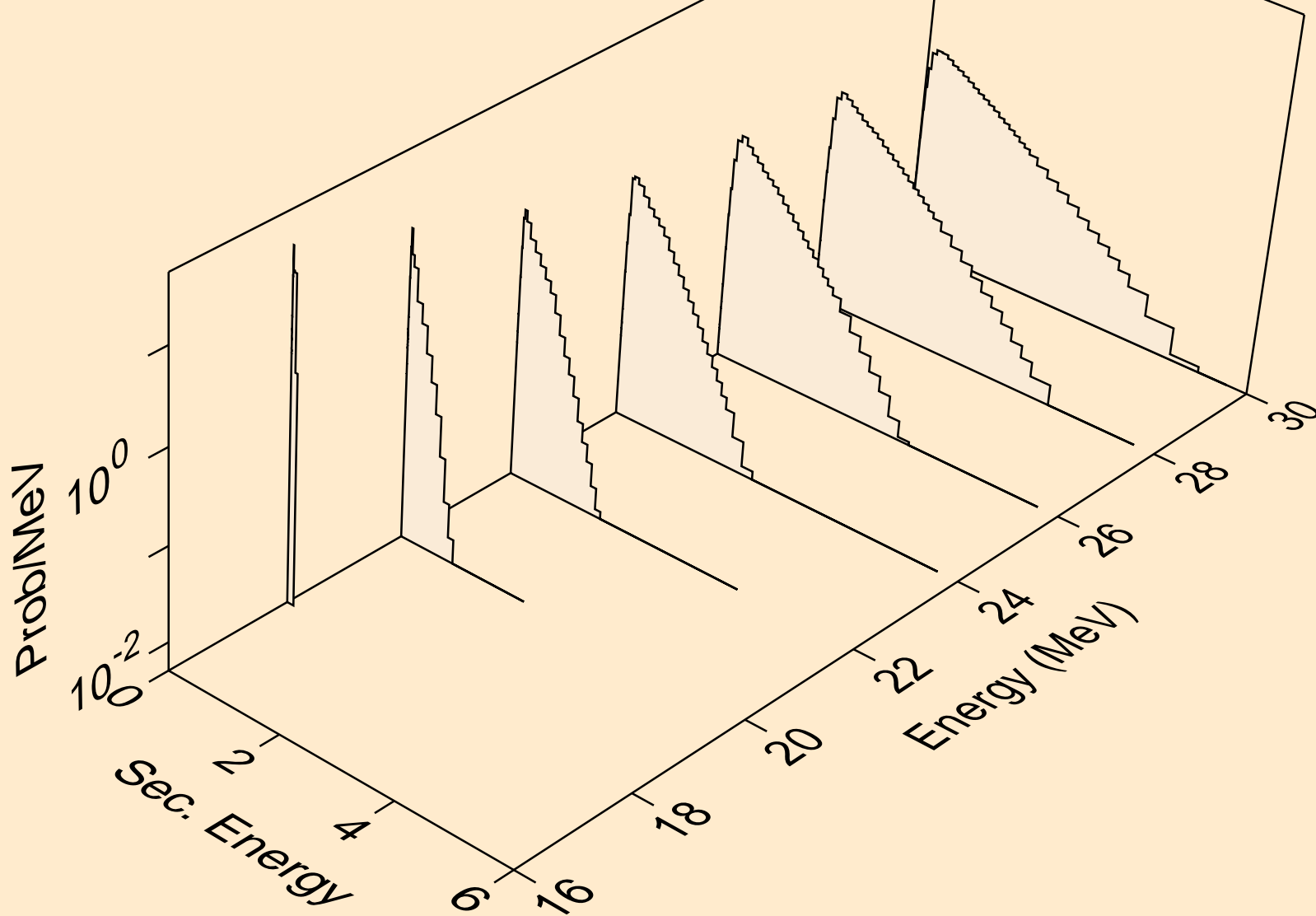

ZN070 NEUTRON ACER TENDL-2019 LIBRARY; T=293.16K
Neutron emission for (n,n*)t

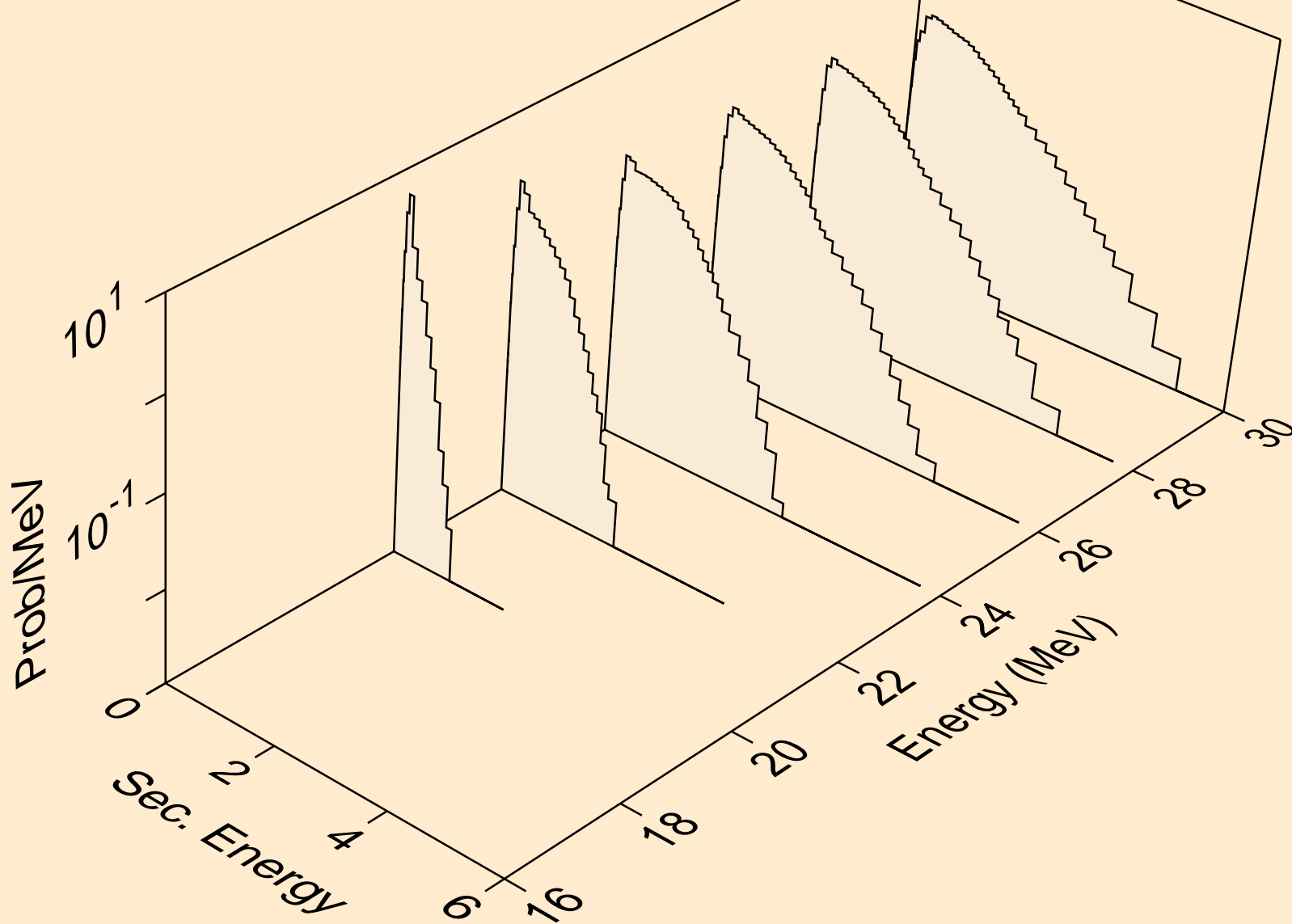

ZN070 NEUTRON ACER TENDL-2019 LIBRARY; T=293.16K
Neutron emission for (n,n*)he3

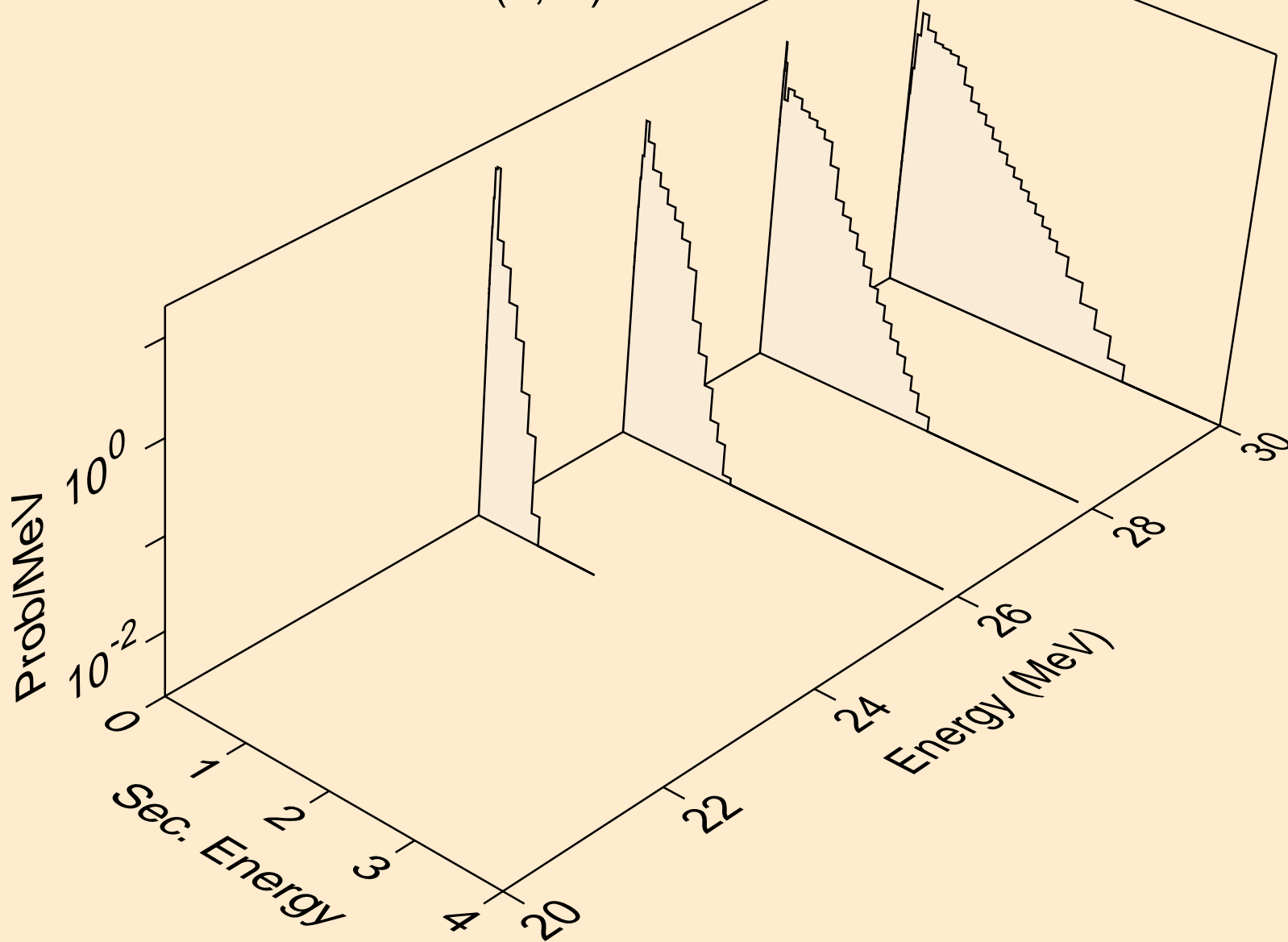

ZN070 NEUTRON ACER TENDL-2019 LIBRARY; T=293.16K
Neutron emission for (n,4n)

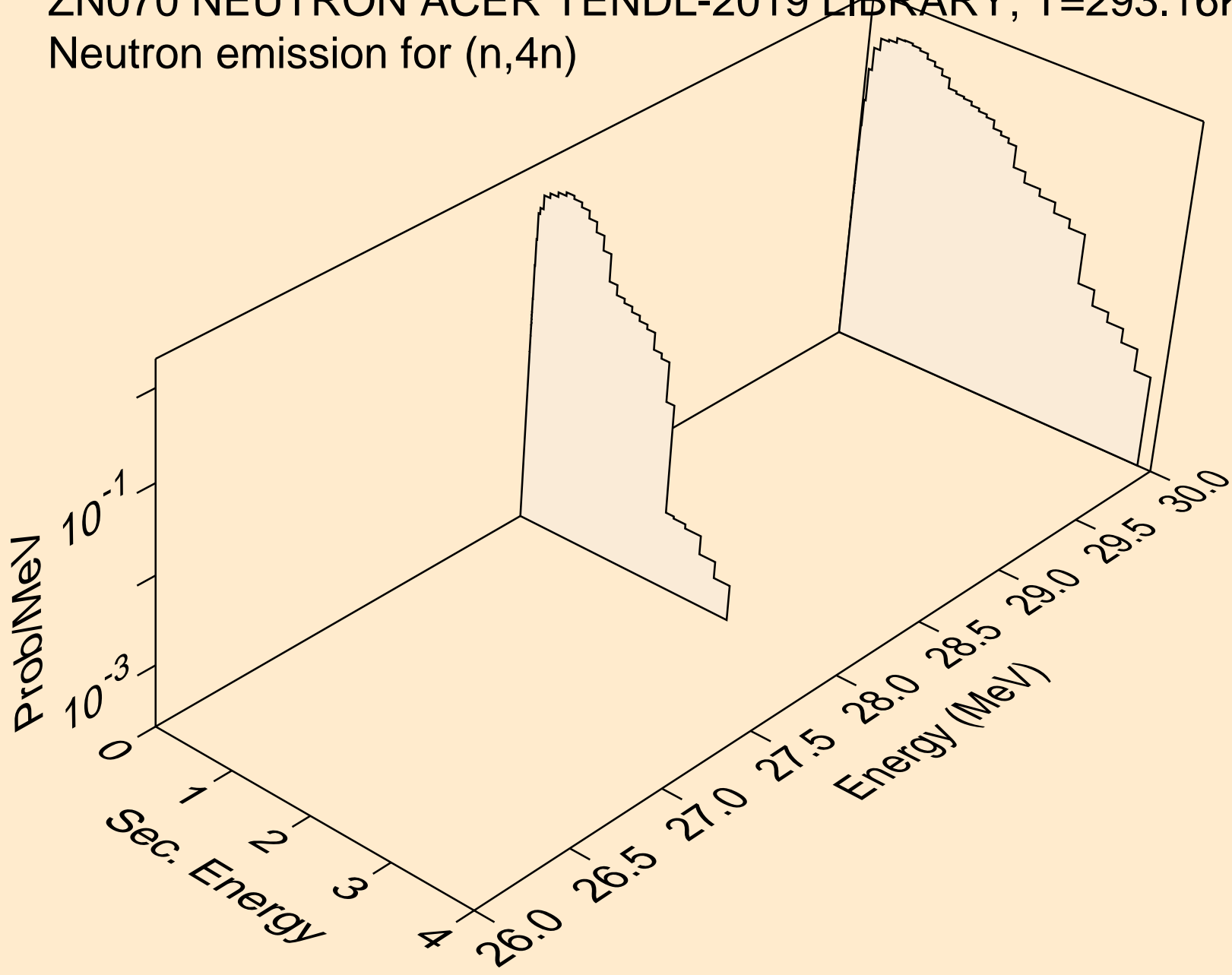

ZN070 NEUTRON ACER TENDL-2019 LIBRARY; T=293.16K
Neutron emission for (n,2np)

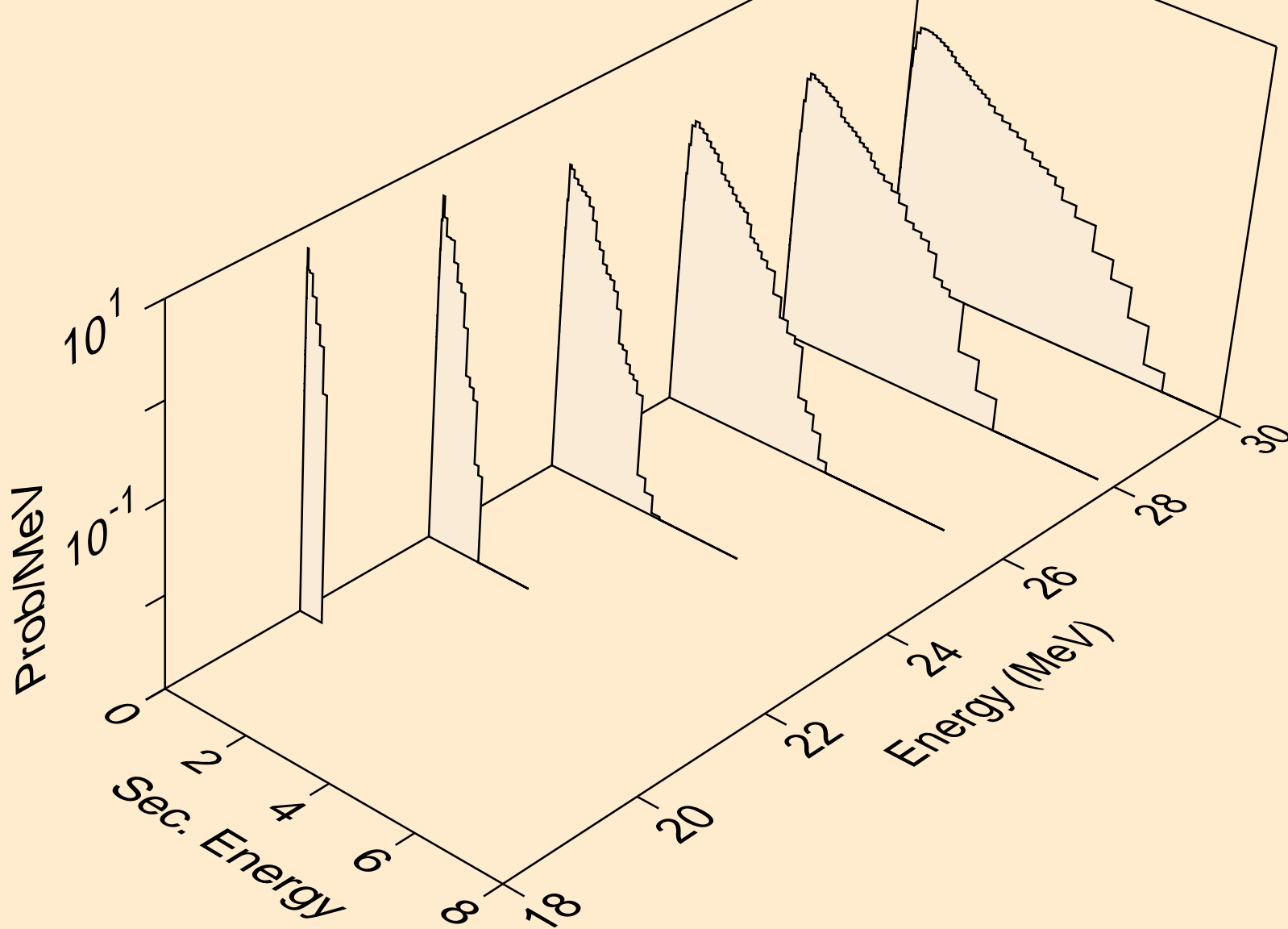

ZN070 NEUTRON ACER TENDL-2019 LIBRARY; T=293.16K
Neutron emission for (n,3np)

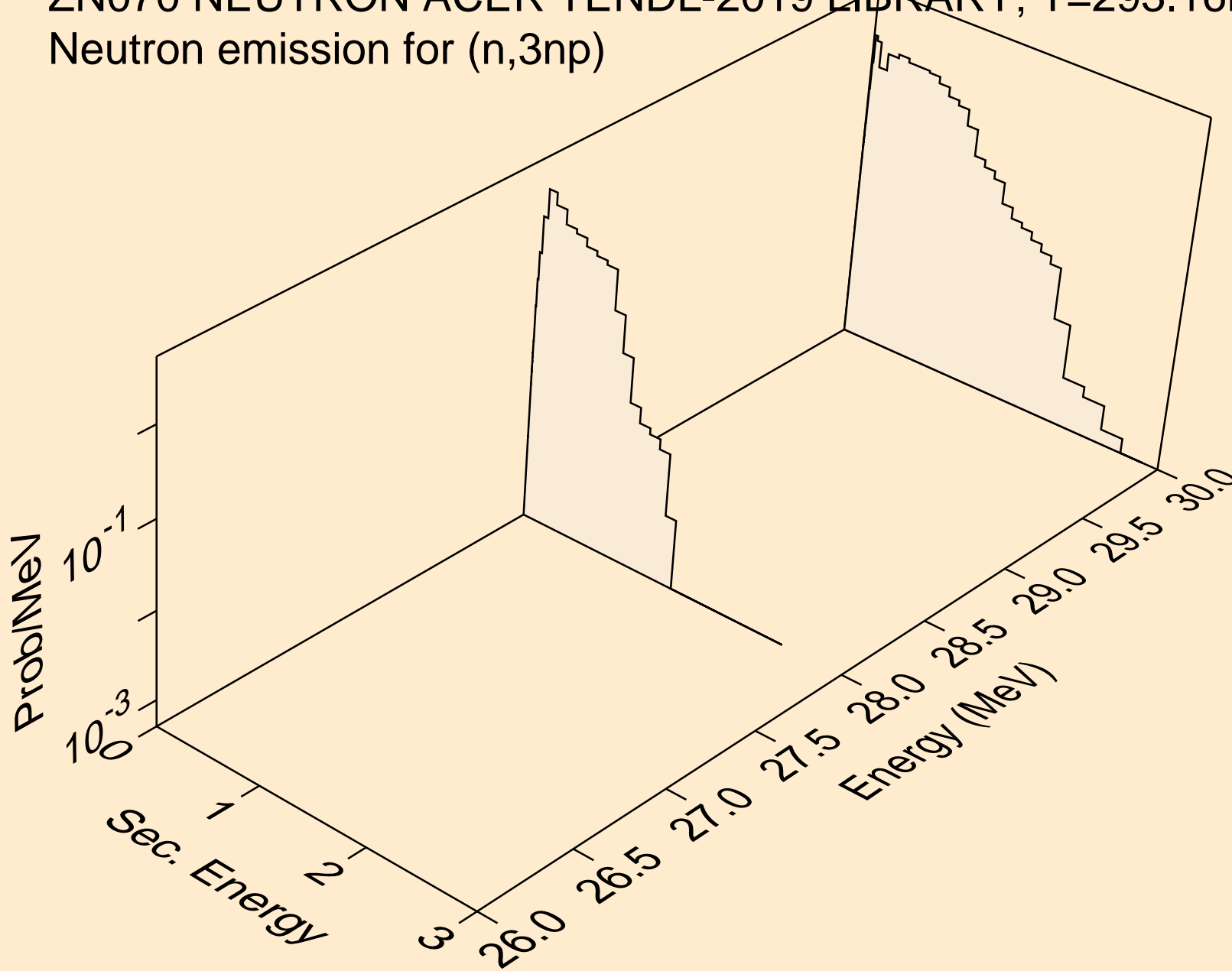

ZN070 NEUTRON ACER TENDL-2019 LIBRARY; T=293.16K
Neutron emission for (n,2np)

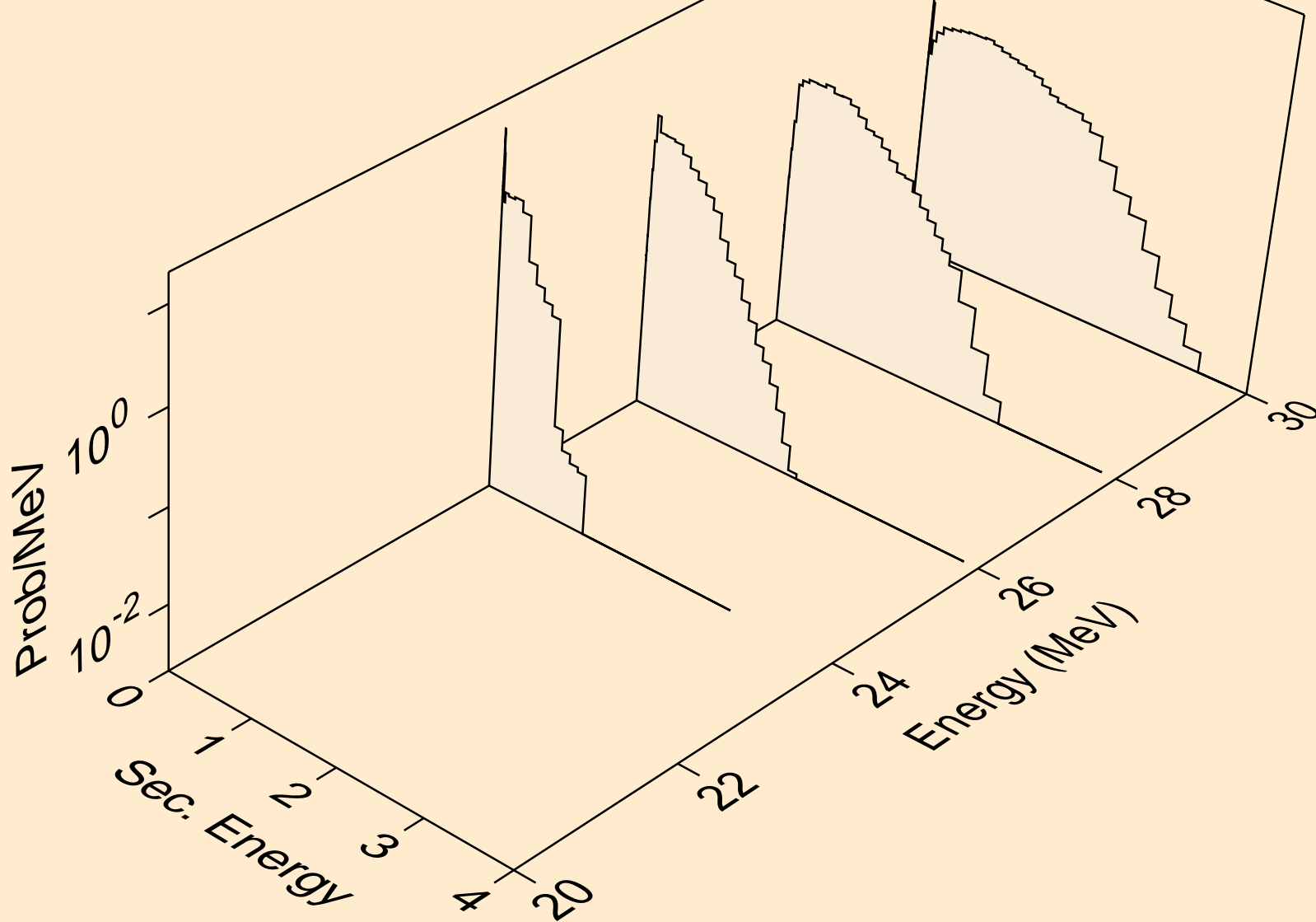

ZN070 NEUTRON ACER TENDL-2019 LIBRARY; T=293.16K
Neutron emission for (n,npa)

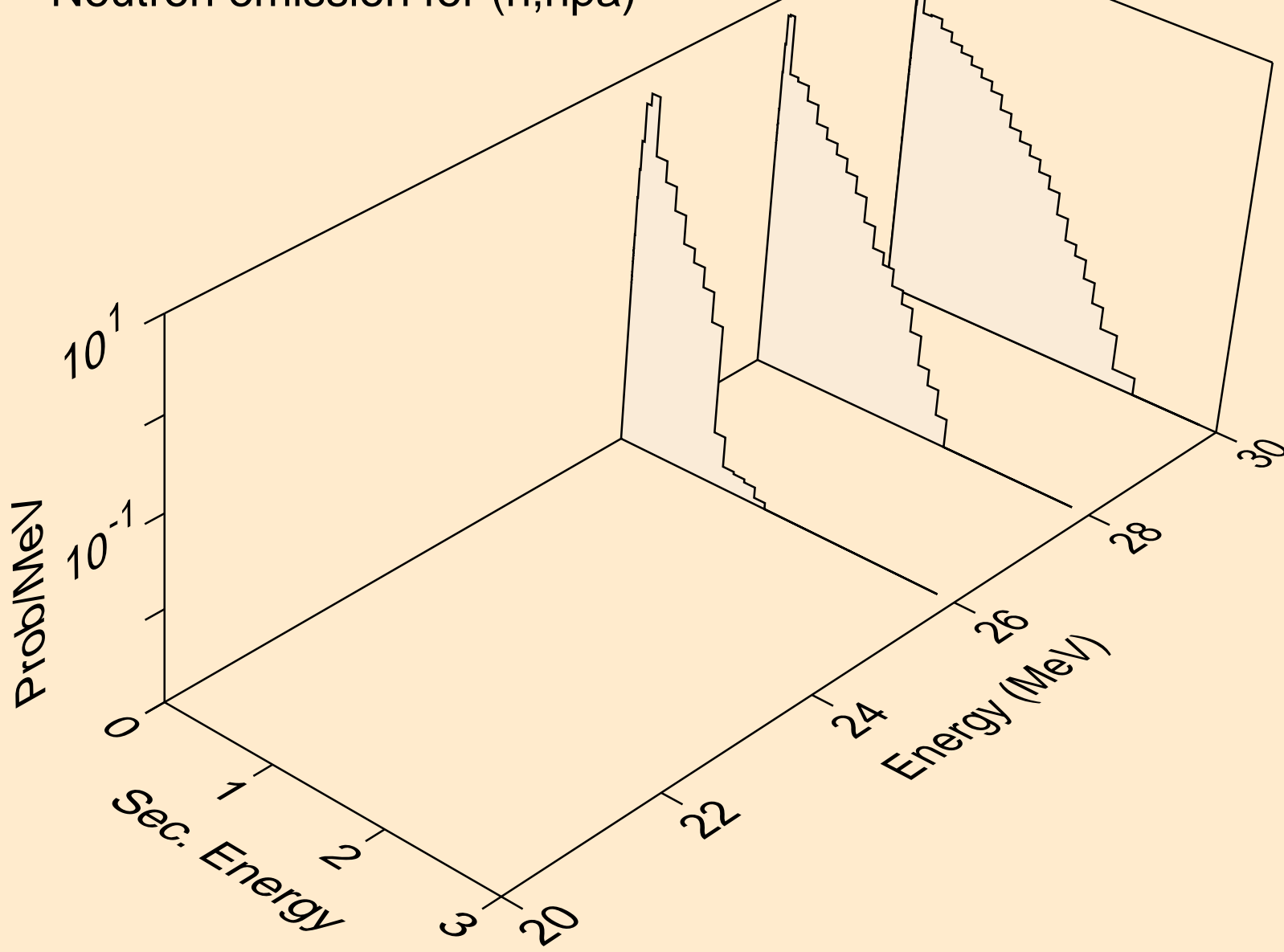

ZN070 NEUTRON ACER TENDL-2019 LIBRARY; T=293.16K
Neutron emission for (n,n*c)

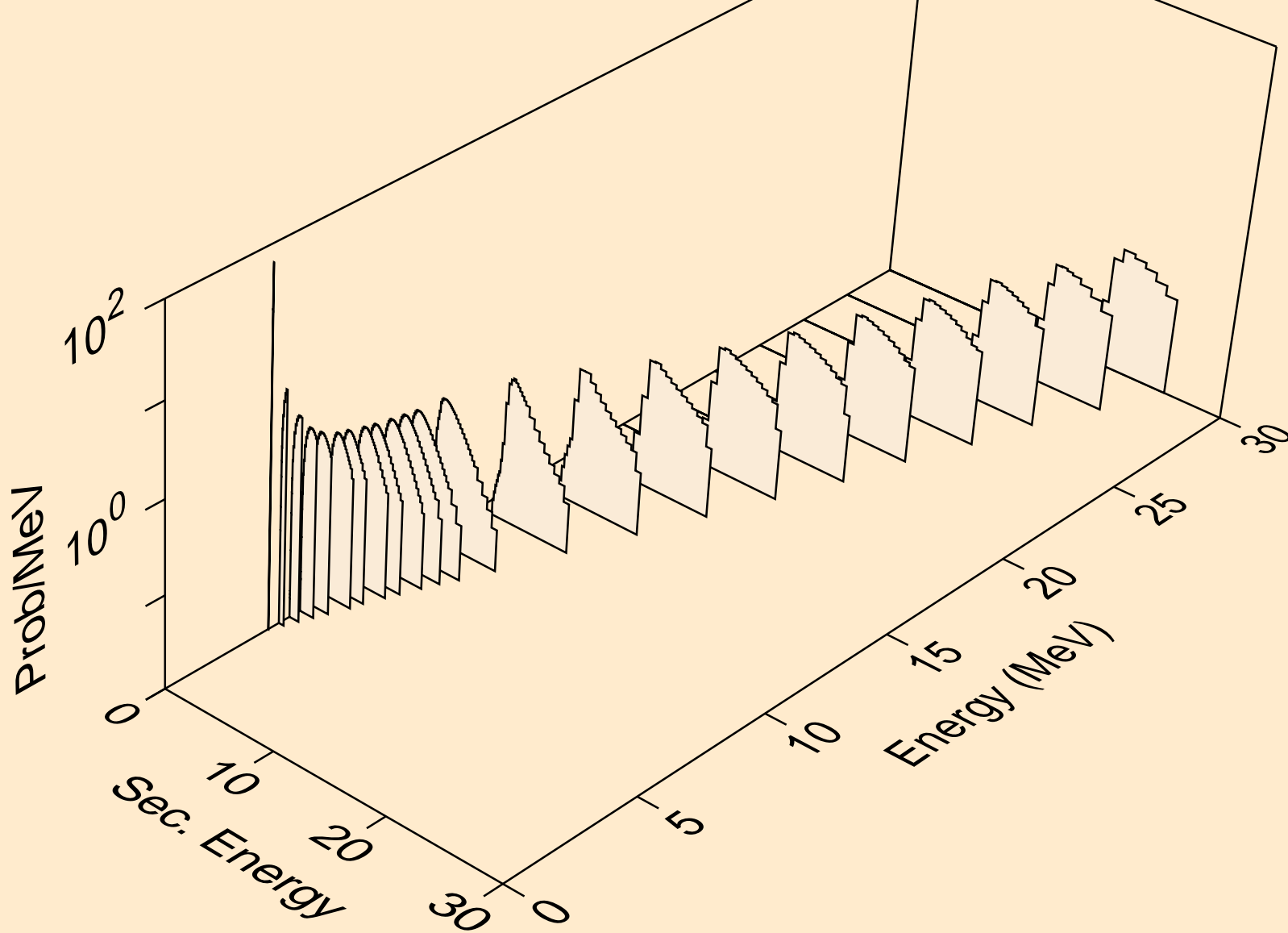

ZN070 NEUTRON ACER TENDL-2019 LIBRARY; T=293.16K
Photon emission for (n,x)

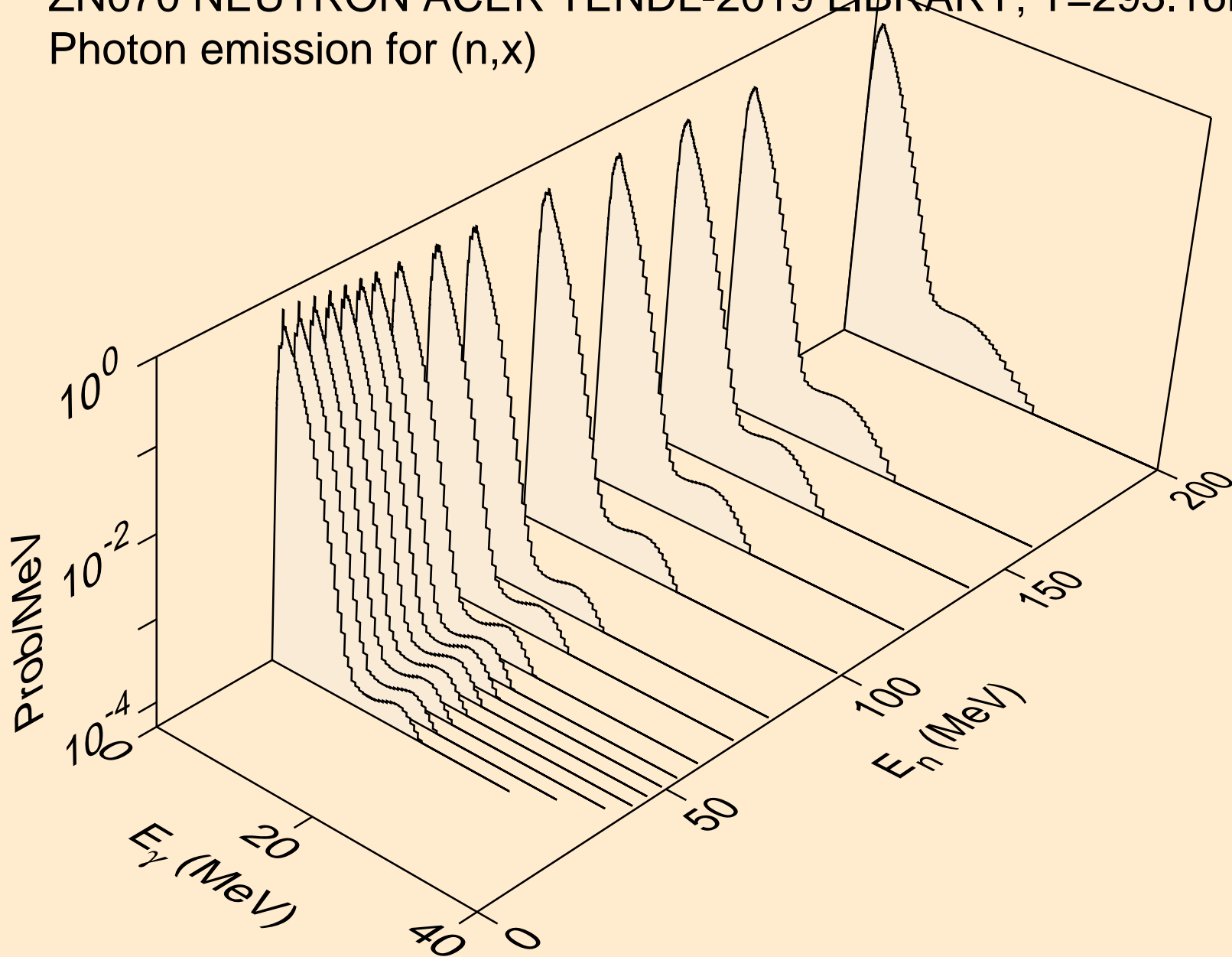

ZN070 NEUTRON ACER TENDL-2019 LIBRARY; T=293.16K
Photon emission for (n,2nd)

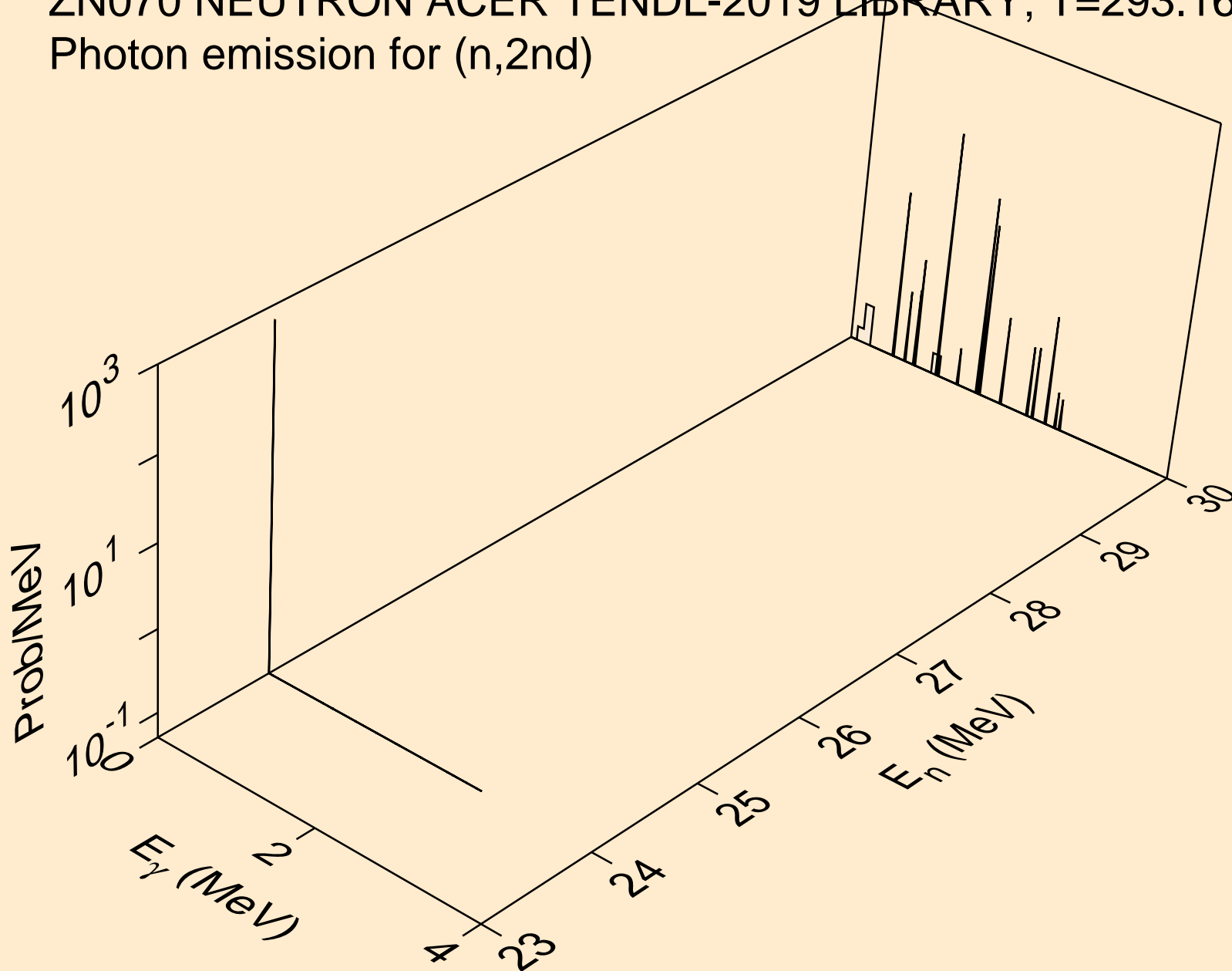

ZN070 NEUTRON ACER TENDL-2019 LIBRARY; T=293.16K
Photon emission for (n,2n)

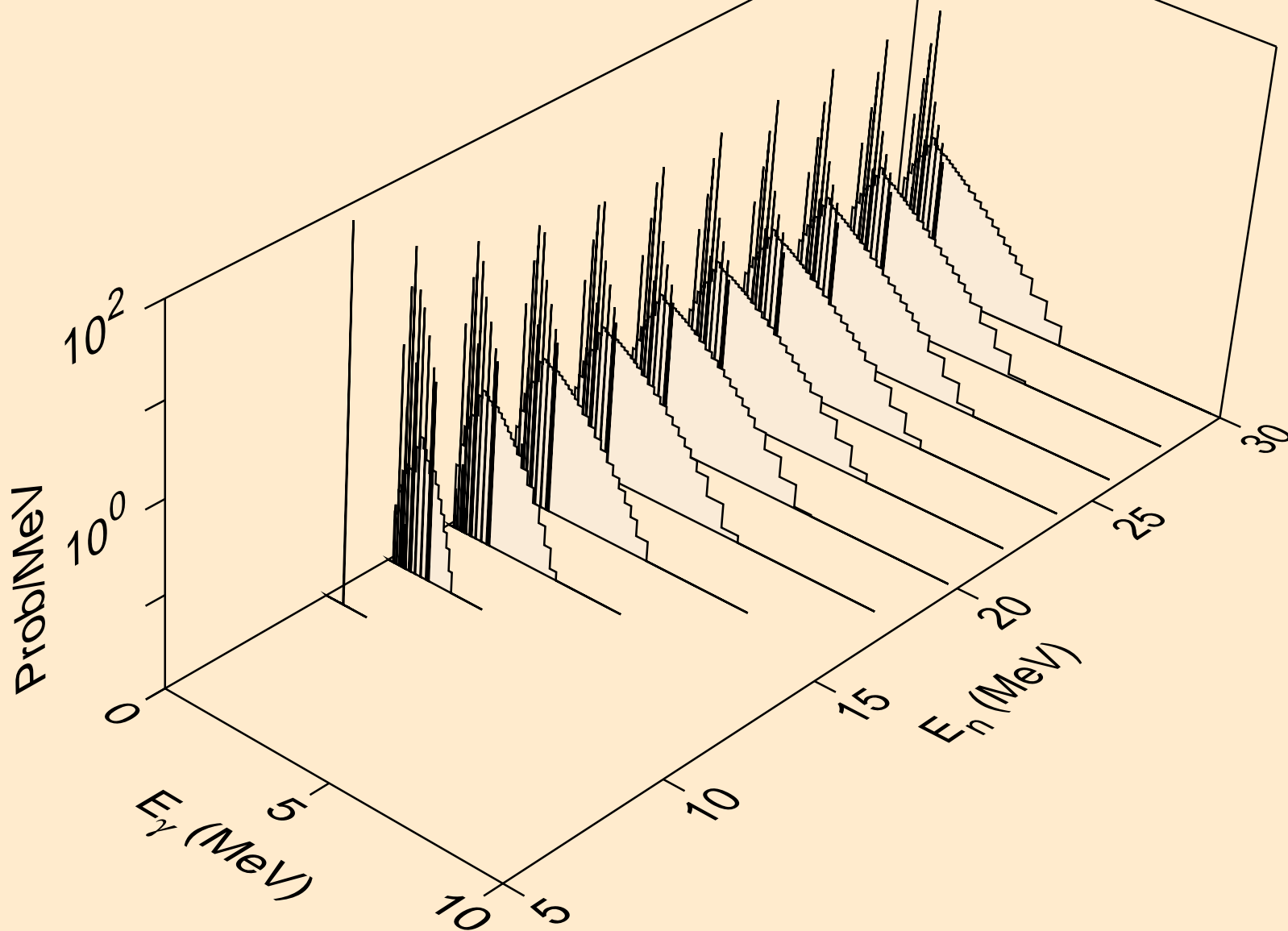

ZN070 NEUTRON ACER TENDL-2019 LIBRARY; T=293.16K
Photon emission for (n,3n)

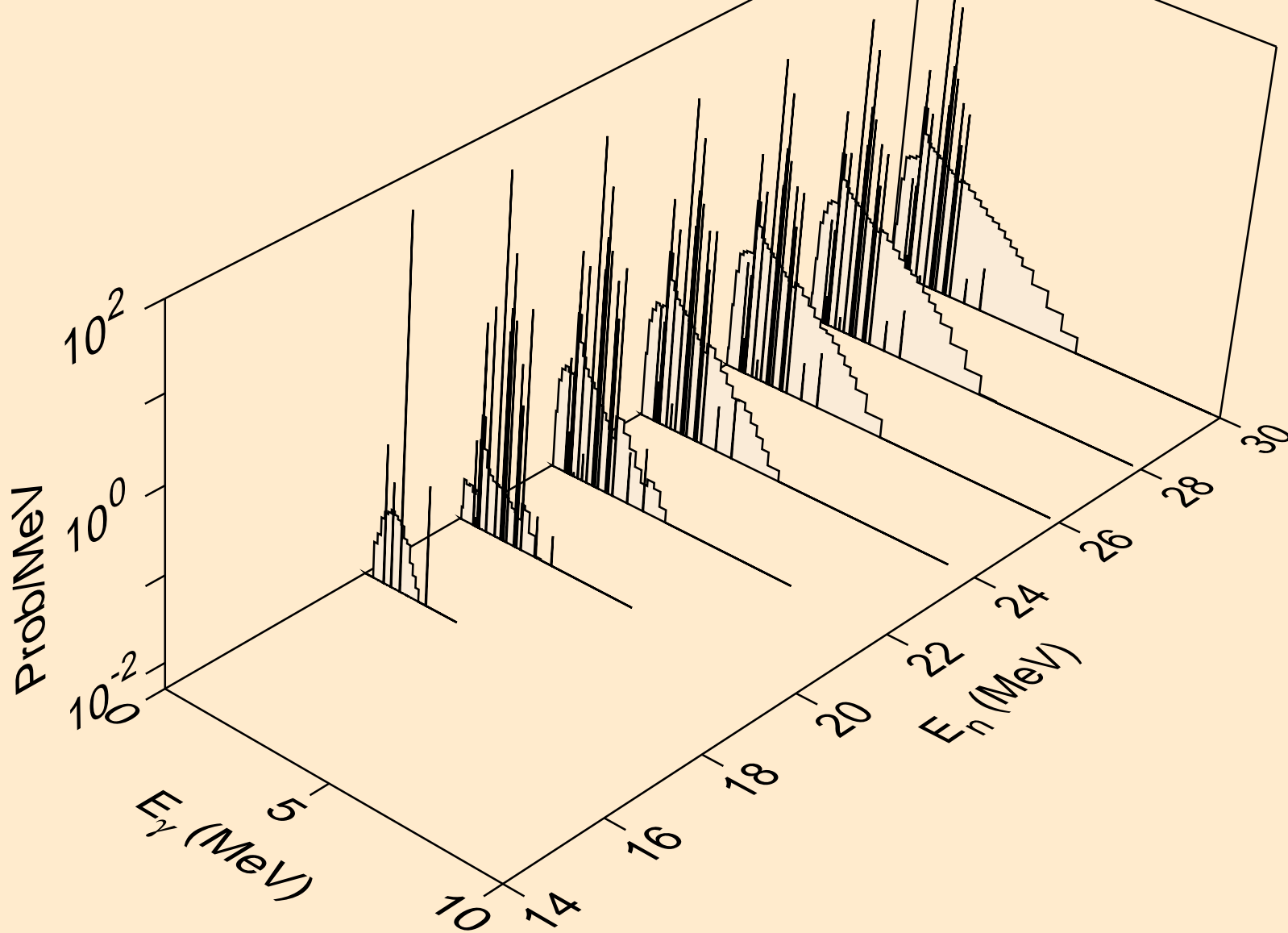

ZN070 NEUTRON ACER TENDL-2019 LIBRARY; T=293.16K
Photon emission for (n,n*)a

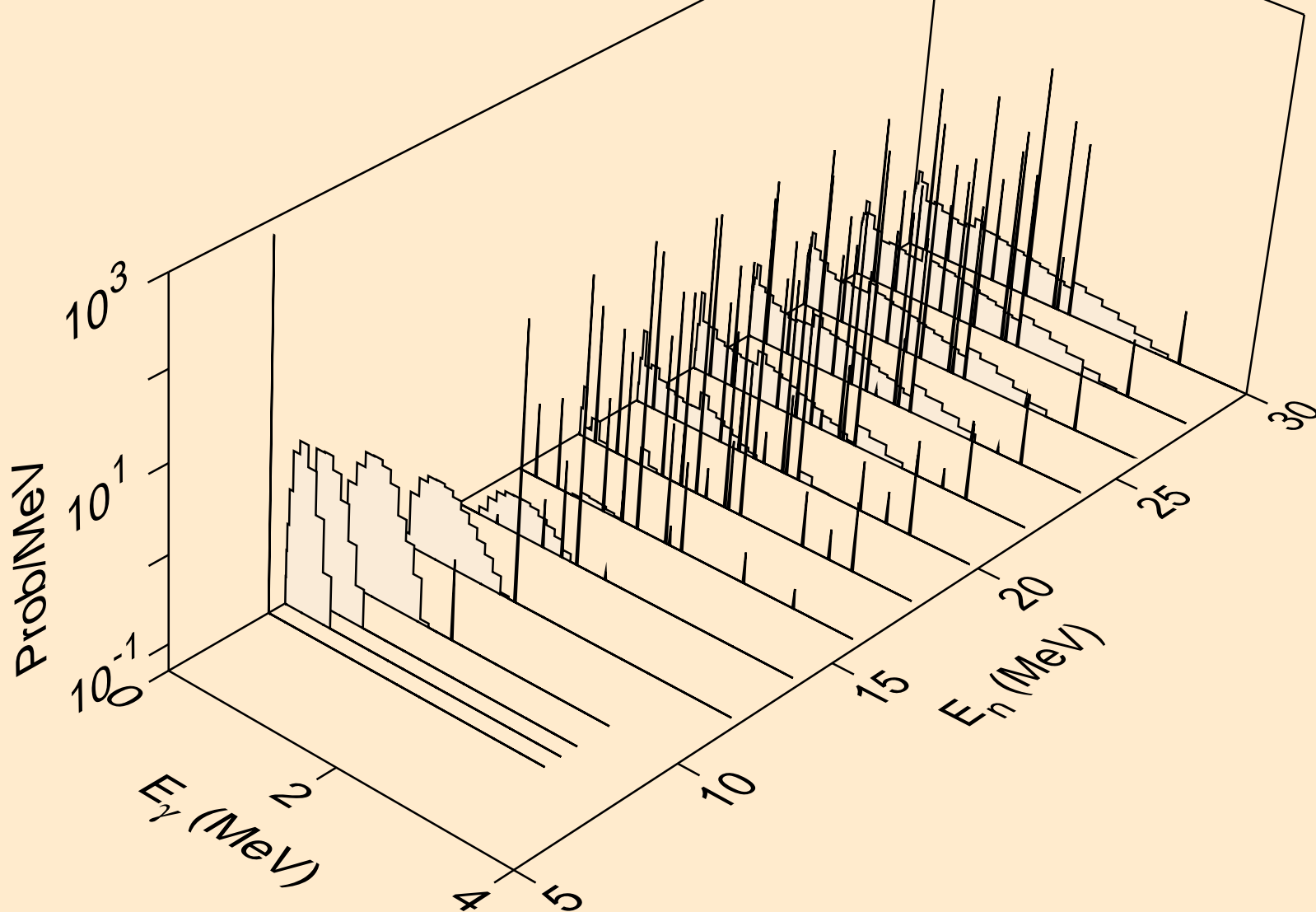

ZN070 NEUTRON ACER TENDL-2019 LIBRARY; T=293.16K
Photon emission for (n,2n)a

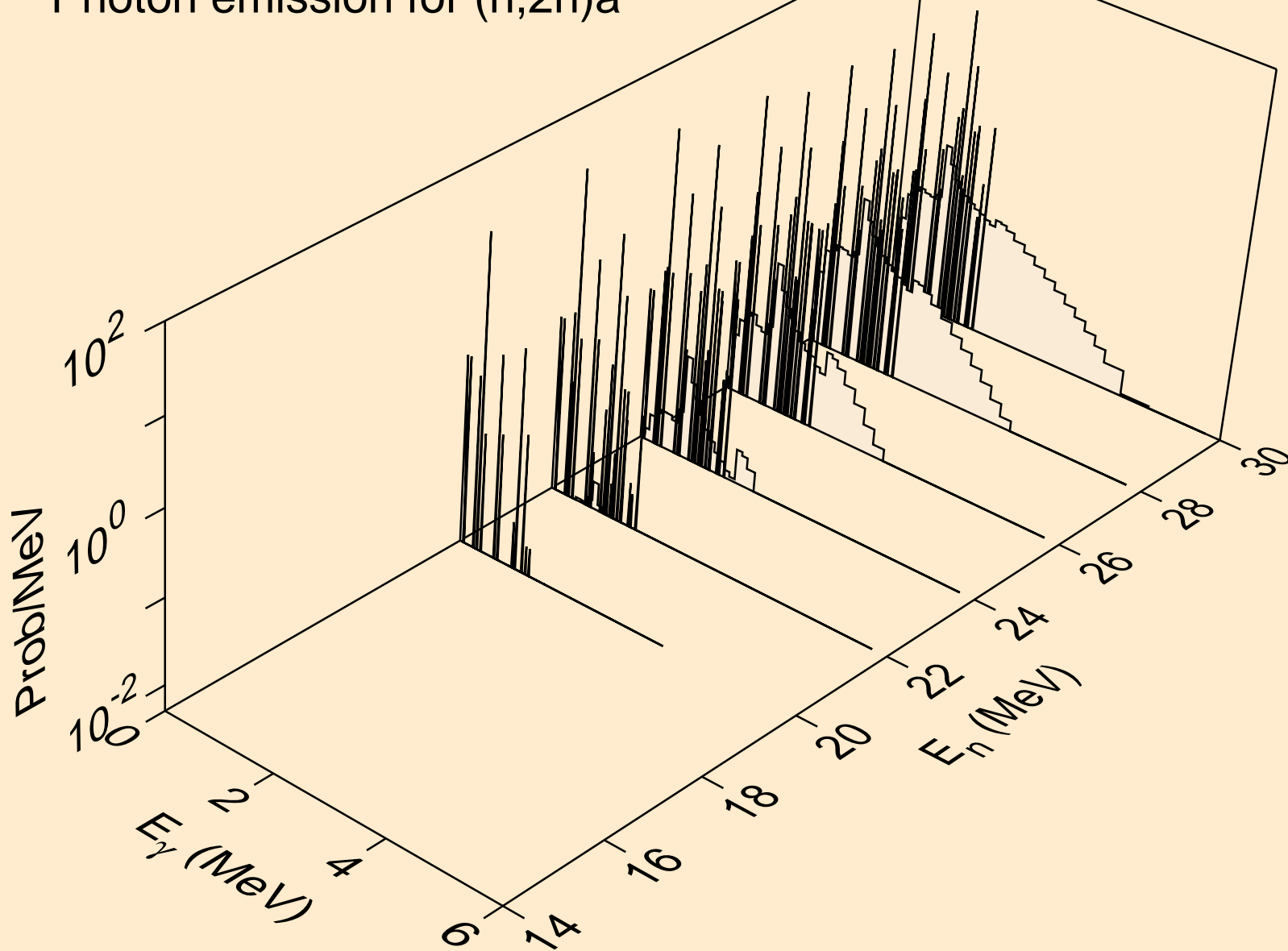

ZN070 NEUTRON ACER TENDL-2019 LIBRARY; T=293.16K
Photon emission for (n,3n)a

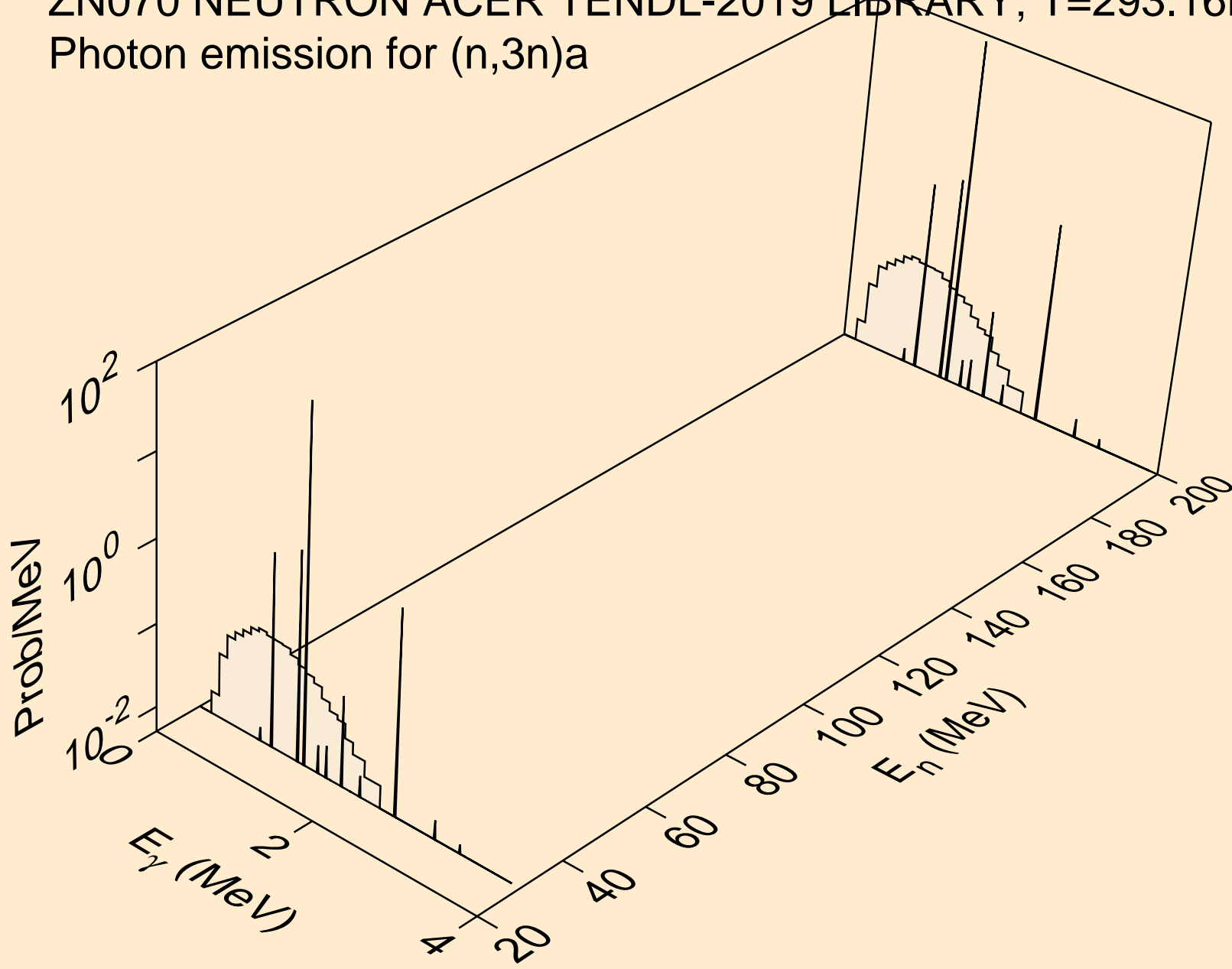

ZN070 NEUTRON ACER TENDL-2019 LIBRARY; T=293.16K
Photon emission for (n,n*)p

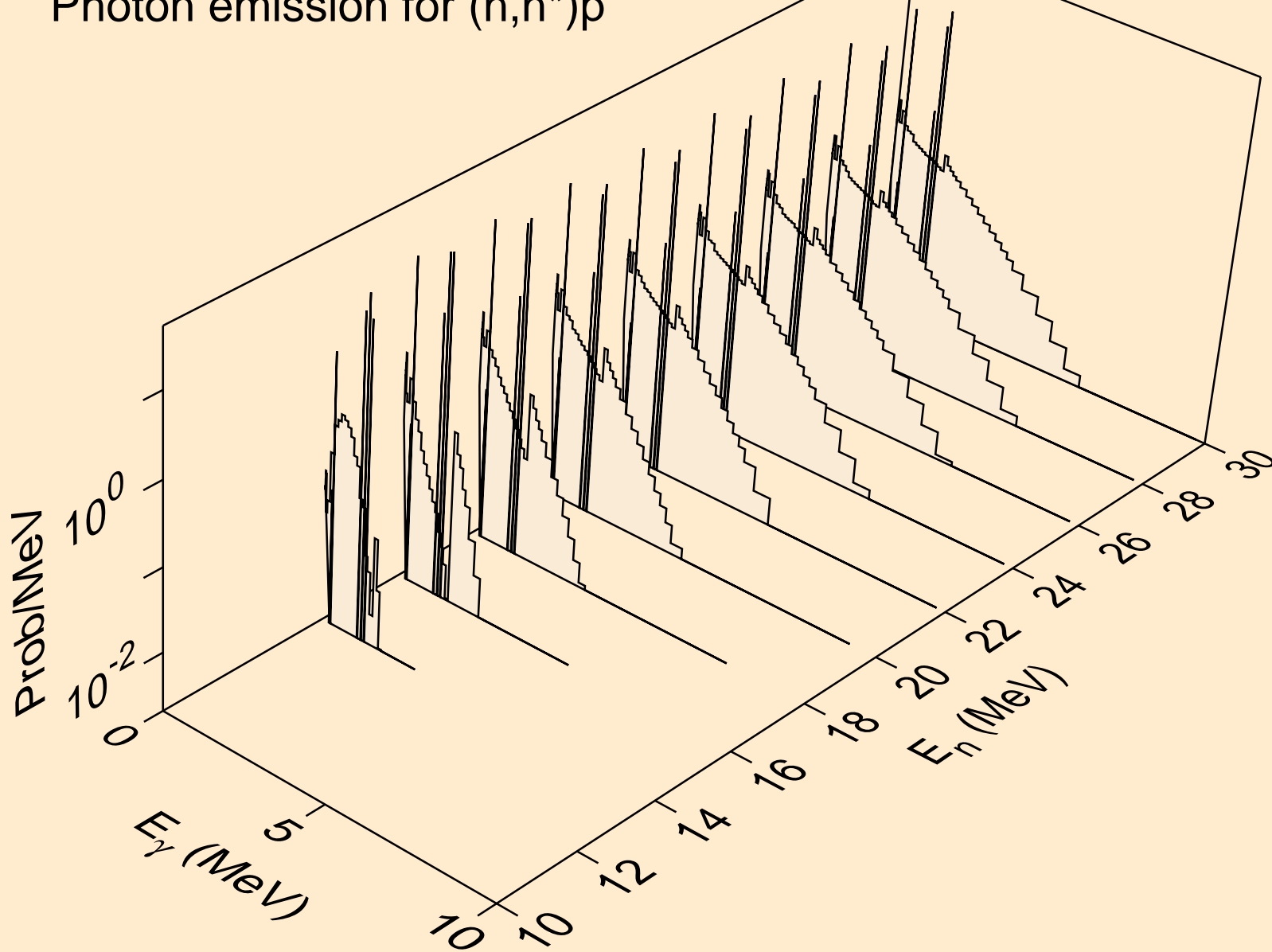

ZN070 NEUTRON ACER TENDL-2019 LIBRARY; T=293.16K
Photon emission for (n,n*)2a

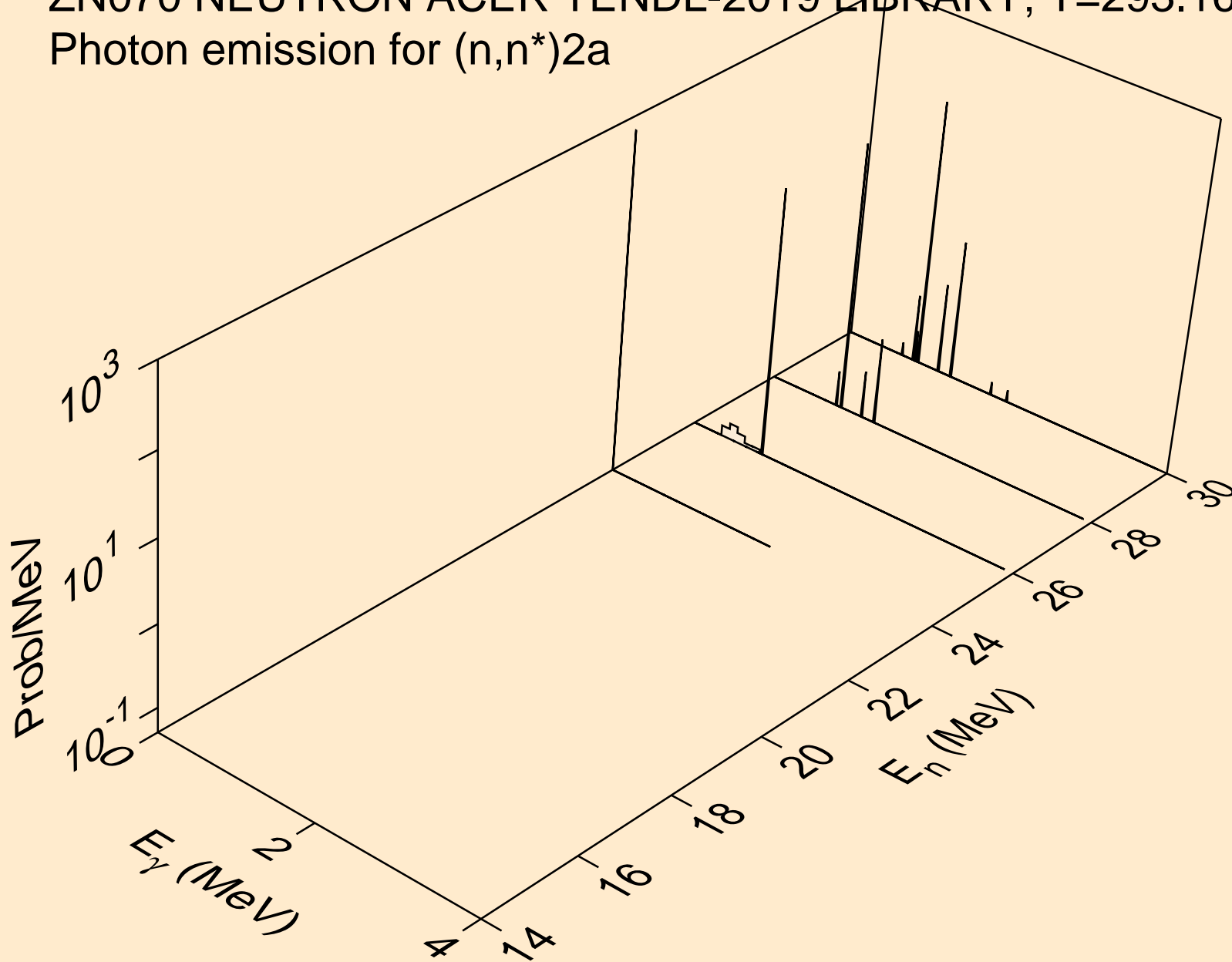

ZN070 NEUTRON ACER TENDL-2019 LIBRARY; T=293.16K
Photon emission for (n,n*)d

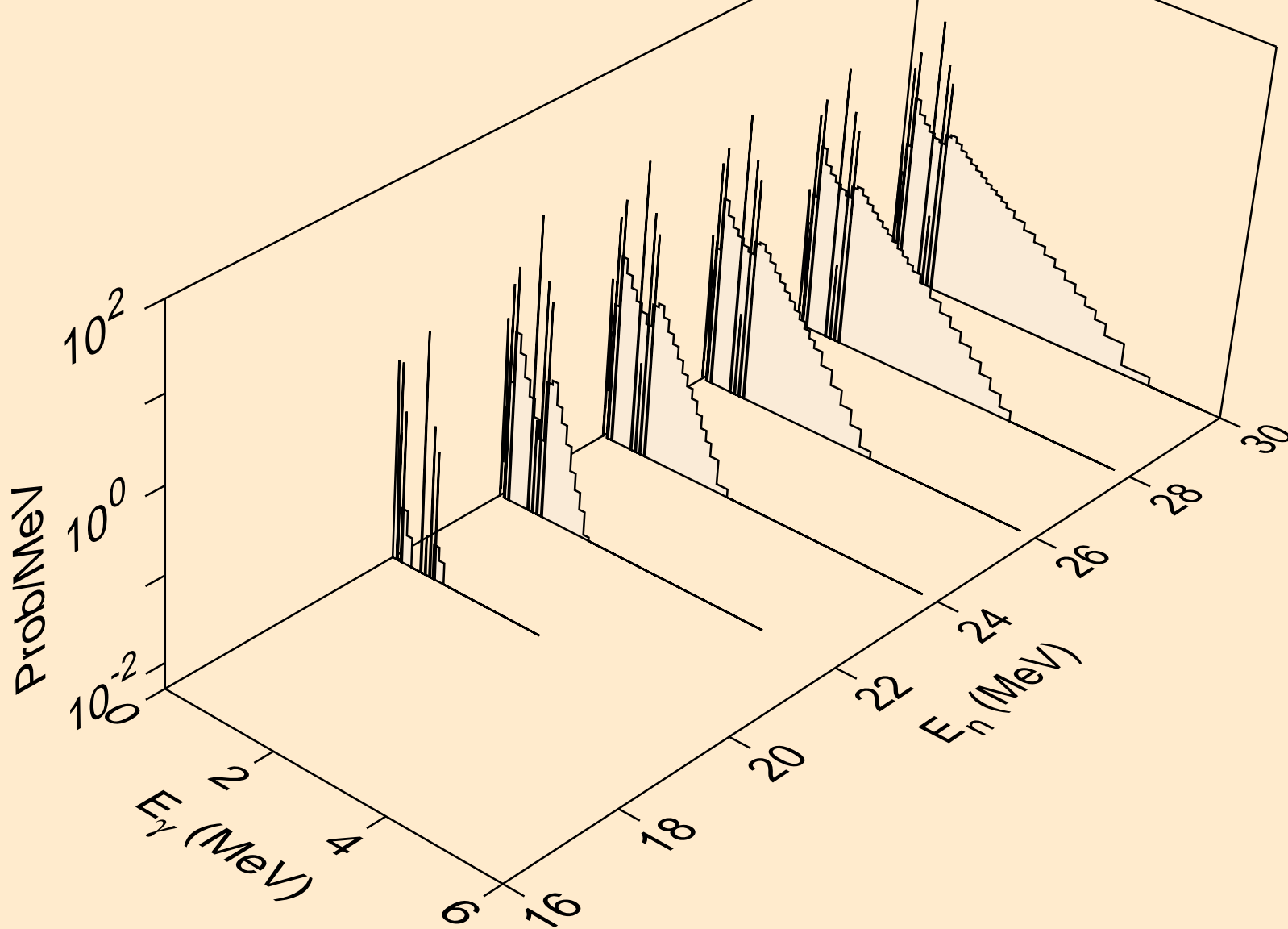

ZN070 NEUTRON ACER TENDL-2019 LIBRARY; T=293.16K
Photon emission for (n,n*)t

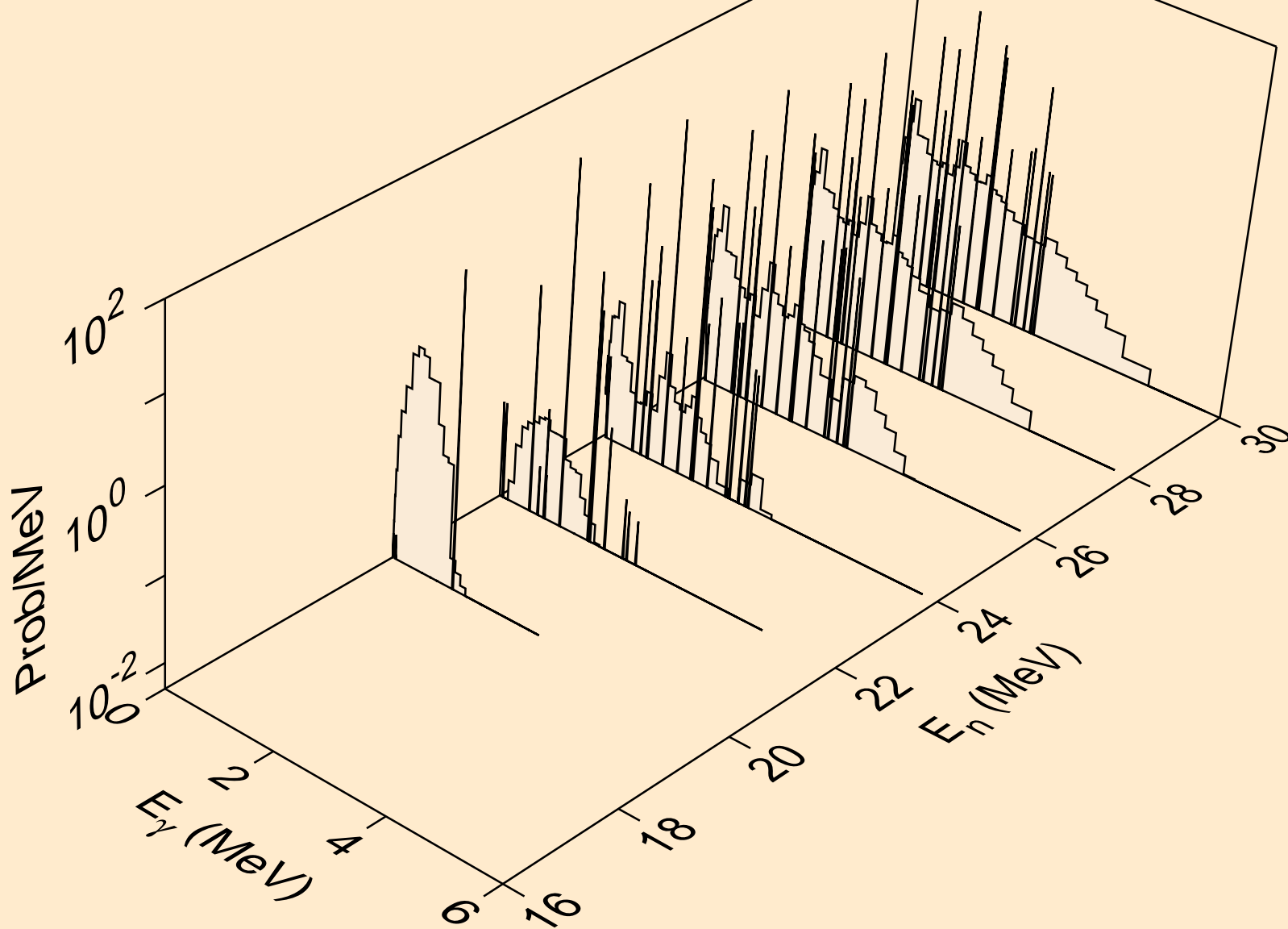

ZN070 NEUTRON ACER TENDL-2019 LIBRARY; T=293.16K
Photon emission for (n,n*)he3

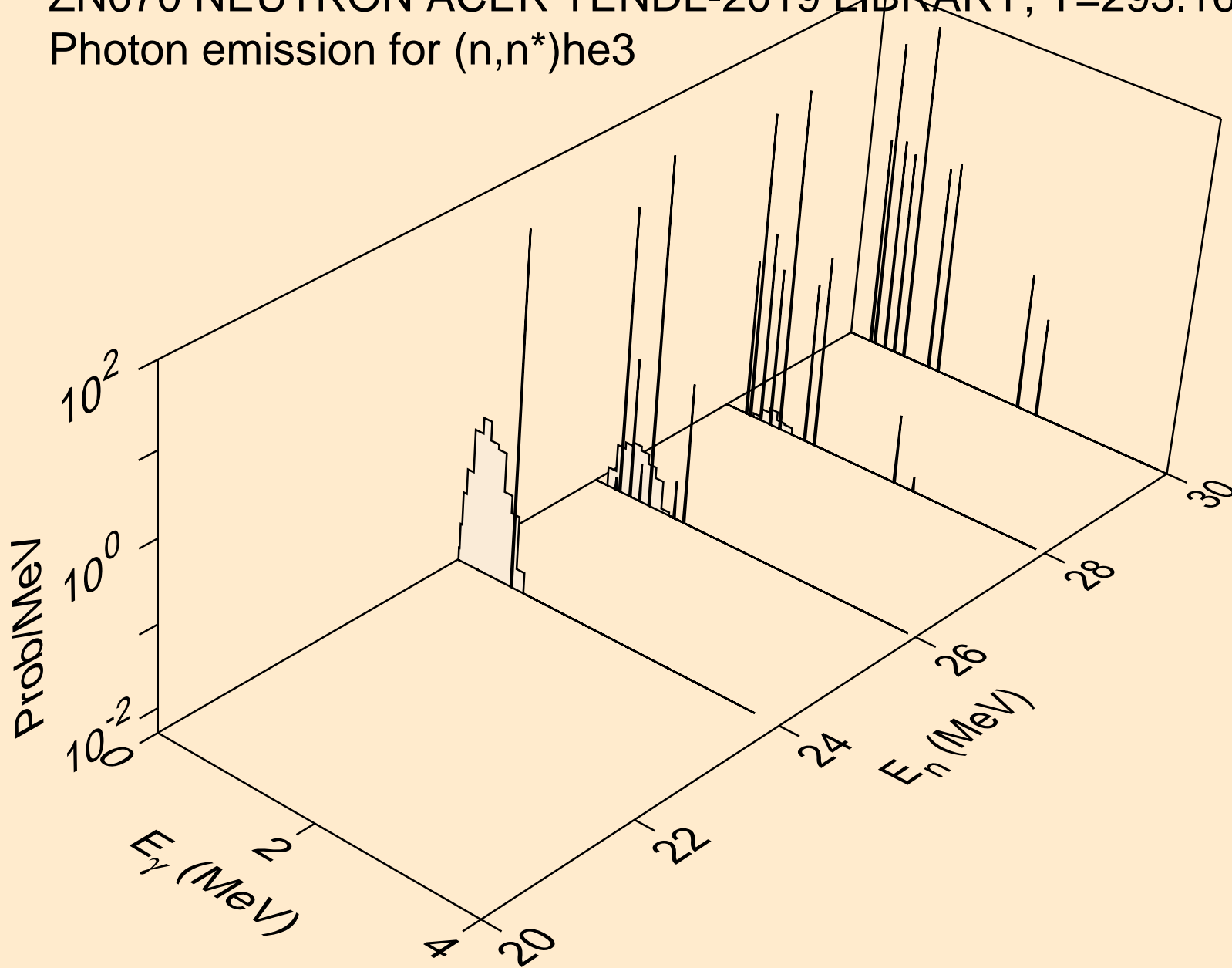

ZN070 NEUTRON ACER TENDL-2019 LIBRARY; T=293.16K
Photon emission for (n,4n)

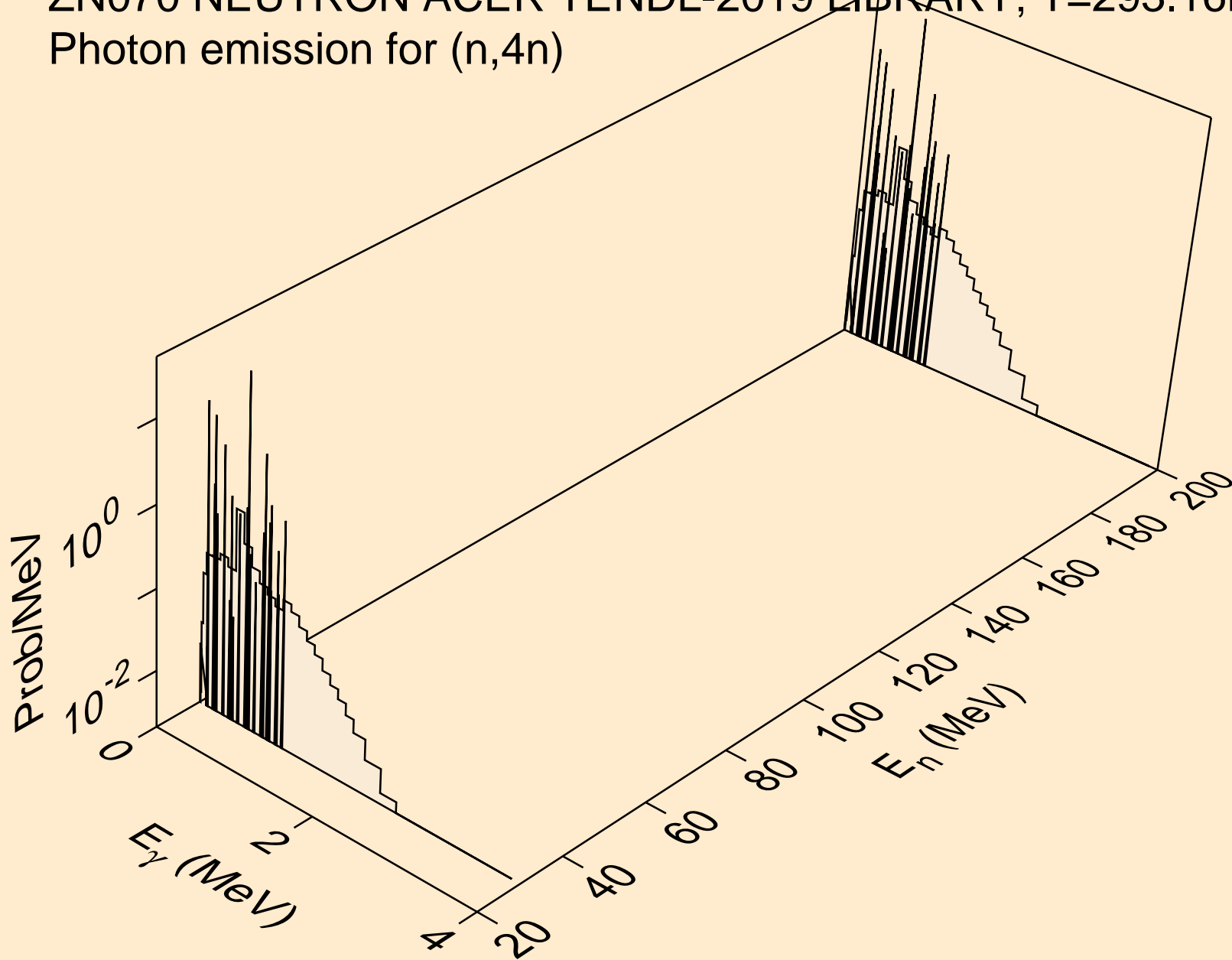

ZN070 NEUTRON ACER TENDL-2019 LIBRARY; T=293.16K
Photon emission for (n,2np)

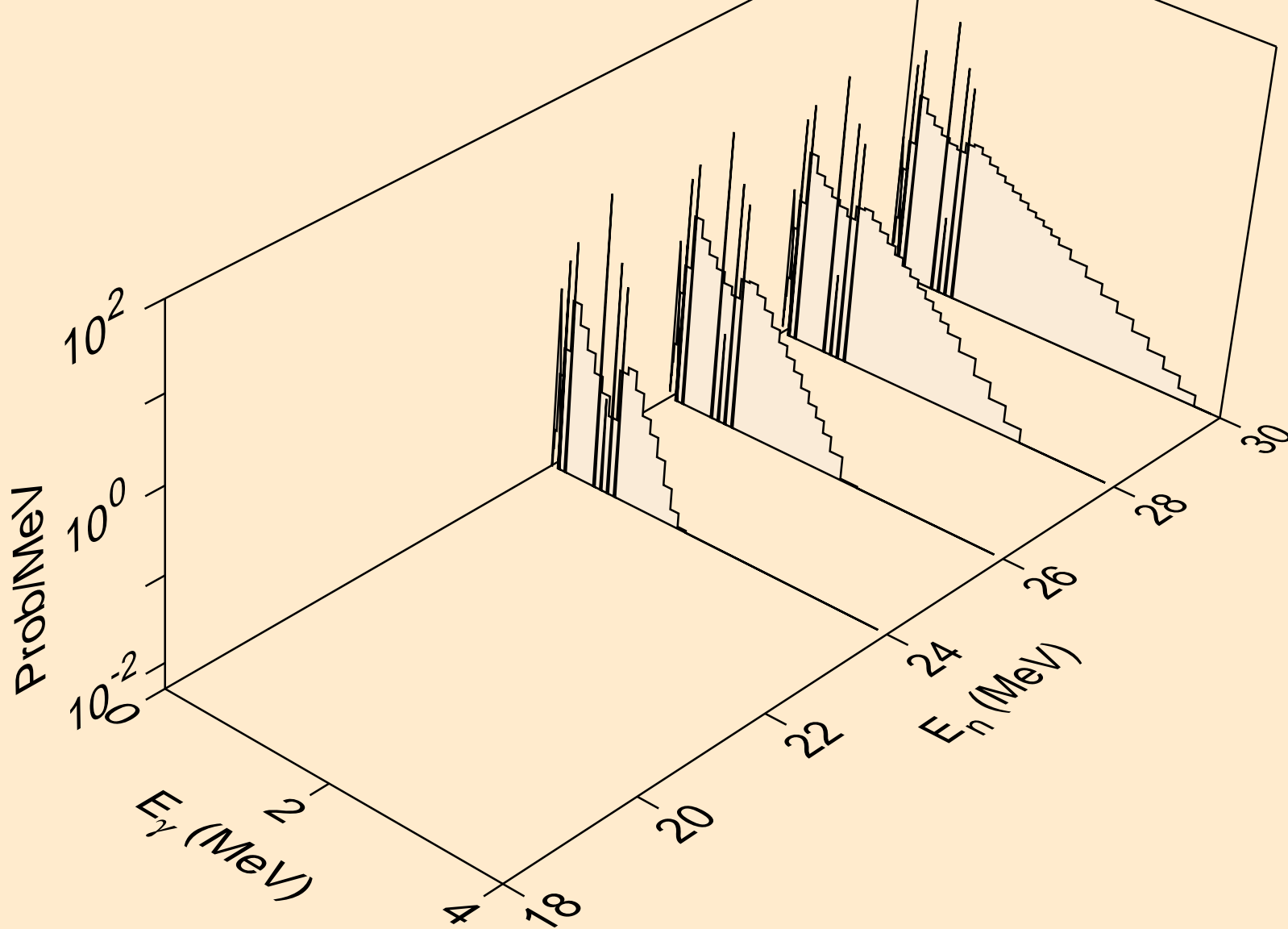

ZN070 NEUTRON ACER TENDL-2019 LIBRARY; T=293.16K
Photon emission for (n,3np)

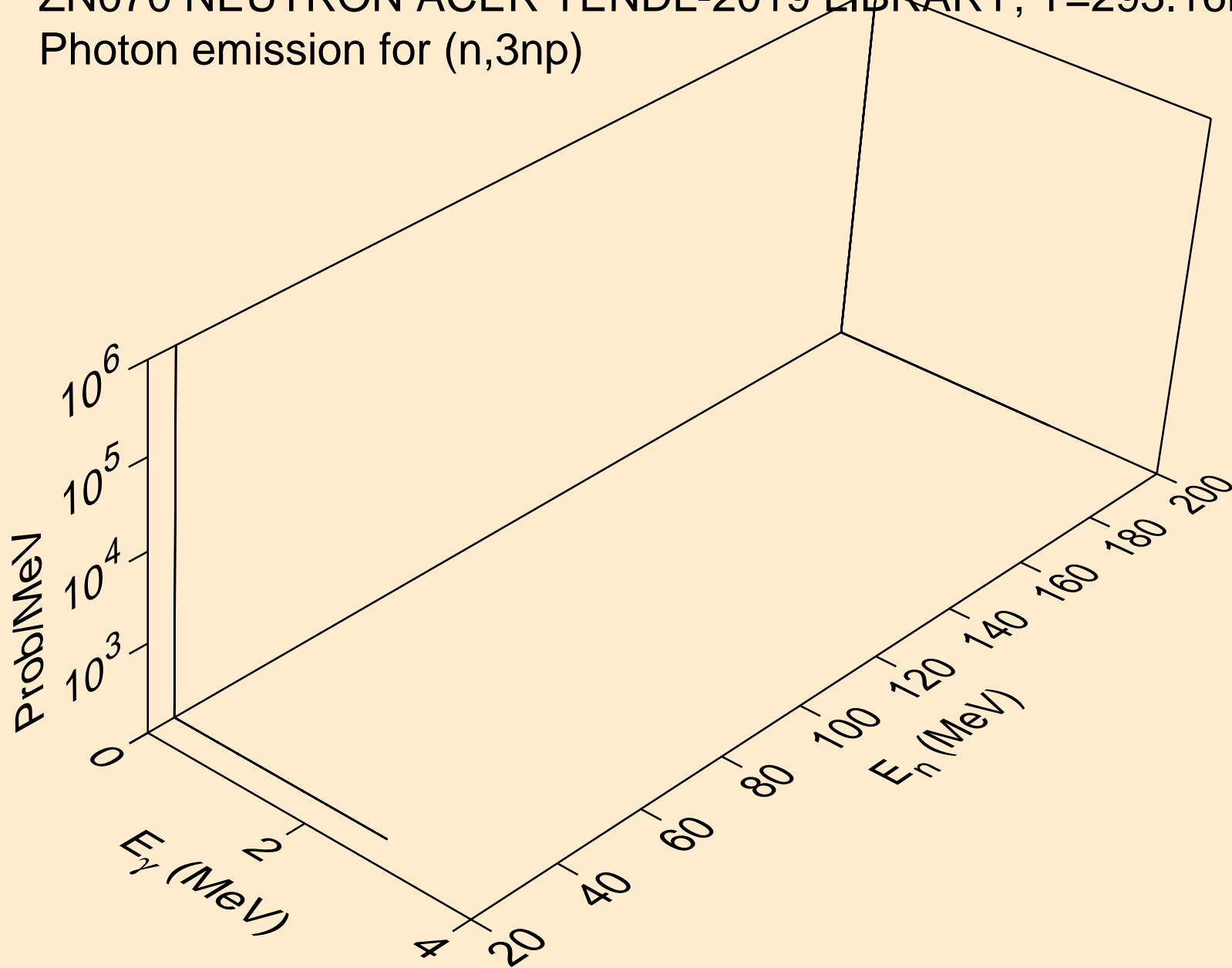

ZN070 NEUTRON ACER TENDL-2019 LIBRARY; T=293.16K
Photon emission for (n,2np)

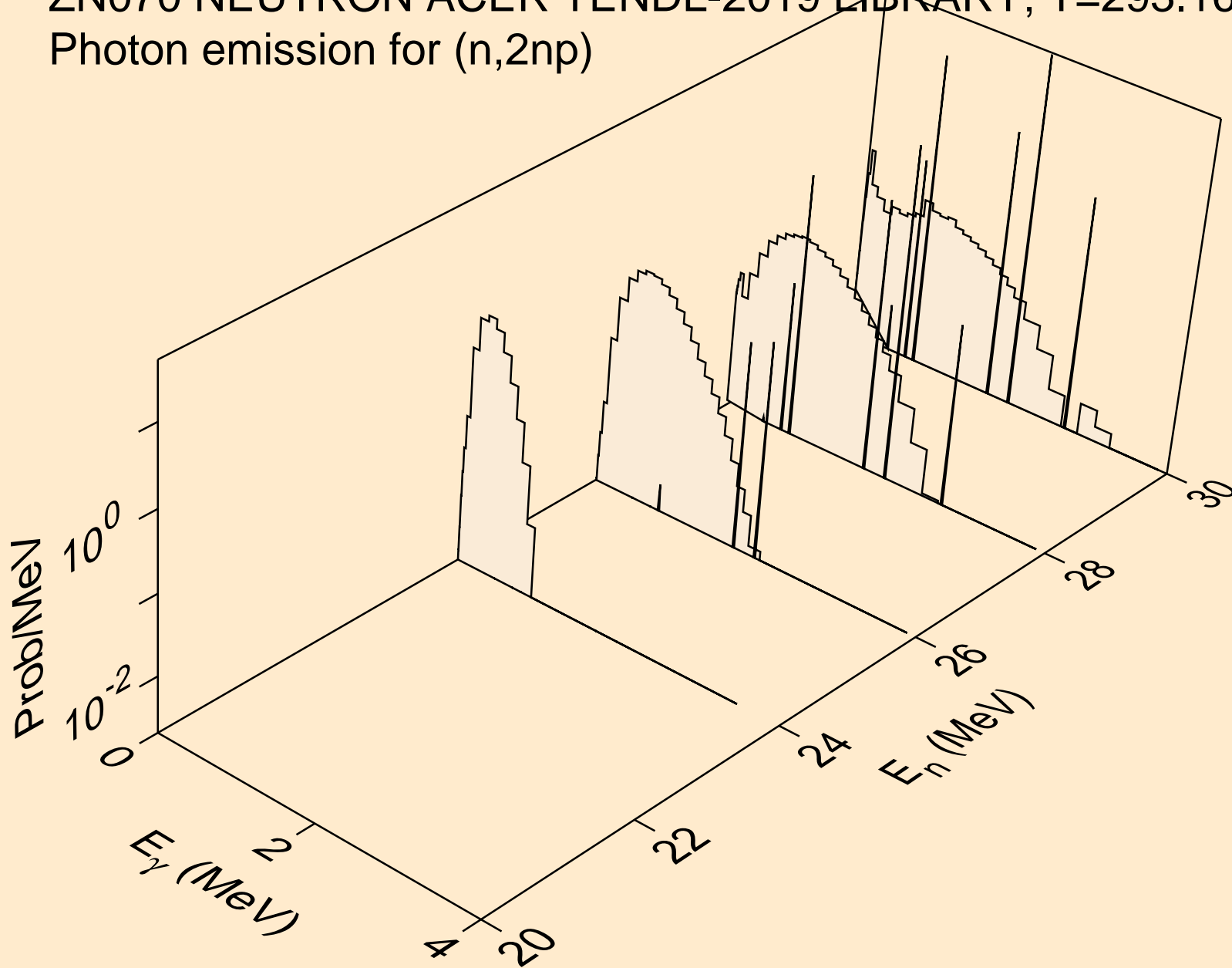

ZN070 NEUTRON ACER TENDL-2019 LIBRARY; T=293.16K
Photon emission for (n,npa)

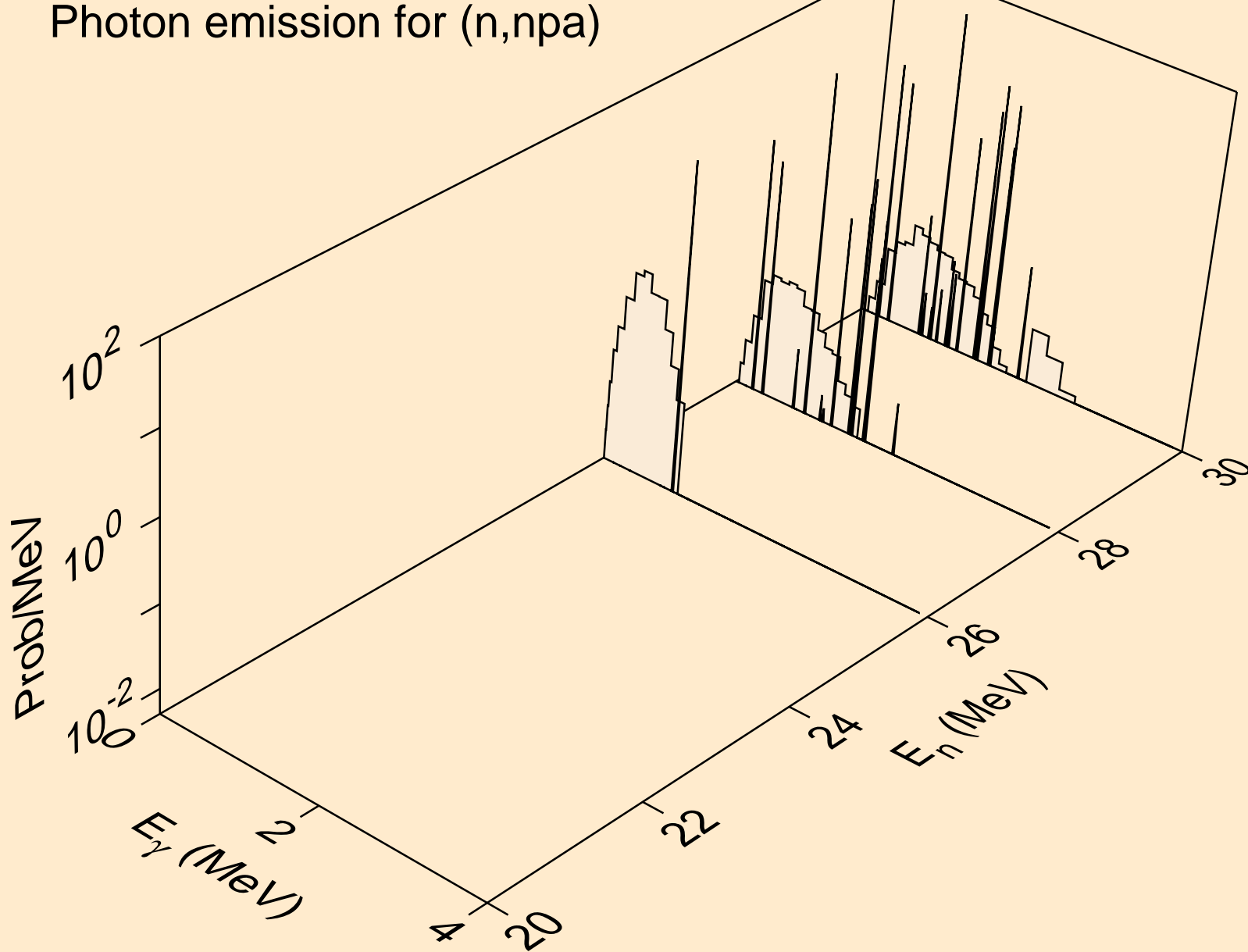

ZN070 NEUTRON ACER TENDL-2019 LIBRARY; T=293.16K
Photon emission for (n,n*c)

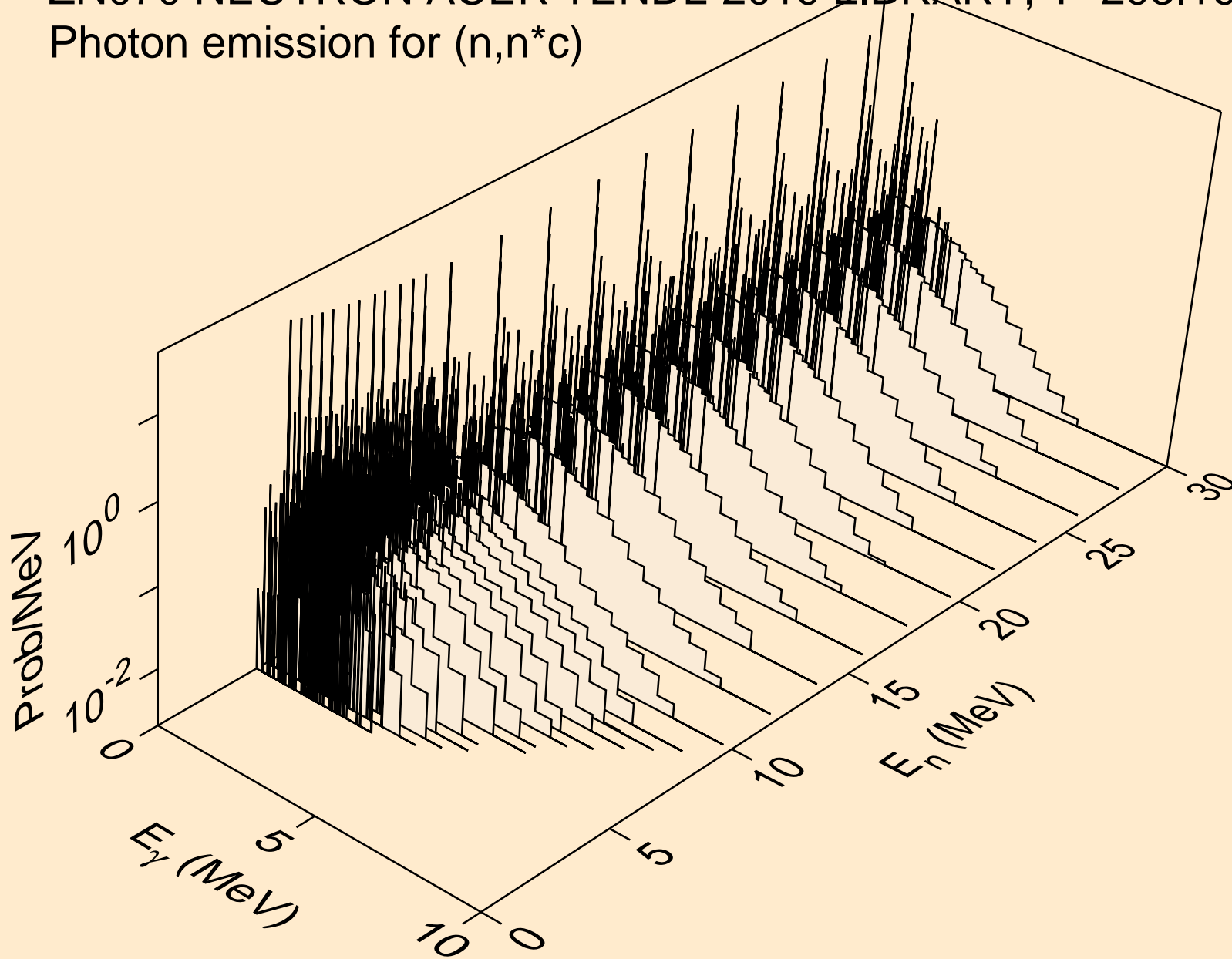

ZN070 NEUTRON ACER TENDL-2019 LIBRARY; T=293.16K
Photon emission for (n,gma)

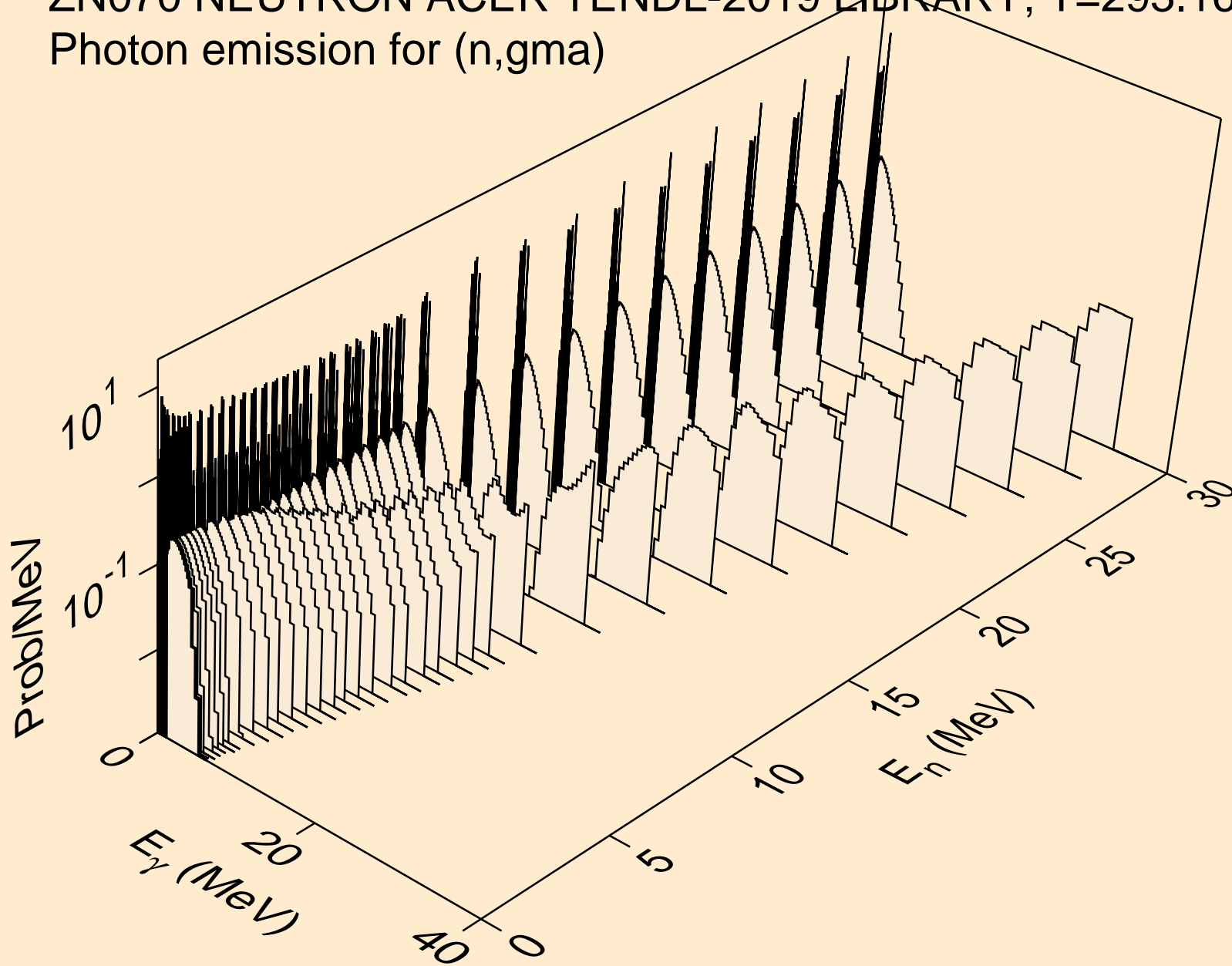

ZN070 NEUTRON ACER TENDL-2019 LIBRARY; T=293.16K
Photon emission for (n,p)

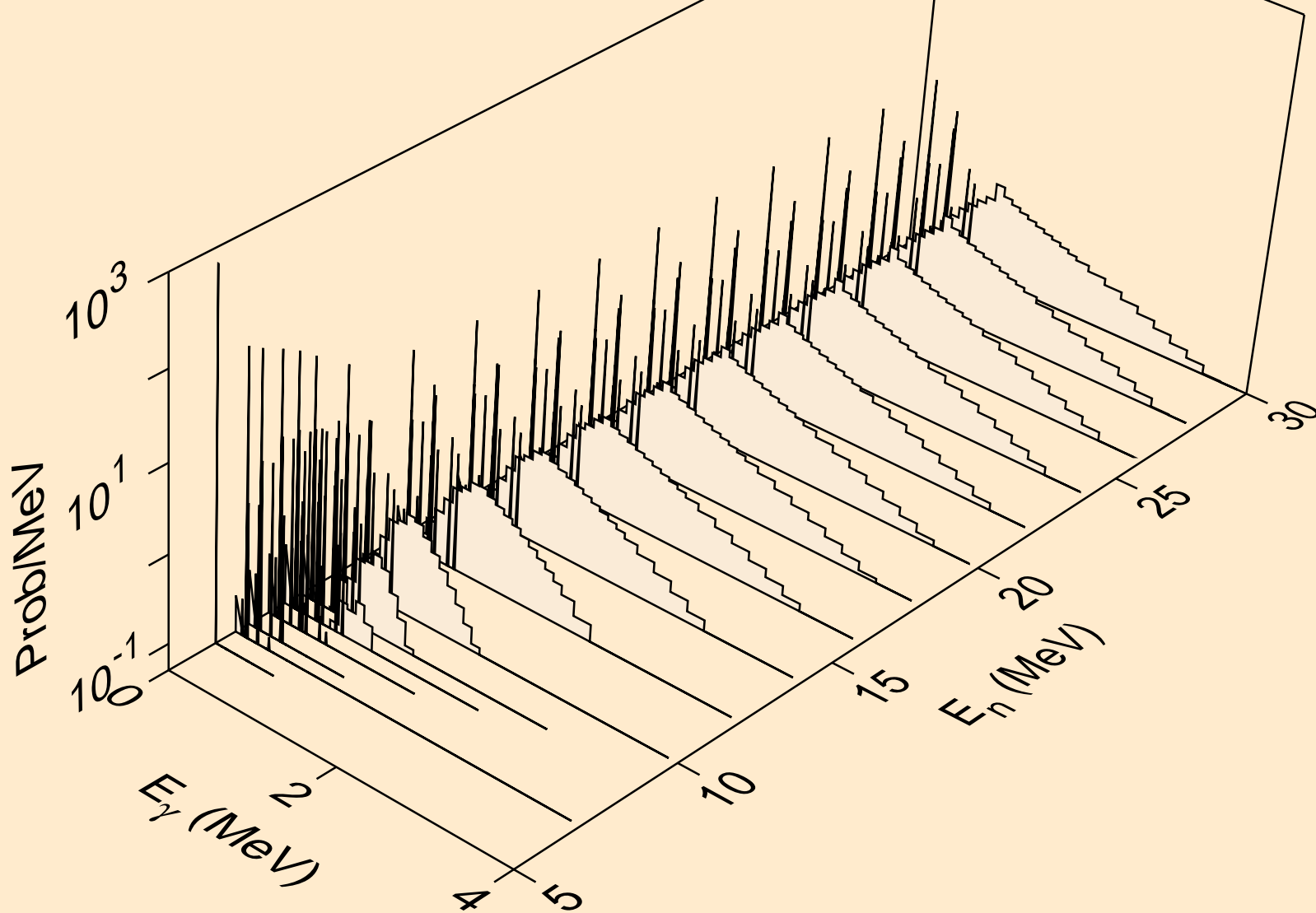

ZN070 NEUTRON ACER TENDL-2019 LIBRARY; T=293.16K
Photon emission for (n,d)

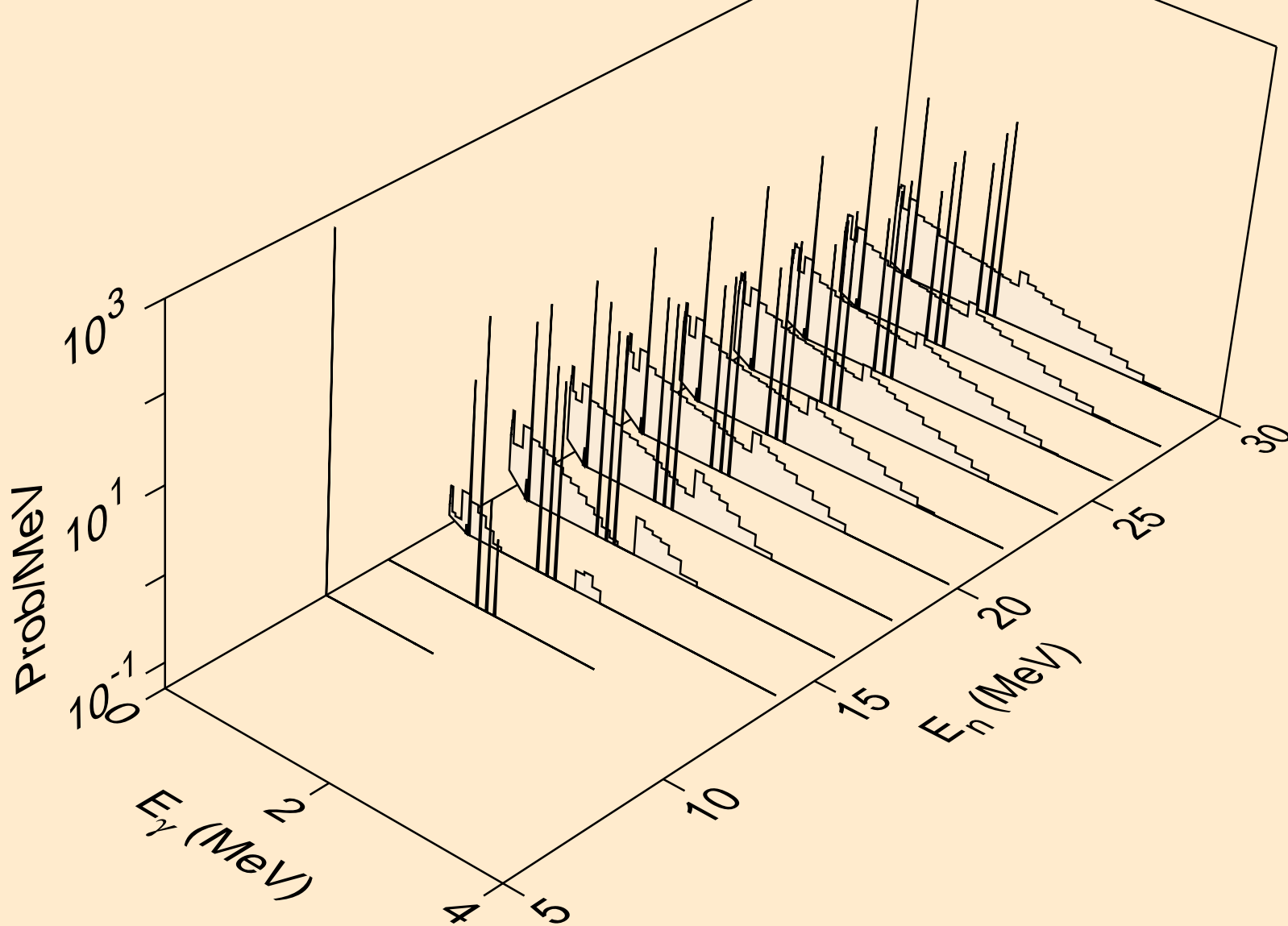

ZN070 NEUTRON ACER TENDL-2019 LIBRARY; T=293.16K
Photon emission for (n,t)

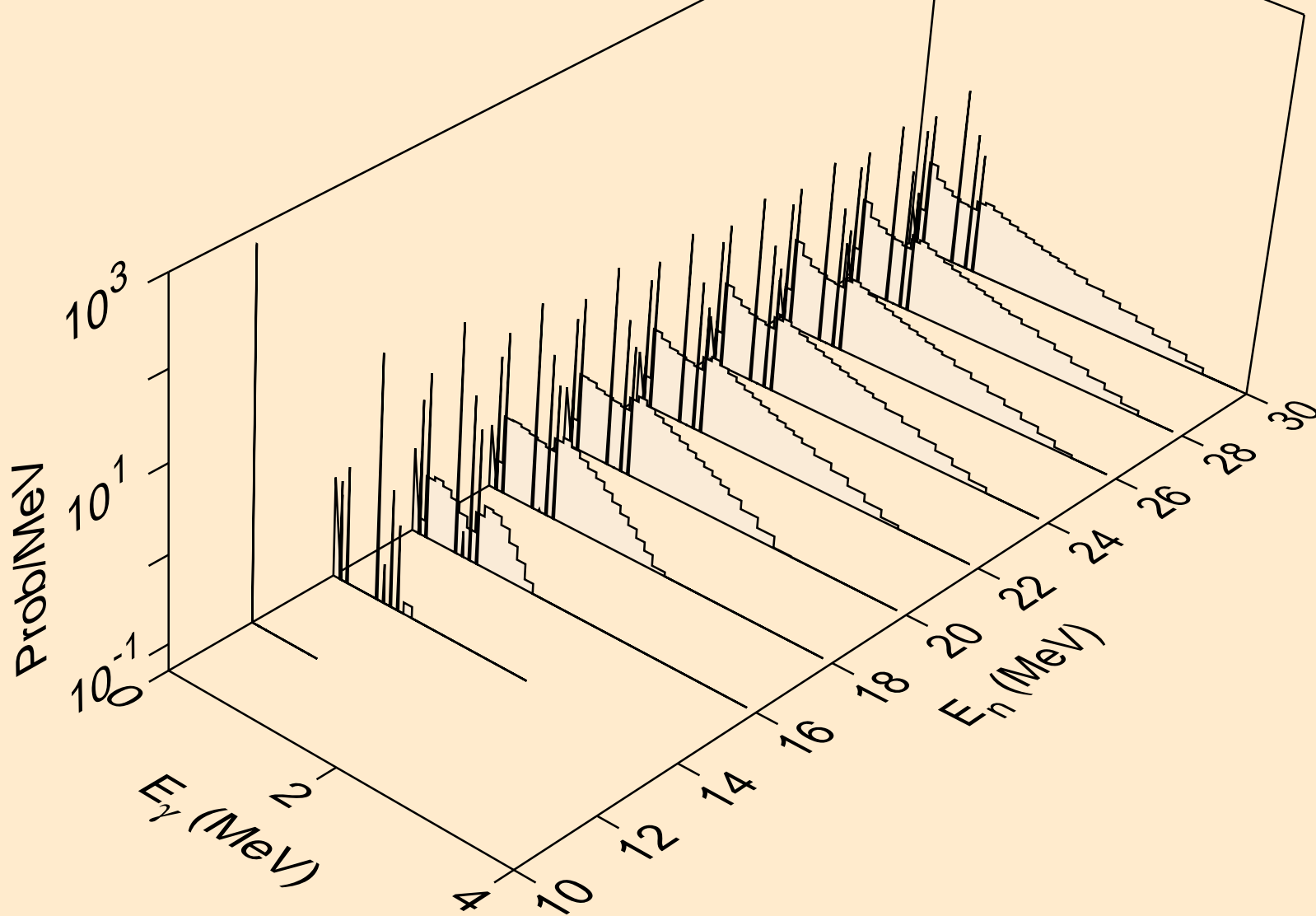

ZN070 NEUTRON ACER TENDL-2019 LIBRARY; T=293.16K
Photon emission for (n,he3)

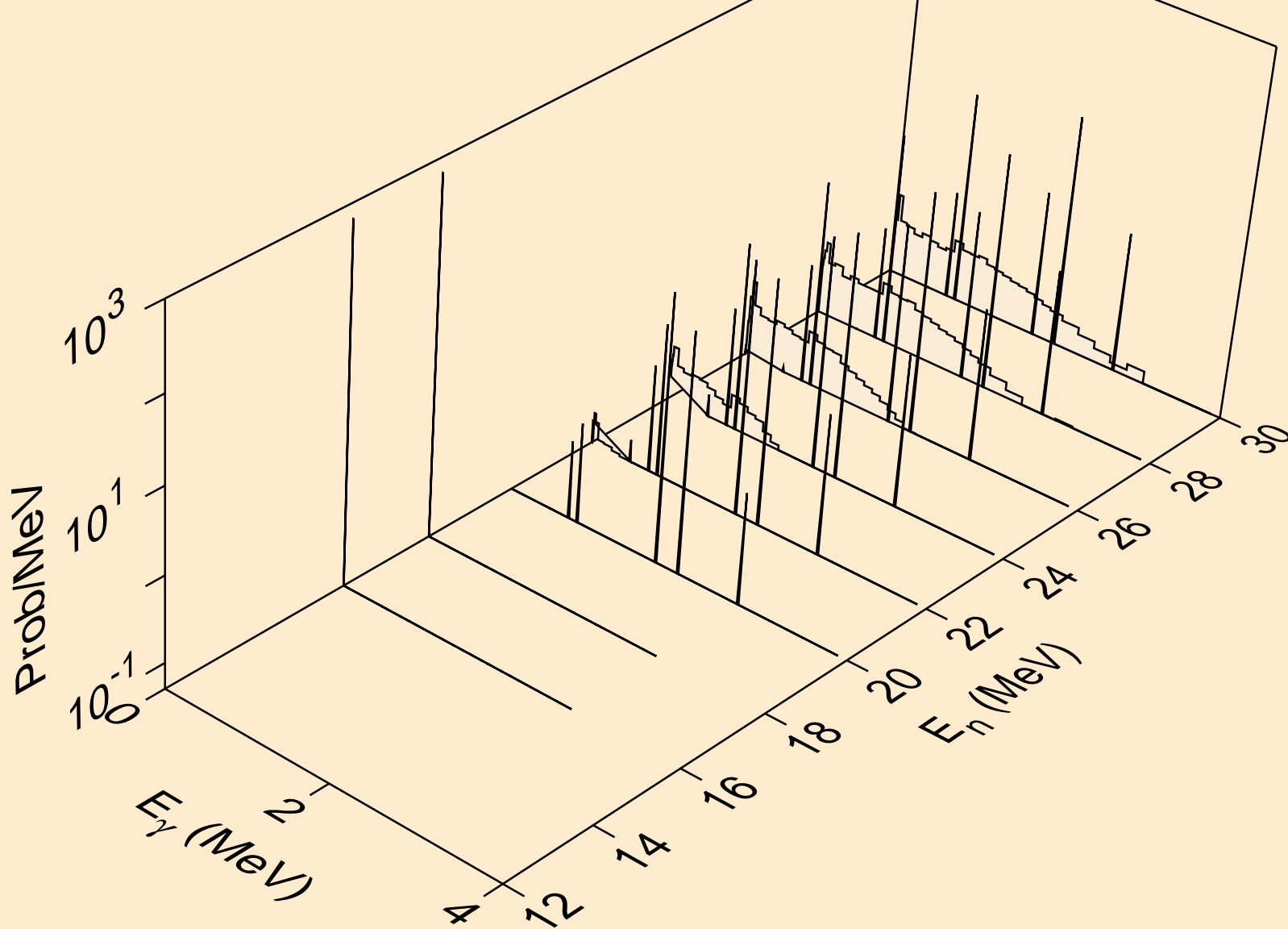

ZN070 NEUTRON ACER TENDL-2019 LIBRARY; T=293.16K
Photon emission for (n,a)

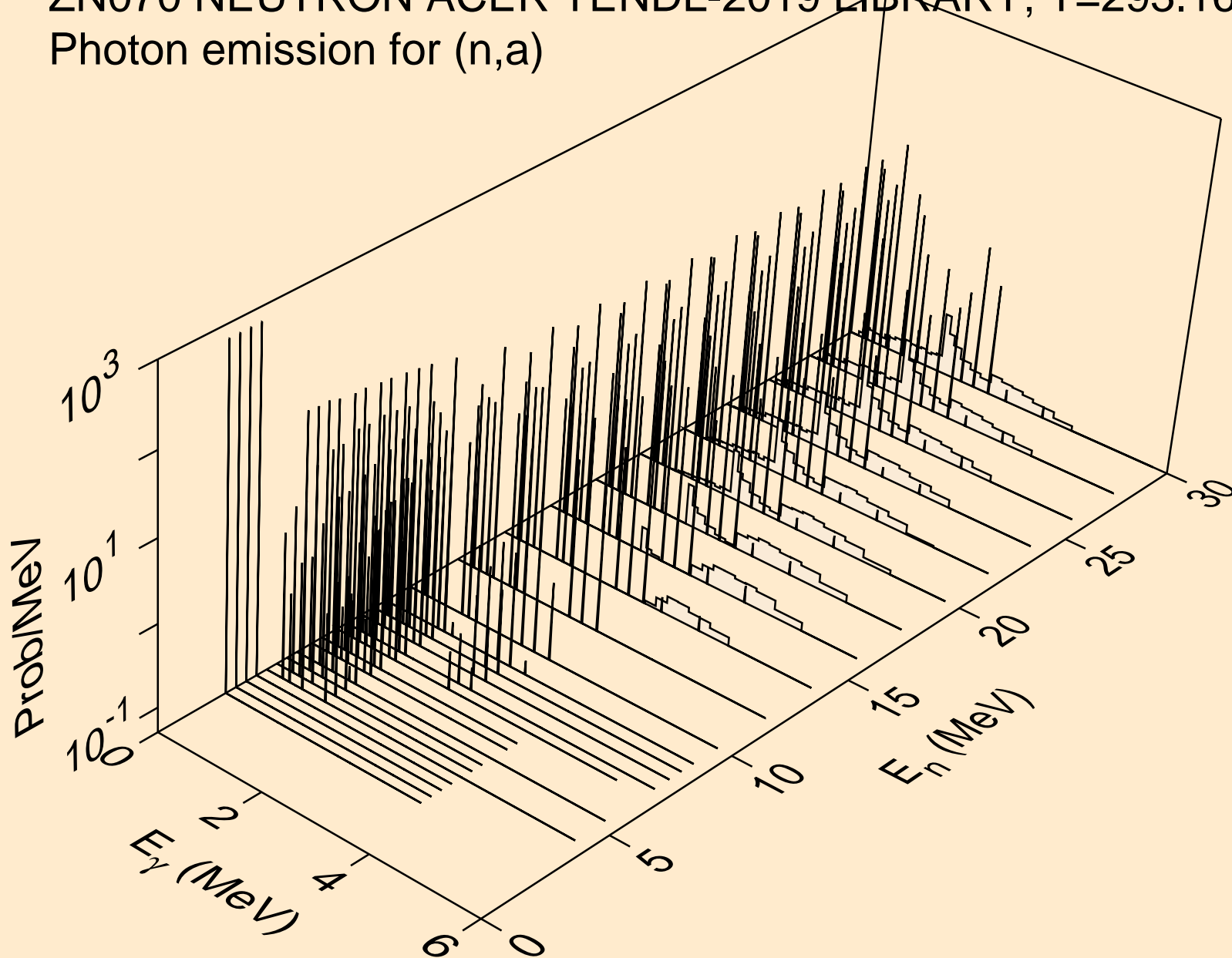

ZN070 NEUTRON ACER TENDL-2019 LIBRARY; T=293.16K
Photon emission for (n,2a)

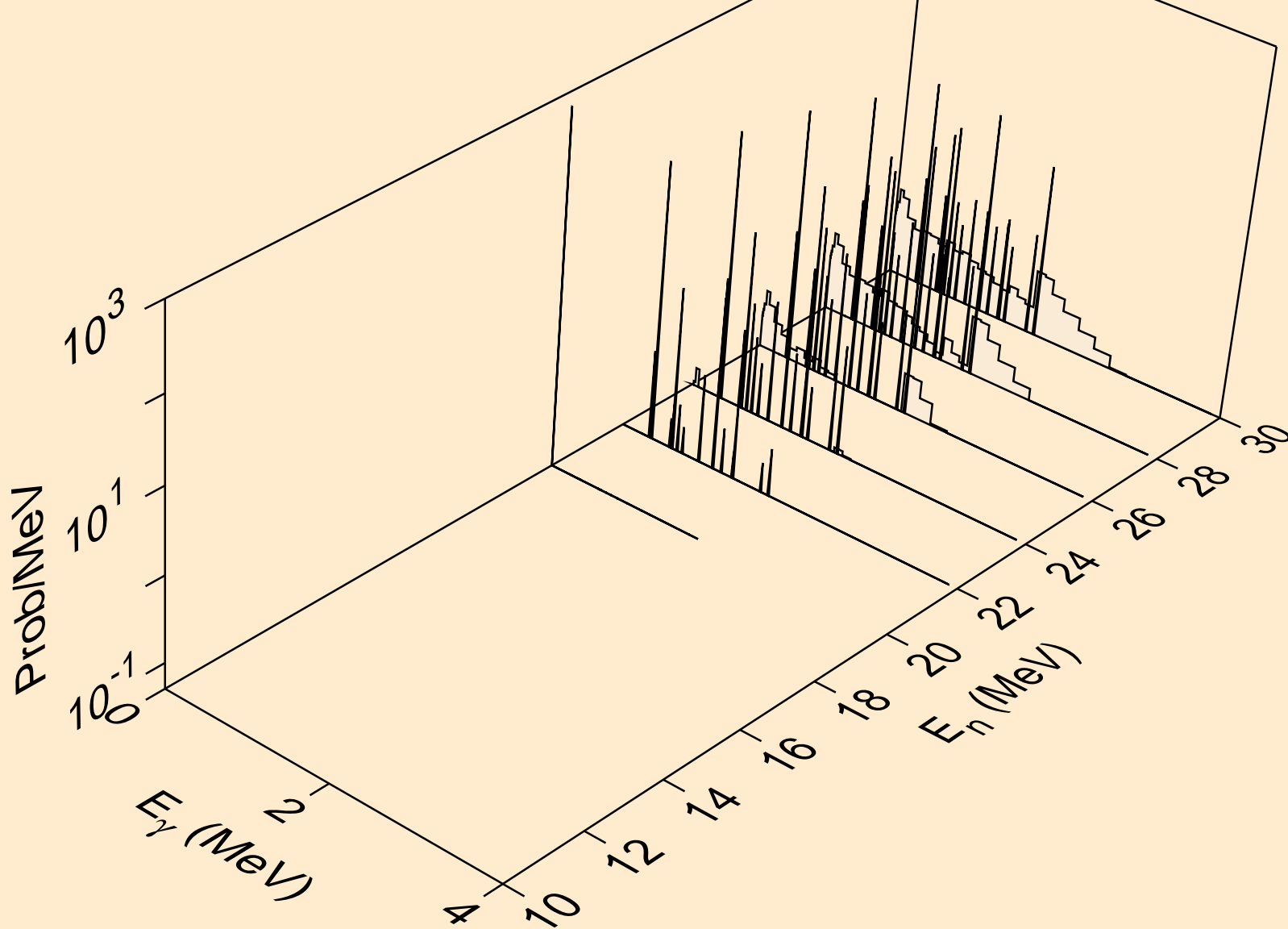

ZN070 NEUTRON ACER TENDL-2019 LIBRARY; T=293.16K
Photon emission for (n,2p)

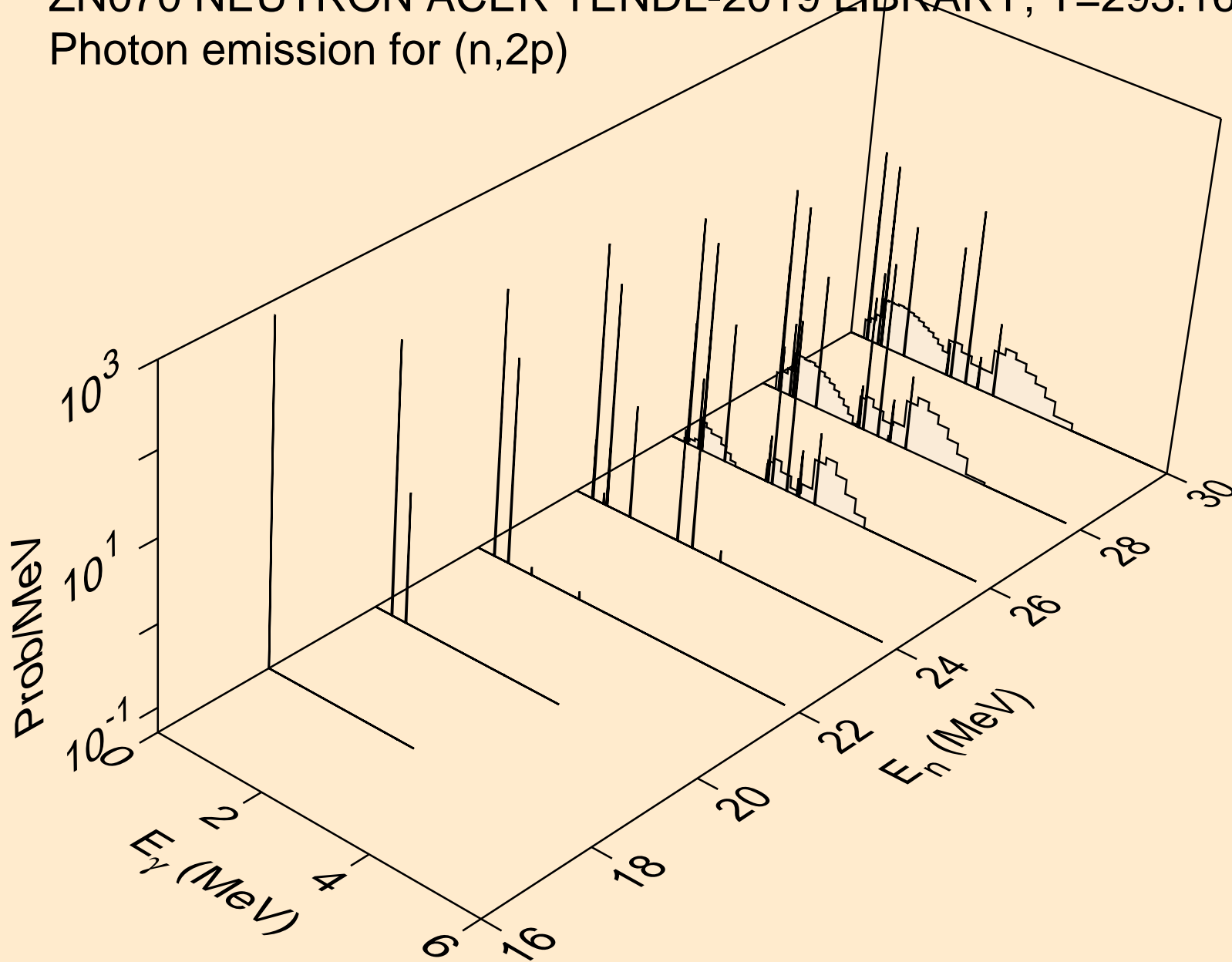

ZN070 NEUTRON ACER TENDL-2019 LIBRARY; T=293.16K
Photon emission for (n,p α)

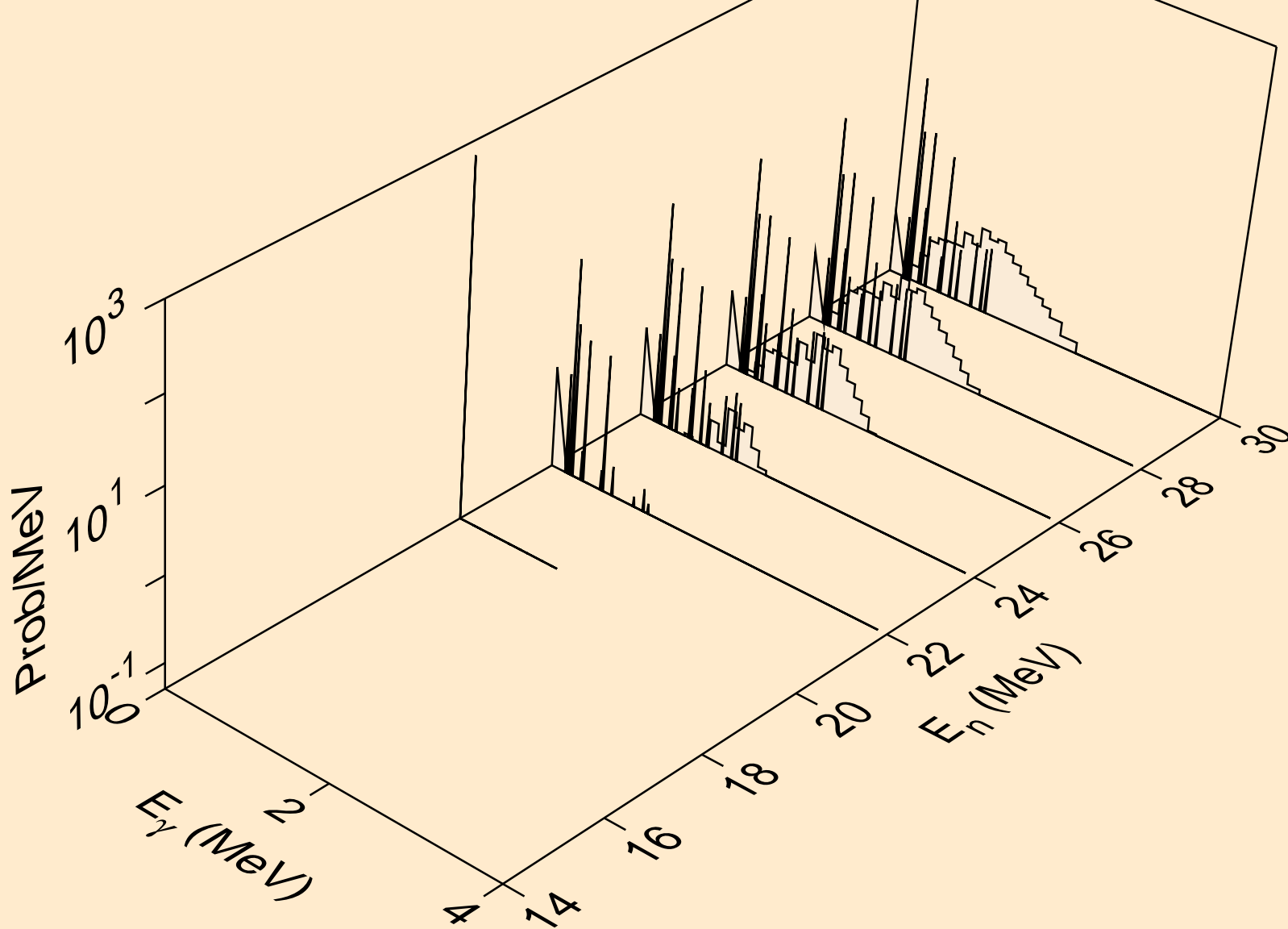

ZN070 NEUTRON ACER TENDL-2019 LIBRARY; T=293.16K
Photon emission for (n,pd)

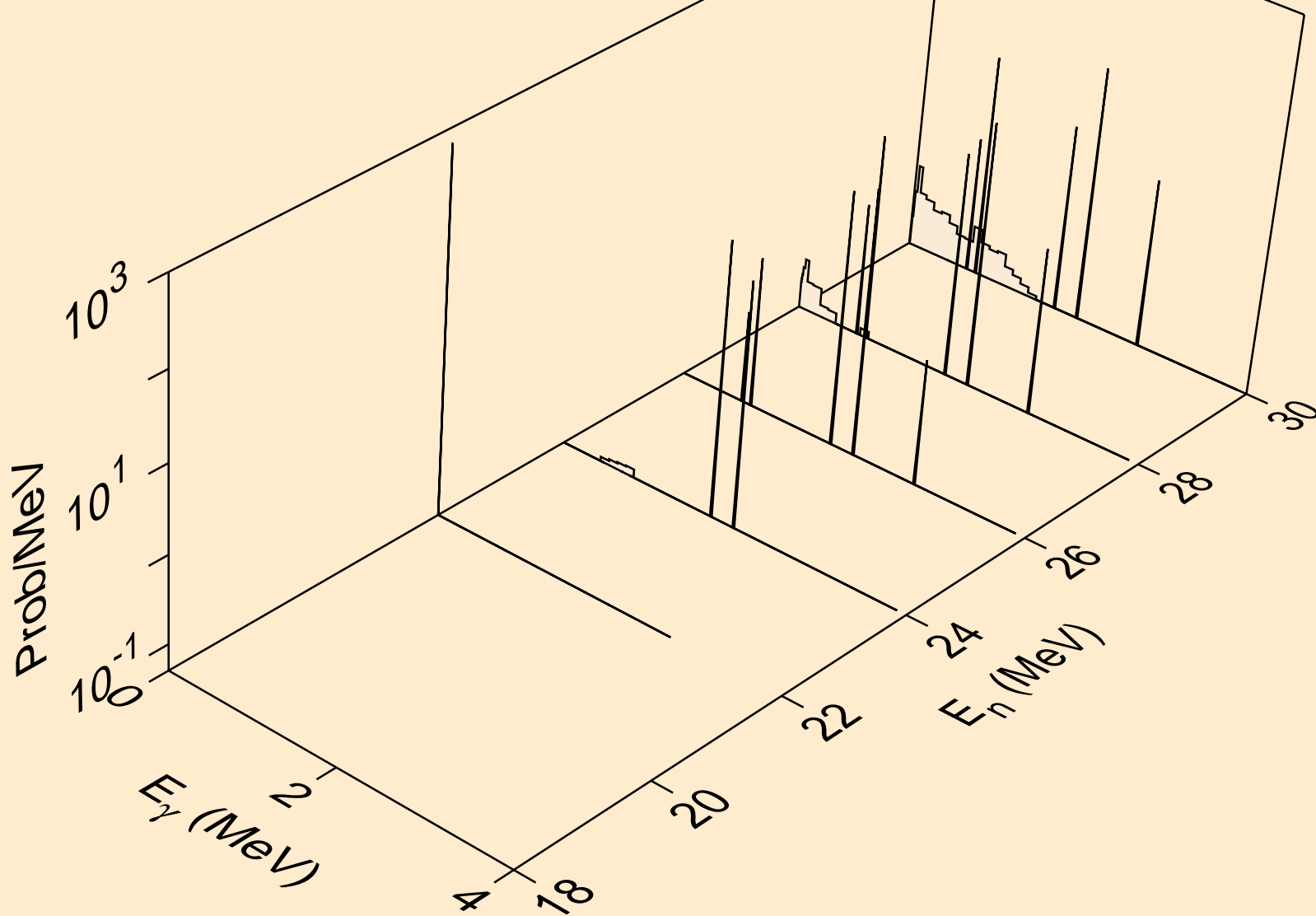

ZN070 NEUTRON ACER TENDL-2019 LIBRARY; T=293.16K
Photon emission for (n,pt)

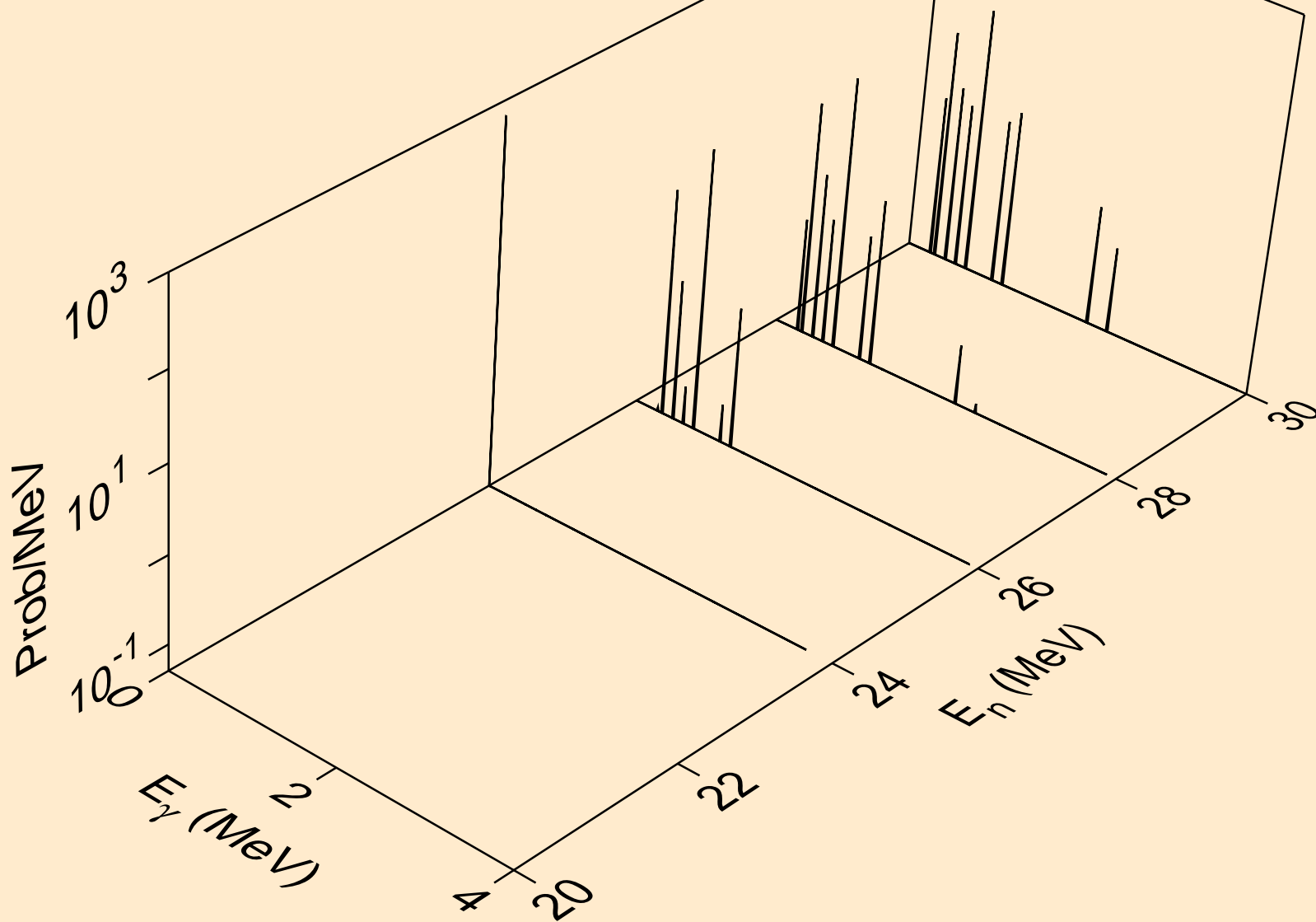

ZN070 NEUTRON ACER TENDL-2019 LIBRARY; T=293.16K
Photon emission for (n,da)

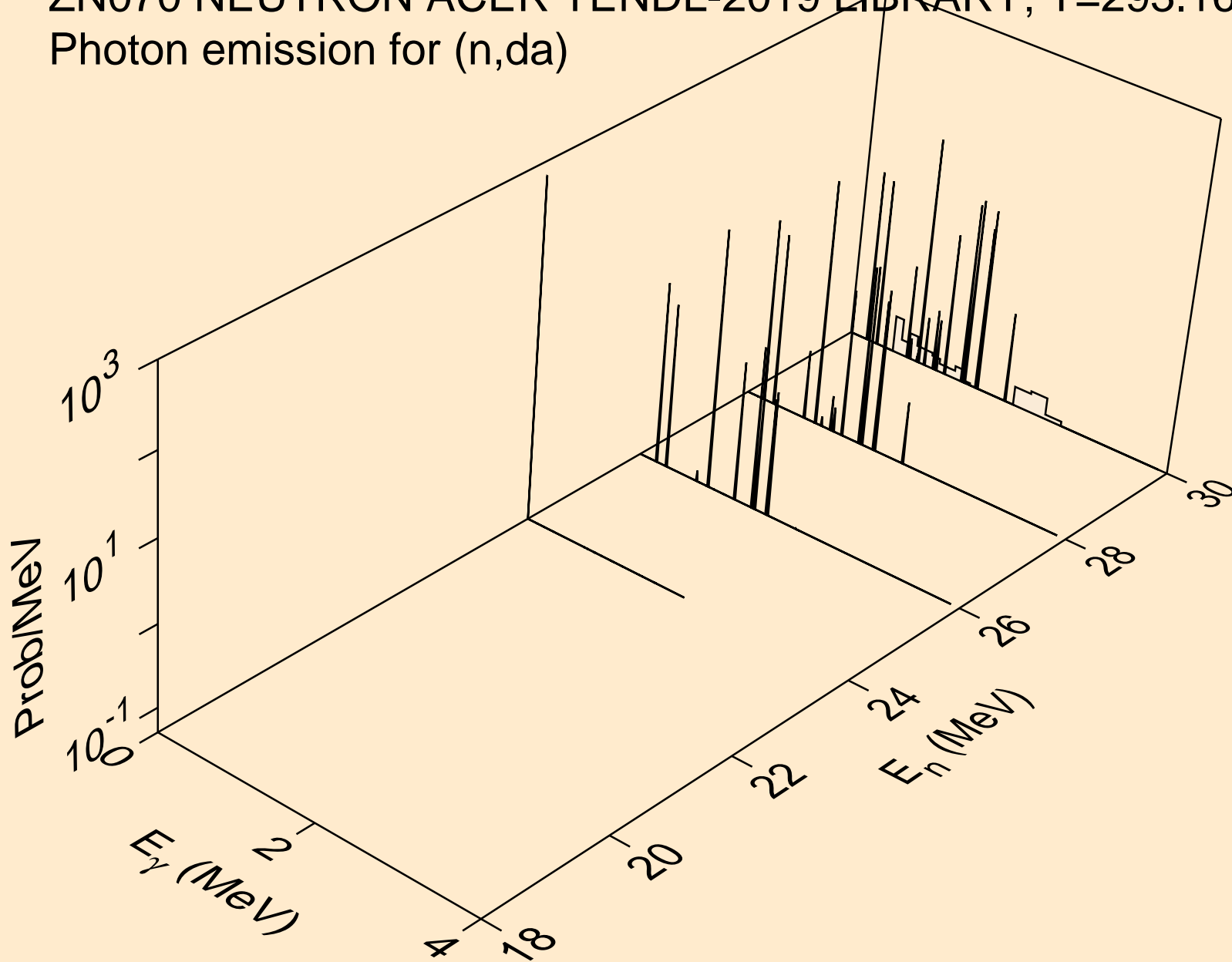

ZN070 NEUTRON ACER TENDL-2019 LIBRARY; T=293.16K
thermal capture photon spectrum

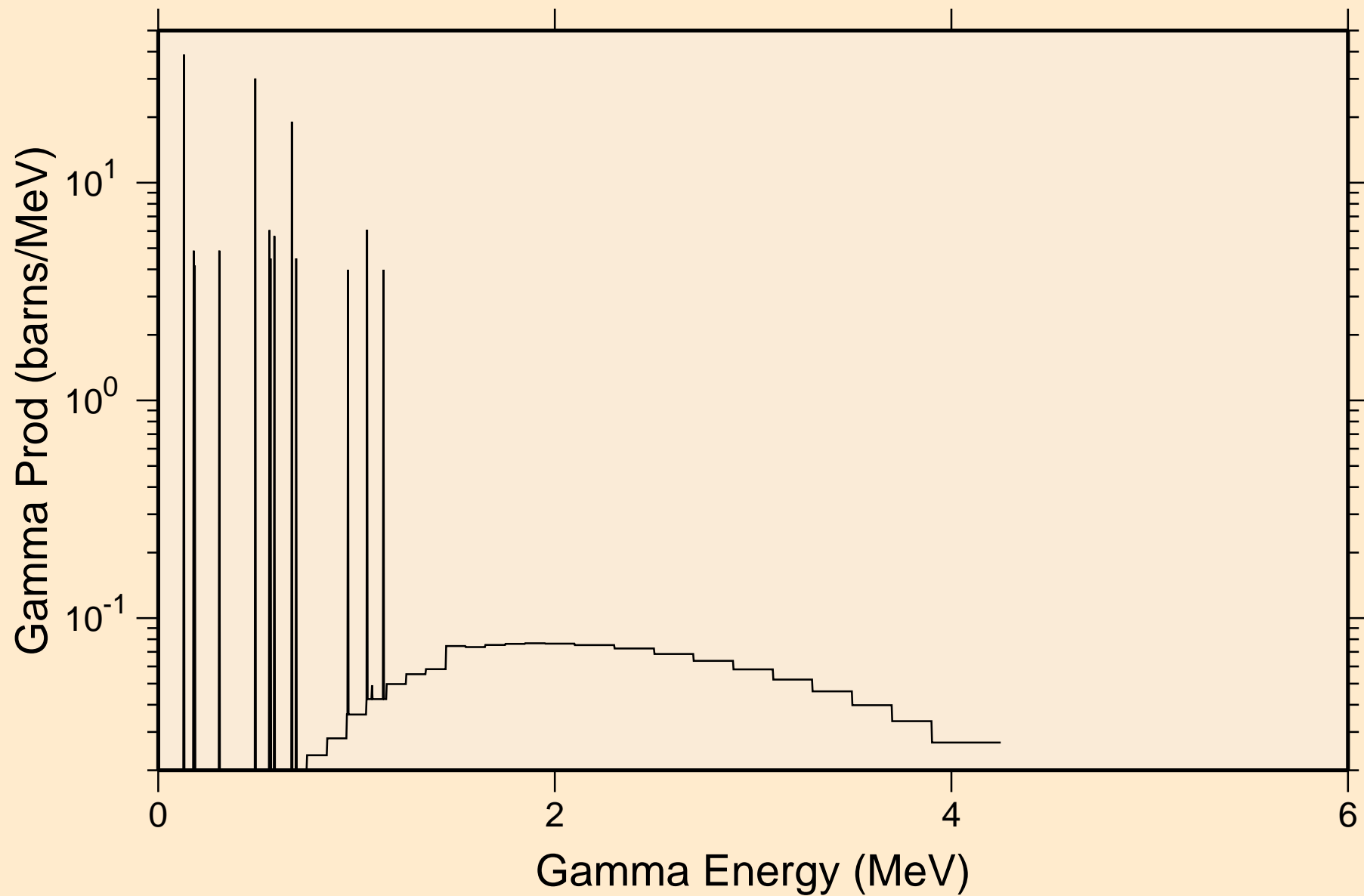

ZN070 NEUTRON ACER TENDL-2019 LIBRARY; T=293.16K
14 MeV photon spectrum

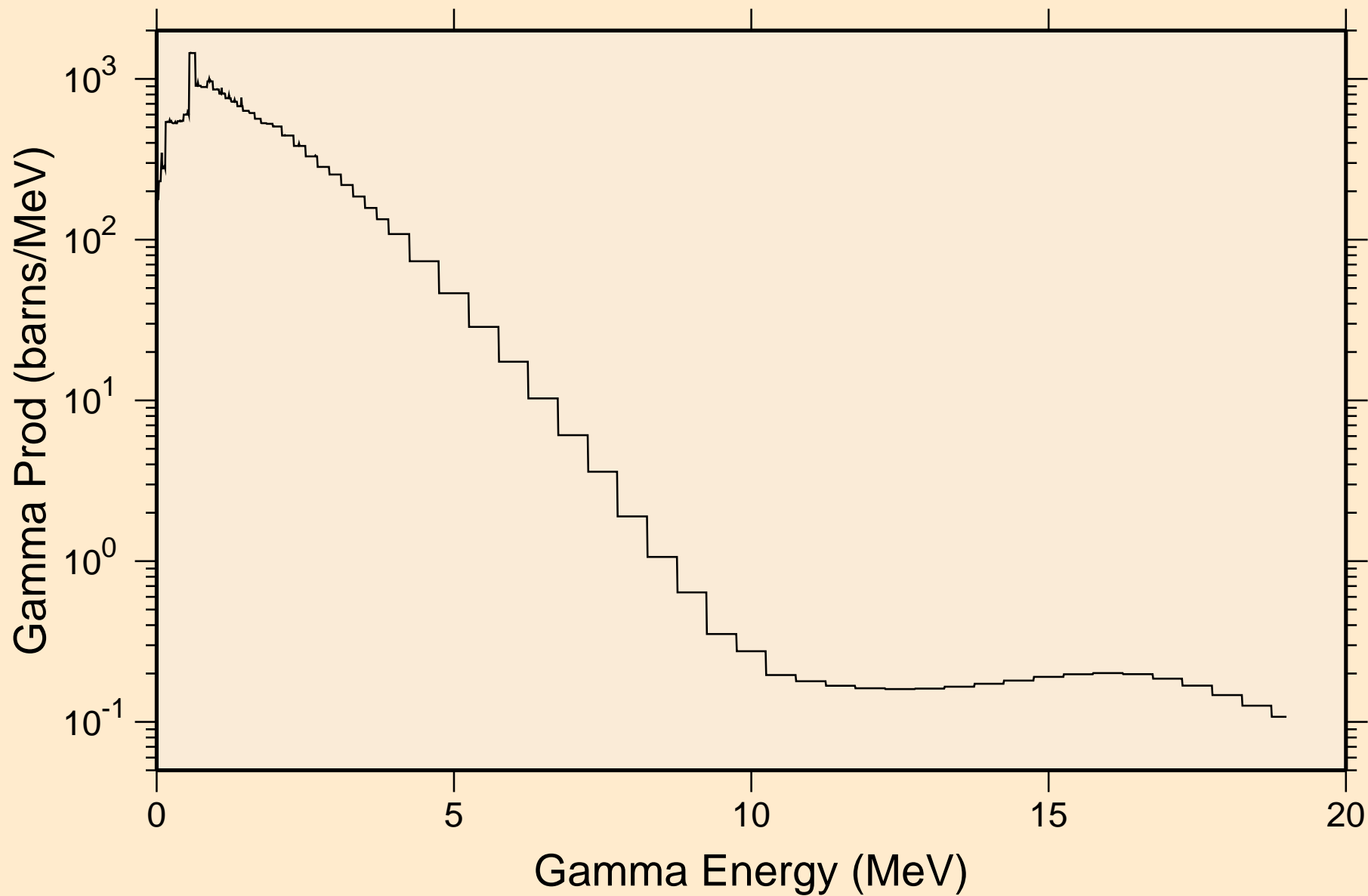

ZN070 NEUTRON ACER TENDL-2019 LIBRARY; T=293.16K

Particle heating contributions

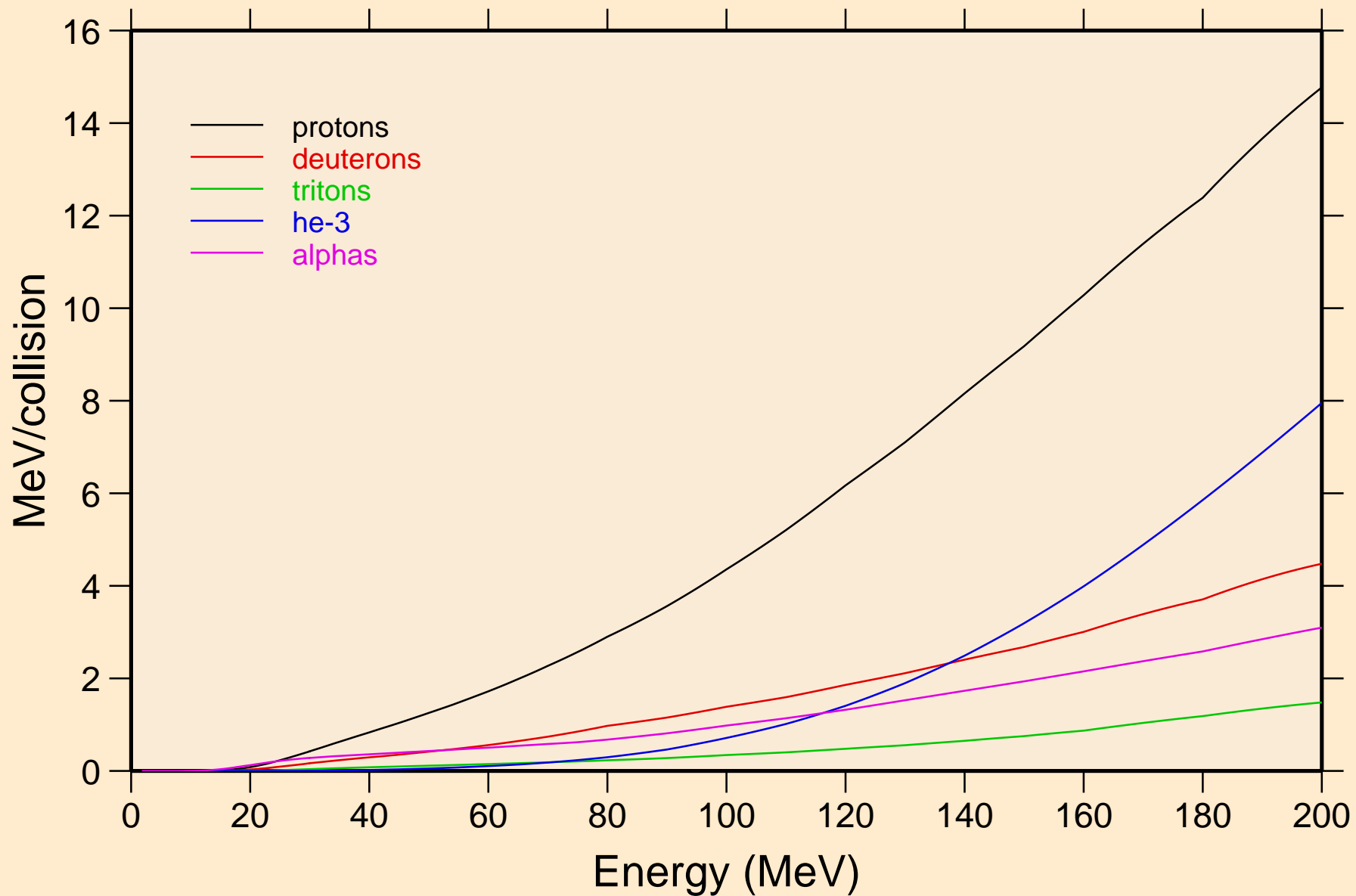

ZN070 NEUTRON ACER TENDL-2019 LIBRARY; T=293.16K
Recoil Heating

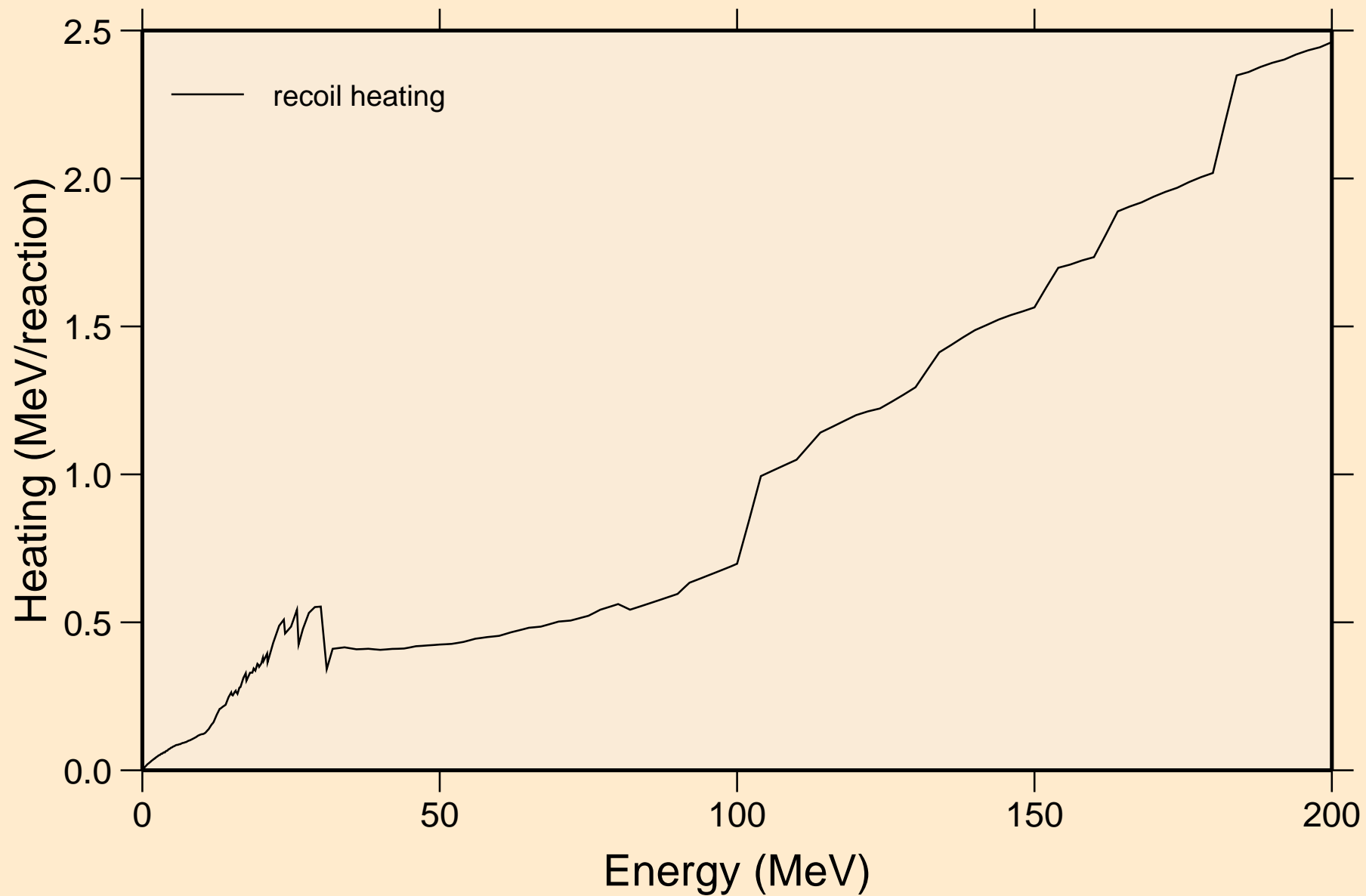

ZN070 NEUTRON ACER TENDL-2019 LIBRARY; T=293.16K
Particle production cross sections

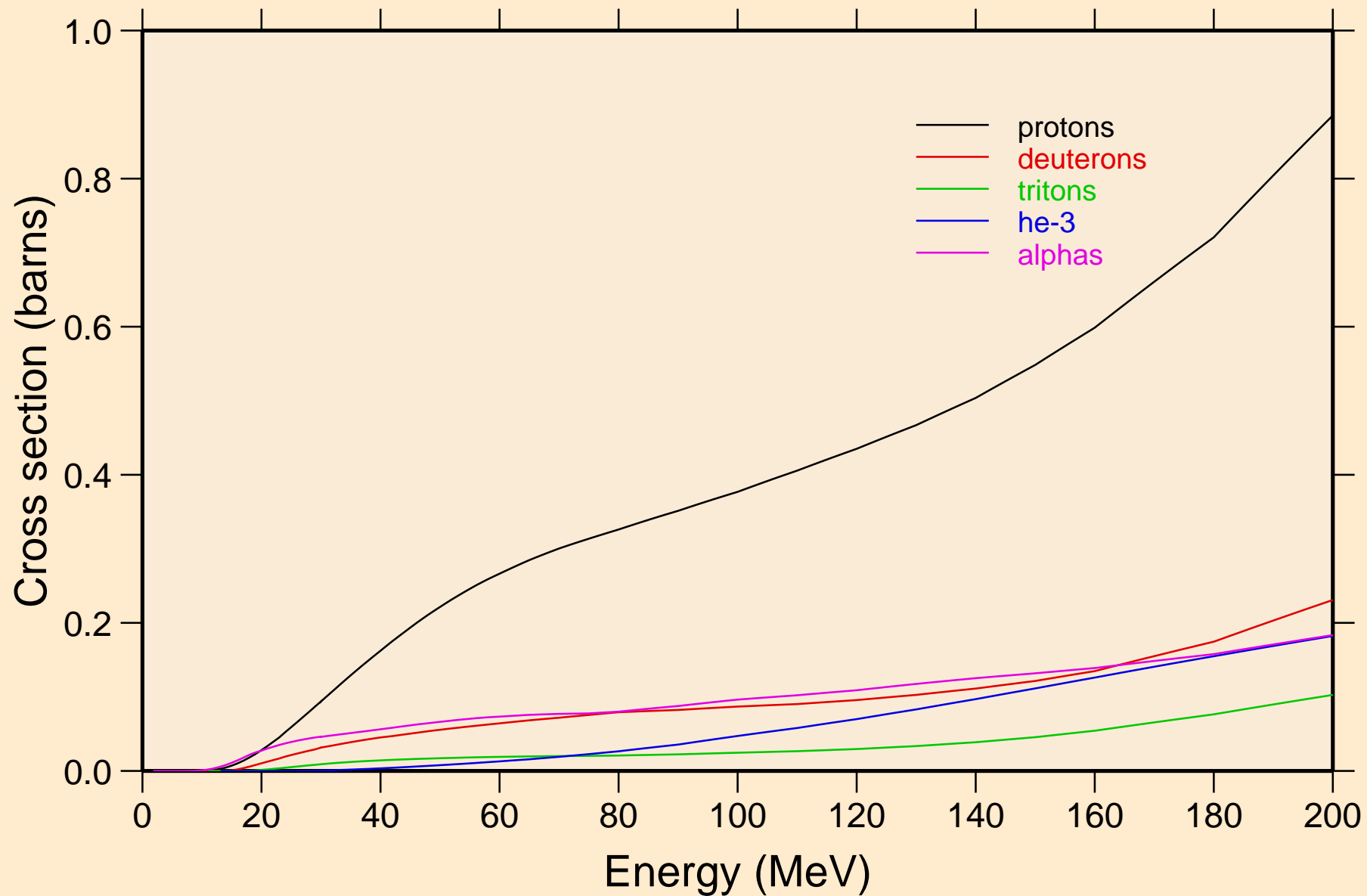

ZN070 NEUTRON ACER TENDL-2019 LIBRARY; T=293.16K
protons from (n,x)

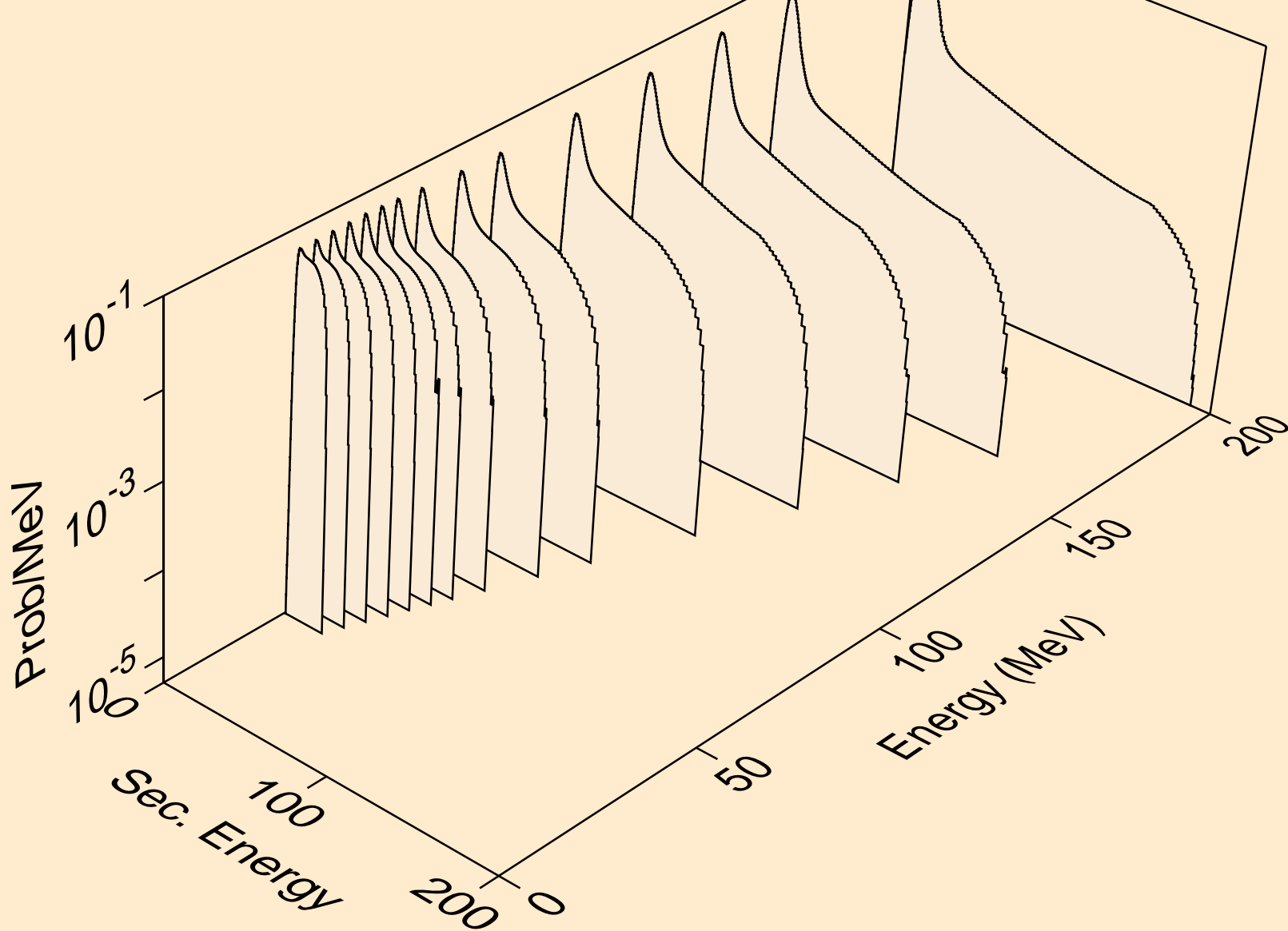

ZN070 NEUTRON ACER TENDL-2019 LIBRARY; T=293.16K
protons from (n,n*)p

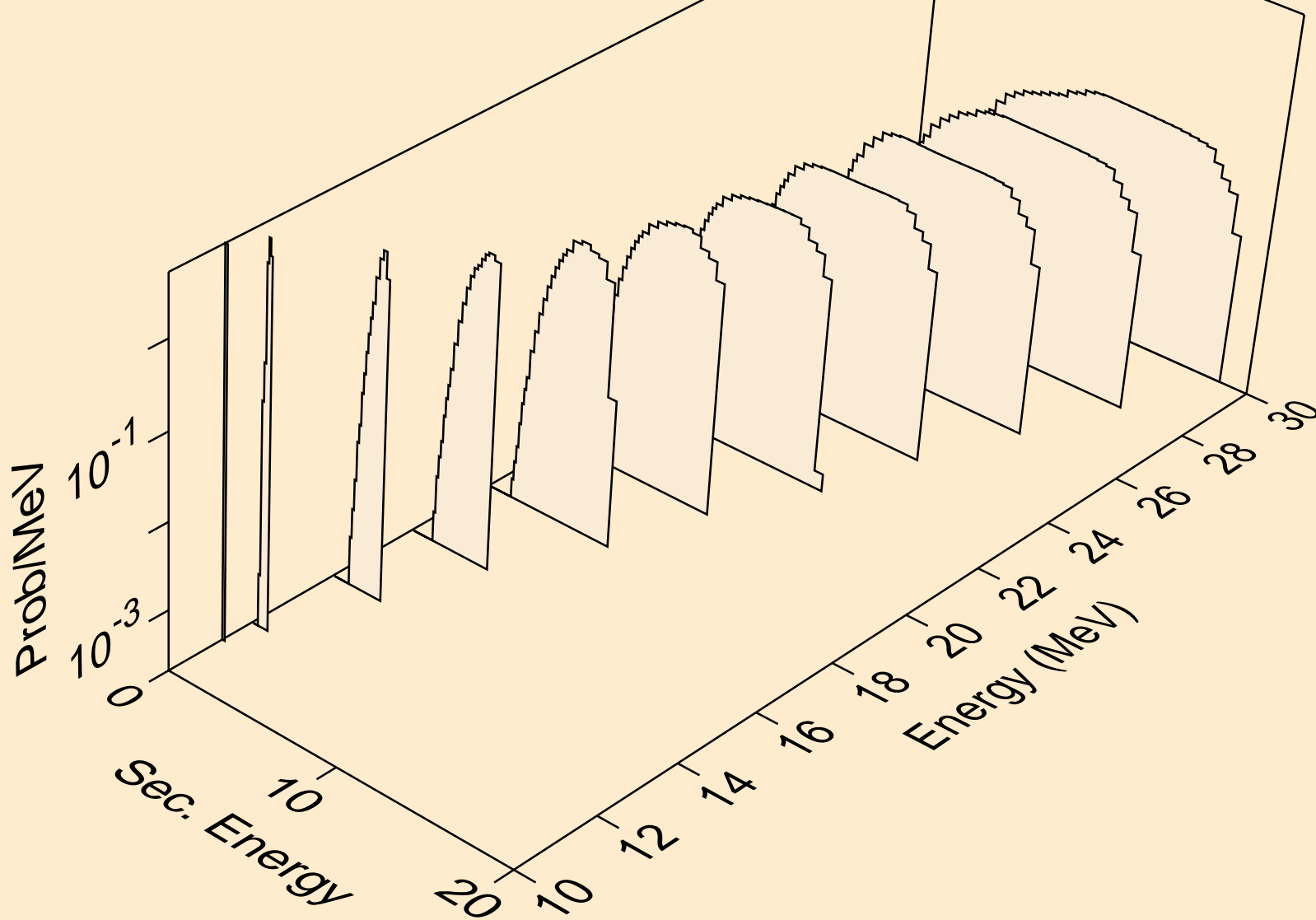

ZN070 NEUTRON ACER TENDL-2019 LIBRARY; T=293.16K
protons from (n,2np)

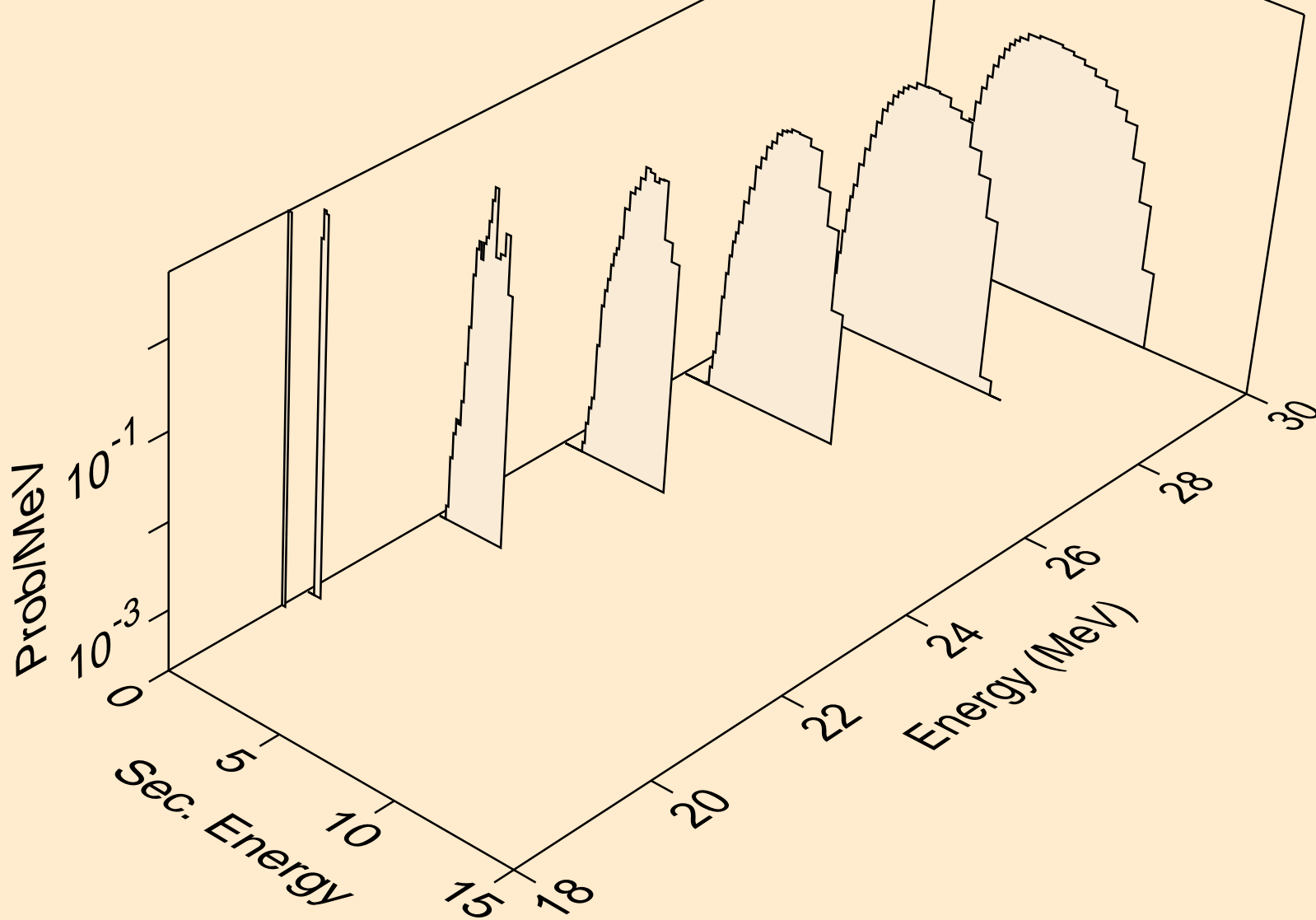

ZN070 NEUTRON ACER TENDL-2019 LIBRARY; T=293.16K
protons from (n,3np)

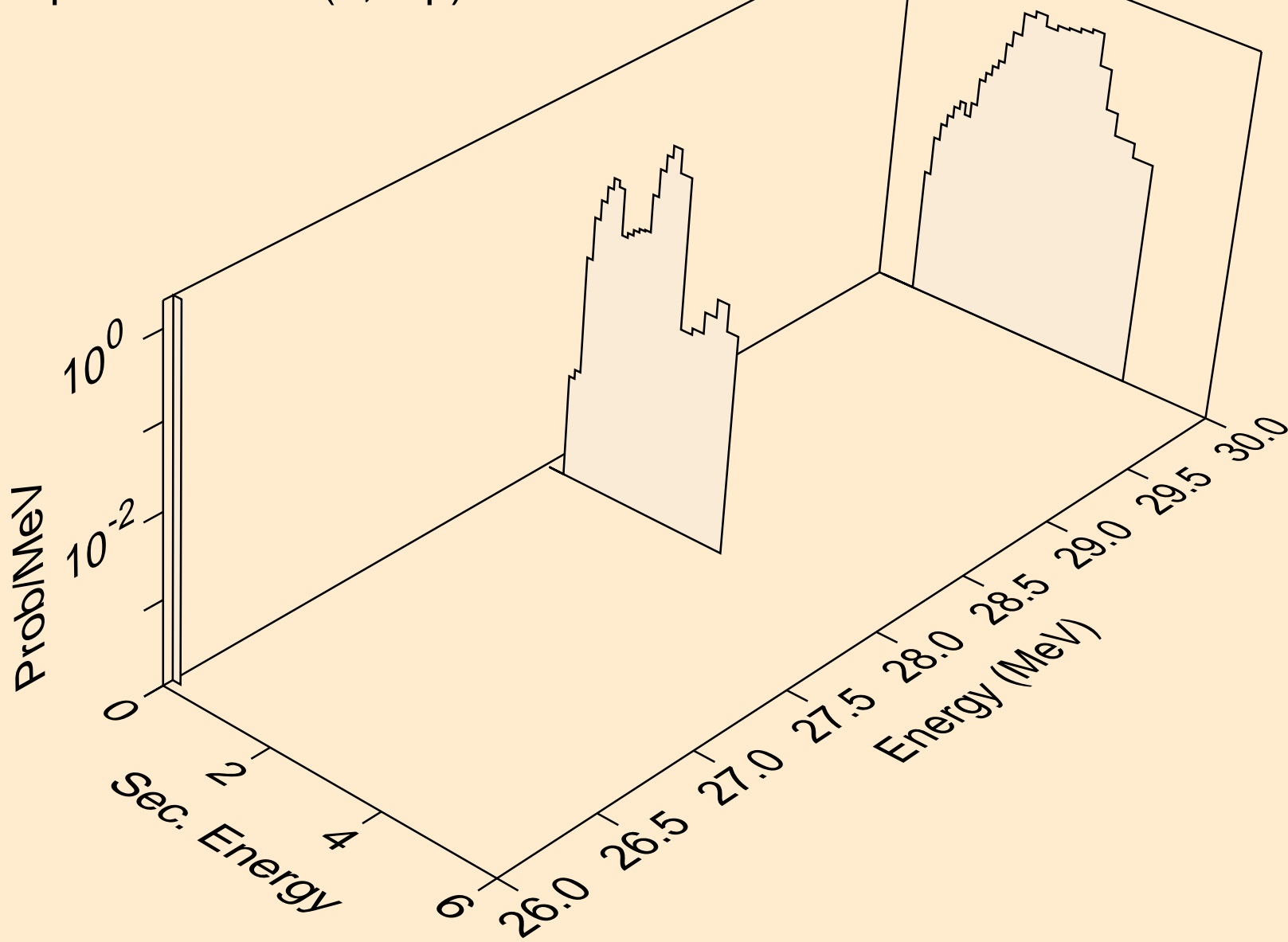

ZN070 NEUTRON ACER TENDL-2019 LIBRARY; T=293.16K
protons from (n,2np)

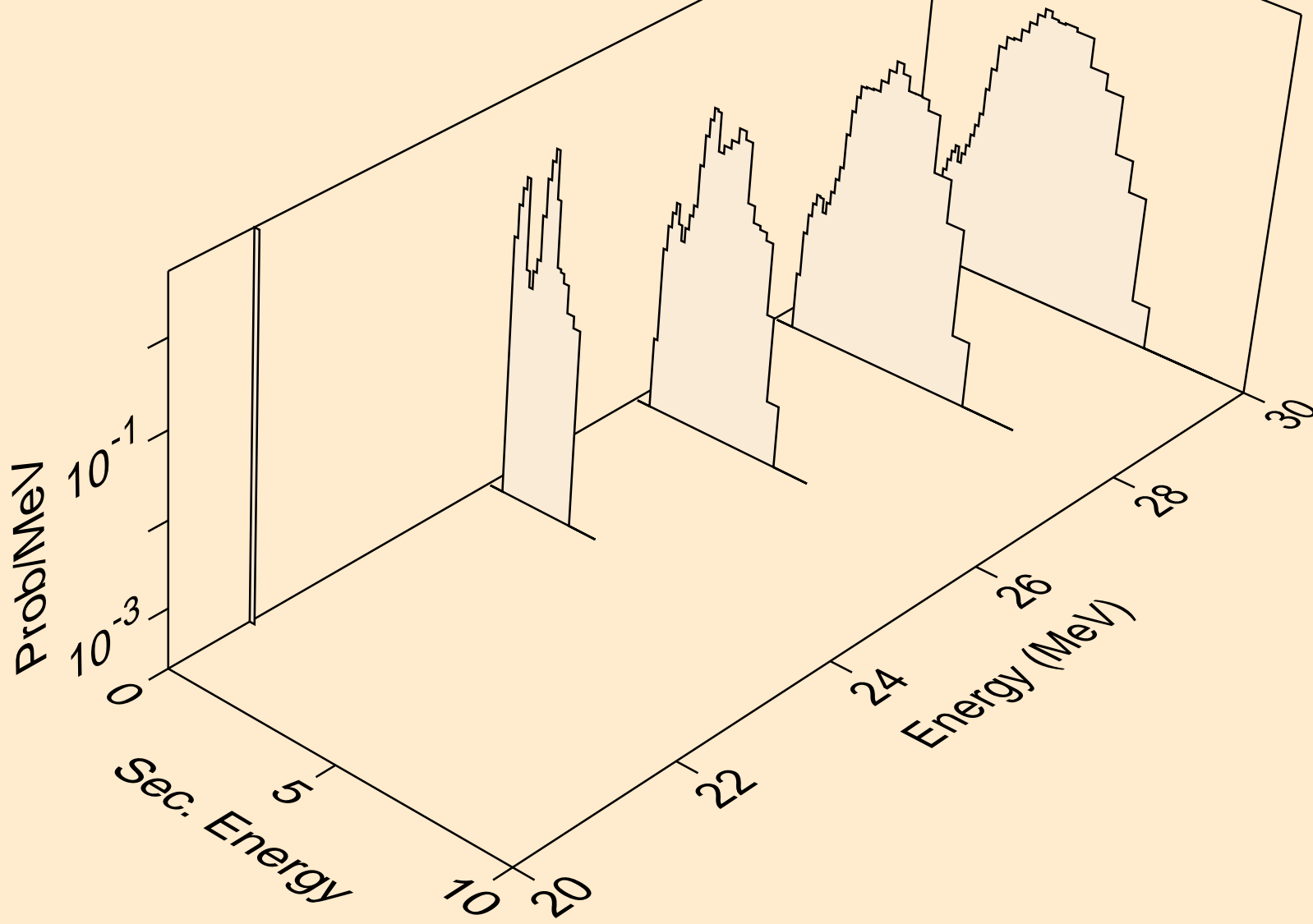

ZN070 NEUTRON ACER TENDL-2019 LIBRARY; T=293.16K
protons from (n,npa)

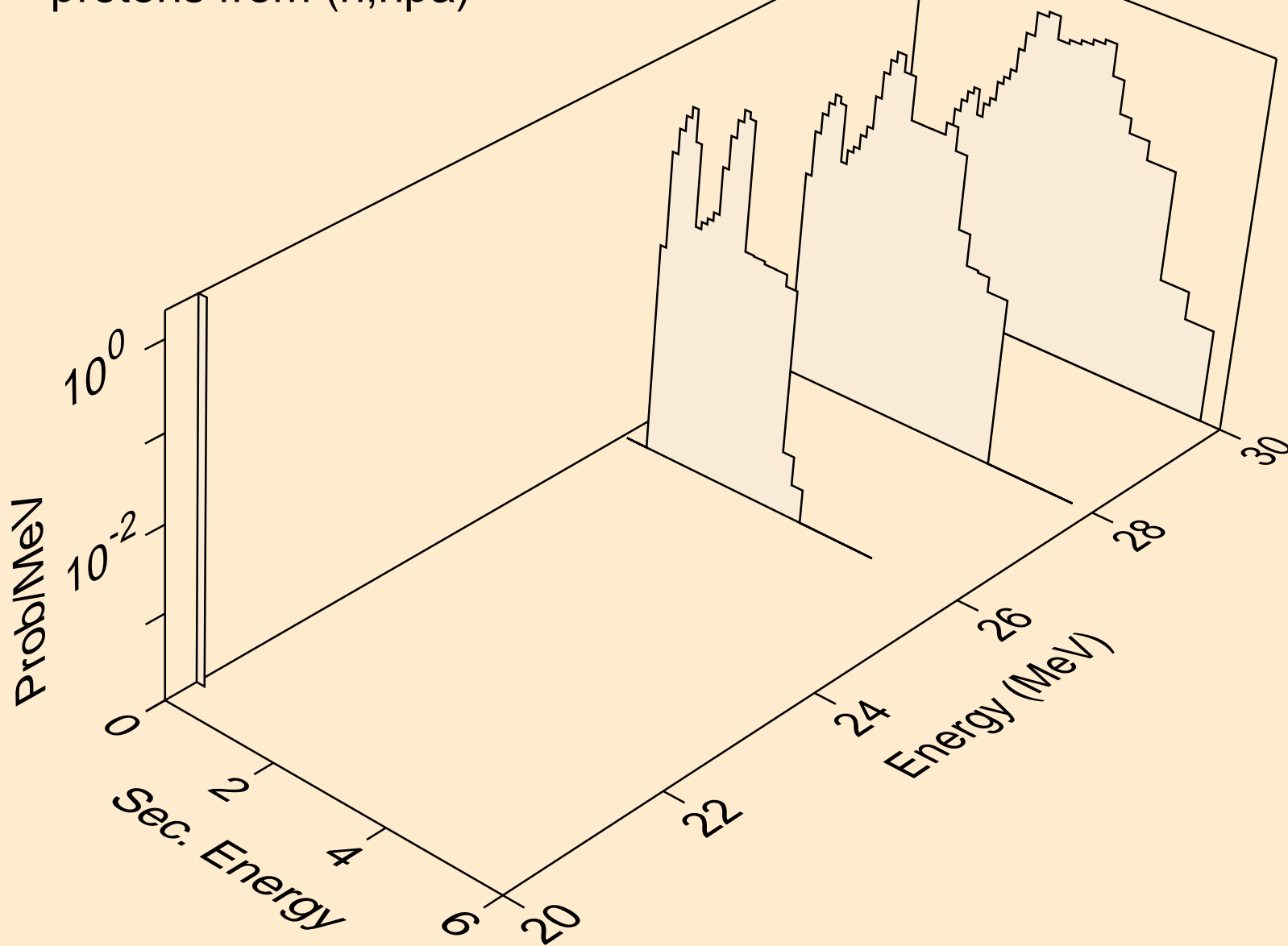

ZN070 NEUTRON ACER TENDL-2019 LIBRARY; T=293.16K
protons from (n,p)

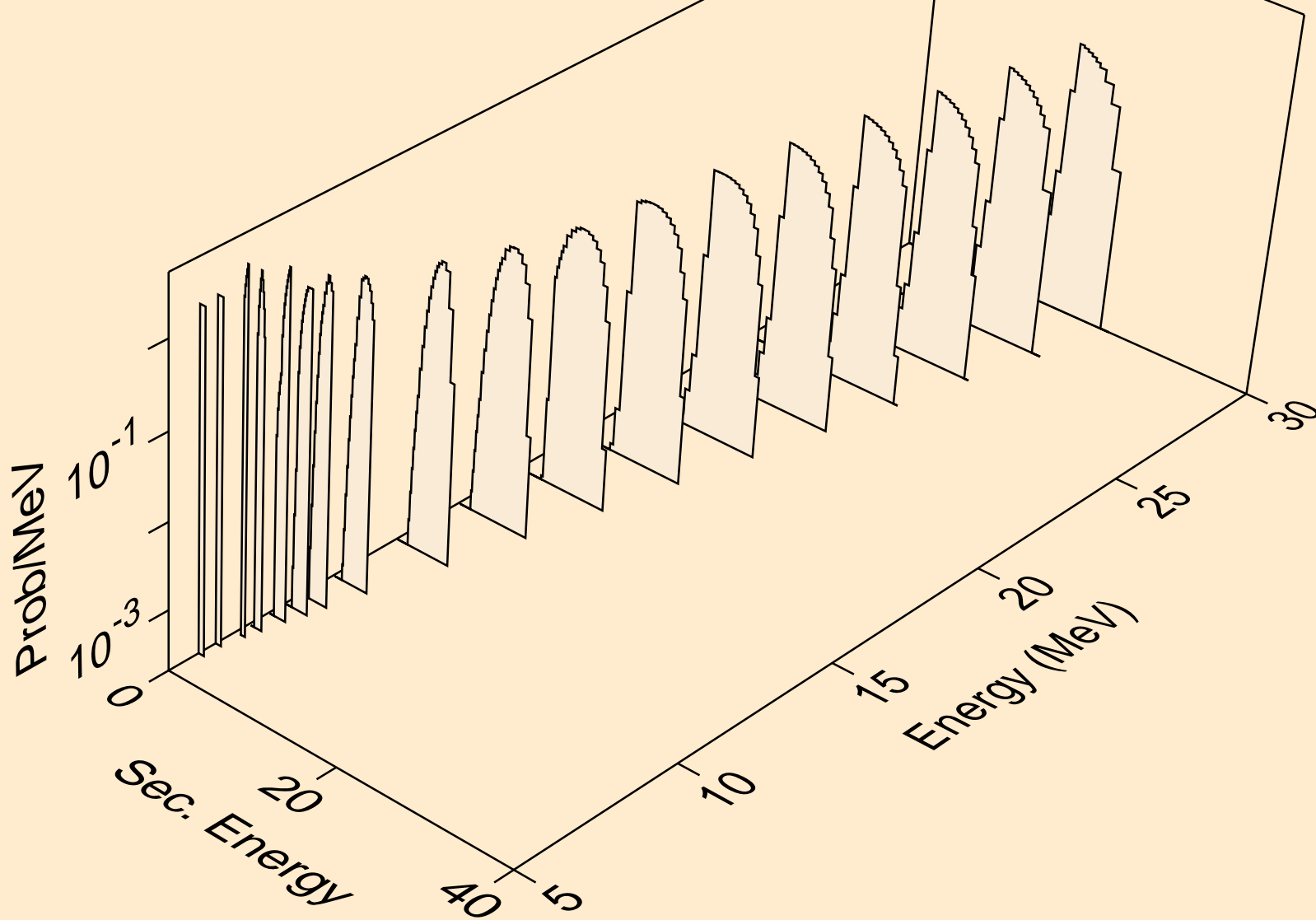

ZN070 NEUTRON ACER TENDL-2019 LIBRARY; T=293.16K
protons from (n,2p)

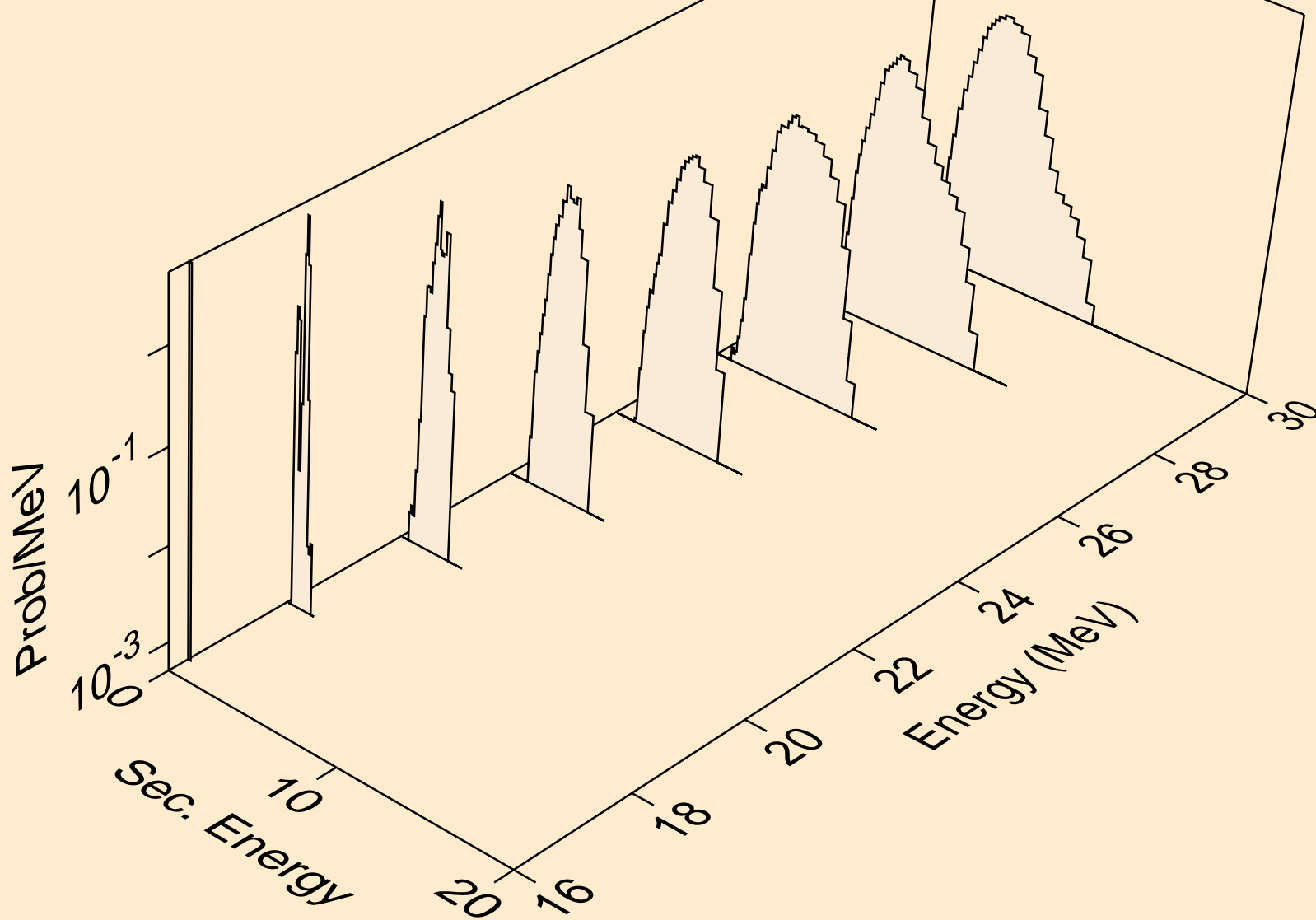

ZN070 NEUTRON ACER TENDL-2019 LIBRARY; T=293.16K
protons from (n,p)

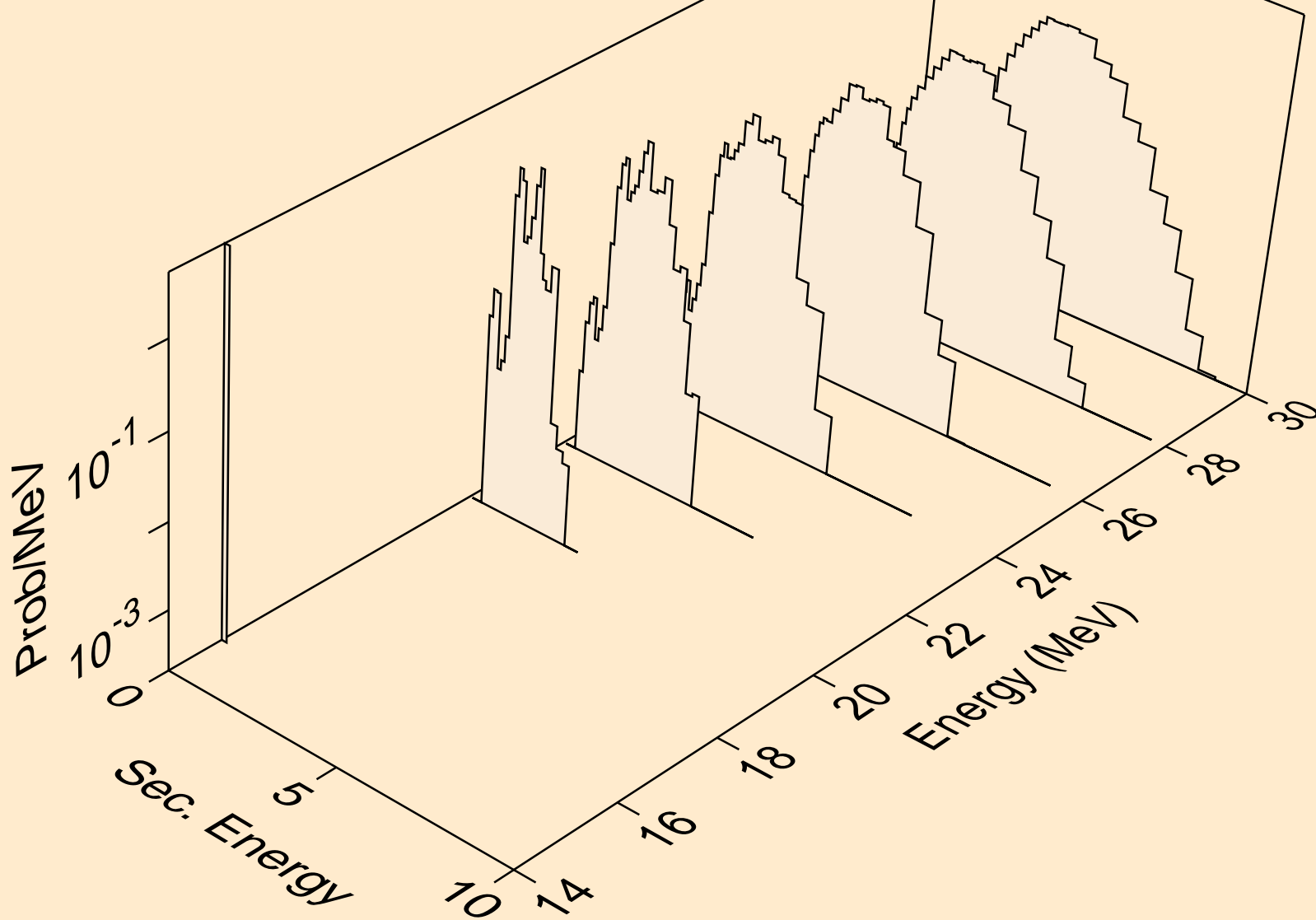

ZN070 NEUTRON ACER TENDL-2019 LIBRARY; T=293.16K
protons from (n,pd)

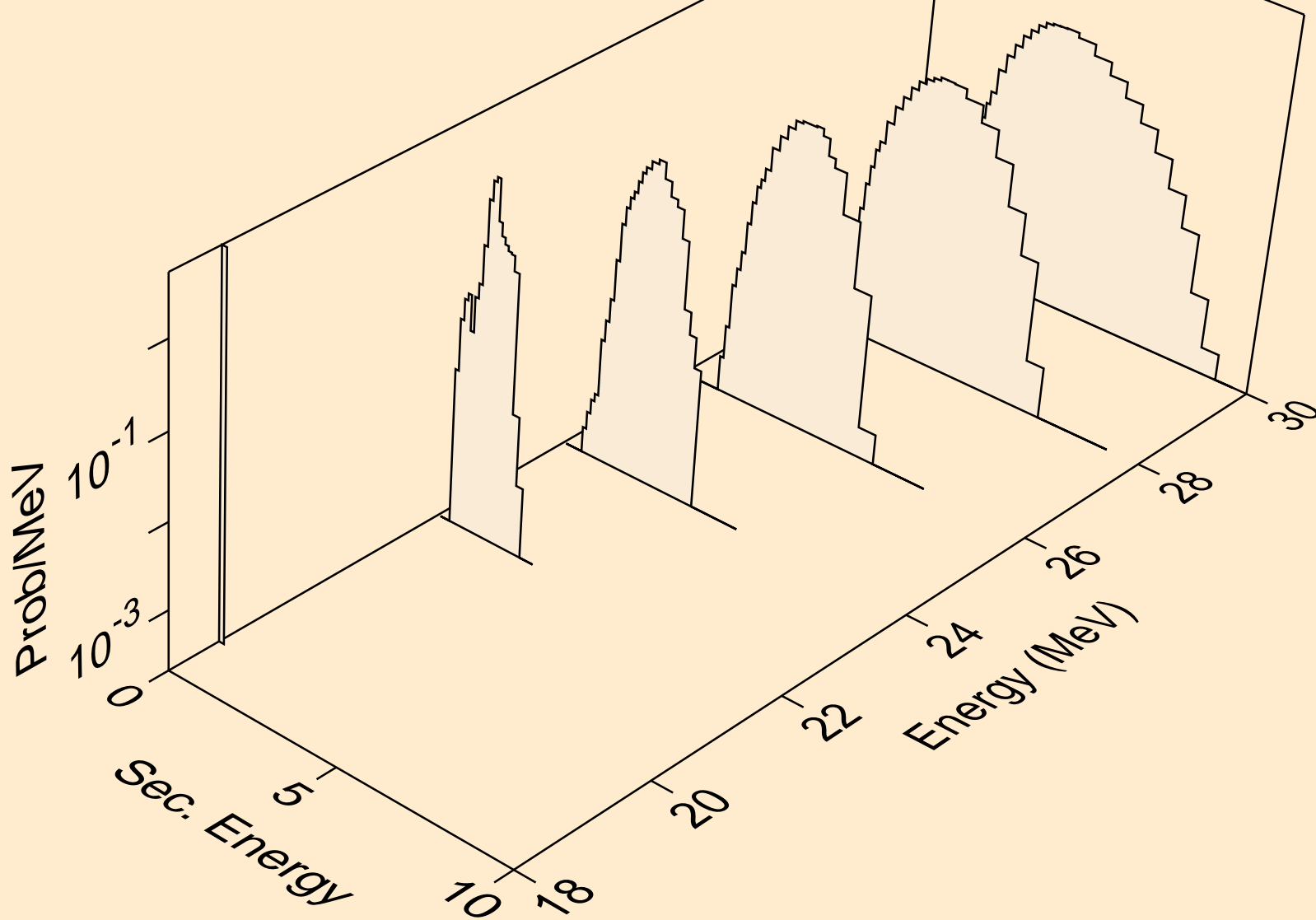

ZN070 NEUTRON ACER TENDL-2019 LIBRARY; T=293.16K
protons from (n,pt)

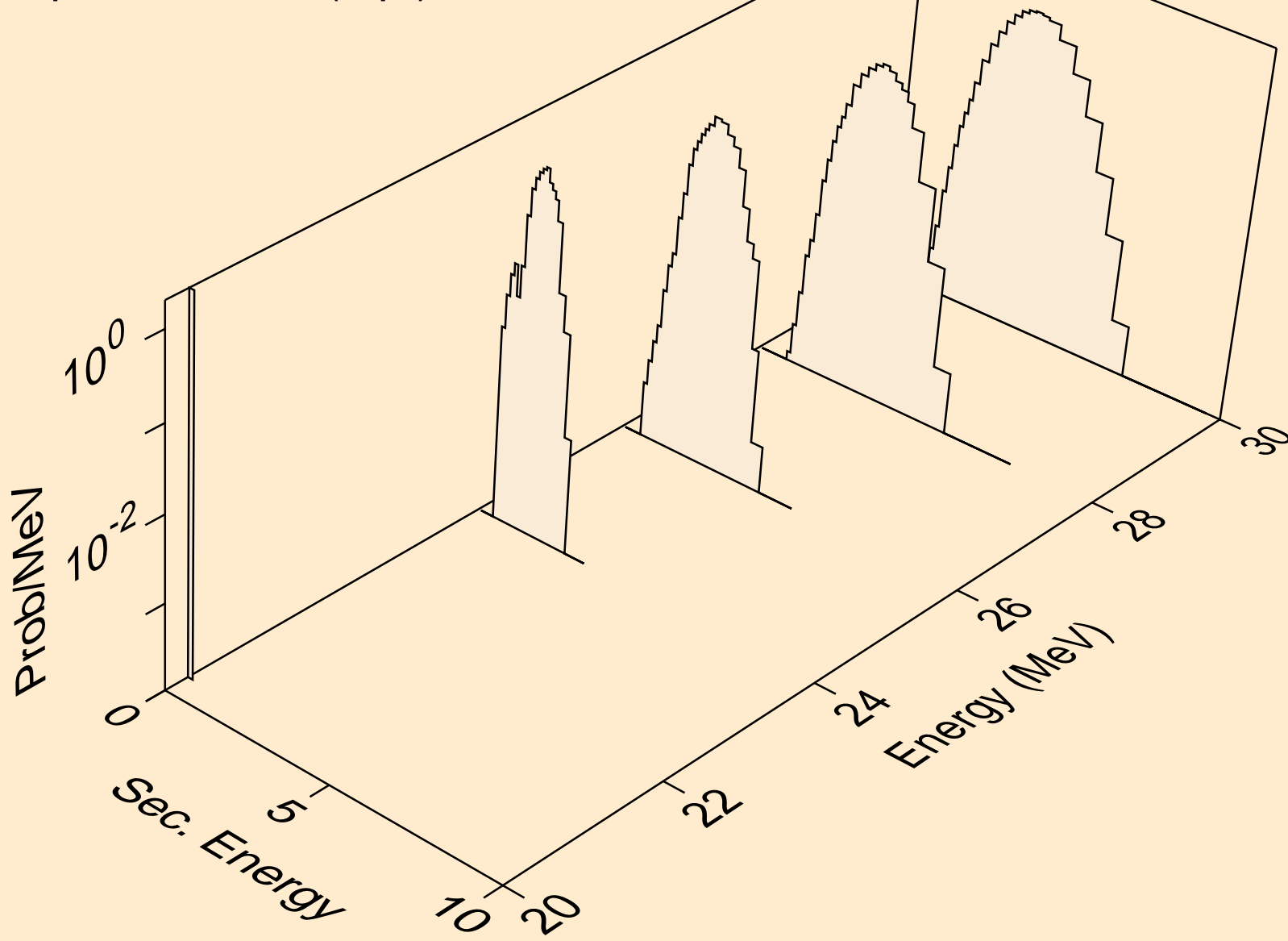

ZN070 NEUTRON ACER TENDL-2019 LIBRARY; T=293.16K
deuterons from (n,x)

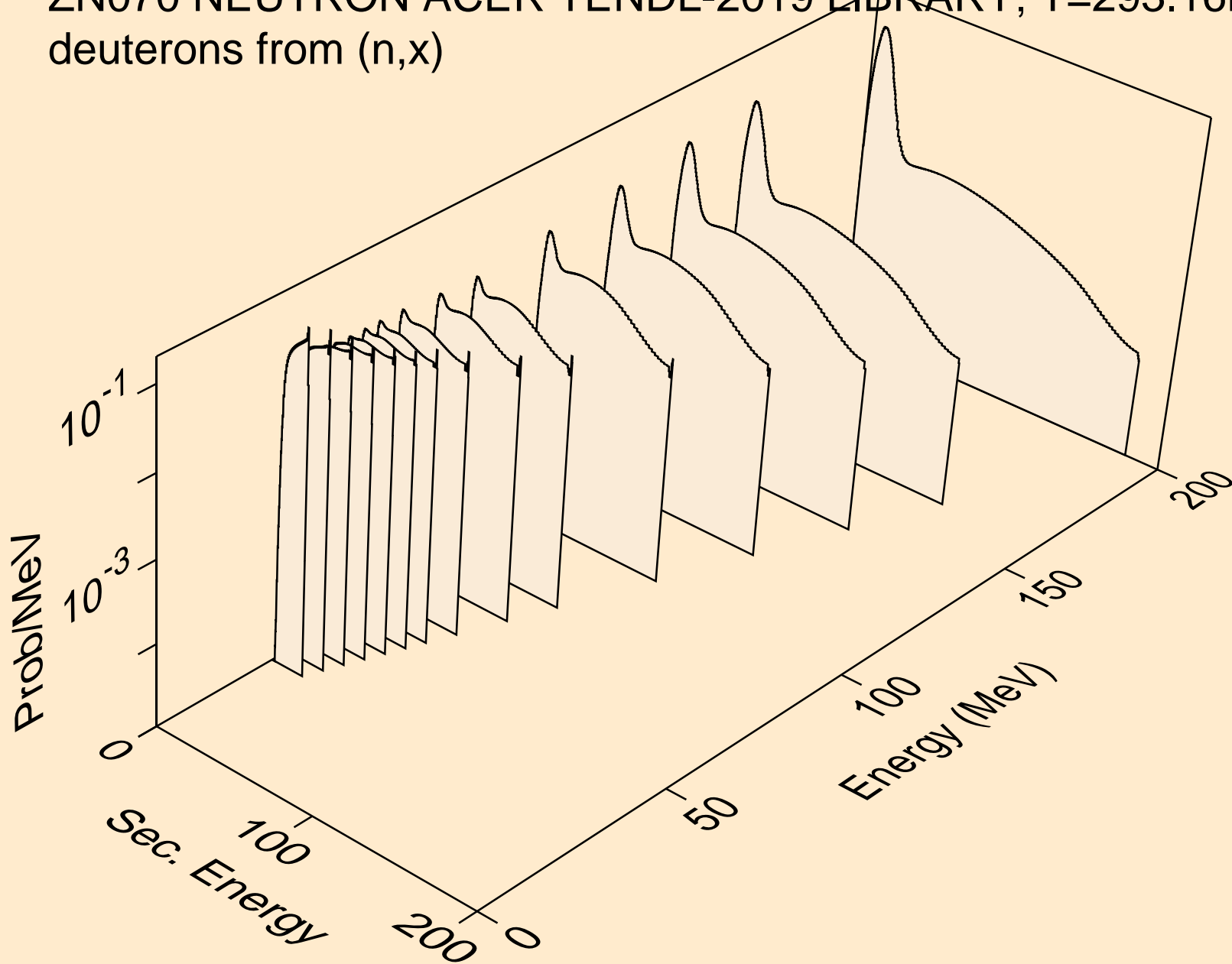

ZN070 NEUTRON ACER TENDL-2019 LIBRARY; T=293.16K
deuterons from (n,2nd)

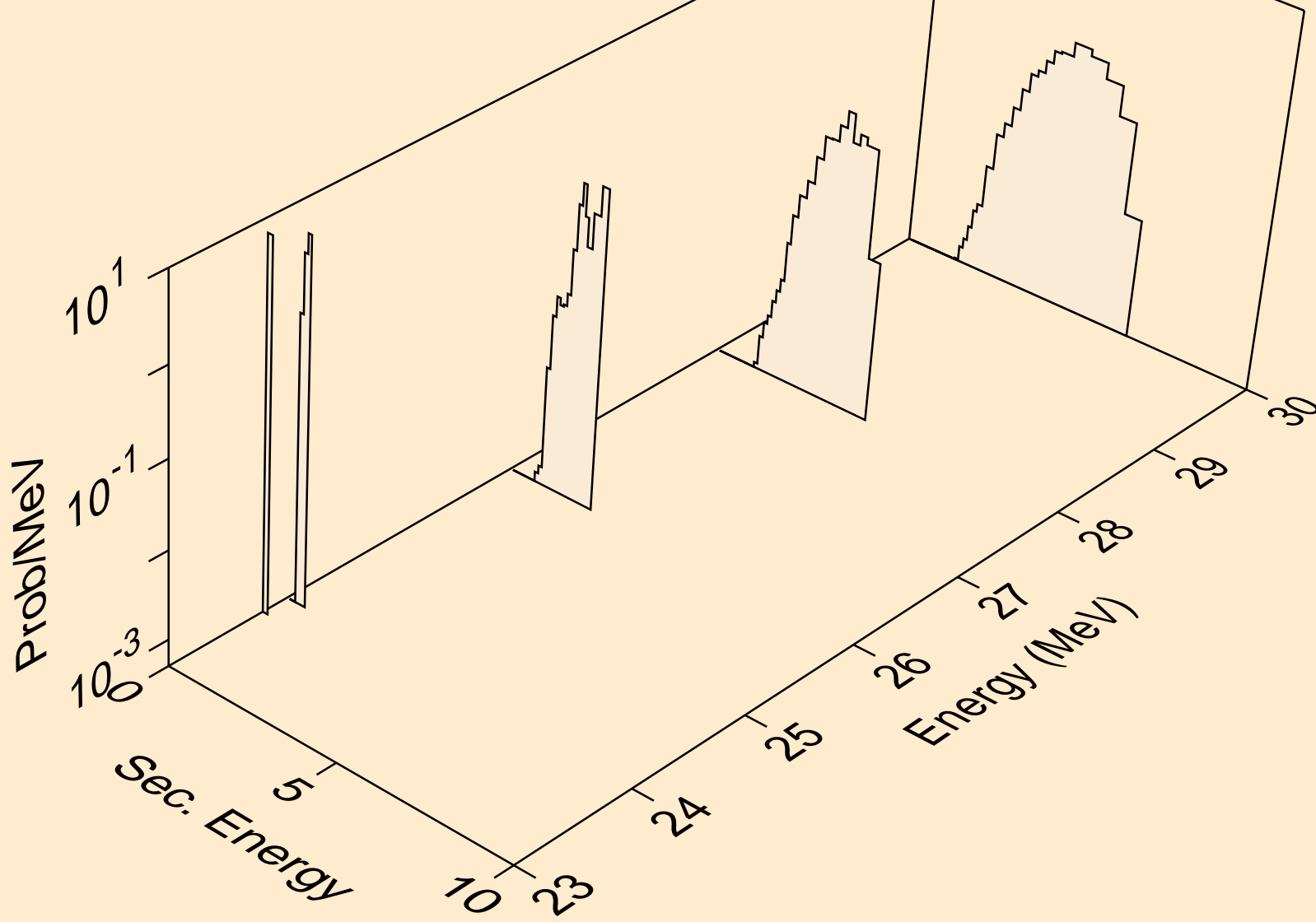

ZN070 NEUTRON ACER TENDL-2019 LIBRARY; T=293.16K
deuterons from (n,n*)d

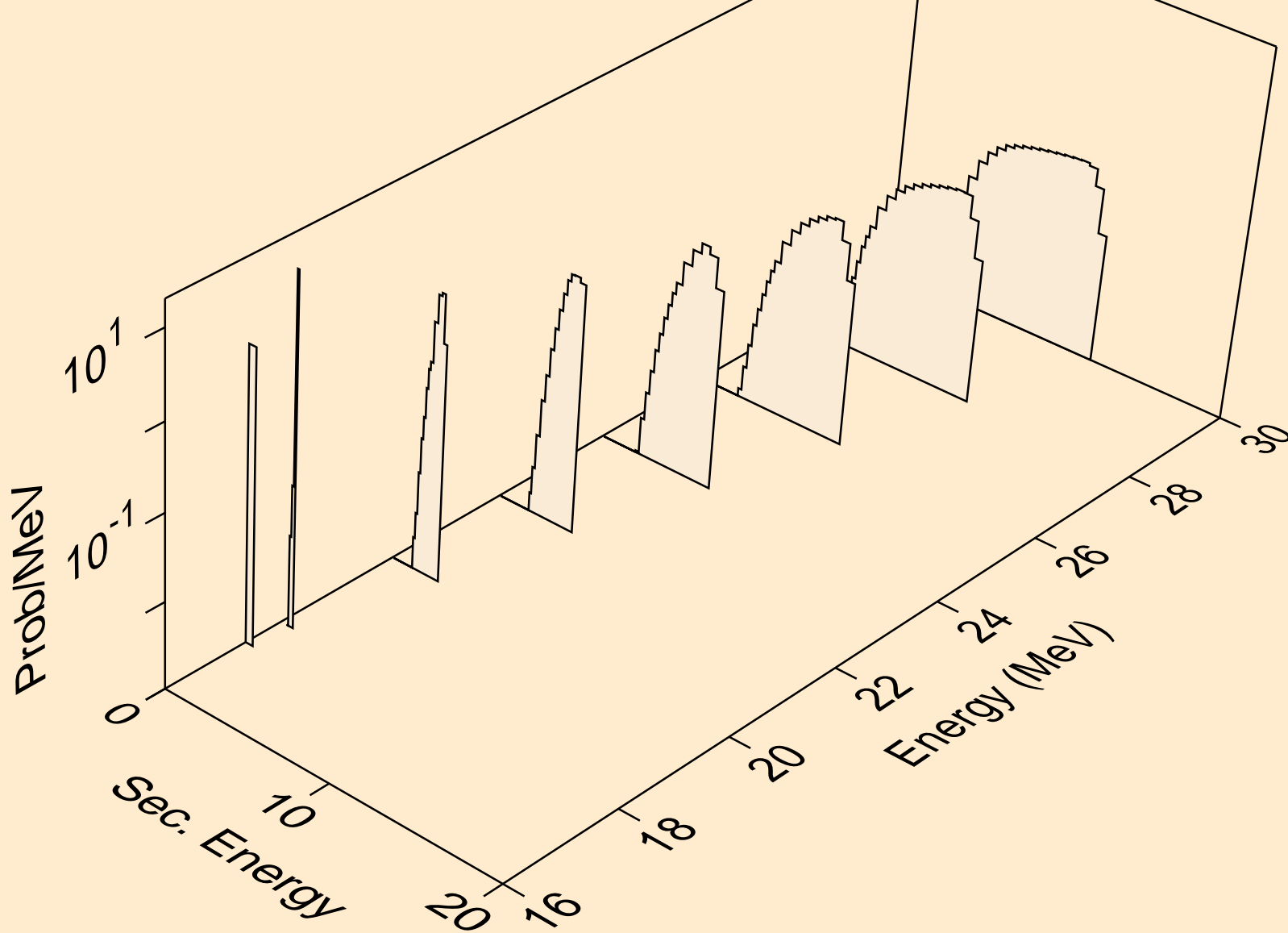

ZN070 NEUTRON ACER TENDL-2019 LIBRARY; T=293.16K
deuterons from (n,d)

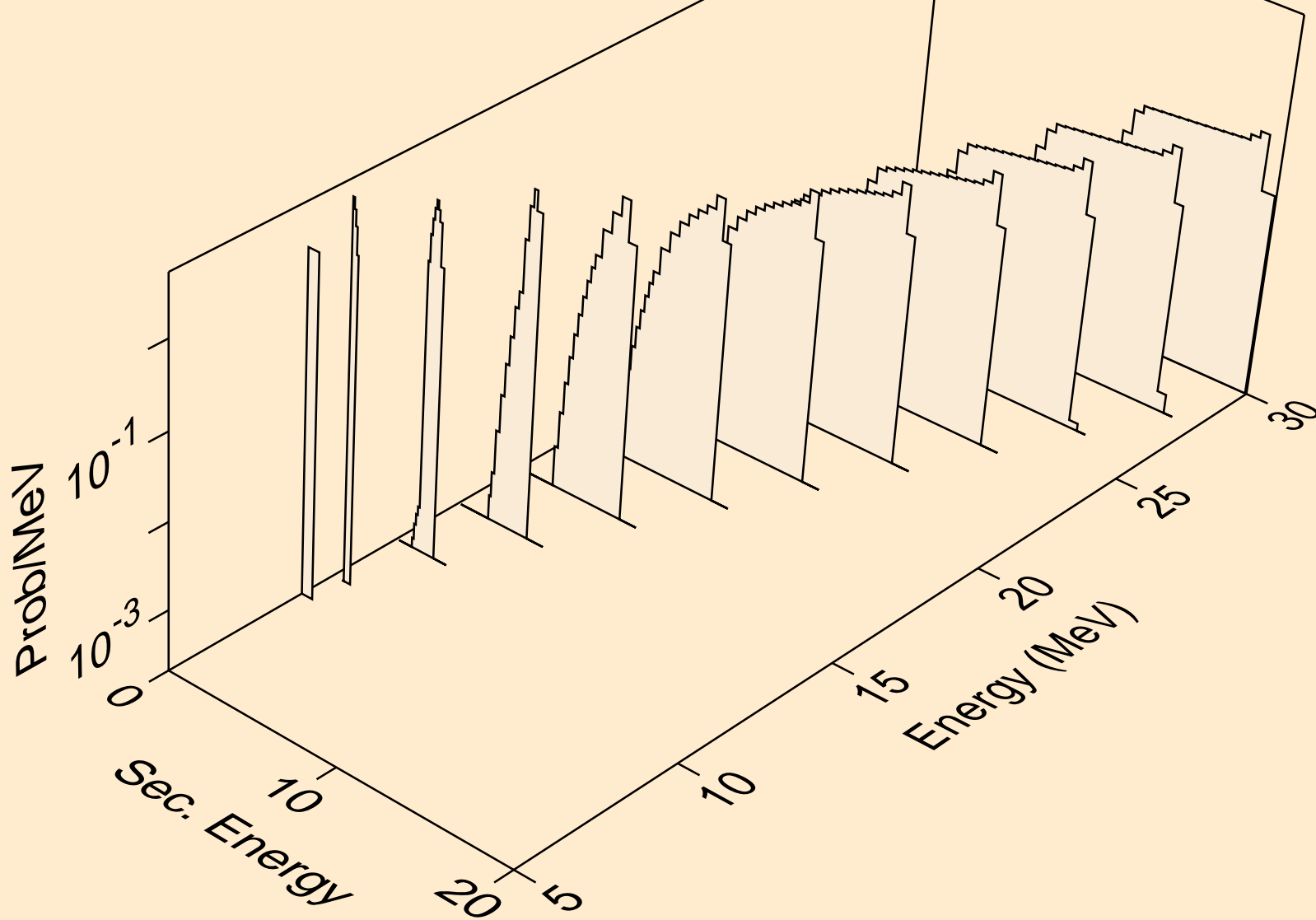

ZN070 NEUTRON ACER TENDL-2019 LIBRARY; T=293.16K
deuterons from (n,pd)

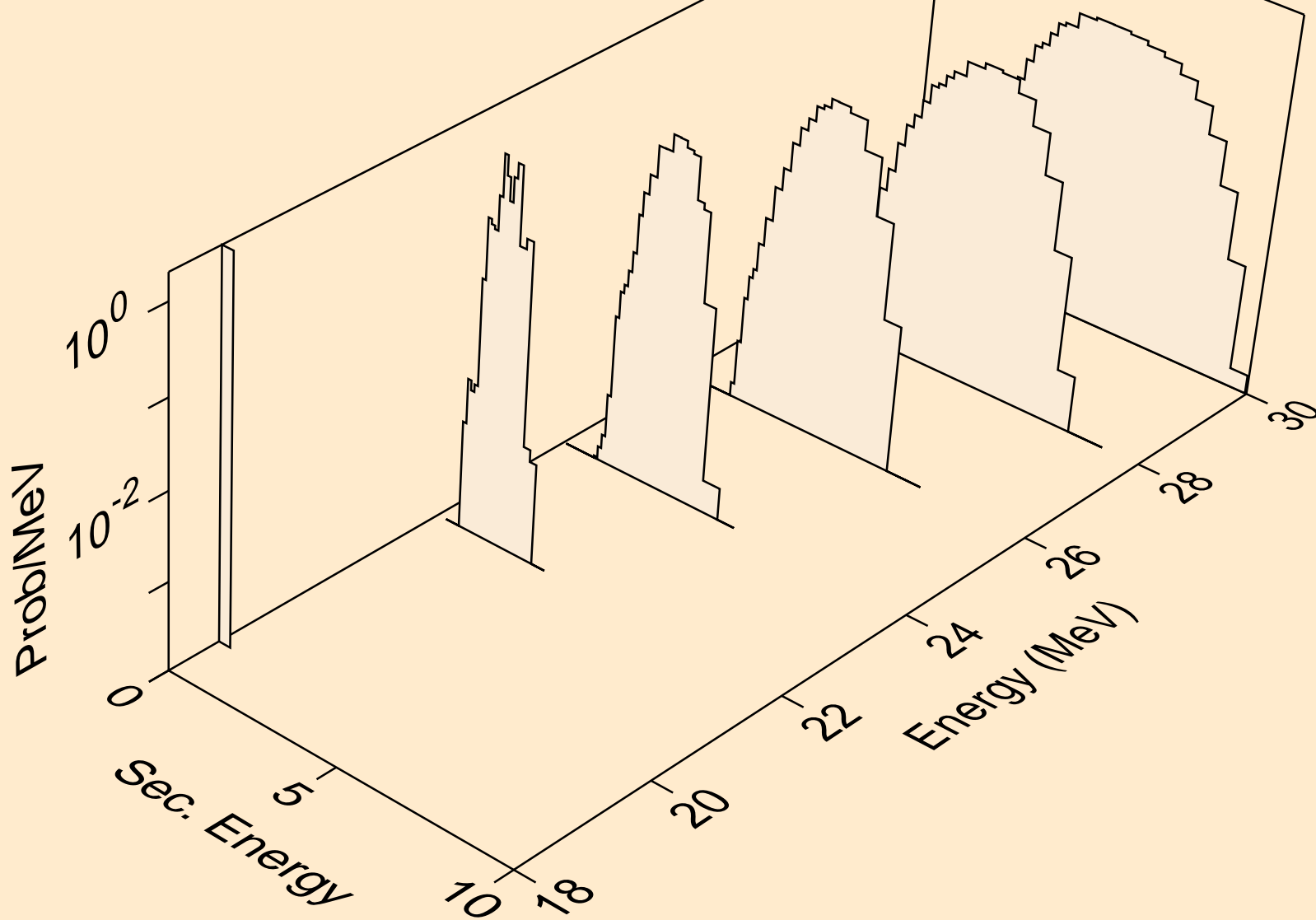

ZN070 NEUTRON ACER TENDL-2019 LIBRARY; T=293.16K
deuterons from (n,da)

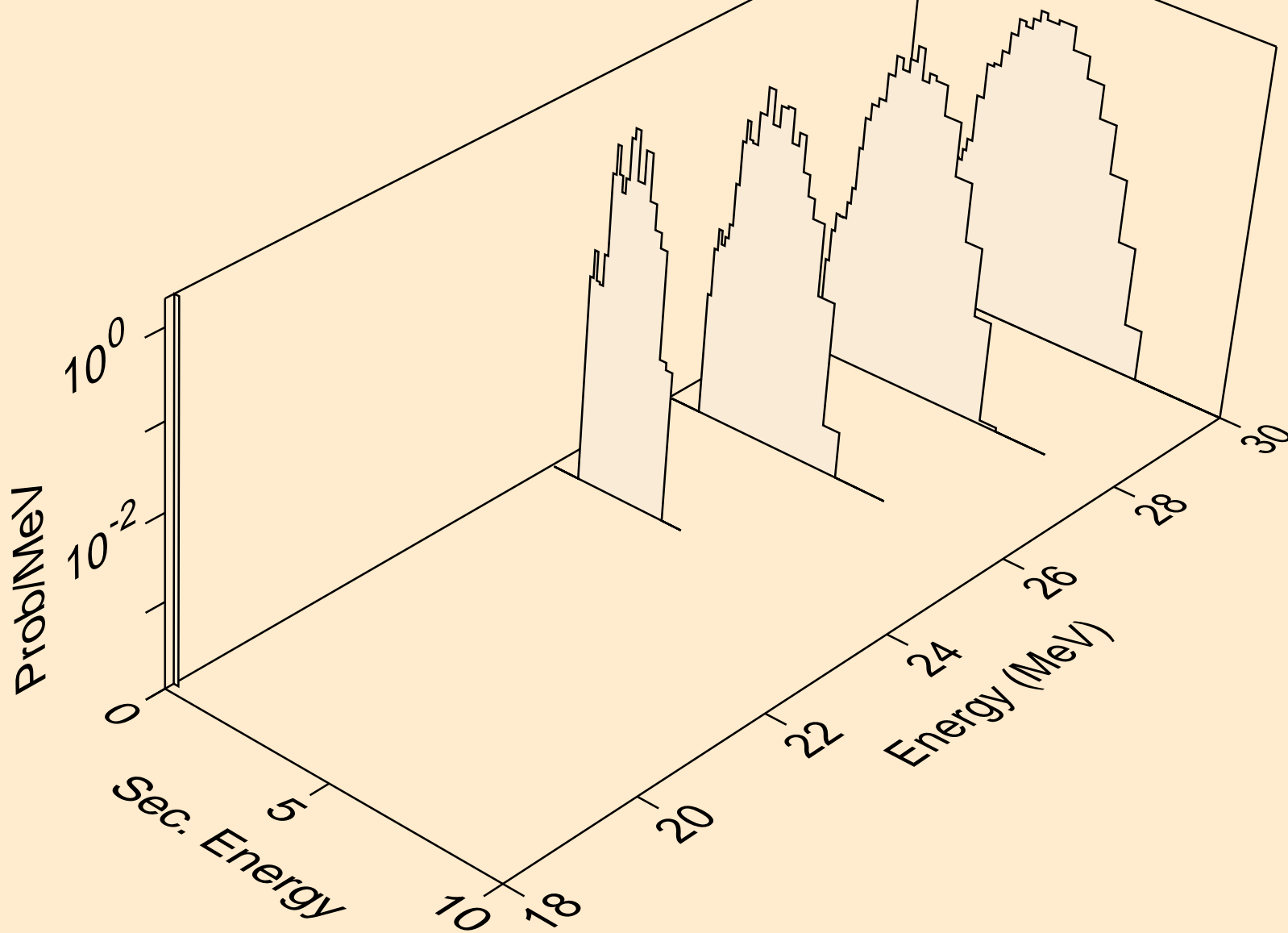

ZN070 NEUTRON ACER TENDL-2019 LIBRARY; T=293.16K
tritons from (n,x)

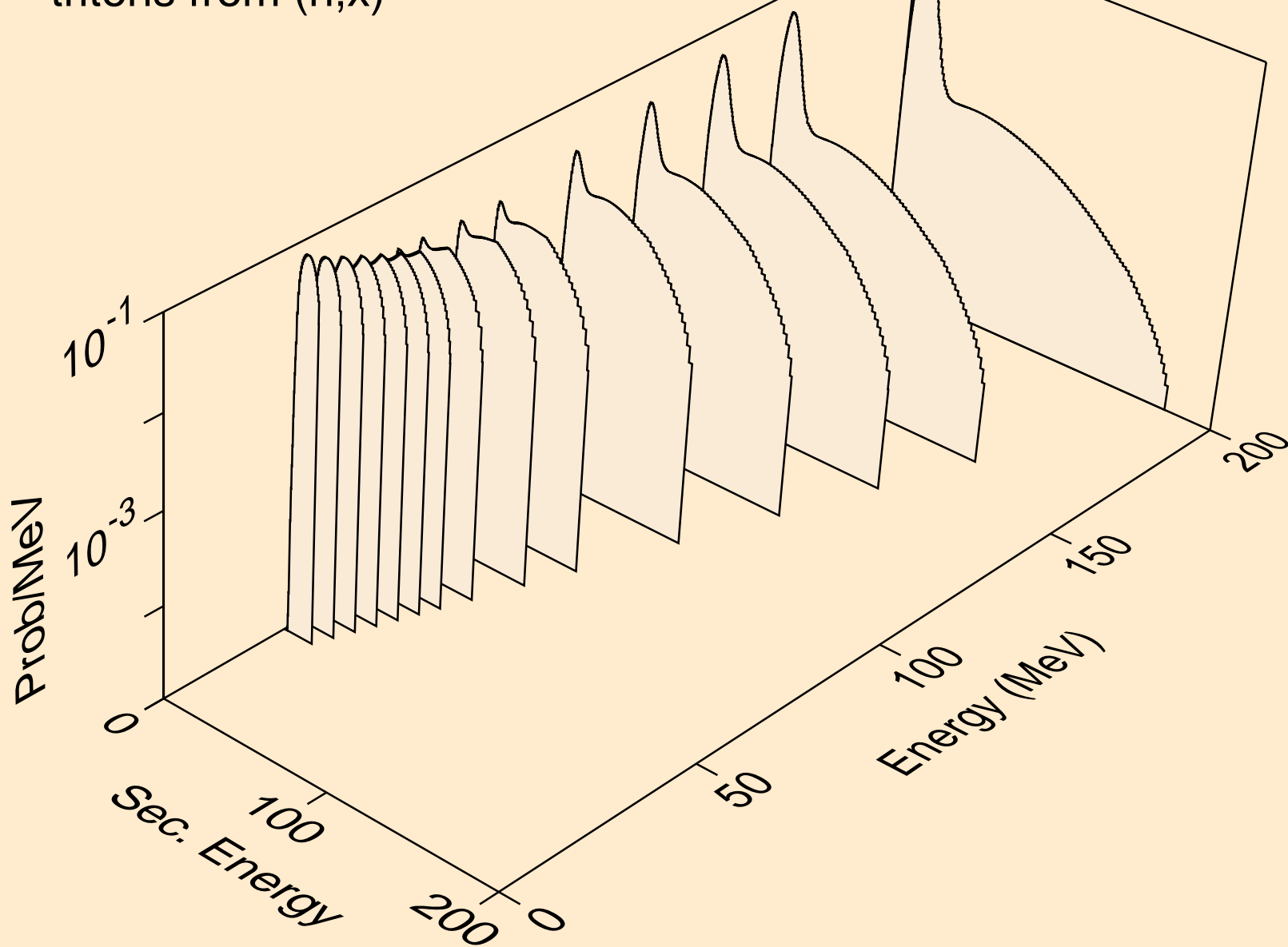

ZN070 NEUTRON ACER TENDL-2019 LIBRARY; T=293.16K
tritons from (n,n*)t

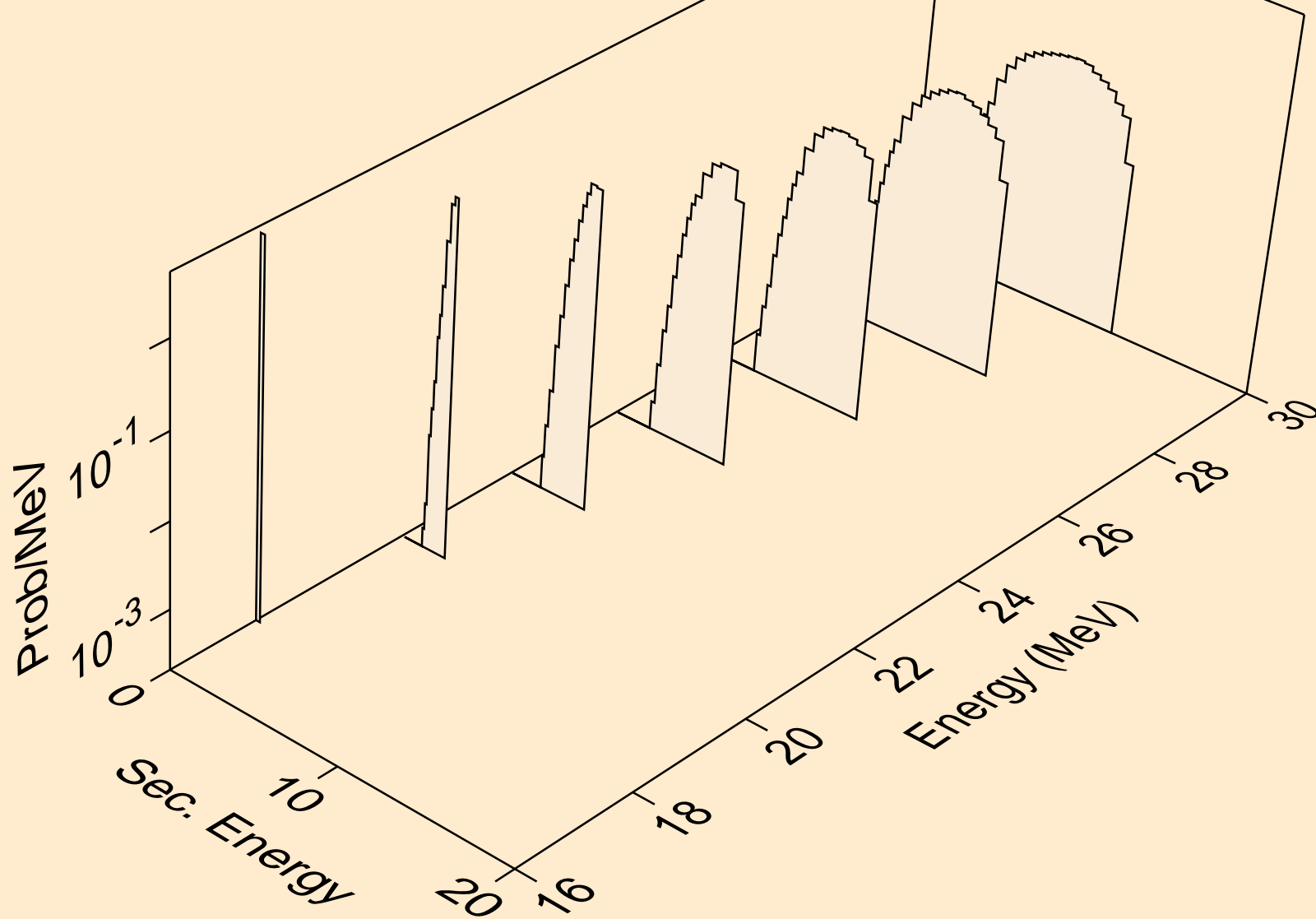

ZN070 NEUTRON ACER TENDL-2019 LIBRARY; T=293.16K
tritons from (n,t)

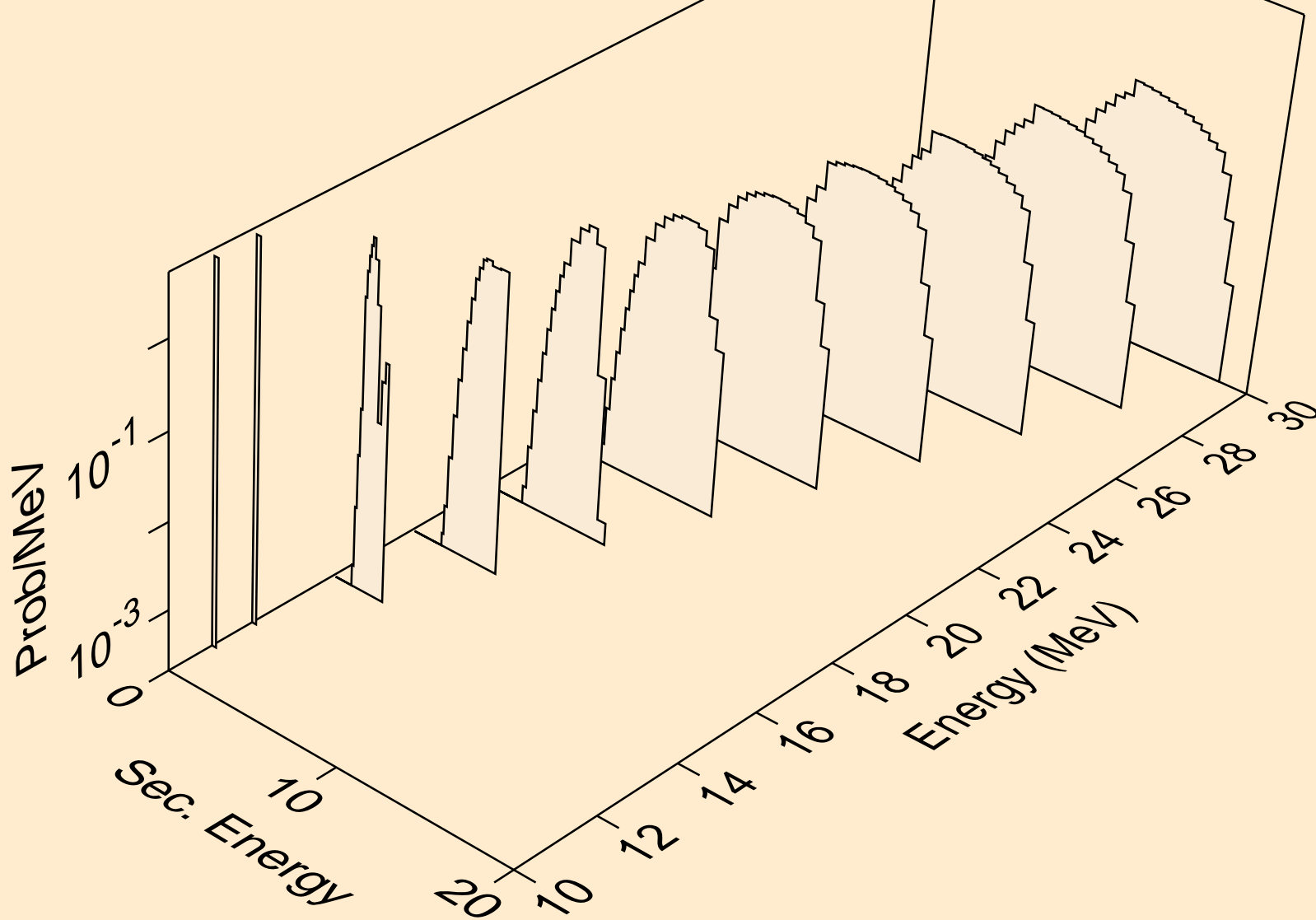

ZN070 NEUTRON ACER TENDL-2019 LIBRARY; T=293.16K
tritons from (n,pt)

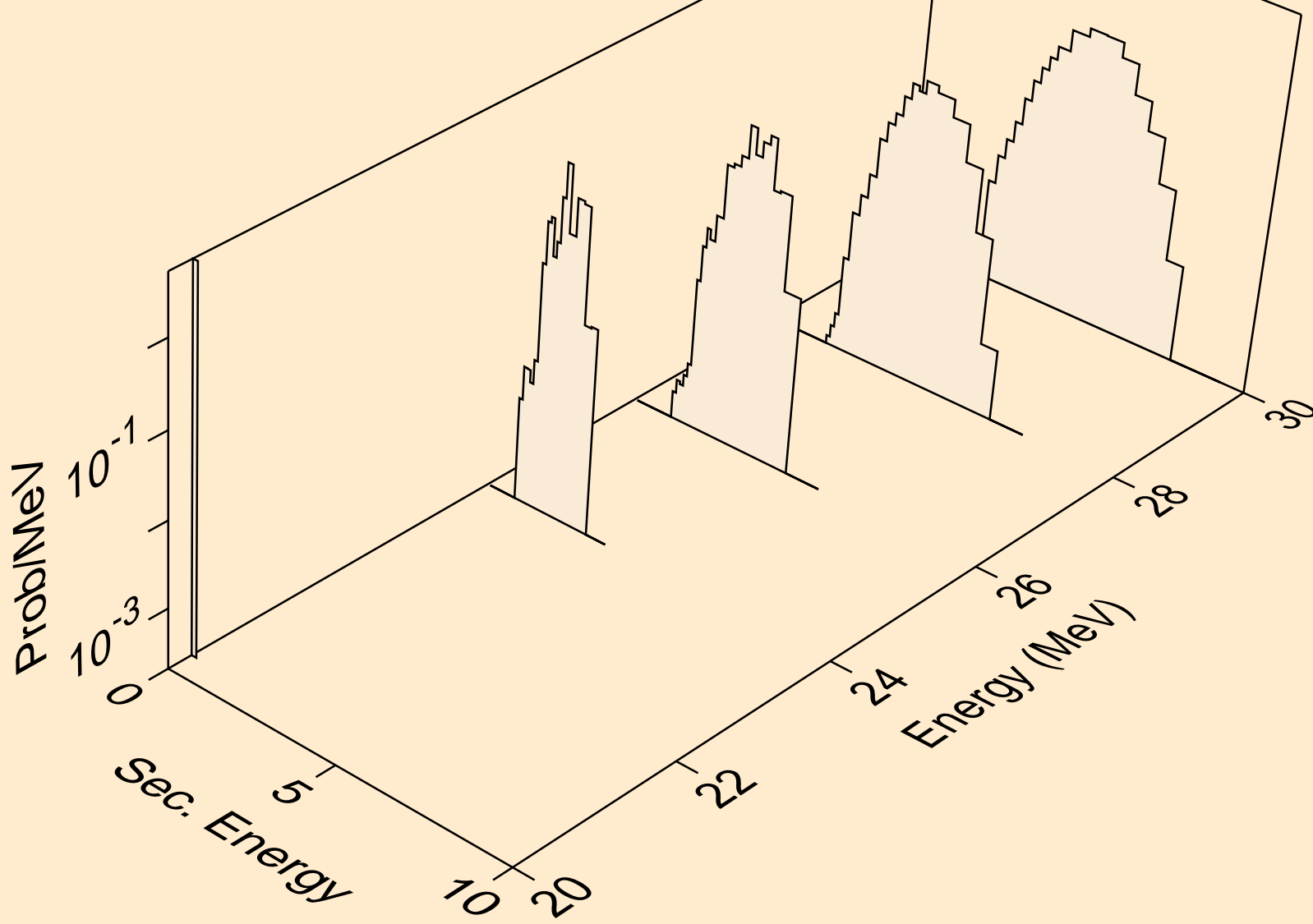

ZN070 NEUTRON ACER TENDL-2019 LIBRARY; T=293.16K
he3s from (n,x)

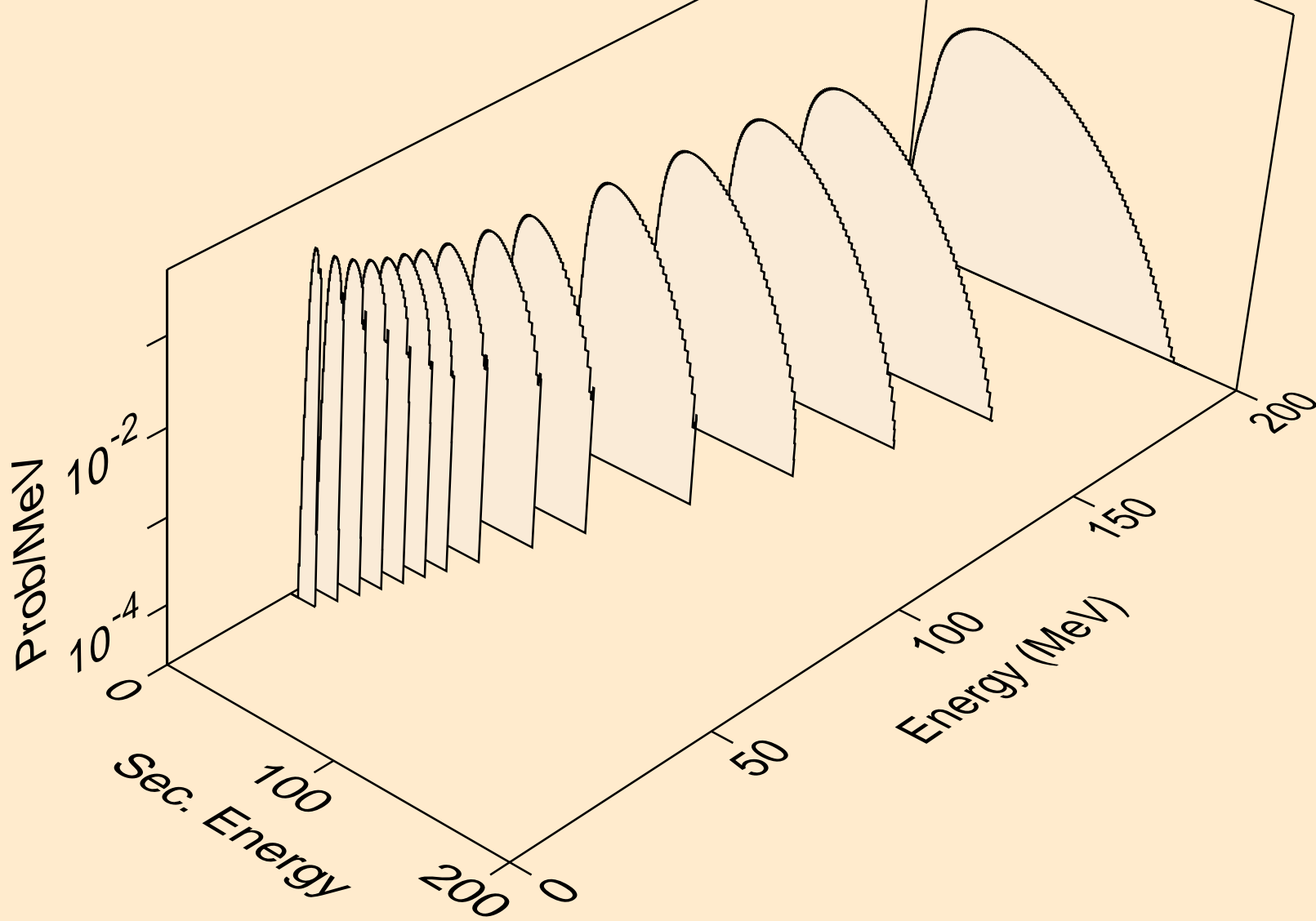

ZN070 NEUTRON ACER TENDL-2019 LIBRARY; T=293.16K
he3s from (n,n*)he3

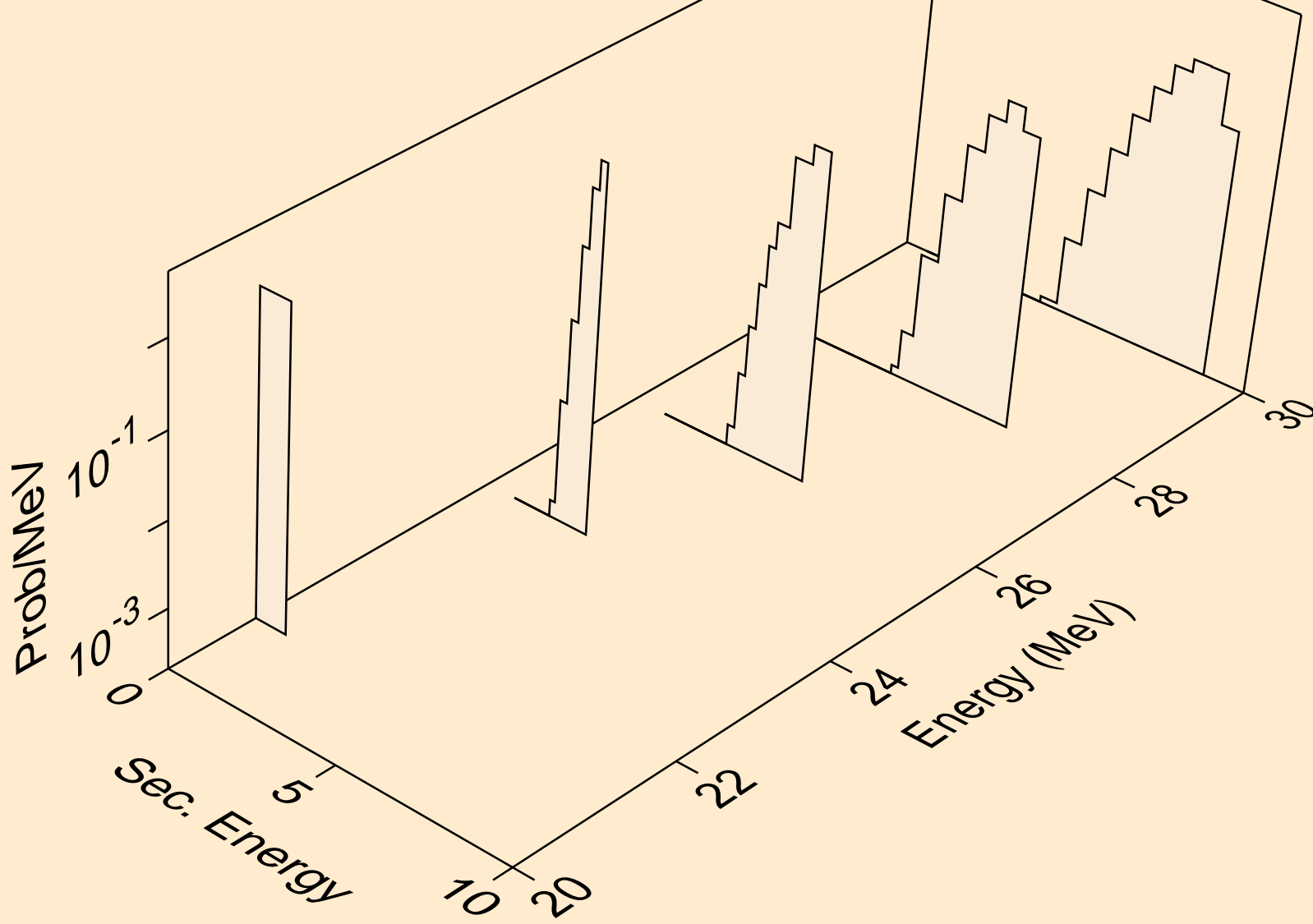

ZN070 NEUTRON ACER TENDL-2019 LIBRARY; T=293.16K
he3s from (n,he3)

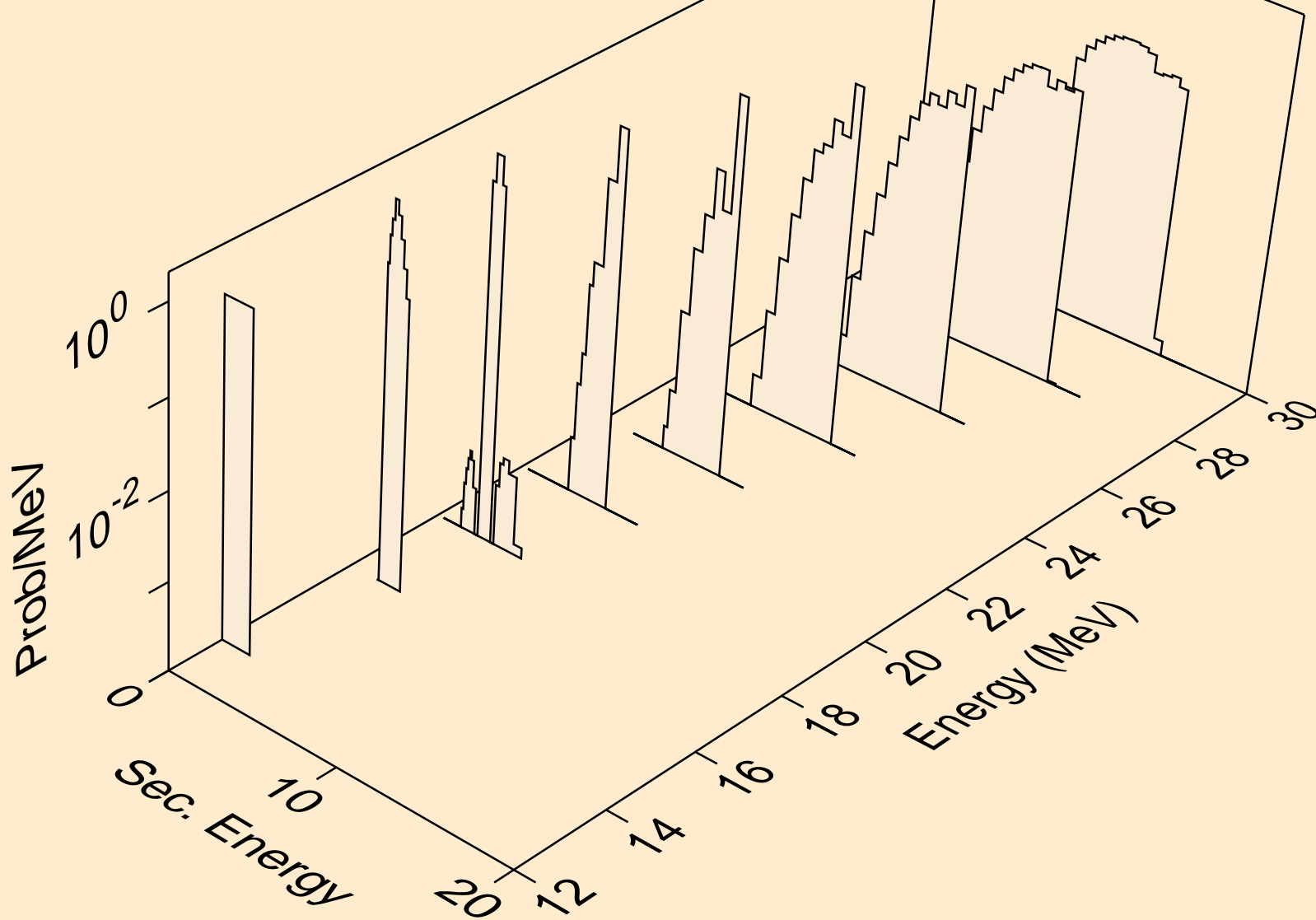

ZN070 NEUTRON ACER TENDL-2019 LIBRARY; T=293.16K
alphas from (n,x)

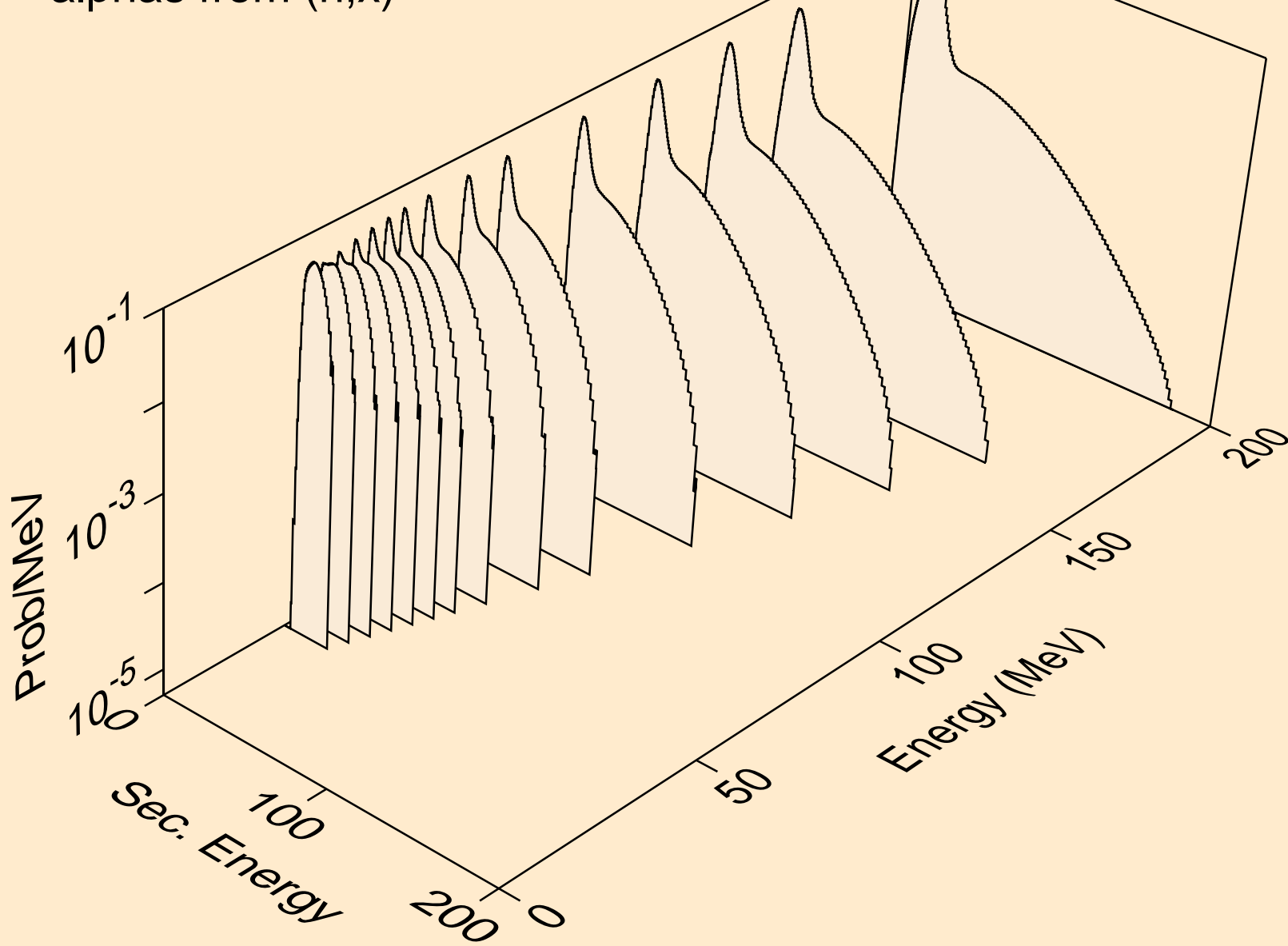

ZN070 NEUTRON ACER TENDL-2019 LIBRARY; T=293.16K
alphas from (n,n*)a

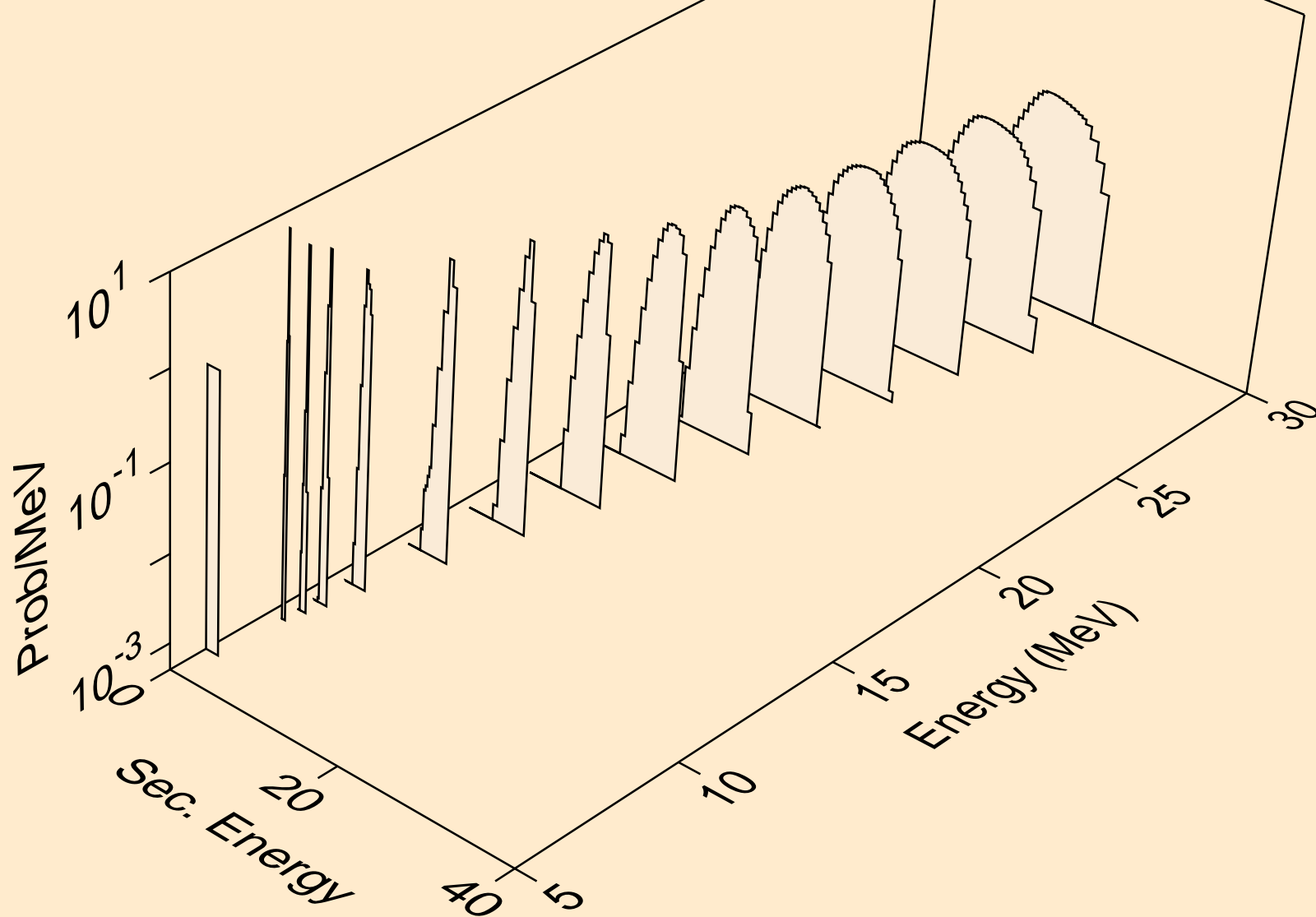

ZN070 NEUTRON ACER TENDL-2019 LIBRARY; T=293.16K
alphas from (n,2n)a

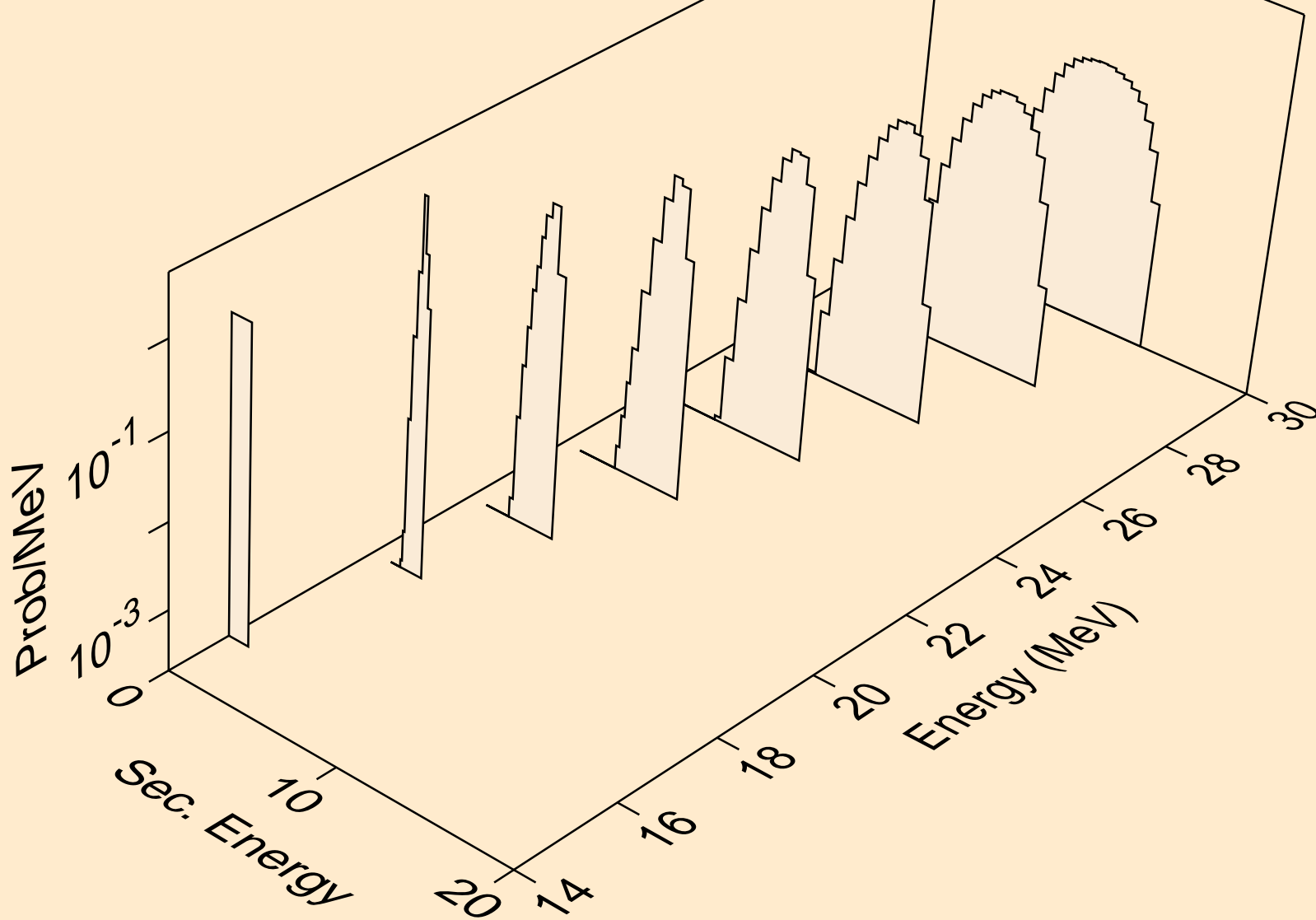

ZN070 NEUTRON ACER TENDL-2019 LIBRARY; T=293.16K
alphas from (n,3n)a

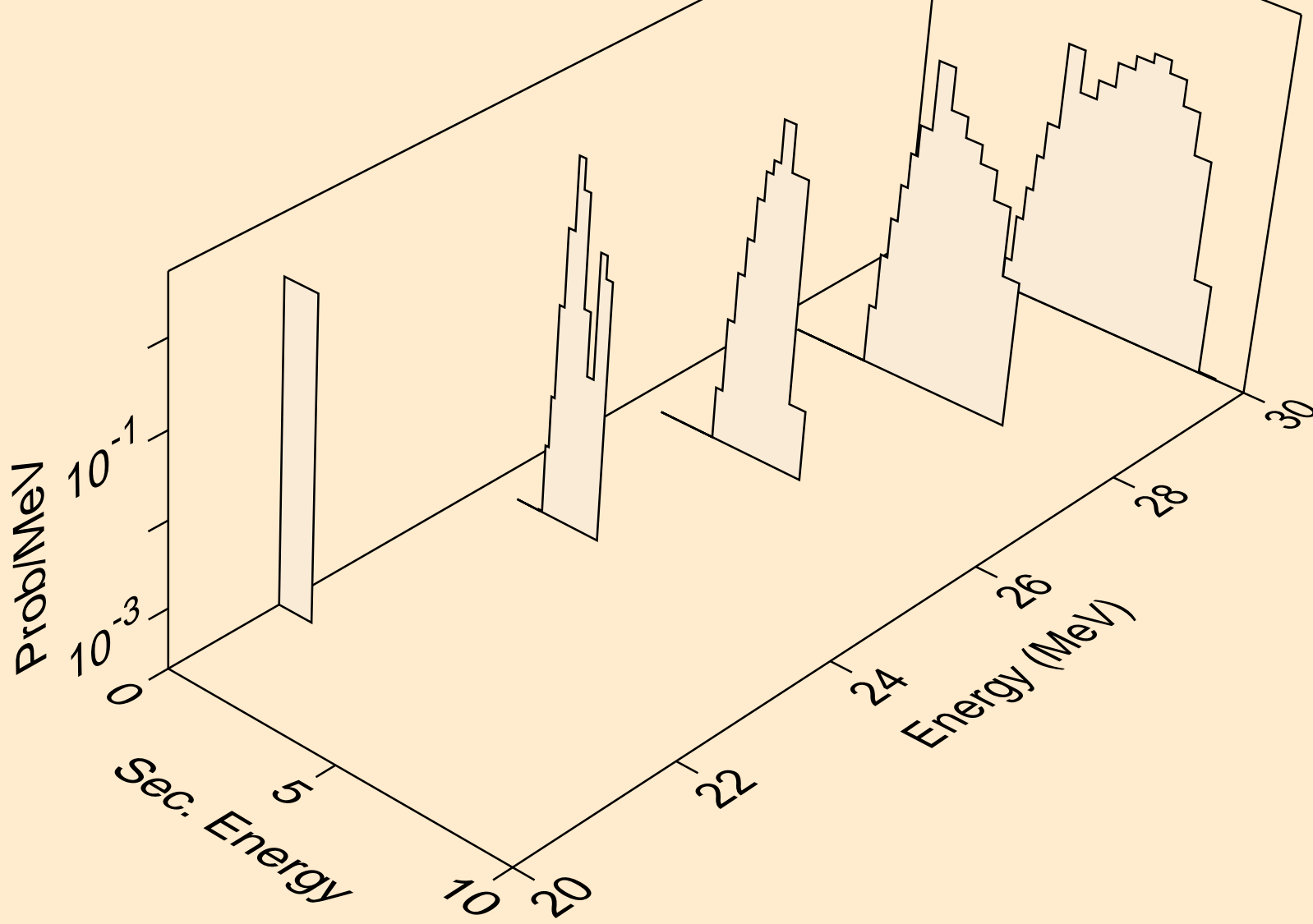

ZN070 NEUTRON ACER TENDL-2019 LIBRARY; T=293.16K
alphas from (n,n*)2a

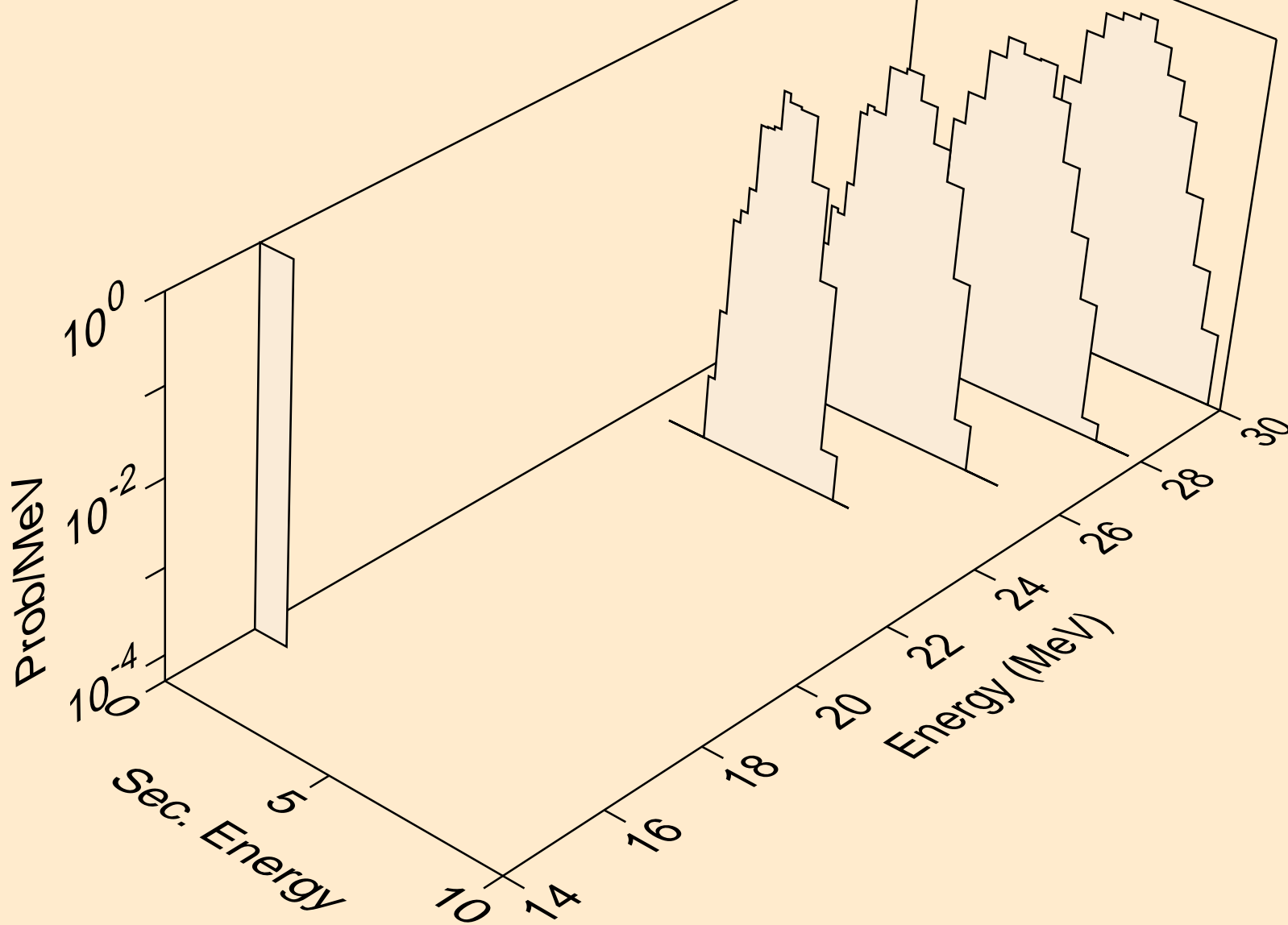

ZN070 NEUTRON ACER TENDL-2019 LIBRARY; T=293.16K
alphas from (n,npa)

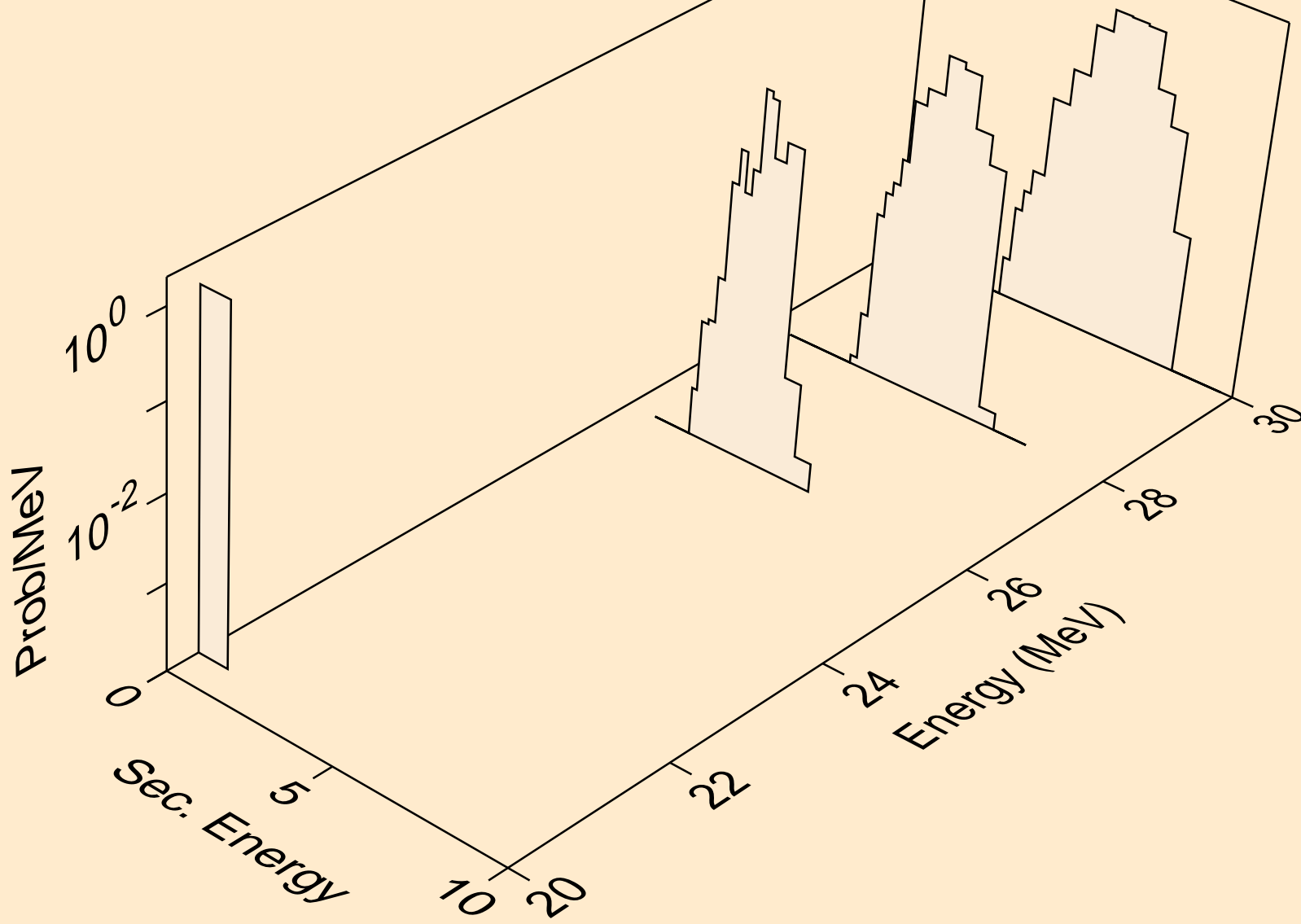

ZN070 NEUTRON ACER TENDL-2019 LIBRARY; T=293.16K
alphas from (n,a)

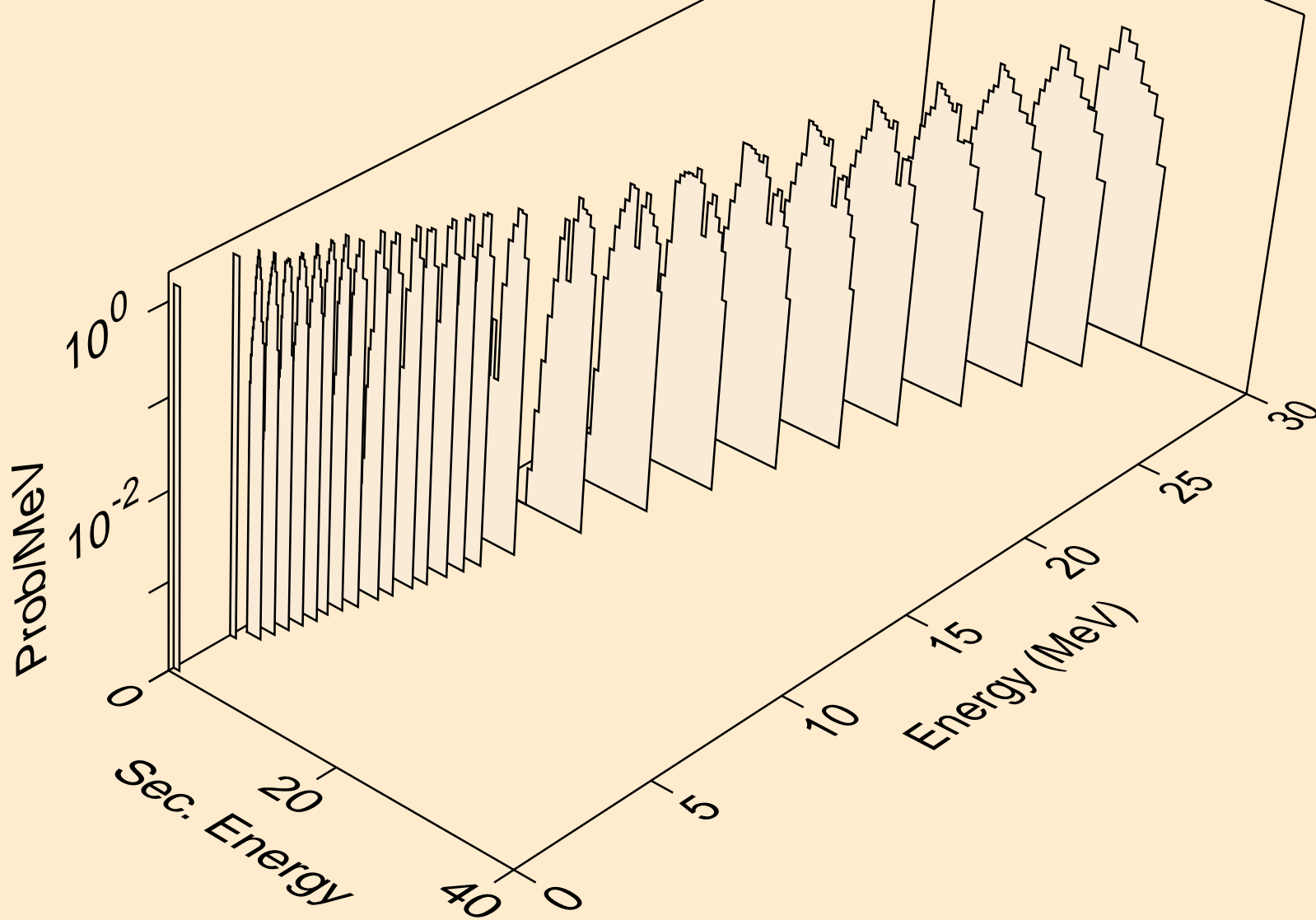

ZN070 NEUTRON ACER TENDL-2019 LIBRARY; T=293.16K
alphas from (n,2a)

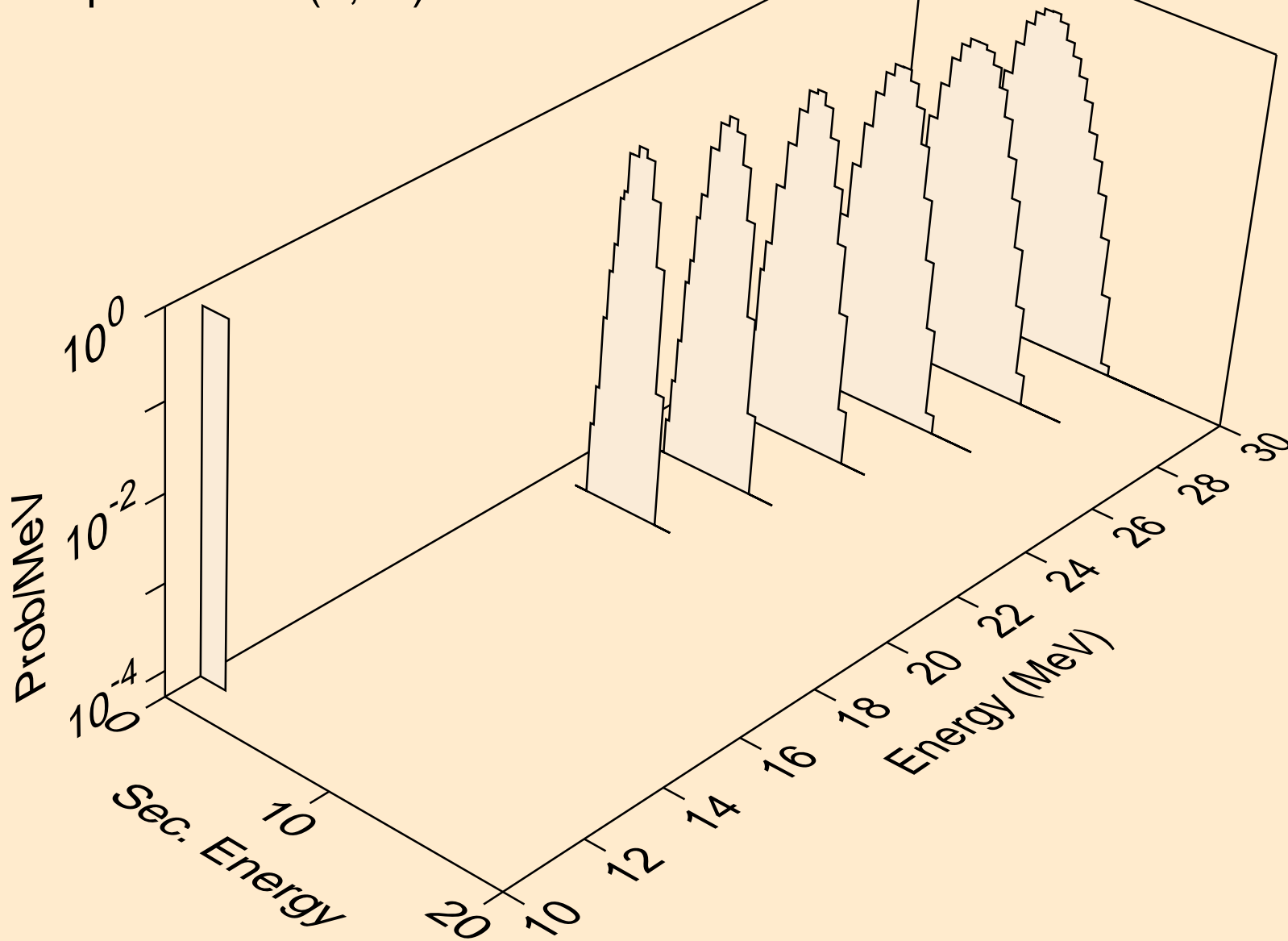

ZN070 NEUTRON ACER TENDL-2019 LIBRARY; T=293.16K
alphas from (n,pa)

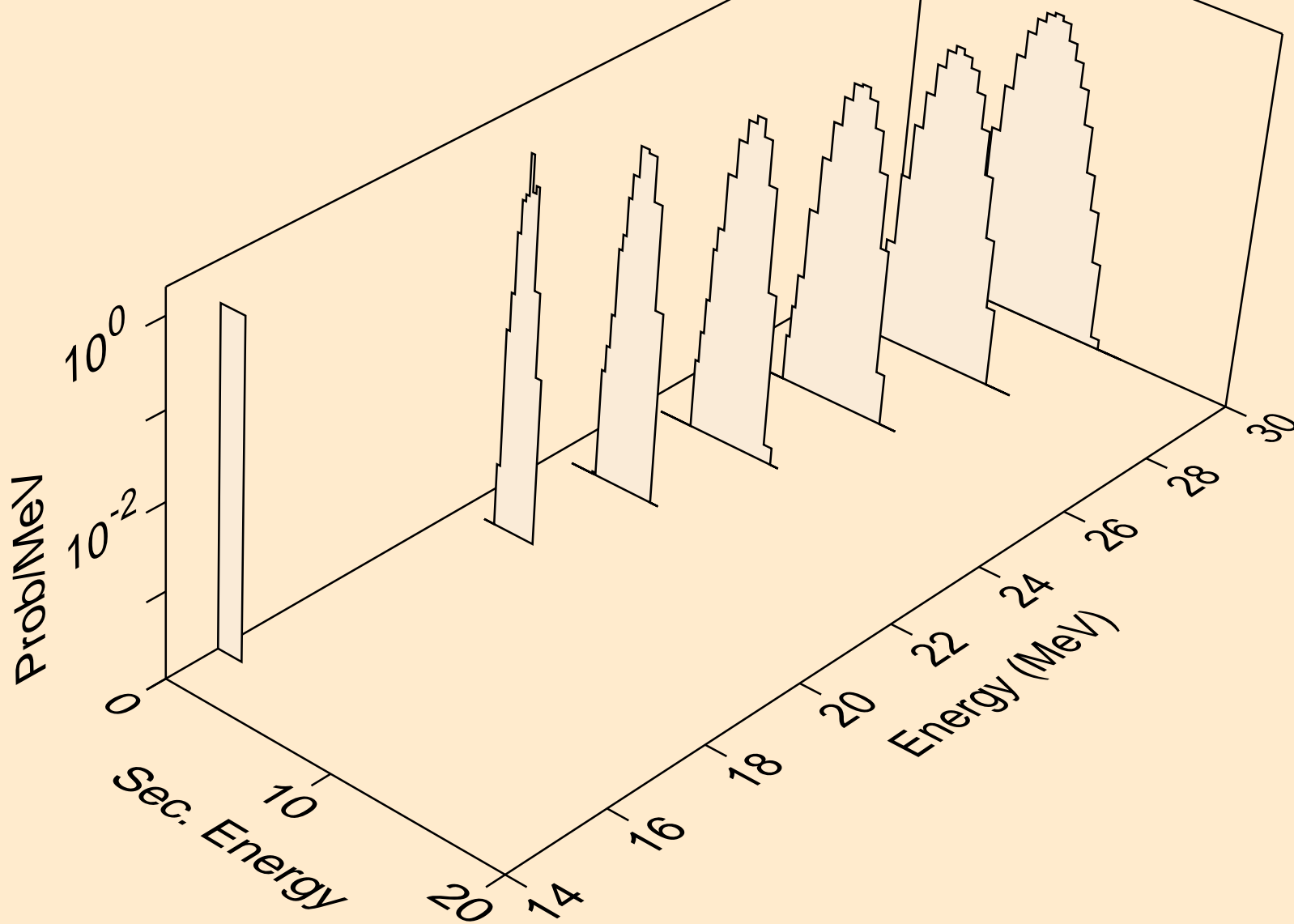

ZN070 NEUTRON ACER TENDL-2019 LIBRARY; T=293.16K
alphas from (n,da)

