

ZN073M NEUTRON ACER TENDL-2019 LIBRARY; T=293.16K
Principal cross sections

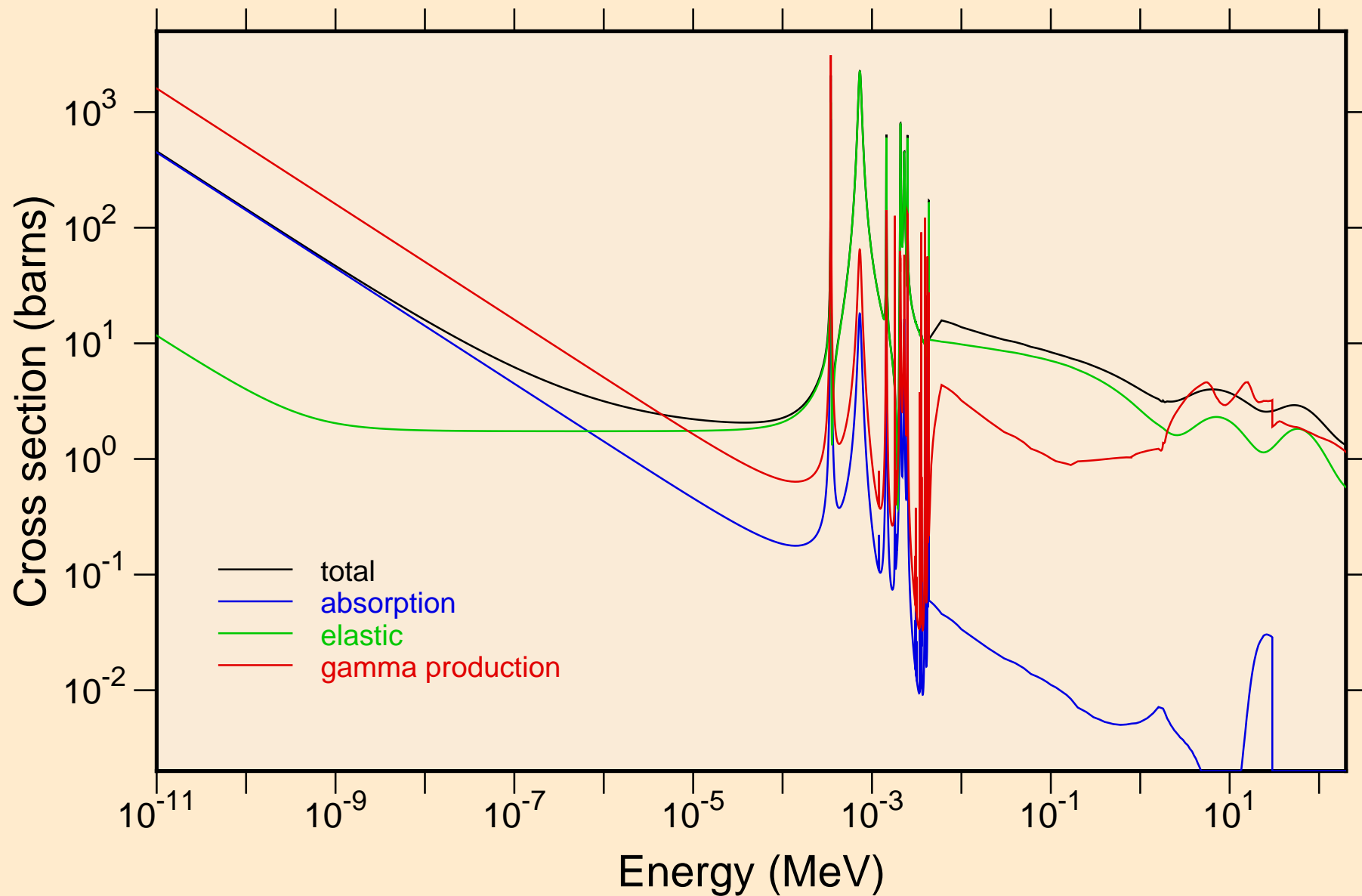

ZN073M NEUTRON ACER TENDL-2019 LIBRARY; T=293.16K
resonance total cross section

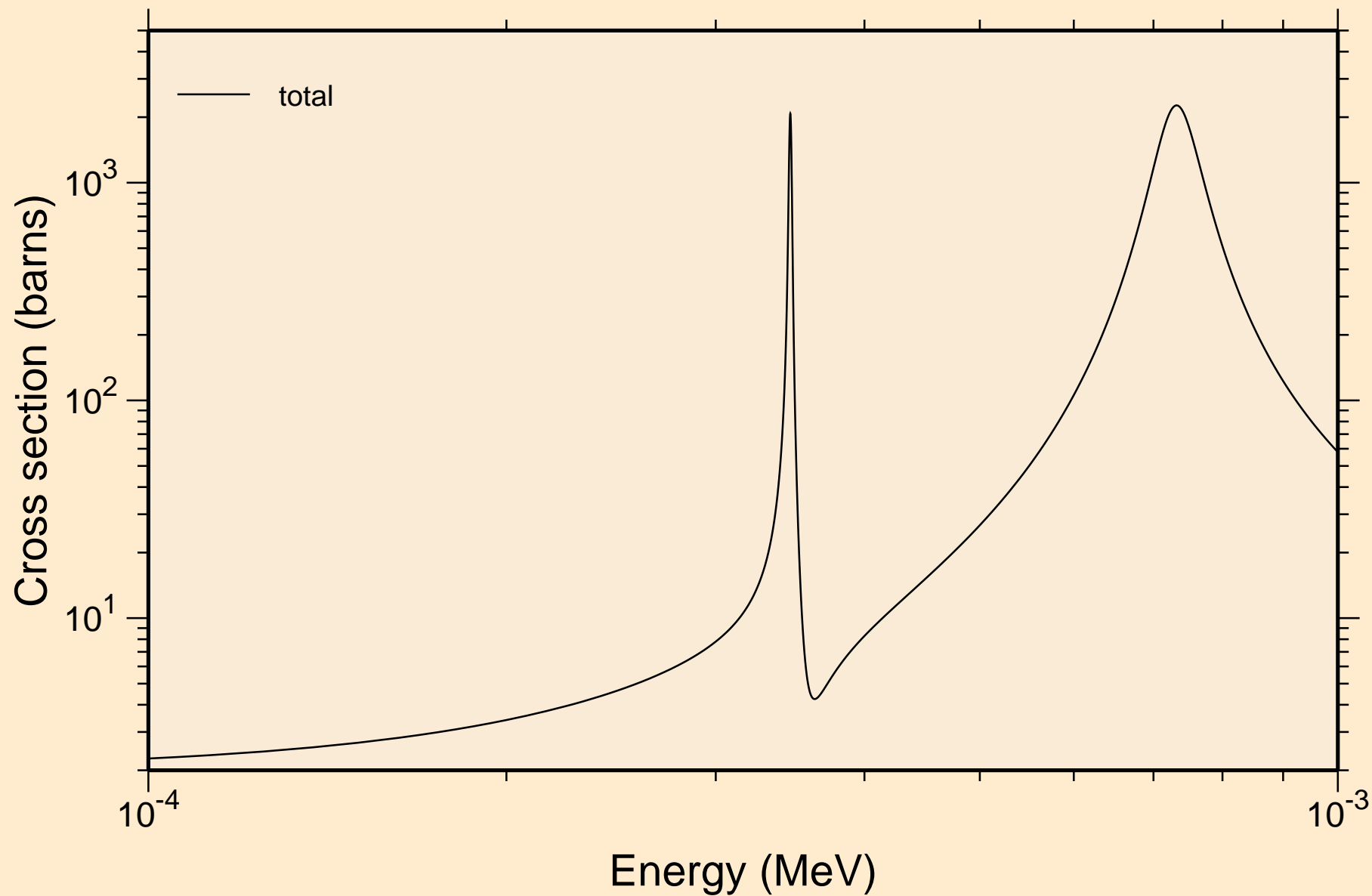

ZN073M NEUTRON ACER TENDL-2019 LIBRARY; T=293.16K
resonance total cross section

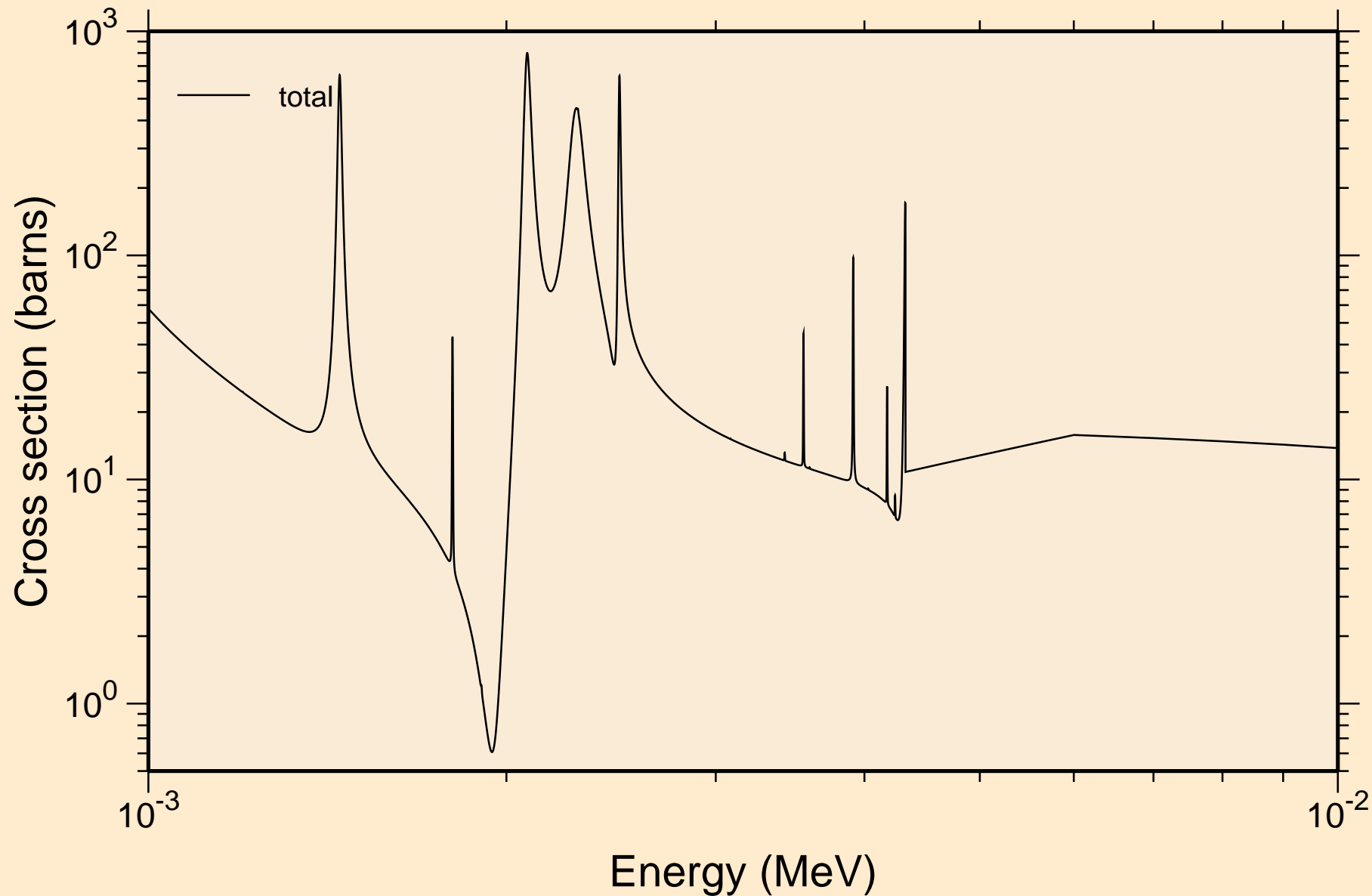

ZN073M NEUTRON ACER TENDL-2019 LIBRARY; T=293.16K
resonance total cross section

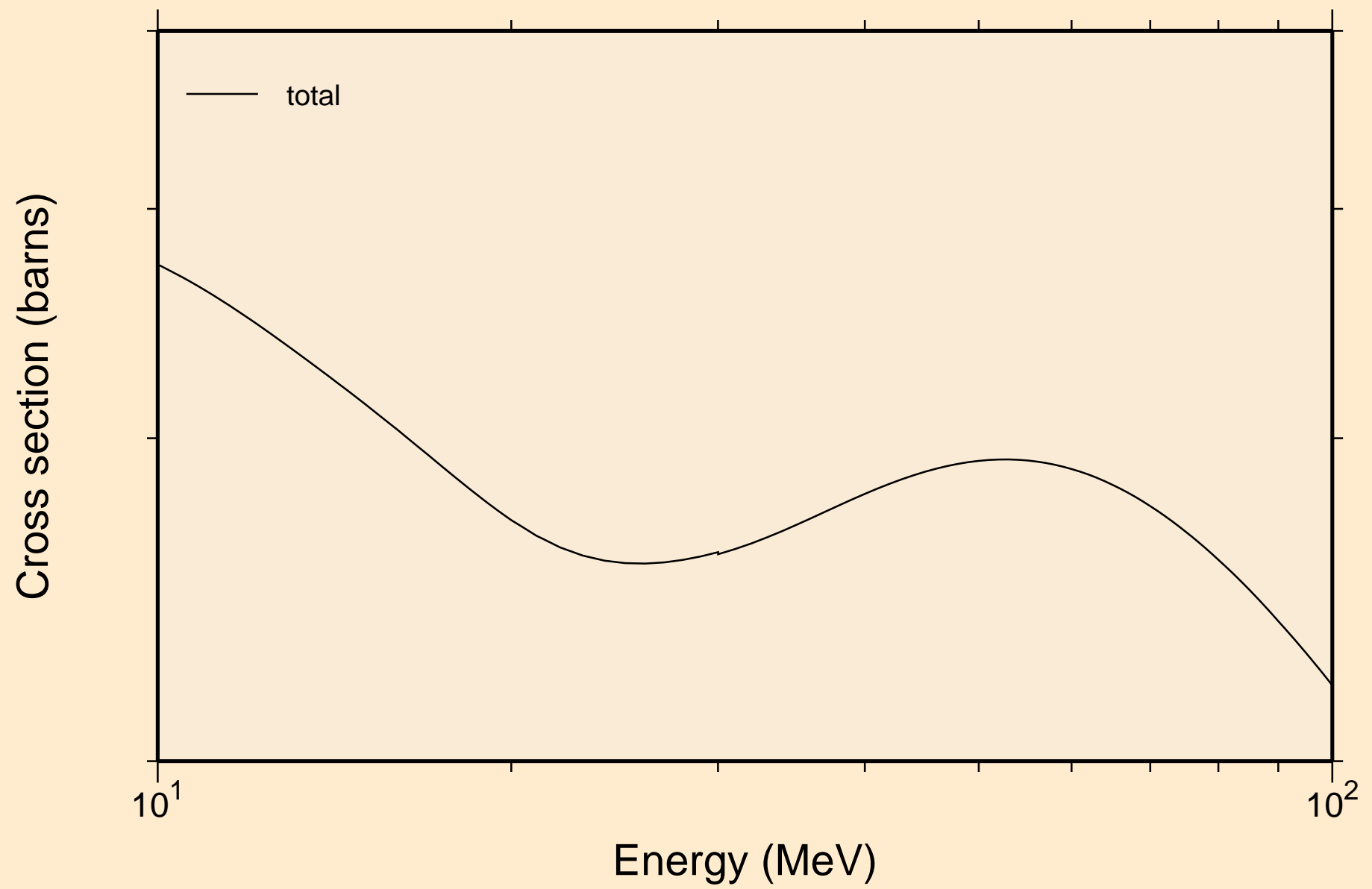

ZN073M NEUTRON ACER TENDL-2019 LIBRARY; T=293.16K
resonance absorption cross sections

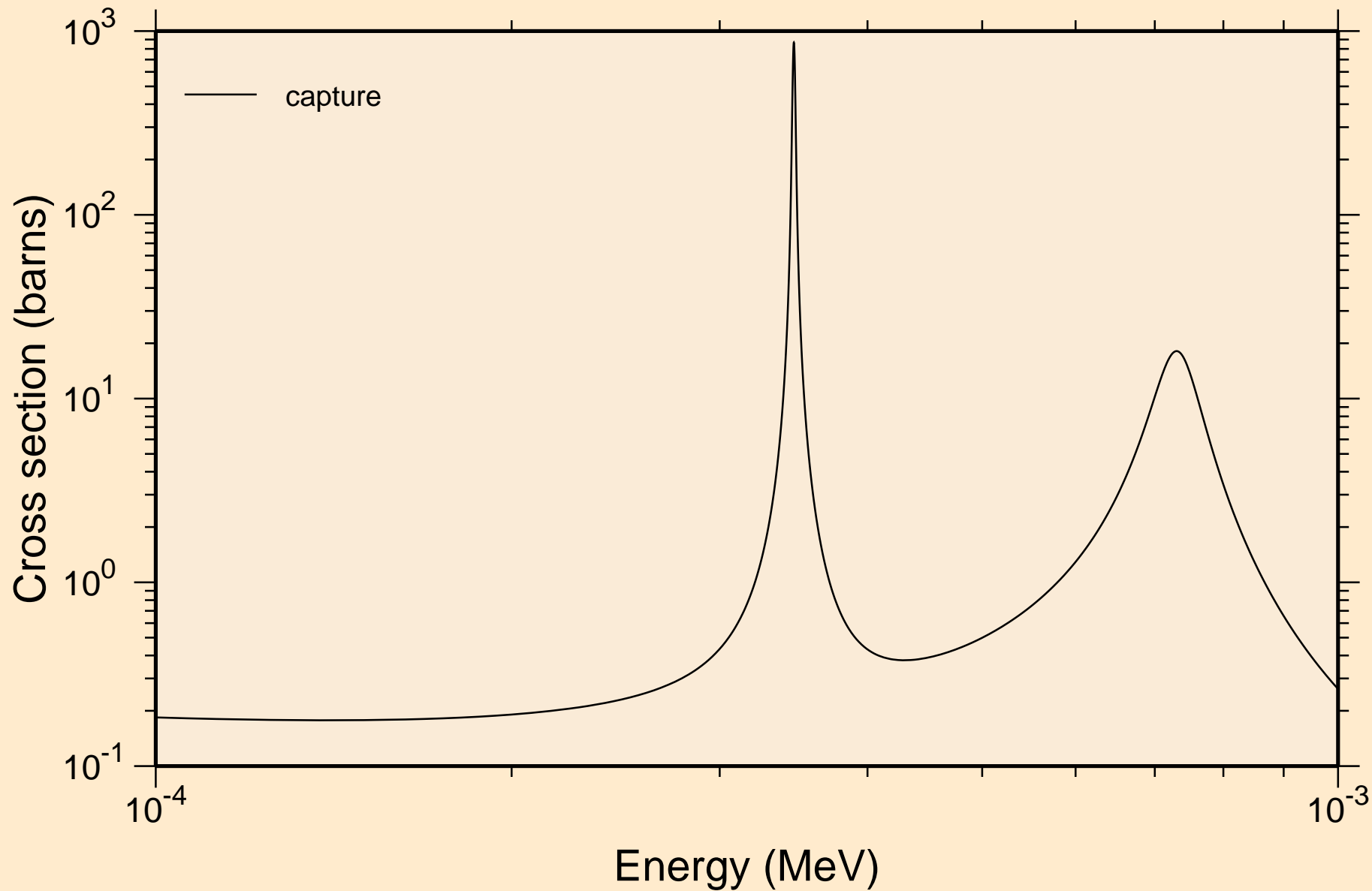

ZN073M NEUTRON ACER TENDL-2019 LIBRARY; T=293.16K
resonance absorption cross sections

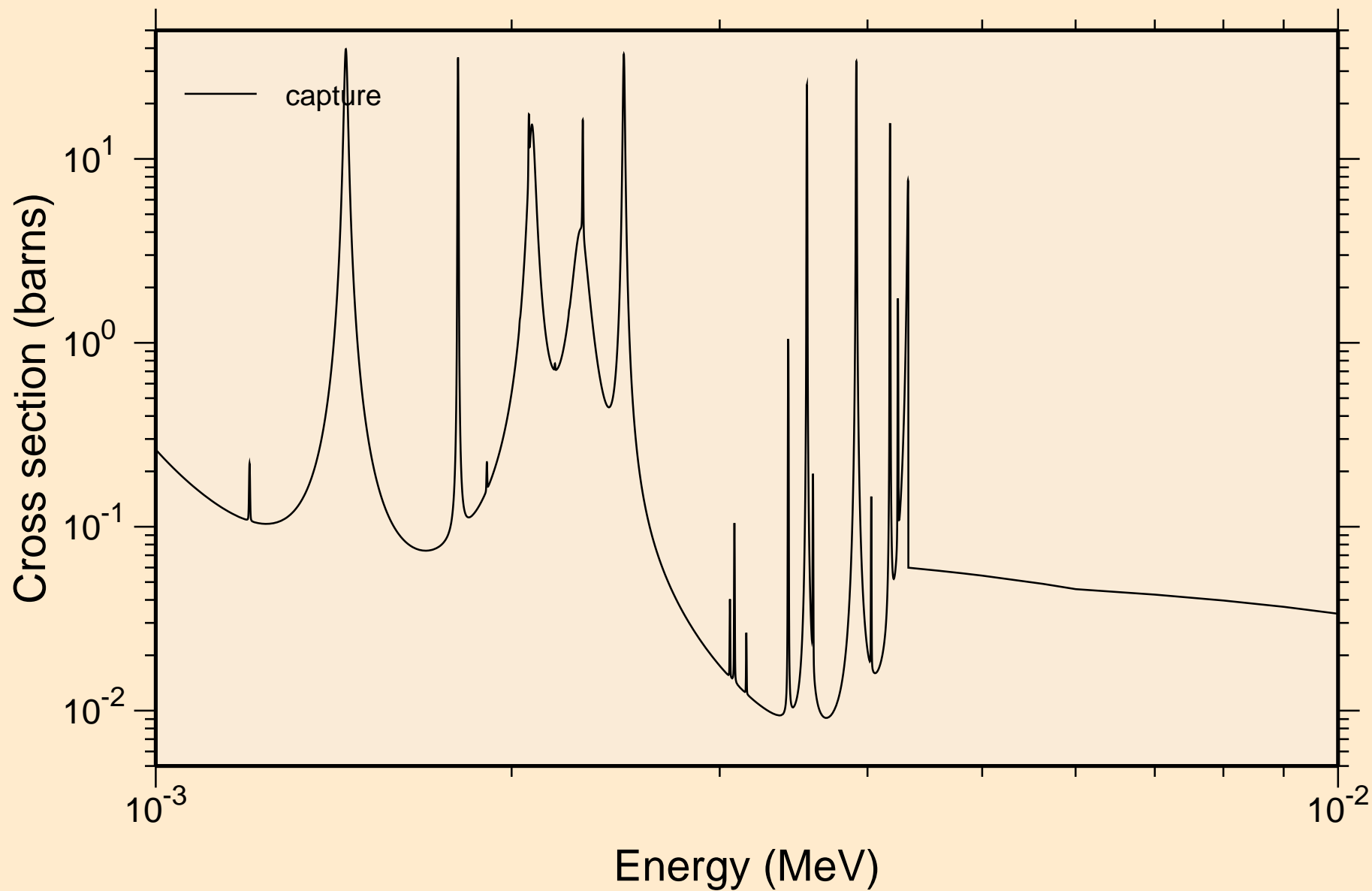

ZN073M NEUTRON ACER TENDL-2019 LIBRARY; T=293.16K
resonance absorption cross sections

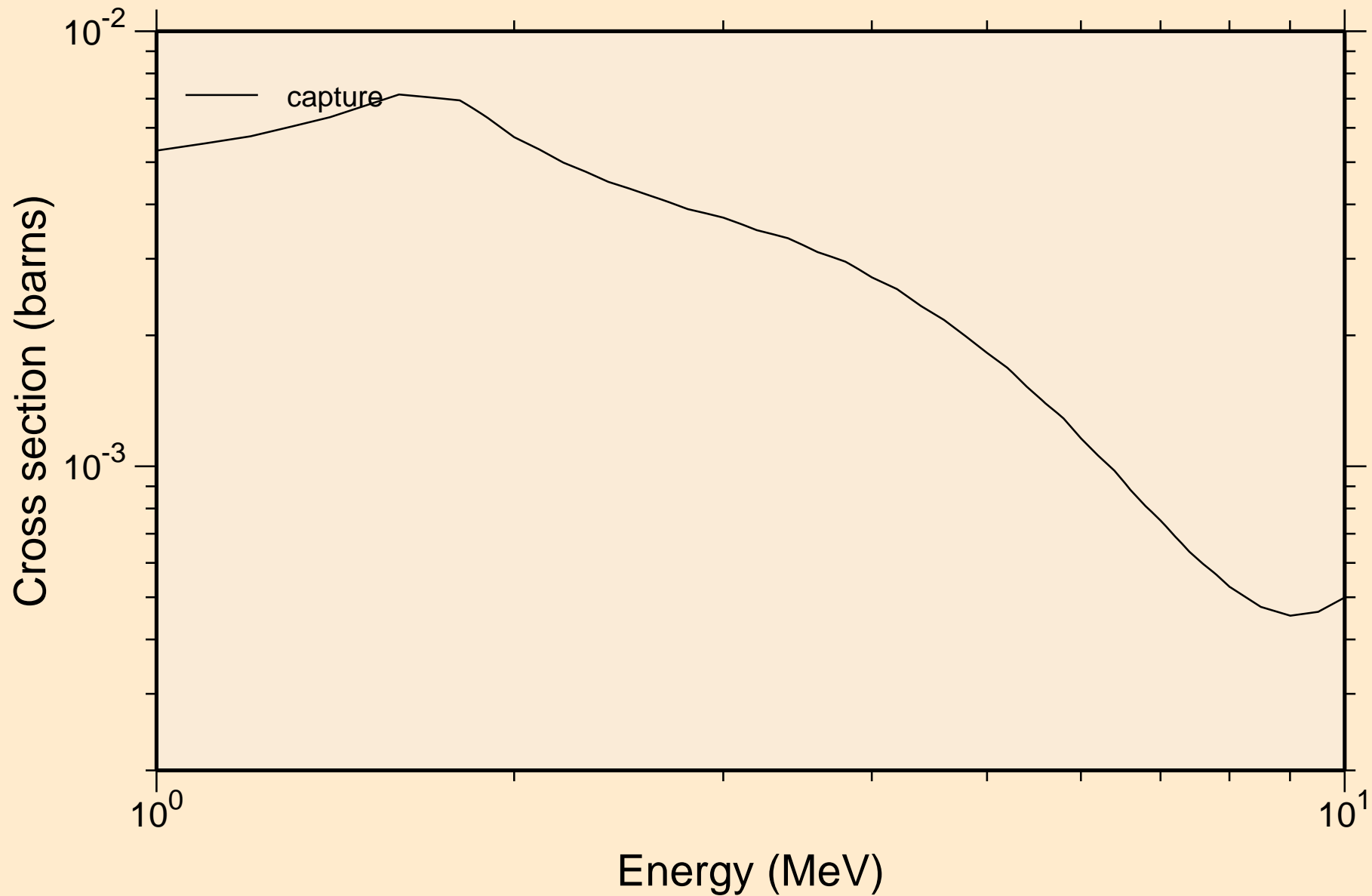

ZN073M NEUTRON ACER TENDL-2019 LIBRARY; T=293.16K
Heating

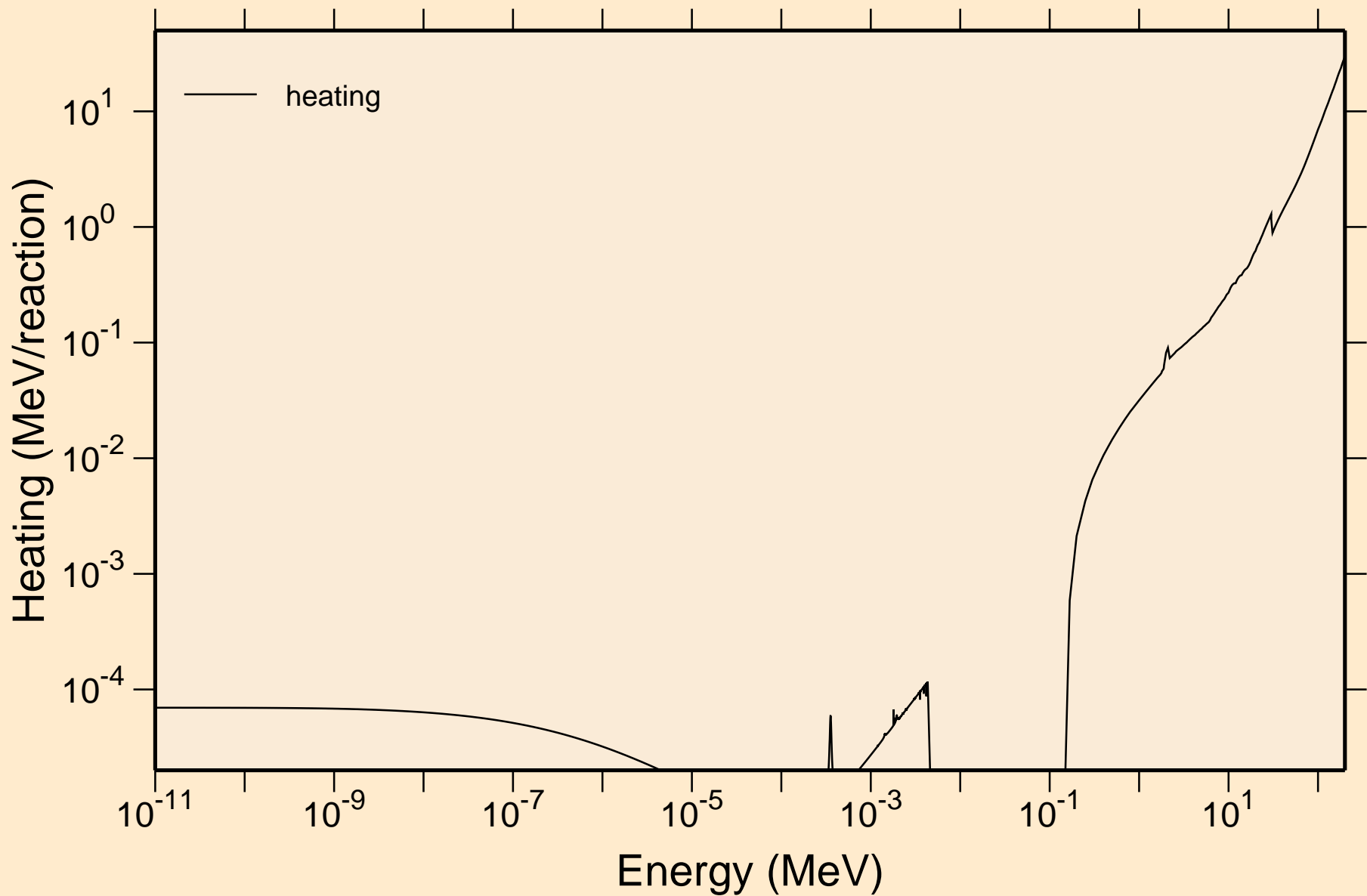

ZN073M NEUTRON ACER TENDL-2019 LIBRARY; T=293.16K
Damage

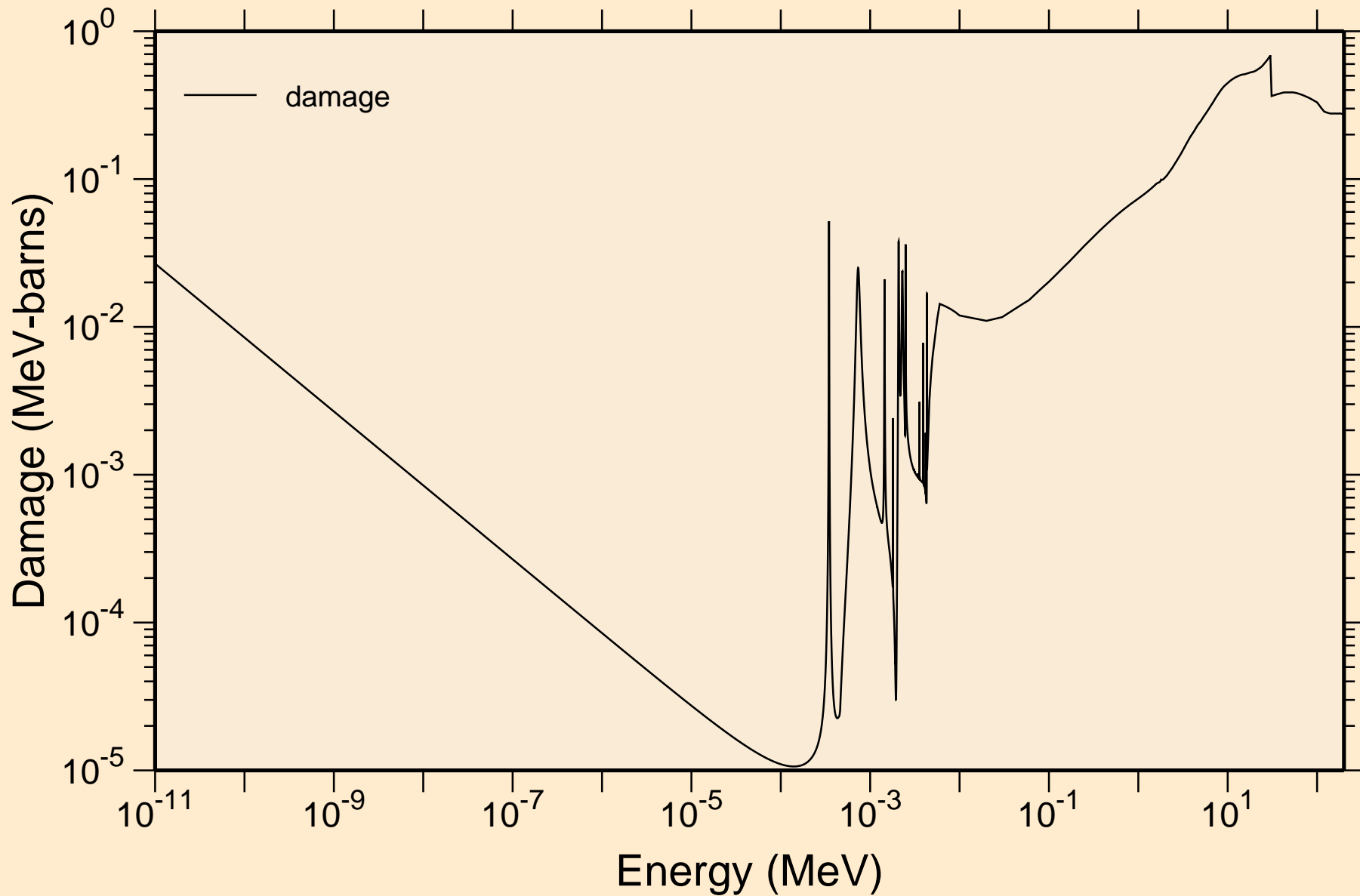

ZN073M NEUTRON ACER TENDL-2019 LIBRARY; T=293.16K
Non-threshold reactions

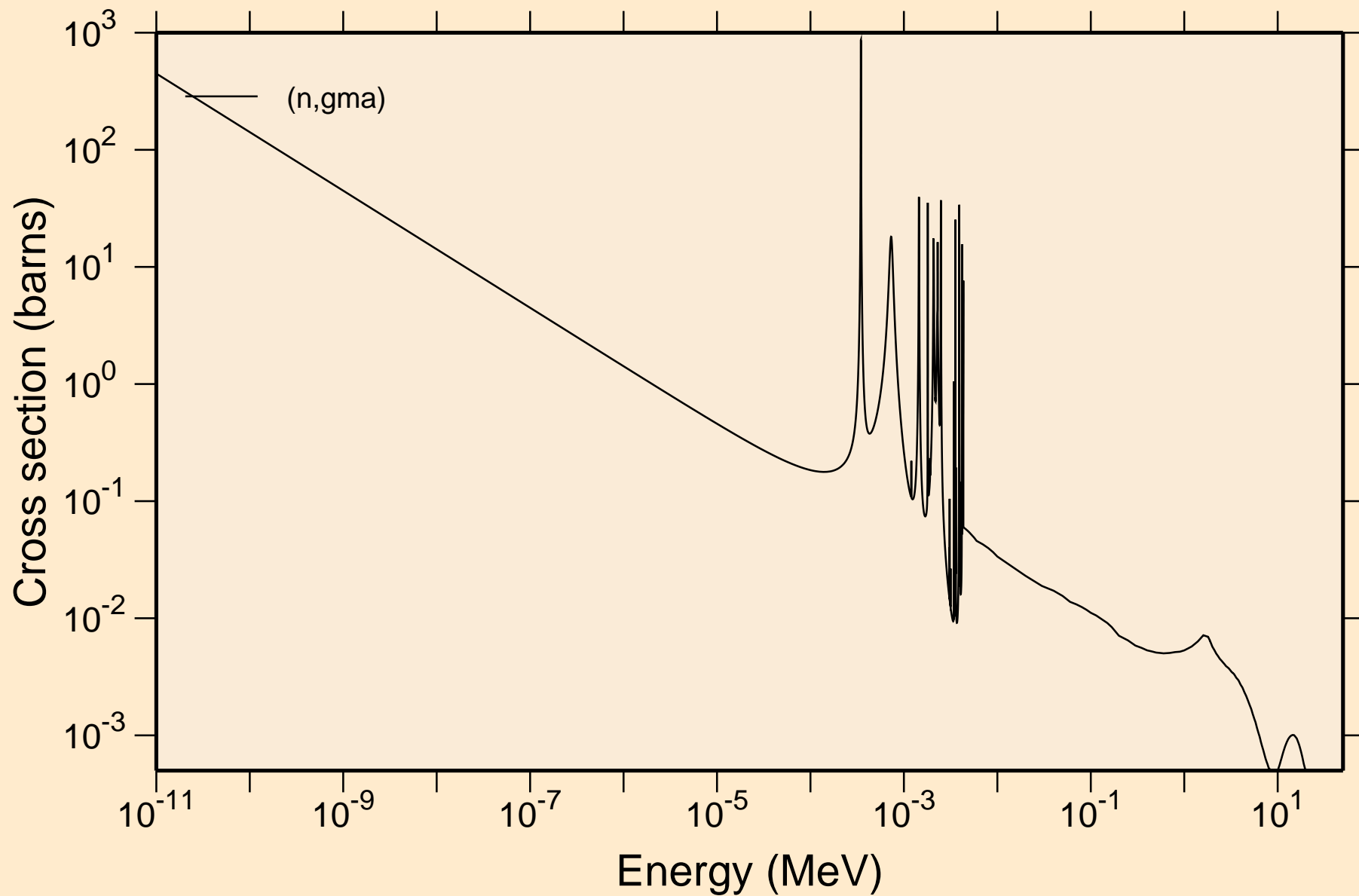

ZN073M NEUTRON ACER TENDL-2019 LIBRARY; T=293.16K
Principal cross sections

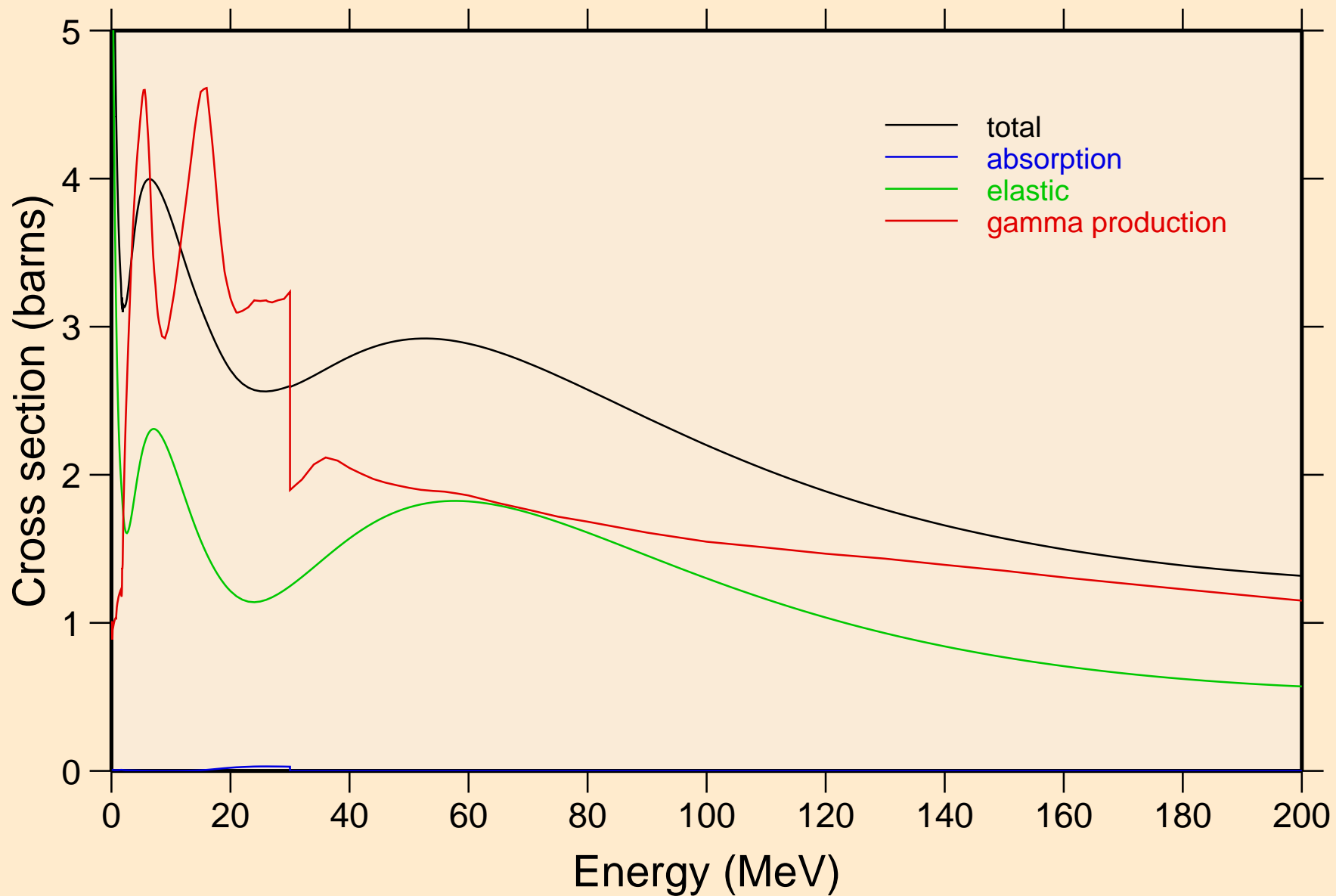

ZN073M NEUTRON ACER TENDL-2019 LIBRARY; T=293.16K
Heating

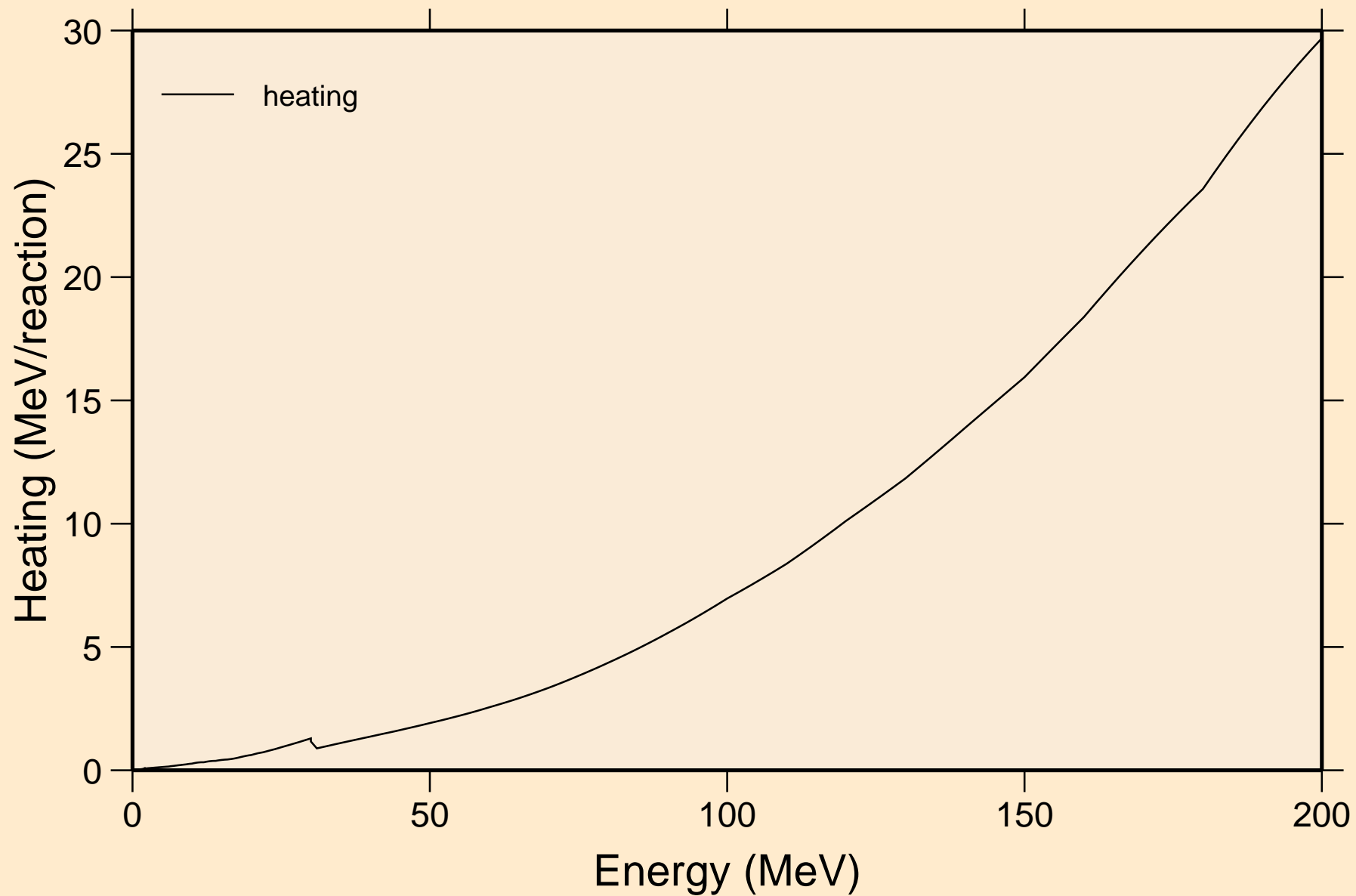

ZN073M NEUTRON ACER TENDL-2019 LIBRARY; T=293.16K
Damage

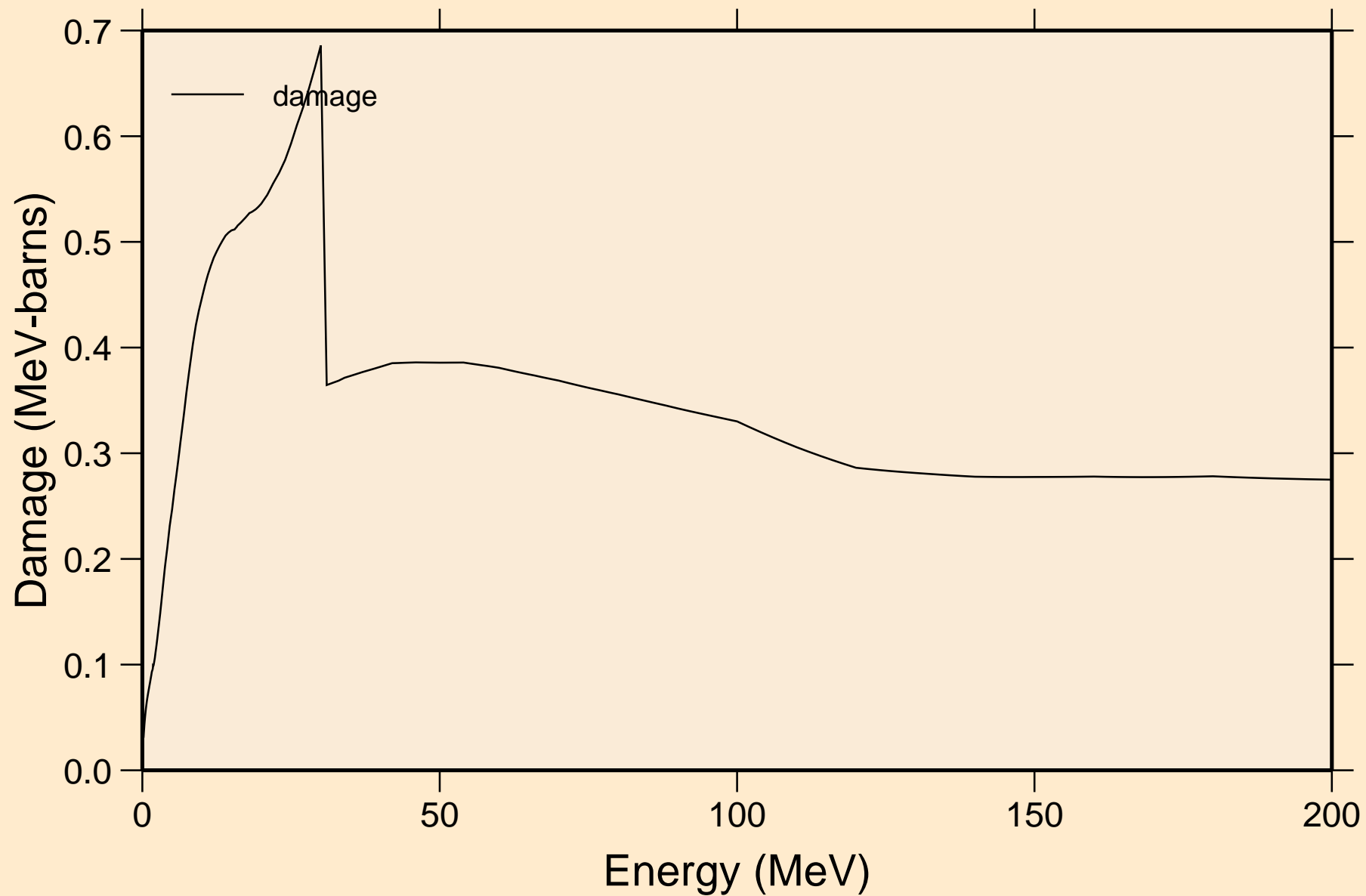

ZN073M NEUTRON ACER TENDL-2019 LIBRARY; T=293.16K
Non-threshold reactions

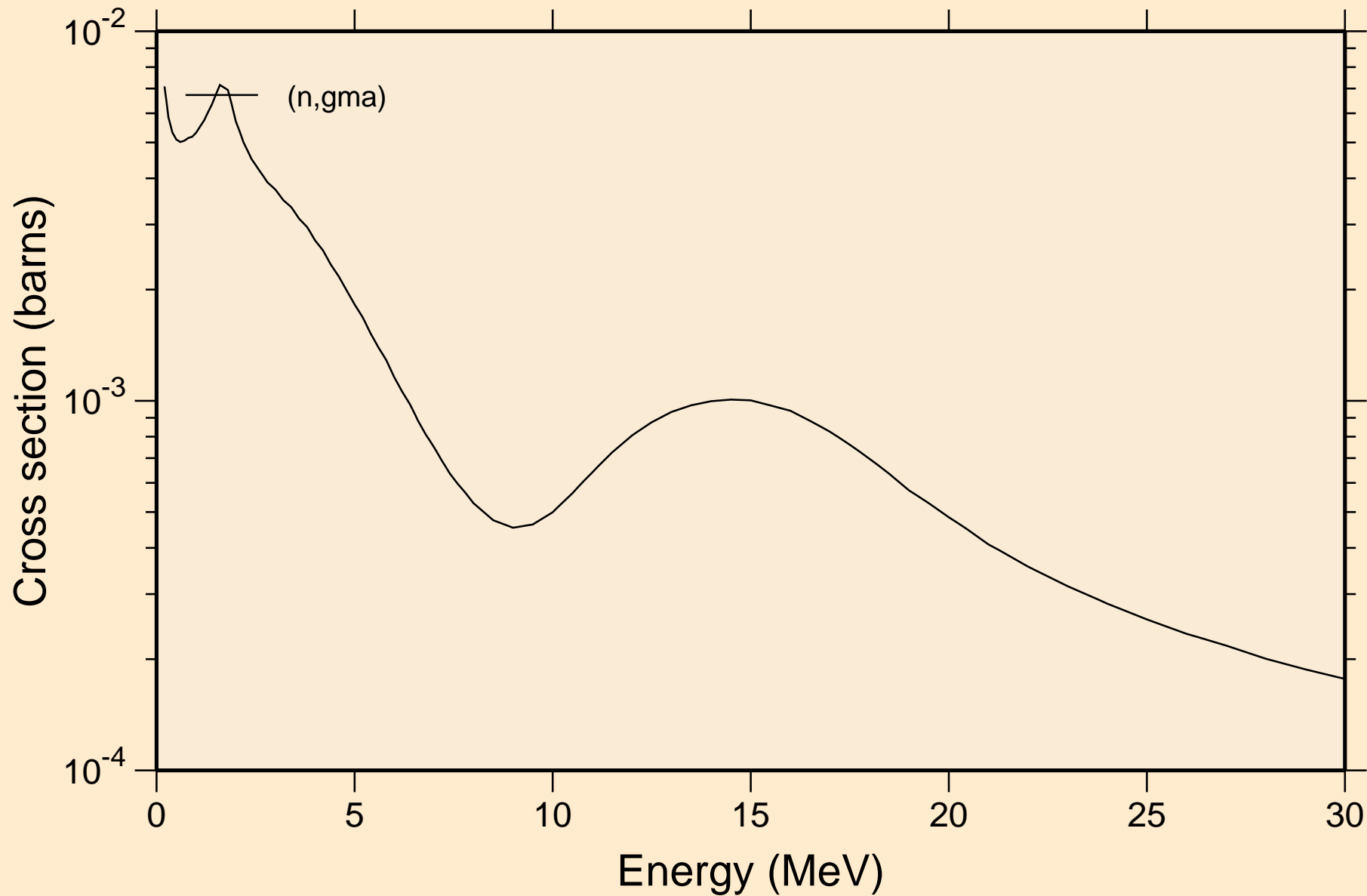

ZN073M NEUTRON ACER TENDL-2019 LIBRARY; T=293.16K
Inelastic levels

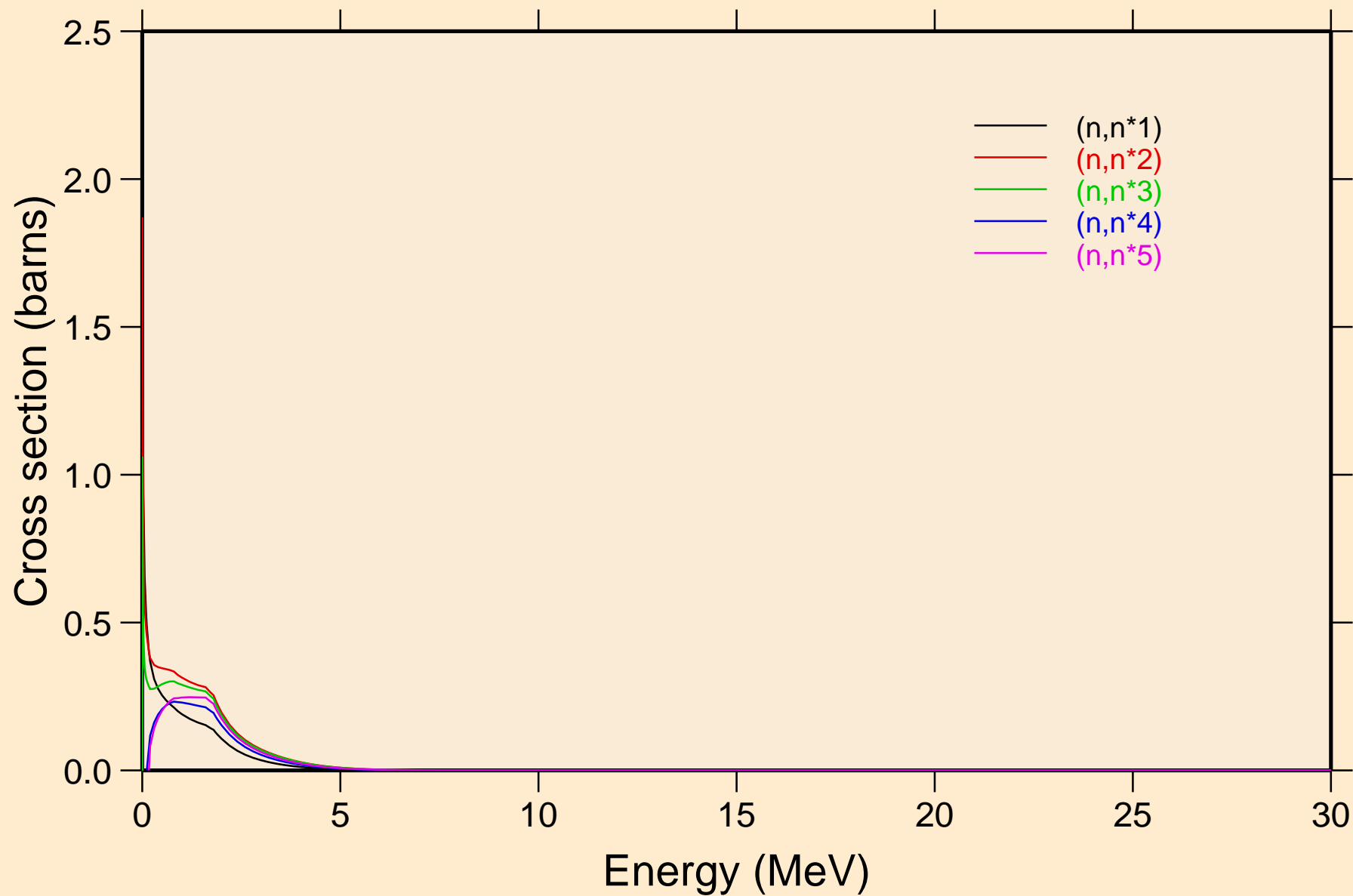

ZN073M NEUTRON ACER TENDL-2019 LIBRARY; T=293.16K
Inelastic levels

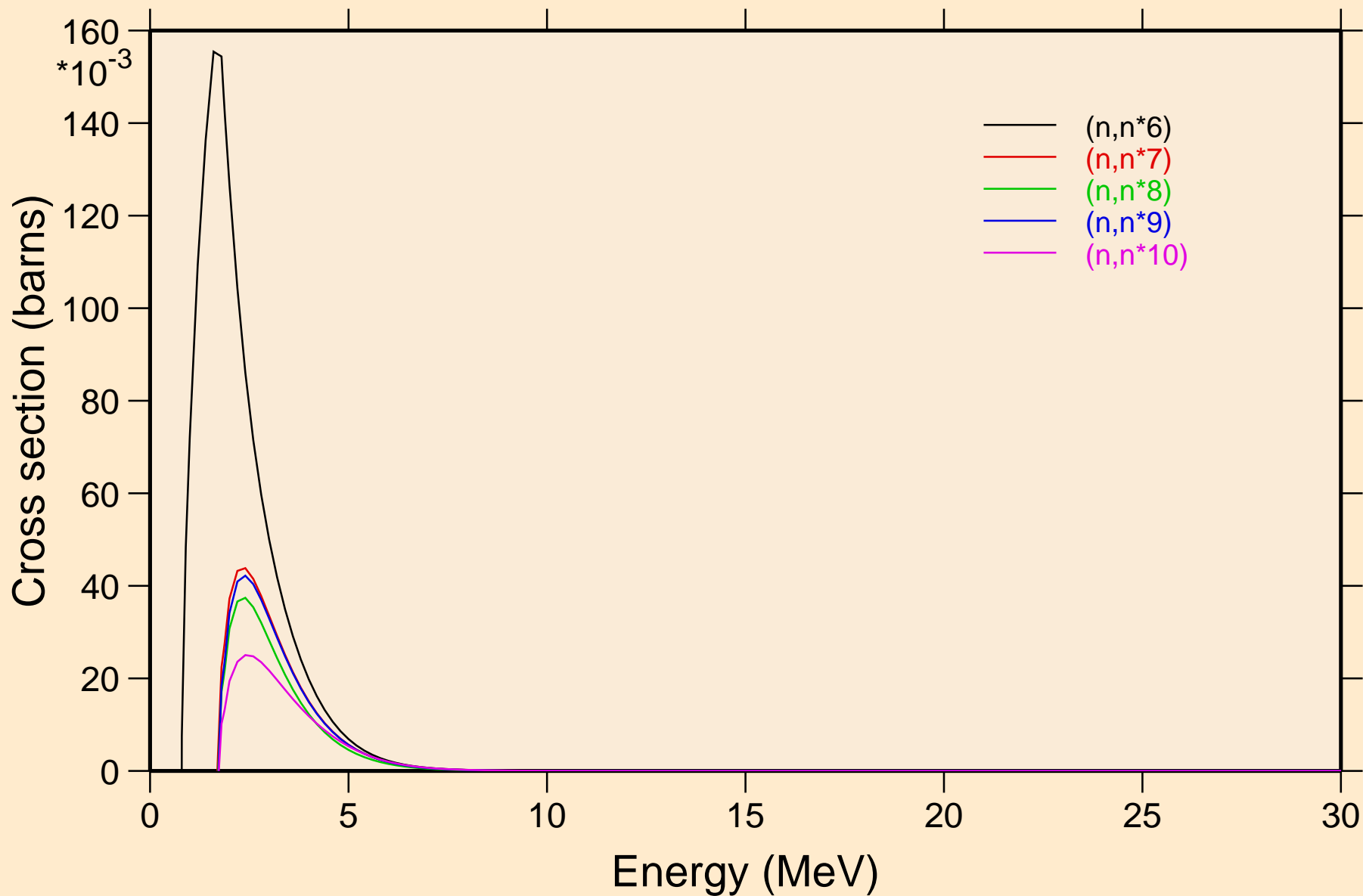

ZN073M NEUTRON ACER TENDL-2019 LIBRARY; T=293.16K
Inelastic levels

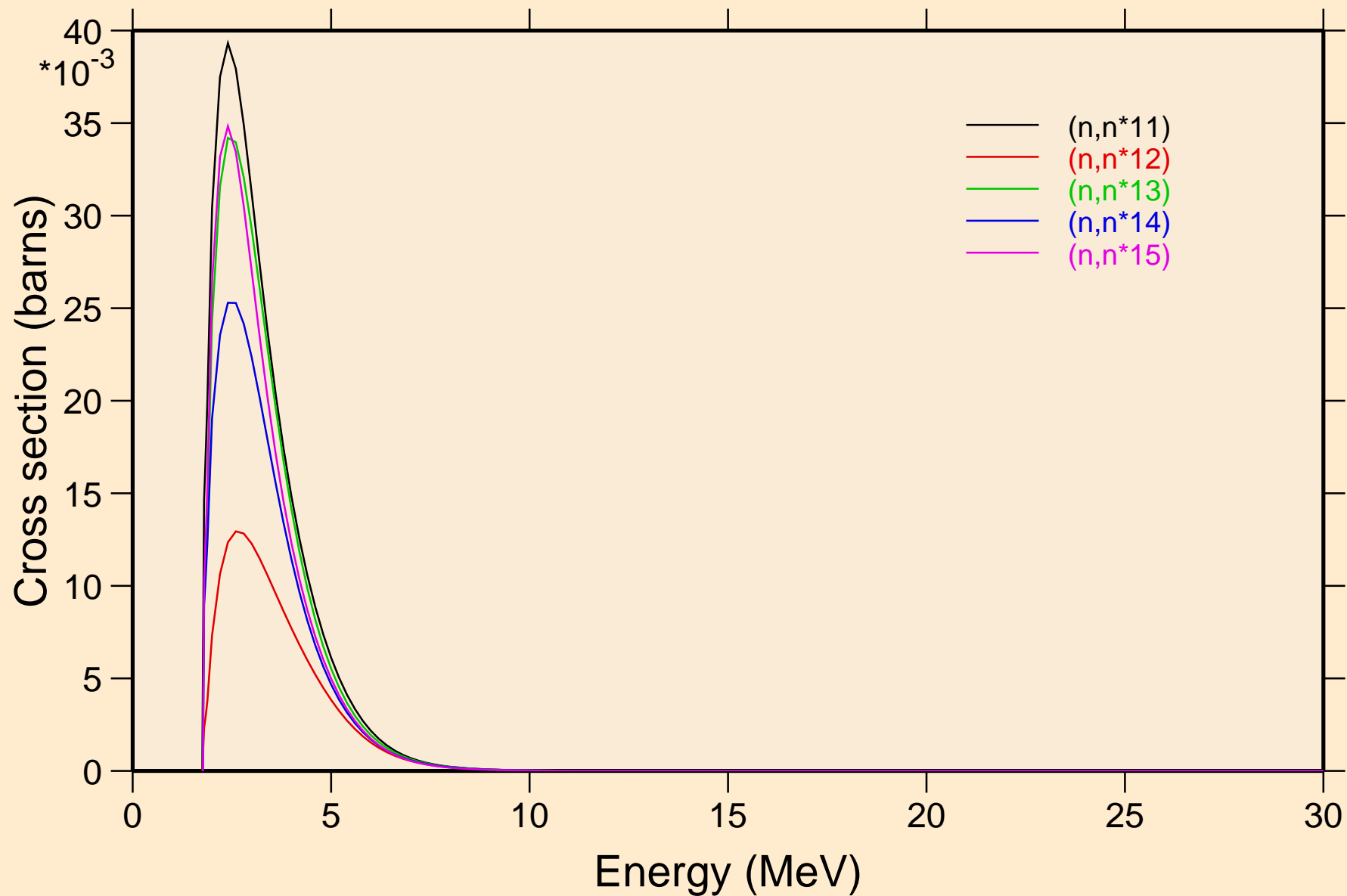

ZN073M NEUTRON ACER TENDL-2019 LIBRARY; T=293.16K
Inelastic levels

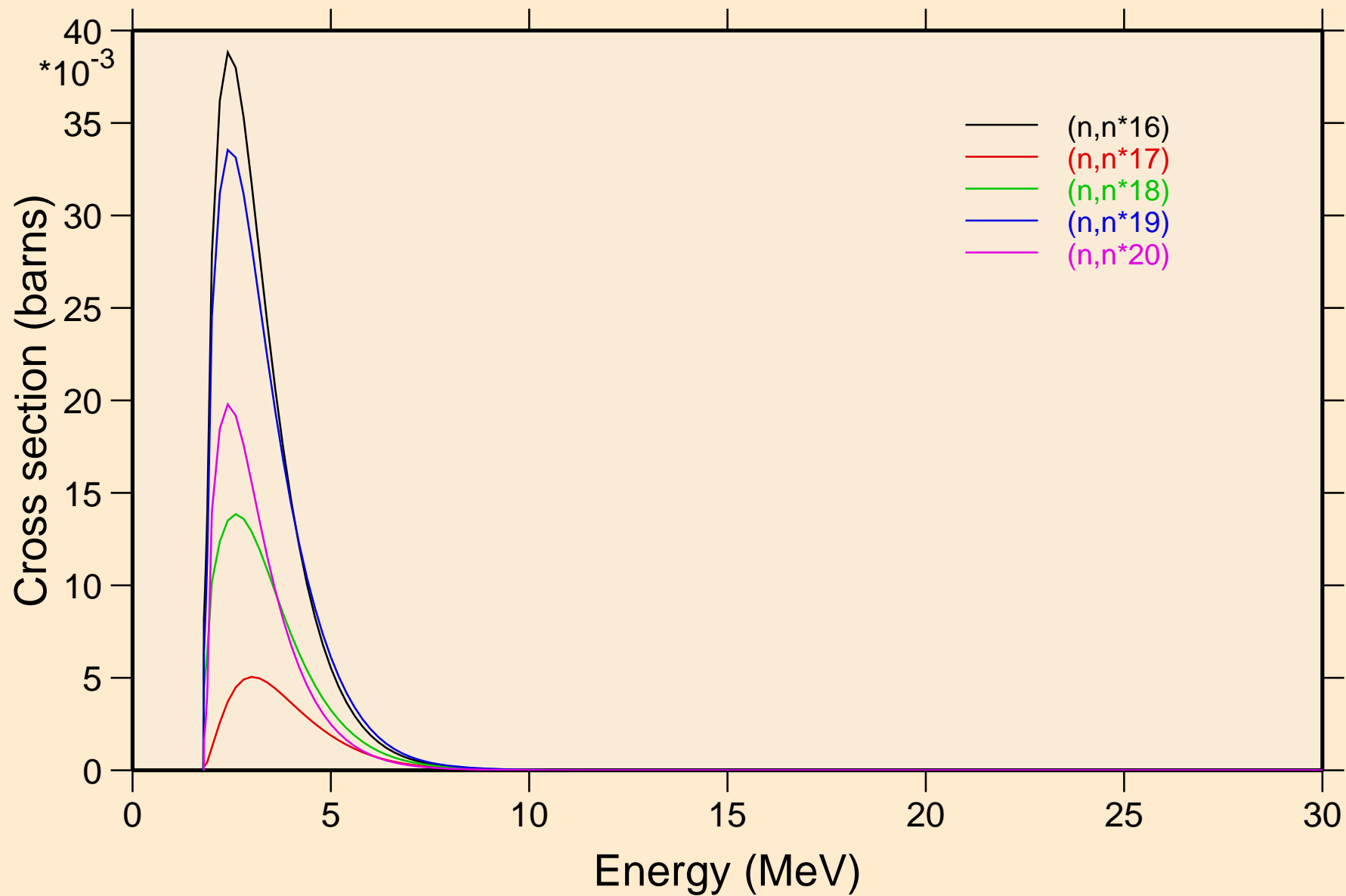

ZN073M NEUTRON ACER TENDL-2019 LIBRARY; T=293.16K
Inelastic levels

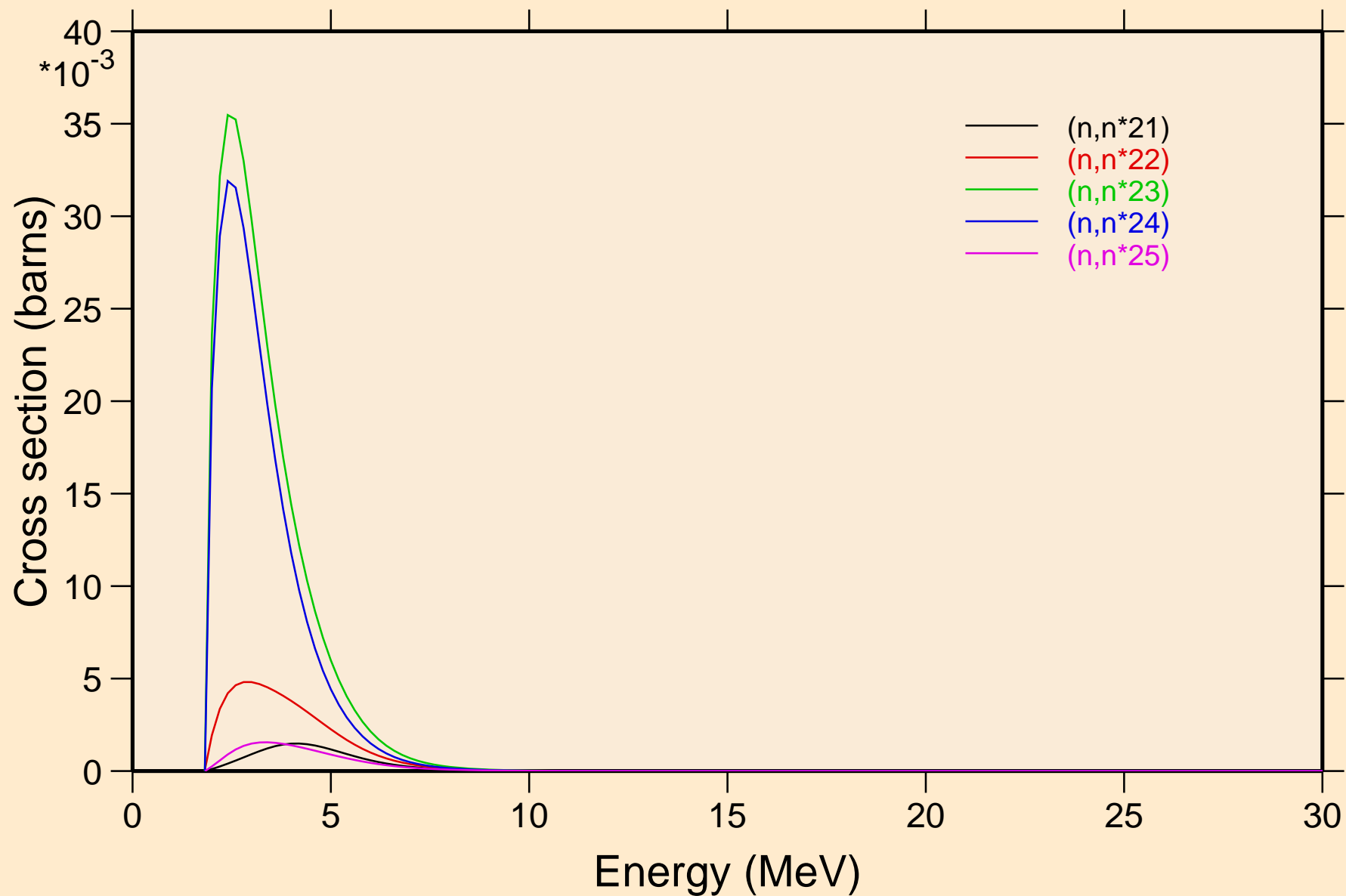

ZN073M NEUTRON ACER TENDL-2019 LIBRARY; T=293.16K
Inelastic levels

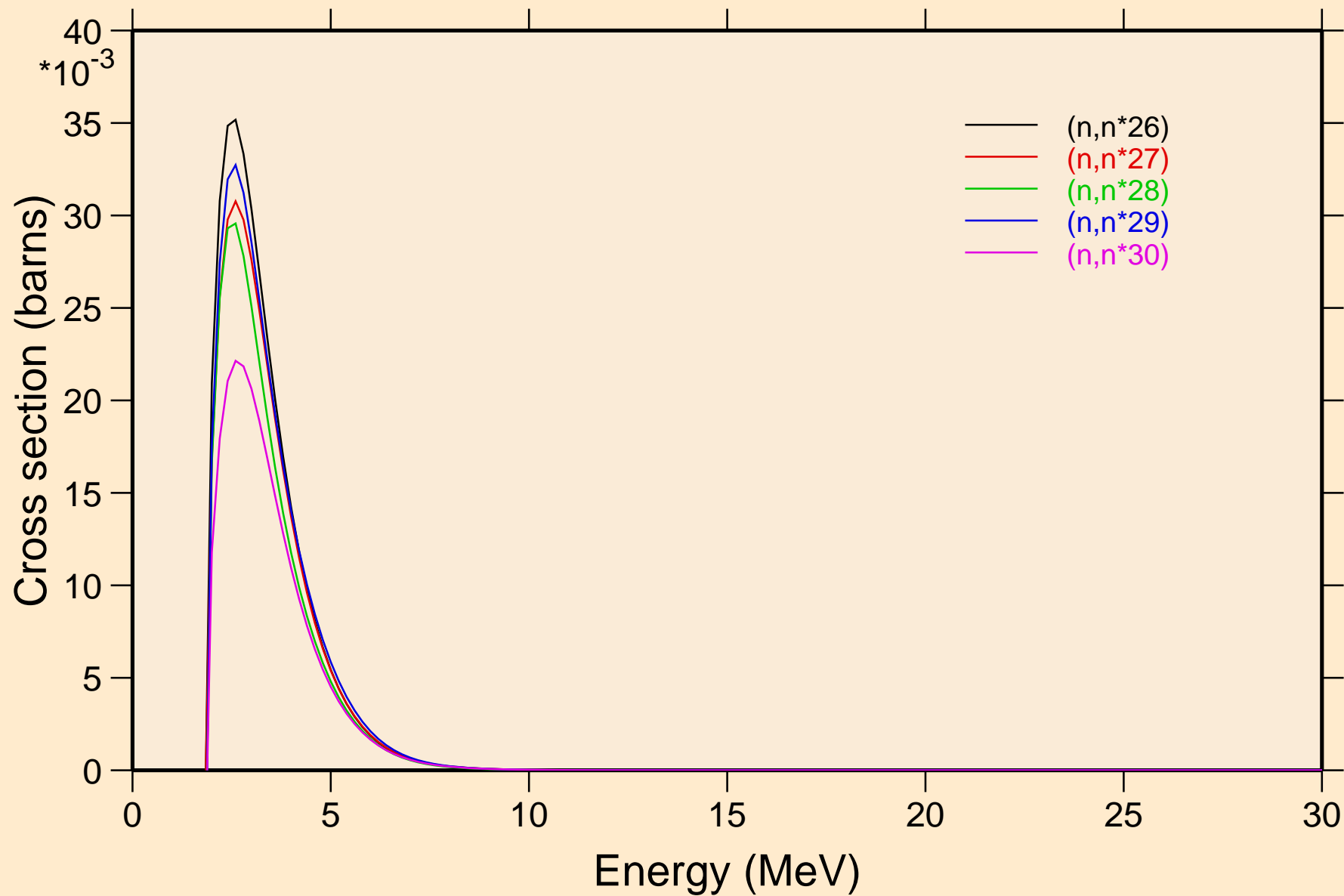

ZN073M NEUTRON ACER TENDL-2019 LIBRARY; T=293.16K
Threshold reactions

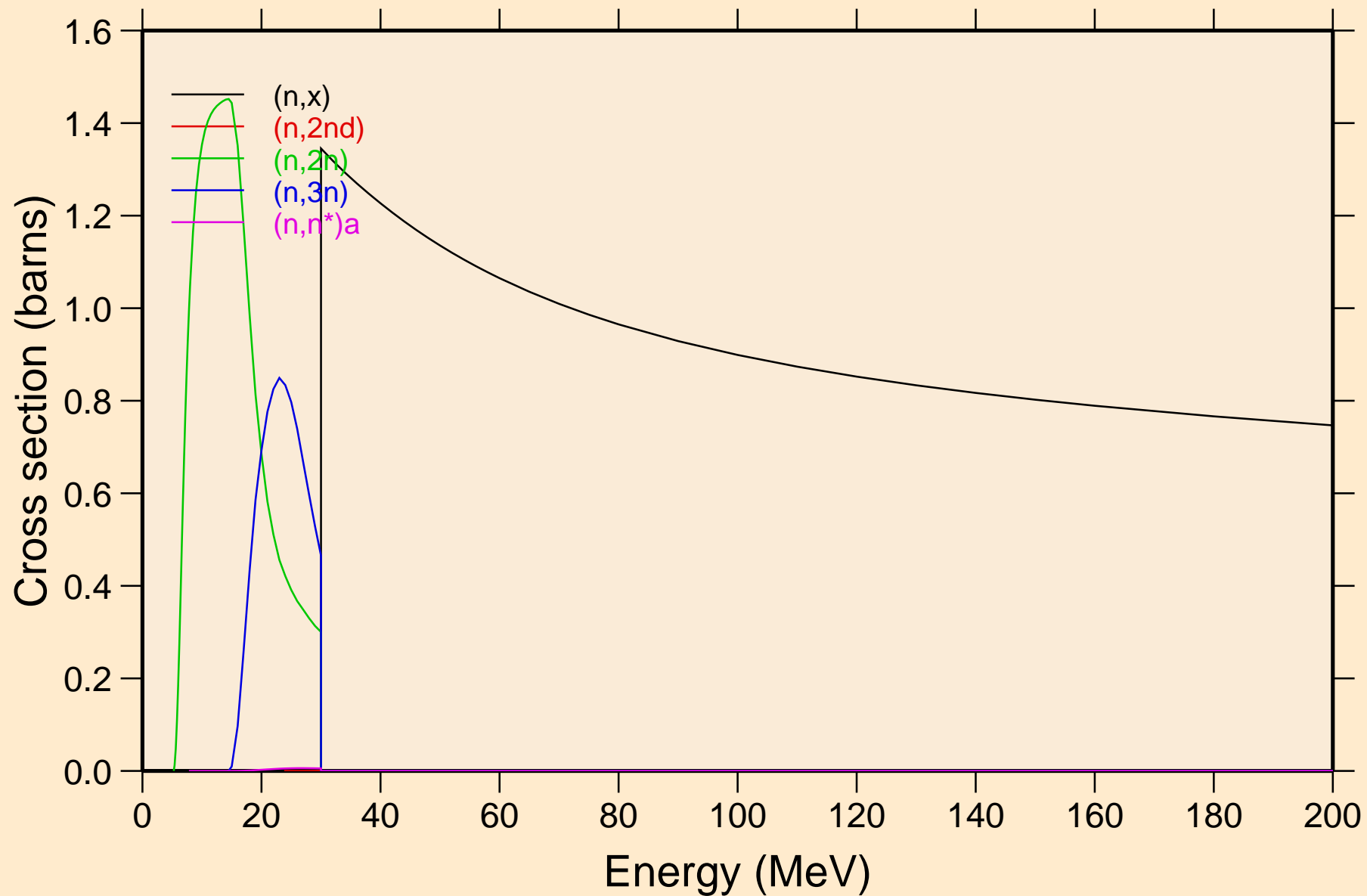

ZN073M NEUTRON ACER TENDL-2019 LIBRARY; T=293.16K
Threshold reactions

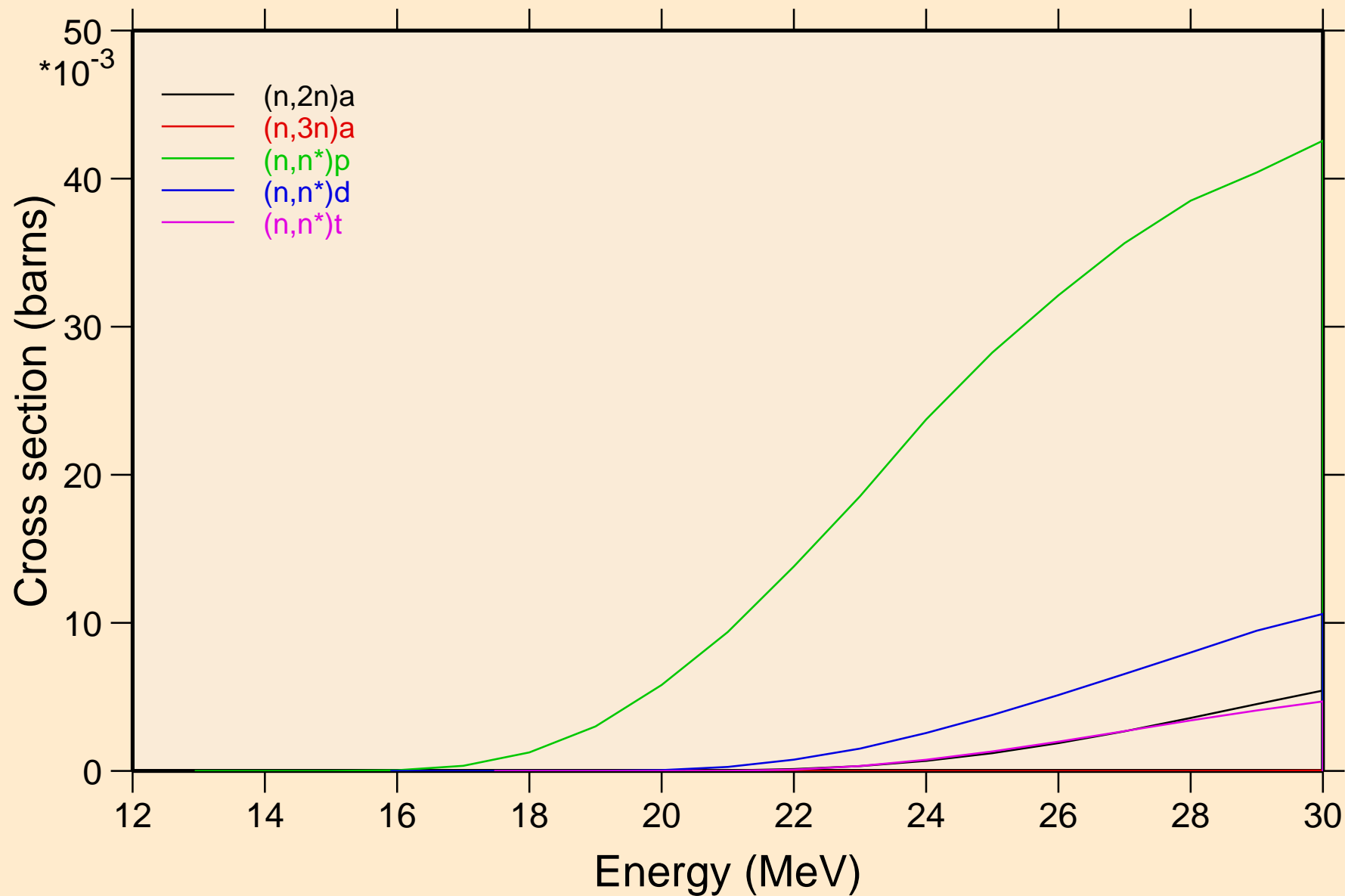

ZN073M NEUTRON ACER TENDL-2019 LIBRARY; T=293.16K
Threshold reactions

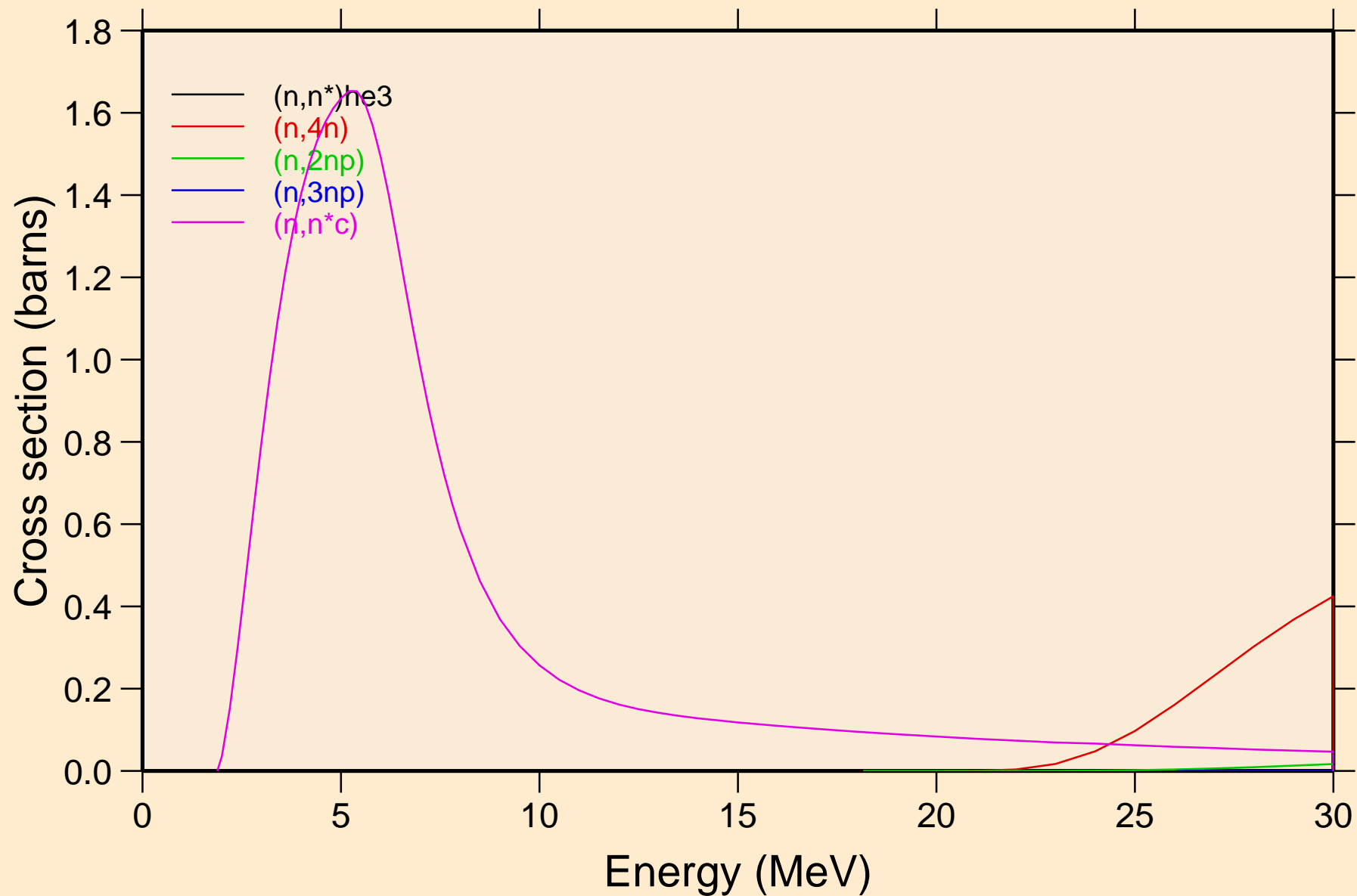

ZN073M NEUTRON ACER TENDL-2019 LIBRARY; T=293.16K
Threshold reactions

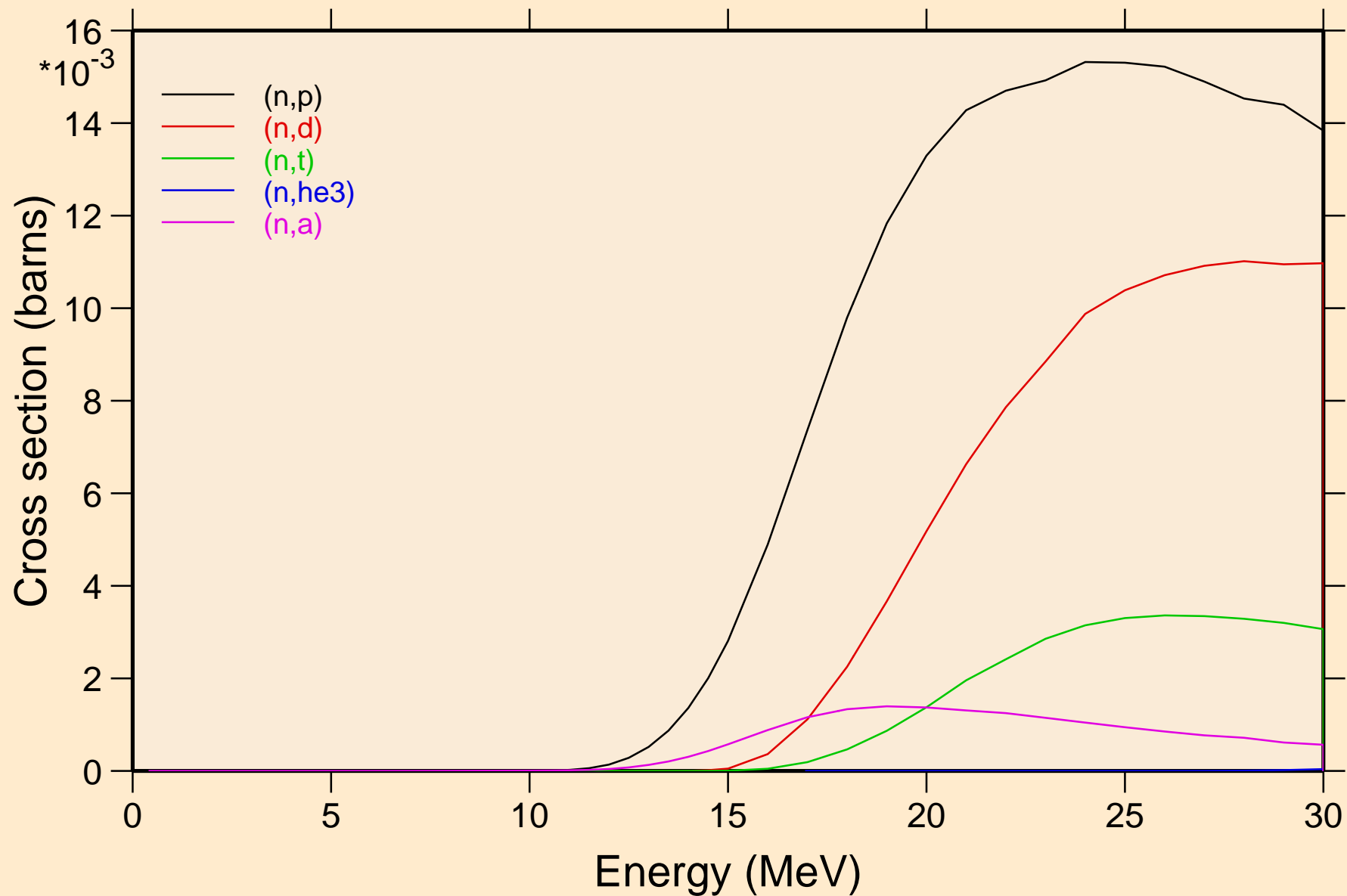

ZN073M NEUTRON ACER TENDL-2019 LIBRARY; T=293.16K
Threshold reactions

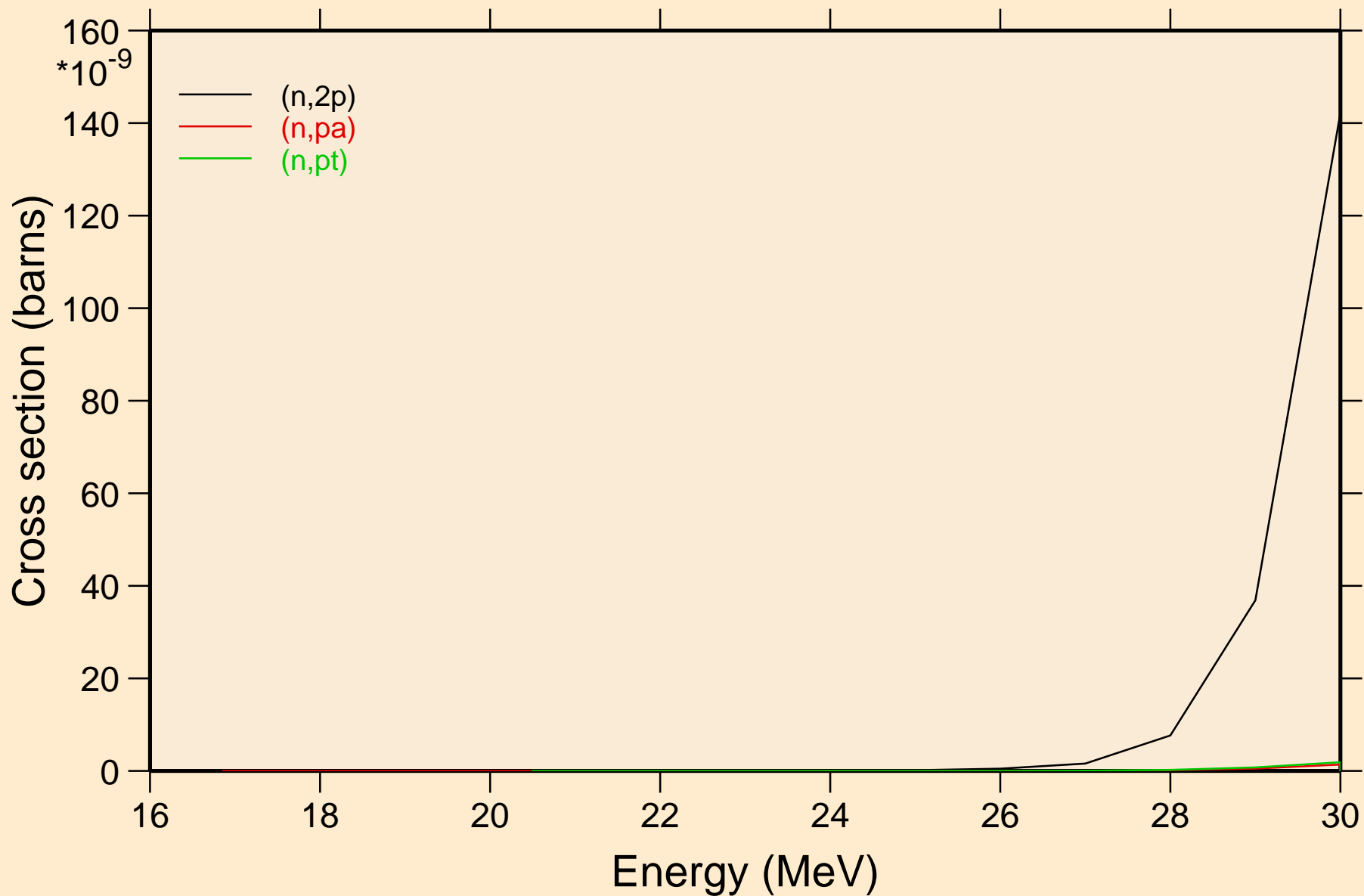

ZN073M NEUTRON ACER TENDL-2019 LIBRARY; T=293.16K
Threshold reactions

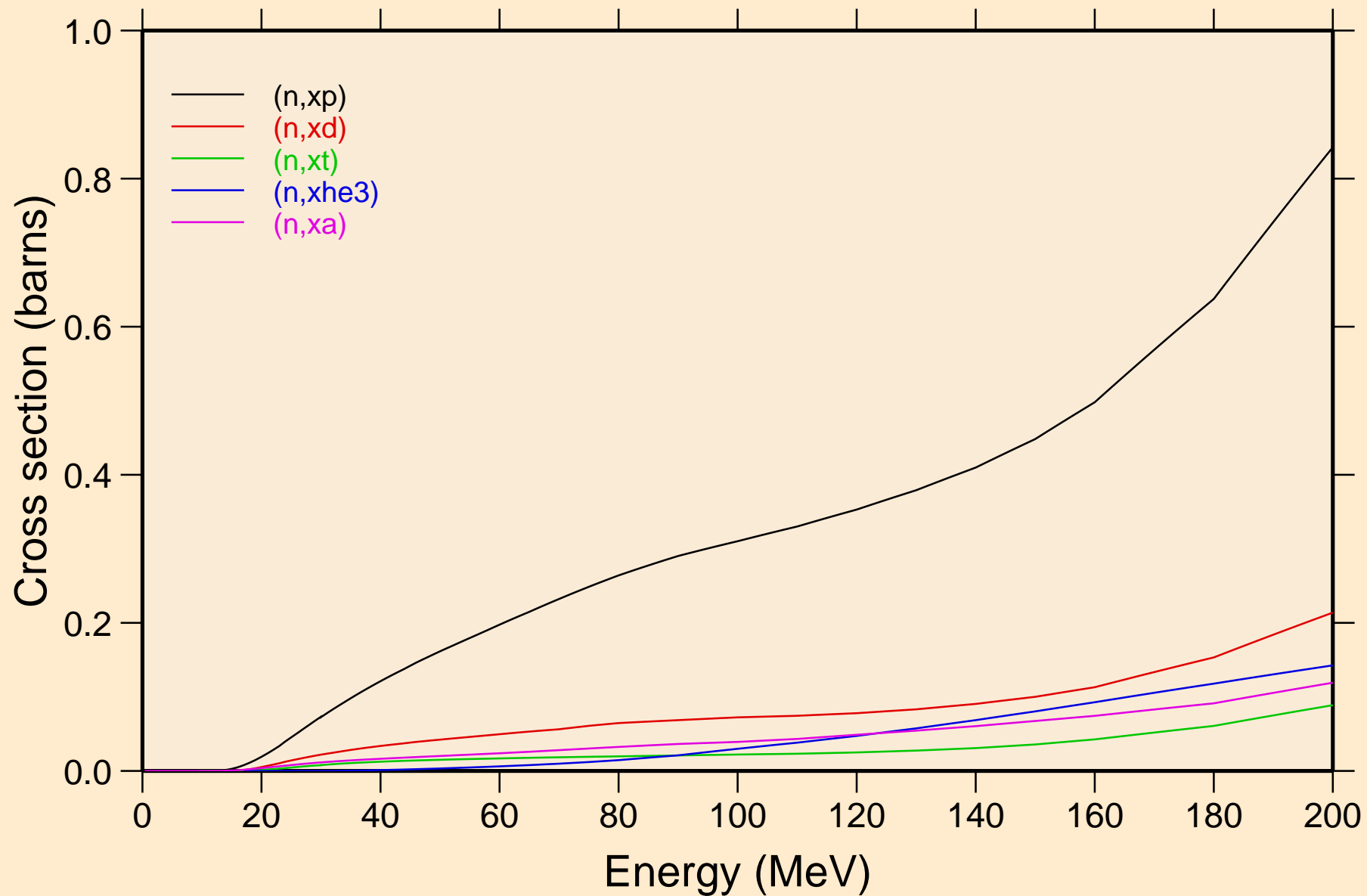

ZN073M NEUTRON ACER TENDL-2019 LIBRARY; T=293.16K
angular distribution for elastic

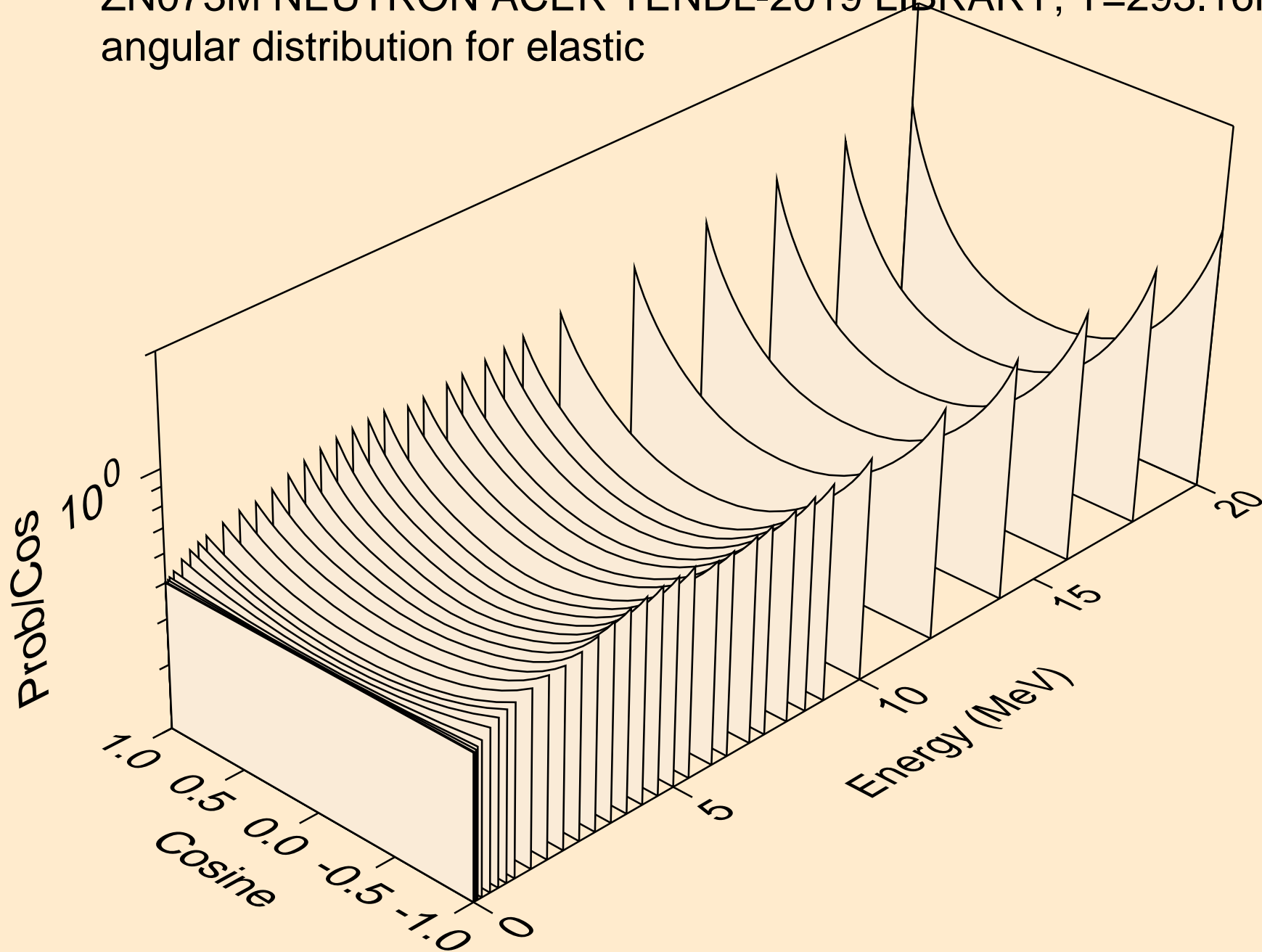

ZN073M NEUTRON ACER TENDL-2019 LIBRARY; T=293.16K
angular distribution for elastic

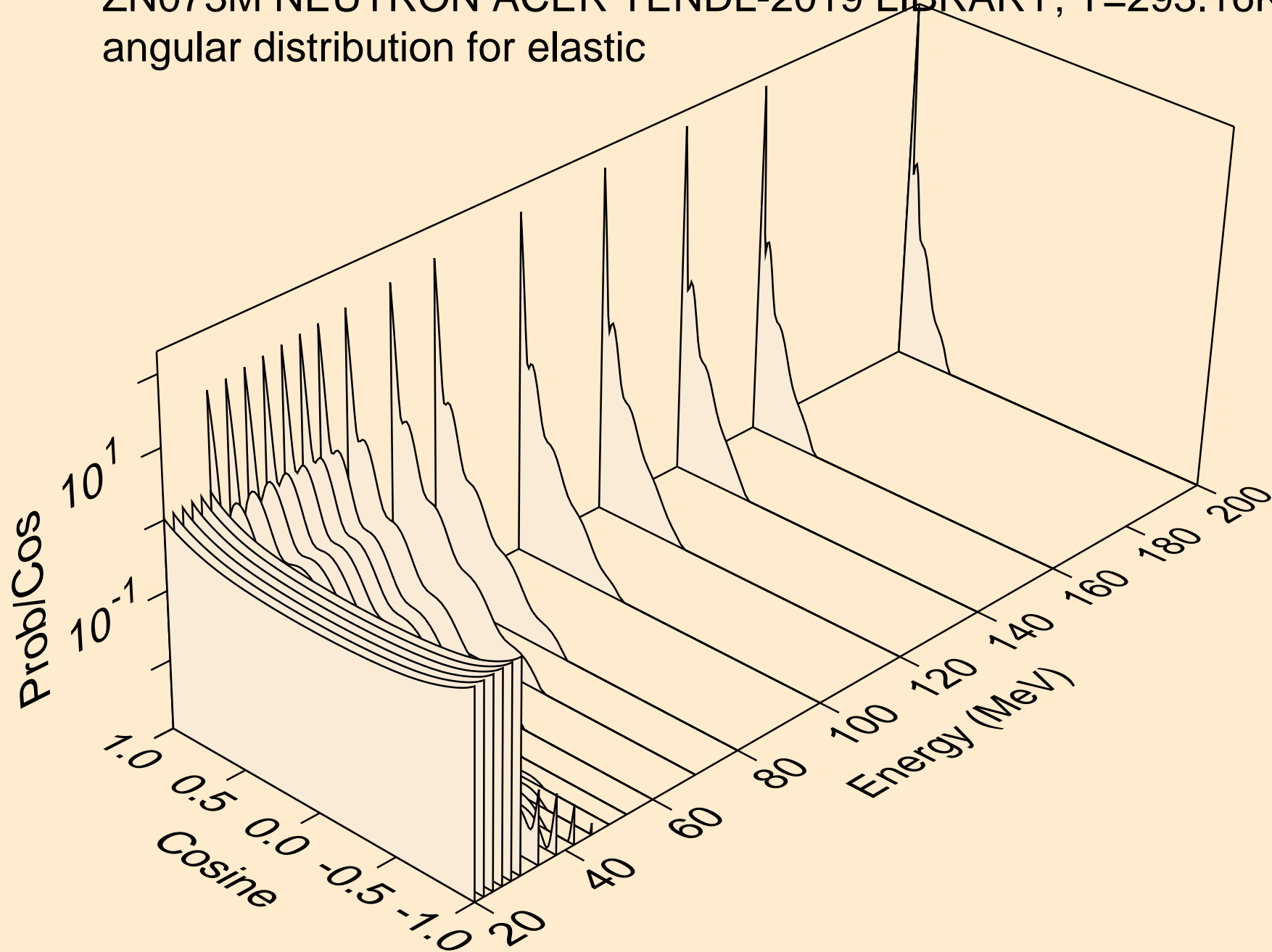

ZN073M NEUTRON ACER TENDL-2019 LIBRARY; T=293.16K
angular distribution for (n,n*1)

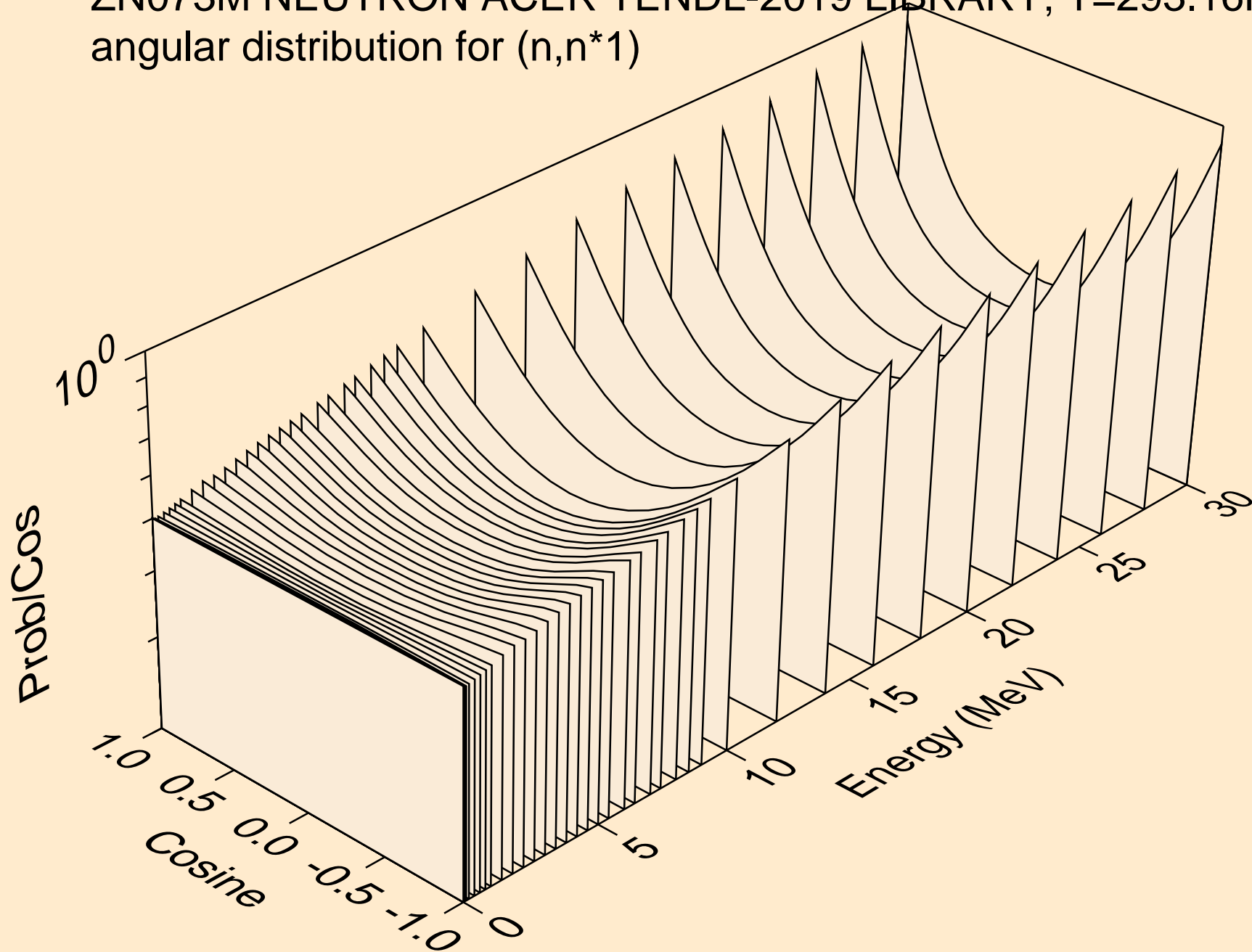

ZN073M NEUTRON ACER TENDL-2019 LIBRARY; T=293.16K
angular distribution for (n,n*2)

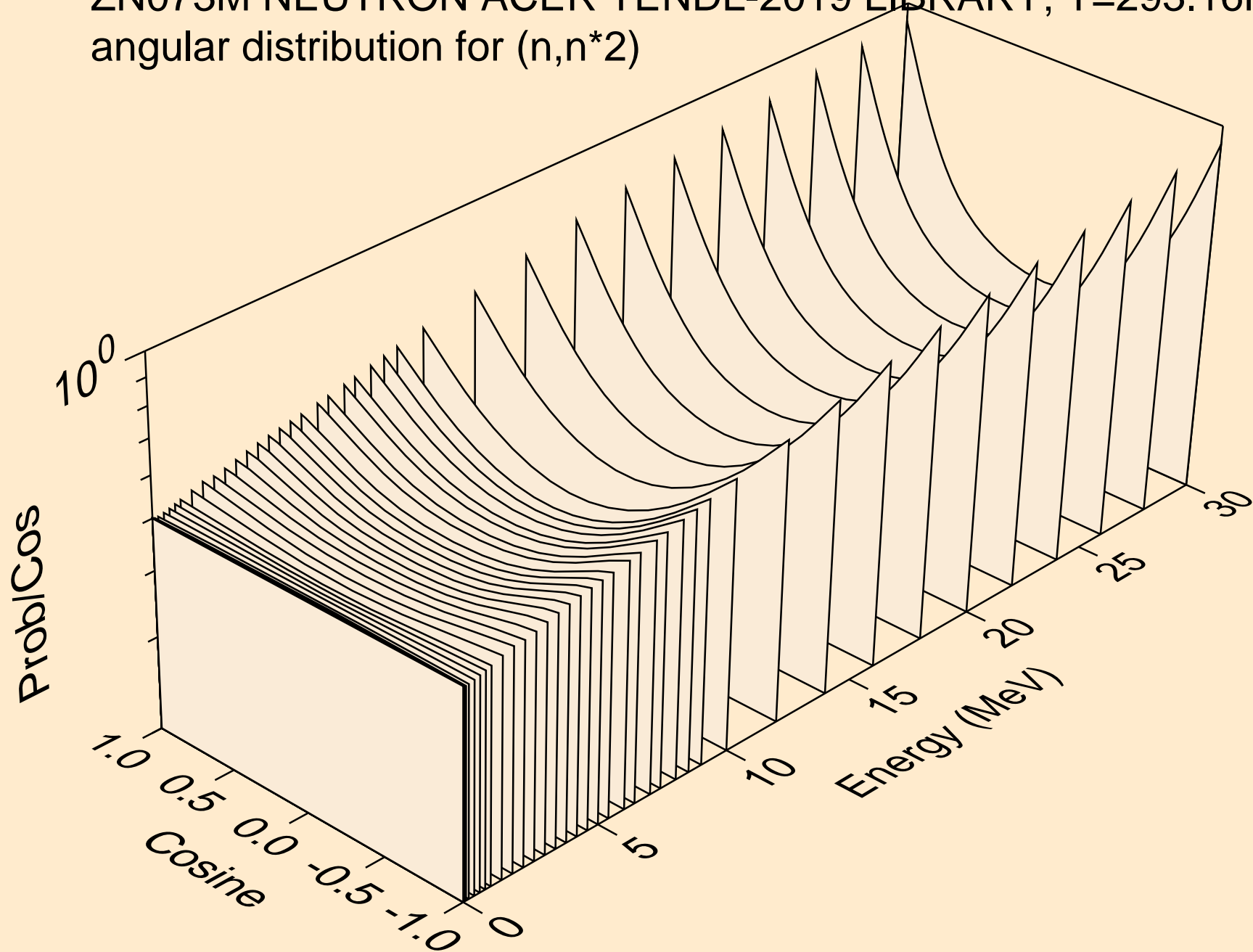

ZN073M NEUTRON ACER TENDL-2019 LIBRARY; T=293.16K
angular distribution for (n,n*3)

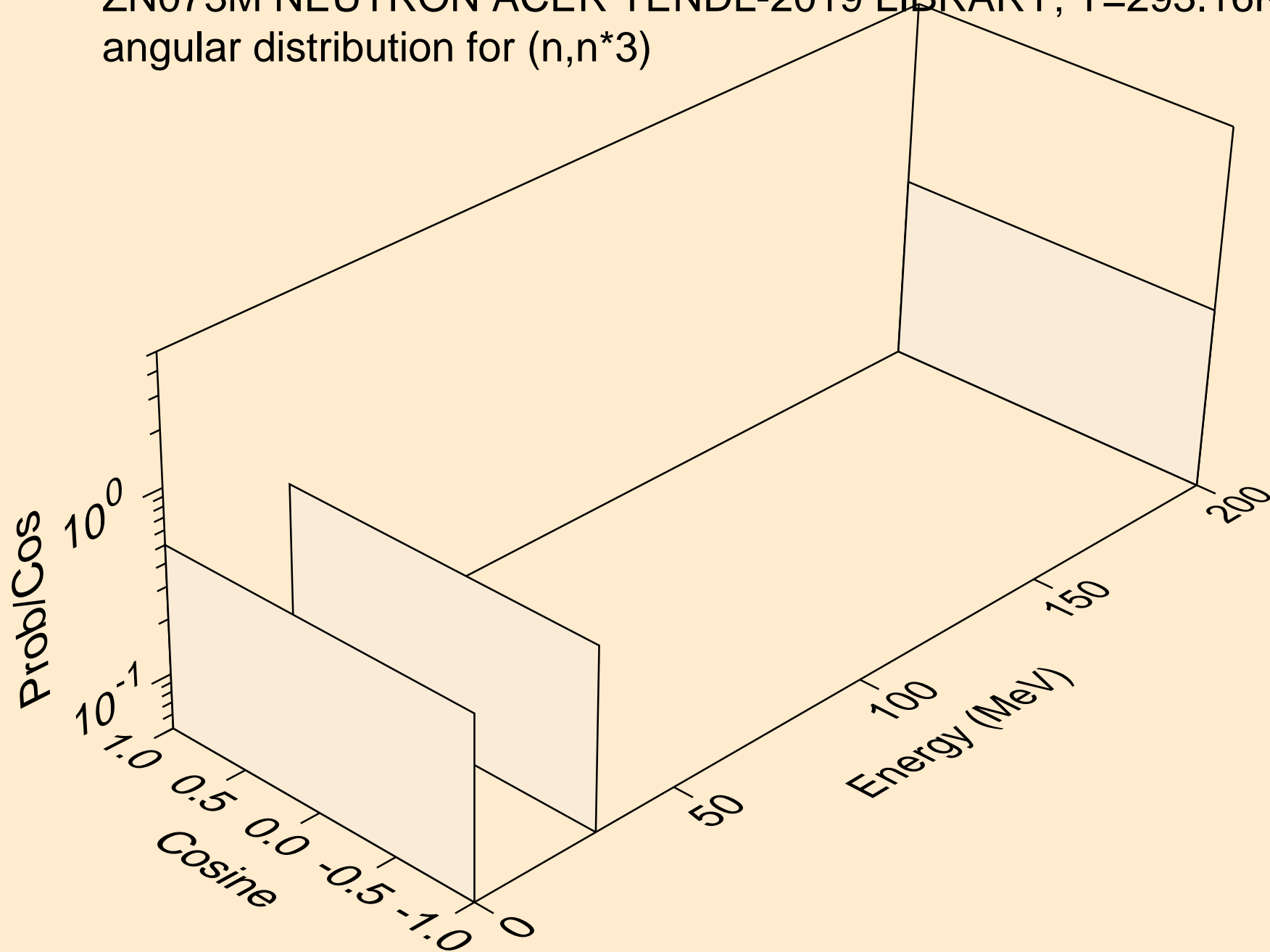

ZN073M NEUTRON ACER TENDL-2019 LIBRARY; T=293.16K
angular distribution for (n,n*4)

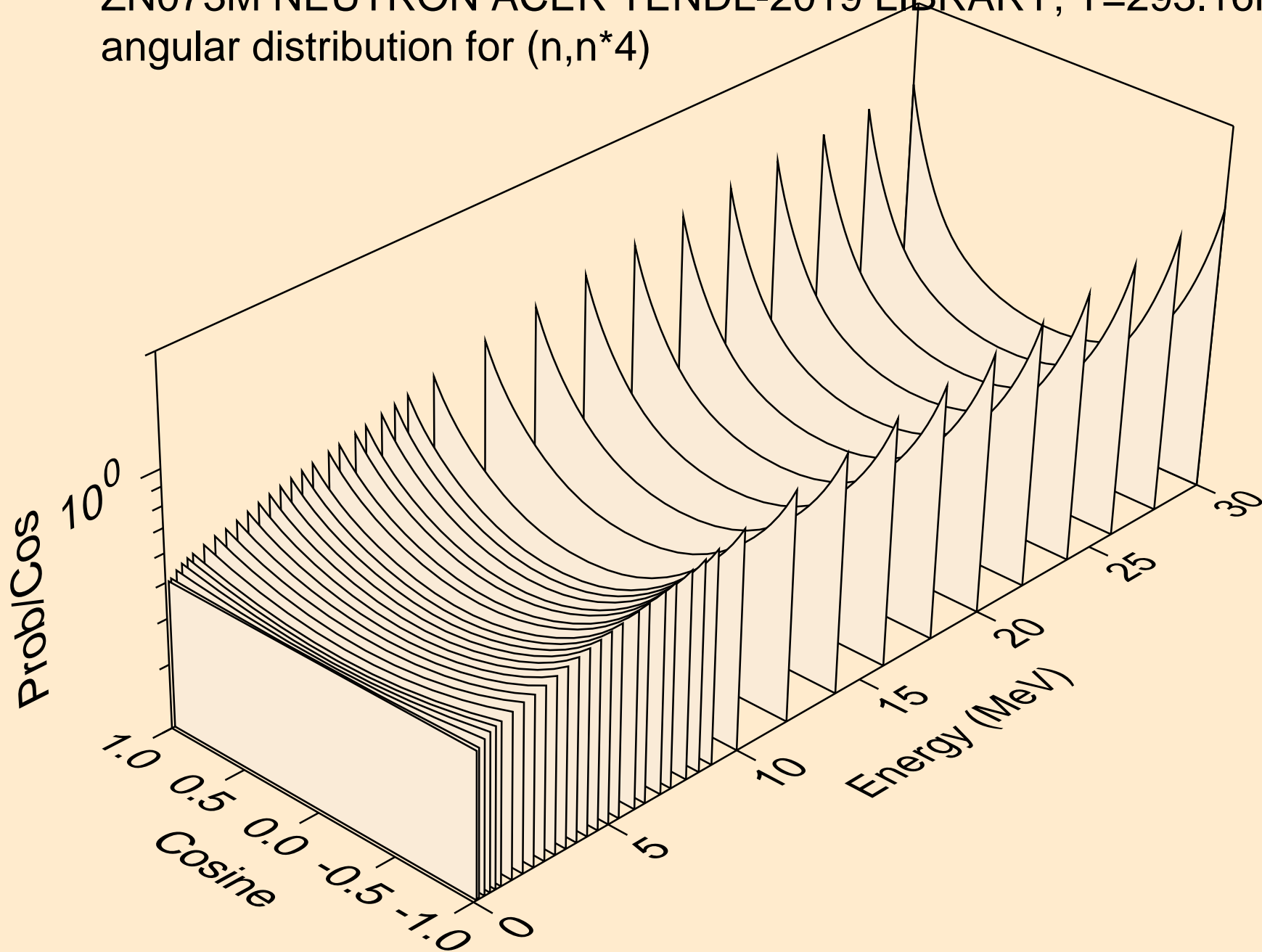

ZN073M NEUTRON ACER TENDL-2019 LIBRARY; T=293.16K
angular distribution for (n,n*5)

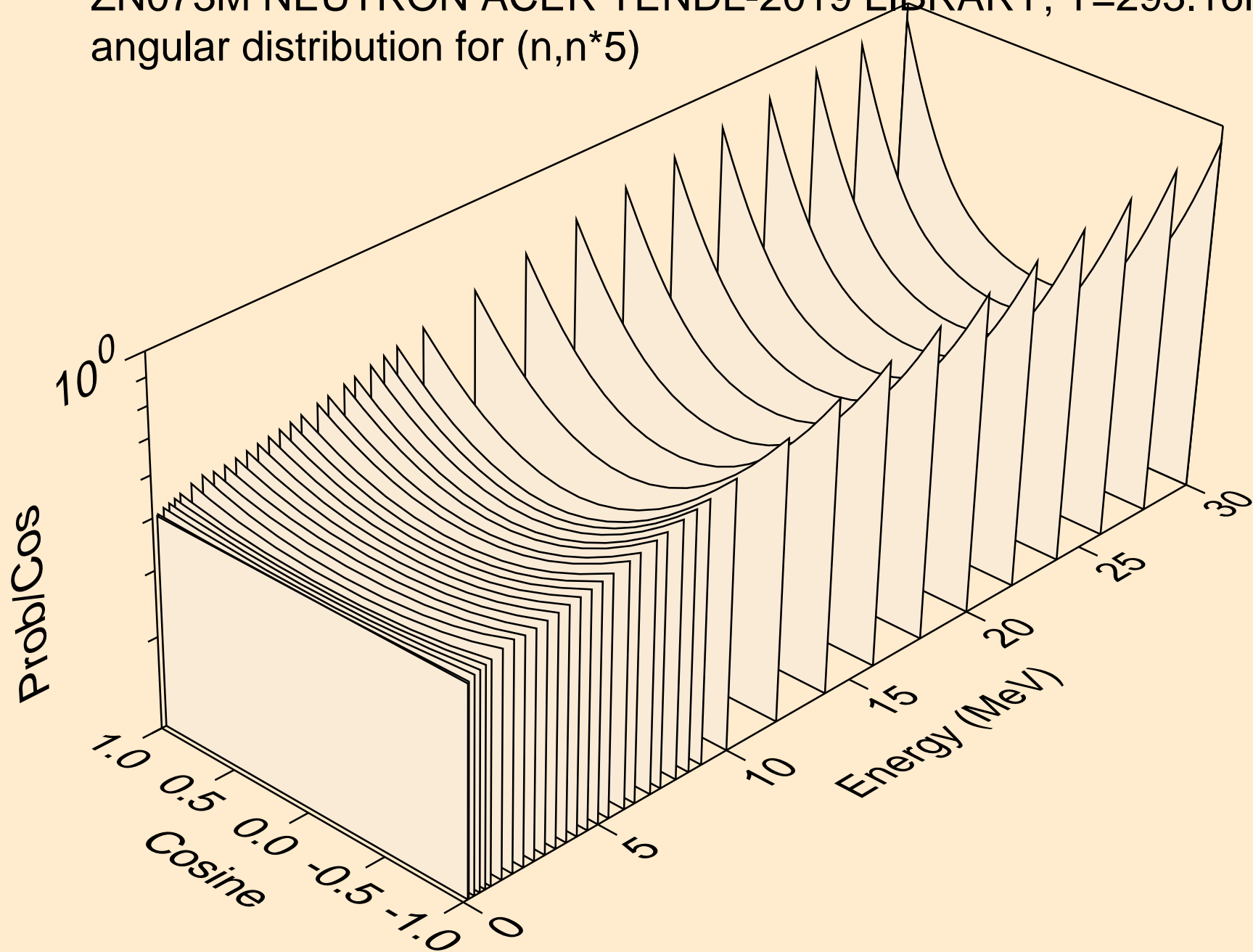

ZN073M NEUTRON ACER TENDL-2019 LIBRARY; T=293.16K
angular distribution for (n,n*6)

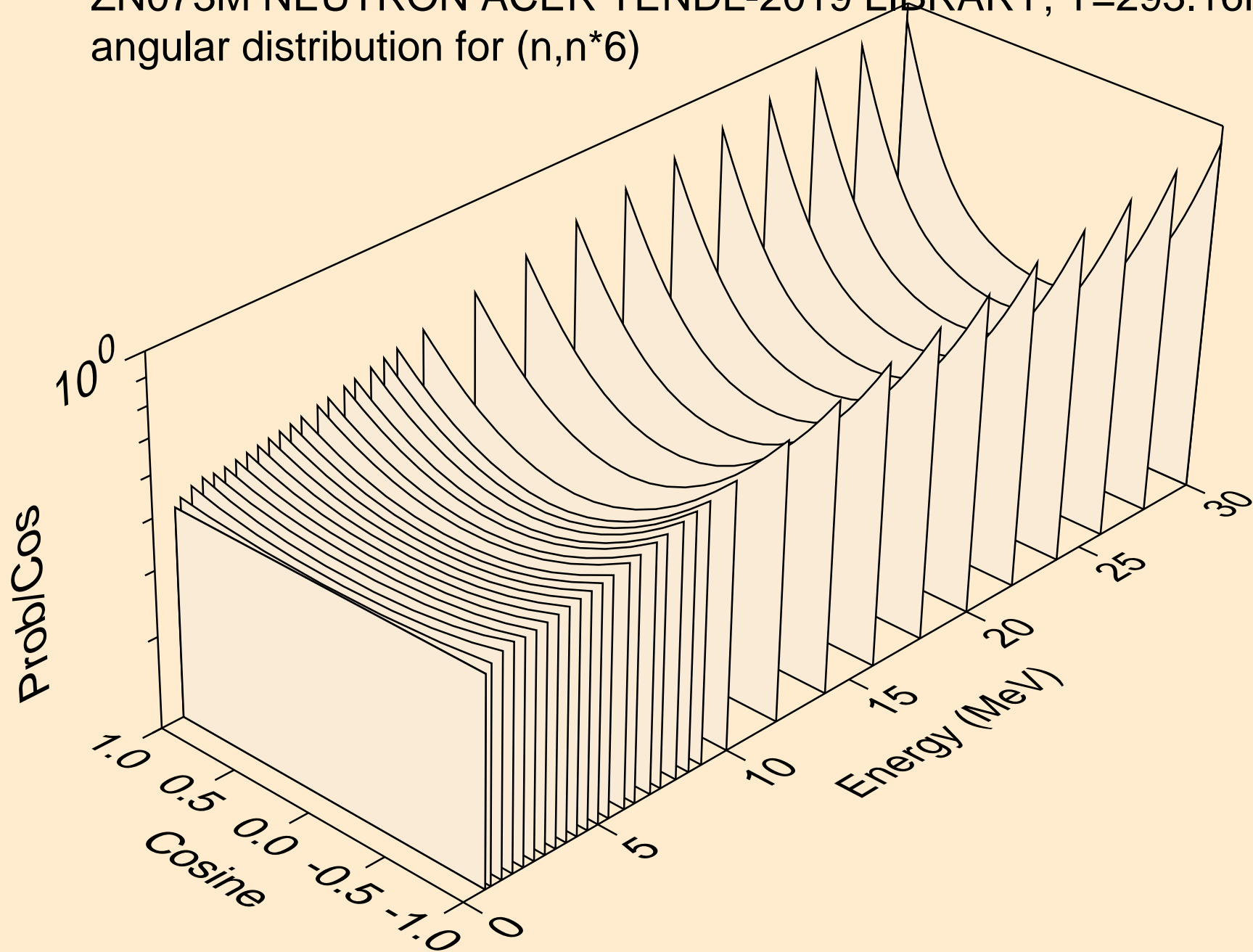

ZN073M NEUTRON ACER TENDL-2019 LIBRARY; T=293.16K
angular distribution for (n,n*7)

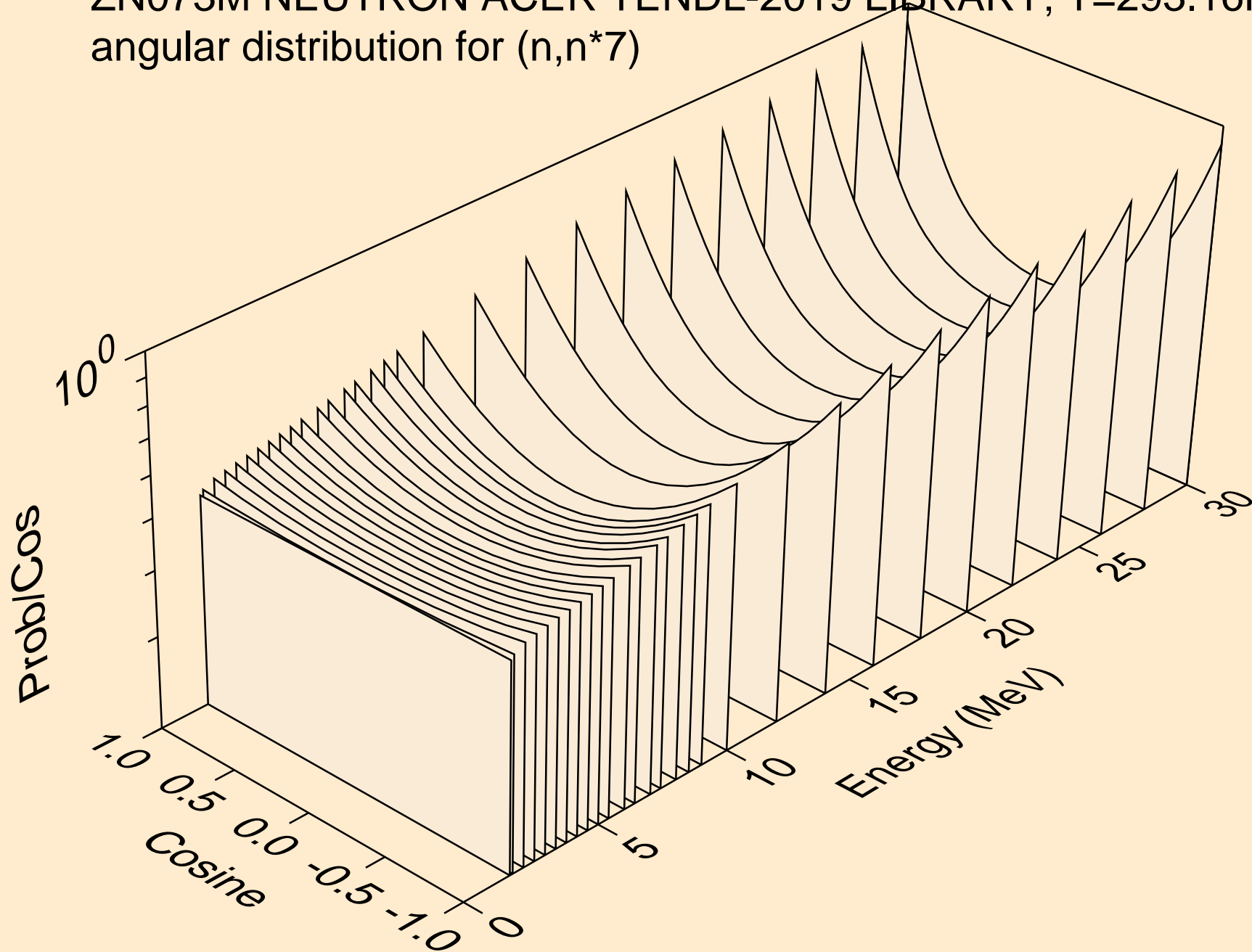

ZN073M NEUTRON ACER TENDL-2019 LIBRARY; T=293.16K
angular distribution for (n,n*8)

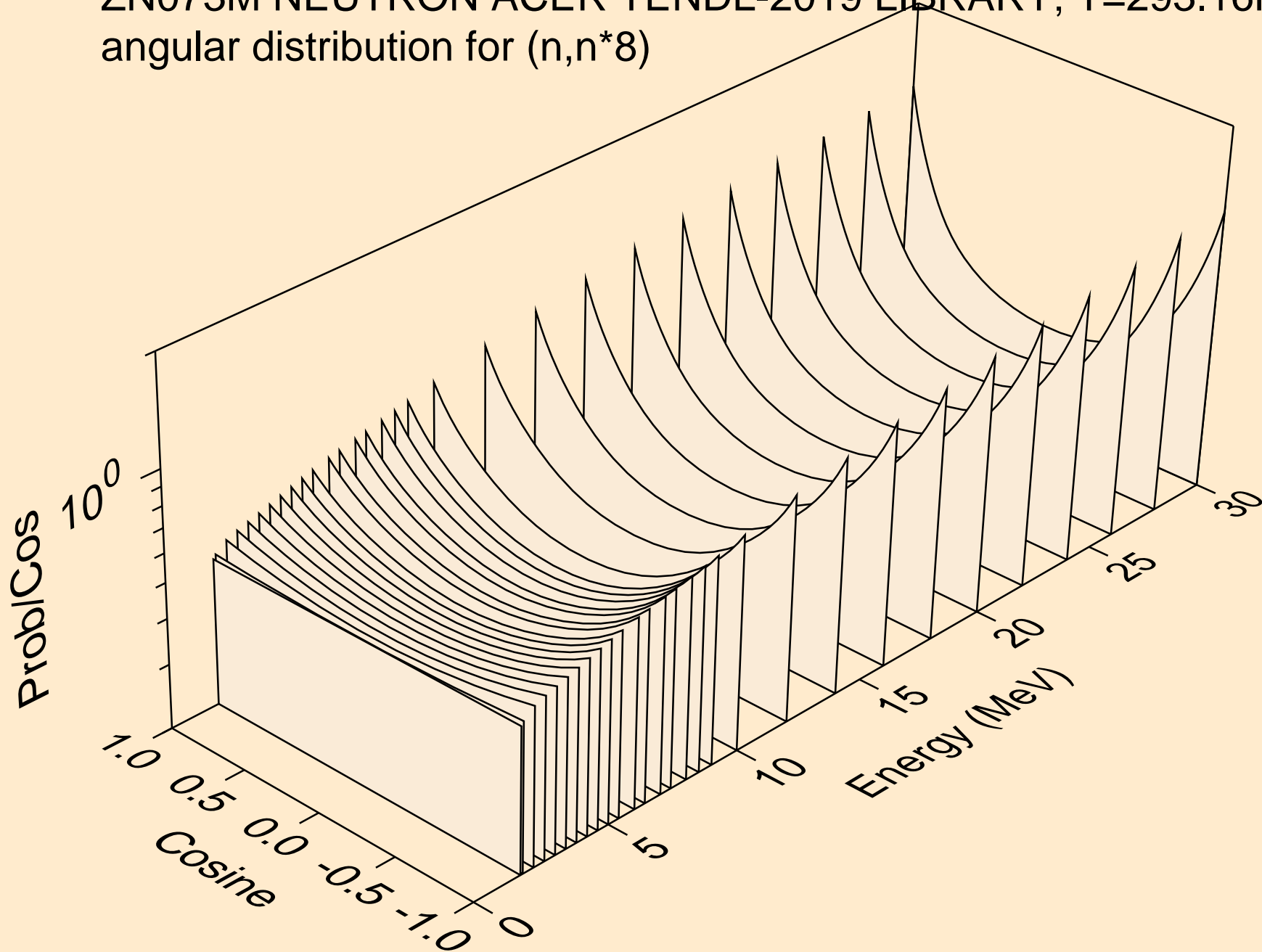

ZN073M NEUTRON ACER TENDL-2019 LIBRARY; T=293.16K
angular distribution for (n,n*9)

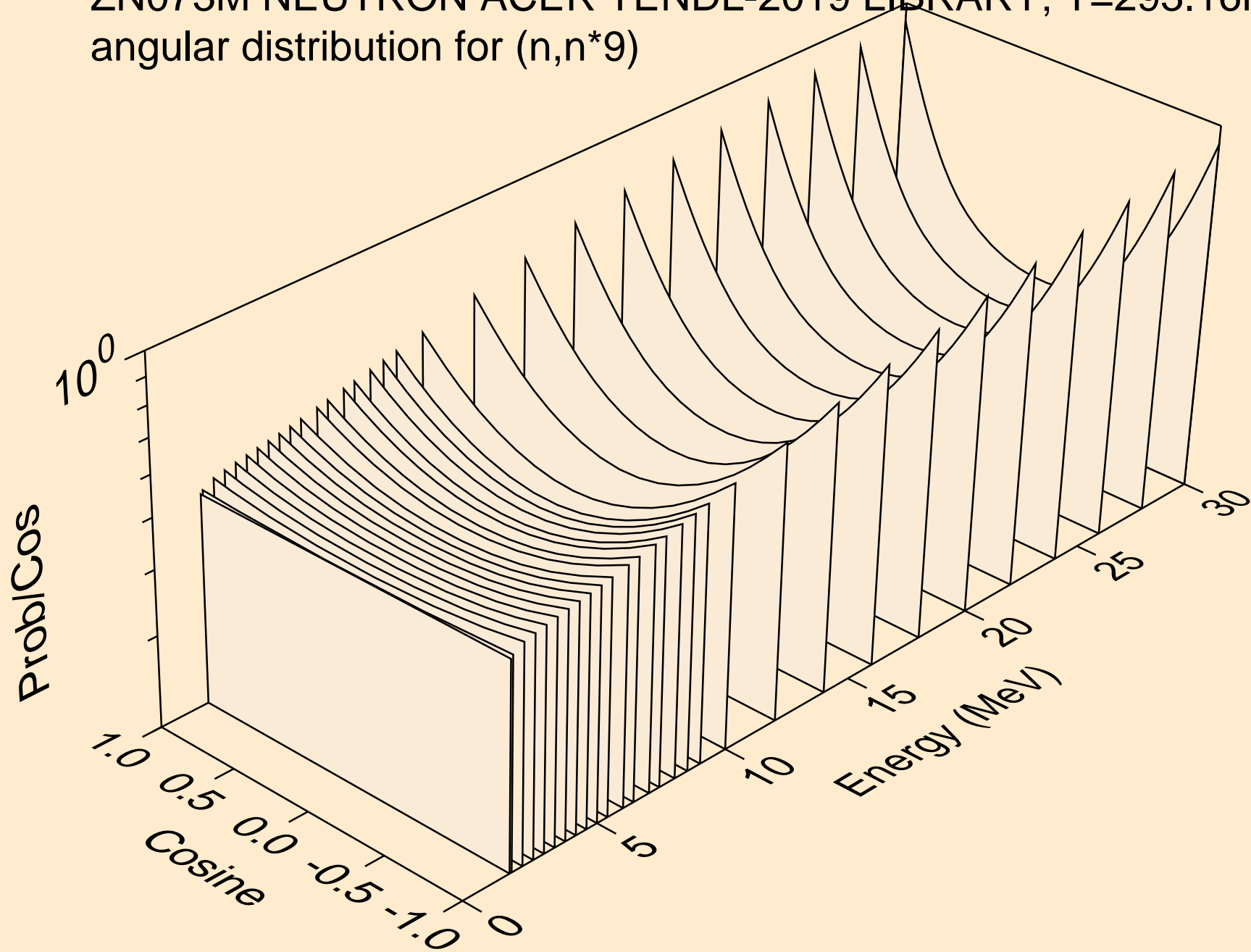

ZN073M NEUTRON ACER TENDL-2019 LIBRARY; T=293.16K
angular distribution for (n,n*10)

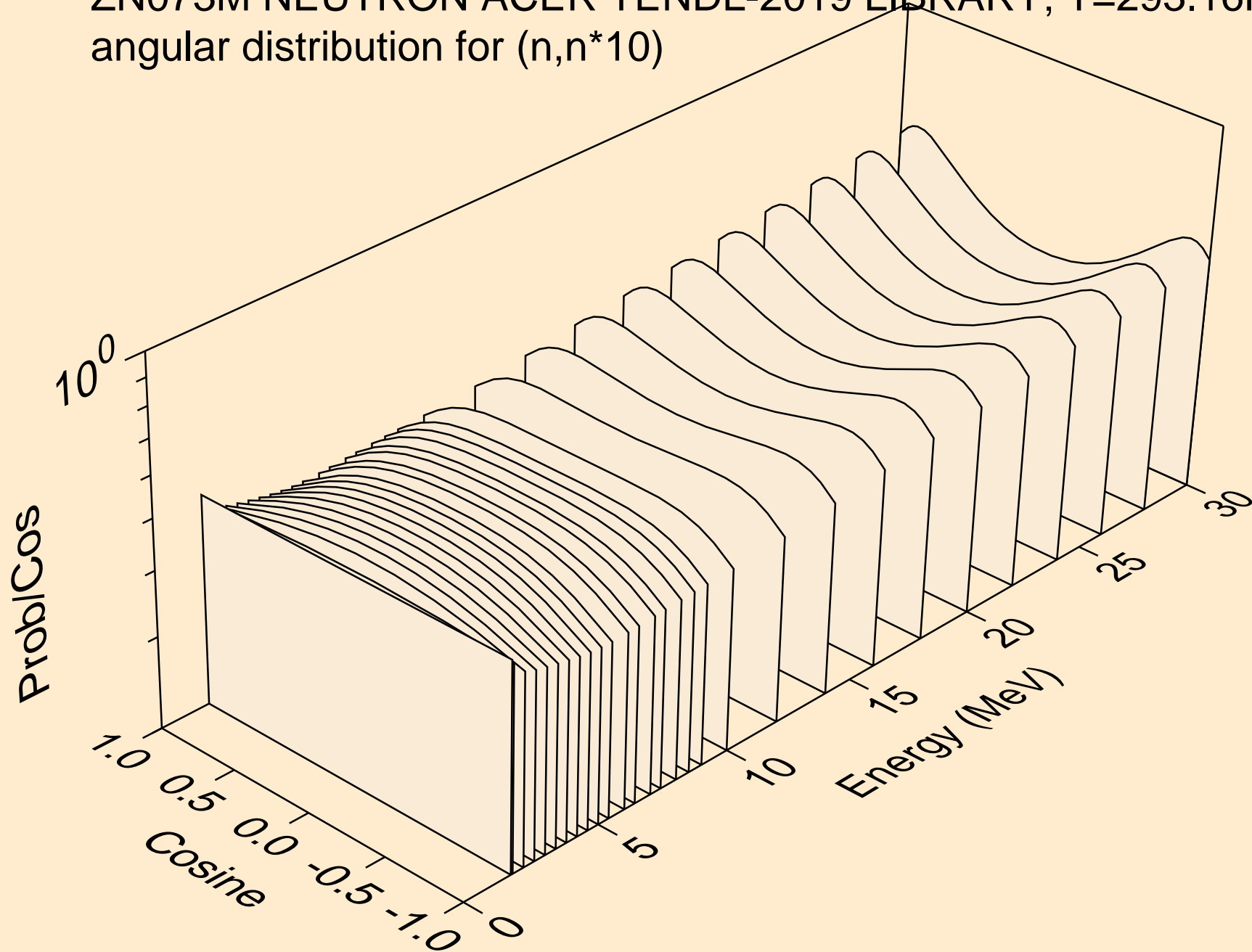

ZN073M NEUTRON ACER TENDL-2019 LIBRARY; T=293.16K
angular distribution for (n,n*11)

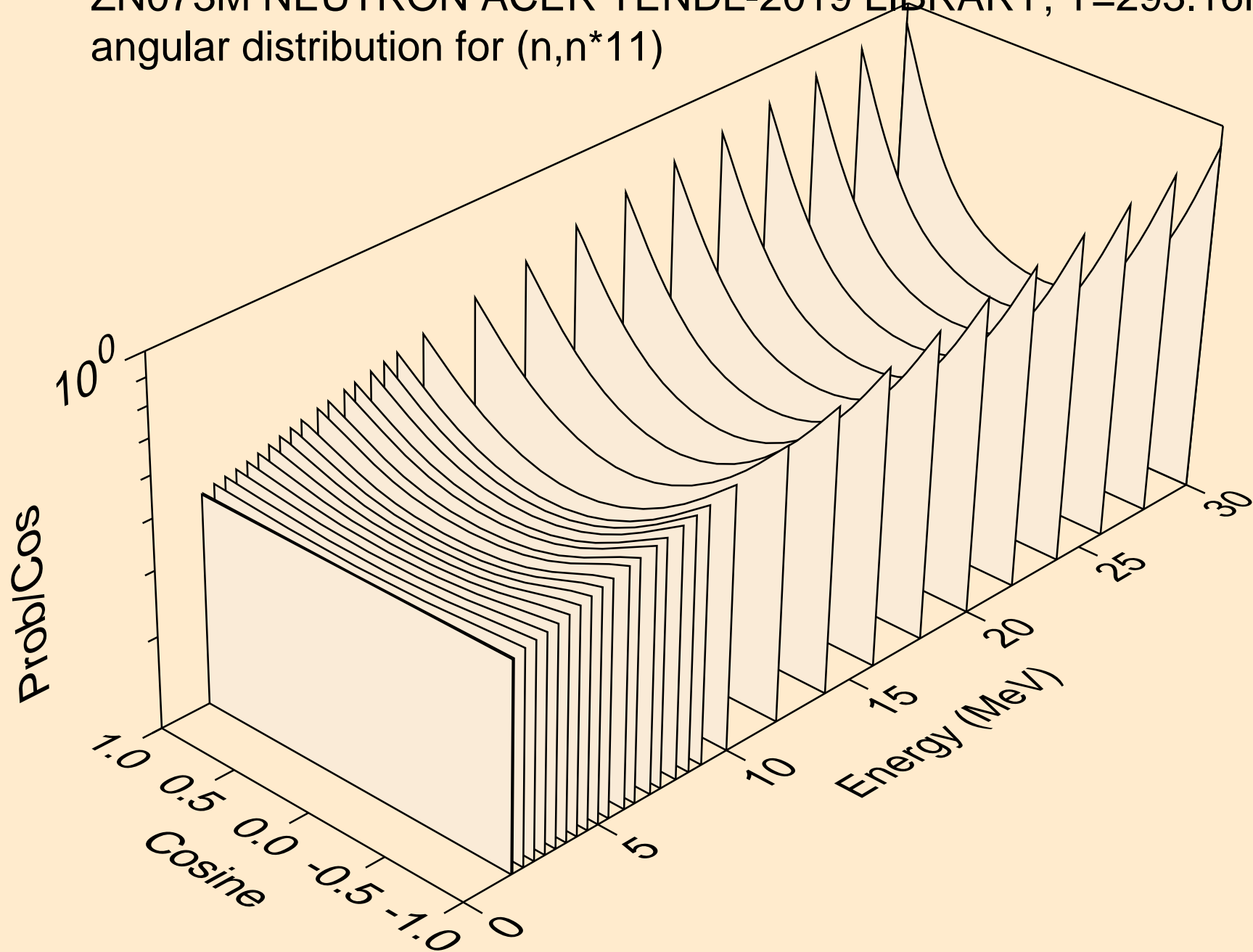

ZN073M NEUTRON ACER TENDL-2019 LIBRARY; T=293.16K
angular distribution for (n,n*12)

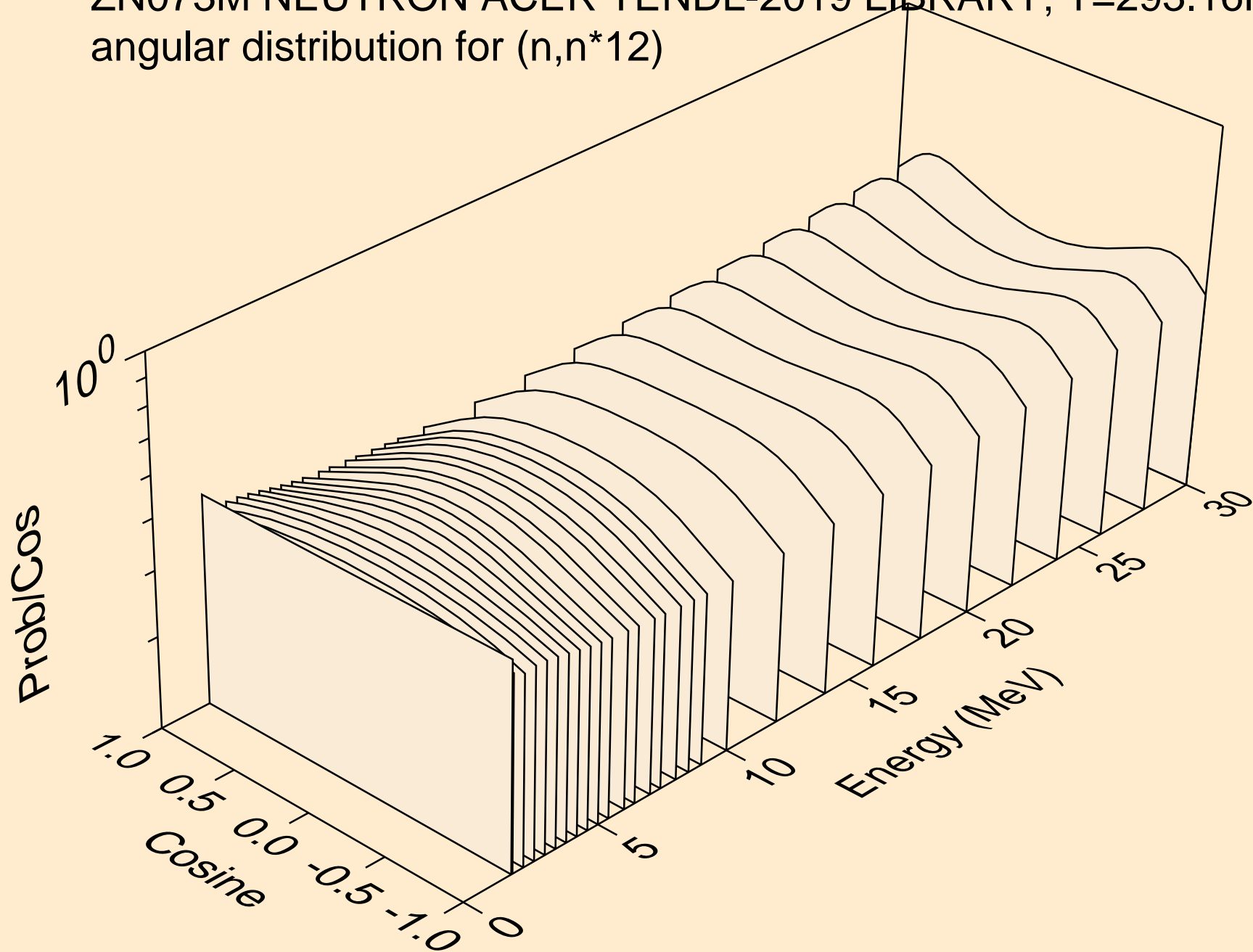

ZN073M NEUTRON ACER TENDL-2019 LIBRARY; T=293.16K
angular distribution for (n,n*13)

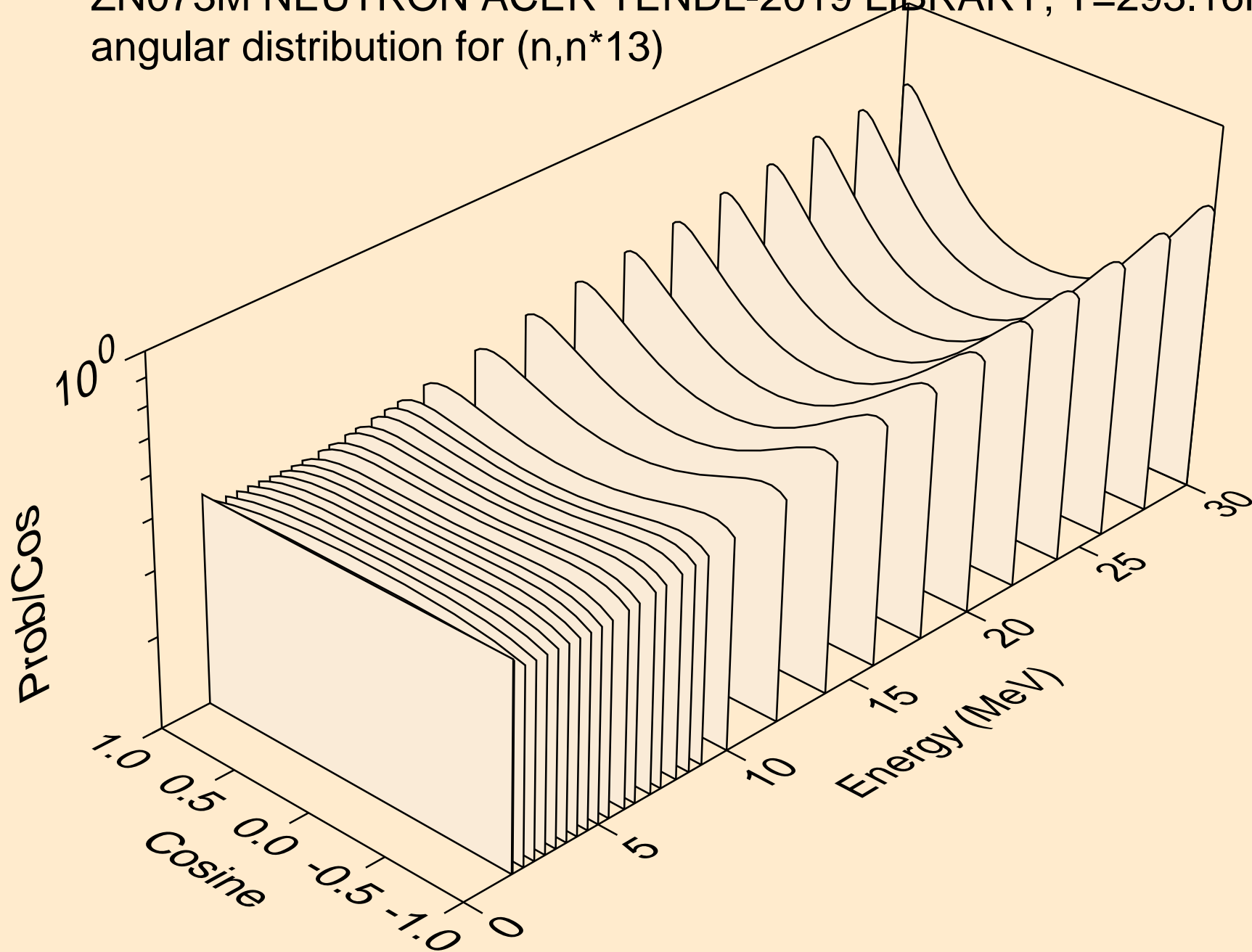

ZN073M NEUTRON ACER TENDL-2019 LIBRARY; T=293.16K
angular distribution for (n,n*14)

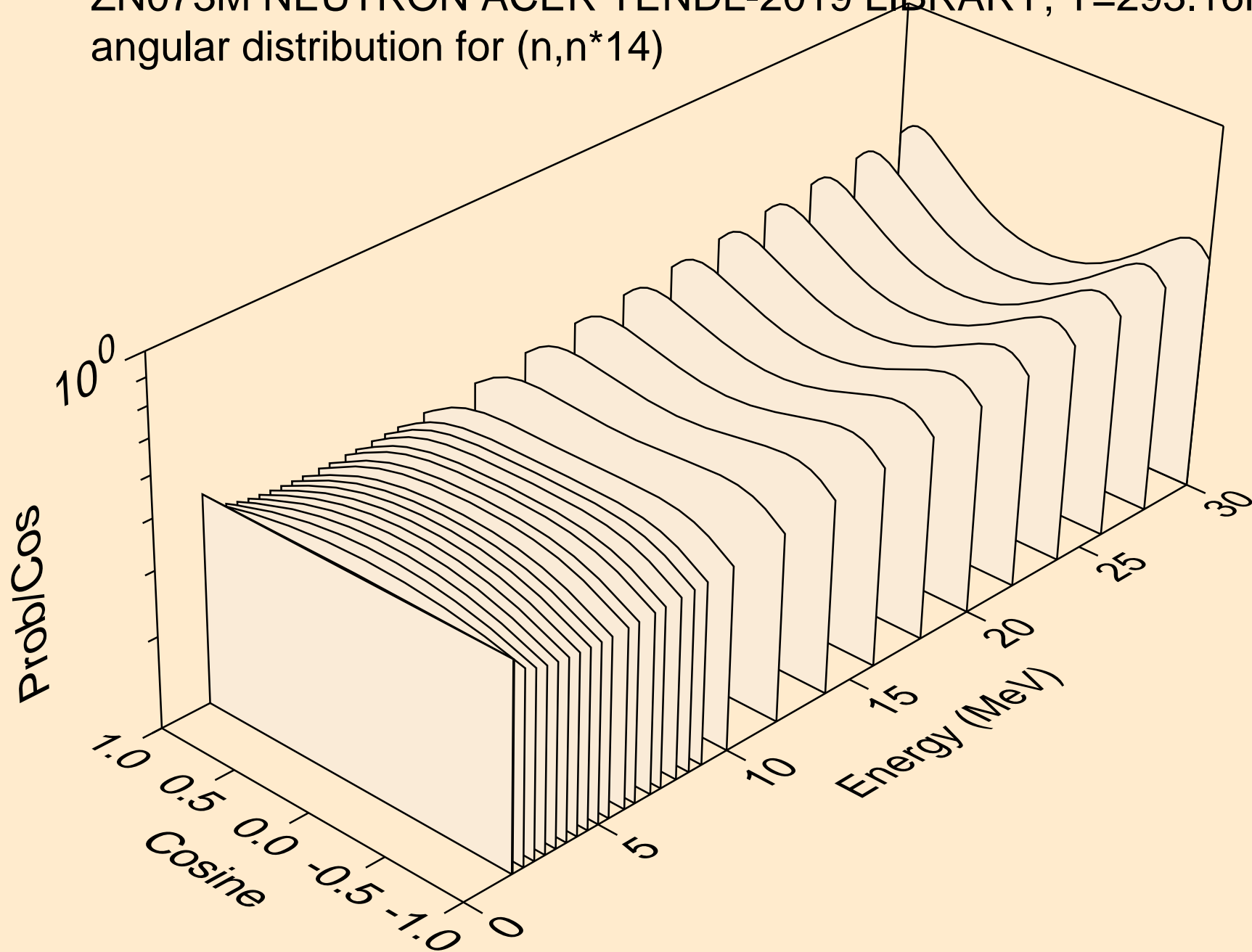

ZN073M NEUTRON ACER TENDL-2019 LIBRARY; T=293.16K
angular distribution for (n,n*15)

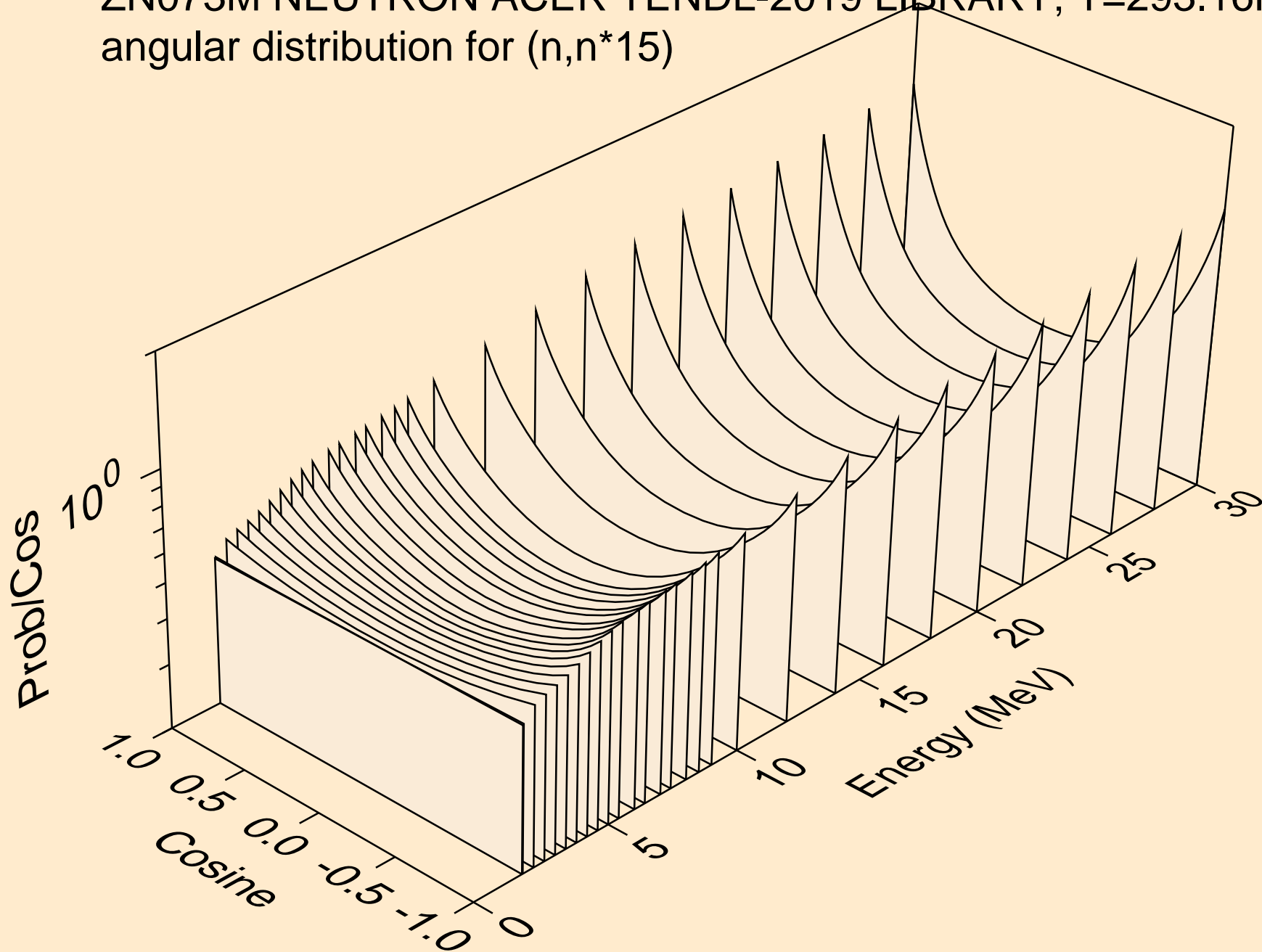

ZN073M NEUTRON ACER TENDL-2019 LIBRARY; T=293.16K
angular distribution for (n,n*16)

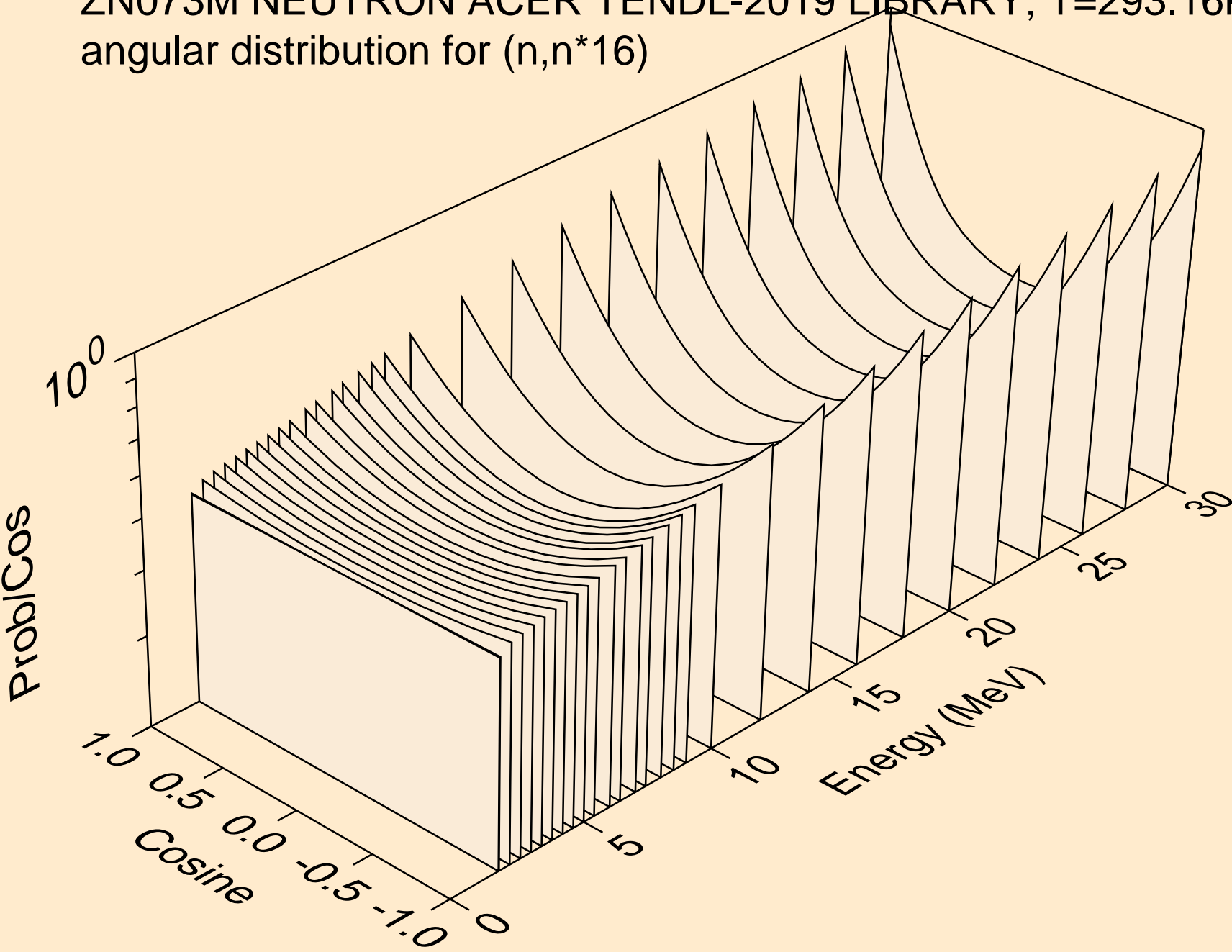

ZN073M NEUTRON ACER TENDL-2019 LIBRARY; T=293.16K
angular distribution for (n,n*17)

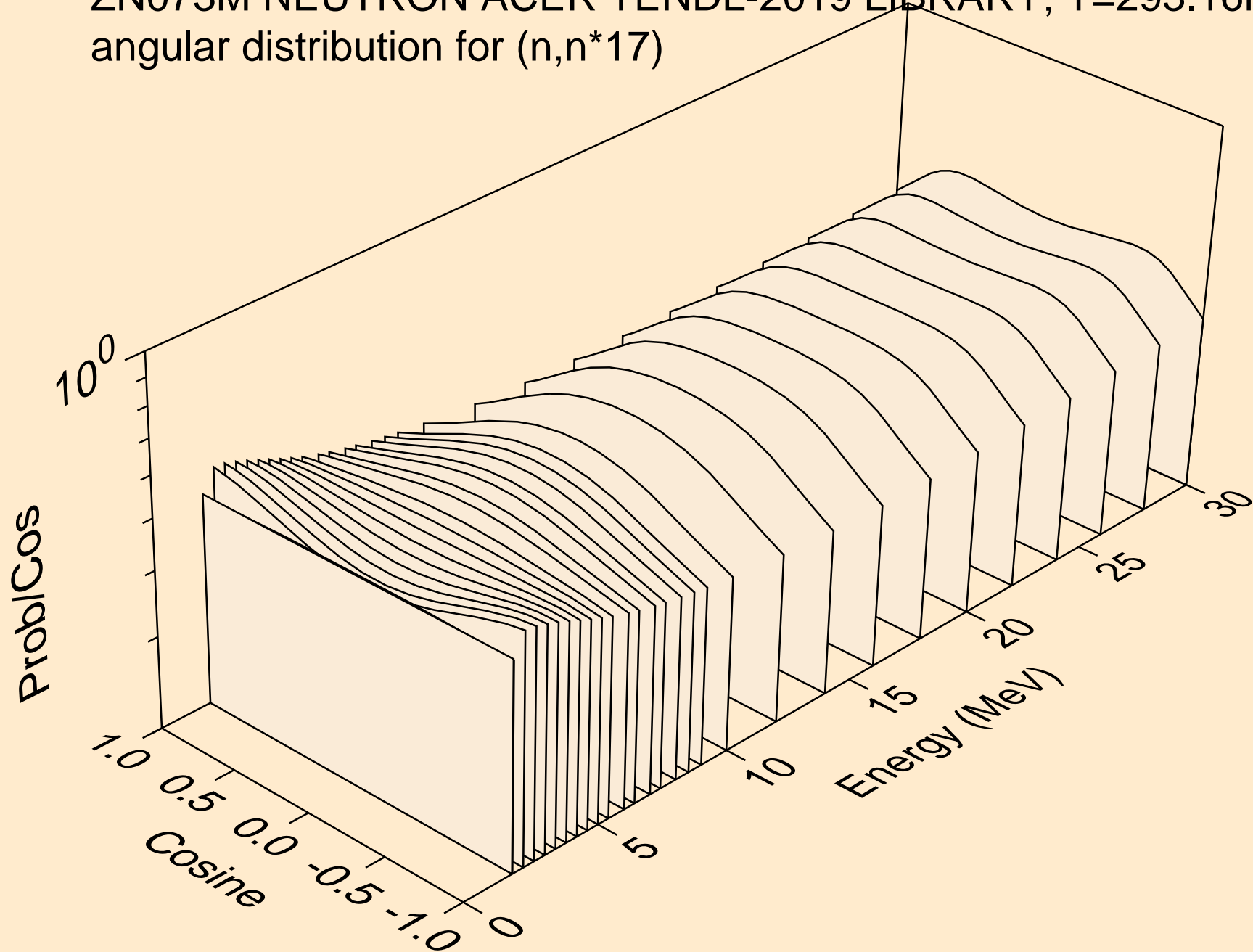

ZN073M NEUTRON ACER TENDL-2019 LIBRARY; T=293.16K
angular distribution for (n,n*18)

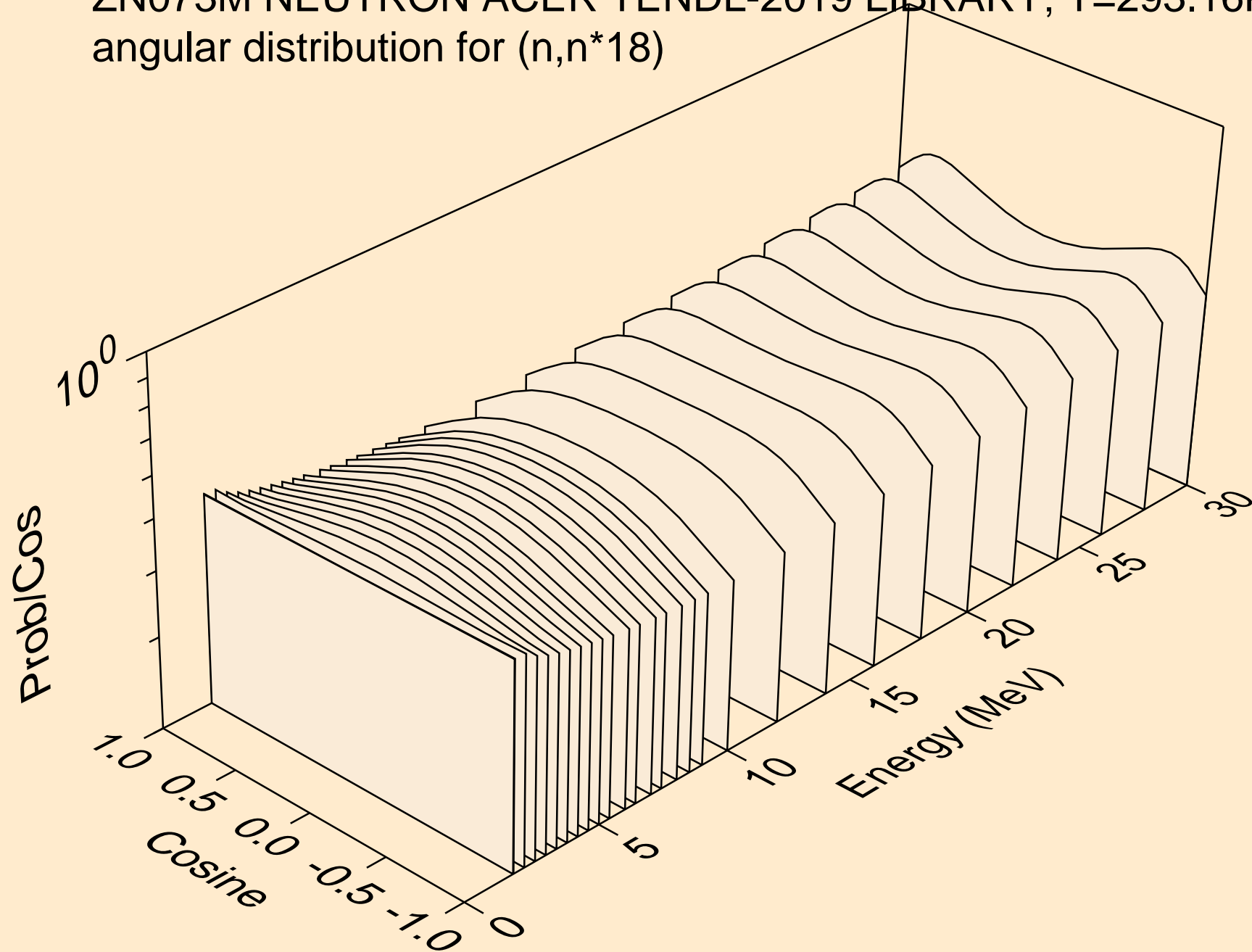

ZN073M NEUTRON ACER TENDL-2019 LIBRARY; T=293.16K
angular distribution for (n,n*19)

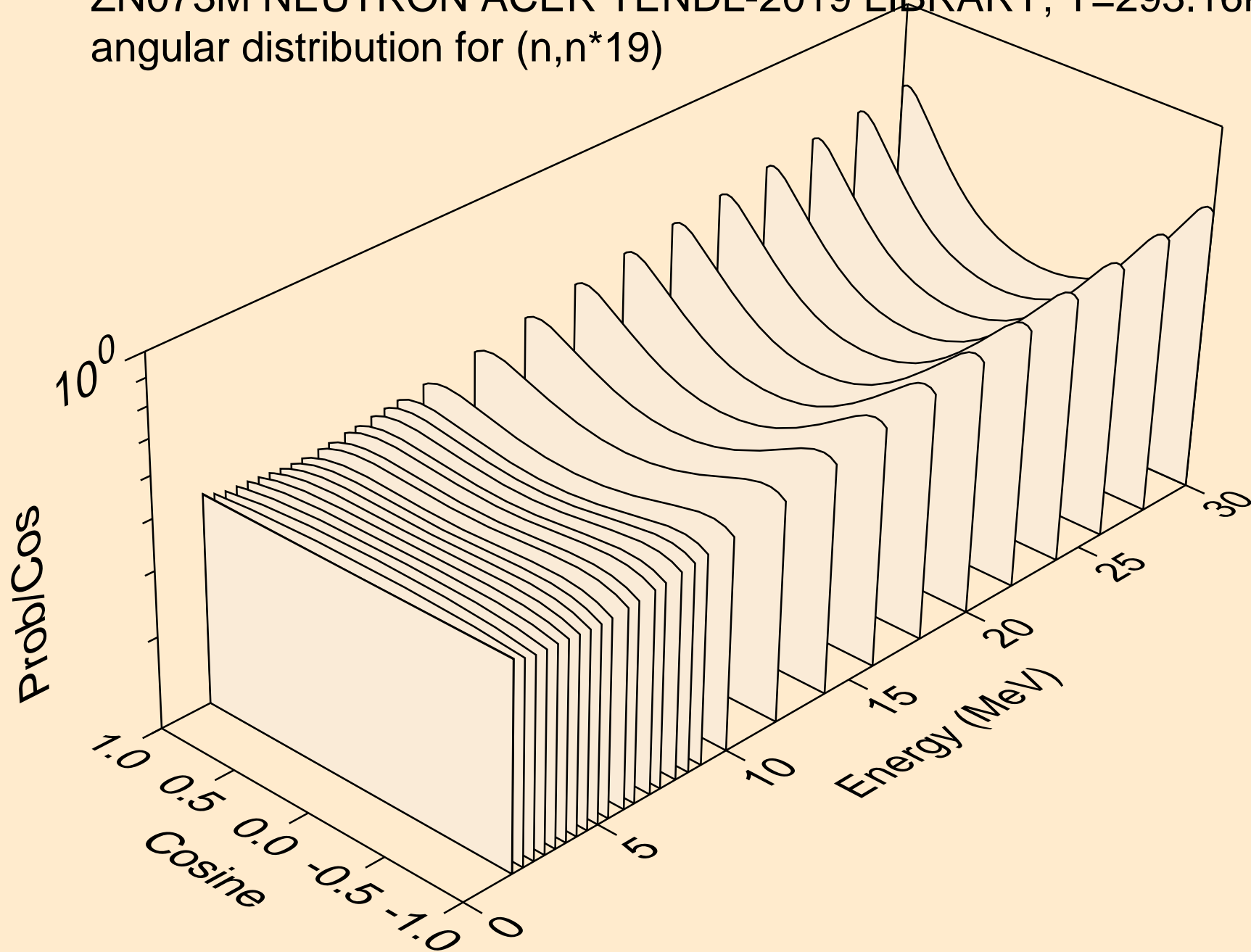

ZN073M NEUTRON ACER TENDL-2019 LIBRARY; T=293.16K
angular distribution for (n,n*20)

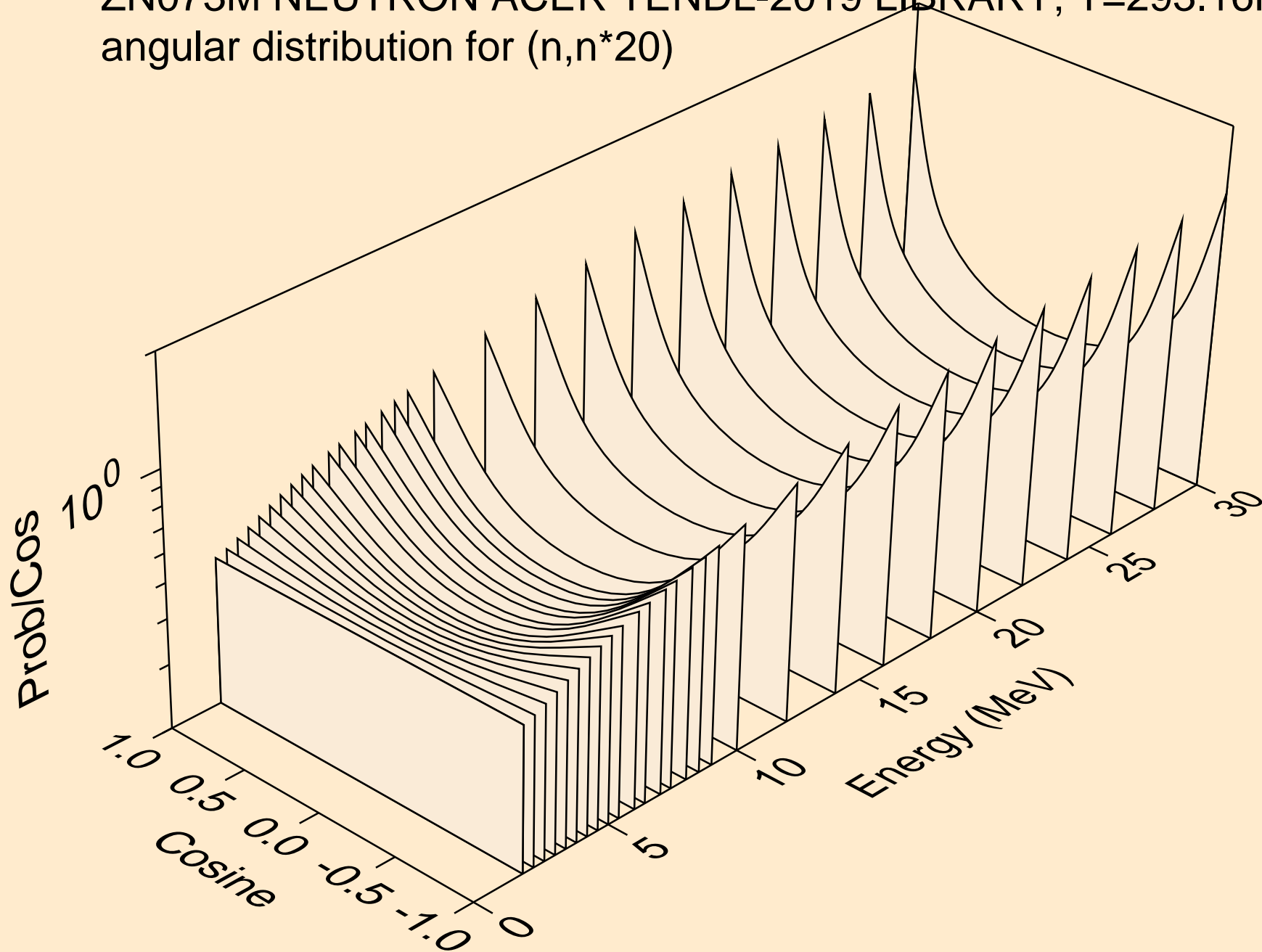

ZN073M NEUTRON ACER TENDL-2019 LIBRARY; T=293.16K
angular distribution for (n,n*21)

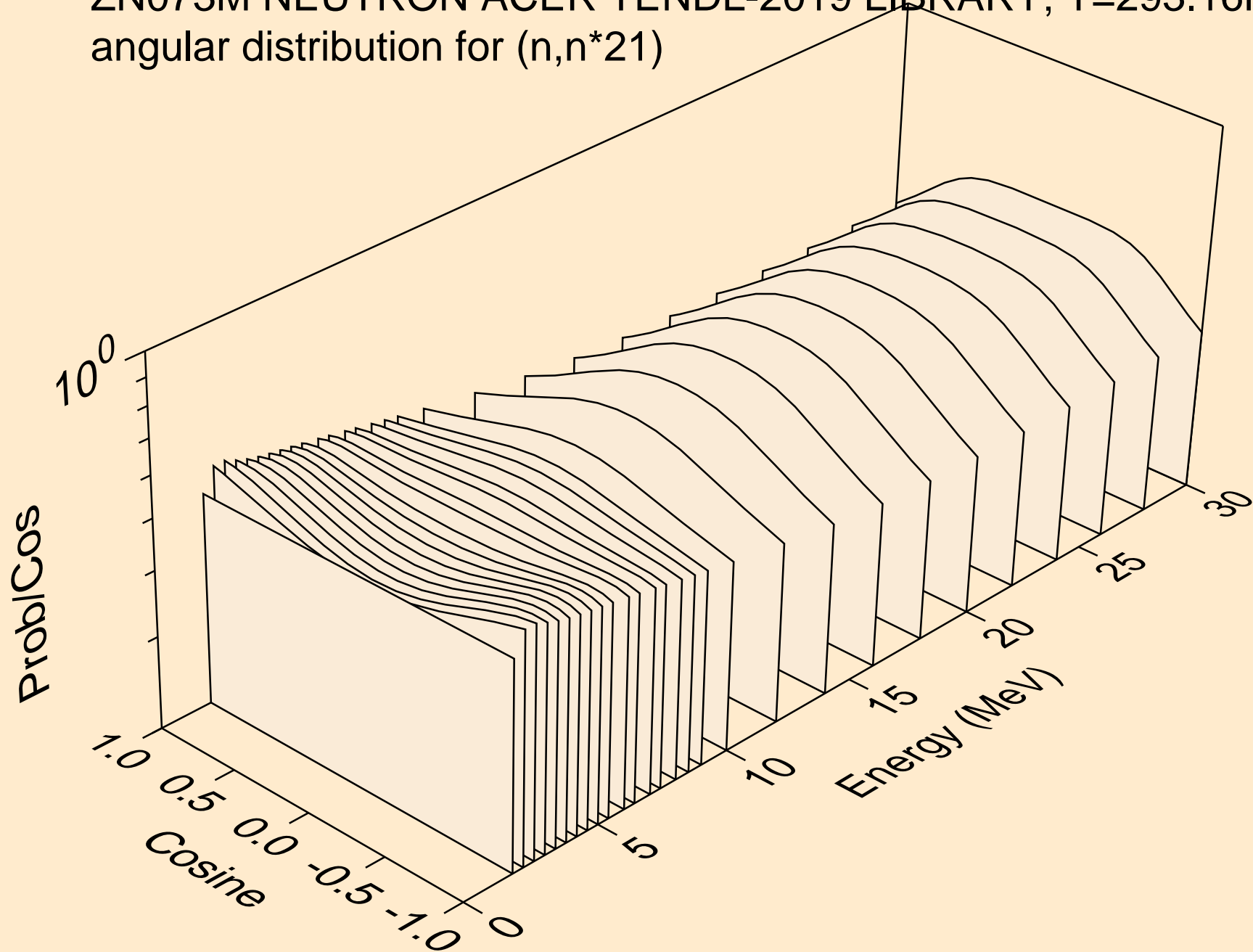

ZN073M NEUTRON ACER TENDL-2019 LIBRARY; T=293.16K
angular distribution for (n,n*22)

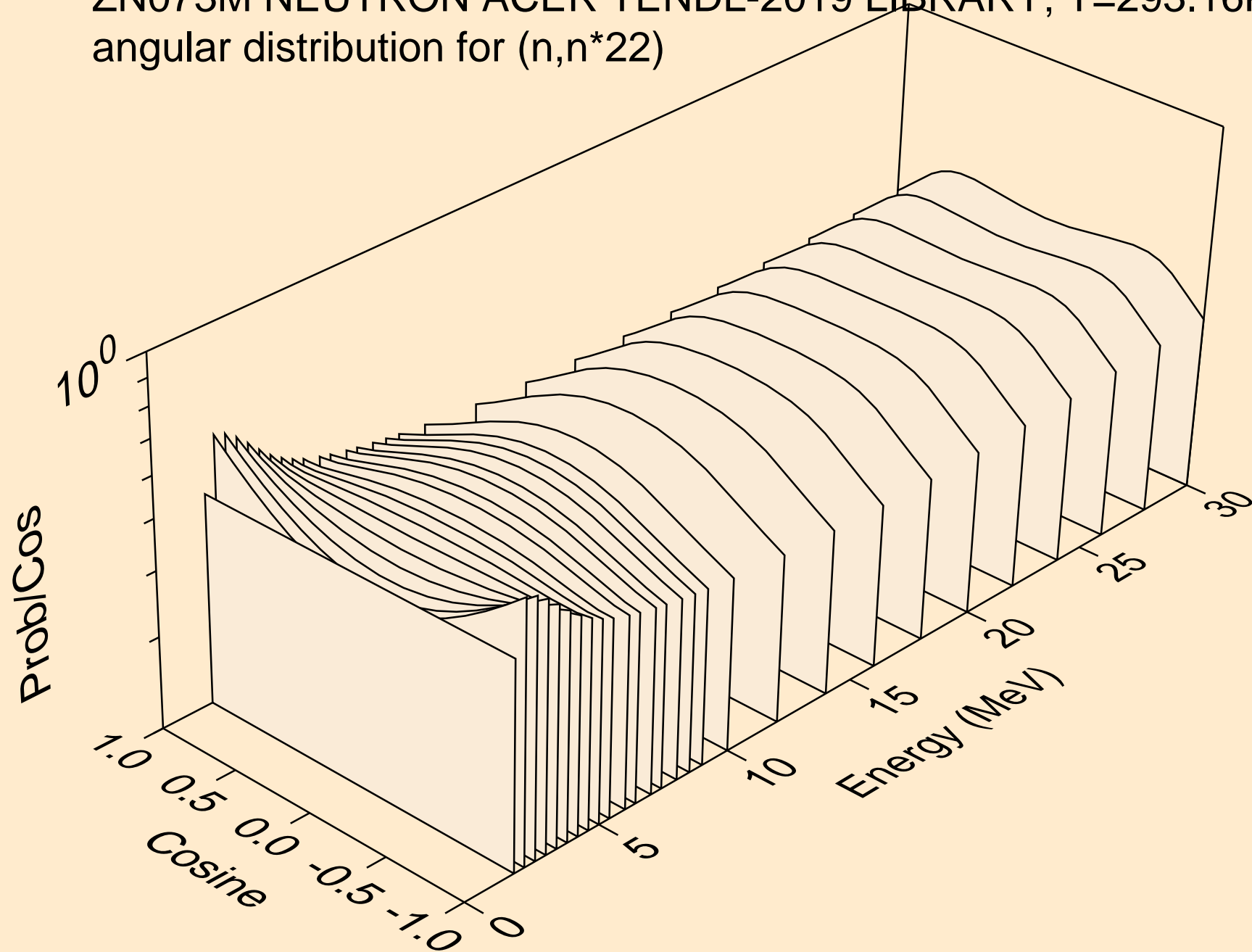

ZN073M NEUTRON ACER TENDL-2019 LIBRARY; T=293.16K
angular distribution for (n,n*23)

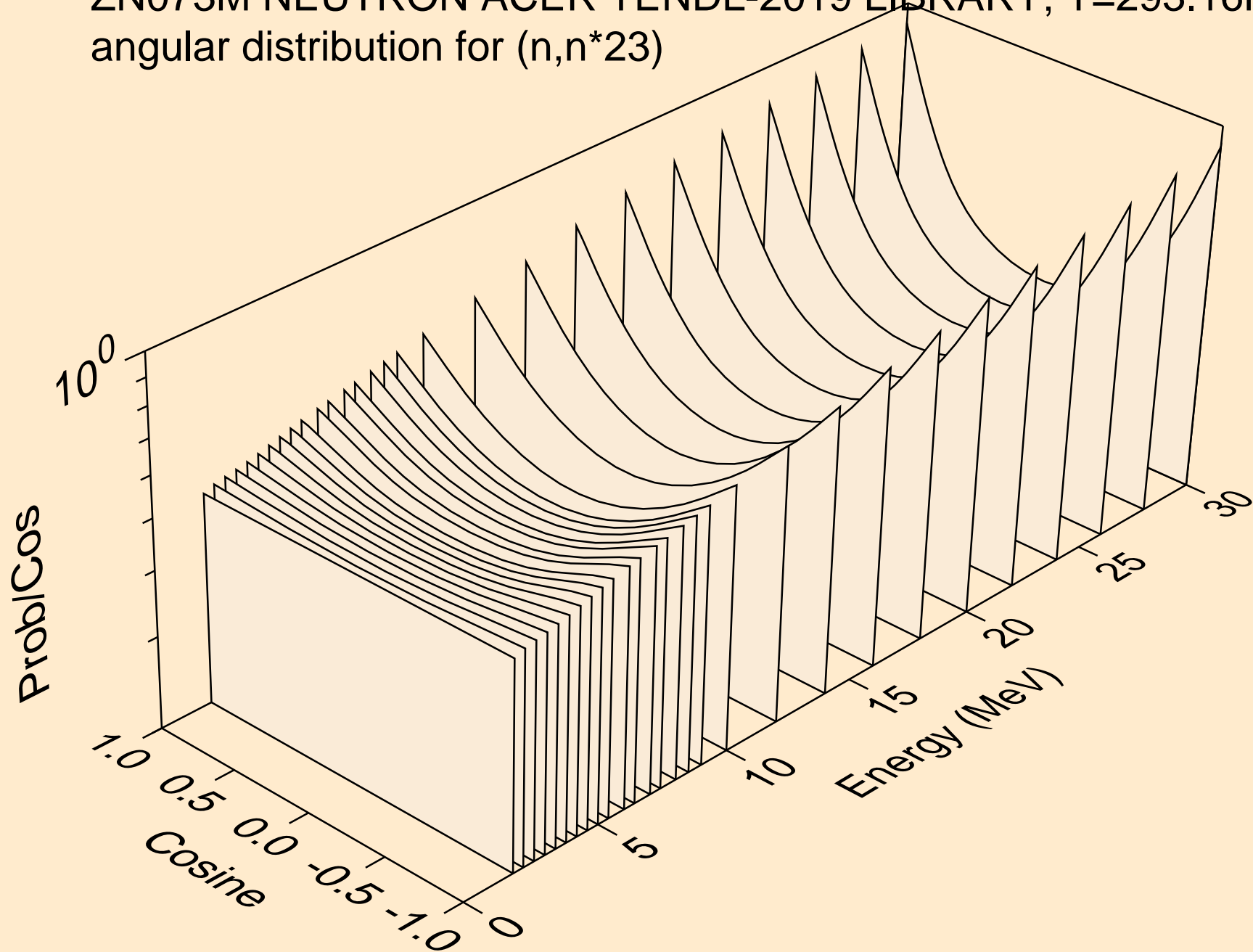

ZN073M NEUTRON ACER TENDL-2019 LIBRARY; T=293.16K
angular distribution for (n,n*24)

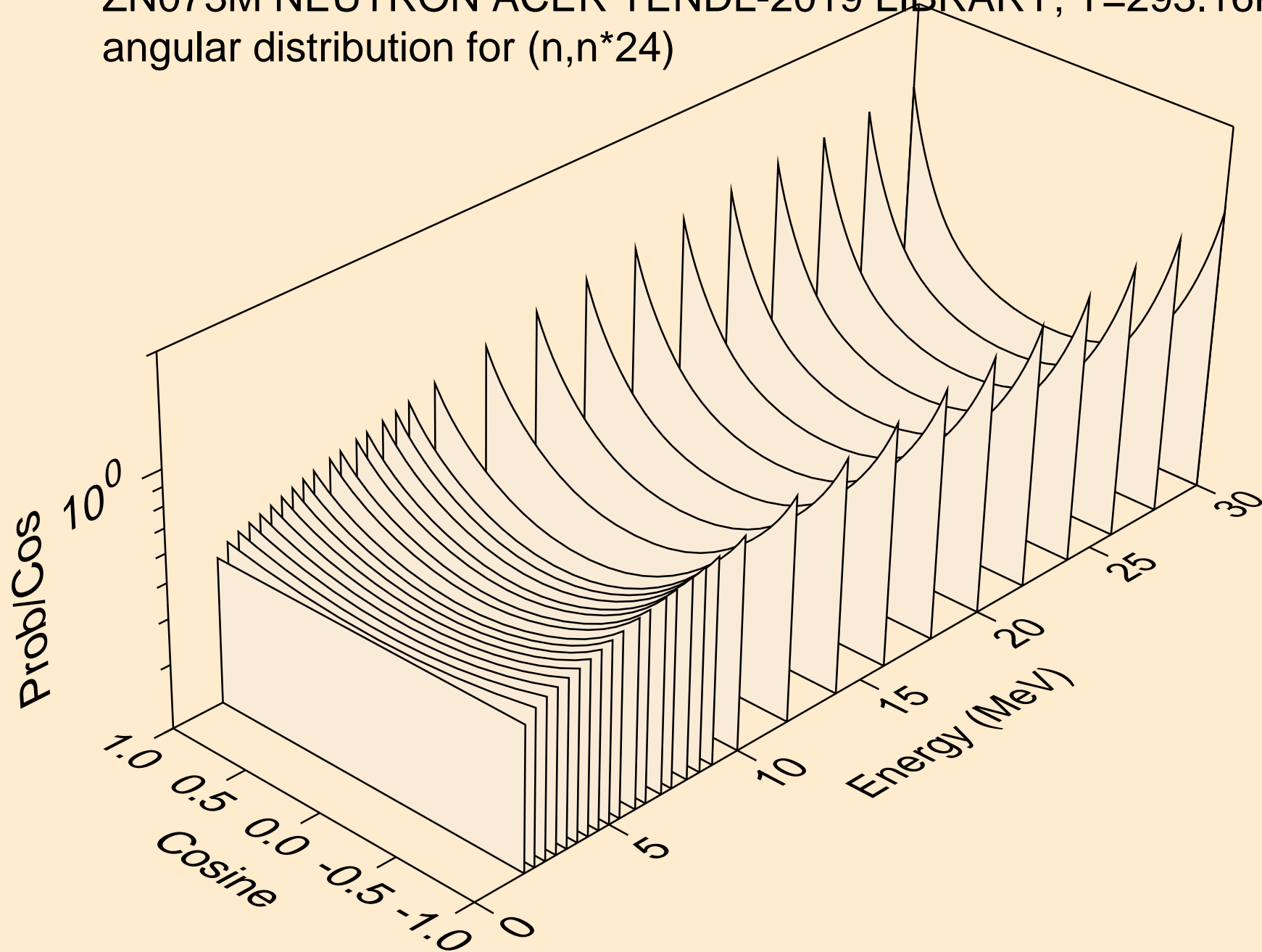

ZN073M NEUTRON ACER TENDL-2019 LIBRARY; T=293.16K
angular distribution for (n,n*25)

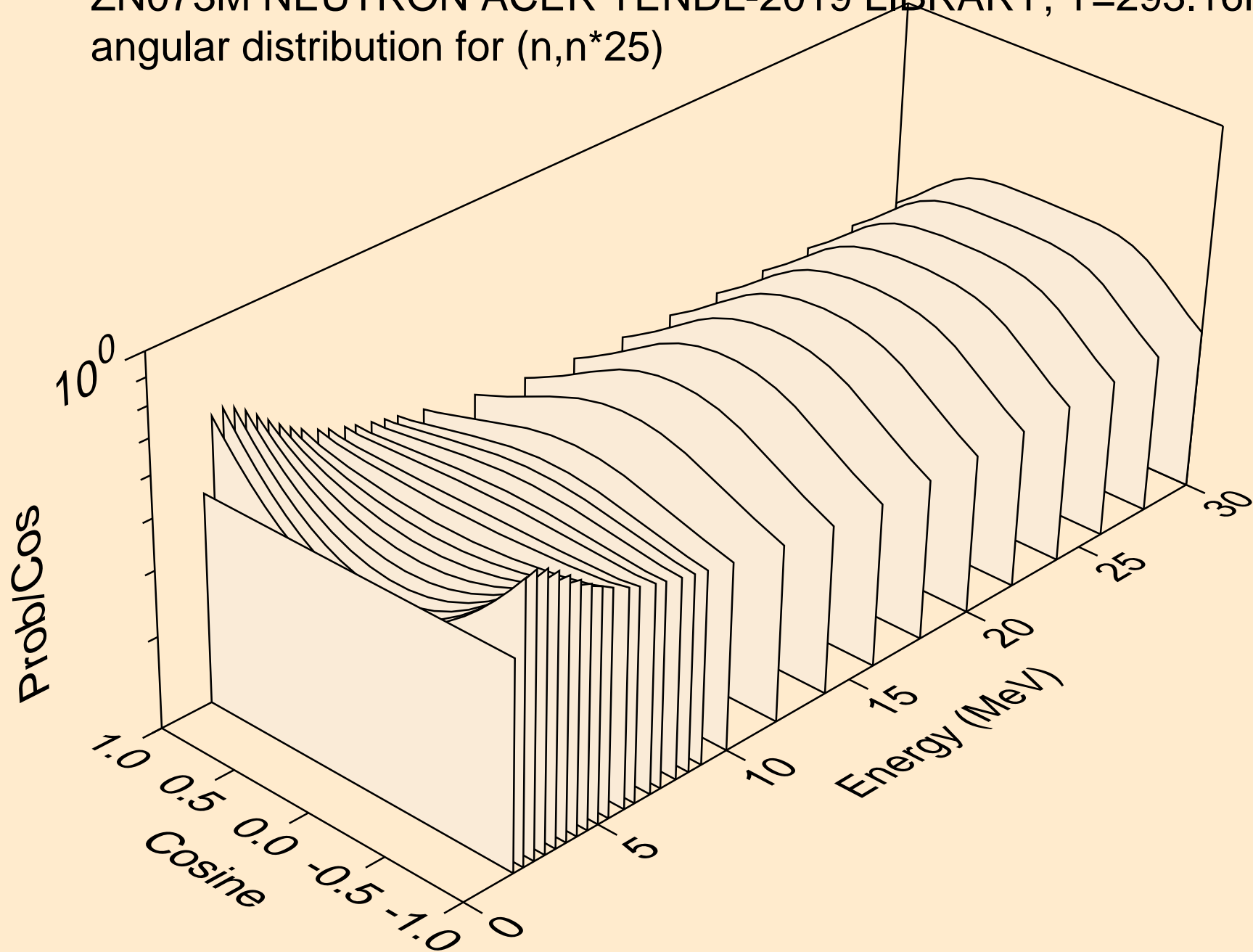

ZN073M NEUTRON ACER TENDL-2019 LIBRARY; T=293.16K
angular distribution for (n,n*26)

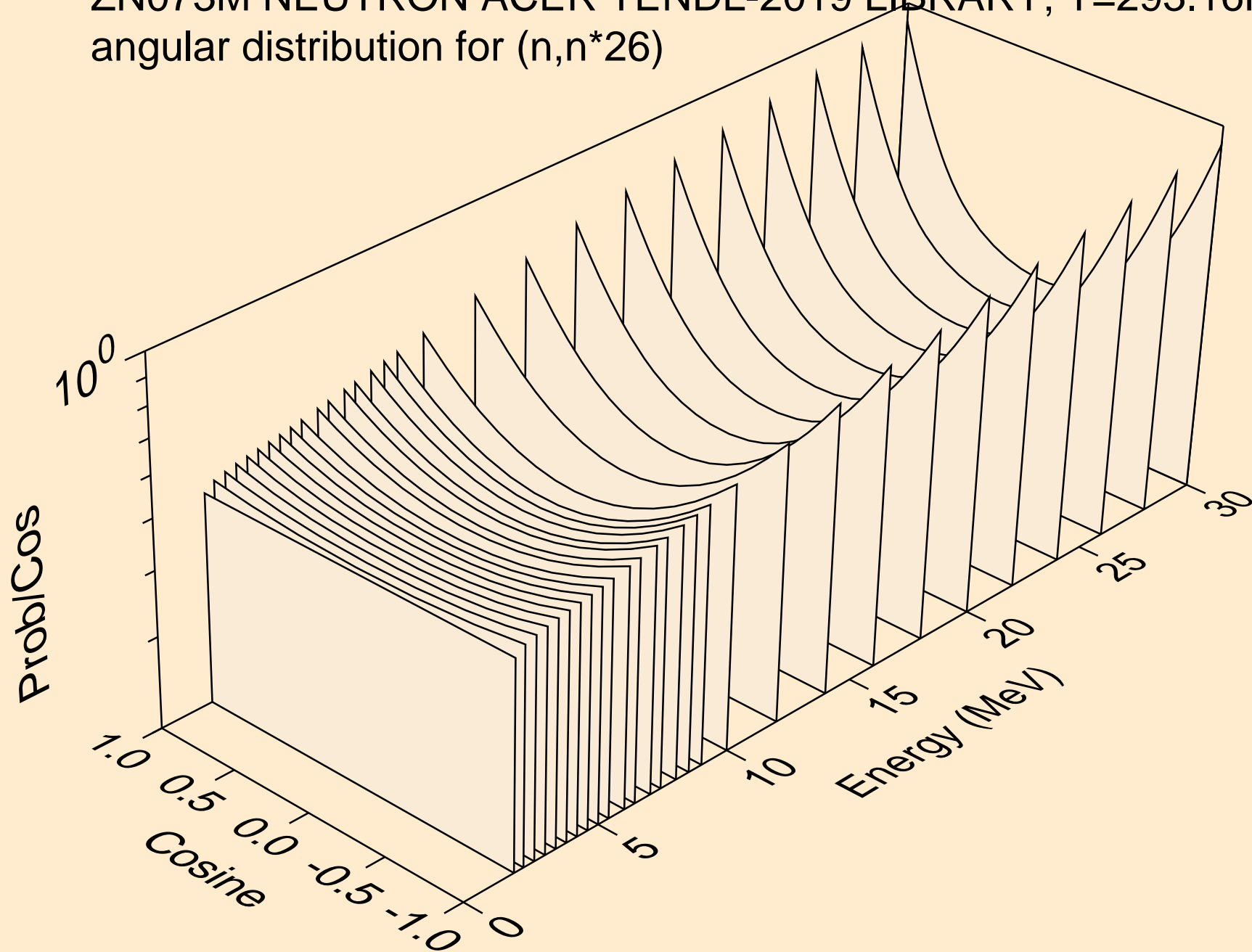

ZN073M NEUTRON ACER TENDL-2019 LIBRARY; T=293.16K
angular distribution for (n,n*27)

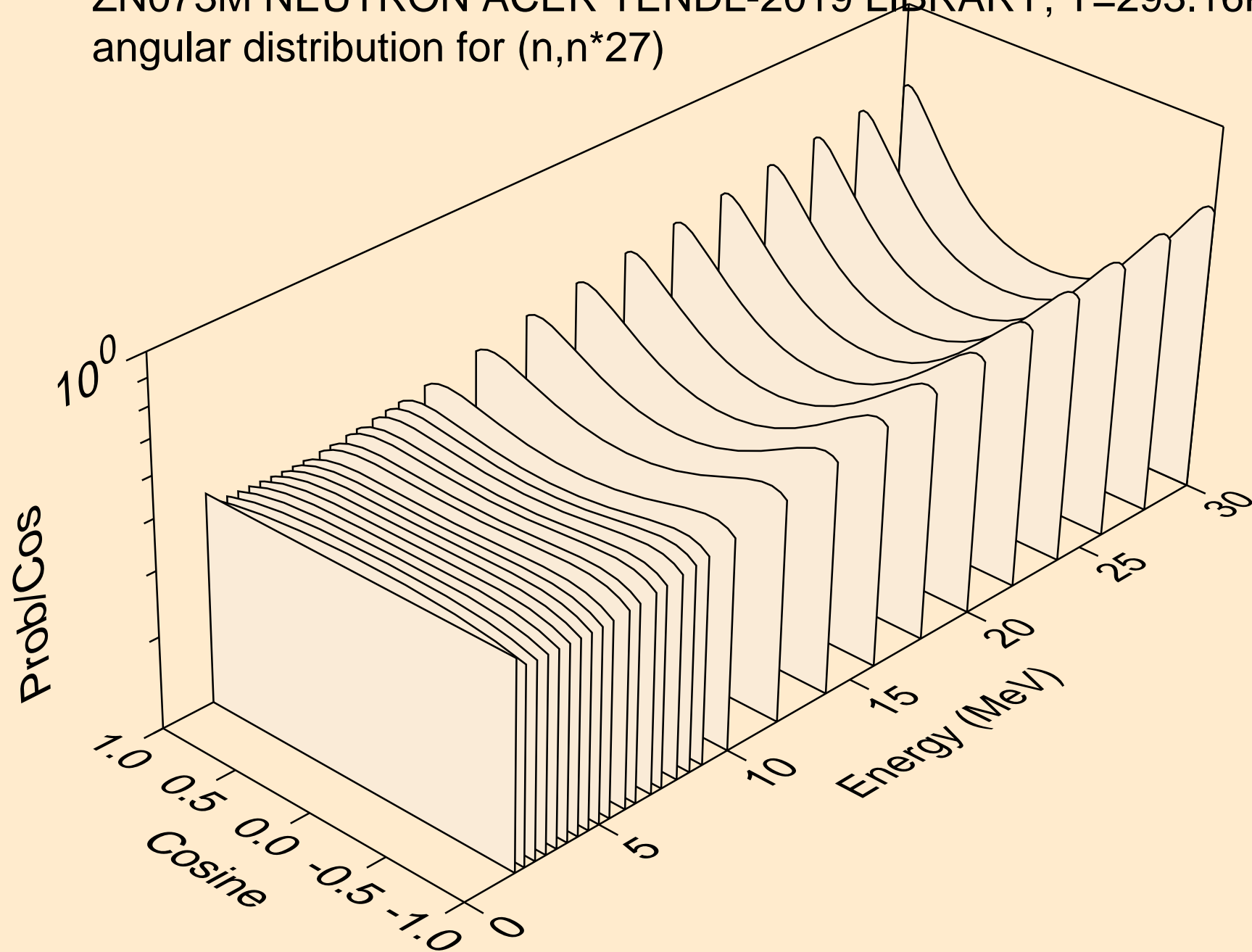

ZN073M NEUTRON ACER TENDL-2019 LIBRARY; T=293.16K
angular distribution for (n,n*28)

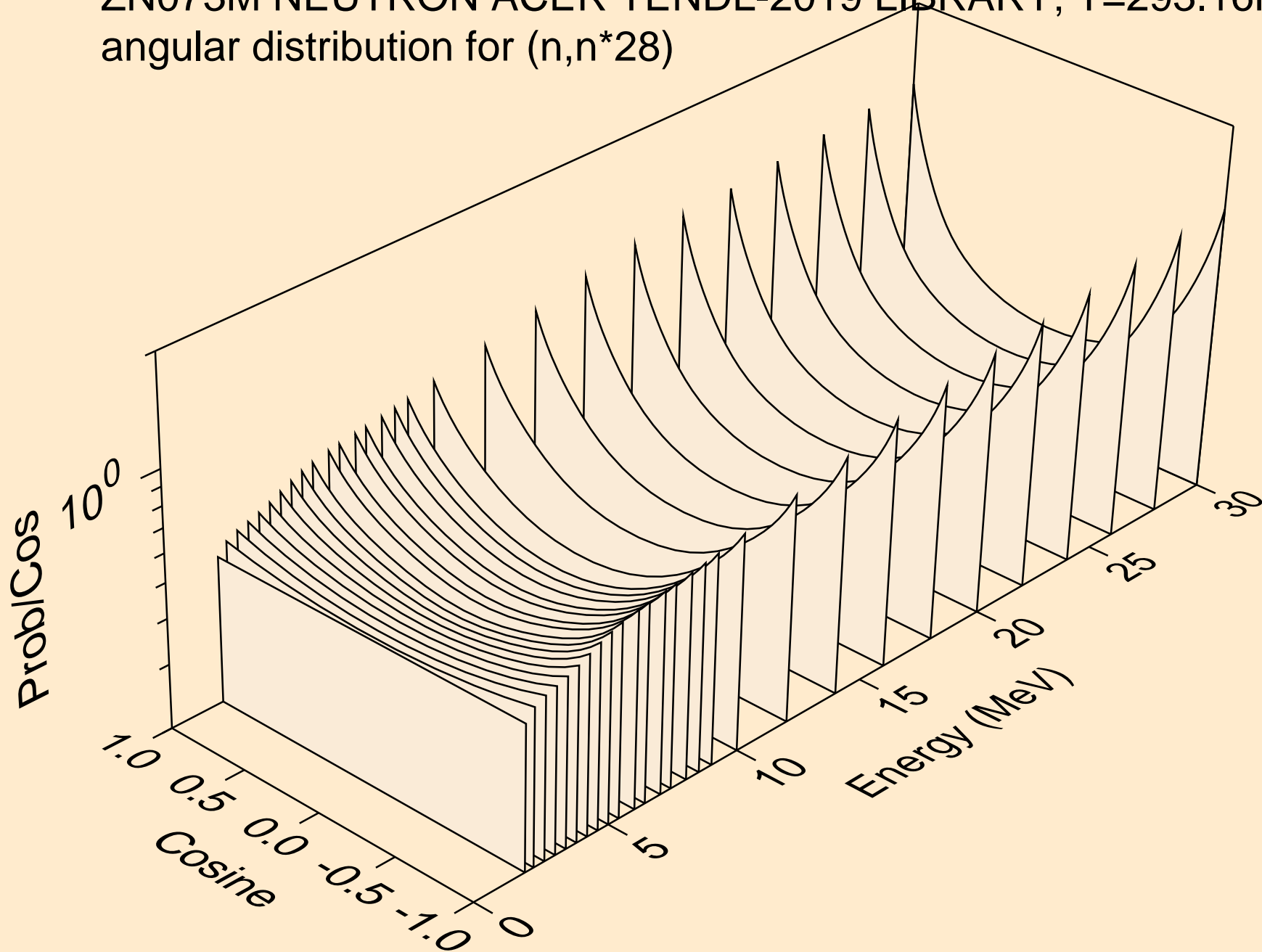

ZN073M NEUTRON ACER TENDL-2019 LIBRARY; T=293.16K
angular distribution for (n,n*29)

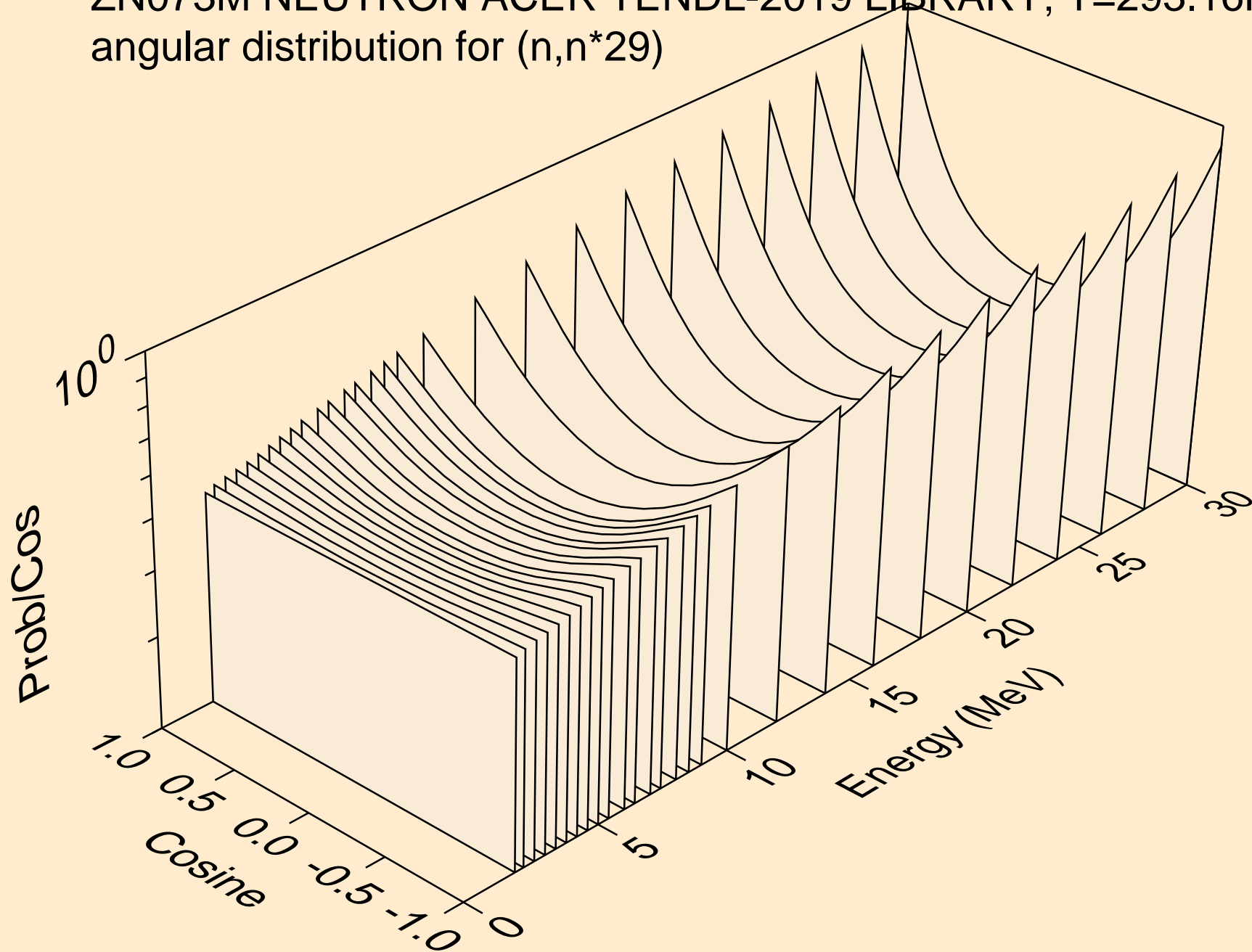

ZN073M NEUTRON ACER TENDL-2019 LIBRARY; T=293.16K
angular distribution for (n,n*30)

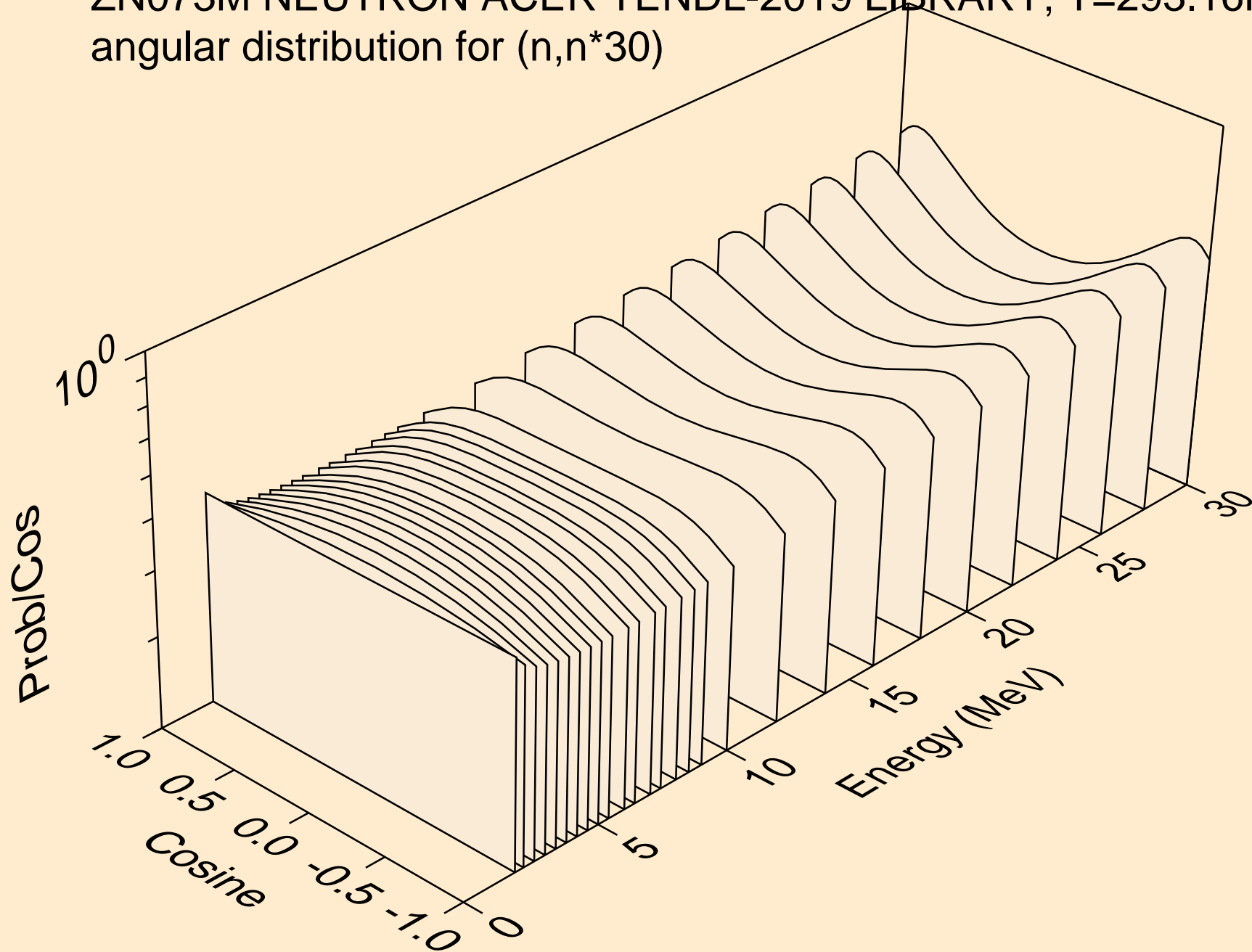

ZN073M NEUTRON ACER TENDL-2019 LIBRARY; T=293.16K
Neutron emission for (n,x)

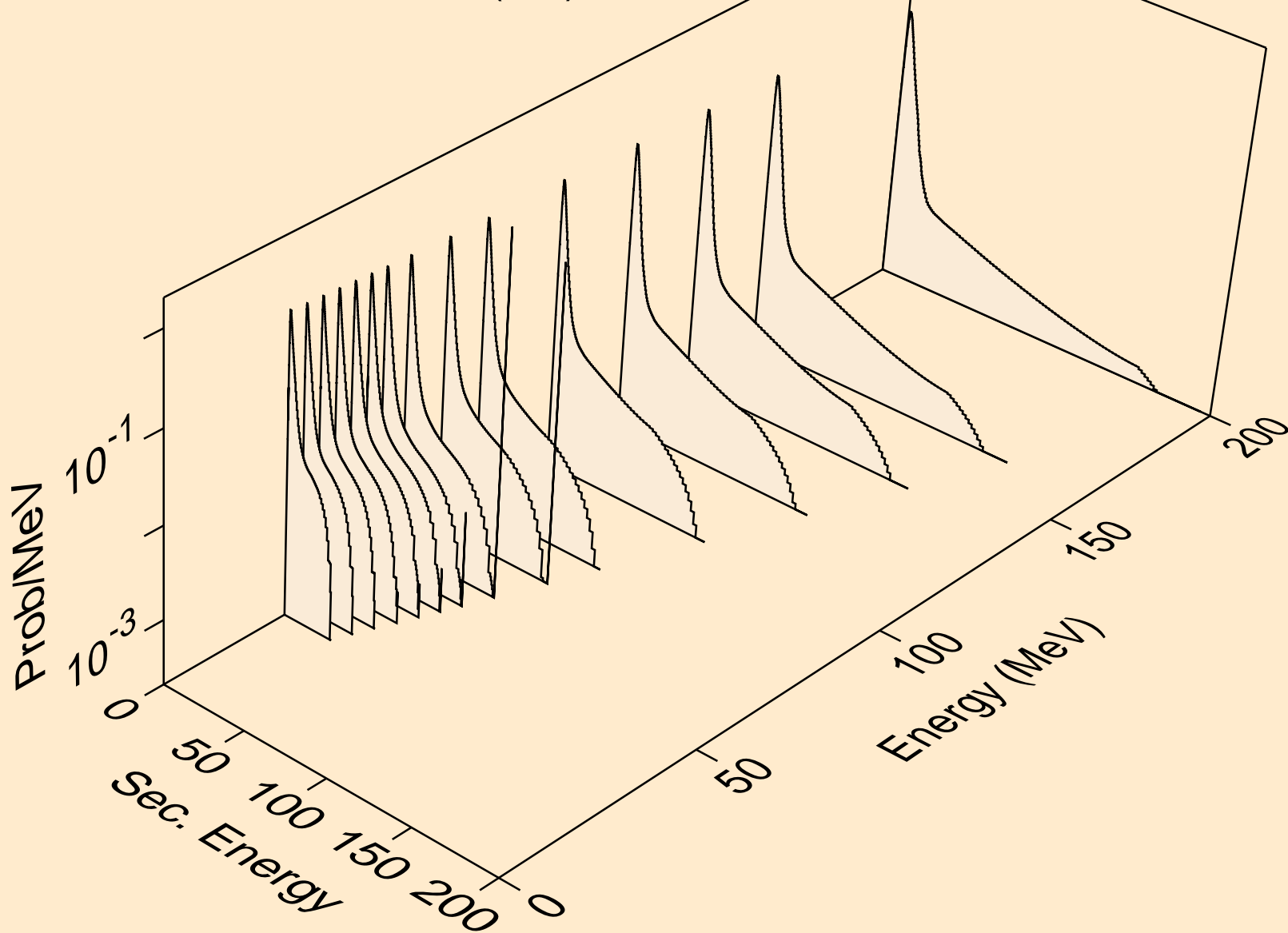

ZN073M NEUTRON ACER TENDL-2019 LIBRARY; T=293.16K
Neutron emission for (n,2nd)

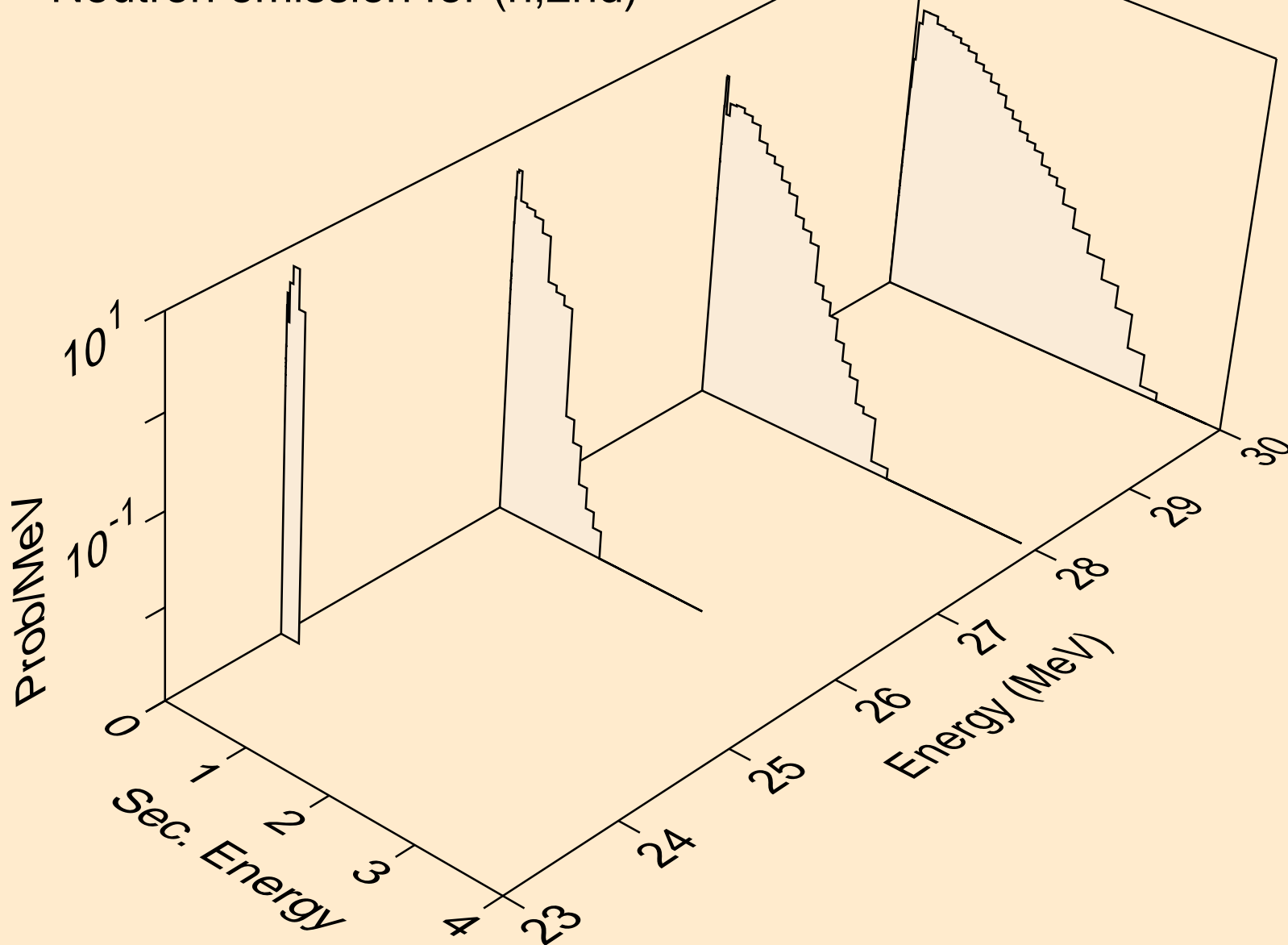

ZN073M NEUTRON ACER TENDL-2019 LIBRARY; T=293.16K
Neutron emission for (n,2n)

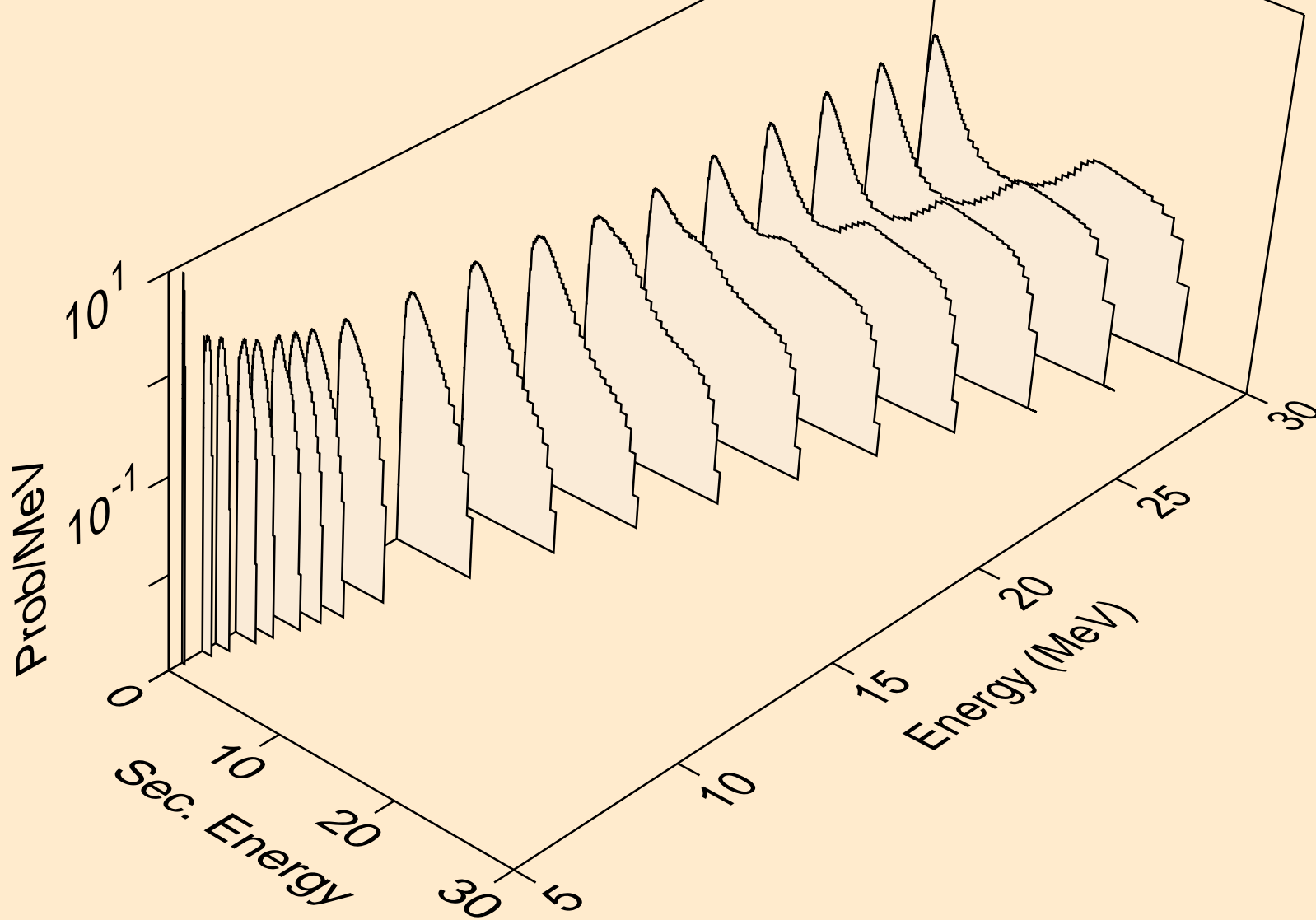

ZN073M NEUTRON ACER TENDL-2019 LIBRARY; T=293.16K
Neutron emission for (n,3n)

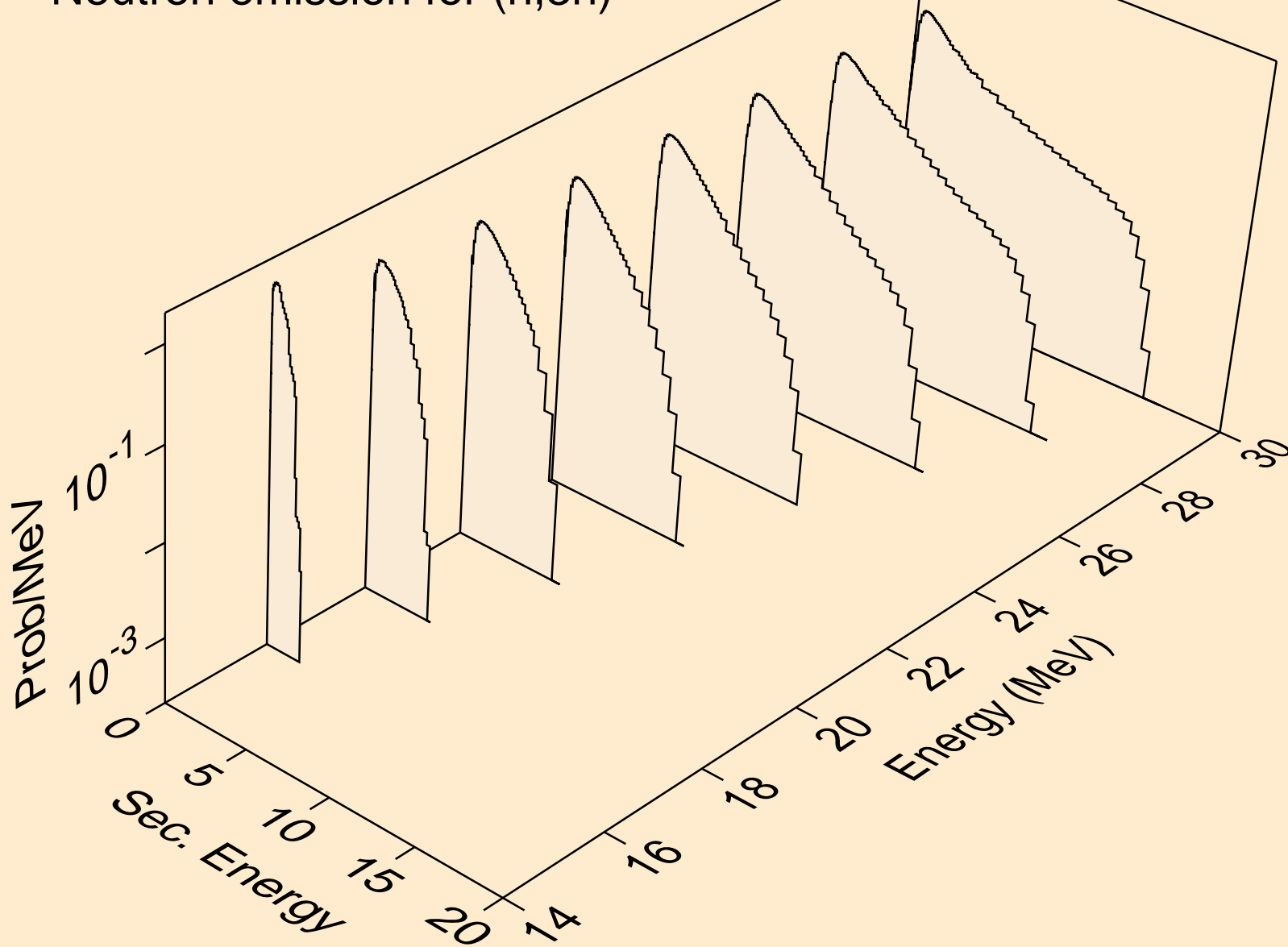

ZN073M NEUTRON ACER TENDL-2019 LIBRARY; T=293.16K
Neutron emission for (n,n*)a

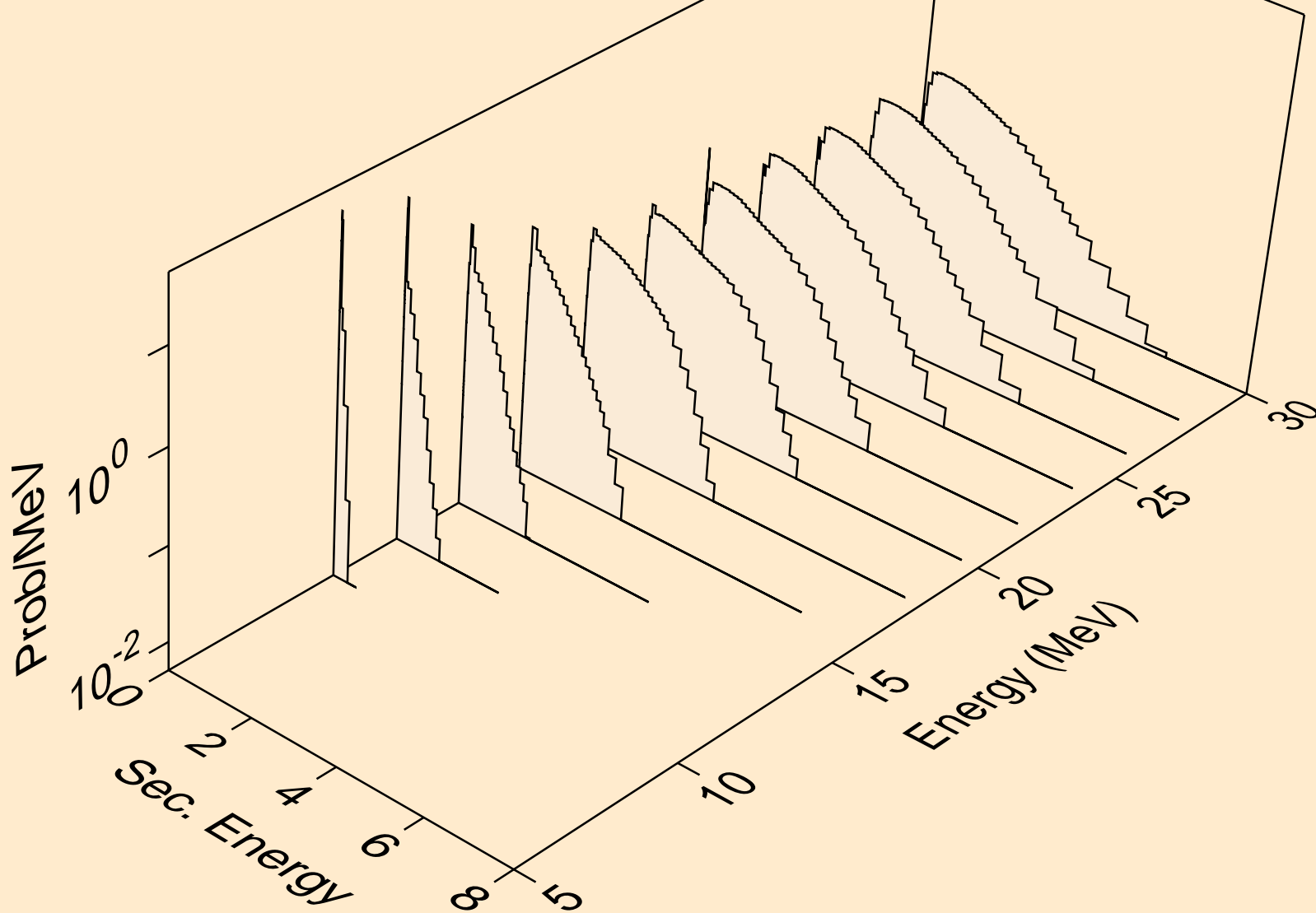

ZN073M NEUTRON ACER TENDL-2019 LIBRARY; T=293.16K
Neutron emission for (n,2n)_a

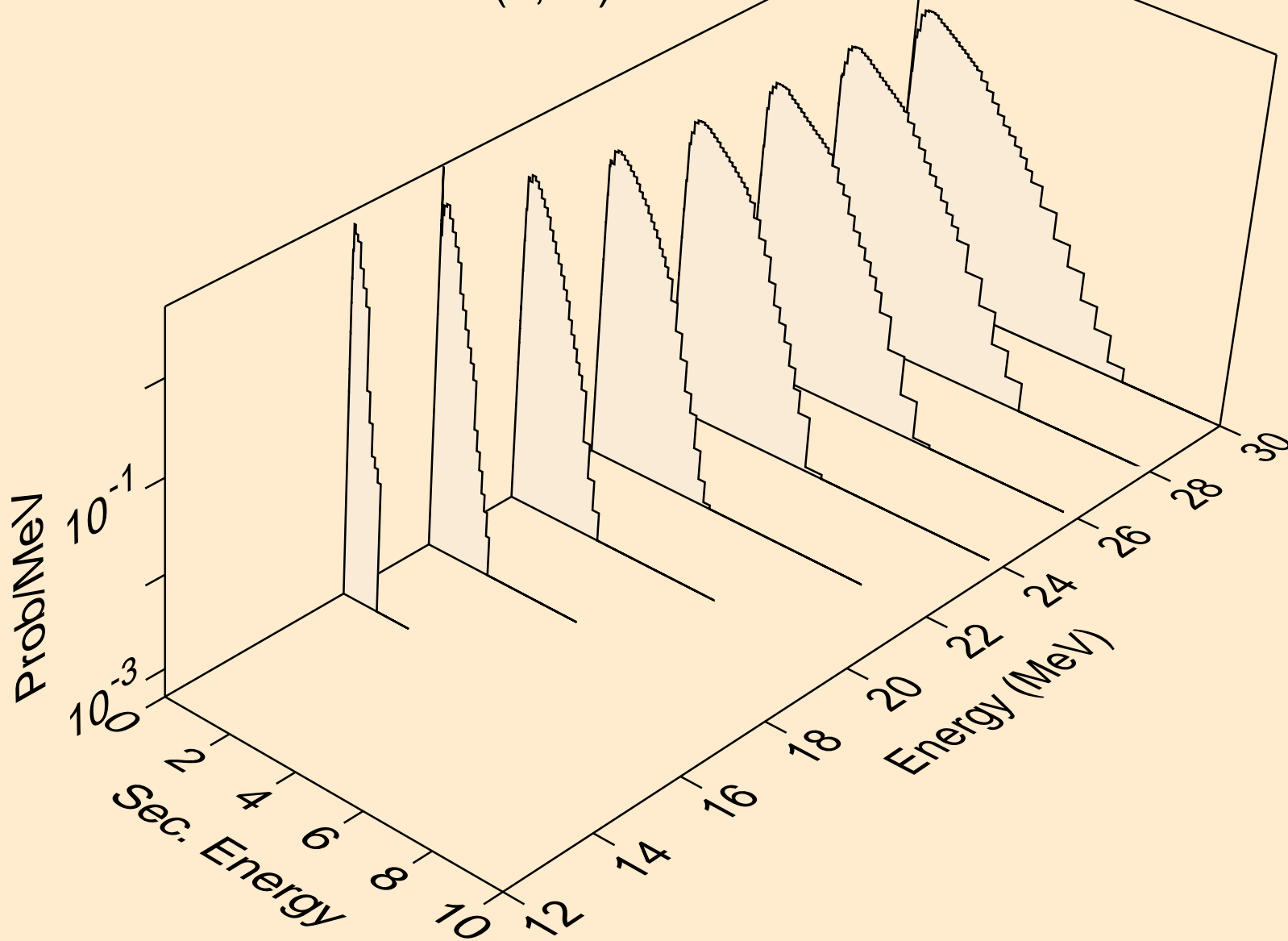

ZN073M NEUTRON ACER TENDL-2019 LIBRARY; T=293.16K
Neutron emission for (n,3n)a

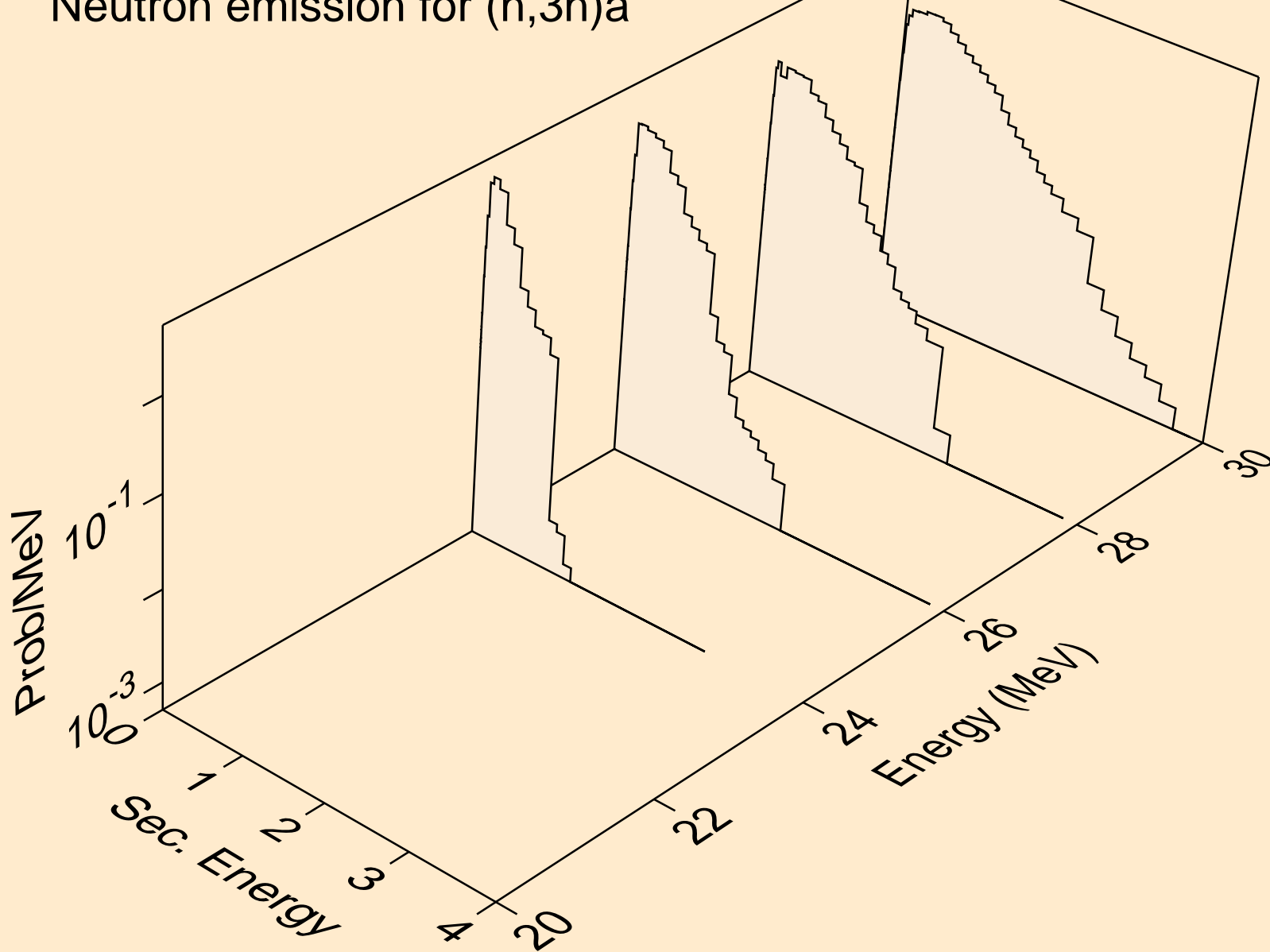

ZN073M NEUTRON ACER TENDL-2019 LIBRARY; T=293.16K
Neutron emission for (n,n*)p

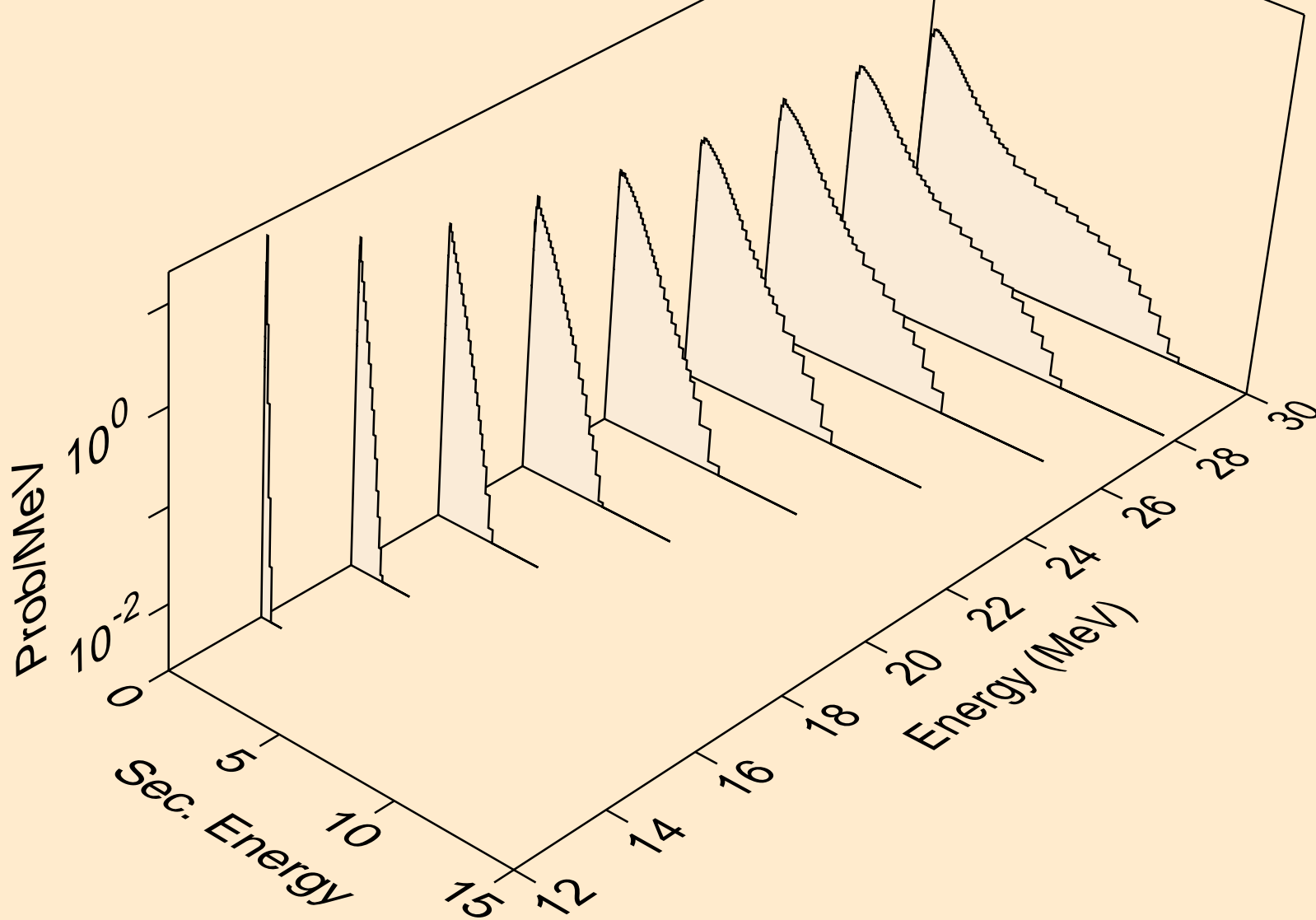

ZN073M NEUTRON ACER TENDL-2019 LIBRARY; T=293.16K
Neutron emission for (n,n*)d

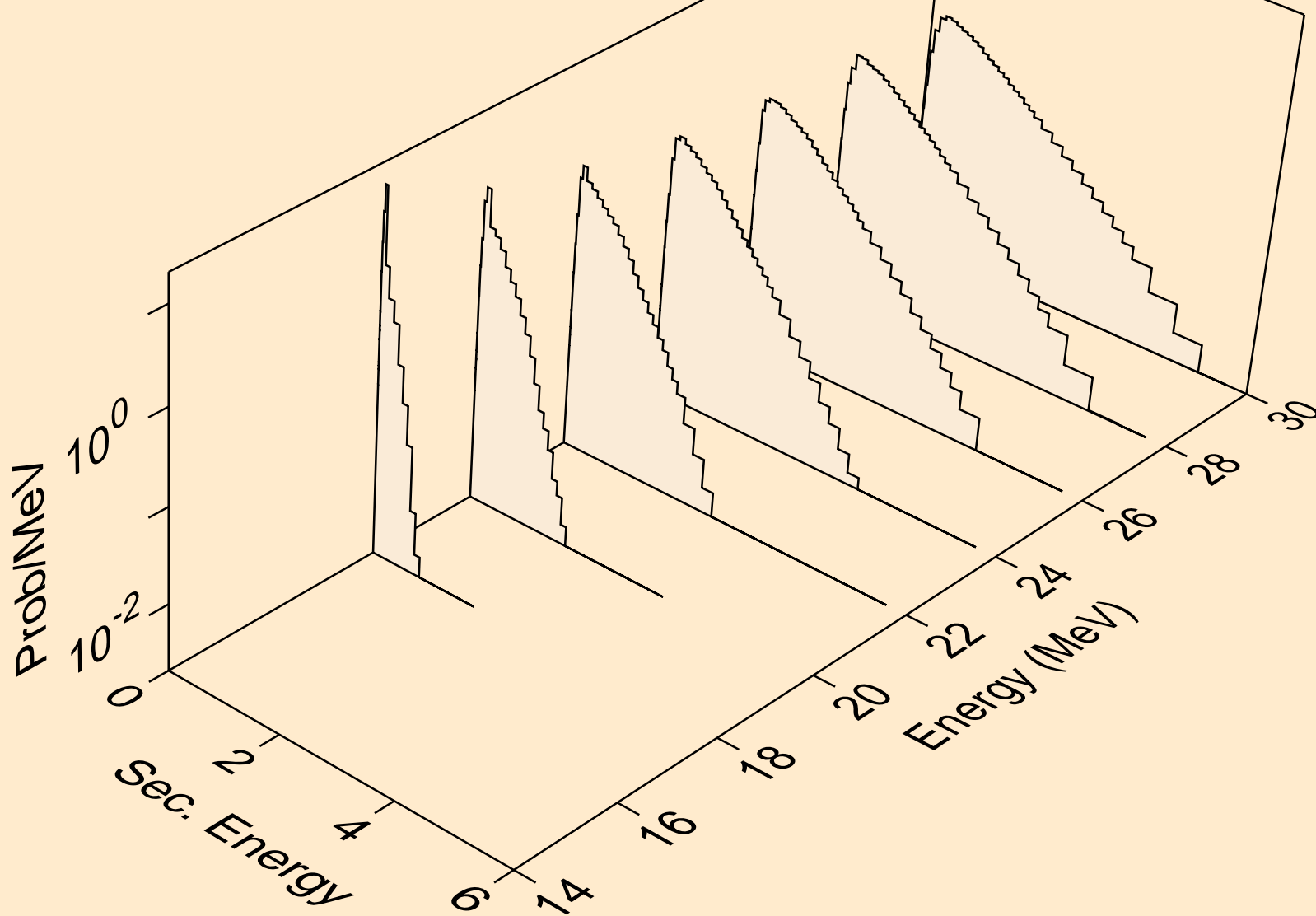

ZN073M NEUTRON ACER TENDL-2019 LIBRARY; T=293.16K
Neutron emission for (n,n*)t

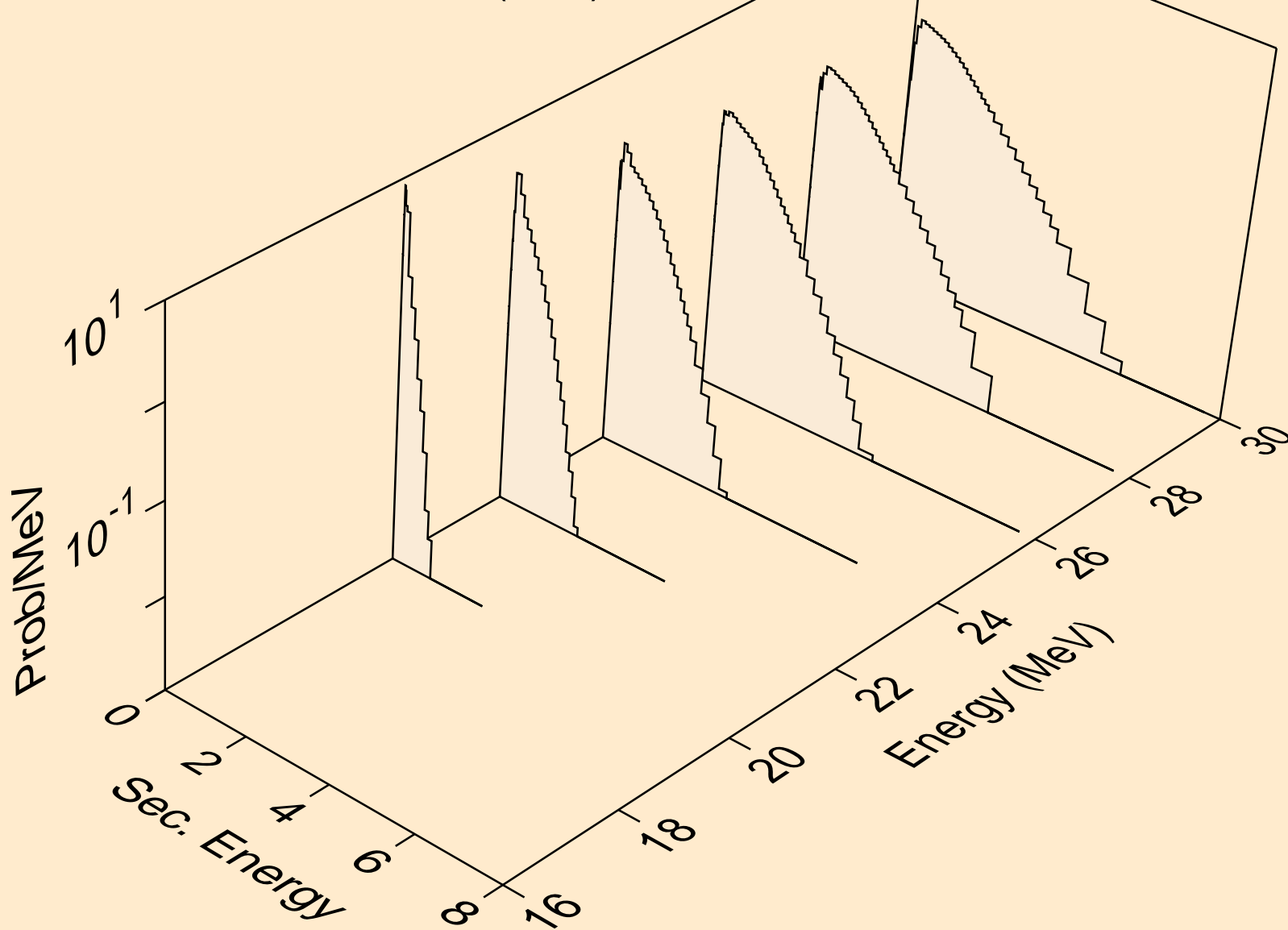

ZN073M NEUTRON ACER TENDL-2019 LIBRARY; T=293.16K
Neutron emission for (n,n*)he3

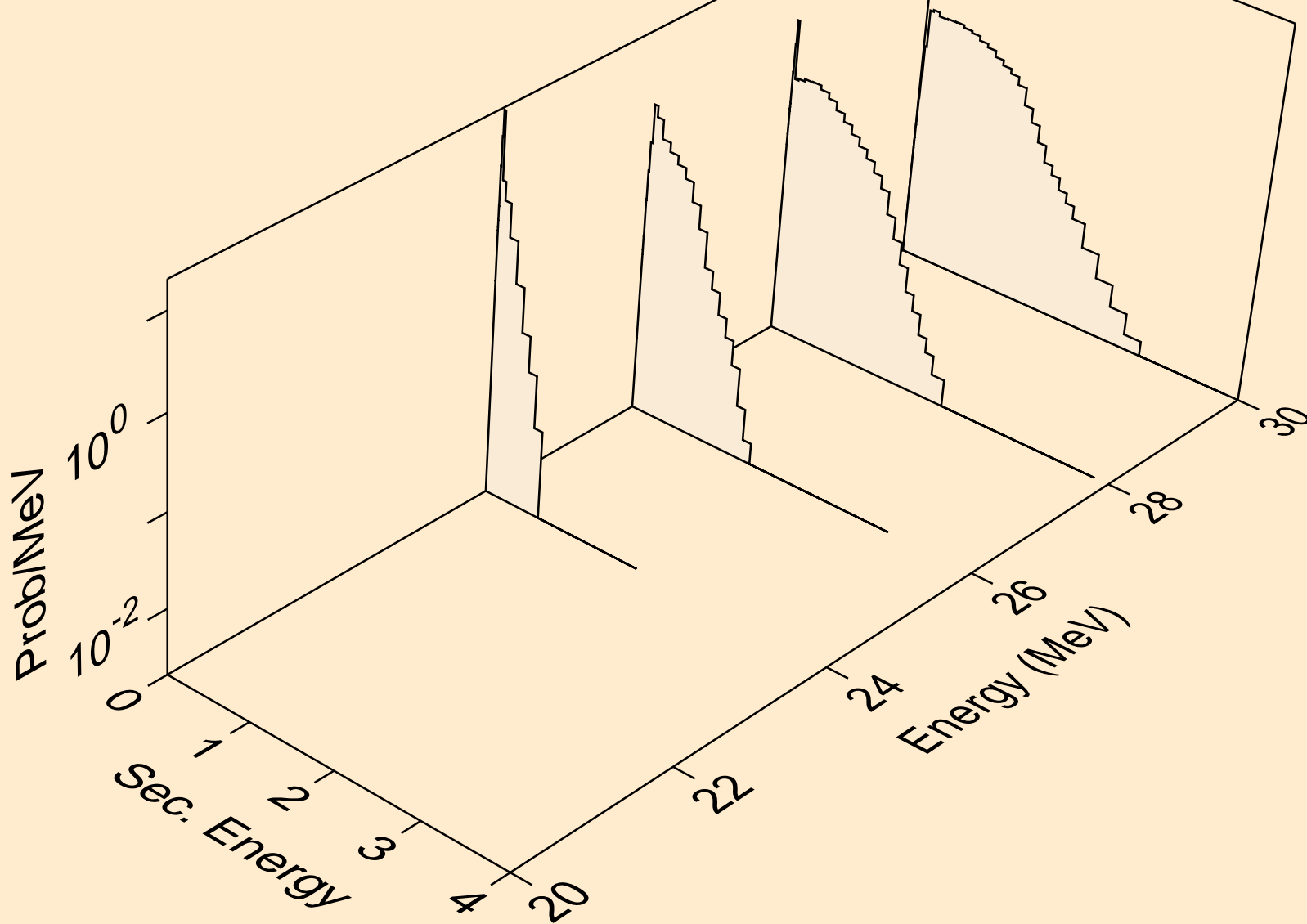

ZN073M NEUTRON ACER TENDL-2019 LIBRARY; T=293.16K
Neutron emission for (n,4n)

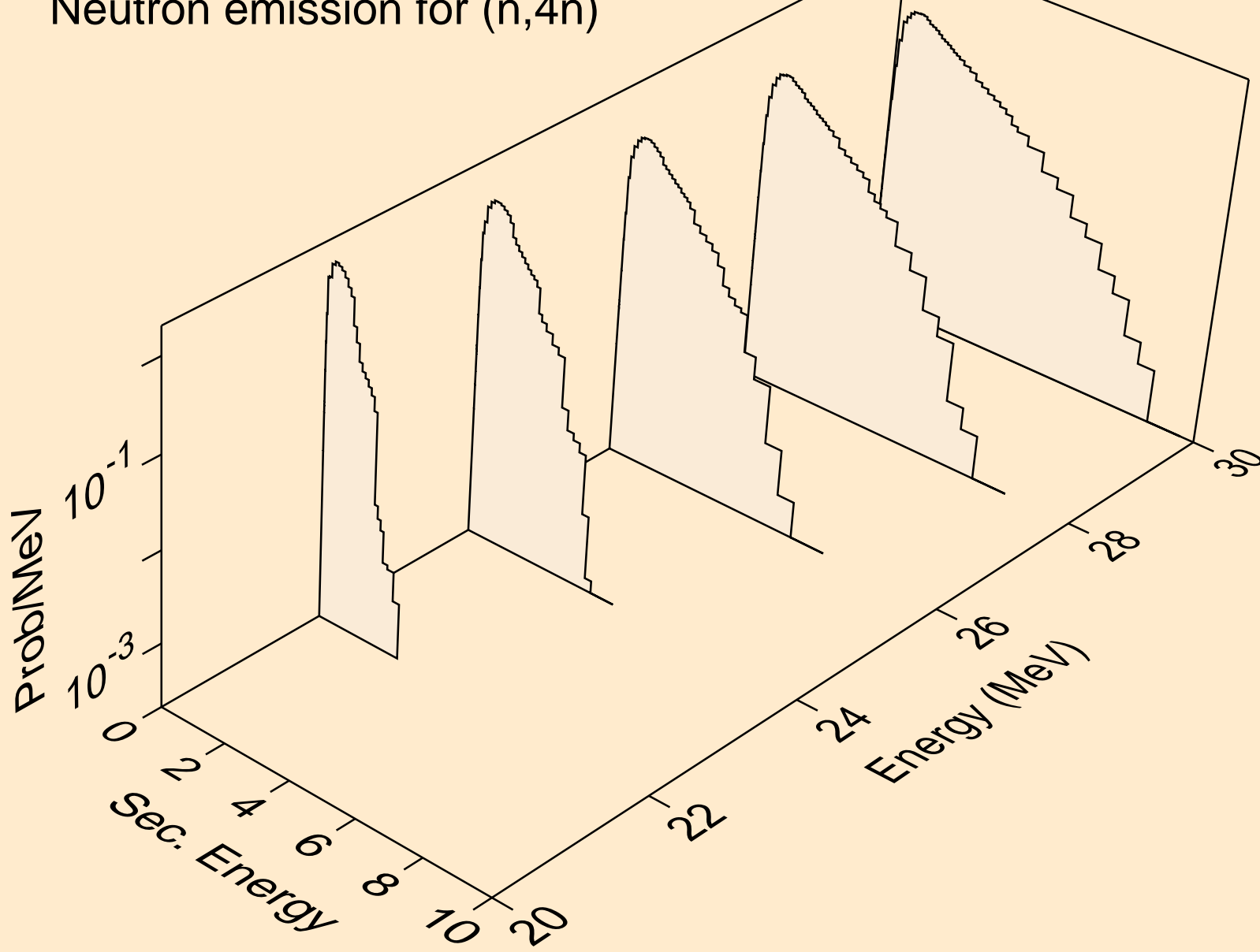

ZN073M NEUTRON ACER TENDL-2019 LIBRARY; T=293.16K
Neutron emission for (n,2np)

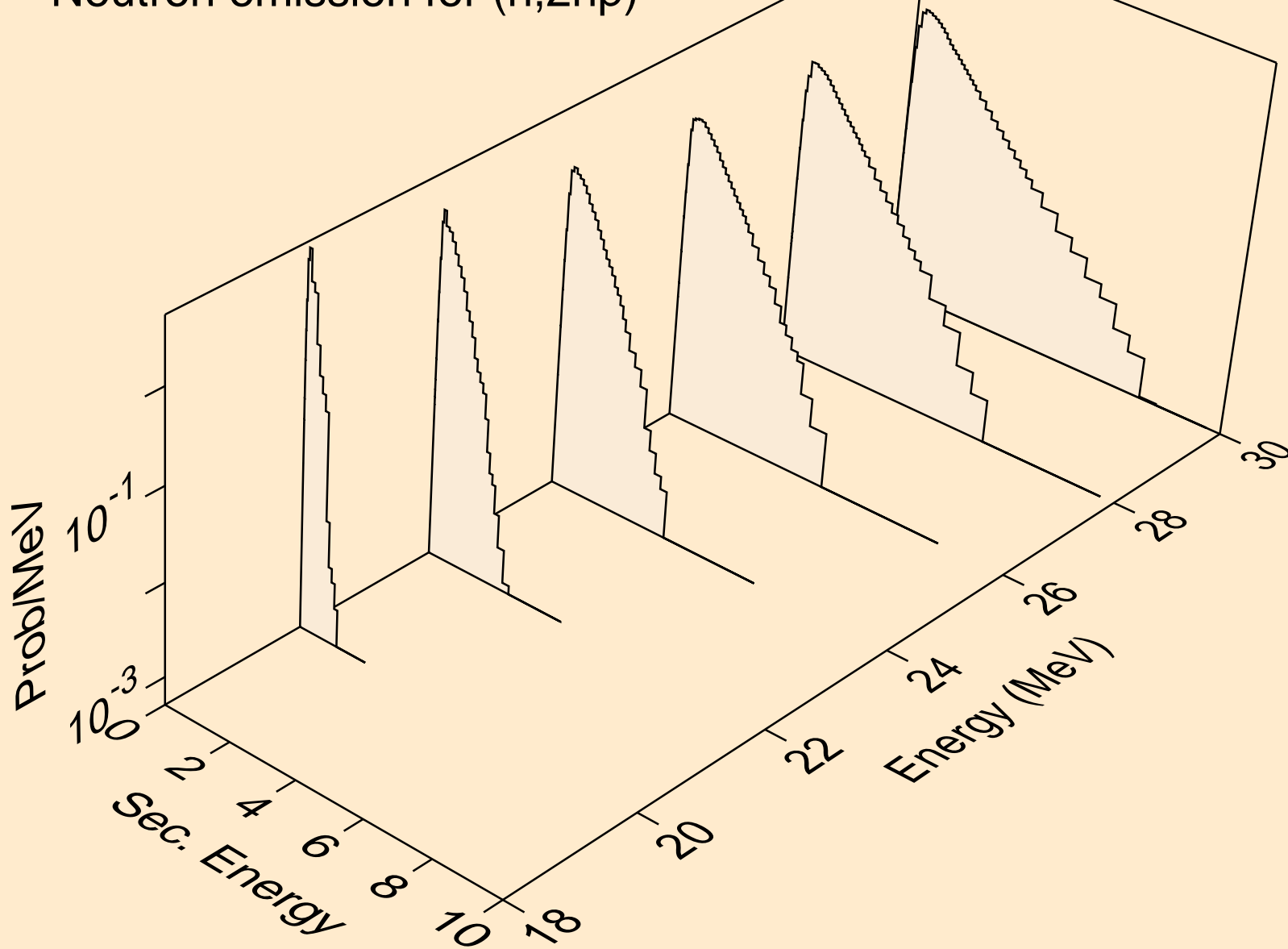

ZN073M NEUTRON ACER TENDL-2019 LIBRARY; T=293.16K
Neutron emission for (n,3np)

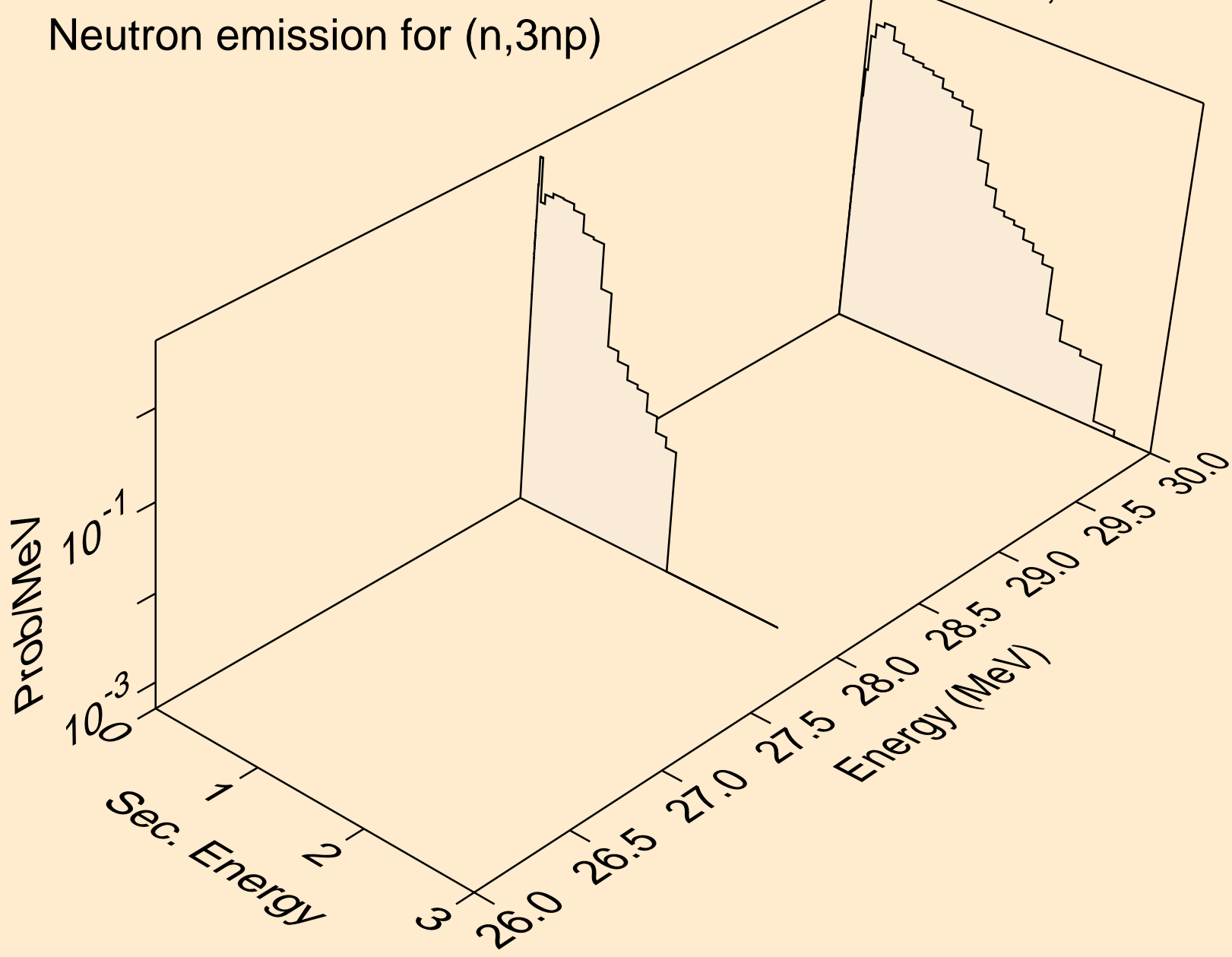

ZN073M NEUTRON ACER TENDL-2019 LIBRARY; T=293.16K
Neutron emission for (n,n*c)

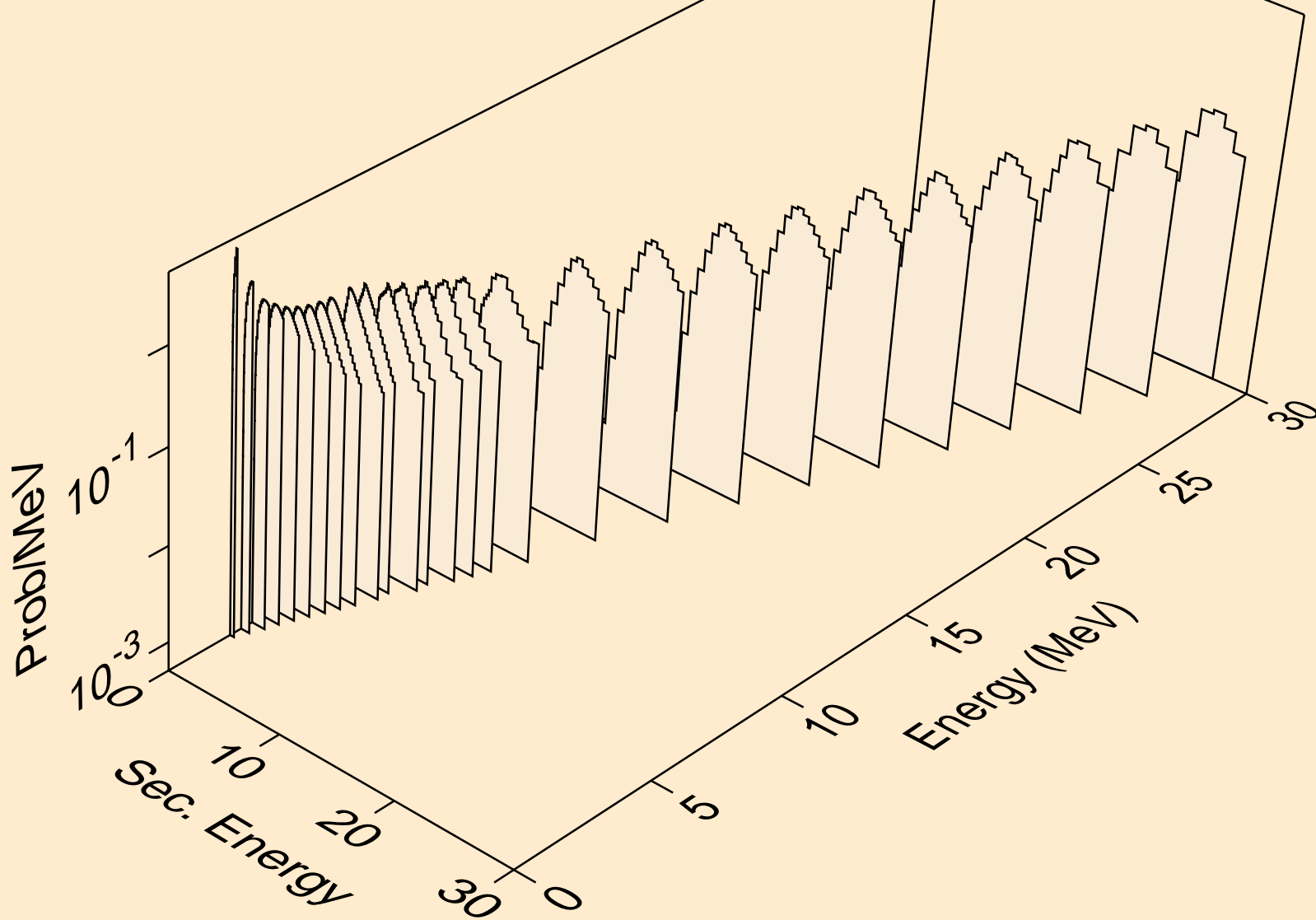

ZN073M NEUTRON ACER TENDL-2019 LIBRARY; T=293.16K
Photon emission for (n,x)

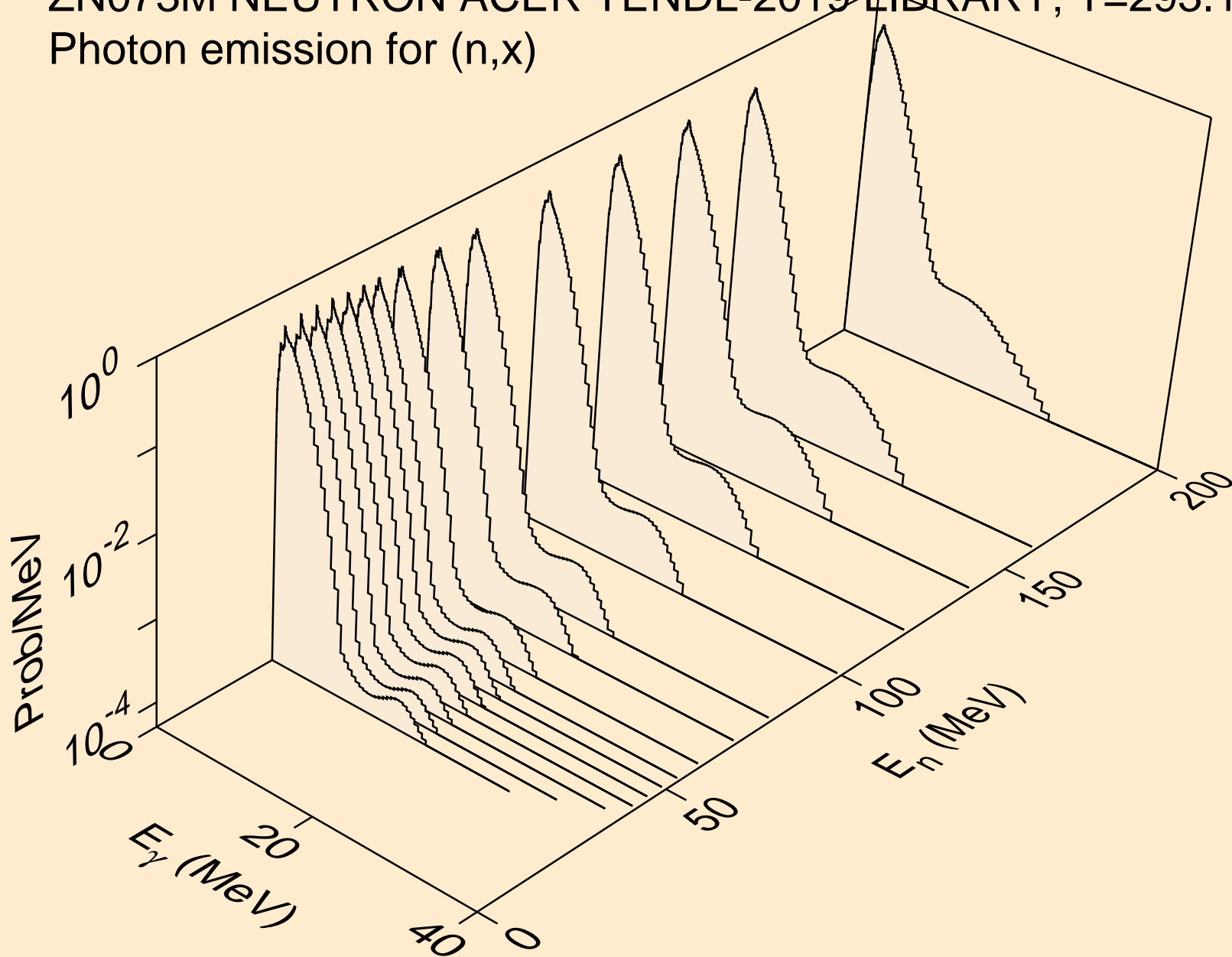

ZN073M NEUTRON ACER TENDL-2019 LIBRARY; T=293.16K
Photon emission for (n,2nd)

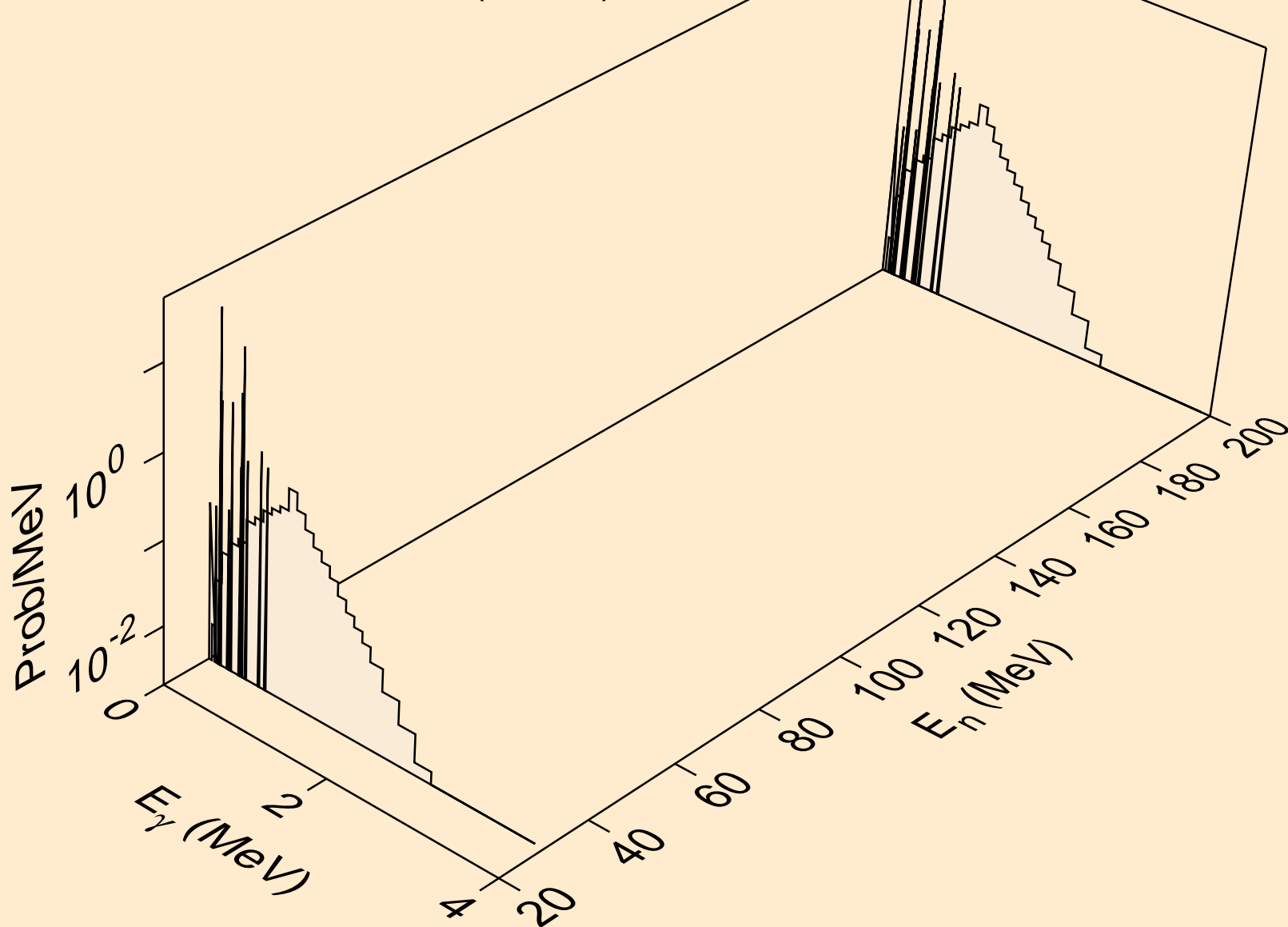

ZN073M NEUTRON ACER TENDL-2019 LIBRARY; T=293.16K
Photon emission for (n,2n)

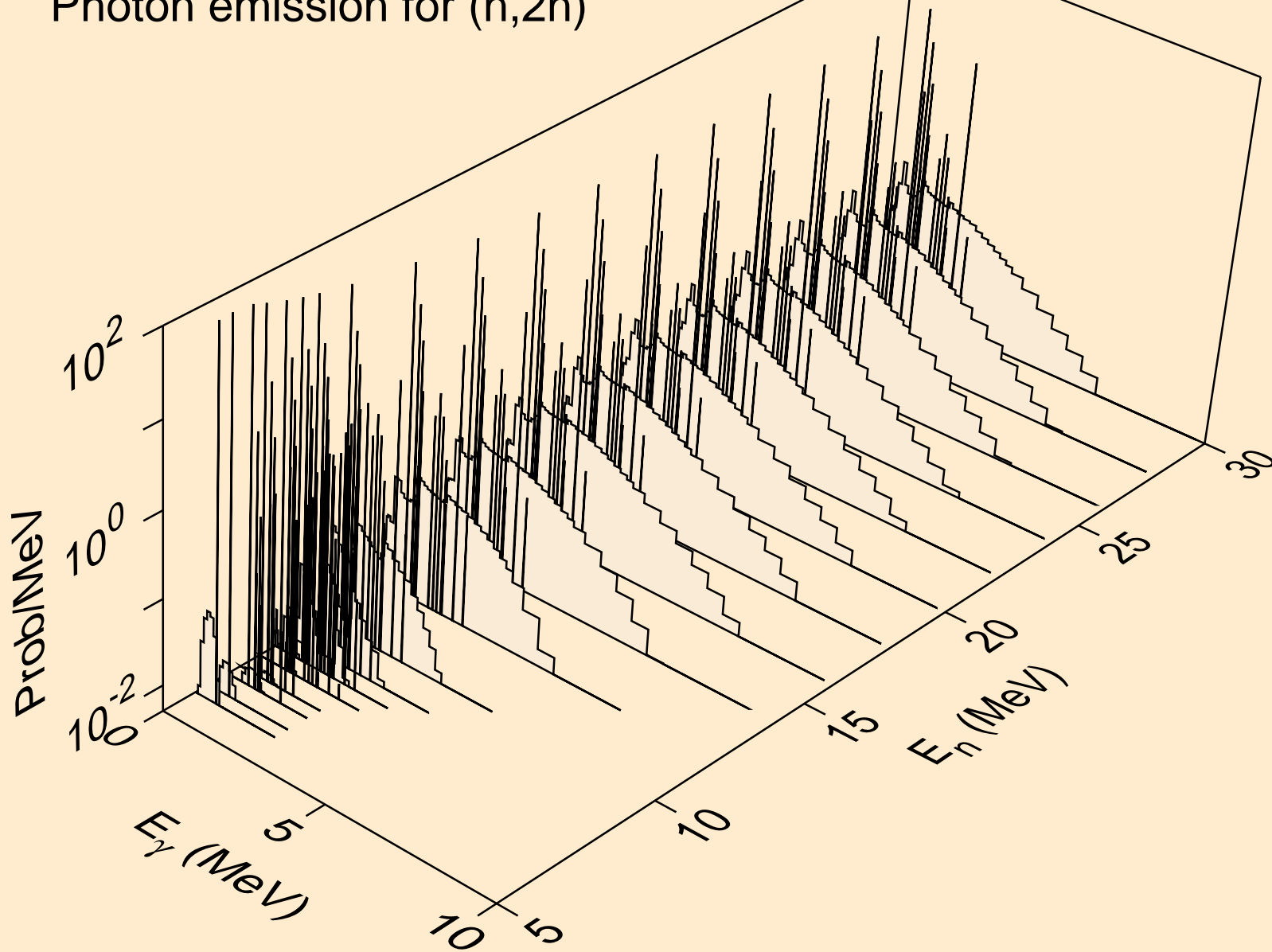

ZN073M NEUTRON ACER TENDL-2019 LIBRARY; T=293.16K
Photon emission for (n,3n)

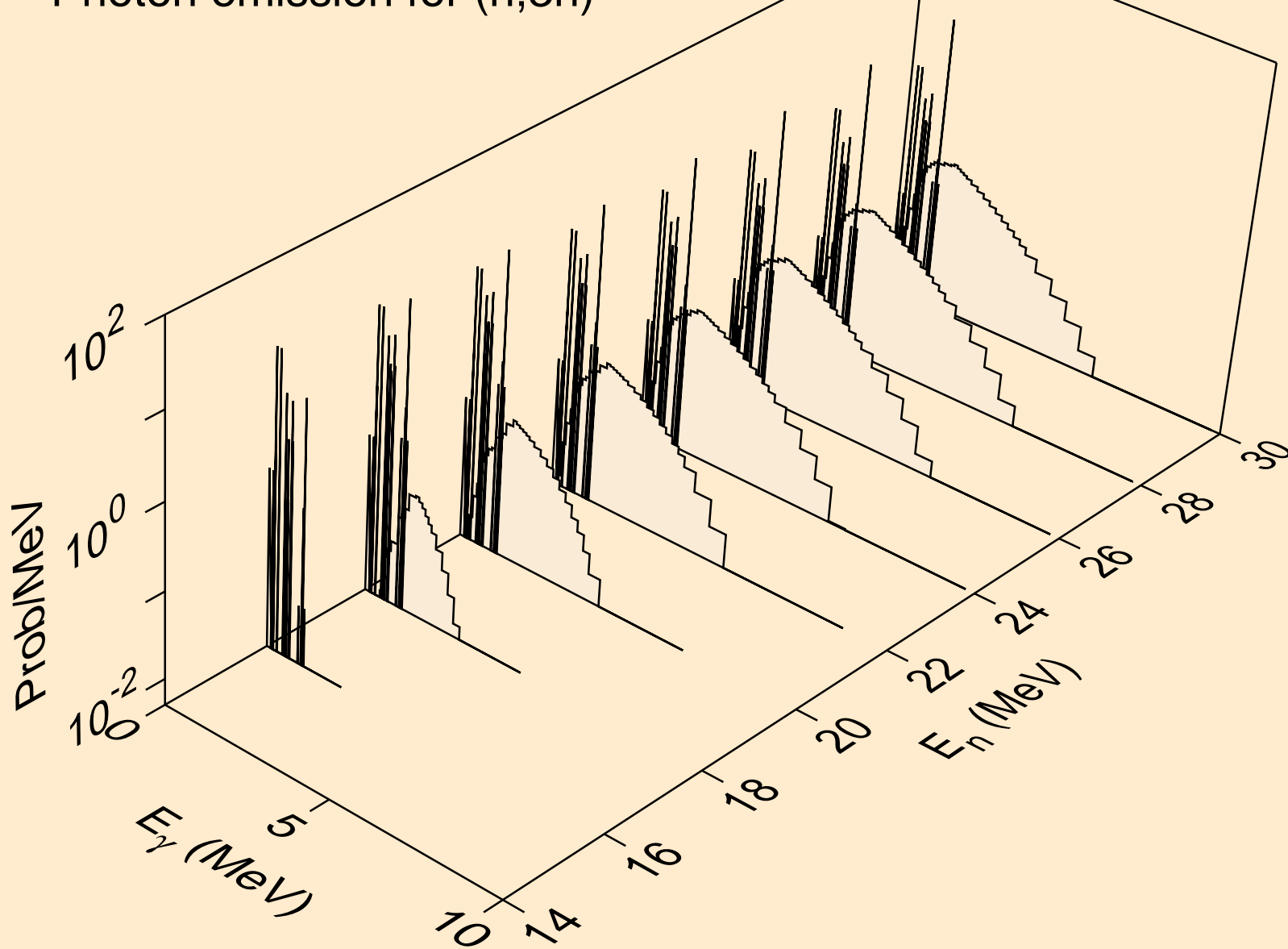

ZN073M NEUTRON ACER TENDL-2019 LIBRARY; T=293.16K
Photon emission for (n,n*)a

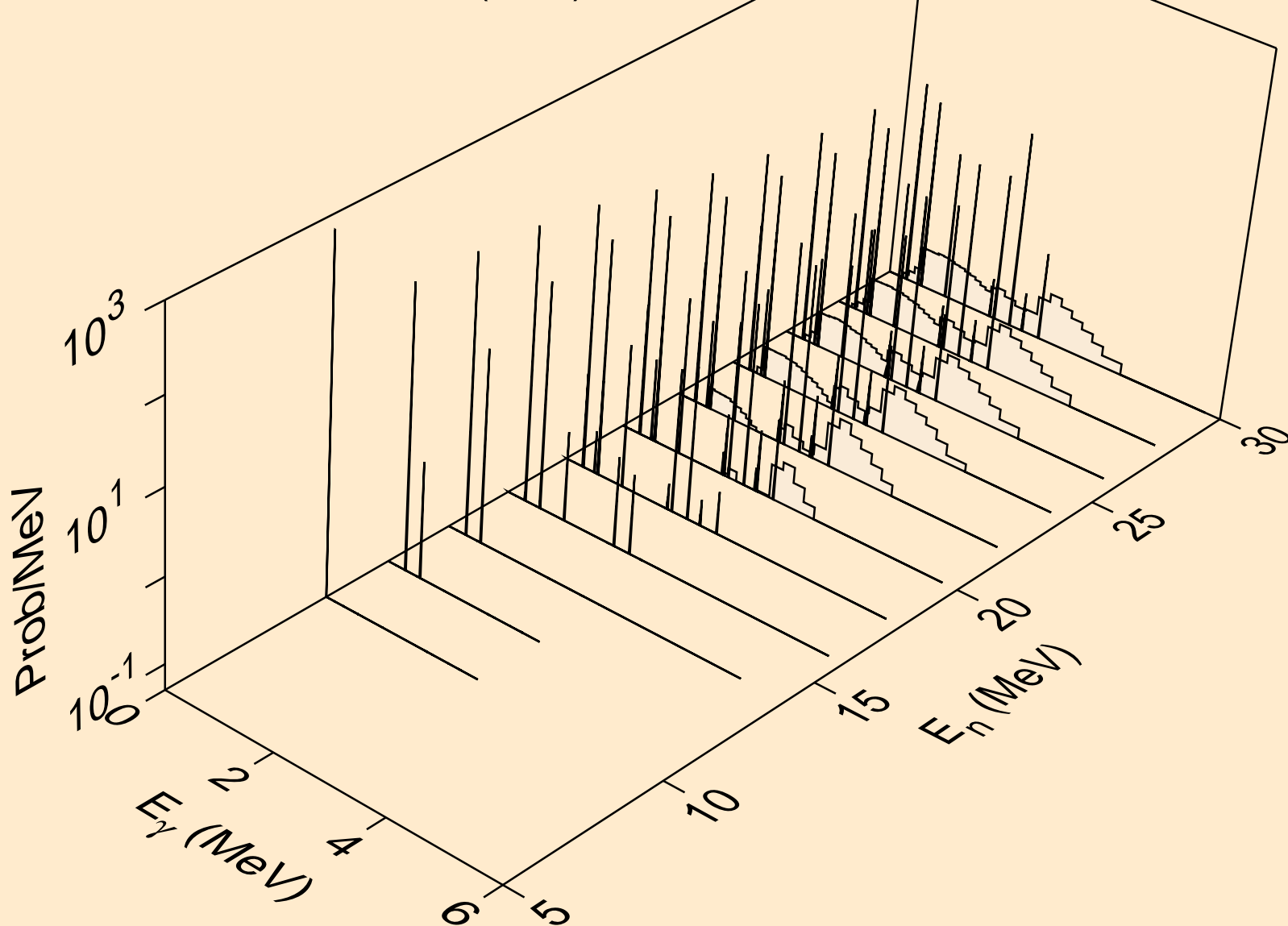

ZN073M NEUTRON ACER TENDL-2019 LIBRARY; T=293.16K
Photon emission for (n,2n)a

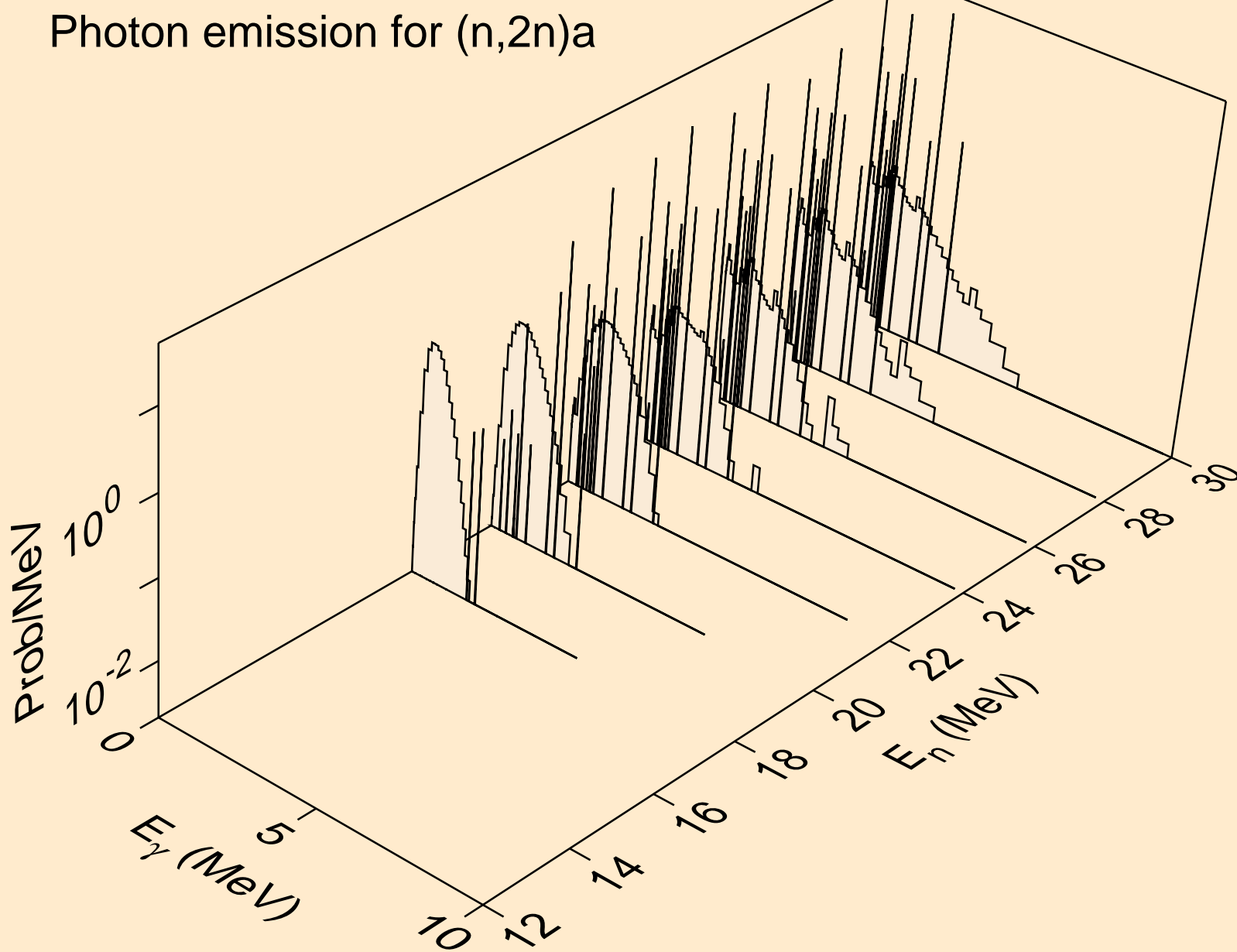

ZN073M NEUTRON ACER TENDL-2019 LIBRARY; T=293.16K
Photon emission for (n,3n)a

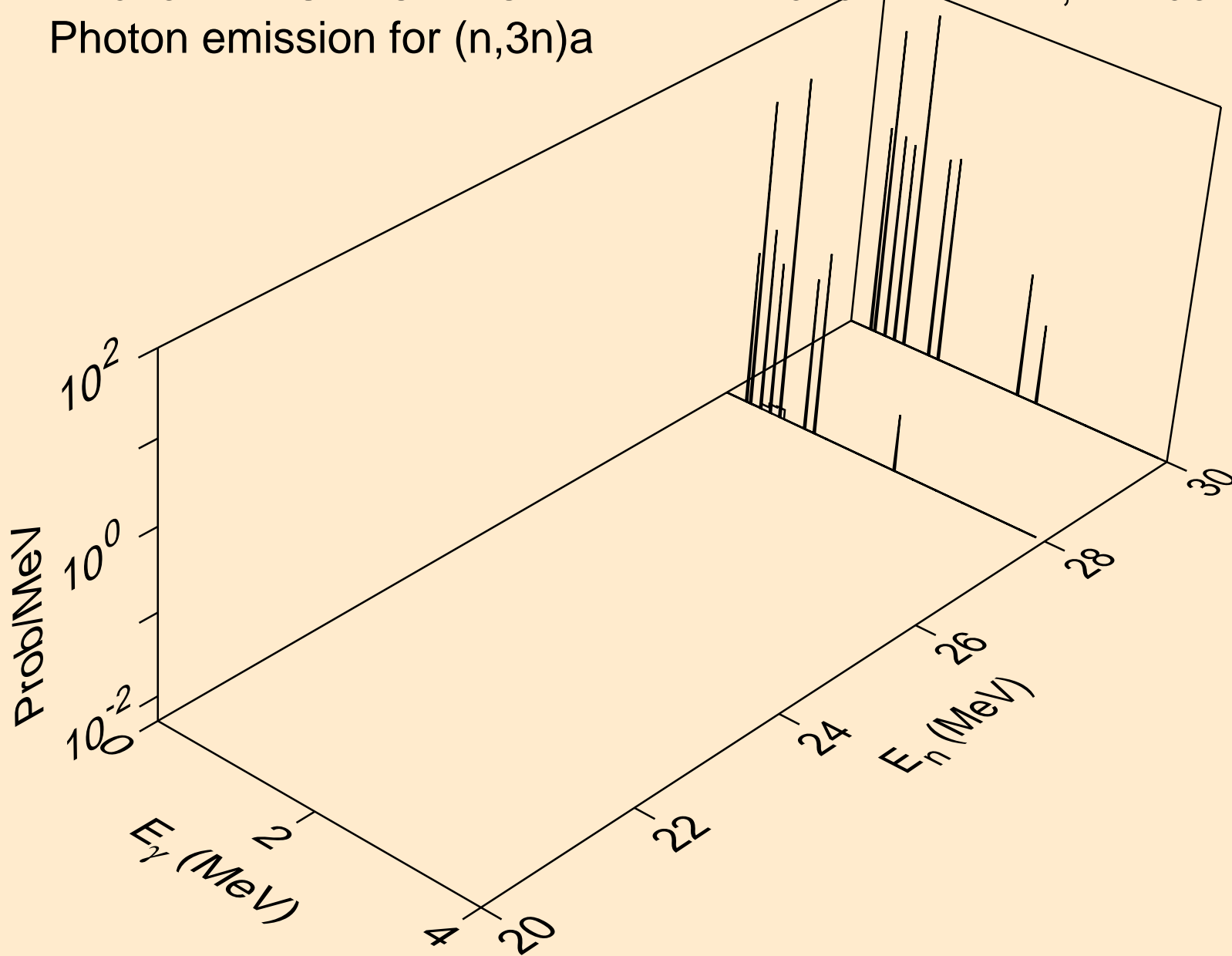

ZN073M NEUTRON ACER TENDL-2019 LIBRARY; T=293.16K
Photon emission for (n,n*)p

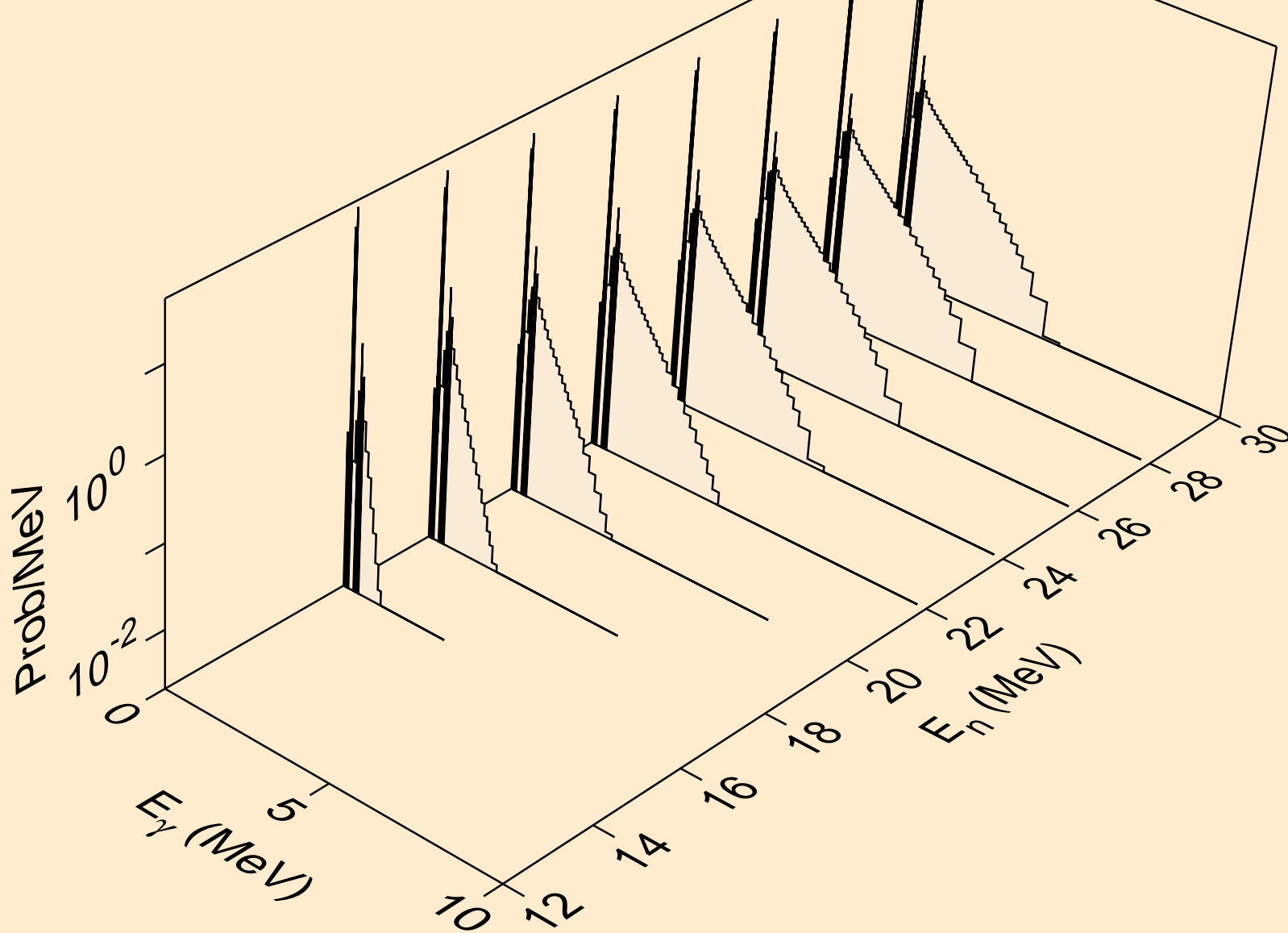

ZN073M NEUTRON ACER TENDL-2019 LIBRARY; T=293.16K
Photon emission for (n,n*)d

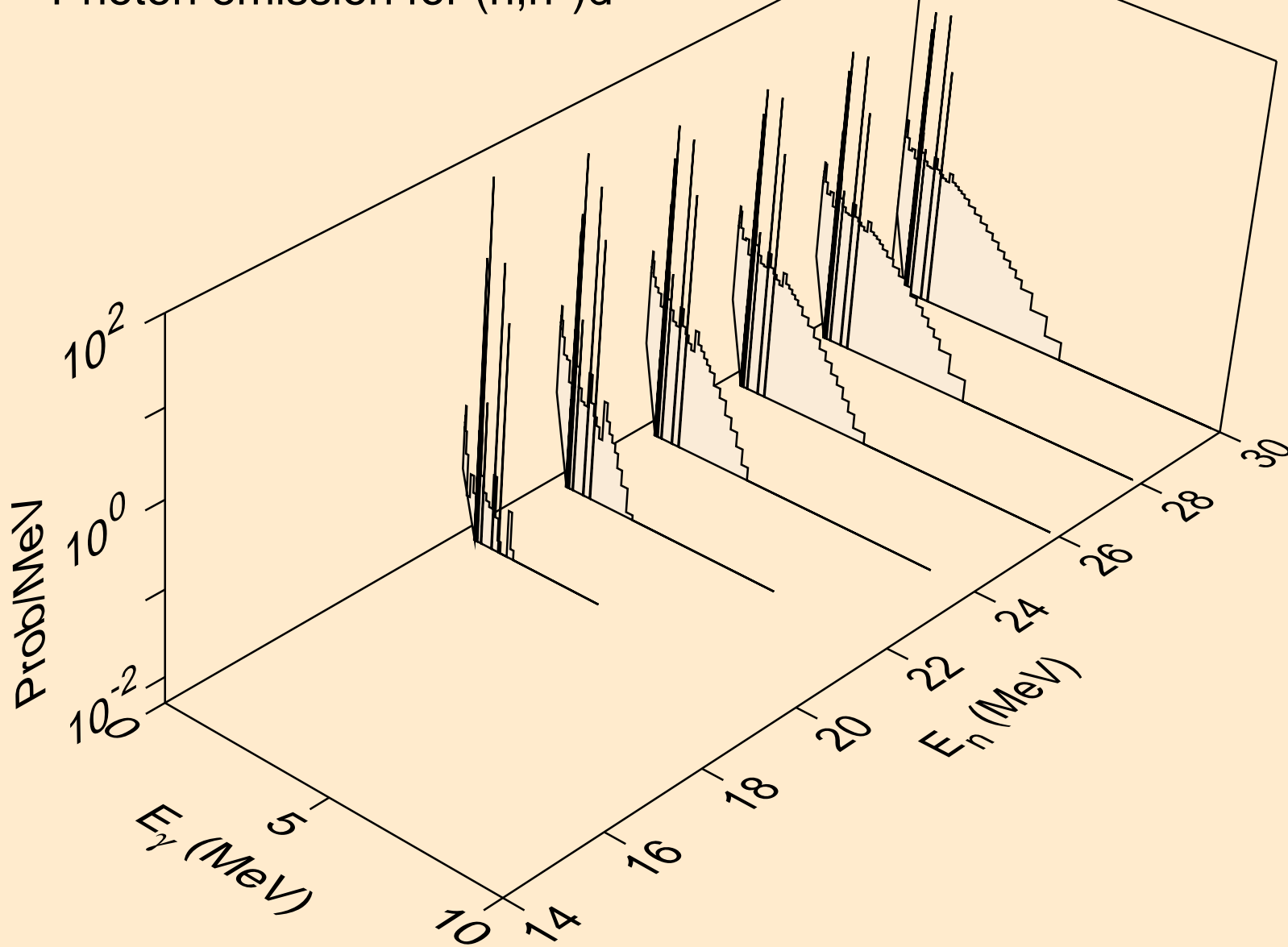

ZN073M NEUTRON ACER TENDL-2019 LIBRARY; T=293.16K
Photon emission for (n,n*)t

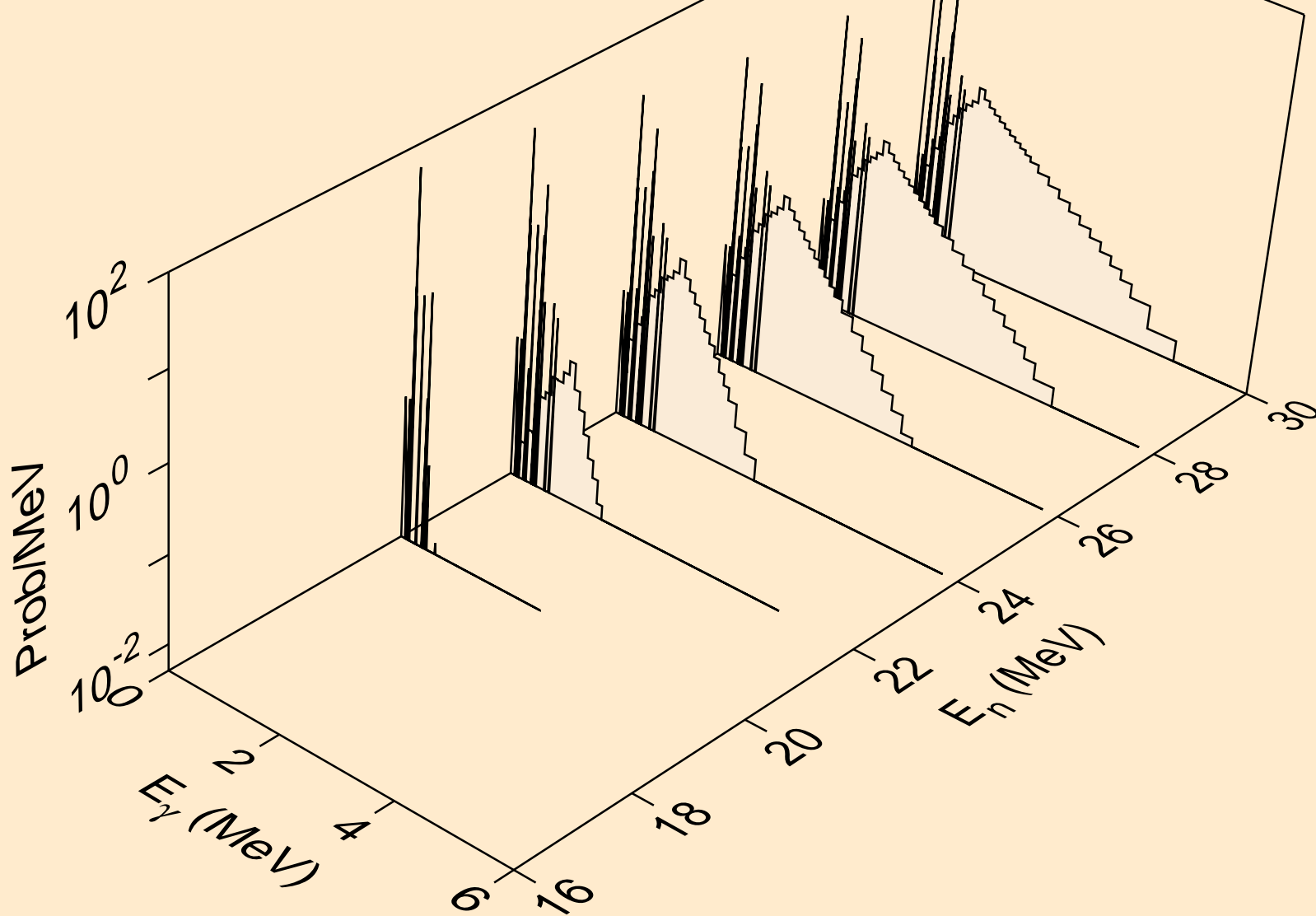

ZN073M NEUTRON ACER TENDL-2019 LIBRARY; T=293.16K
Photon emission for (n,n*)he3

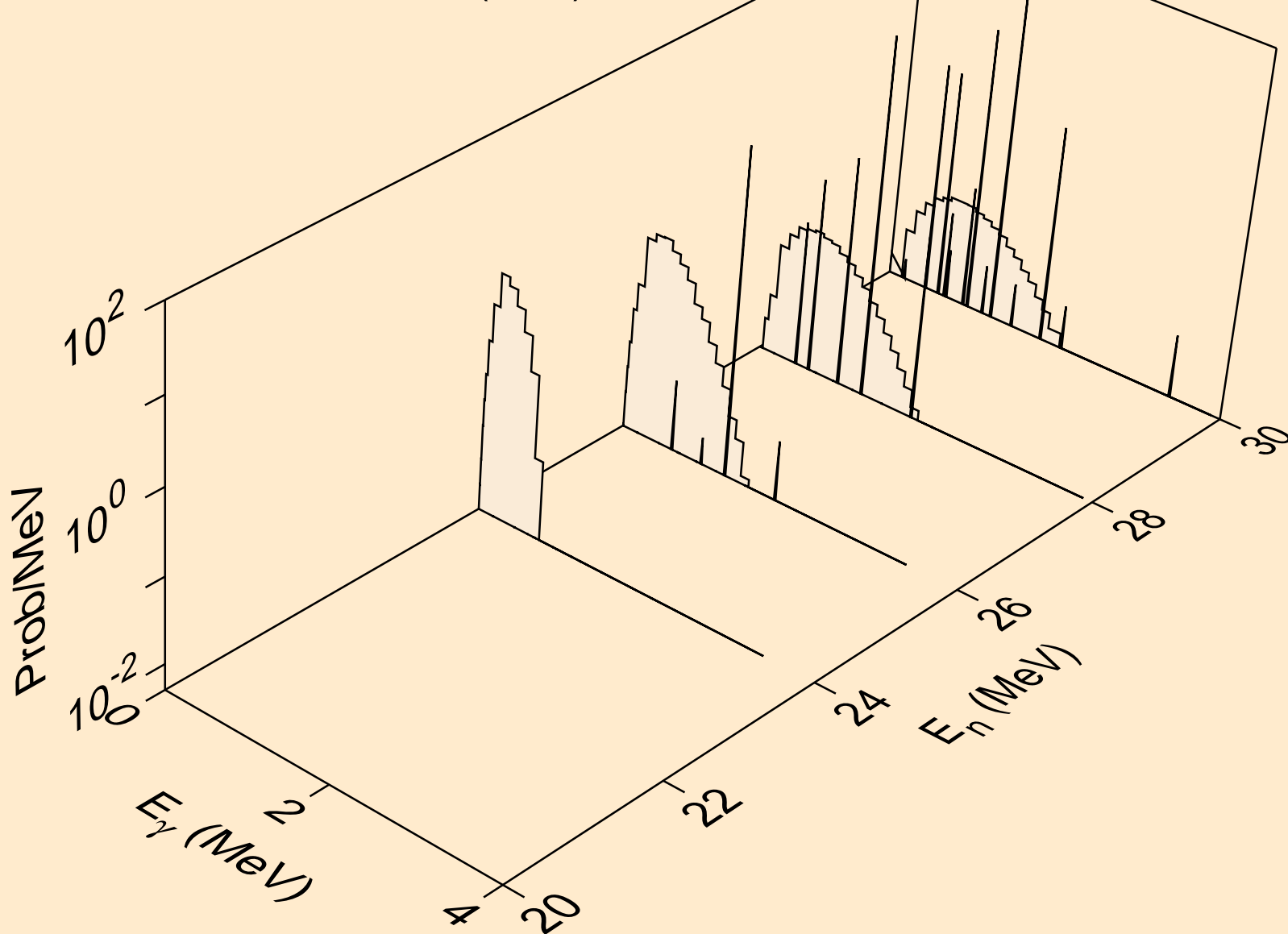

ZN073M NEUTRON ACER TENDL-2019 LIBRARY; T=293.16K
Photon emission for (n,4n)

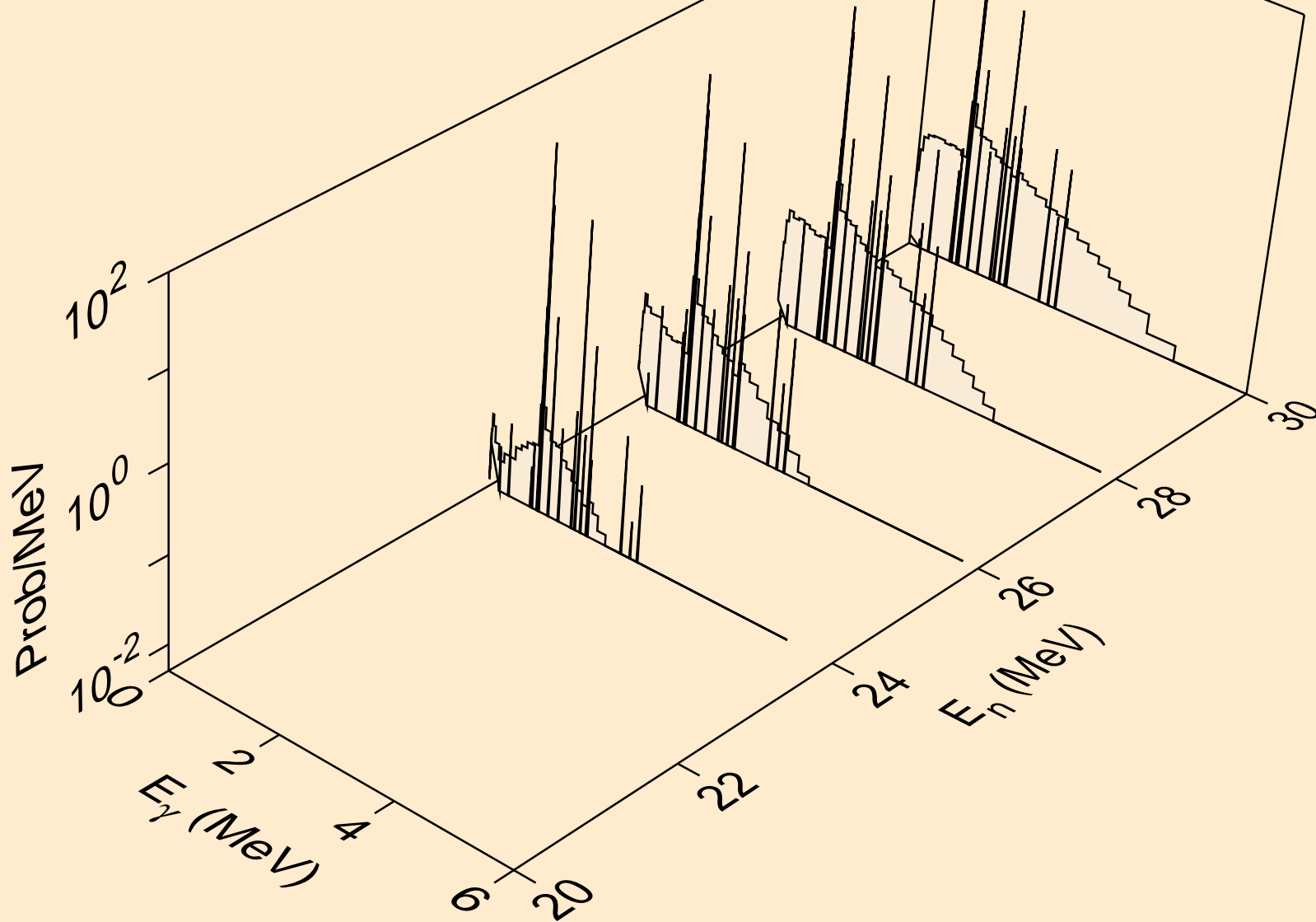

ZN073M NEUTRON ACER TENDL-2019 LIBRARY; T=293.16K
Photon emission for (n,2np)

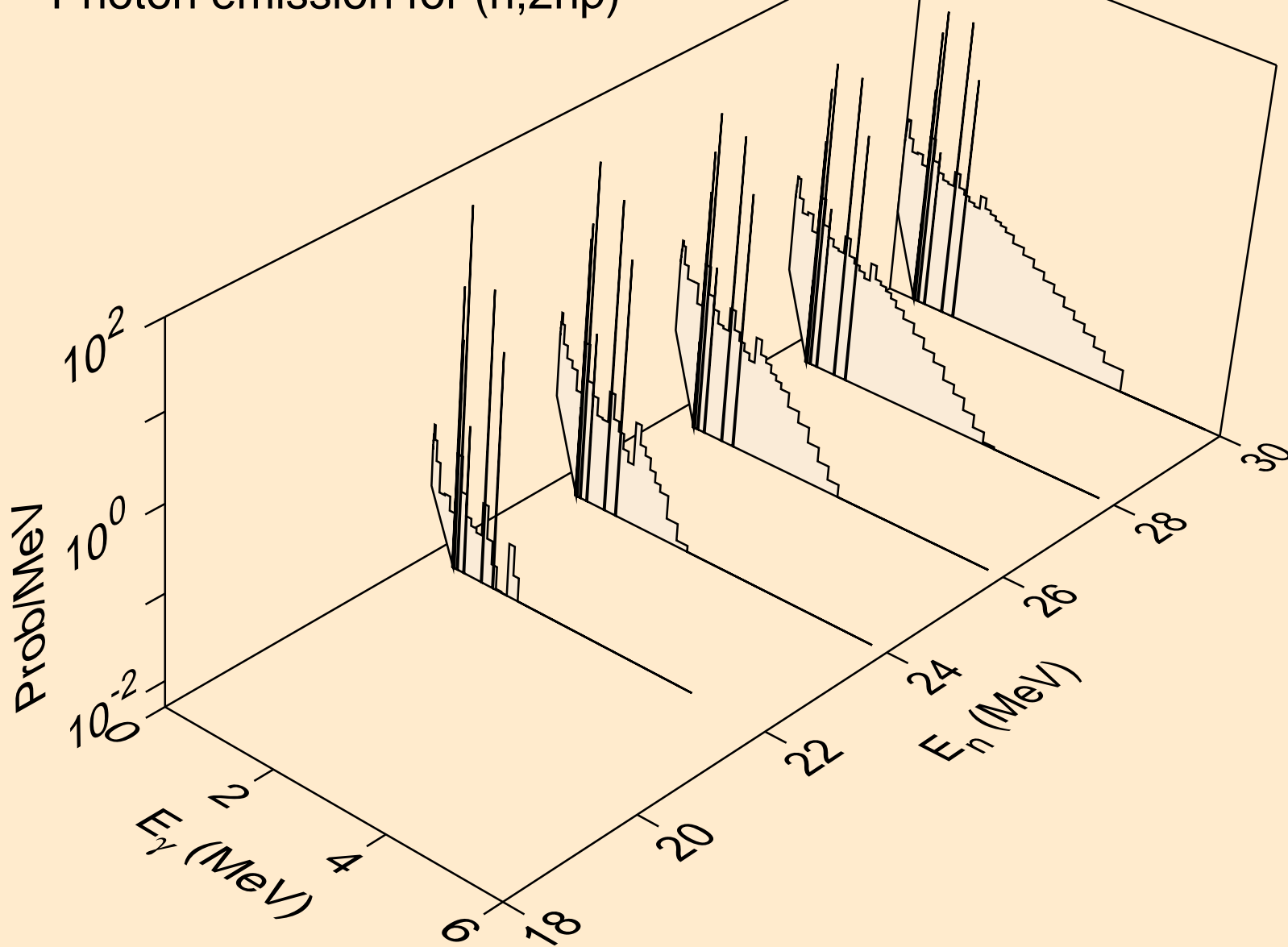

ZN073M NEUTRON ACER TENDL-2019 LIBRARY; T=293.16K
Photon emission for (n,3np)

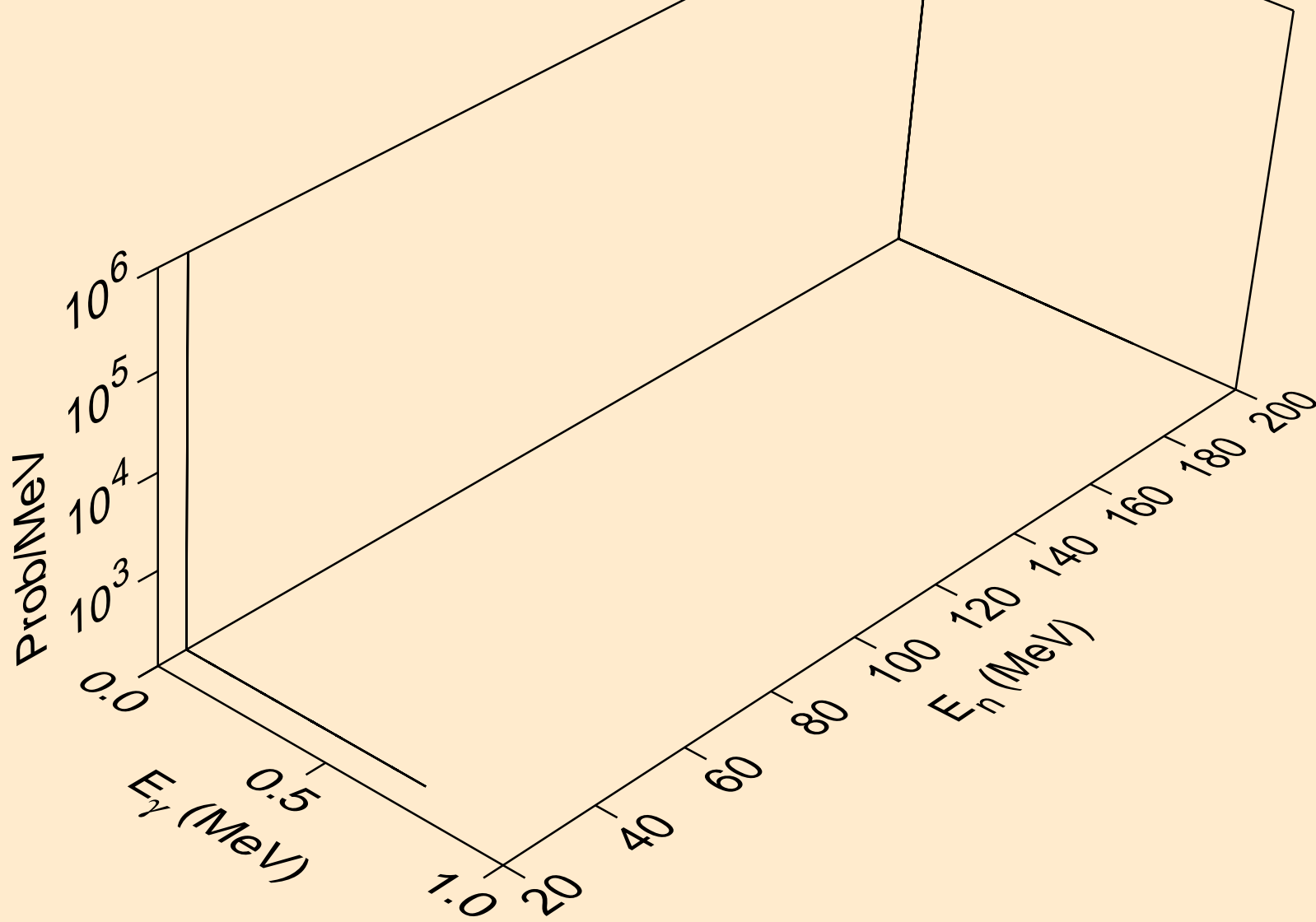

ZN073M NEUTRON ACER TENDL-2019 LIBRARY; T=293.16K
Photon emission for (n,n*1)

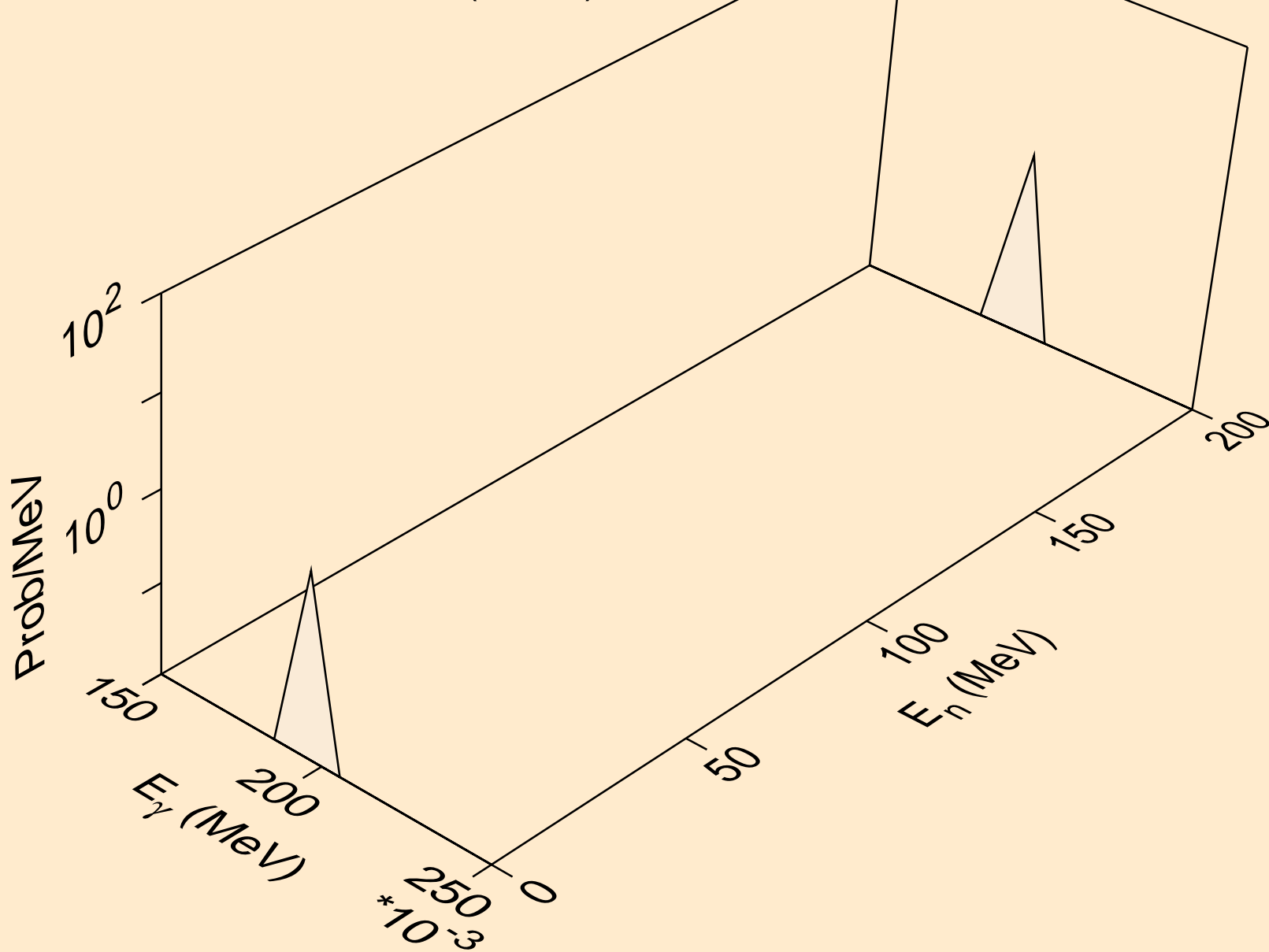

ZN073M NEUTRON ACER TENDL-2019 LIBRARY; T=293.16K
Photon emission for (n,n*2)

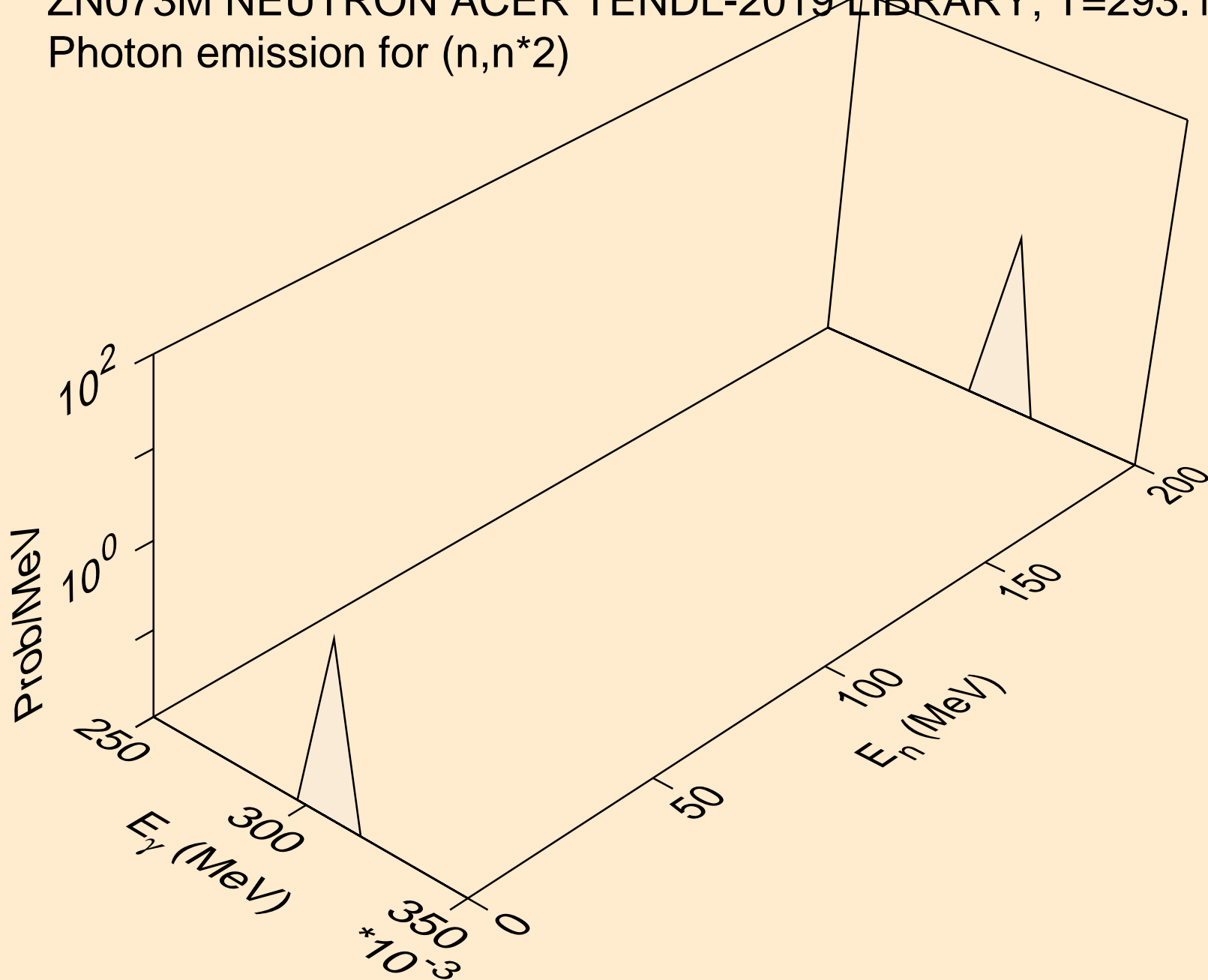

ZN073M NEUTRON ACER TENDL-2019 LIBRARY; T=293.16K
Photon emission for (n,n*4)

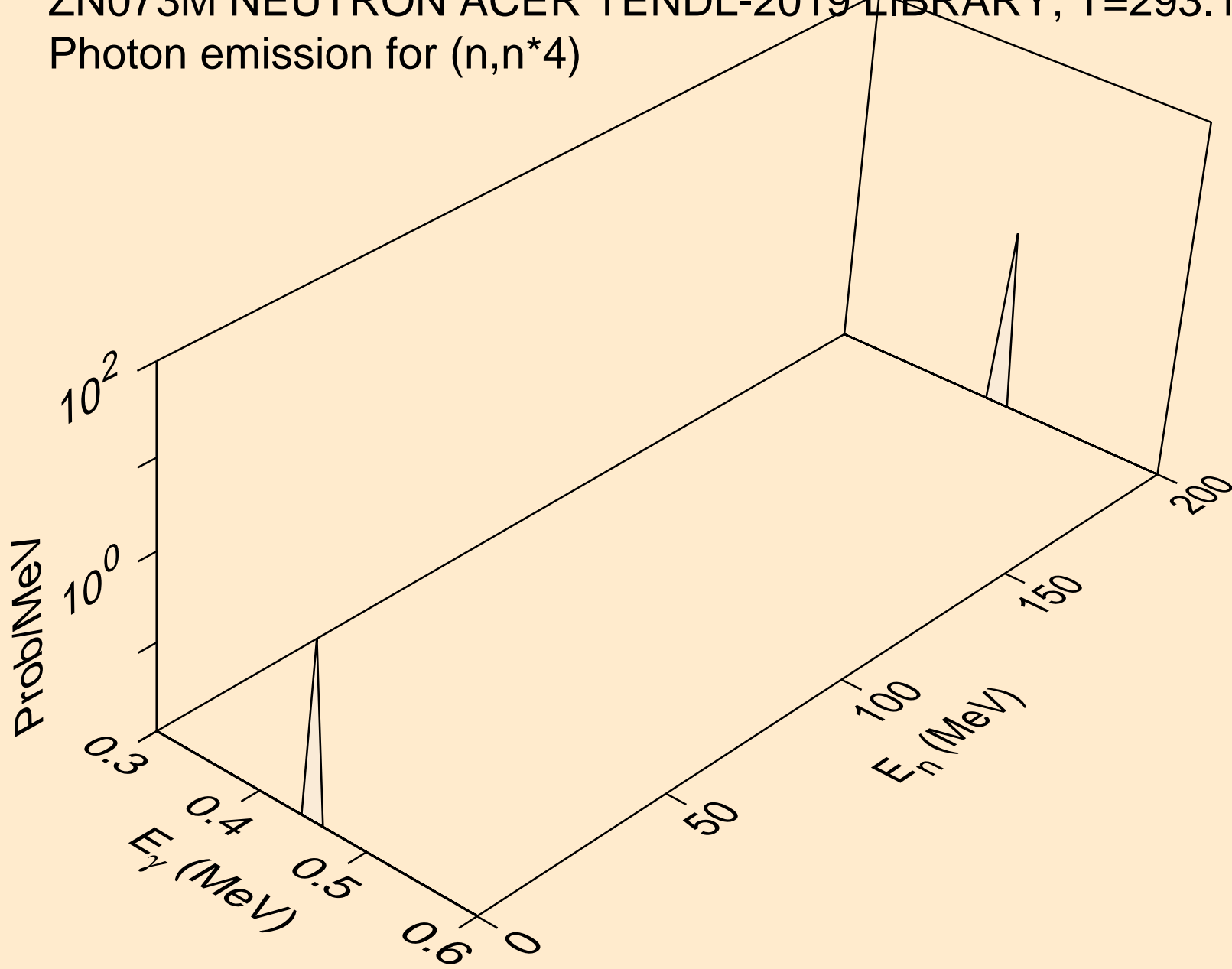

ZN073M NEUTRON ACER TENDL-2019 LIBRARY; T=293.16K
Photon emission for (n,n*5)

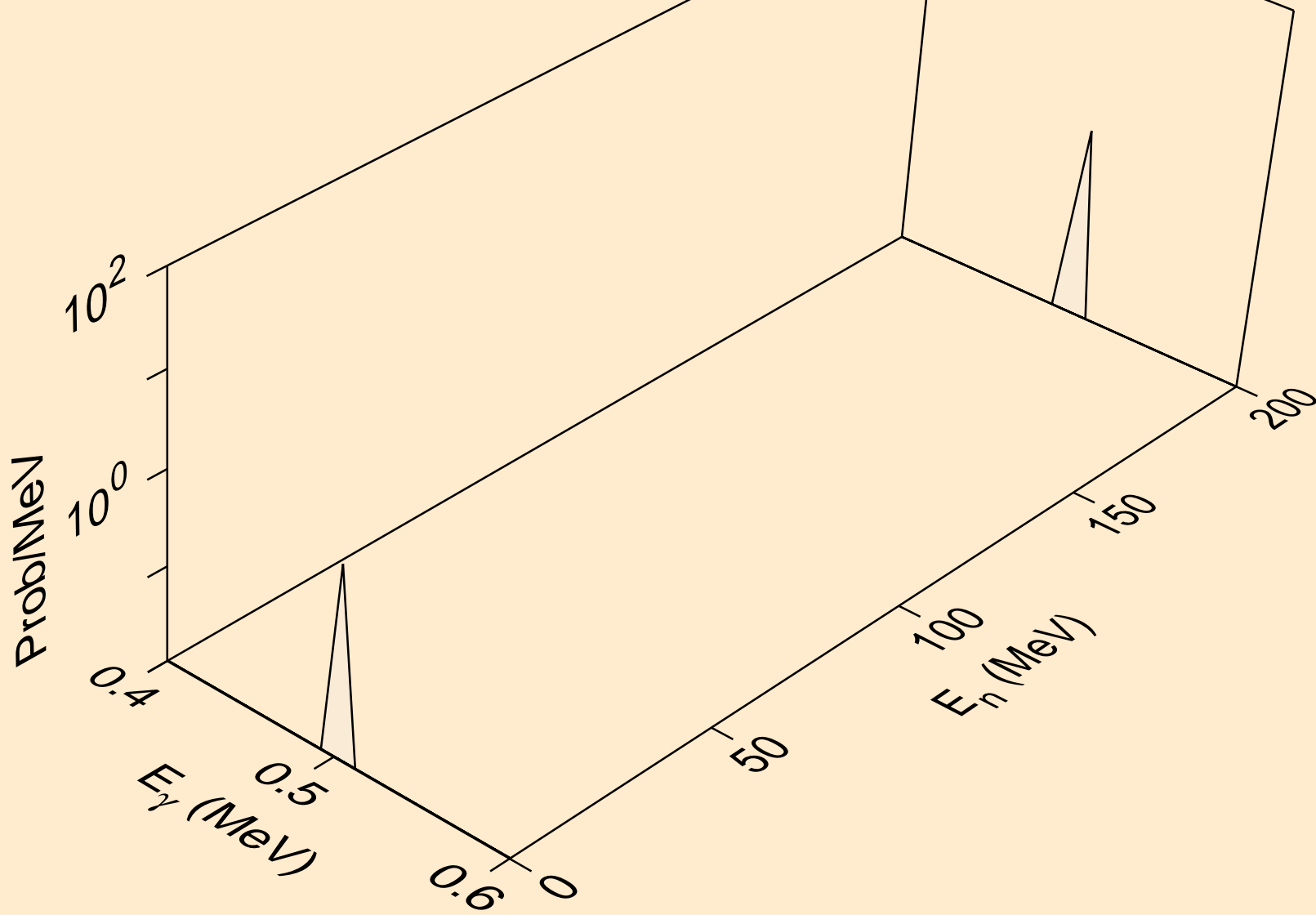

ZN073M NEUTRON ACER TENDL-2019 LIBRARY; T=293.16K
Photon emission for (n,n*6)

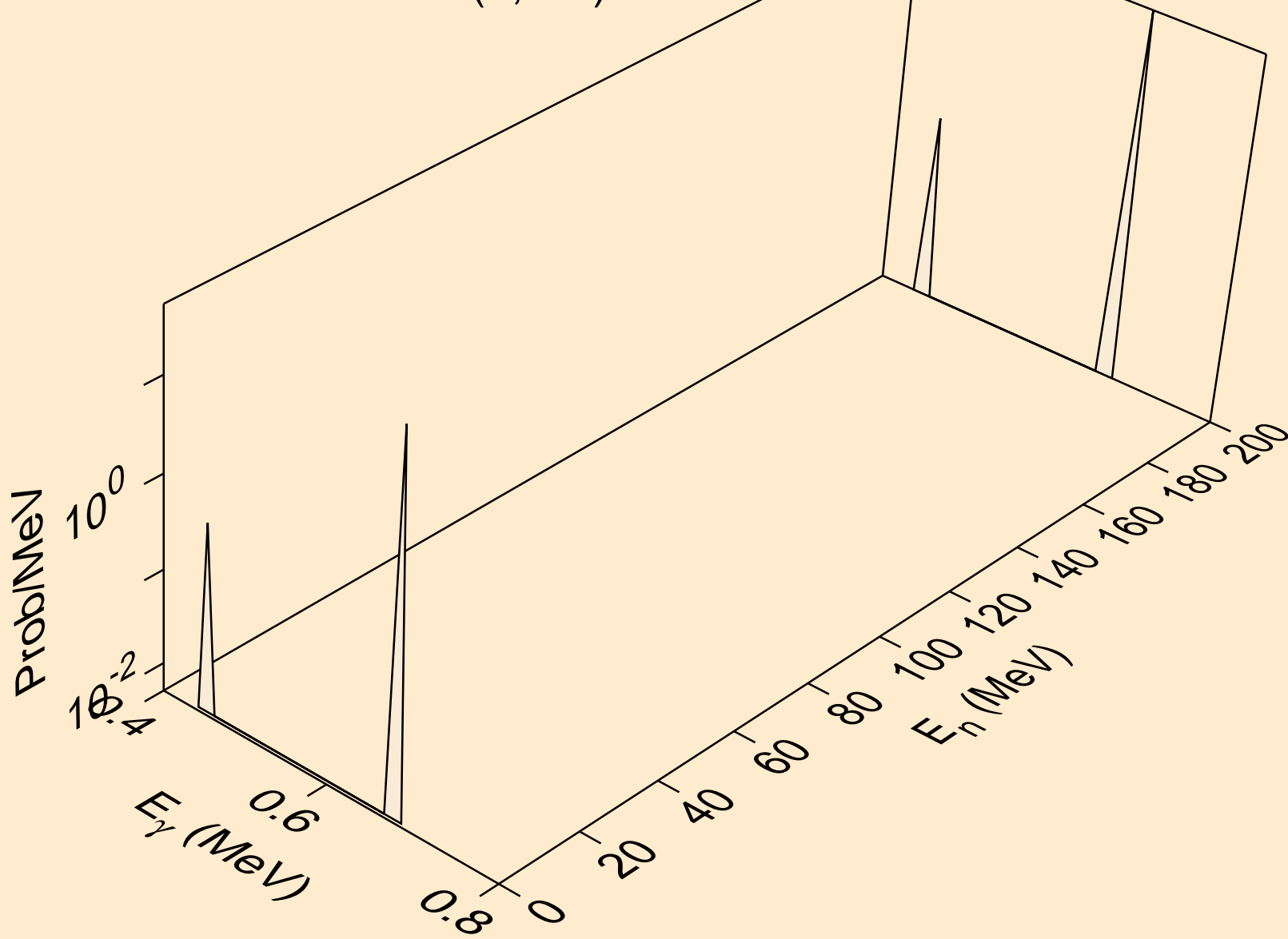

ZN073M NEUTRON ACER TENDL-2019 LIBRARY; T=293.16K
Photon emission for (n,n*7)

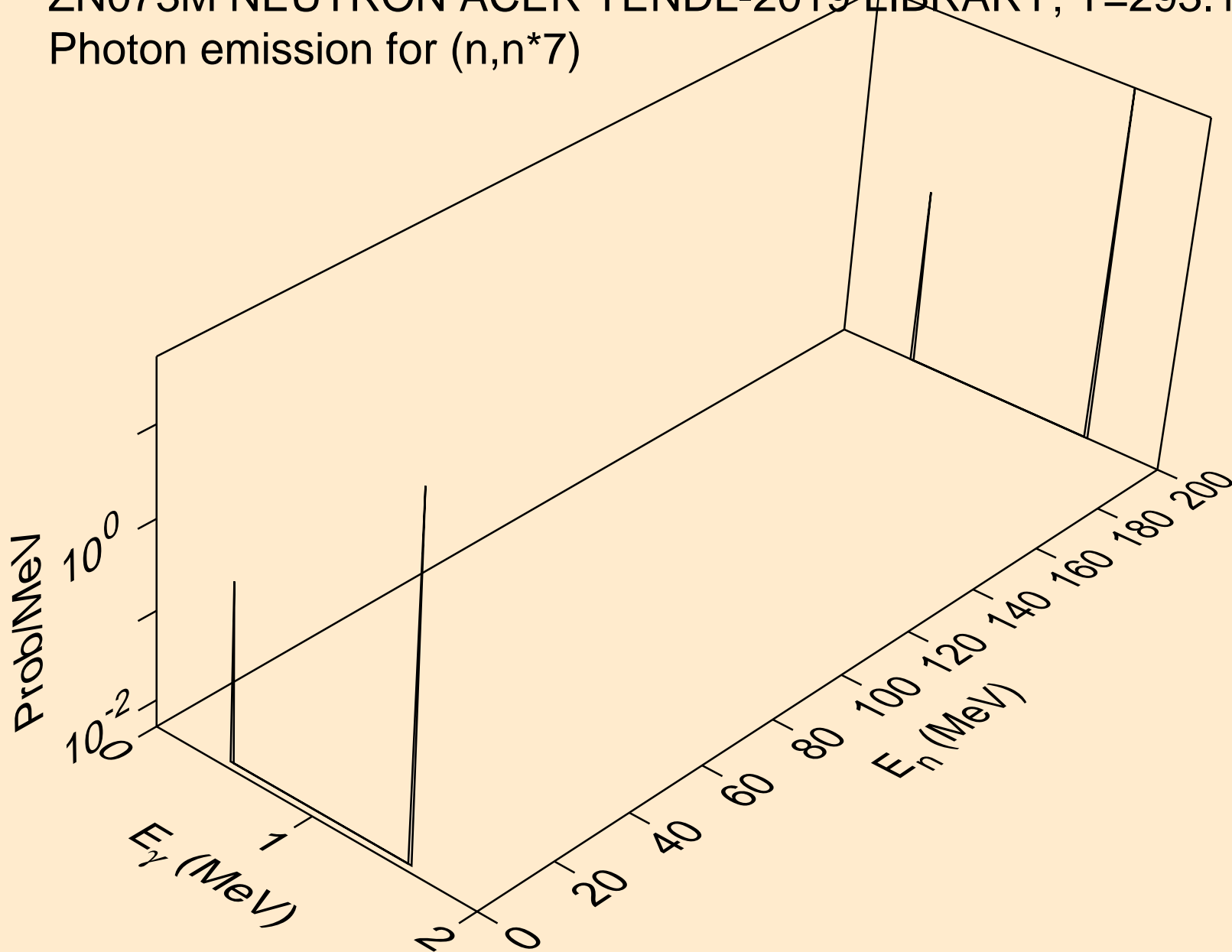

ZN073M NEUTRON ACER TENDL-2019 LIBRARY; T=293.16K
Photon emission for (n,n*8)

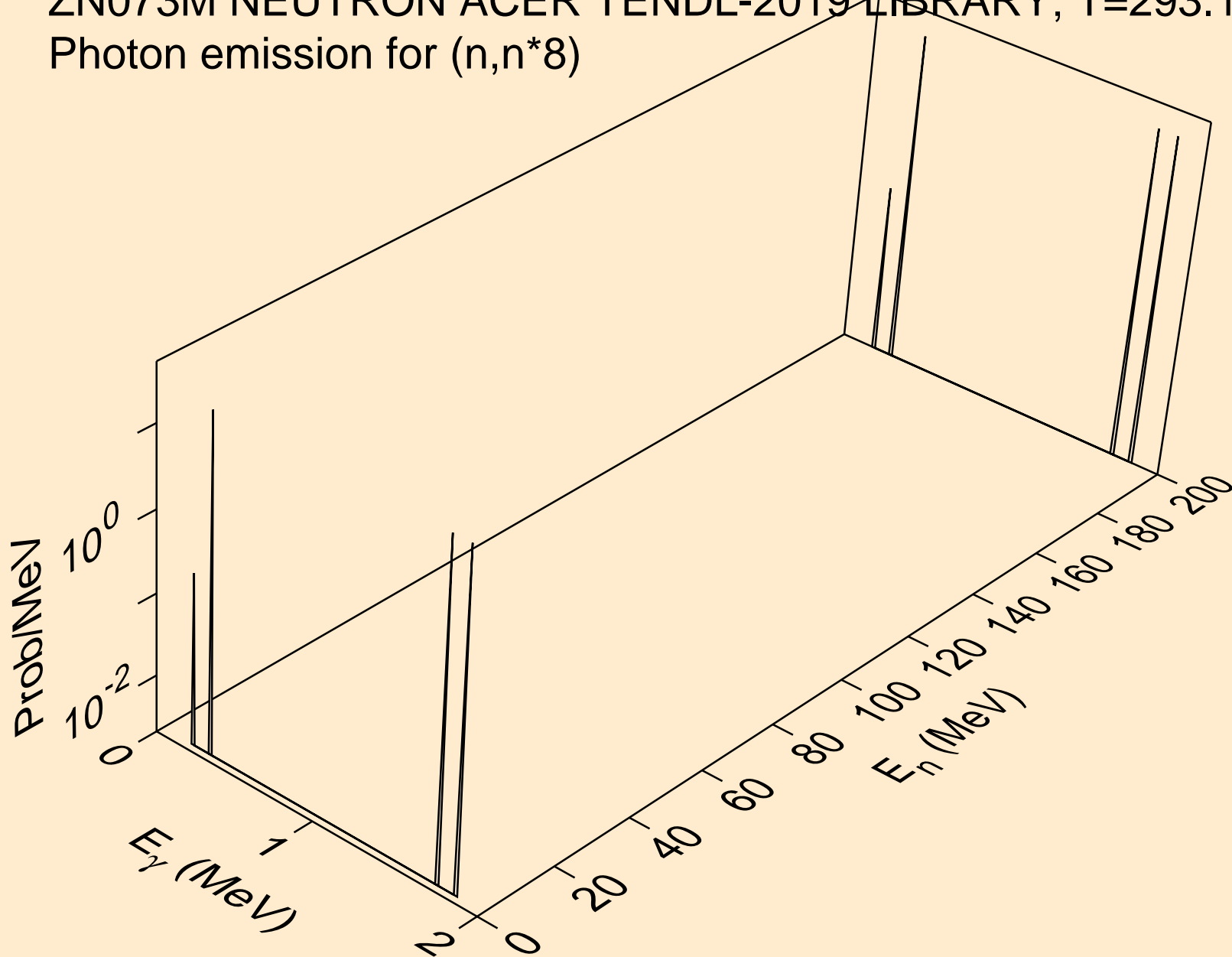

ZN073M NEUTRON ACER TENDL-2019 LIBRARY; T=293.16K
Photon emission for (n,n*9)

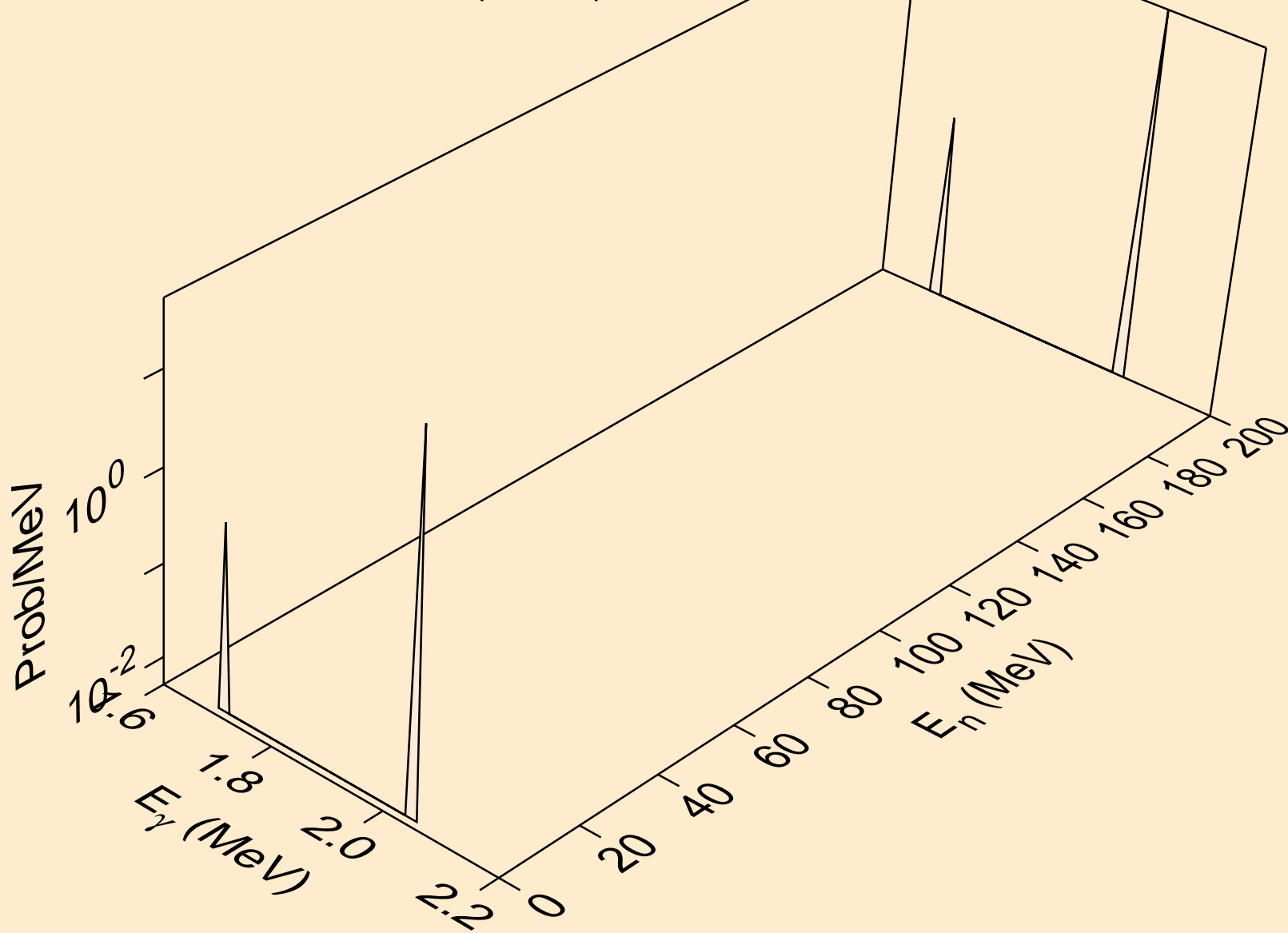

ZN073M NEUTRON ACER TENDL-2019 LIBRARY; T=293.16K
Photon emission for (n,n*10)

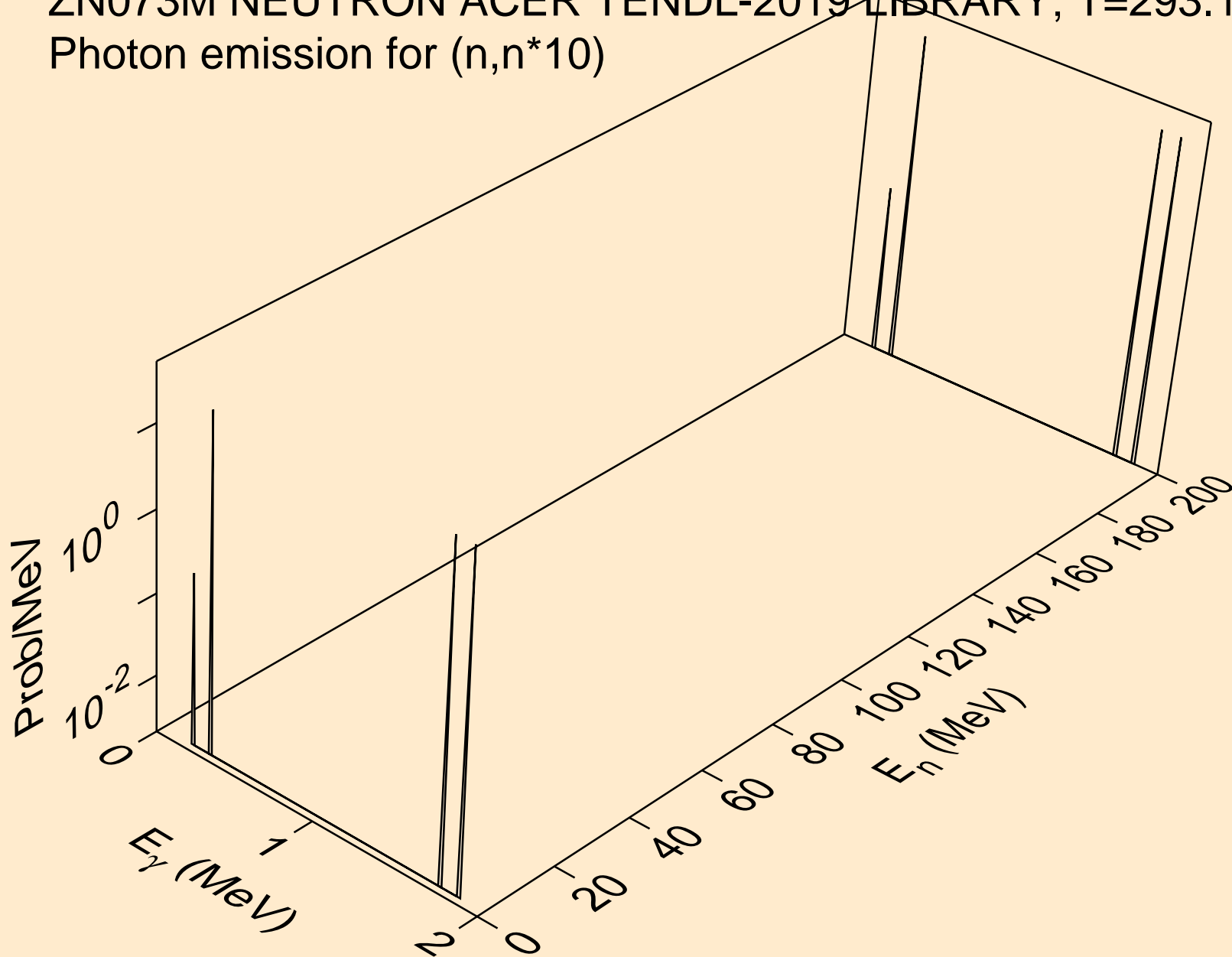

ZN073M NEUTRON ACER TENDL-2019 LIBRARY; T=293.16K
Photon emission for (n,n*11)

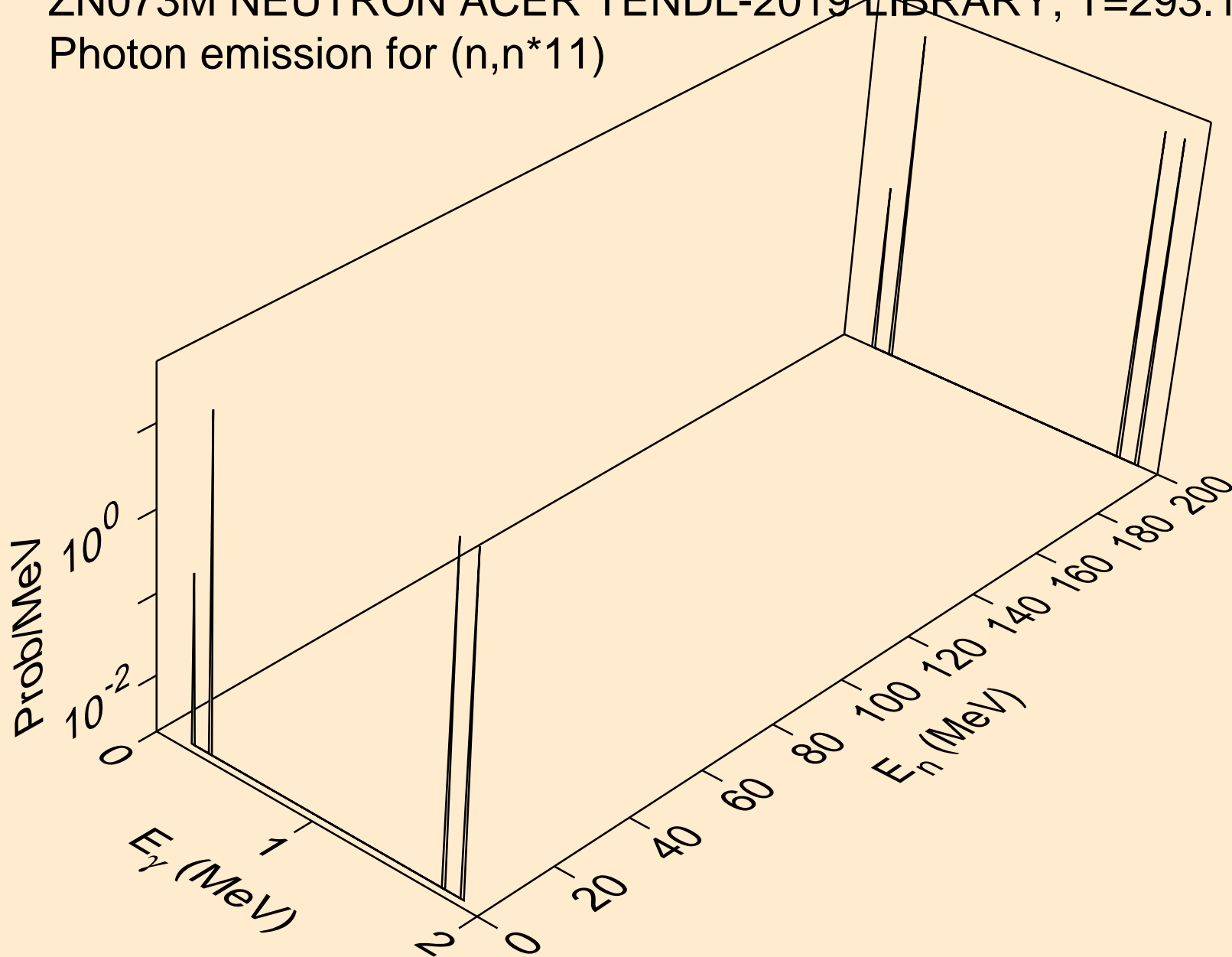

ZN073M NEUTRON ACER TENDL-2019 LIBRARY; T=293.16K
Photon emission for (n,n*12)

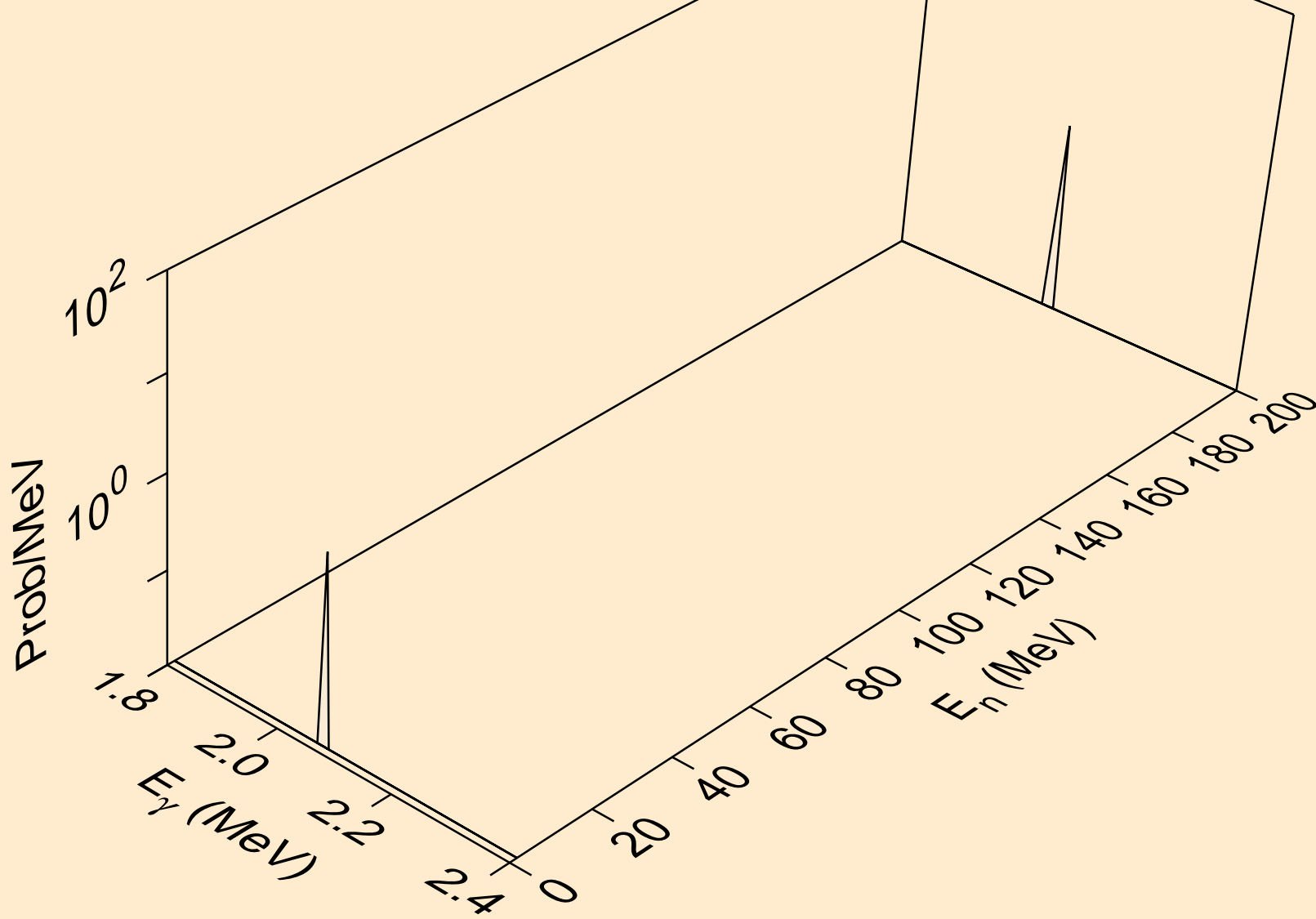

ZN073M NEUTRON ACER TENDL-2019 LIBRARY; T=293.16K
Photon emission for (n,n*13)

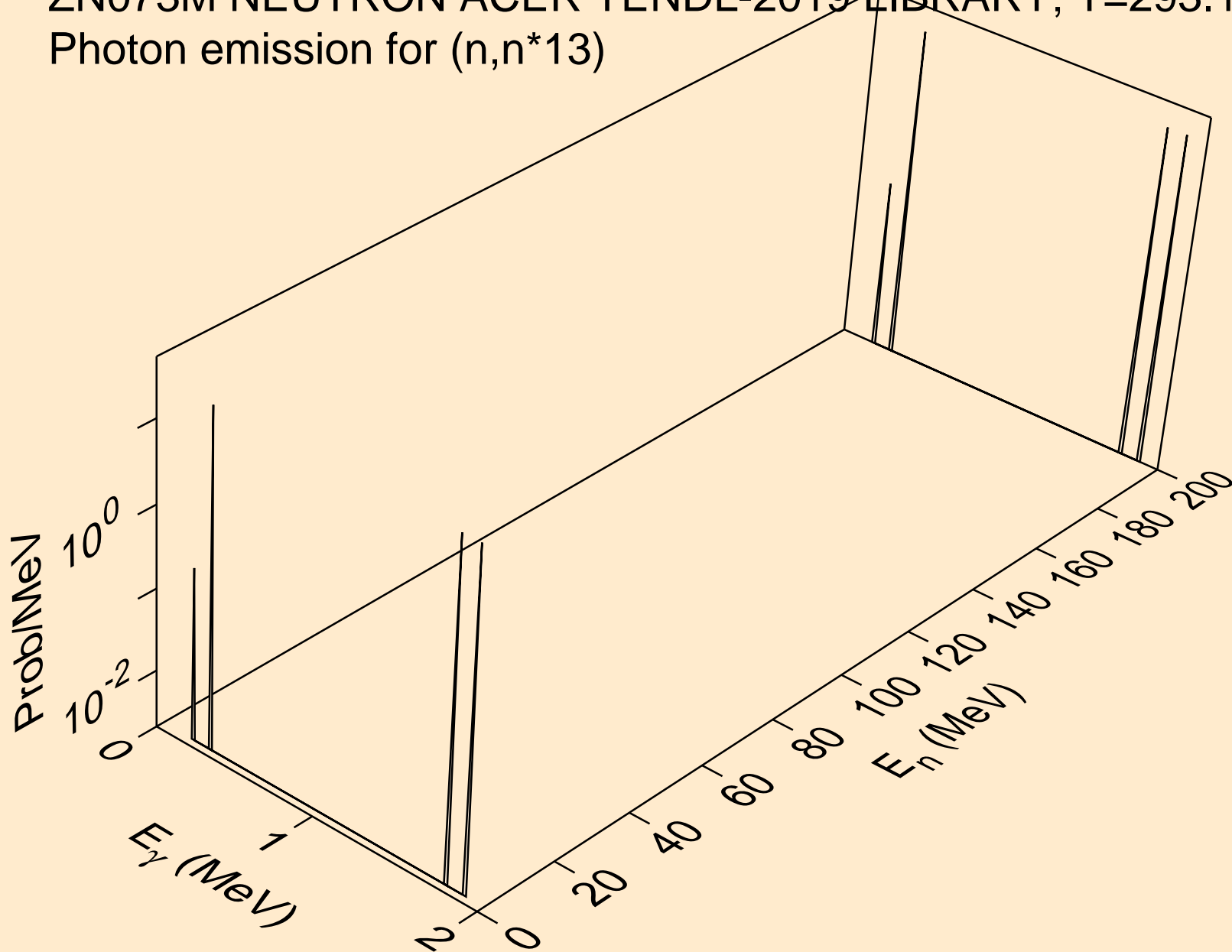

ZN073M NEUTRON ACER TENDL-2019 LIBRARY; T=293.16K
Photon emission for (n,n*14)

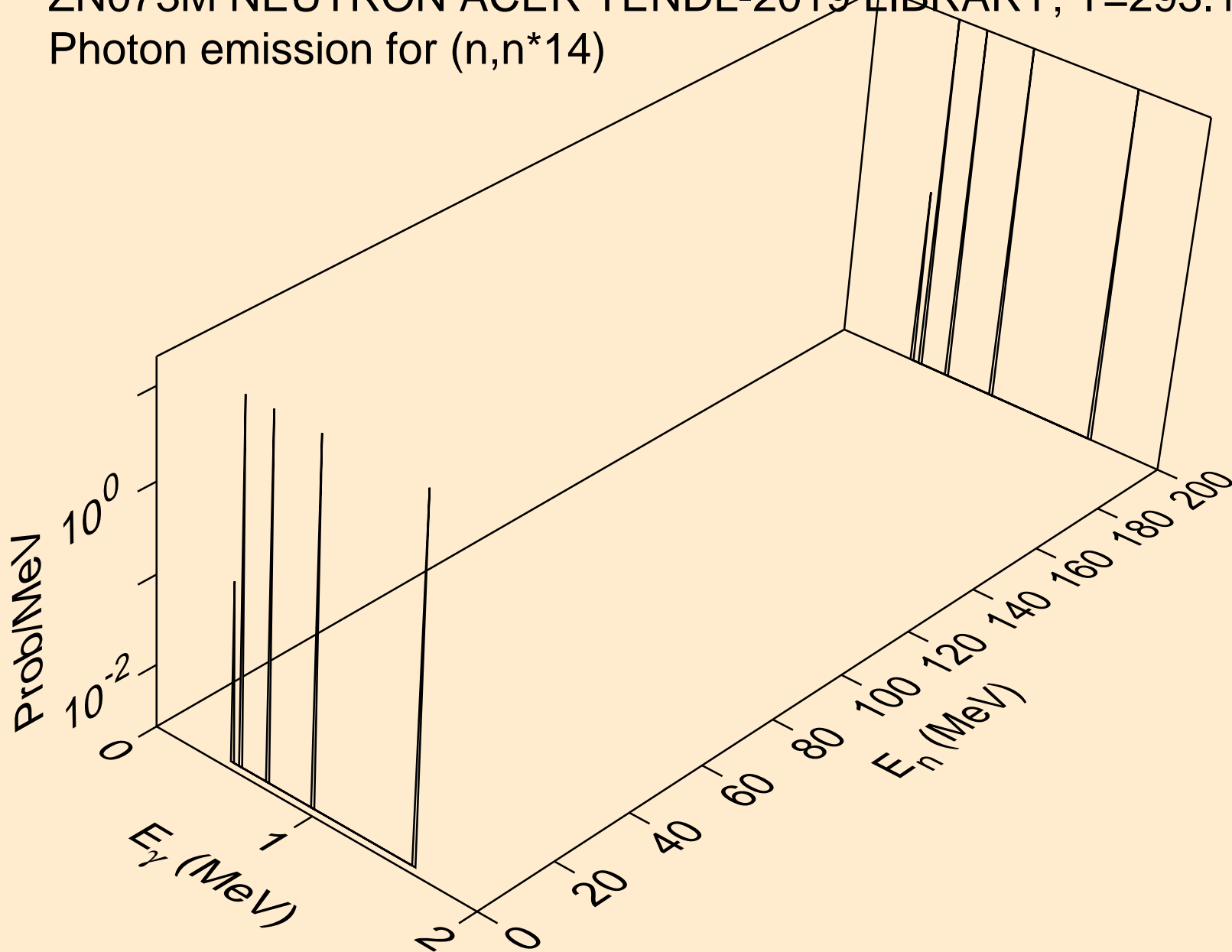

ZN073M NEUTRON ACER TENDL-2019 LIBRARY; T=293.16K
Photon emission for (n,n*15)

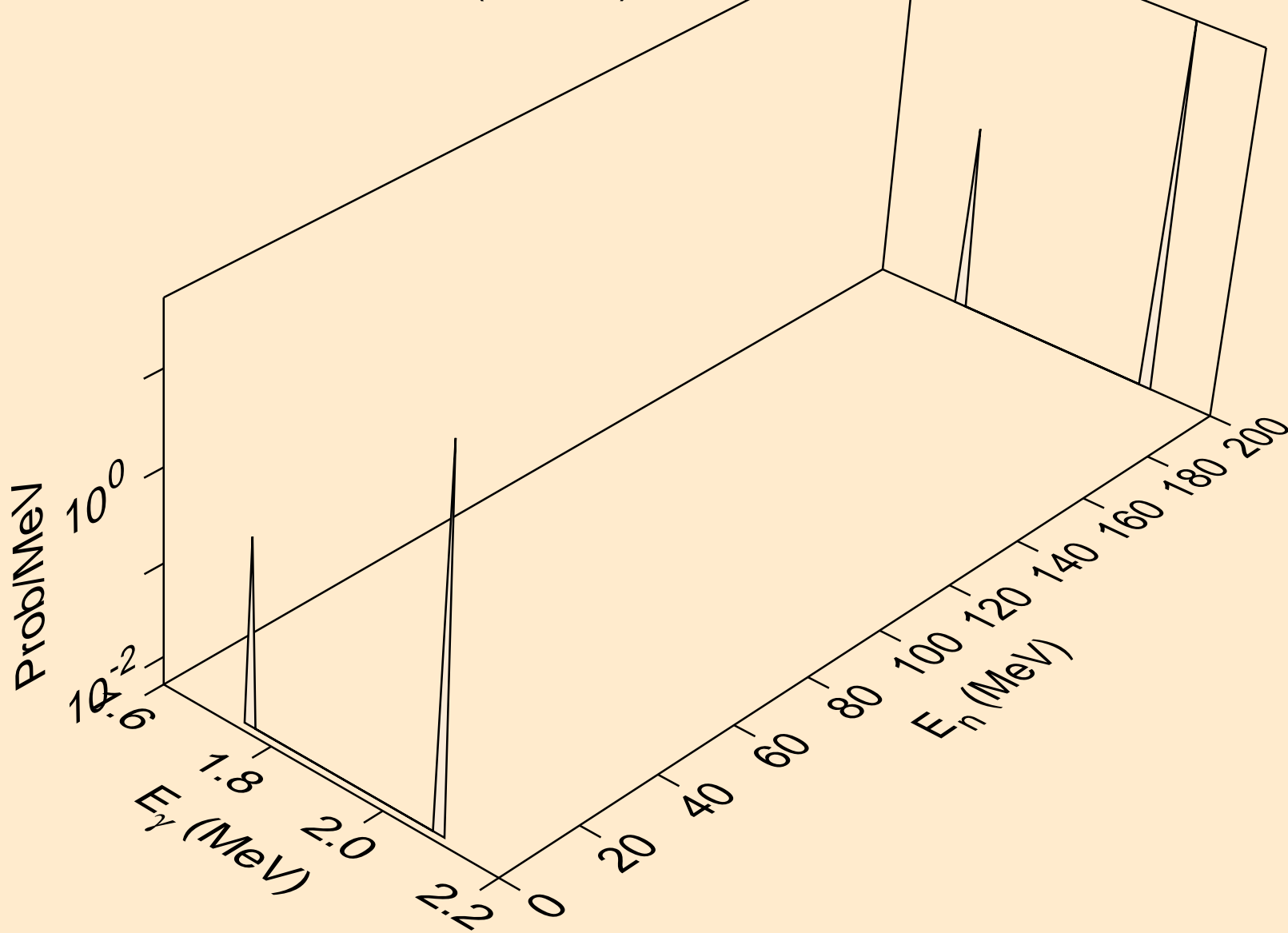

ZN073M NEUTRON ACER TENDL-2019 LIBRARY; T=293.16K
Photon emission for (n,n*16)

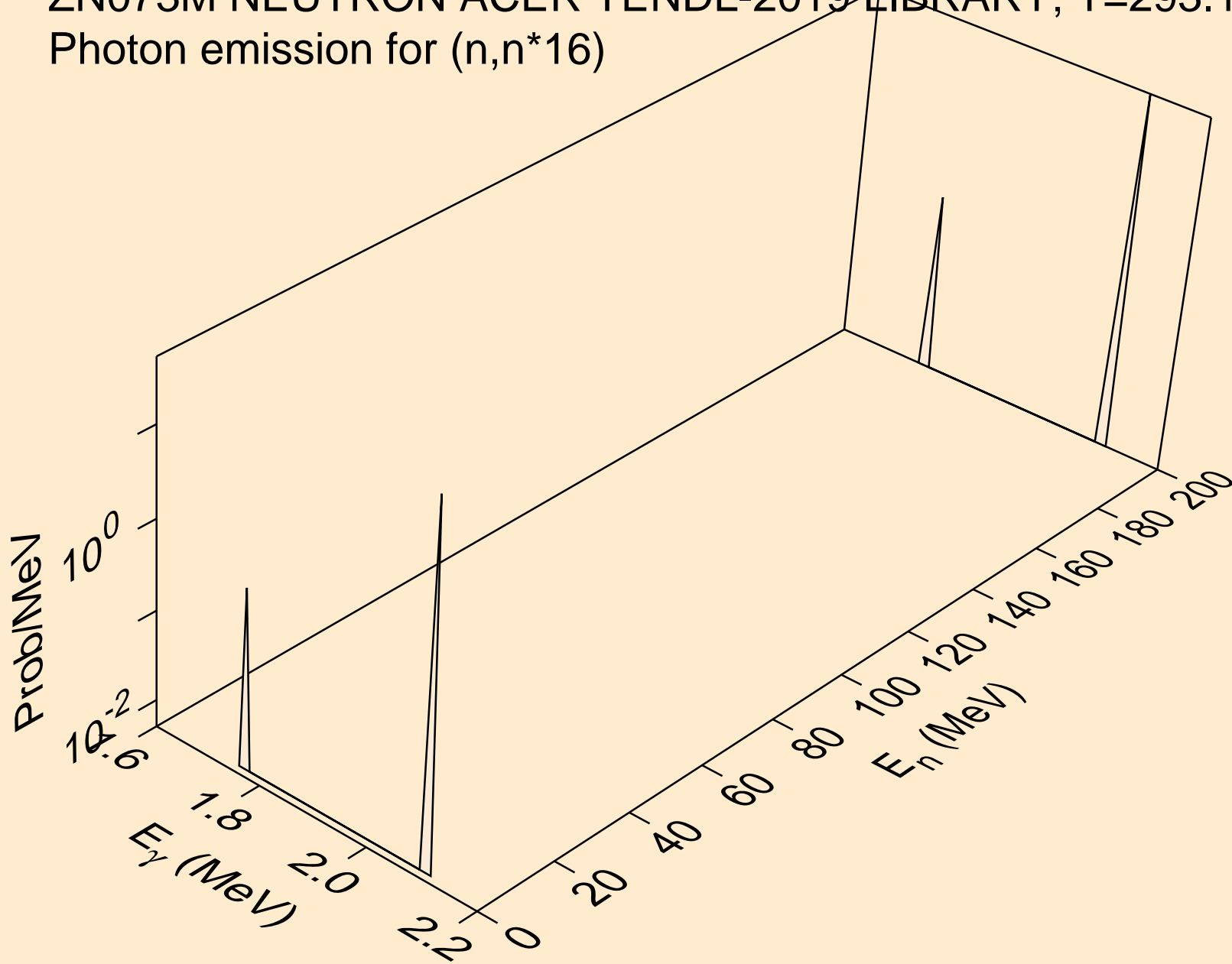

ZN073M NEUTRON ACER TENDL-2019 LIBRARY; T=293.16K
Photon emission for (n,n*17)

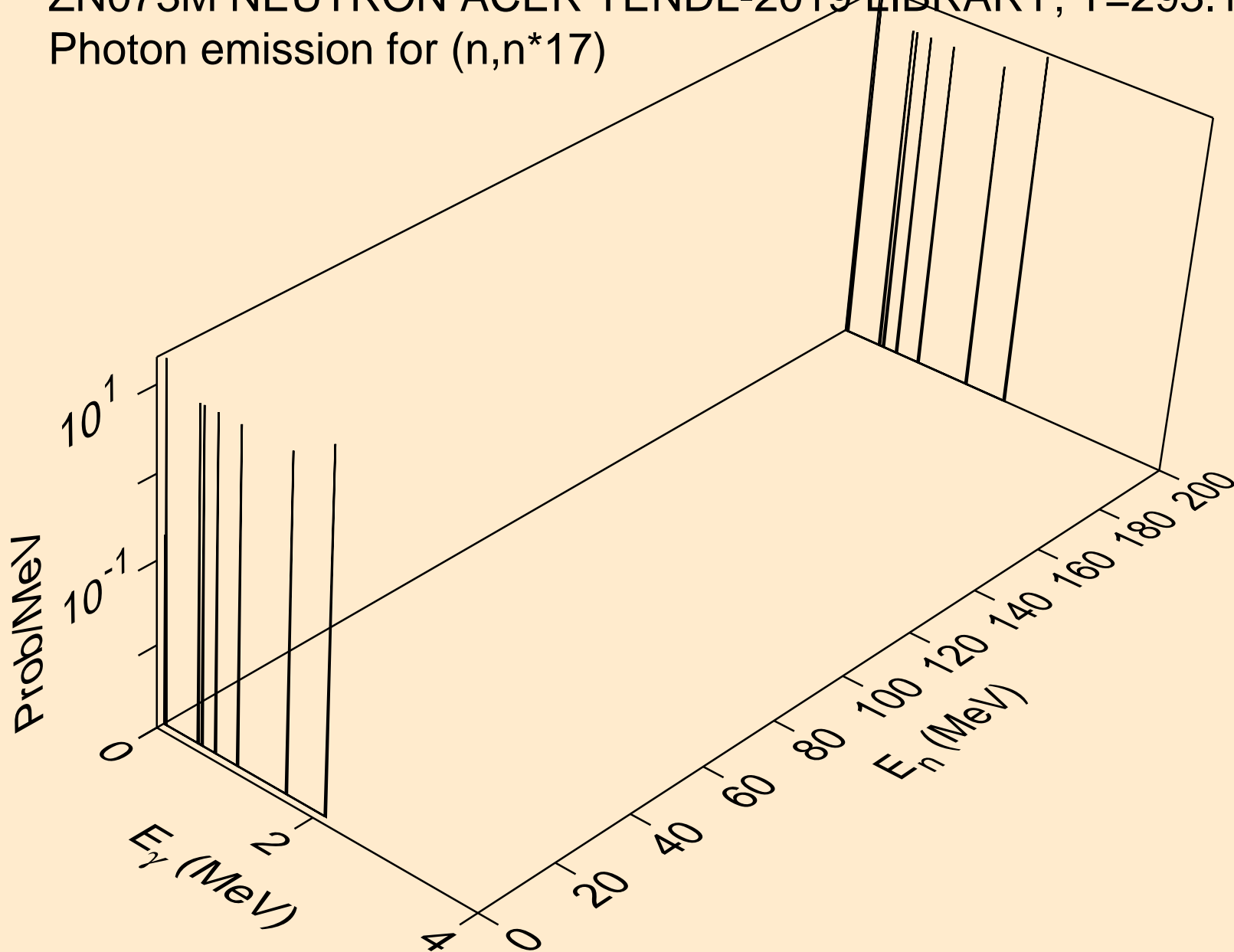

ZN073M NEUTRON ACER TENDL-2019 LIBRARY; T=293.16K
Photon emission for (n,n*18)

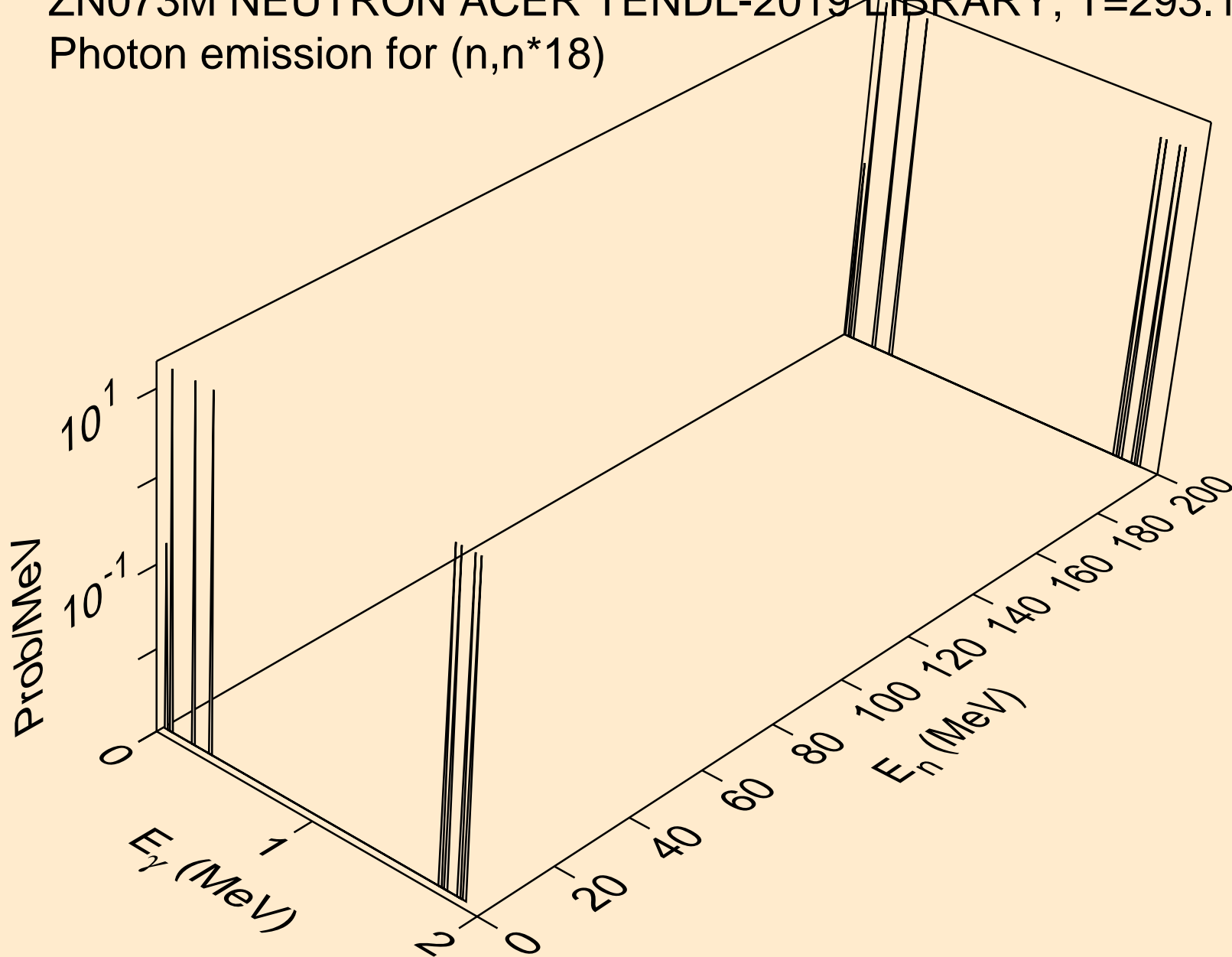

ZN073M NEUTRON ACER TENDL-2019 LIBRARY; T=293.16K
Photon emission for (n,n*19)

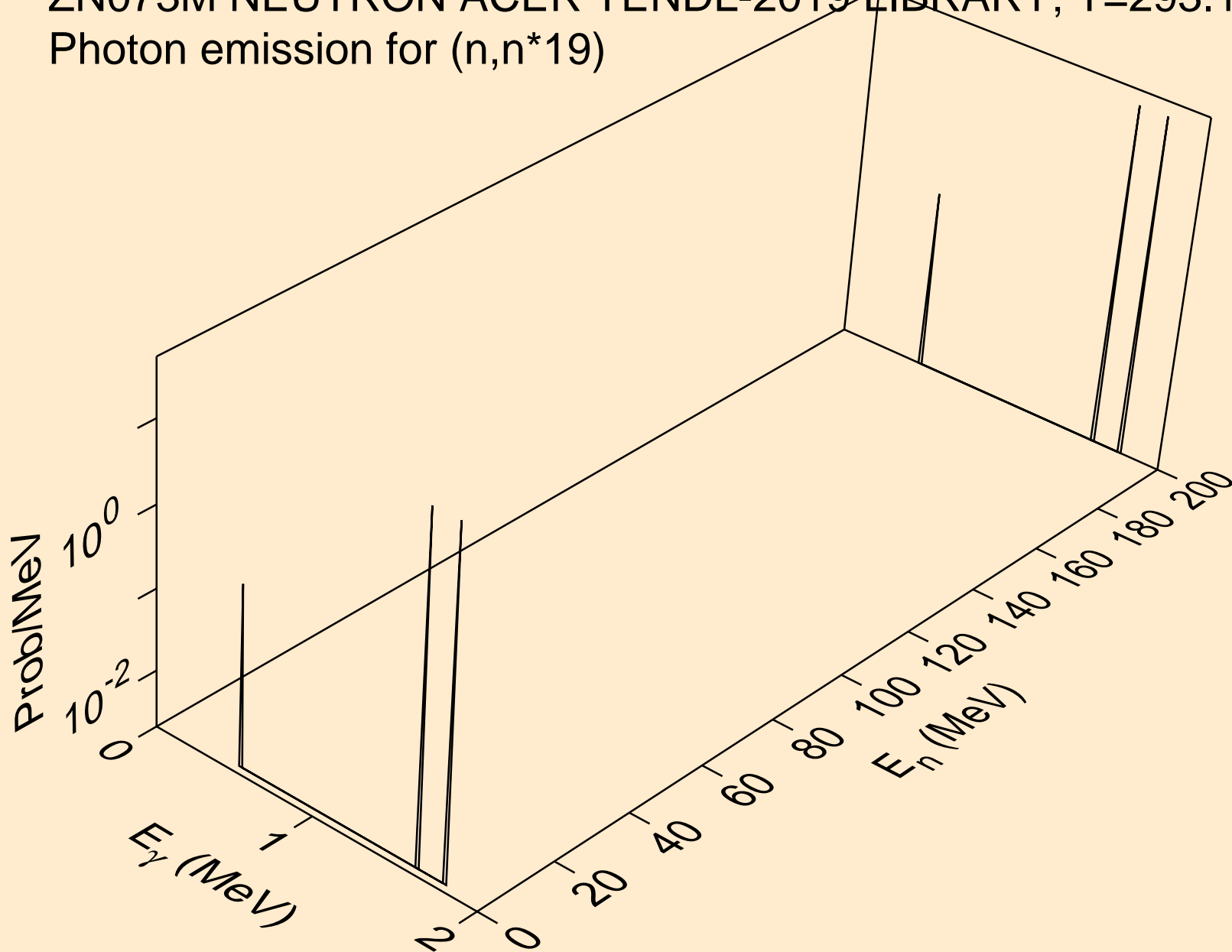

ZN073M NEUTRON ACER TENDL-2019 LIBRARY; T=293.16K
Photon emission for (n,n*20)

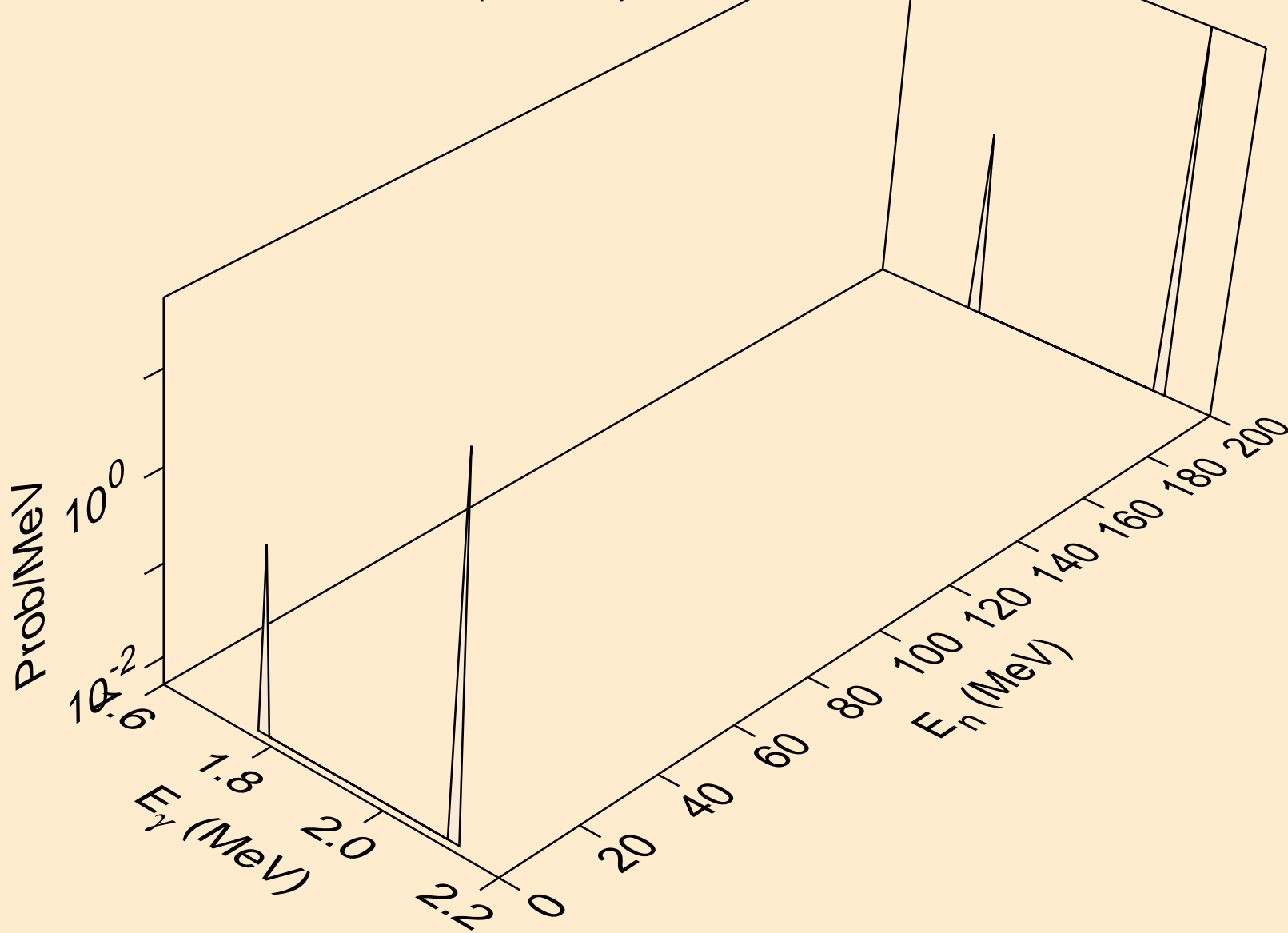

ZN073M NEUTRON ACER TENDL-2019 LIBRARY; T=293.16K
Photon emission for (n,n*21)

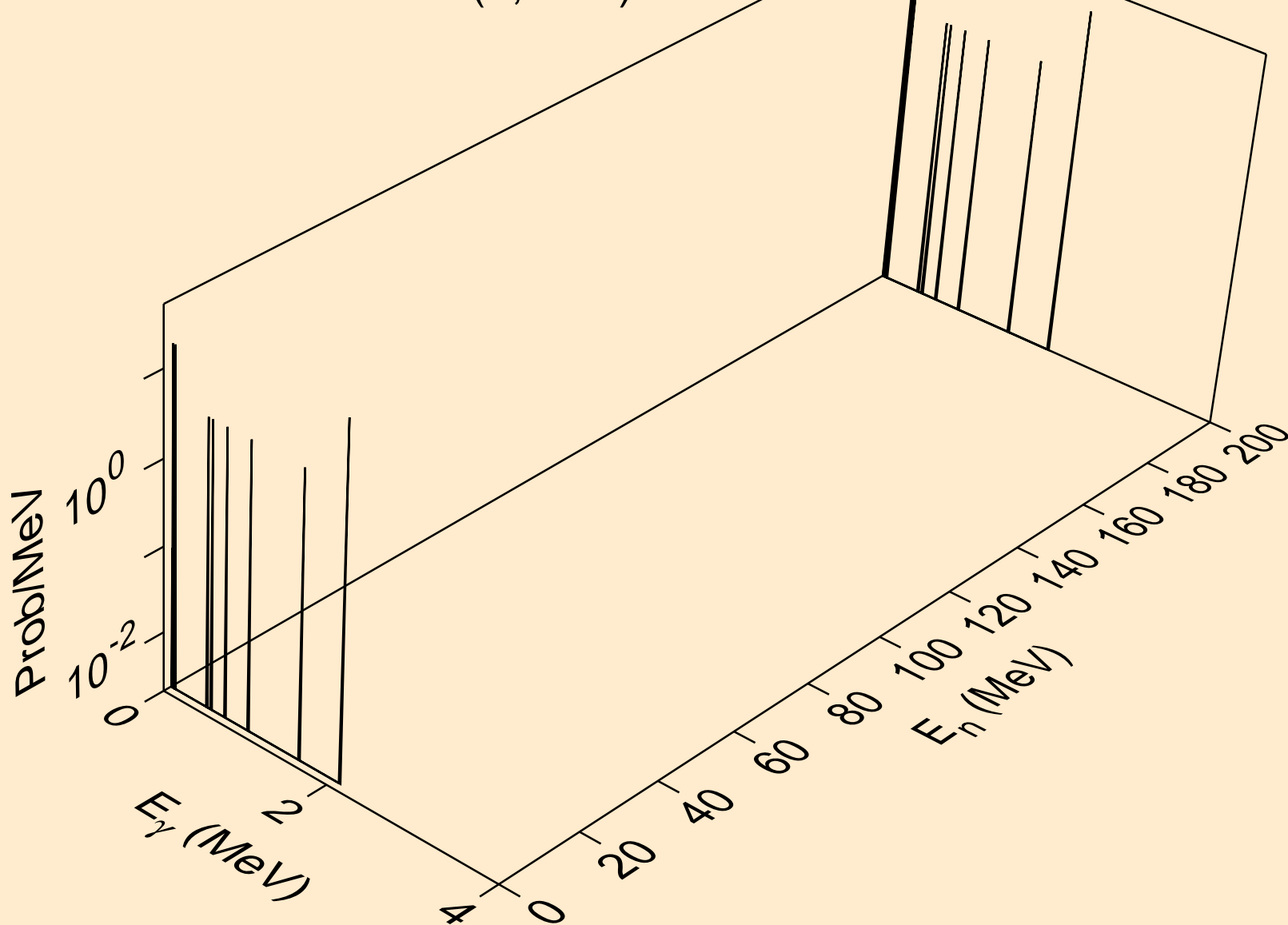

ZN073M NEUTRON ACER TENDL-2019 LIBRARY; T=293.16K
Photon emission for (n,n*22)

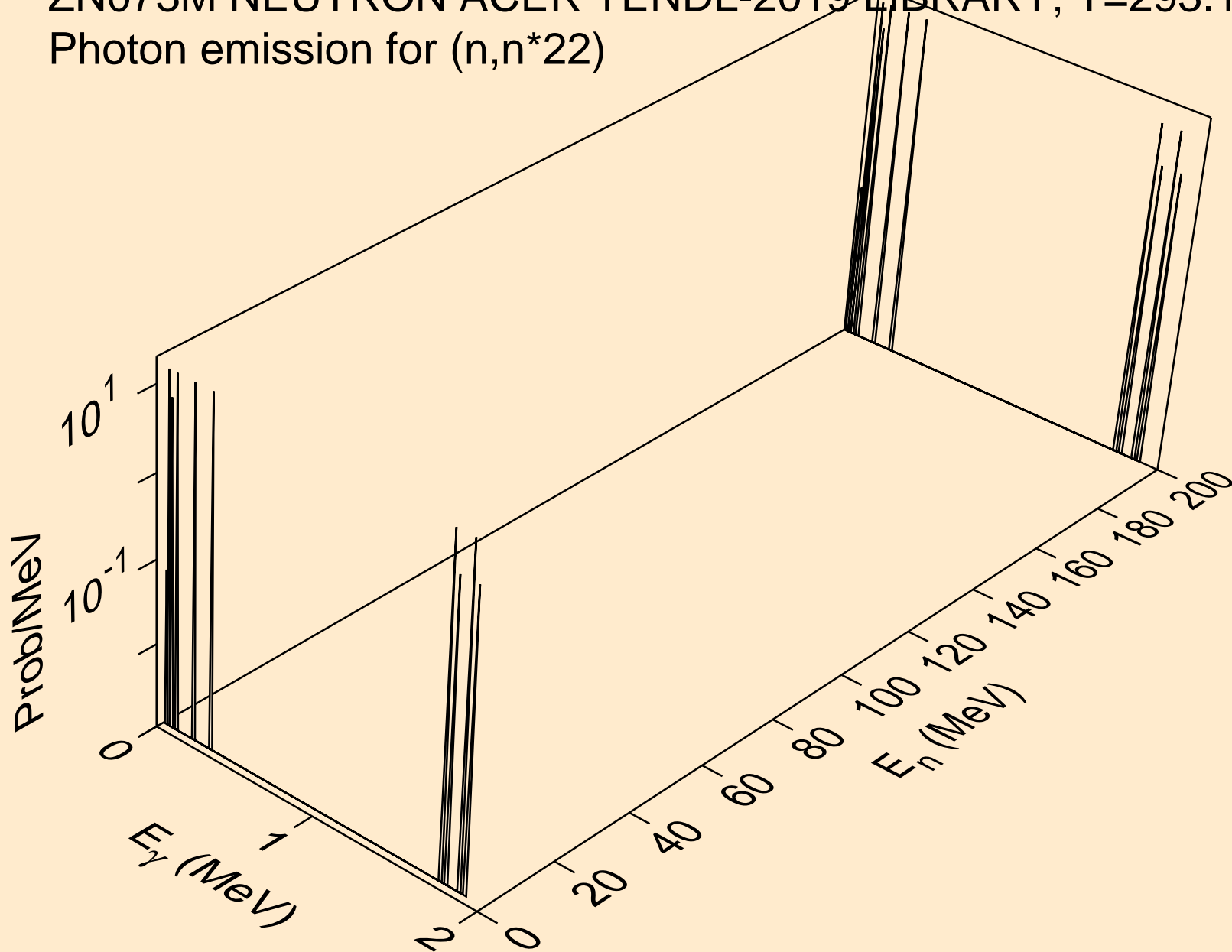

ZN073M NEUTRON ACER TENDL-2019 LIBRARY; T=293.16K
Photon emission for (n,n*23)

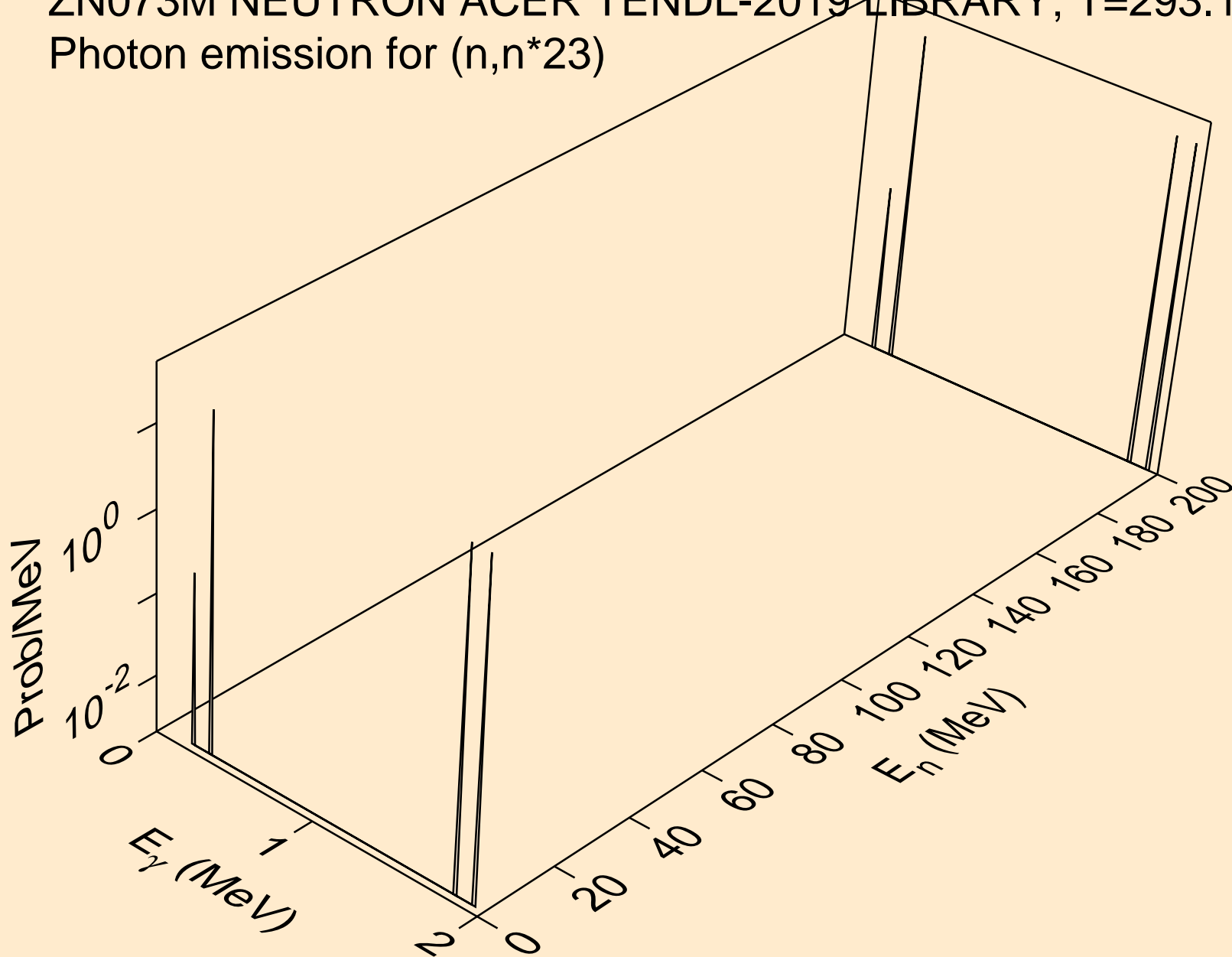

ZN073M NEUTRON ACER TENDL-2019 LIBRARY; T=293.16K
Photon emission for (n,n*24)

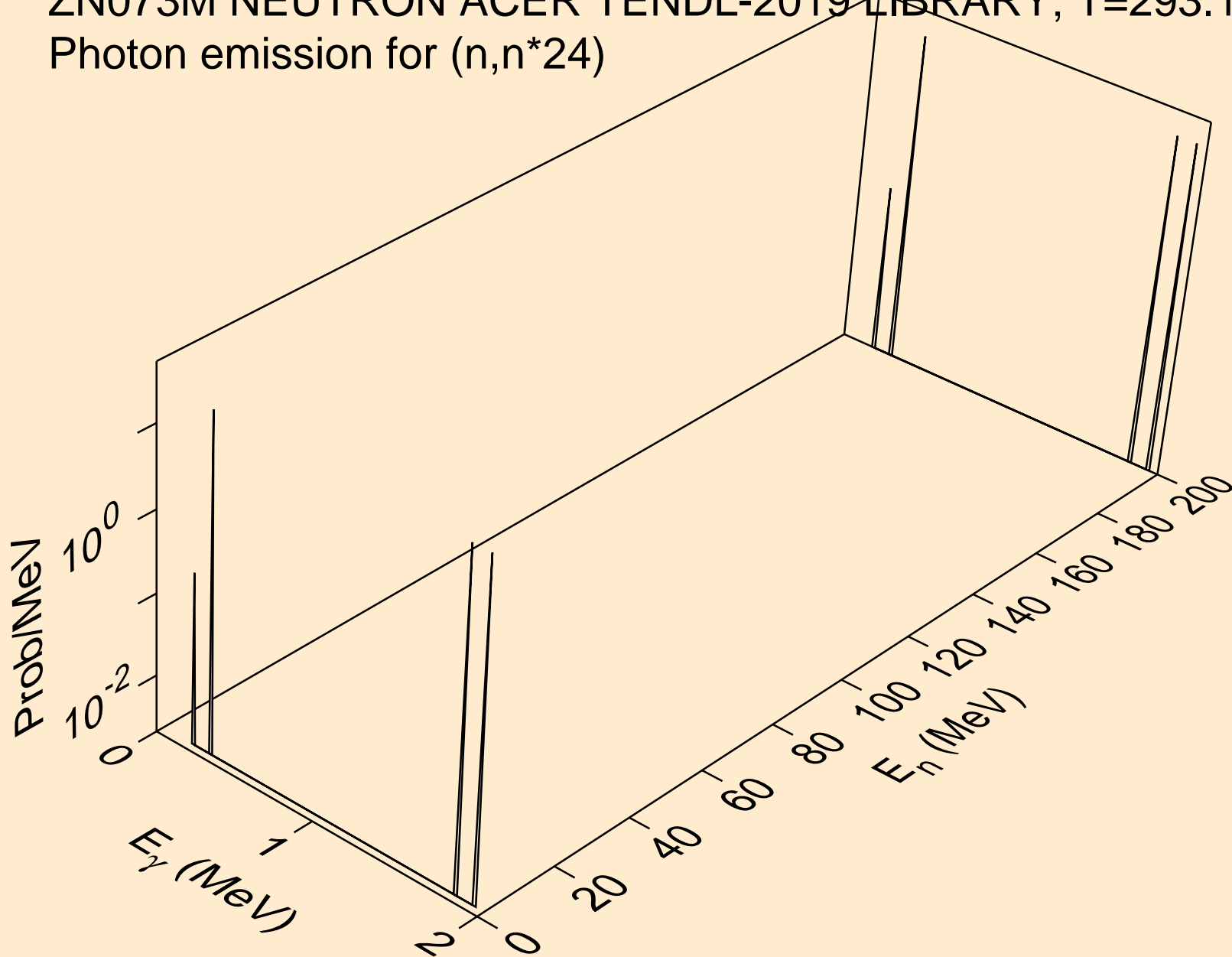

ZN073M NEUTRON ACER TENDL-2019 LIBRARY; T=293.16K
Photon emission for (n,n*25)

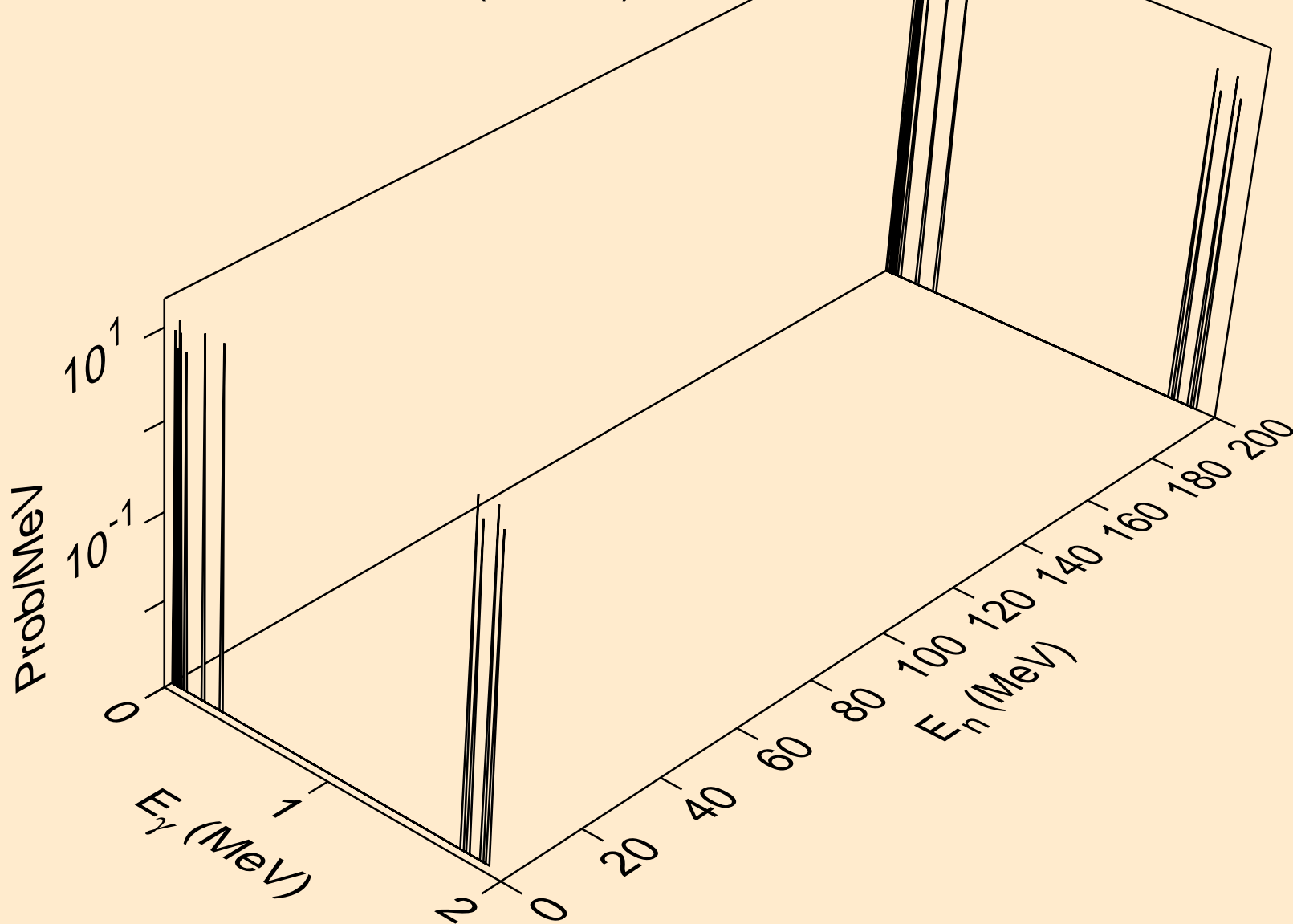

ZN073M NEUTRON ACER TENDL-2019 LIBRARY; T=293.16K
Photon emission for (n,n*26)

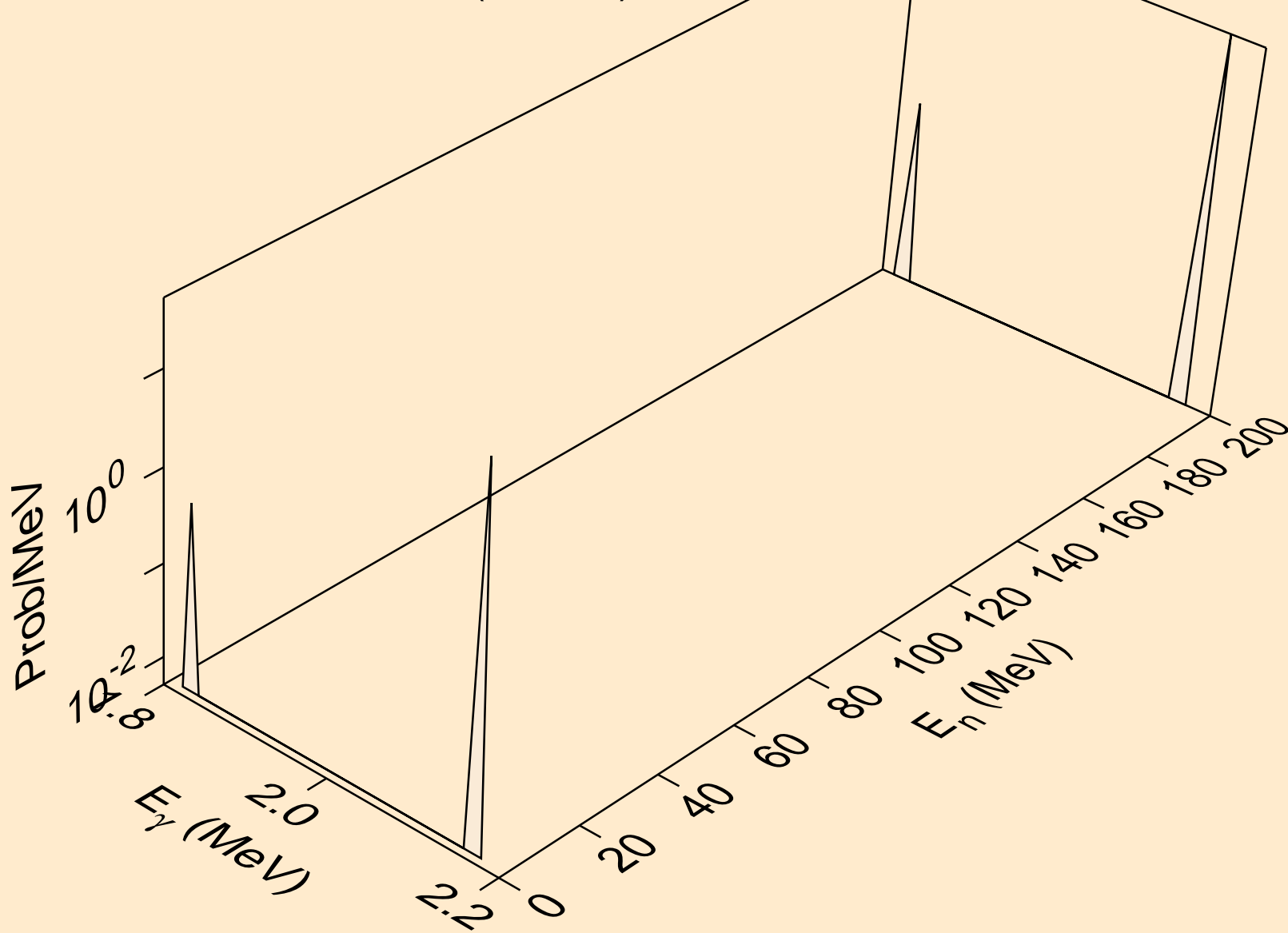

ZN073M NEUTRON ACER TENDL-2019 LIBRARY; T=293.16K
Photon emission for (n,n*27)

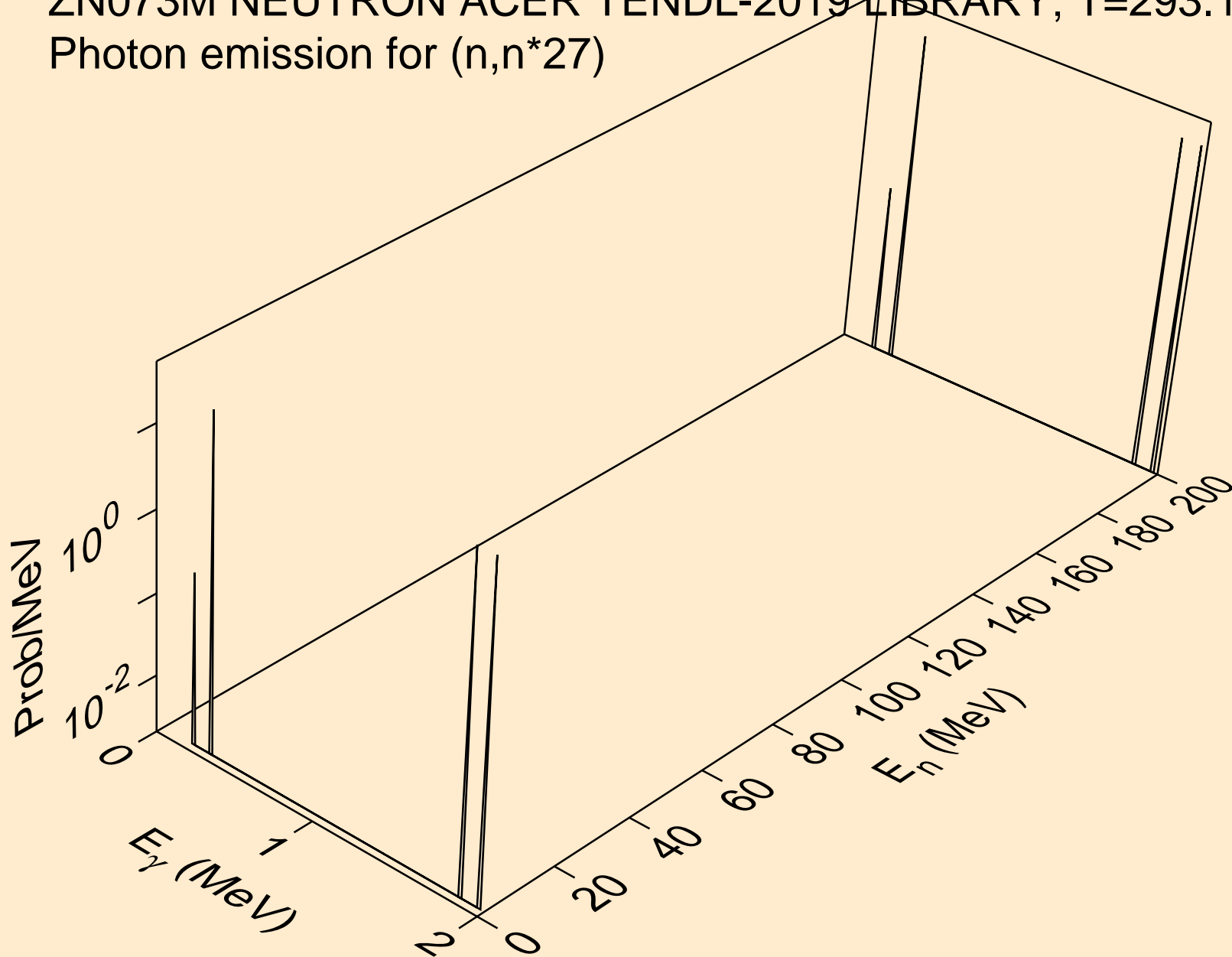

ZN073M NEUTRON ACER TENDL-2019 LIBRARY; T=293.16K
Photon emission for (n,n*28)

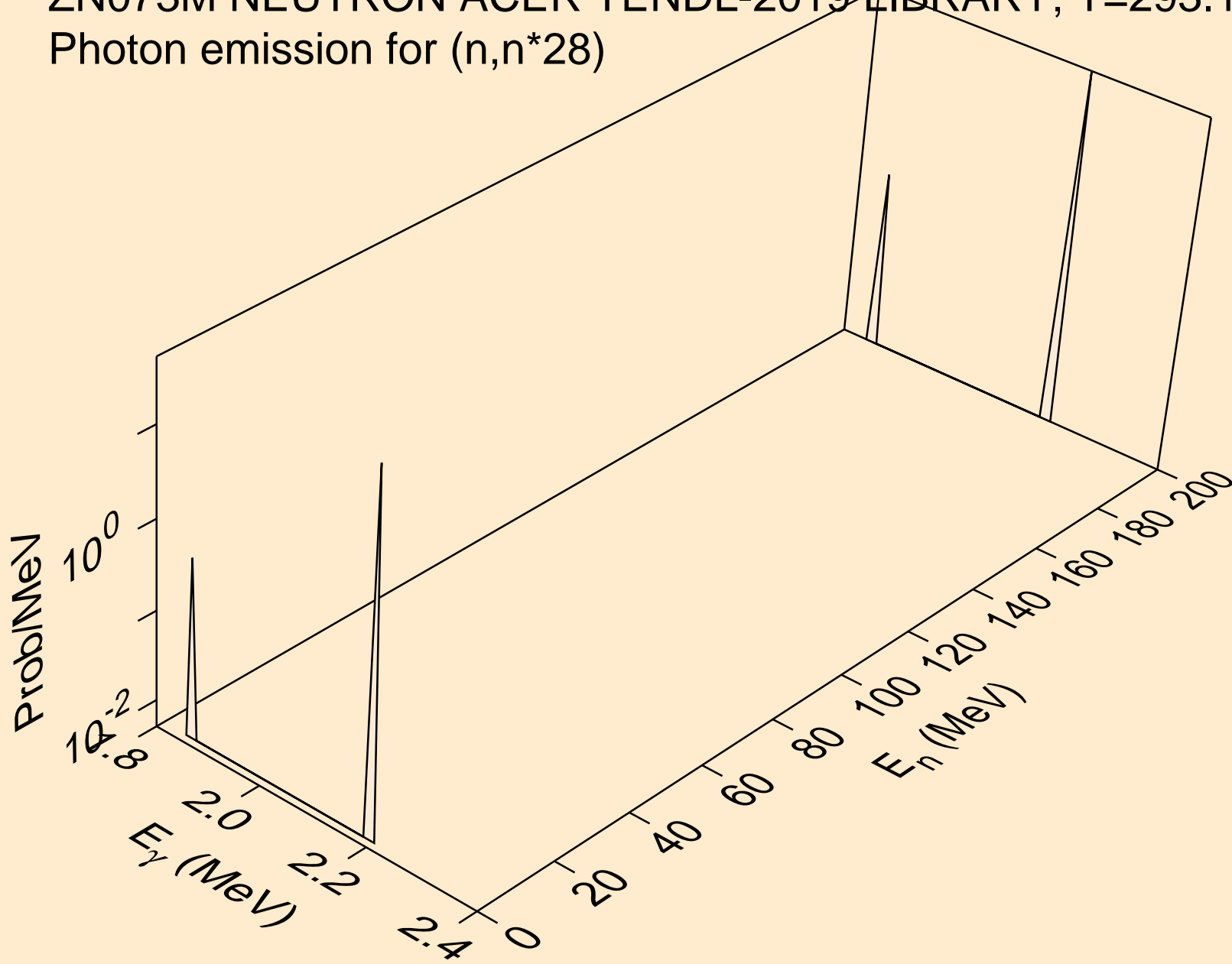

ZN073M NEUTRON ACER TENDL-2019 LIBRARY; T=293.16K
Photon emission for (n,n*29)

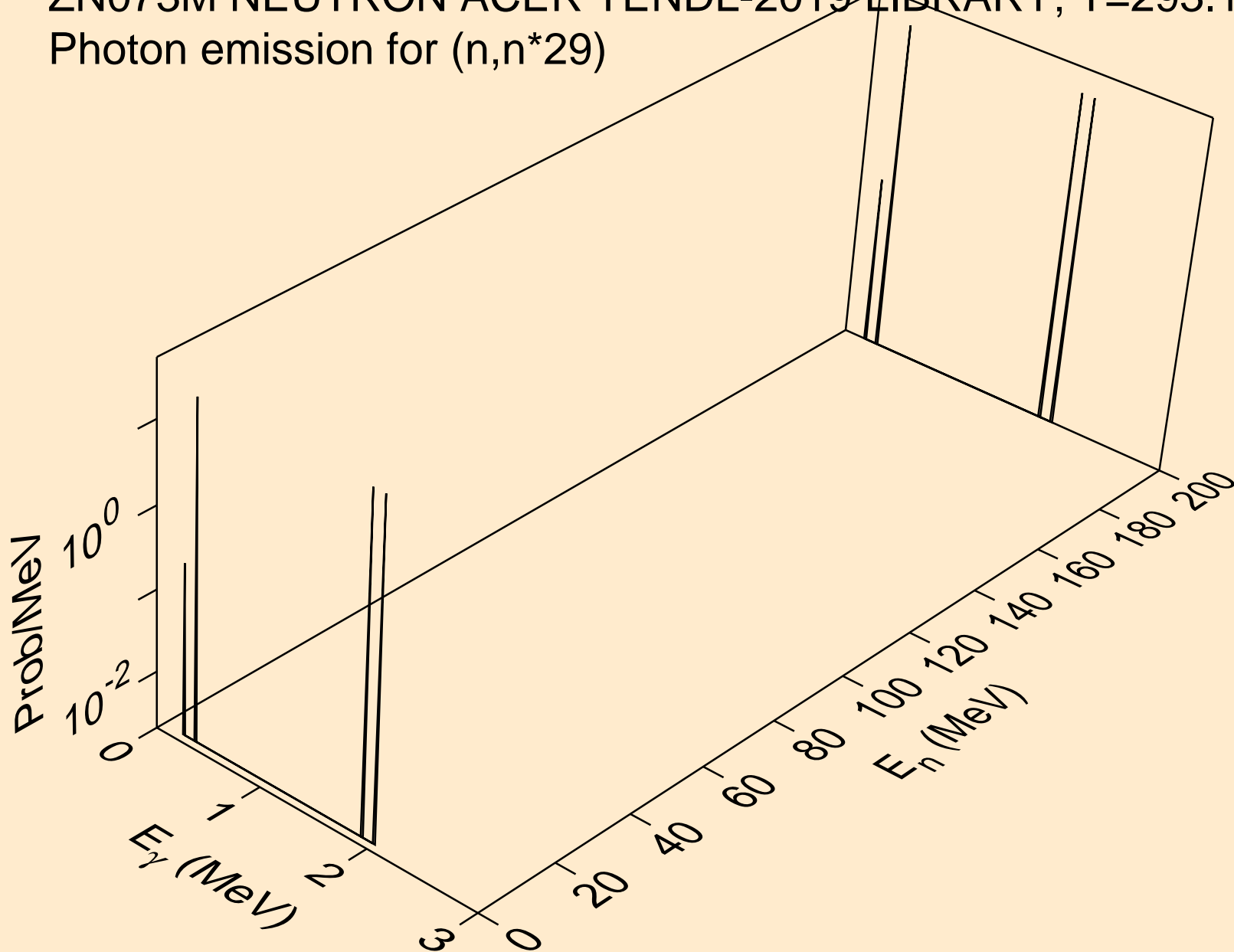

ZN073M NEUTRON ACER TENDL-2019 LIBRARY; T=293.16K
Photon emission for (n,n*30)

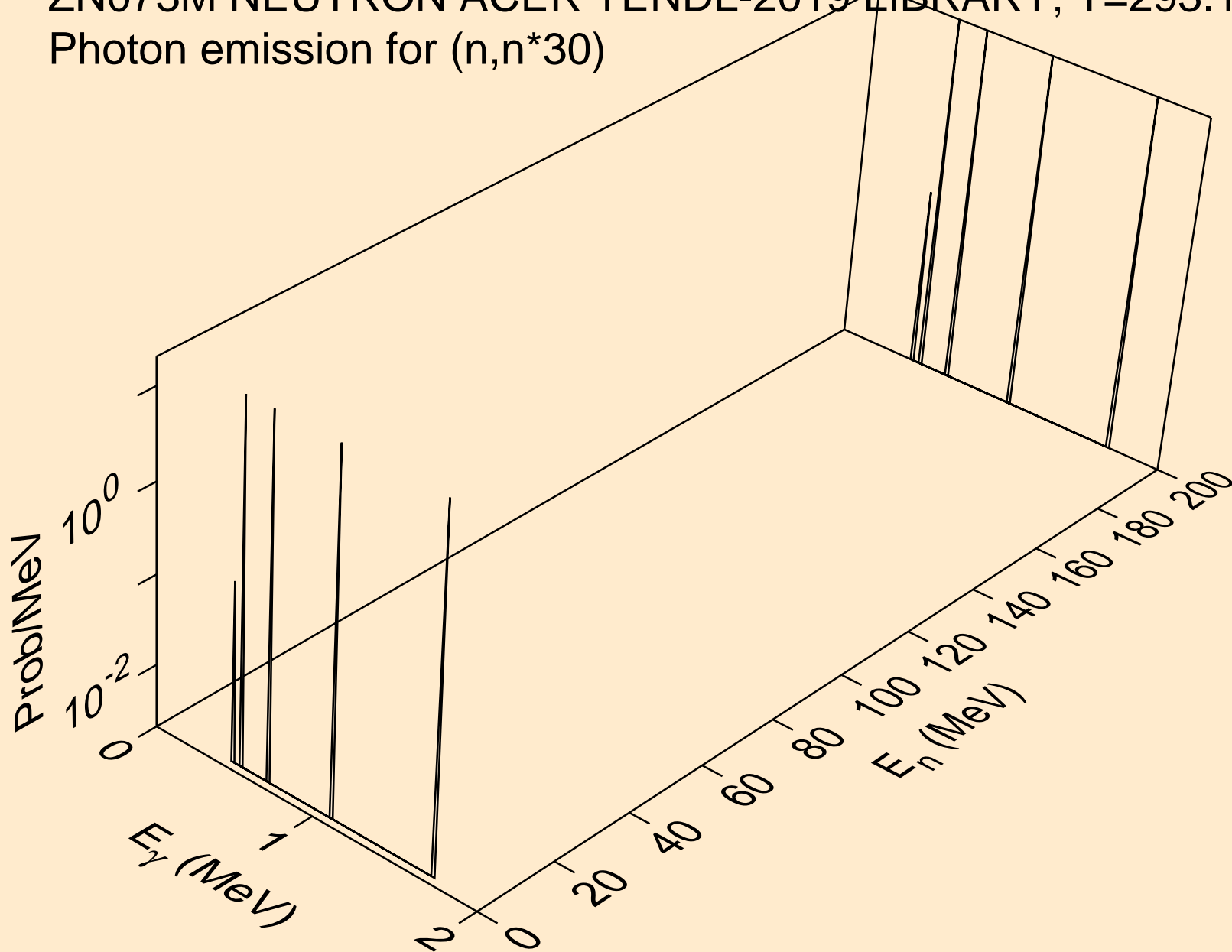

ZN073M NEUTRON ACER TENDL-2019 LIBRARY; T=293.16K
Photon emission for (n,n*c)

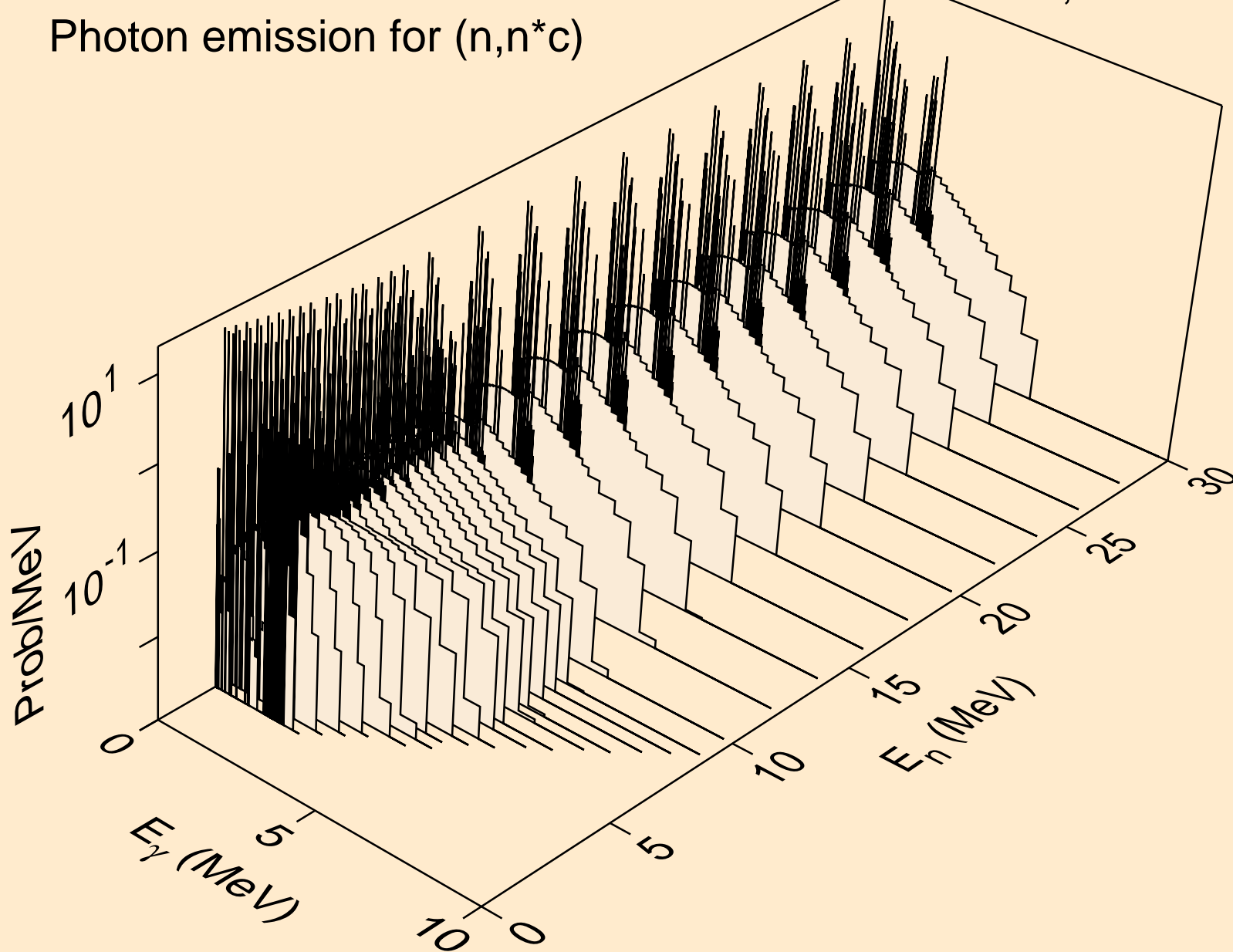

ZN073M NEUTRON ACER TENDL-2019 LIBRARY; T=293.16K
Photon emission for (n,gma)

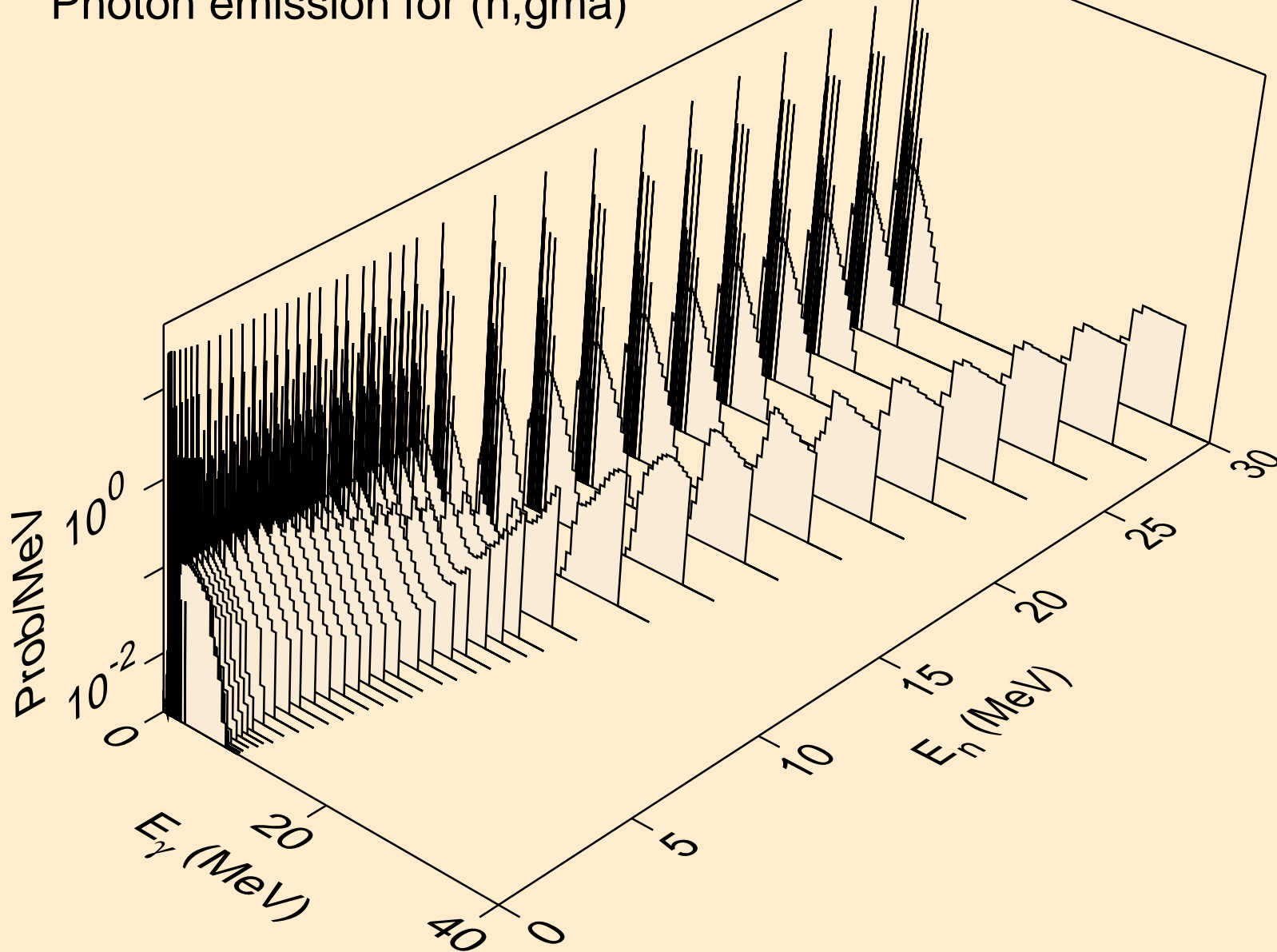

ZN073M NEUTRON ACER TENDL-2019 LIBRARY; T=293.16K
Photon emission for (n,p)

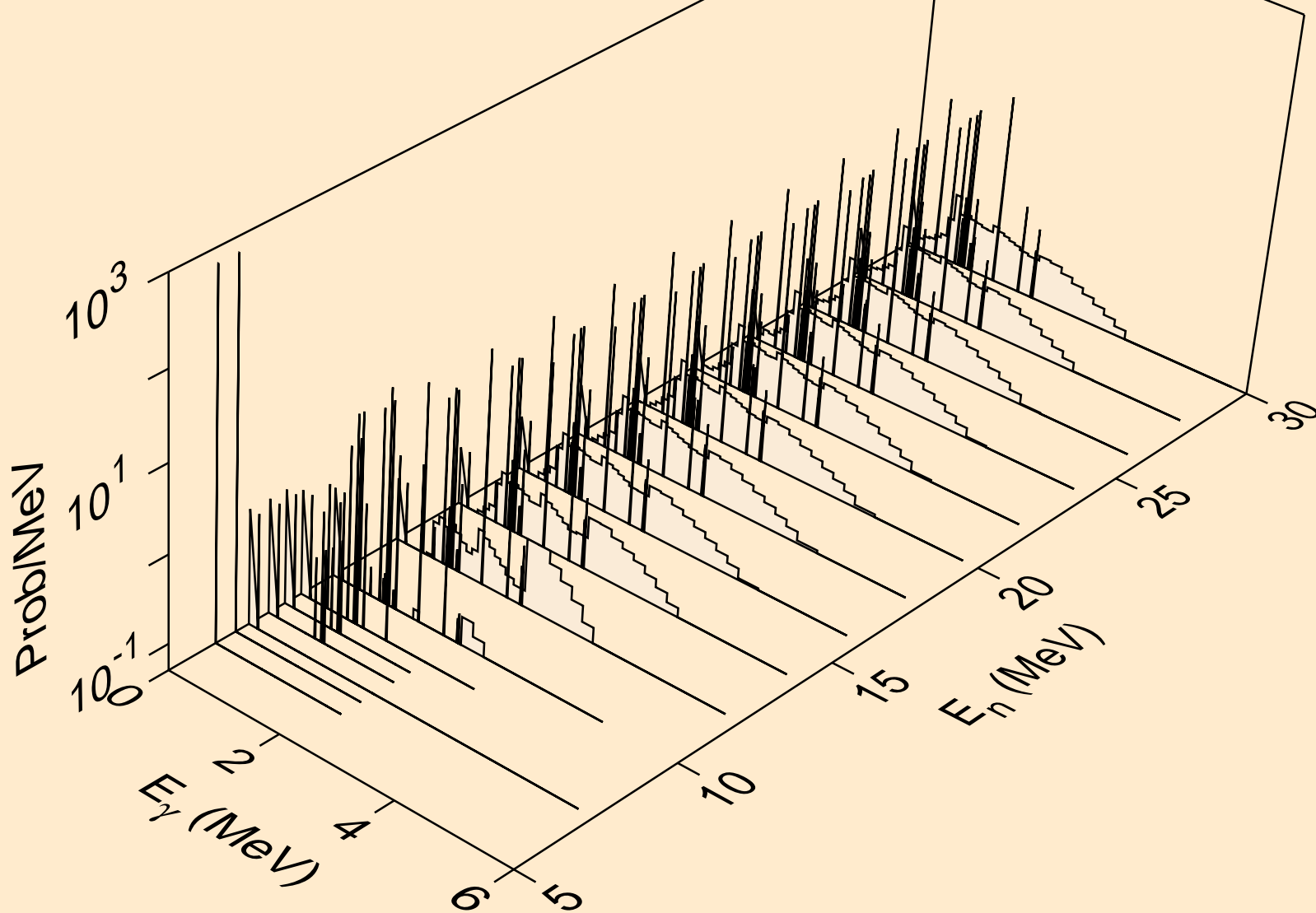

ZN073M NEUTRON ACER TENDL-2019 LIBRARY; T=293.16K
Photon emission for (n,d)

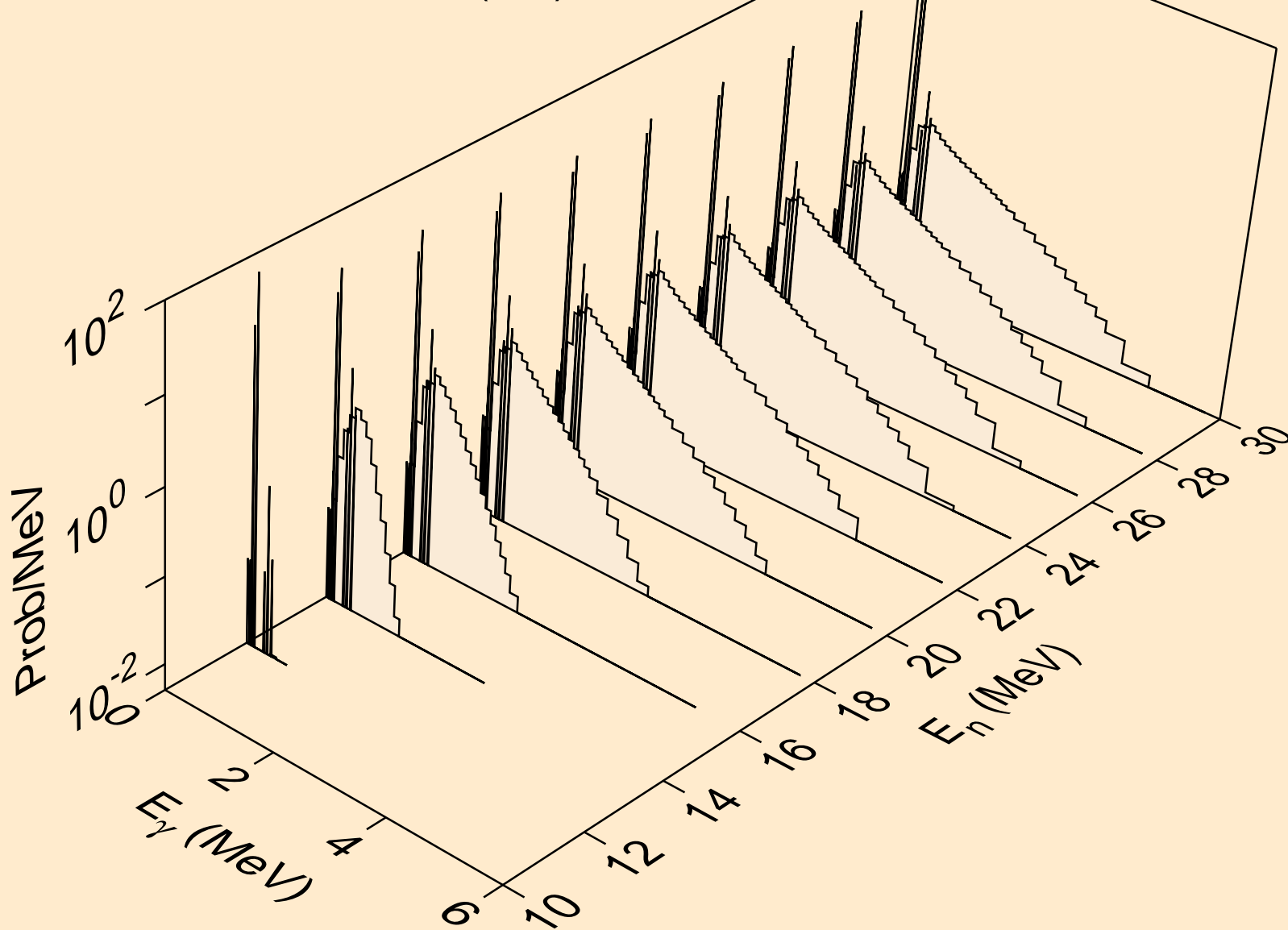

ZN073M NEUTRON ACER TENDL-2019 LIBRARY; T=293.16K
Photon emission for (n,t)

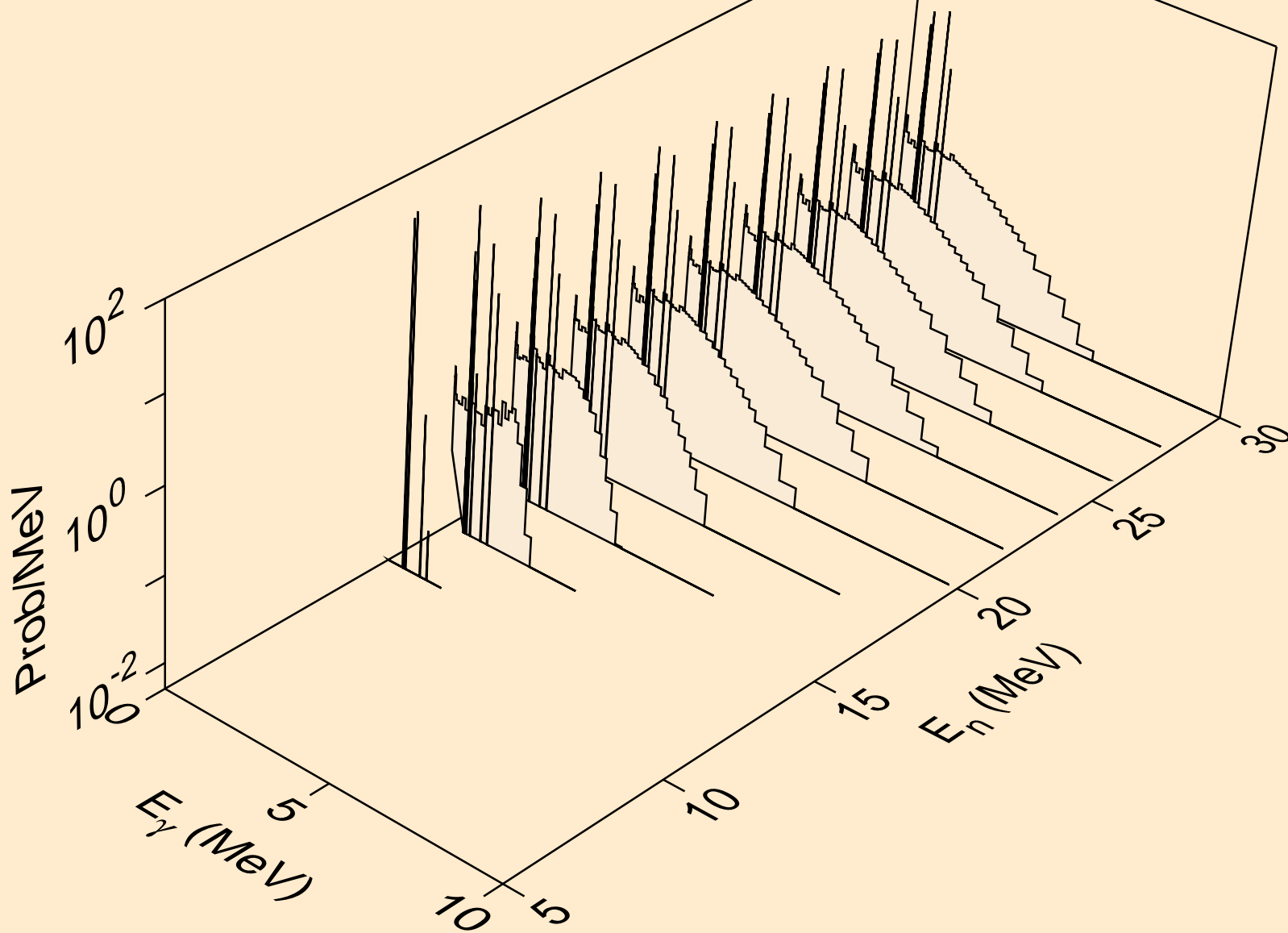

ZN073M NEUTRON ACER TENDL-2019 LIBRARY; T=293.16K
Photon emission for (n,he3)

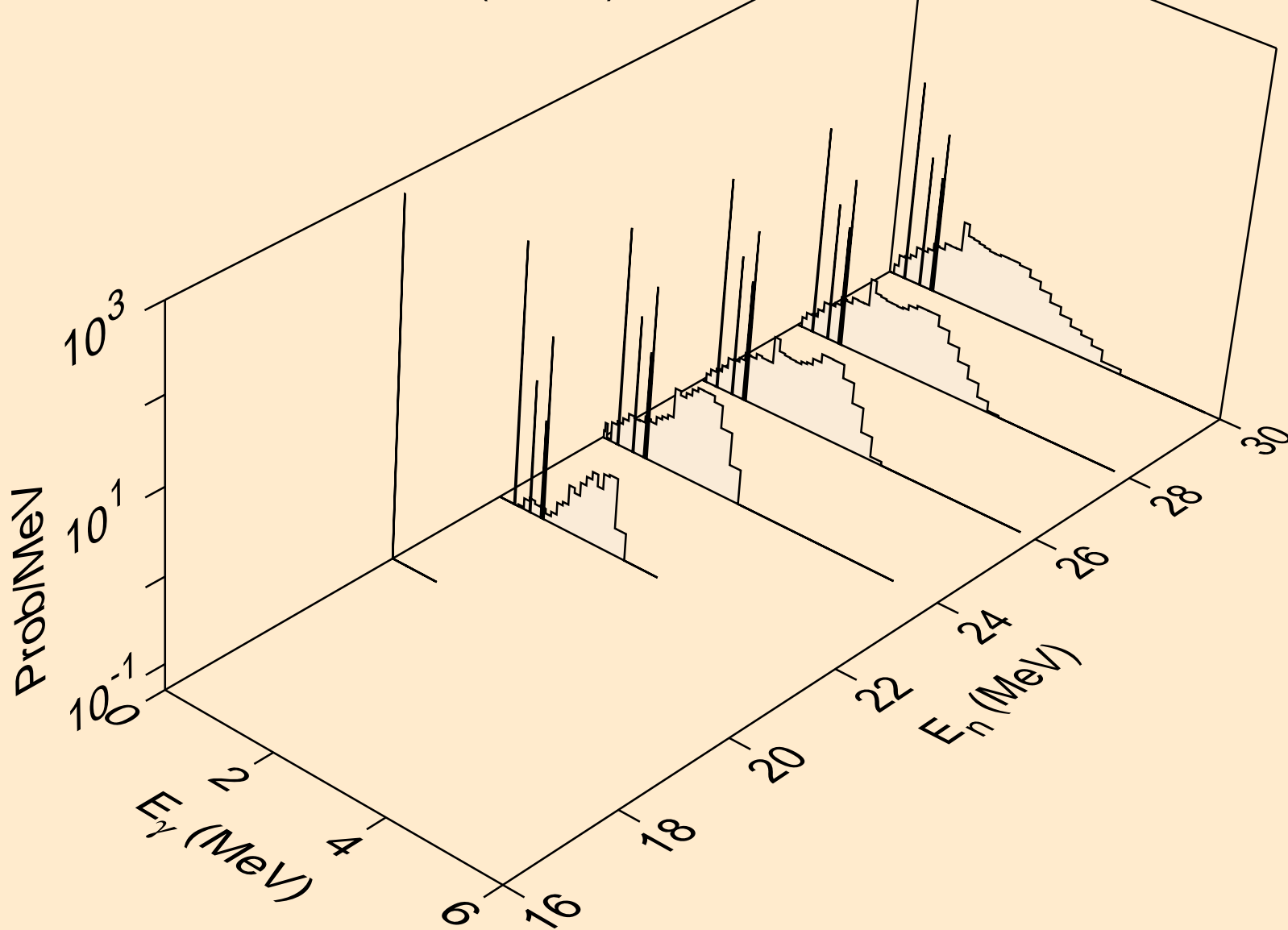

ZN073M NEUTRON ACER TENDL-2019 LIBRARY; T=293.16K
Photon emission for (n,a)

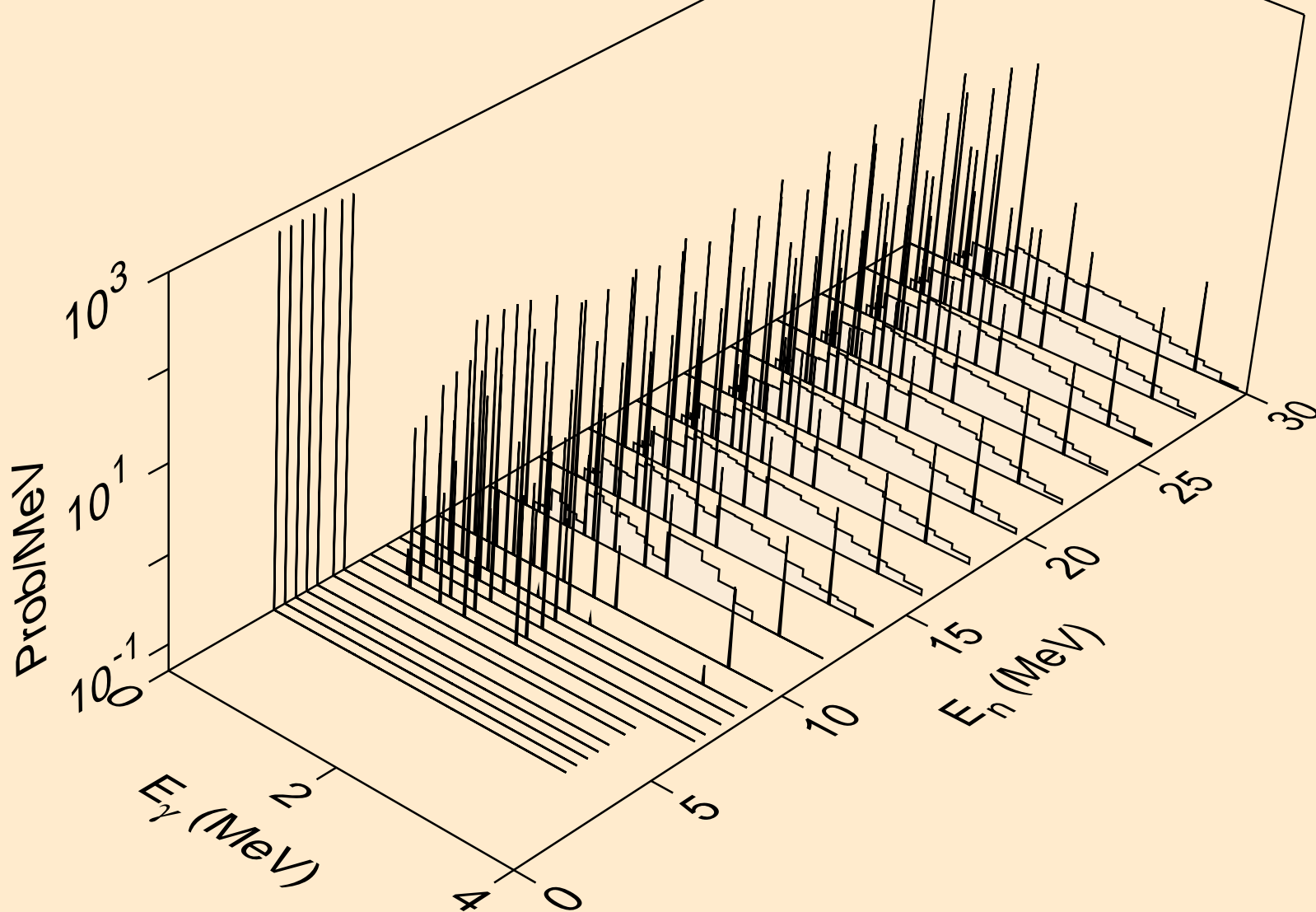

ZN073M NEUTRON ACER TENDL-2019 LIBRARY; T=293.16K
Photon emission for (n,2p)

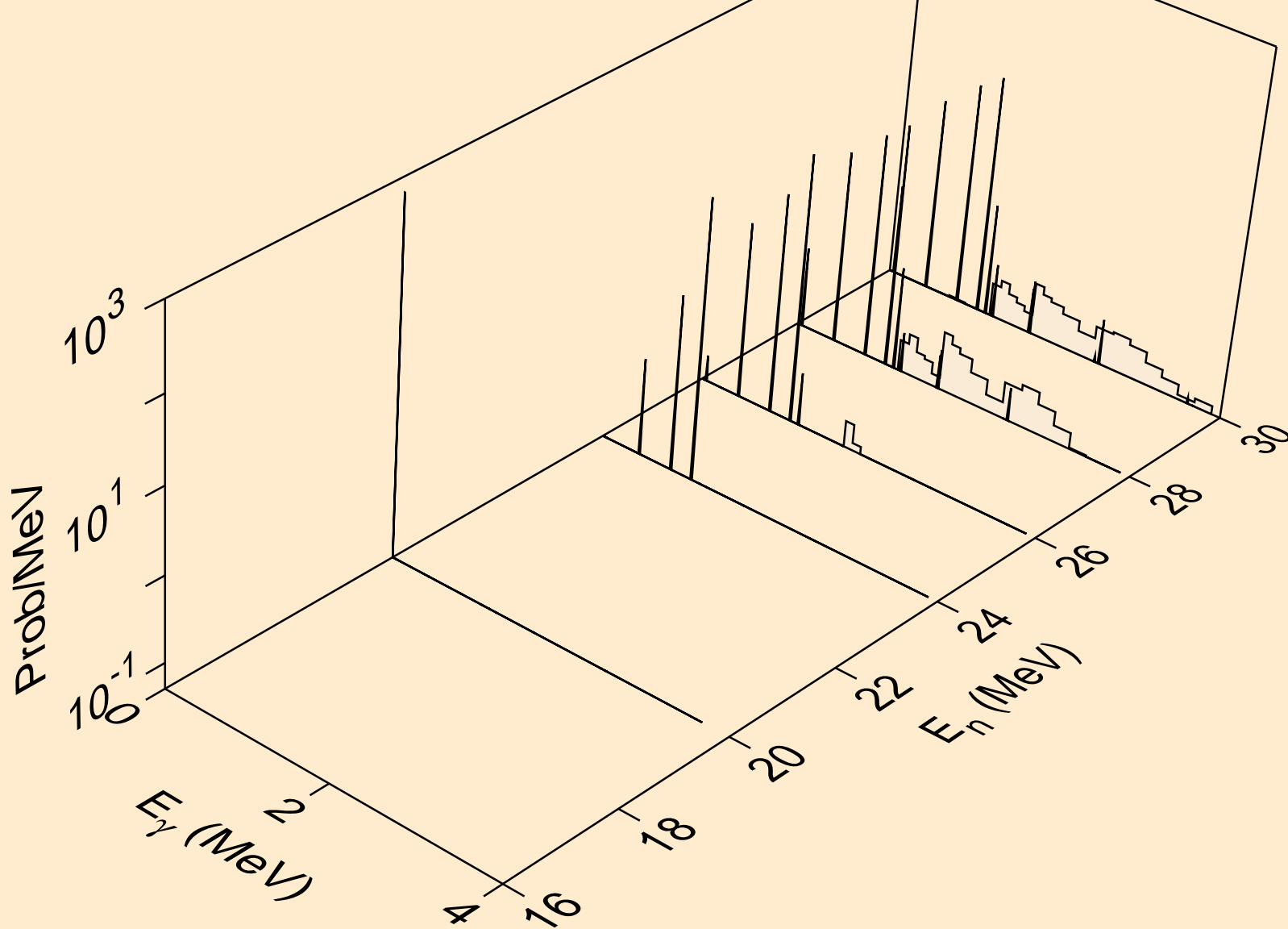

ZN073M NEUTRON ACER TENDL-2019 LIBRARY; T=293.16K
Photon emission for (n,p α)

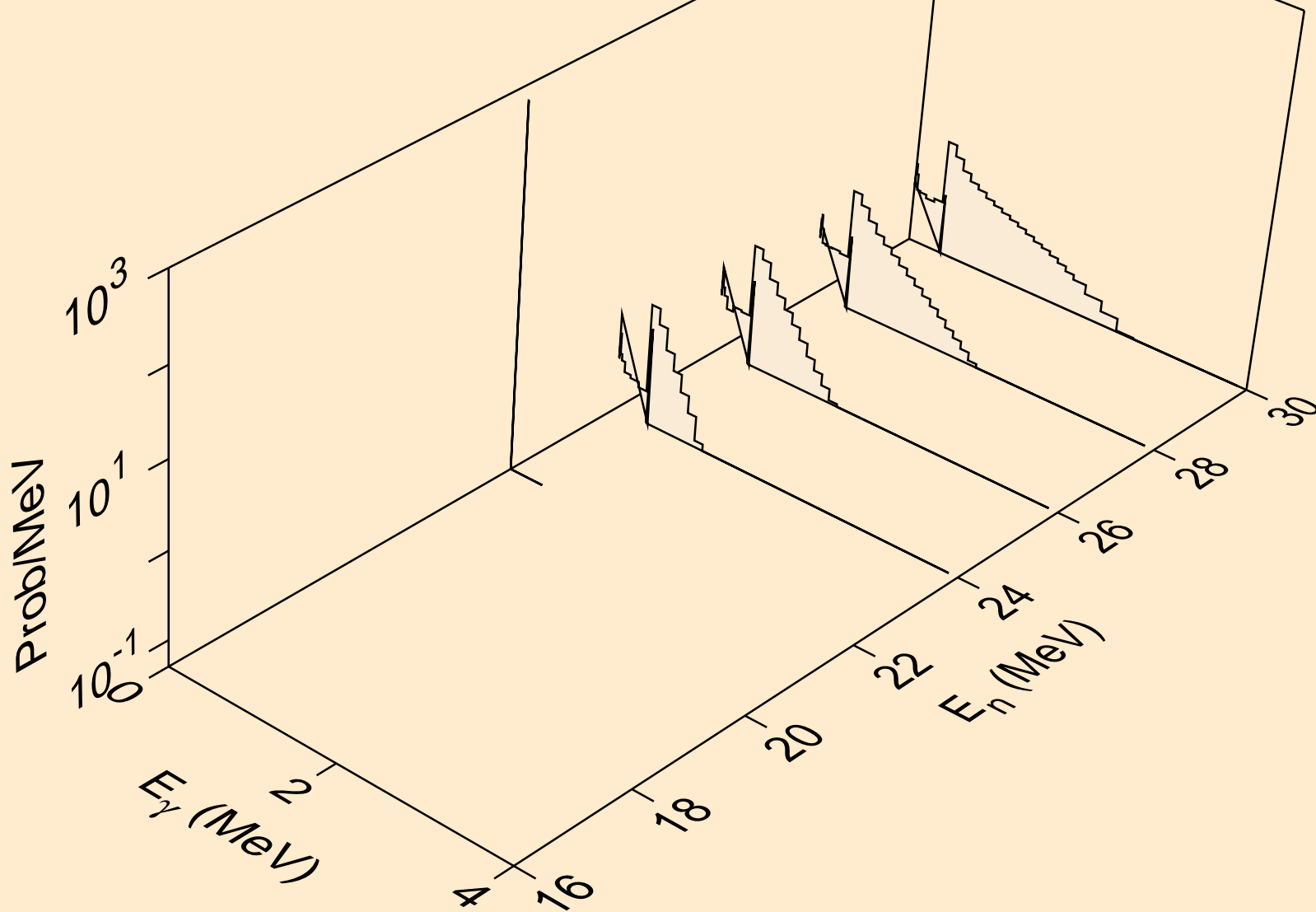

ZN073M NEUTRON ACER TENDL-2019 LIBRARY; T=293.16K
Photon emission for (n,pt)

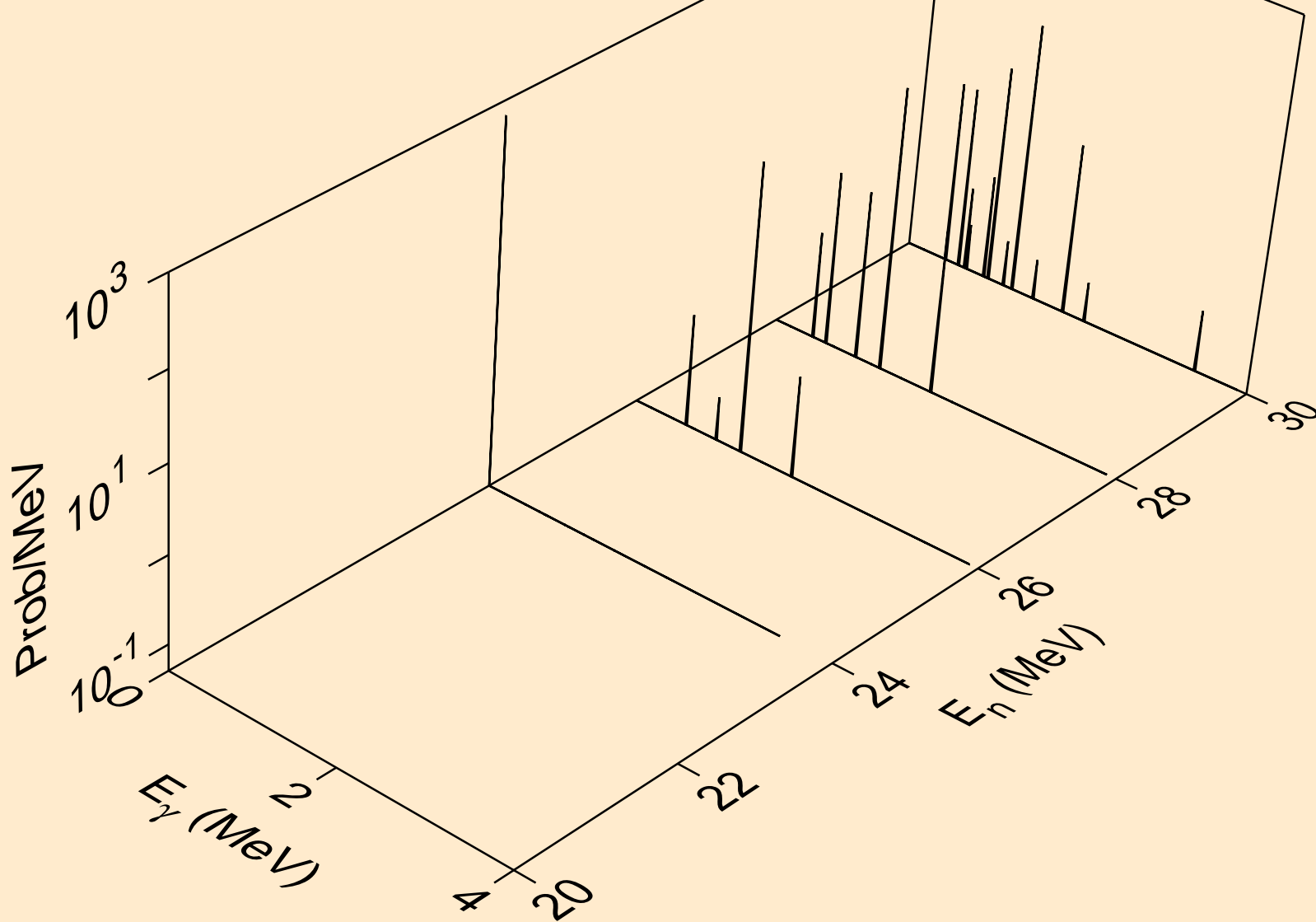

ZN073M NEUTRON ACER TENDL-2019 LIBRARY; T=293.16K
thermal capture photon spectrum

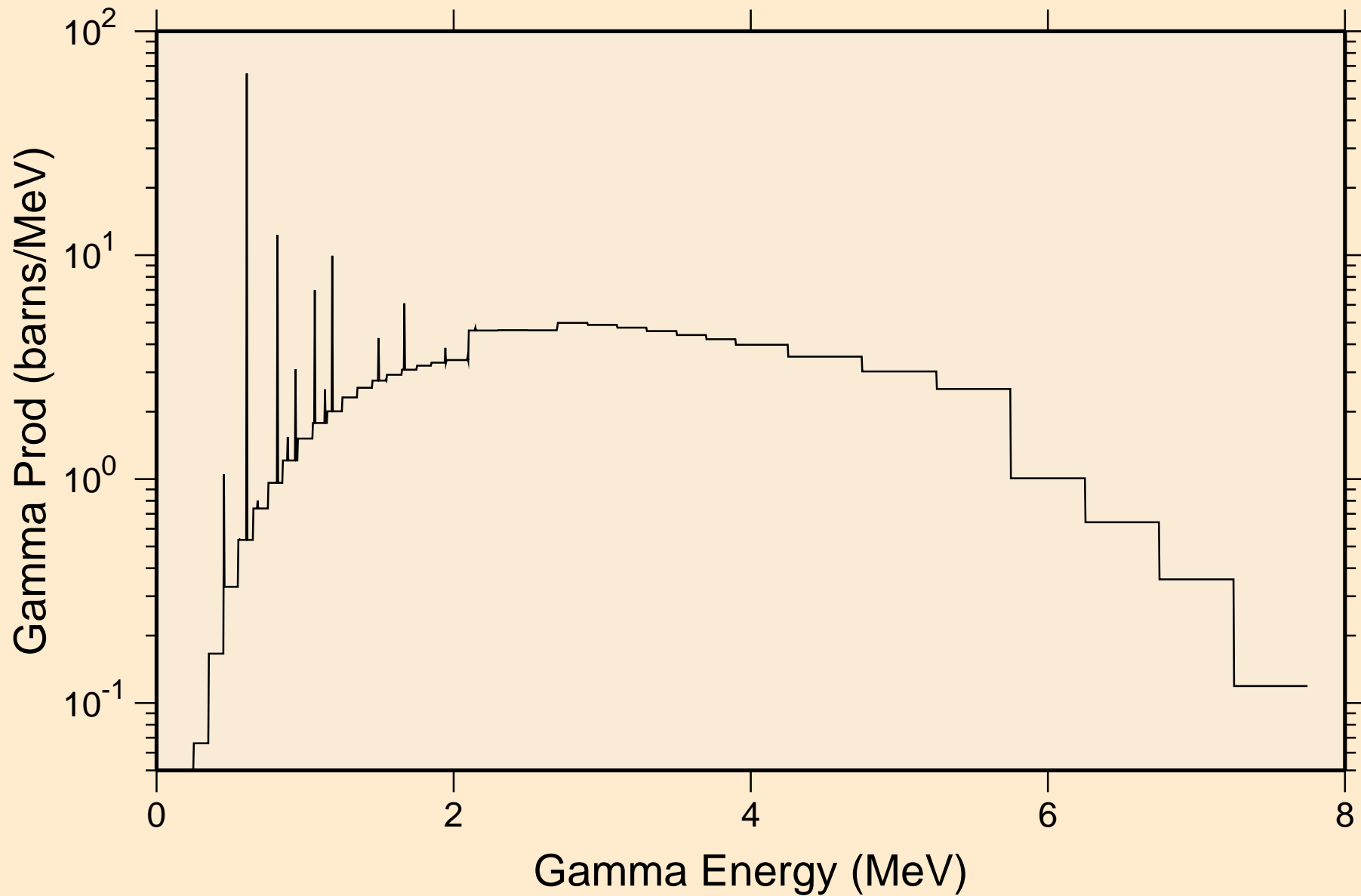

ZN073M NEUTRON ACER TENDL-2019 LIBRARY; T=293.16K
14 MeV photon spectrum

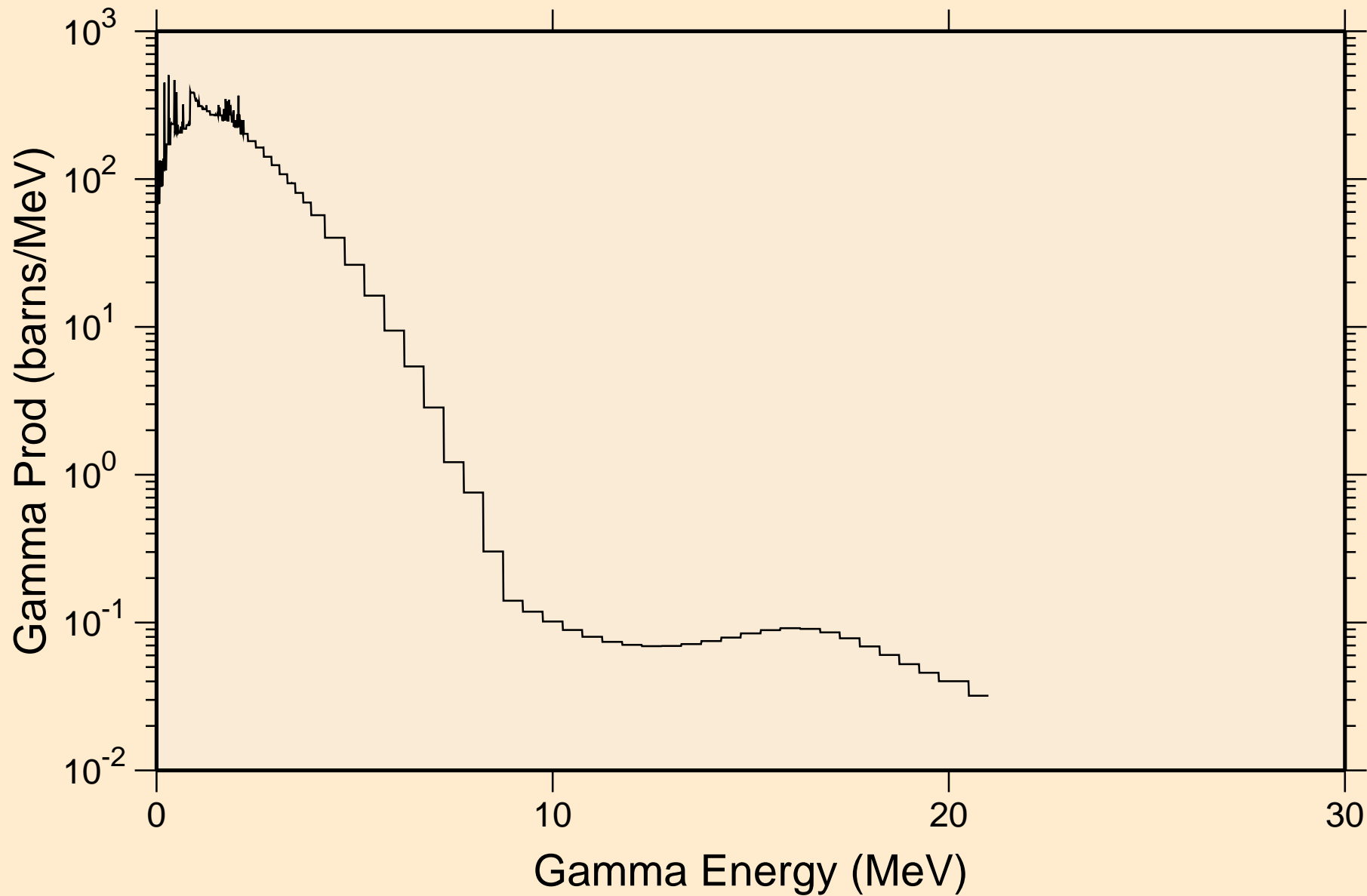

ZN073M NEUTRON ACER TENDL-2019 LIBRARY; T=293.16K

Particle heating contributions

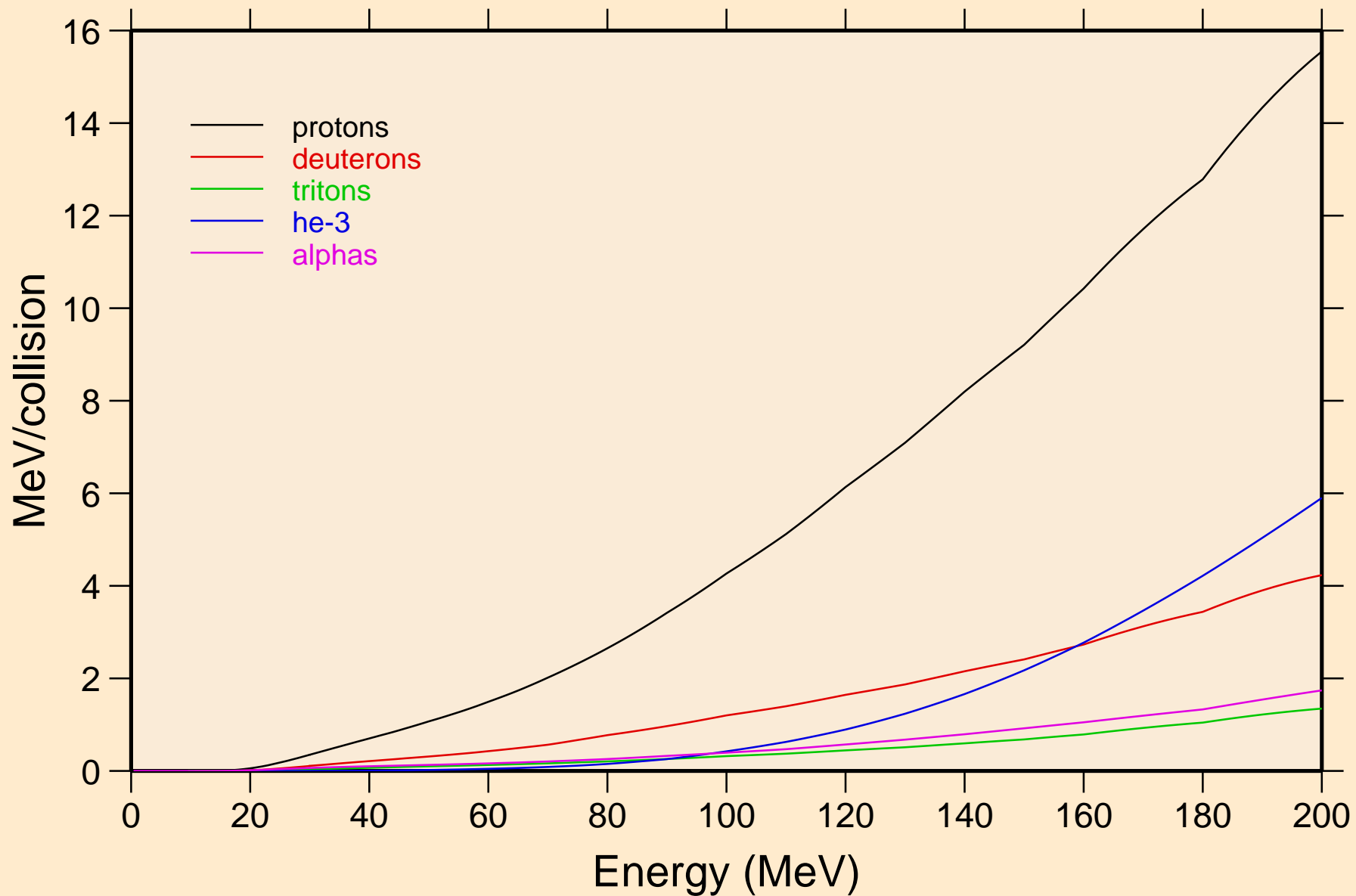

ZN073M NEUTRON ACER TENDL-2019 LIBRARY; T=293.16K
Recoil Heating

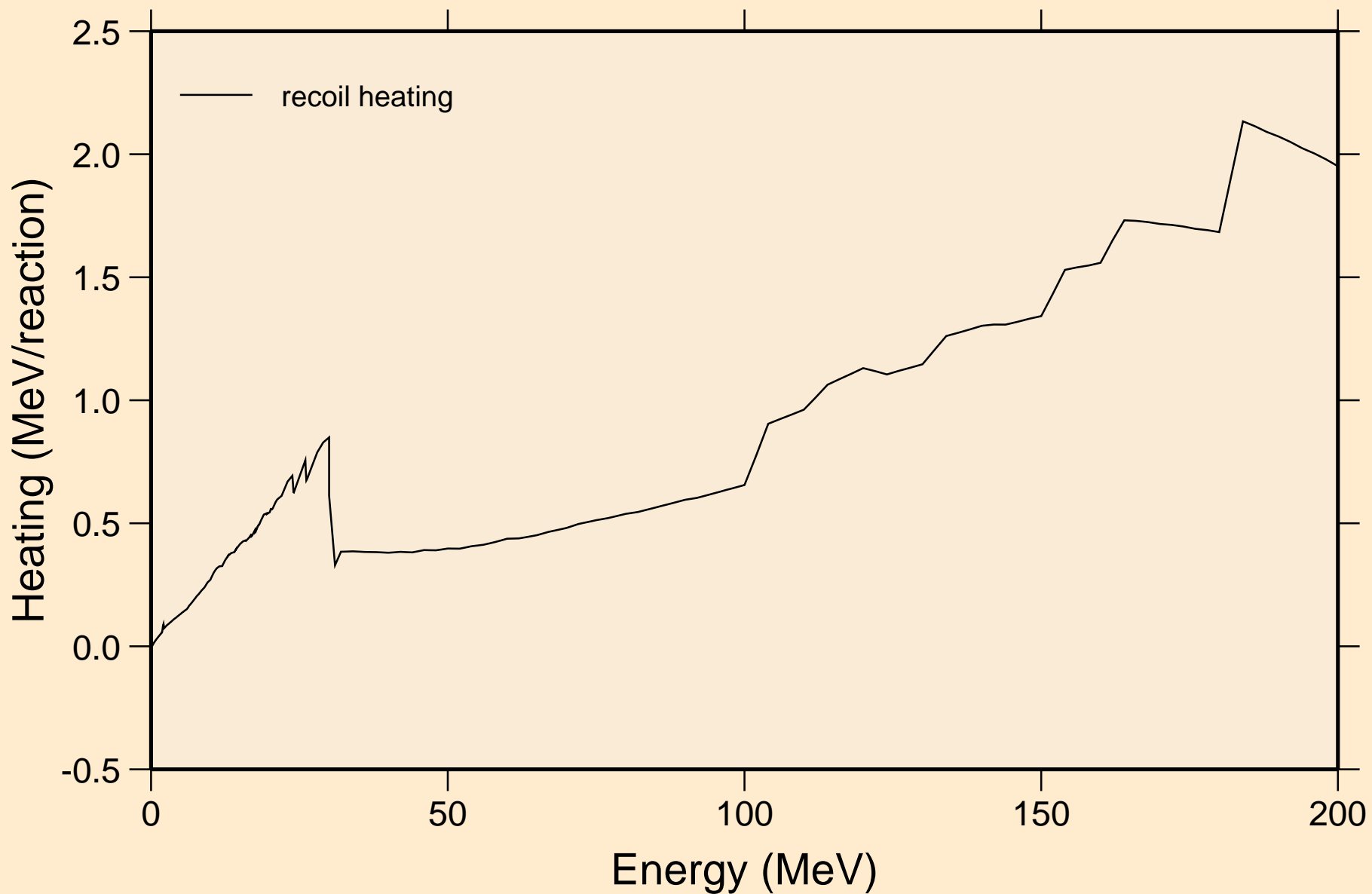

ZN073M NEUTRON ACER TENDL-2019 LIBRARY; T=293.16K

Particle production cross sections

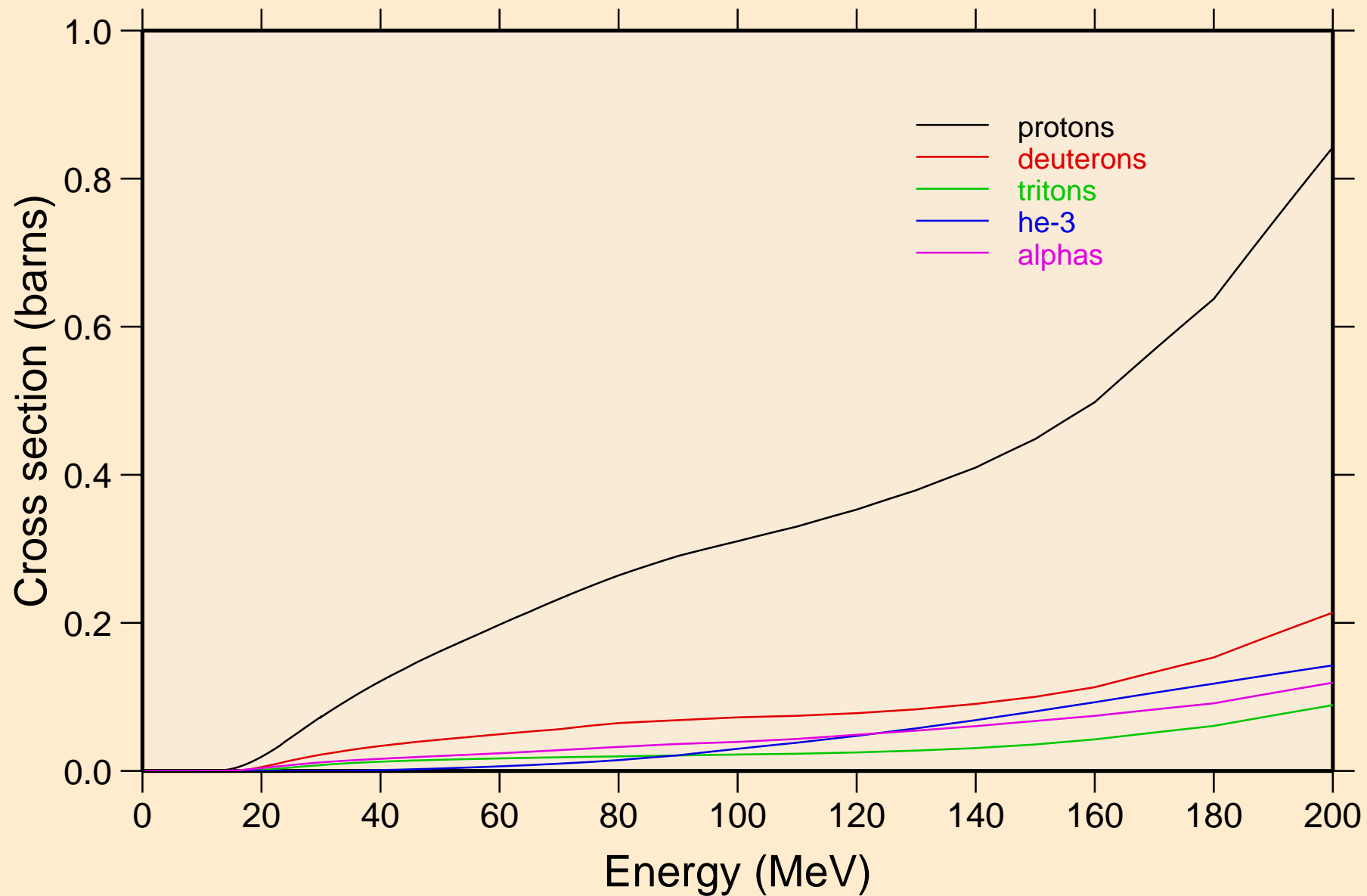

ZN073M NEUTRON ACER TENDL-2019 LIBRARY; T=293.16K
protons from (n,x)

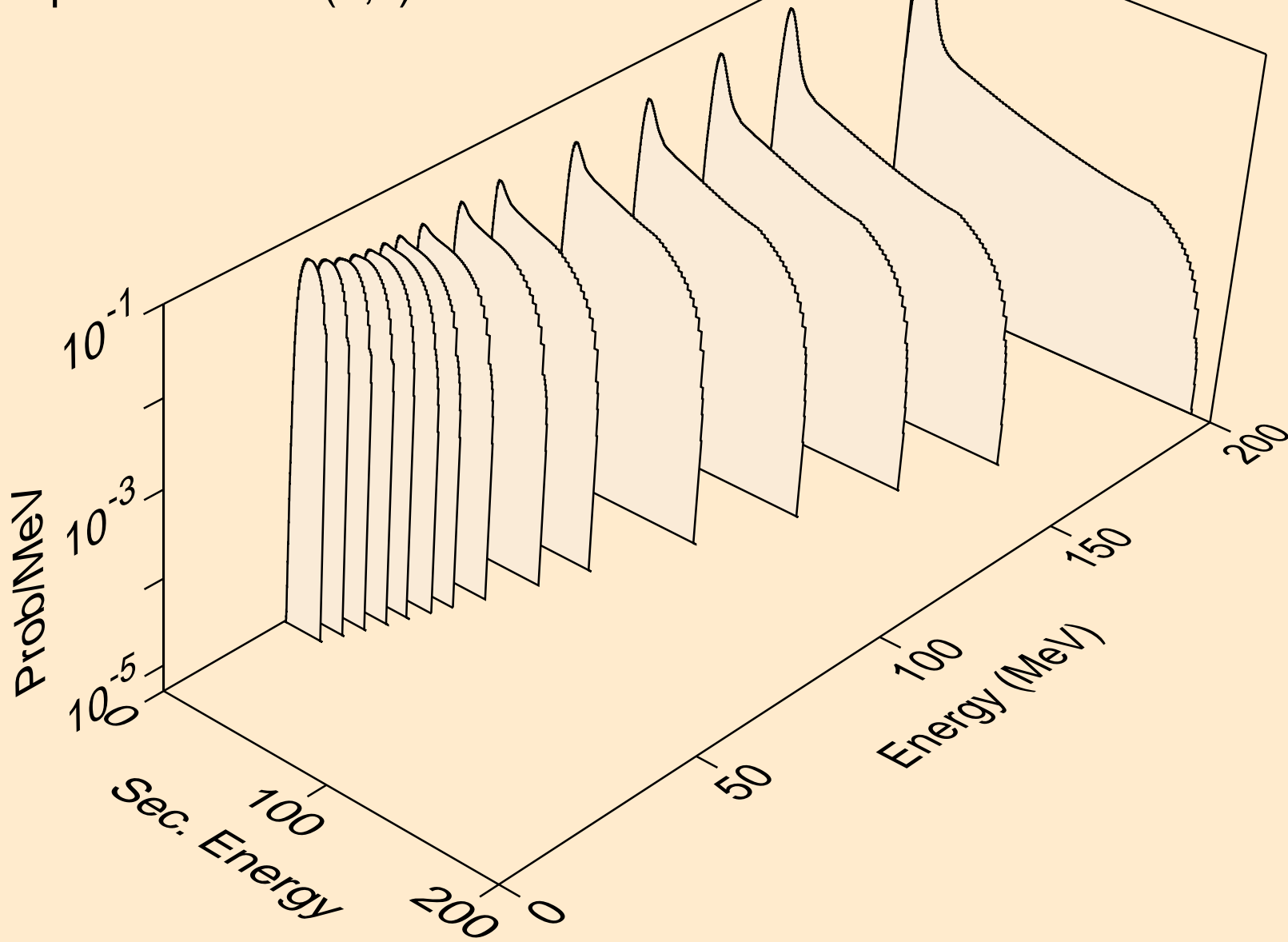

ZN073M NEUTRON ACER TENDL-2019 LIBRARY; T=293.16K
protons from (n,n*)p

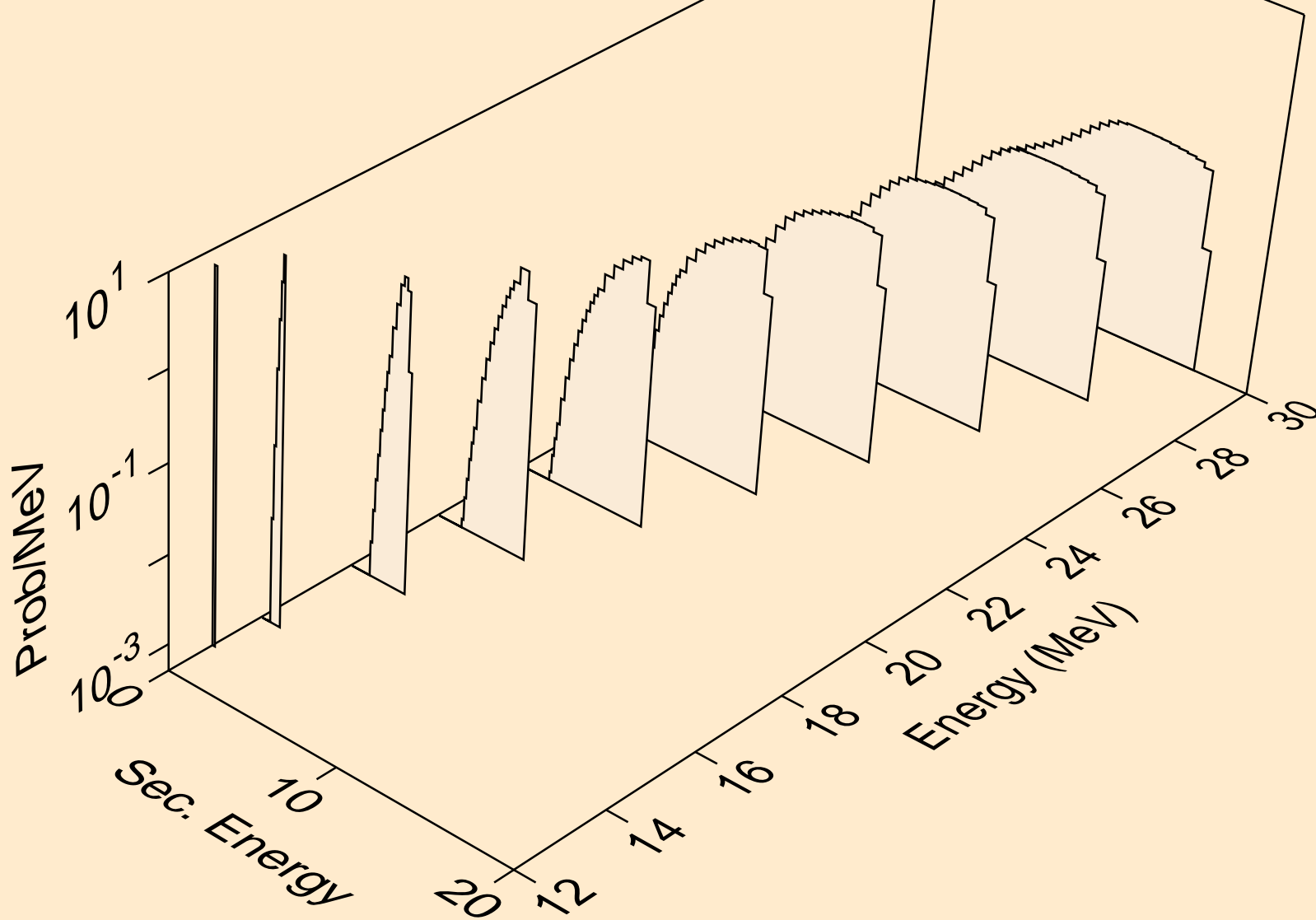

ZN073M NEUTRON ACER TENDL-2019 LIBRARY; T=293.16K
protons from (n,2np)

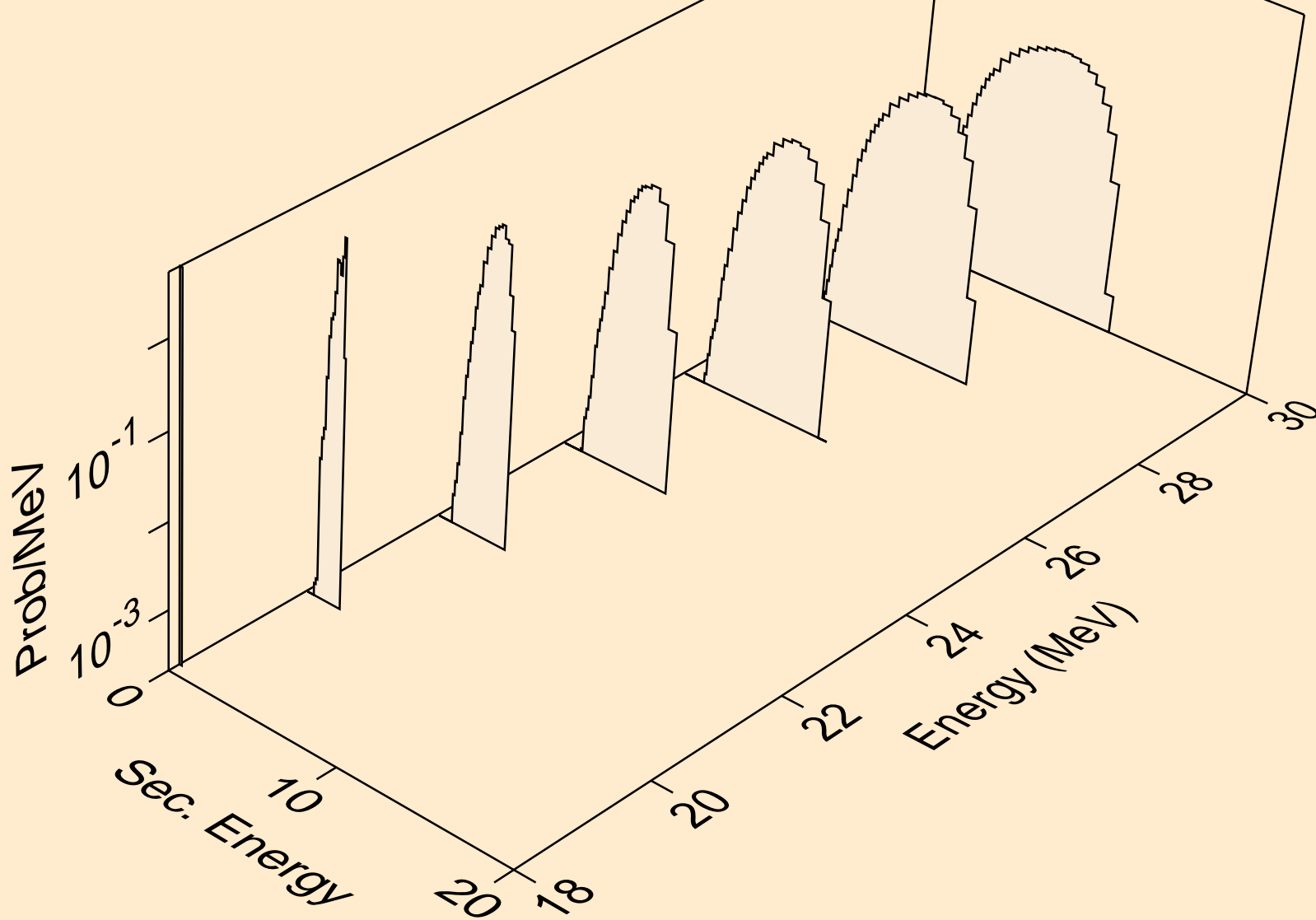

ZN073M NEUTRON ACER TENDL-2019 LIBRARY; T=293.16K
protons from (n,3np)

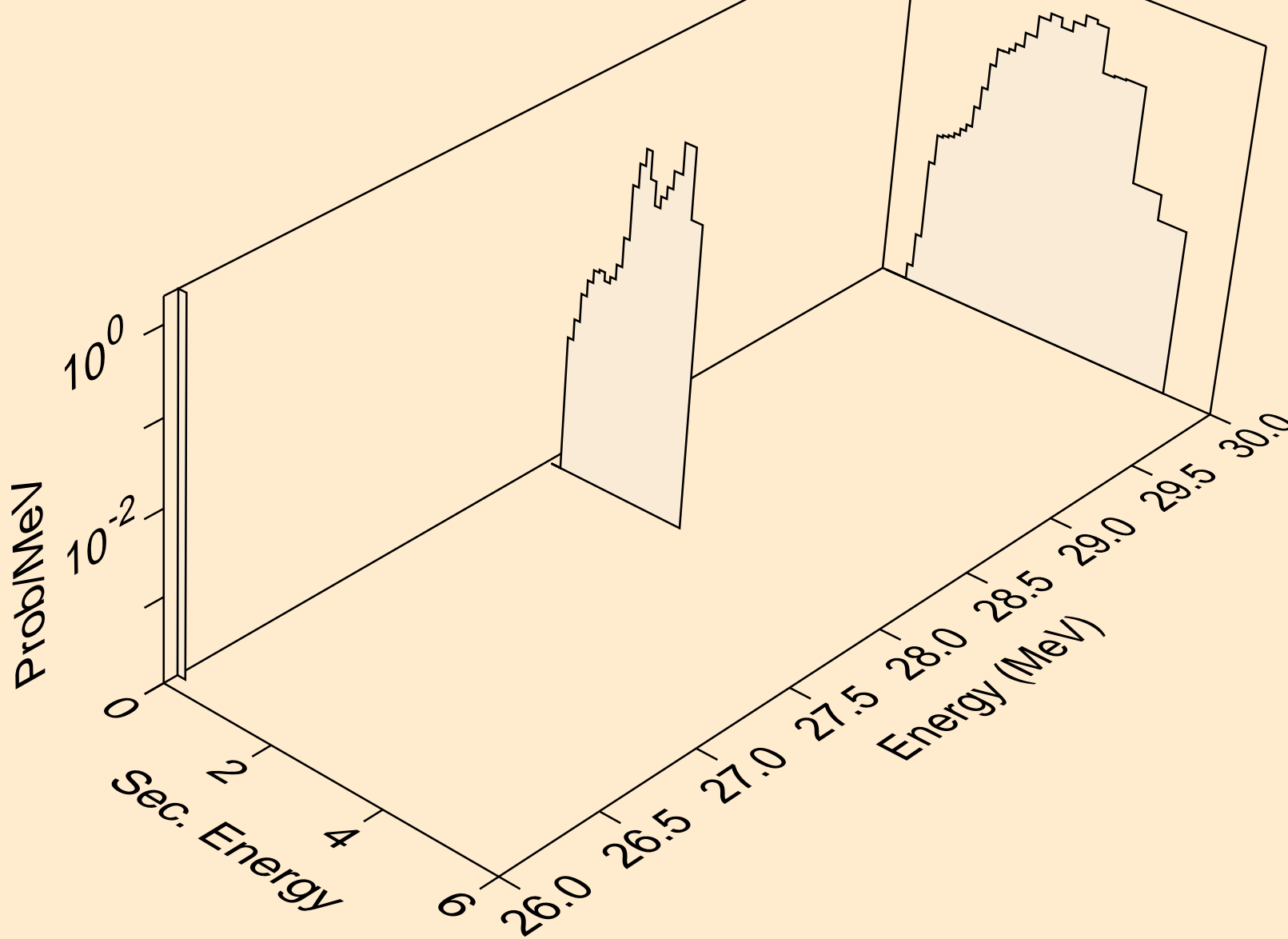

ZN073M NEUTRON ACER TENDL-2019 LIBRARY; T=293.16K
protons from (n,p)

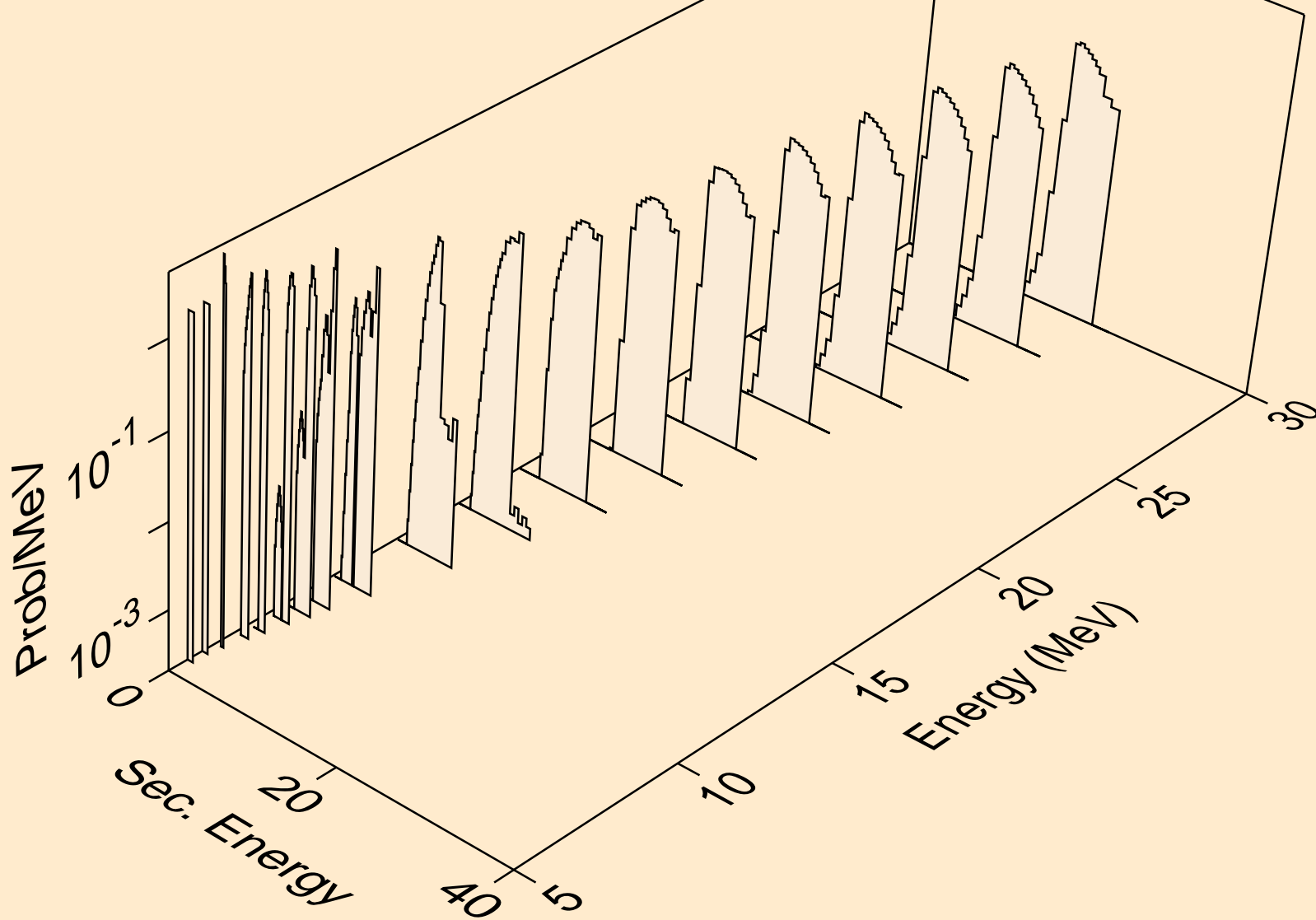

ZN073M NEUTRON ACER TENDL-2019 LIBRARY; T=293.16K
protons from (n,2p)

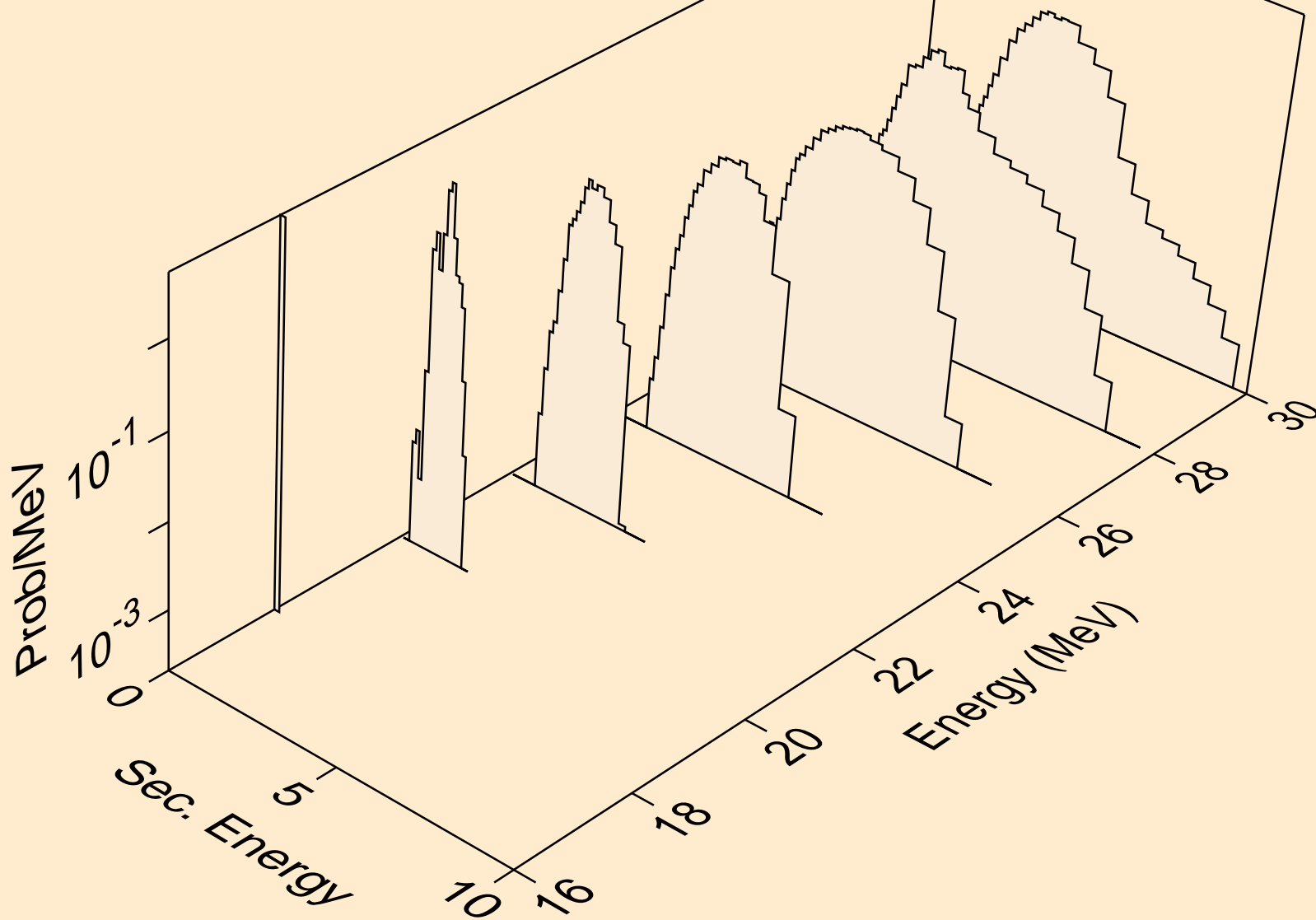

ZN073M NEUTRON ACER TENDL-2019 LIBRARY; T=293.16K
protons from (n,p)

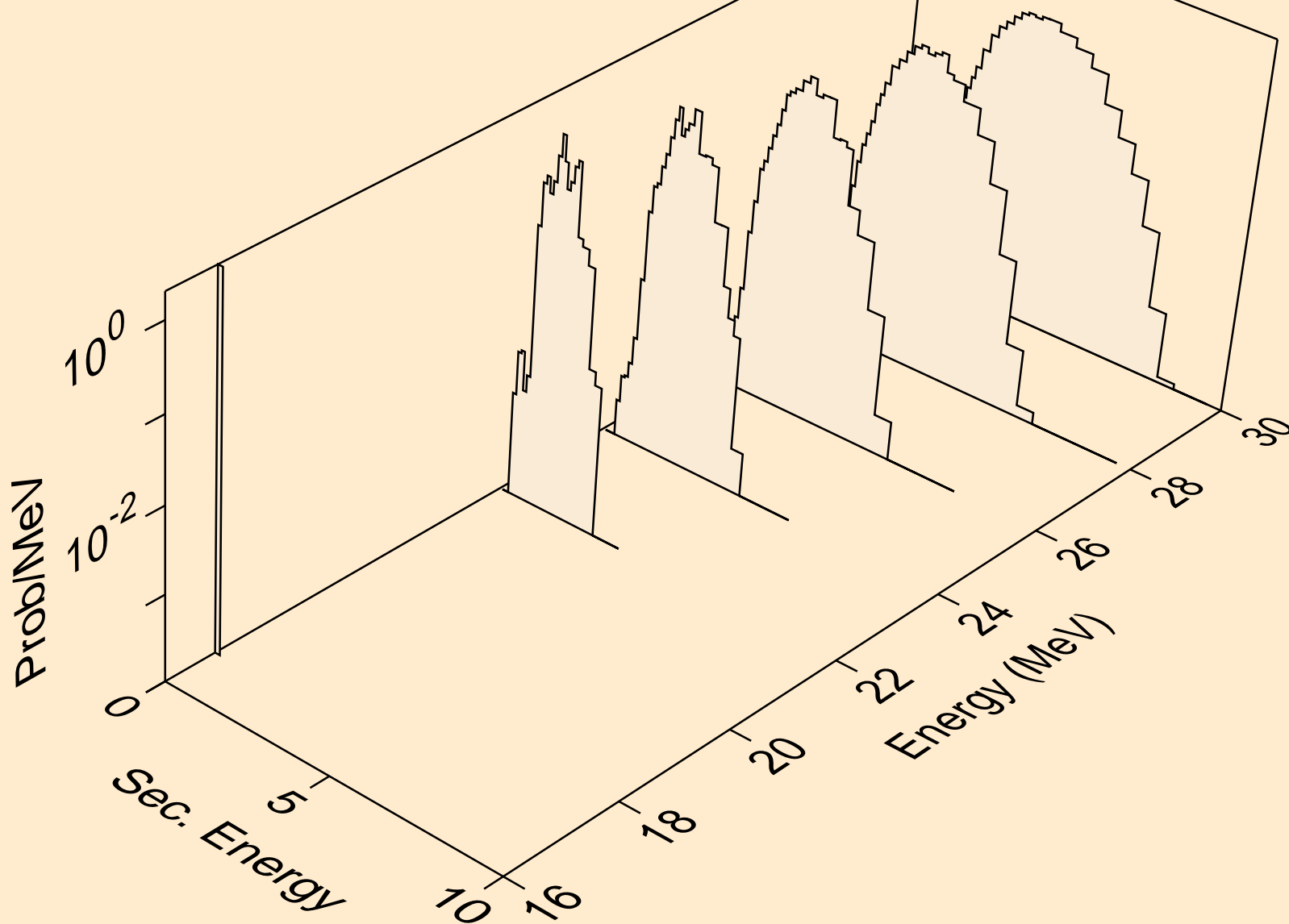

ZN073M NEUTRON ACER TENDL-2019 LIBRARY; T=293.16K
protons from (n,pt)

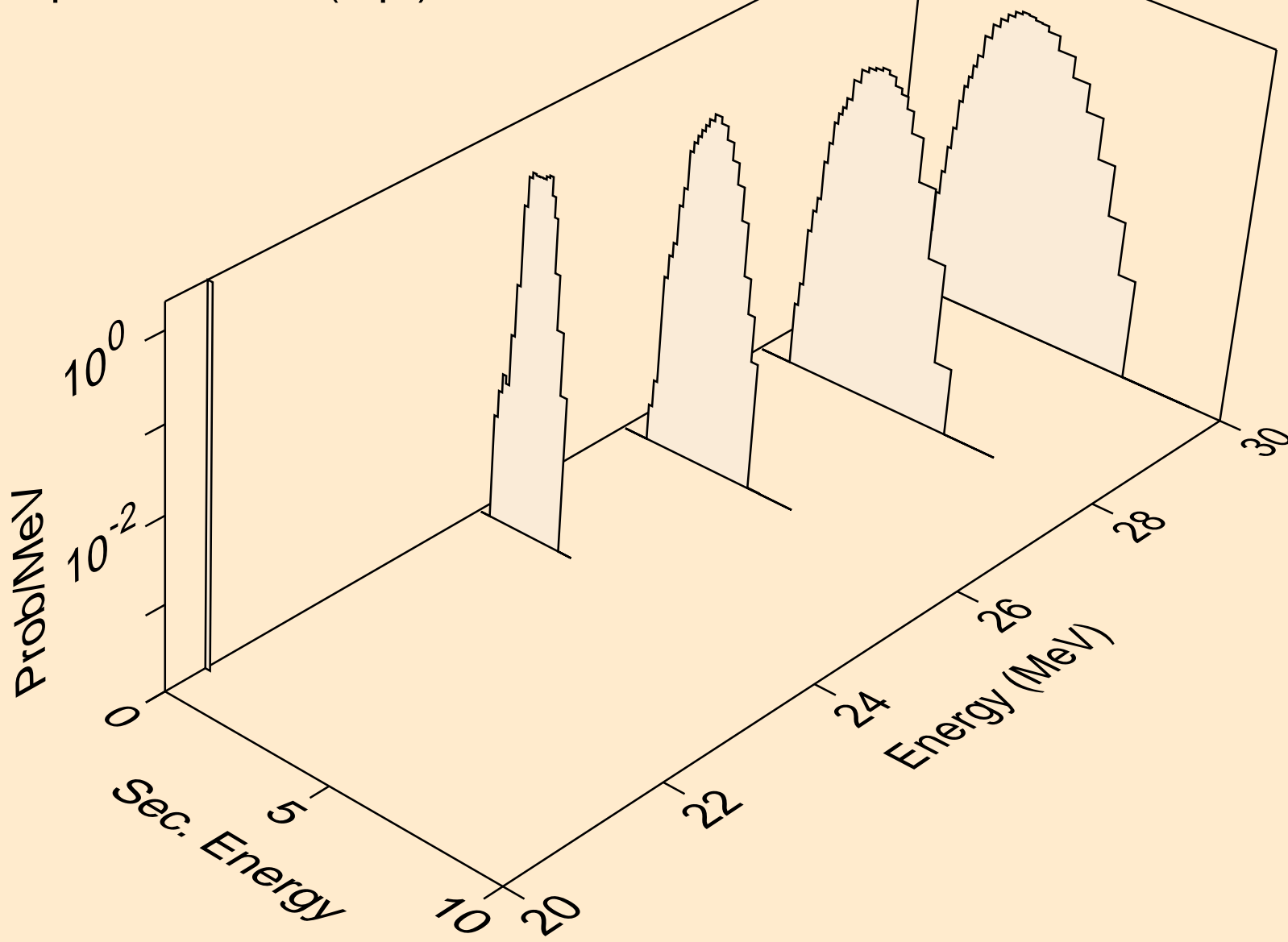

ZN073M NEUTRON ACER TENDL-2019 LIBRARY; T=293.16K
deuterons from (n,x)

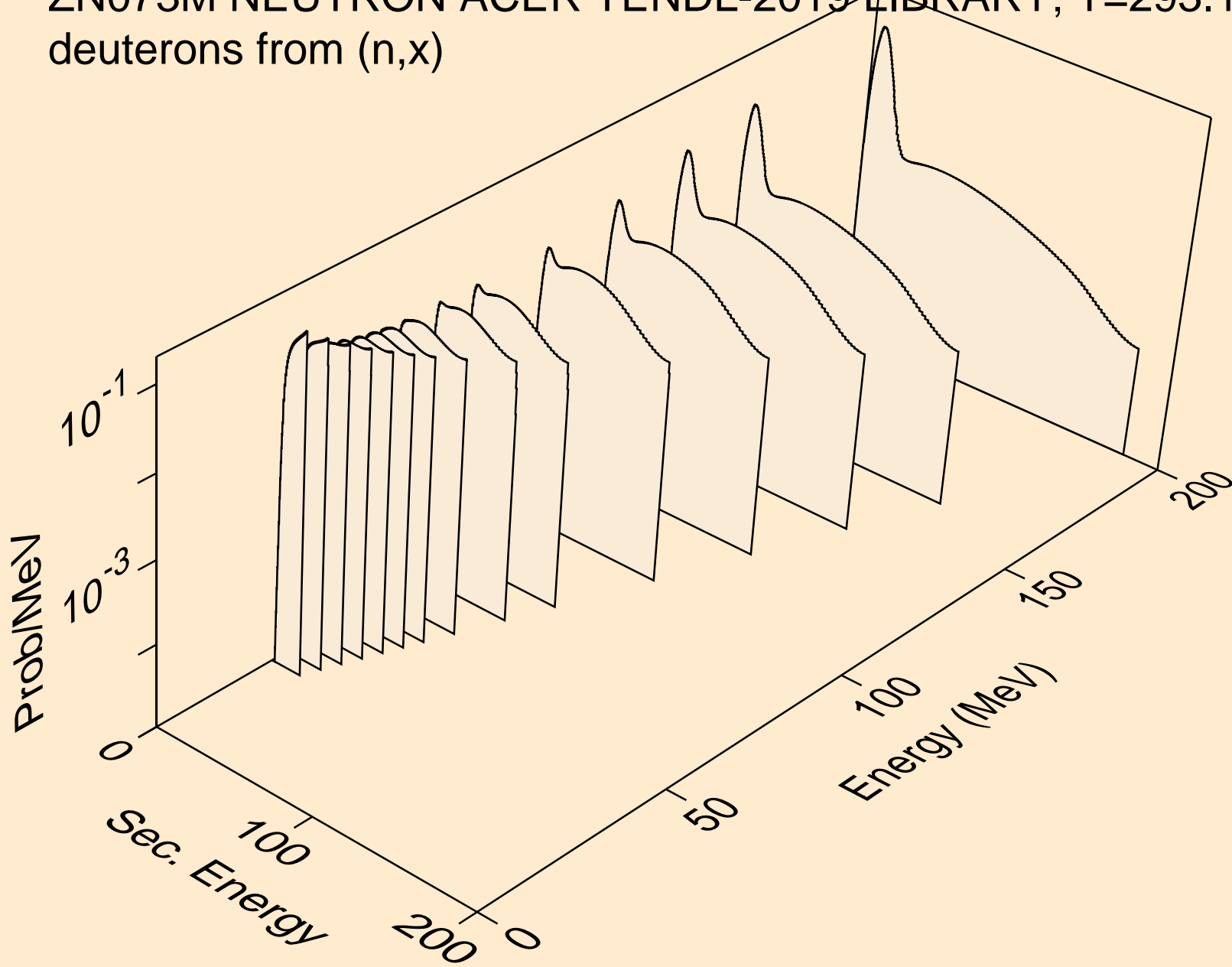

ZN073M NEUTRON ACER TENDL-2019 LIBRARY; T=293.16K
deuterons from (n,2nd)

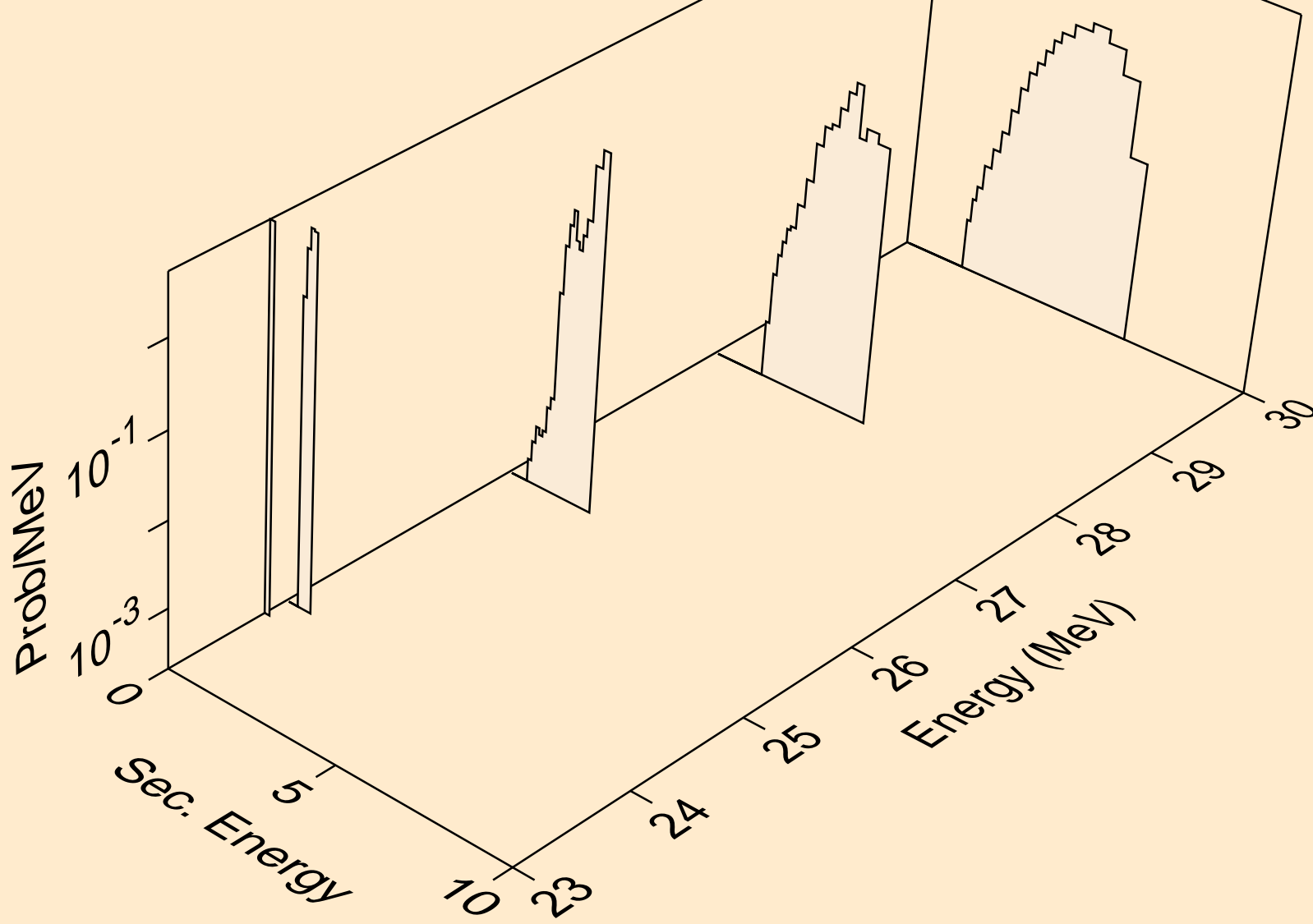

ZN073M NEUTRON ACER TENDL-2019 LIBRARY; T=293.16K
deuterons from (n,n*)d

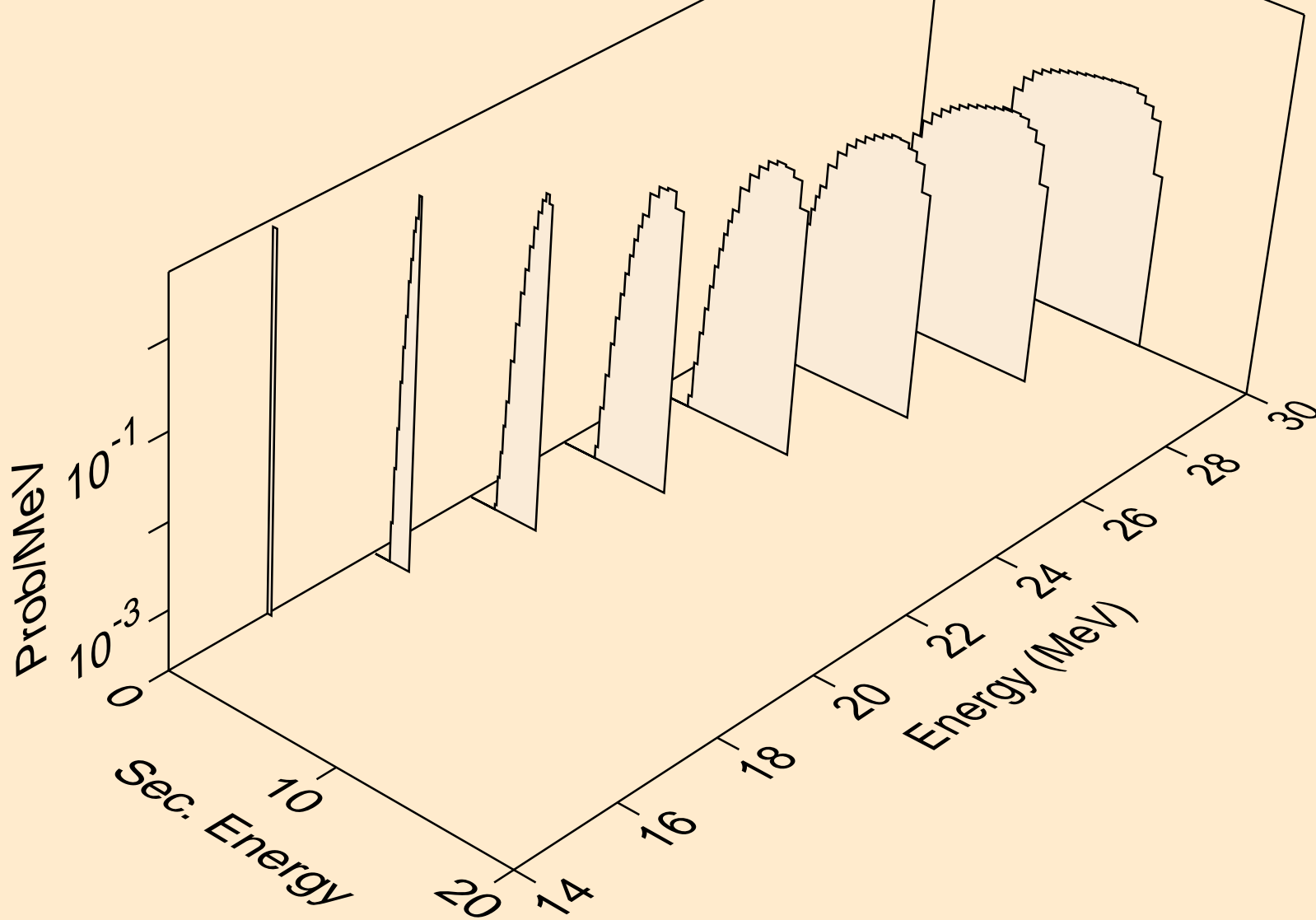

ZN073M NEUTRON ACER TENDL-2019 LIBRARY; T=293.16K
deuterons from (n,d)

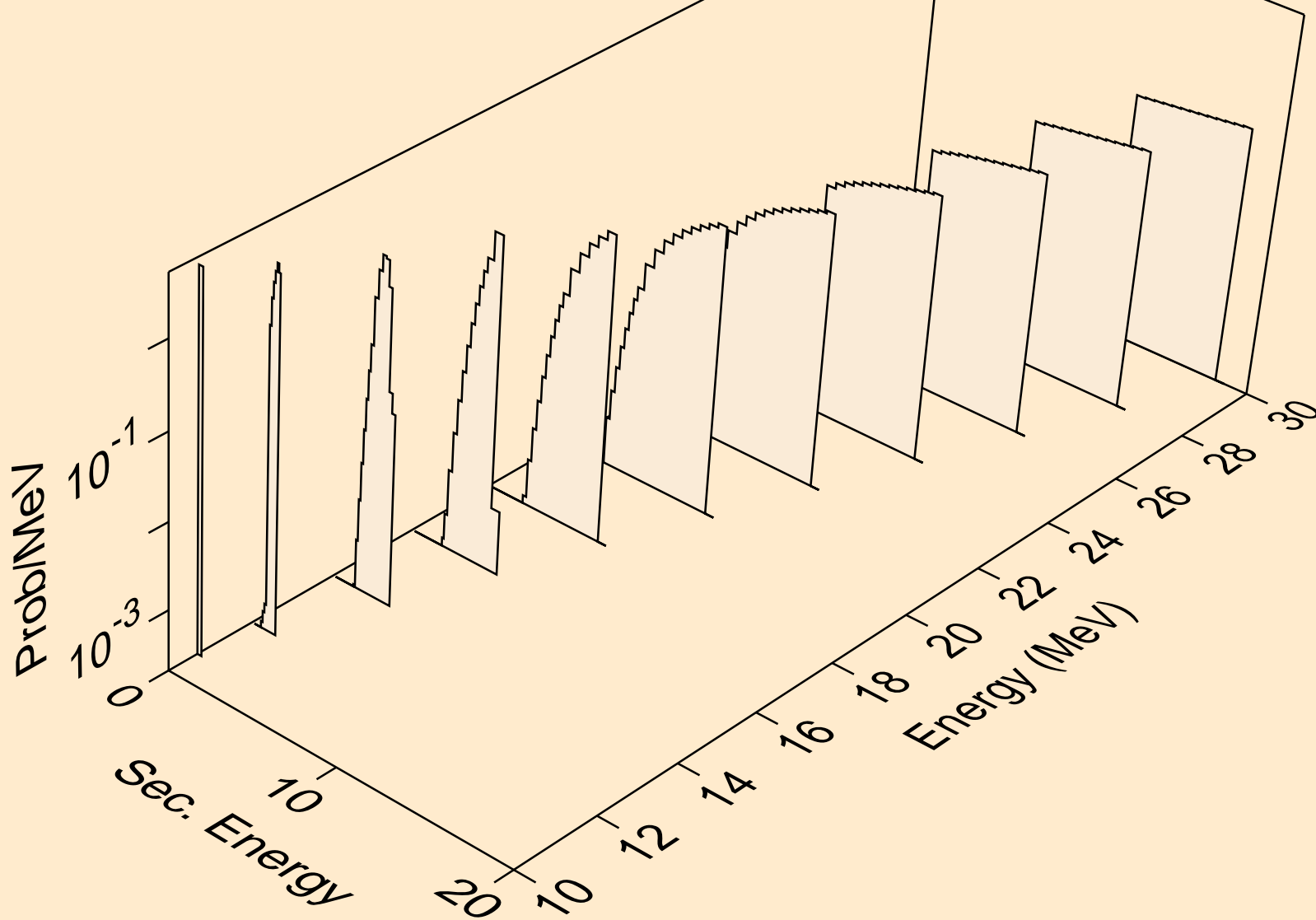

ZN073M NEUTRON ACER TENDL-2019 LIBRARY; T=293.16K
tritons from (n,x)

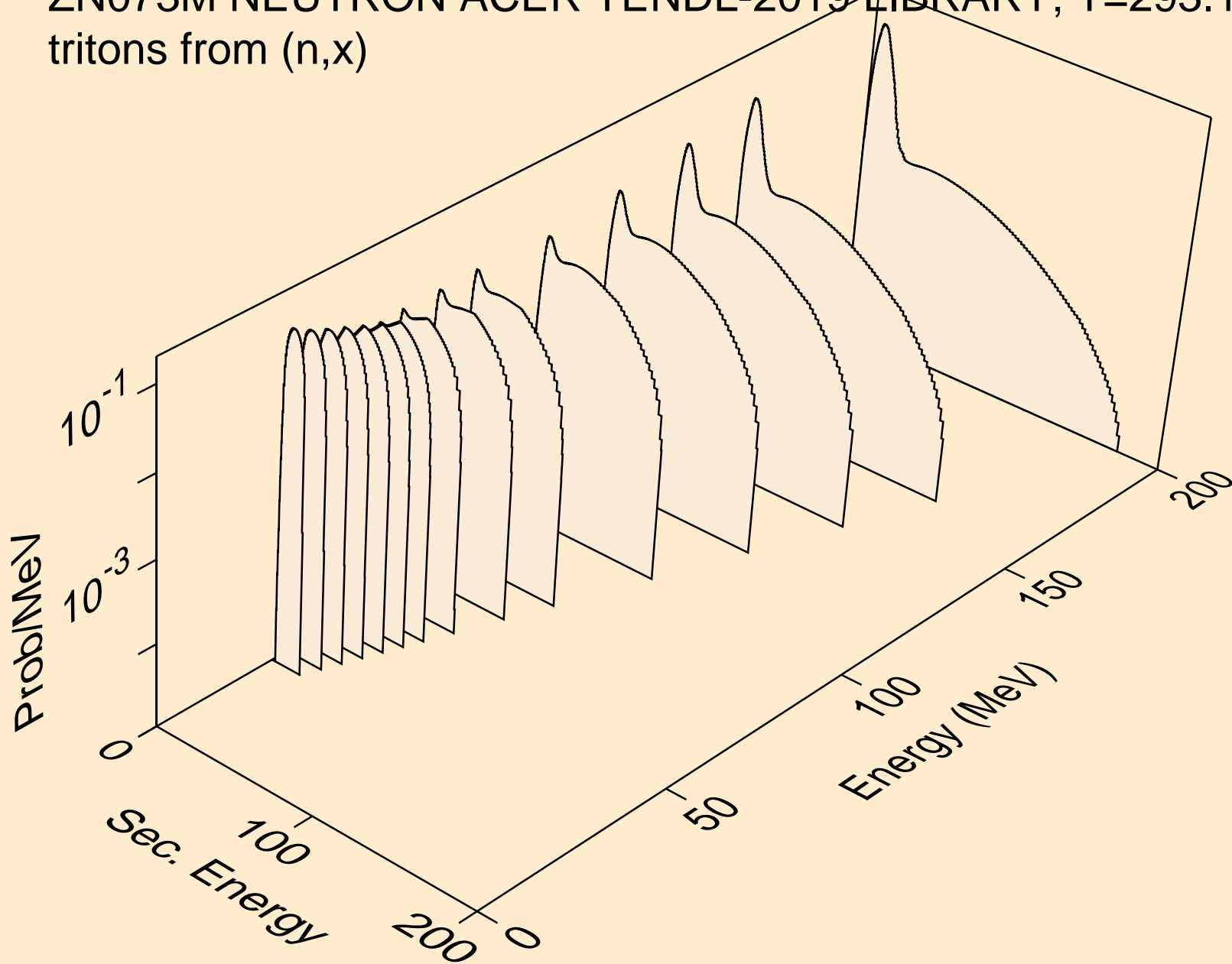

ZN073M NEUTRON ACER TENDL-2019 LIBRARY; T=293.16K
tritons from (n,n*)t

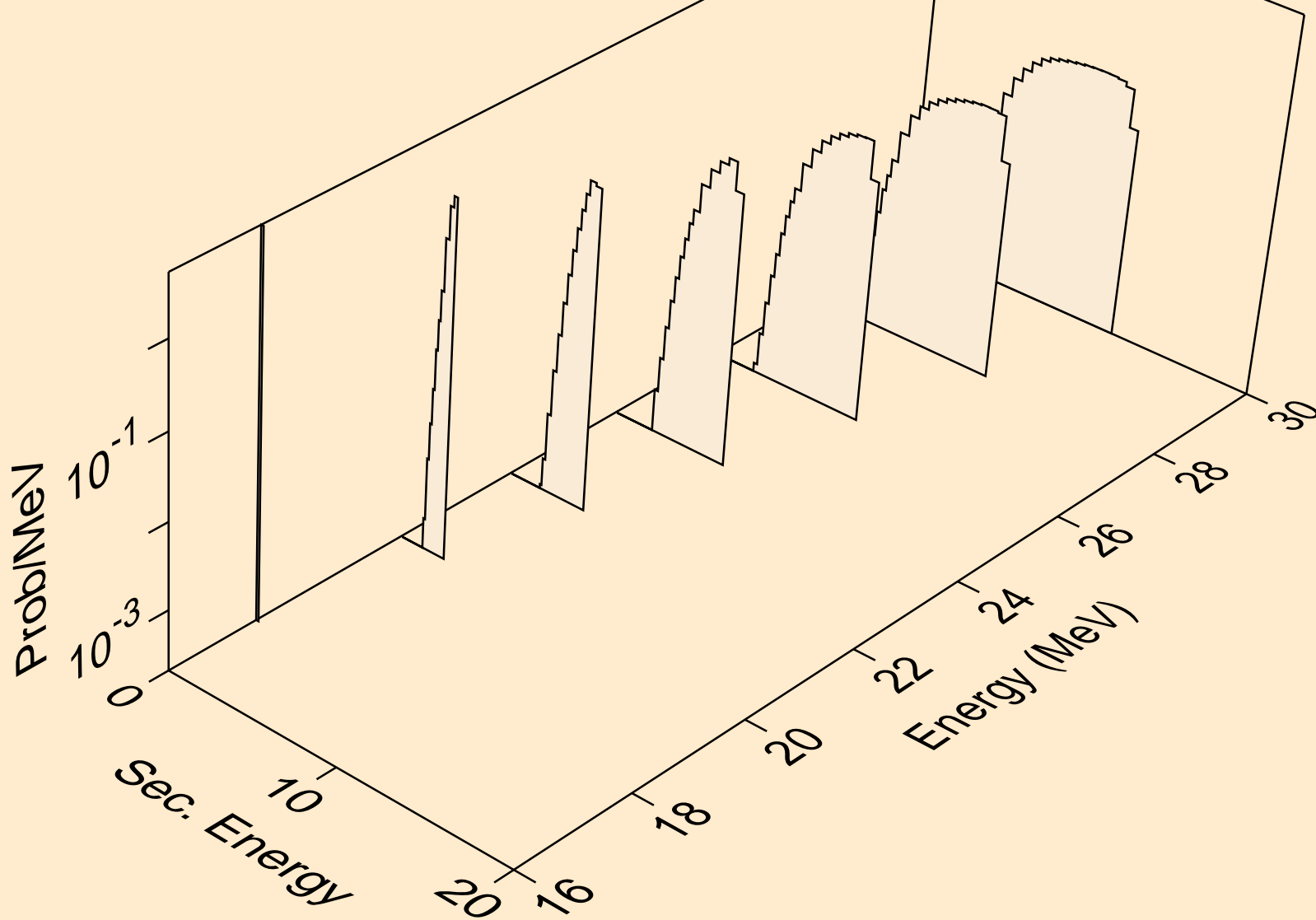

ZN073M NEUTRON ACER TENDL-2019 LIBRARY; T=293.16K
tritons from (n,t)

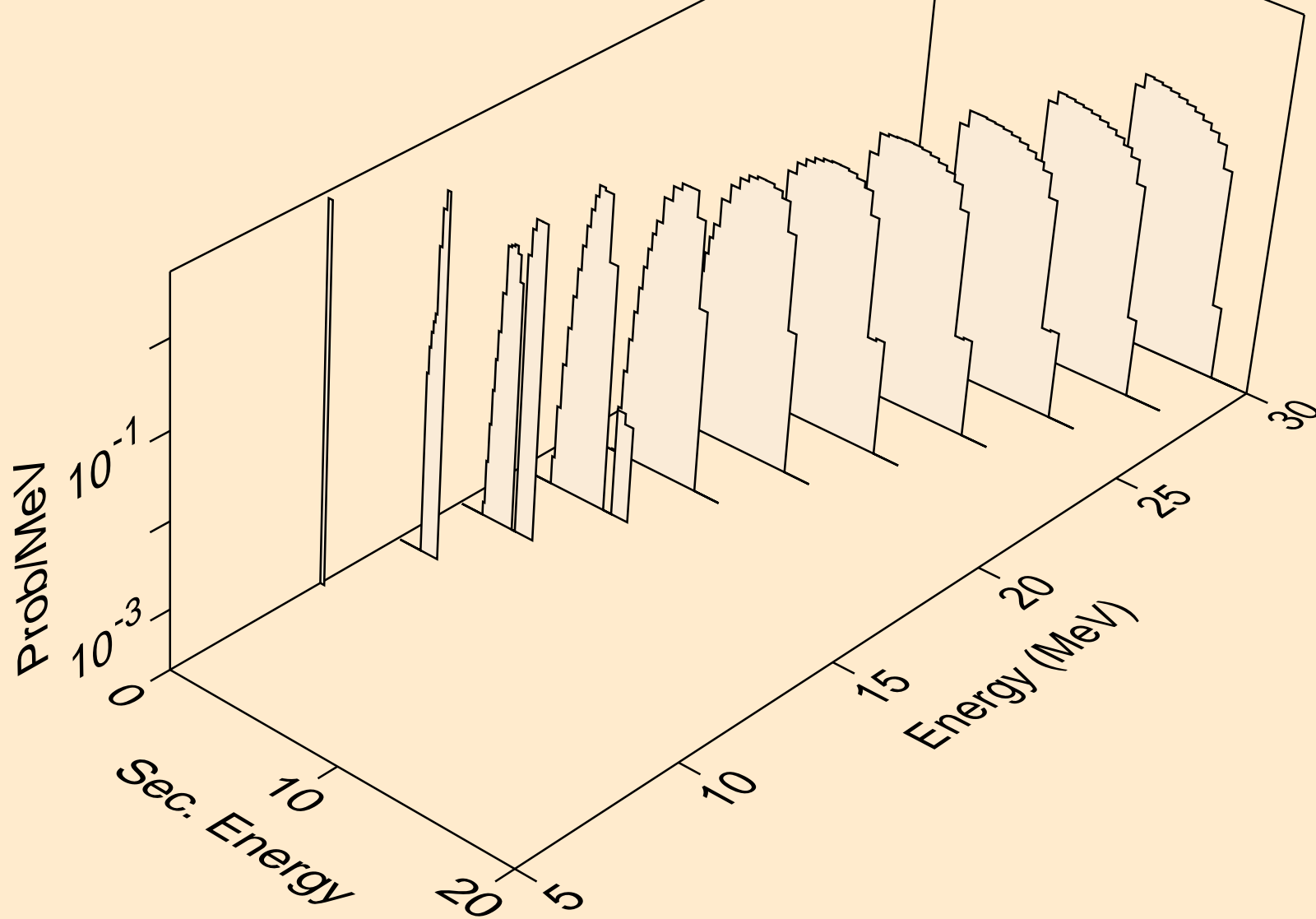

ZN073M NEUTRON ACER TENDL-2019 LIBRARY; T=293.16K
tritons from (n,pt)

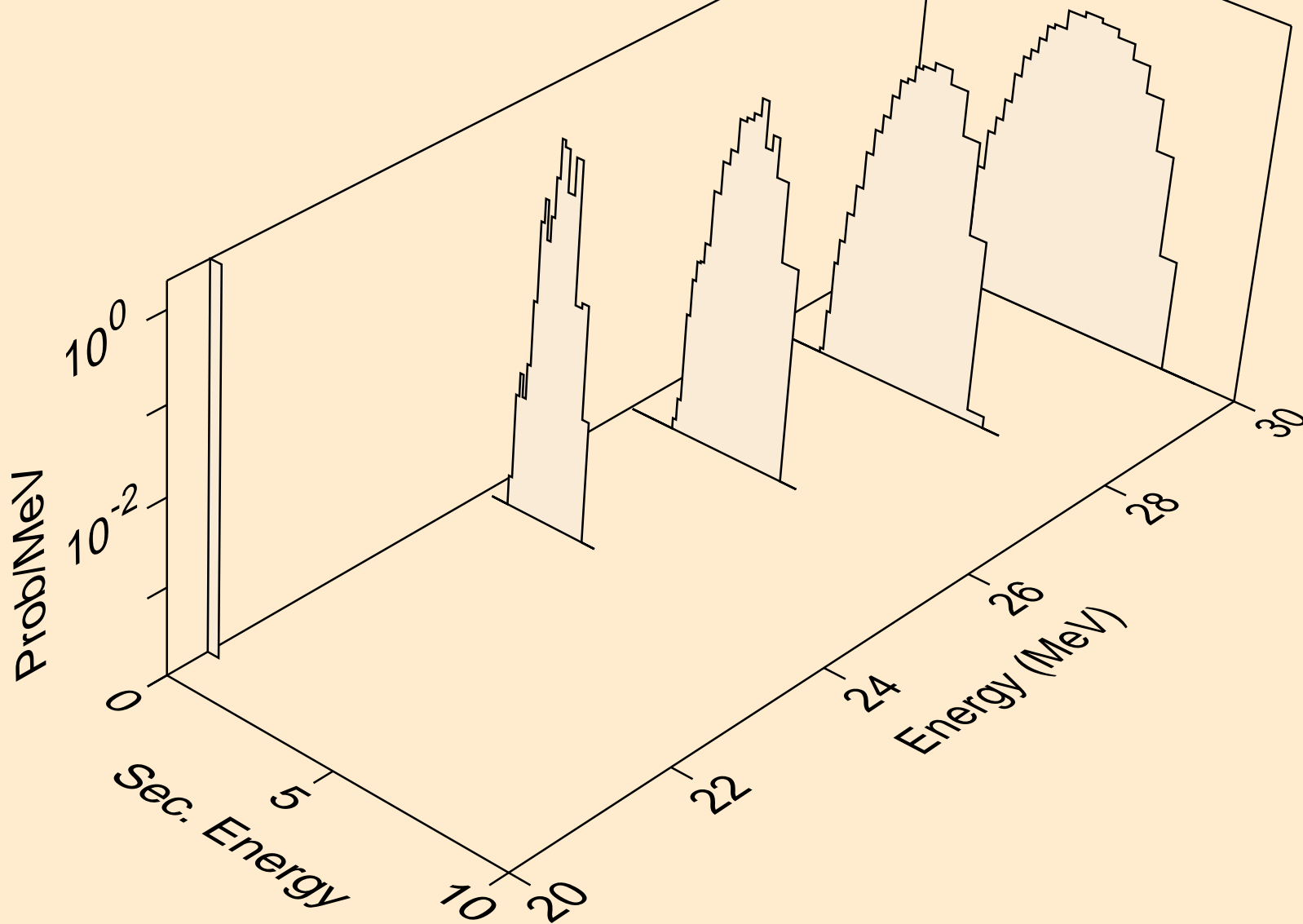

ZN073M NEUTRON ACER TENDL-2019 LIBRARY; T=293.16K
he3s from (n,x)

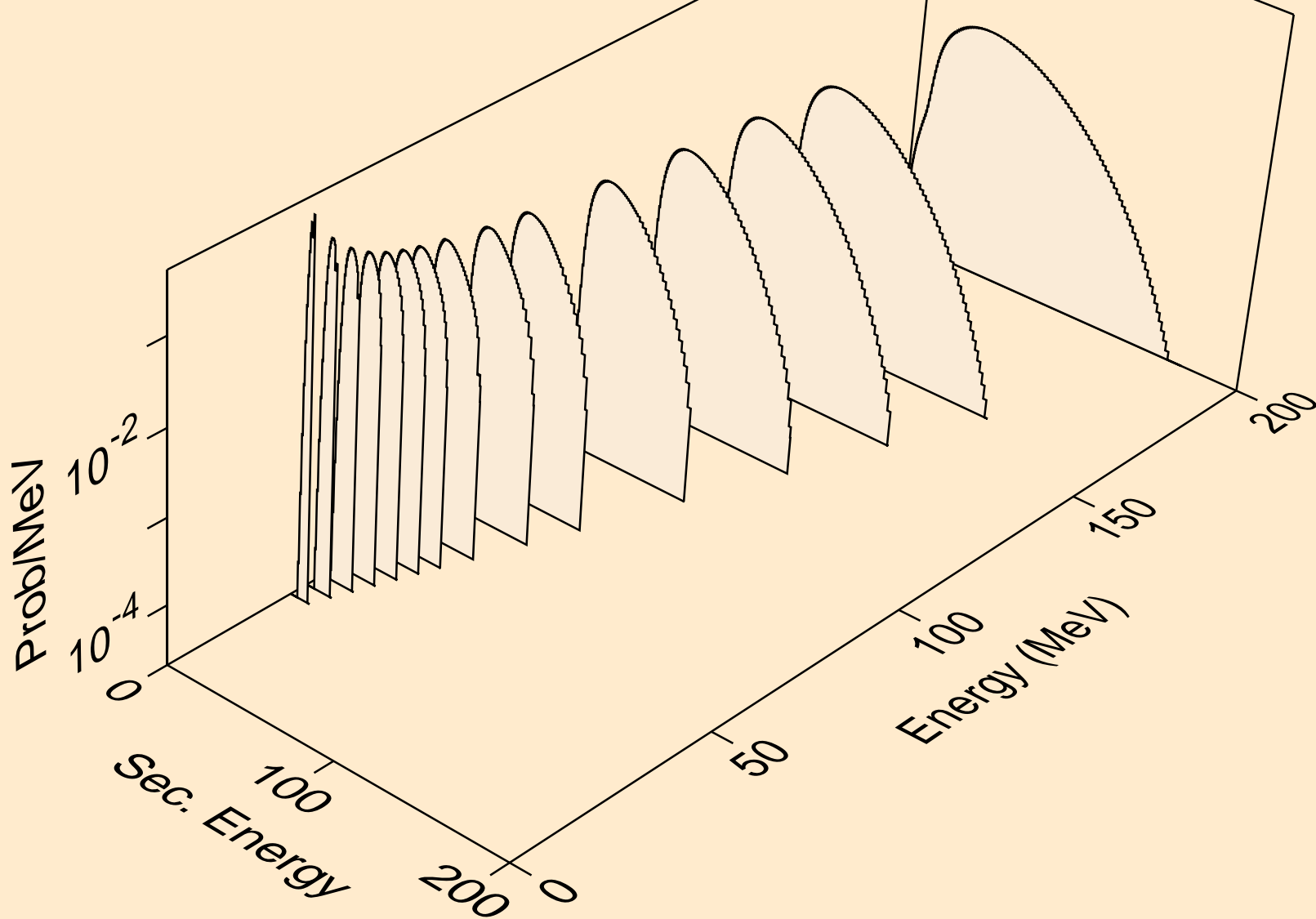

ZN073M NEUTRON ACER TENDL-2019 LIBRARY; T=293.16K
he3s from (n,n*)he3

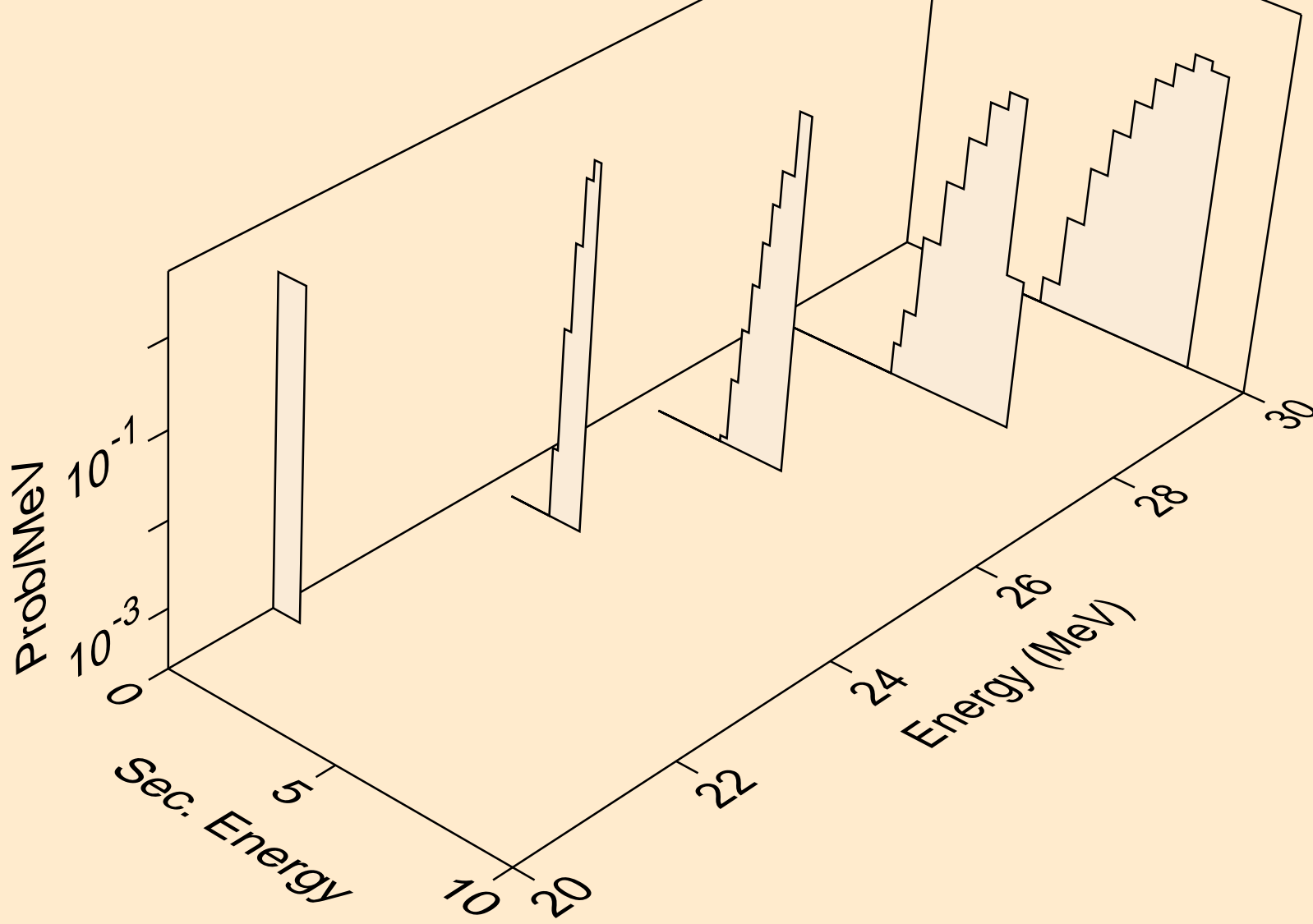

ZN073M NEUTRON ACER TENDL-2019 LIBRARY; T=293.16K
he3s from (n,he3)

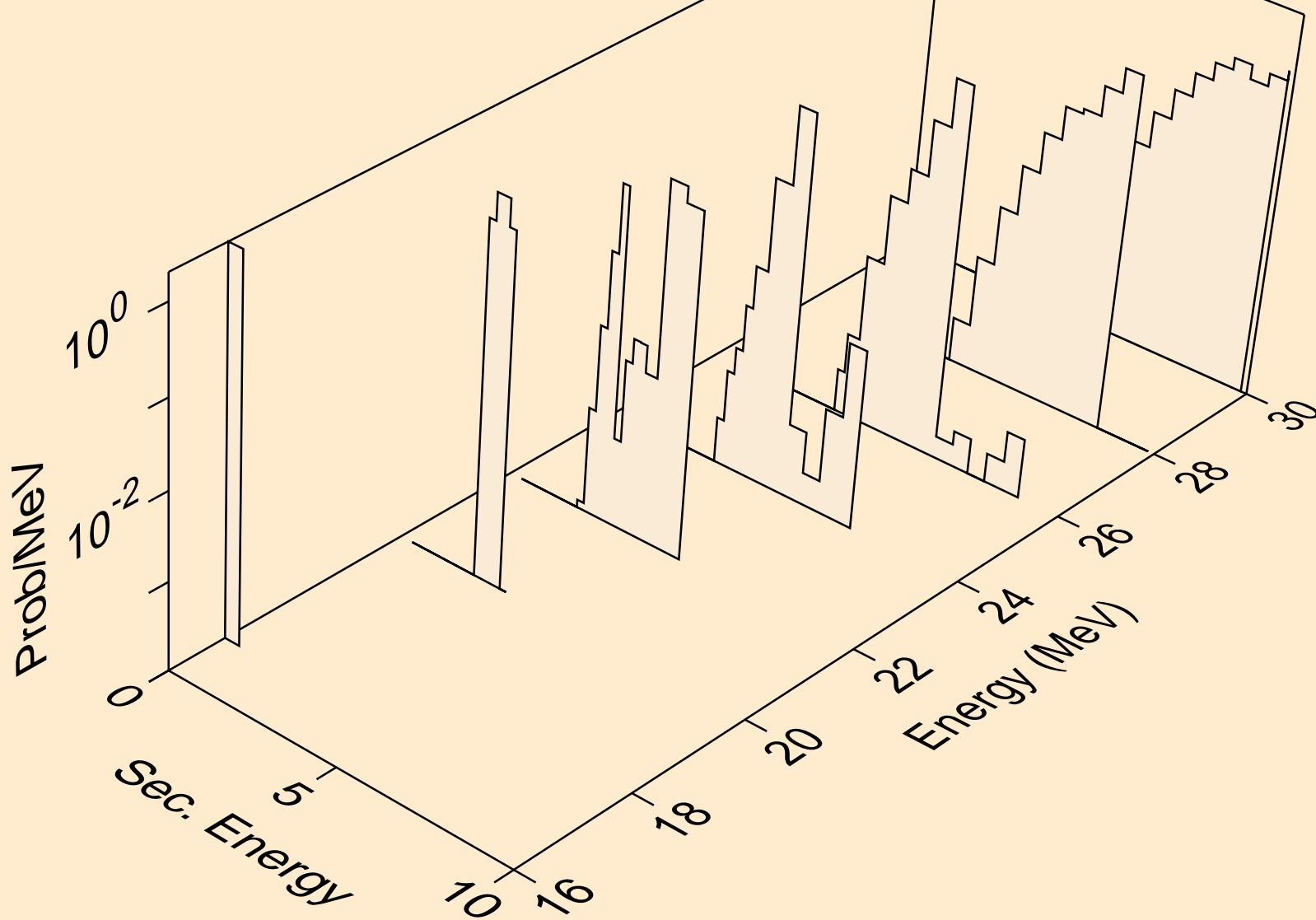

ZN073M NEUTRON ACER TENDL-2019 LIBRARY; T=293.16K
alphas from (n,x)

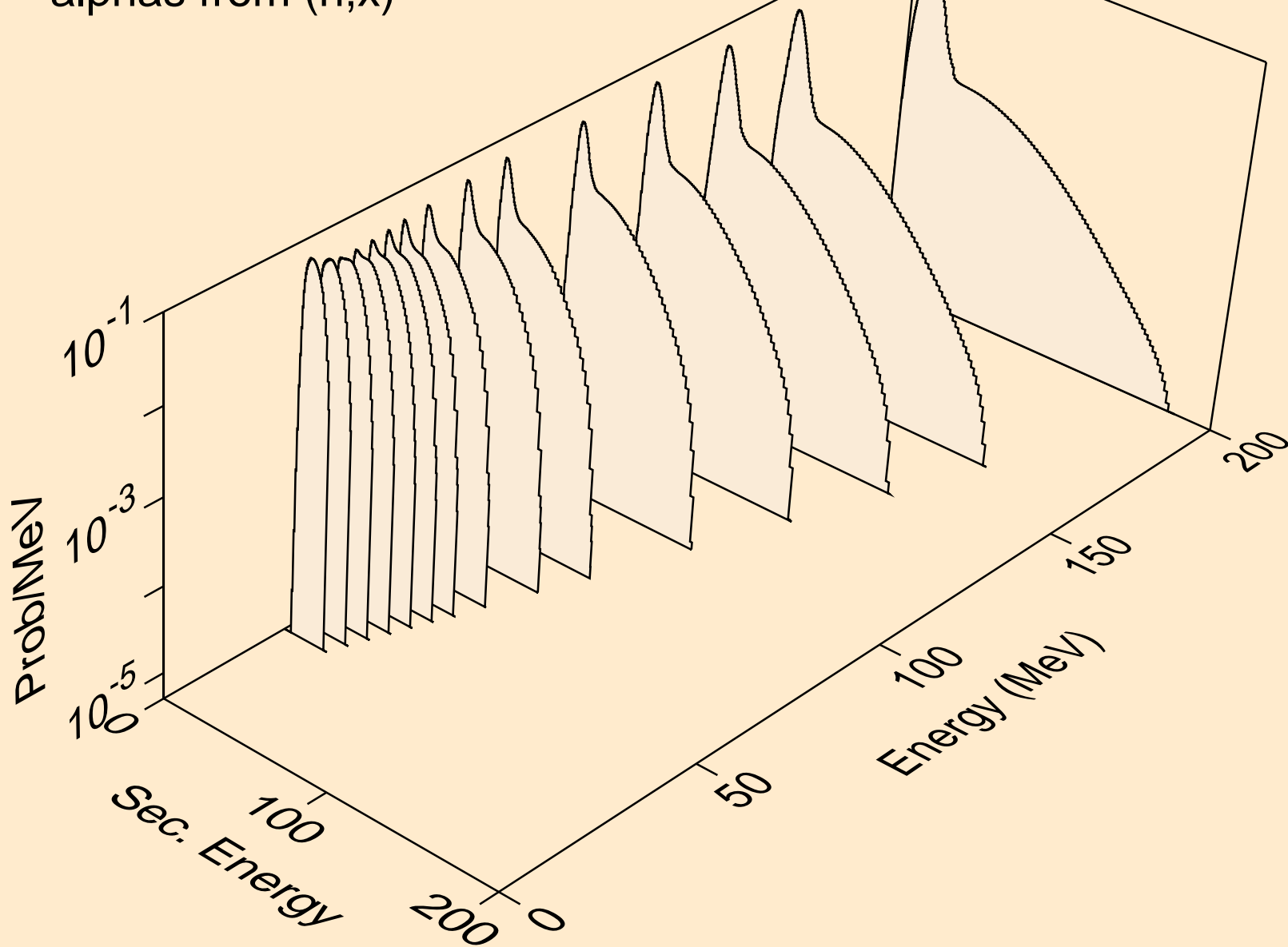

ZN073M NEUTRON ACER TENDL-2019 LIBRARY; T=293.16K
alphas from (n,n*)a

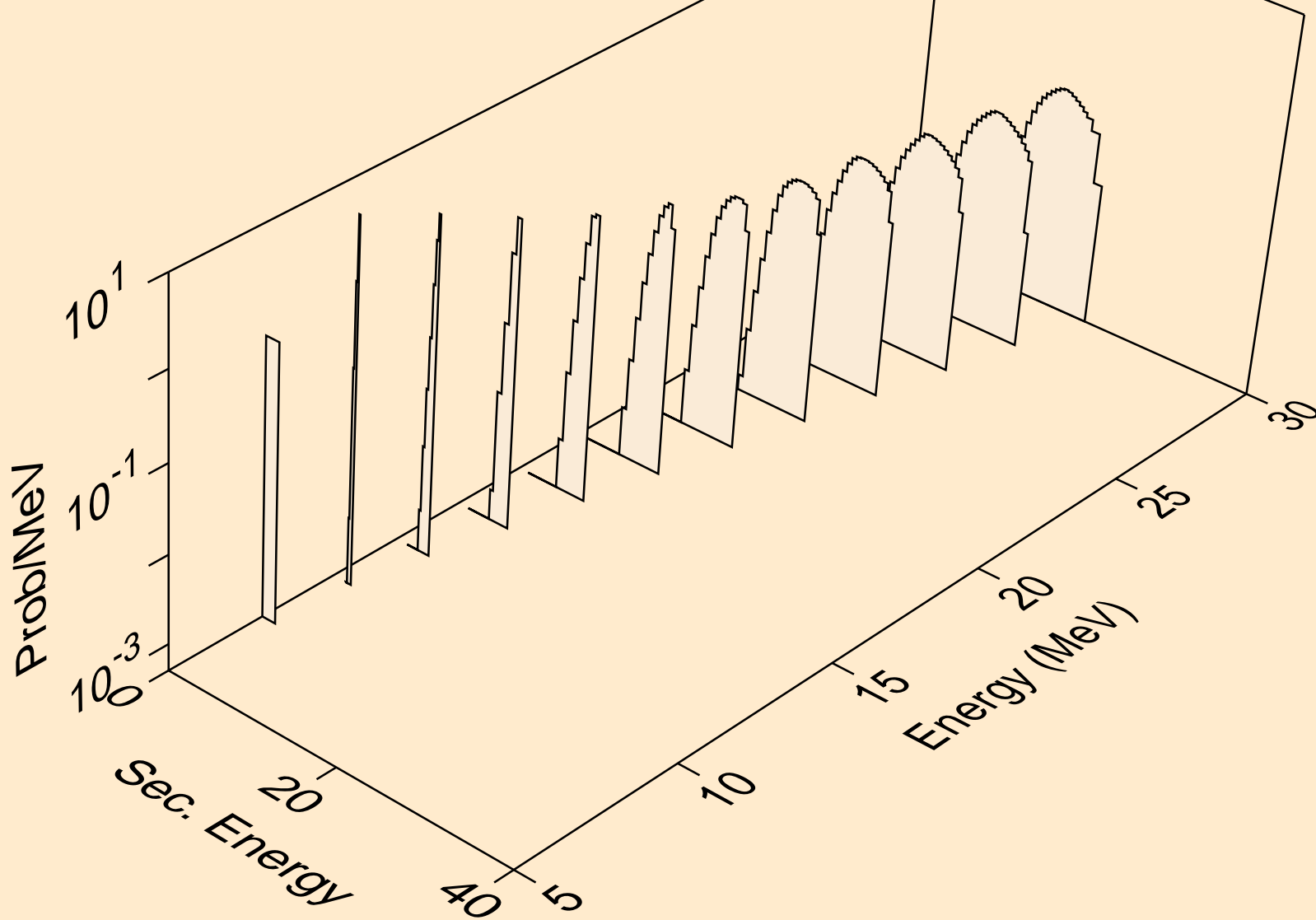

ZN073M NEUTRON ACER TENDL-2019 LIBRARY; T=293.16K
alphas from (n,2n)a

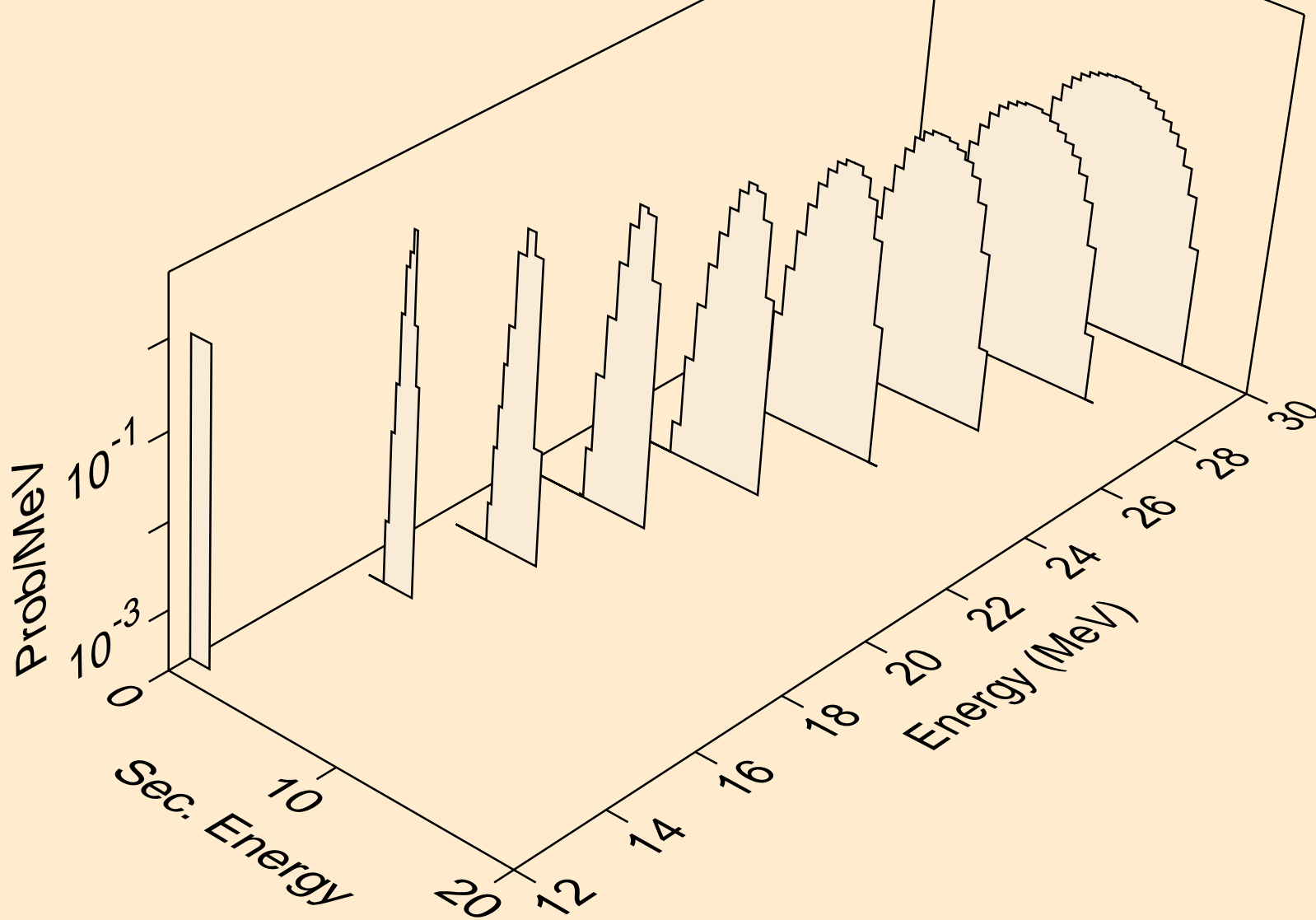

ZN073M NEUTRON ACER TENDL-2019 LIBRARY; T=293.16K
alphas from (n,3n)a

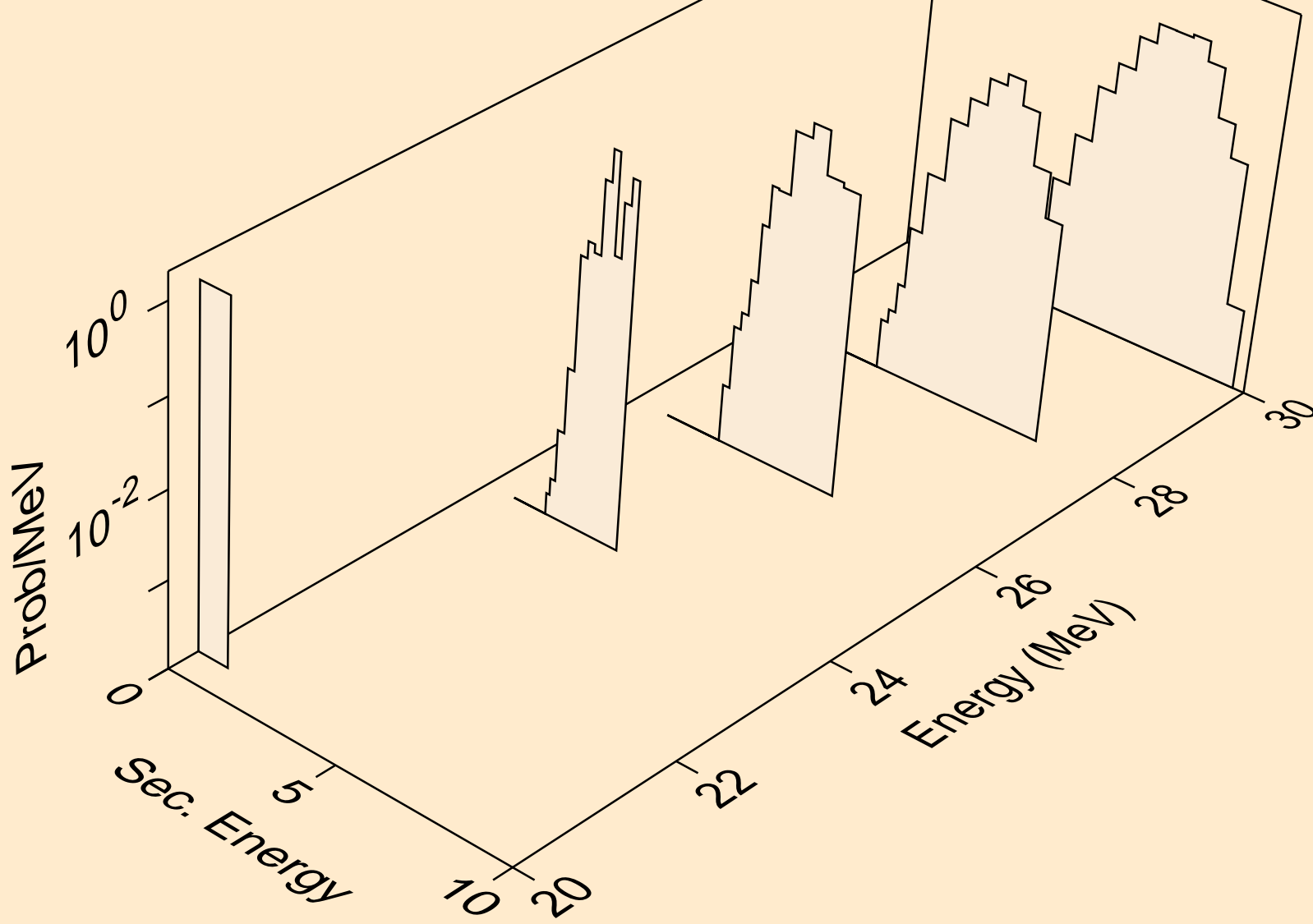

ZN073M NEUTRON ACER TENDL-2019 LIBRARY; T=293.16K
alphas from (n,a)

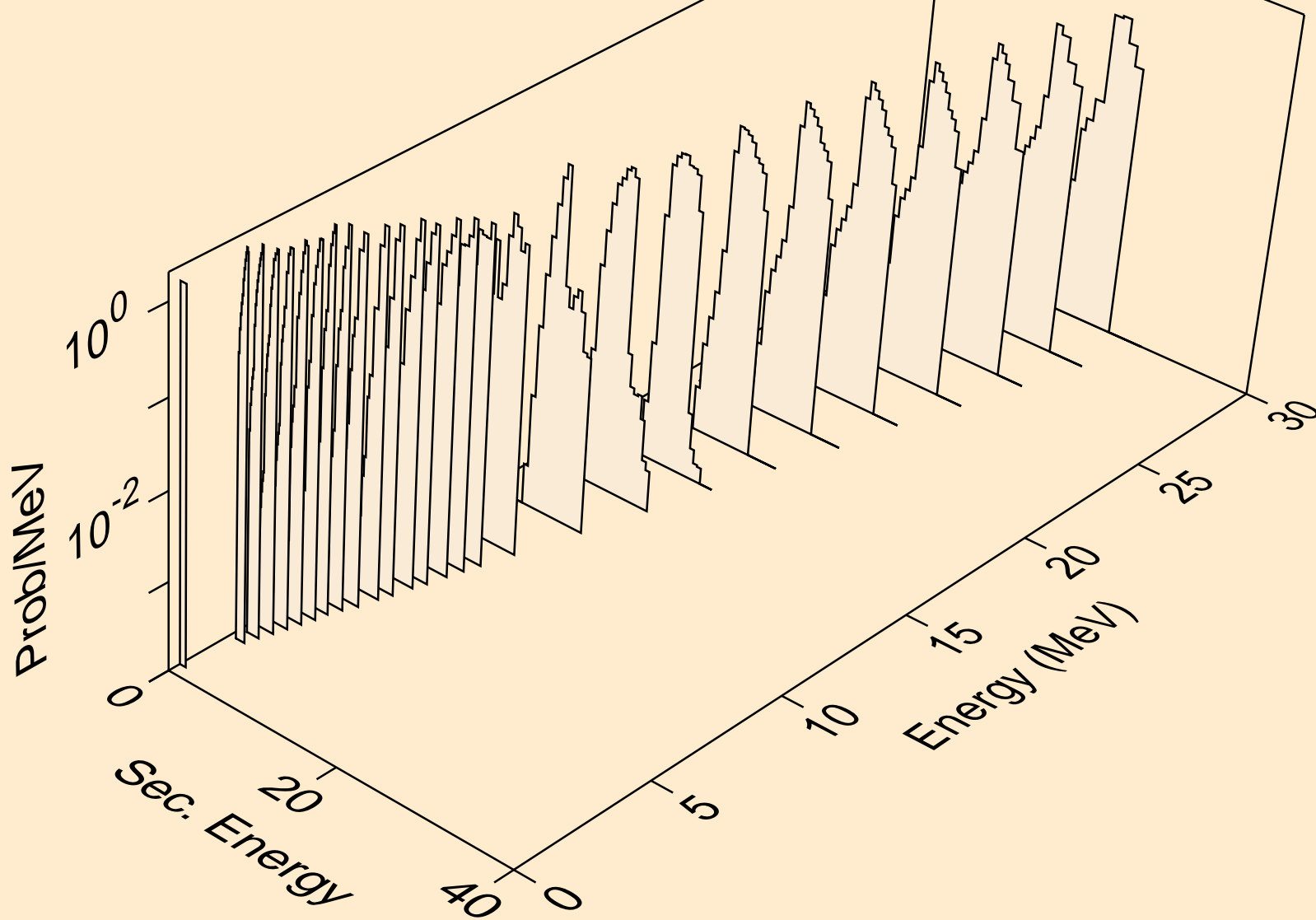

ZN073M NEUTRON ACER TENDL-2019 LIBRARY; T=293.16K
alphas from (n,pa)

