

ZR087M NEUTRON ACER TENDL-2019 LIBRARY; T=293.16K
Principal cross sections

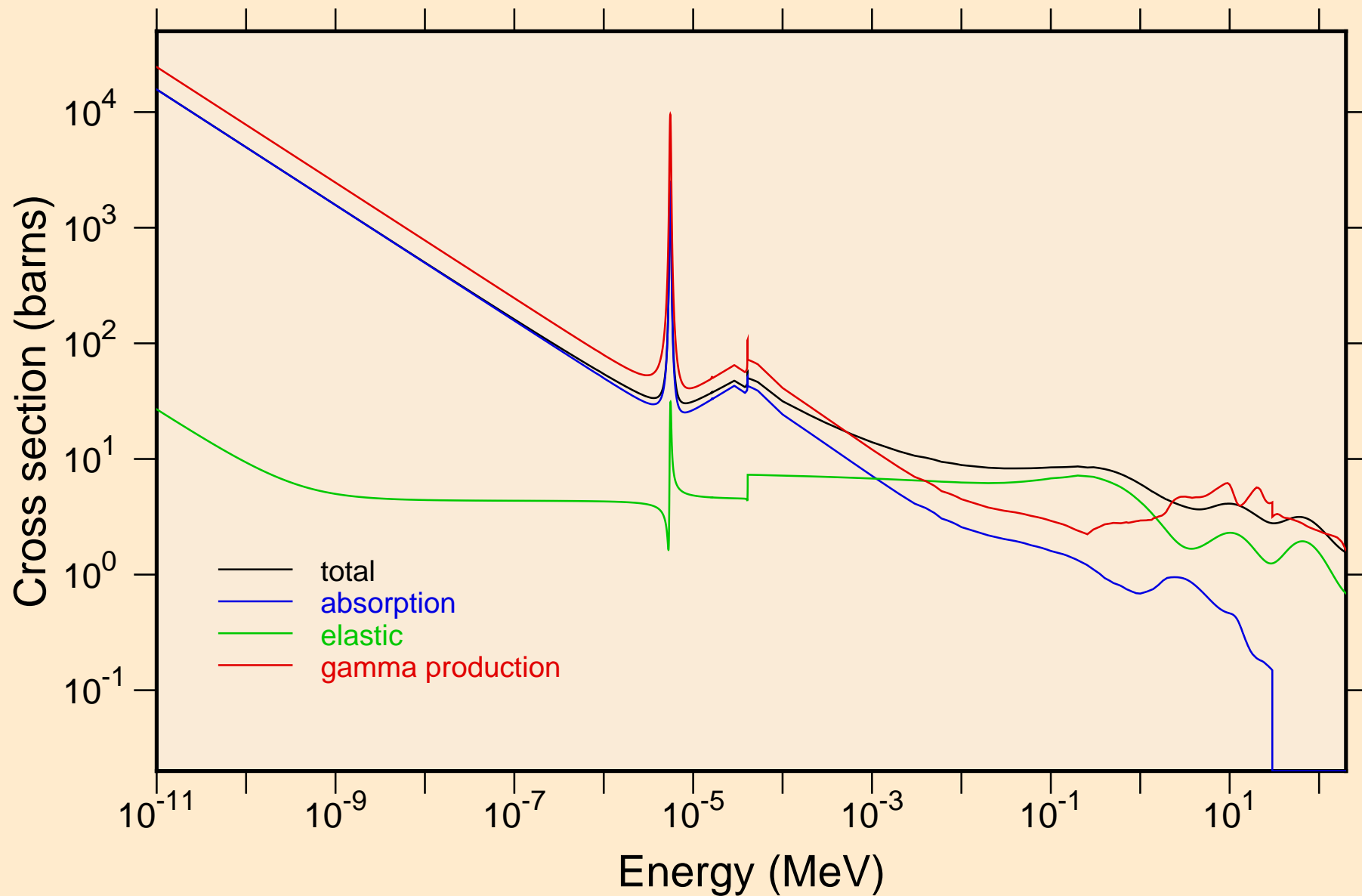

ZR087M NEUTRON ACER TENDL-2019 LIBRARY; T=293.16K
Heating

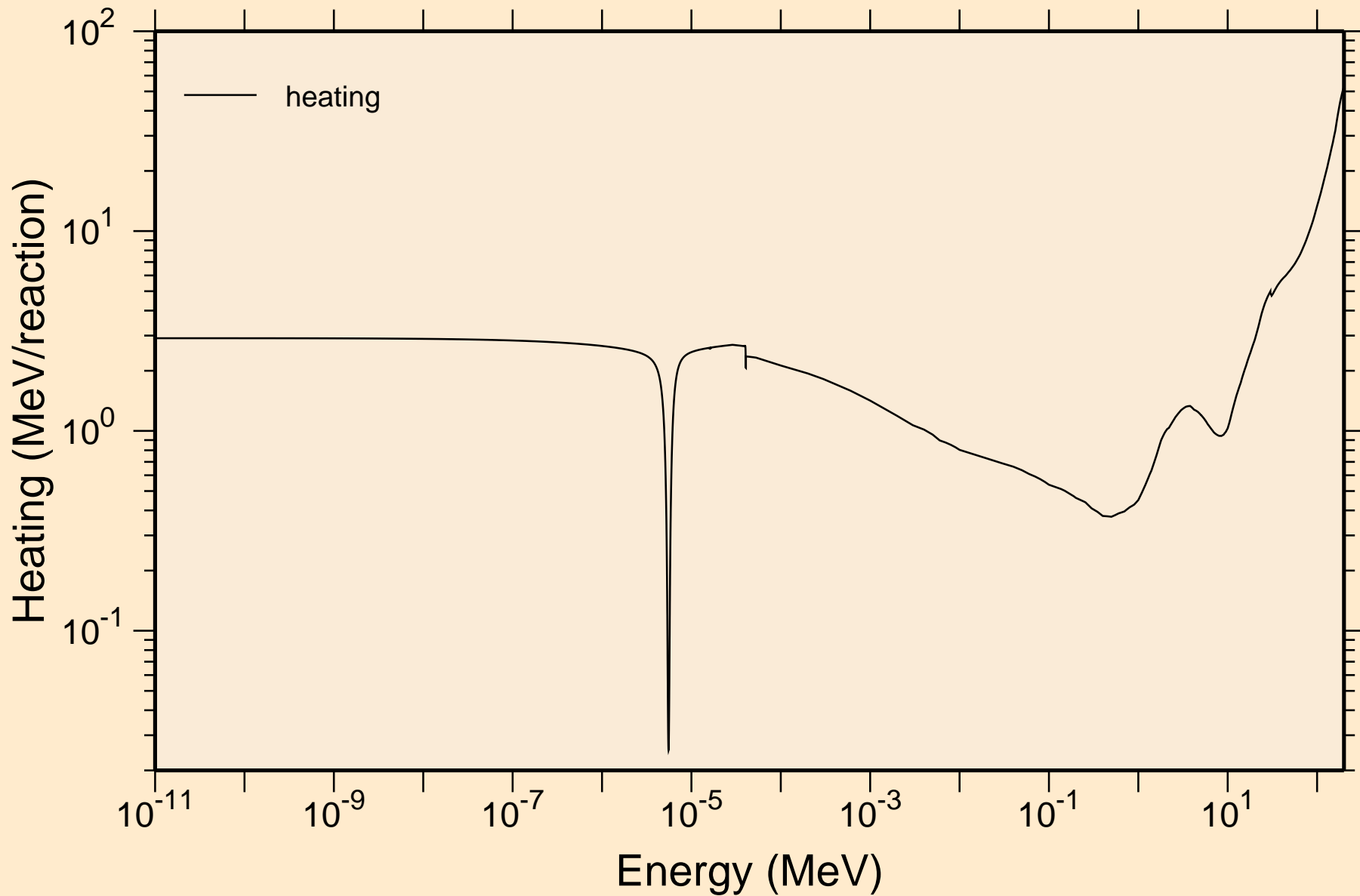

ZR087M NEUTRON ACER TENDL-2019 LIBRARY; T=293.16K
Damage

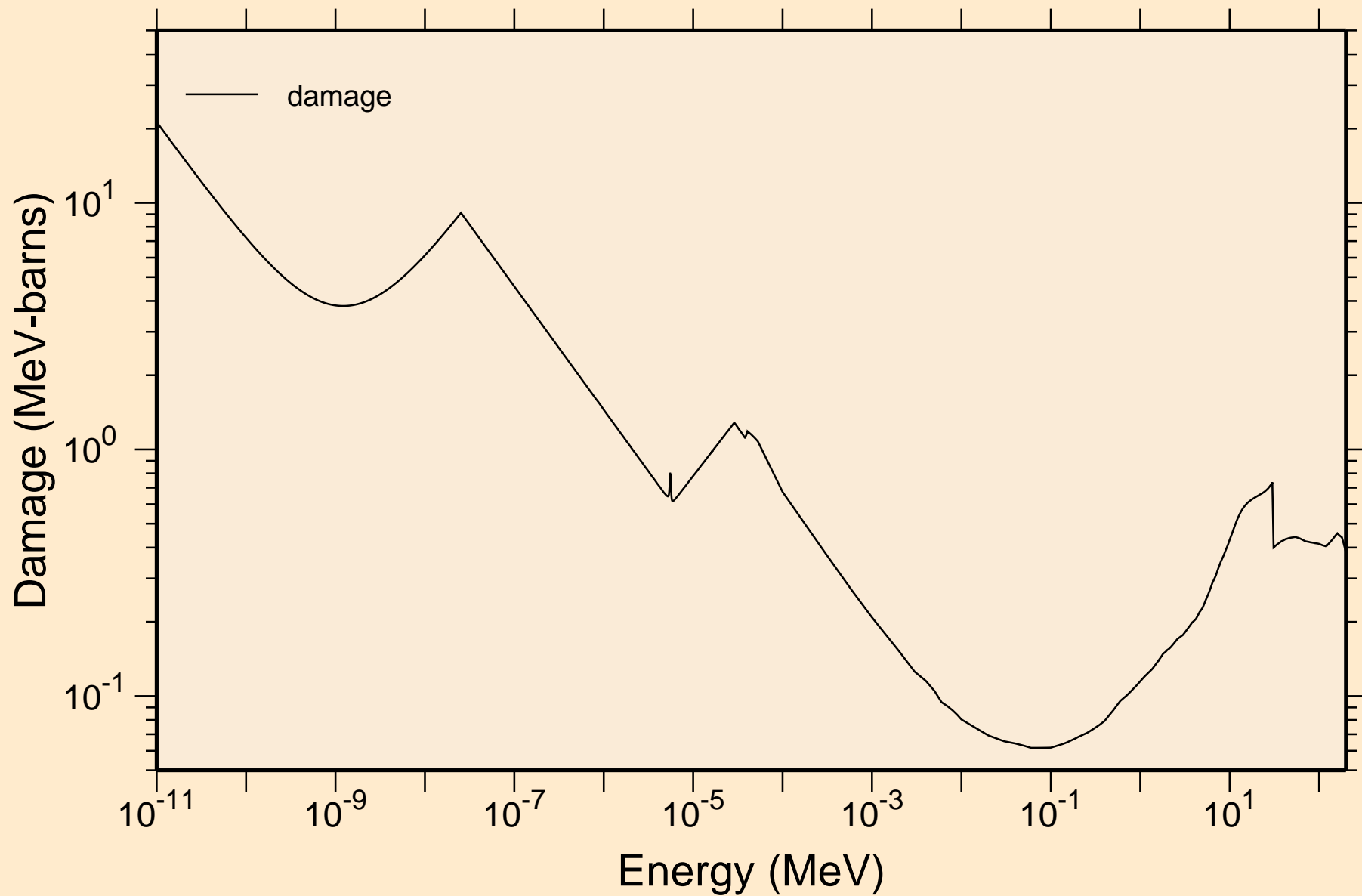

ZR087M NEUTRON ACER TENDL-2019 LIBRARY; T=293.16K
Non-threshold reactions

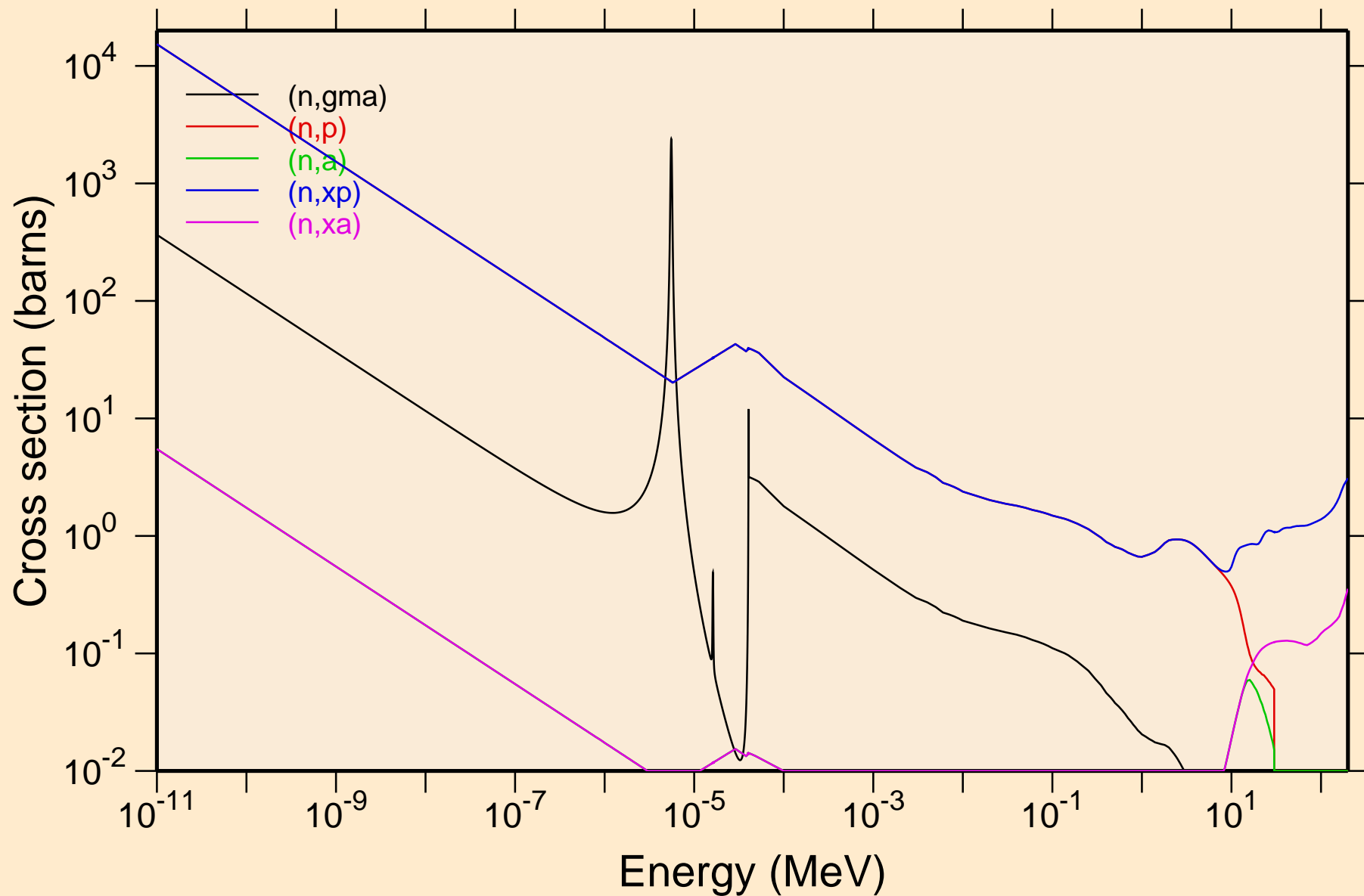

ZR087M NEUTRON ACER TENDL-2019 LIBRARY; T=293.16K
Principal cross sections

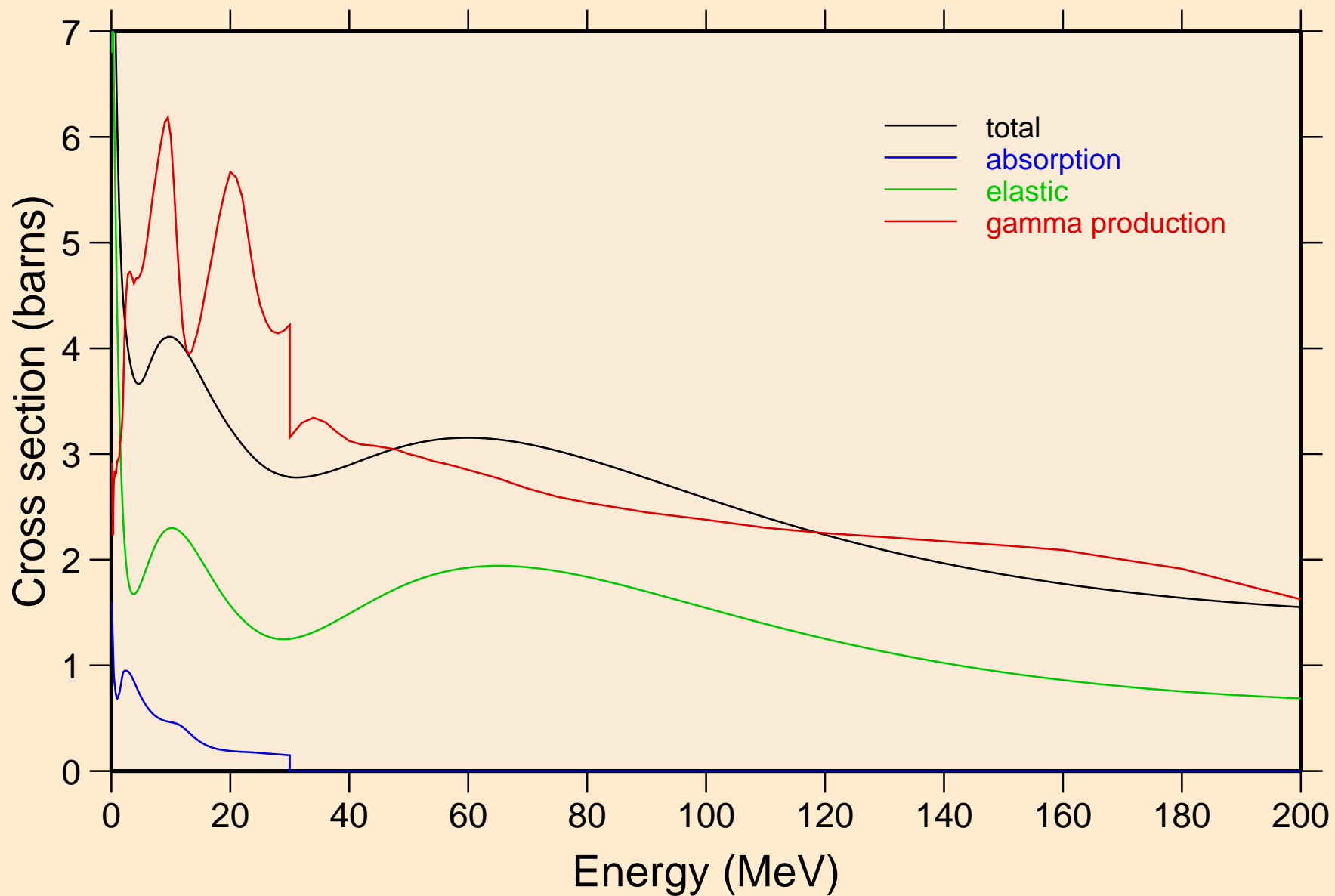

ZR087M NEUTRON ACER TENDL-2019 LIBRARY; T=293.16K
Heating

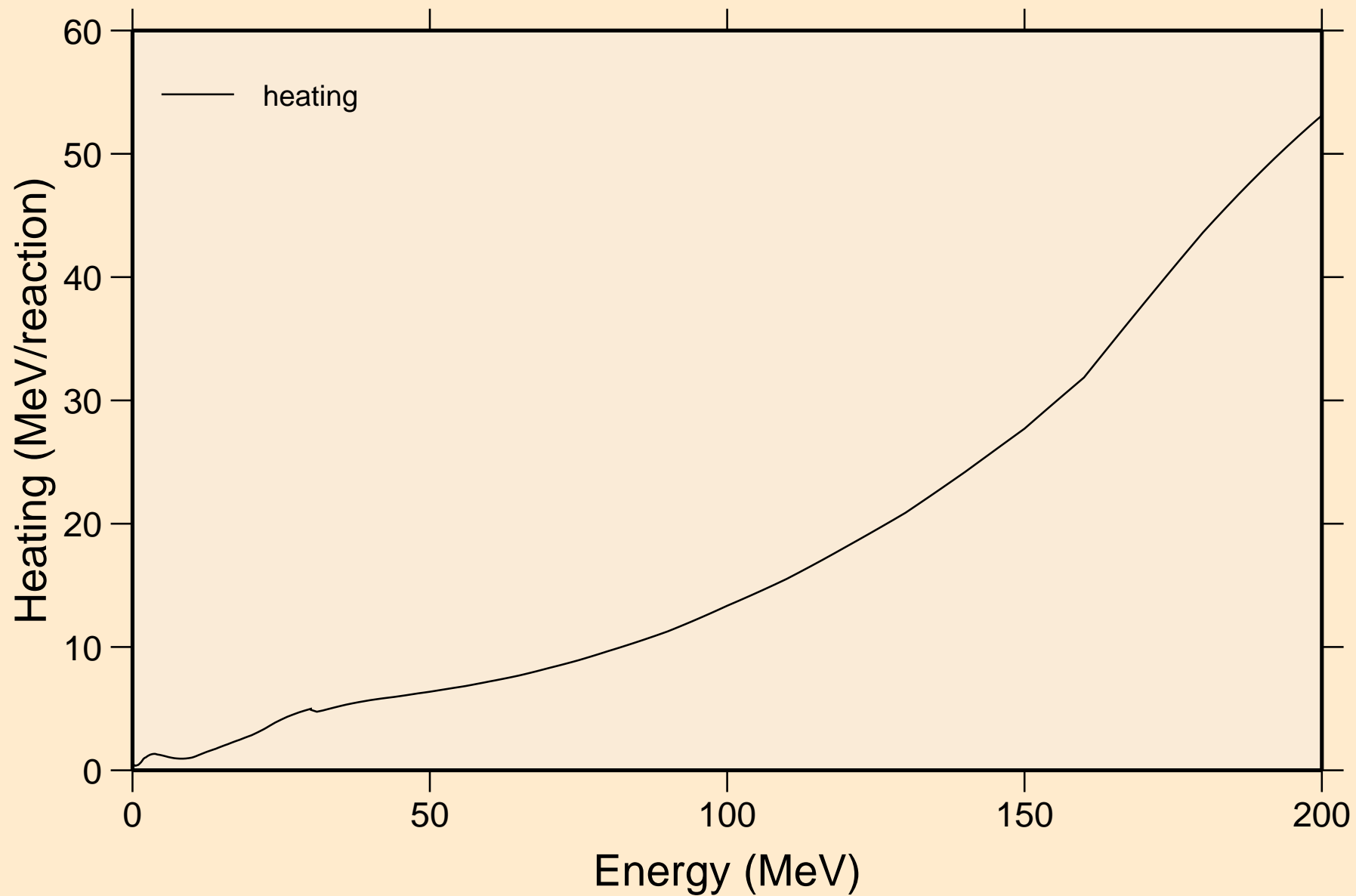

ZR087M NEUTRON ACER TENDL-2019 LIBRARY; T=293.16K
Damage

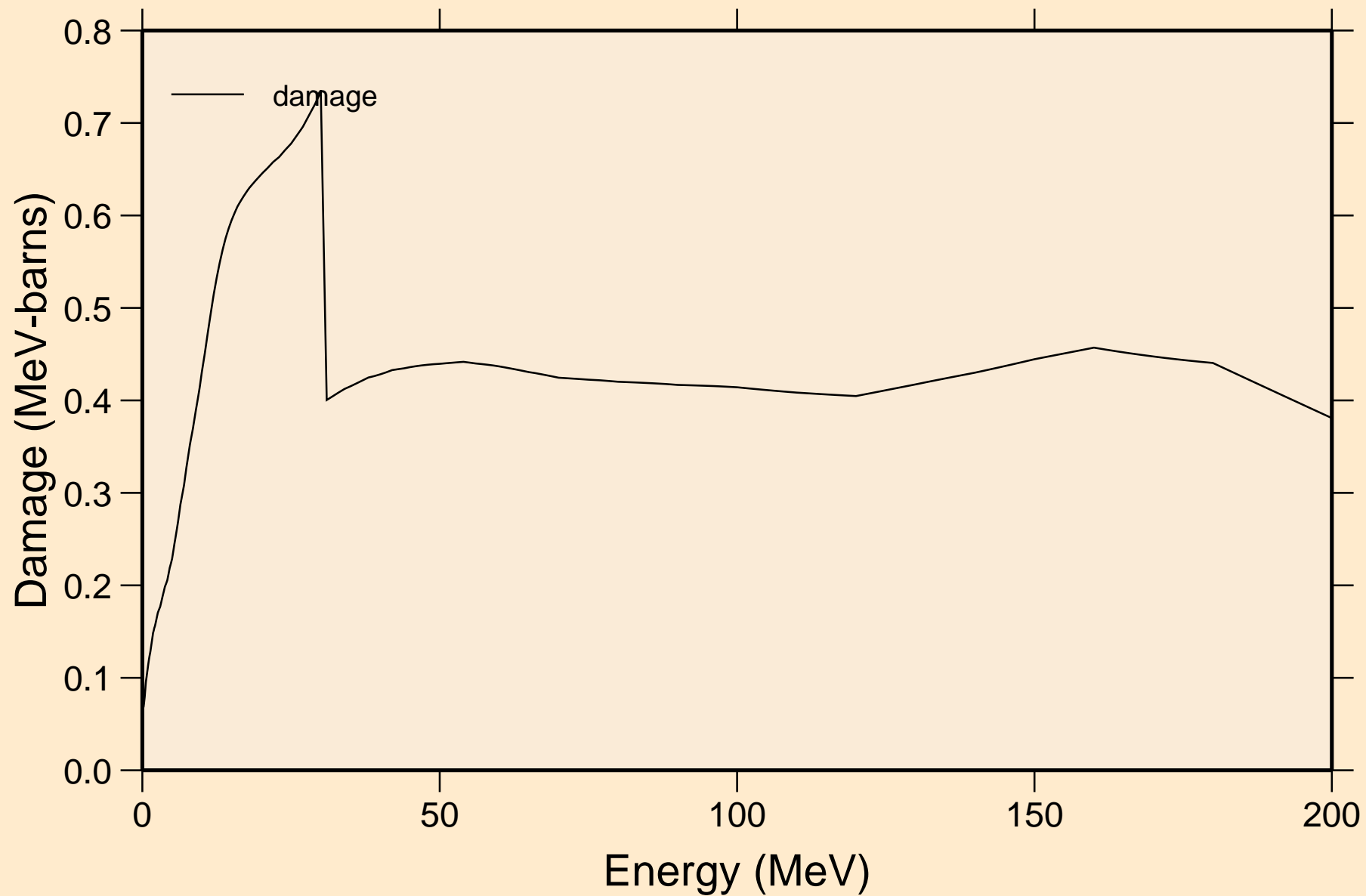

ZR087M NEUTRON ACER TENDL-2019 LIBRARY; T=293.16K
Non-threshold reactions

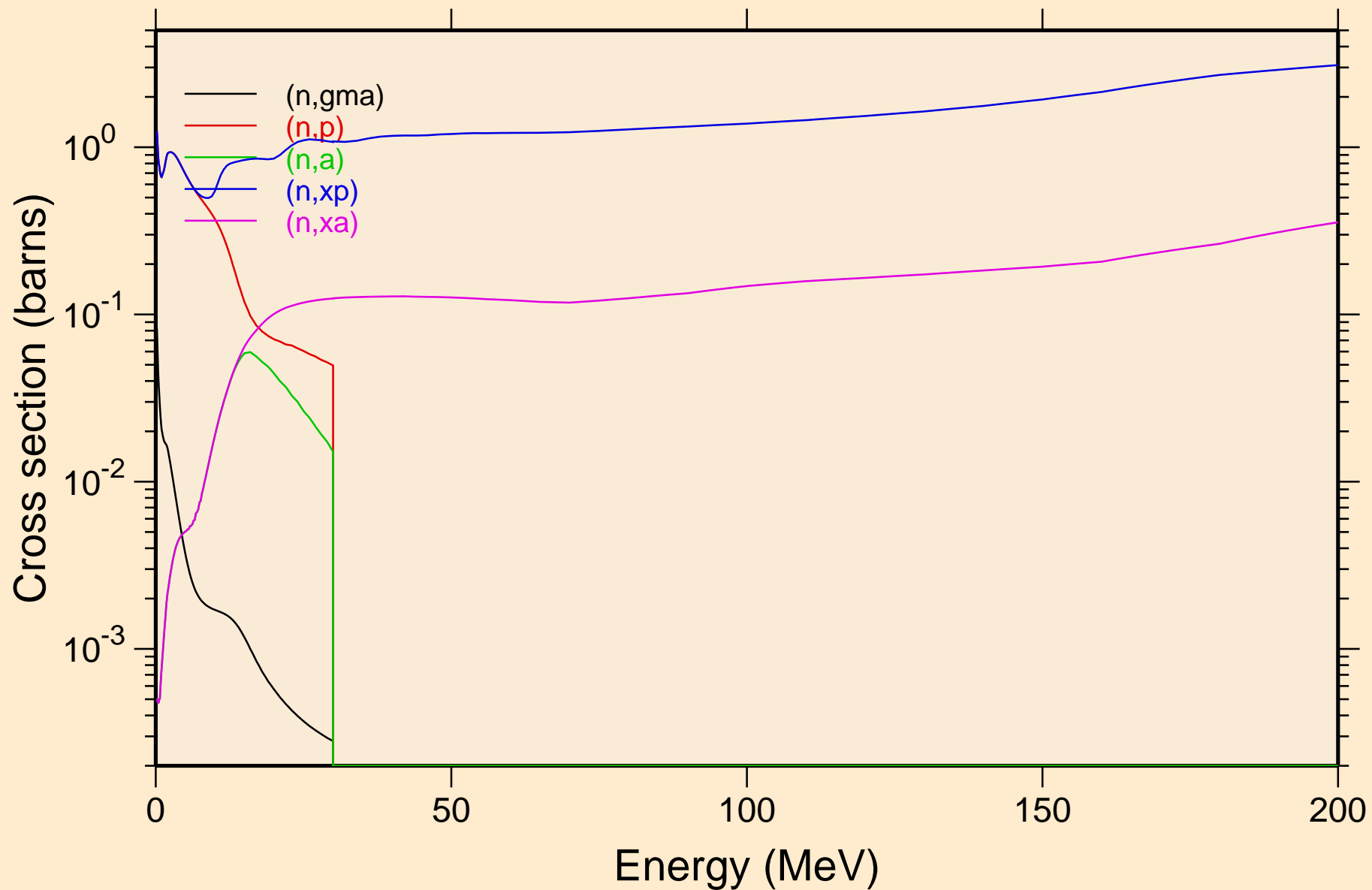

ZR087M NEUTRON ACER TENDL-2019 LIBRARY; T=293.16K
Inelastic levels

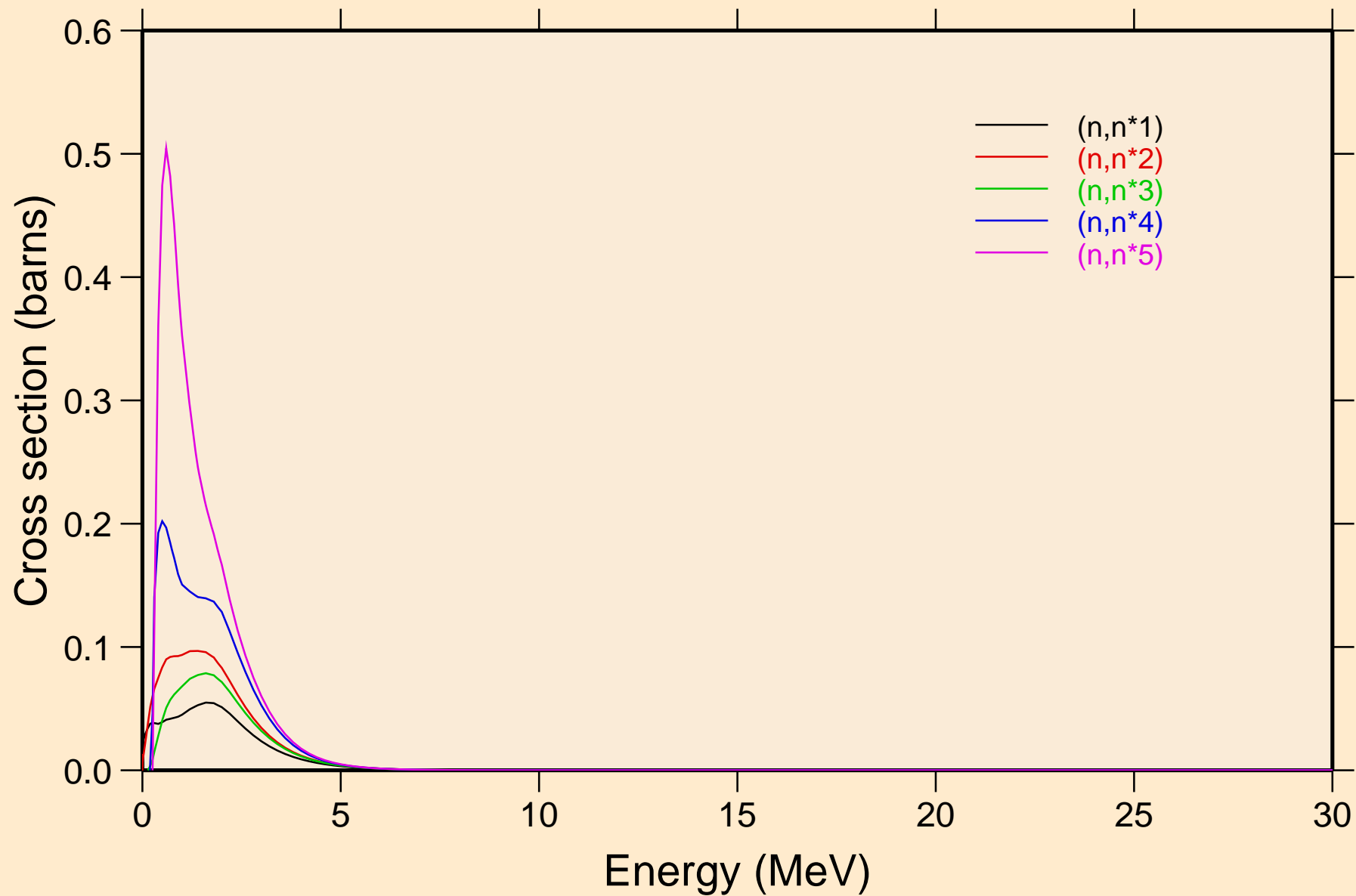

ZR087M NEUTRON ACER TENDL-2019 LIBRARY; T=293.16K
Inelastic levels

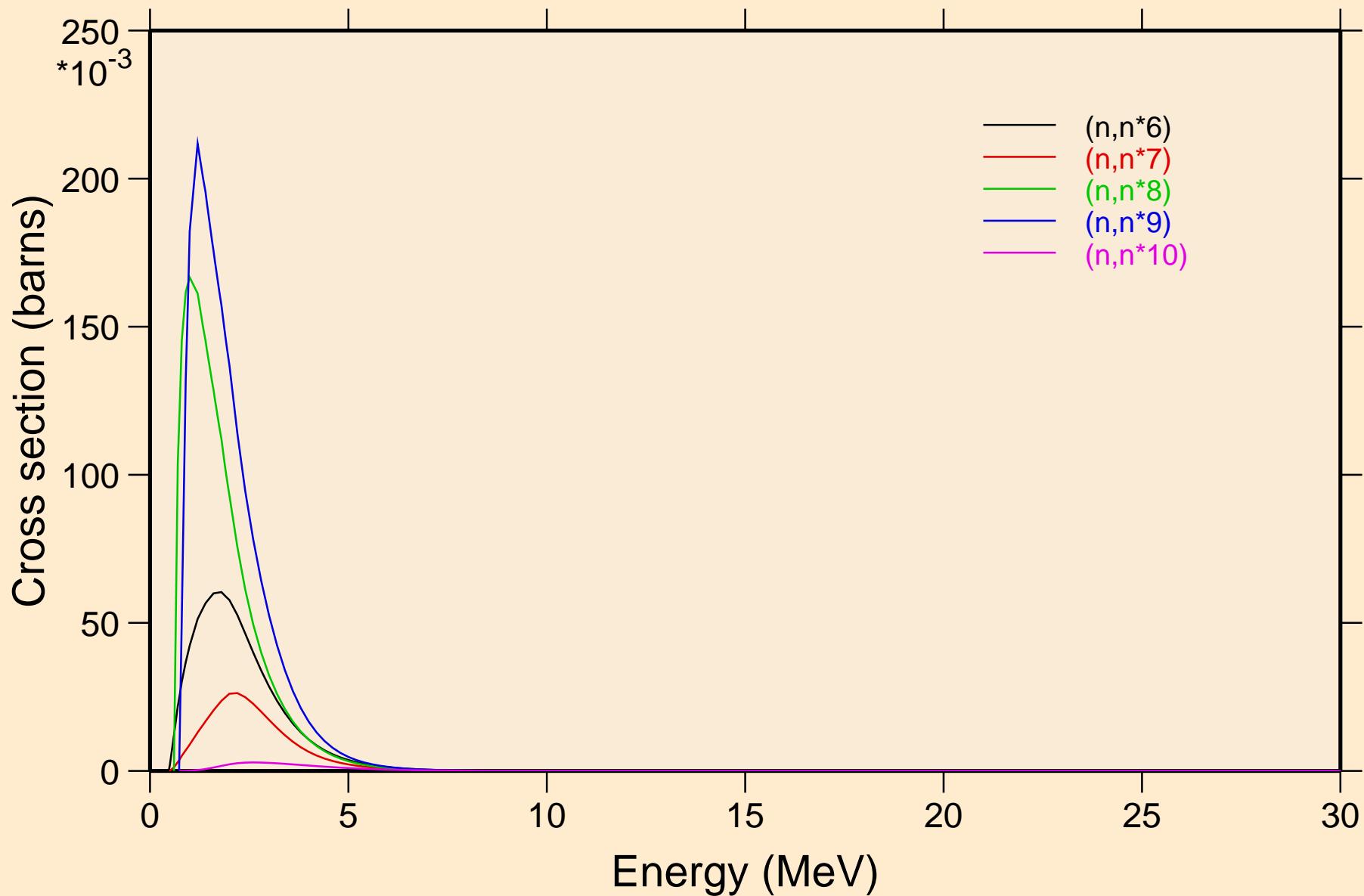

ZR087M NEUTRON ACER TENDL-2019 LIBRARY; T=293.16K
Inelastic levels

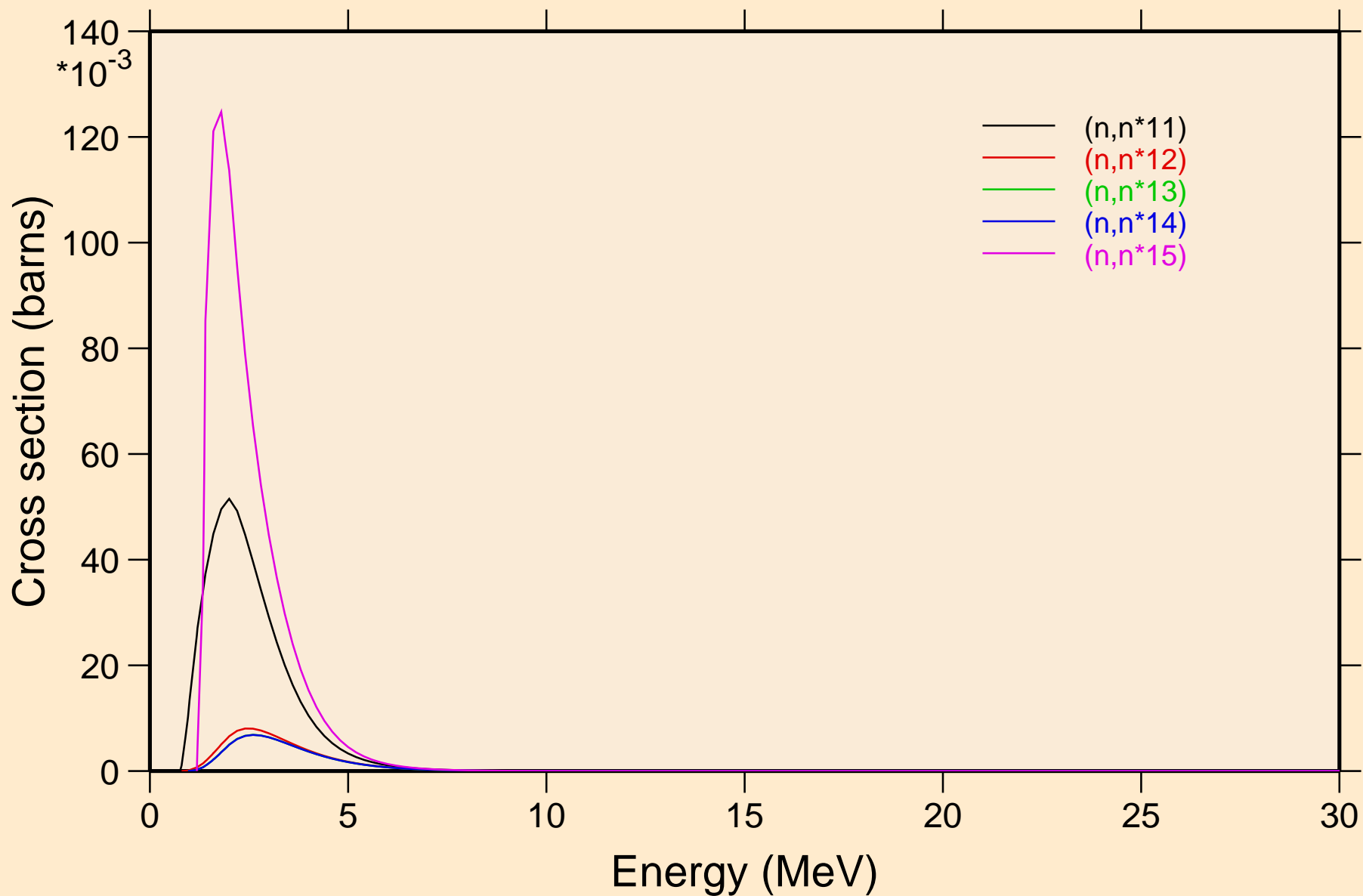

ZR087M NEUTRON ACER TENDL-2019 LIBRARY; T=293.16K
Inelastic levels

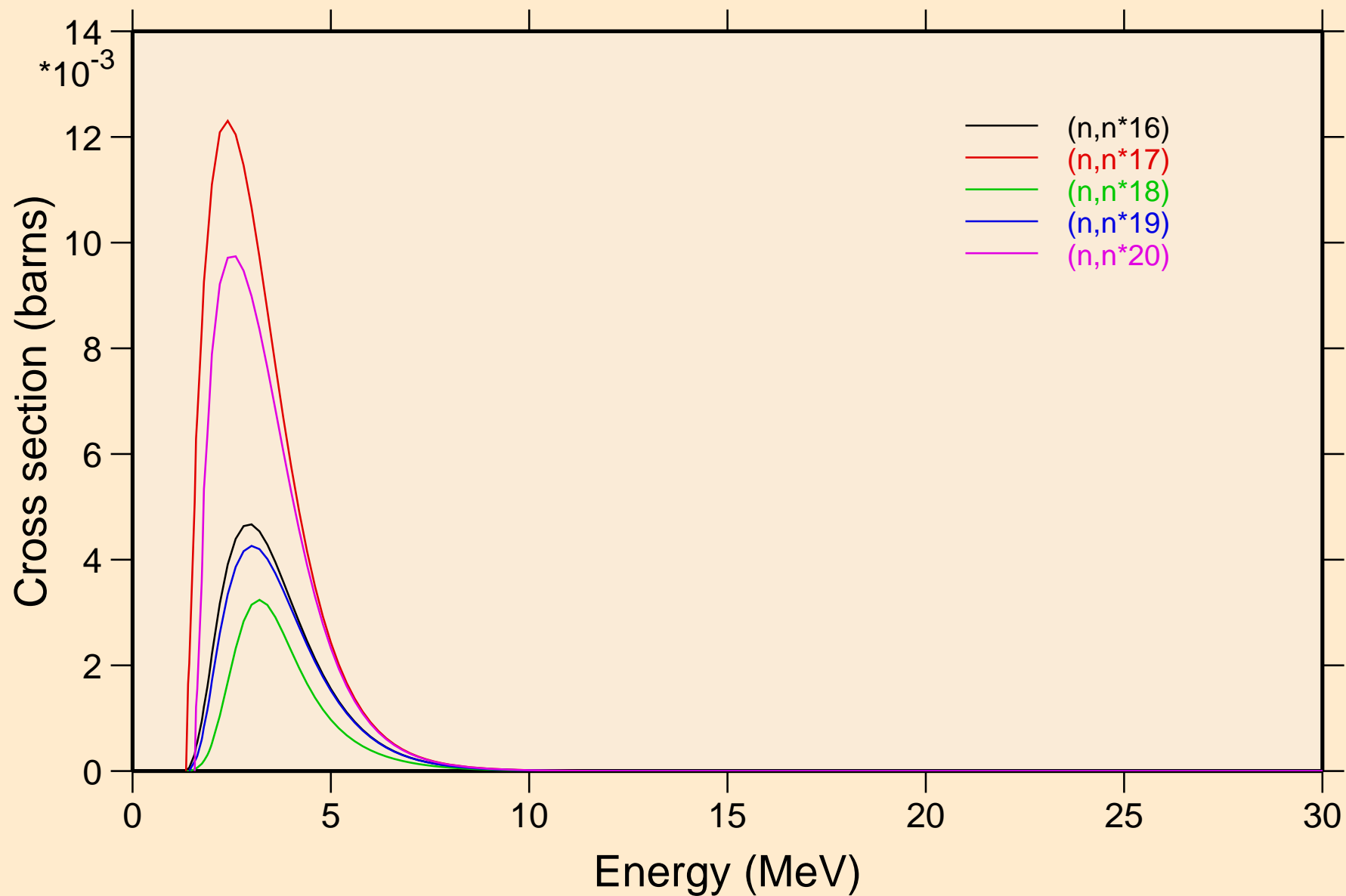

ZR087M NEUTRON ACER TENDL-2019 LIBRARY; T=293.16K
Inelastic levels

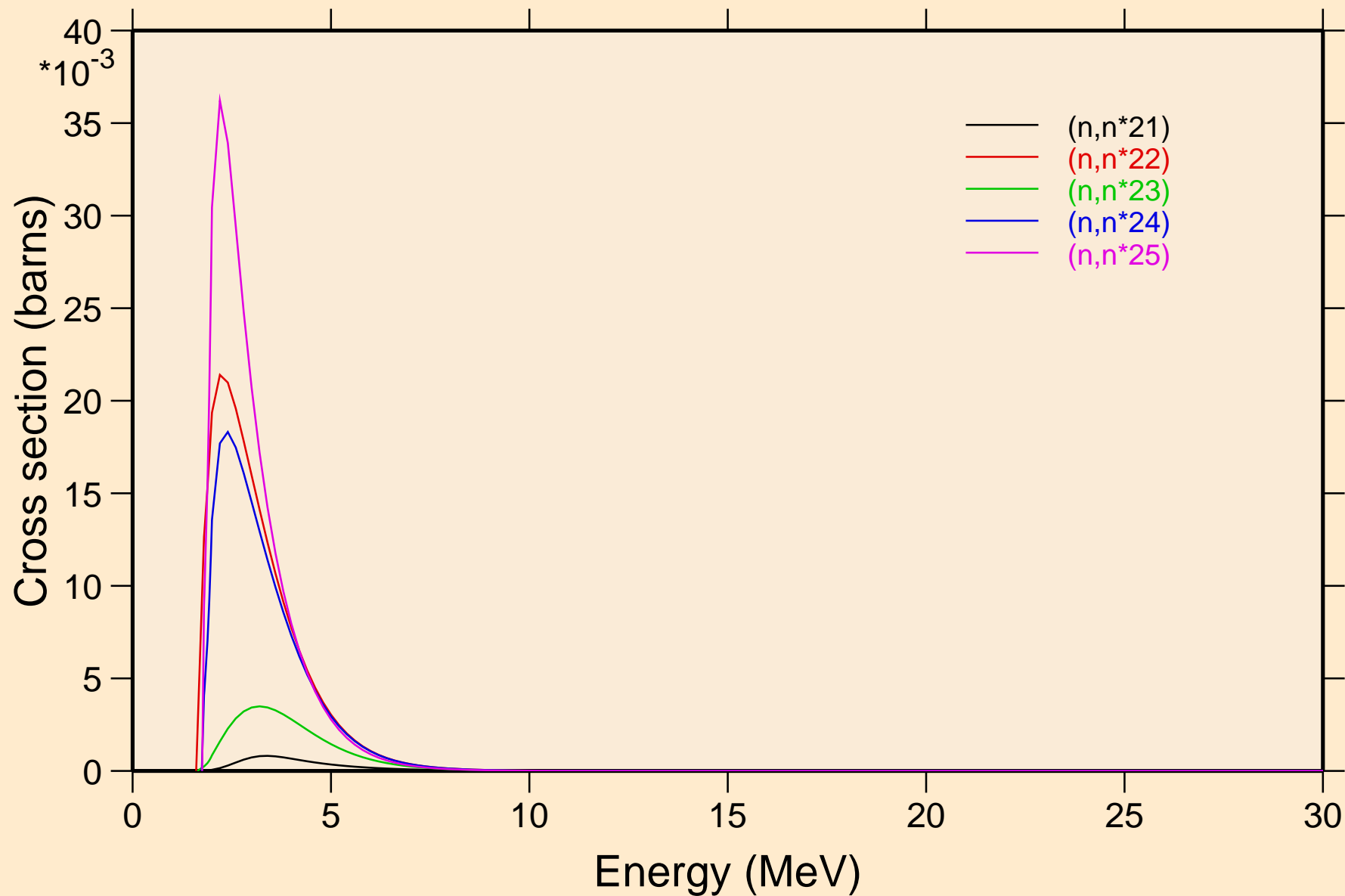

ZR087M NEUTRON ACER TENDL-2019 LIBRARY; T=293.16K
Inelastic levels

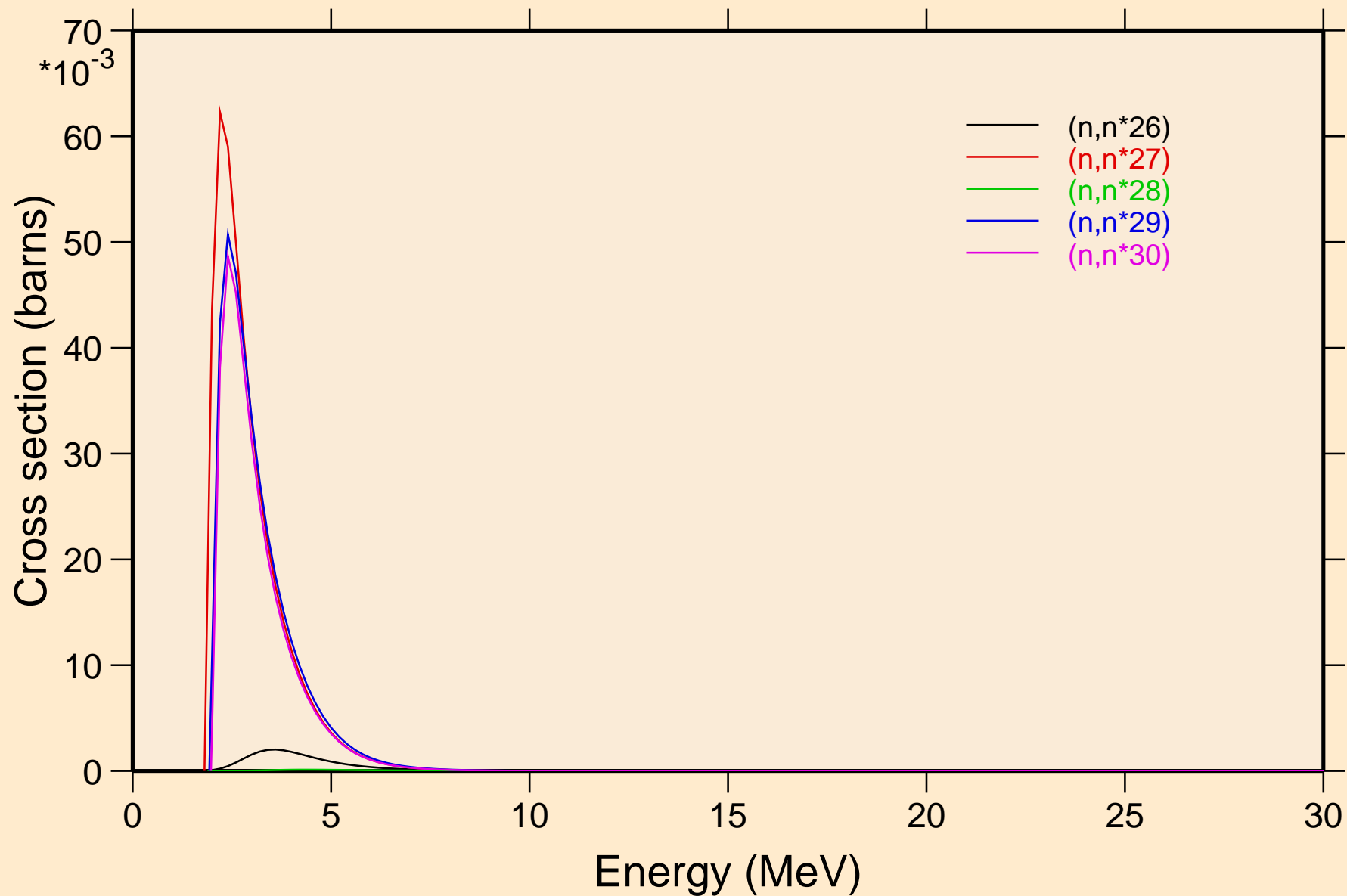

ZR087M NEUTRON ACER TENDL-2019 LIBRARY; T=293.16K
Threshold reactions

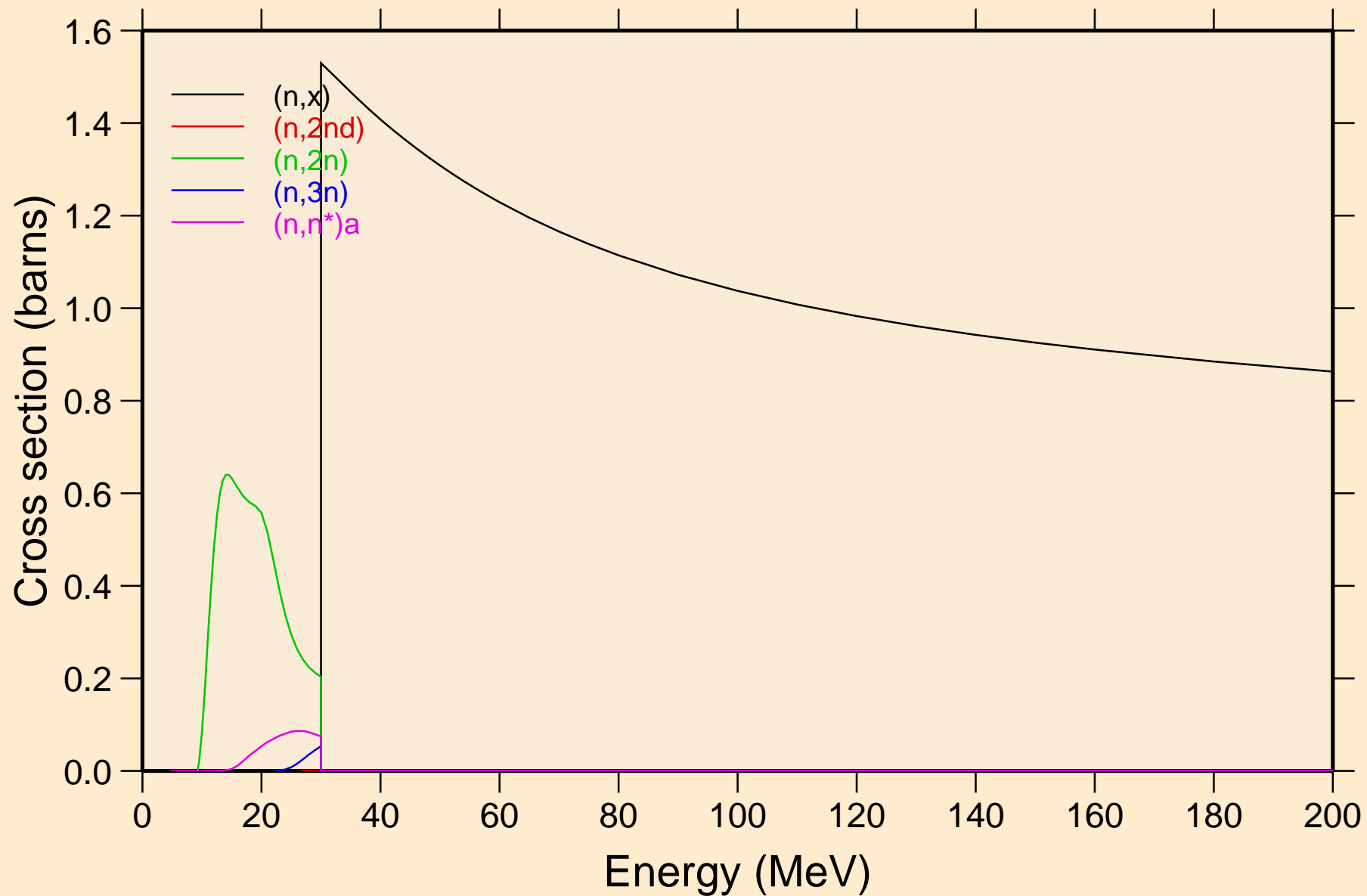

ZR087M NEUTRON ACER TENDL-2019 LIBRARY; T=293.16K
Threshold reactions

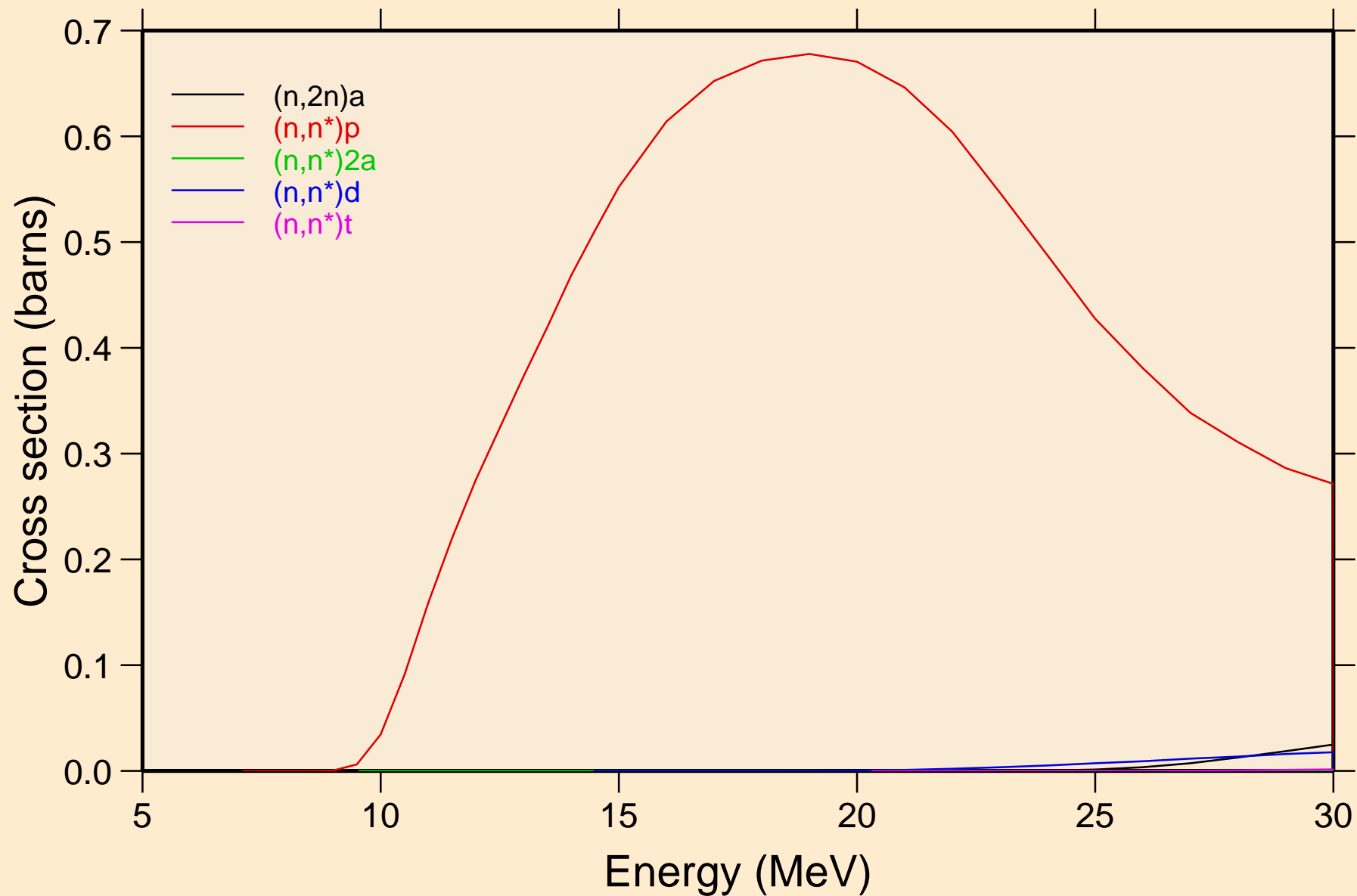

ZR087M NEUTRON ACER TENDL-2019 LIBRARY; T=293.16K
Threshold reactions

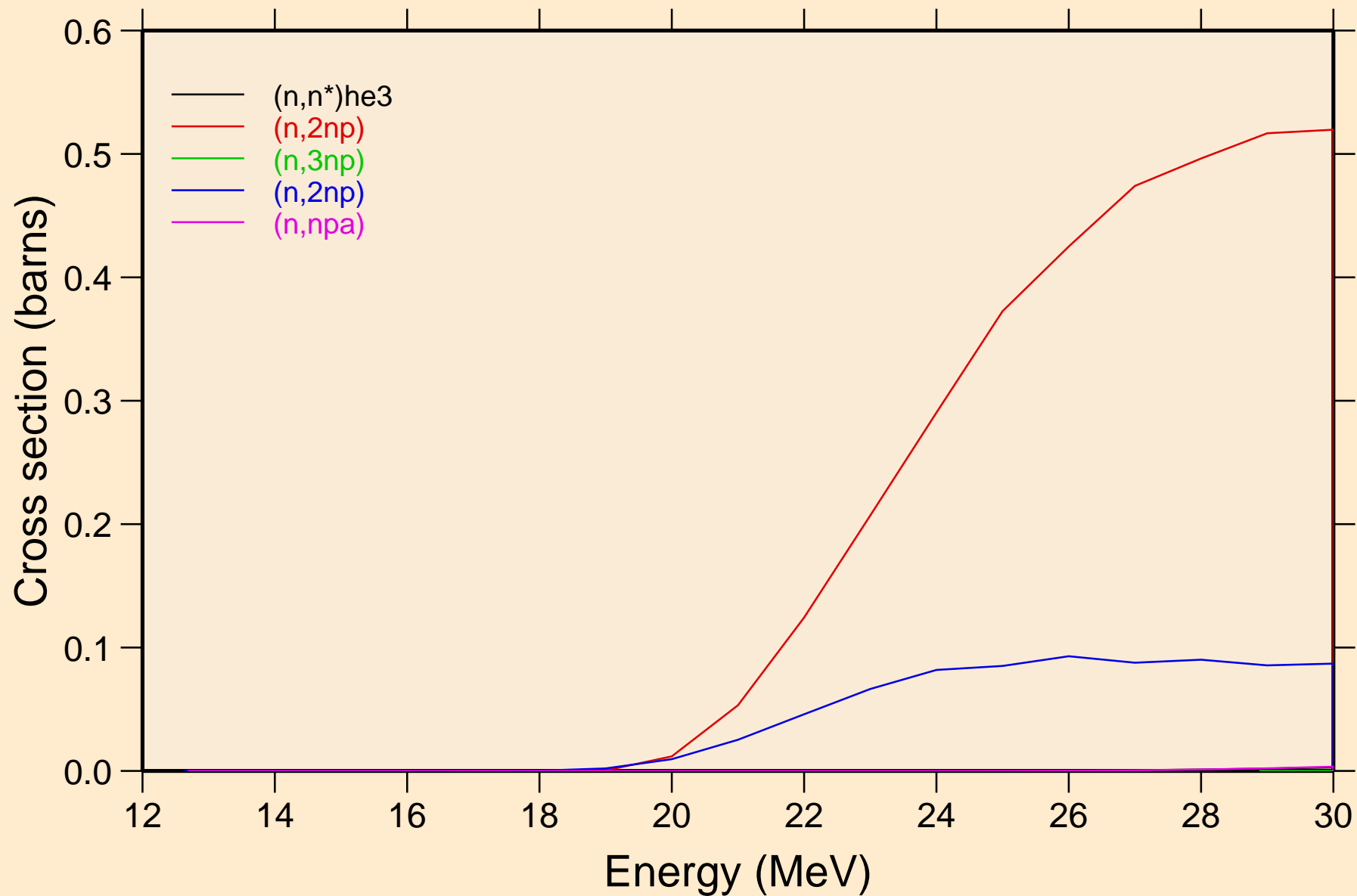

ZR087M NEUTRON ACER TENDL-2019 LIBRARY; T=293.16K
Threshold reactions

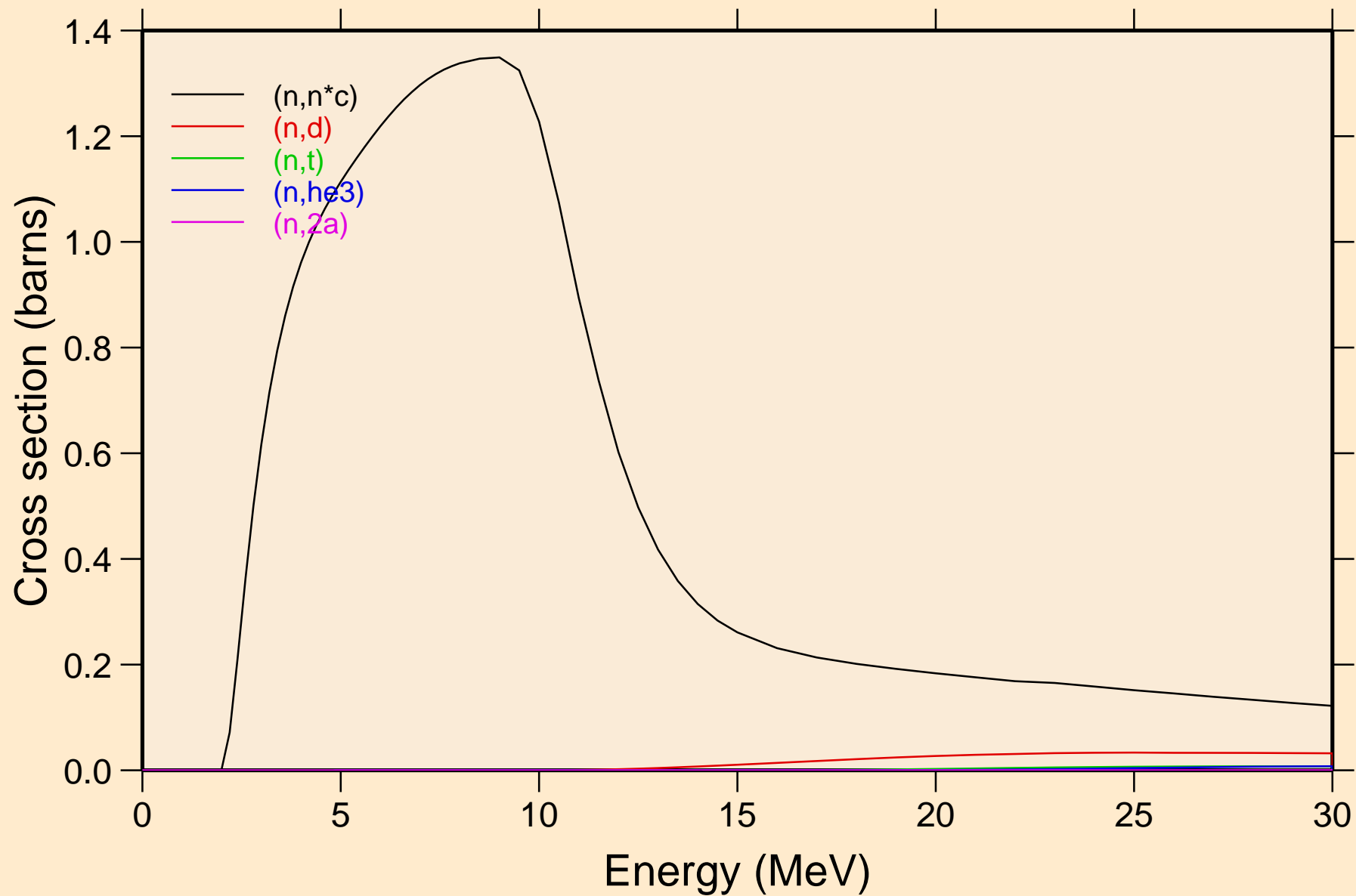

ZR087M NEUTRON ACER TENDL-2019 LIBRARY; T=293.16K
Threshold reactions

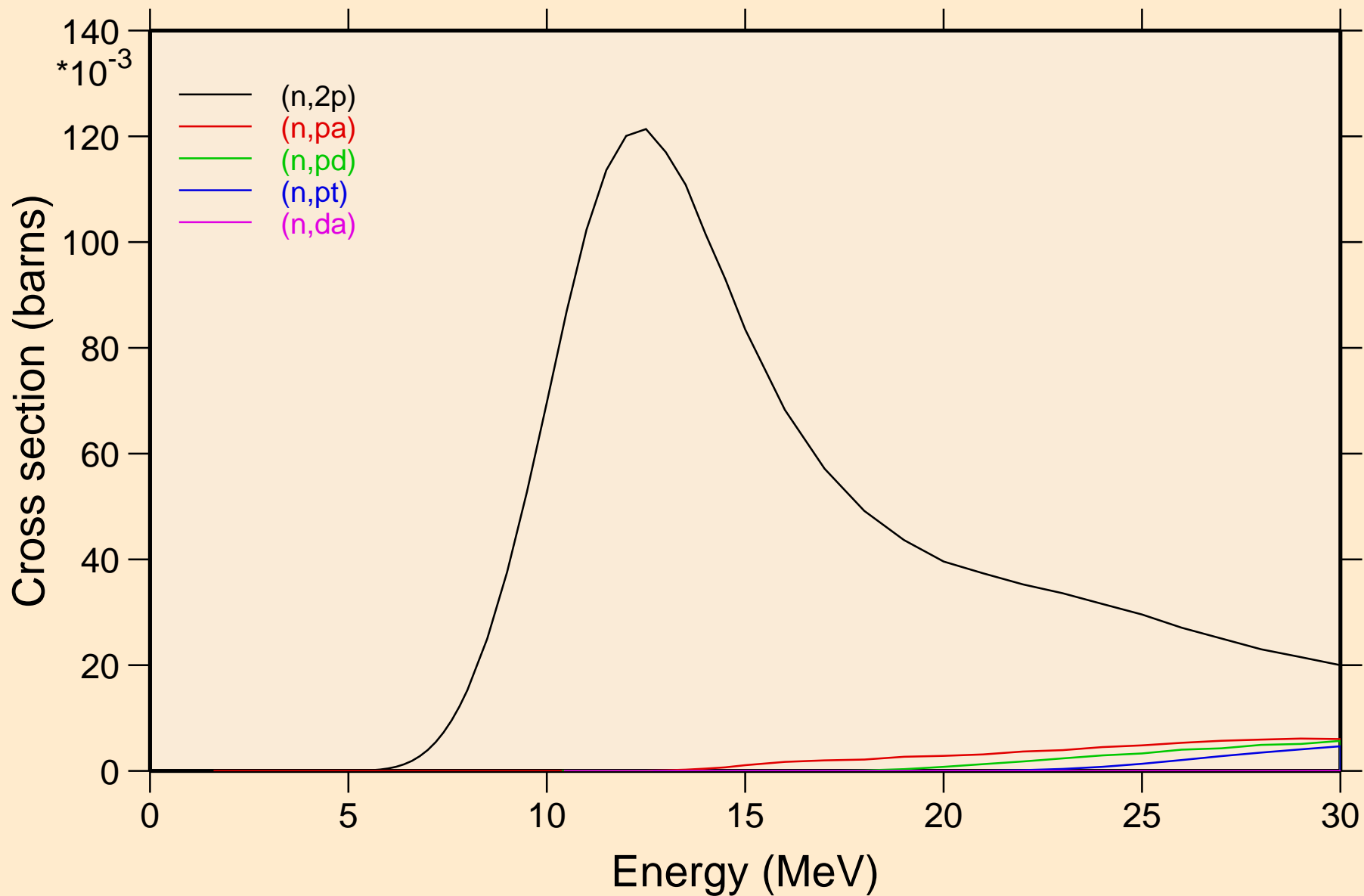

ZR087M NEUTRON ACER TENDL-2019 LIBRARY; T=293.16K
Threshold reactions

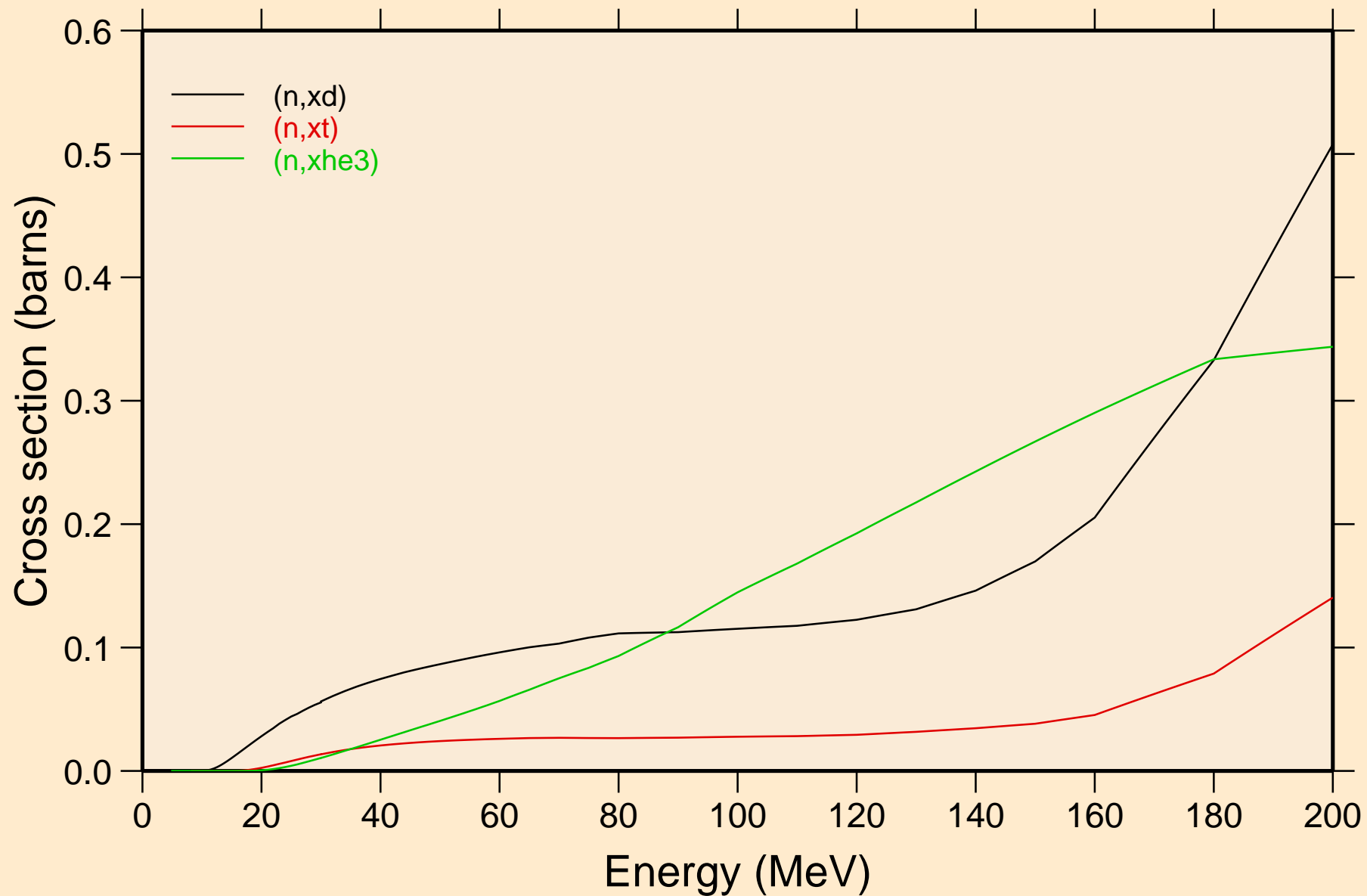

ZR087M NEUTRON ACER TENDL-2019 LIBRARY; T=293.16K
angular distribution for elastic

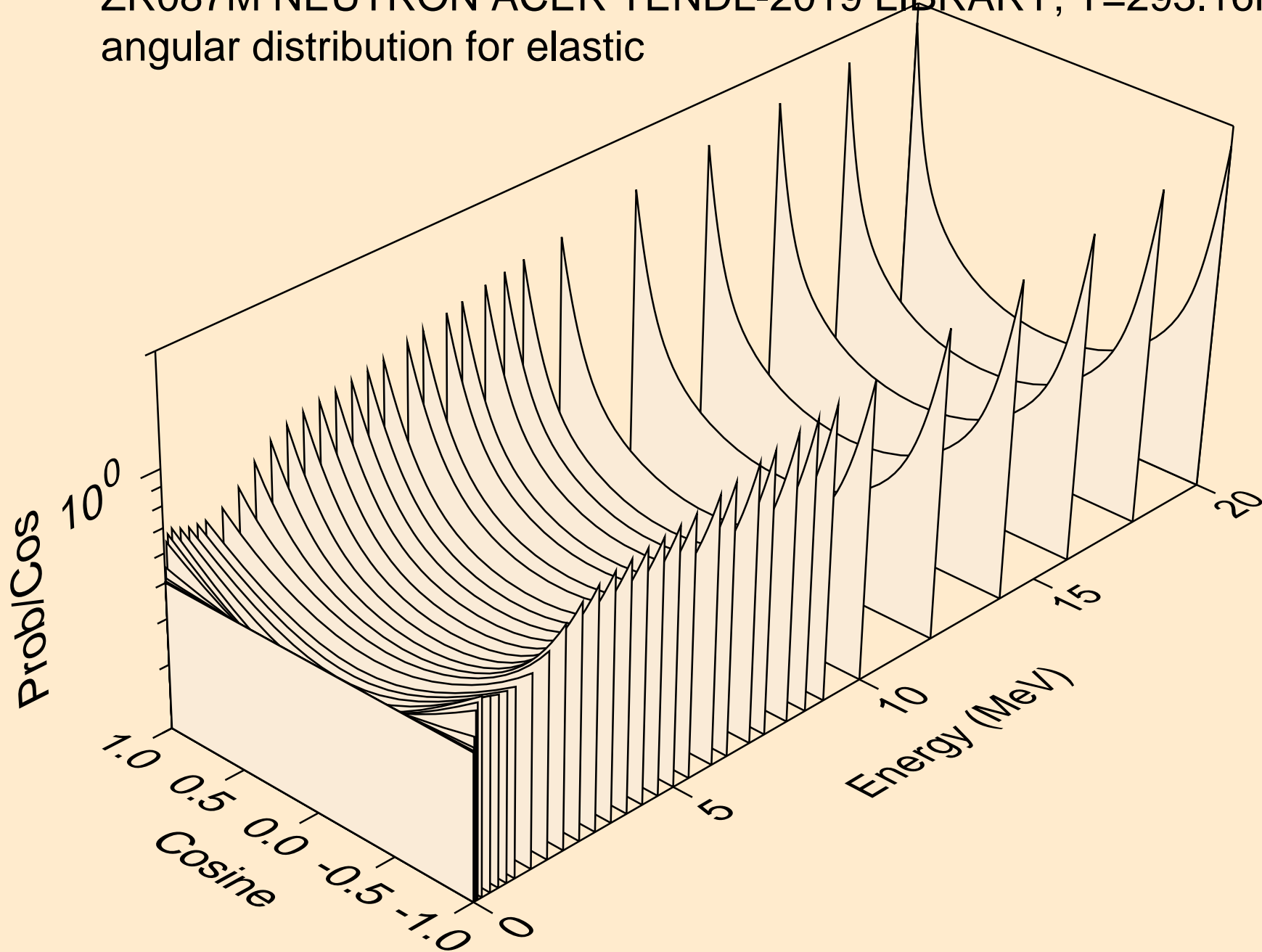

ZR087M NEUTRON ACER TENDL-2019 LIBRARY; T=293.16K
angular distribution for elastic

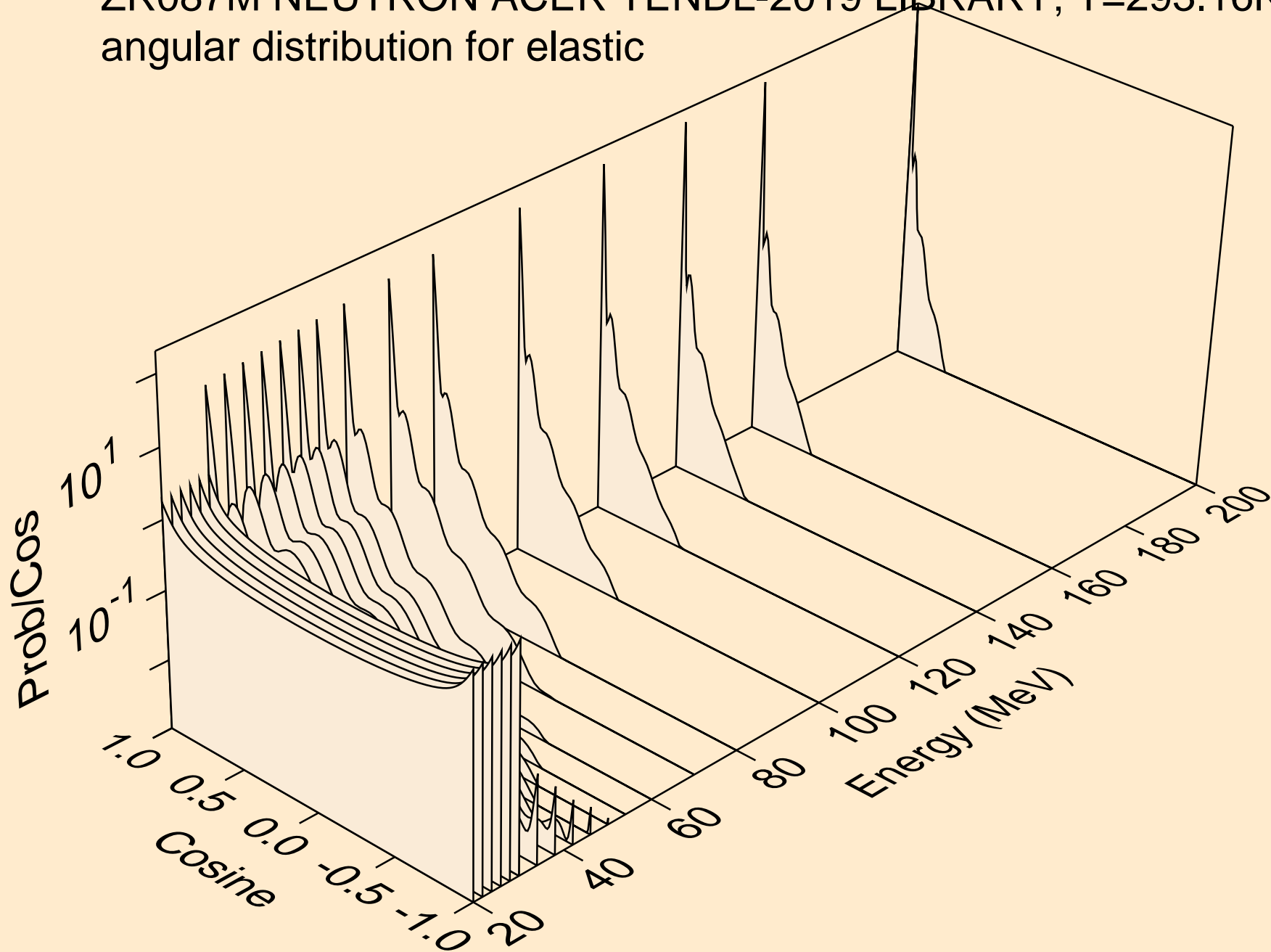

ZR087M NEUTRON ACER TENDL-2019 LIBRARY; T=293.16K
angular distribution for (n,n*1)

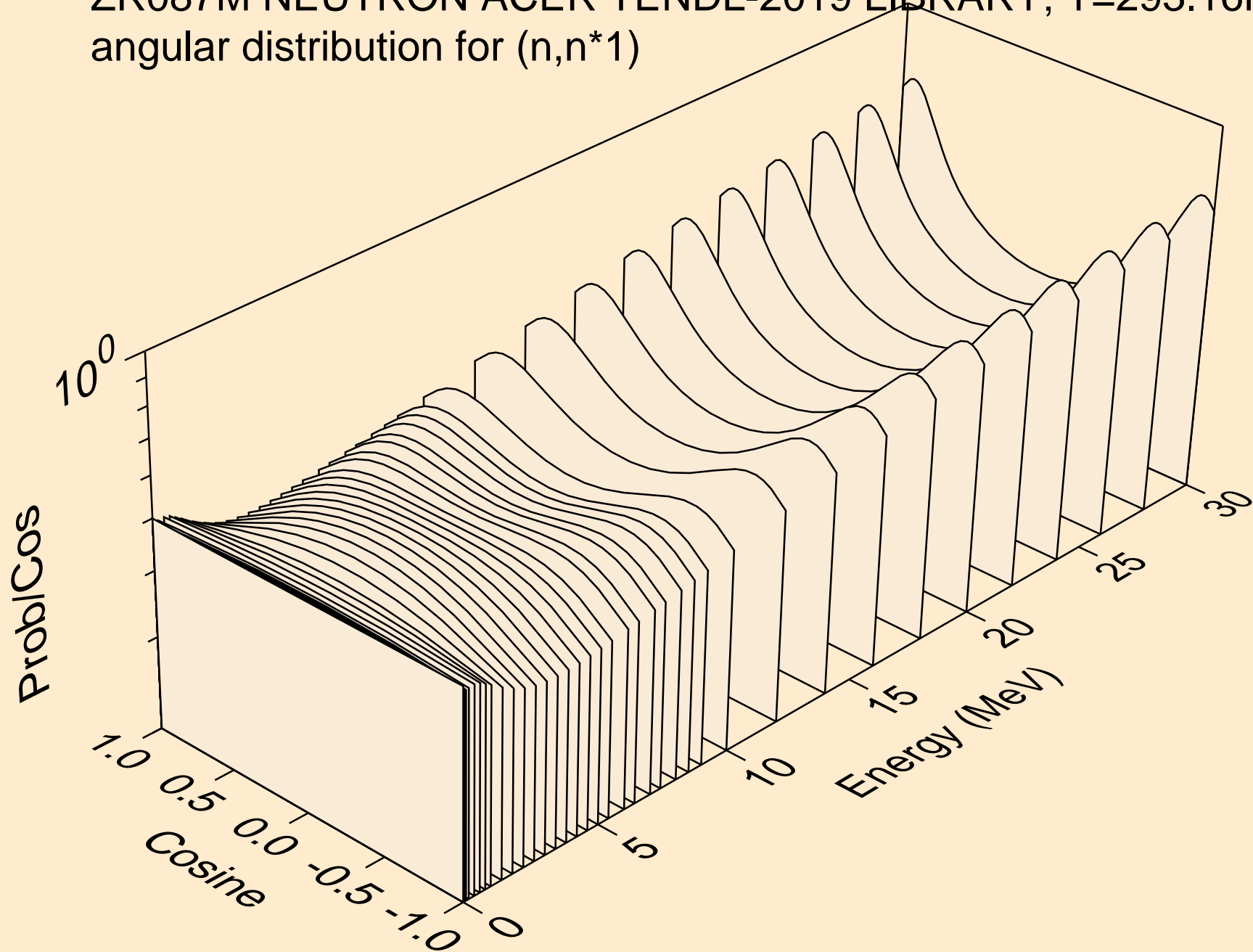

ZR087M NEUTRON ACER TENDL-2019 LIBRARY; T=293.16K
angular distribution for (n,n*2)

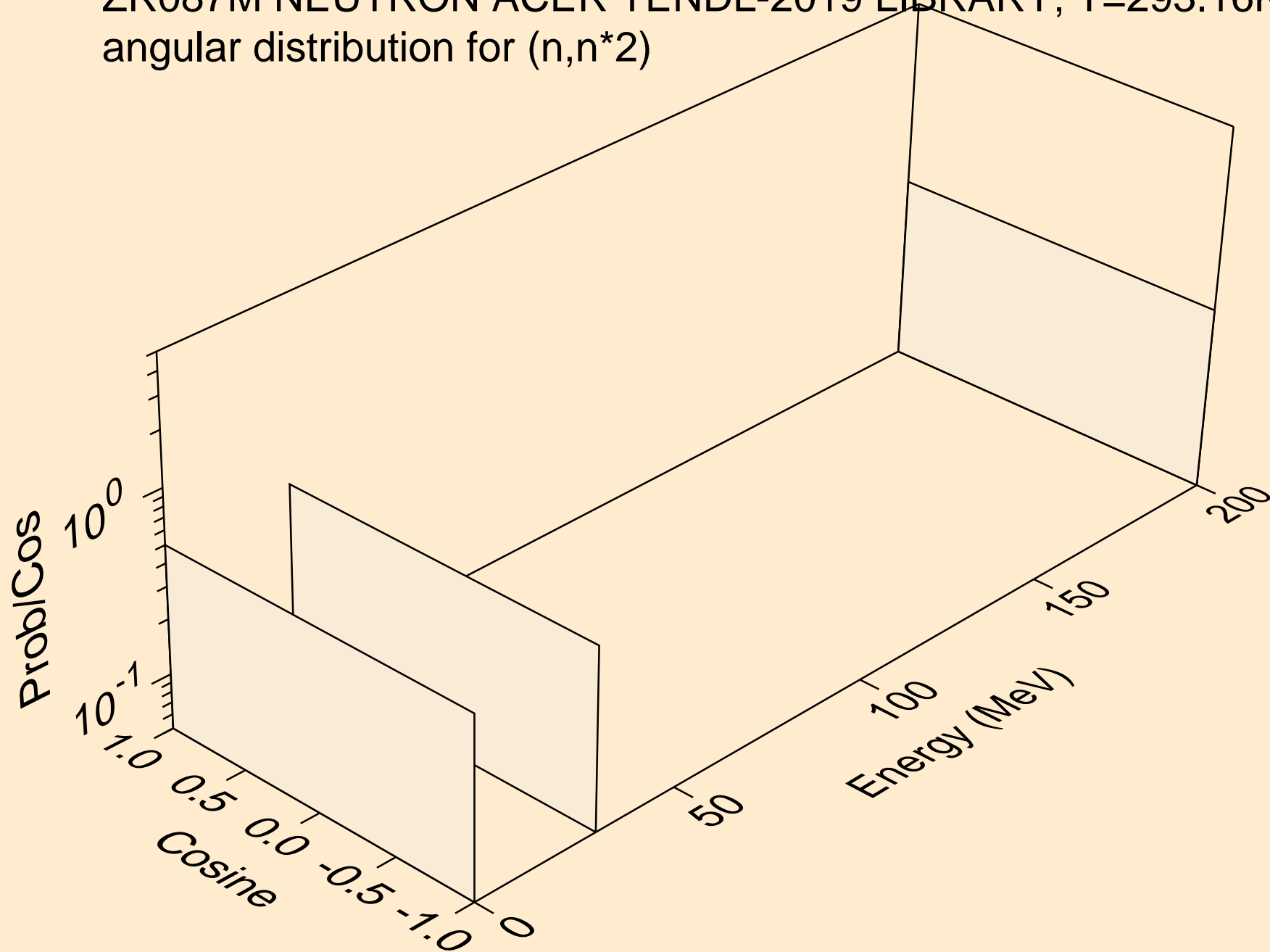

ZR087M NEUTRON ACER TENDL-2019 LIBRARY; T=293.16K
angular distribution for (n,n*3)

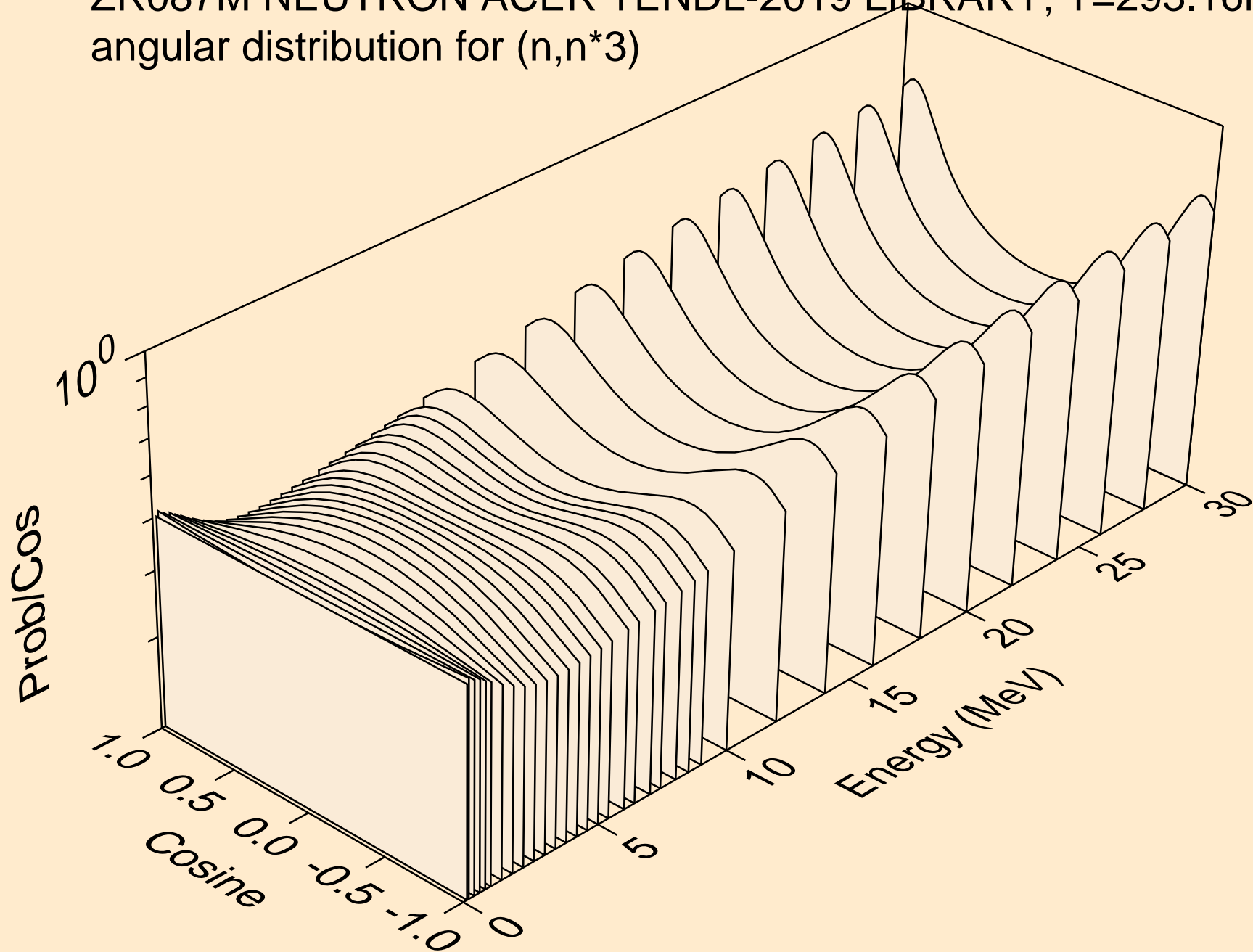

ZR087M NEUTRON ACER TENDL-2019 LIBRARY; T=293.16K
angular distribution for (n,n*4)

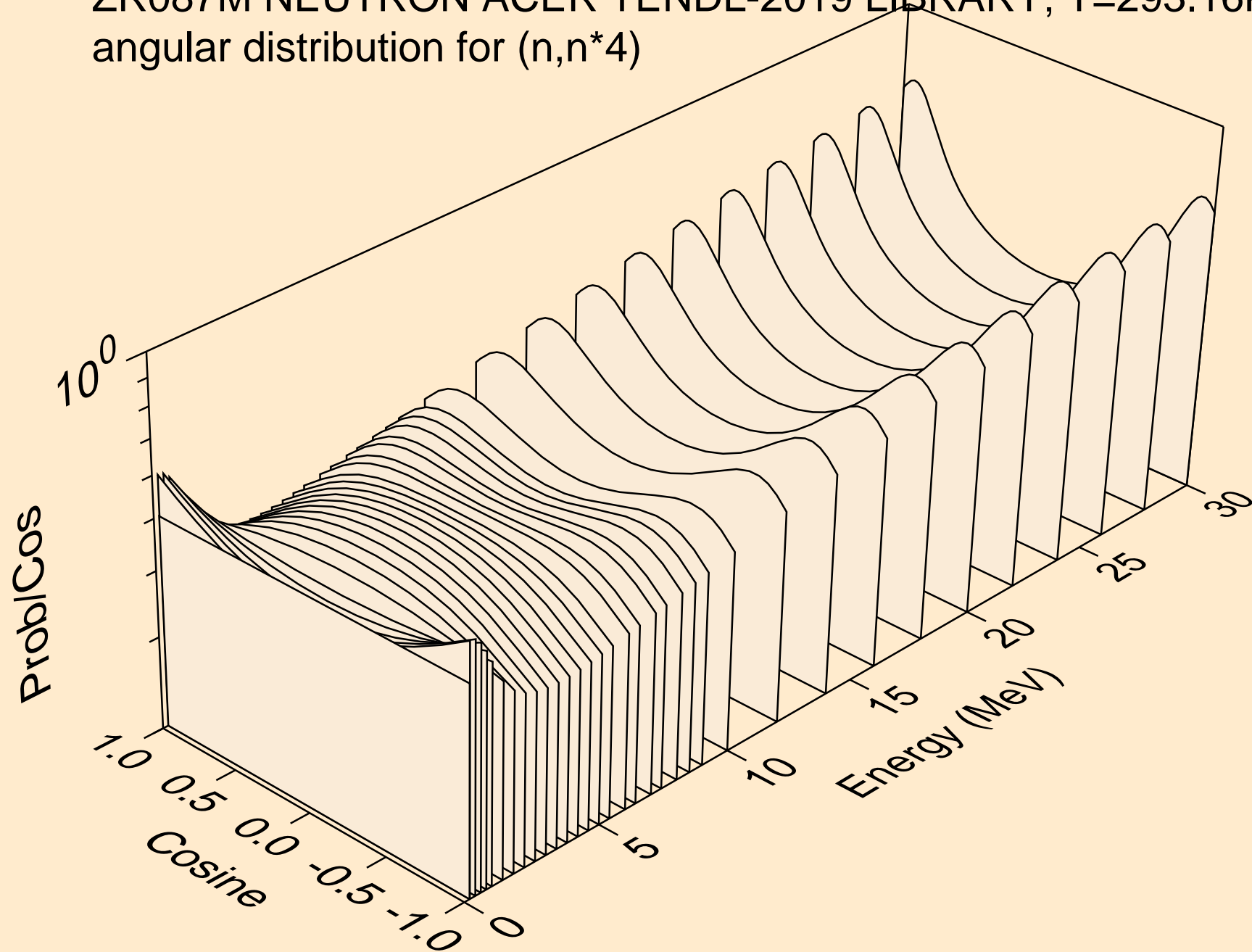

ZR087M NEUTRON ACER TENDL-2019 LIBRARY; T=293.16K
angular distribution for (n,n*5)

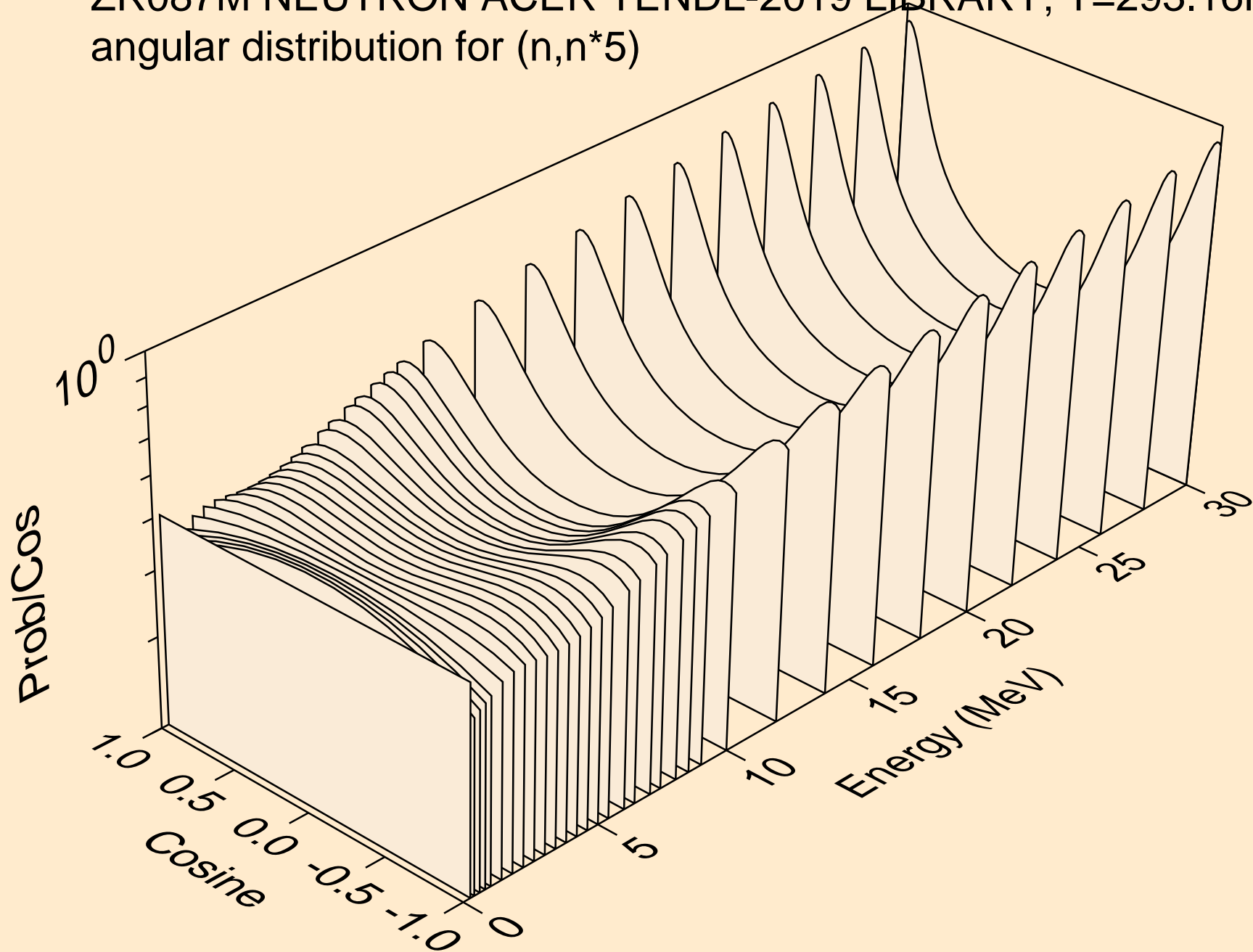

ZR087M NEUTRON ACER TENDL-2019 LIBRARY; T=293.16K
angular distribution for (n,n*6)

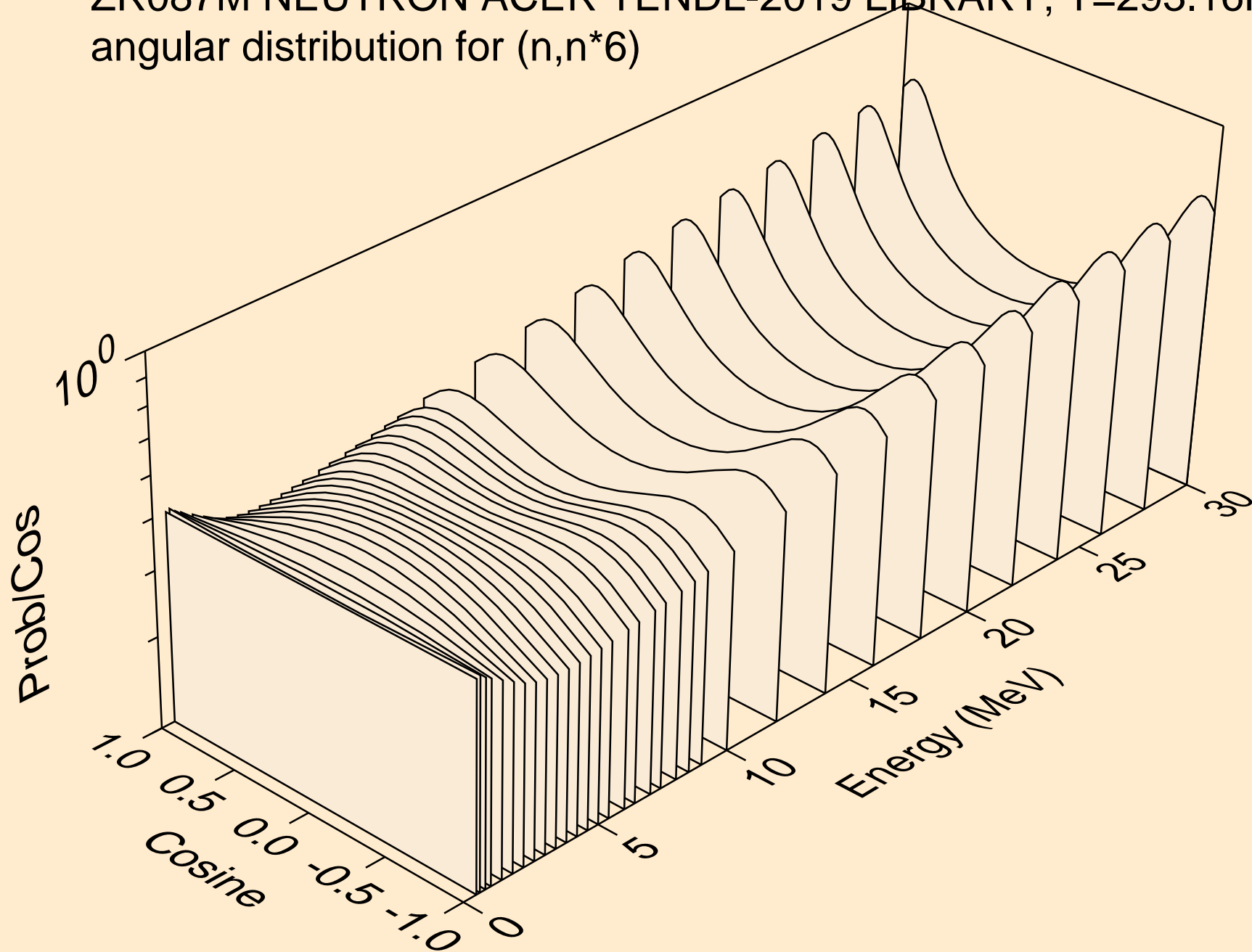

ZR087M NEUTRON ACER TENDL-2019 LIBRARY; T=293.16K
angular distribution for (n,n*7)

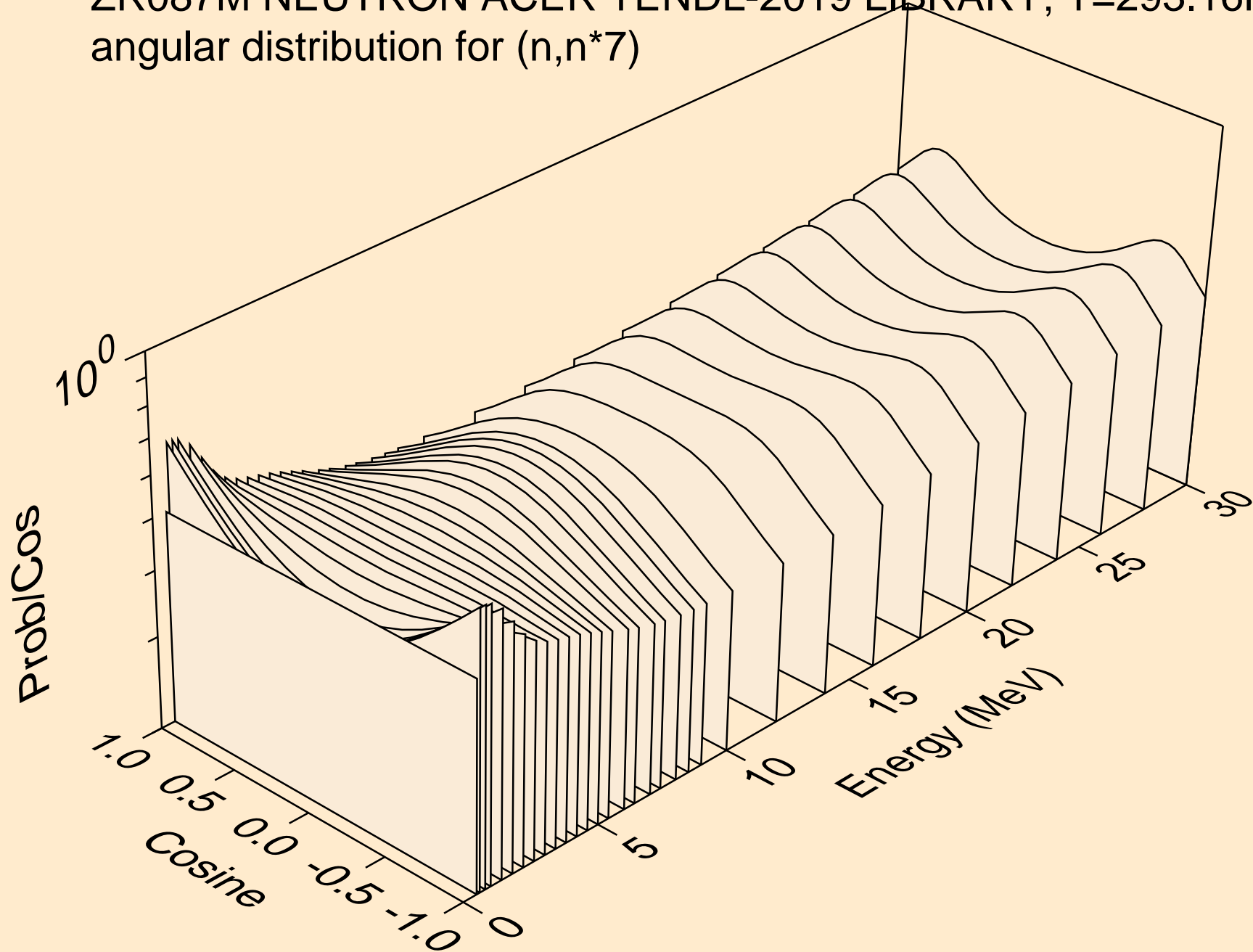

ZR087M NEUTRON ACER TENDL-2019 LIBRARY; T=293.16K
angular distribution for (n,n*8)

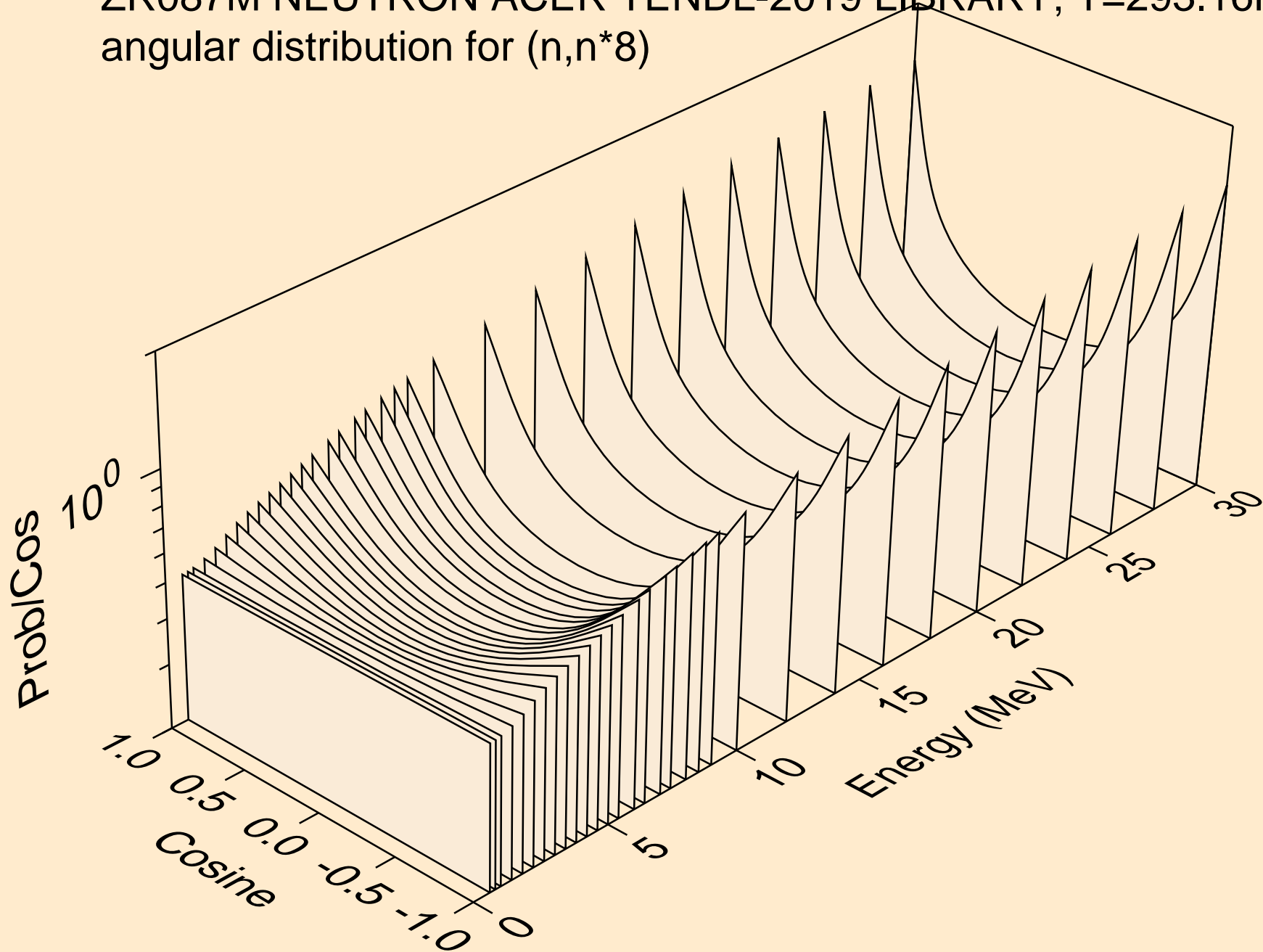

ZR087M NEUTRON ACER TENDL-2019 LIBRARY; T=293.16K
angular distribution for (n,n*9)

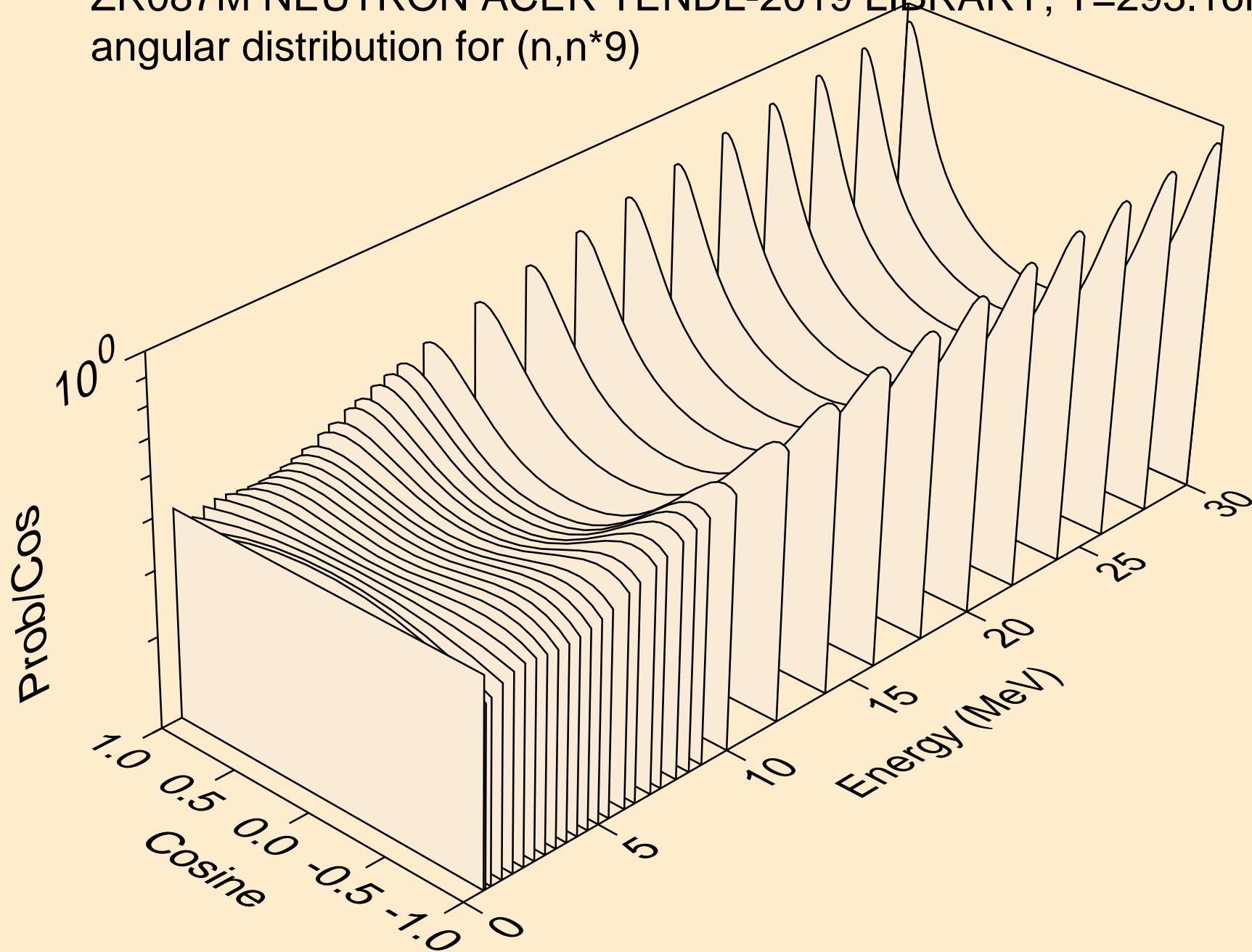

ZR087M NEUTRON ACER TENDL-2019 LIBRARY; T=293.16K
angular distribution for (n,n*10)

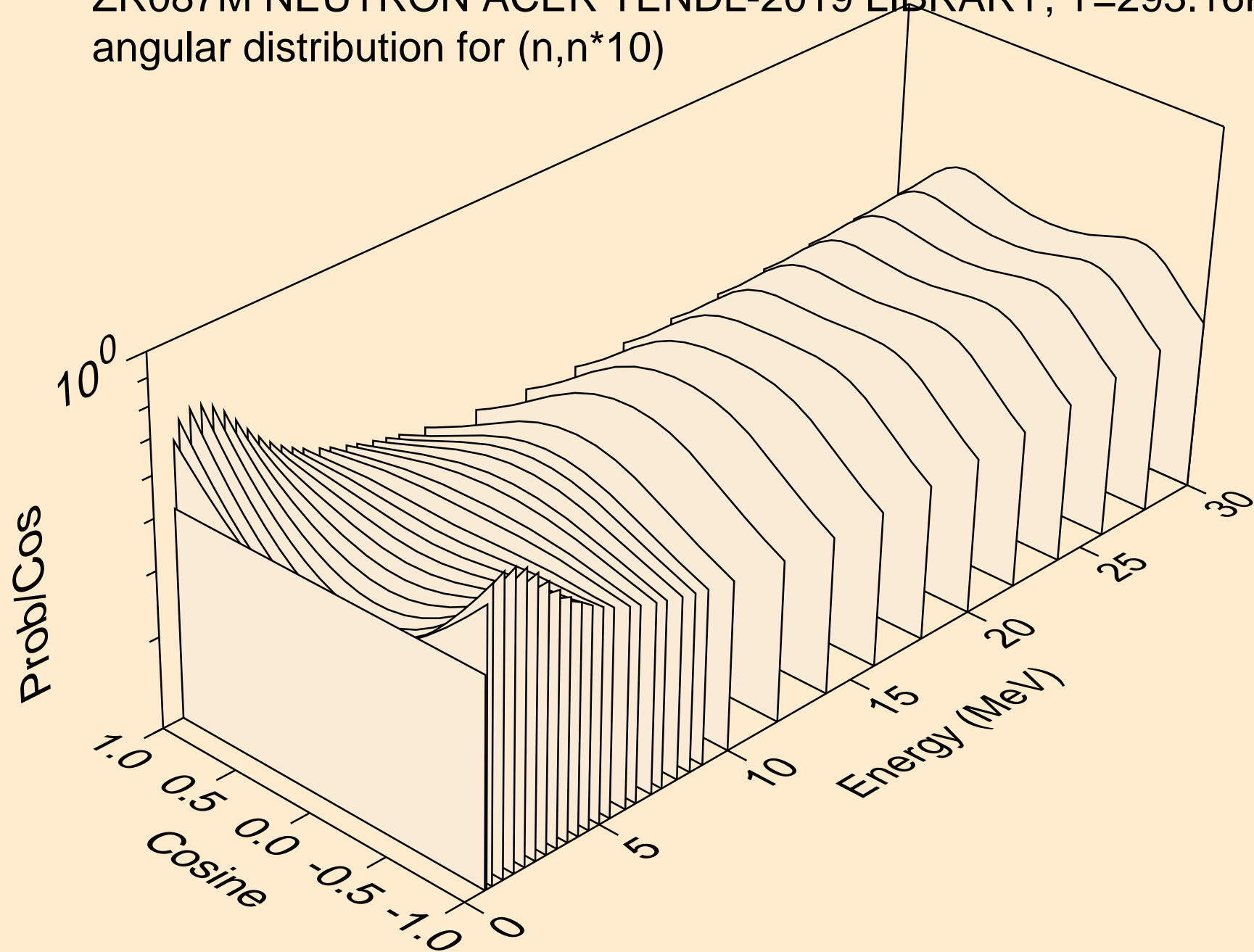

ZR087M NEUTRON ACER TENDL-2019 LIBRARY; T=293.16K
angular distribution for (n,n*11)

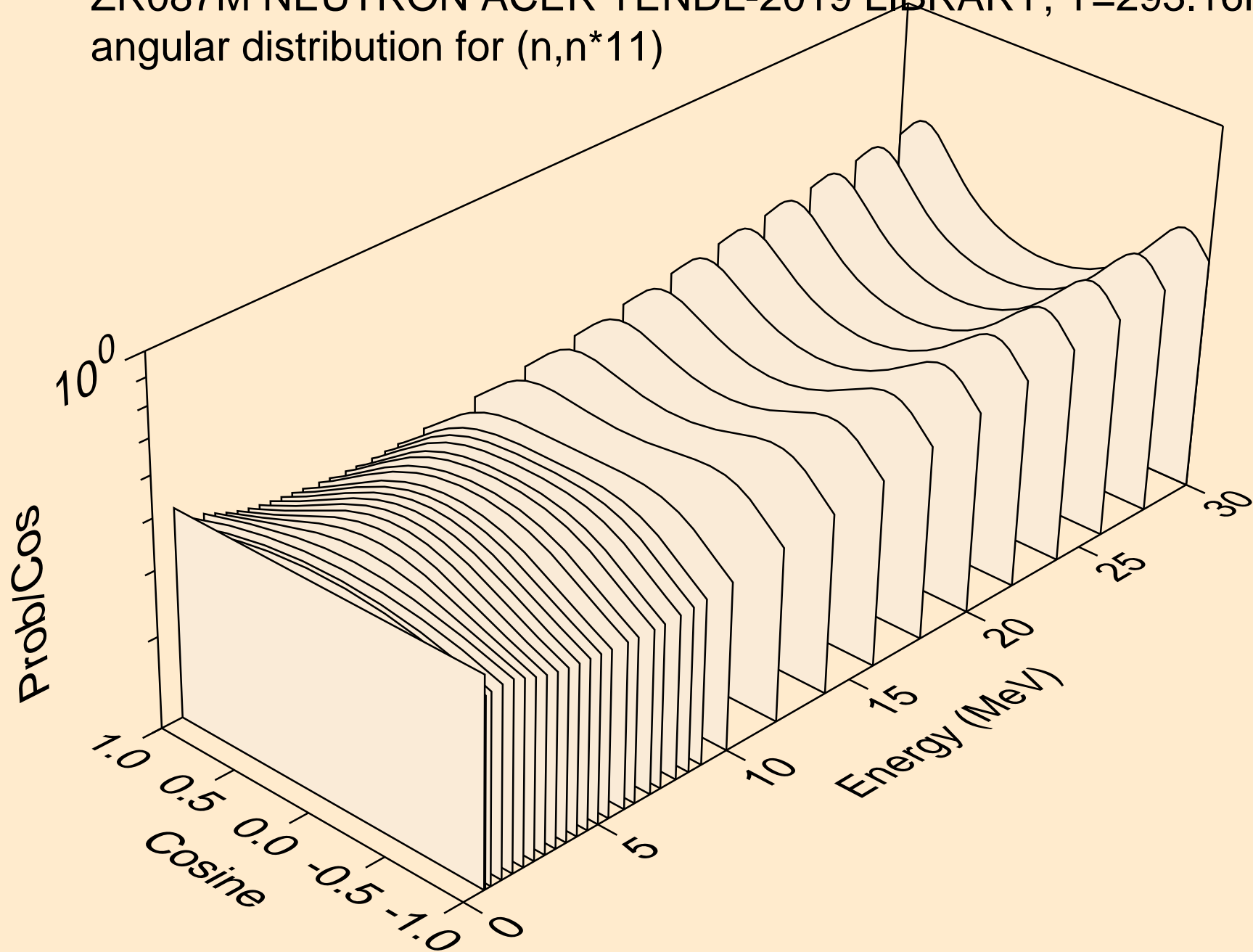

ZR087M NEUTRON ACER TENDL-2019 LIBRARY; T=293.16K
angular distribution for (n,n*12)

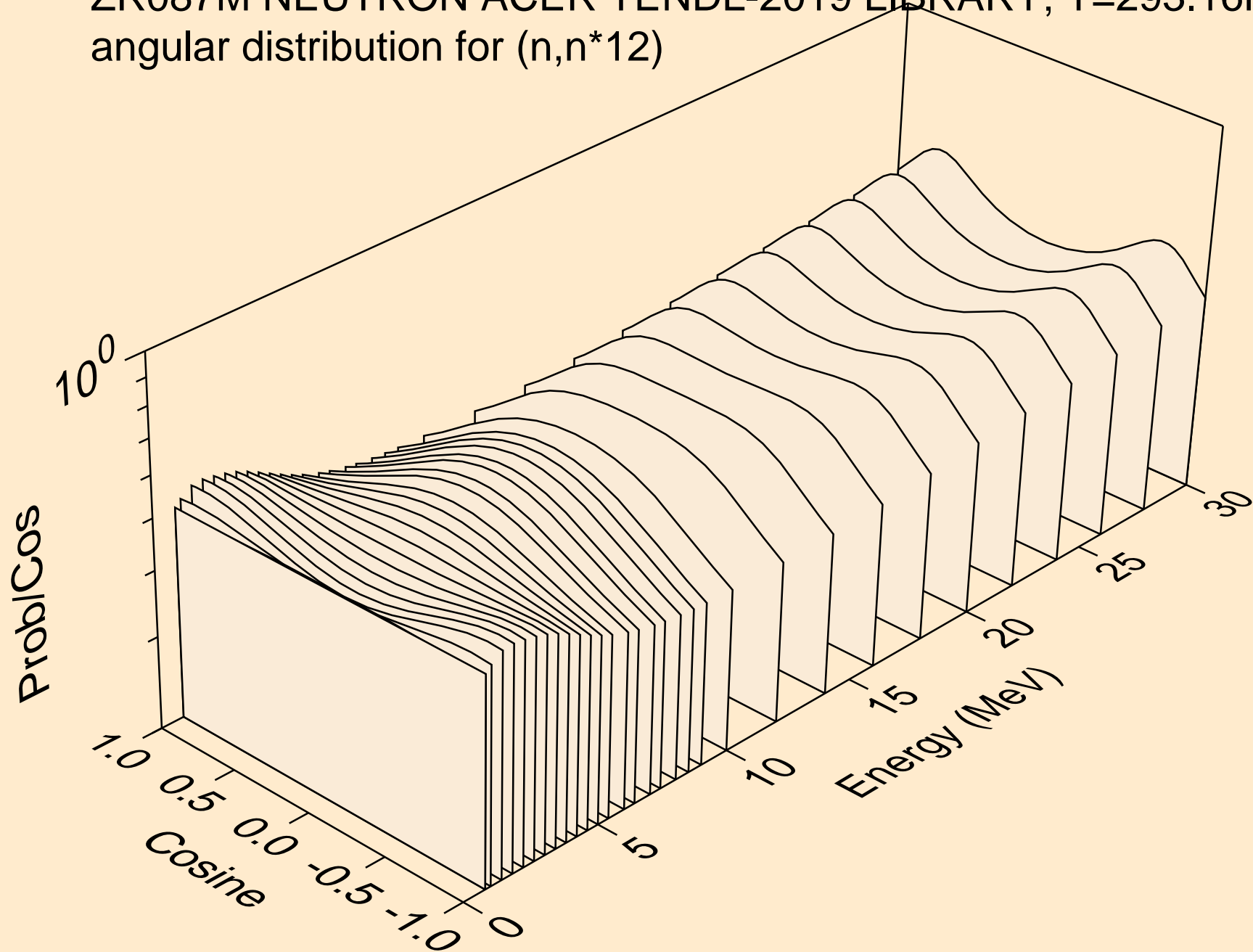

ZR087M NEUTRON ACER TENDL-2019 LIBRARY; T=293.16K
angular distribution for (n,n*13)

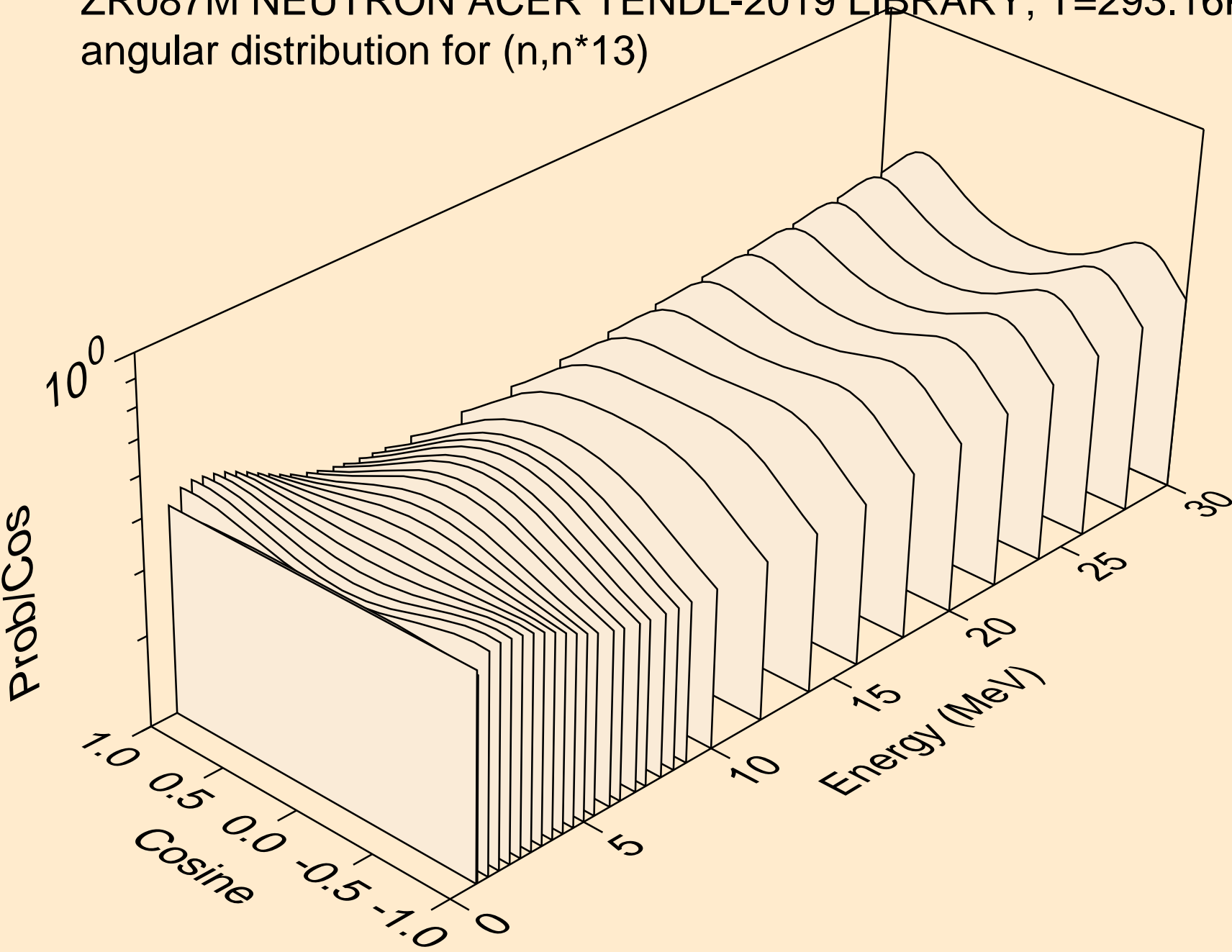

ZR087M NEUTRON ACER TENDL-2019 LIBRARY; T=293.16K
angular distribution for (n,n*14)

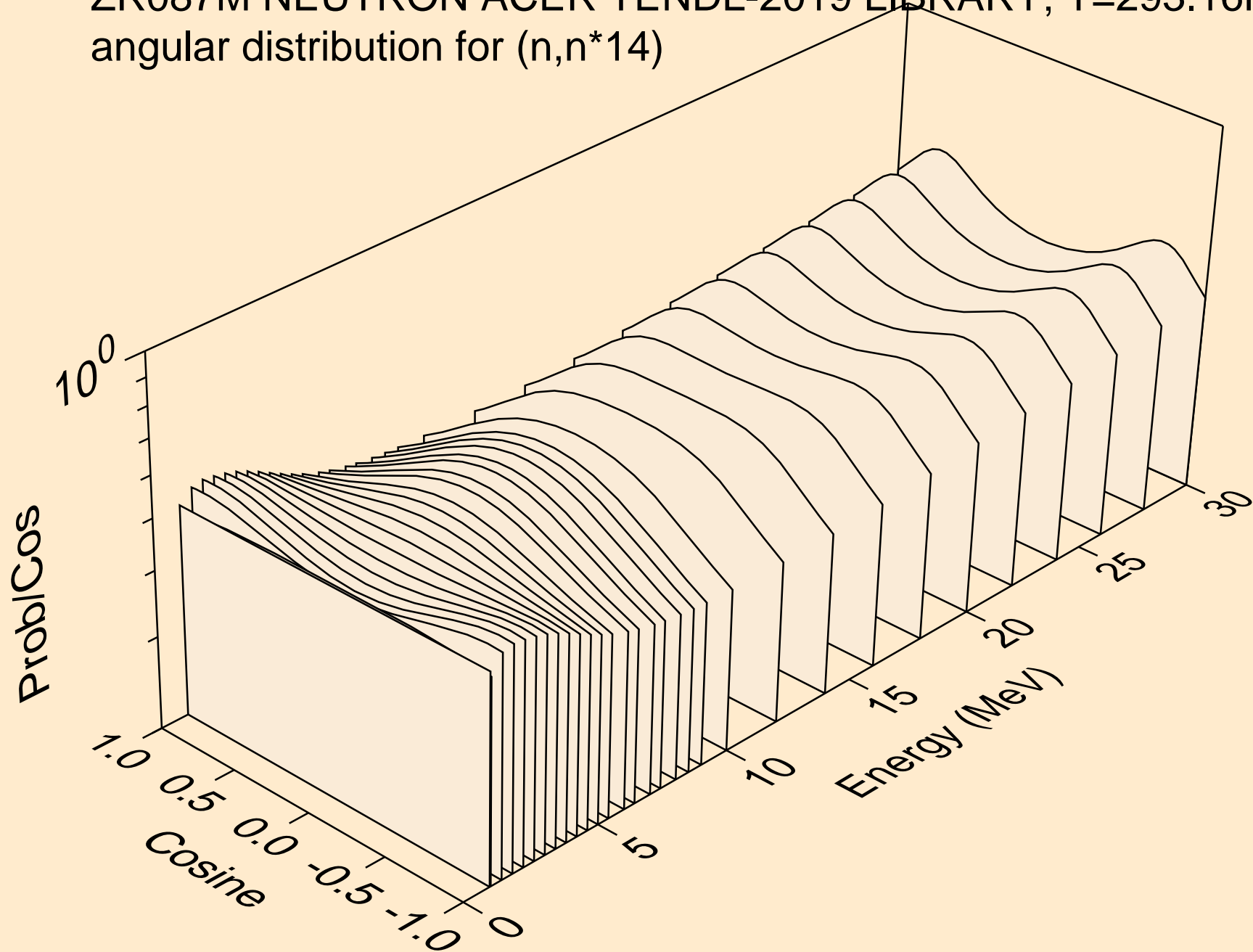

ZR087M NEUTRON ACER TENDL-2019 LIBRARY; T=293.16K
angular distribution for (n,n*15)

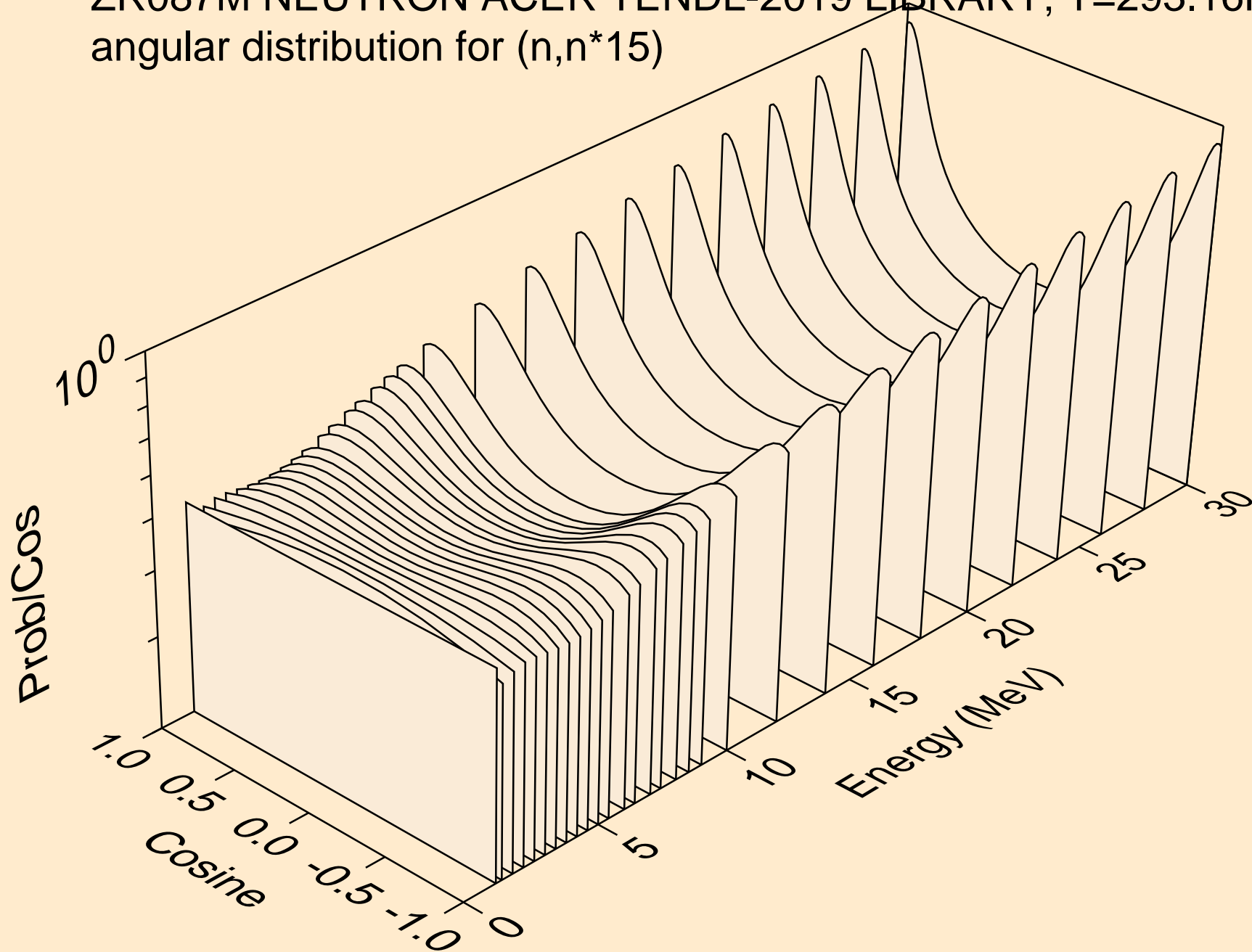

ZR087M NEUTRON ACER TENDL-2019 LIBRARY; T=293.16K
angular distribution for (n,n*16)

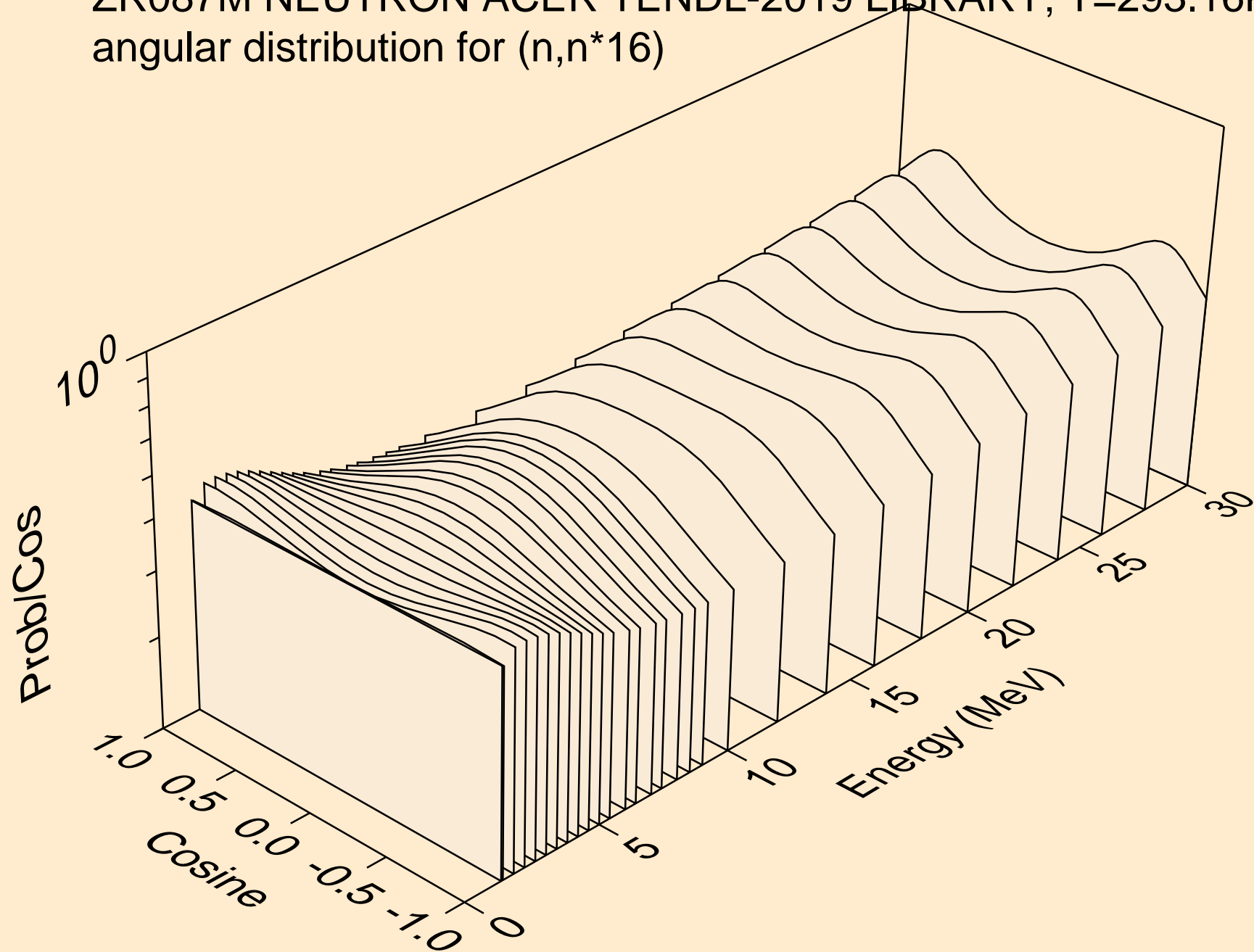

ZR087M NEUTRON ACER TENDL-2019 LIBRARY; T=293.16K
angular distribution for (n,n*17)

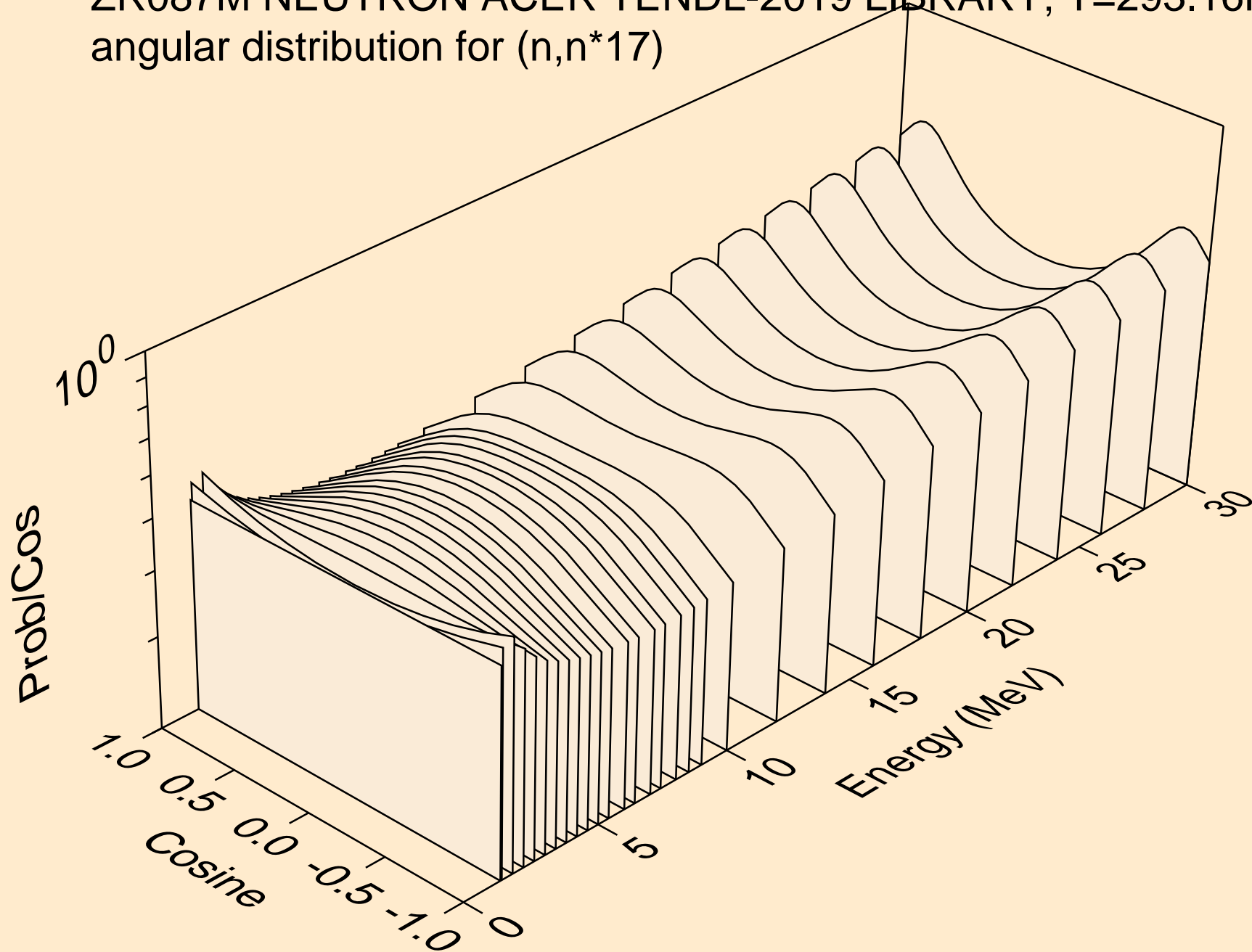

ZR087M NEUTRON ACER TENDL-2019 LIBRARY; T=293.16K
angular distribution for (n,n*18)

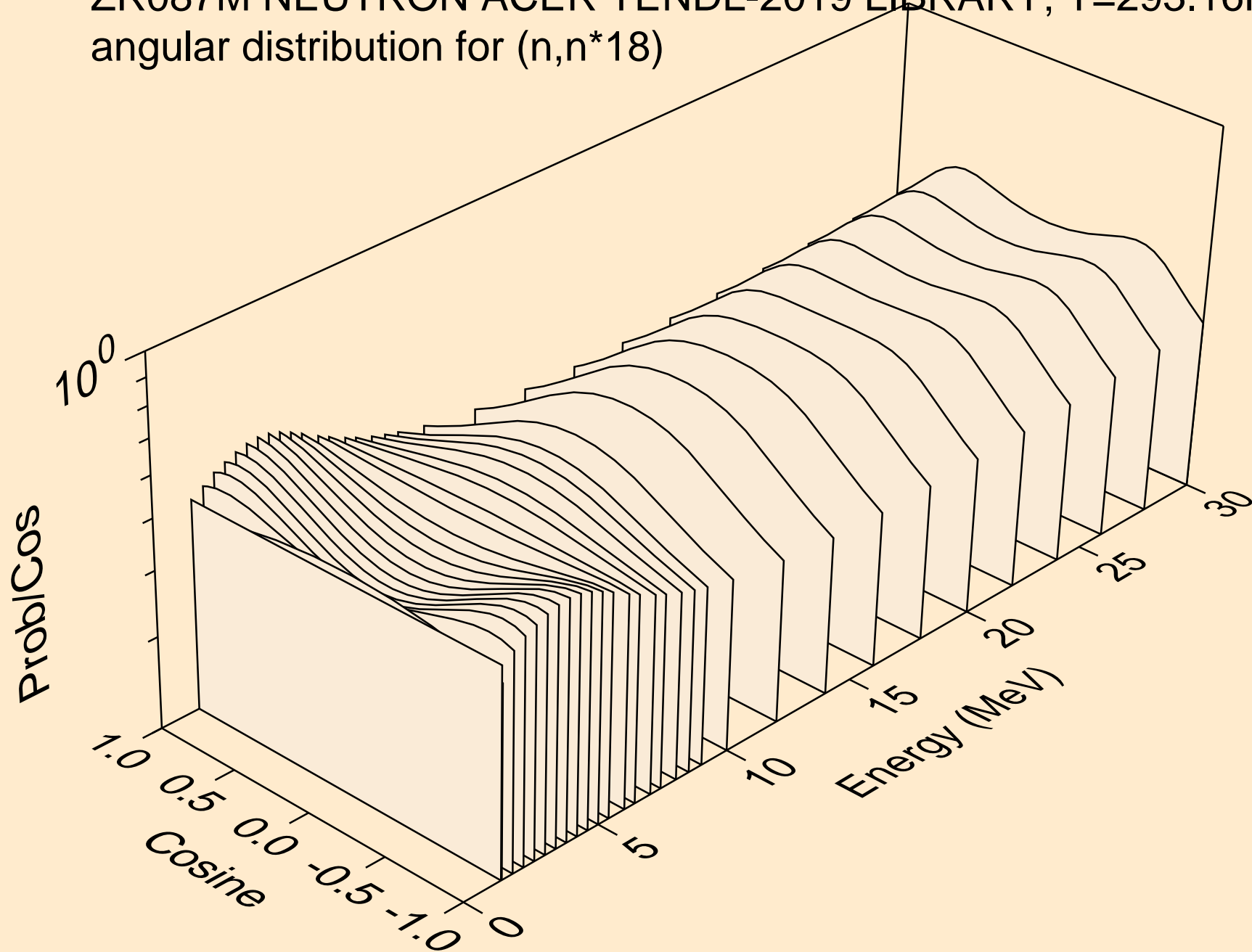

ZR087M NEUTRON ACER TENDL-2019 LIBRARY; T=293.16K
angular distribution for (n,n*19)

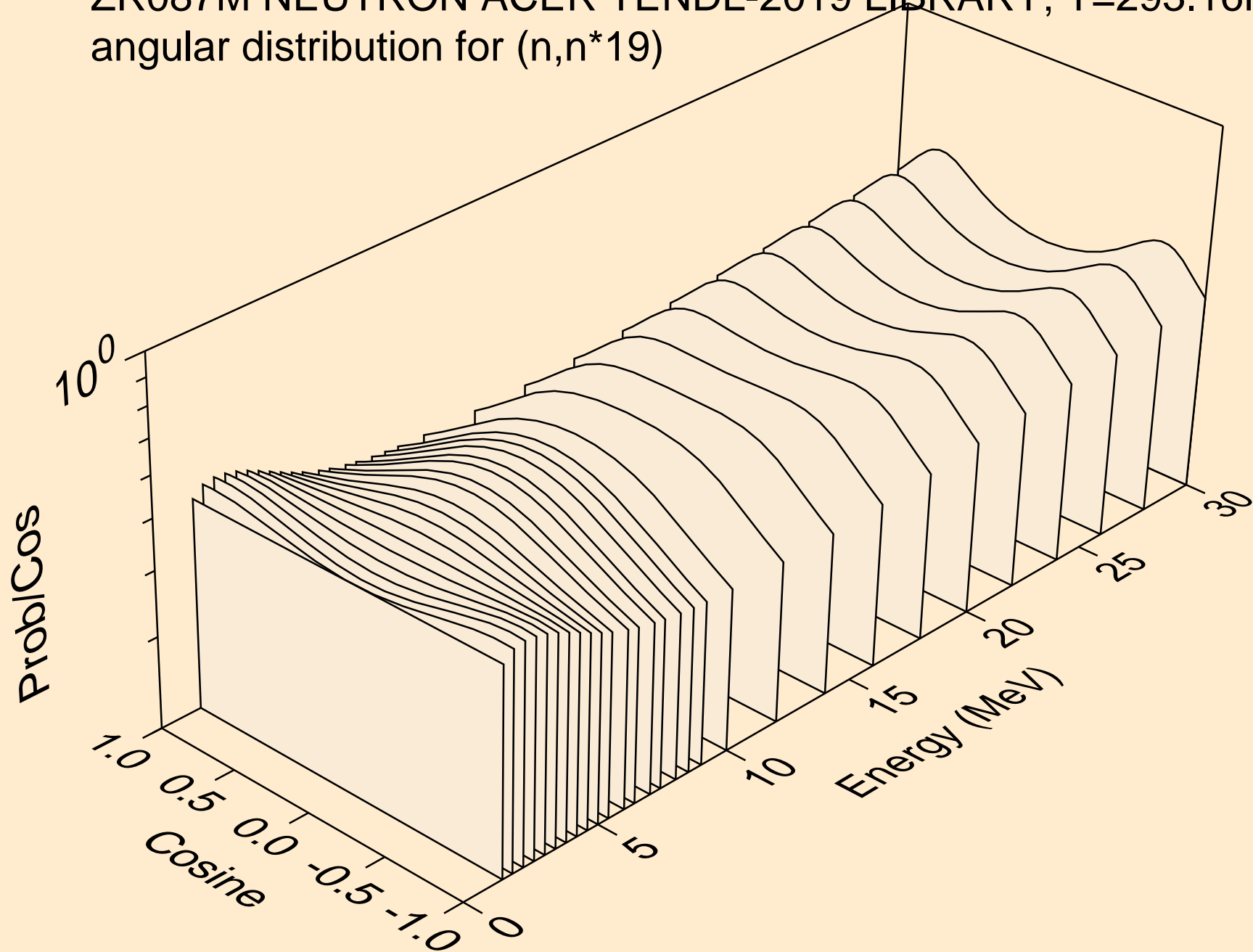

ZR087M NEUTRON ACER TENDL-2019 LIBRARY; T=293.16K
angular distribution for (n,n*20)

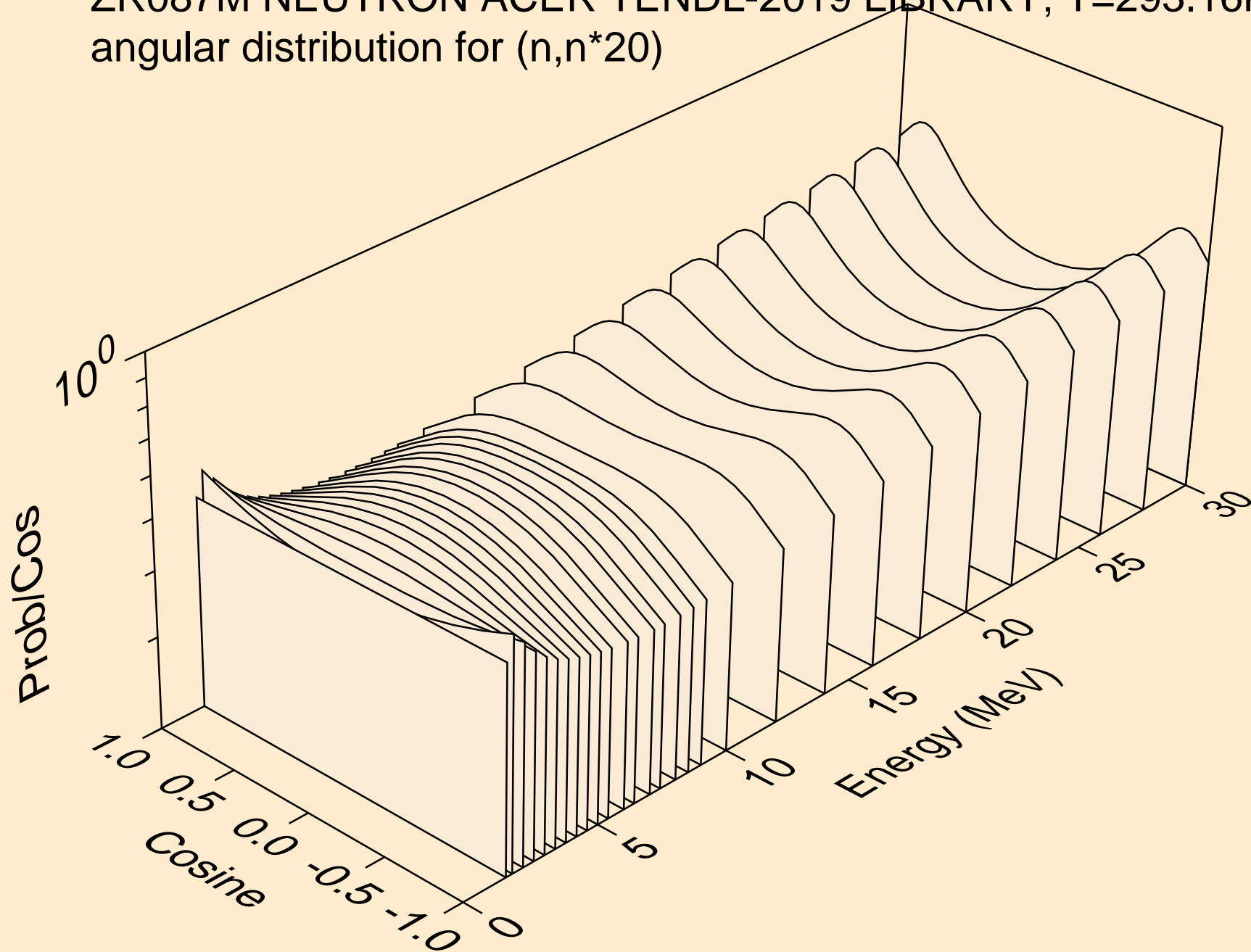

ZR087M NEUTRON ACER TENDL-2019 LIBRARY; T=293.16K
angular distribution for (n,n*21)

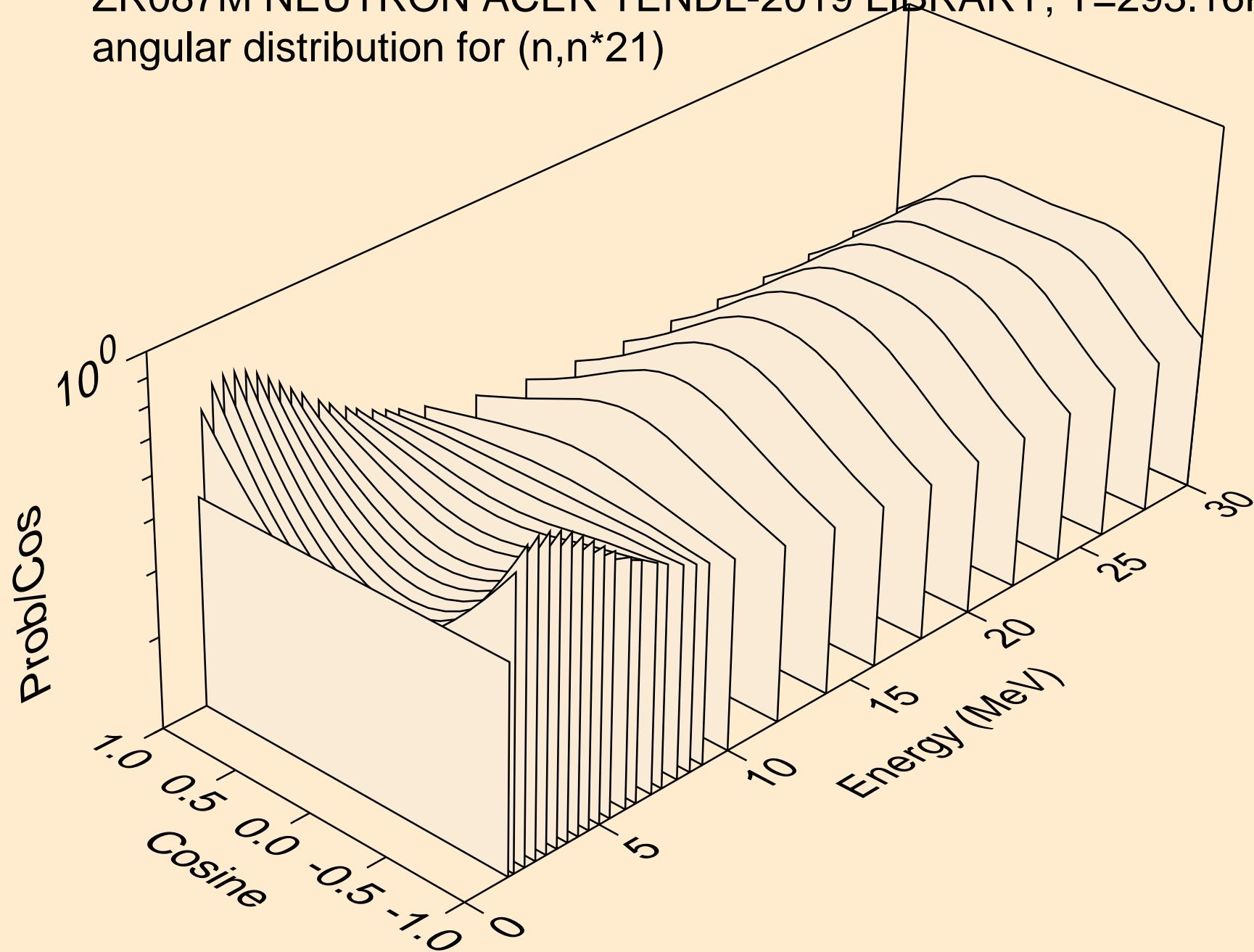

ZR087M NEUTRON ACER TENDL-2019 LIBRARY; T=293.16K
angular distribution for (n,n*22)

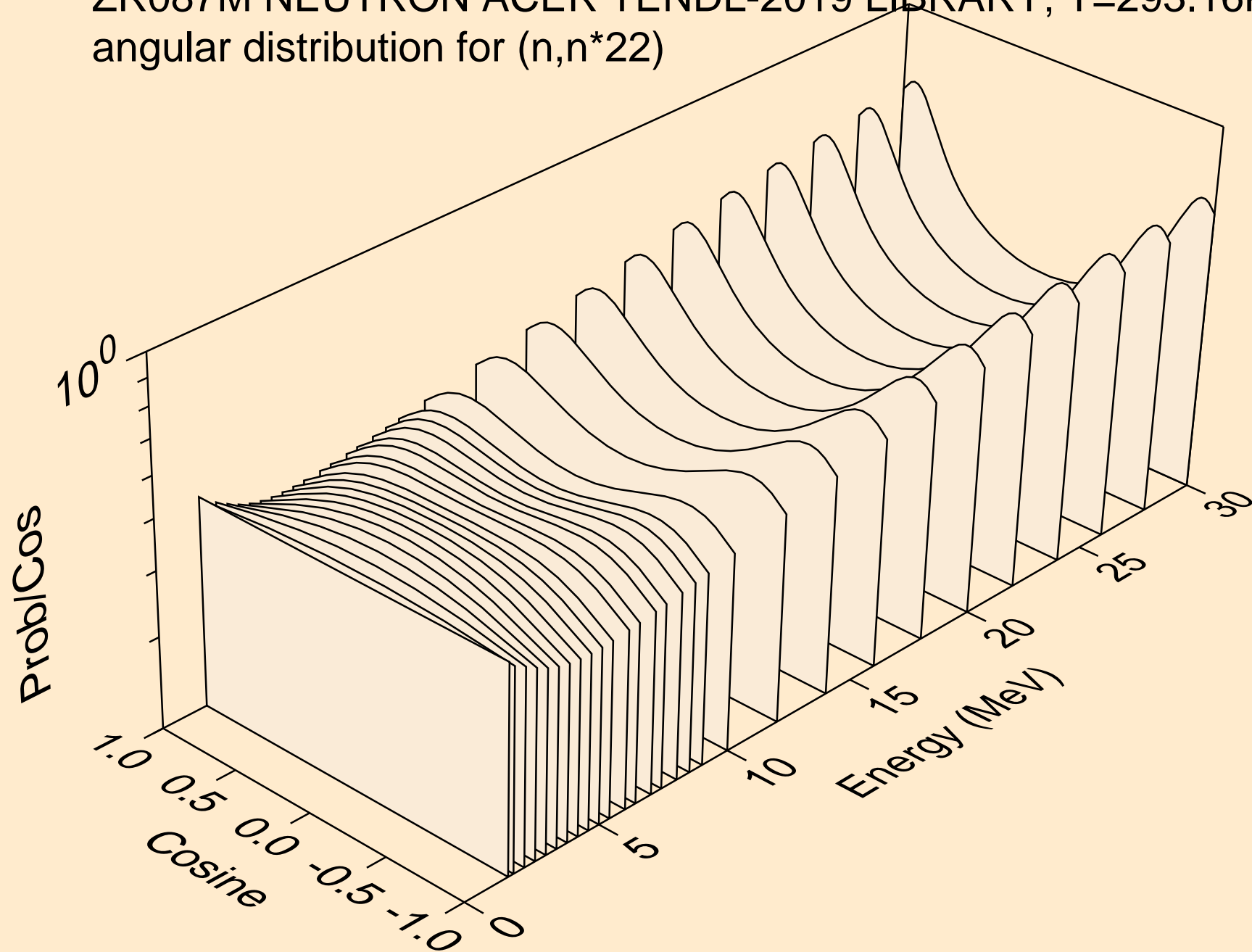

ZR087M NEUTRON ACER TENDL-2019 LIBRARY; T=293.16K
angular distribution for (n,n*23)

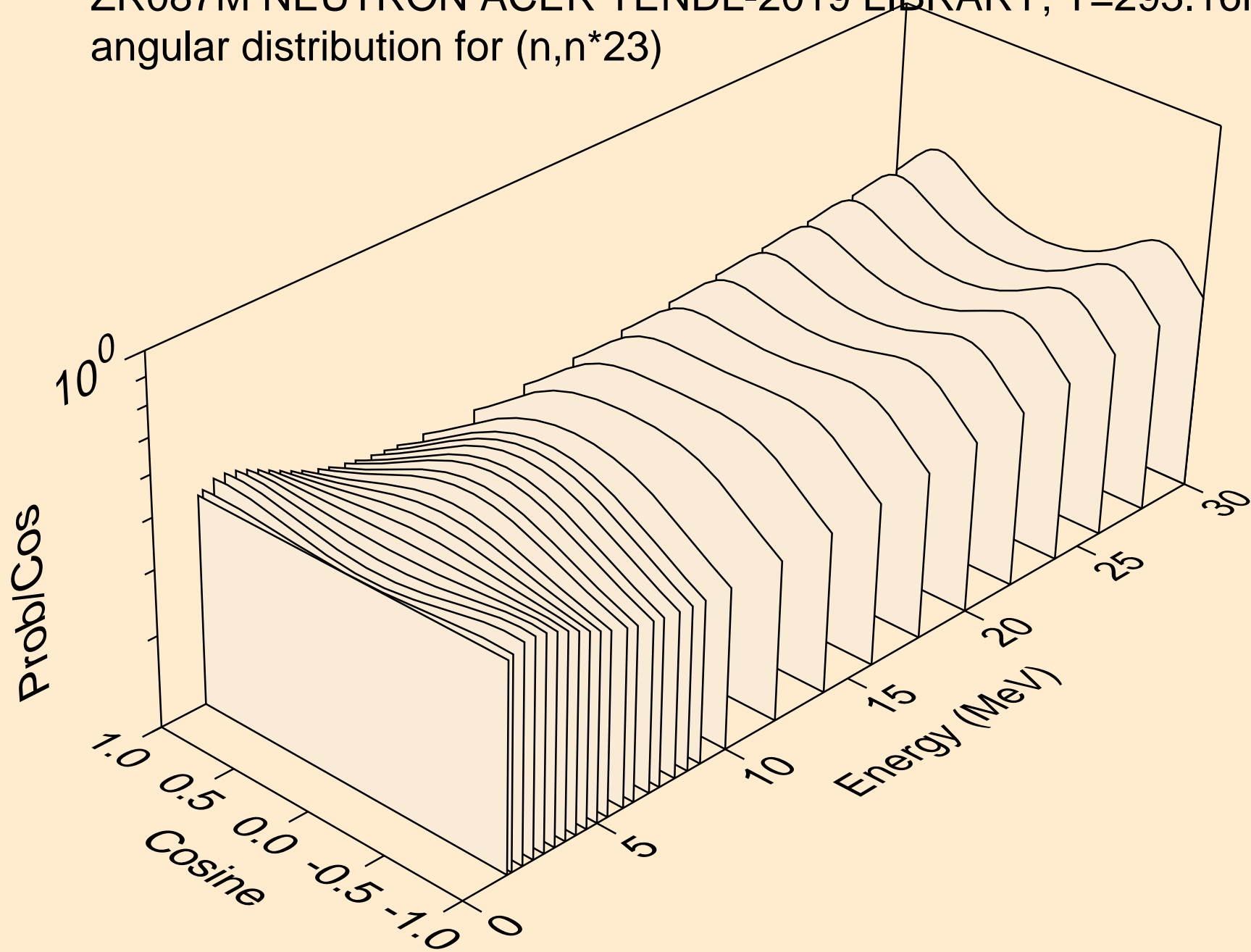

ZR087M NEUTRON ACER TENDL-2019 LIBRARY; T=293.16K
angular distribution for (n,n*24)

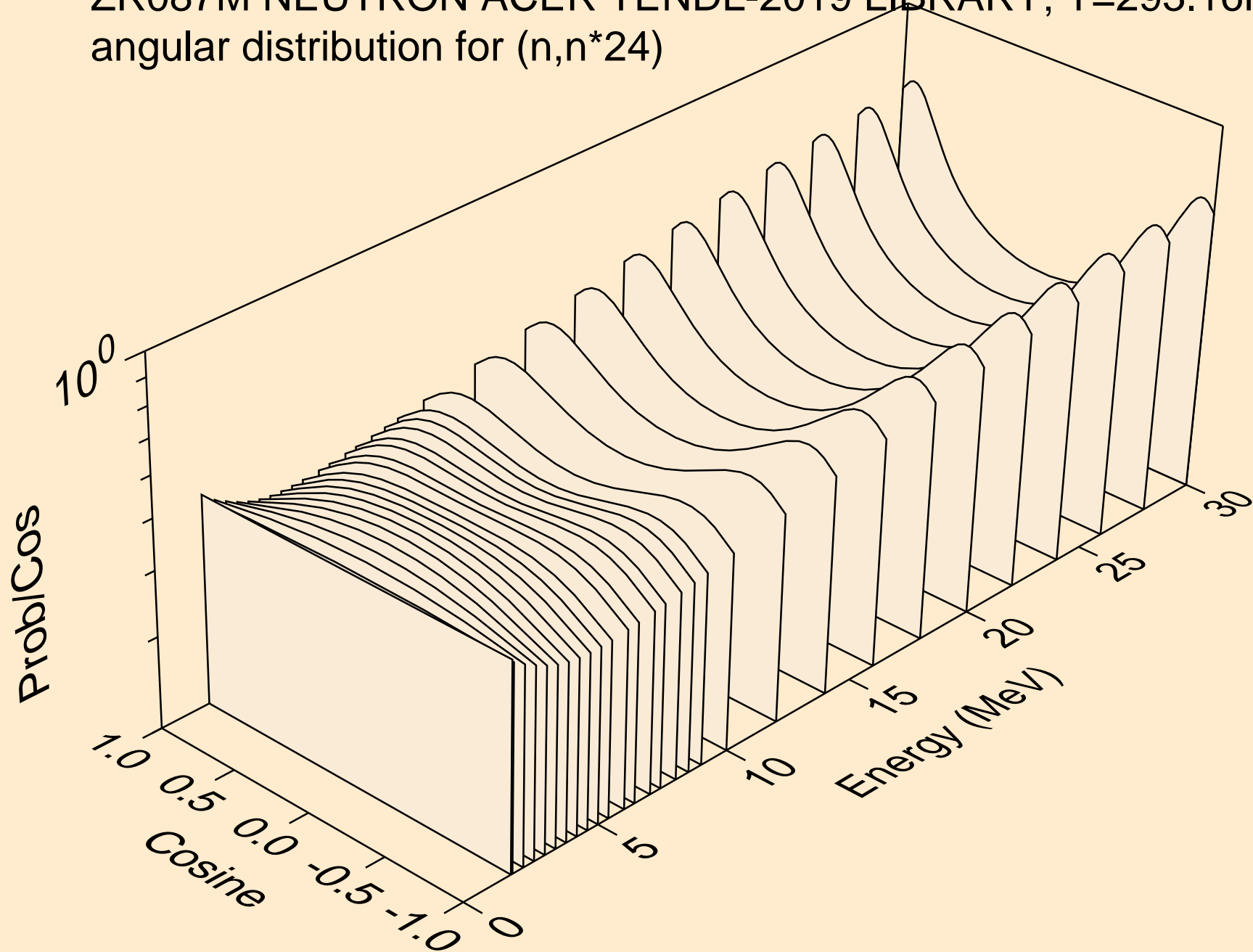

ZR087M NEUTRON ACER TENDL-2019 LIBRARY; T=293.16K
angular distribution for (n,n*25)

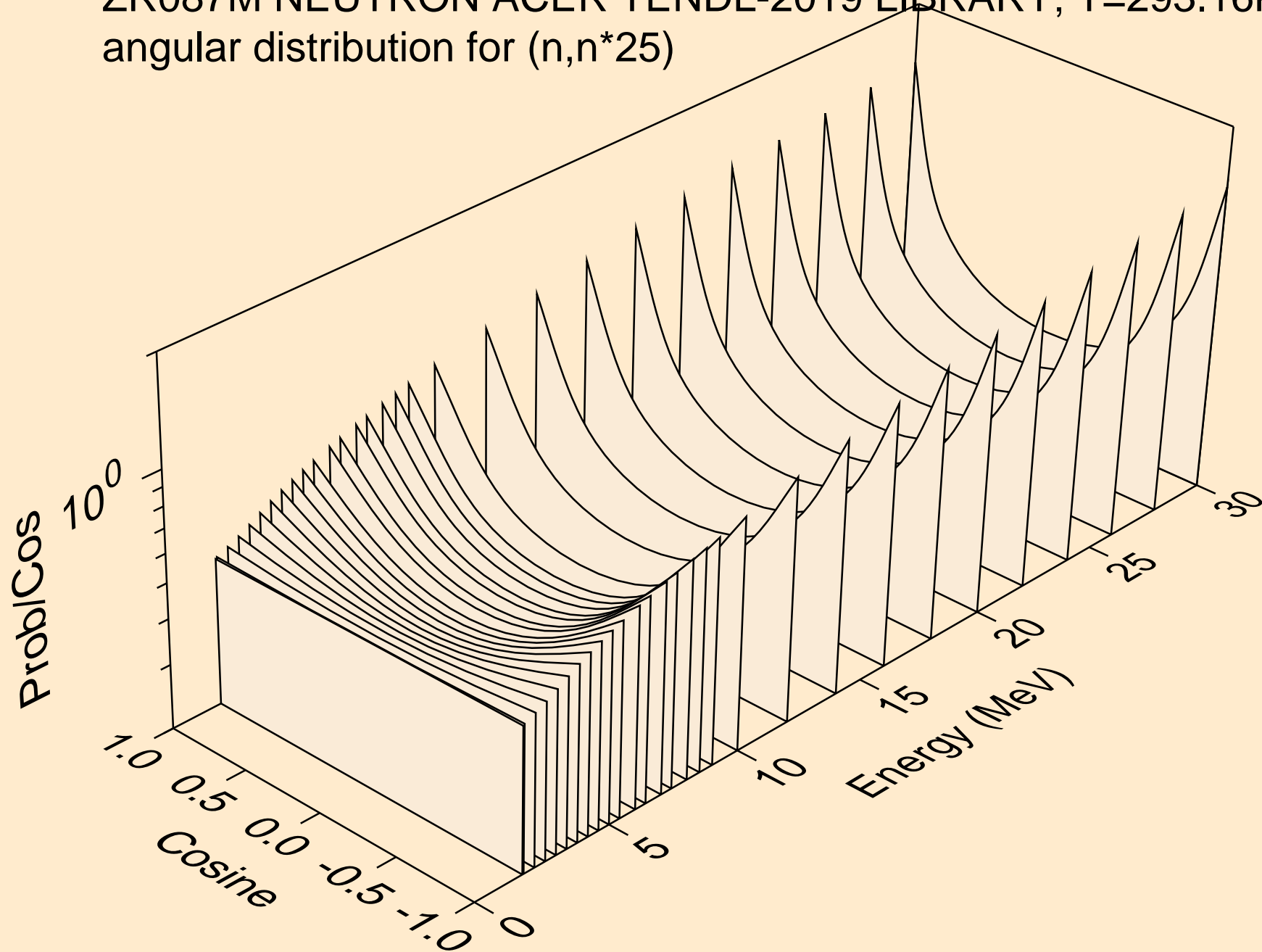

ZR087M NEUTRON ACER TENDL-2019 LIBRARY; T=293.16K
angular distribution for (n,n*26)

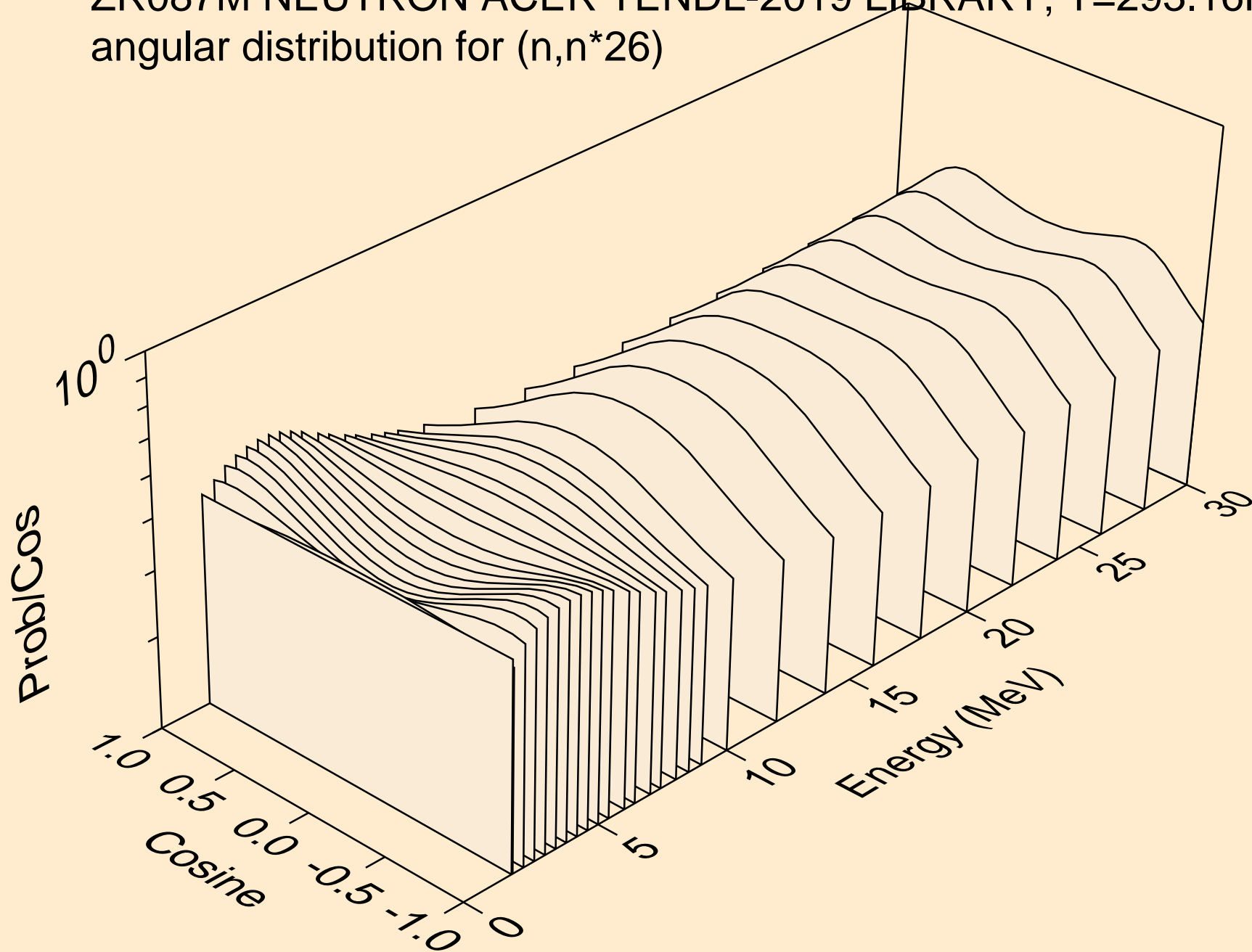

ZR087M NEUTRON ACER TENDL-2019 LIBRARY; T=293.16K
angular distribution for (n,n*27)

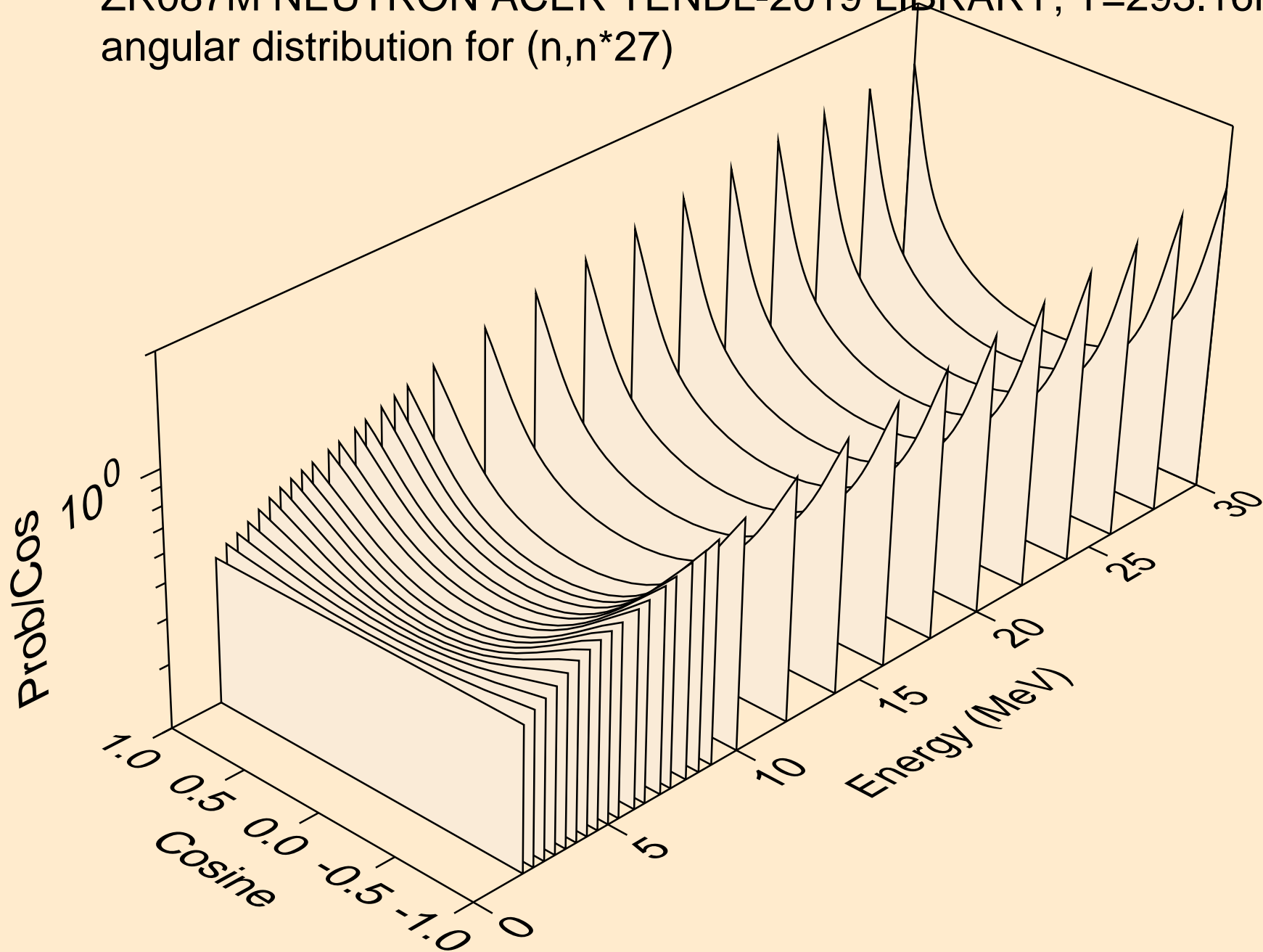

ZR087M NEUTRON ACER TENDL-2019 LIBRARY; T=293.16K
angular distribution for (n,n*28)

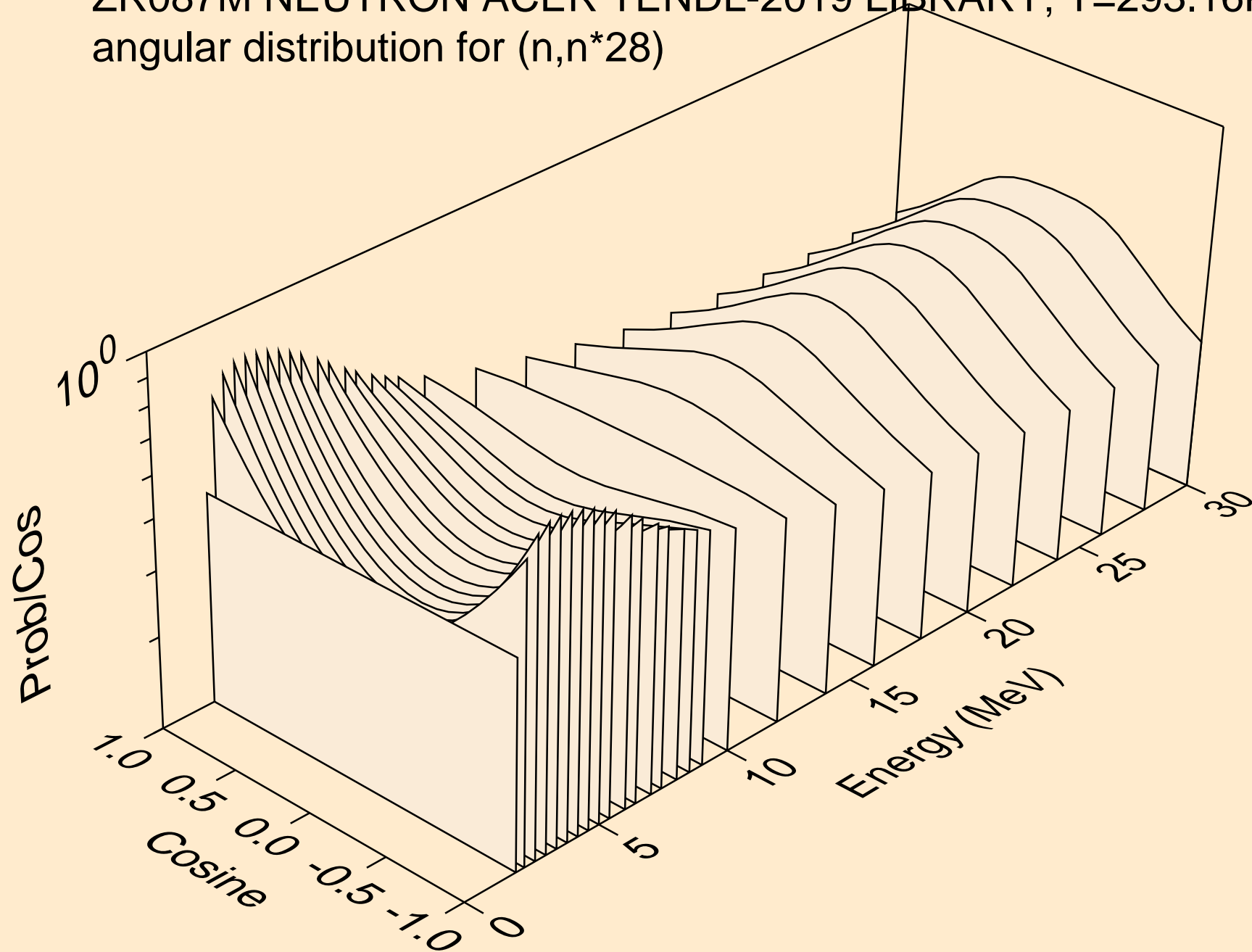

ZR087M NEUTRON ACER TENDL-2019 LIBRARY; T=293.16K
angular distribution for (n,n*29)

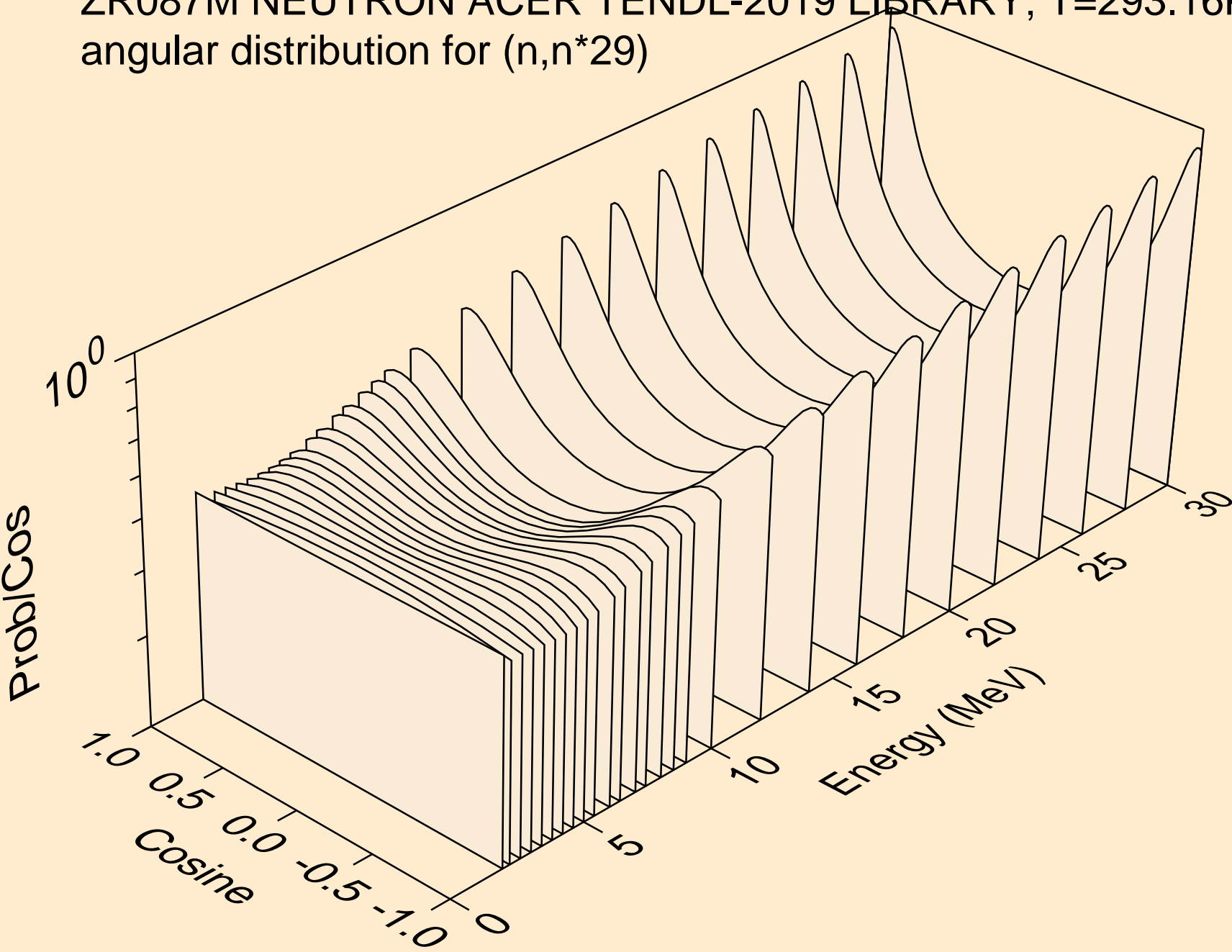

ZR087M NEUTRON ACER TENDL-2019 LIBRARY; T=293.16K
angular distribution for (n,n*30)

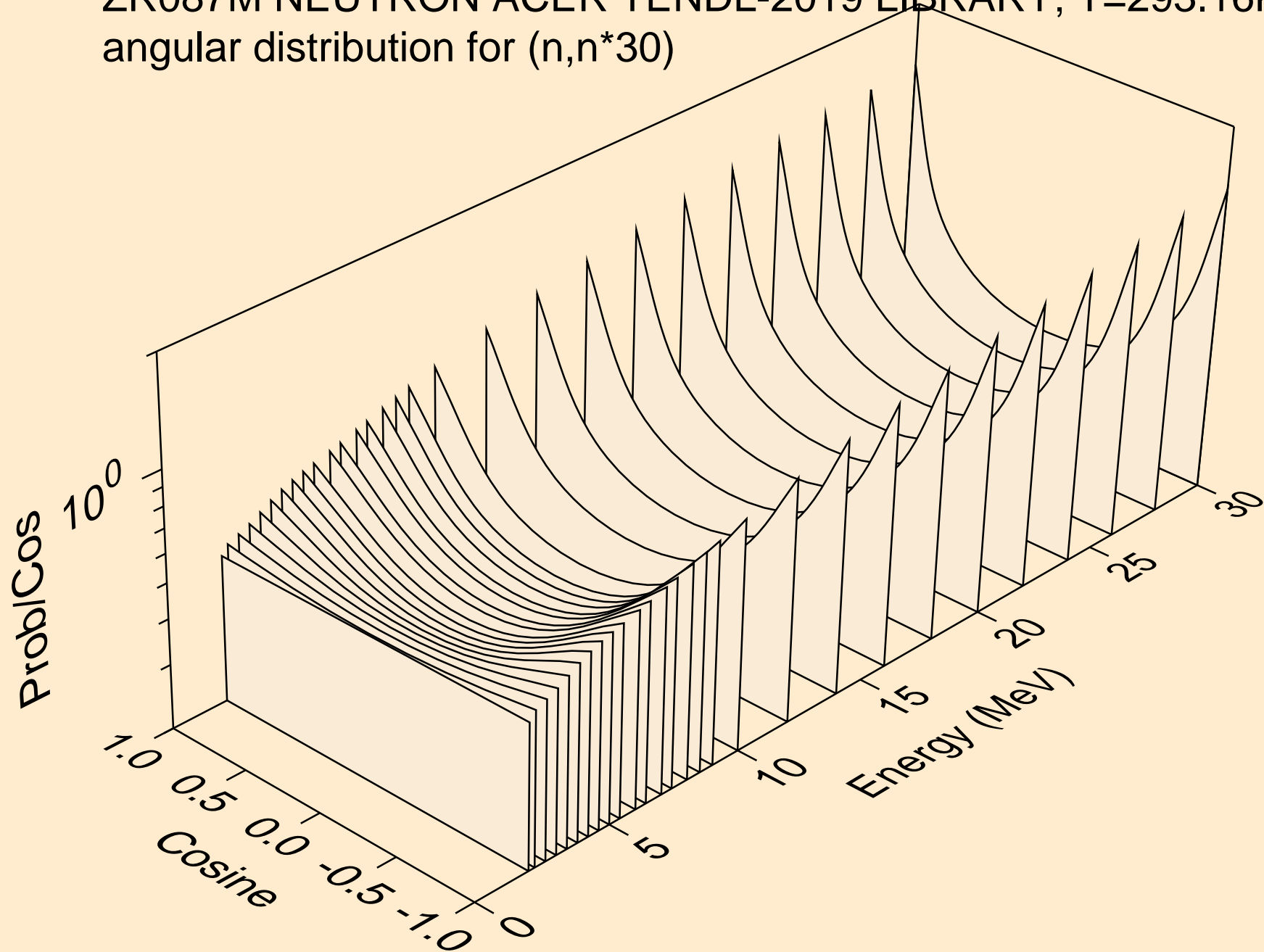

ZR087M NEUTRON ACER TENDL-2019 LIBRARY; T=293.16K
Neutron emission for (n,x)

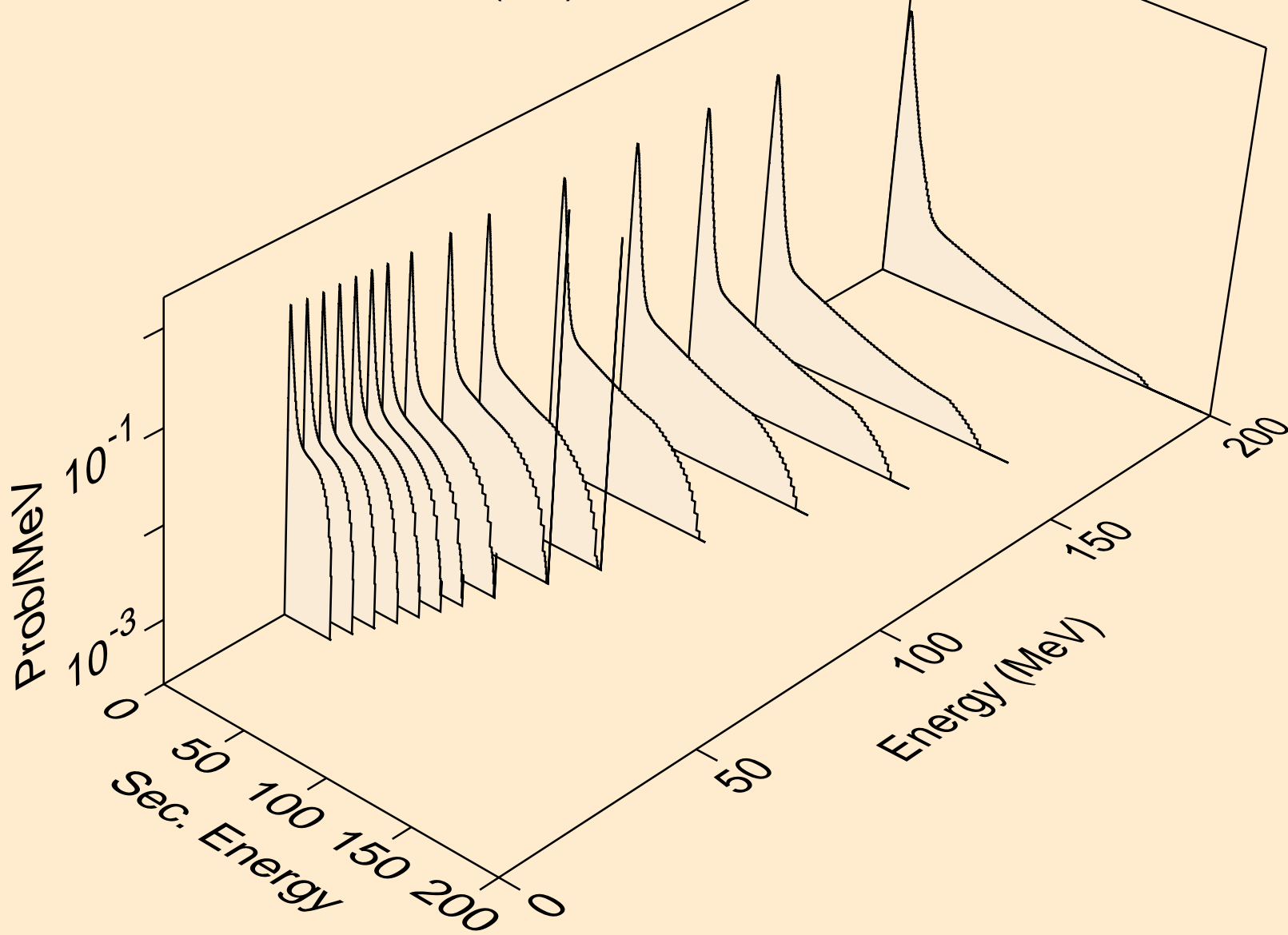

ZR087M NEUTRON ACER TENDL-2019 LIBRARY; T=293.16K
Neutron emission for (n,2nd)

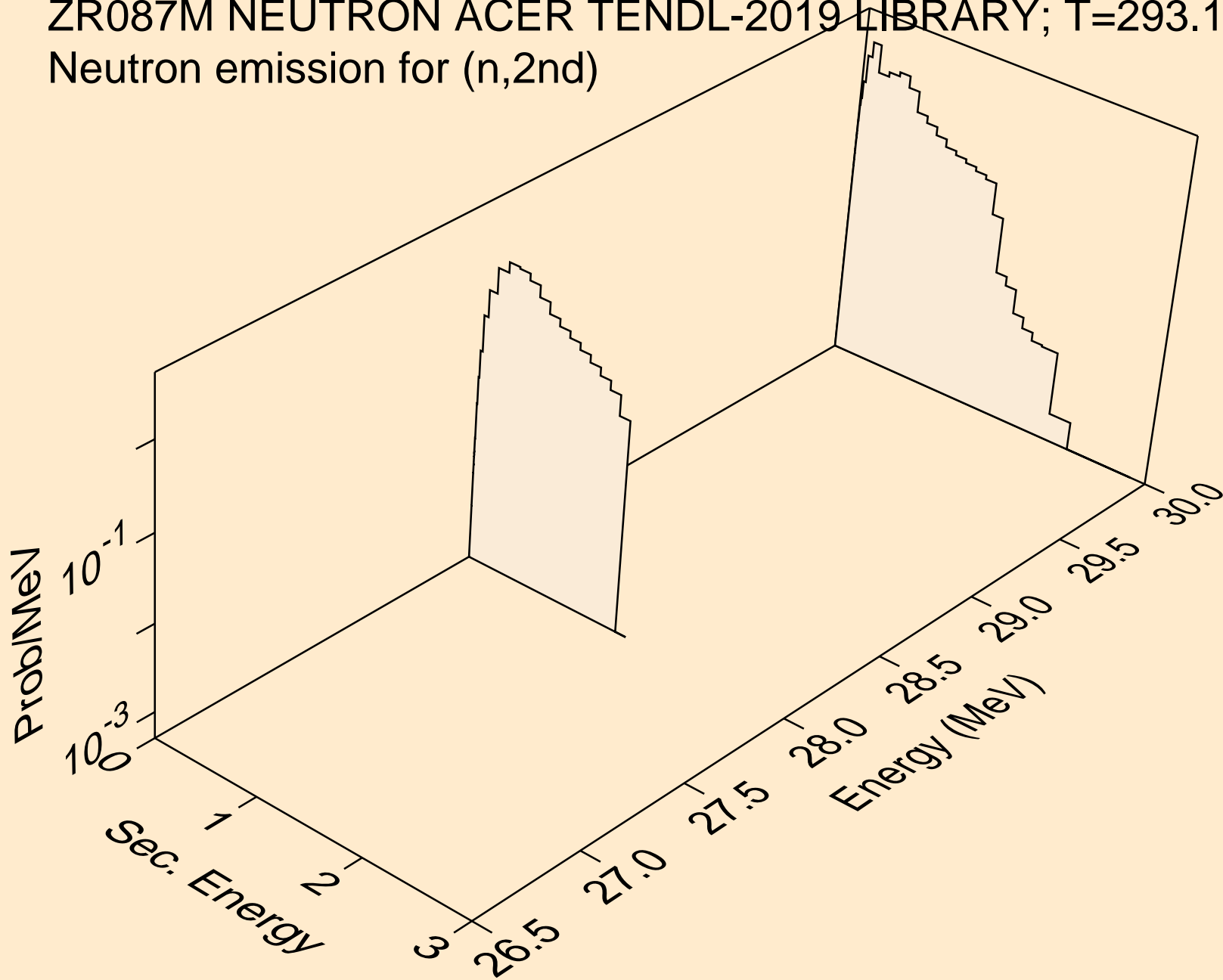

ZR087M NEUTRON ACER TENDL-2019 LIBRARY; T=293.16K
Neutron emission for (n,2n)

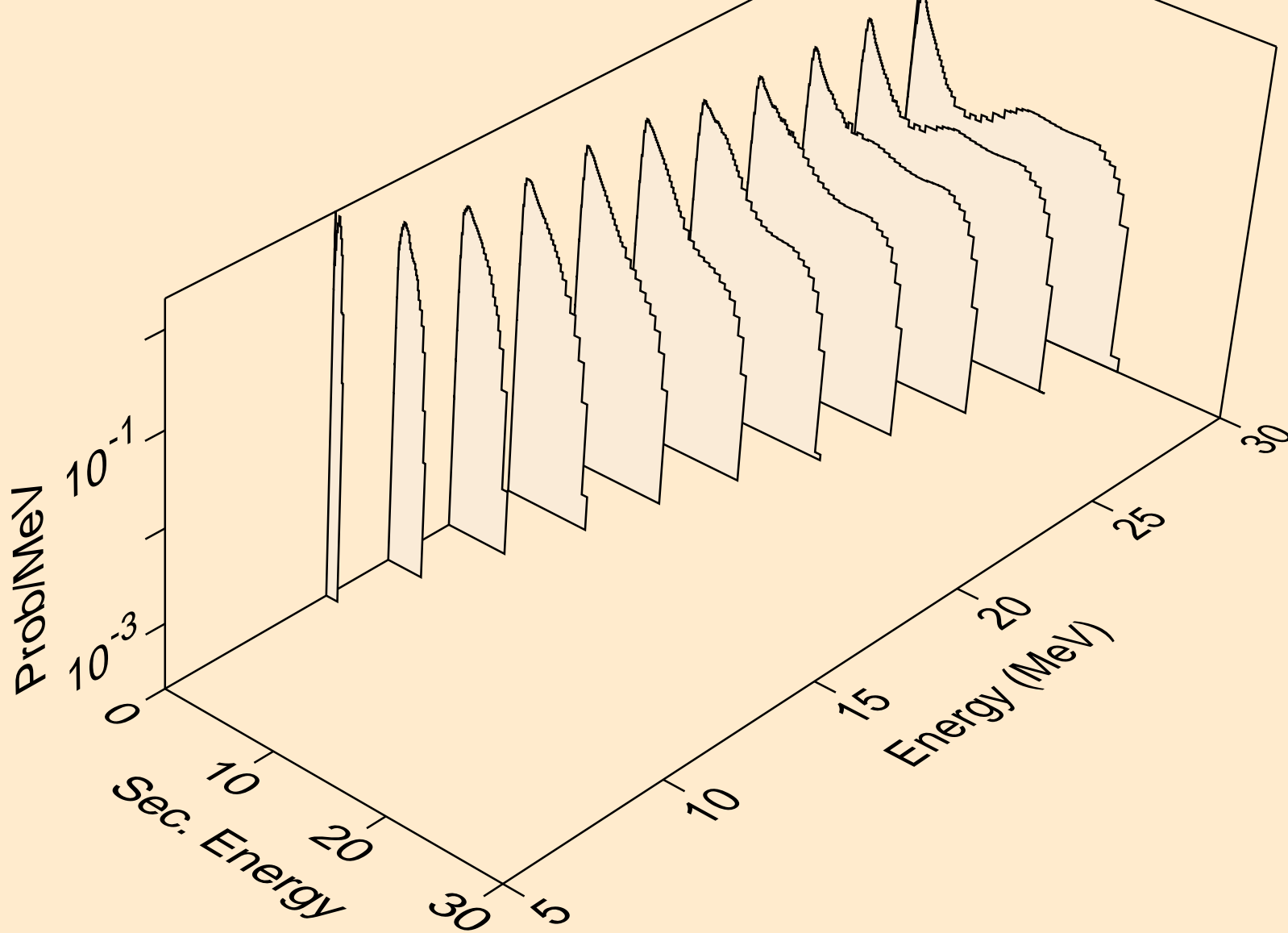

ZR087M NEUTRON ACER TENDL-2019 LIBRARY; T=293.16K
Neutron emission for (n,3n)

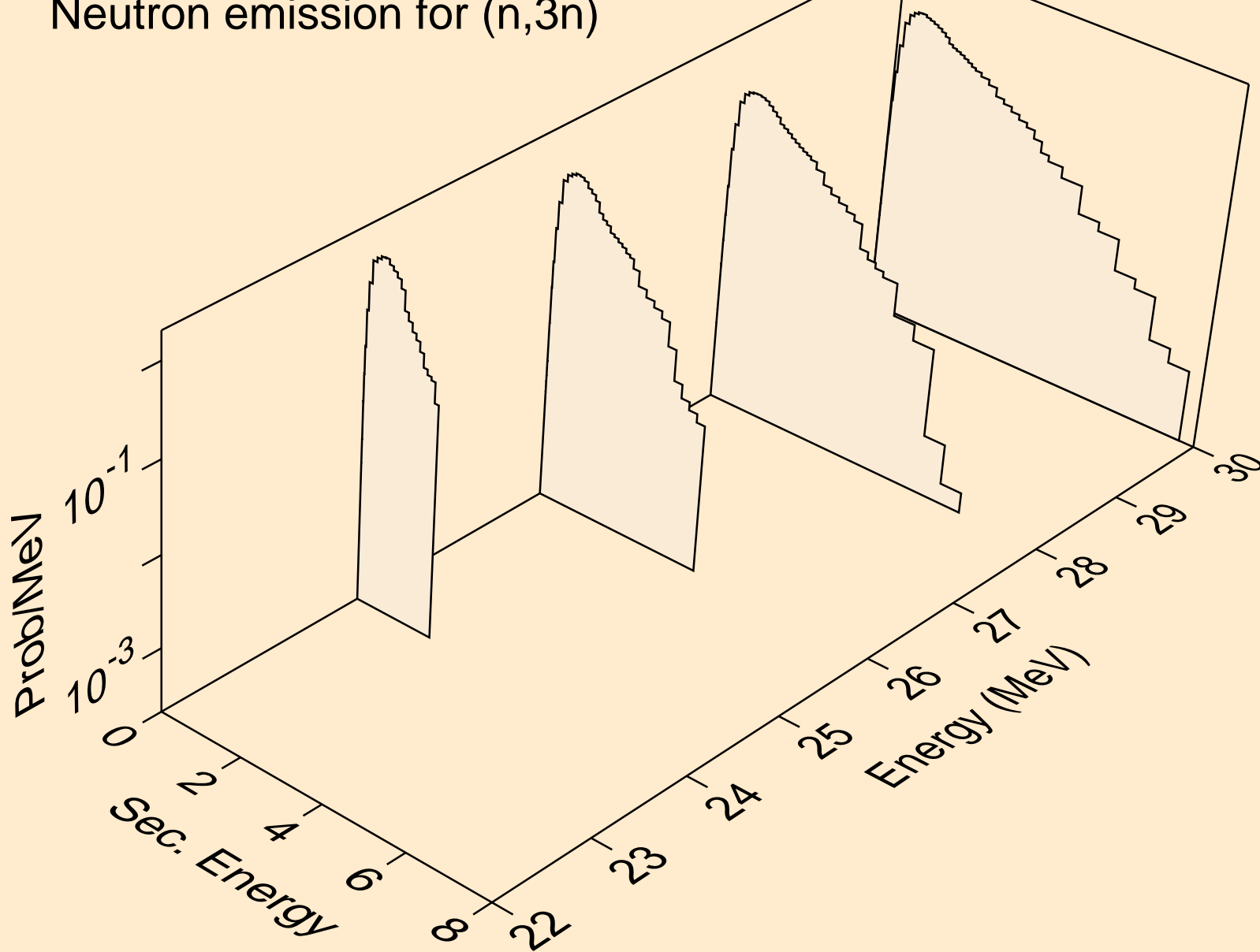

ZR087M NEUTRON ACER TENDL-2019 LIBRARY; T=293.16K
Neutron emission for (n,n*)a

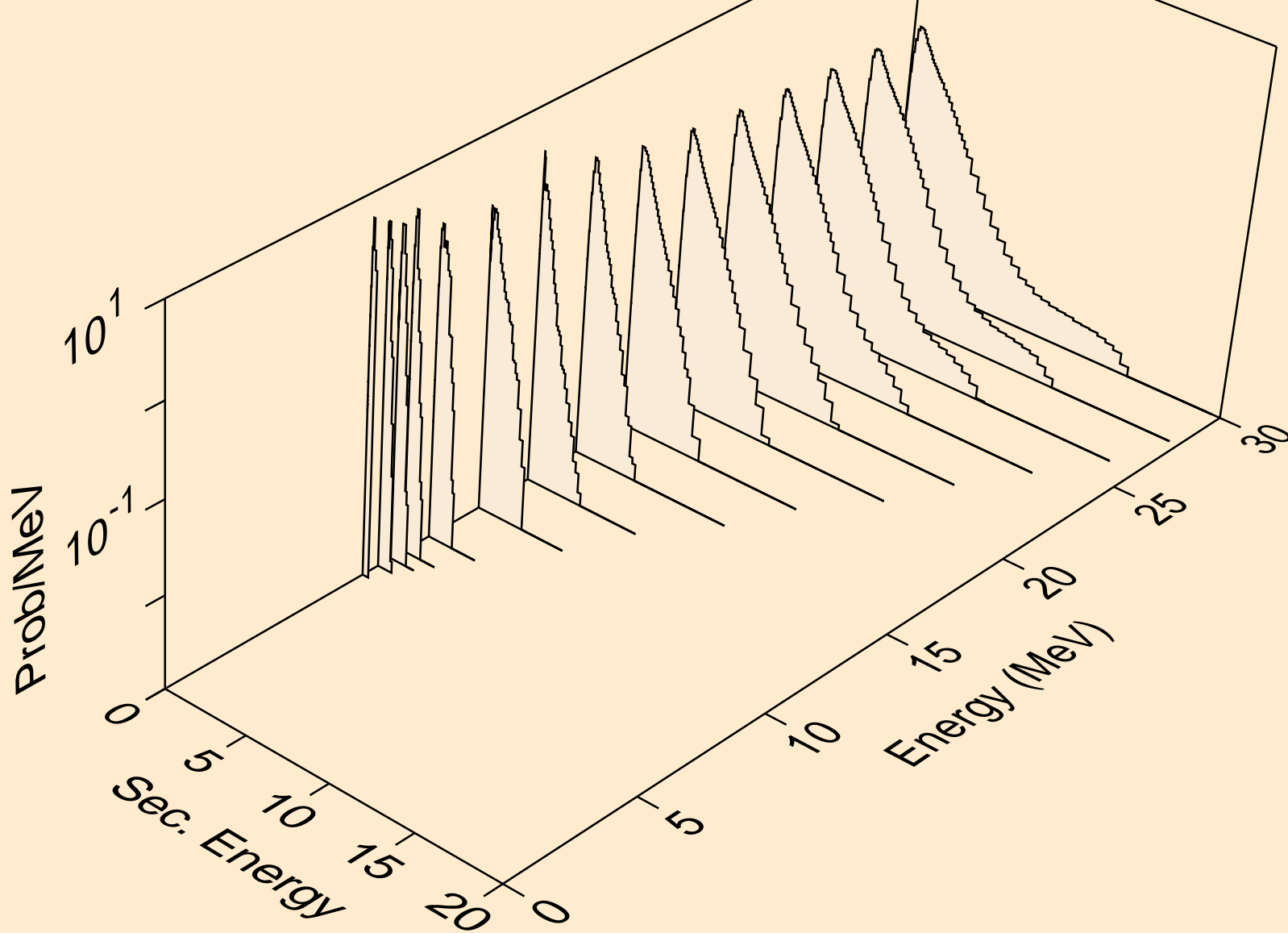

ZR087M NEUTRON ACER TENDL-2019 LIBRARY; T=293.16K
Neutron emission for (n,2n)a

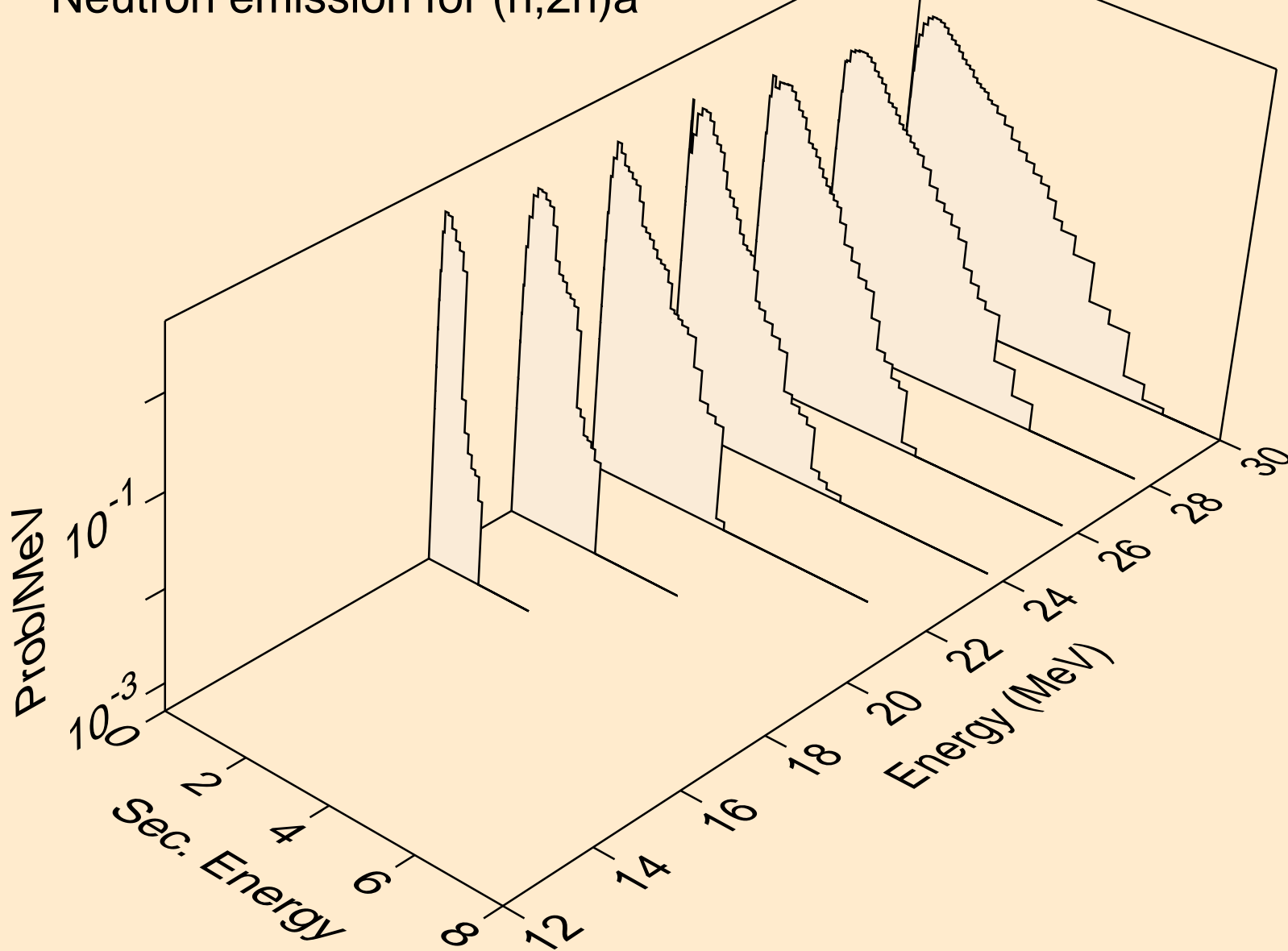

ZR087M NEUTRON ACER TENDL-2019 LIBRARY; T=293.16K
Neutron emission for (n,n*)p

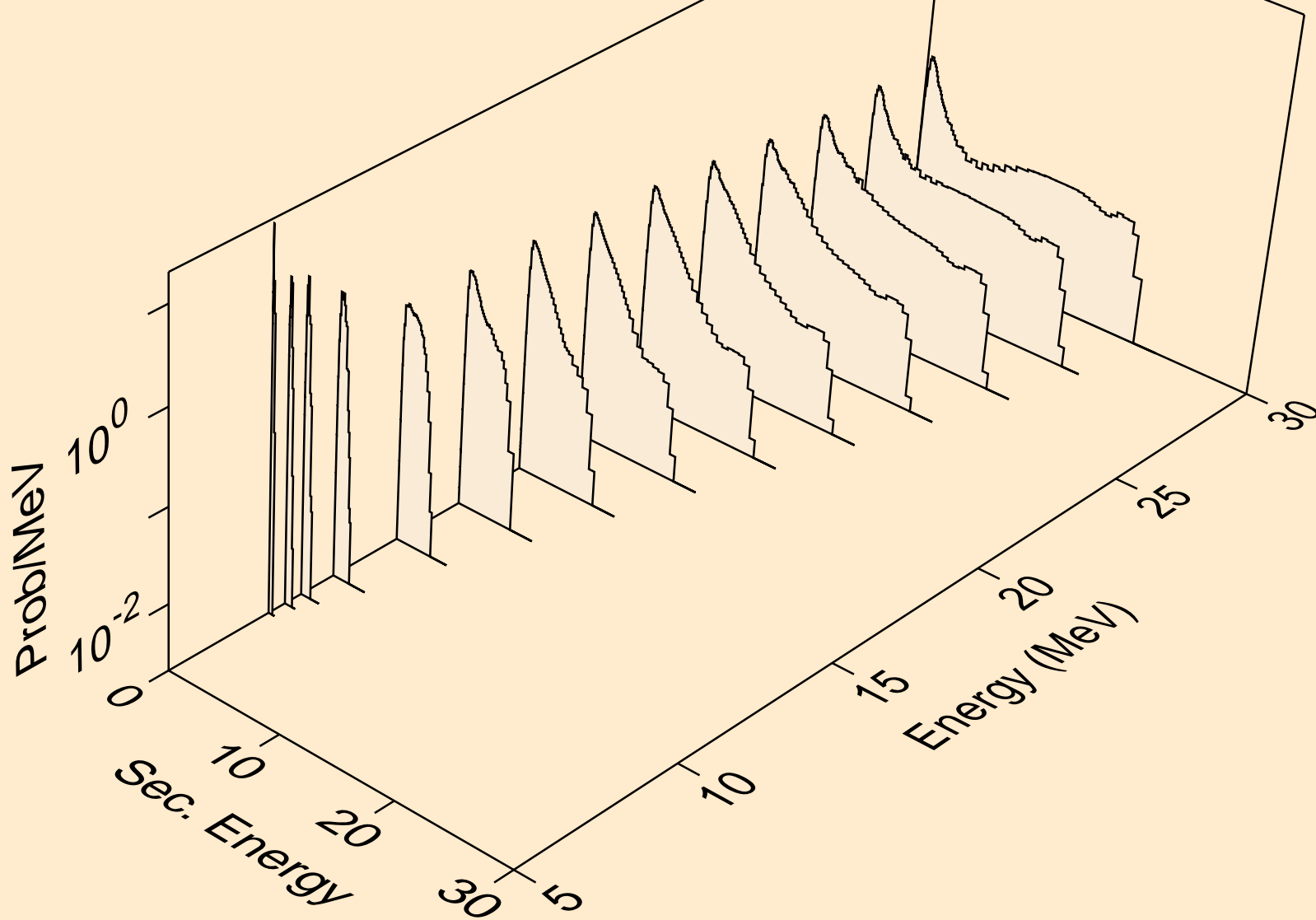

ZR087M NEUTRON ACER TENDL-2019 LIBRARY; T=293.16K
Neutron emission for (n,n*)2a

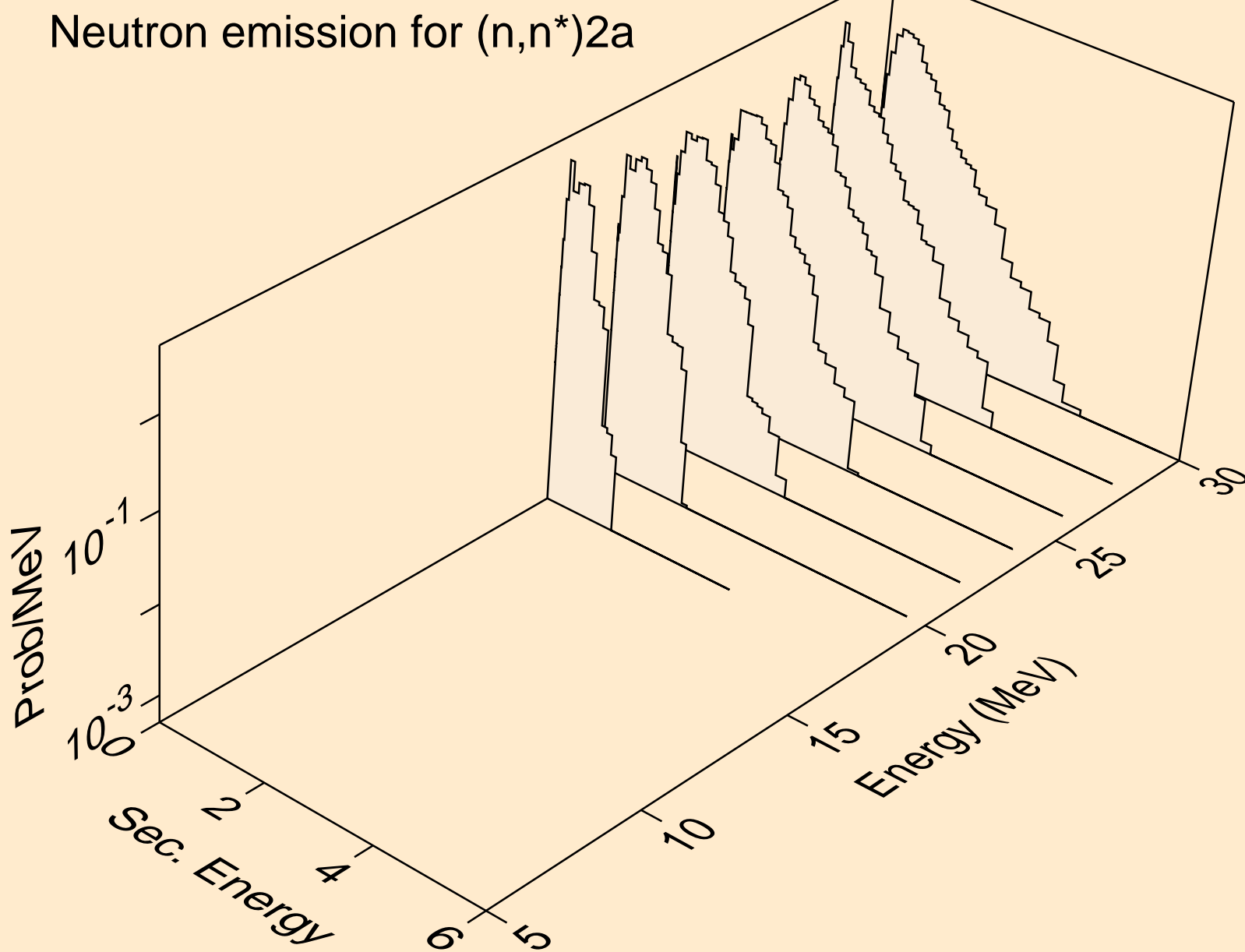

ZR087M NEUTRON ACER TENDL-2019 LIBRARY; T=293.16K
Neutron emission for (n,n*)d

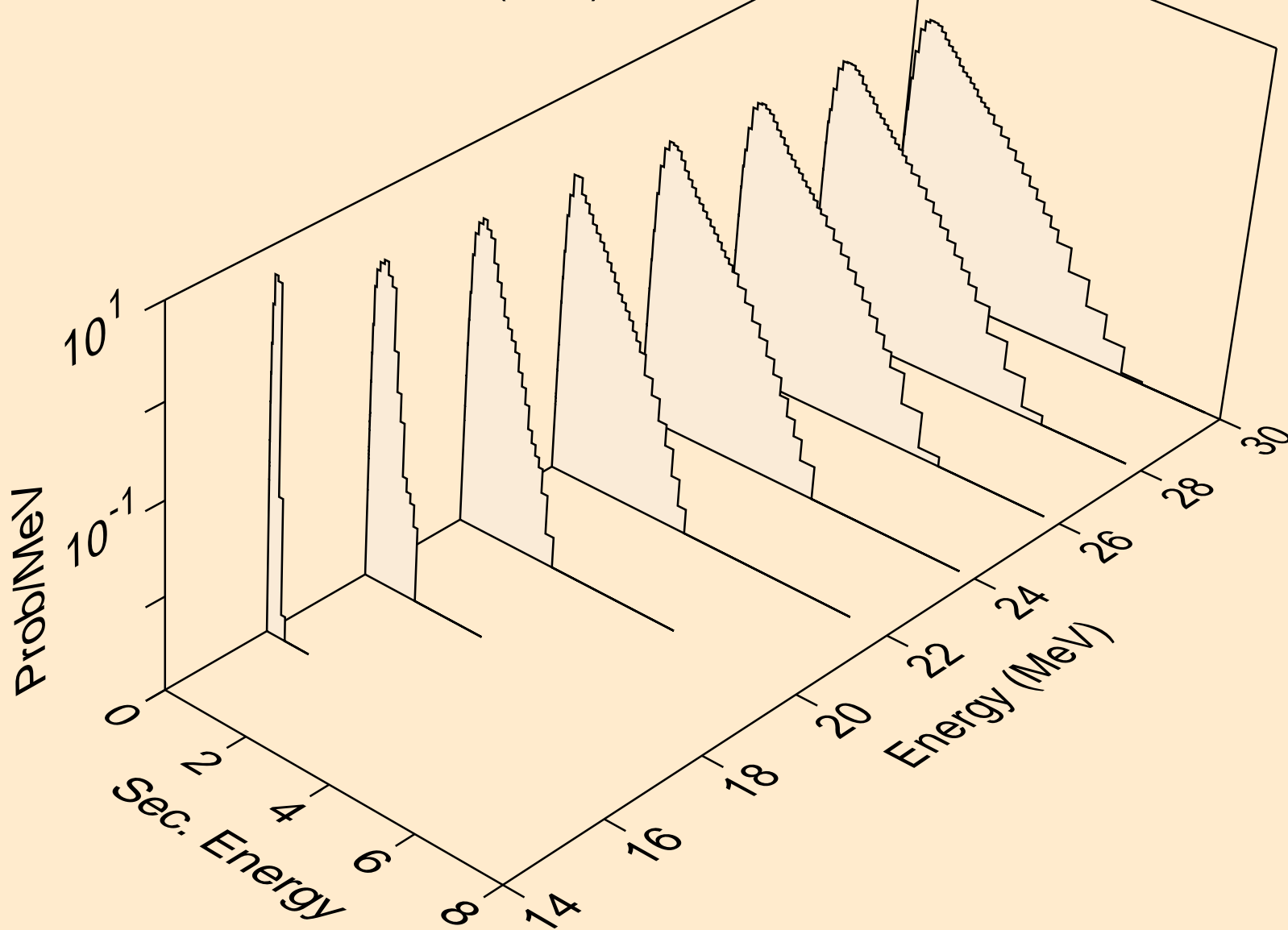

ZR087M NEUTRON ACER TENDL-2019 LIBRARY; T=293.16K
Neutron emission for (n,n*)t

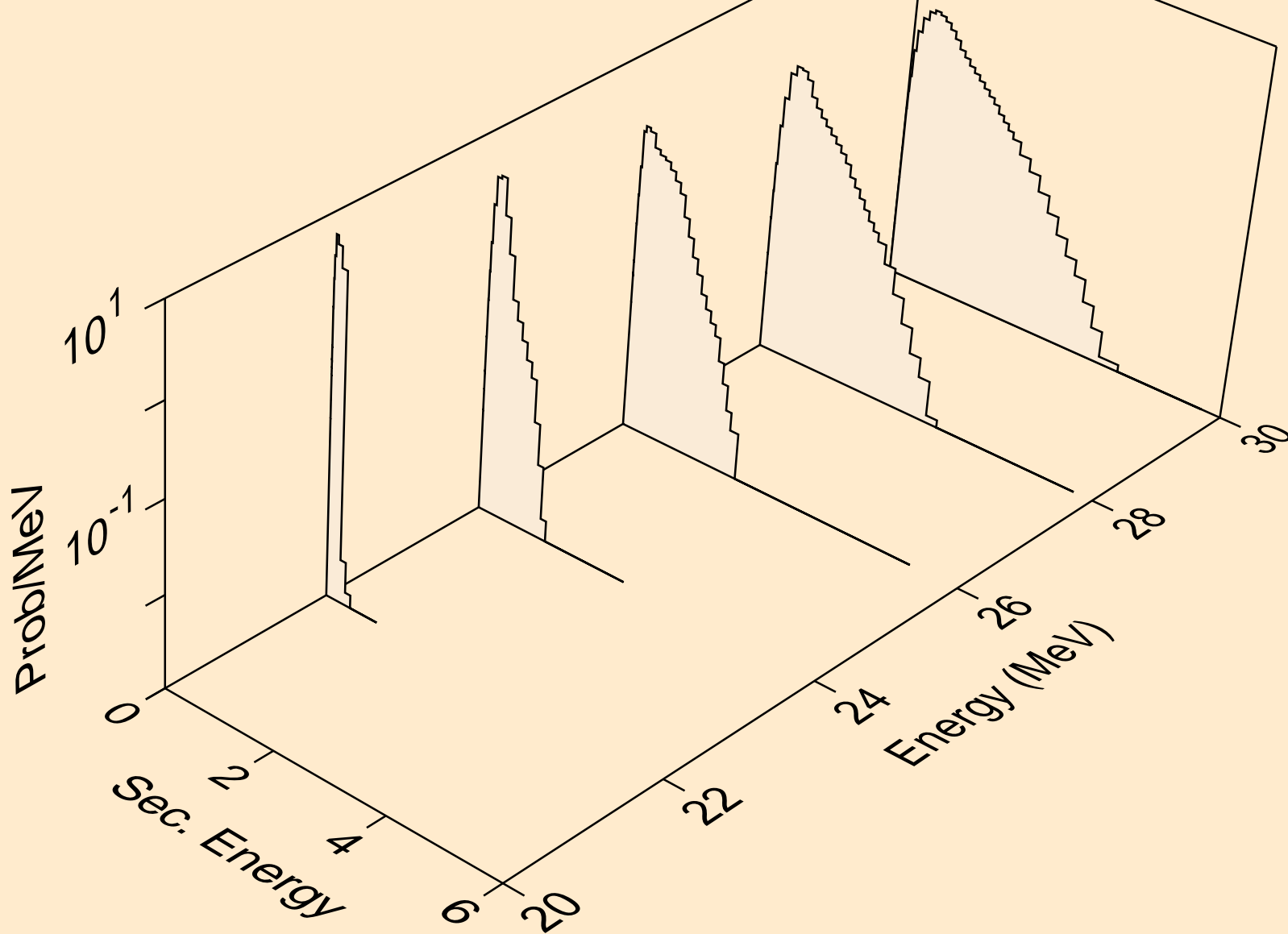

ZR087M NEUTRON ACER TENDL-2019 LIBRARY; T=293.16K
Neutron emission for (n,n*)he3

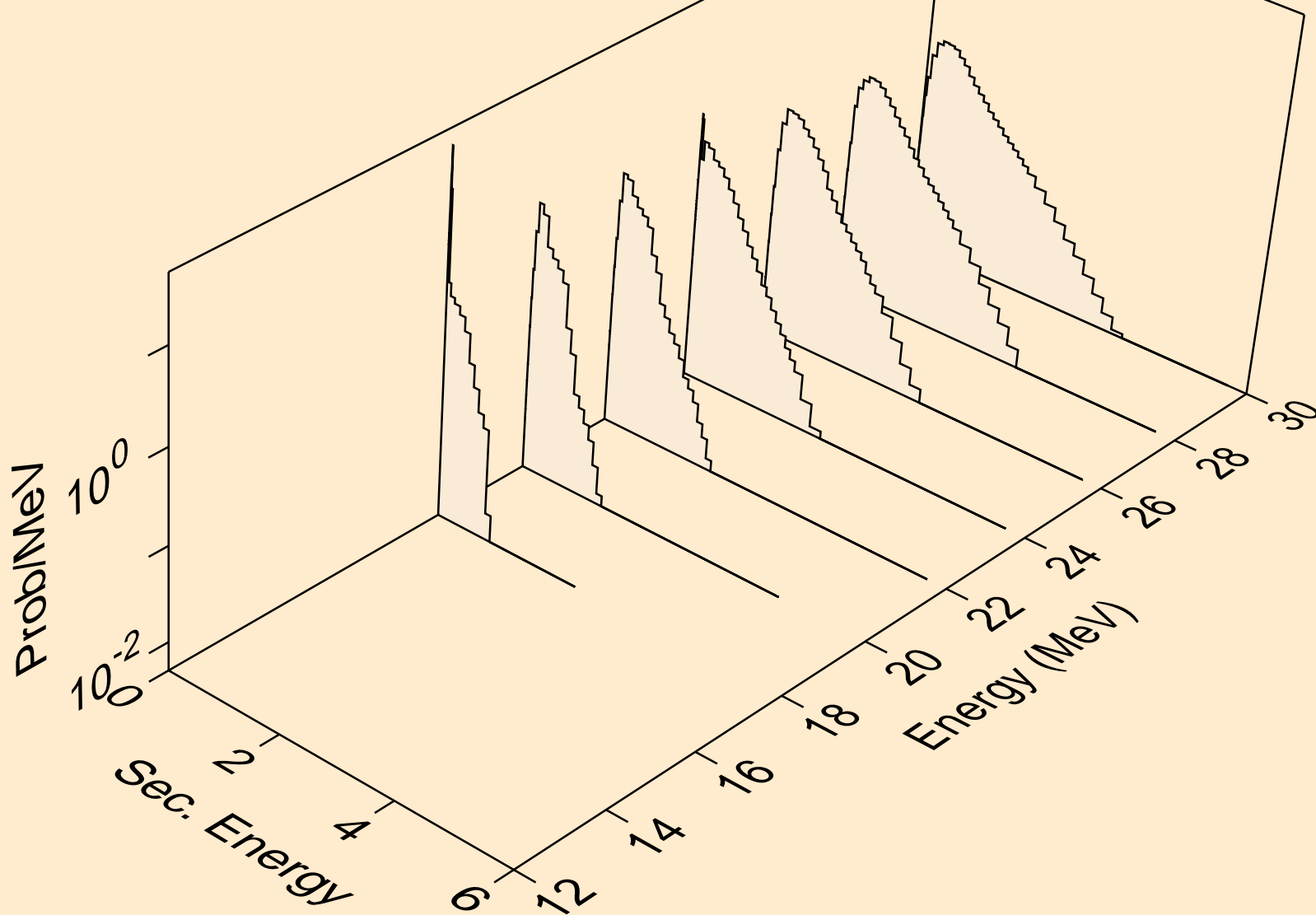

ZR087M NEUTRON ACER TENDL-2019 LIBRARY; T=293.16K
Neutron emission for (n,2np)

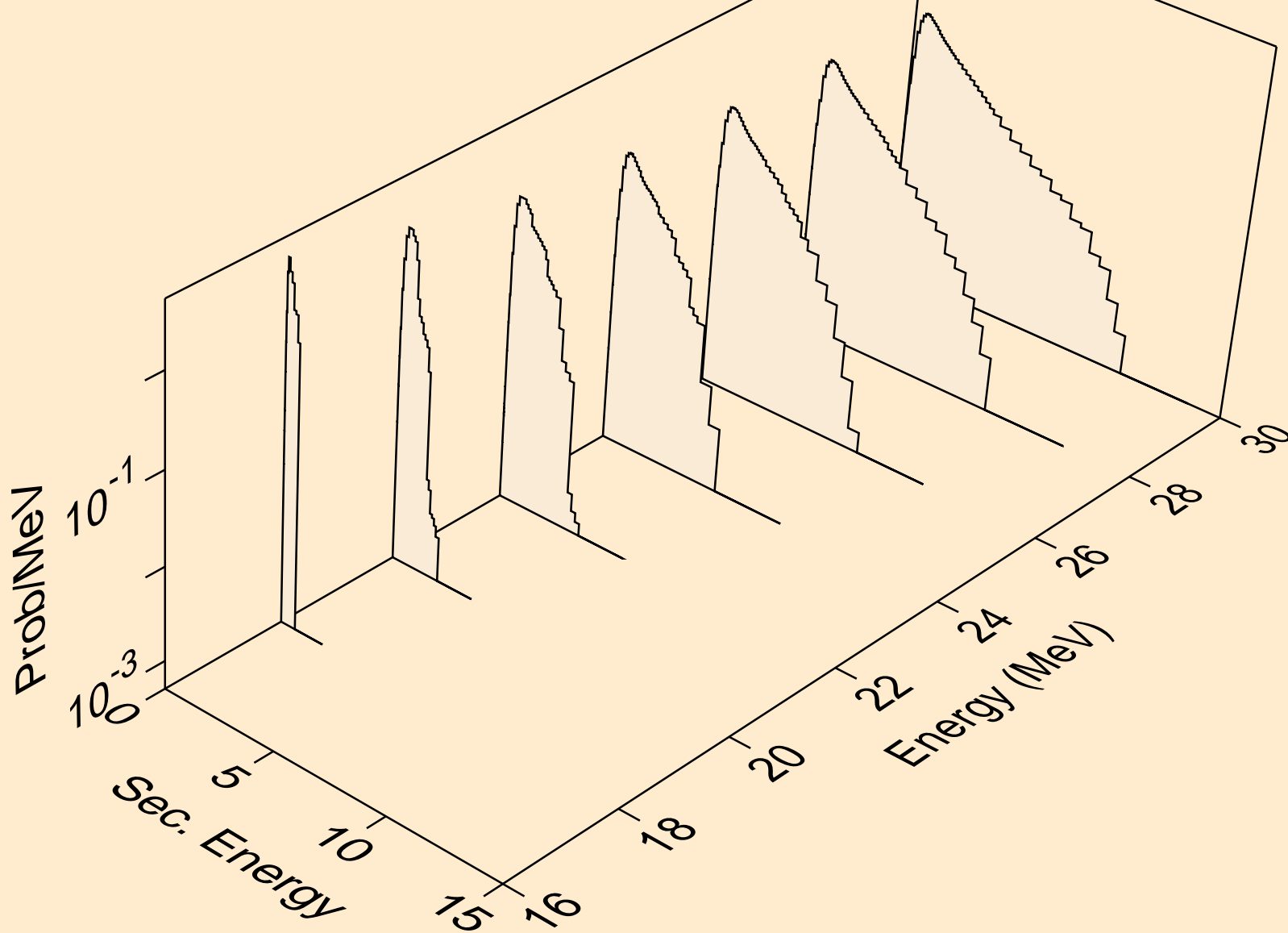

ZR087M NEUTRON ACER TENDL-2019 LIBRARY; T=293.16K
Neutron emission for (n,3np)

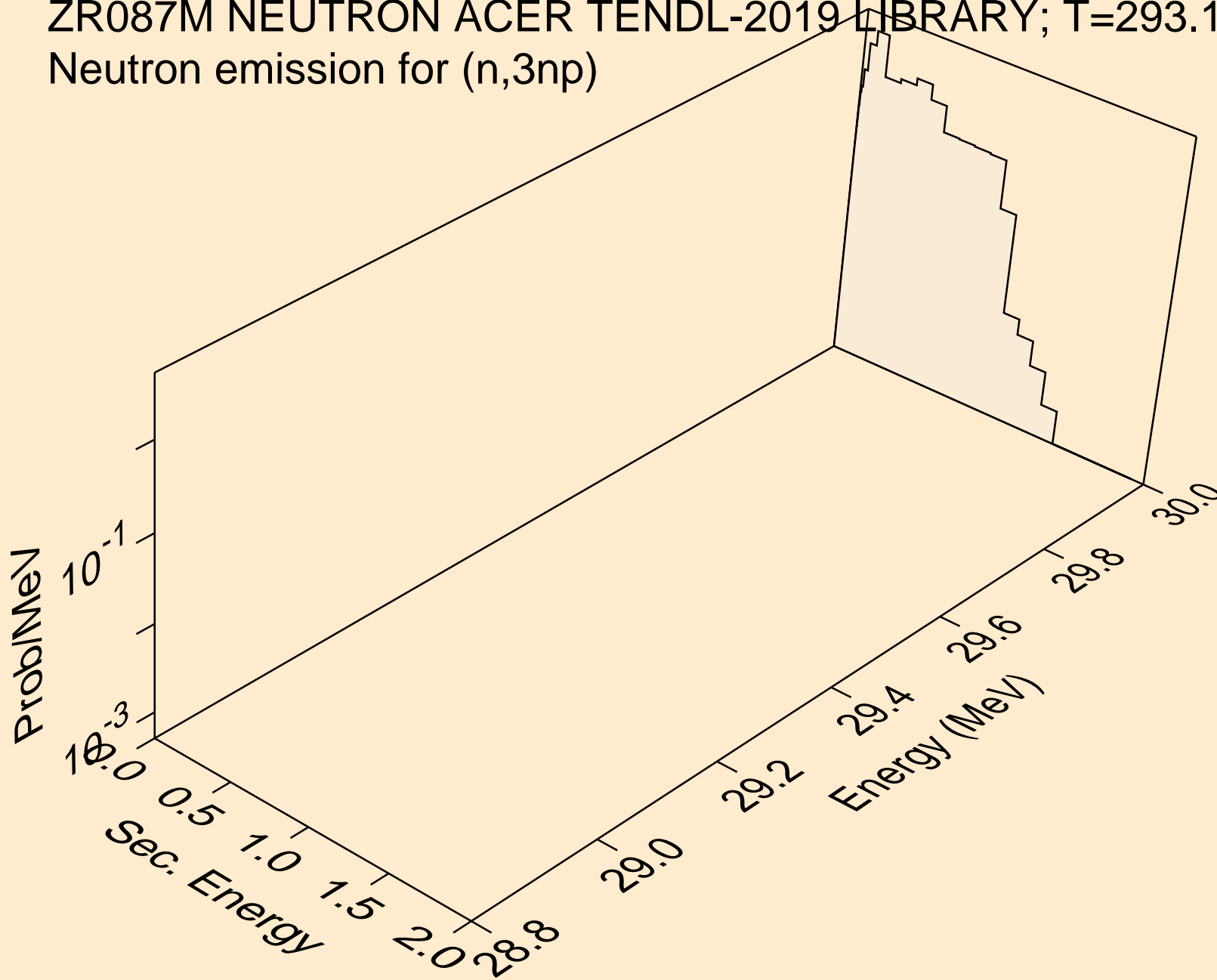

ZR087M NEUTRON ACER TENDL-2019 LIBRARY; T=293.16K
Neutron emission for (n,2np)

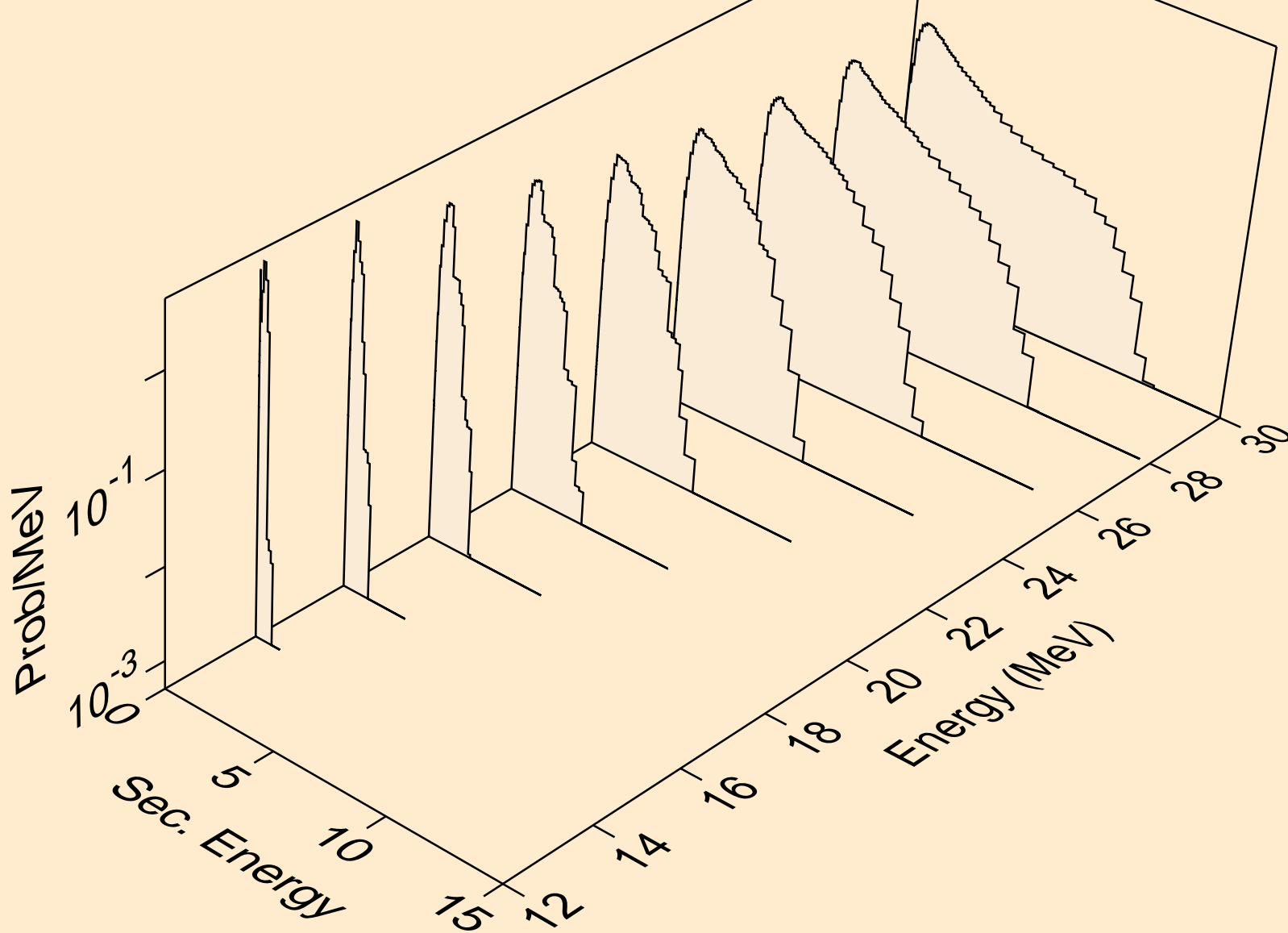

ZR087M NEUTRON ACER TENDL-2019 LIBRARY; T=293.16K
Neutron emission for (n,npa)

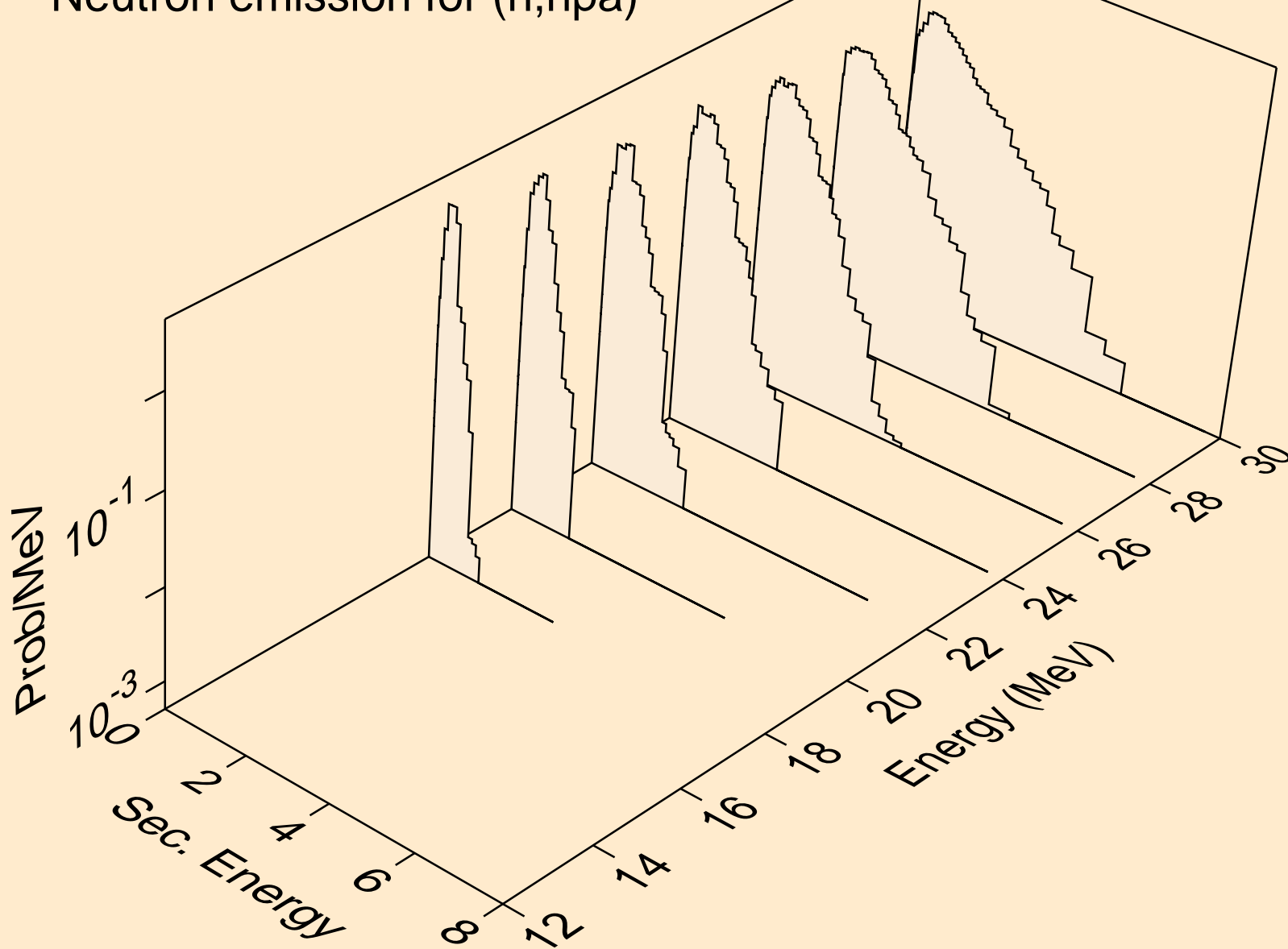

ZR087M NEUTRON ACER TENDL-2019 LIBRARY; T=293.16K
Neutron emission for (n,n*c)

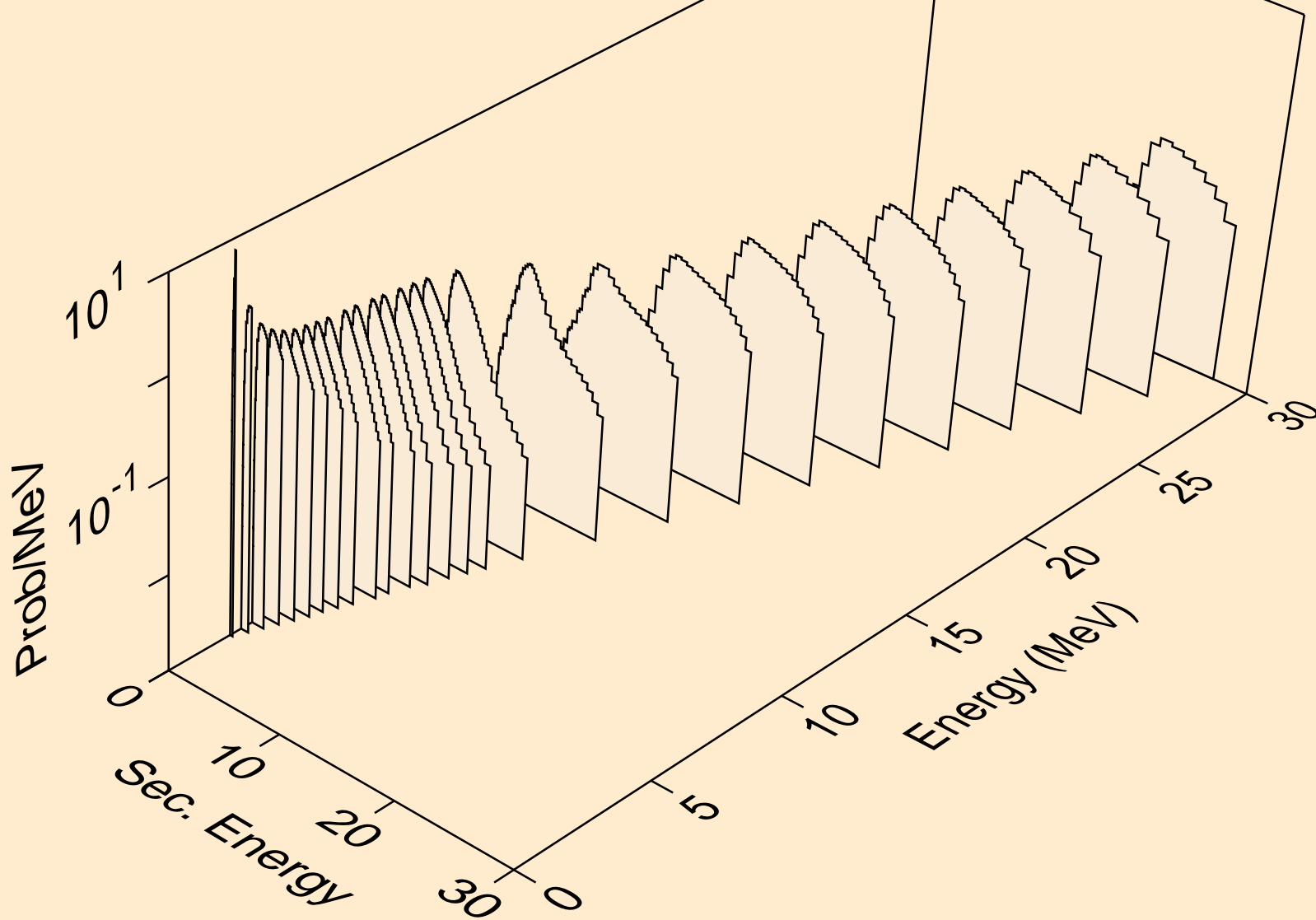

ZR087M NEUTRON ACER TENDL-2019 LIBRARY; T=293.16K
Photon emission for (n,x)

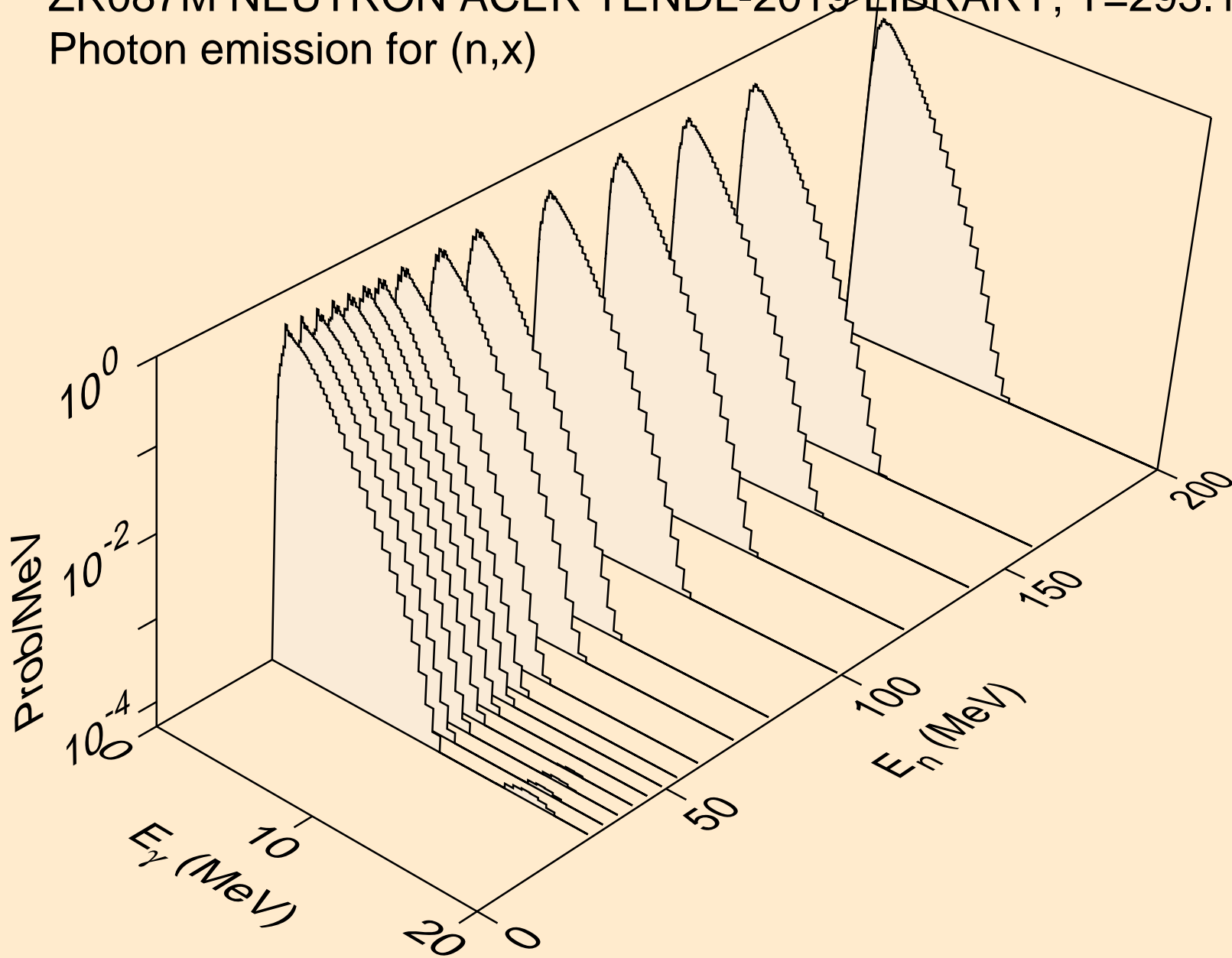

ZR087M NEUTRON ACER TENDL-2019 LIBRARY; T=293.16K
Photon emission for (n,2nd)

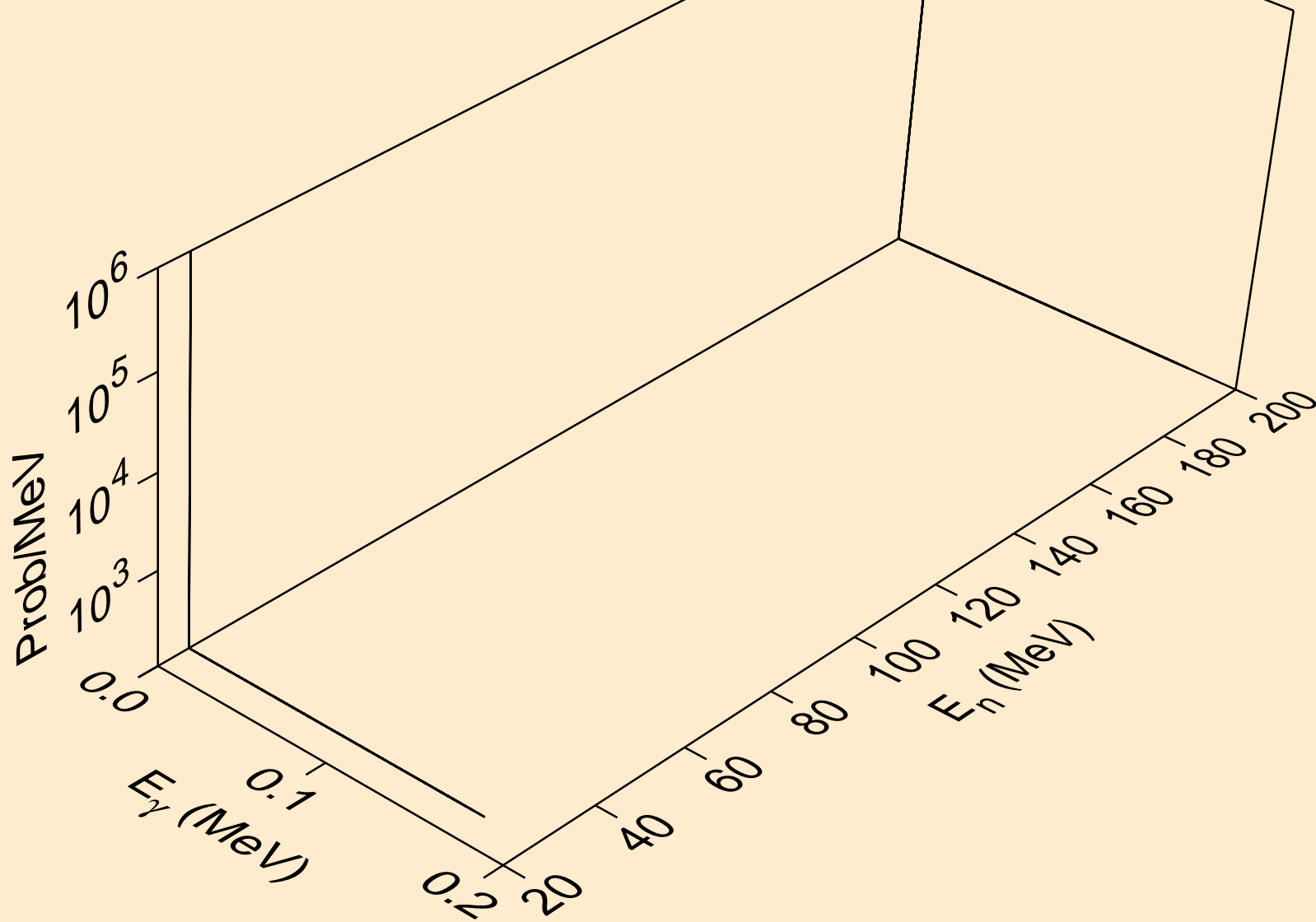

ZR087M NEUTRON ACER TENDL-2019 LIBRARY; T=293.16K
Photon emission for (n,2n)

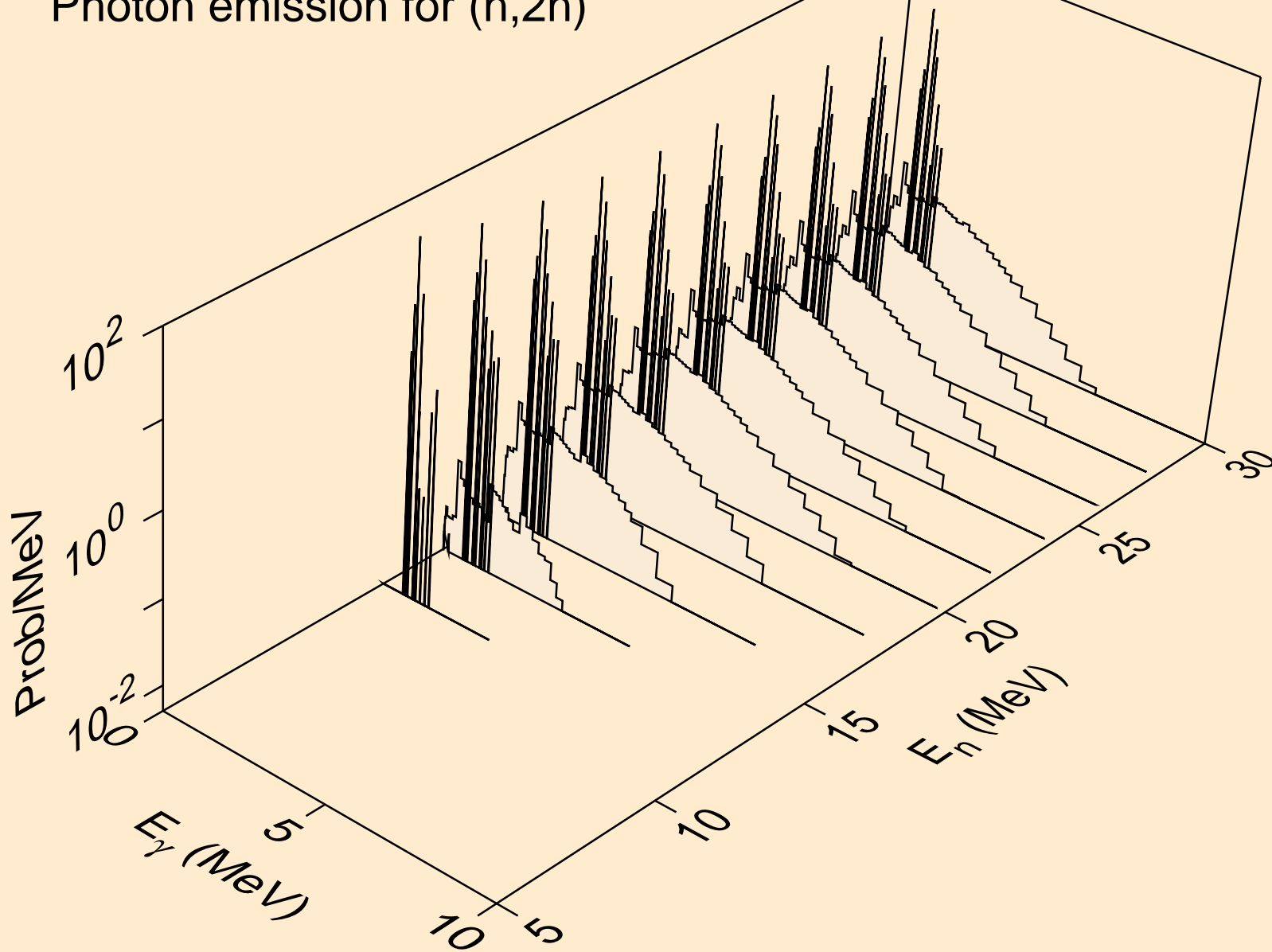

ZR087M NEUTRON ACER TENDL-2019 LIBRARY; T=293.16K
Photon emission for (n,3n)

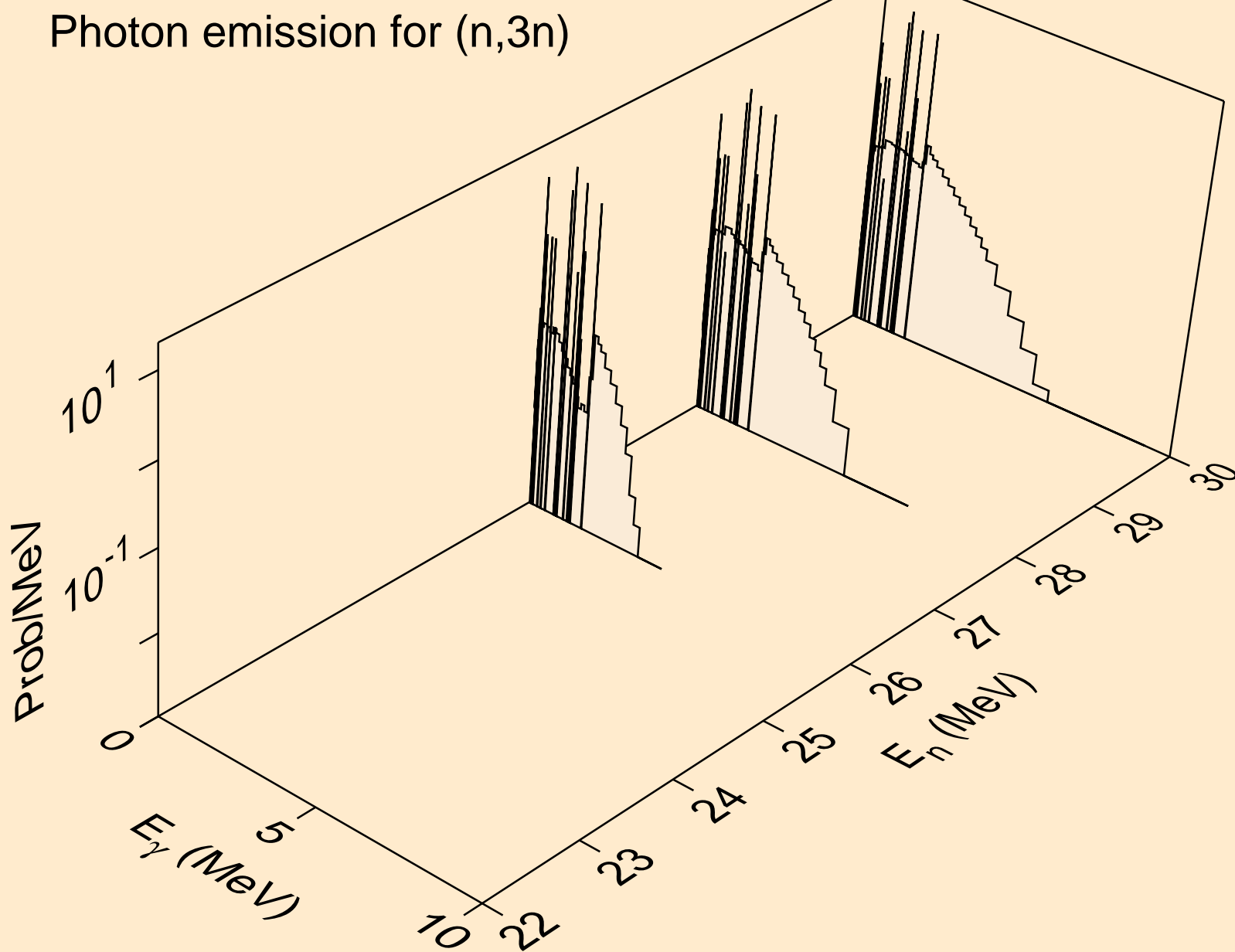

ZR087M NEUTRON ACER TENDL-2019 LIBRARY; T=293.16K
Photon emission for (n,n*)a

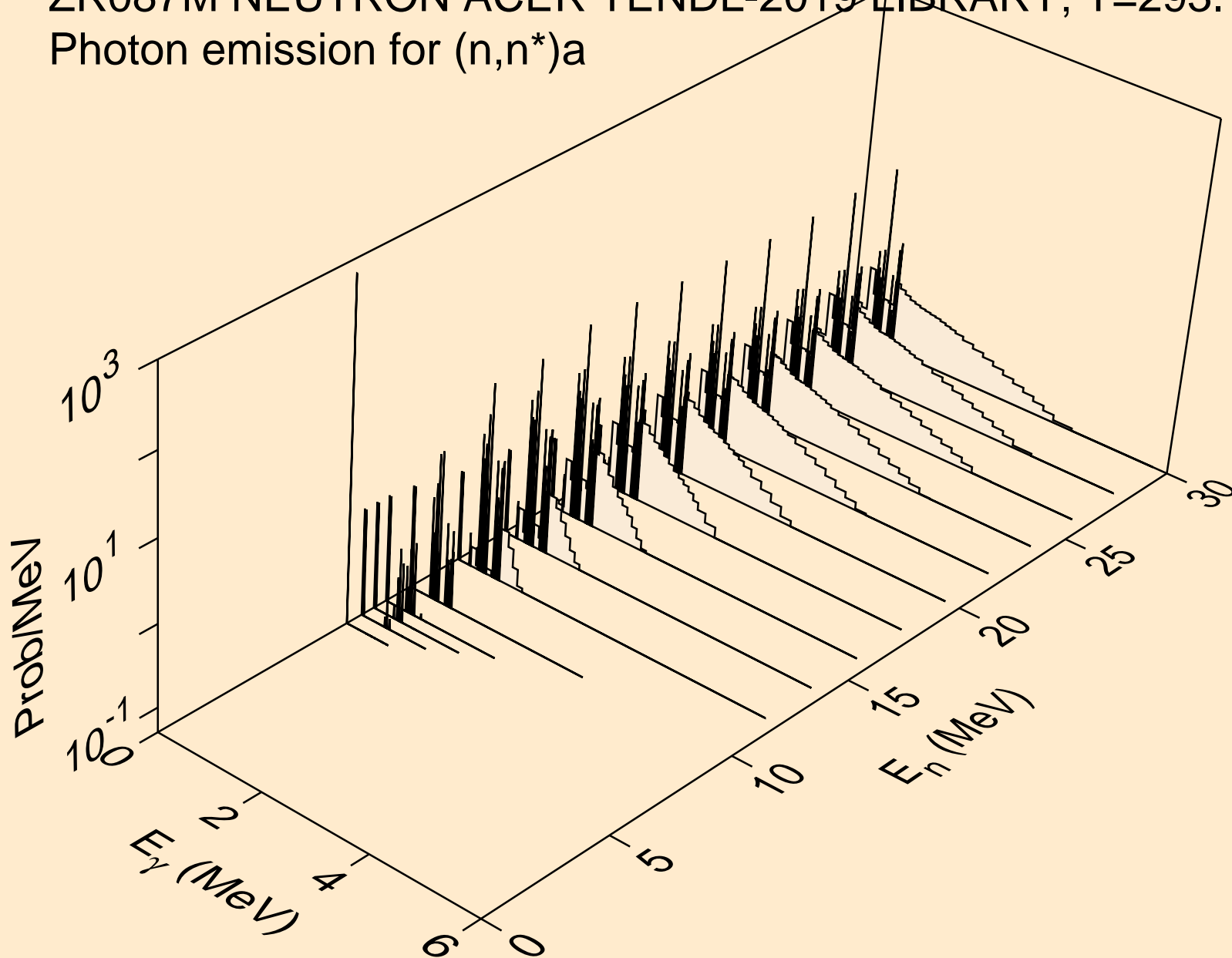

ZR087M NEUTRON ACER TENDL-2019 LIBRARY; T=293.16K
Photon emission for (n,2n)a

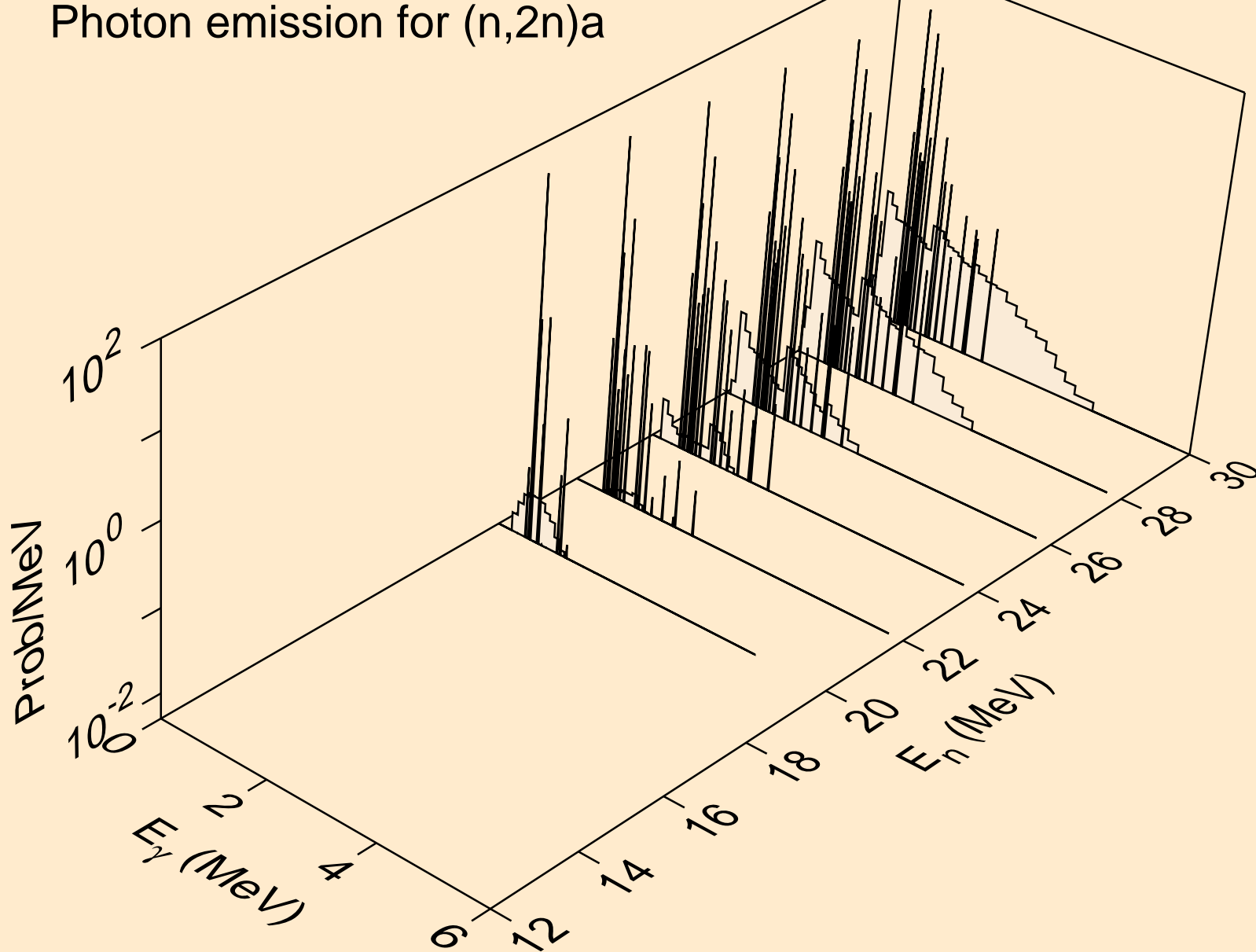

ZR087M NEUTRON ACER TENDL-2019 LIBRARY; T=293.16K
Photon emission for (n,n*)p

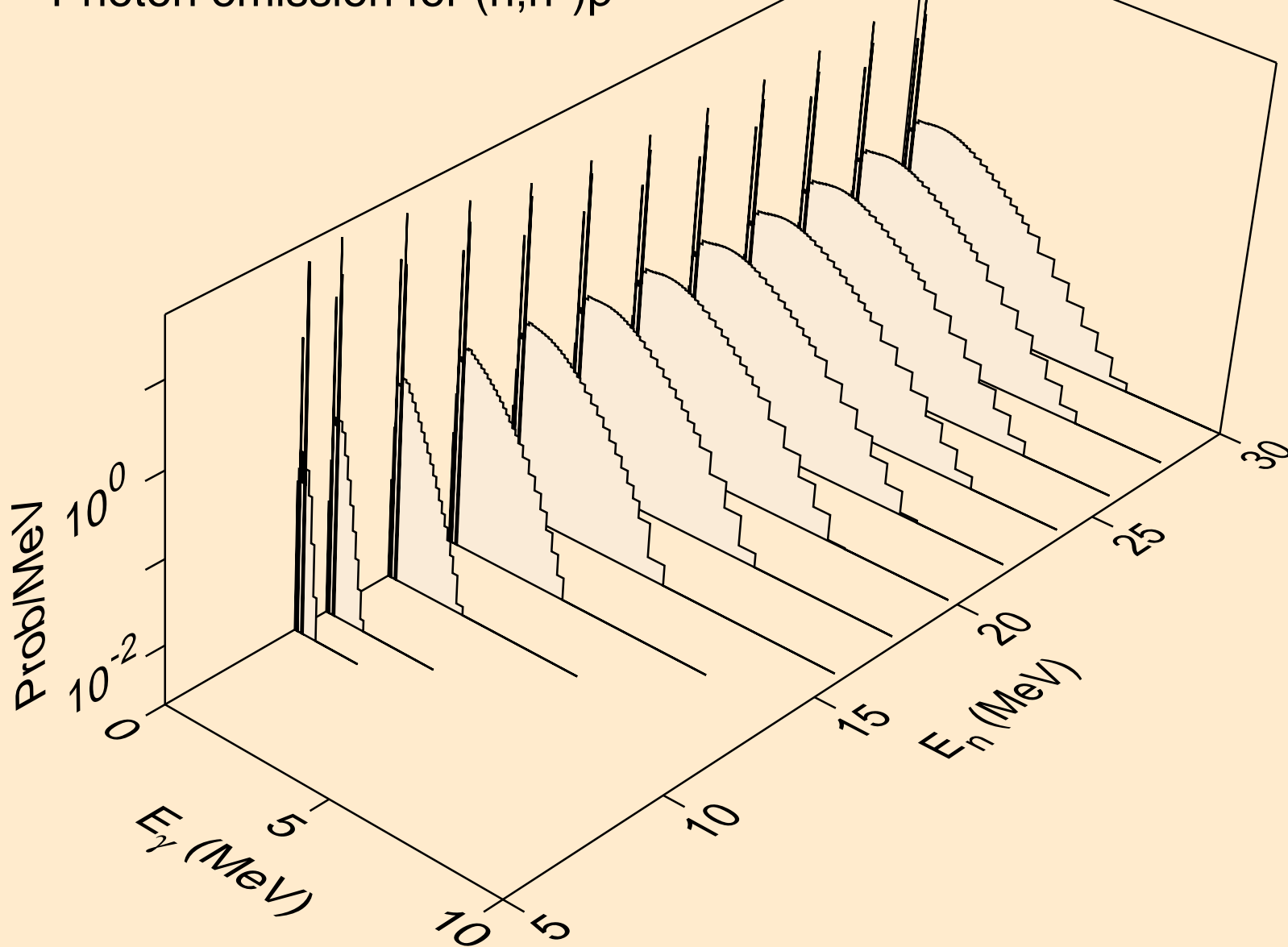

ZR087M NEUTRON ACER TENDL-2019 LIBRARY; T=293.16K
Photon emission for (n,n*)2a

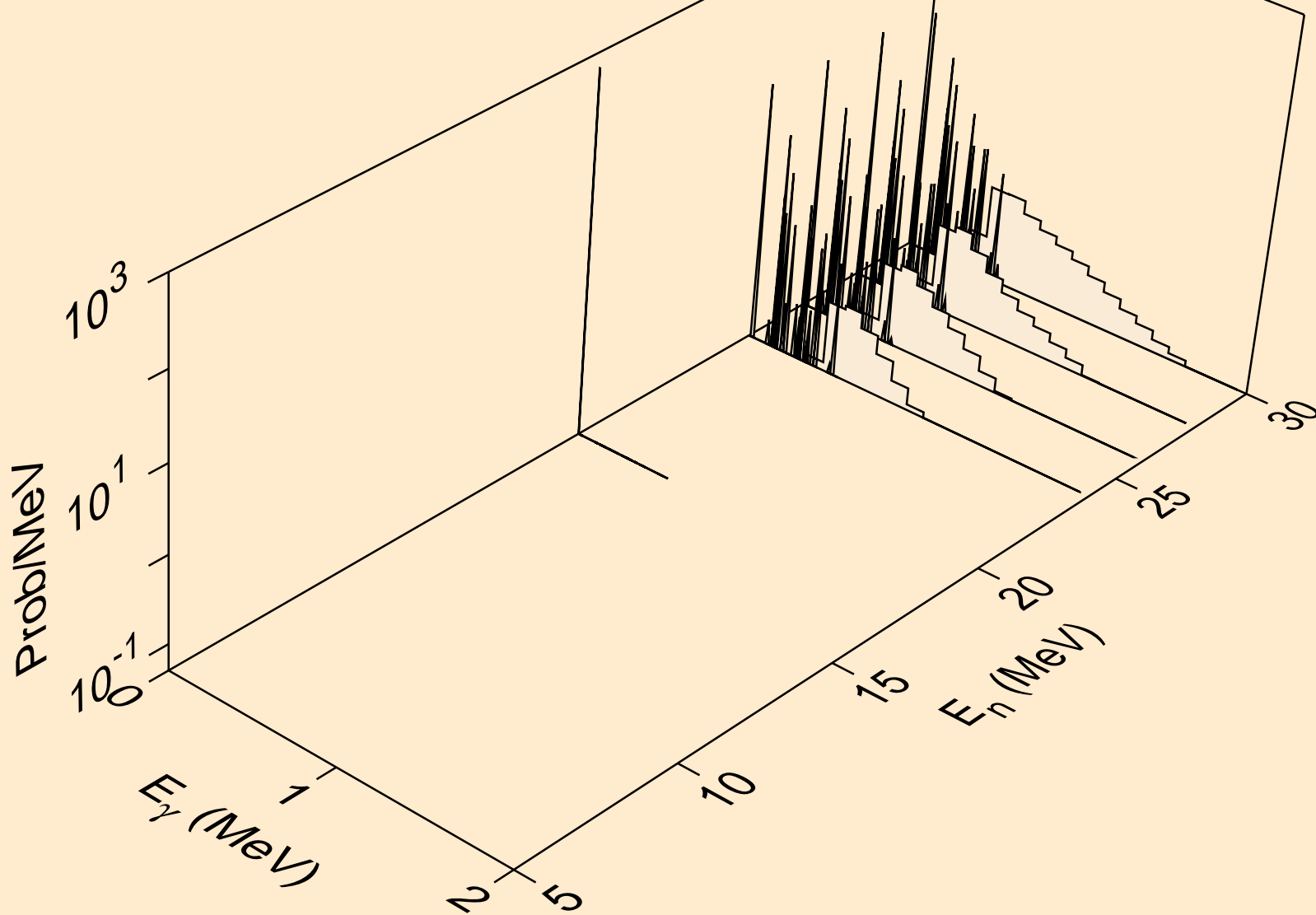

ZR087M NEUTRON ACER TENDL-2019 LIBRARY; T=293.16K
Photon emission for (n,n*)d

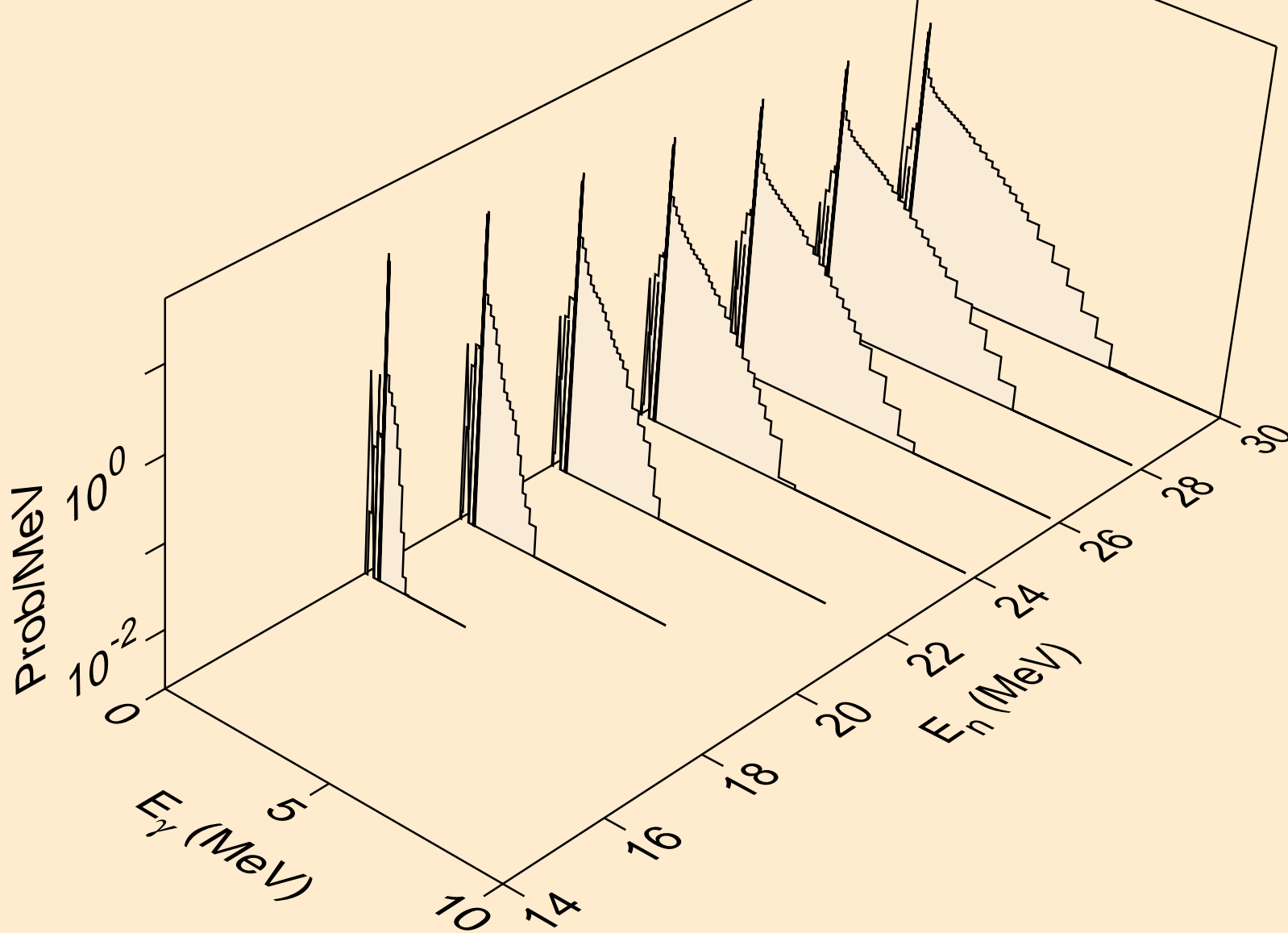

ZR087M NEUTRON ACER TENDL-2019 LIBRARY; T=293.16K
Photon emission for (n,n*)t

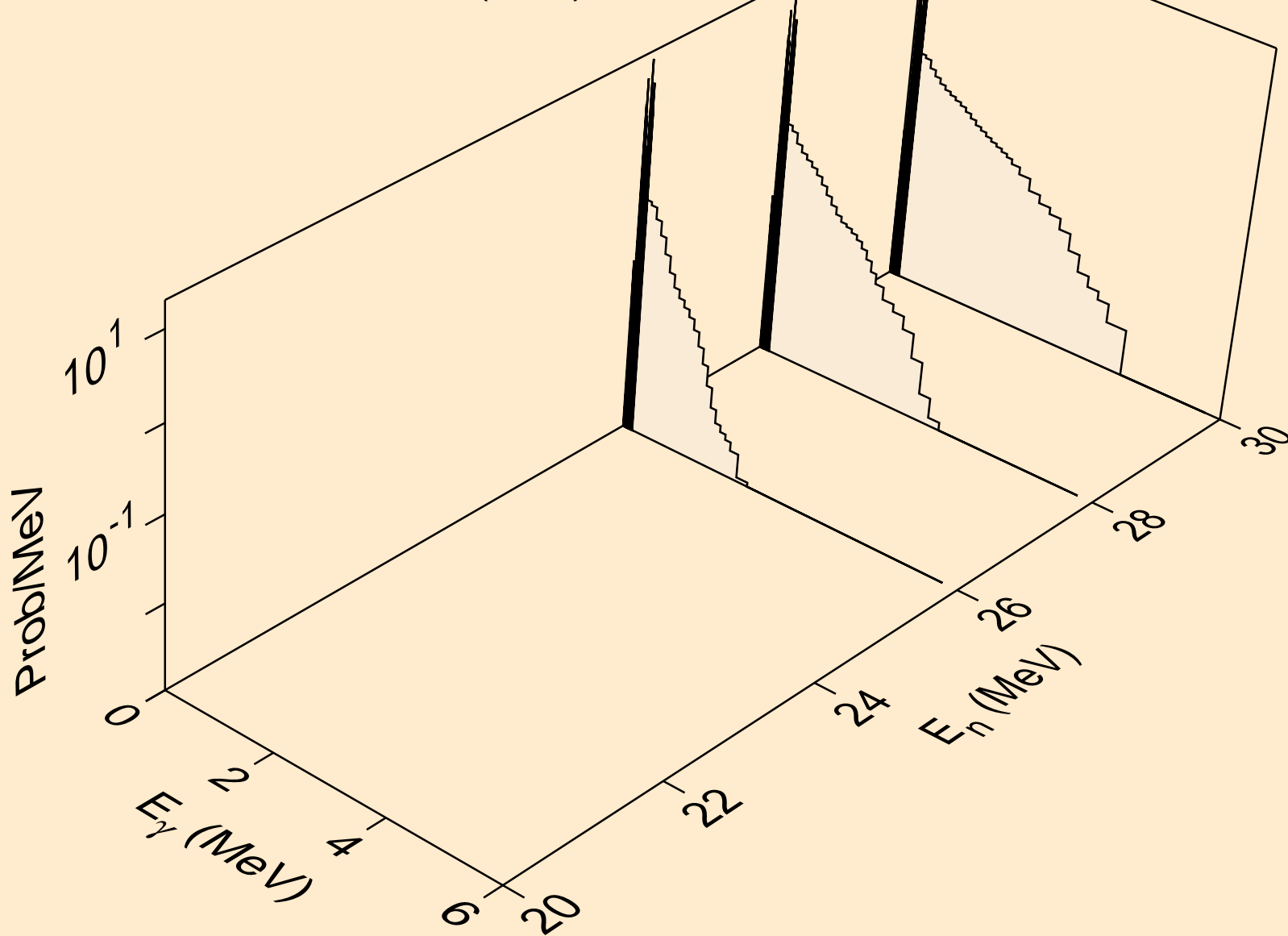

ZR087M NEUTRON ACER TENDL-2019 LIBRARY; T=293.16K
Photon emission for (n,n*)he3

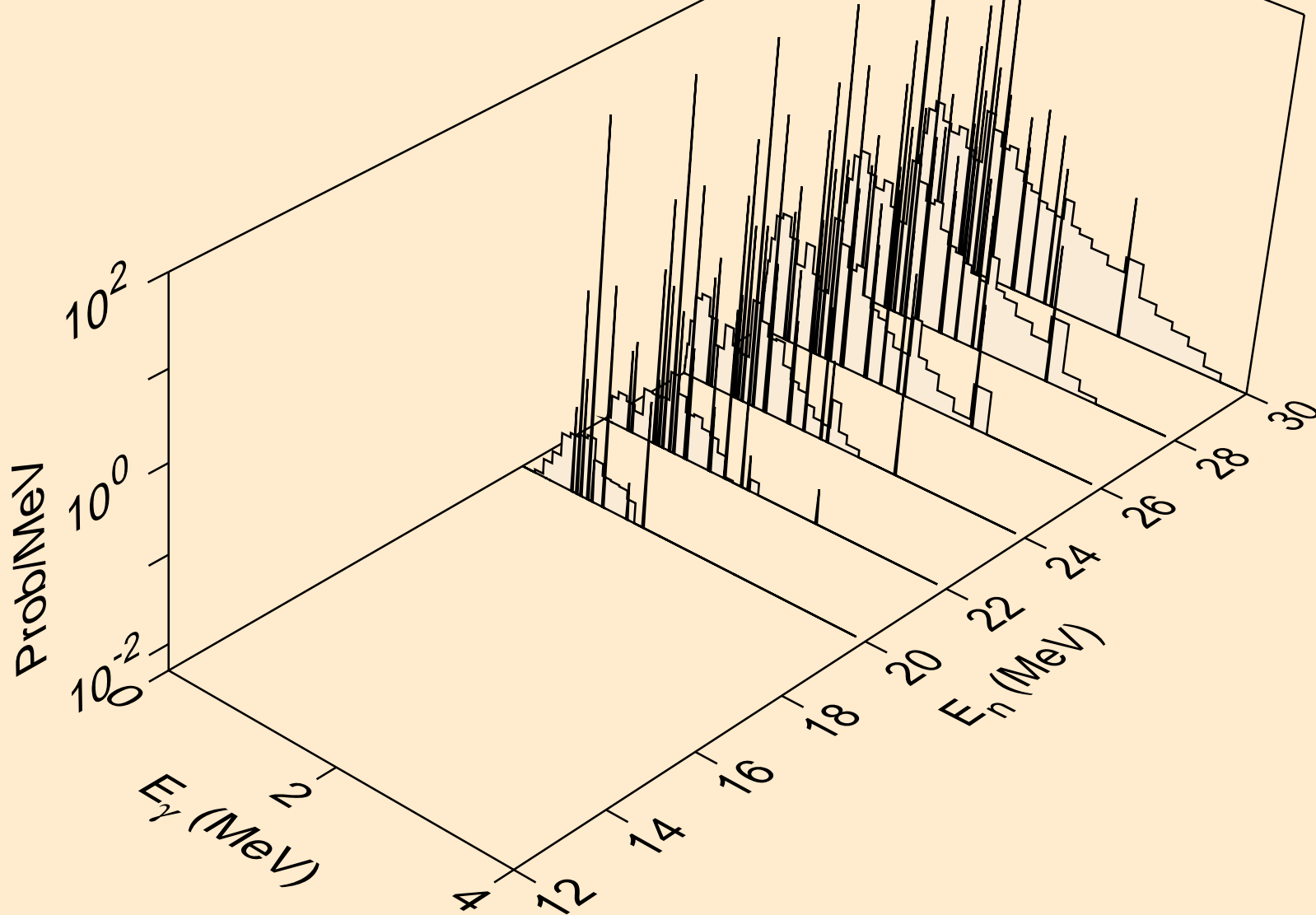

ZR087M NEUTRON ACER TENDL-2019 LIBRARY; T=293.16K
Photon emission for (n,2np)

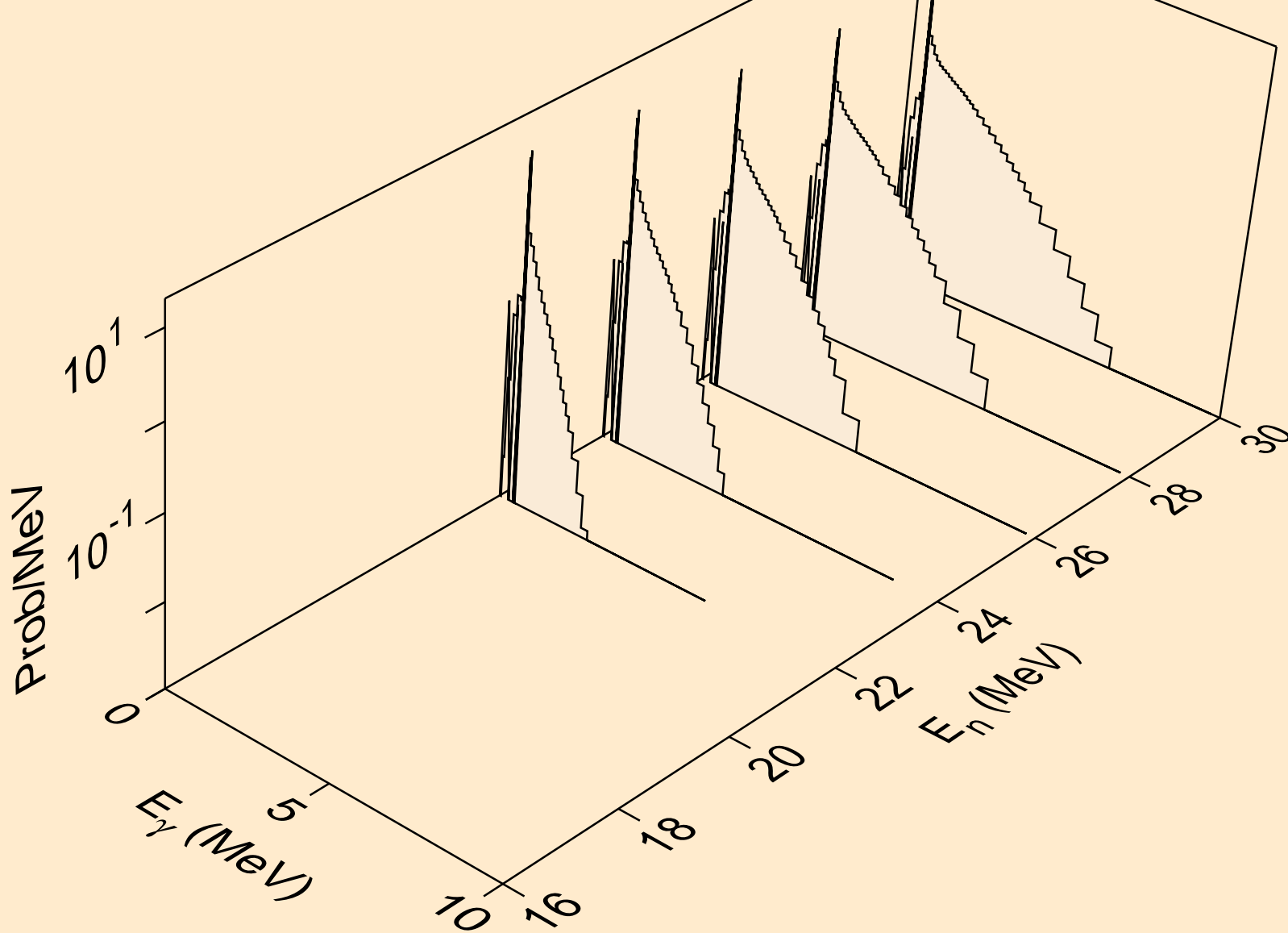

ZR087M NEUTRON ACER TENDL-2019 LIBRARY; T=293.16K
Photon emission for (n,3np)

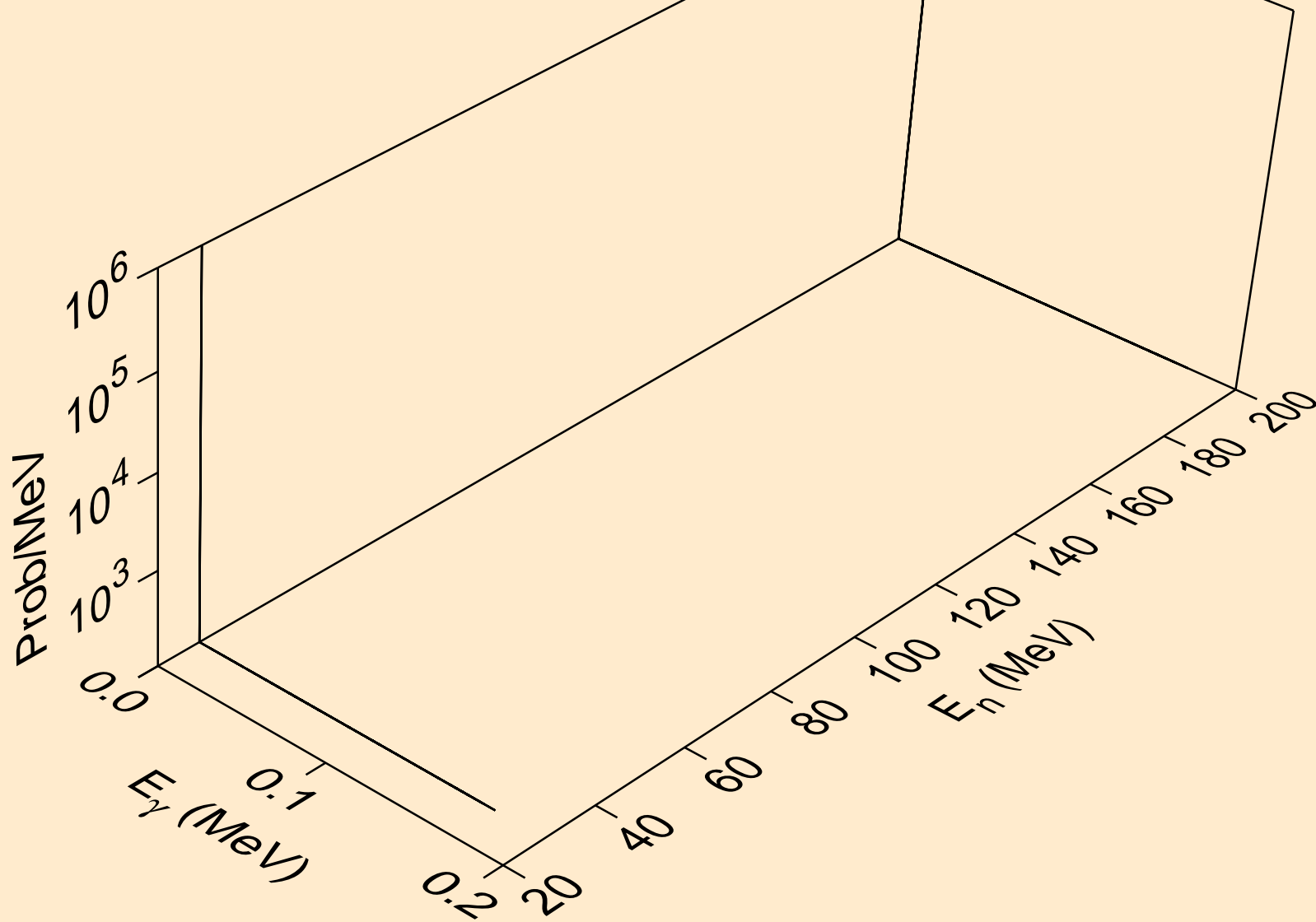

ZR087M NEUTRON ACER TENDL-2019 LIBRARY; T=293.16K
Photon emission for (n,2np)

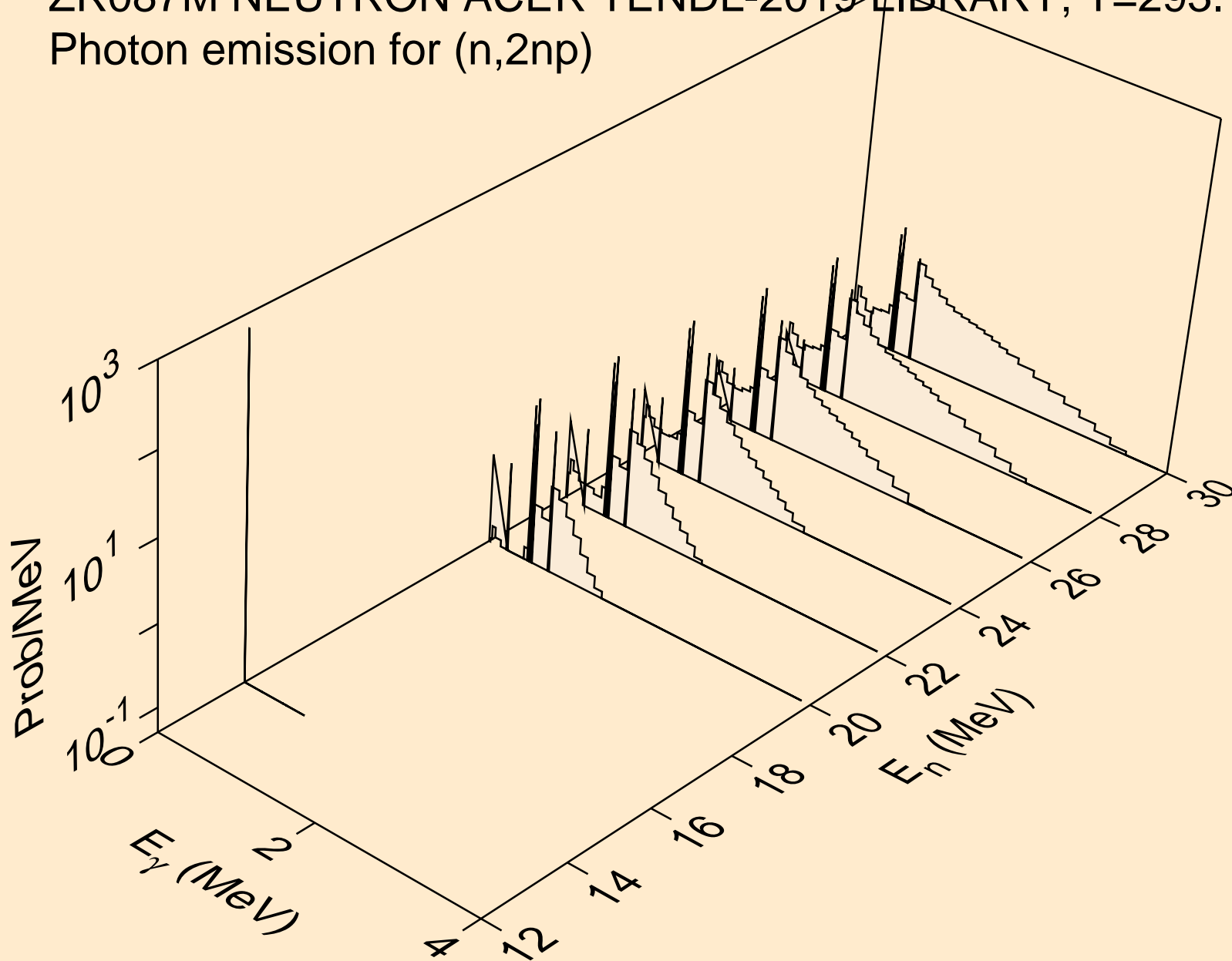

ZR087M NEUTRON ACER TENDL-2019 LIBRARY; T=293.16K
Photon emission for (n,npa)

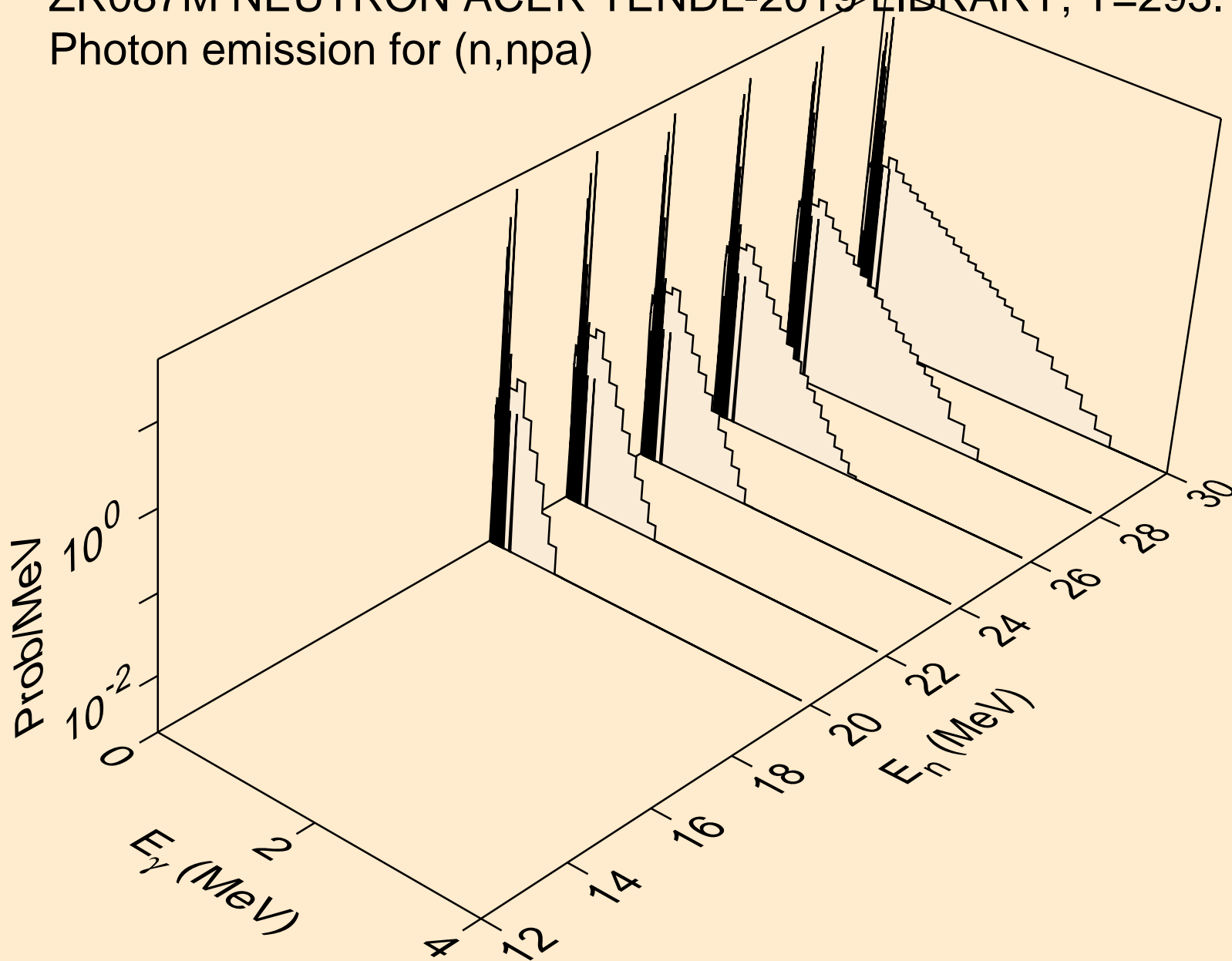

ZR087M NEUTRON ACER TENDL-2019 LIBRARY; T=293.16K
Photon emission for (n,n*1)

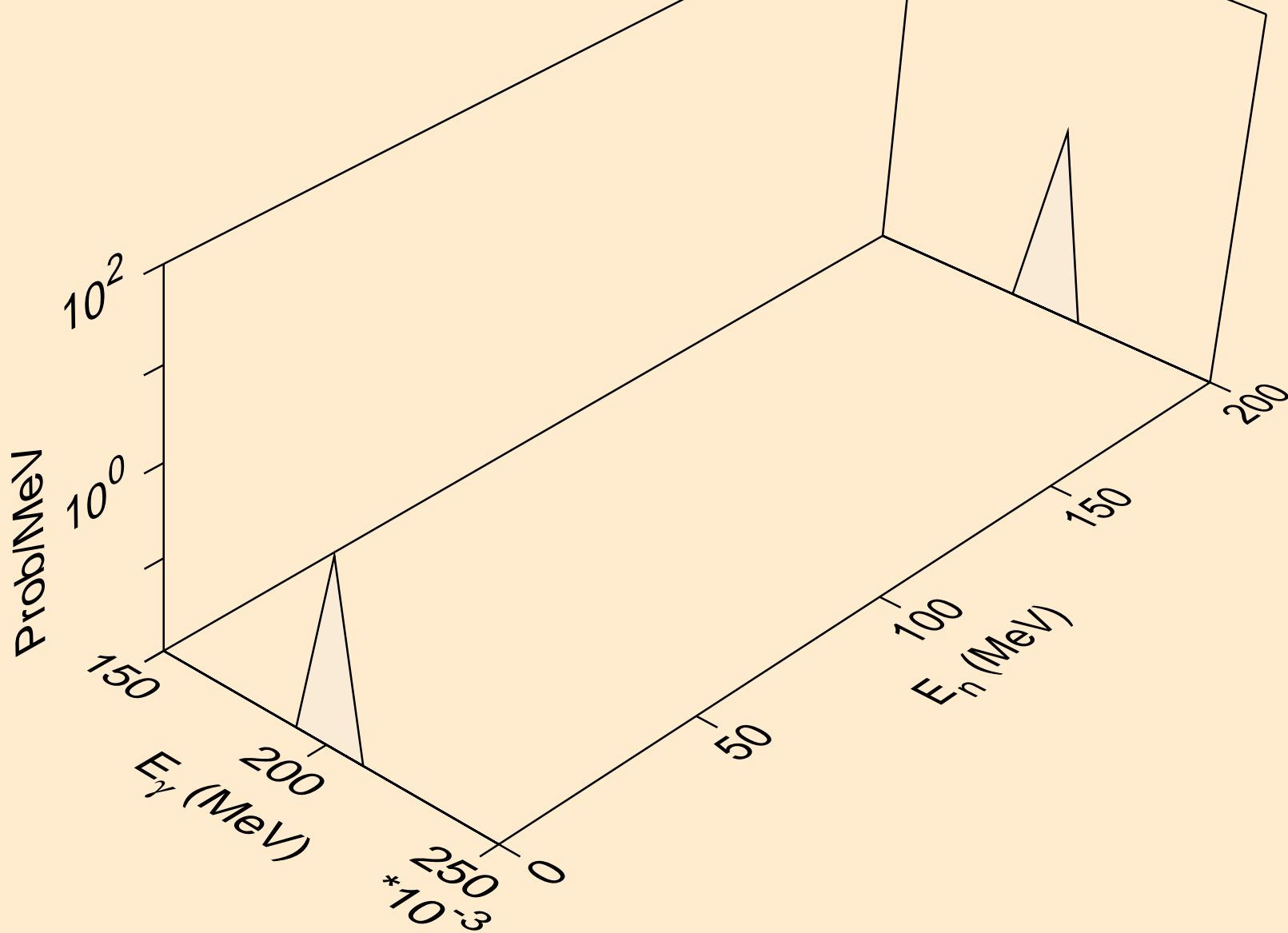

ZR087M NEUTRON ACER TENDL-2019 LIBRARY; T=293.16K
Photon emission for (n,n*3)

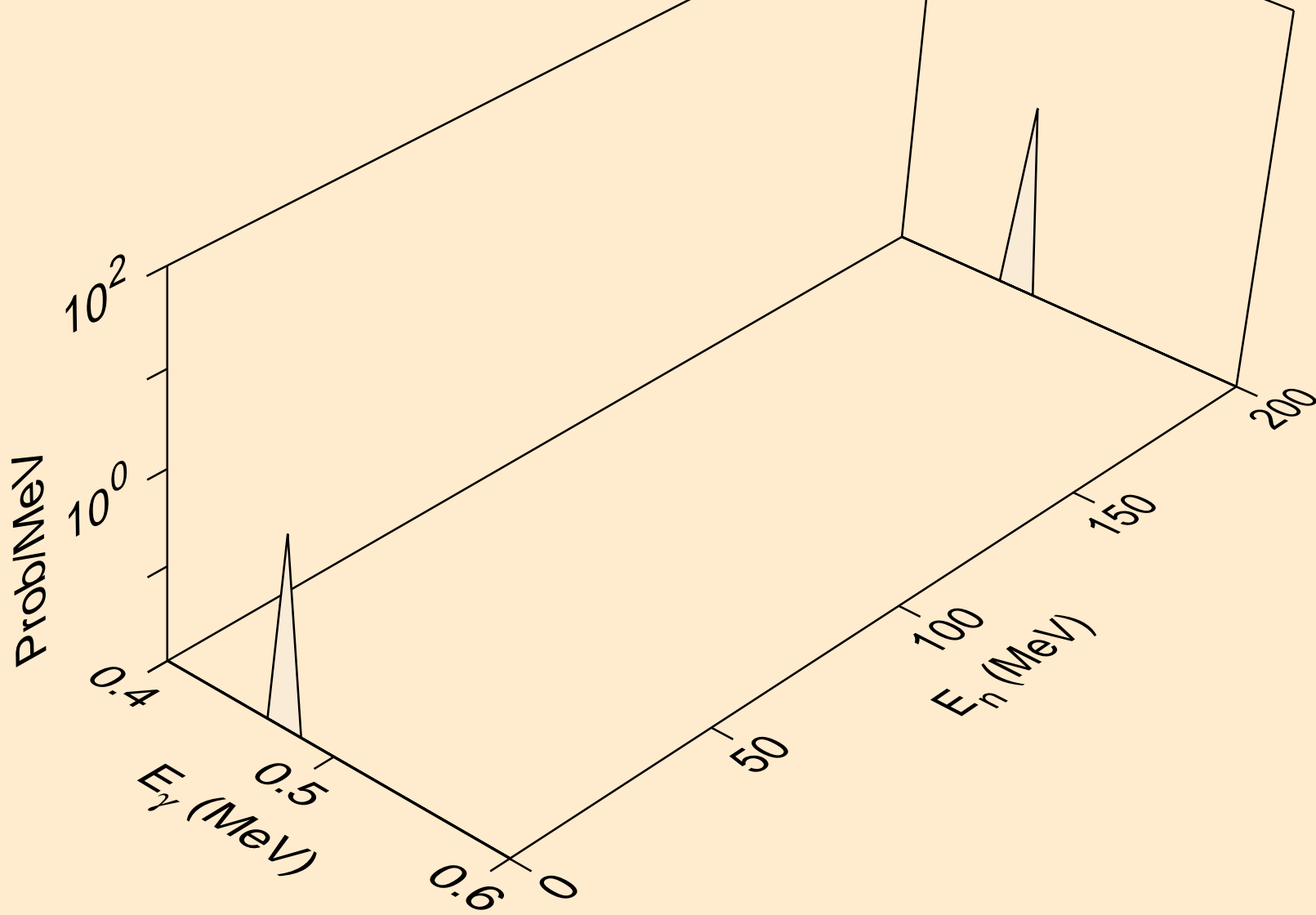

ZR087M NEUTRON ACER TENDL-2019 LIBRARY; T=293.16K
Photon emission for (n,n*4)

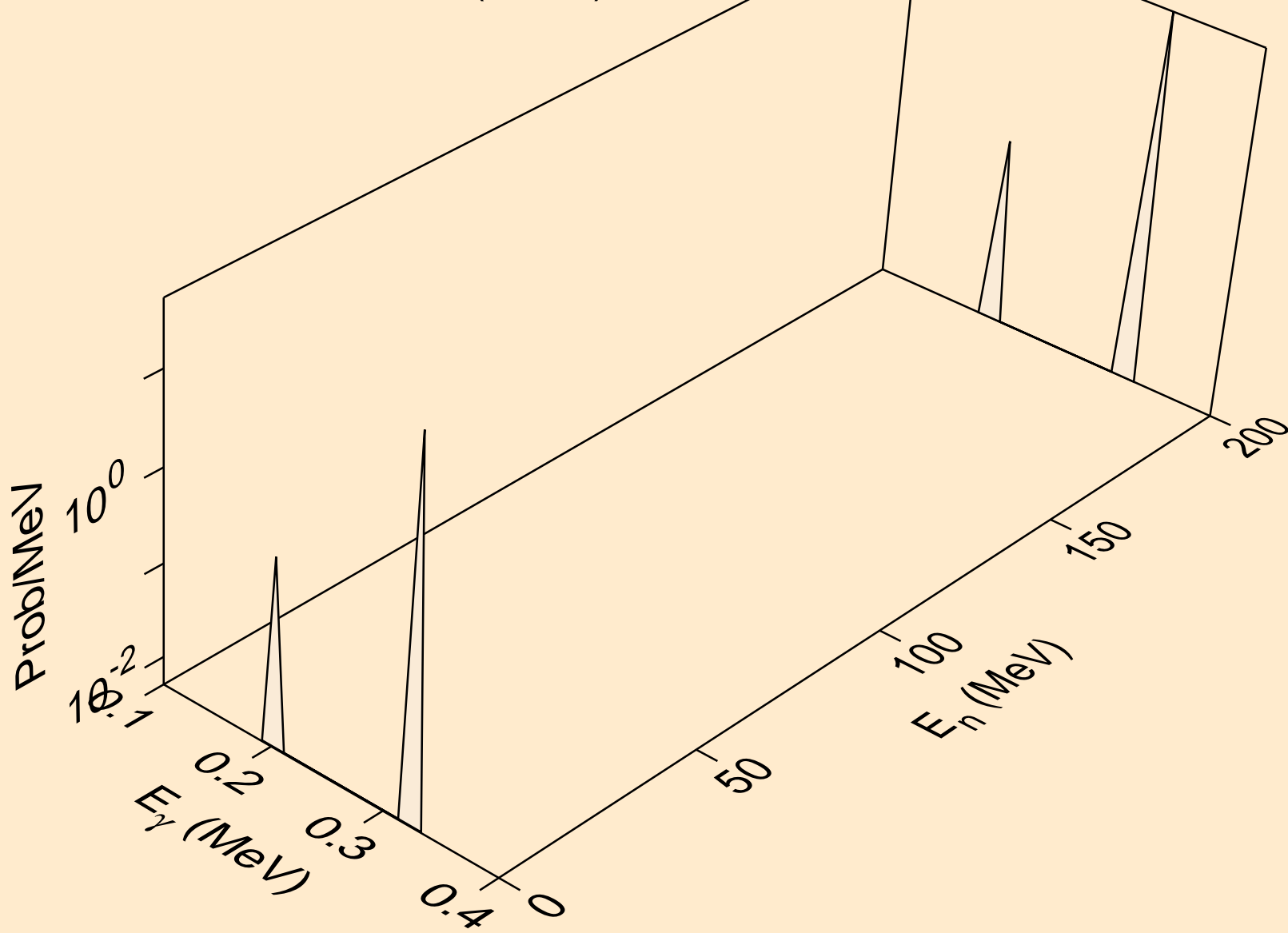

ZR087M NEUTRON ACER TENDL-2019 LIBRARY; T=293.16K
Photon emission for (n,n*5)

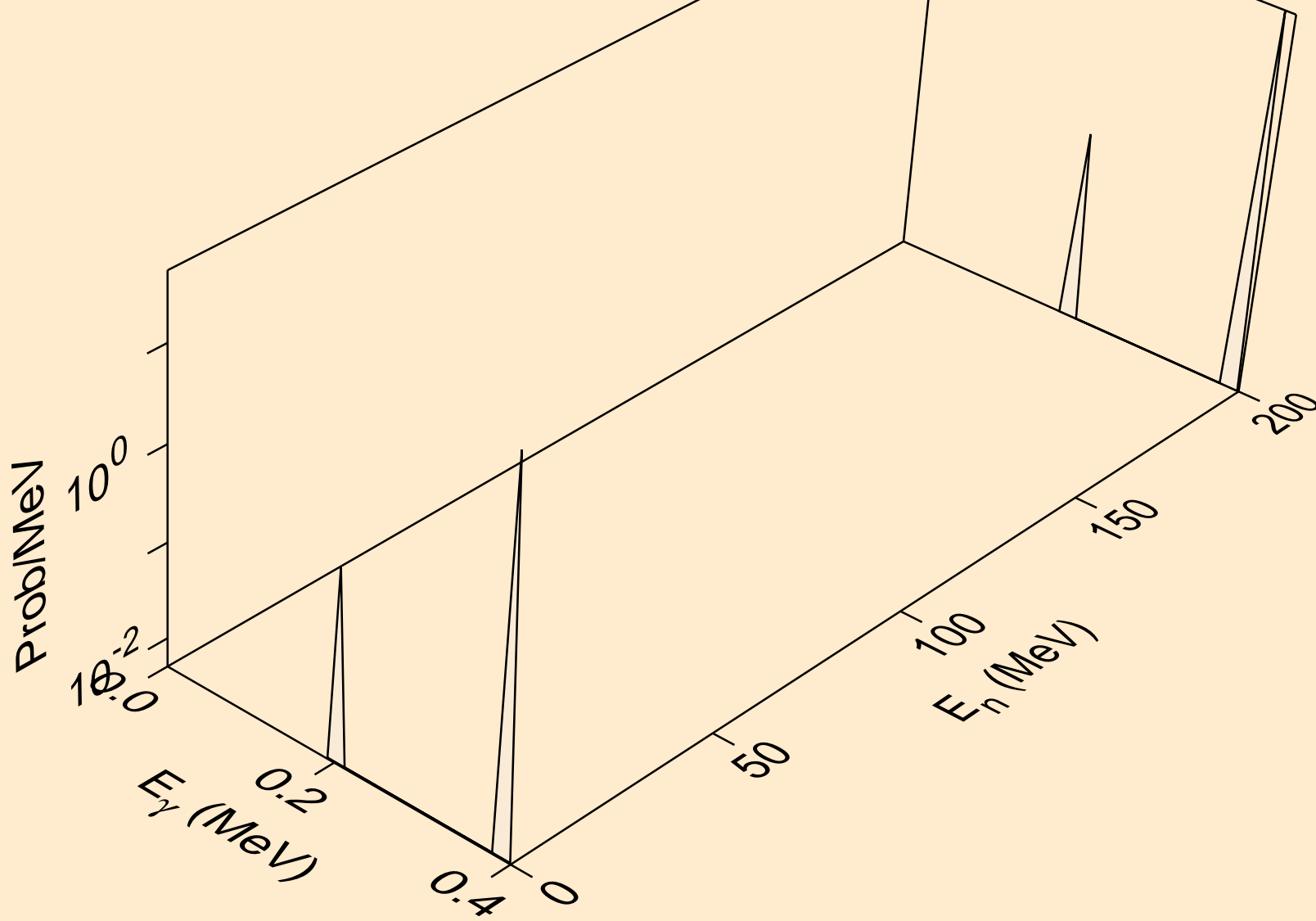

ZR087M NEUTRON ACER TENDL-2019 LIBRARY; T=293.16K
Photon emission for (n,n*6)

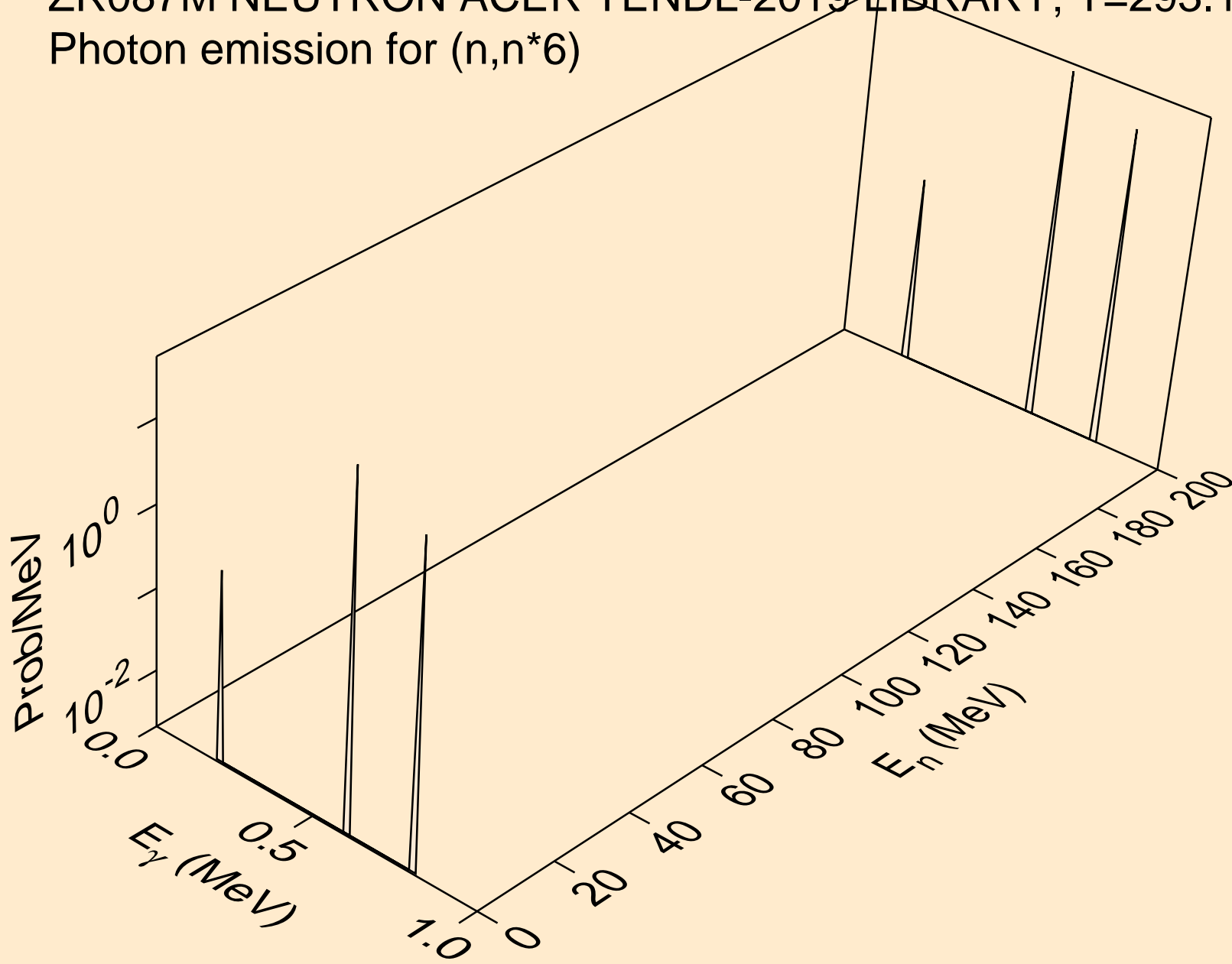

ZR087M NEUTRON ACER TENDL-2019 LIBRARY; T=293.16K
Photon emission for (n,n*7)

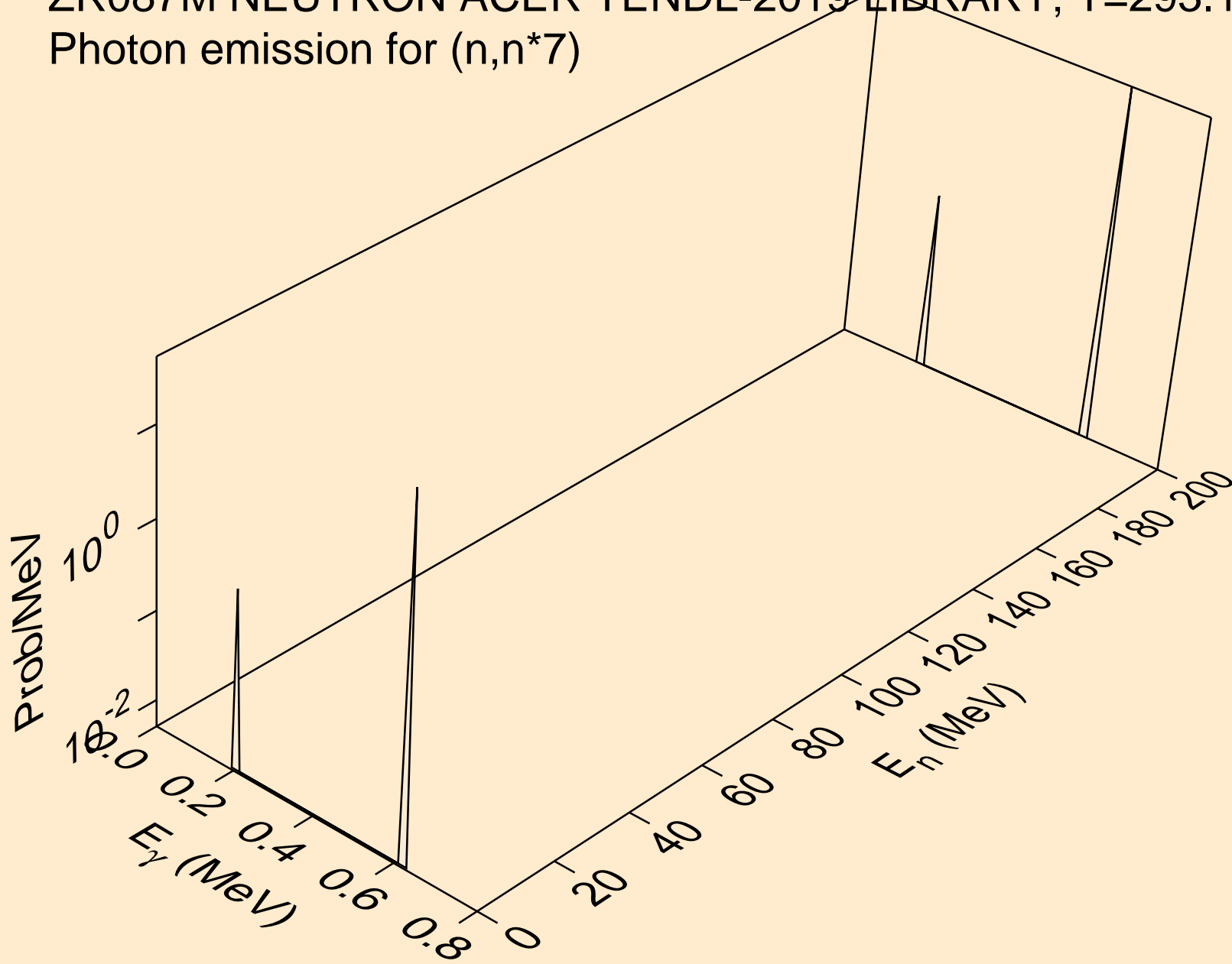

ZR087M NEUTRON ACER TENDL-2019 LIBRARY; T=293.16K
Photon emission for (n,n*8)

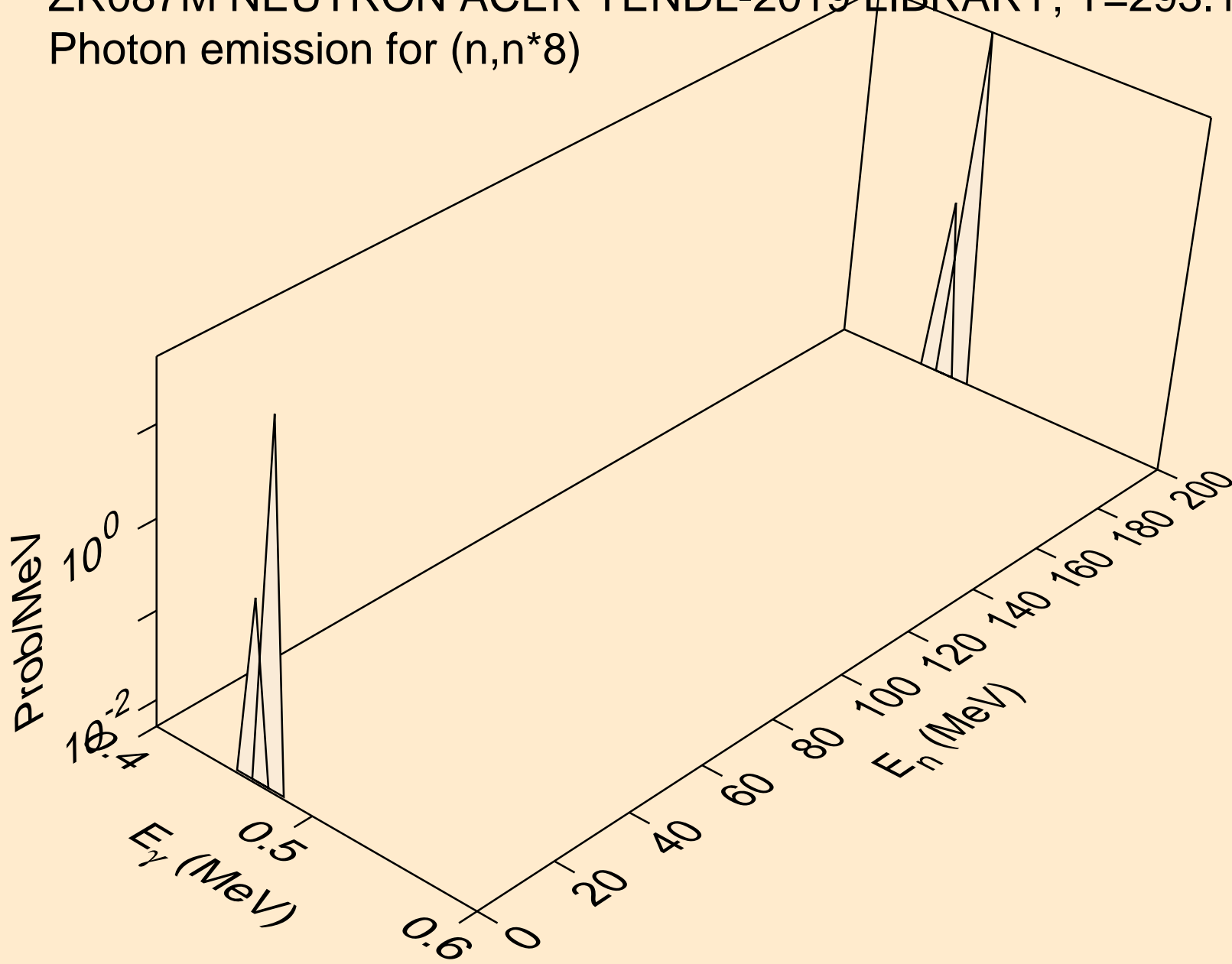

ZR087M NEUTRON ACER TENDL-2019 LIBRARY; T=293.16K
Photon emission for (n,n*9)

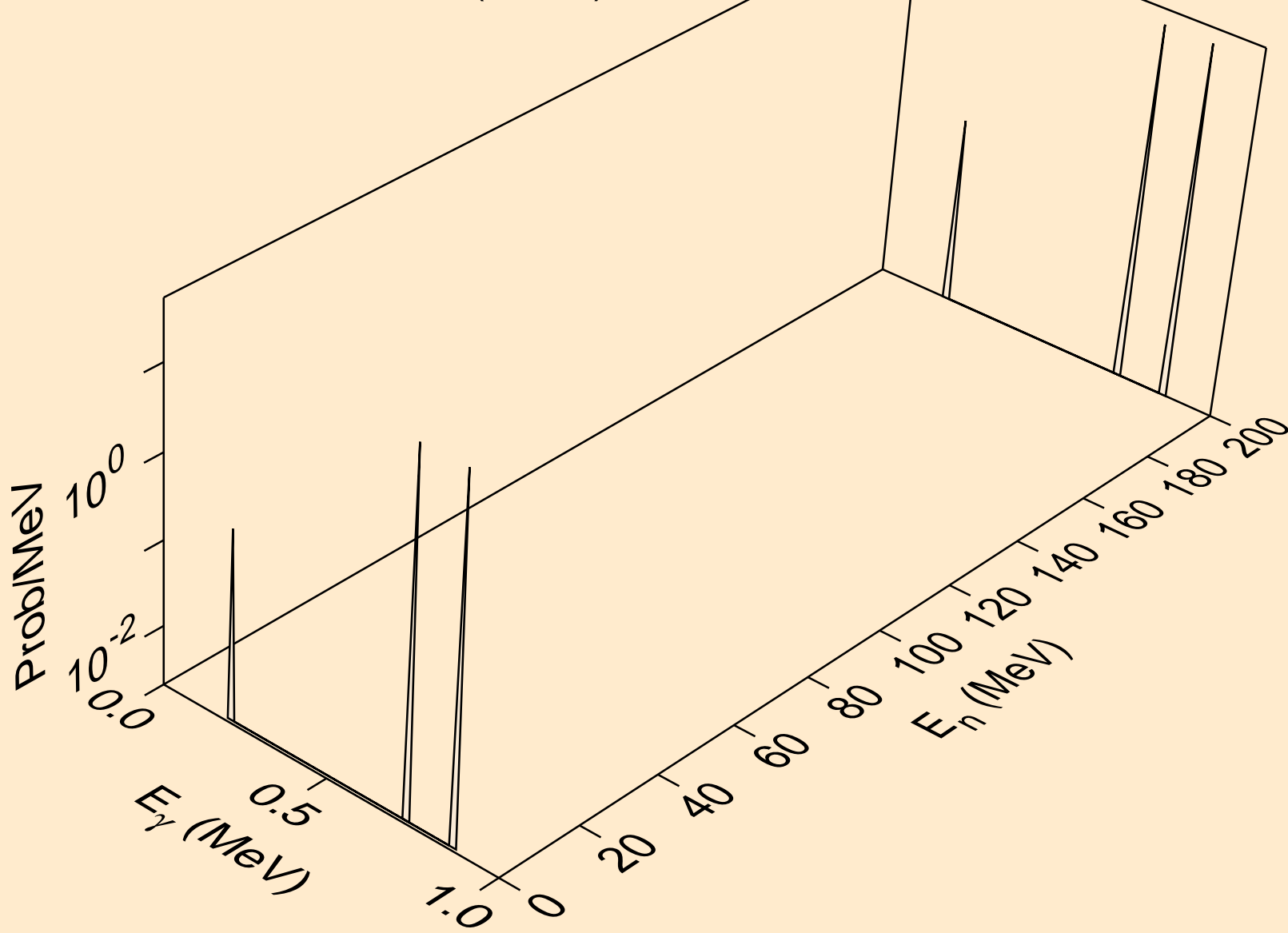

ZR087M NEUTRON ACER TENDL-2019 LIBRARY; T=293.16K
Photon emission for (n,n*10)

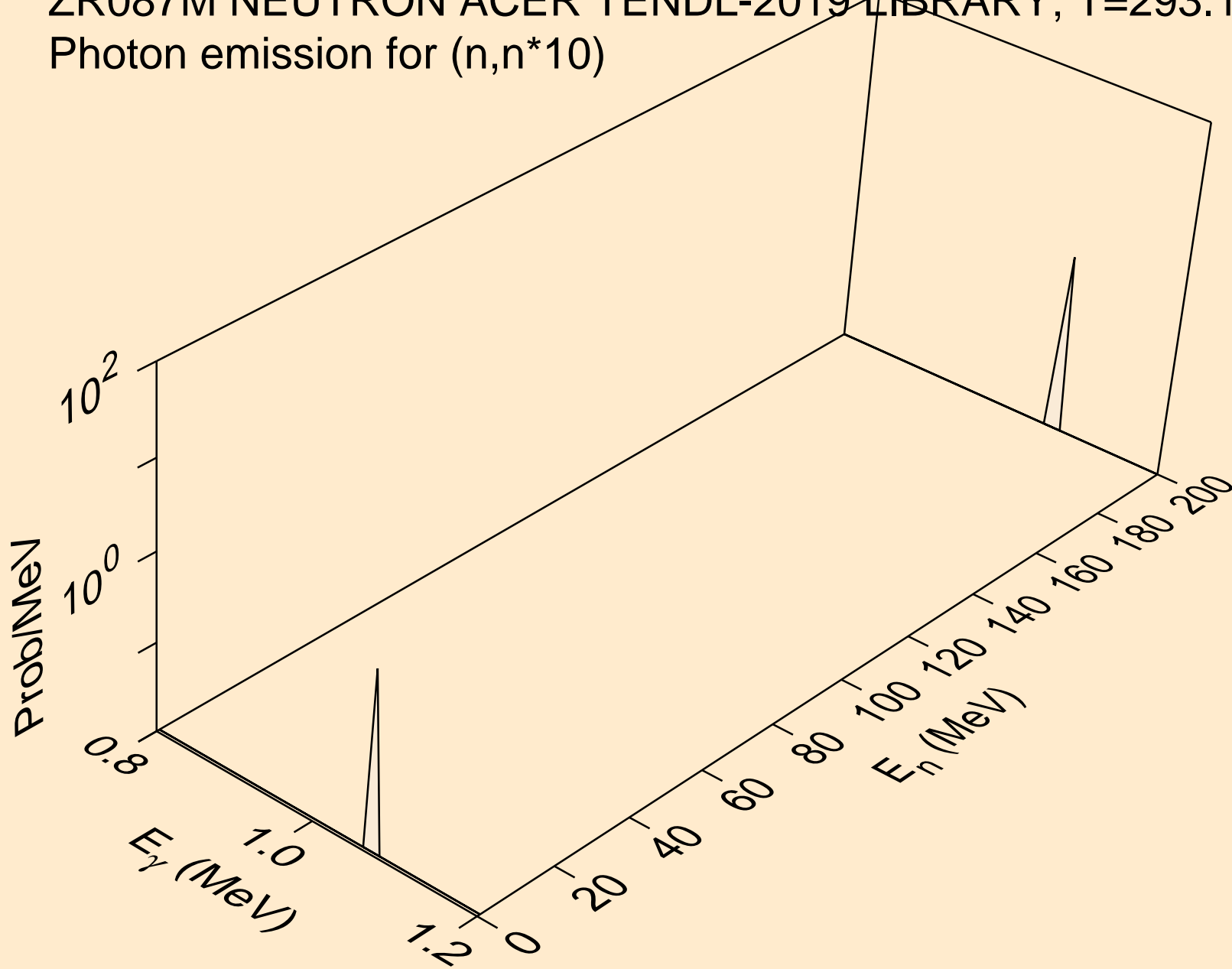

ZR087M NEUTRON ACER TENDL-2019 LIBRARY; T=293.16K
Photon emission for (n,n*11)

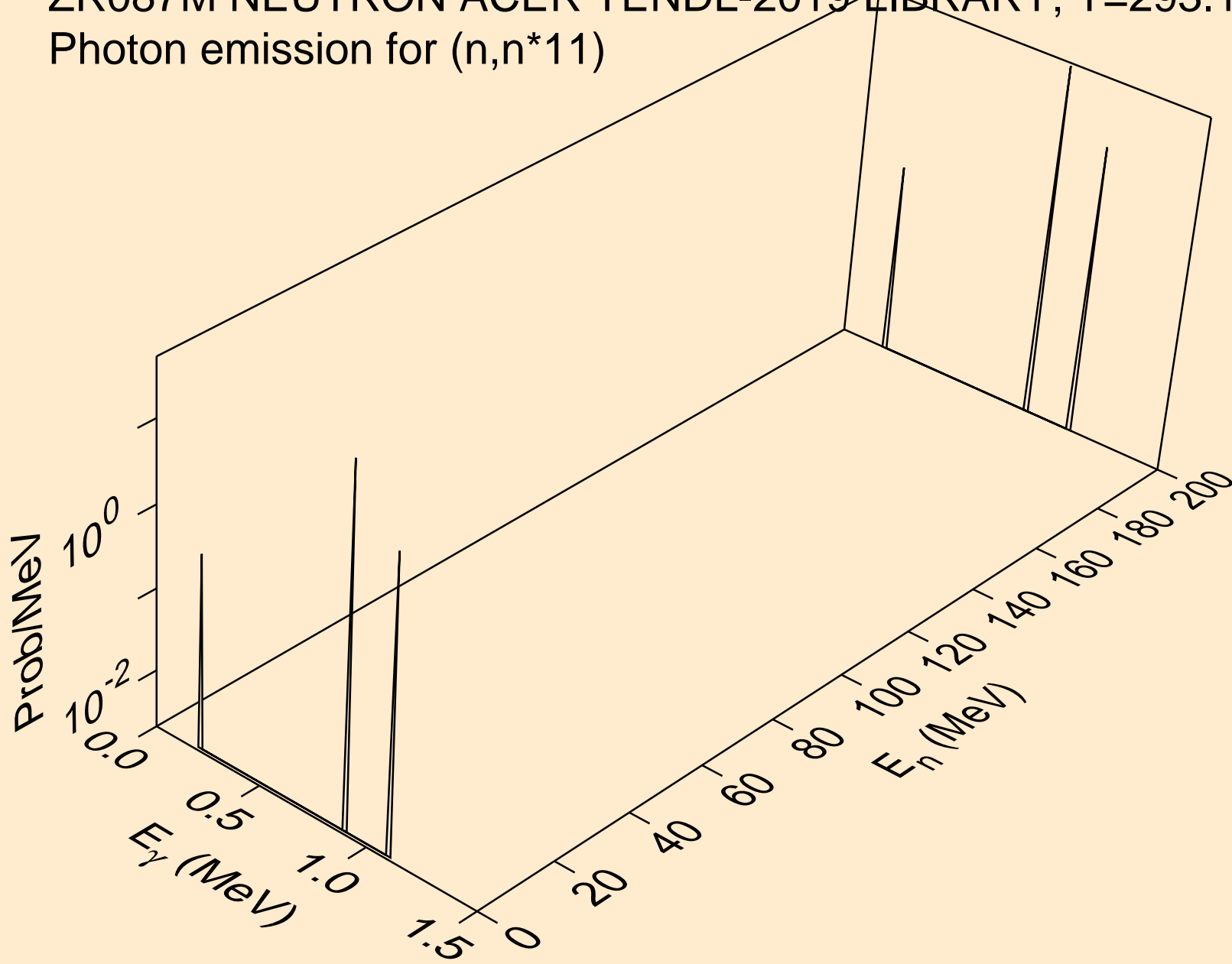

ZR087M NEUTRON ACER TENDL-2019 LIBRARY; T=293.16K
Photon emission for (n,n*12)

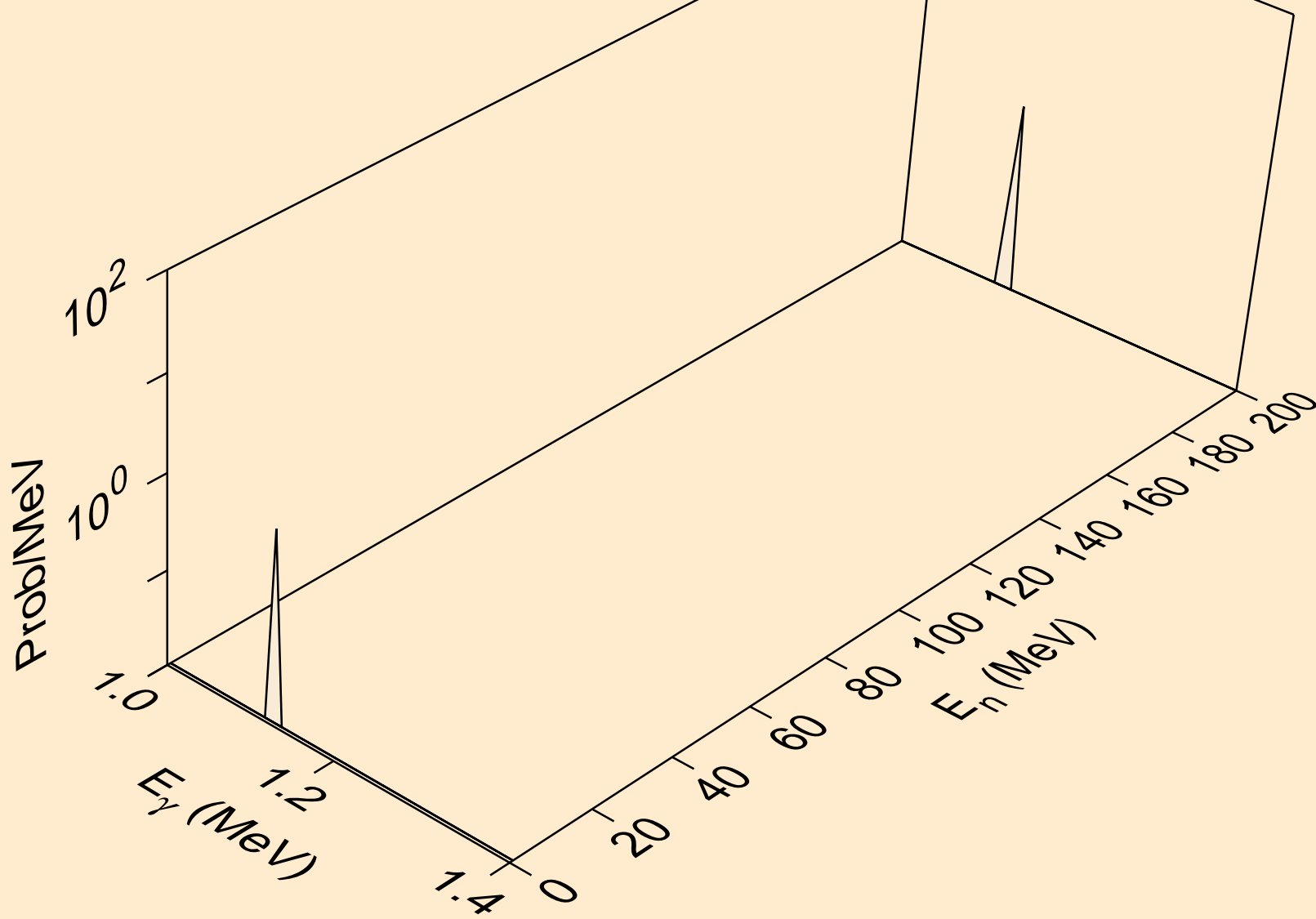

ZR087M NEUTRON ACER TENDL-2019 LIBRARY; T=293.16K
Photon emission for (n,n*13)

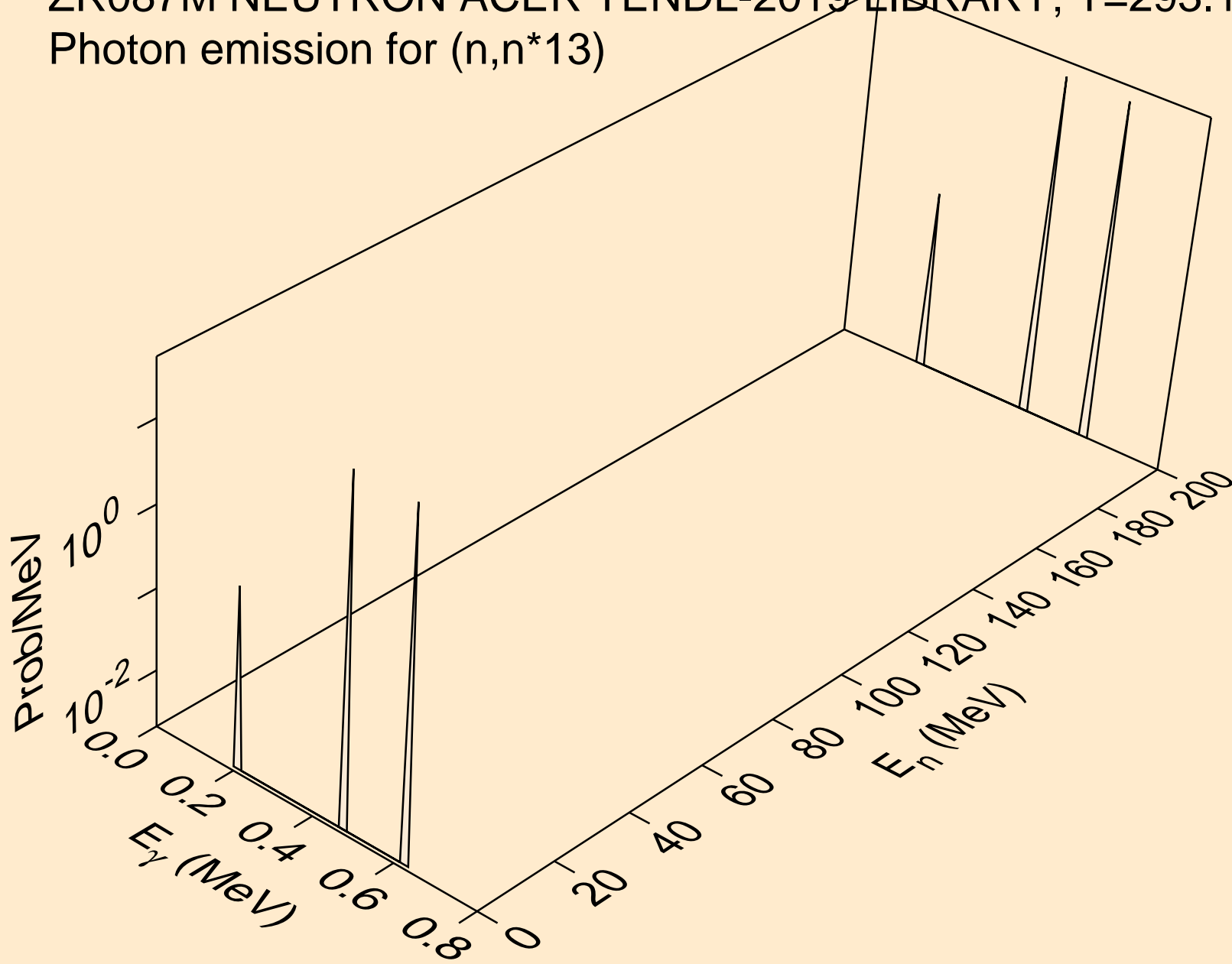

ZR087M NEUTRON ACER TENDL-2019 LIBRARY; T=293.16K
Photon emission for (n,n*14)

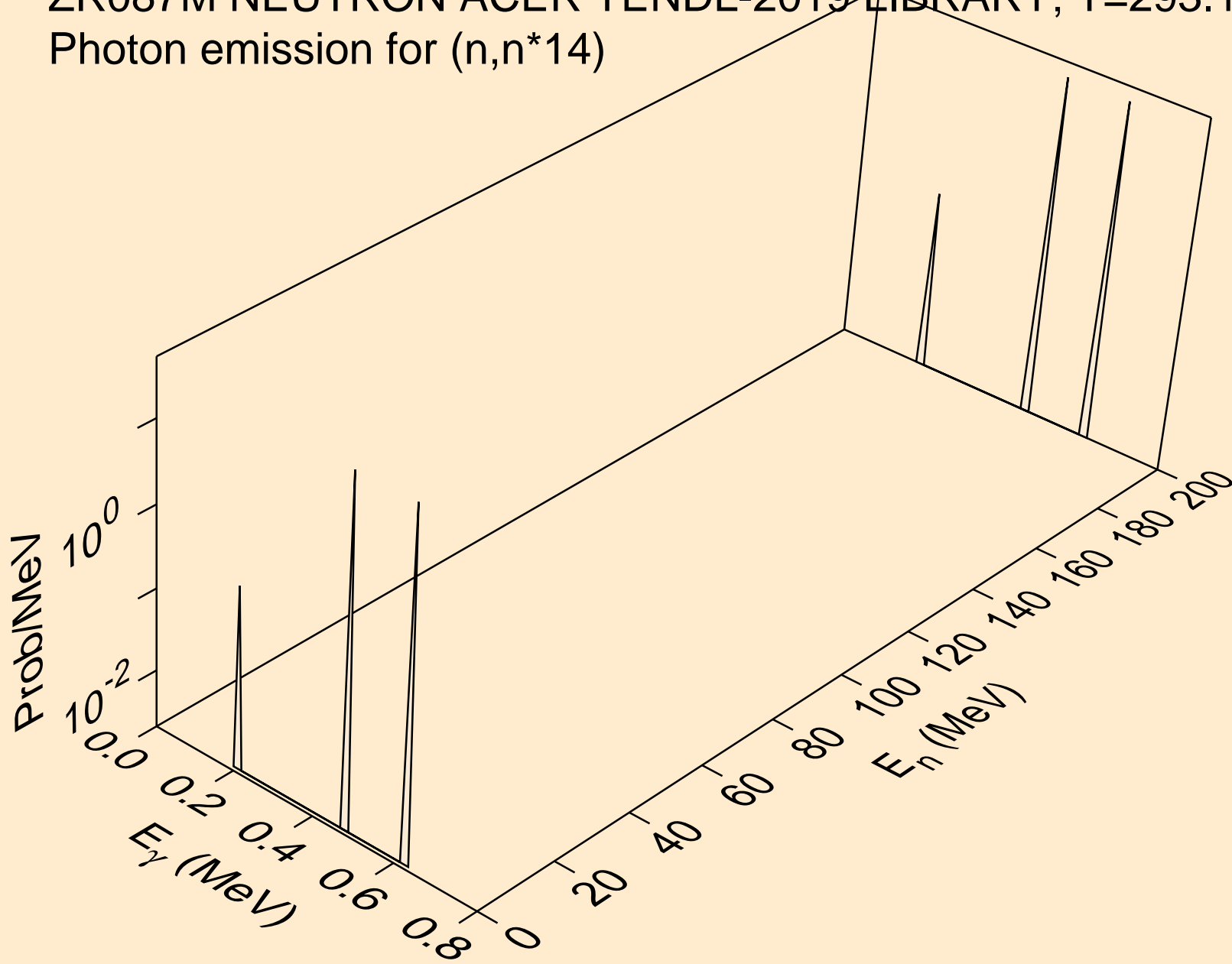

ZR087M NEUTRON ACER TENDL-2019 LIBRARY; T=293.16K
Photon emission for (n,n*15)

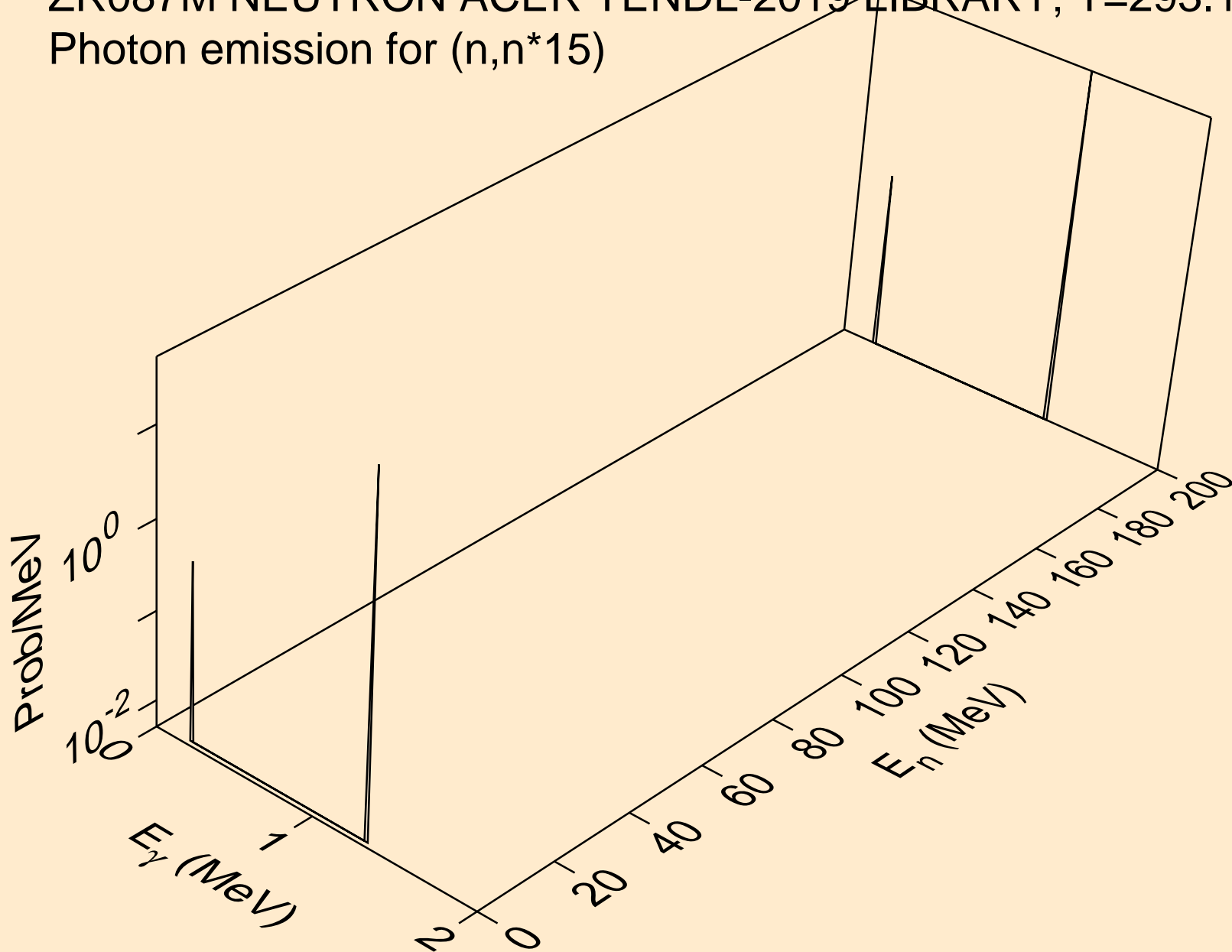

ZR087M NEUTRON ACER TENDL-2019 LIBRARY; T=293.16K
Photon emission for (n,n*16)

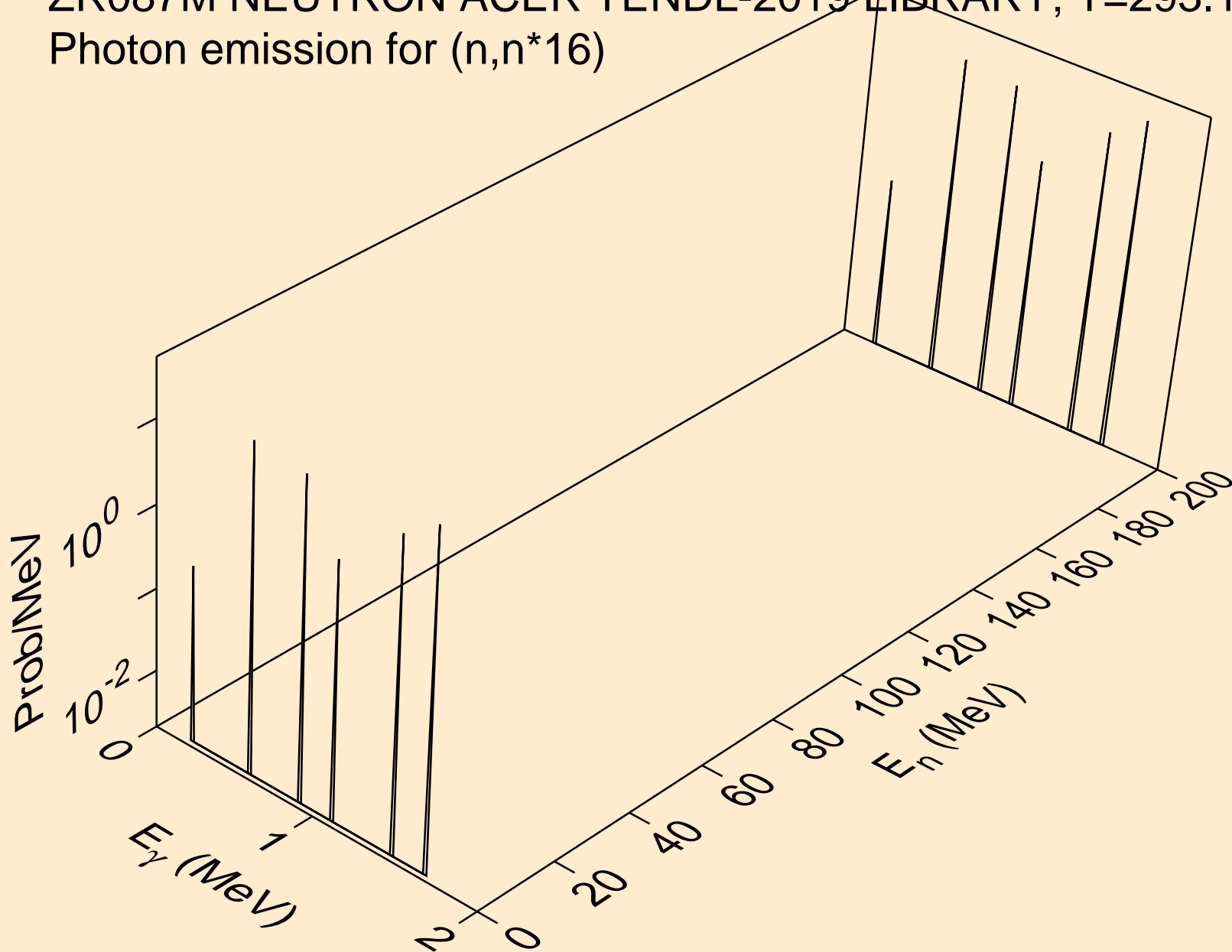

ZR087M NEUTRON ACER TENDL-2019 LIBRARY; T=293.16K
Photon emission for (n,n*17)

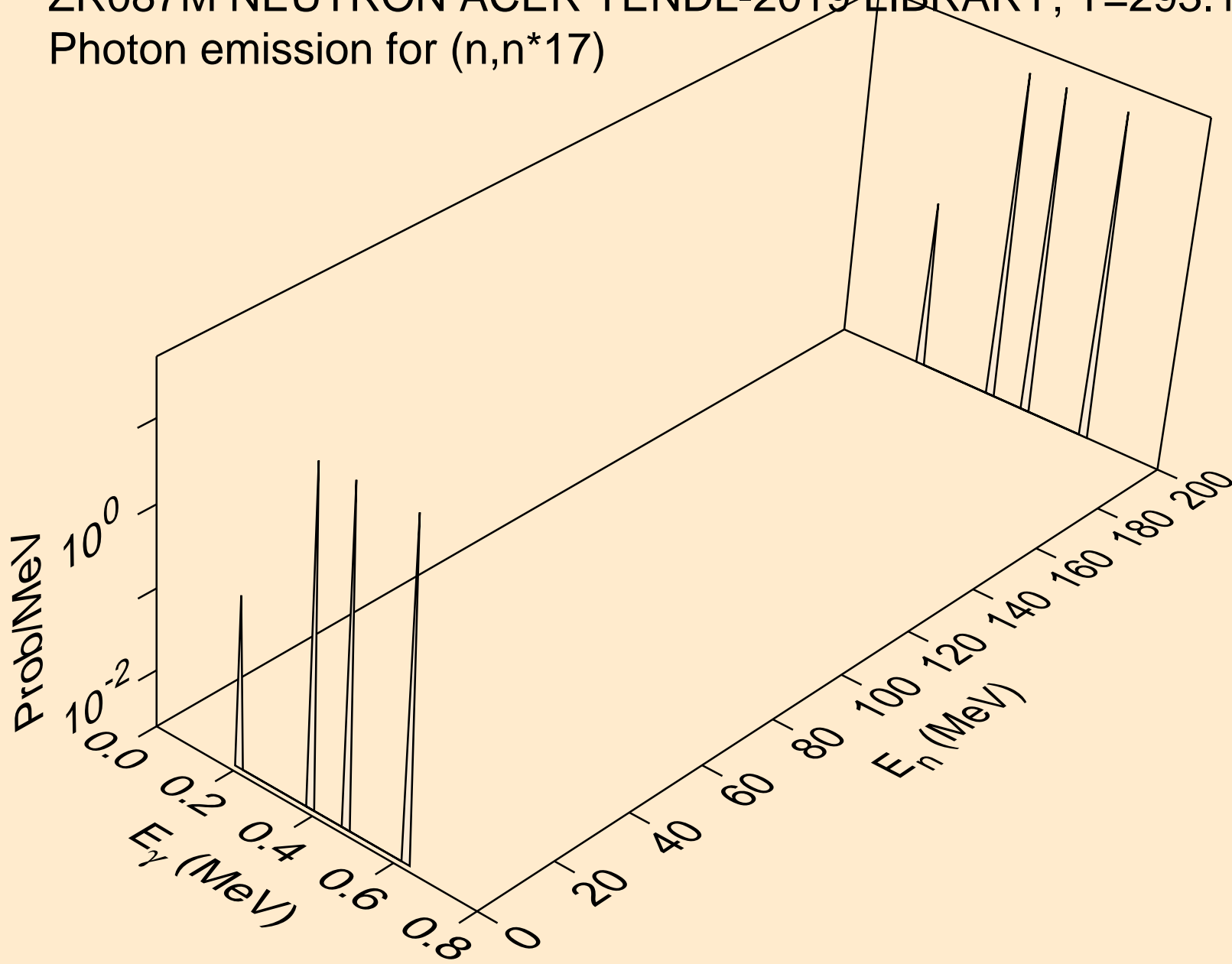

ZR087M NEUTRON ACER TENDL-2019 LIBRARY; T=293.16K
Photon emission for (n,n*18)

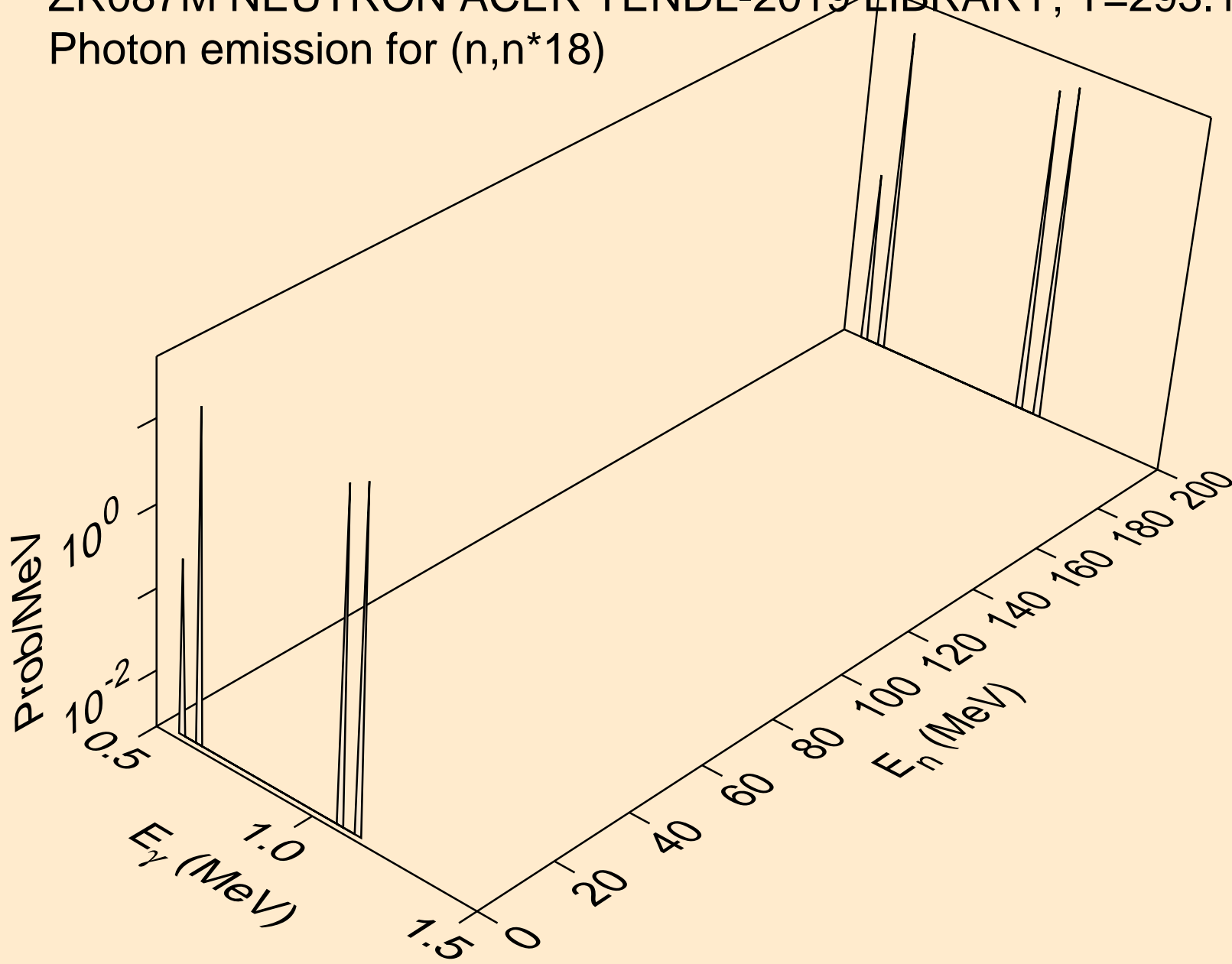

ZR087M NEUTRON ACER TENDL-2019 LIBRARY; T=293.16K
Photon emission for (n,n*19)

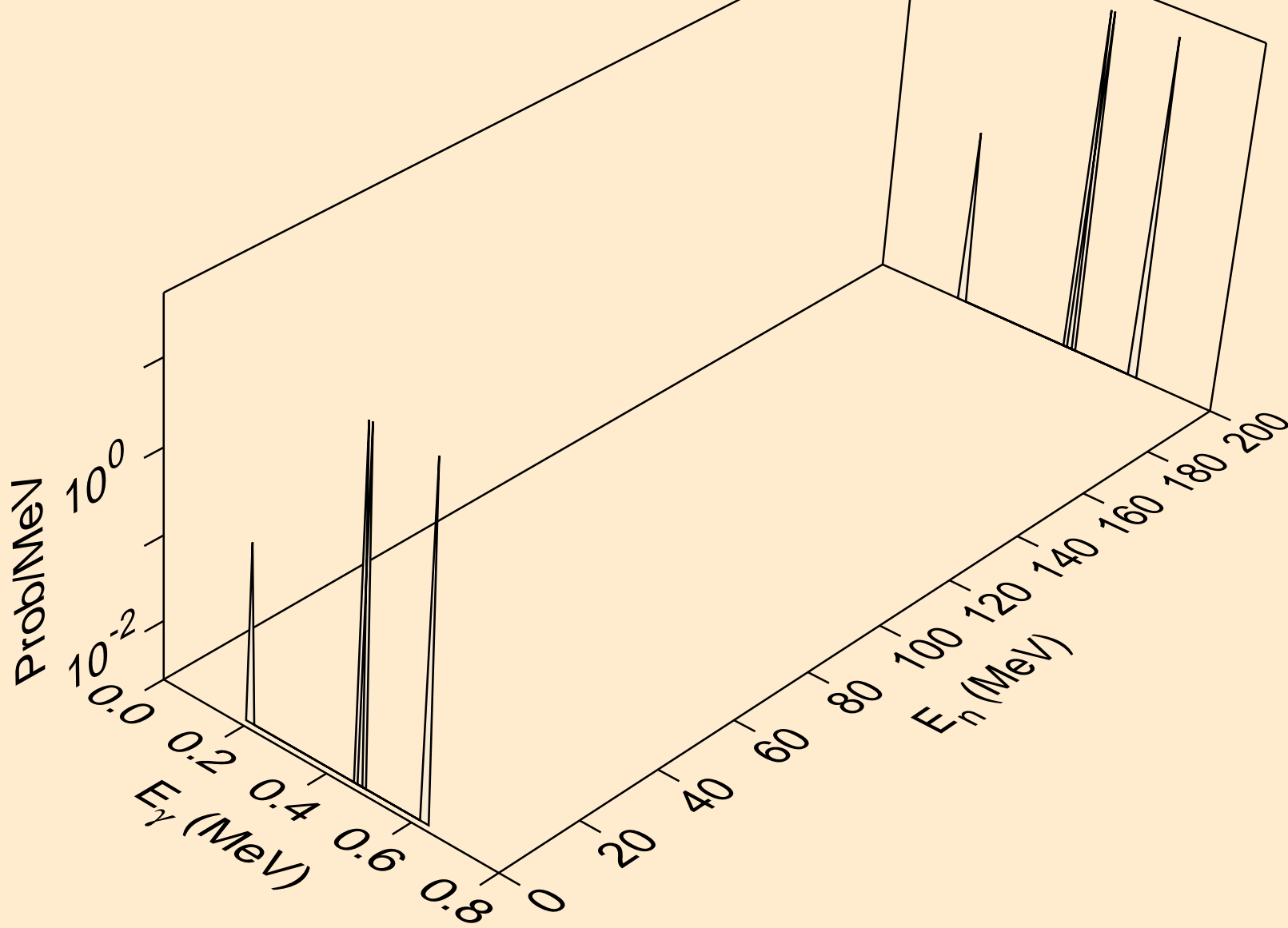

ZR087M NEUTRON ACER TENDL-2019 LIBRARY; T=293.16K
Photon emission for (n,n*20)

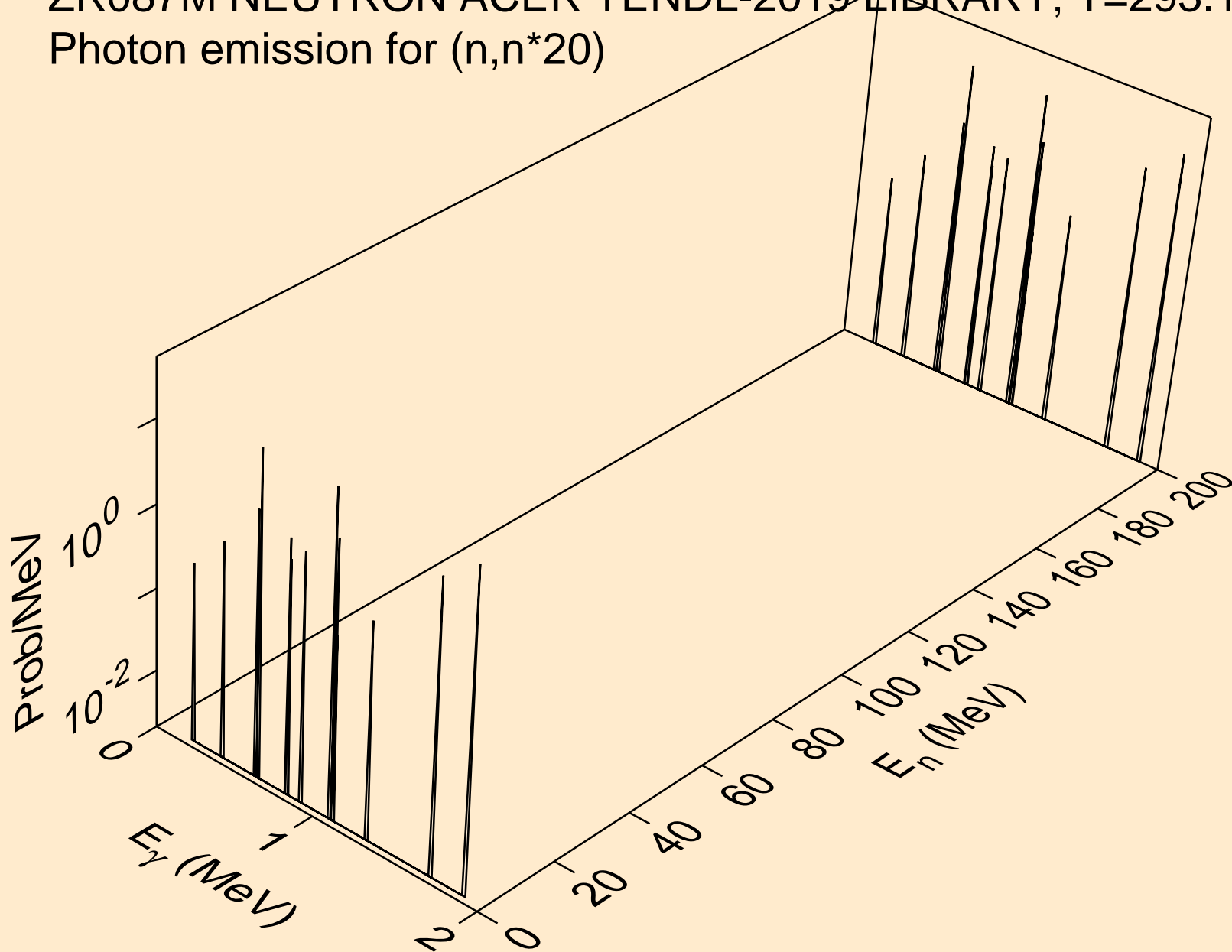

ZR087M NEUTRON ACER TENDL-2019 LIBRARY; T=293.16K
Photon emission for (n,n*21)

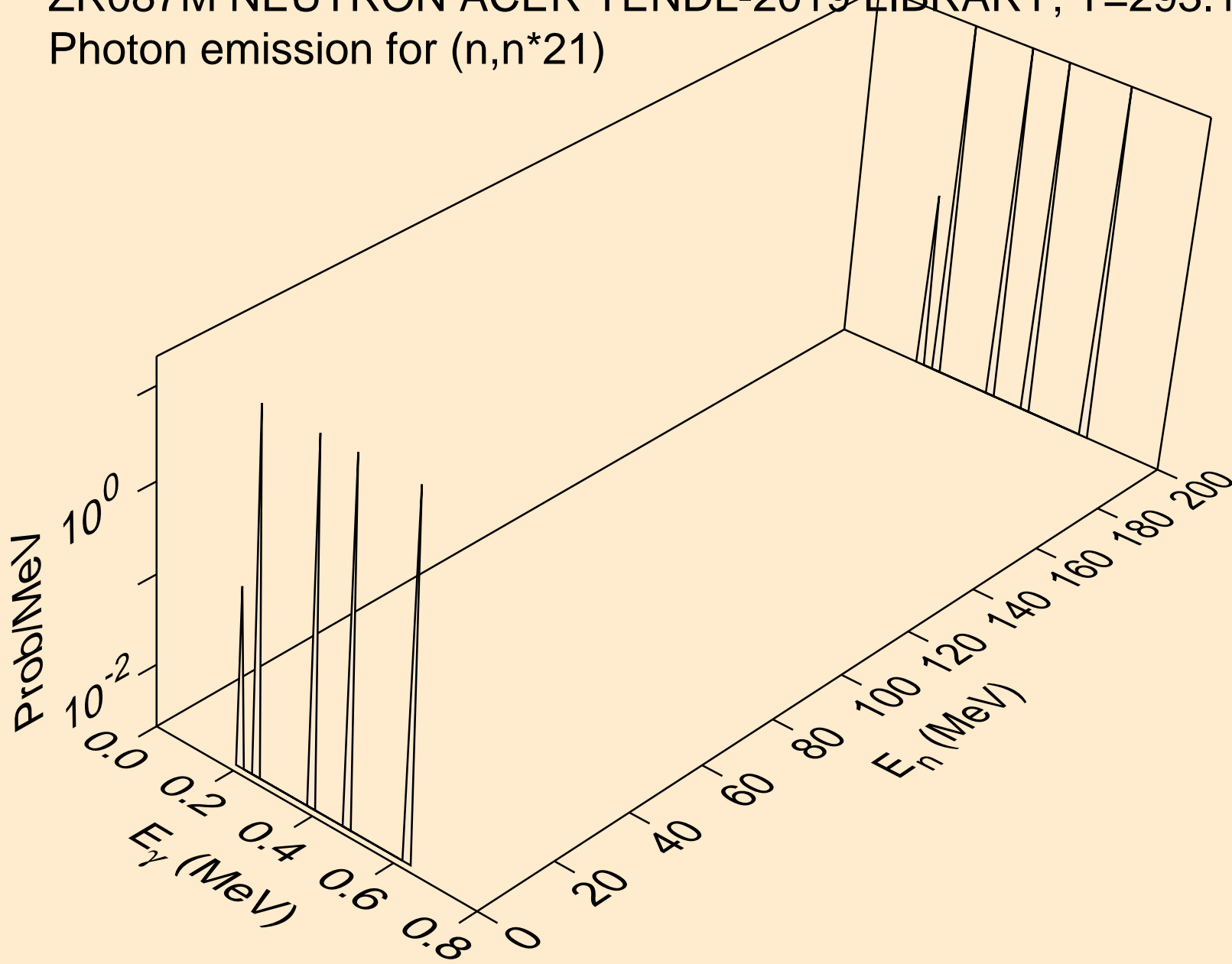

ZR087M NEUTRON ACER TENDL-2019 LIBRARY; T=293.16K
Photon emission for (n,n*22)

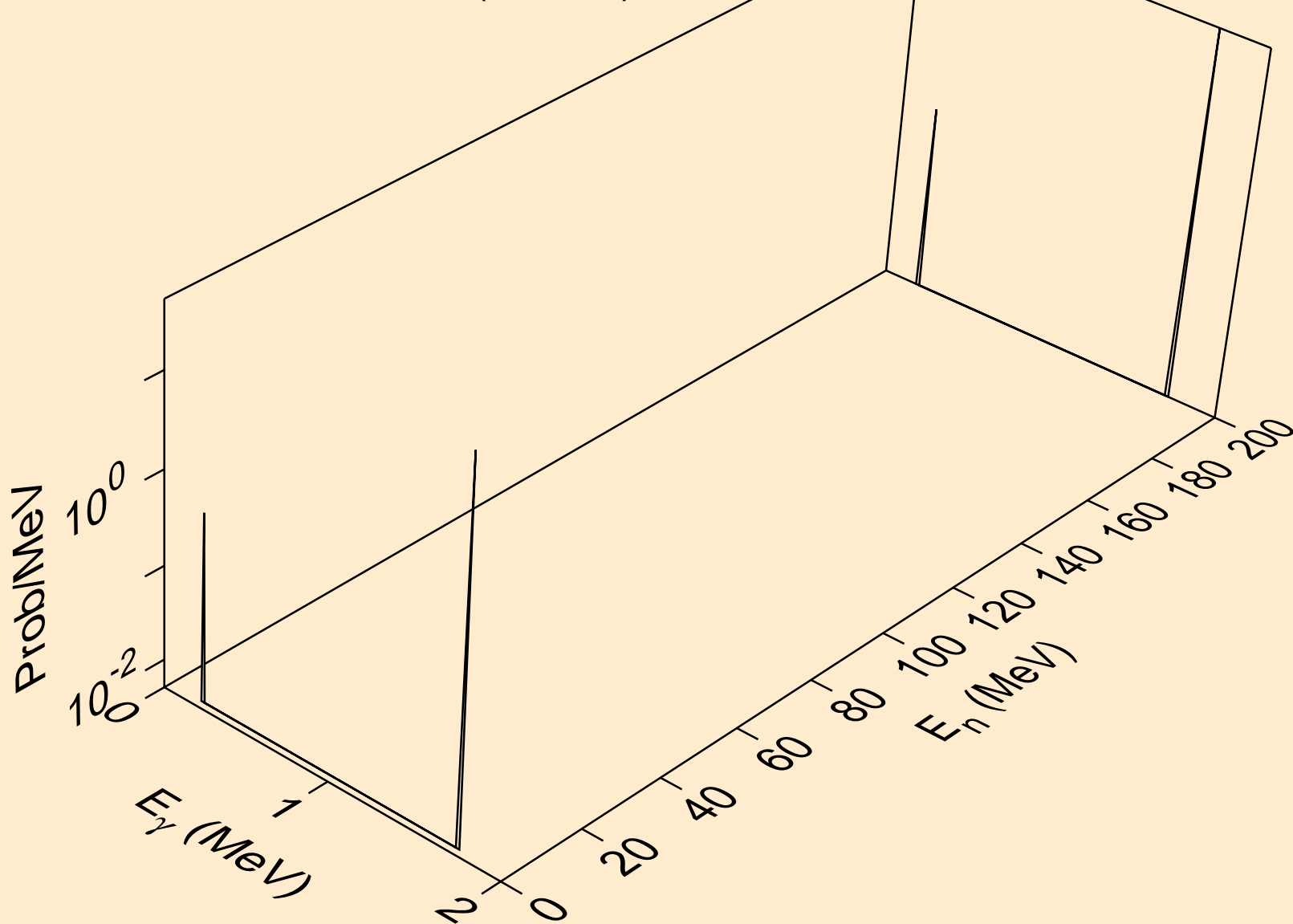

ZR087M NEUTRON ACER TENDL-2019 LIBRARY; T=293.16K
Photon emission for (n,n*23)

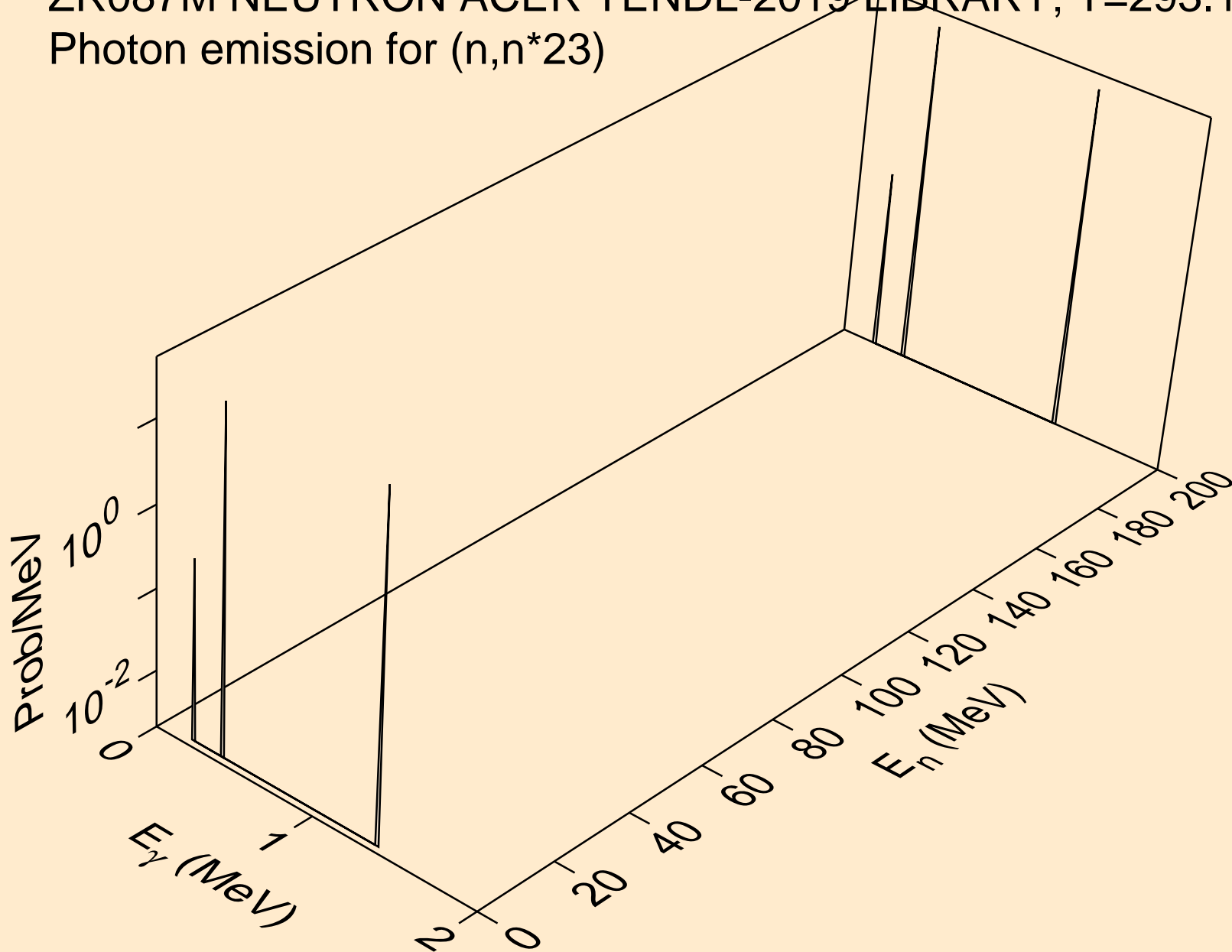

ZR087M NEUTRON ACER TENDL-2019 LIBRARY; T=293.16K
Photon emission for (n,n*24)

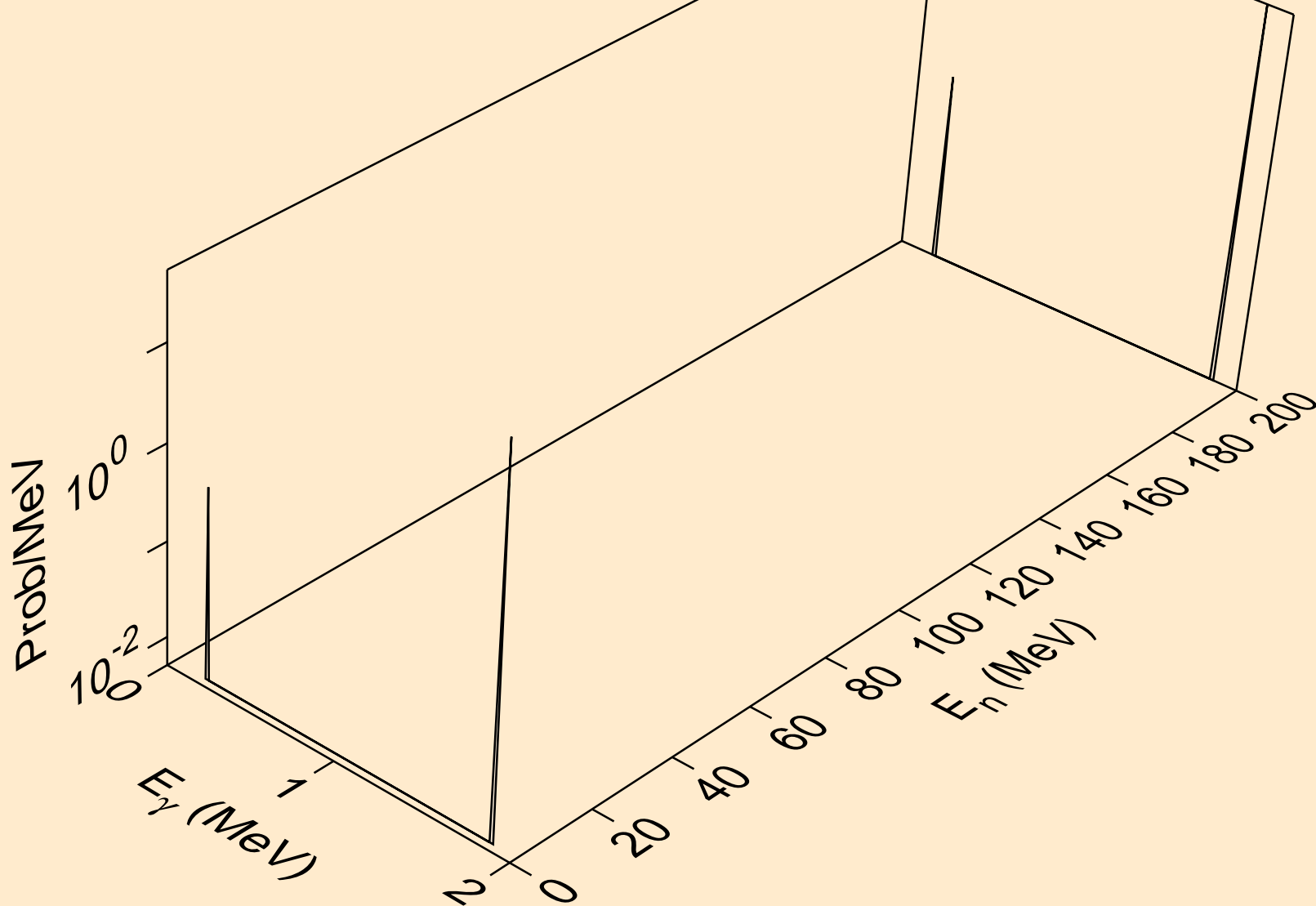

ZR087M NEUTRON ACER TENDL-2019 LIBRARY; T=293.16K
Photon emission for (n,n*25)

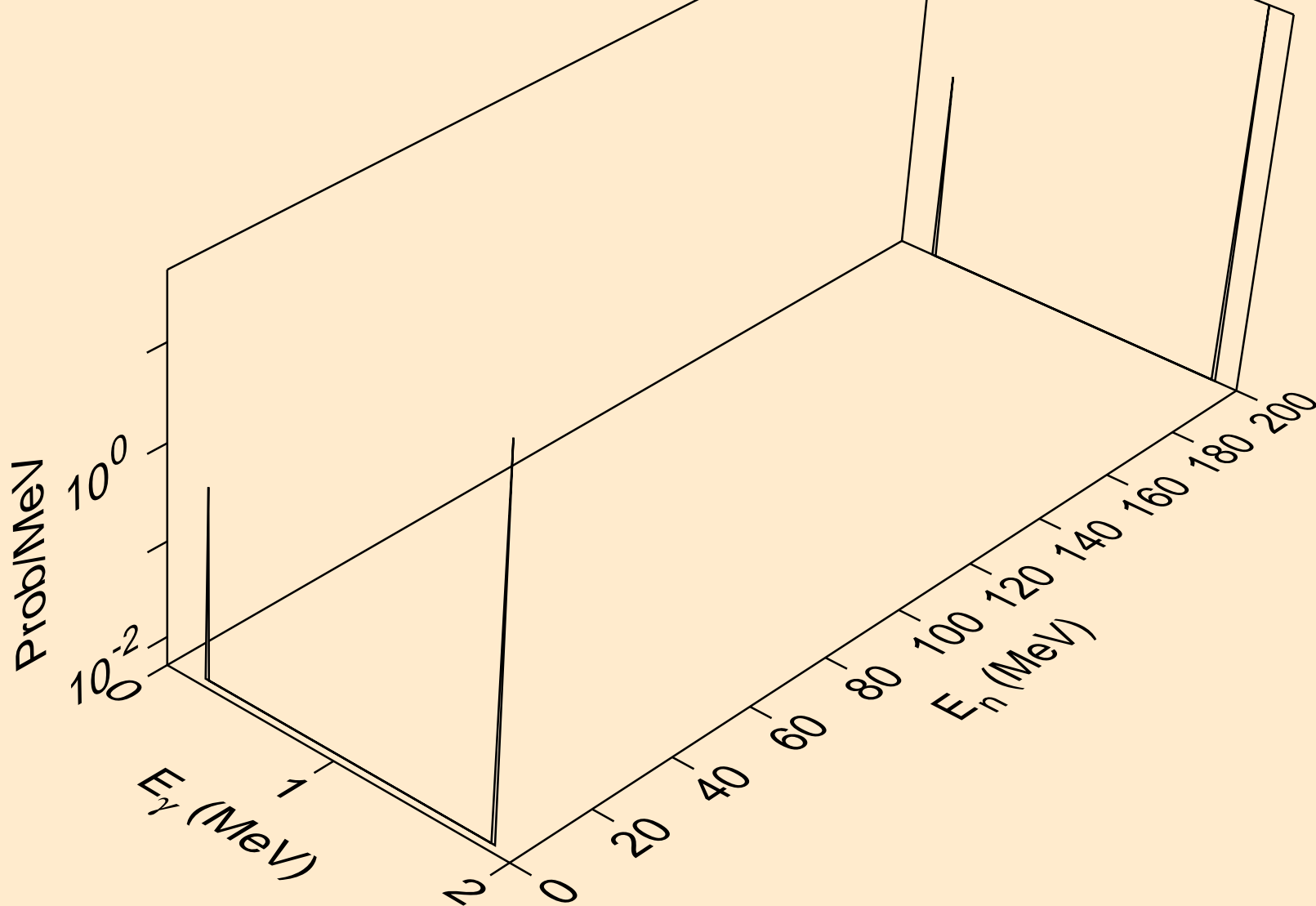

ZR087M NEUTRON ACER TENDL-2019 LIBRARY; T=293.16K
Photon emission for (n,n*26)

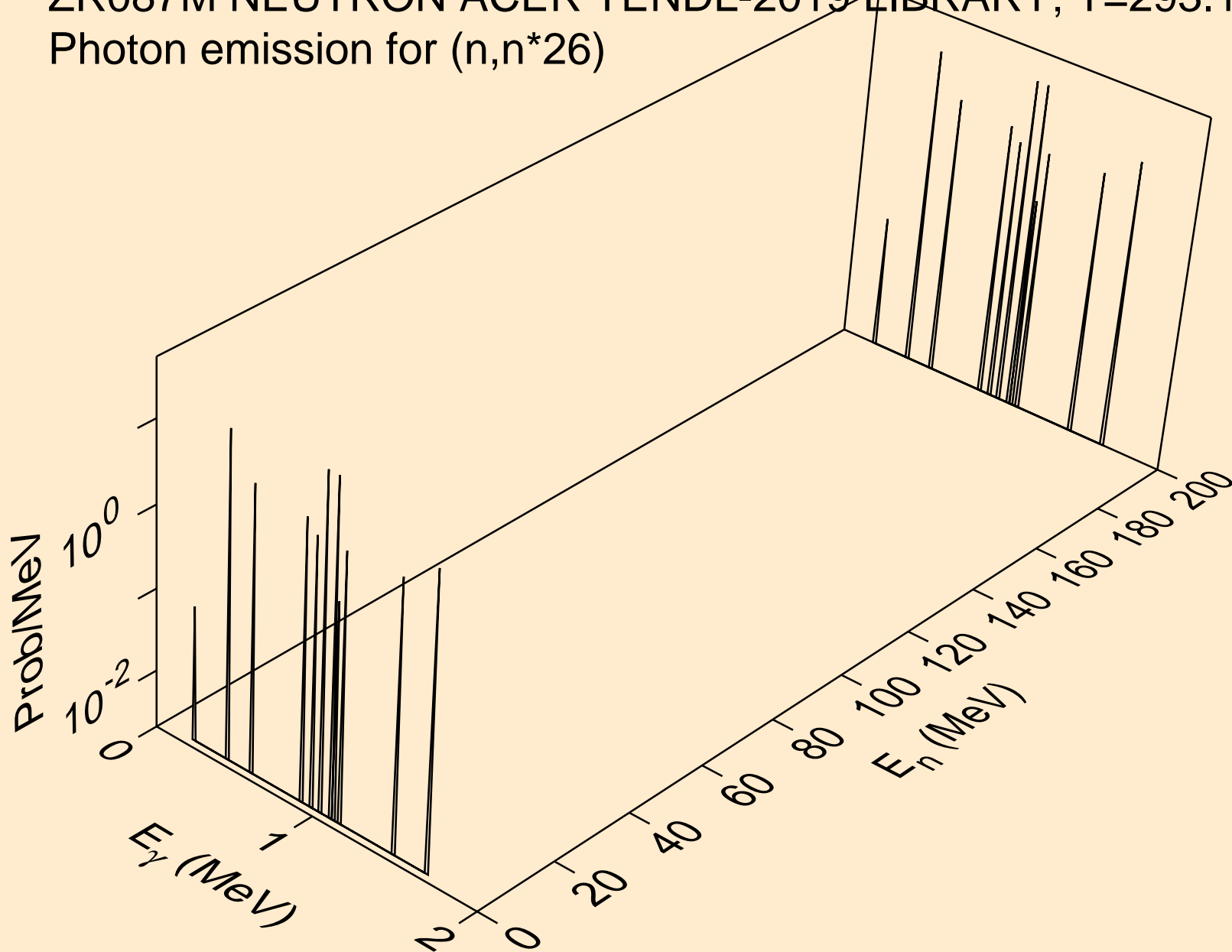

ZR087M NEUTRON ACER TENDL-2019 LIBRARY; T=293.16K
Photon emission for (n,n*27)

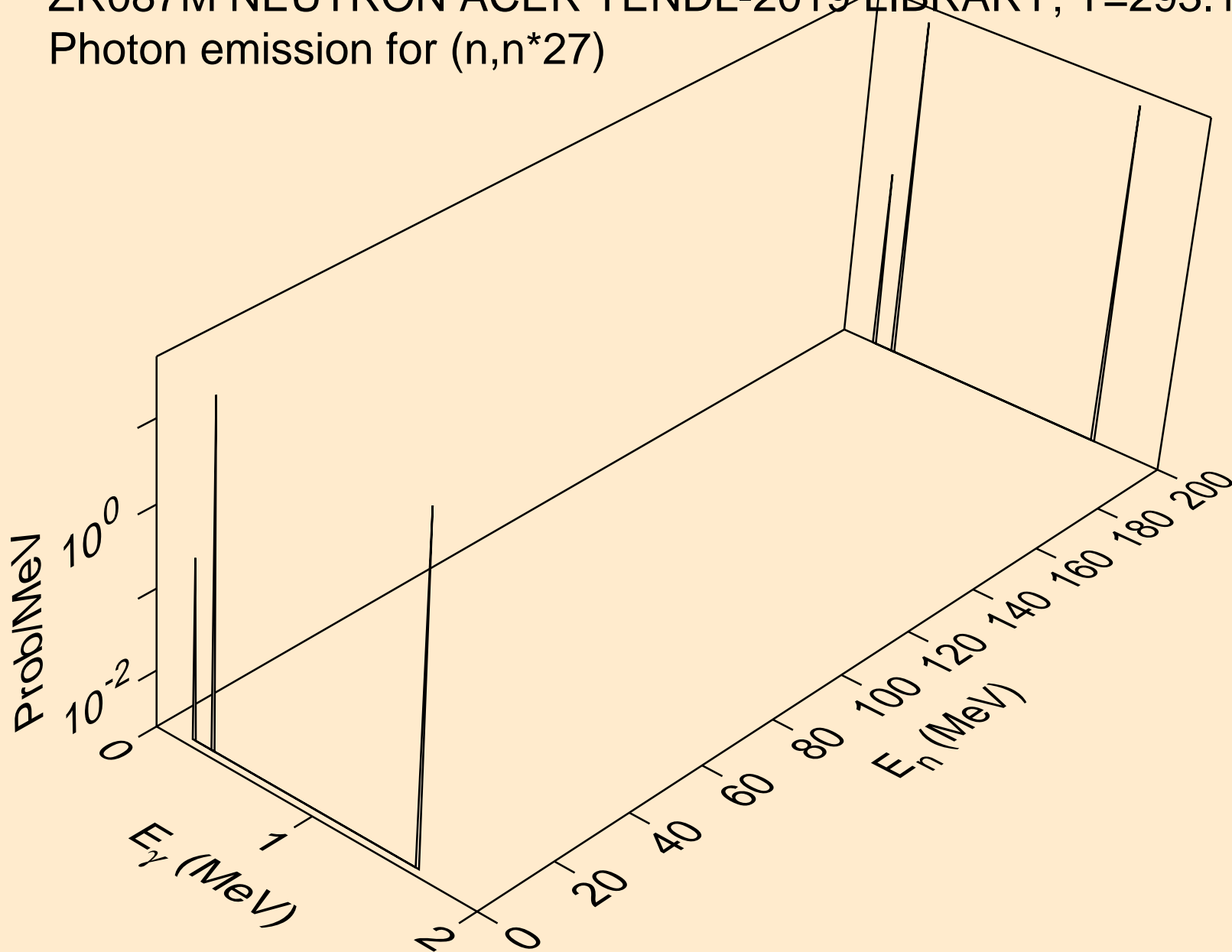

ZR087M NEUTRON ACER TENDL-2019 LIBRARY; T=293.16K
Photon emission for (n,n*28)

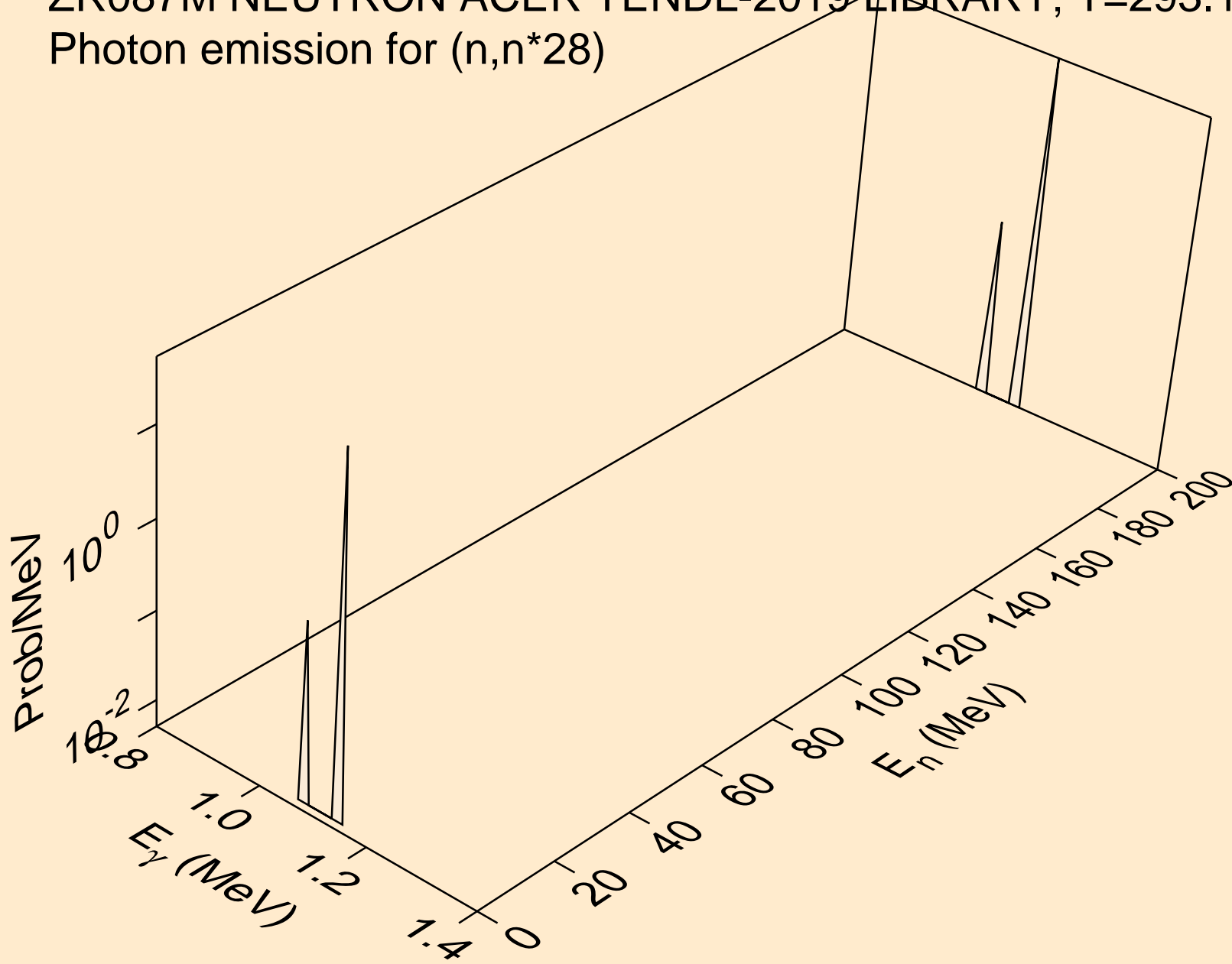

ZR087M NEUTRON ACER TENDL-2019 LIBRARY; T=293.16K
Photon emission for (n,n*29)

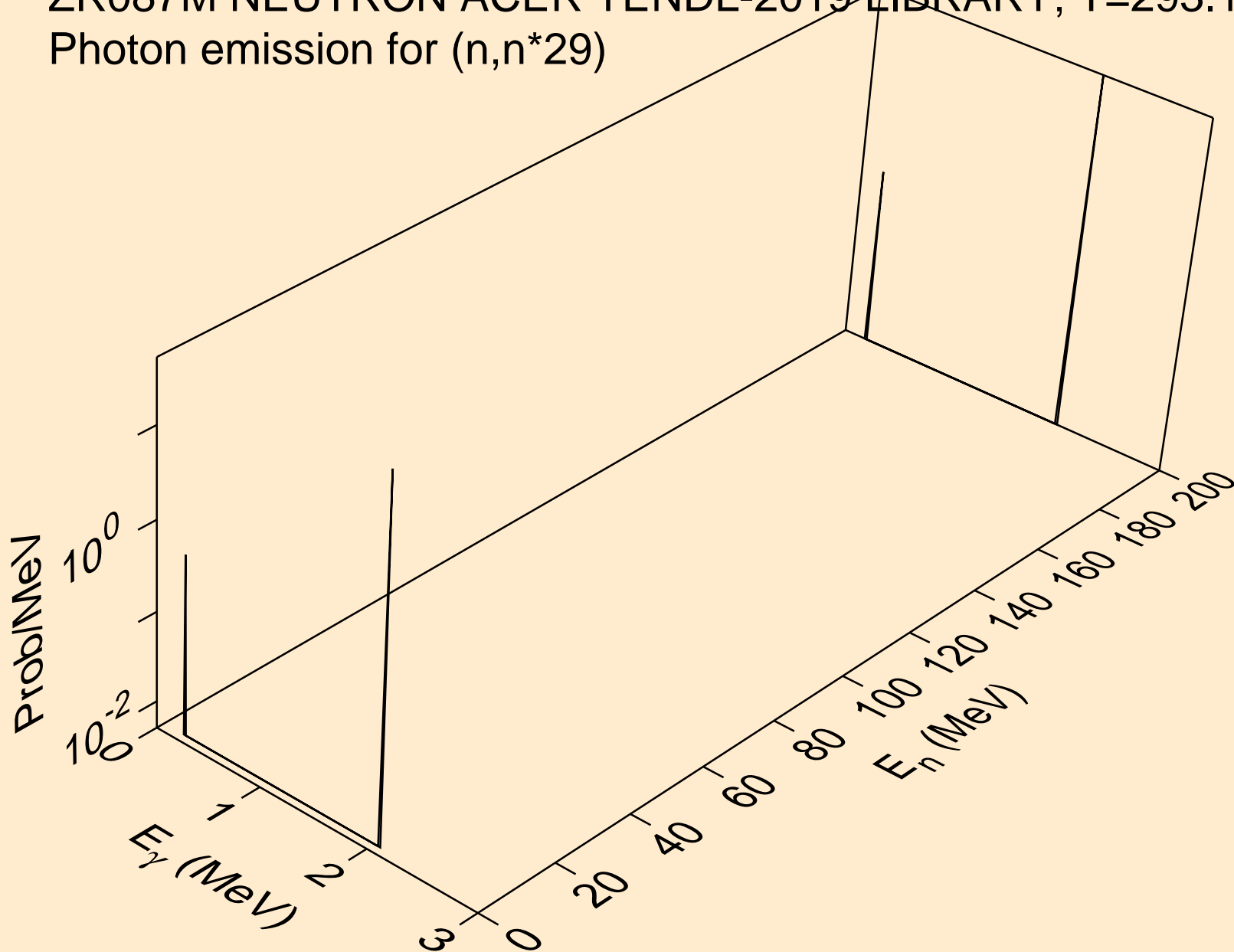

ZR087M NEUTRON ACER TENDL-2019 LIBRARY; T=293.16K
Photon emission for (n,n*30)

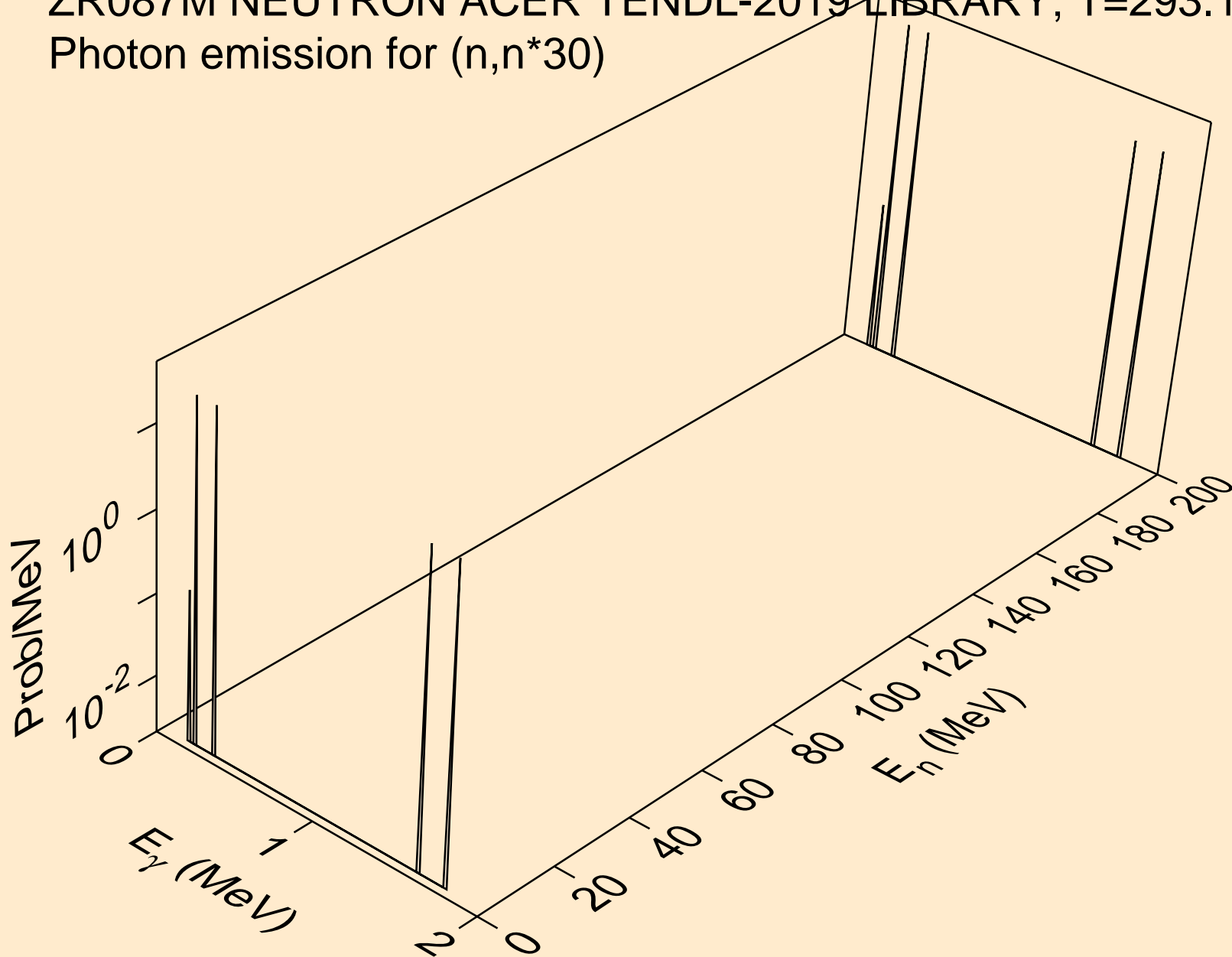

ZR087M NEUTRON ACER TENDL-2019 LIBRARY; T=293.16K
Photon emission for (n,n*c)

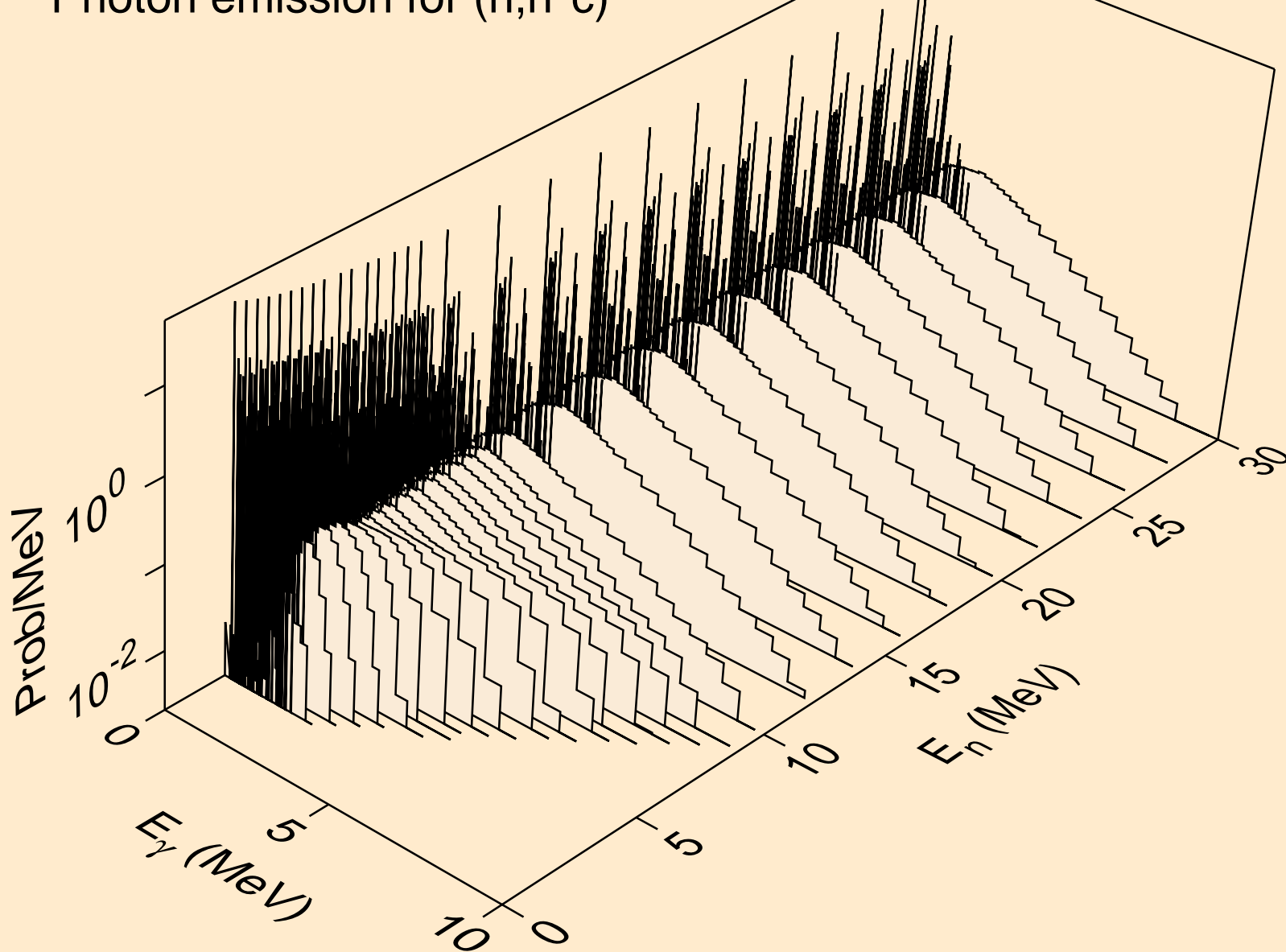

ZR087M NEUTRON ACER TENDL-2019 LIBRARY; T=293.16K
Photon emission for (n,gma)

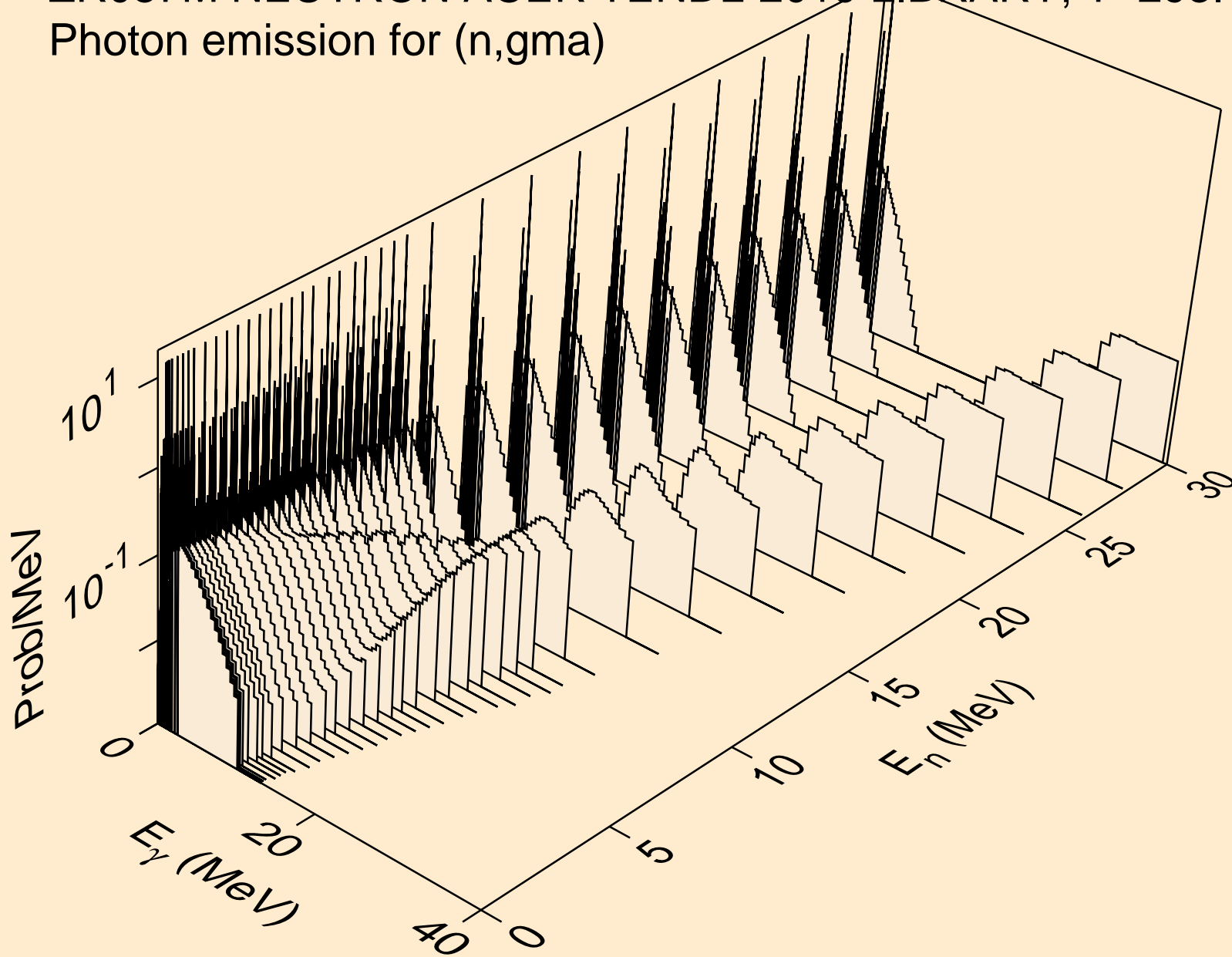

ZR087M NEUTRON ACER TENDL-2019 LIBRARY; T=293.16K
Photon emission for (n,p)

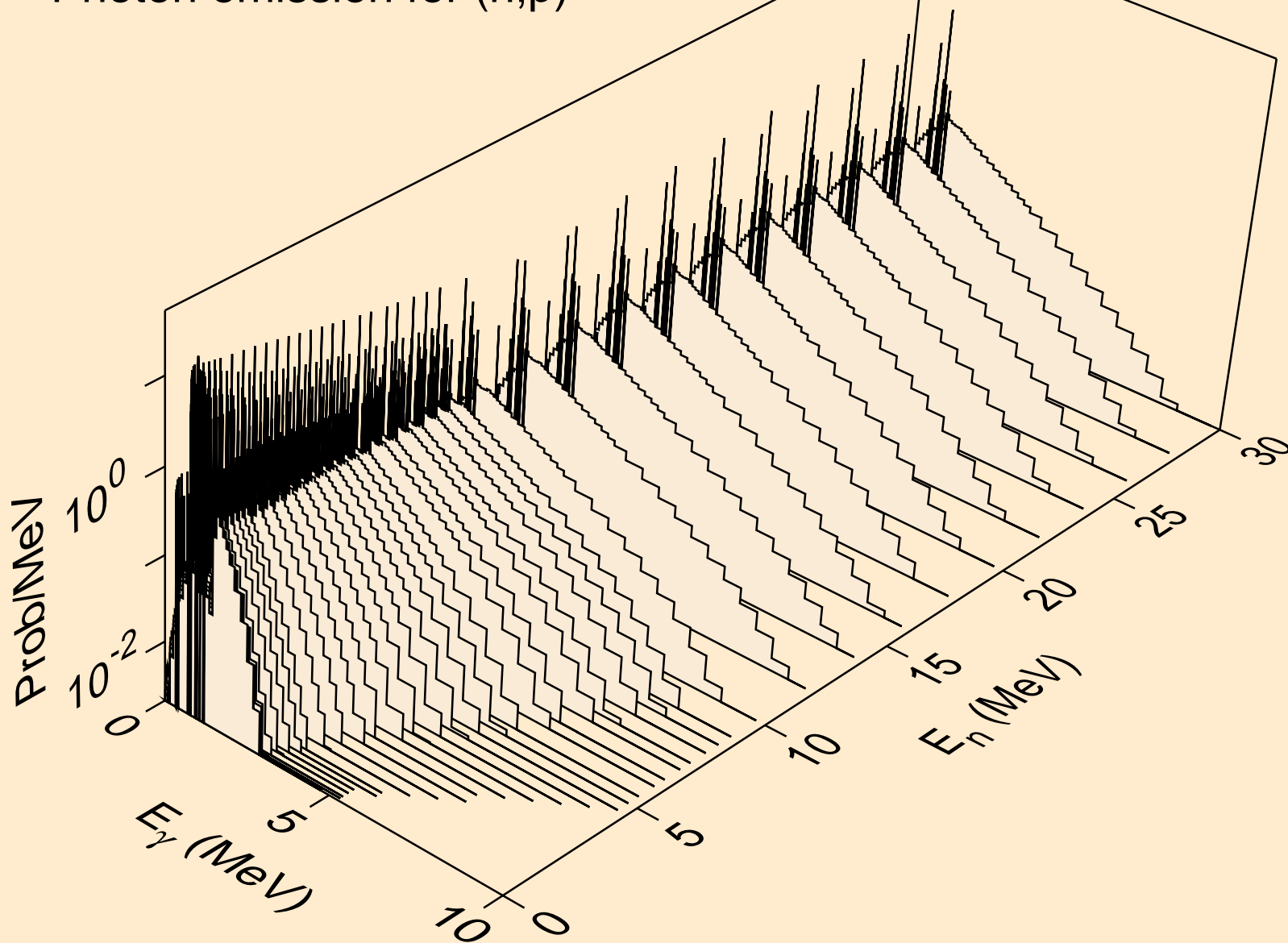

ZR087M NEUTRON ACER TENDL-2019 LIBRARY; T=293.16K
Photon emission for (n,d)

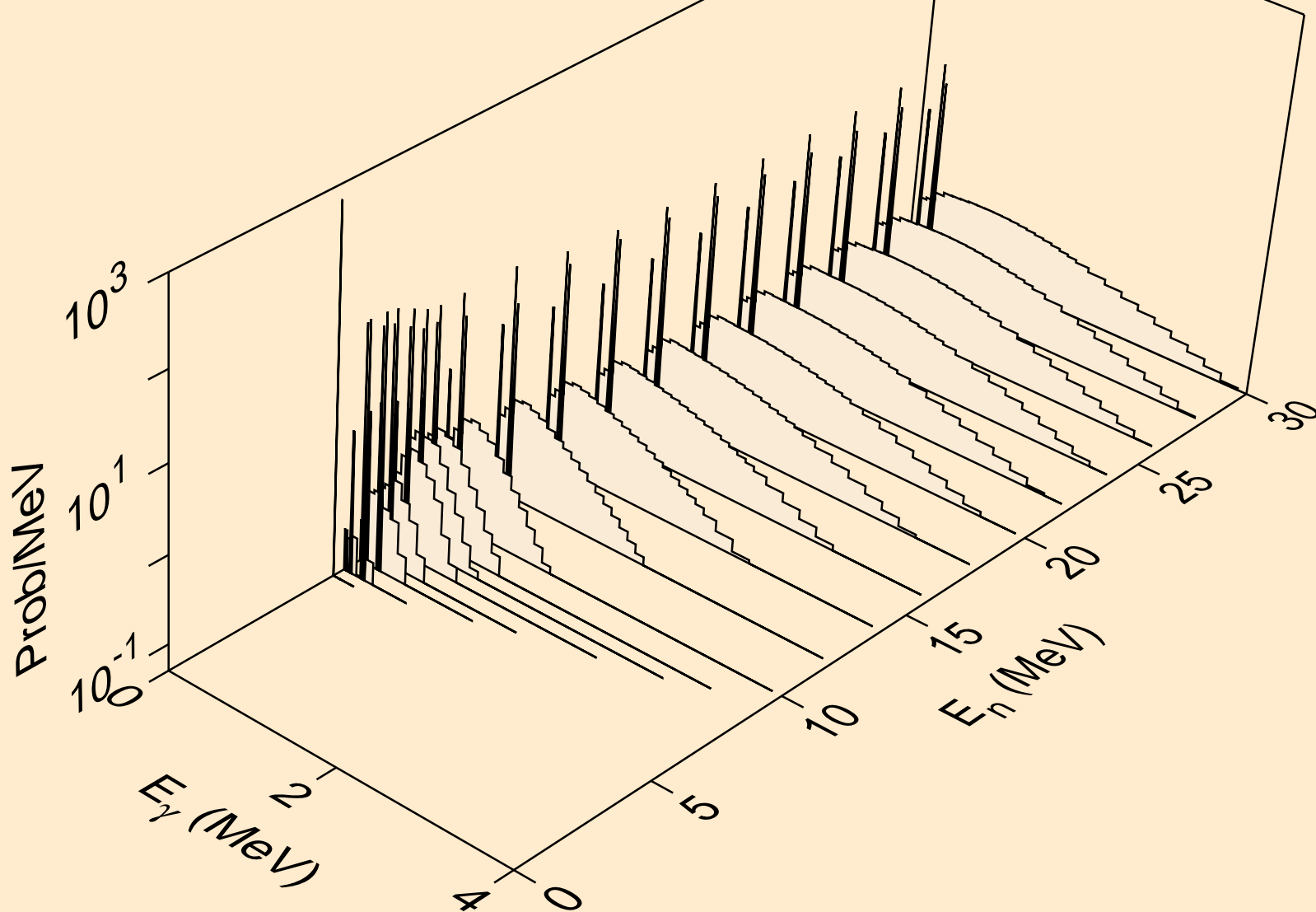

ZR087M NEUTRON ACER TENDL-2019 LIBRARY; T=293.16K
Photon emission for (n,t)

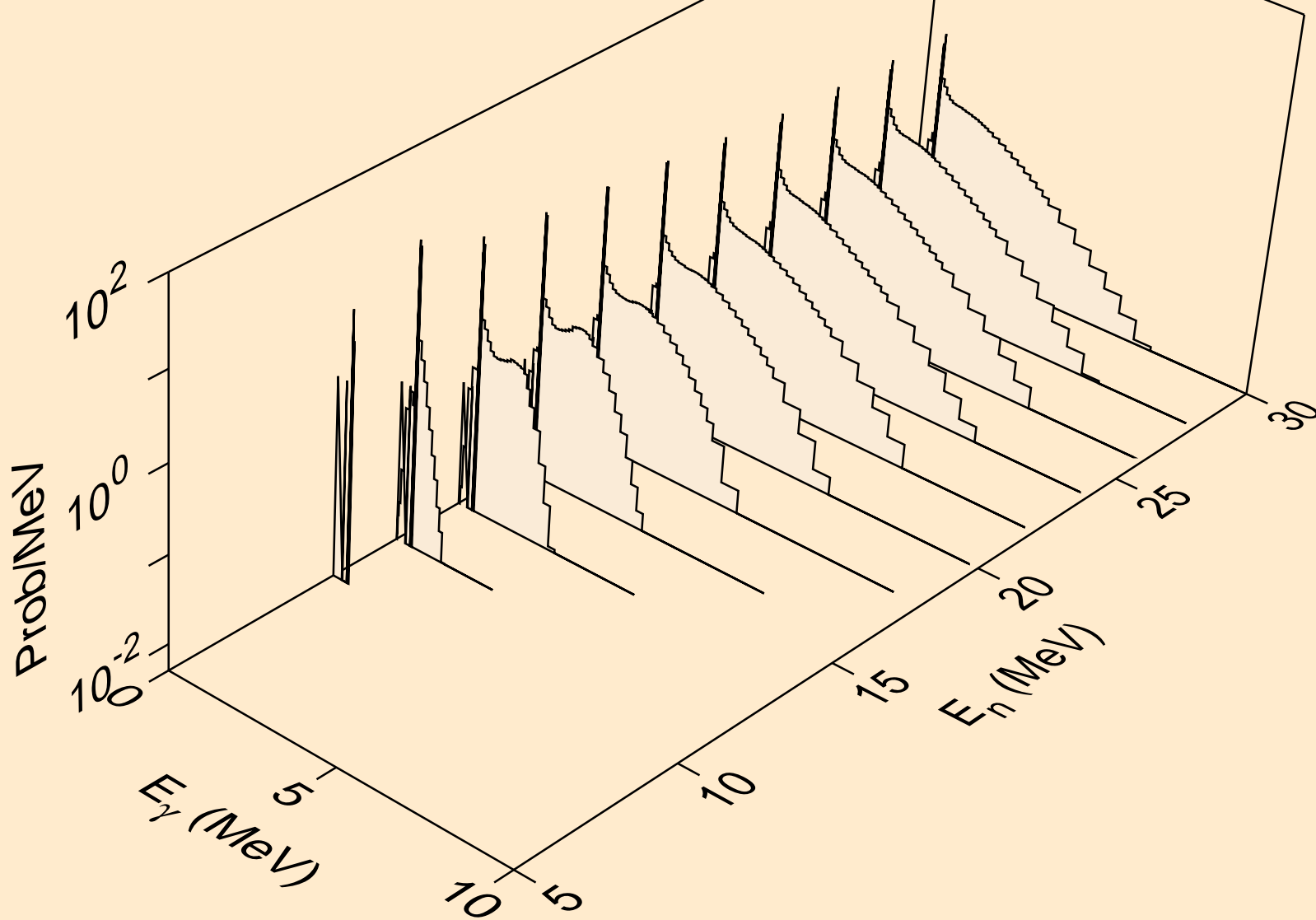

ZR087M NEUTRON ACER TENDL-2019 LIBRARY; T=293.16K
Photon emission for (n,he3)

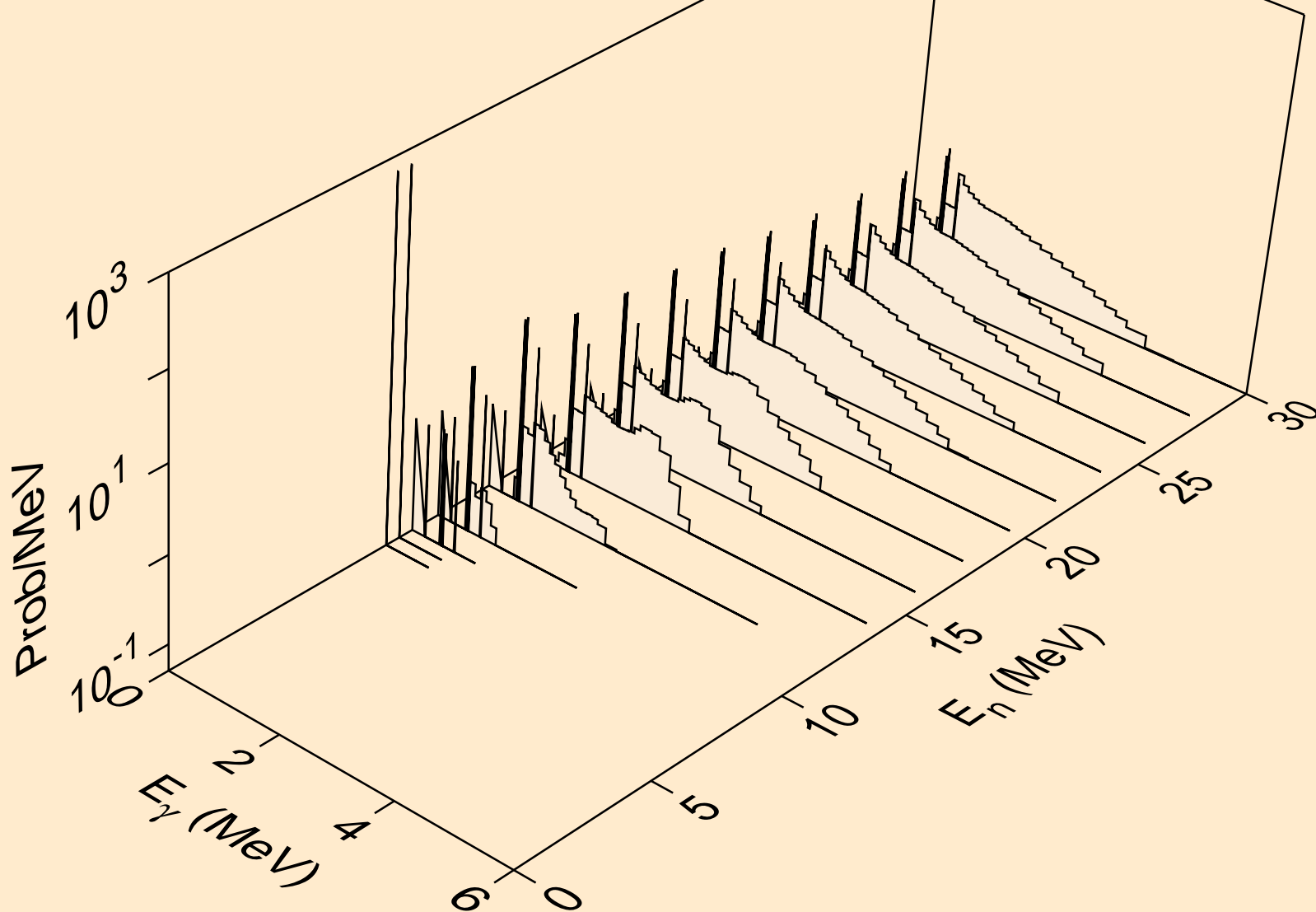

ZR087M NEUTRON ACER TENDL-2019 LIBRARY; T=293.16K
Photon emission for (n,a)

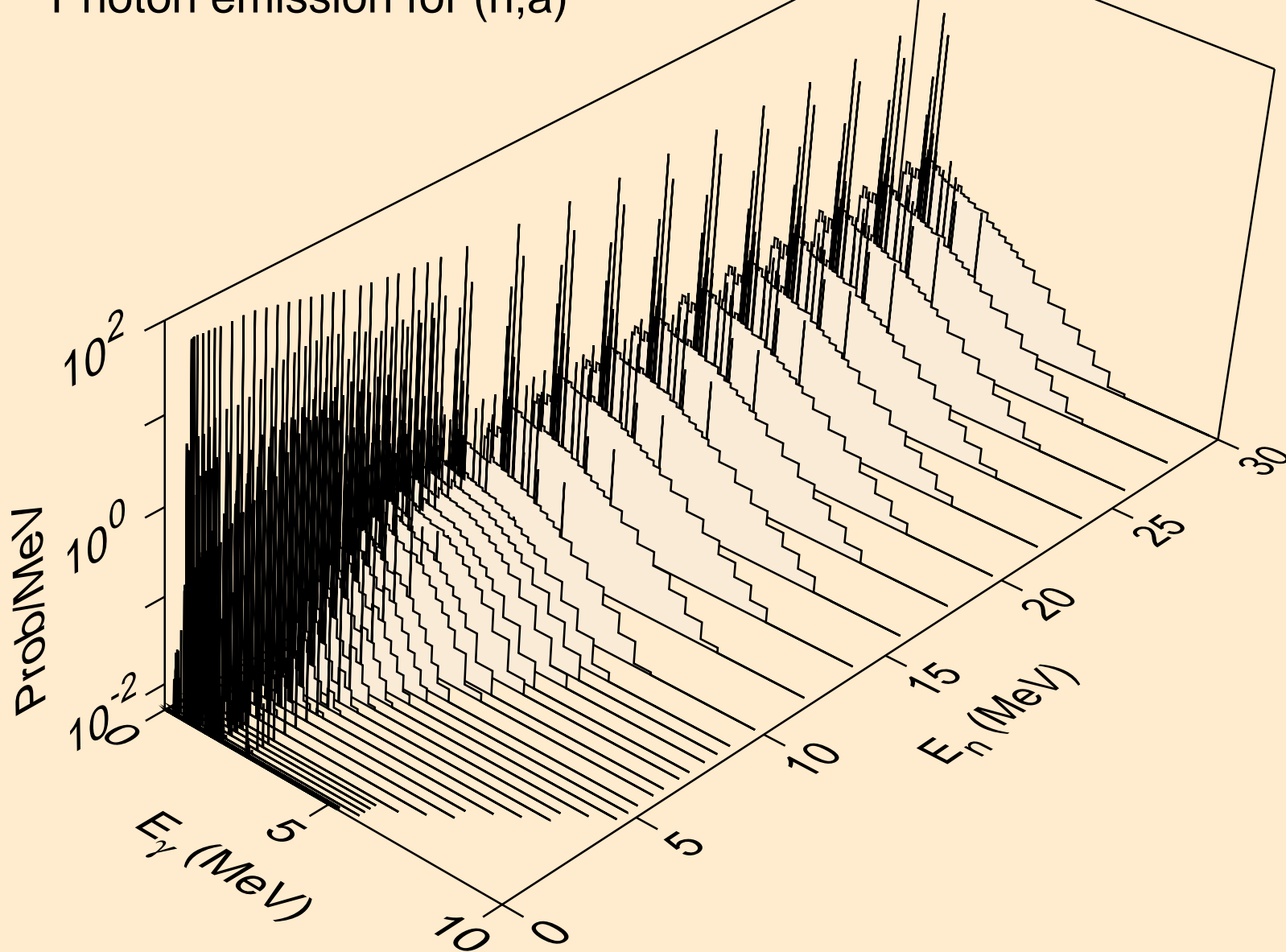

ZR087M NEUTRON ACER TENDL-2019 LIBRARY; T=293.16K
Photon emission for (n,2a)

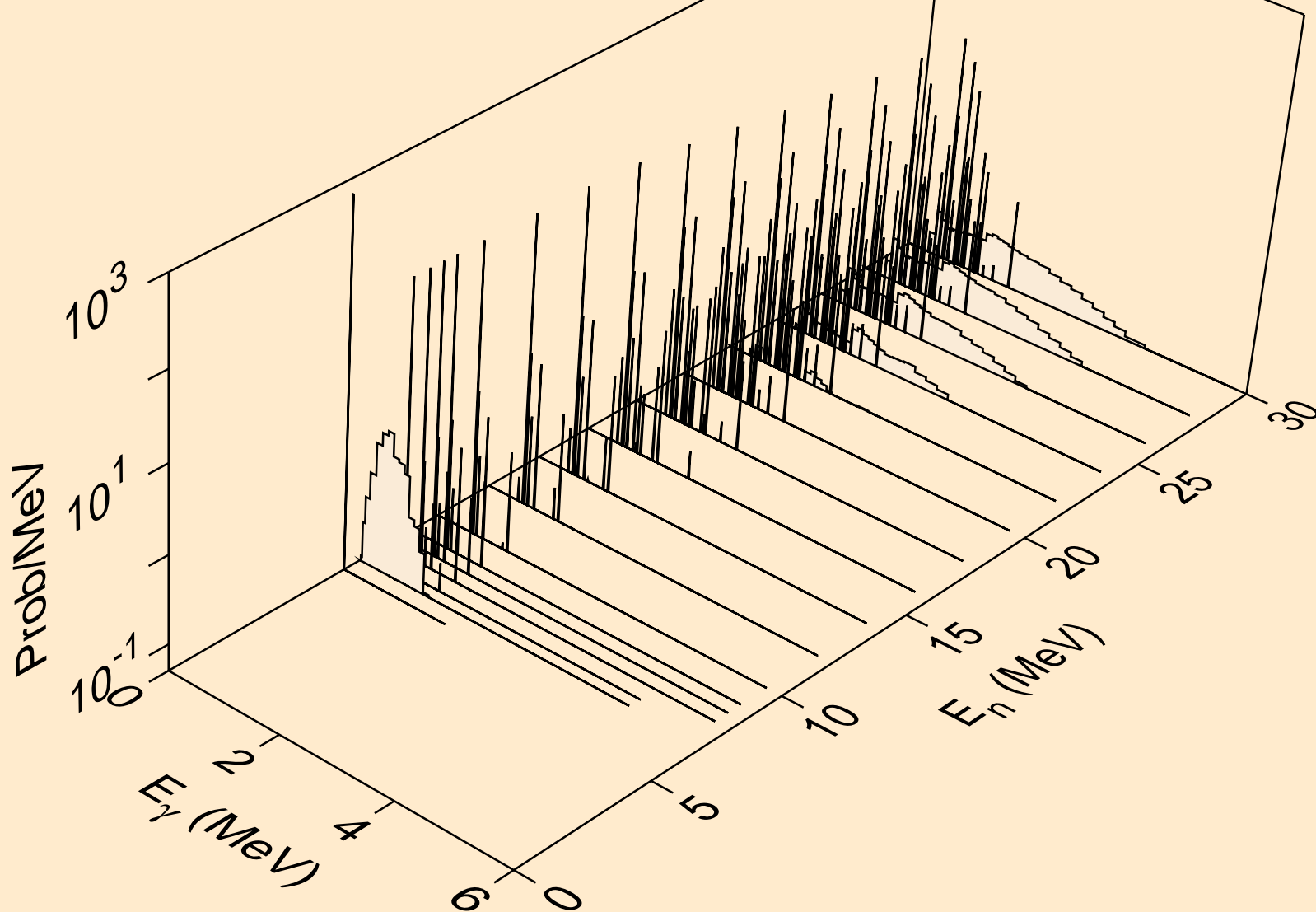

ZR087M NEUTRON ACER TENDL-2019 LIBRARY; T=293.16K
Photon emission for (n,2p)

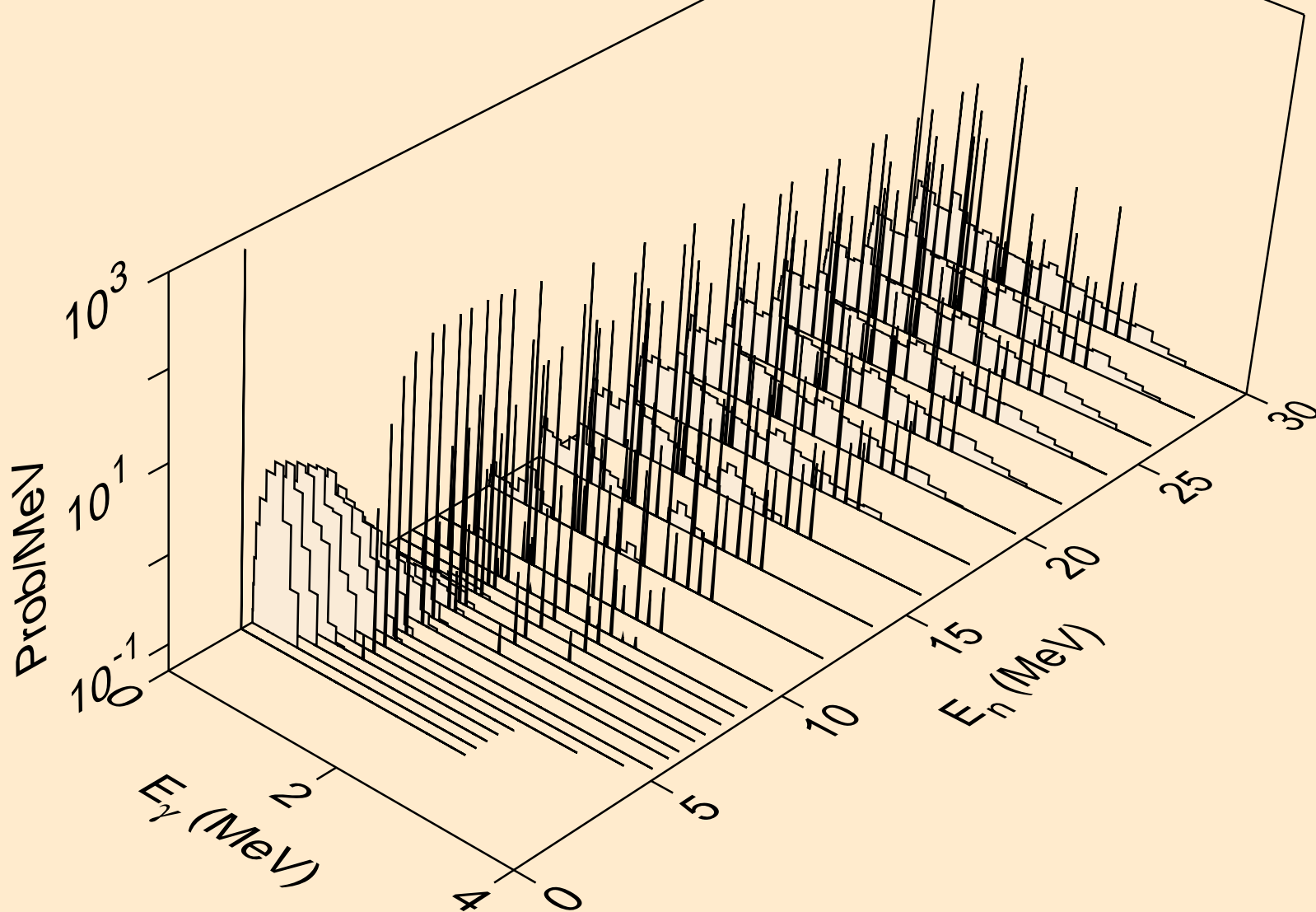

ZR087M NEUTRON ACER TENDL-2019 LIBRARY; T=293.16K
Photon emission for (n,p α)

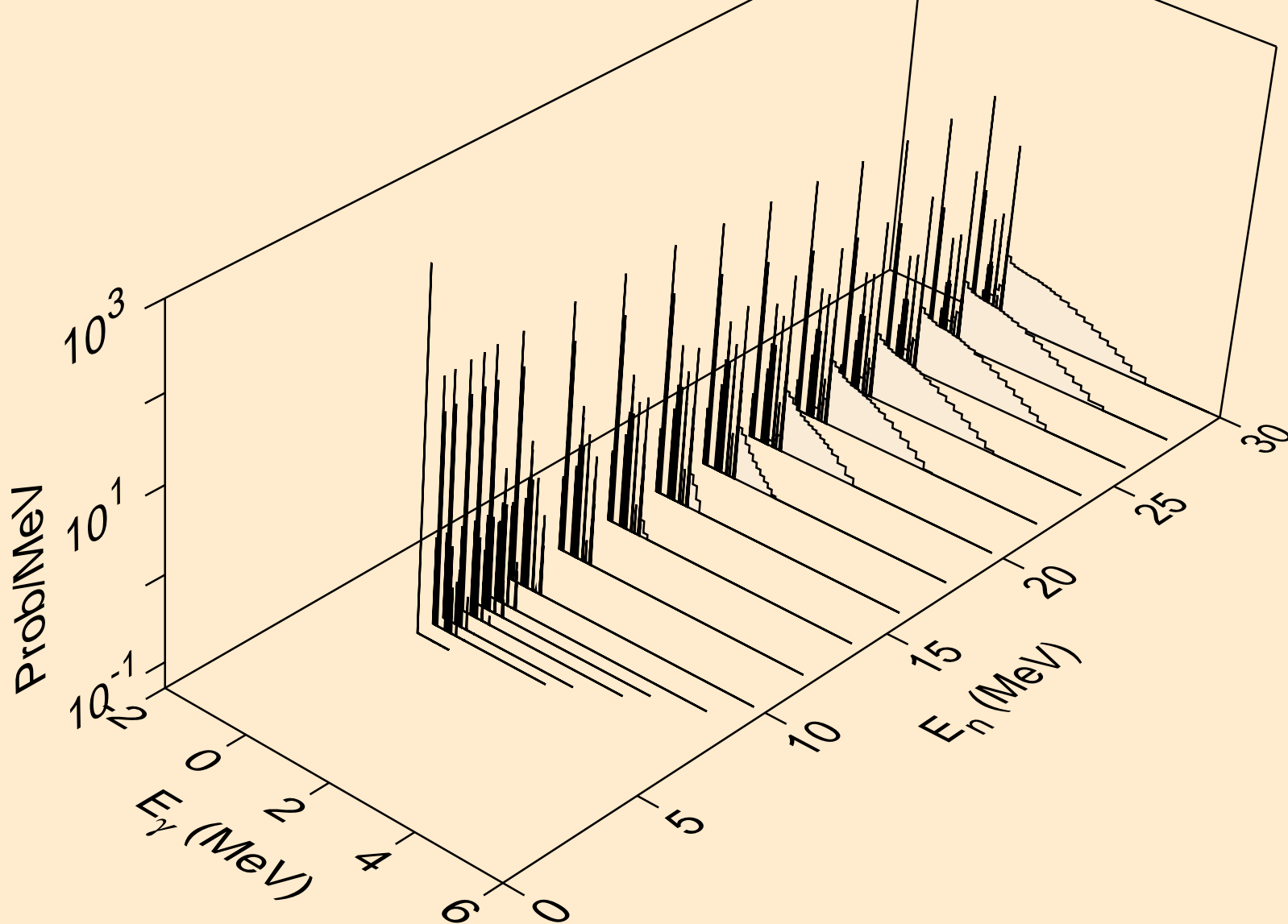

ZR087M NEUTRON ACER TENDL-2019 LIBRARY; T=293.16K
Photon emission for (n,pd)

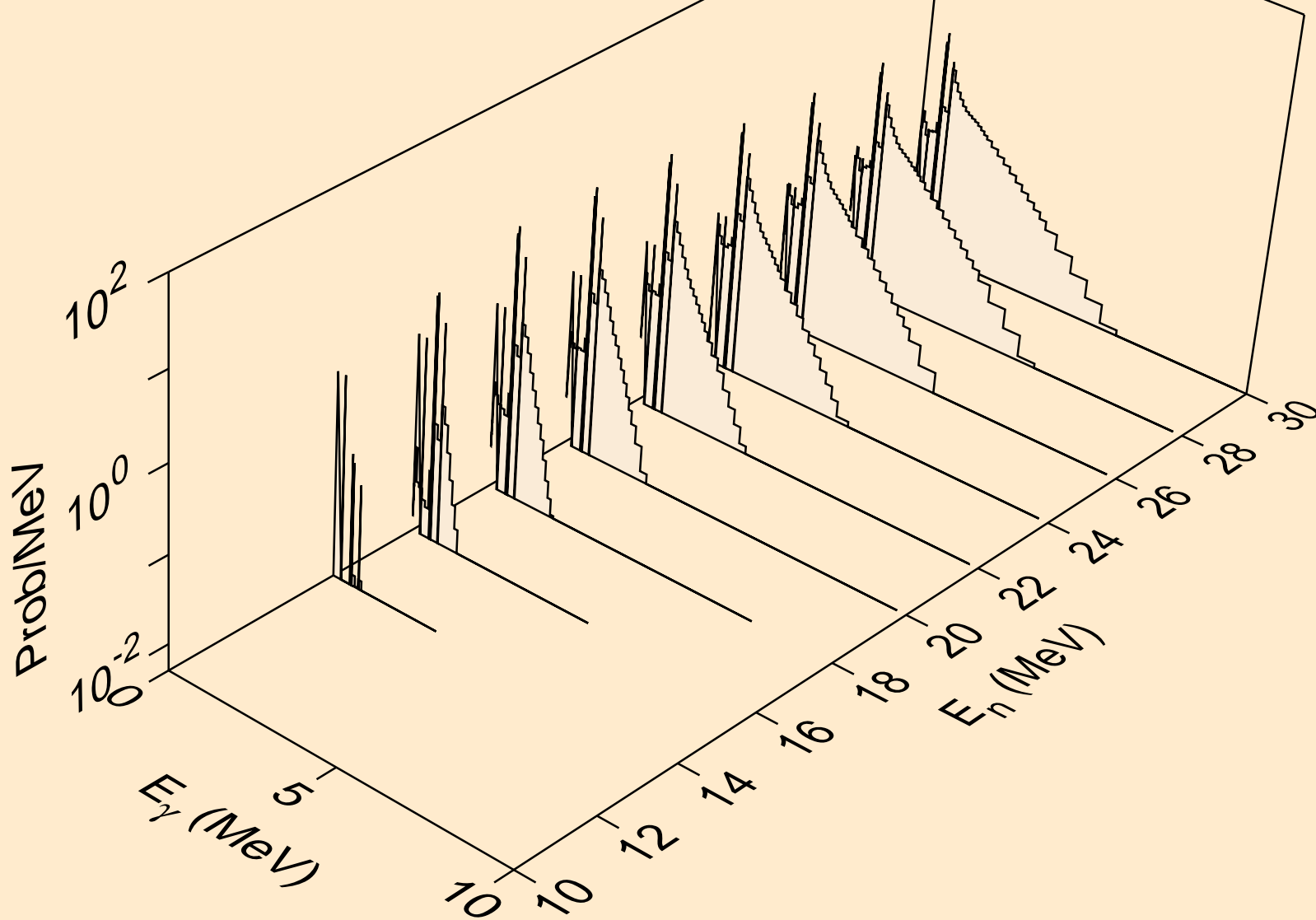

ZR087M NEUTRON ACER TENDL-2019 LIBRARY; T=293.16K
Photon emission for (n,pt)

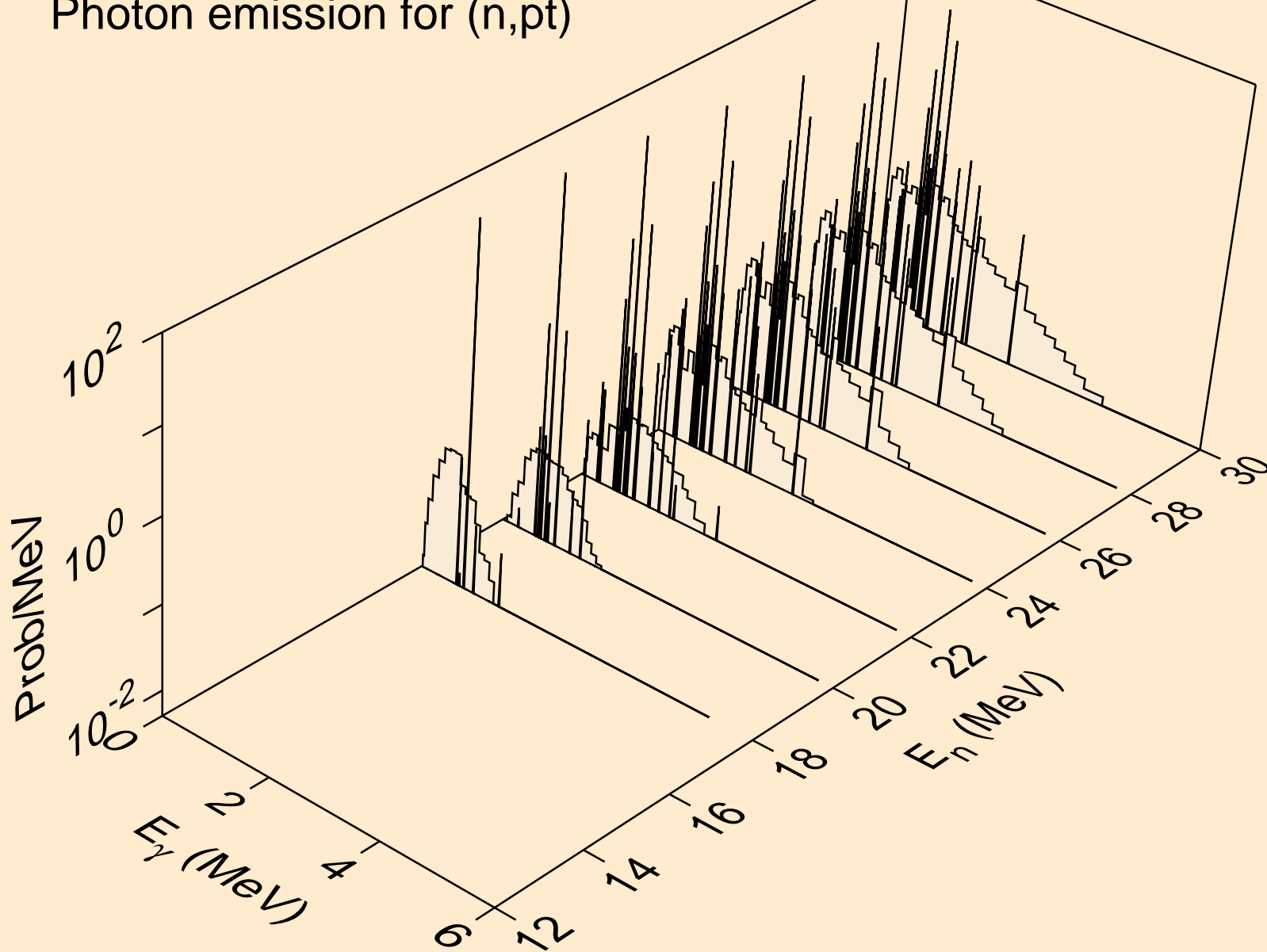

ZR087M NEUTRON ACER TENDL-2019 LIBRARY; T=293.16K
Photon emission for (n,da)

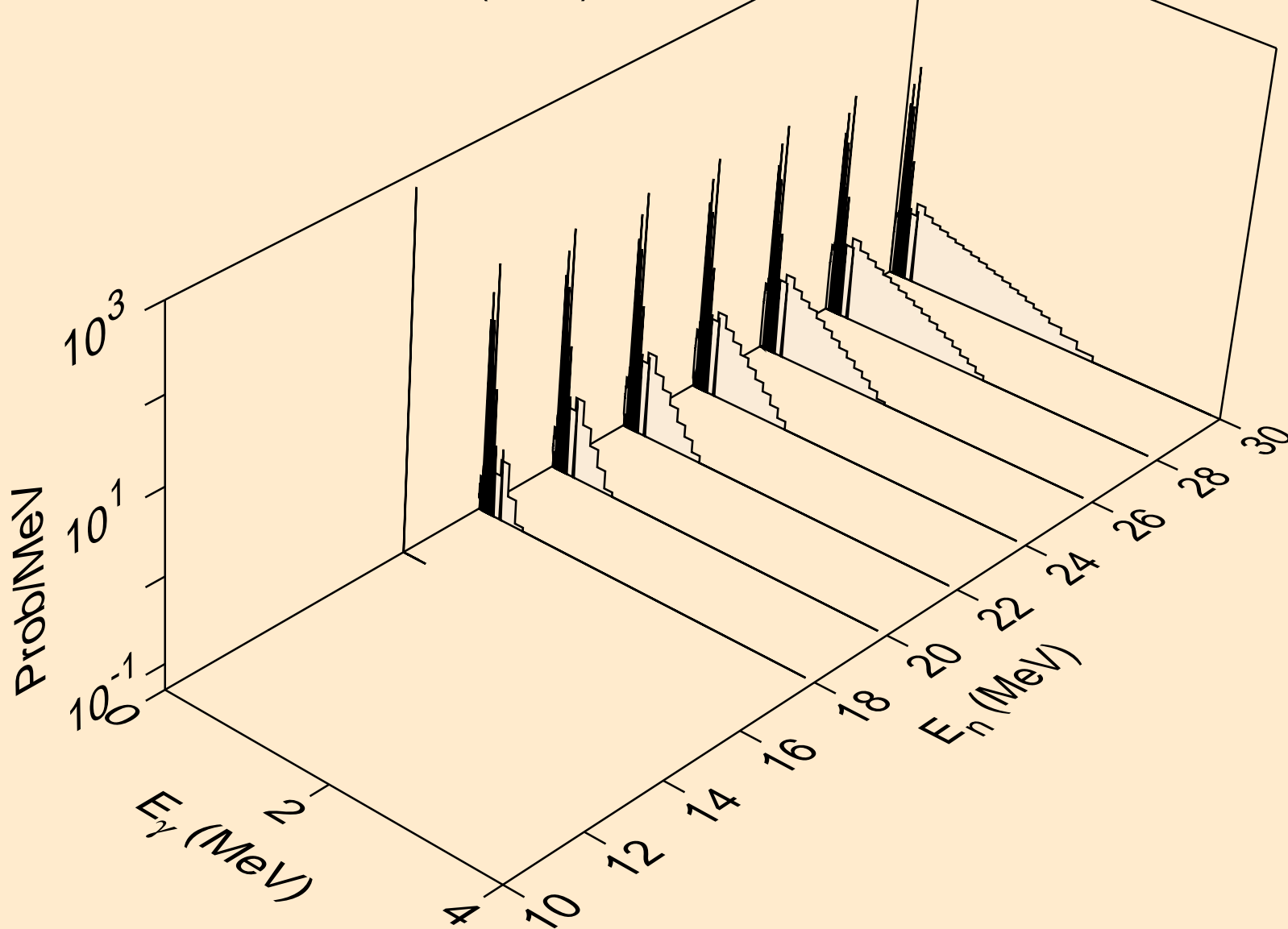

ZR087M NEUTRON ACER TENDL-2019 LIBRARY; T=293.16K
thermal capture photon spectrum

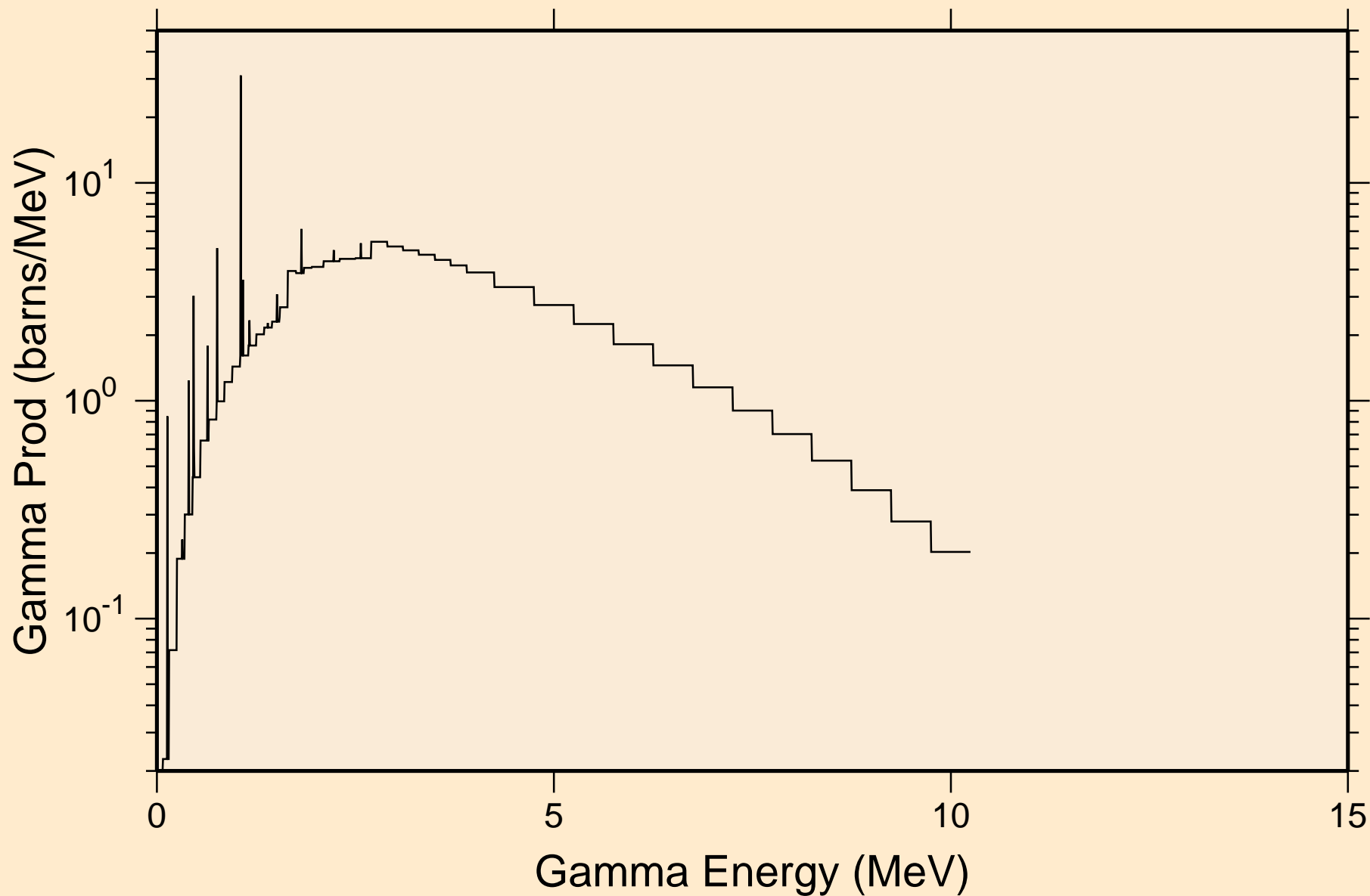

ZR087M NEUTRON ACER TENDL-2019 LIBRARY; T=293.16K
14 MeV photon spectrum

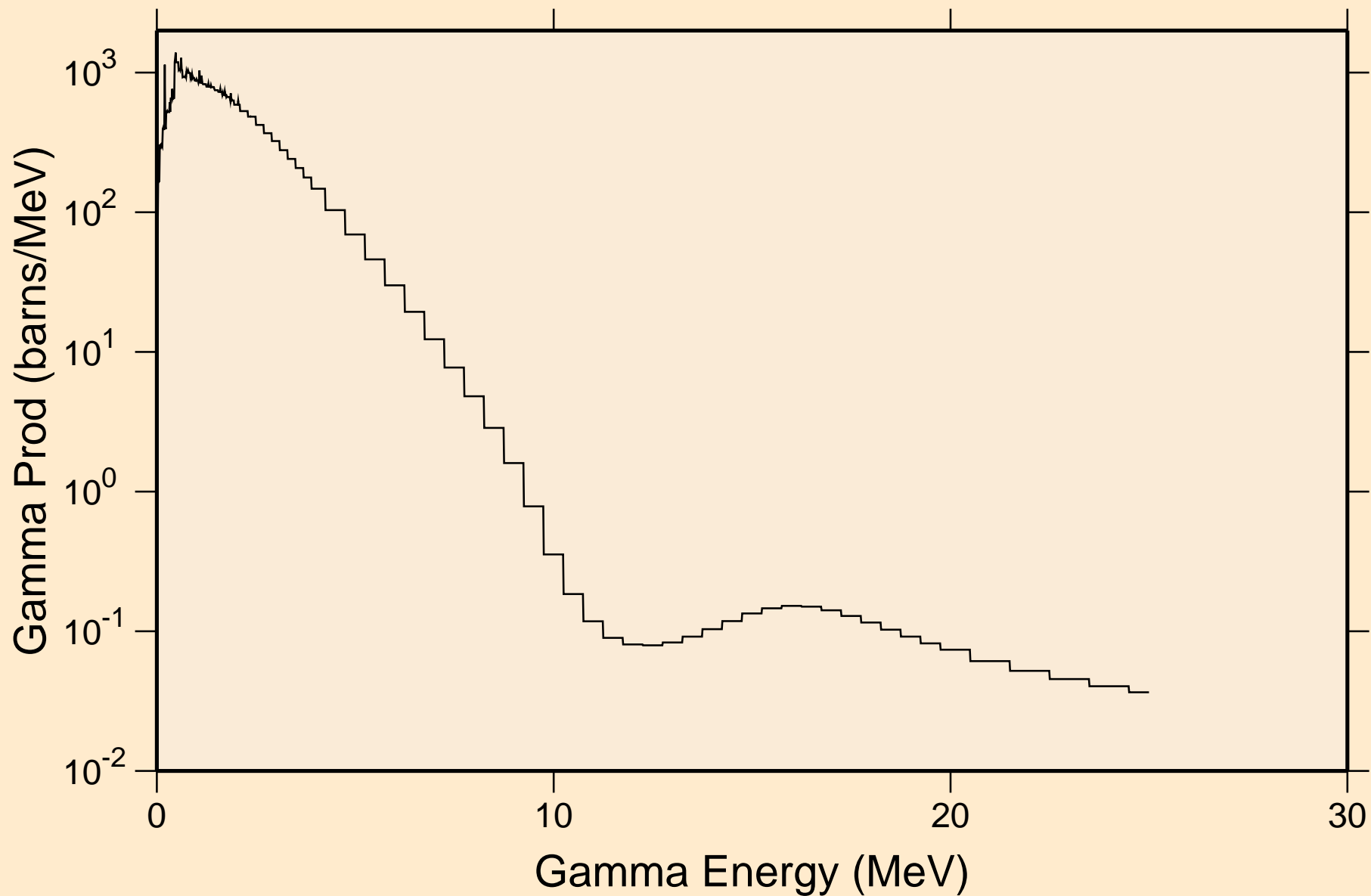

ZR087M NEUTRON ACER TENDL-2019 LIBRARY; T=293.16K
Particle heating contributions

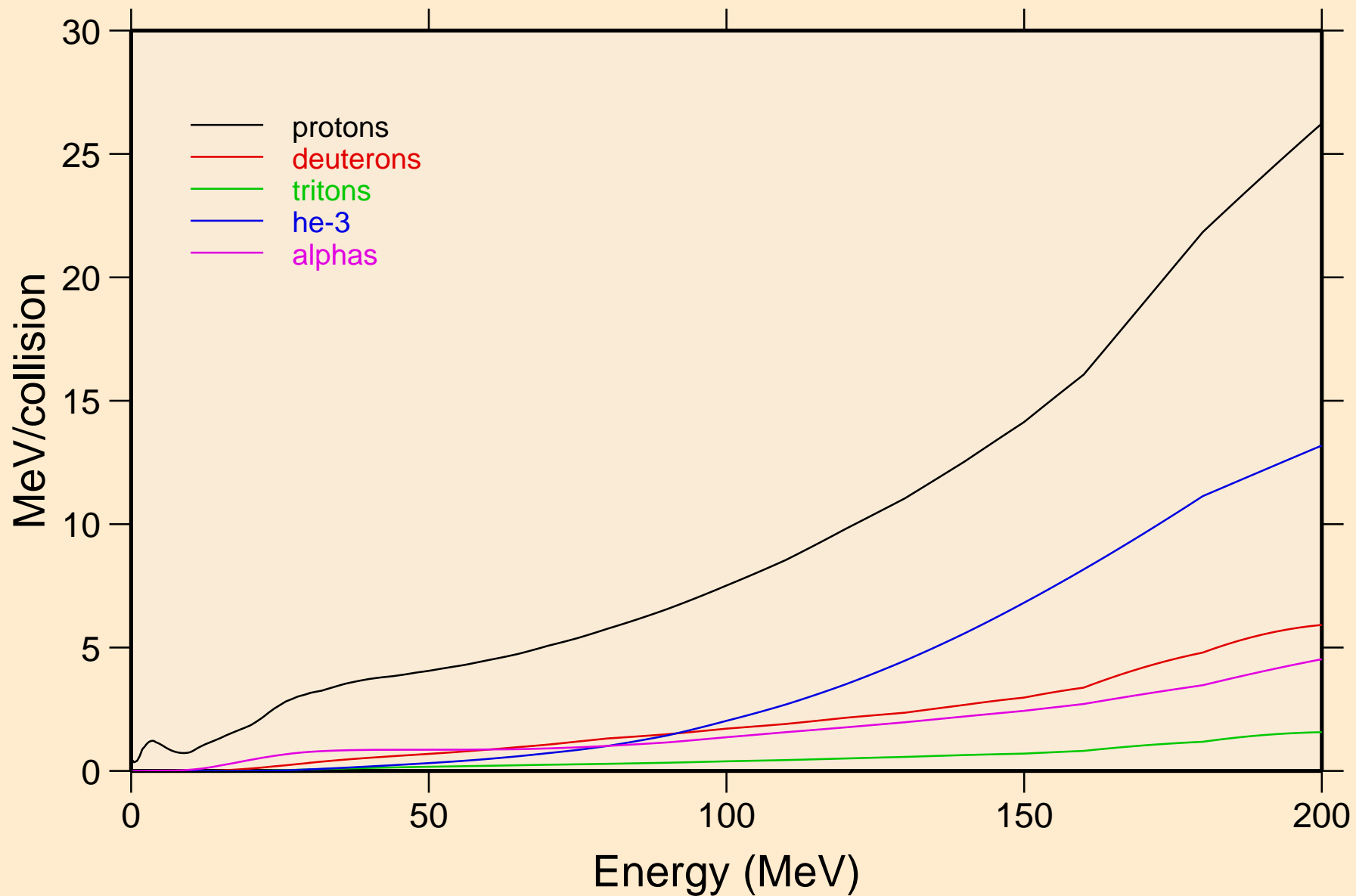

ZR087M NEUTRON ACER TENDL-2019 LIBRARY; T=293.16K
Recoil Heating

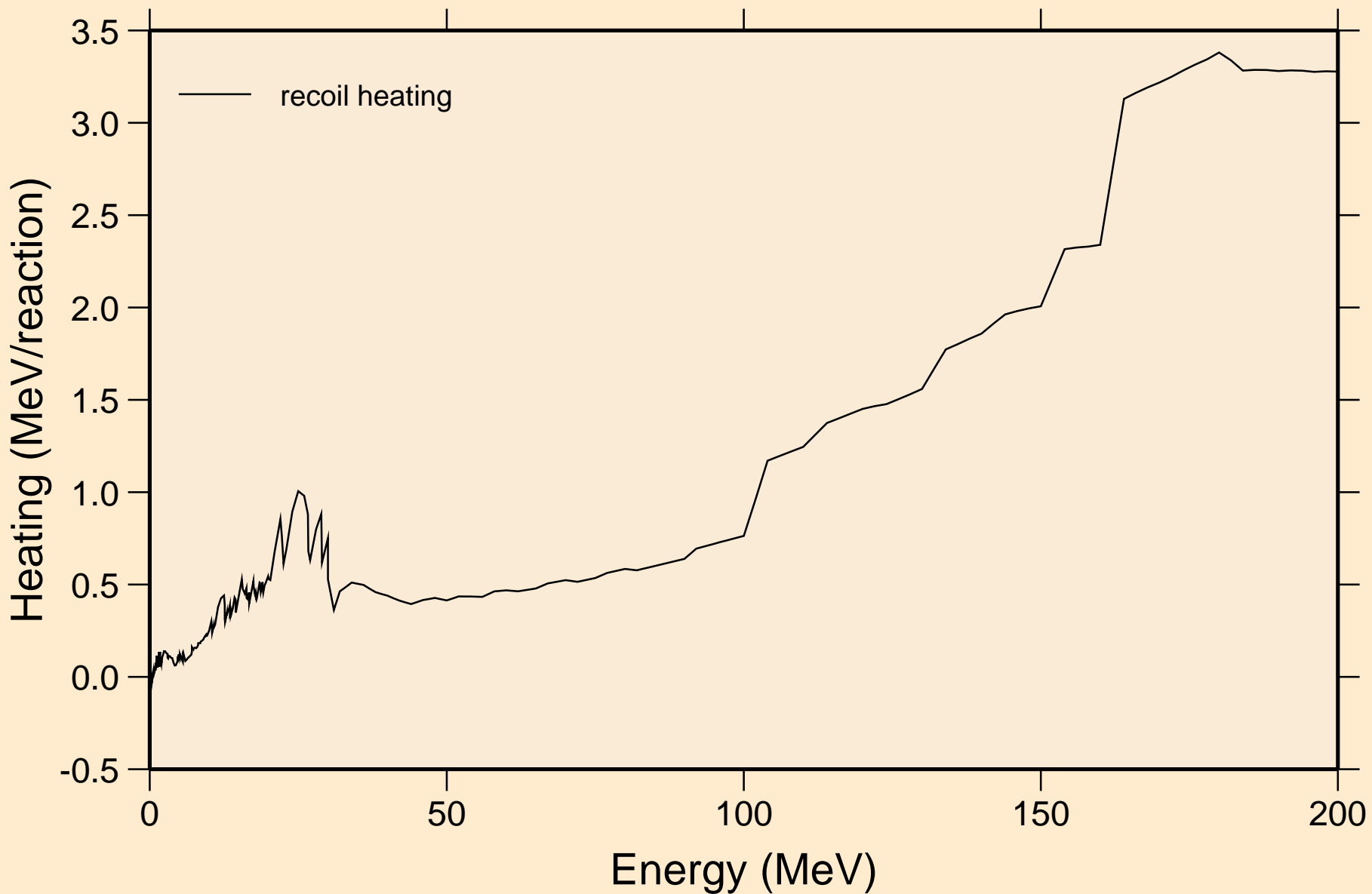

ZR087M NEUTRON ACER TENDL-2019 LIBRARY; T=293.16K

Particle production cross sections

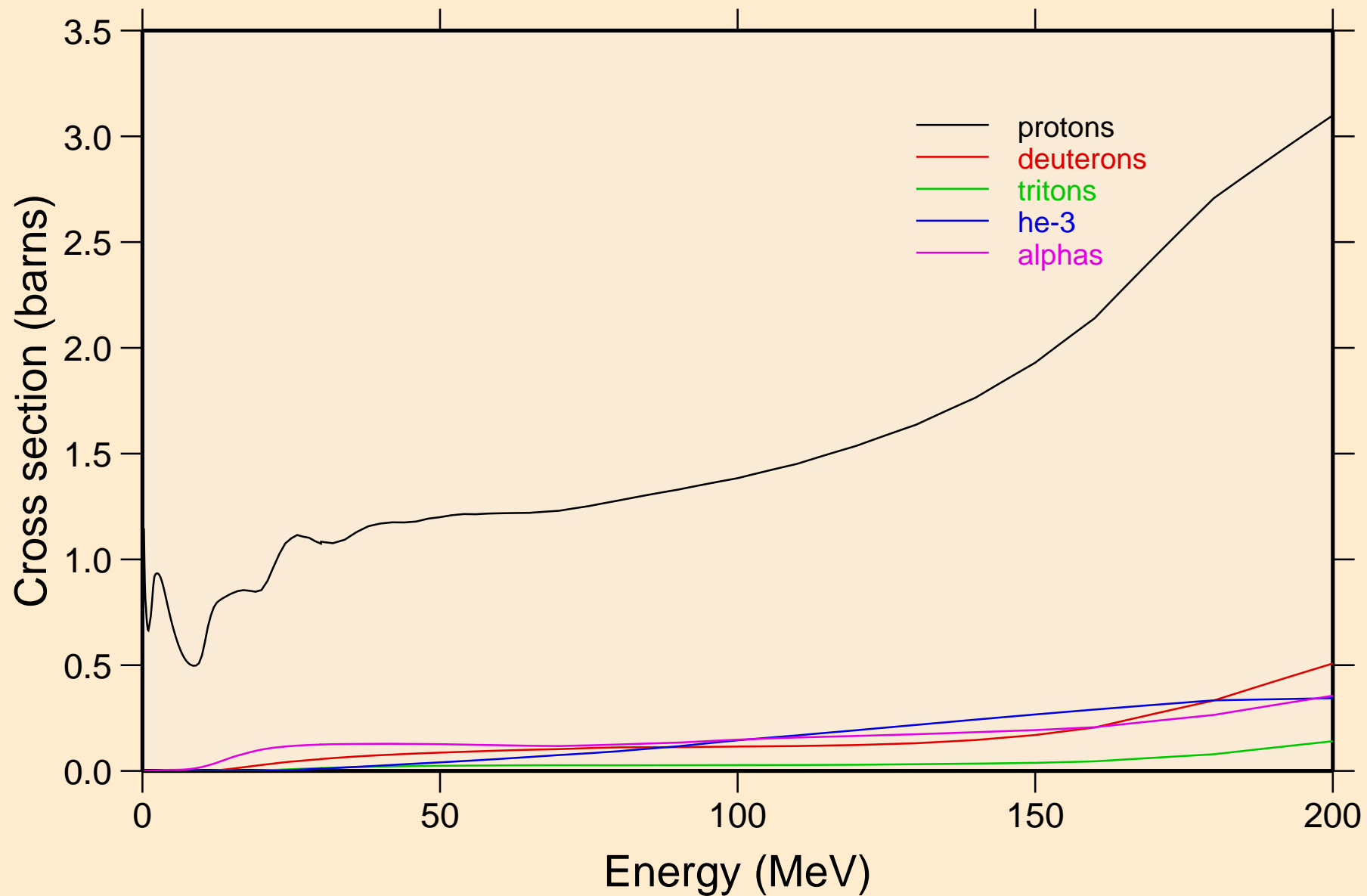

ZR087M NEUTRON ACER TENDL-2019 LIBRARY; T=293.16K
protons from (n,x)

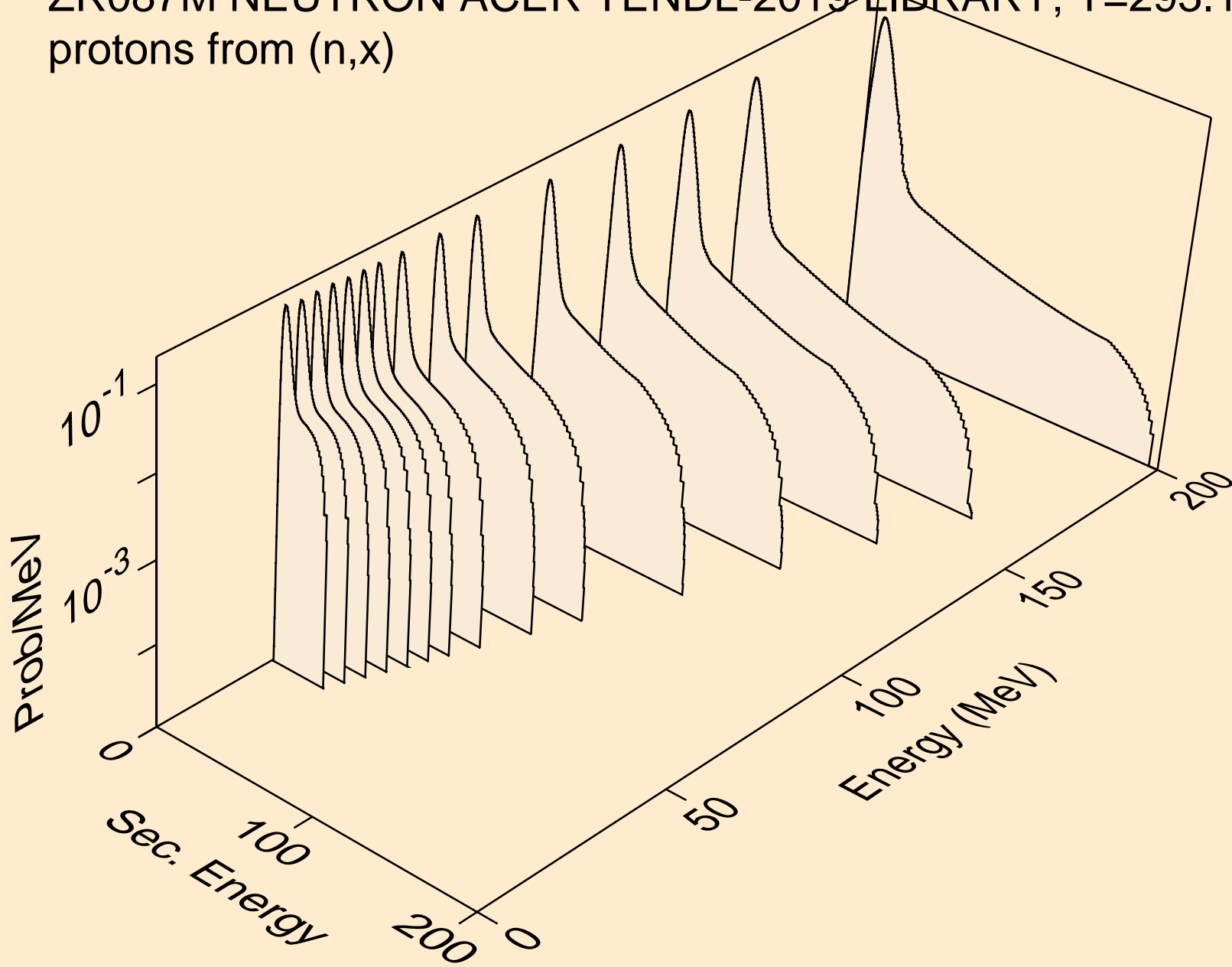

ZR087M NEUTRON ACER TENDL-2019 LIBRARY; T=293.16K
protons from (n,n*)p

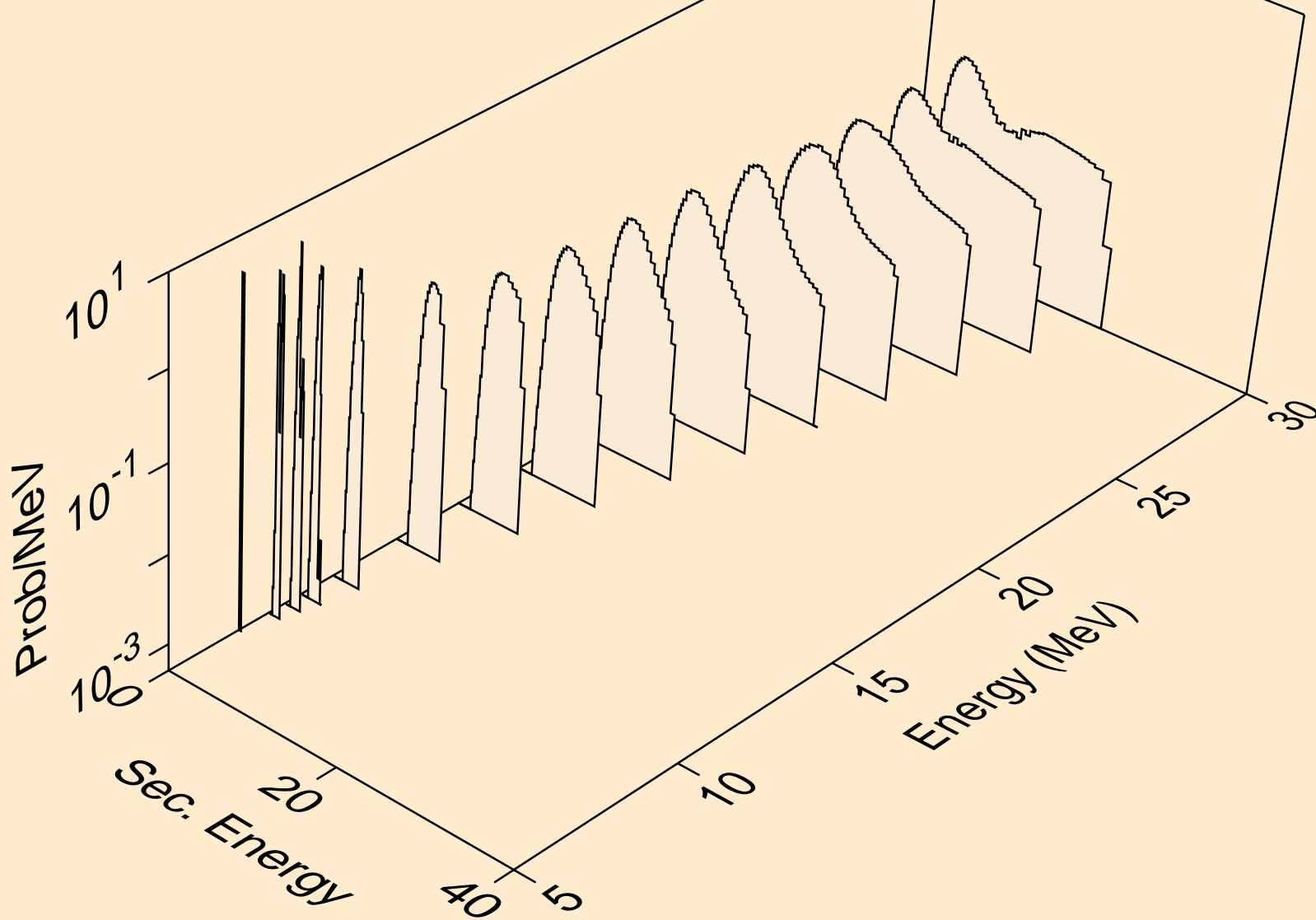

ZR087M NEUTRON ACER TENDL-2019 LIBRARY; T=293.16K
protons from (n,2np)

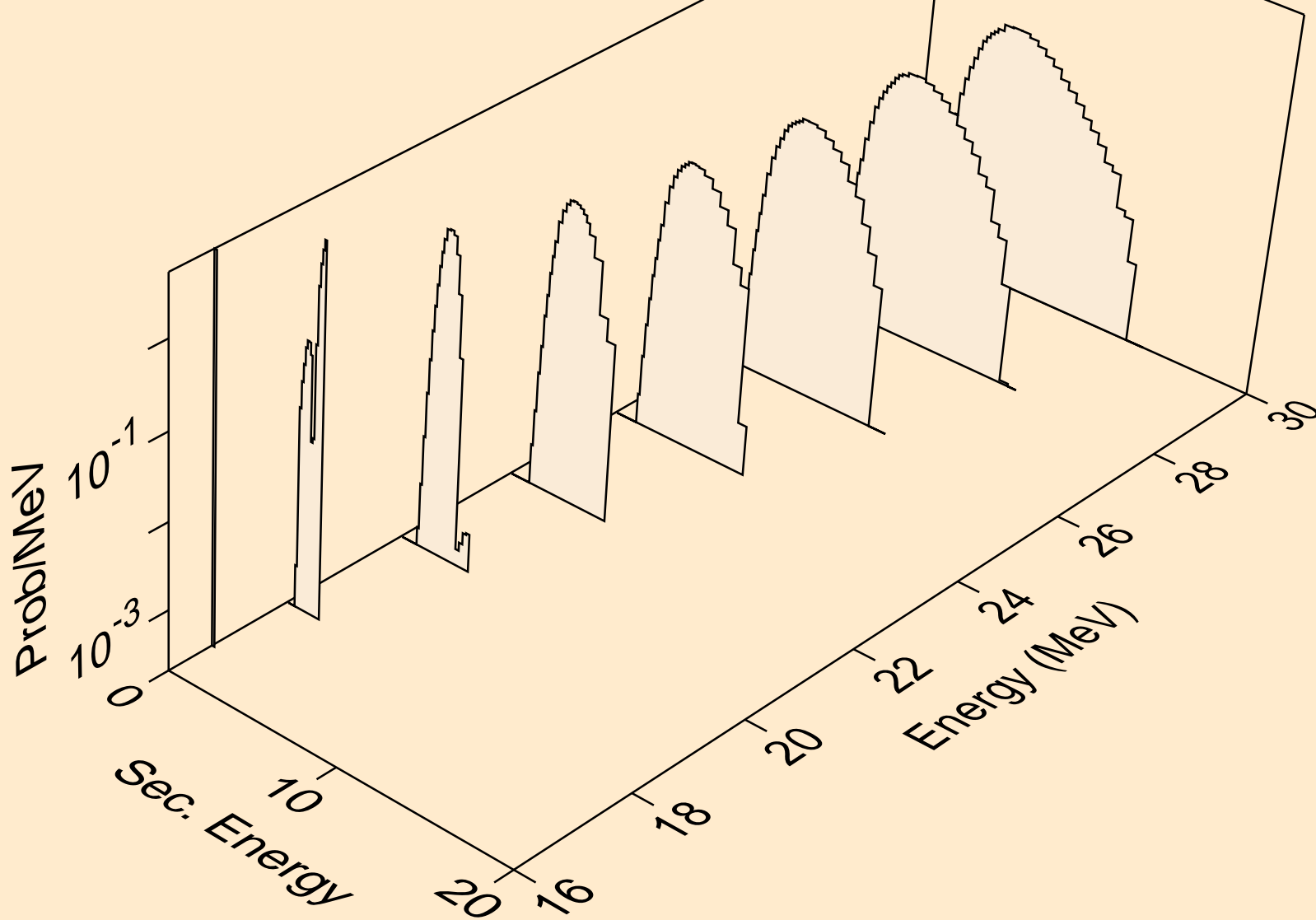

ZR087M NEUTRON ACER TENDL-2019 LIBRARY; T=293.16K
protons from (n,3np)

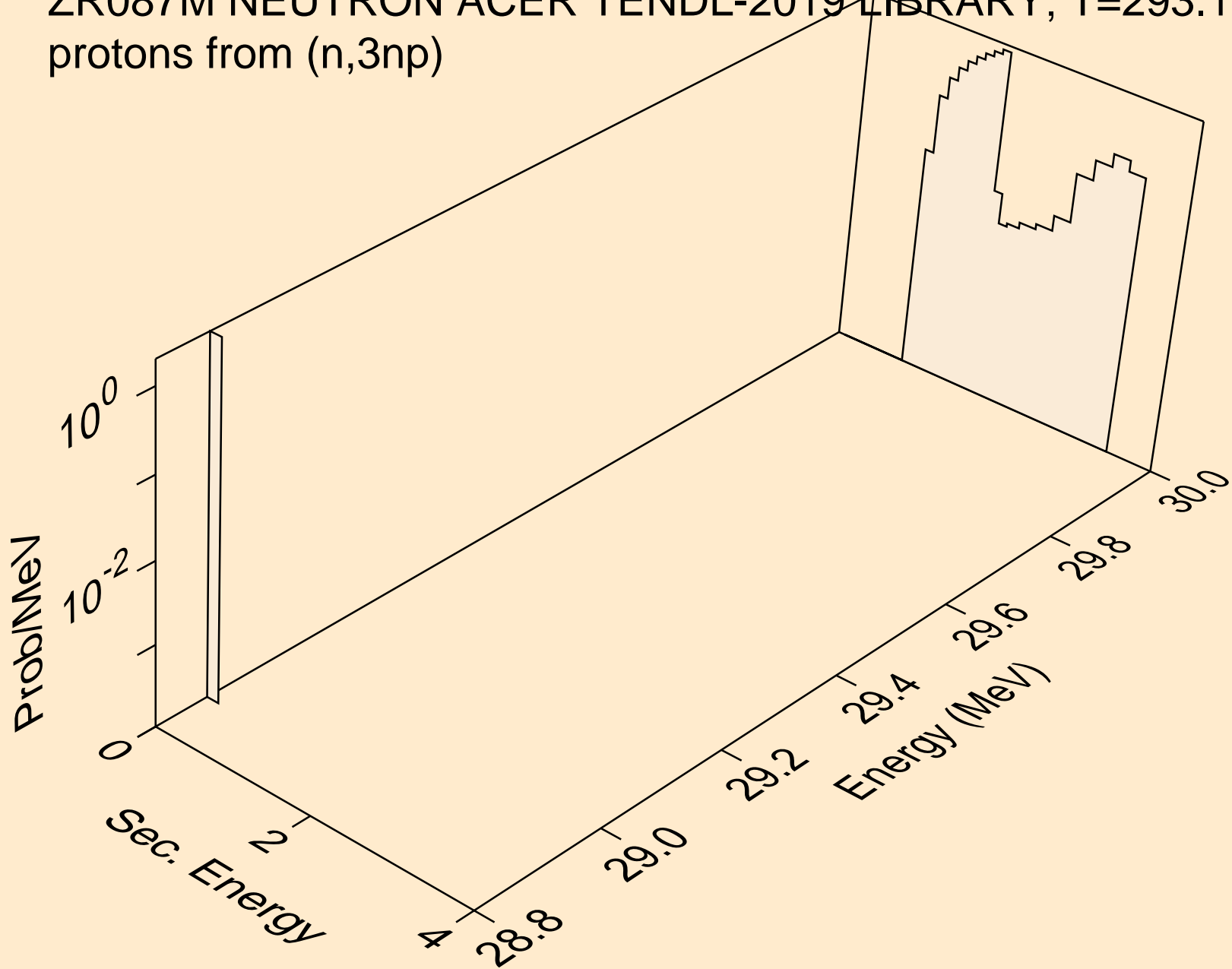

ZR087M NEUTRON ACER TENDL-2019 LIBRARY; T=293.16K
protons from (n,2np)

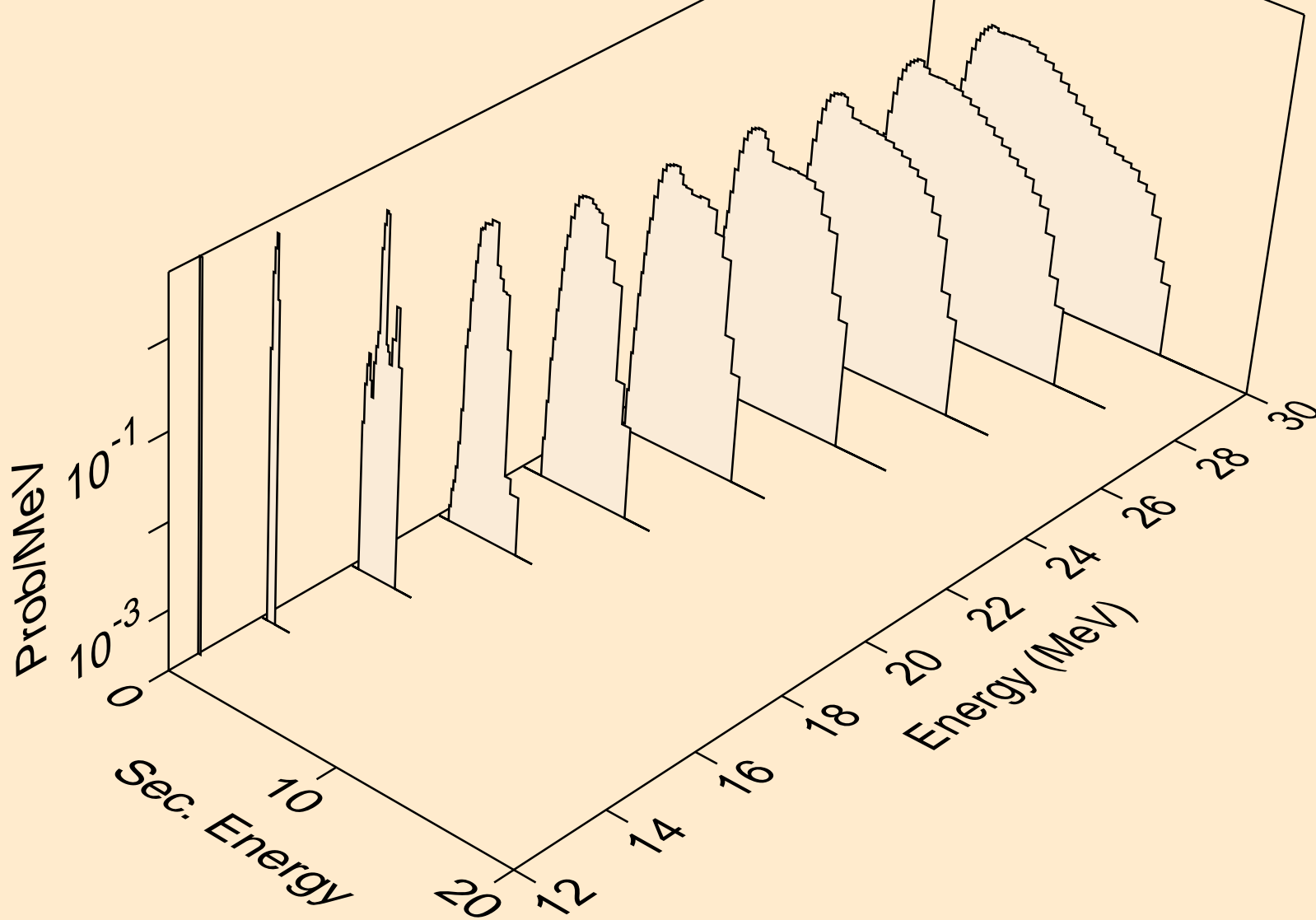

ZR087M NEUTRON ACER TENDL-2019 LIBRARY; T=293.16K
protons from (n,npa)

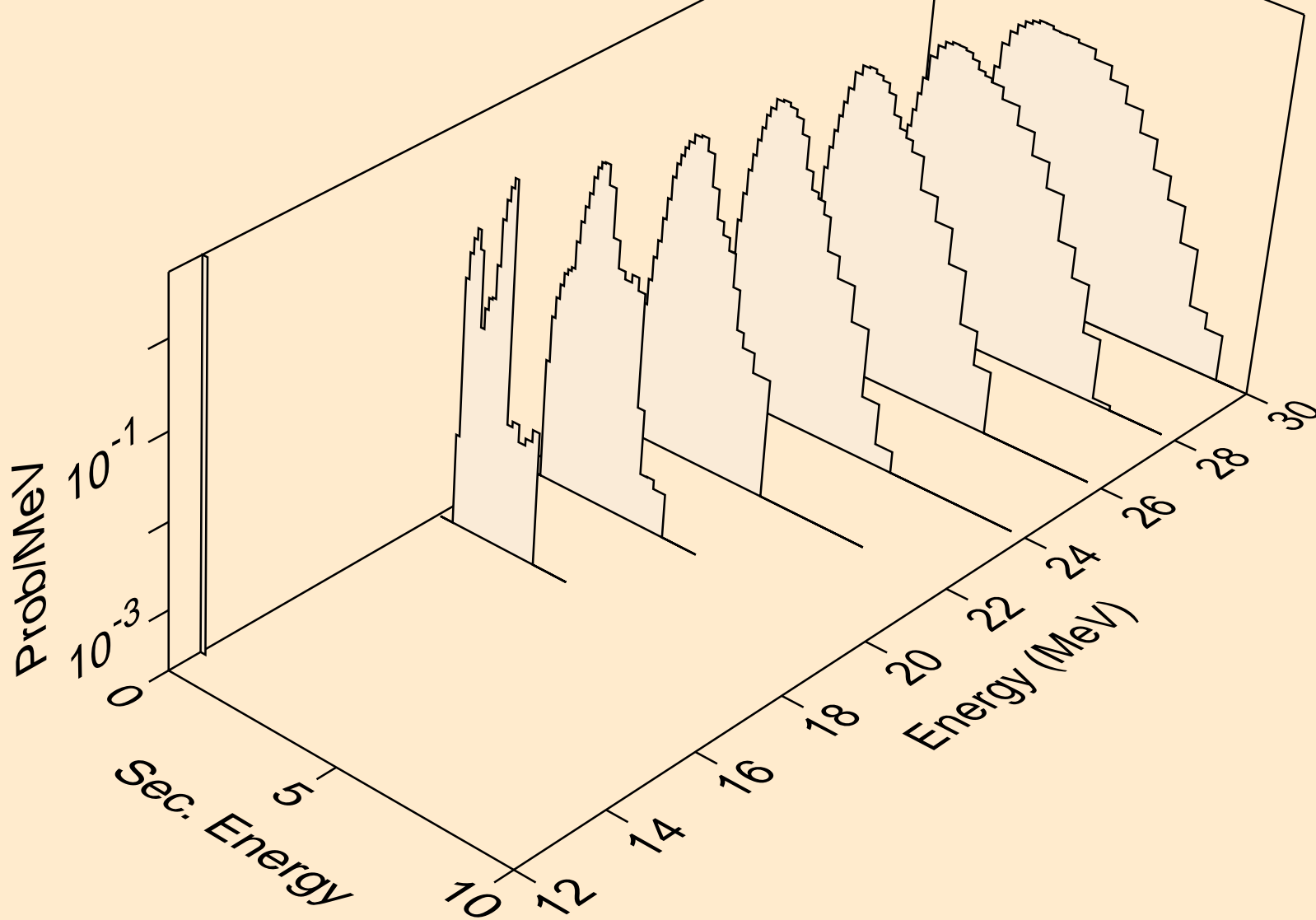

ZR087M NEUTRON ACER TENDL-2019 LIBRARY; T=293.16K
protons from (n,p)

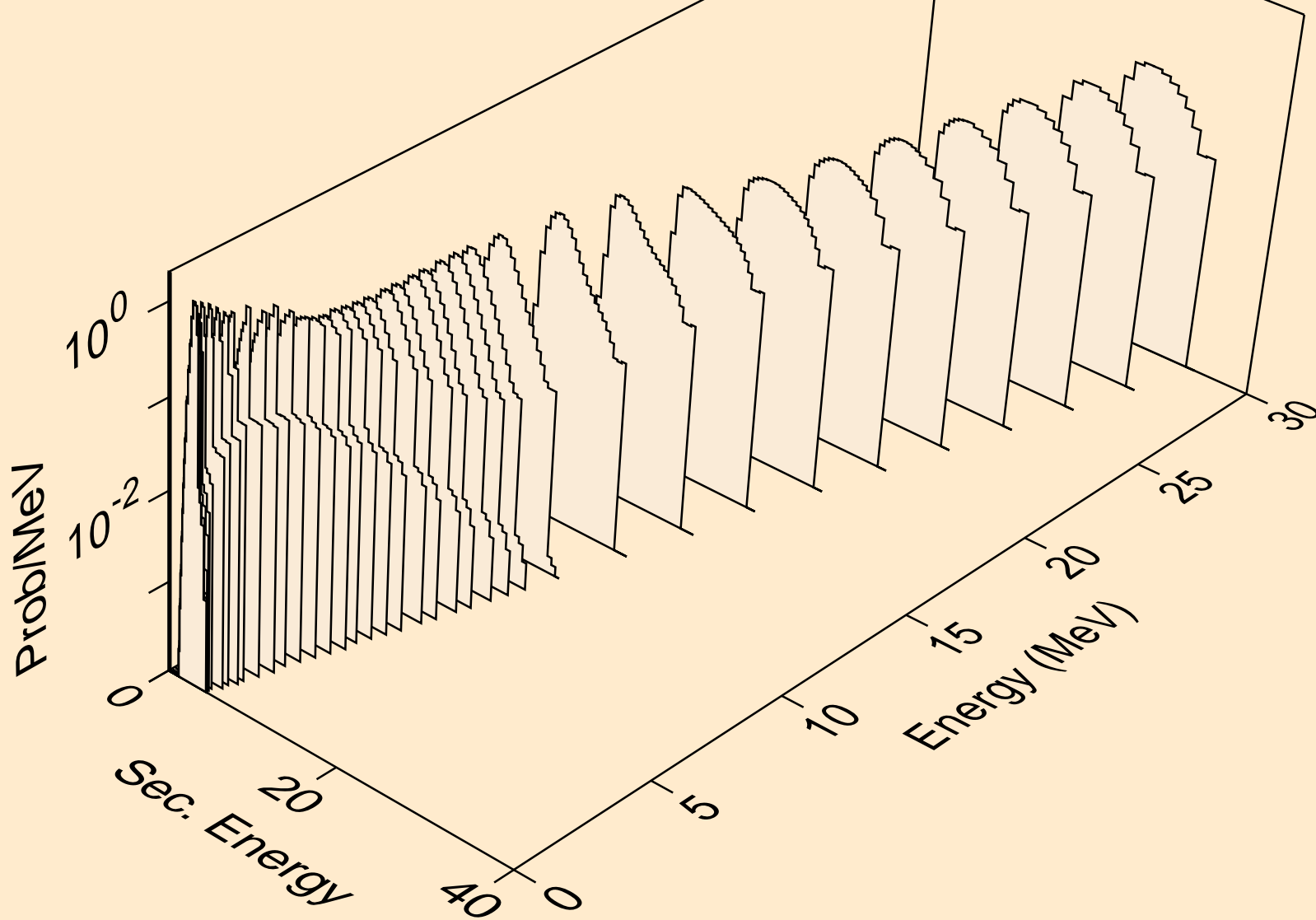

ZR087M NEUTRON ACER TENDL-2019 LIBRARY; T=293.16K
protons from (n,2p)

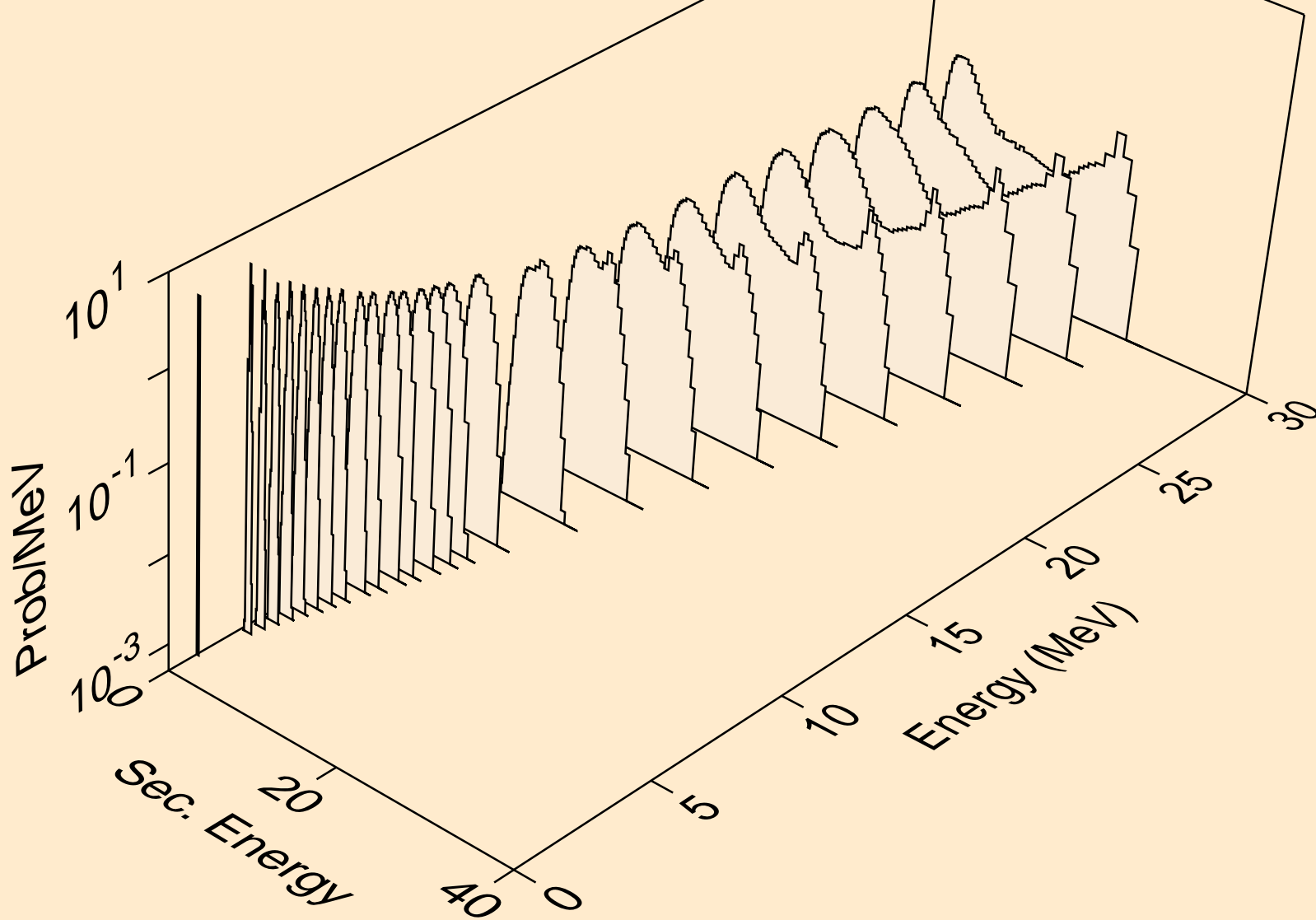

ZR087M NEUTRON ACER TENDL-2019 LIBRARY; T=293.16K
protons from (n,p)

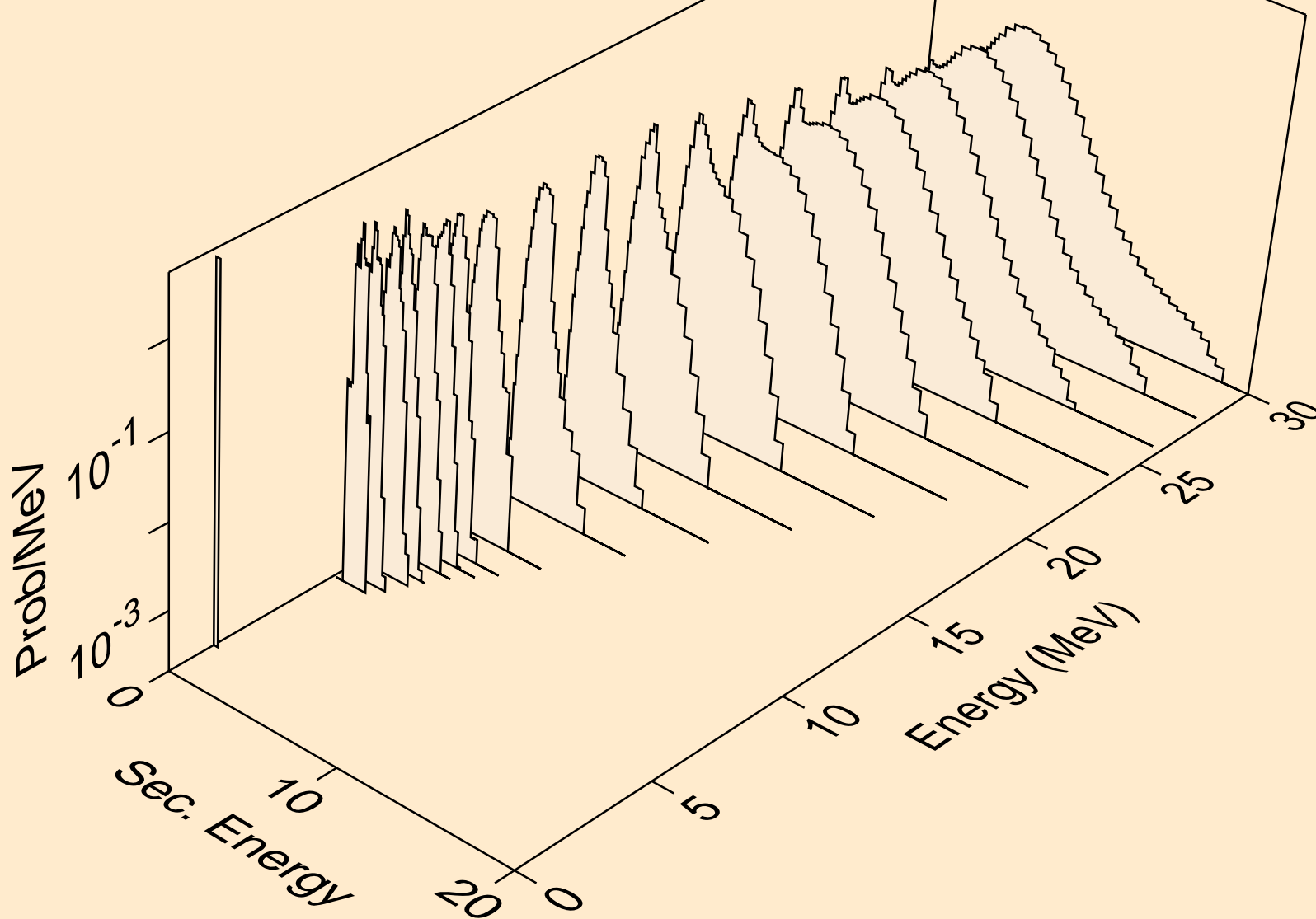

ZR087M NEUTRON ACER TENDL-2019 LIBRARY; T=293.16K
protons from (n,pd)

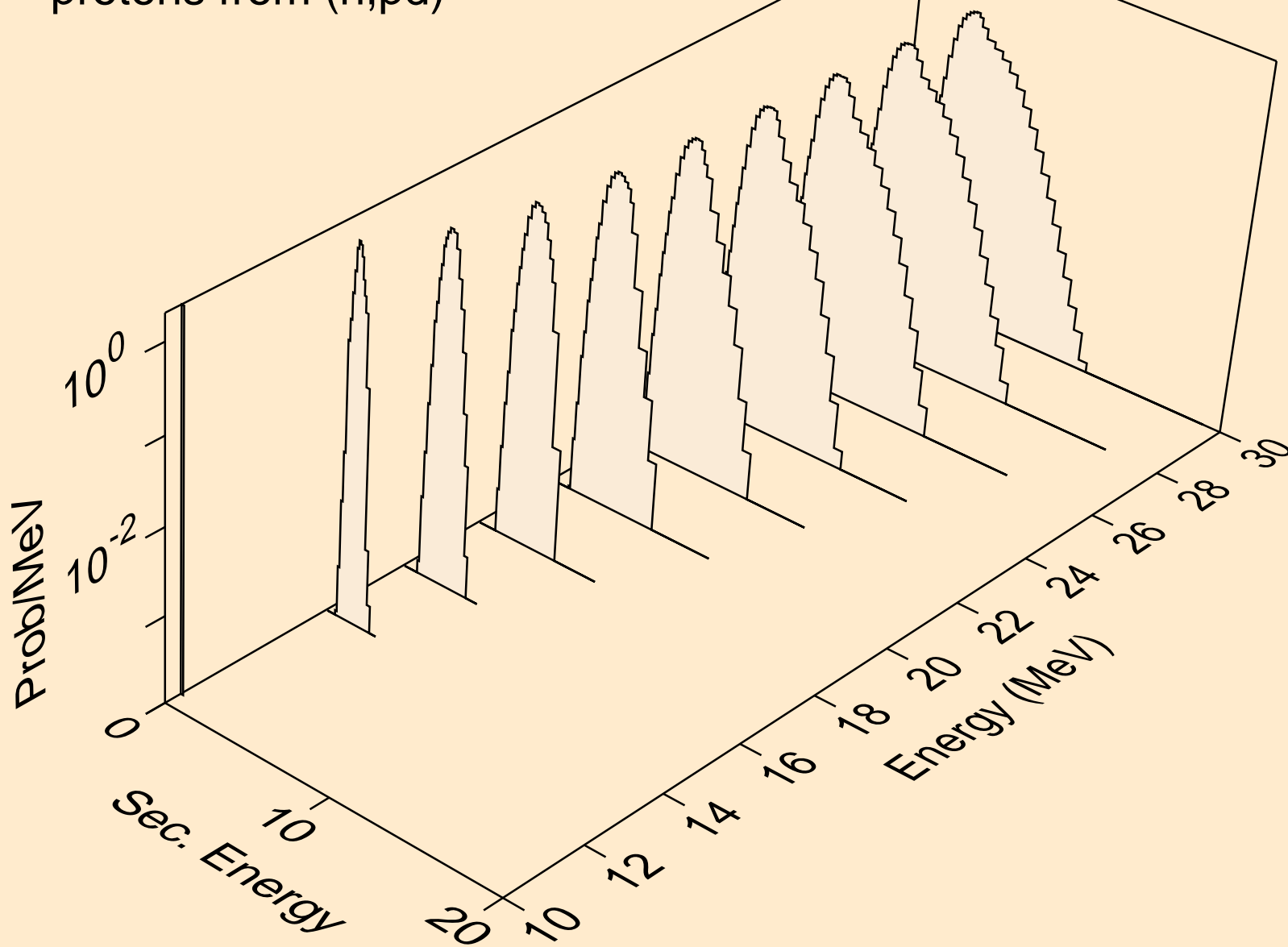

ZR087M NEUTRON ACER TENDL-2019 LIBRARY; T=293.16K
protons from (n,pt)

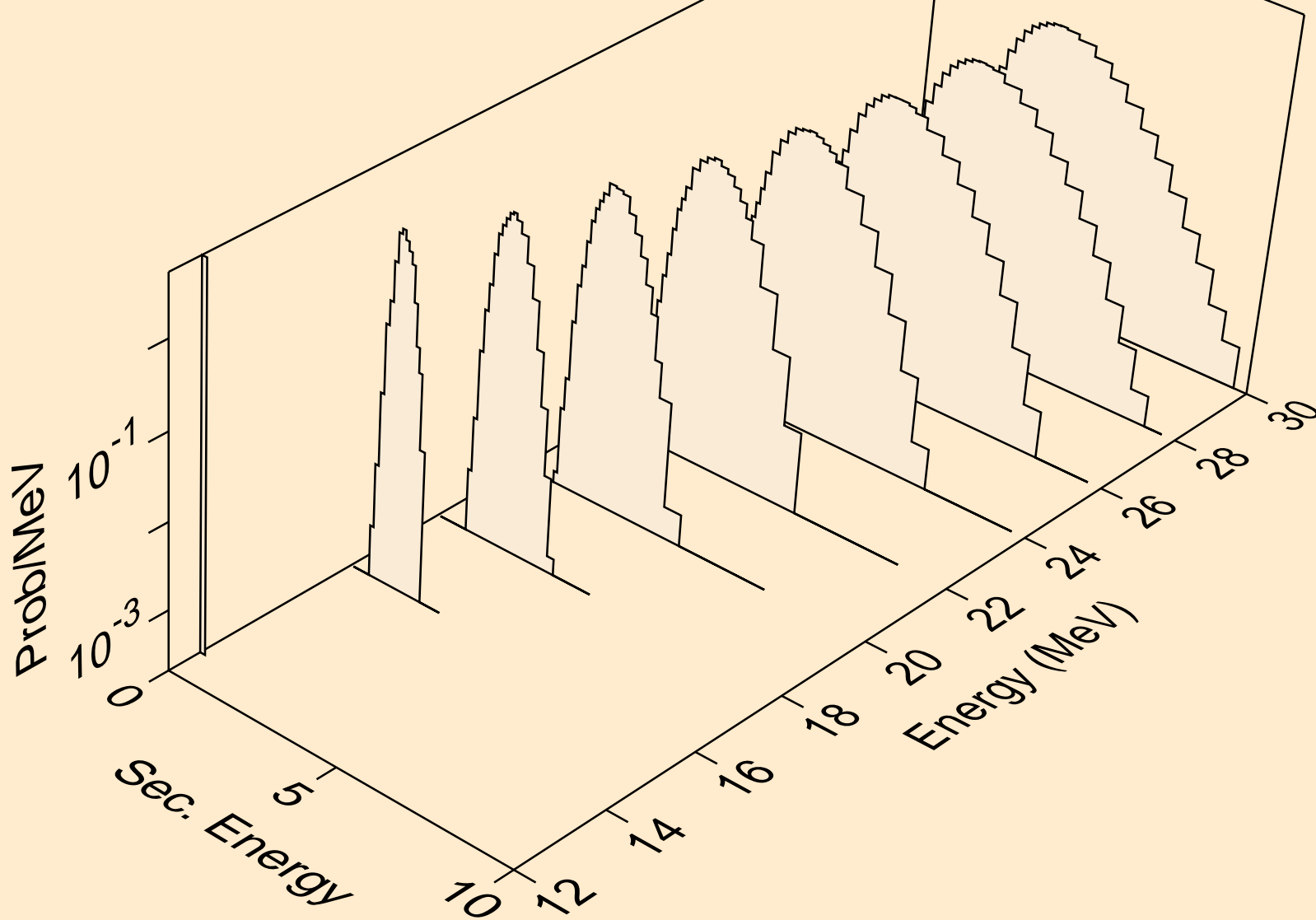

ZR087M NEUTRON ACER TENDL-2019 LIBRARY; T=293.16K
deuterons from (n,x)

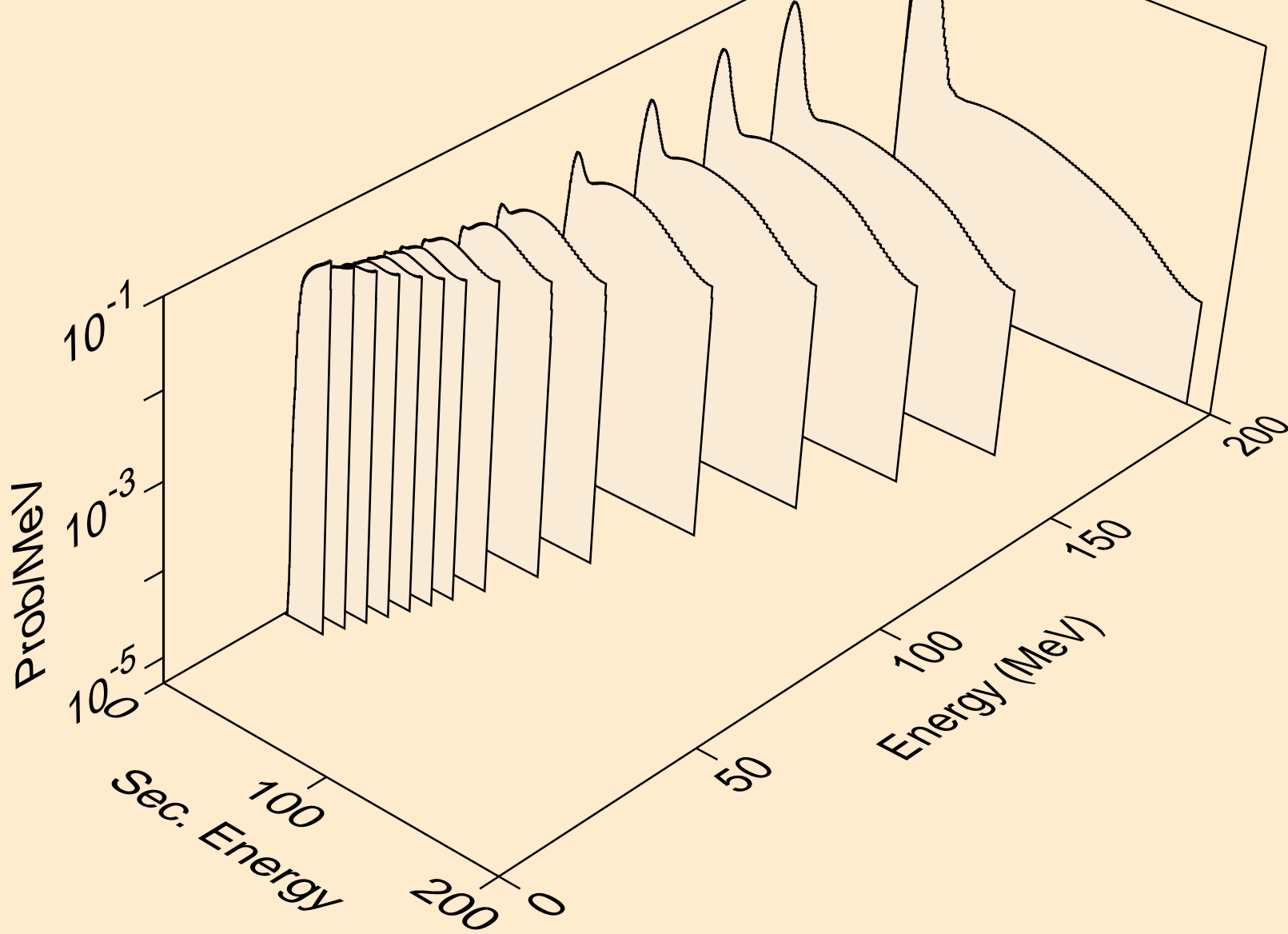

ZR087M NEUTRON ACER TENDL-2019 LIBRARY; T=293.16K
deuterons from (n,2nd)

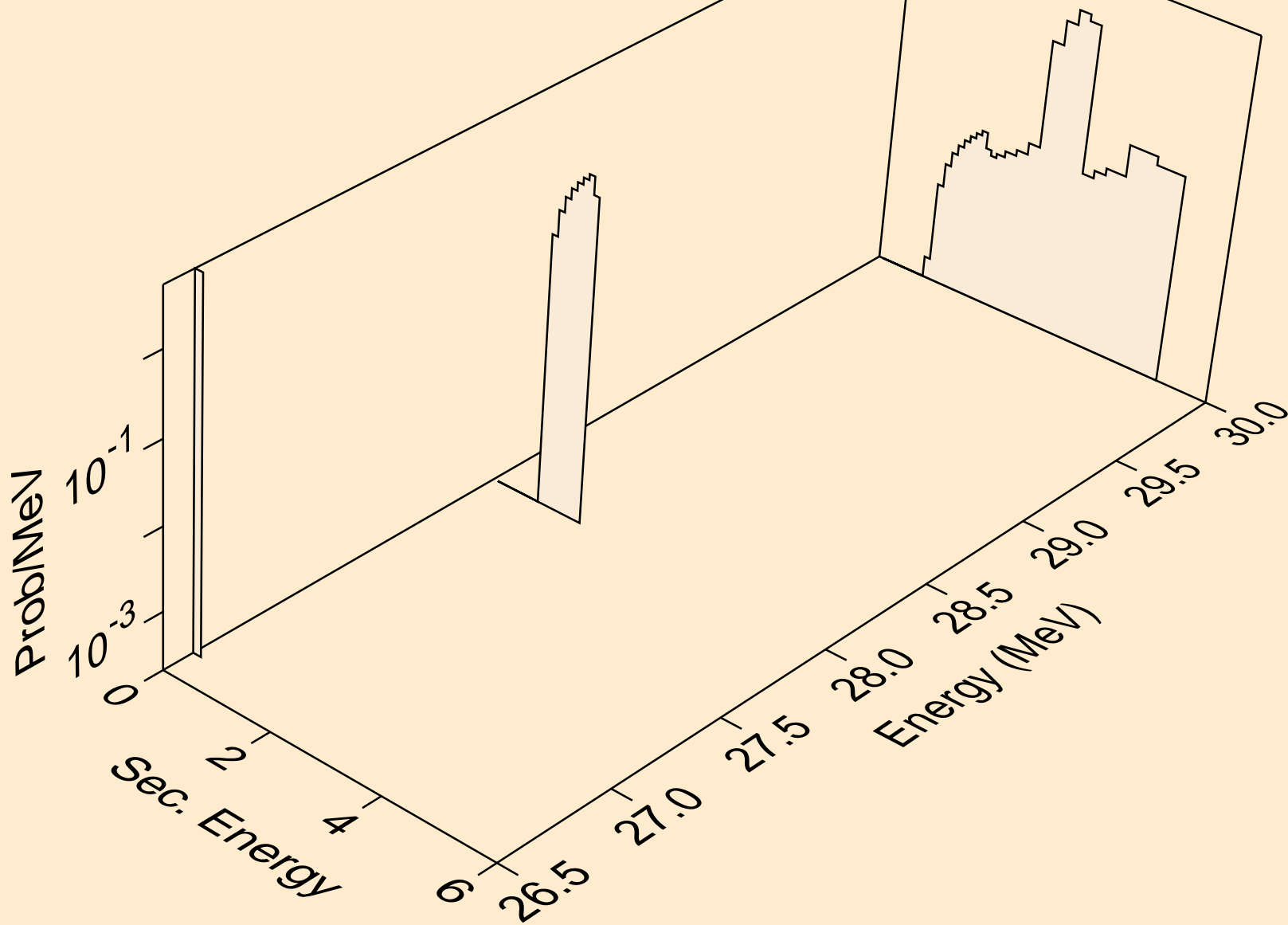

ZR087M NEUTRON ACER TENDL-2019 LIBRARY; T=293.16K
deuterons from (n,n*)d

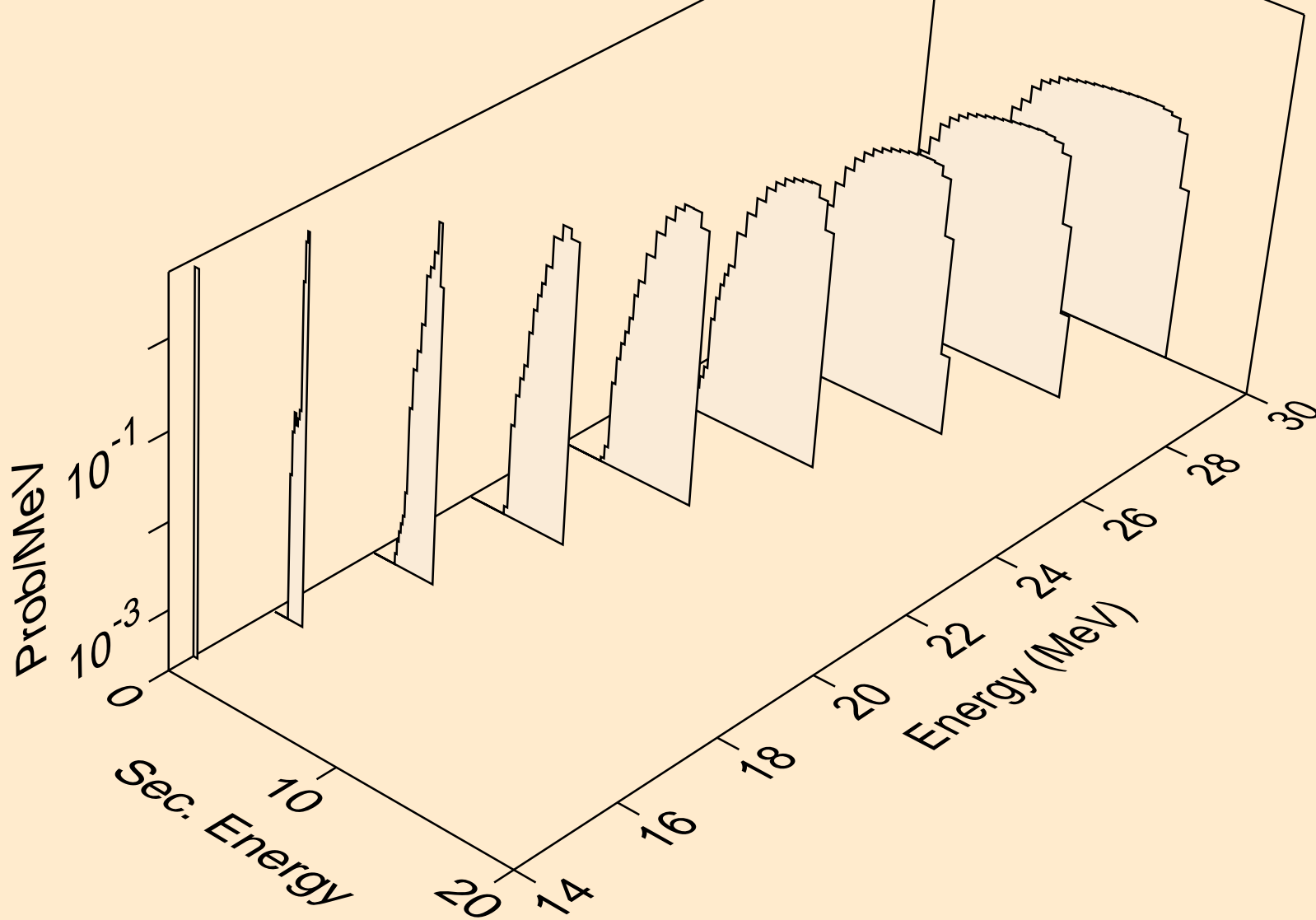

ZR087M NEUTRON ACER TENDL-2019 LIBRARY; T=293.16K
deuterons from (n,d)

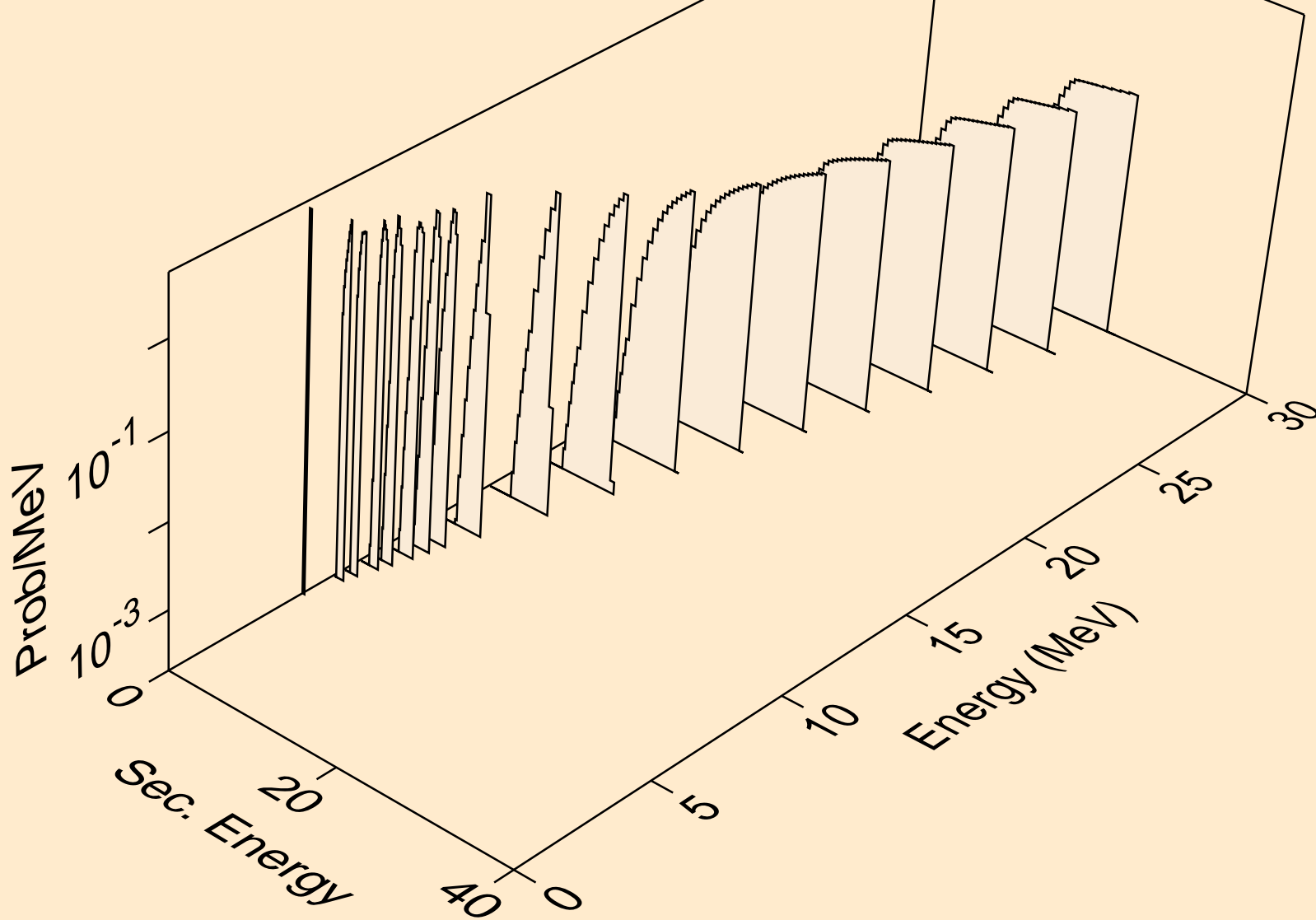

ZR087M NEUTRON ACER TENDL-2019 LIBRARY; T=293.16K
deuterons from (n,pd)

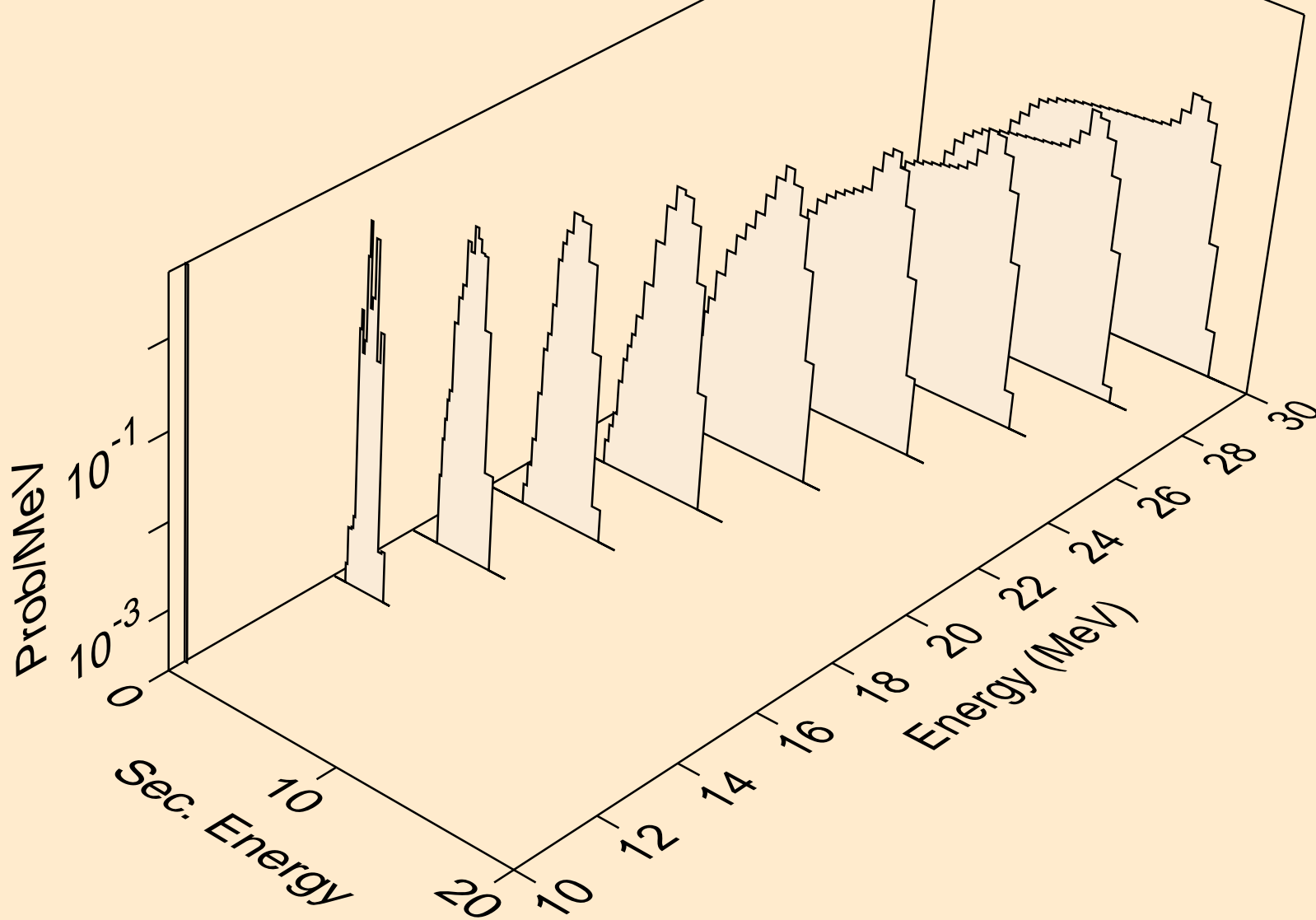

ZR087M NEUTRON ACER TENDL-2019 LIBRARY; T=293.16K
deuterons from (n,da)

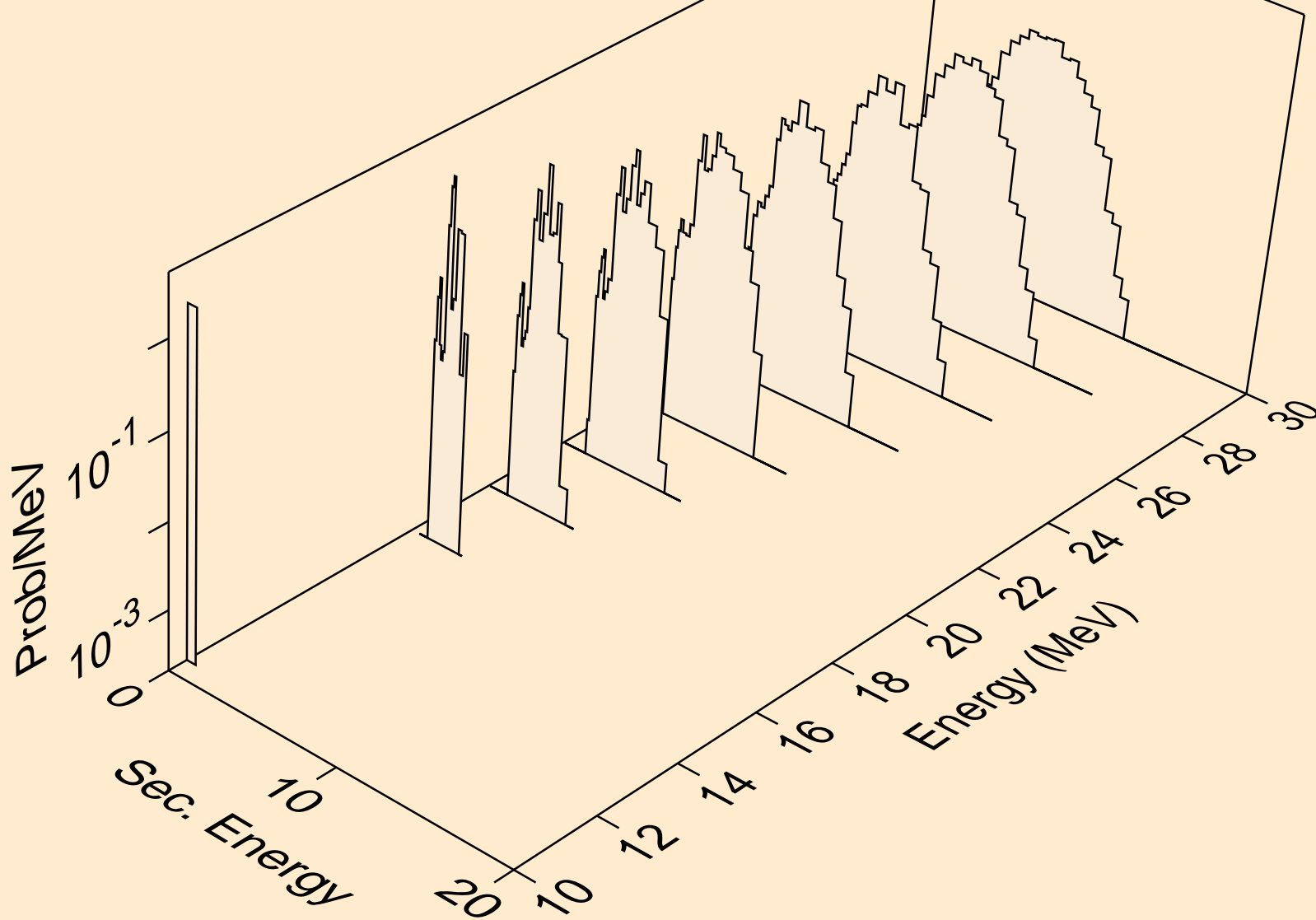

ZR087M NEUTRON ACER TENDL-2019 LIBRARY; T=293.16K
tritons from (n,x)

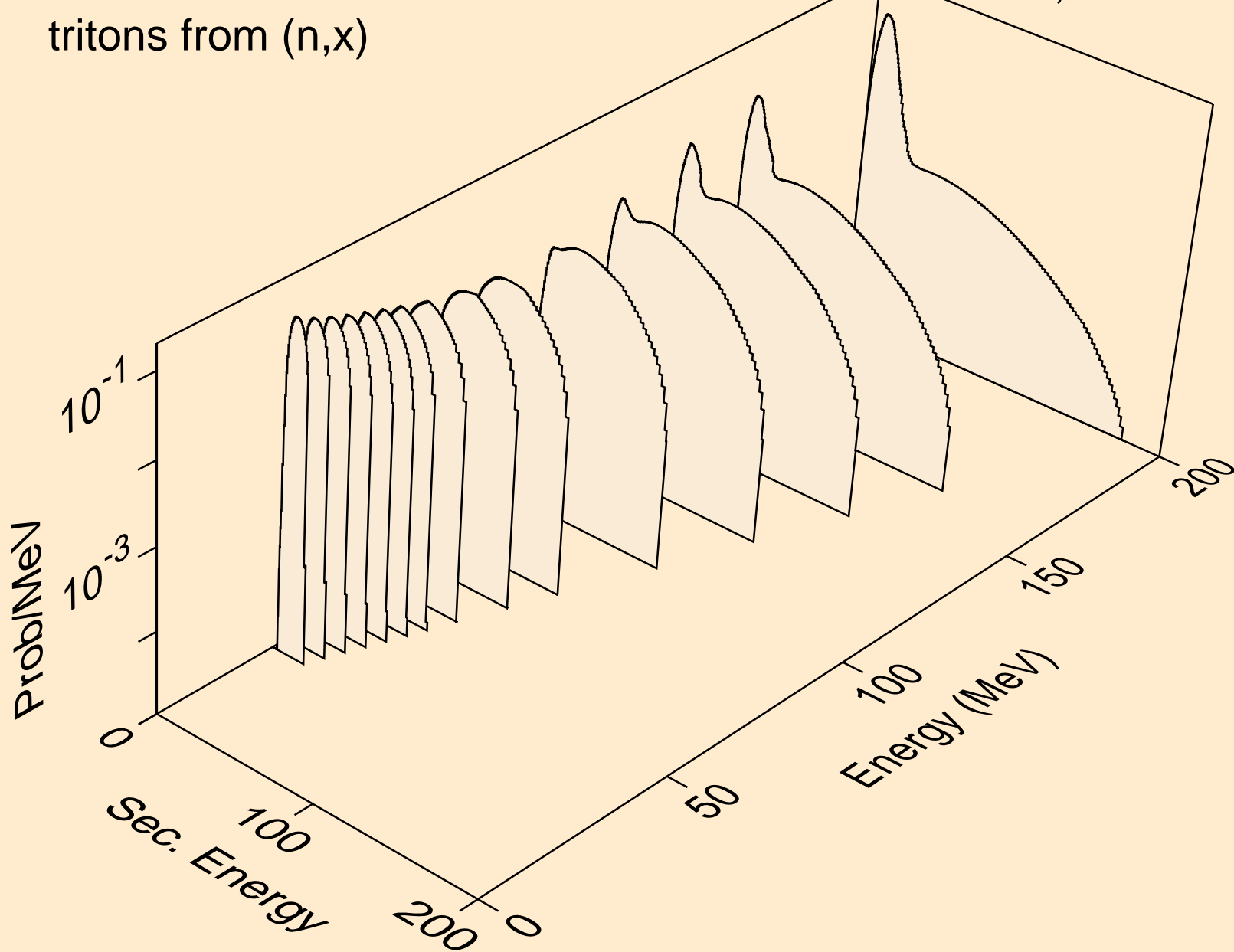

ZR087M NEUTRON ACER TENDL-2019 LIBRARY; T=293.16K
tritons from (n,n*)t

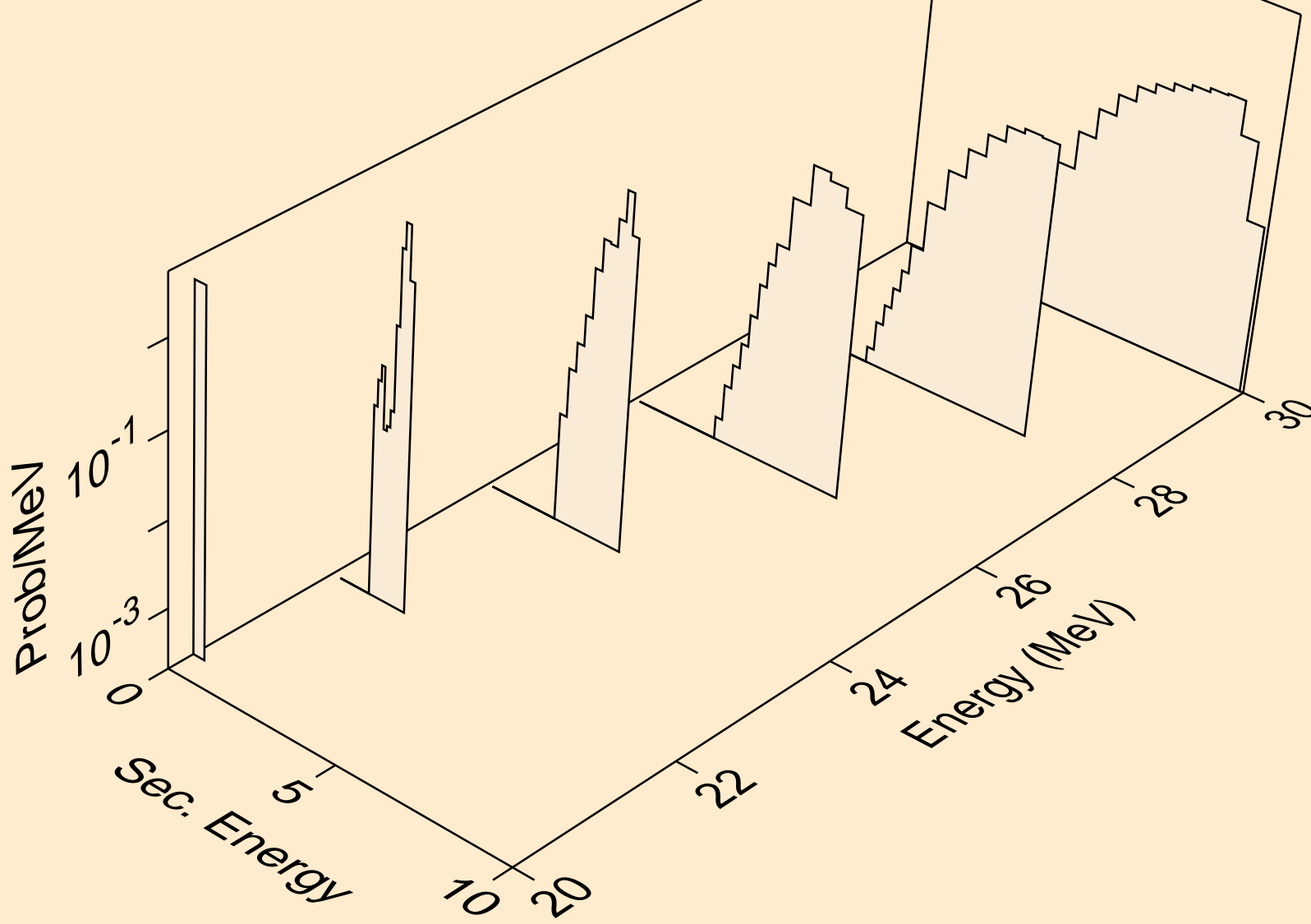

ZR087M NEUTRON ACER TENDL-2019 LIBRARY; T=293.16K
tritons from (n,t)

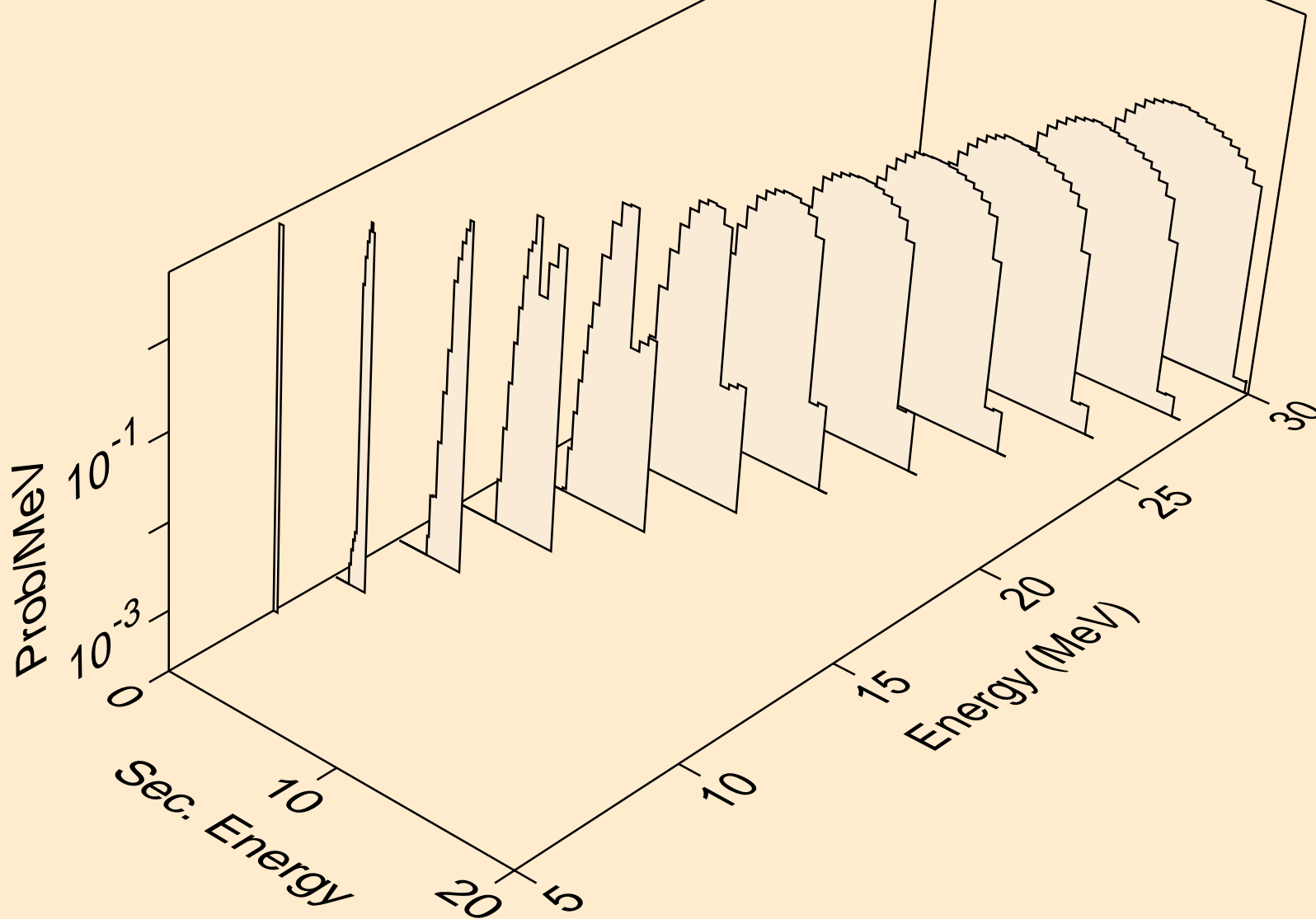

ZR087M NEUTRON ACER TENDL-2019 LIBRARY; T=293.16K
tritons from (n,pt)

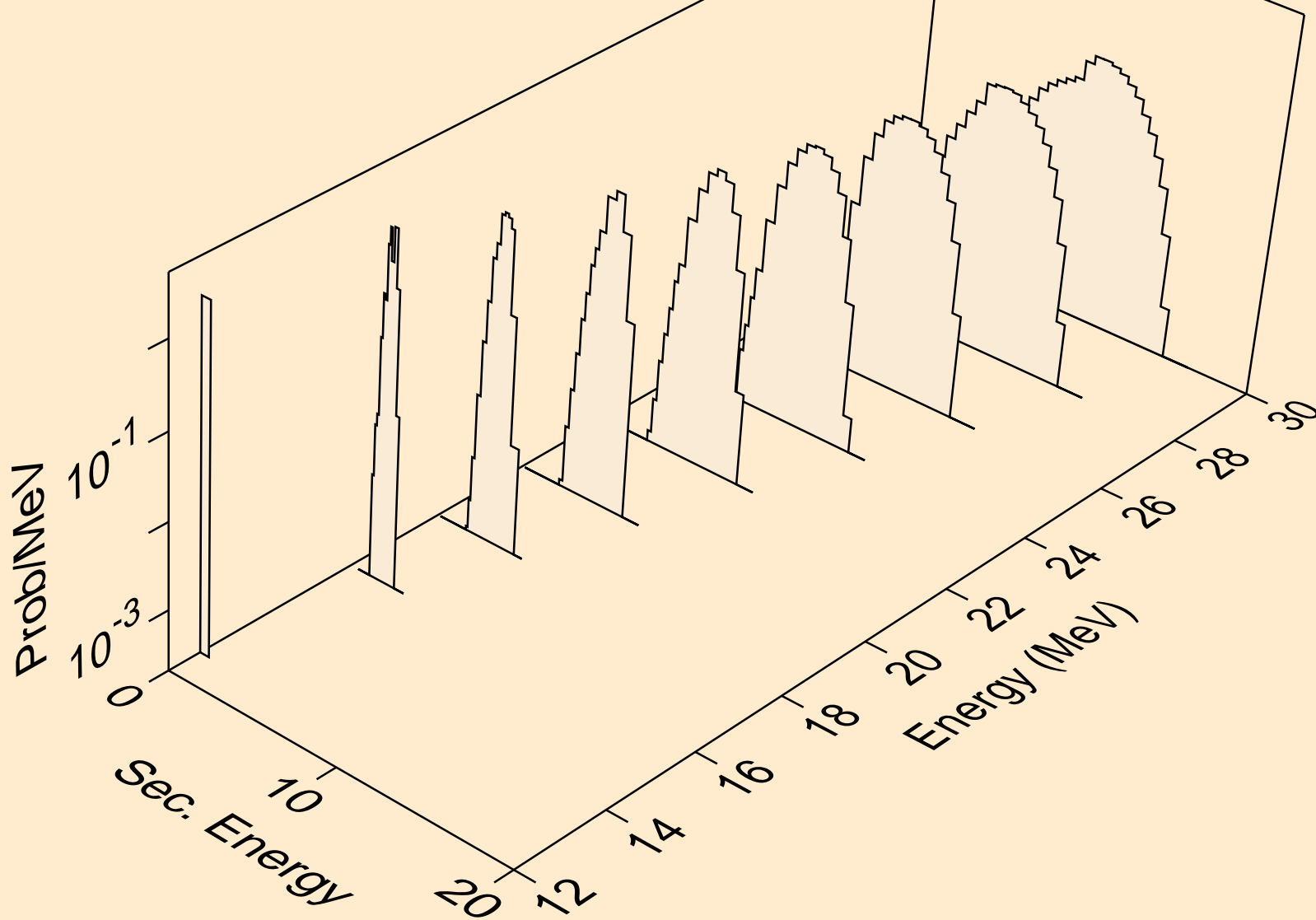

ZR087M NEUTRON ACER TENDL-2019 LIBRARY; T=293.16K
he3s from (n,x)

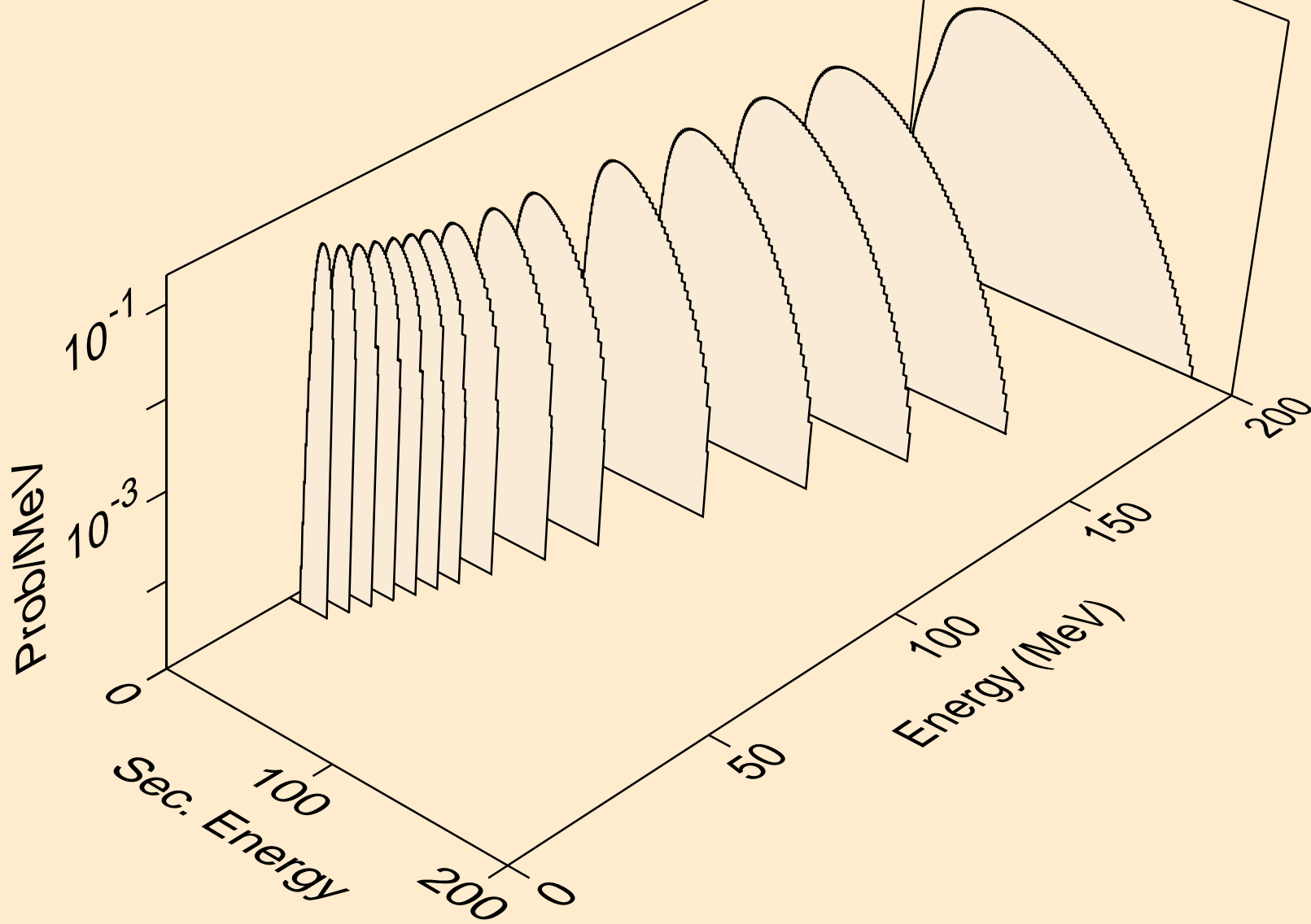

ZR087M NEUTRON ACER TENDL-2019 LIBRARY; T=293.16K
he3s from (n,n*)he3

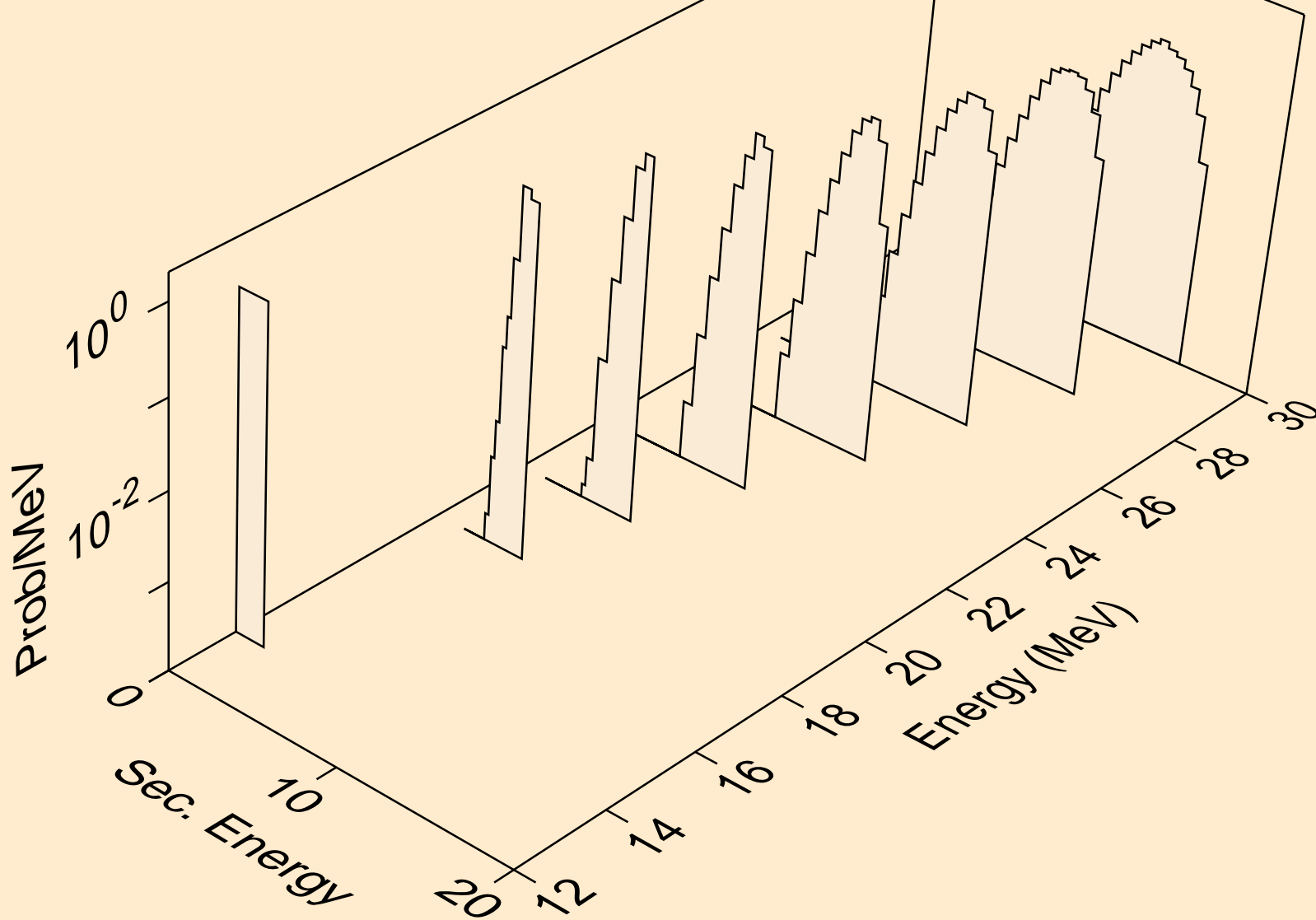

ZR087M NEUTRON ACER TENDL-2019 LIBRARY; T=293.16K
he3s from (n,he3)

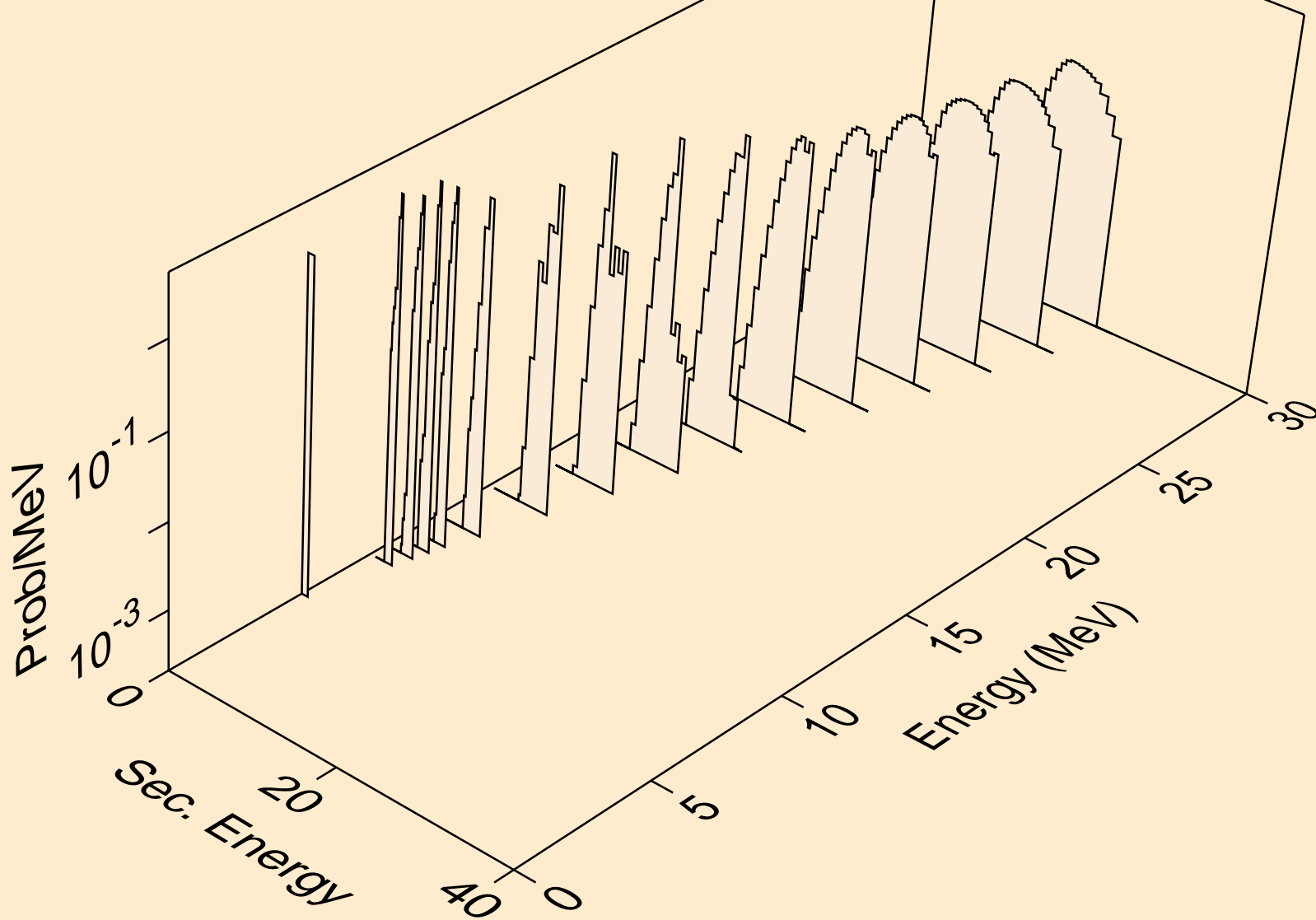

ZR087M NEUTRON ACER TENDL-2019 LIBRARY; T=293.16K
alphas from (n,x)

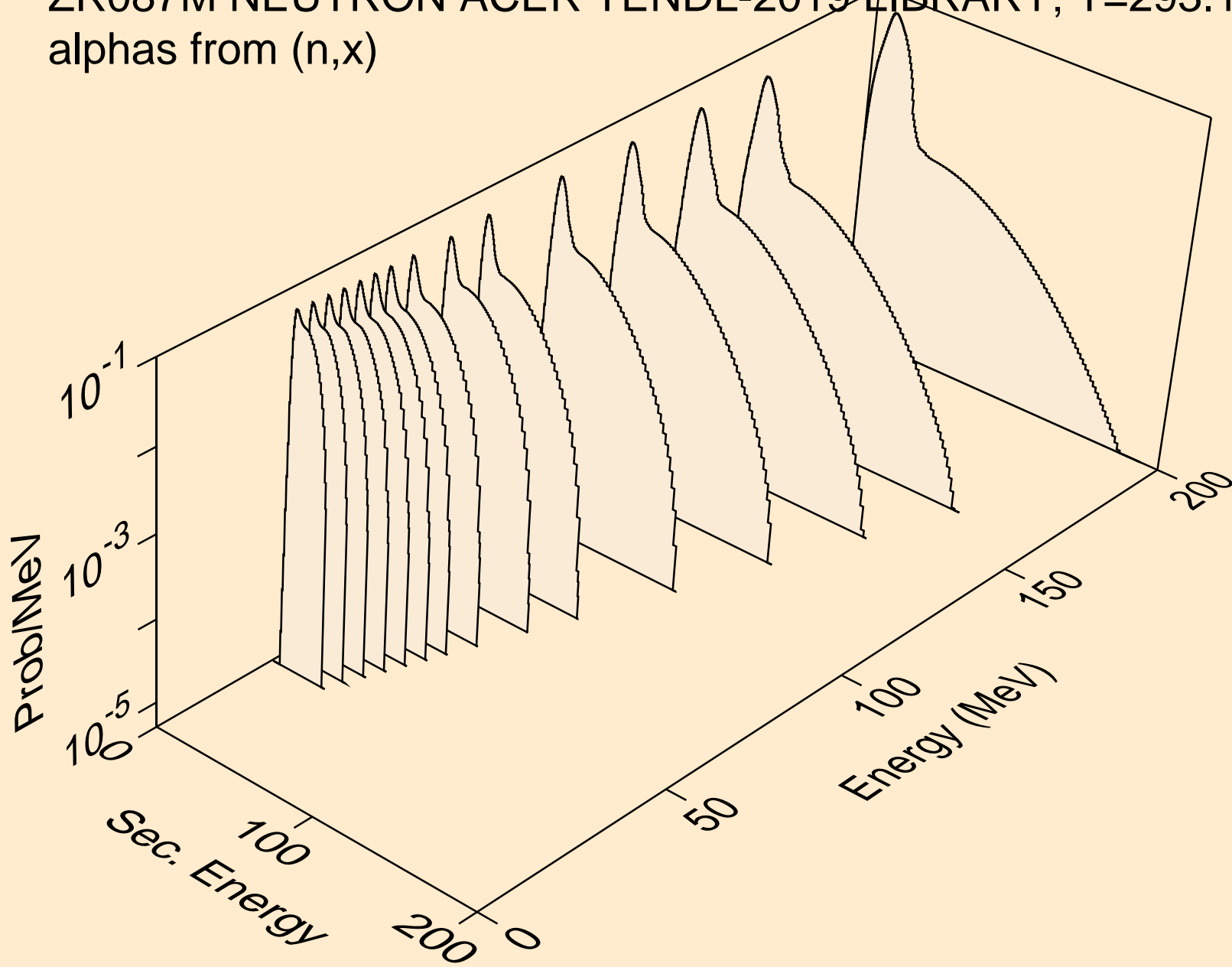

ZR087M NEUTRON ACER TENDL-2019 LIBRARY; T=293.16K
alphas from (n,n*)a

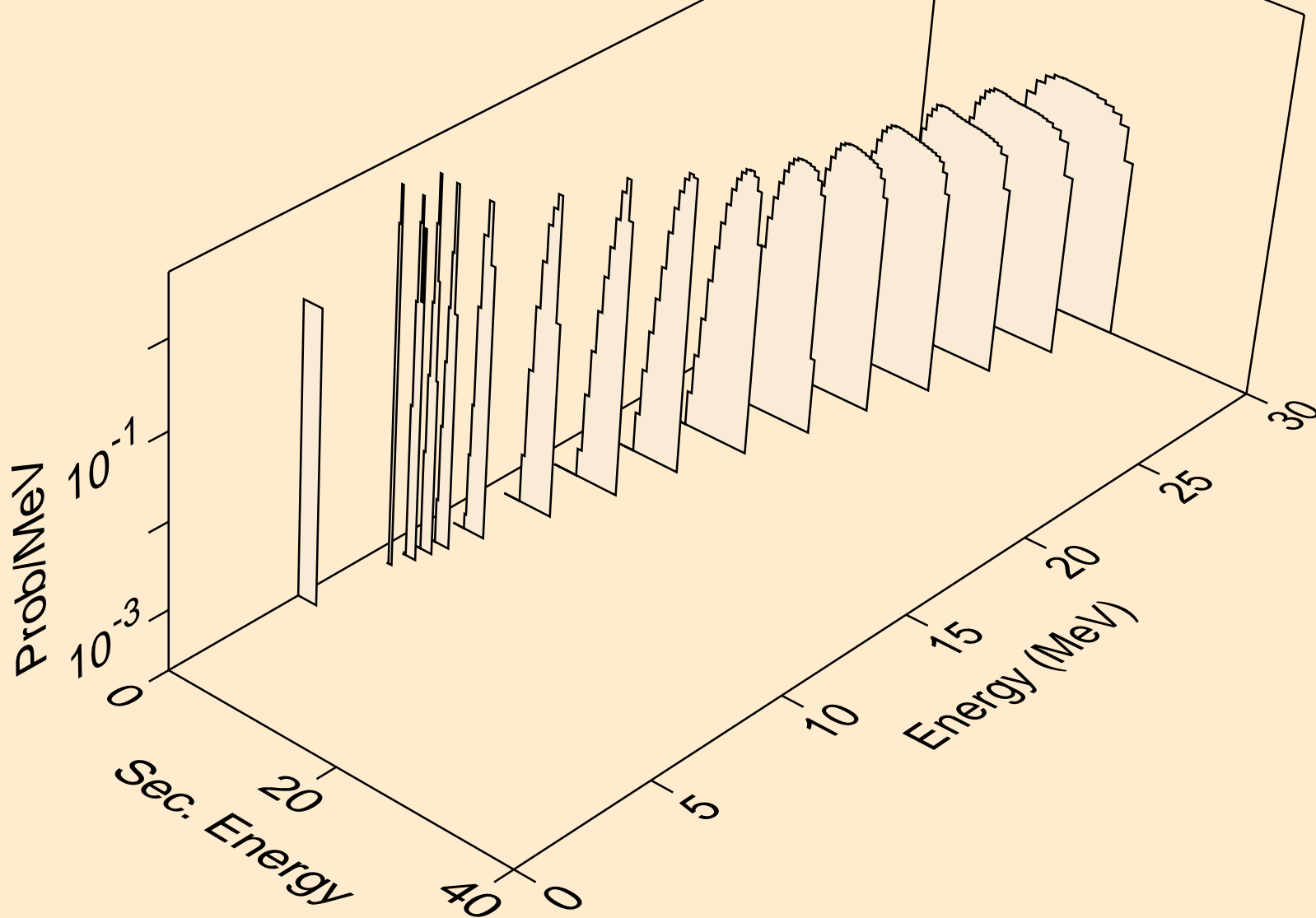

ZR087M NEUTRON ACER TENDL-2019 LIBRARY; T=293.16K
alphas from (n,2n)a

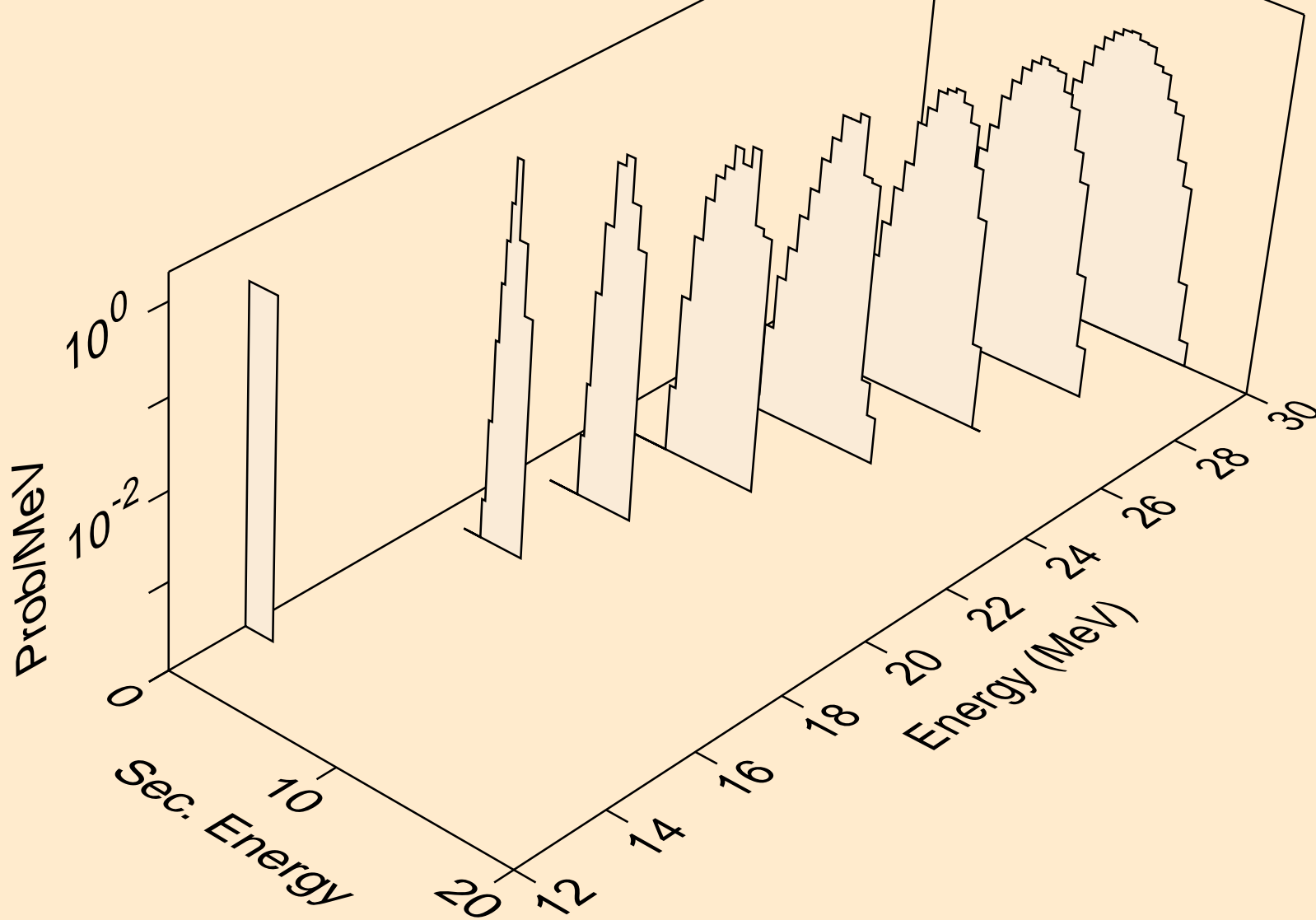

ZR087M NEUTRON ACER TENDL-2019 LIBRARY; T=293.16K
alphas from (n,n*)2a

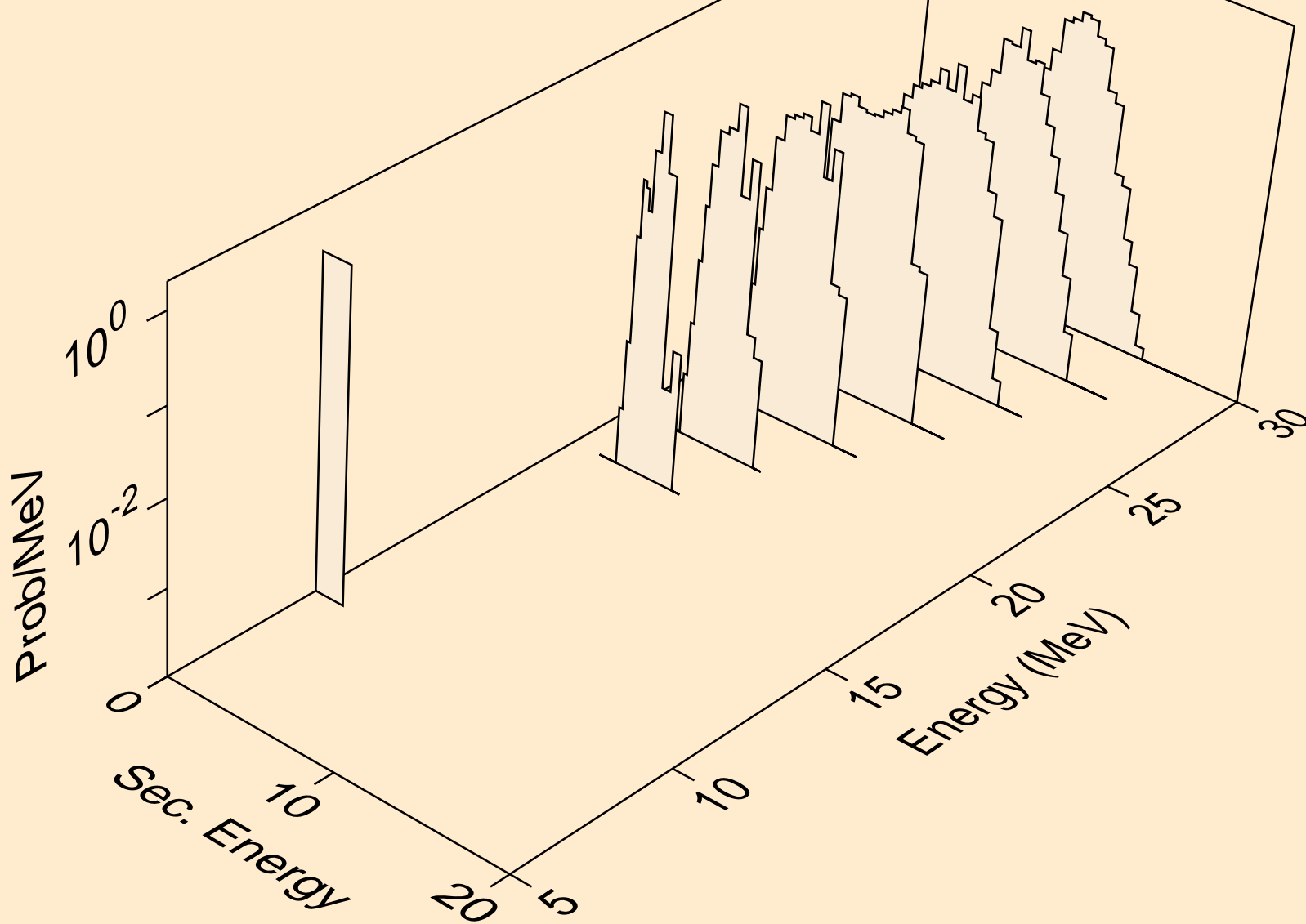

ZR087M NEUTRON ACER TENDL-2019 LIBRARY; T=293.16K
alphas from (n,npa)

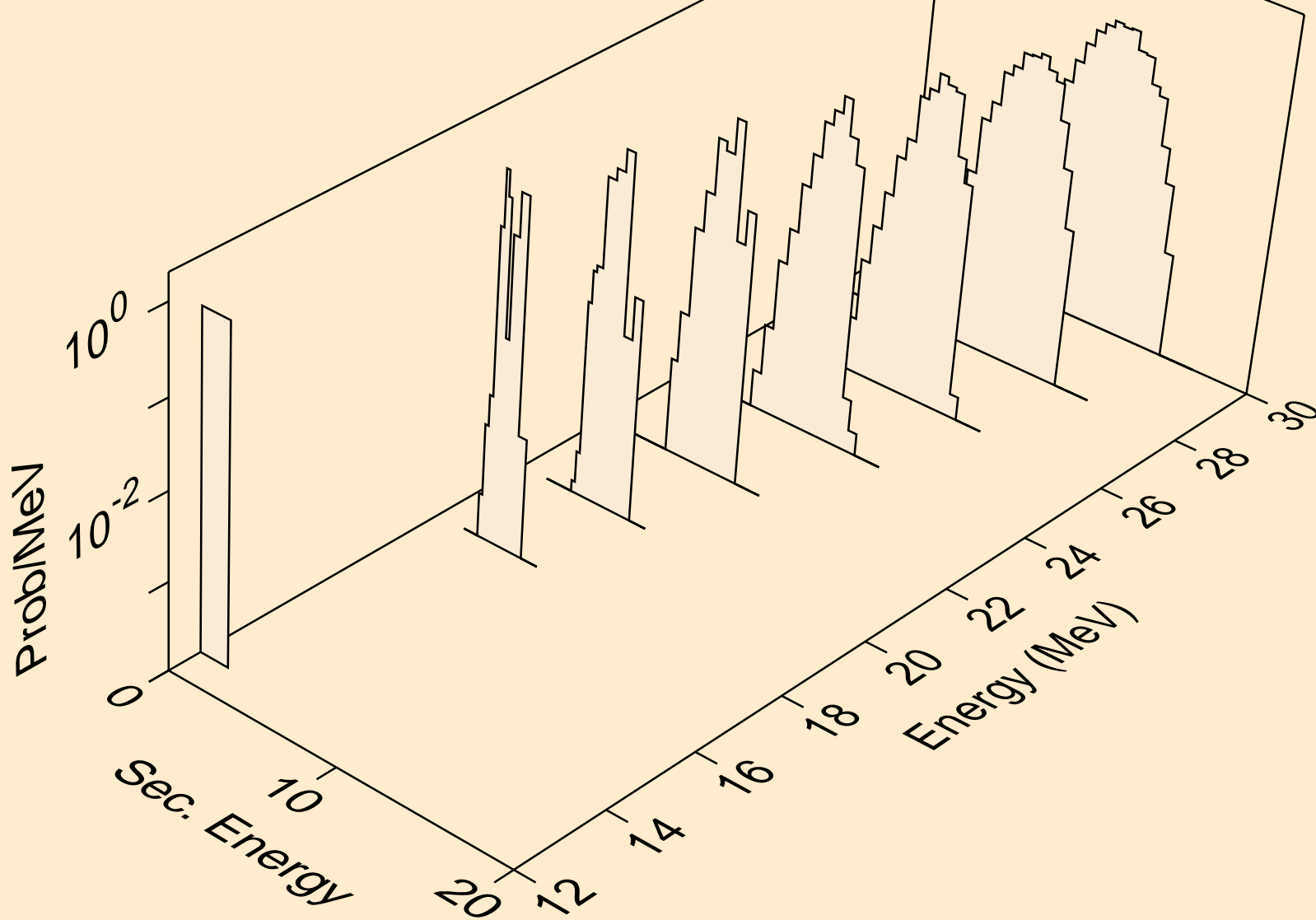

ZR087M NEUTRON ACER TENDL-2019 LIBRARY; T=293.16K
alphas from (n,a)

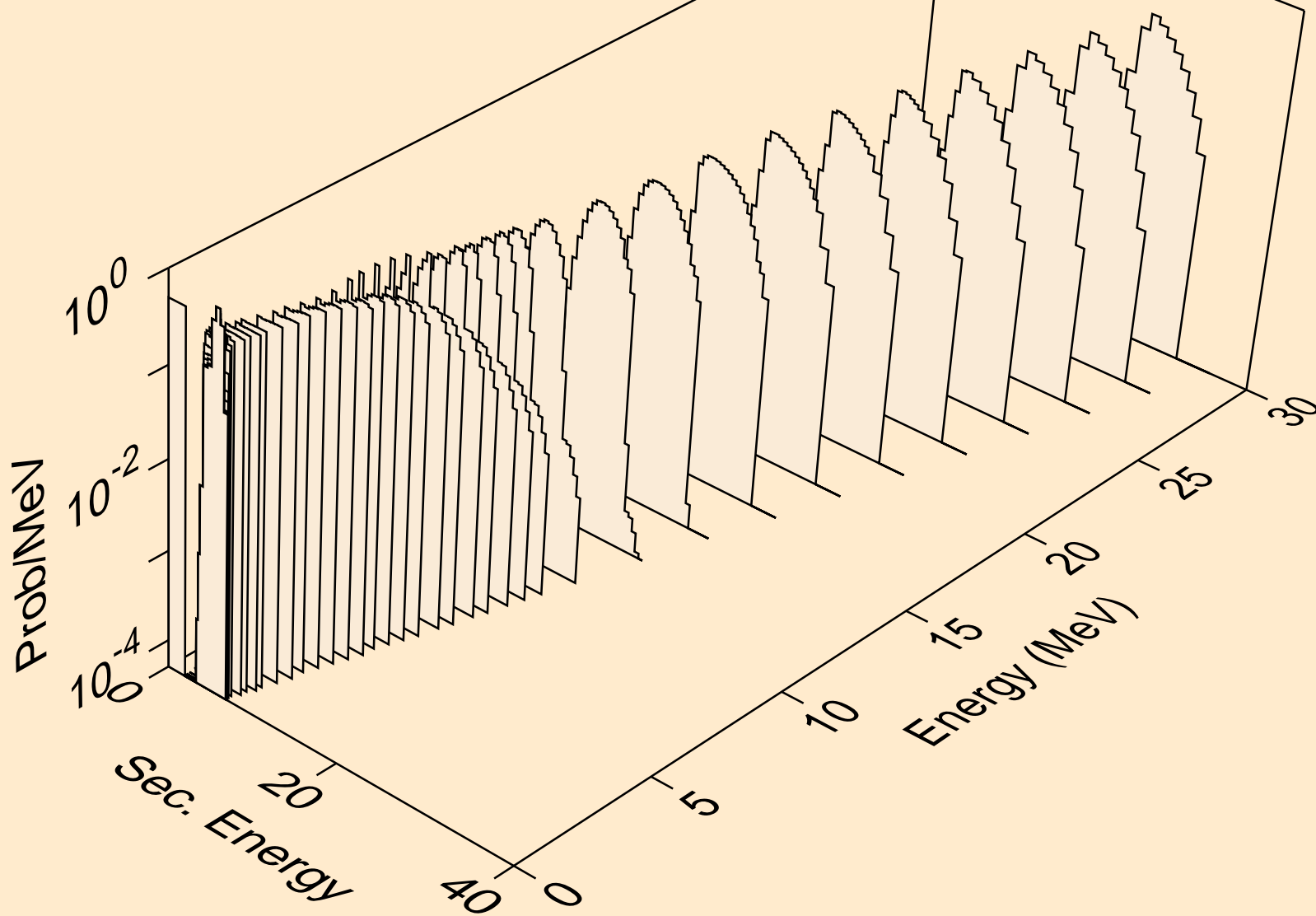

ZR087M NEUTRON ACER TENDL-2019 LIBRARY; T=293.16K
alphas from (n,2a)

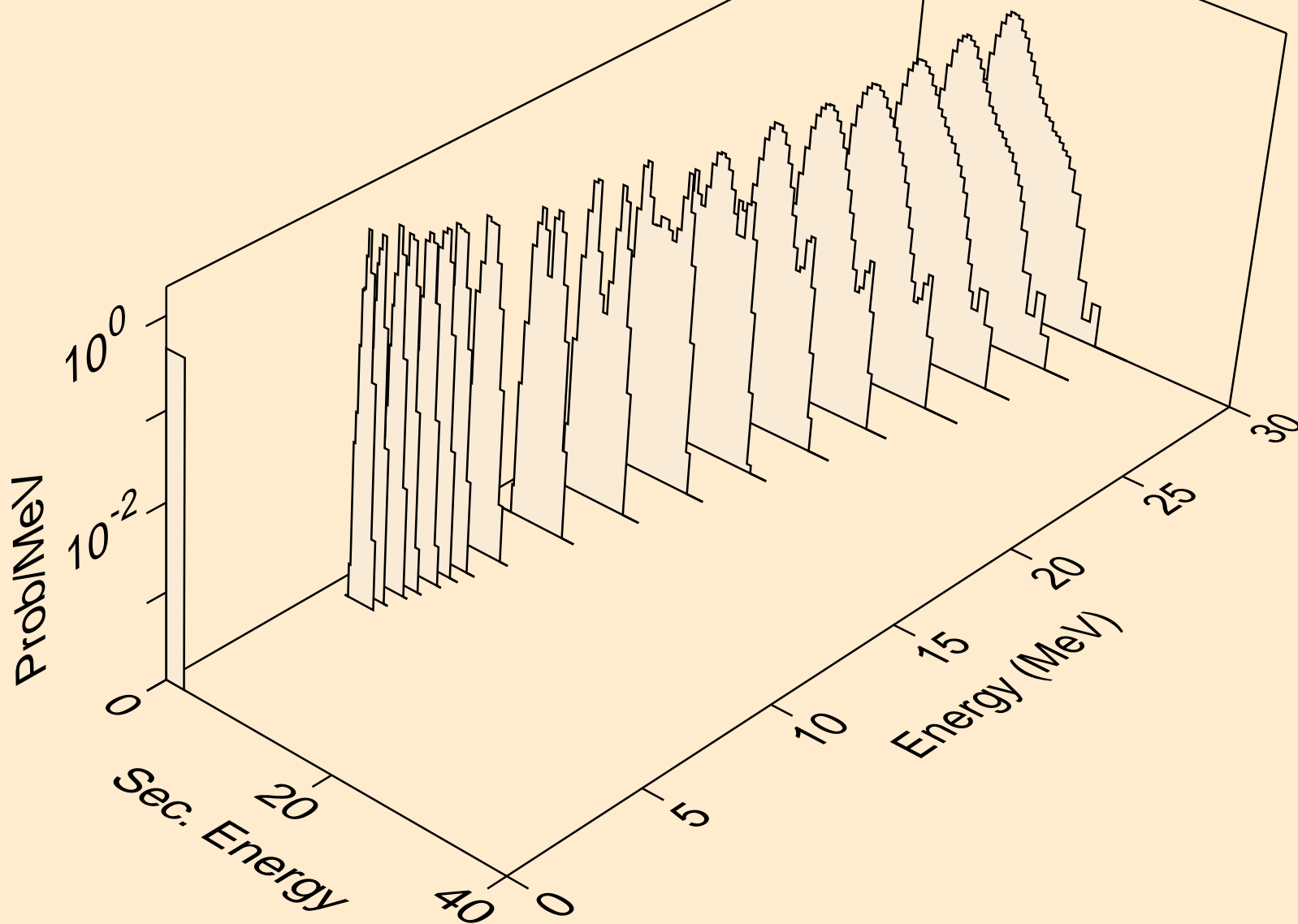

ZR087M NEUTRON ACER TENDL-2019 LIBRARY; T=293.16K
alphas from (n,pa)

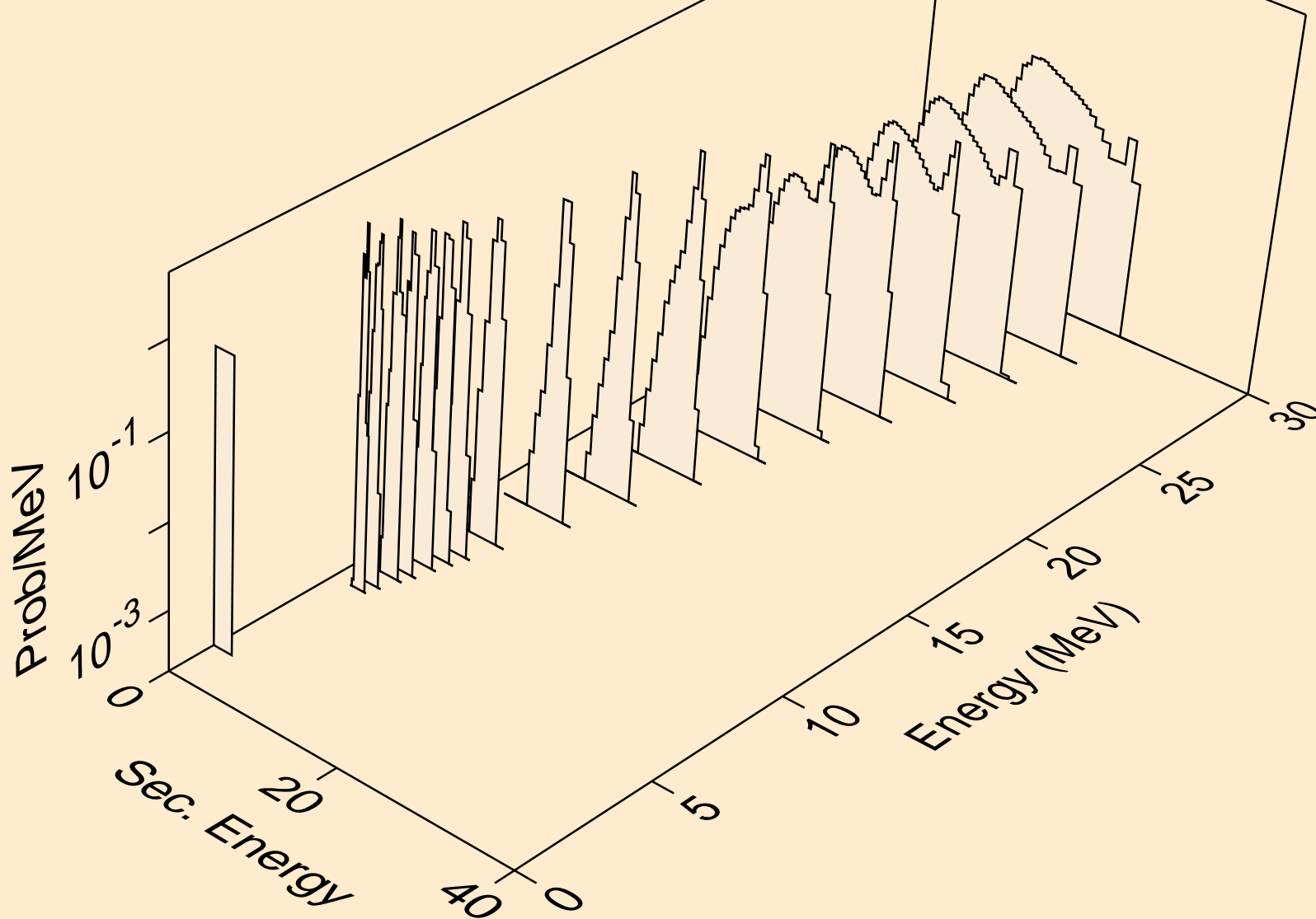

ZR087M NEUTRON ACER TENDL-2019 LIBRARY; T=293.16K
alphas from (n,da)

