

ZR089 NEUTRON ACER TENDL-2019 LIBRARY; T=293.16K  
Principal cross sections

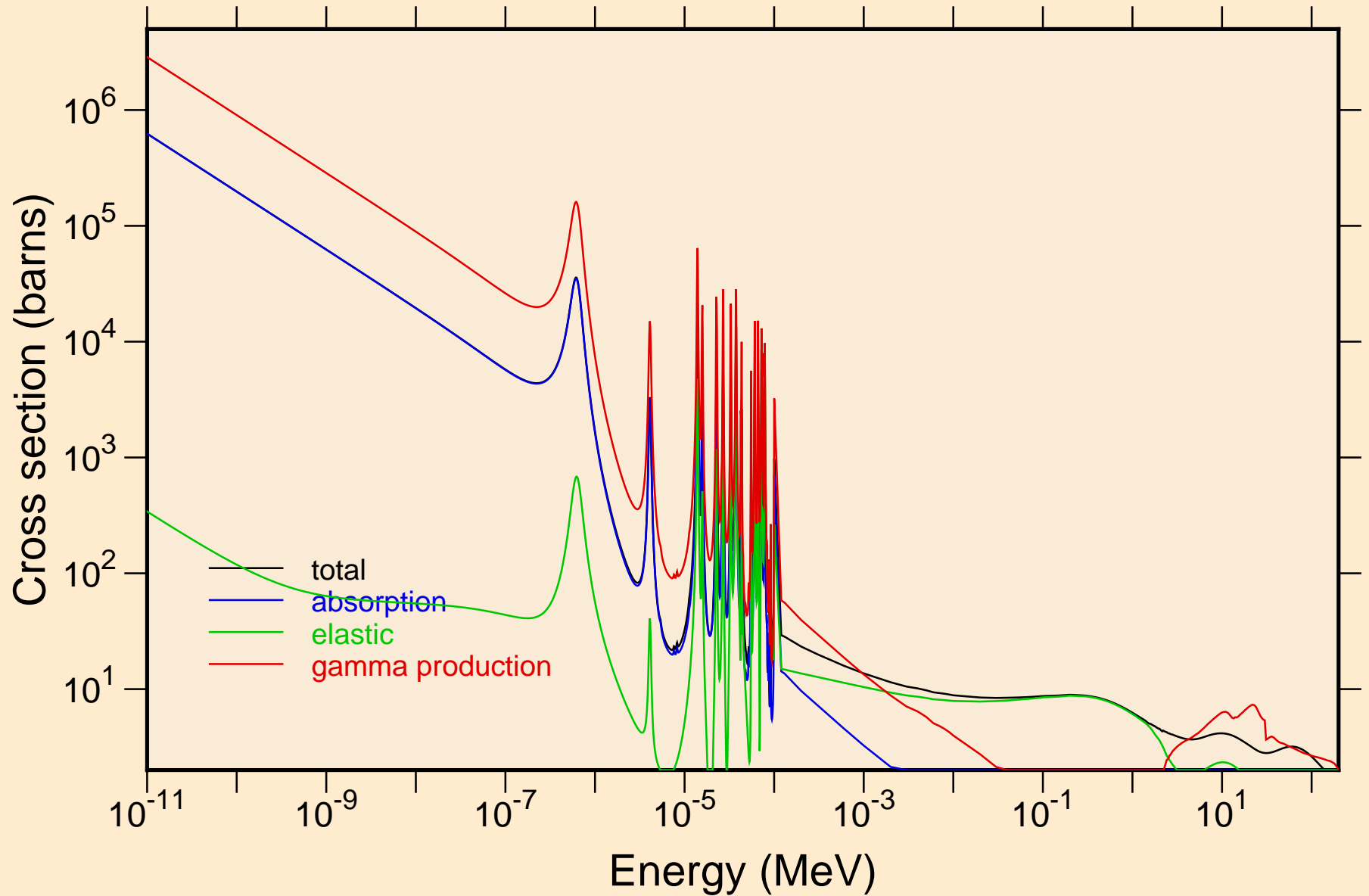

ZR089 NEUTRON ACER TENDL-2019 LIBRARY; T=293.16K  
resonance total cross section

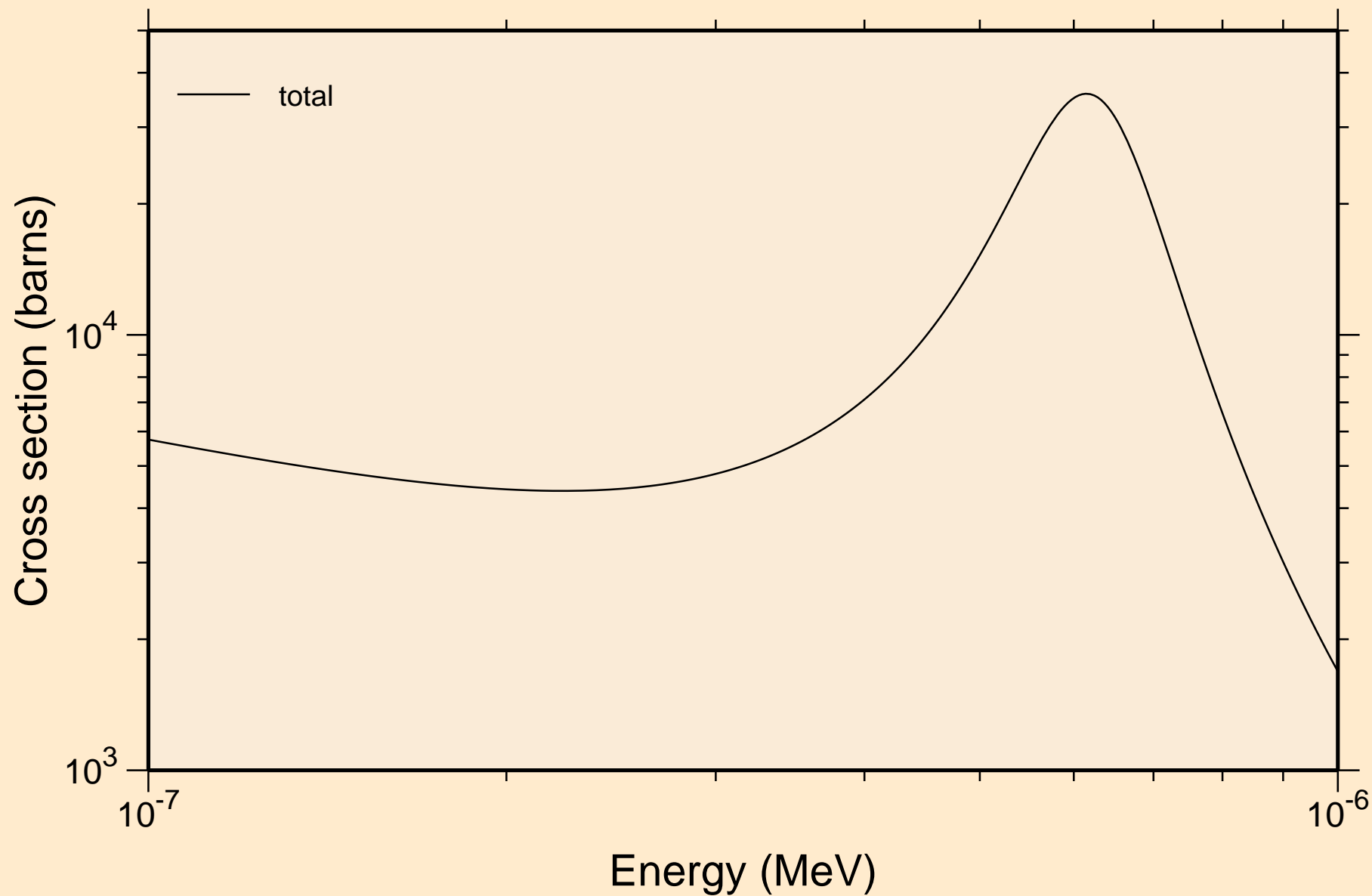

ZR089 NEUTRON ACER TENDL-2019 LIBRARY; T=293.16K  
resonance total cross section

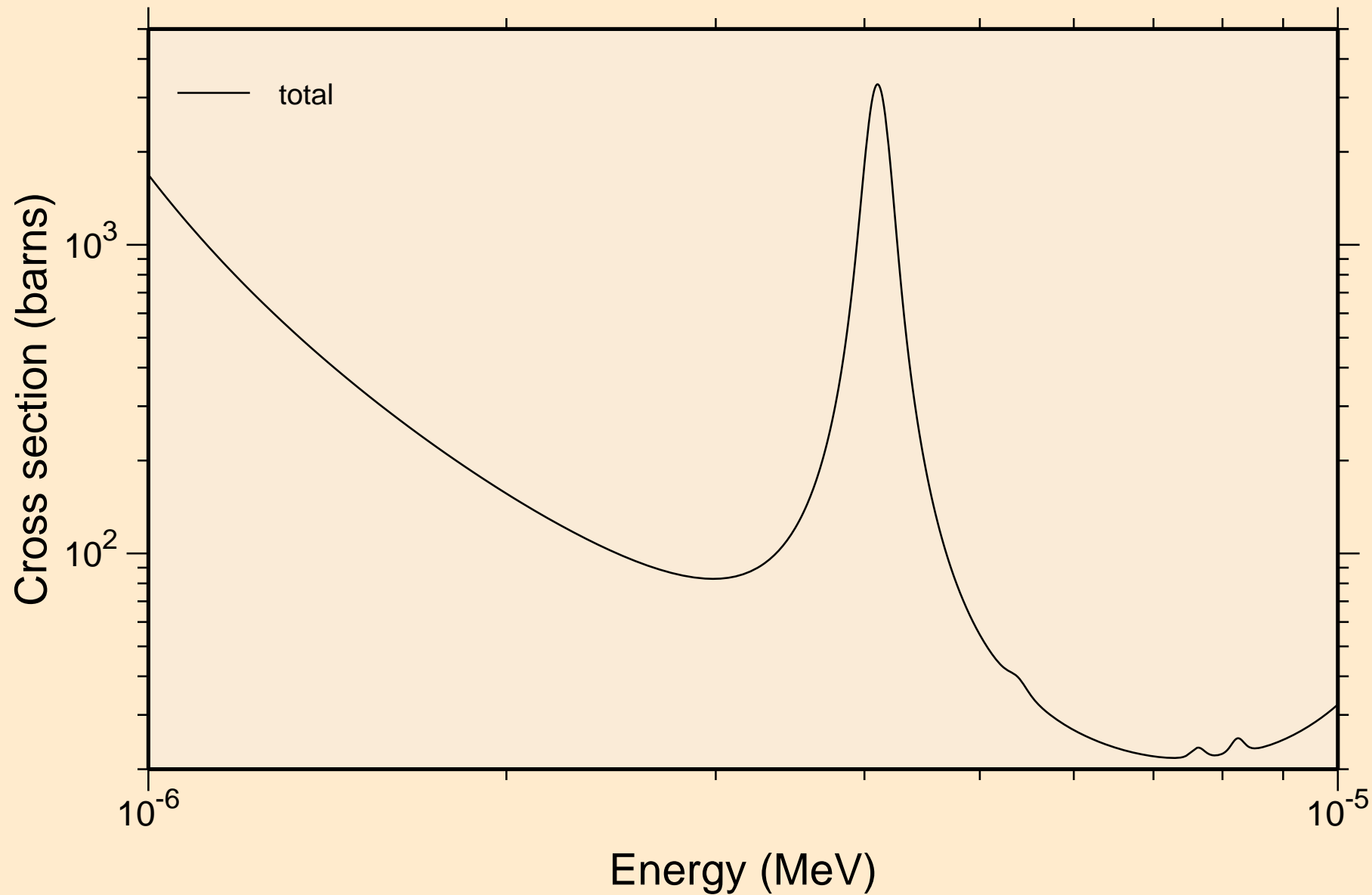

ZR089 NEUTRON ACER TENDL-2019 LIBRARY; T=293.16K  
resonance total cross section

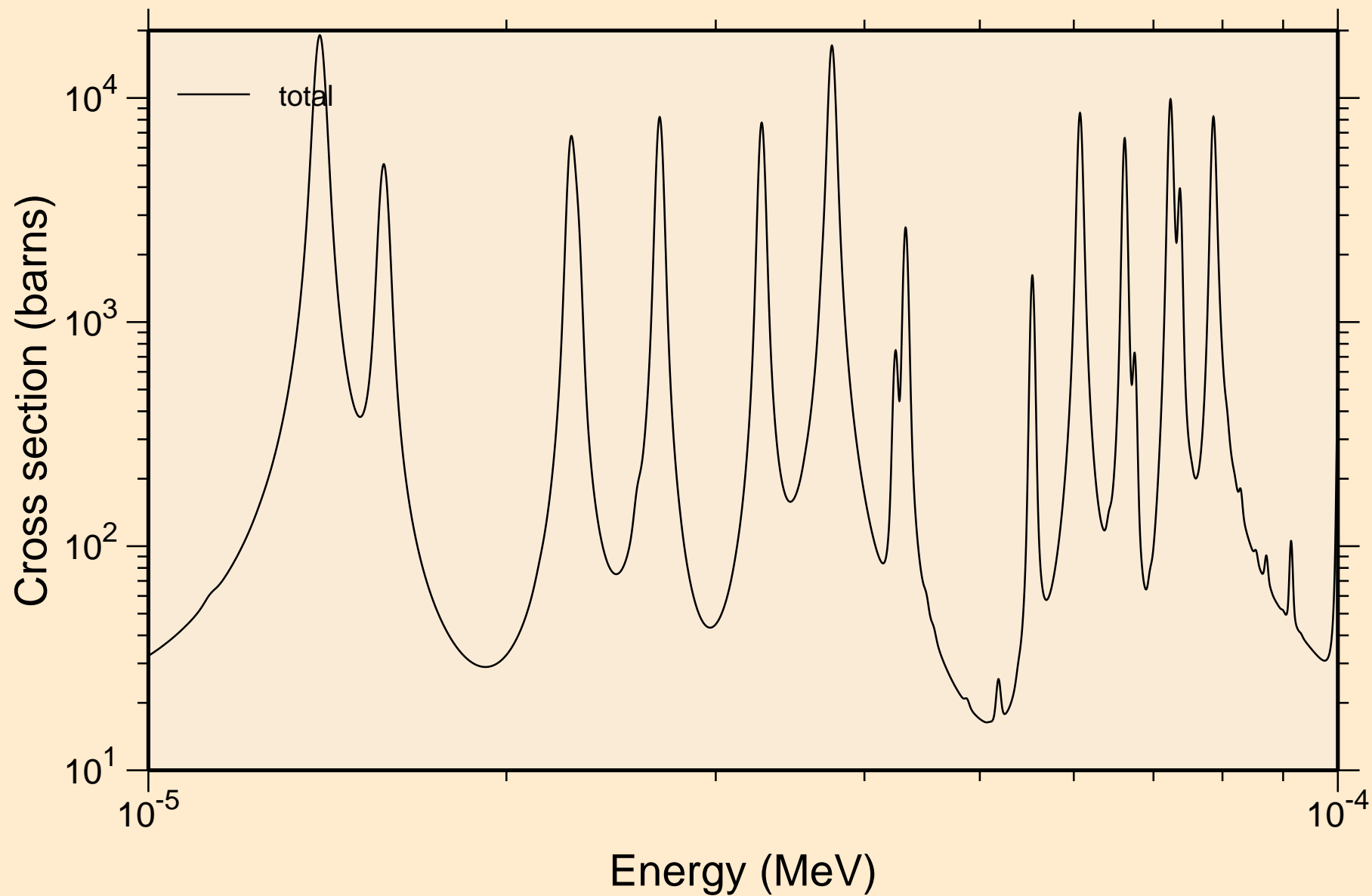

ZR089 NEUTRON ACER TENDL-2019 LIBRARY; T=293.16K  
resonance total cross section

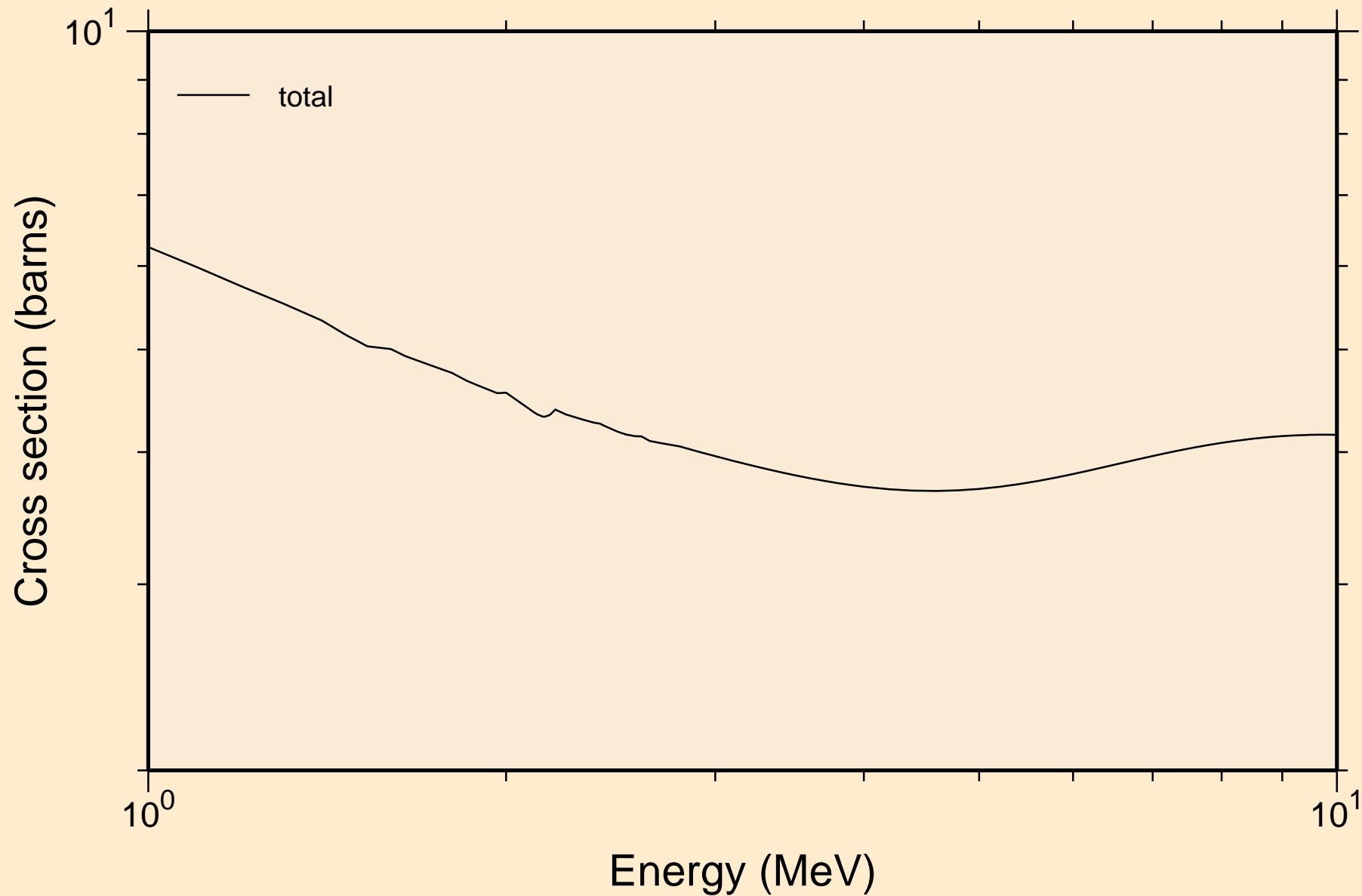

ZR089 NEUTRON ACER TENDL-2019 LIBRARY; T=293.16K  
resonance absorption cross sections

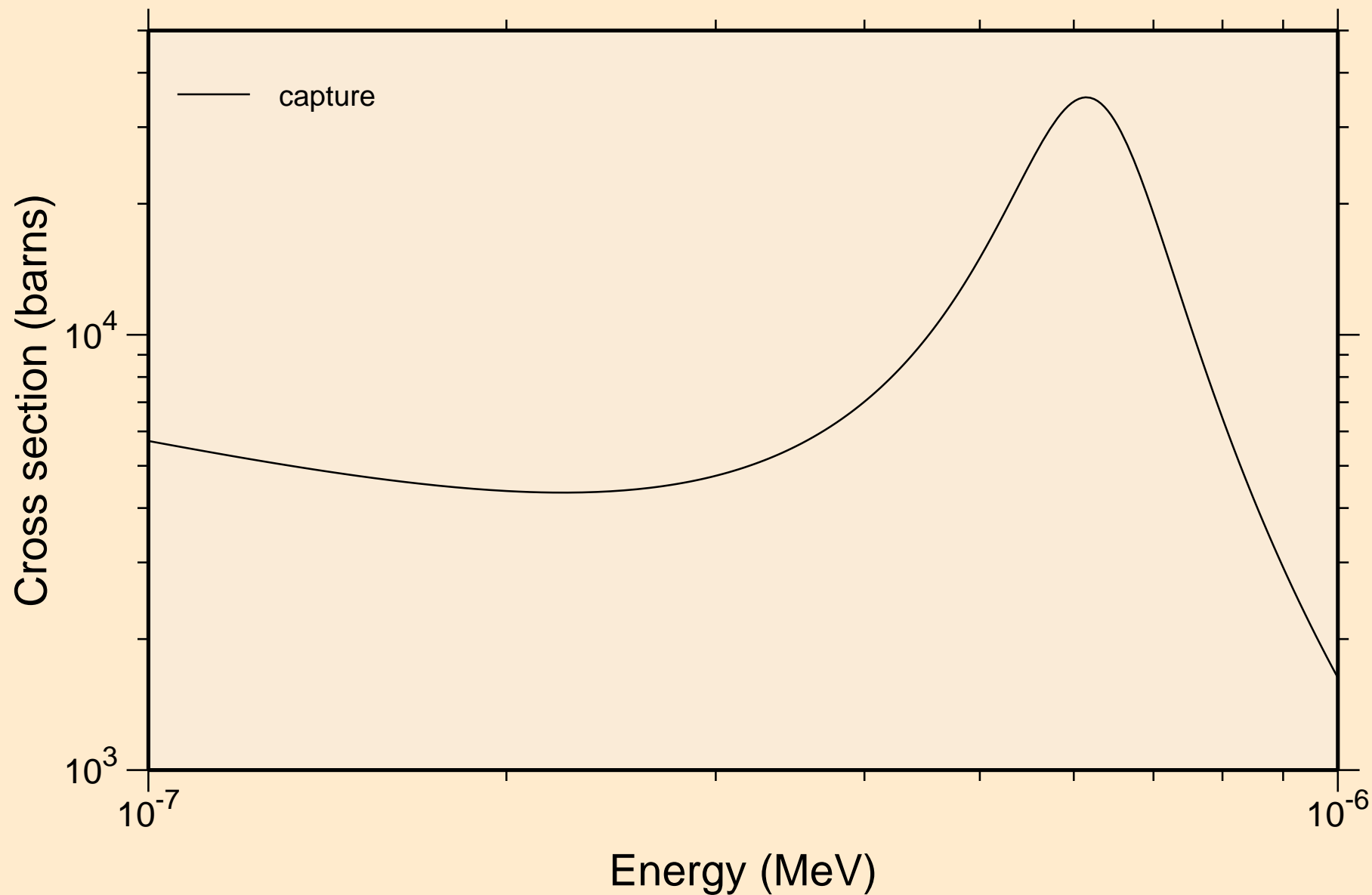

ZR089 NEUTRON ACER TENDL-2019 LIBRARY; T=293.16K  
resonance absorption cross sections

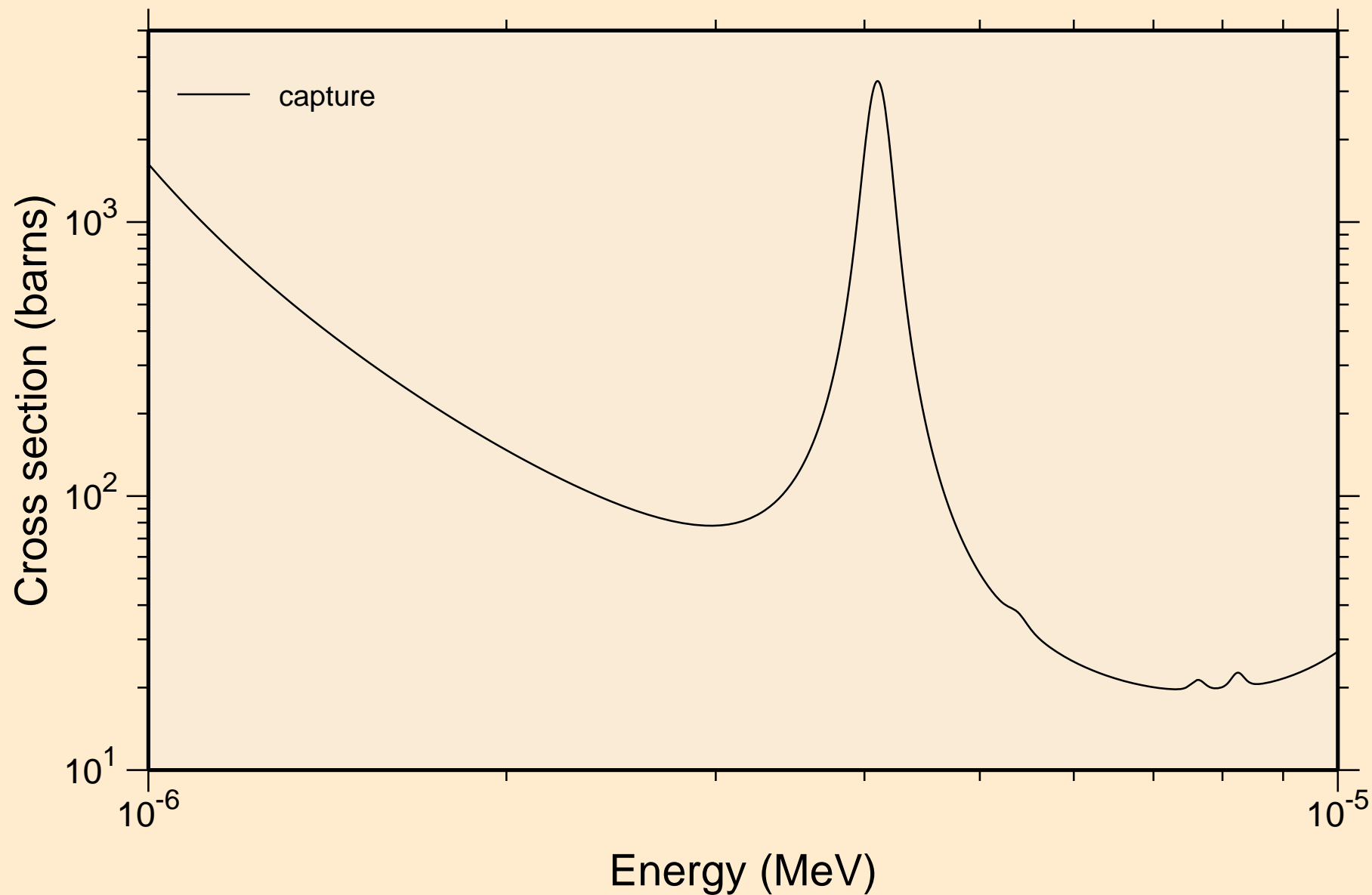

ZR089 NEUTRON ACER TENDL-2019 LIBRARY; T=293.16K  
resonance absorption cross sections

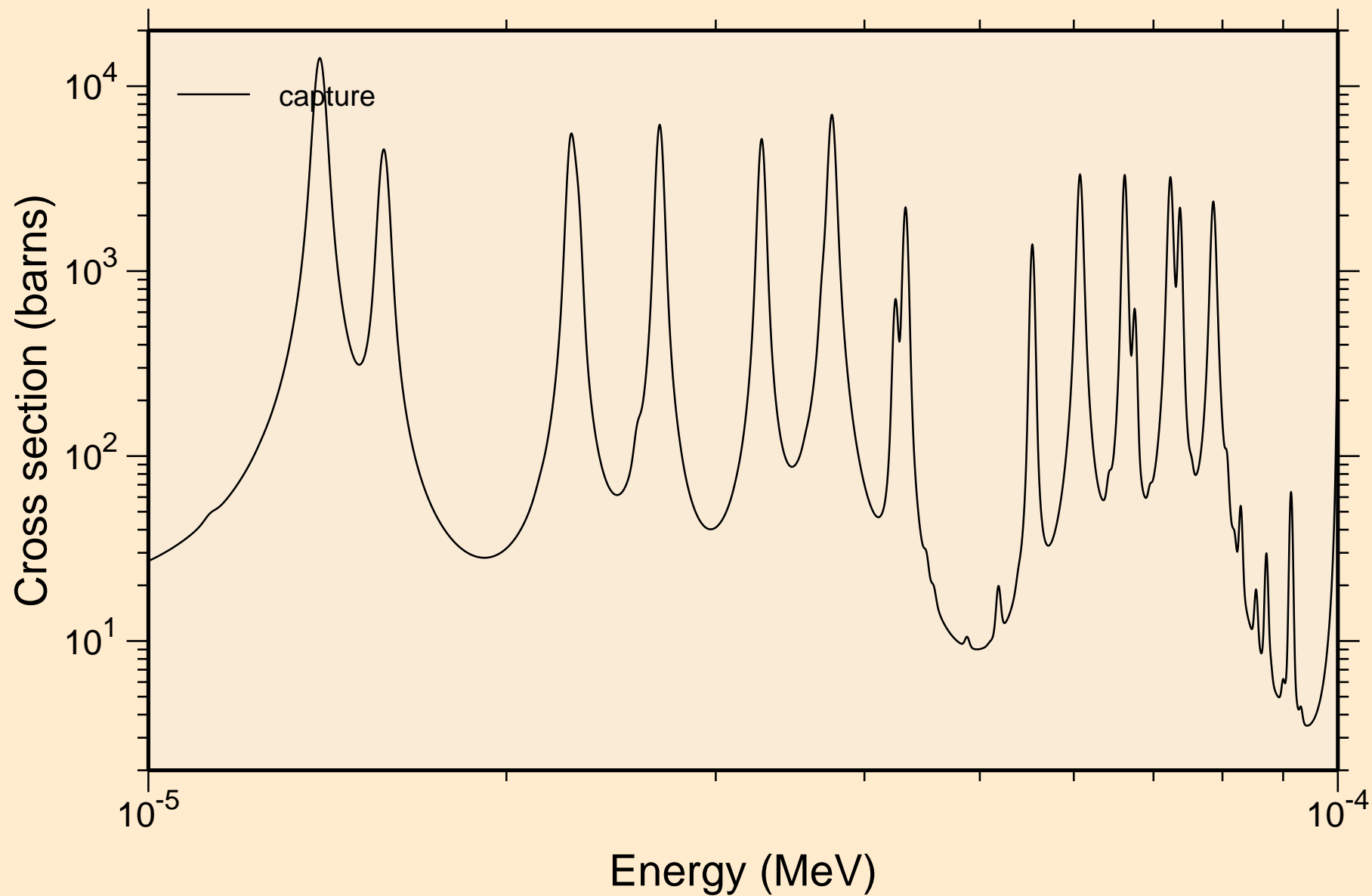



ZR089 NEUTRON ACER TENDL-2019 LIBRARY; T=293.16K  
resonance absorption cross sections

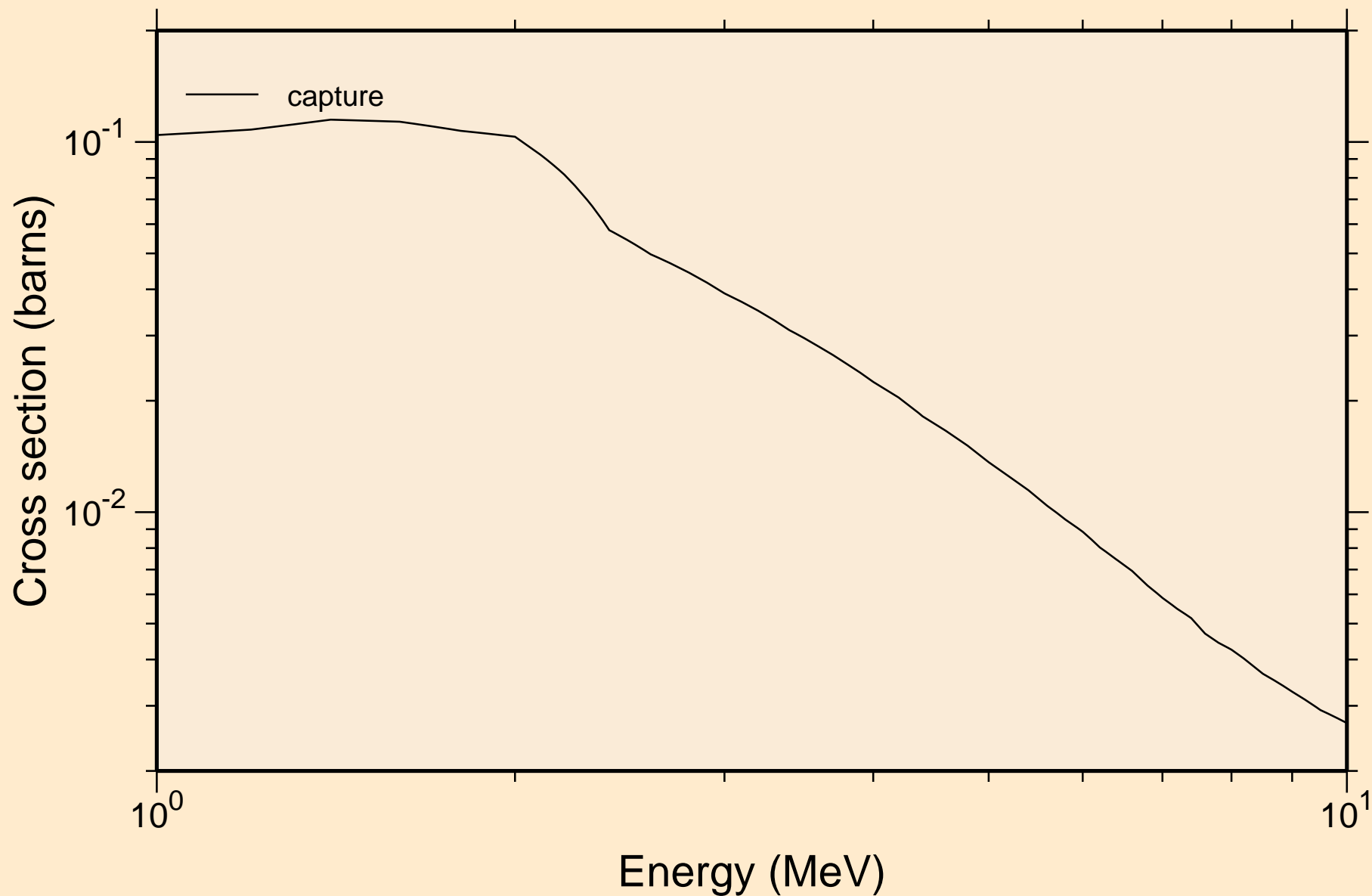

ZR089 NEUTRON ACER TENDL-2019 LIBRARY; T=293.16K  
Heating

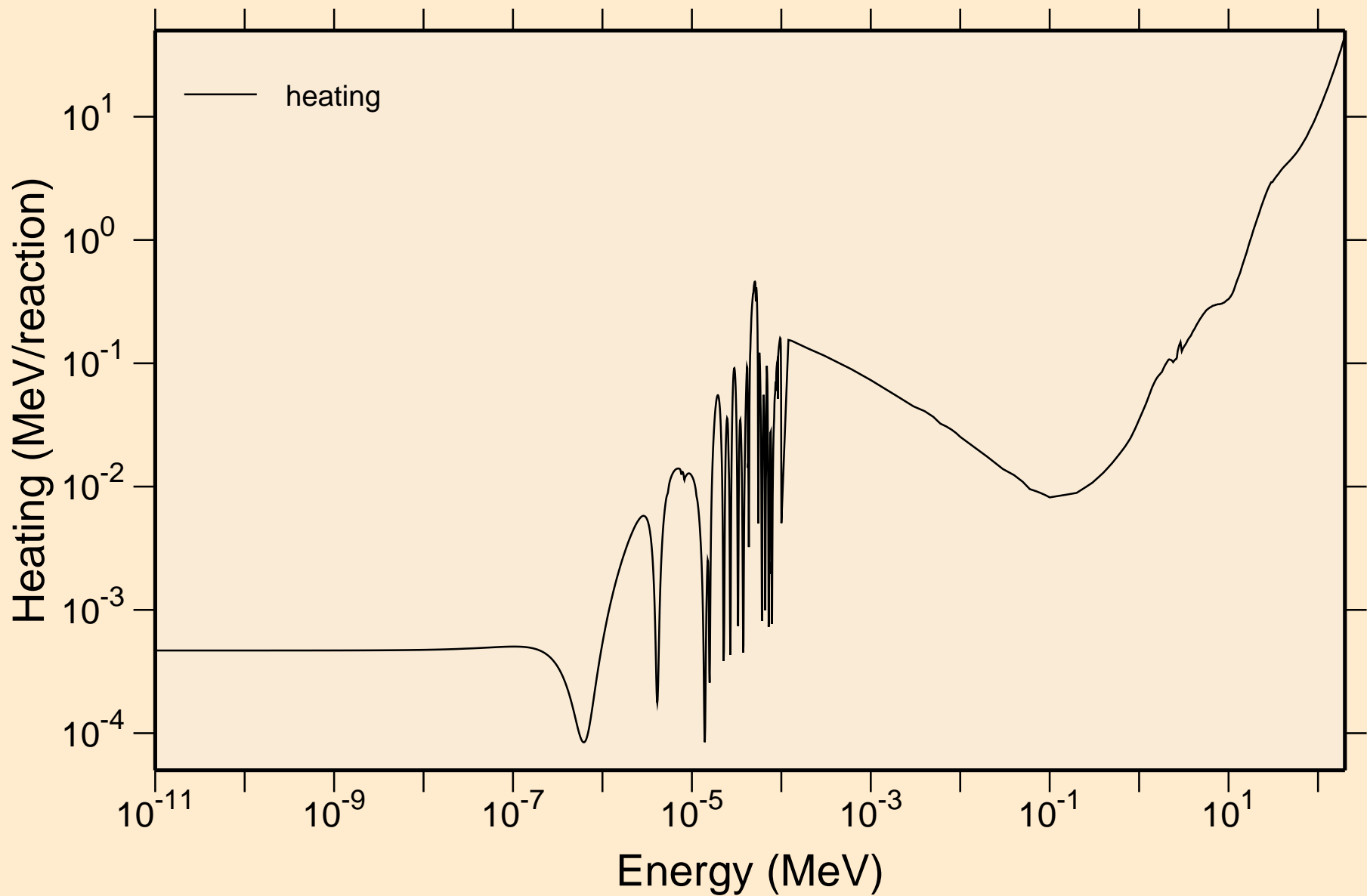

ZR089 NEUTRON ACER TENDL-2019 LIBRARY; T=293.16K  
Damage

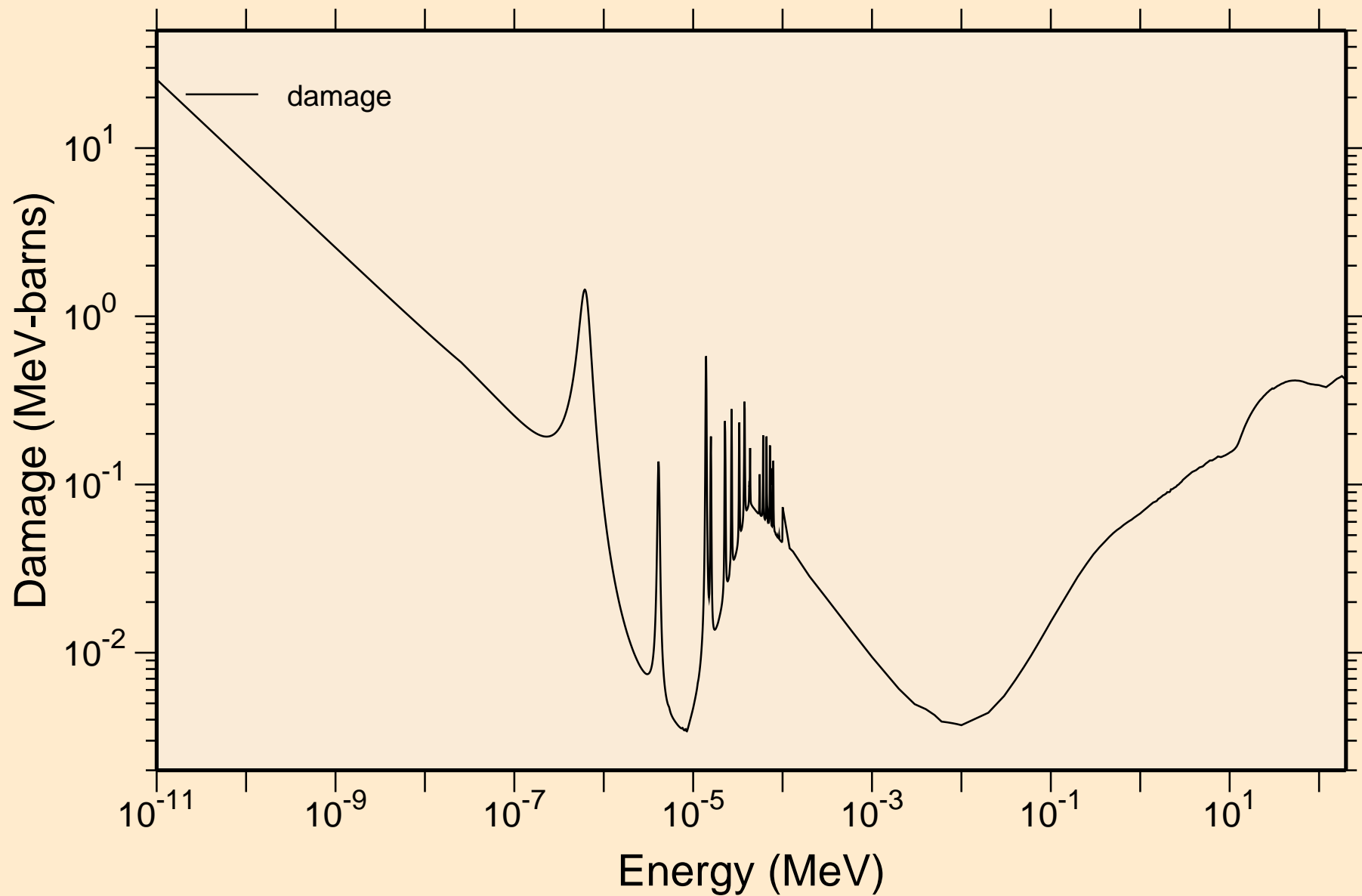

ZR089 NEUTRON ACER TENDL-2019 LIBRARY; T=293.16K  
Non-threshold reactions

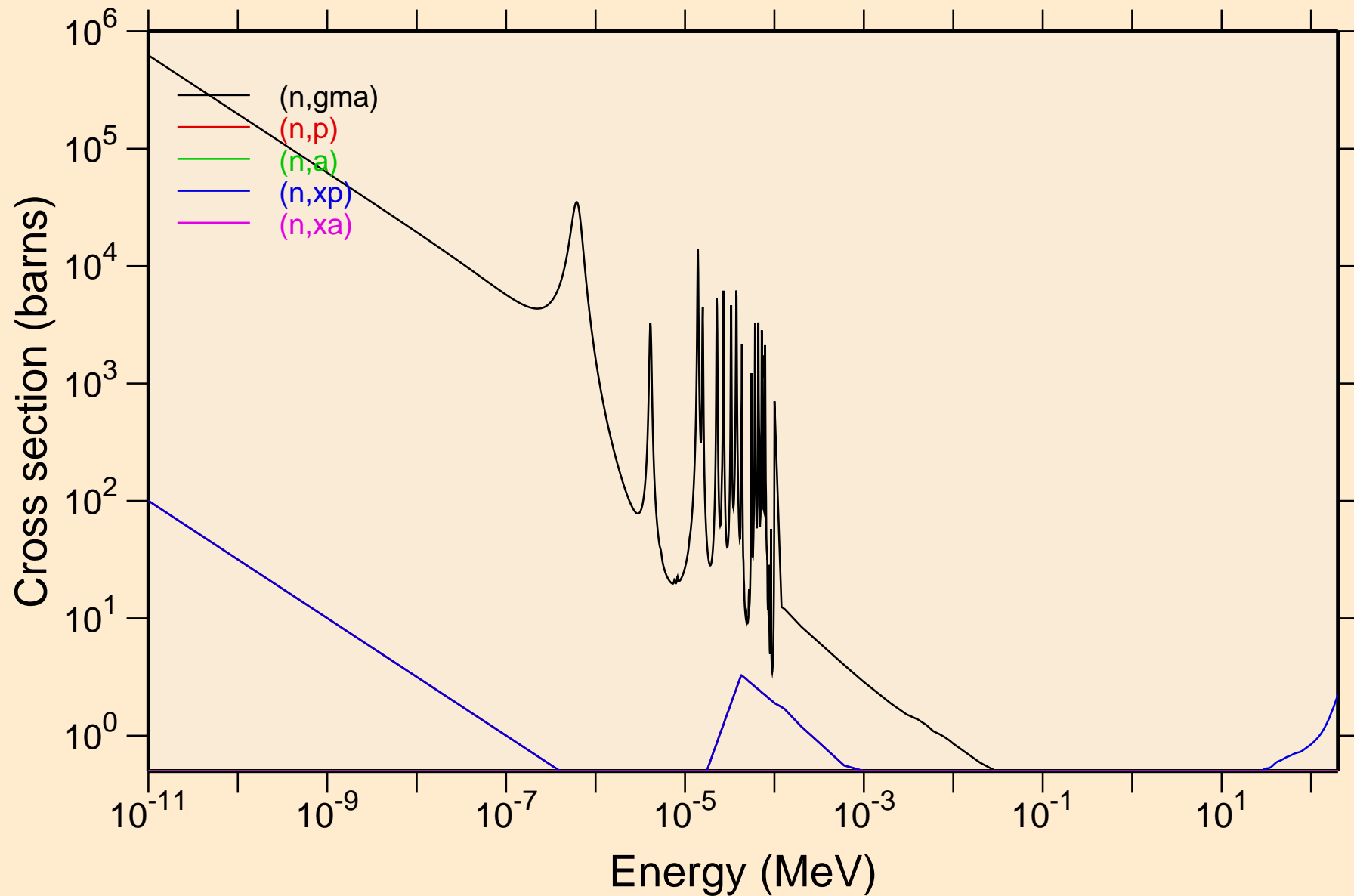

ZR089 NEUTRON ACER TENDL-2019 LIBRARY; T=293.16K  
Principal cross sections

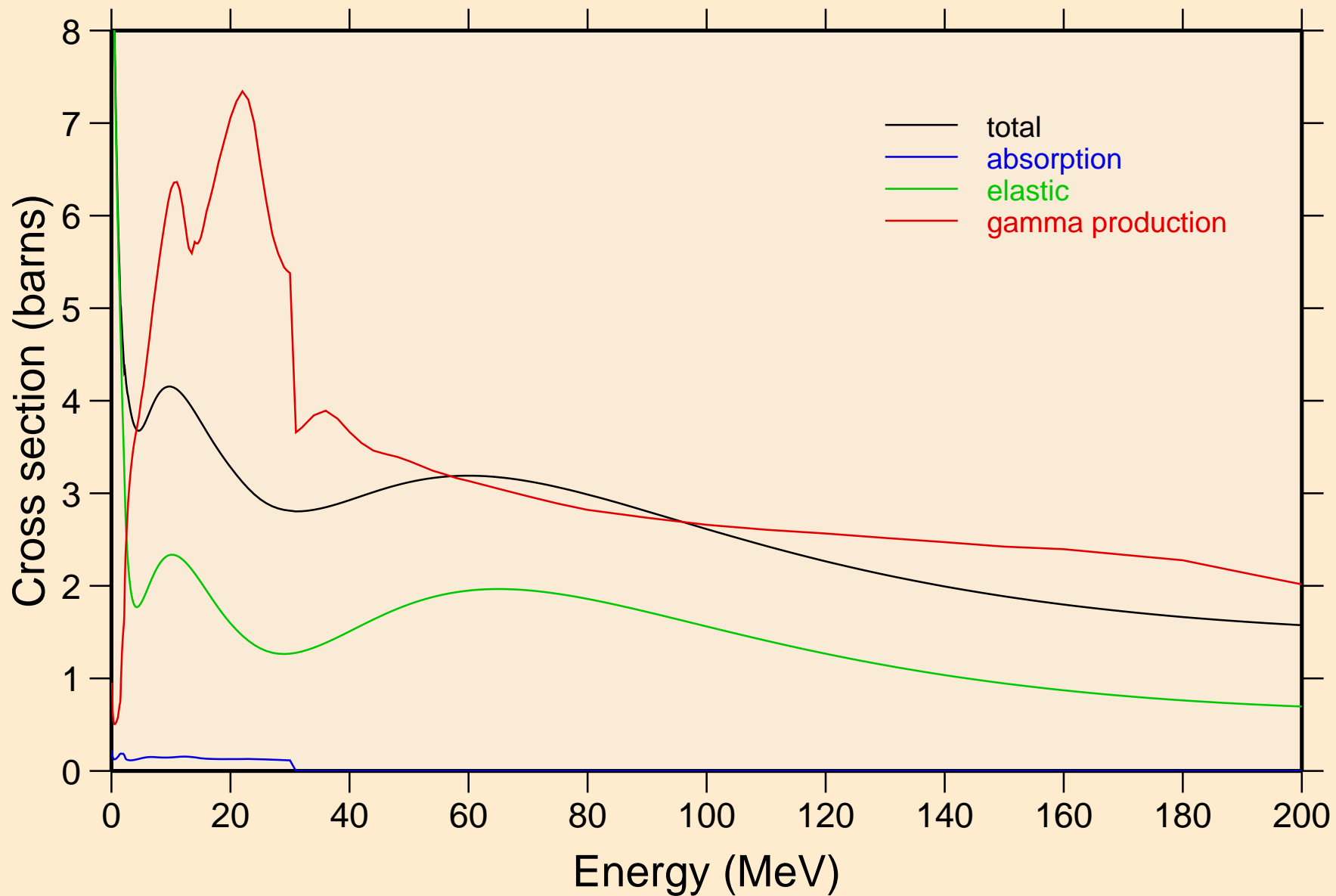

ZR089 NEUTRON ACER TENDL-2019 LIBRARY; T=293.16K  
Heating

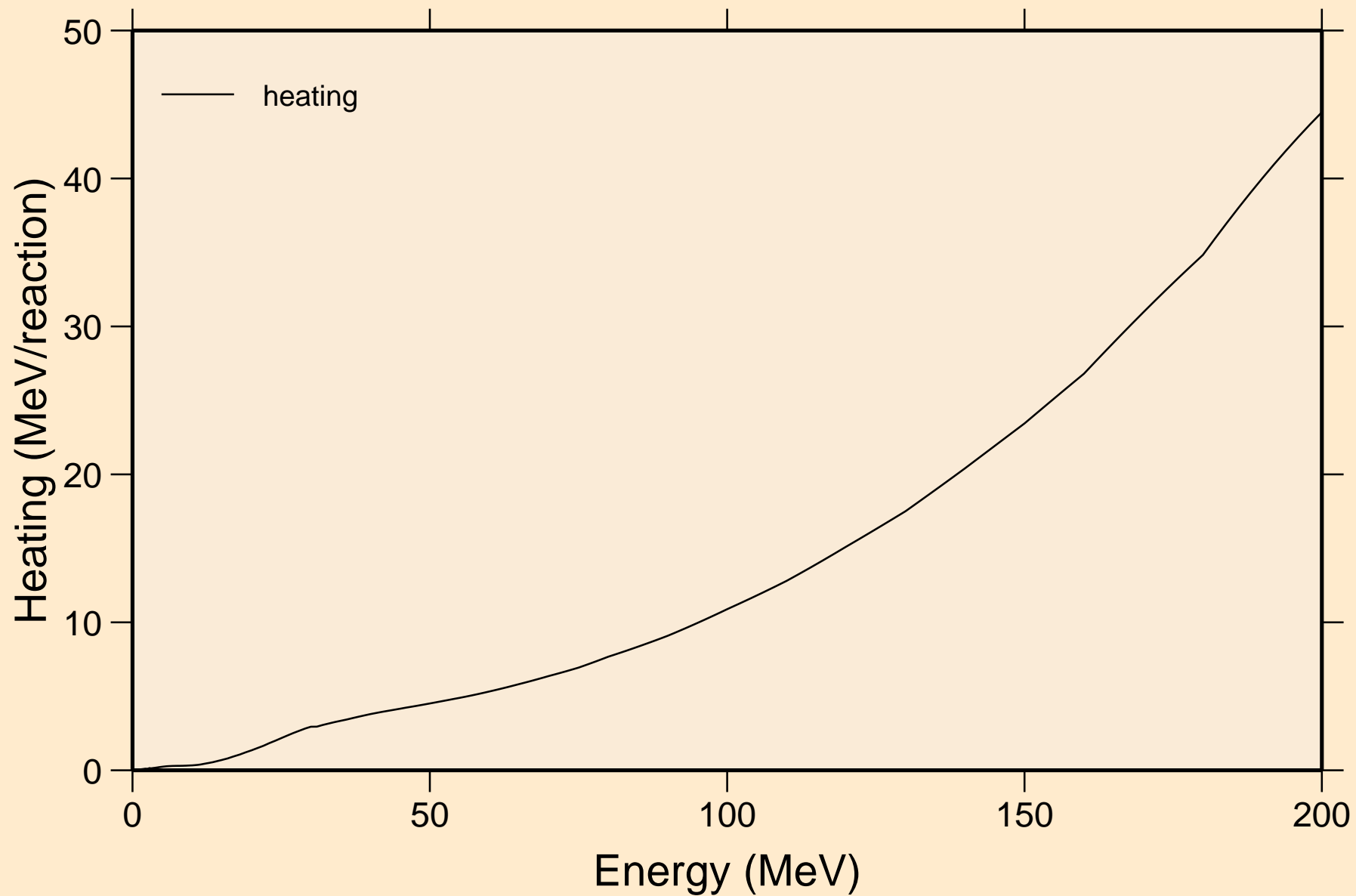

ZR089 NEUTRON ACER TENDL-2019 LIBRARY; T=293.16K  
Damage

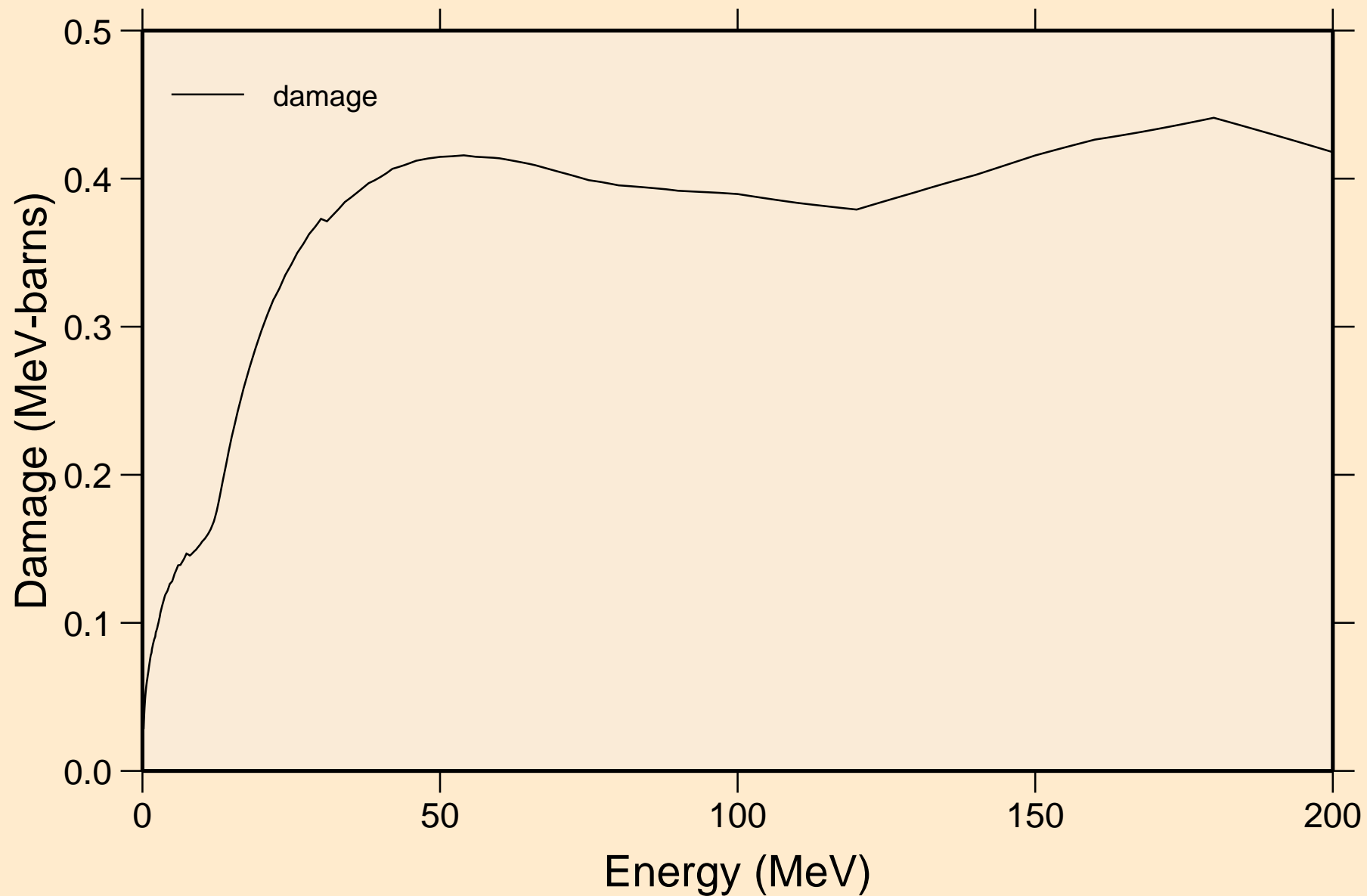

ZR089 NEUTRON ACER TENDL-2019 LIBRARY; T=293.16K  
Non-threshold reactions

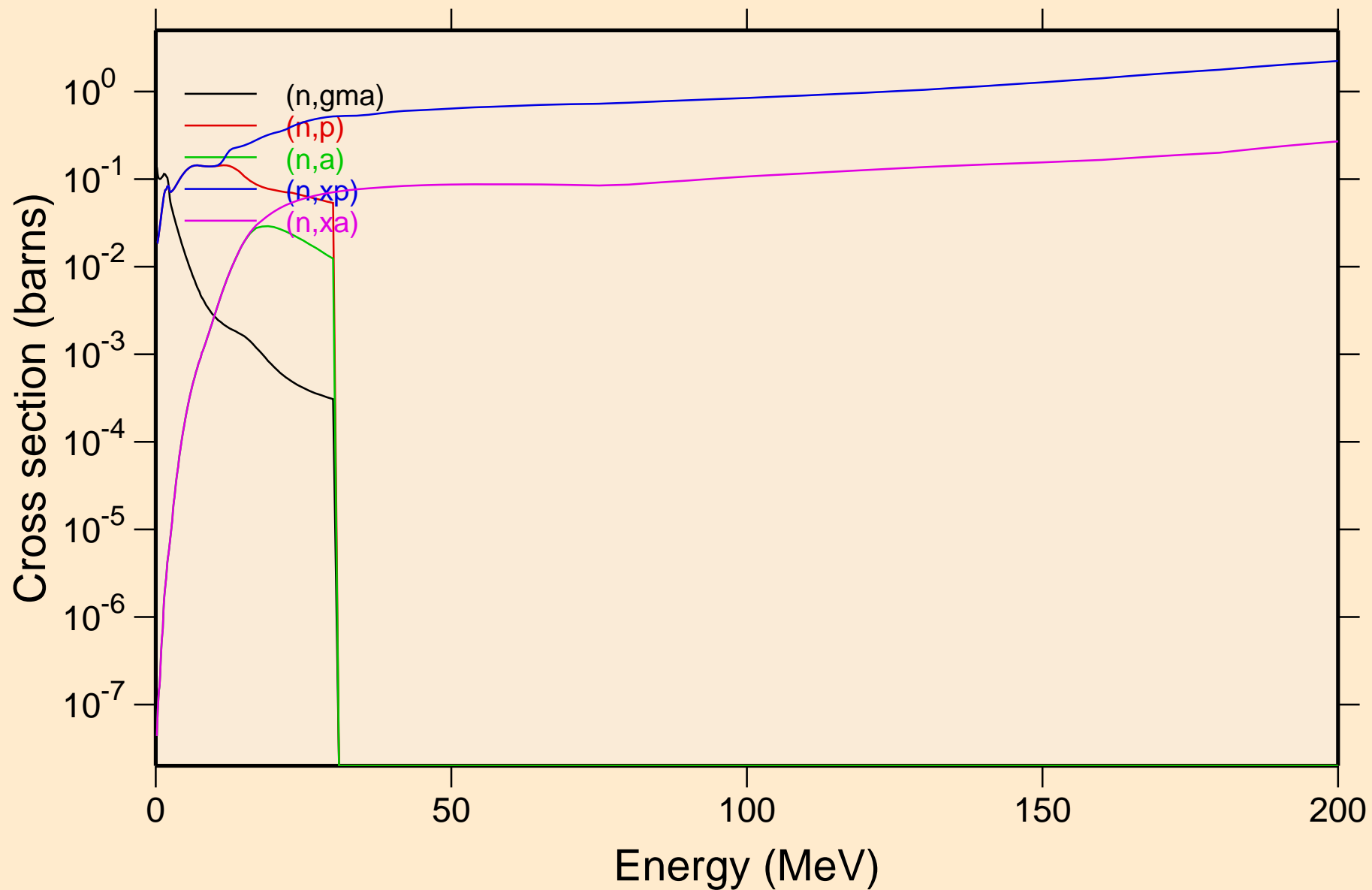



ZR089 NEUTRON ACER TENDL-2019 LIBRARY; T=293.16K  
Inelastic levels

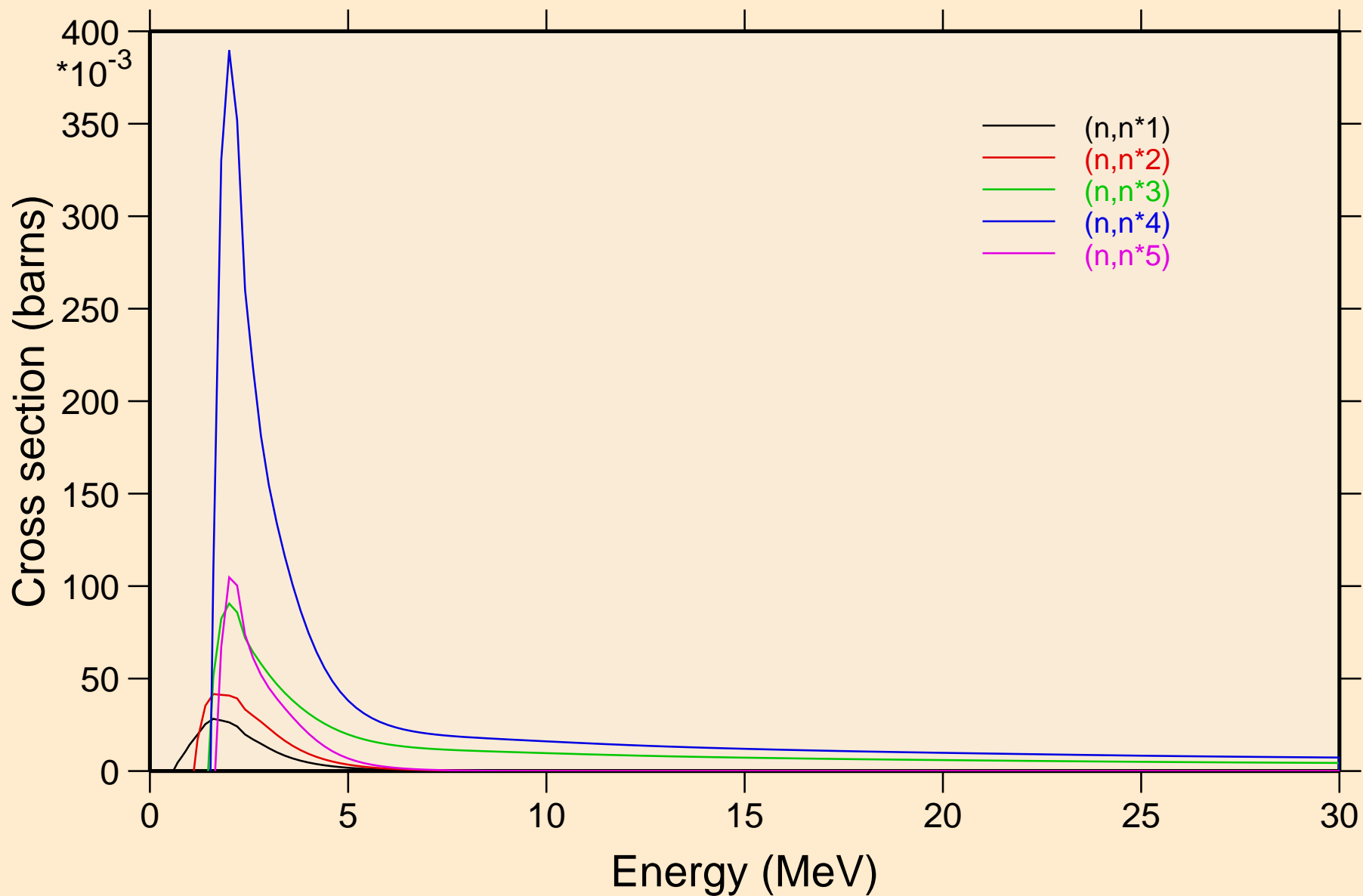

ZR089 NEUTRON ACER TENDL-2019 LIBRARY; T=293.16K  
Inelastic levels

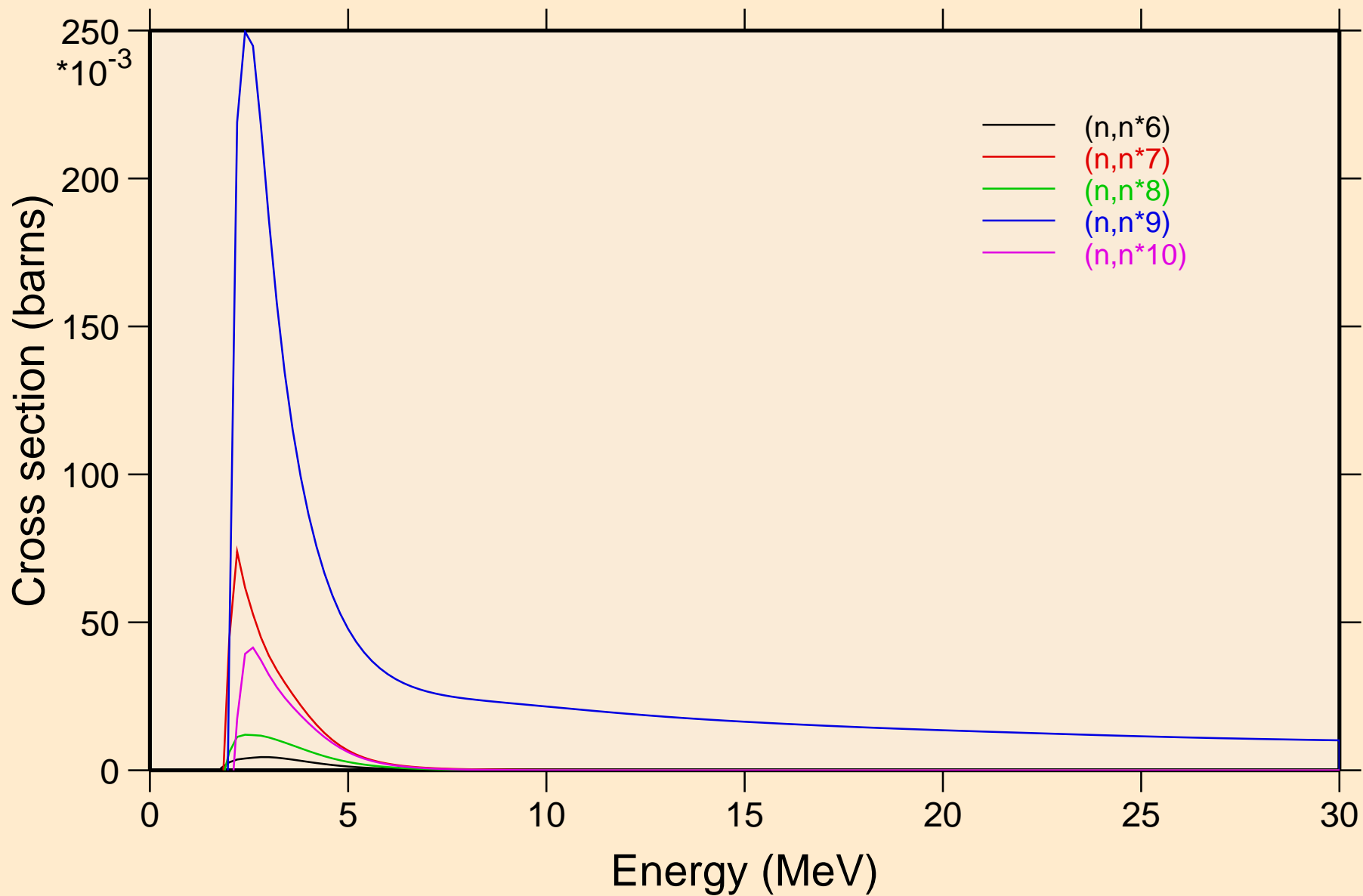

ZR089 NEUTRON ACER TENDL-2019 LIBRARY; T=293.16K  
Inelastic levels

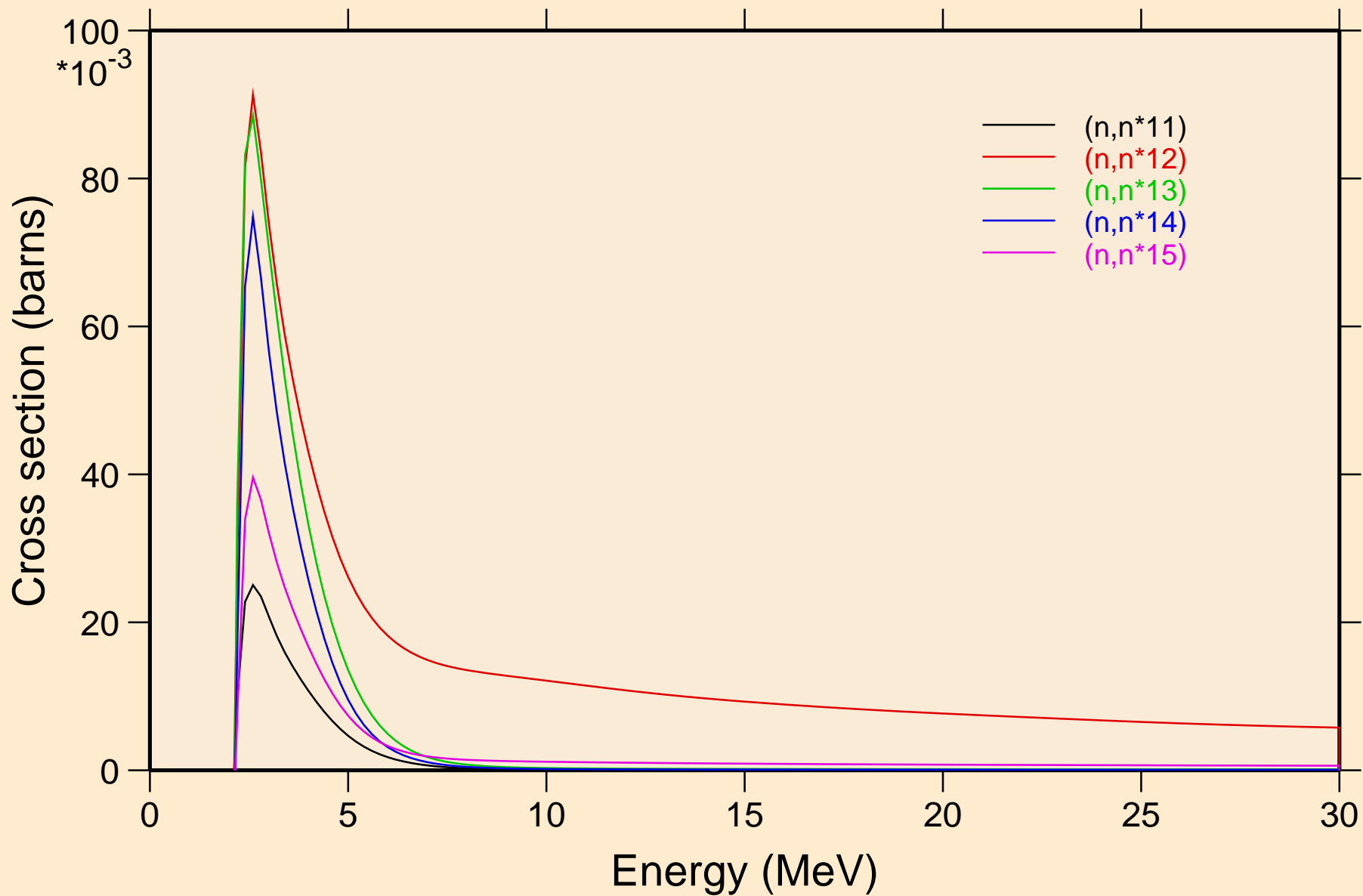

ZR089 NEUTRON ACER TENDL-2019 LIBRARY; T=293.16K  
Inelastic levels

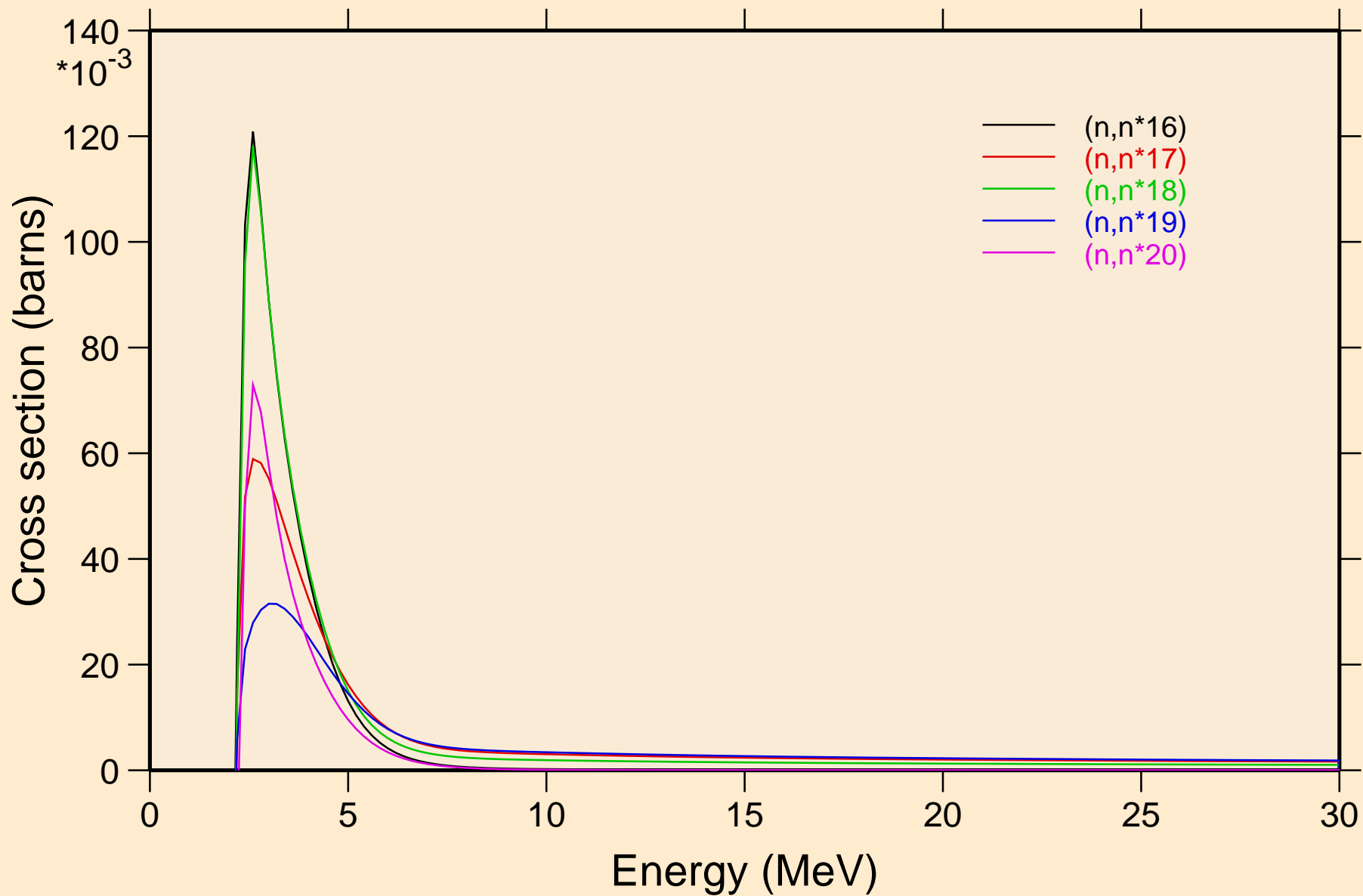

ZR089 NEUTRON ACER TENDL-2019 LIBRARY; T=293.16K  
Inelastic levels

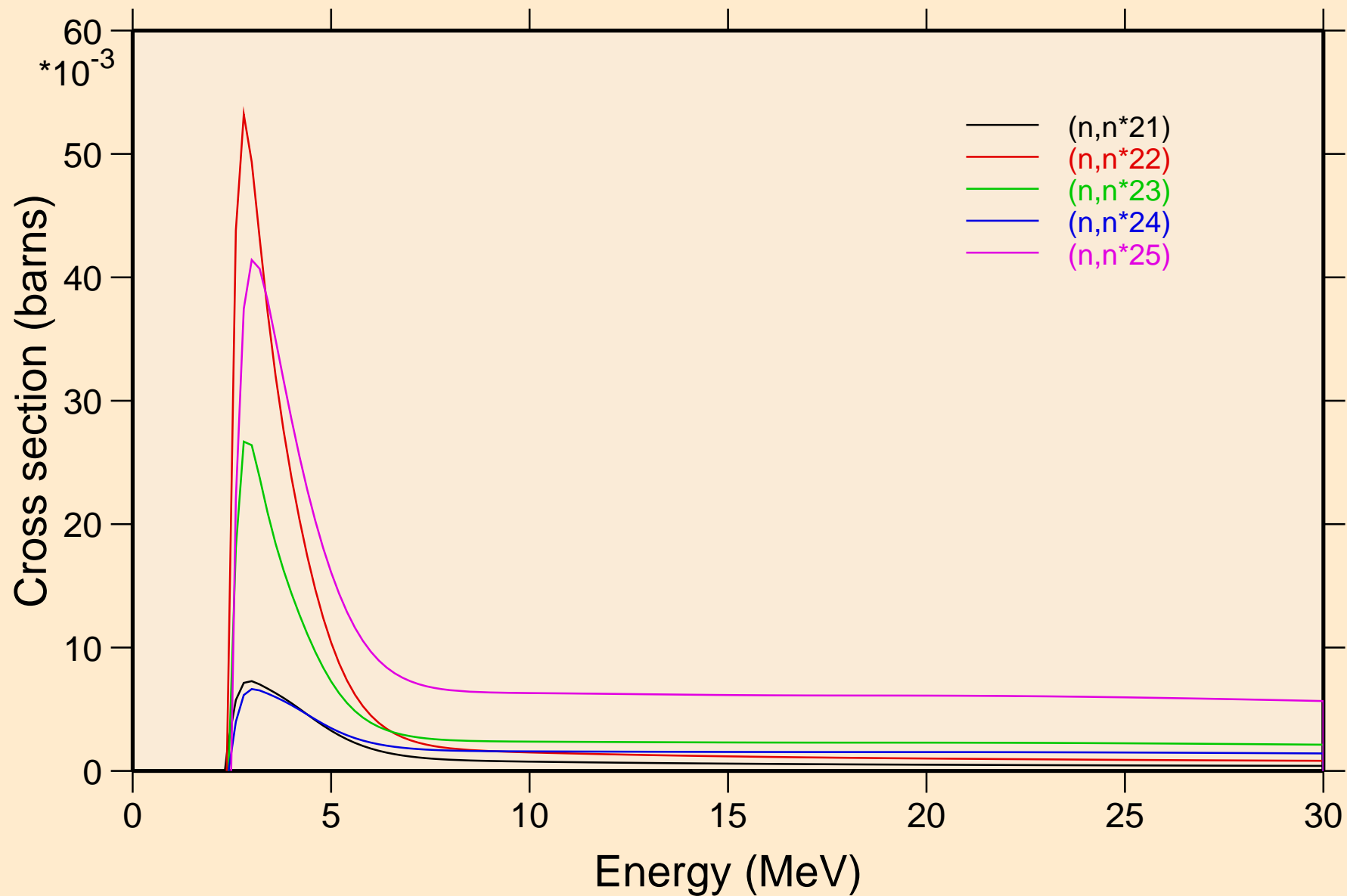

ZR089 NEUTRON ACER TENDL-2019 LIBRARY; T=293.16K  
Inelastic levels

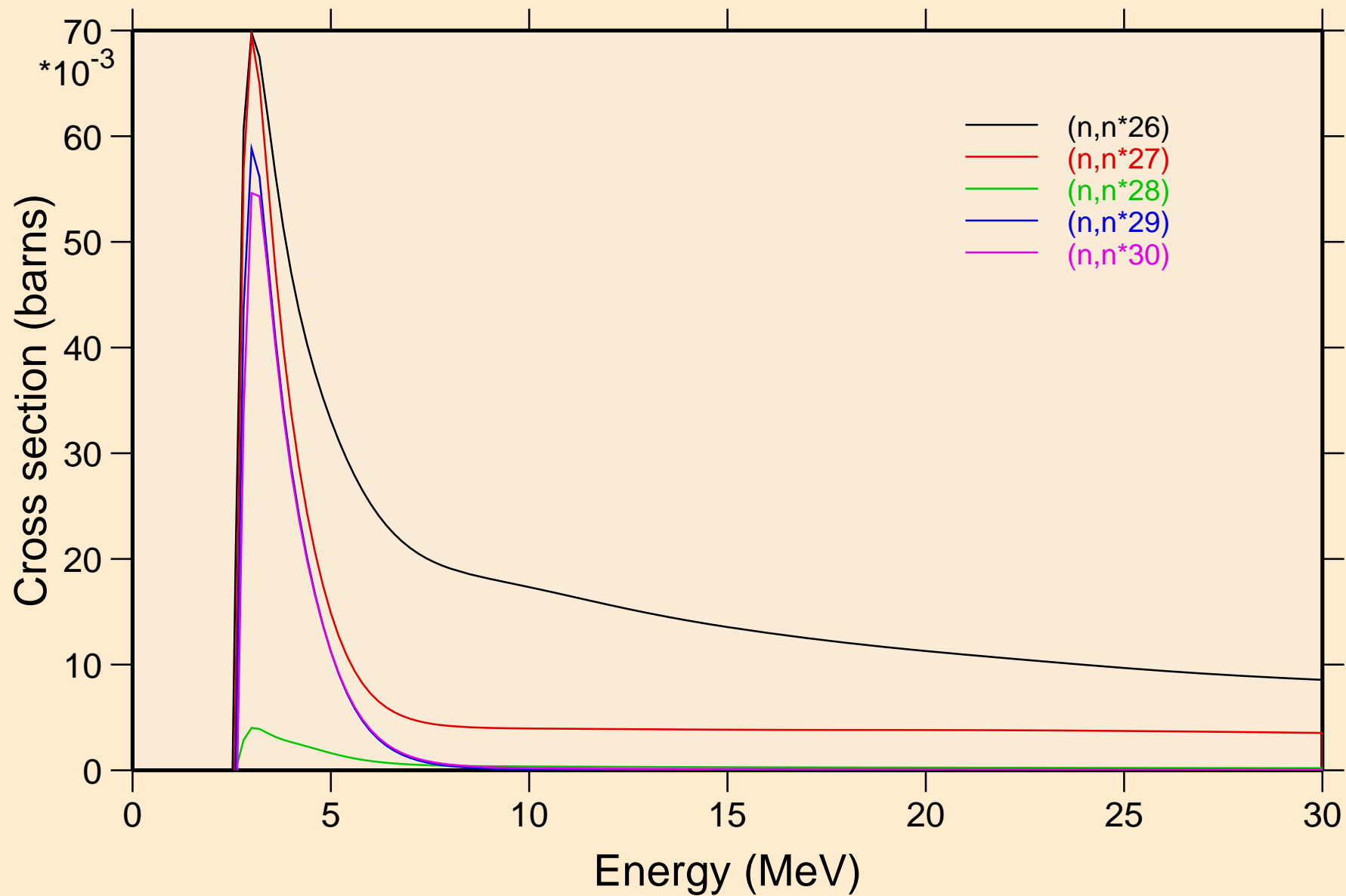

ZR089 NEUTRON ACER TENDL-2019 LIBRARY; T=293.16K  
Threshold reactions

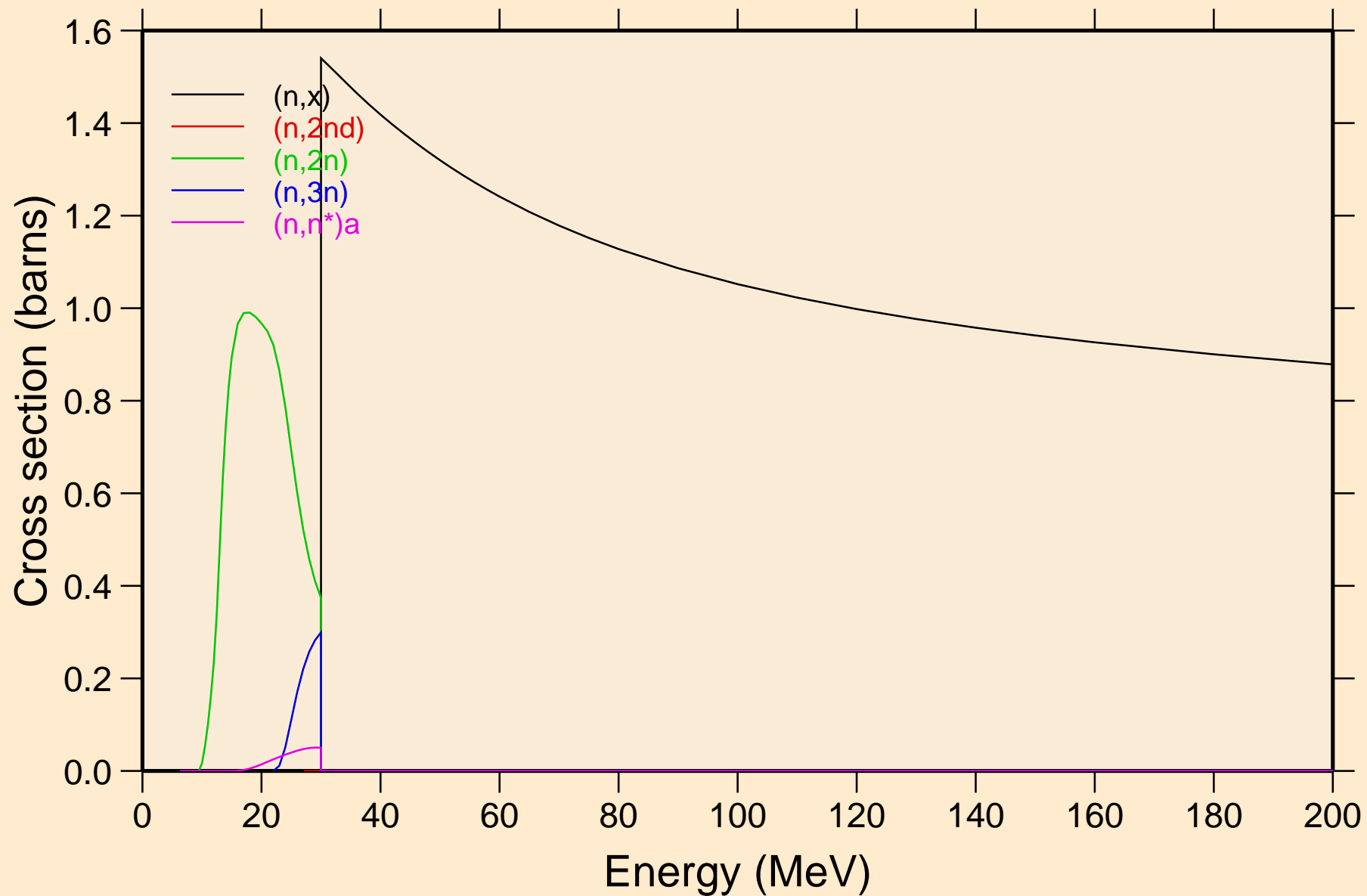

ZR089 NEUTRON ACER TENDL-2019 LIBRARY; T=293.16K  
Threshold reactions

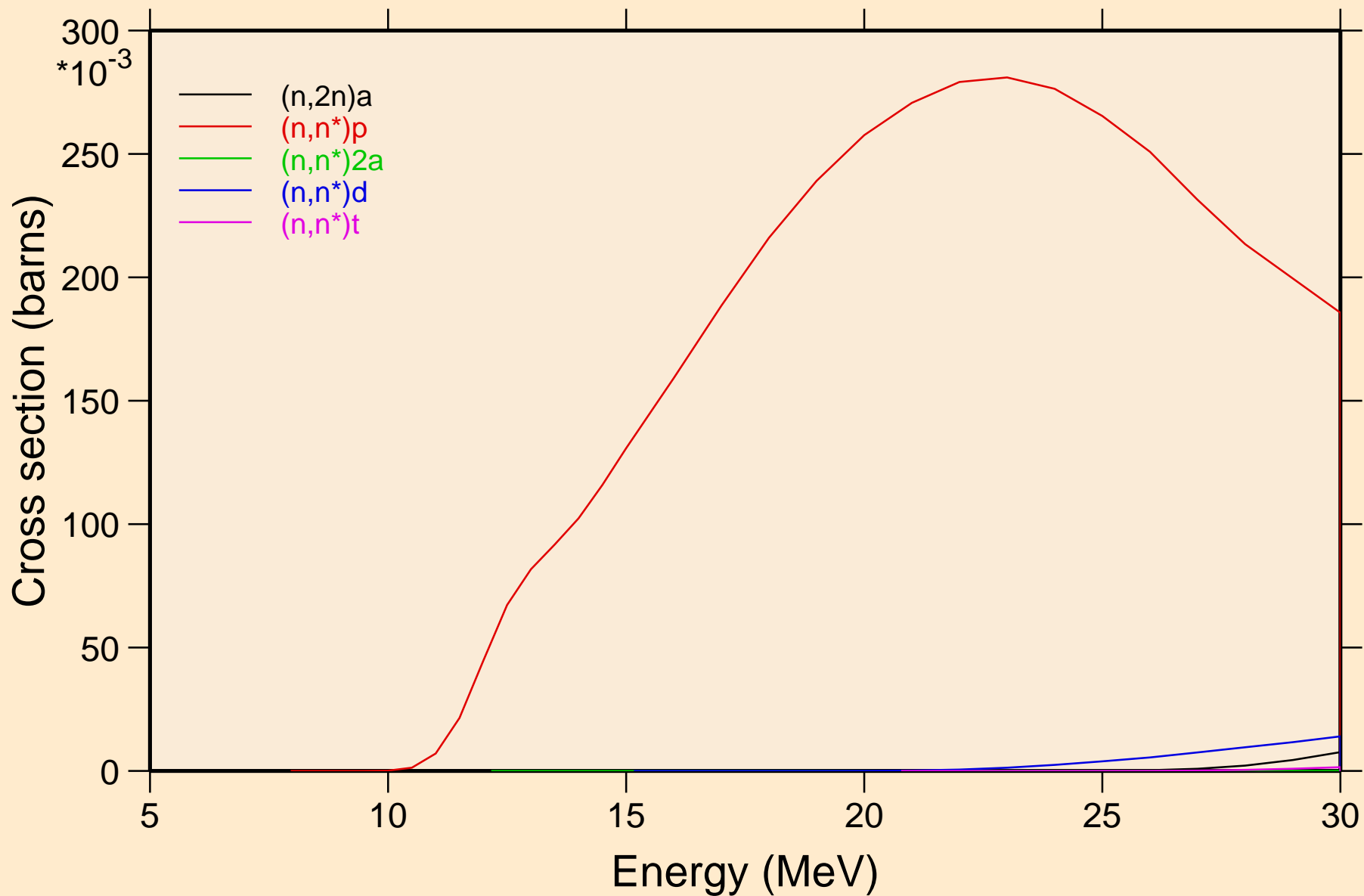



ZR089 NEUTRON ACER TENDL-2019 LIBRARY; T=293.16K  
Threshold reactions

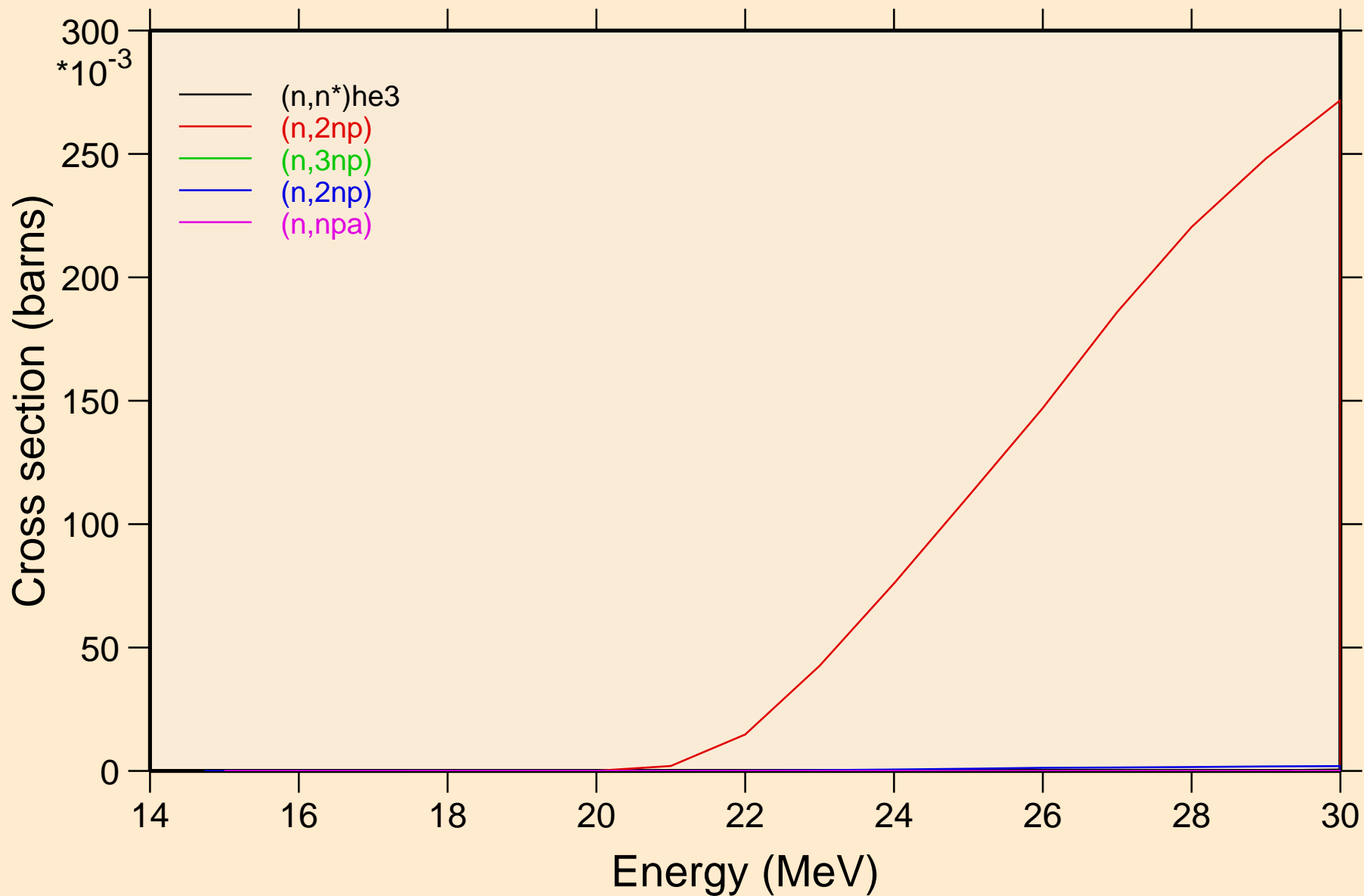

ZR089 NEUTRON ACER TENDL-2019 LIBRARY; T=293.16K  
Threshold reactions

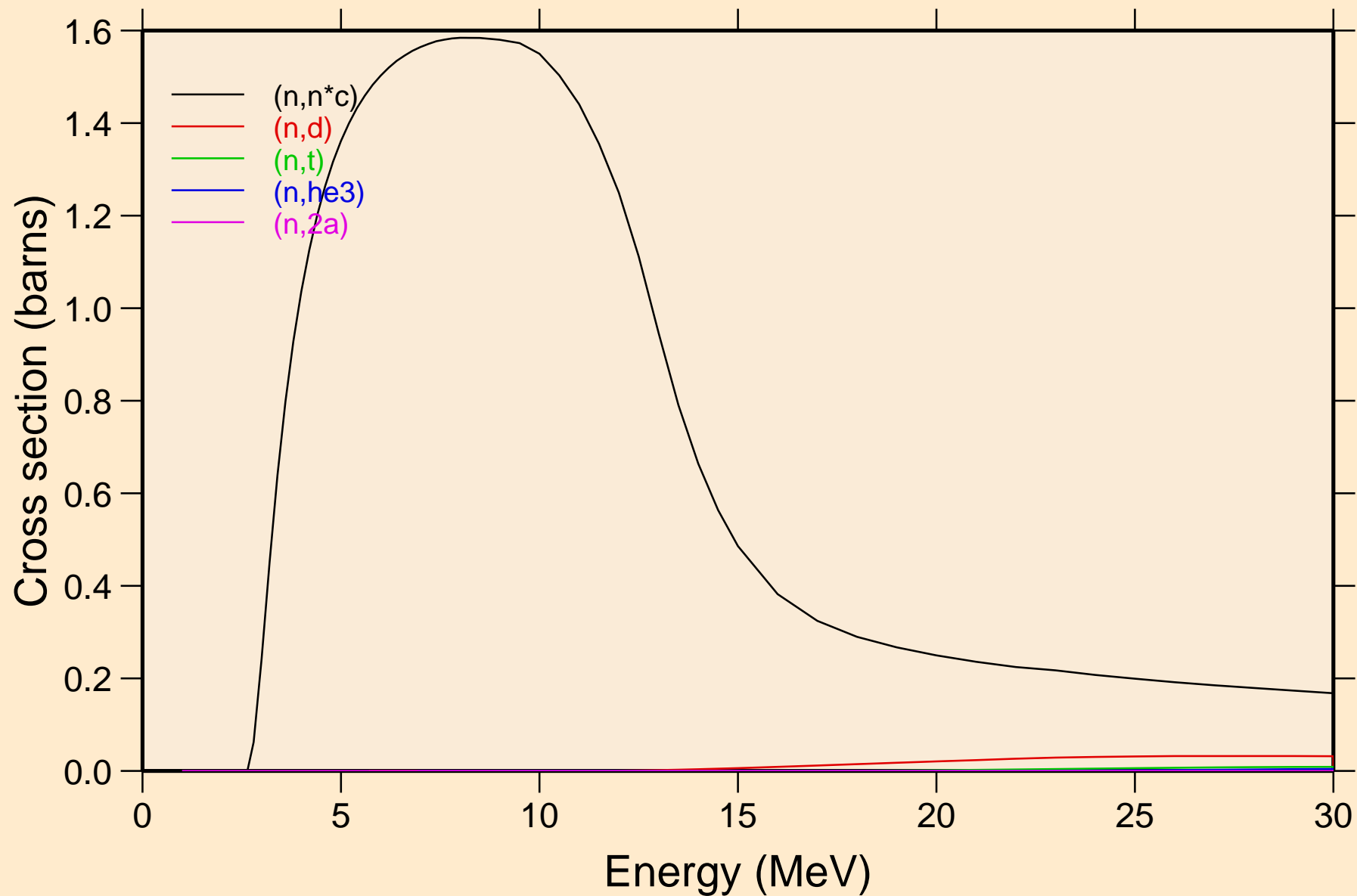

ZR089 NEUTRON ACER TENDL-2019 LIBRARY; T=293.16K  
Threshold reactions

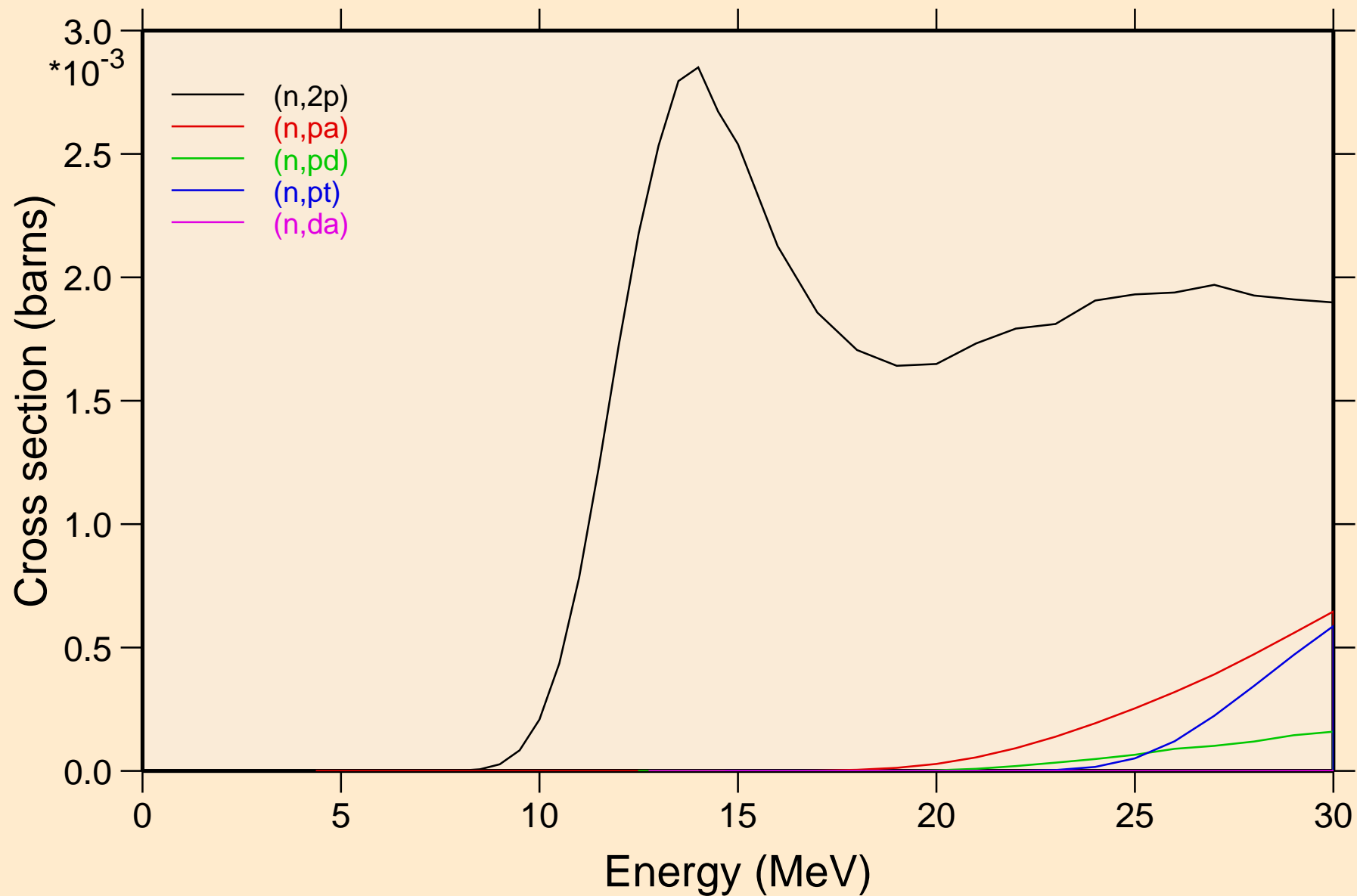

ZR089 NEUTRON ACER TENDL-2019 LIBRARY; T=293.16K  
Threshold reactions

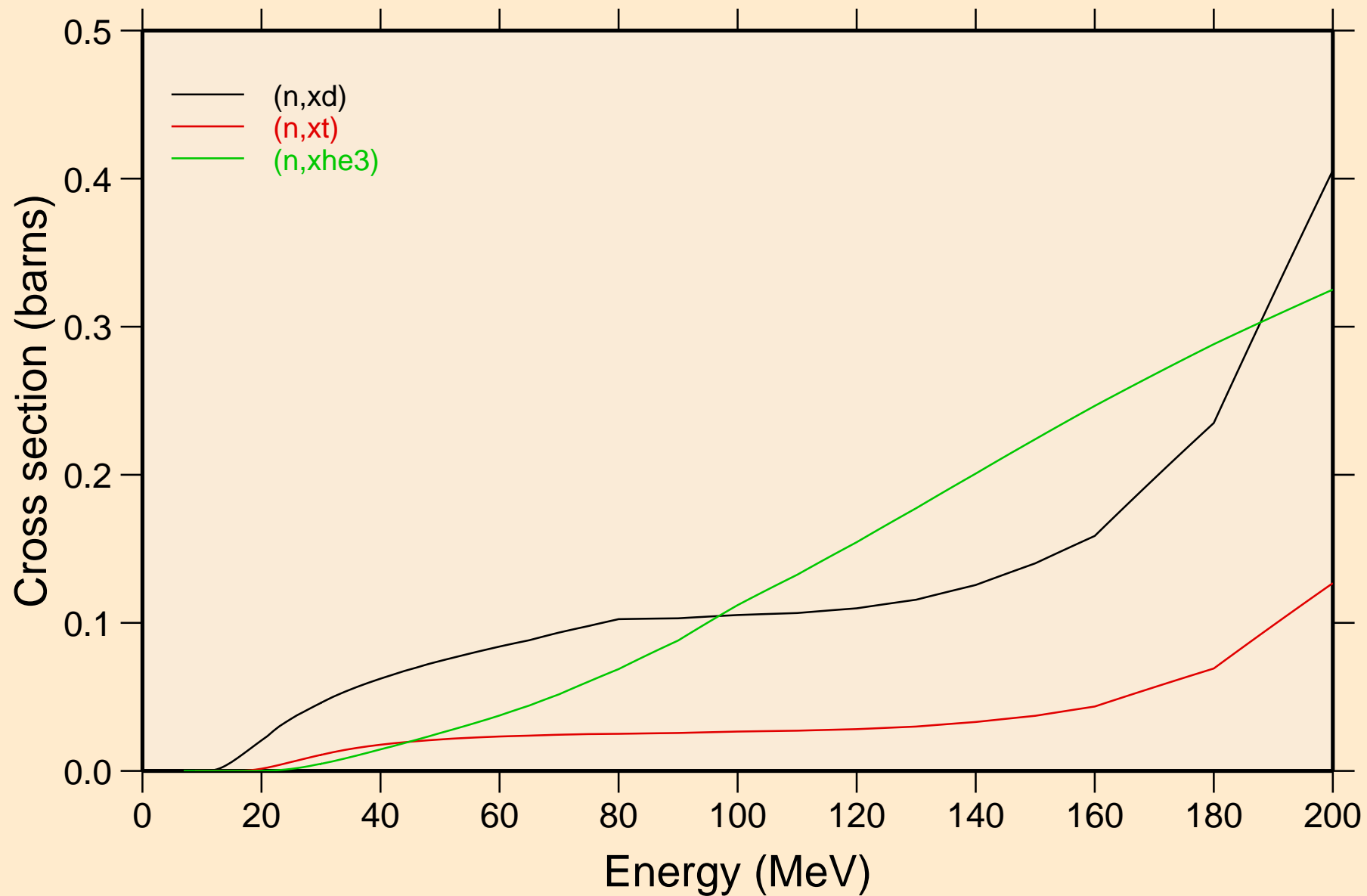

ZR089 NEUTRON ACER TENDL-2019 LIBRARY; T=293.16K  
angular distribution for elastic

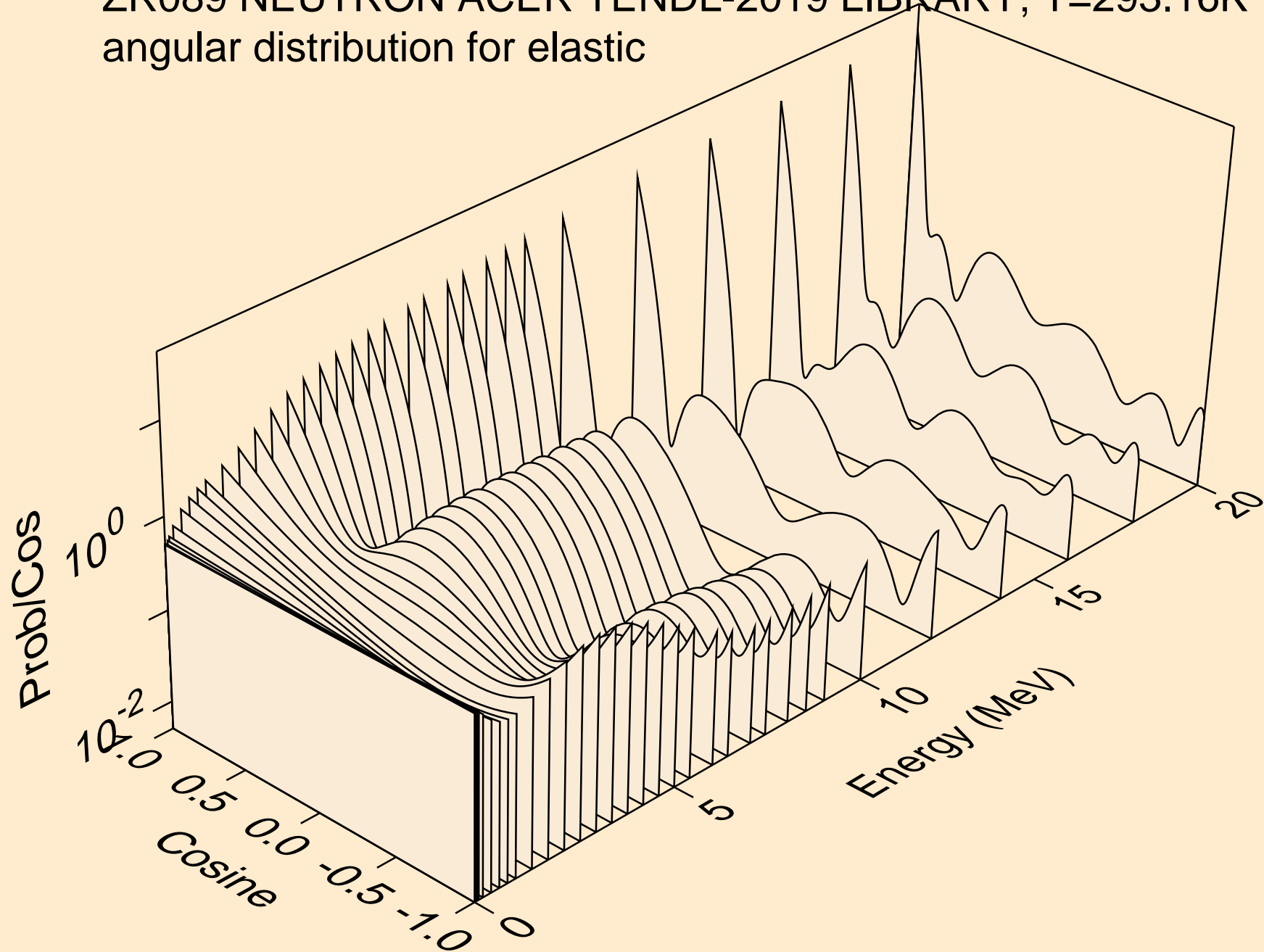

ZR089 NEUTRON ACER TENDL-2019 LIBRARY; T=293.16K  
angular distribution for elastic

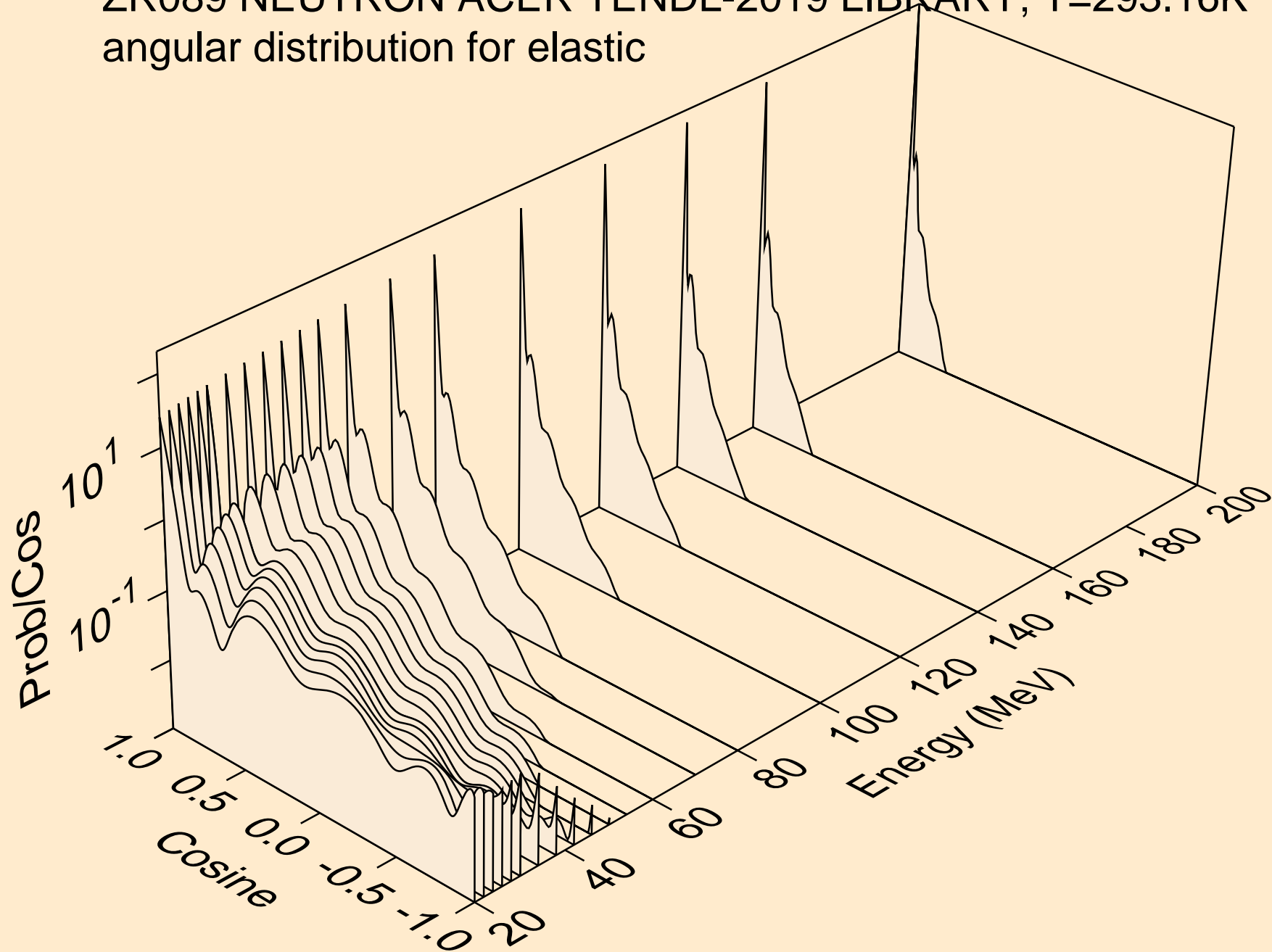

ZR089 NEUTRON ACER TENDL-2019 LIBRARY; T=293.16K  
angular distribution for (n,n\*1)

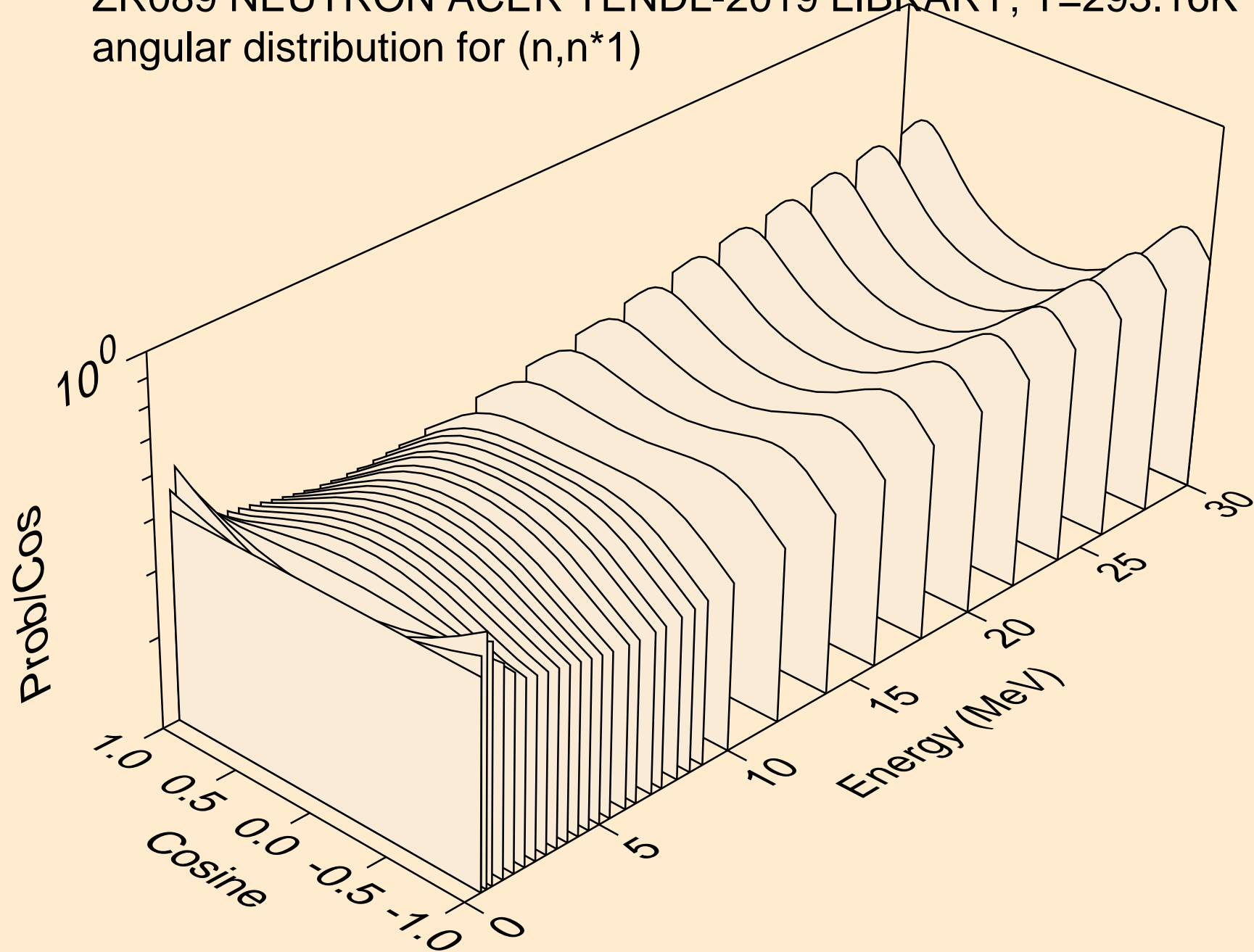

ZR089 NEUTRON ACER TENDL-2019 LIBRARY; T=293.16K  
angular distribution for (n,n\*2)

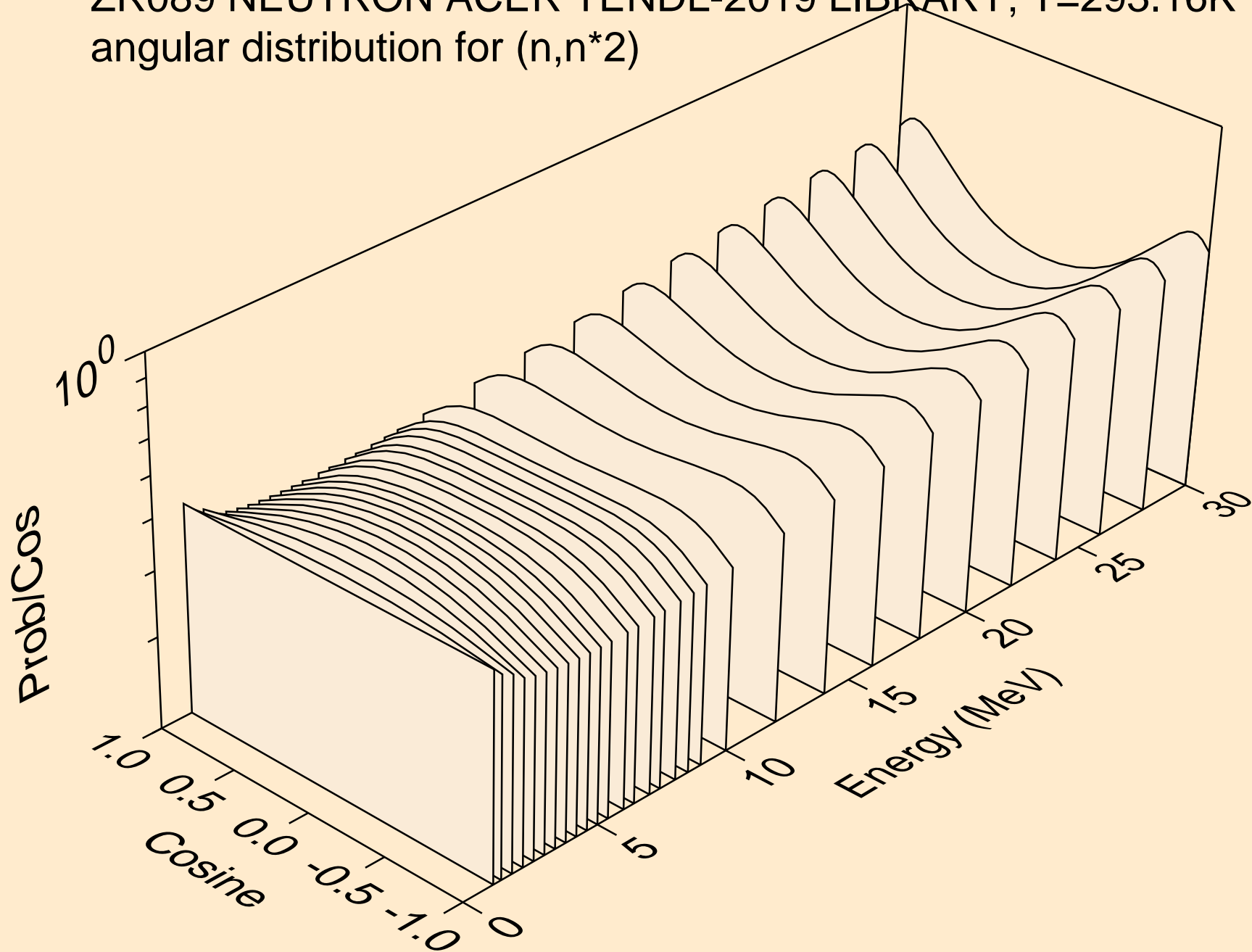



ZR089 NEUTRON ACER TENDL-2019 LIBRARY; T=293.16K  
angular distribution for (n,n\*3)

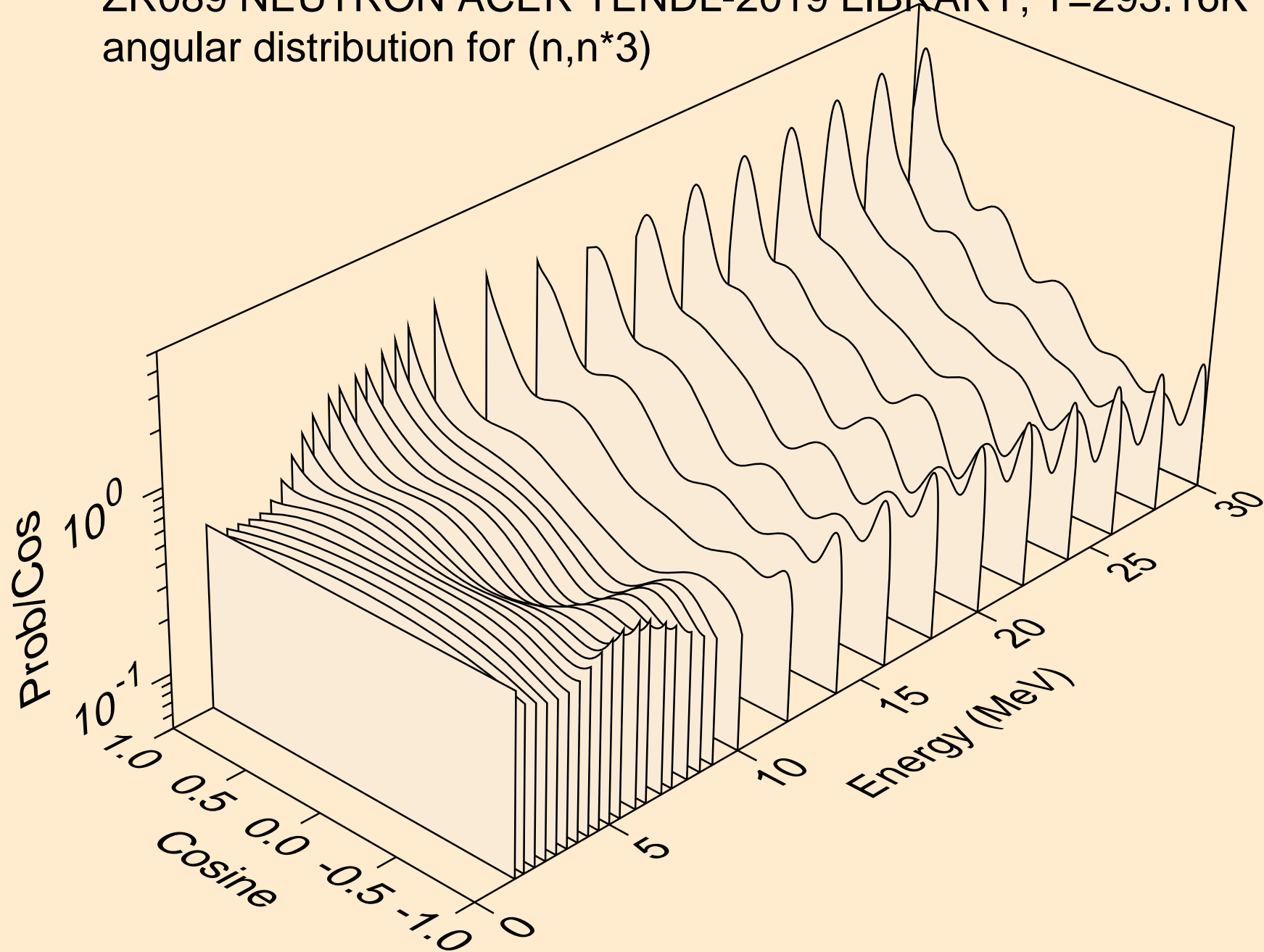

ZR089 NEUTRON ACER TENDL-2019 LIBRARY; T=293.16K  
angular distribution for (n,n\*4)

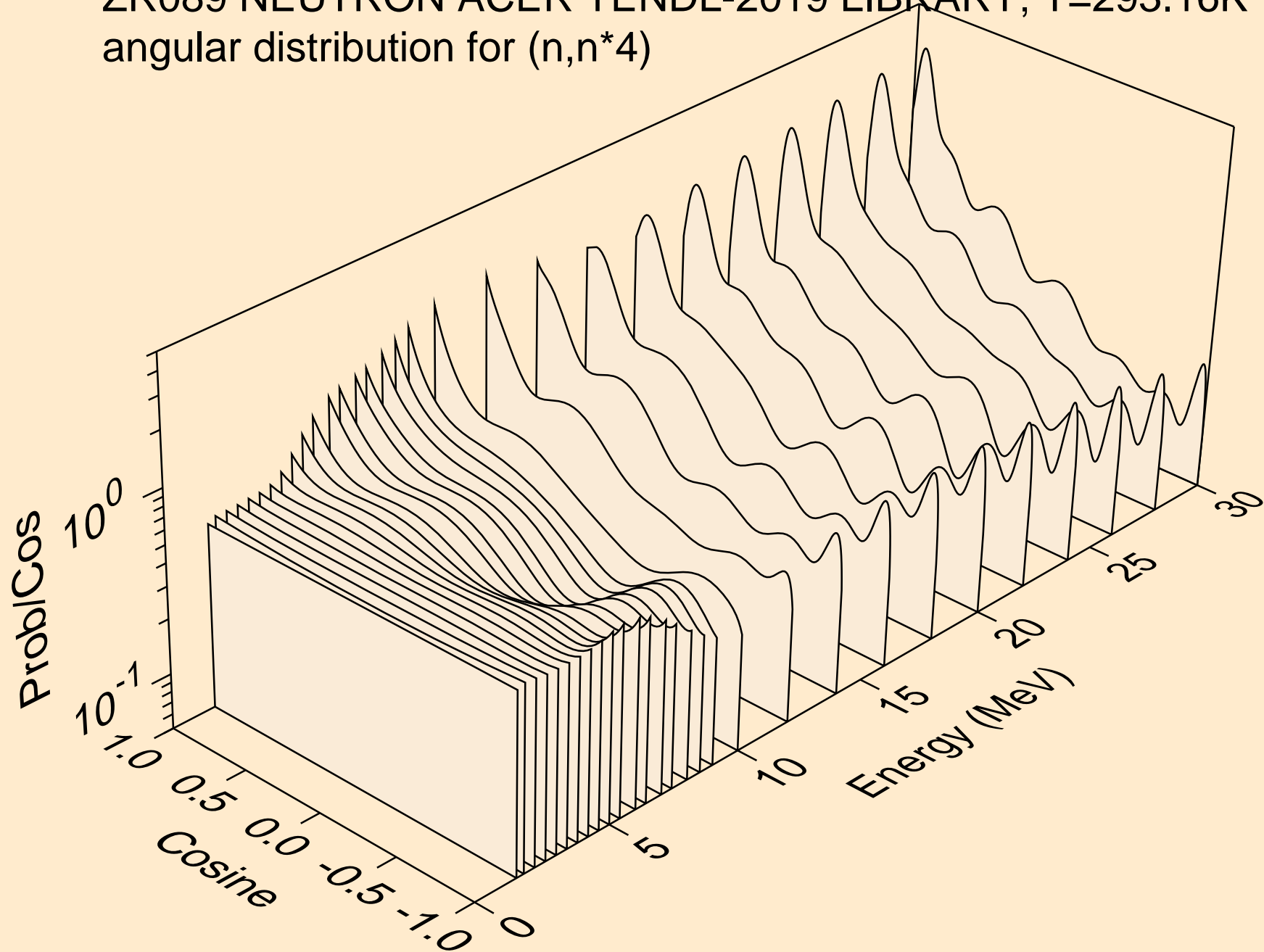

ZR089 NEUTRON ACER TENDL-2019 LIBRARY; T=293.16K  
angular distribution for (n,n\*5)

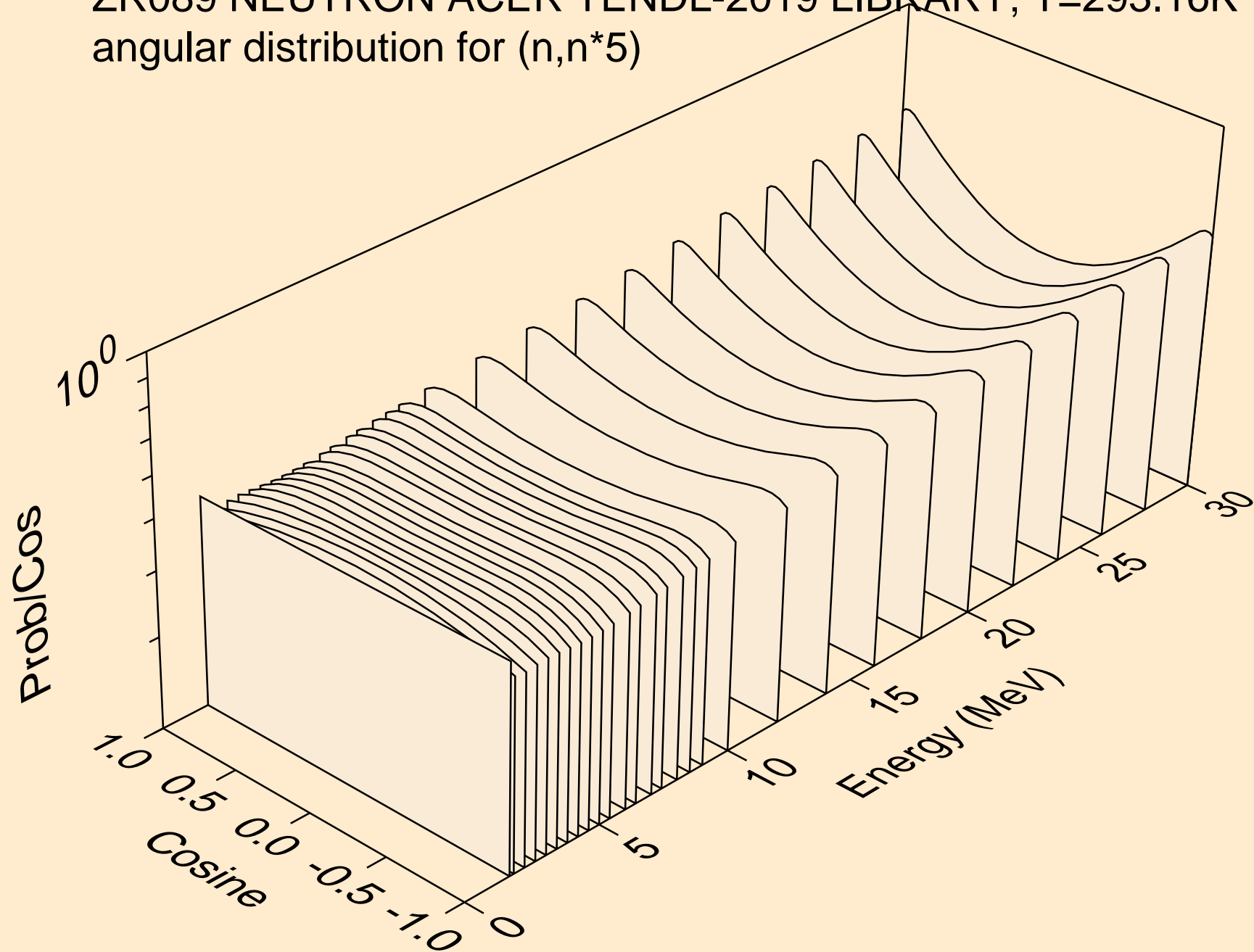

ZR089 NEUTRON ACER TENDL-2019 LIBRARY; T=293.16K  
angular distribution for (n,n\*6)

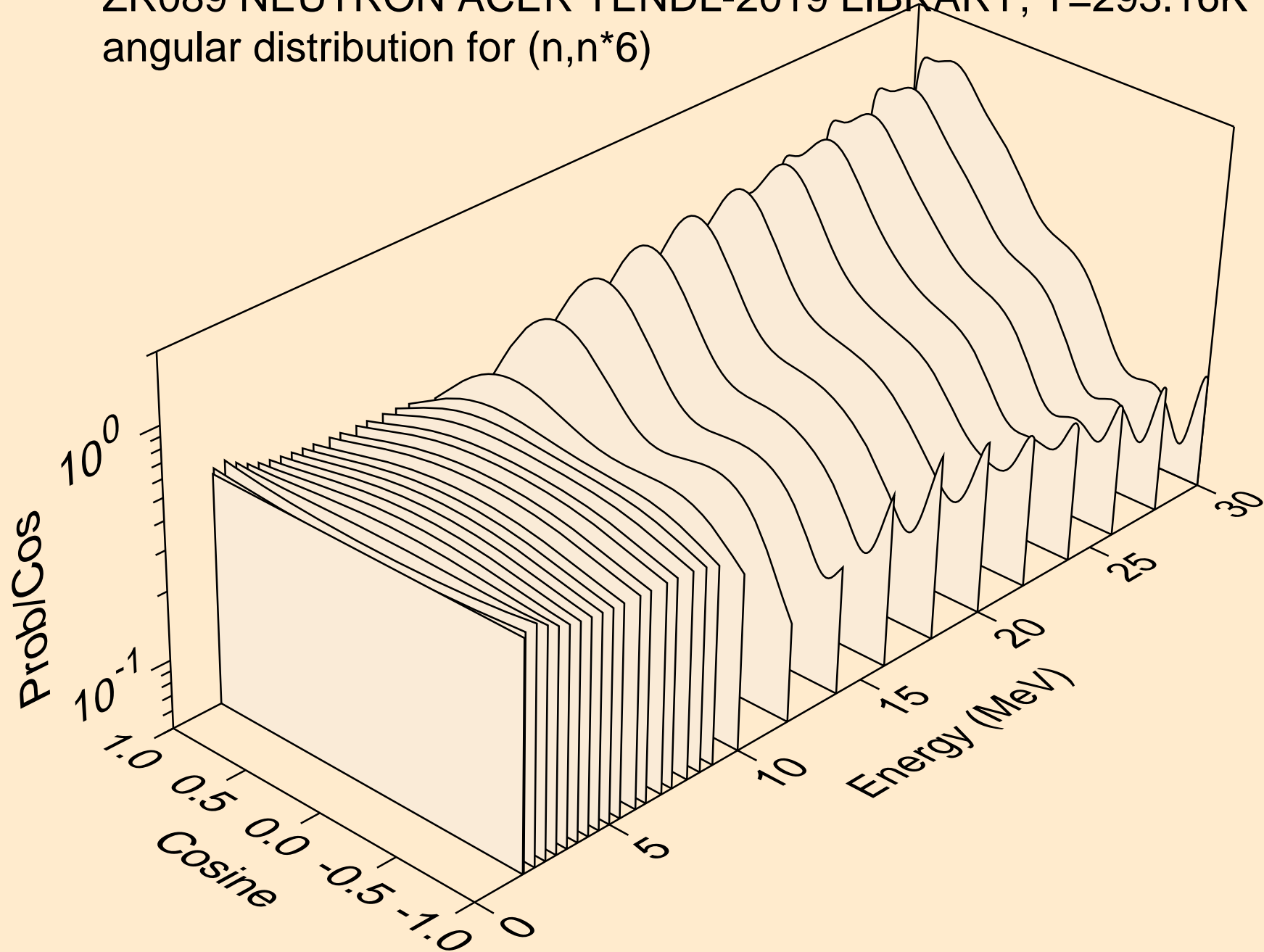

ZR089 NEUTRON ACER TENDL-2019 LIBRARY; T=293.16K  
angular distribution for (n,n\*7)

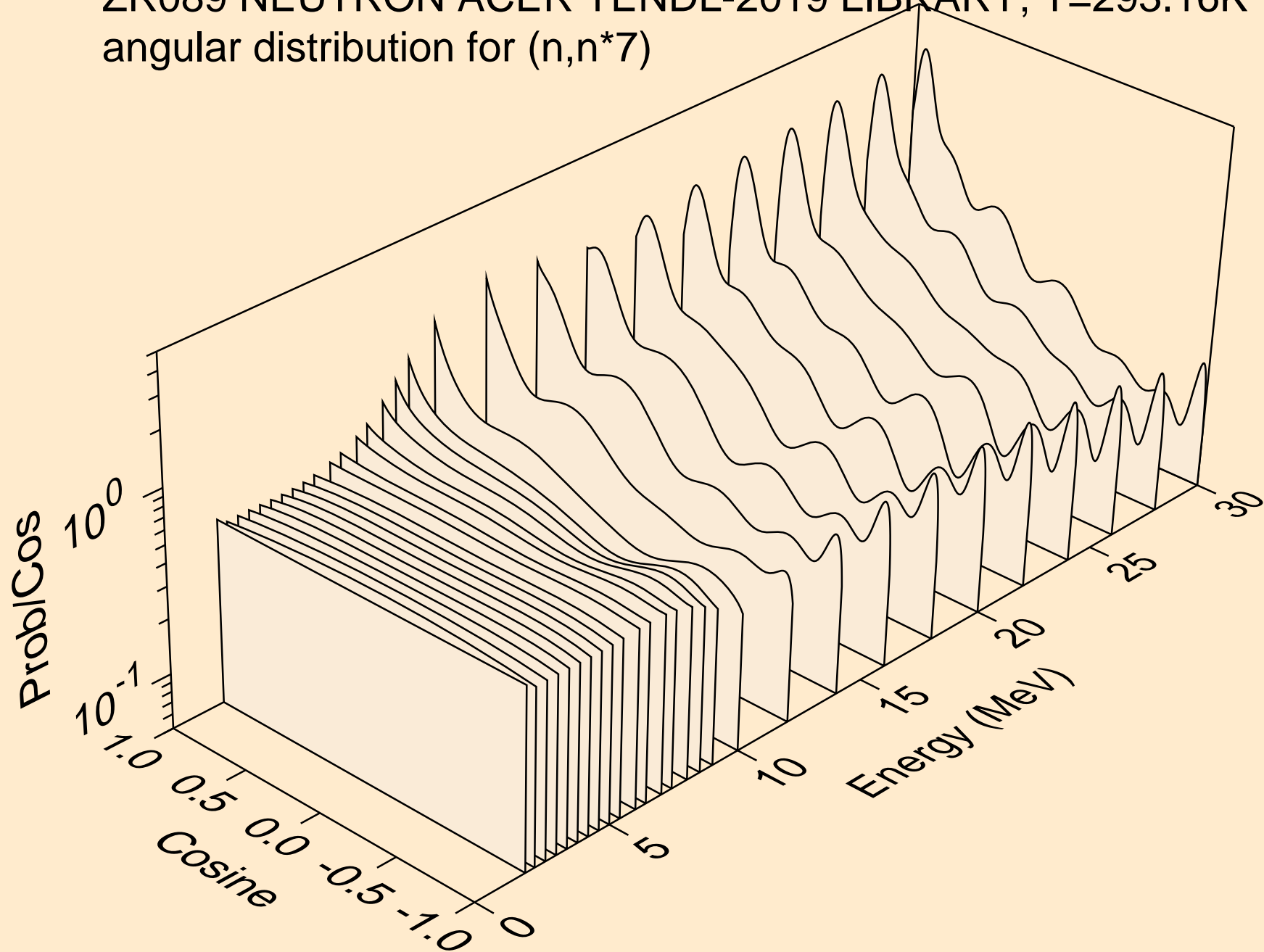

ZR089 NEUTRON ACER TENDL-2019 LIBRARY; T=293.16K  
angular distribution for (n,n\*8)

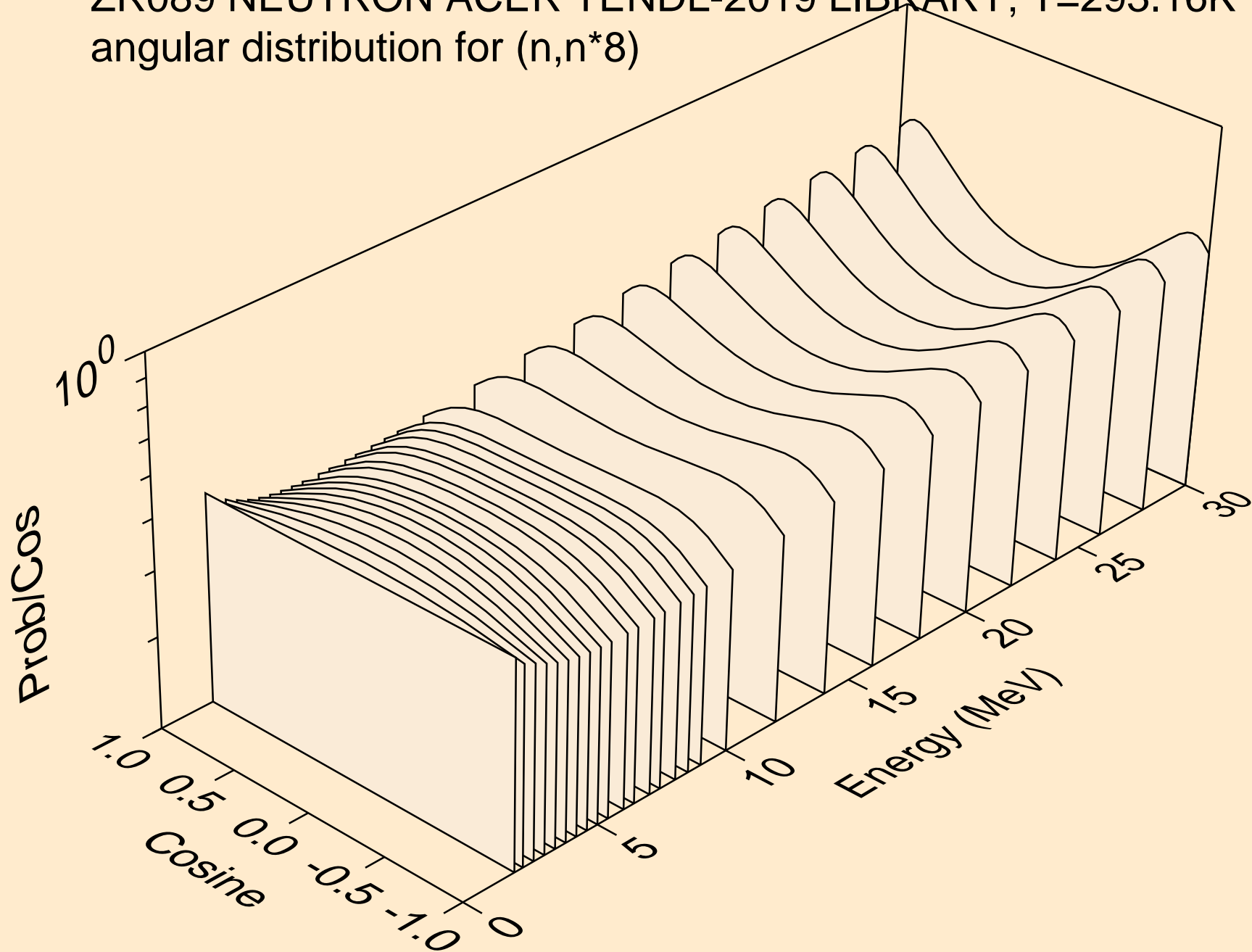

ZR089 NEUTRON ACER TENDL-2019 LIBRARY; T=293.16K  
angular distribution for (n,n\*9)

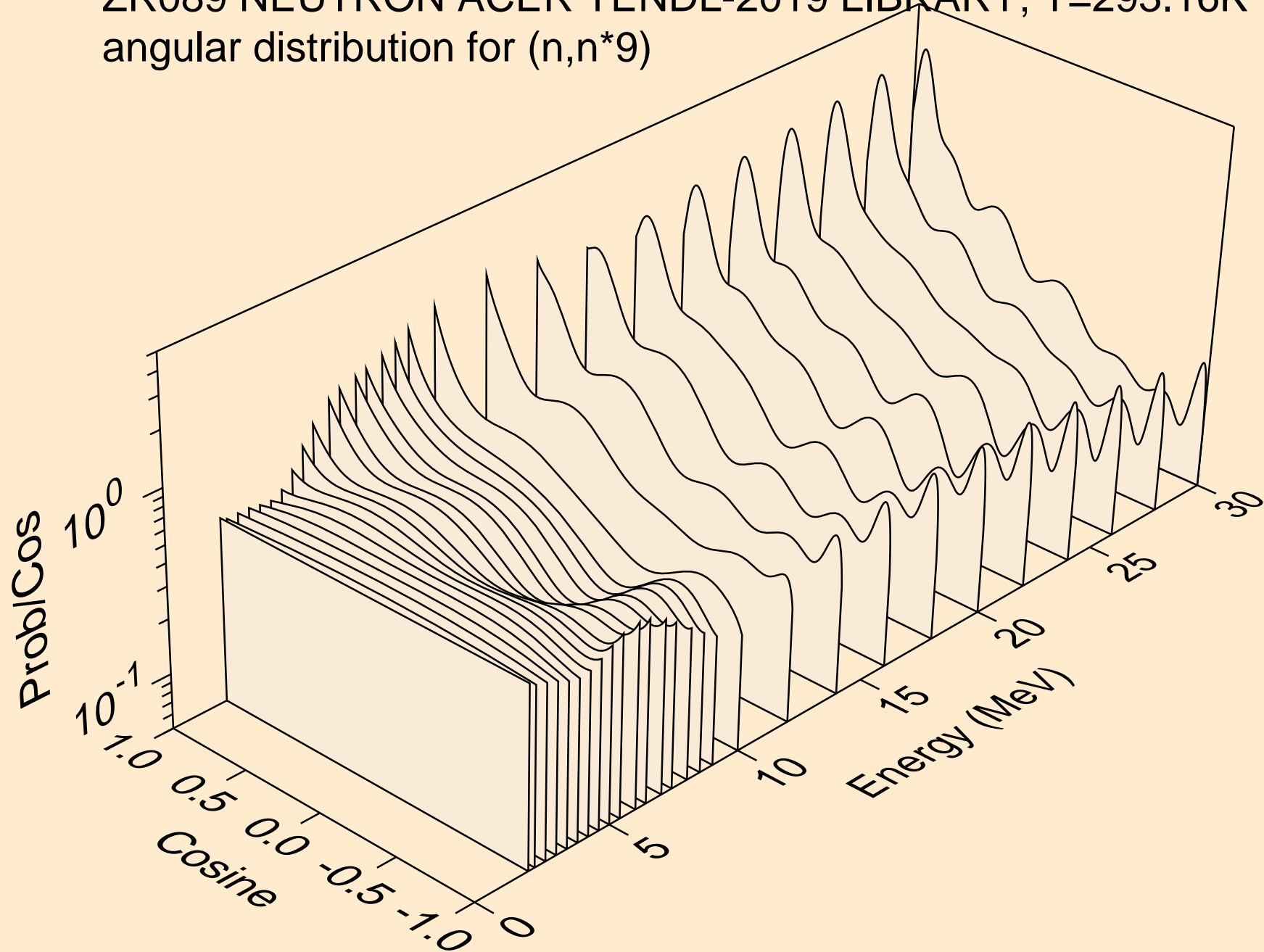

ZR089 NEUTRON ACER TENDL-2019 LIBRARY; T=293.16K  
angular distribution for (n,n\*10)

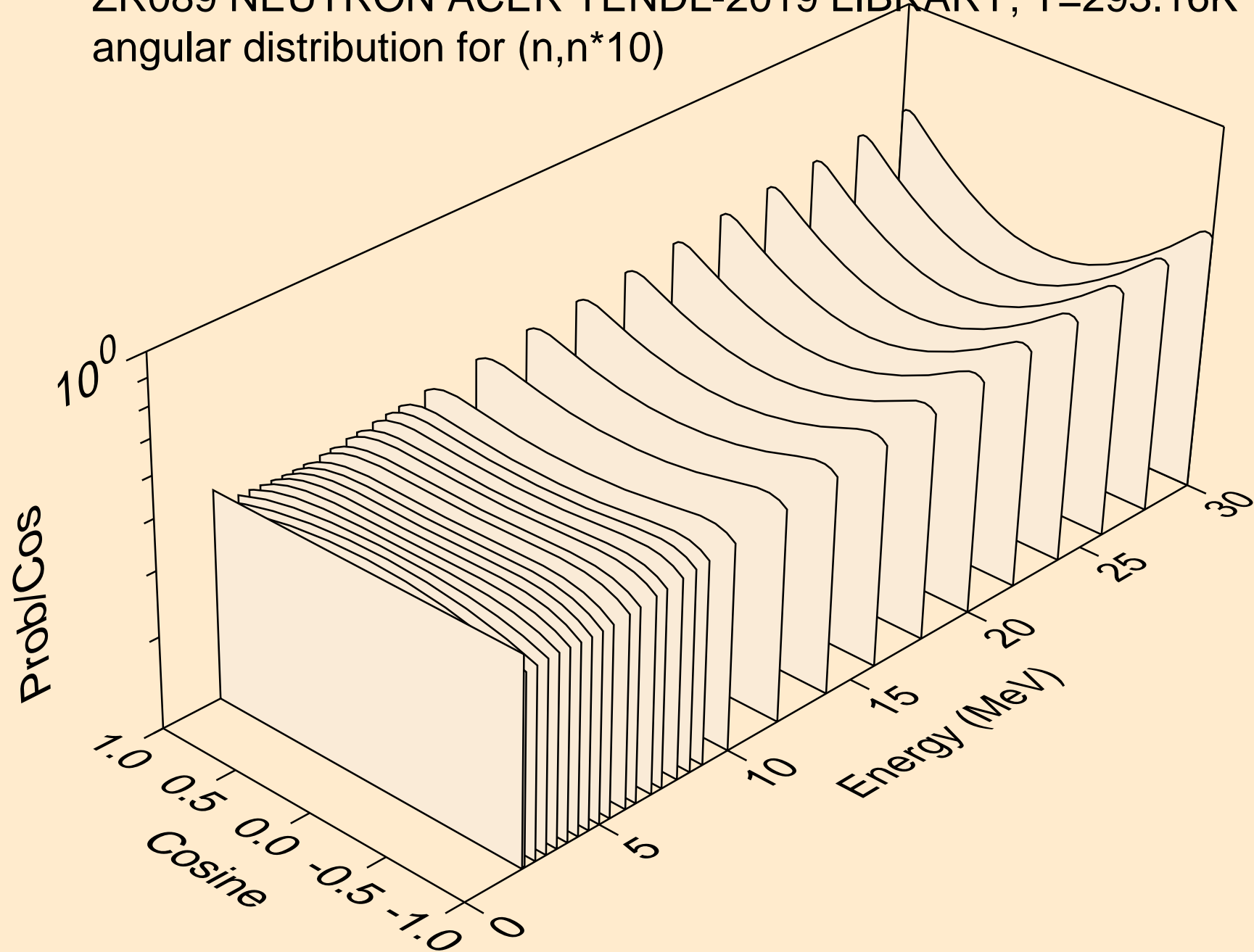



ZR089 NEUTRON ACER TENDL-2019 LIBRARY; T=293.16K  
angular distribution for (n,n\*11)

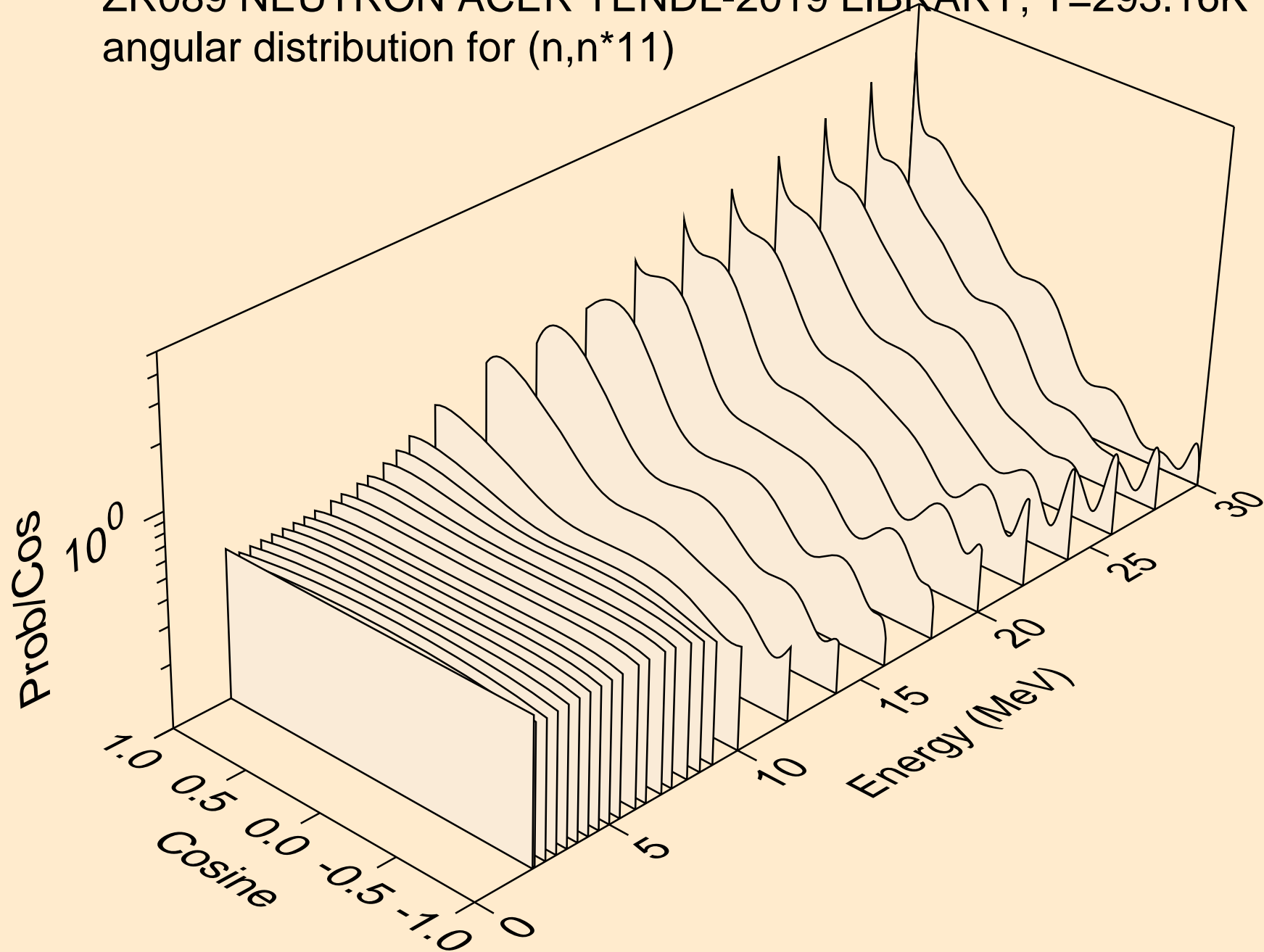

ZR089 NEUTRON ACER TENDL-2019 LIBRARY; T=293.16K  
angular distribution for (n,n\*12)

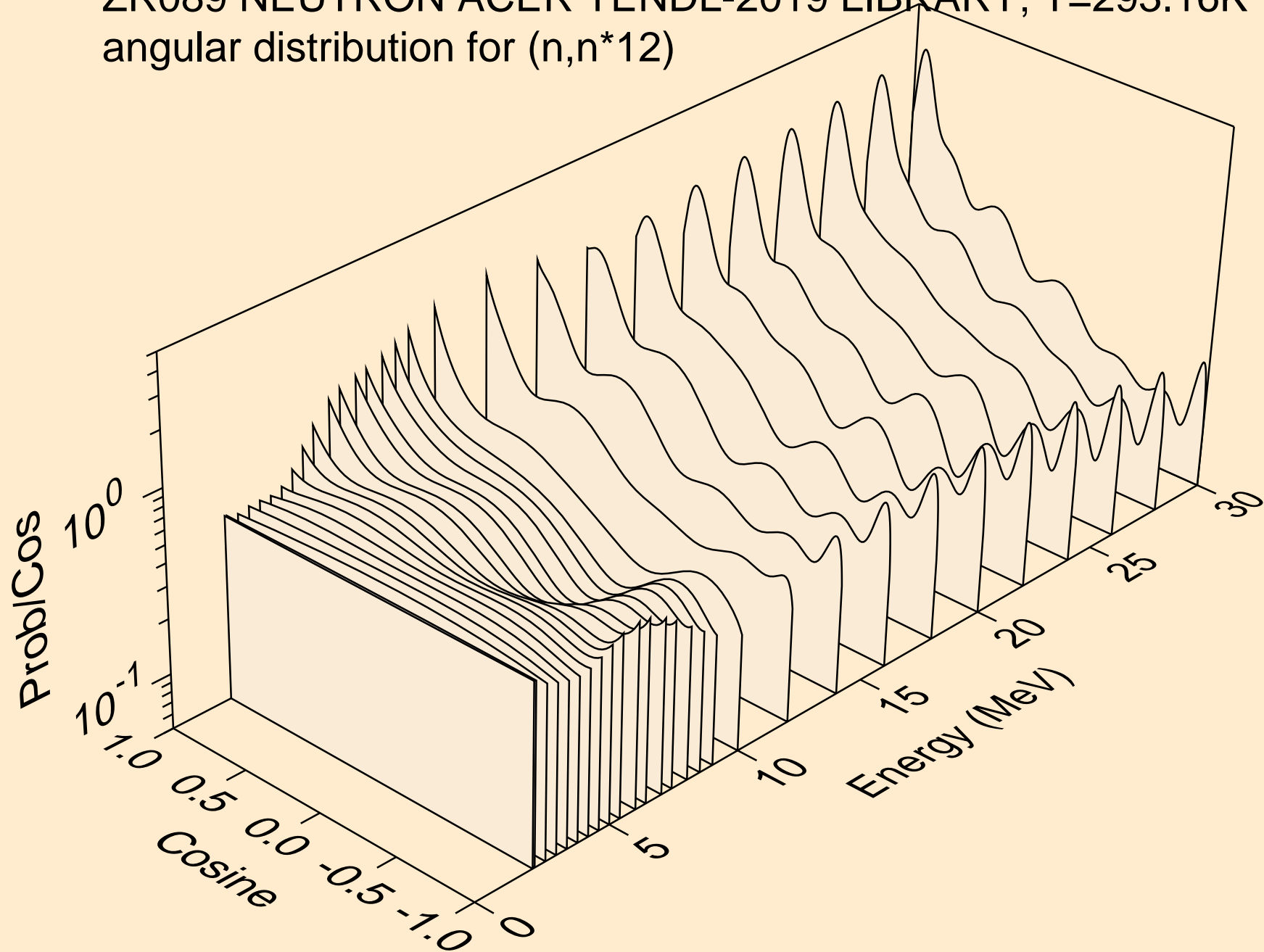

ZR089 NEUTRON ACER TENDL-2019 LIBRARY; T=293.16K  
angular distribution for (n,n\*13)

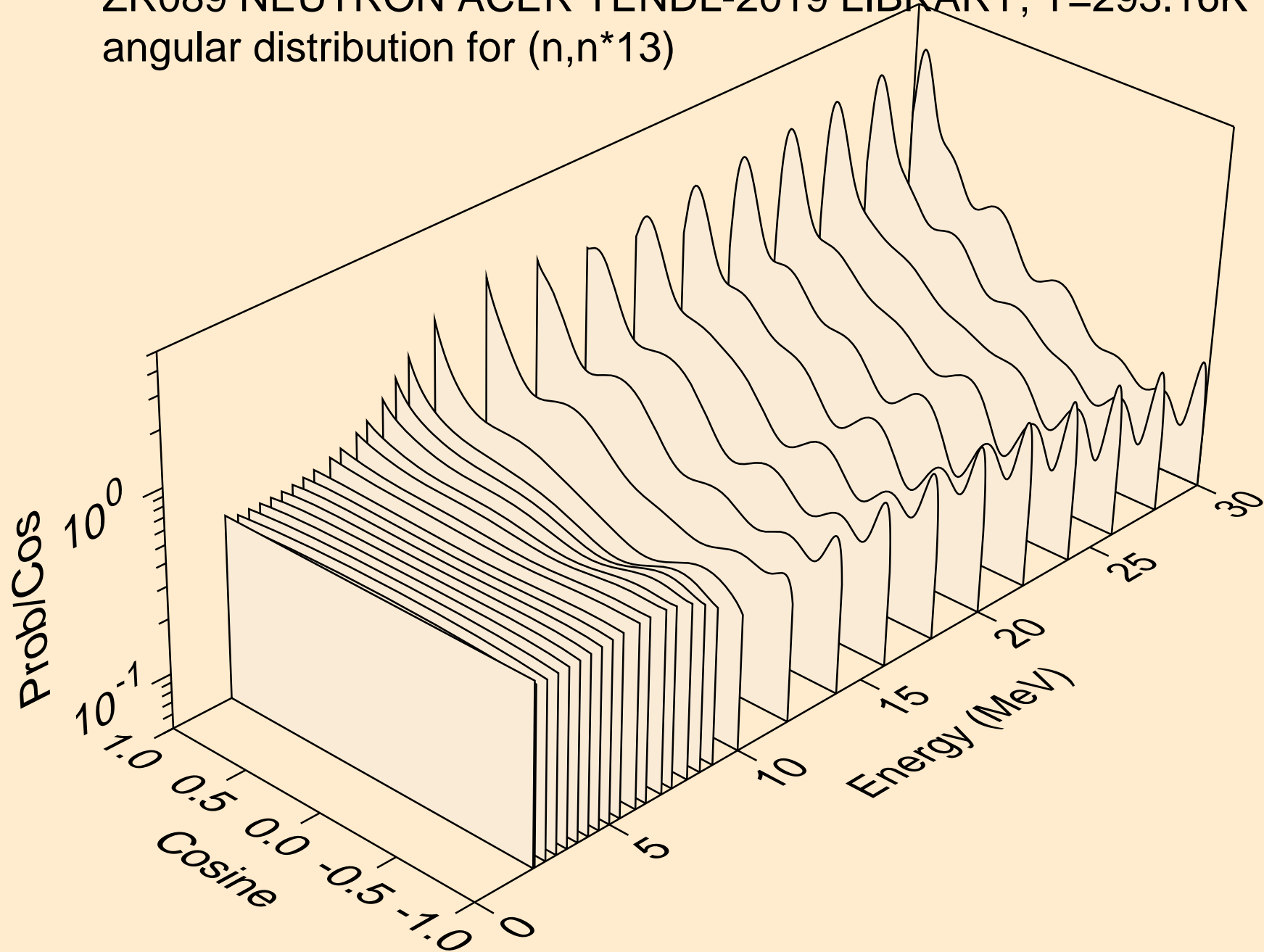

ZR089 NEUTRON ACER TENDL-2019 LIBRARY; T=293.16K  
angular distribution for (n,n\*14)

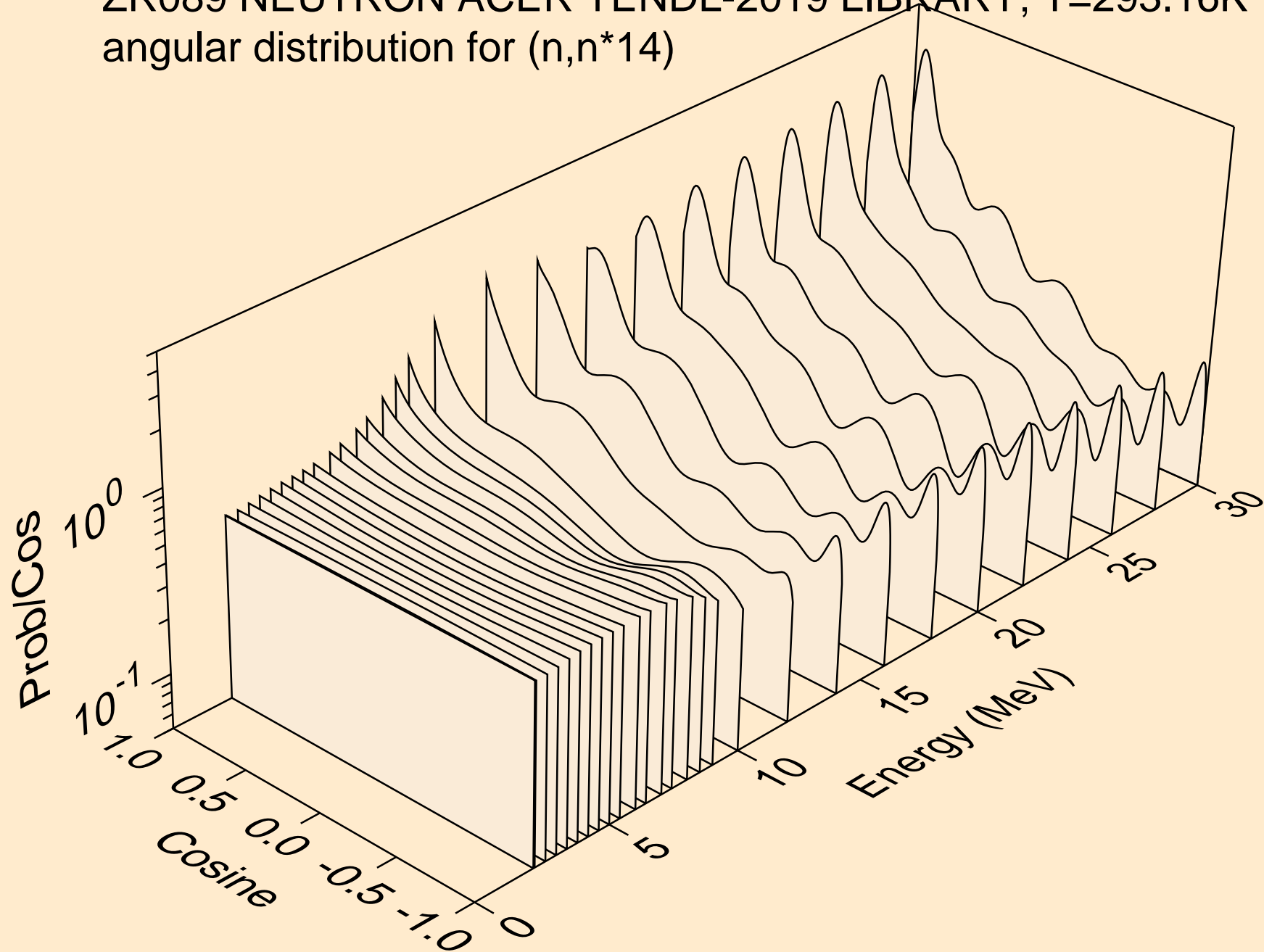

ZR089 NEUTRON ACER TENDL-2019 LIBRARY; T=293.16K  
angular distribution for (n,n\*15)

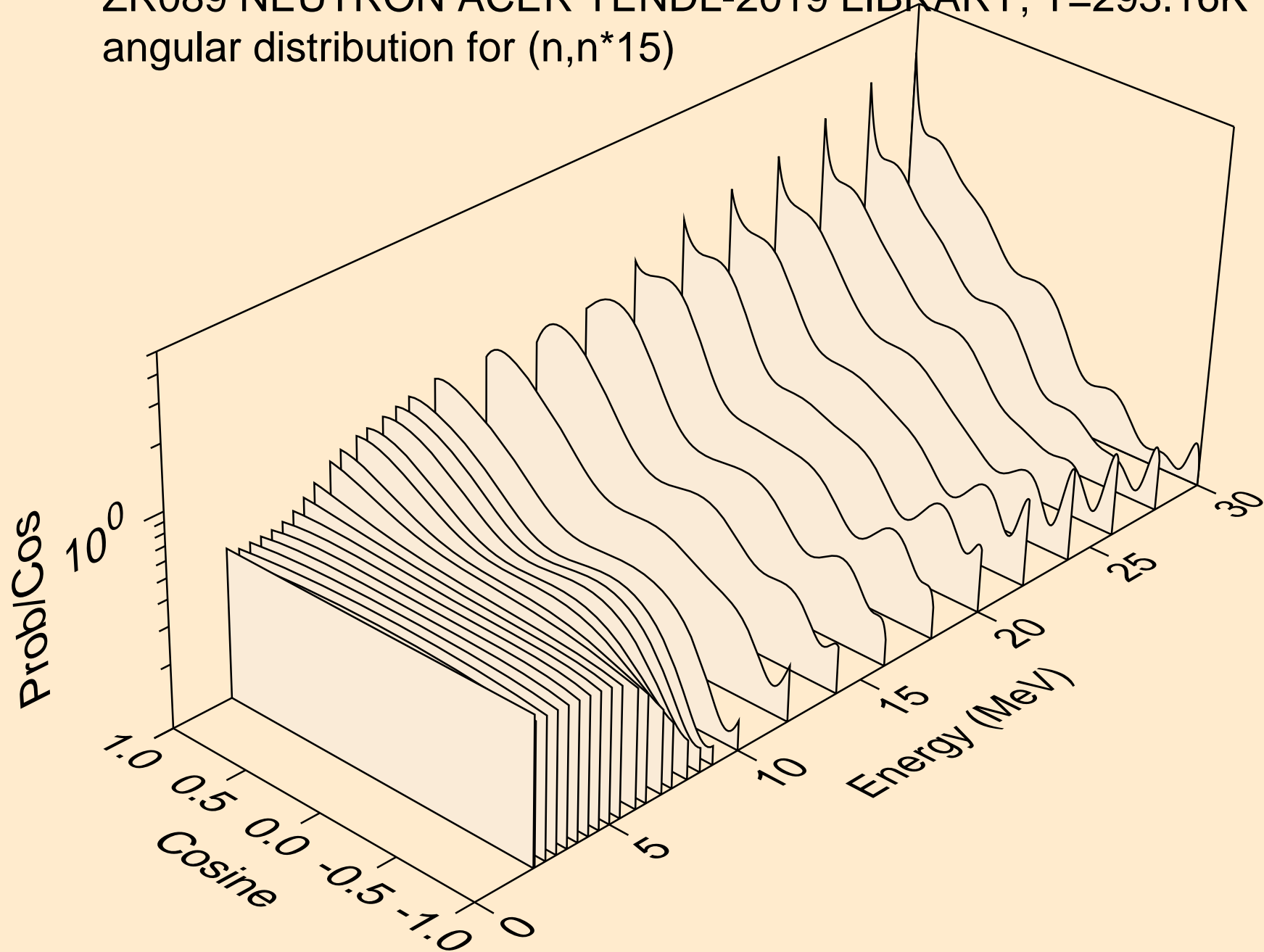

ZR089 NEUTRON ACER TENDL-2019 LIBRARY; T=293.16K  
angular distribution for (n,n\*16)

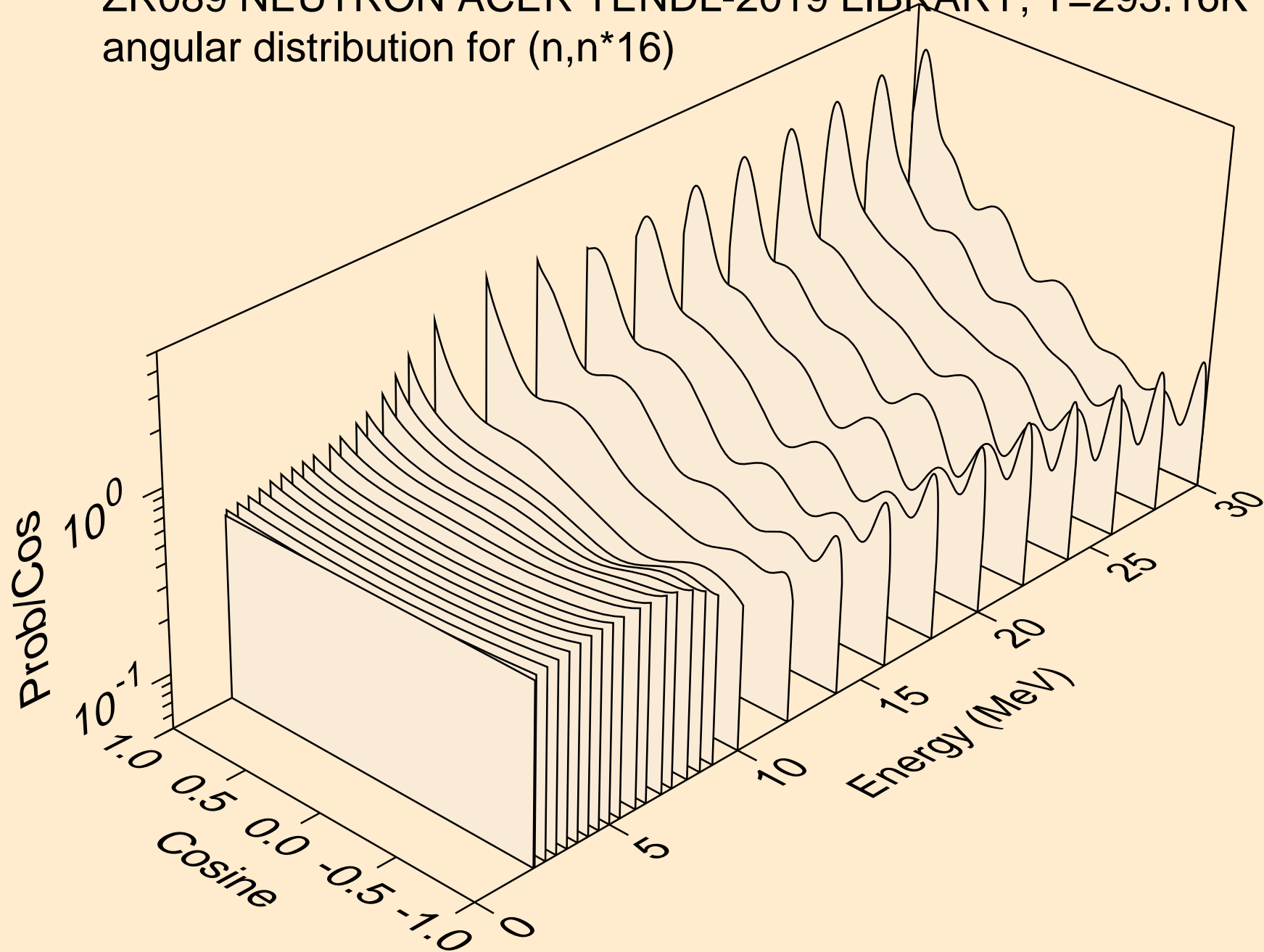

ZR089 NEUTRON ACER TENDL-2019 LIBRARY; T=293.16K  
angular distribution for (n,n\*17)

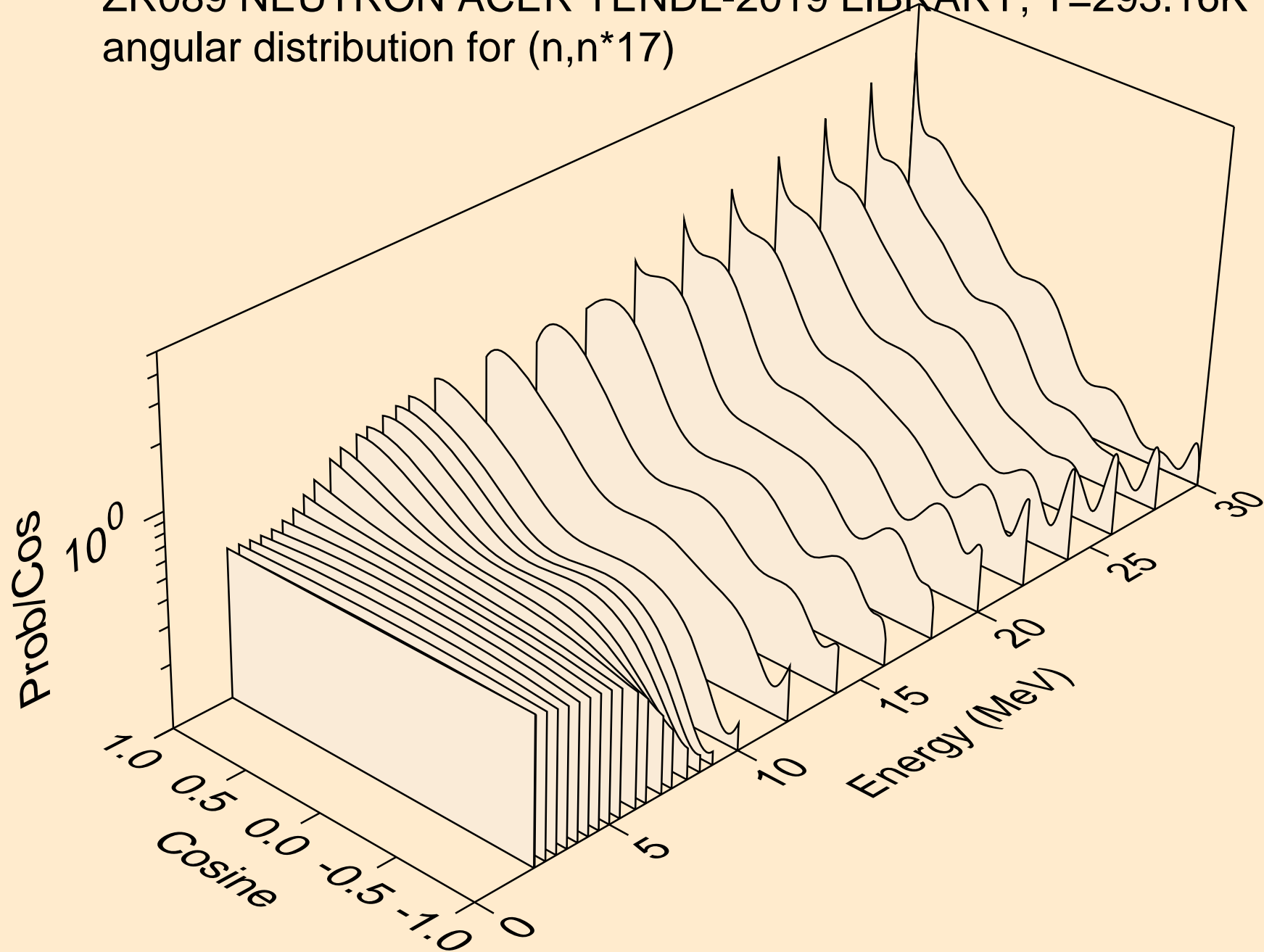

ZR089 NEUTRON ACER TENDL-2019 LIBRARY; T=293.16K  
angular distribution for (n,n\*18)

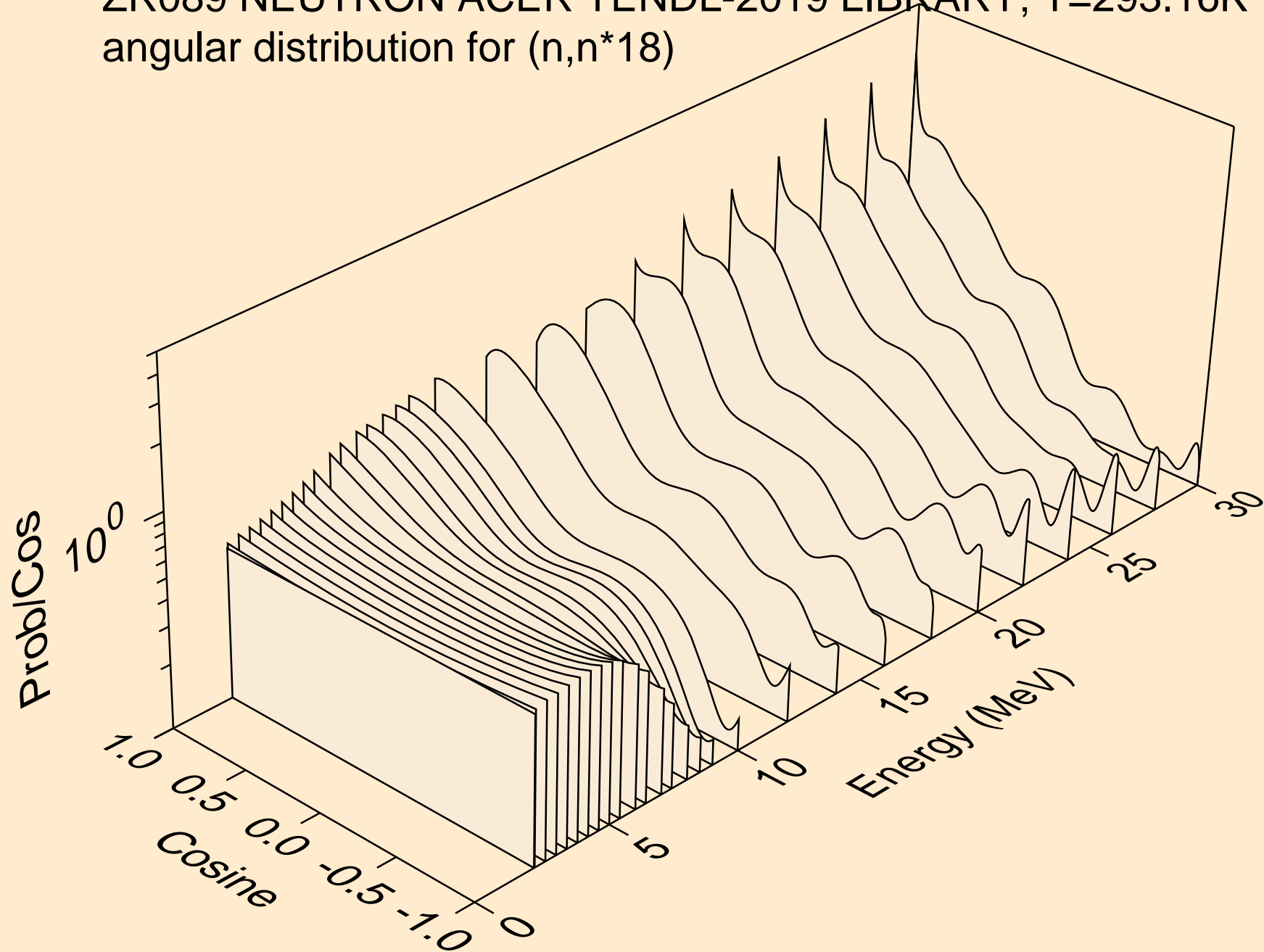



ZR089 NEUTRON ACER TENDL-2019 LIBRARY; T=293.16K  
angular distribution for (n,n\*19)

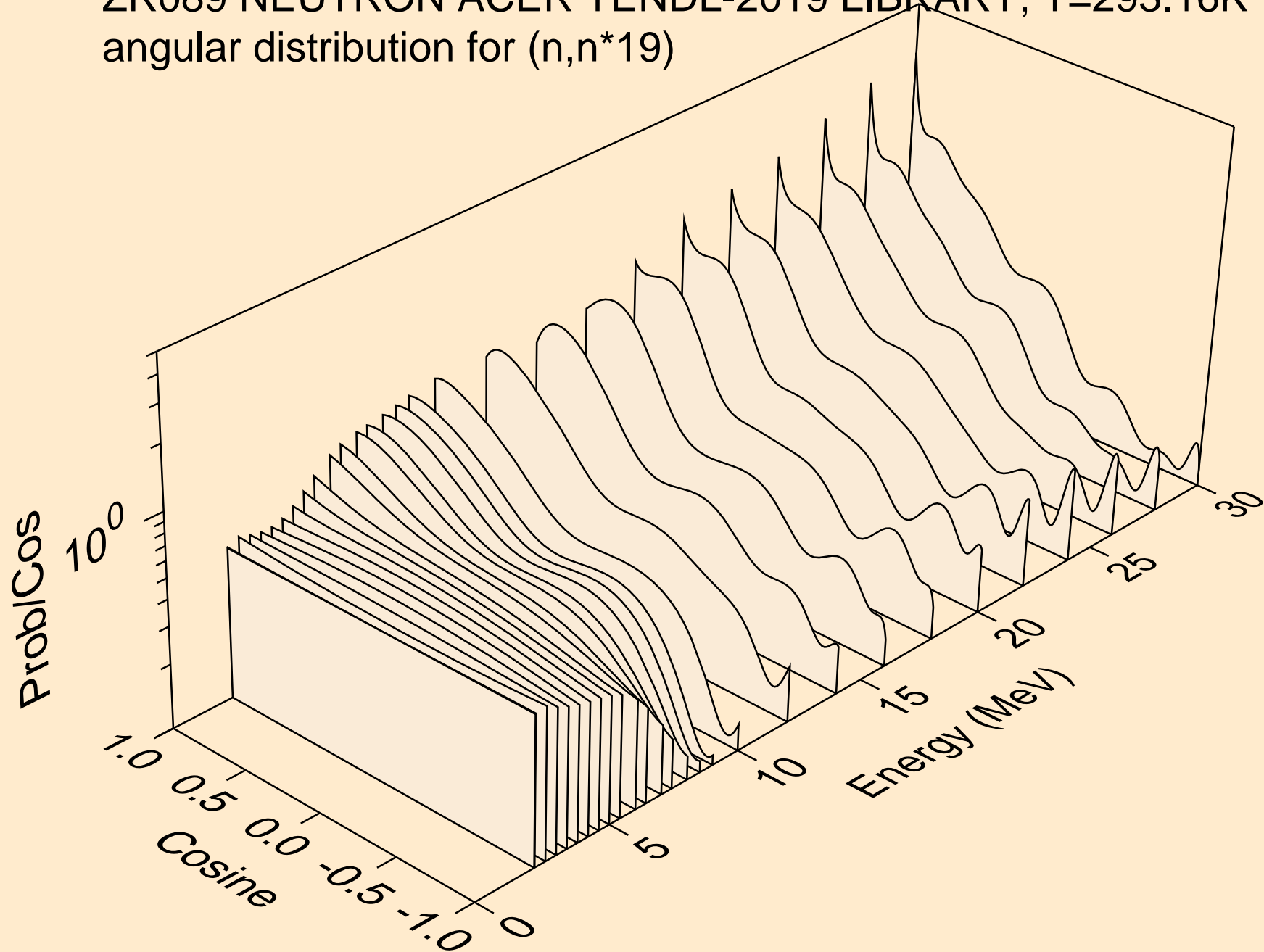

ZR089 NEUTRON ACER TENDL-2019 LIBRARY; T=293.16K  
angular distribution for (n,n\*20)

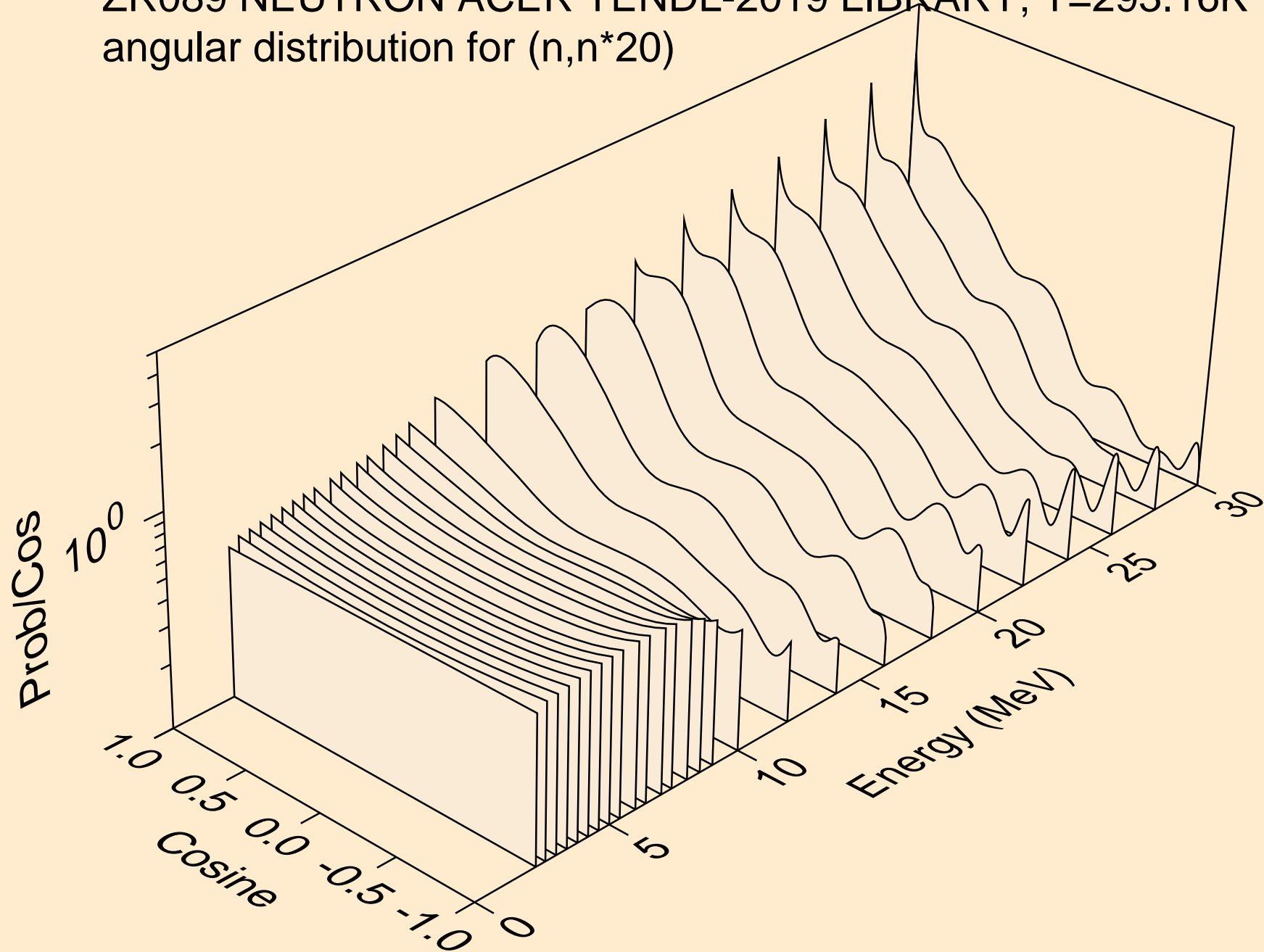

ZR089 NEUTRON ACER TENDL-2019 LIBRARY; T=293.16K  
angular distribution for (n,n\*21)

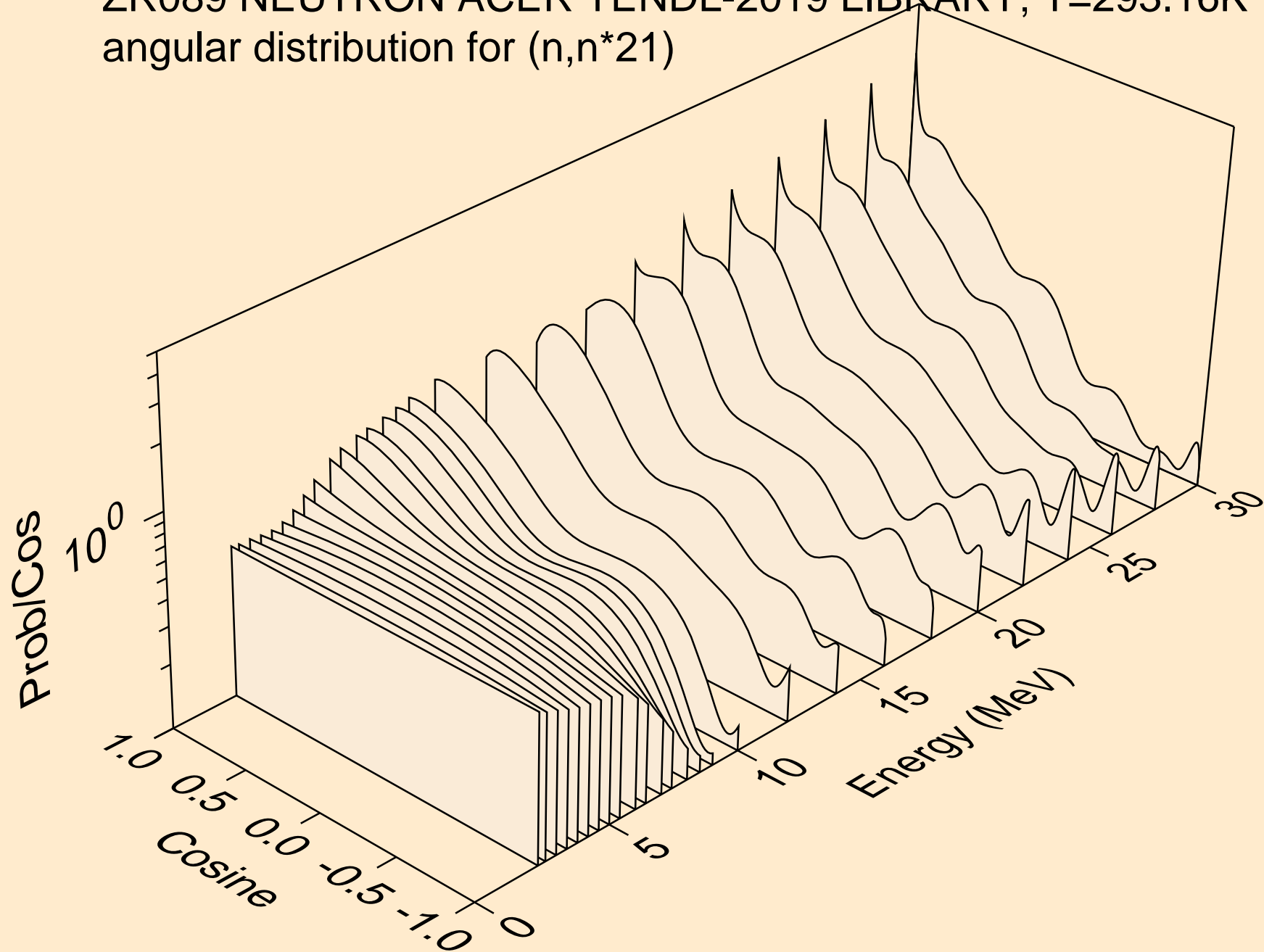

ZR089 NEUTRON ACER TENDL-2019 LIBRARY; T=293.16K  
angular distribution for (n,n\*22)

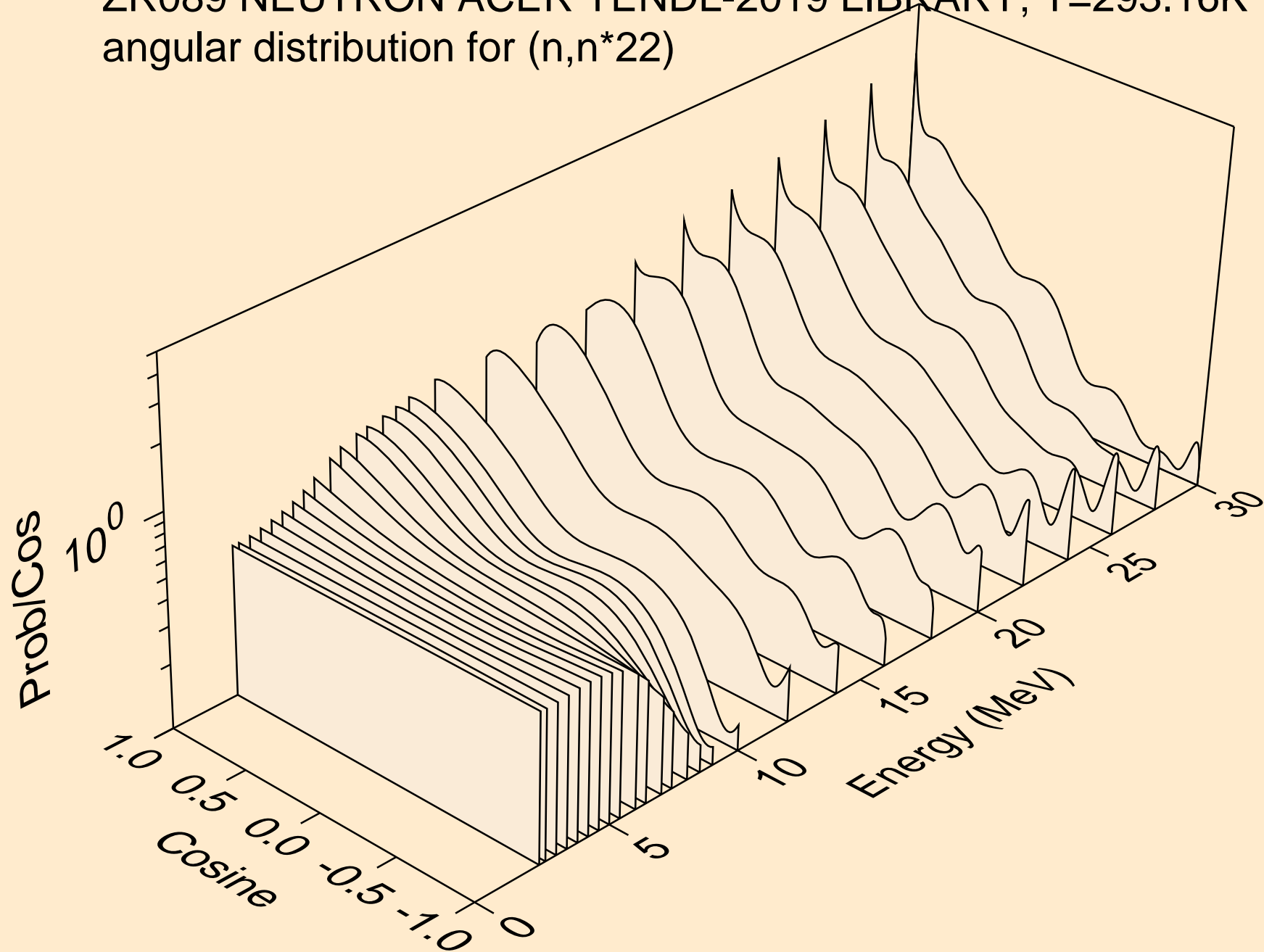

ZR089 NEUTRON ACER TENDL-2019 LIBRARY; T=293.16K  
angular distribution for (n,n\*23)

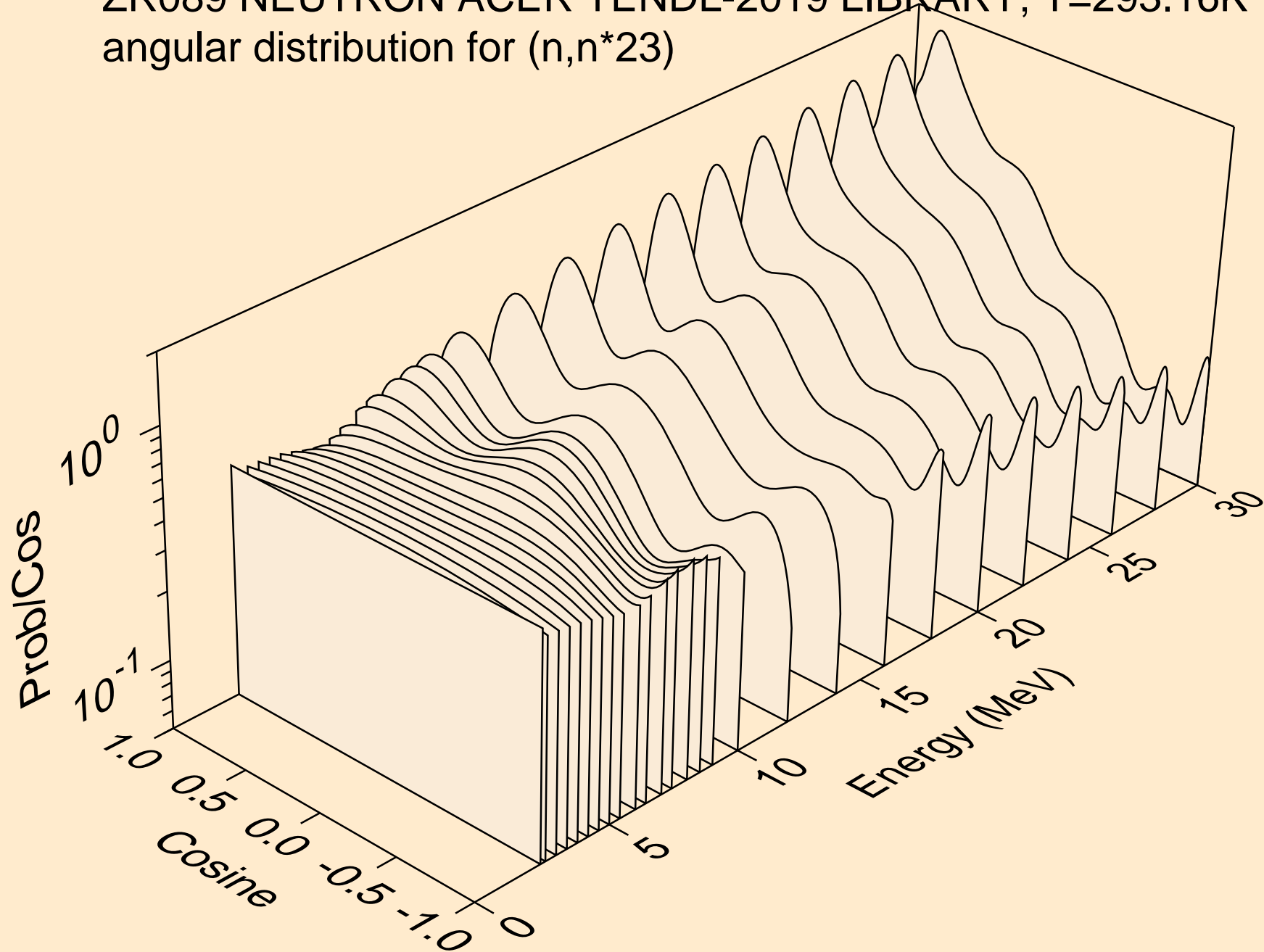

ZR089 NEUTRON ACER TENDL-2019 LIBRARY; T=293.16K  
angular distribution for (n,n\*24)

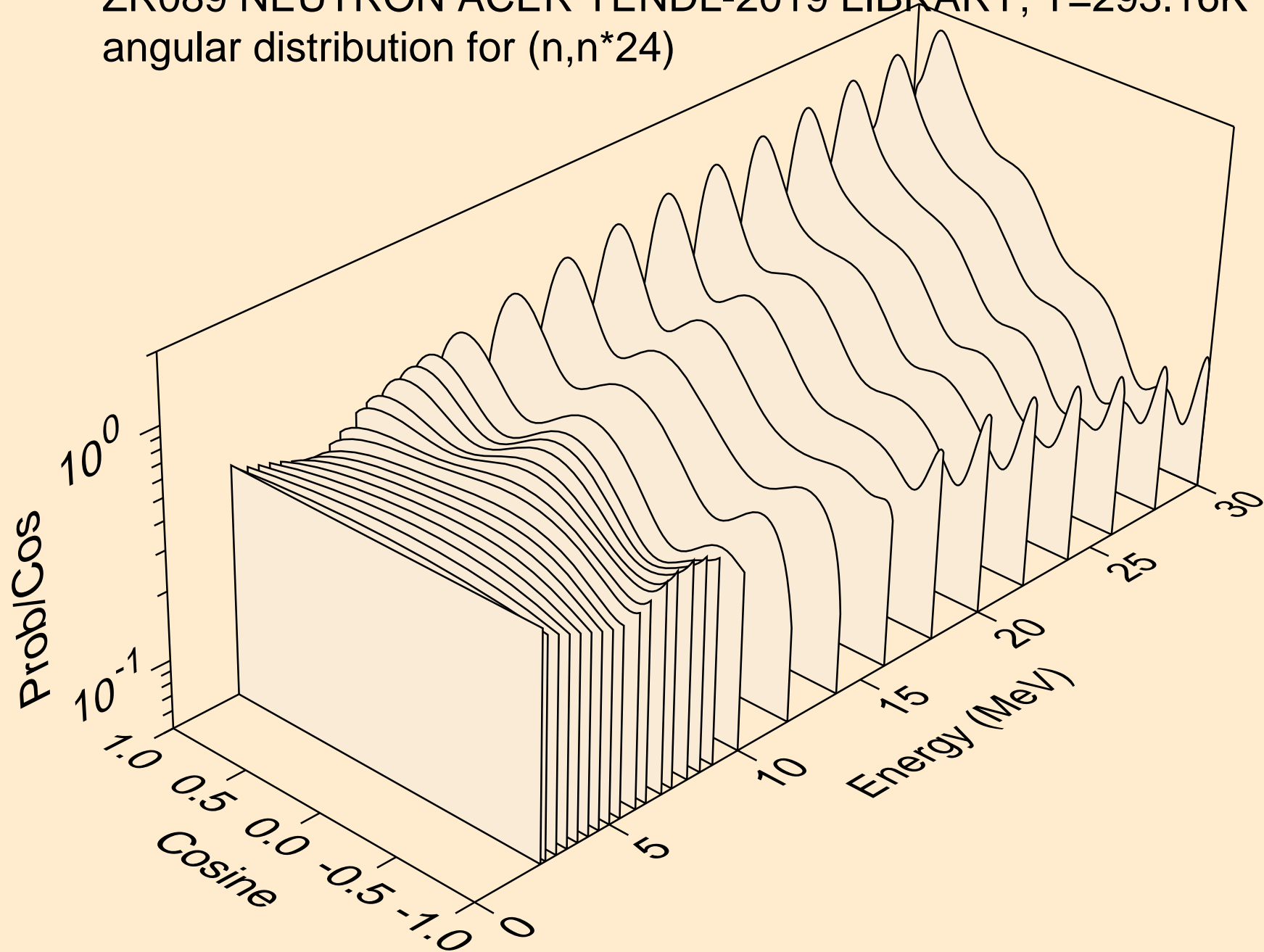

ZR089 NEUTRON ACER TENDL-2019 LIBRARY; T=293.16K  
angular distribution for (n,n\*25)

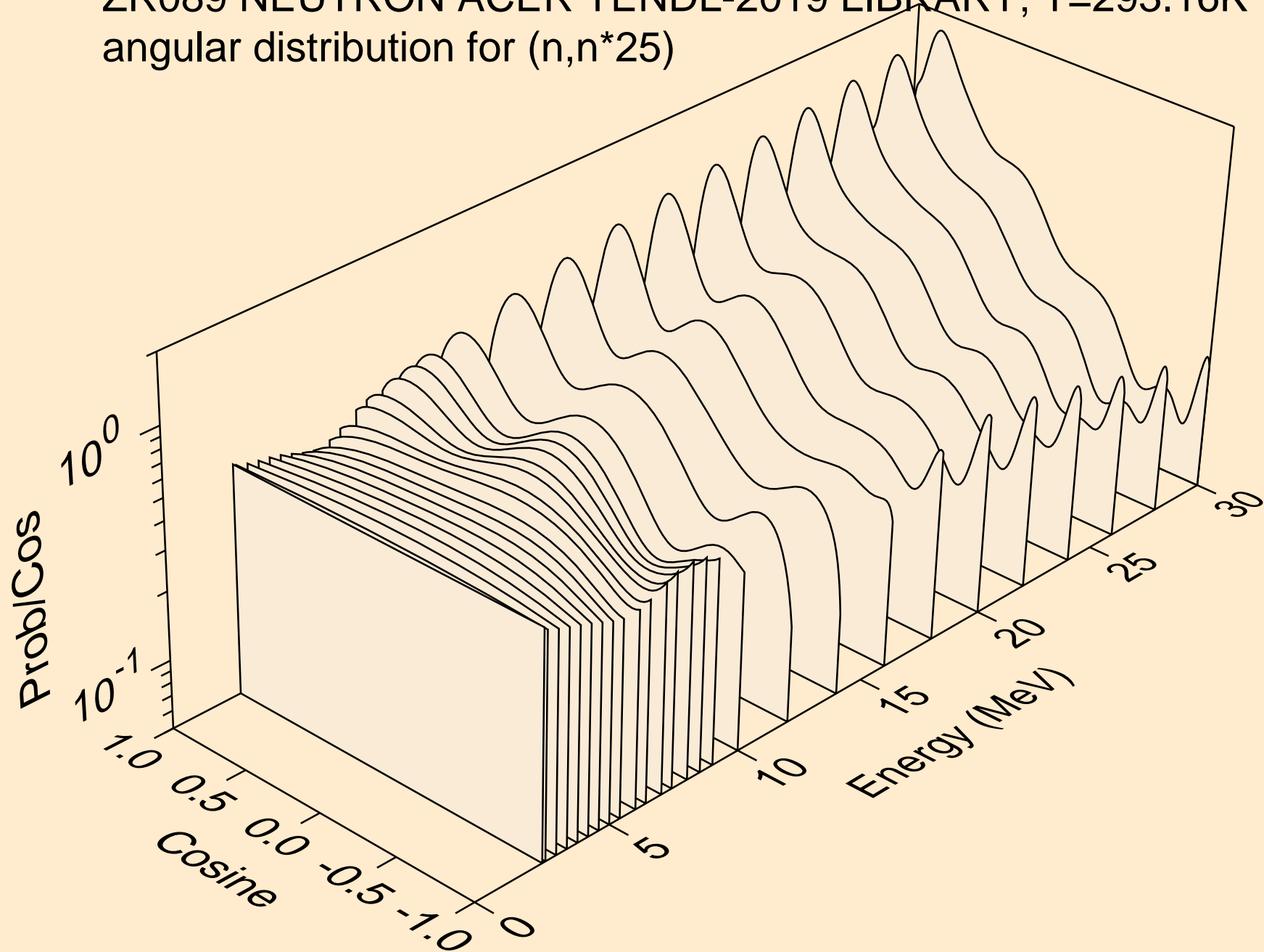

ZR089 NEUTRON ACER TENDL-2019 LIBRARY; T=293.16K  
angular distribution for (n,n\*26)

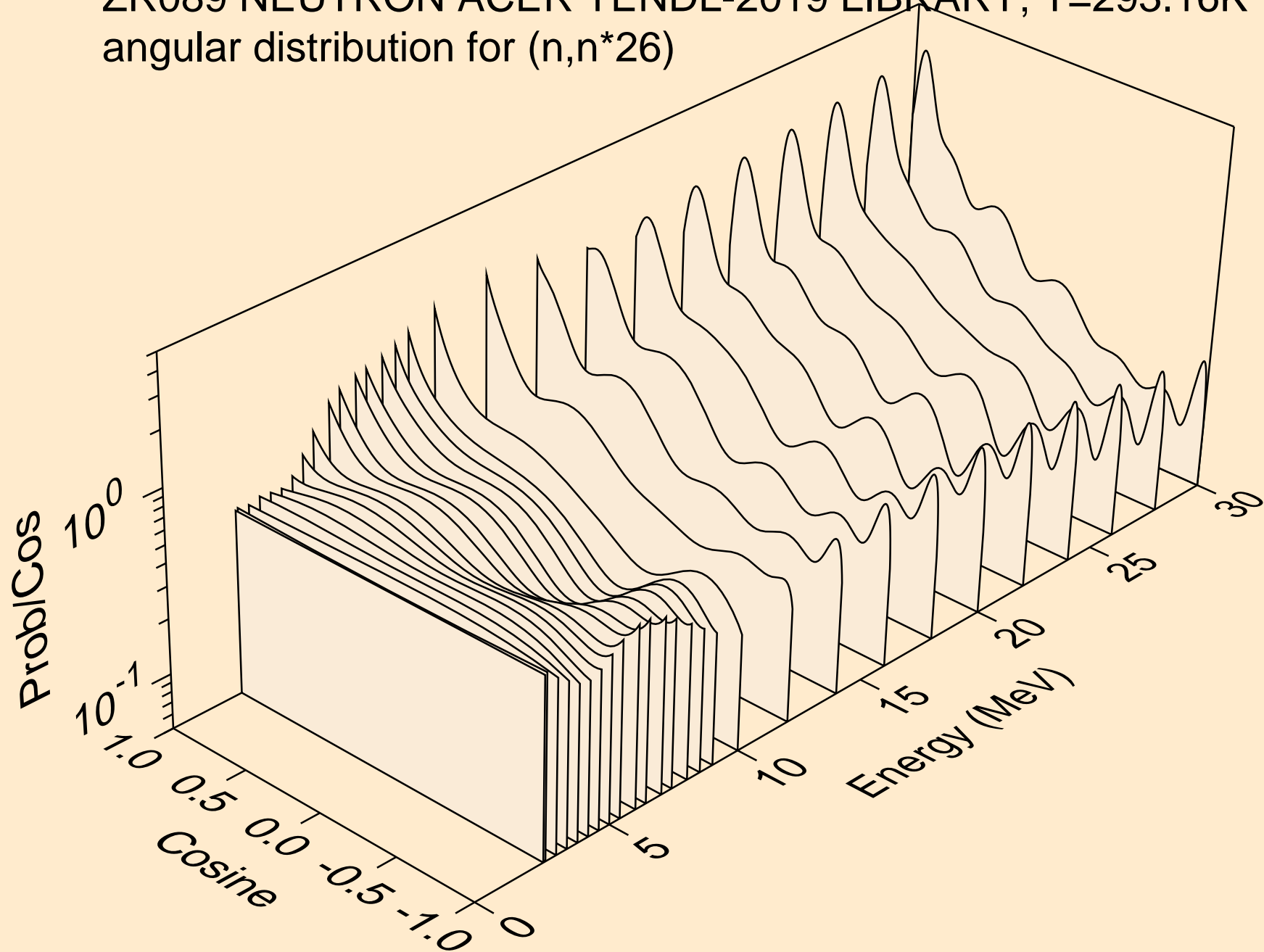



ZR089 NEUTRON ACER TENDL-2019 LIBRARY; T=293.16K  
angular distribution for (n,n\*27)

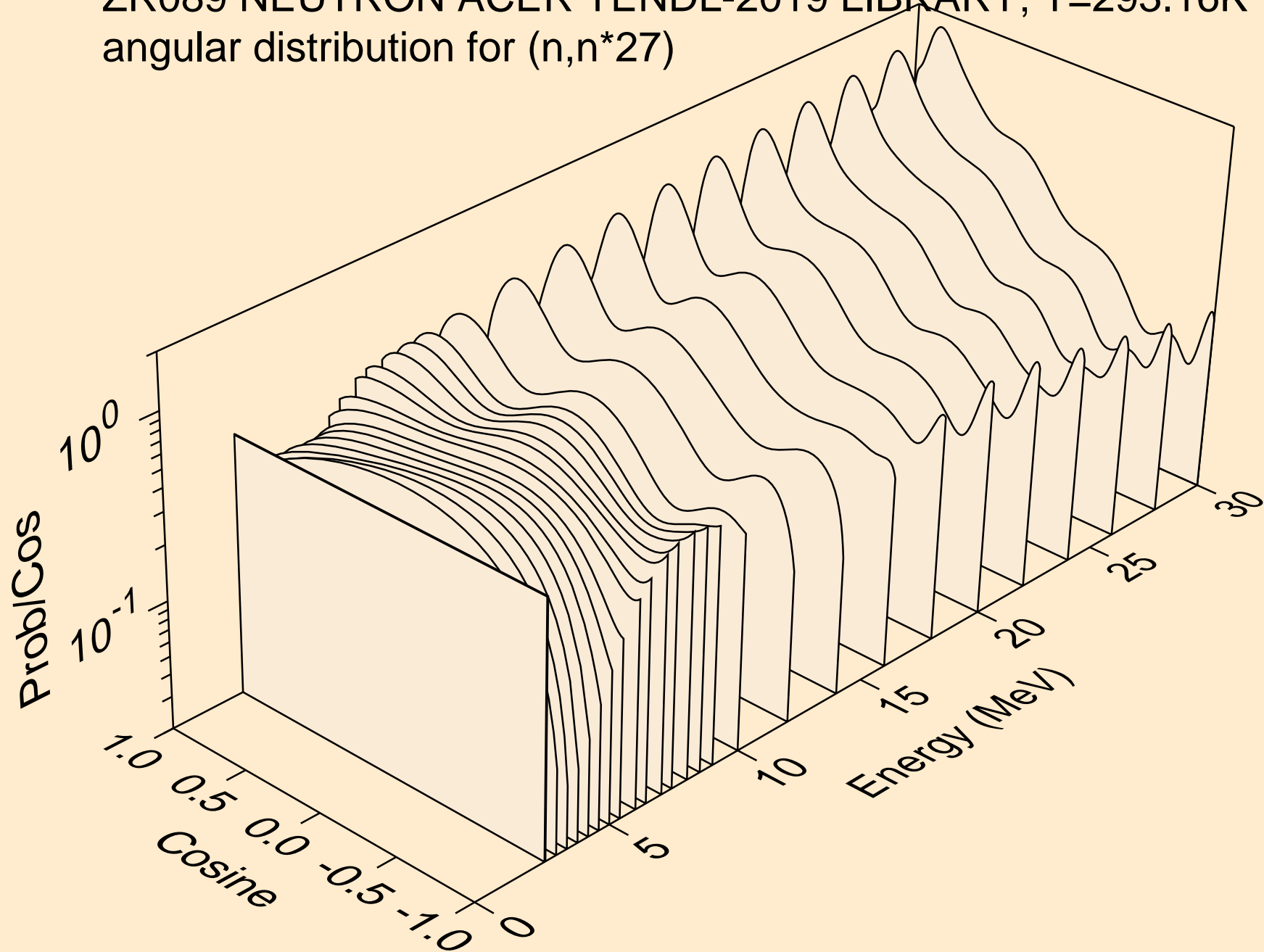

ZR089 NEUTRON ACER TENDL-2019 LIBRARY; T=293.16K  
angular distribution for (n,n\*28)

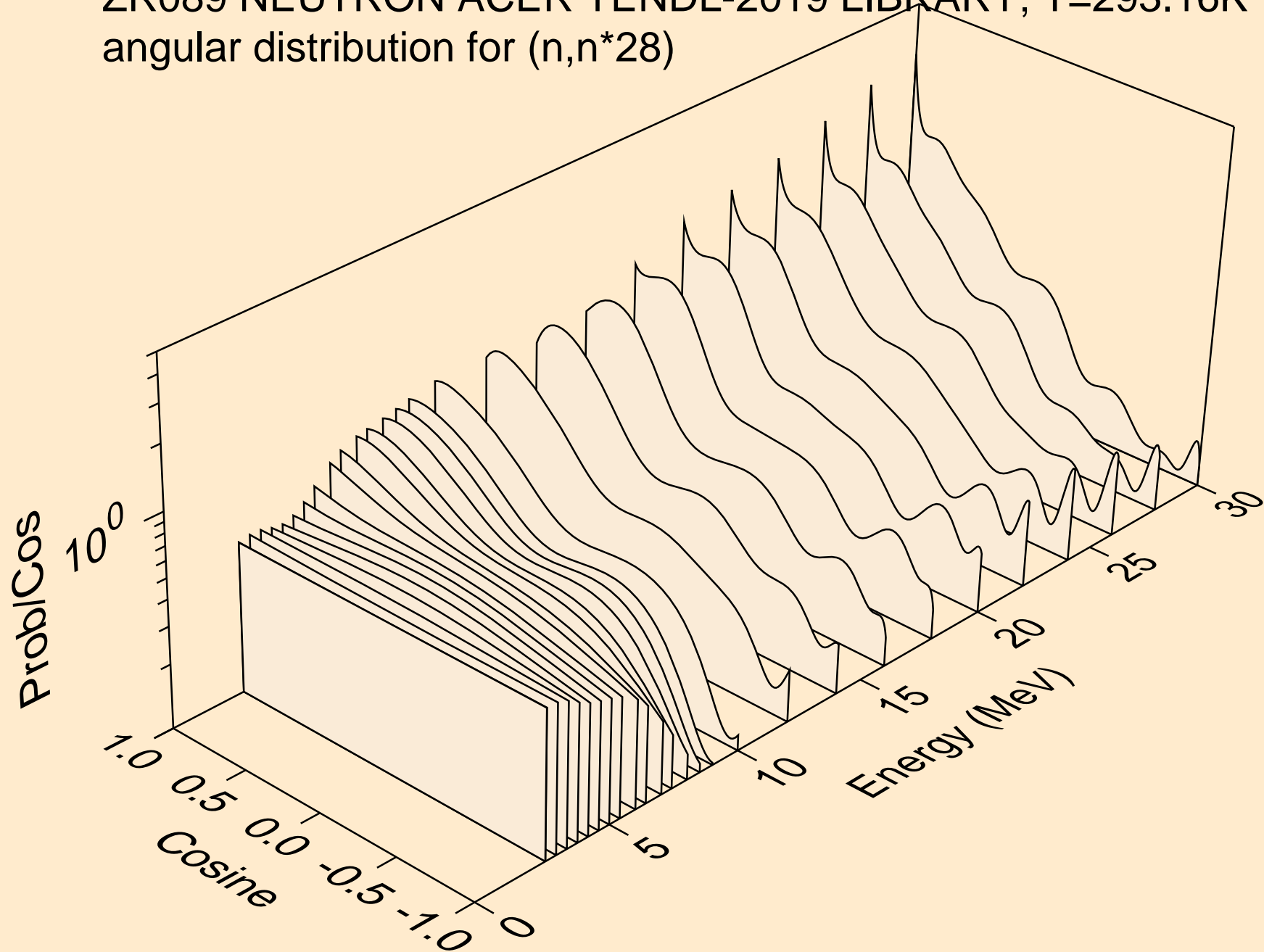

ZR089 NEUTRON ACER TENDL-2019 LIBRARY; T=293.16K  
angular distribution for (n,n\*29)

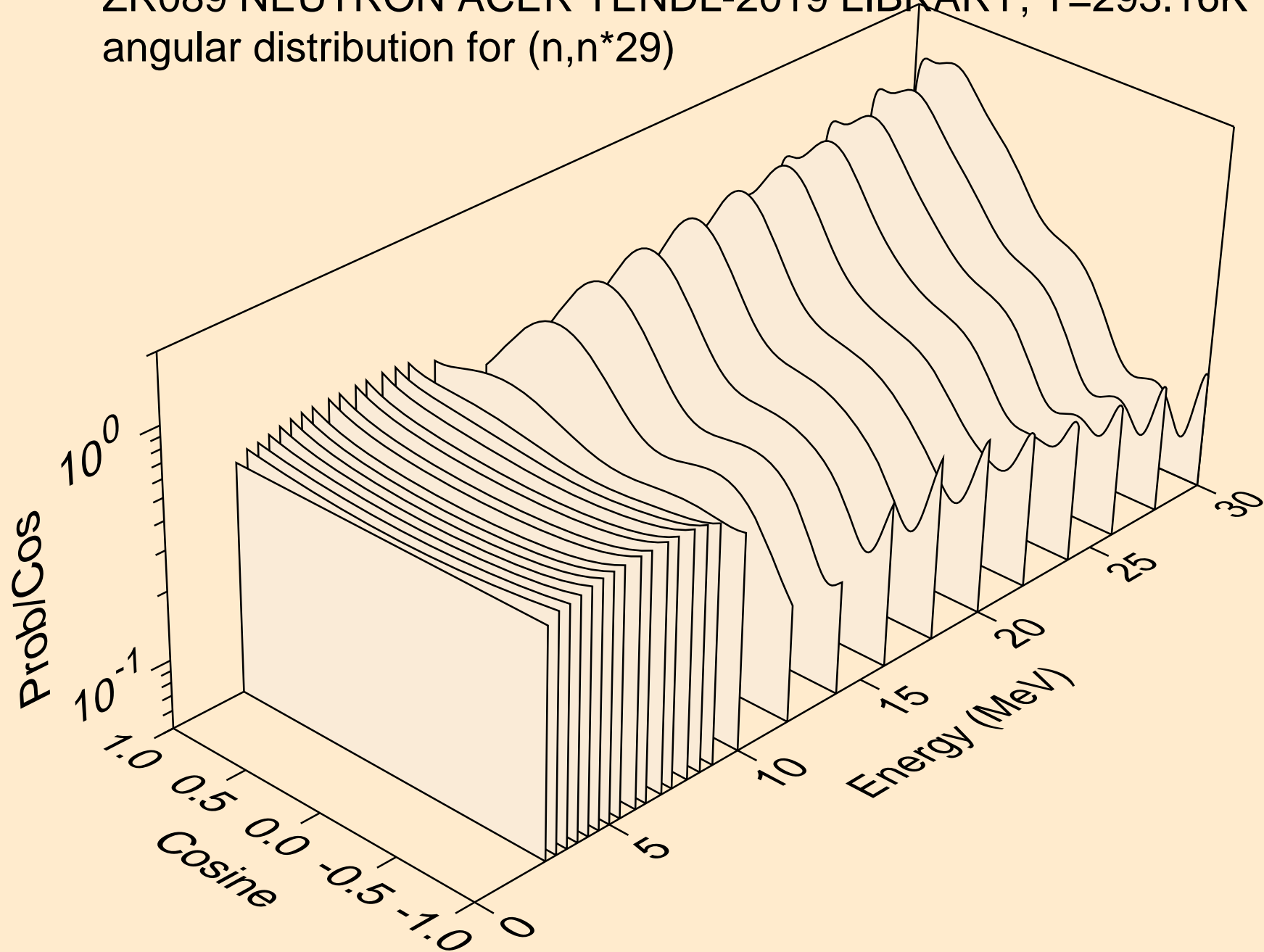

ZR089 NEUTRON ACER TENDL-2019 LIBRARY; T=293.16K  
angular distribution for (n,n\*30)

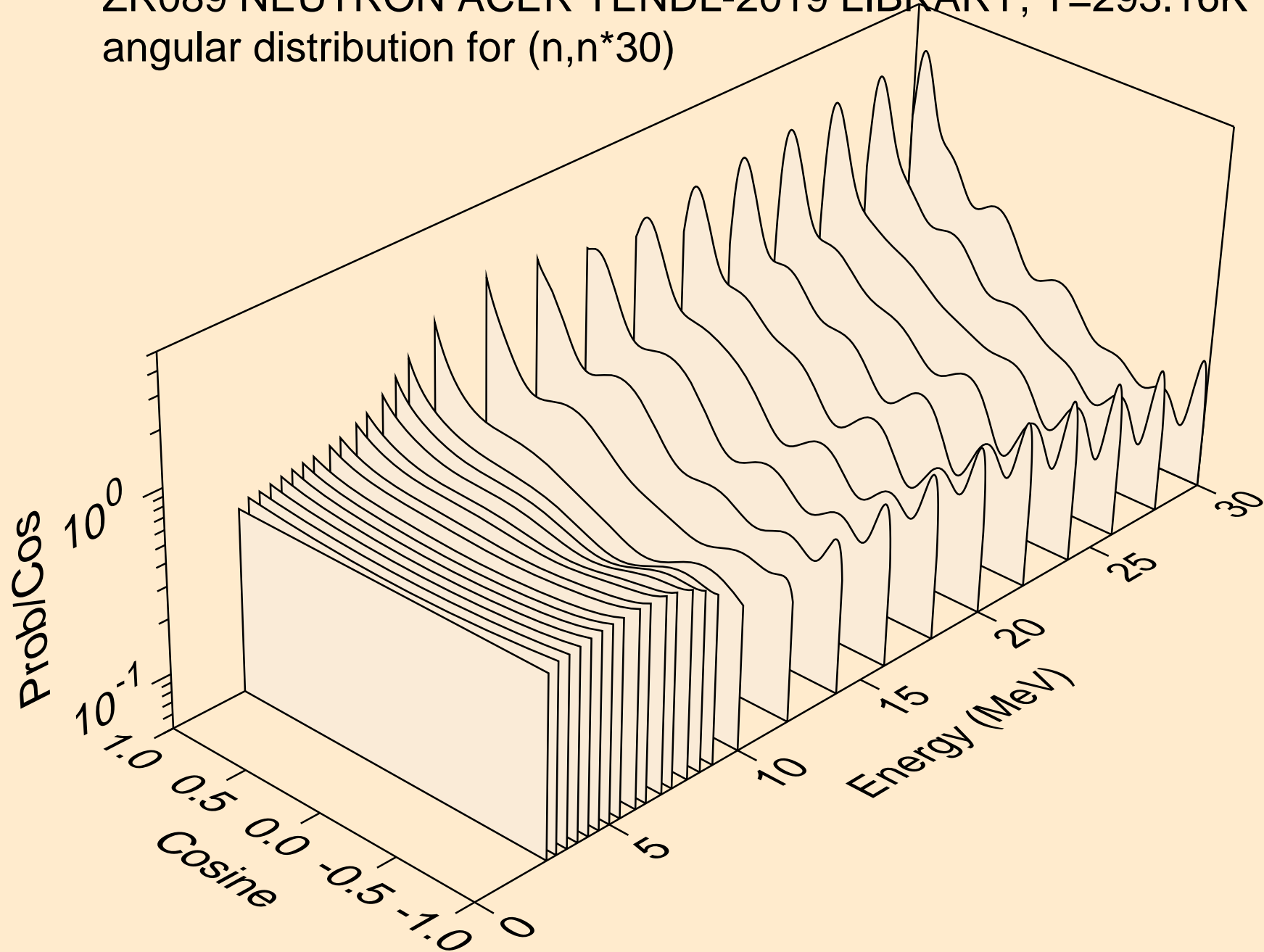

ZR089 NEUTRON ACER TENDL-2019 LIBRARY; T=293.16K  
Neutron emission for (n,x)

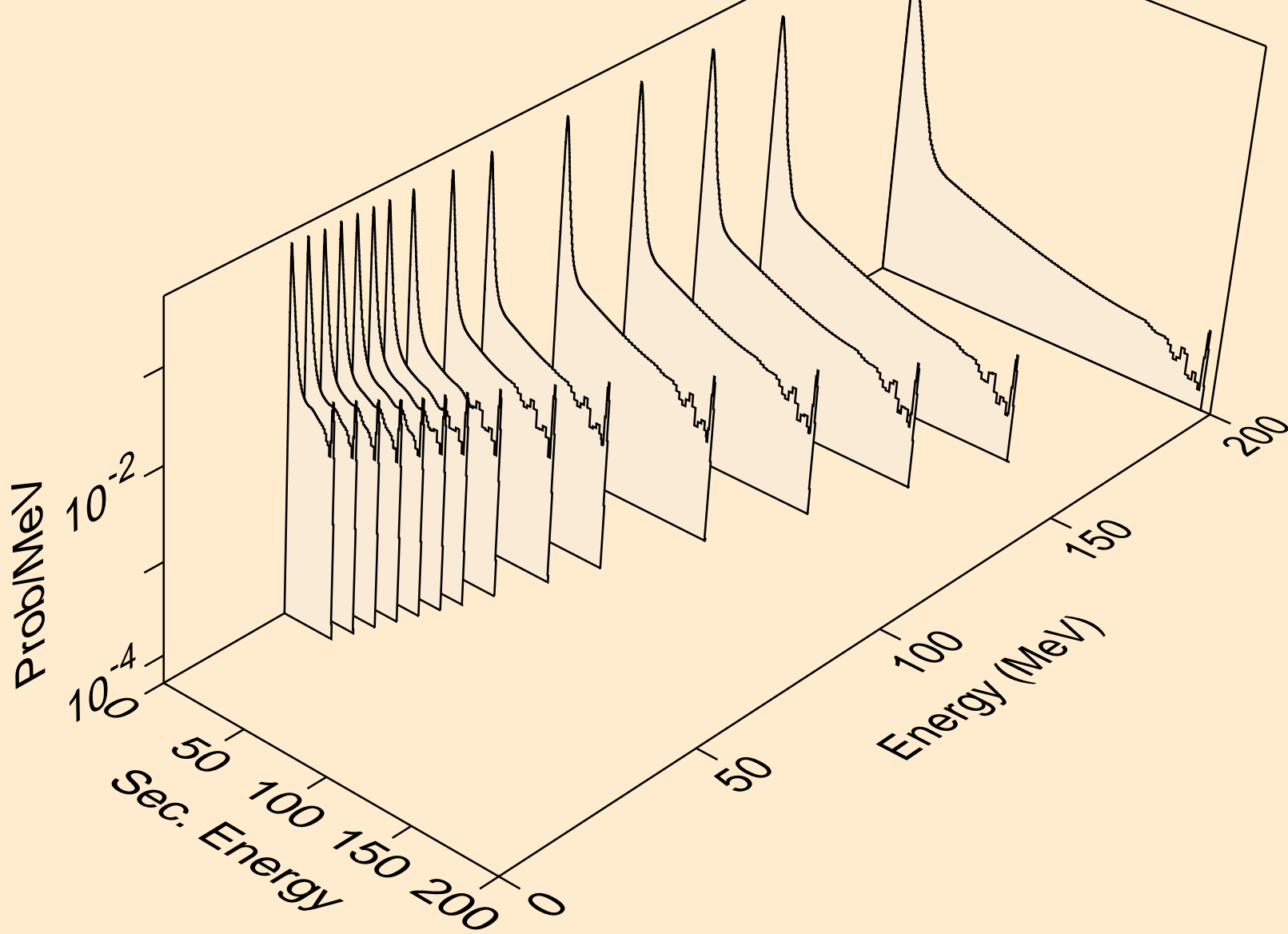

ZR089 NEUTRON ACER TENDL-2019 LIBRARY; T=293.16K  
Neutron emission for (n,2nd)

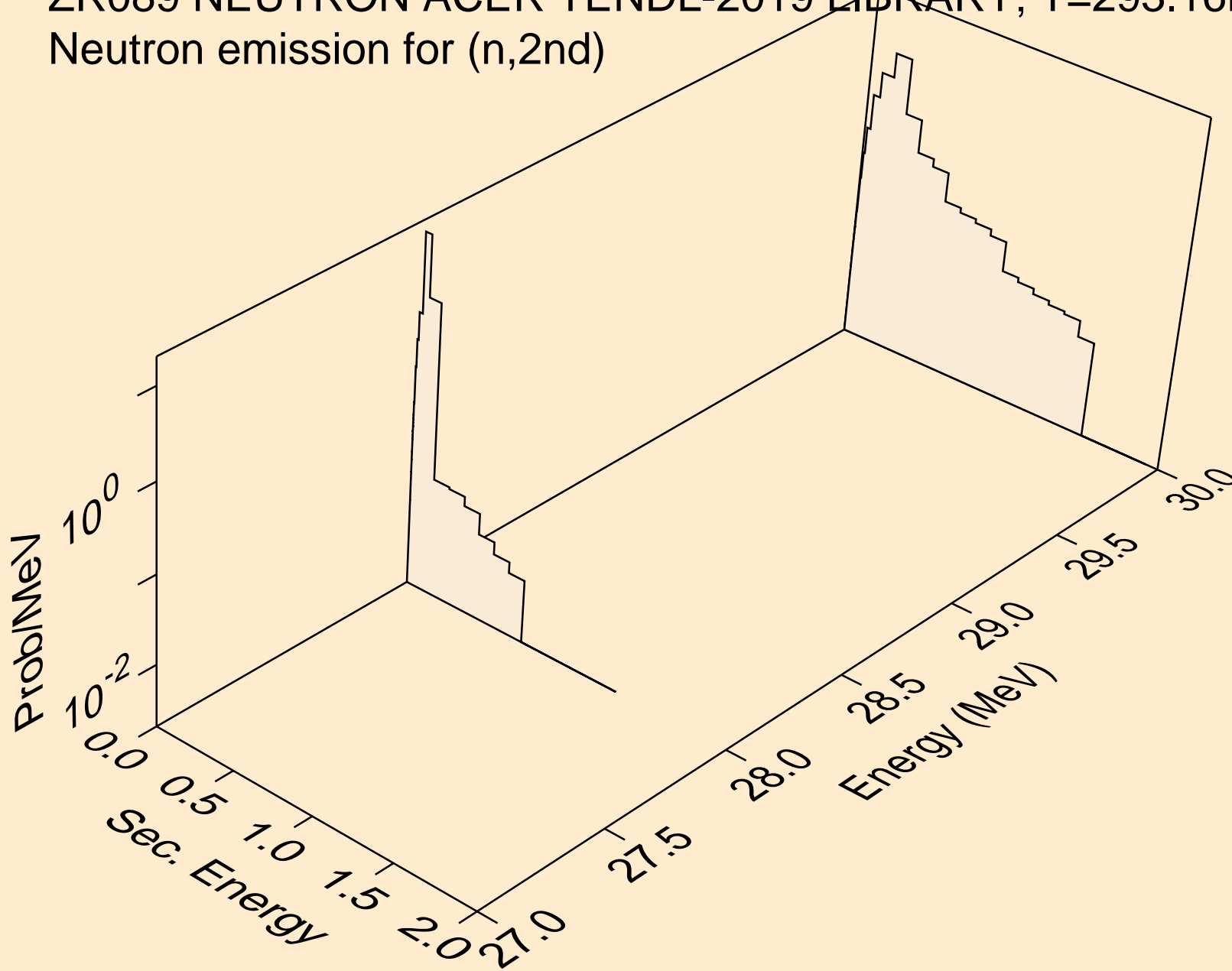

ZR089 NEUTRON ACER TENDL-2019 LIBRARY; T=293.16K  
Neutron emission for (n,2n)

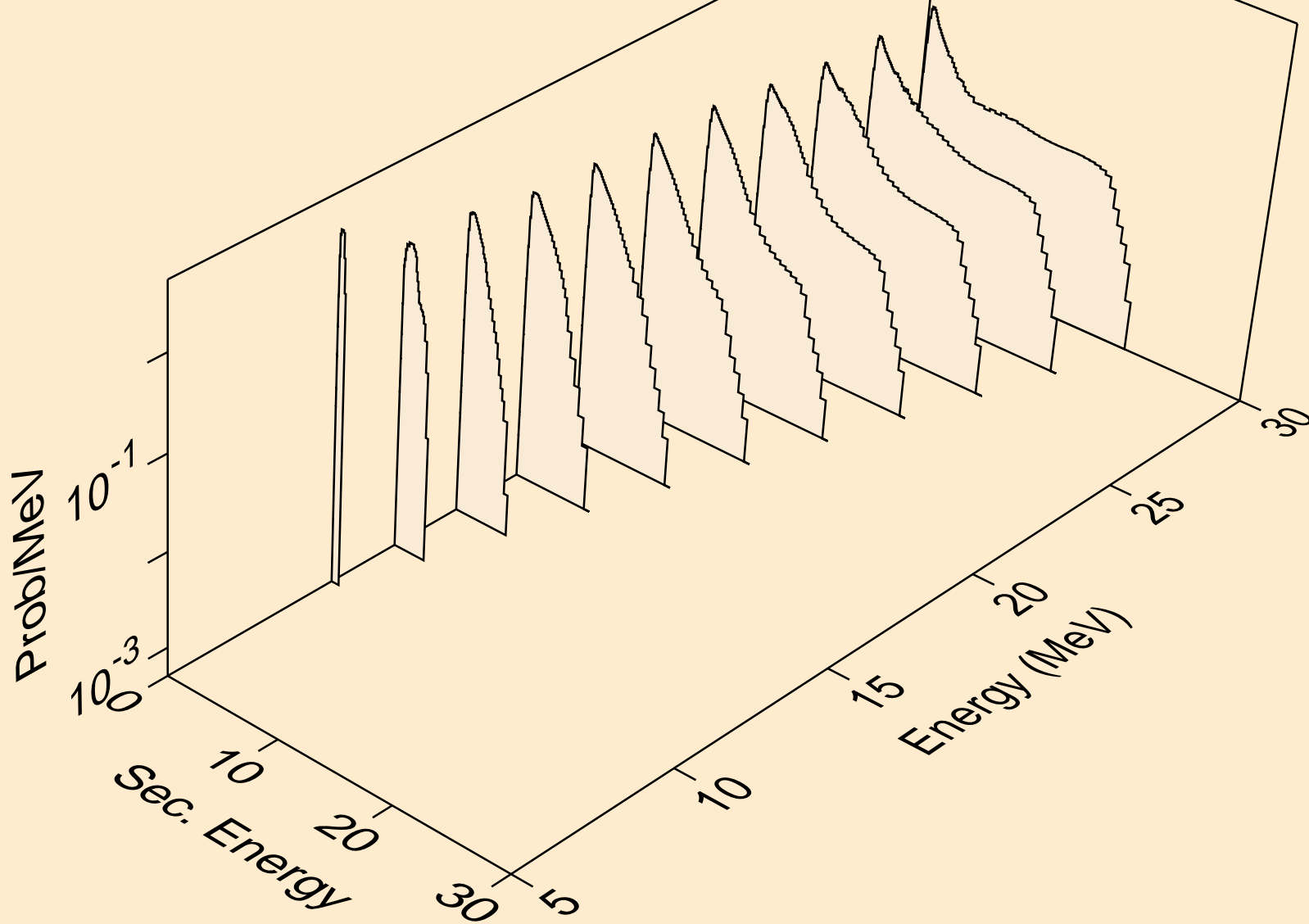

ZR089 NEUTRON ACER TENDL-2019 LIBRARY; T=293.16K  
Neutron emission for (n,3n)

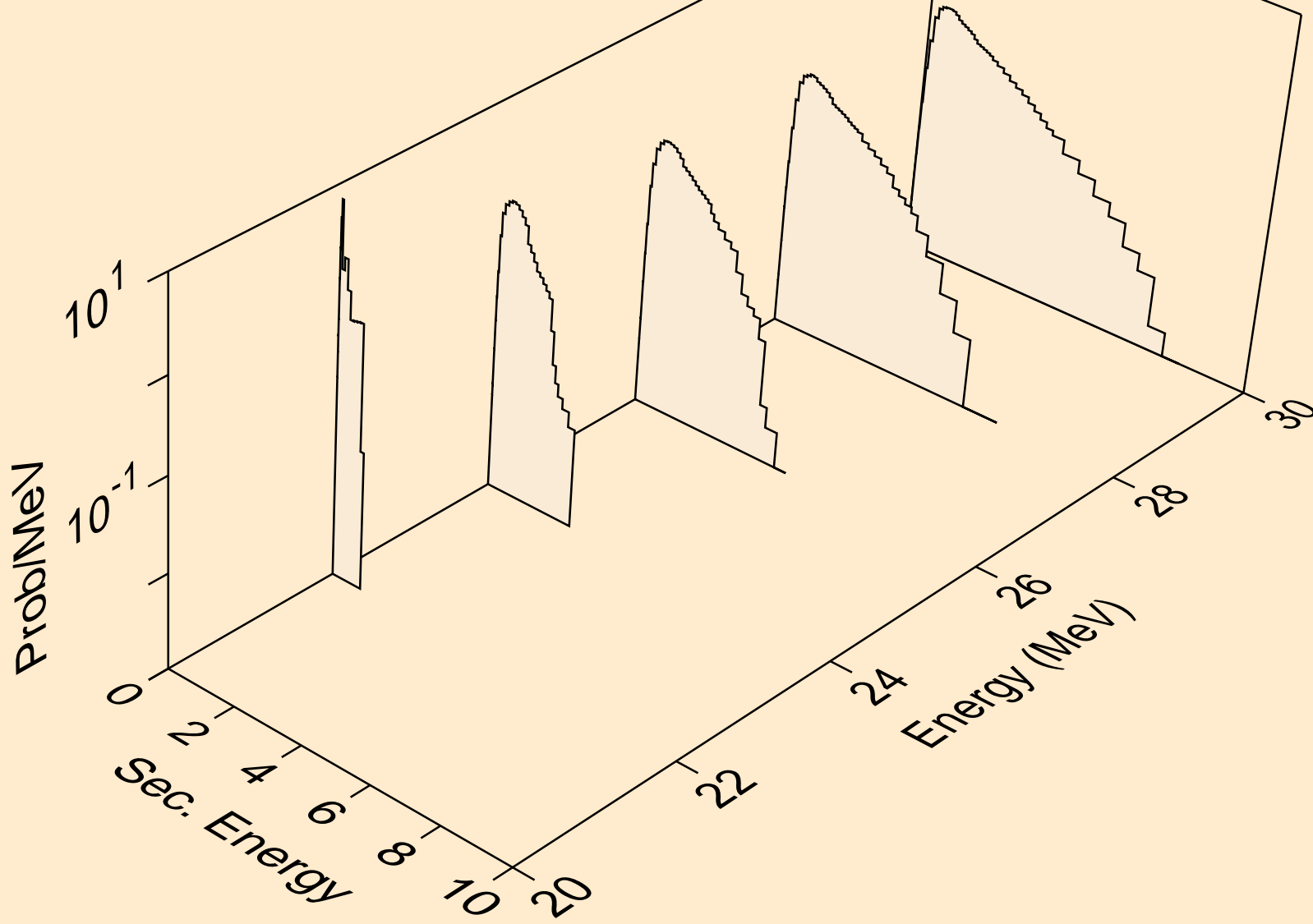



ZR089 NEUTRON ACER TENDL-2019 LIBRARY; T=293.16K  
Neutron emission for (n,n\*)a

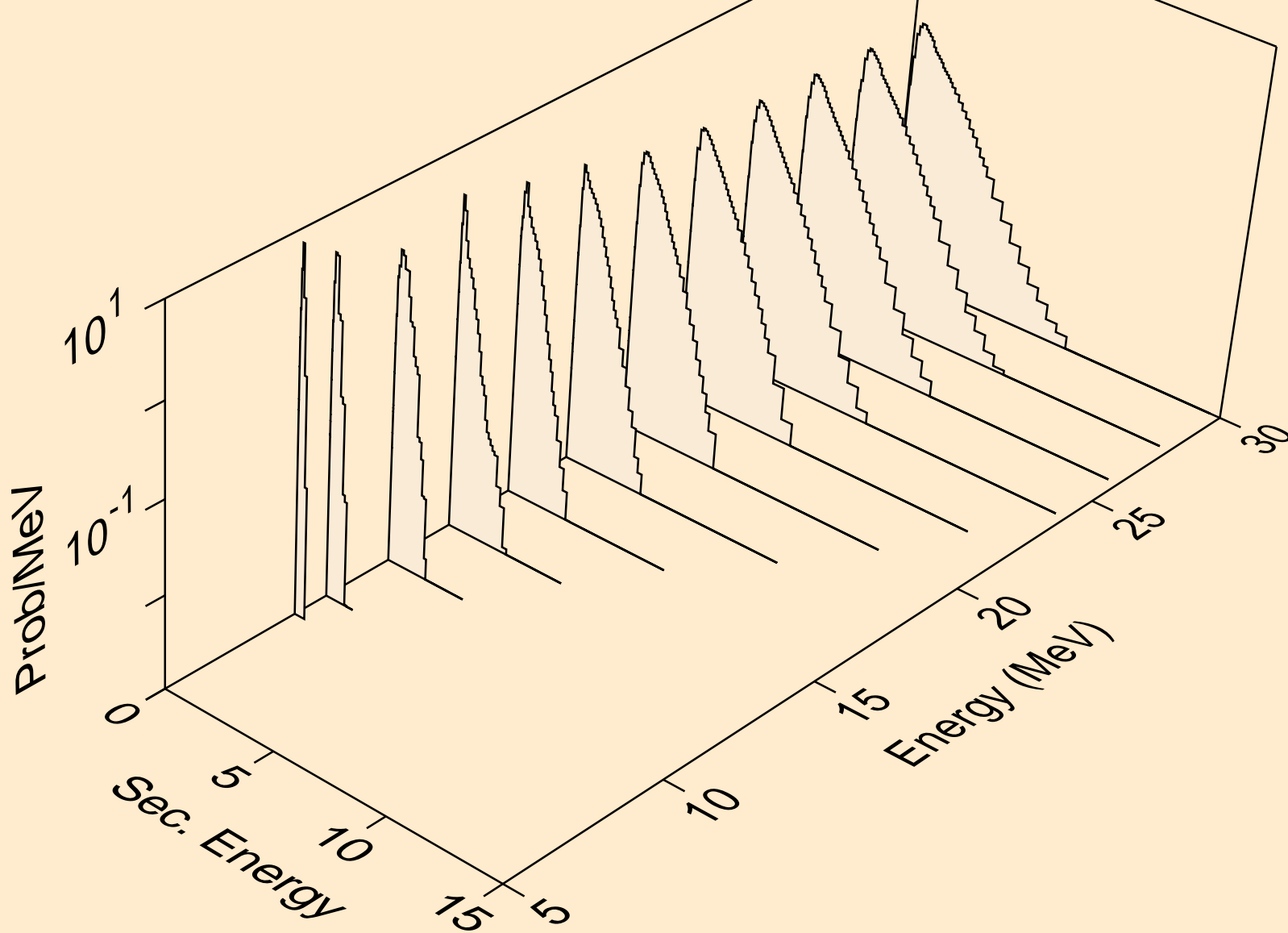

ZR089 NEUTRON ACER TENDL-2019 LIBRARY; T=293.16K  
Neutron emission for (n,2n)<sub>a</sub>

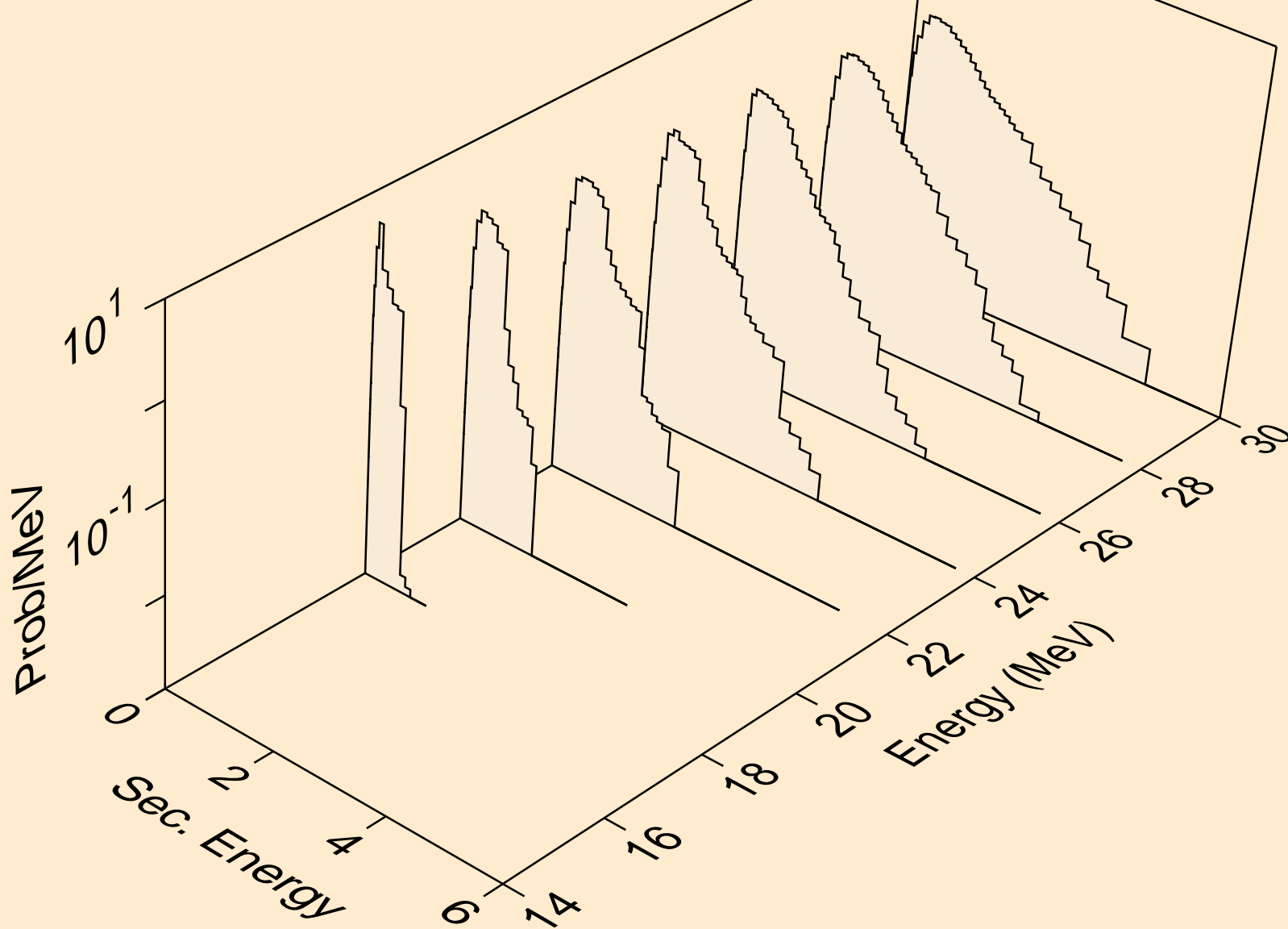

ZR089 NEUTRON ACER TENDL-2019 LIBRARY; T=293.16K  
Neutron emission for (n,n\*)p

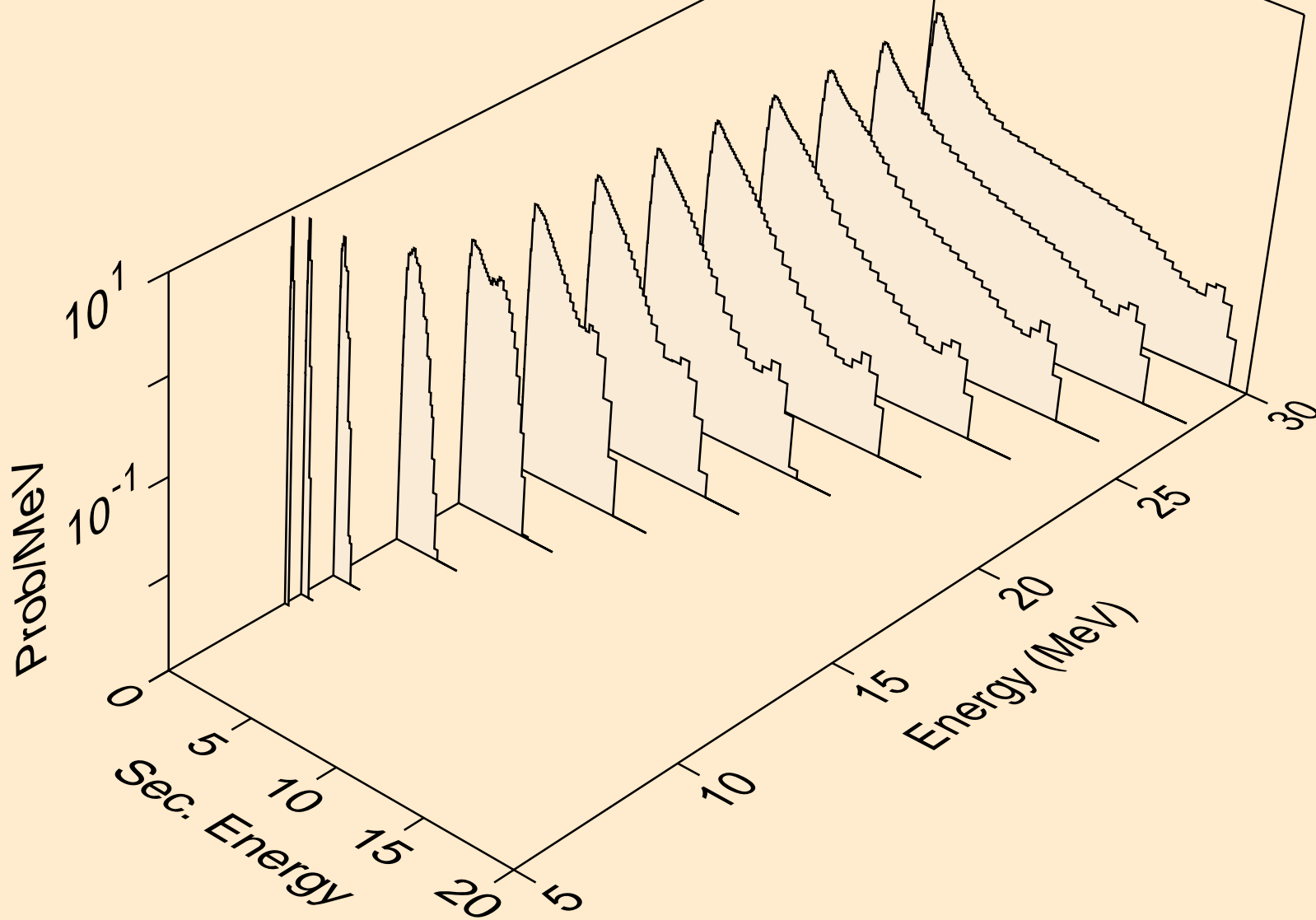

ZR089 NEUTRON ACER TENDL-2019 LIBRARY; T=293.16K  
Neutron emission for (n,n\*)2a

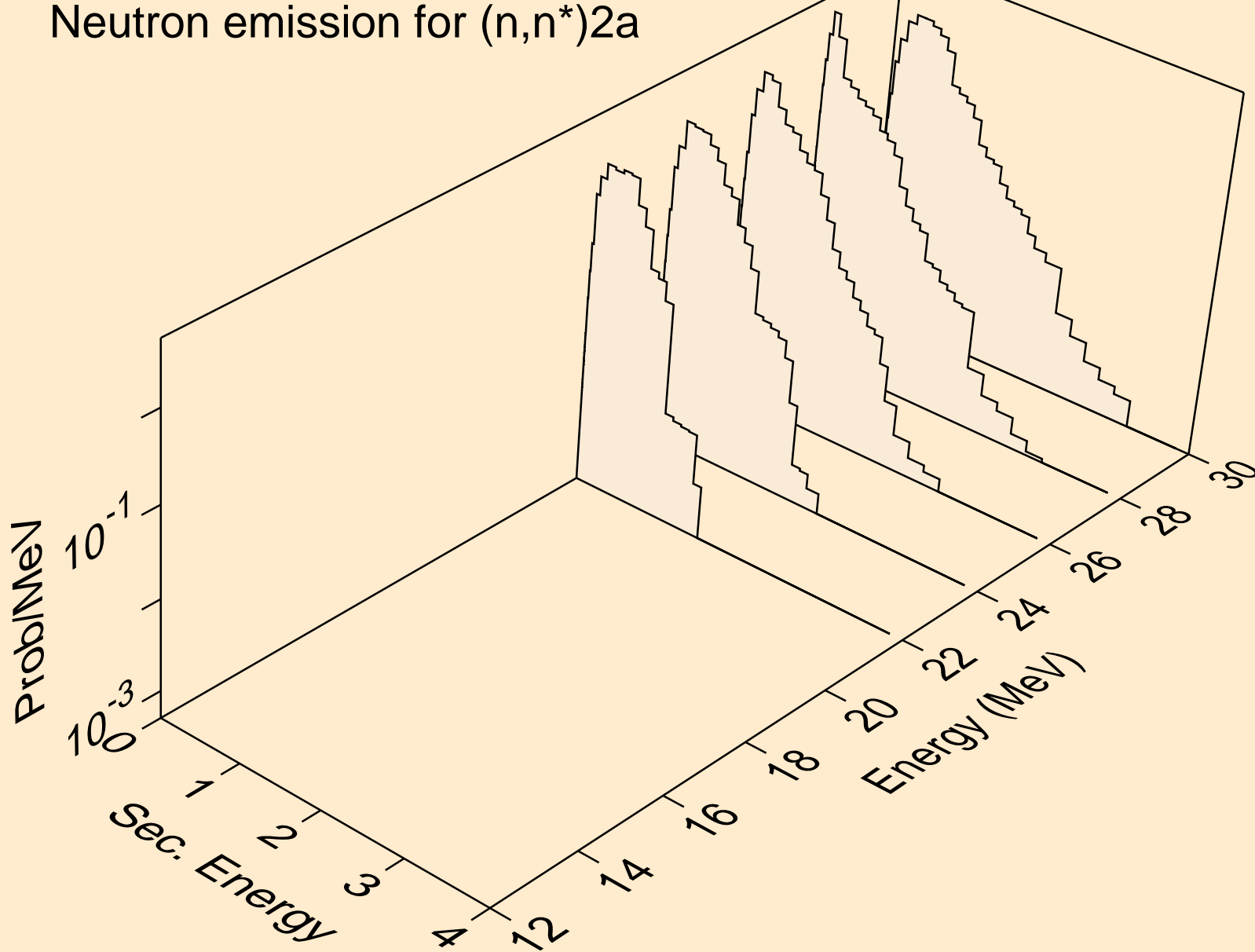

ZR089 NEUTRON ACER TENDL-2019 LIBRARY; T=293.16K  
Neutron emission for (n,n\*)d

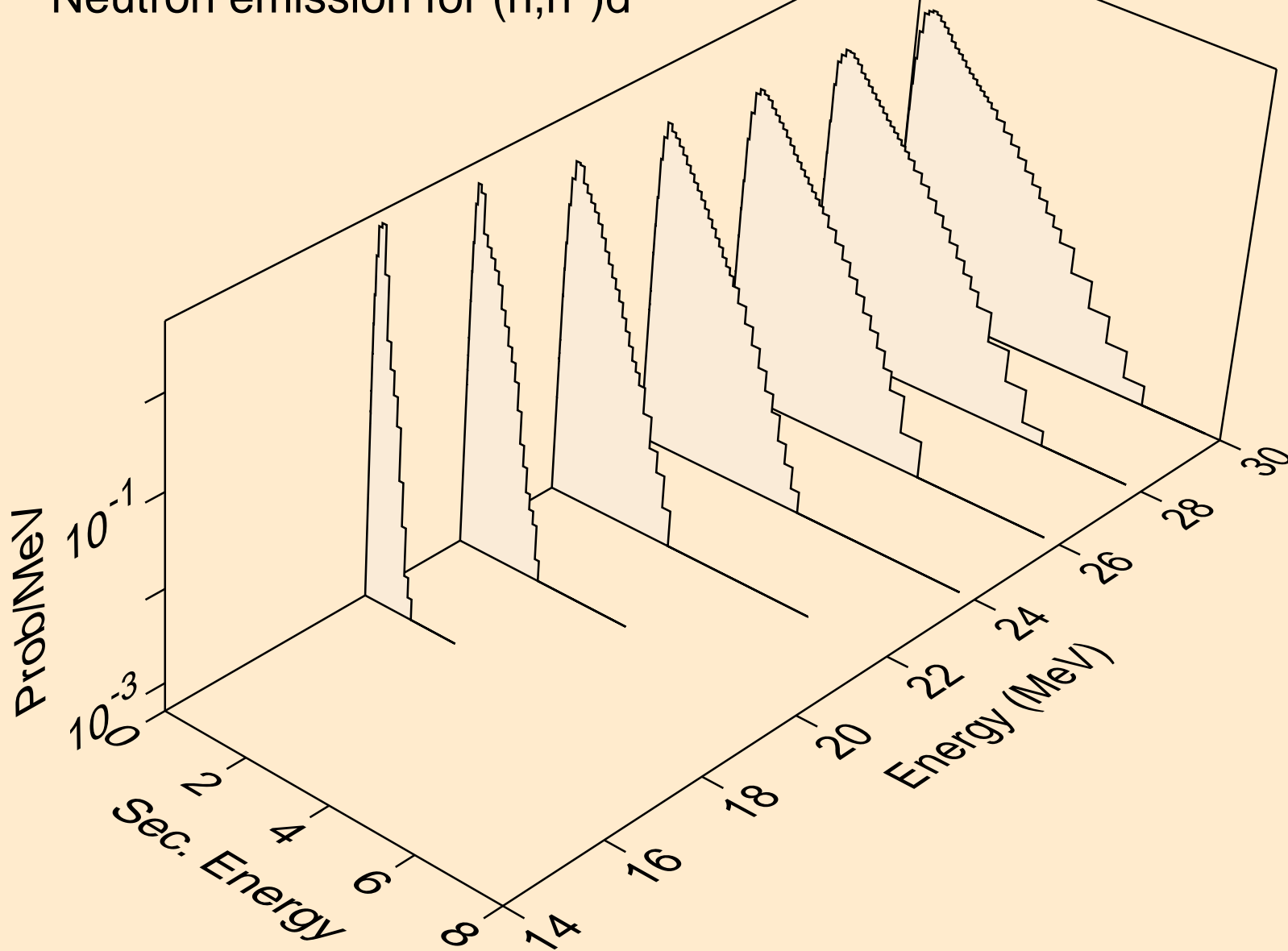

ZR089 NEUTRON ACER TENDL-2019 LIBRARY; T=293.16K  
Neutron emission for (n,n\*)t

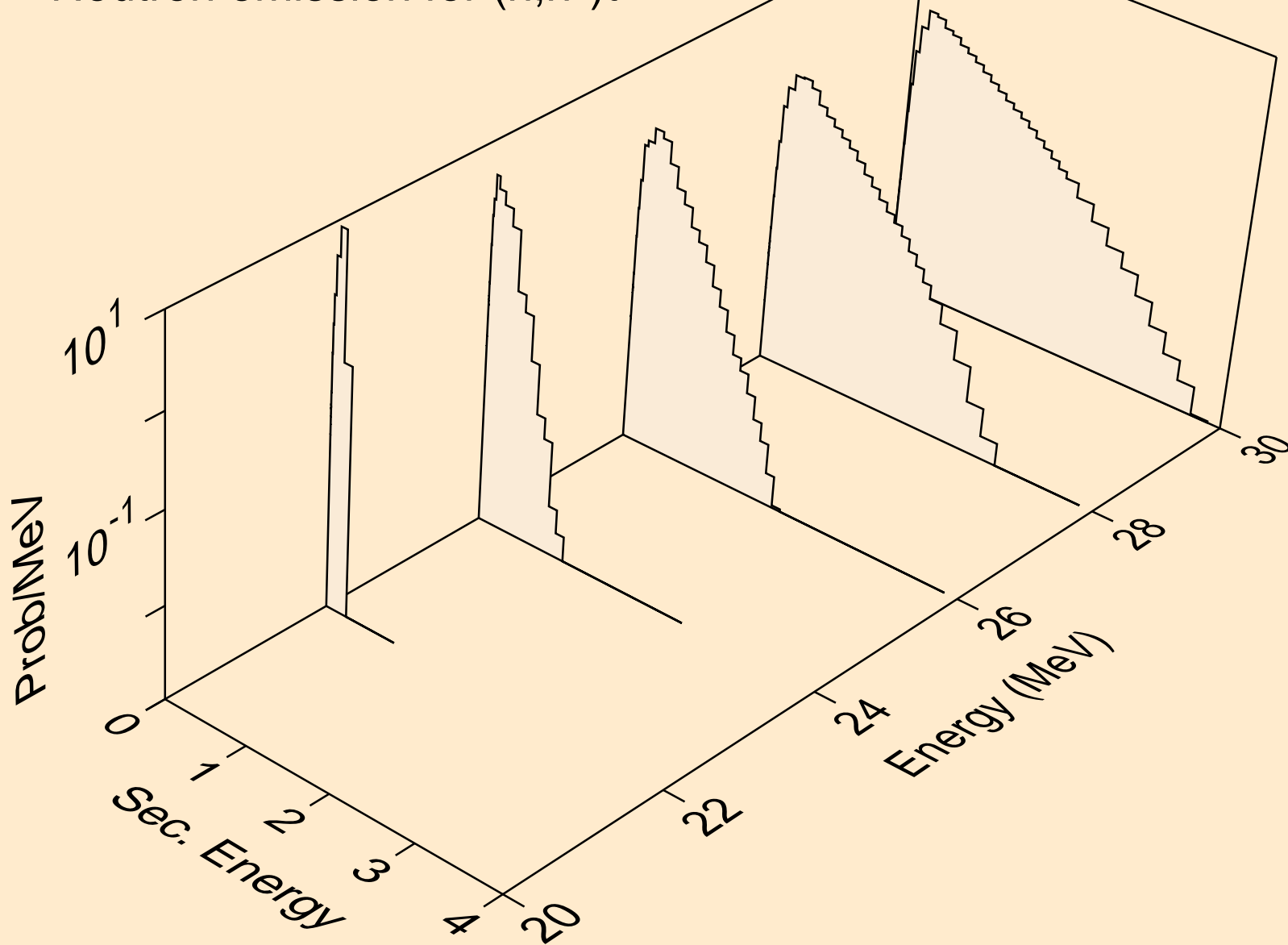

ZR089 NEUTRON ACER TENDL-2019 LIBRARY; T=293.16K  
Neutron emission for (n,n\*)he3

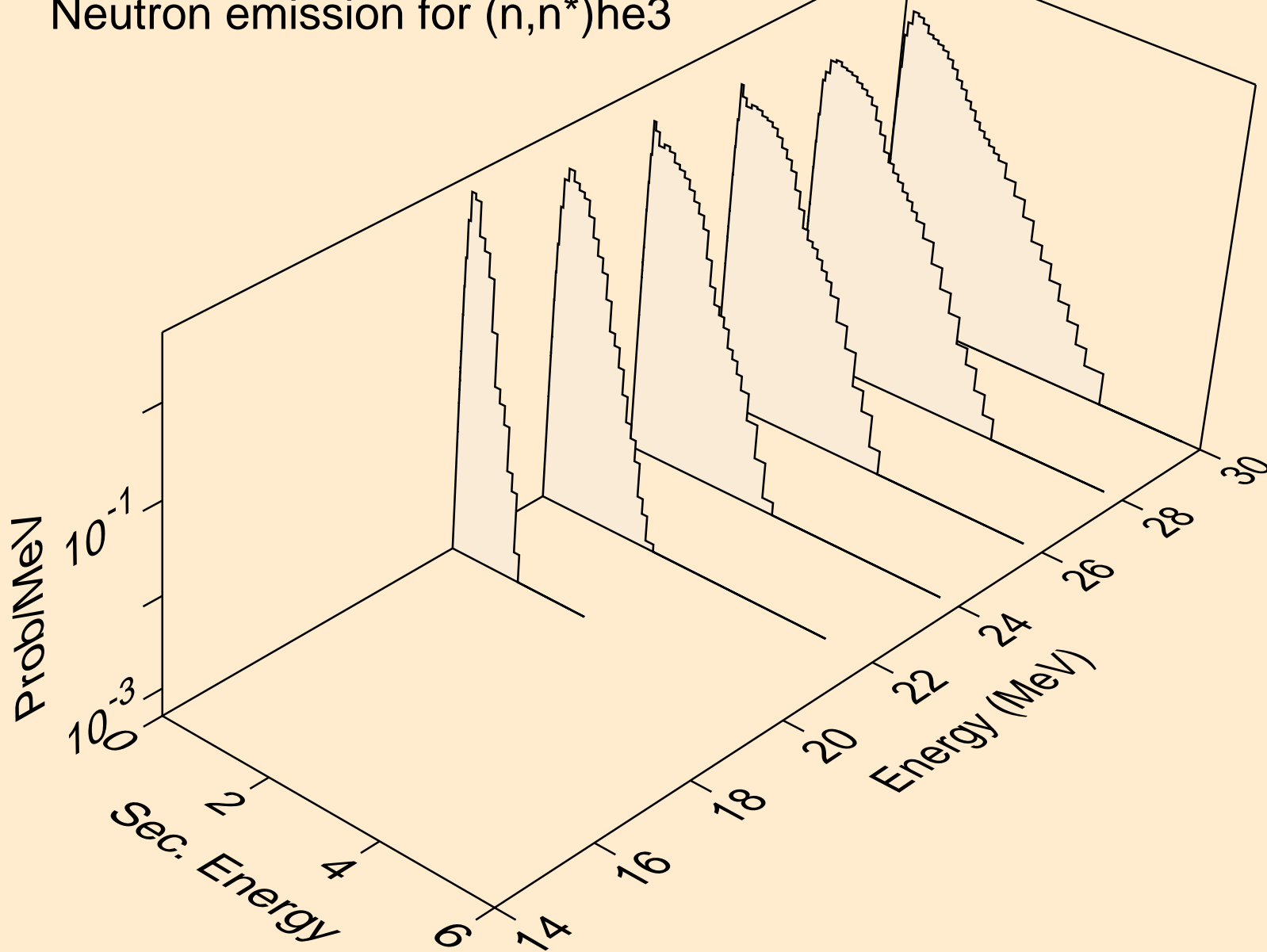

ZR089 NEUTRON ACER TENDL-2019 LIBRARY; T=293.16K  
Neutron emission for (n,2np)

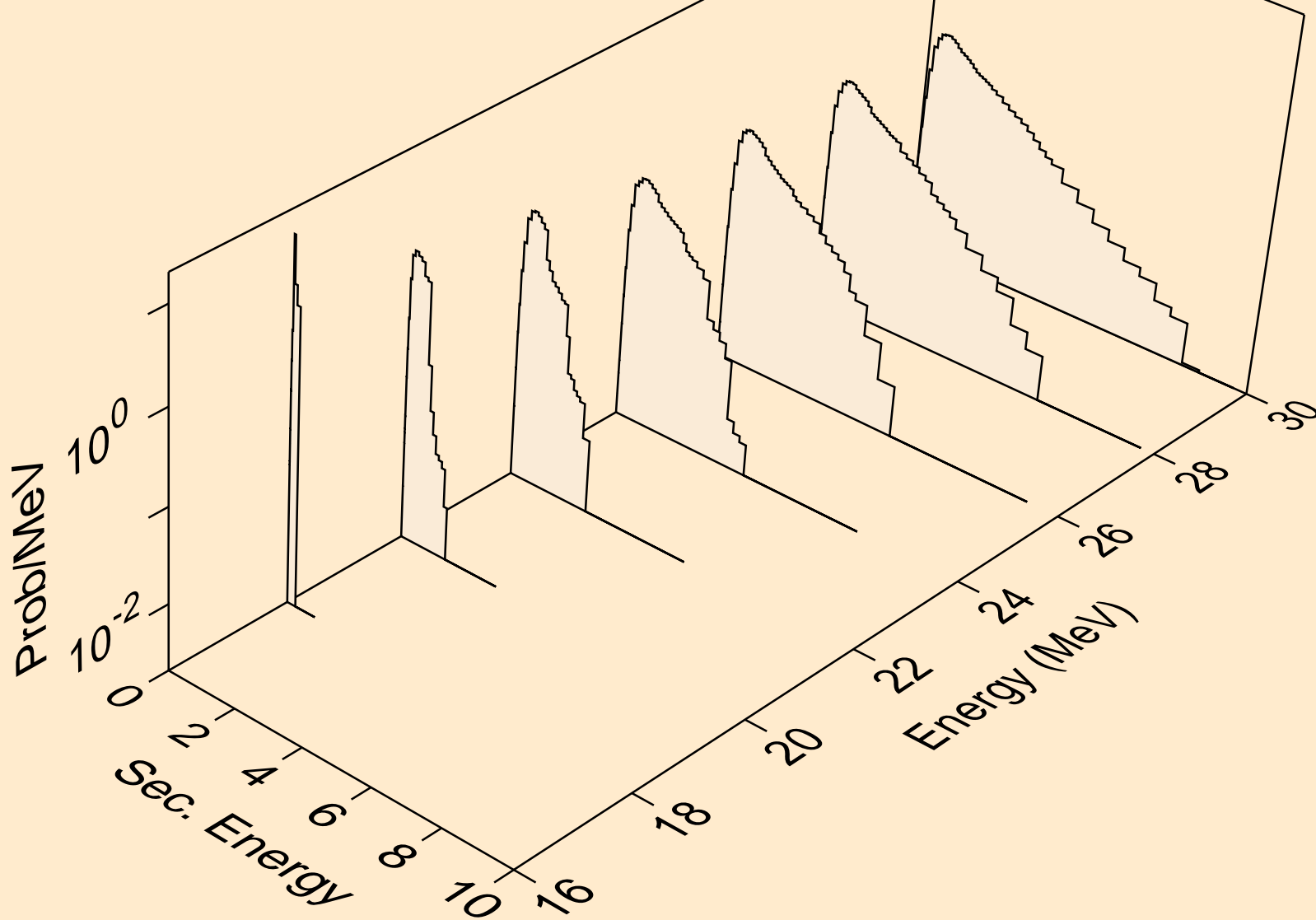



ZR089 NEUTRON ACER TENDL-2019 LIBRARY; T=293.16K  
Neutron emission for (n,3np)

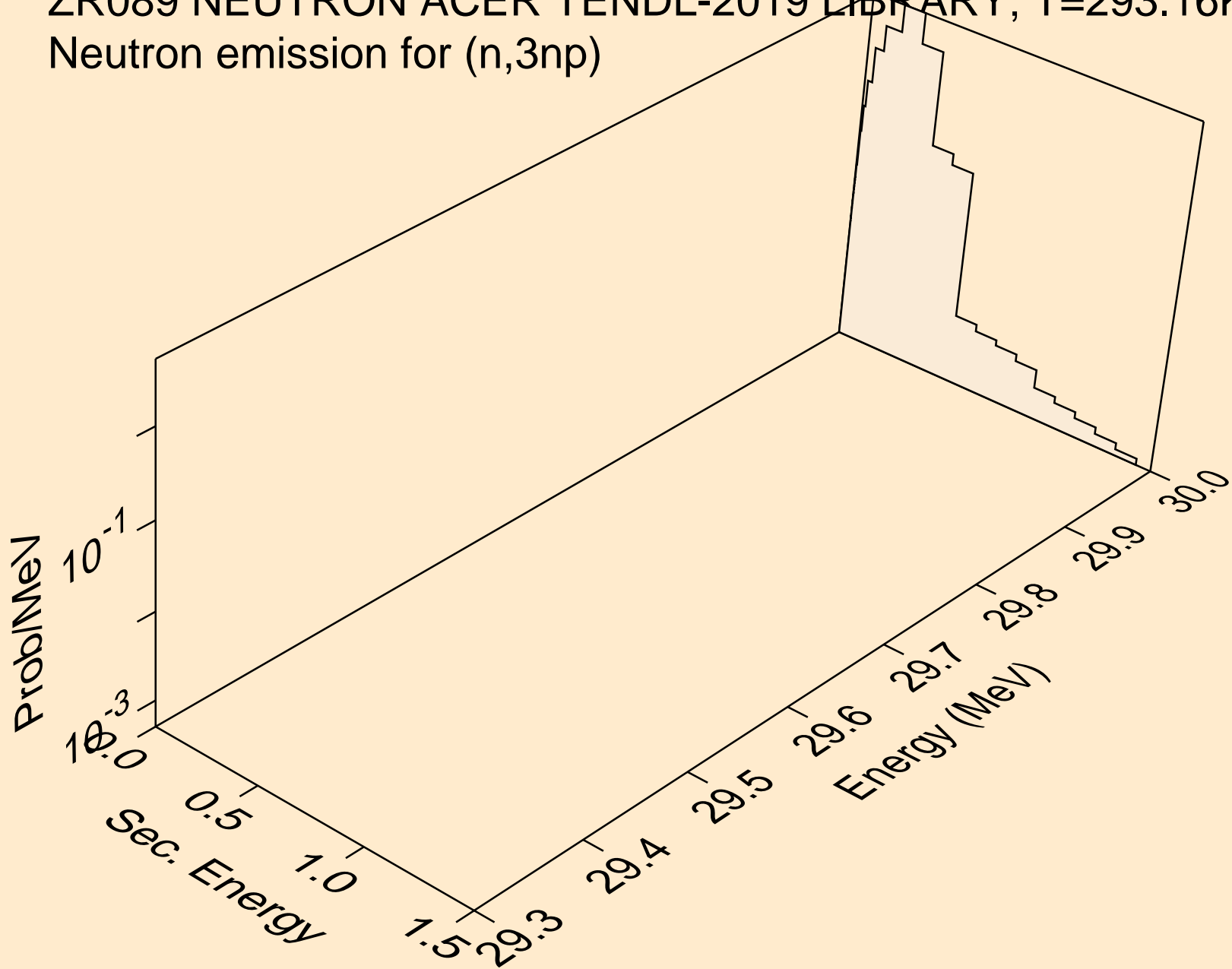

ZR089 NEUTRON ACER TENDL-2019 LIBRARY; T=293.16K  
Neutron emission for (n,2np)

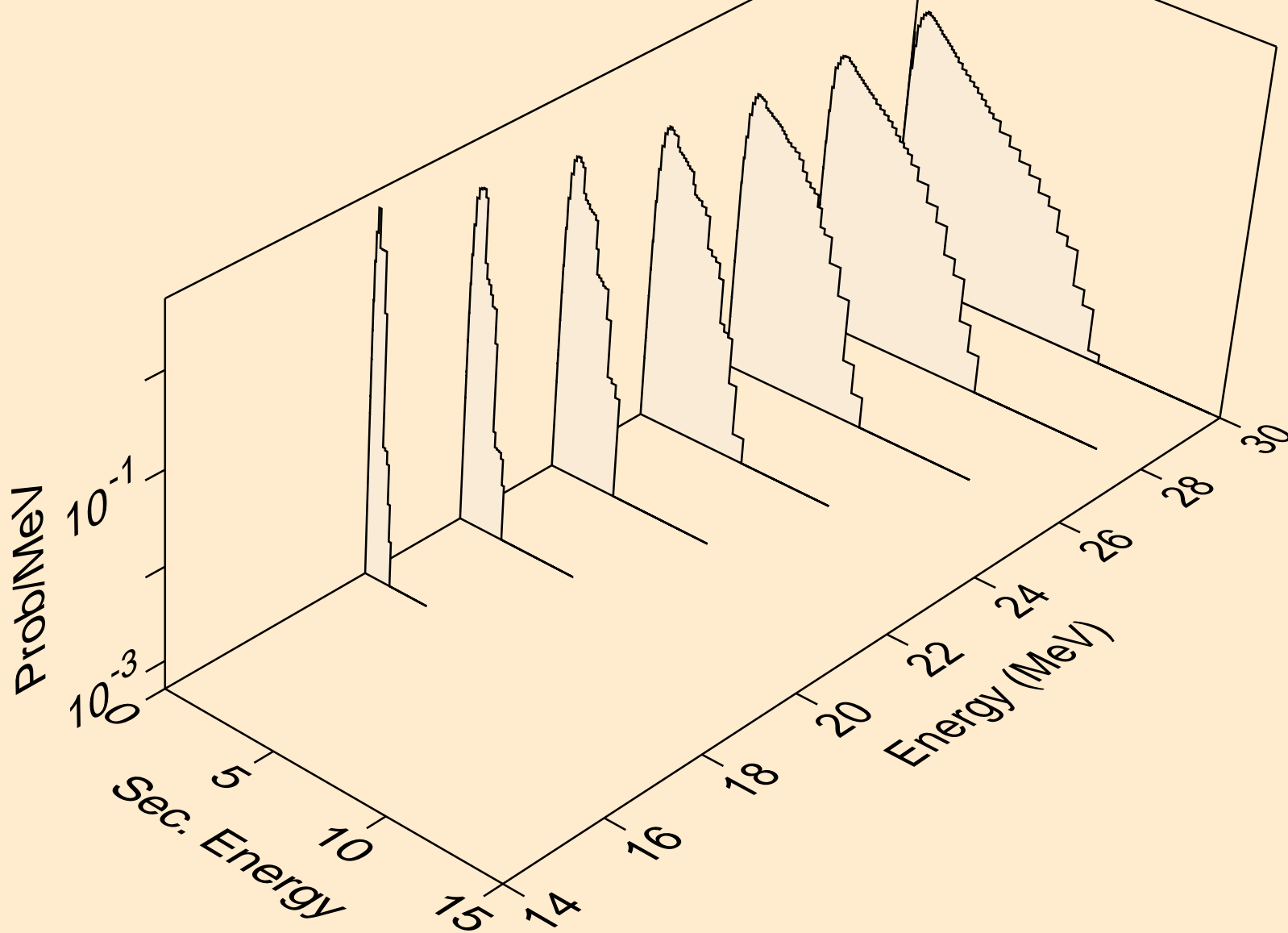

ZR089 NEUTRON ACER TENDL-2019 LIBRARY; T=293.16K  
Neutron emission for (n,npa)

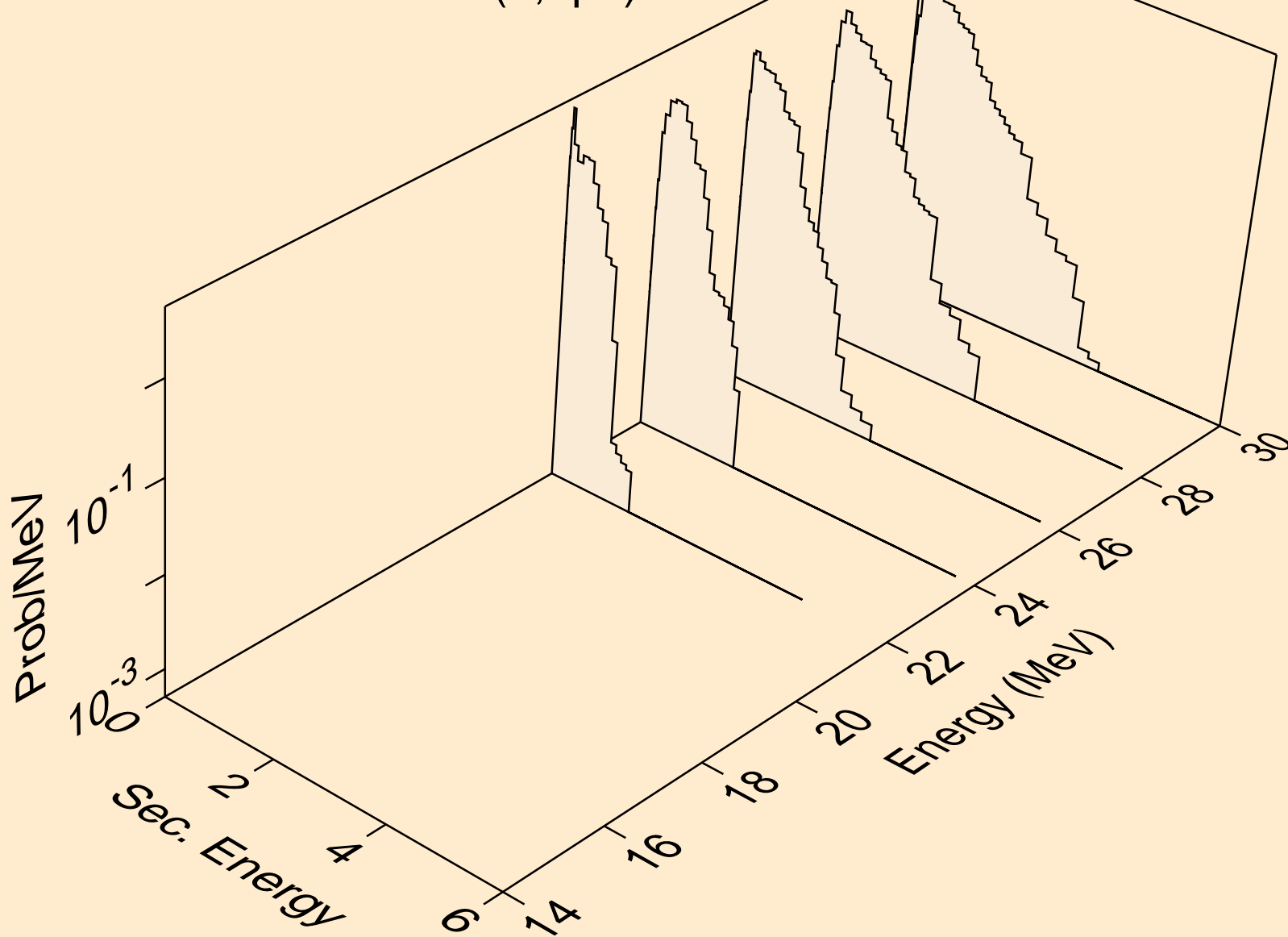

ZR089 NEUTRON ACER TENDL-2019 LIBRARY; T=293.16K  
Neutron emission for (n,n\*c)

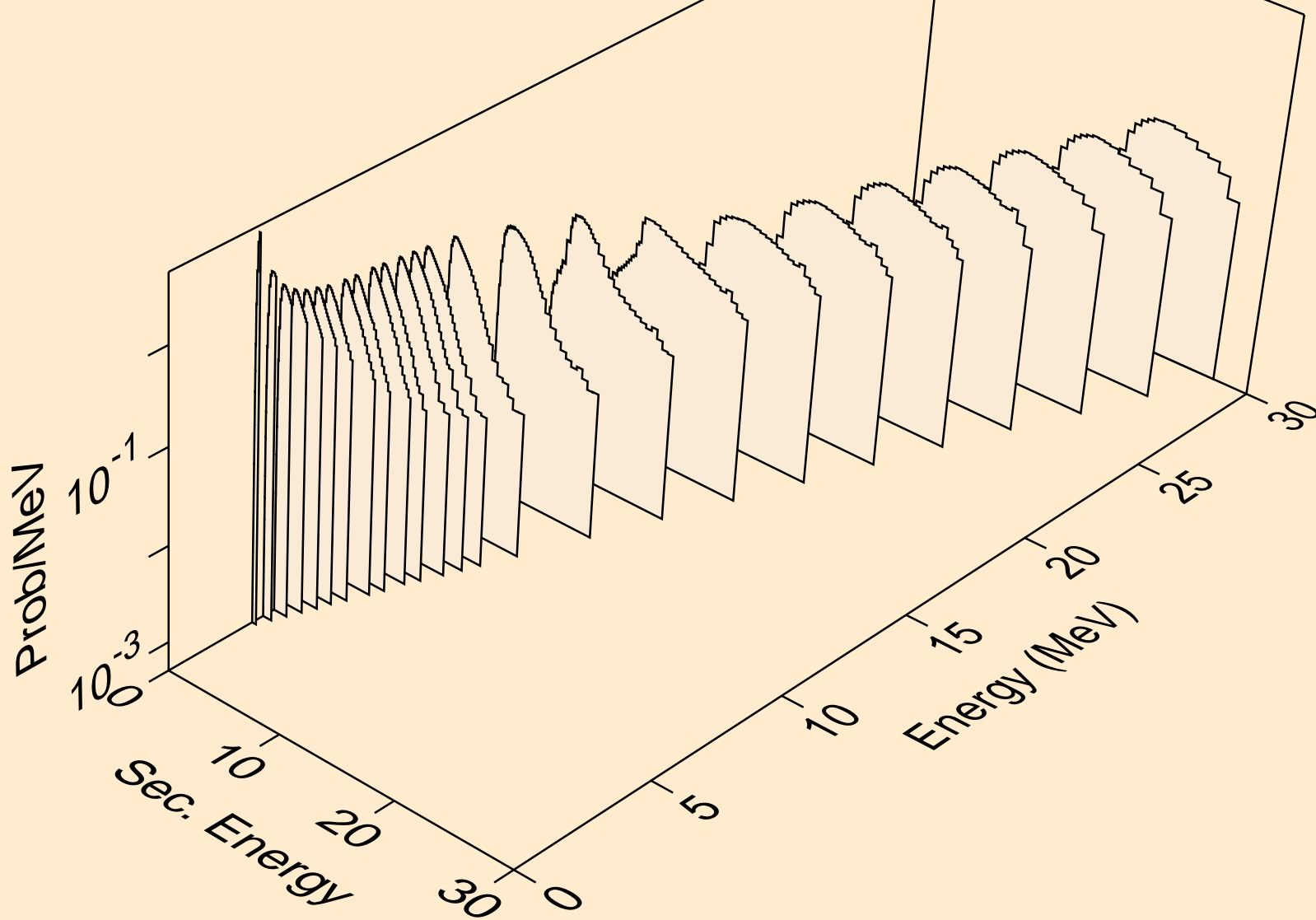

ZR089 NEUTRON ACER TENDL-2019 LIBRARY; T=293.16K  
Photon emission for (n,x)

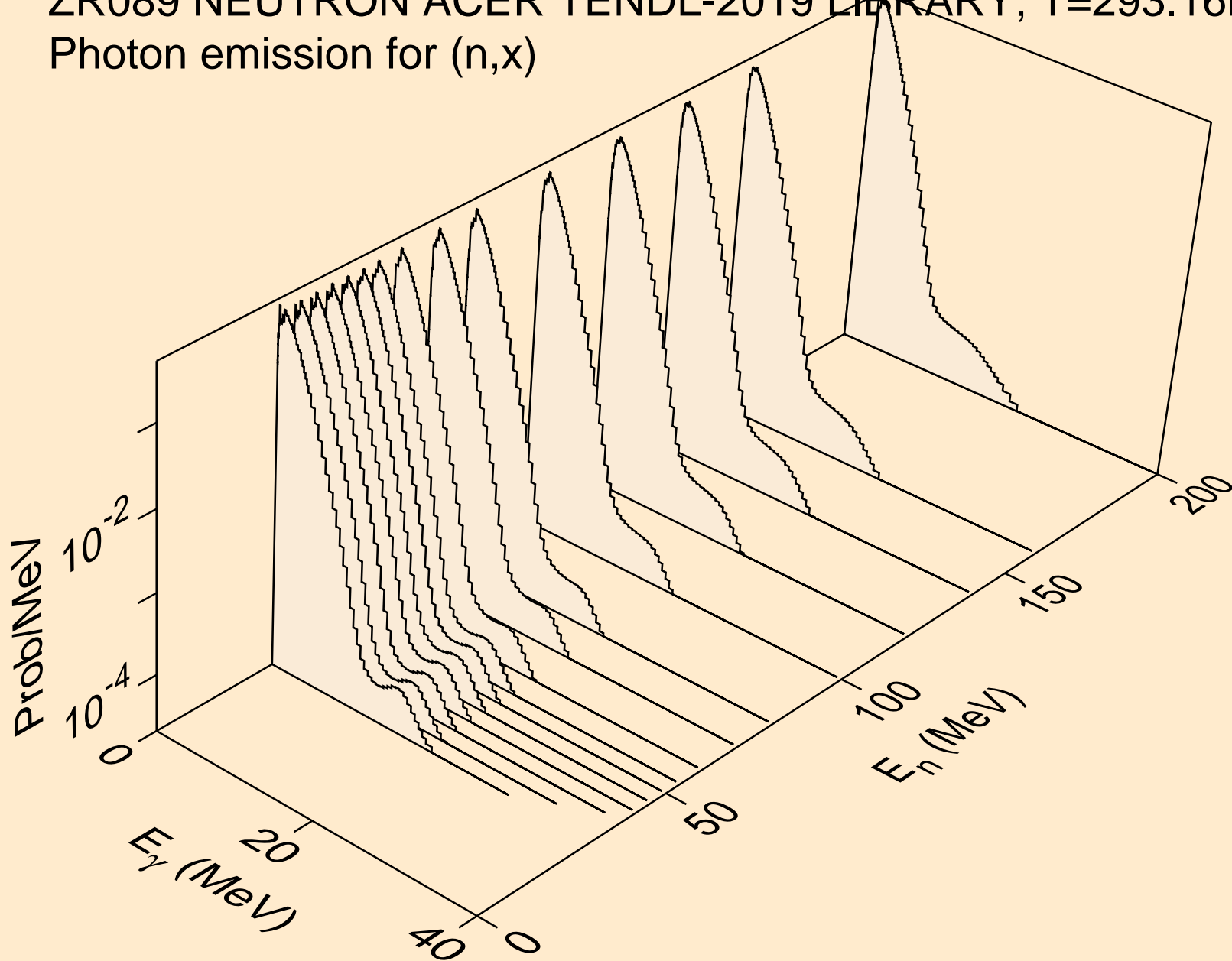

ZR089 NEUTRON ACER TENDL-2019 LIBRARY; T=293.16K  
Photon emission for (n,2nd)

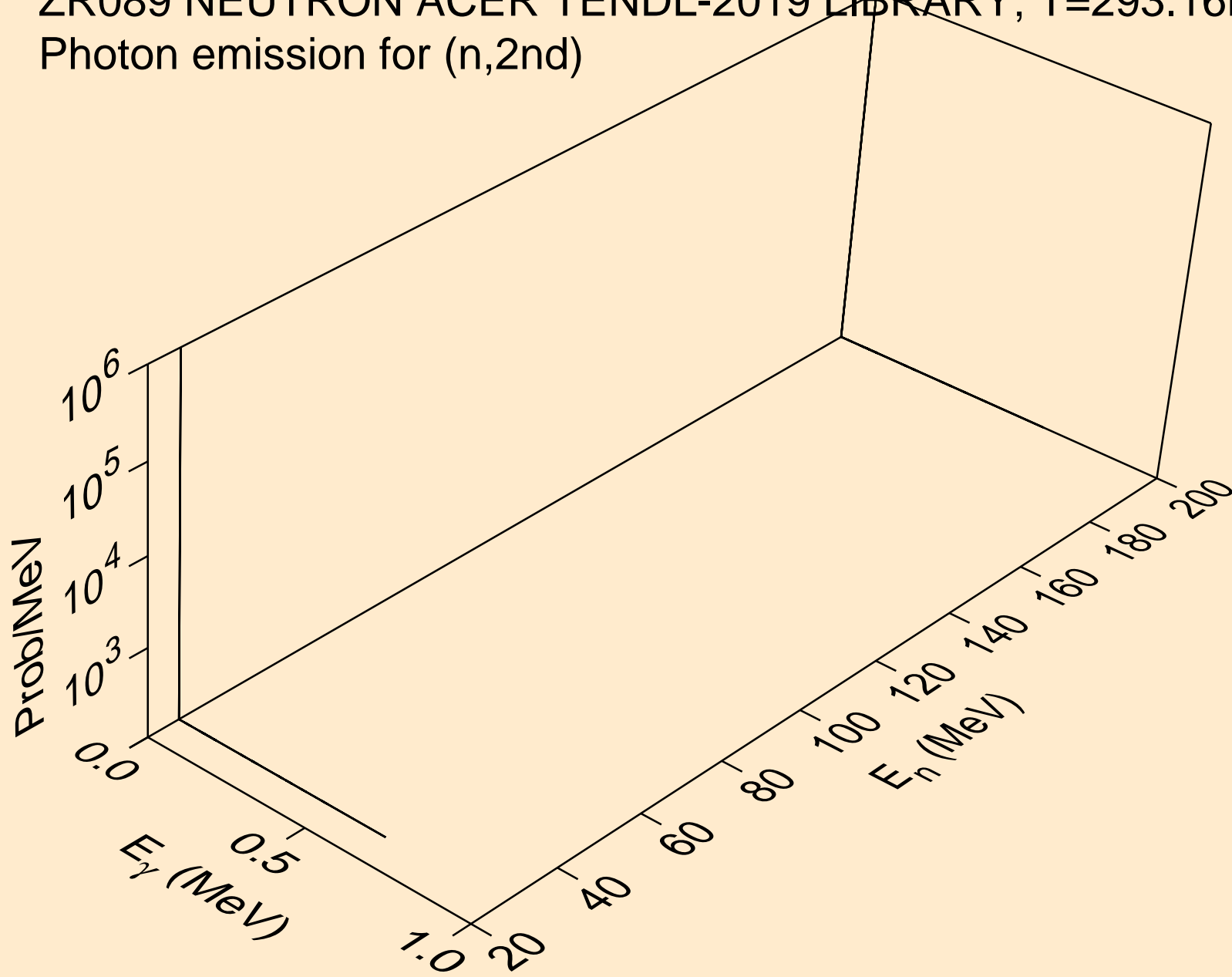

ZR089 NEUTRON ACER TENDL-2019 LIBRARY; T=293.16K  
Photon emission for (n,2n)

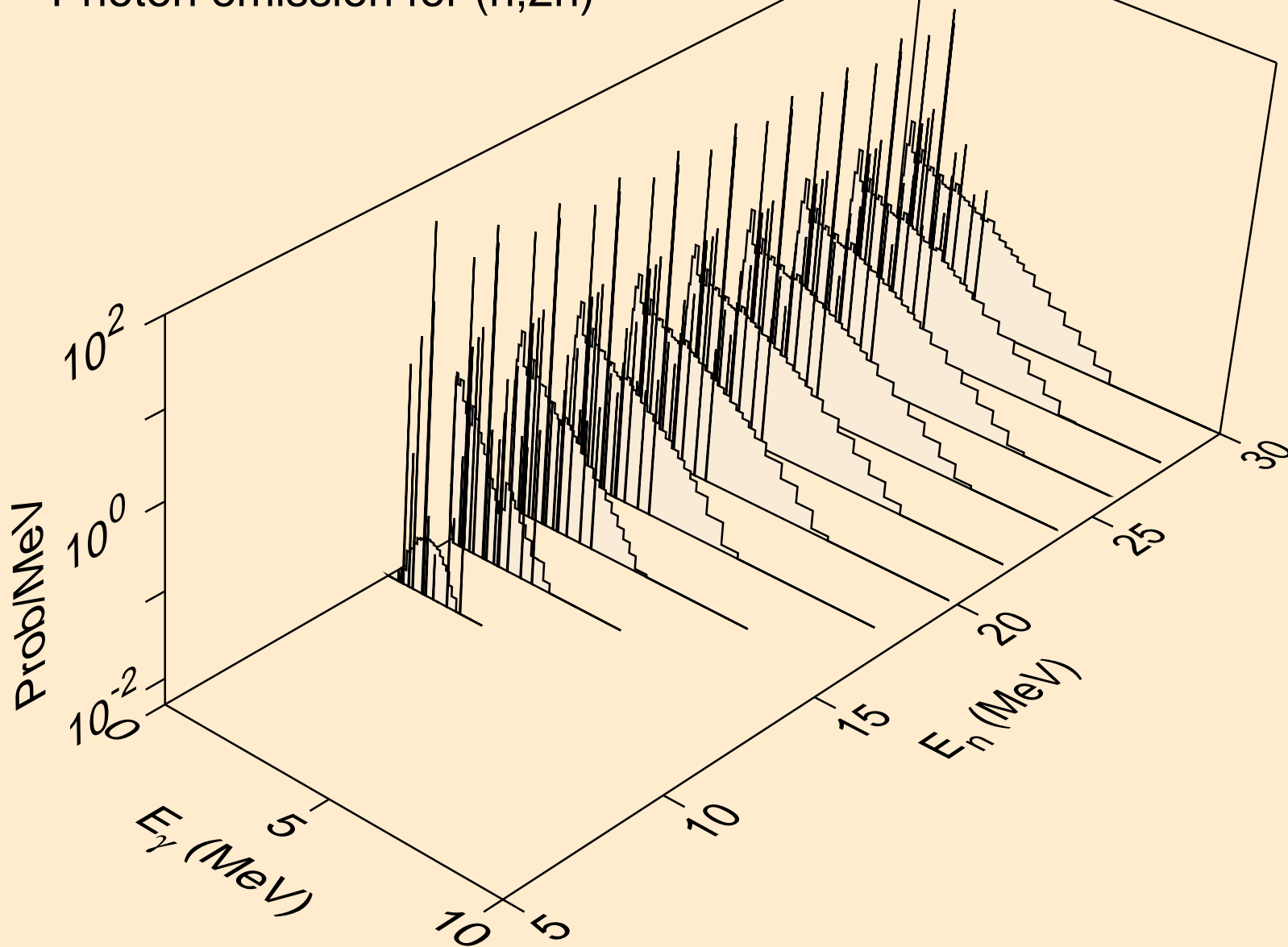

ZR089 NEUTRON ACER TENDL-2019 LIBRARY; T=293.16K  
Photon emission for (n,3n)

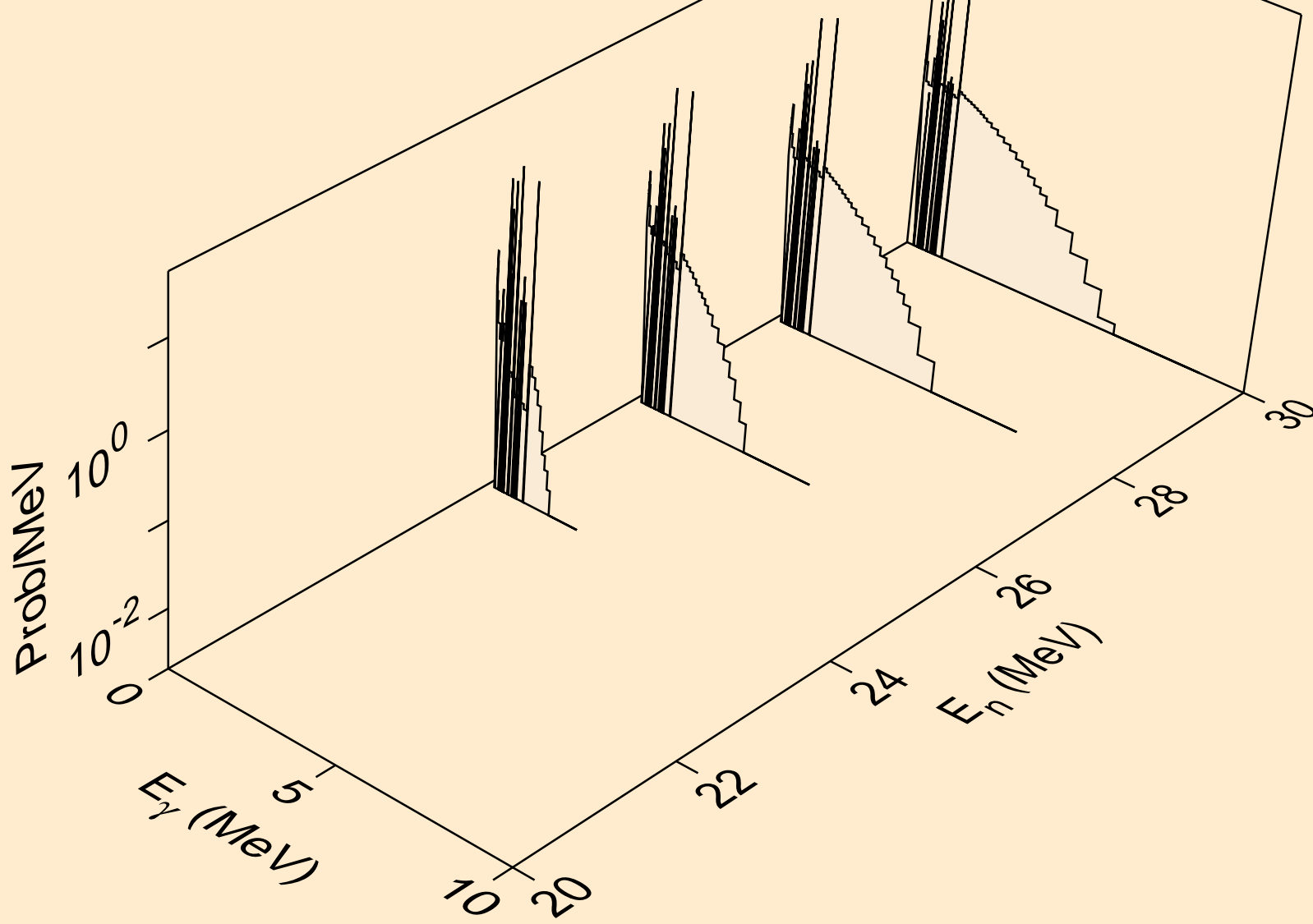



ZR089 NEUTRON ACER TENDL-2019 LIBRARY; T=293.16K  
Photon emission for (n,n\*)a

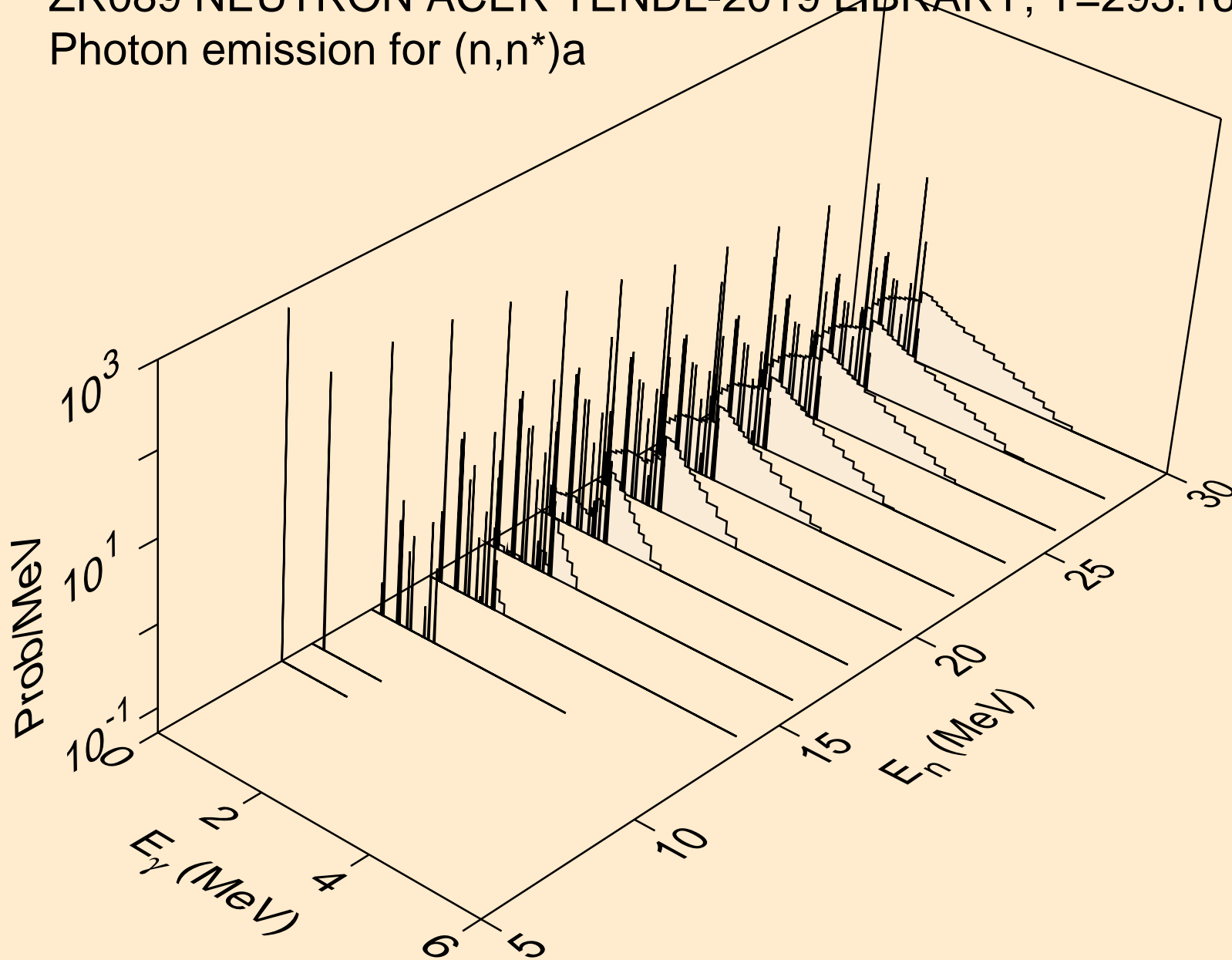

ZR089 NEUTRON ACER TENDL-2019 LIBRARY; T=293.16K  
Photon emission for (n,2n)a

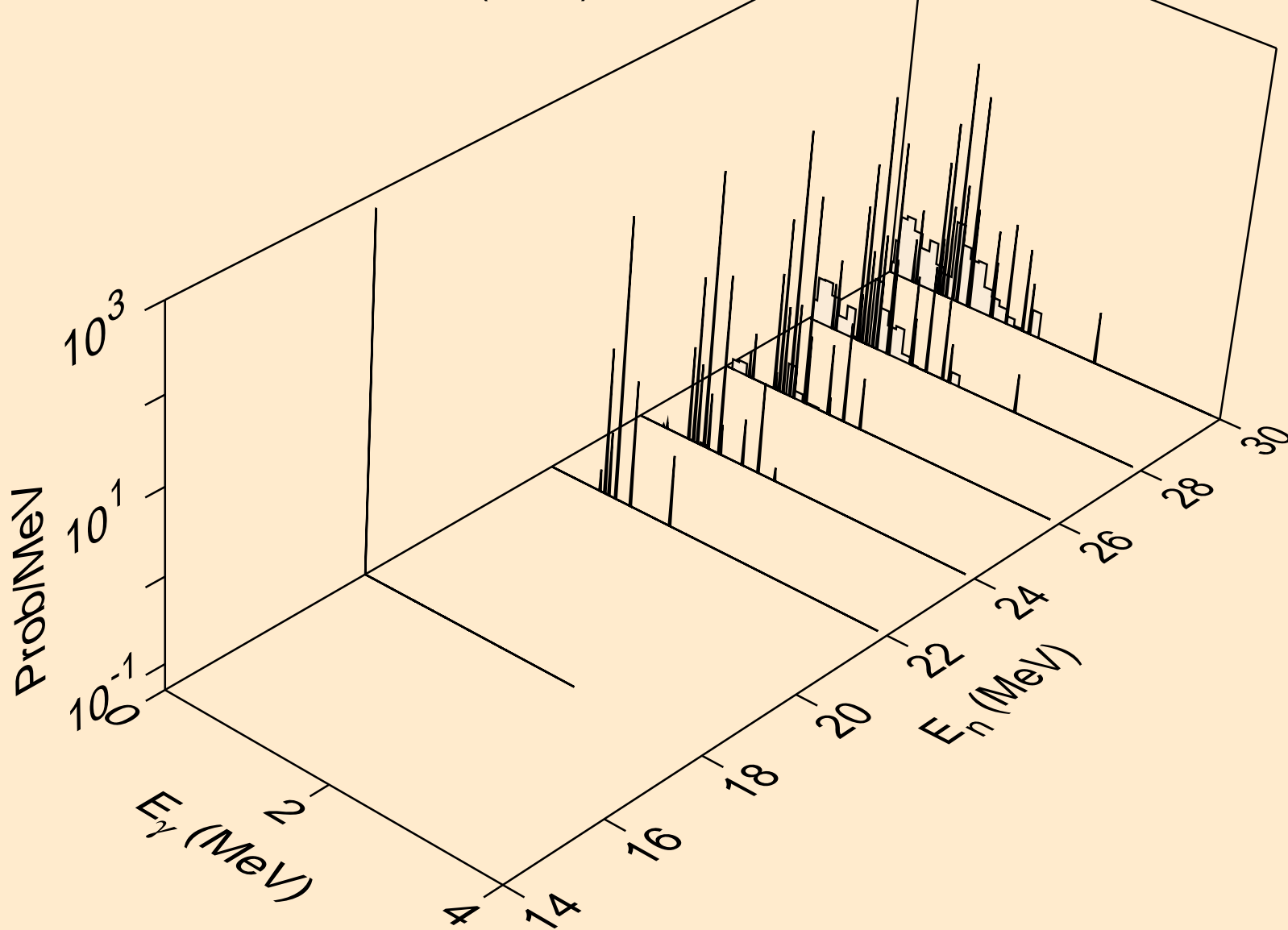

ZR089 NEUTRON ACER TENDL-2019 LIBRARY; T=293.16K  
Photon emission for (n,n\*)p

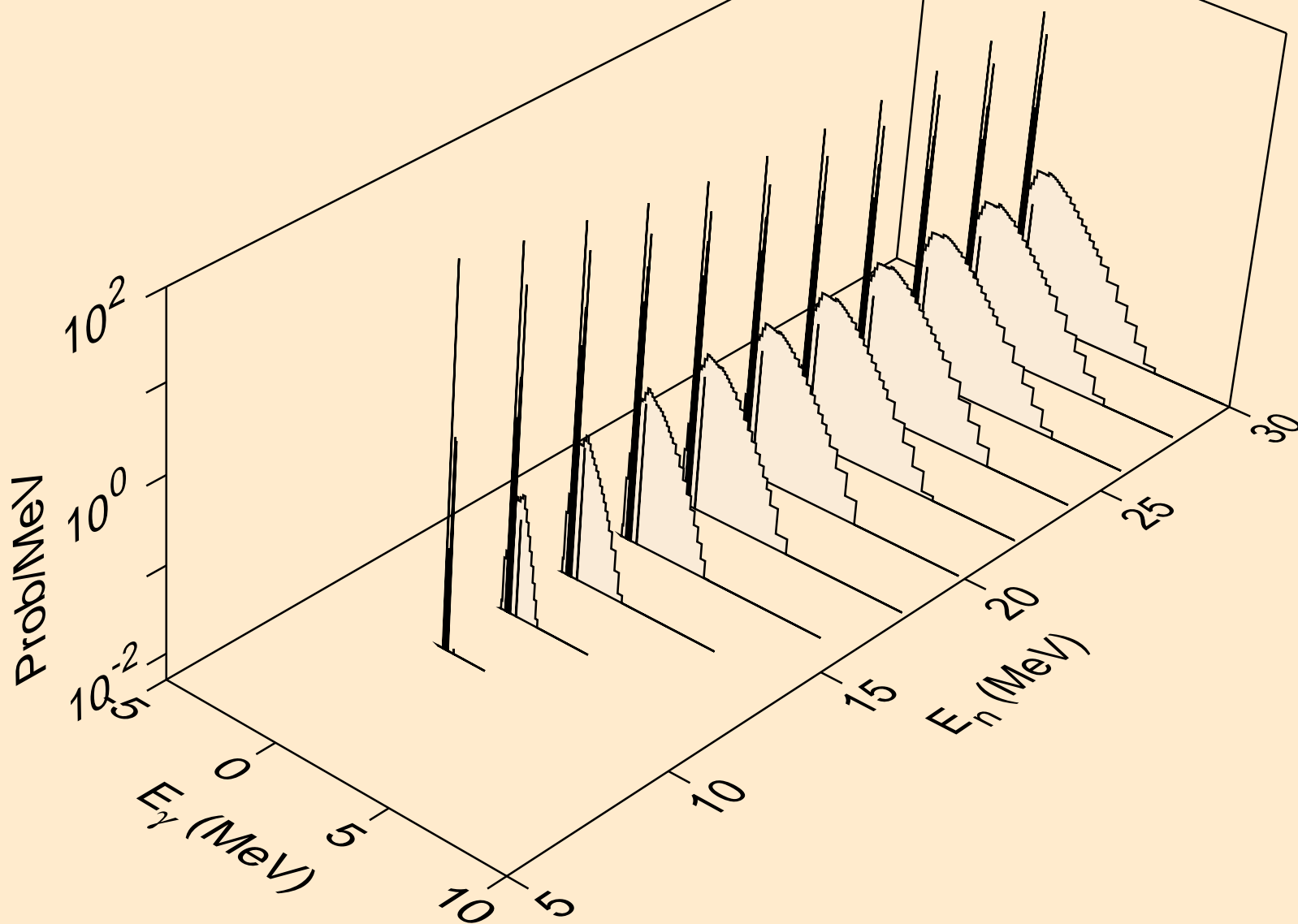

ZR089 NEUTRON ACER TENDL-2019 LIBRARY; T=293.16K  
Photon emission for (n,n\*)2a

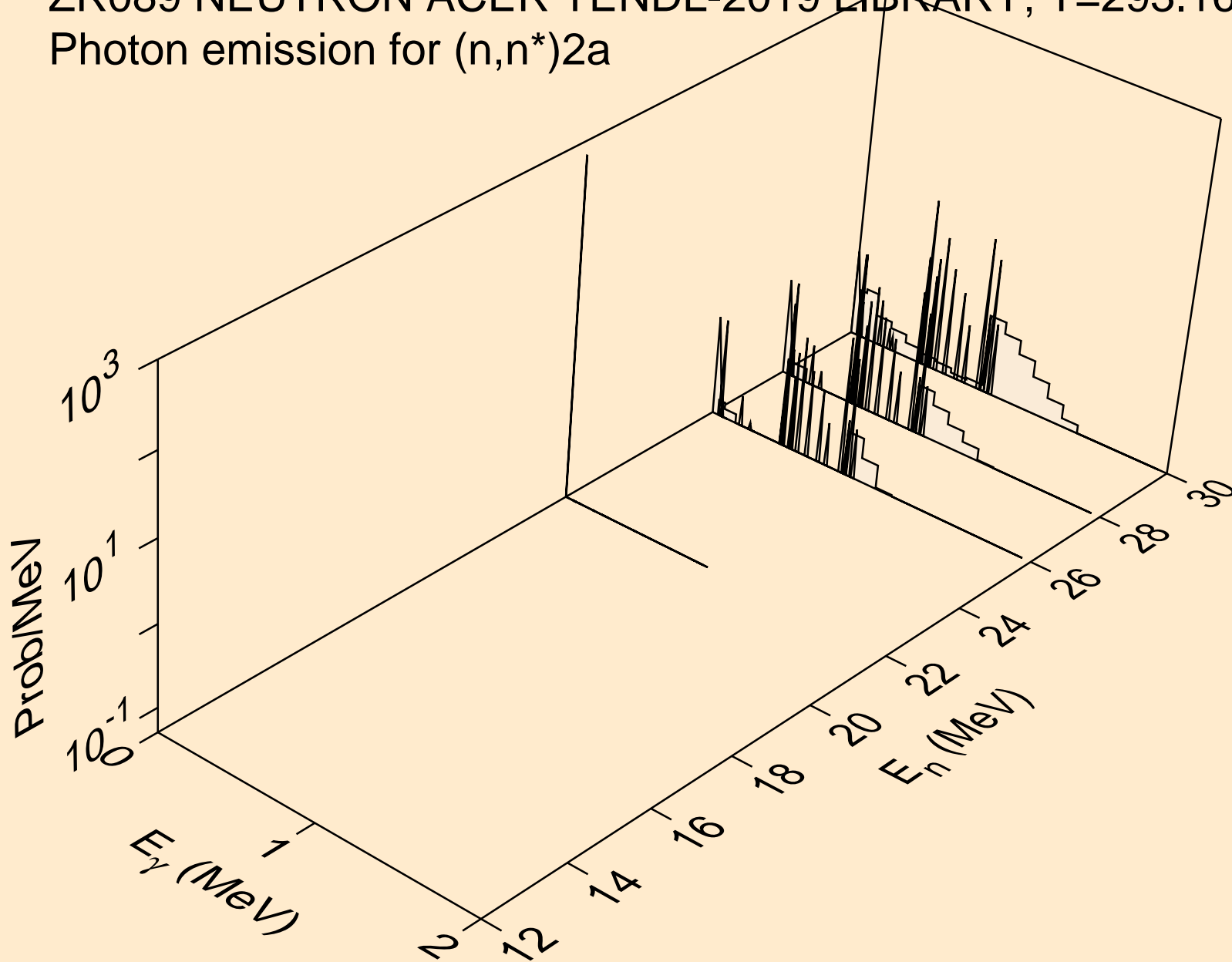

ZR089 NEUTRON ACER TENDL-2019 LIBRARY; T=293.16K  
Photon emission for (n,n\*)d

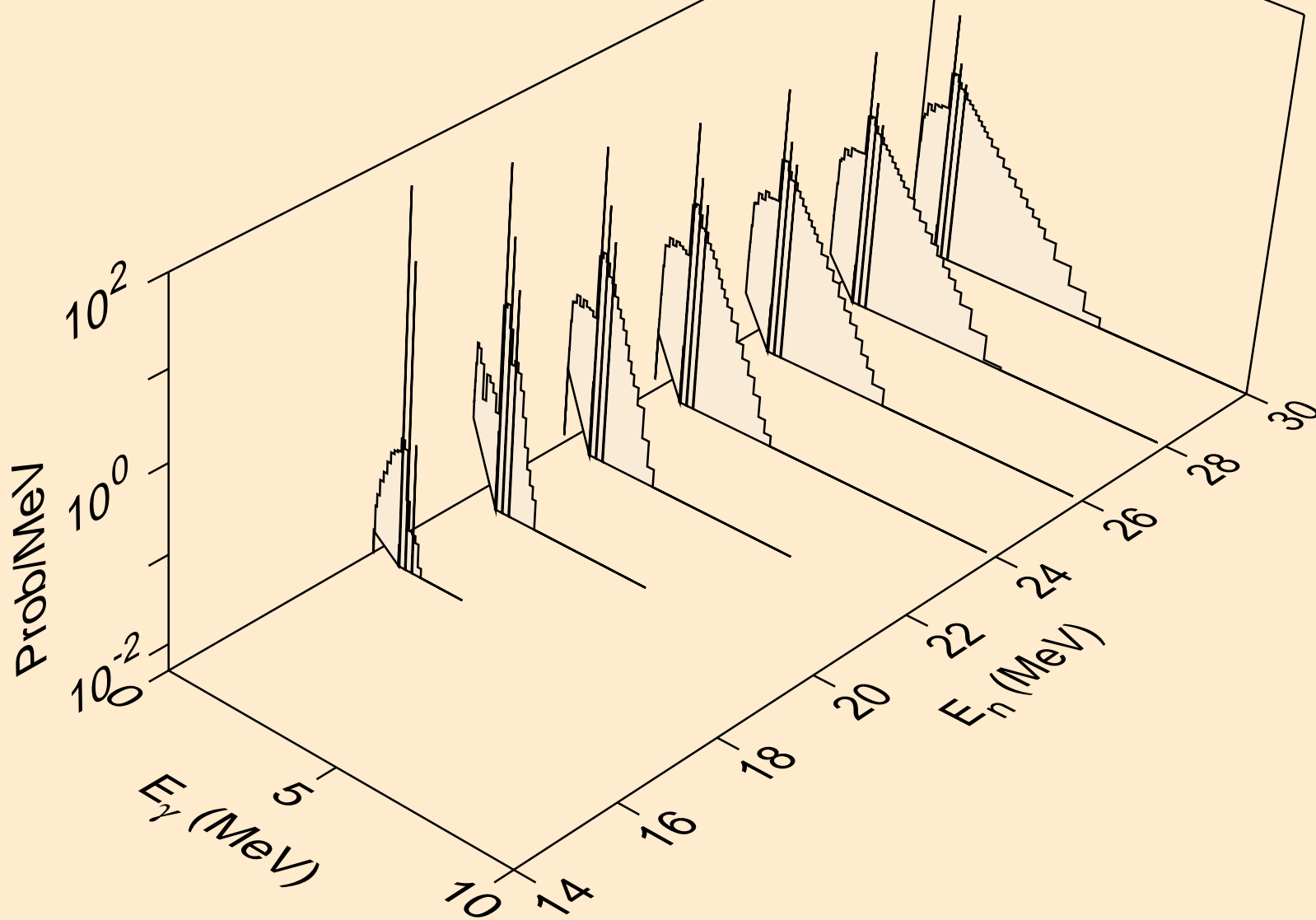

ZR089 NEUTRON ACER TENDL-2019 LIBRARY; T=293.16K  
Photon emission for (n,n\*)t

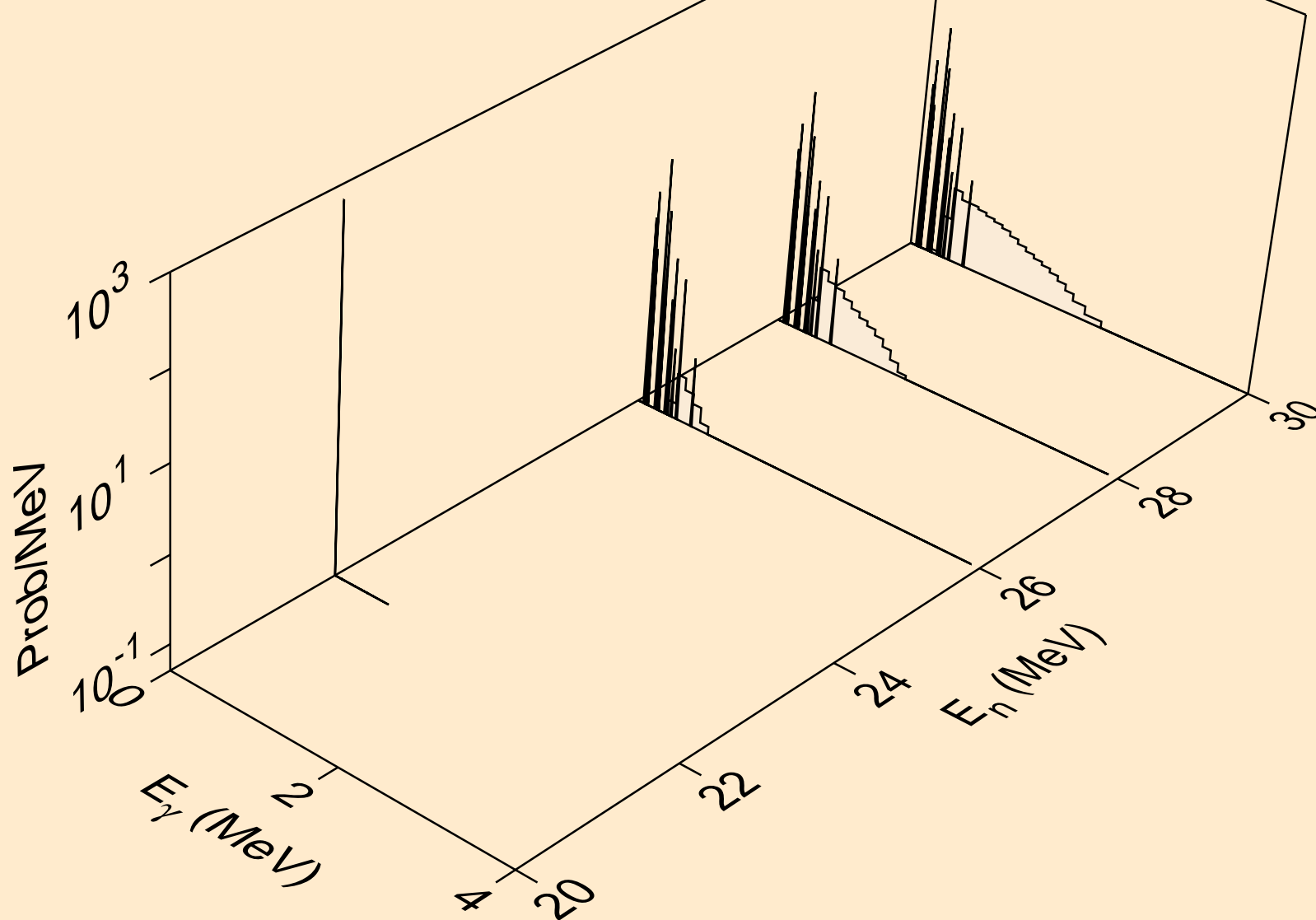

ZR089 NEUTRON ACER TENDL-2019 LIBRARY; T=293.16K  
Photon emission for (n,n\*)he3

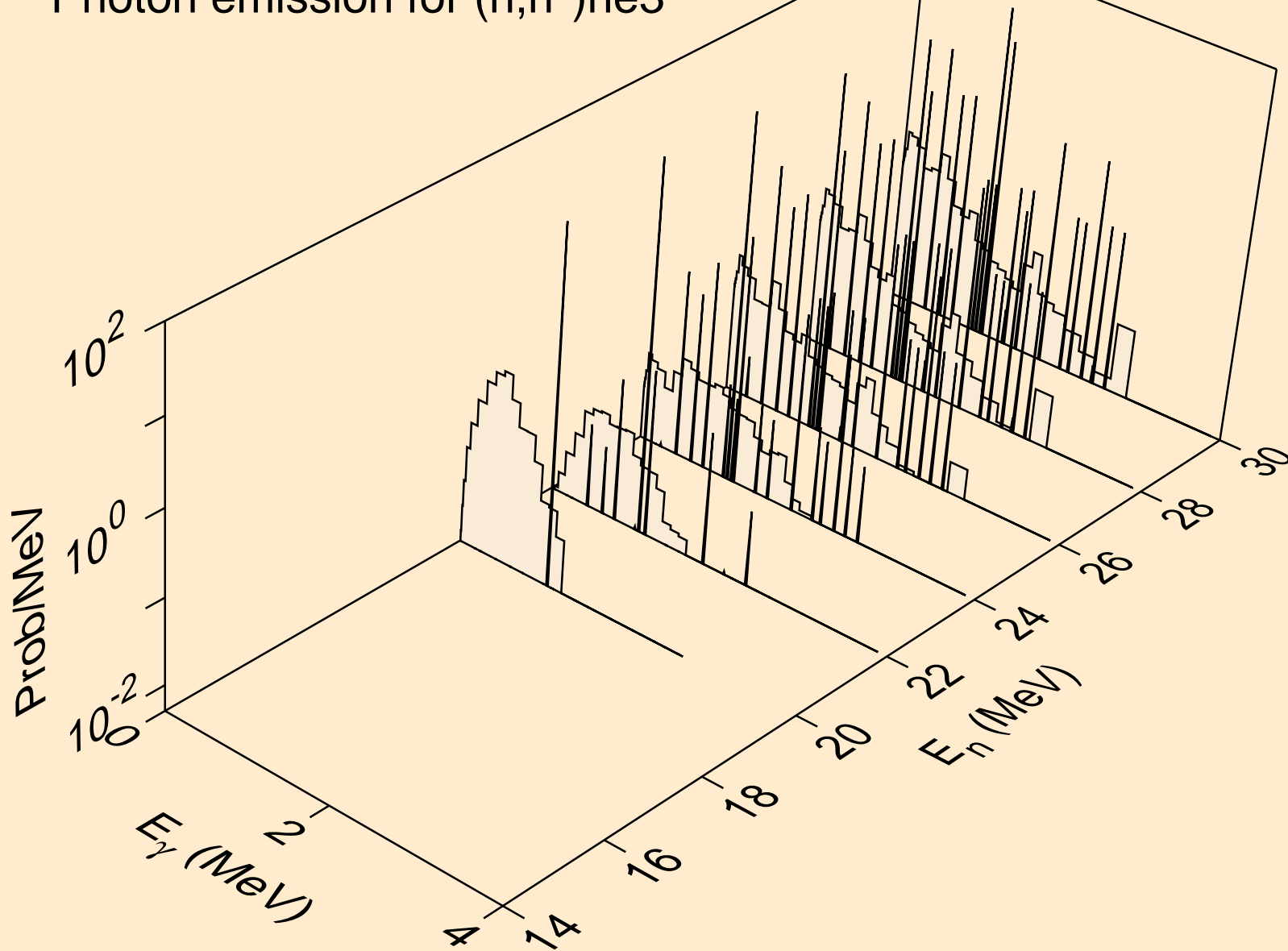

ZR089 NEUTRON ACER TENDL-2019 LIBRARY; T=293.16K  
Photon emission for (n,2np)

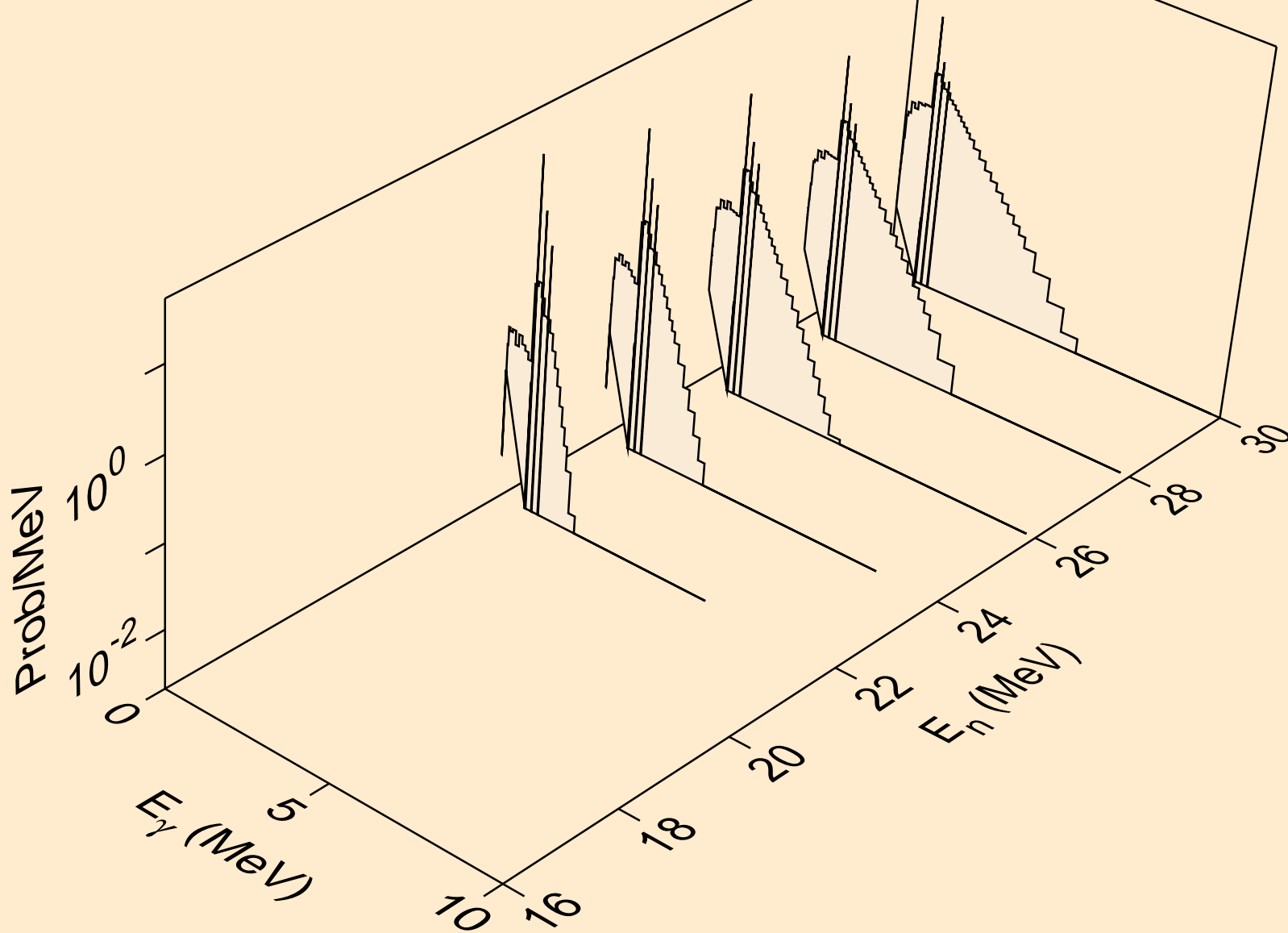



ZR089 NEUTRON ACER TENDL-2019 LIBRARY; T=293.16K  
Photon emission for (n,3np)

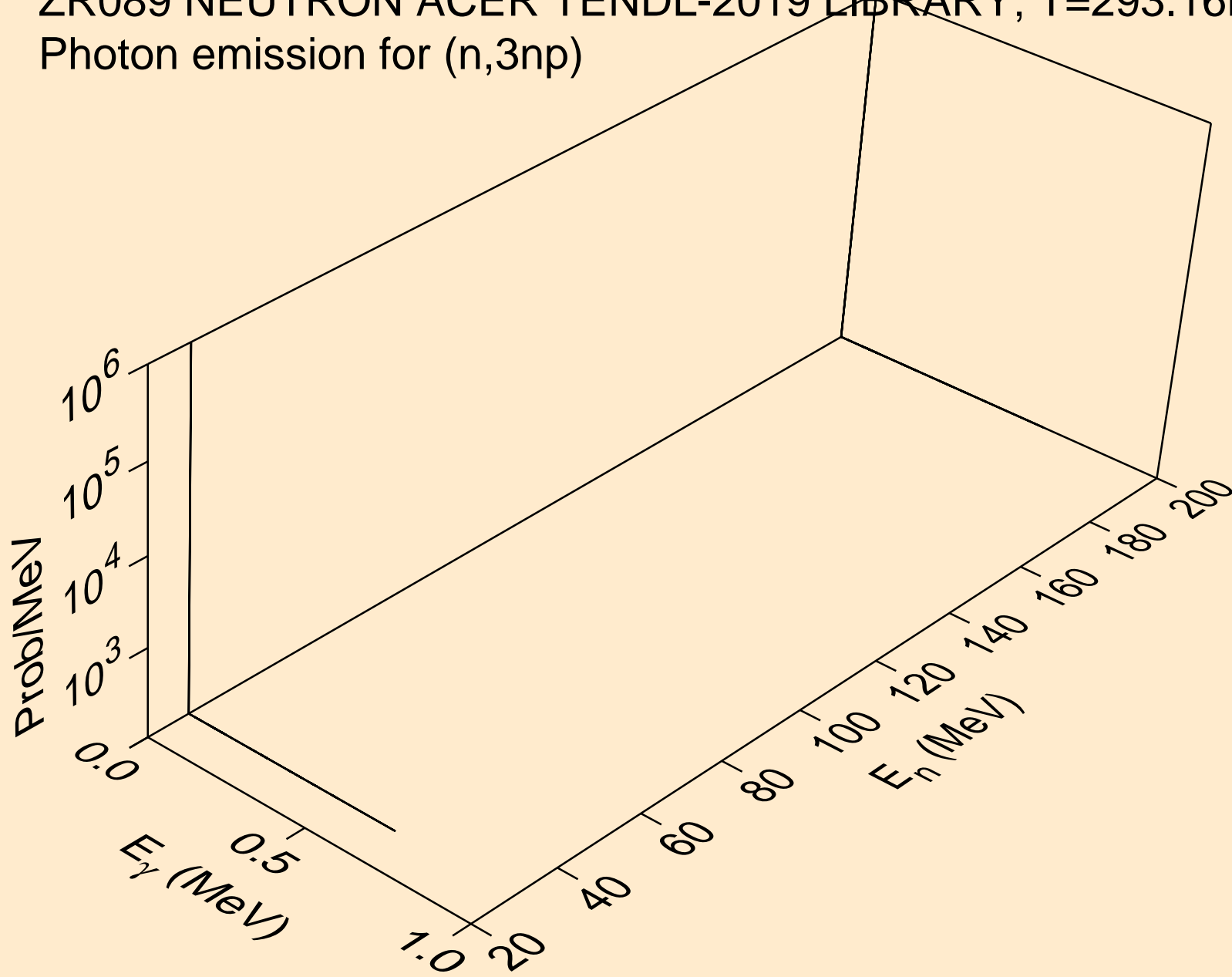

ZR089 NEUTRON ACER TENDL-2019 LIBRARY; T=293.16K  
Photon emission for (n,2np)

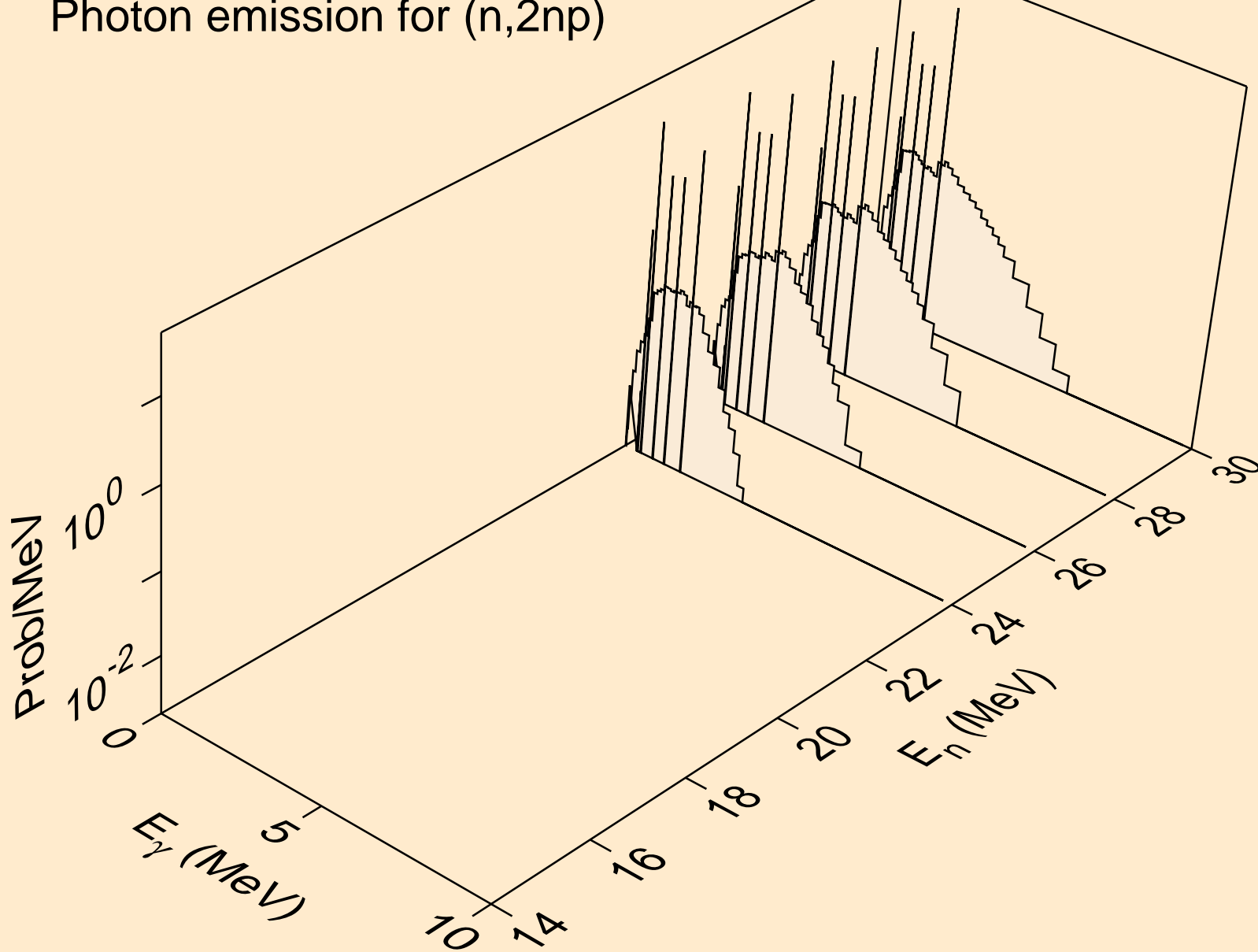

ZR089 NEUTRON ACER TENDL-2019 LIBRARY; T=293.16K  
Photon emission for (n,npa)

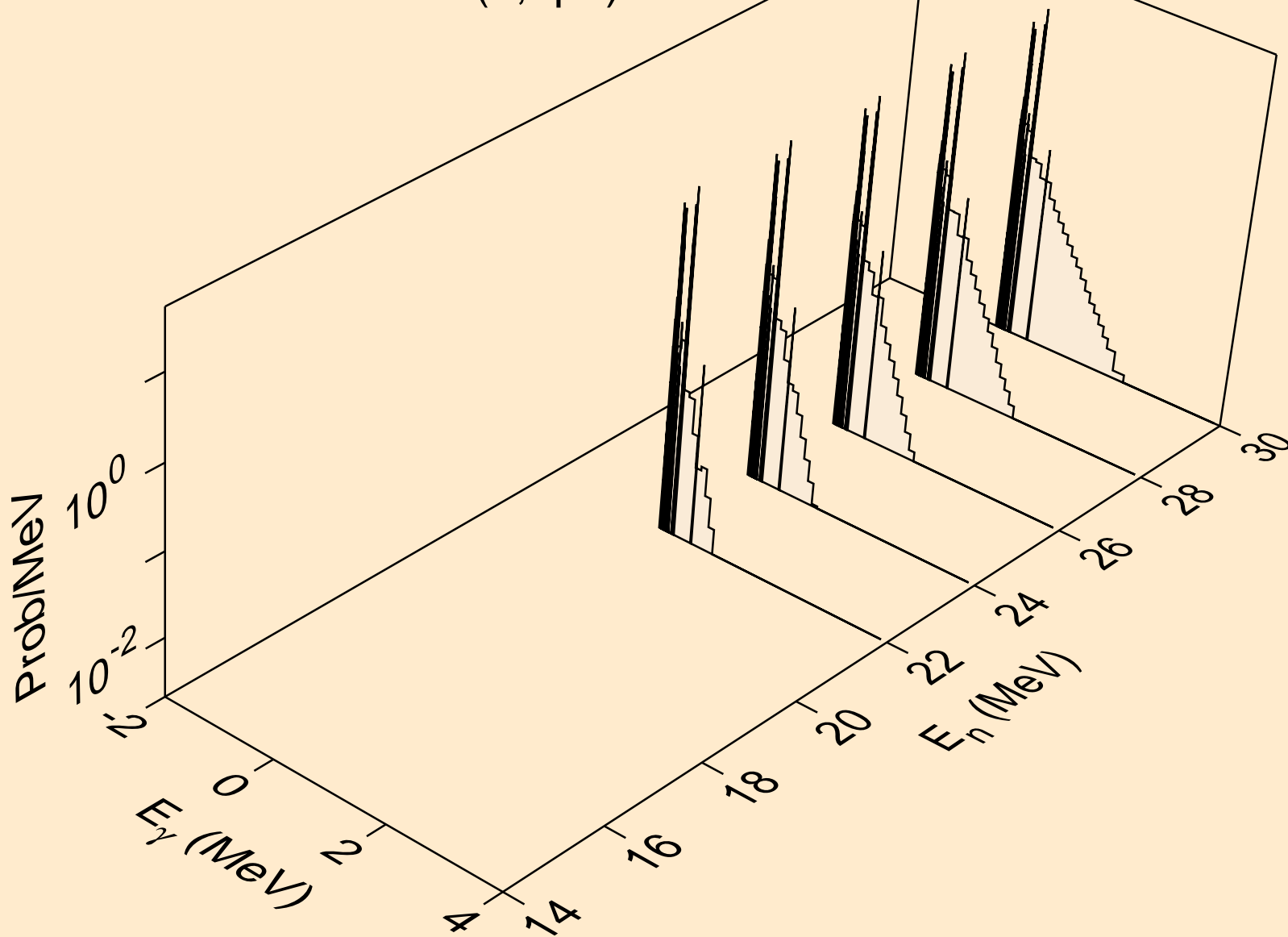

ZR089 NEUTRON ACER TENDL-2019 LIBRARY; T=293.16K  
Photon emission for (n,n\*c)

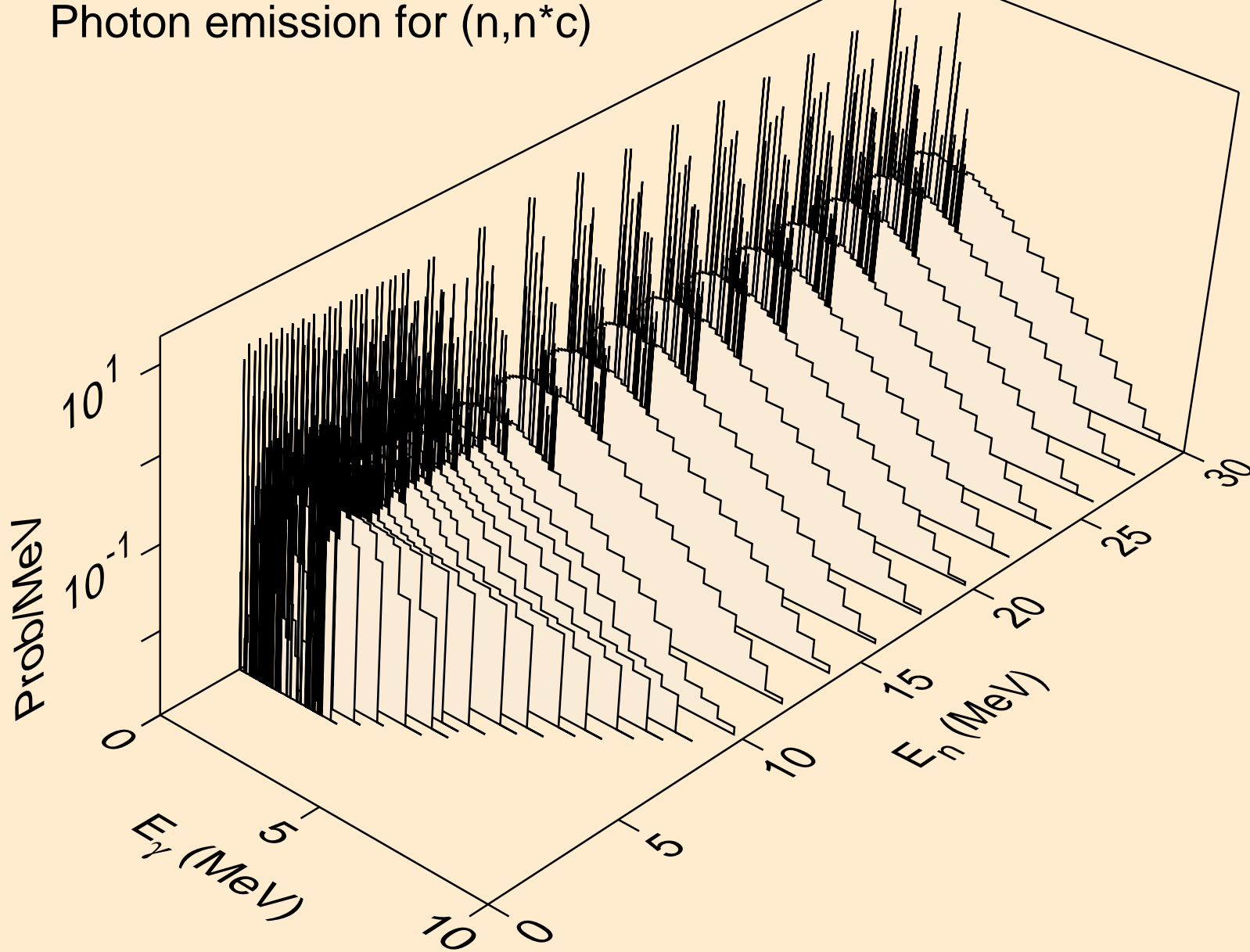

ZR089 NEUTRON ACER TENDL-2019 LIBRARY; T=293.16K  
Photon emission for (n,gma)

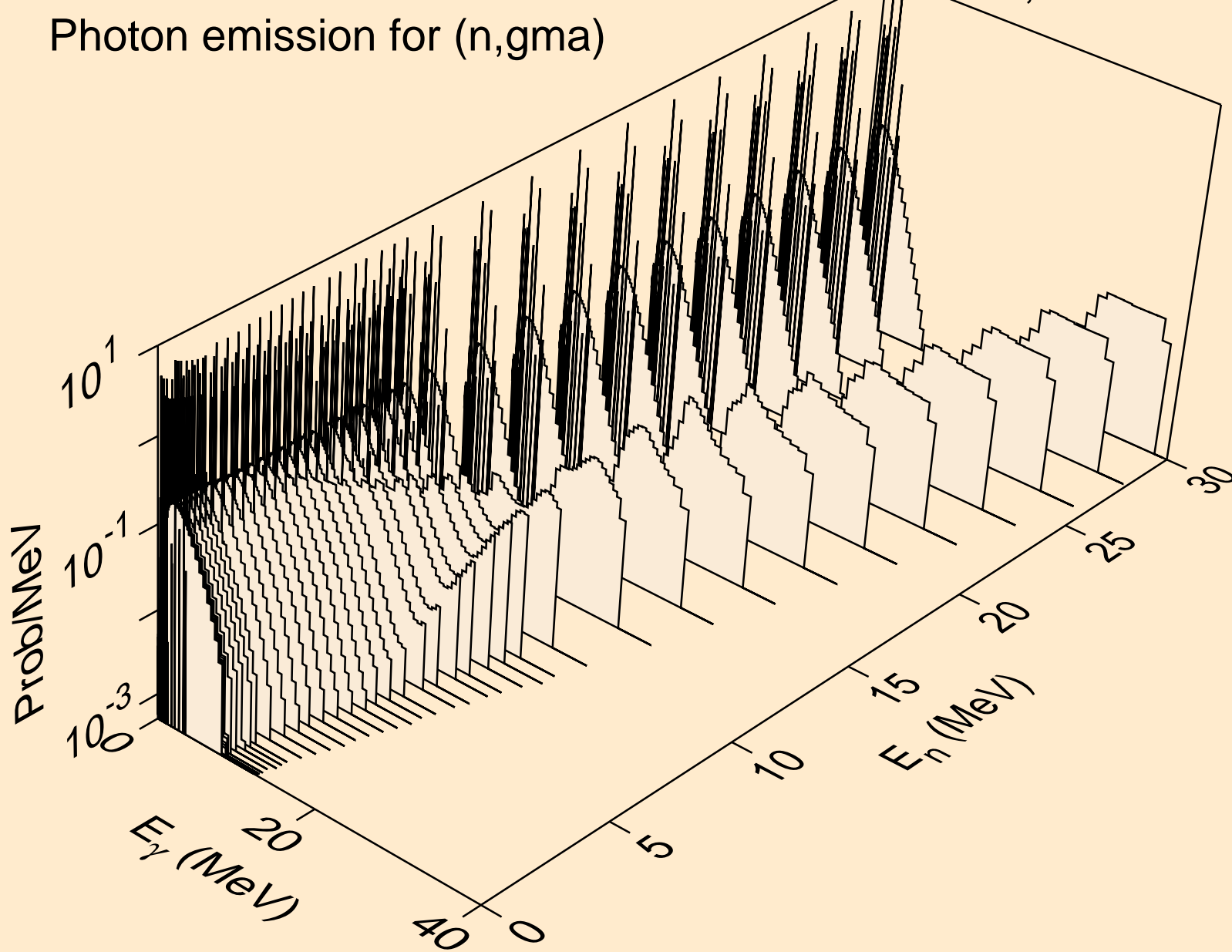

ZR089 NEUTRON ACER TENDL-2019 LIBRARY; T=293.16K  
Photon emission for (n,p)

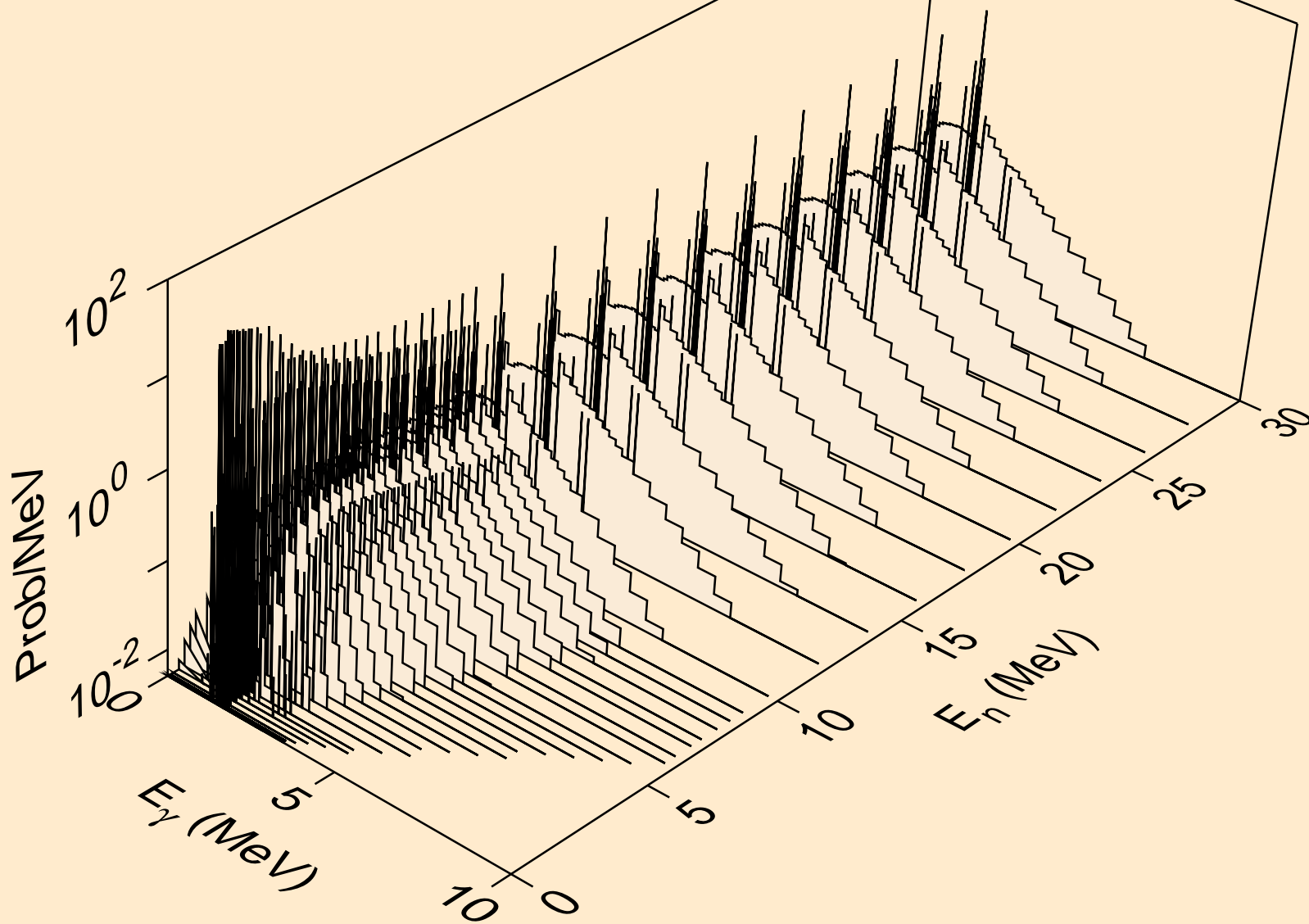

ZR089 NEUTRON ACER TENDL-2019 LIBRARY; T=293.16K  
Photon emission for (n,d)

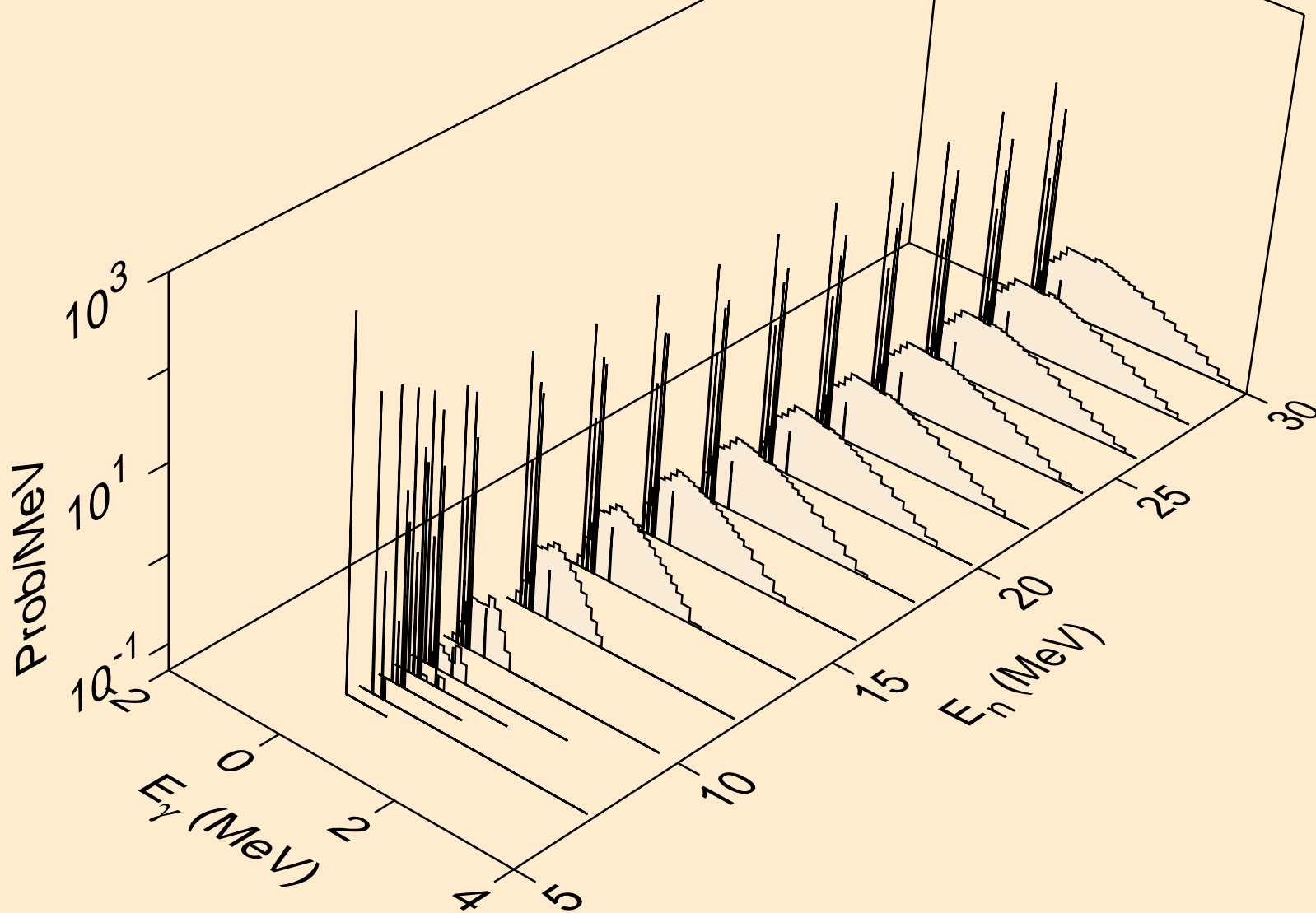

ZR089 NEUTRON ACER TENDL-2019 LIBRARY; T=293.16K  
Photon emission for (n,t)

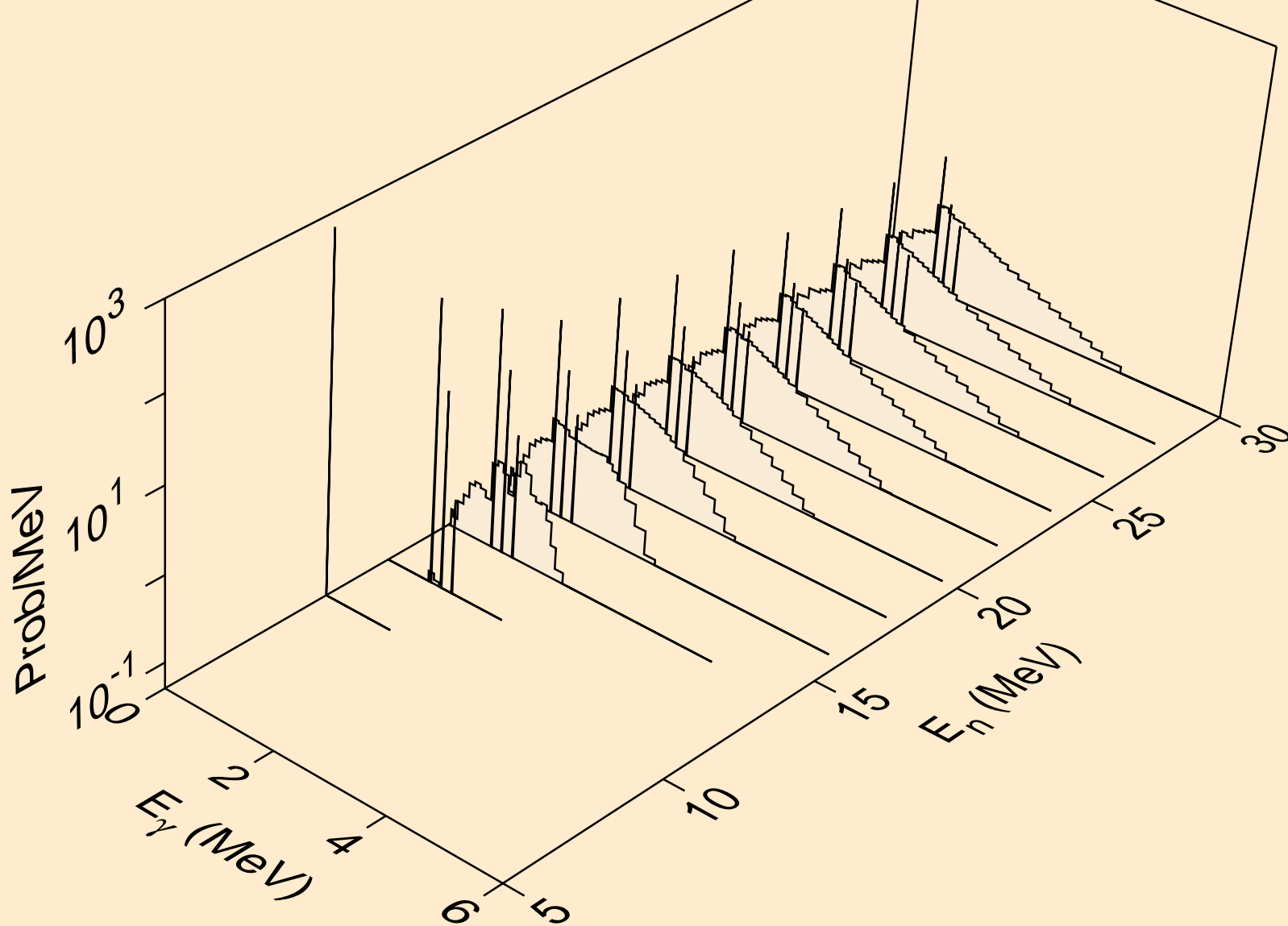



ZR089 NEUTRON ACER TENDL-2019 LIBRARY; T=293.16K  
Photon emission for (n,he3)

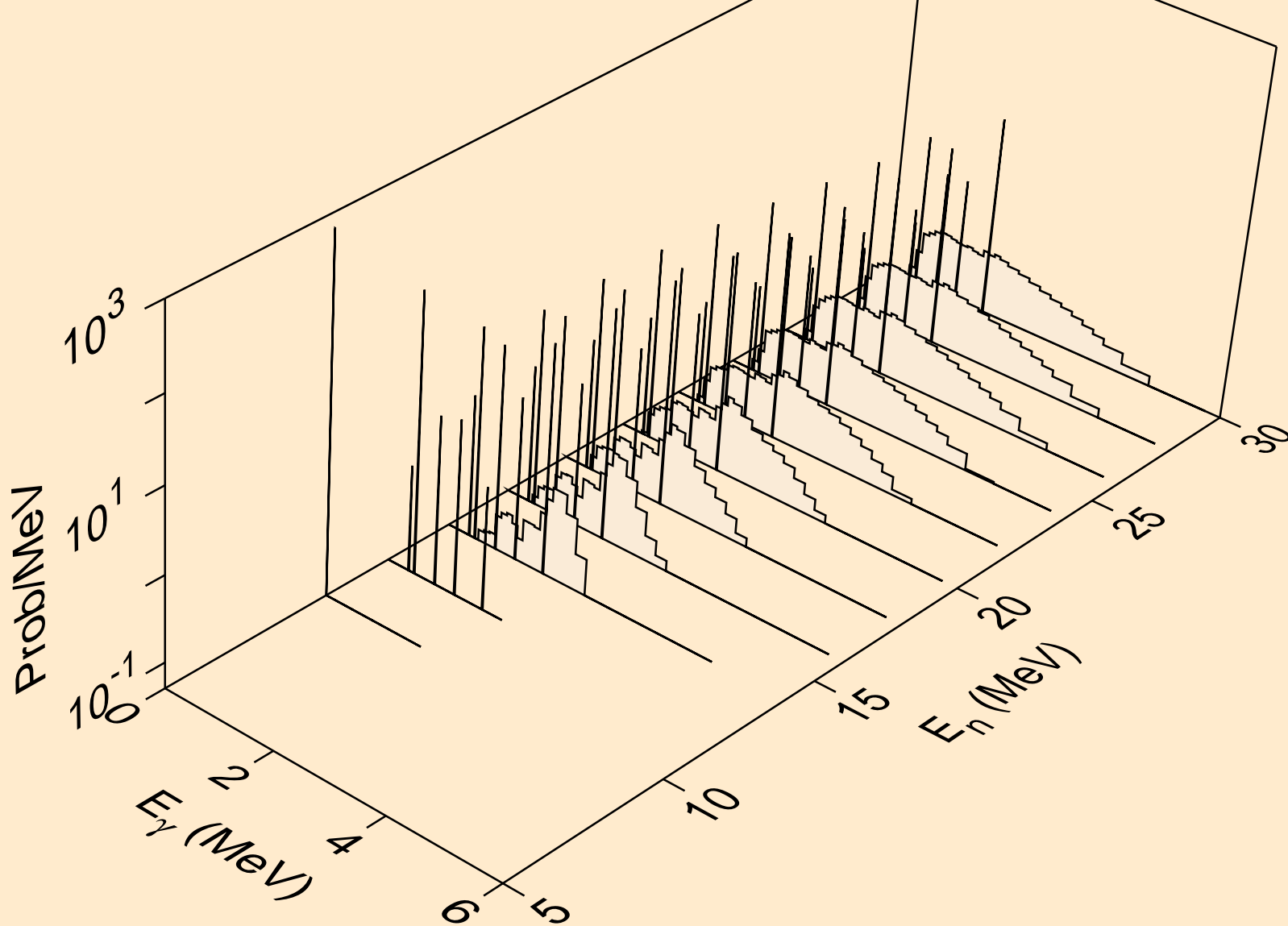

ZR089 NEUTRON ACER TENDL-2019 LIBRARY; T=293.16K  
Photon emission for (n,a)

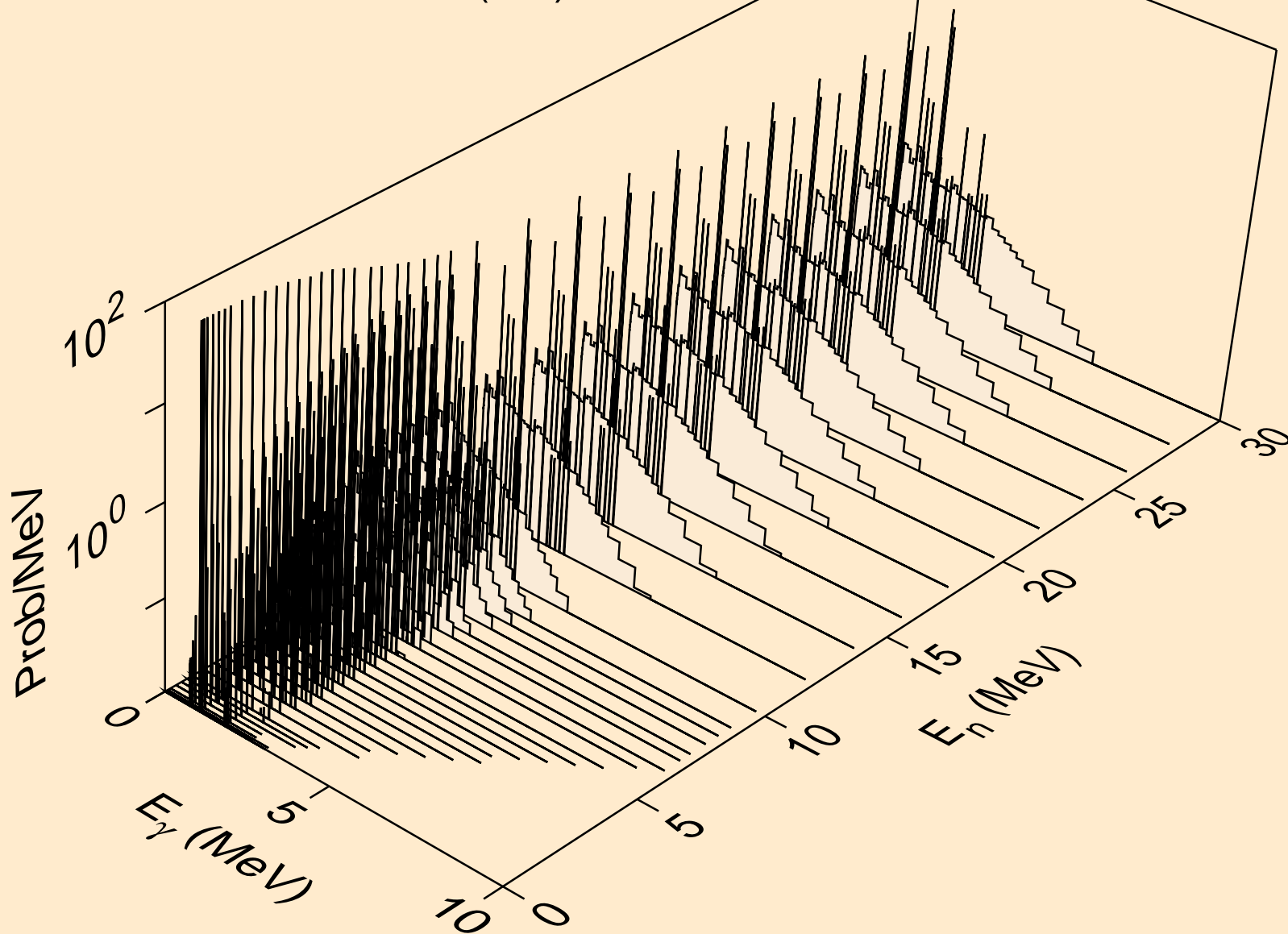

ZR089 NEUTRON ACER TENDL-2019 LIBRARY; T=293.16K  
Photon emission for (n,2a)

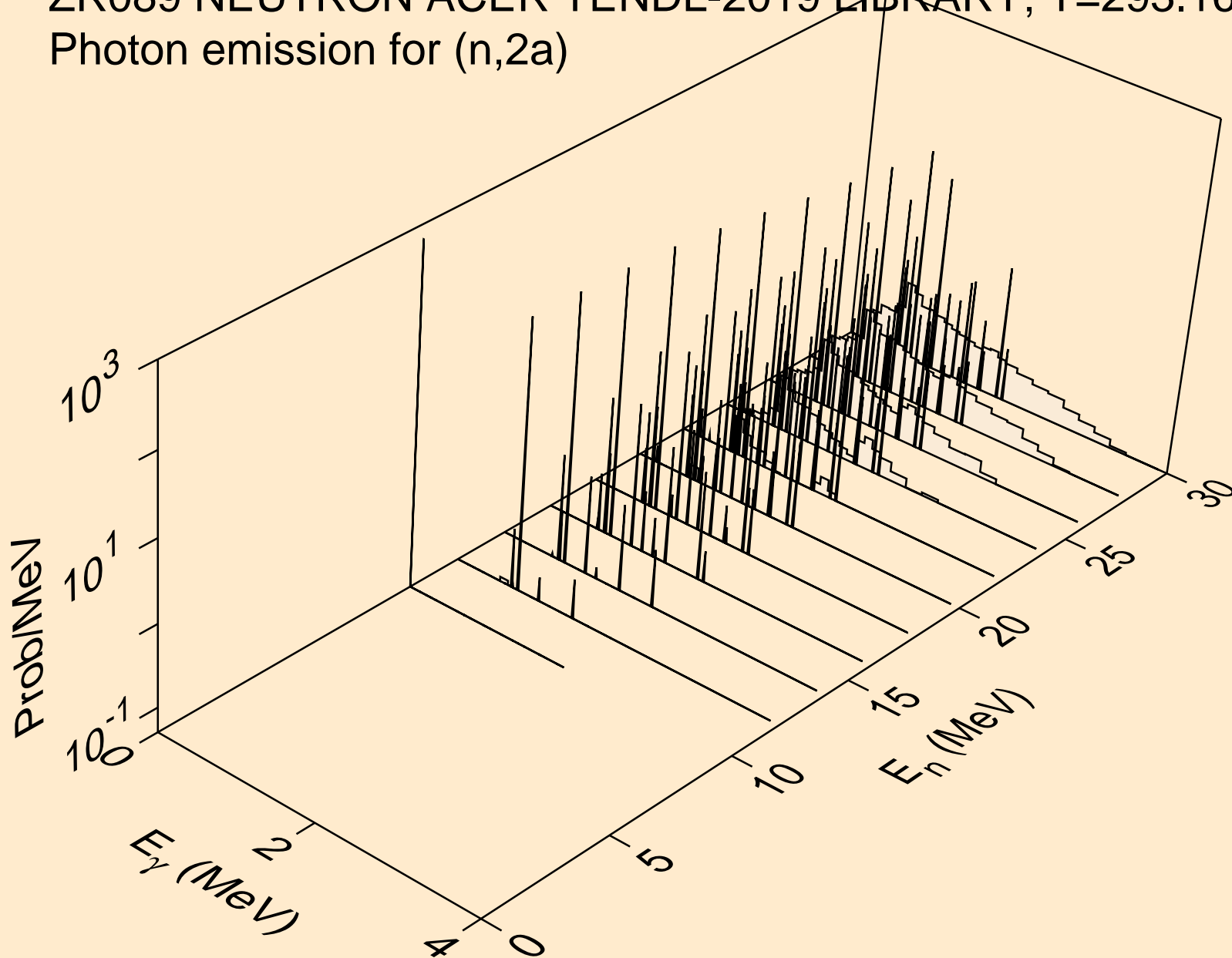

ZR089 NEUTRON ACER TENDL-2019 LIBRARY; T=293.16K  
Photon emission for (n,2p)

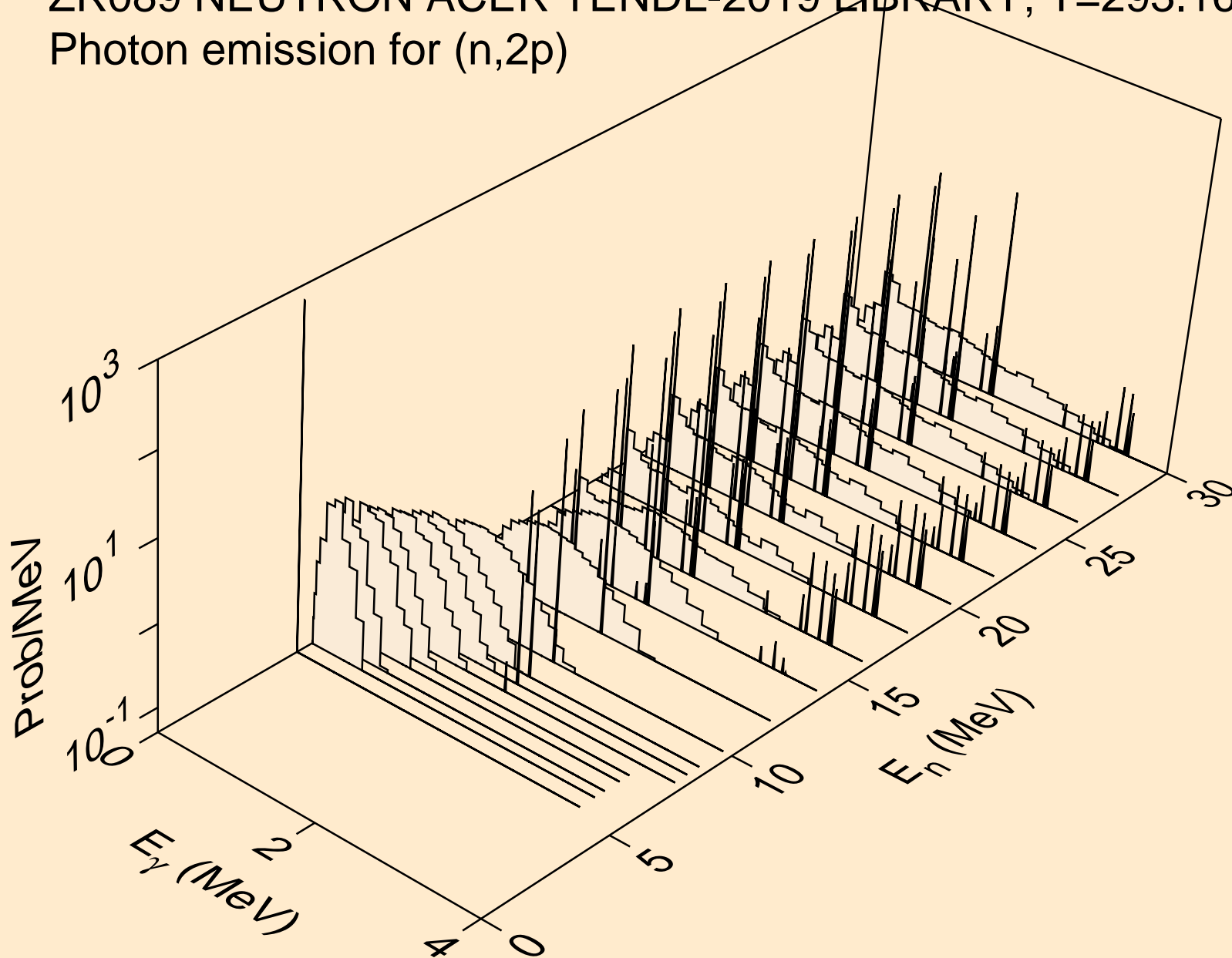

ZR089 NEUTRON ACER TENDL-2019 LIBRARY; T=293.16K  
Photon emission for (n,p $\alpha$ )

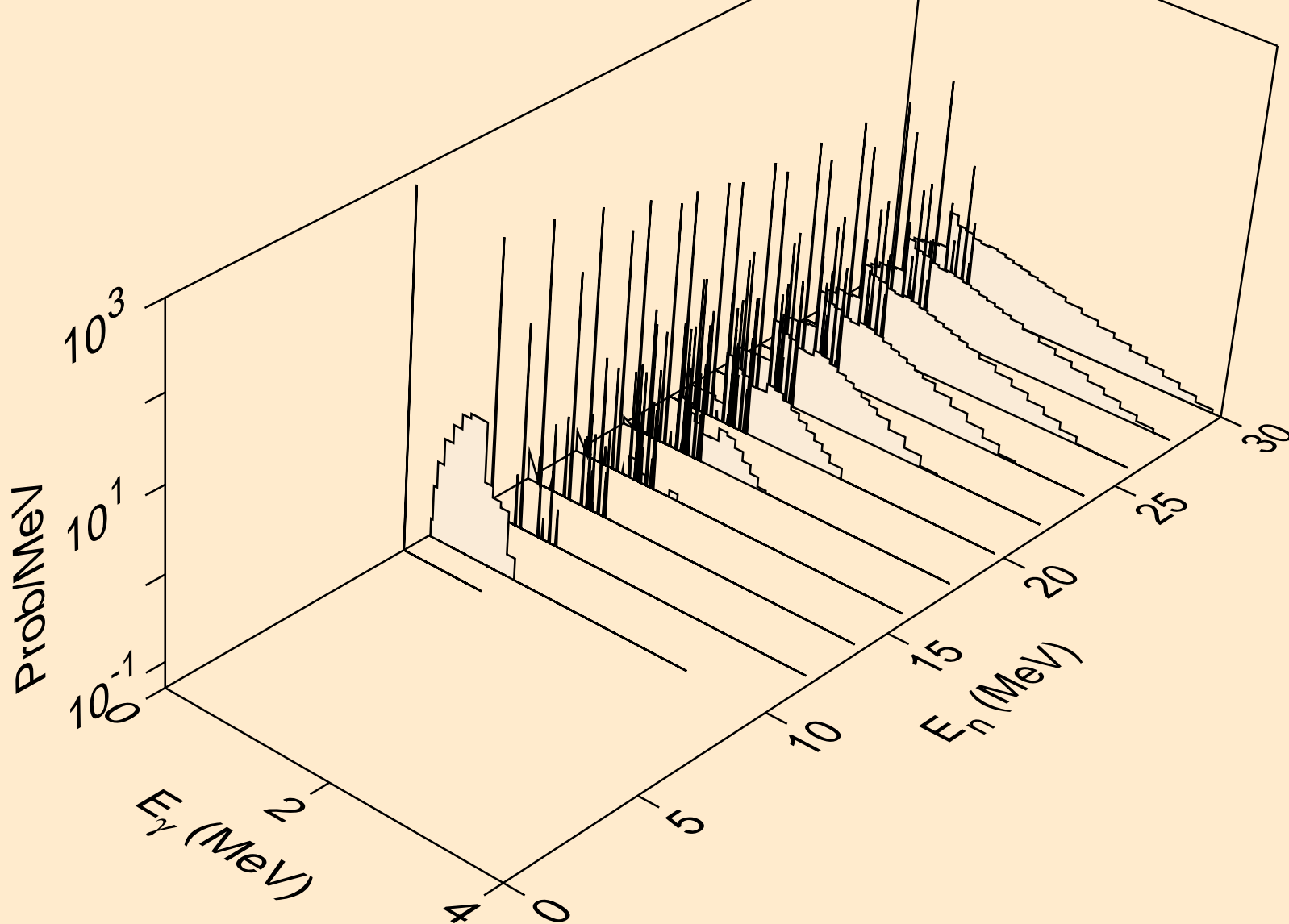

ZR089 NEUTRON ACER TENDL-2019 LIBRARY; T=293.16K  
Photon emission for (n,pd)

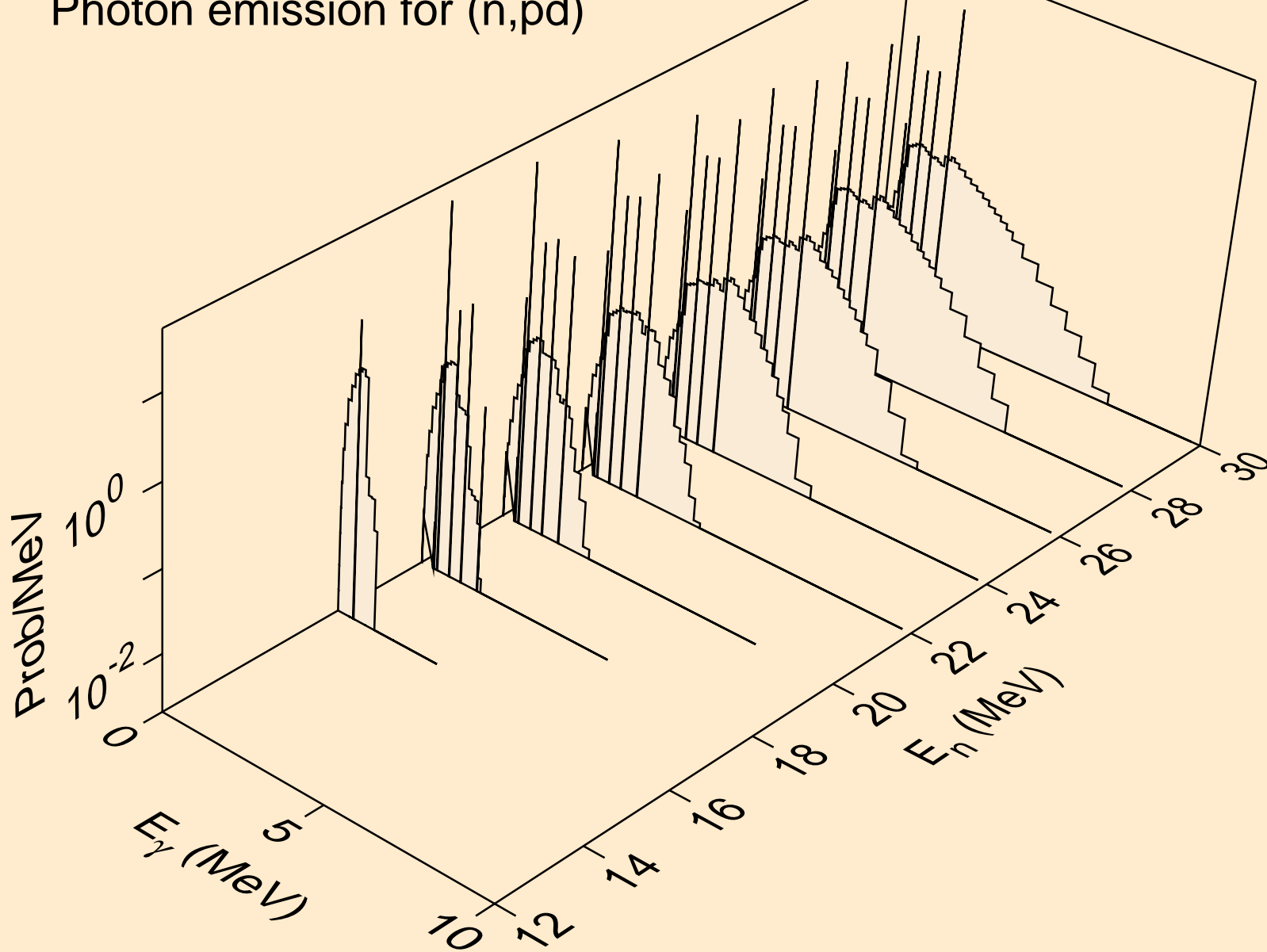

ZR089 NEUTRON ACER TENDL-2019 LIBRARY; T=293.16K  
Photon emission for (n,pt)

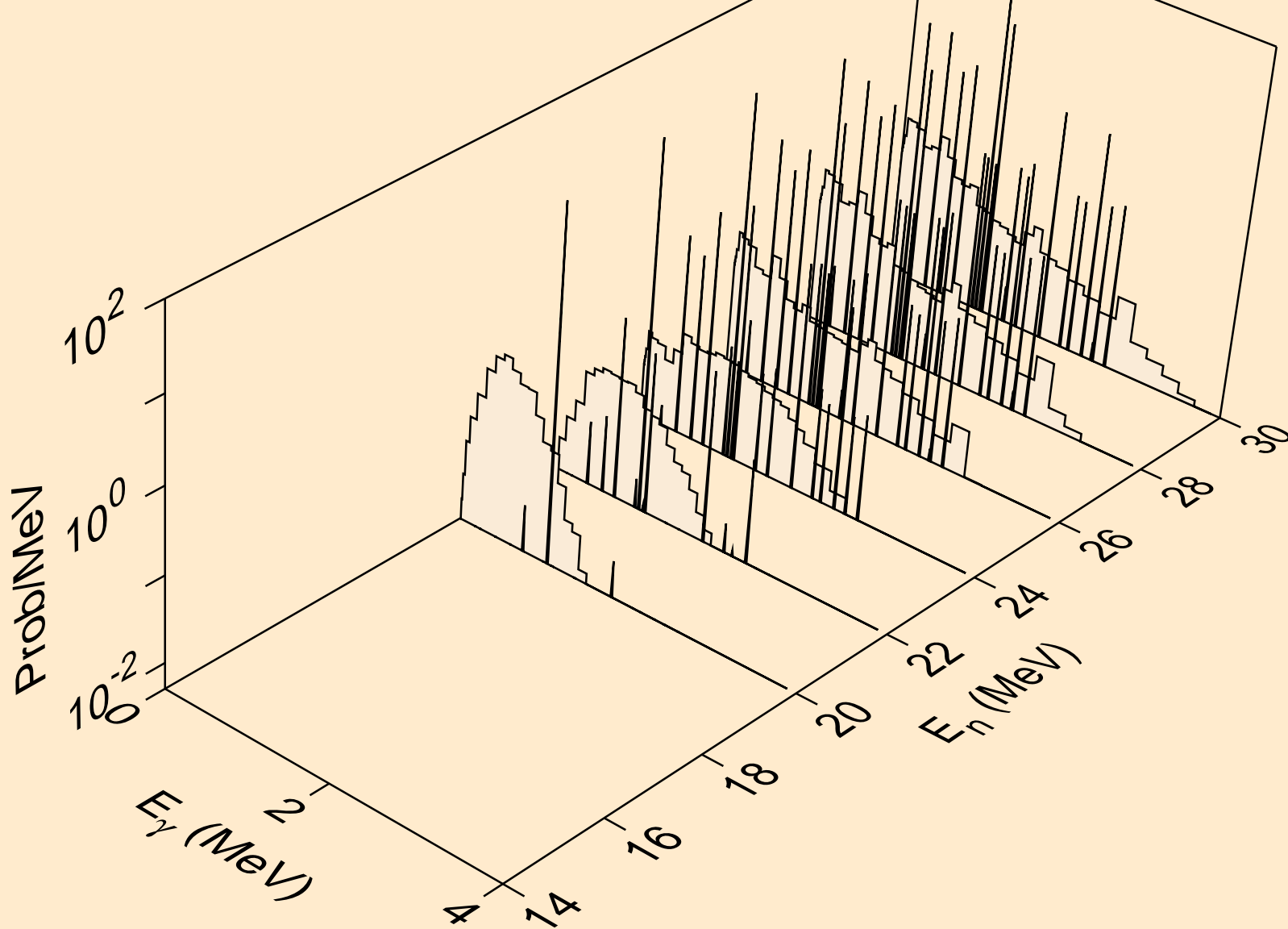

ZR089 NEUTRON ACER TENDL-2019 LIBRARY; T=293.16K  
Photon emission for (n,da)

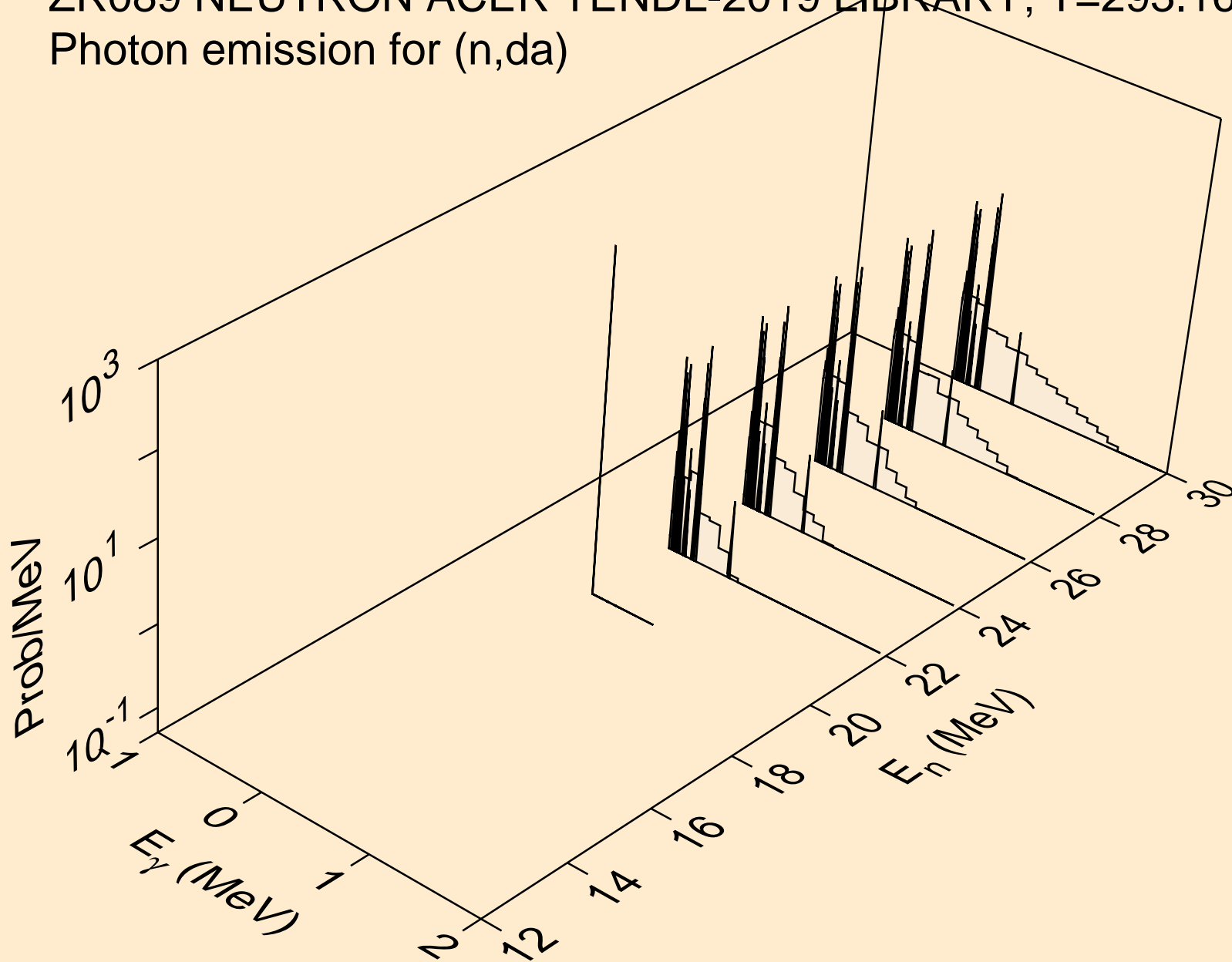



ZR089 NEUTRON ACER TENDL-2019 LIBRARY; T=293.16K  
thermal capture photon spectrum

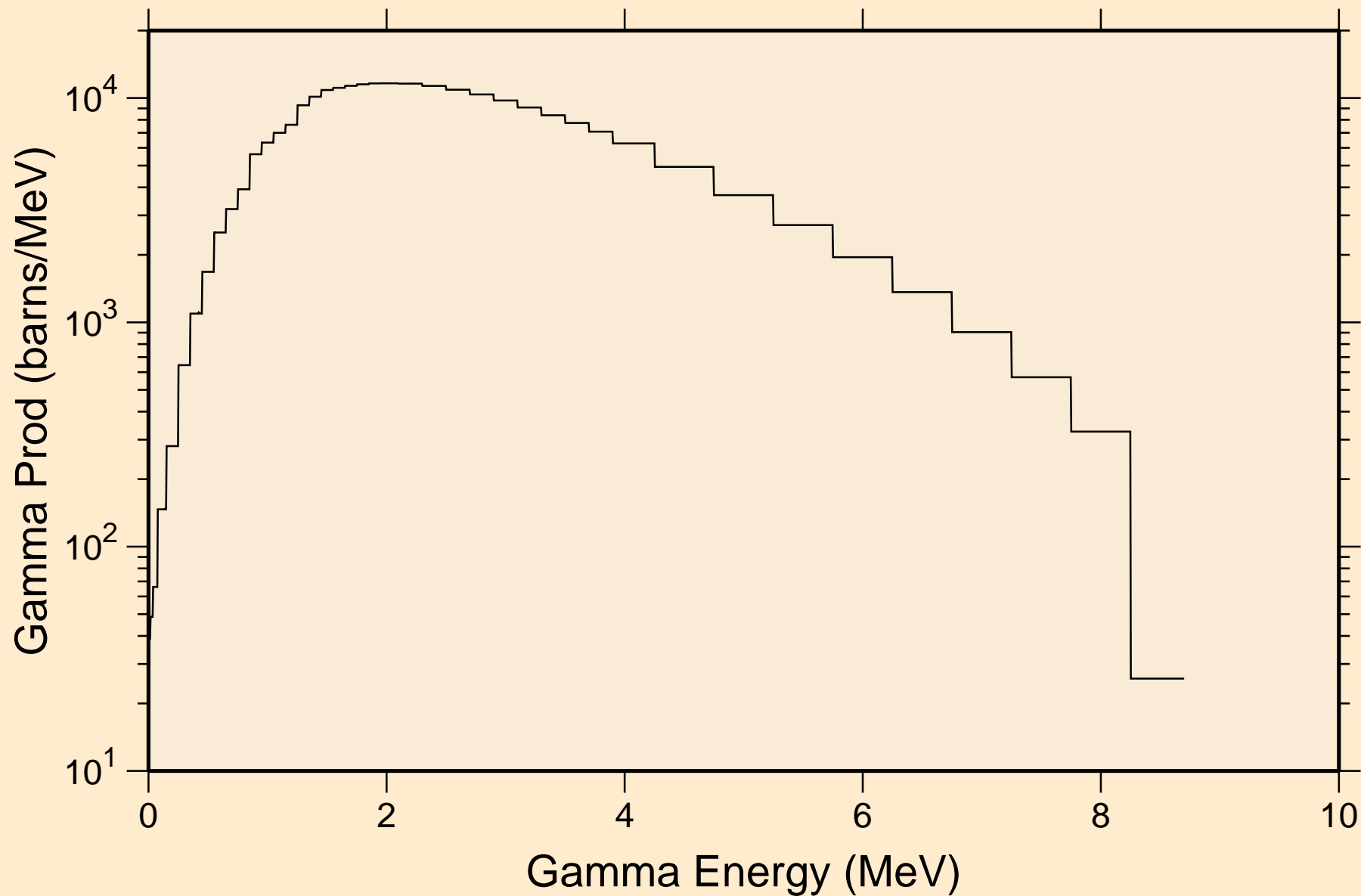

ZR089 NEUTRON ACER TENDL-2019 LIBRARY; T=293.16K  
14 MeV photon spectrum

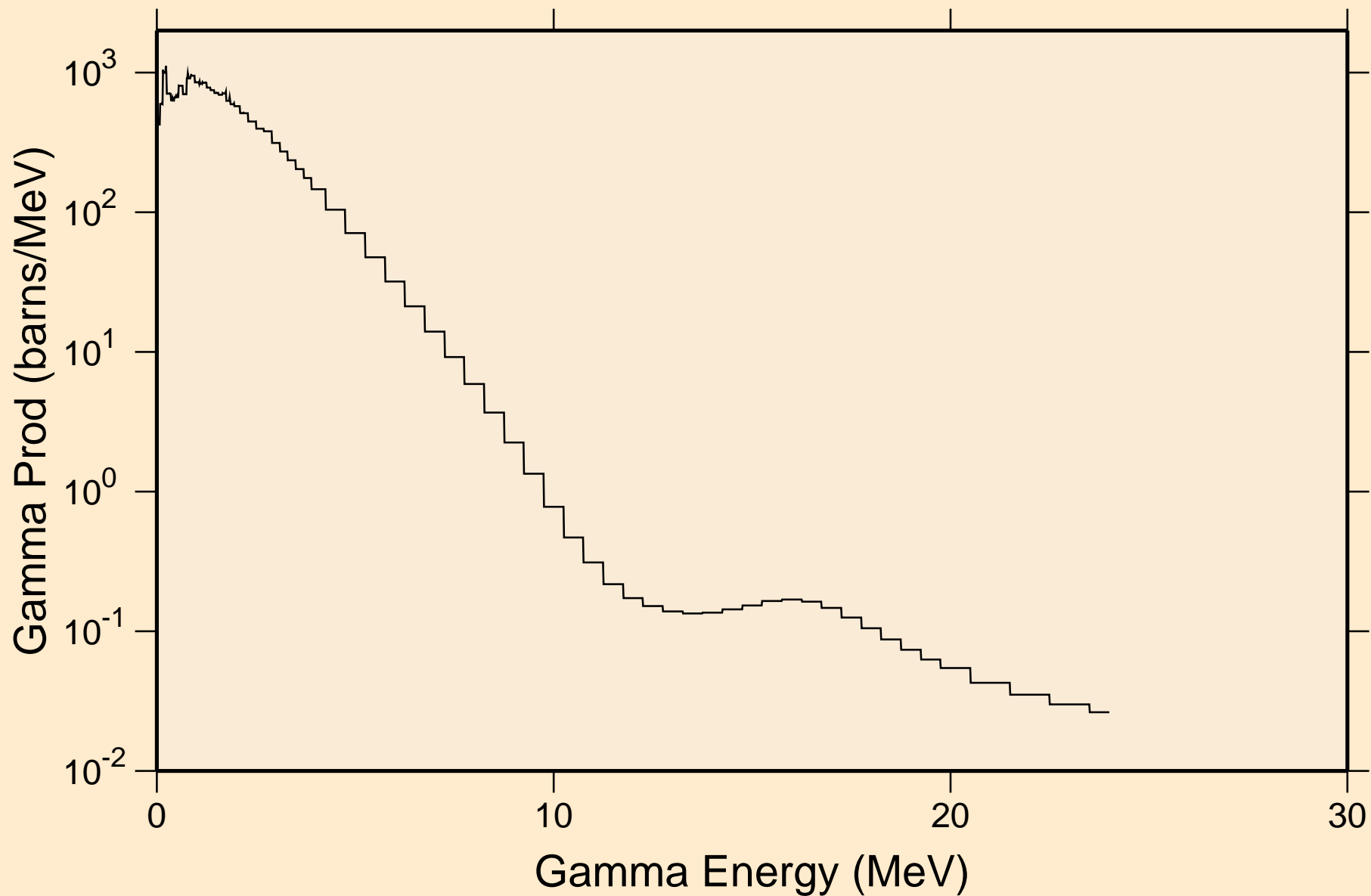

ZR089 NEUTRON ACER TENDL-2019 LIBRARY; T=293.16K  
Particle heating contributions

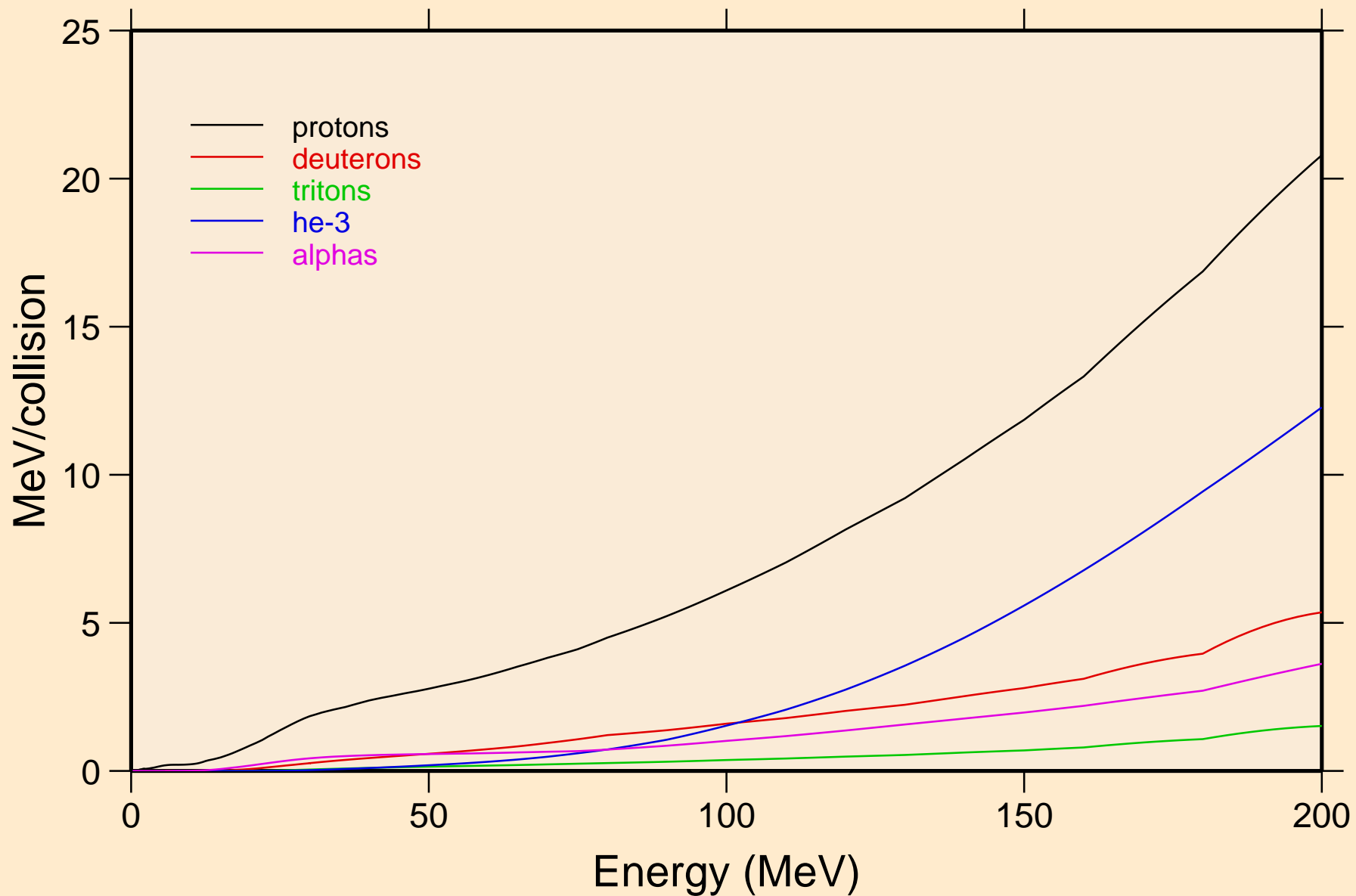

ZR089 NEUTRON ACER TENDL-2019 LIBRARY; T=293.16K  
Recoil Heating

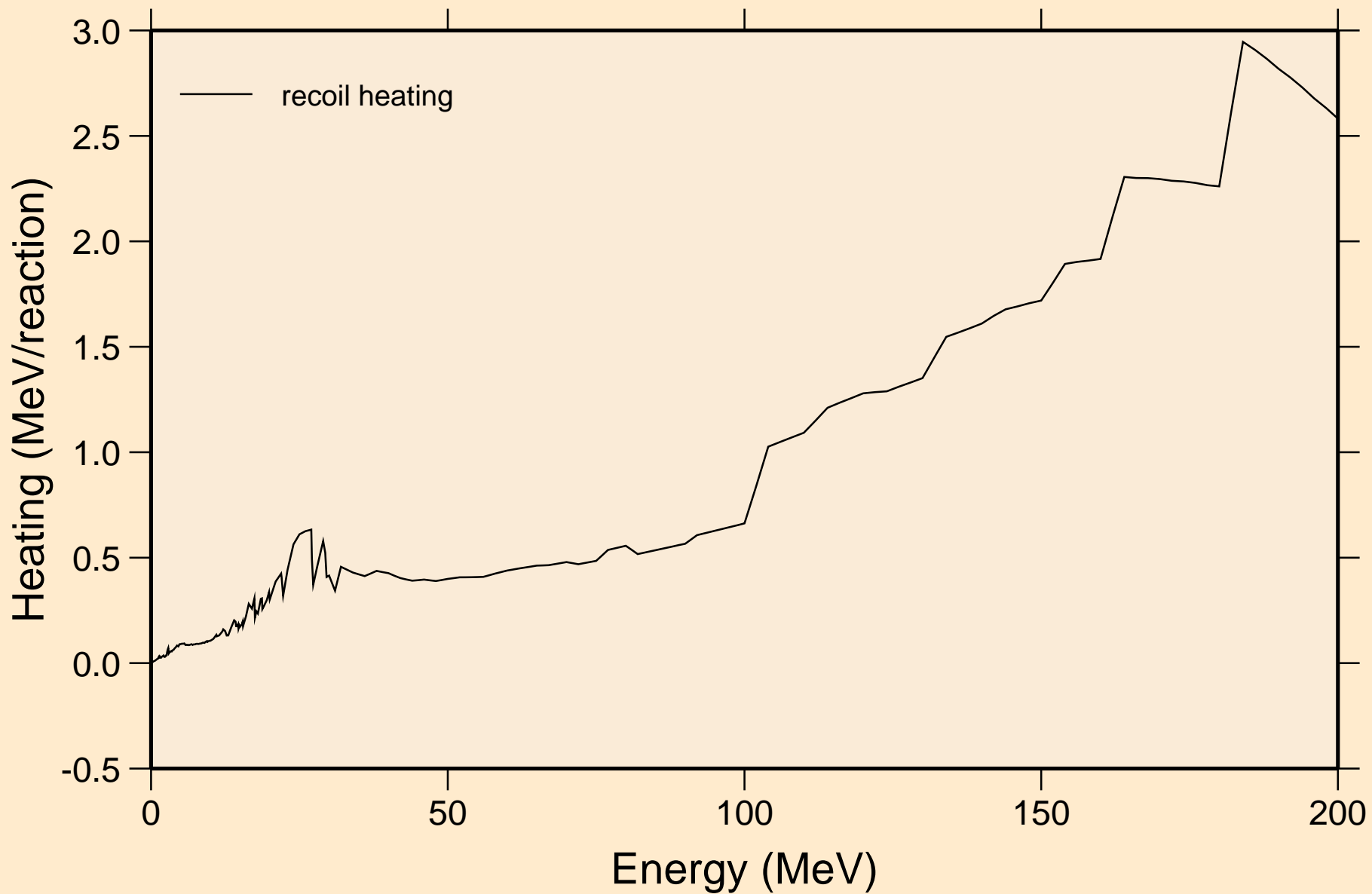

ZR089 NEUTRON ACER TENDL-2019 LIBRARY; T=293.16K  
Particle production cross sections

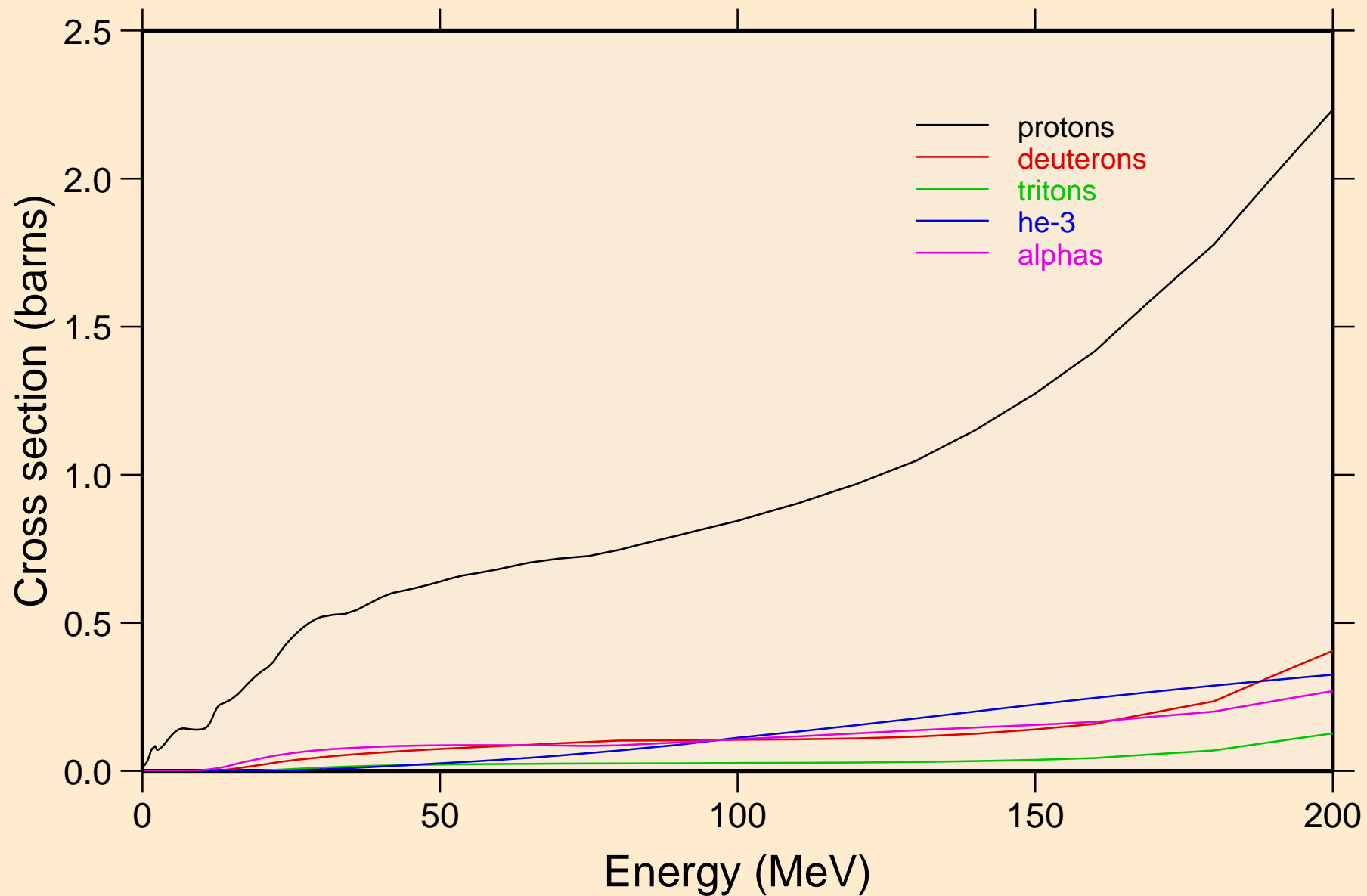

ZR089 NEUTRON ACER TENDL-2019 LIBRARY; T=293.16K  
protons from (n,x)

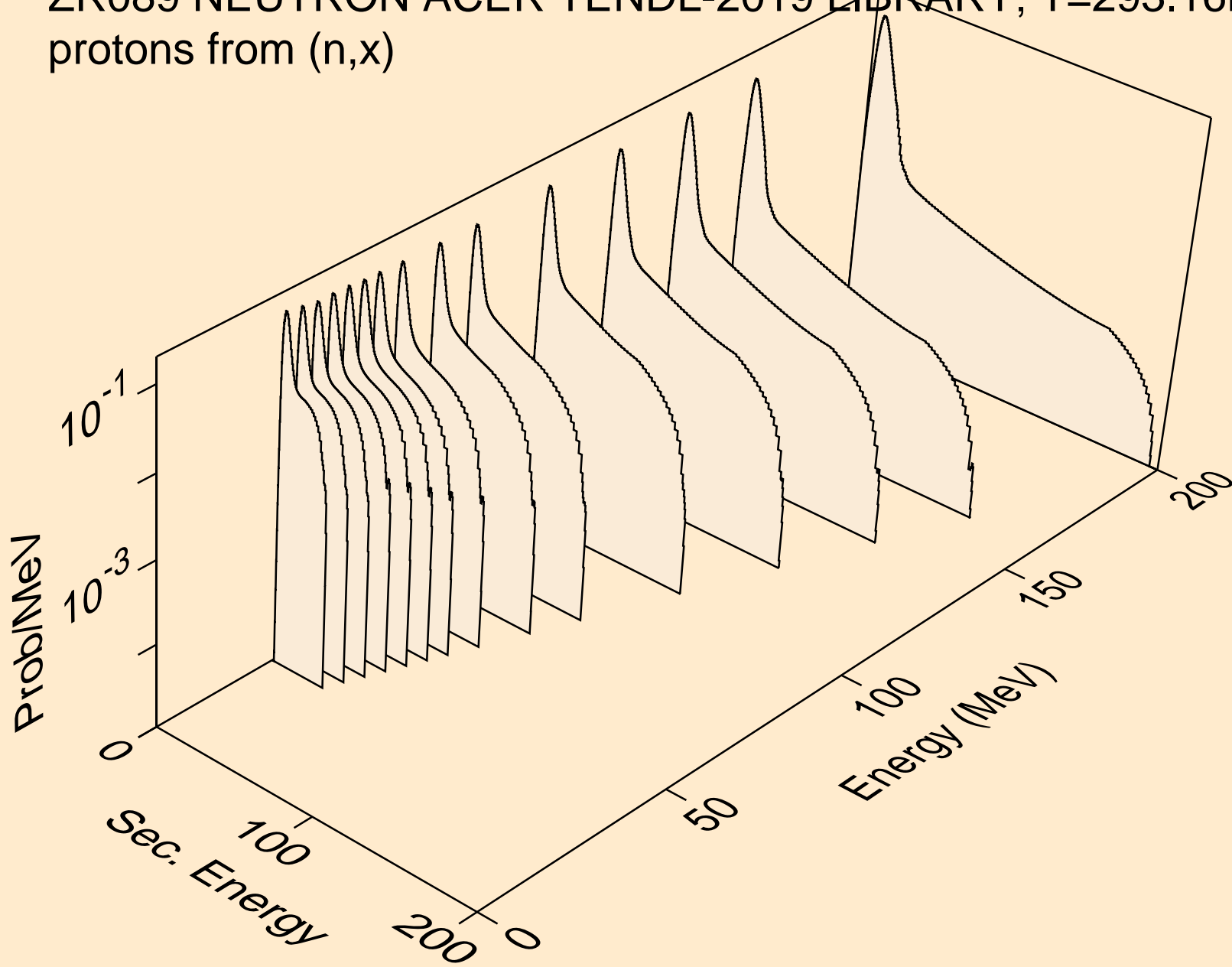

ZR089 NEUTRON ACER TENDL-2019 LIBRARY; T=293.16K  
protons from (n,n\*)p

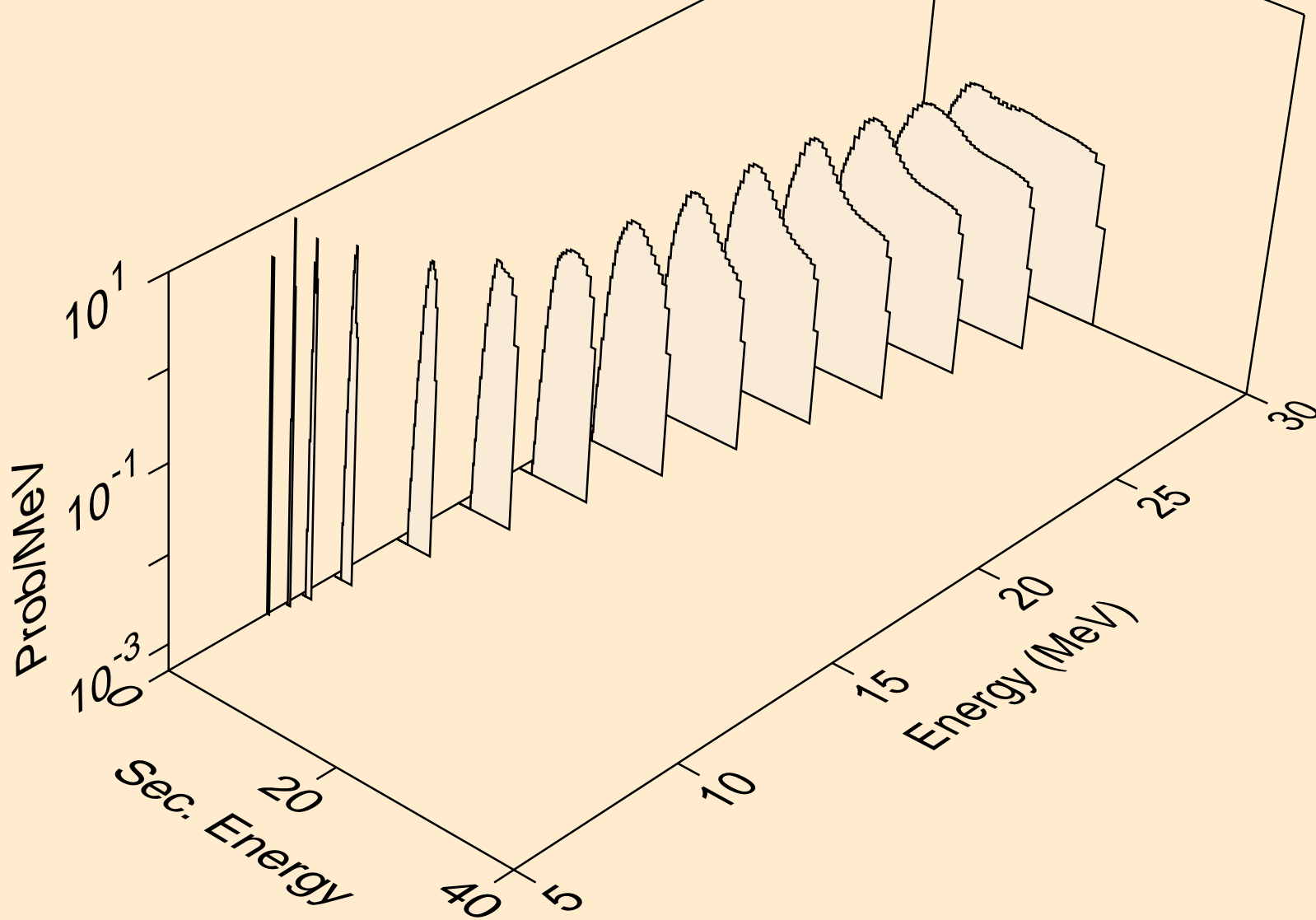

ZR089 NEUTRON ACER TENDL-2019 LIBRARY; T=293.16K  
protons from (n,2np)

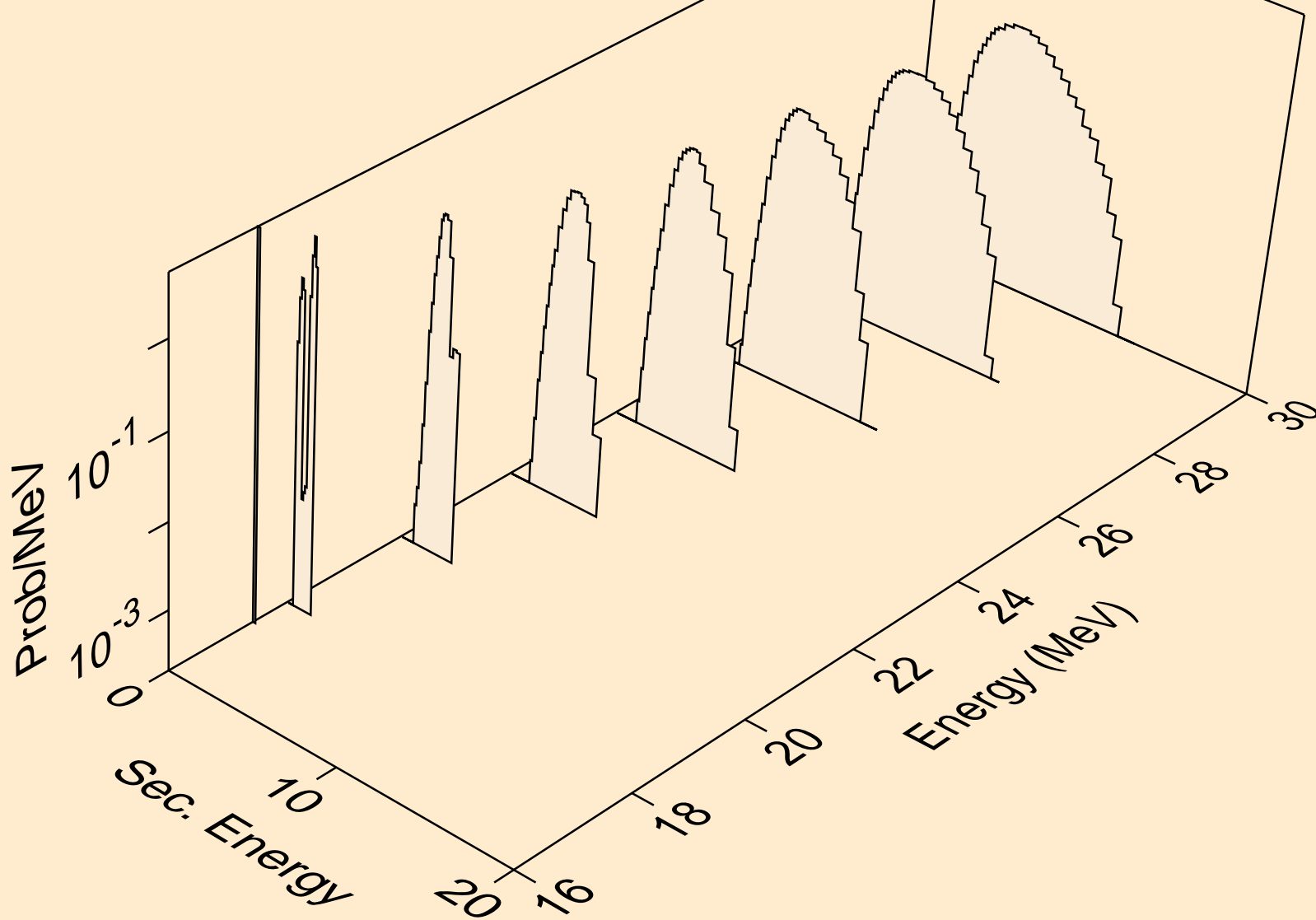



ZR089 NEUTRON ACER TENDL-2019 LIBRARY; T=293.16K  
protons from (n,3np)

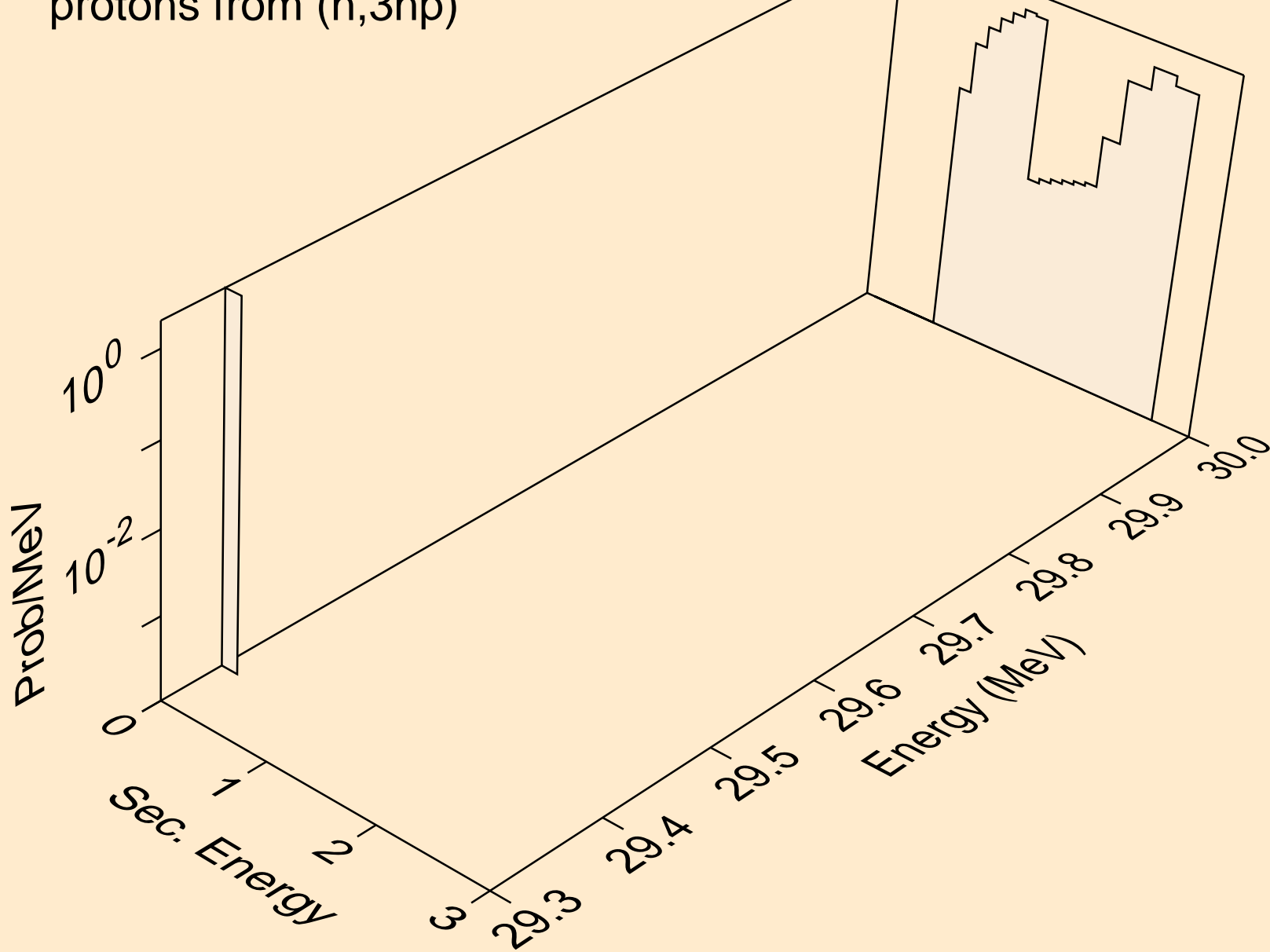

ZR089 NEUTRON ACER TENDL-2019 LIBRARY; T=293.16K  
protons from (n,2np)

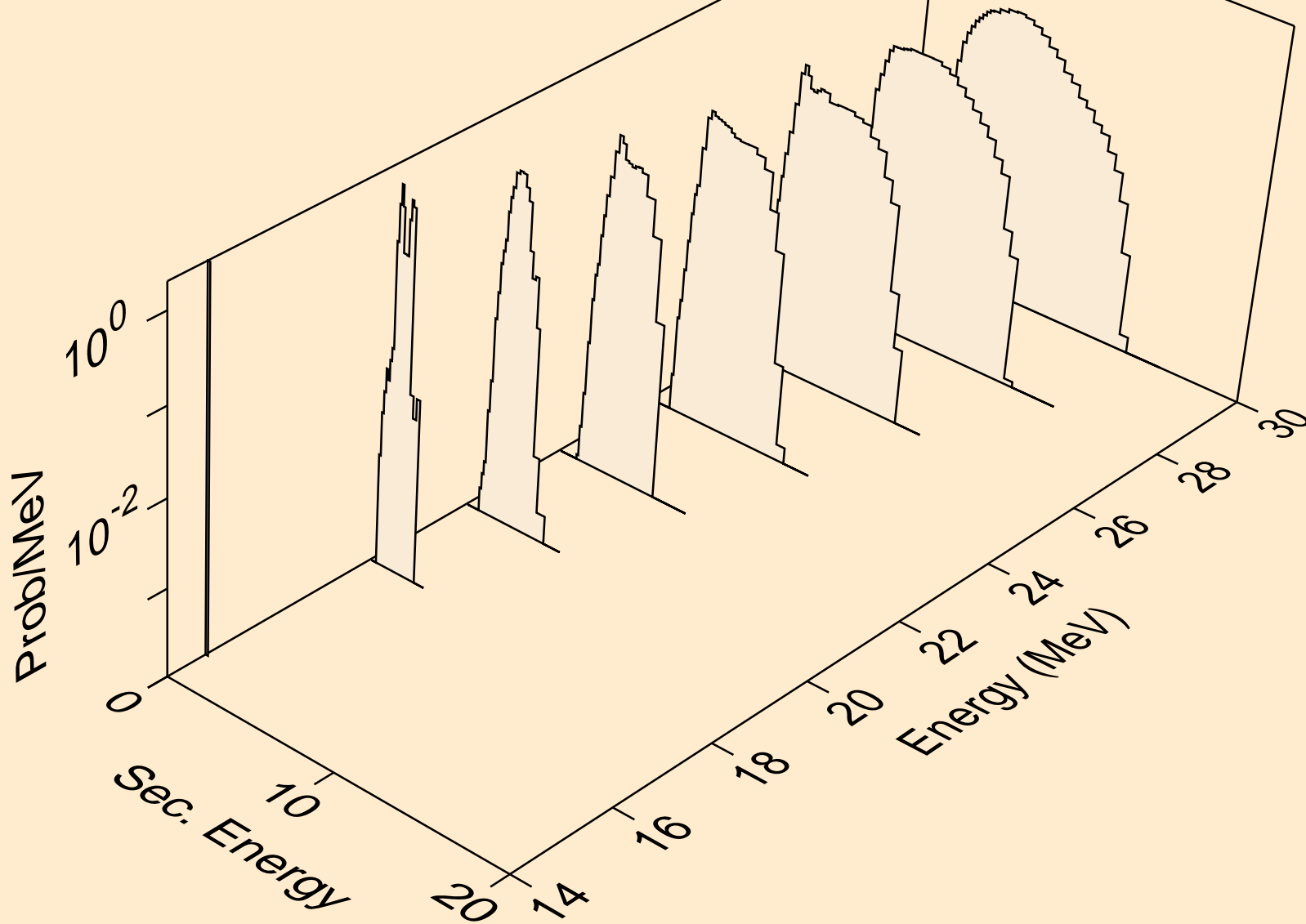

ZR089 NEUTRON ACER TENDL-2019 LIBRARY; T=293.16K  
protons from (n,npa)

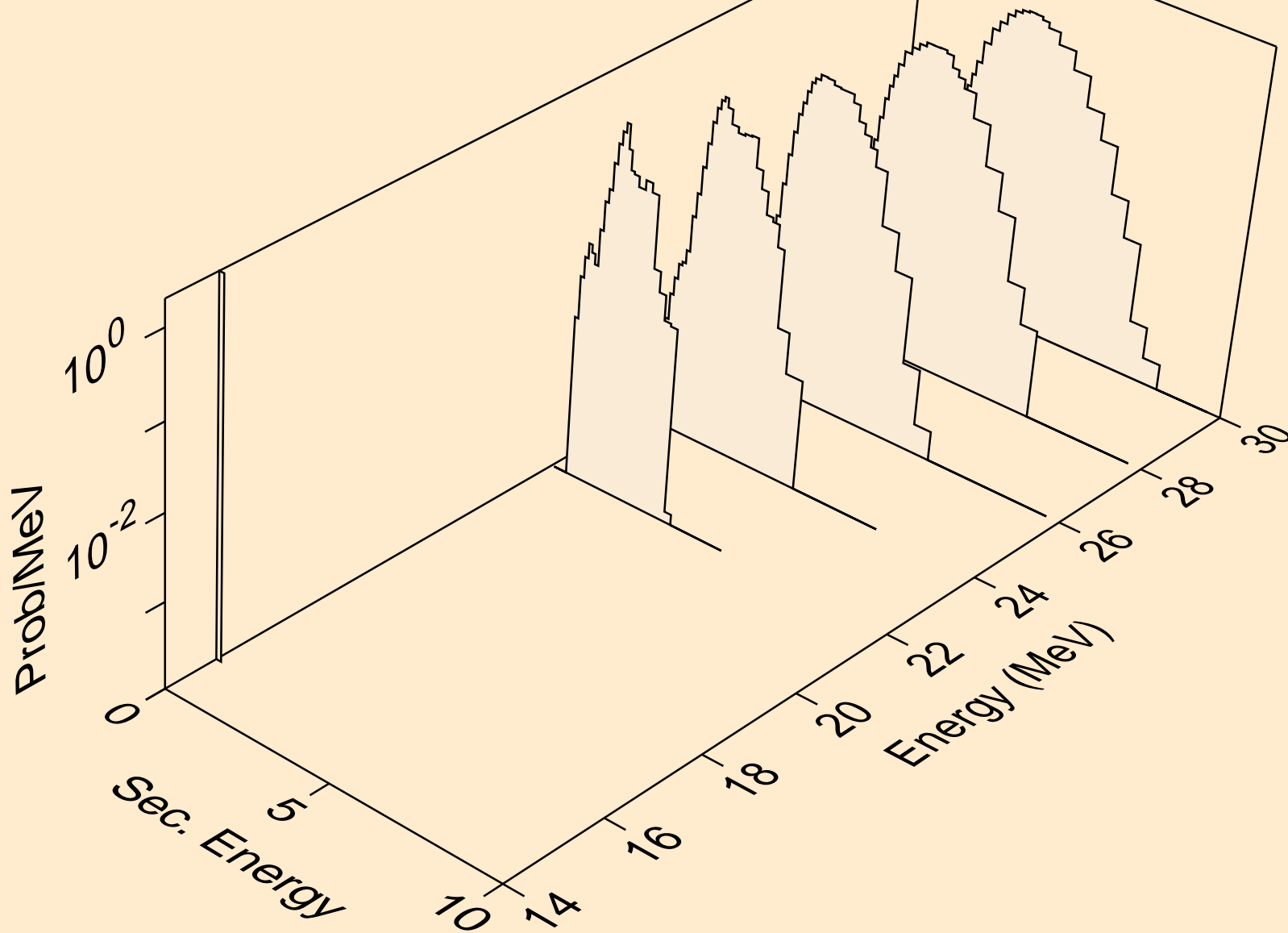

ZR089 NEUTRON ACER TENDL-2019 LIBRARY; T=293.16K  
protons from (n,p)

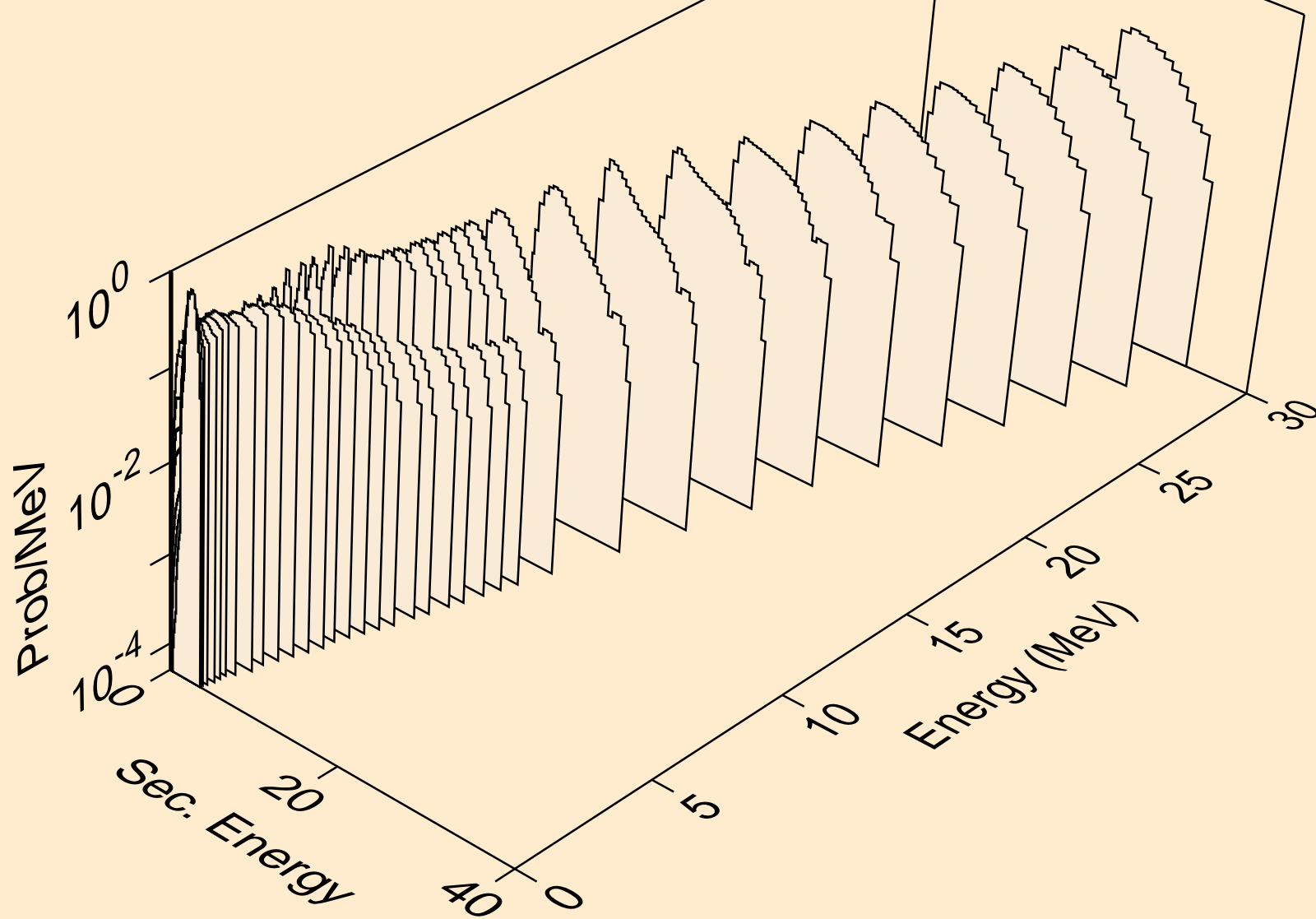

ZR089 NEUTRON ACER TENDL-2019 LIBRARY; T=293.16K  
protons from (n,2p)

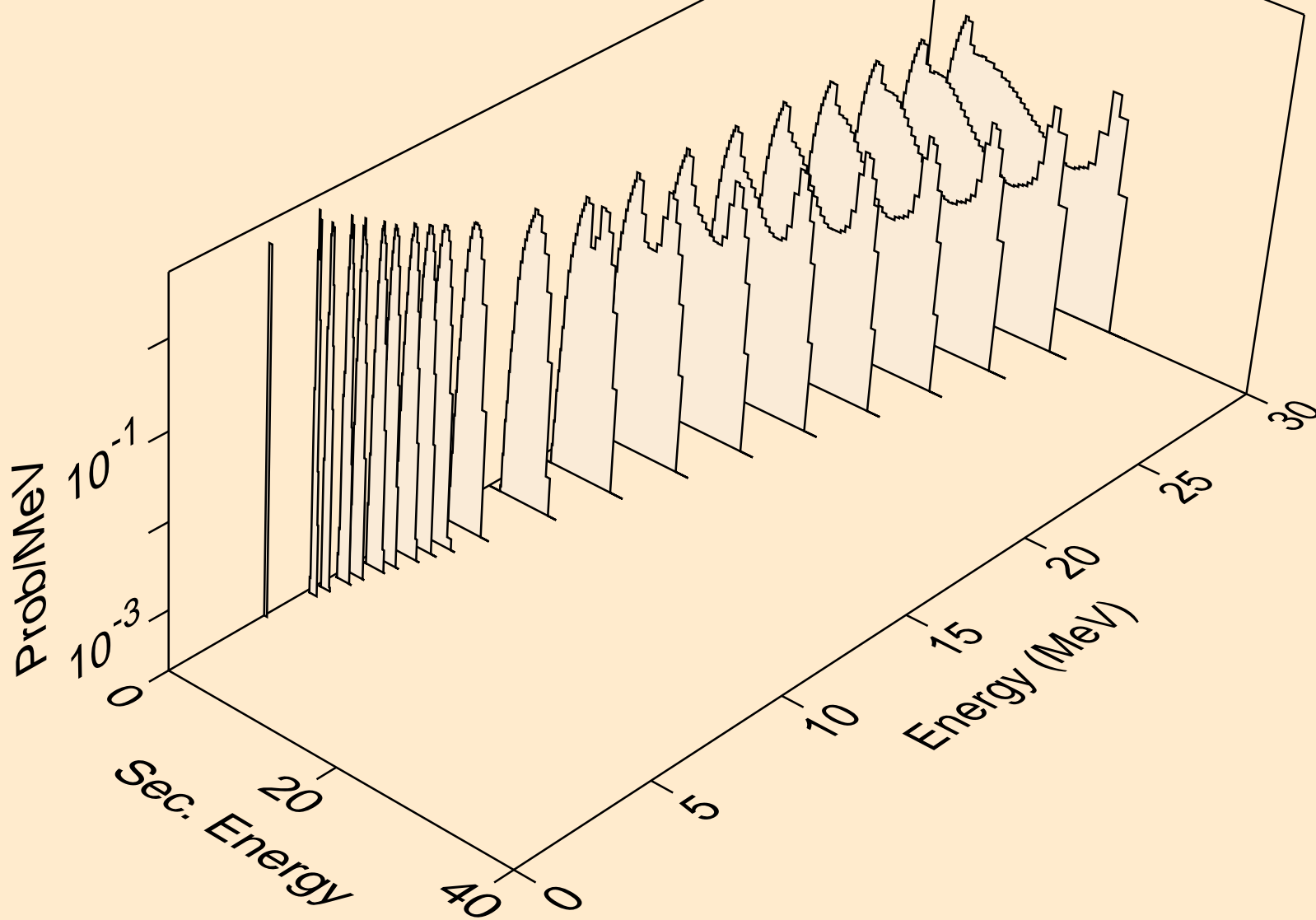

ZR089 NEUTRON ACER TENDL-2019 LIBRARY; T=293.16K  
protons from (n,p)

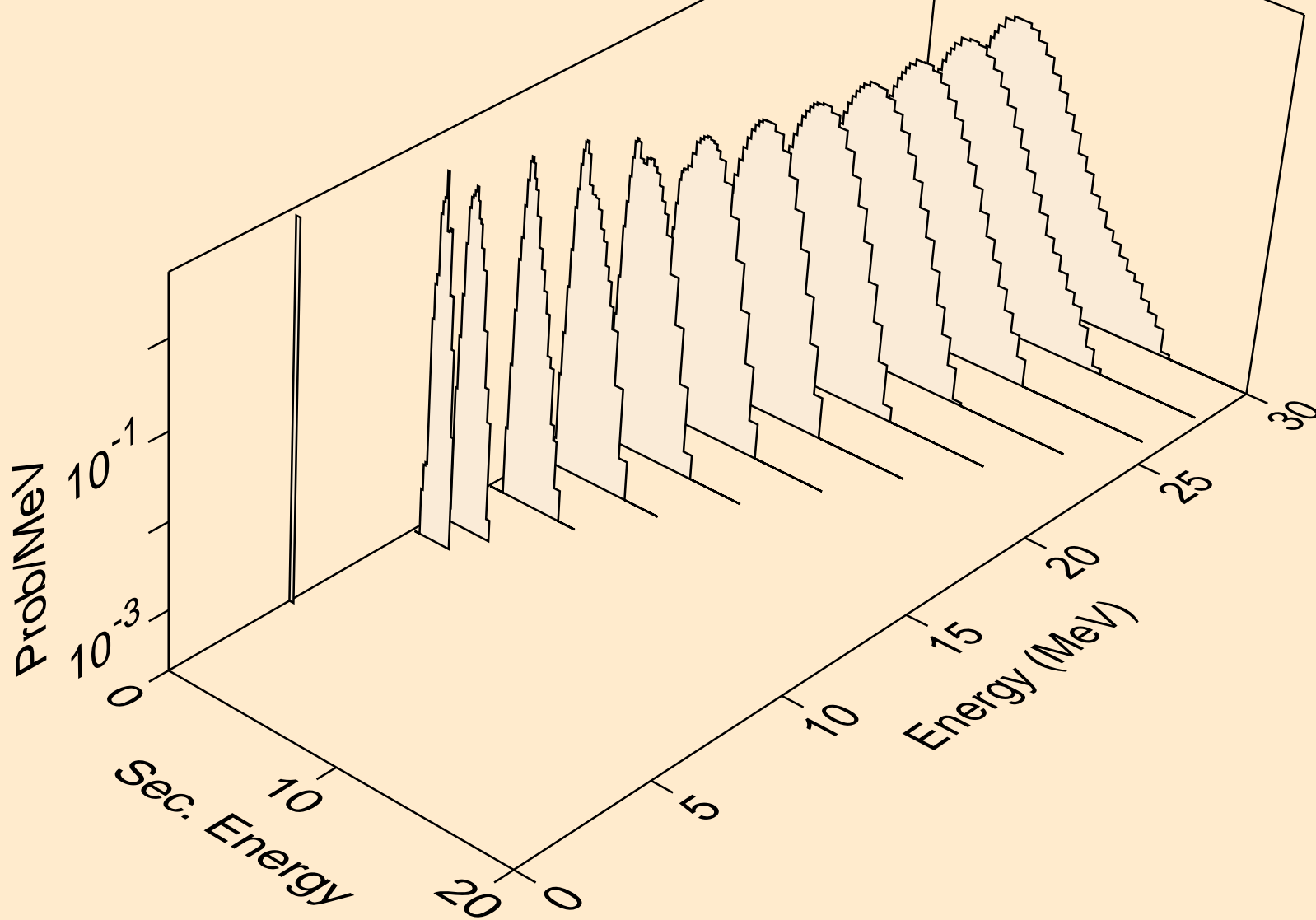

ZR089 NEUTRON ACER TENDL-2019 LIBRARY; T=293.16K  
protons from (n,pd)

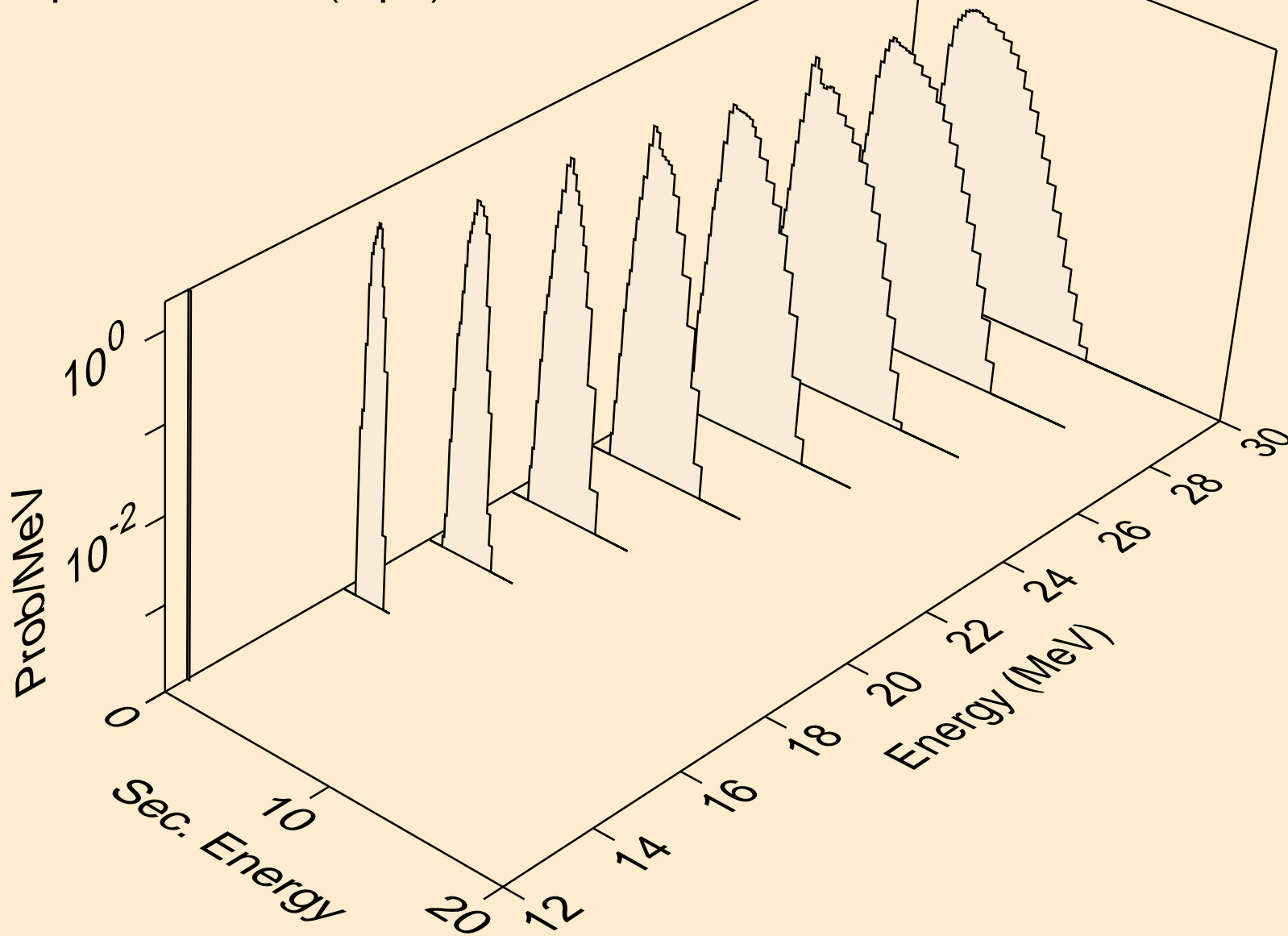

ZR089 NEUTRON ACER TENDL-2019 LIBRARY; T=293.16K  
protons from (n,pt)

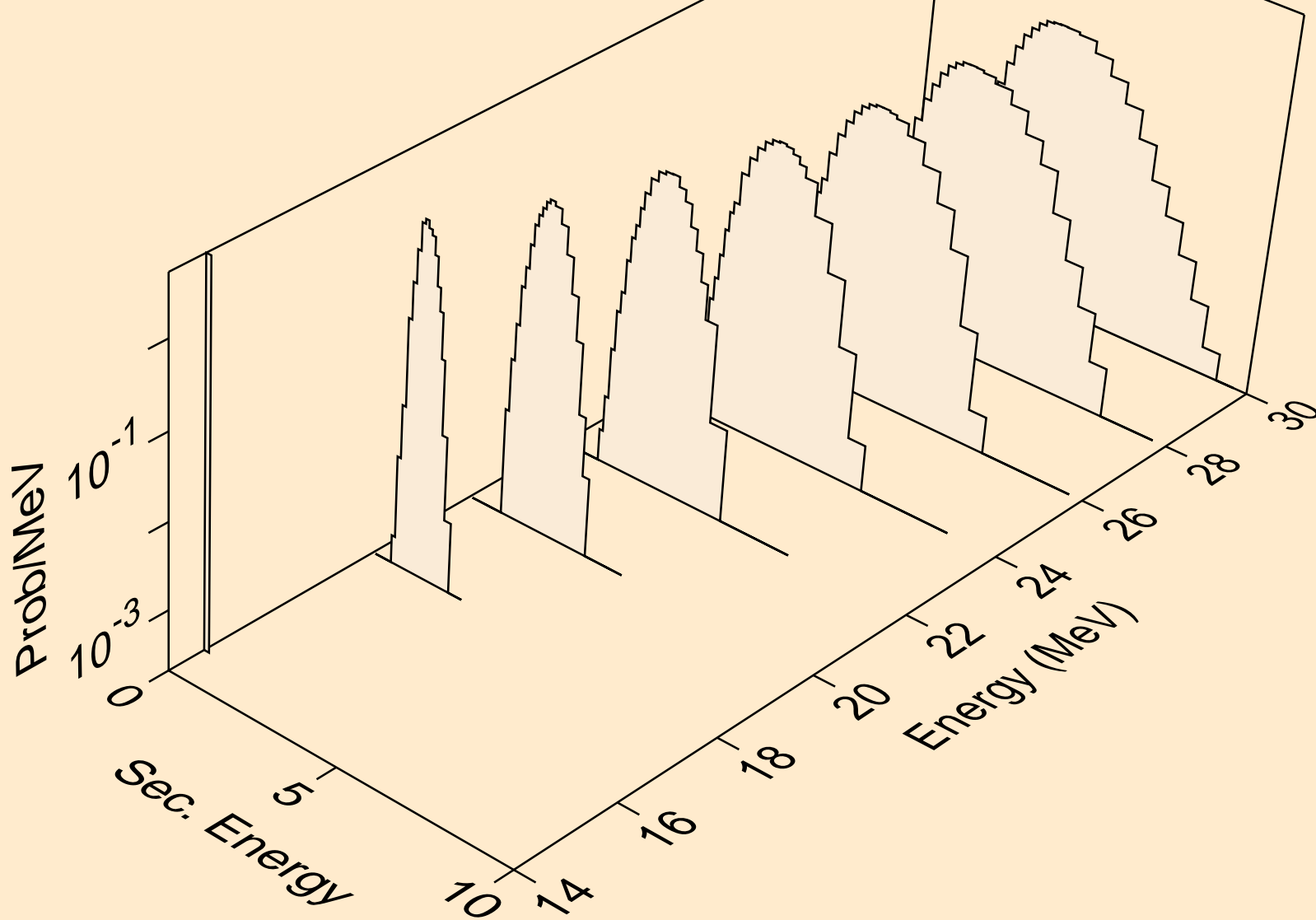



ZR089 NEUTRON ACER TENDL-2019 LIBRARY; T=293.16K  
deuterons from (n,x)

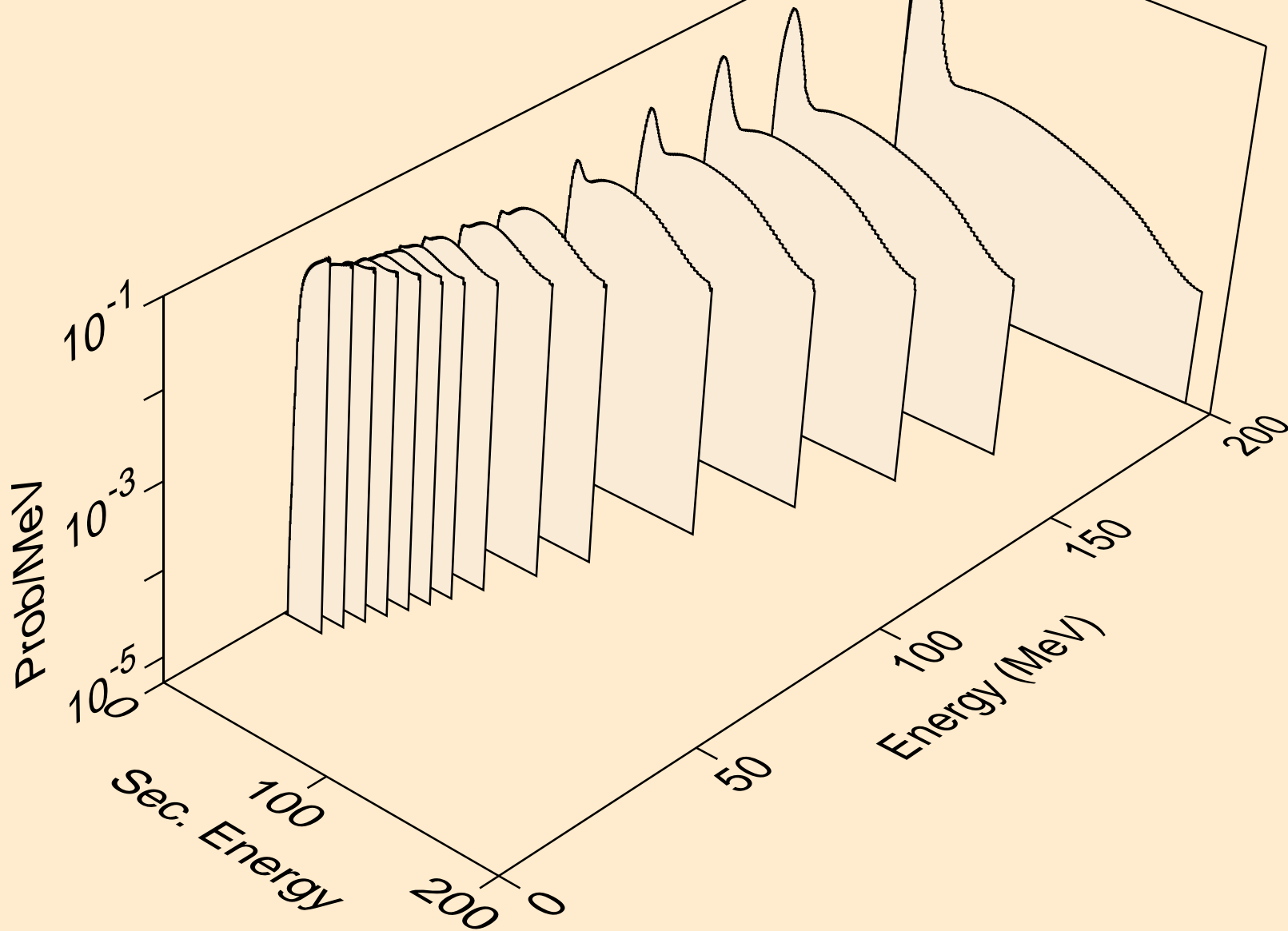

ZR089 NEUTRON ACER TENDL-2019 LIBRARY; T=293.16K  
deuterons from (n,2nd)

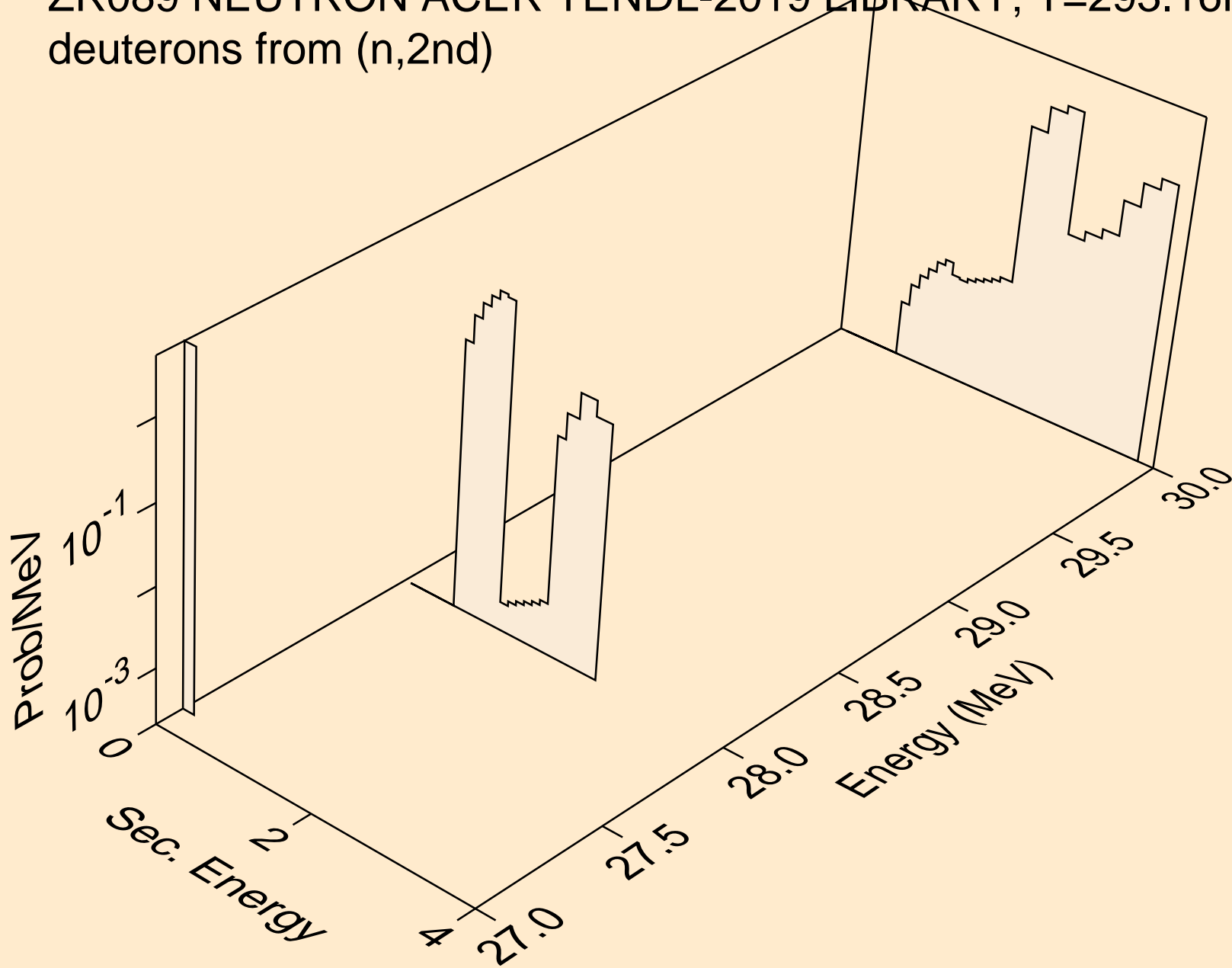

ZR089 NEUTRON ACER TENDL-2019 LIBRARY; T=293.16K  
deuterons from (n,n\*)d

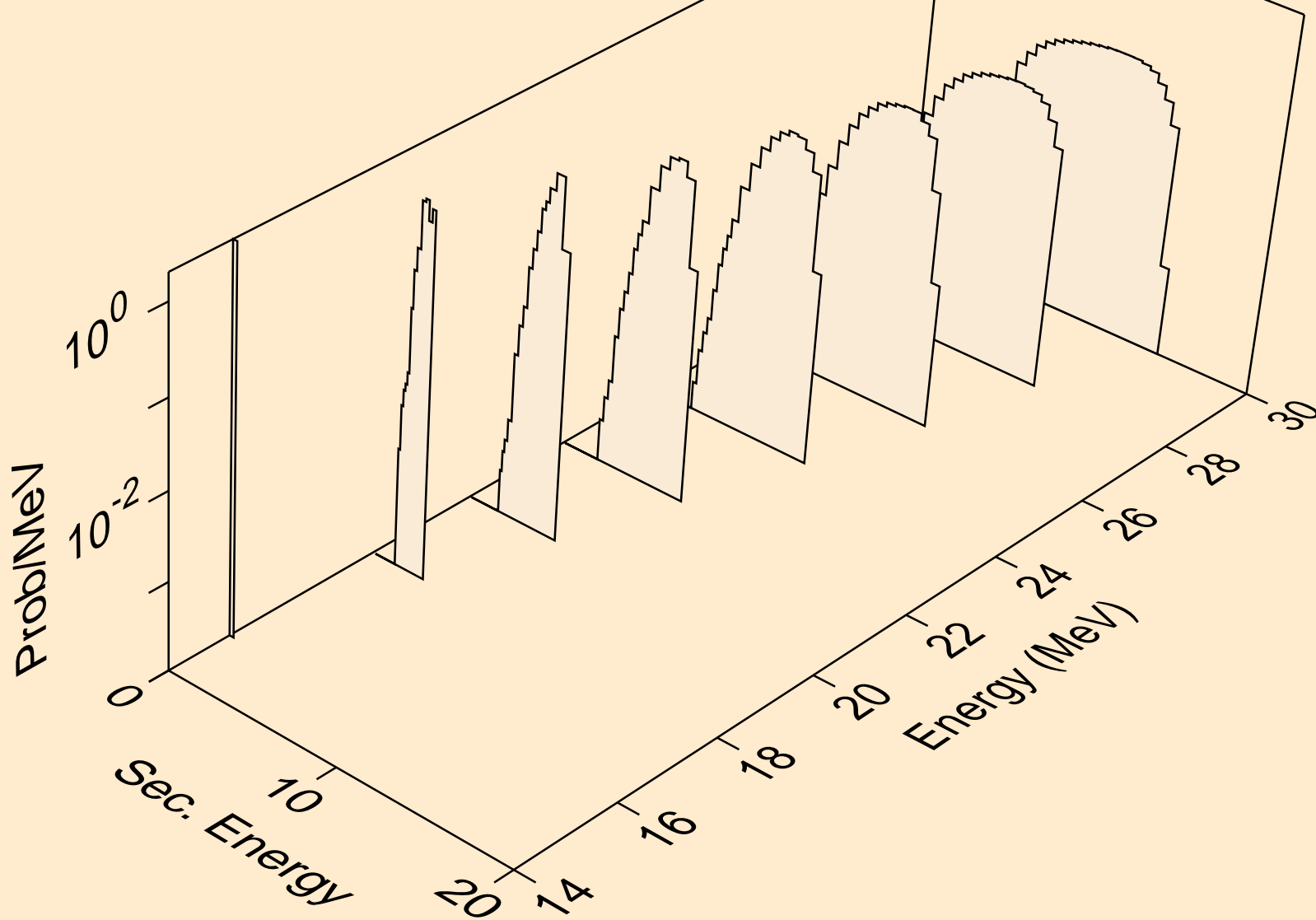

ZR089 NEUTRON ACER TENDL-2019 LIBRARY; T=293.16K  
deuterons from (n,d)

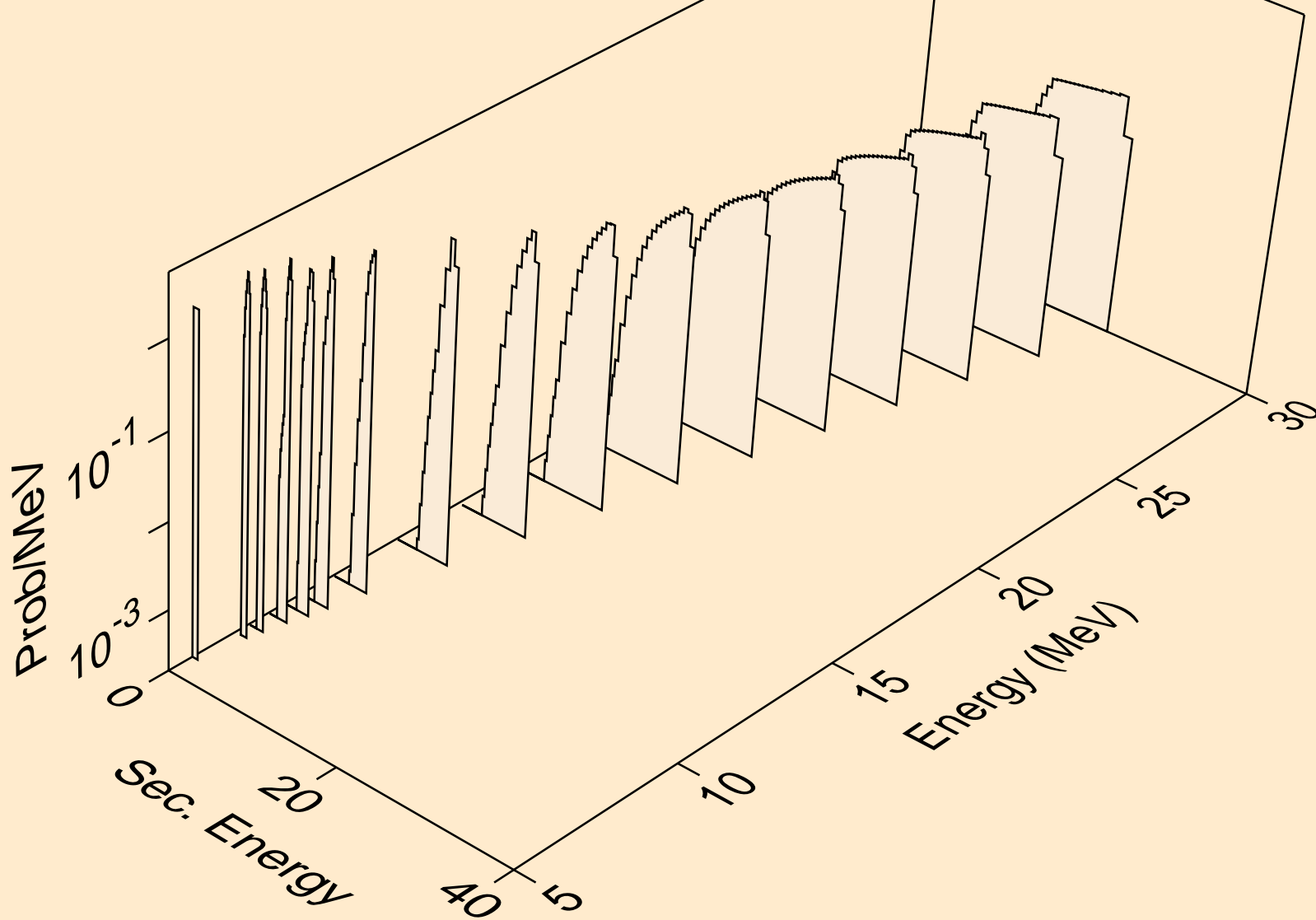

ZR089 NEUTRON ACER TENDL-2019 LIBRARY; T=293.16K  
deuterons from (n,pd)

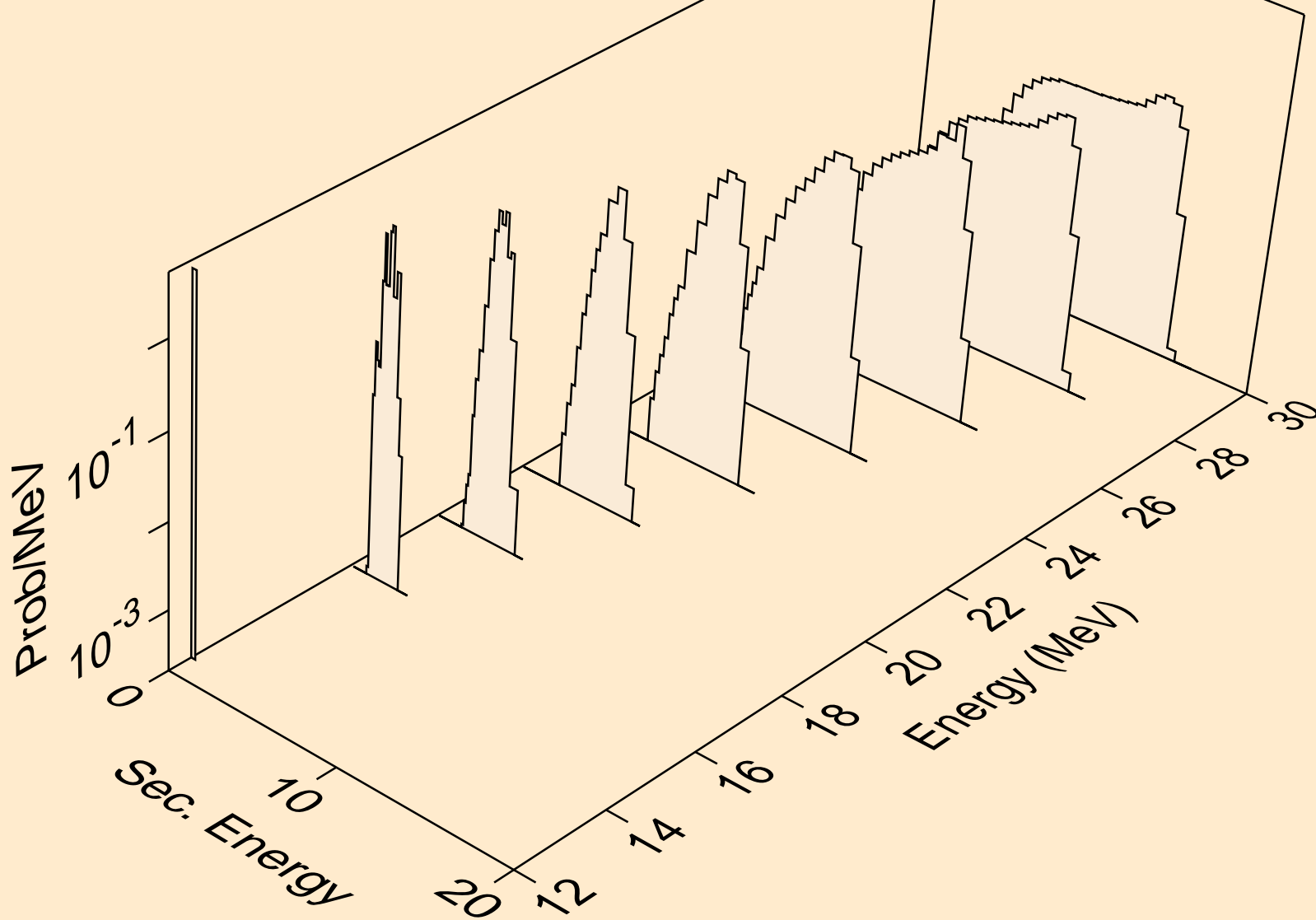

ZR089 NEUTRON ACER TENDL-2019 LIBRARY; T=293.16K  
deuterons from (n,da)

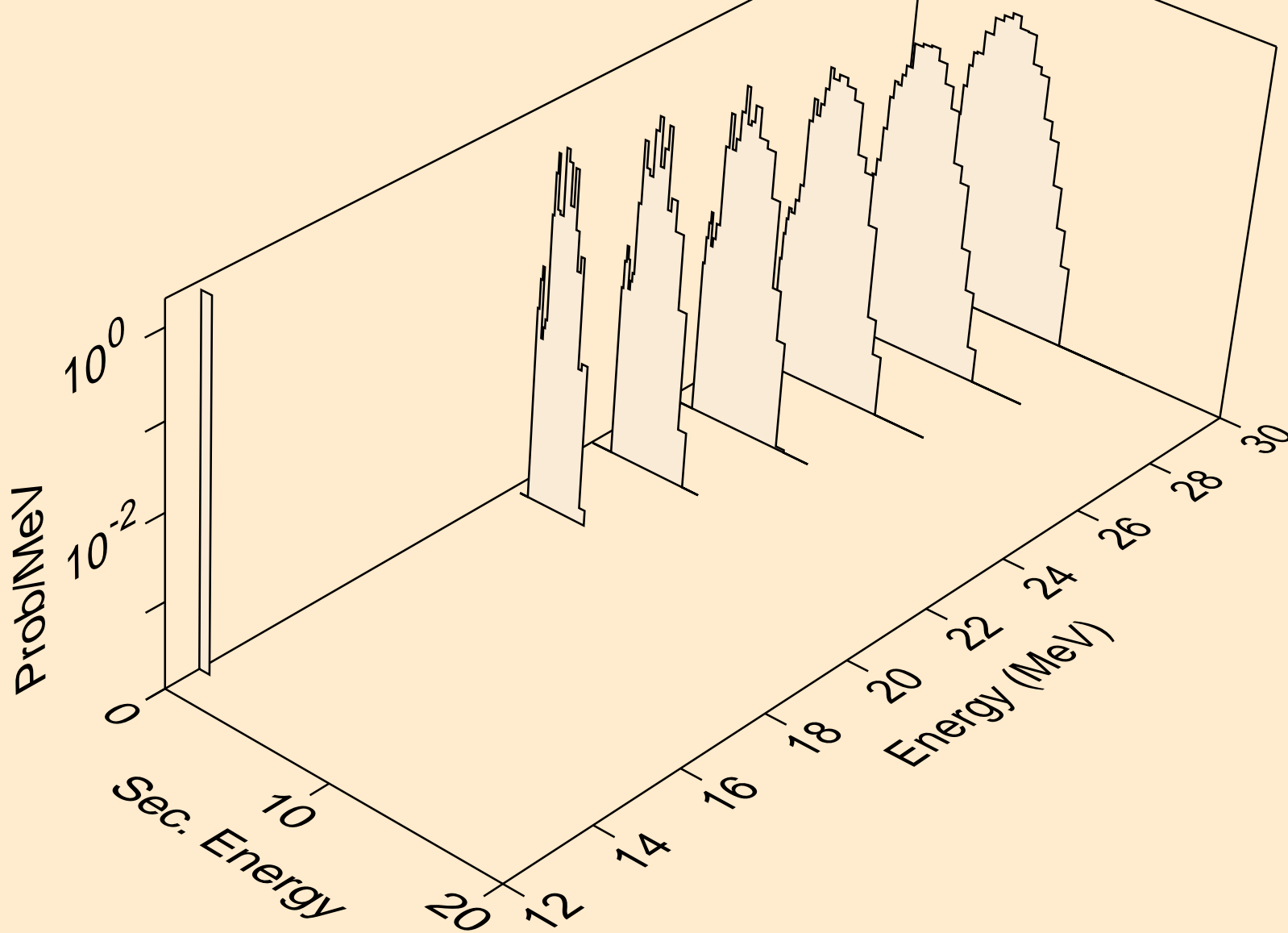

ZR089 NEUTRON ACER TENDL-2019 LIBRARY; T=293.16K  
tritons from (n,x)

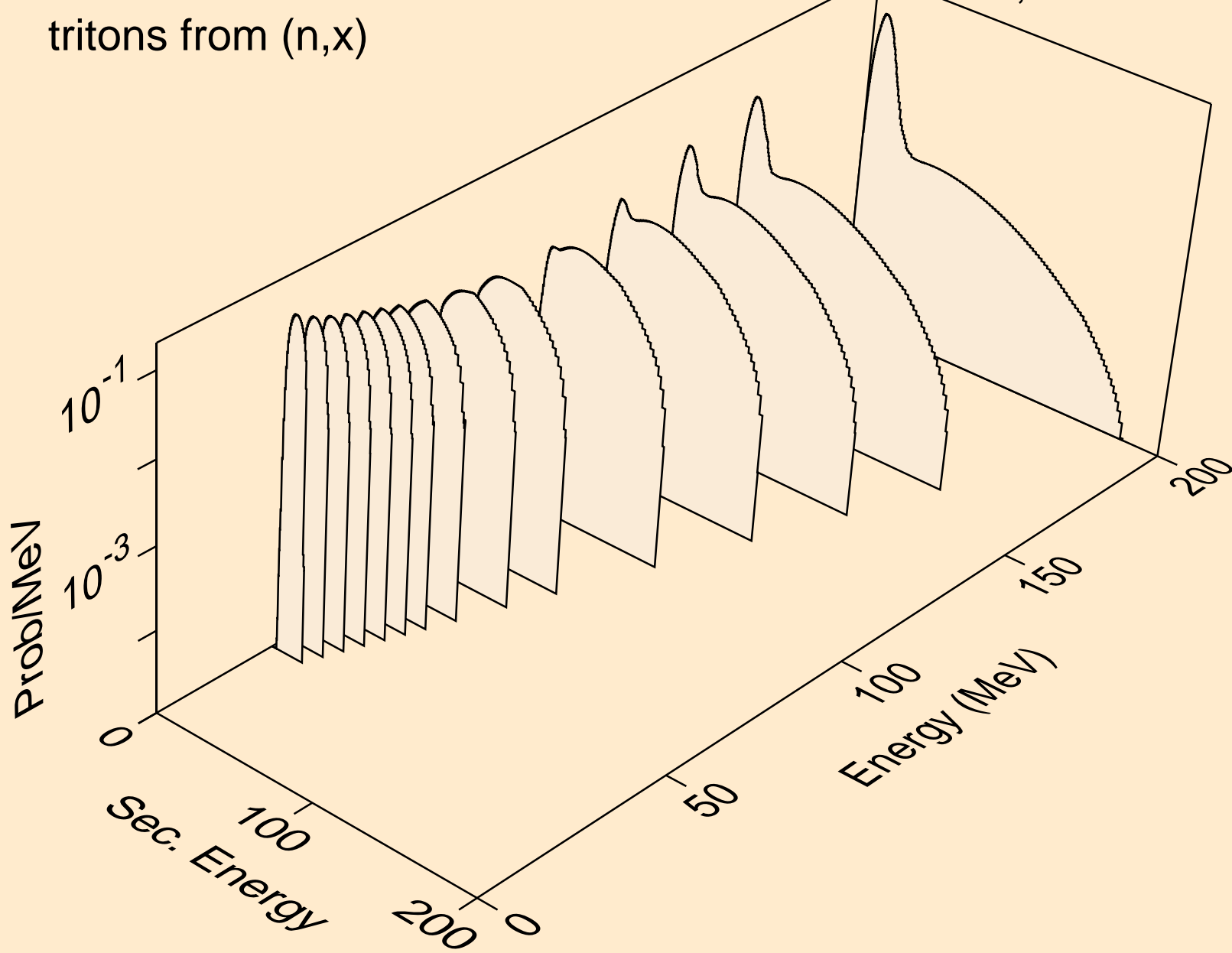

ZR089 NEUTRON ACER TENDL-2019 LIBRARY; T=293.16K  
tritons from (n,n\*)t

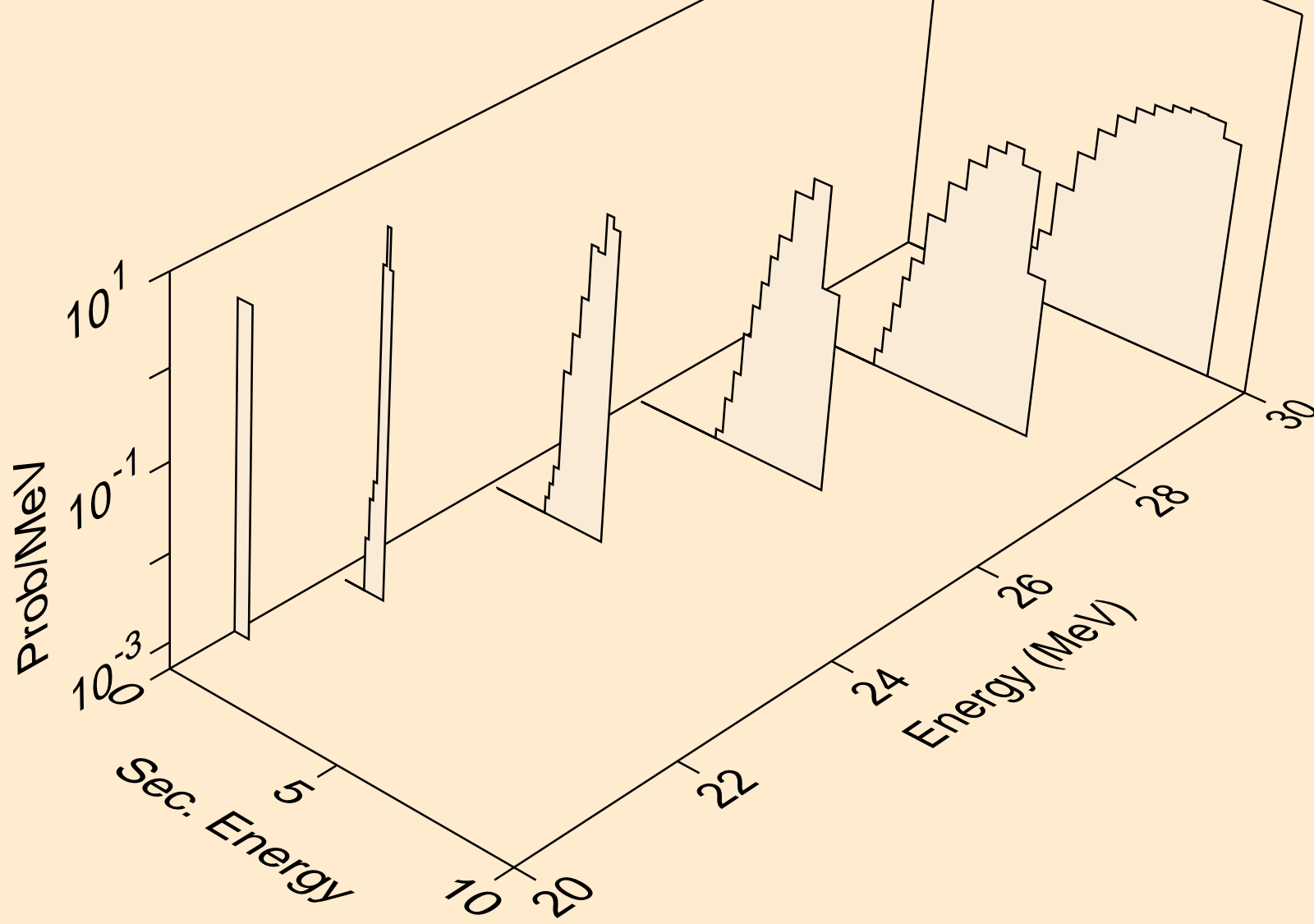



ZR089 NEUTRON ACER TENDL-2019 LIBRARY; T=293.16K  
tritons from (n,t)

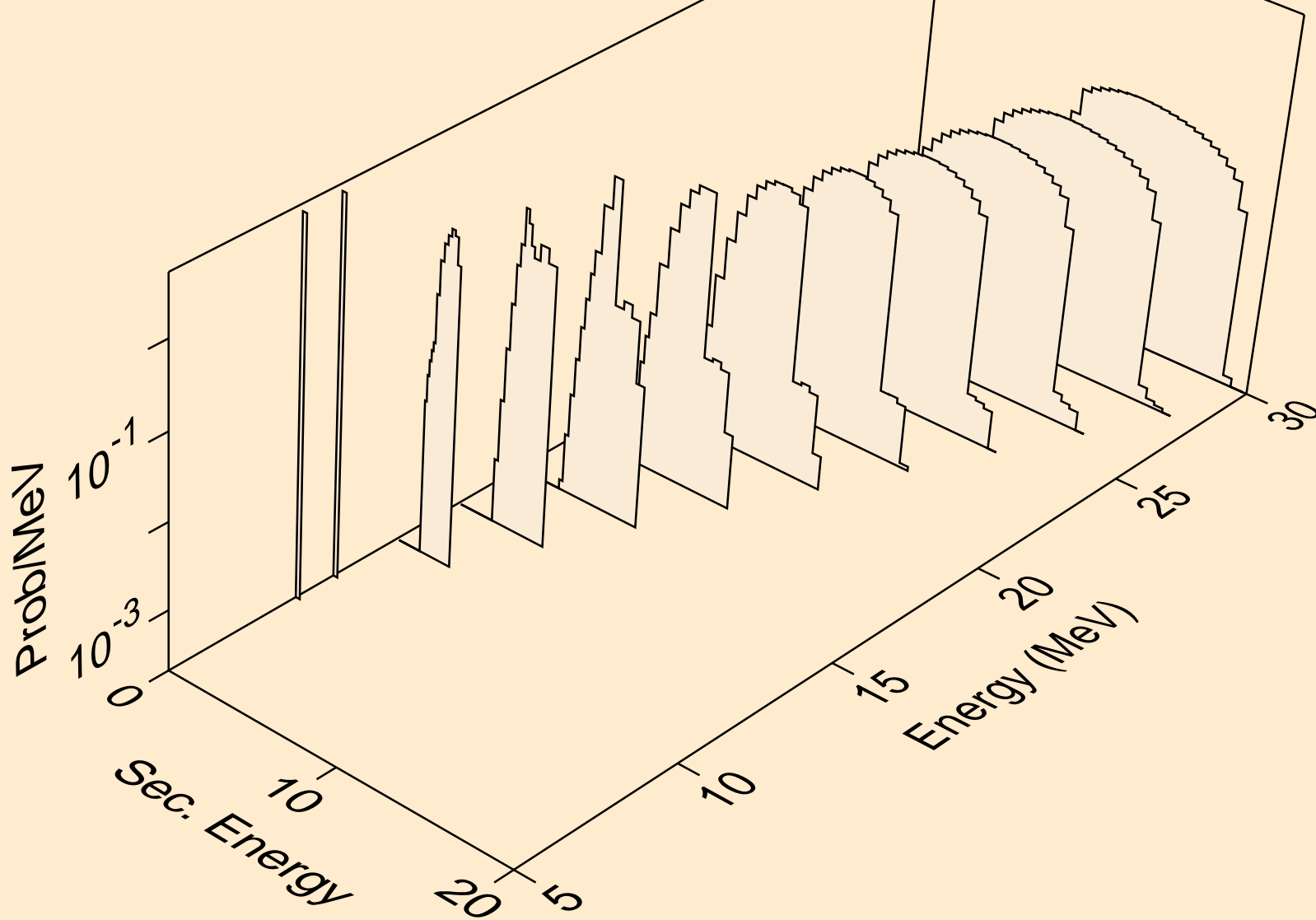

ZR089 NEUTRON ACER TENDL-2019 LIBRARY; T=293.16K  
tritons from (n,pt)

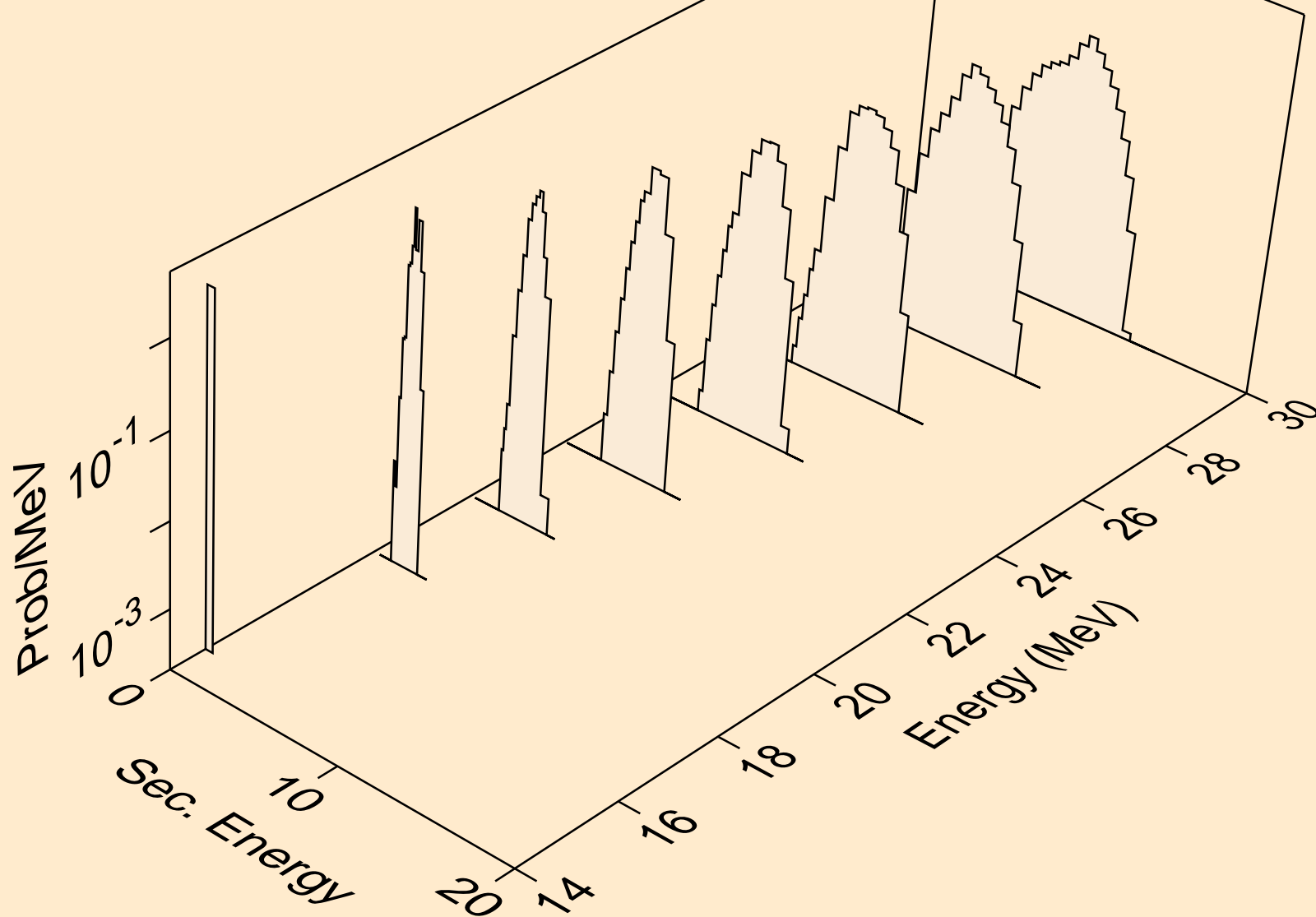

ZR089 NEUTRON ACER TENDL-2019 LIBRARY; T=293.16K  
he3s from (n,x)

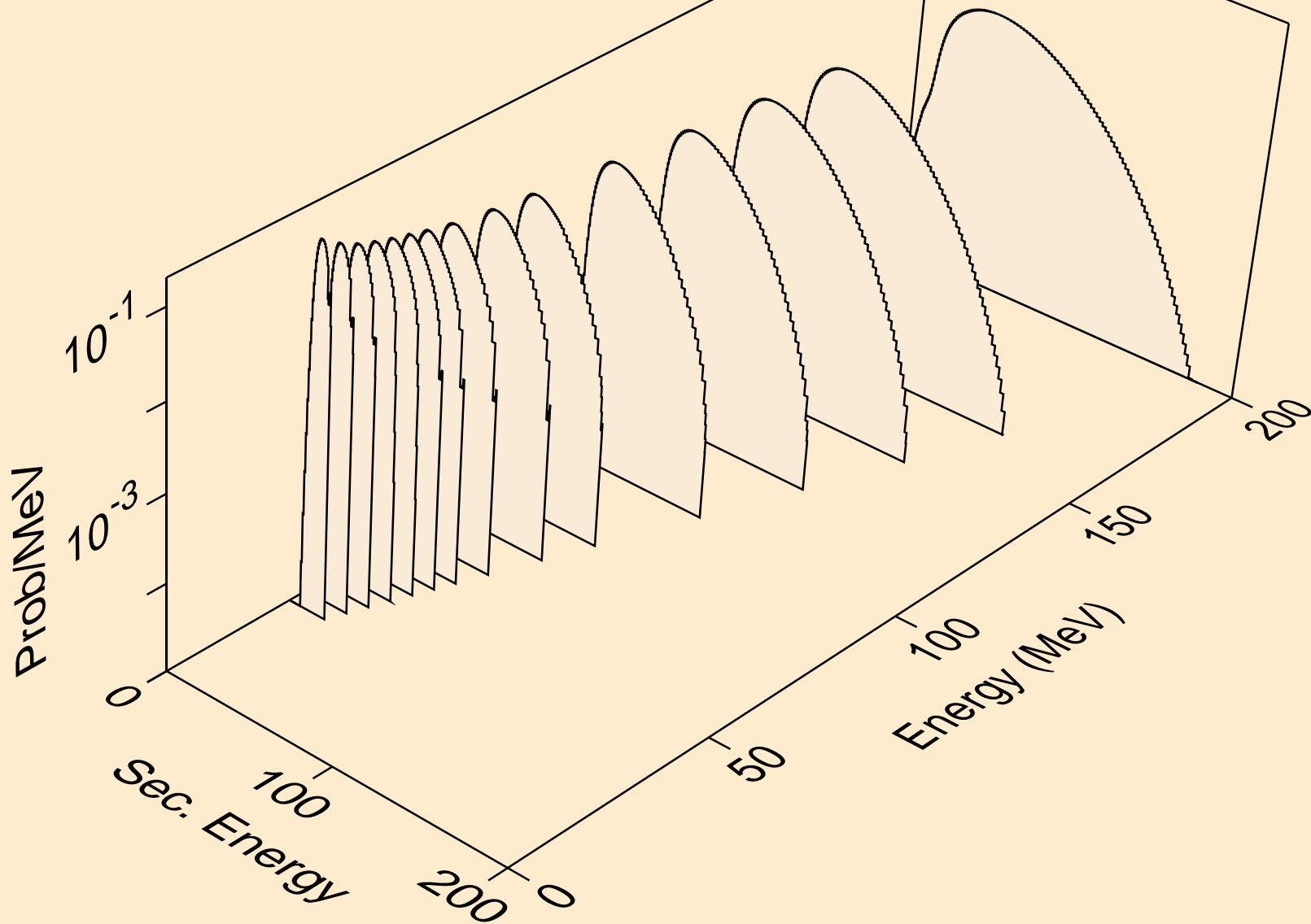

ZR089 NEUTRON ACER TENDL-2019 LIBRARY; T=293.16K  
he3s from (n,n\*)he3

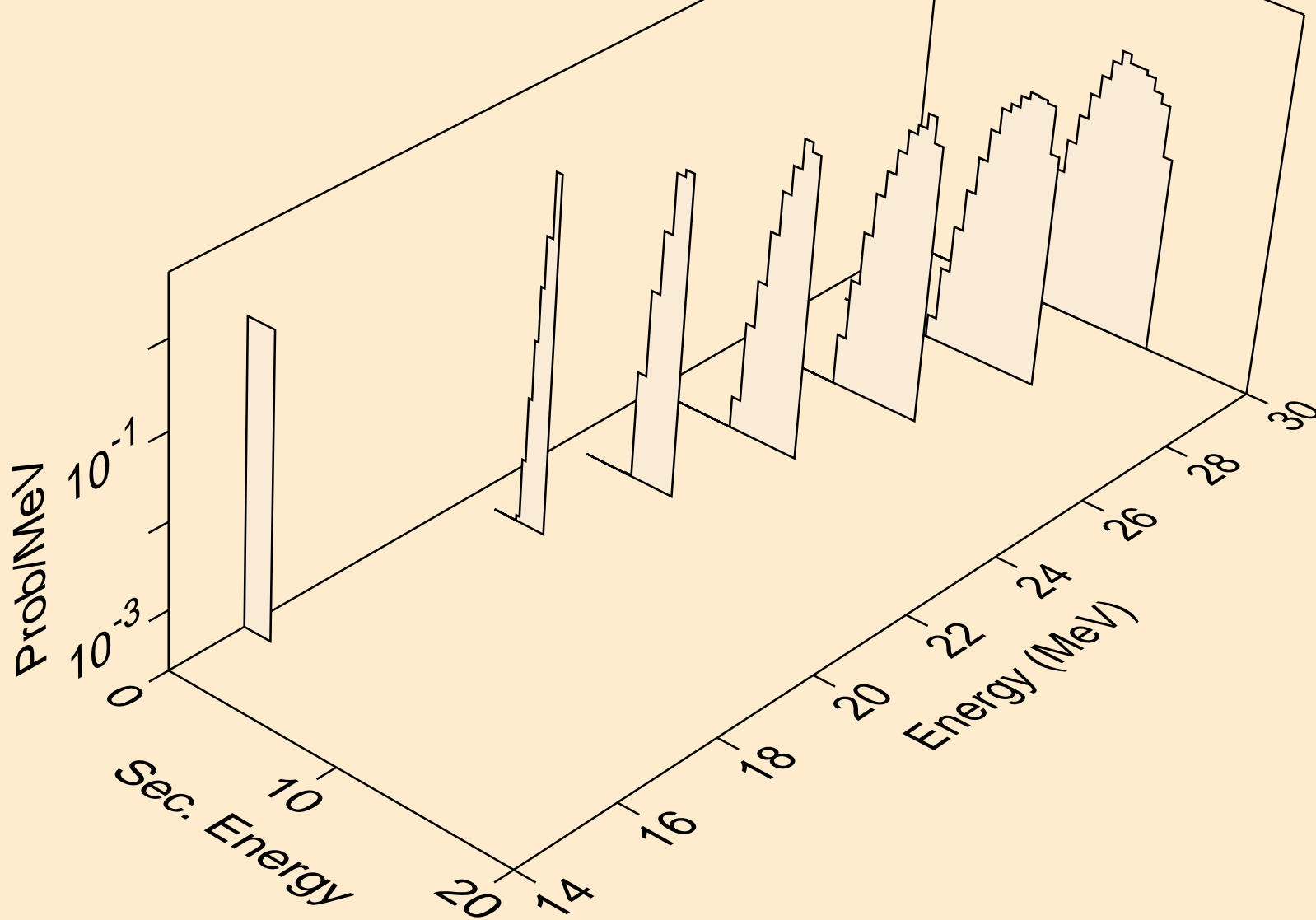

ZR089 NEUTRON ACER TENDL-2019 LIBRARY; T=293.16K  
he3s from (n,he3)

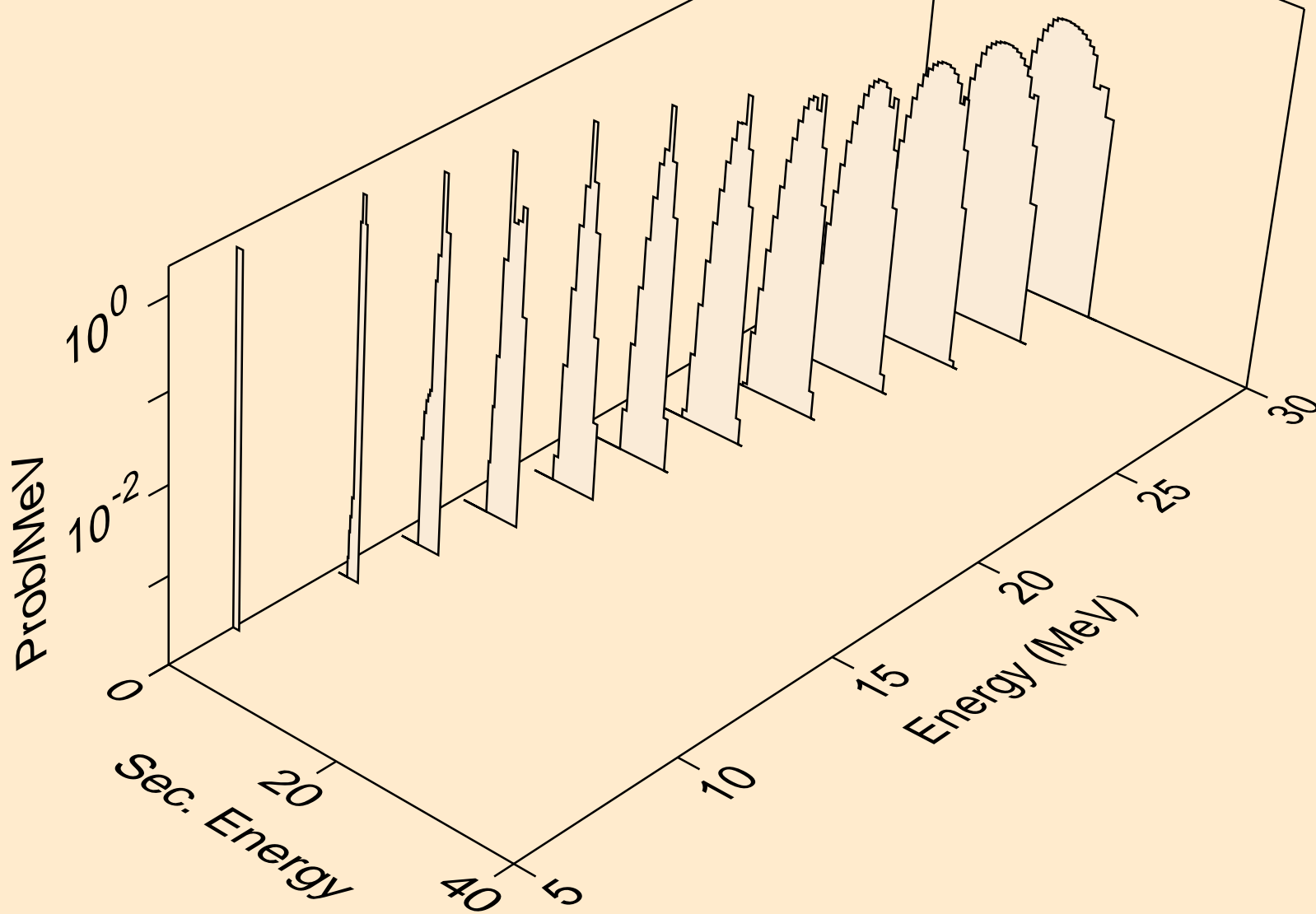

ZR089 NEUTRON ACER TENDL-2019 LIBRARY; T=293.16K  
alphas from (n,x)

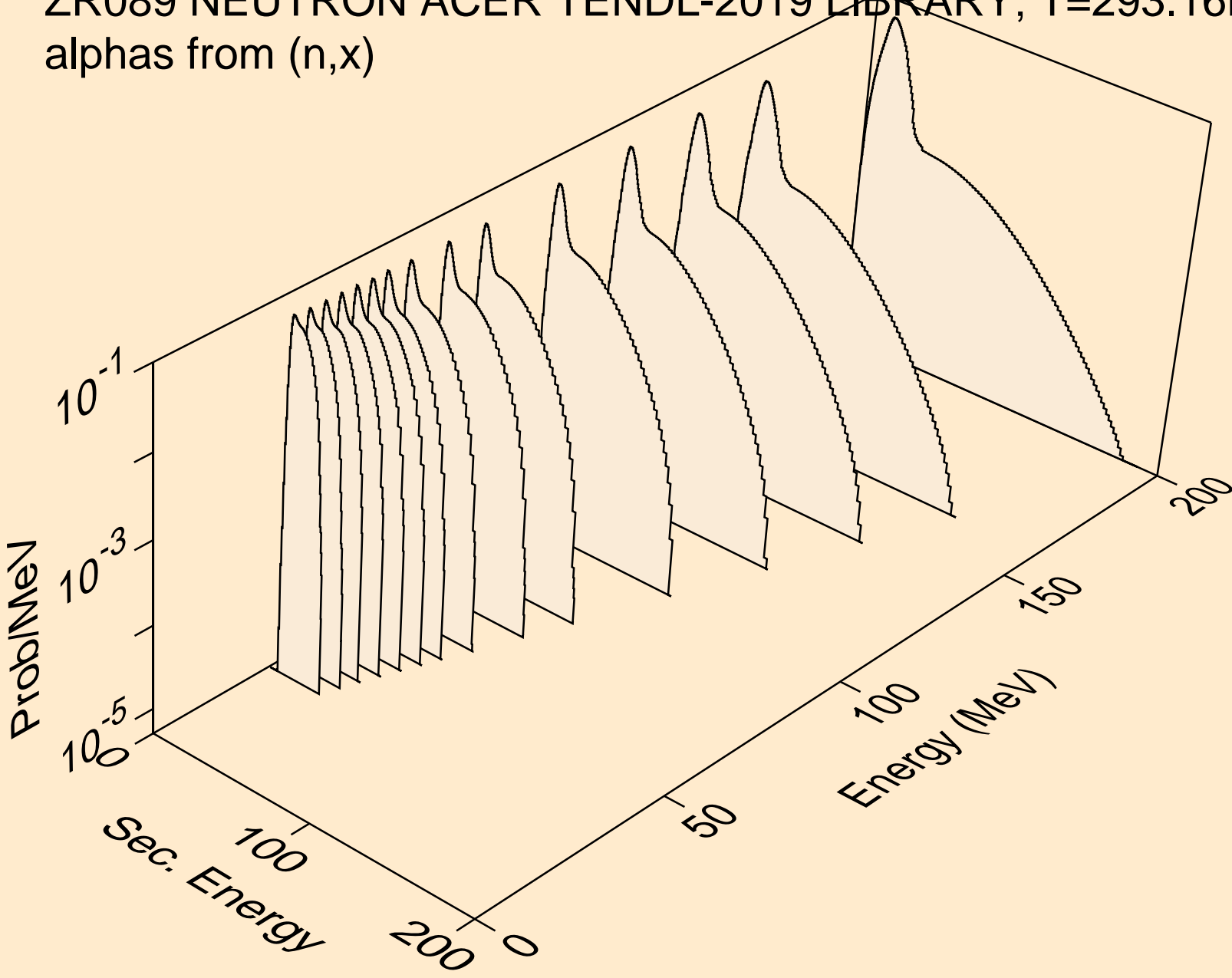

ZR089 NEUTRON ACER TENDL-2019 LIBRARY; T=293.16K  
alphas from (n,n\*)a

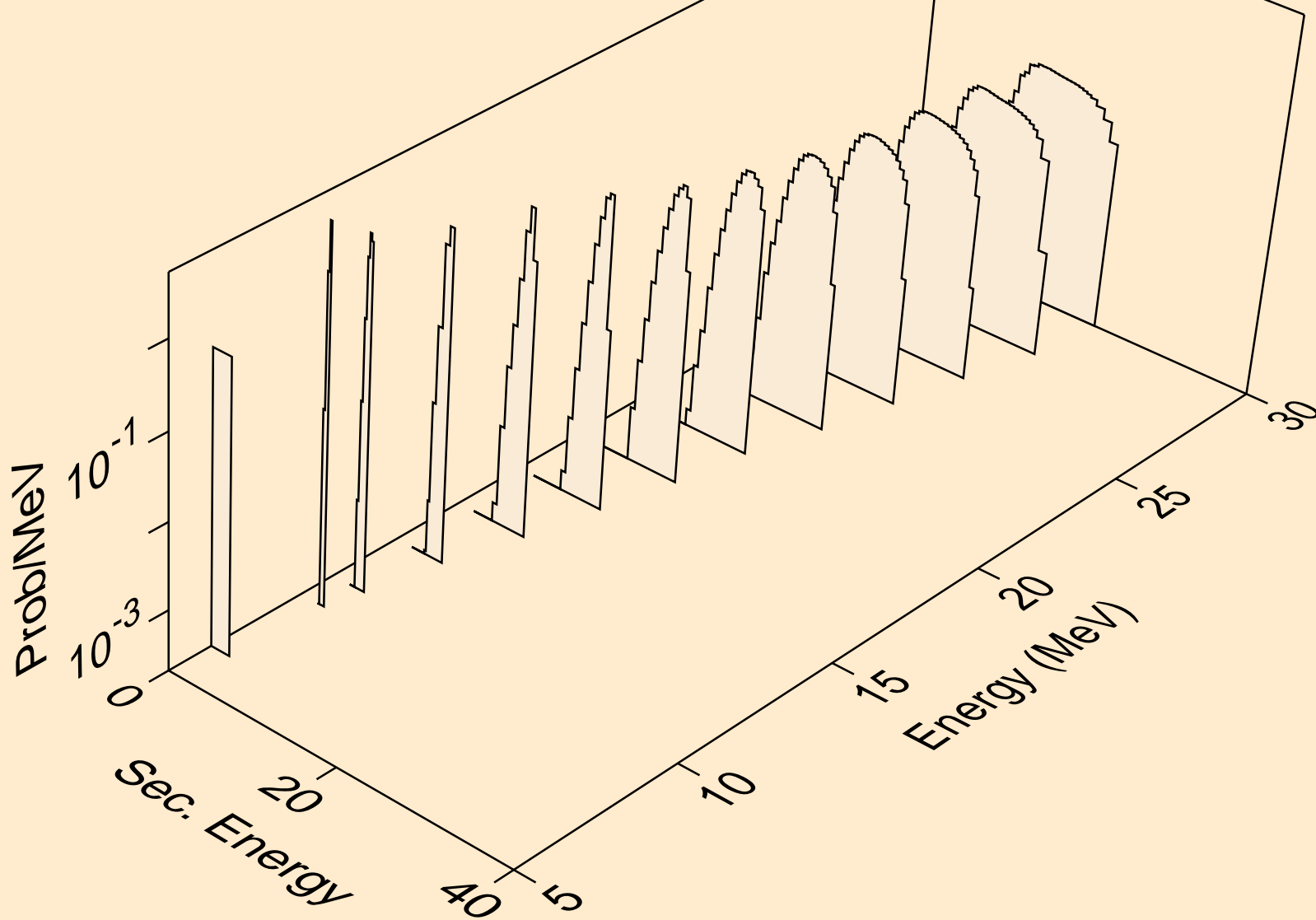

ZR089 NEUTRON ACER TENDL-2019 LIBRARY; T=293.16K  
alphas from (n,2n)a

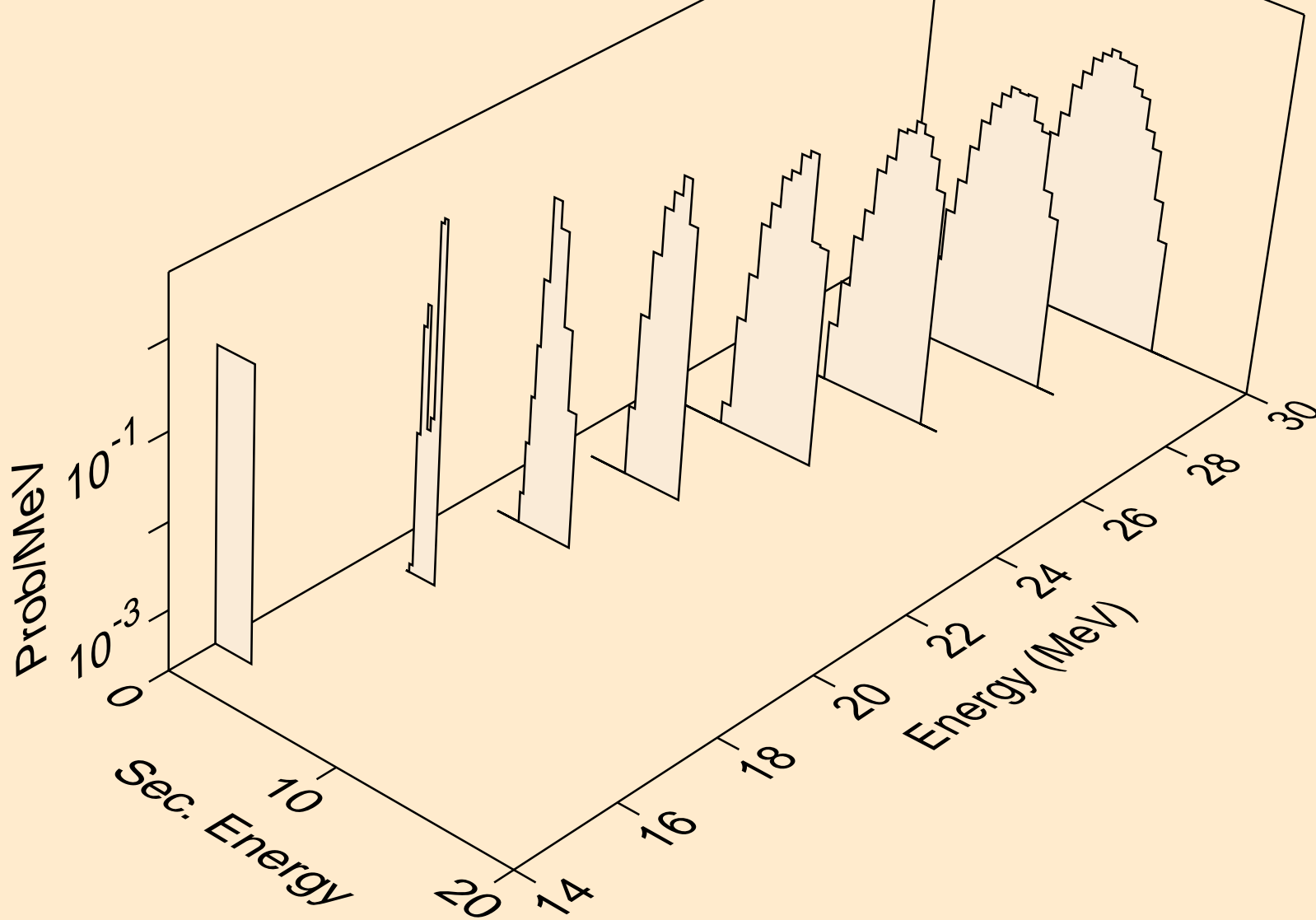



ZR089 NEUTRON ACER TENDL-2019 LIBRARY; T=293.16K  
alphas from (n,n\*)2a

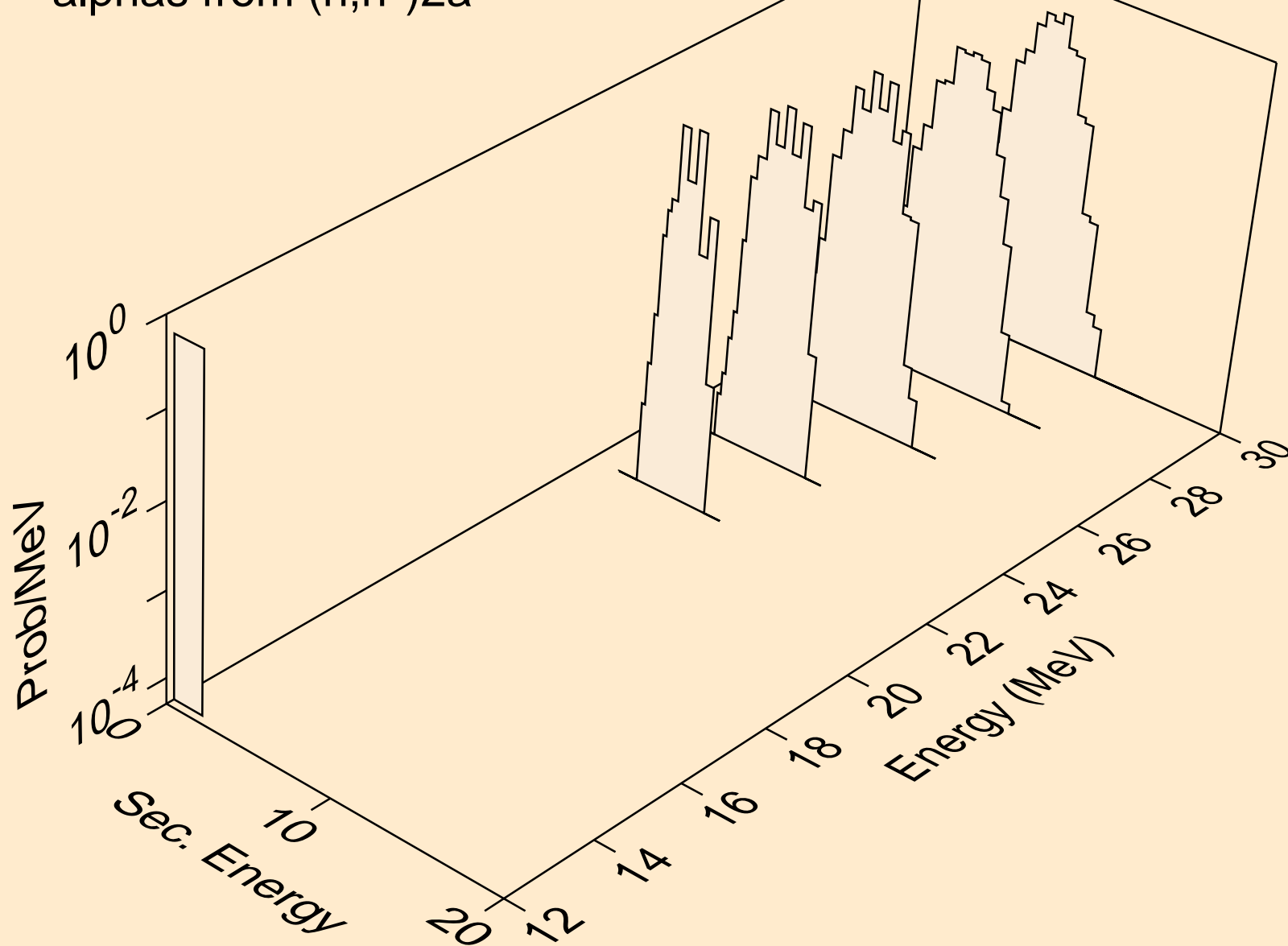

ZR089 NEUTRON ACER TENDL-2019 LIBRARY; T=293.16K  
alphas from (n,npa)

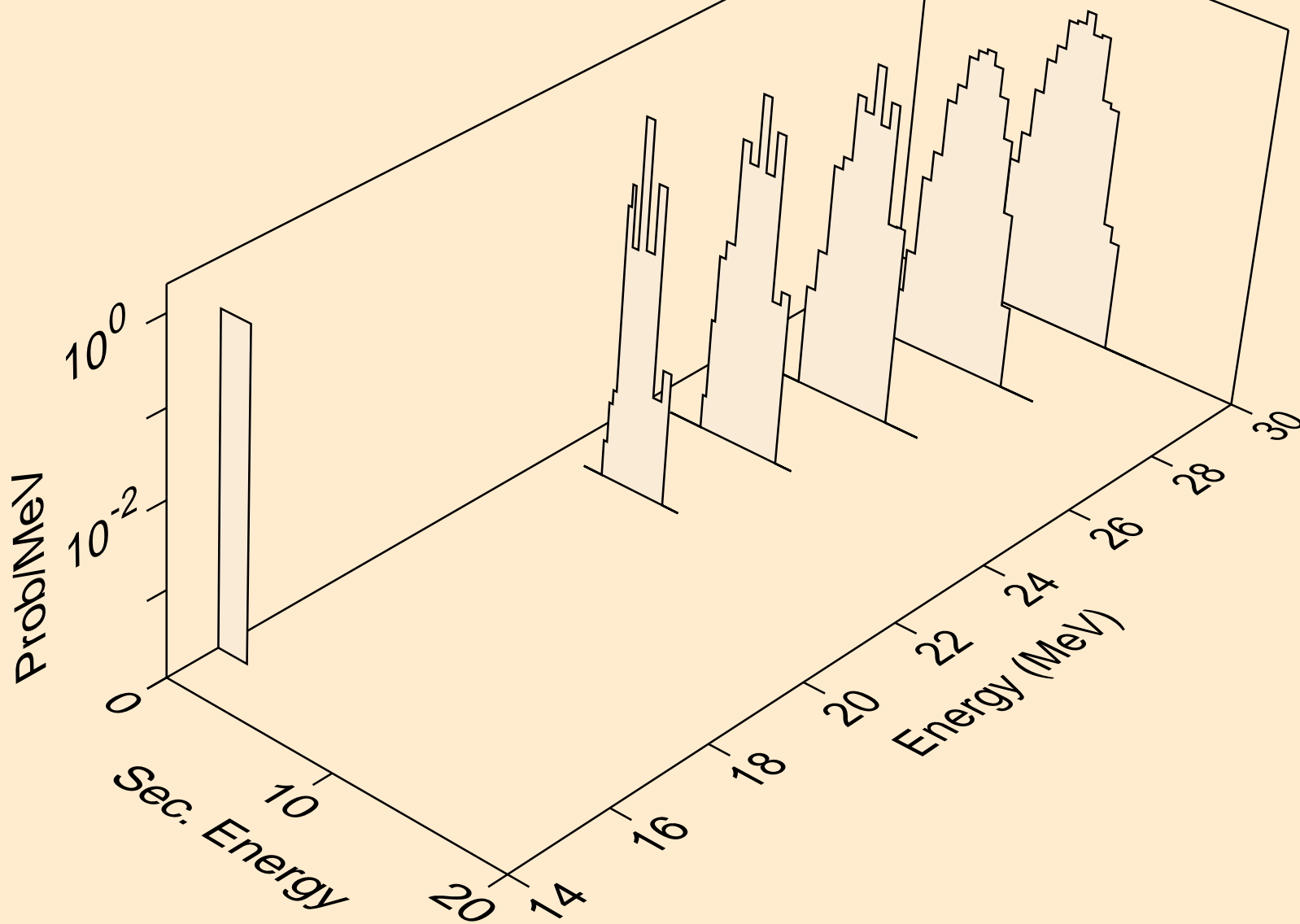

ZR089 NEUTRON ACER TENDL-2019 LIBRARY; T=293.16K  
alphas from (n,a)

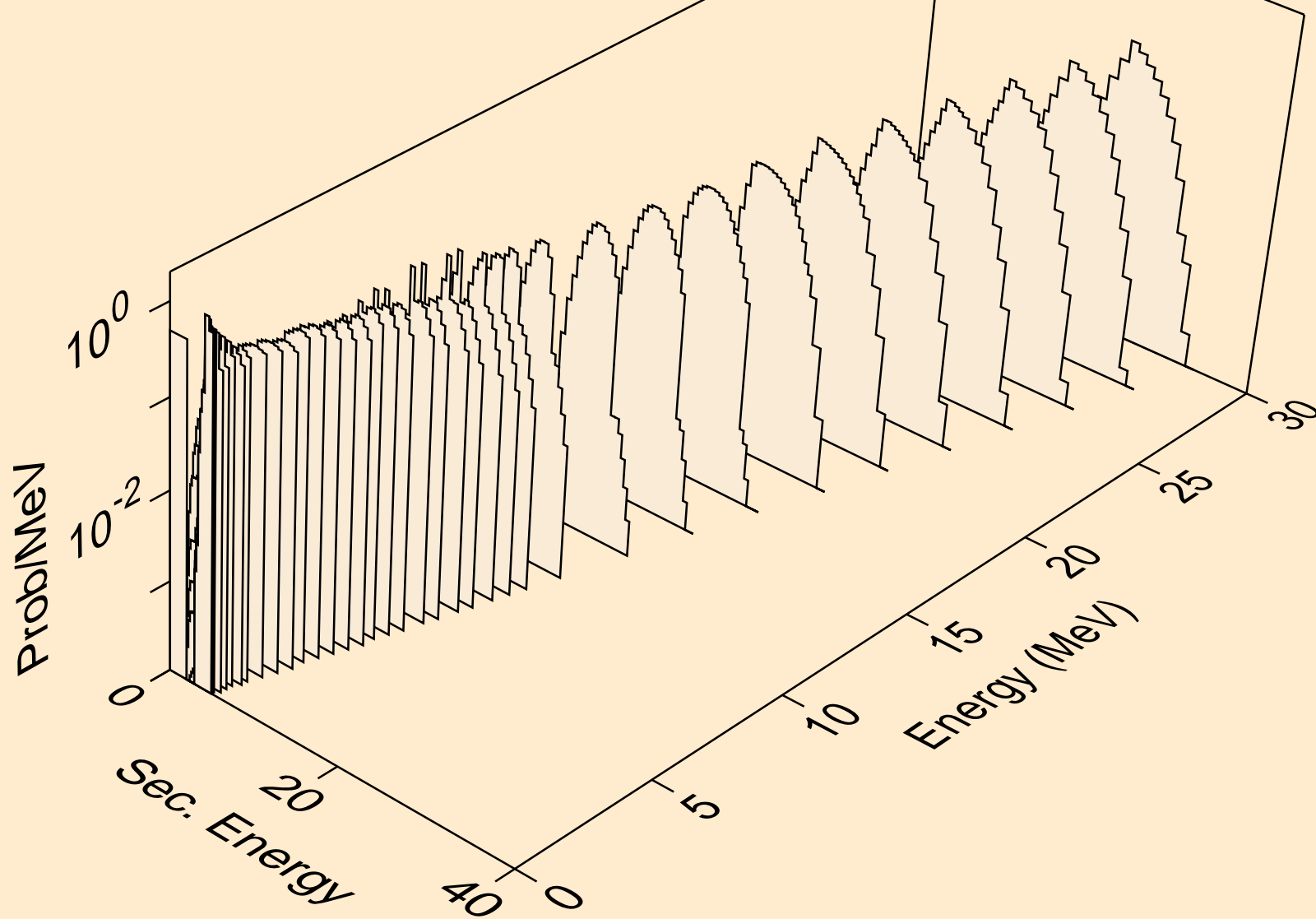

ZR089 NEUTRON ACER TENDL-2019 LIBRARY; T=293.16K  
alphas from (n,2a)

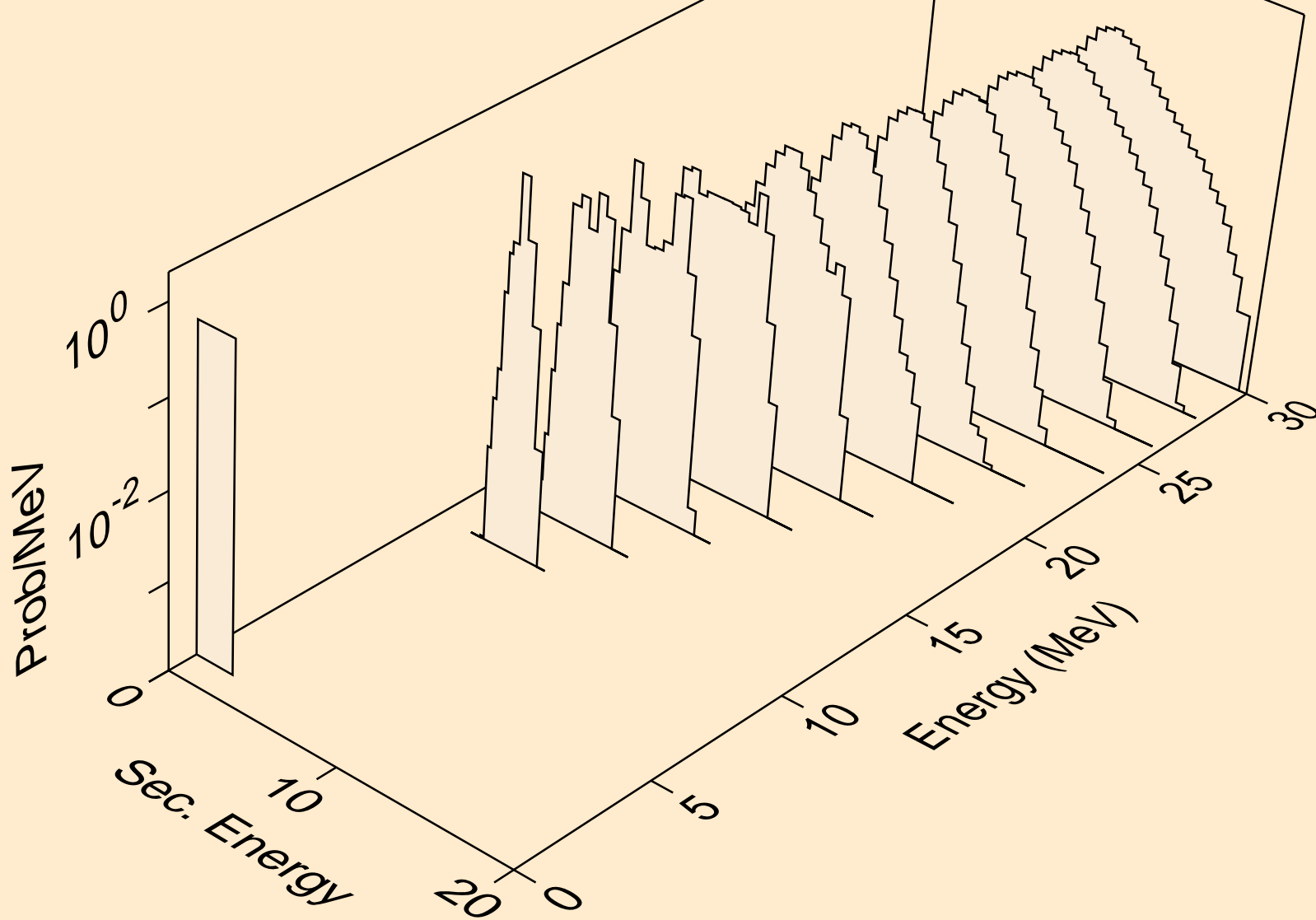

ZR089 NEUTRON ACER TENDL-2019 LIBRARY; T=293.16K  
alphas from (n,pa)

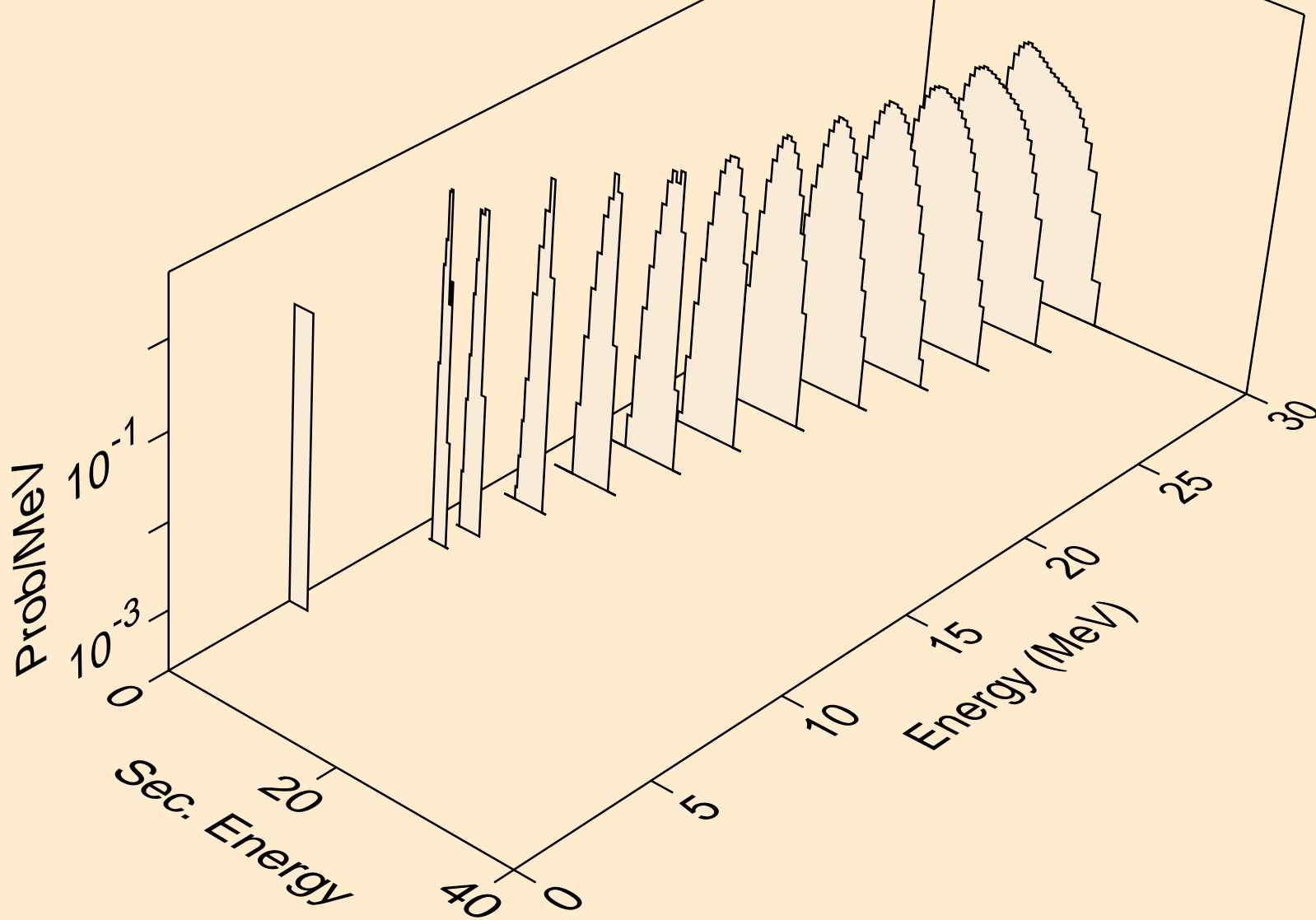

ZR089 NEUTRON ACER TENDL-2019 LIBRARY; T=293.16K  
alphas from (n,da)

