

ZR098 NEUTRON ACER TENDL-2019 LIBRARY; T=293.16K  
Principal cross sections

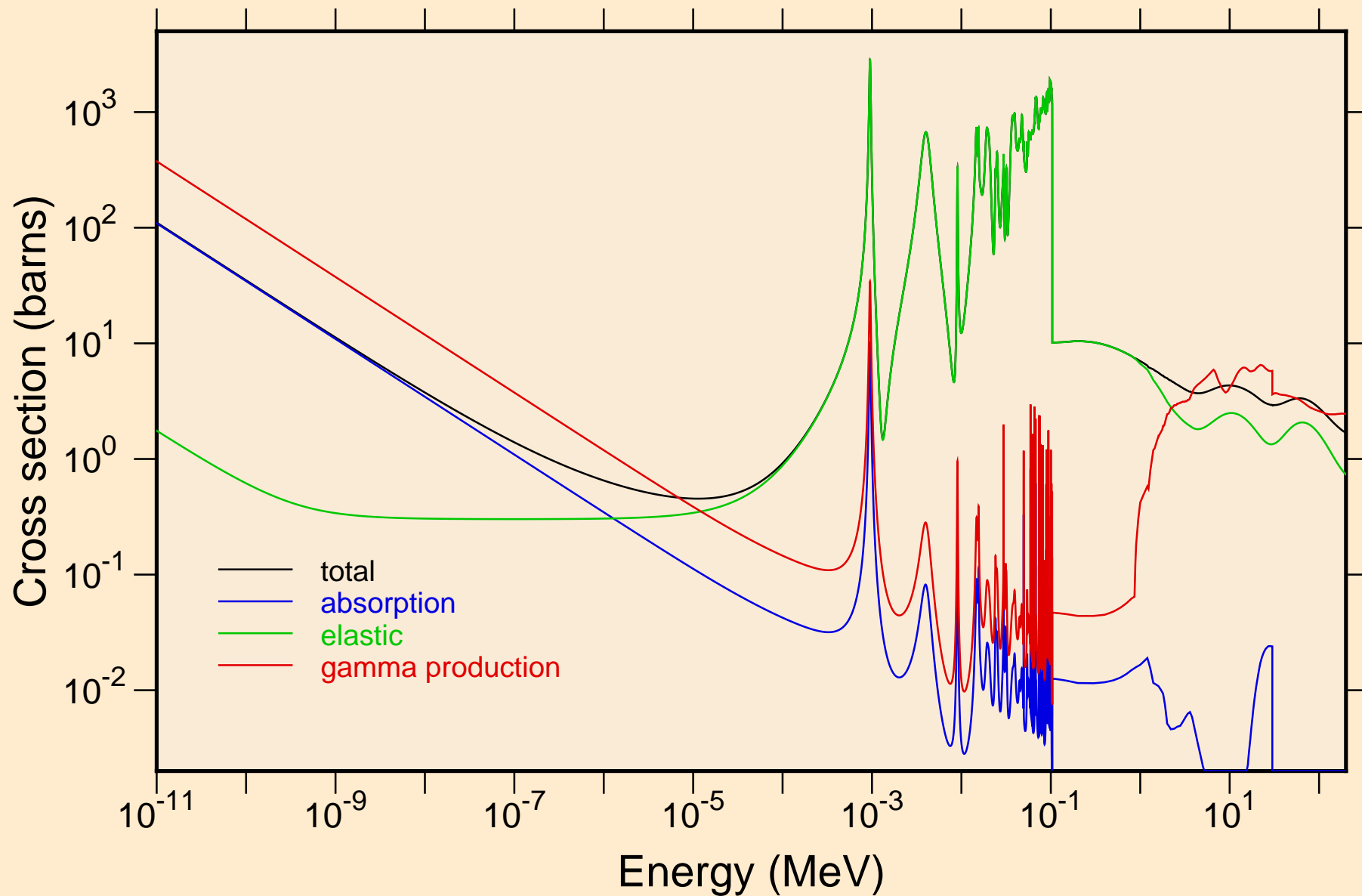

ZR098 NEUTRON ACER TENDL-2019 LIBRARY; T=293.16K  
resonance total cross section

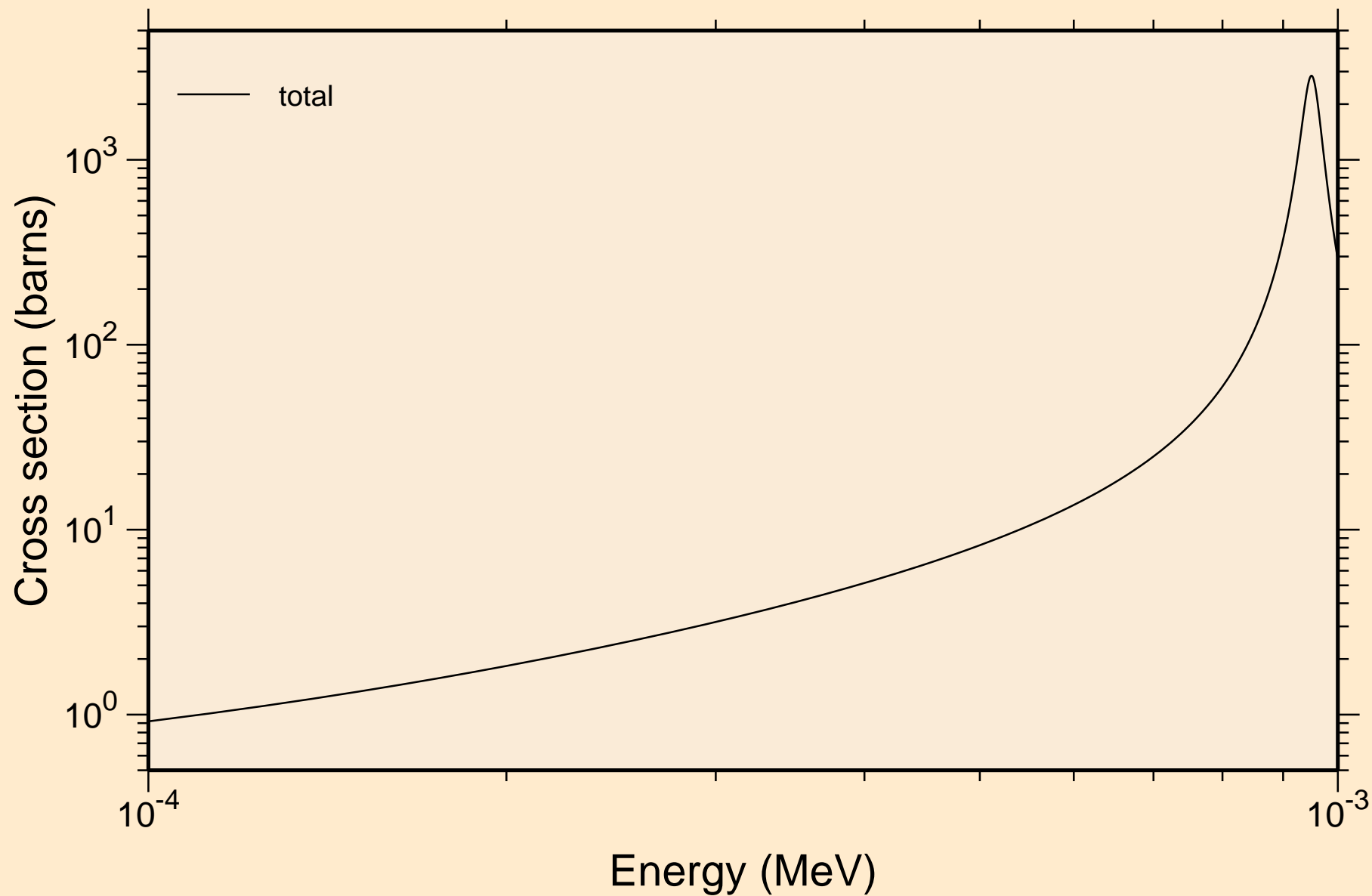

ZR098 NEUTRON ACER TENDL-2019 LIBRARY; T=293.16K  
resonance total cross section

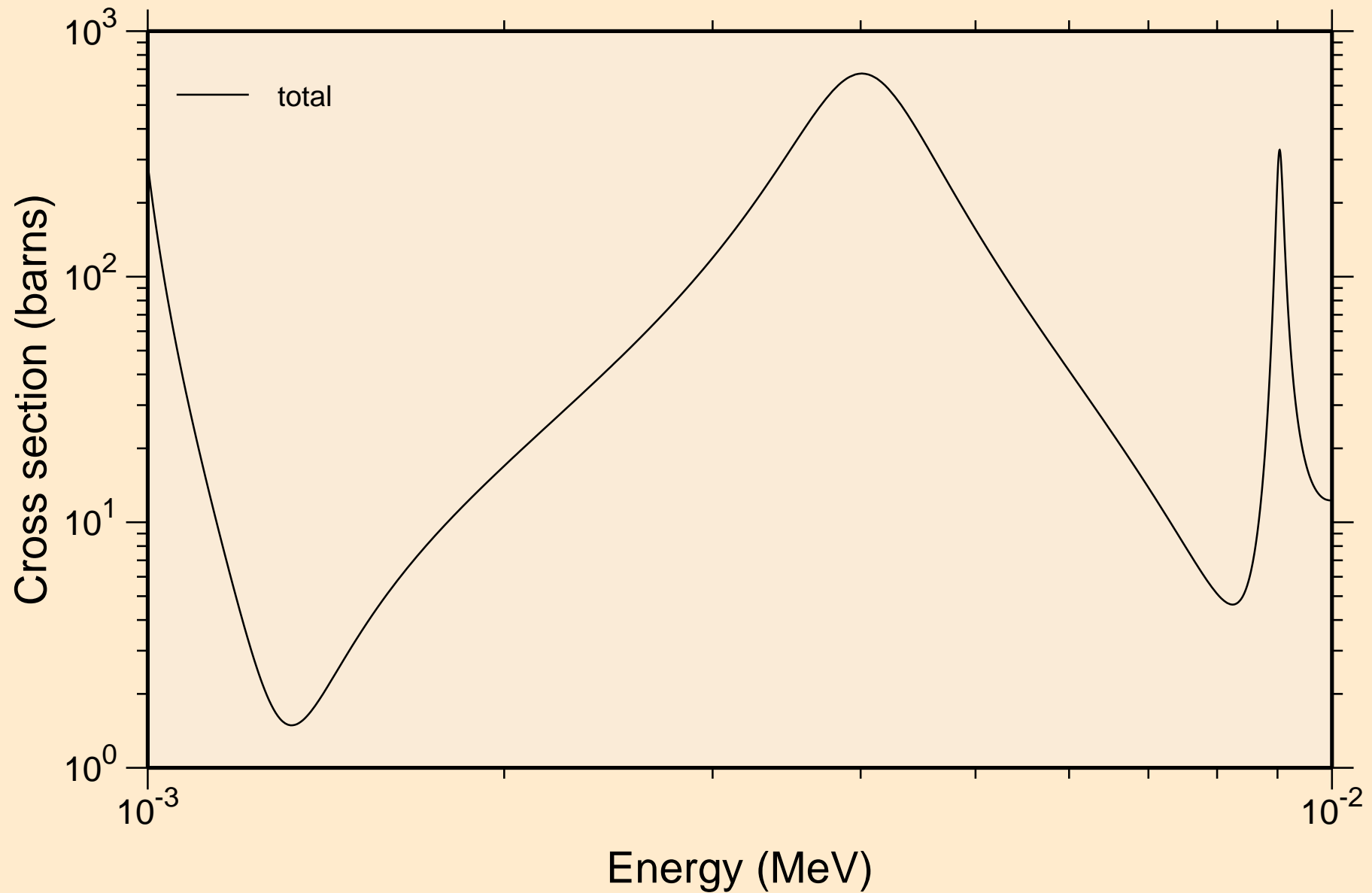

ZR098 NEUTRON ACER TENDL-2019 LIBRARY; T=293.16K  
resonance total cross section

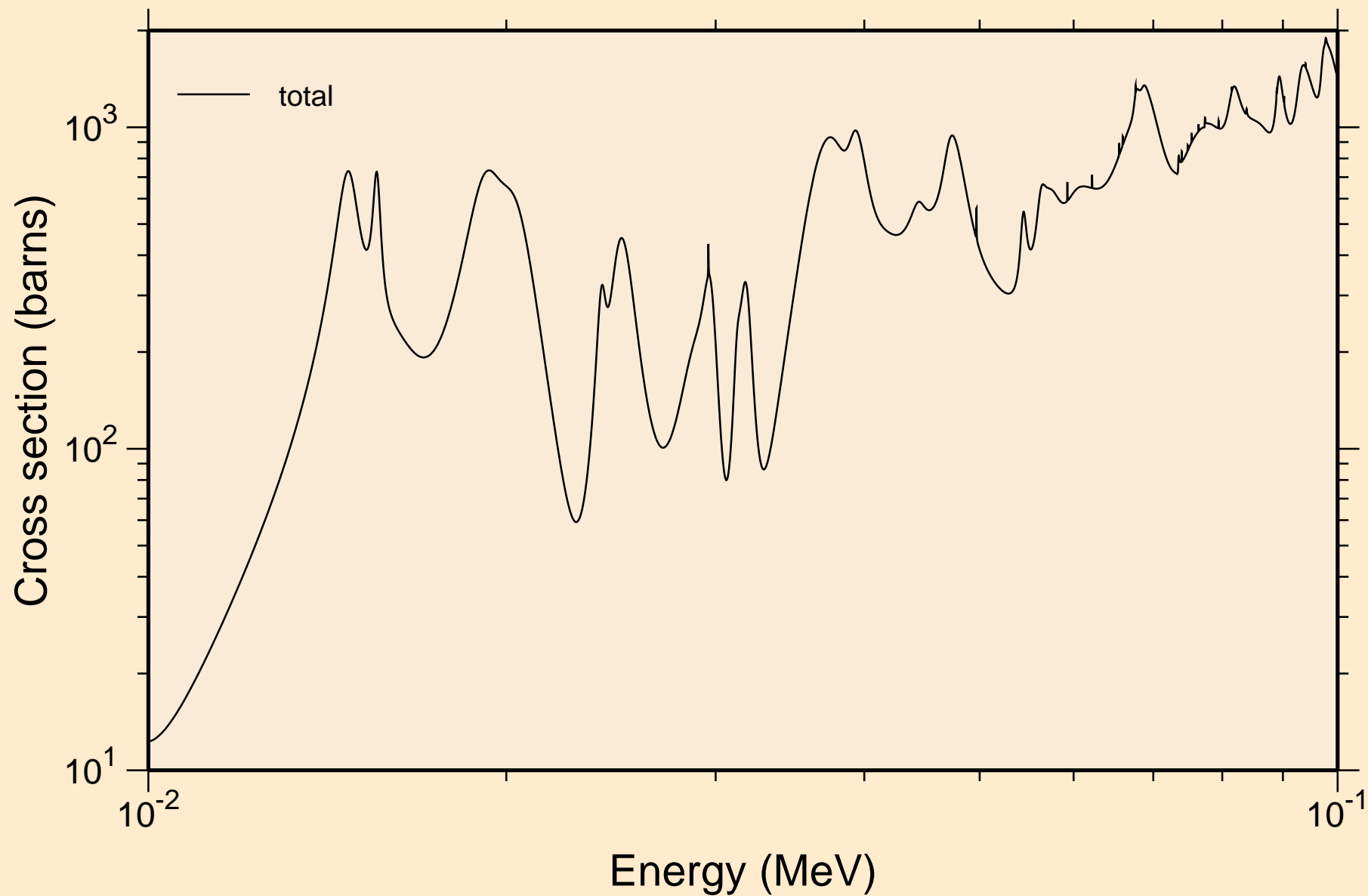

ZR098 NEUTRON ACER TENDL-2019 LIBRARY; T=293.16K  
resonance total cross section

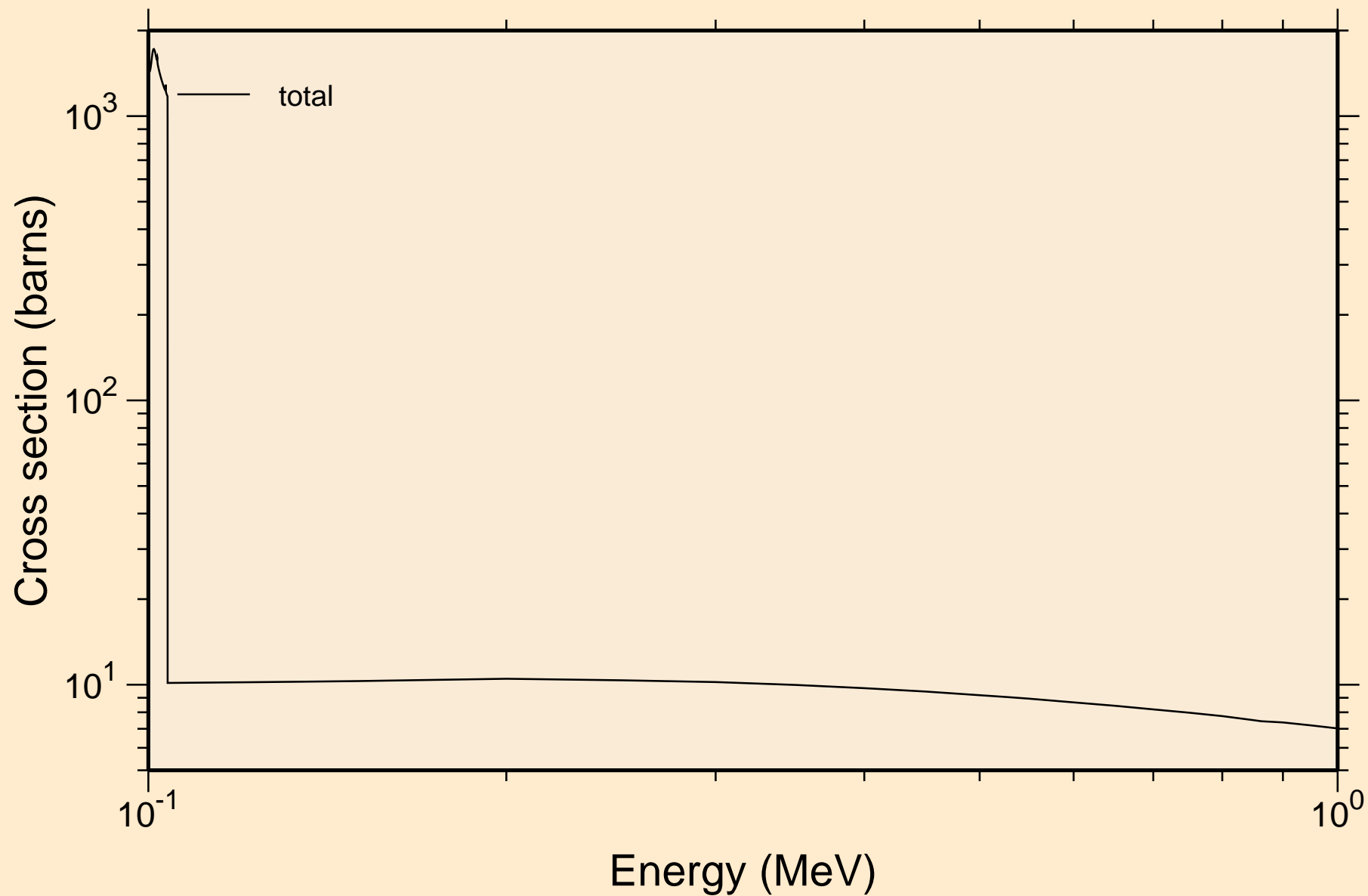

ZR098 NEUTRON ACER TENDL-2019 LIBRARY; T=293.16K  
resonance total cross section

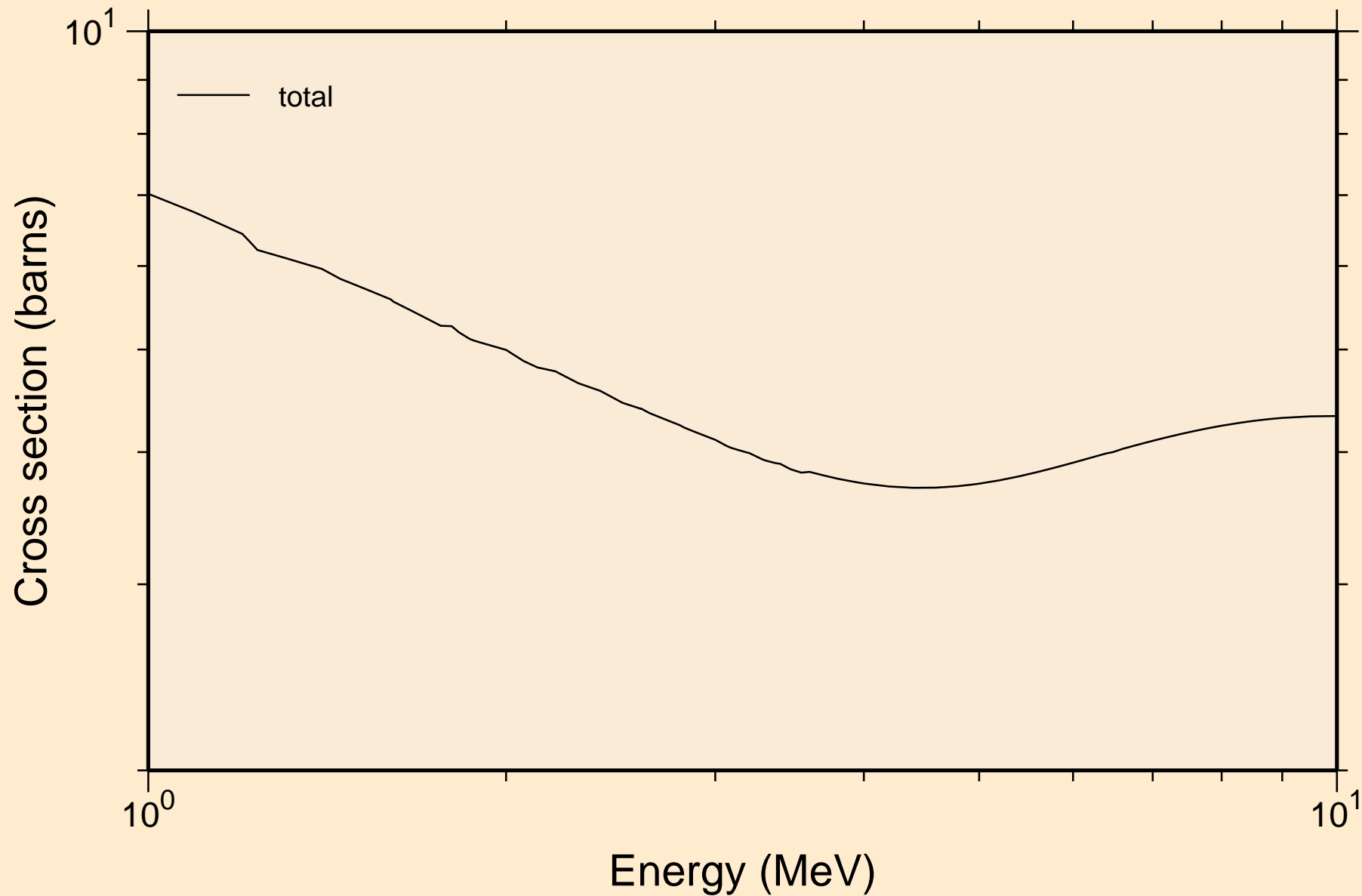

ZR098 NEUTRON ACER TENDL-2019 LIBRARY; T=293.16K  
resonance absorption cross sections

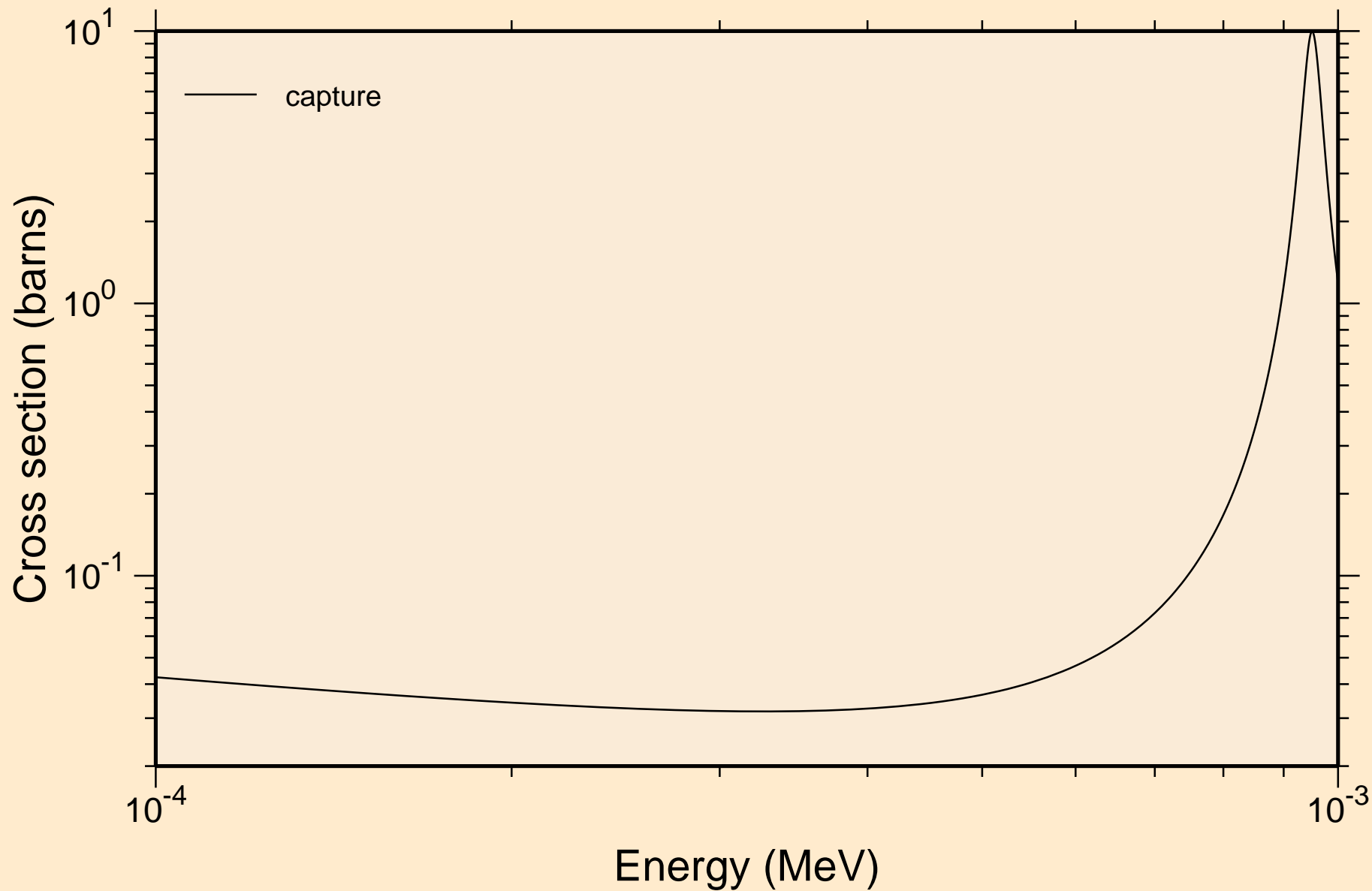

ZR098 NEUTRON ACER TENDL-2019 LIBRARY; T=293.16K  
resonance absorption cross sections

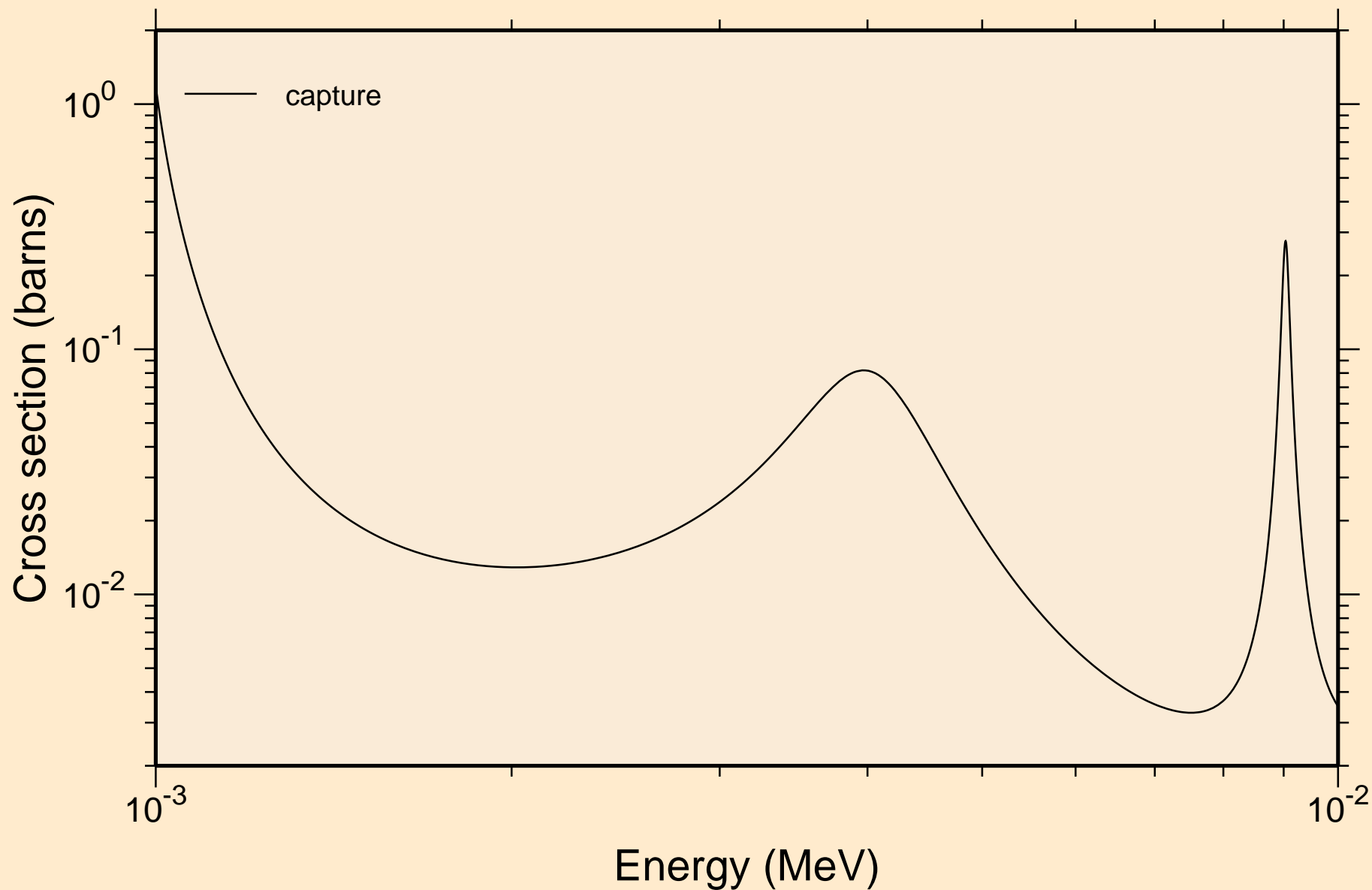



ZR098 NEUTRON ACER TENDL-2019 LIBRARY; T=293.16K  
resonance absorption cross sections

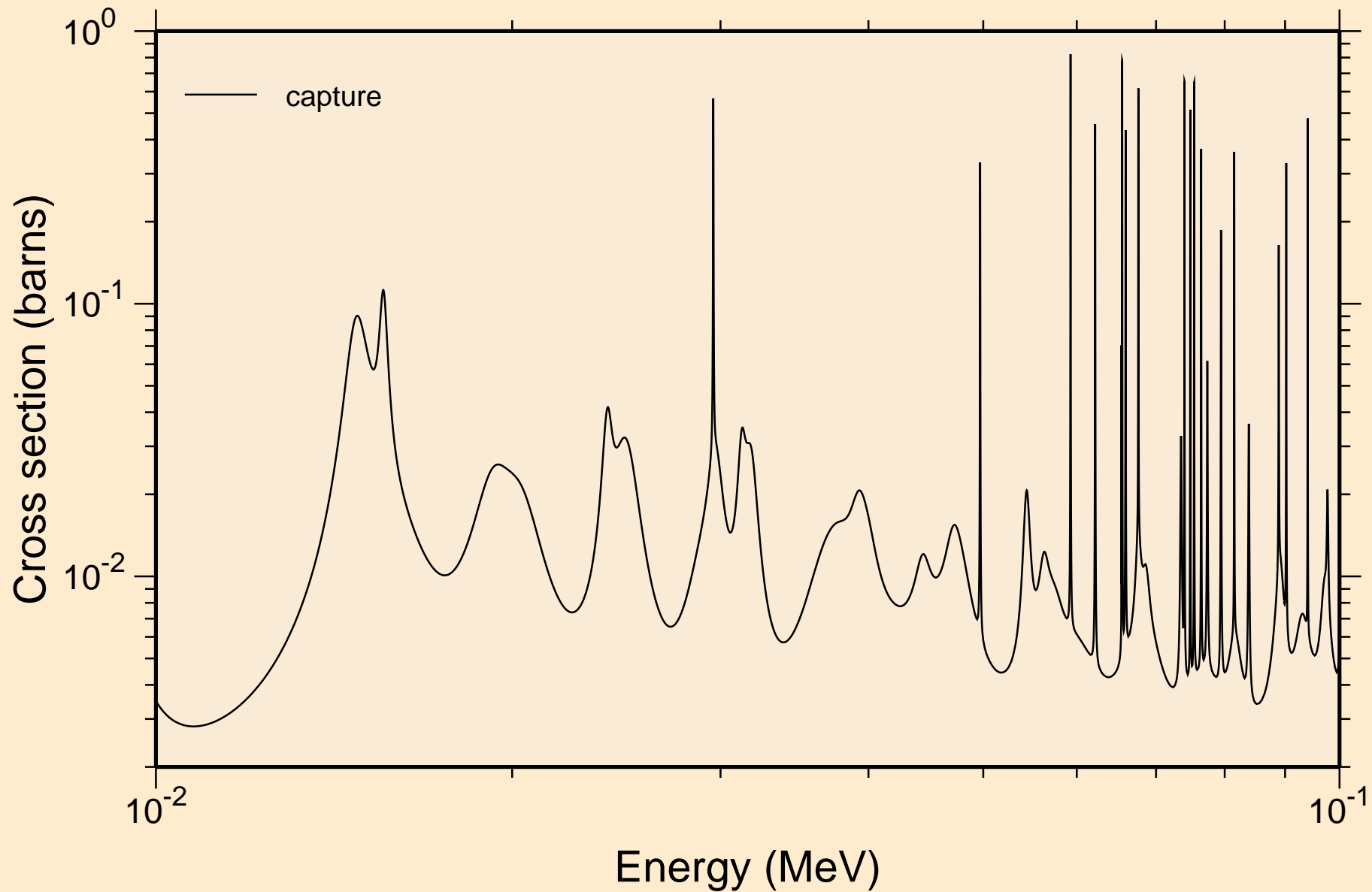

ZR098 NEUTRON ACER TENDL-2019 LIBRARY; T=293.16K  
resonance absorption cross sections

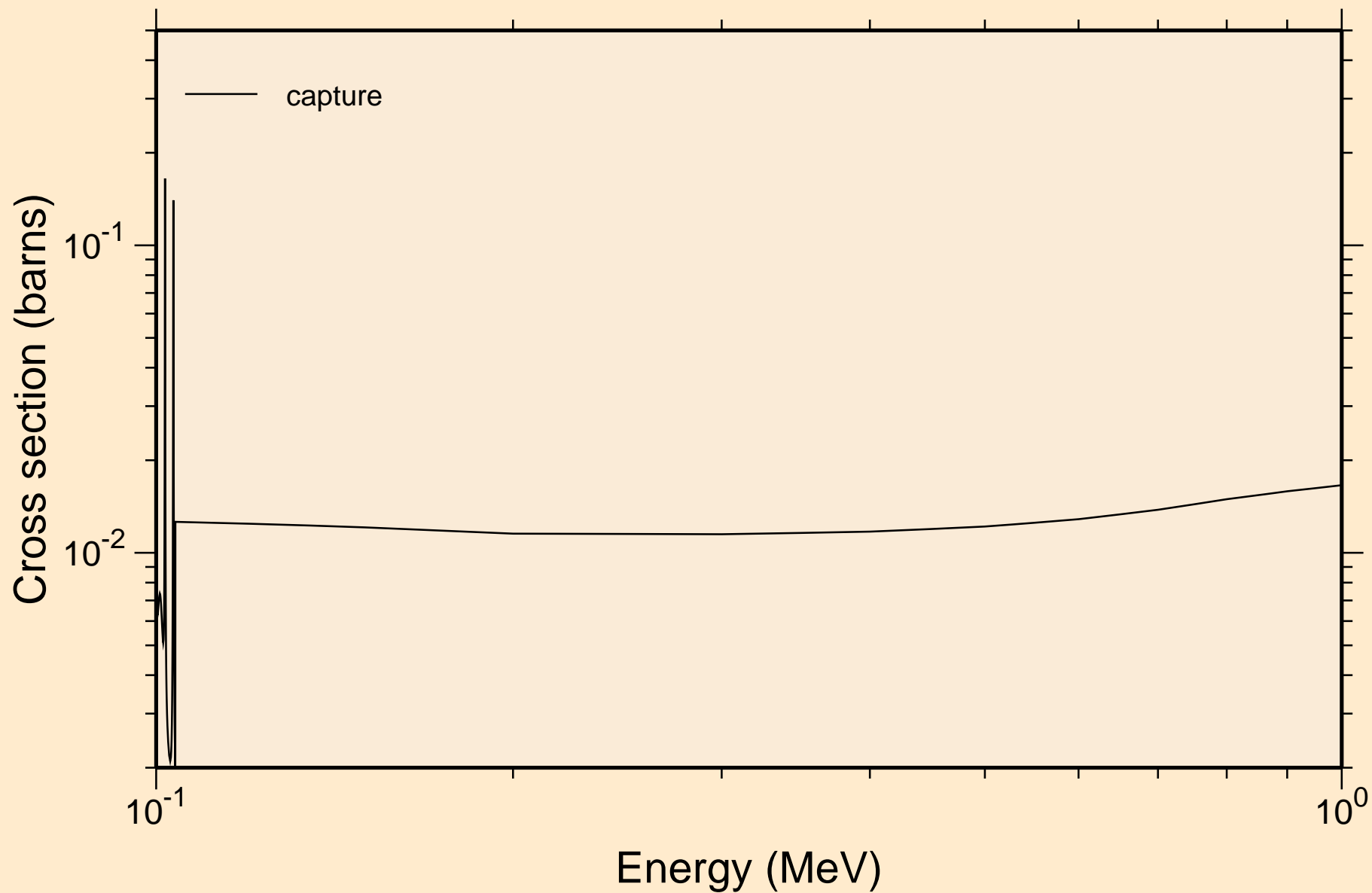

ZR098 NEUTRON ACER TENDL-2019 LIBRARY; T=293.16K  
resonance absorption cross sections

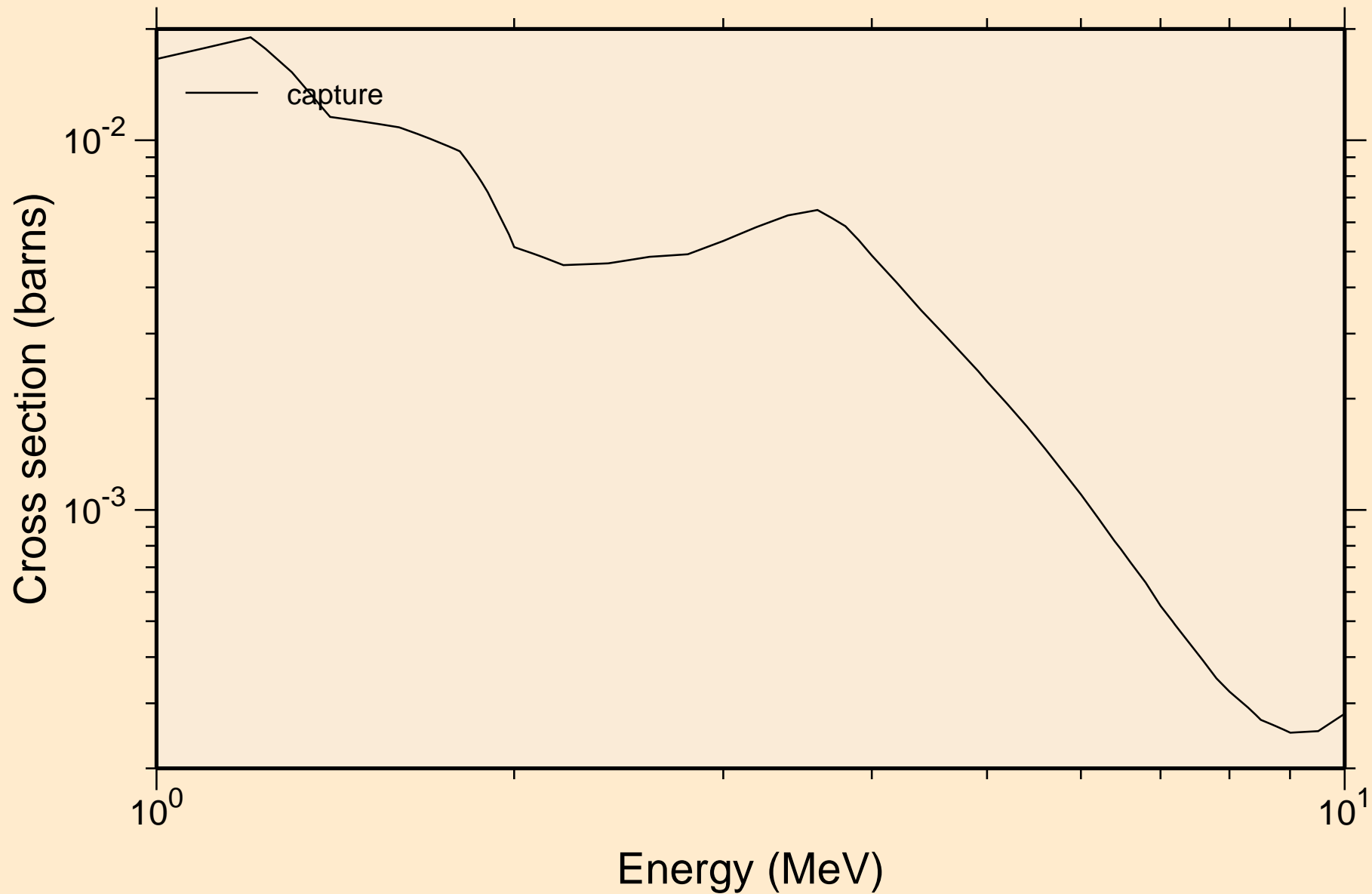

ZR098 NEUTRON ACER TENDL-2019 LIBRARY; T=293.16K  
Heating

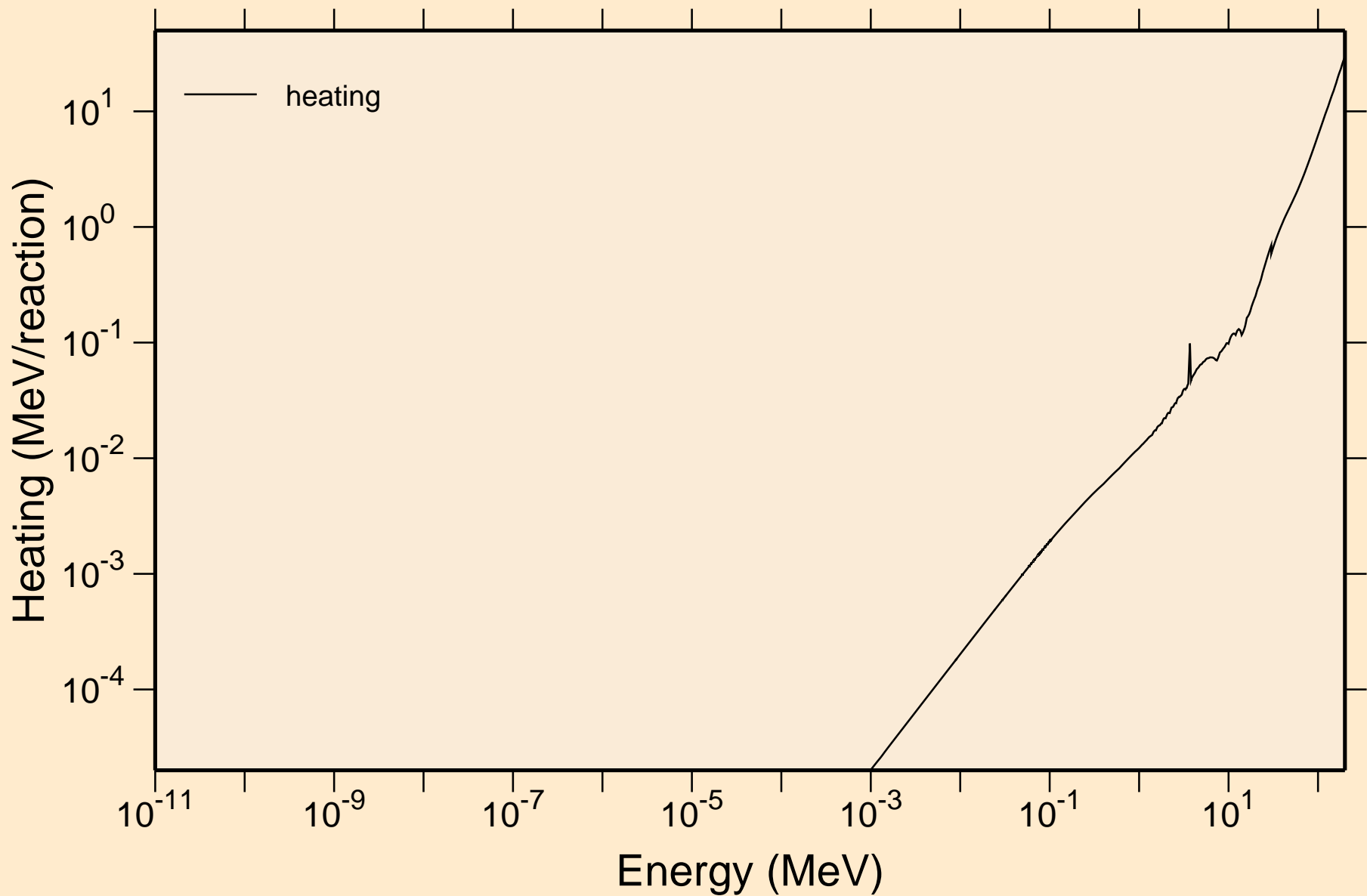

ZR098 NEUTRON ACER TENDL-2019 LIBRARY; T=293.16K  
Damage

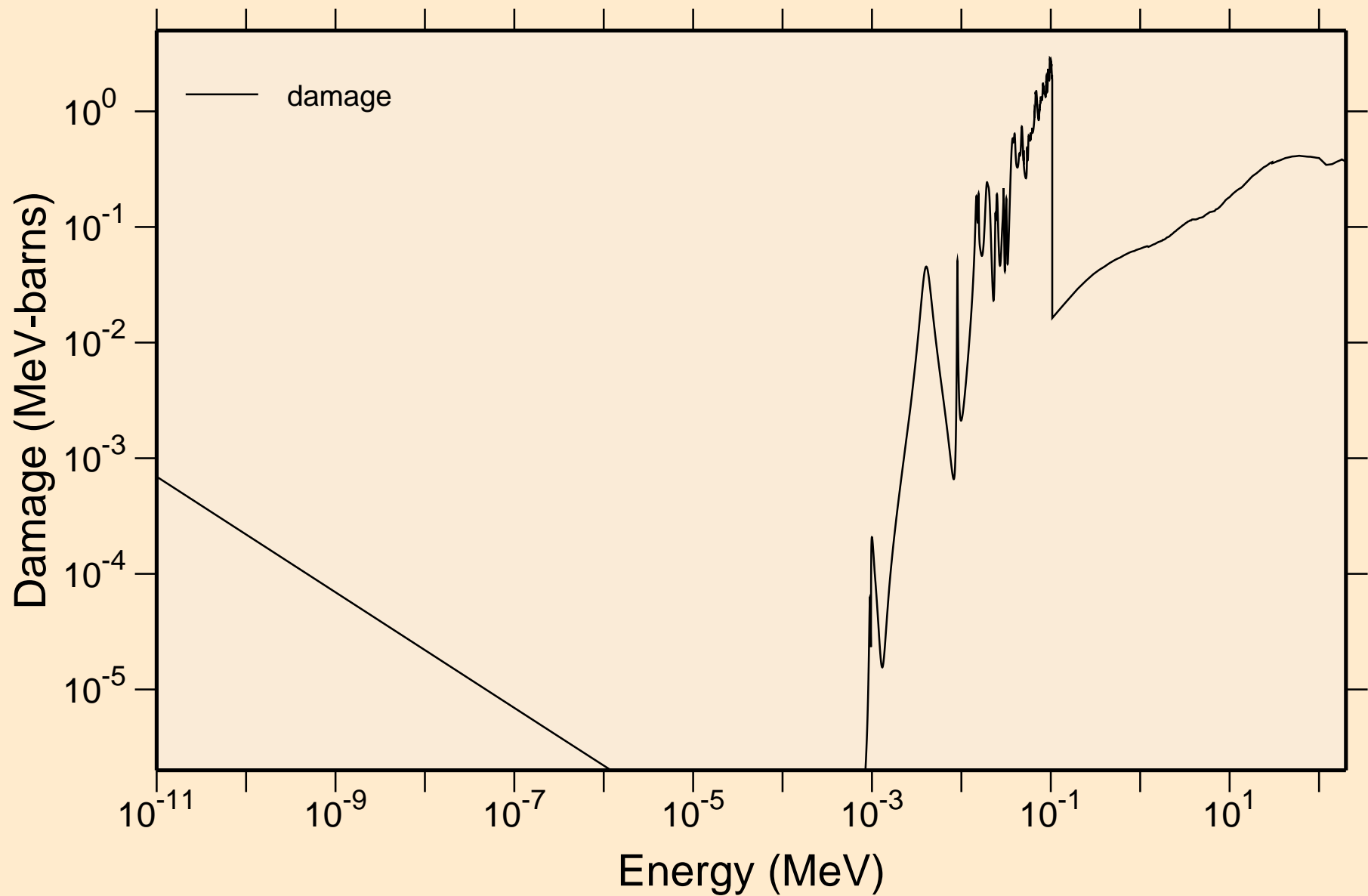

ZR098 NEUTRON ACER TENDL-2019 LIBRARY; T=293.16K  
Non-threshold reactions

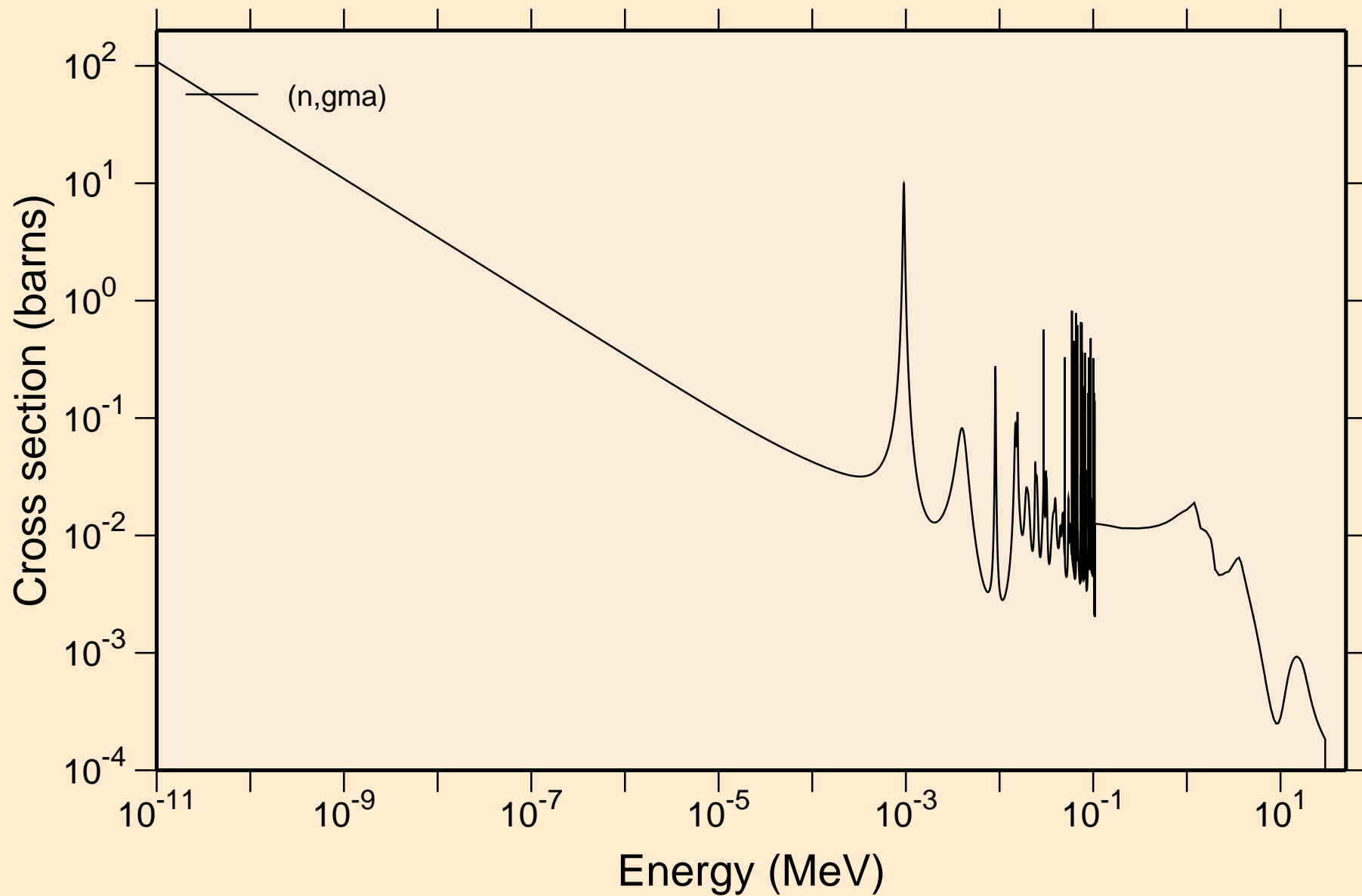

ZR098 NEUTRON ACER TENDL-2019 LIBRARY; T=293.16K  
Principal cross sections

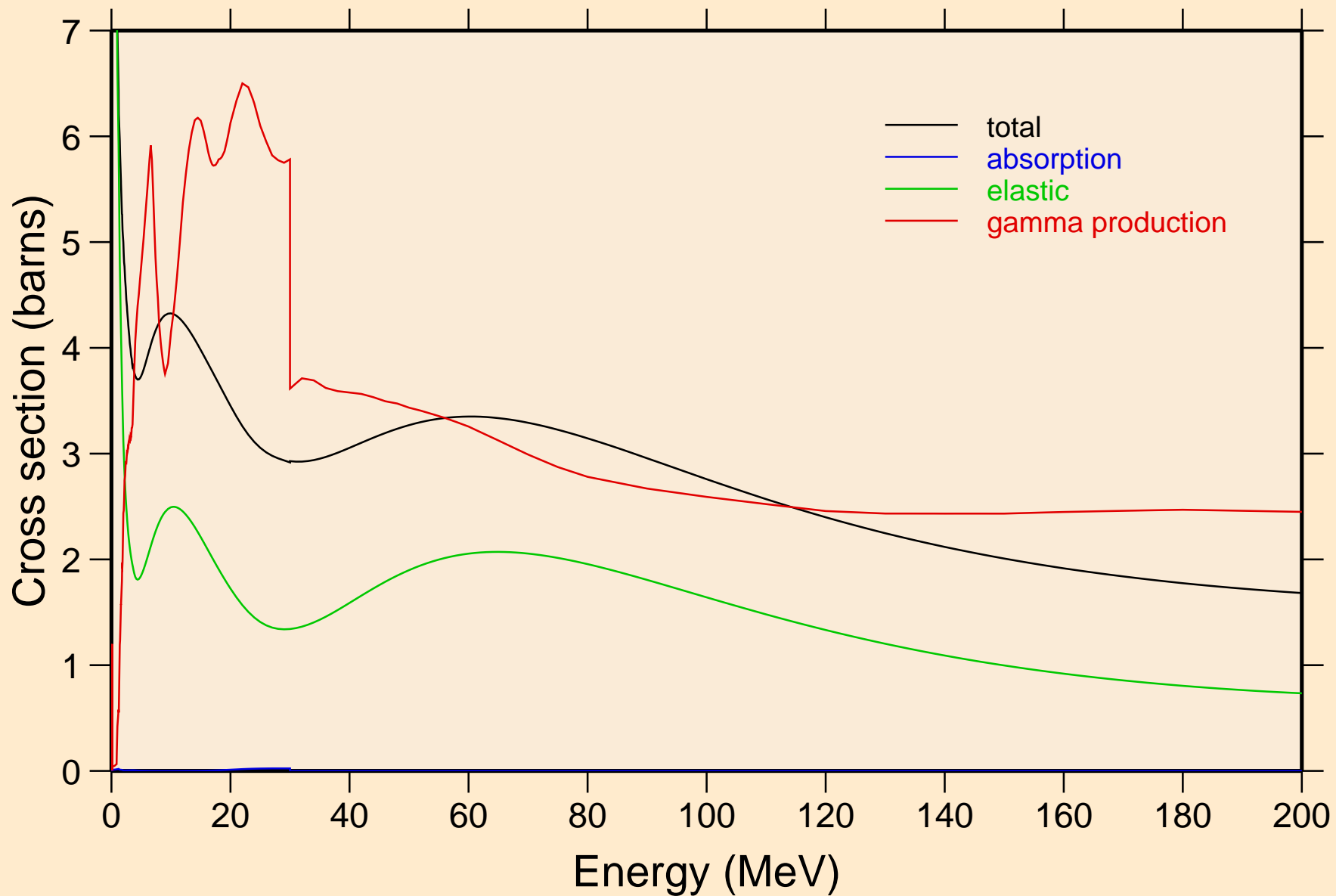

ZR098 NEUTRON ACER TENDL-2019 LIBRARY; T=293.16K  
Heating

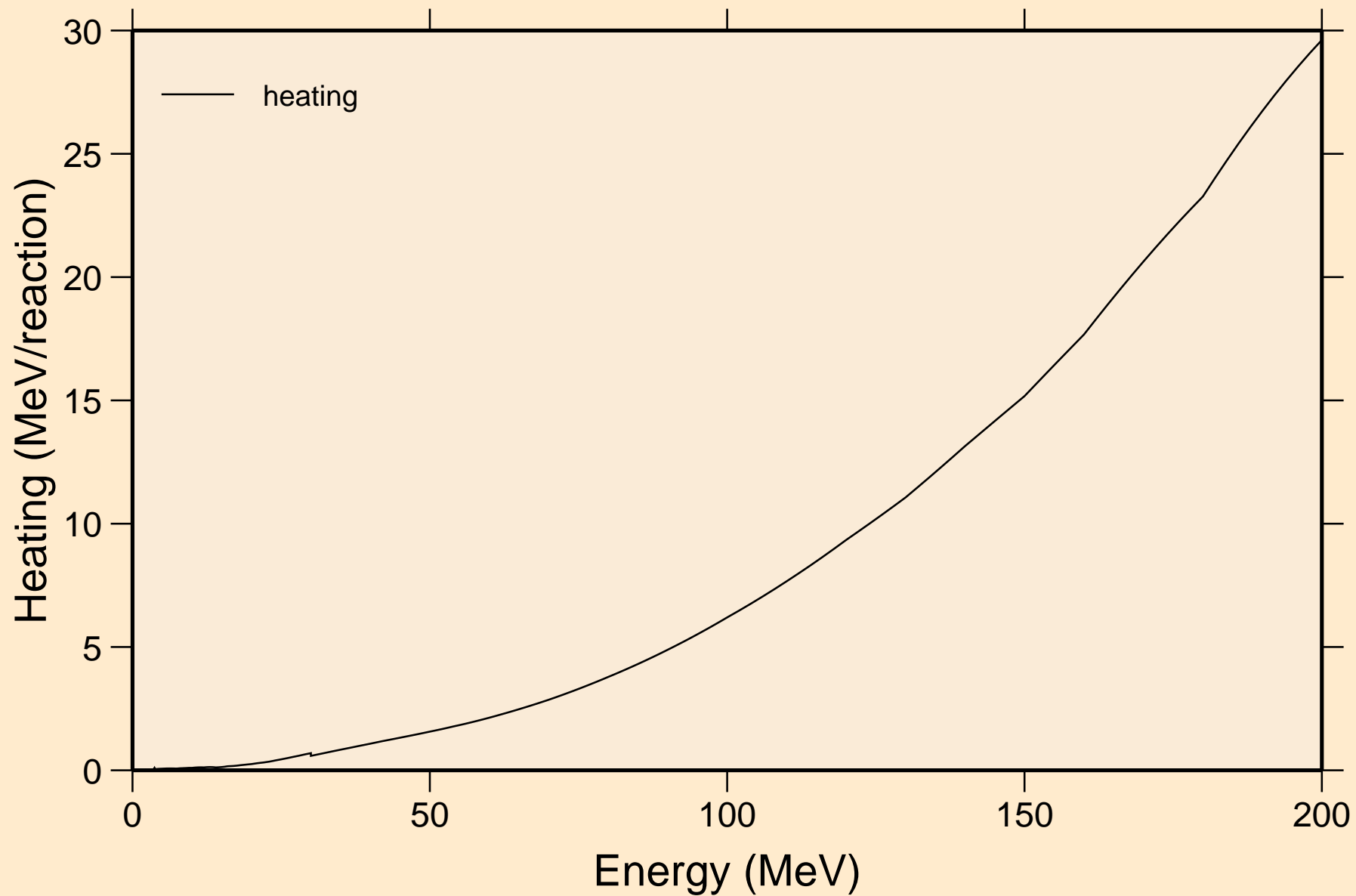



ZR098 NEUTRON ACER TENDL-2019 LIBRARY; T=293.16K  
Damage

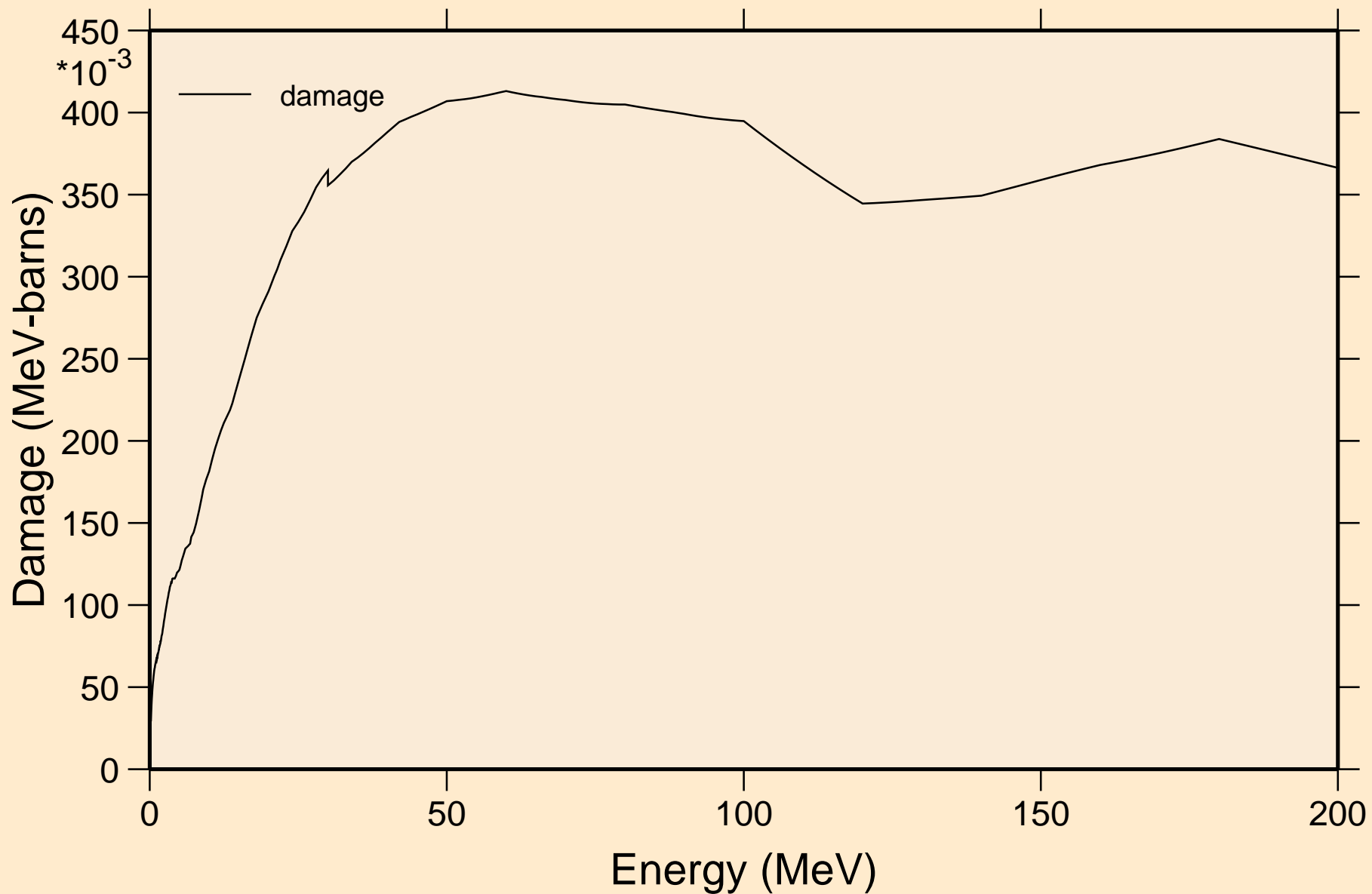

ZR098 NEUTRON ACER TENDL-2019 LIBRARY; T=293.16K  
Non-threshold reactions

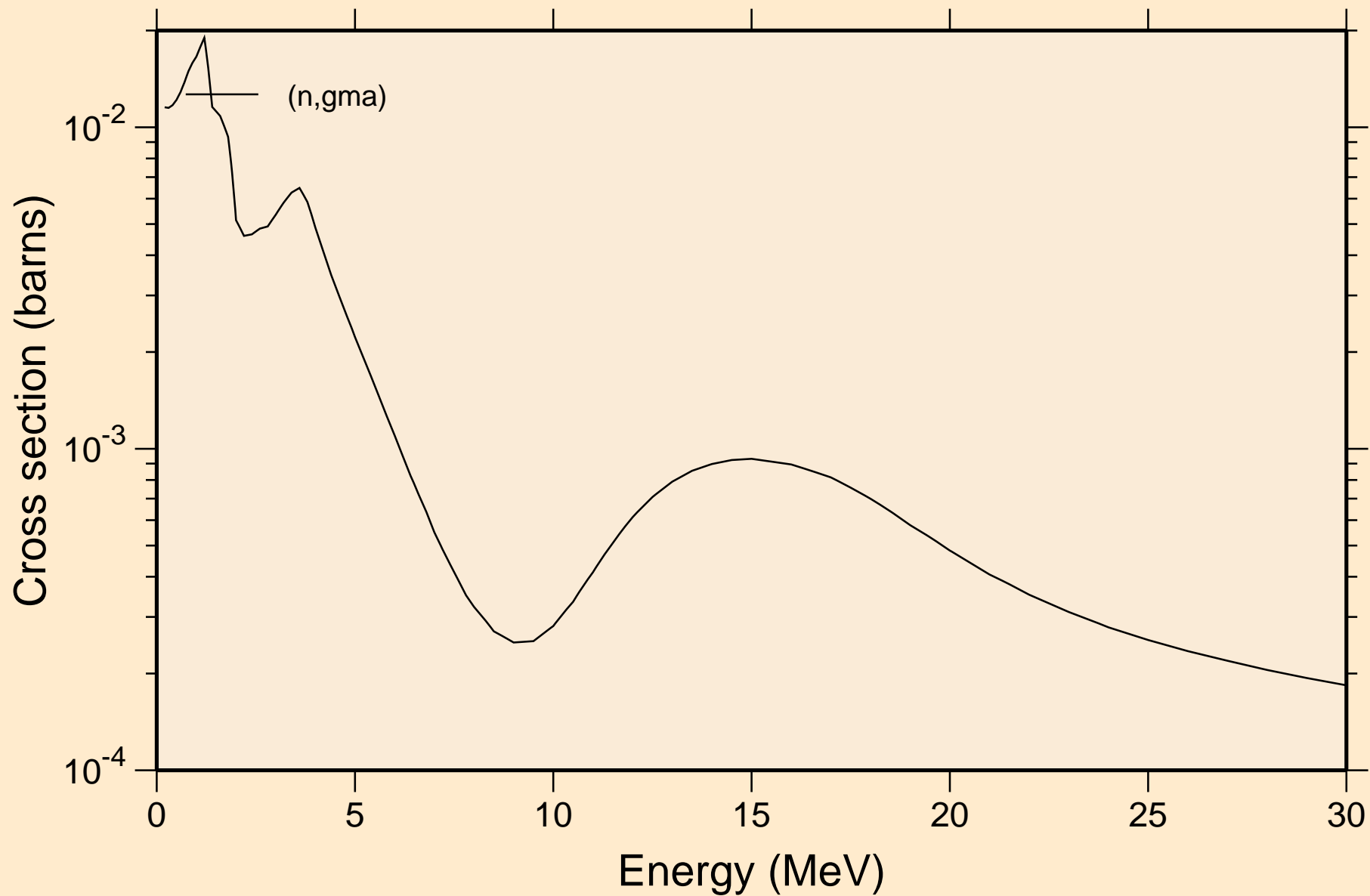

ZR098 NEUTRON ACER TENDL-2019 LIBRARY; T=293.16K  
Inelastic levels

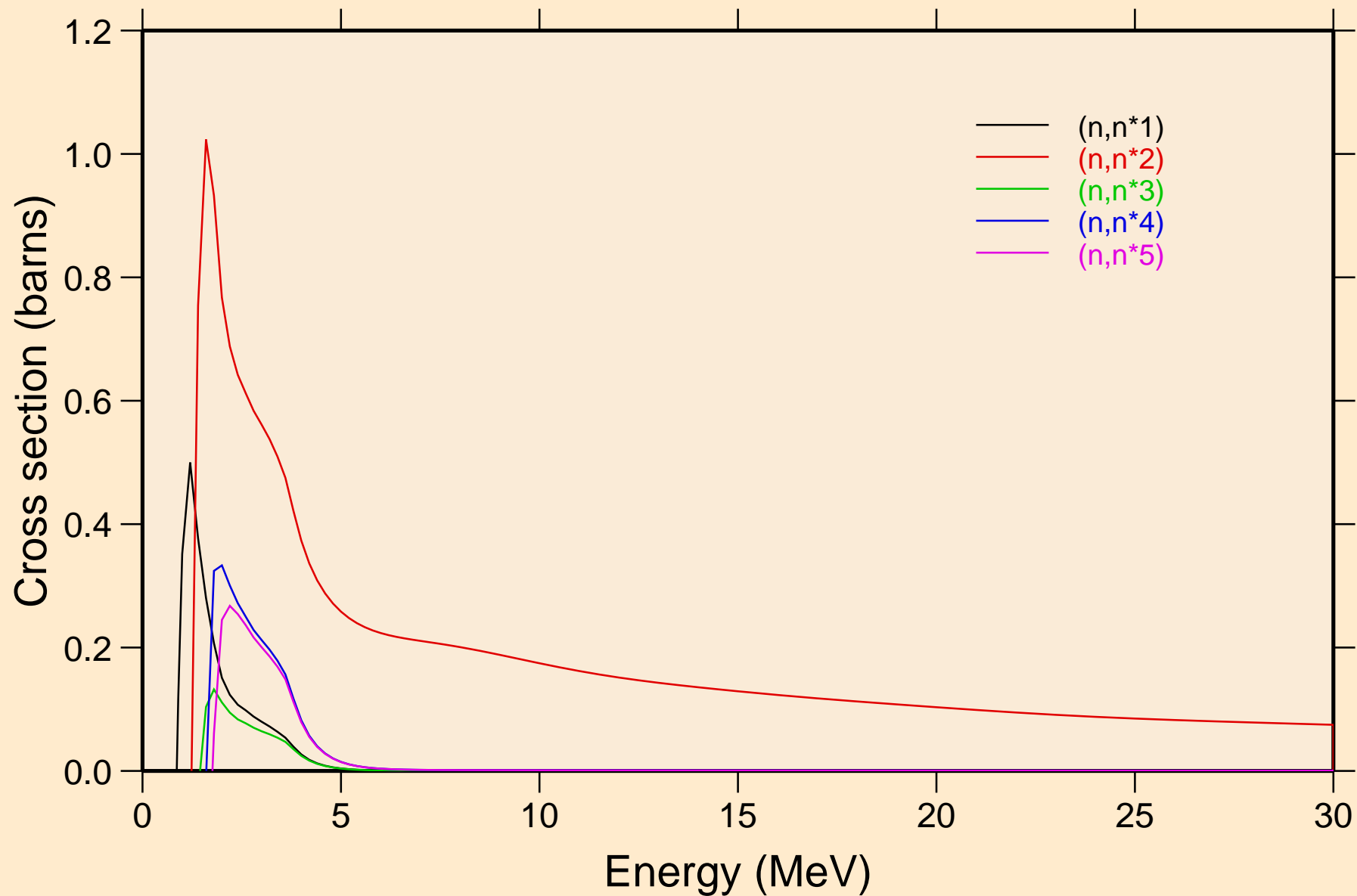

ZR098 NEUTRON ACER TENDL-2019 LIBRARY; T=293.16K  
Inelastic levels

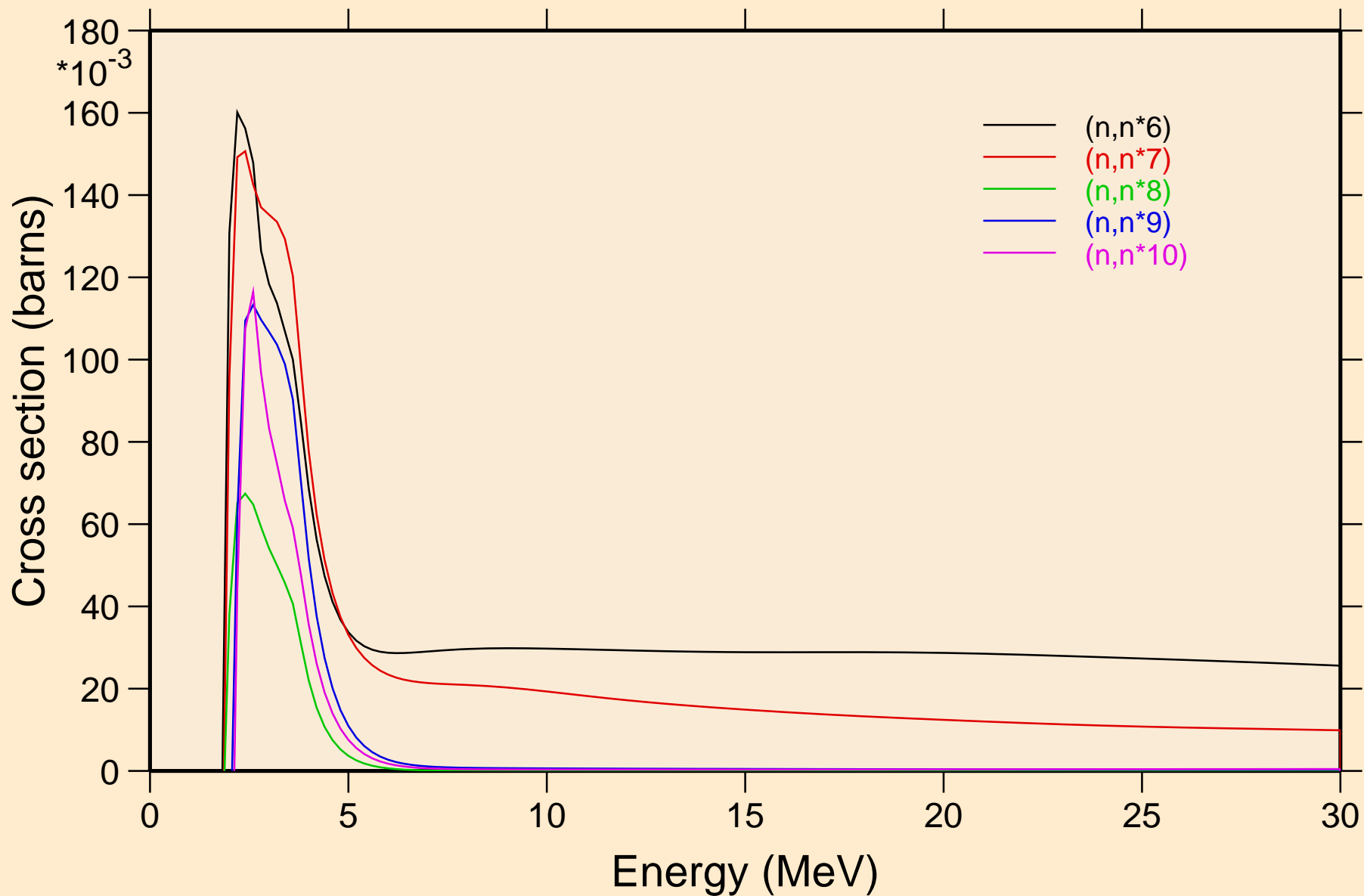

ZR098 NEUTRON ACER TENDL-2019 LIBRARY; T=293.16K  
Inelastic levels

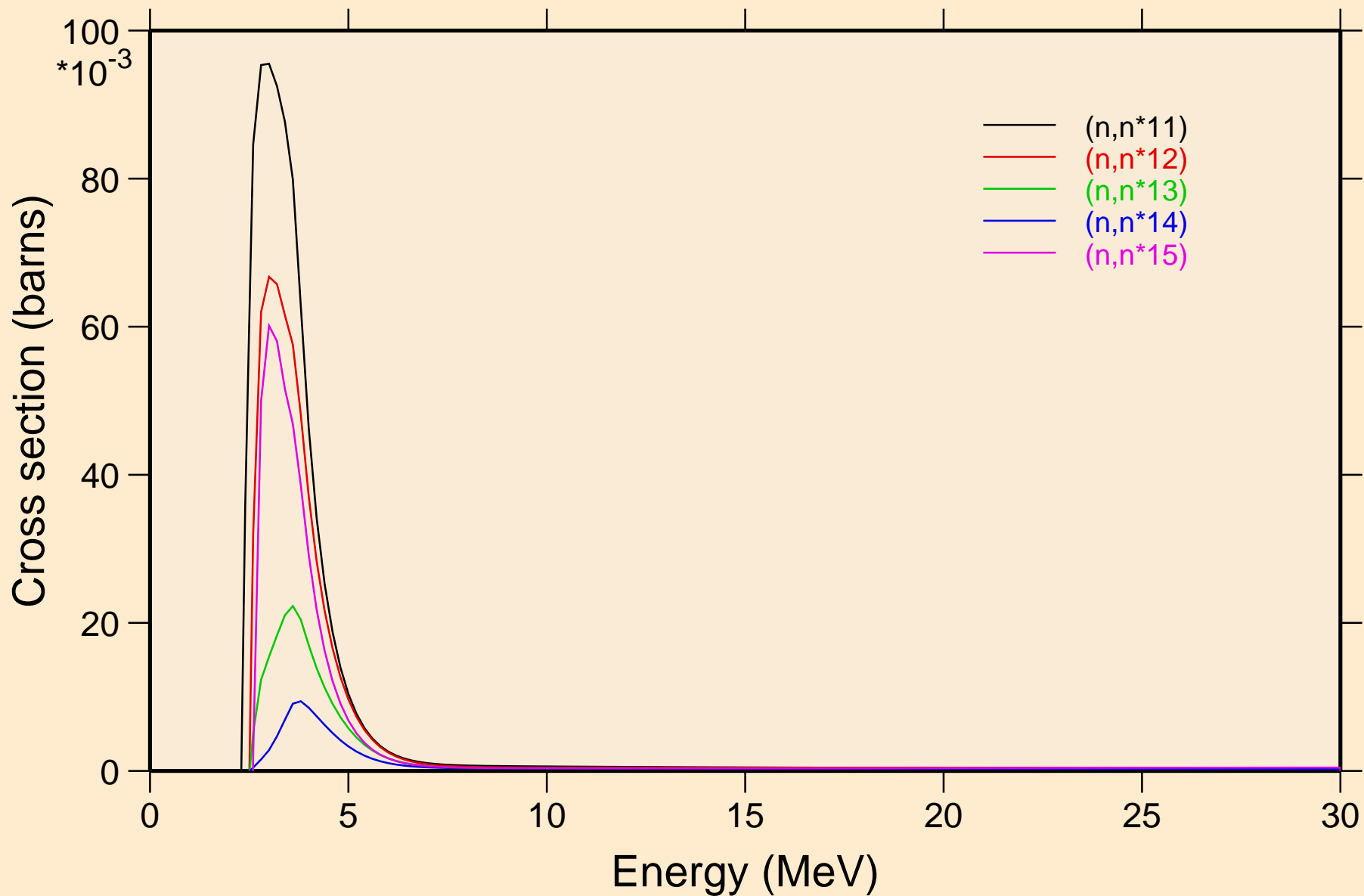

ZR098 NEUTRON ACER TENDL-2019 LIBRARY; T=293.16K  
Inelastic levels

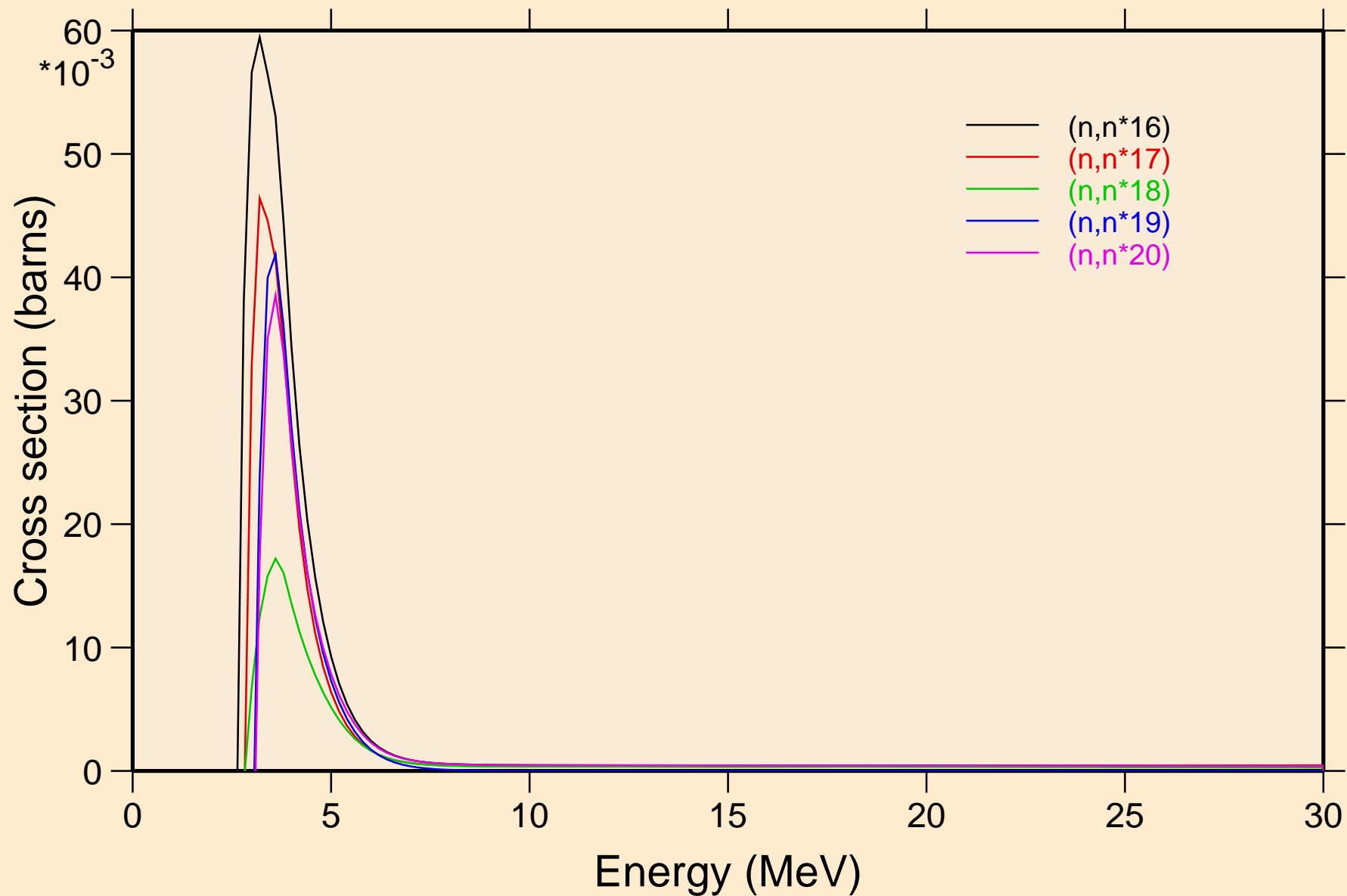

ZR098 NEUTRON ACER TENDL-2019 LIBRARY; T=293.16K  
Inelastic levels

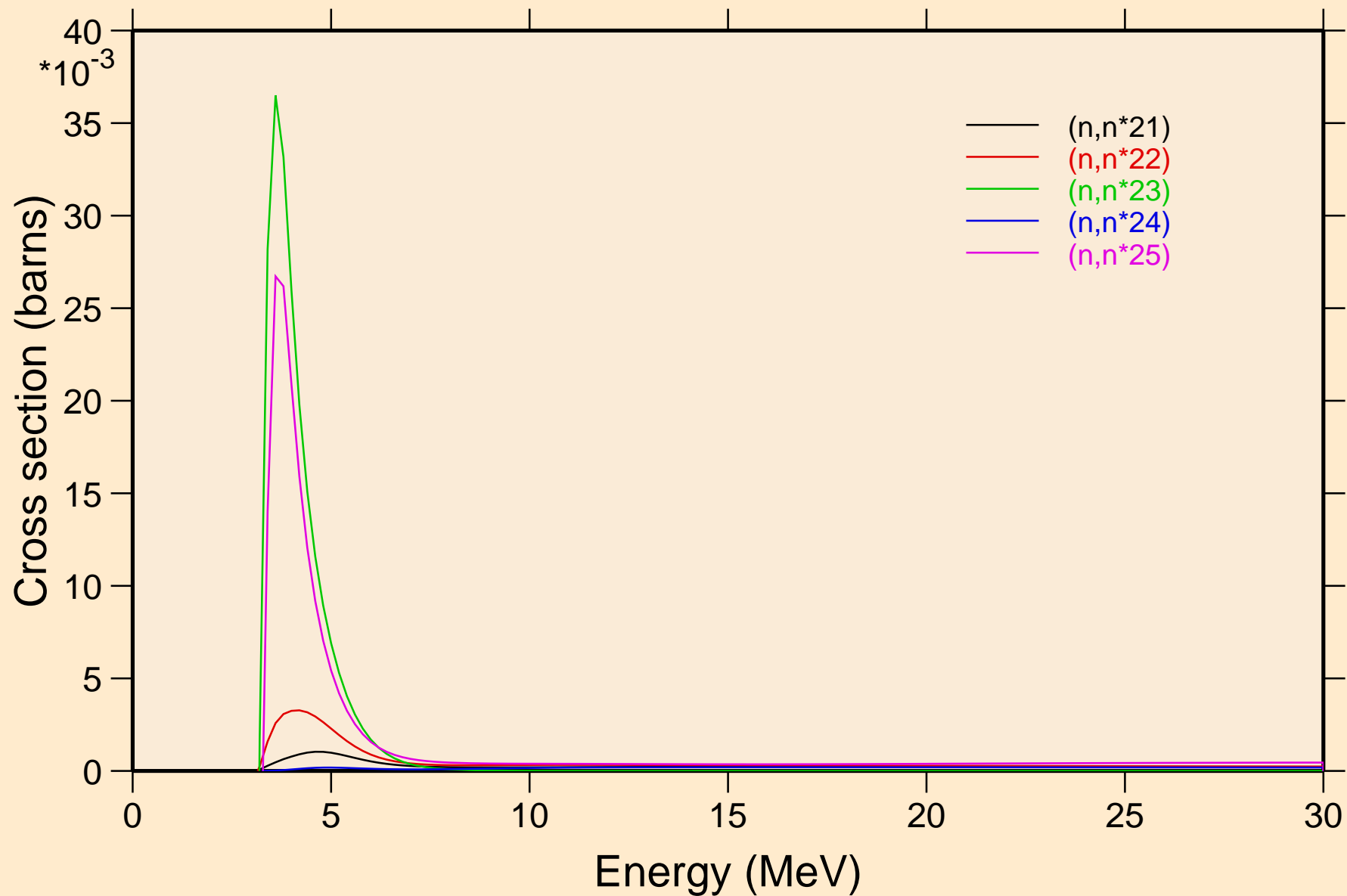

ZR098 NEUTRON ACER TENDL-2019 LIBRARY; T=293.16K  
Inelastic levels

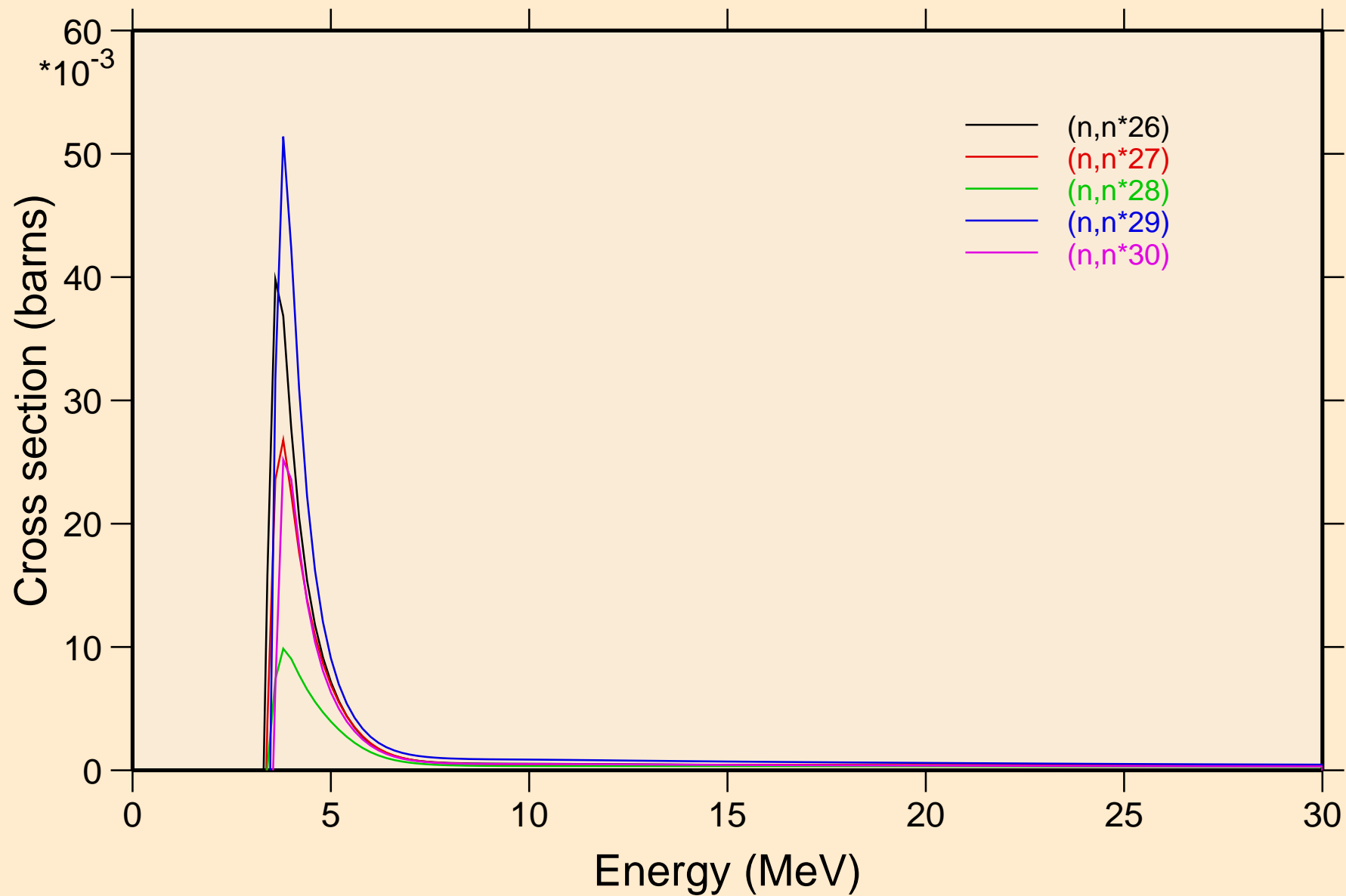



ZR098 NEUTRON ACER TENDL-2019 LIBRARY; T=293.16K  
Threshold reactions

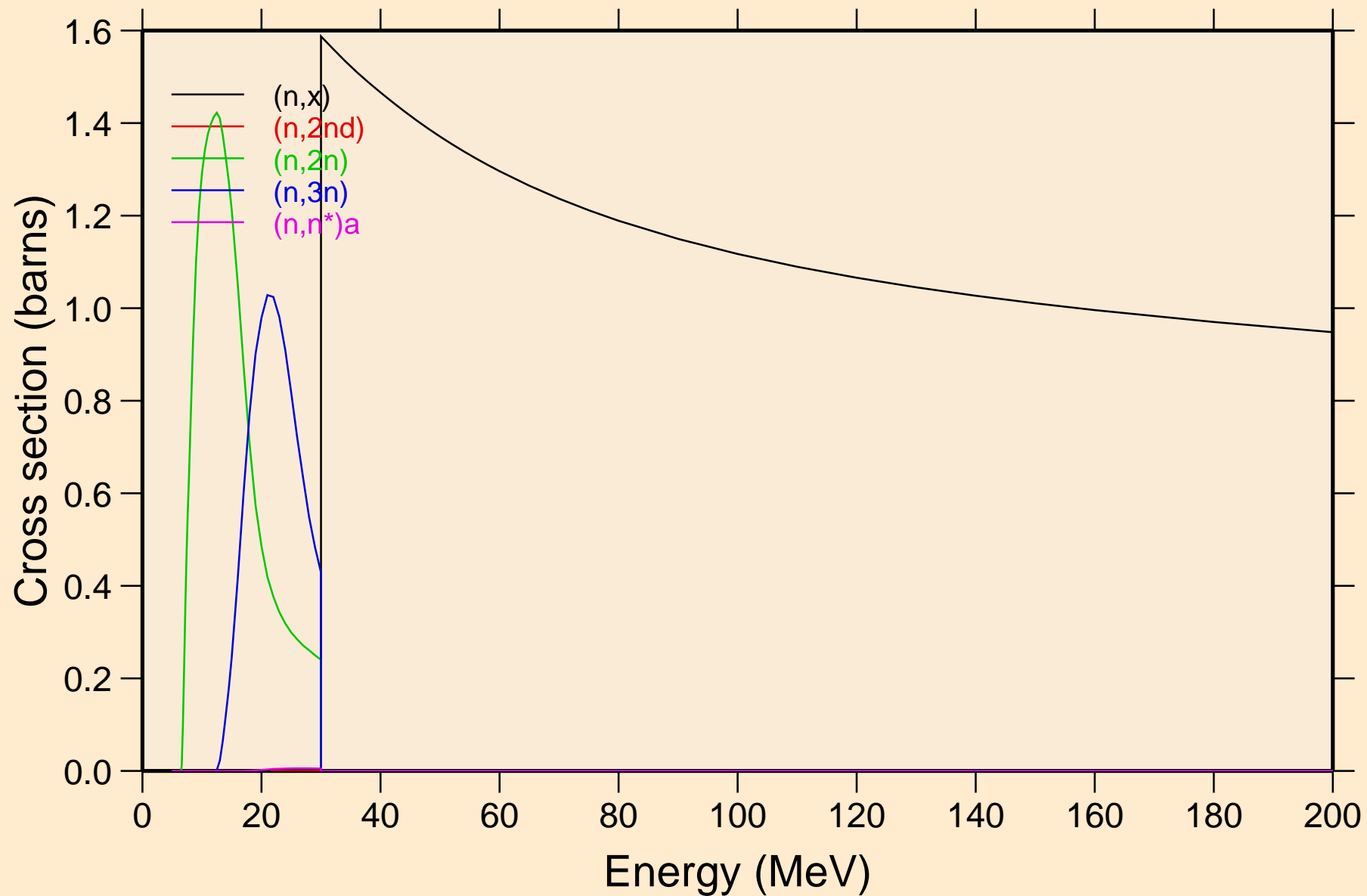

ZR098 NEUTRON ACER TENDL-2019 LIBRARY; T=293.16K  
Threshold reactions

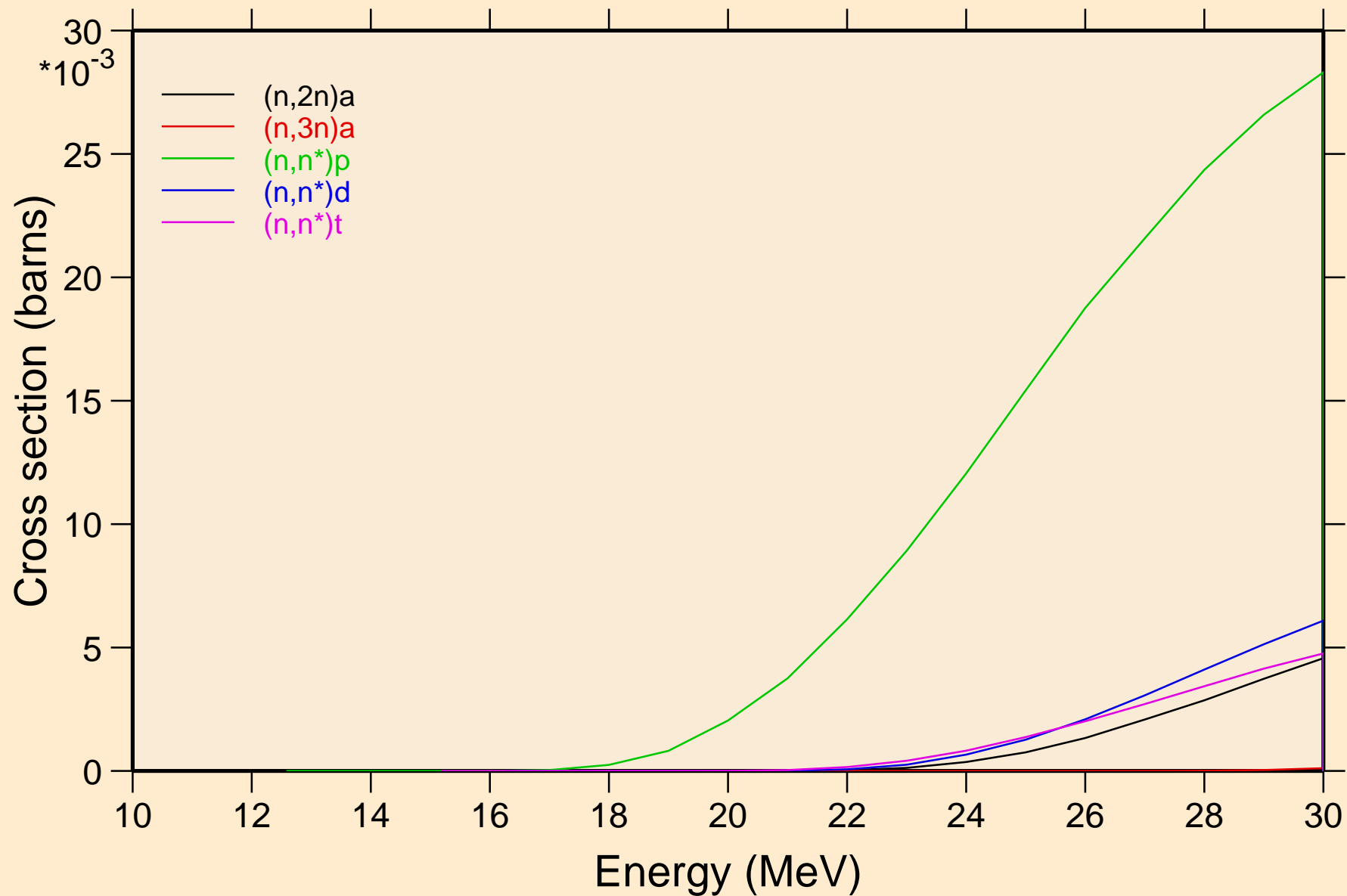

ZR098 NEUTRON ACER TENDL-2019 LIBRARY; T=293.16K  
Threshold reactions

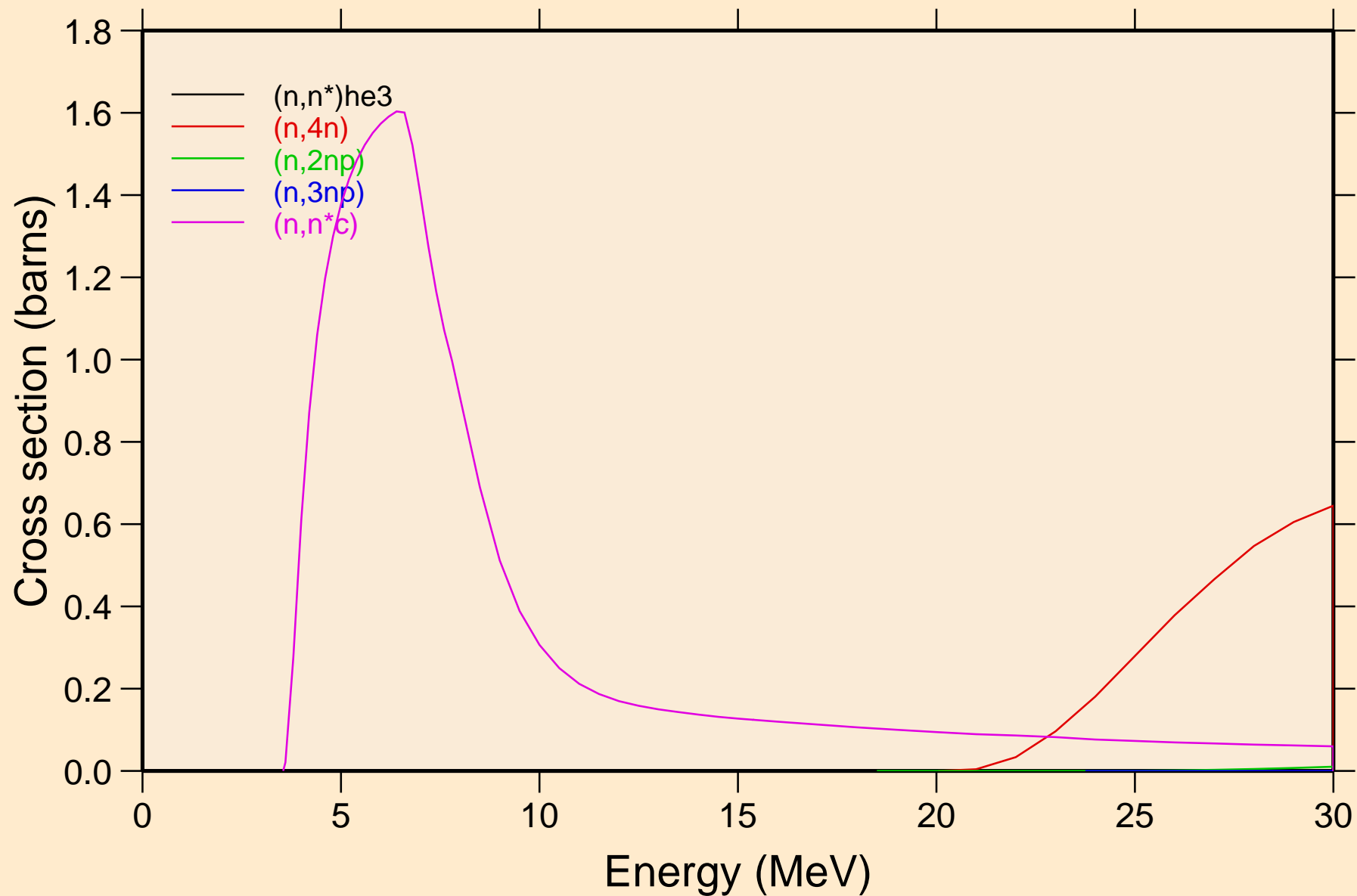

ZR098 NEUTRON ACER TENDL-2019 LIBRARY; T=293.16K  
Threshold reactions

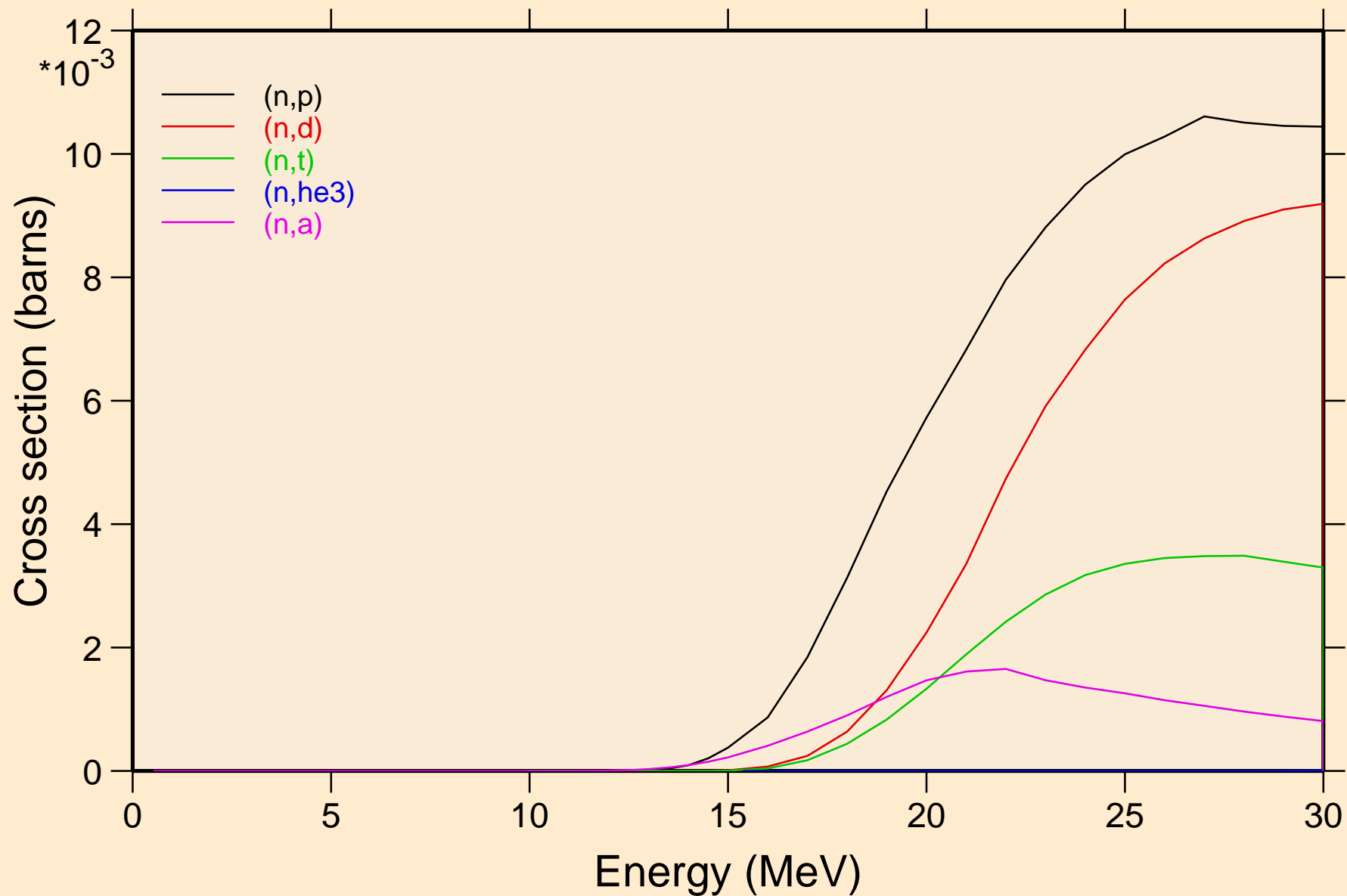

ZR098 NEUTRON ACER TENDL-2019 LIBRARY; T=293.16K  
Threshold reactions

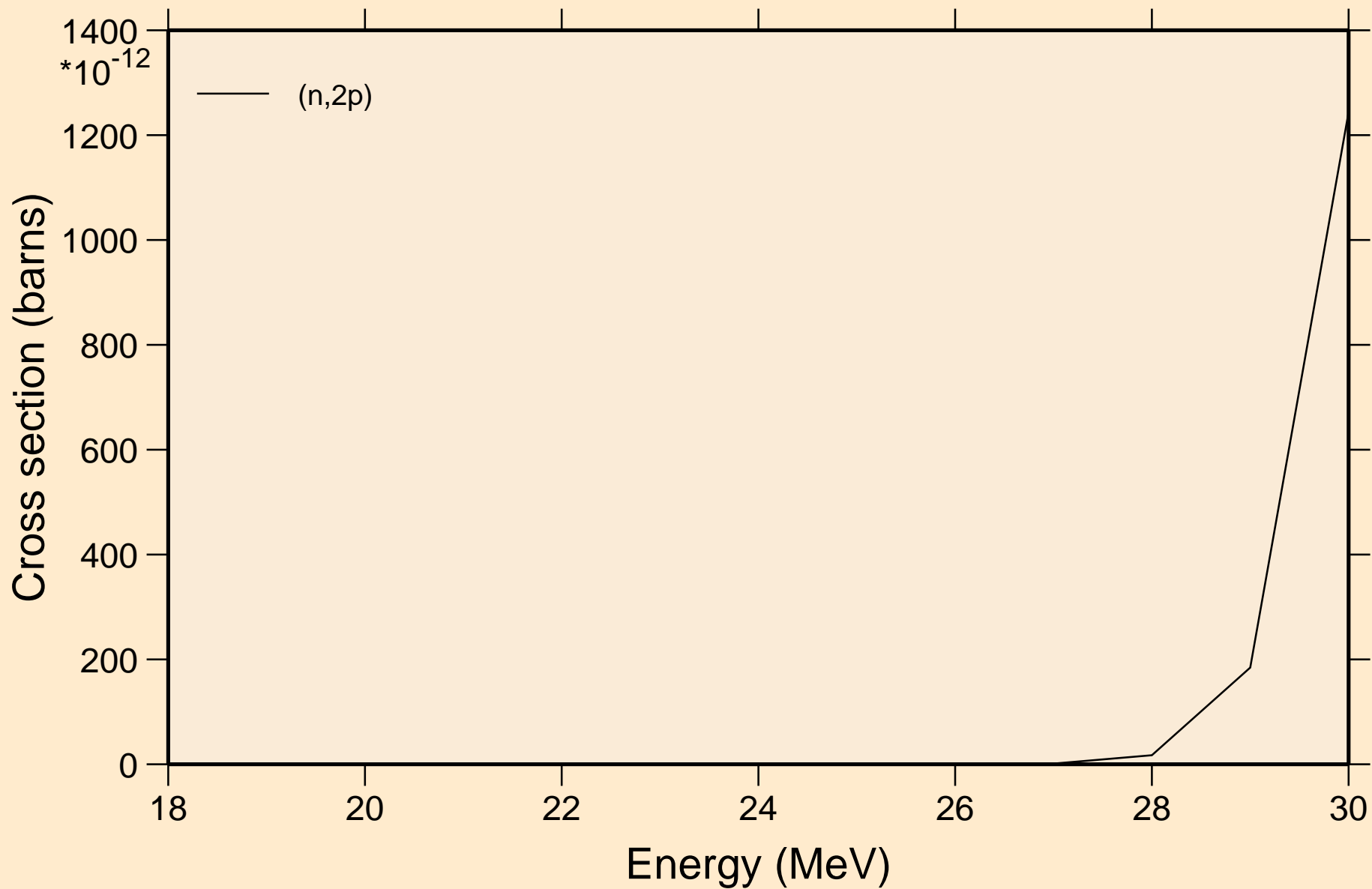

ZR098 NEUTRON ACER TENDL-2019 LIBRARY; T=293.16K  
Threshold reactions

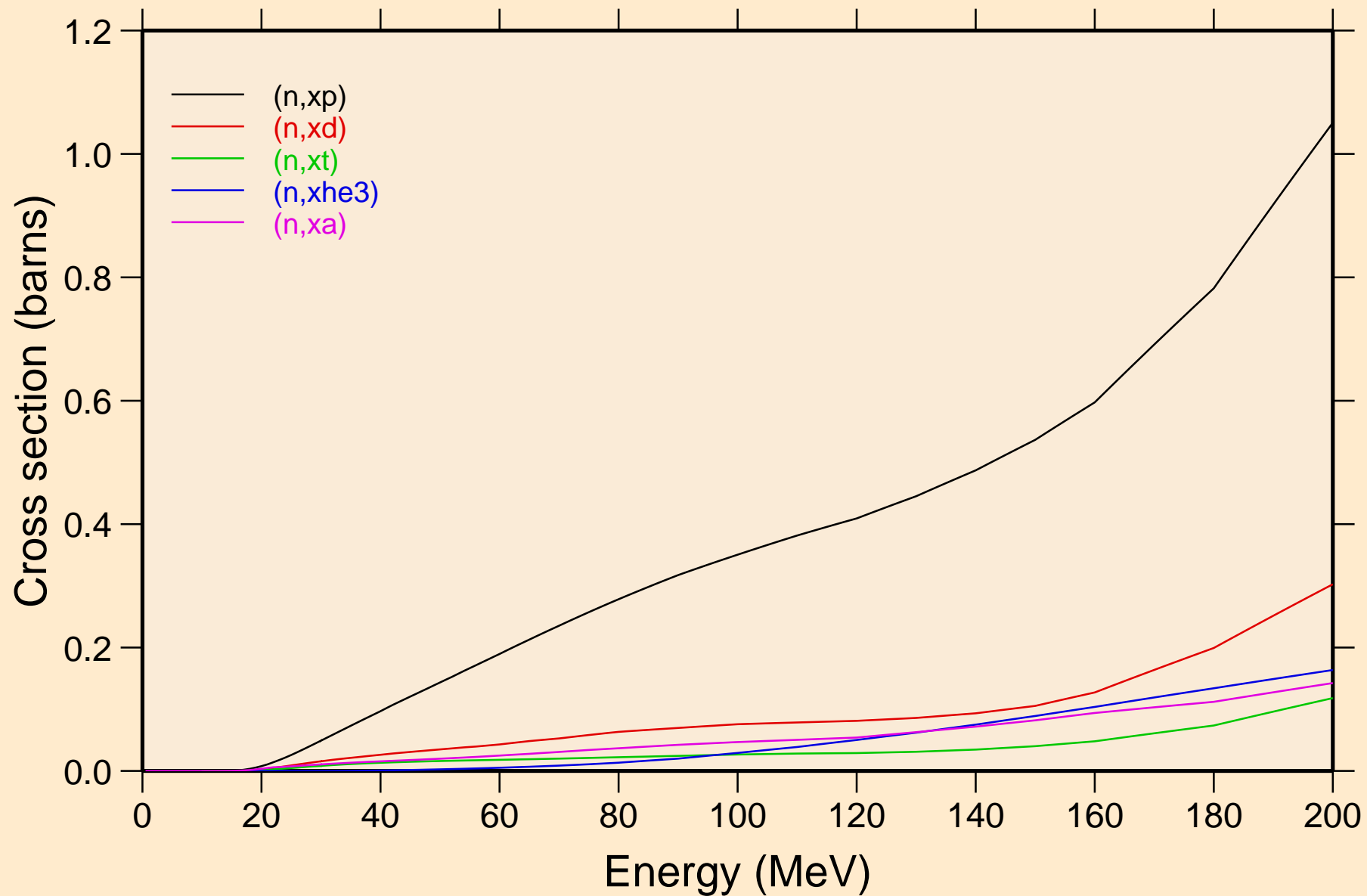

ZR098 NEUTRON ACER TENDL-2019 LIBRARY; T=293.16K  
angular distribution for elastic

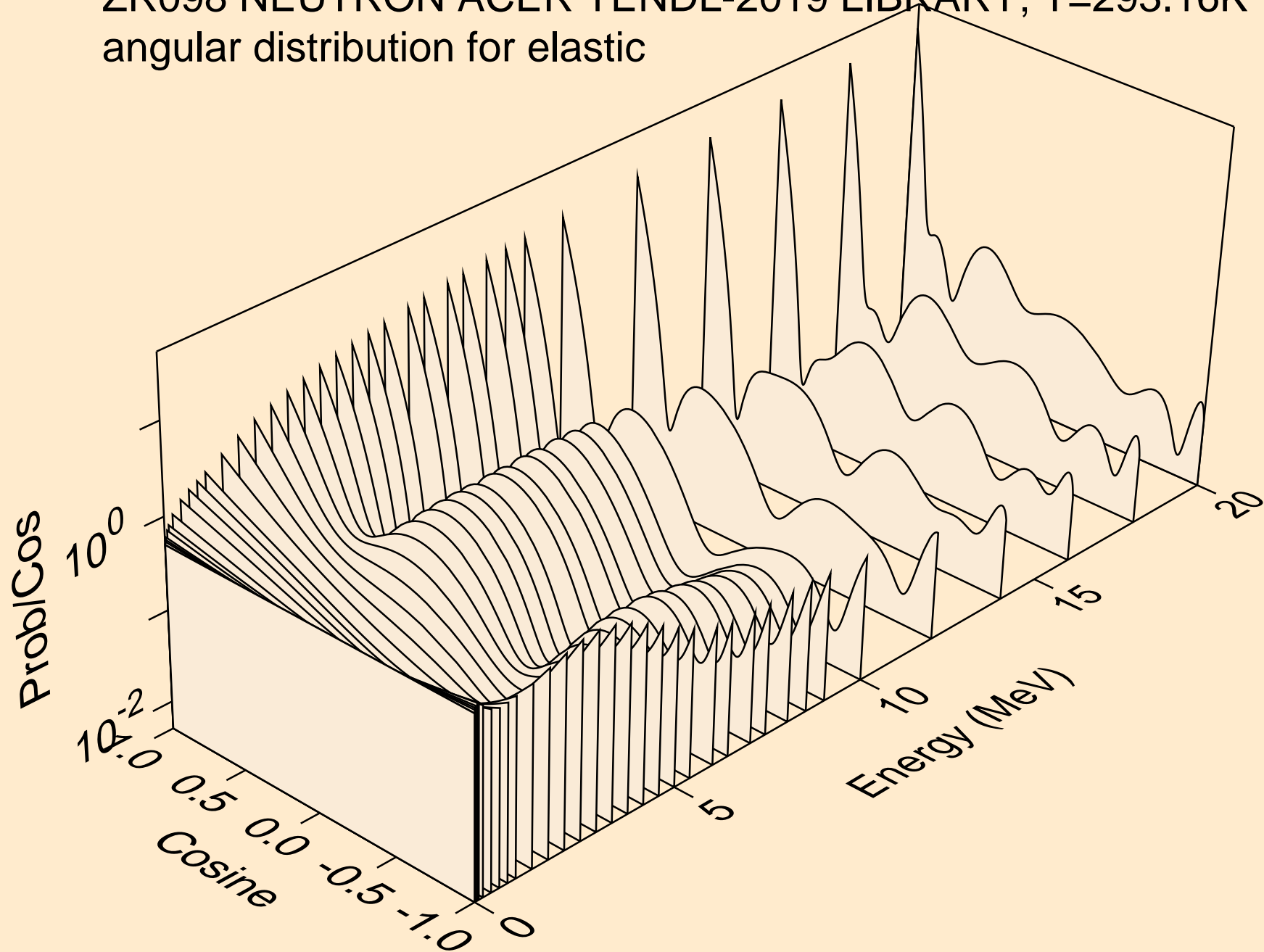

ZR098 NEUTRON ACER TENDL-2019 LIBRARY; T=293.16K  
angular distribution for elastic

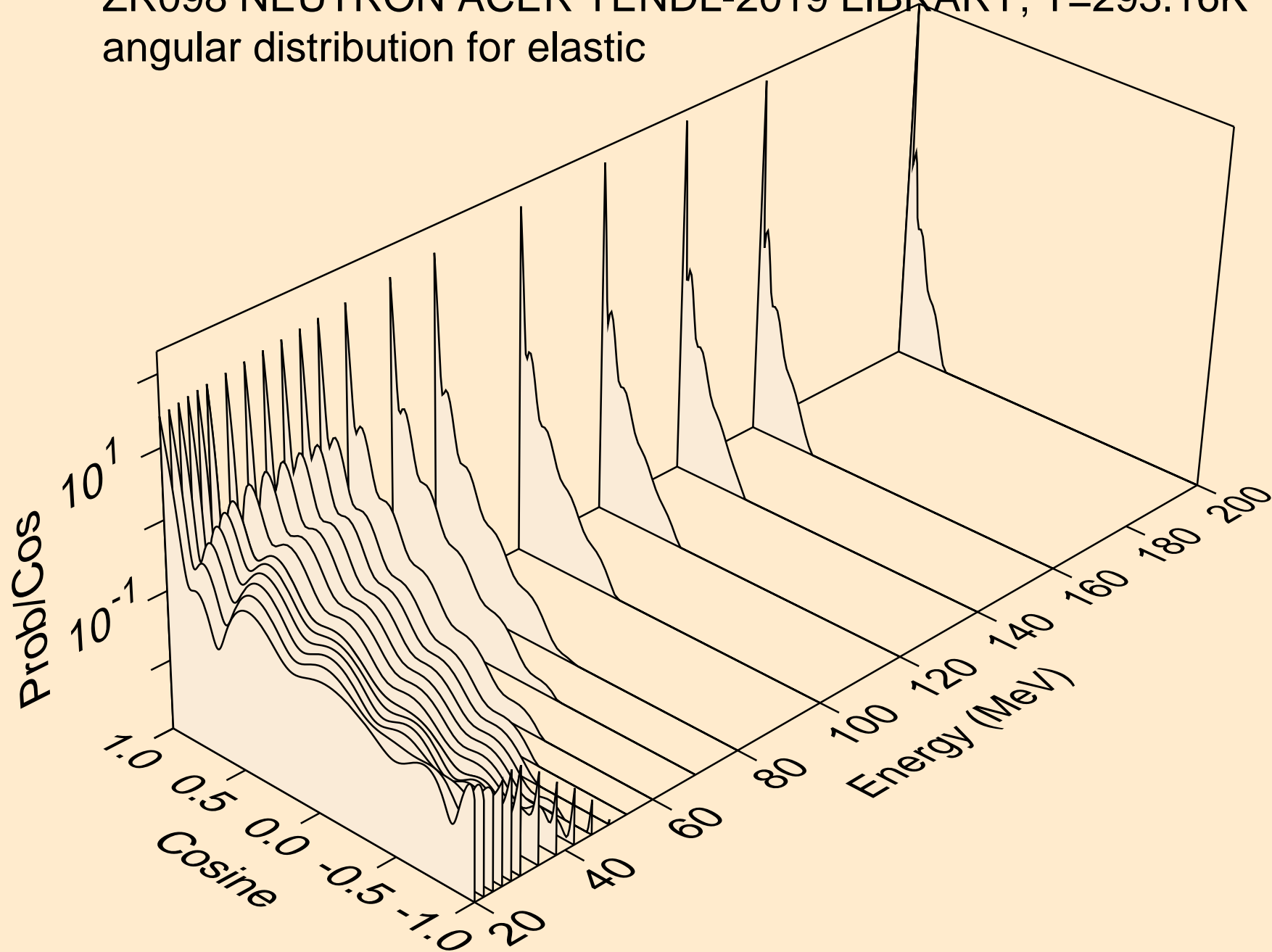



ZR098 NEUTRON ACER TENDL-2019 LIBRARY; T=293.16K  
angular distribution for (n,n\*1)

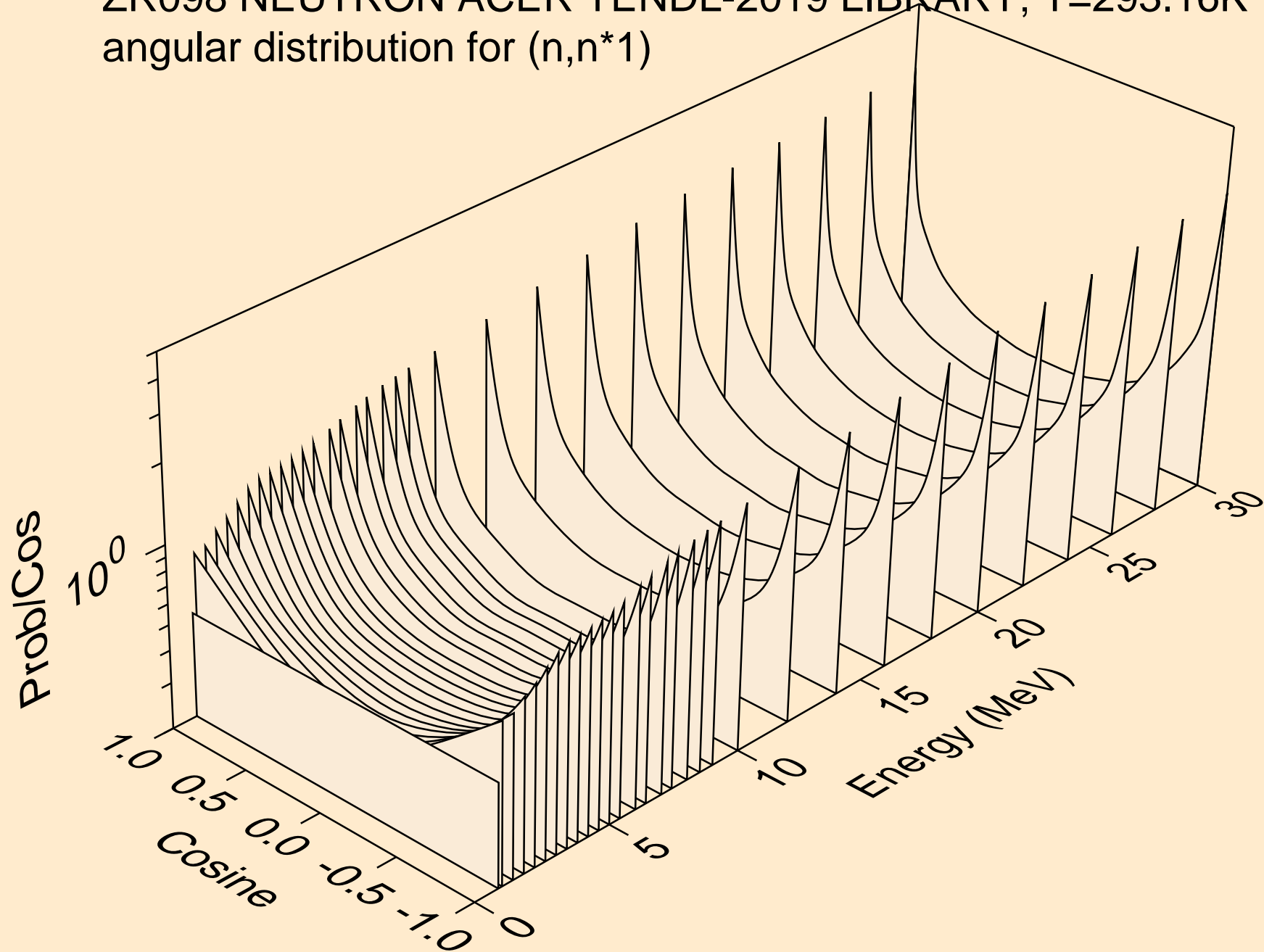

ZR098 NEUTRON ACER TENDL-2019 LIBRARY; T=293.16K  
angular distribution for (n,n\*2)

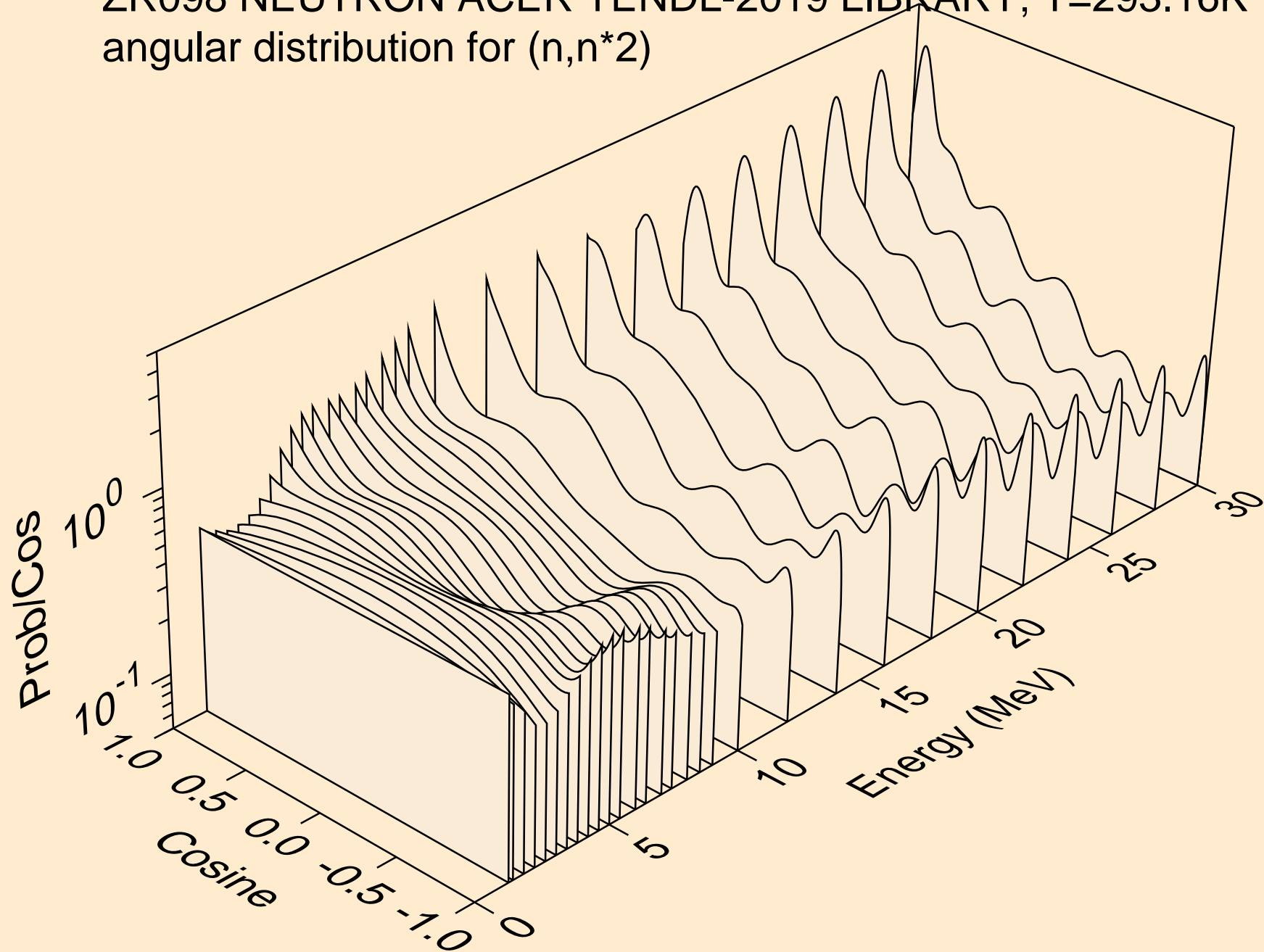

ZR098 NEUTRON ACER TENDL-2019 LIBRARY; T=293.16K  
angular distribution for (n,n\*3)

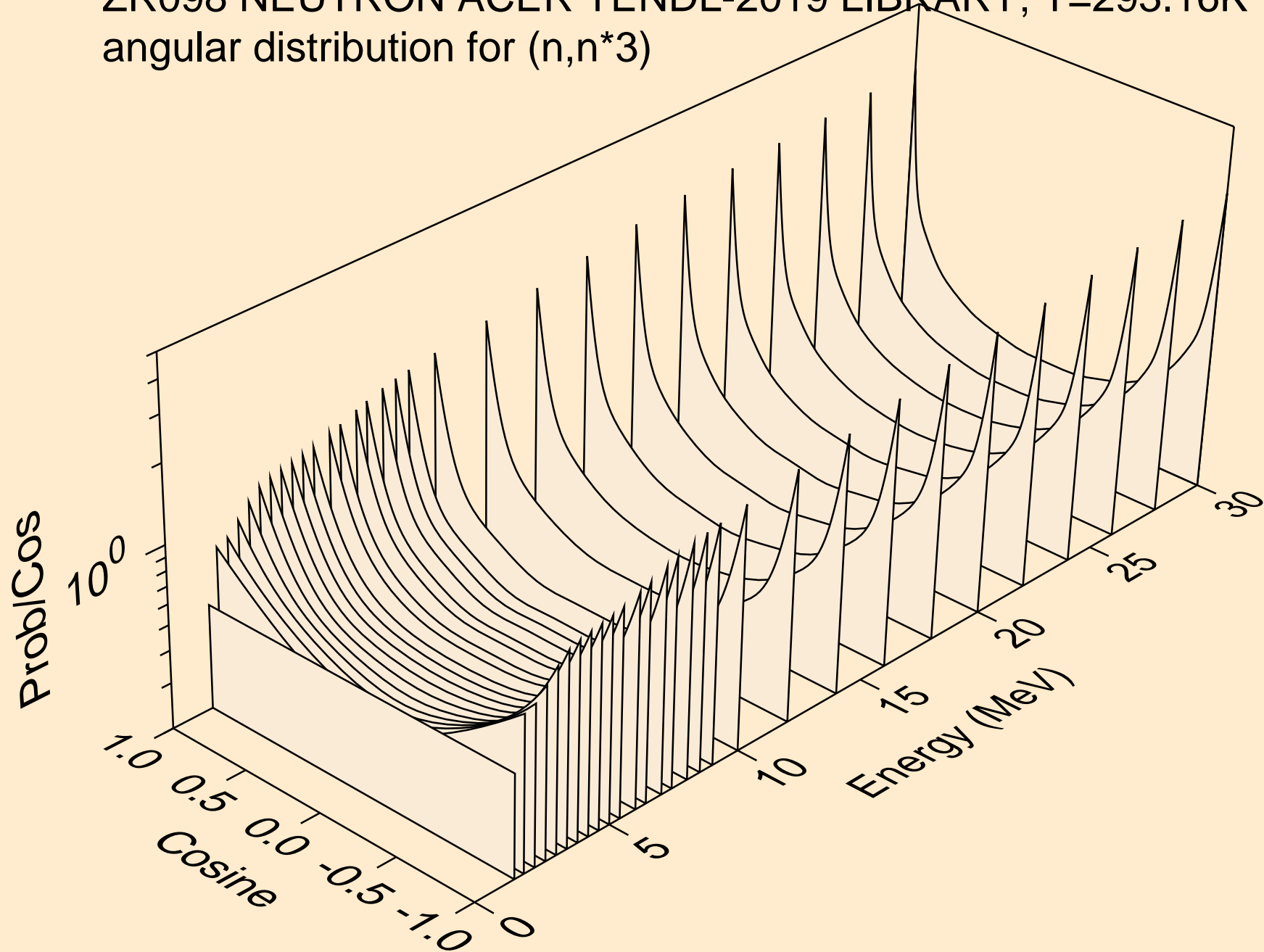

ZR098 NEUTRON ACER TENDL-2019 LIBRARY; T=293.16K  
angular distribution for (n,n\*4)

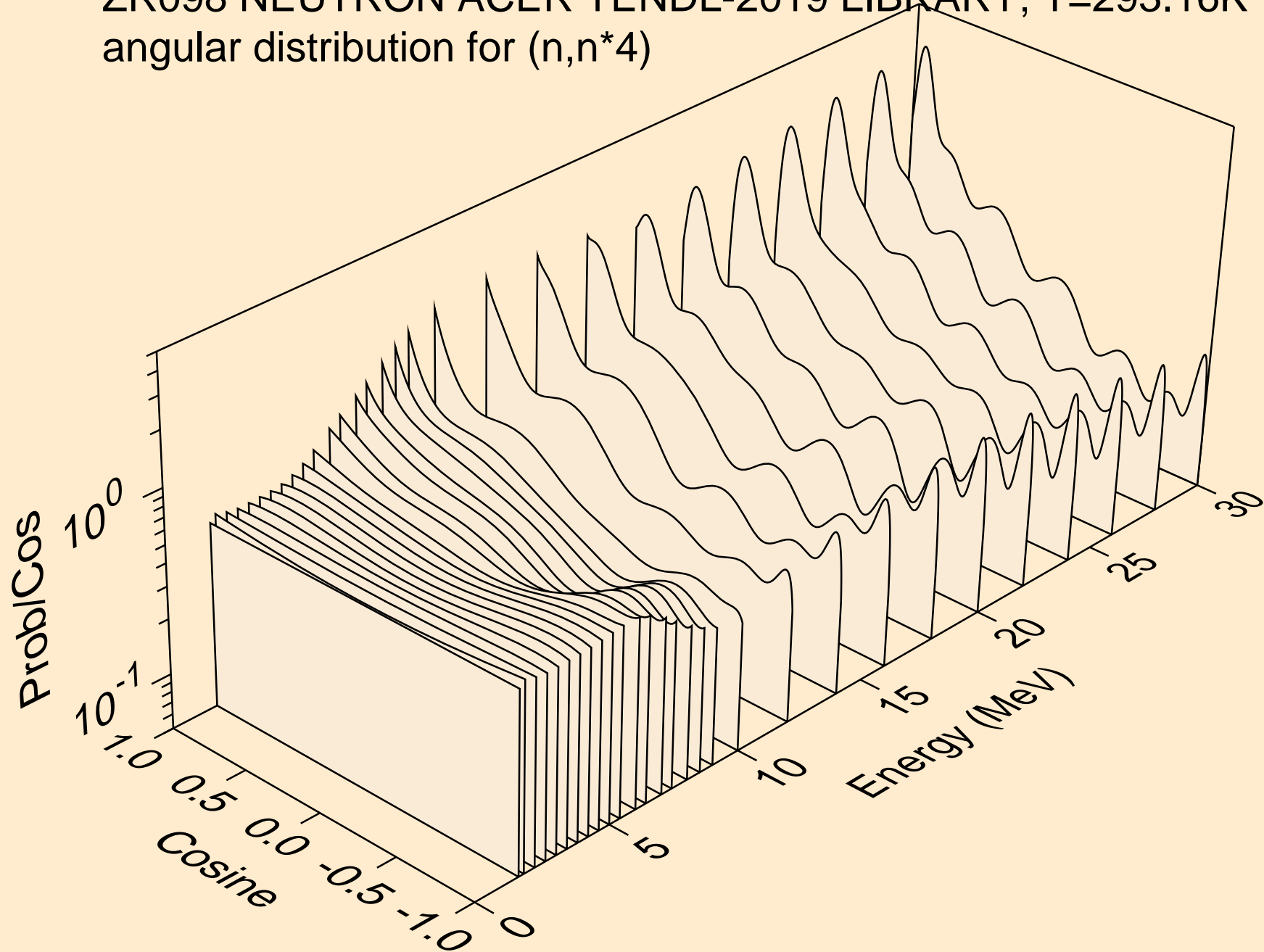

ZR098 NEUTRON ACER TENDL-2019 LIBRARY; T=293.16K  
angular distribution for (n,n\*5)

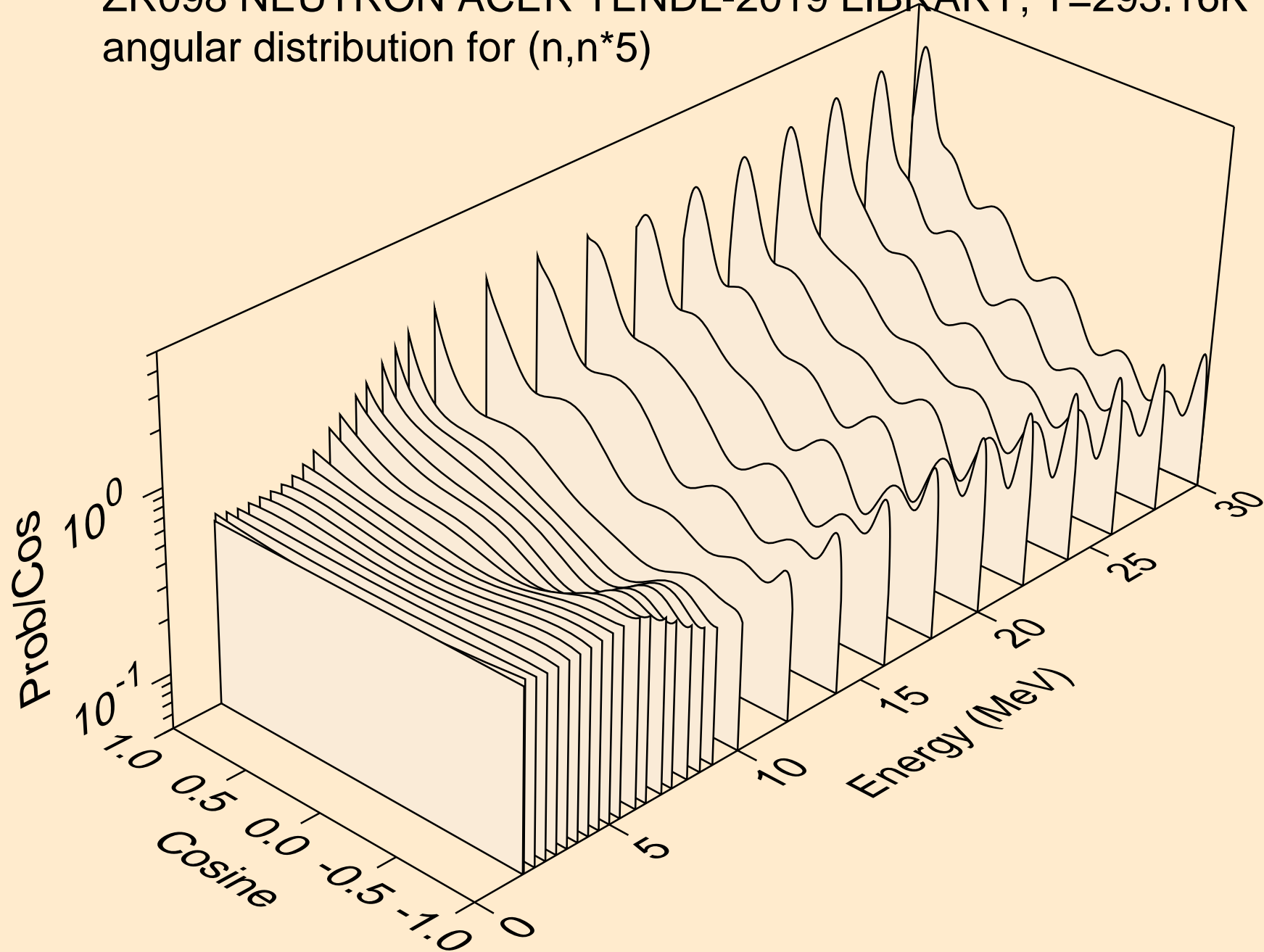

ZR098 NEUTRON ACER TENDL-2019 LIBRARY; T=293.16K  
angular distribution for (n,n\*6)

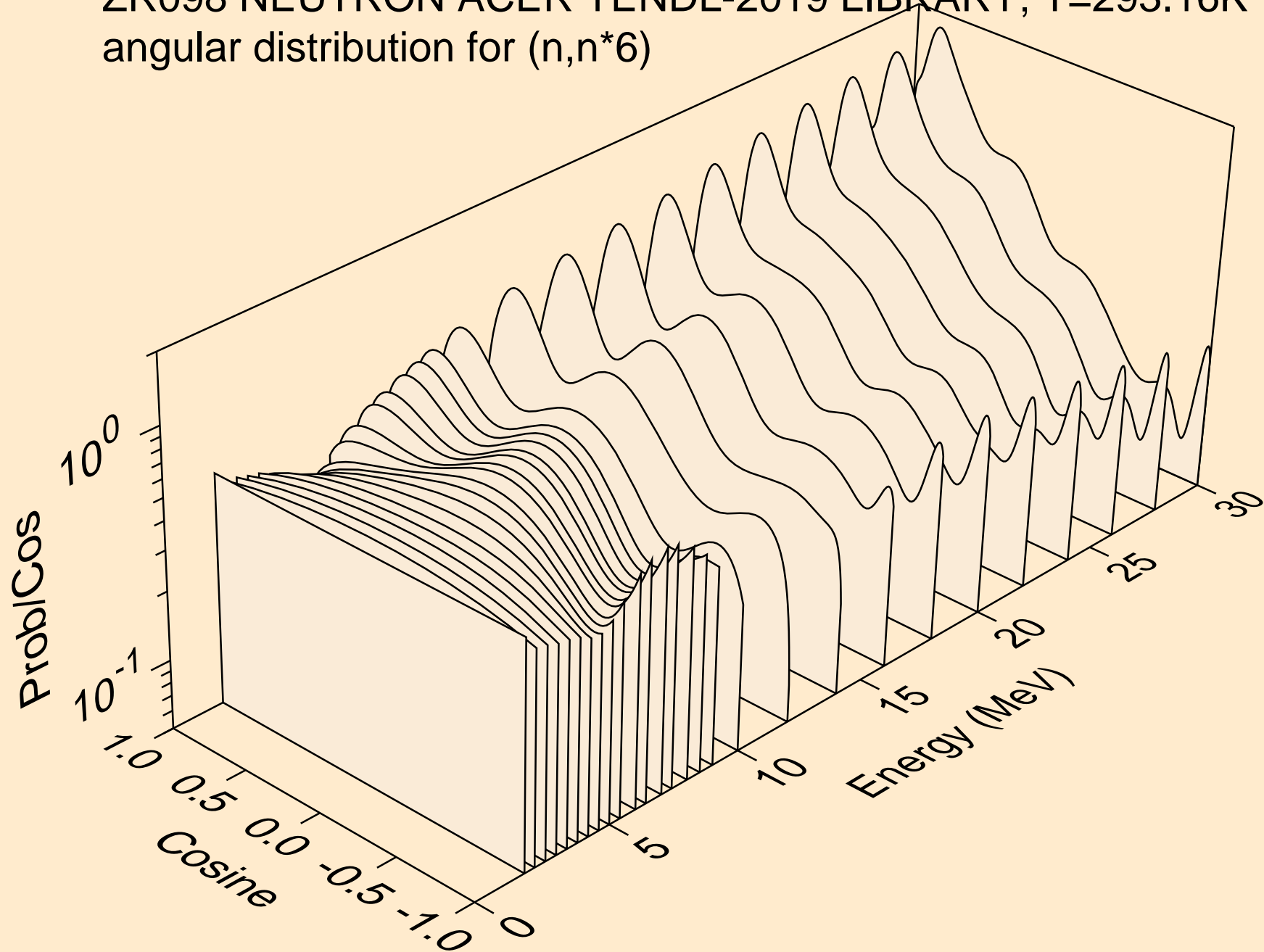

ZR098 NEUTRON ACER TENDL-2019 LIBRARY; T=293.16K  
angular distribution for (n,n\*7)

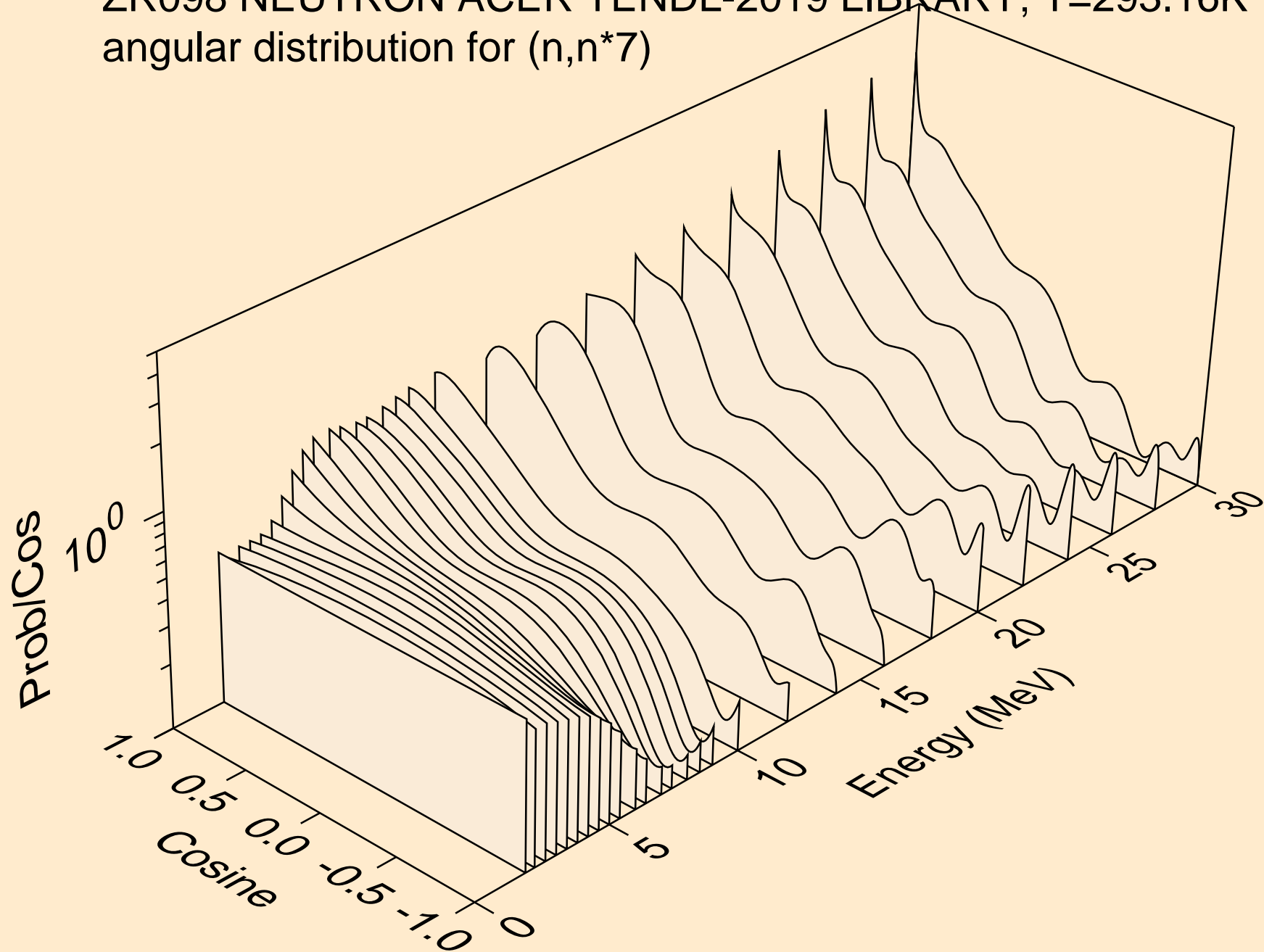

ZR098 NEUTRON ACER TENDL-2019 LIBRARY; T=293.16K  
angular distribution for (n,n\*8)

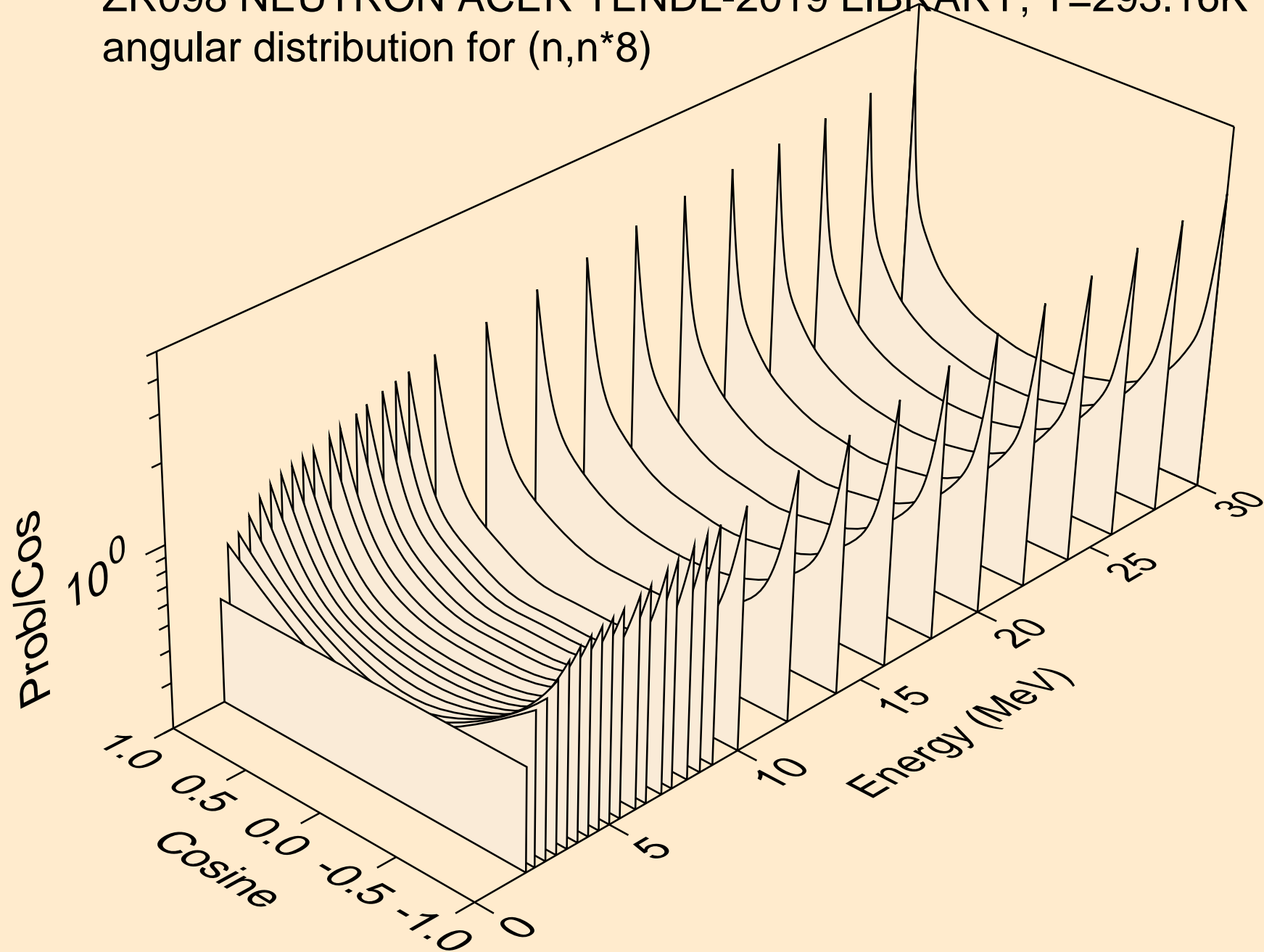



ZR098 NEUTRON ACER TENDL-2019 LIBRARY; T=293.16K  
angular distribution for (n,n\*9)

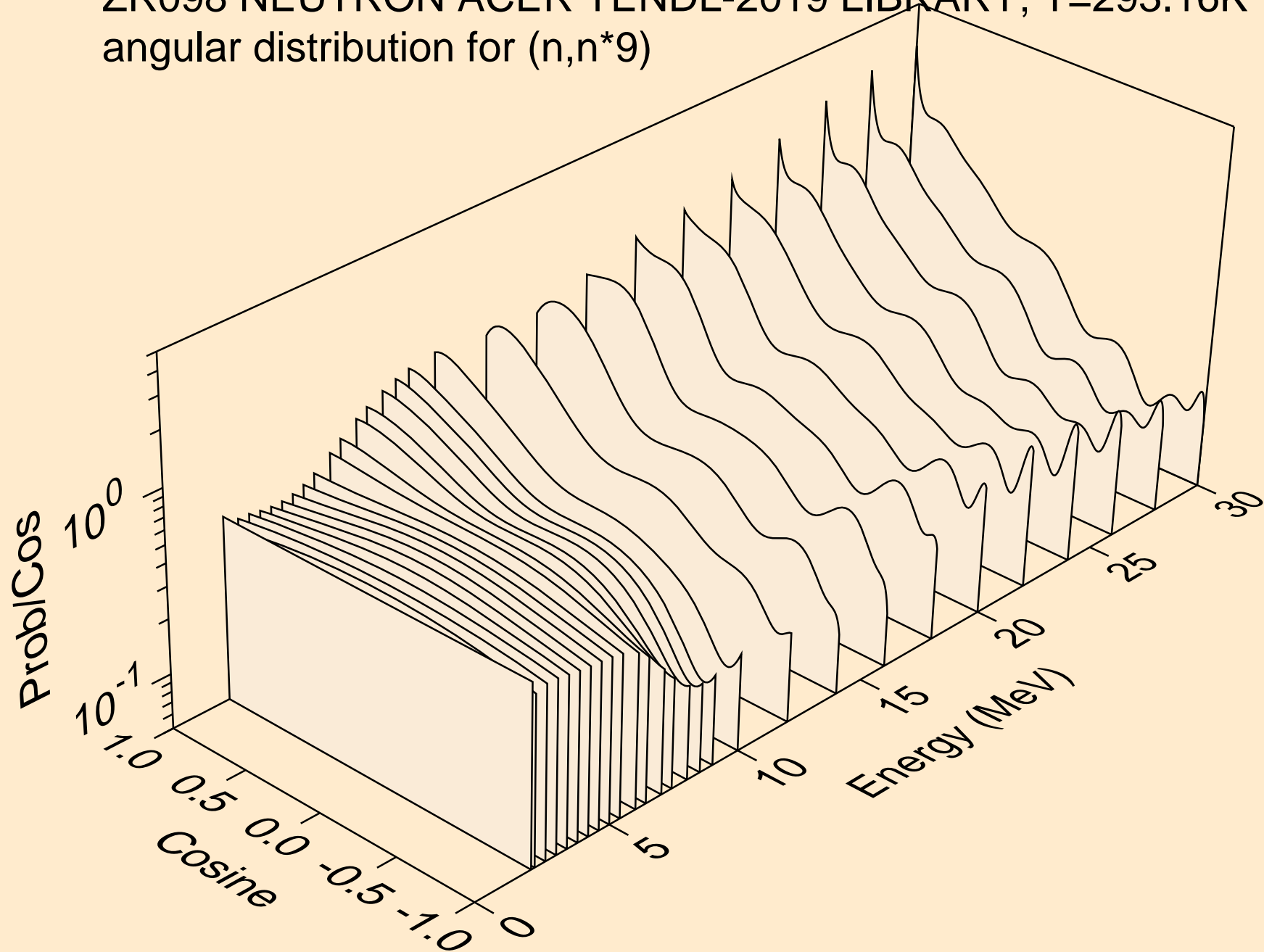

ZR098 NEUTRON ACER TENDL-2019 LIBRARY; T=293.16K  
angular distribution for (n,n\*10)

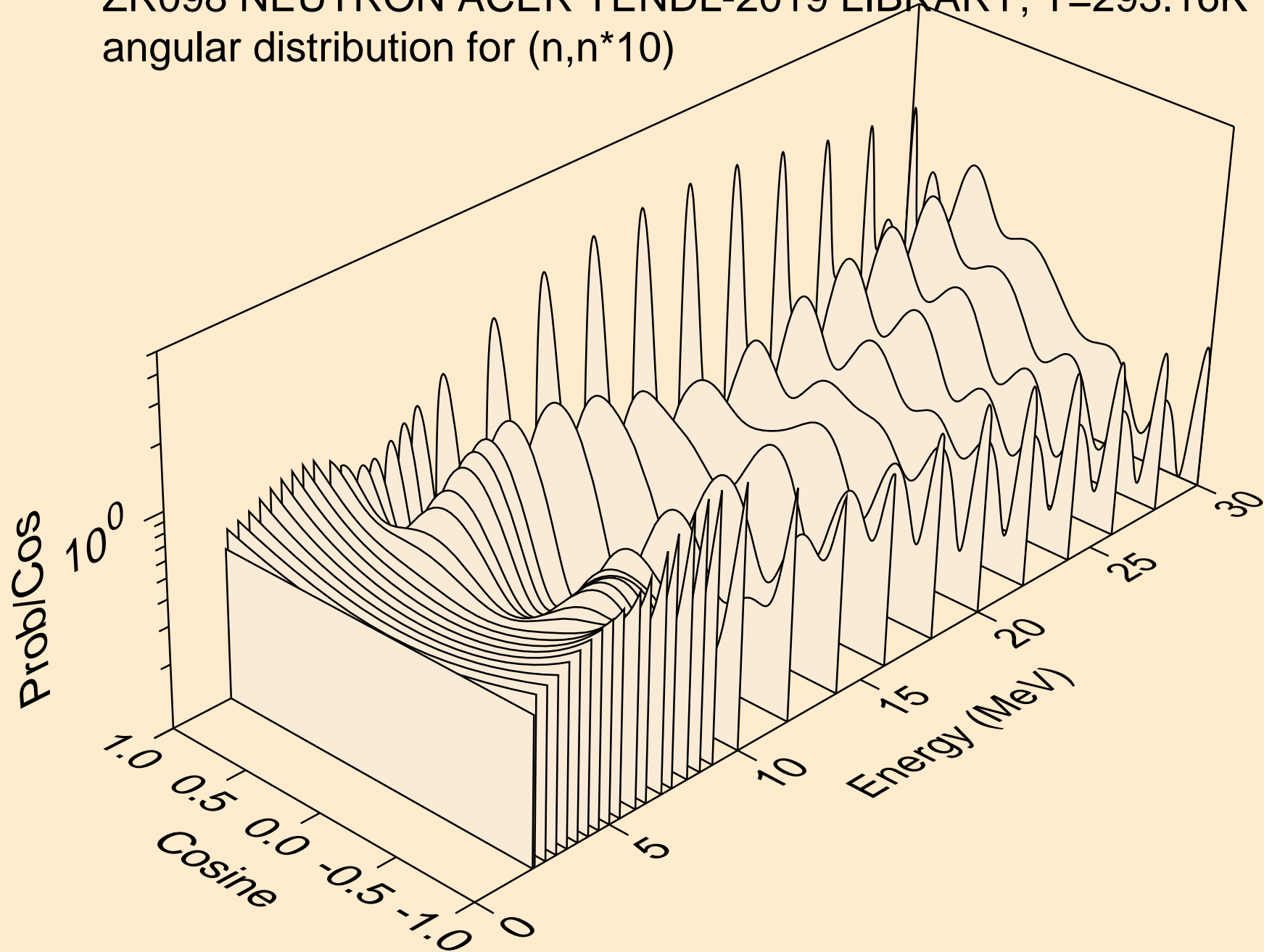

ZR098 NEUTRON ACER TENDL-2019 LIBRARY; T=293.16K  
angular distribution for (n,n\*11)

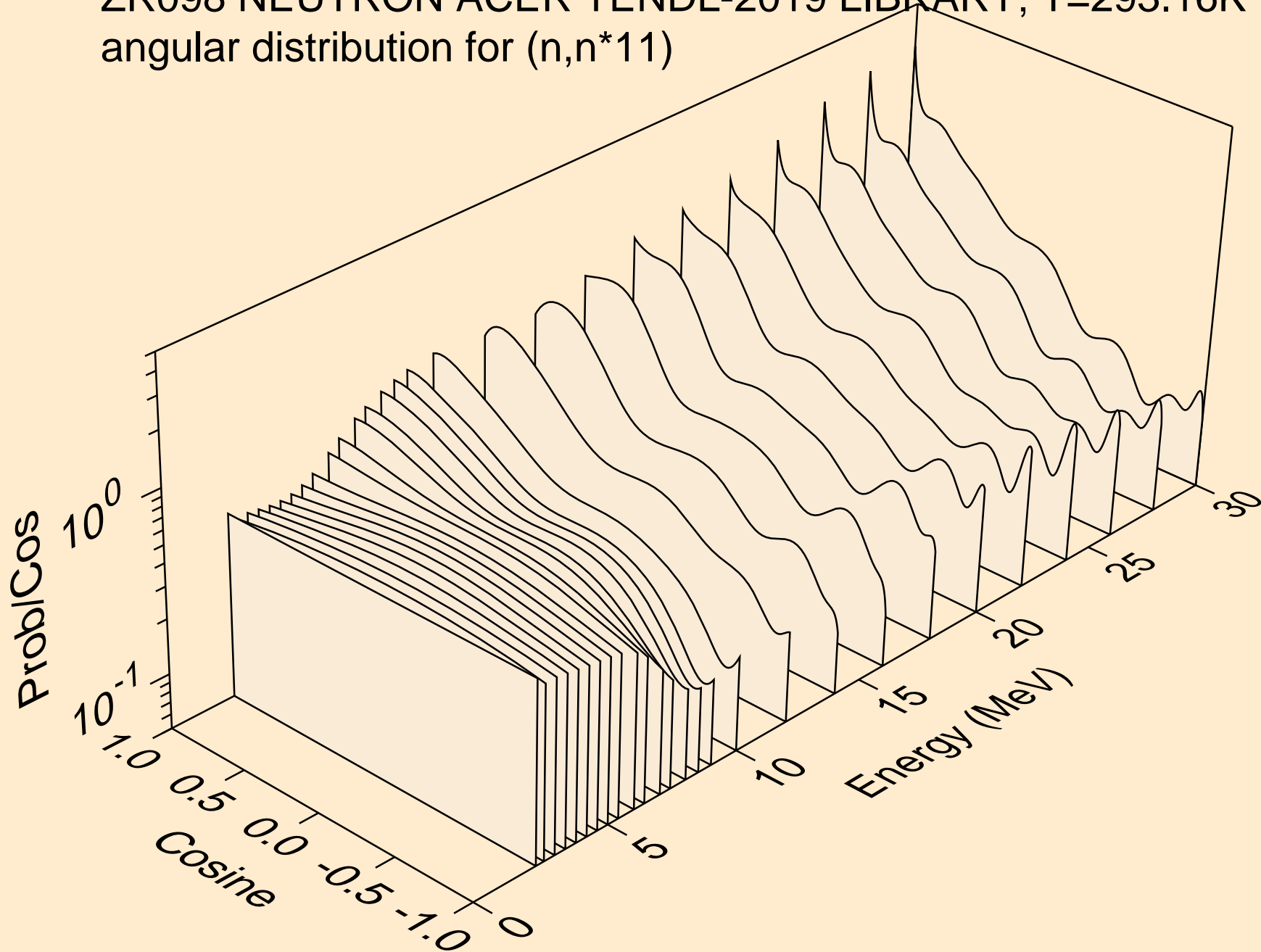

ZR098 NEUTRON ACER TENDL-2019 LIBRARY; T=293.16K  
angular distribution for (n,n\*12)

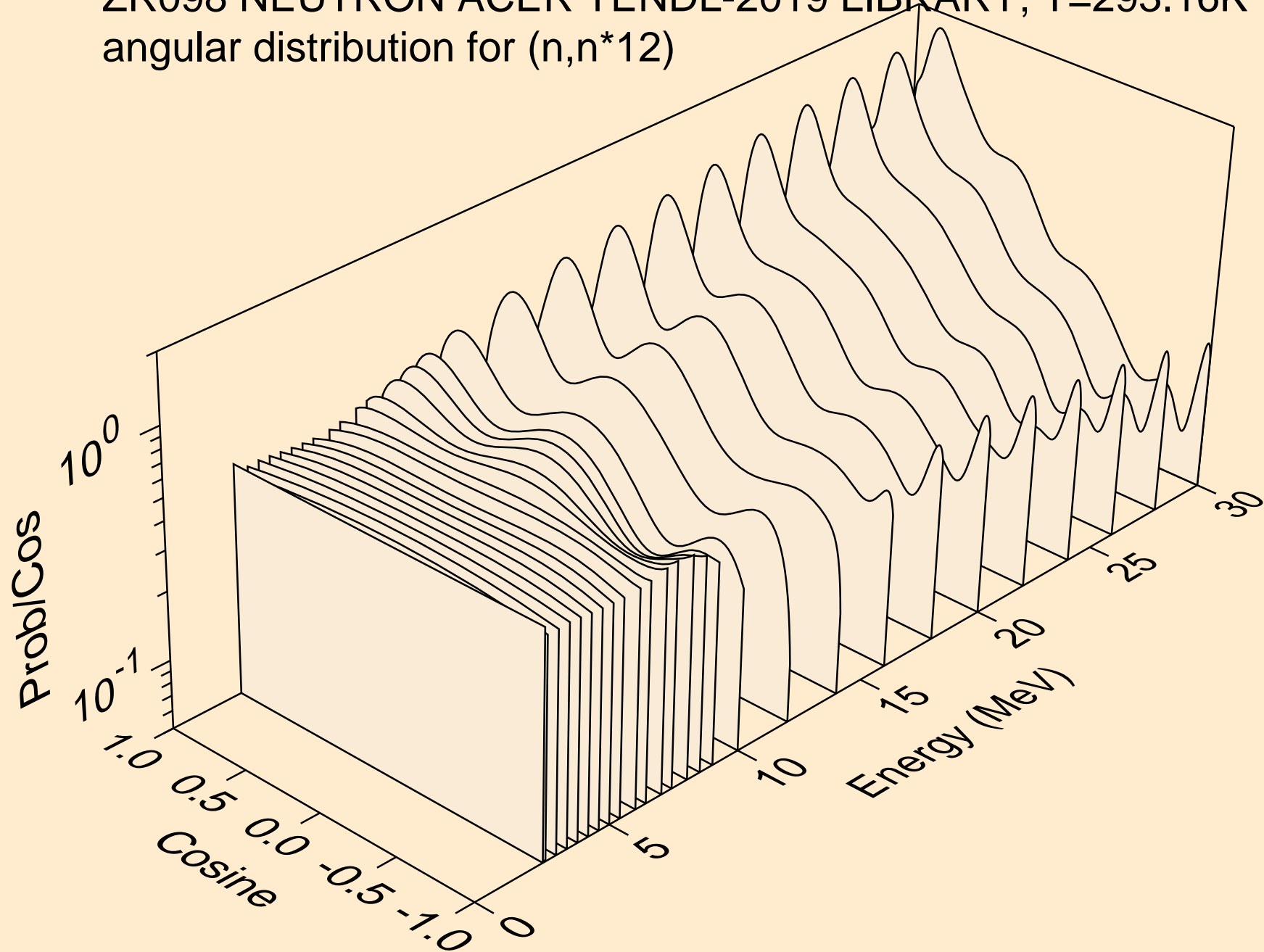

ZR098 NEUTRON ACER TENDL-2019 LIBRARY; T=293.16K  
angular distribution for (n,n\*13)

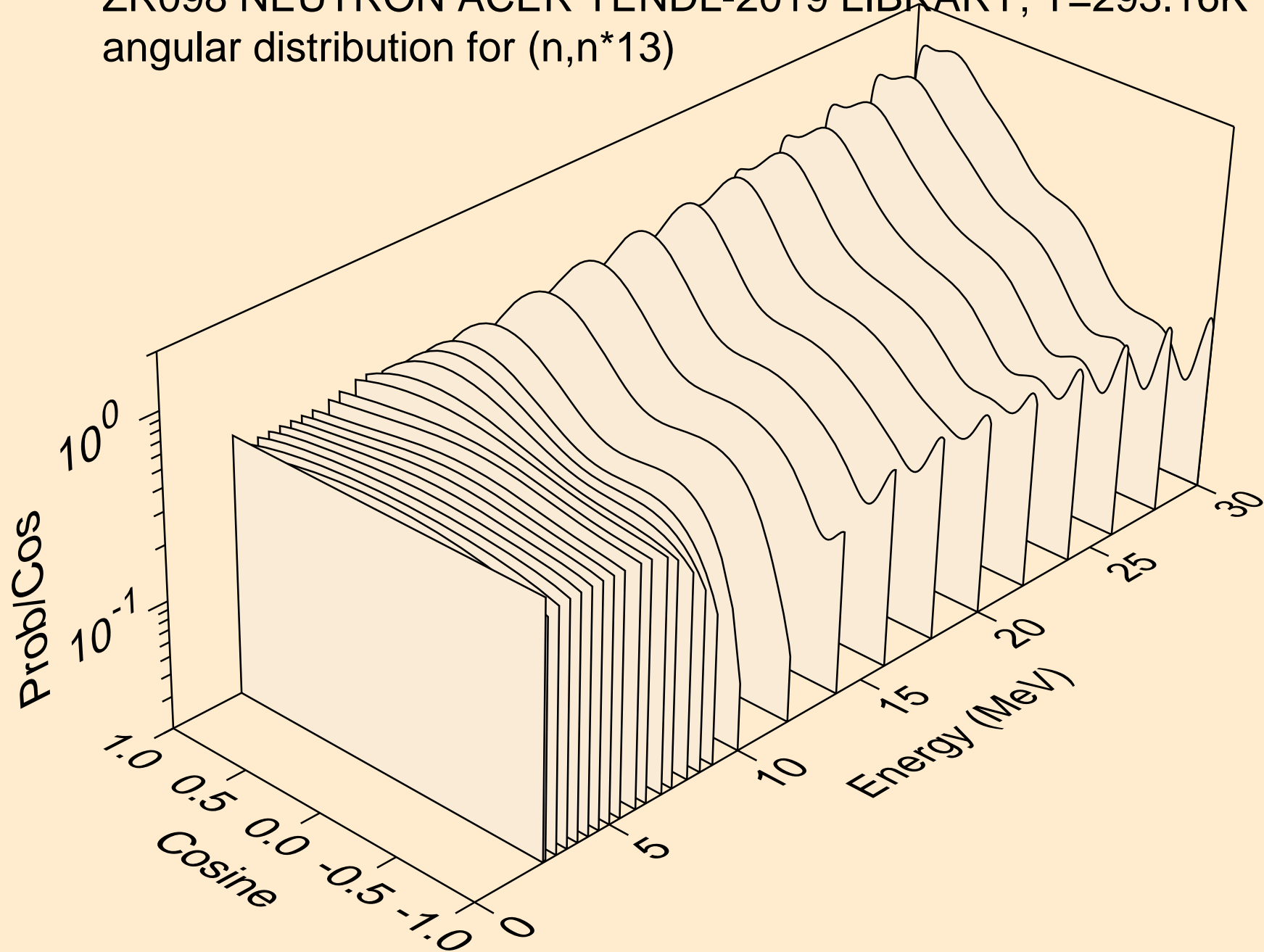

ZR098 NEUTRON ACER TENDL-2019 LIBRARY; T=293.16K  
angular distribution for (n,n\*14)

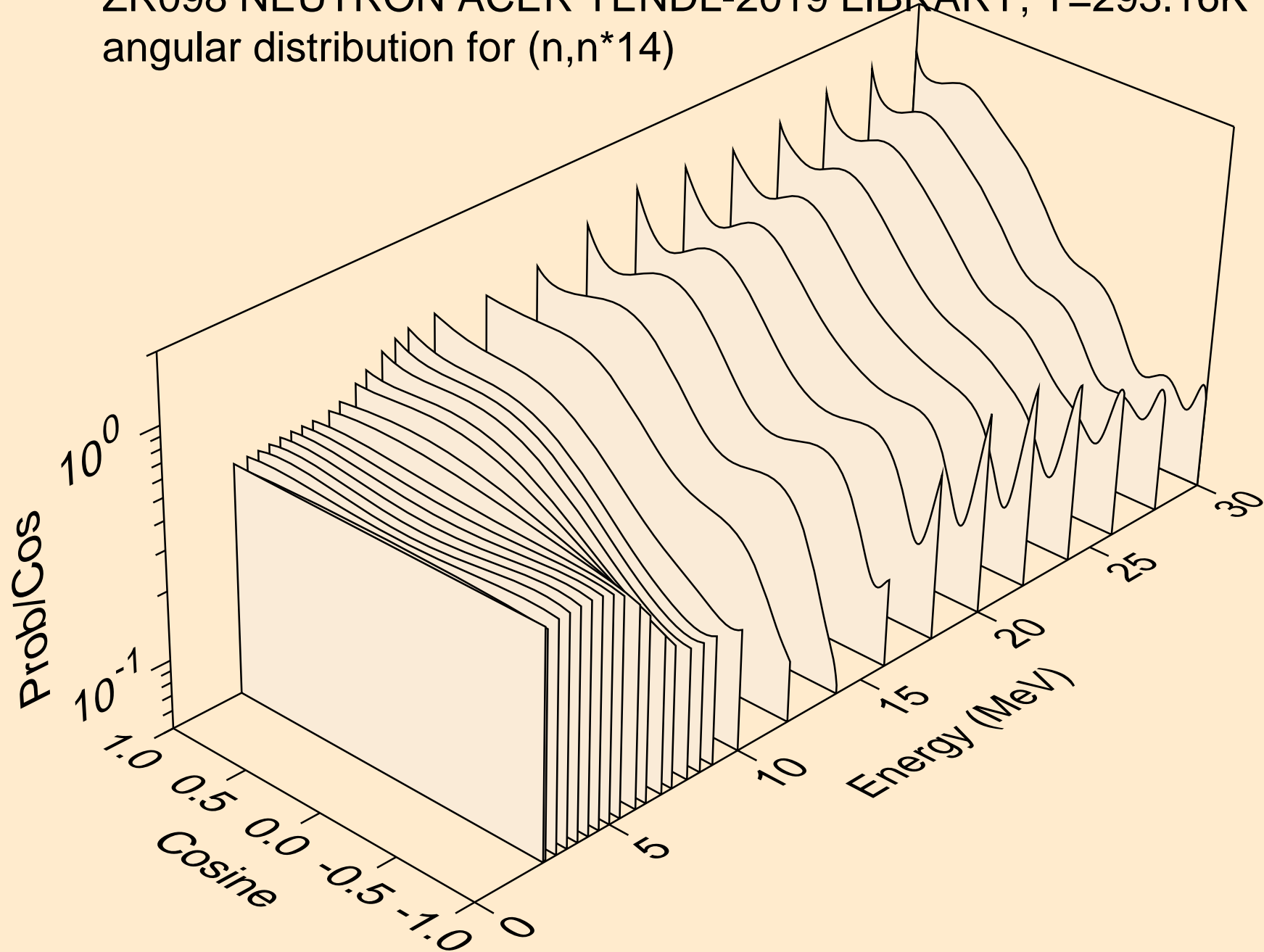

ZR098 NEUTRON ACER TENDL-2019 LIBRARY; T=293.16K  
angular distribution for (n,n\*15)

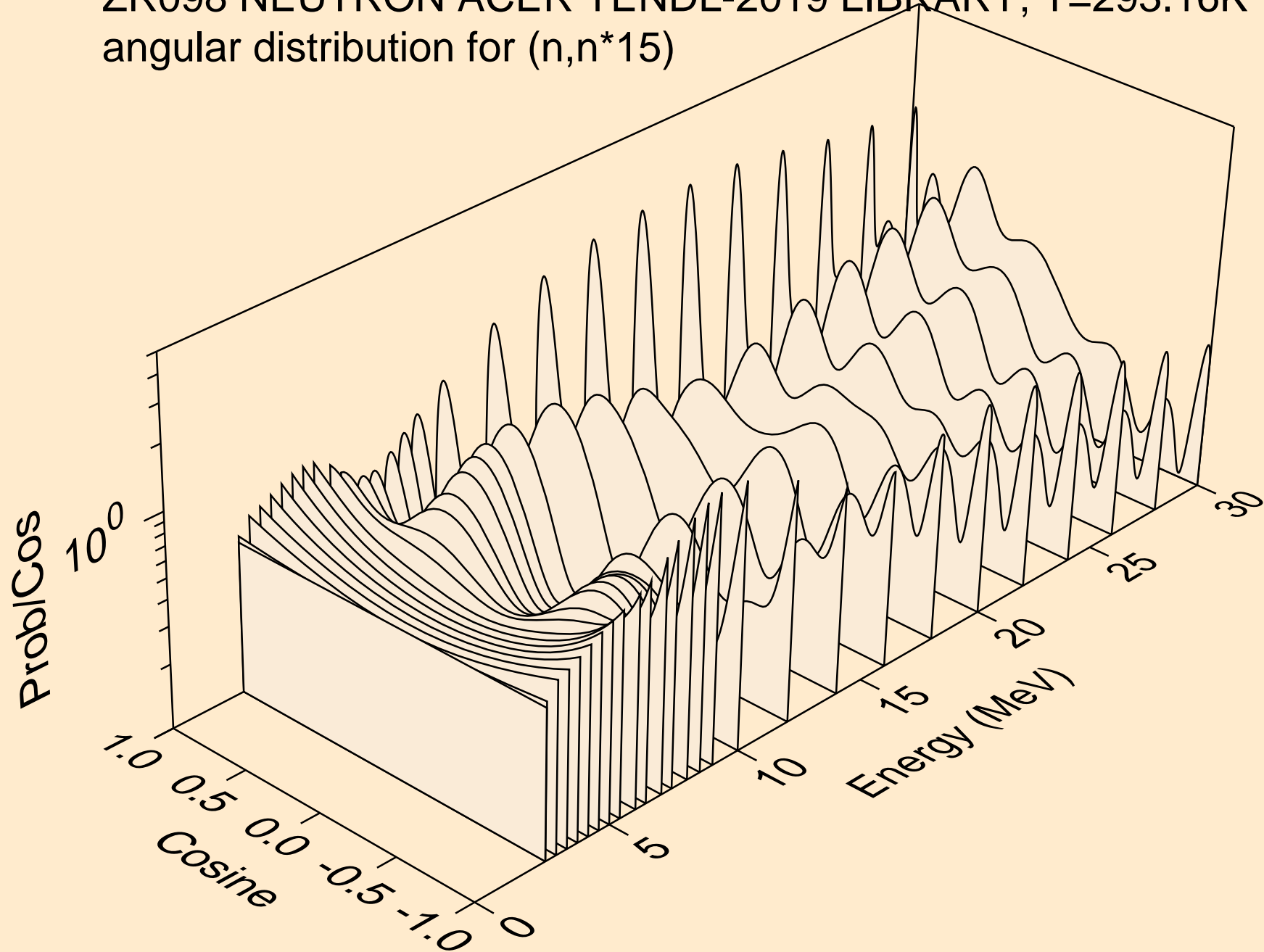

ZR098 NEUTRON ACER TENDL-2019 LIBRARY; T=293.16K  
angular distribution for (n,n\*16)

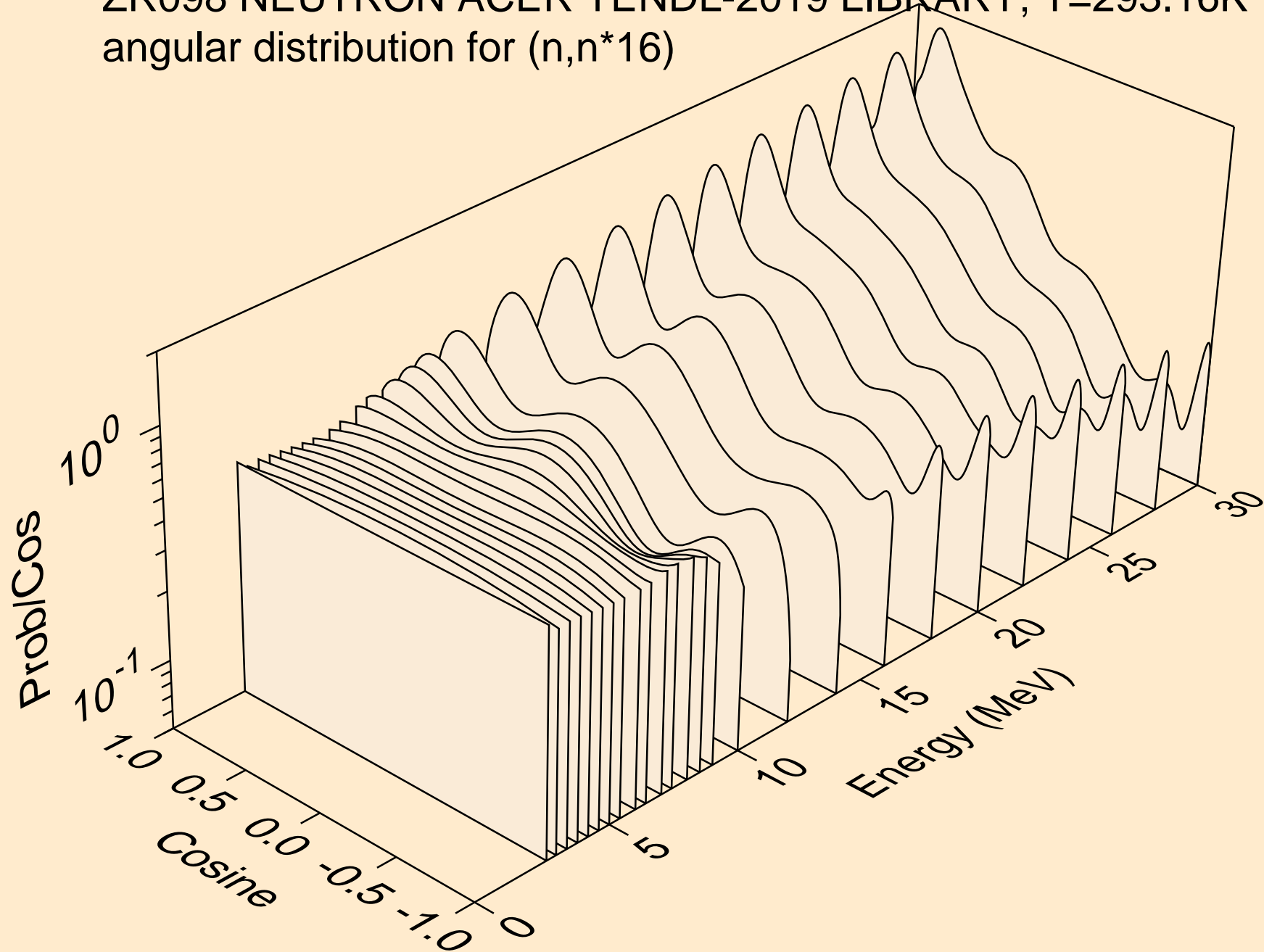



ZR098 NEUTRON ACER TENDL-2019 LIBRARY; T=293.16K  
angular distribution for (n,n\*17)

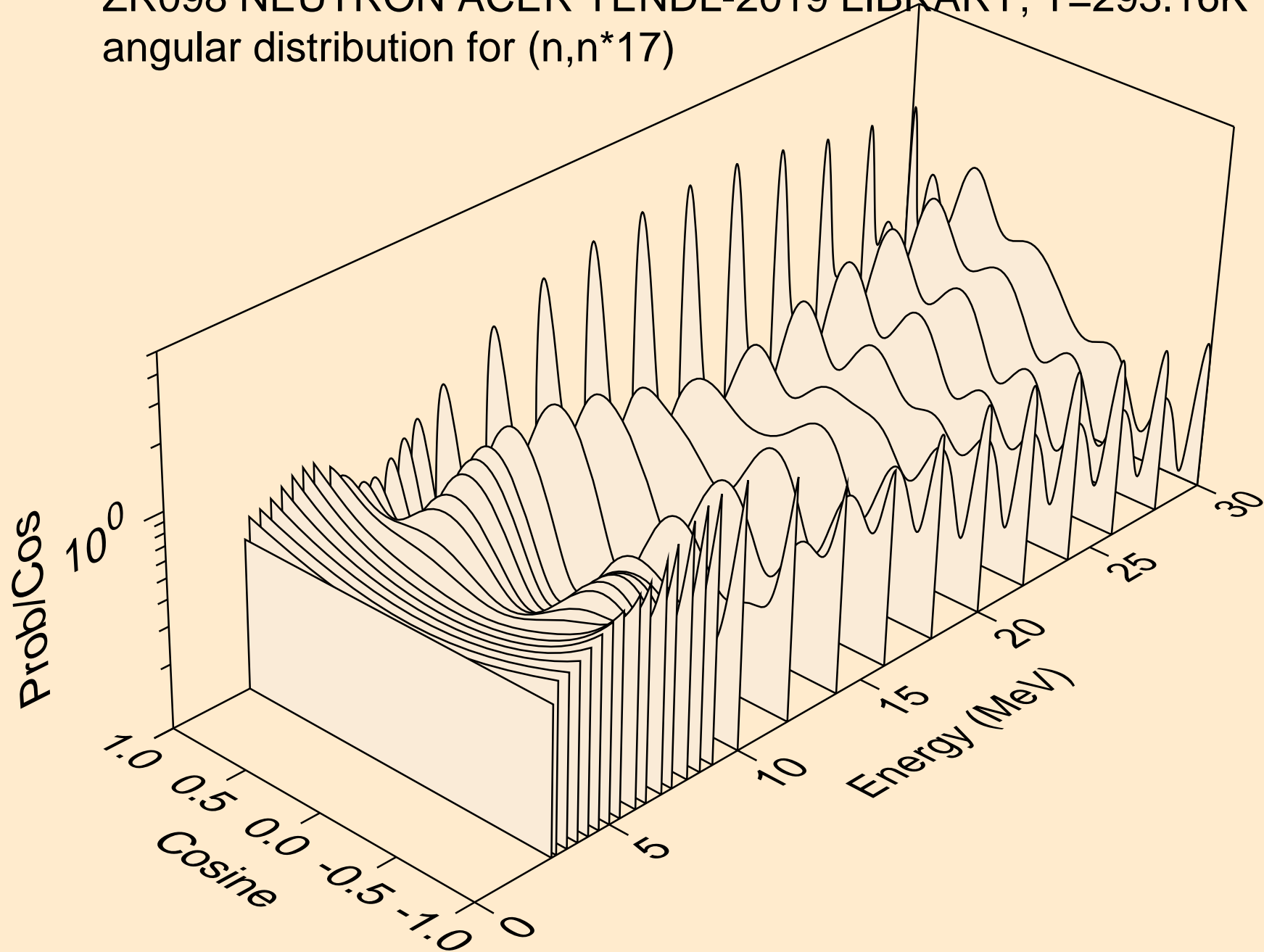

ZR098 NEUTRON ACER TENDL-2019 LIBRARY; T=293.16K  
angular distribution for (n,n\*18)

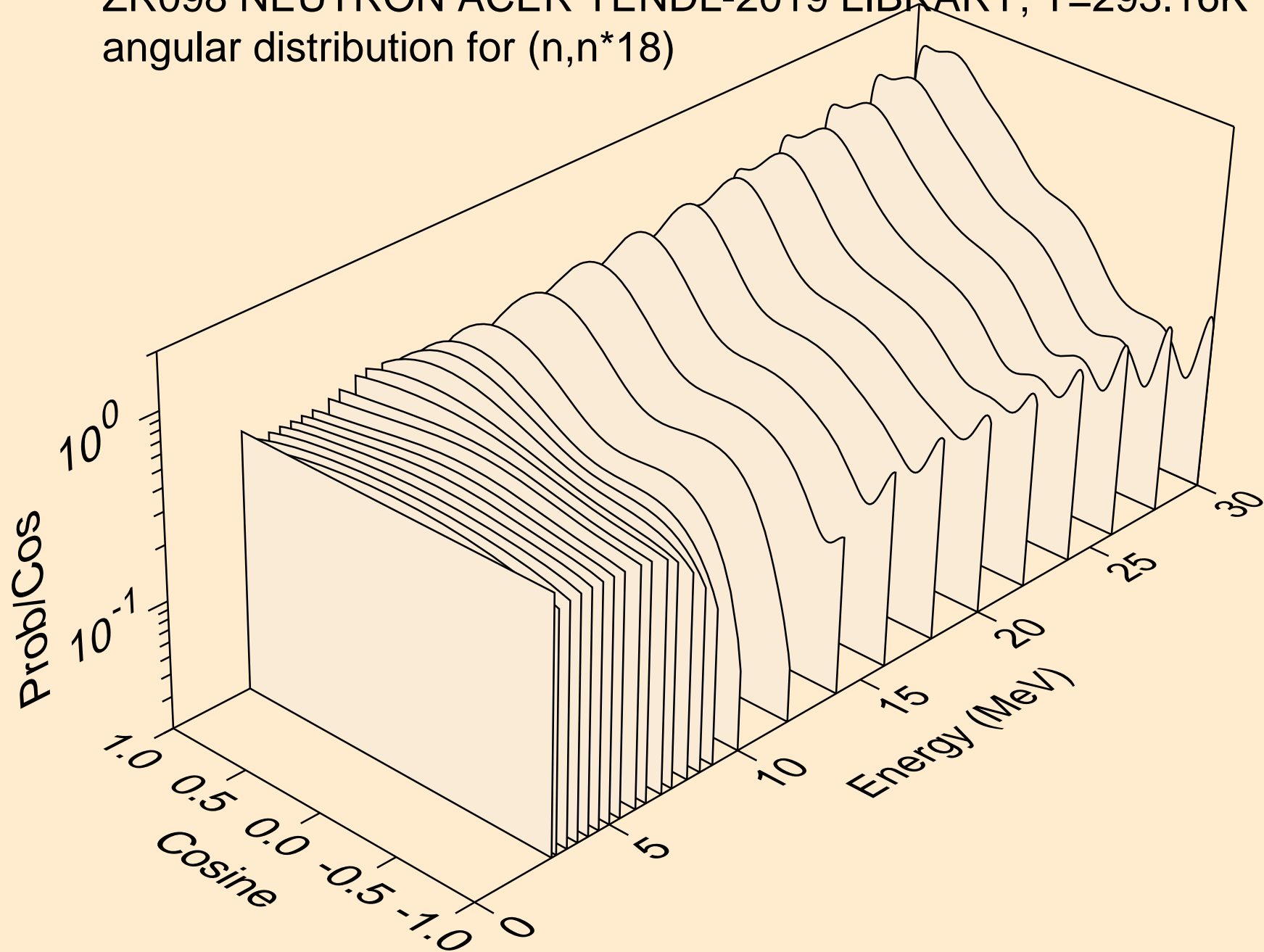

ZR098 NEUTRON ACER TENDL-2019 LIBRARY; T=293.16K  
angular distribution for (n,n\*19)

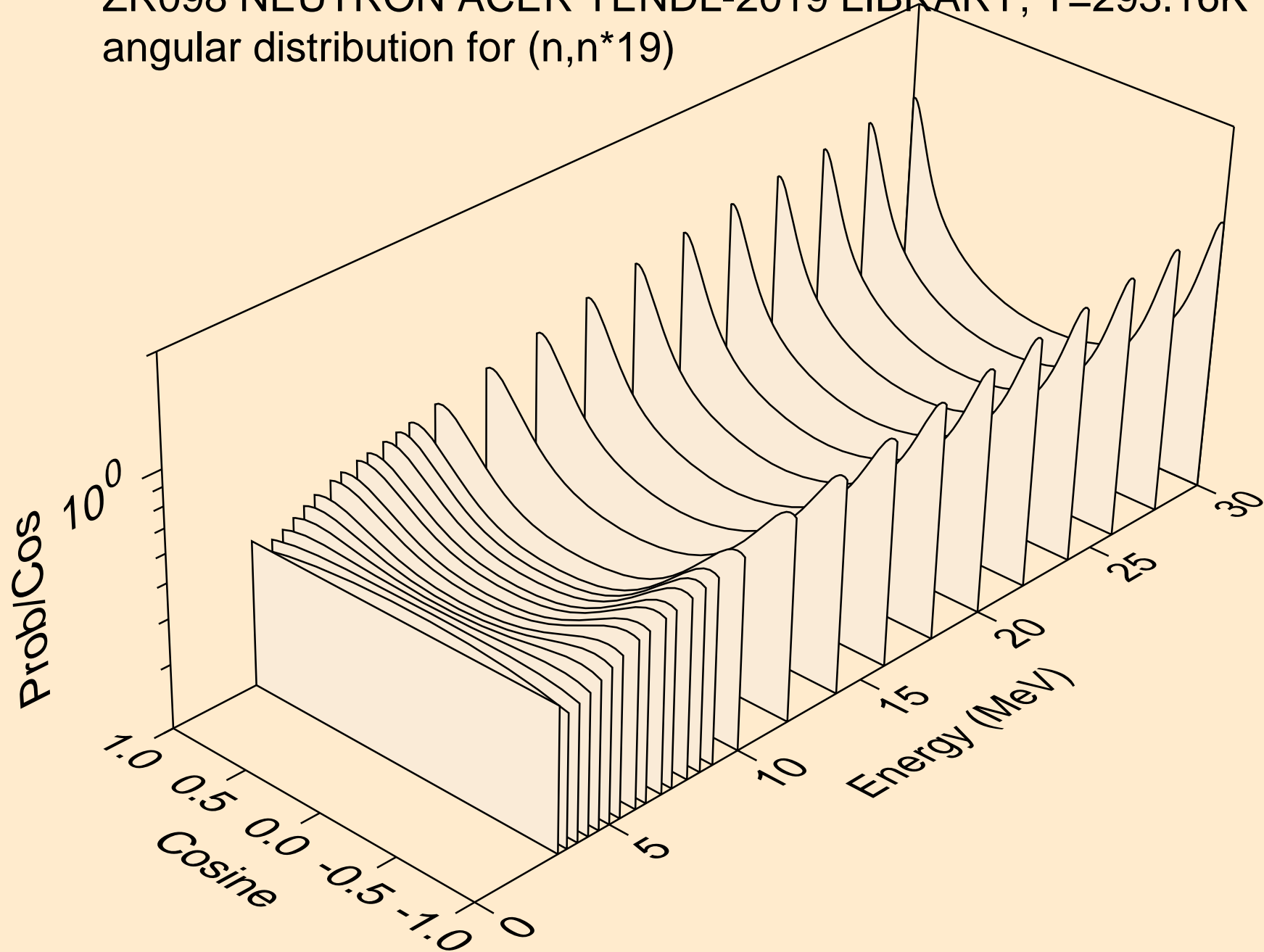

ZR098 NEUTRON ACER TENDL-2019 LIBRARY; T=293.16K  
angular distribution for (n,n\*20)

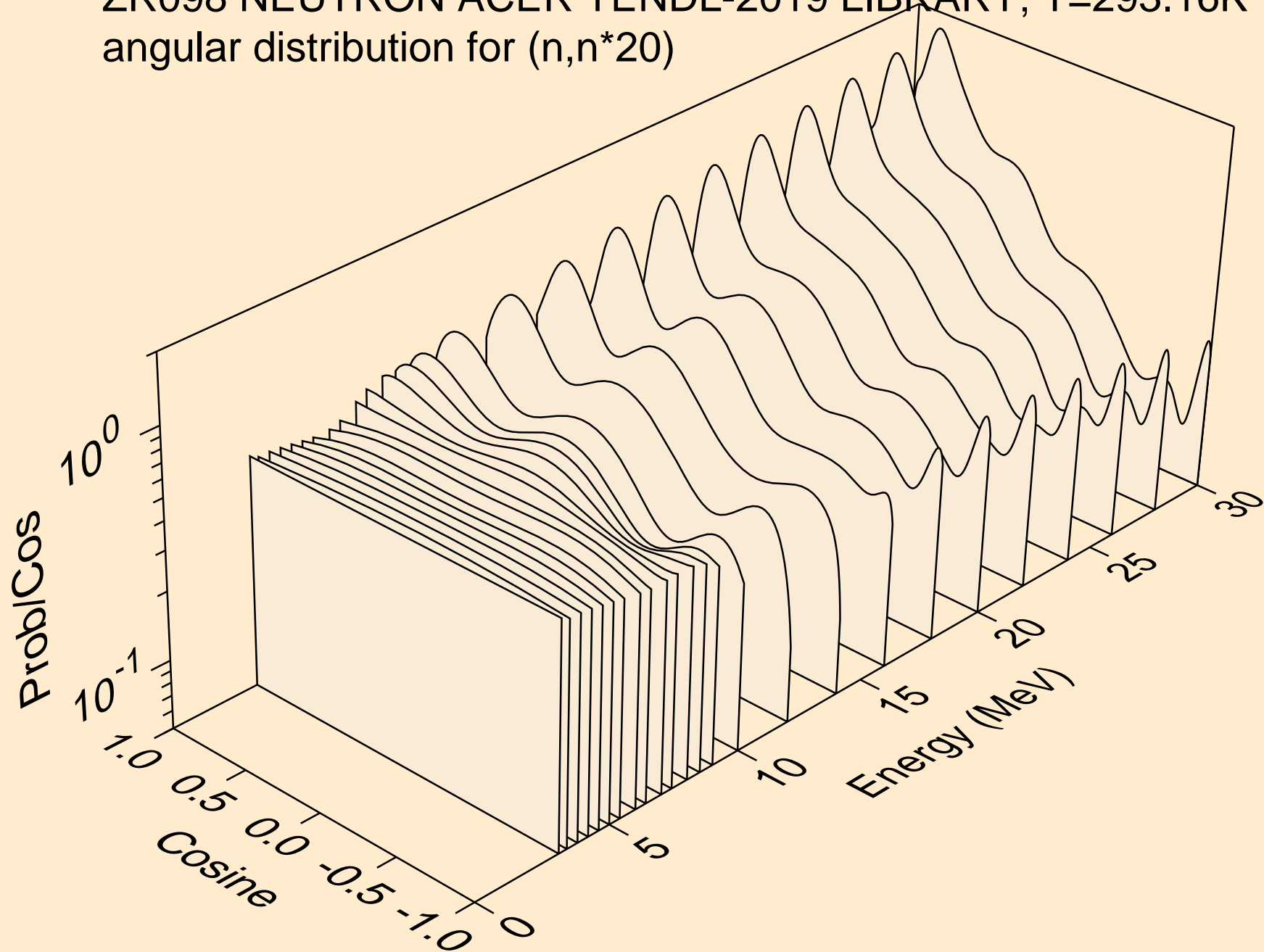

ZR098 NEUTRON ACER TENDL-2019 LIBRARY; T=293.16K  
angular distribution for (n,n\*21)

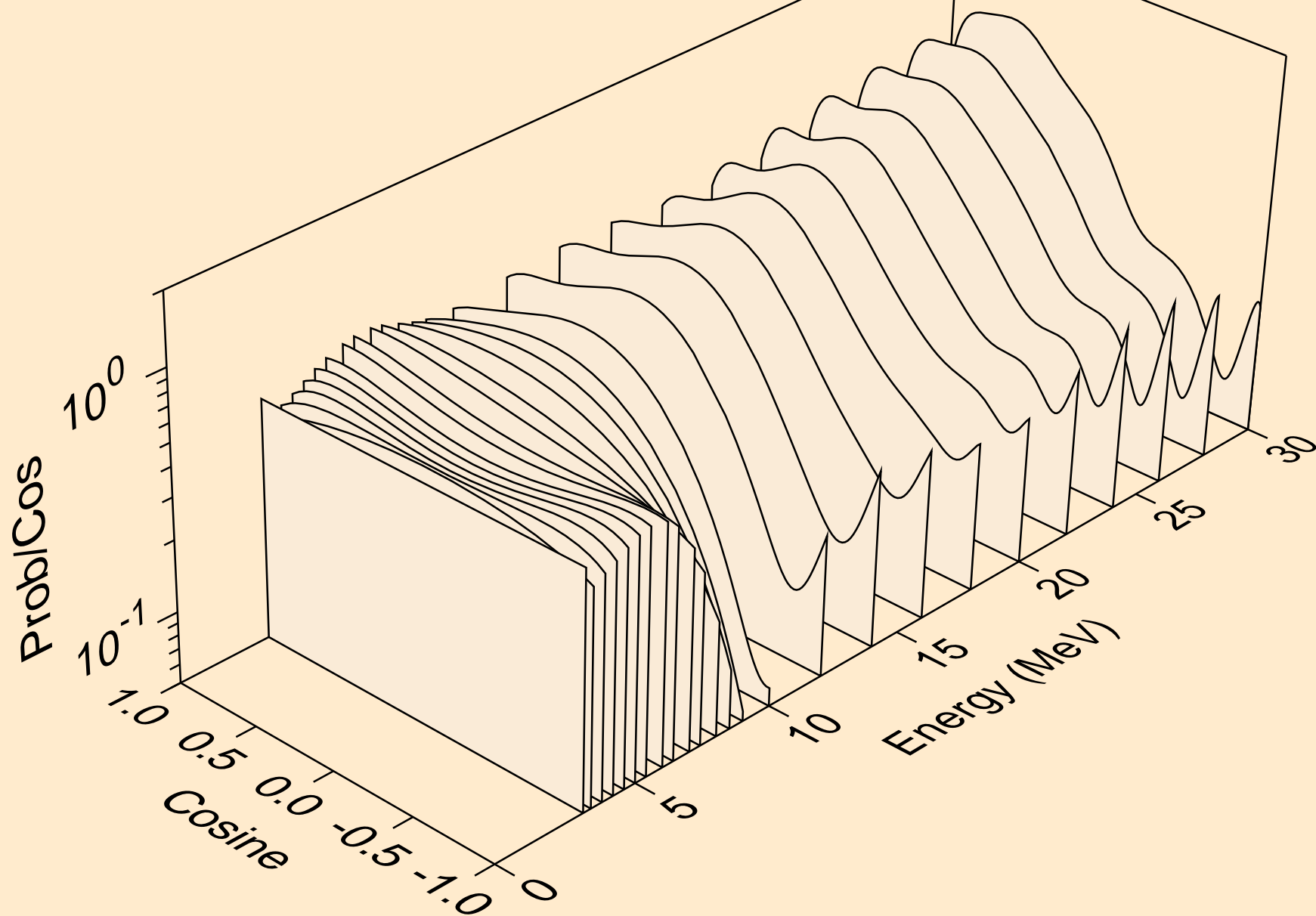

ZR098 NEUTRON ACER TENDL-2019 LIBRARY; T=293.16K  
angular distribution for (n,n\*22)

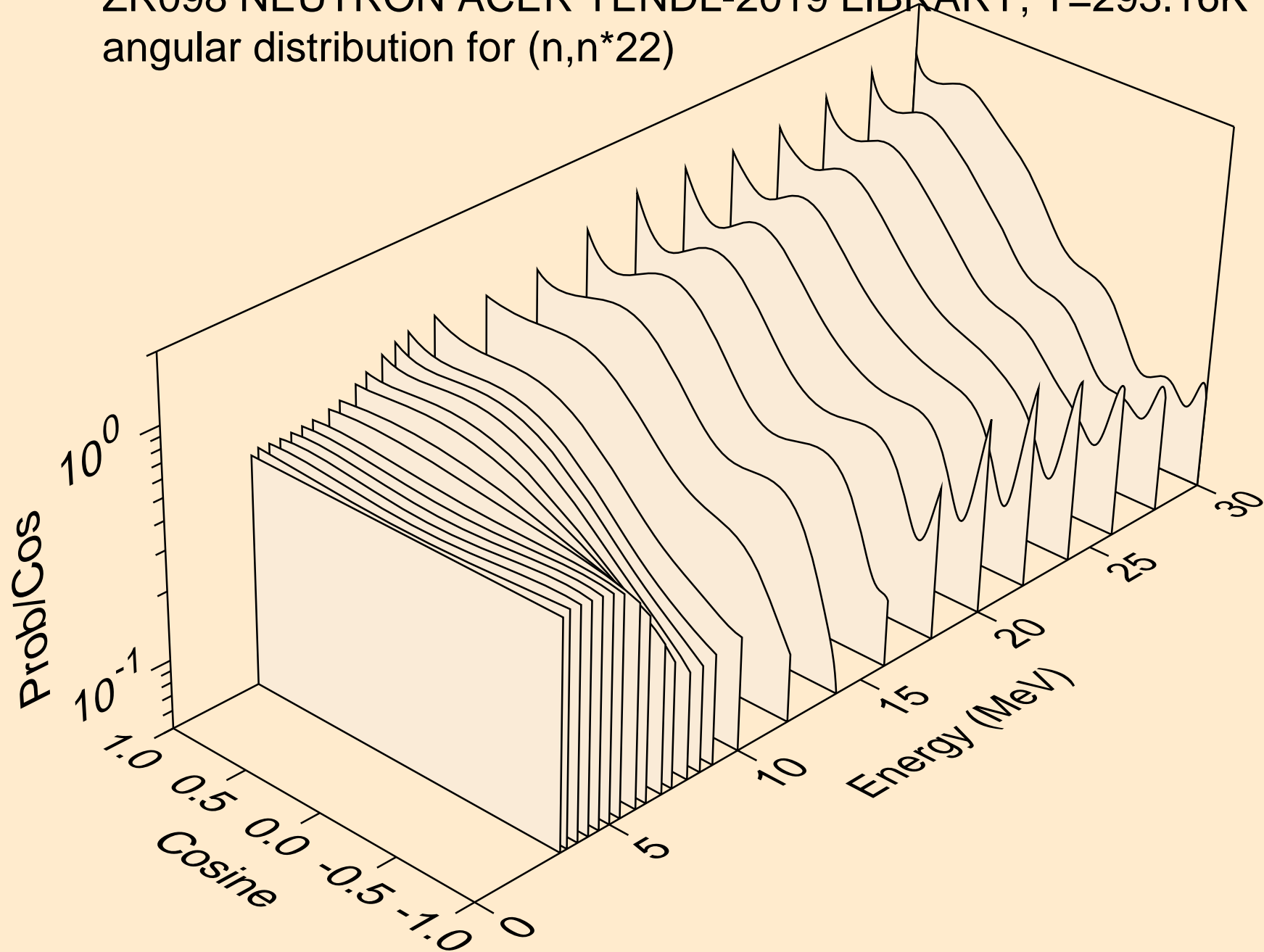

ZR098 NEUTRON ACER TENDL-2019 LIBRARY; T=293.16K  
angular distribution for (n,n\*23)

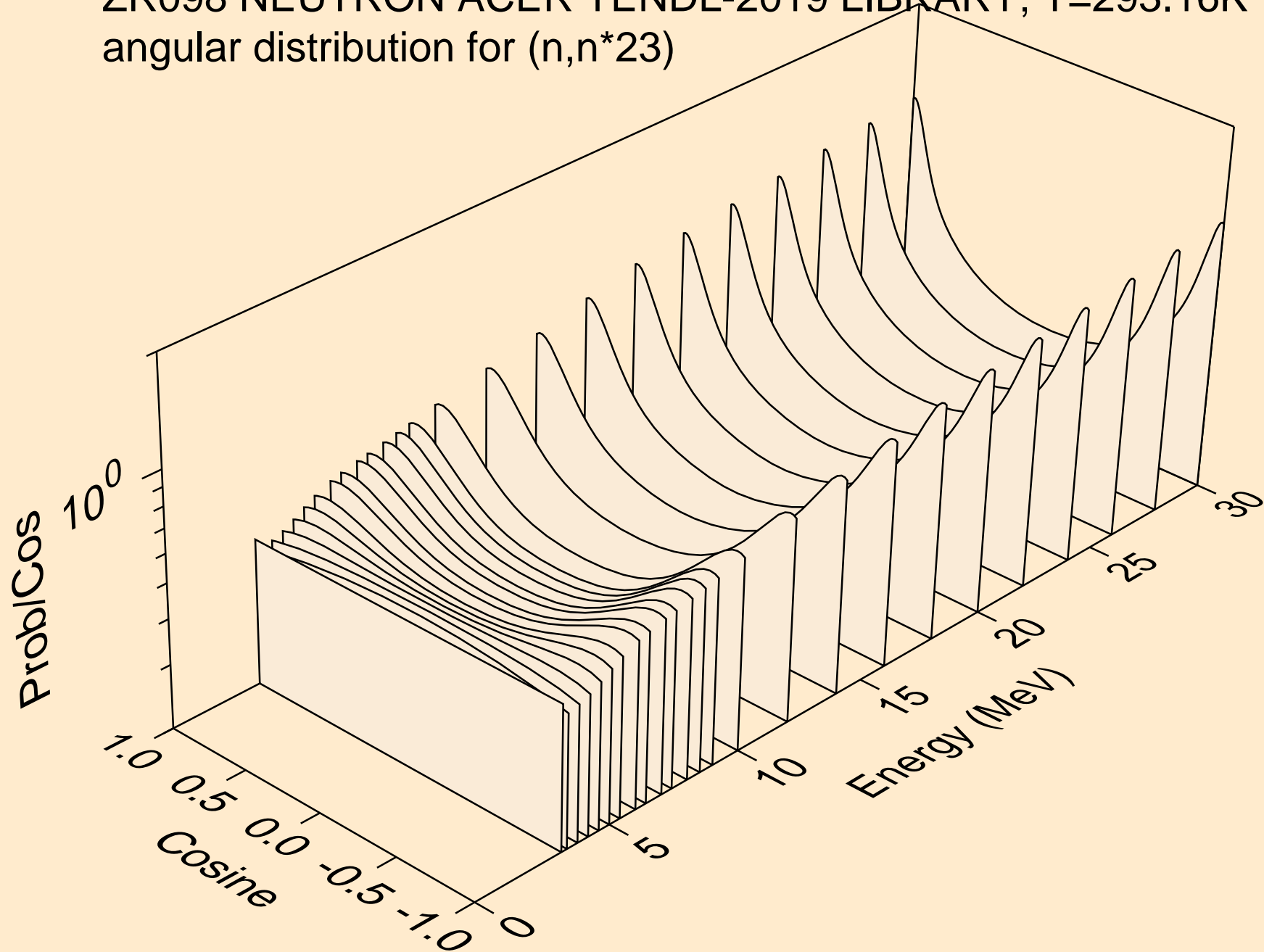

ZR098 NEUTRON ACER TENDL-2019 LIBRARY; T=293.16K  
angular distribution for (n,n\*24)

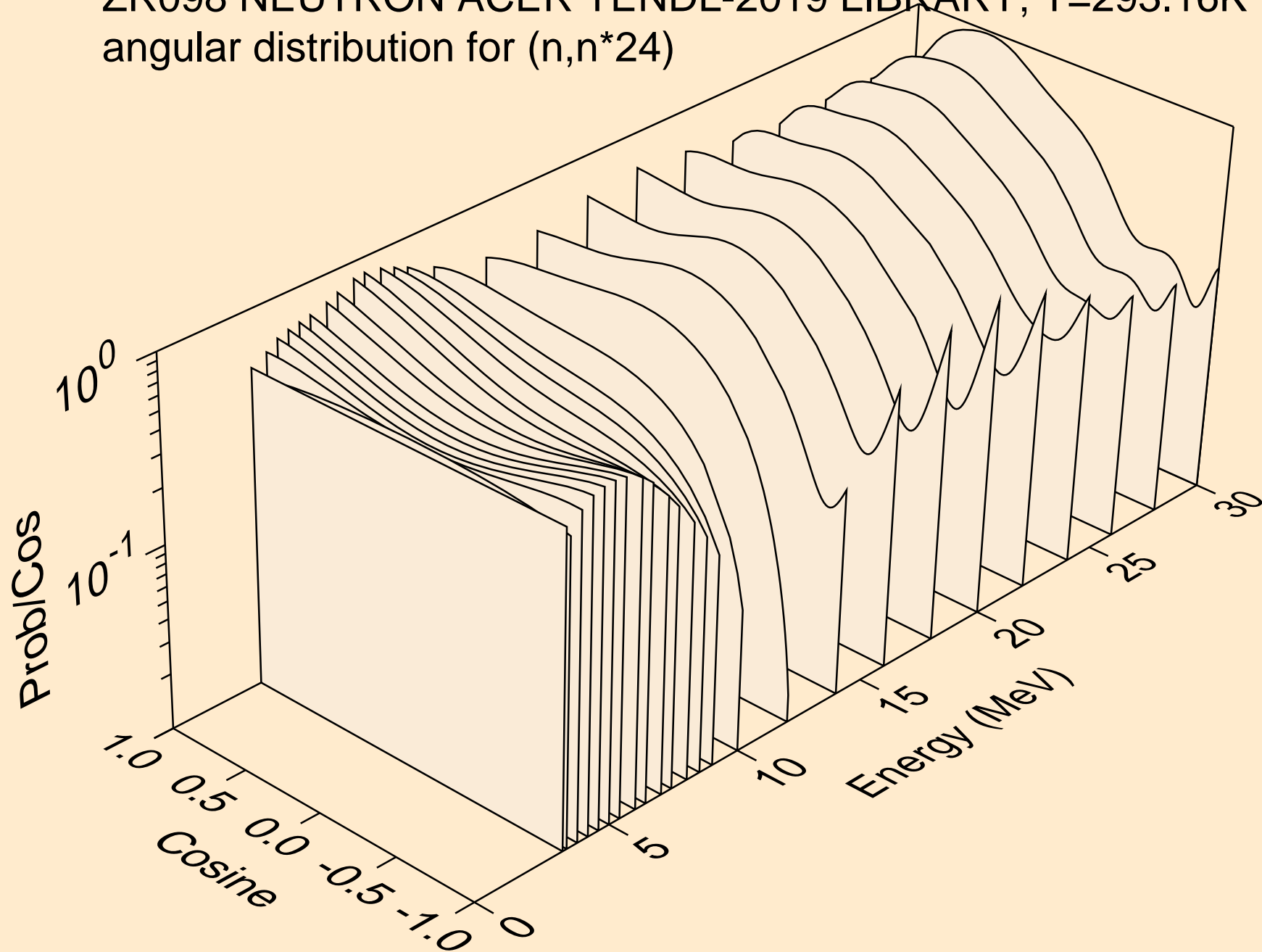



ZR098 NEUTRON ACER TENDL-2019 LIBRARY; T=293.16K  
angular distribution for (n,n\*25)

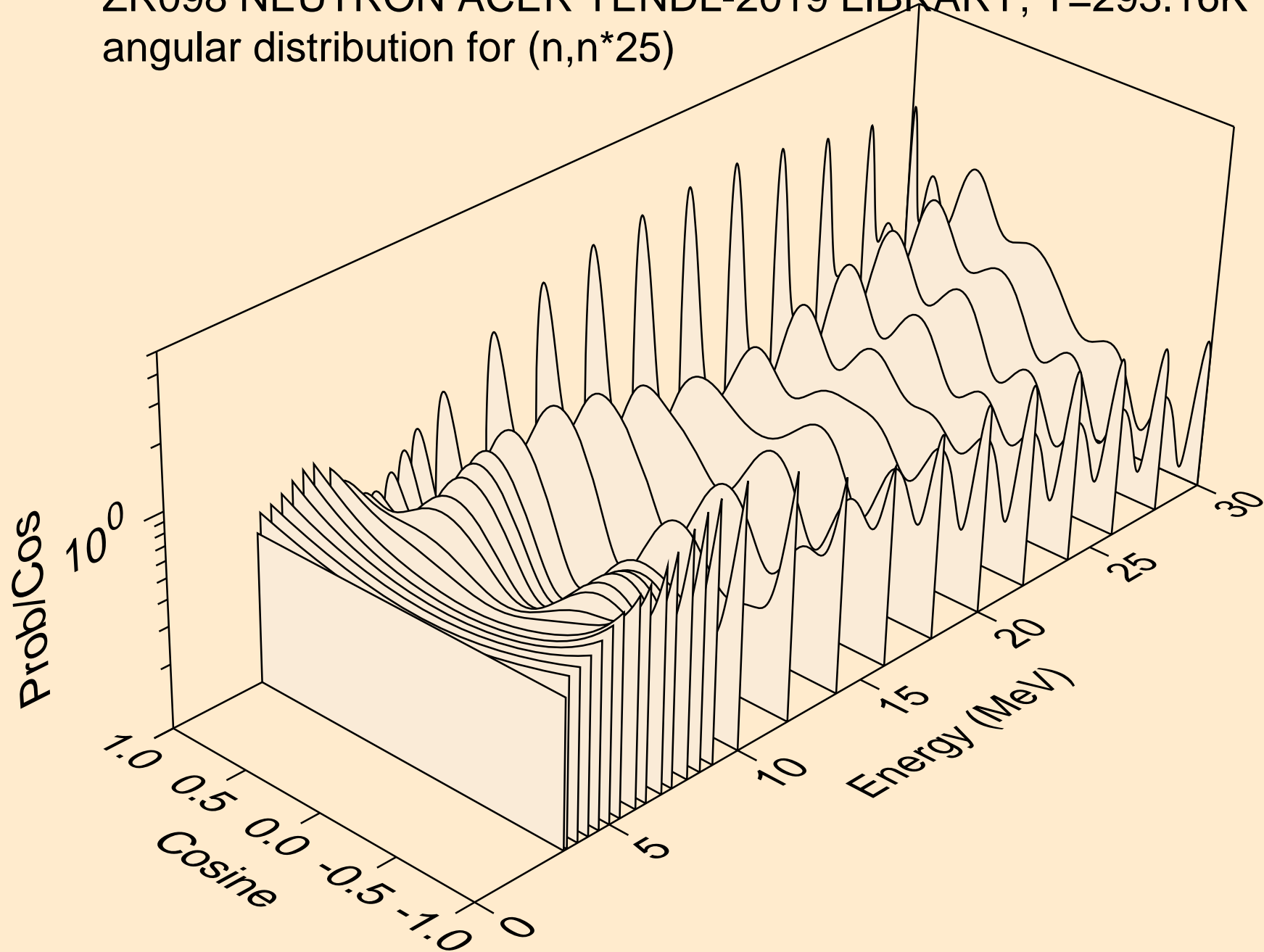

ZR098 NEUTRON ACER TENDL-2019 LIBRARY; T=293.16K  
angular distribution for (n,n\*26)

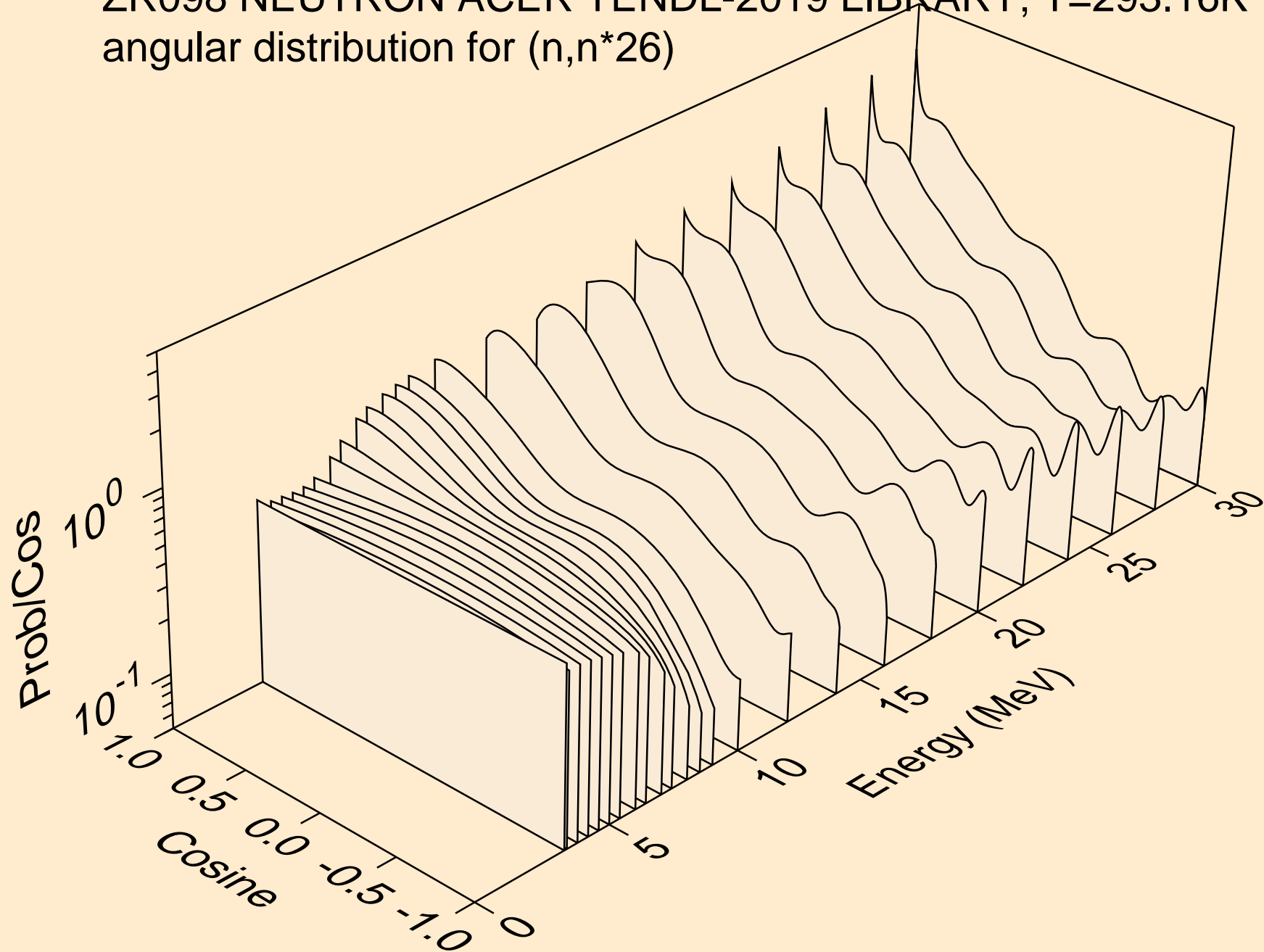

ZR098 NEUTRON ACER TENDL-2019 LIBRARY; T=293.16K  
angular distribution for (n,n\*27)

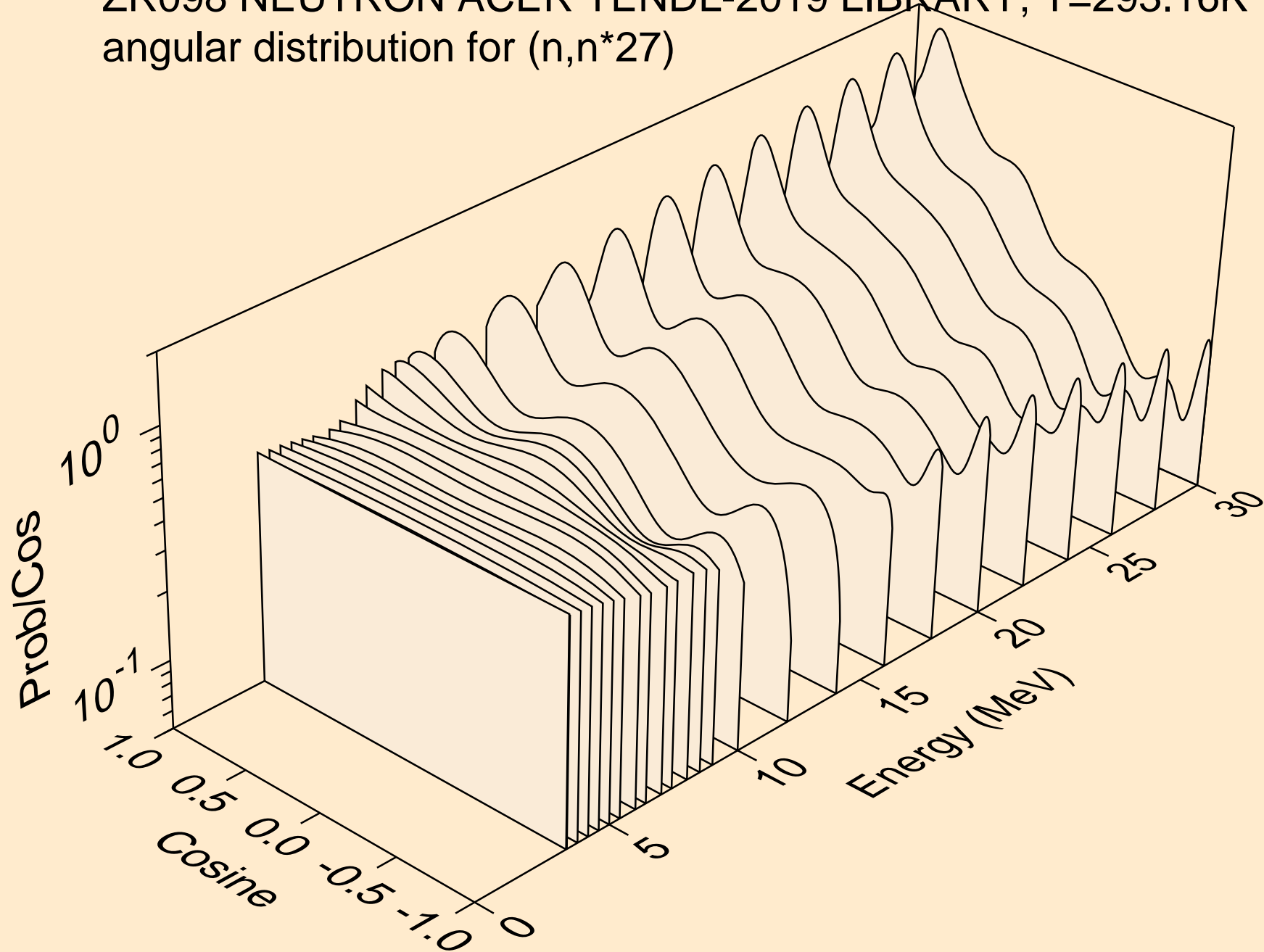

ZR098 NEUTRON ACER TENDL-2019 LIBRARY; T=293.16K  
angular distribution for (n,n\*28)

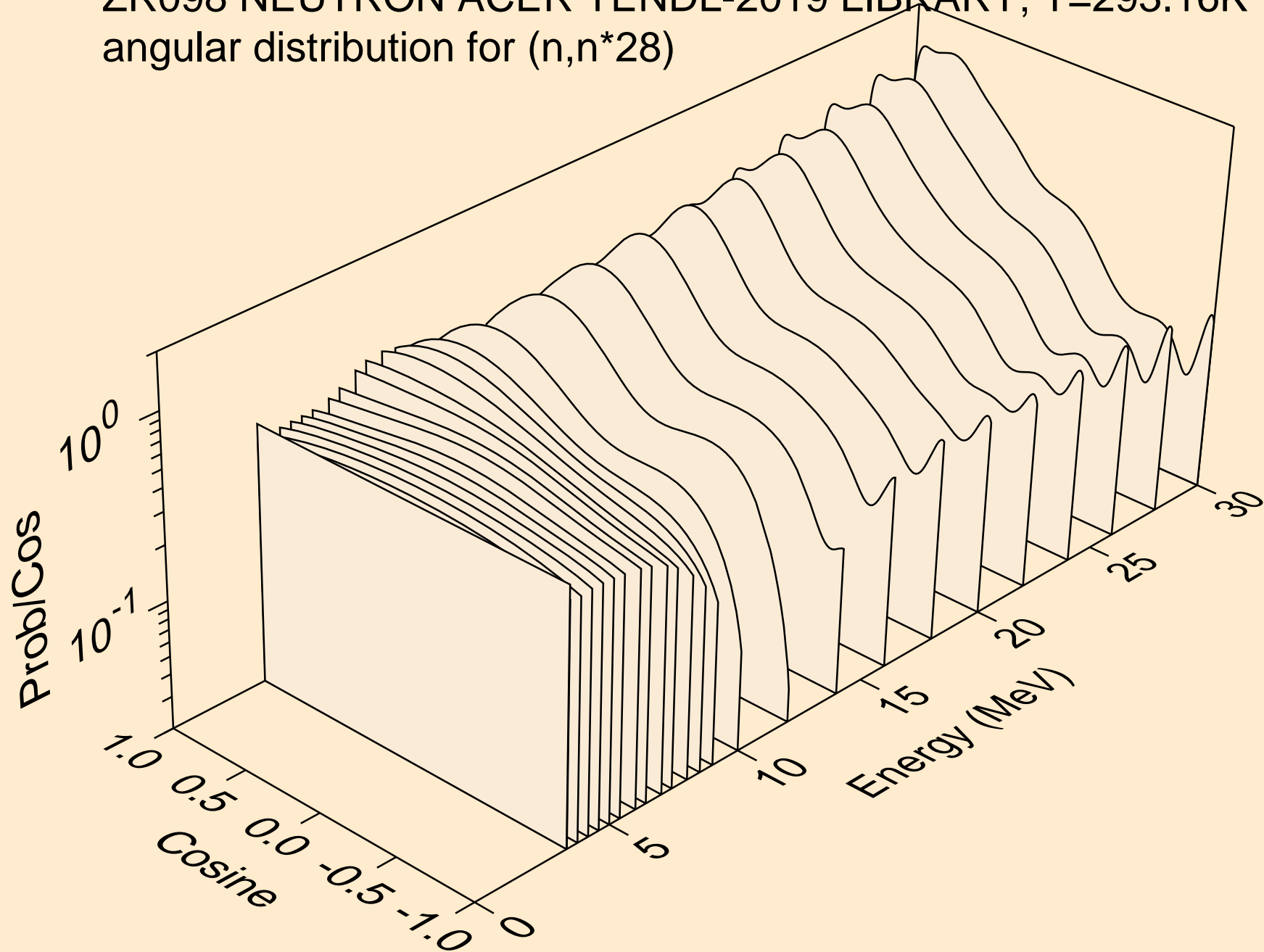

ZR098 NEUTRON ACER TENDL-2019 LIBRARY; T=293.16K  
angular distribution for (n,n\*29)

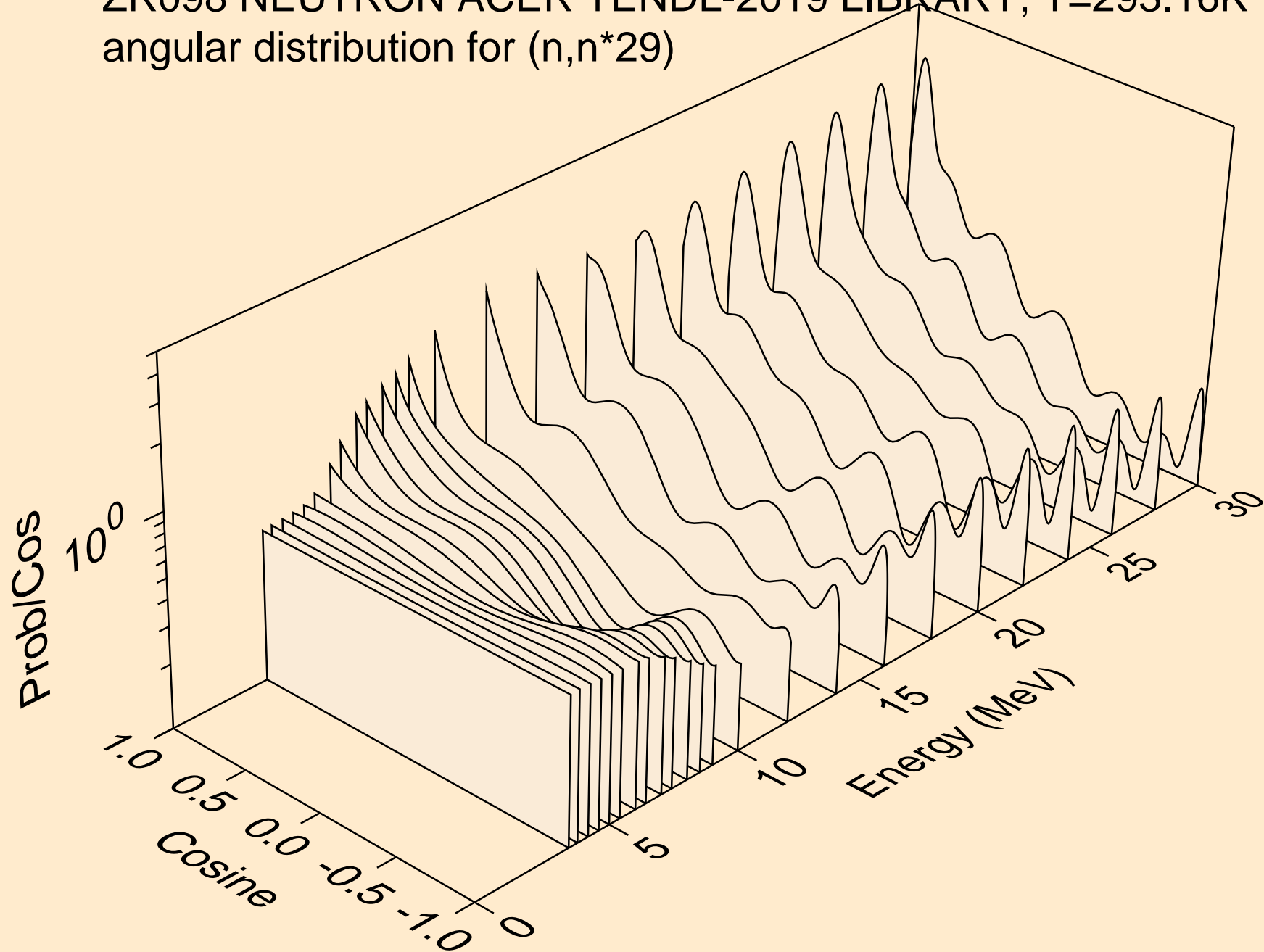

ZR098 NEUTRON ACER TENDL-2019 LIBRARY; T=293.16K  
angular distribution for (n,n\*30)

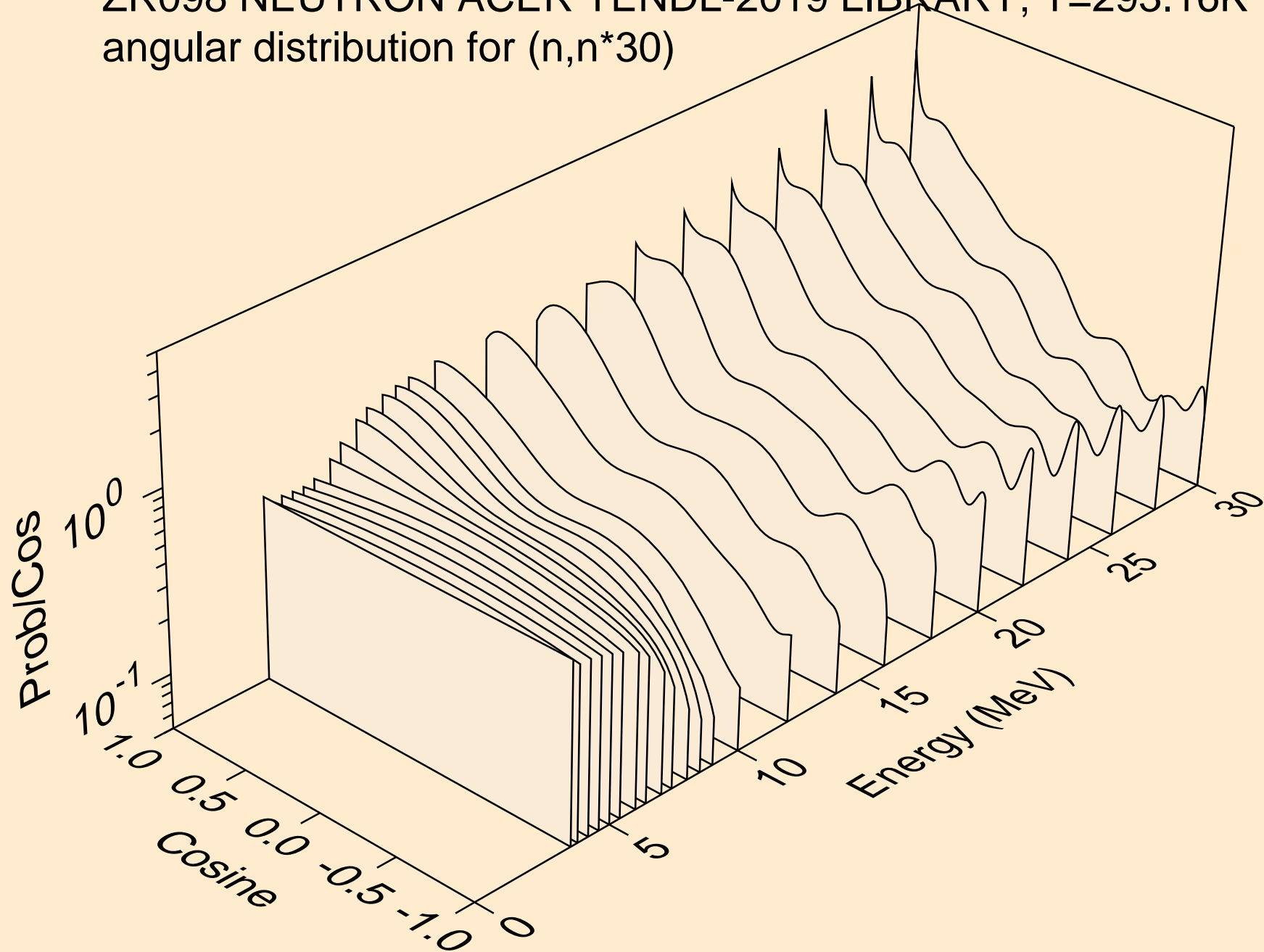

ZR098 NEUTRON ACER TENDL-2019 LIBRARY; T=293.16K  
Neutron emission for (n,x)

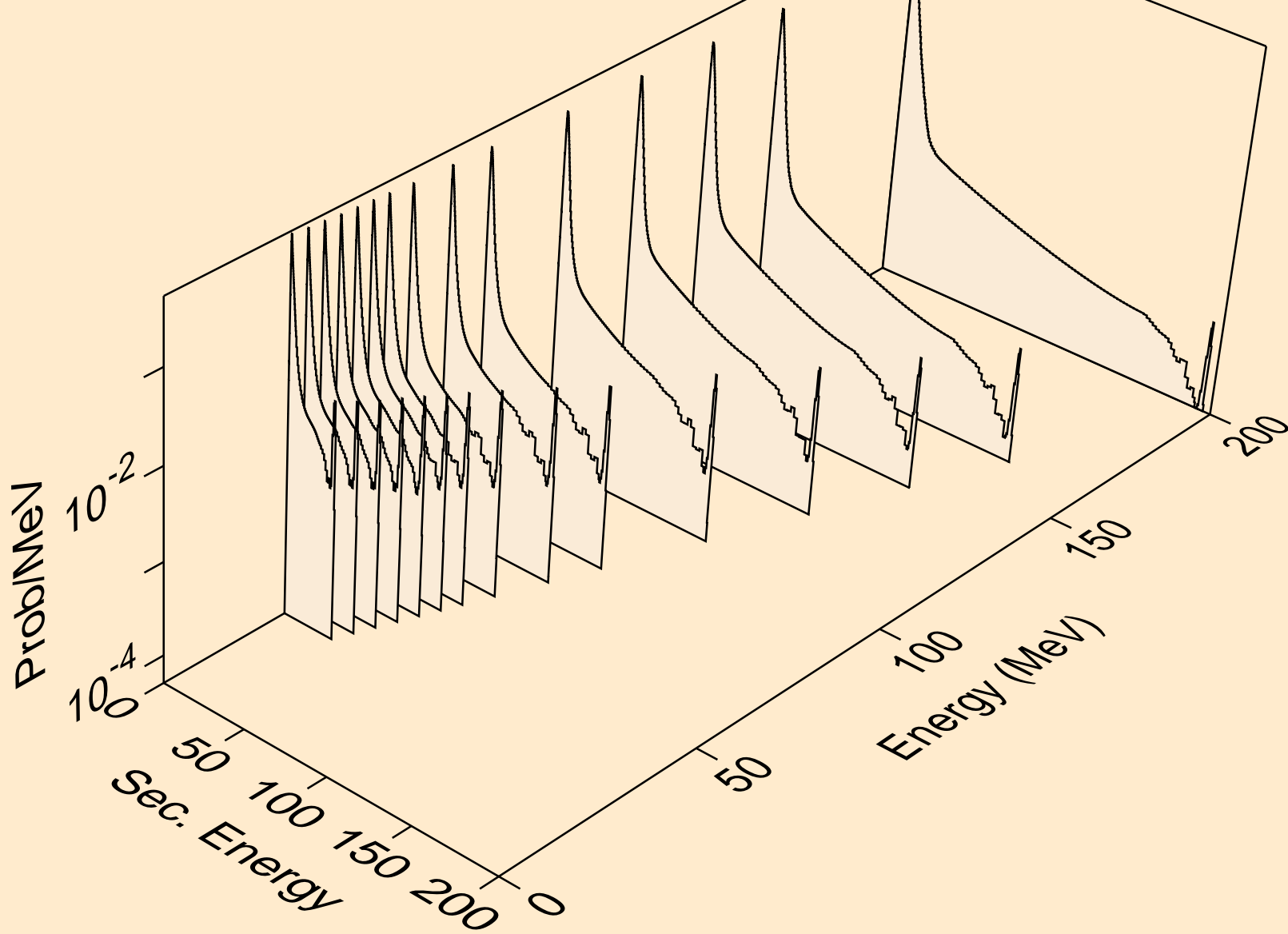

ZR098 NEUTRON ACER TENDL-2019 LIBRARY; T=293.16K  
Neutron emission for (n,2nd)

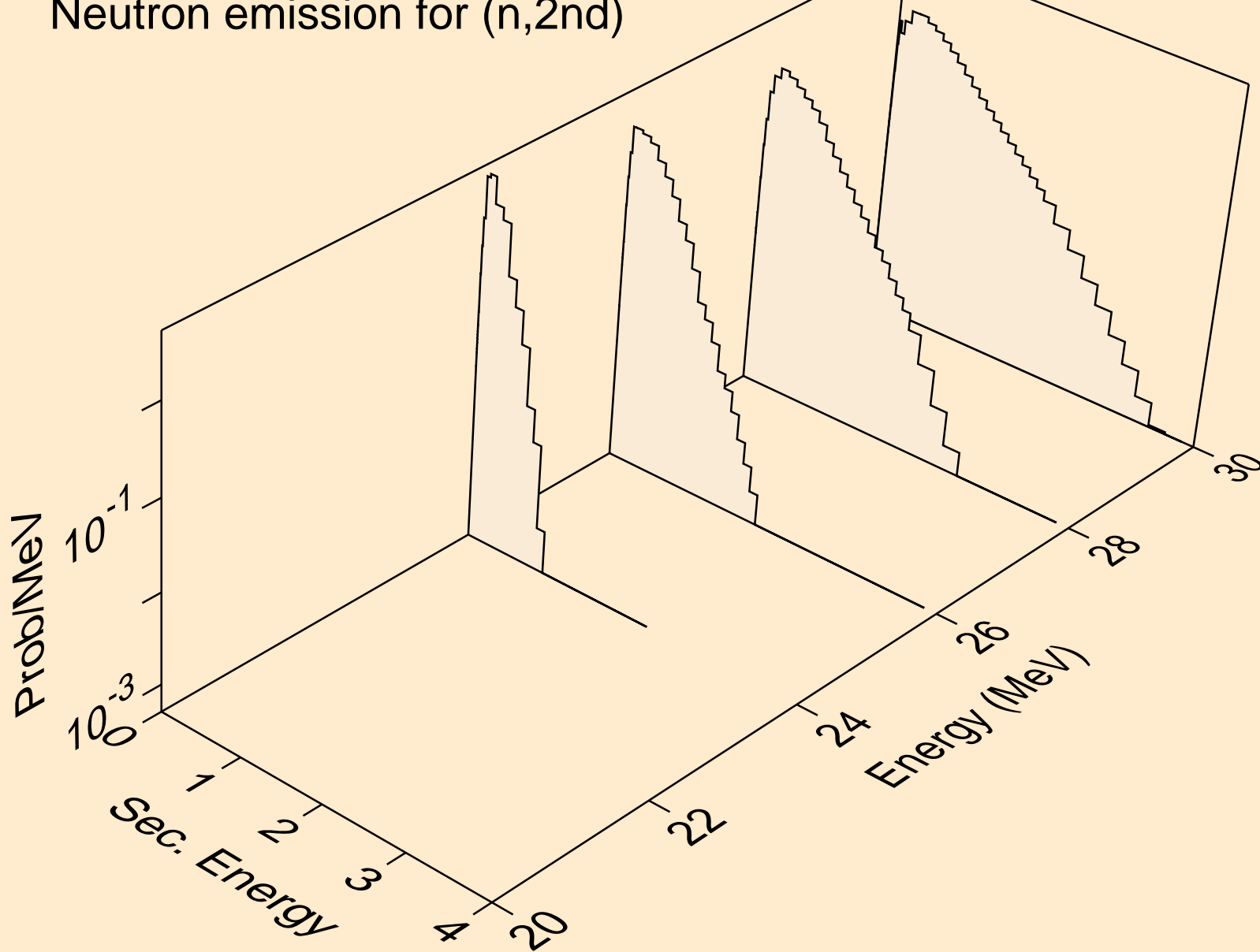



ZR098 NEUTRON ACER TENDL-2019 LIBRARY; T=293.16K  
Neutron emission for (n,2n)

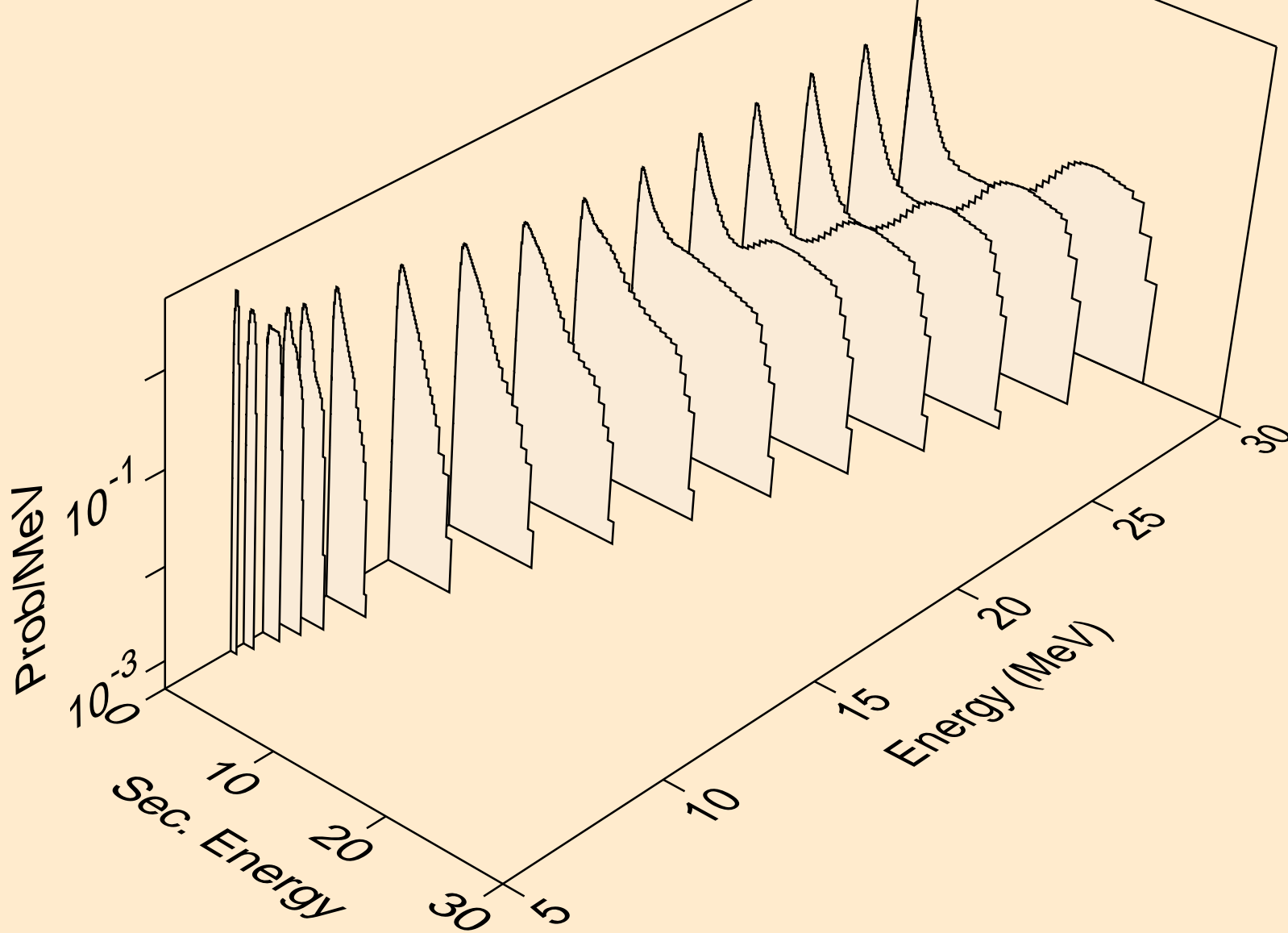

ZR098 NEUTRON ACER TENDL-2019 LIBRARY; T=293.16K  
Neutron emission for (n,3n)

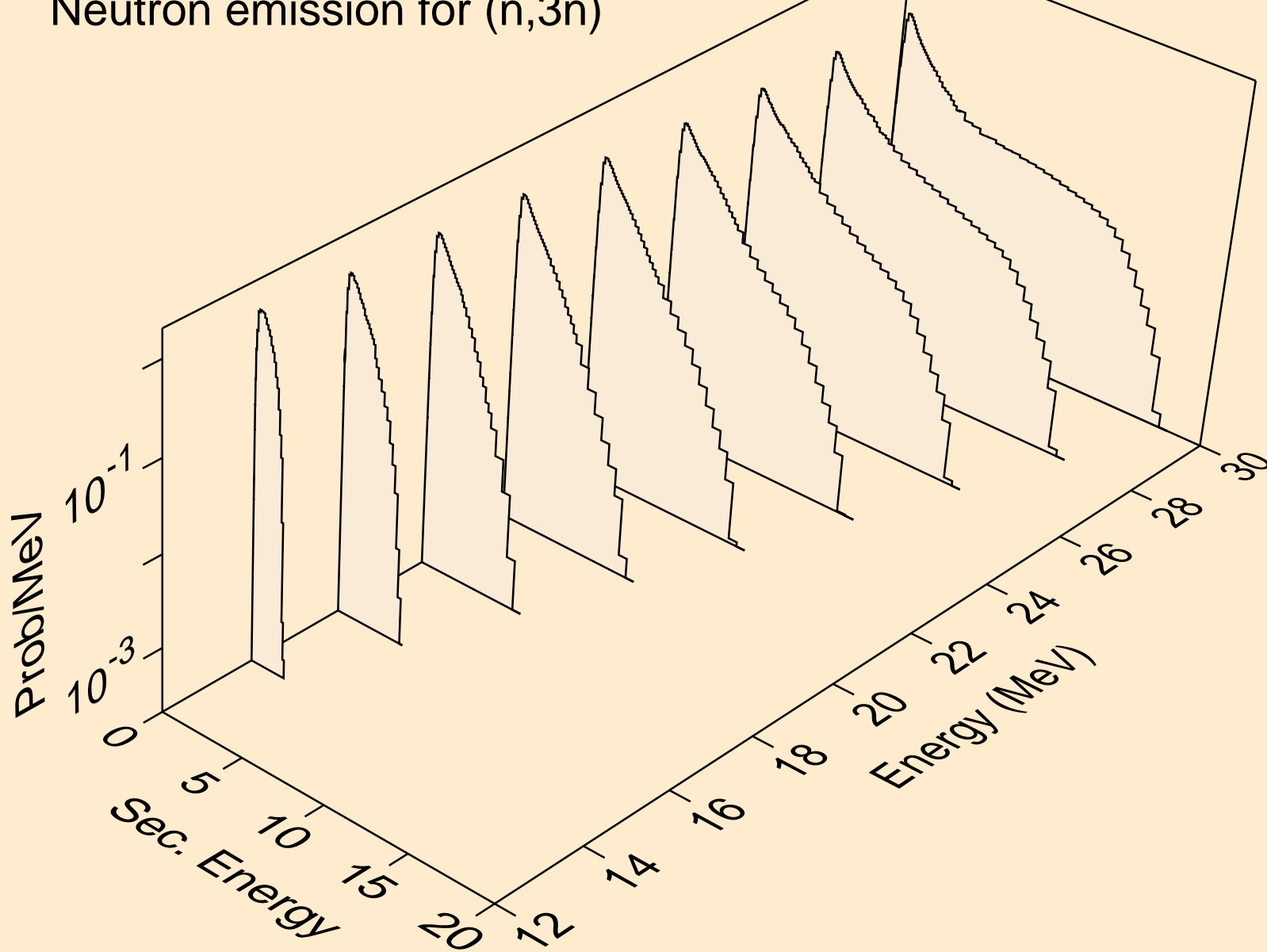

ZR098 NEUTRON ACER TENDL-2019 LIBRARY; T=293.16K  
Neutron emission for (n,n\*)a

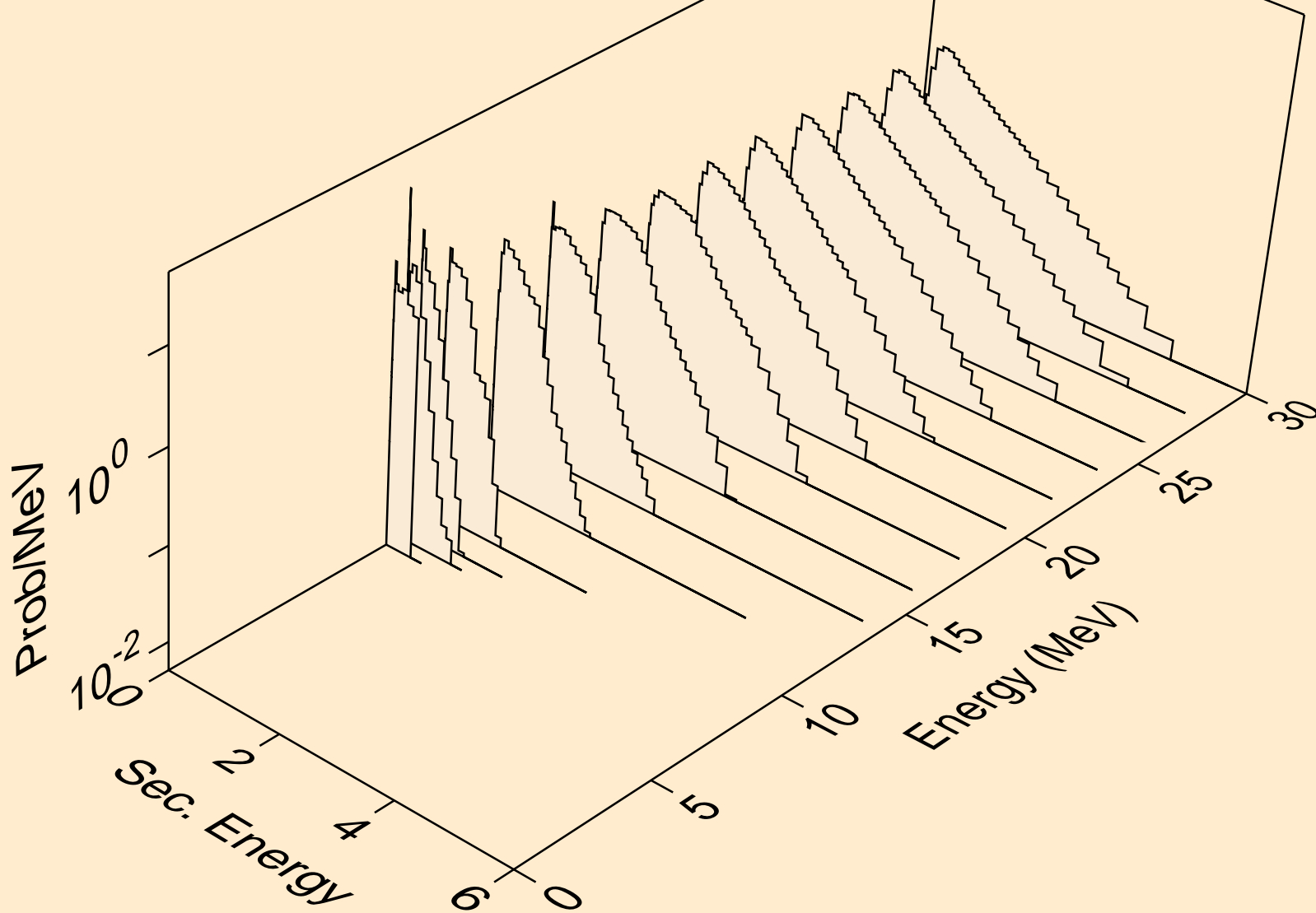

ZR098 NEUTRON ACER TENDL-2019 LIBRARY; T=293.16K  
Neutron emission for (n,2n)a

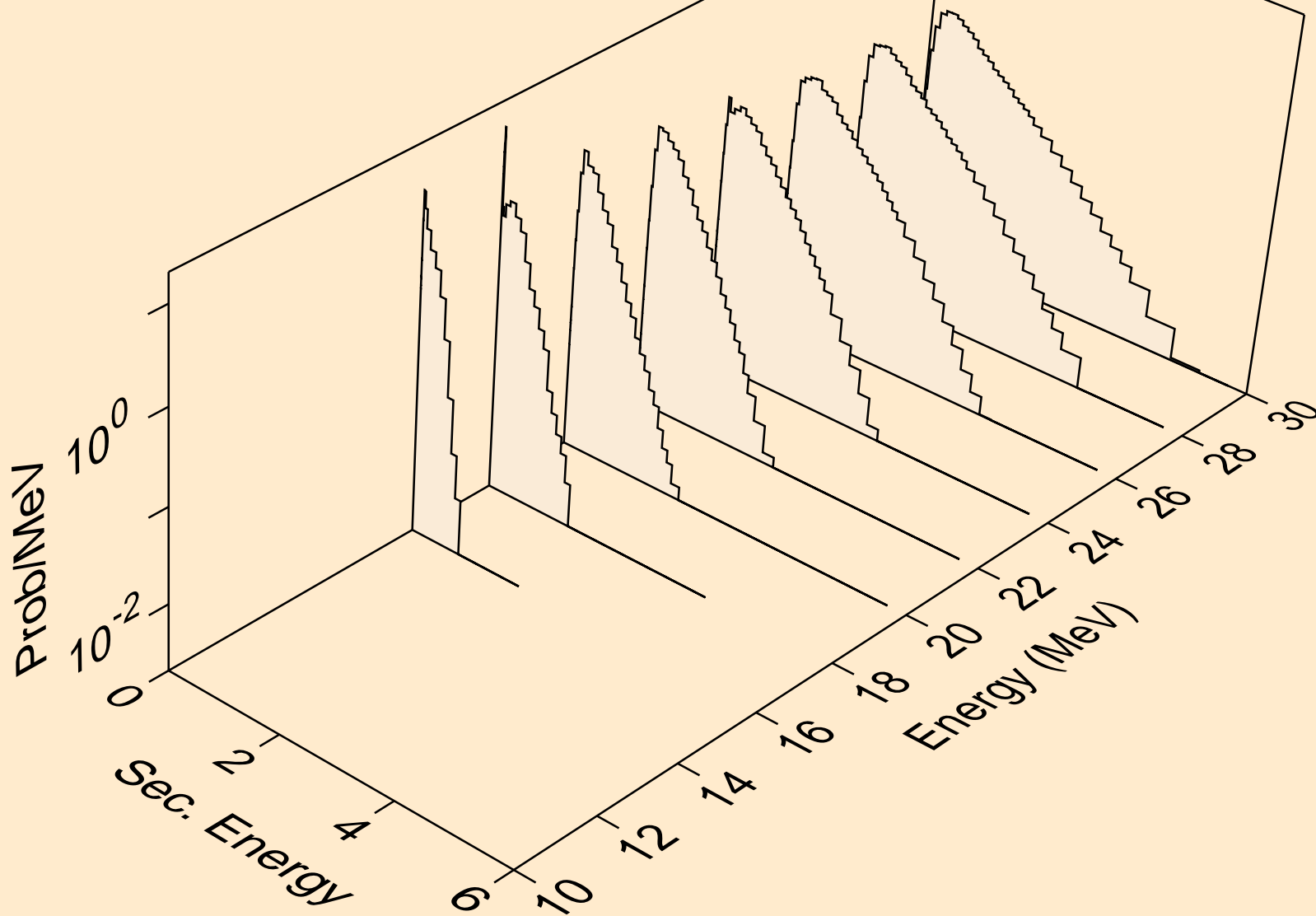

ZR098 NEUTRON ACER TENDL-2019 LIBRARY; T=293.16K  
Neutron emission for (n,3n)a

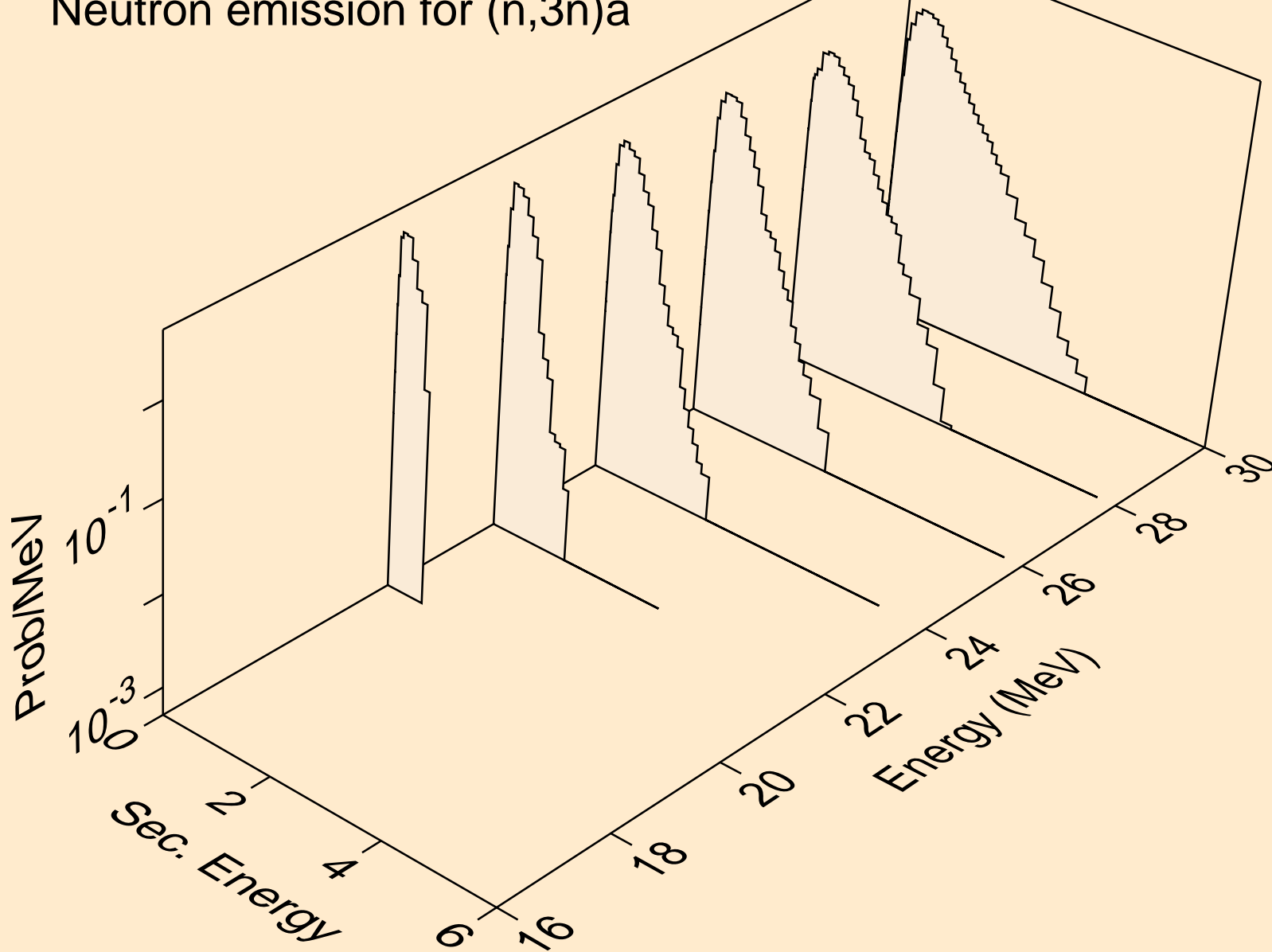

ZR098 NEUTRON ACER TENDL-2019 LIBRARY; T=293.16K  
Neutron emission for (n,n\*)p

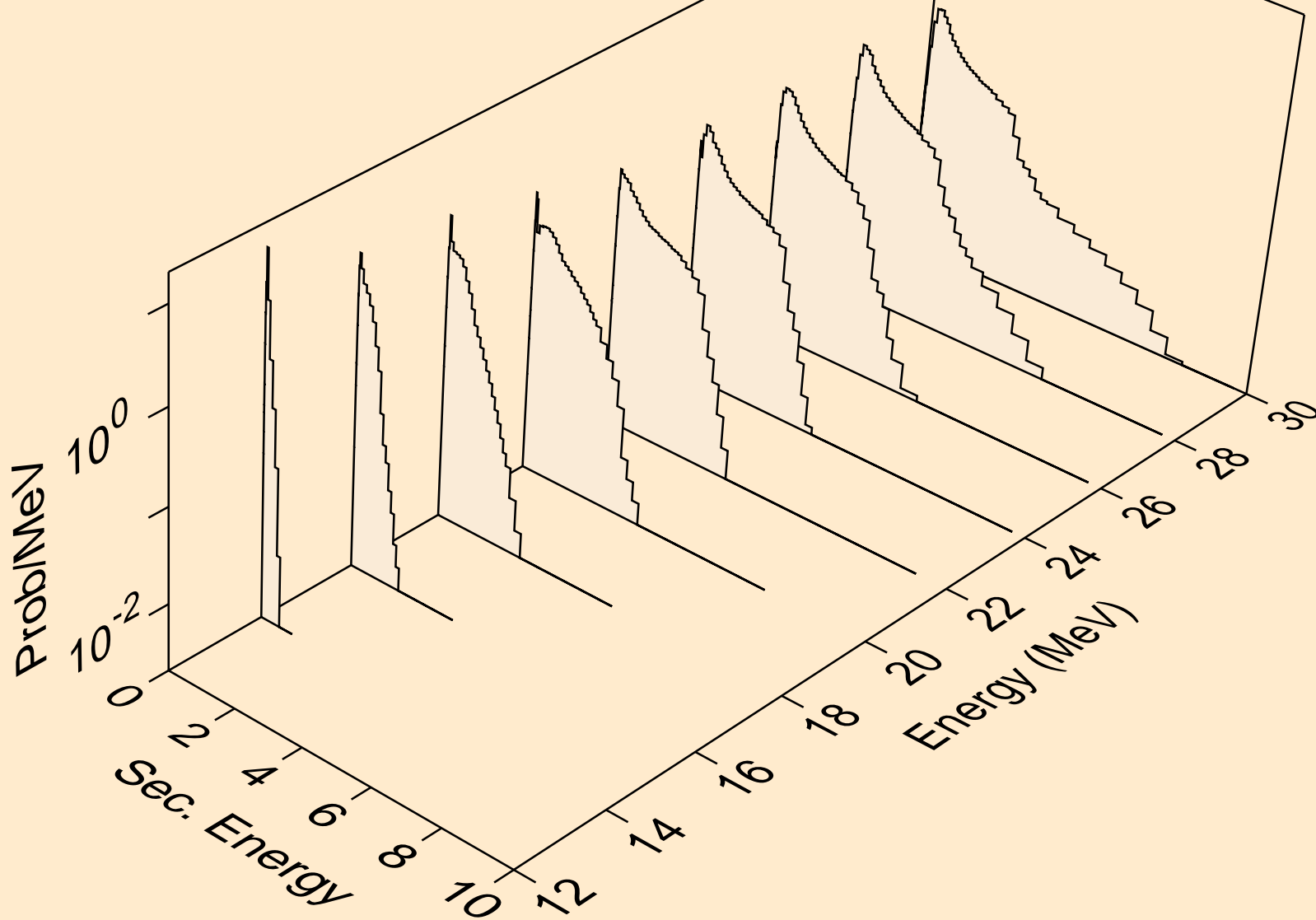

ZR098 NEUTRON ACER TENDL-2019 LIBRARY; T=293.16K  
Neutron emission for (n,n\*)d

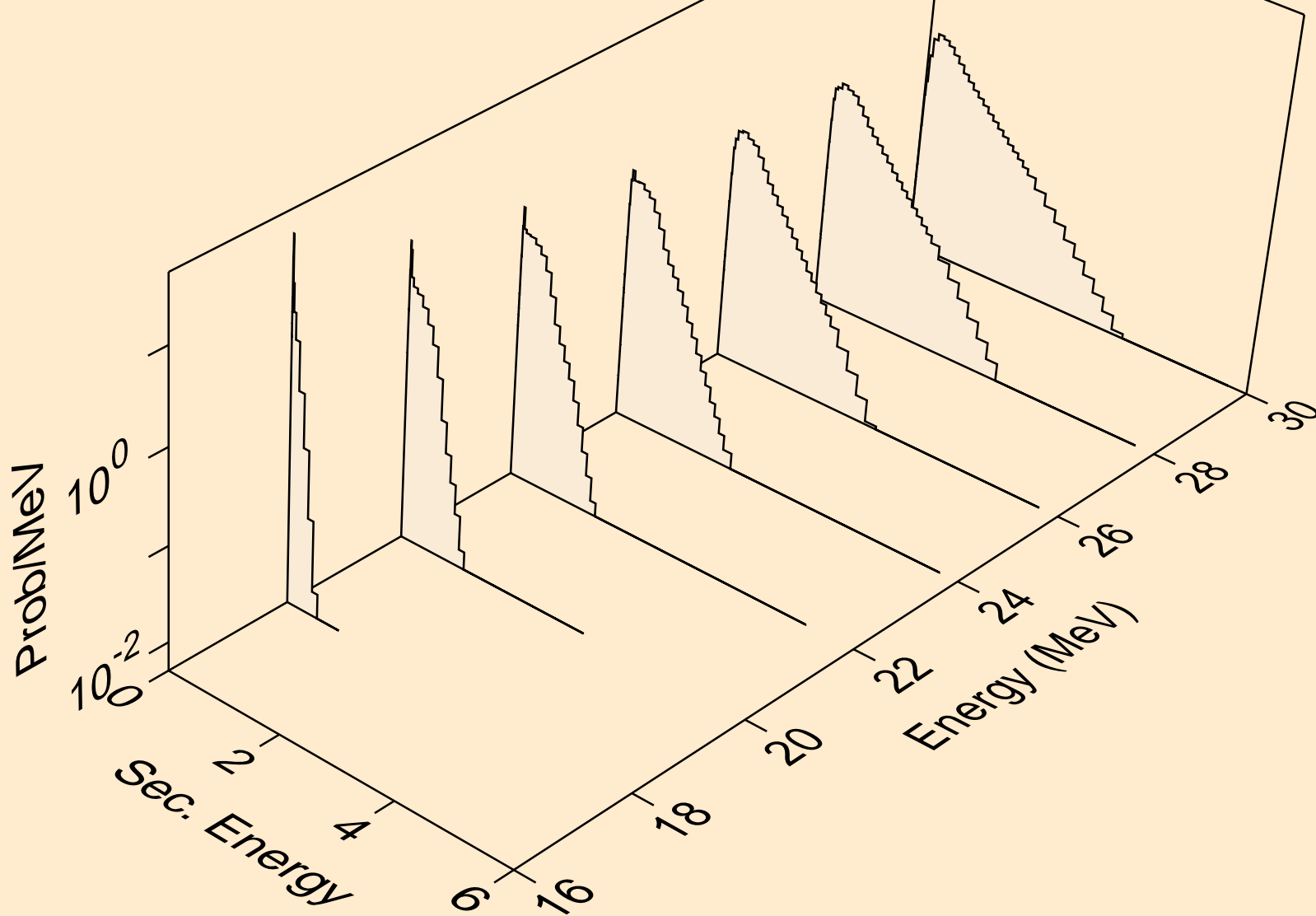

ZR098 NEUTRON ACER TENDL-2019 LIBRARY; T=293.16K  
Neutron emission for (n,n\*)t

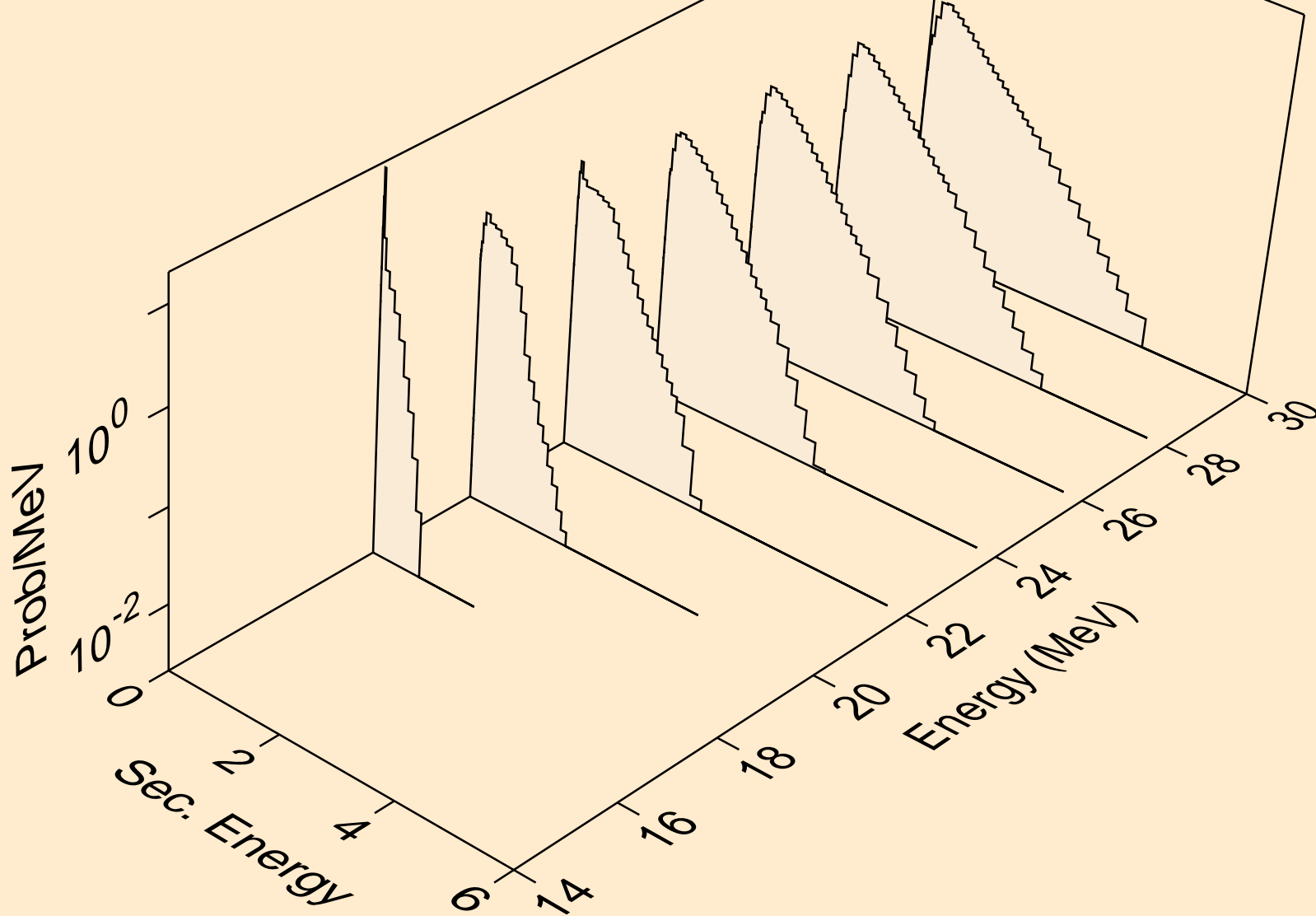



ZR098 NEUTRON ACER TENDL-2019 LIBRARY; T=293.16K  
Neutron emission for (n,n\*)he3

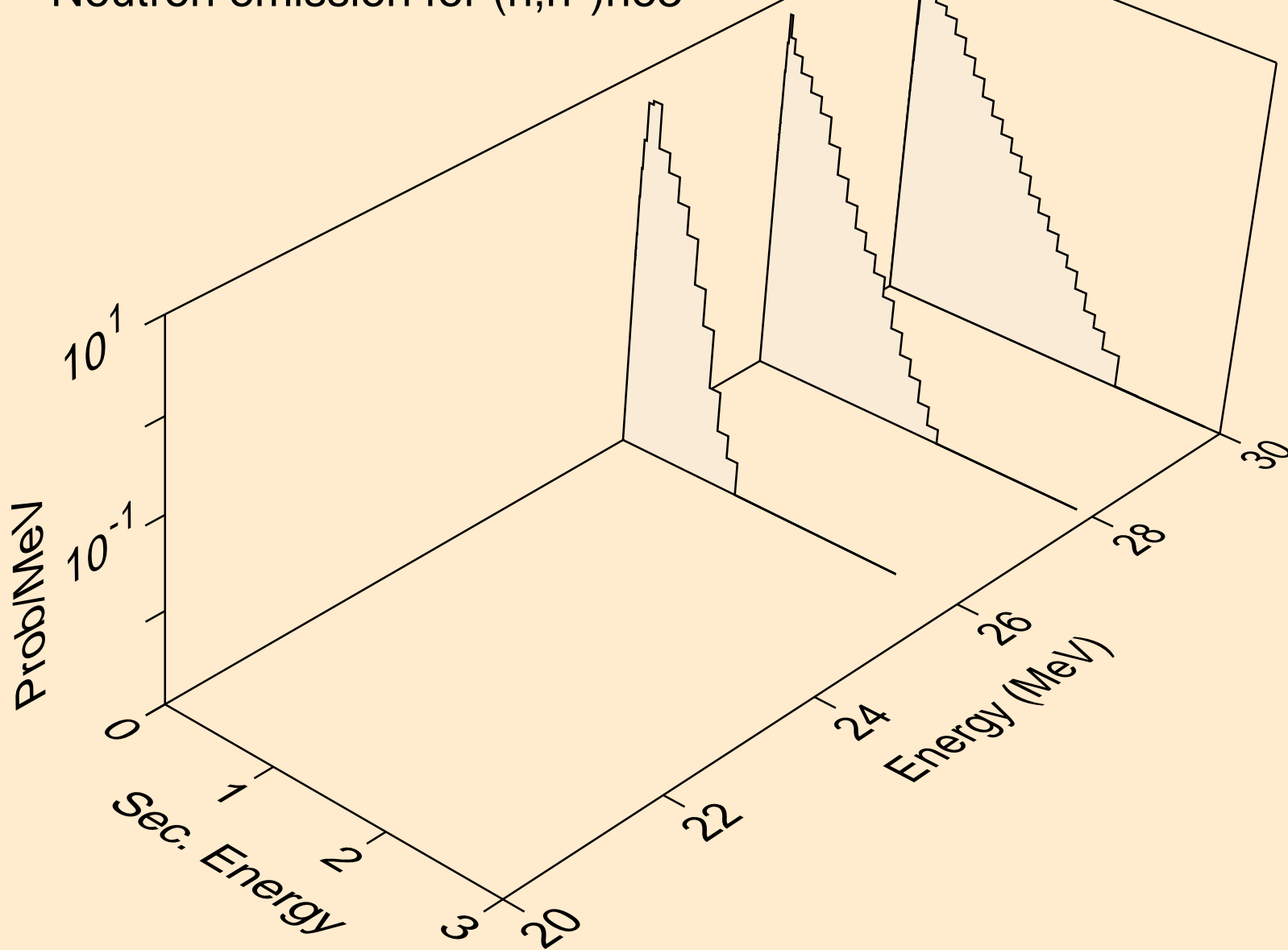

ZR098 NEUTRON ACER TENDL-2019 LIBRARY; T=293.16K  
Neutron emission for (n,4n)

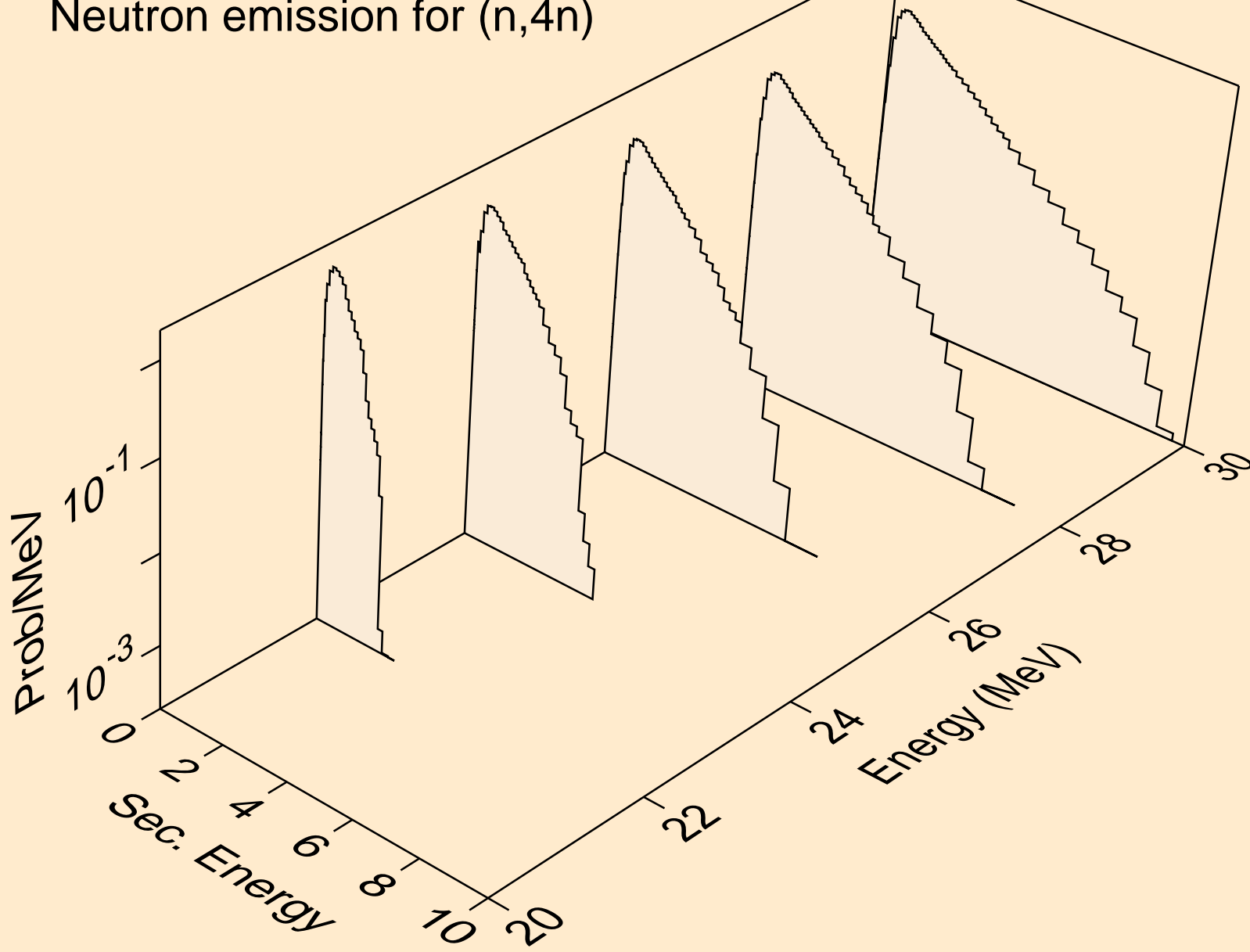

ZR098 NEUTRON ACER TENDL-2019 LIBRARY; T=293.16K  
Neutron emission for (n,2np)

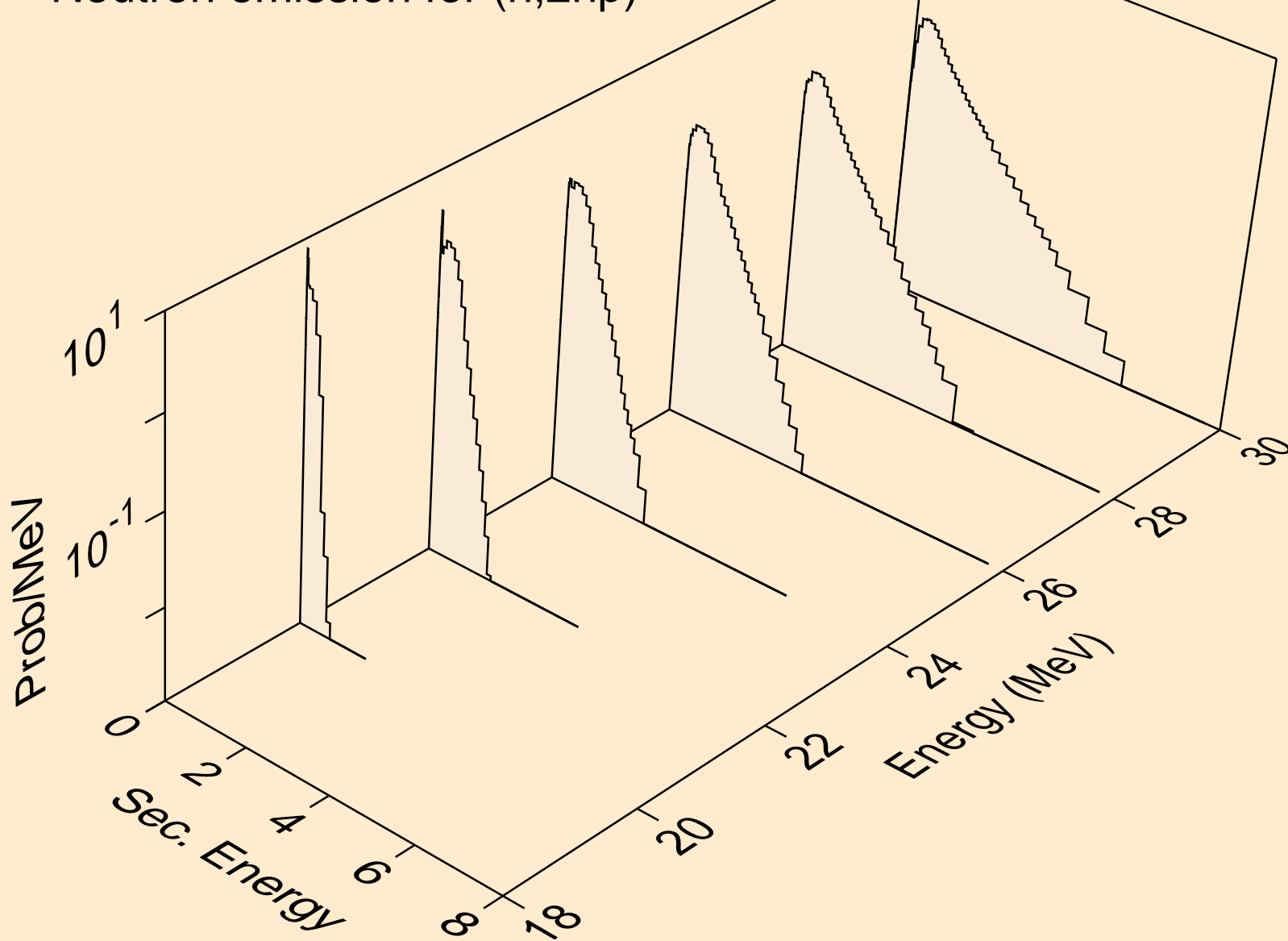

ZR098 NEUTRON ACER TENDL-2019 LIBRARY; T=293.16K  
Neutron emission for (n,3np)

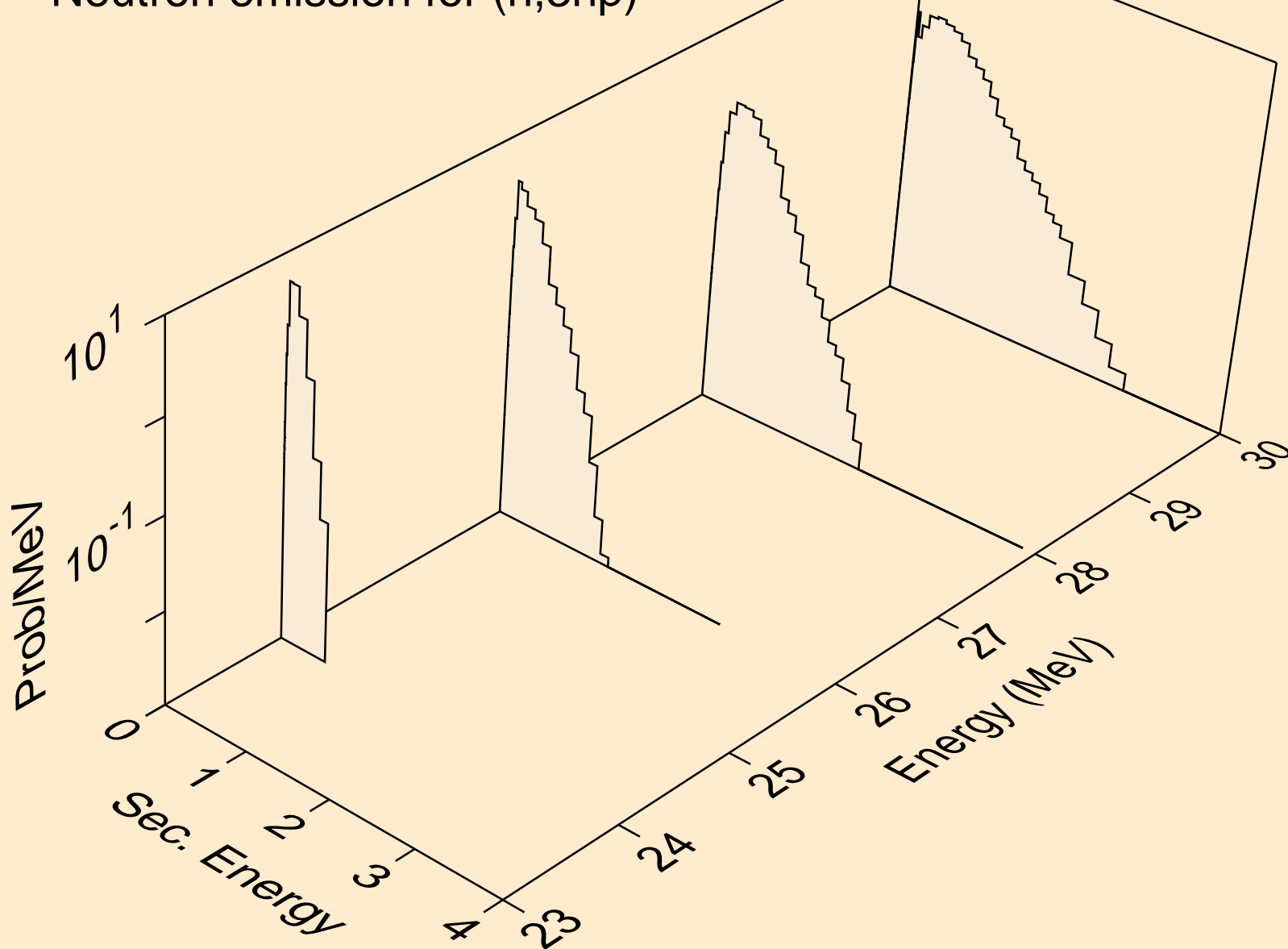

ZR098 NEUTRON ACER TENDL-2019 LIBRARY; T=293.16K  
Neutron emission for (n,n\*c)

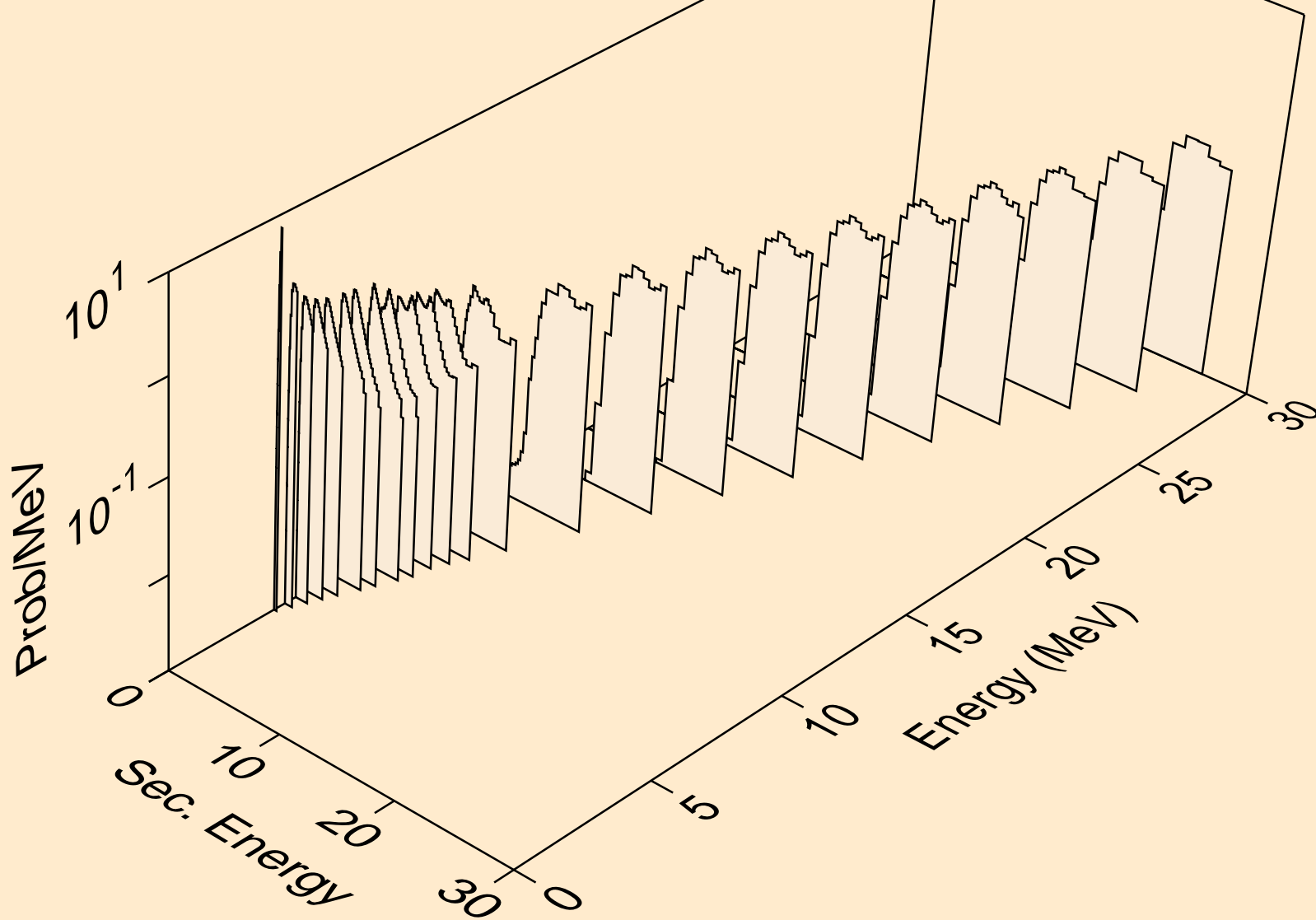

ZR098 NEUTRON ACER TENDL-2019 LIBRARY; T=293.16K  
Photon emission for (n,x)

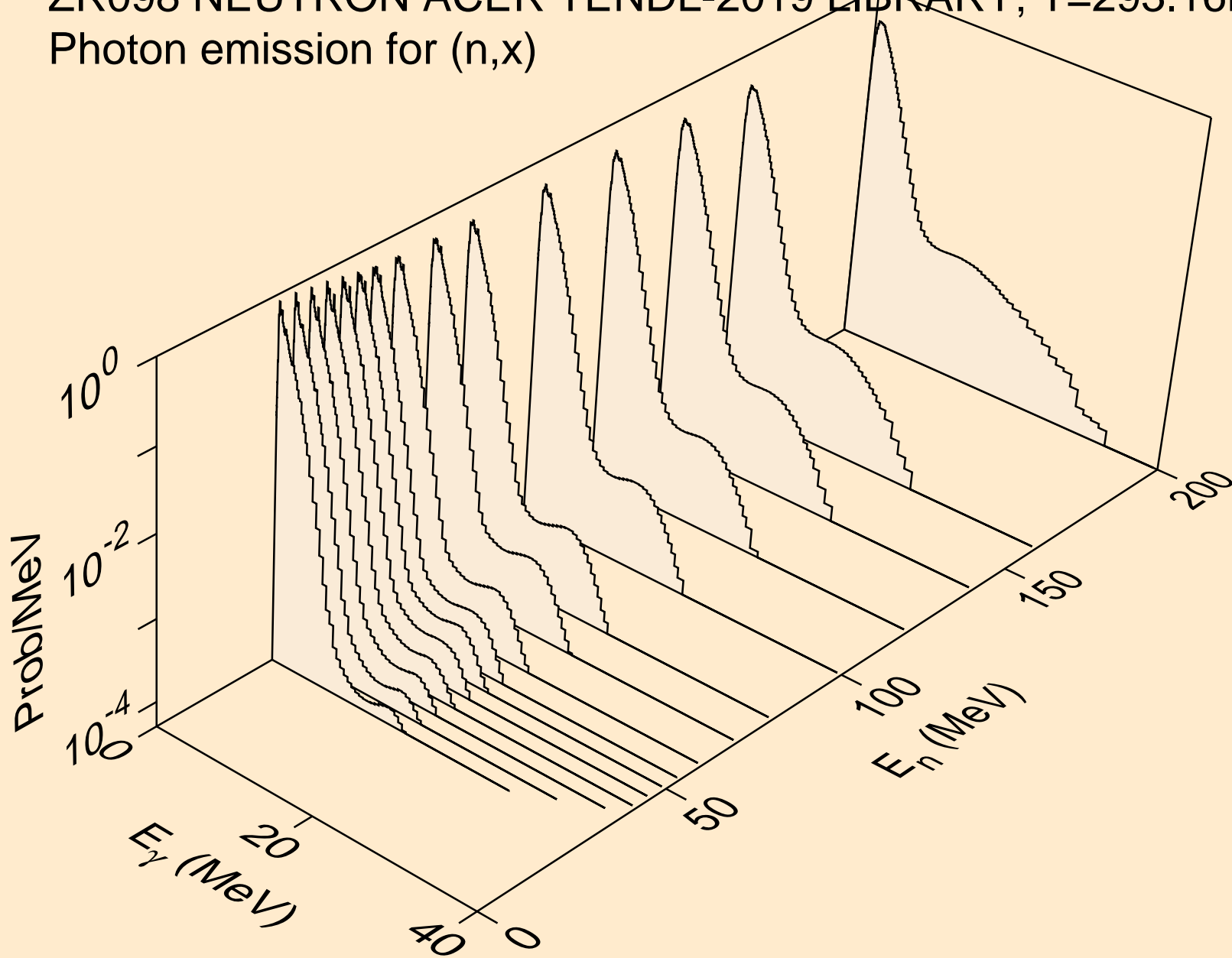

ZR098 NEUTRON ACER TENDL-2019 LIBRARY; T=293.16K  
Photon emission for (n,2nd)

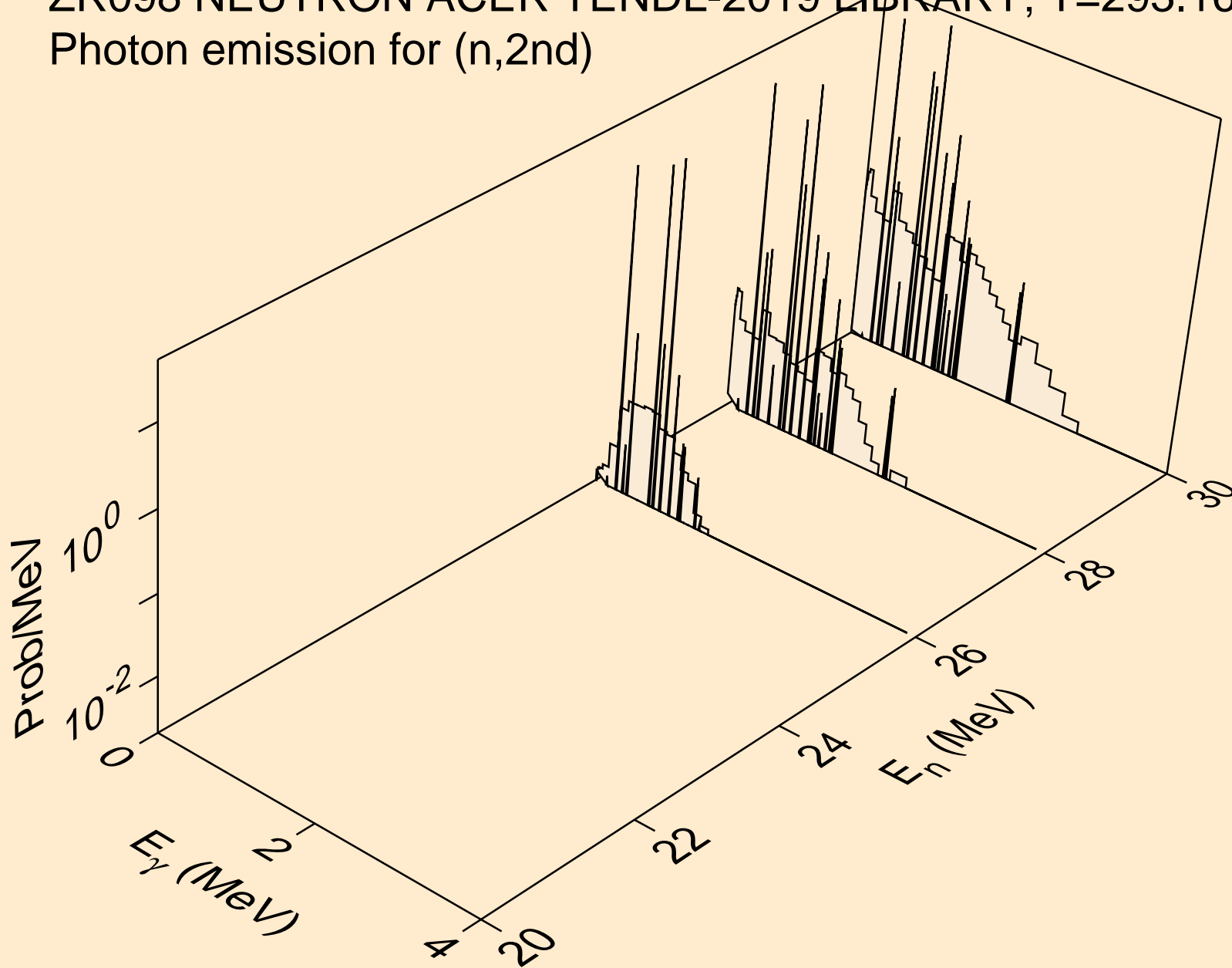

ZR098 NEUTRON ACER TENDL-2019 LIBRARY; T=293.16K  
Photon emission for (n,2n)

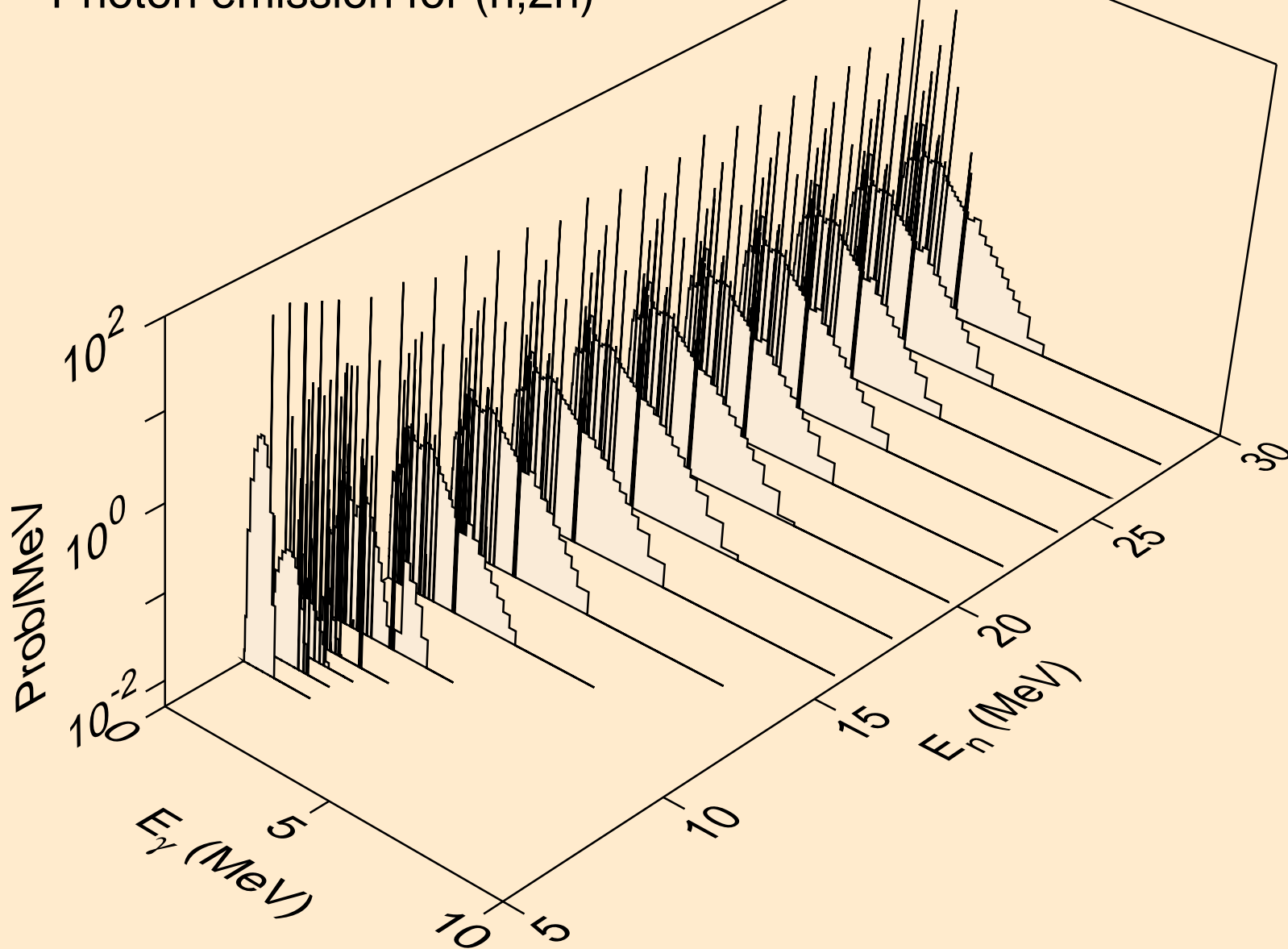



ZR098 NEUTRON ACER TENDL-2019 LIBRARY; T=293.16K  
Photon emission for (n,3n)

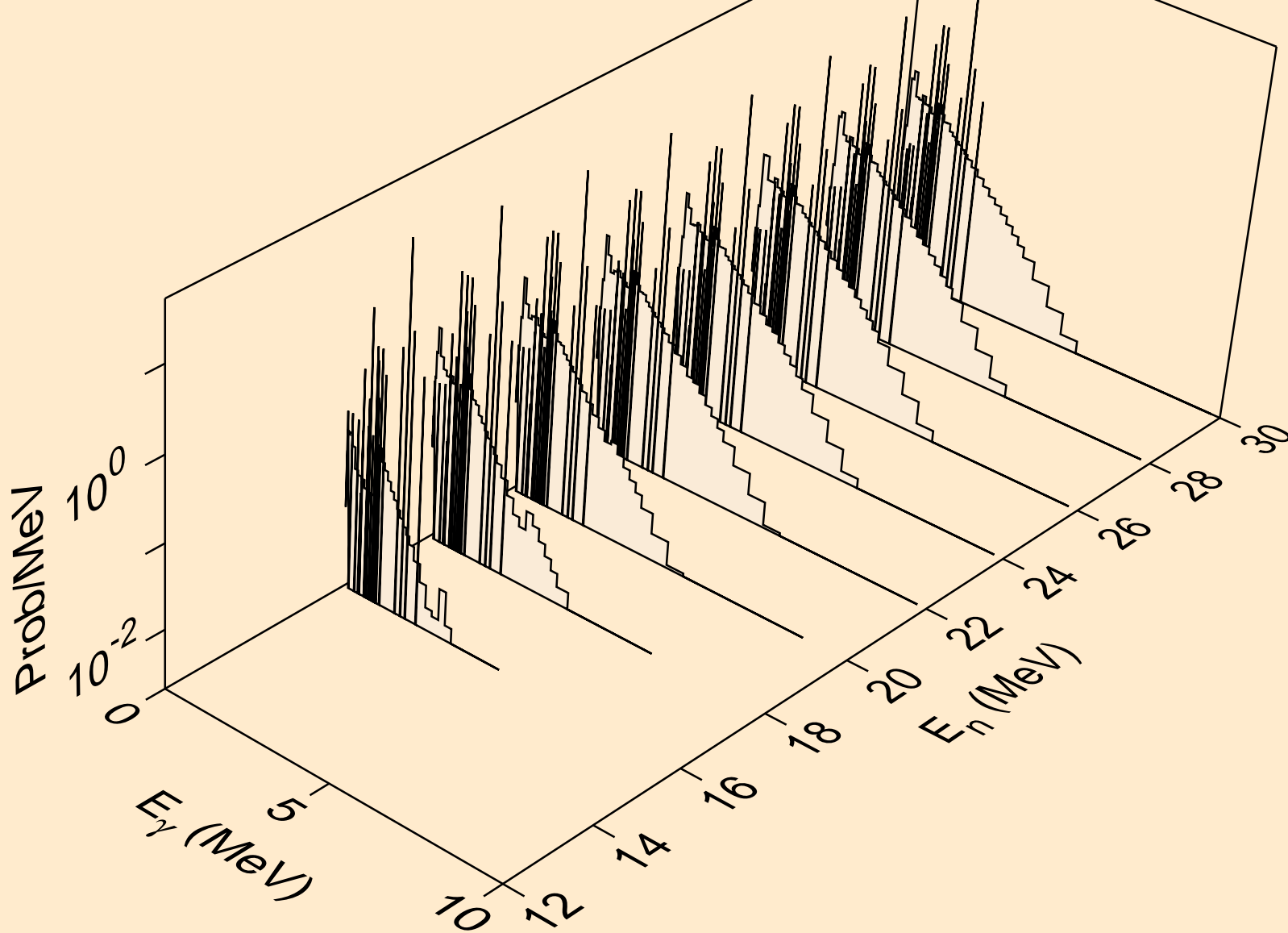

ZR098 NEUTRON ACER TENDL-2019 LIBRARY; T=293.16K  
Photon emission for (n,n\*)a

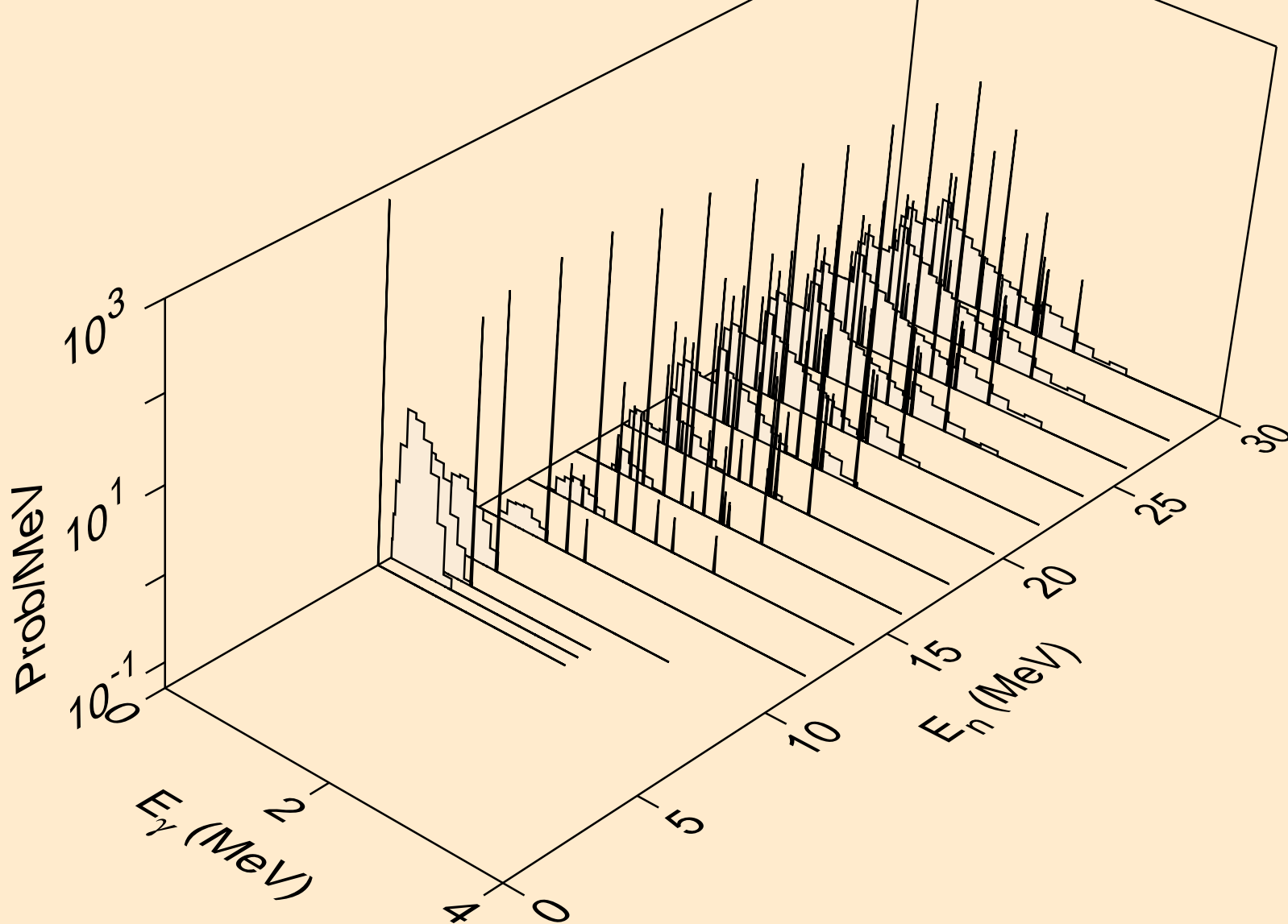

ZR098 NEUTRON ACER TENDL-2019 LIBRARY; T=293.16K  
Photon emission for (n,2n)a

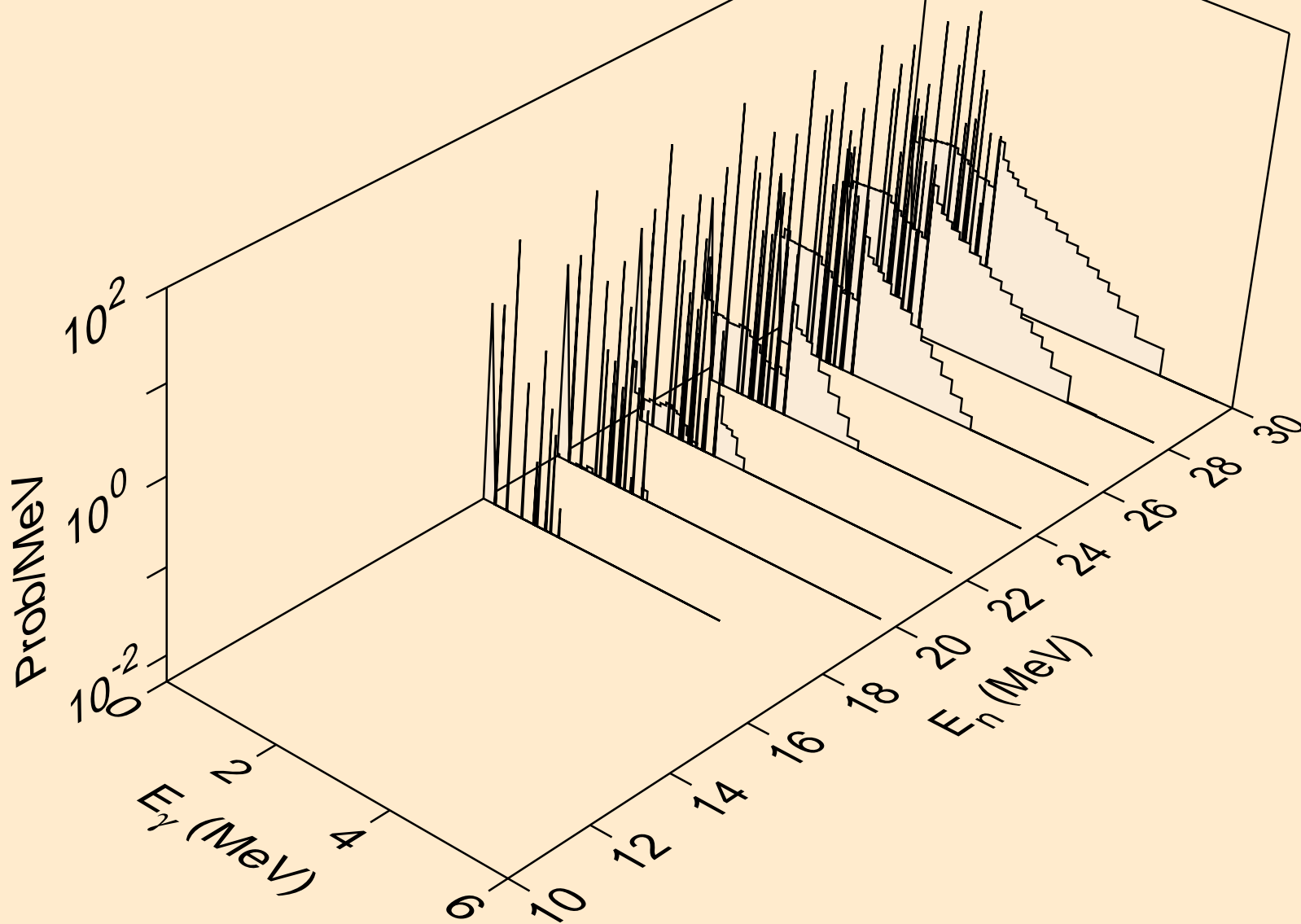

ZR098 NEUTRON ACER TENDL-2019 LIBRARY; T=293.16K  
Photon emission for (n,3n)a

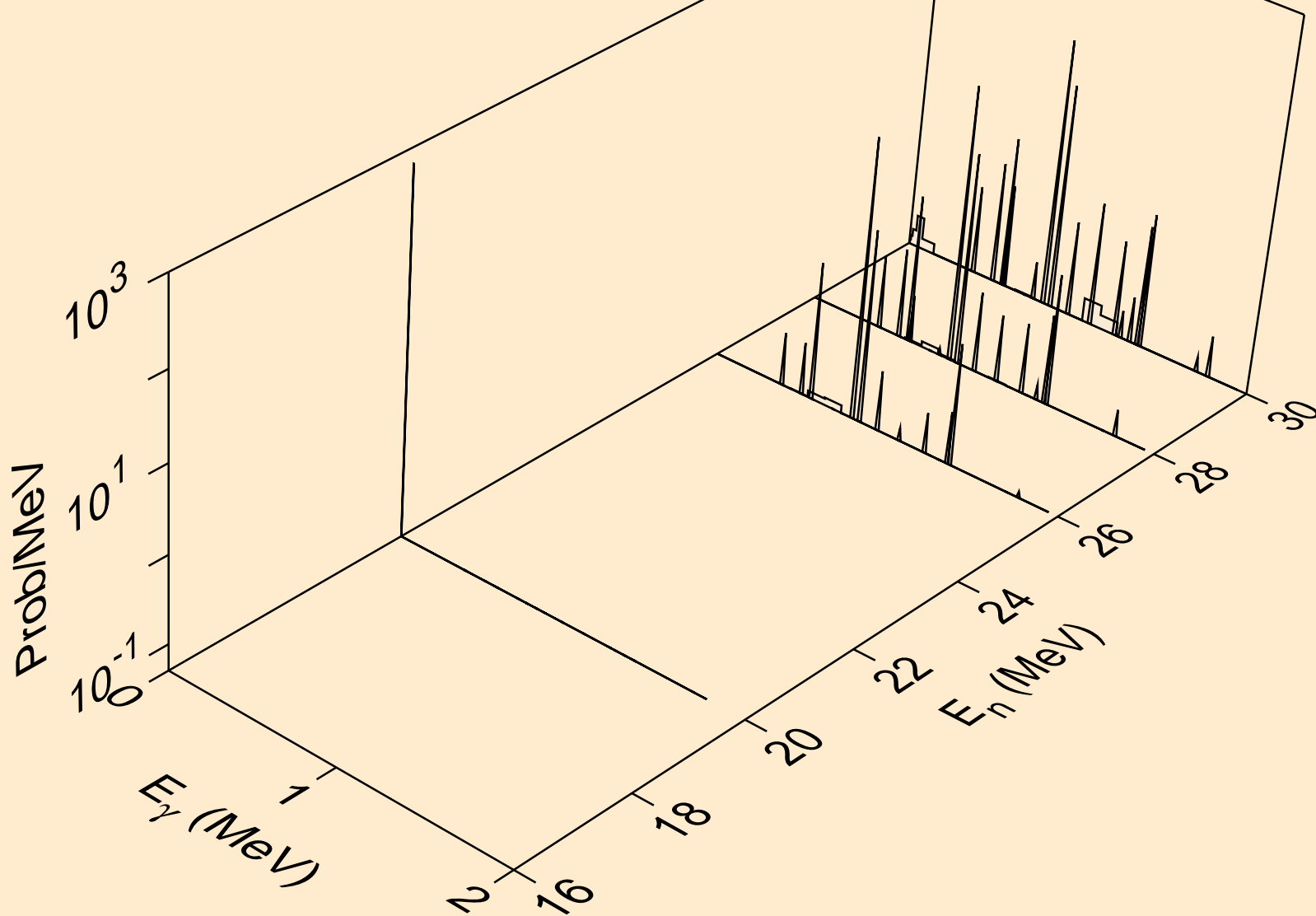

ZR098 NEUTRON ACER TENDL-2019 LIBRARY; T=293.16K  
Photon emission for (n,n\*)p

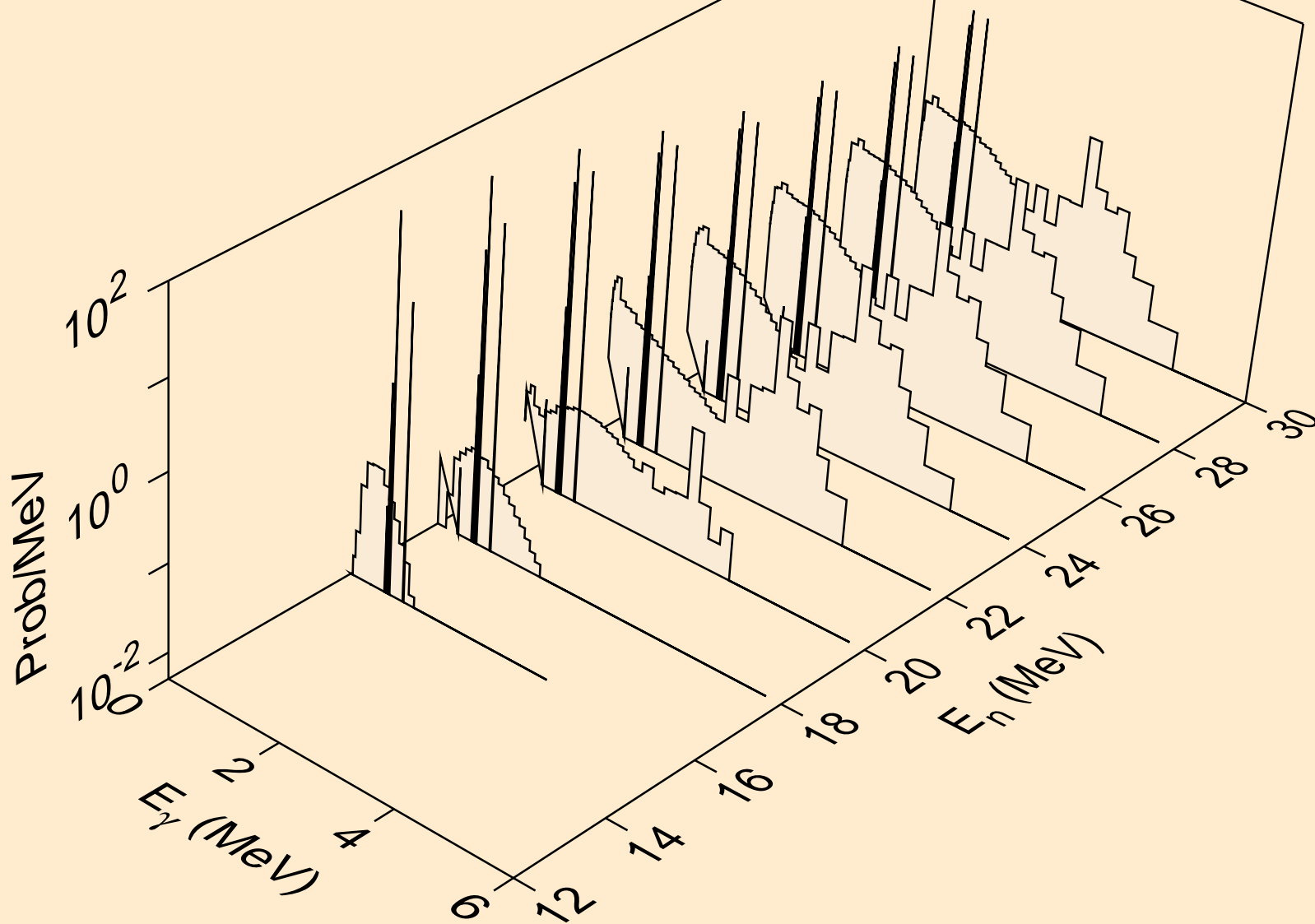

ZR098 NEUTRON ACER TENDL-2019 LIBRARY; T=293.16K  
Photon emission for (n,n\*)d

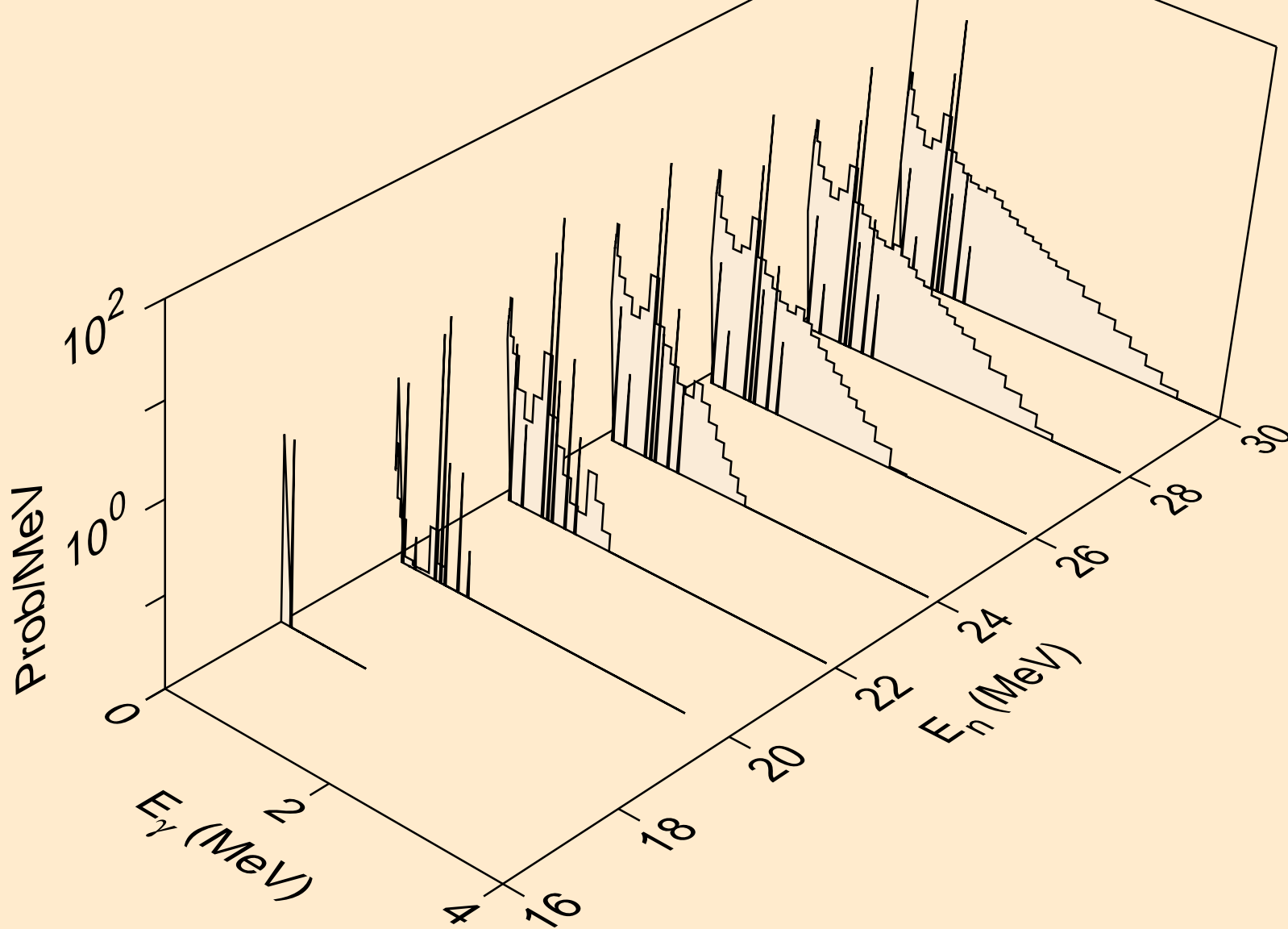

ZR098 NEUTRON ACER TENDL-2019 LIBRARY; T=293.16K  
Photon emission for (n,n\*)t

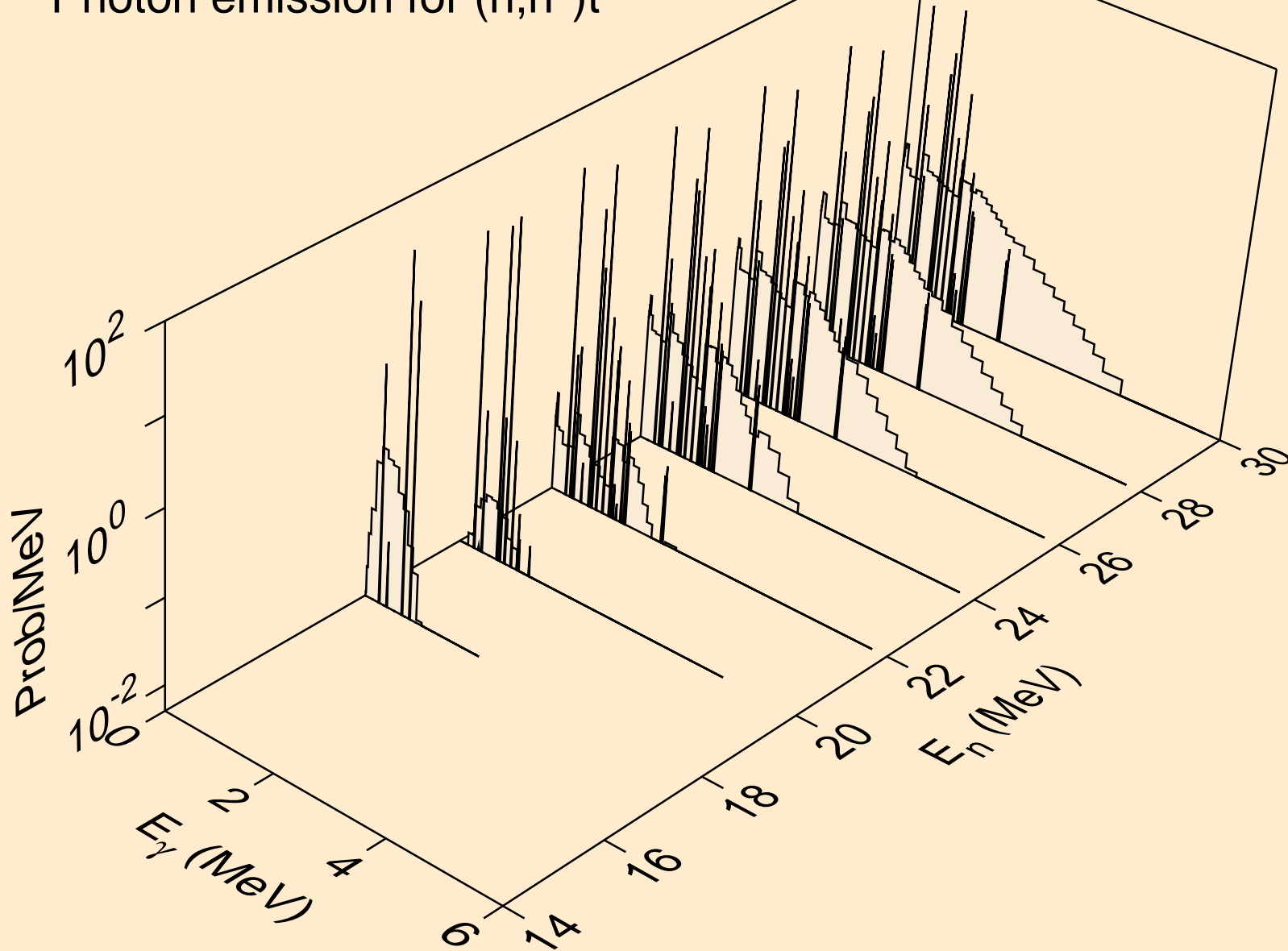

ZR098 NEUTRON ACER TENDL-2019 LIBRARY; T=293.16K  
Photon emission for (n,n\*)he3

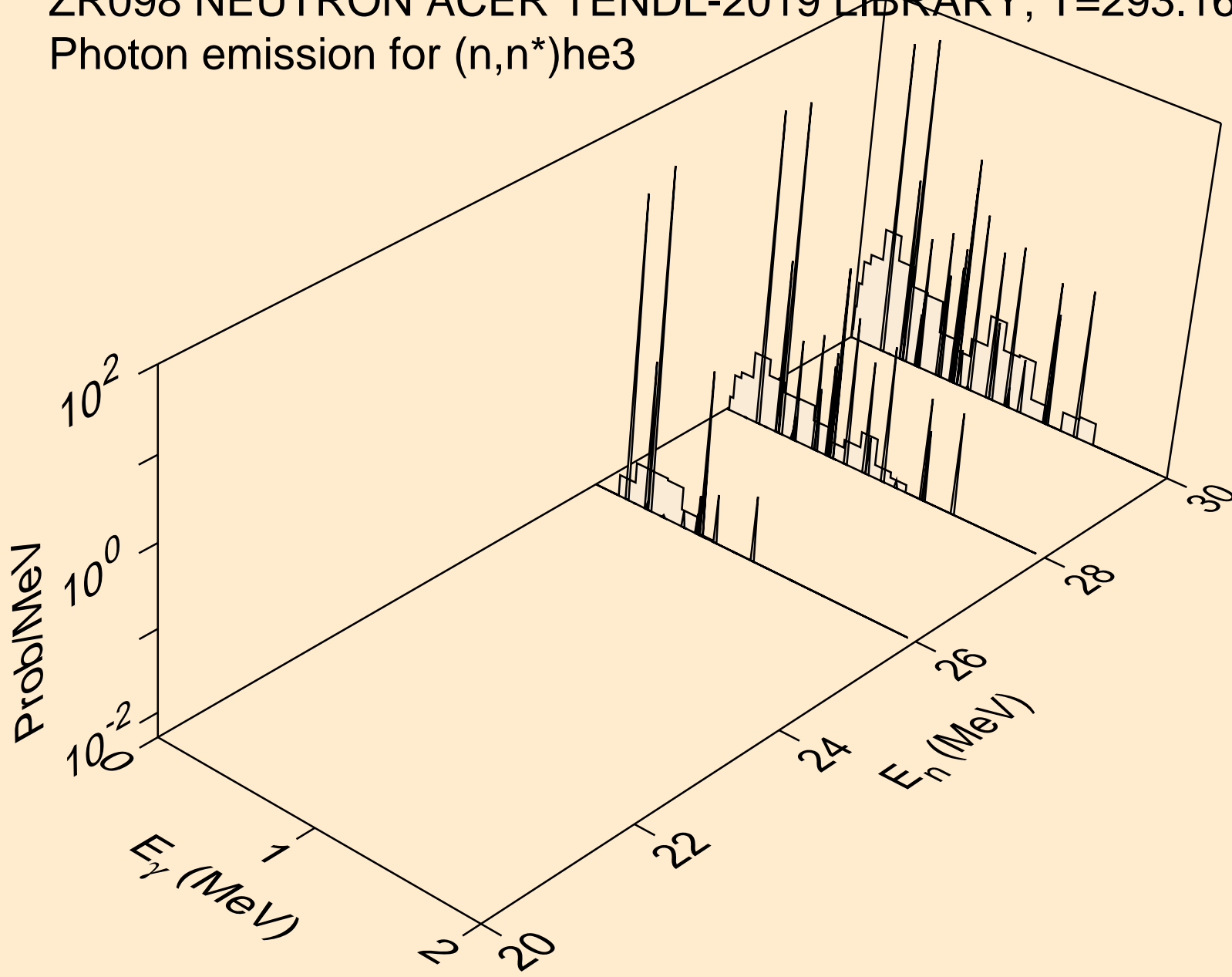



ZR098 NEUTRON ACER TENDL-2019 LIBRARY; T=293.16K  
Photon emission for (n,4n)

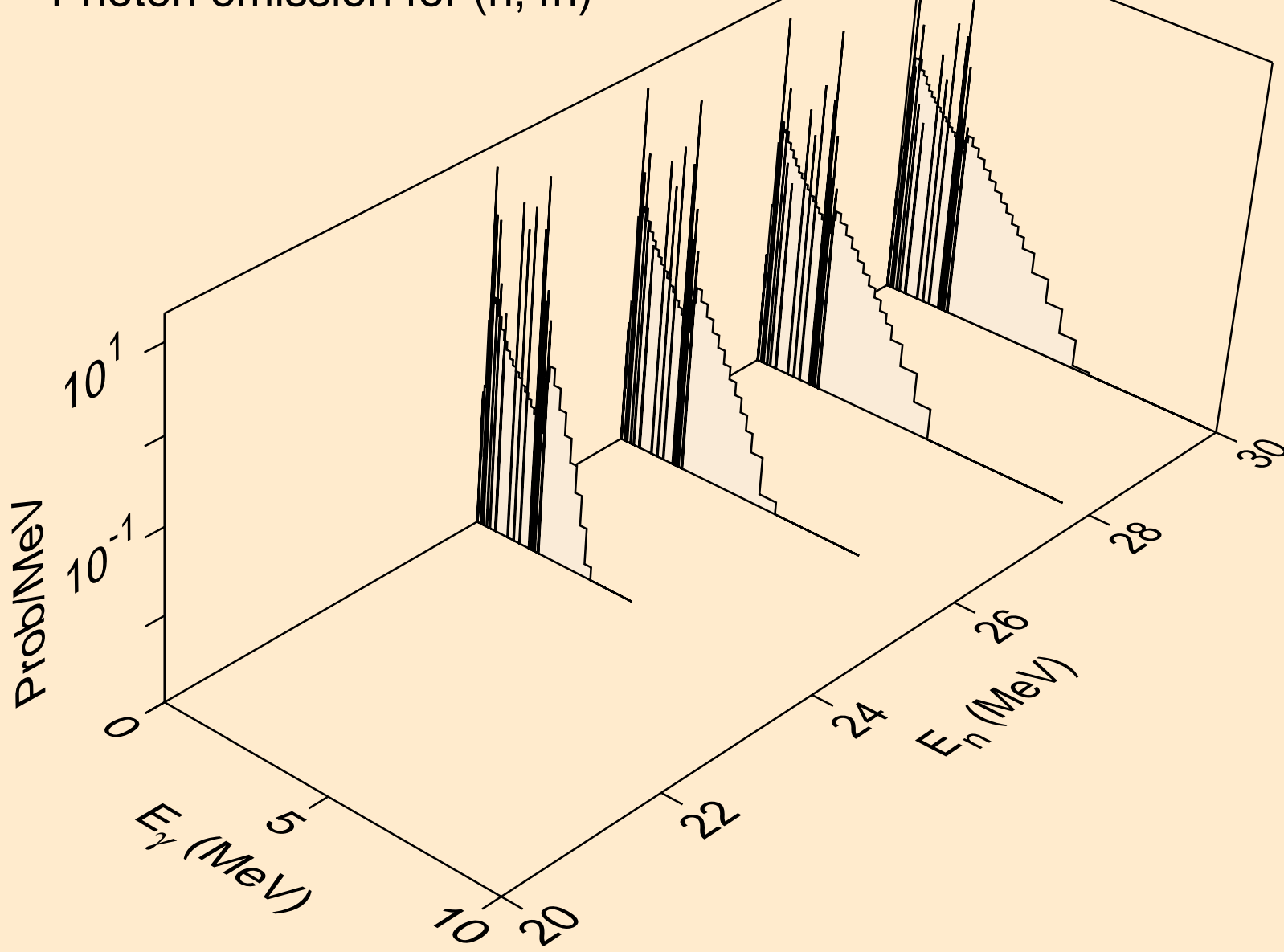

ZR098 NEUTRON ACER TENDL-2019 LIBRARY; T=293.16K  
Photon emission for (n,2np)

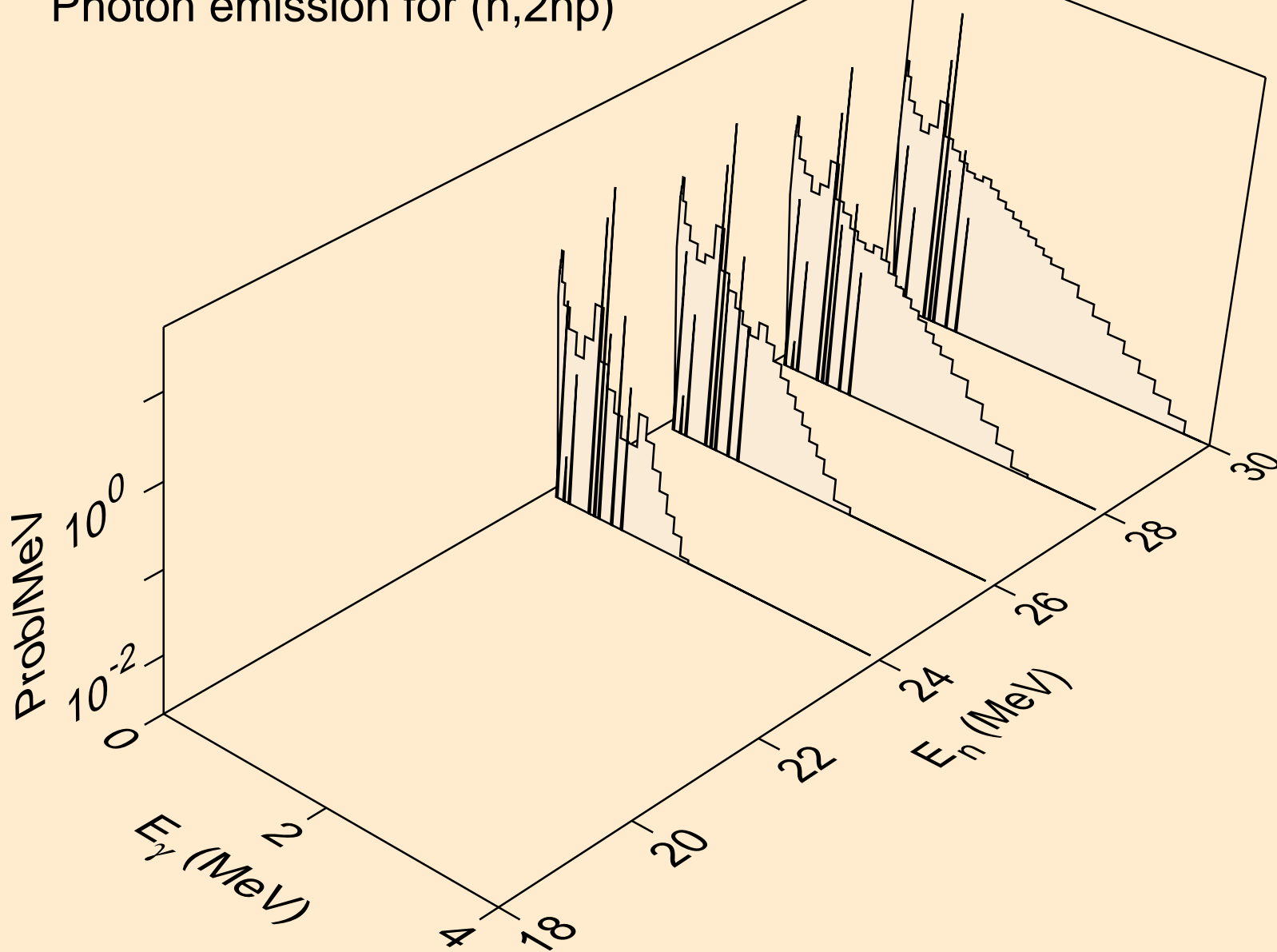

ZR098 NEUTRON ACER TENDL-2019 LIBRARY; T=293.16K  
Photon emission for (n,3np)

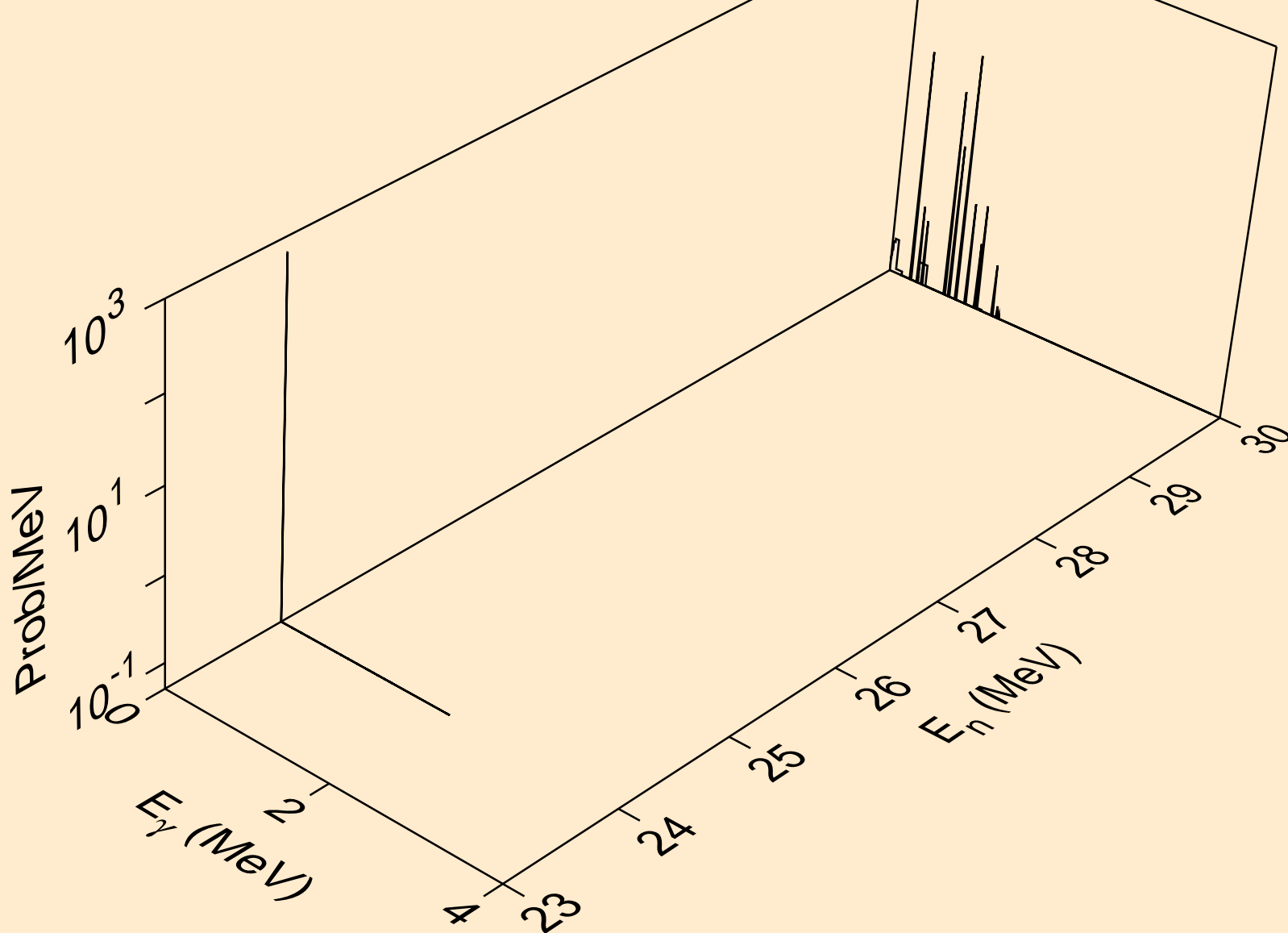

ZR098 NEUTRON ACER TENDL-2019 LIBRARY; T=293.16K  
Photon emission for (n,n\*c)

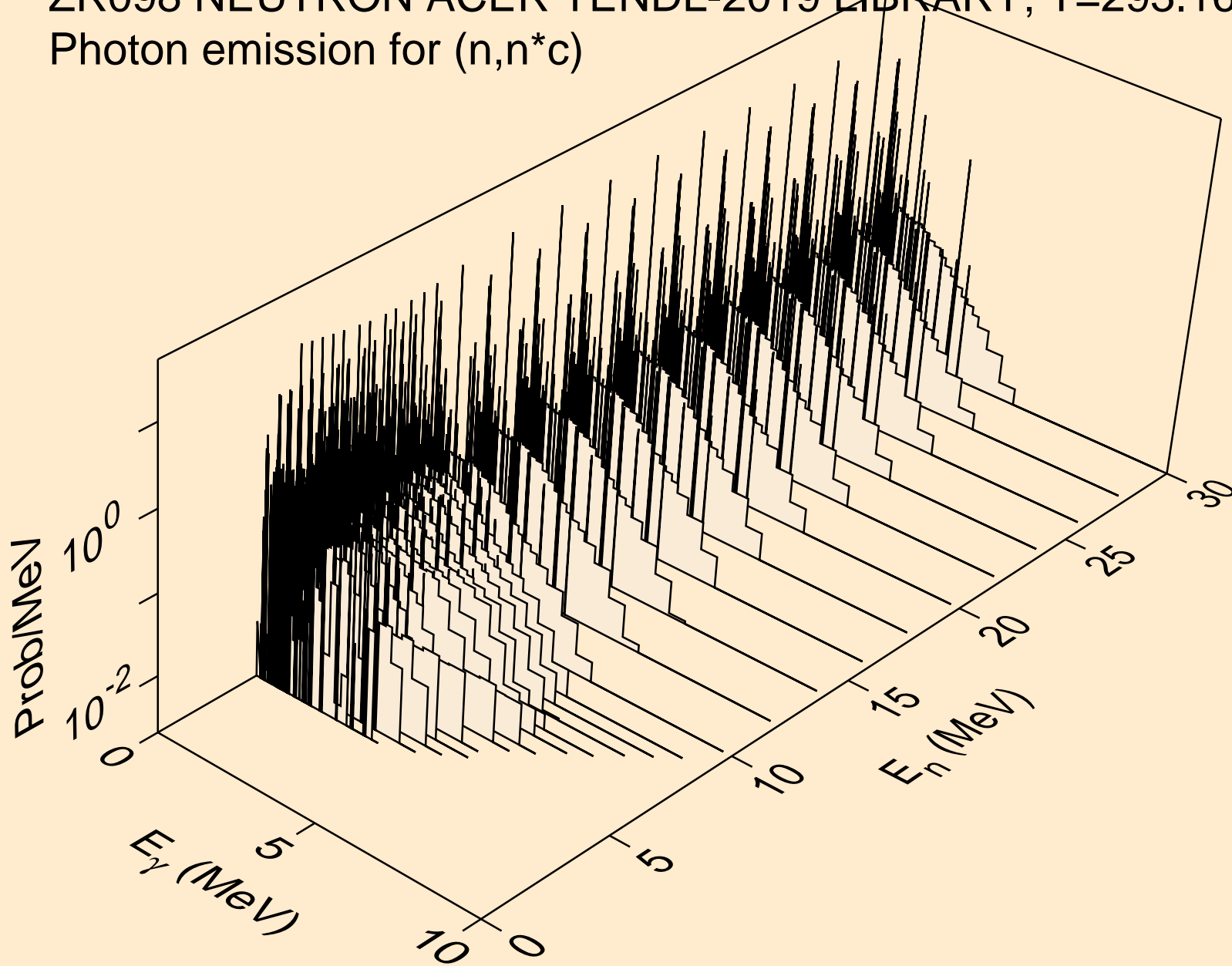

ZR098 NEUTRON ACER TENDL-2019 LIBRARY; T=293.16K  
Photon emission for (n,gma)

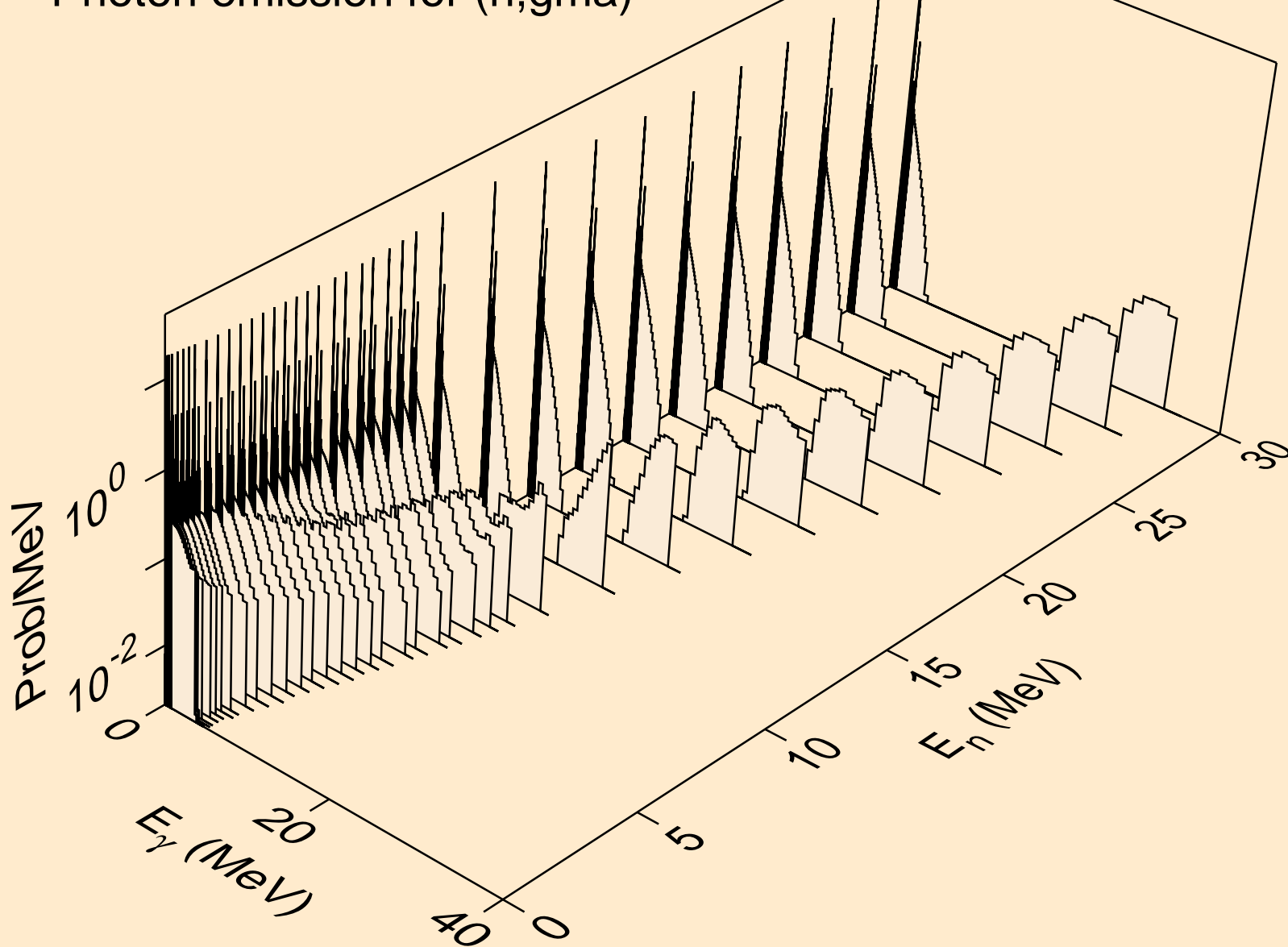

ZR098 NEUTRON ACER TENDL-2019 LIBRARY; T=293.16K  
Photon emission for (n,p)

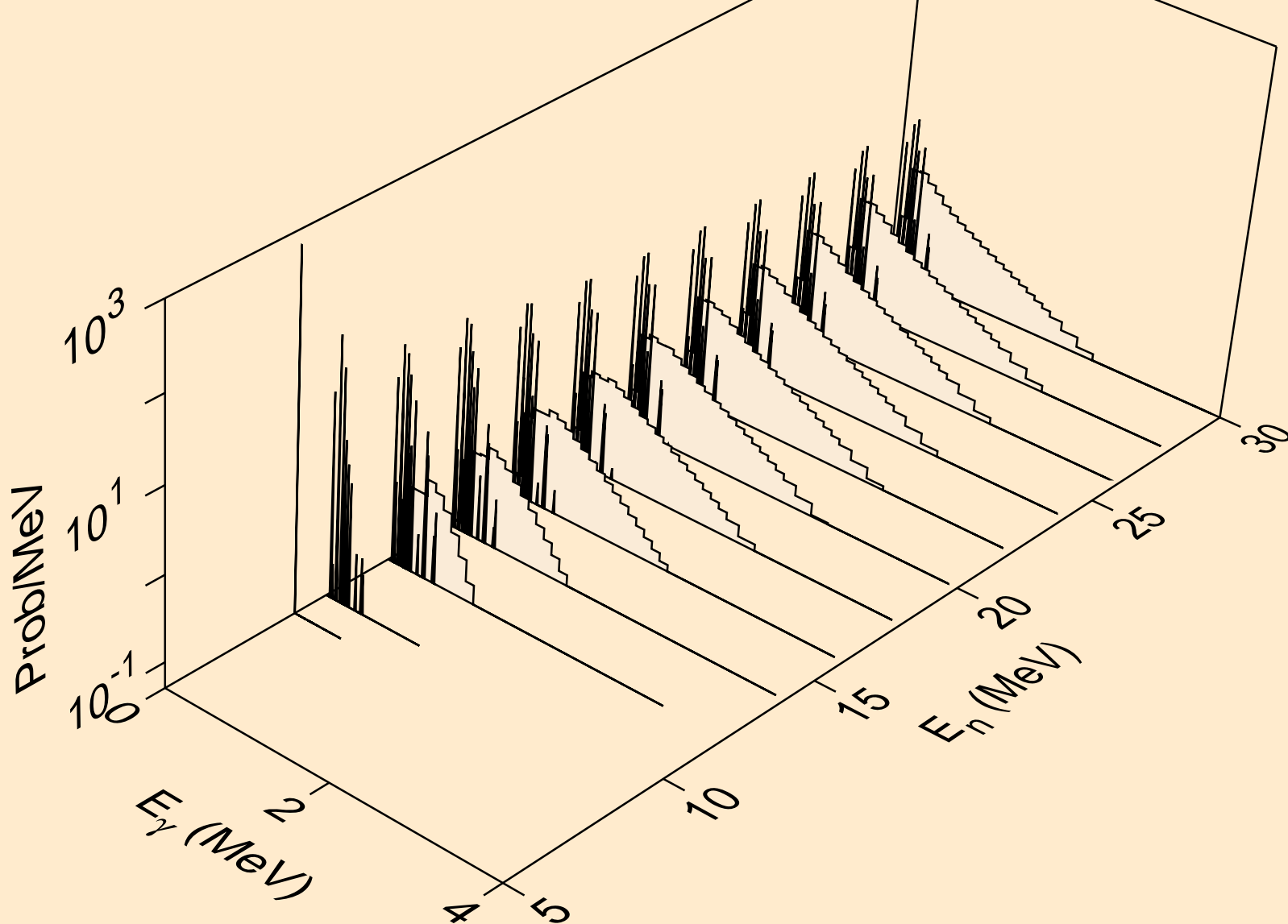

ZR098 NEUTRON ACER TENDL-2019 LIBRARY; T=293.16K  
Photon emission for (n,d)

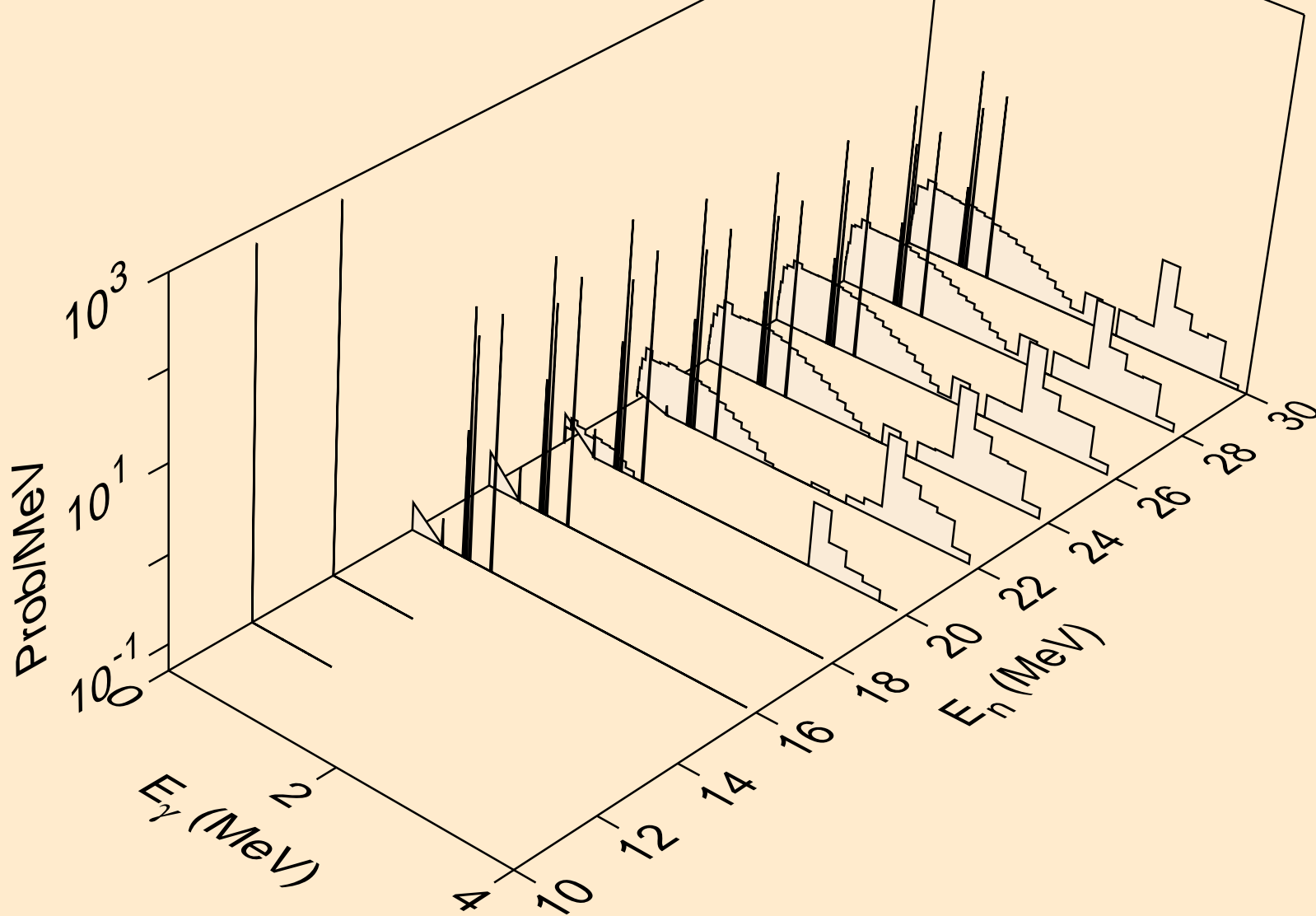

ZR098 NEUTRON ACER TENDL-2019 LIBRARY; T=293.16K  
Photon emission for (n,t)

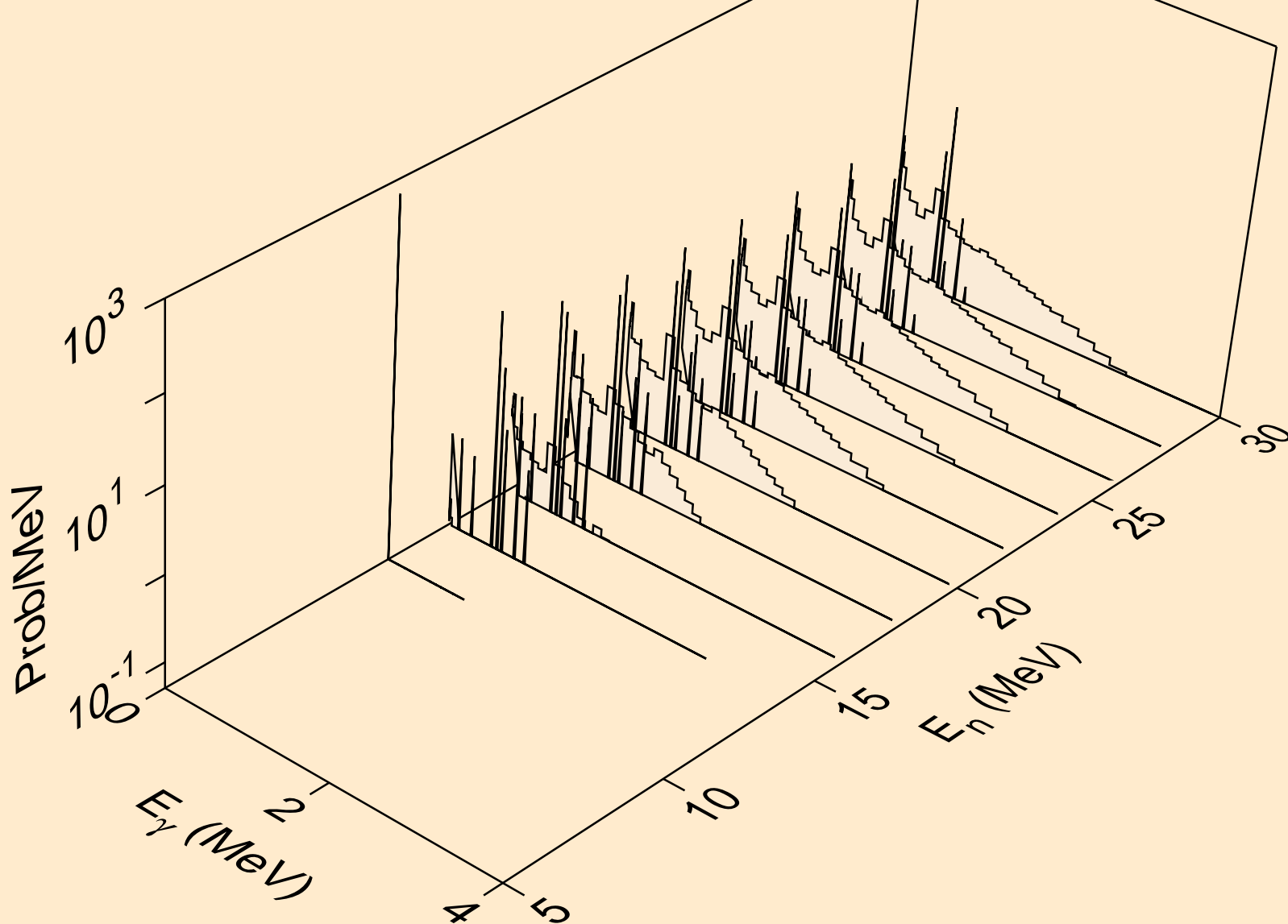



ZR098 NEUTRON ACER TENDL-2019 LIBRARY; T=293.16K  
Photon emission for (n,he3)

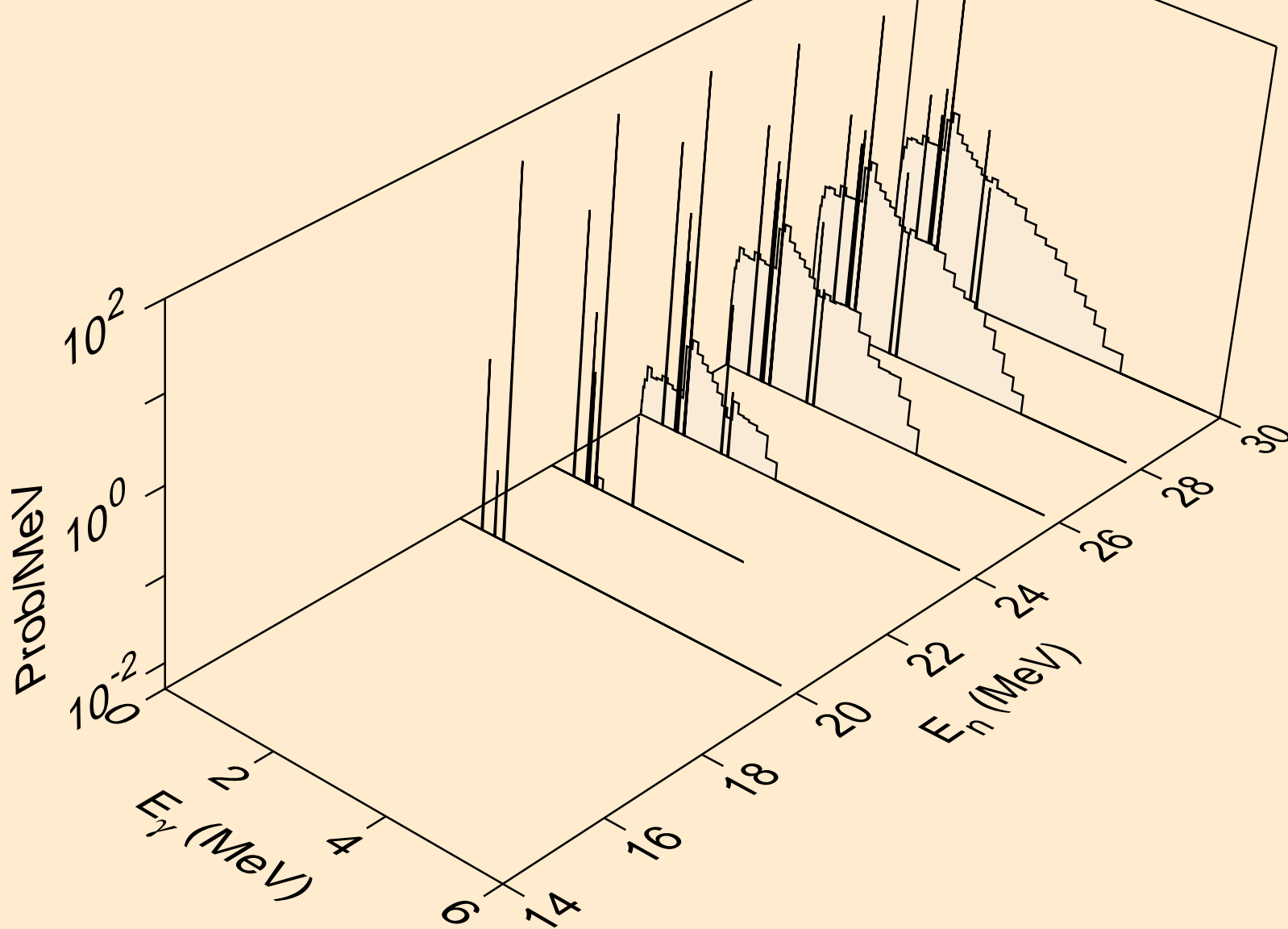

ZR098 NEUTRON ACER TENDL-2019 LIBRARY; T=293.16K  
Photon emission for (n,a)

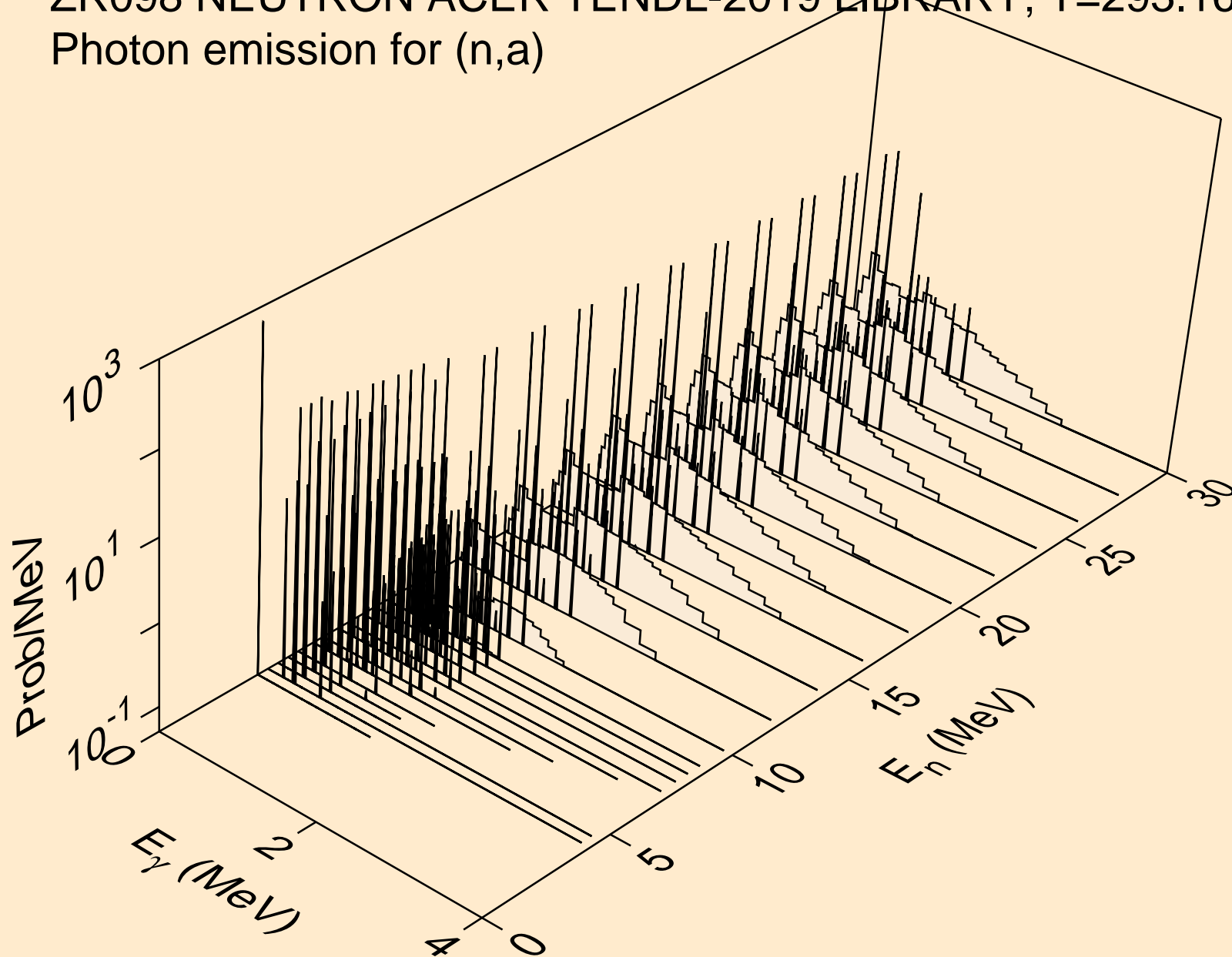

ZR098 NEUTRON ACER TENDL-2019 LIBRARY; T=293.16K  
Photon emission for (n,2p)

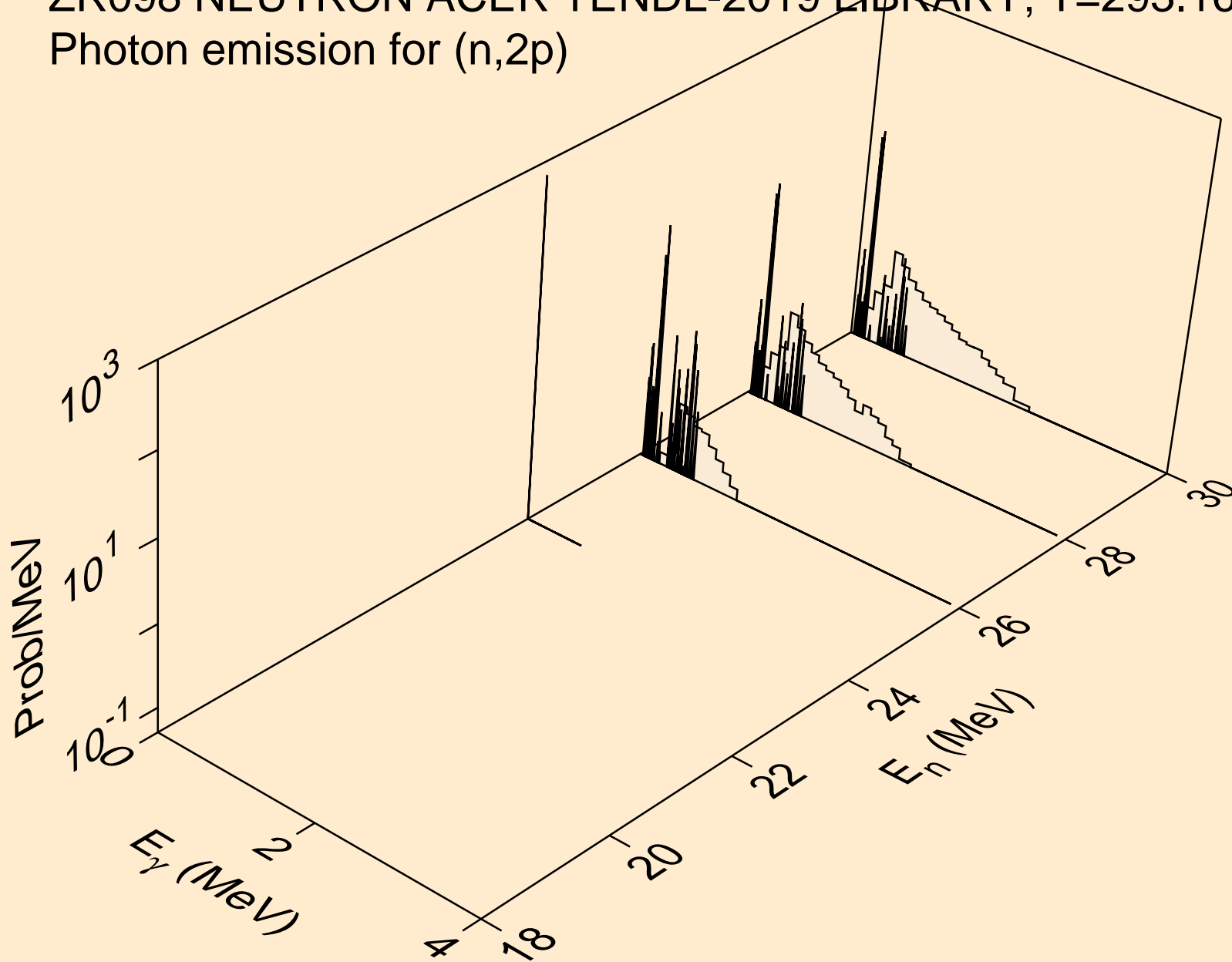

ZR098 NEUTRON ACER TENDL-2019 LIBRARY; T=293.16K  
thermal capture photon spectrum

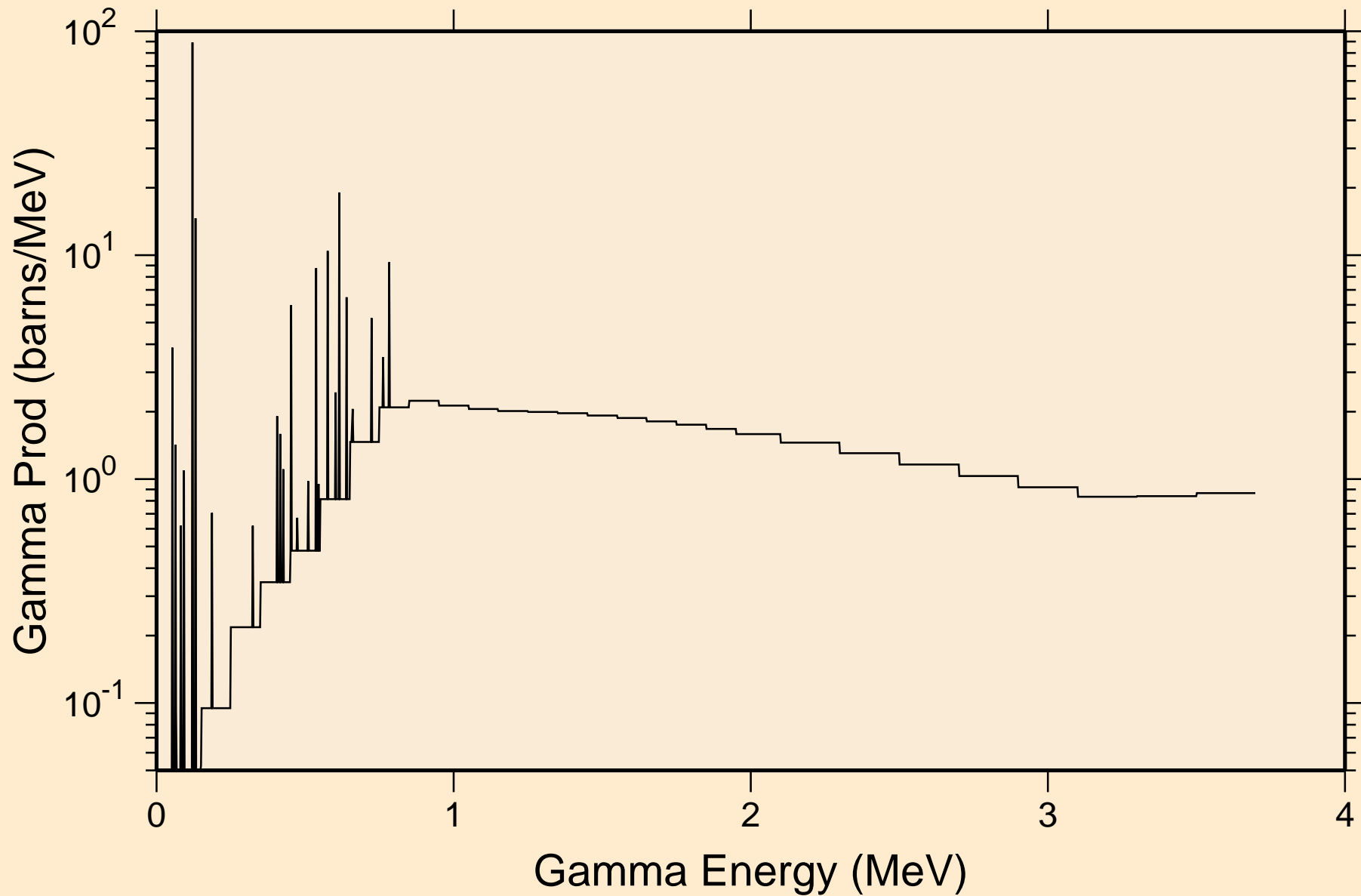

ZR098 NEUTRON ACER TENDL-2019 LIBRARY; T=293.16K  
14 MeV photon spectrum

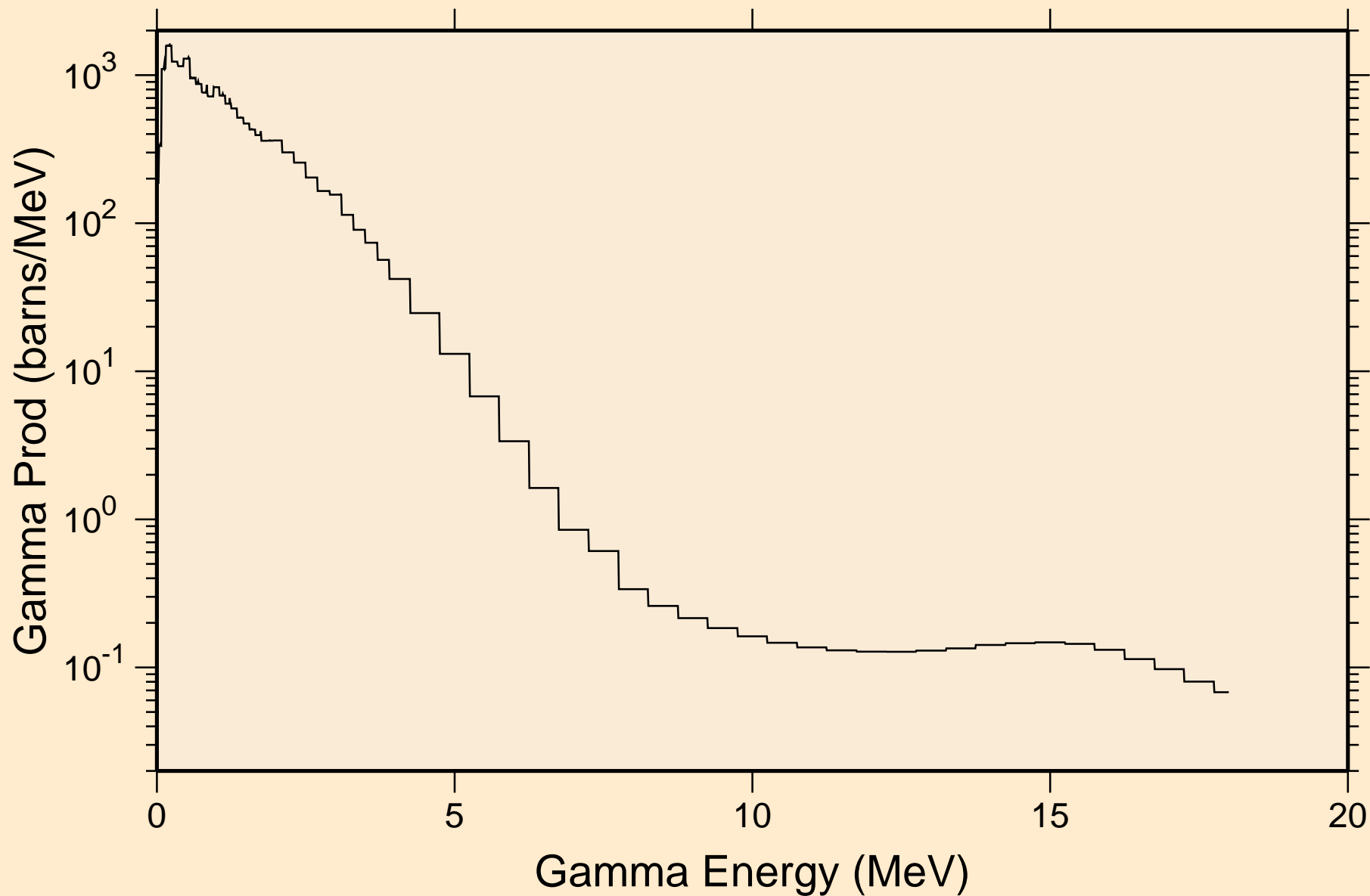

ZR098 NEUTRON ACER TENDL-2019 LIBRARY; T=293.16K  
Particle heating contributions

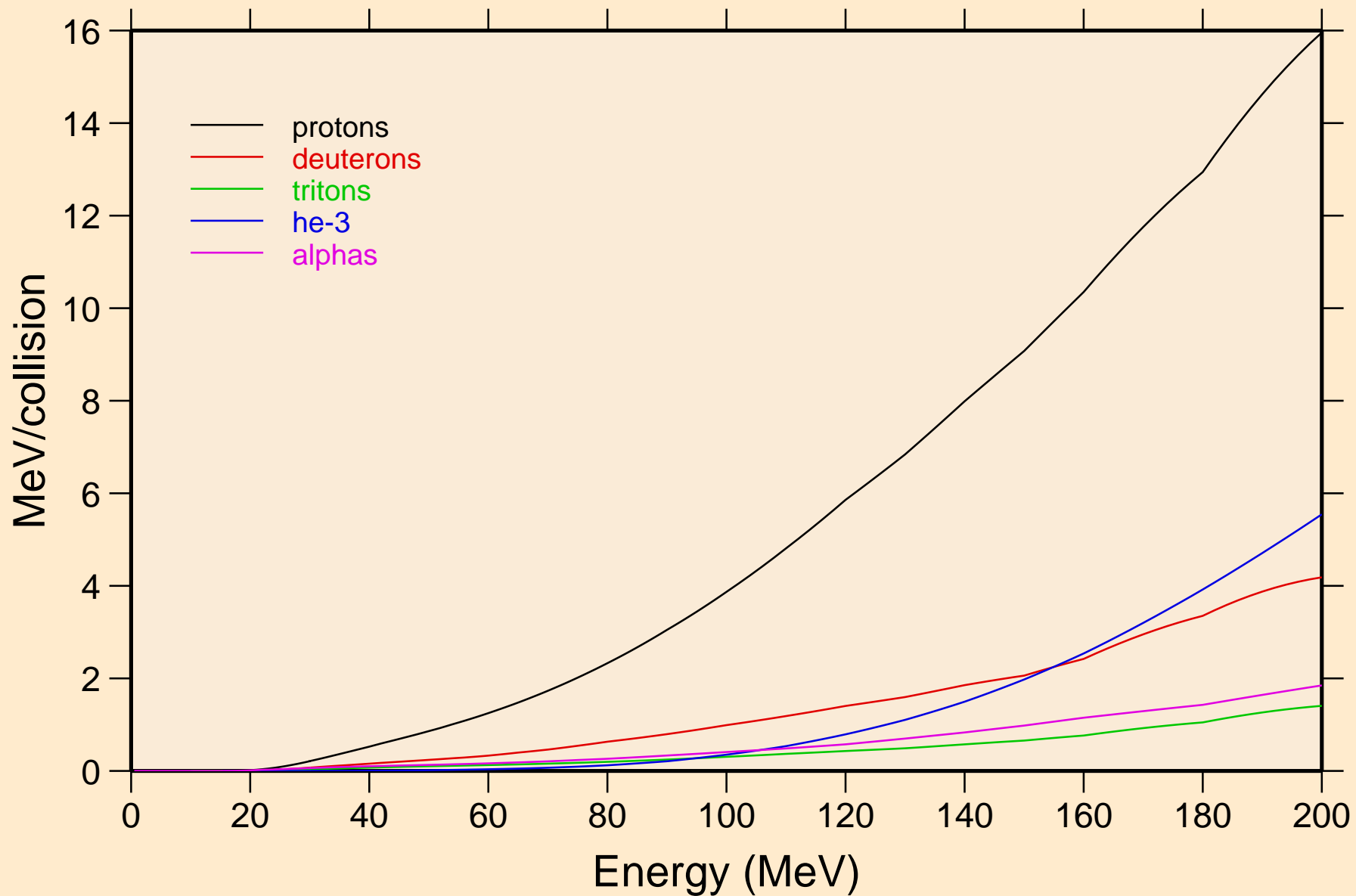

ZR098 NEUTRON ACER TENDL-2019 LIBRARY; T=293.16K  
Recoil Heating

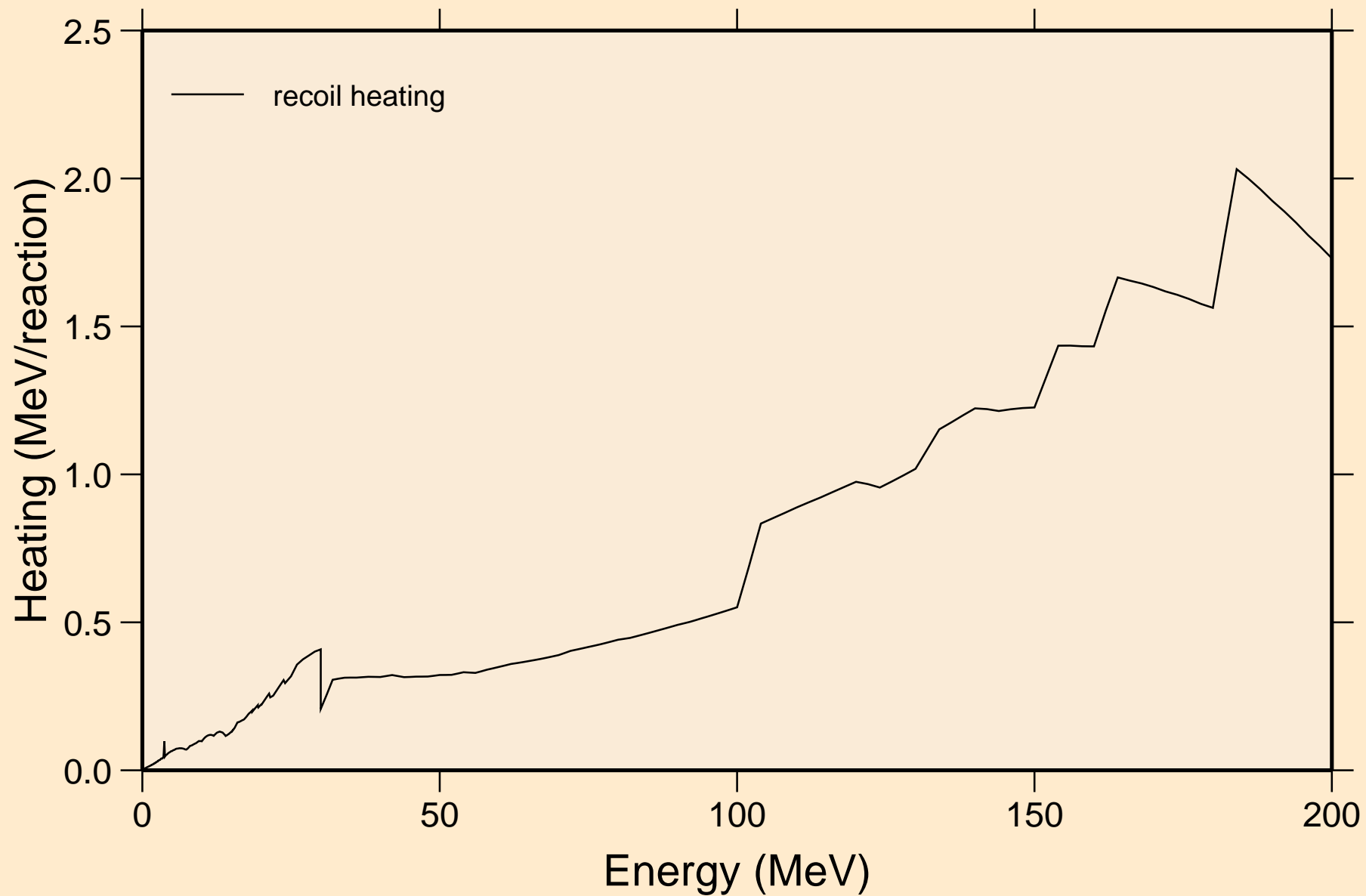

ZR098 NEUTRON ACER TENDL-2019 LIBRARY; T=293.16K  
Particle production cross sections

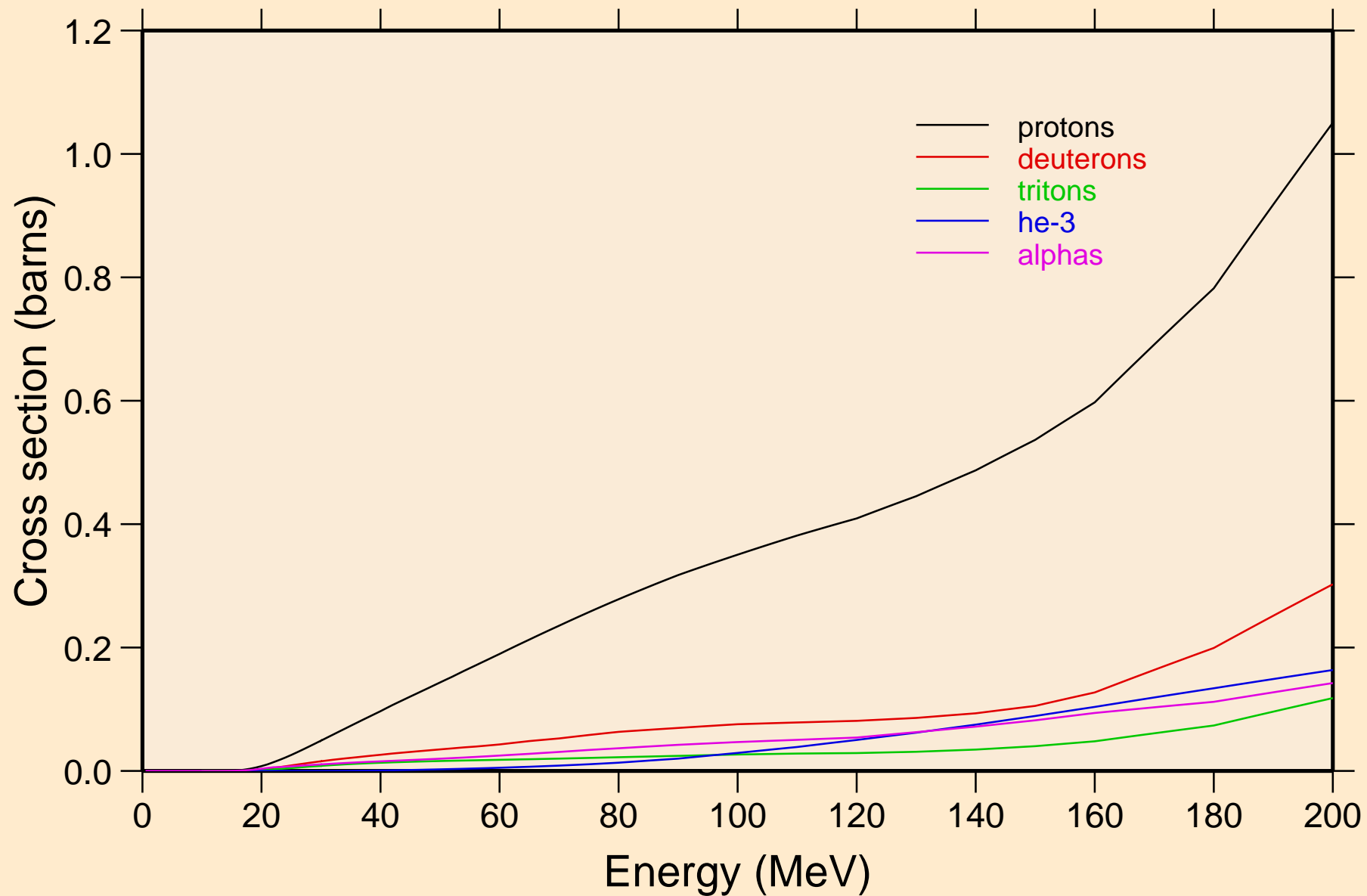



ZR098 NEUTRON ACER TENDL-2019 LIBRARY; T=293.16K  
protons from (n,x)

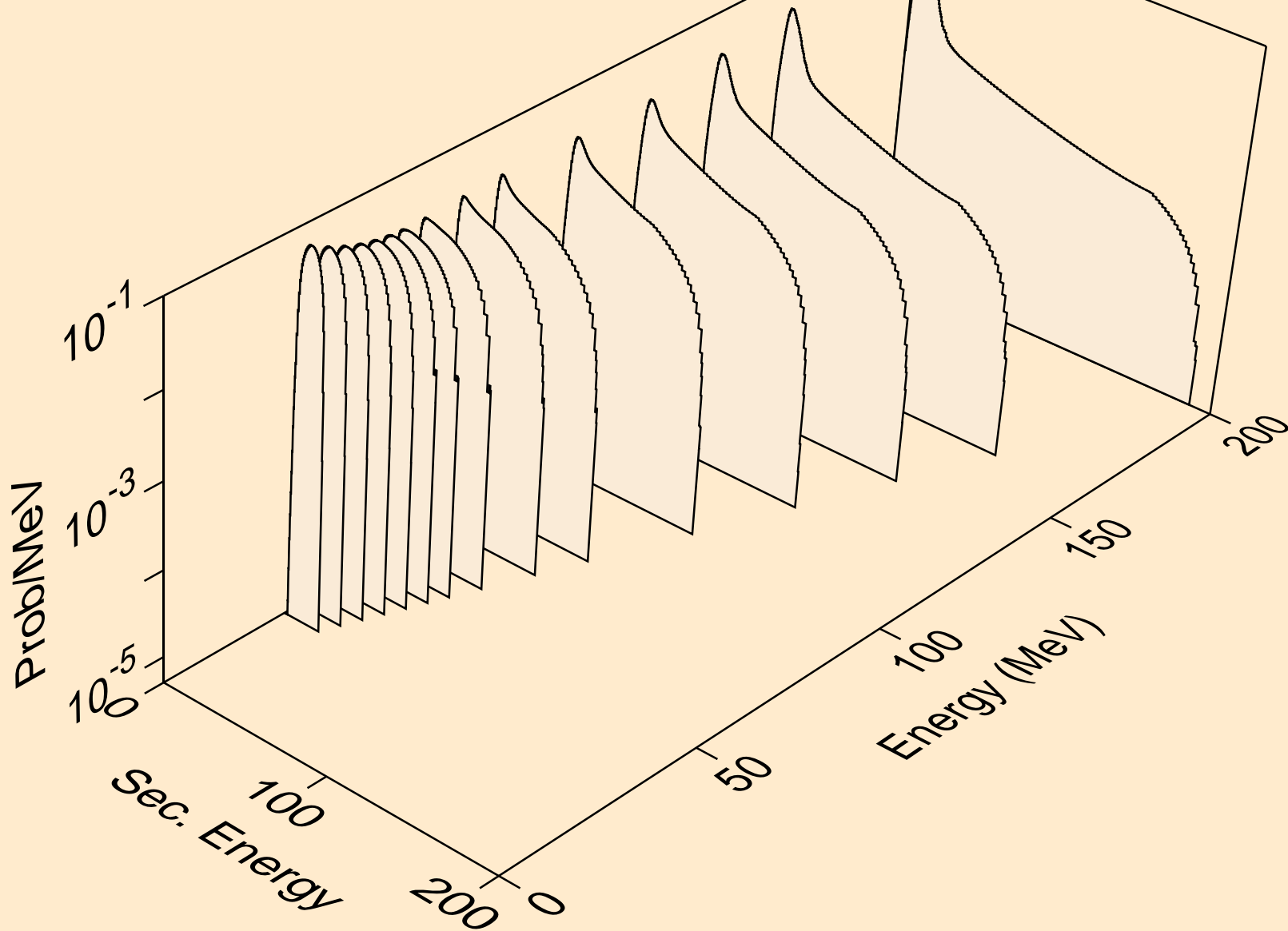

ZR098 NEUTRON ACER TENDL-2019 LIBRARY; T=293.16K  
protons from (n,n\*)p

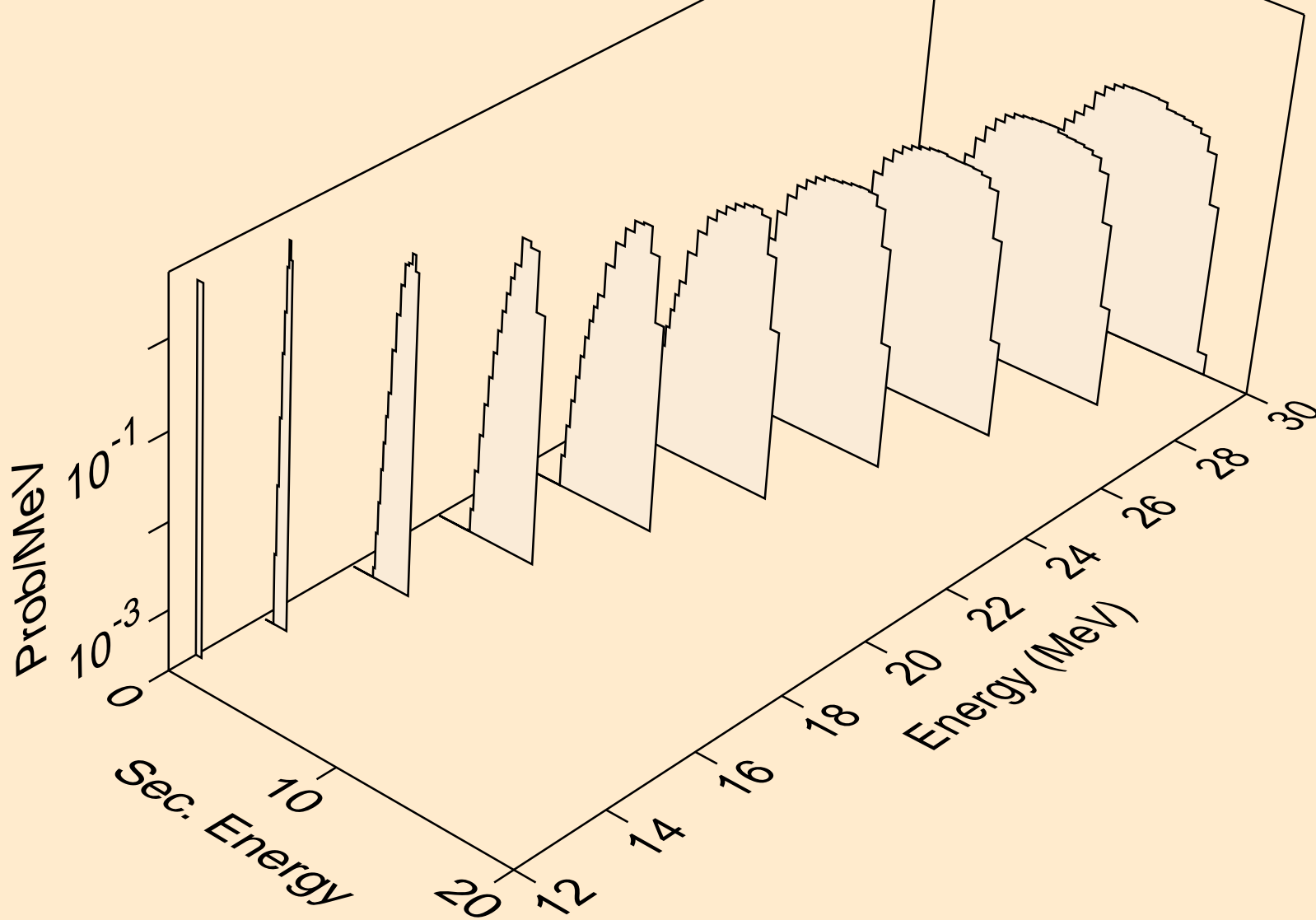

ZR098 NEUTRON ACER TENDL-2019 LIBRARY; T=293.16K  
protons from (n,2np)

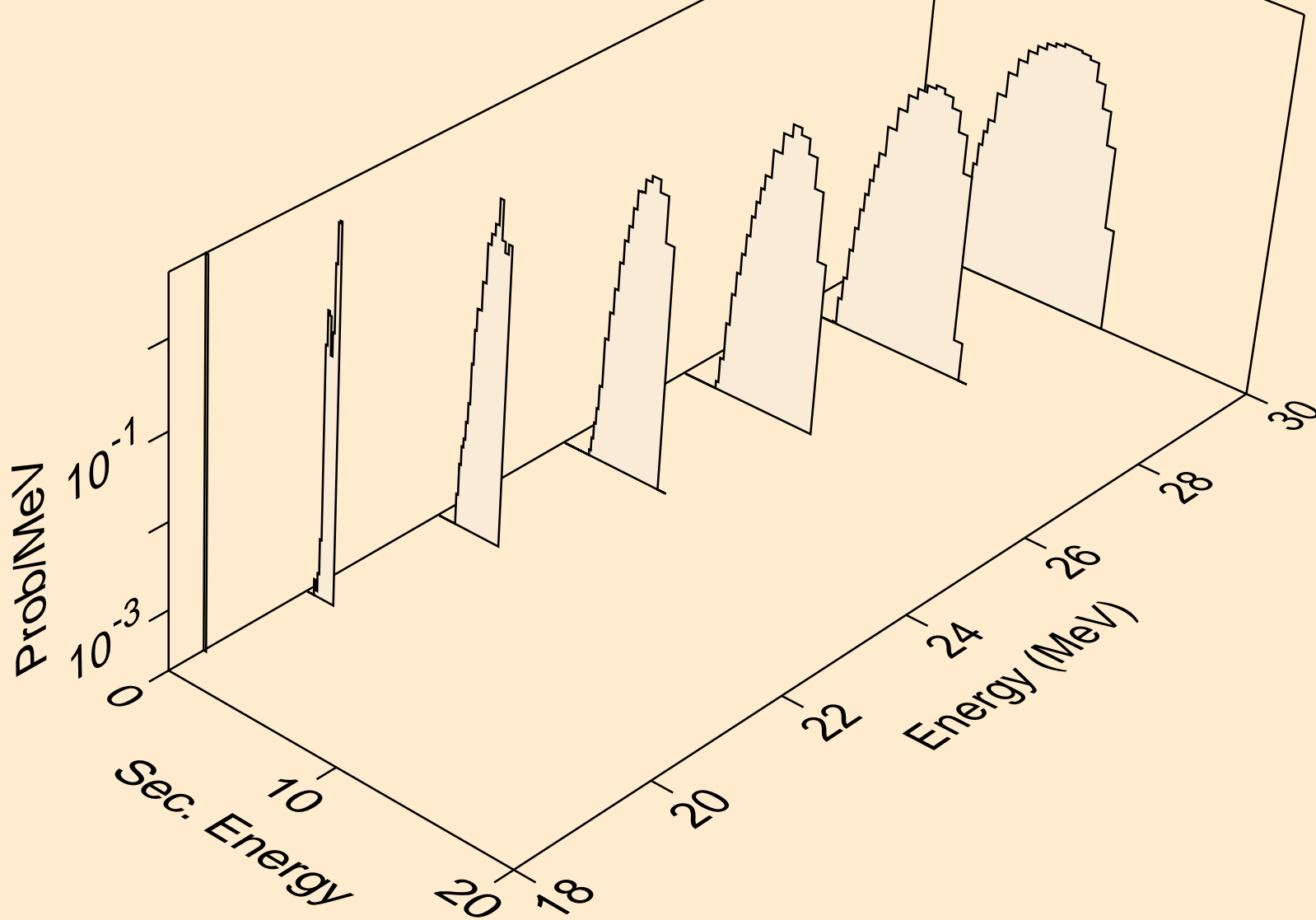

ZR098 NEUTRON ACER TENDL-2019 LIBRARY; T=293.16K  
protons from (n,3np)

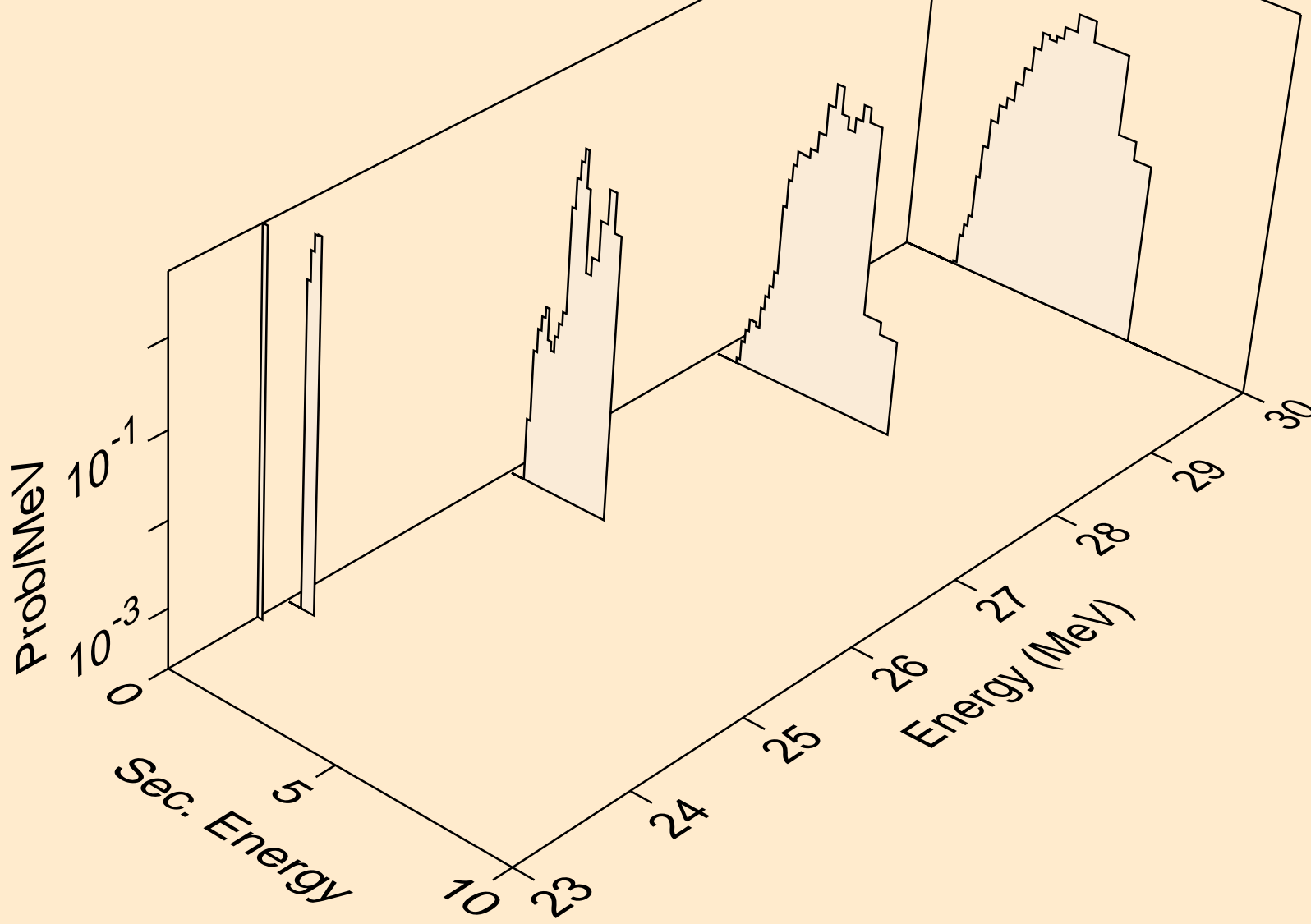

ZR098 NEUTRON ACER TENDL-2019 LIBRARY; T=293.16K  
protons from (n,p)

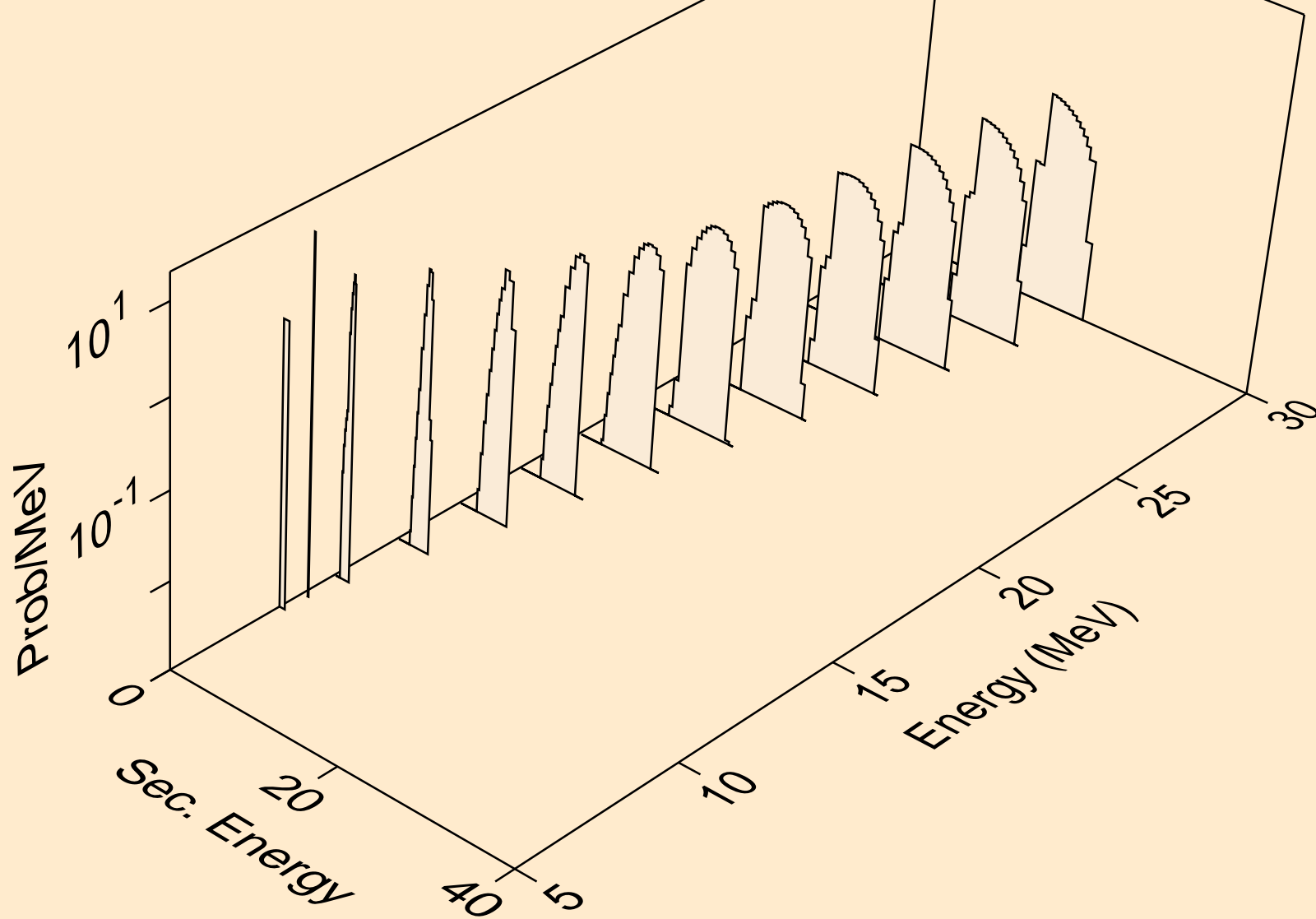

ZR098 NEUTRON ACER TENDL-2019 LIBRARY; T=293.16K  
protons from (n,2p)

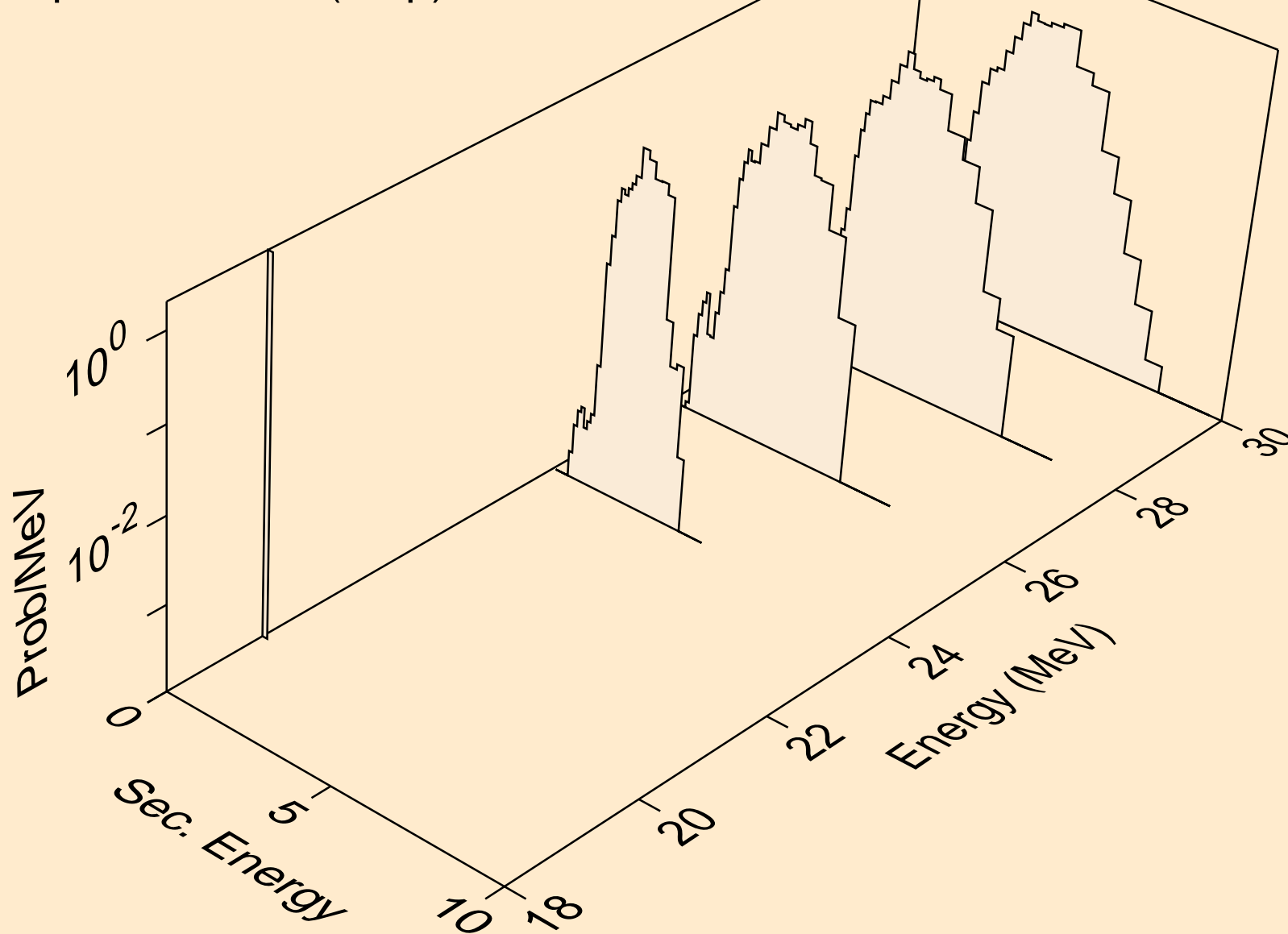

ZR098 NEUTRON ACER TENDL-2019 LIBRARY; T=293.16K  
deuterons from (n,x)

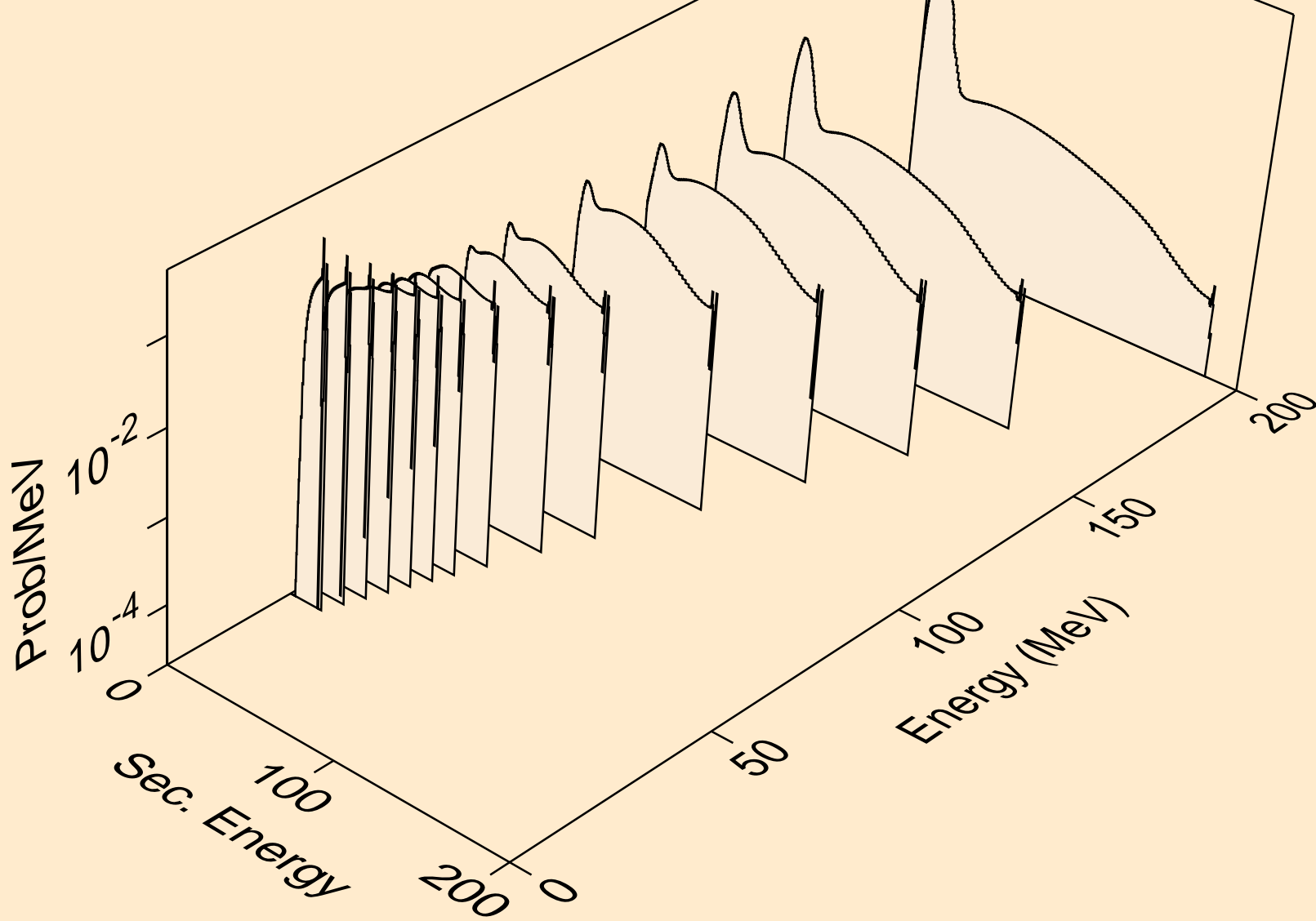

ZR098 NEUTRON ACER TENDL-2019 LIBRARY; T=293.16K  
deuterons from (n,2nd)

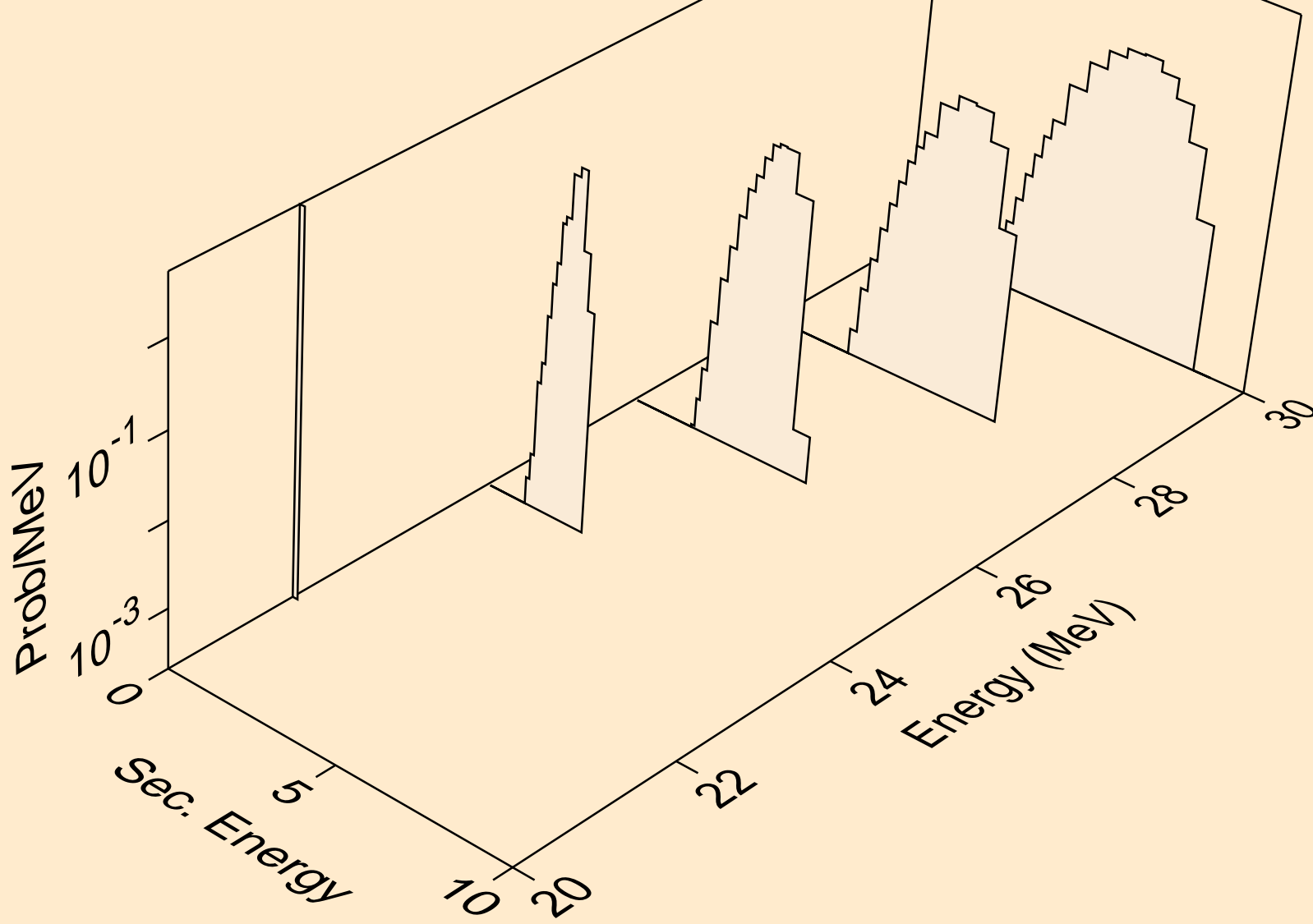



ZR098 NEUTRON ACER TENDL-2019 LIBRARY; T=293.16K  
deuterons from (n,n\*)d

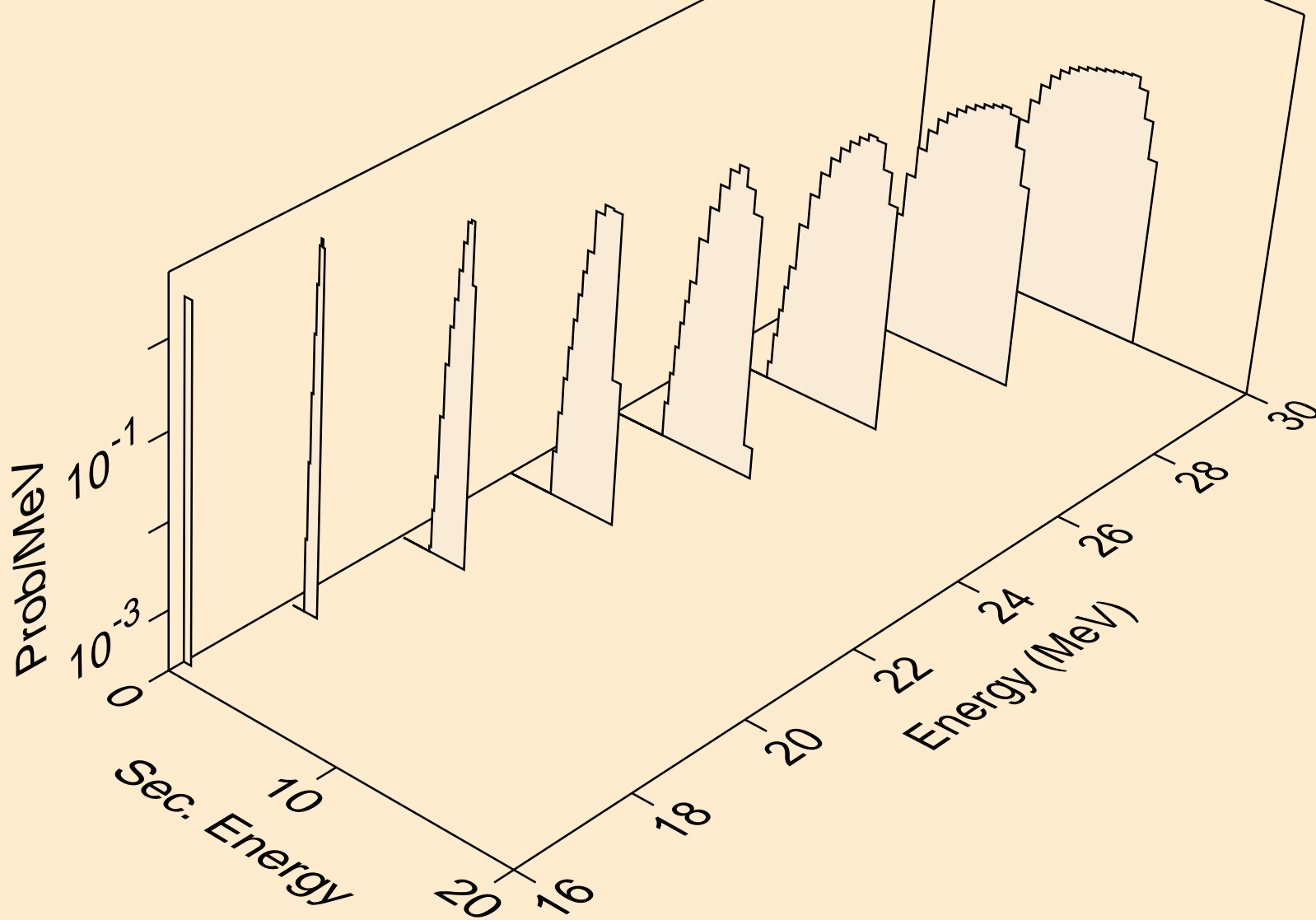

ZR098 NEUTRON ACER TENDL-2019 LIBRARY; T=293.16K  
deuterons from (n,d)

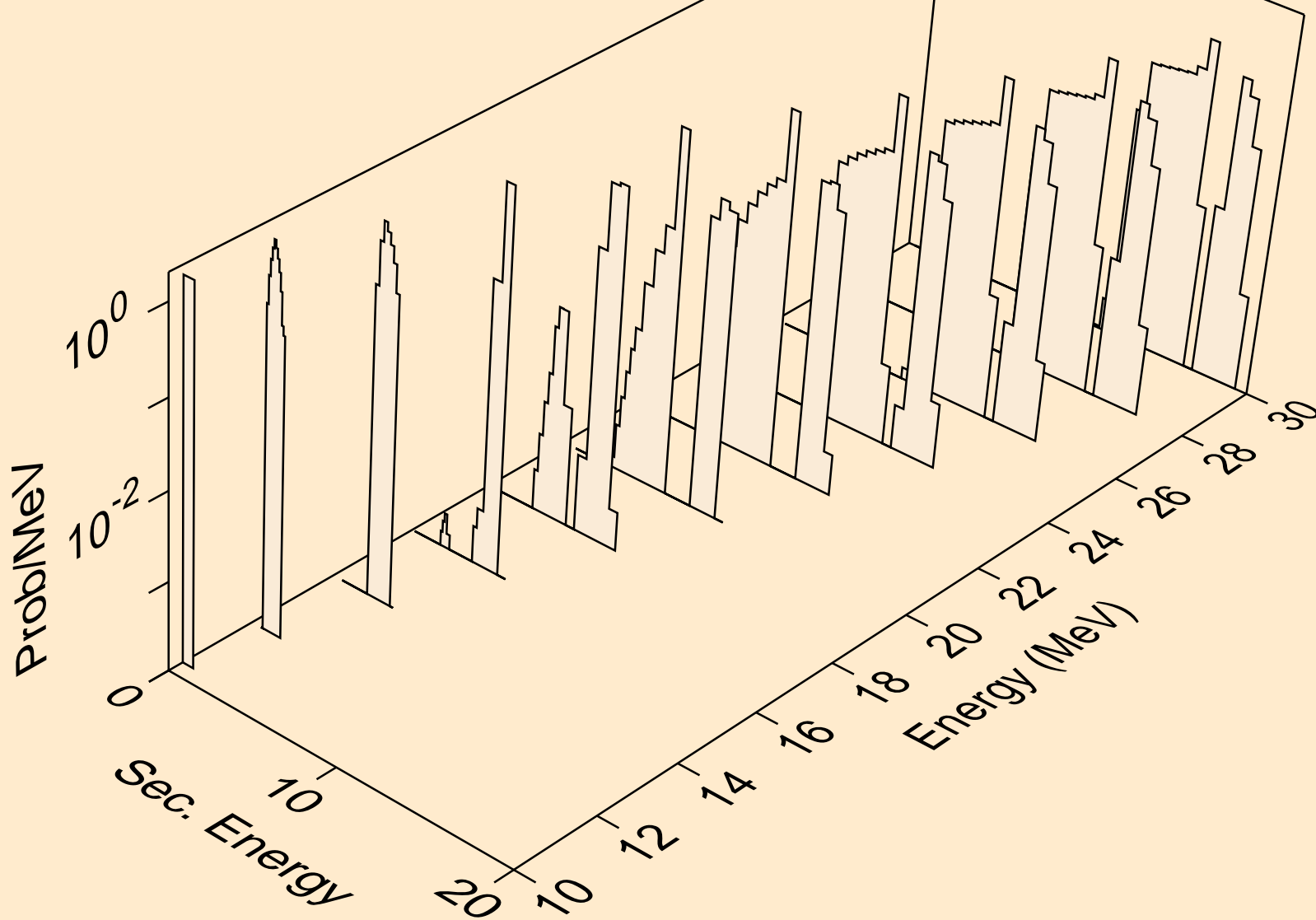

ZR098 NEUTRON ACER TENDL-2019 LIBRARY; T=293.16K  
tritons from (n,x)

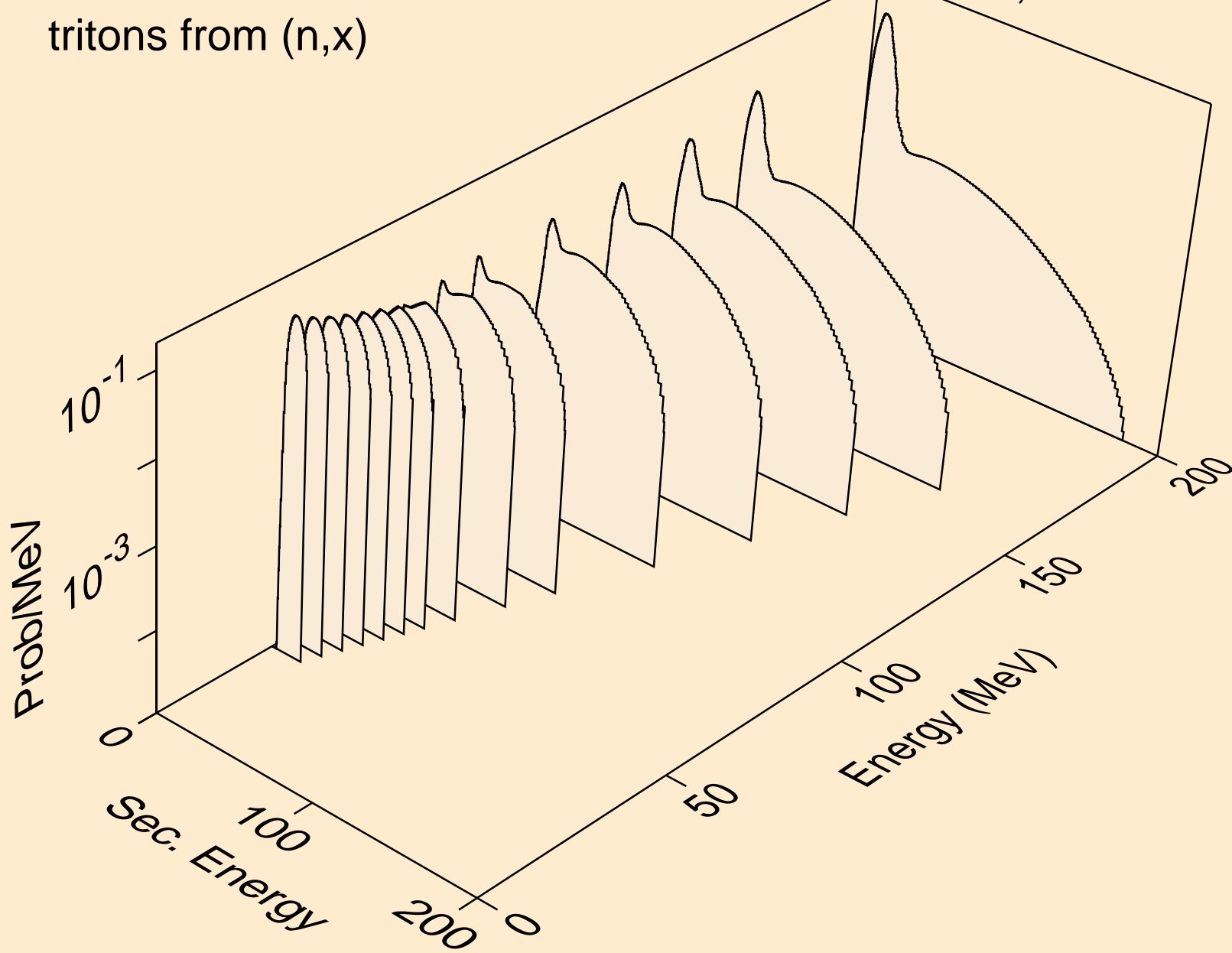

ZR098 NEUTRON ACER TENDL-2019 LIBRARY; T=293.16K  
tritons from (n,n\*)t

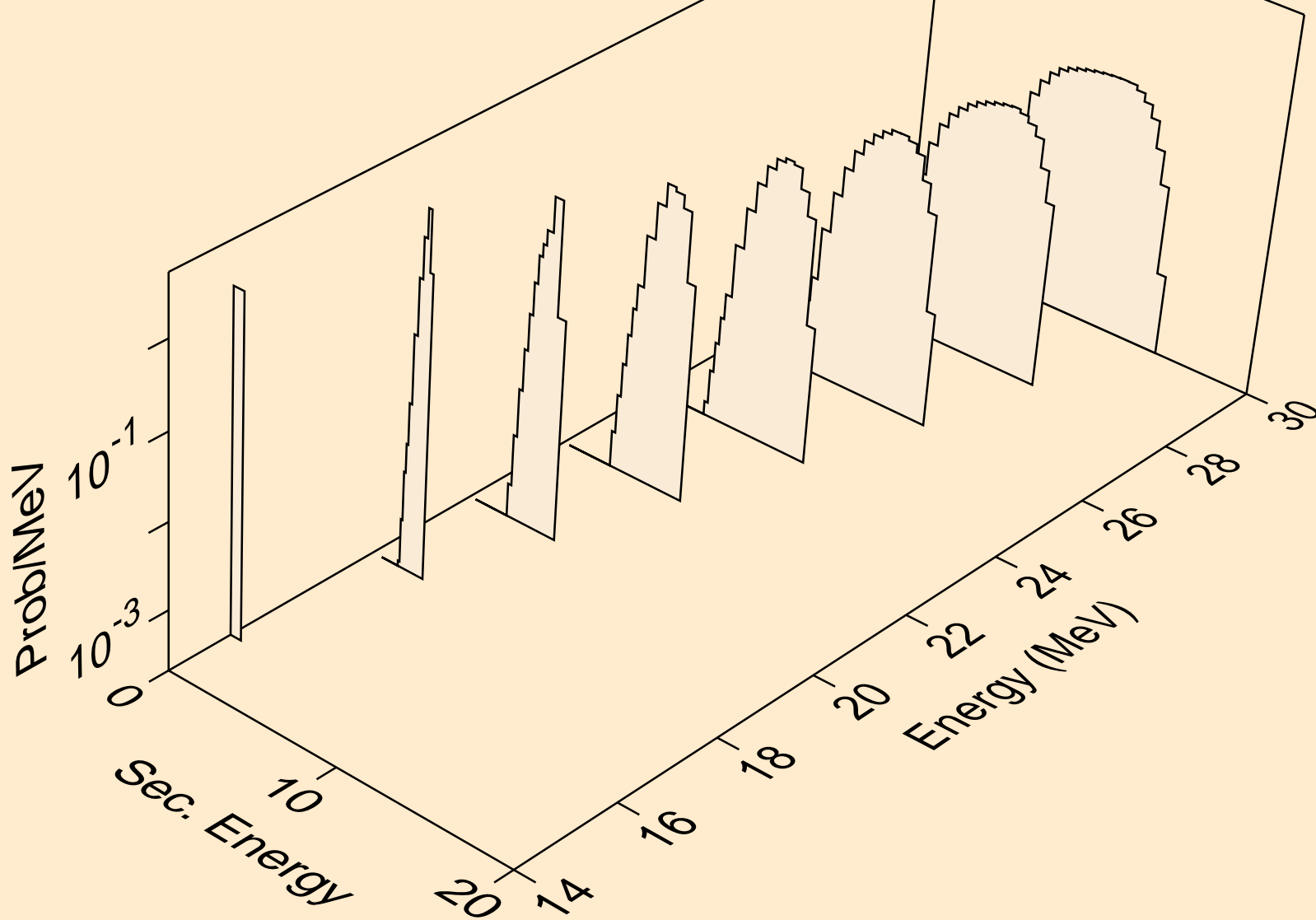

ZR098 NEUTRON ACER TENDL-2019 LIBRARY; T=293.16K  
tritons from (n,t)

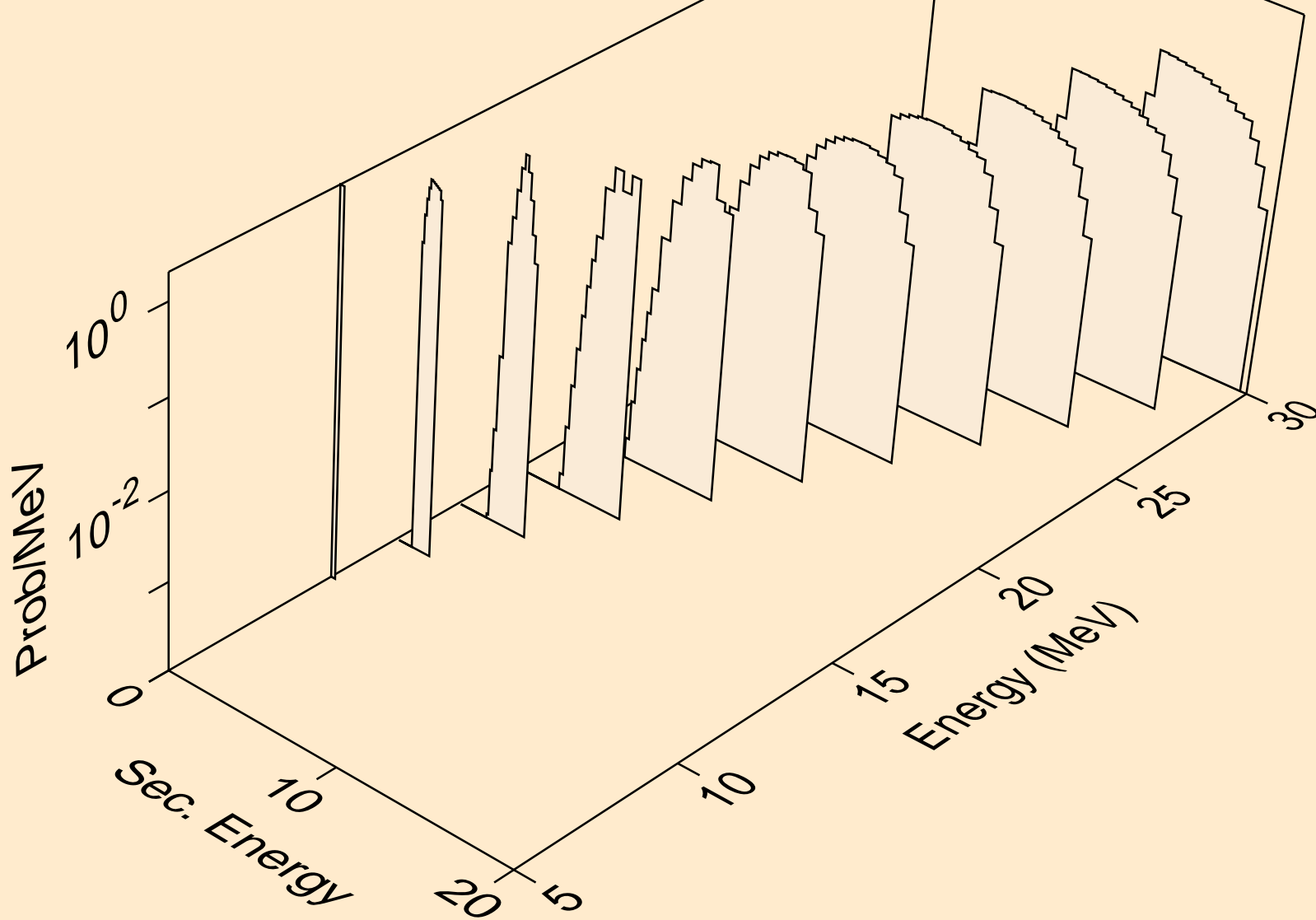

ZR098 NEUTRON ACER TENDL-2019 LIBRARY; T=293.16K  
he3s from (n,x)

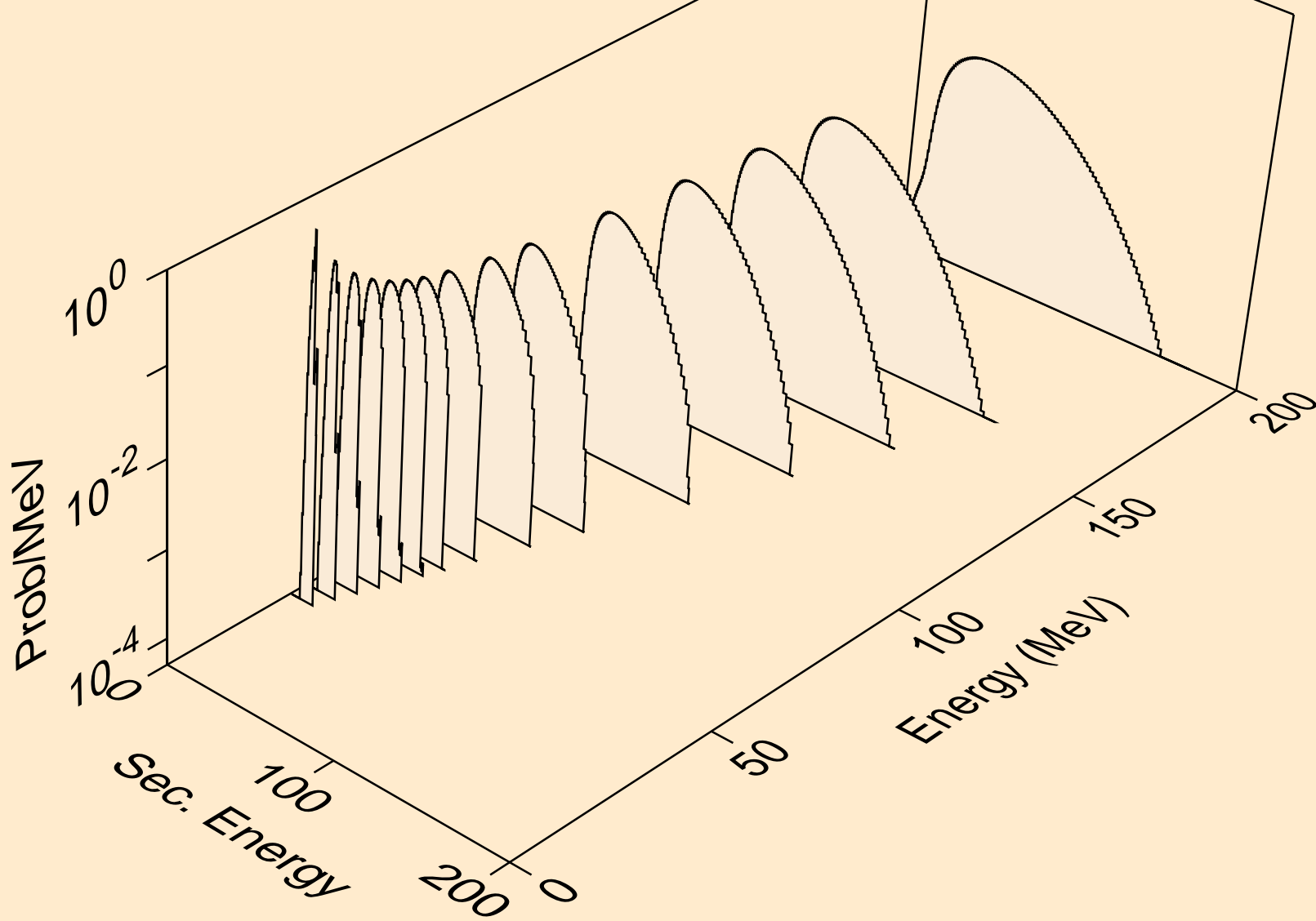

ZR098 NEUTRON ACER TENDL-2019 LIBRARY; T=293.16K  
he3s from (n,n\*)he3

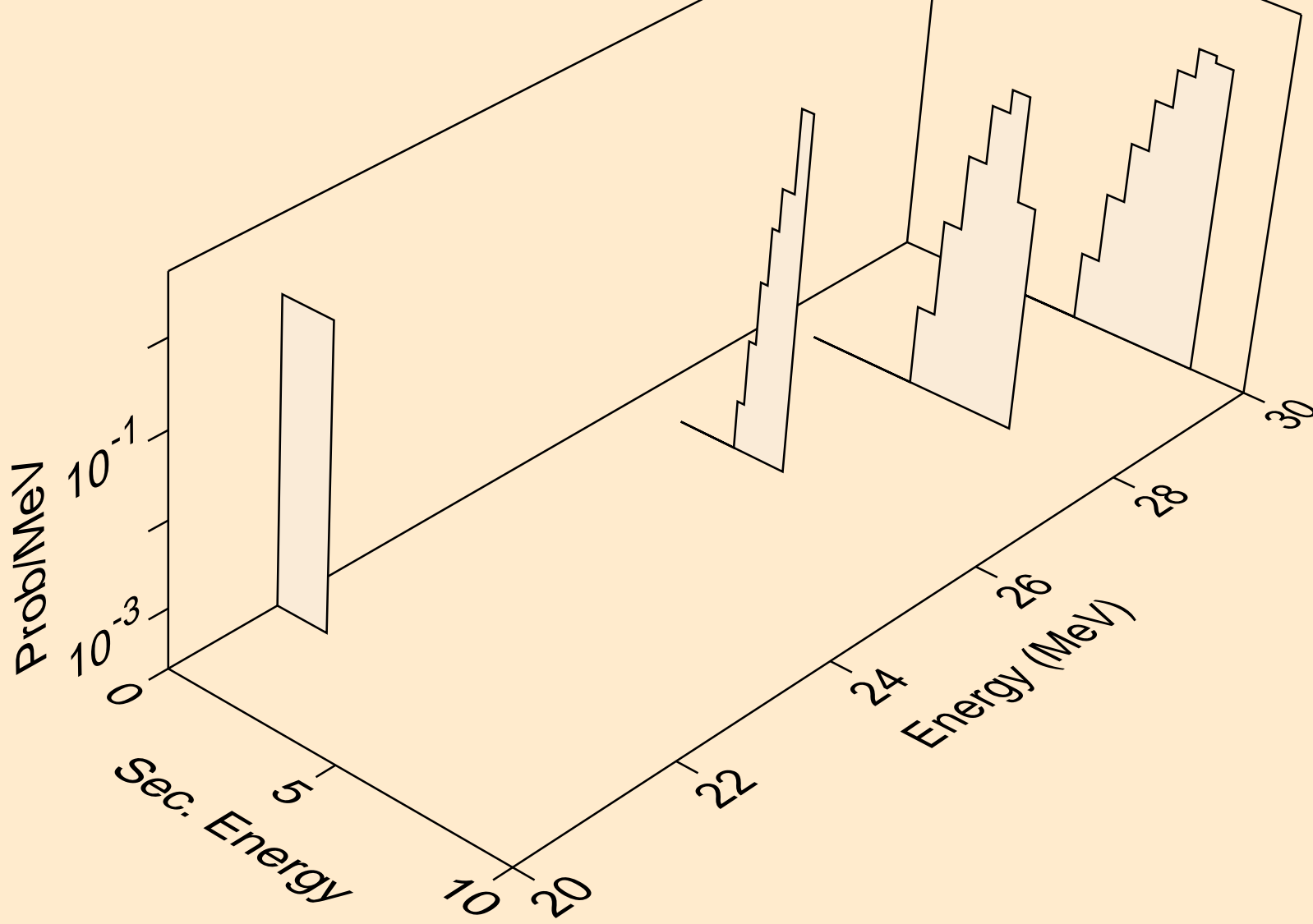

ZR098 NEUTRON ACER TENDL-2019 LIBRARY; T=293.16K  
he3s from (n,he3)

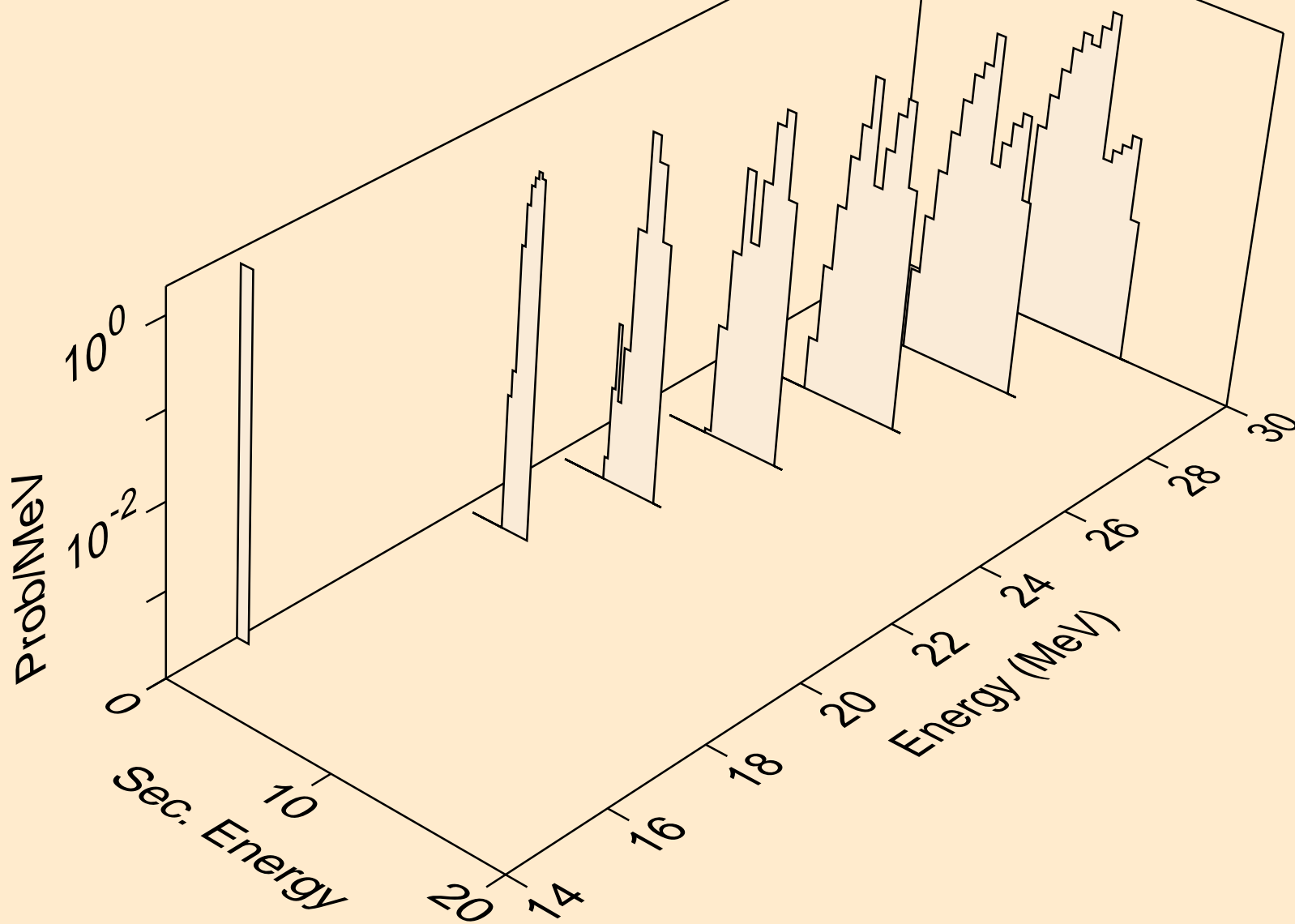



ZR098 NEUTRON ACER TENDL-2019 LIBRARY; T=293.16K  
alphas from (n,x)

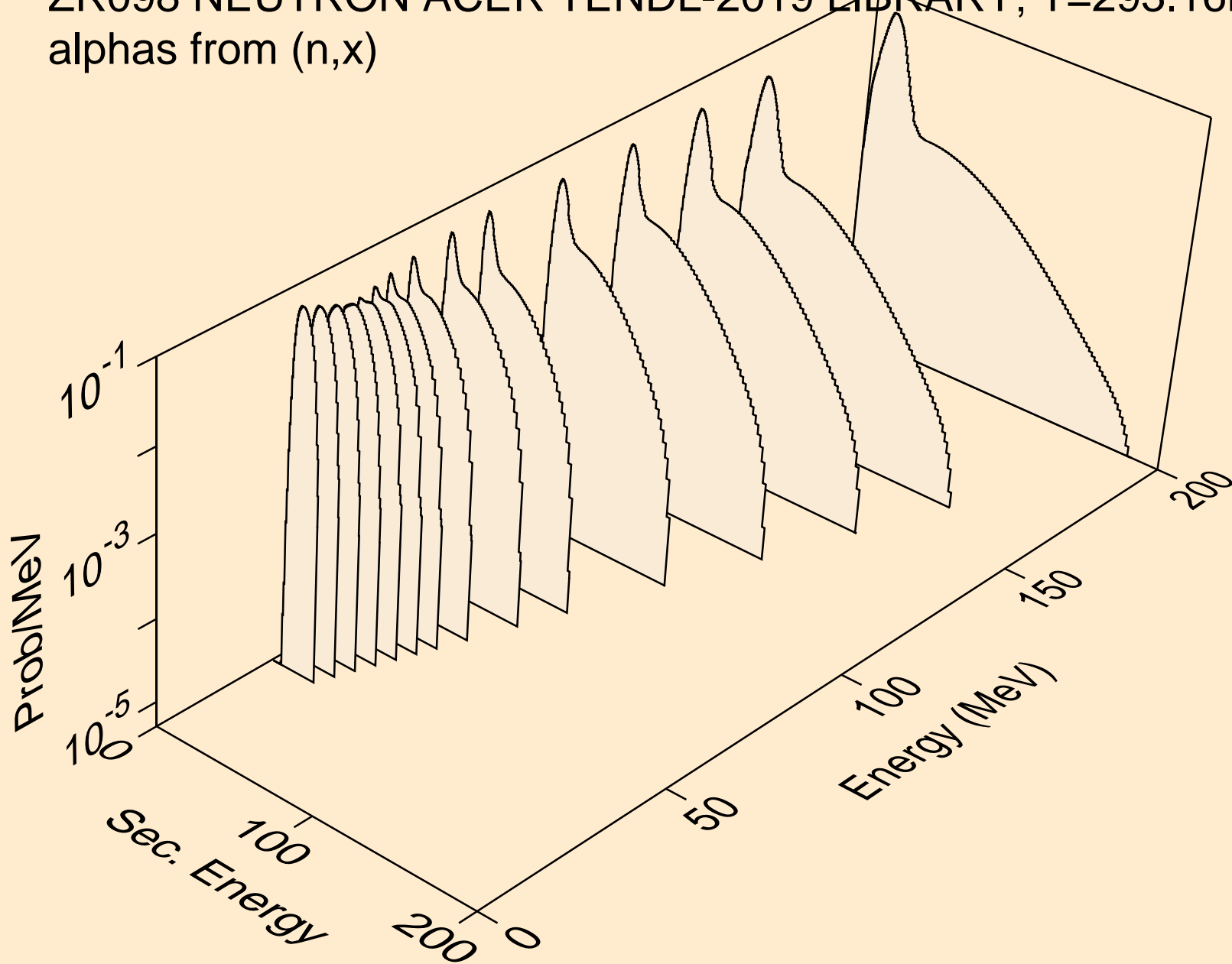

ZR098 NEUTRON ACER TENDL-2019 LIBRARY; T=293.16K  
alphas from (n,n\*)a

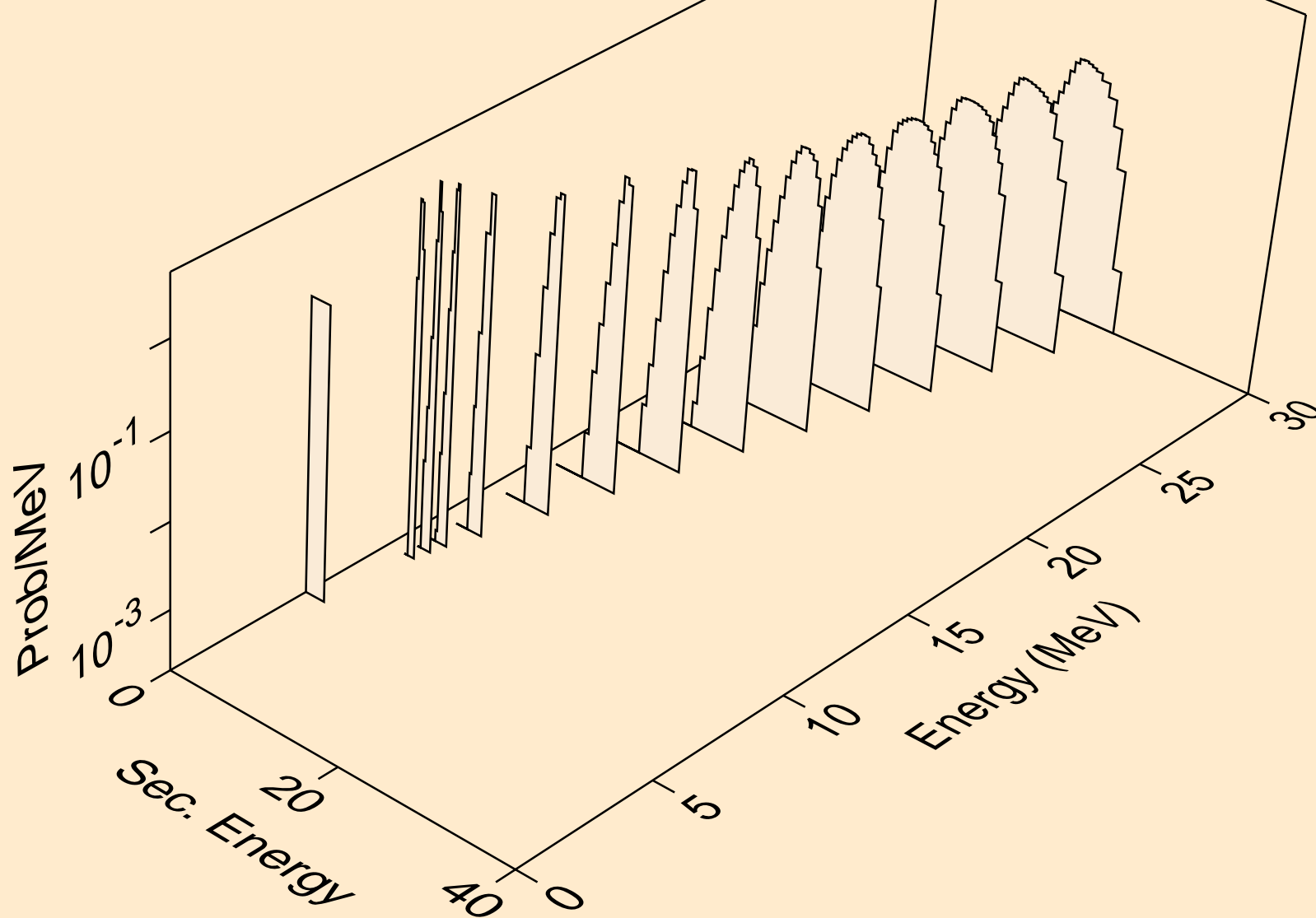

ZR098 NEUTRON ACER TENDL-2019 LIBRARY; T=293.16K  
alphas from (n,2n)a

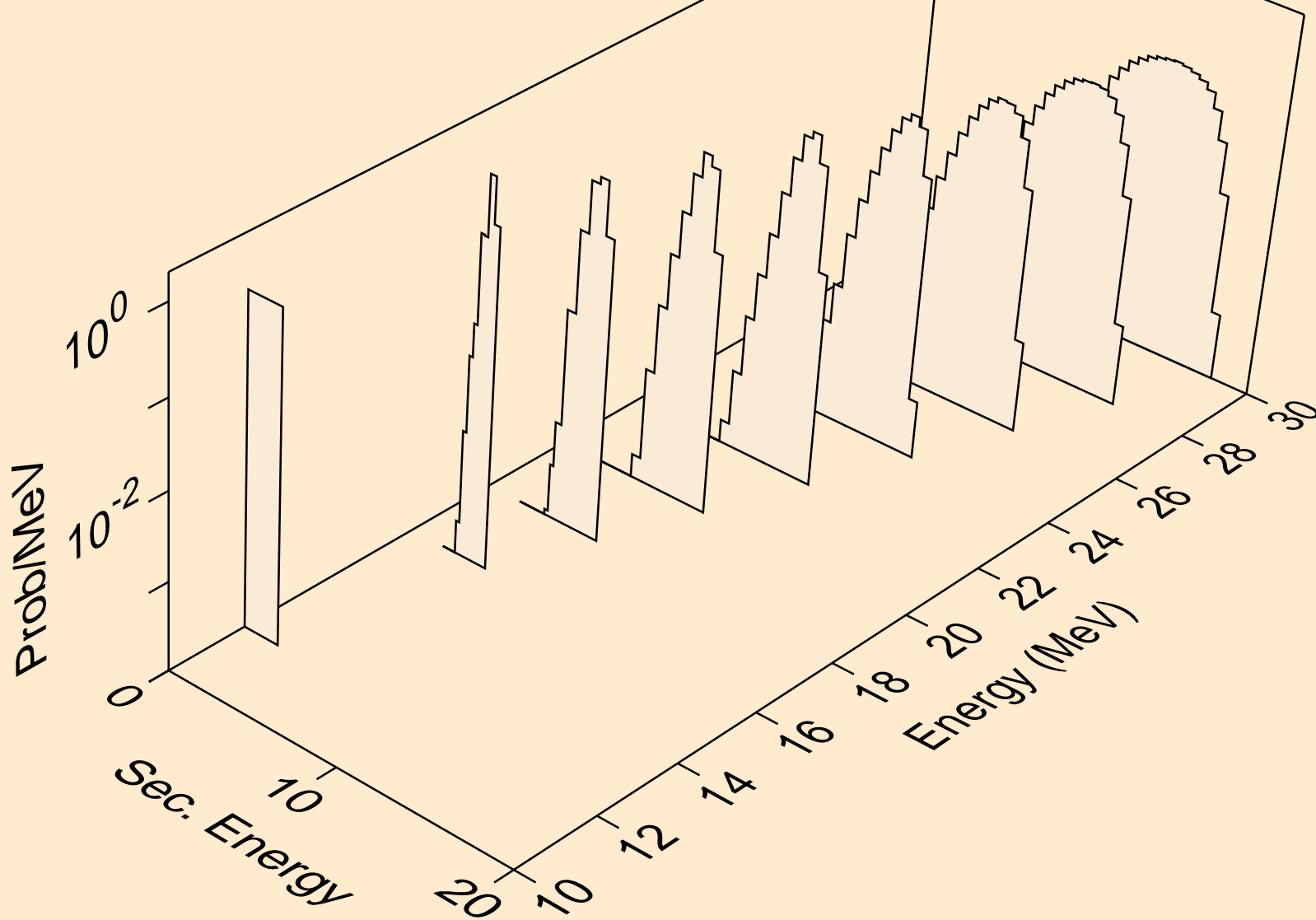

ZR098 NEUTRON ACER TENDL-2019 LIBRARY; T=293.16K  
alphas from (n,3n)a

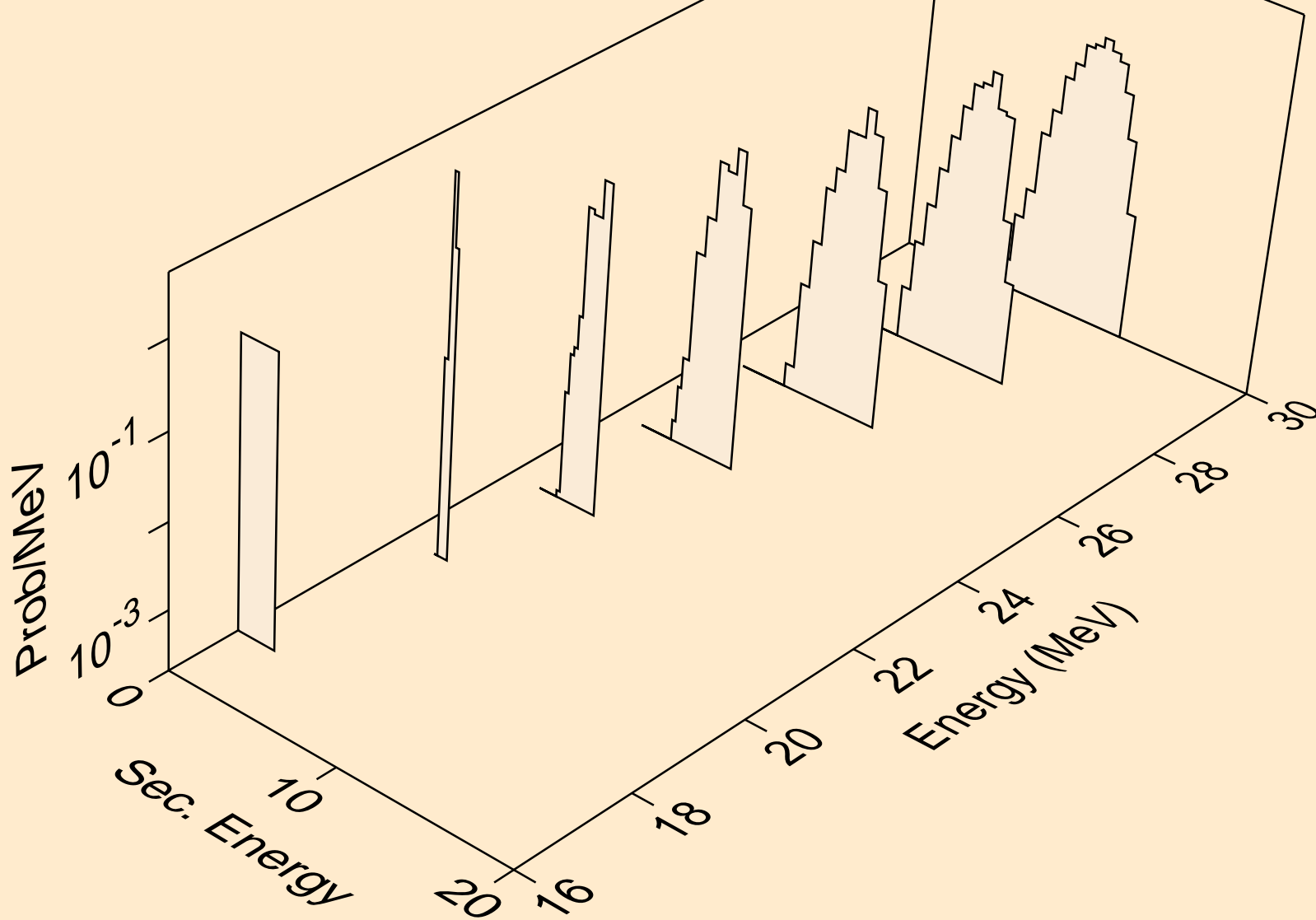

ZR098 NEUTRON ACER TENDL-2019 LIBRARY; T=293.16K  
alphas from (n,a)

