

ZR103 NEUTRON ACER TENDL-2019 LIBRARY; T=293.16K
Principal cross sections

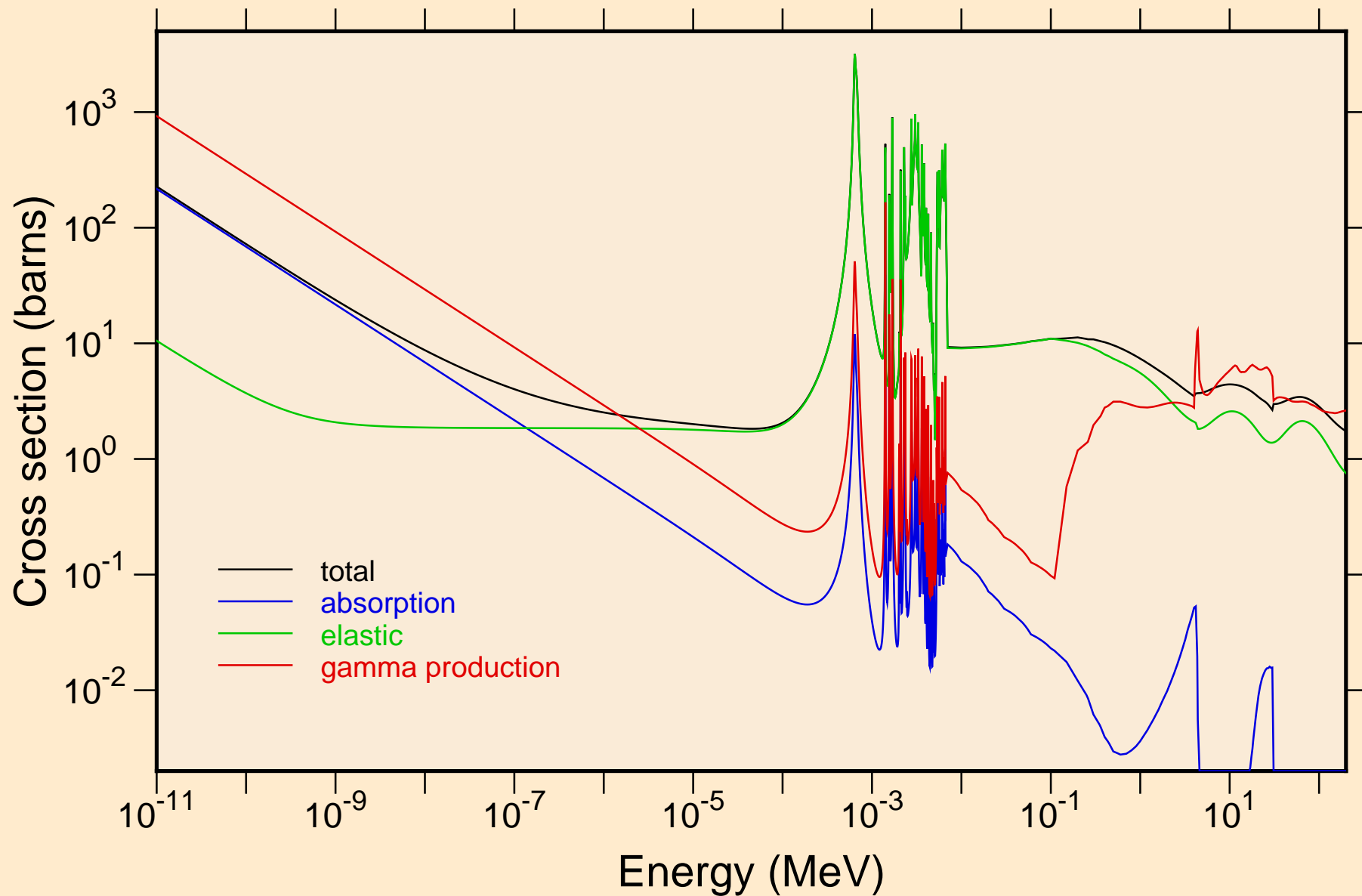

ZR103 NEUTRON ACER TENDL-2019 LIBRARY; T=293.16K
resonance total cross section

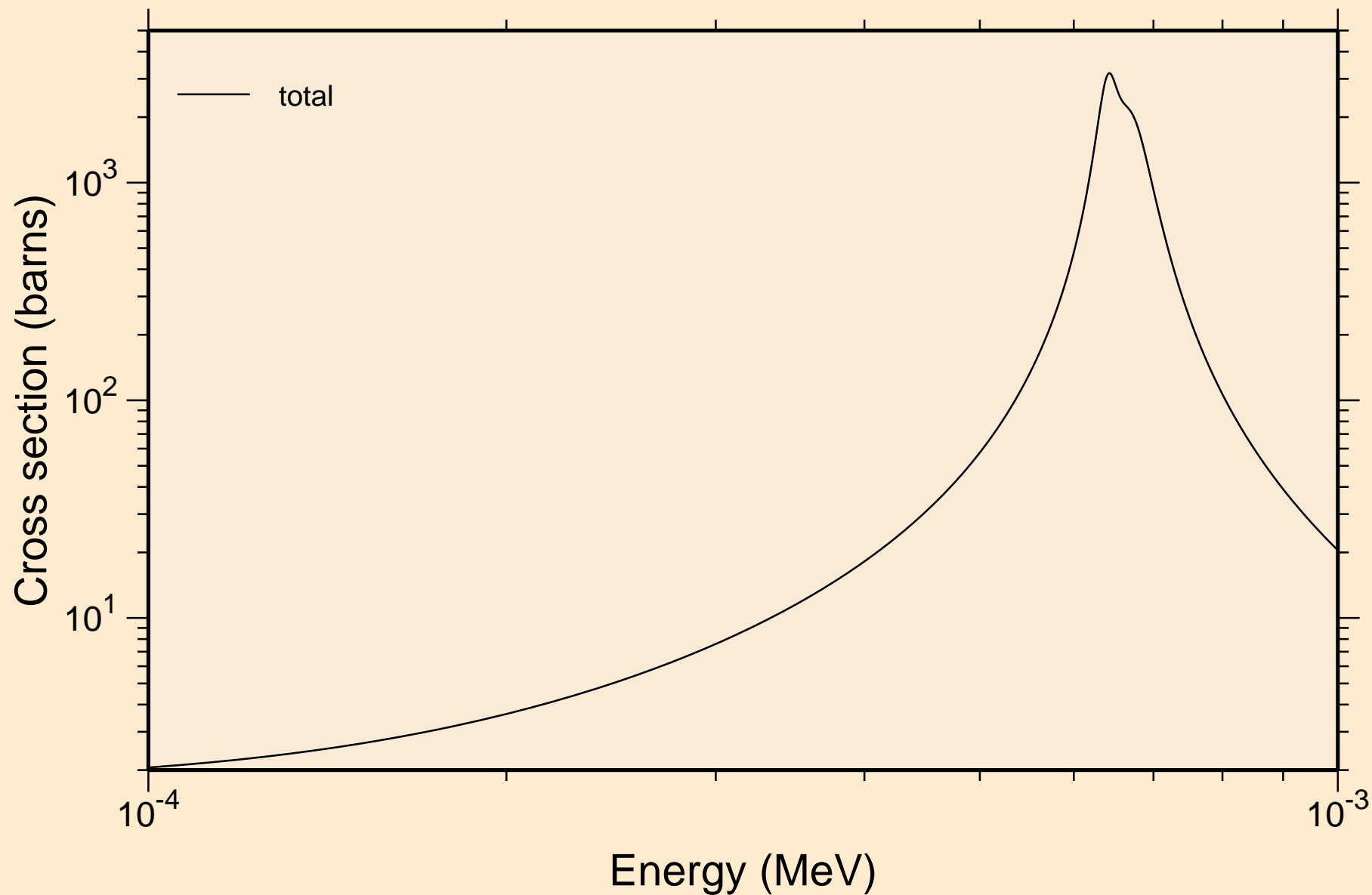

ZR103 NEUTRON ACER TENDL-2019 LIBRARY; T=293.16K
resonance total cross section

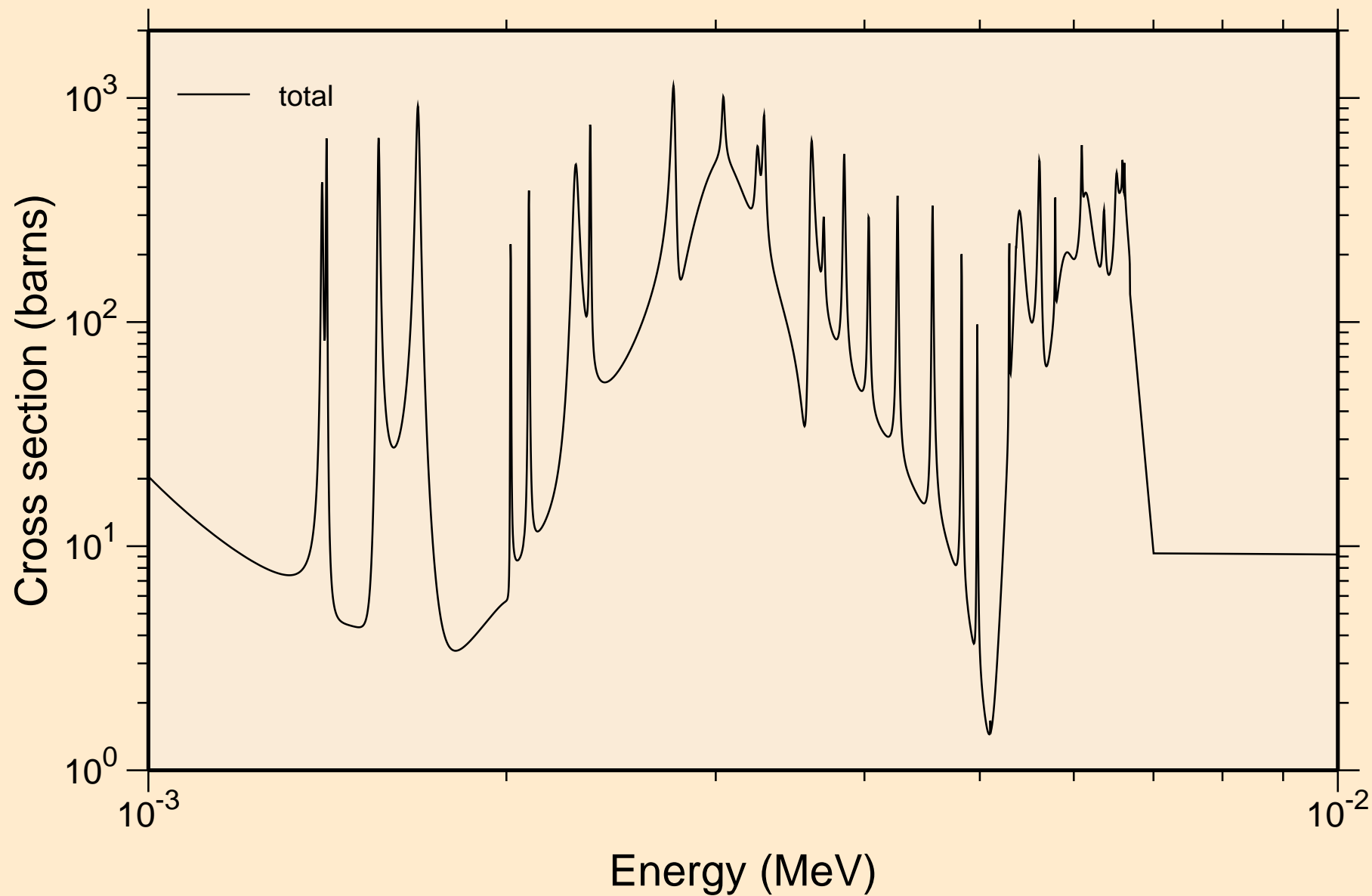

ZR103 NEUTRON ACER TENDL-2019 LIBRARY; T=293.16K
resonance total cross section

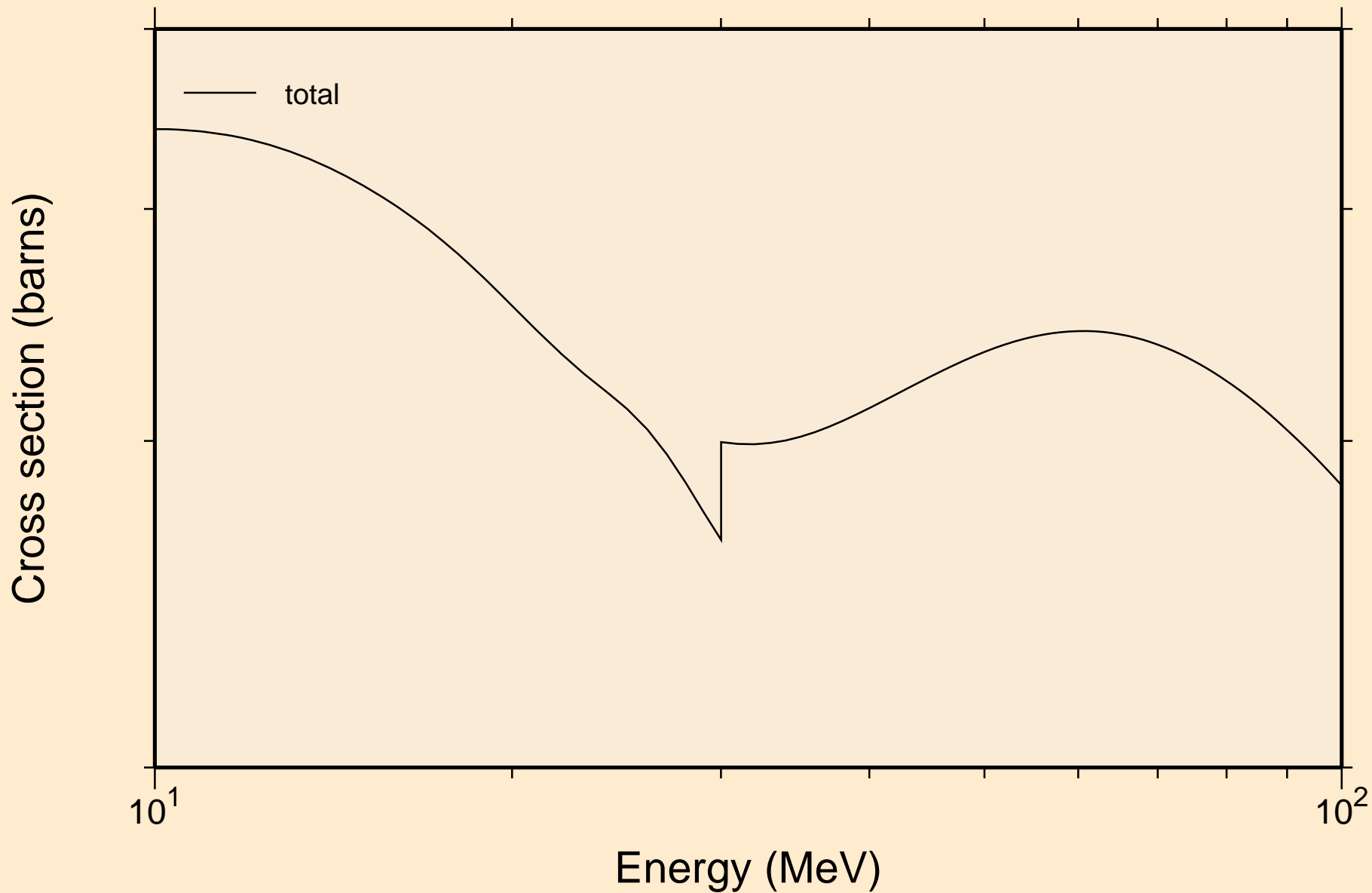

ZR103 NEUTRON ACER TENDL-2019 LIBRARY; T=293.16K
resonance absorption cross sections

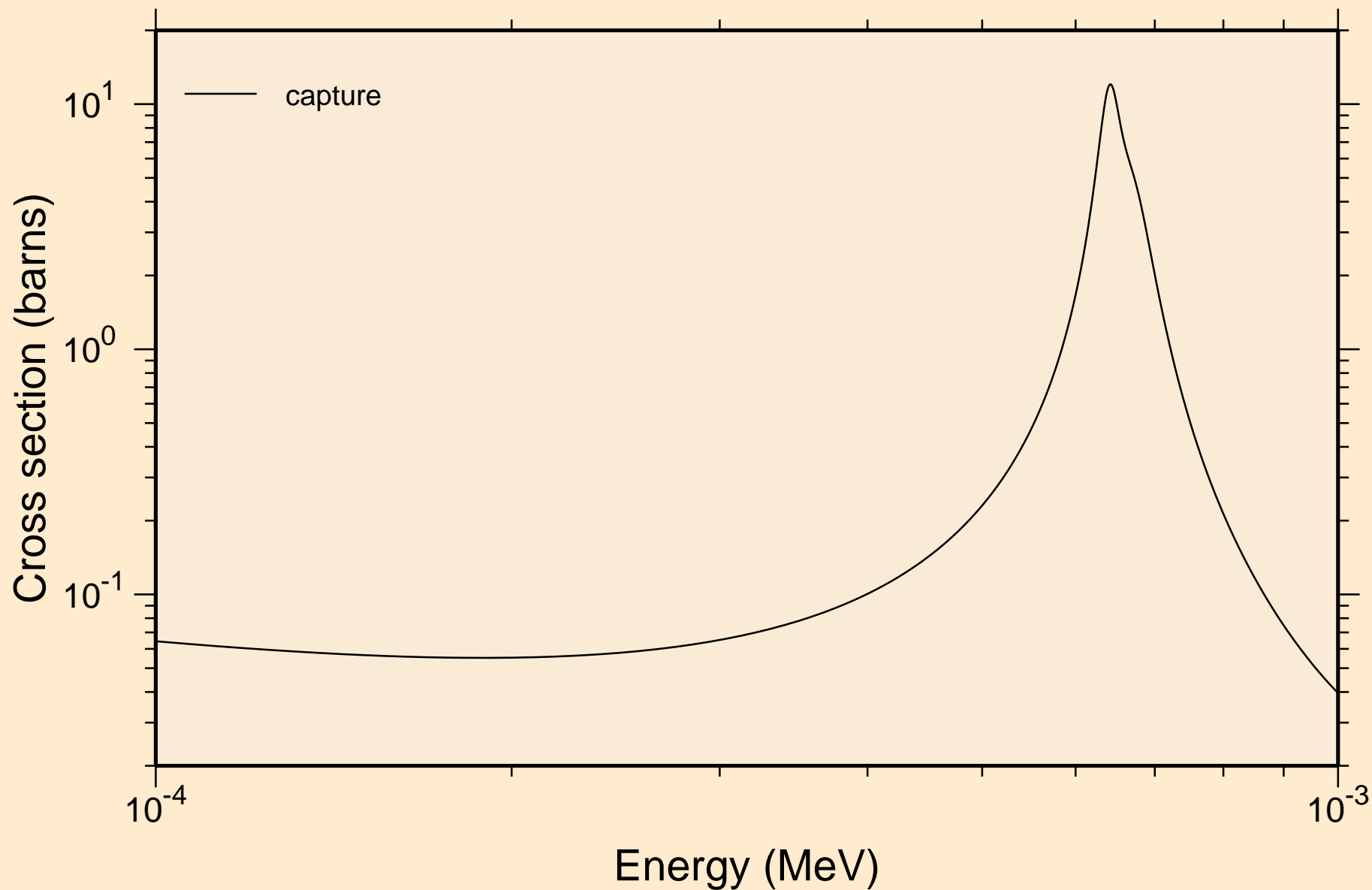

ZR103 NEUTRON ACER TENDL-2019 LIBRARY; T=293.16K
resonance absorption cross sections

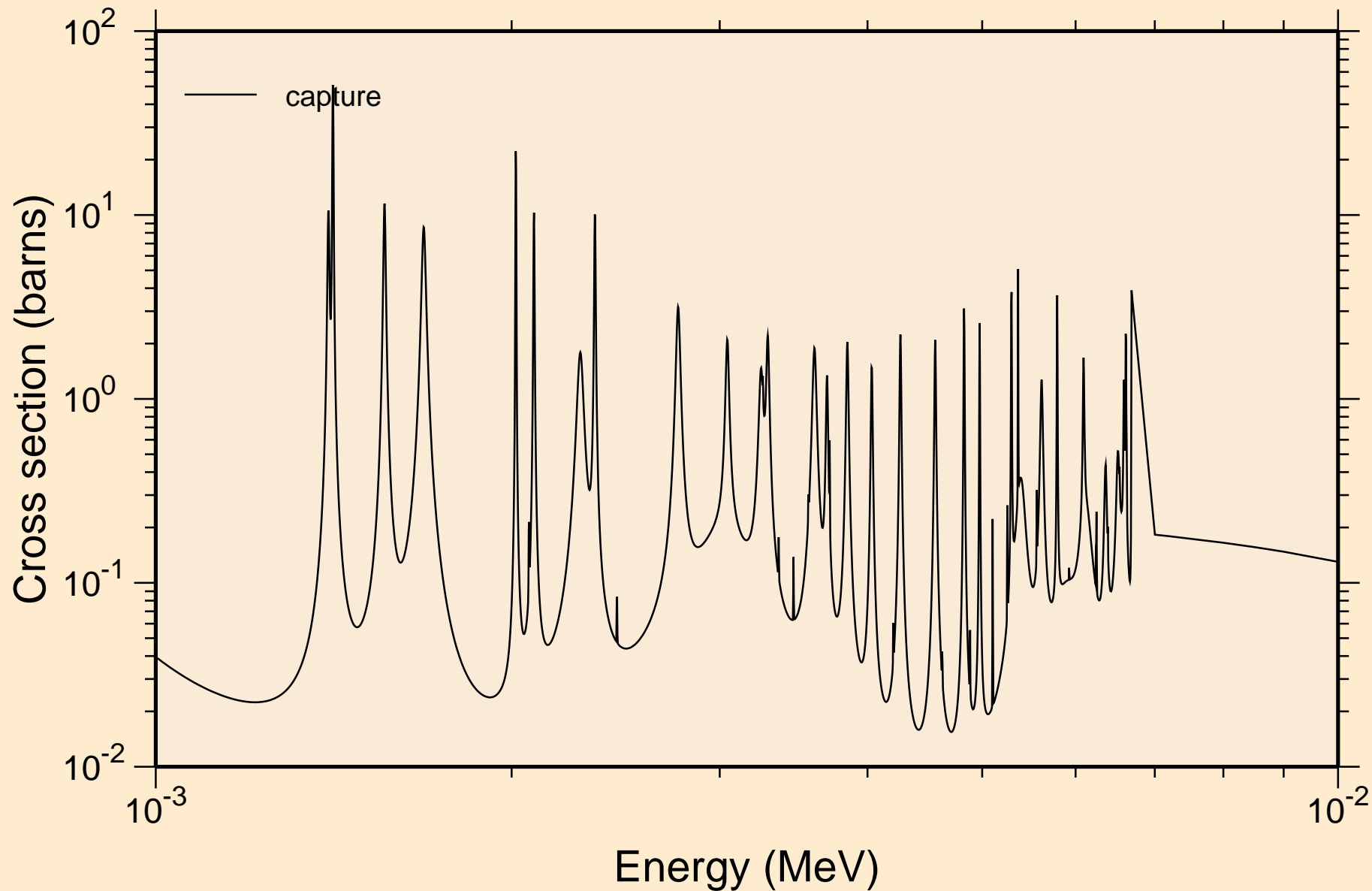

ZR103 NEUTRON ACER TENDL-2019 LIBRARY; T=293.16K
resonance absorption cross sections

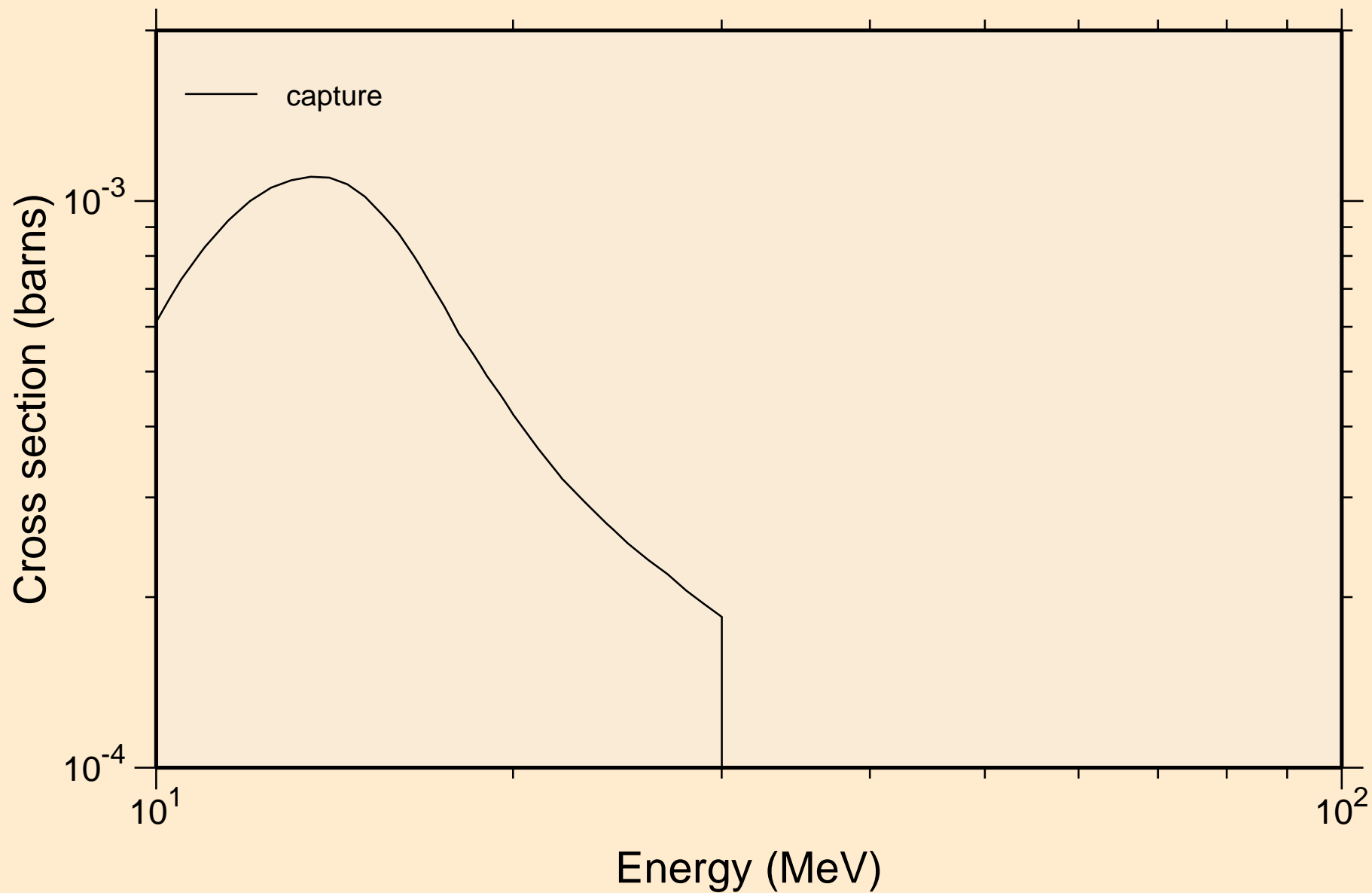

ZR103 NEUTRON ACER TENDL-2019 LIBRARY; T=293.16K
Heating

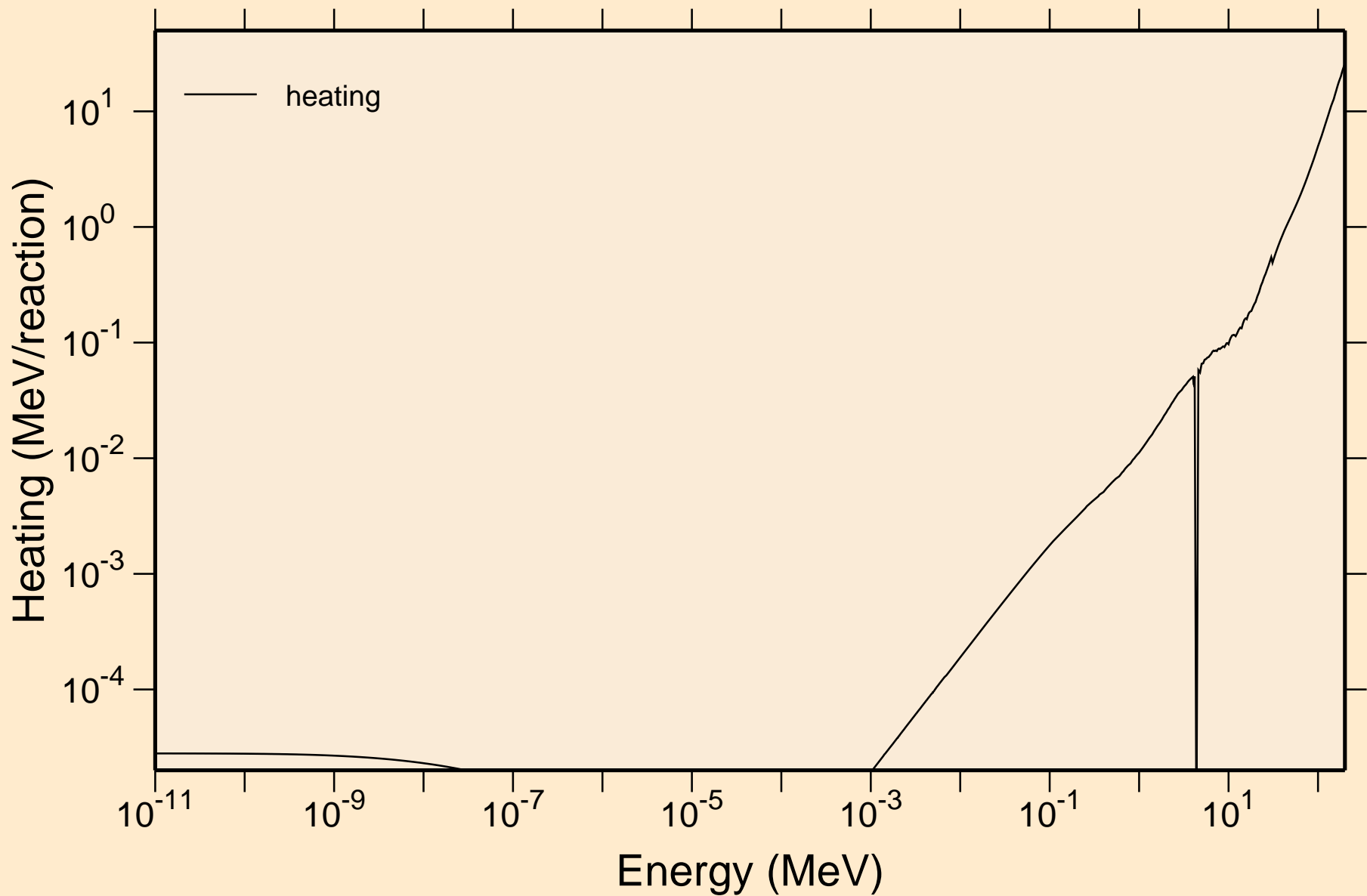

ZR103 NEUTRON ACER TENDL-2019 LIBRARY; T=293.16K
Damage

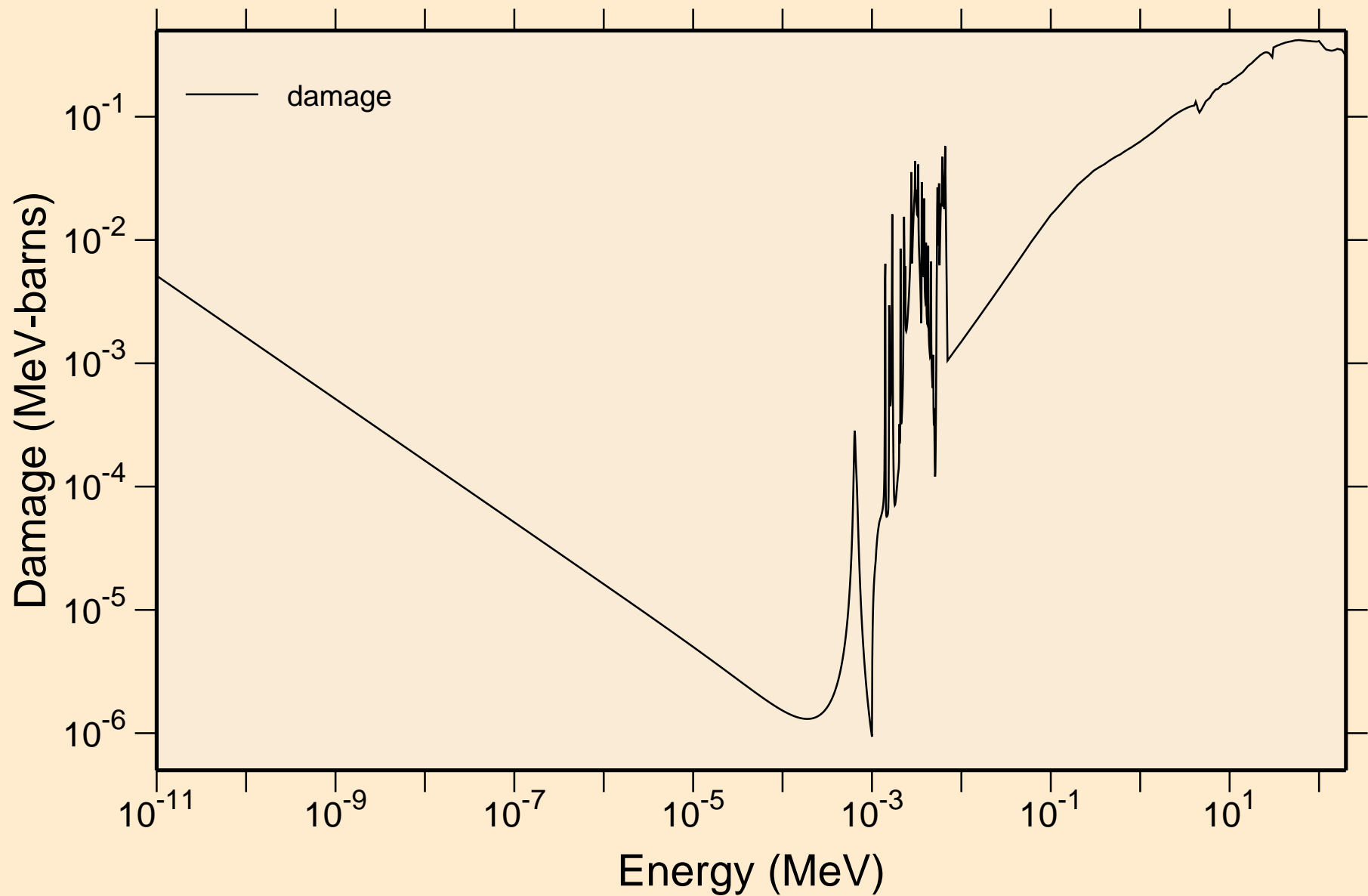

ZR103 NEUTRON ACER TENDL-2019 LIBRARY; T=293.16K
Non-threshold reactions

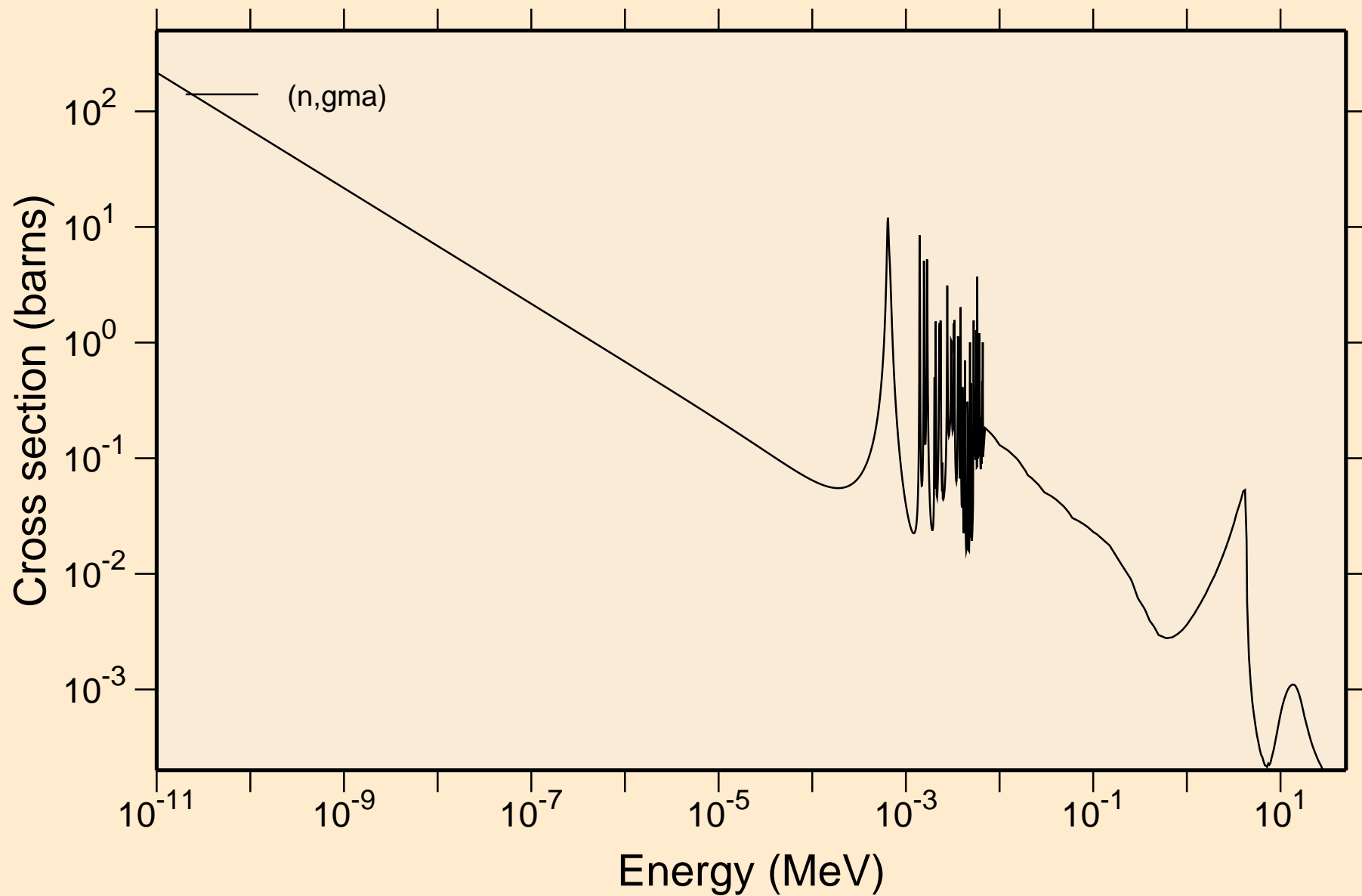

ZR103 NEUTRON ACER TENDL-2019 LIBRARY; T=293.16K

Principal cross sections

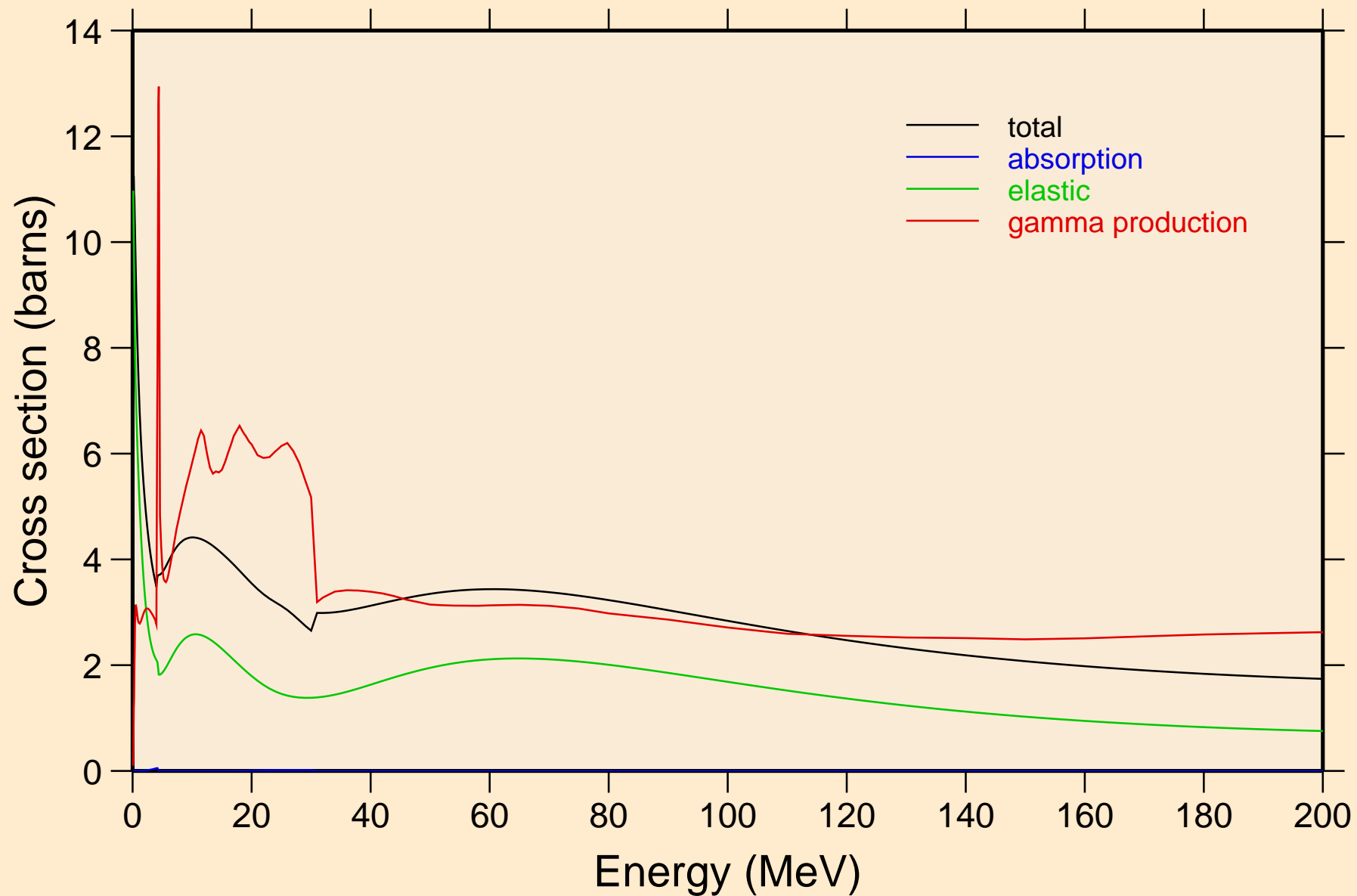

ZR103 NEUTRON ACER TENDL-2019 LIBRARY; T=293.16K
Heating

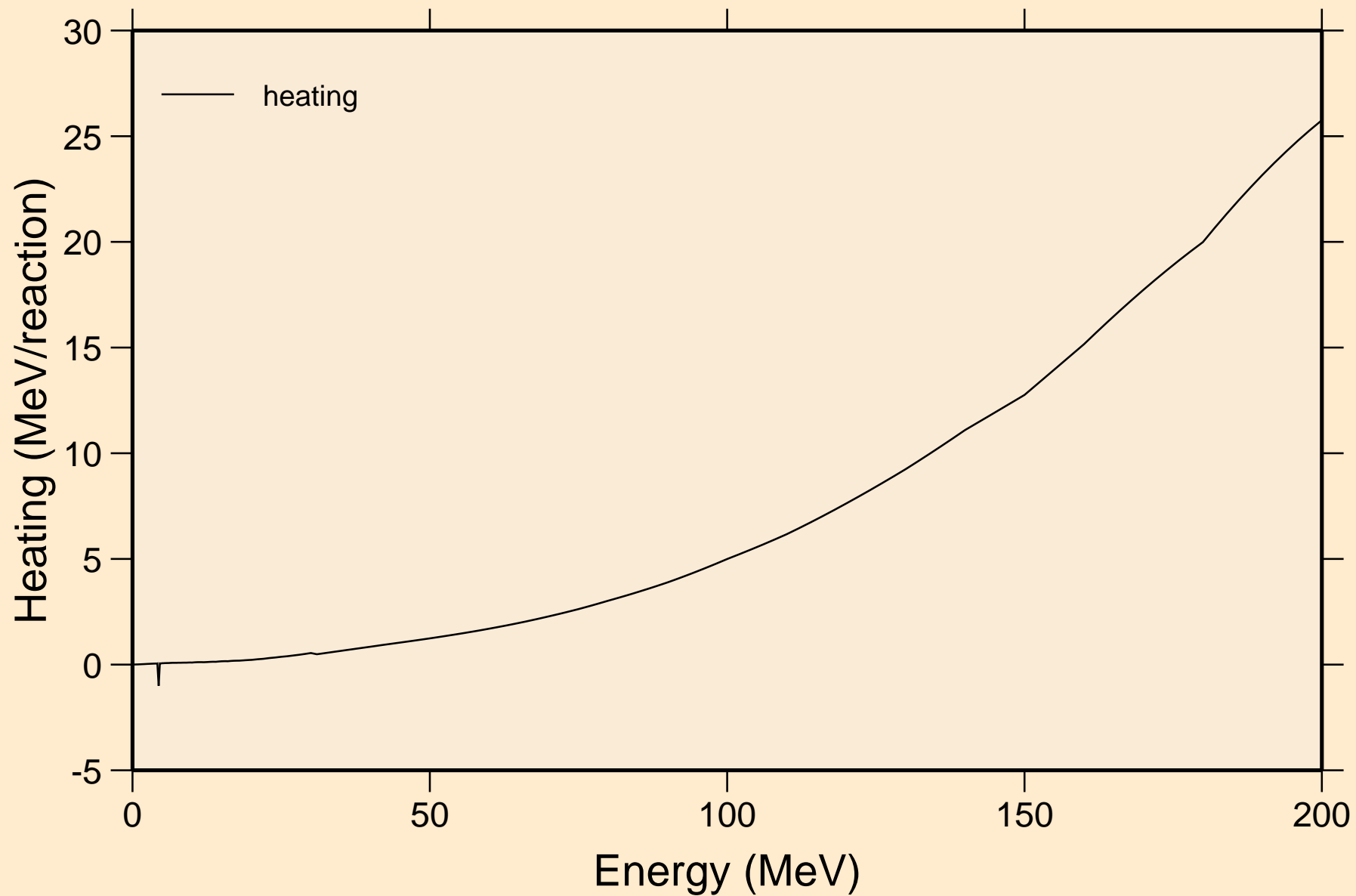

ZR103 NEUTRON ACER TENDL-2019 LIBRARY; T=293.16K
Damage

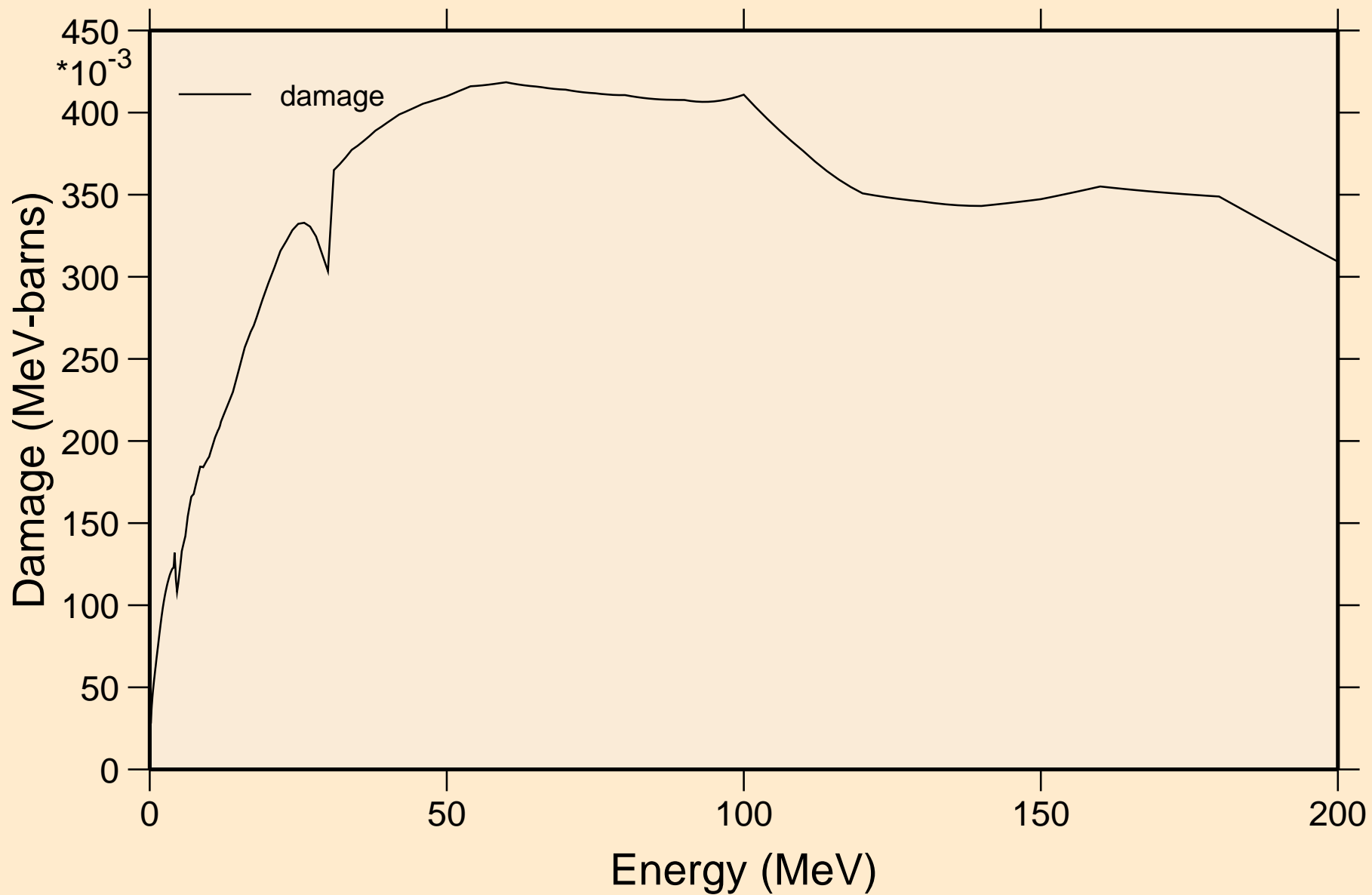

ZR103 NEUTRON ACER TENDL-2019 LIBRARY; T=293.16K
Non-threshold reactions

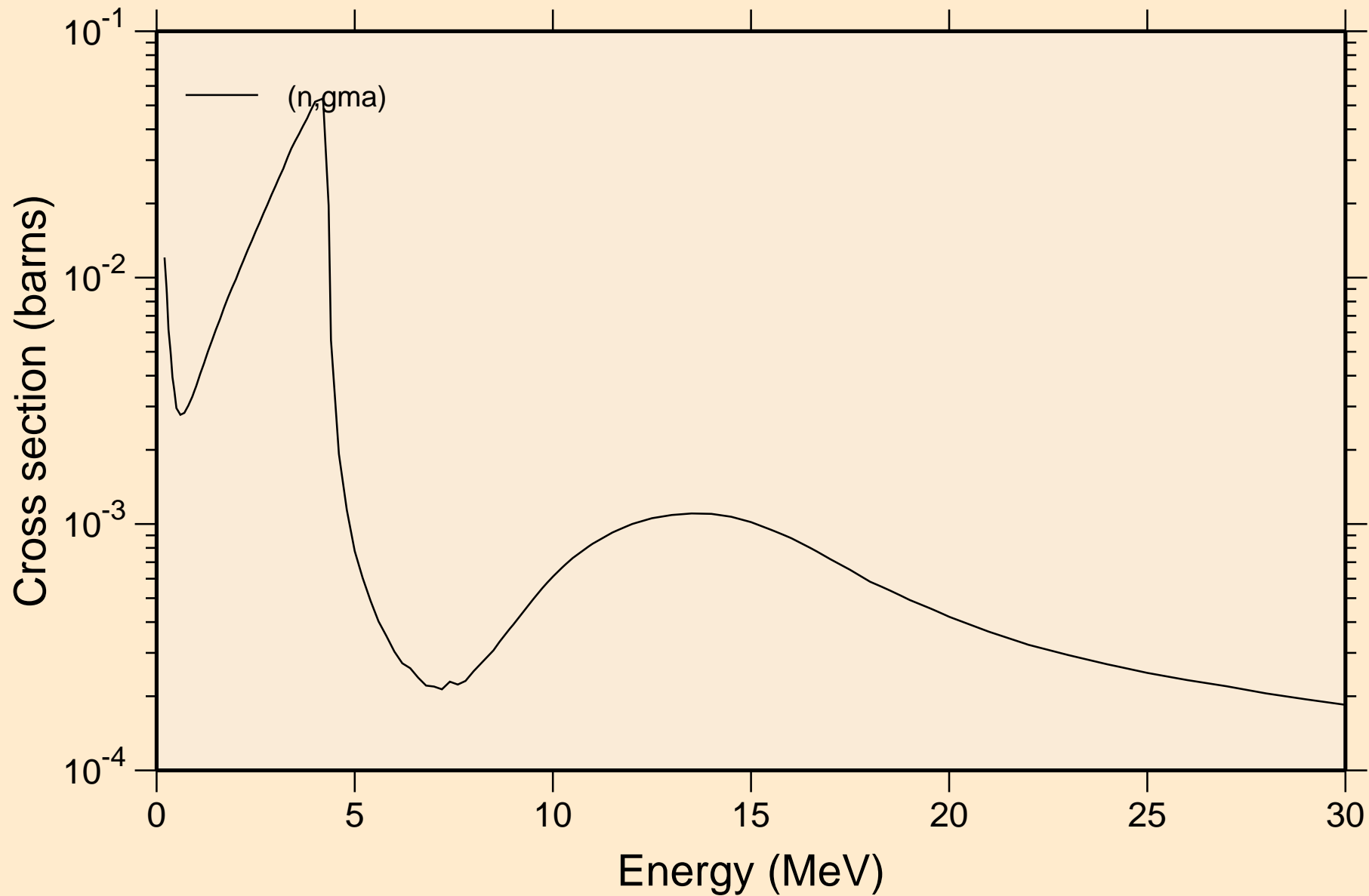

ZR103 NEUTRON ACER TENDL-2019 LIBRARY; T=293.16K
Inelastic levels

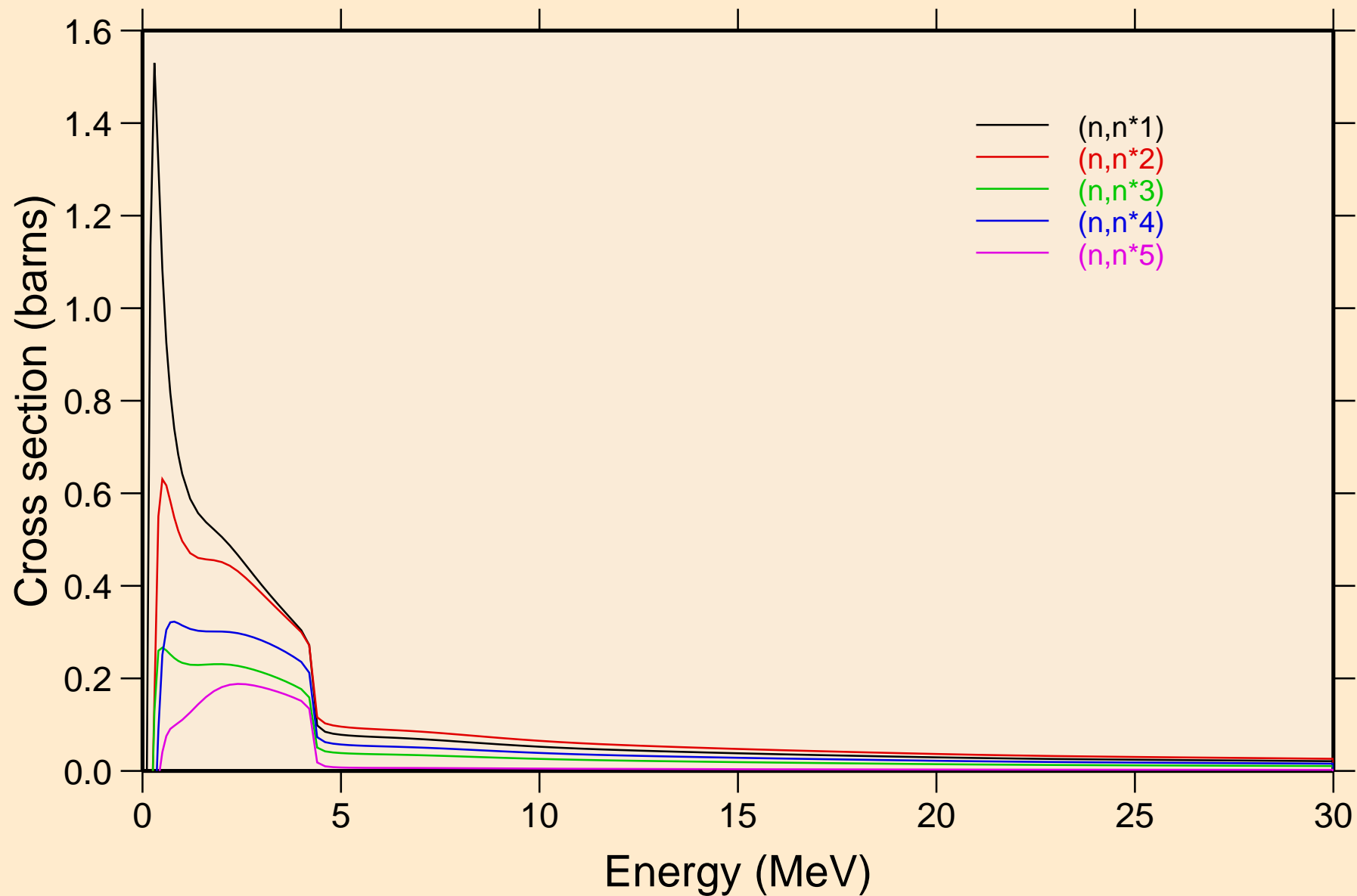

ZR103 NEUTRON ACER TENDL-2019 LIBRARY; T=293.16K
Inelastic levels

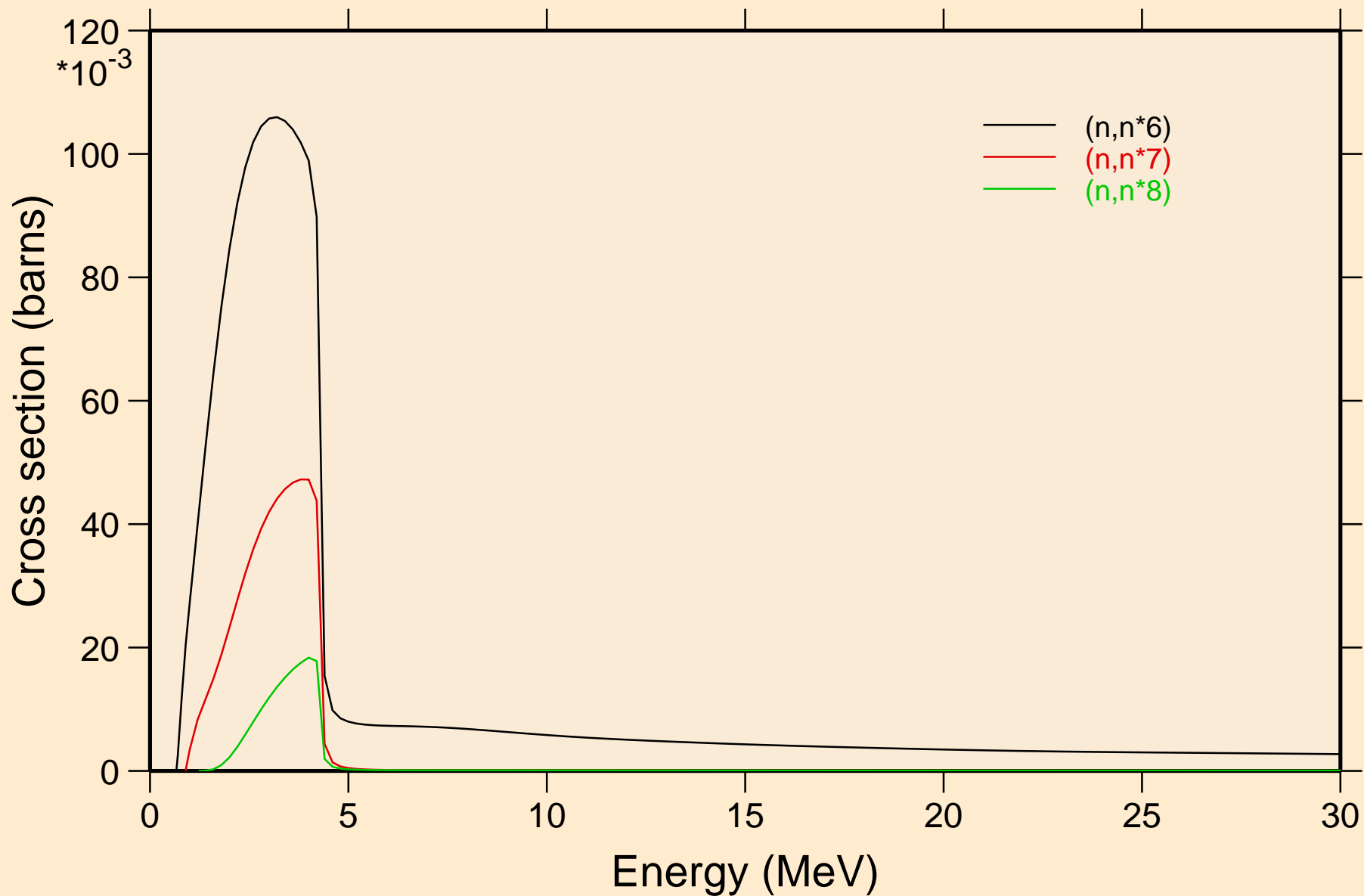

ZR103 NEUTRON ACER TENDL-2019 LIBRARY; T=293.16K
Threshold reactions

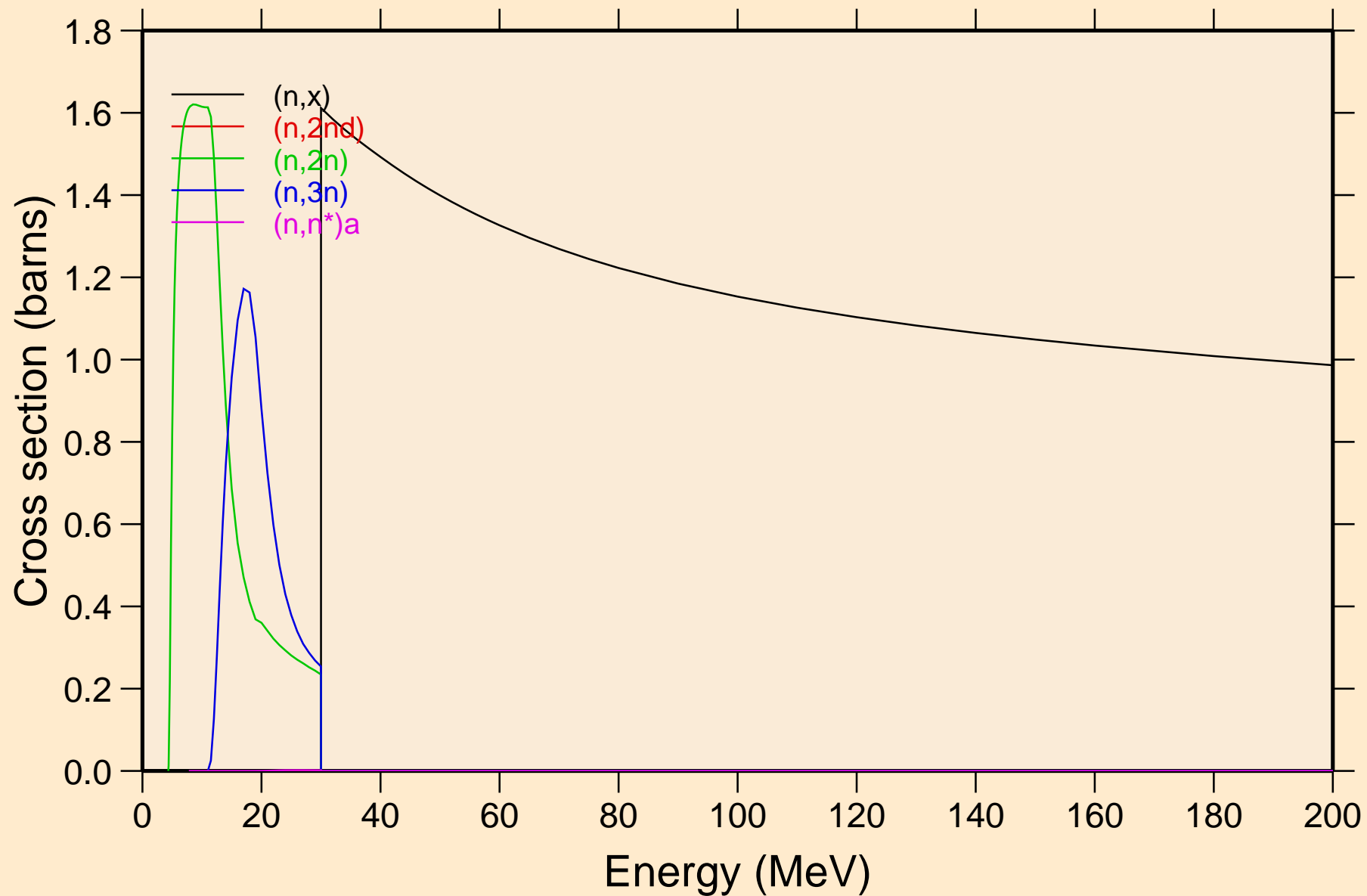

ZR103 NEUTRON ACER TENDL-2019 LIBRARY; T=293.16K
Threshold reactions

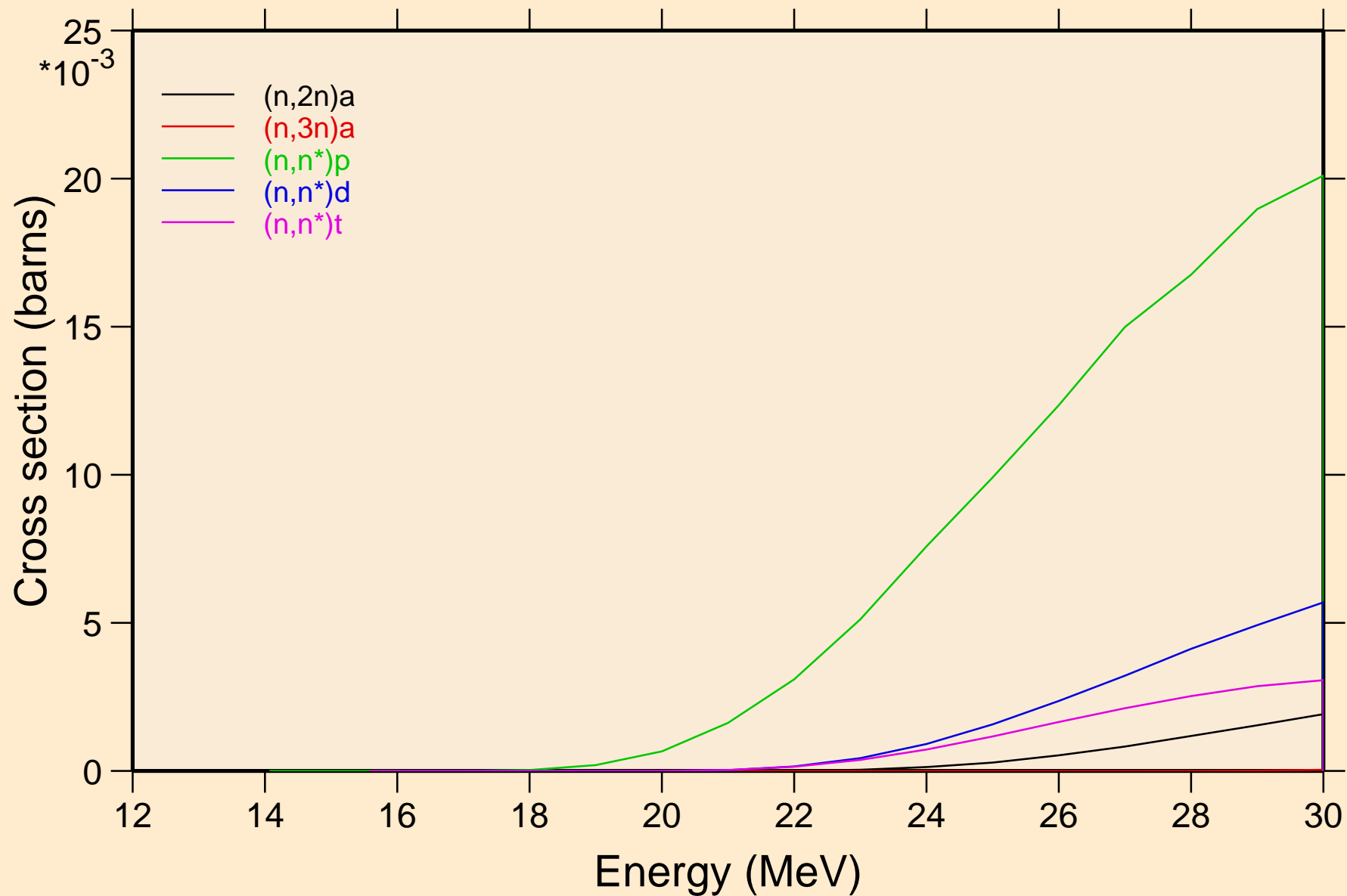

ZR103 NEUTRON ACER TENDL-2019 LIBRARY; T=293.16K
Threshold reactions

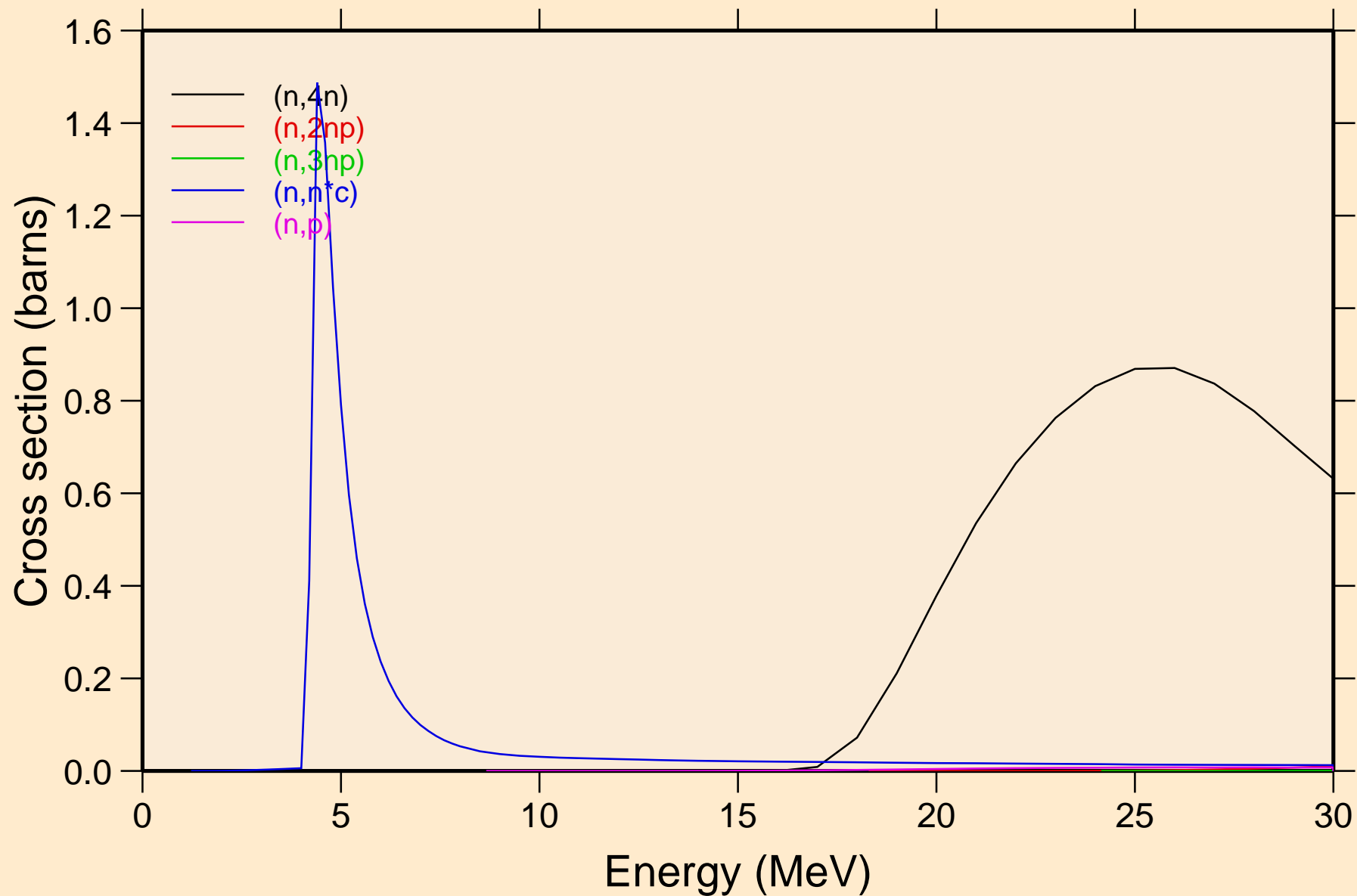

ZR103 NEUTRON ACER TENDL-2019 LIBRARY; T=293.16K
Threshold reactions

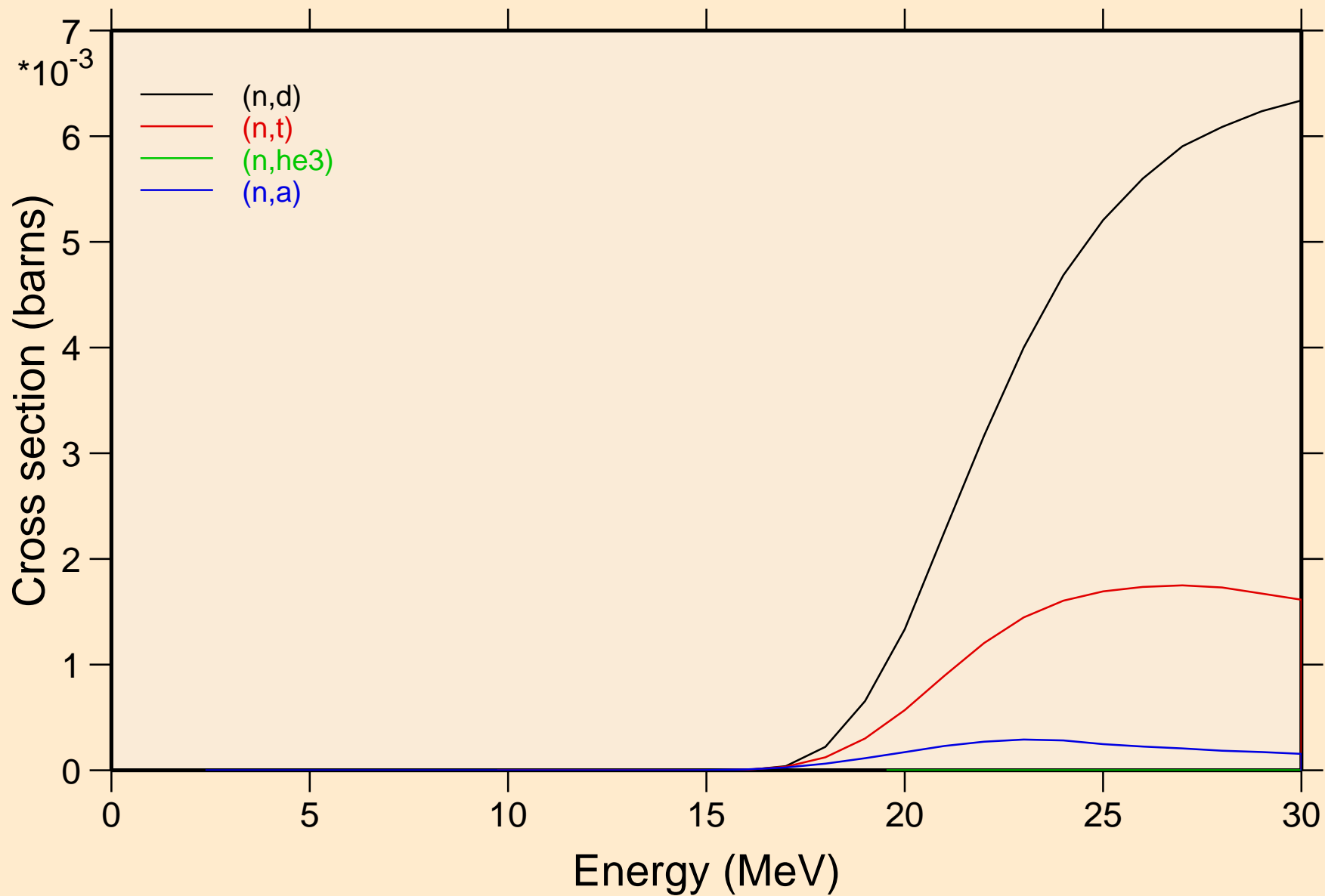

ZR103 NEUTRON ACER TENDL-2019 LIBRARY; T=293.16K
Threshold reactions

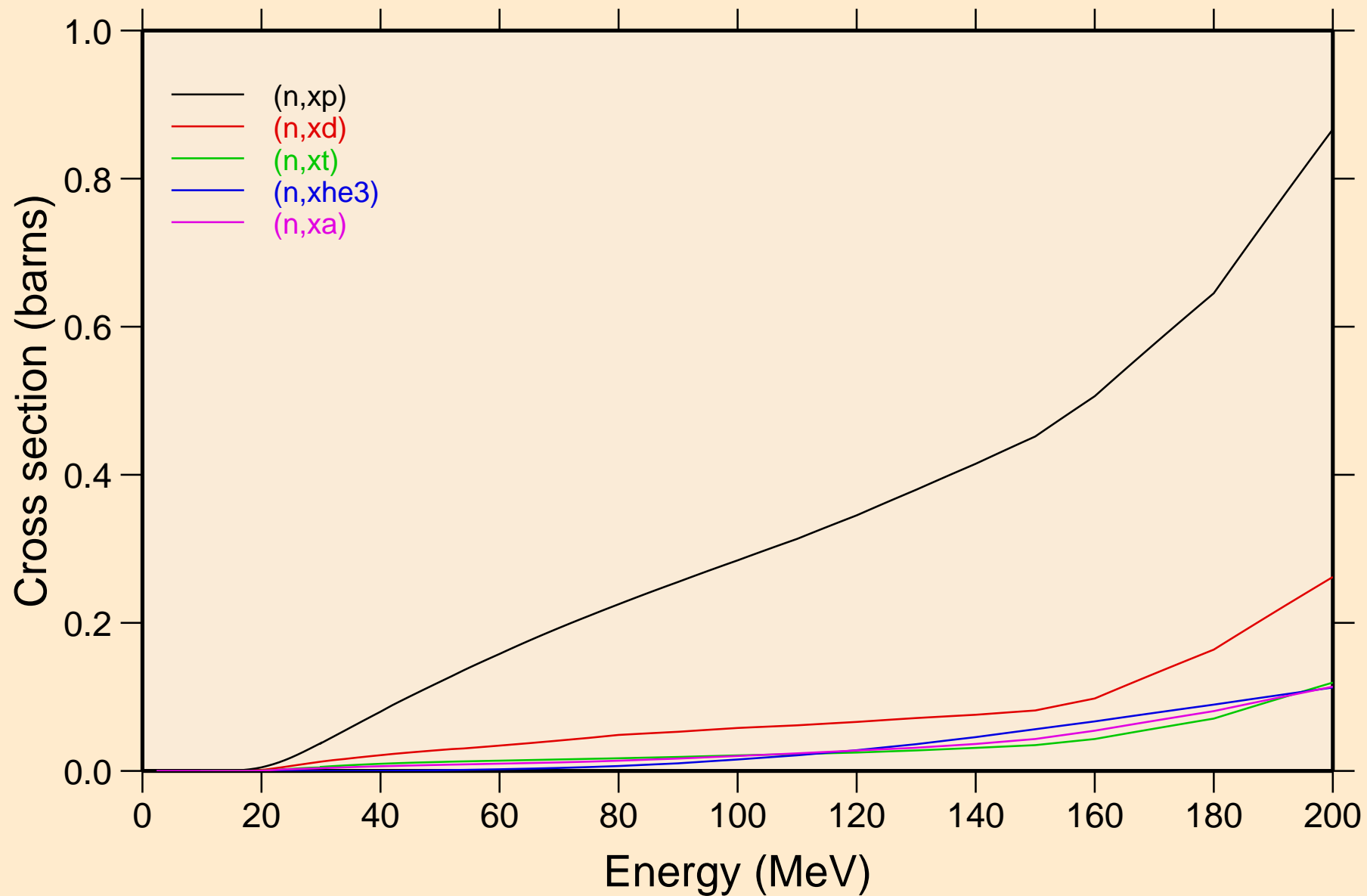

ZR103 NEUTRON ACER TENDL-2019 LIBRARY; T=293.16K
angular distribution for elastic

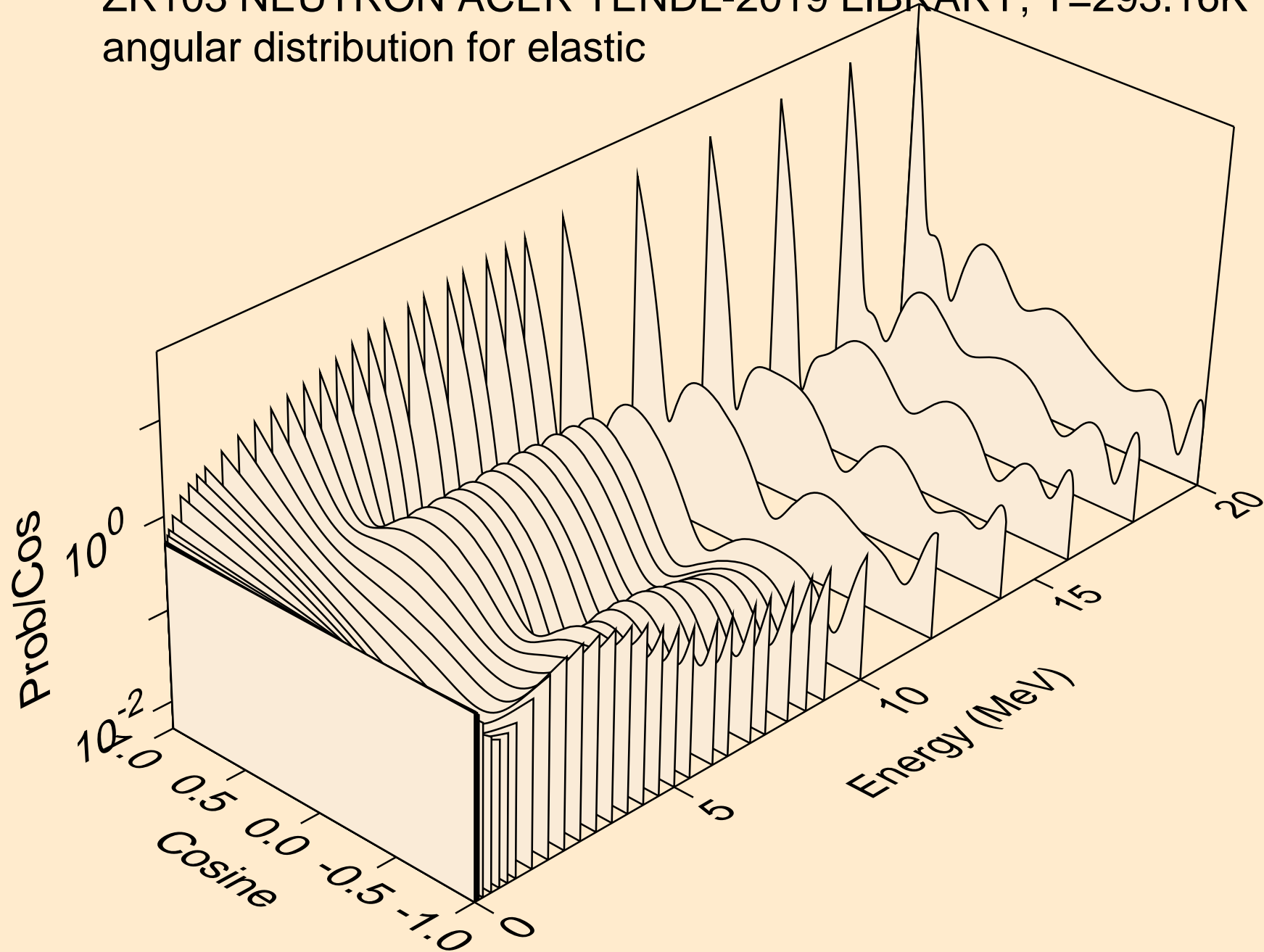

ZR103 NEUTRON ACER TENDL-2019 LIBRARY; T=293.16K
angular distribution for elastic

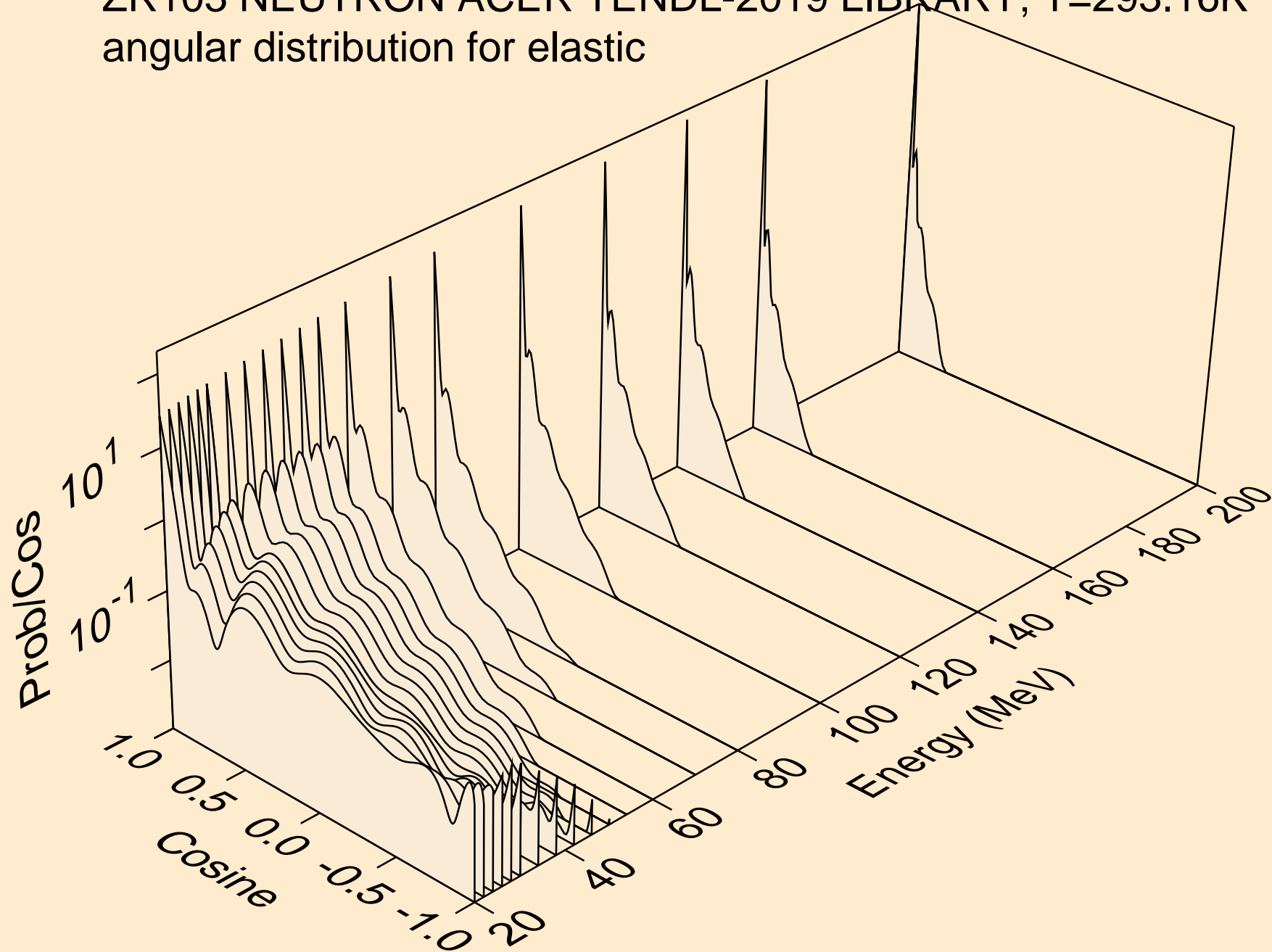

ZR103 NEUTRON ACER TENDL-2019 LIBRARY; T=293.16K
angular distribution for (n,n*1)

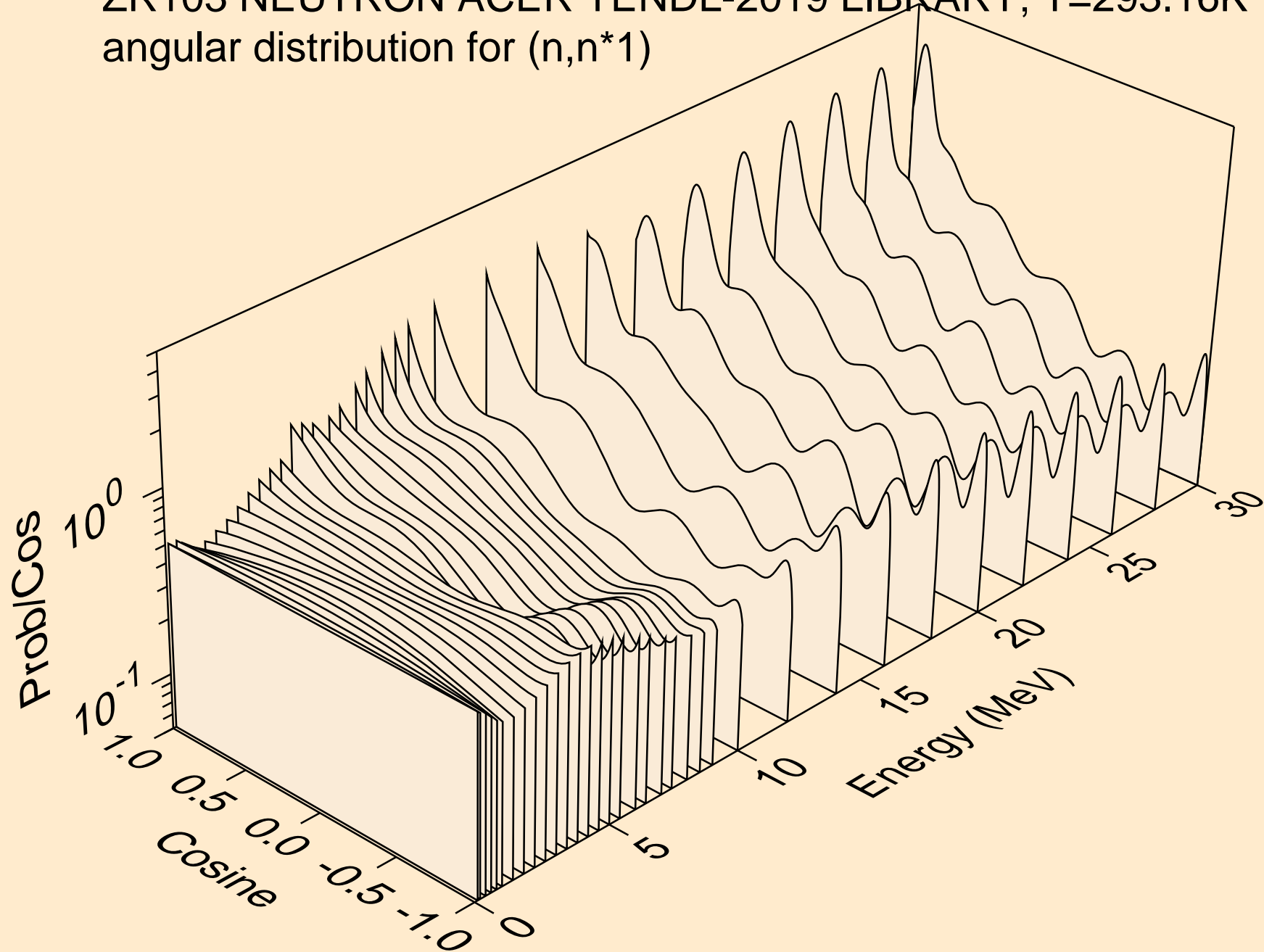

ZR103 NEUTRON ACER TENDL-2019 LIBRARY; T=293.16K
angular distribution for (n,n*2)

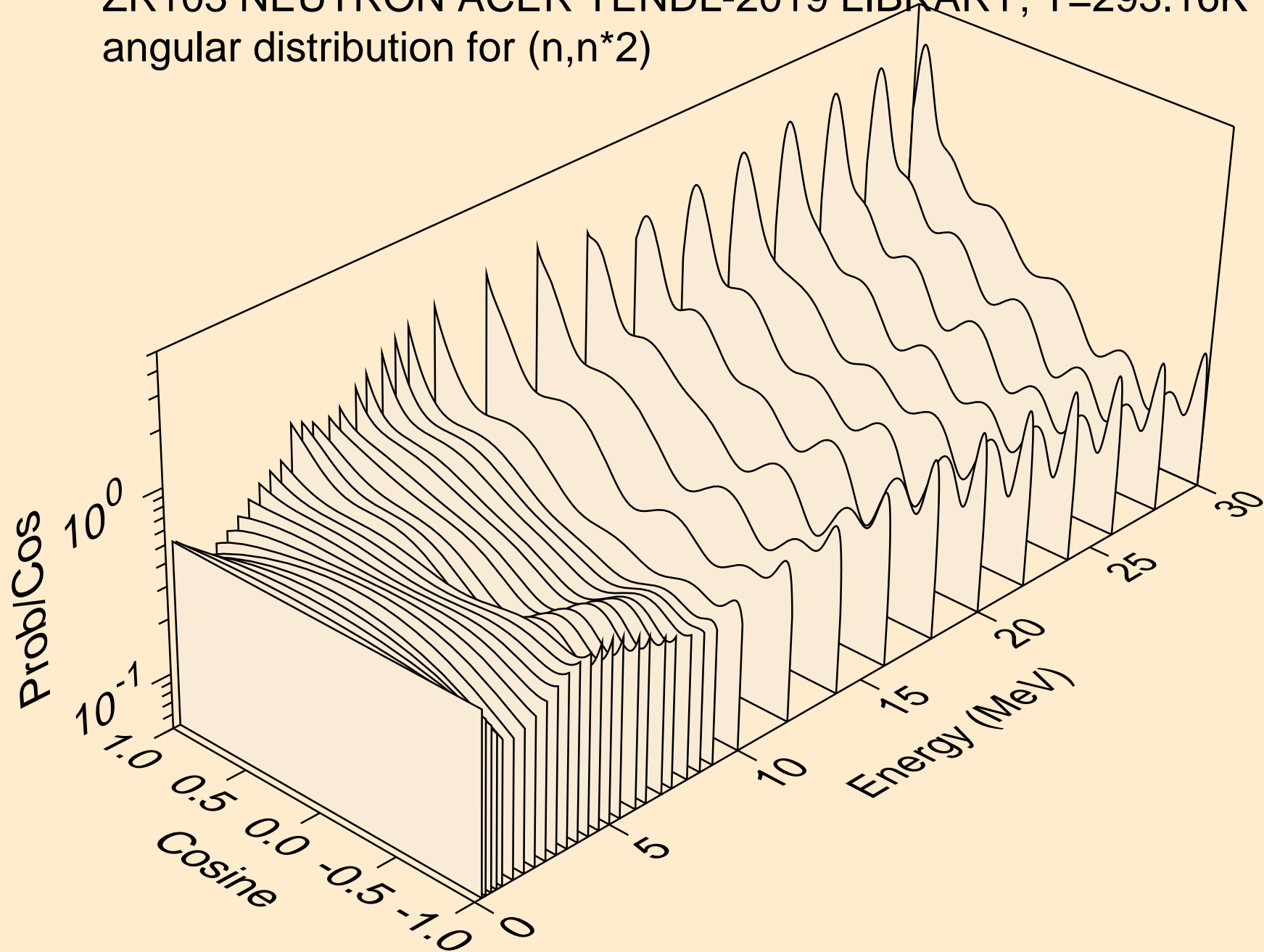

ZR103 NEUTRON ACER TENDL-2019 LIBRARY; T=293.16K
angular distribution for (n,n*3)

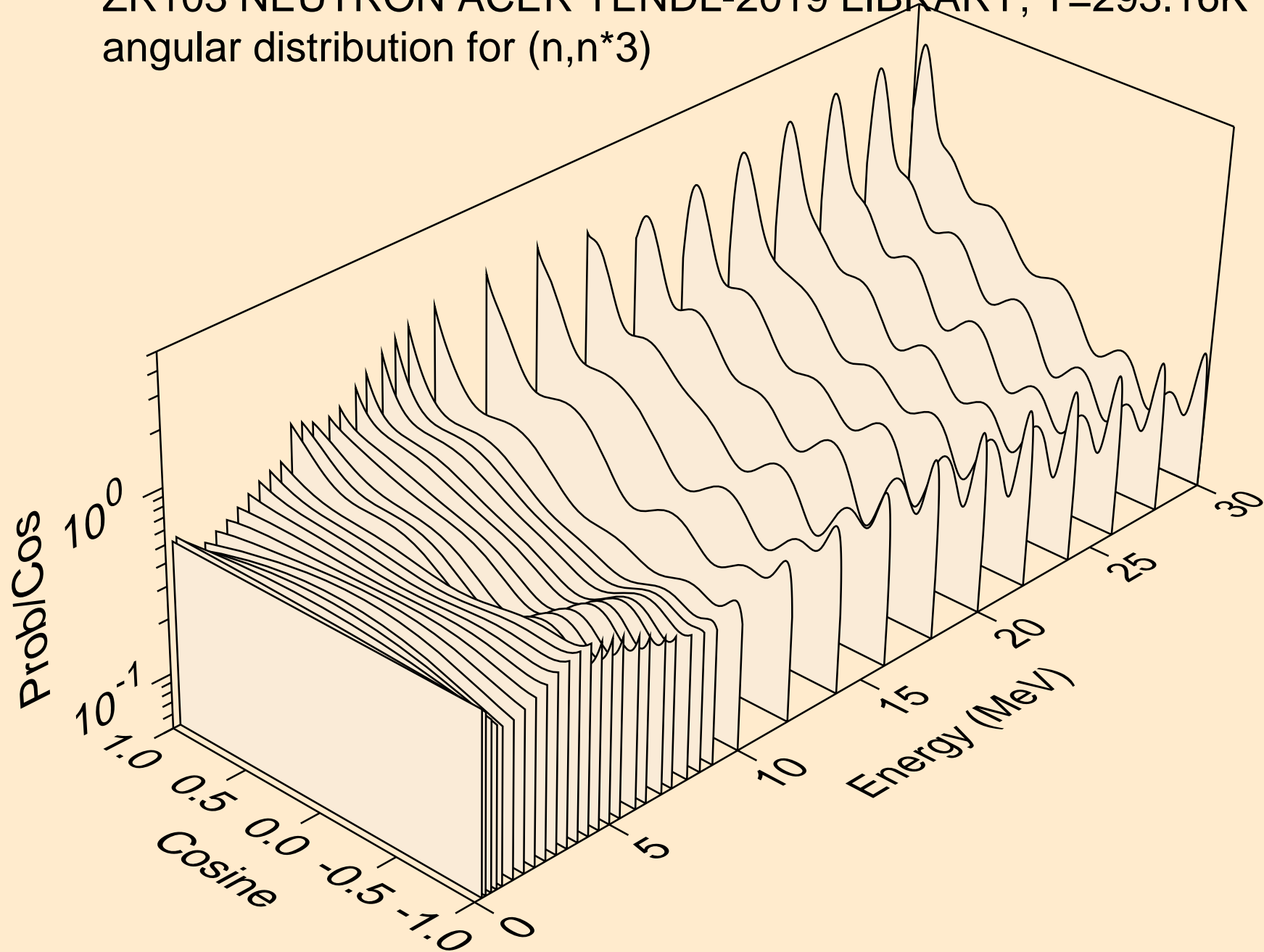

ZR103 NEUTRON ACER TENDL-2019 LIBRARY; T=293.16K
angular distribution for (n,n*4)

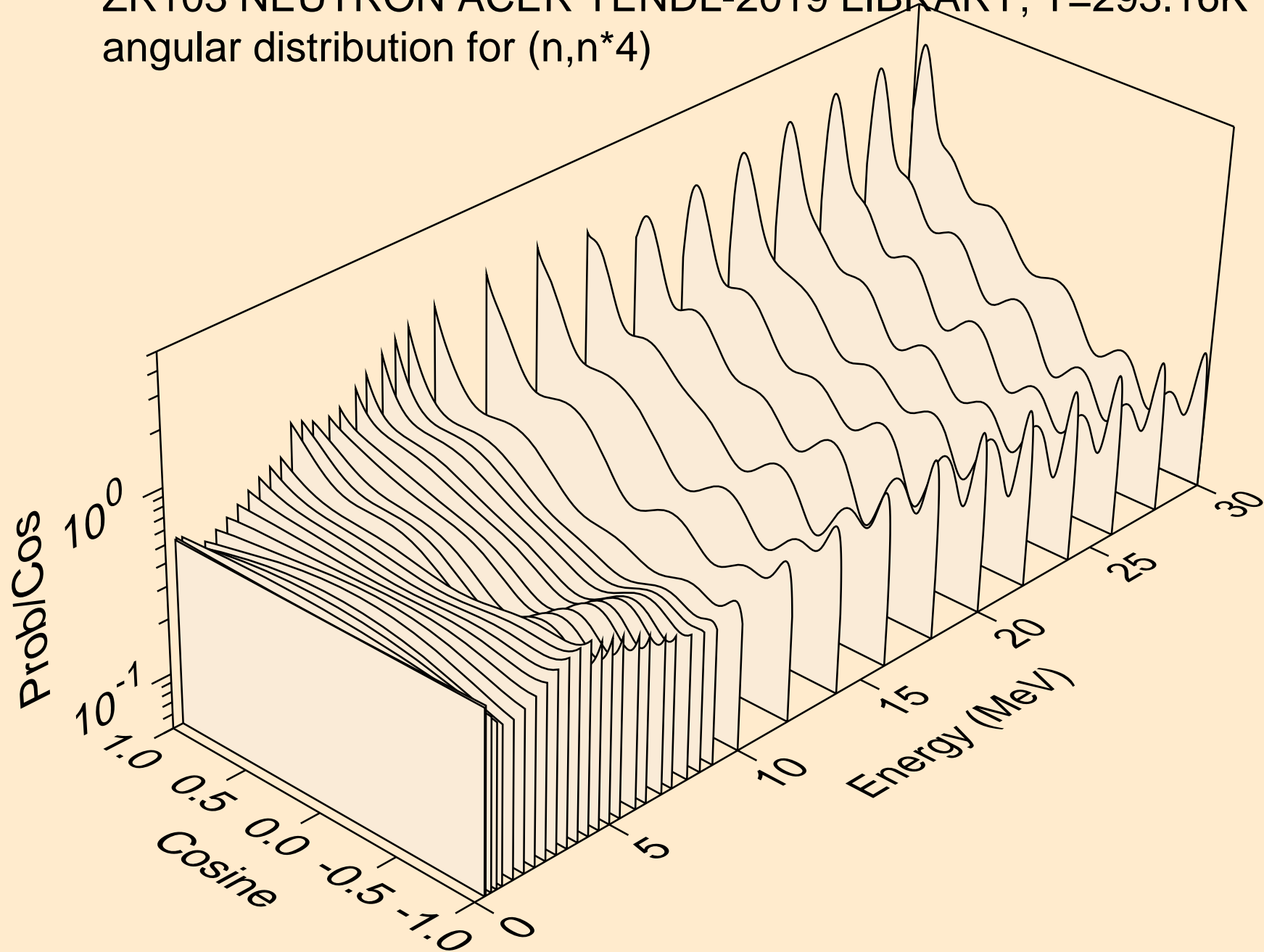

ZR103 NEUTRON ACER TENDL-2019 LIBRARY; T=293.16K
angular distribution for (n,n*5)

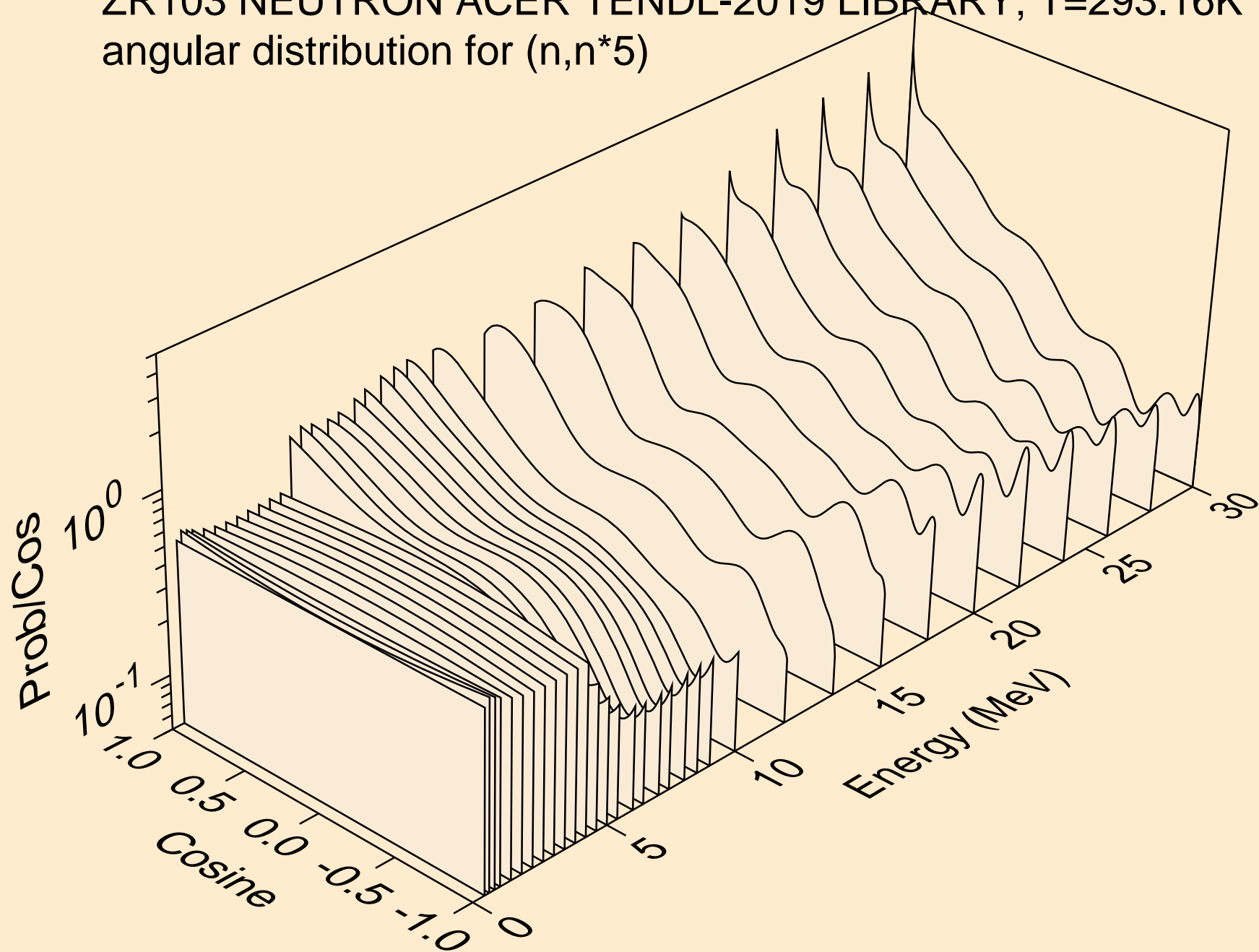

ZR103 NEUTRON ACER TENDL-2019 LIBRARY; T=293.16K
angular distribution for (n,n*6)

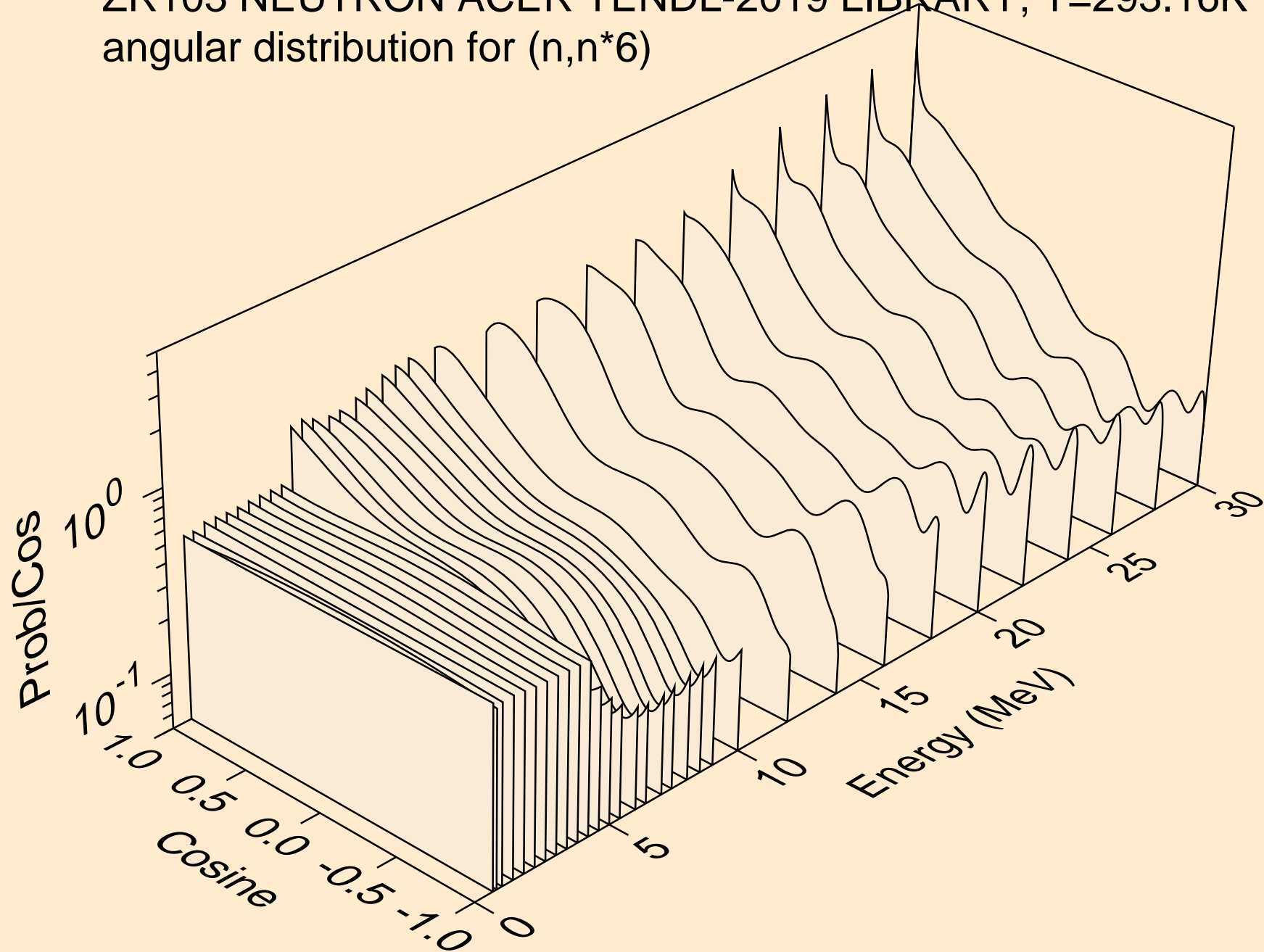

ZR103 NEUTRON ACER TENDL-2019 LIBRARY; T=293.16K
angular distribution for (n,n*7)

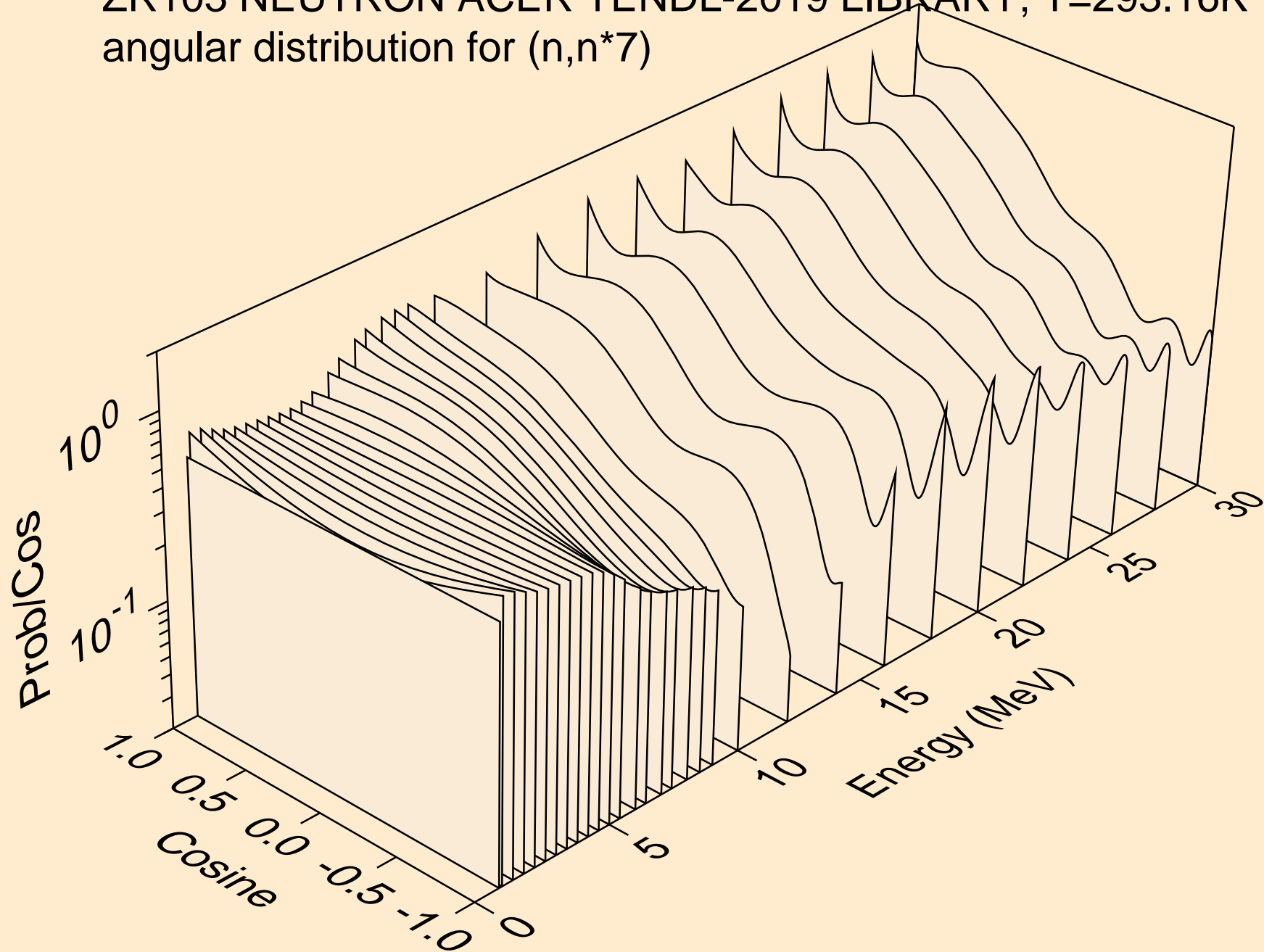

ZR103 NEUTRON ACER TENDL-2019 LIBRARY; T=293.16K
angular distribution for (n,n*8)

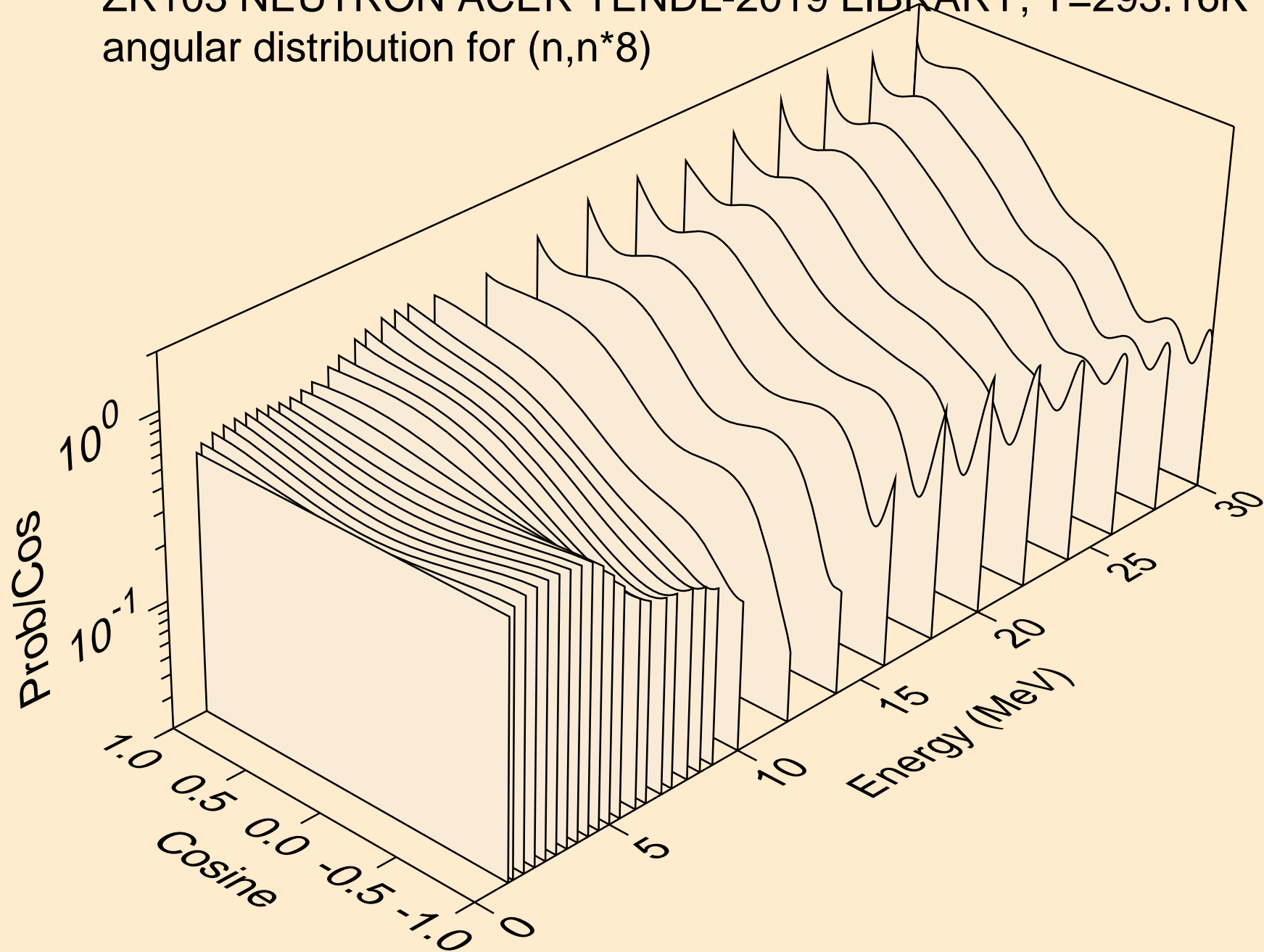

ZR103 NEUTRON ACER TENDL-2019 LIBRARY; T=293.16K
Neutron emission for (n,x)

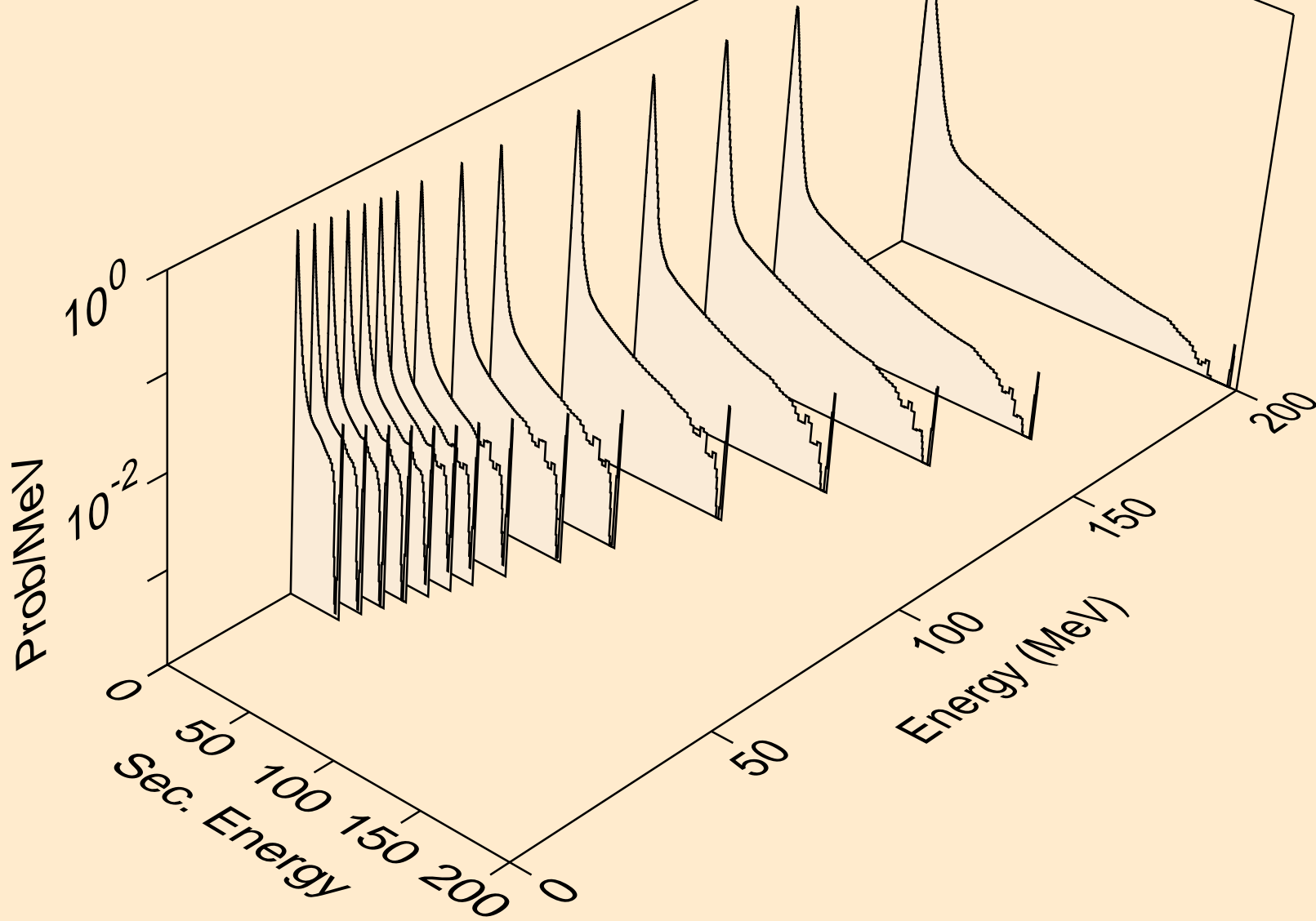

ZR103 NEUTRON ACER TENDL-2019 LIBRARY; T=293.16K
Neutron emission for (n,2nd)

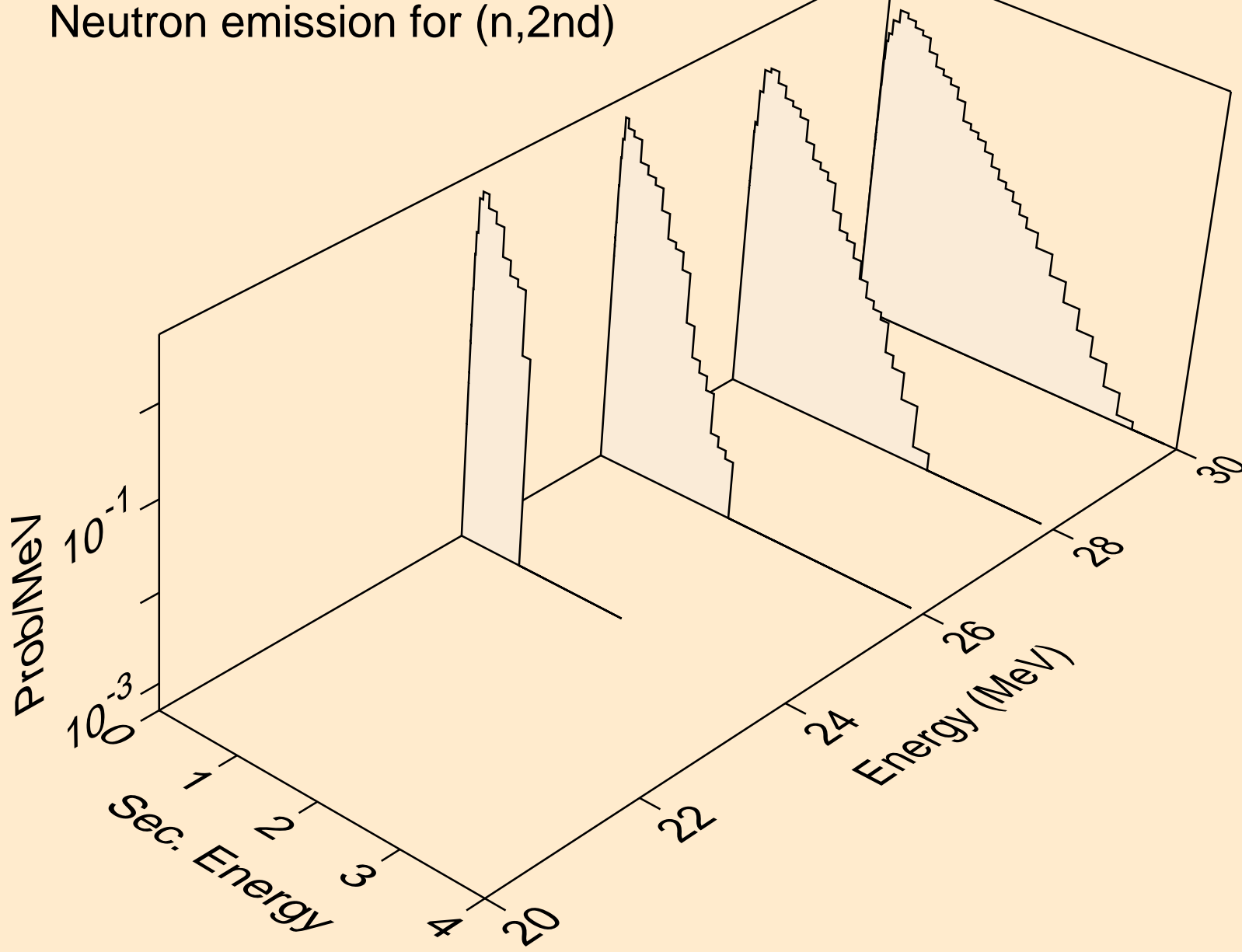

ZR103 NEUTRON ACER TENDL-2019 LIBRARY; T=293.16K
Neutron emission for (n,2n)

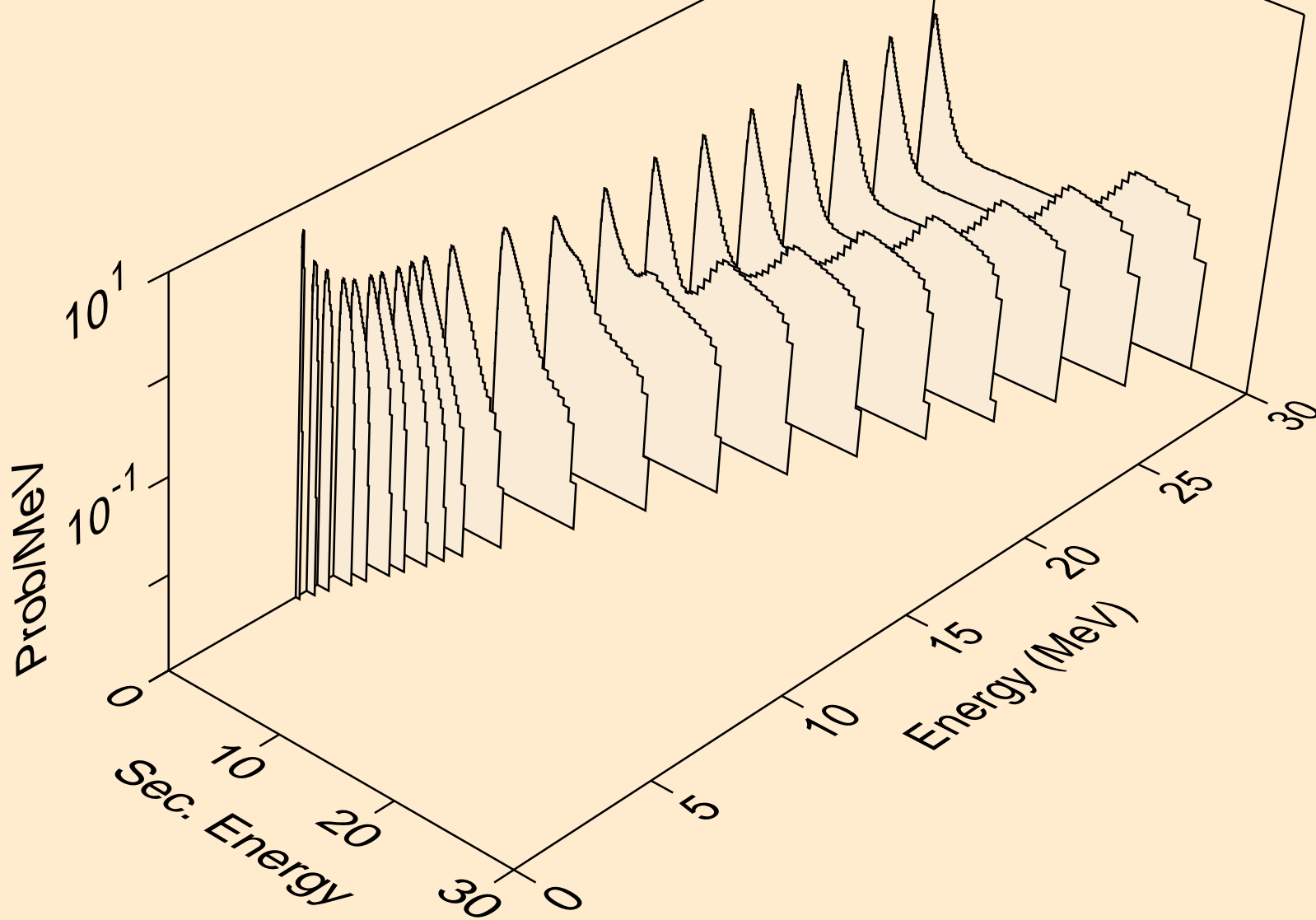

ZR103 NEUTRON ACER TENDL-2019 LIBRARY; T=293.16K
Neutron emission for (n,3n)

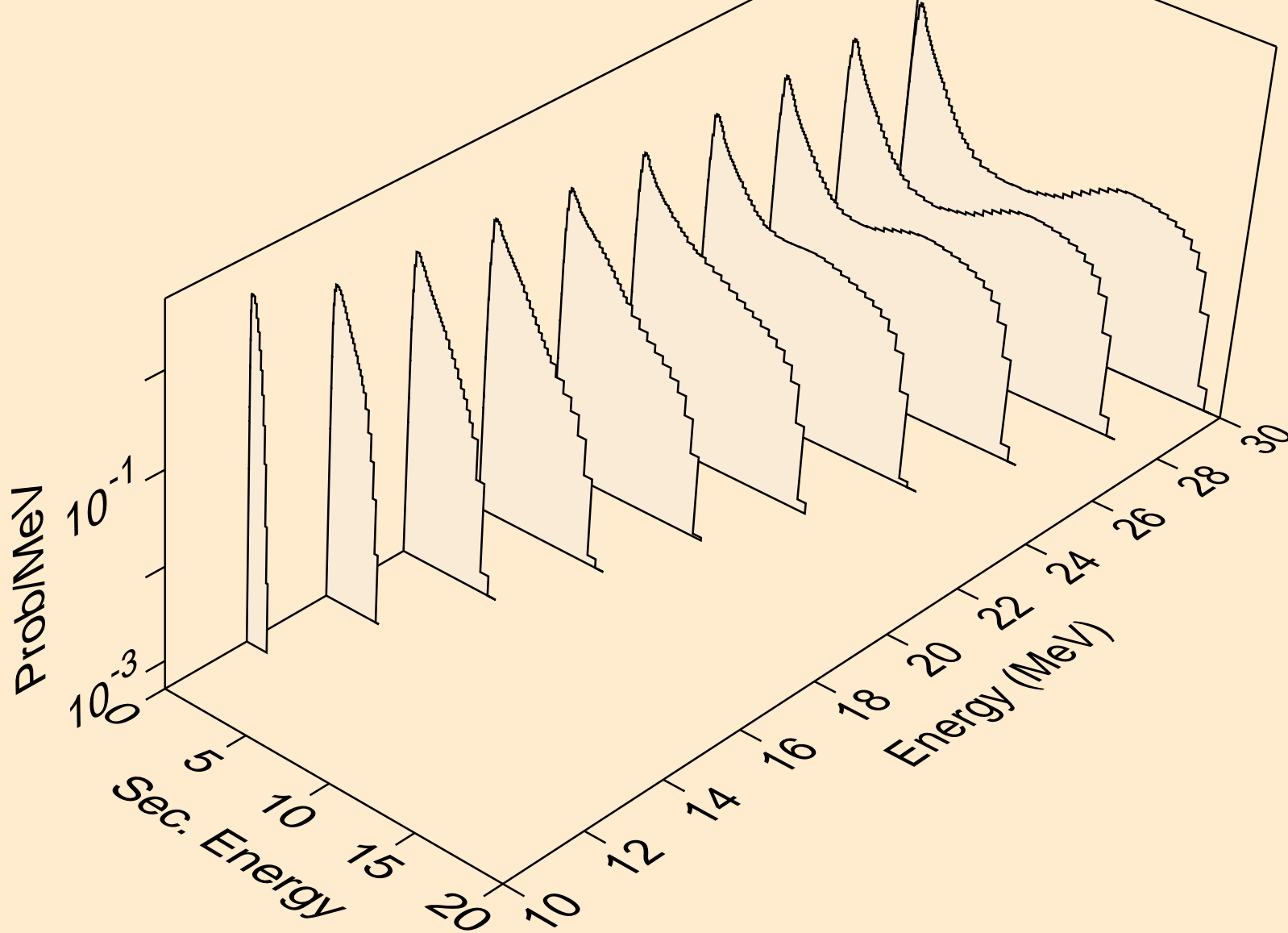

ZR103 NEUTRON ACER TENDL-2019 LIBRARY; T=293.16K
Neutron emission for (n,n*)a

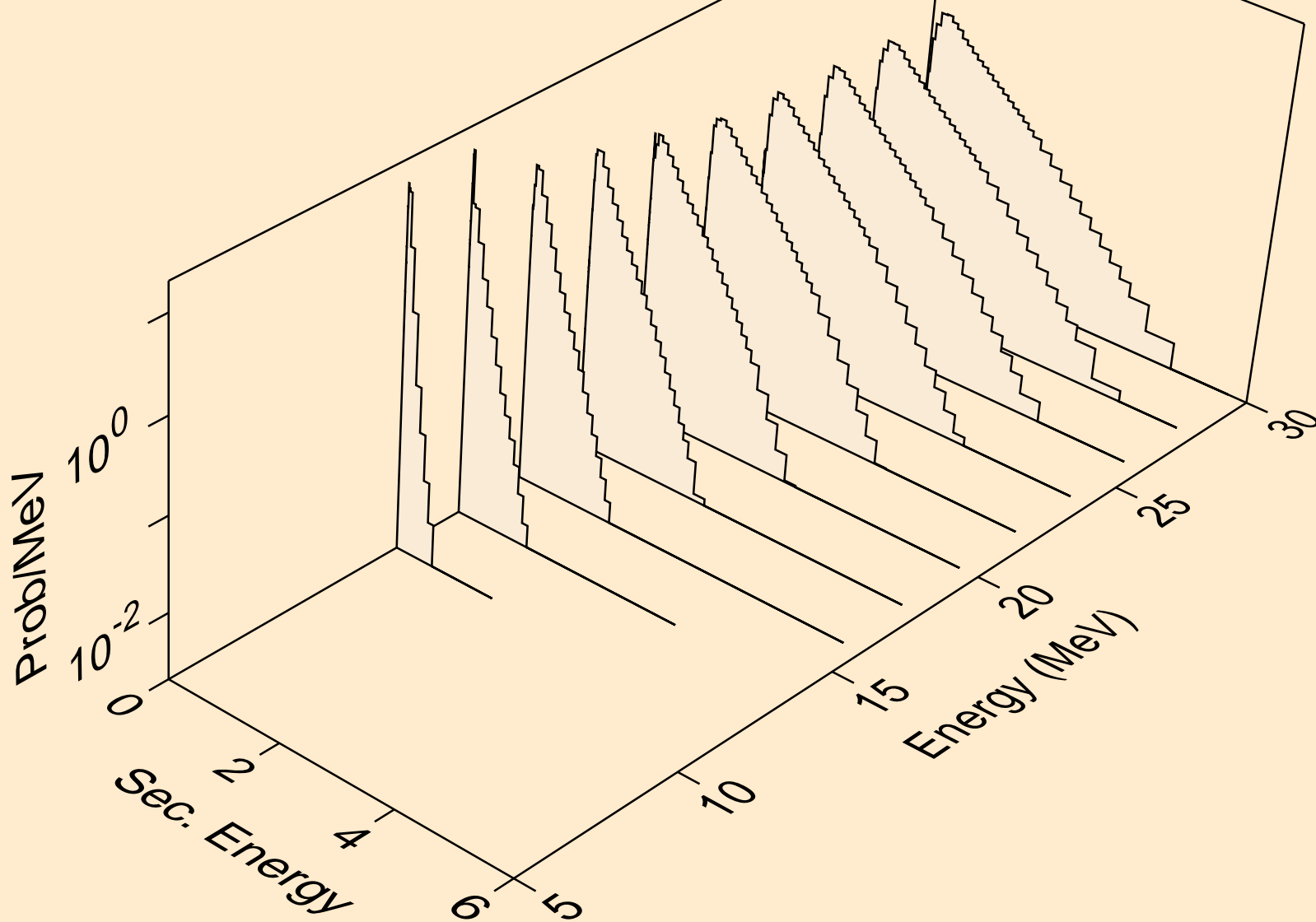

ZR103 NEUTRON ACER TENDL-2019 LIBRARY; T=293.16K
Neutron emission for (n,2n)a

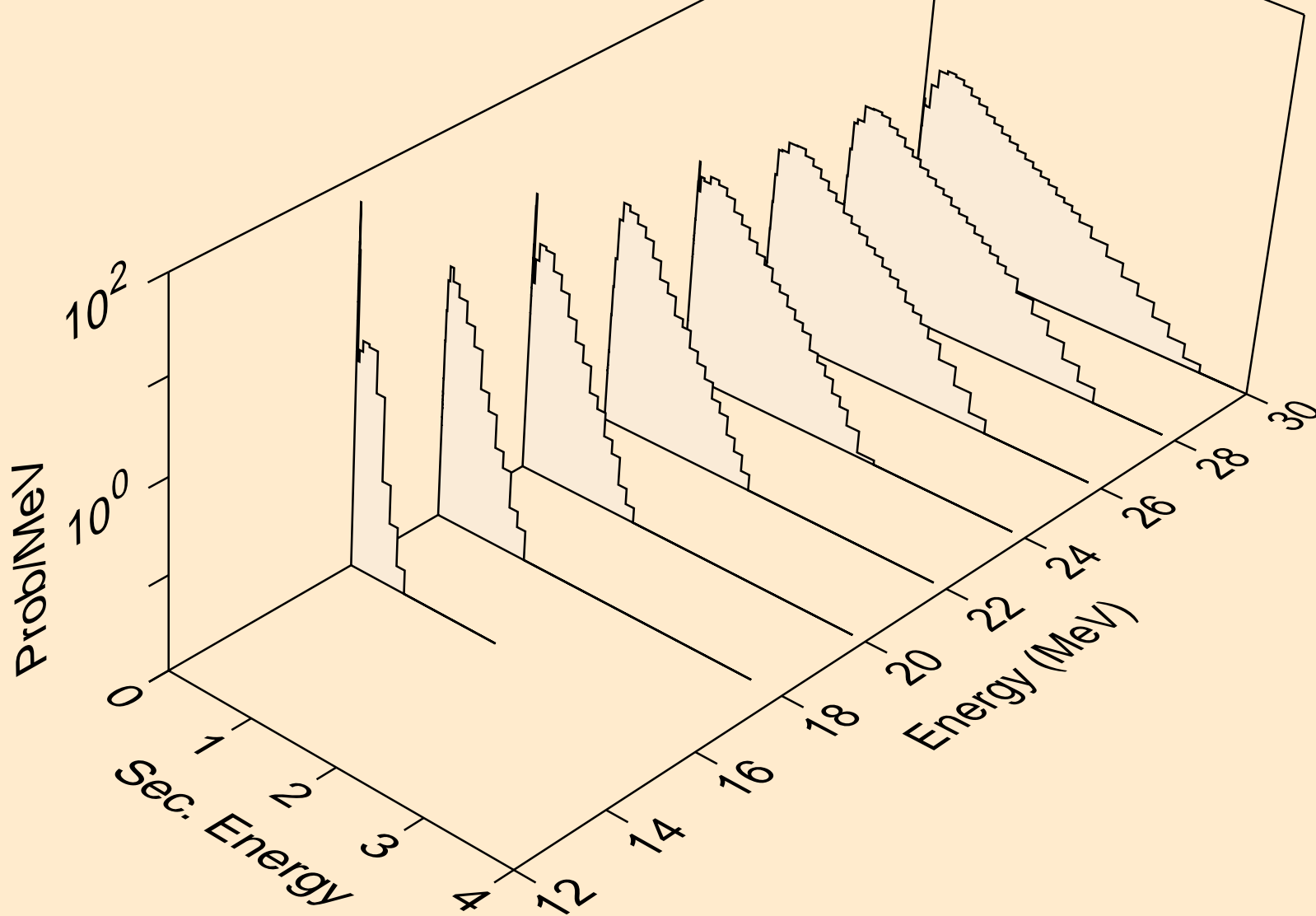

ZR103 NEUTRON ACER TENDL-2019 LIBRARY; T=293.16K
Neutron emission for (n,3n)a

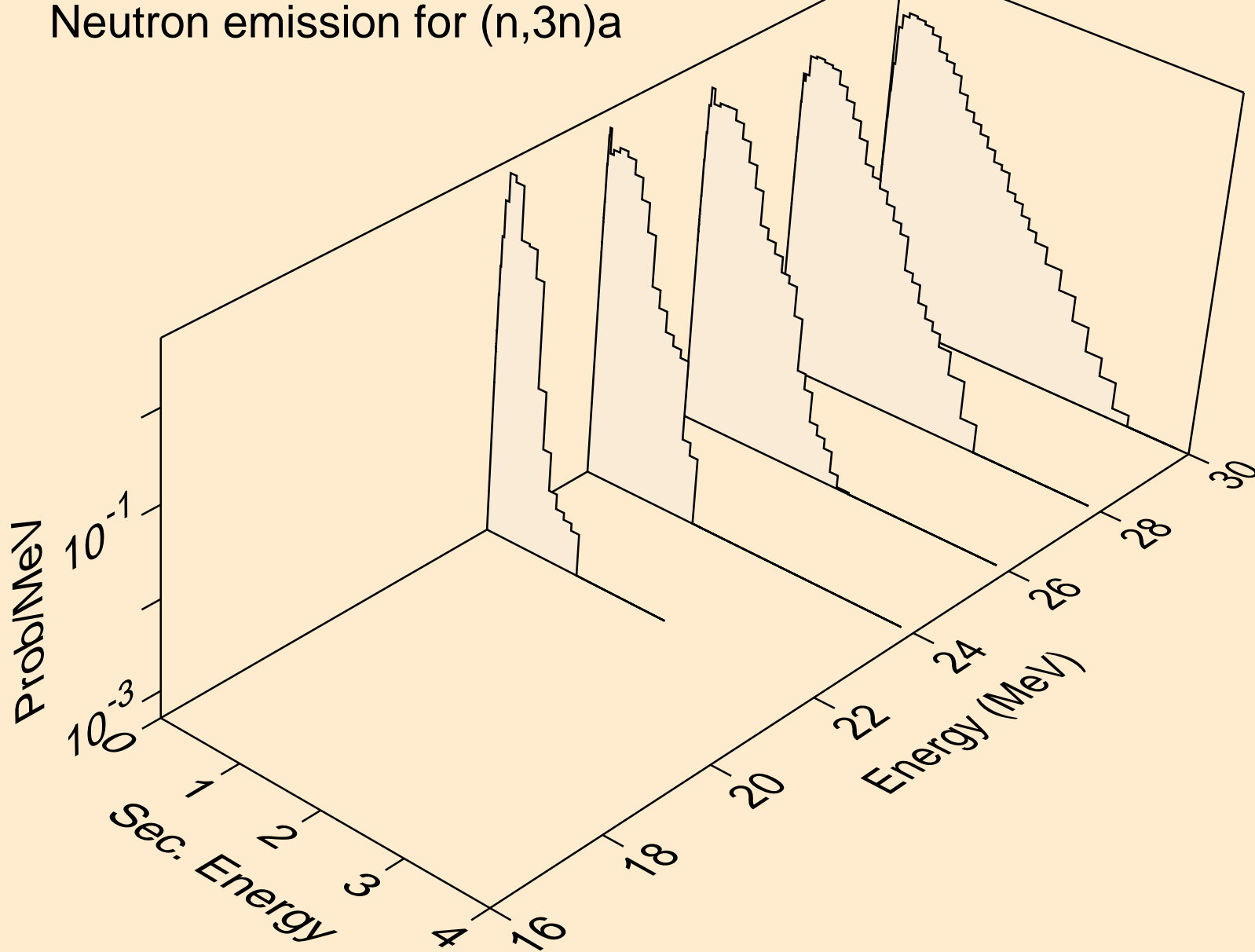

ZR103 NEUTRON ACER TENDL-2019 LIBRARY; T=293.16K
Neutron emission for (n,n*)p

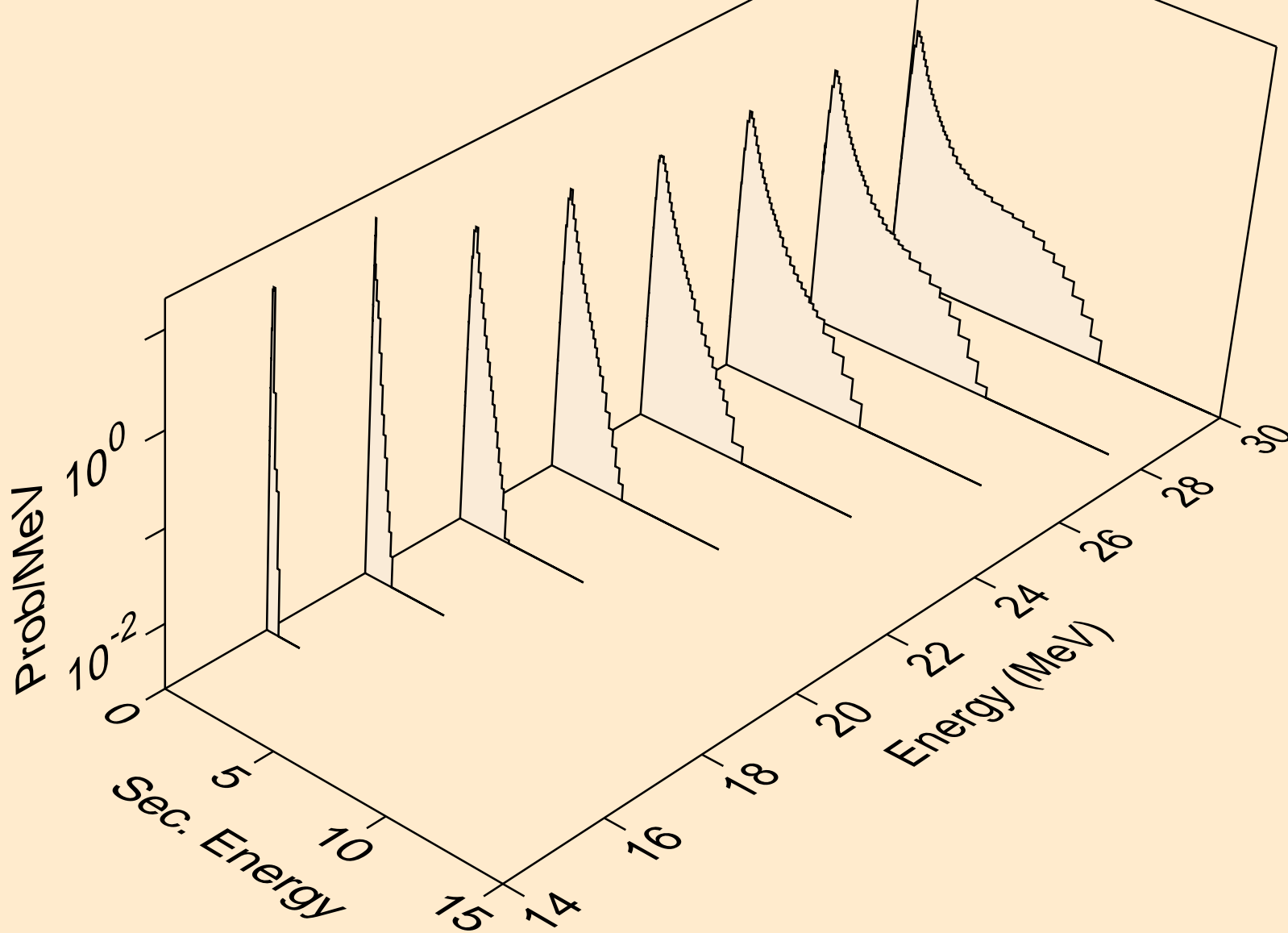

ZR103 NEUTRON ACER TENDL-2019 LIBRARY; T=293.16K
Neutron emission for (n,n*)d

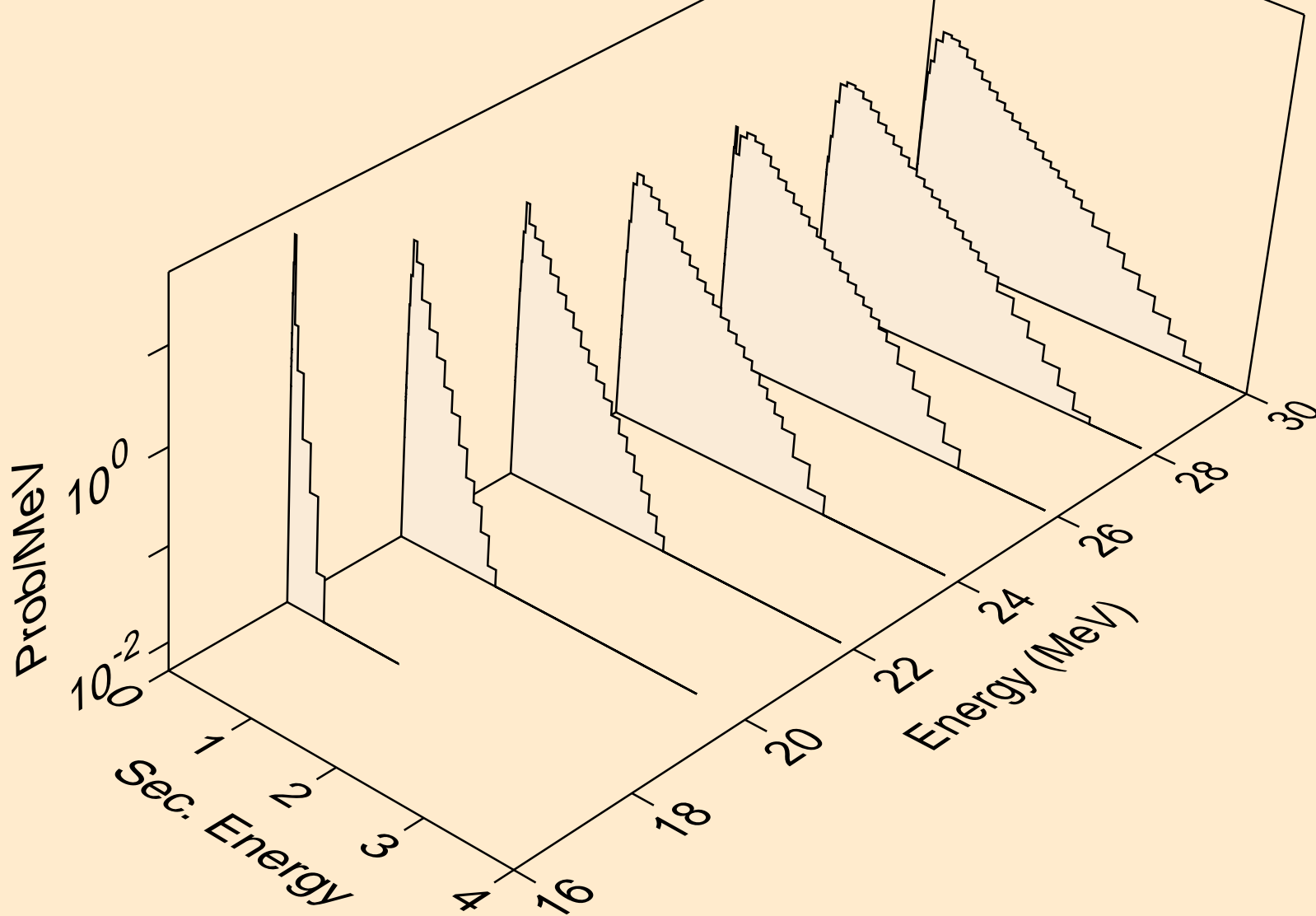

ZR103 NEUTRON ACER TENDL-2019 LIBRARY; T=293.16K
Neutron emission for (n,n*)t

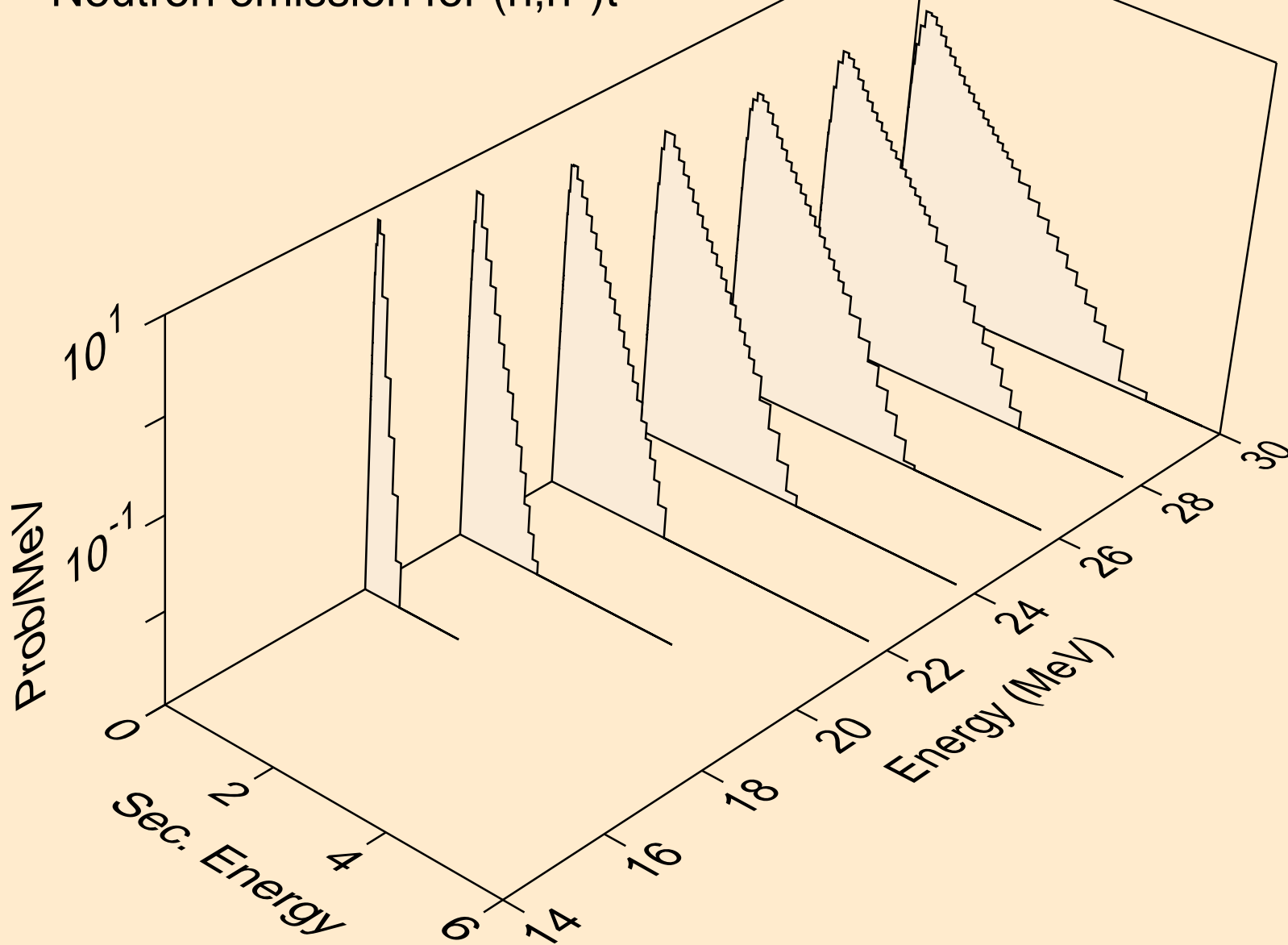

ZR103 NEUTRON ACER TENDL-2019 LIBRARY; T=293.16K
Neutron emission for (n,4n)

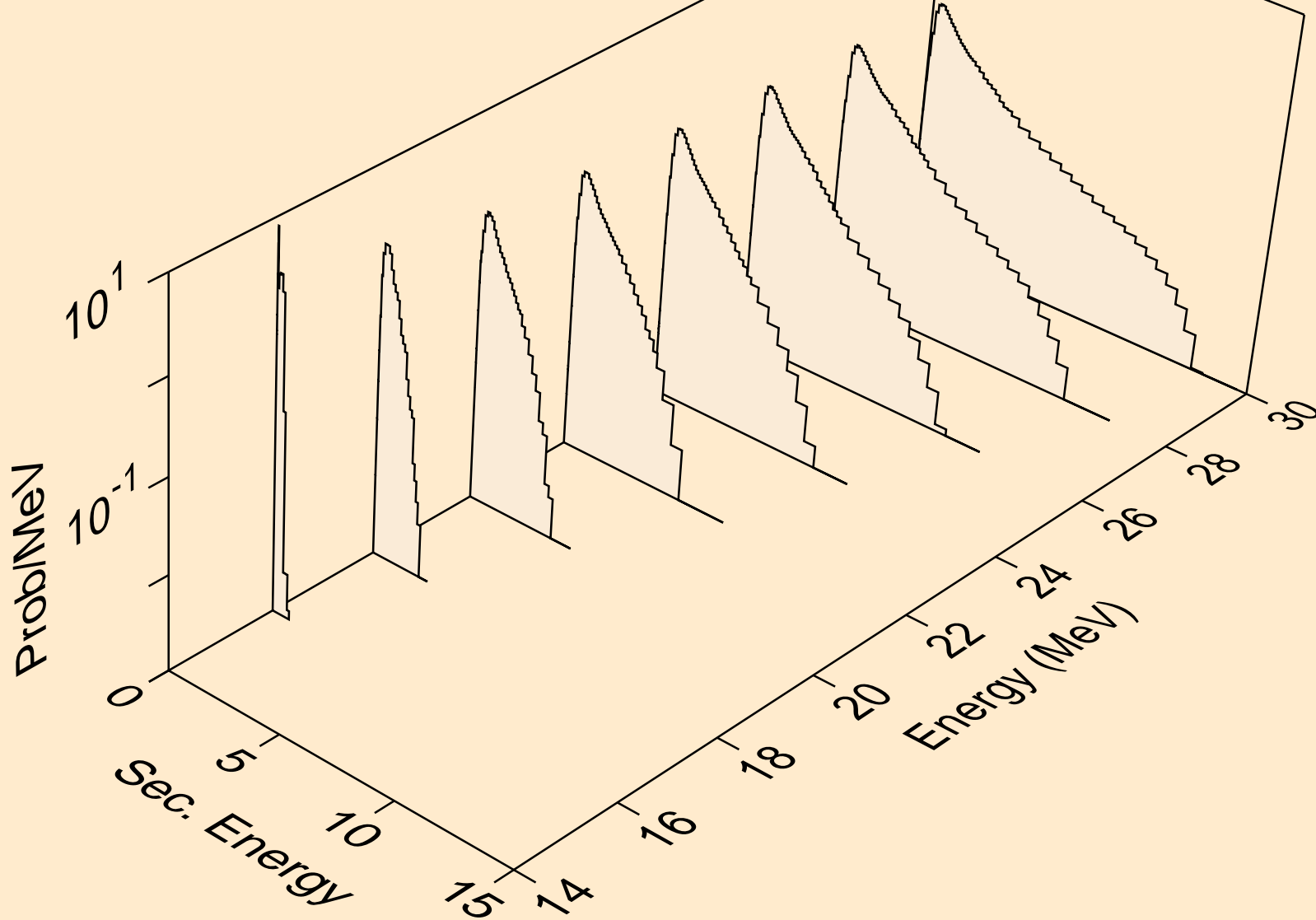

ZR103 NEUTRON ACER TENDL-2019 LIBRARY; T=293.16K
Neutron emission for (n,2np)

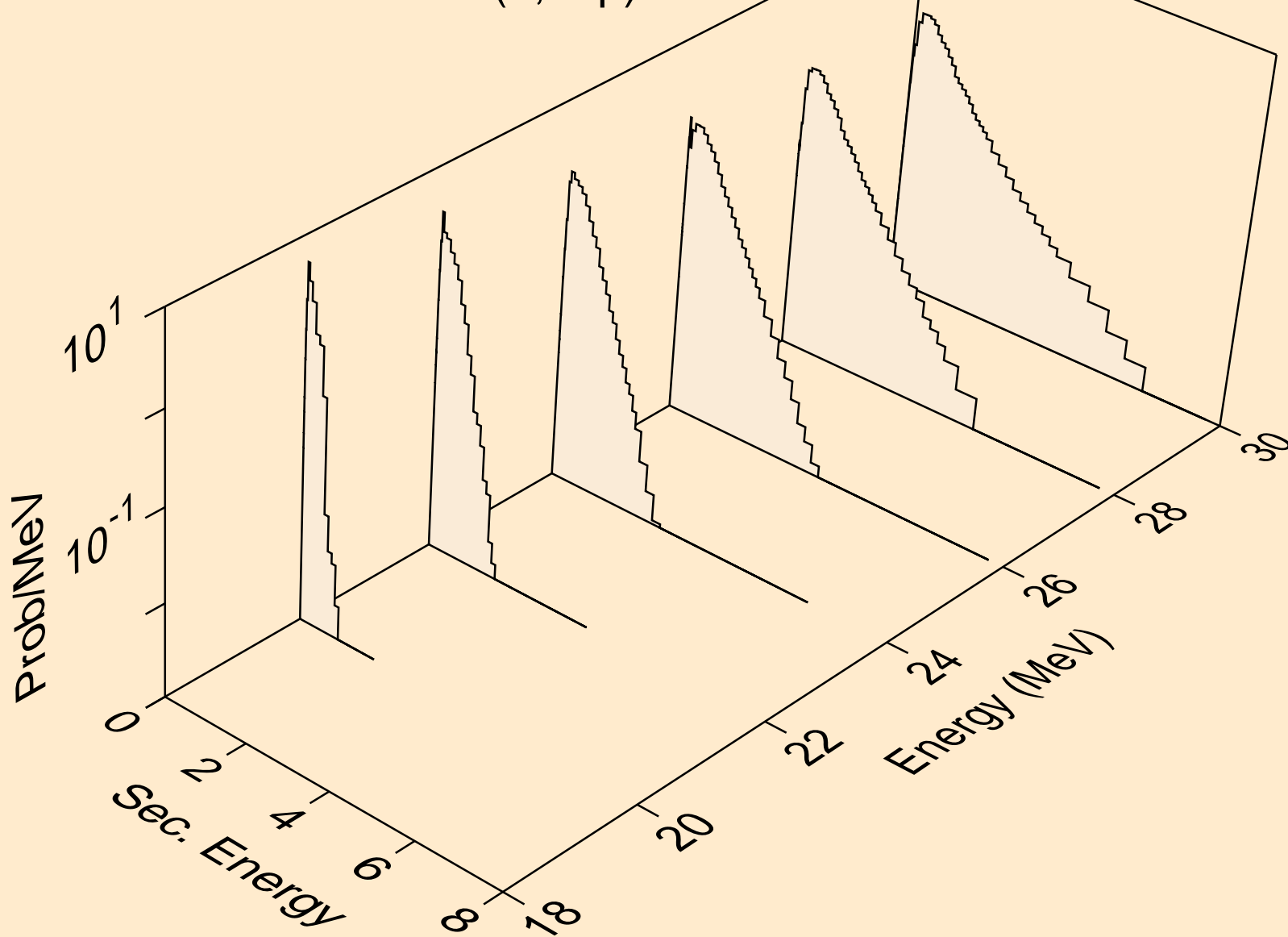

ZR103 NEUTRON ACER TENDL-2019 LIBRARY; T=293.16K
Neutron emission for (n,3np)

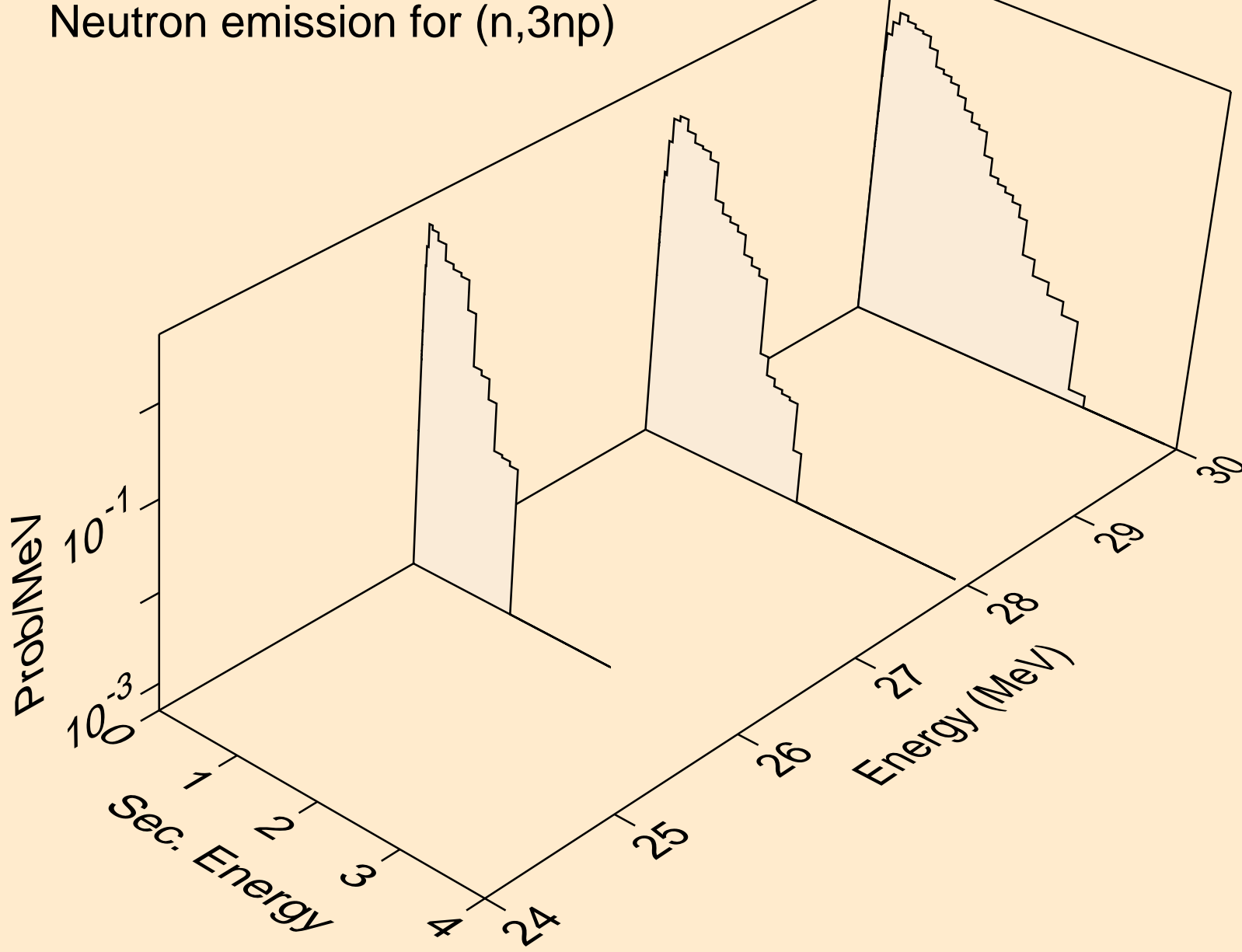

ZR103 NEUTRON ACER TENDL-2019 LIBRARY; T=293.16K
Neutron emission for (n,n*c)

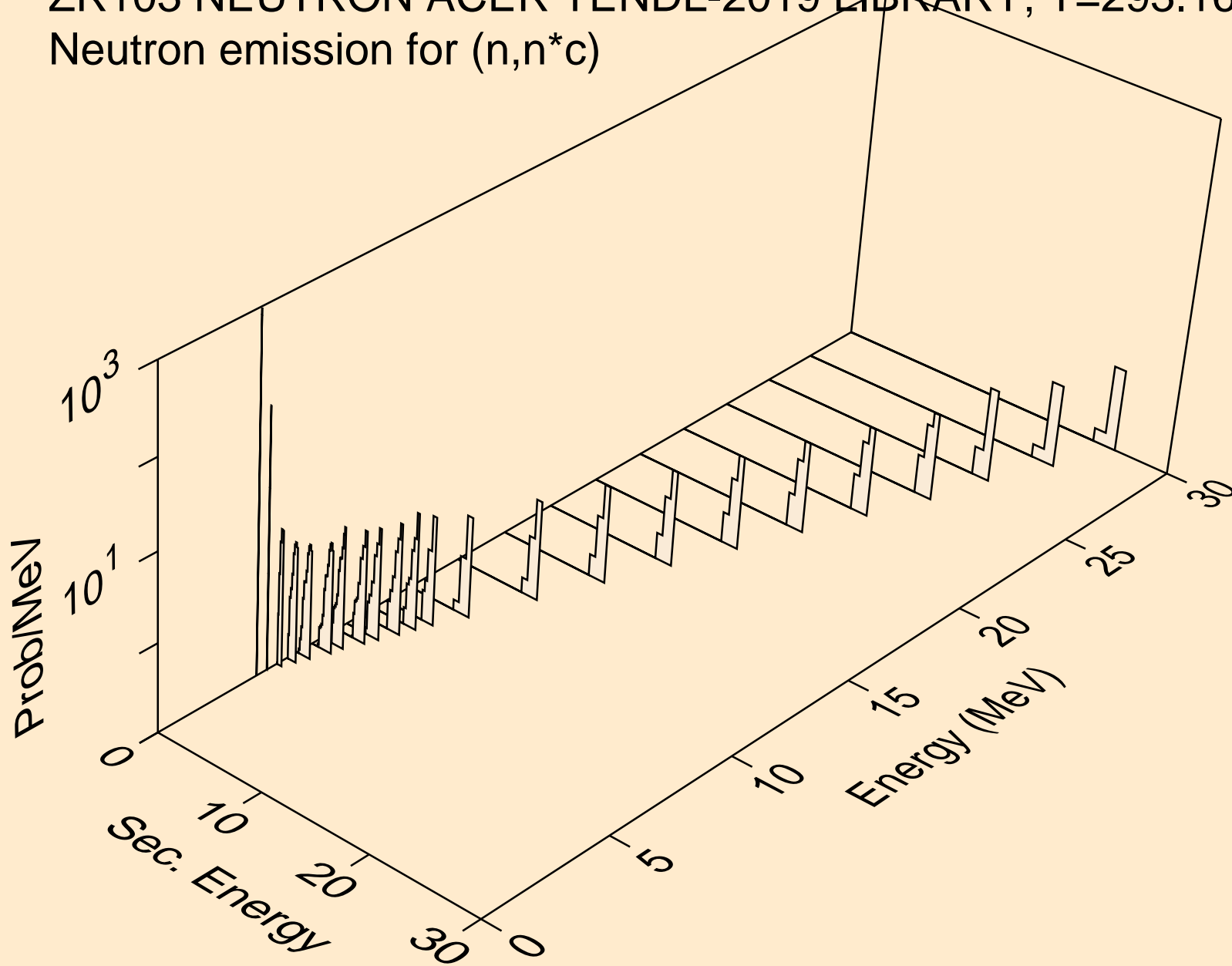

ZR103 NEUTRON ACER TENDL-2019 LIBRARY; T=293.16K
Photon emission for (n,x)

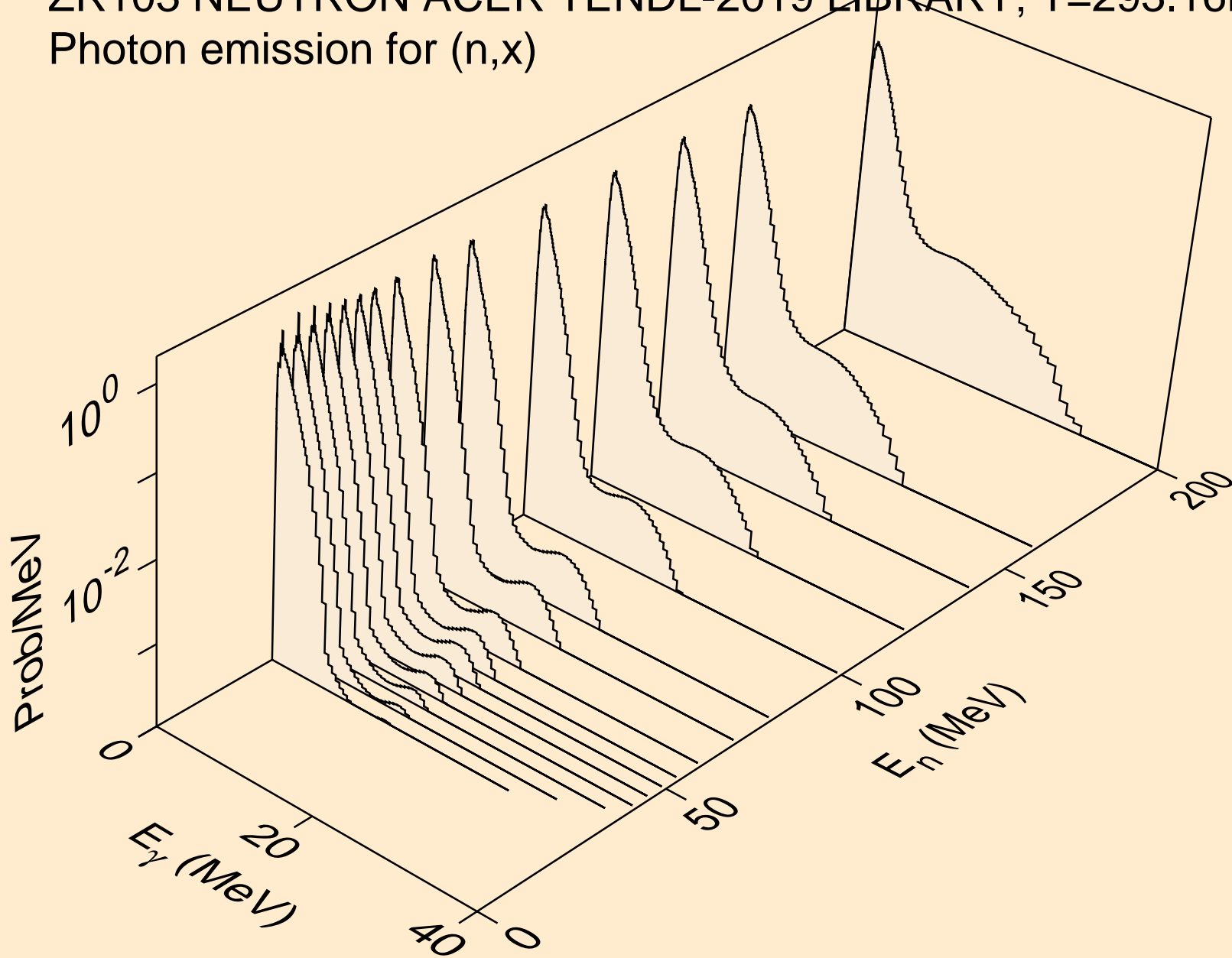

ZR103 NEUTRON ACER TENDL-2019 LIBRARY; T=293.16K
Photon emission for (n,2nd)

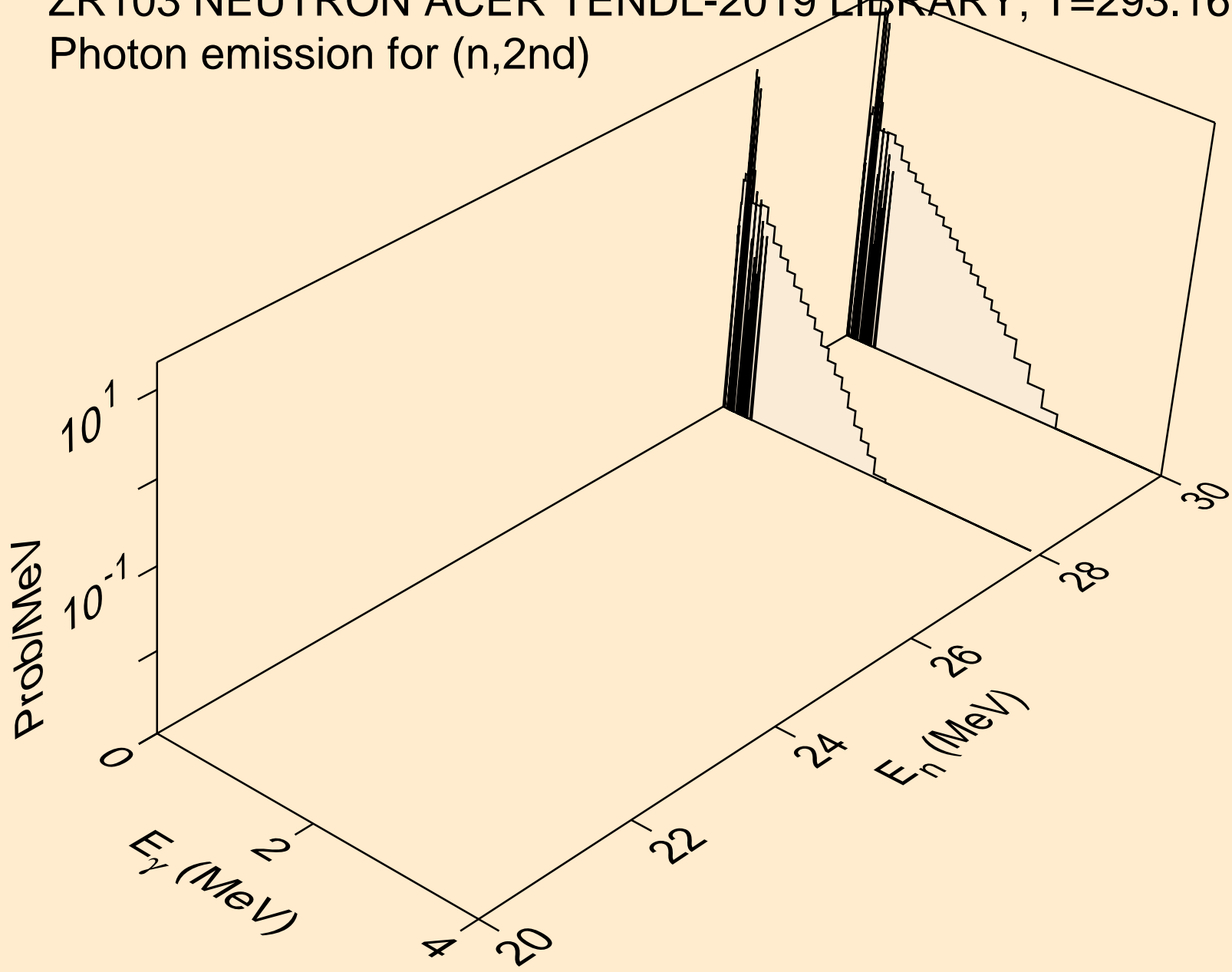

ZR103 NEUTRON ACER TENDL-2019 LIBRARY; T=293.16K
Photon emission for (n,2n)

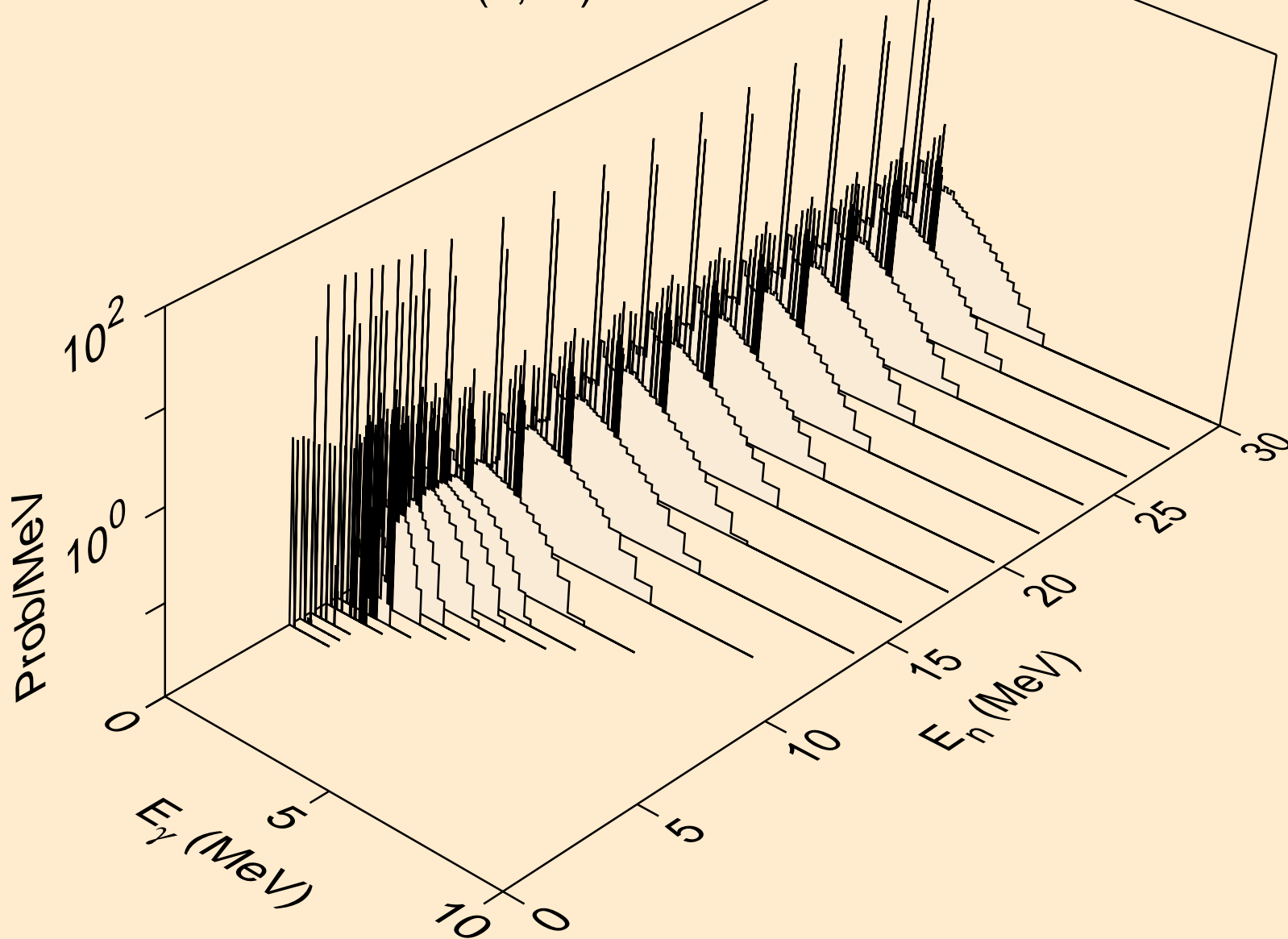

ZR103 NEUTRON ACER TENDL-2019 LIBRARY; T=293.16K
Photon emission for (n,3n)

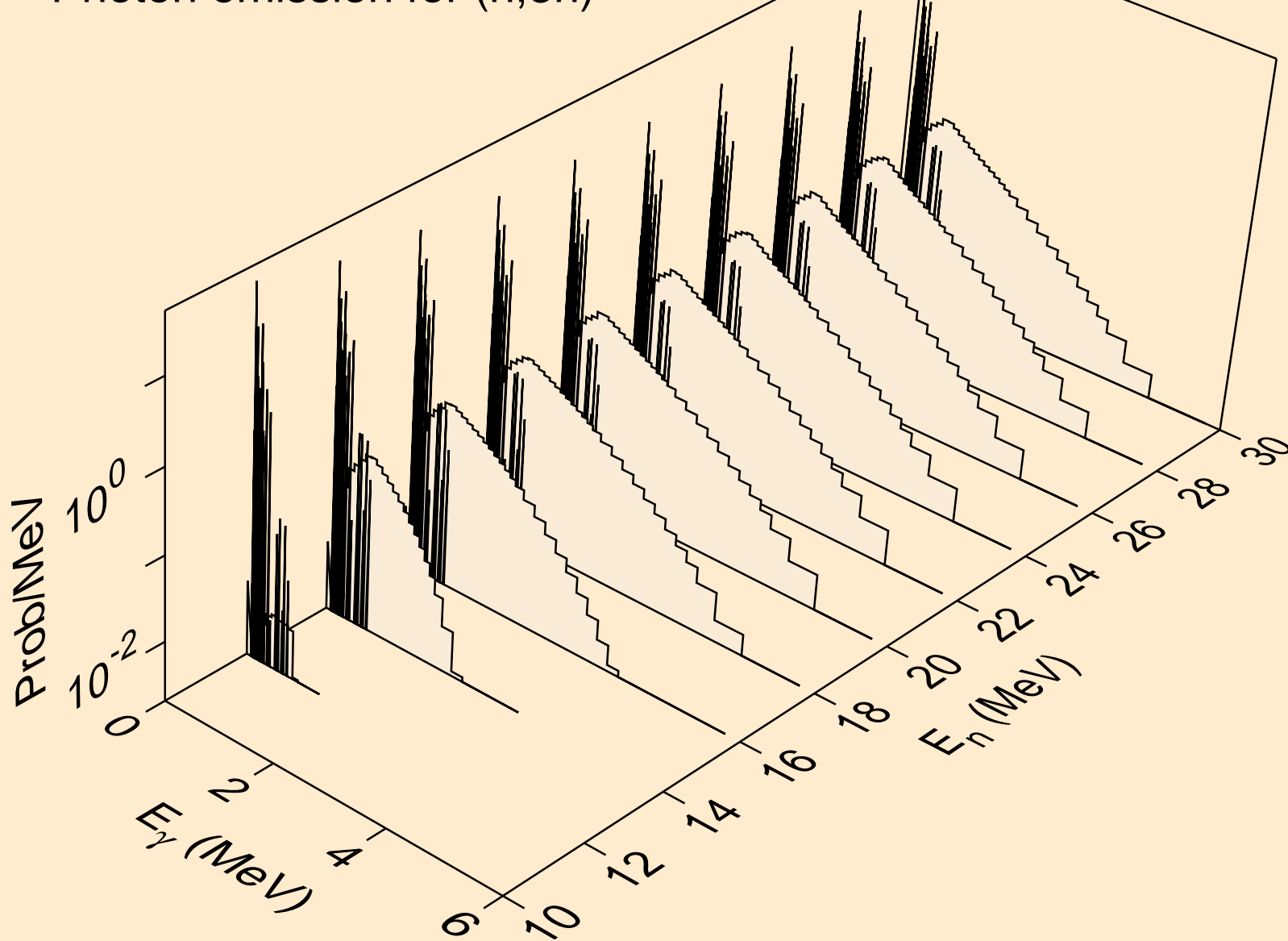

ZR103 NEUTRON ACER TENDL-2019 LIBRARY; T=293.16K
Photon emission for (n,n*)a

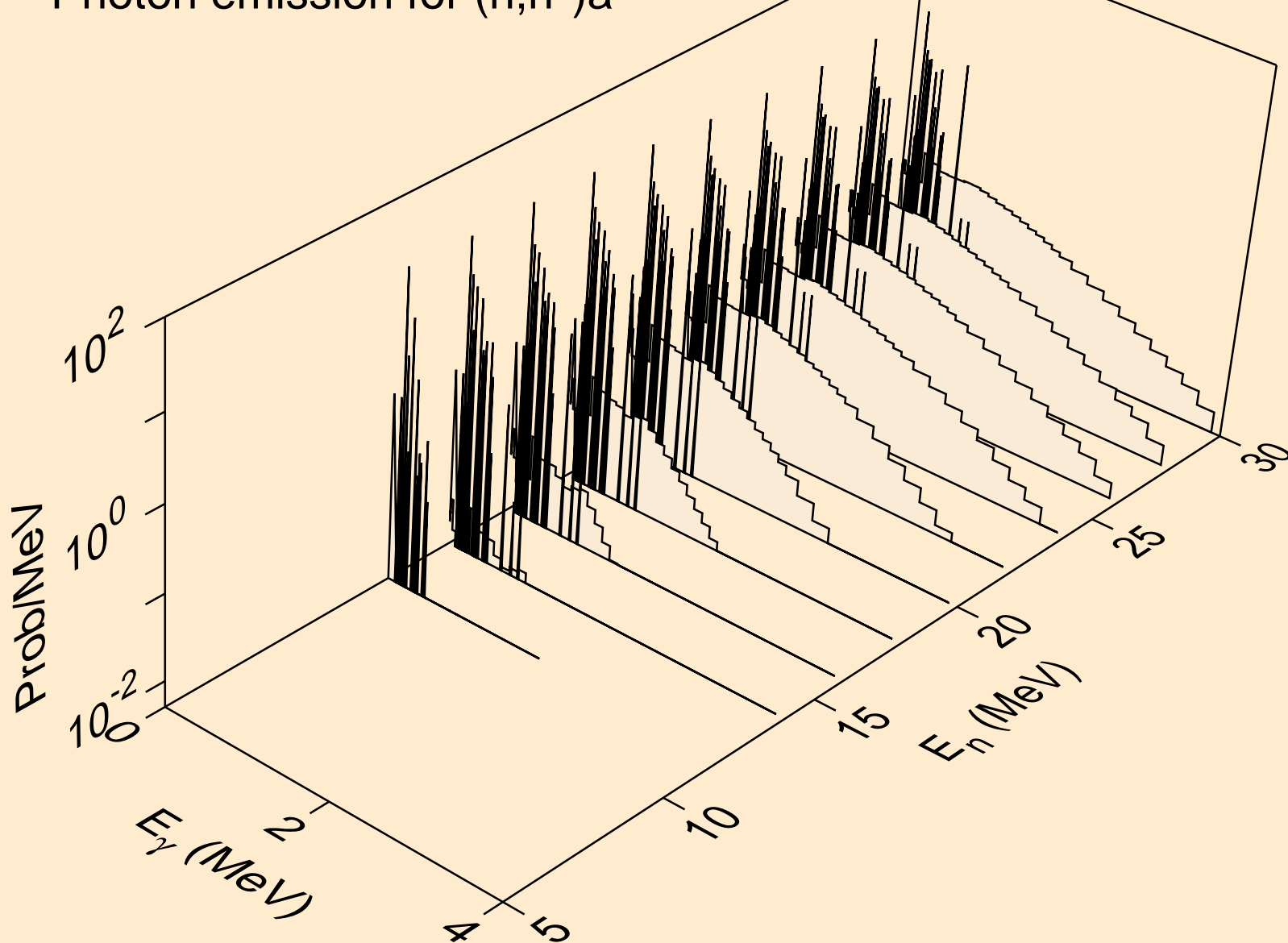

ZR103 NEUTRON ACER TENDL-2019 LIBRARY; T=293.16K
Photon emission for (n,2n)a

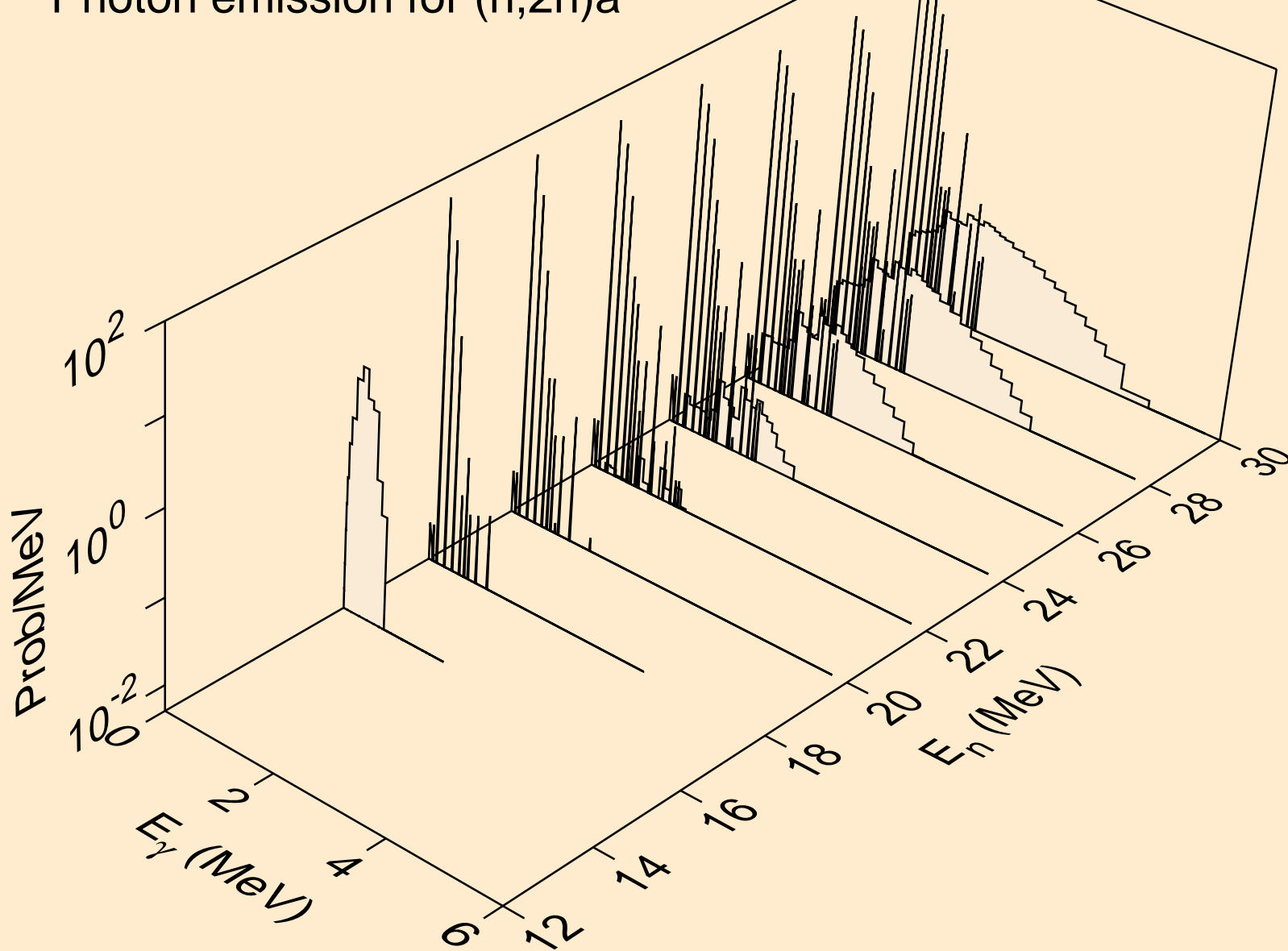

ZR103 NEUTRON ACER TENDL-2019 LIBRARY; T=293.16K
Photon emission for (n,3n)a

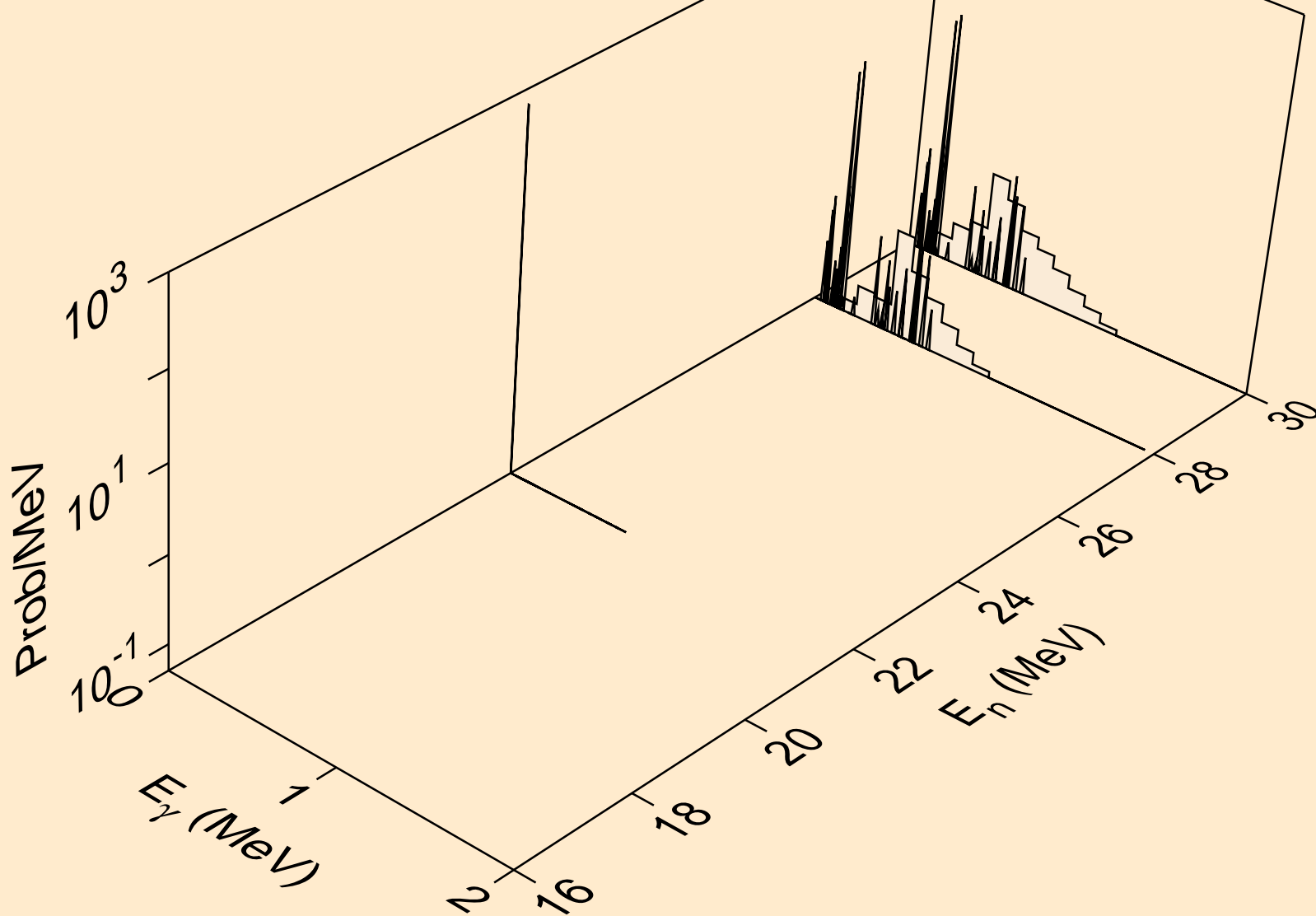

ZR103 NEUTRON ACER TENDL-2019 LIBRARY; T=293.16K
Photon emission for (n,n*)p

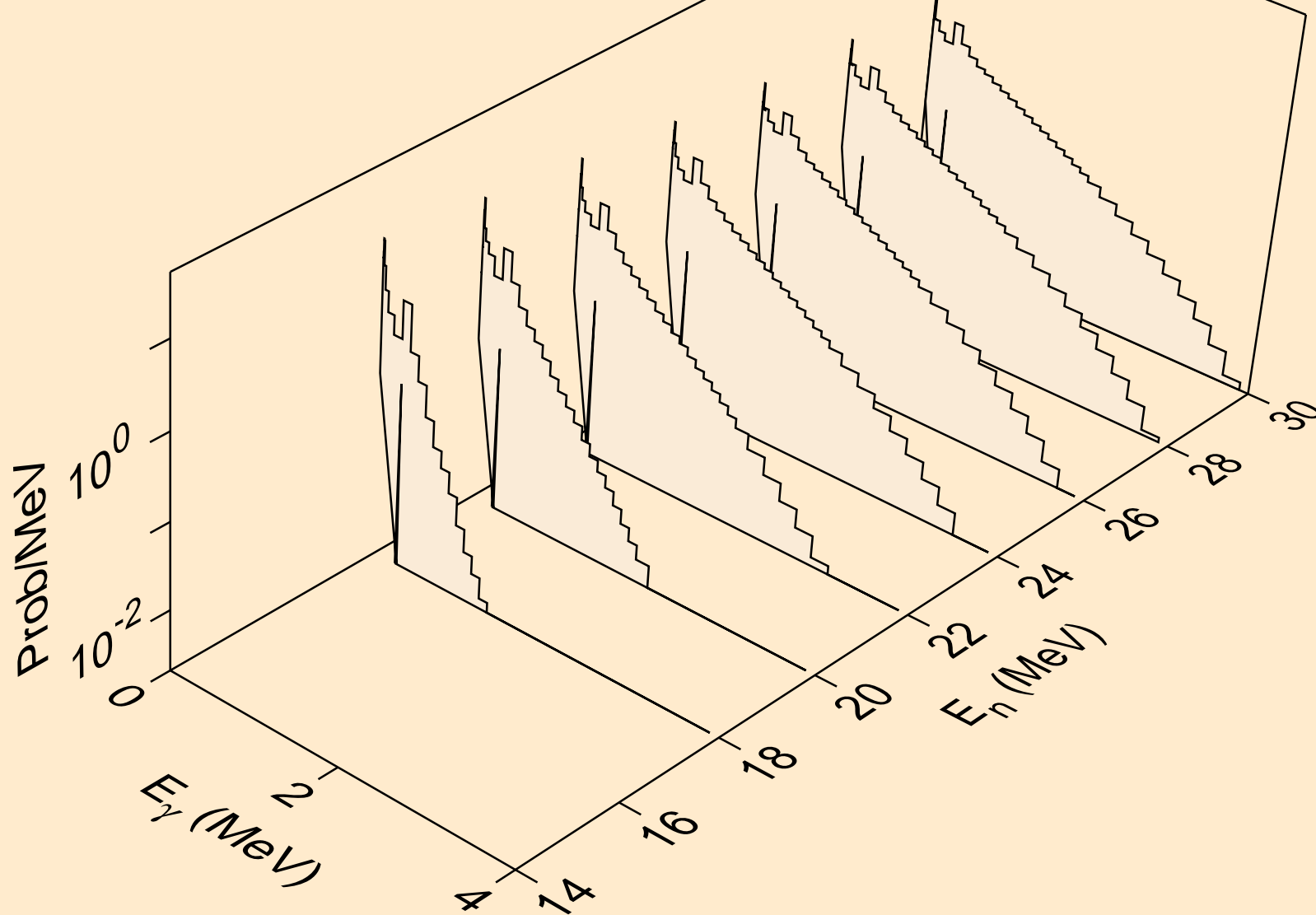

ZR103 NEUTRON ACER TENDL-2019 LIBRARY; T=293.16K
Photon emission for (n,n*)d

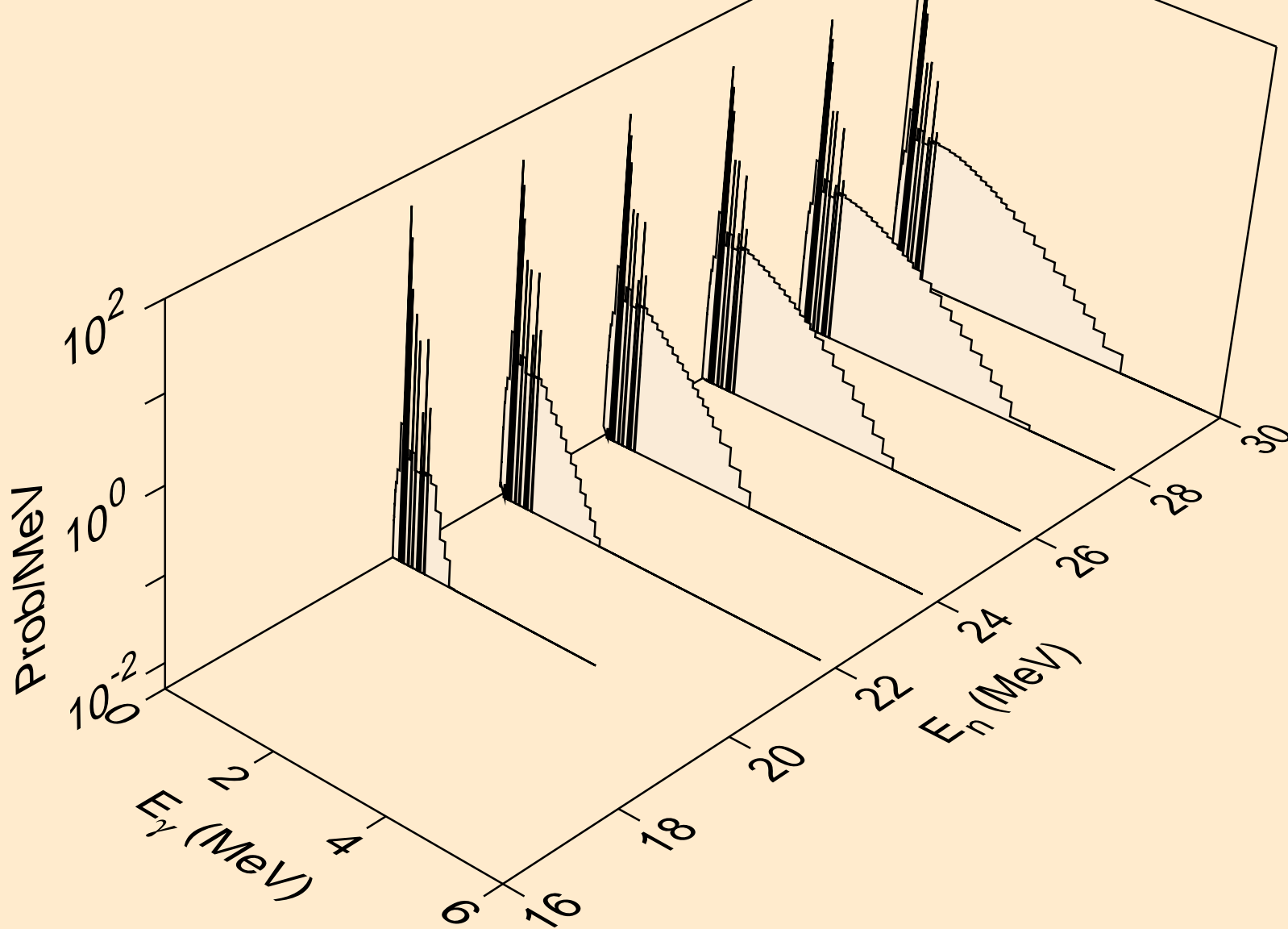

ZR103 NEUTRON ACER TENDL-2019 LIBRARY; T=293.16K
Photon emission for (n,n*)t

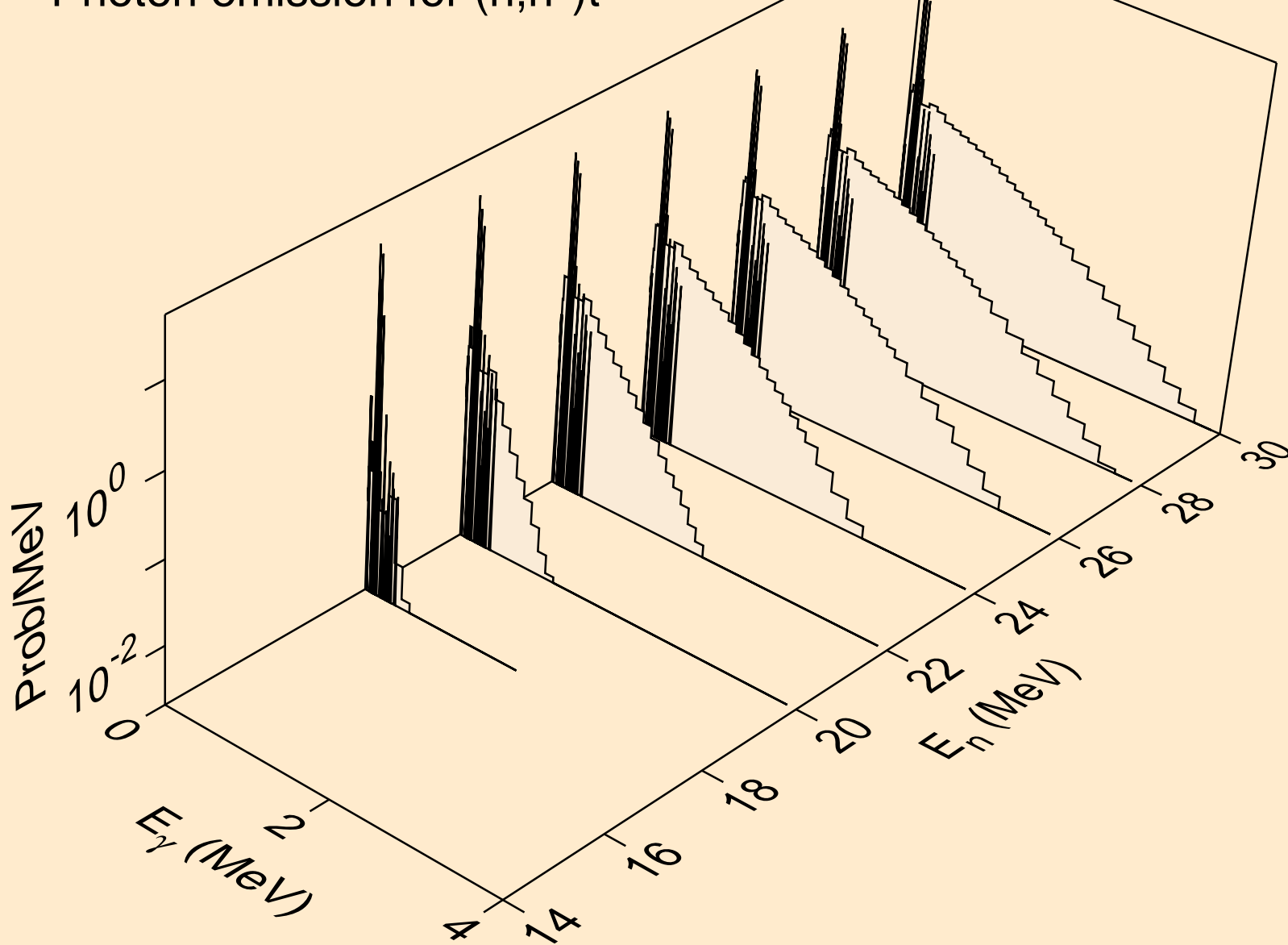

ZR103 NEUTRON ACER TENDL-2019 LIBRARY; T=293.16K
Photon emission for (n,4n)

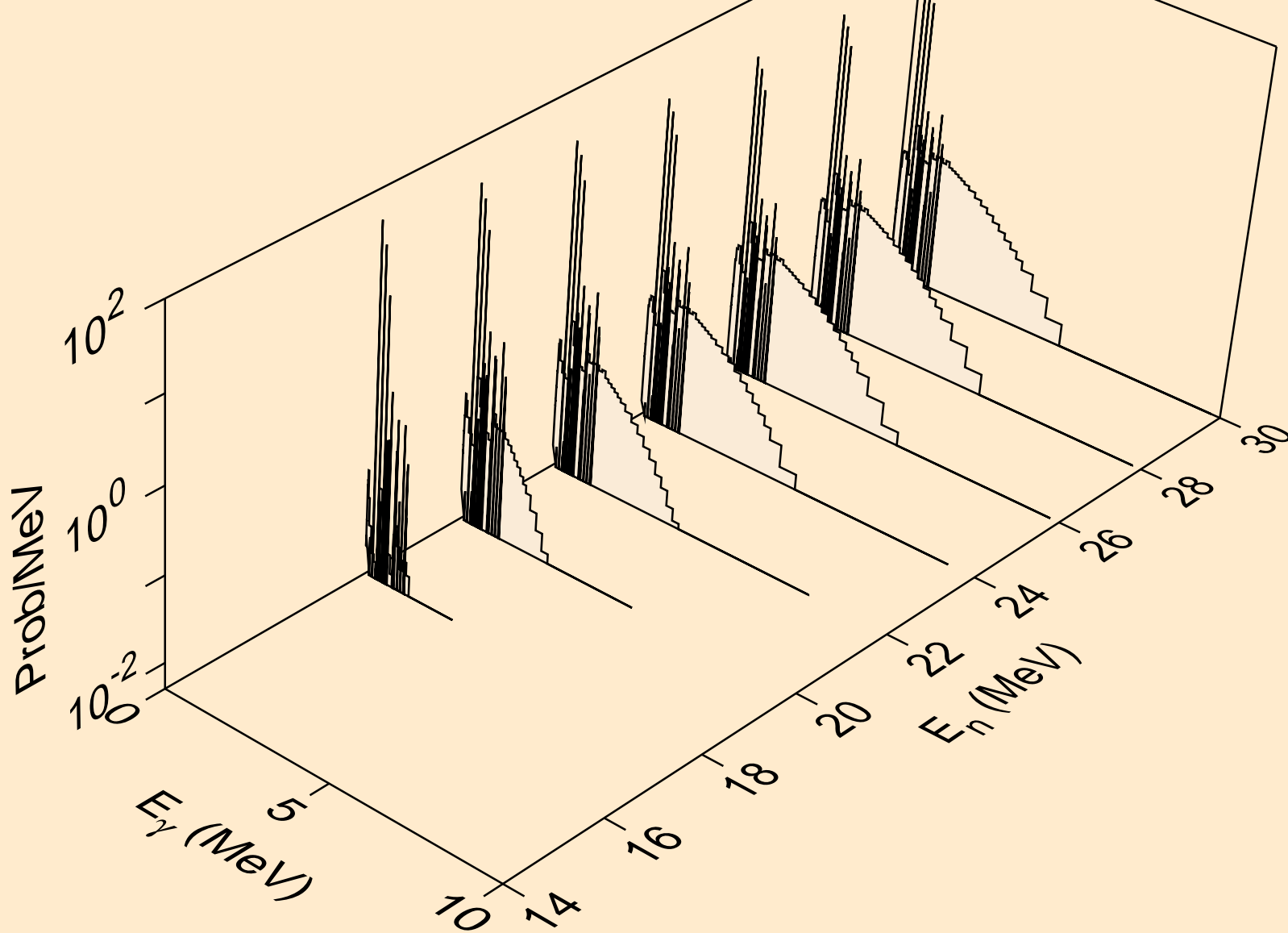

ZR103 NEUTRON ACER TENDL-2019 LIBRARY; T=293.16K
Photon emission for (n,2np)

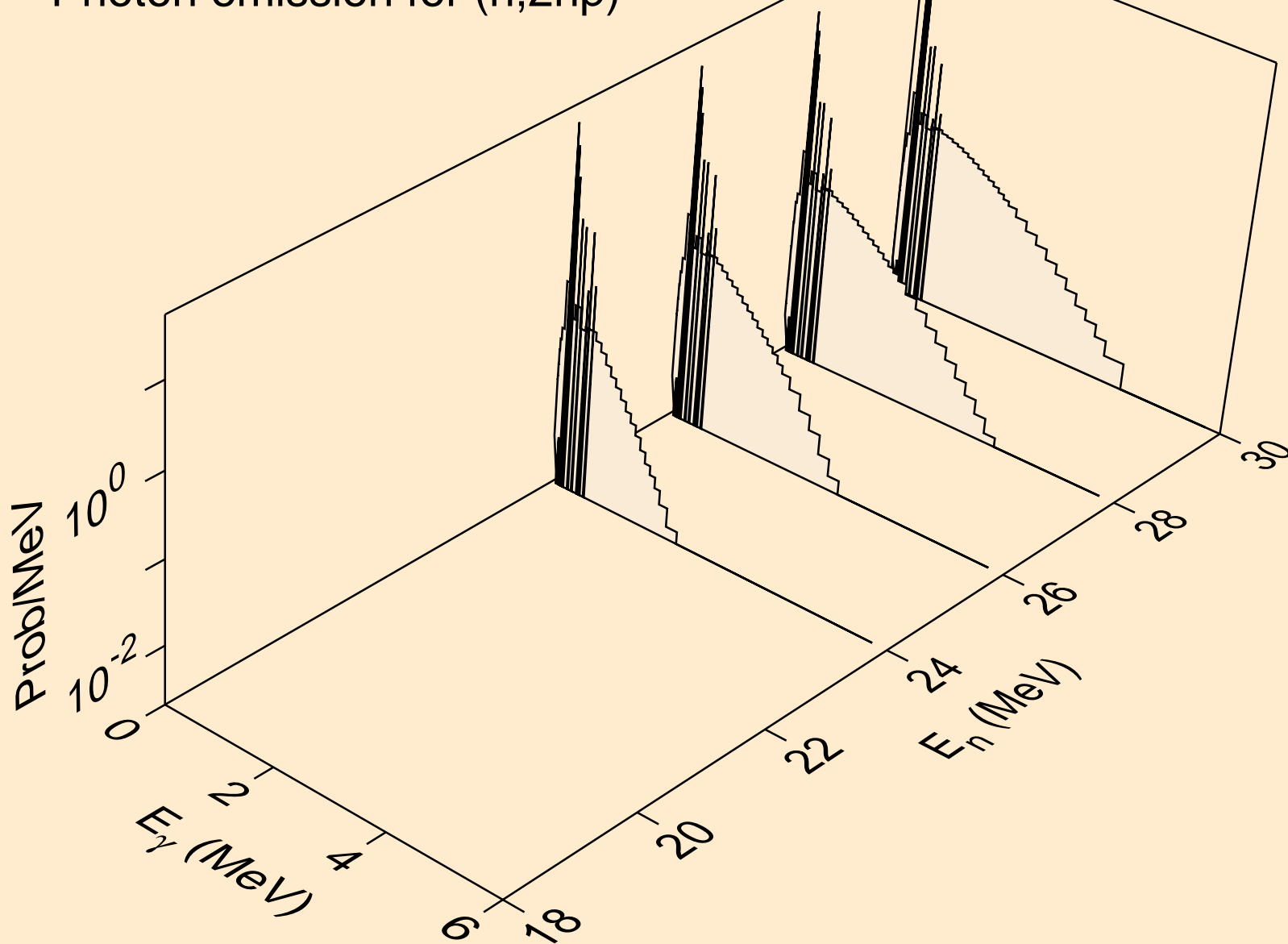

ZR103 NEUTRON ACER TENDL-2019 LIBRARY; T=293.16K
Photon emission for (n,3np)

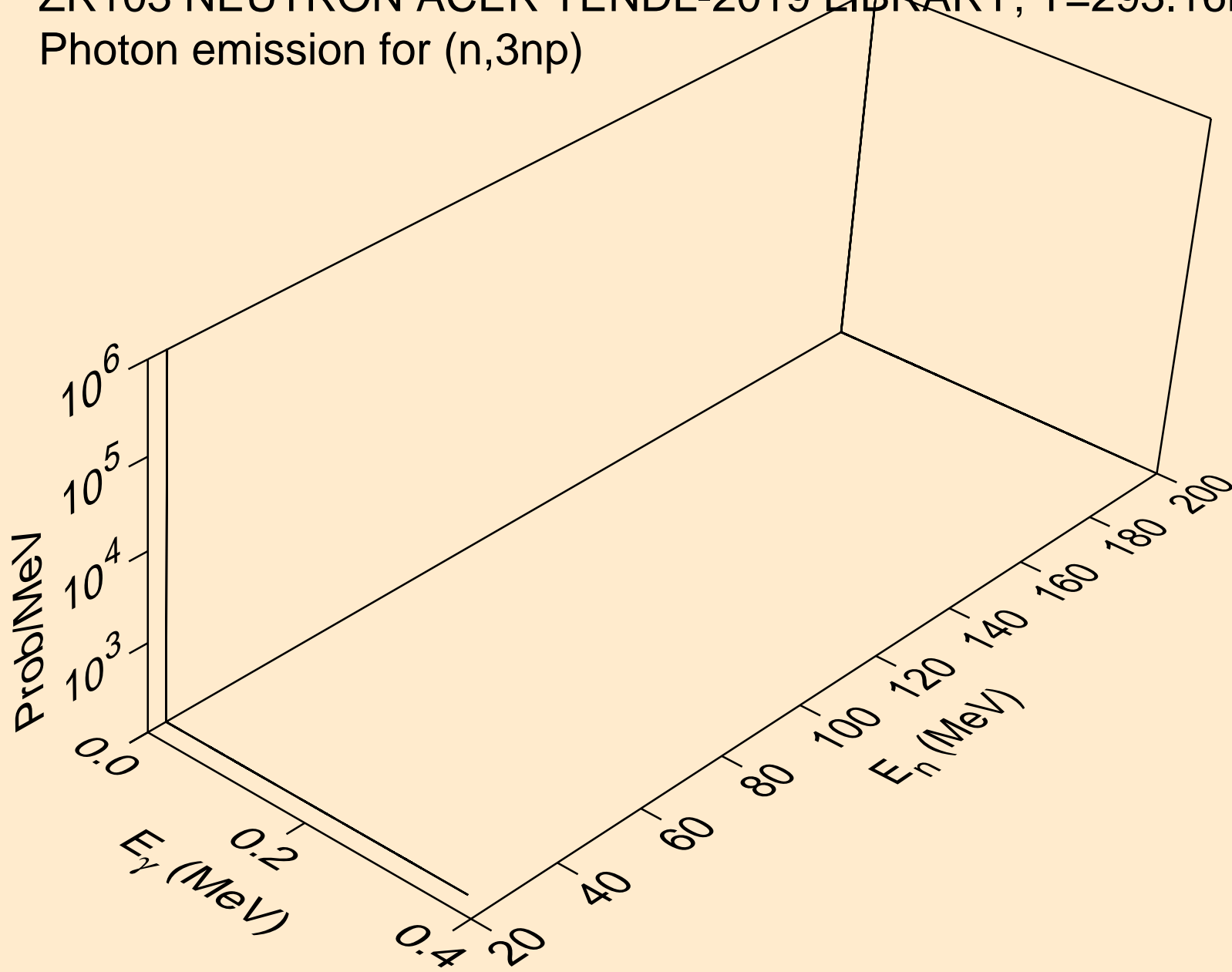

ZR103 NEUTRON ACER TENDL-2019 LIBRARY; T=293.16K
Photon emission for (n,n*c)

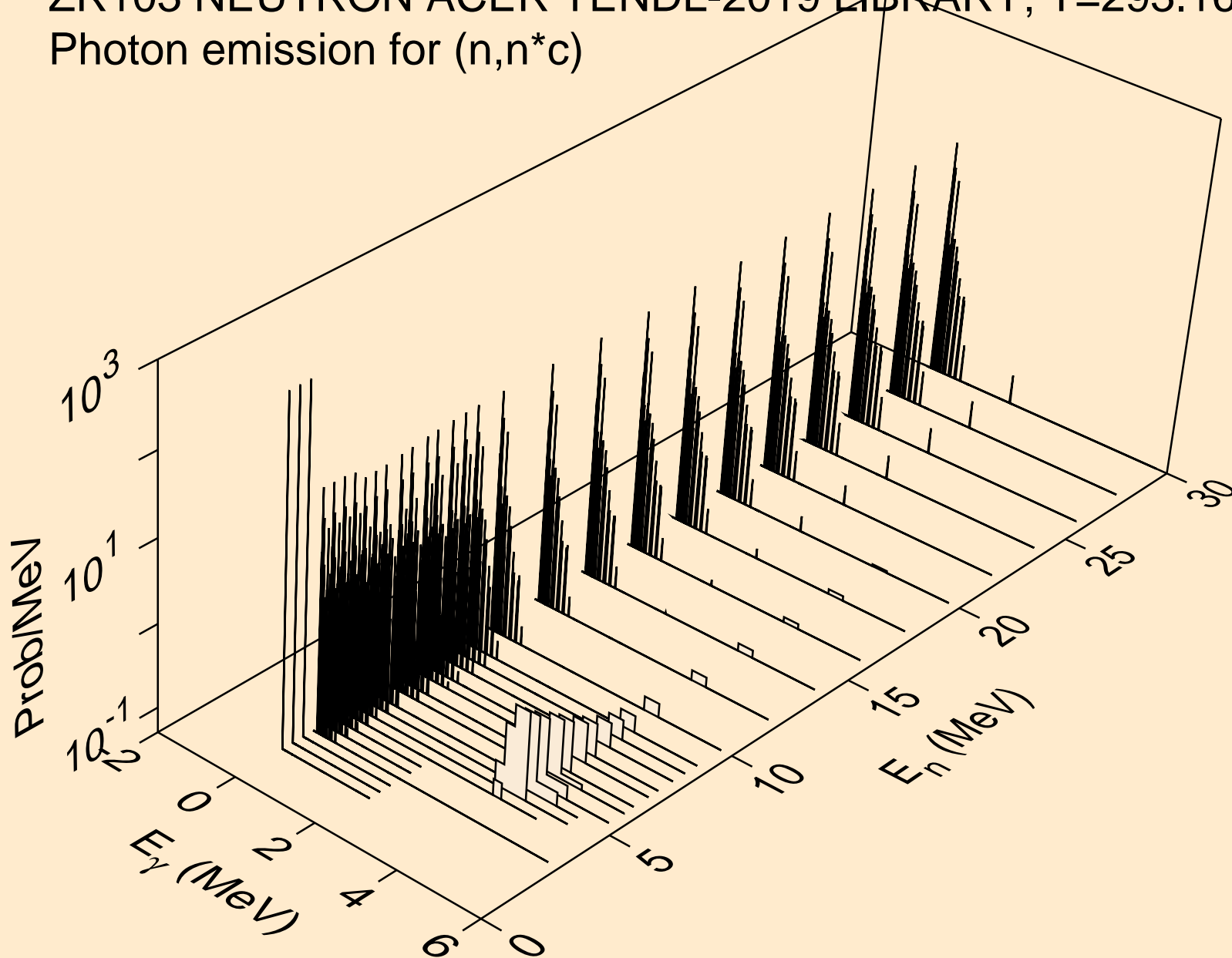

ZR103 NEUTRON ACER TENDL-2019 LIBRARY; T=293.16K
Photon emission for (n,gma)

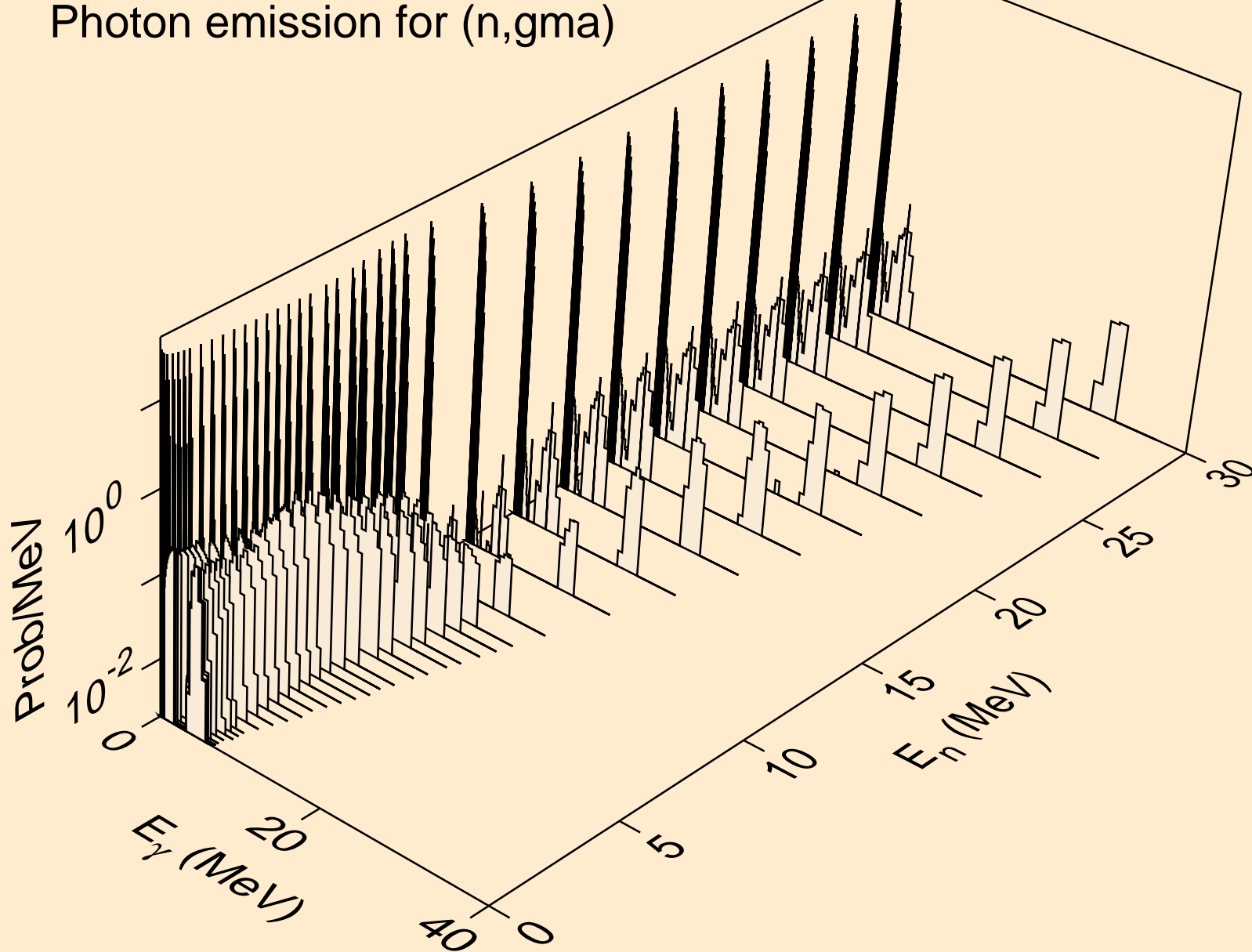

ZR103 NEUTRON ACER TENDL-2019 LIBRARY; T=293.16K
Photon emission for (n,p)

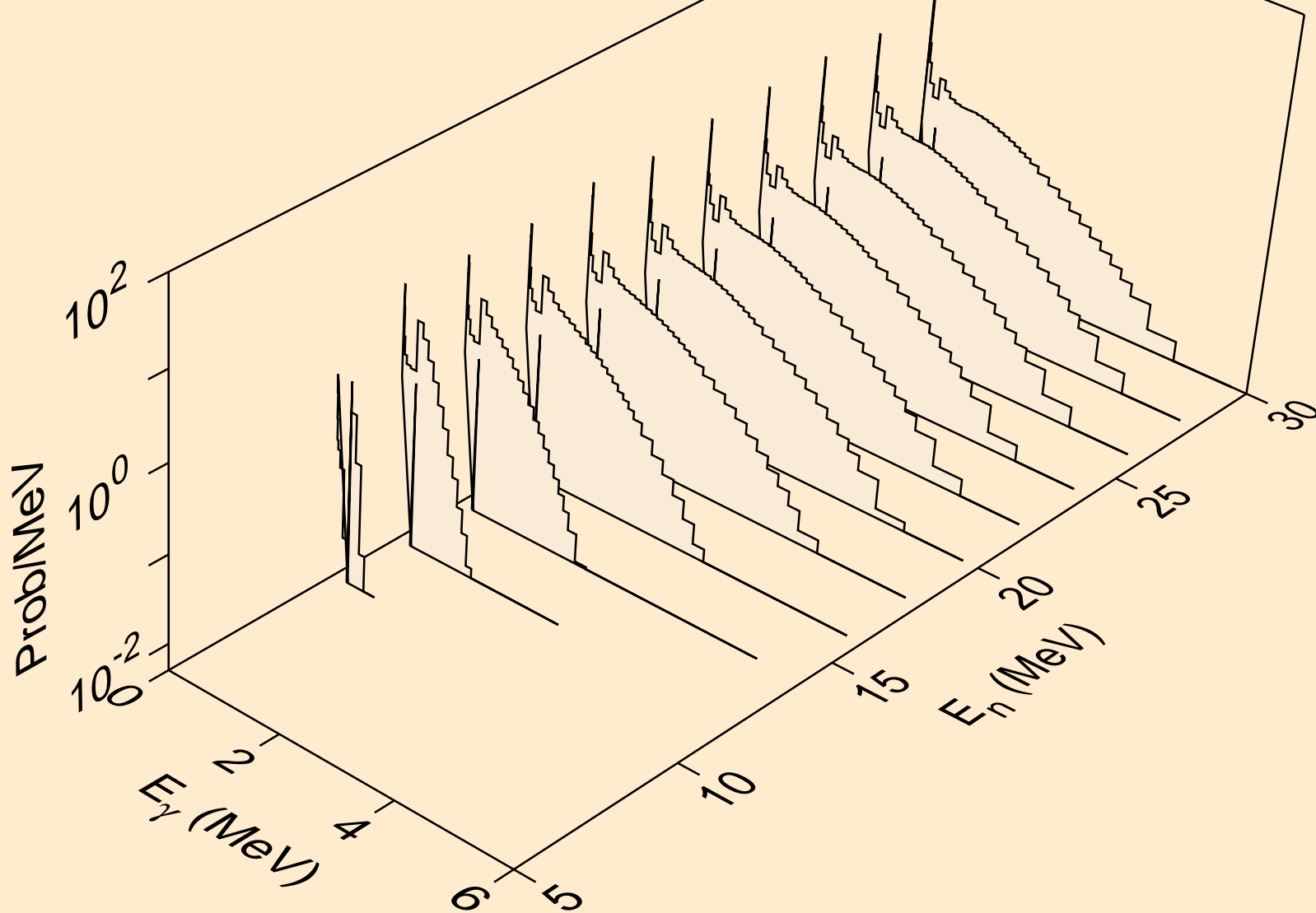

ZR103 NEUTRON ACER TENDL-2019 LIBRARY; T=293.16K
Photon emission for (n,d)

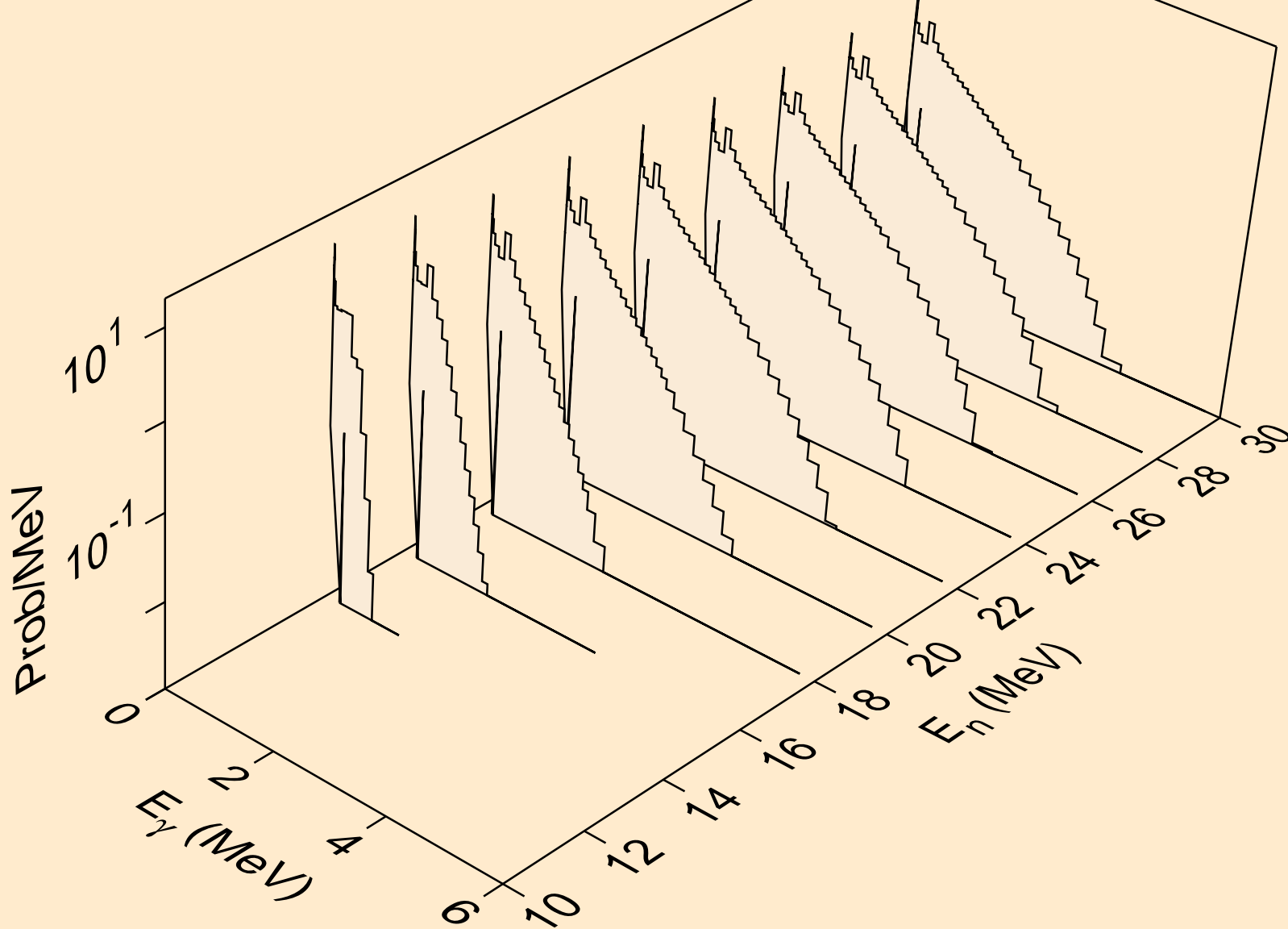

ZR103 NEUTRON ACER TENDL-2019 LIBRARY; T=293.16K
Photon emission for (n,t)

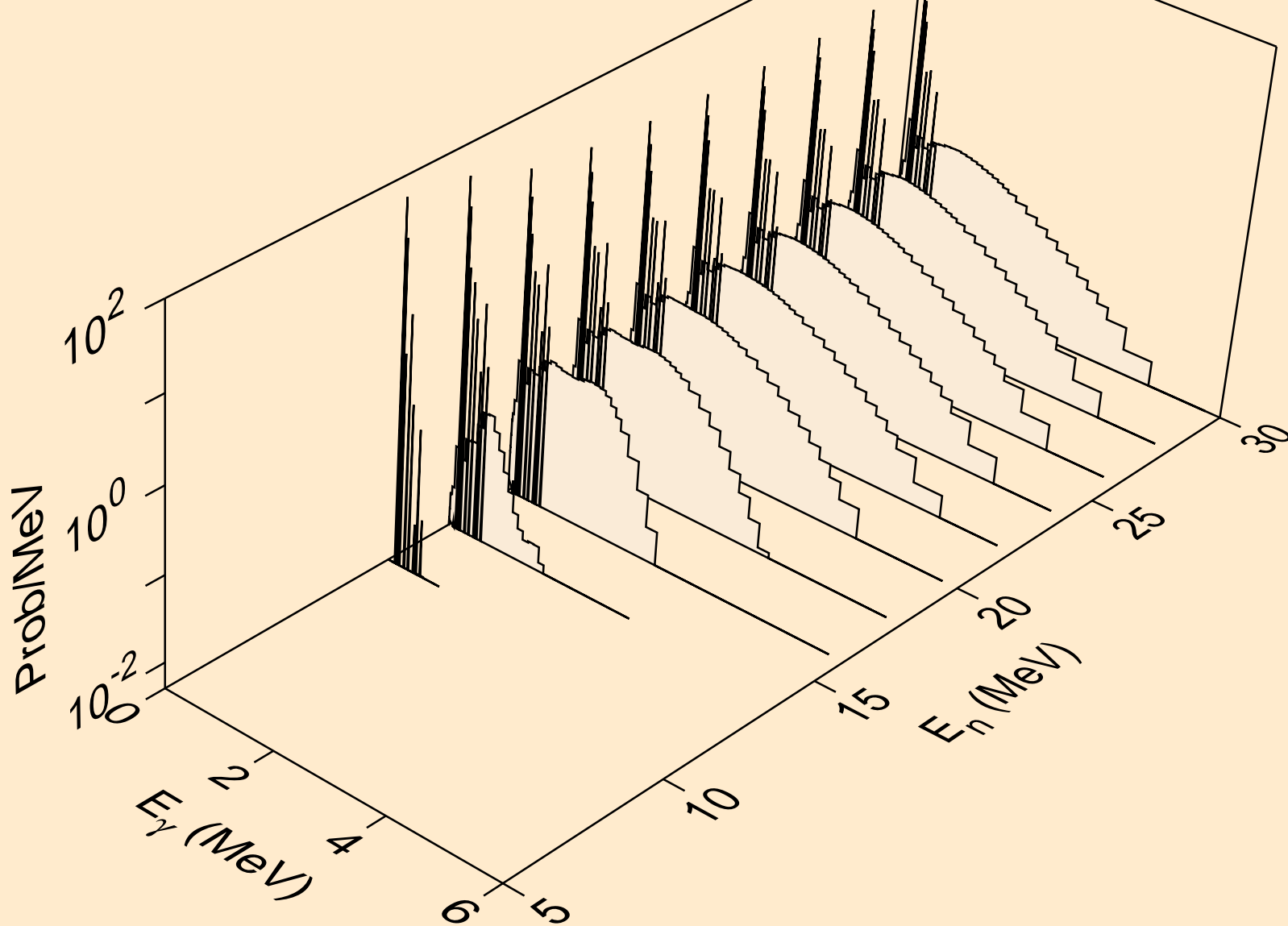

ZR103 NEUTRON ACER TENDL-2019 LIBRARY; T=293.16K
Photon emission for (n,he3)

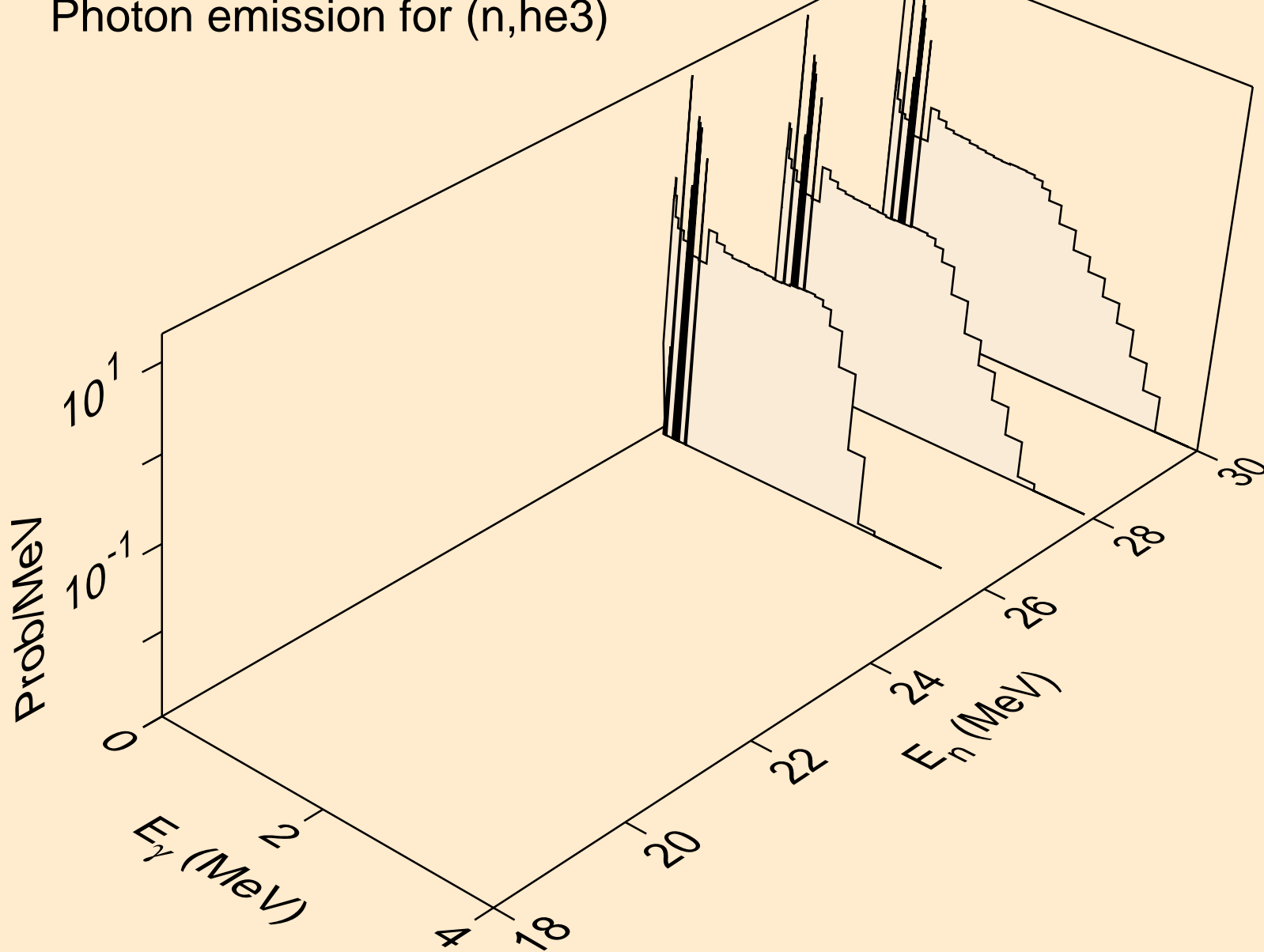

ZR103 NEUTRON ACER TENDL-2019 LIBRARY; T=293.16K
Photon emission for (n,a)

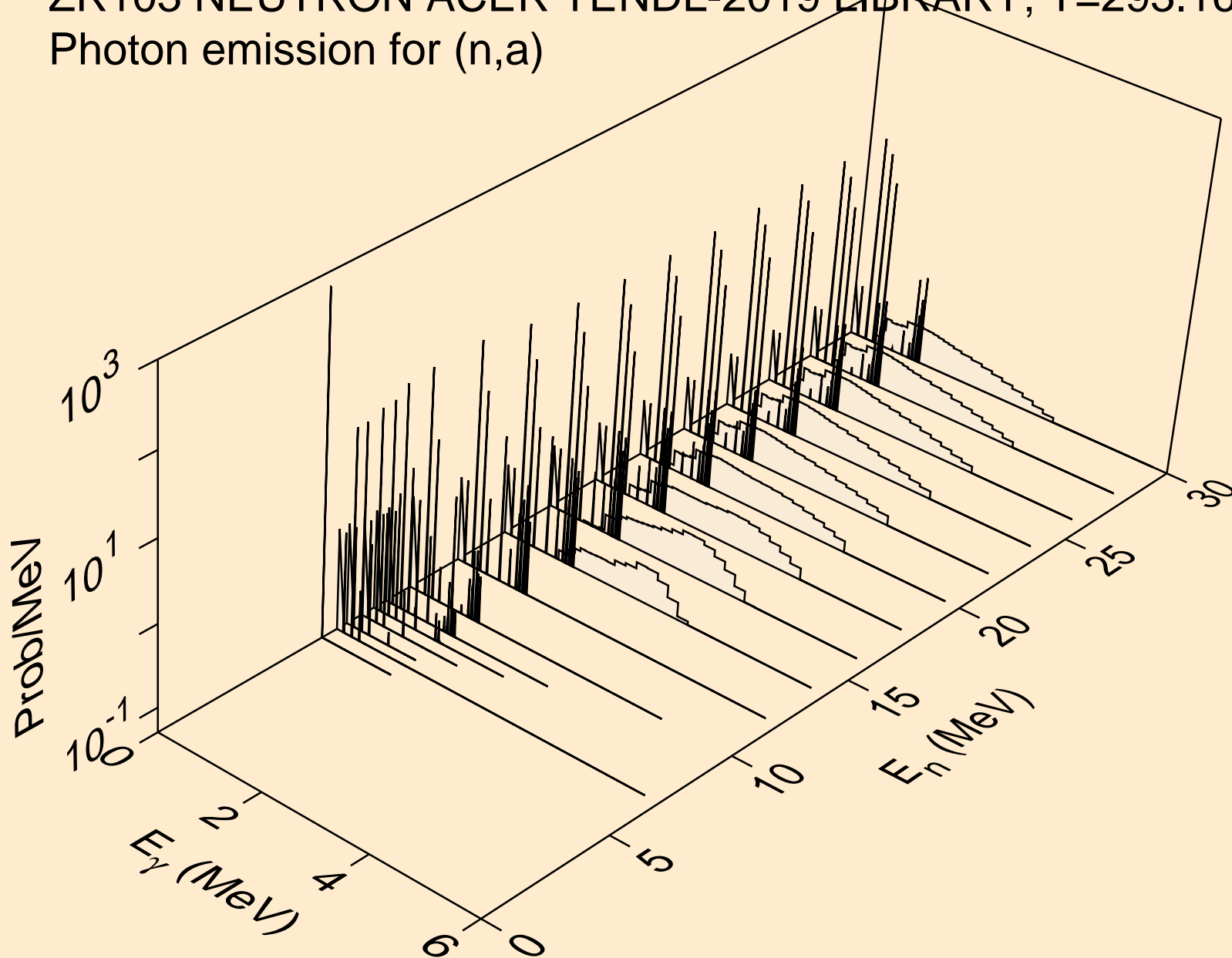

ZR103 NEUTRON ACER TENDL-2019 LIBRARY; T=293.16K
thermal capture photon spectrum

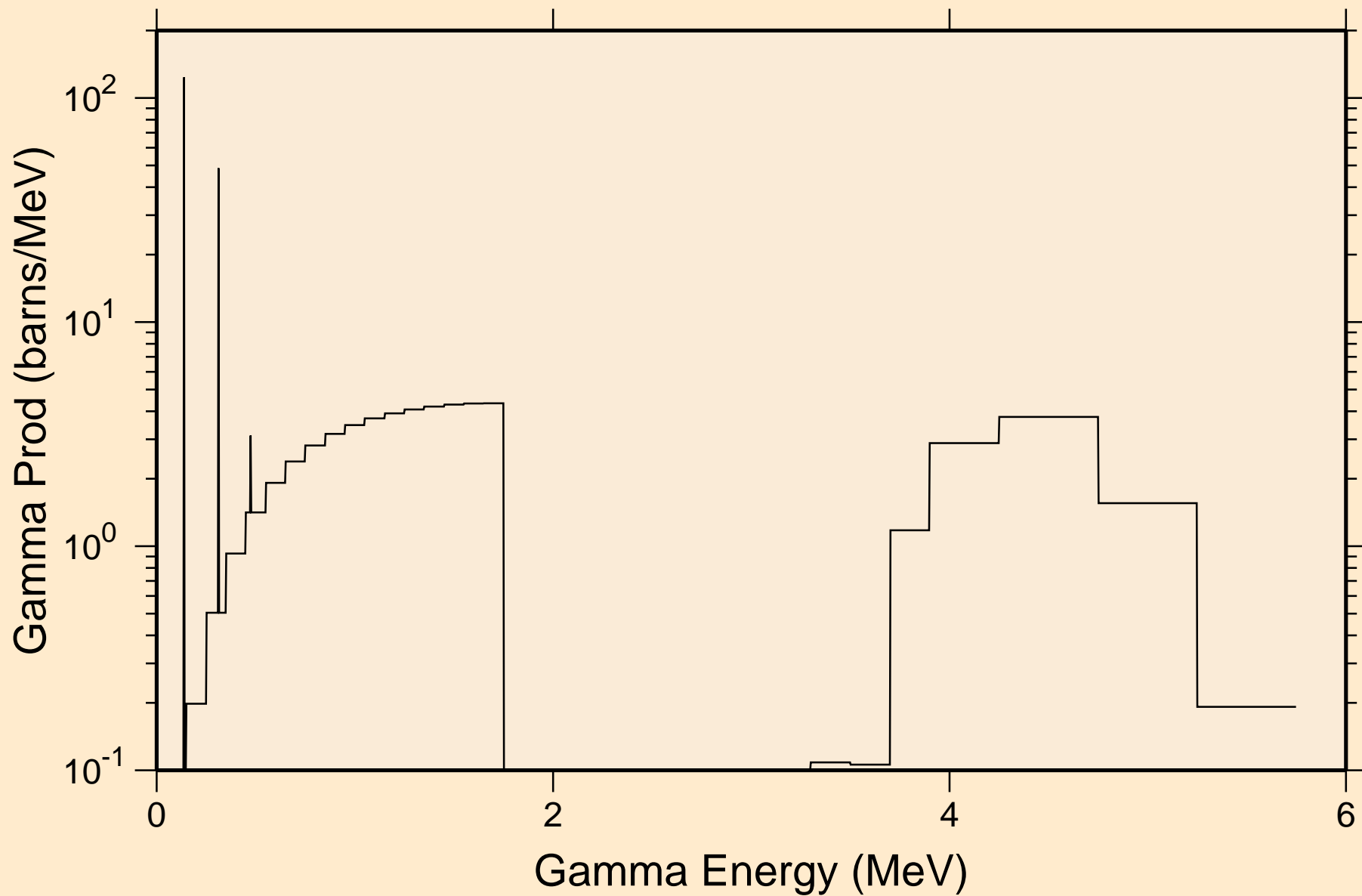

ZR103 NEUTRON ACER TENDL-2019 LIBRARY; T=293.16K
14 MeV photon spectrum

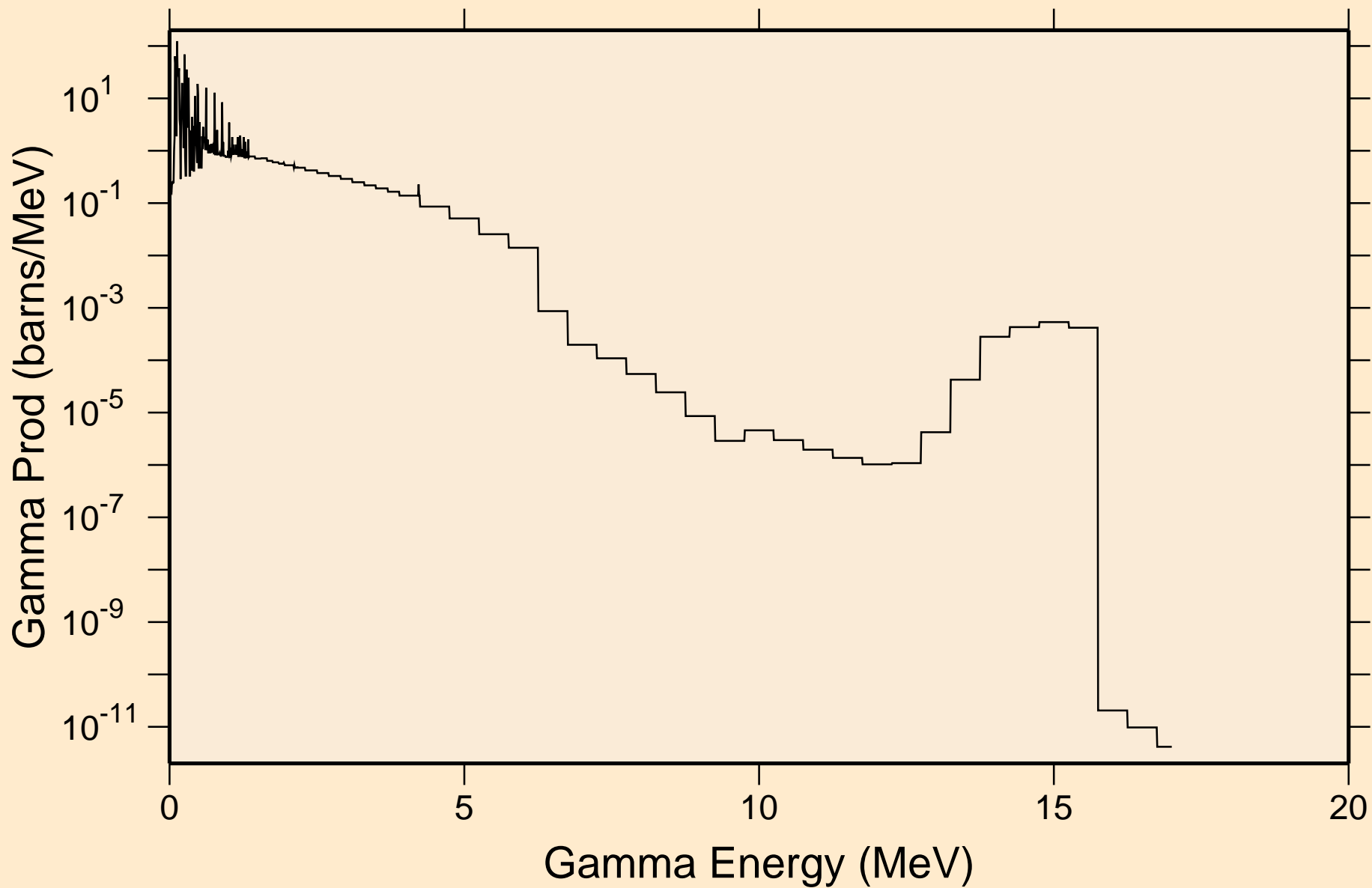

ZR103 NEUTRON ACER TENDL-2019 LIBRARY; T=293.16K

Particle heating contributions

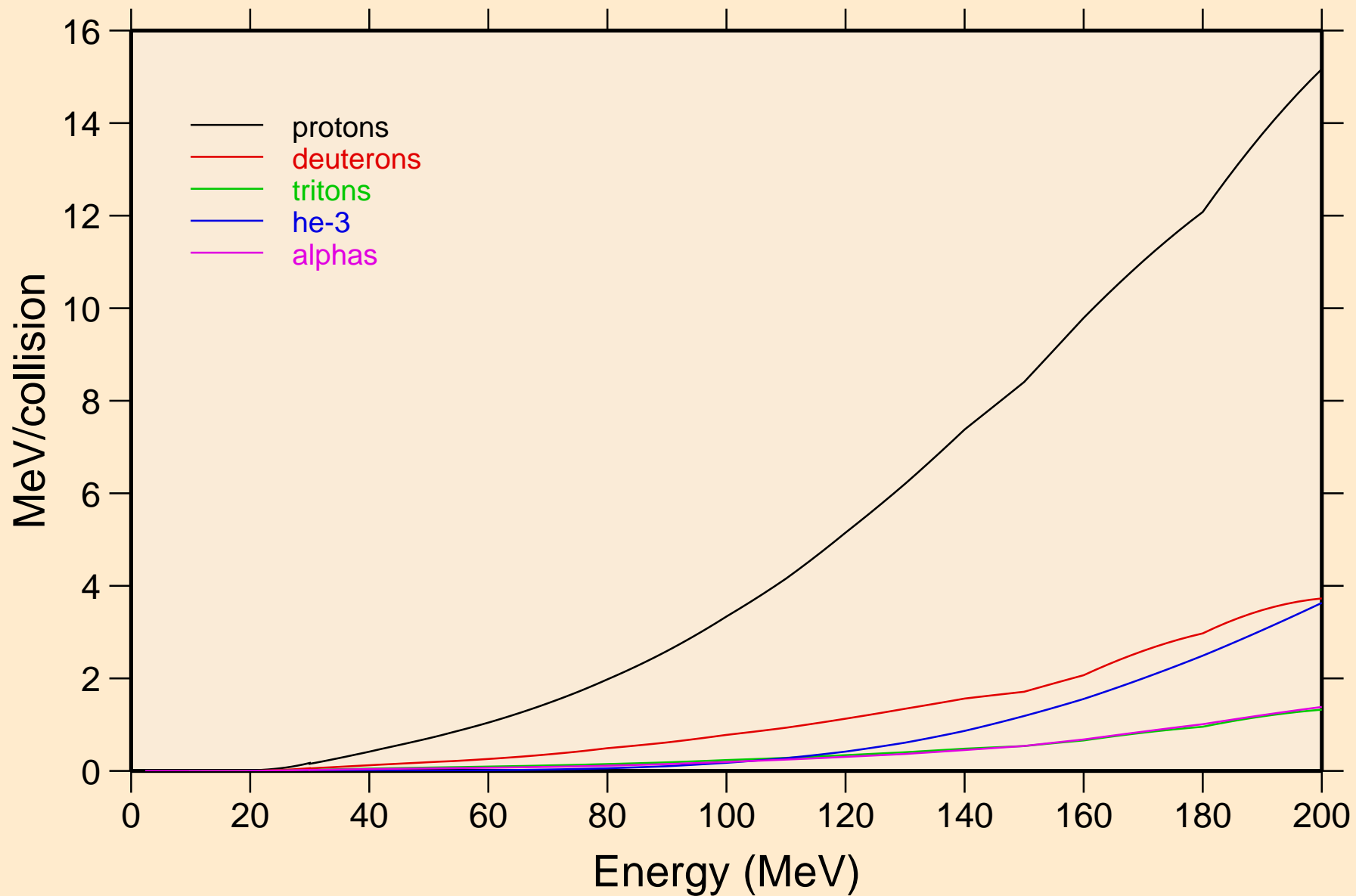

ZR103 NEUTRON ACER TENDL-2019 LIBRARY; T=293.16K
Recoil Heating

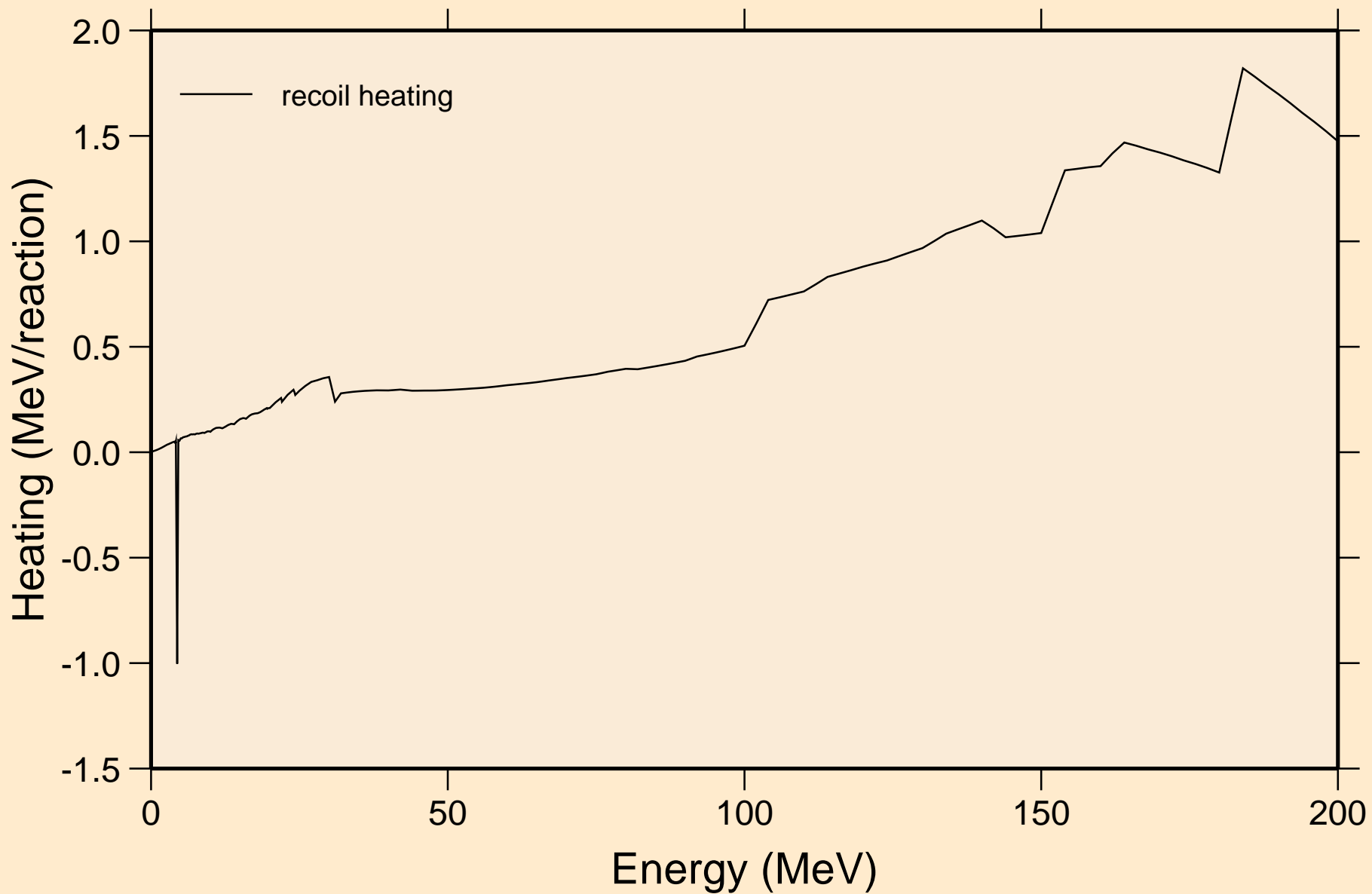

ZR103 NEUTRON ACER TENDL-2019 LIBRARY; T=293.16K
Particle production cross sections

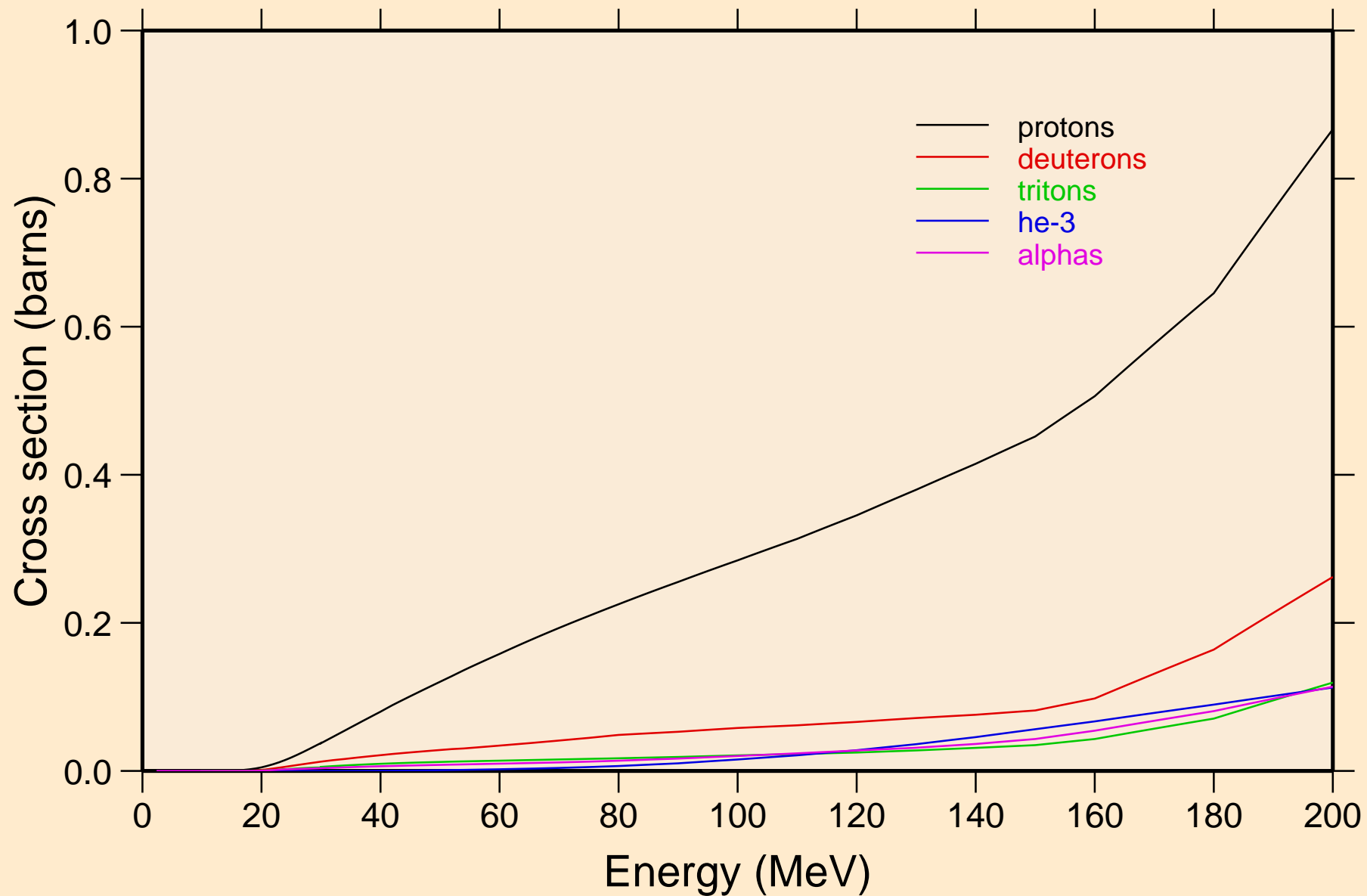

ZR103 NEUTRON ACER TENDL-2019 LIBRARY; T=293.16K
protons from (n,x)

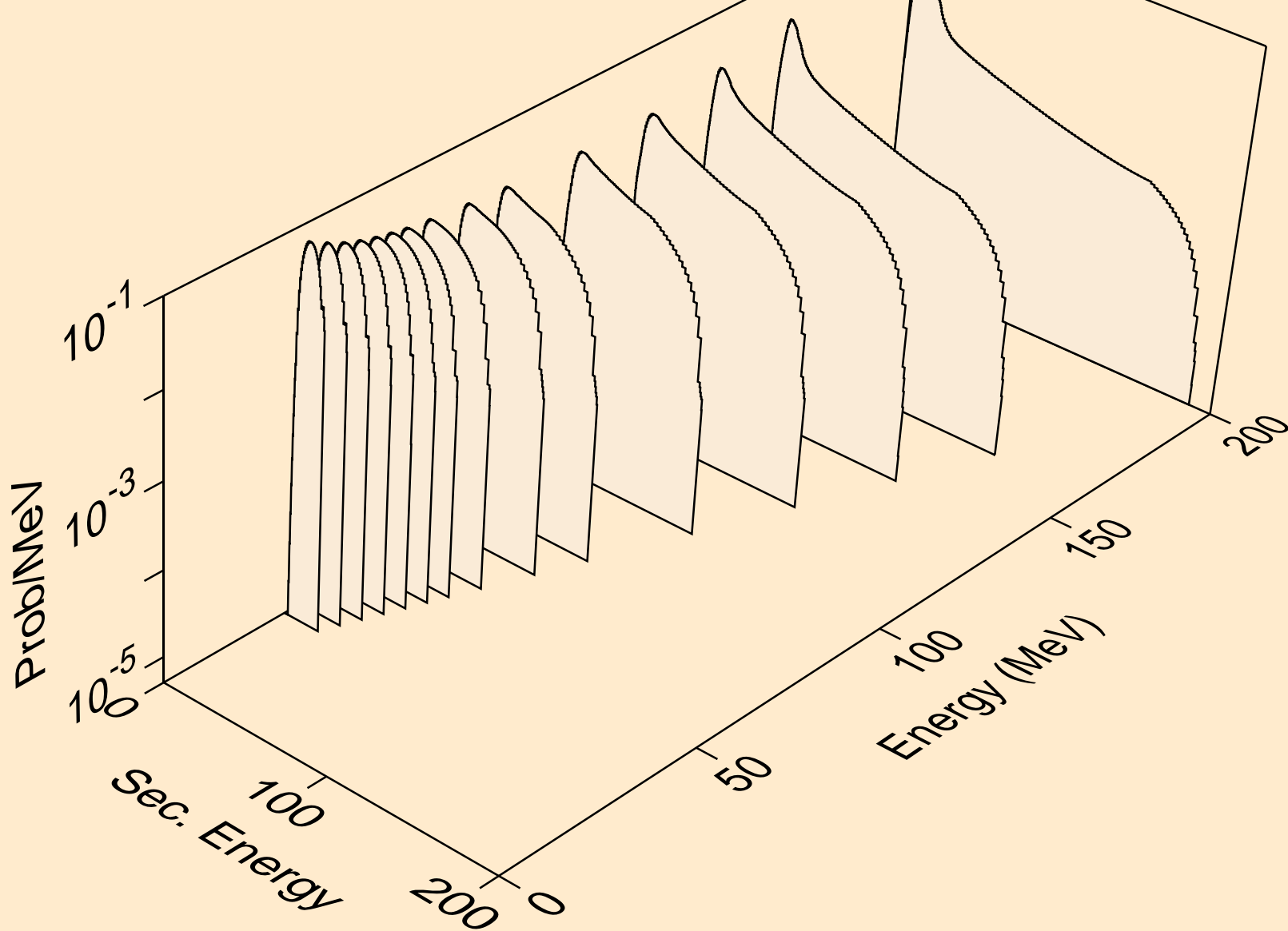

ZR103 NEUTRON ACER TENDL-2019 LIBRARY; T=293.16K
protons from (n,n*)p

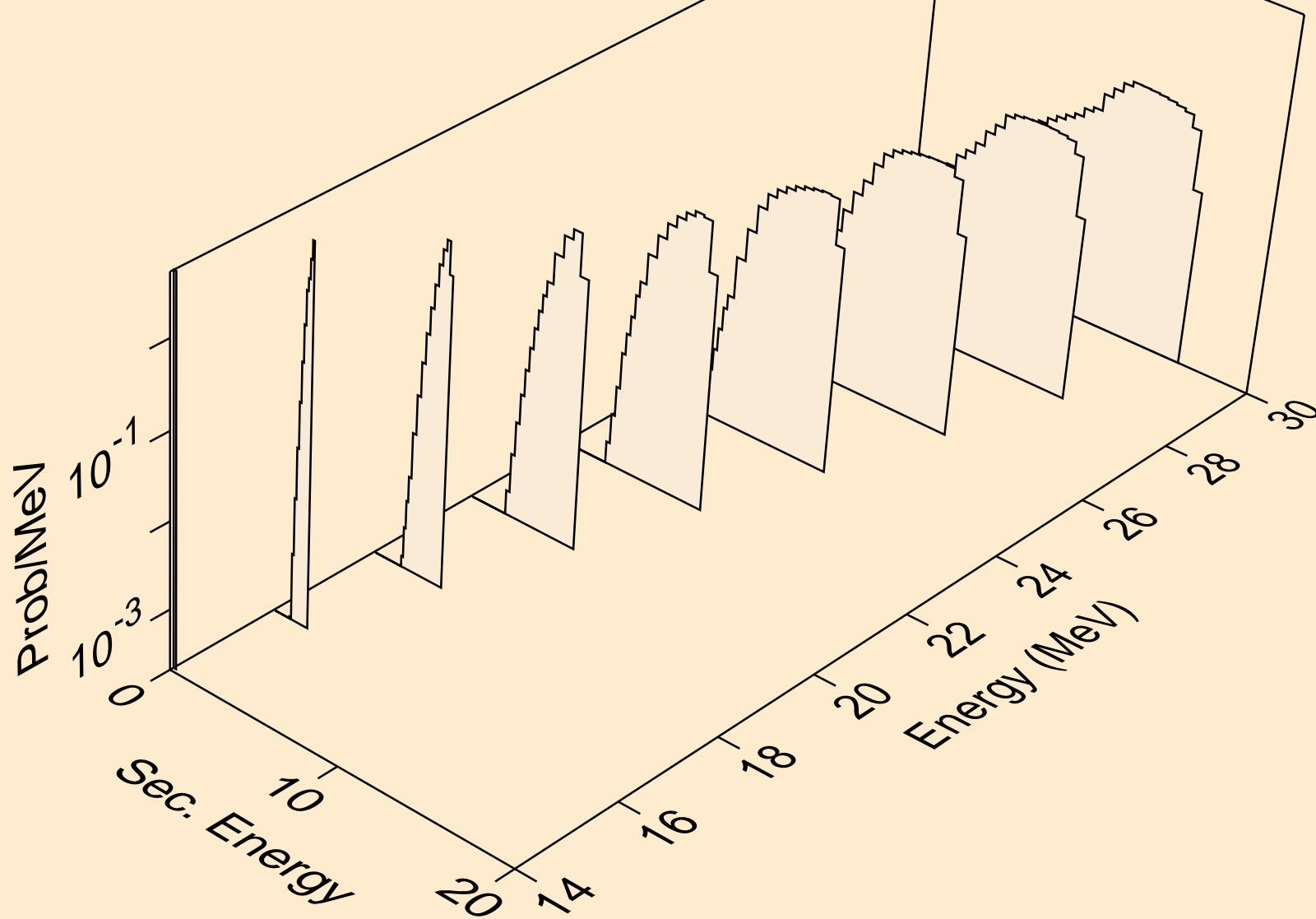

ZR103 NEUTRON ACER TENDL-2019 LIBRARY; T=293.16K
protons from (n,2np)

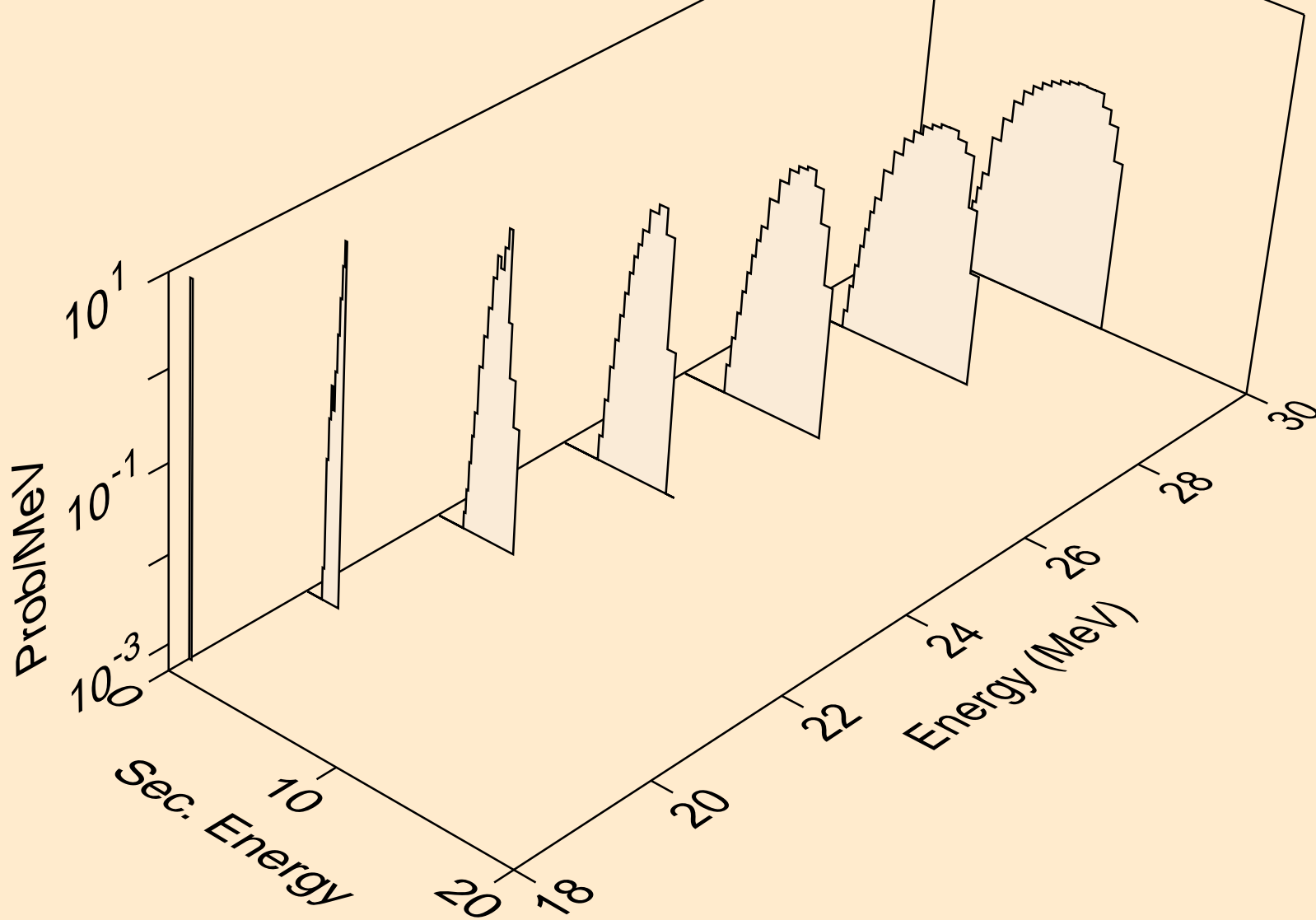

ZR103 NEUTRON ACER TENDL-2019 LIBRARY; T=293.16K
protons from (n,3np)

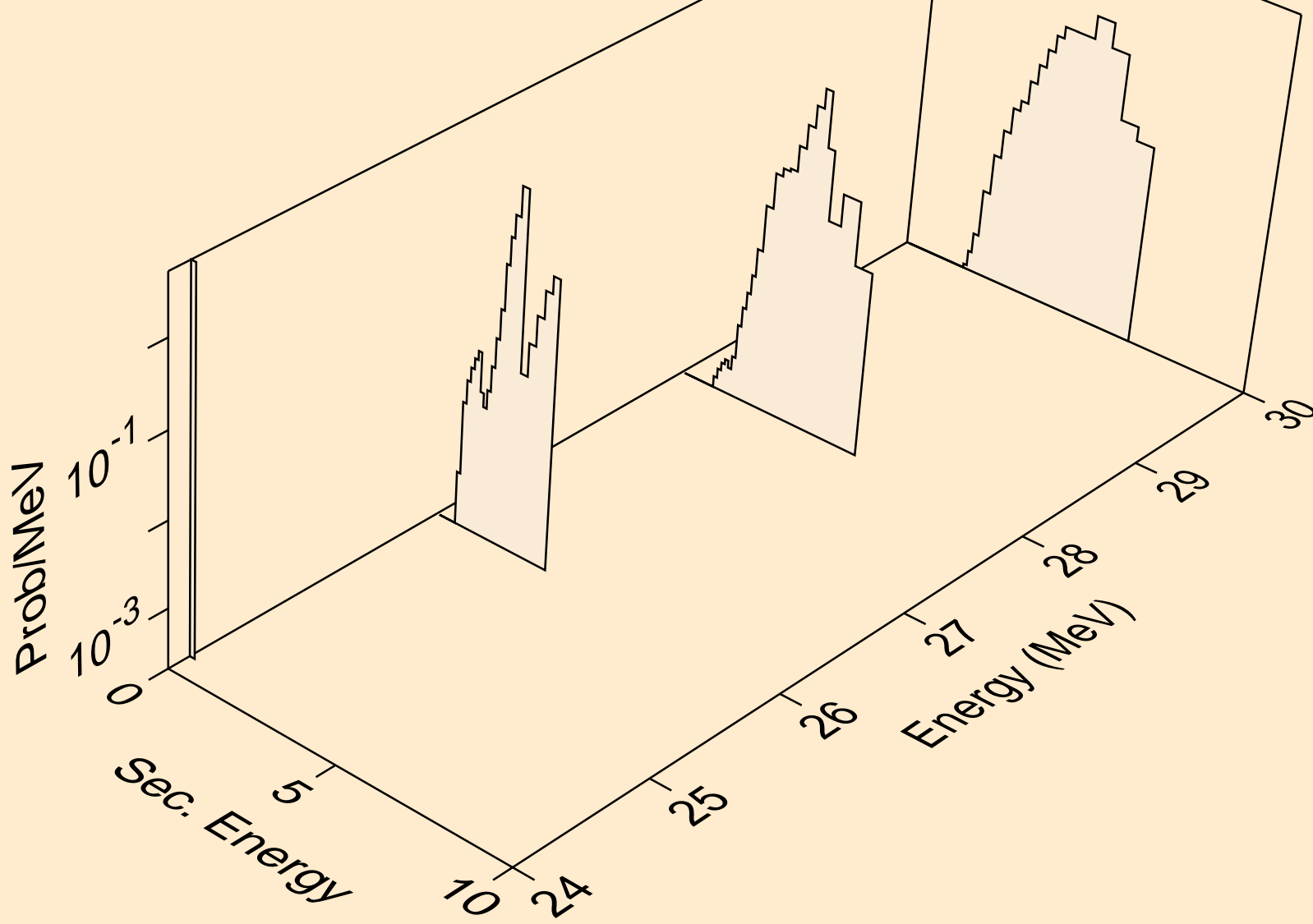

ZR103 NEUTRON ACER TENDL-2019 LIBRARY; T=293.16K
protons from (n,p)

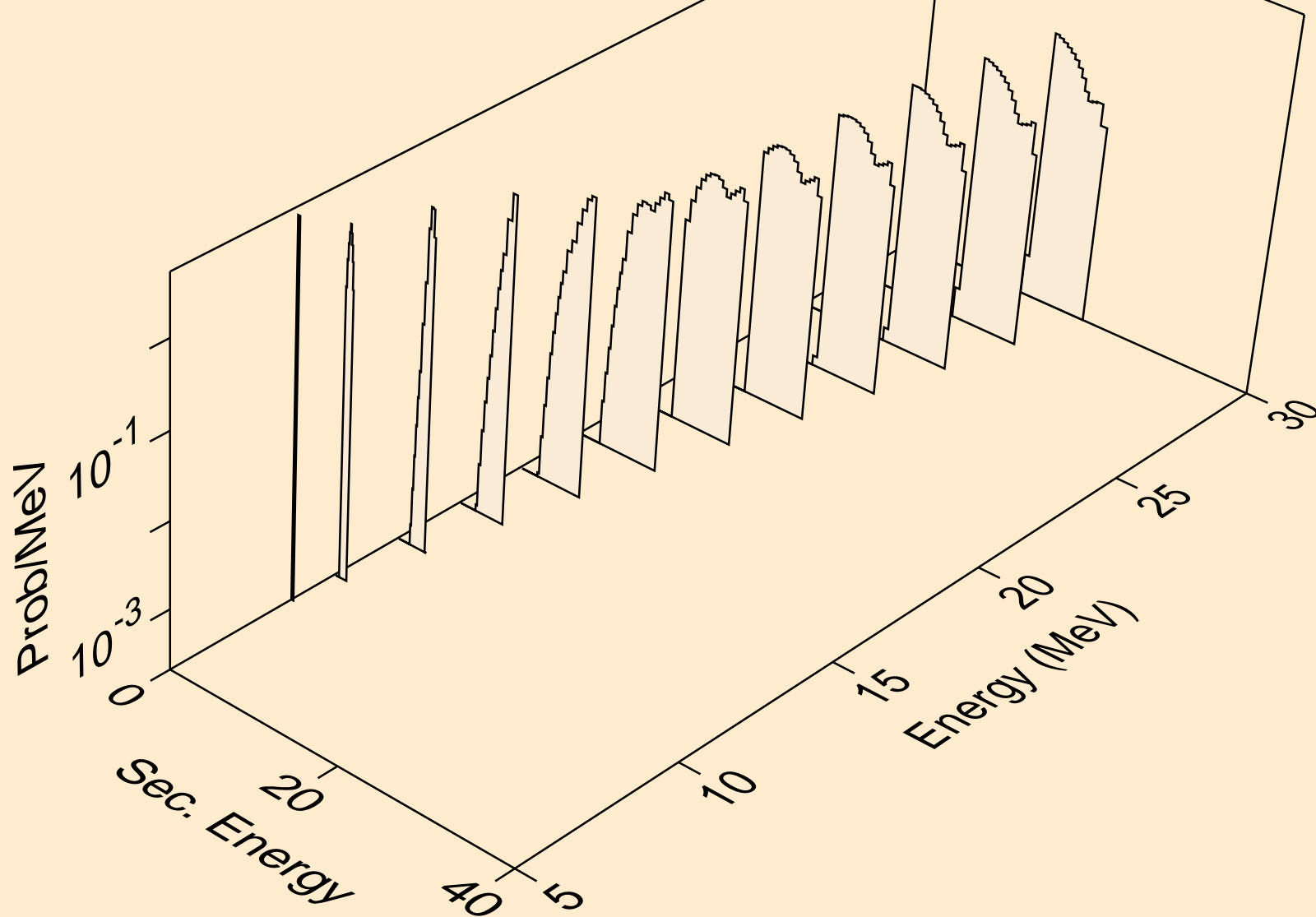

ZR103 NEUTRON ACER TENDL-2019 LIBRARY; T=293.16K
deuterons from (n,x)

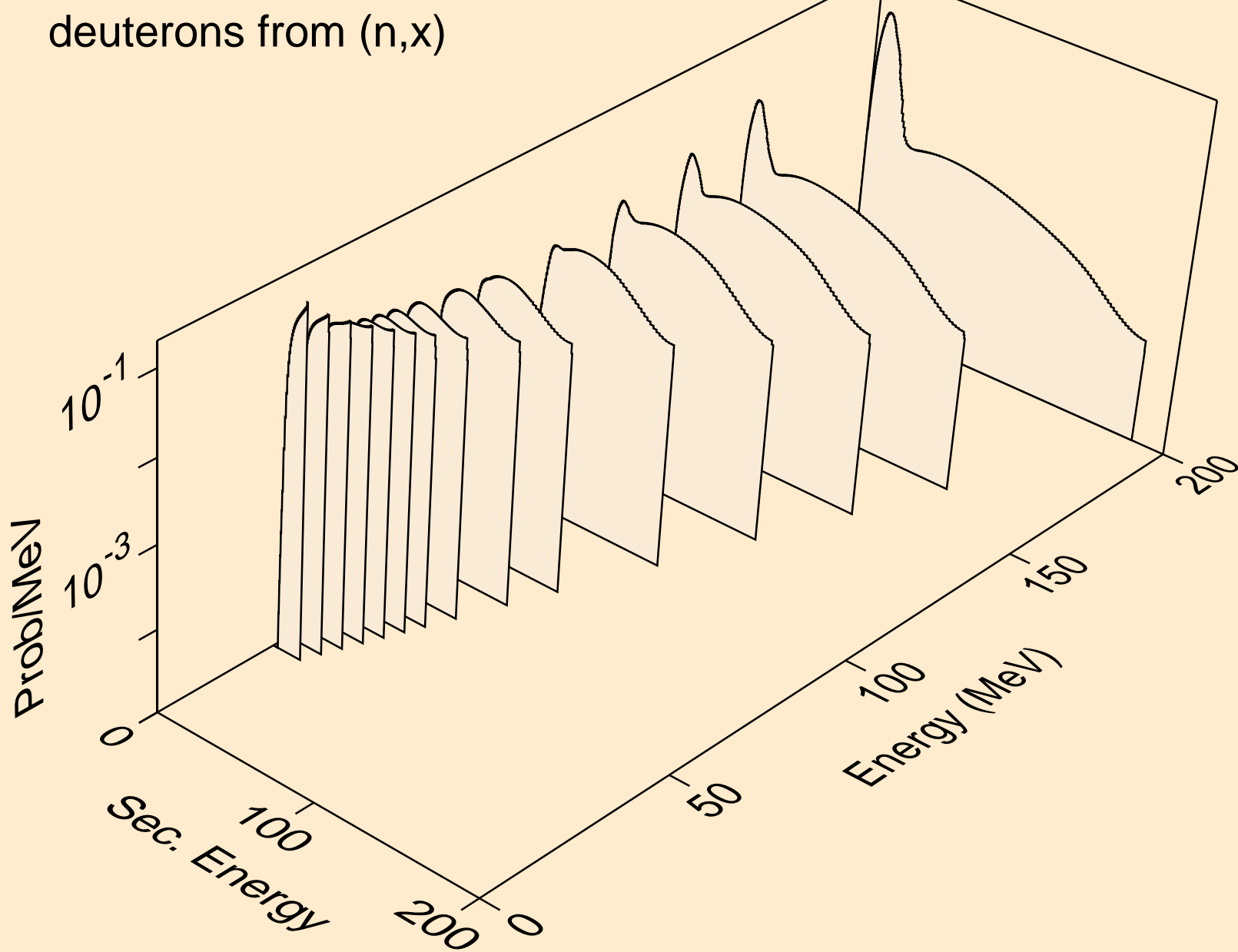

ZR103 NEUTRON ACER TENDL-2019 LIBRARY; T=293.16K
deuterons from (n,2nd)

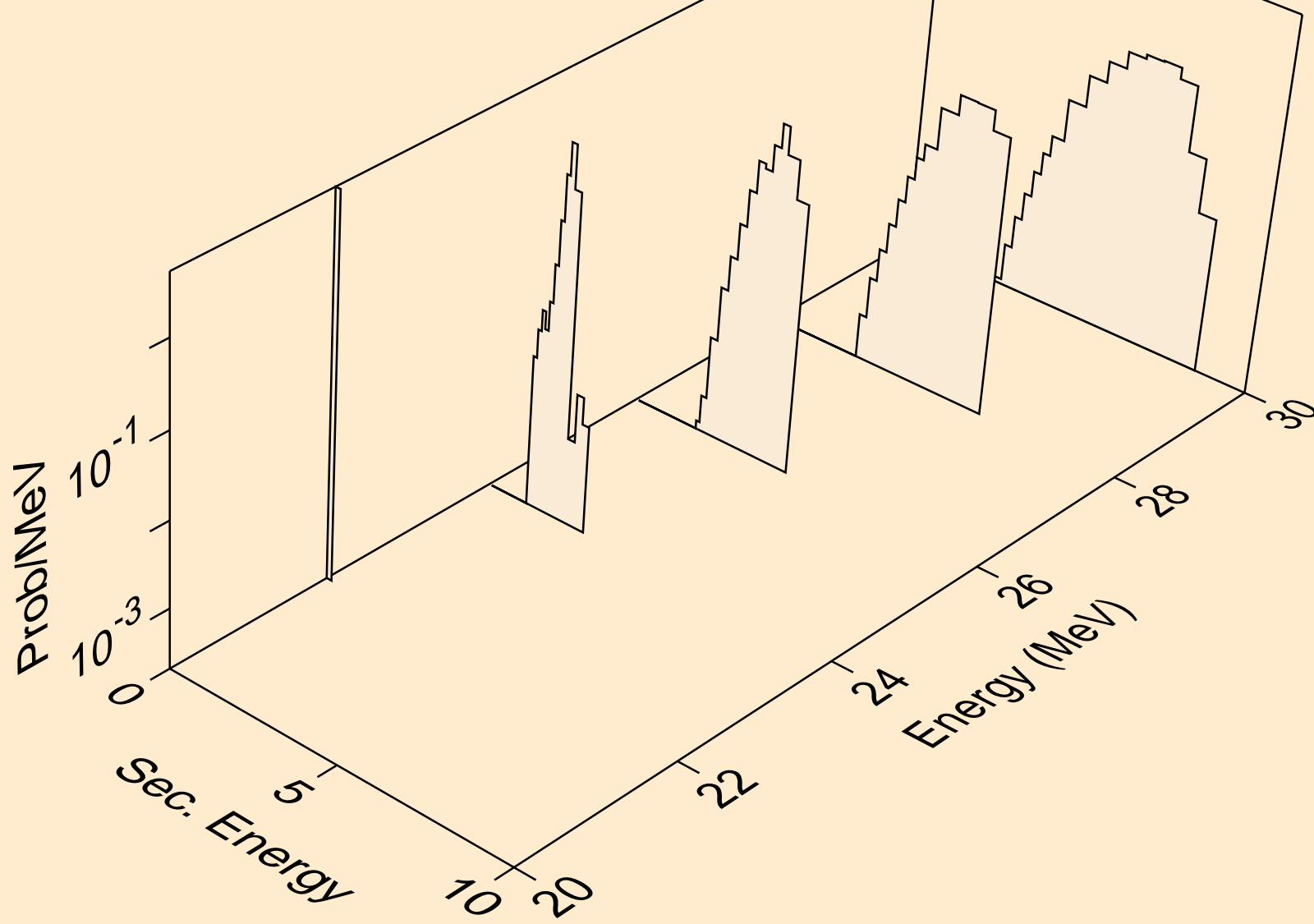

ZR103 NEUTRON ACER TENDL-2019 LIBRARY; T=293.16K
deuterons from (n,n*)d

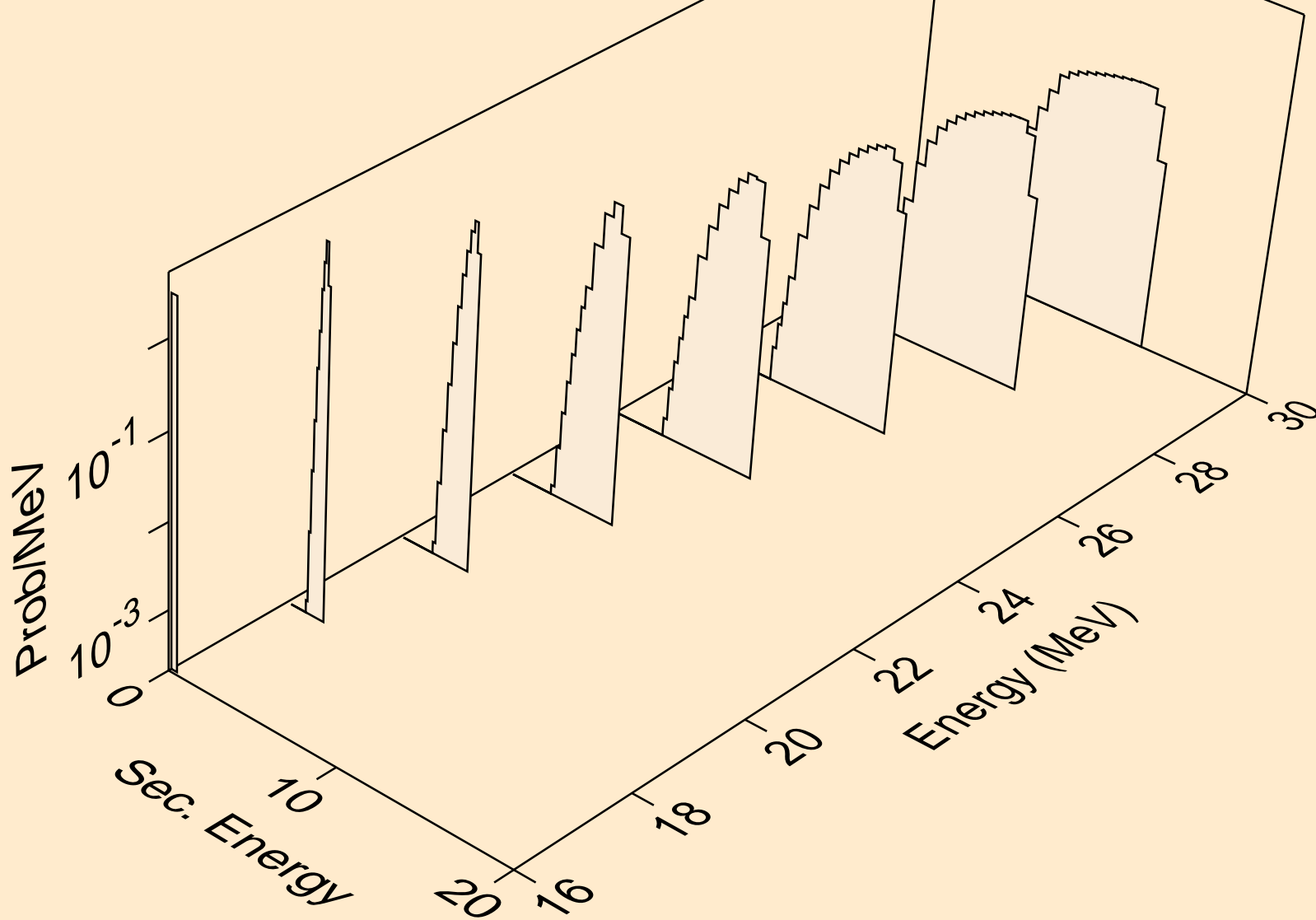

ZR103 NEUTRON ACER TENDL-2019 LIBRARY; T=293.16K
deuterons from (n,d)

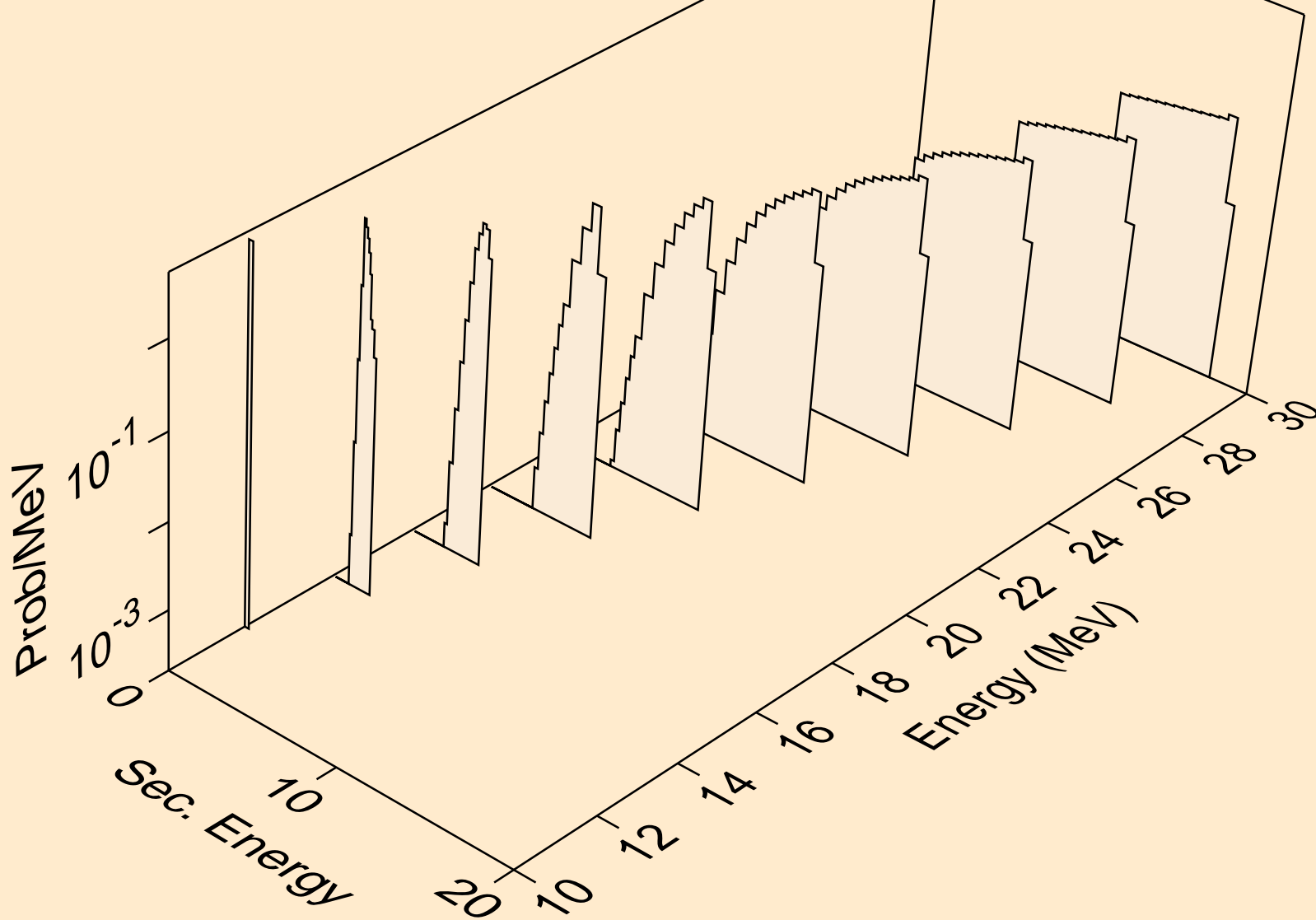

ZR103 NEUTRON ACER TENDL-2019 LIBRARY; T=293.16K
tritons from (n,x)

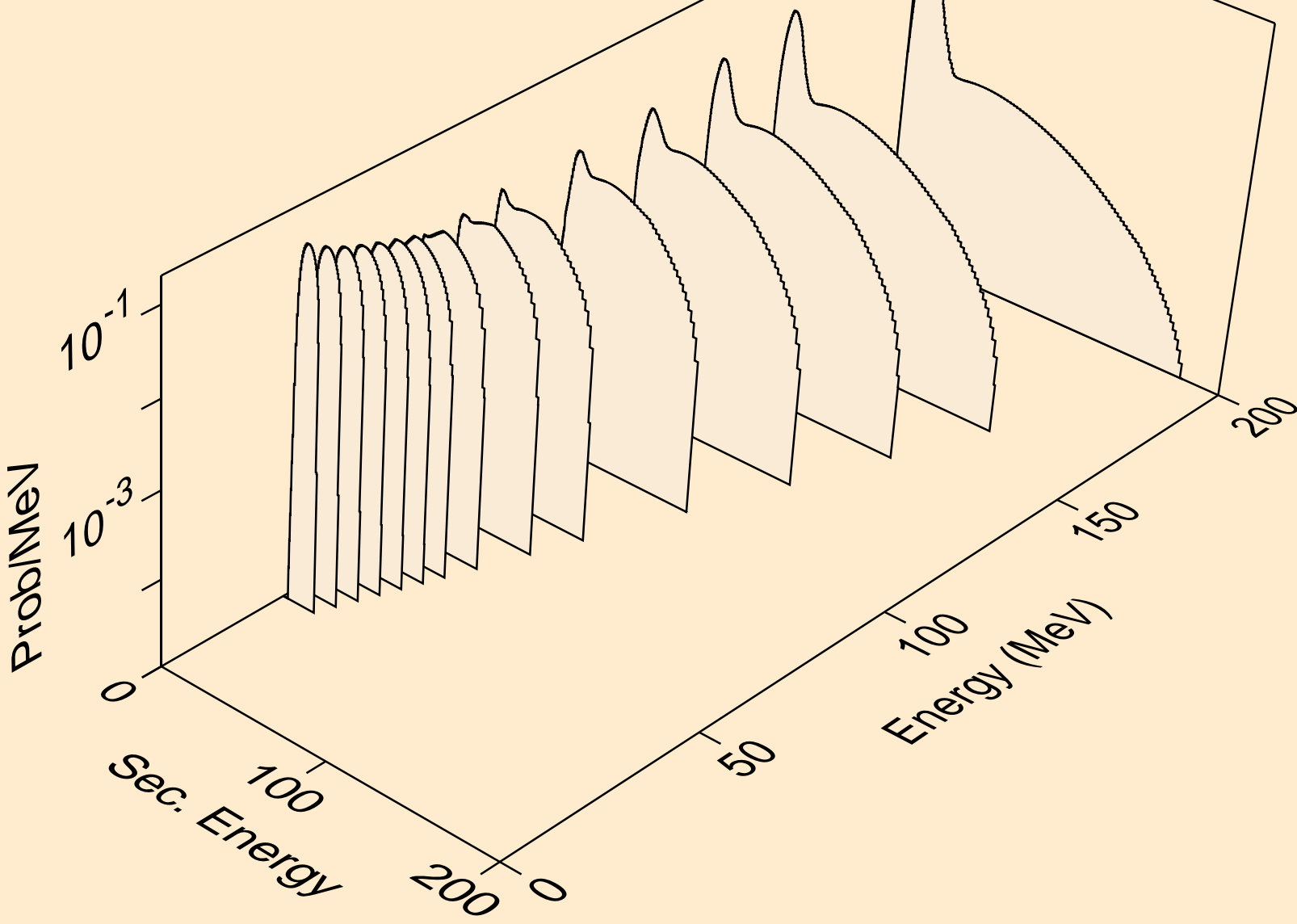

ZR103 NEUTRON ACER TENDL-2019 LIBRARY; T=293.16K
tritons from (n,n*)t

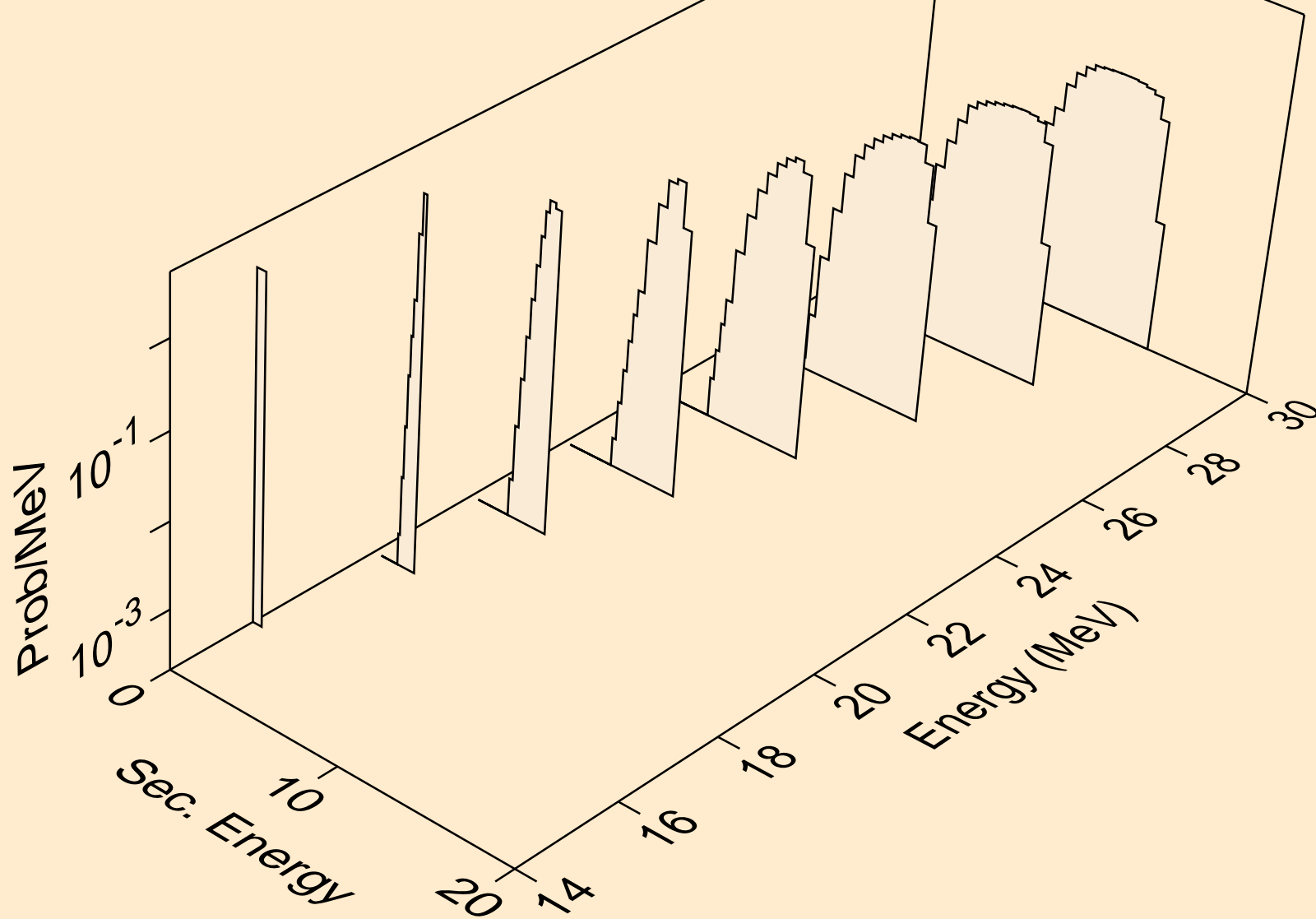

ZR103 NEUTRON ACER TENDL-2019 LIBRARY; T=293.16K
tritons from (n,t)

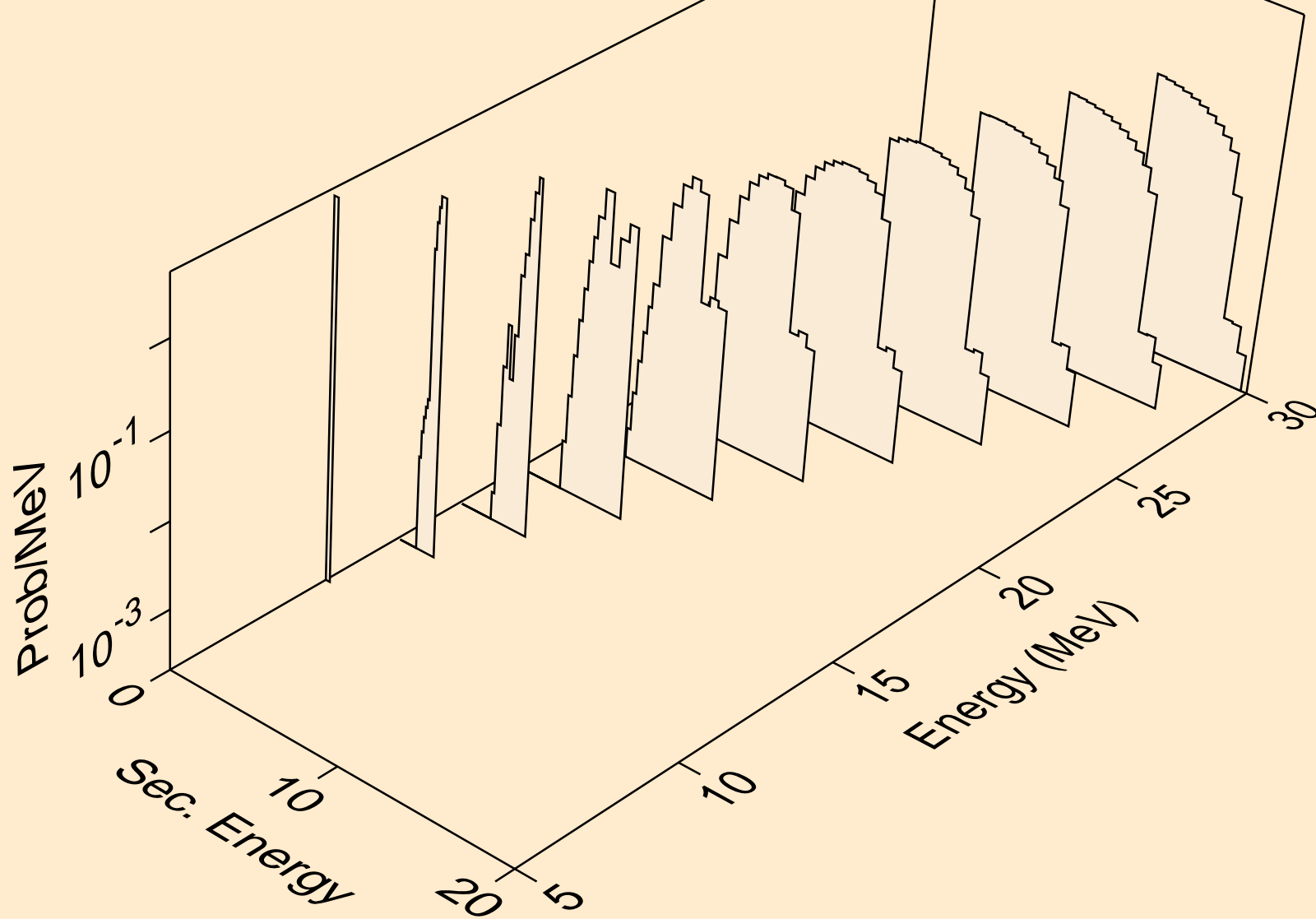

ZR103 NEUTRON ACER TENDL-2019 LIBRARY; T=293.16K
he3s from (n,x)

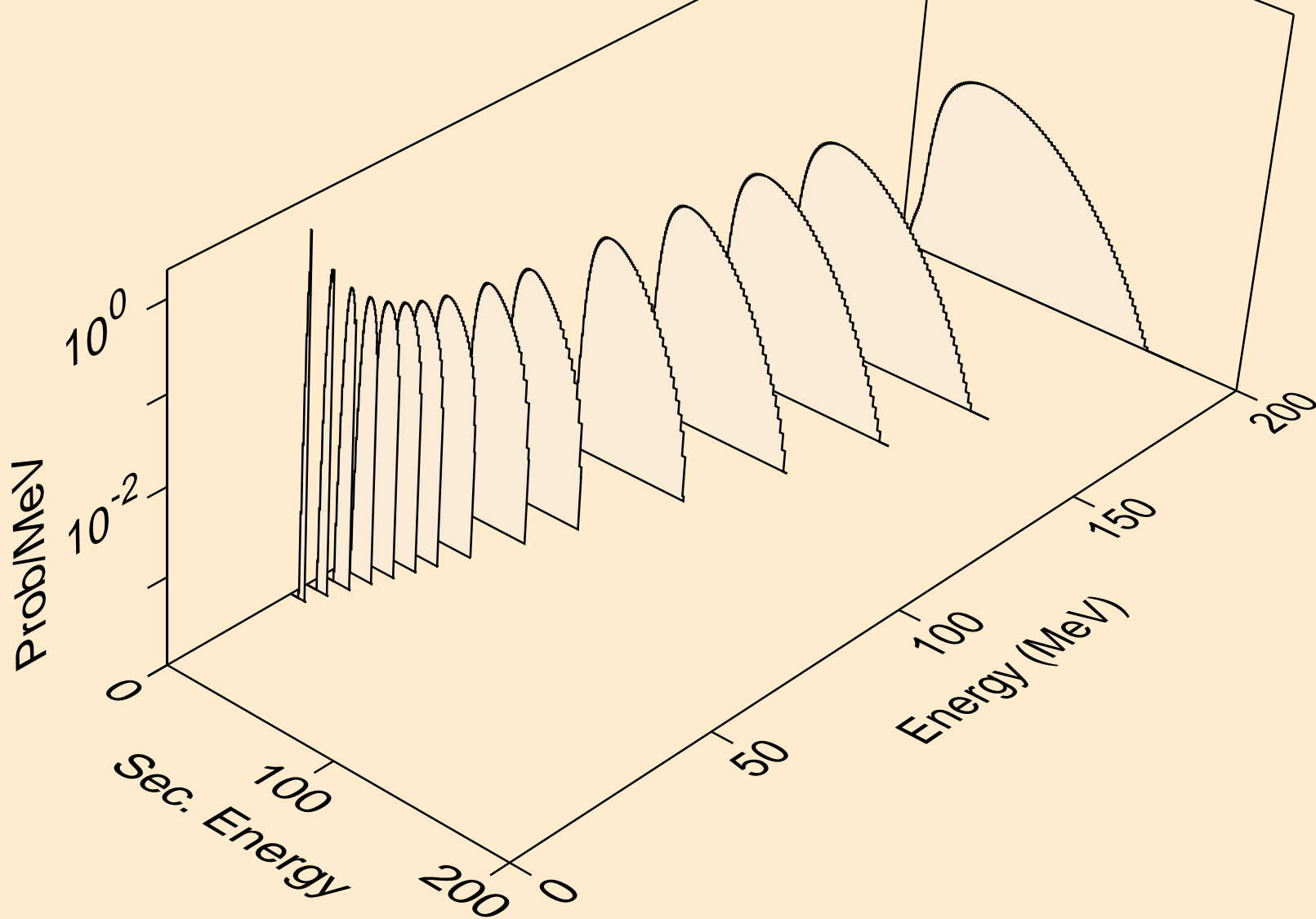

ZR103 NEUTRON ACER TENDL-2019 LIBRARY; T=293.16K
he3s from (n,he3)

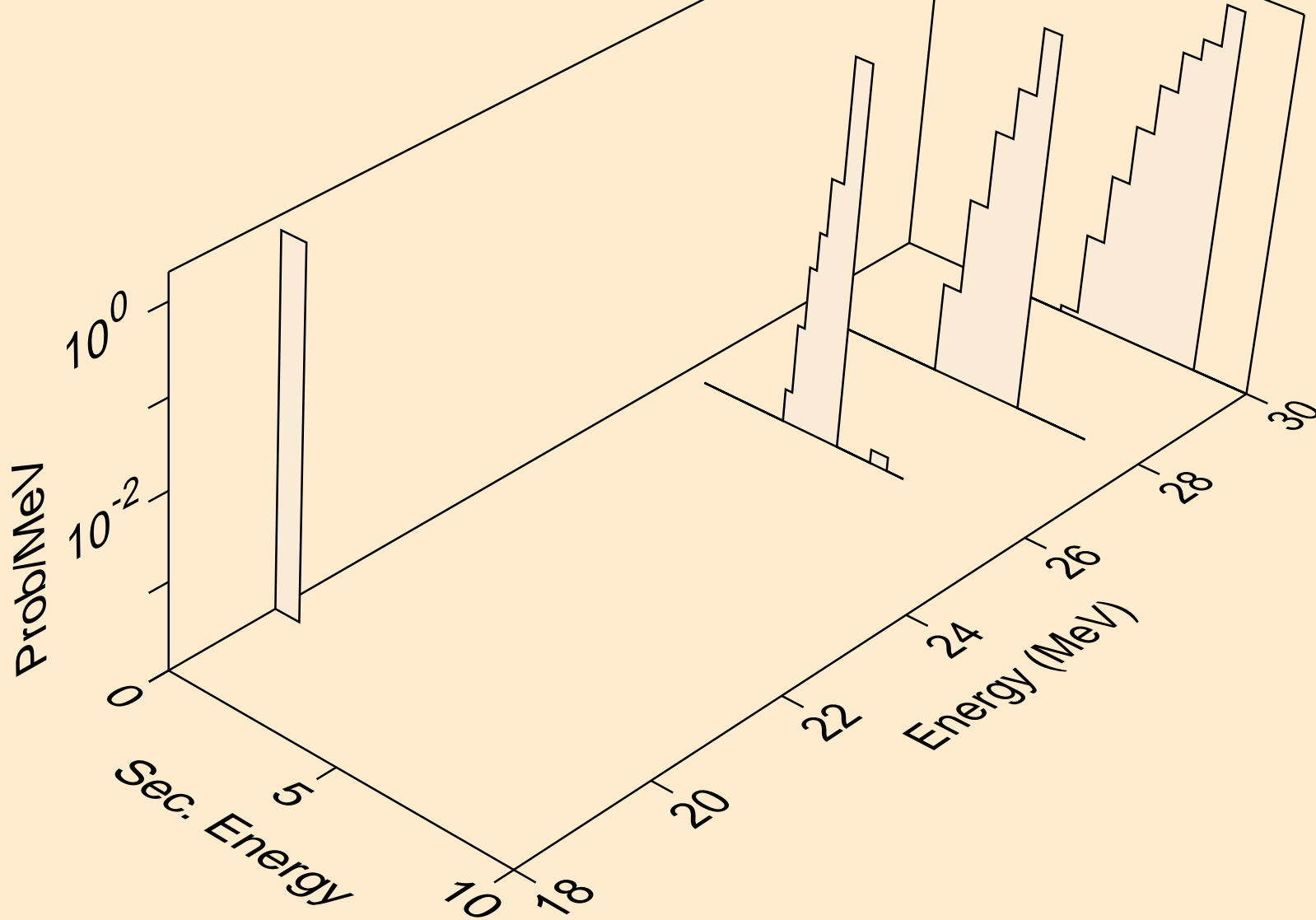

ZR103 NEUTRON ACER TENDL-2019 LIBRARY; T=293.16K
alphas from (n,x)

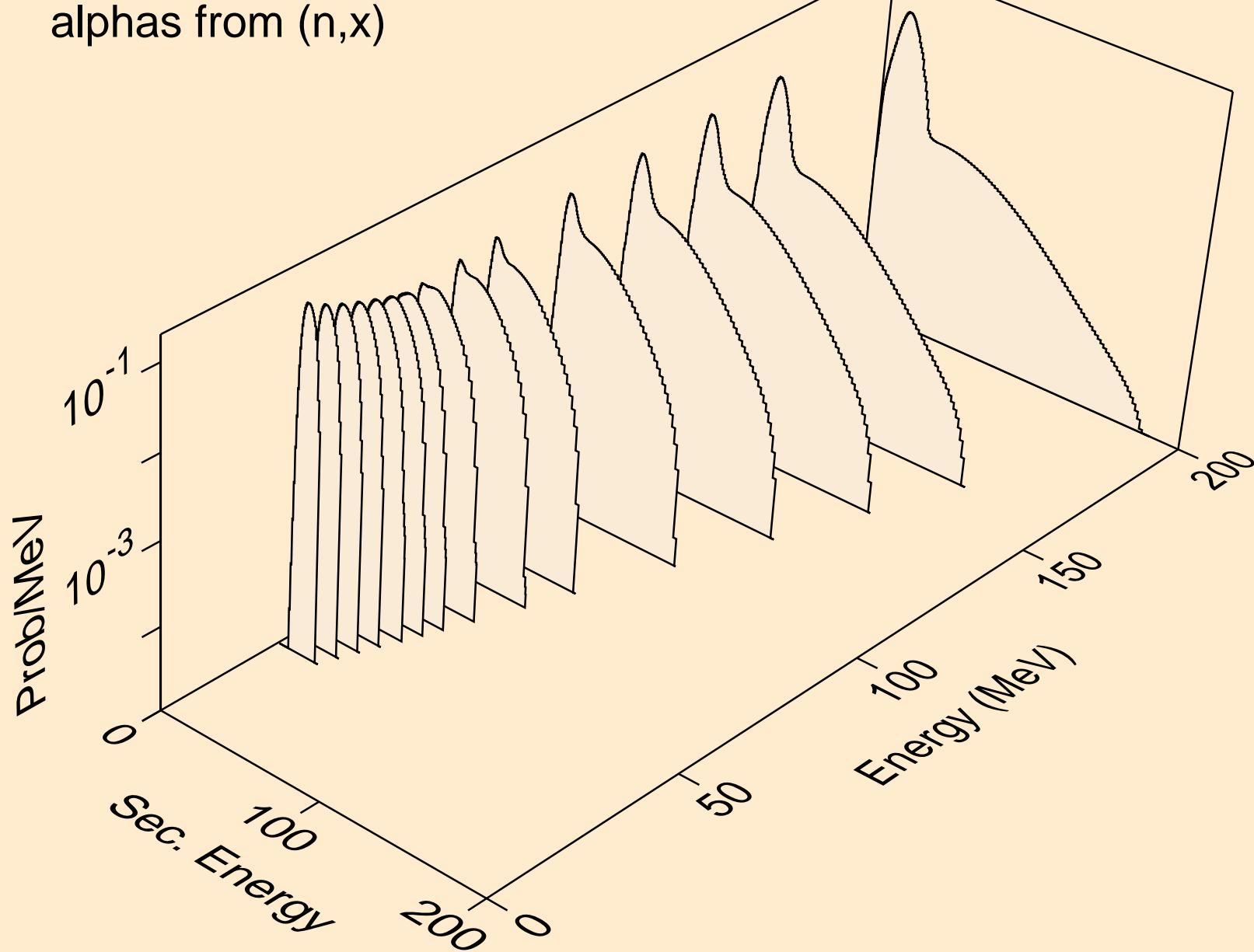

ZR103 NEUTRON ACER TENDL-2019 LIBRARY; T=293.16K
alphas from (n,n*)a

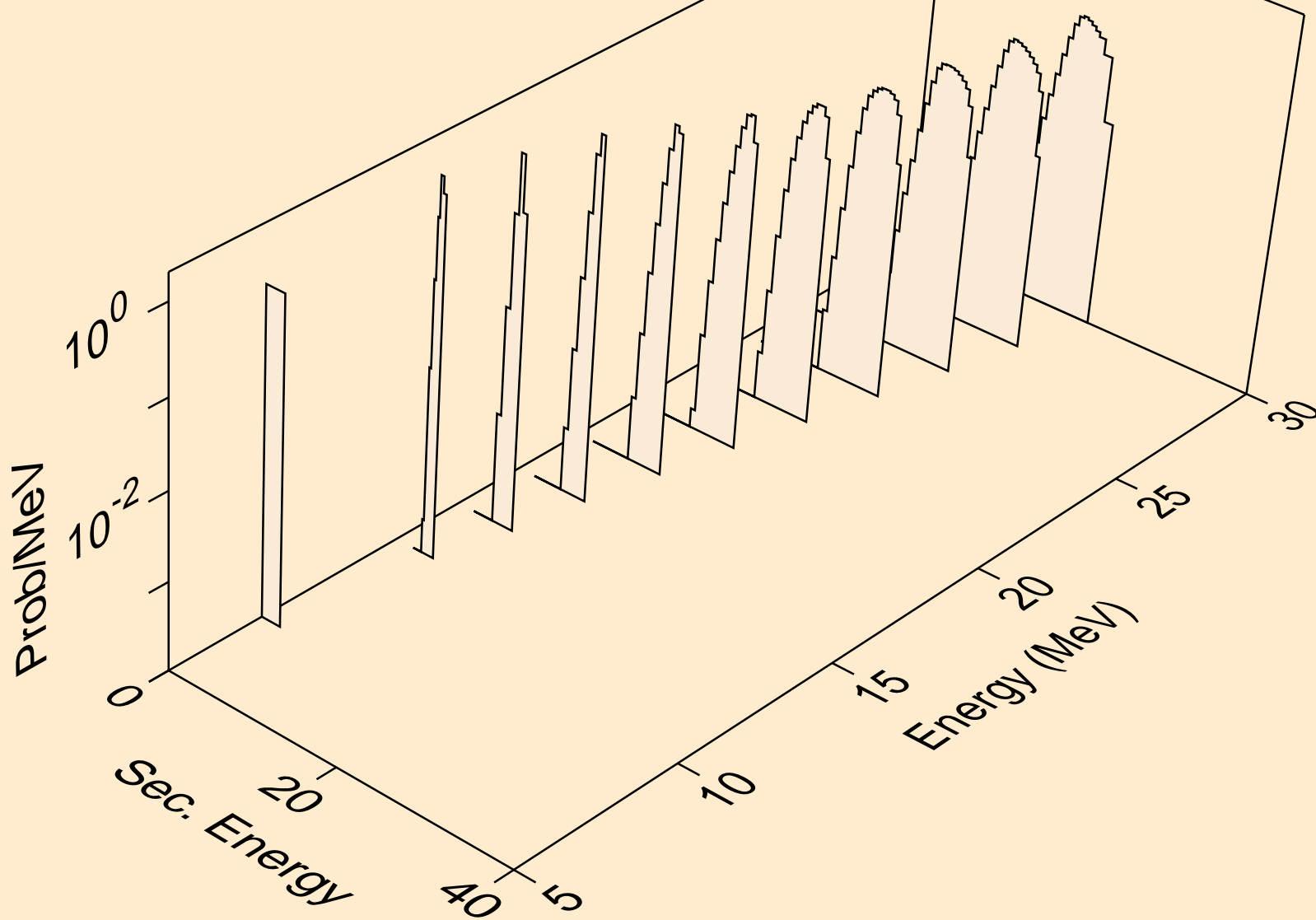

ZR103 NEUTRON ACER TENDL-2019 LIBRARY; T=293.16K
alphas from (n,2n)a

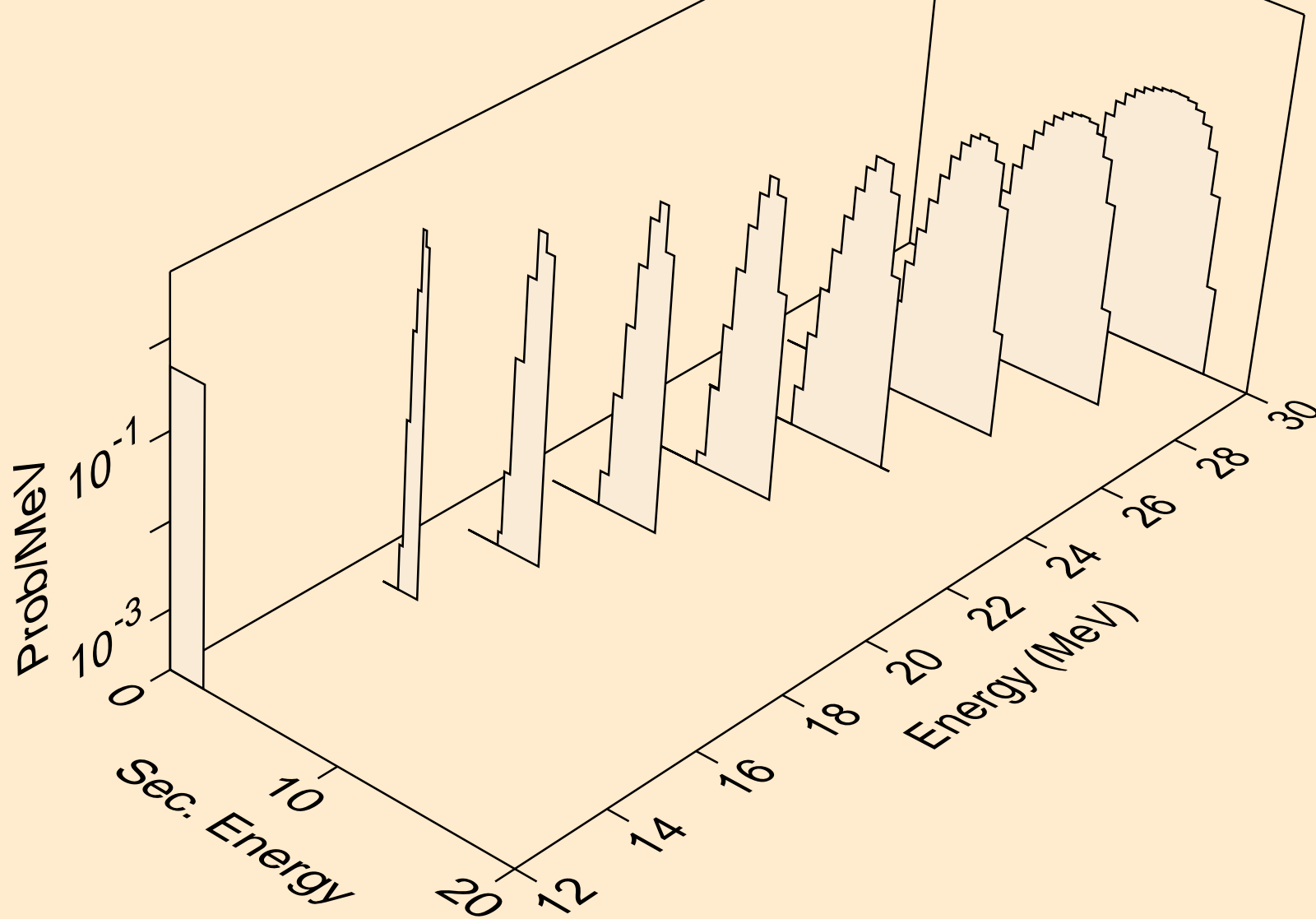

ZR103 NEUTRON ACER TENDL-2019 LIBRARY; T=293.16K
alphas from (n,3n)a

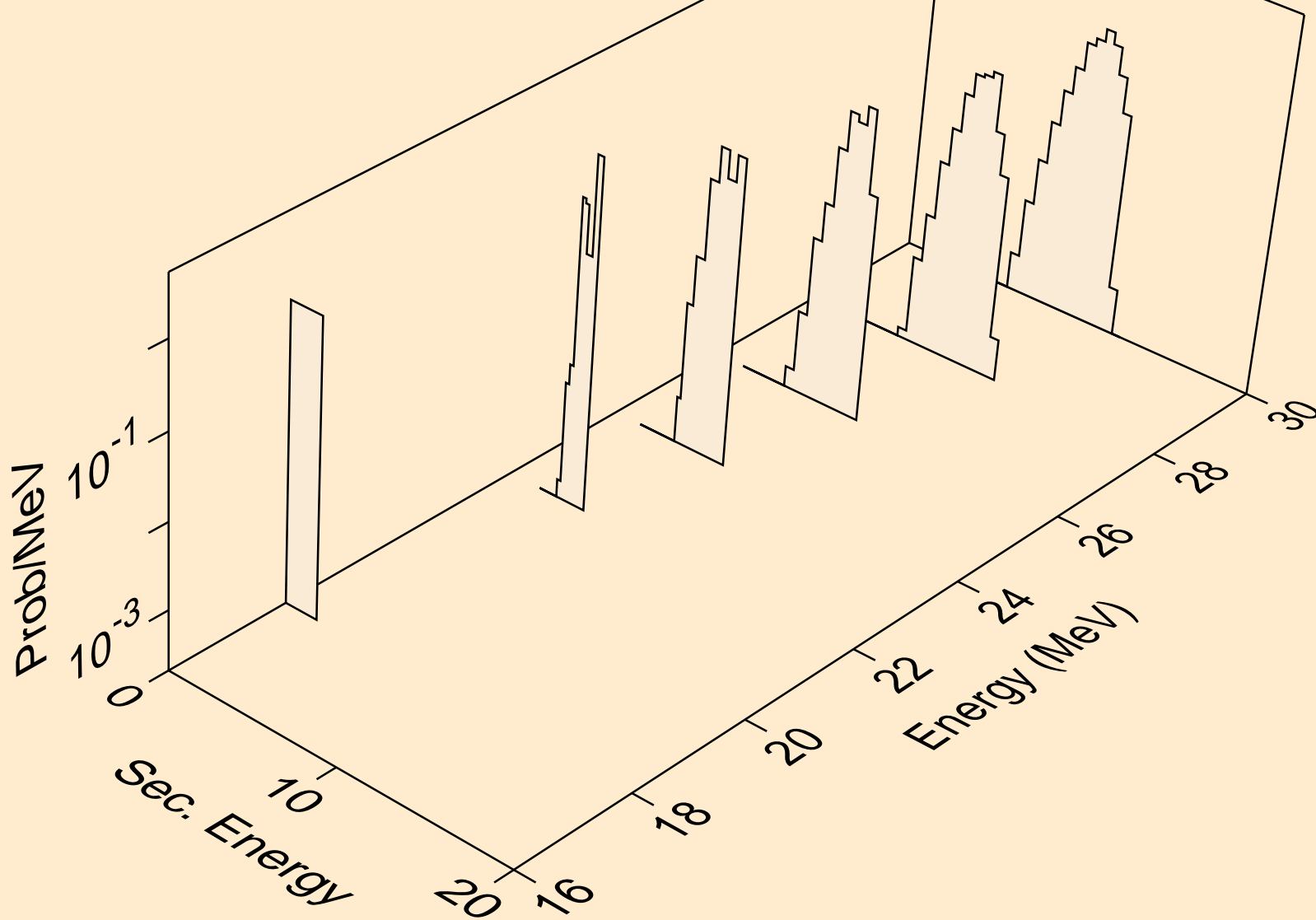

ZR103 NEUTRON ACER TENDL-2019 LIBRARY; T=293.16K
alphas from (n,a)

