

AC236 NEUTRON ACER TENDL-2019 LIBRARY; T=293.16K
Principal cross sections

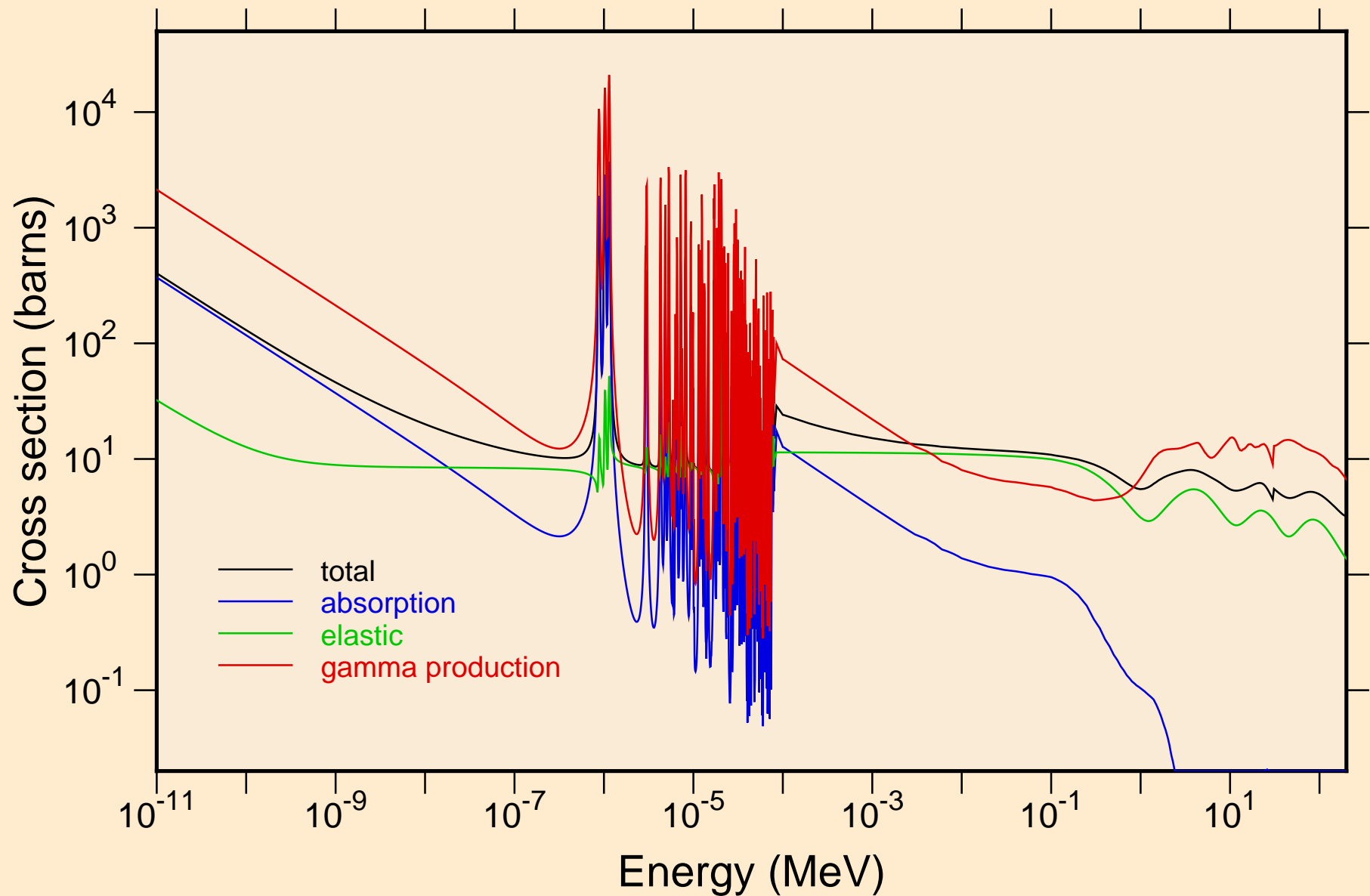

AC236 NEUTRON ACER TENDL-2019 LIBRARY; T=293.16K
resonance total cross section

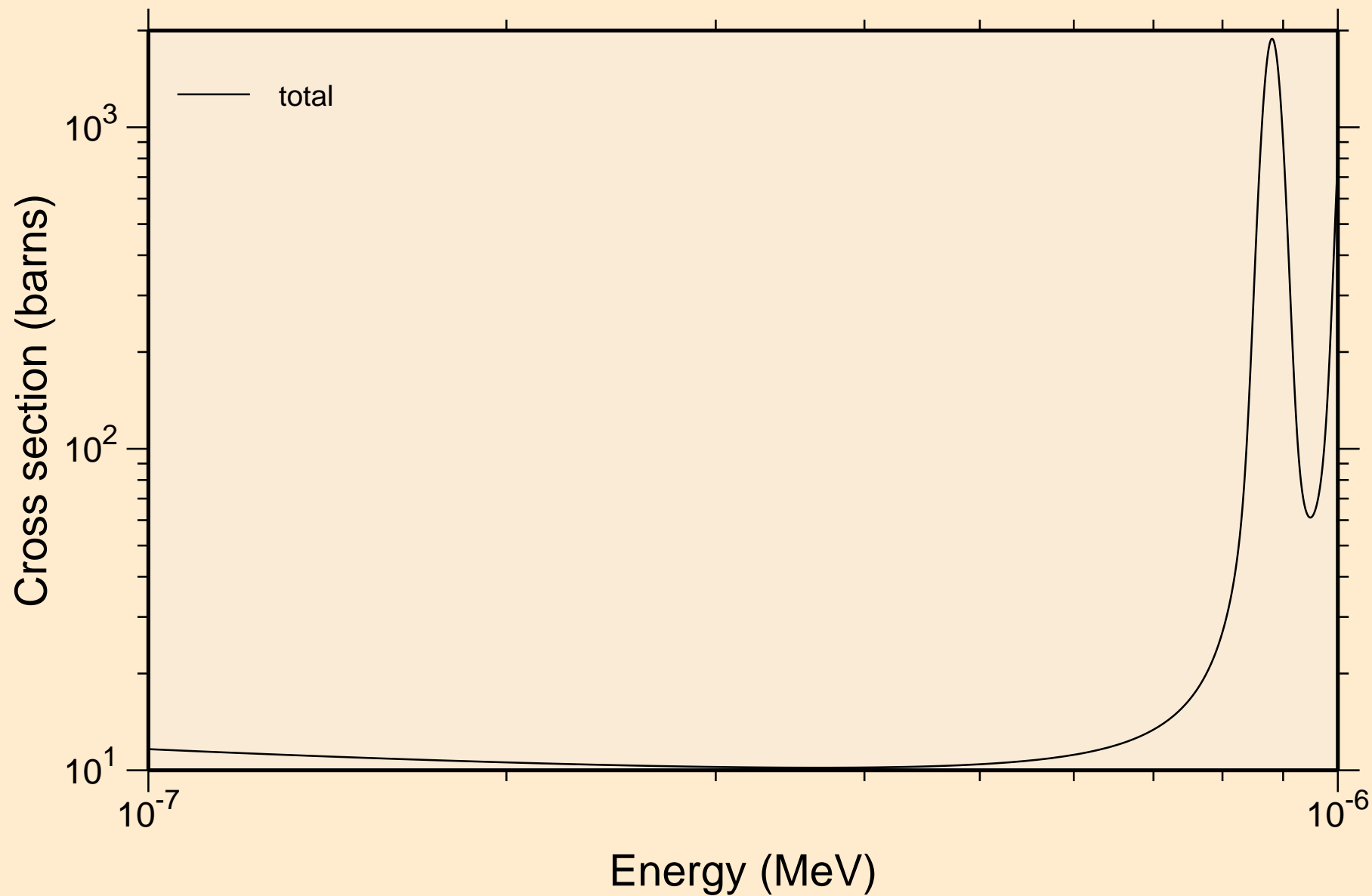

AC236 NEUTRON ACER TENDL-2019 LIBRARY; T=293.16K
resonance total cross section

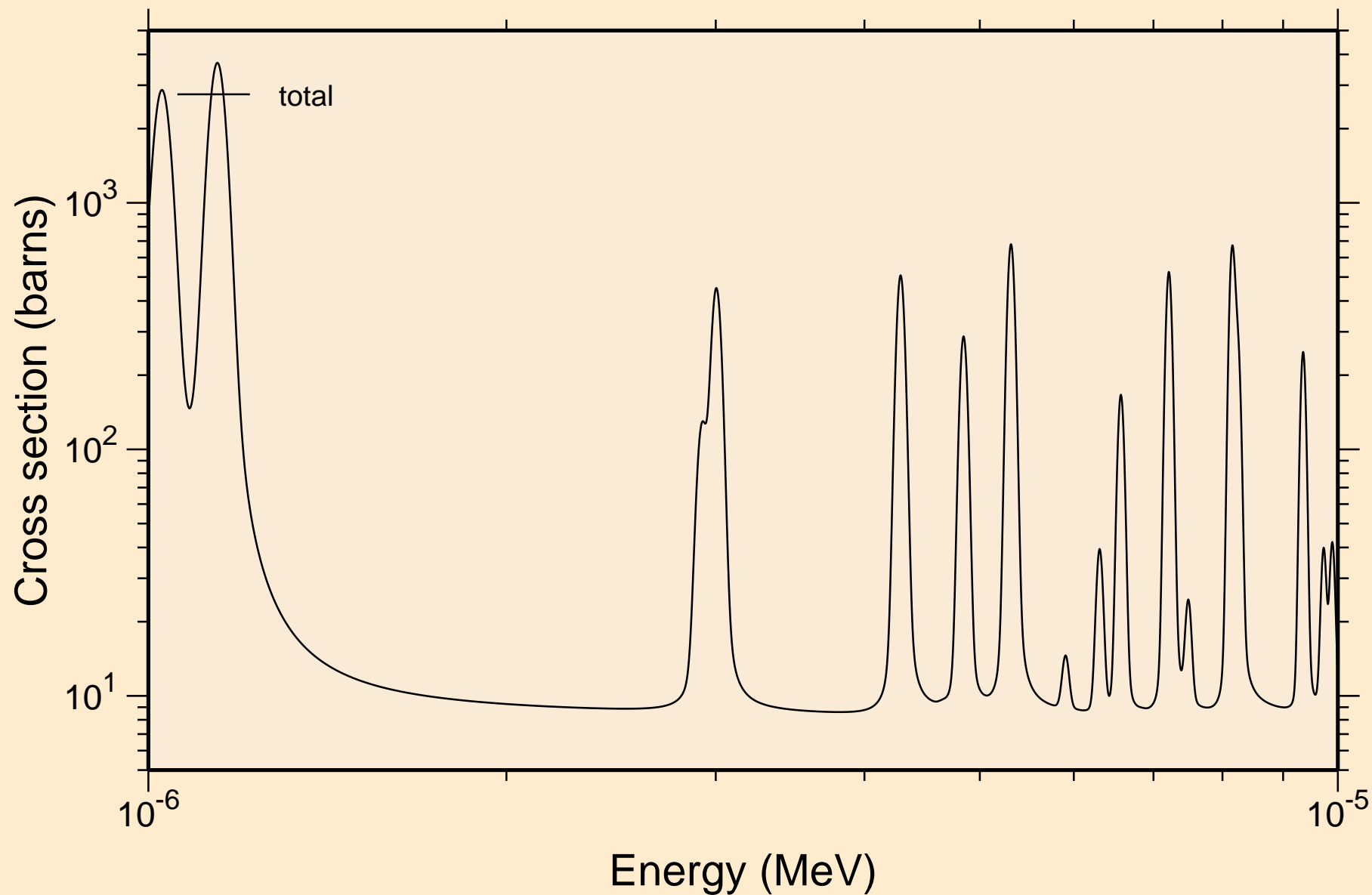

AC236 NEUTRON ACER TENDL-2019 LIBRARY; T=293.16K
resonance total cross section

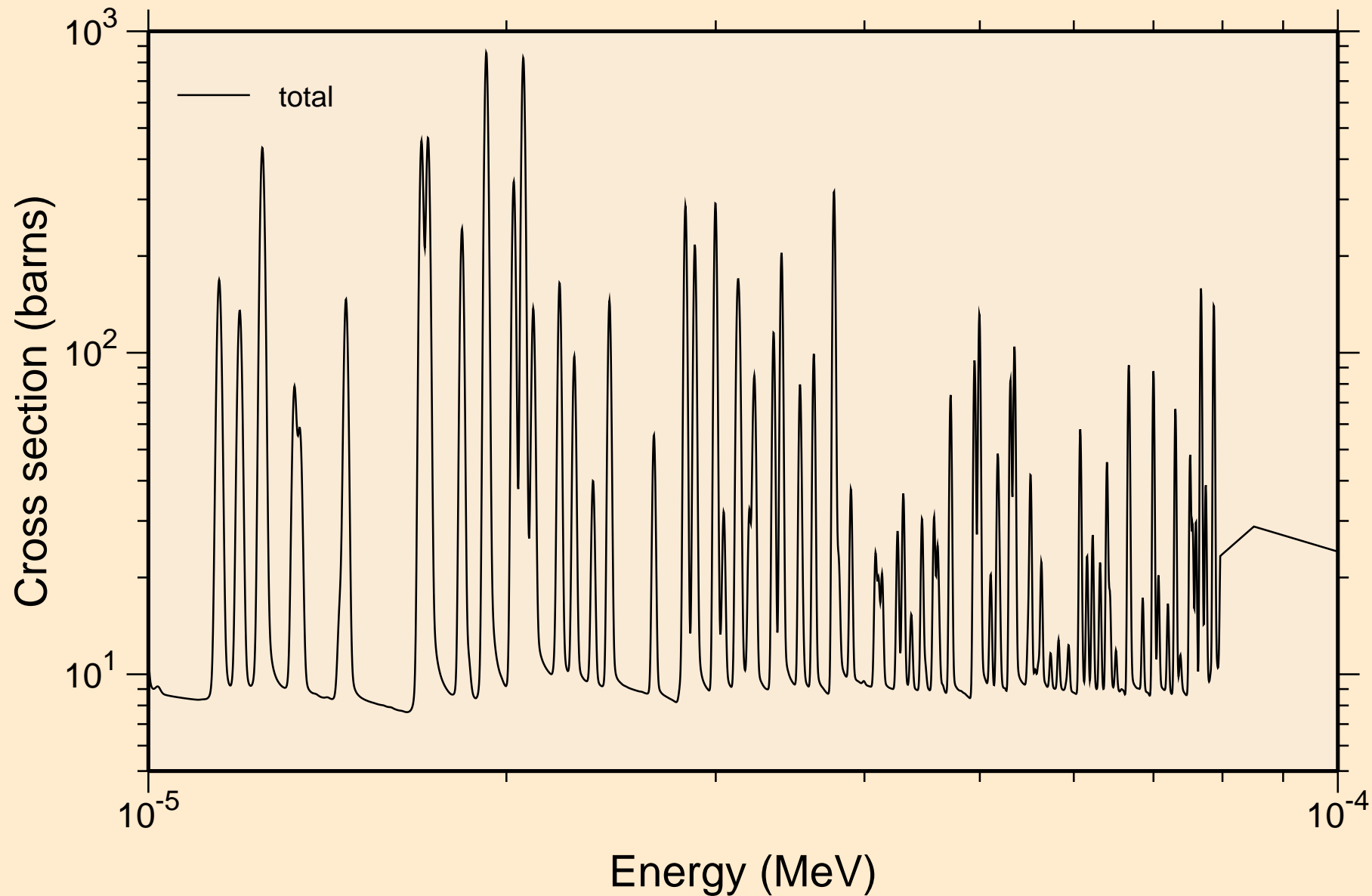

AC236 NEUTRON ACER TENDL-2019 LIBRARY; T=293.16K
resonance total cross section

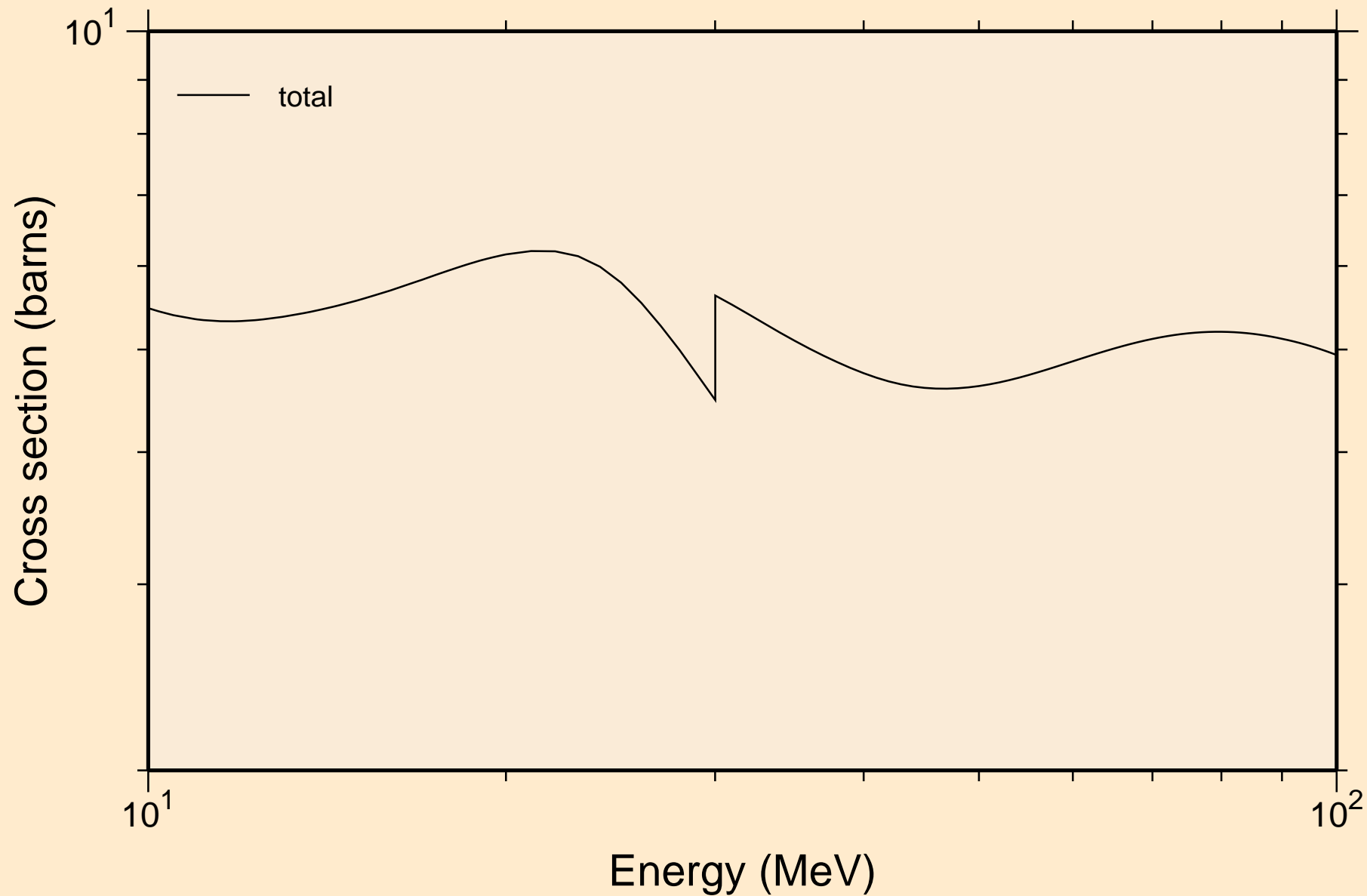

AC236 NEUTRON ACER TENDL-2019 LIBRARY; T=293.16K
resonance absorption cross sections

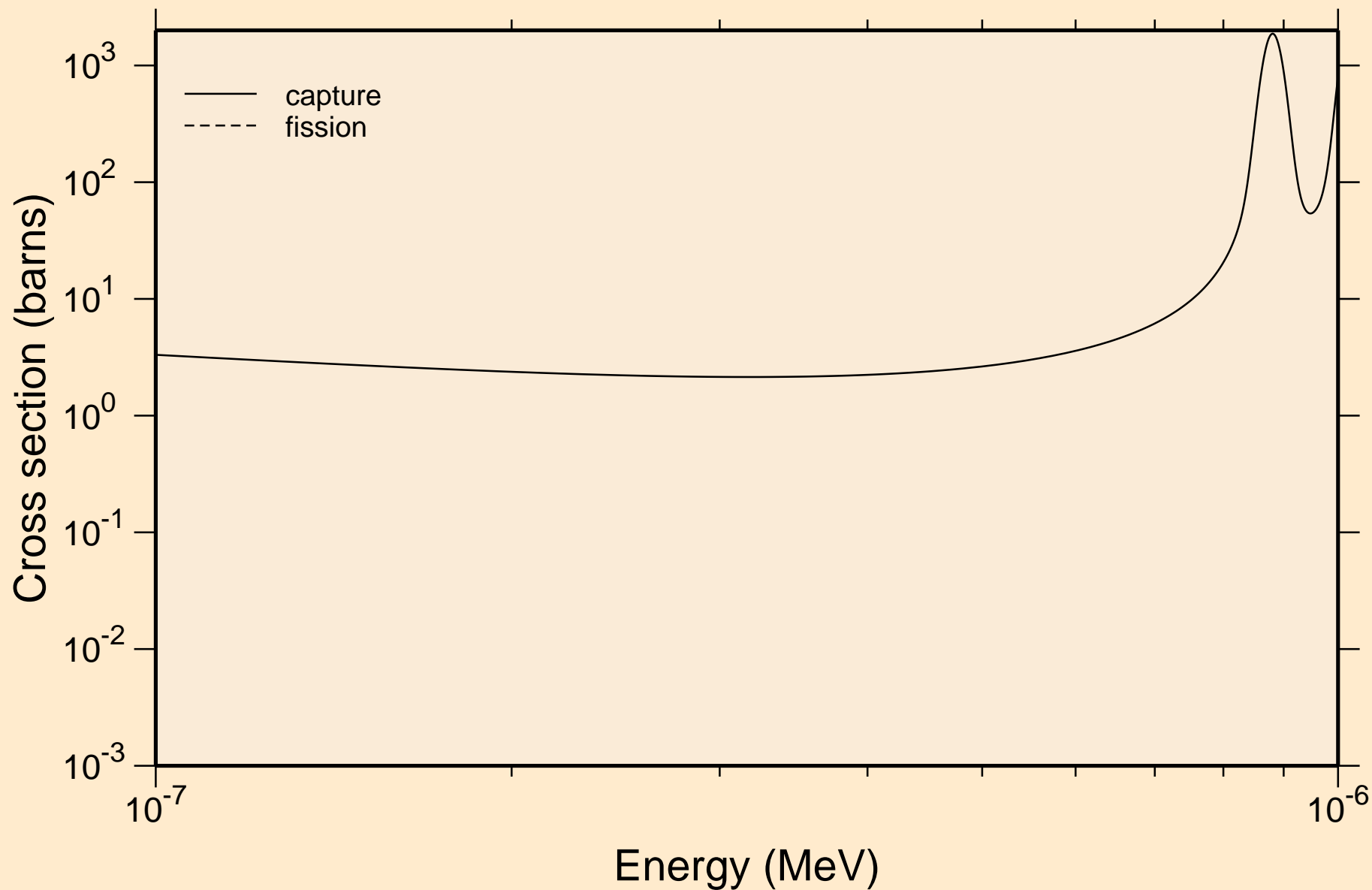

AC236 NEUTRON ACER TENDL-2019 LIBRARY; T=293.16K
resonance absorption cross sections

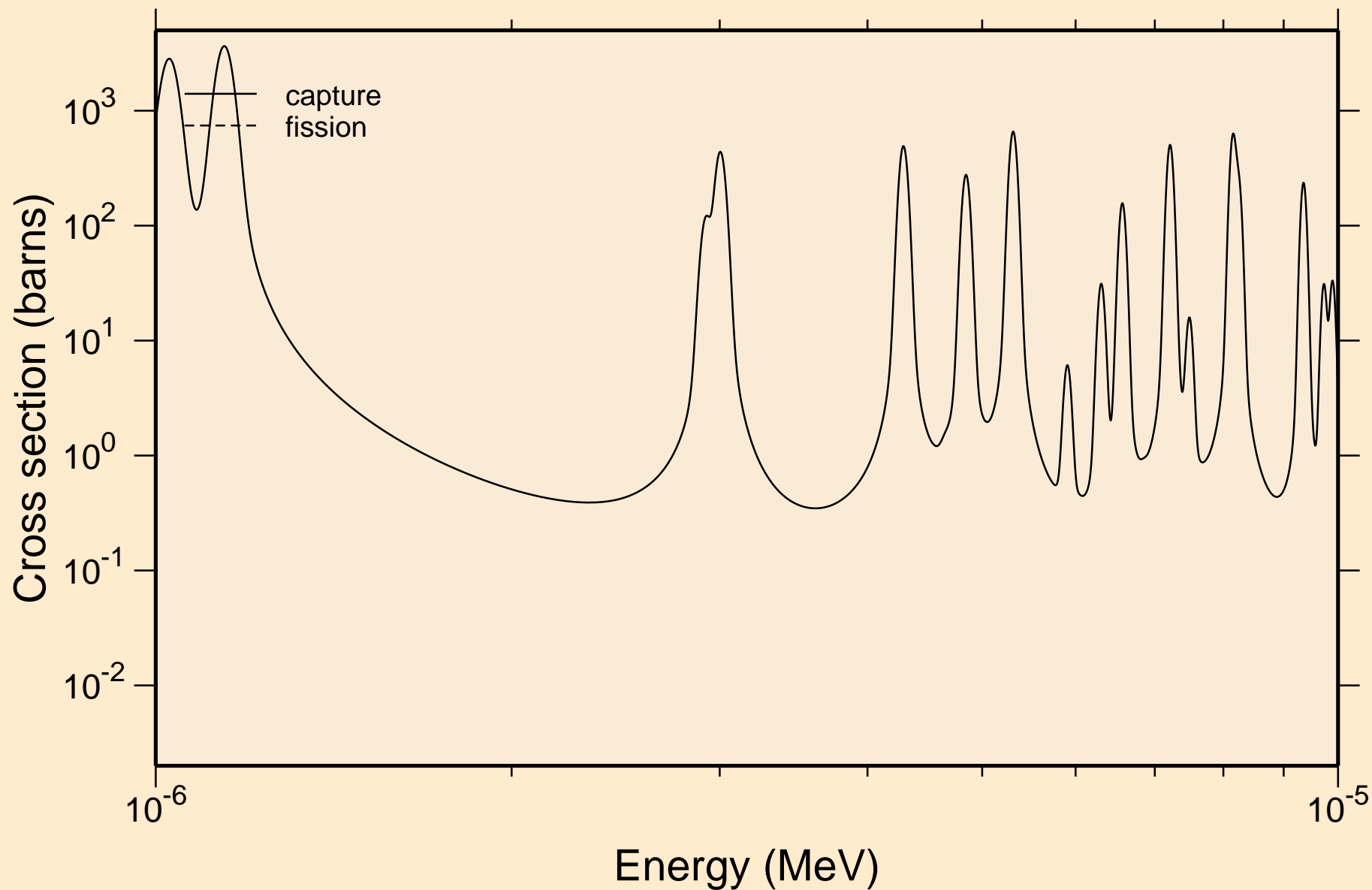

AC236 NEUTRON ACER TENDL-2019 LIBRARY; T=293.16K
resonance absorption cross sections

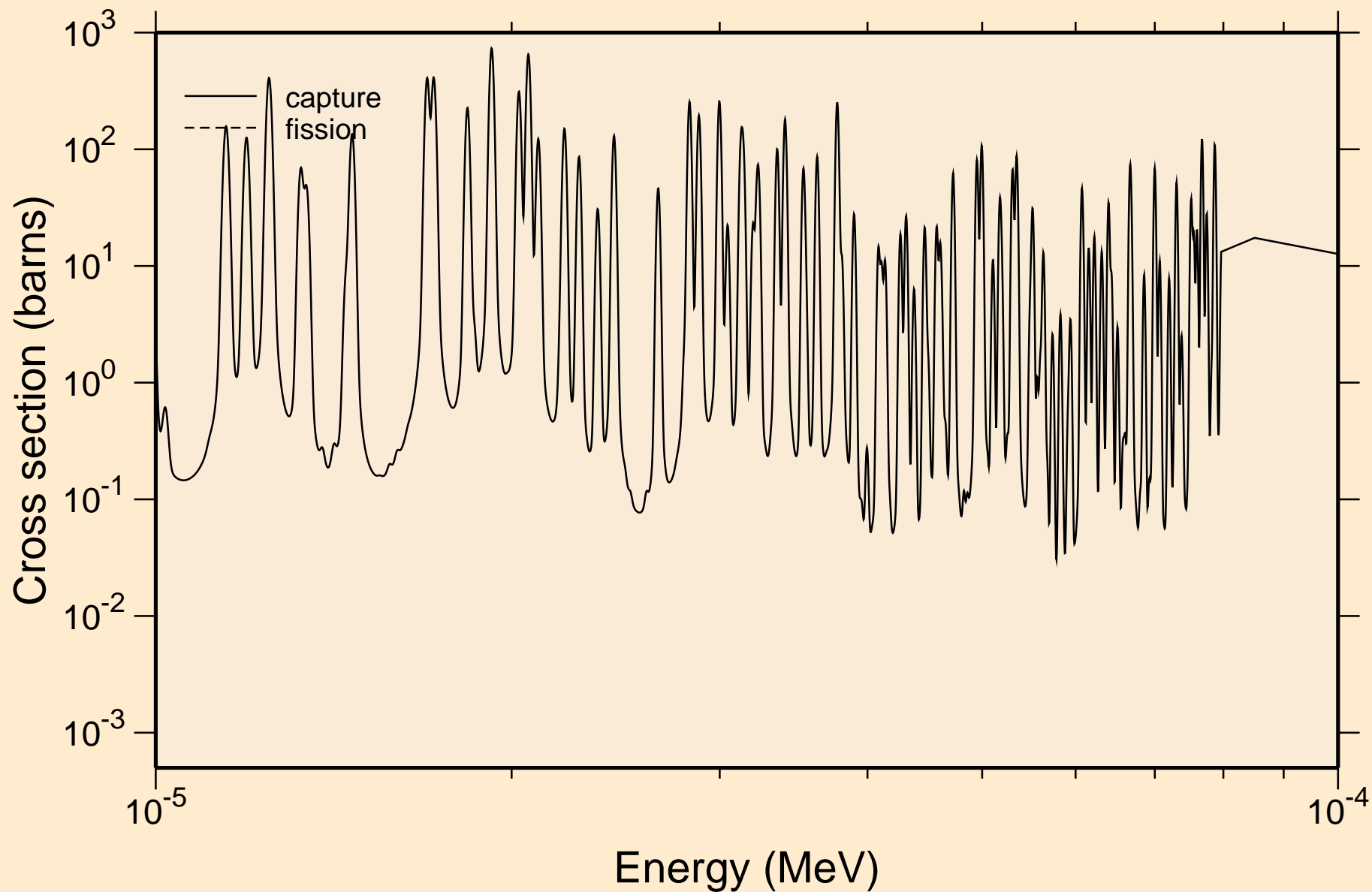

AC236 NEUTRON ACER TENDL-2019 LIBRARY; T=293.16K
resonance absorption cross sections

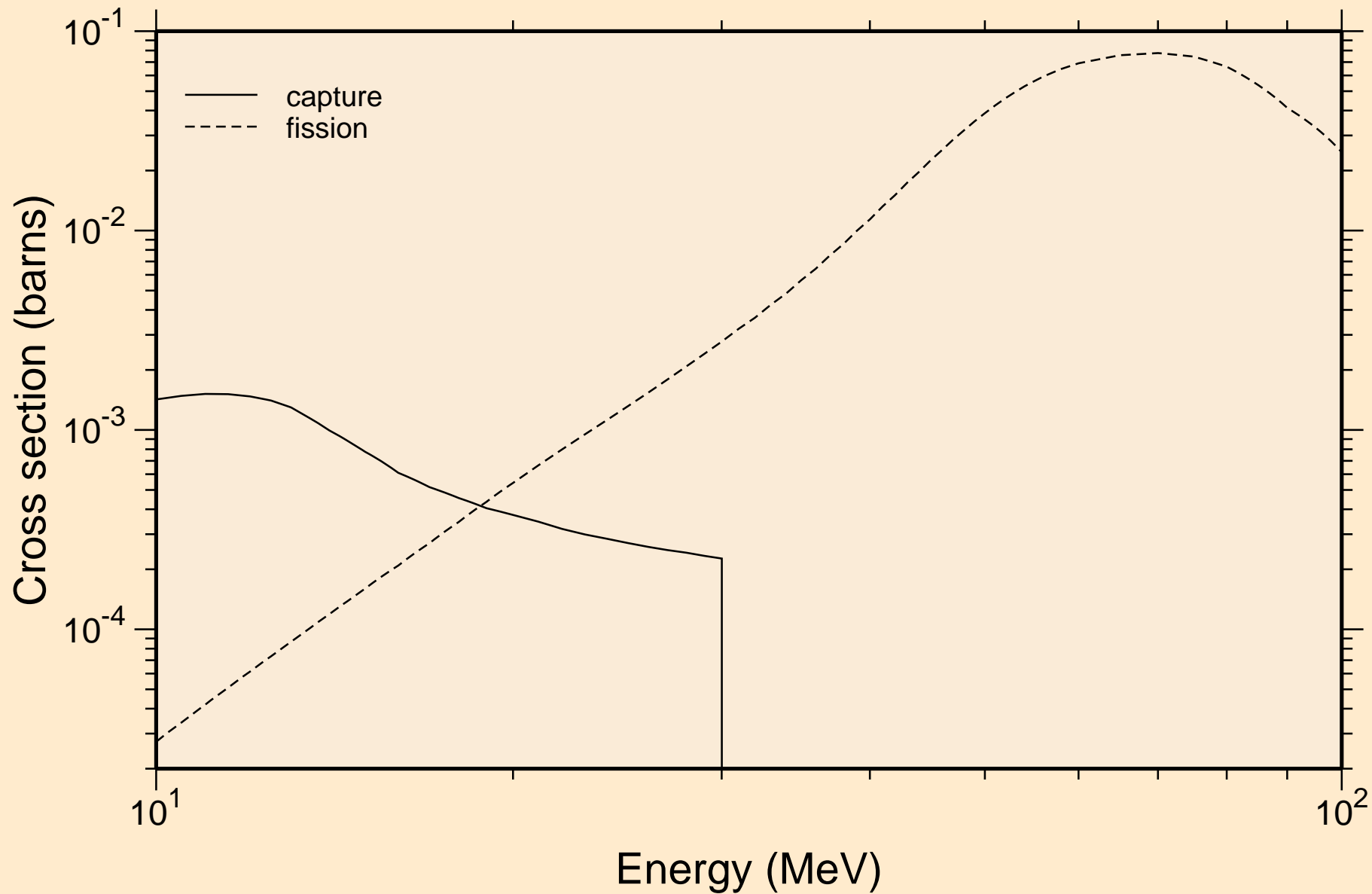

AC236 NEUTRON ACER TENDL-2019 LIBRARY; T=293.16K
Heating

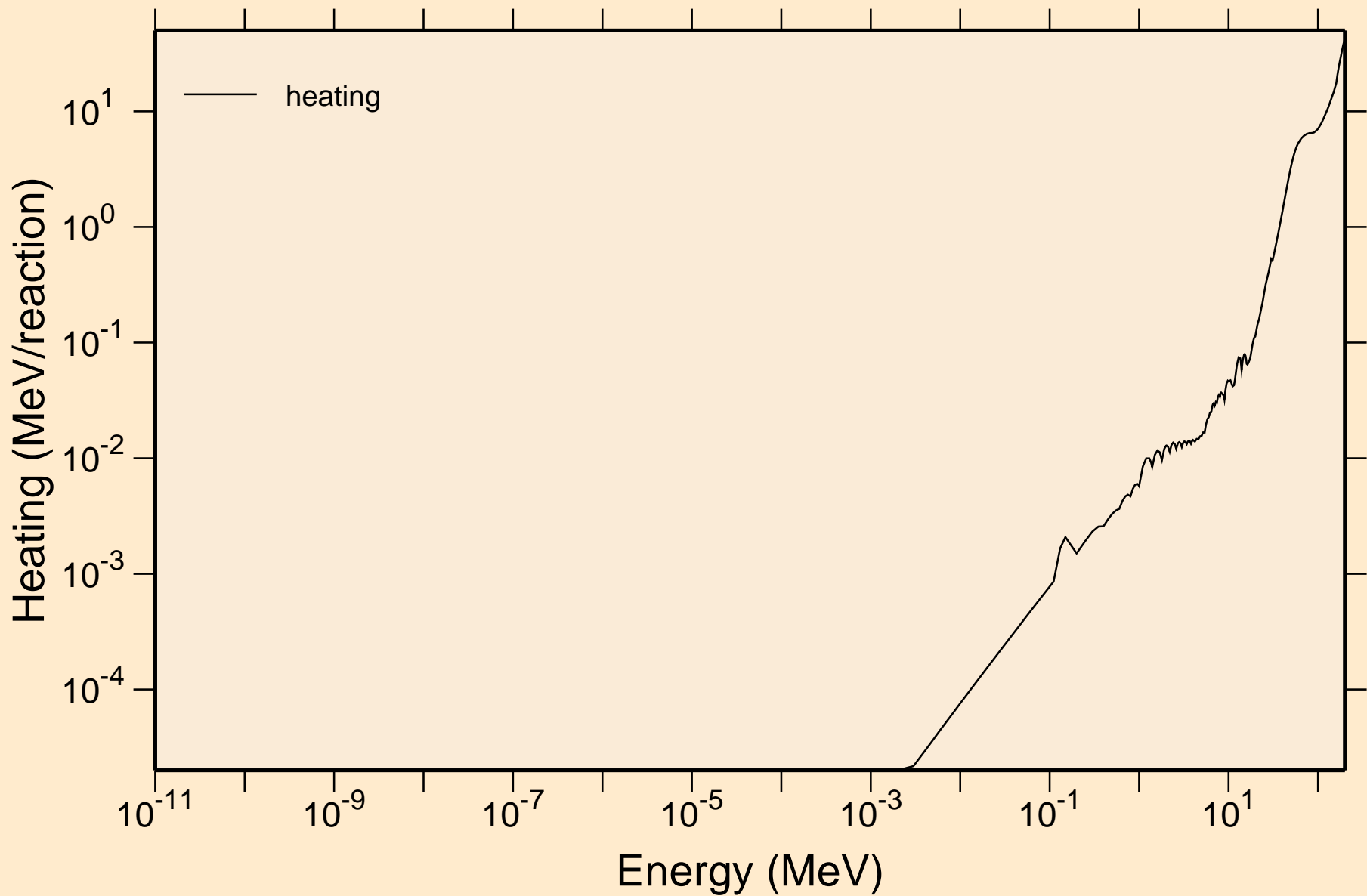

AC236 NEUTRON ACER TENDL-2019 LIBRARY; T=293.16K
Damage

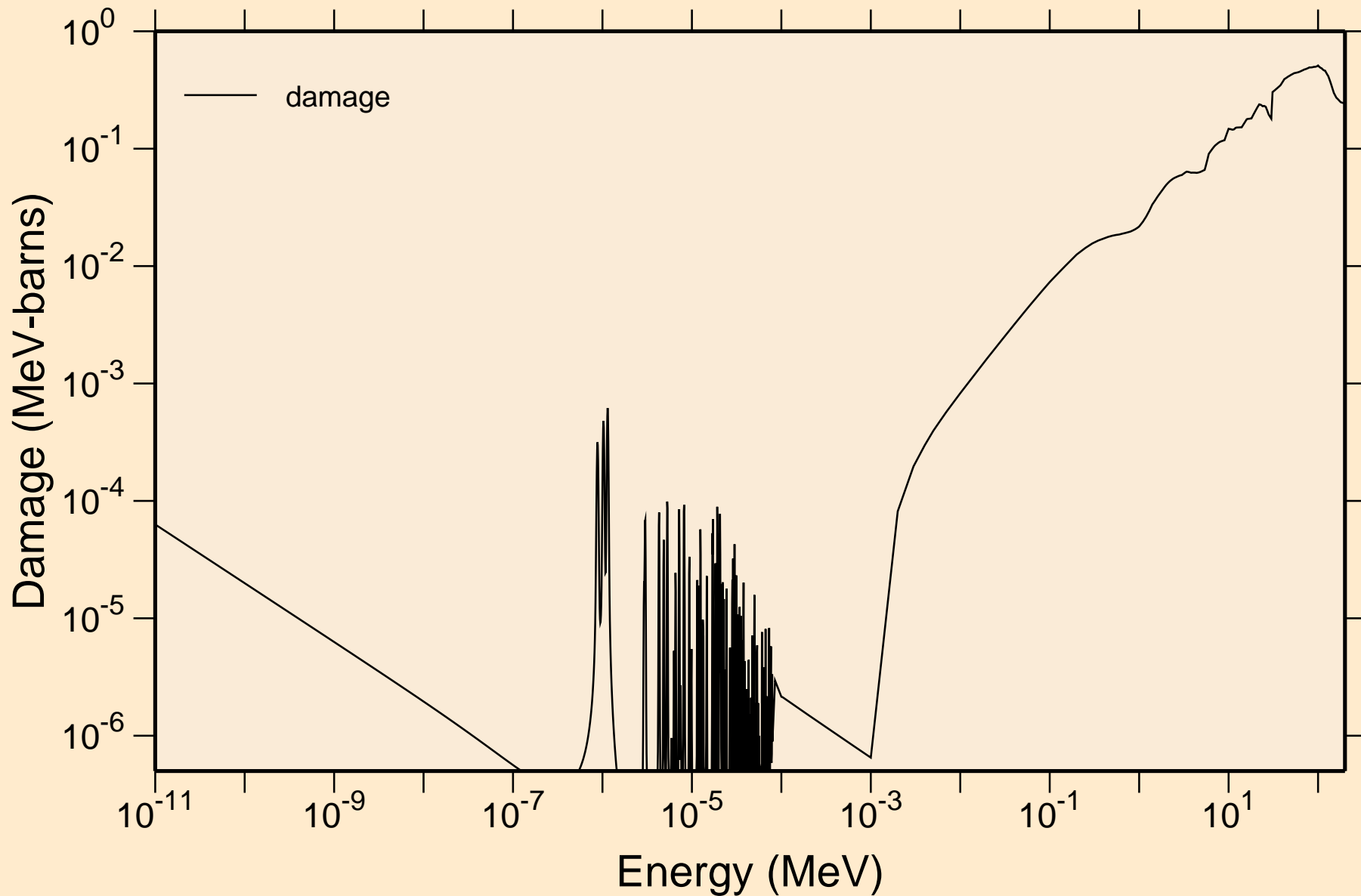

AC236 NEUTRON ACER TENDL-2019 LIBRARY; T=293.16K
Non-threshold reactions

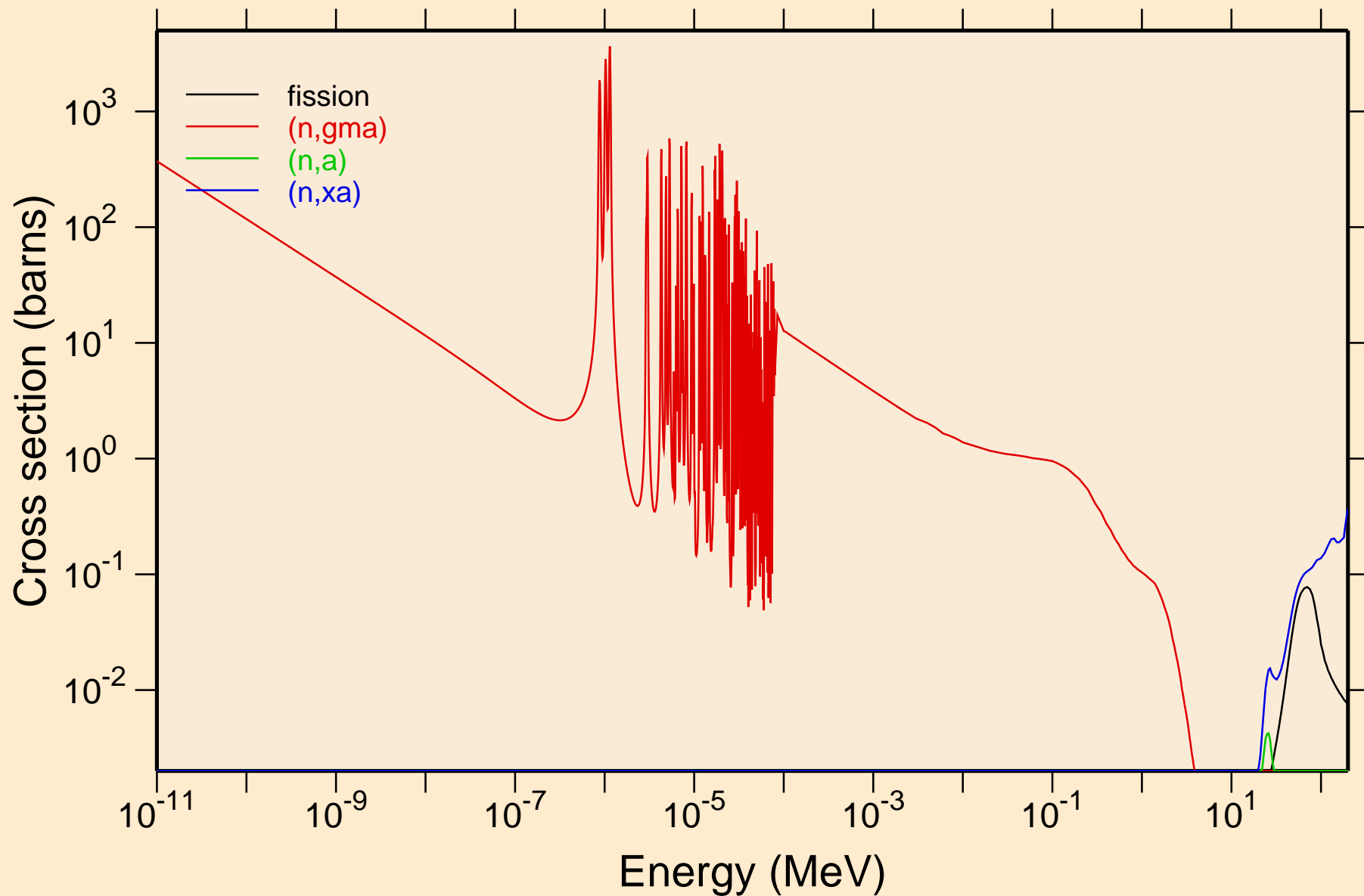

AC236 NEUTRON ACER TENDL-2019 LIBRARY; T=293.16K
Principal cross sections

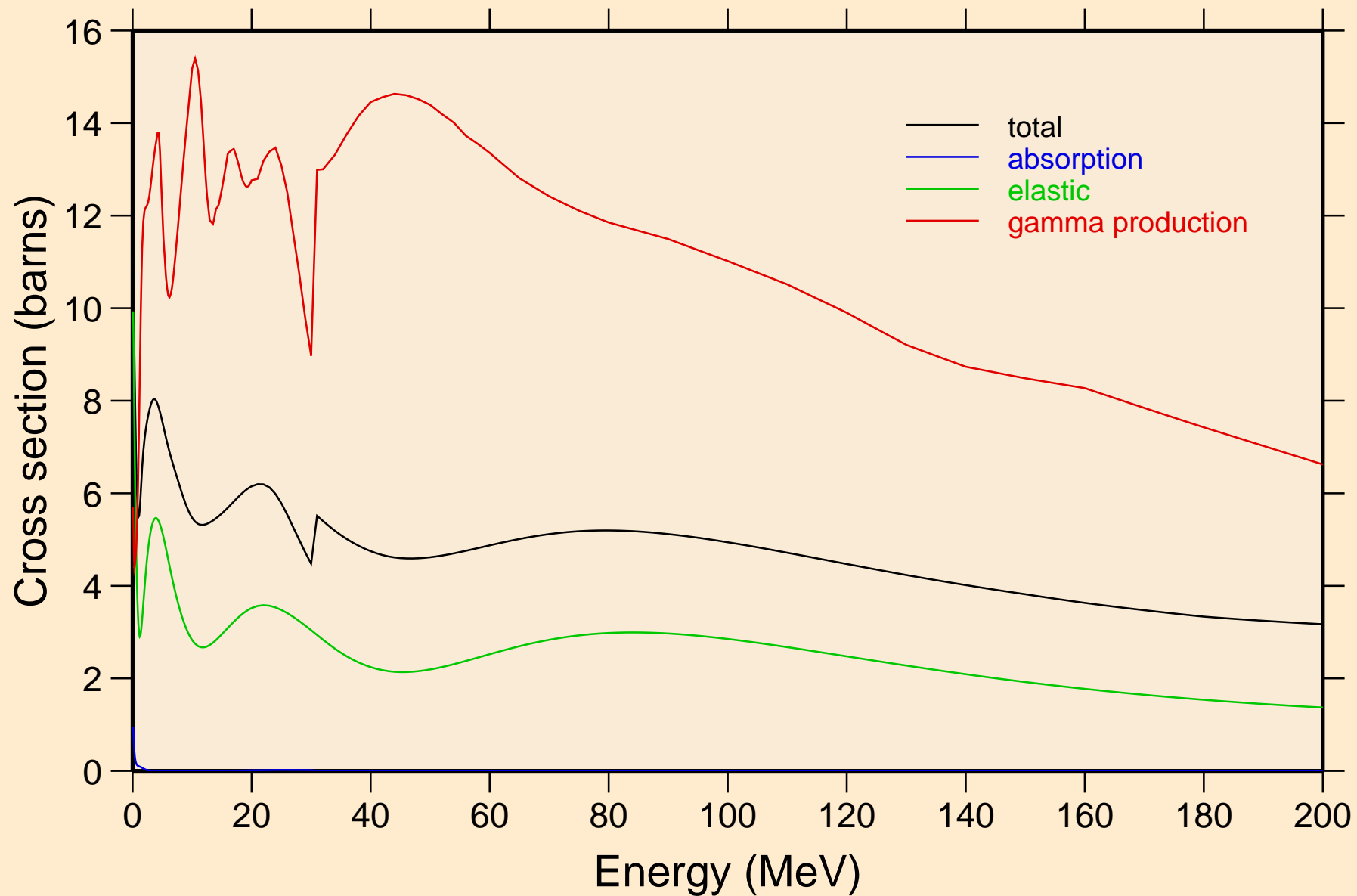

AC236 NEUTRON ACER TENDL-2019 LIBRARY; T=293.16K
Heating

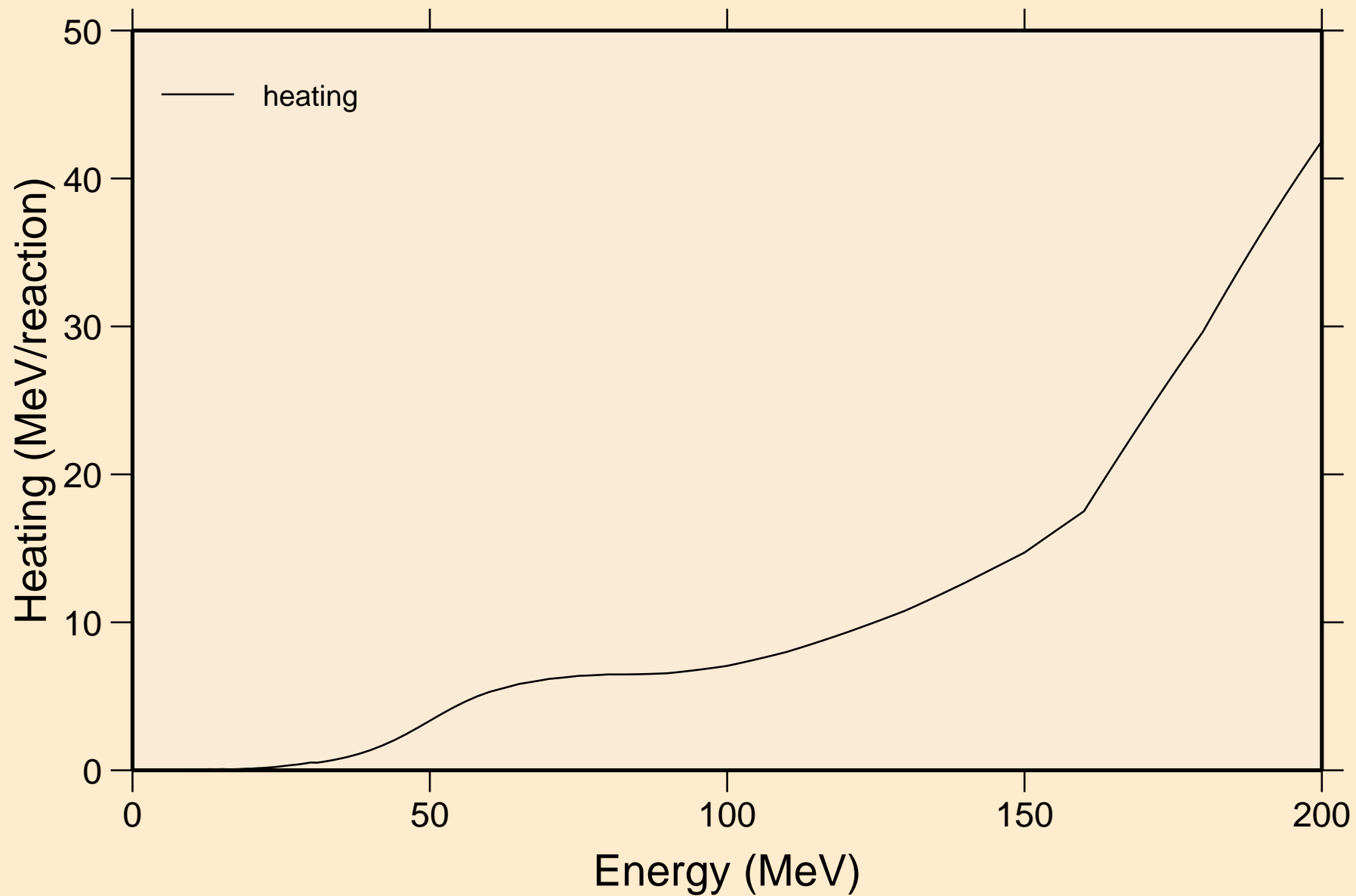

AC236 NEUTRON ACER TENDL-2019 LIBRARY; T=293.16K
Damage

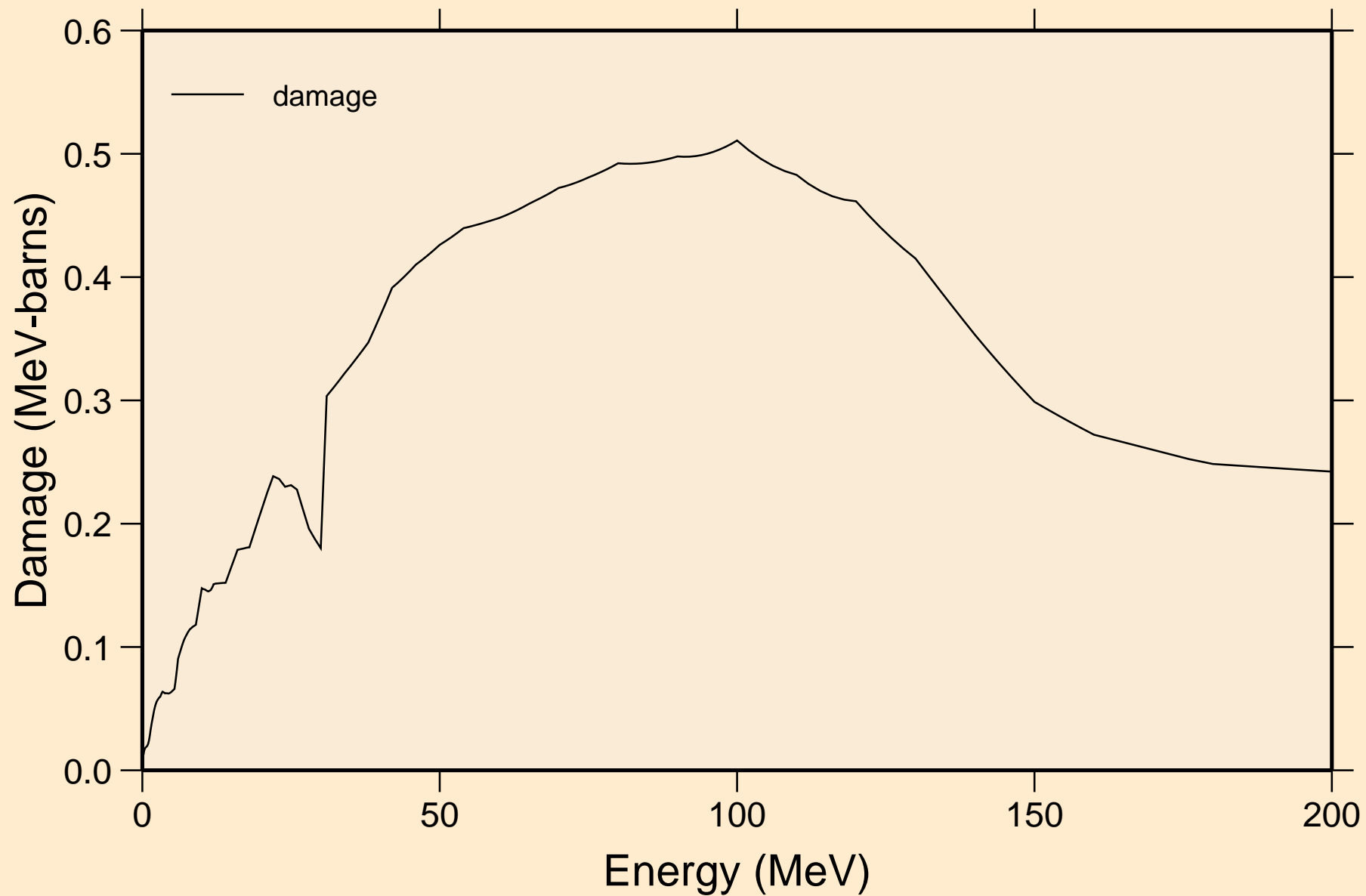

AC236 NEUTRON ACER TENDL-2019 LIBRARY; T=293.16K
Non-threshold reactions

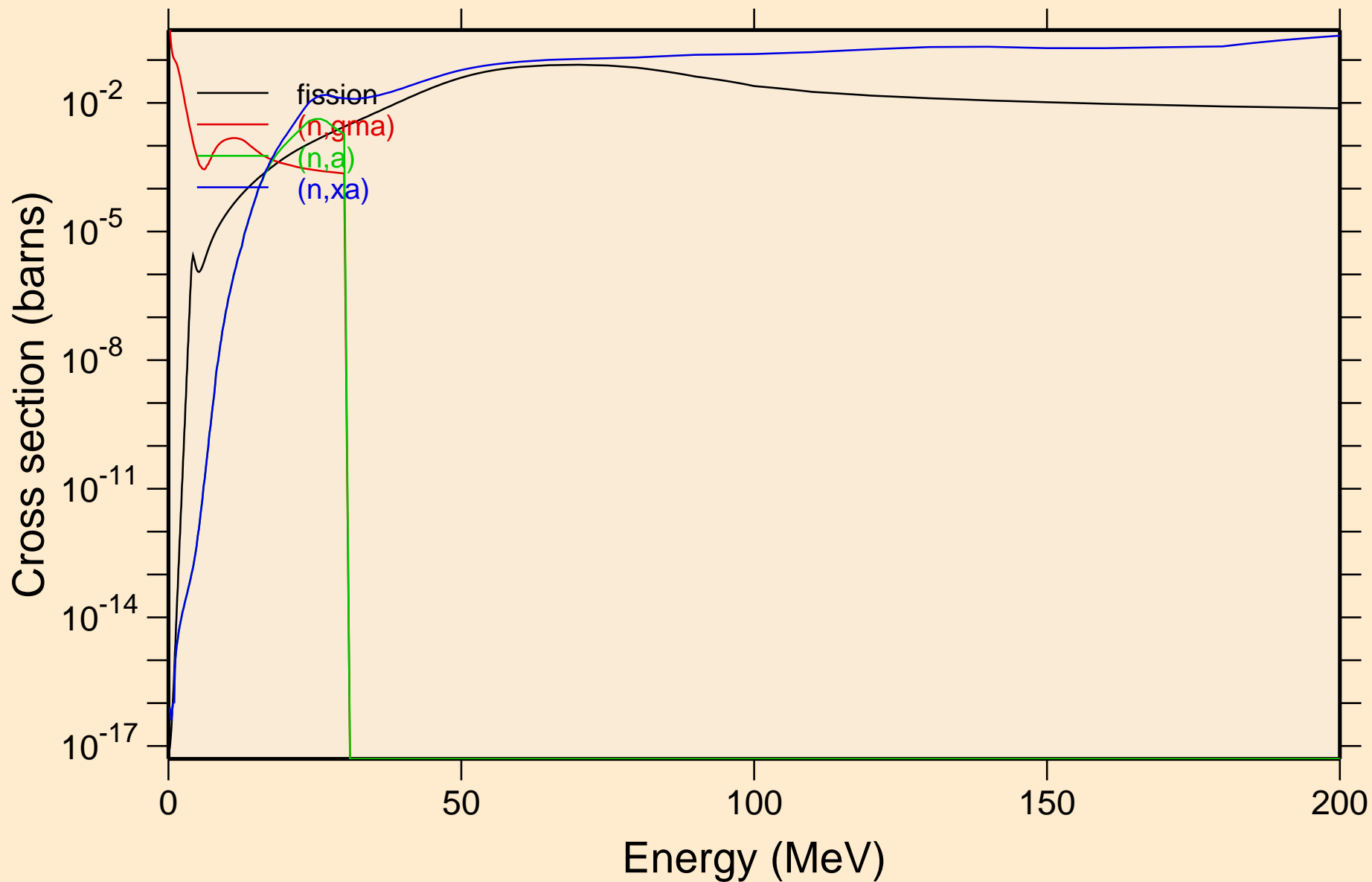

AC236 NEUTRON ACER TENDL-2019 LIBRARY; T=293.16K
Inelastic levels

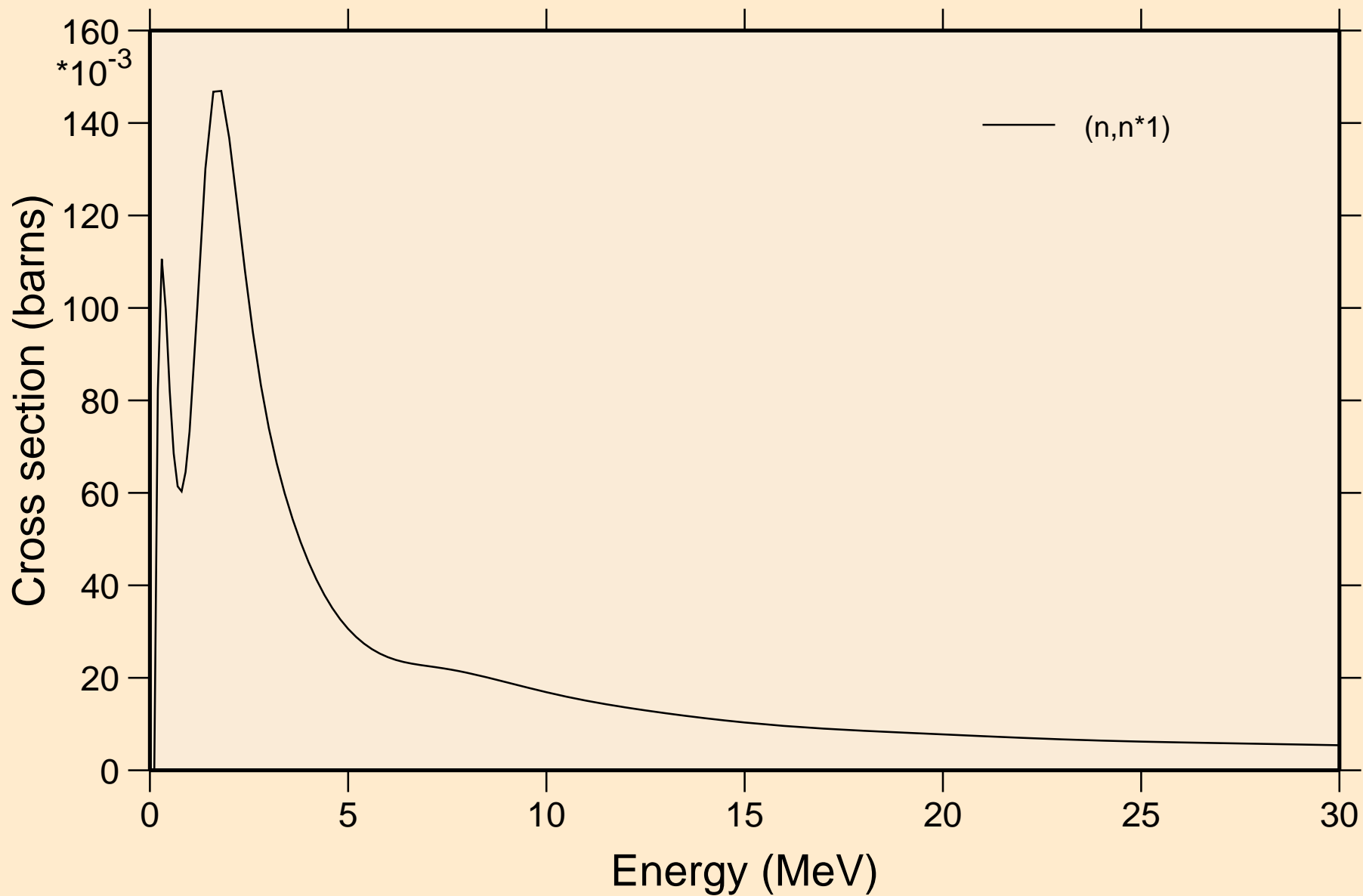

AC236 NEUTRON ACER TENDL-2019 LIBRARY; T=293.16K
Threshold reactions

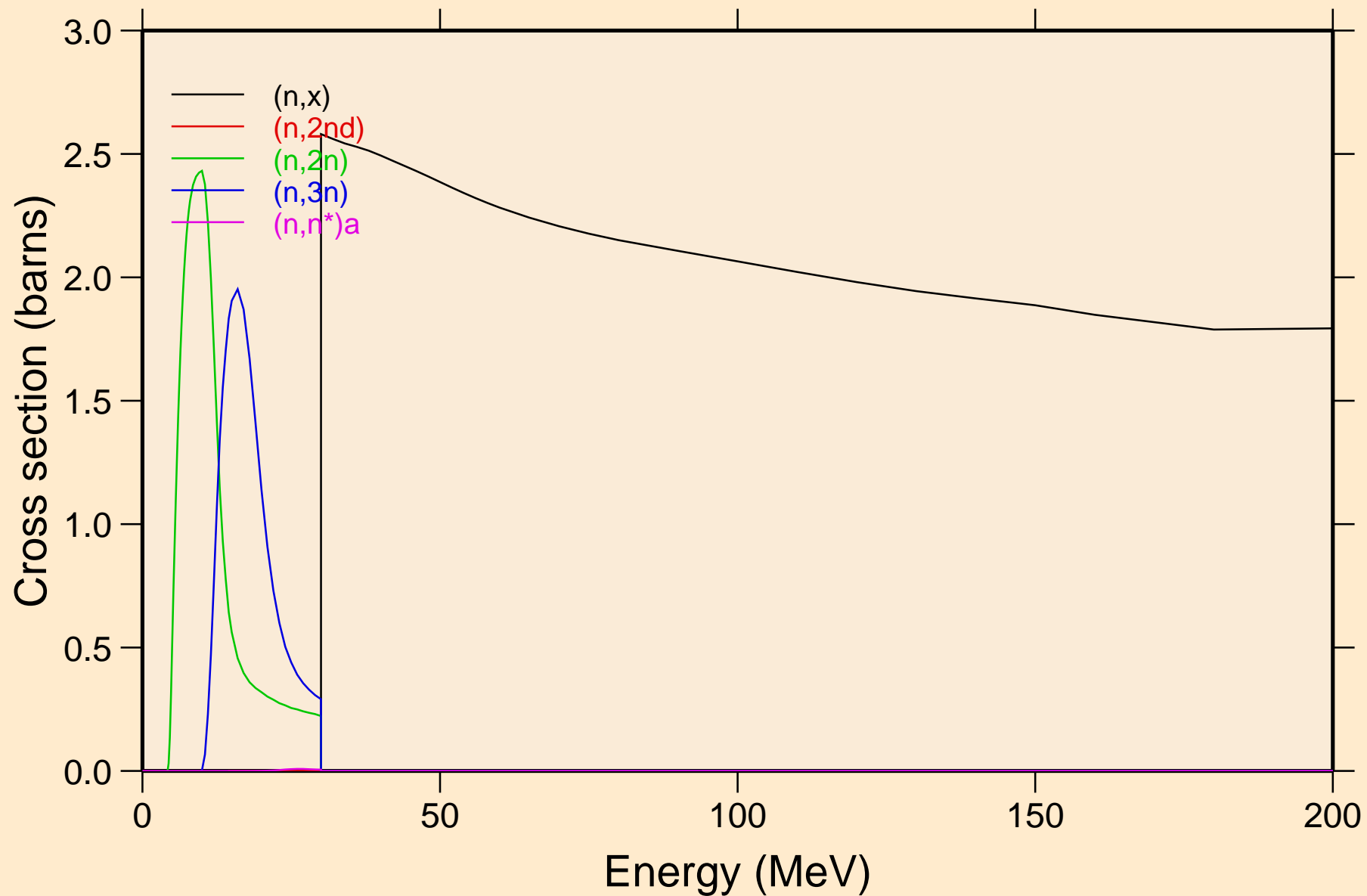

AC236 NEUTRON ACER TENDL-2019 LIBRARY; T=293.16K
Threshold reactions

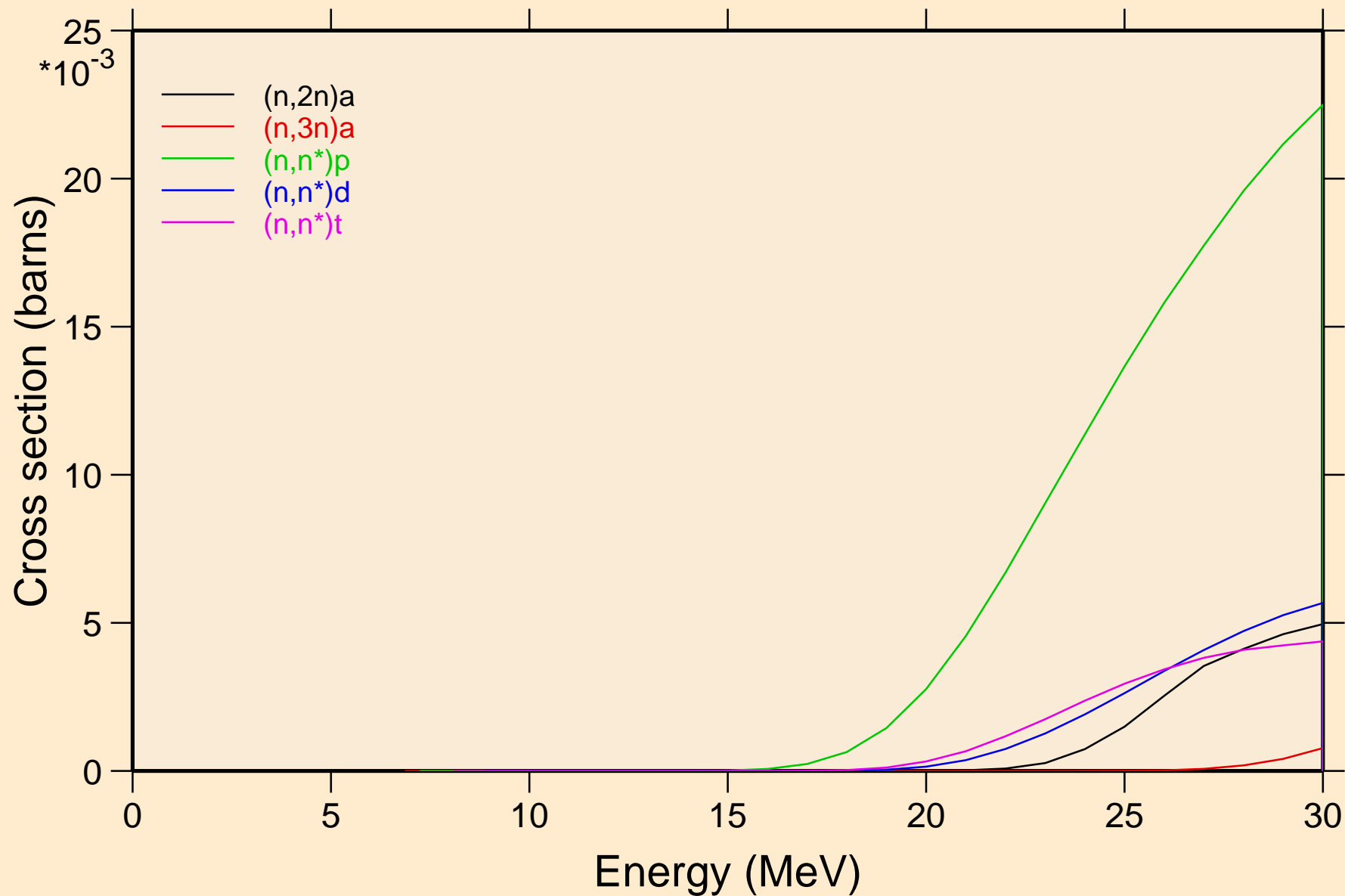

AC236 NEUTRON ACER TENDL-2019 LIBRARY; T=293.16K
Threshold reactions

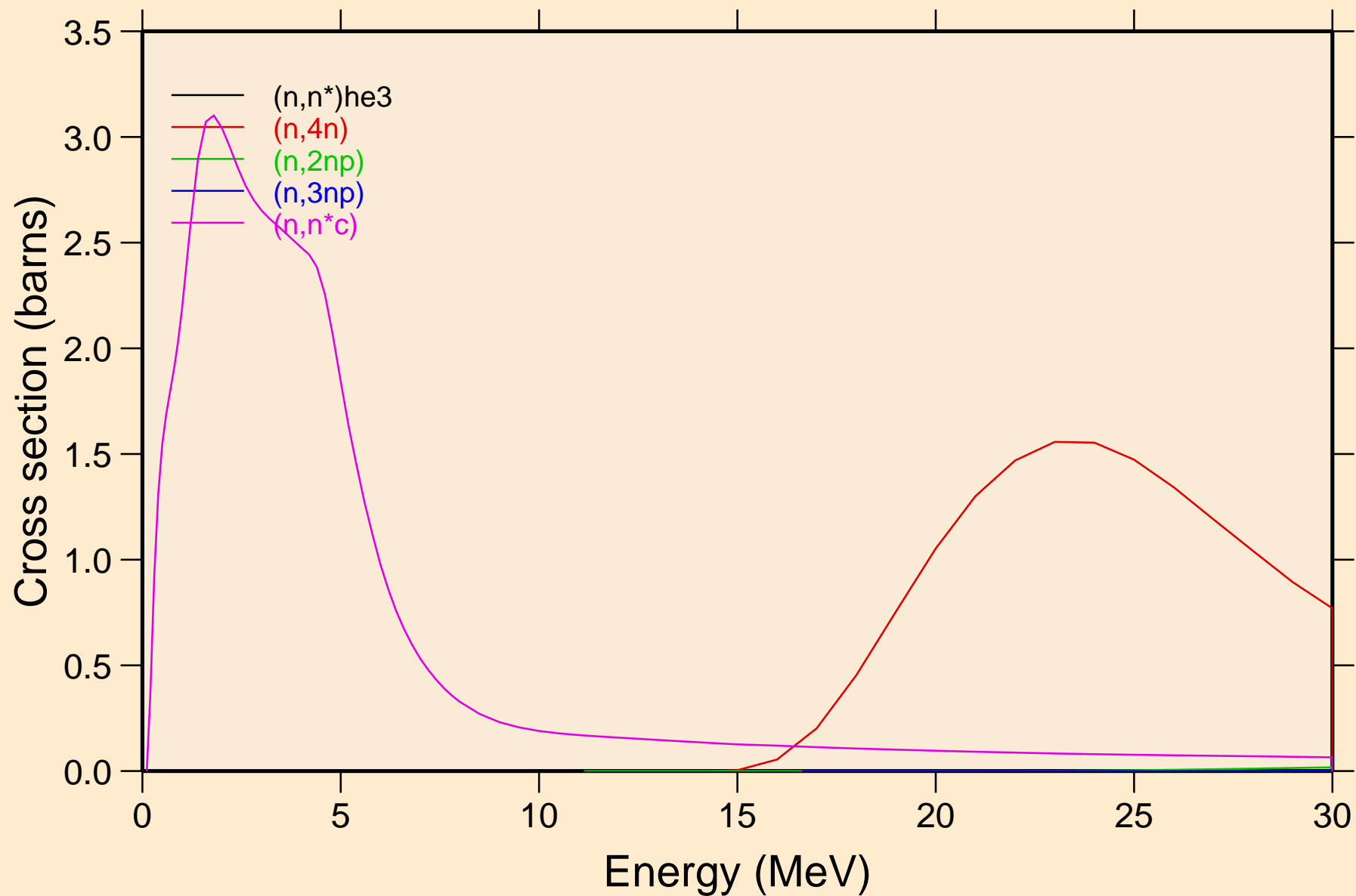

AC236 NEUTRON ACER TENDL-2019 LIBRARY; T=293.16K
Threshold reactions

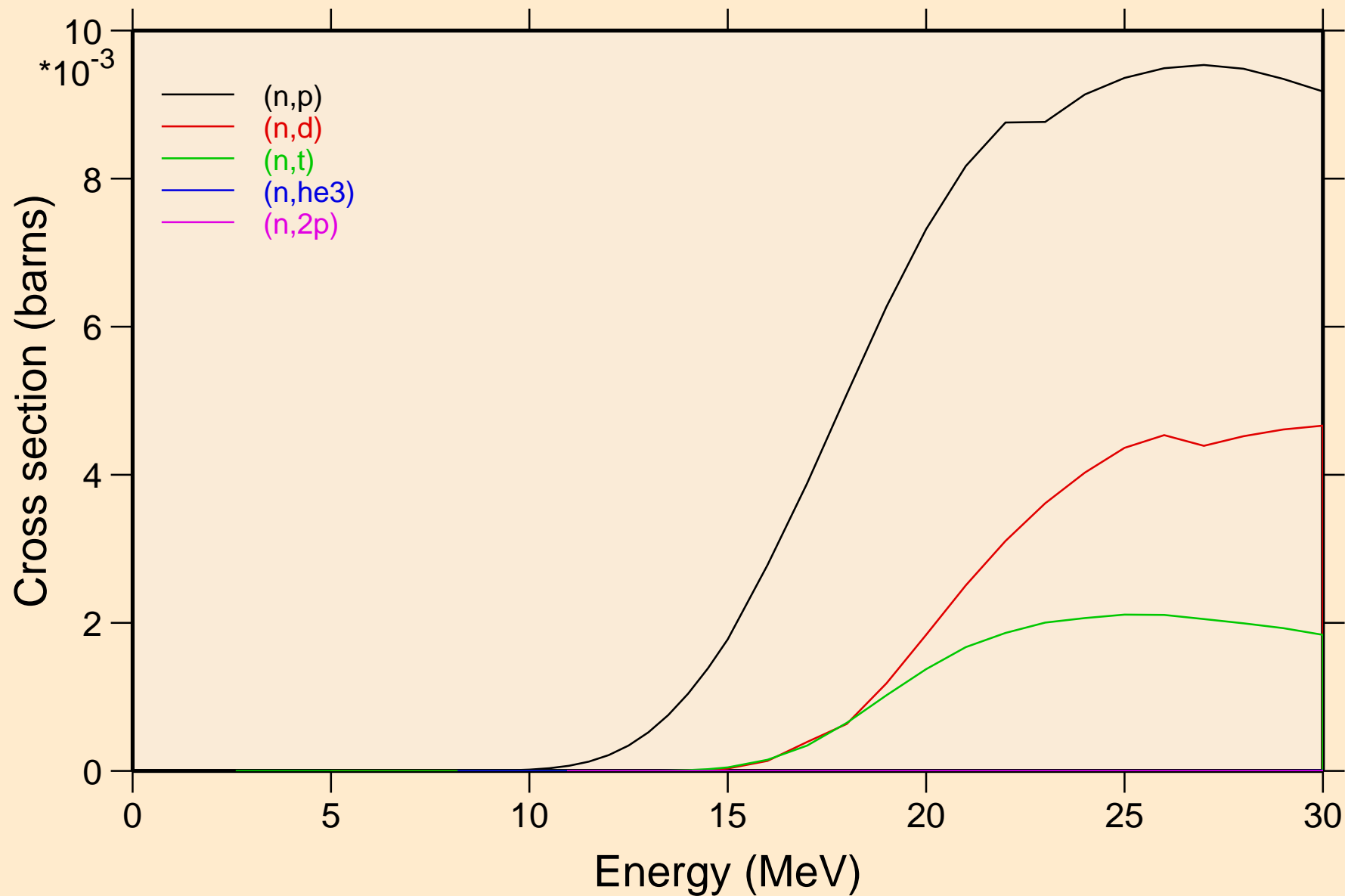

AC236 NEUTRON ACER TENDL-2019 LIBRARY; T=293.16K
Threshold reactions

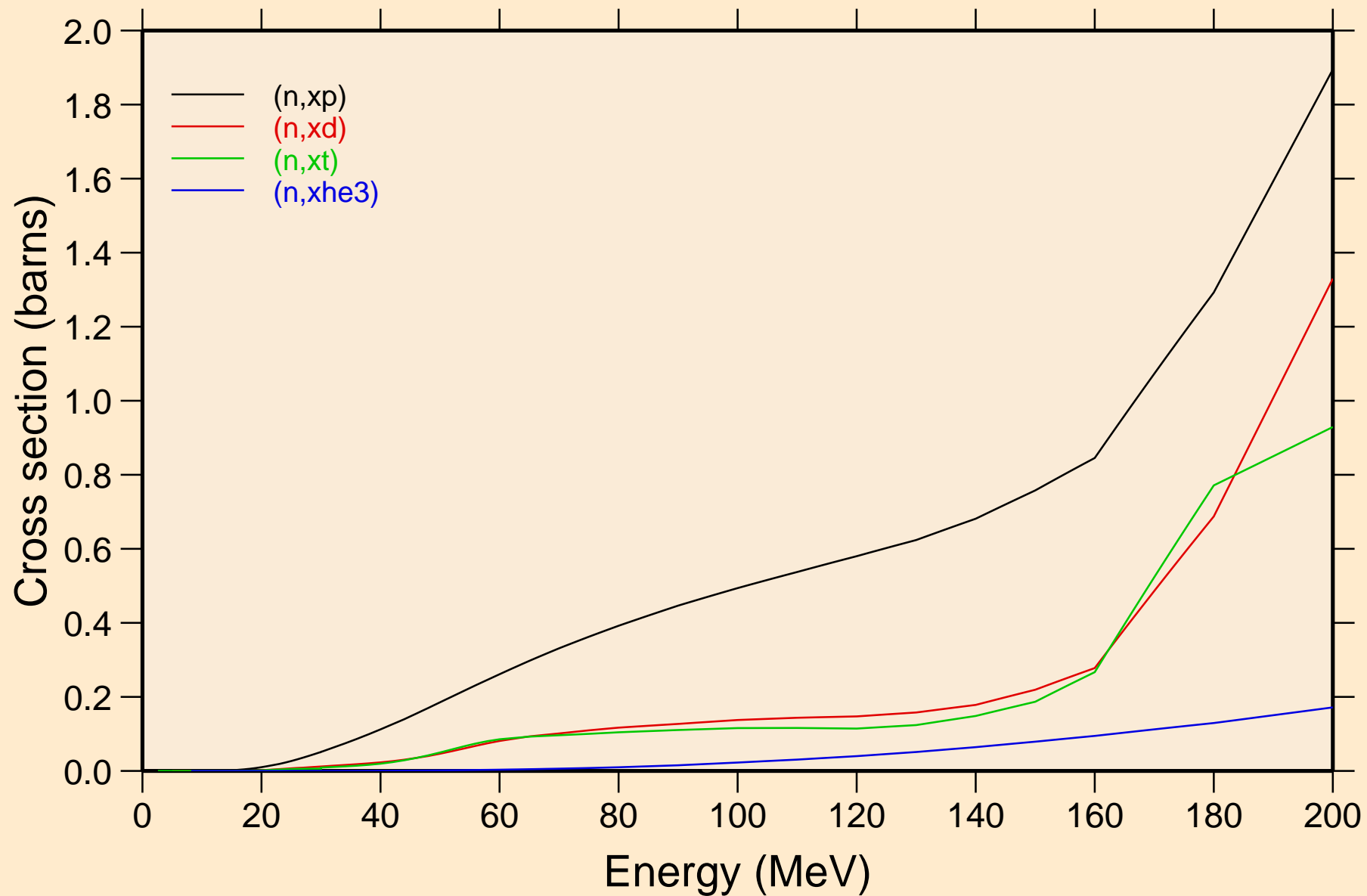

AC236 NEUTRON ACER TENDL-2019 LIBRARY; T=293.16K
angular distribution for elastic

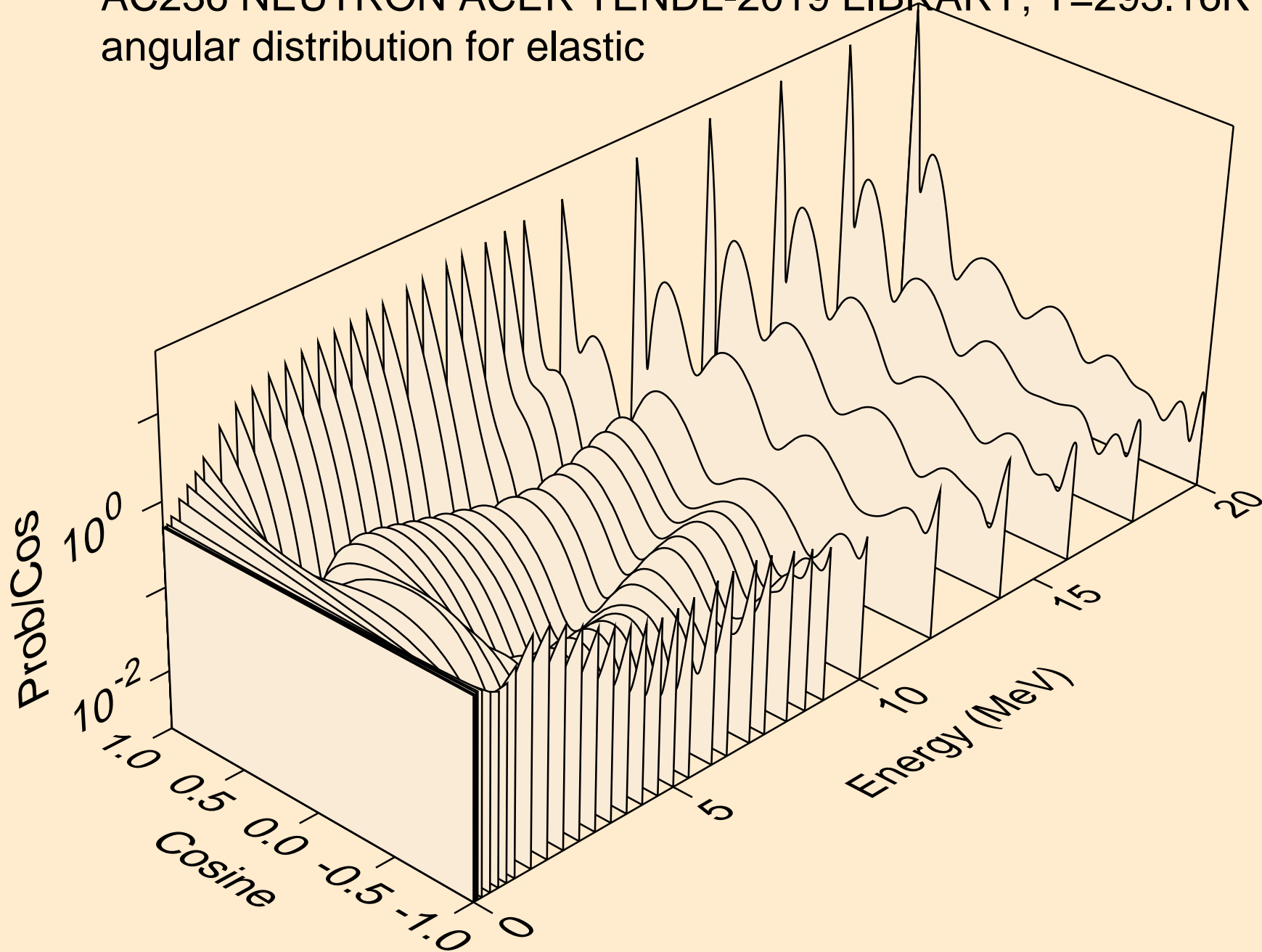

AC236 NEUTRON ACER TENDL-2019 LIBRARY; T=293.16K
angular distribution for elastic

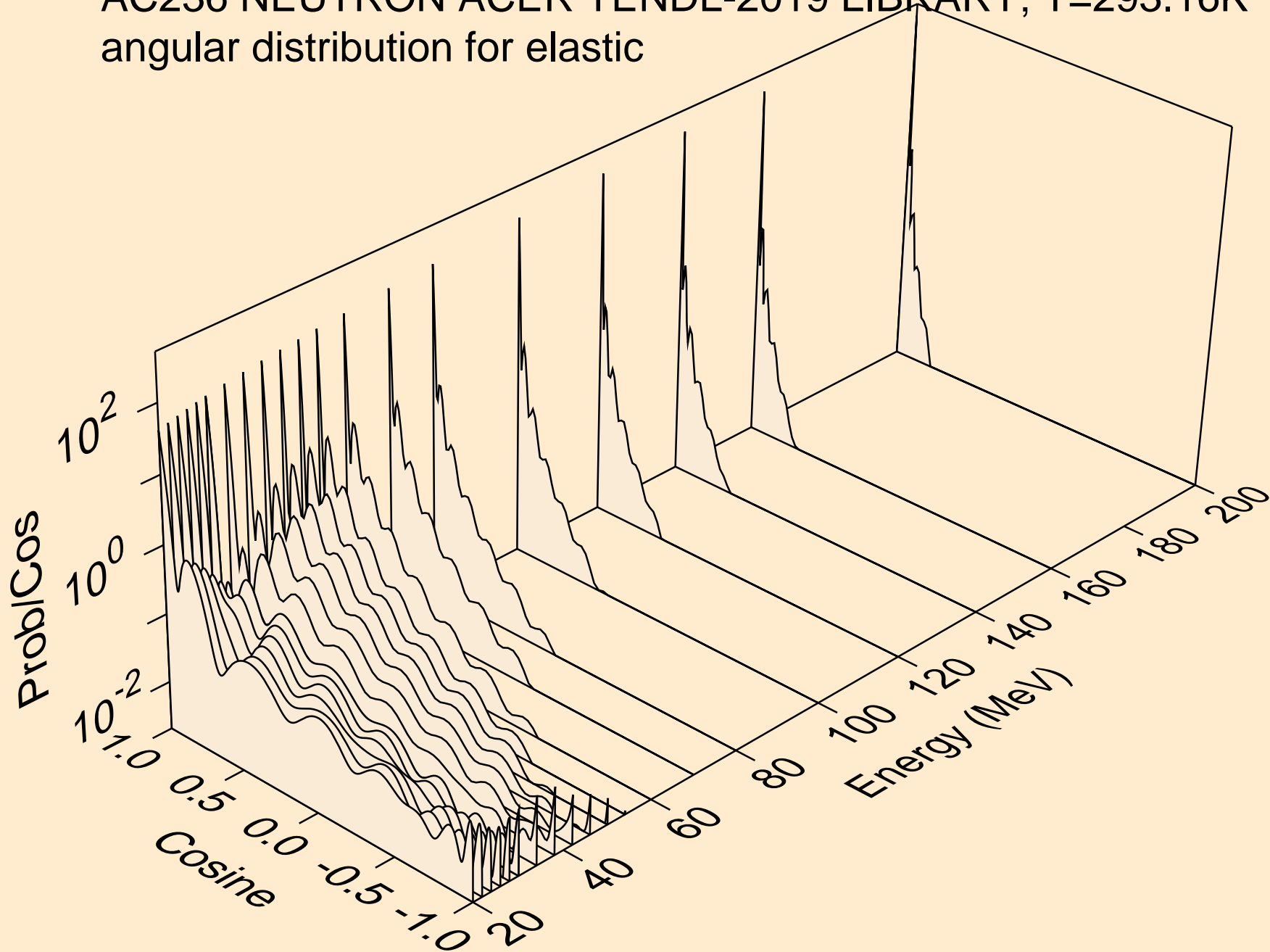

AC236 NEUTRON ACER TENDL-2019 LIBRARY; T=293.16K
angular distribution for (n,n*1)

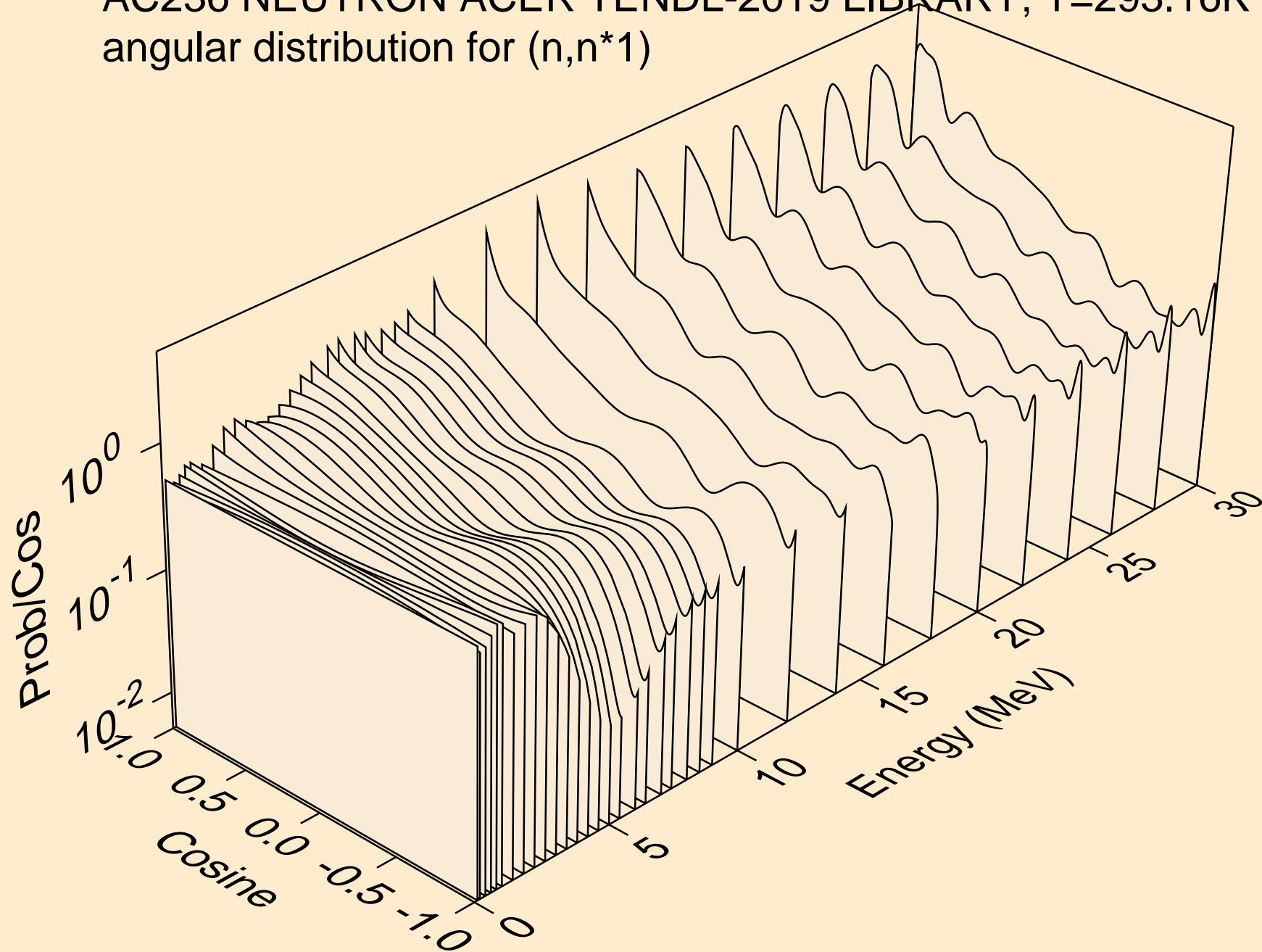

AC236 NEUTRON ACER TENDL-2019 LIBRARY; T=293.16K
Total fission nubar

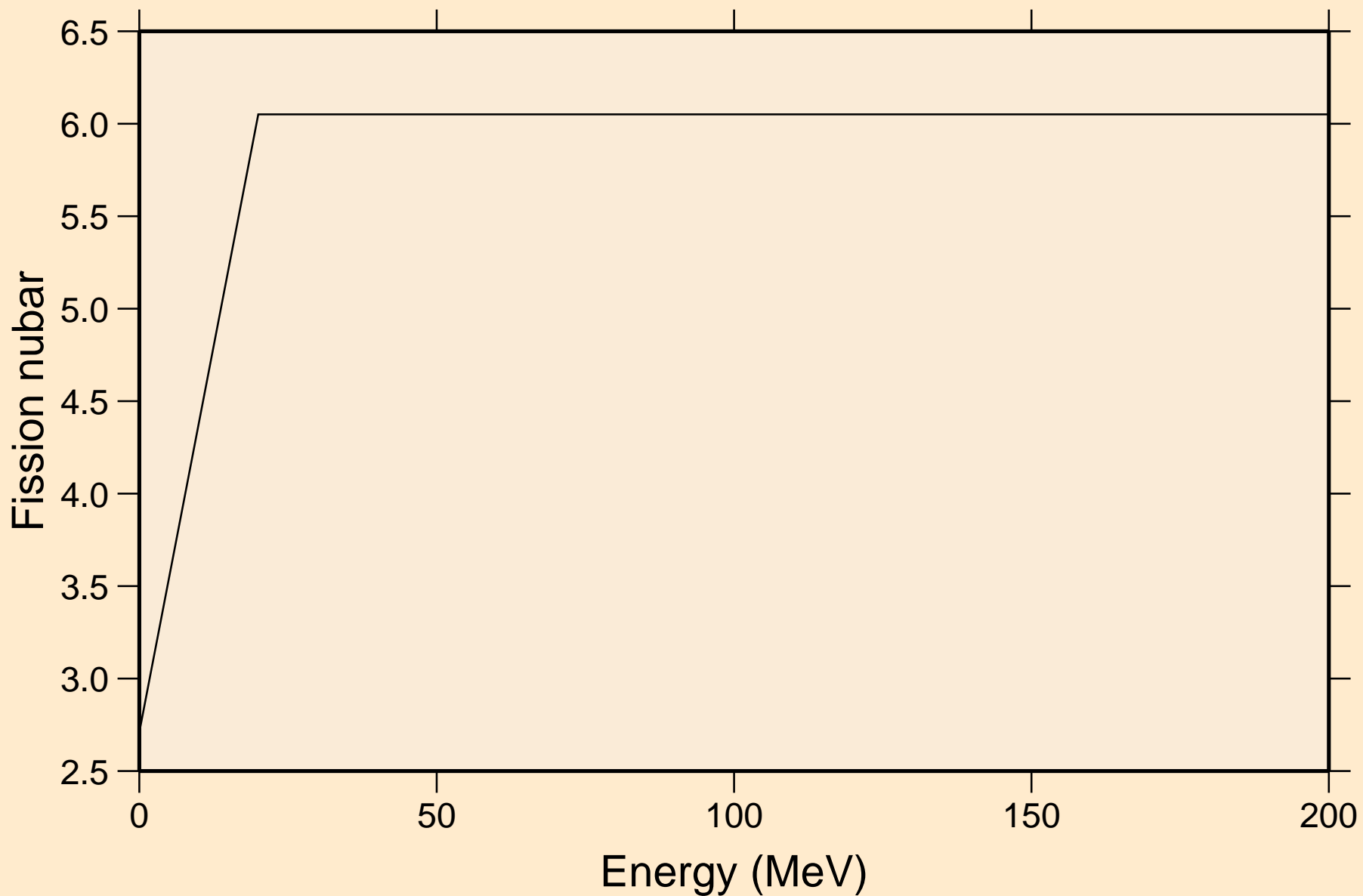

AC236 NEUTRON ACER TENDL-2019 LIBRARY; T=293.16K
Neutron emission for (n,x)

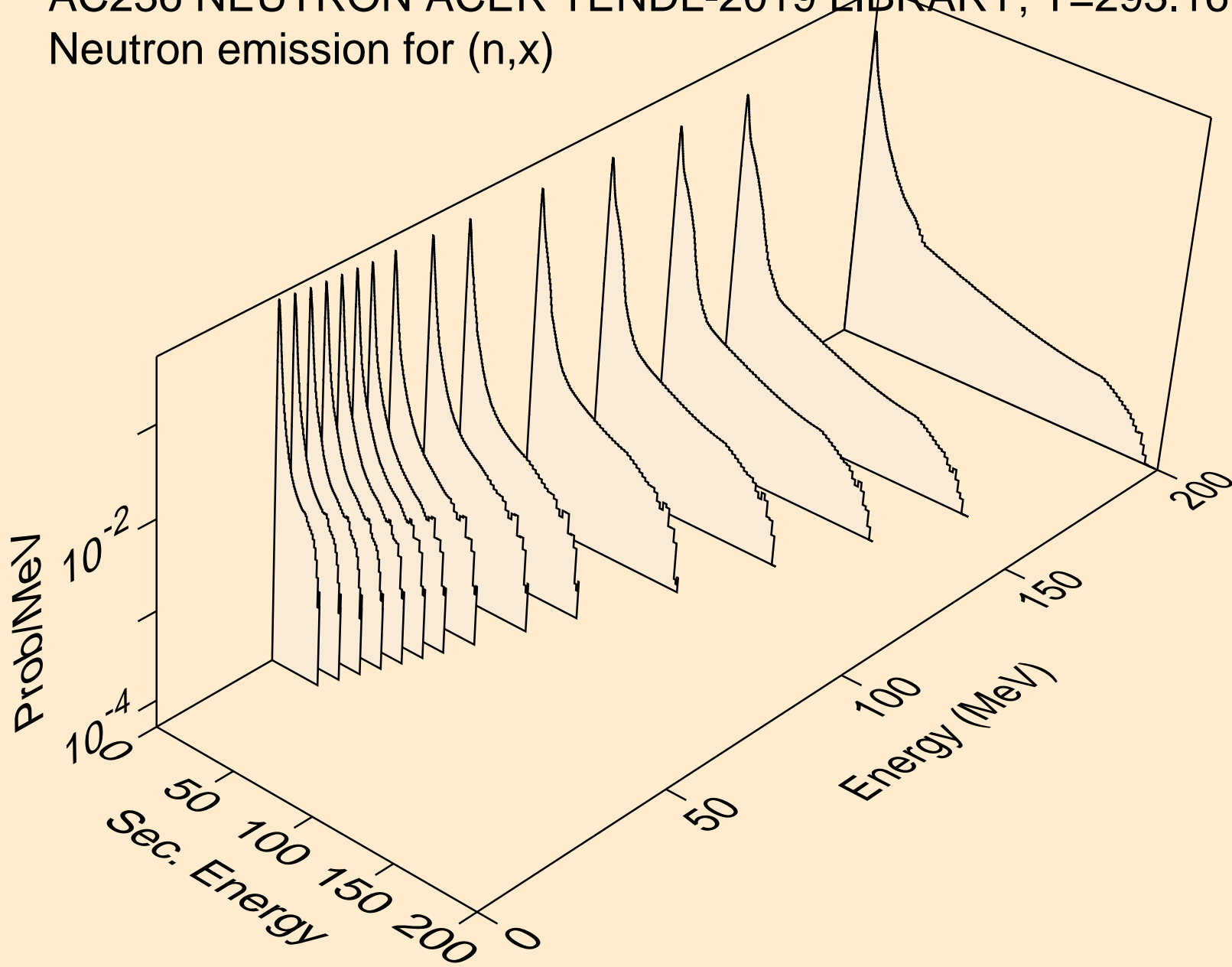

AC236 NEUTRON ACER TENDL-2019 LIBRARY; T=293.16K
Neutron emission for (n,2nd)

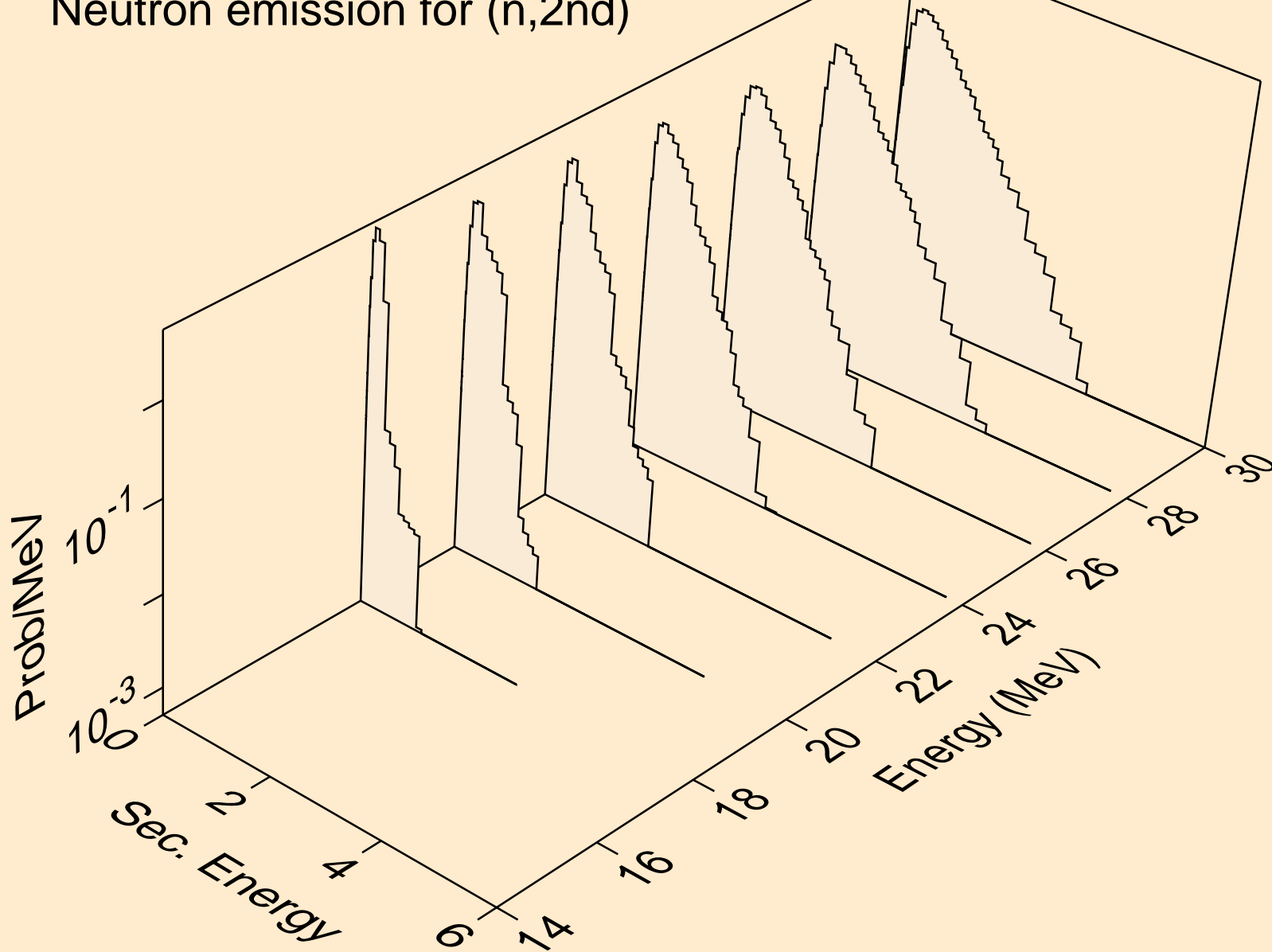

AC236 NEUTRON ACER TENDL-2019 LIBRARY; T=293.16K
Neutron emission for (n,2n)

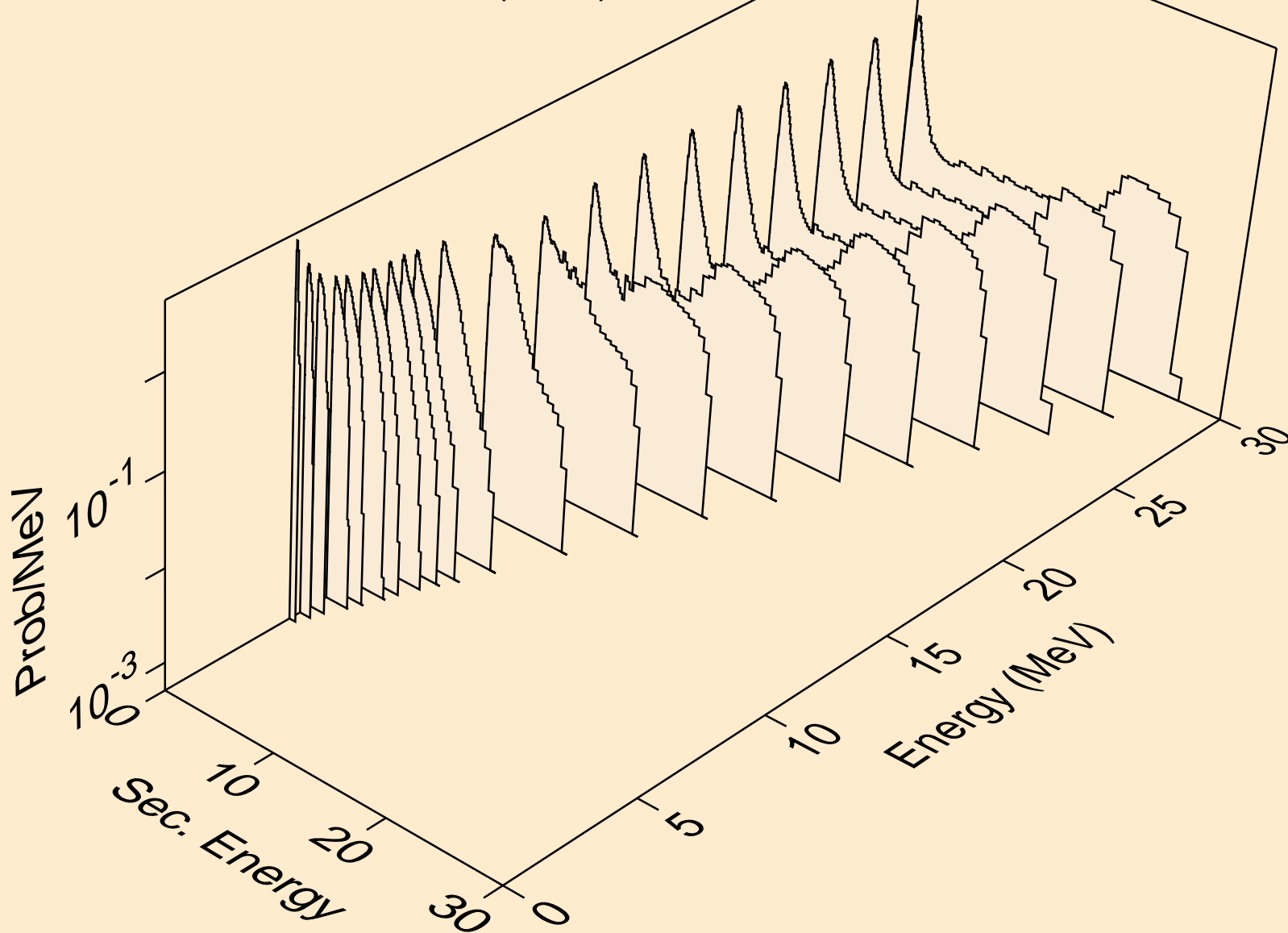

AC236 NEUTRON ACER TENDL-2019 LIBRARY; T=293.16K
Neutron emission for (n,3n)

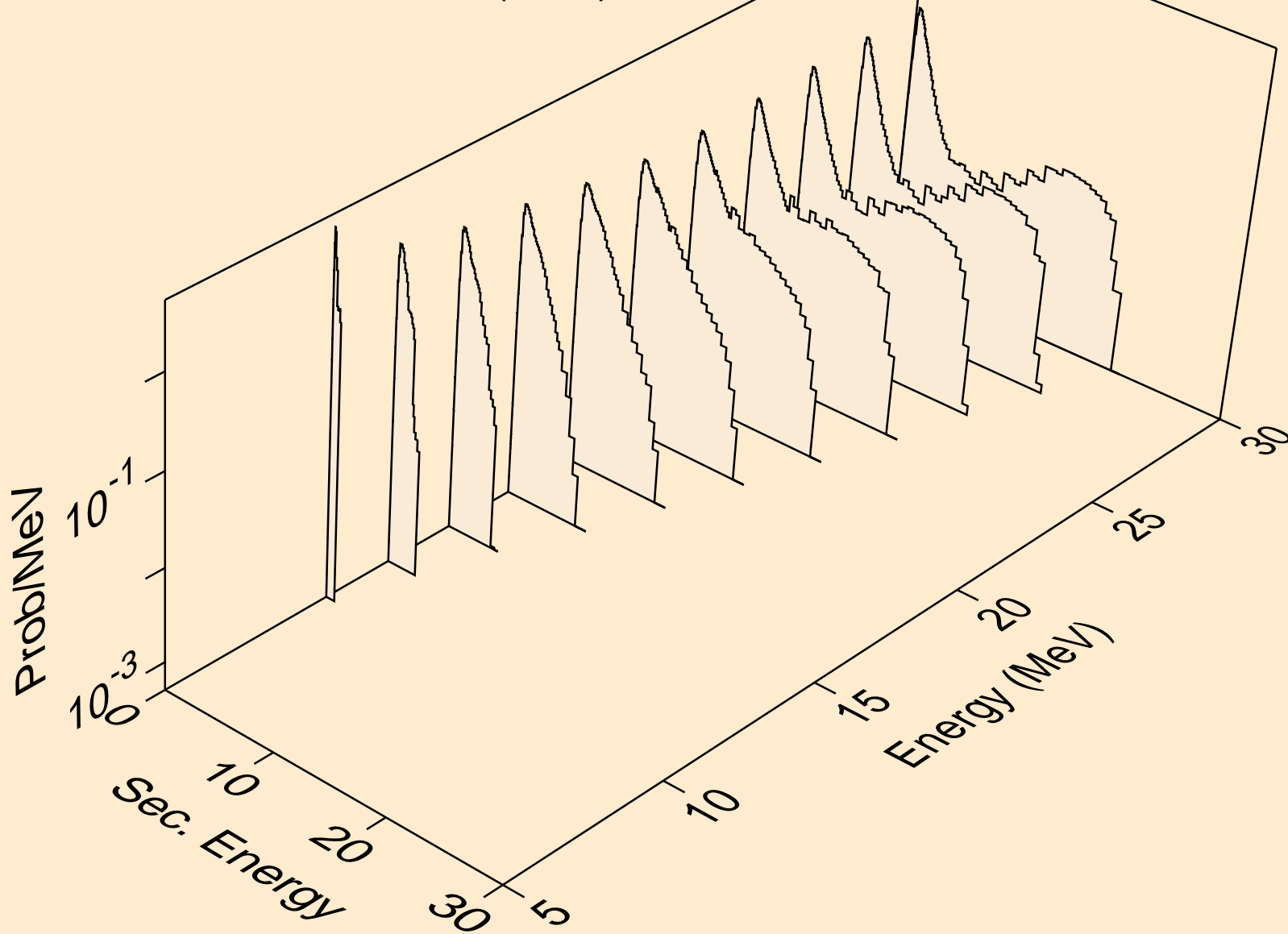

AC236 NEUTRON ACER TENDL-2019 LIBRARY; T=293.16K
Neutron emission for fission

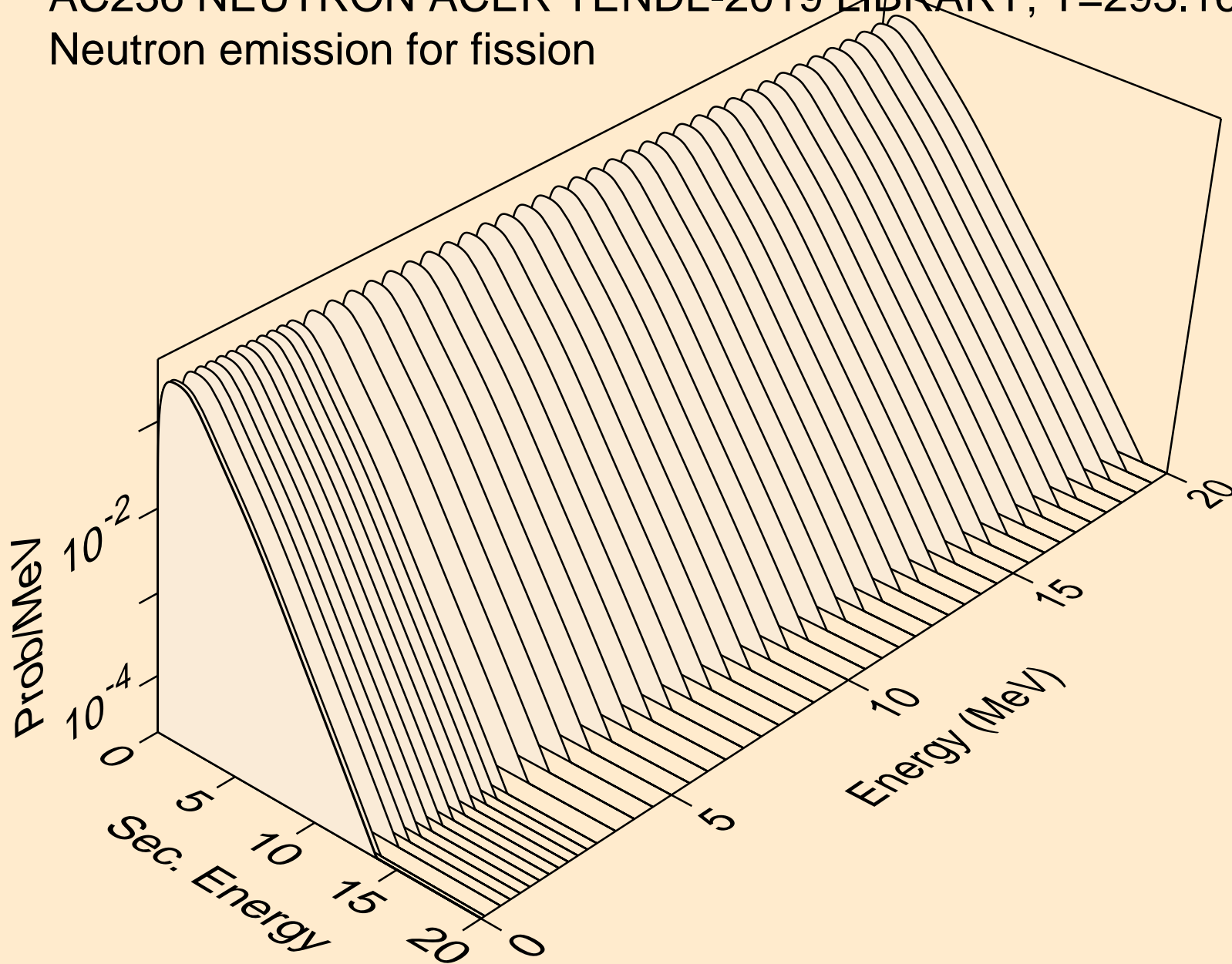

AC236 NEUTRON ACER TENDL-2019 LIBRARY; T=293.16K
Neutron emission for (n,n*)a

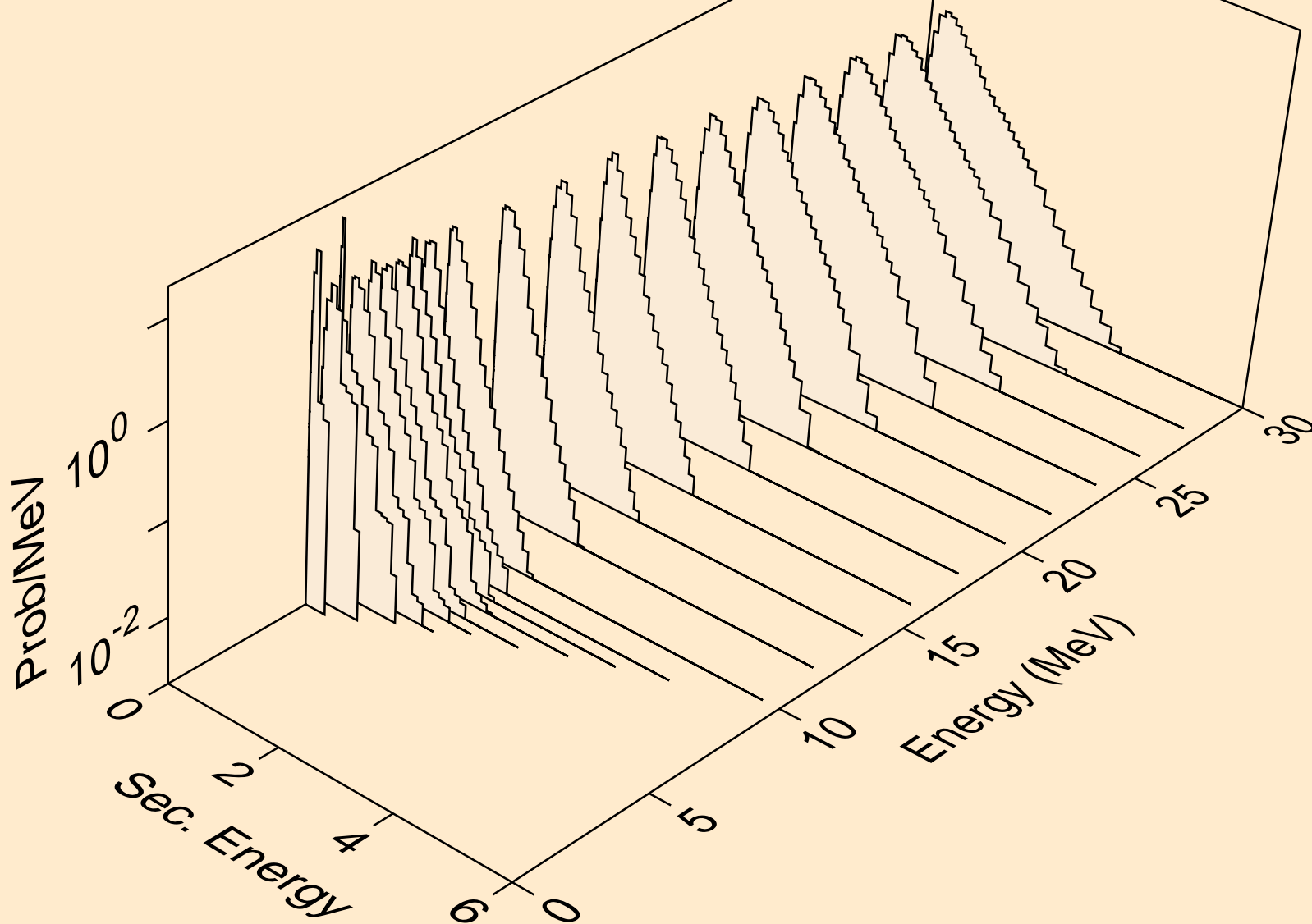

AC236 NEUTRON ACER TENDL-2019 LIBRARY; T=293.16K
Neutron emission for (n,2n)a

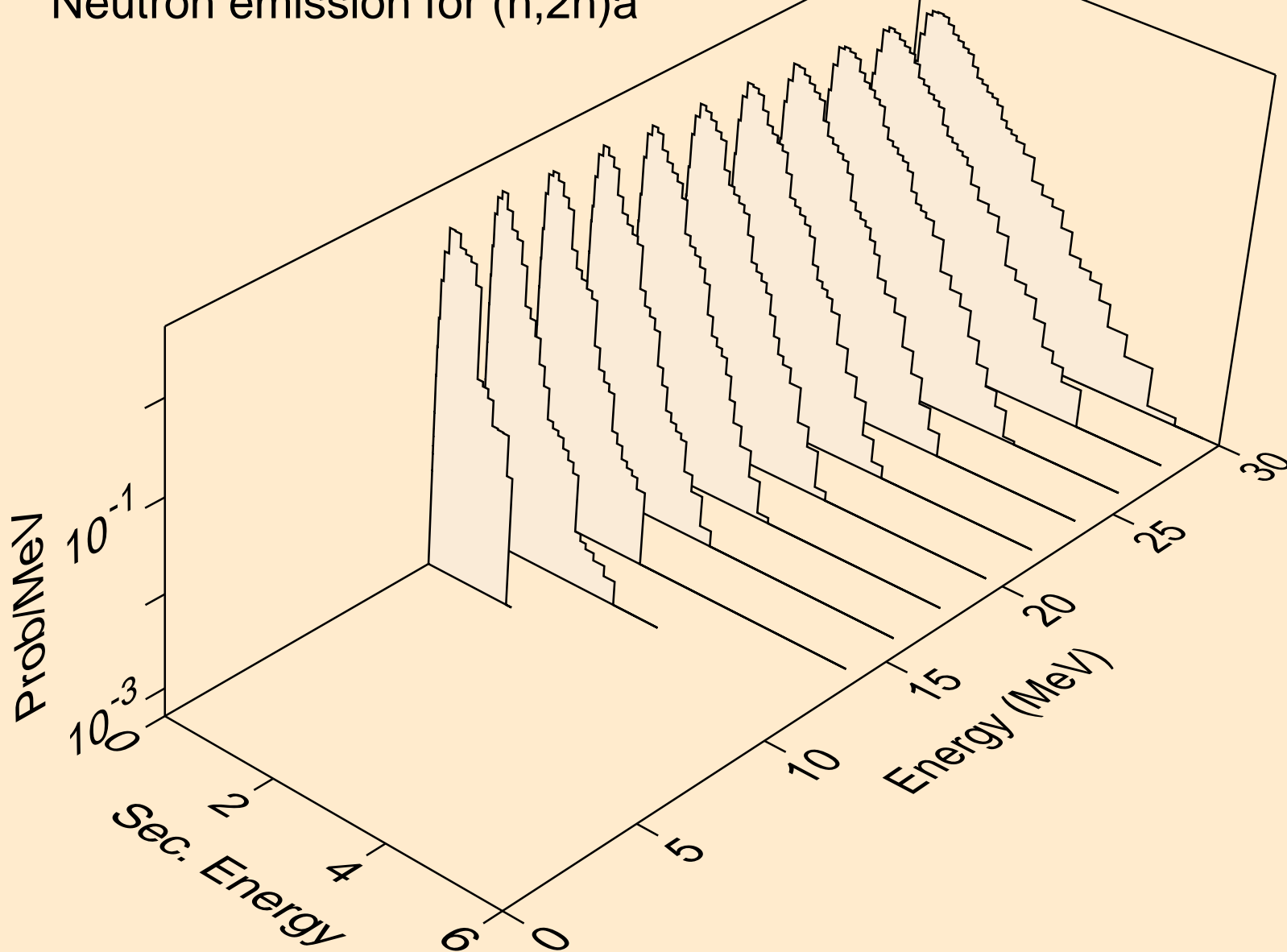

AC236 NEUTRON ACER TENDL-2019 LIBRARY; T=293.16K
Neutron emission for (n,3n)a

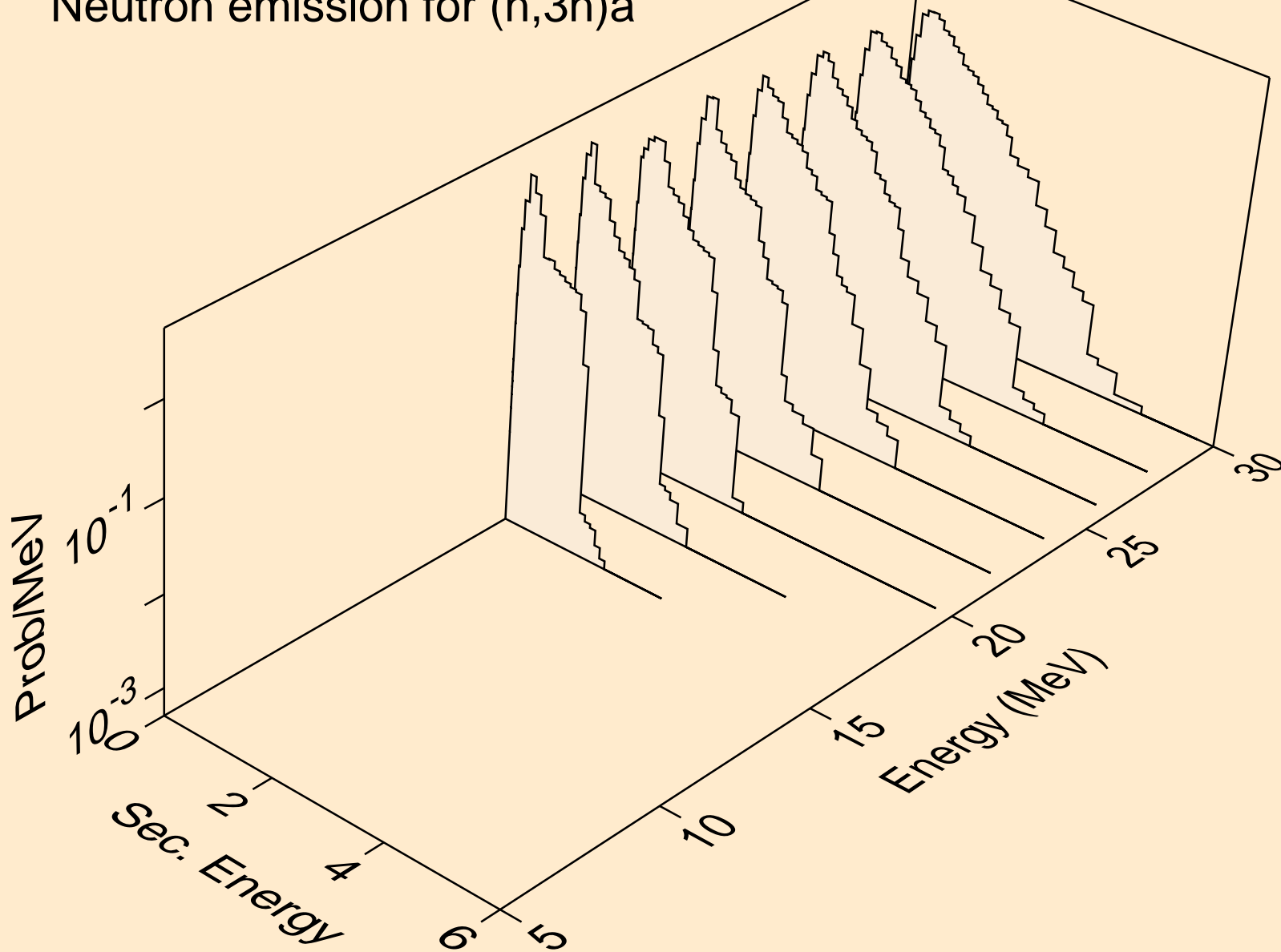

AC236 NEUTRON ACER TENDL-2019 LIBRARY; T=293.16K
Neutron emission for (n,n*)p

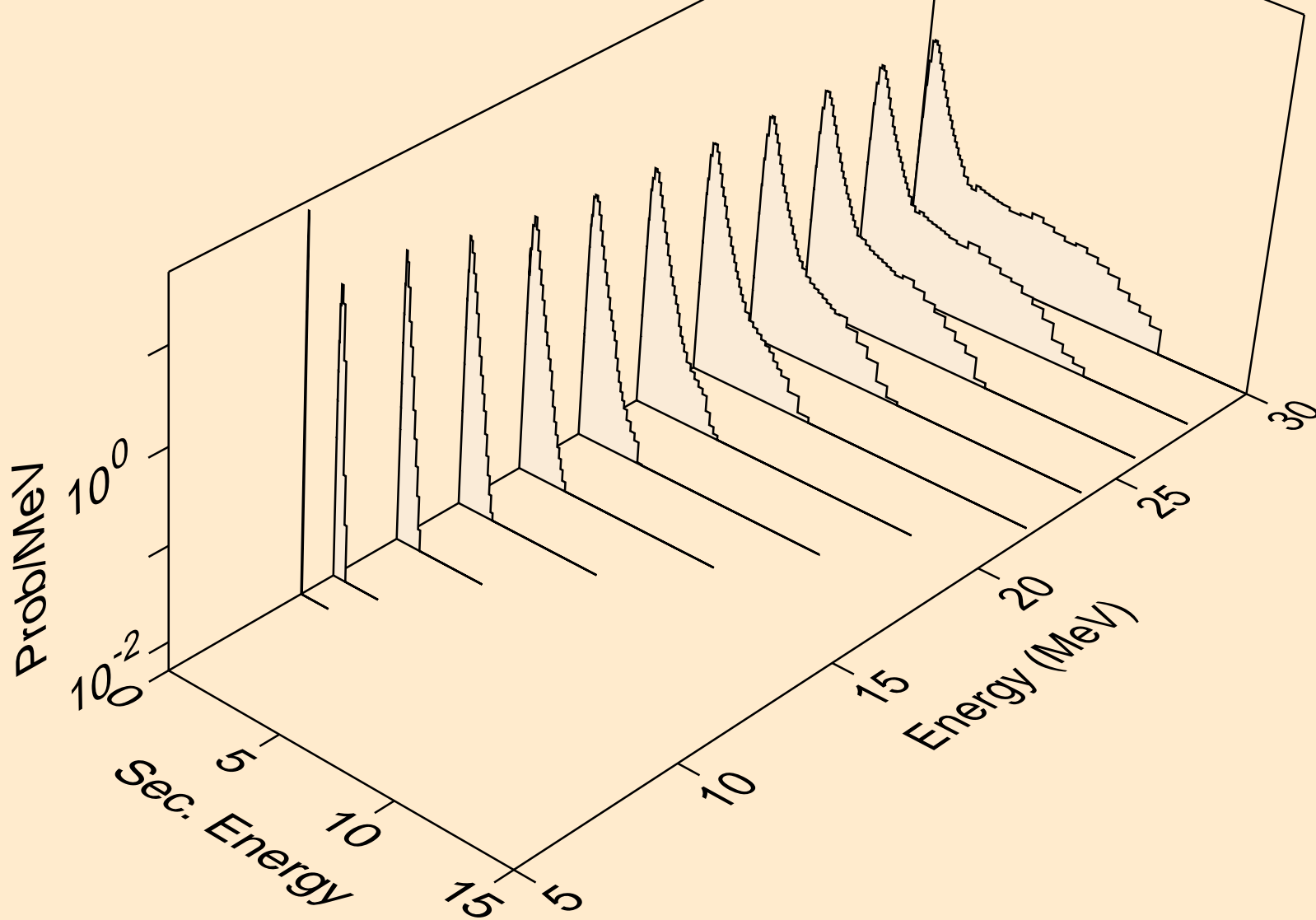

AC236 NEUTRON ACER TENDL-2019 LIBRARY; T=293.16K
Neutron emission for (n,n*)d

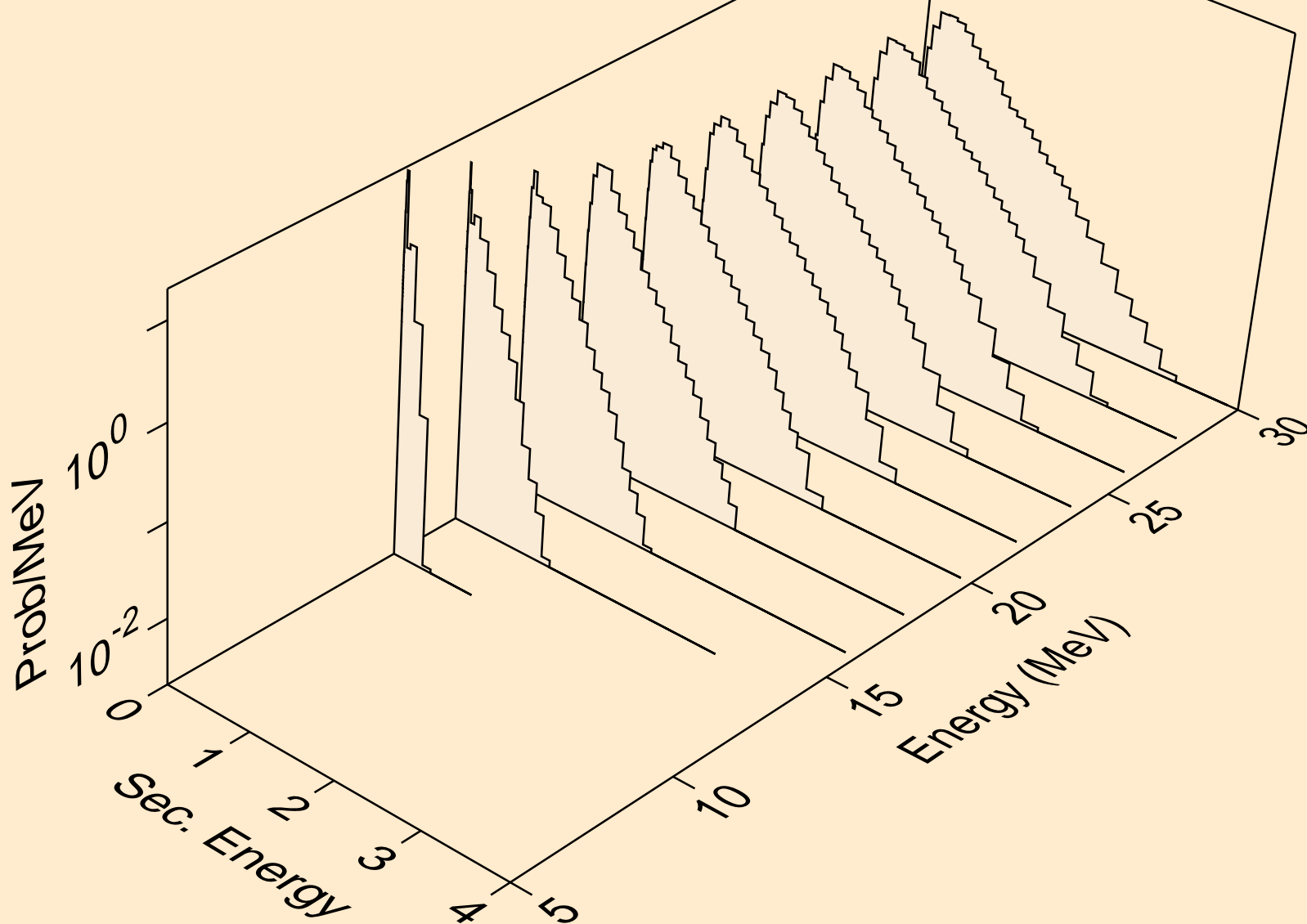

AC236 NEUTRON ACER TENDL-2019 LIBRARY; T=293.16K
Neutron emission for (n,n*)t

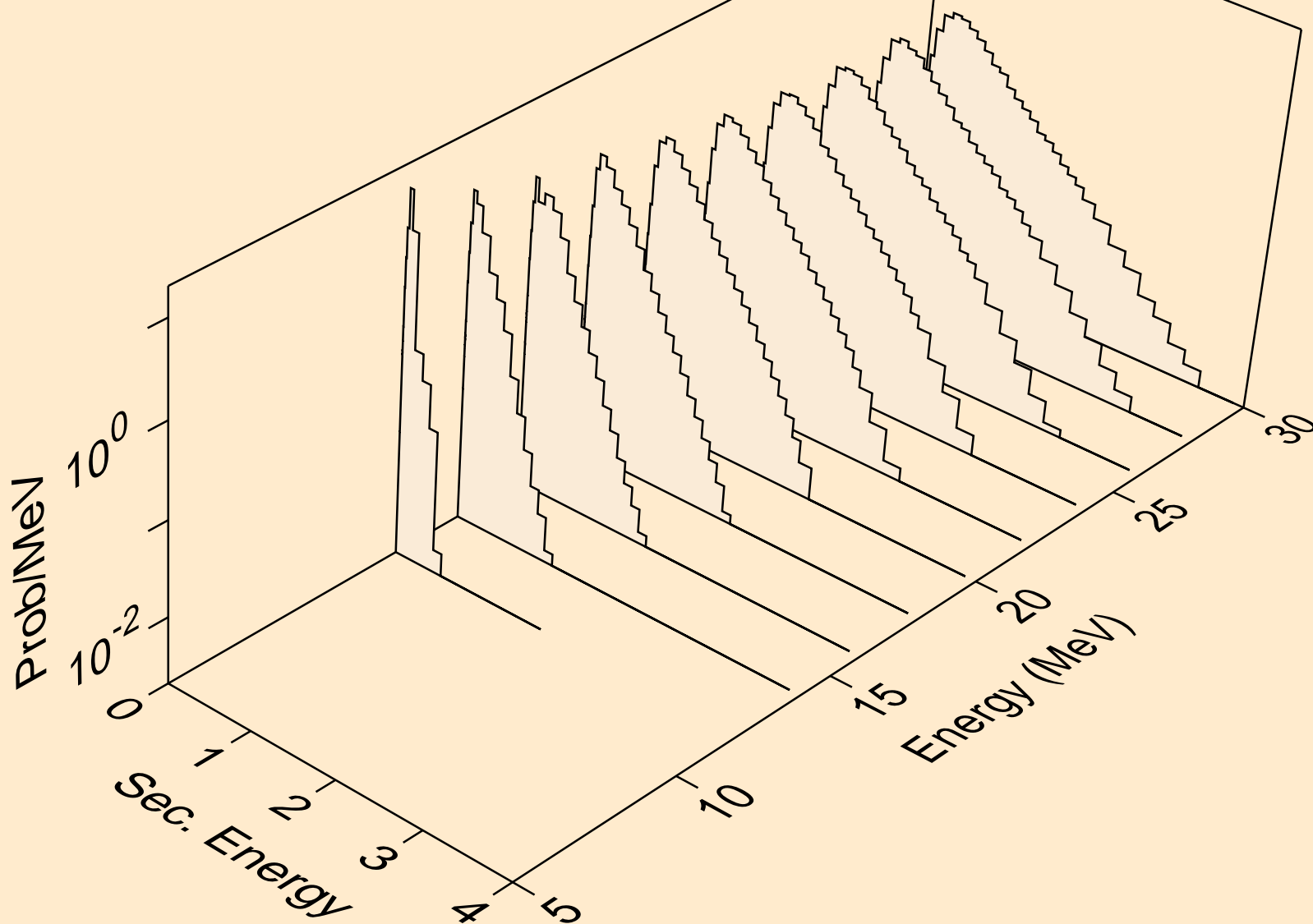

AC236 NEUTRON ACER TENDL-2019 LIBRARY; T=293.16K
Neutron emission for (n,n*)he3

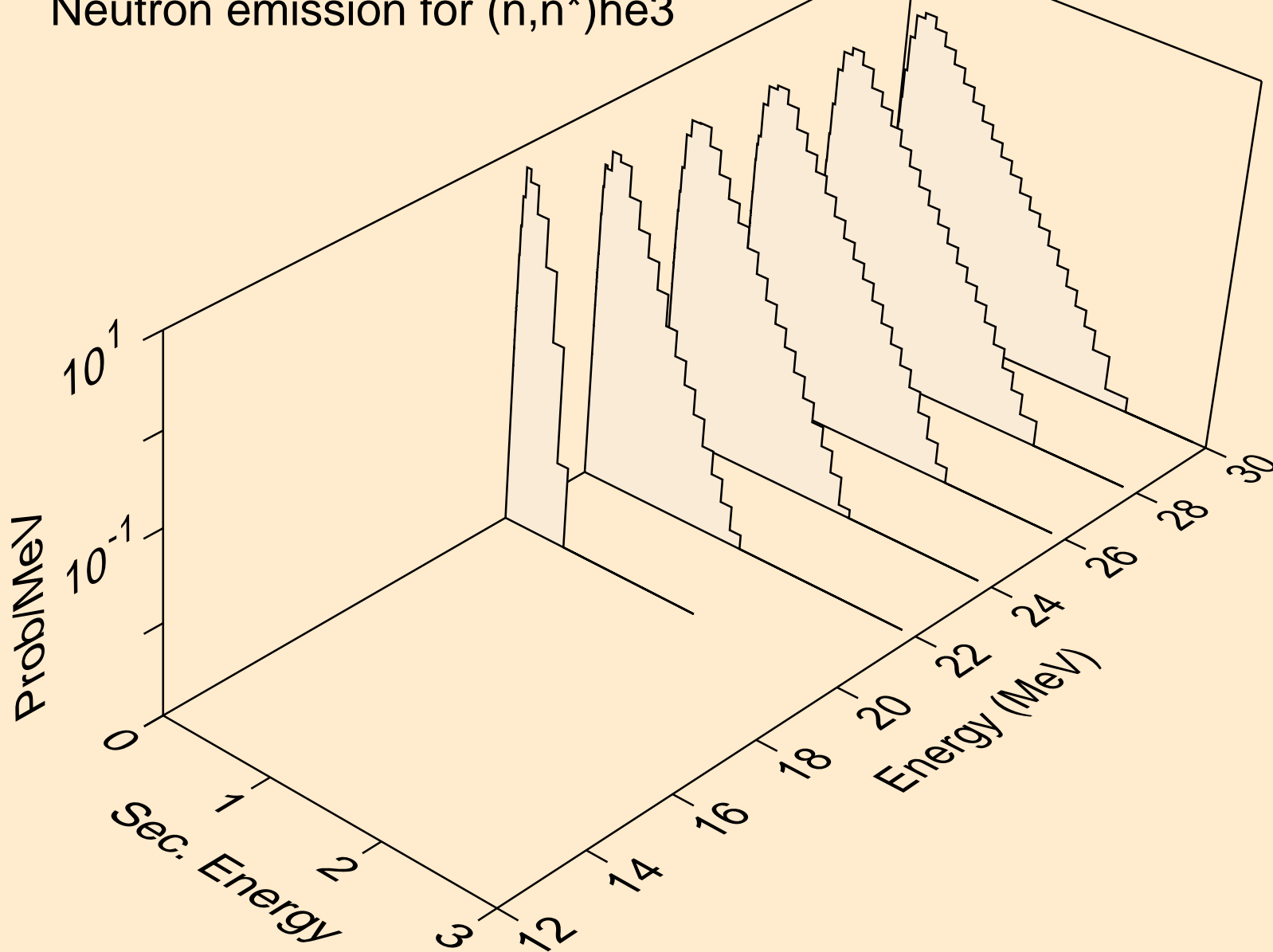

AC236 NEUTRON ACER TENDL-2019 LIBRARY; T=293.16K
Neutron emission for (n,4n)

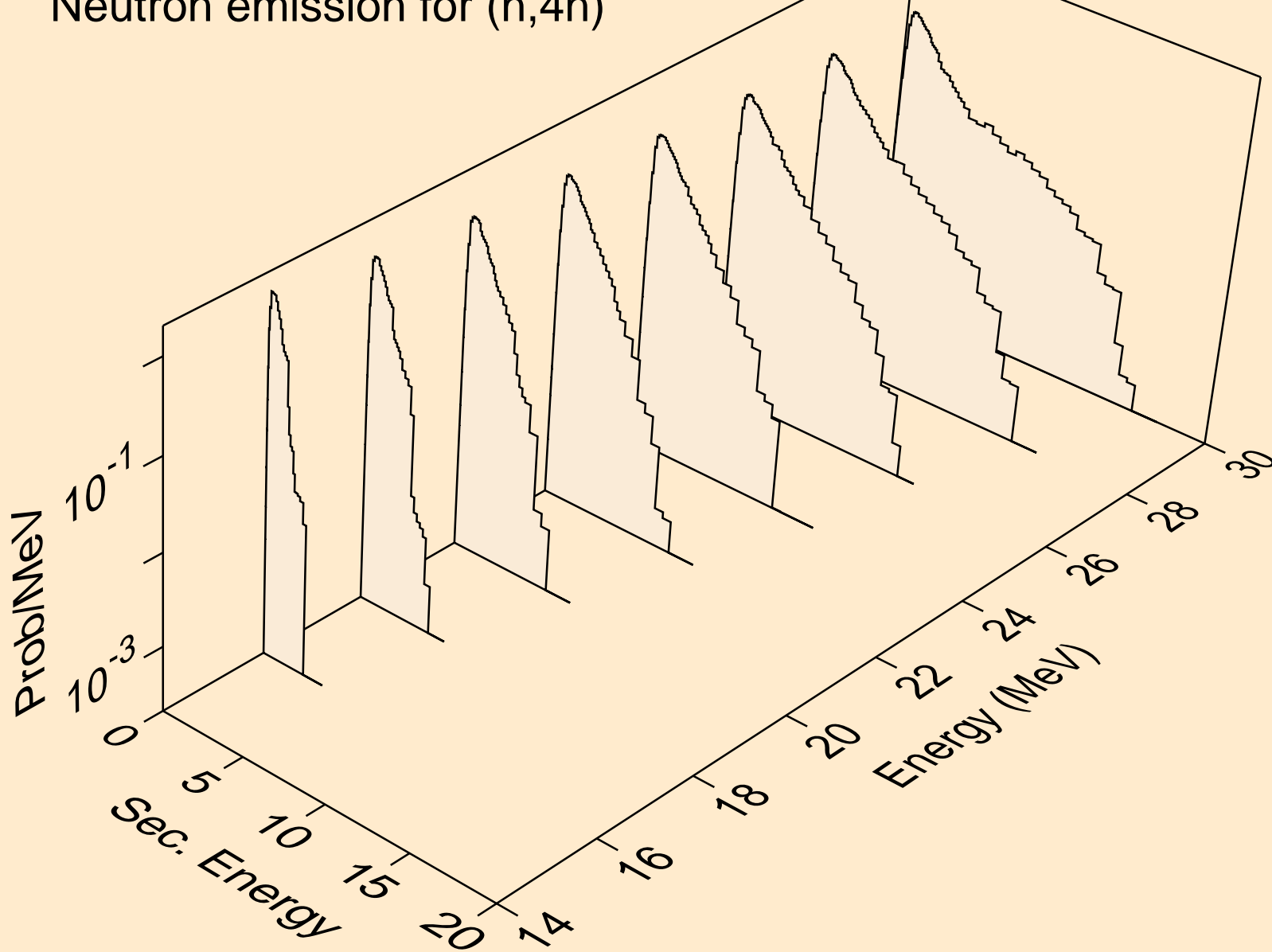

AC236 NEUTRON ACER TENDL-2019 LIBRARY; T=293.16K
Neutron emission for (n,2np)

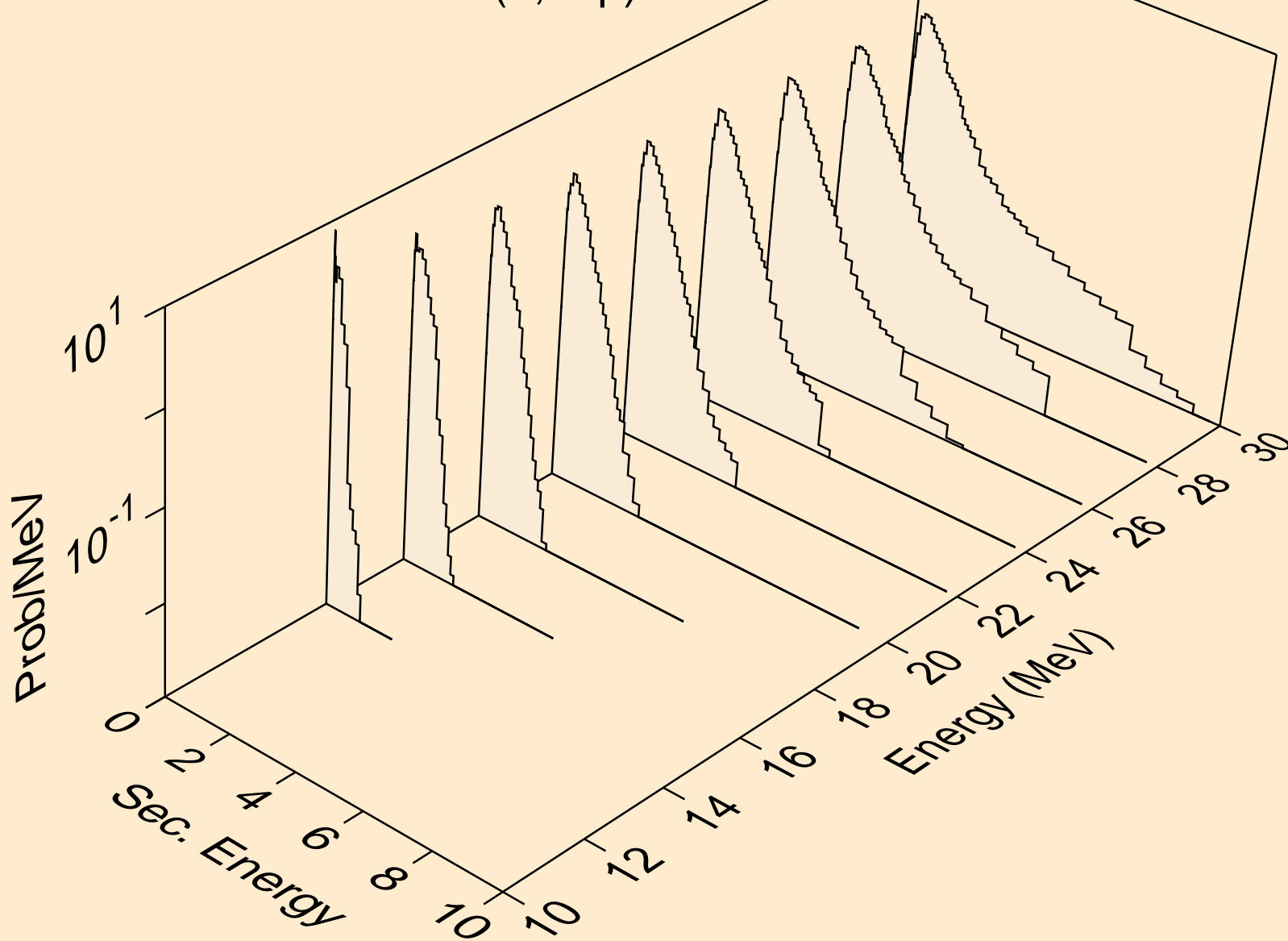

AC236 NEUTRON ACER TENDL-2019 LIBRARY; T=293.16K
Neutron emission for (n,3np)

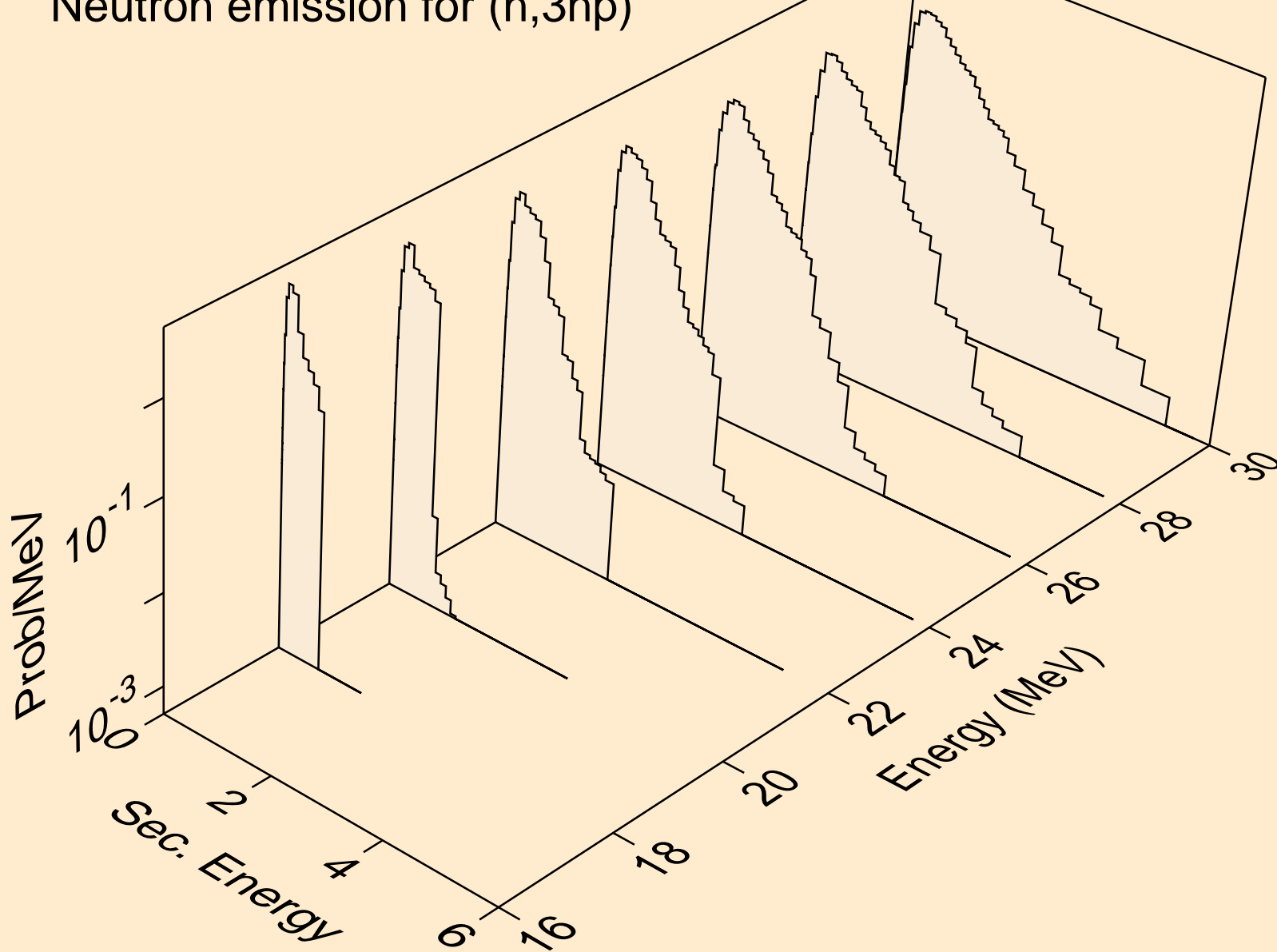

AC236 NEUTRON ACER TENDL-2019 LIBRARY; T=293.16K
Neutron emission for (n,n*c)

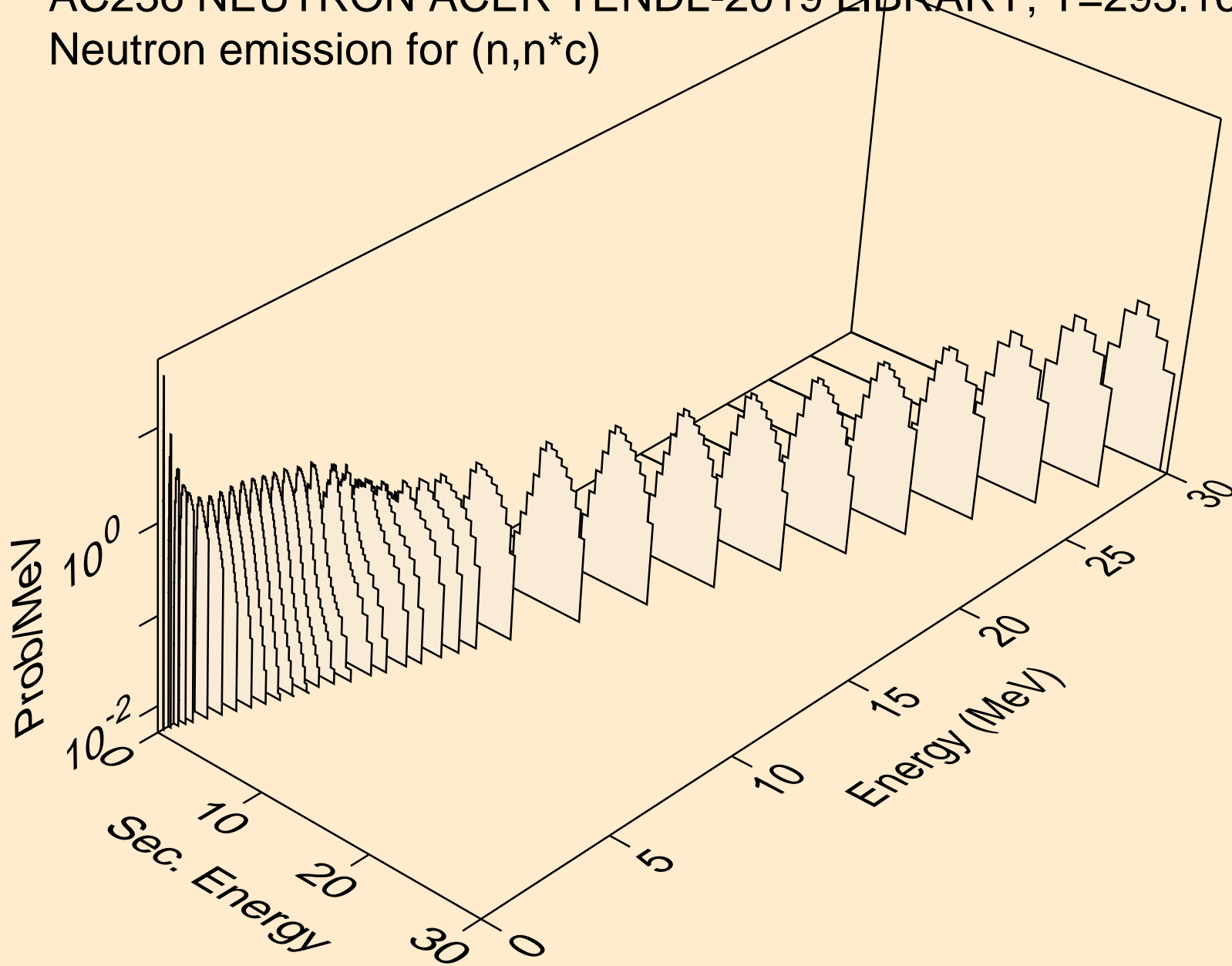

AC236 NEUTRON ACER TENDL-2019 LIBRARY; T=293.16K

Delayed nubar

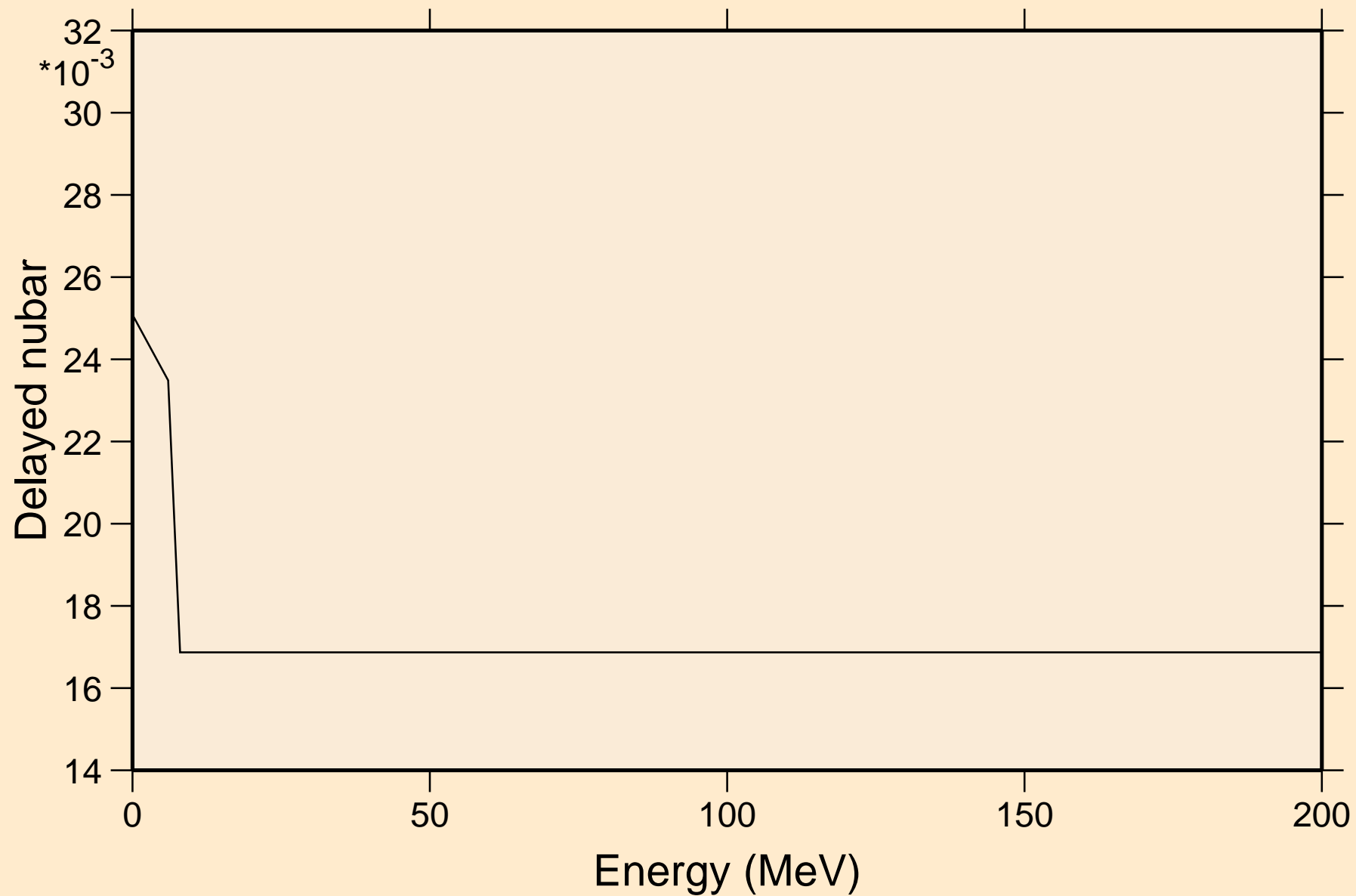

AC236 NEUTRON ACER TENDL-2019 LIBRARY; T=293.16K
Delayed neutron spectra

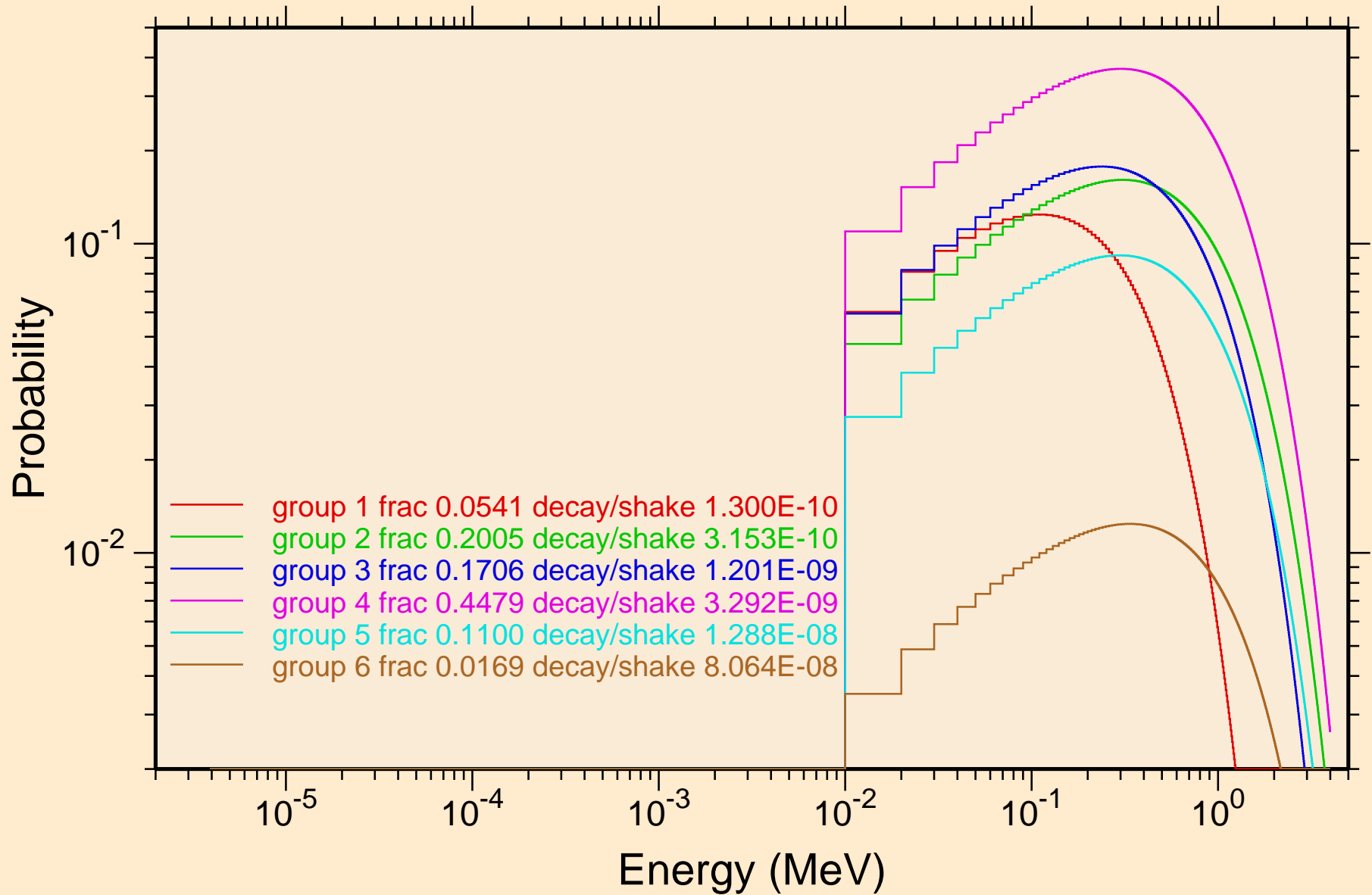

AC236 NEUTRON ACER TENDL-2019 LIBRARY; T=293.16K
Photon emission for (n,x)

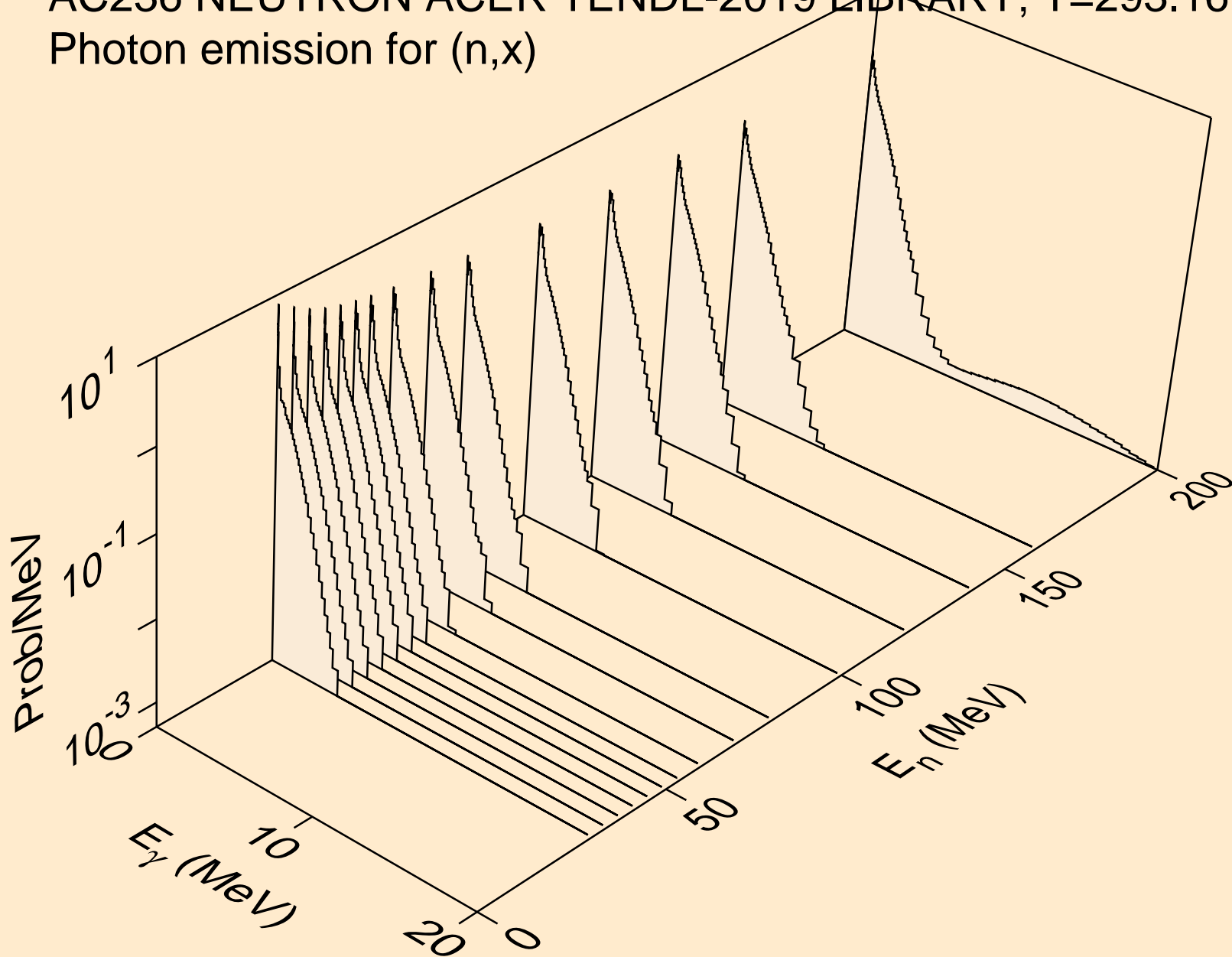

AC236 NEUTRON ACER TENDL-2019 LIBRARY; T=293.16K
Photon emission for (n,2nd)

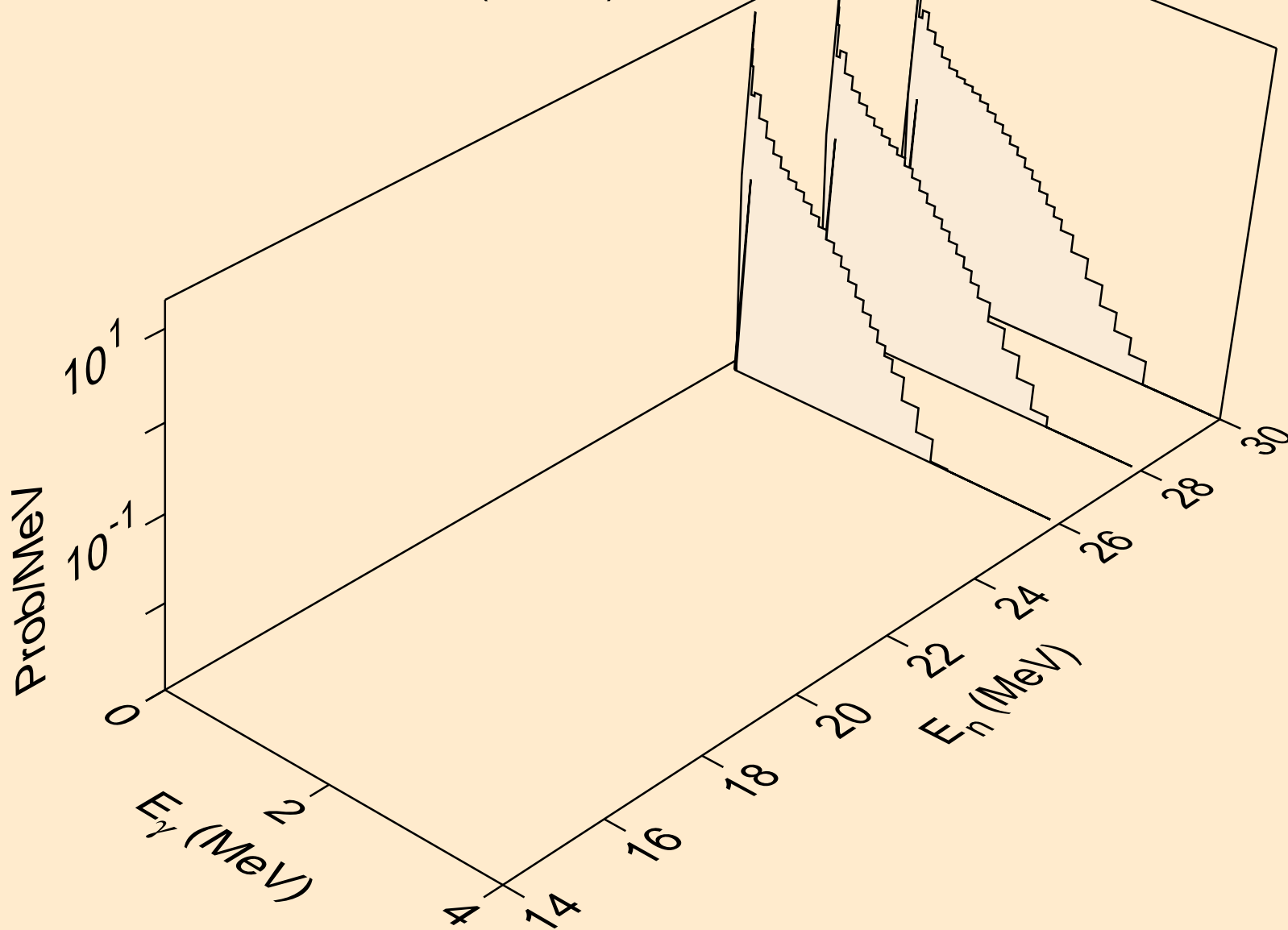

AC236 NEUTRON ACER TENDL-2019 LIBRARY; T=293.16K
Photon emission for (n,2n)

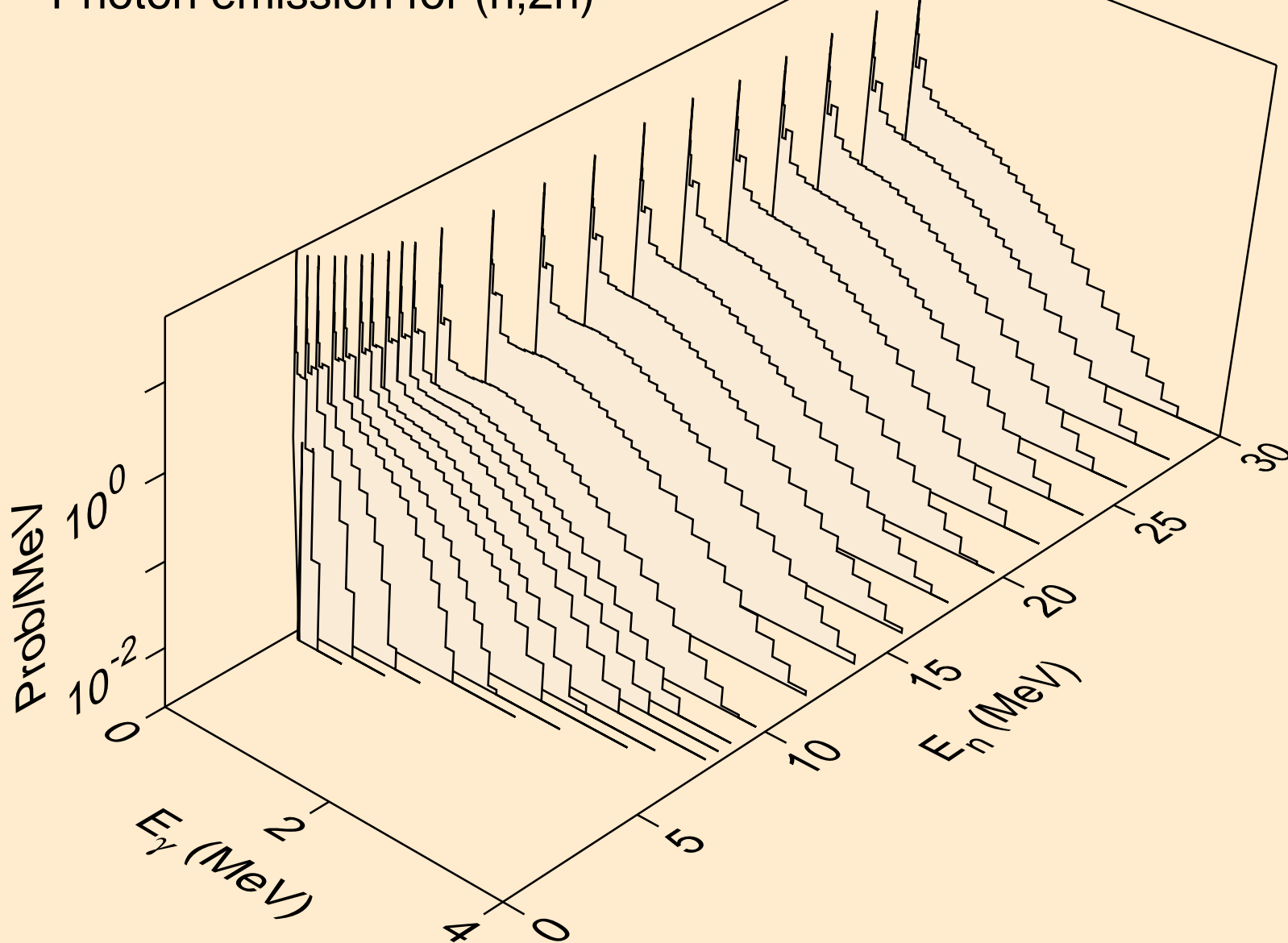

AC236 NEUTRON ACER TENDL-2019 LIBRARY; T=293.16K
Photon emission for (n,3n)

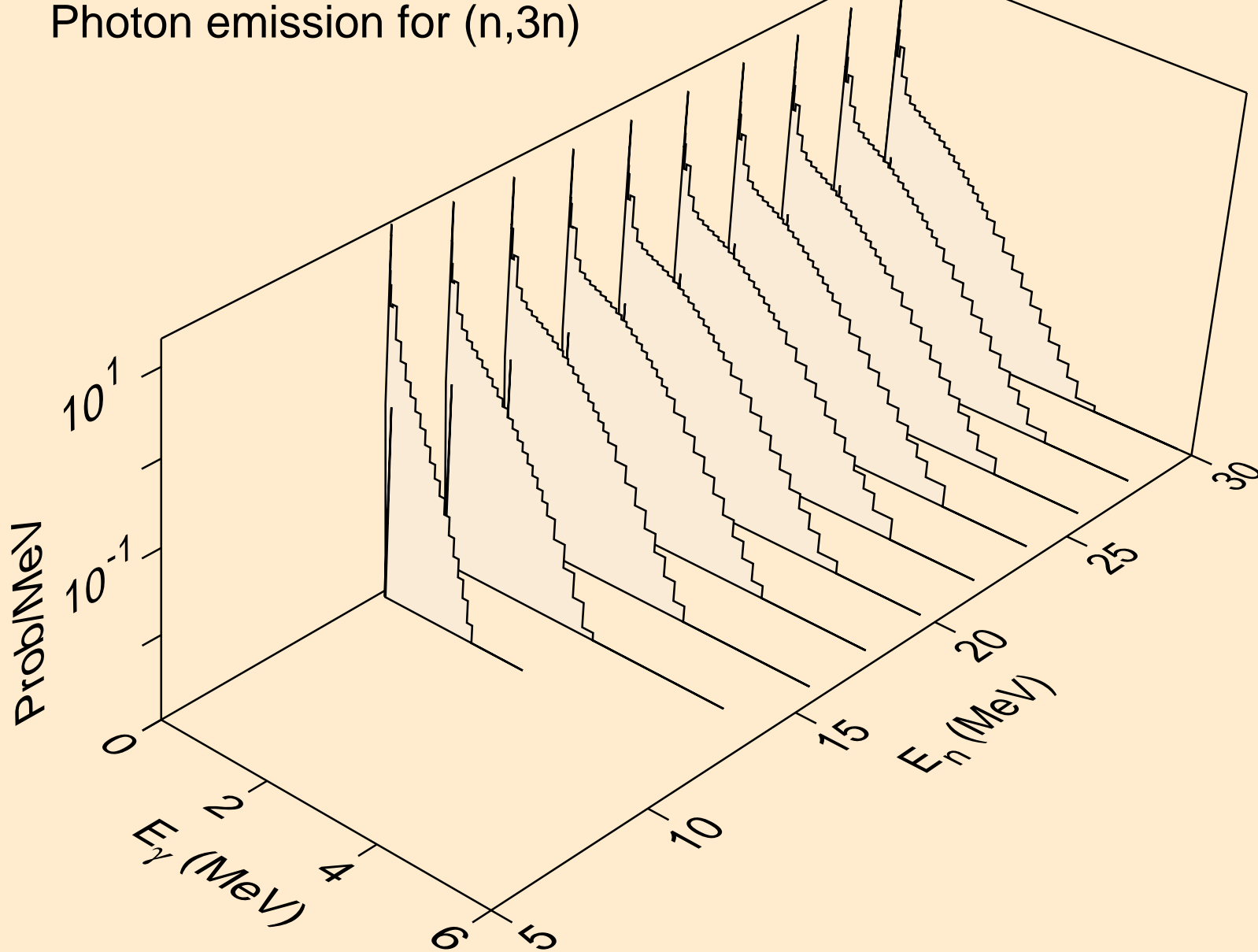

AC236 NEUTRON ACER TENDL-2019 LIBRARY; T=293.16K
Photon emission for (n,n*)a

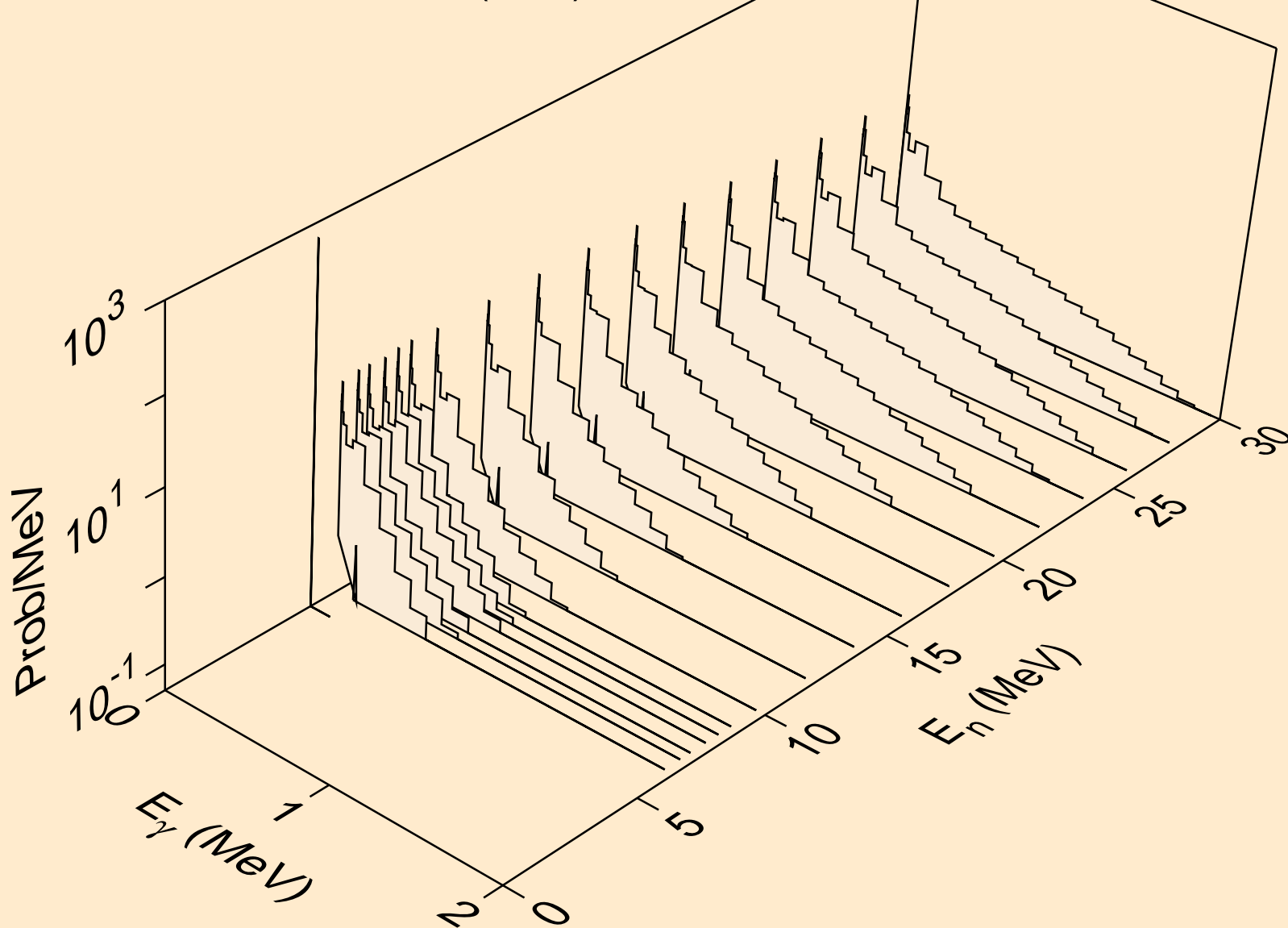

AC236 NEUTRON ACER TENDL-2019 LIBRARY; T=293.16K
Photon emission for (n,2n)a

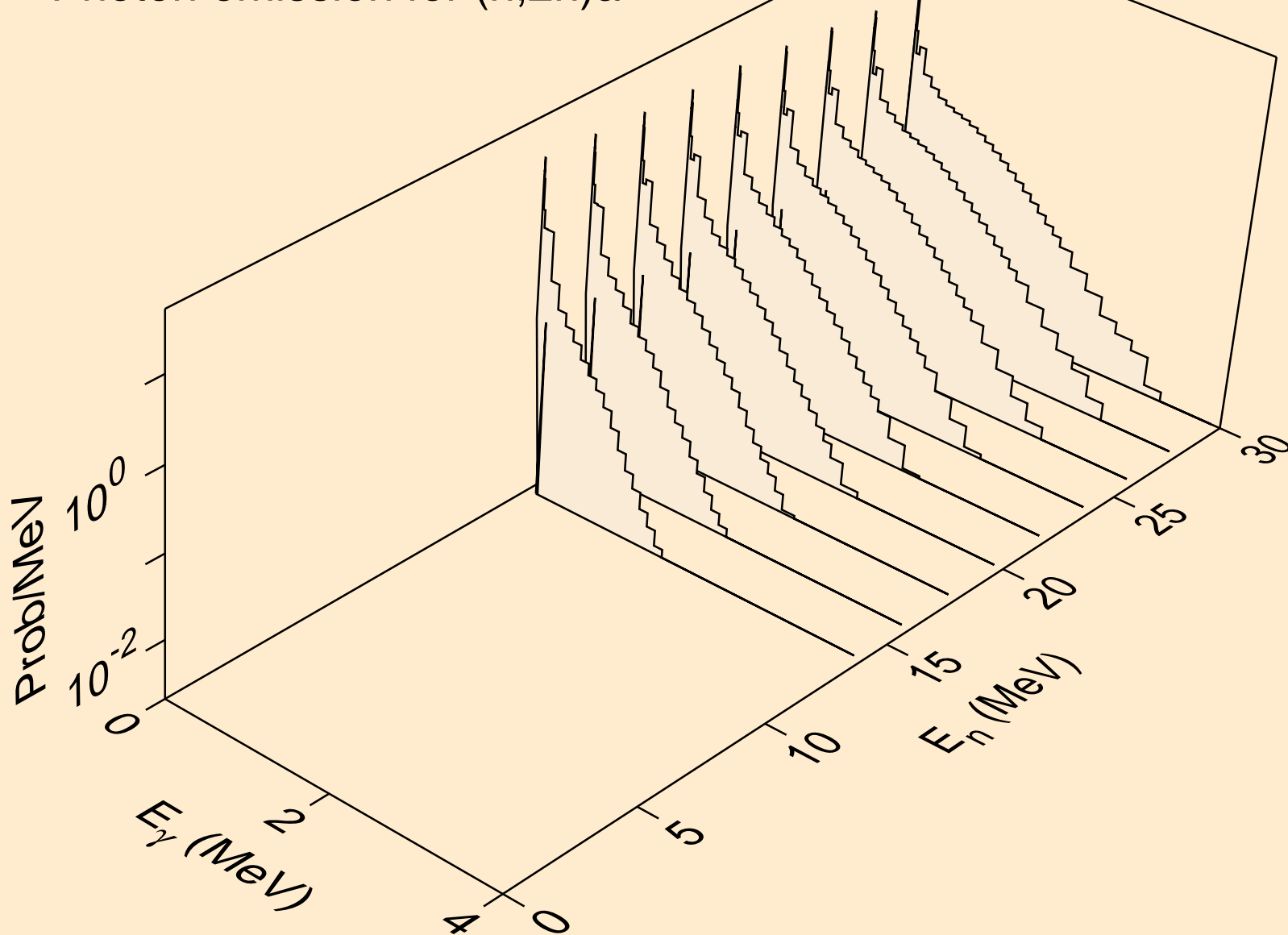

AC236 NEUTRON ACER TENDL-2019 LIBRARY; T=293.16K
Photon emission for (n,3n)a

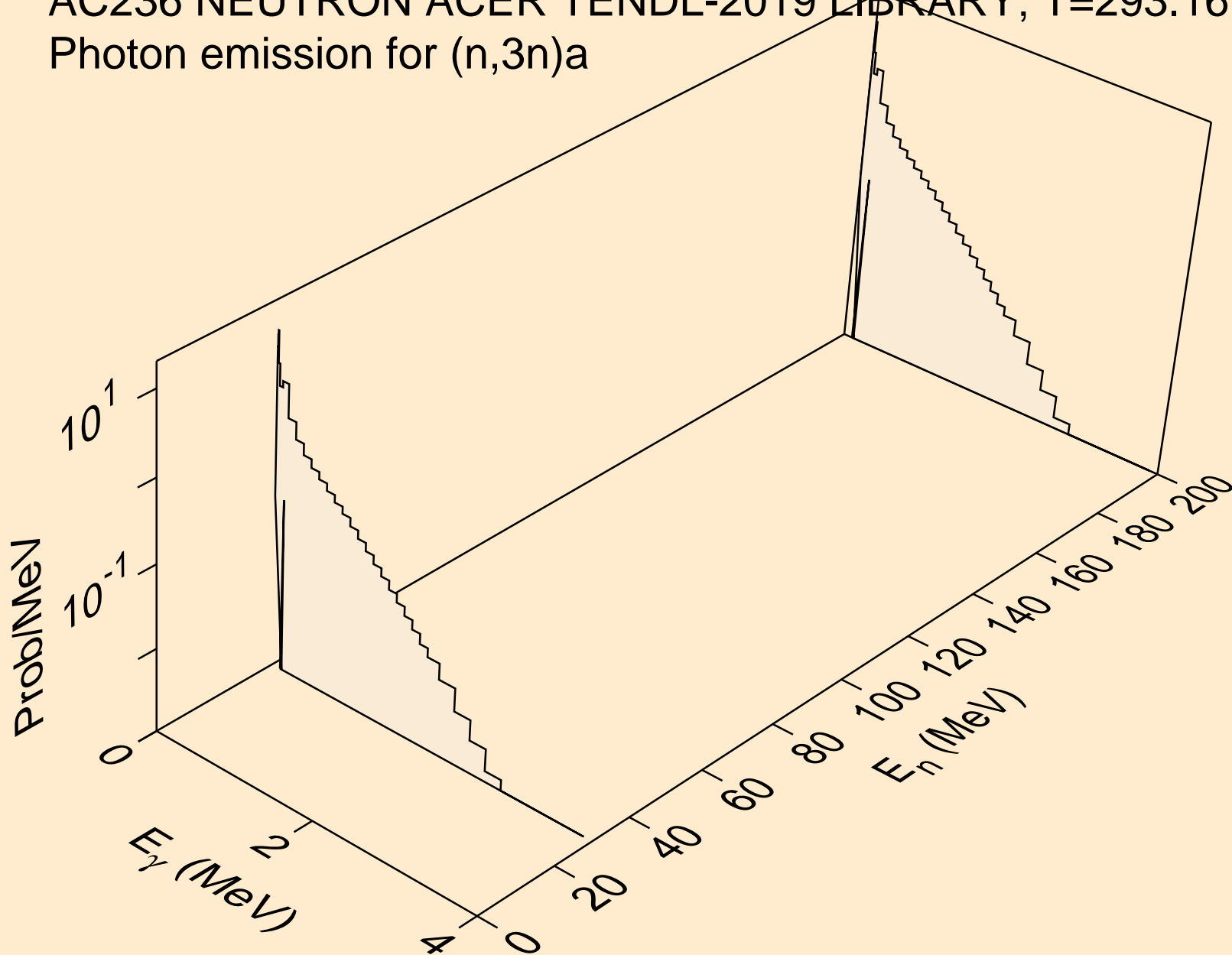

AC236 NEUTRON ACER TENDL-2019 LIBRARY; T=293.16K
Photon emission for (n,n*)p

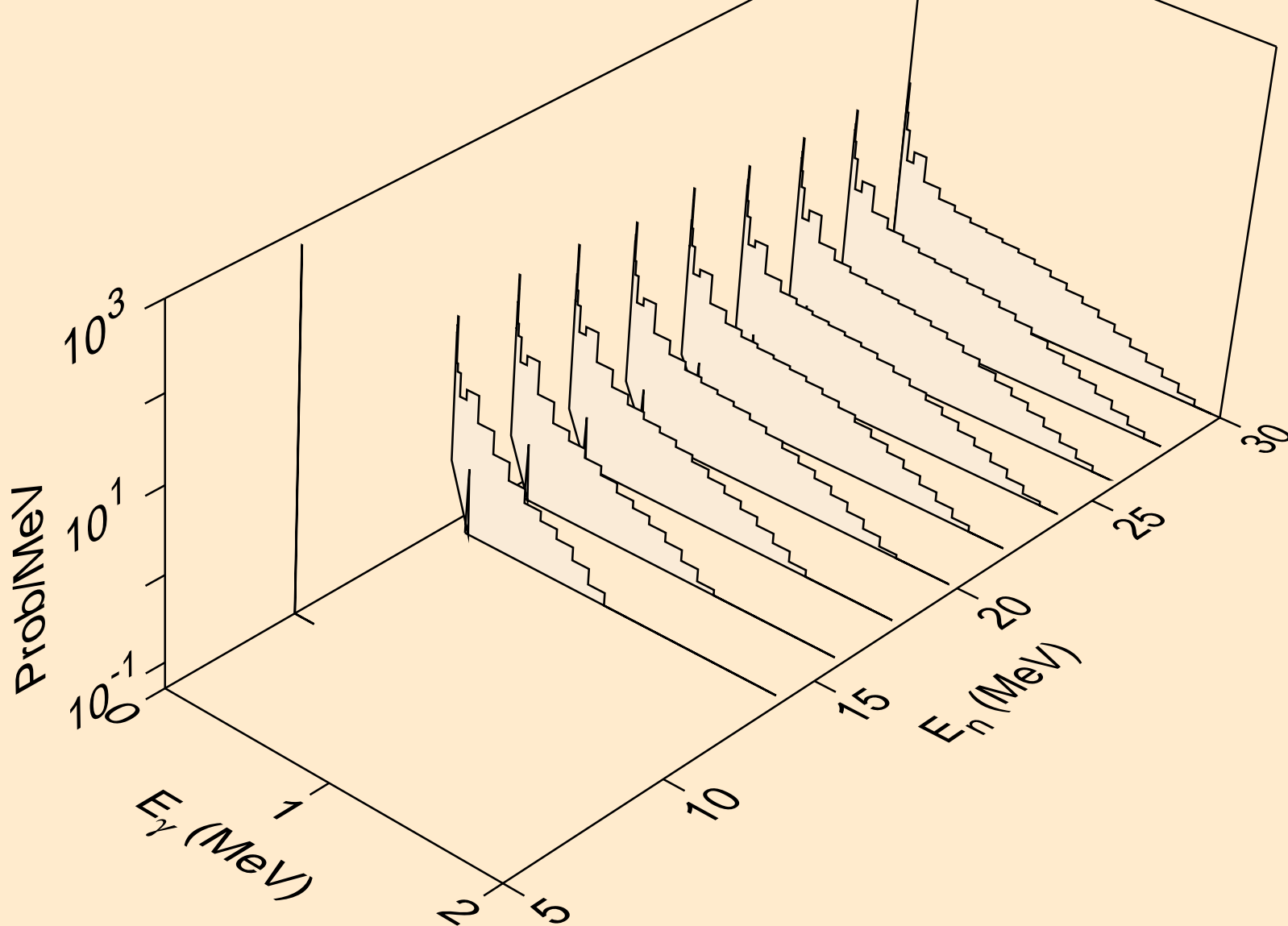

AC236 NEUTRON ACER TENDL-2019 LIBRARY; T=293.16K
Photon emission for (n,n*)d

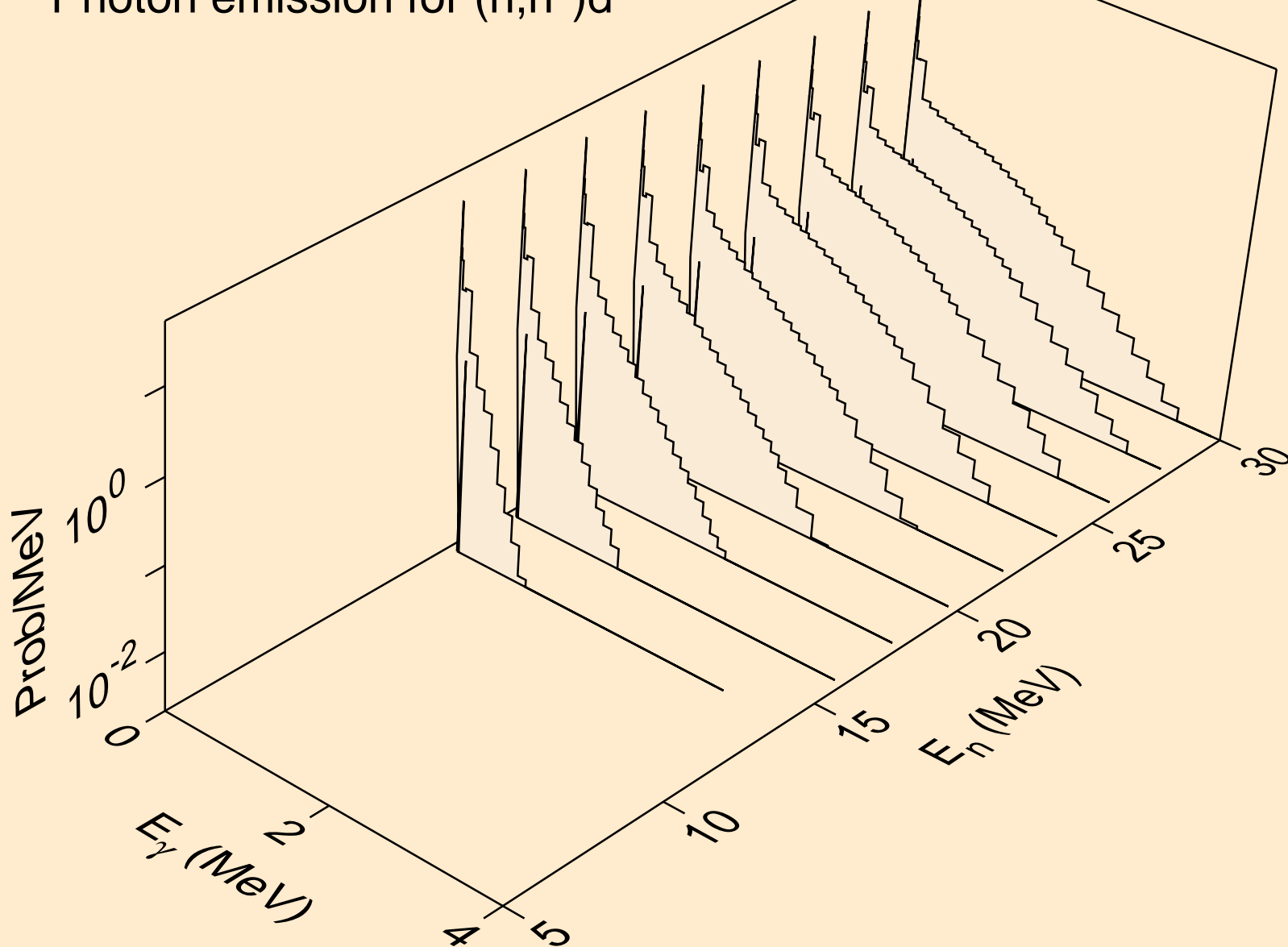

AC236 NEUTRON ACER TENDL-2019 LIBRARY; T=293.16K
Photon emission for (n,n*)t

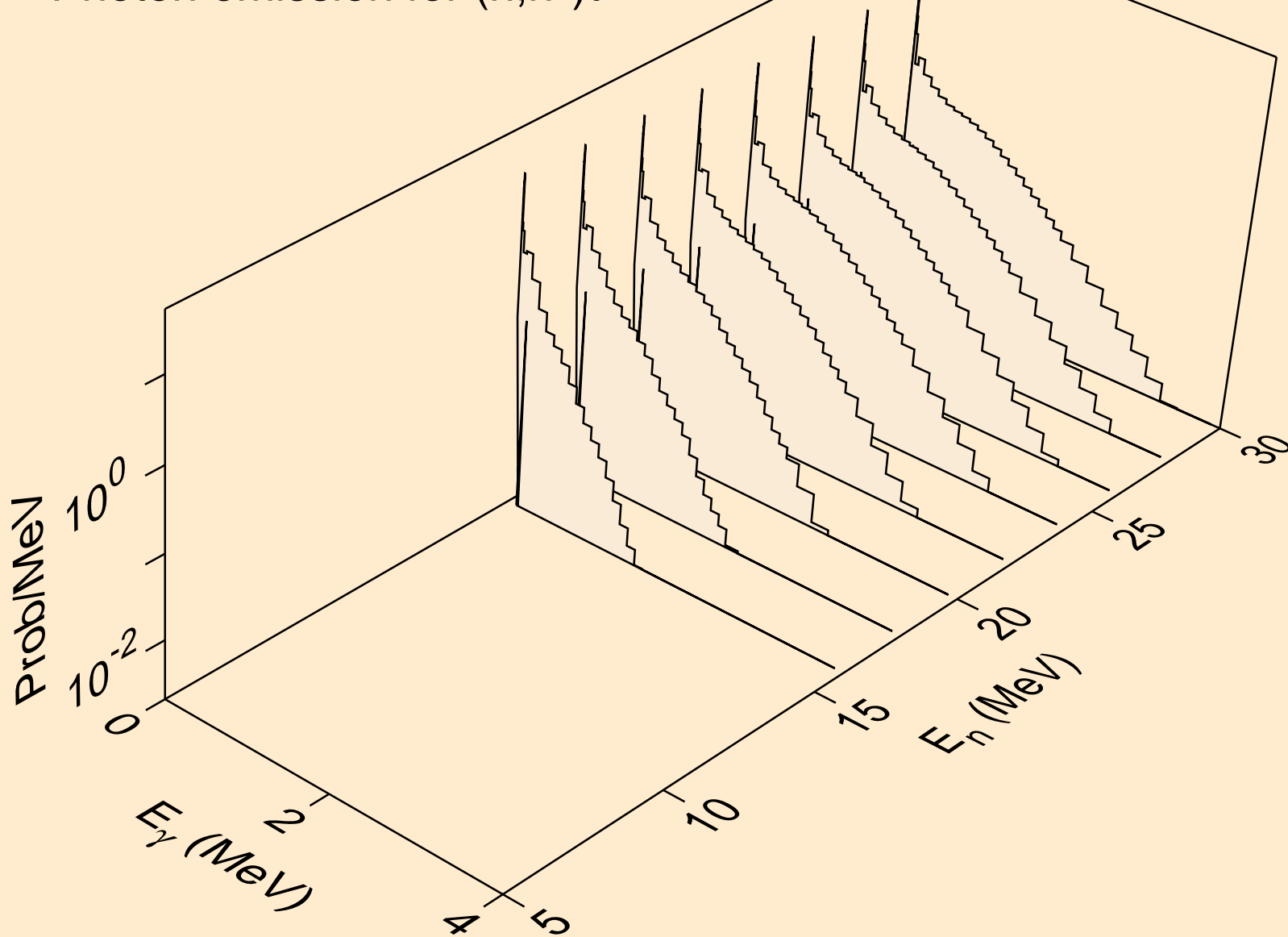

AC236 NEUTRON ACER TENDL-2019 LIBRARY; T=293.16K
Photon emission for (n,n*)he3

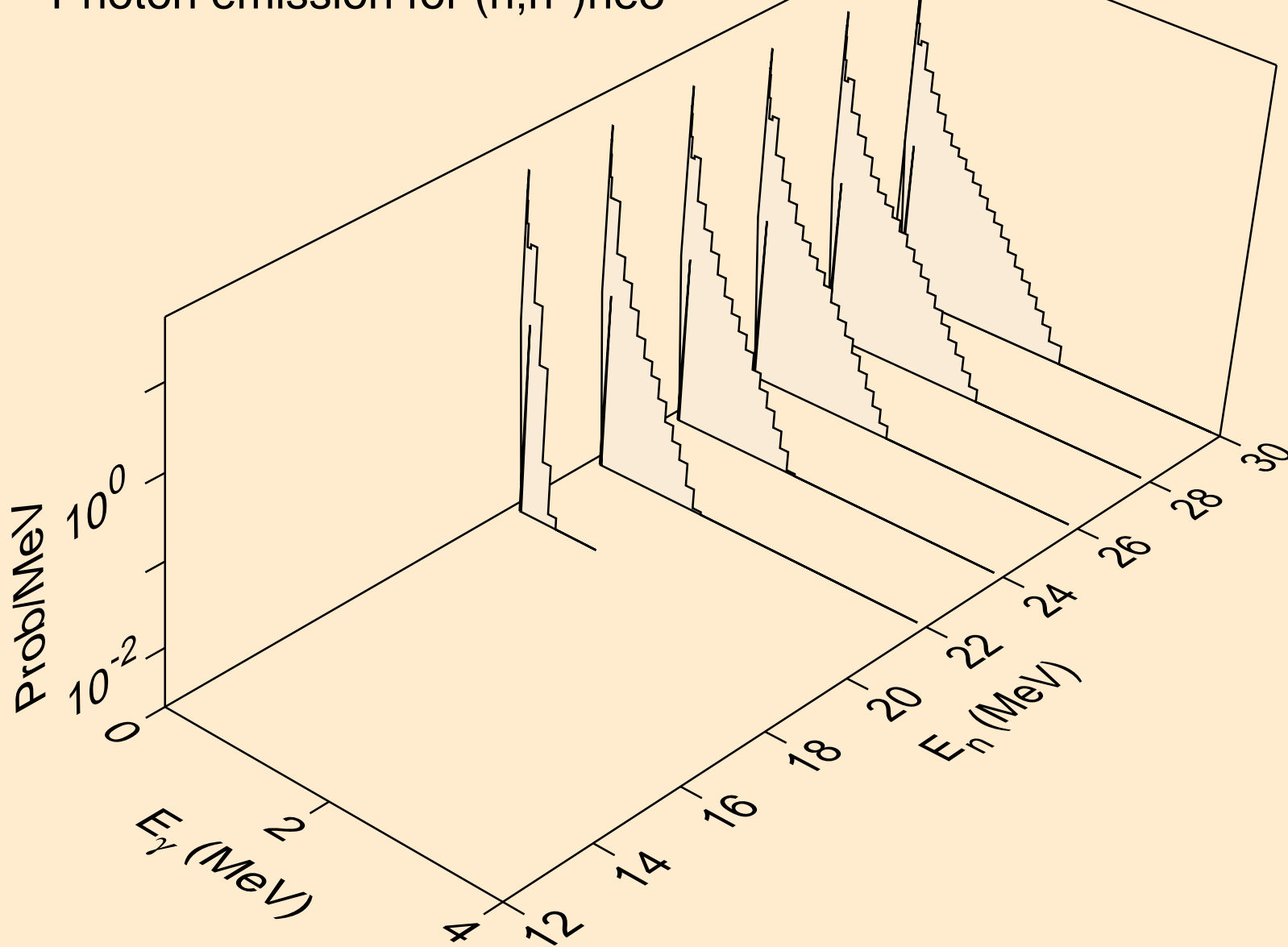

AC236 NEUTRON ACER TENDL-2019 LIBRARY; T=293.16K
Photon emission for (n,4n)

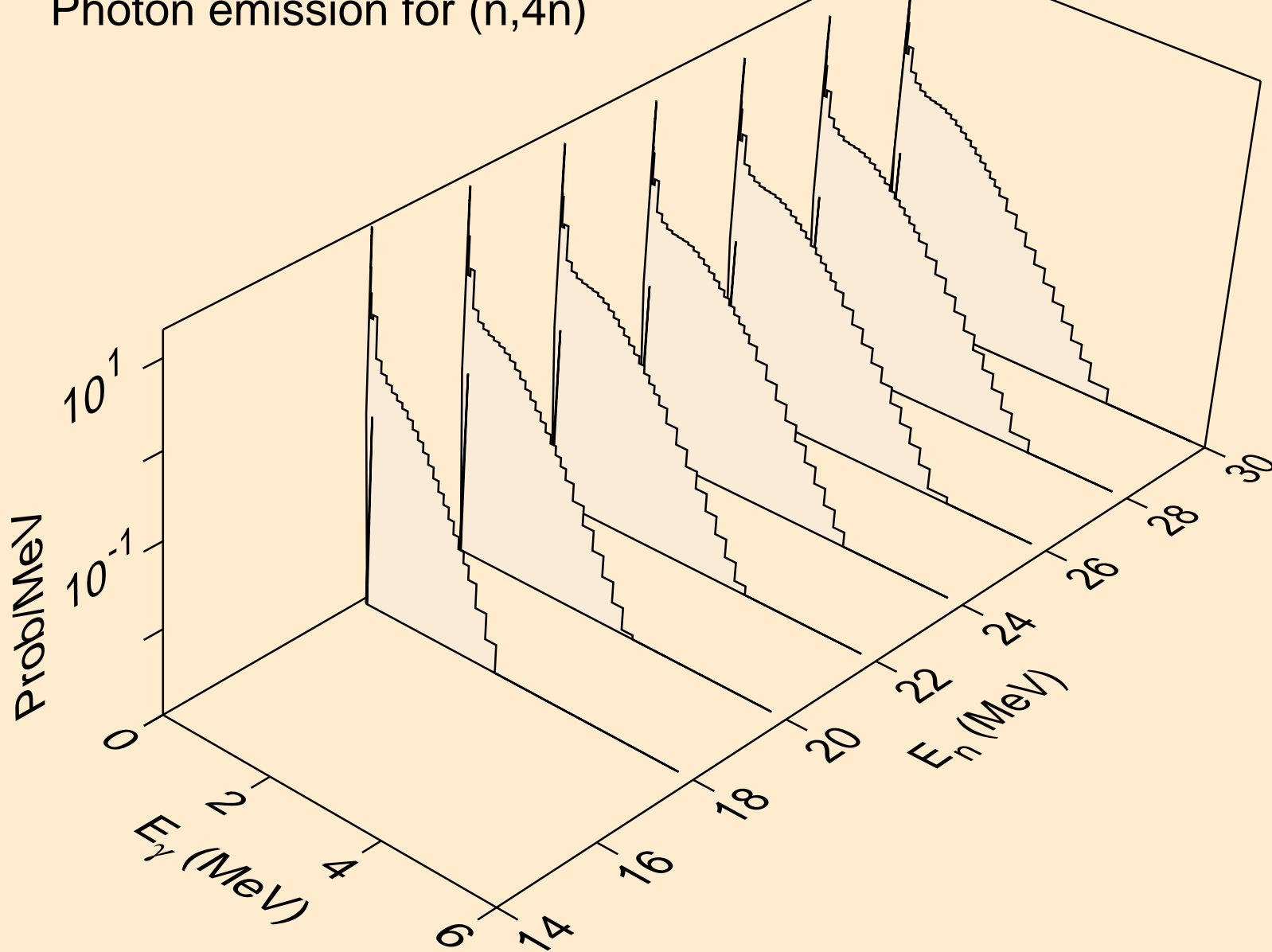

AC236 NEUTRON ACER TENDL-2019 LIBRARY; T=293.16K
Photon emission for (n,2np)

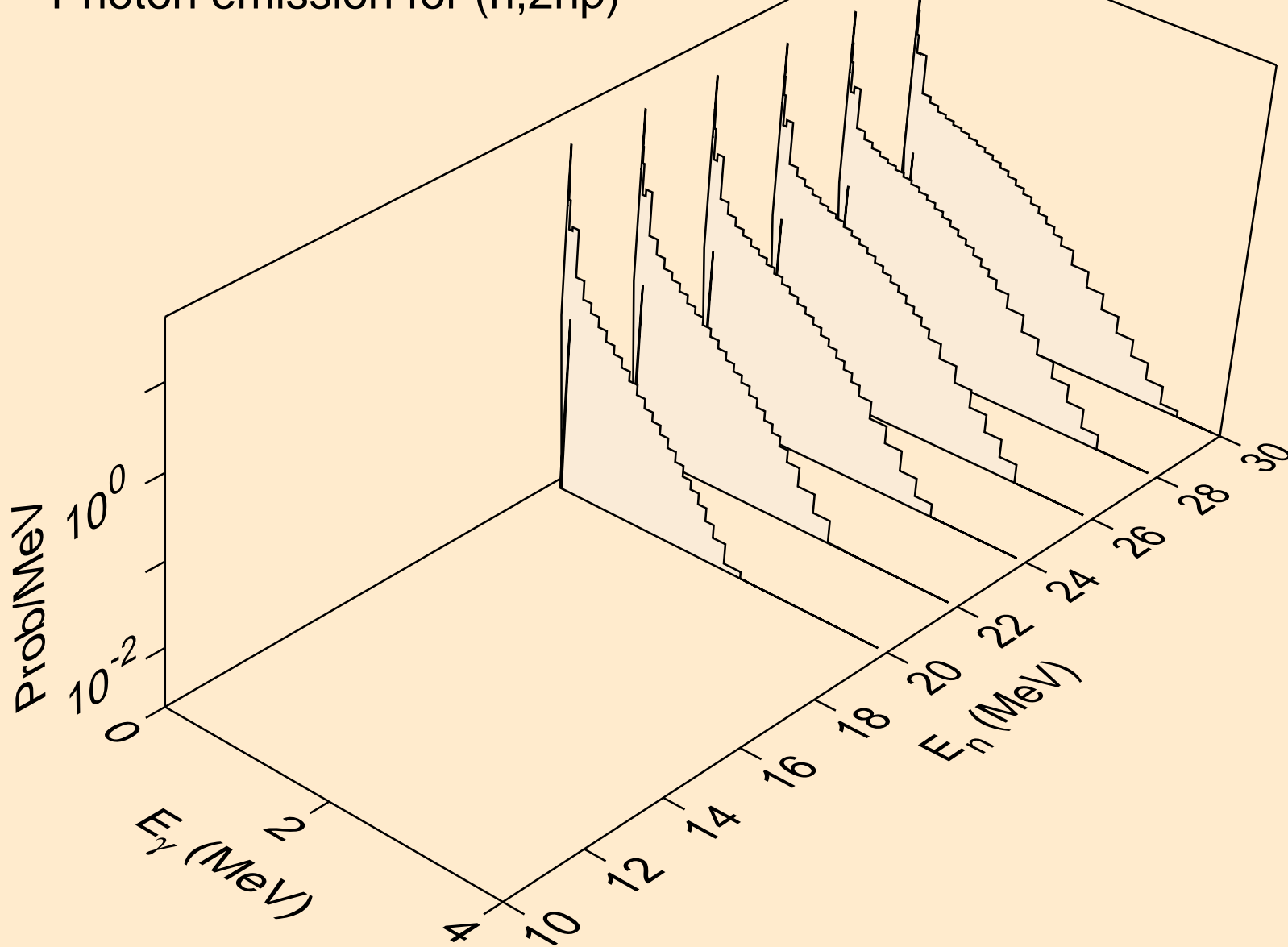

AC236 NEUTRON ACER TENDL-2019 LIBRARY; T=293.16K
Photon emission for (n,3np)

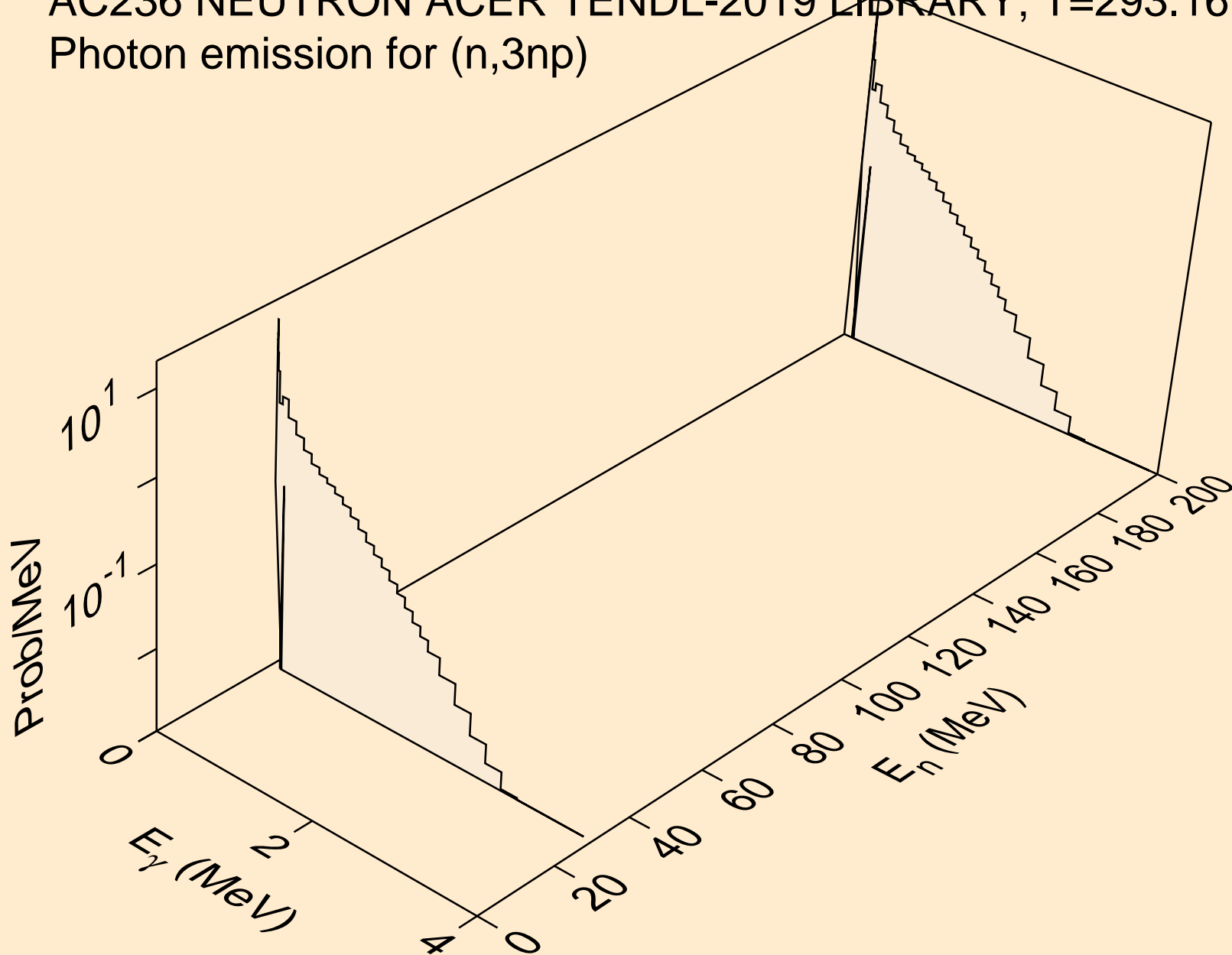

AC236 NEUTRON ACER TENDL-2019 LIBRARY; T=293.16K
Photon emission for (n,n*c)

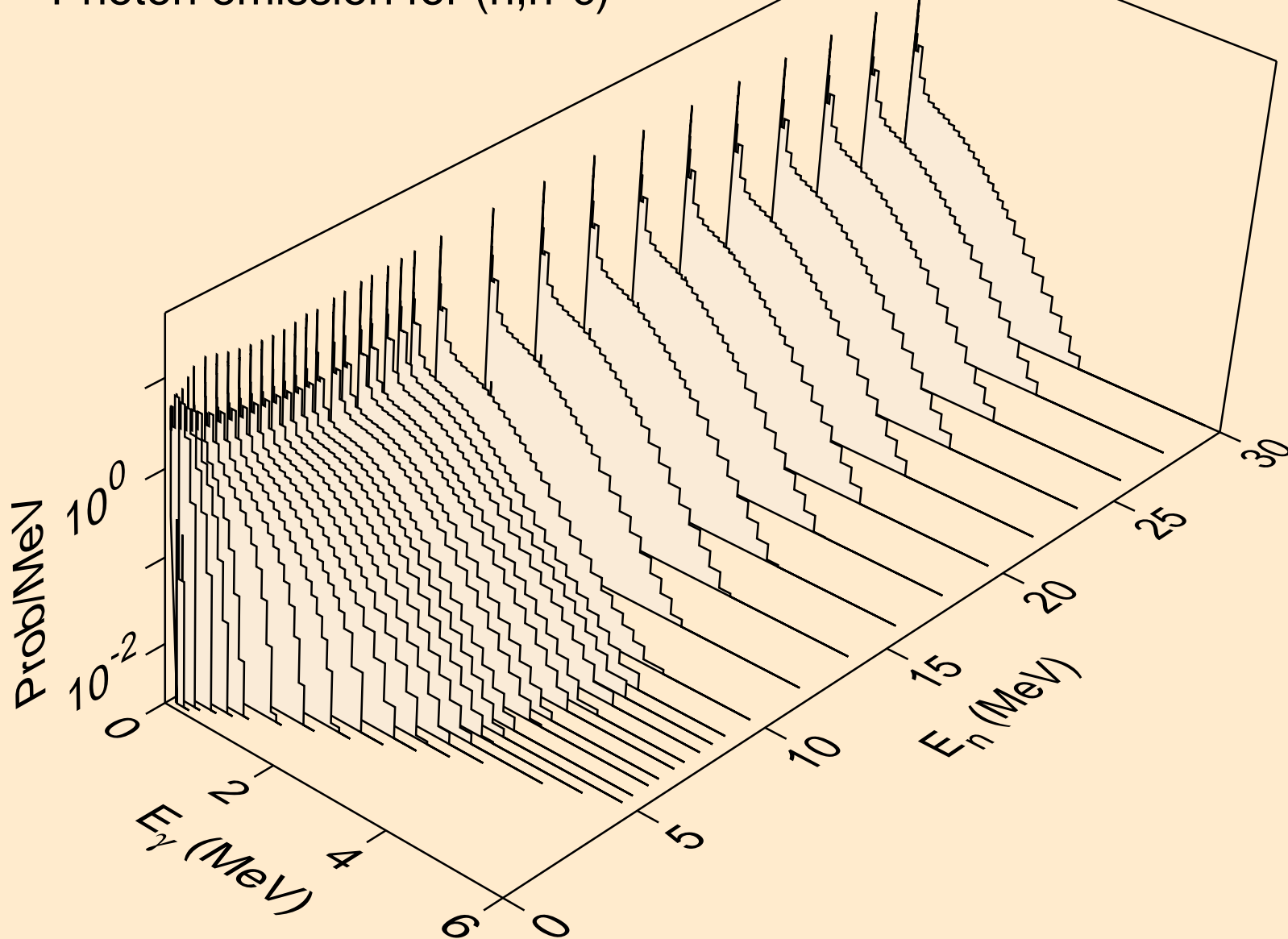

AC236 NEUTRON ACER TENDL-2019 LIBRARY; T=293.16K
Photon emission for (n,gma)

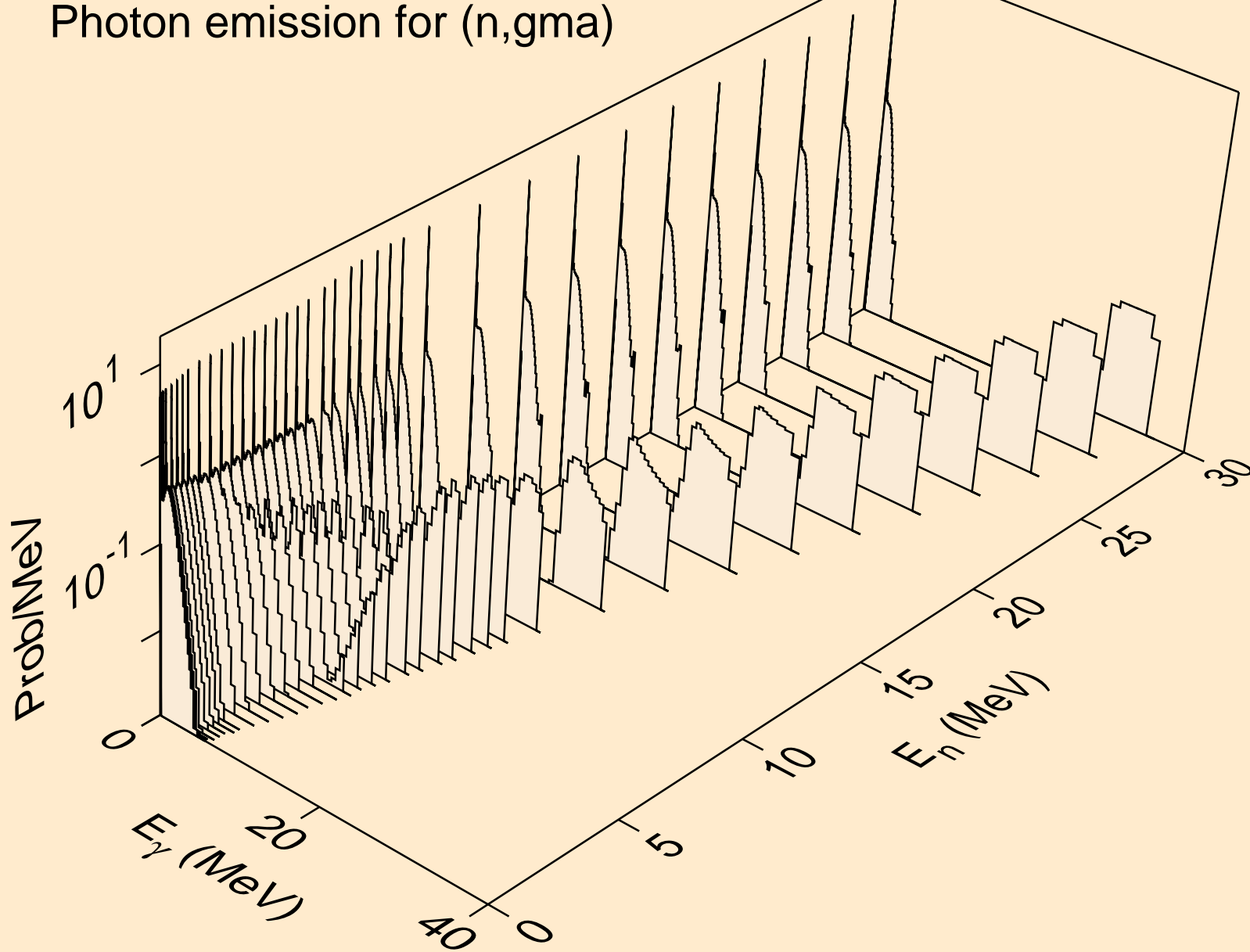

AC236 NEUTRON ACER TENDL-2019 LIBRARY; T=293.16K
Photon emission for (n,p)

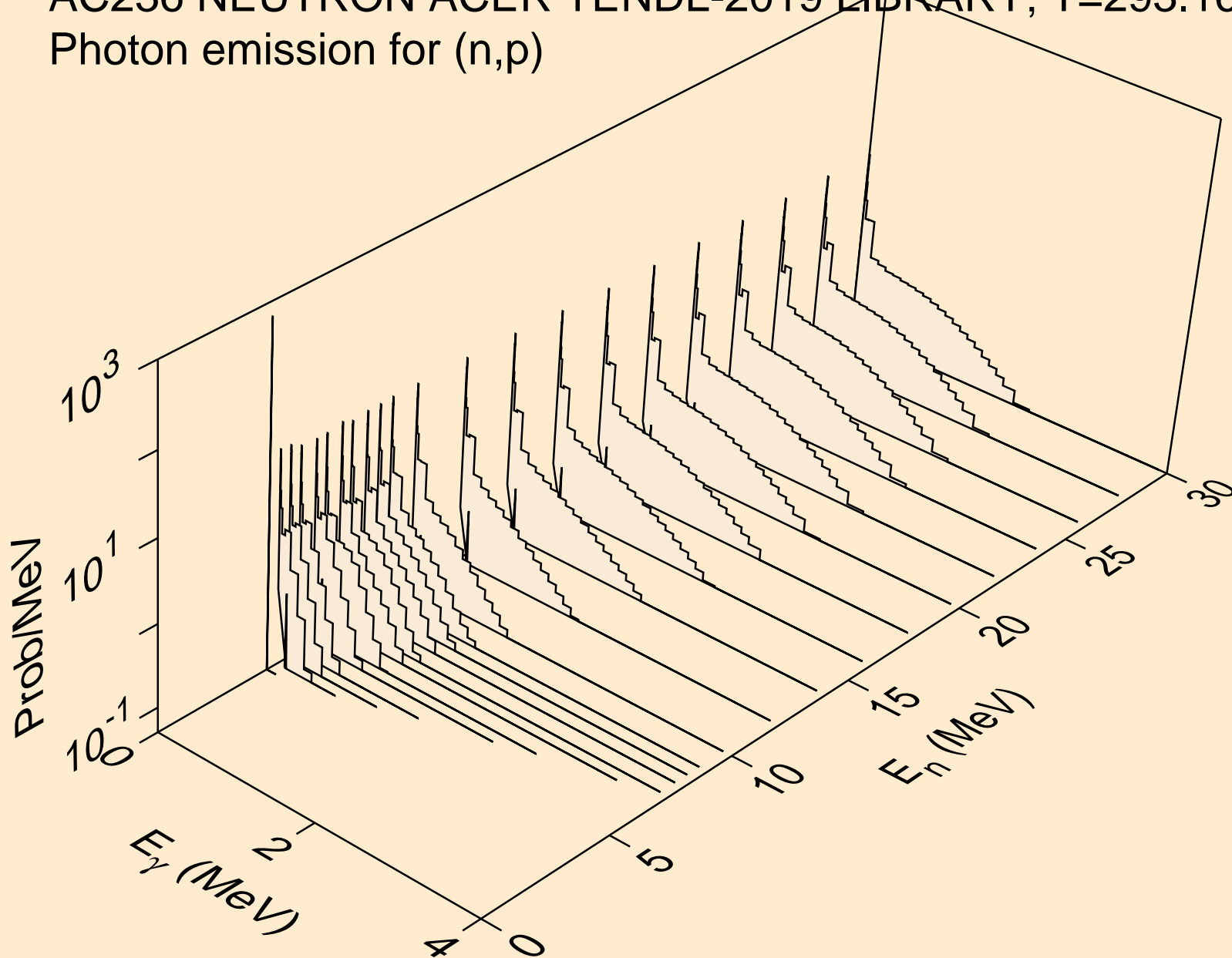

AC236 NEUTRON ACER TENDL-2019 LIBRARY; T=293.16K
Photon emission for (n,d)

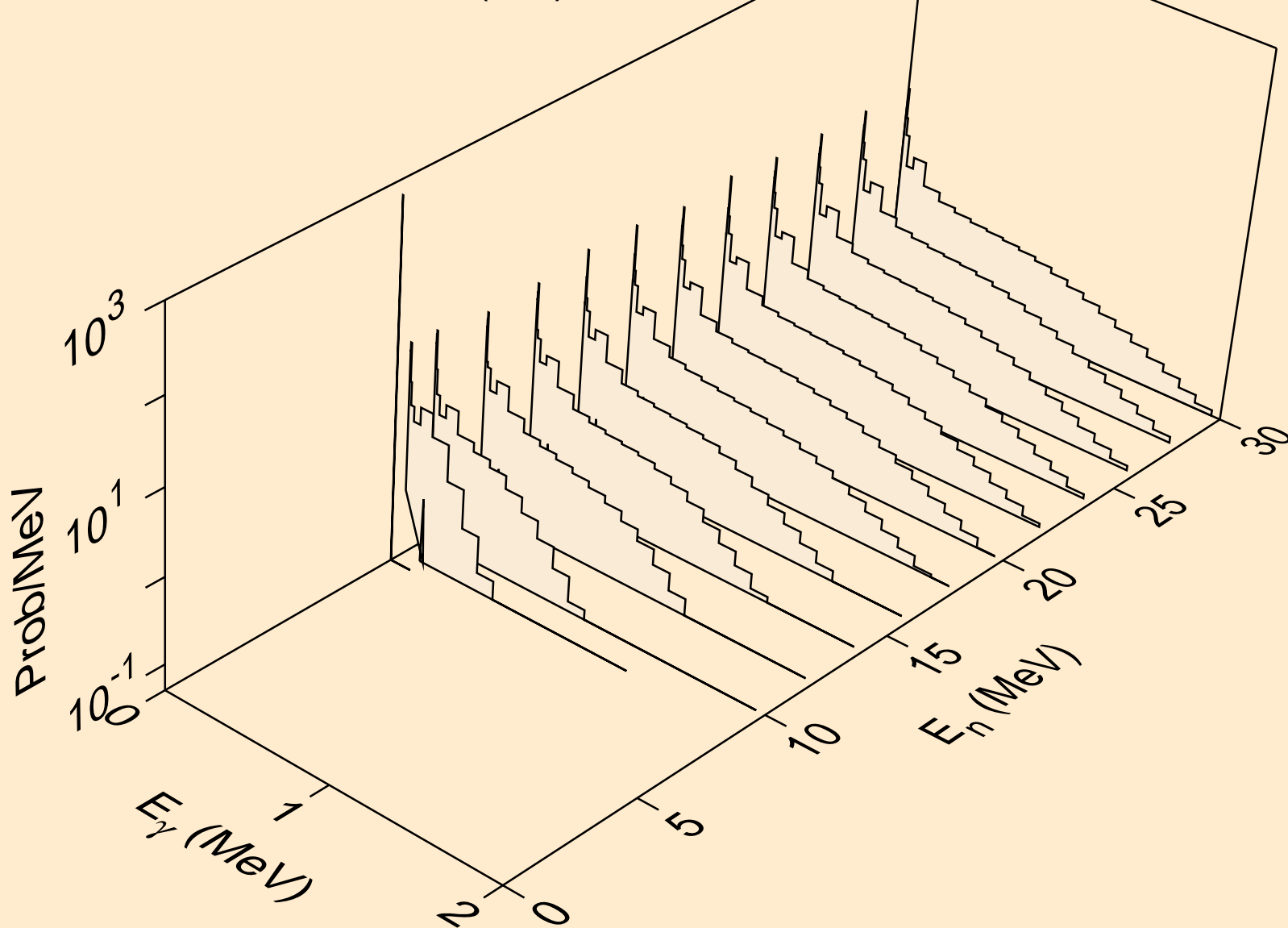

AC236 NEUTRON ACER TENDL-2019 LIBRARY; T=293.16K
Photon emission for (n,t)

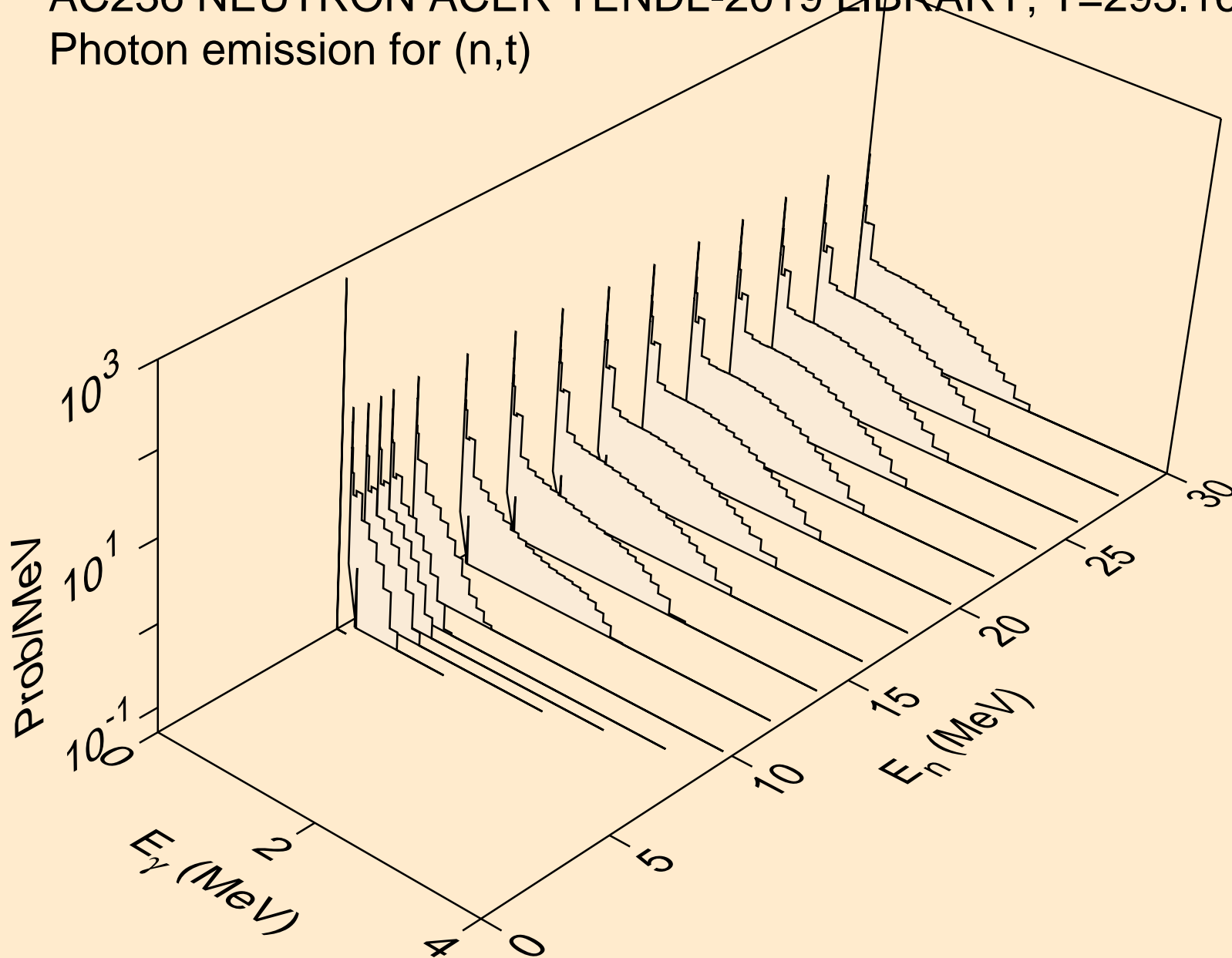

AC236 NEUTRON ACER TENDL-2019 LIBRARY; T=293.16K
Photon emission for (n,he3)

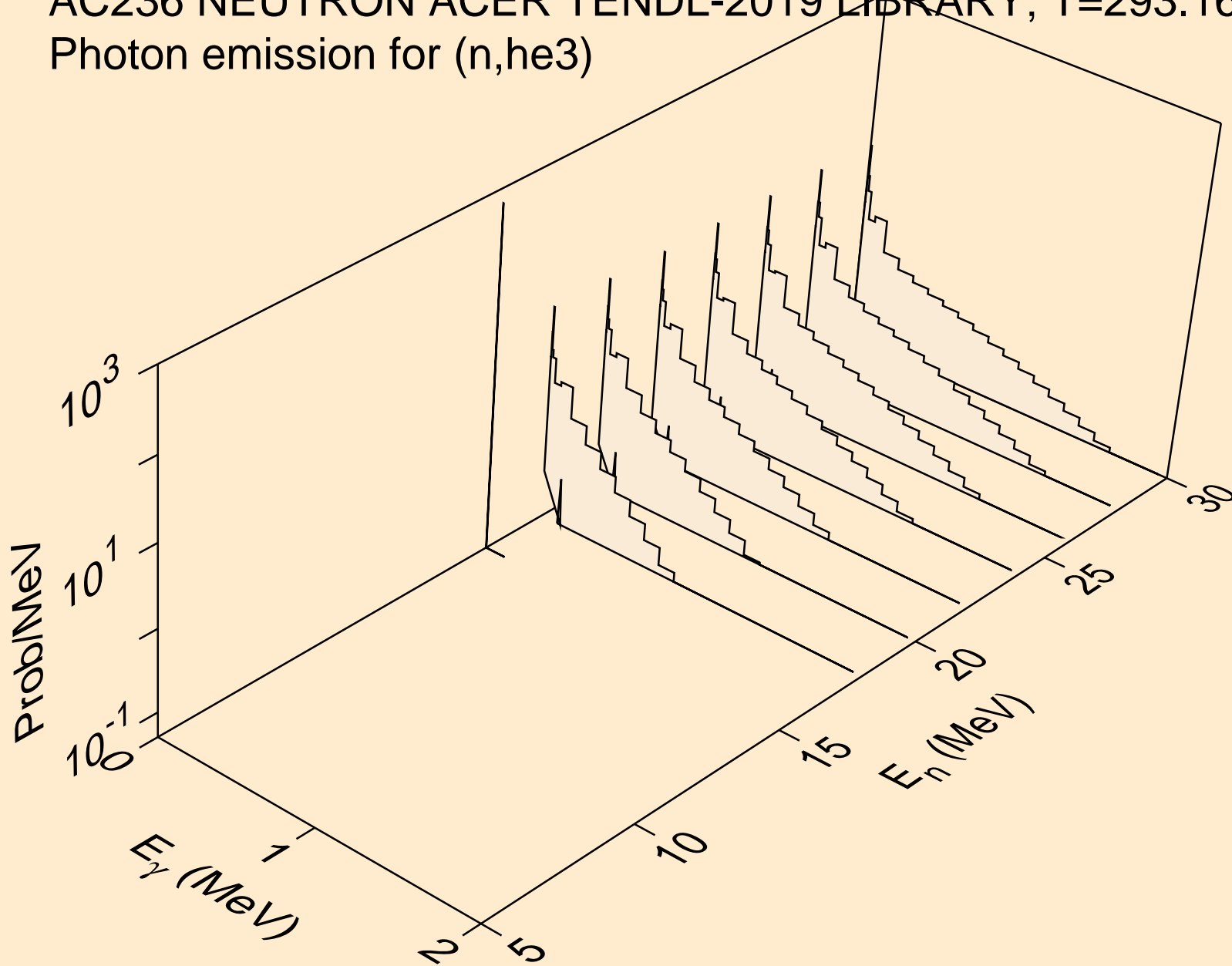

AC236 NEUTRON ACER TENDL-2019 LIBRARY; T=293.16K
Photon emission for (n,a)

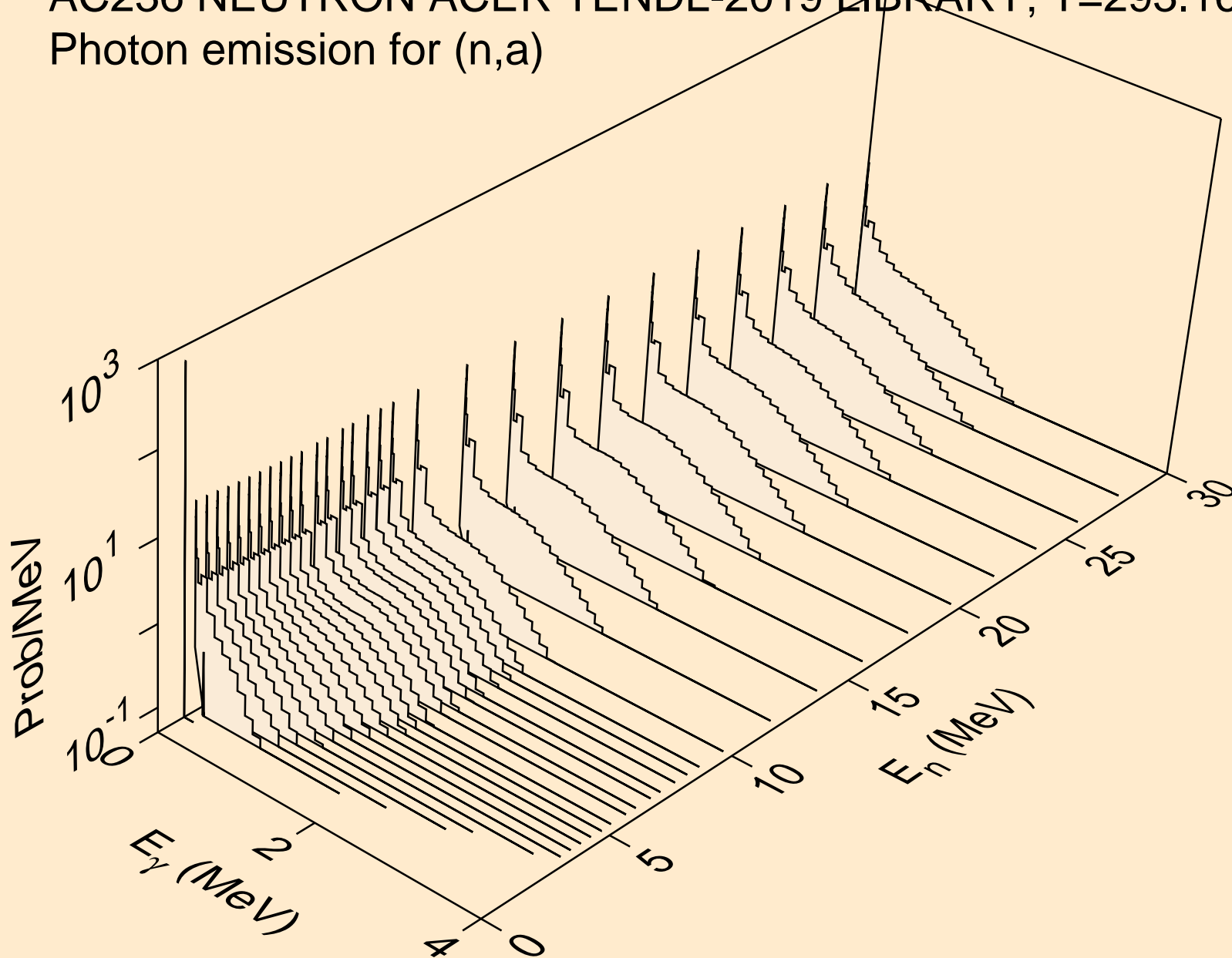

AC236 NEUTRON ACER TENDL-2019 LIBRARY; T=293.16K
Photon emission for (n,2p)

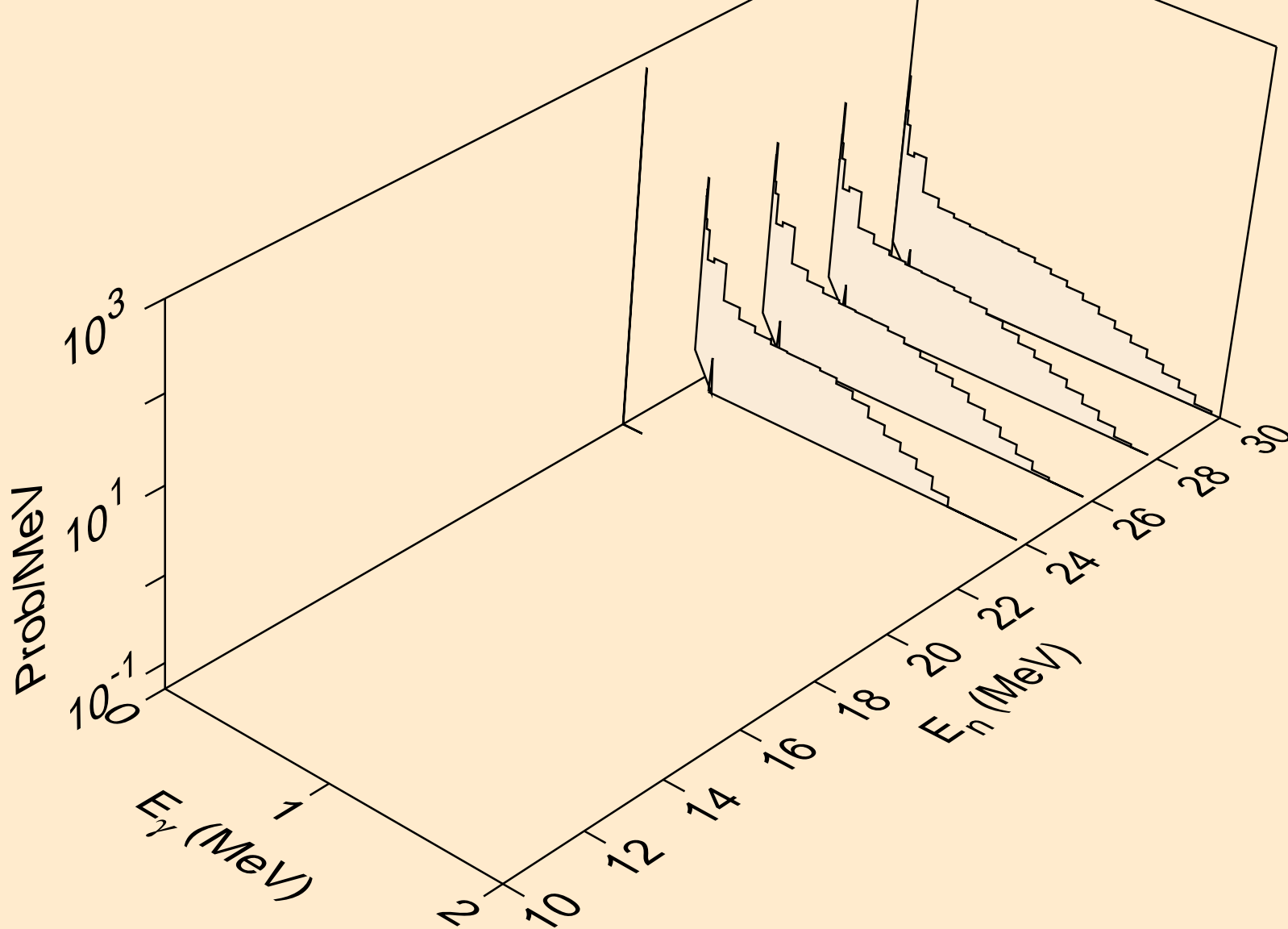

AC236 NEUTRON ACER TENDL-2019 LIBRARY; T=293.16K
thermal capture photon spectrum

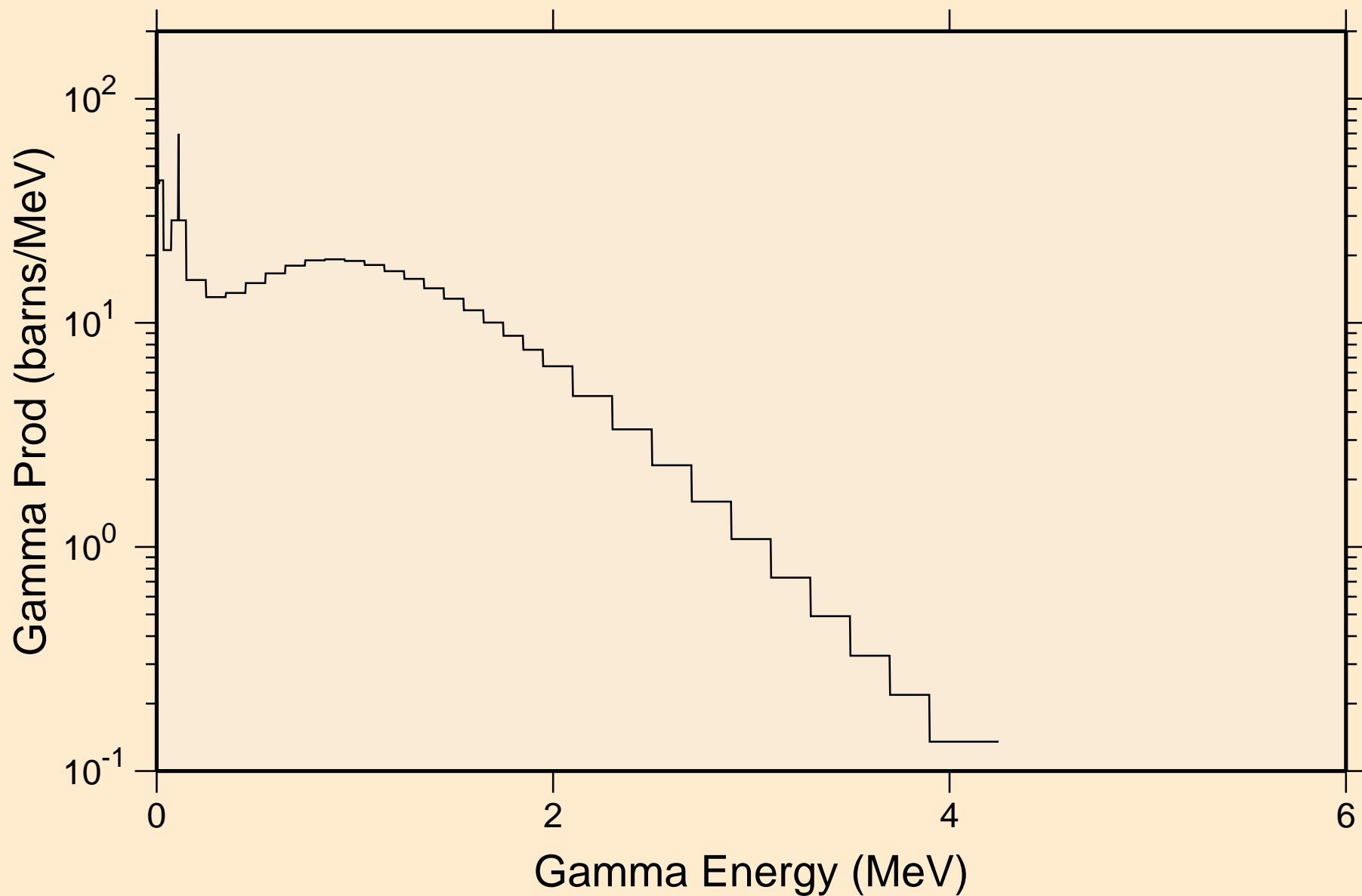

AC236 NEUTRON ACER TENDL-2019 LIBRARY; T=293.16K
14 MeV photon spectrum

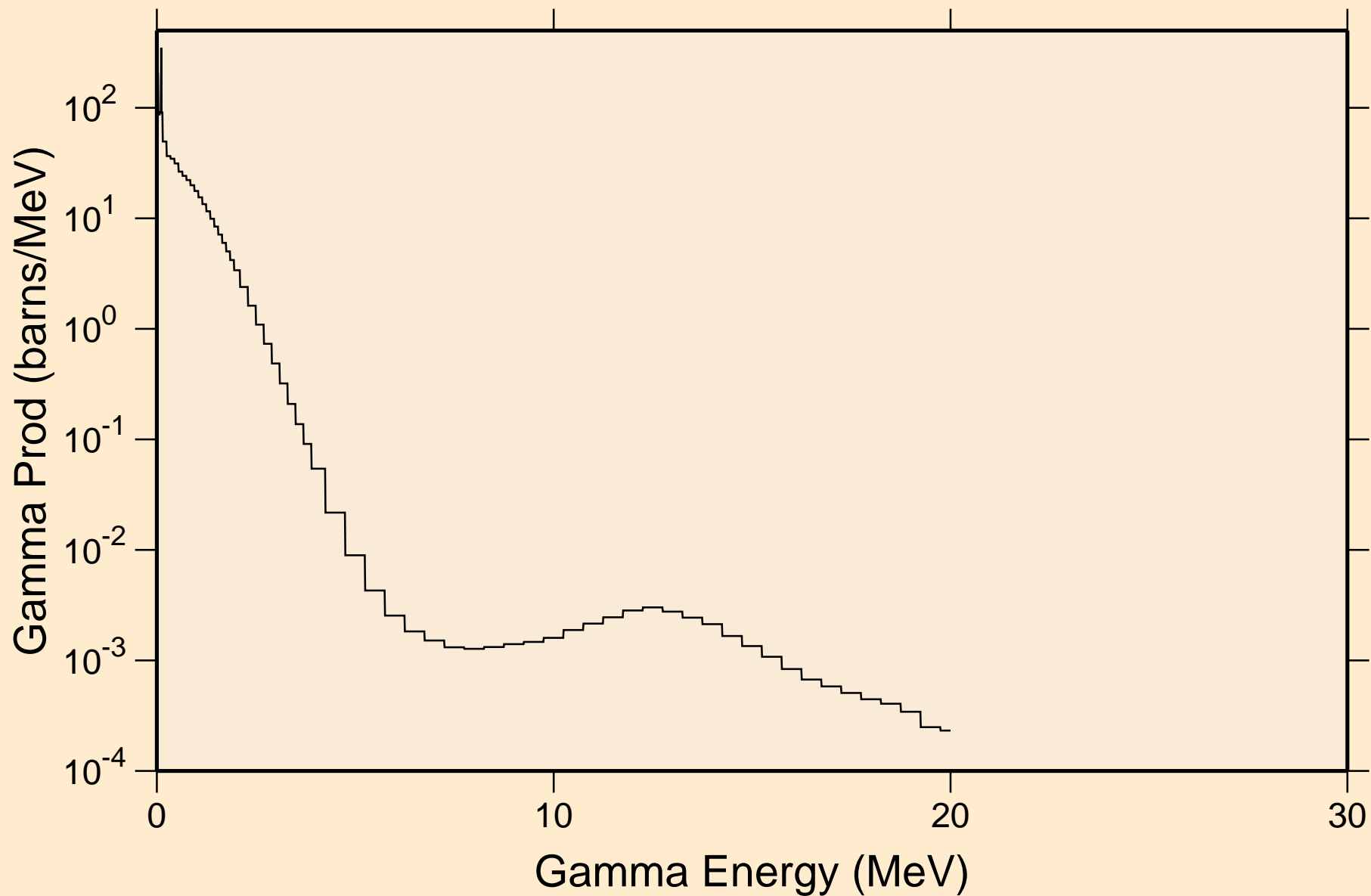

AC236 NEUTRON ACER TENDL-2019 LIBRARY; T=293.16K
Particle heating contributions

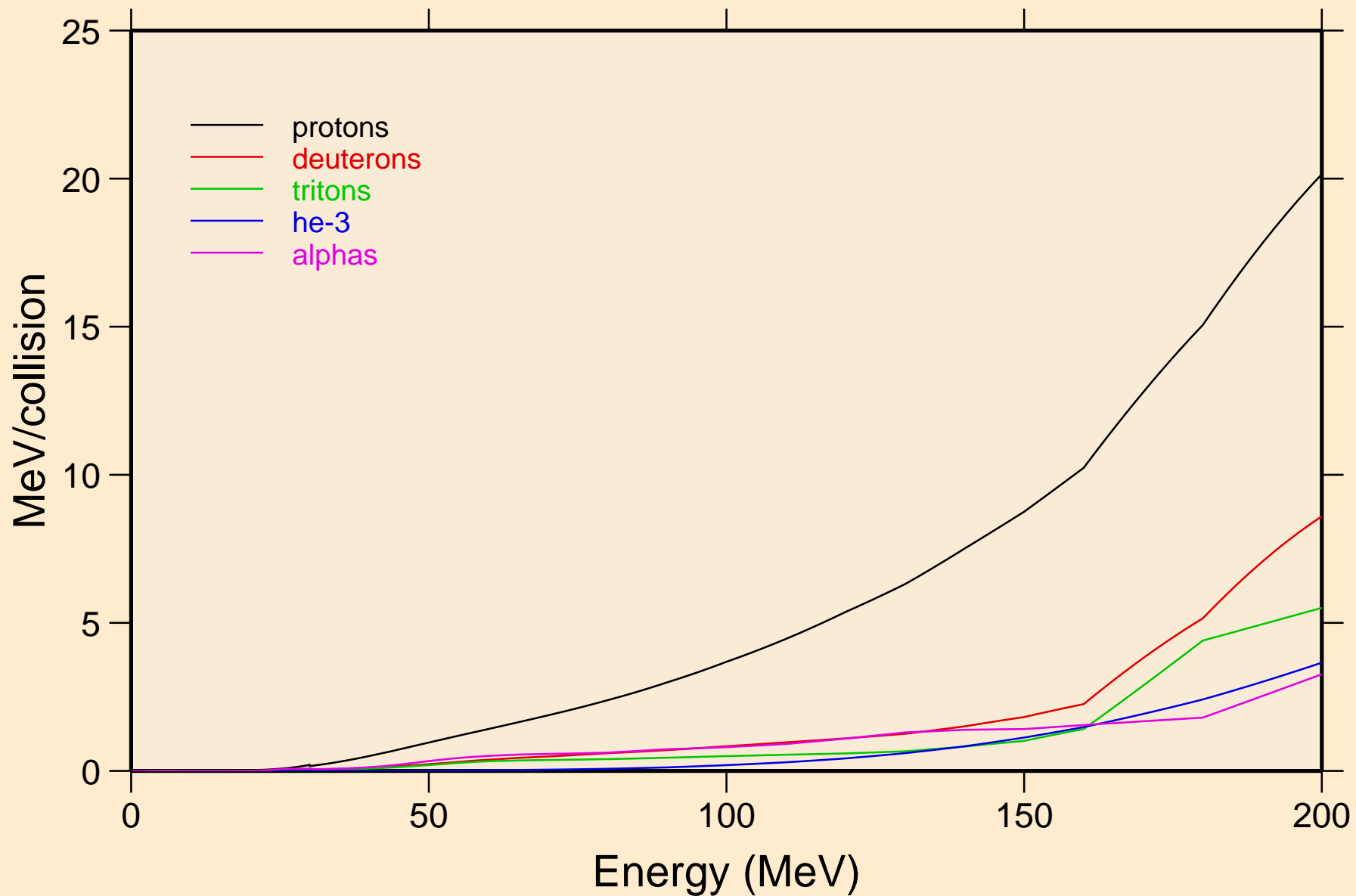

AC236 NEUTRON ACER TENDL-2019 LIBRARY; T=293.16K
Recoil Heating

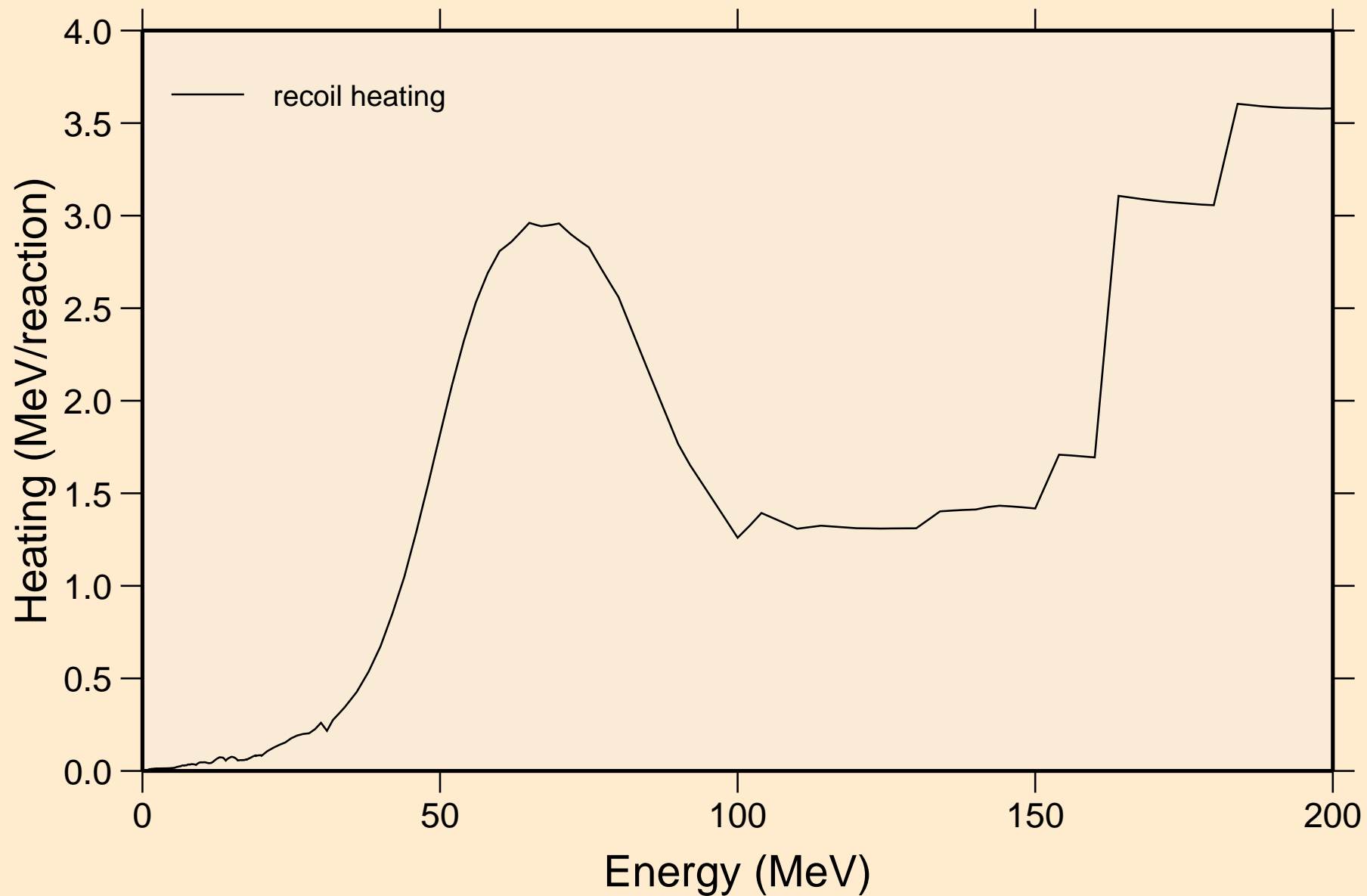

AC236 NEUTRON ACER TENDL-2019 LIBRARY; T=293.16K
Particle production cross sections

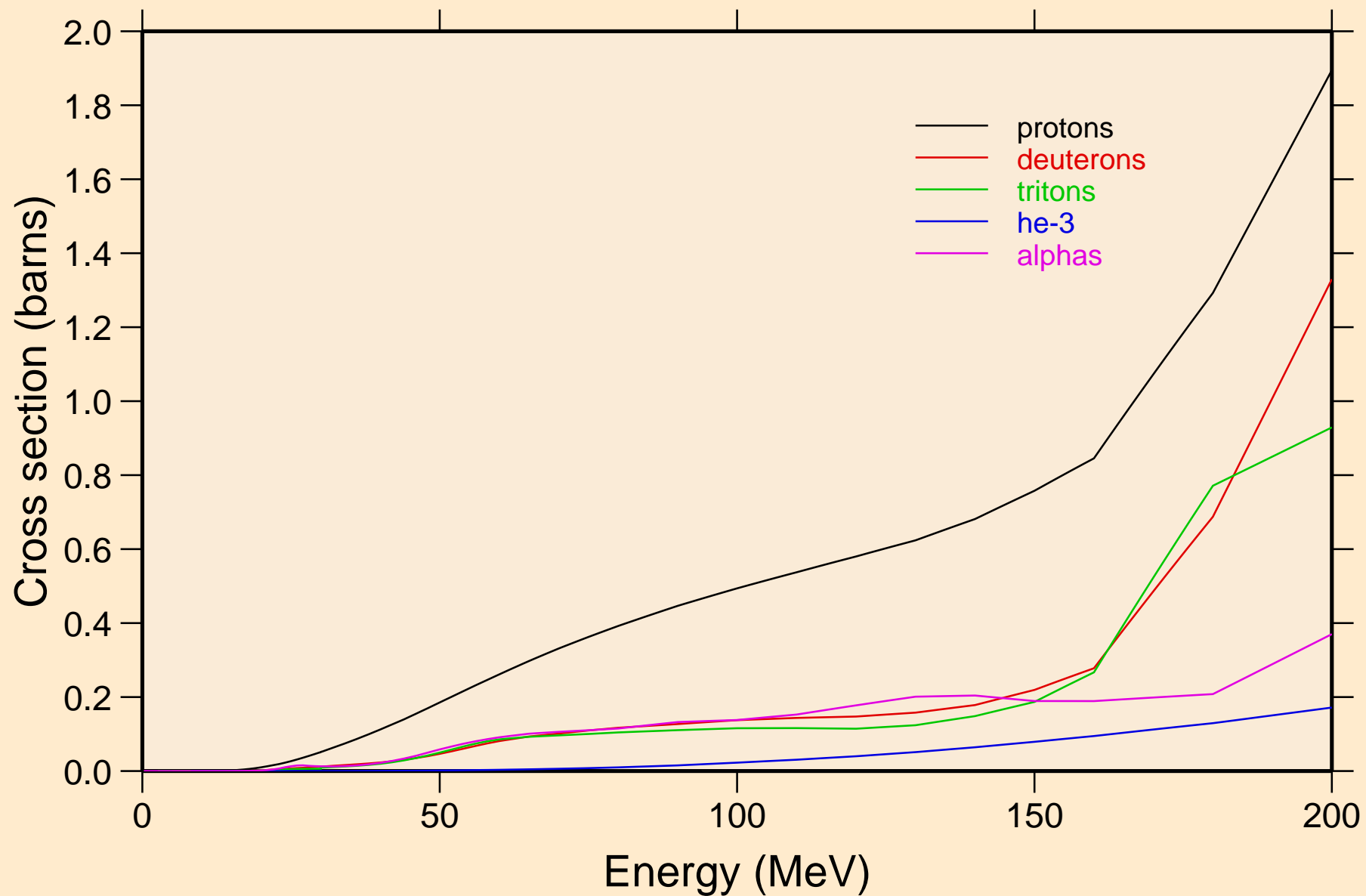

AC236 NEUTRON ACER TENDL-2019 LIBRARY; T=293.16K
protons from (n,x)

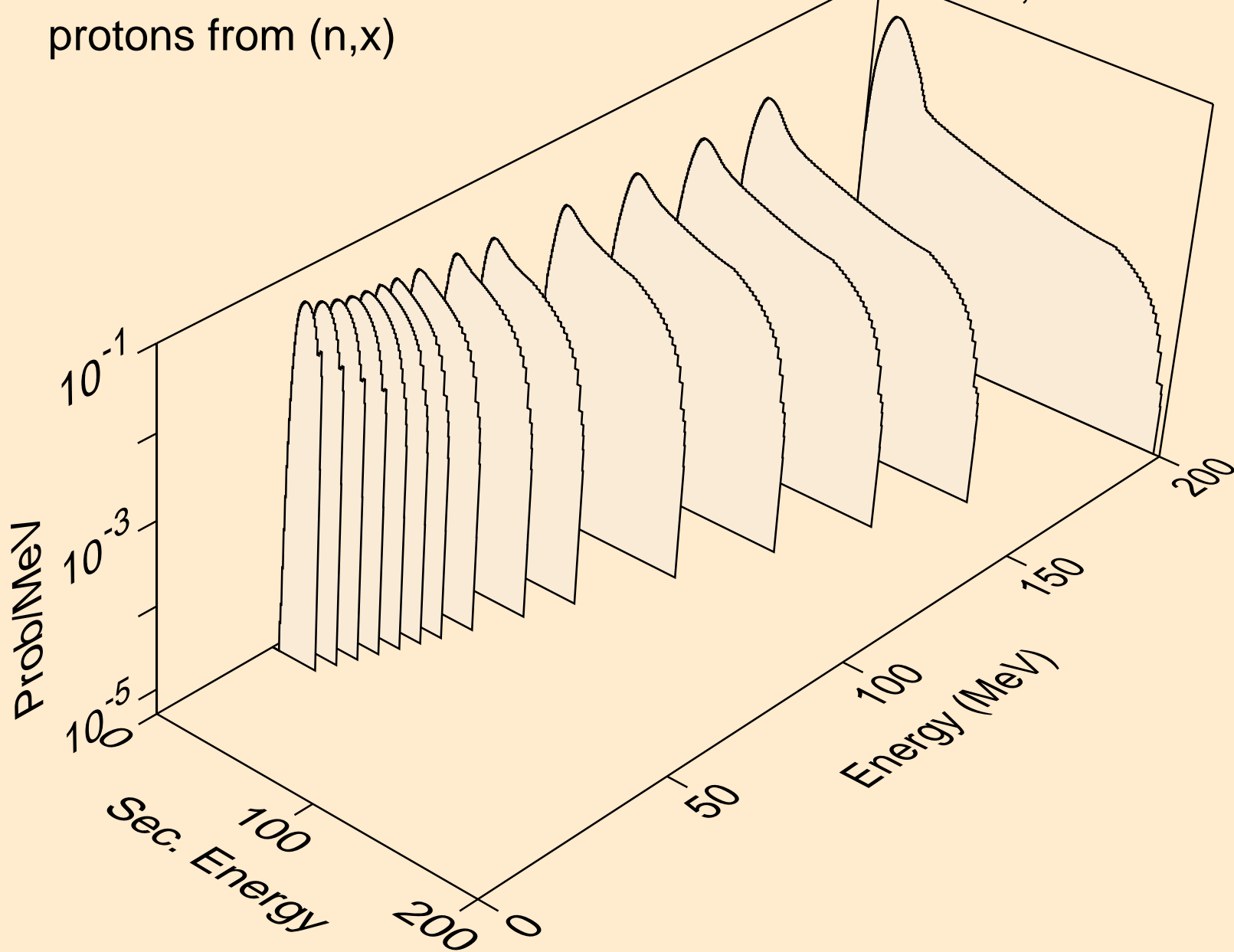

AC236 NEUTRON ACER TENDL-2019 LIBRARY; T=293.16K
protons from (n,n*)p

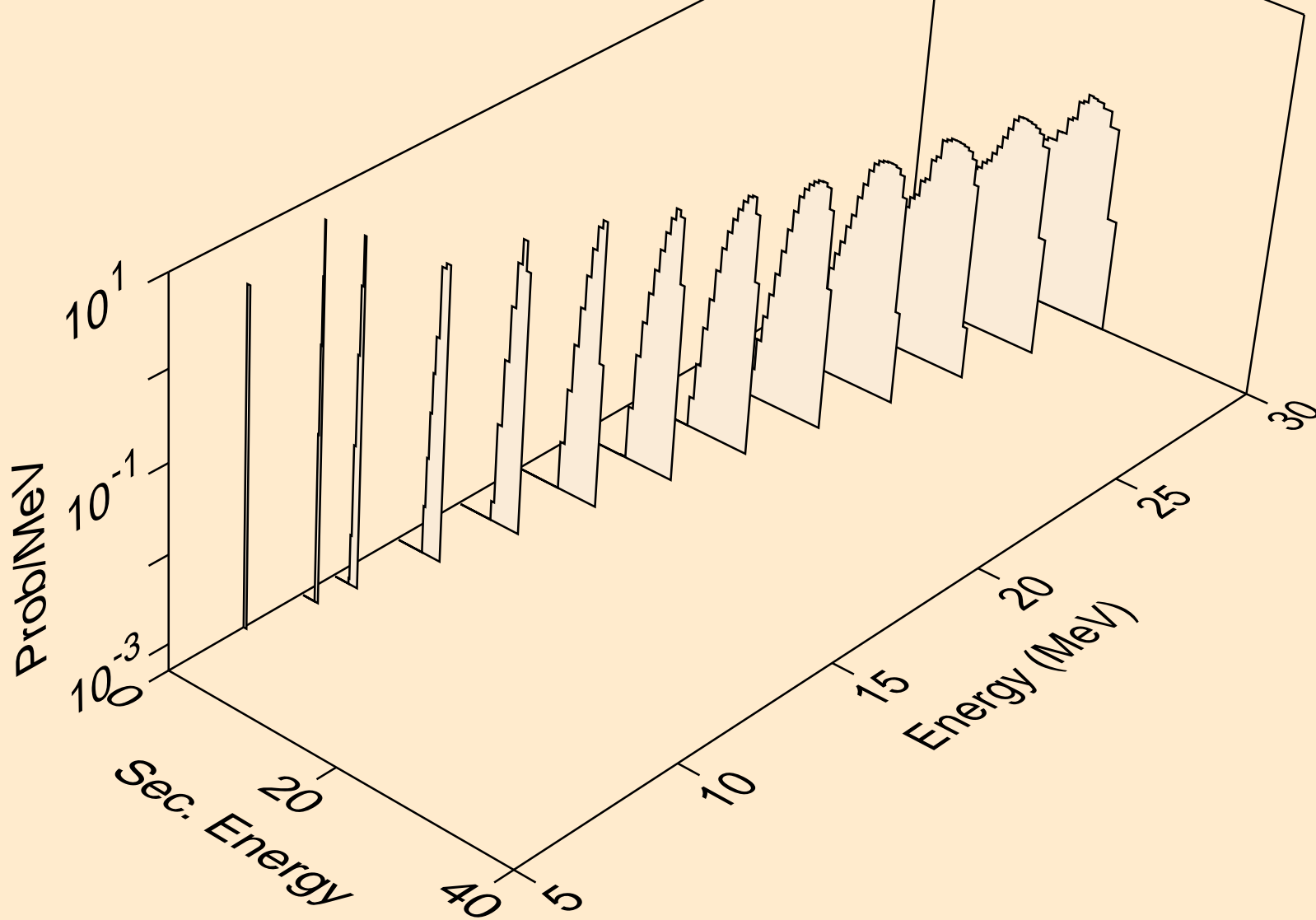

AC236 NEUTRON ACER TENDL-2019 LIBRARY; T=293.16K
protons from (n,2np)

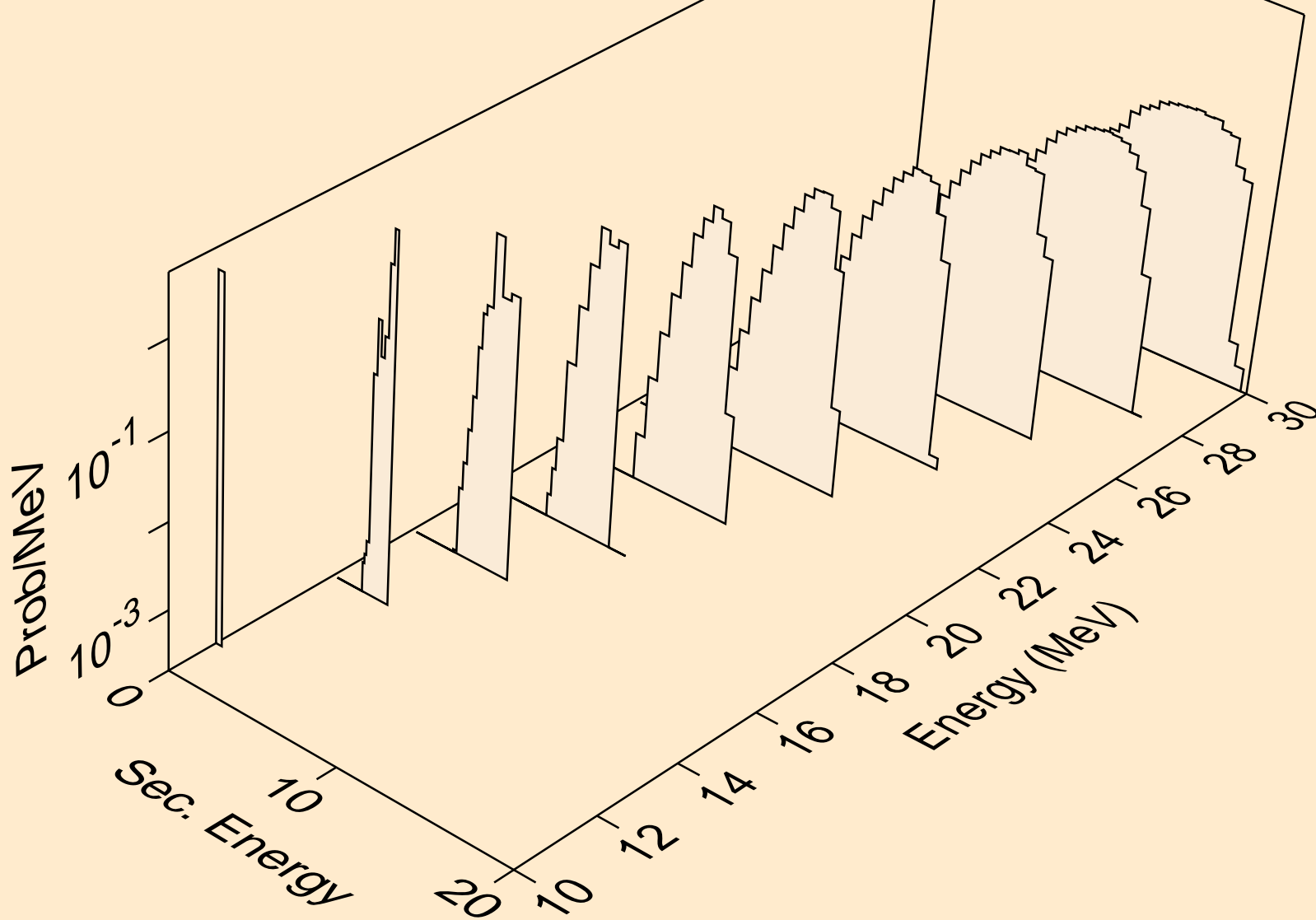

AC236 NEUTRON ACER TENDL-2019 LIBRARY; T=293.16K
protons from (n,3np)

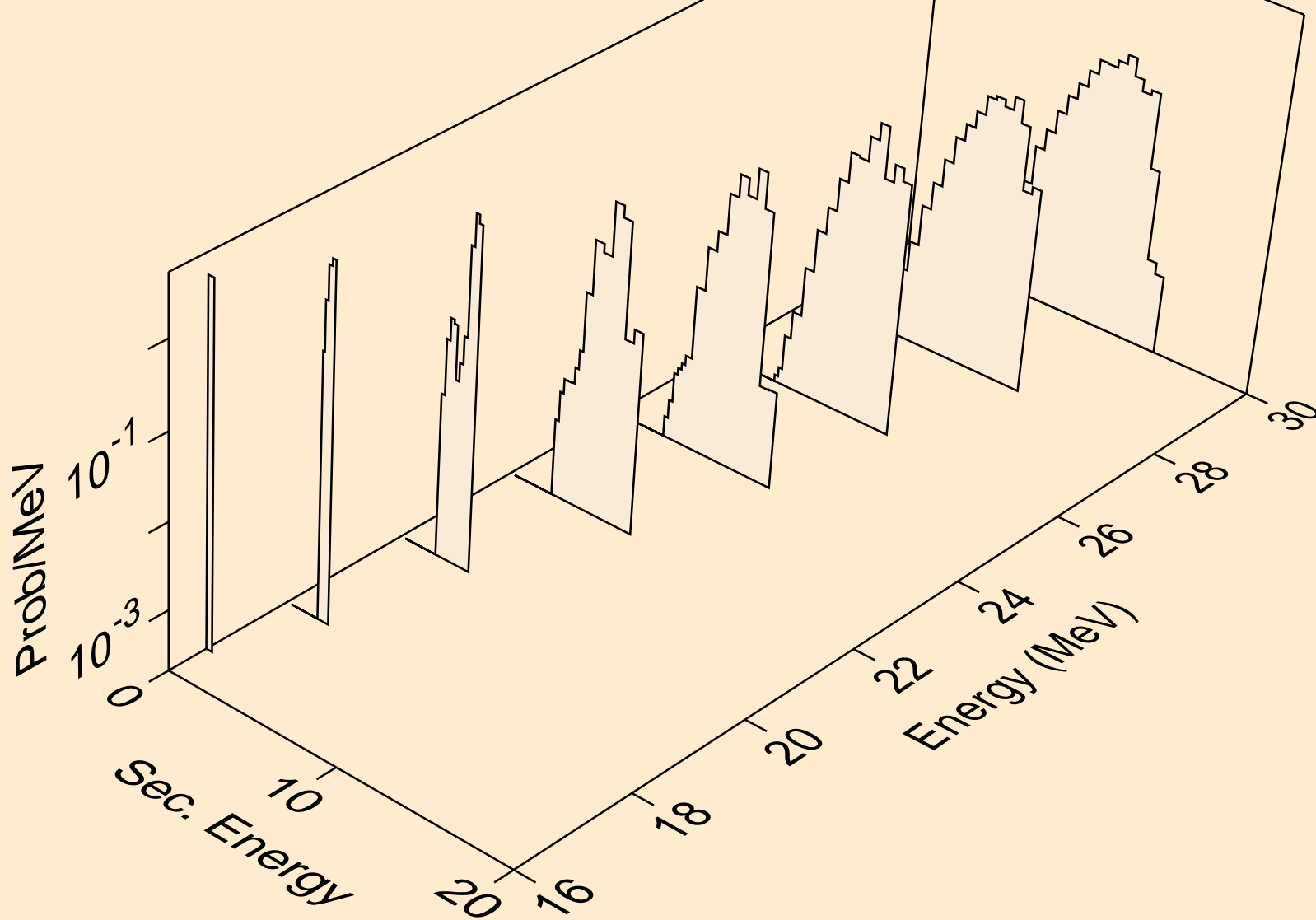

AC236 NEUTRON ACER TENDL-2019 LIBRARY; T=293.16K
protons from (n,p)

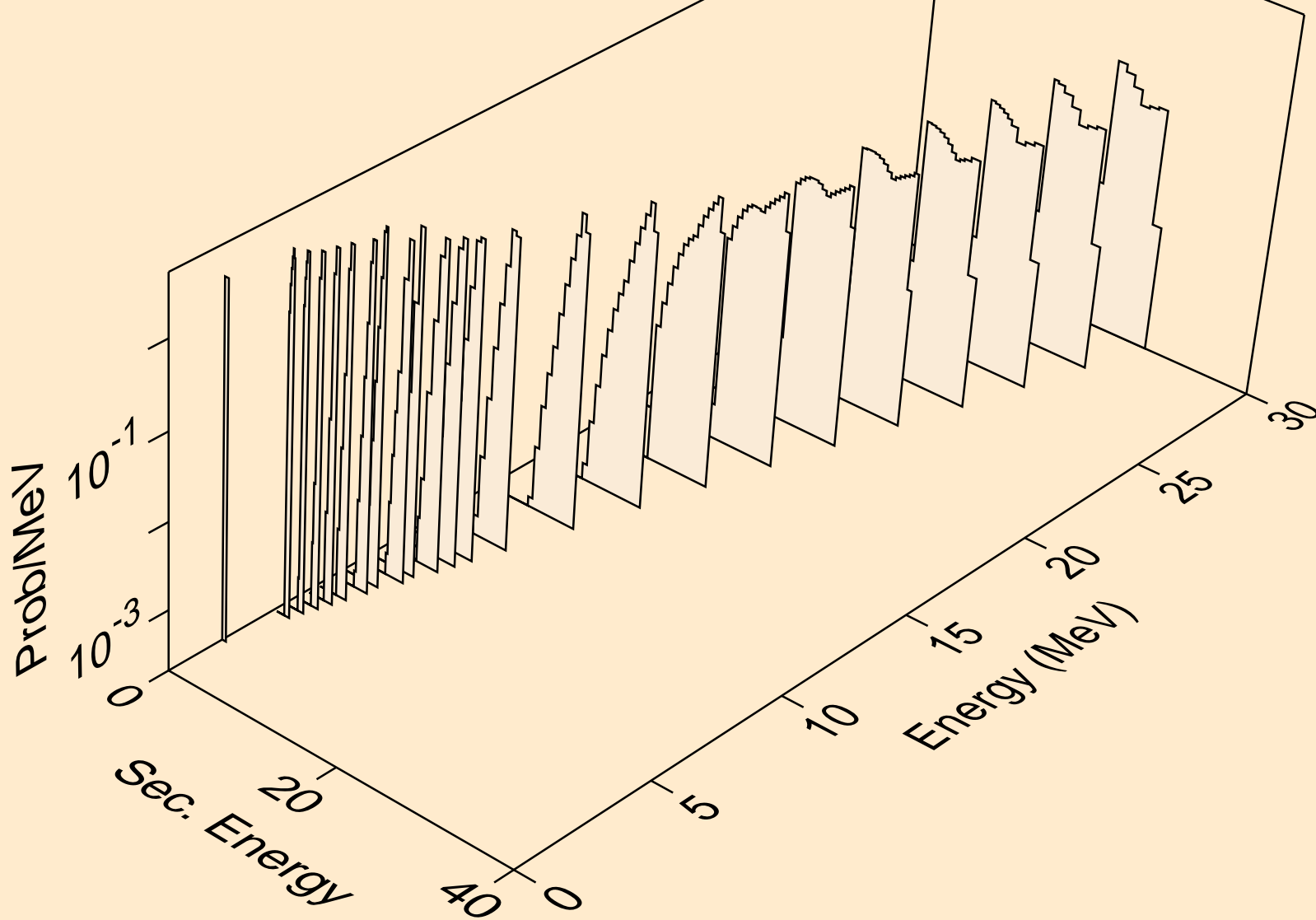

AC236 NEUTRON ACER TENDL-2019 LIBRARY; T=293.16K
protons from (n,2p)

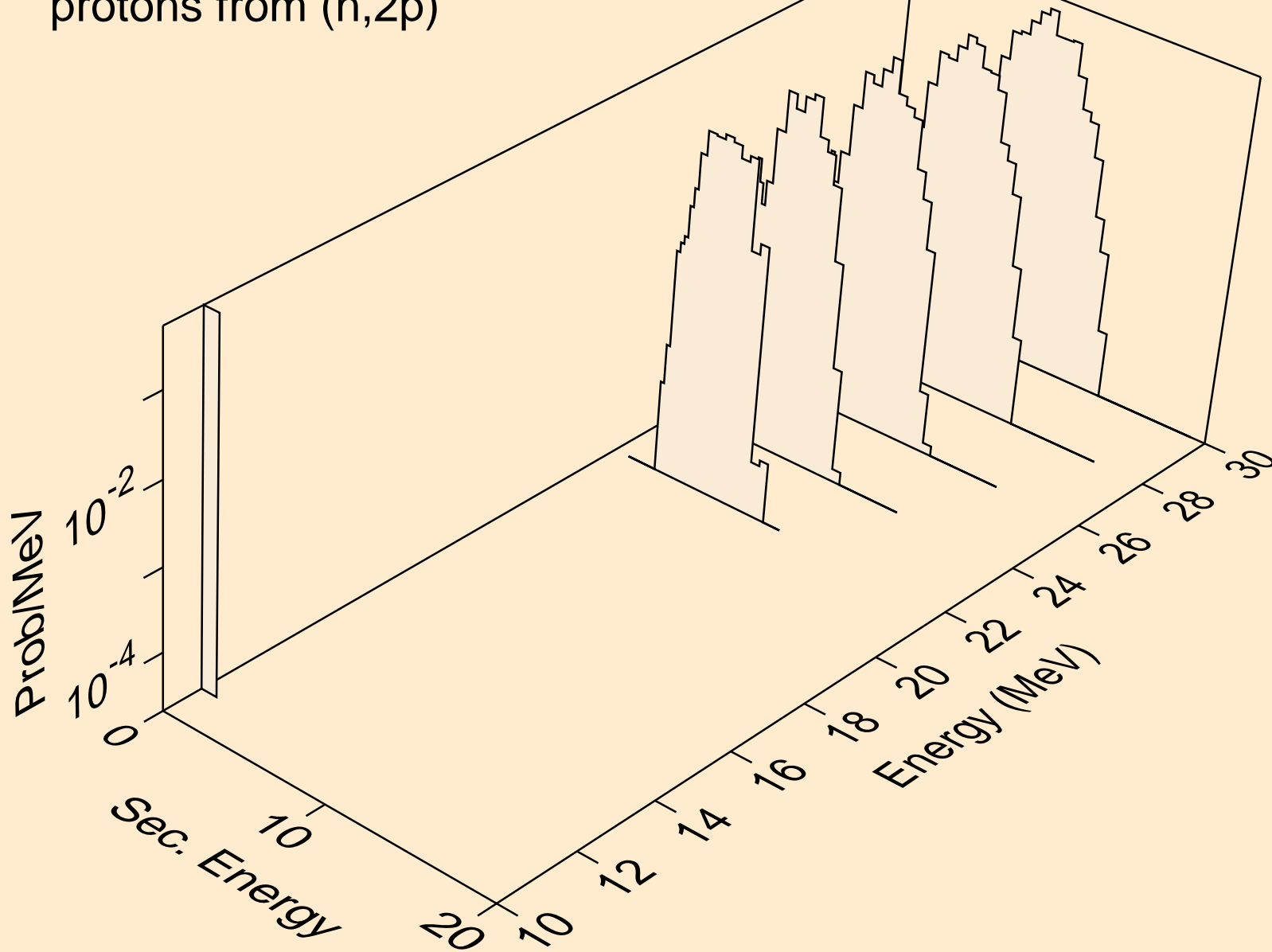

AC236 NEUTRON ACER TENDL-2019 LIBRARY; T=293.16K
deuterons from (n,x)

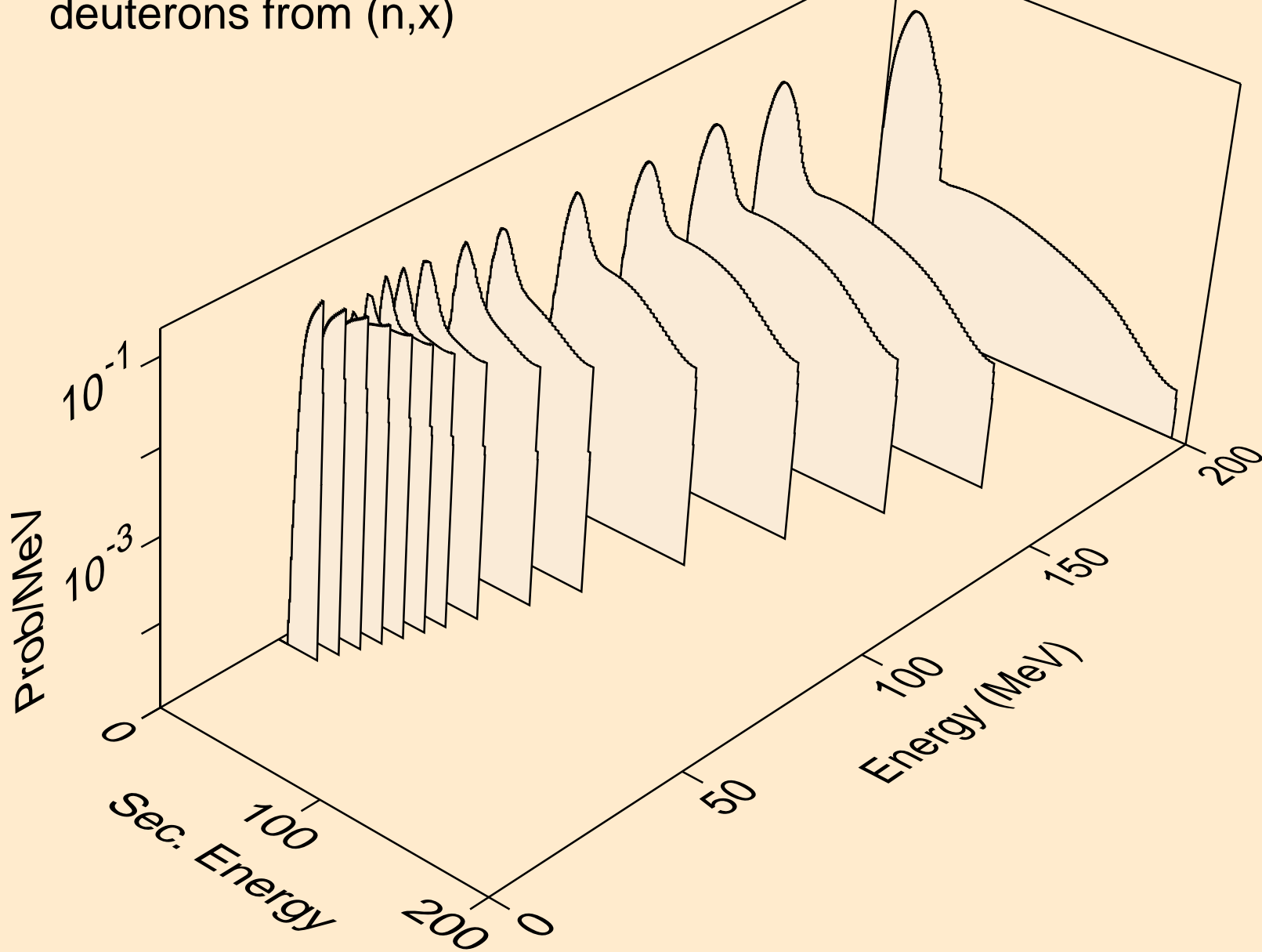

AC236 NEUTRON ACER TENDL-2019 LIBRARY; T=293.16K
deuterons from (n,2nd)

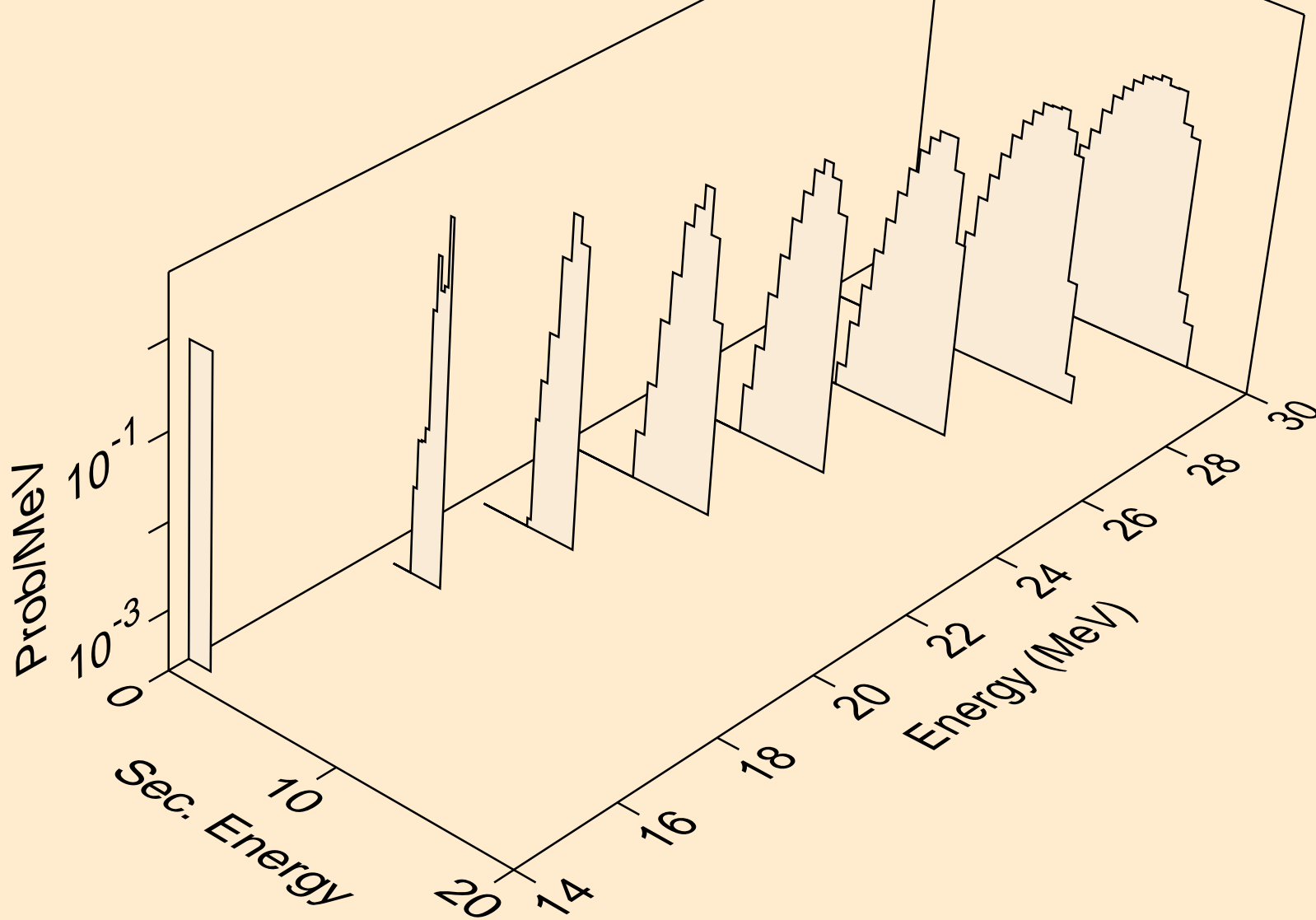

AC236 NEUTRON ACER TENDL-2019 LIBRARY; T=293.16K
deuterons from (n,n*)d

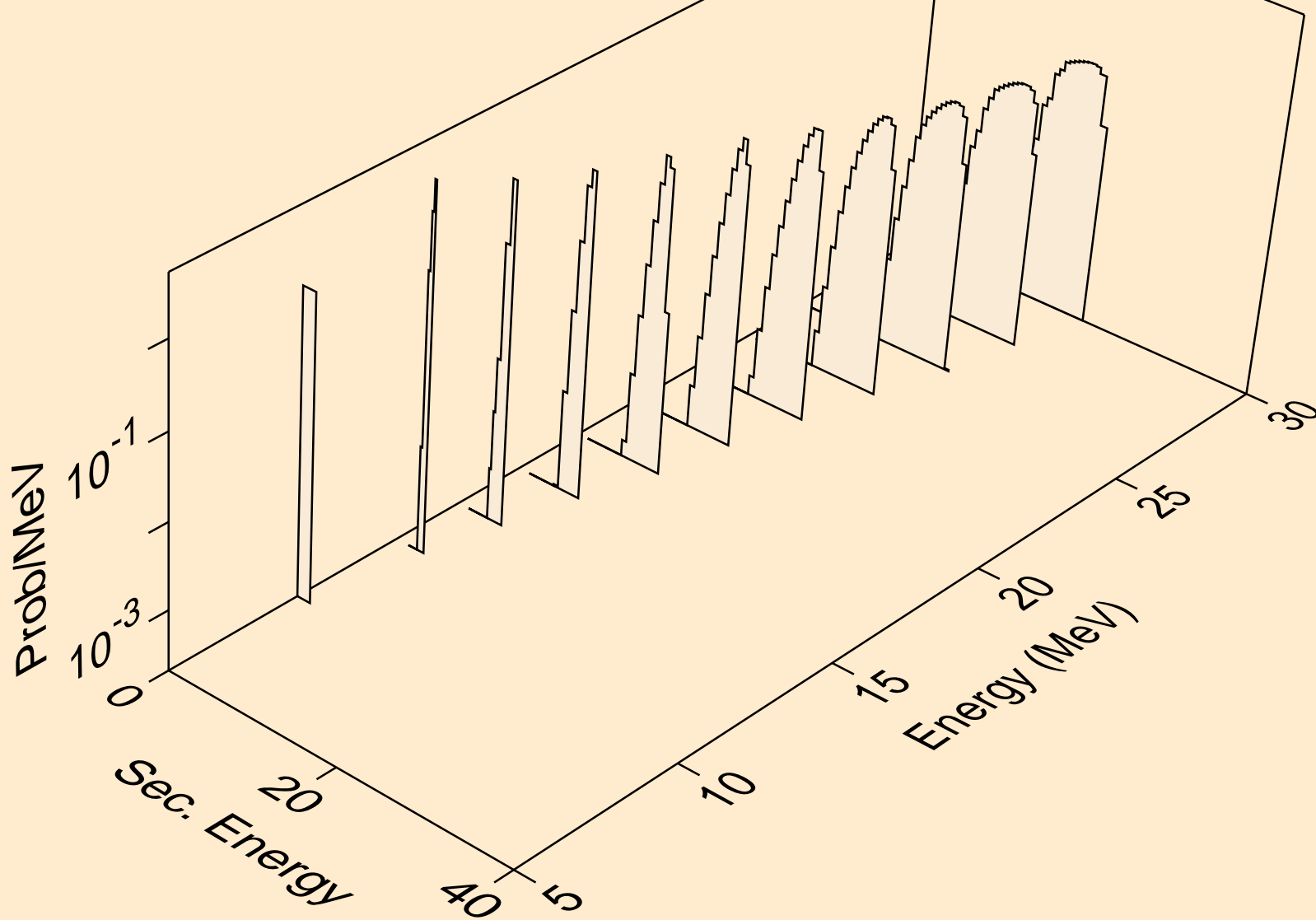

AC236 NEUTRON ACER TENDL-2019 LIBRARY; T=293.16K
deuterons from (n,d)

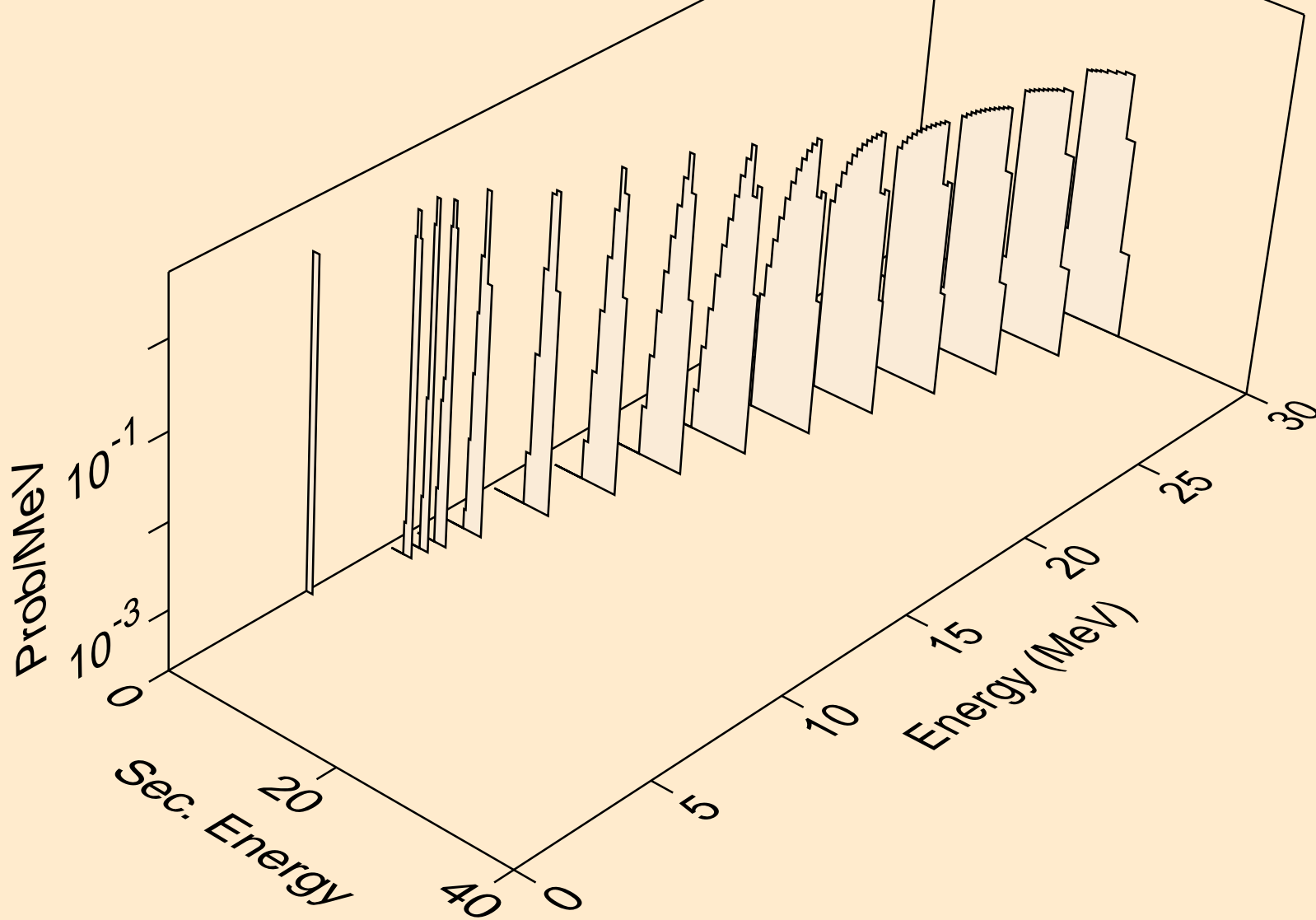

AC236 NEUTRON ACER TENDL-2019 LIBRARY; T=293.16K
tritons from (n,x)

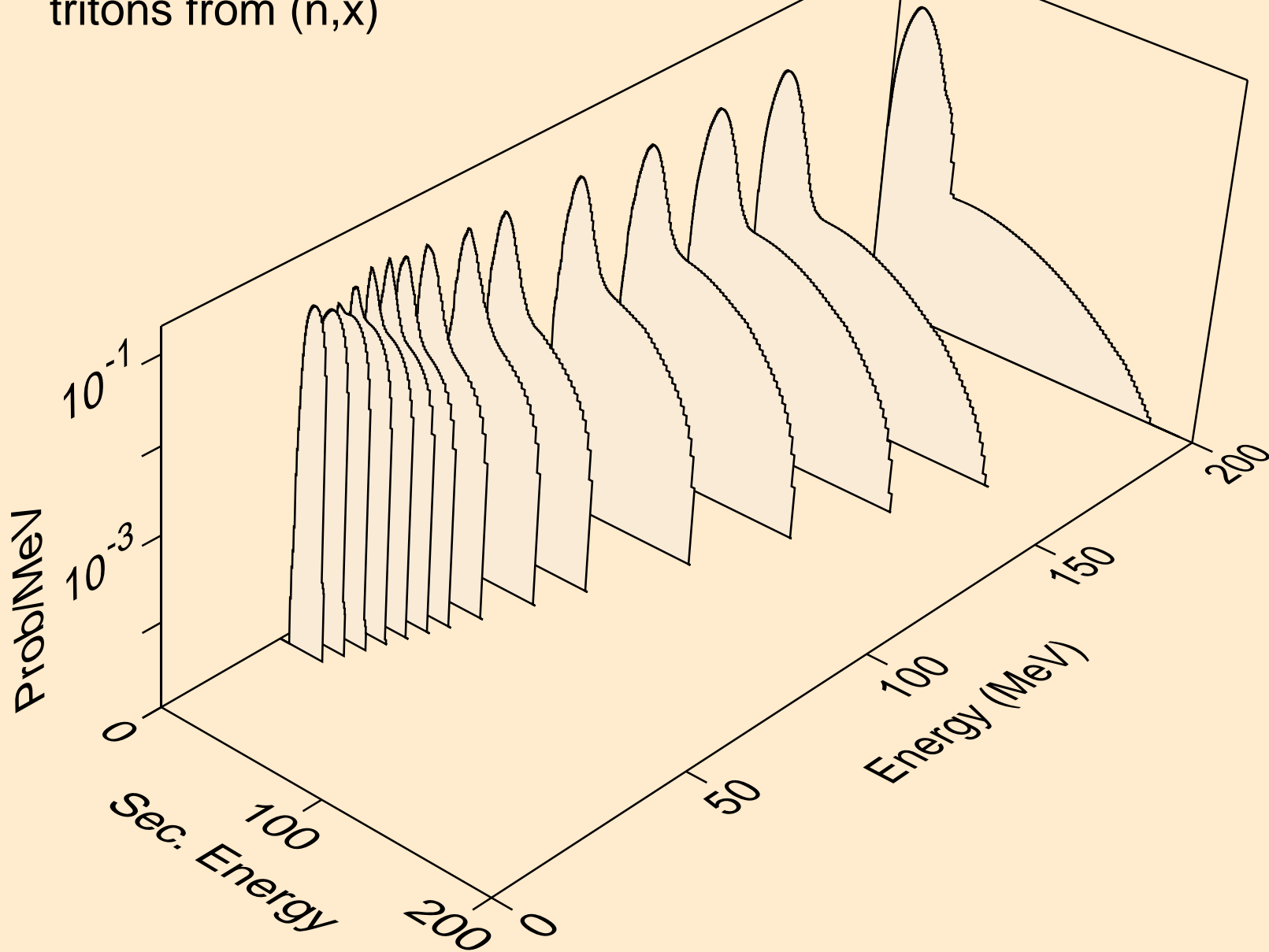

AC236 NEUTRON ACER TENDL-2019 LIBRARY; T=293.16K
tritons from (n,n*)t

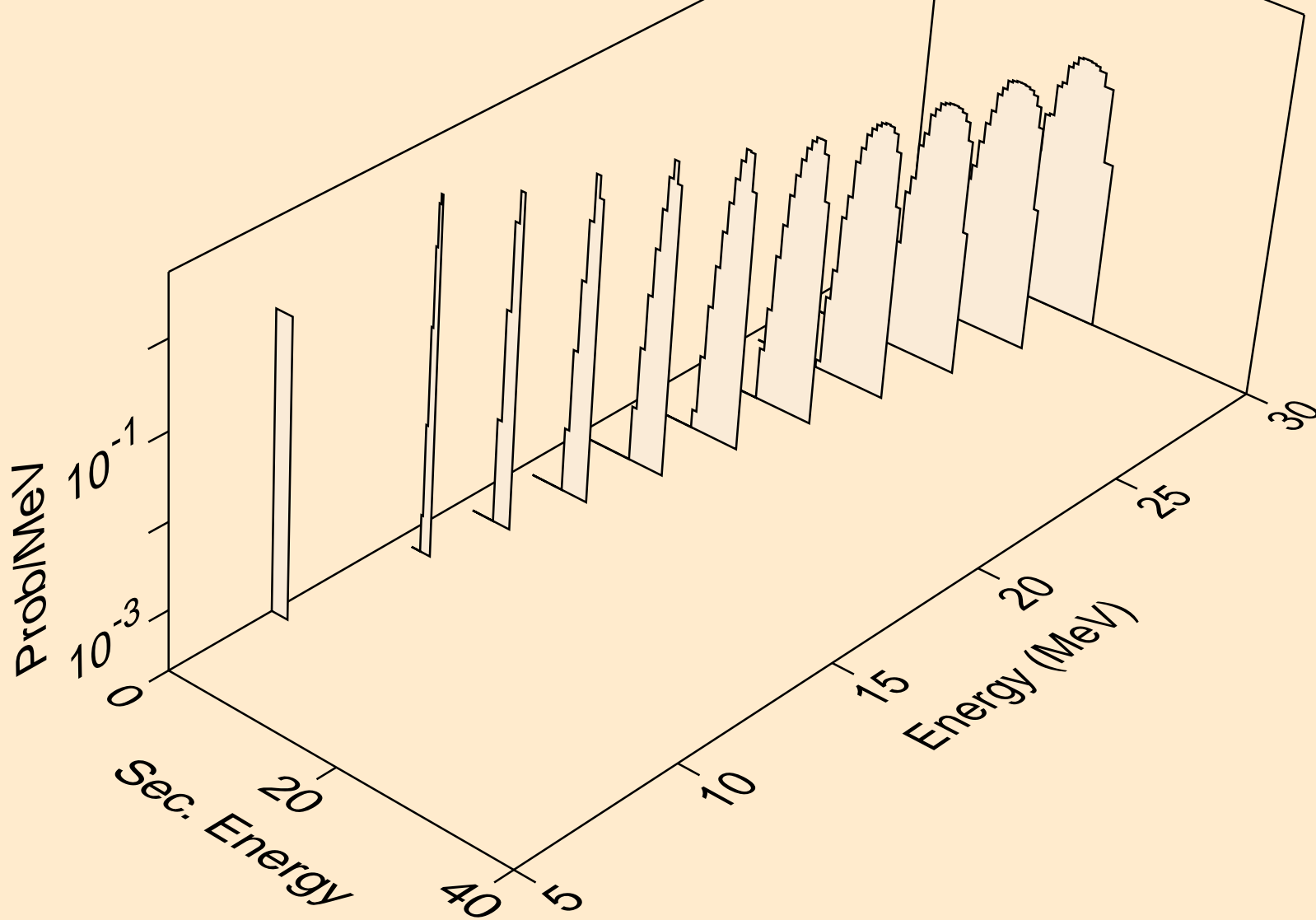

AC236 NEUTRON ACER TENDL-2019 LIBRARY; T=293.16K
tritons from (n,t)

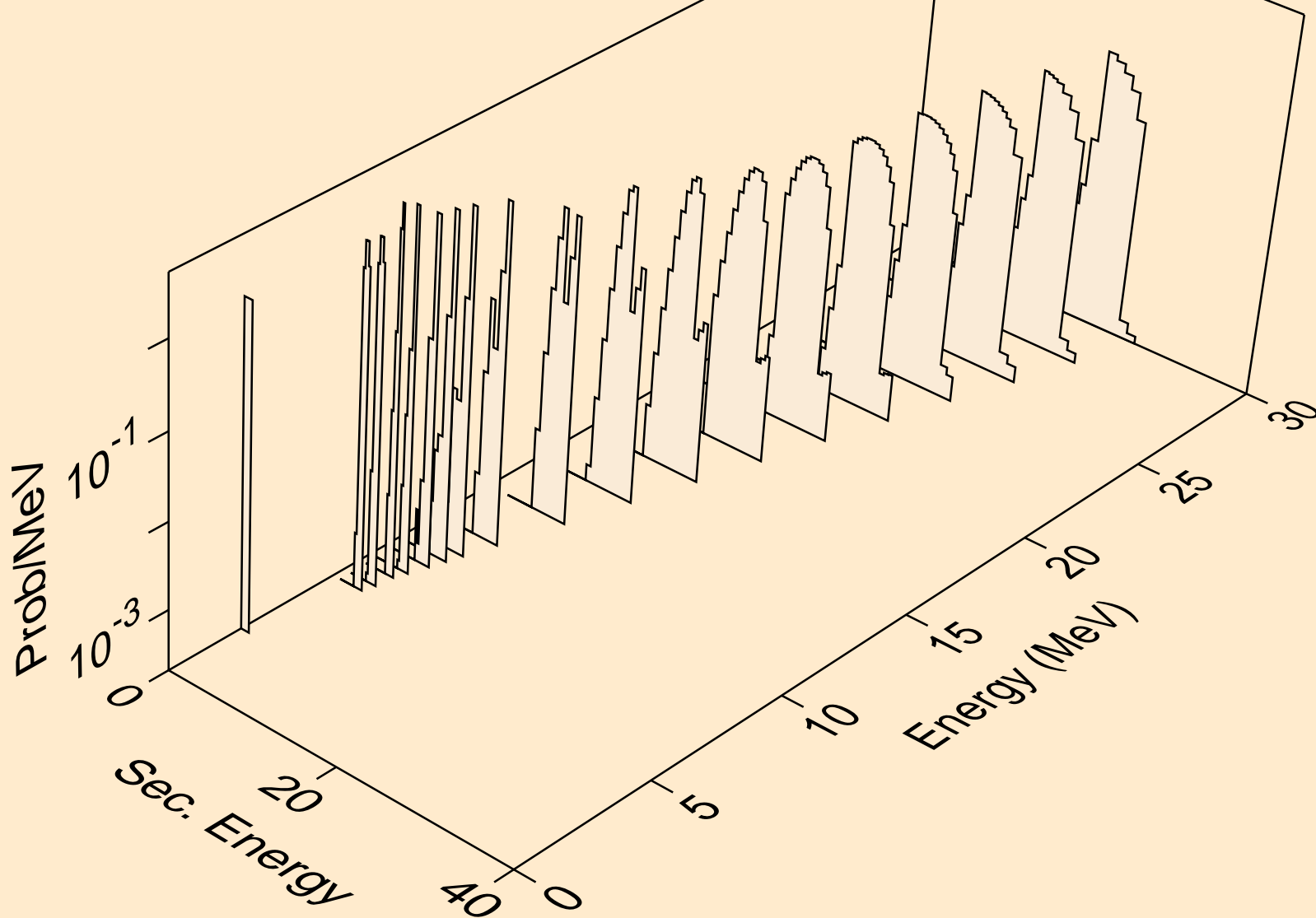

AC236 NEUTRON ACER TENDL-2019 LIBRARY; T=293.16K
he3s from (n,x)

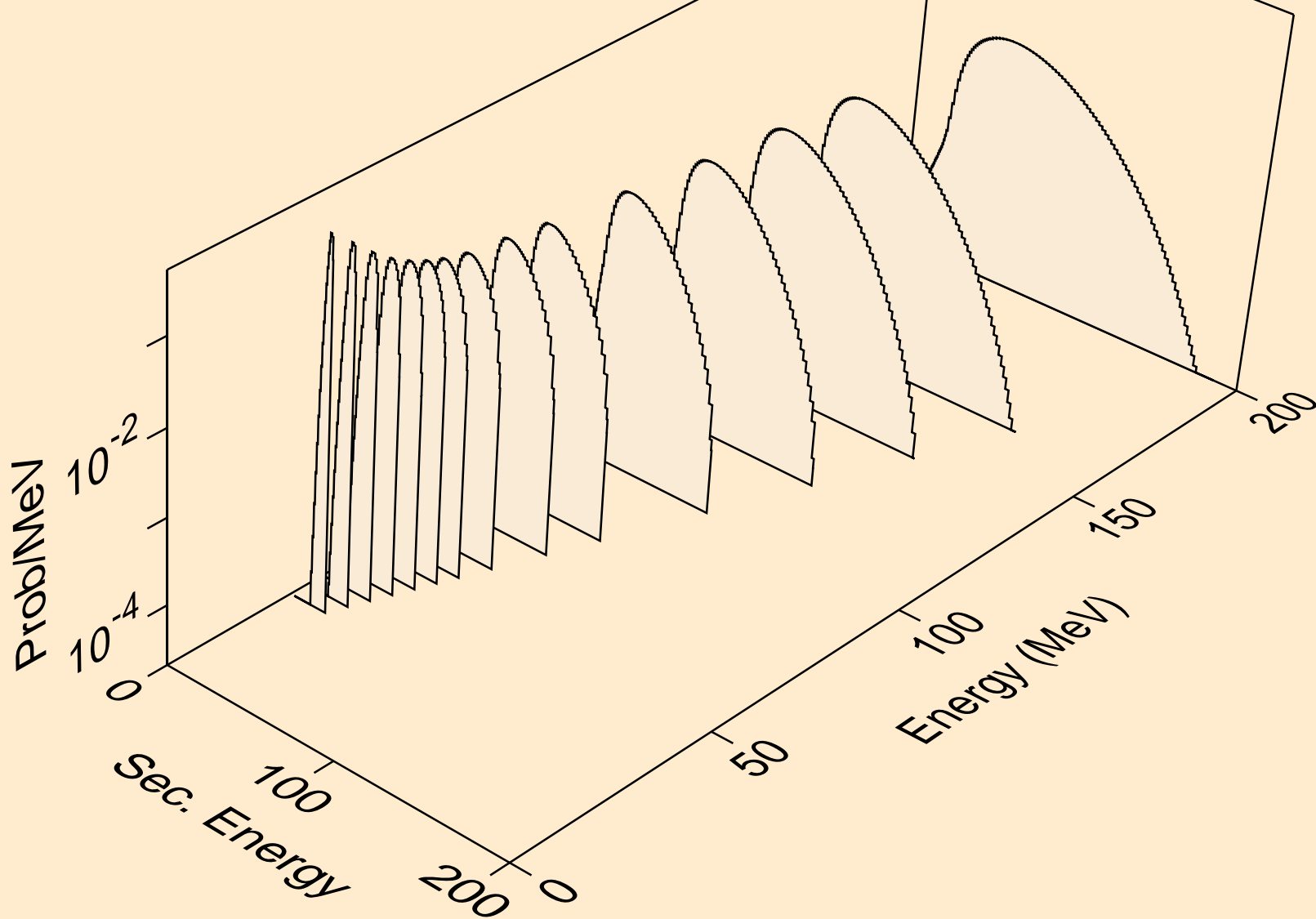

AC236 NEUTRON ACER TENDL-2019 LIBRARY; T=293.16K
he3s from (n,n*)he3

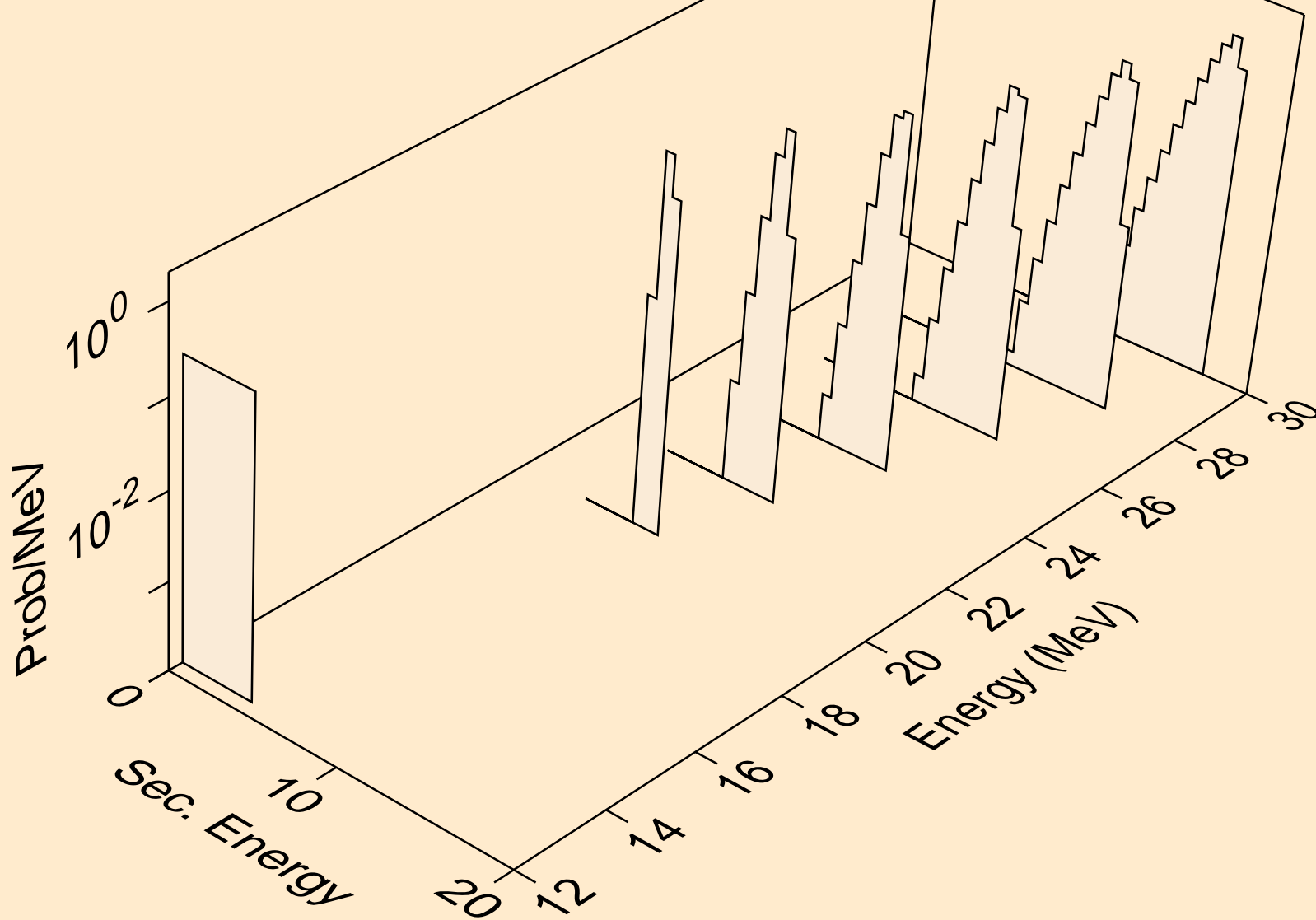

AC236 NEUTRON ACER TENDL-2019 LIBRARY; T=293.16K
he3s from (n,he3)

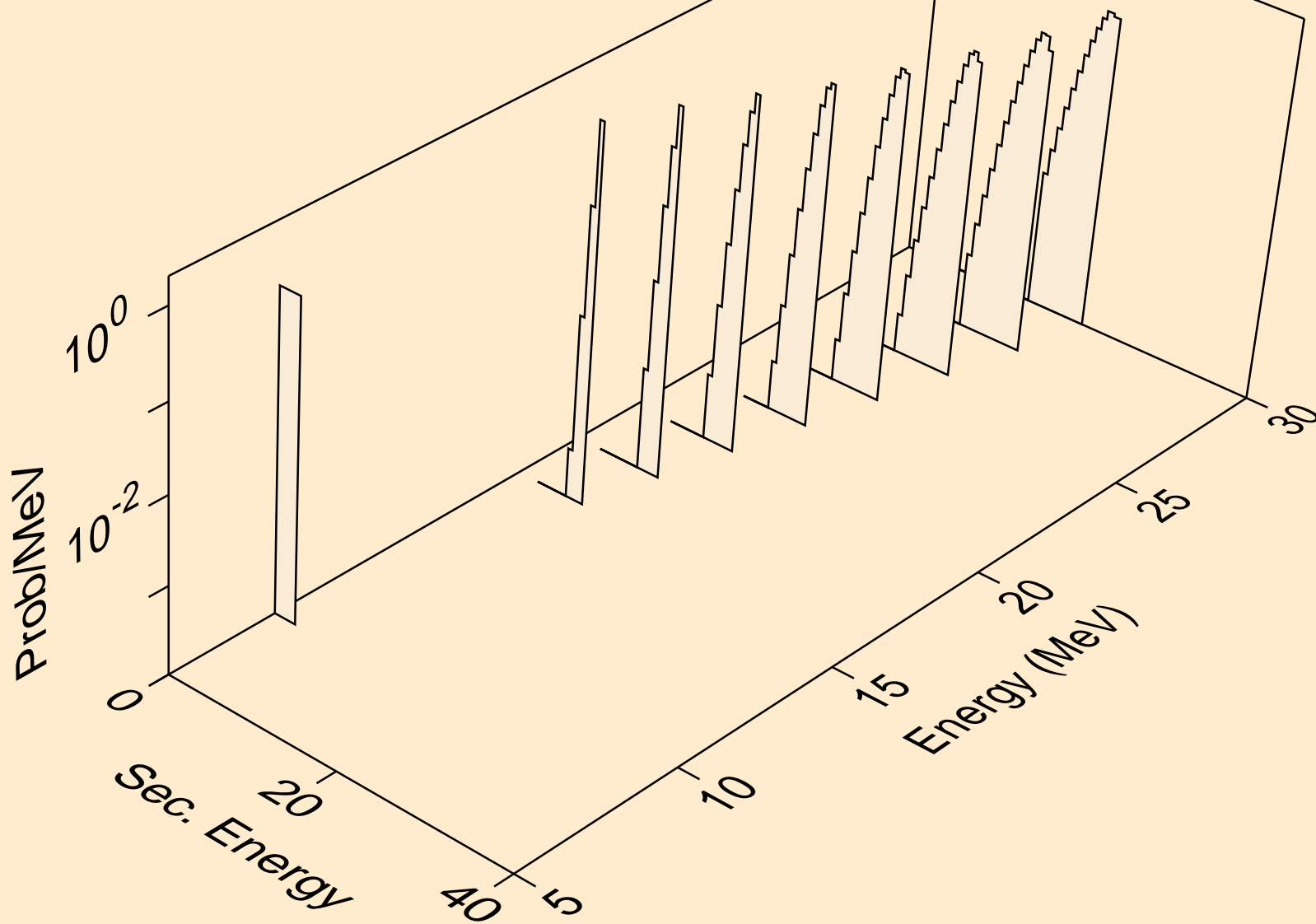

AC236 NEUTRON ACER TENDL-2019 LIBRARY; T=293.16K
alphas from (n,x)

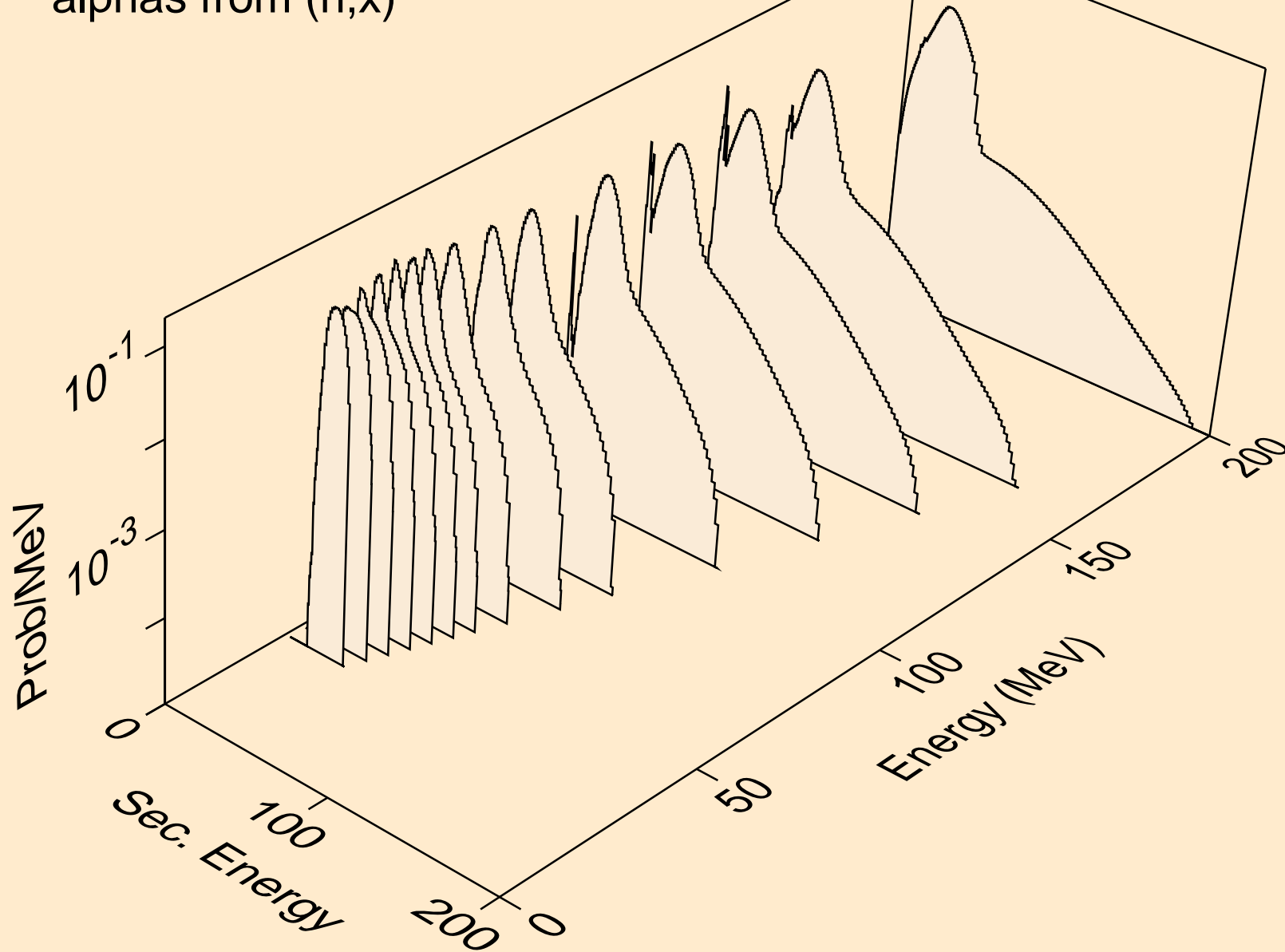

AC236 NEUTRON ACER TENDL-2019 LIBRARY; T=293.16K
alphas from (n,n*)a

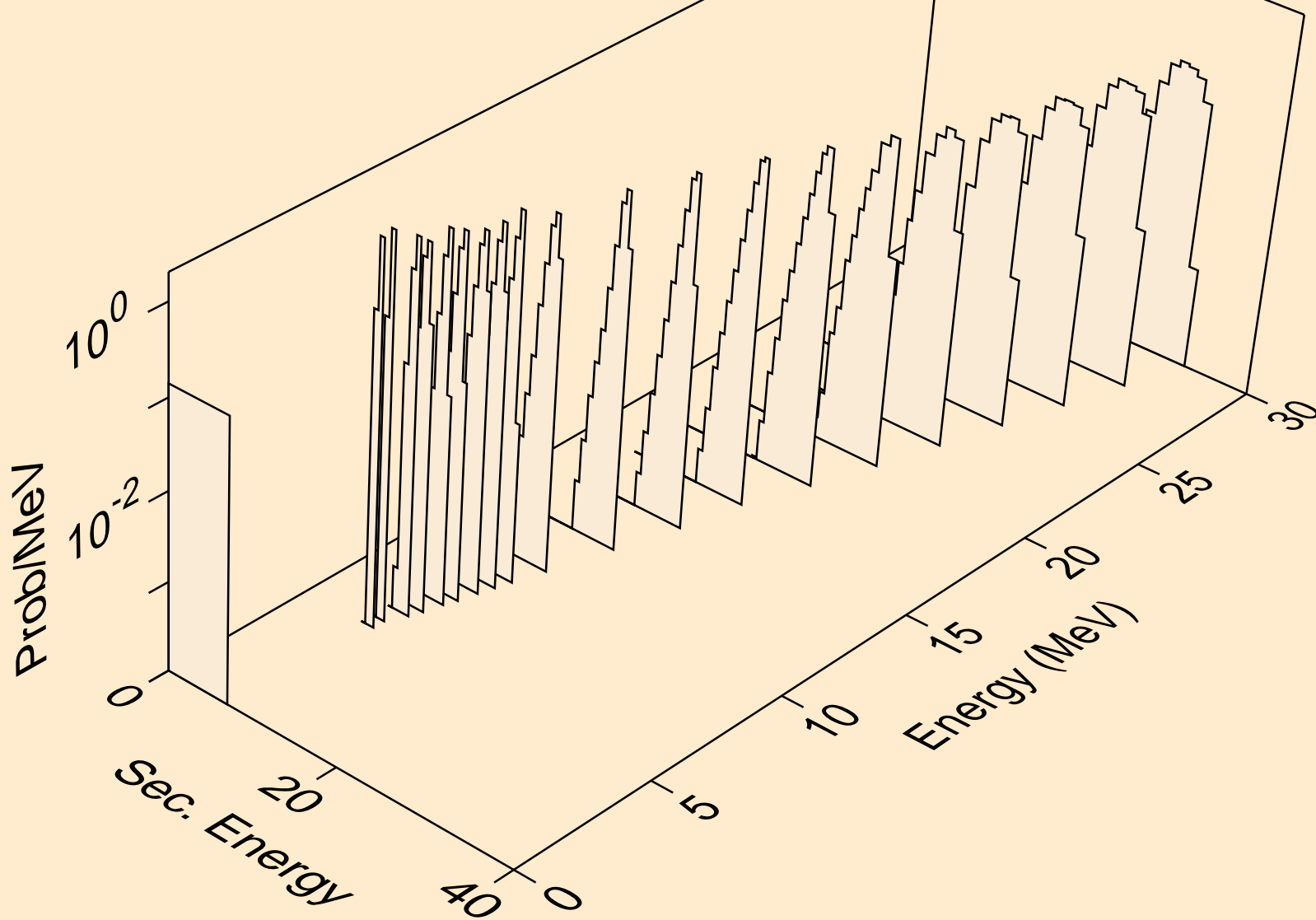

AC236 NEUTRON ACER TENDL-2019 LIBRARY; T=293.16K
alphas from (n,2n)a

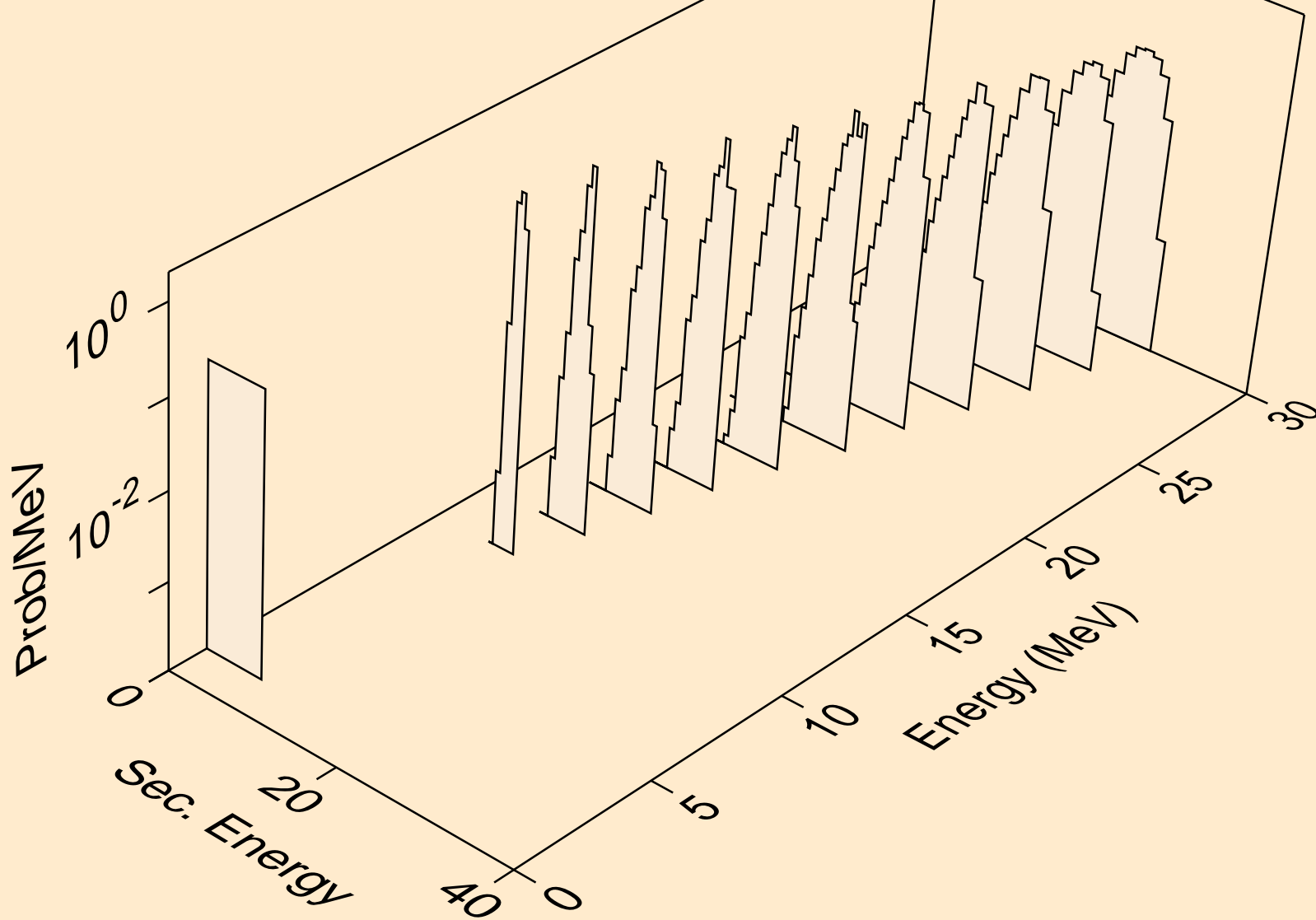

AC236 NEUTRON ACER TENDL-2019 LIBRARY; T=293.16K
alphas from (n,3n)a

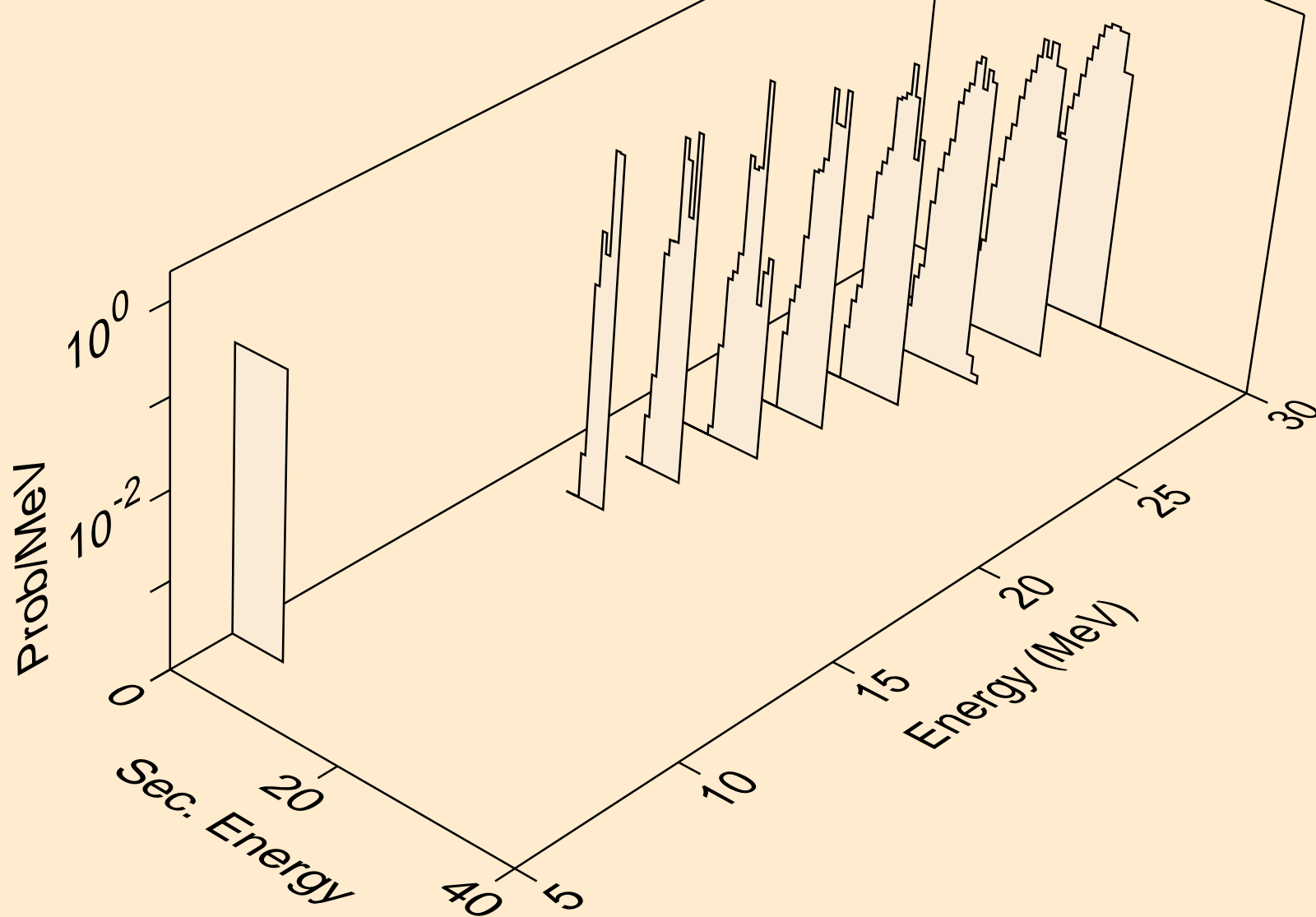

AC236 NEUTRON ACER TENDL-2019 LIBRARY; T=293.16K
alphas from (n,a)

