

AM235 NEUTRON ACER TENDL-2019 LIBRARY; T=293.16K
Principal cross sections

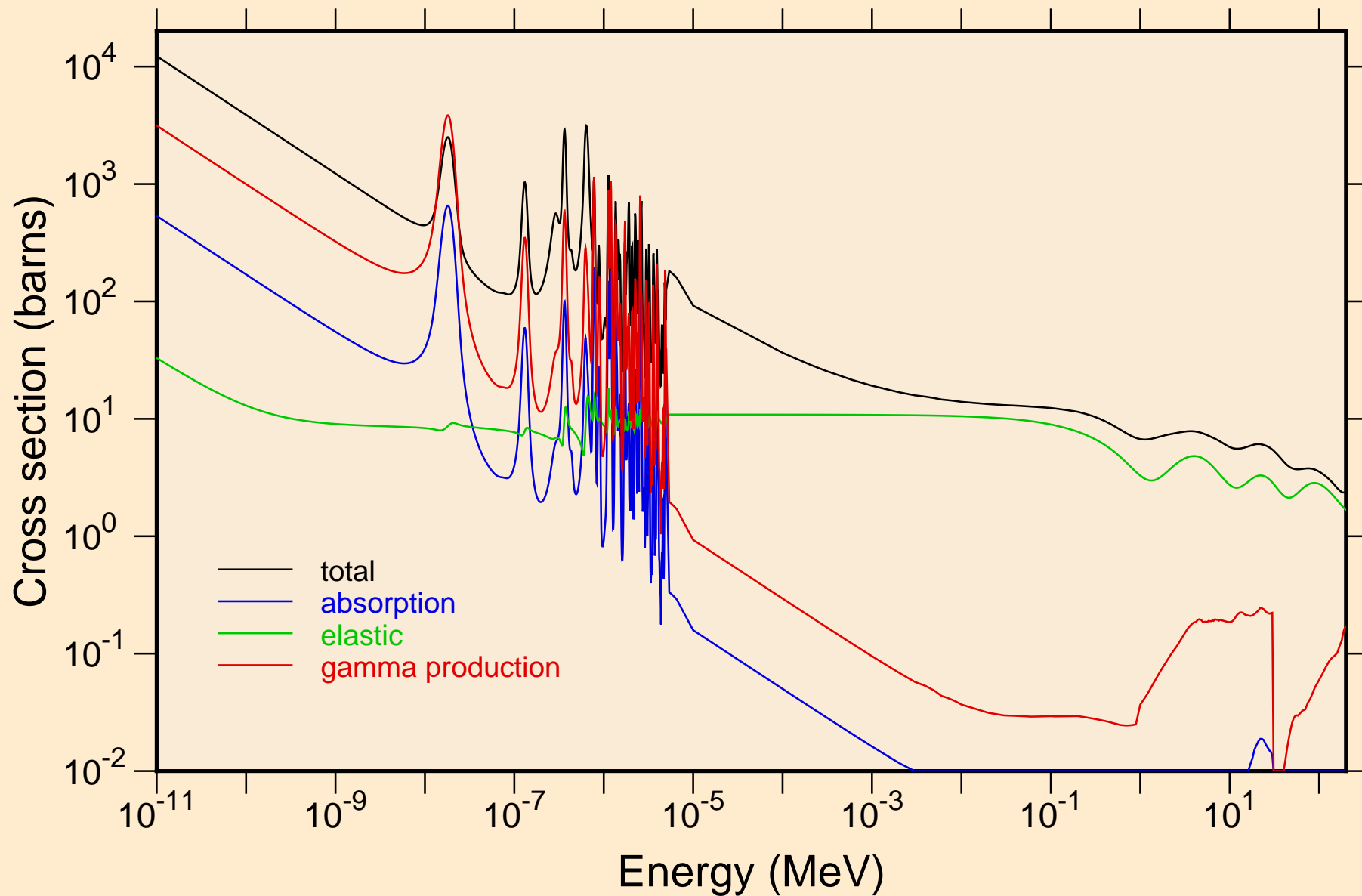

AM235 NEUTRON ACER TENDL-2019 LIBRARY; T=293.16K
resonance total cross section

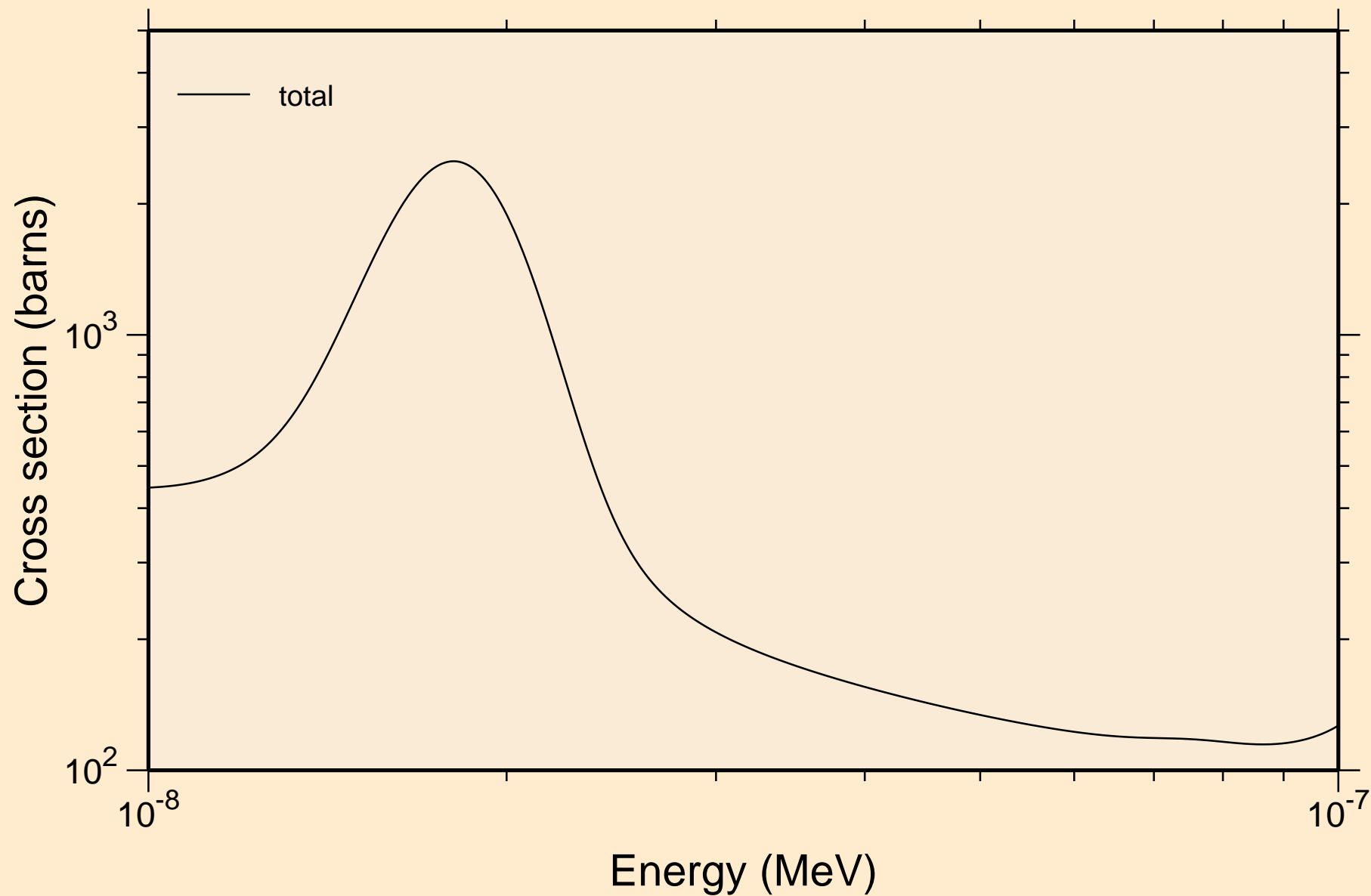

AM235 NEUTRON ACER TENDL-2019 LIBRARY; T=293.16K
resonance total cross section

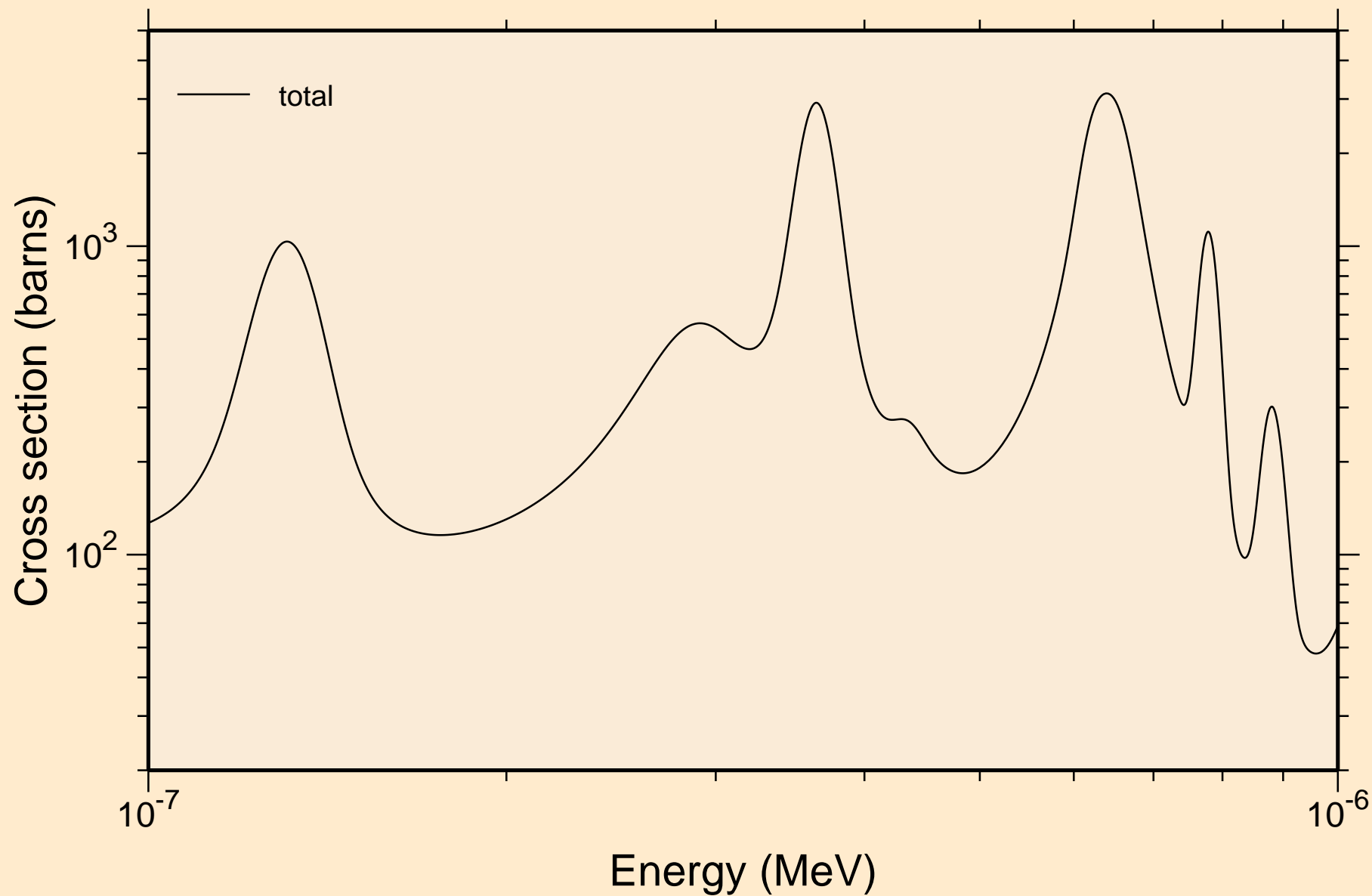

AM235 NEUTRON ACER TENDL-2019 LIBRARY; T=293.16K
resonance total cross section

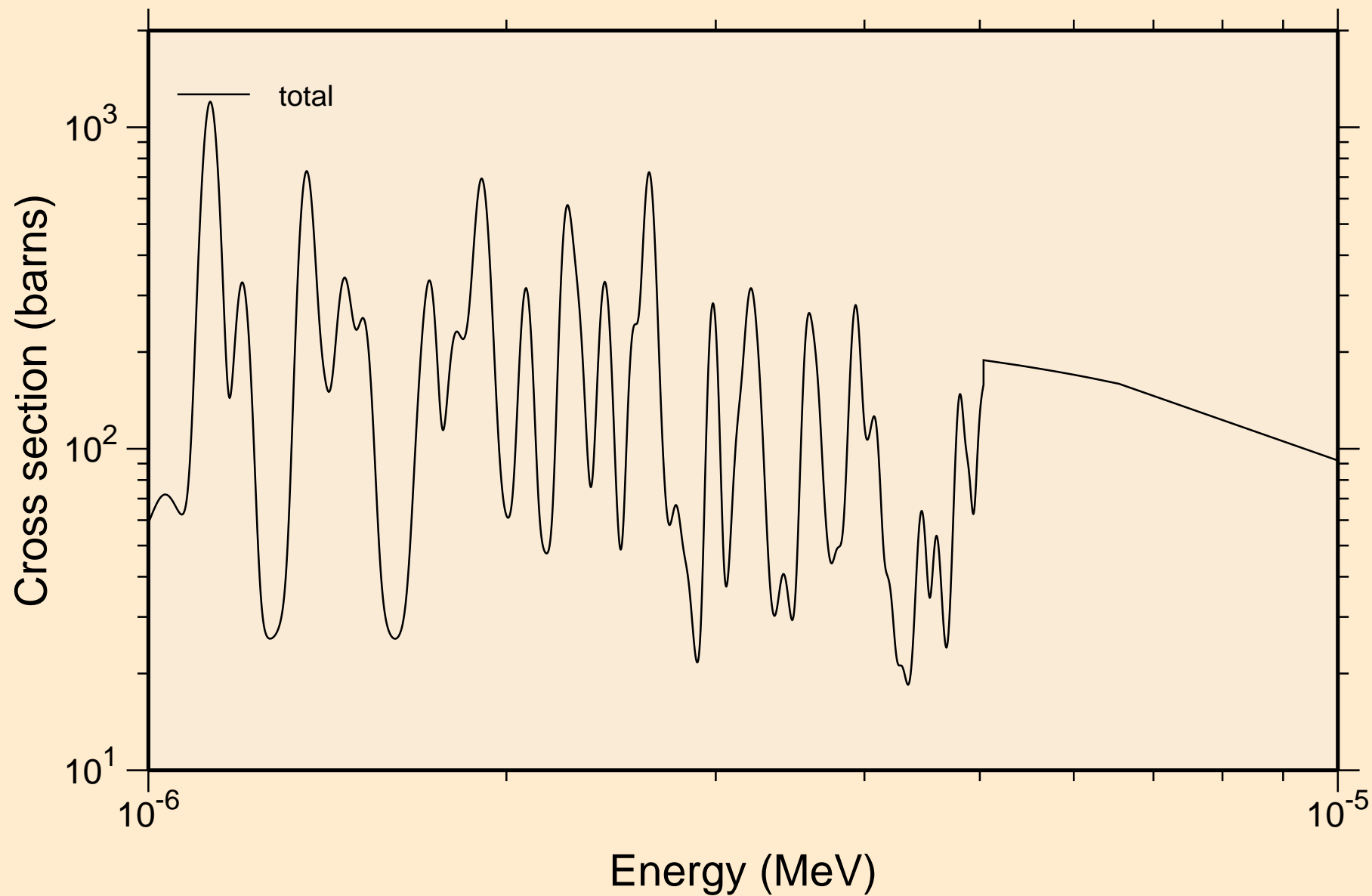

AM235 NEUTRON ACER TENDL-2019 LIBRARY; T=293.16K
resonance total cross section

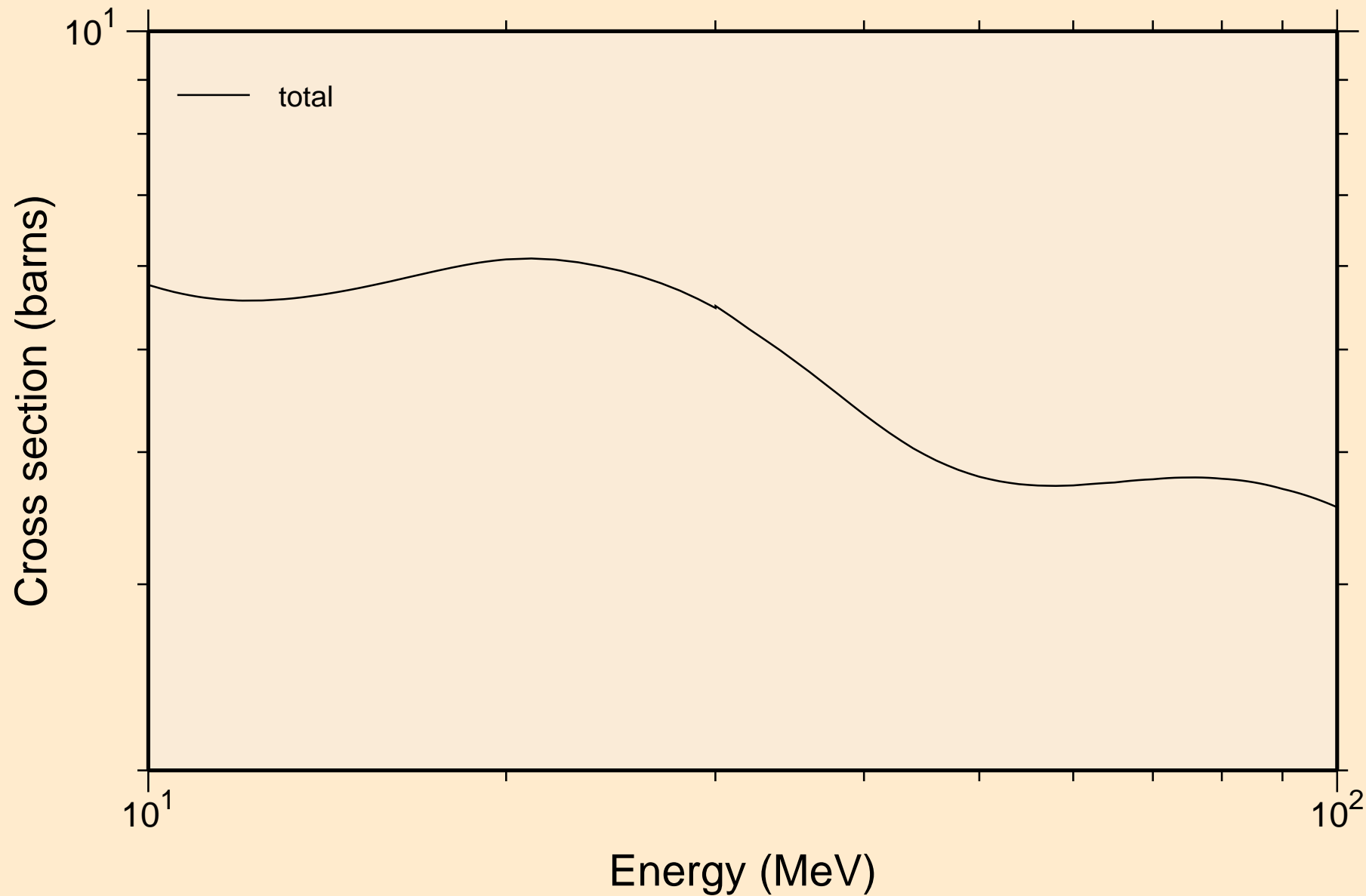

AM235 NEUTRON ACER TENDL-2019 LIBRARY; T=293.16K
resonance absorption cross sections

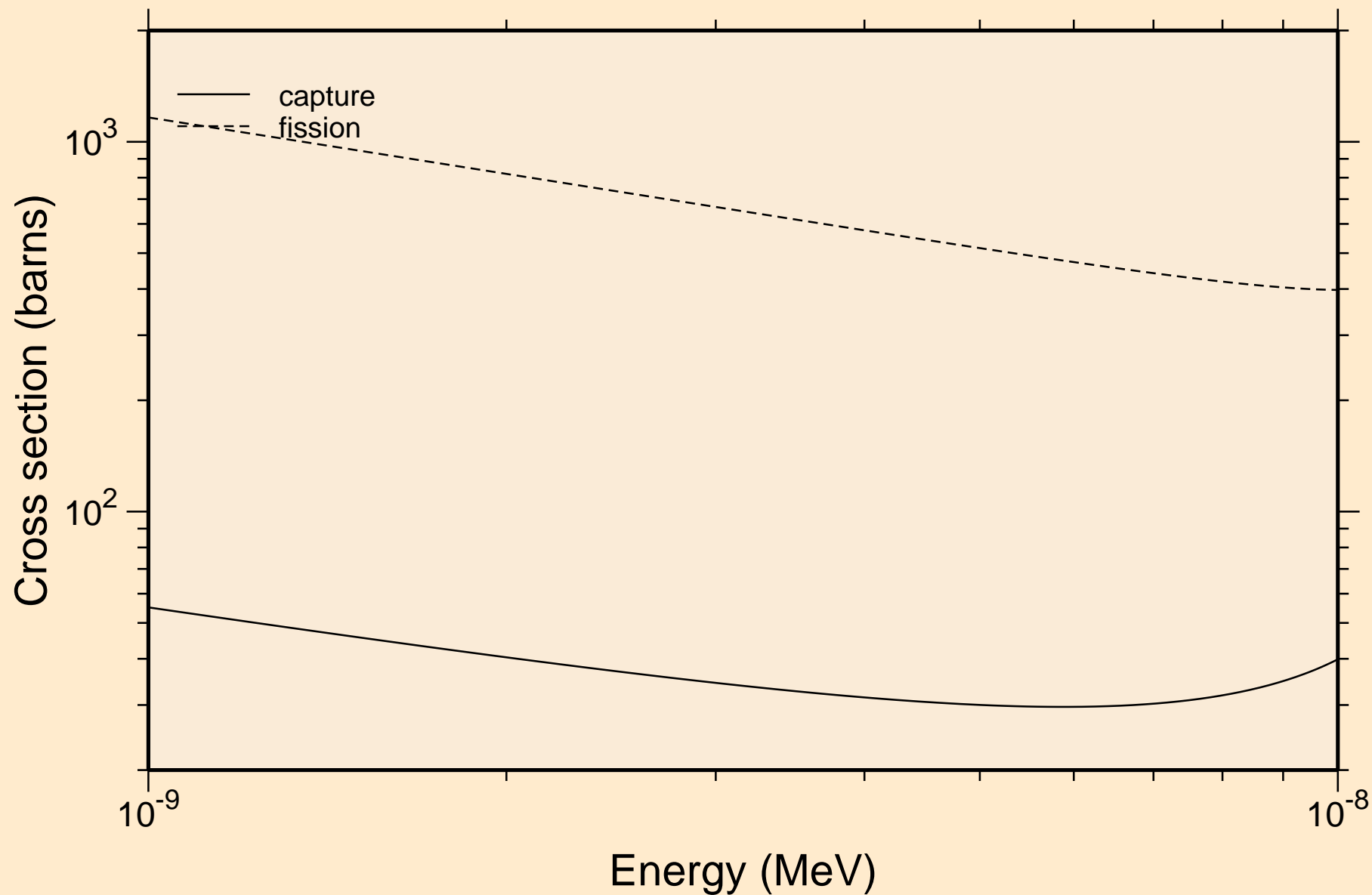

AM235 NEUTRON ACER TENDL-2019 LIBRARY; T=293.16K
resonance absorption cross sections

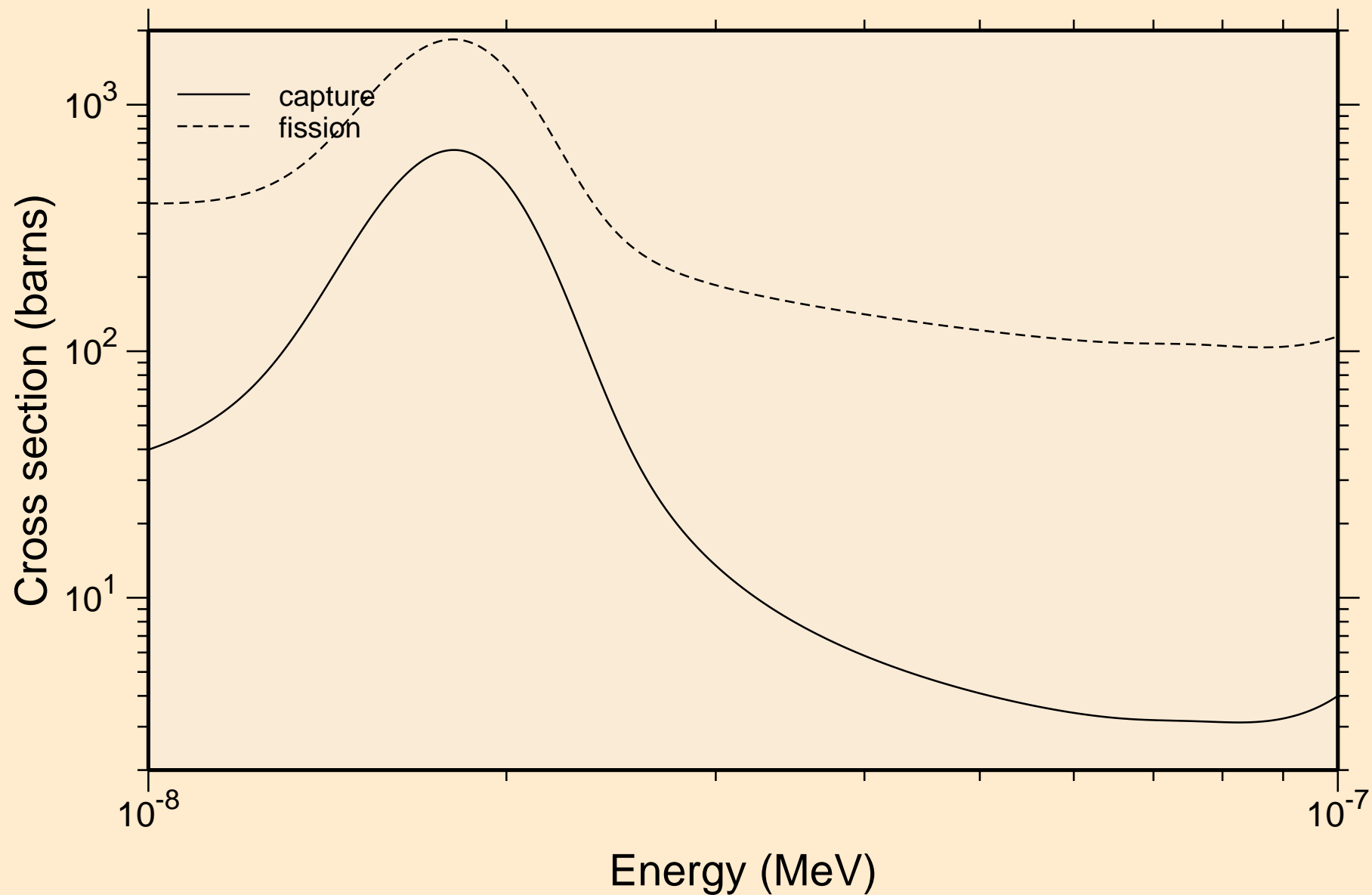

AM235 NEUTRON ACER TENDL-2019 LIBRARY; T=293.16K
resonance absorption cross sections

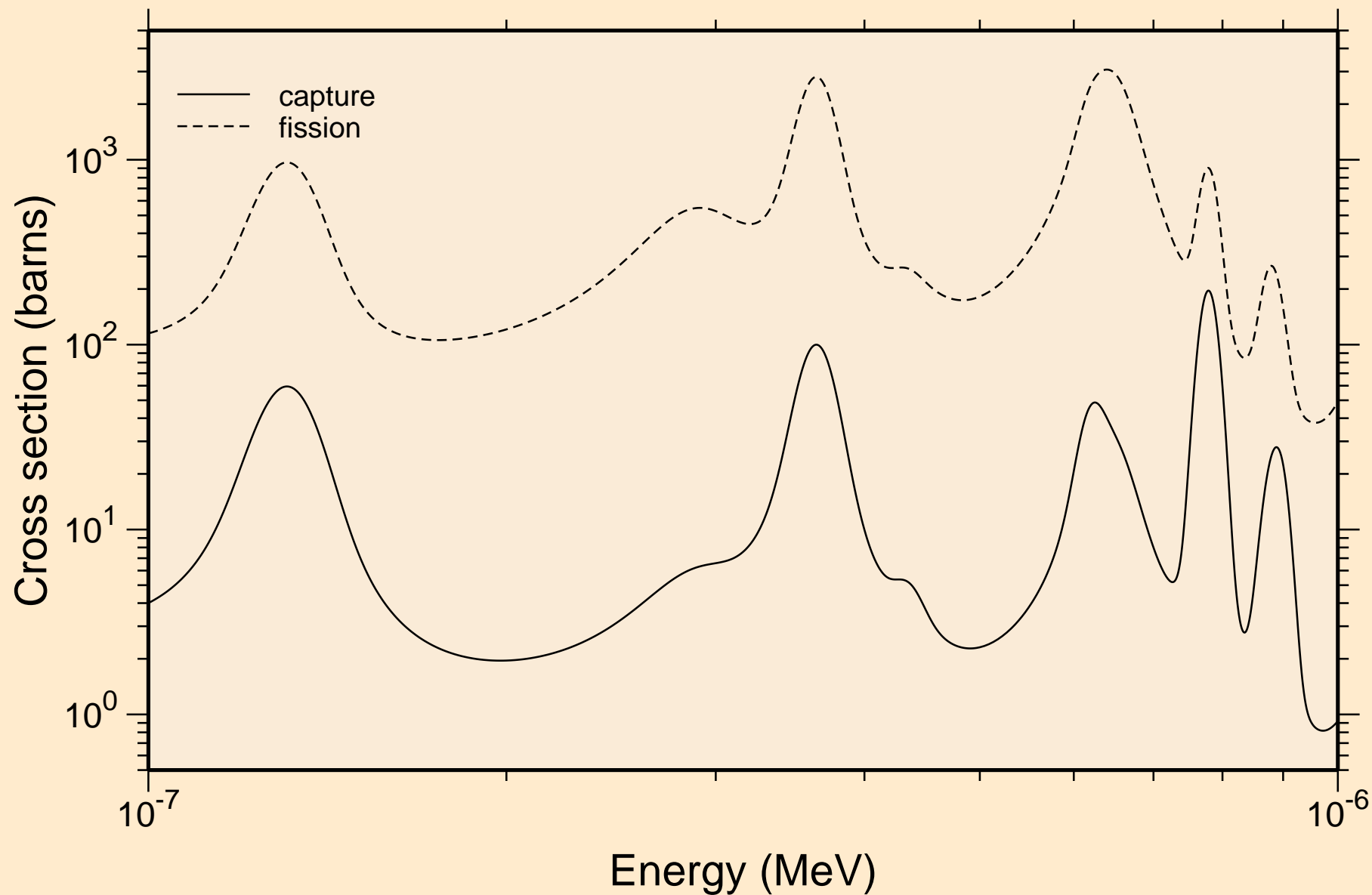

AM235 NEUTRON ACER TENDL-2019 LIBRARY; T=293.16K
resonance absorption cross sections

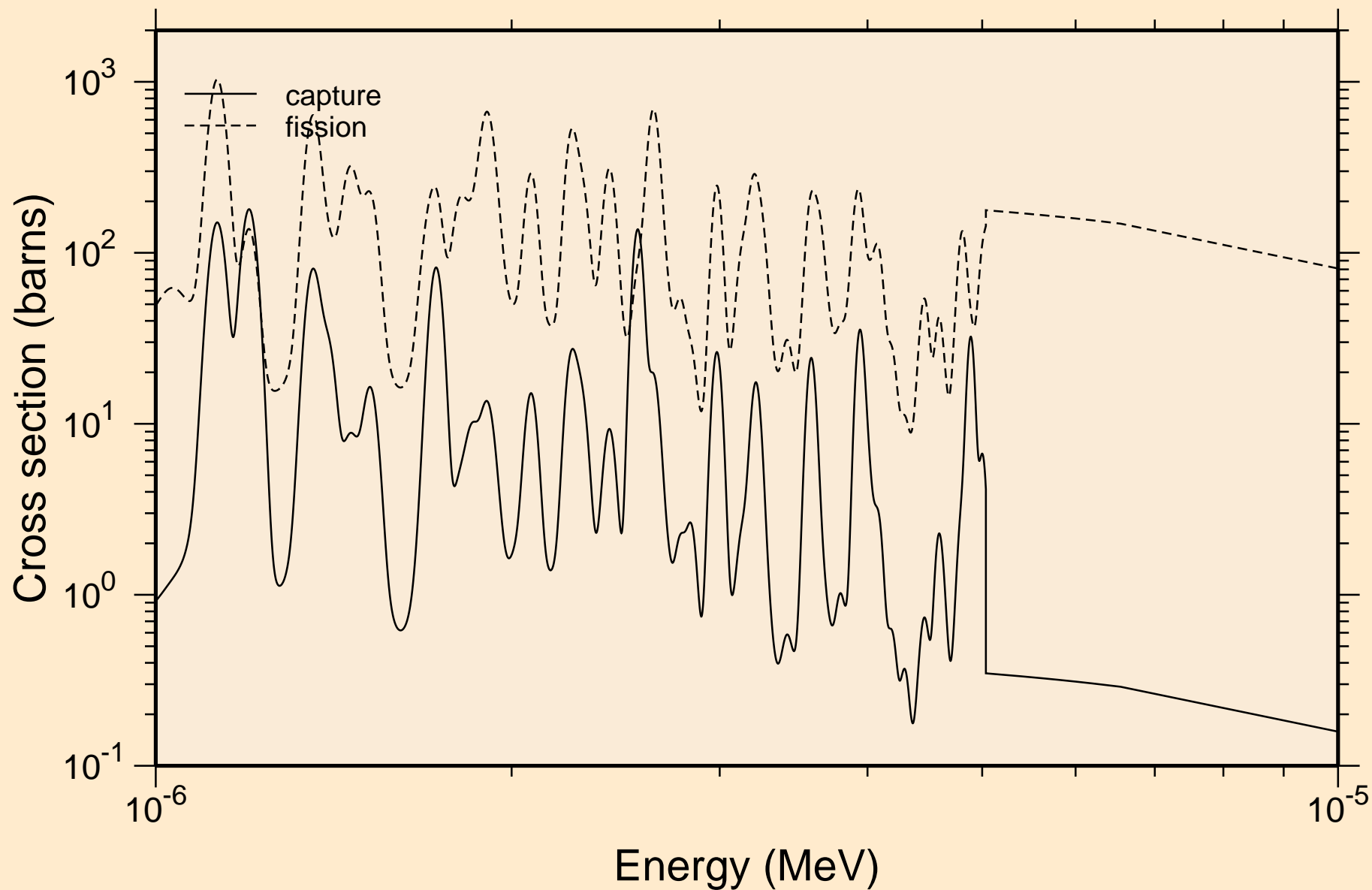

AM235 NEUTRON ACER TENDL-2019 LIBRARY; T=293.16K
resonance absorption cross sections

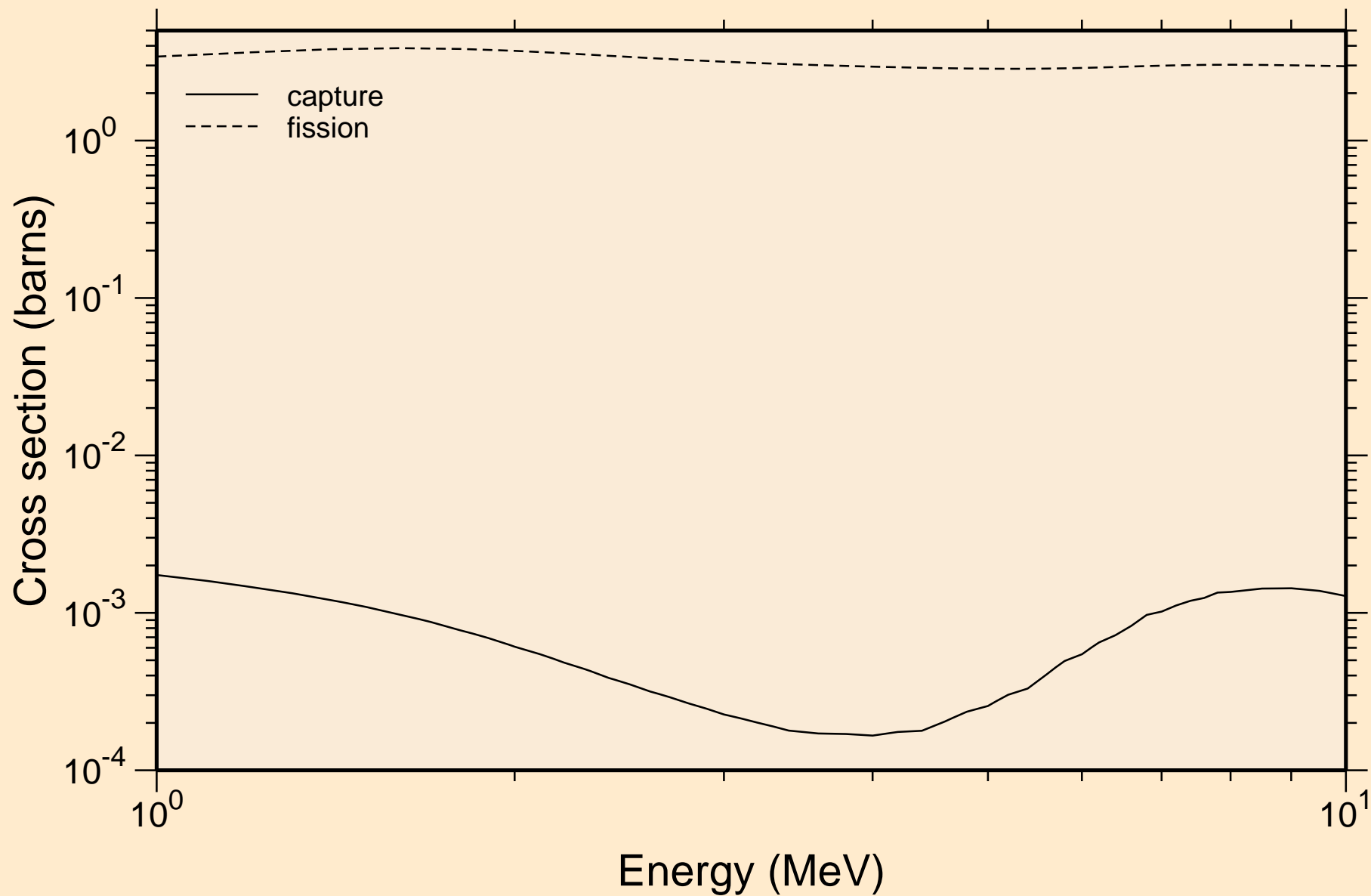

AM235 NEUTRON ACER TENDL-2019 LIBRARY; T=293.16K
Heating

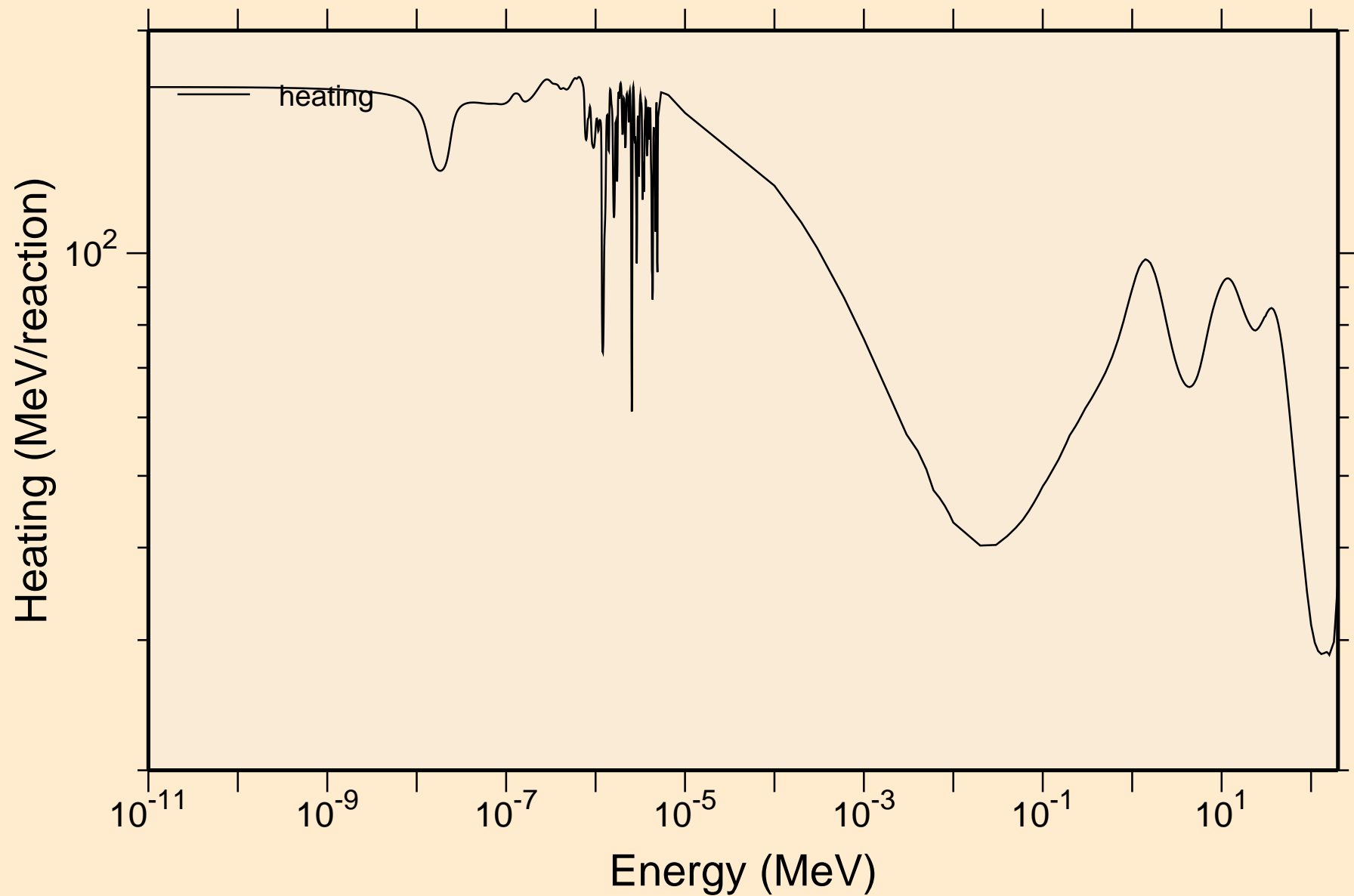

AM235 NEUTRON ACER TENDL-2019 LIBRARY; T=293.16K Damage

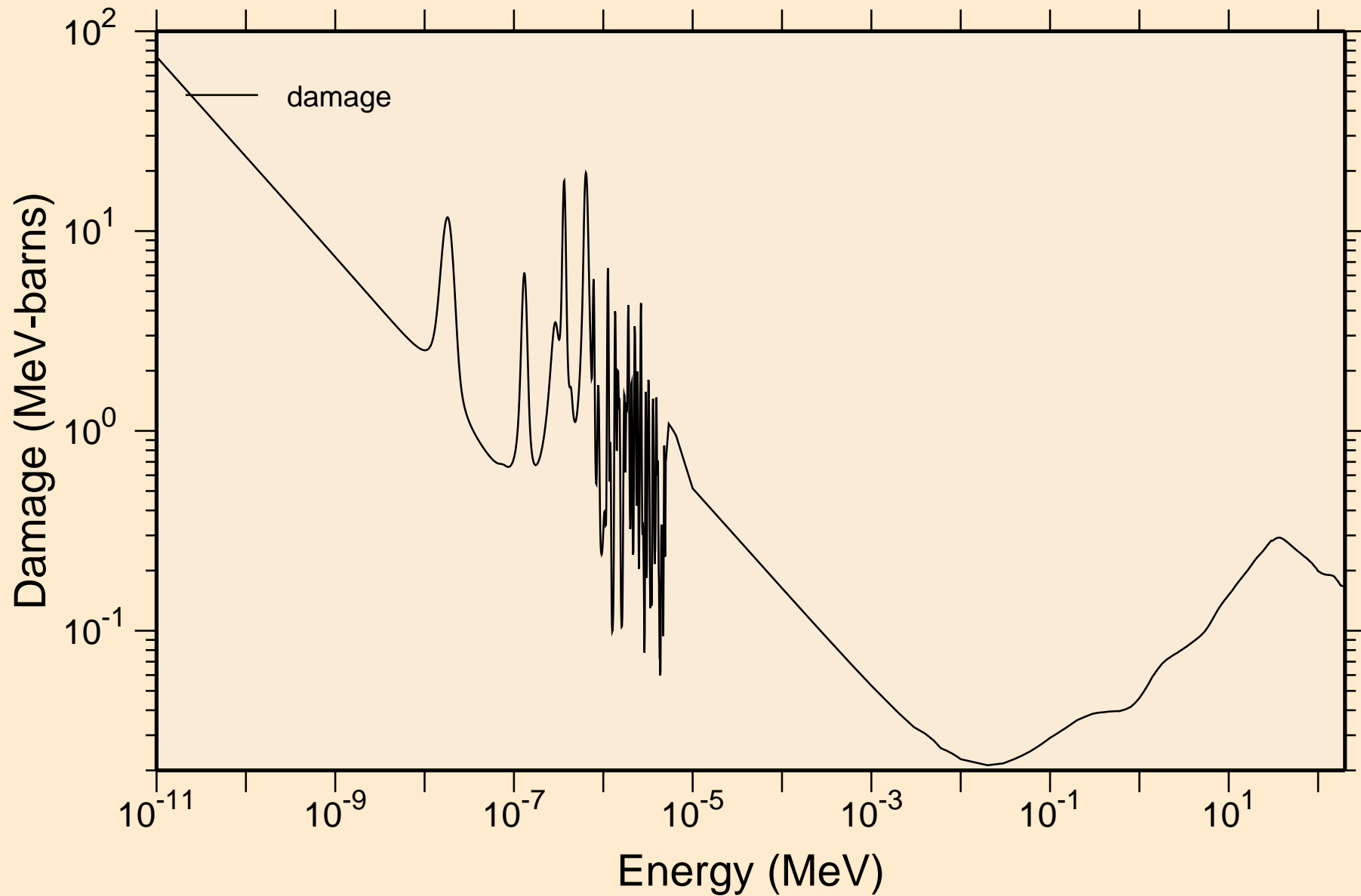

AM235 NEUTRON ACER TENDL-2019 LIBRARY; T=293.16K
Non-threshold reactions

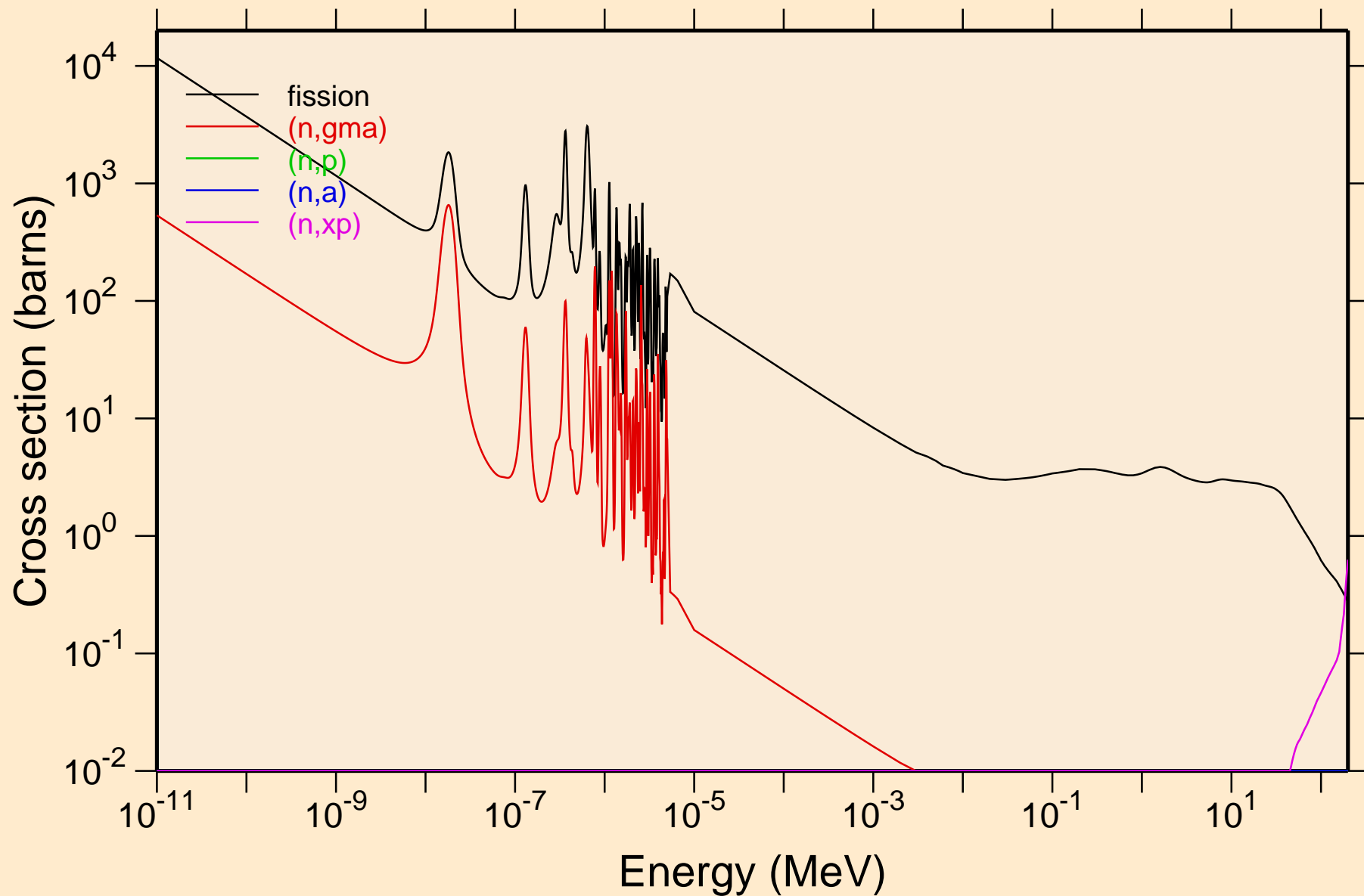

AM235 NEUTRON ACER TENDL-2019 LIBRARY; T=293.16K
Non-threshold reactions

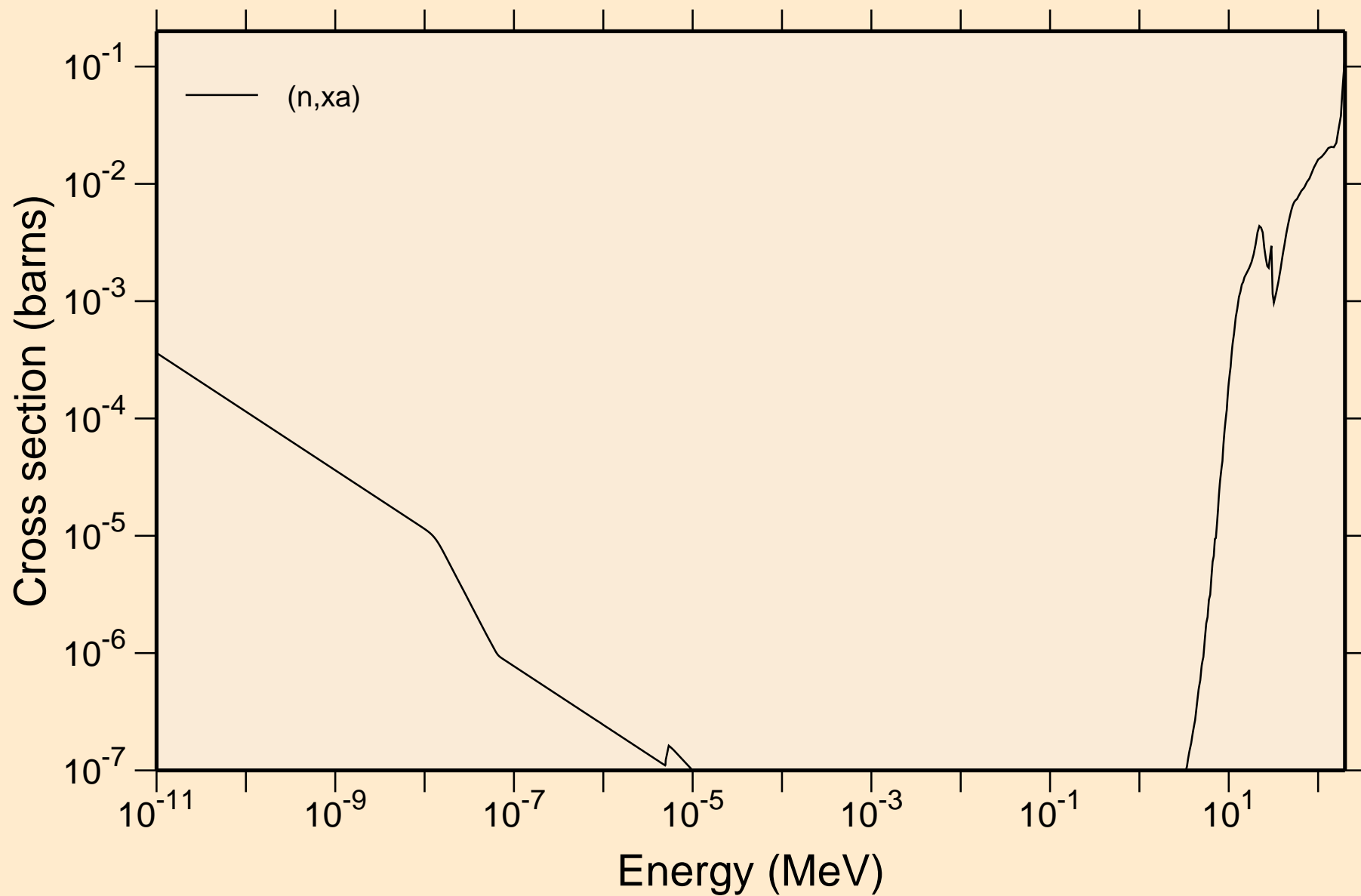

AM235 NEUTRON ACER TENDL-2019 LIBRARY; T=293.16K
Principal cross sections

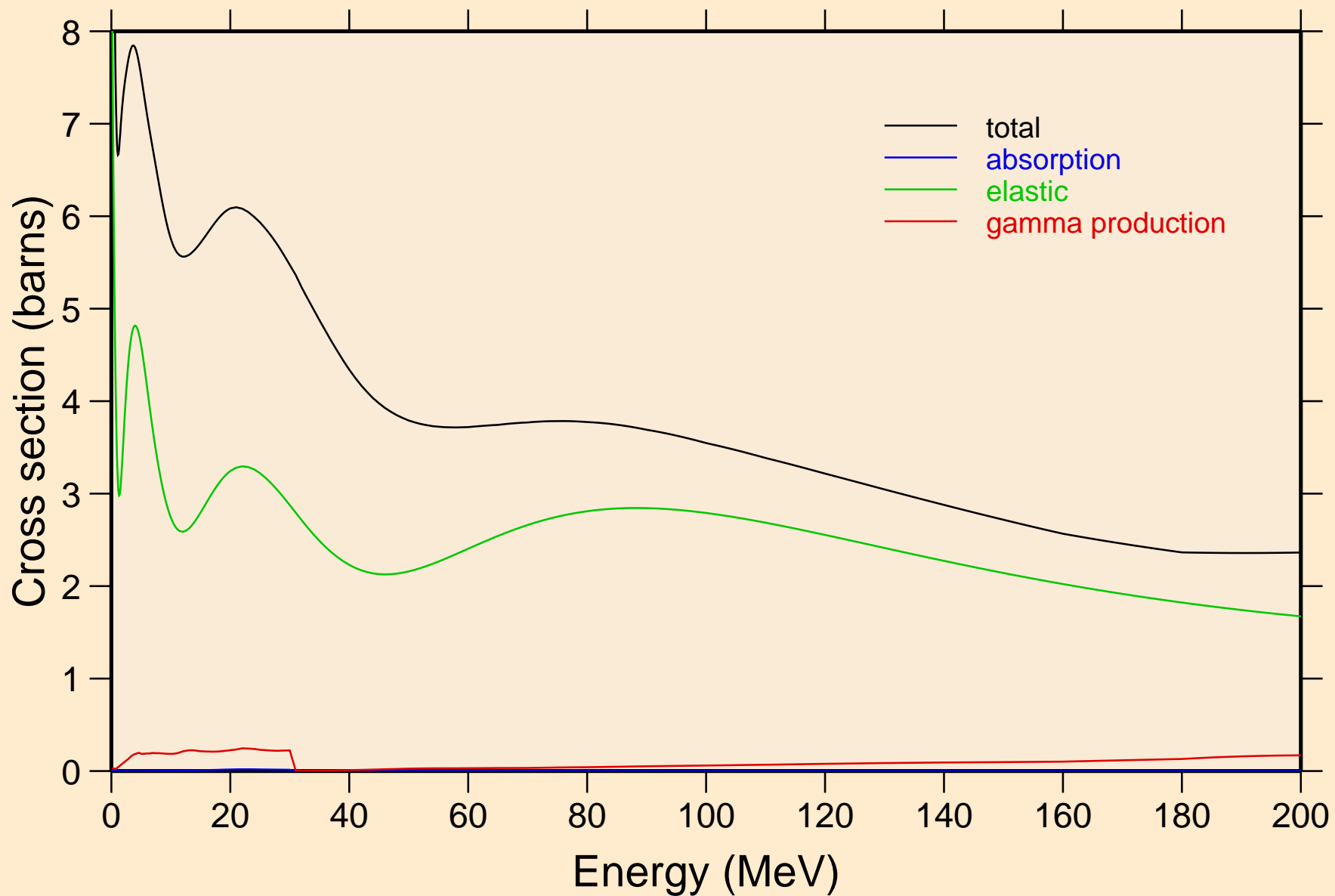

AM235 NEUTRON ACER TENDL-2019 LIBRARY; T=293.16K
Heating

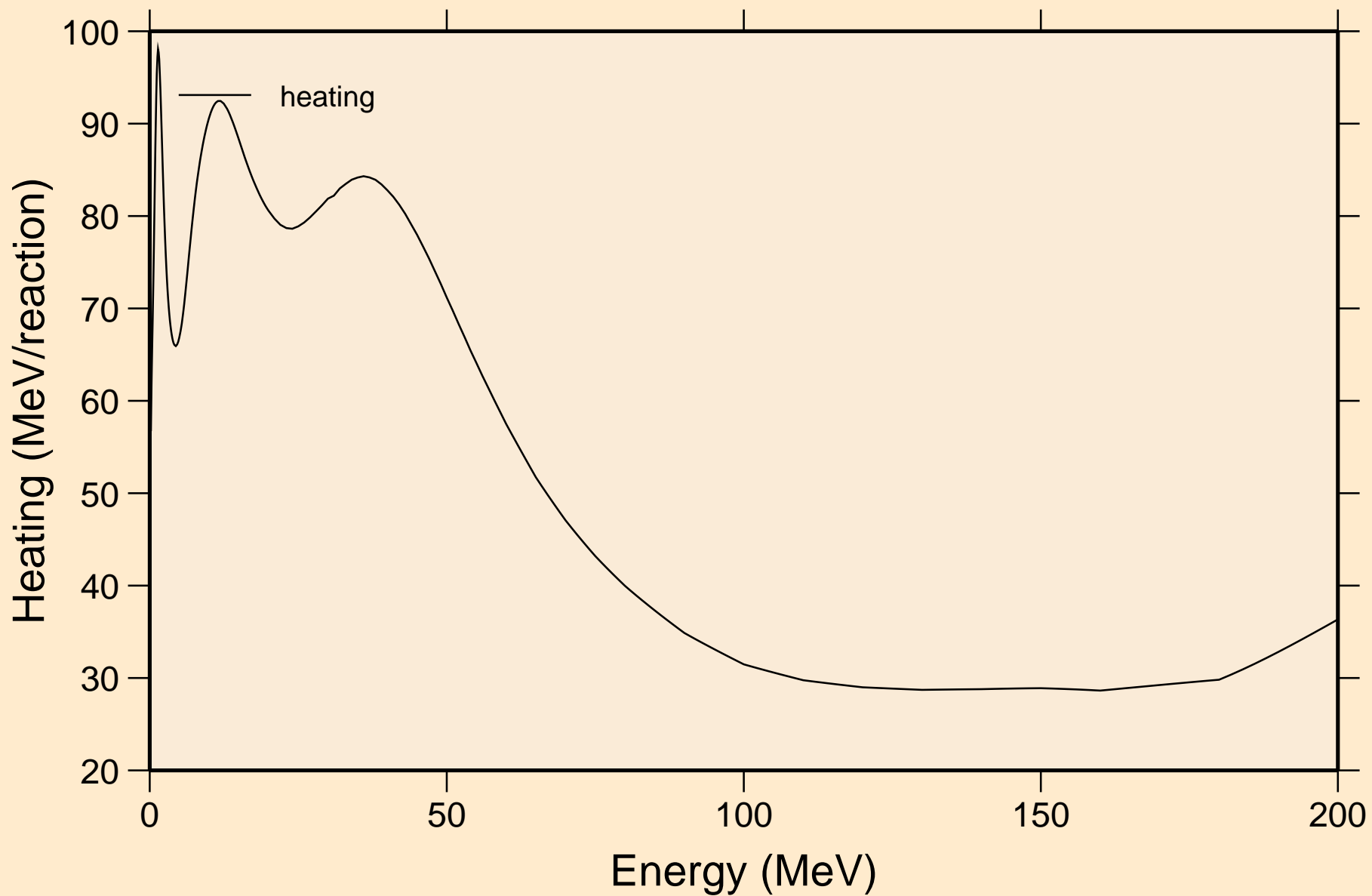

AM235 NEUTRON ACER TENDL-2019 LIBRARY; T=293.16K
Damage

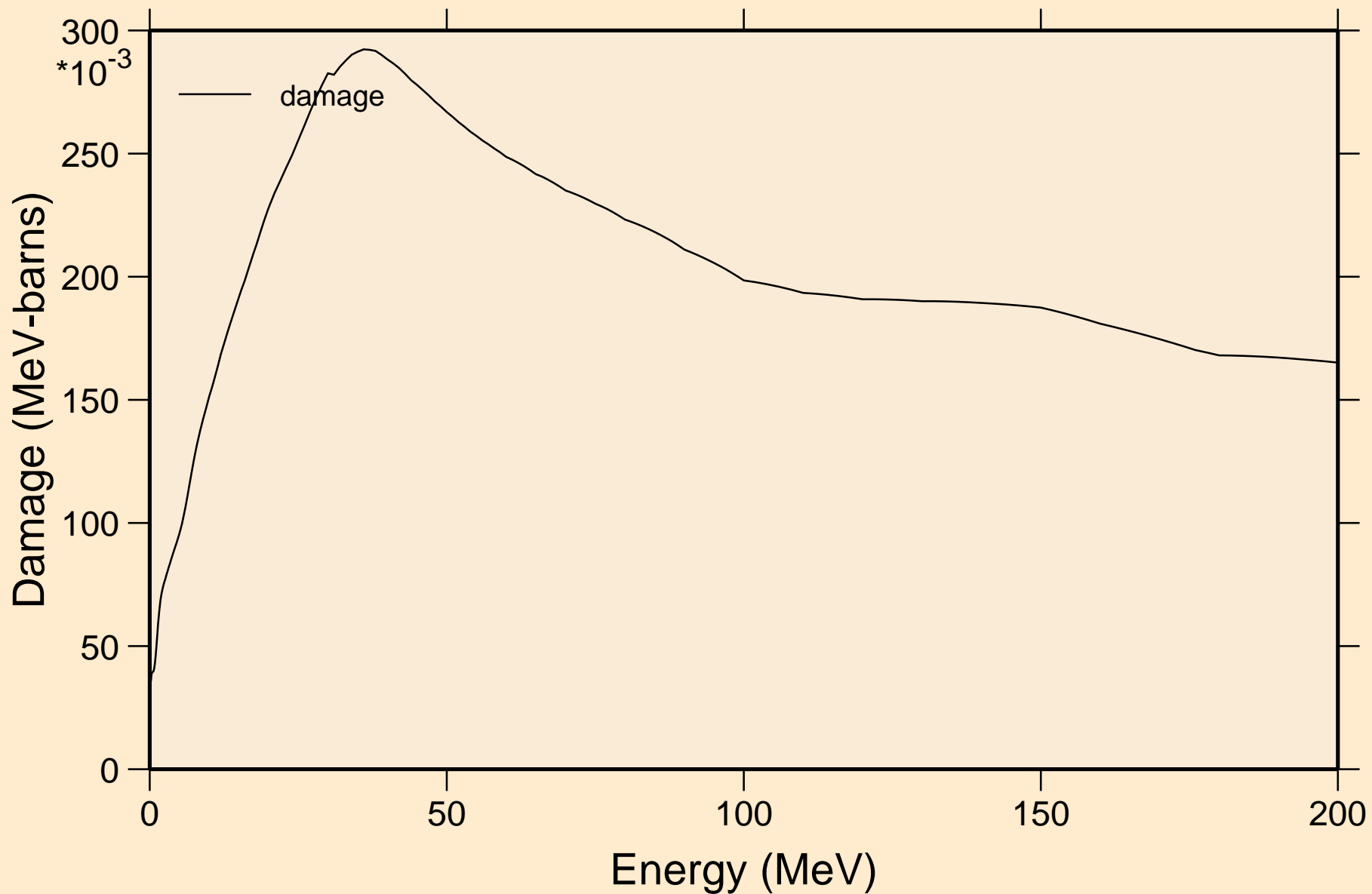

AM235 NEUTRON ACER TENDL-2019 LIBRARY; T=293.16K

Non-threshold reactions

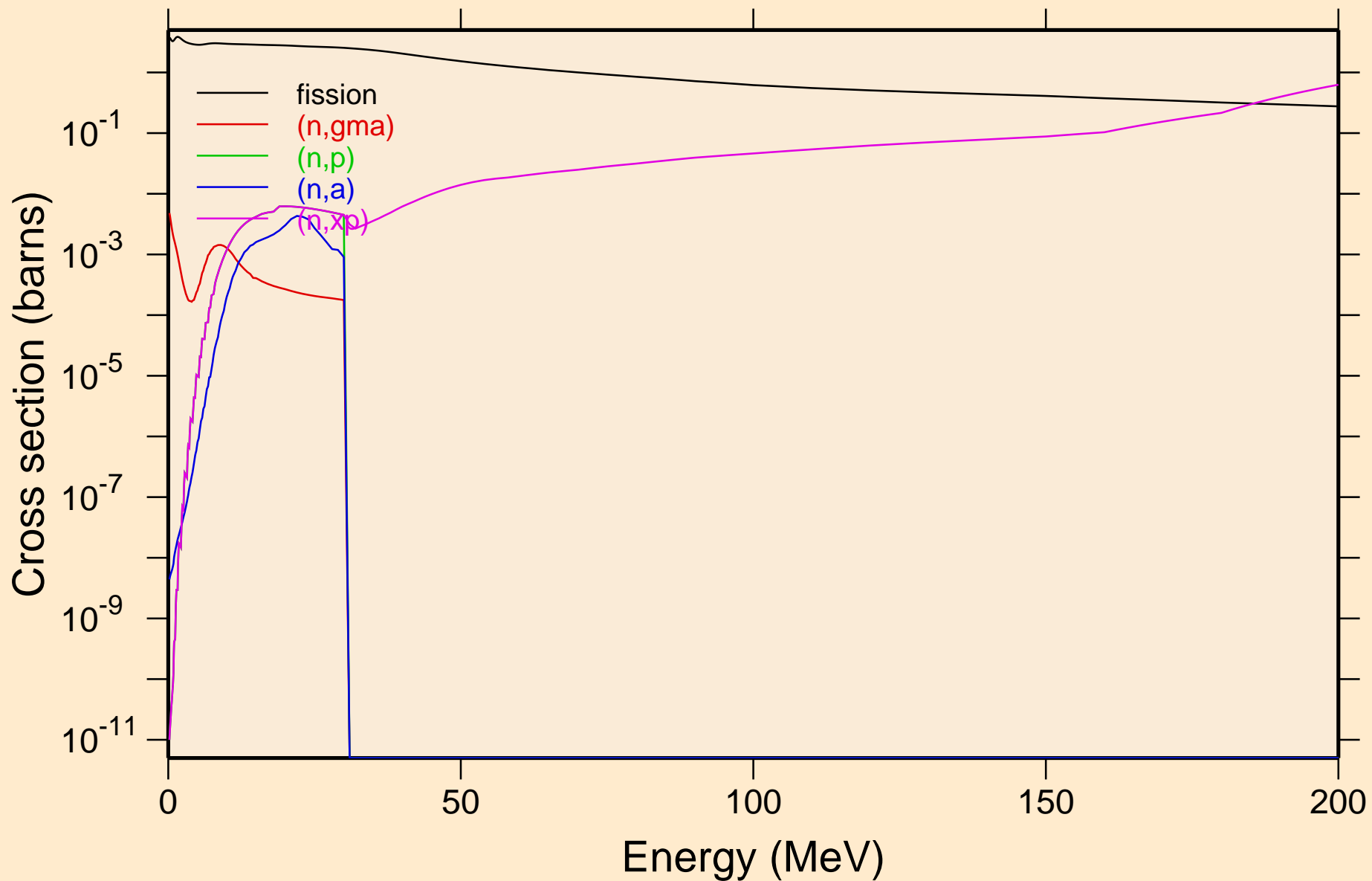

AM235 NEUTRON ACER TENDL-2019 LIBRARY; T=293.16K
Non-threshold reactions

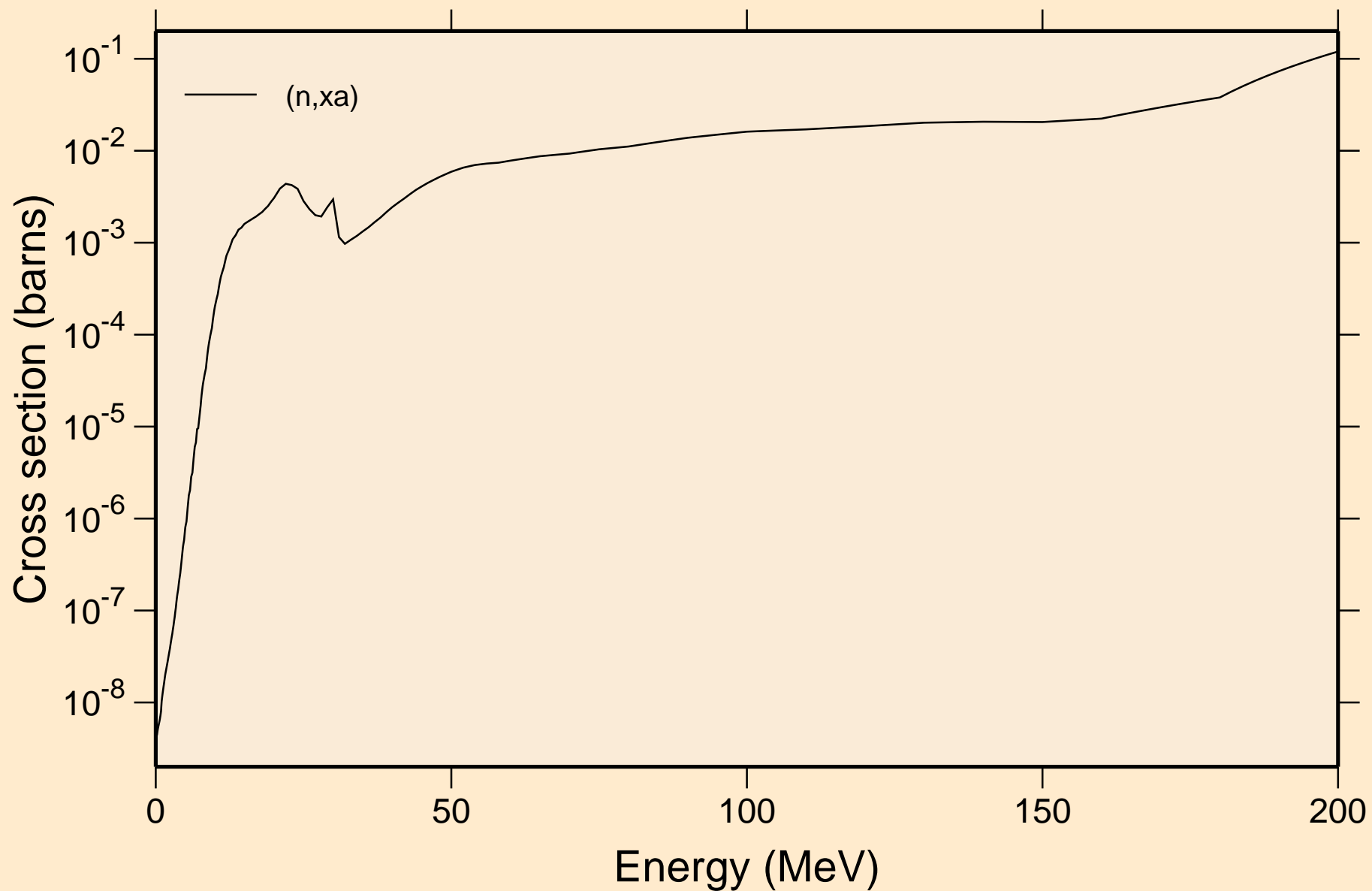

AM235 NEUTRON ACER TENDL-2019 LIBRARY; T=293.16K
Inelastic levels

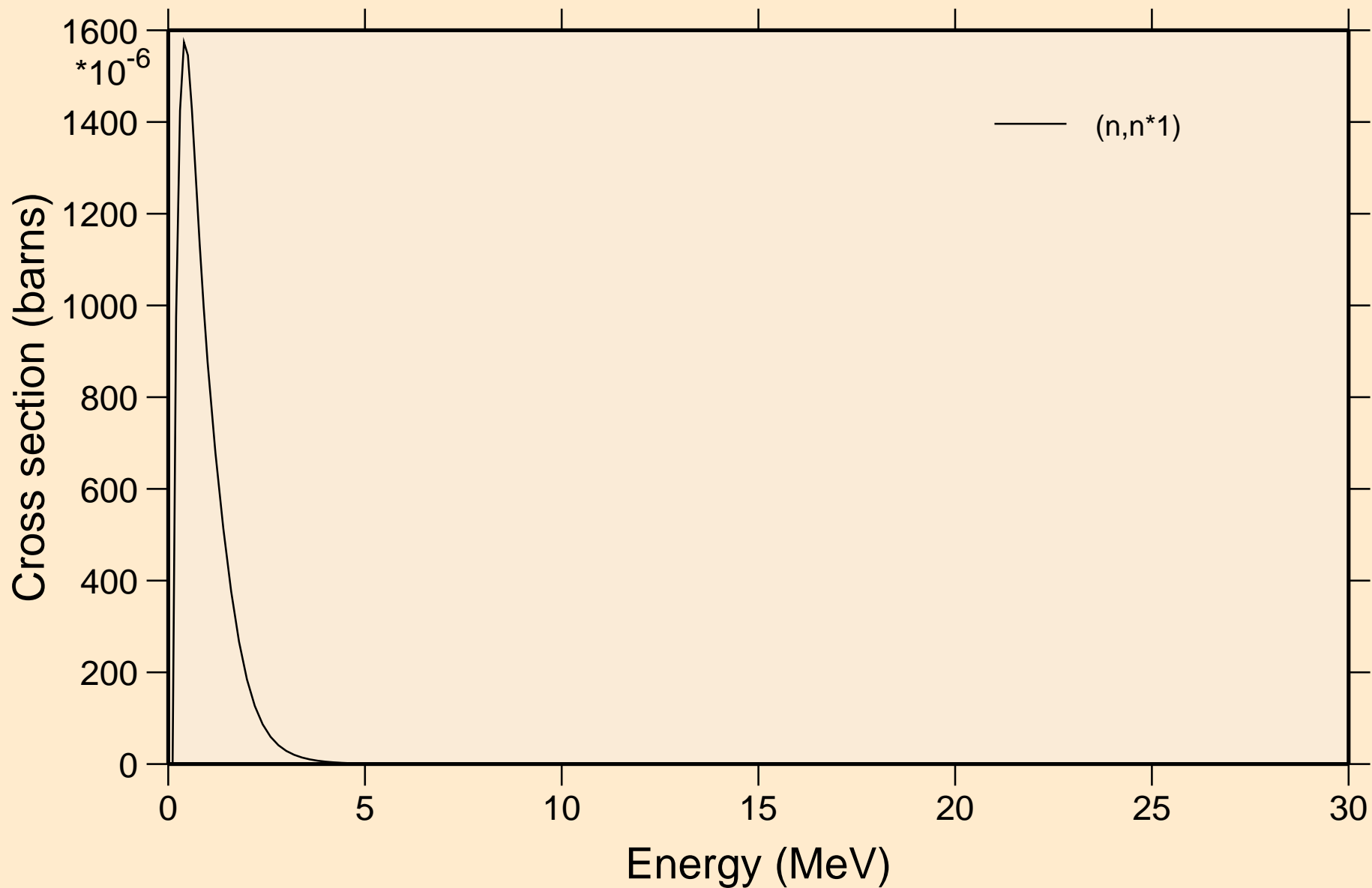

AM235 NEUTRON ACER TENDL-2019 LIBRARY; T=293.16K
Threshold reactions

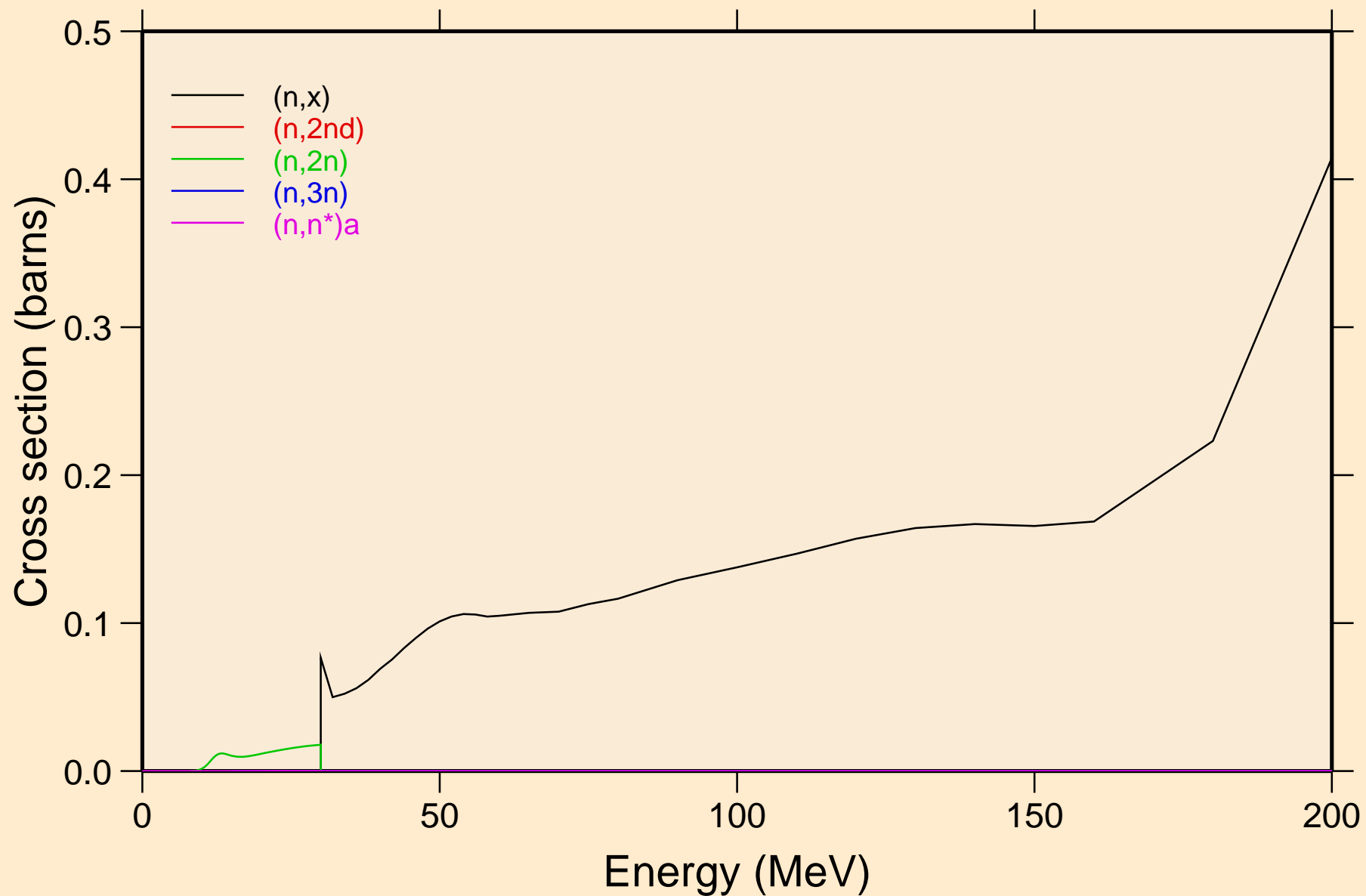

AM235 NEUTRON ACER TENDL-2019 LIBRARY; T=293.16K
Threshold reactions

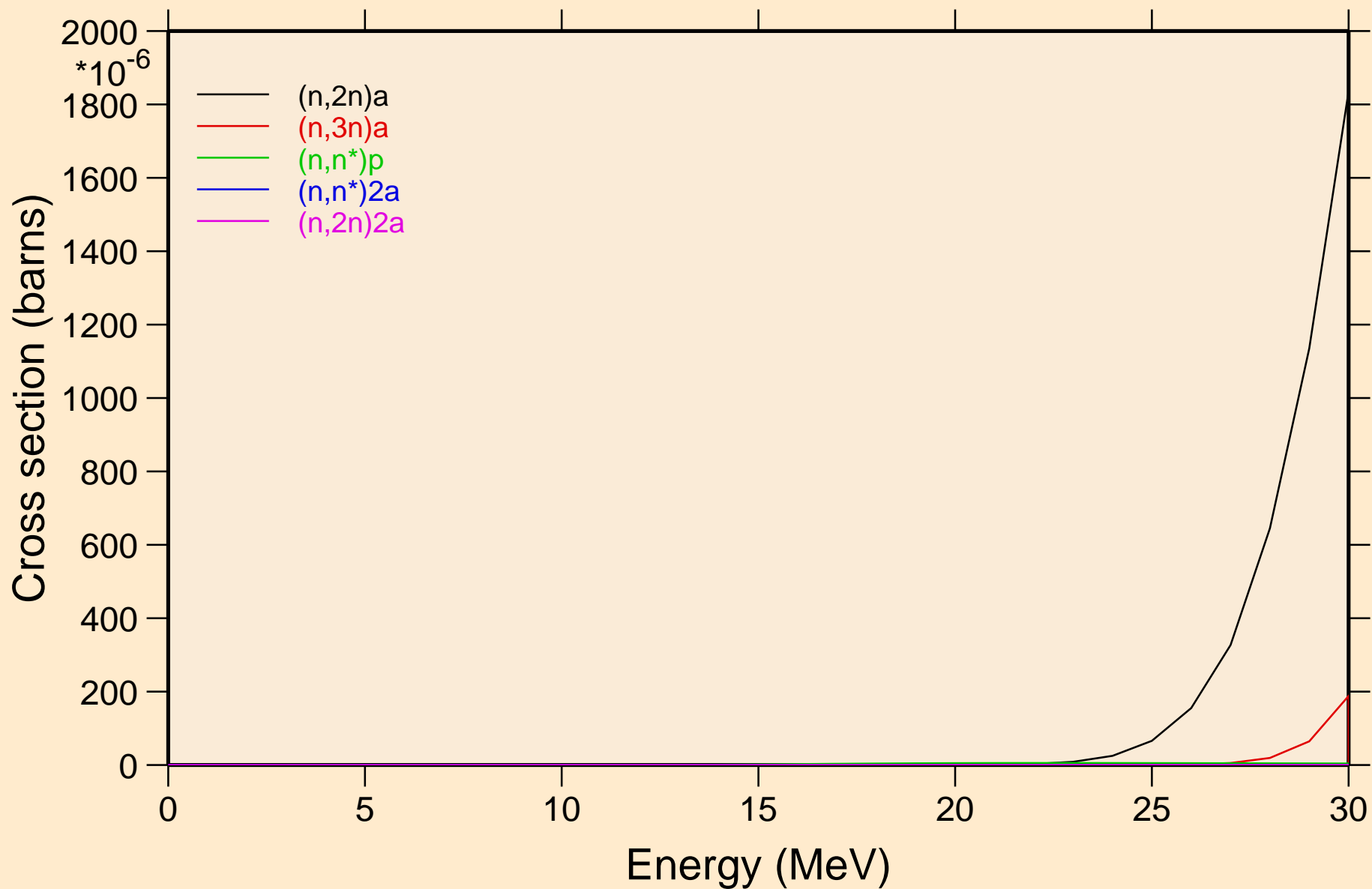

AM235 NEUTRON ACER TENDL-2019 LIBRARY; T=293.16K

Threshold reactions

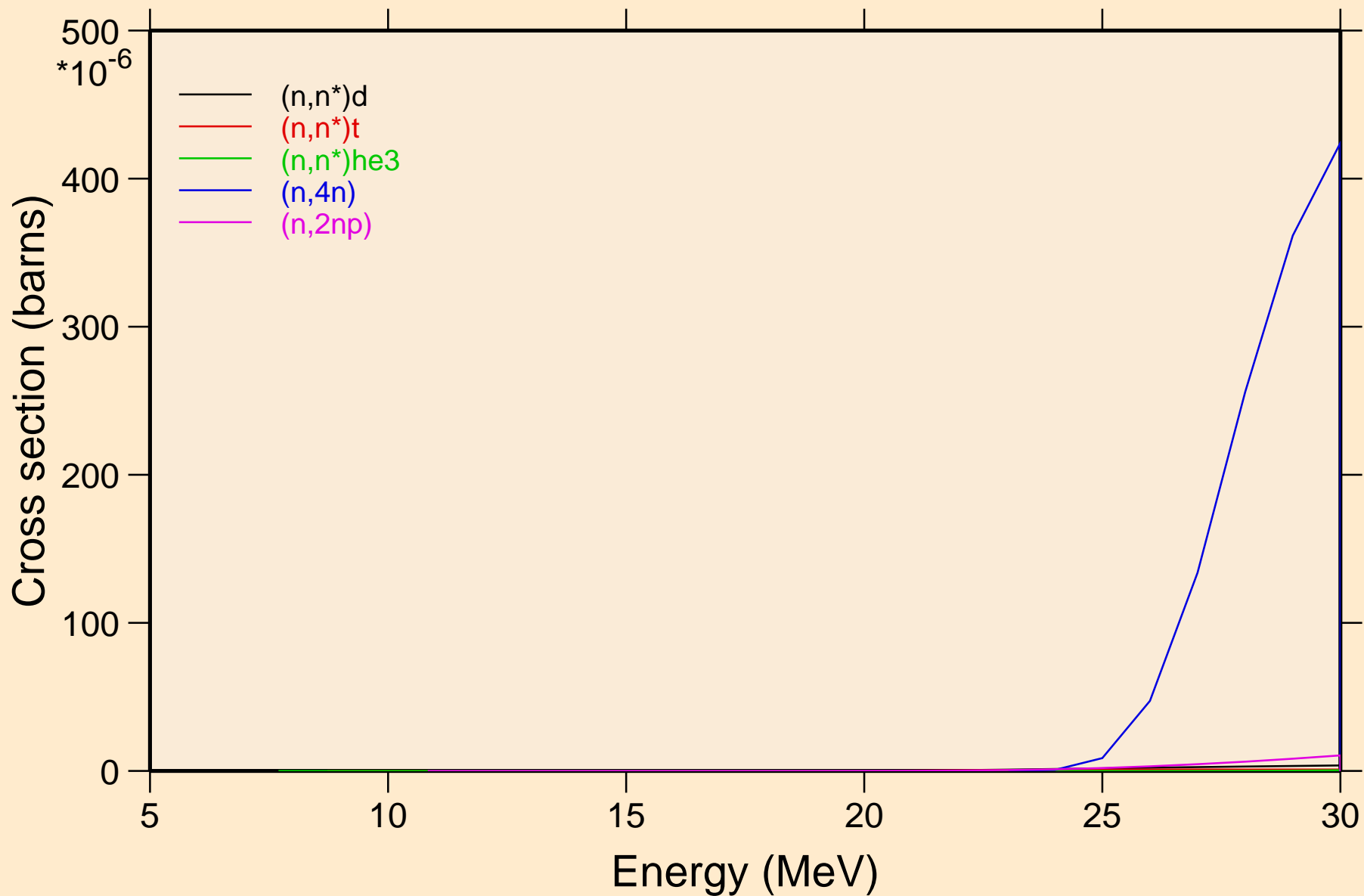

AM235 NEUTRON ACER TENDL-2019 LIBRARY; T=293.16K
Threshold reactions

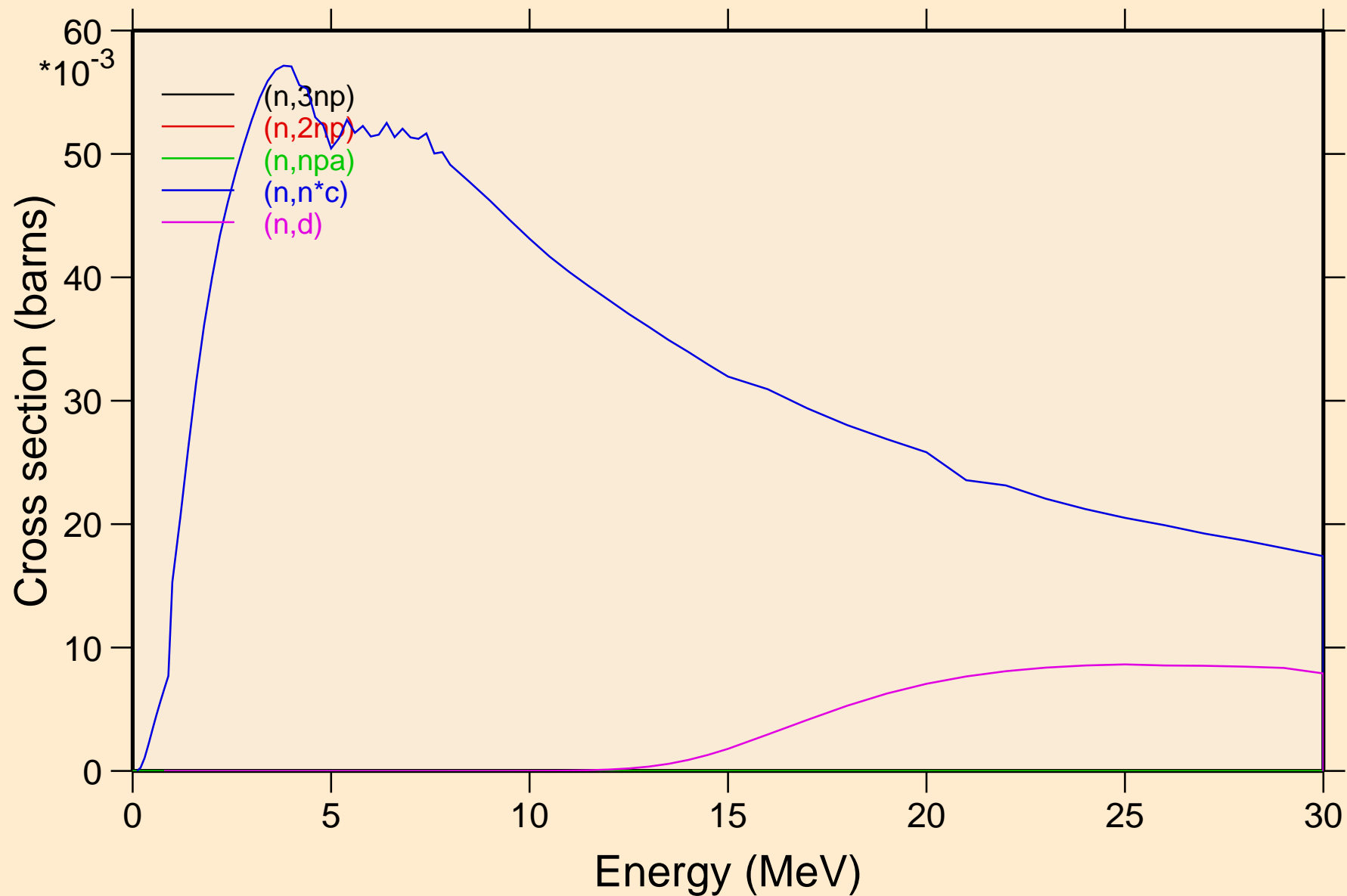

AM235 NEUTRON ACER TENDL-2019 LIBRARY; T=293.16K
Threshold reactions

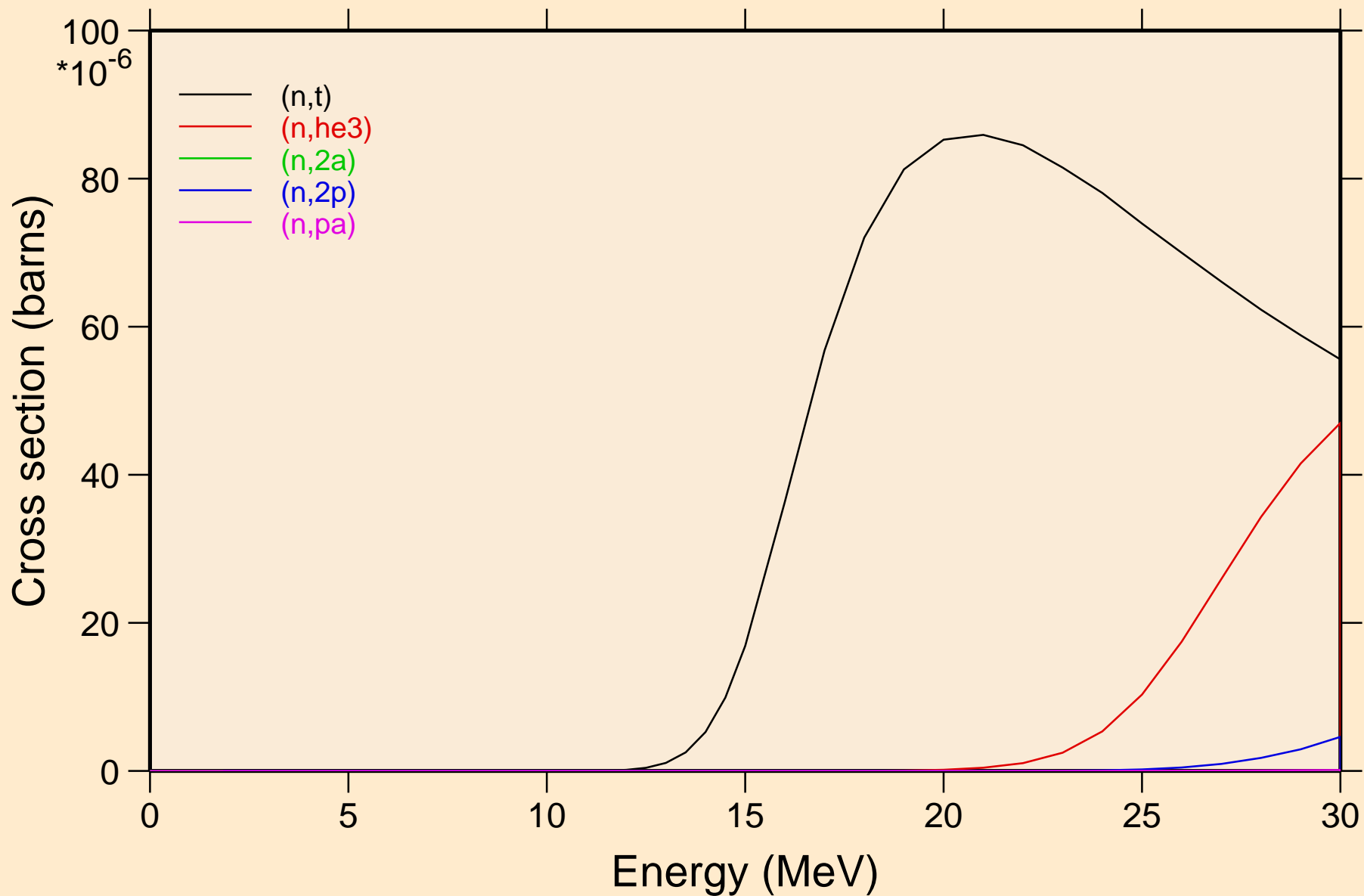

AM235 NEUTRON ACER TENDL-2019 LIBRARY; T=293.16K
Threshold reactions

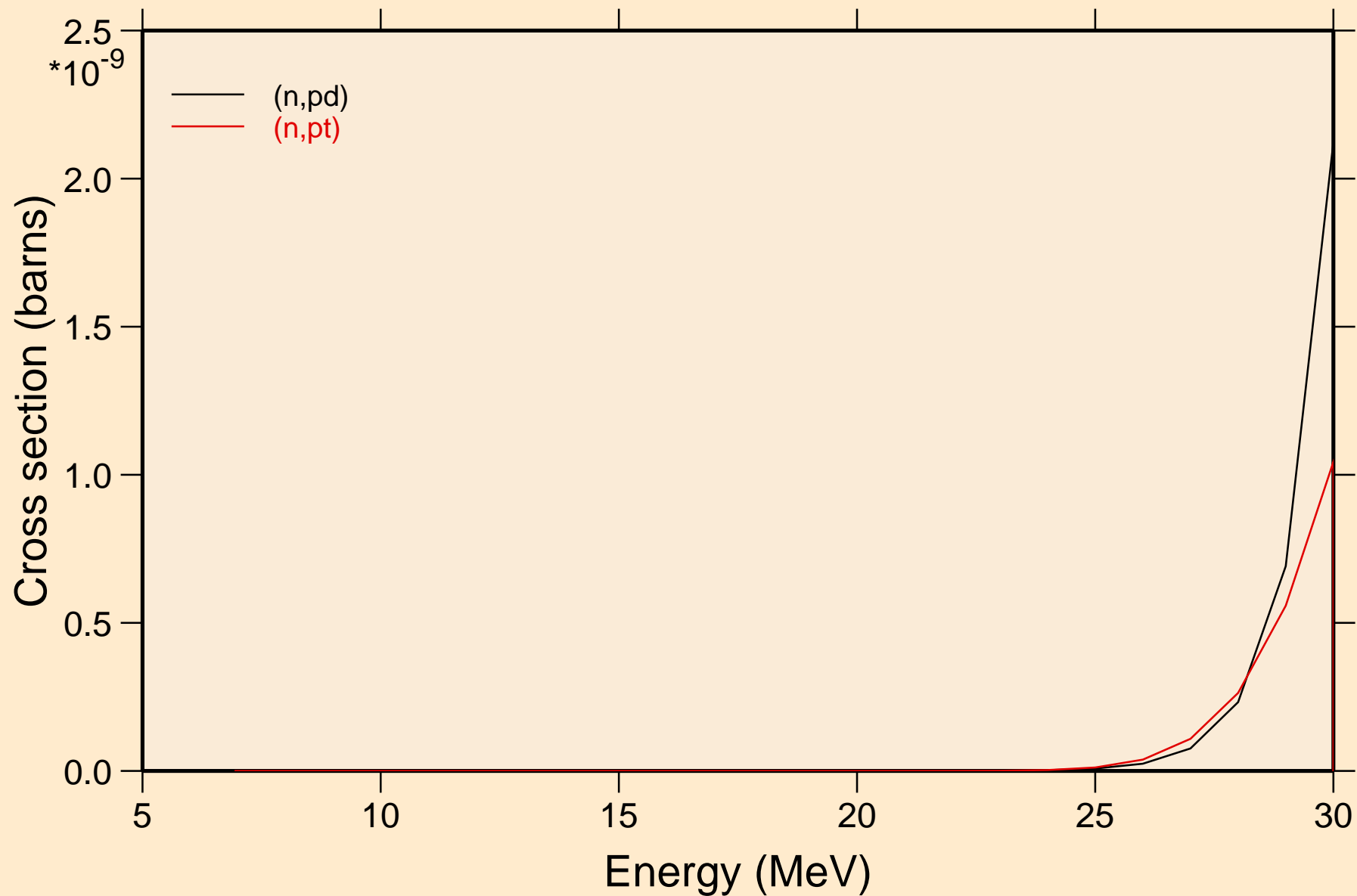

AM235 NEUTRON ACER TENDL-2019 LIBRARY; T=293.16K

Threshold reactions

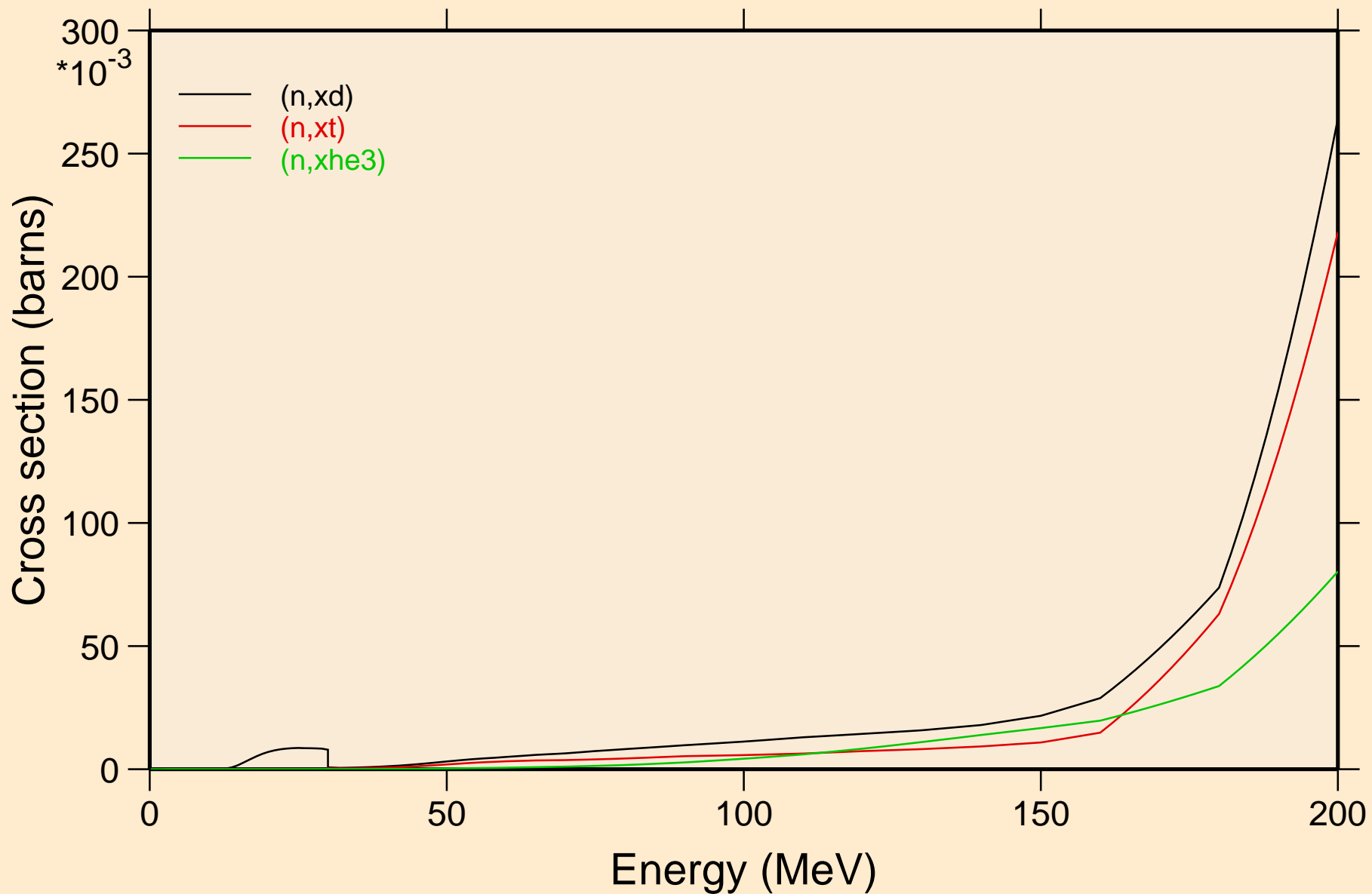

AM235 NEUTRON ACER TENDL-2019 LIBRARY; T=293.16K
angular distribution for elastic

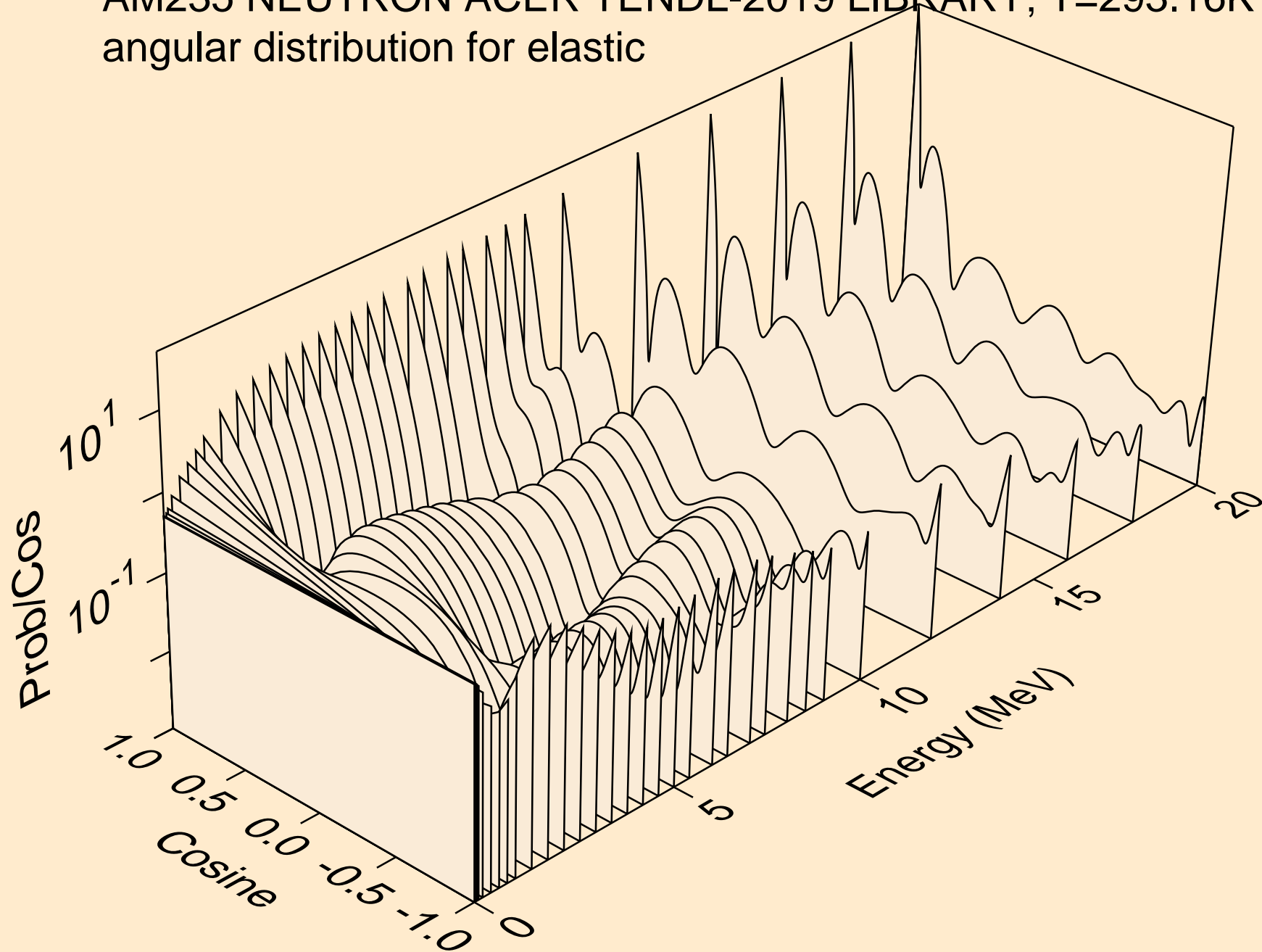

AM235 NEUTRON ACER TENDL-2019 LIBRARY; T=293.16K
angular distribution for elastic

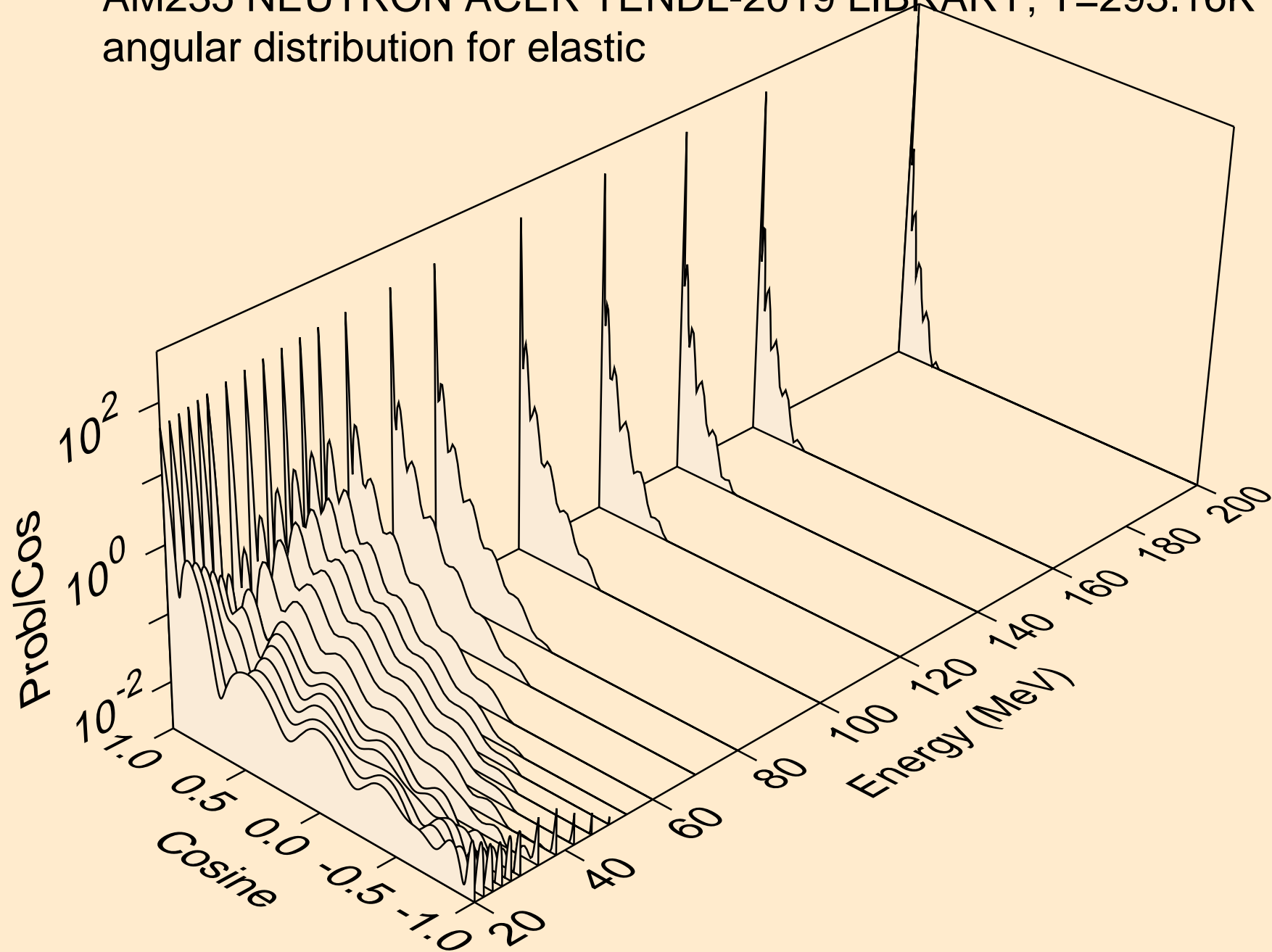

AM235 NEUTRON ACER TENDL-2019 LIBRARY; T=293.16K
angular distribution for (n,n*1)

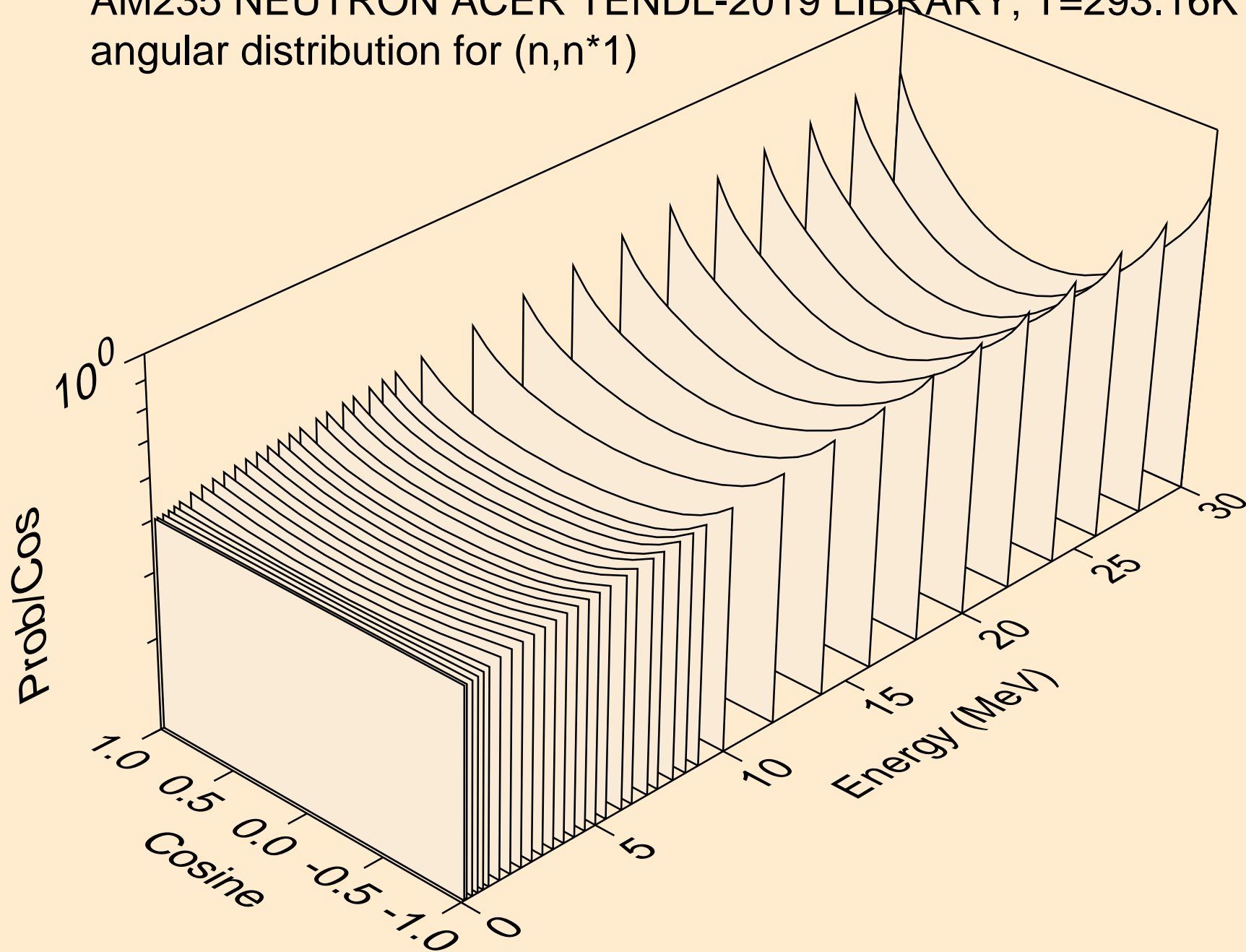

AM235 NEUTRON ACER TENDL-2019 LIBRARY; T=293.16K
Total fission nubar

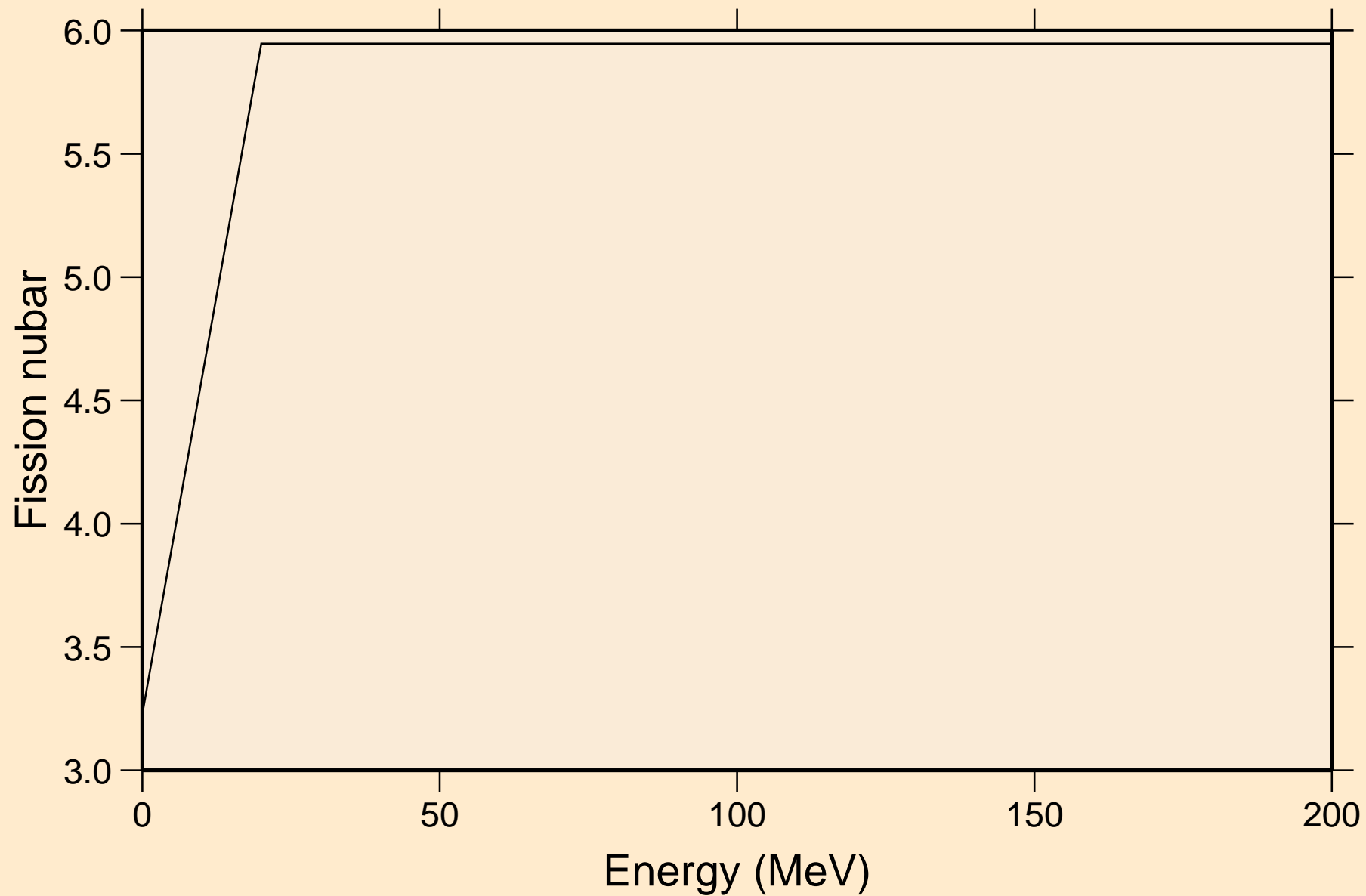

AM235 NEUTRON ACER TENDL-2019 LIBRARY; T=293.16K
Neutron emission for (n,x)

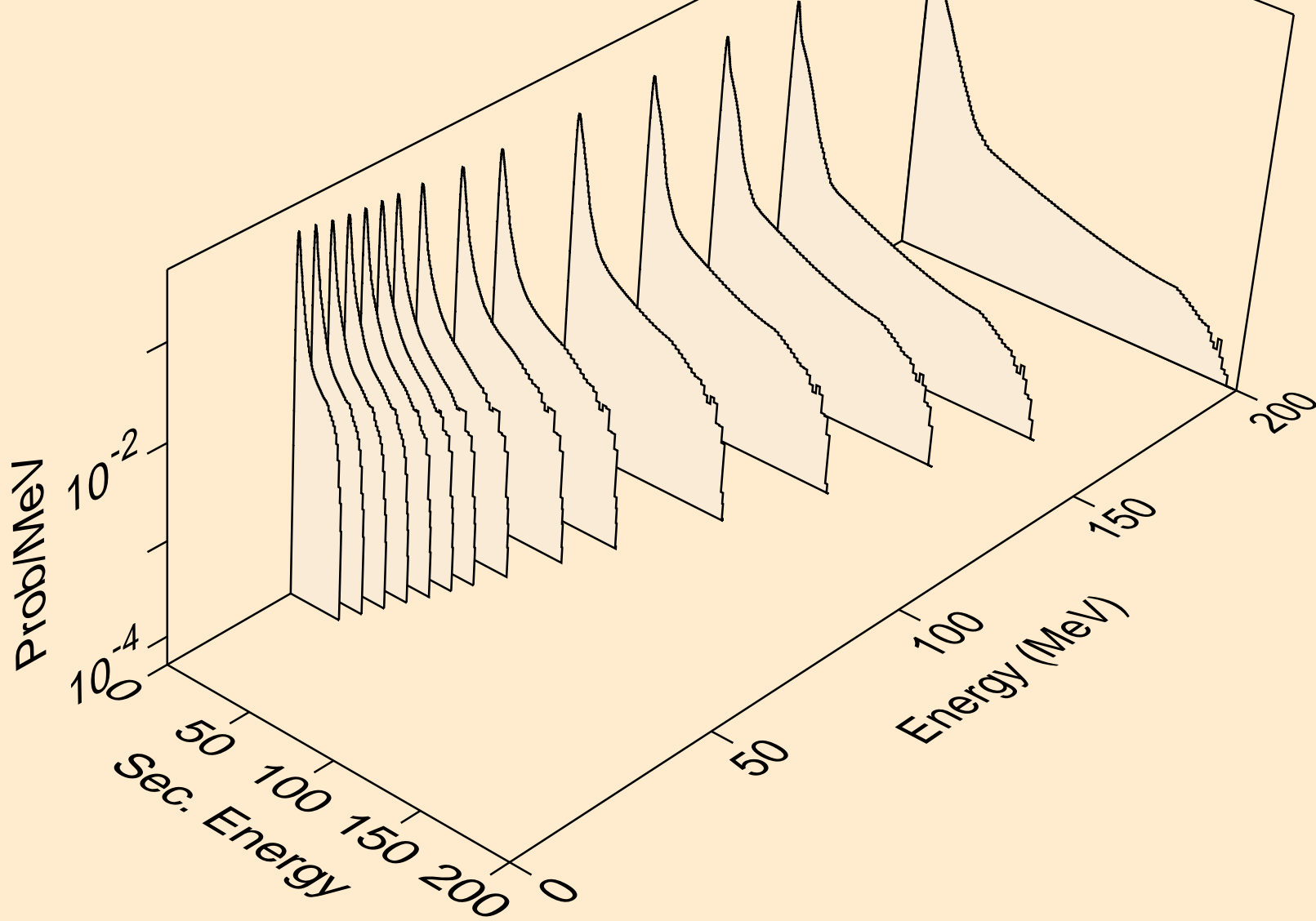

AM235 NEUTRON ACER TENDL-2019 LIBRARY; T=293.16K
Neutron emission for (n,2nd)

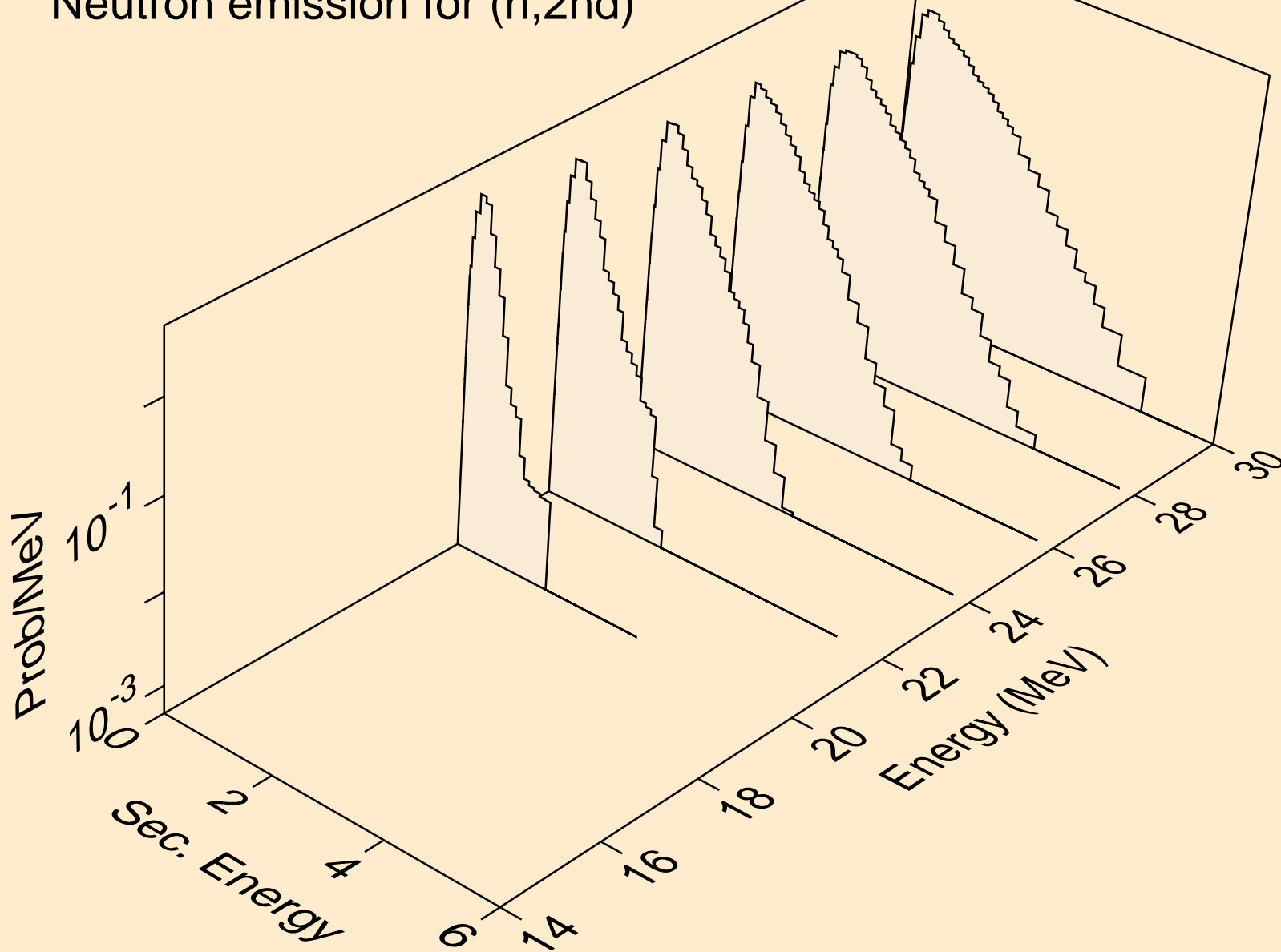

AM235 NEUTRON ACER TENDL-2019 LIBRARY; T=293.16K
Neutron emission for (n,2n)

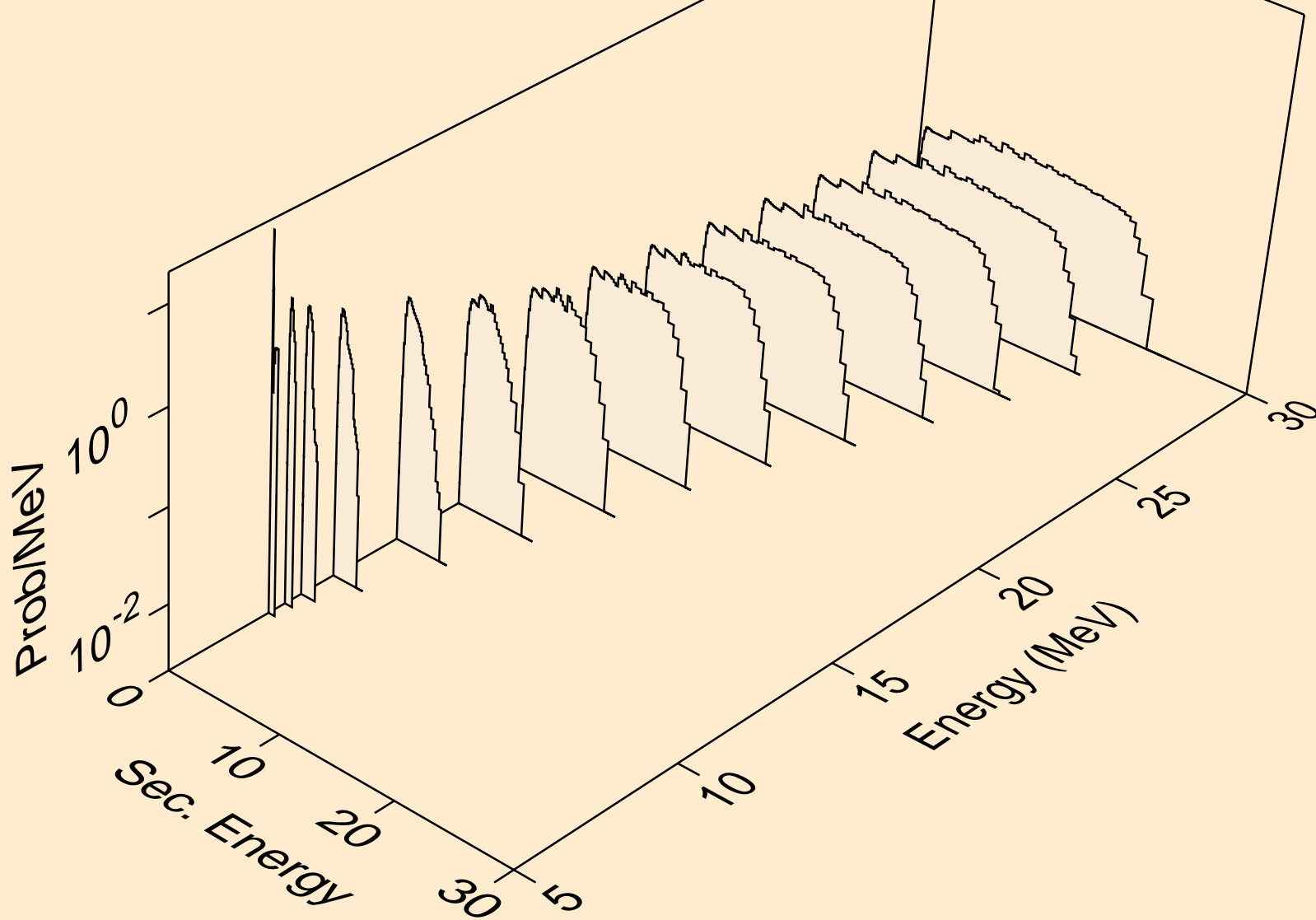

AM235 NEUTRON ACER TENDL-2019 LIBRARY; T=293.16K
Neutron emission for (n,3n)

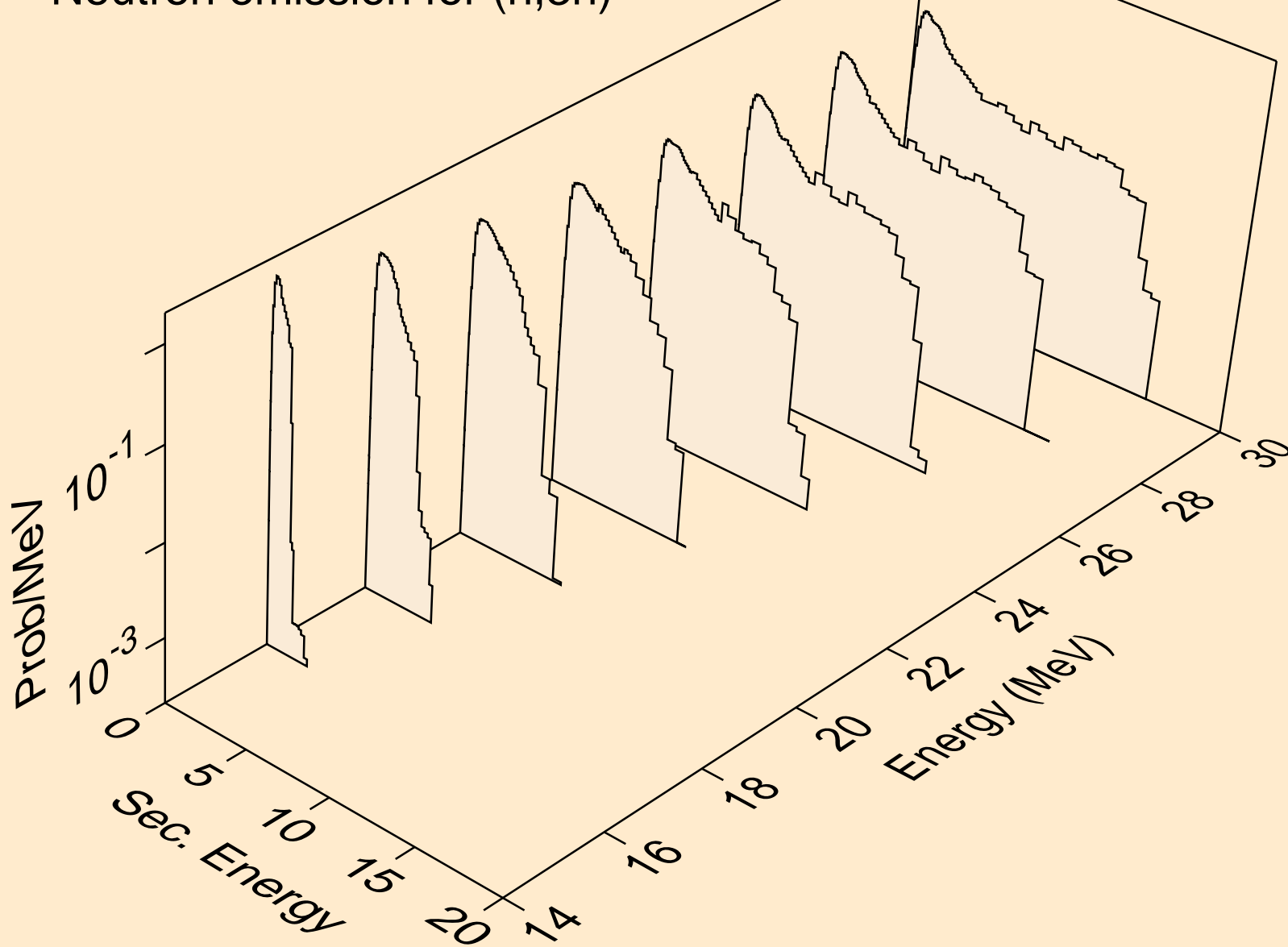

AM235 NEUTRON ACER TENDL-2019 LIBRARY; T=293.16K
Neutron emission for fission

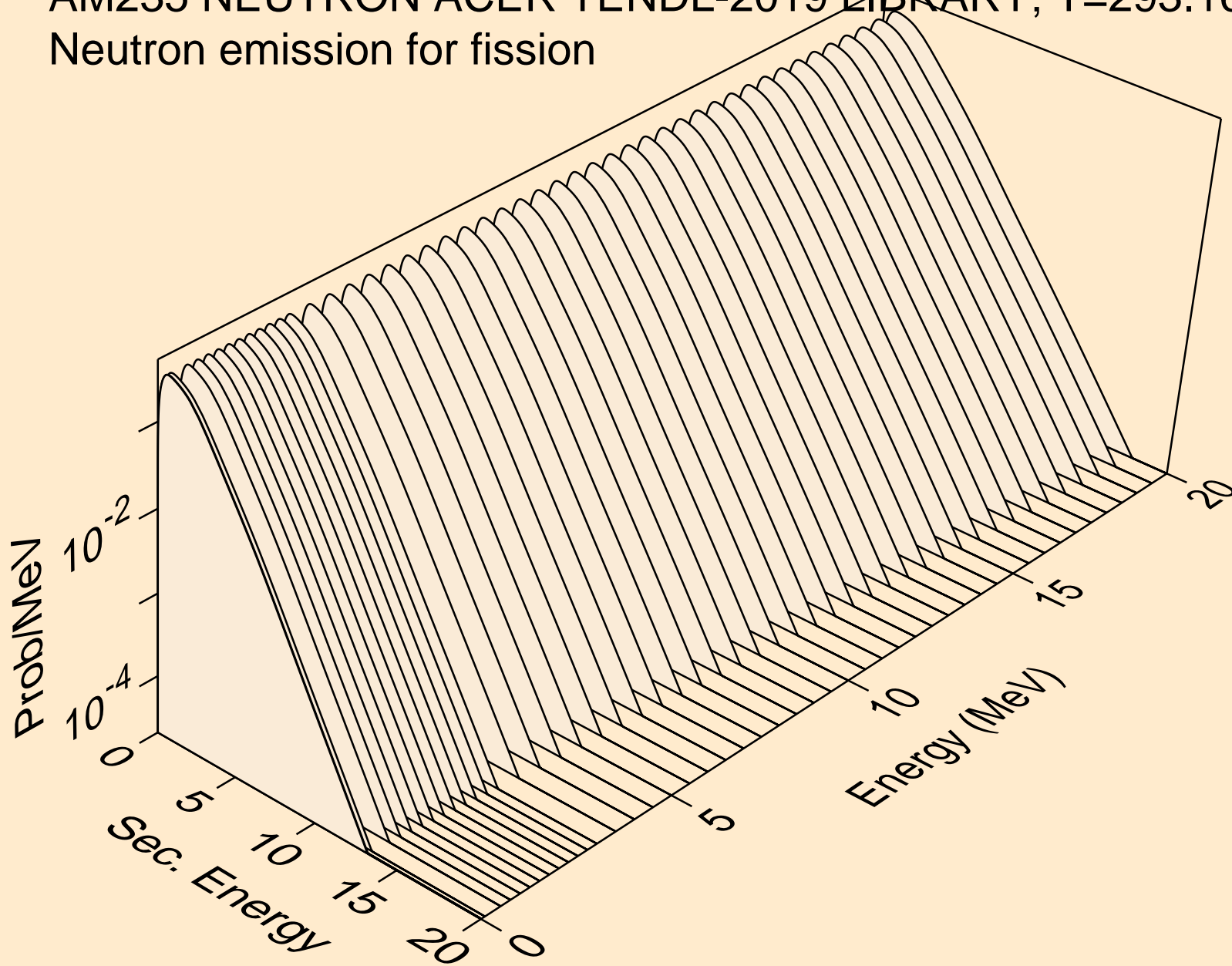

AM235 NEUTRON ACER TENDL-2019 LIBRARY; T=293.16K
Neutron emission for (n,n*)a

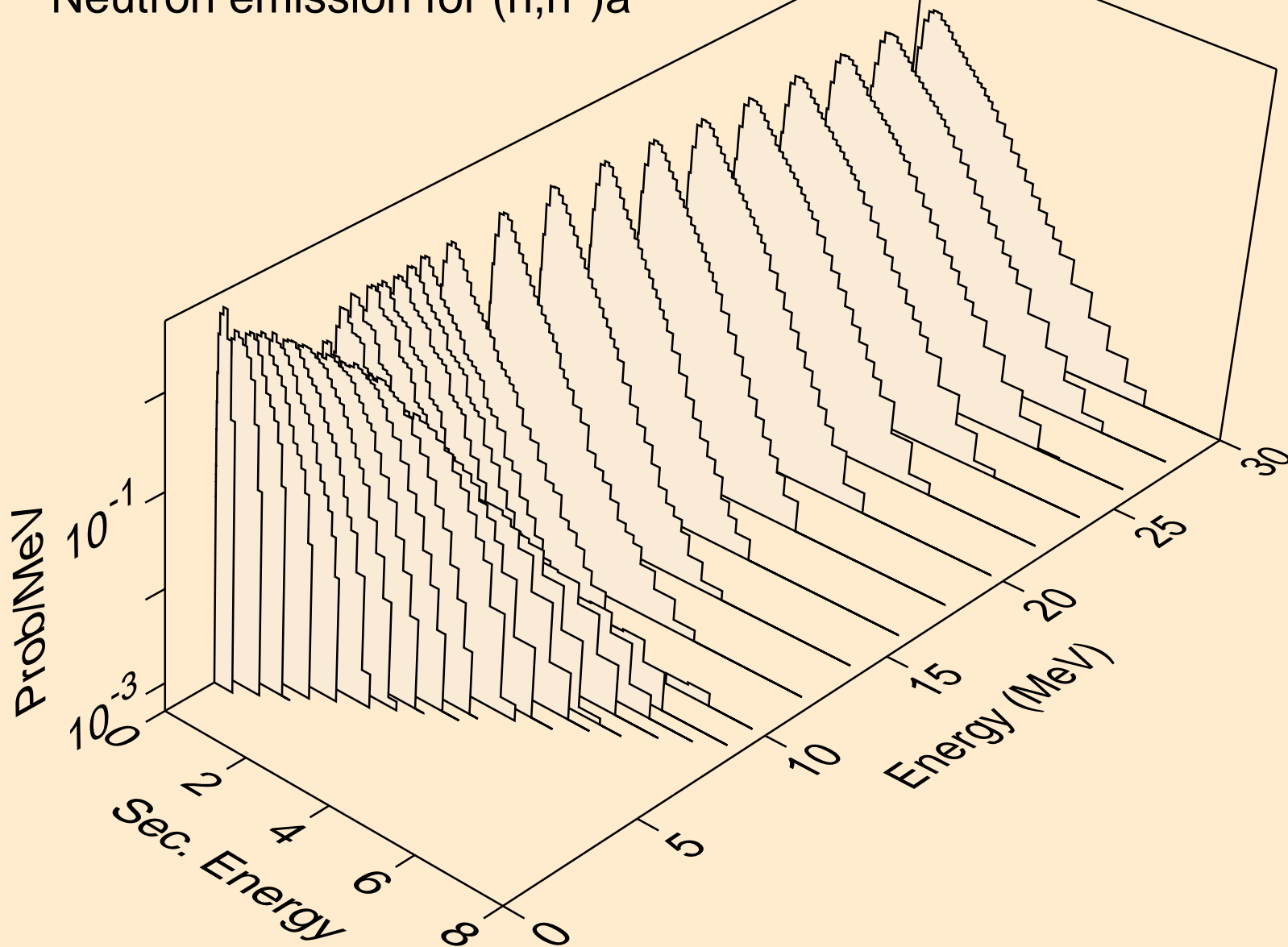

AM235 NEUTRON ACER TENDL-2019 LIBRARY; T=293.16K
Neutron emission for (n,2n)a

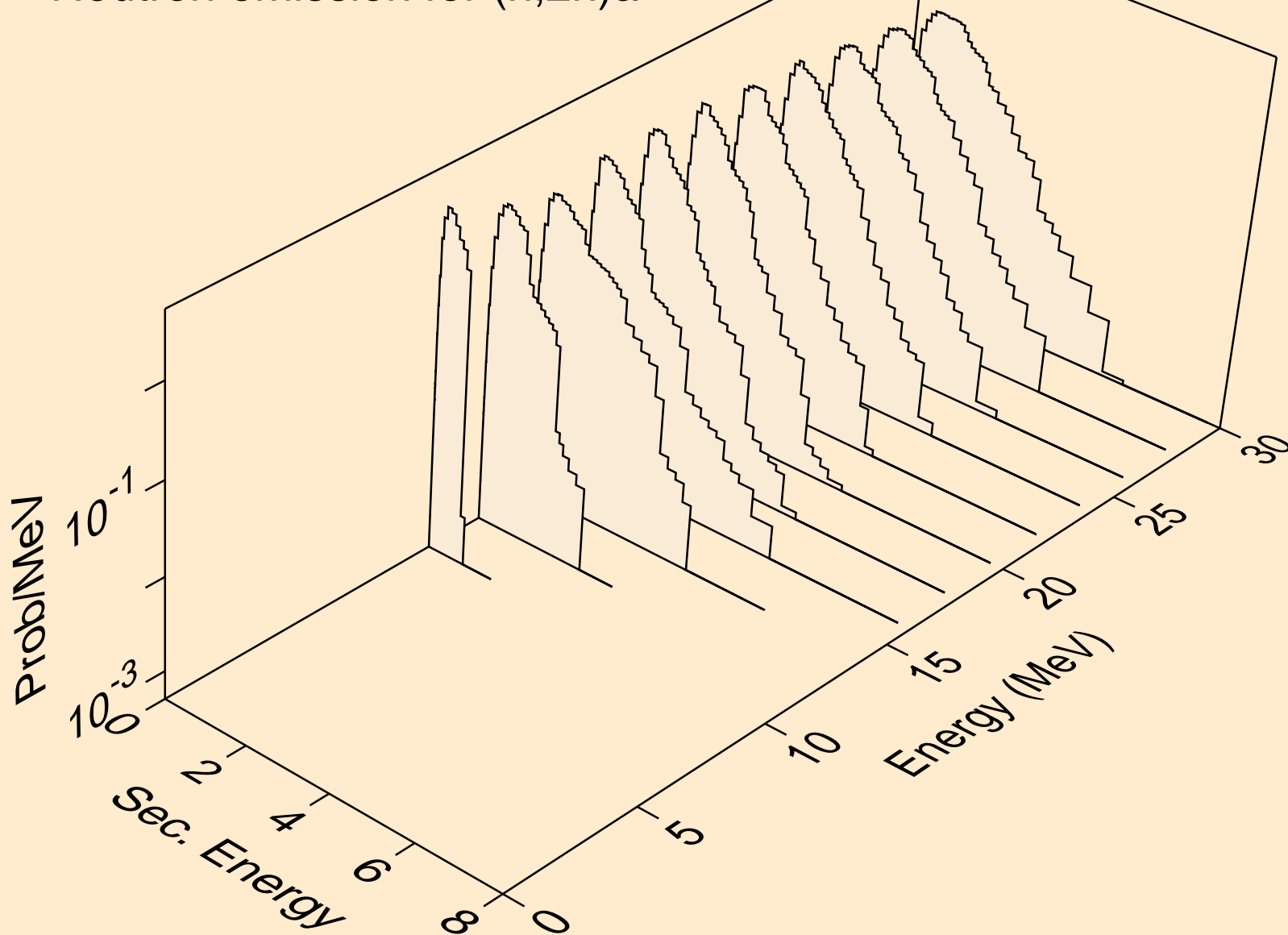

AM235 NEUTRON ACER TENDL-2019 LIBRARY; T=293.16K
Neutron emission for (n,3n)a

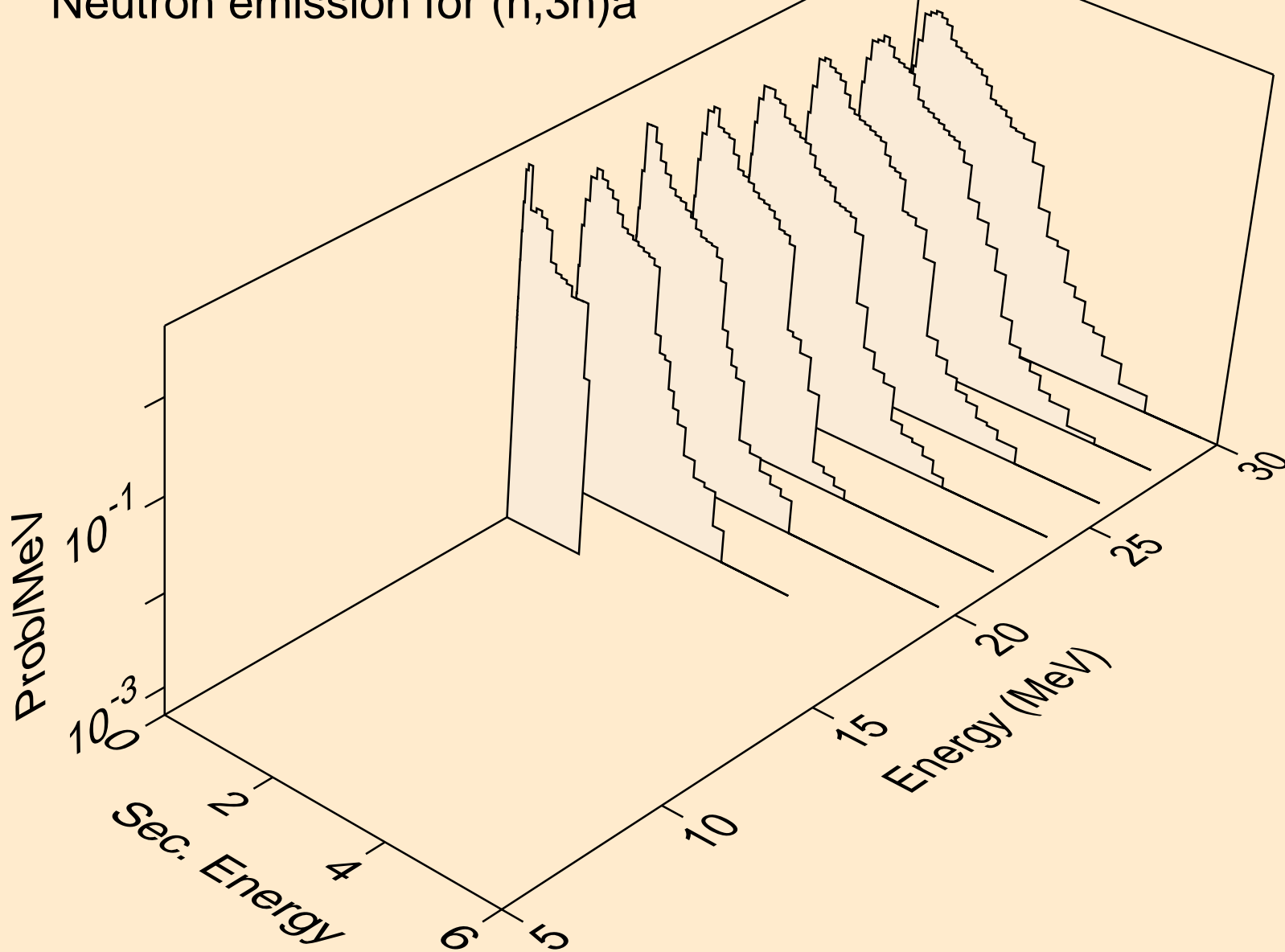

AM235 NEUTRON ACER TENDL-2019 LIBRARY; T=293.16K
Neutron emission for (n,n*)p

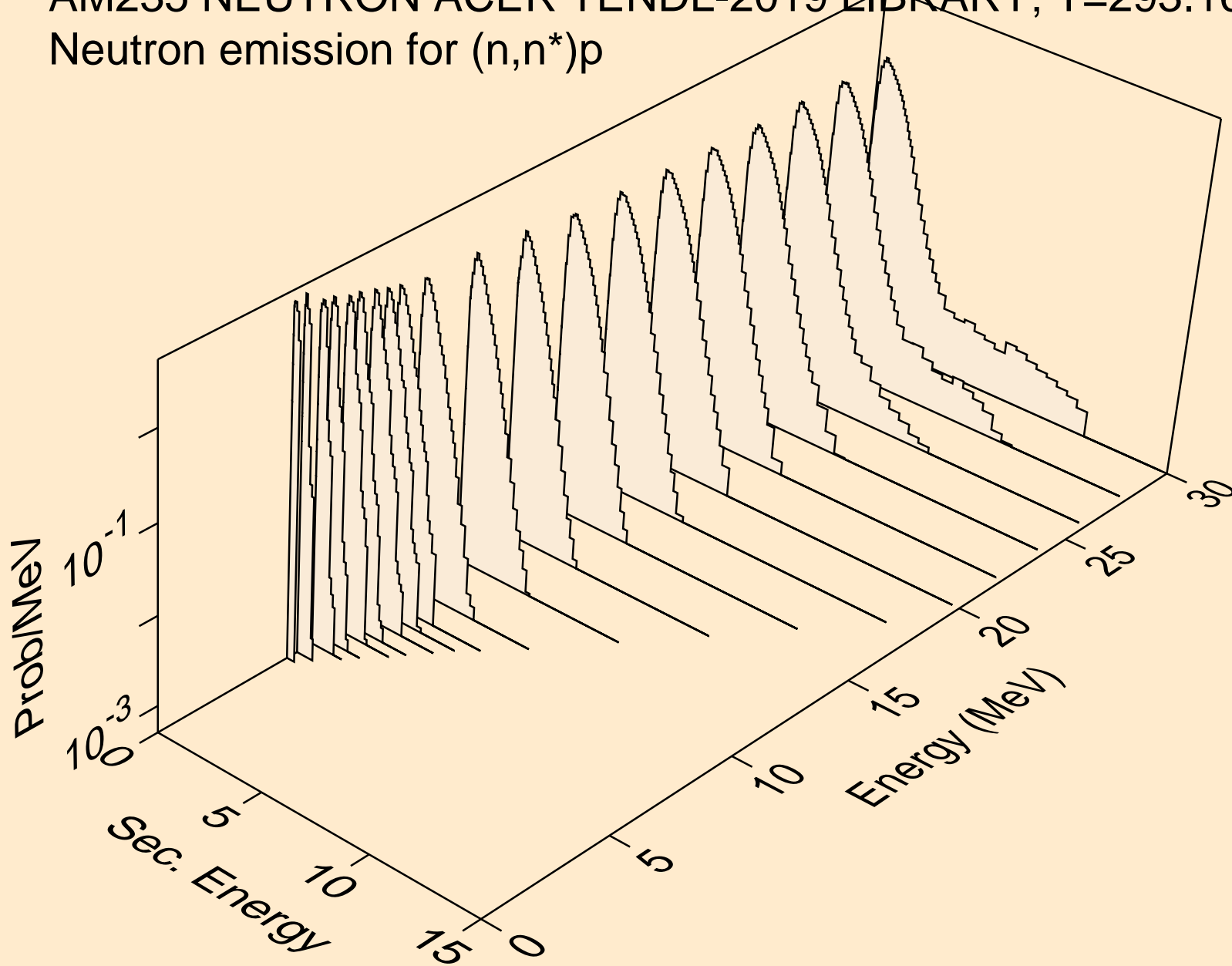

AM235 NEUTRON ACER TENDL-2019 LIBRARY; T=293.16K
Neutron emission for (n,n*)2a

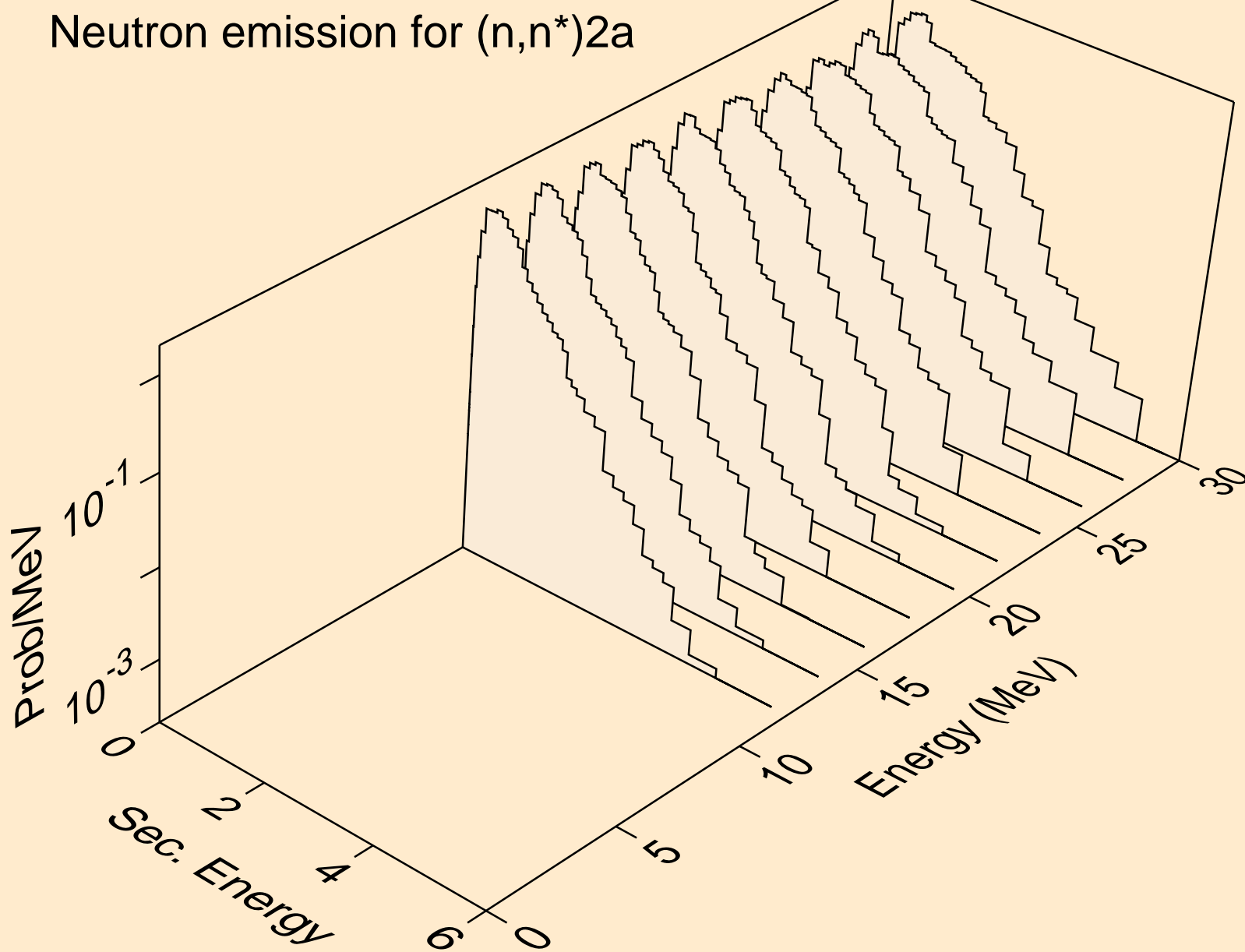

AM235 NEUTRON ACER TENDL-2019 LIBRARY; T=293.16K
Neutron emission for (n,2n)2a

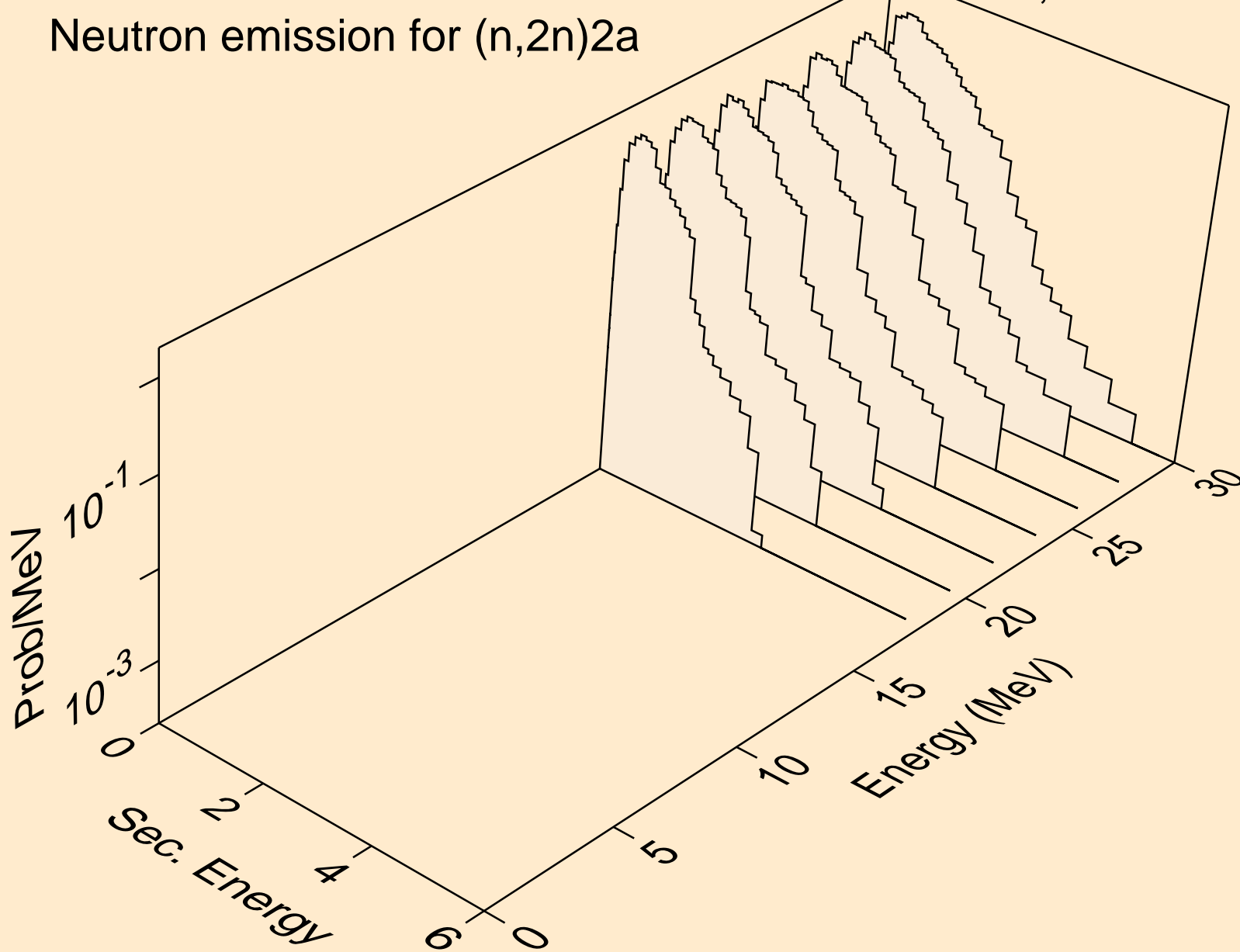

AM235 NEUTRON ACER TENDL-2019 LIBRARY; T=293.16K
Neutron emission for (n,n*)d

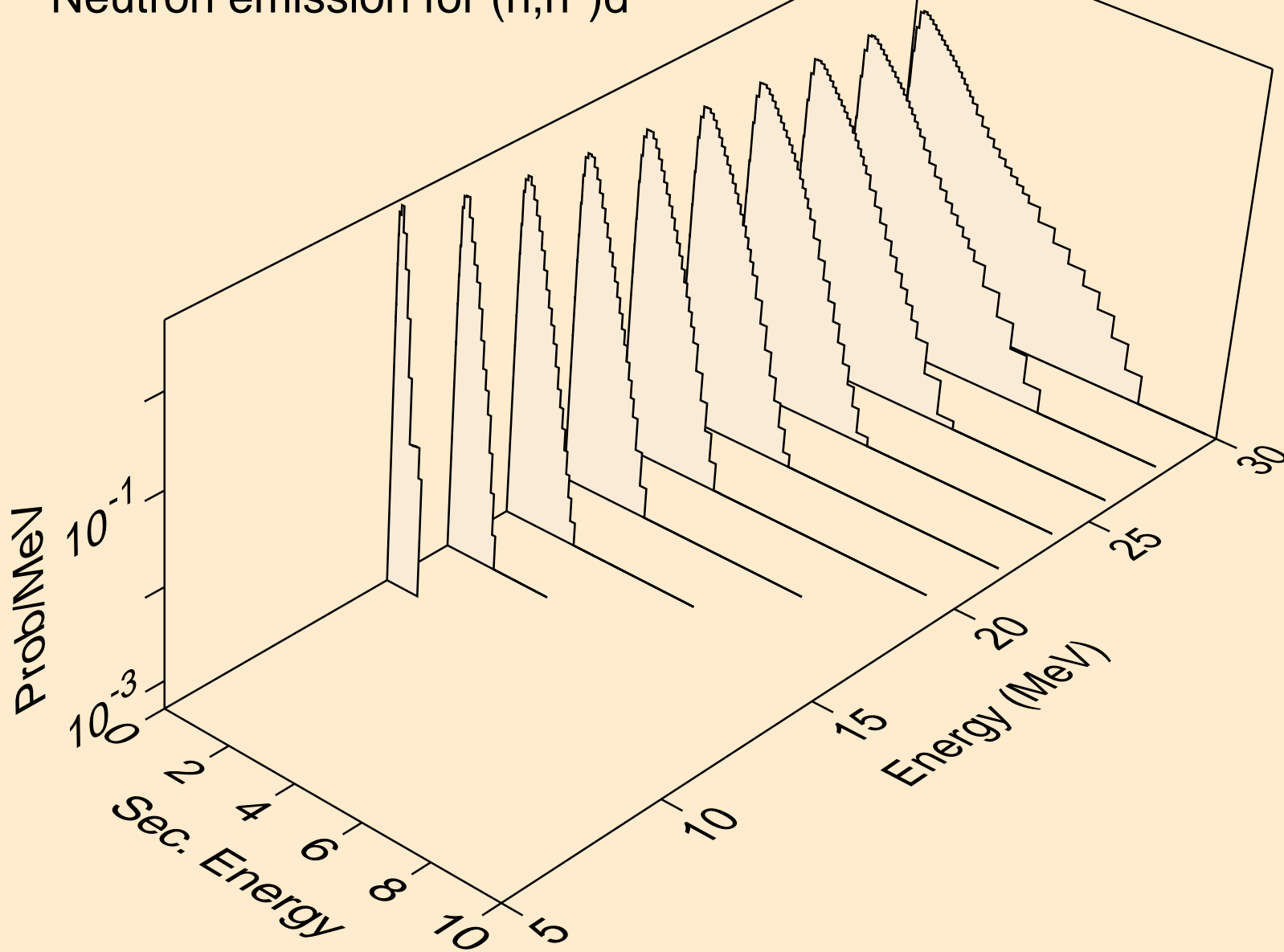

AM235 NEUTRON ACER TENDL-2019 LIBRARY; T=293.16K
Neutron emission for (n,n*)t

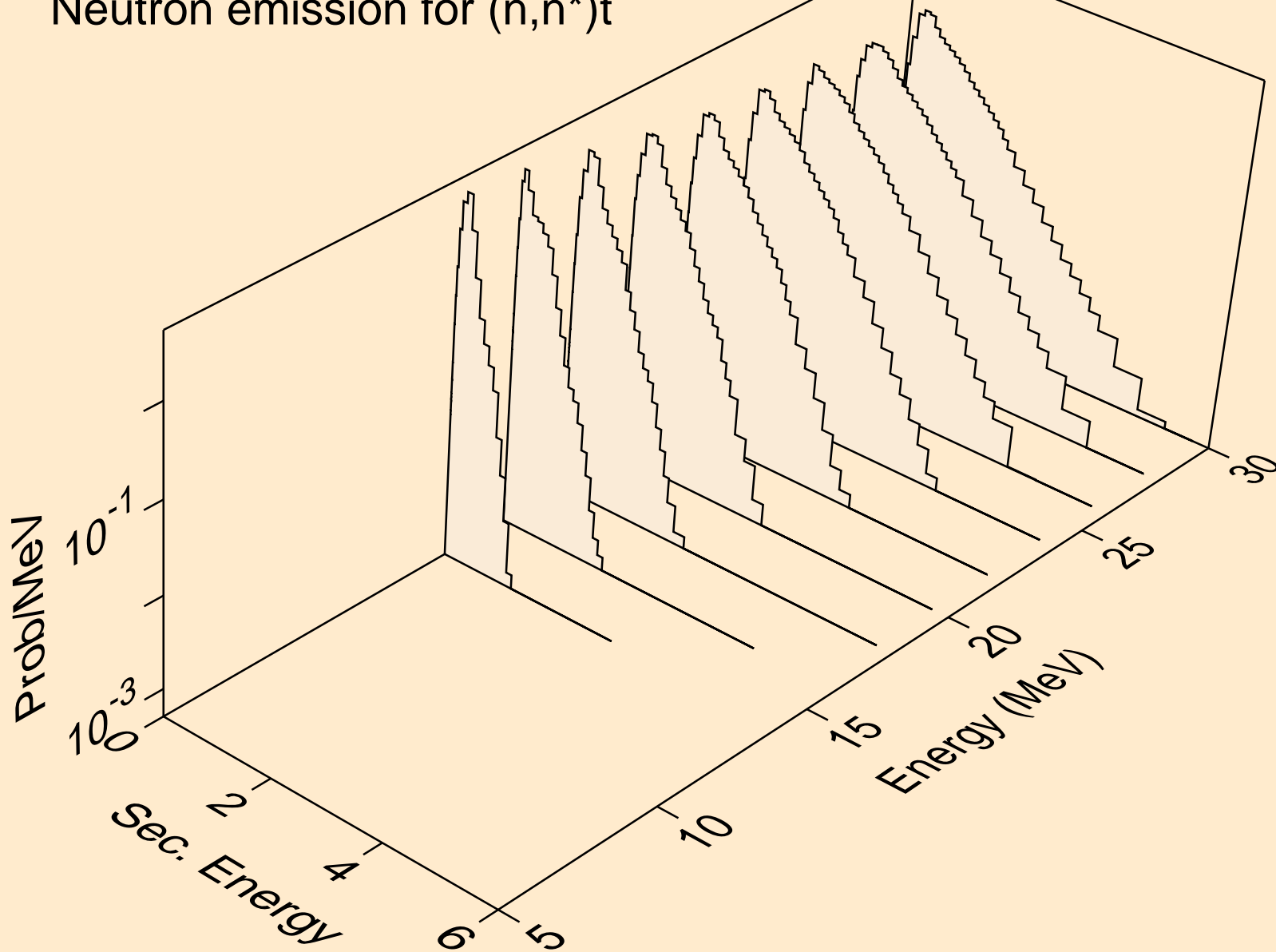

AM235 NEUTRON ACER TENDL-2019 LIBRARY; T=293.16K
Neutron emission for (n,n*)he3

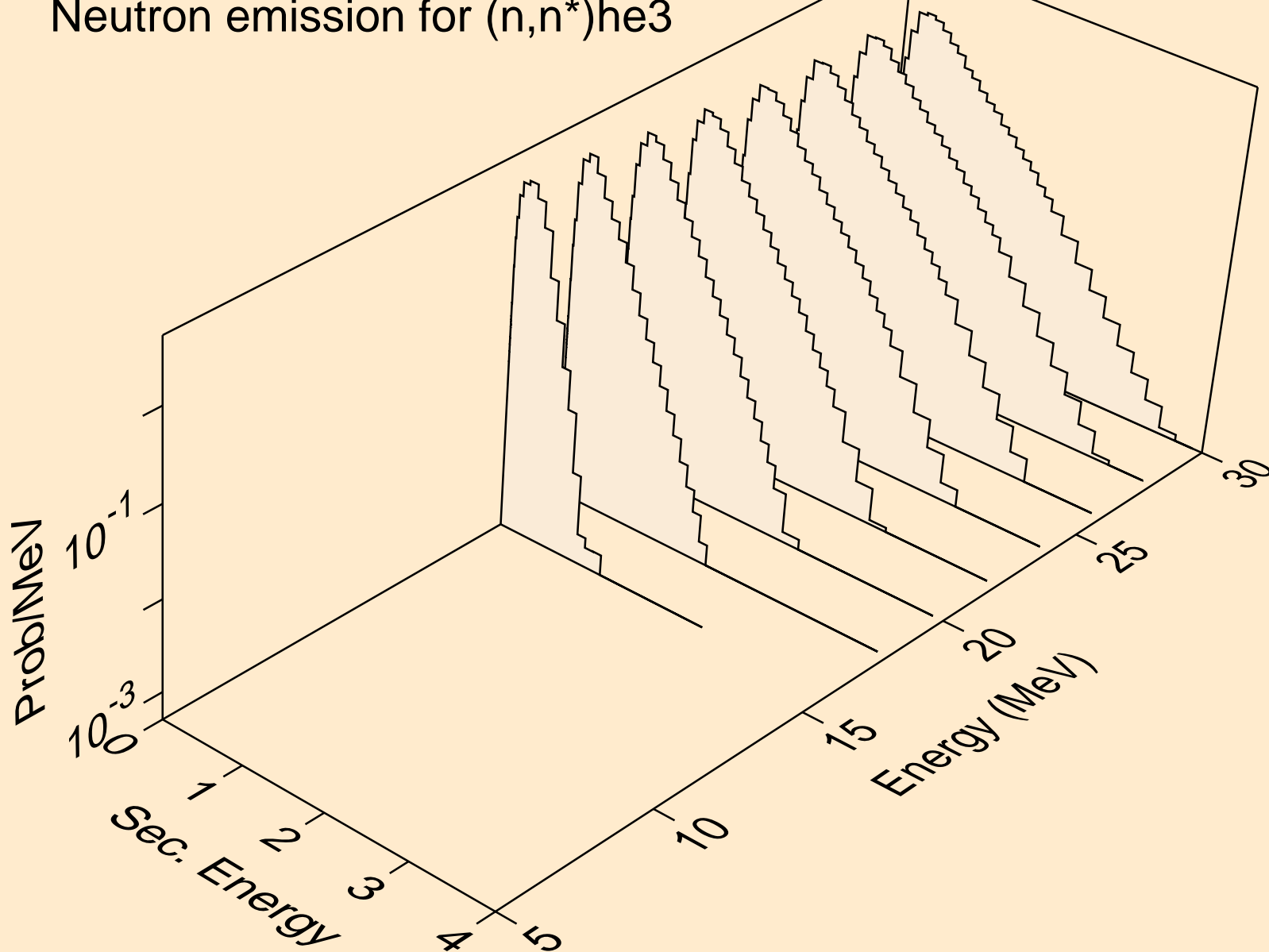

AM235 NEUTRON ACER TENDL-2019 LIBRARY; T=293.16K
Neutron emission for (n,4n)

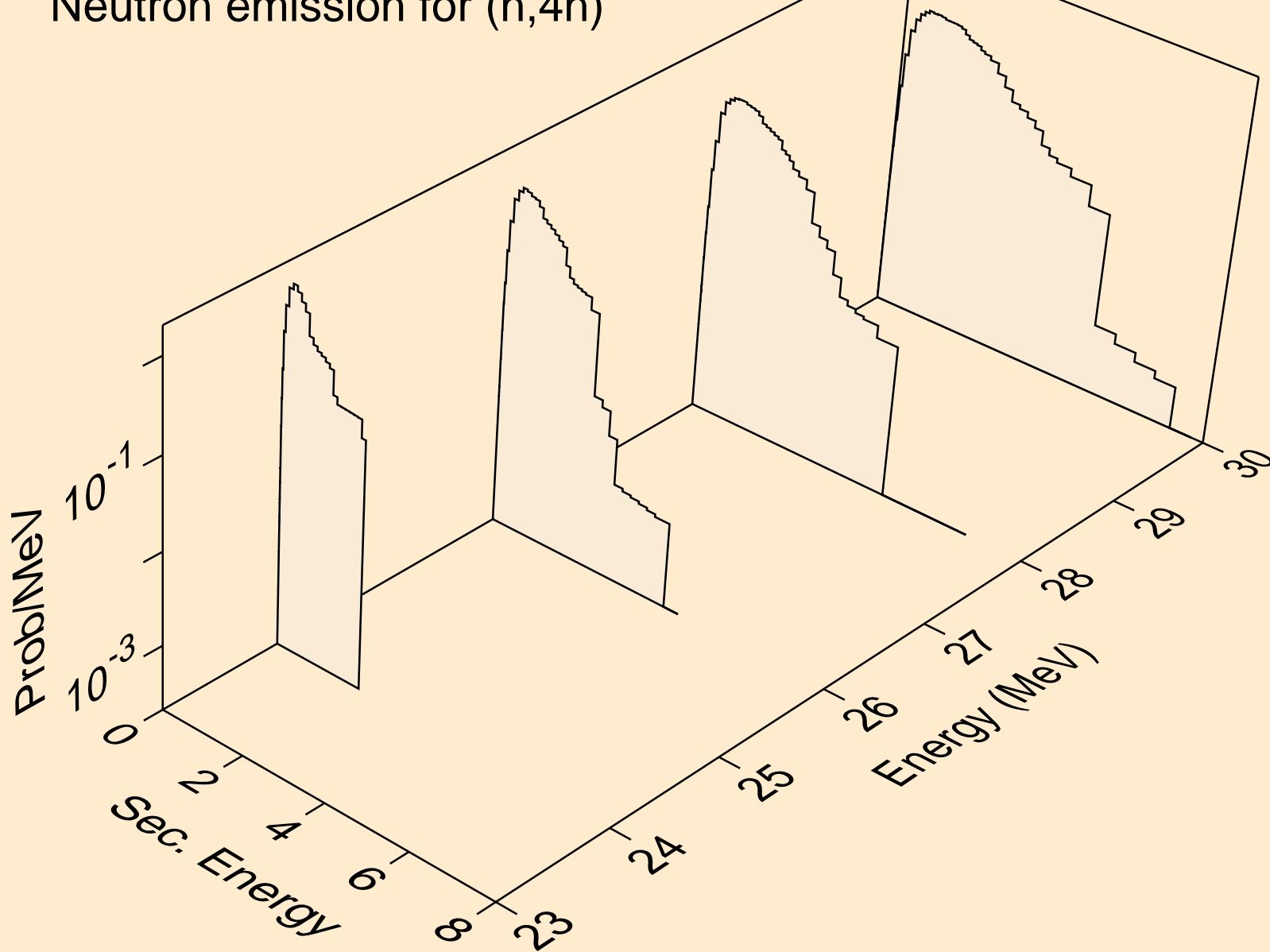

AM235 NEUTRON ACER TENDL-2019 LIBRARY; T=293.16K
Neutron emission for (n,2np)

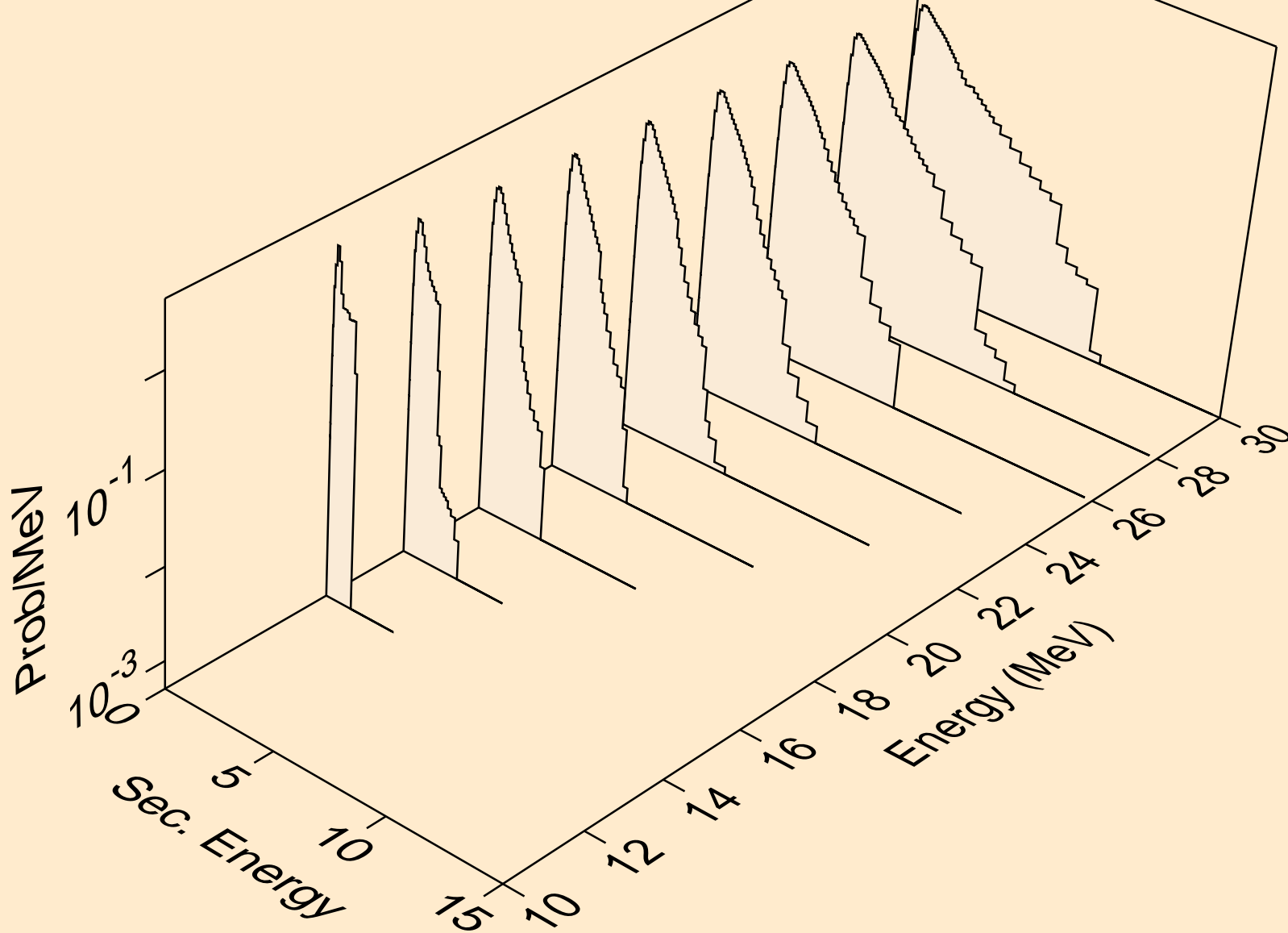

AM235 NEUTRON ACER TENDL-2019 LIBRARY; T=293.16K
Neutron emission for (n,3np)

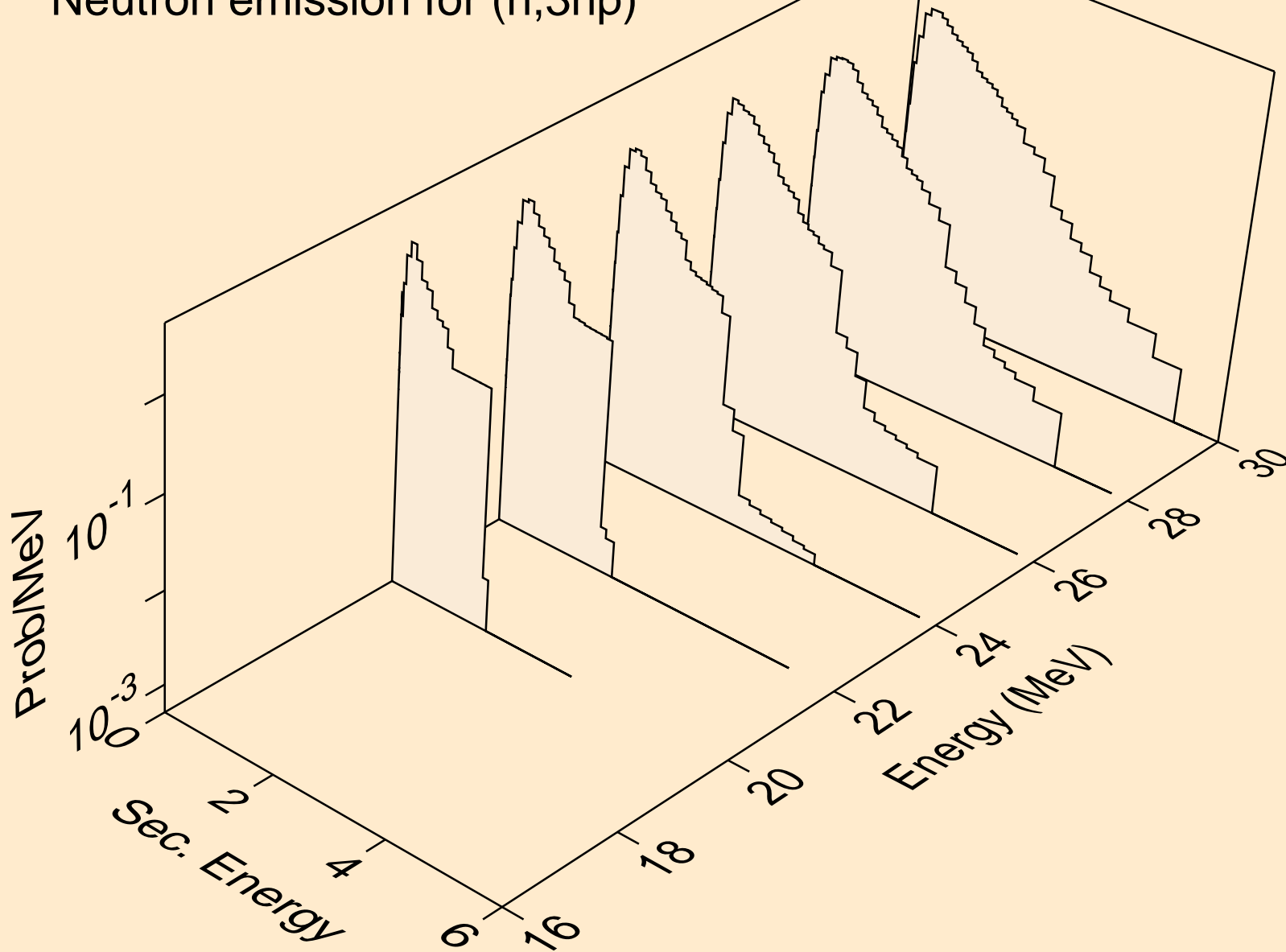

AM235 NEUTRON ACER TENDL-2019 LIBRARY; T=293.16K
Neutron emission for (n,2np)

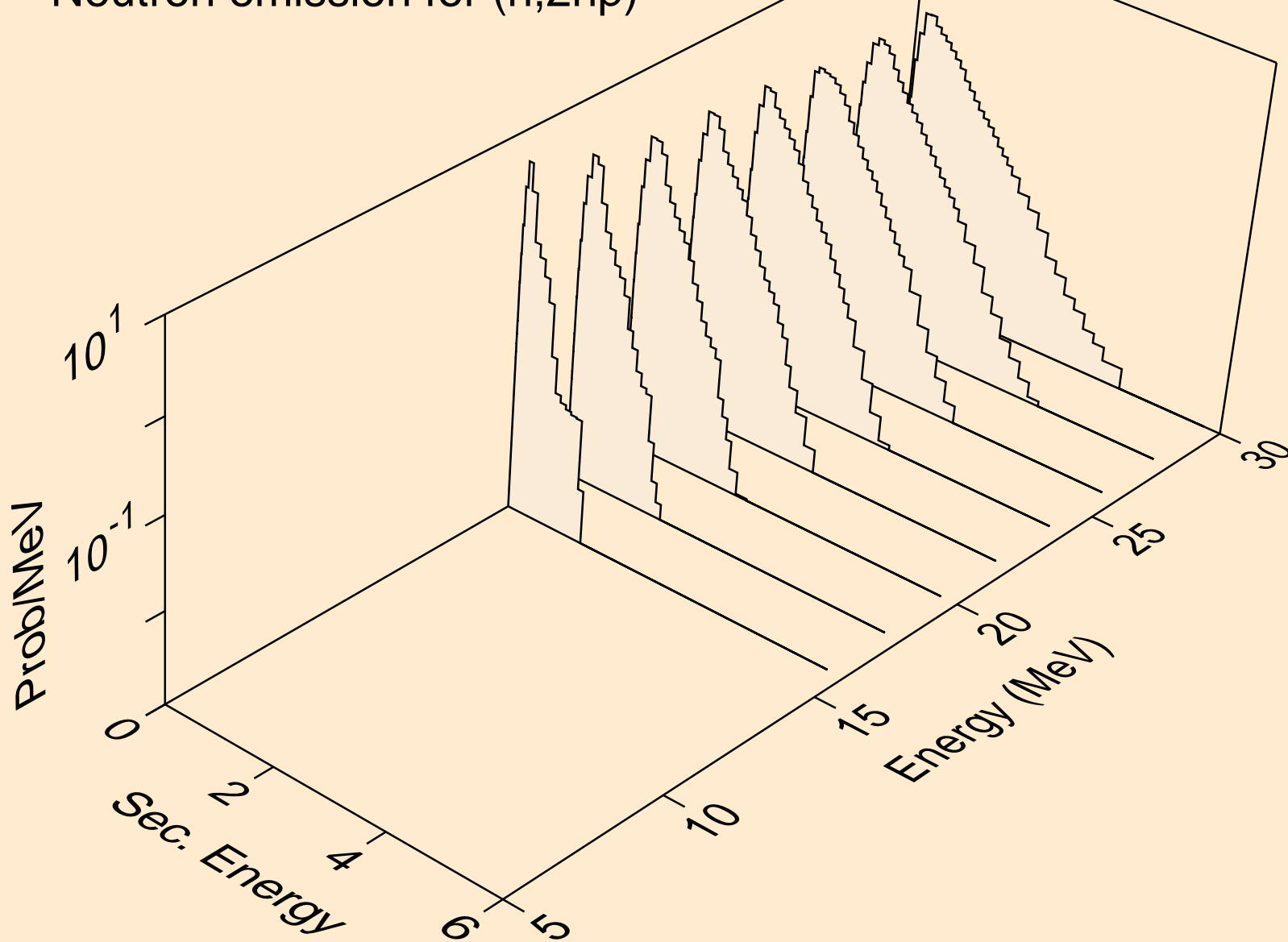

AM235 NEUTRON ACER TENDL-2019 LIBRARY; T=293.16K
Neutron emission for (n,npa)

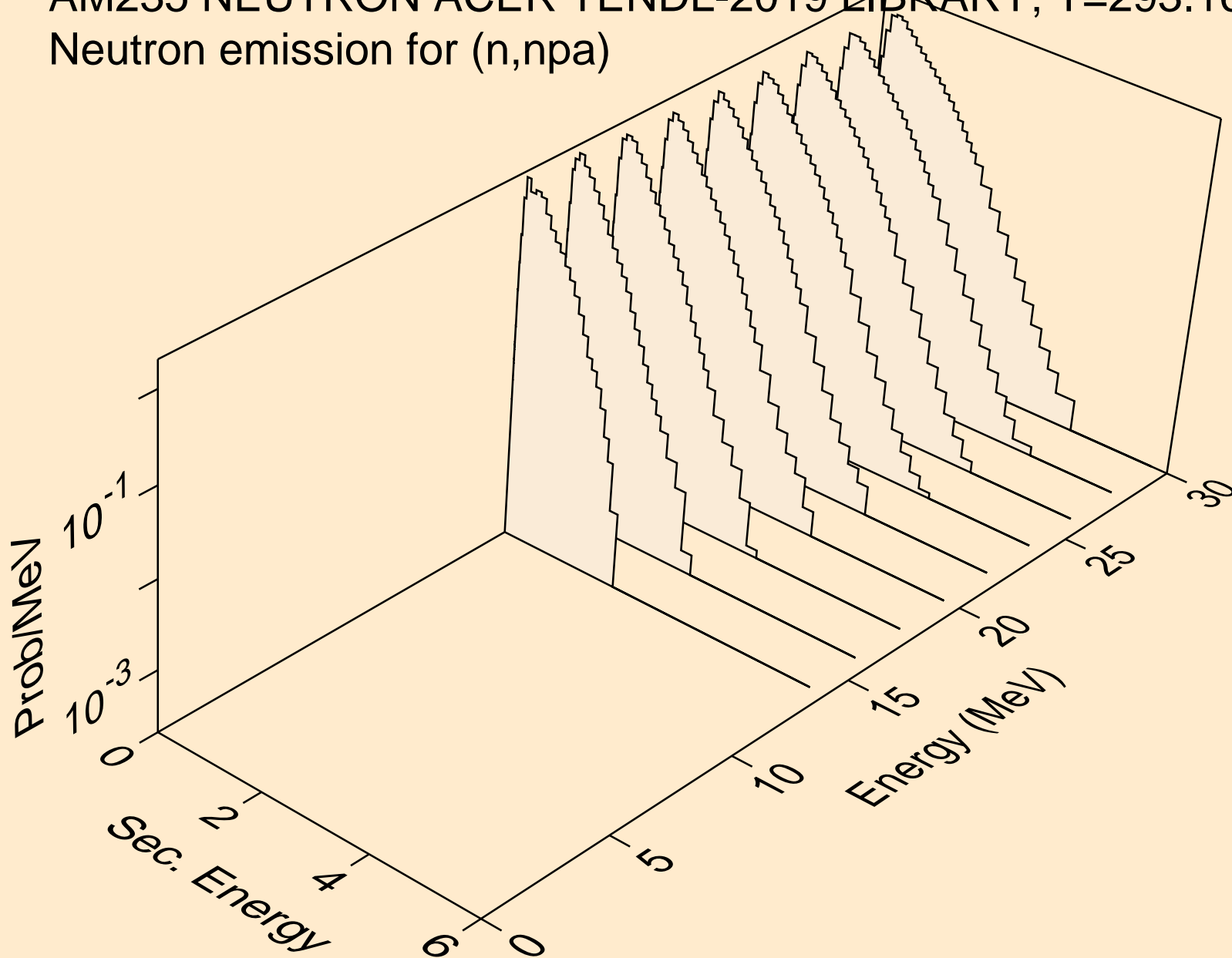

AM235 NEUTRON ACER TENDL-2019 LIBRARY; T=293.16K
Neutron emission for (n,n*c)

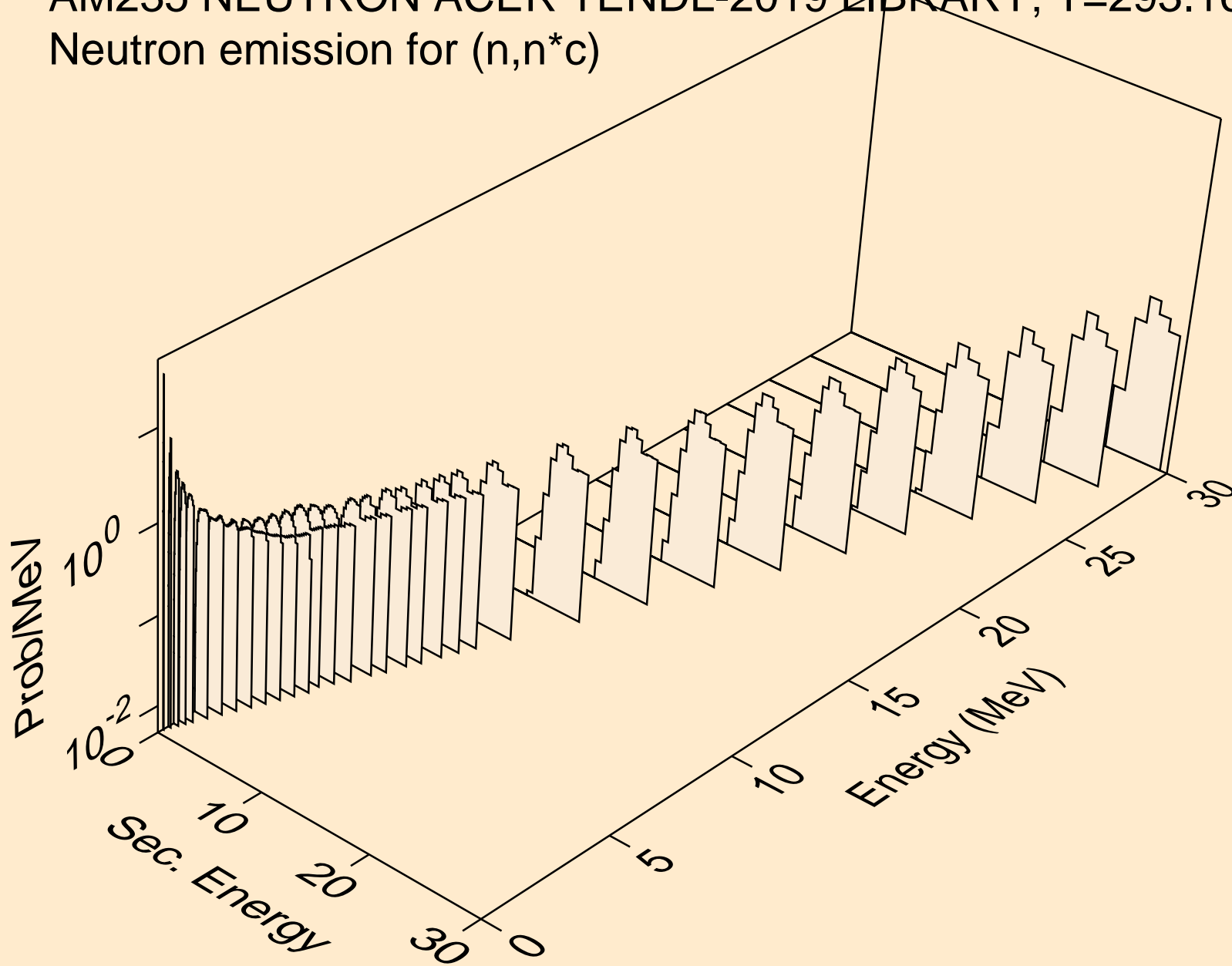

AM235 NEUTRON ACER TENDL-2019 LIBRARY; T=293.16K

Delayed nubar

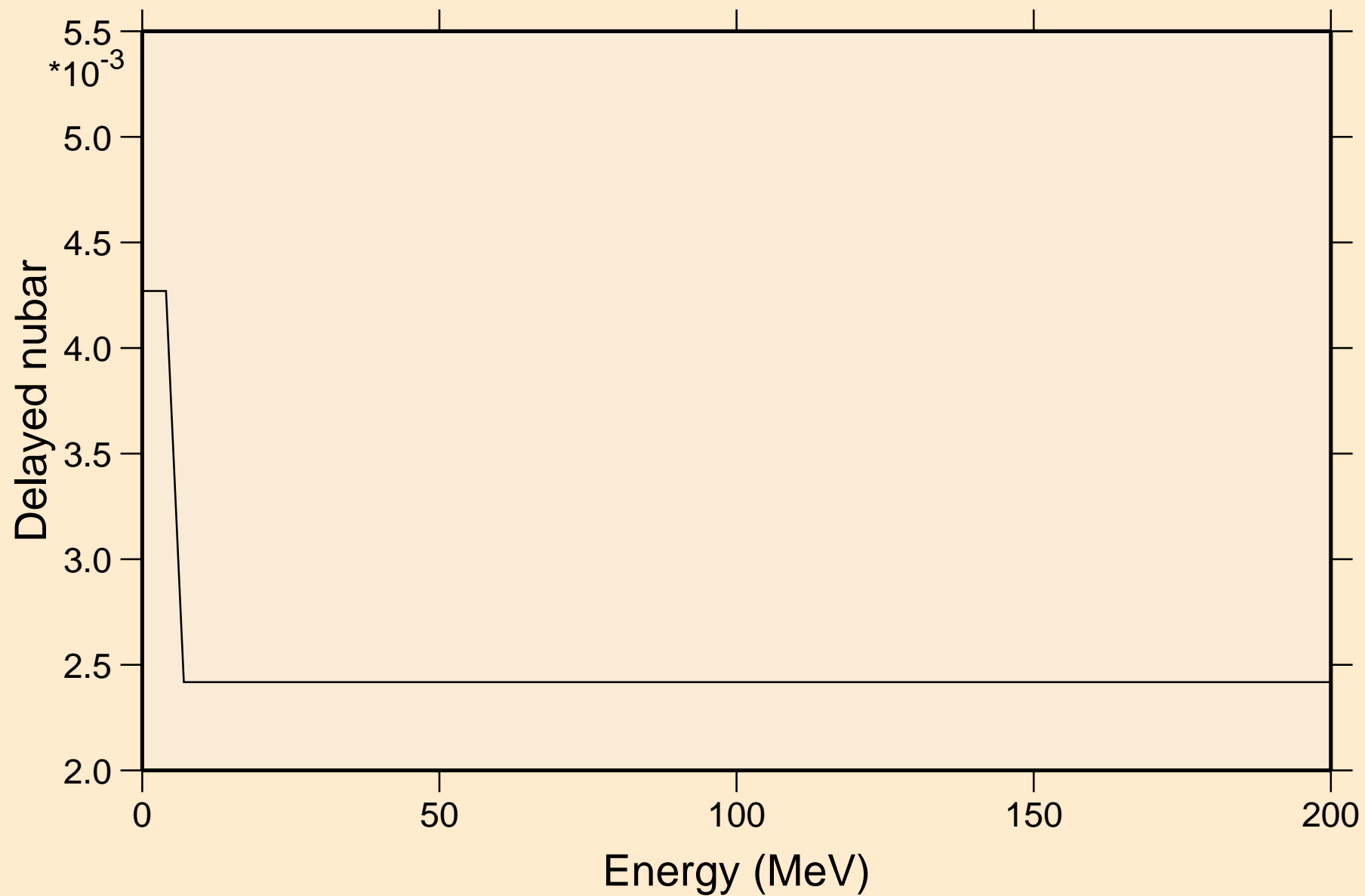

AM235 NEUTRON ACER TENDL-2019 LIBRARY; T=293.16K
Delayed neutron spectra

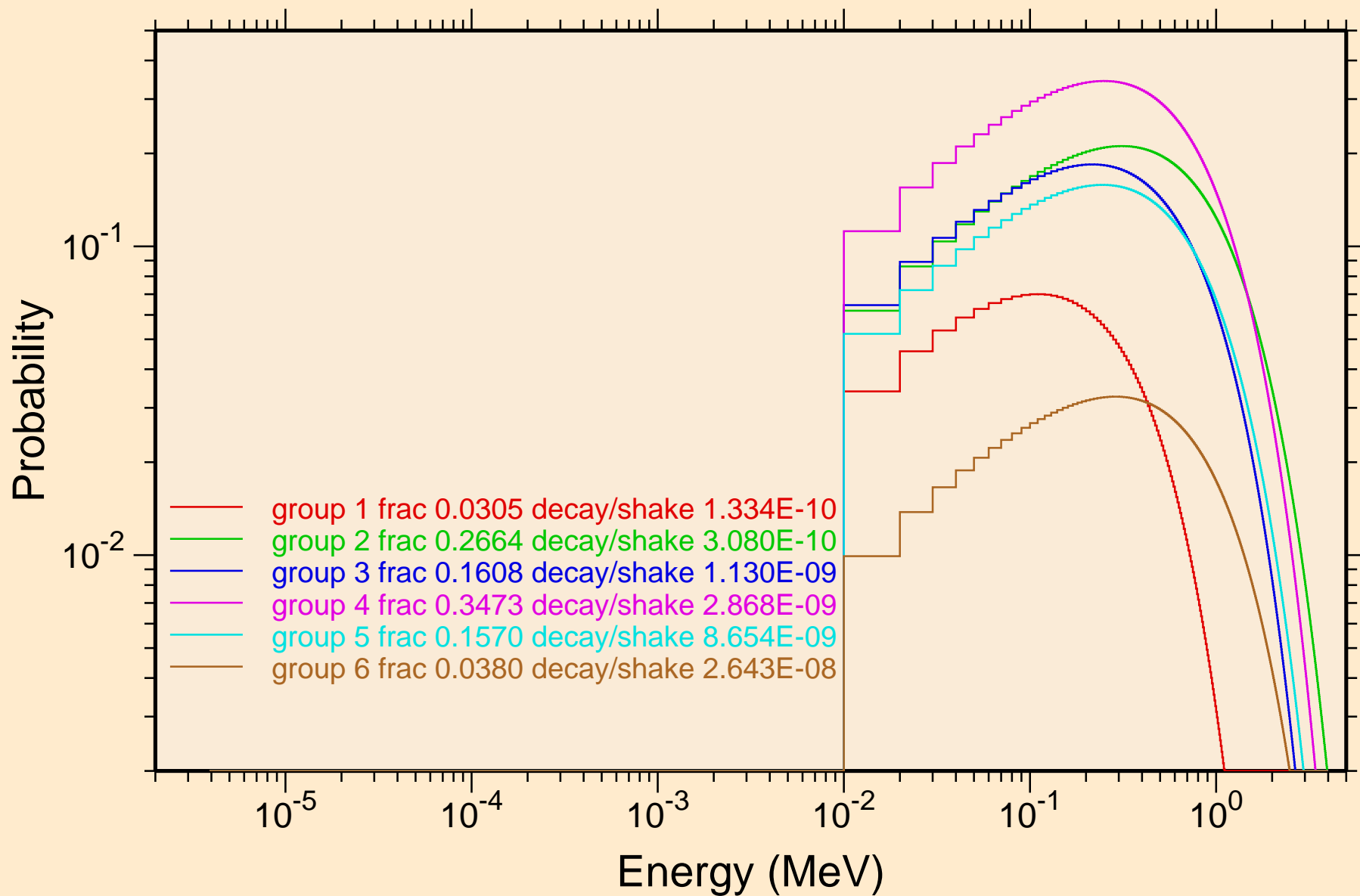

AM235 NEUTRON ACER TENDL-2019 LIBRARY; T=293.16K
Photon emission for (n,x)

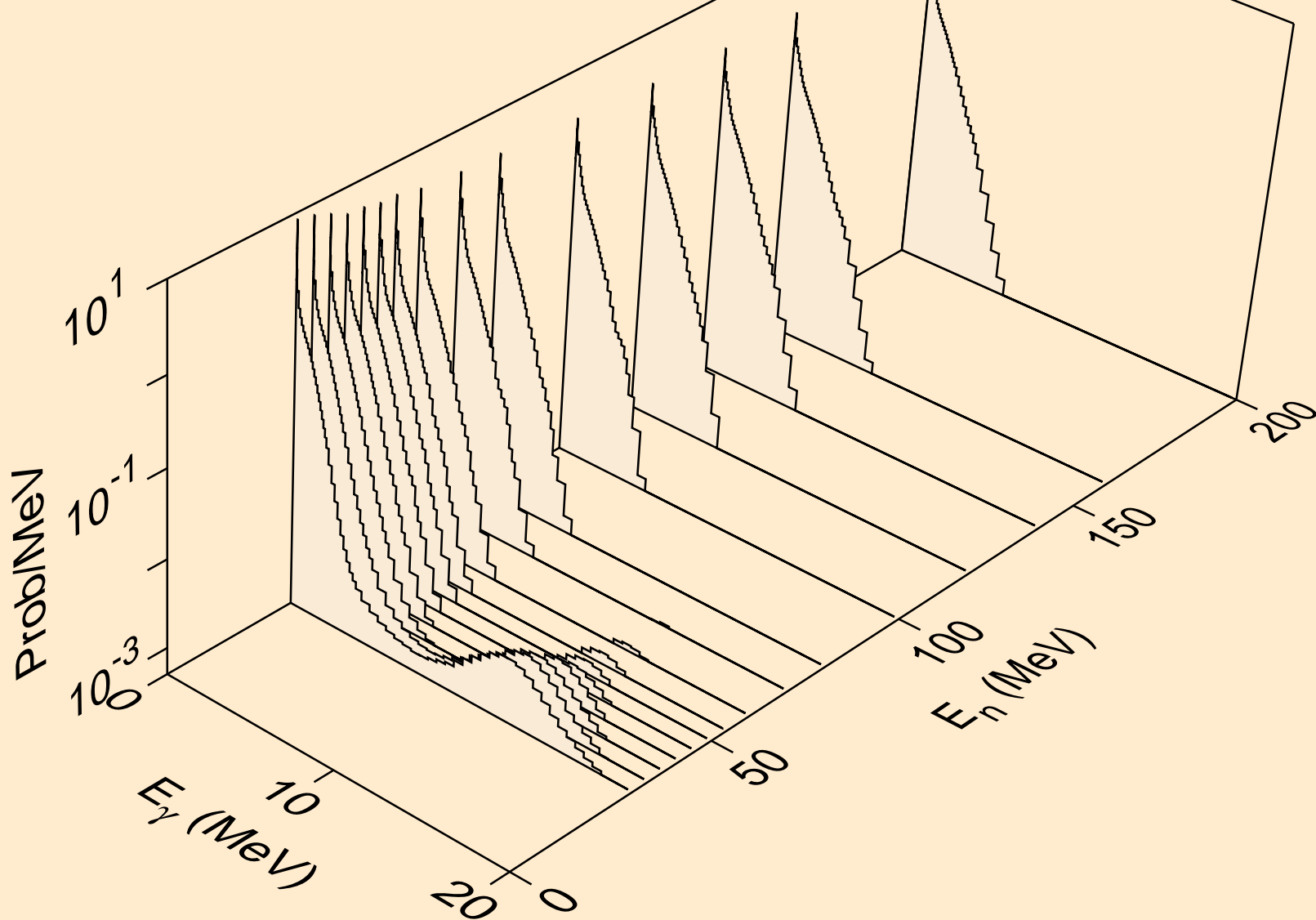

AM235 NEUTRON ACER TENDL-2019 LIBRARY; T=293.16K
Photon emission for (n,2nd)

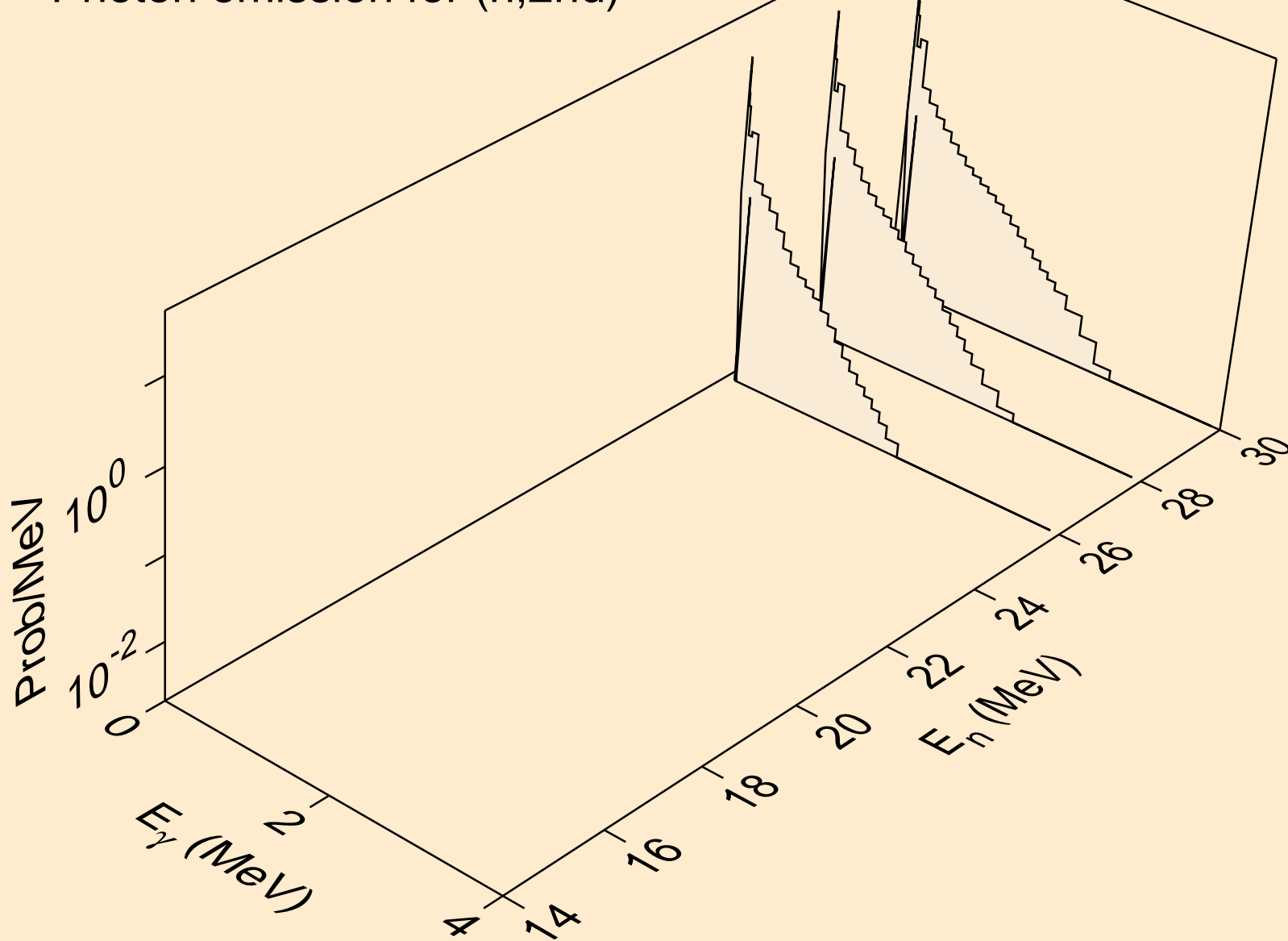

AM235 NEUTRON ACER TENDL-2019 LIBRARY; T=293.16K
Photon emission for (n,2n)

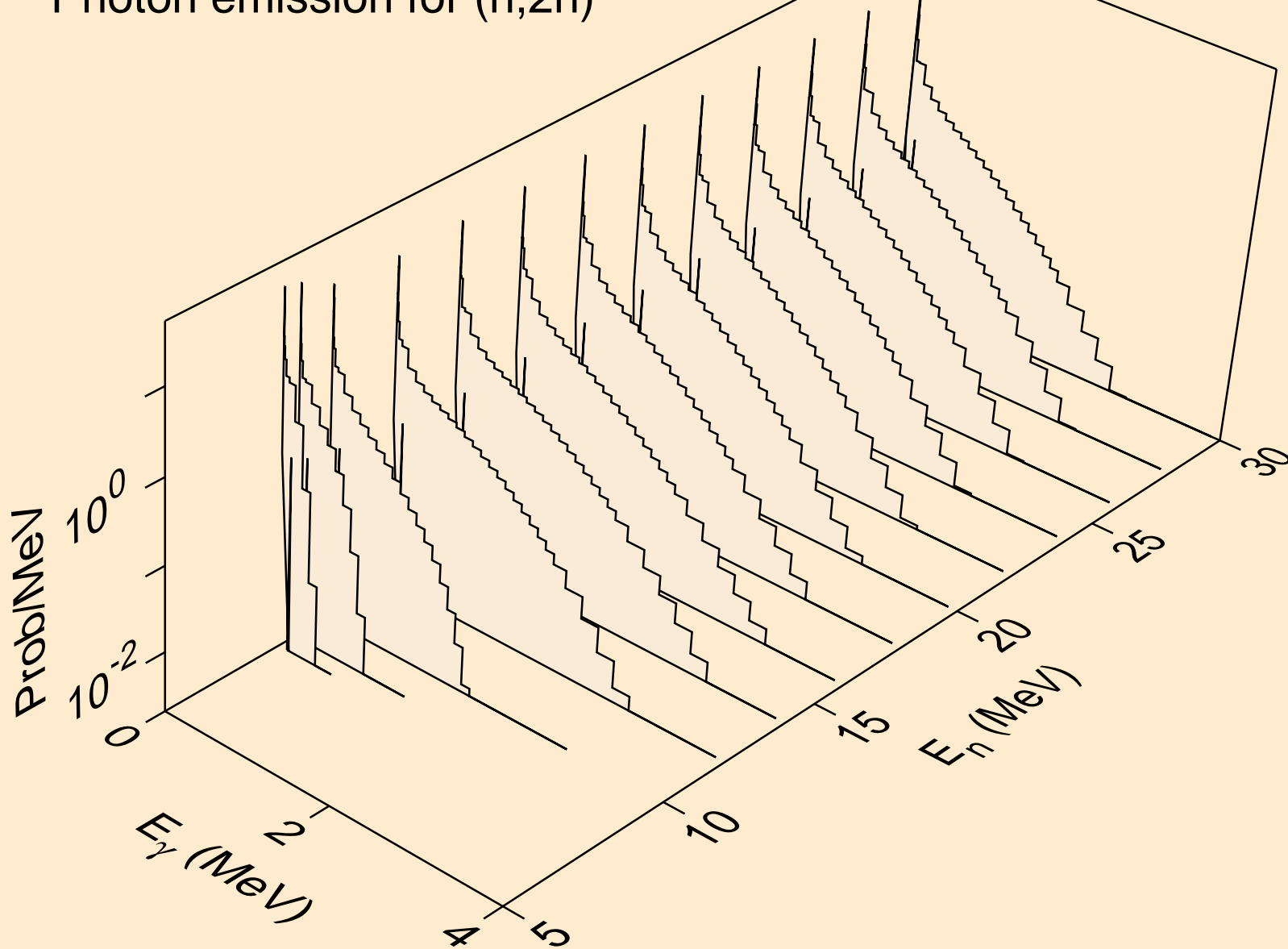

AM235 NEUTRON ACER TENDL-2019 LIBRARY; T=293.16K
Photon emission for (n,3n)

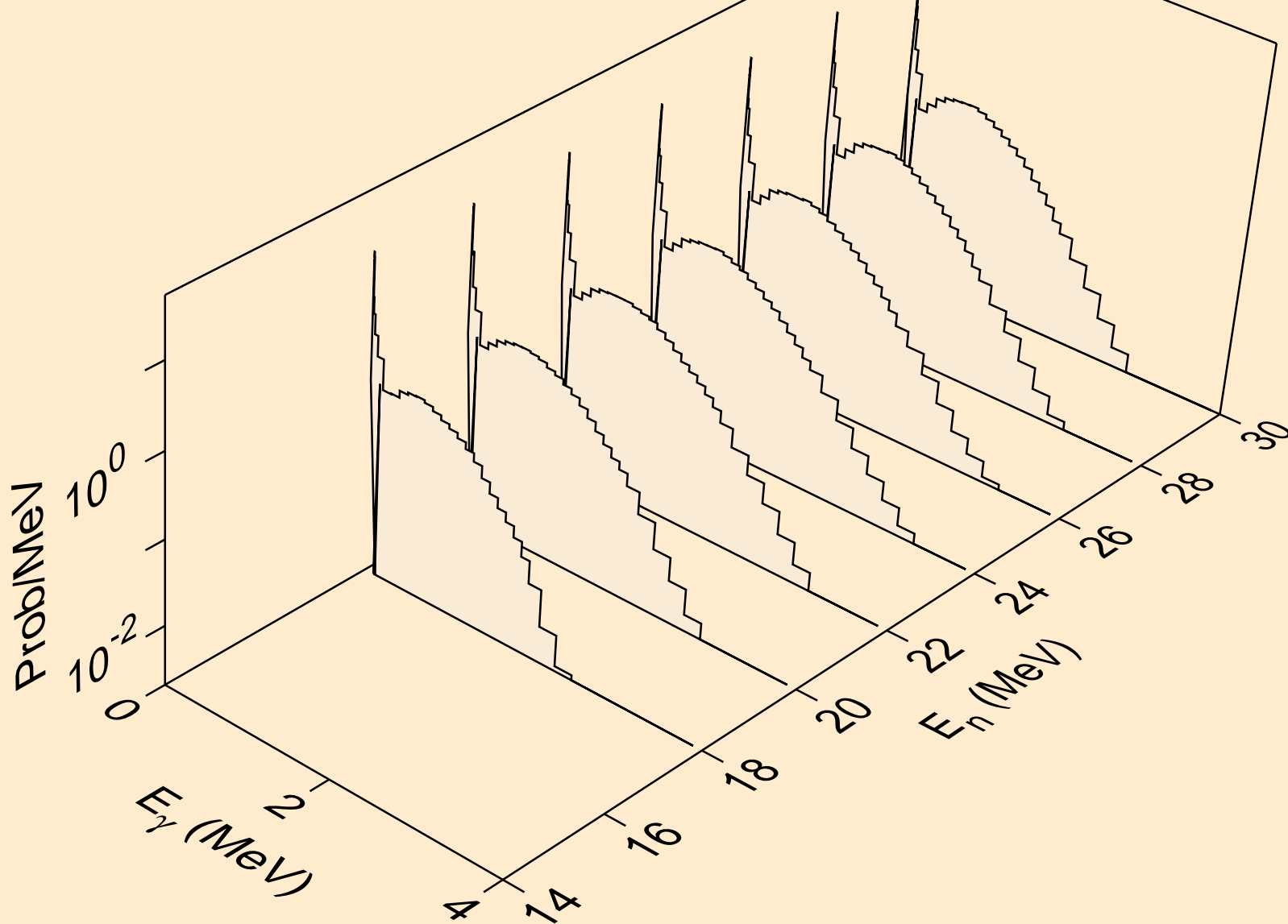

AM235 NEUTRON ACER TENDL-2019 LIBRARY; T=293.16K
Photon emission for (n,n*)a

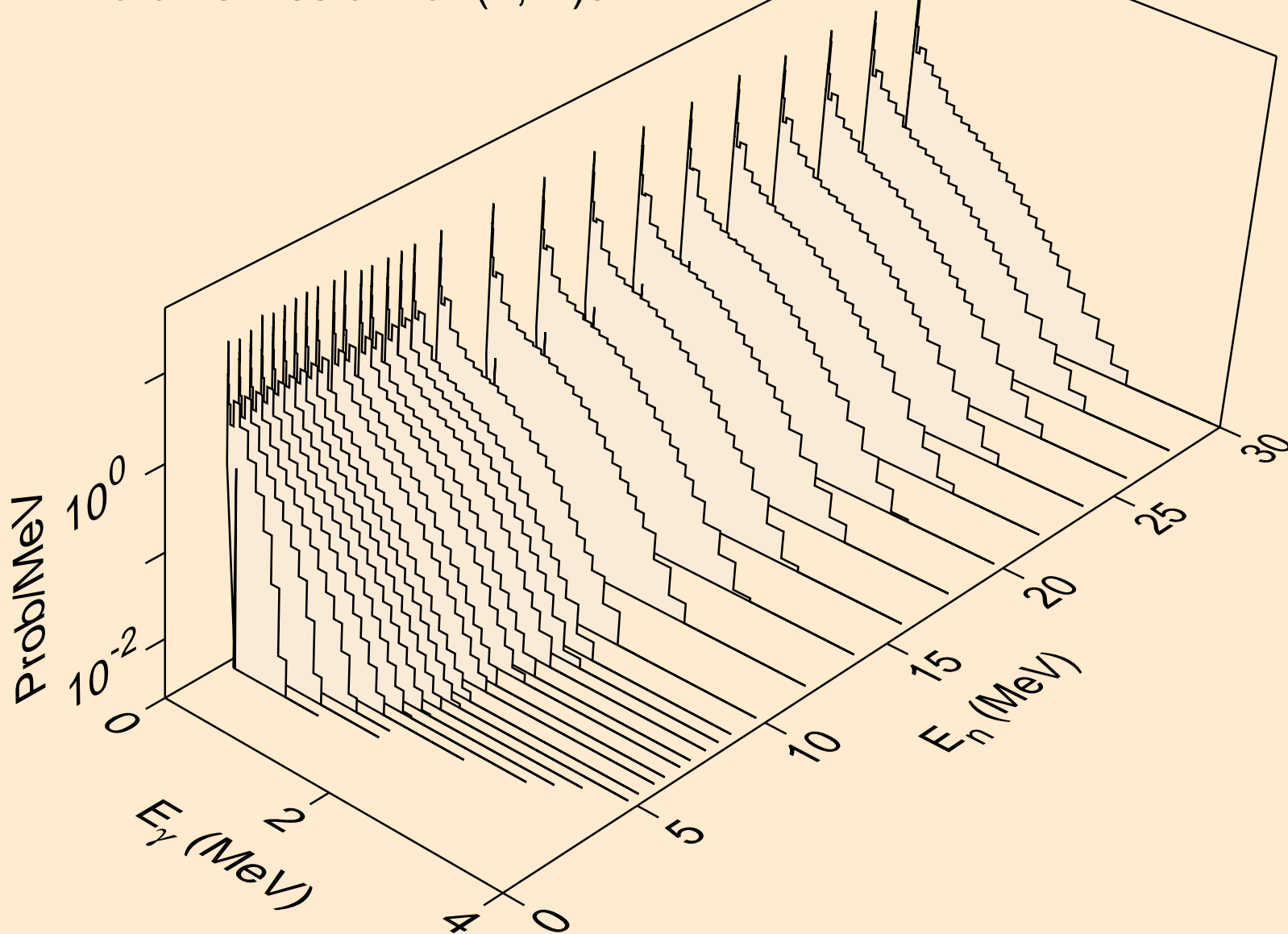

AM235 NEUTRON ACER TENDL-2019 LIBRARY; T=293.16K
Photon emission for (n,2n)a

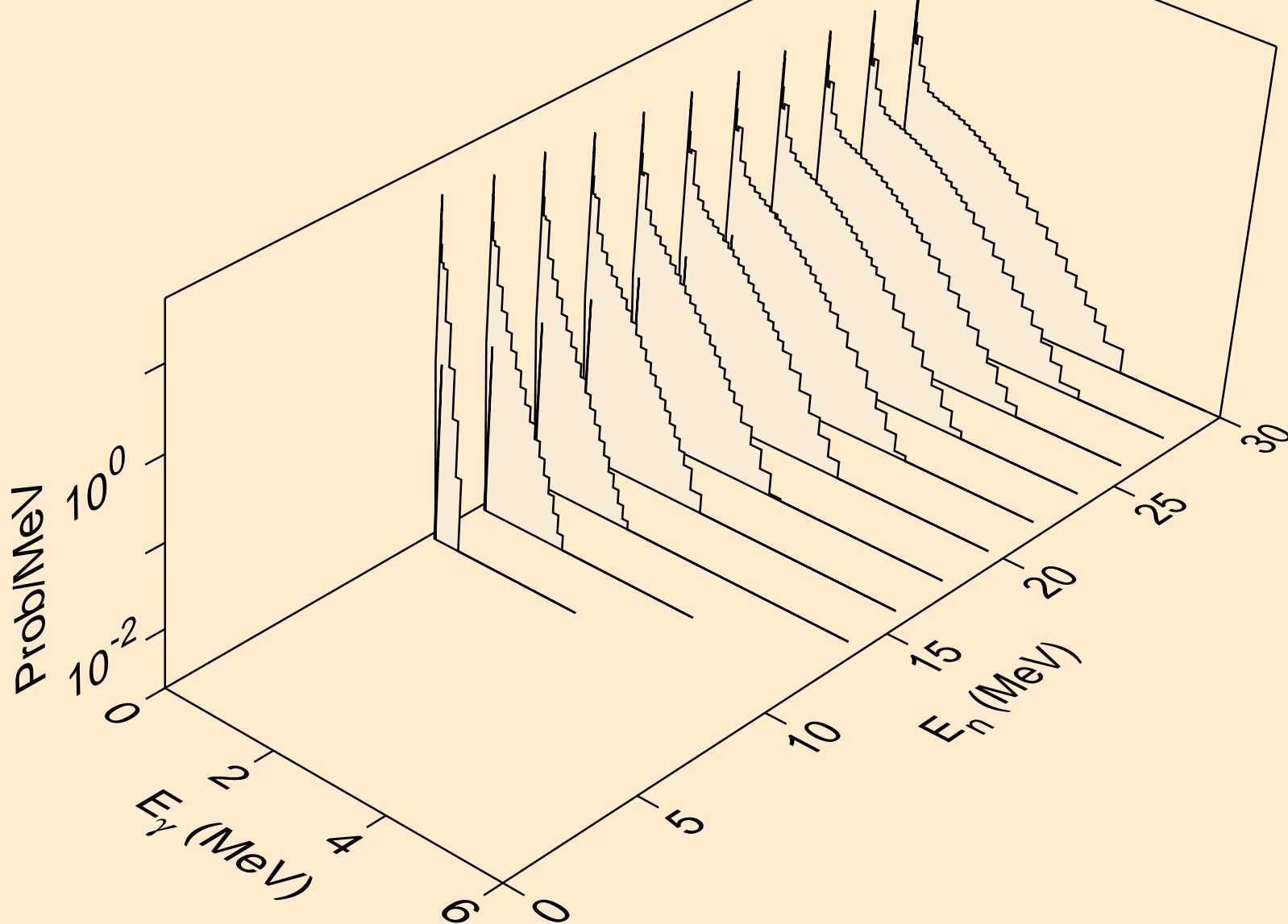

AM235 NEUTRON ACER TENDL-2019 LIBRARY; T=293.16K
Photon emission for (n,3n)a

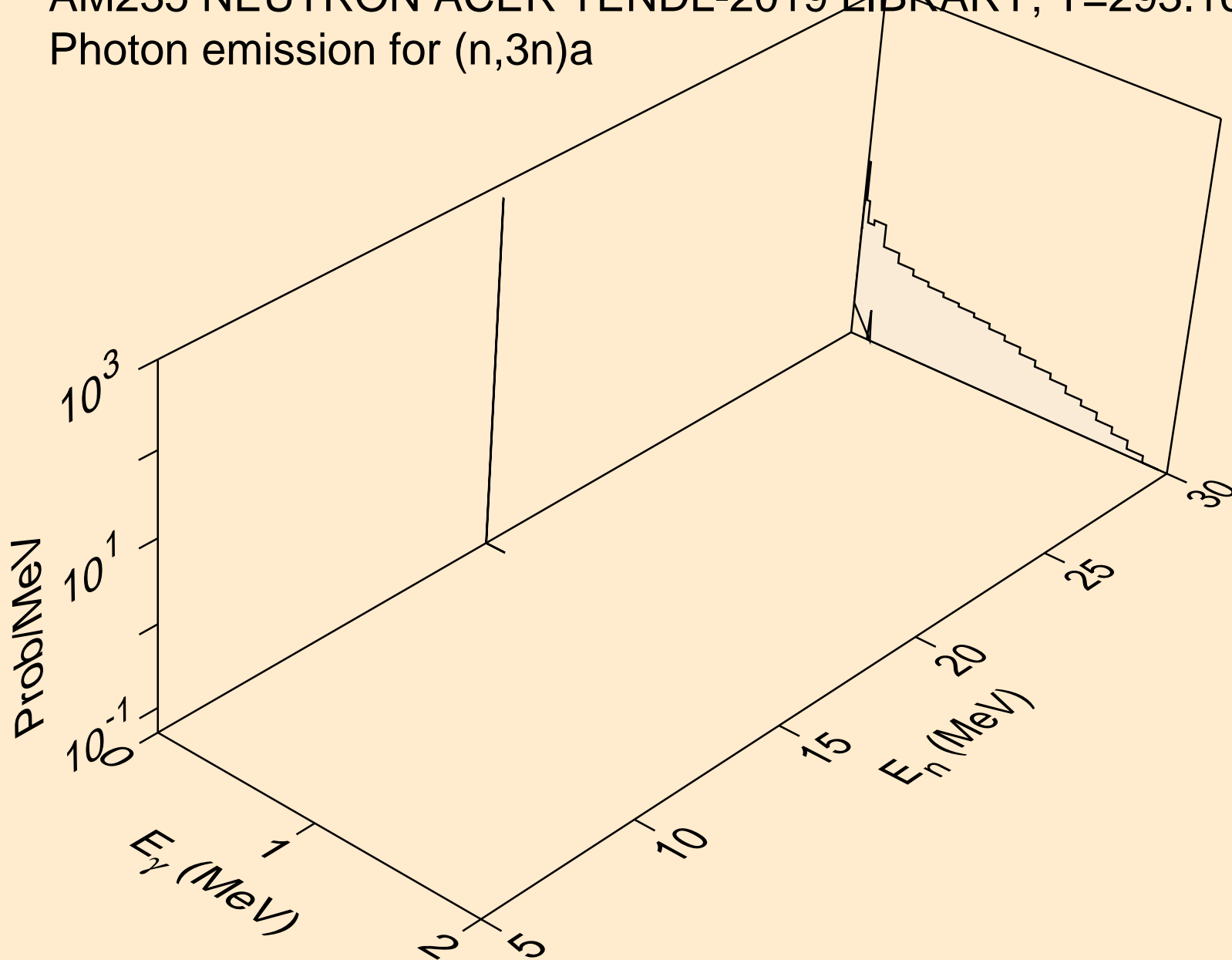

AM235 NEUTRON ACER TENDL-2019 LIBRARY; T=293.16K
Photon emission for (n,n*)p

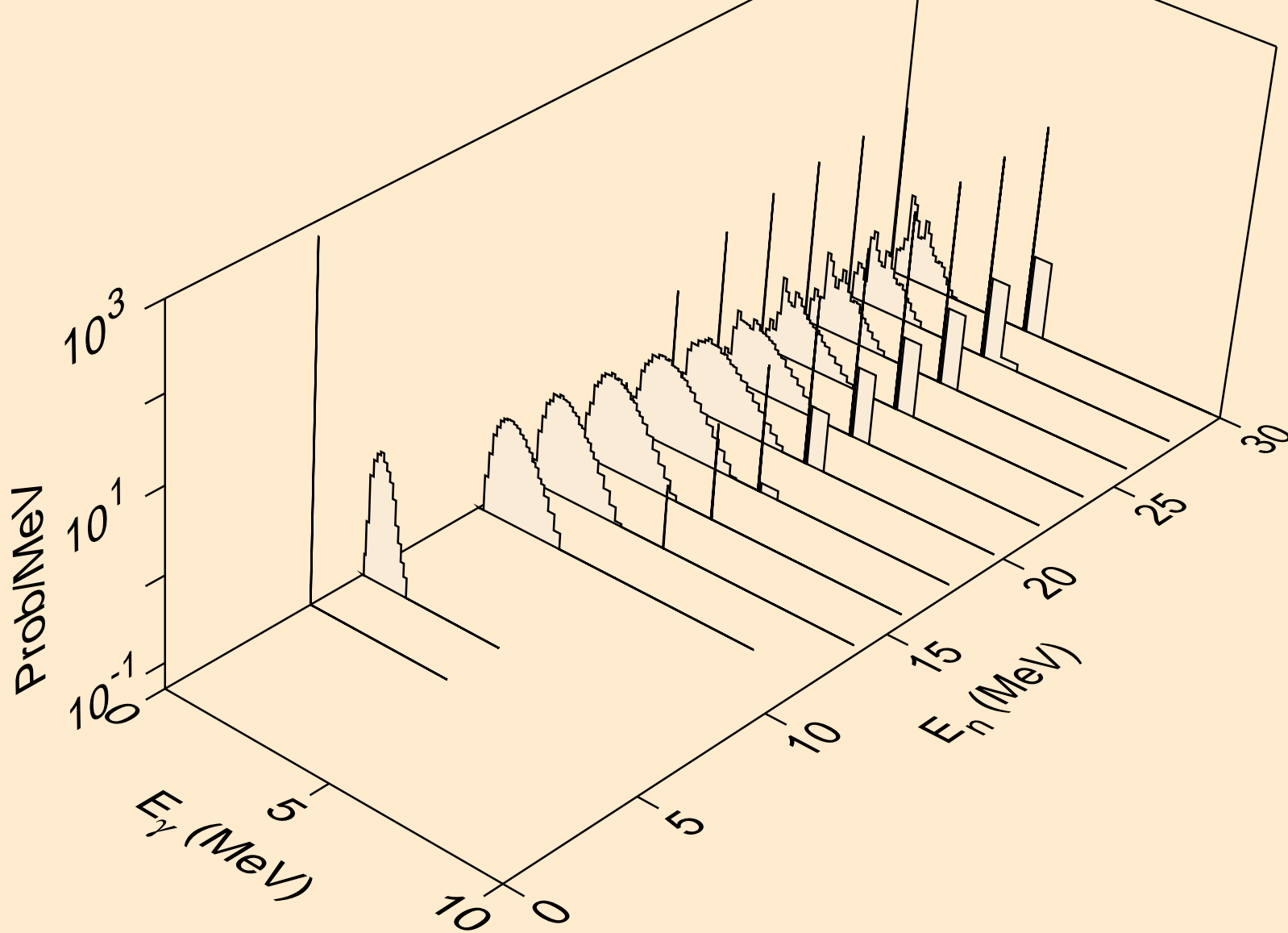

AM235 NEUTRON ACER TENDL-2019 LIBRARY; T=293.16K
Photon emission for (n,n*)2a

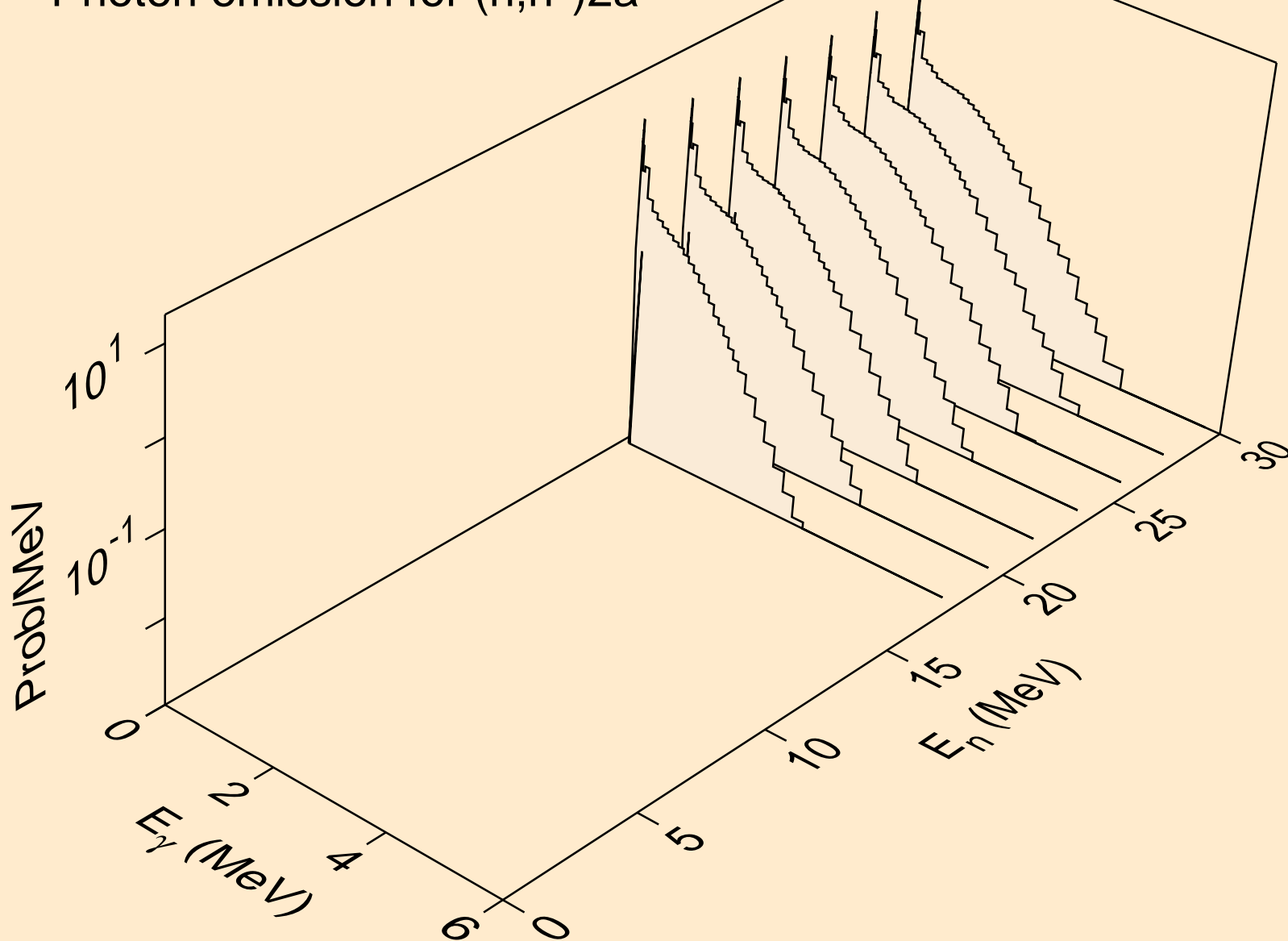

AM235 NEUTRON ACER TENDL-2019 LIBRARY; T=293.16K
Photon emission for (n,2n)2a

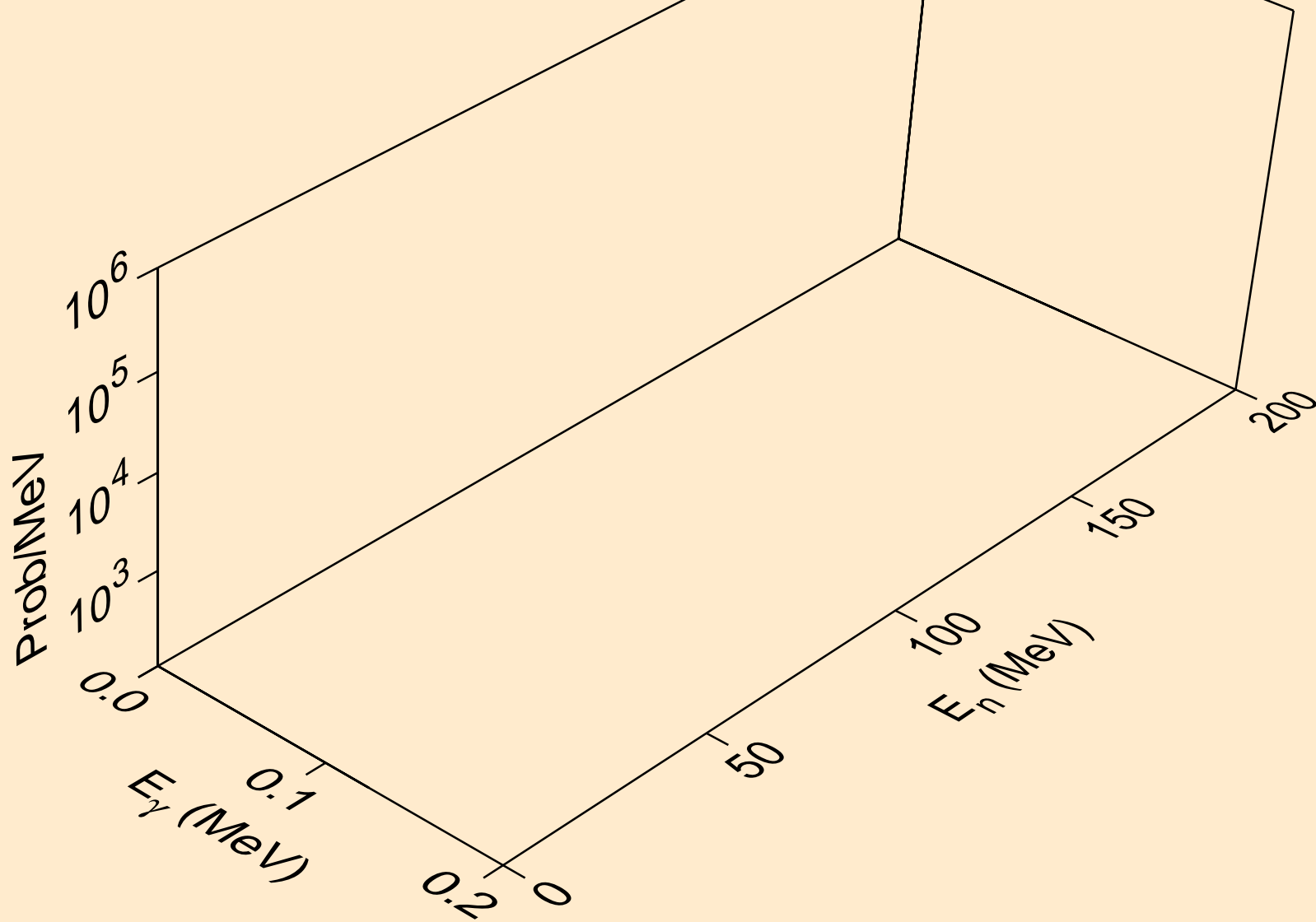

AM235 NEUTRON ACER TENDL-2019 LIBRARY; T=293.16K
Photon emission for (n,n*)d

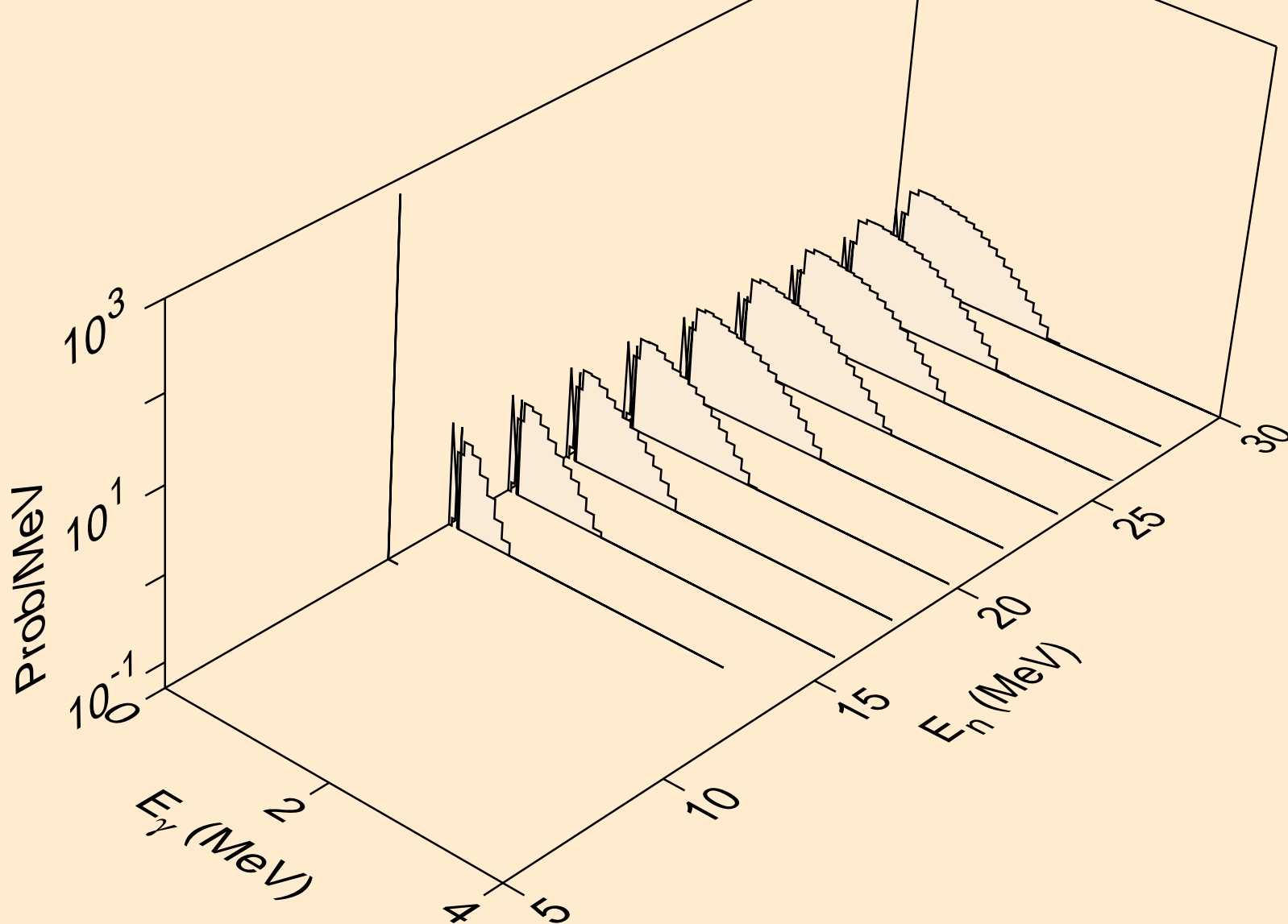

AM235 NEUTRON ACER TENDL-2019 LIBRARY; T=293.16K
Photon emission for (n,n*)t

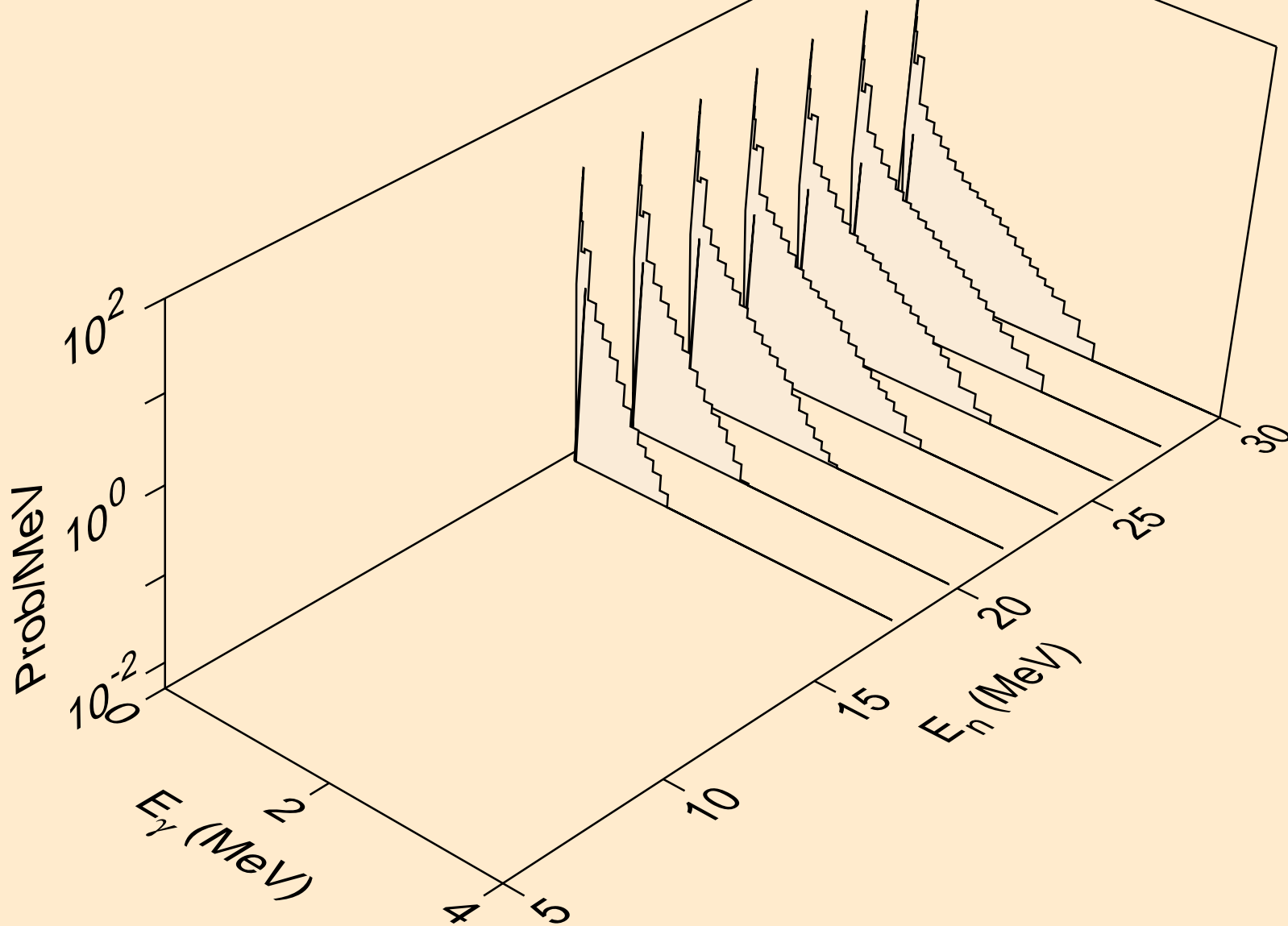

AM235 NEUTRON ACER TENDL-2019 LIBRARY; T=293.16K
Photon emission for (n,n*)he3

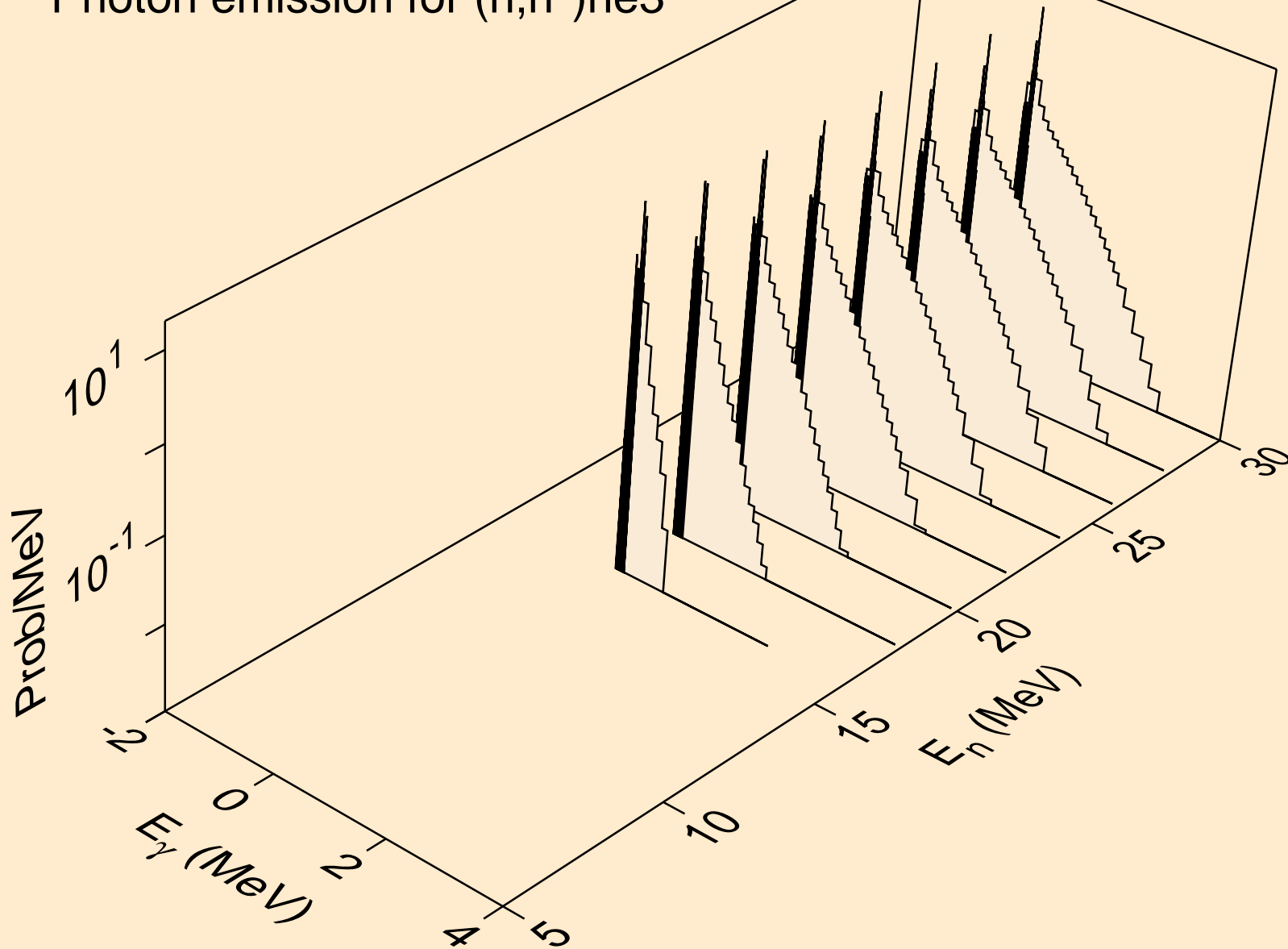

AM235 NEUTRON ACER TENDL-2019 LIBRARY; T=293.16K
Photon emission for (n,4n)

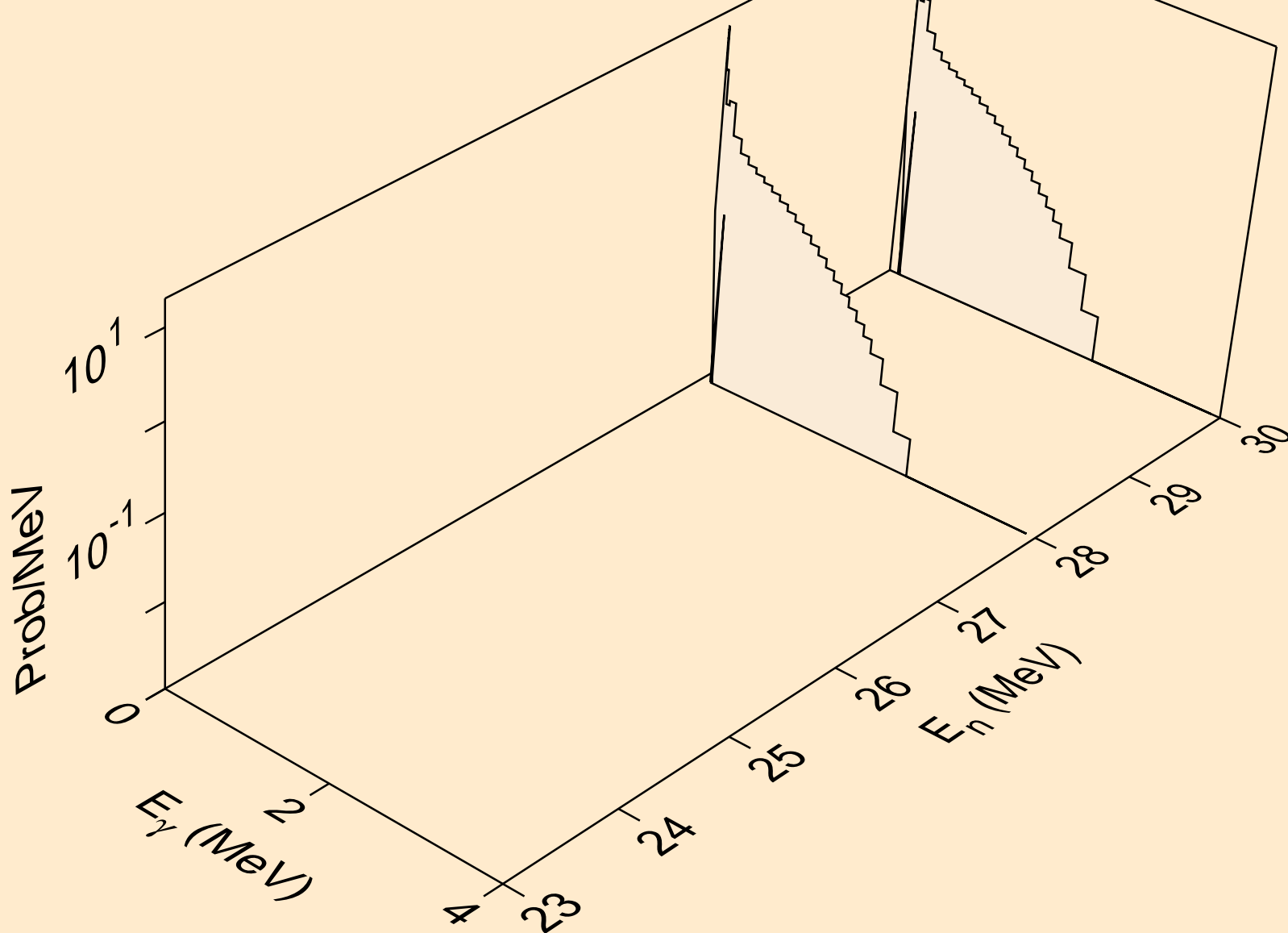

AM235 NEUTRON ACER TENDL-2019 LIBRARY; T=293.16K
Photon emission for (n,2np)

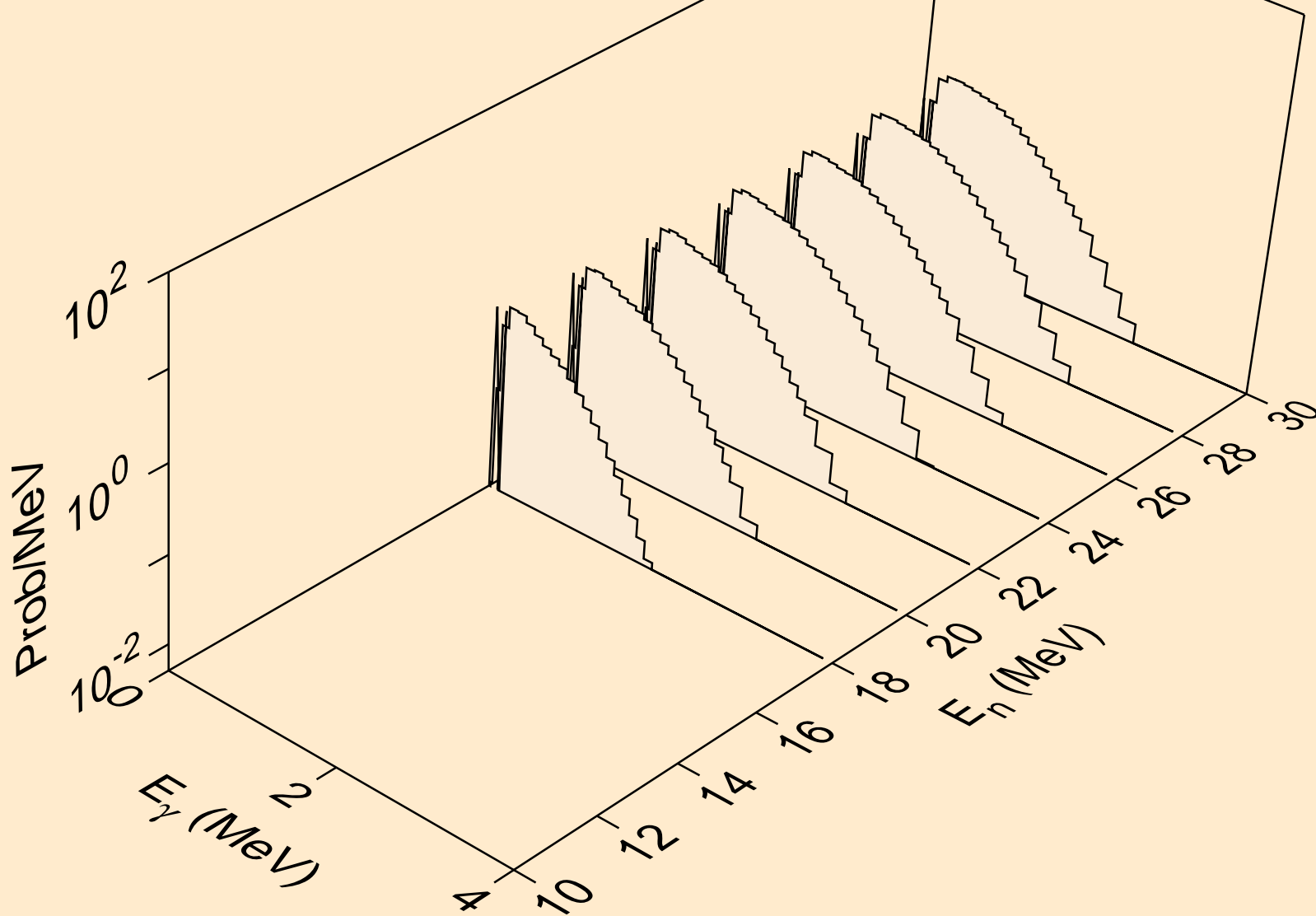

AM235 NEUTRON ACER TENDL-2019 LIBRARY; T=293.16K
Photon emission for (n,3np)

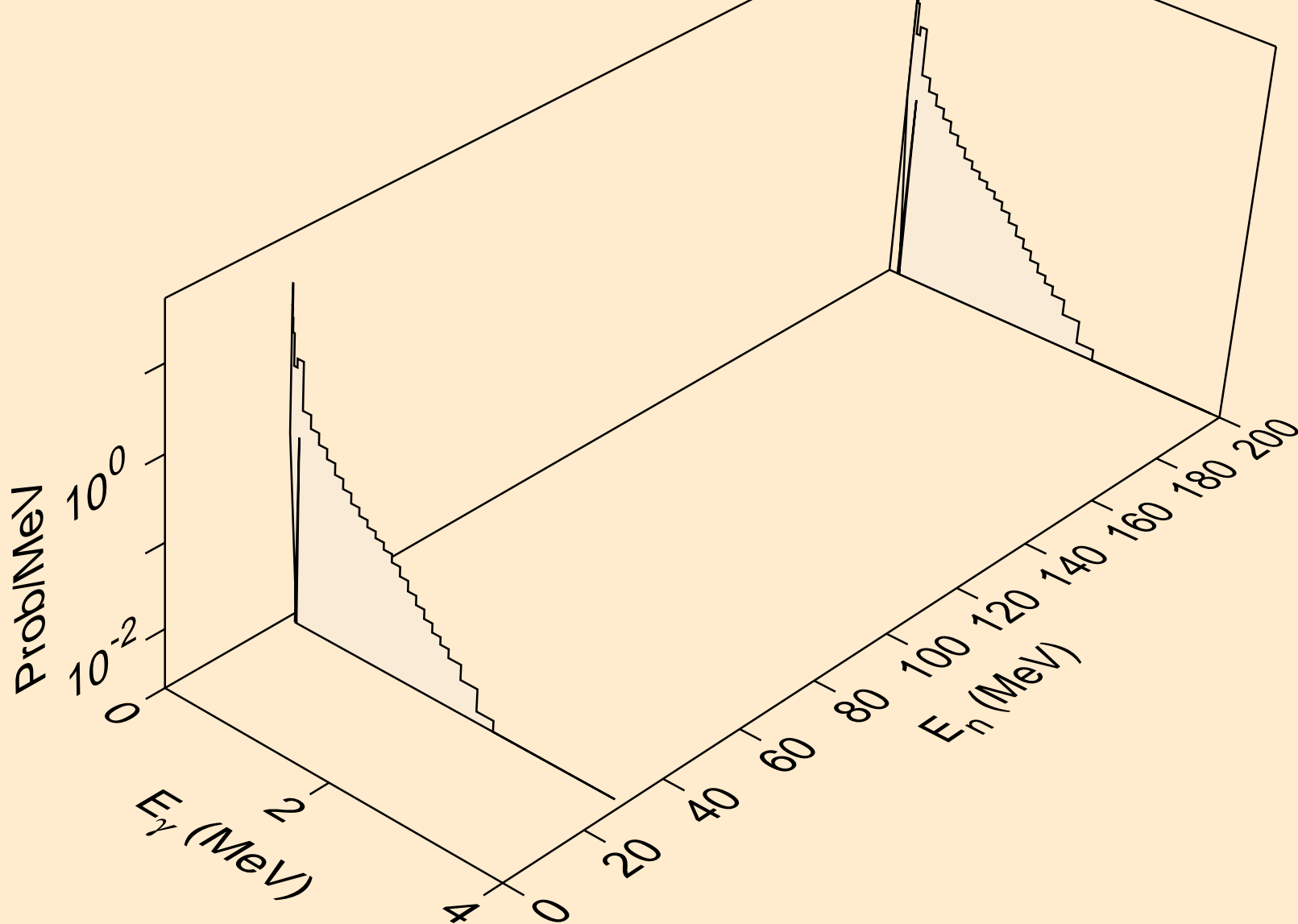

AM235 NEUTRON ACER TENDL-2019 LIBRARY; T=293.16K
Photon emission for (n,2np)

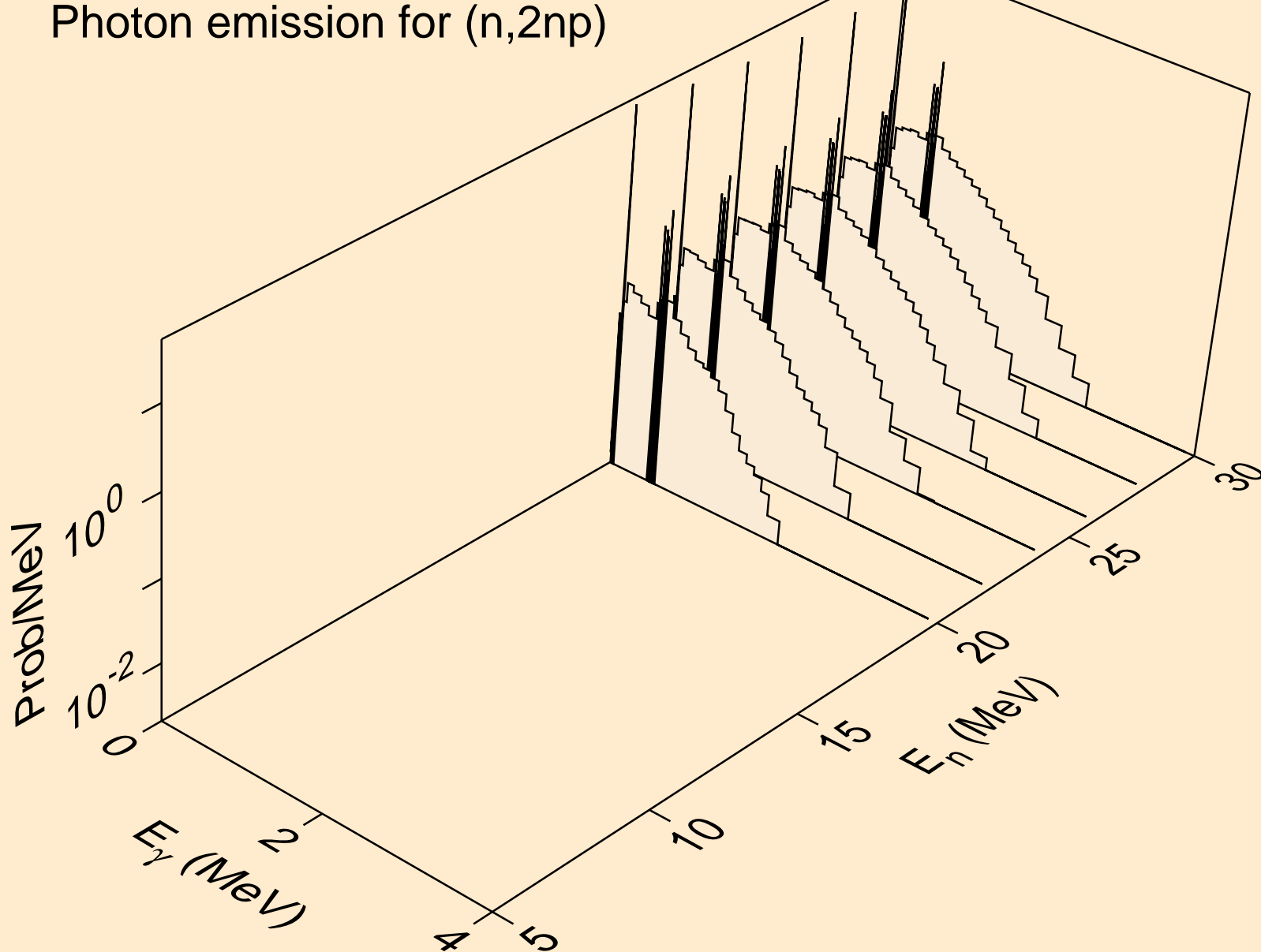

AM235 NEUTRON ACER TENDL-2019 LIBRARY; T=293.16K
Photon emission for (n,npa)

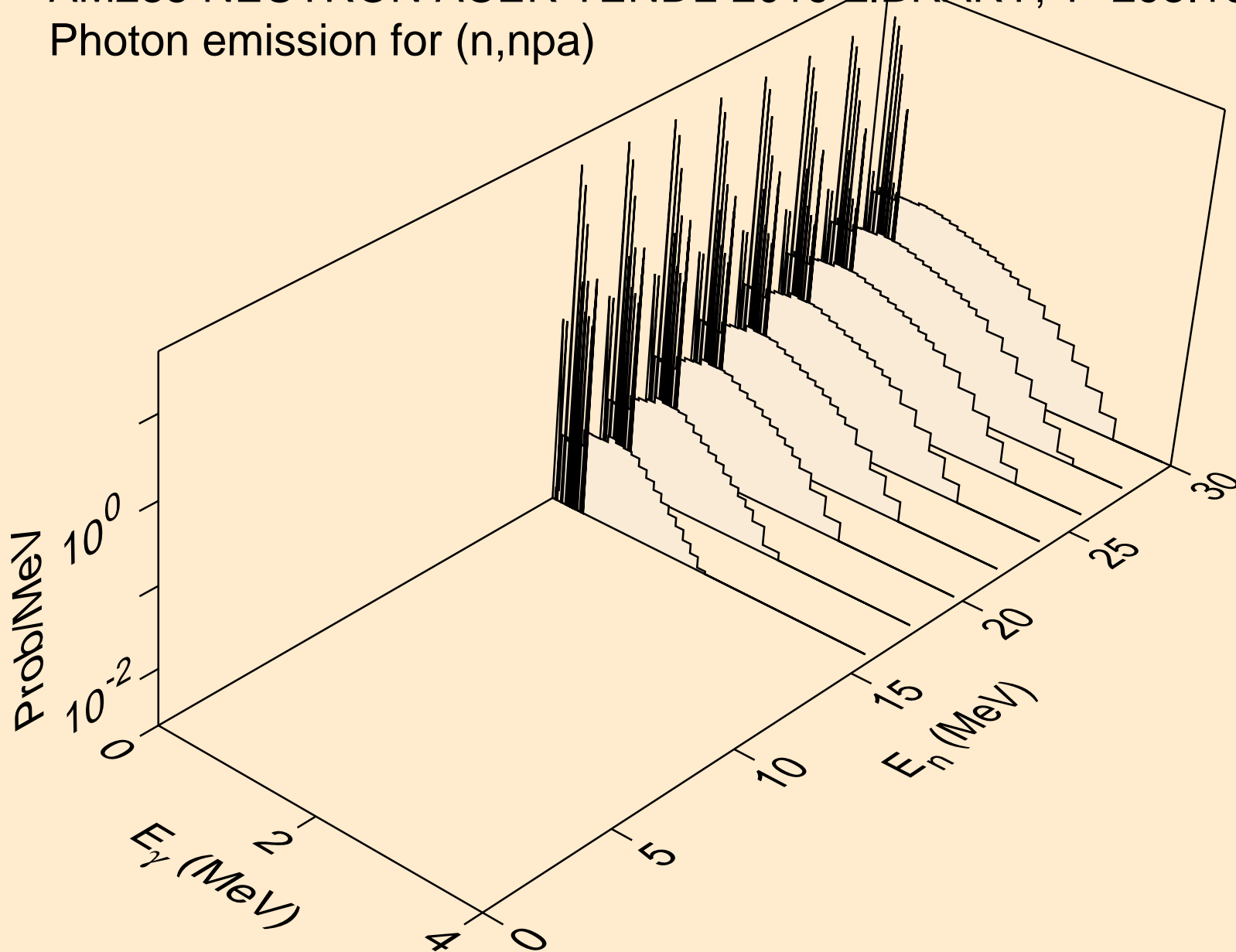

AM235 NEUTRON ACER TENDL-2019 LIBRARY; T=293.16K
Photon emission for (n,n*c)

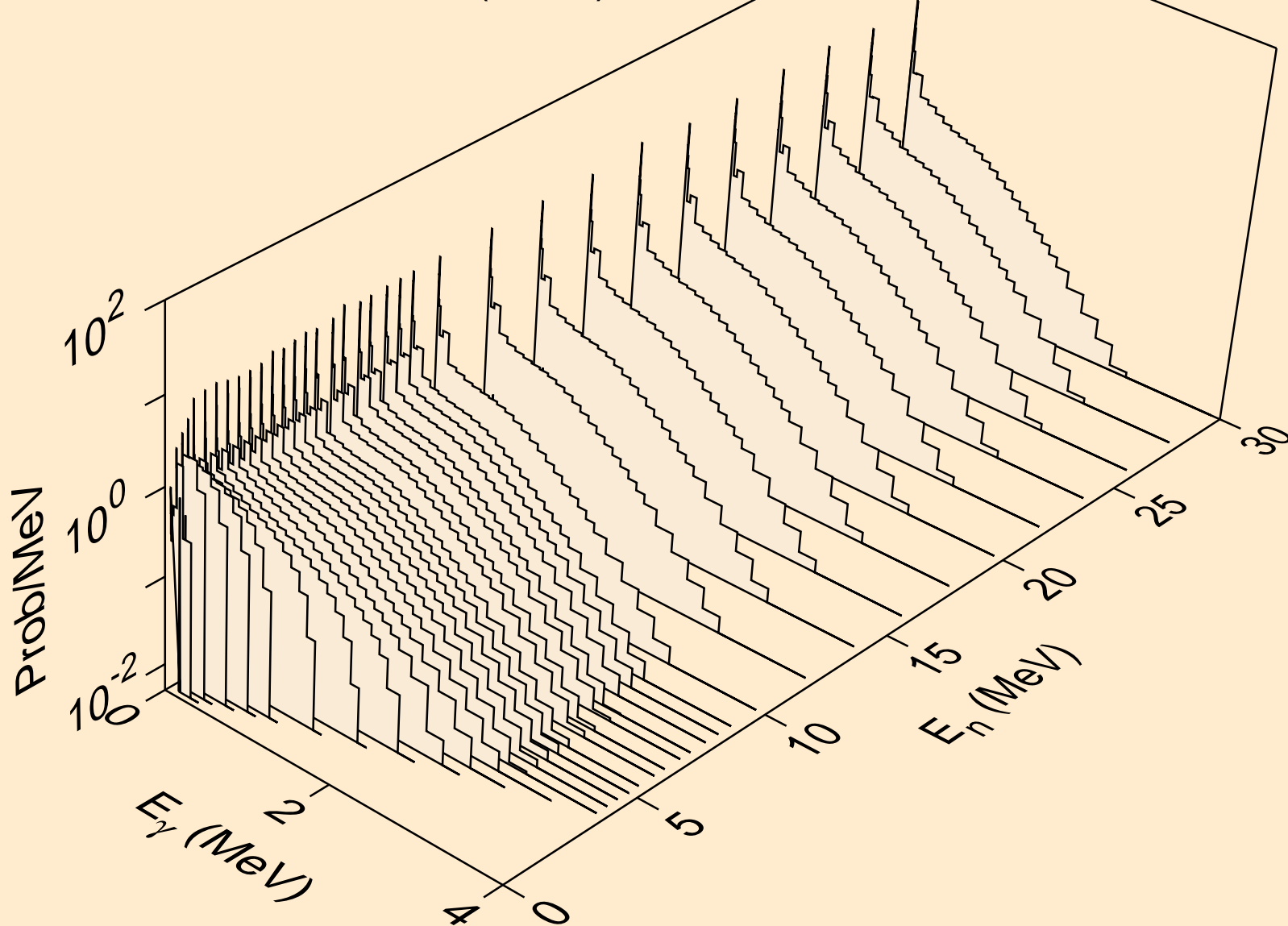

AM235 NEUTRON ACER TENDL-2019 LIBRARY; T=293.16K
Photon emission for (n,gma)

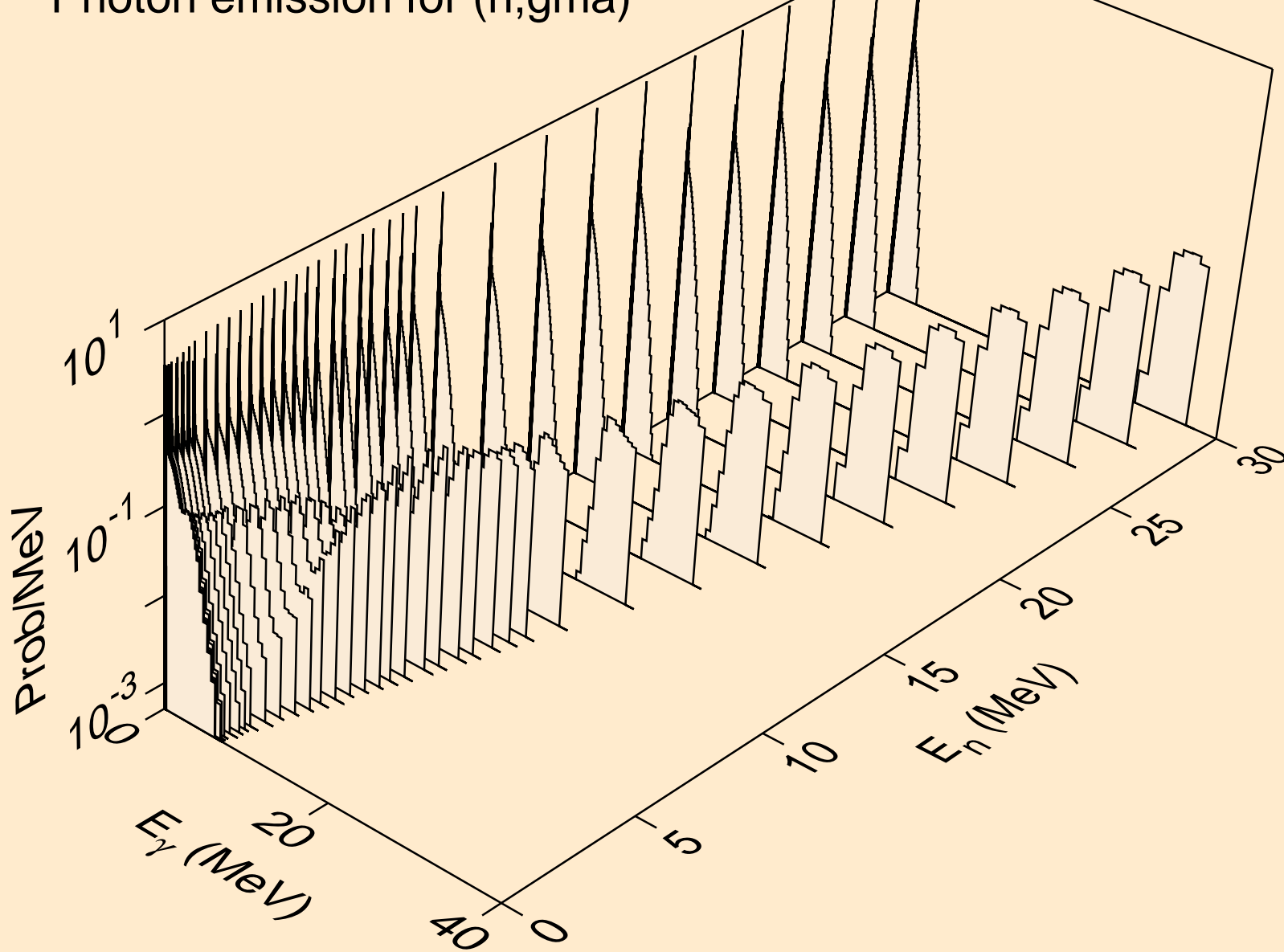

AM235 NEUTRON ACER TENDL-2019 LIBRARY; T=293.16K
Photon emission for (n,p)

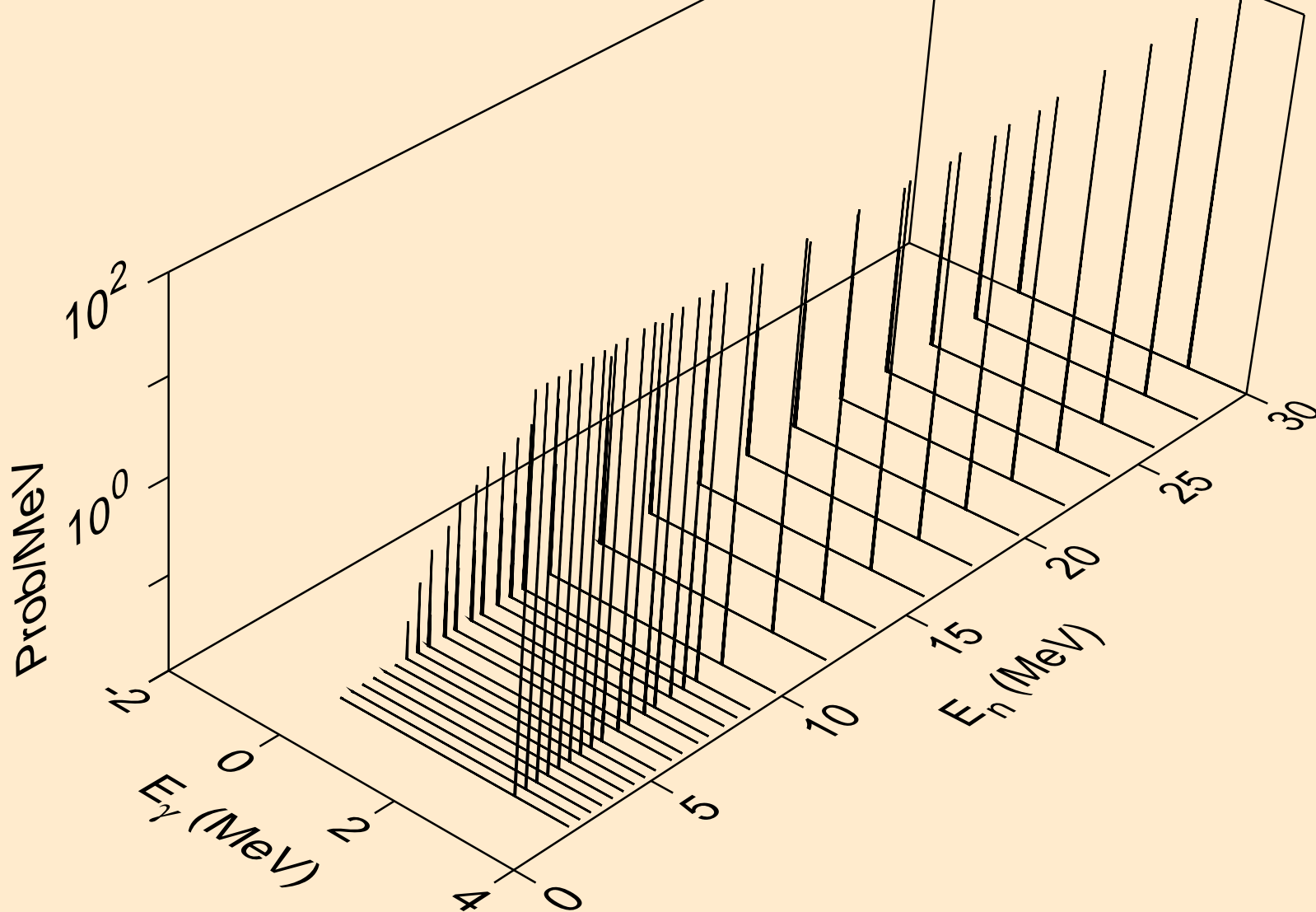

AM235 NEUTRON ACER TENDL-2019 LIBRARY; T=293.16K
Photon emission for (n,d)

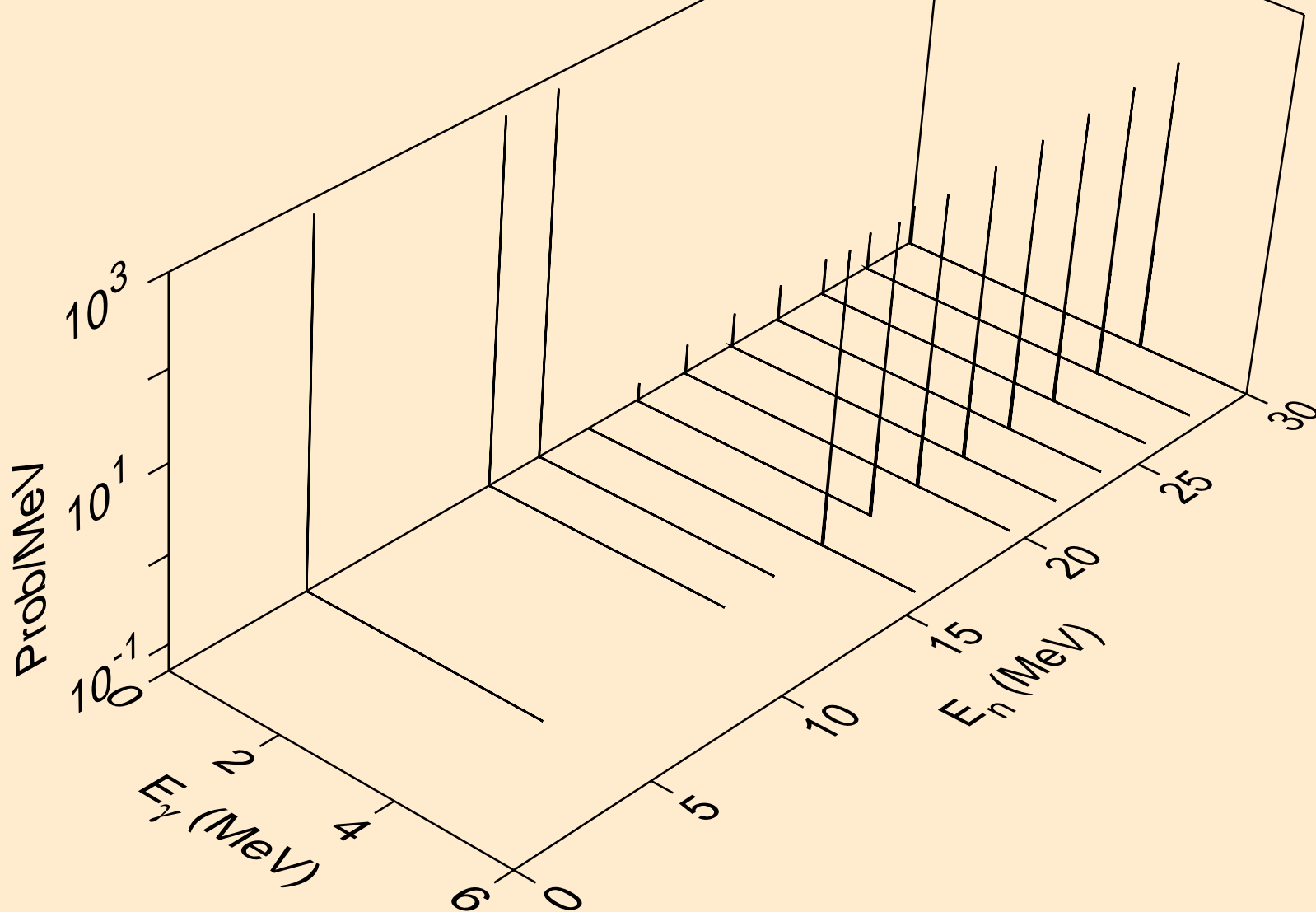

AM235 NEUTRON ACER TENDL-2019 LIBRARY; T=293.16K
Photon emission for (n,t)

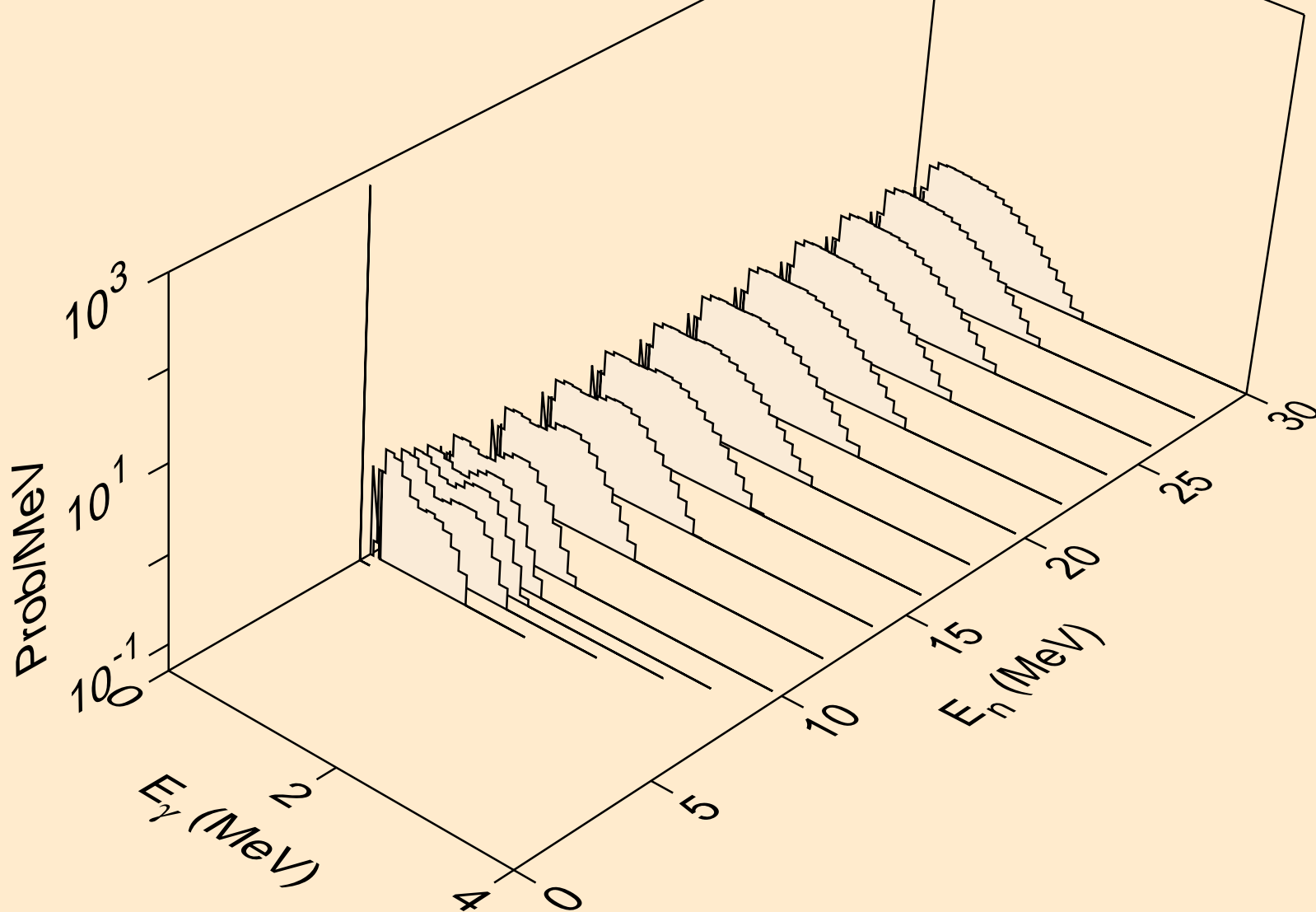

AM235 NEUTRON ACER TENDL-2019 LIBRARY; T=293.16K
Photon emission for (n,he3)

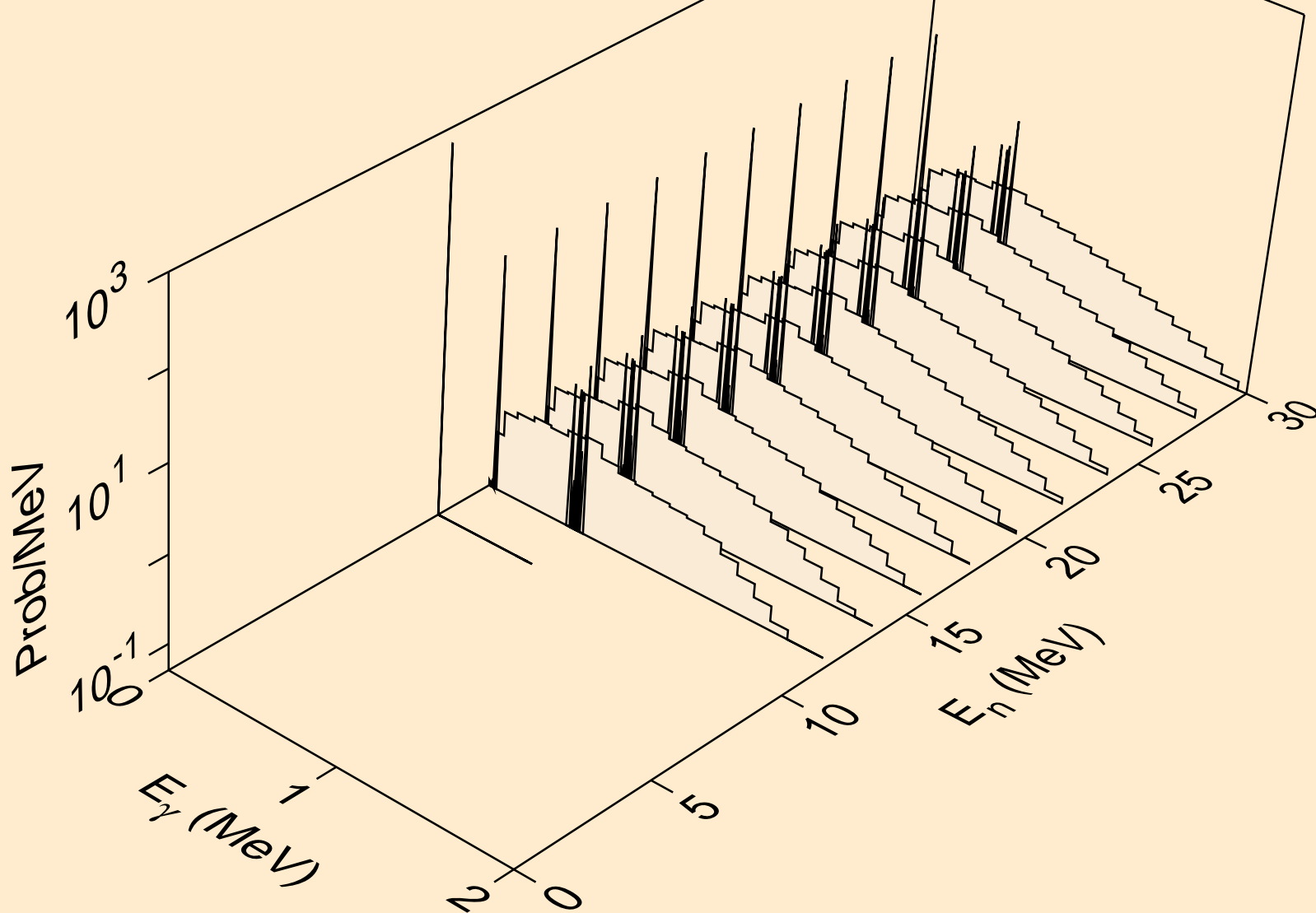

AM235 NEUTRON ACER TENDL-2019 LIBRARY; T=293.16K
Photon emission for (n,a)

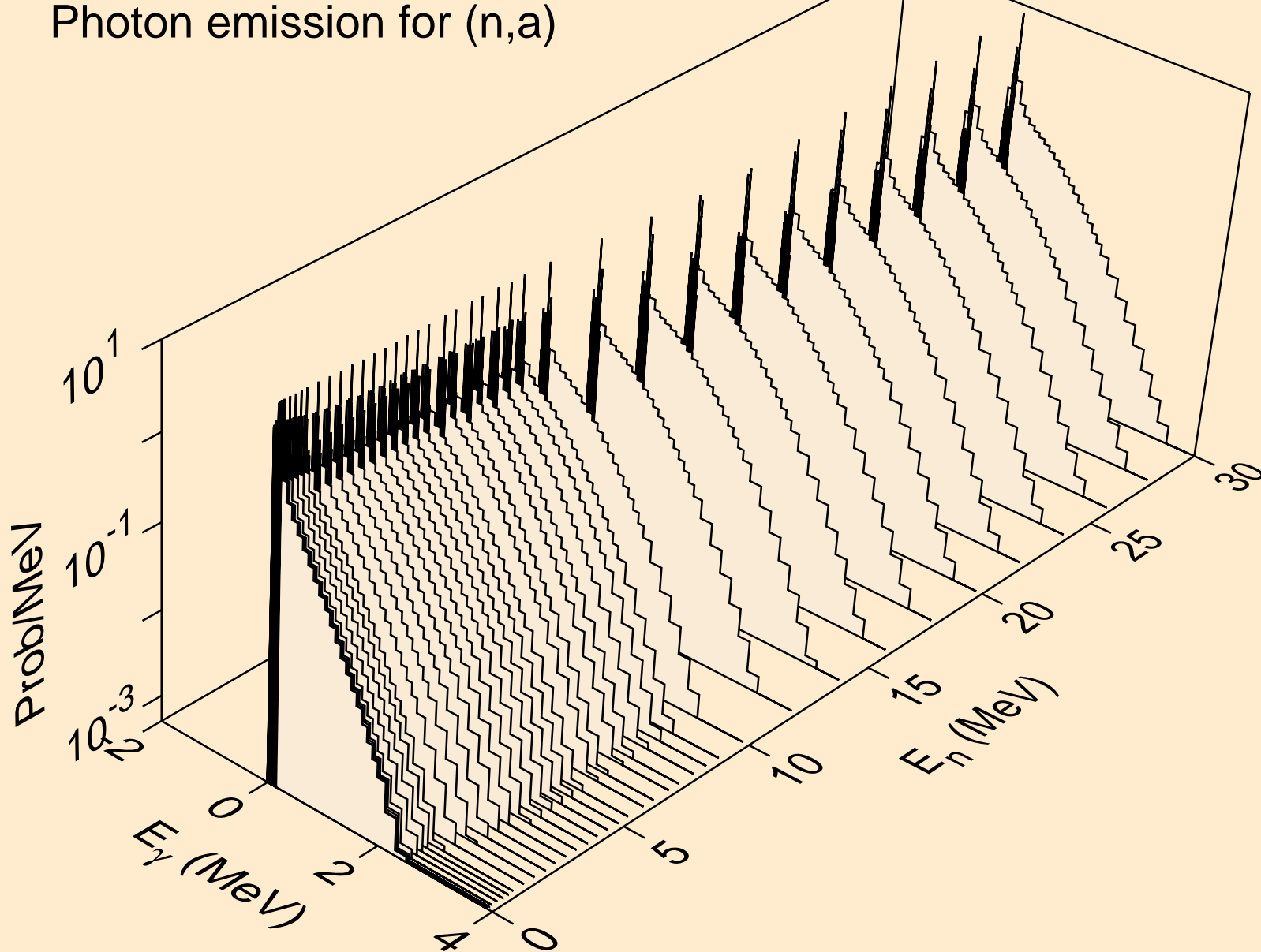

AM235 NEUTRON ACER TENDL-2019 LIBRARY; T=293.16K
Photon emission for (n,2a)

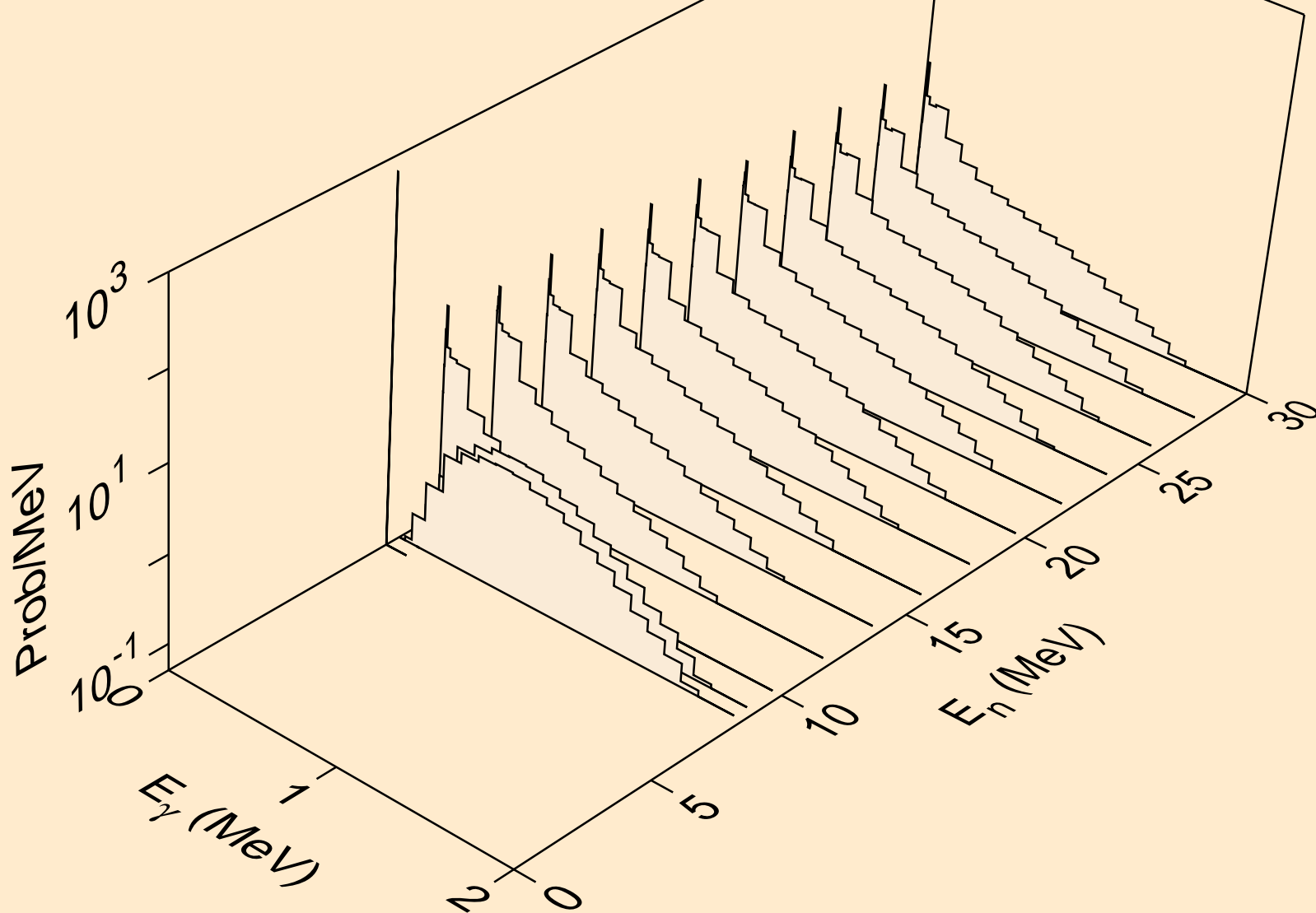

AM235 NEUTRON ACER TENDL-2019 LIBRARY; T=293.16K
Photon emission for (n,2p)

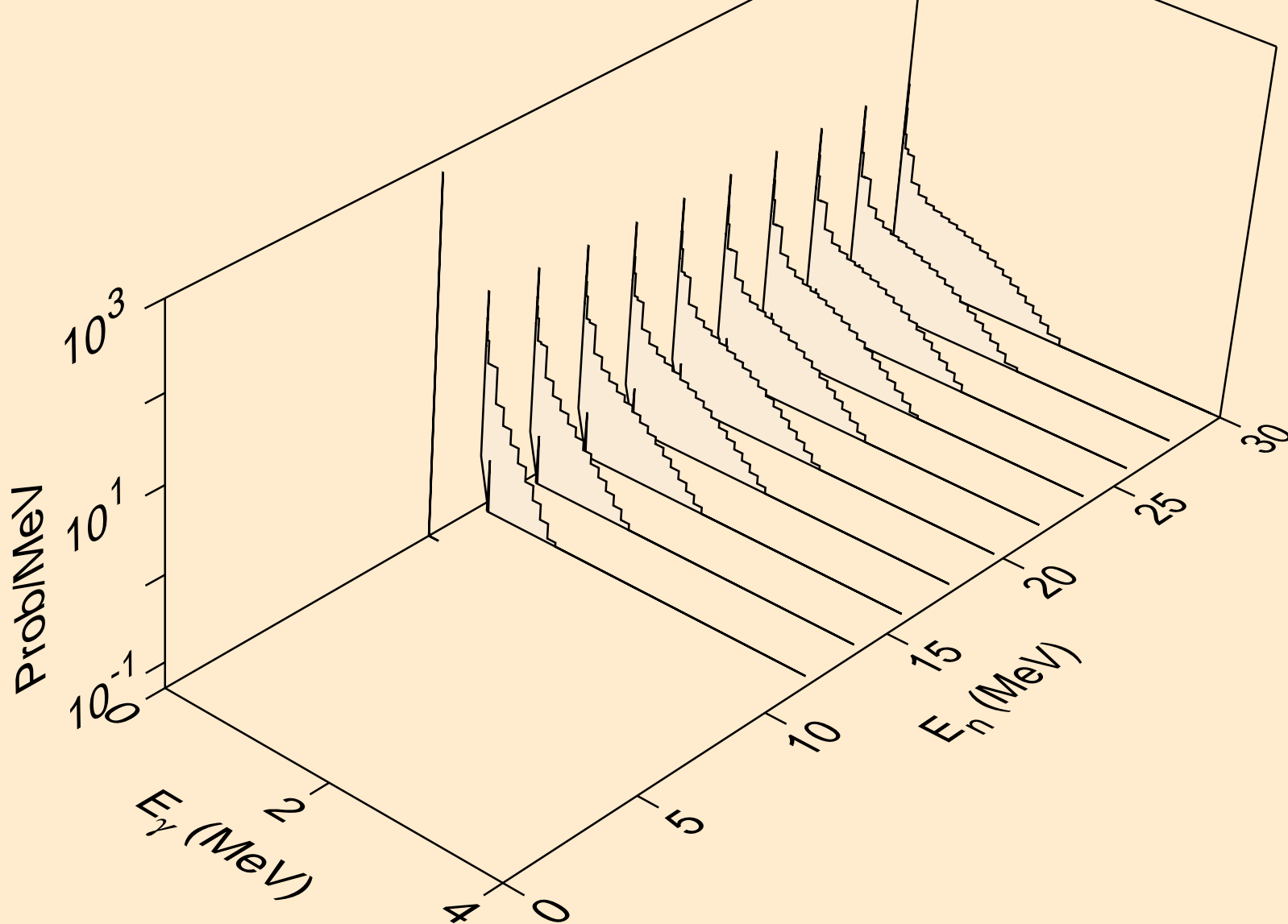

AM235 NEUTRON ACER TENDL-2019 LIBRARY; T=293.16K
Photon emission for (n,p α)

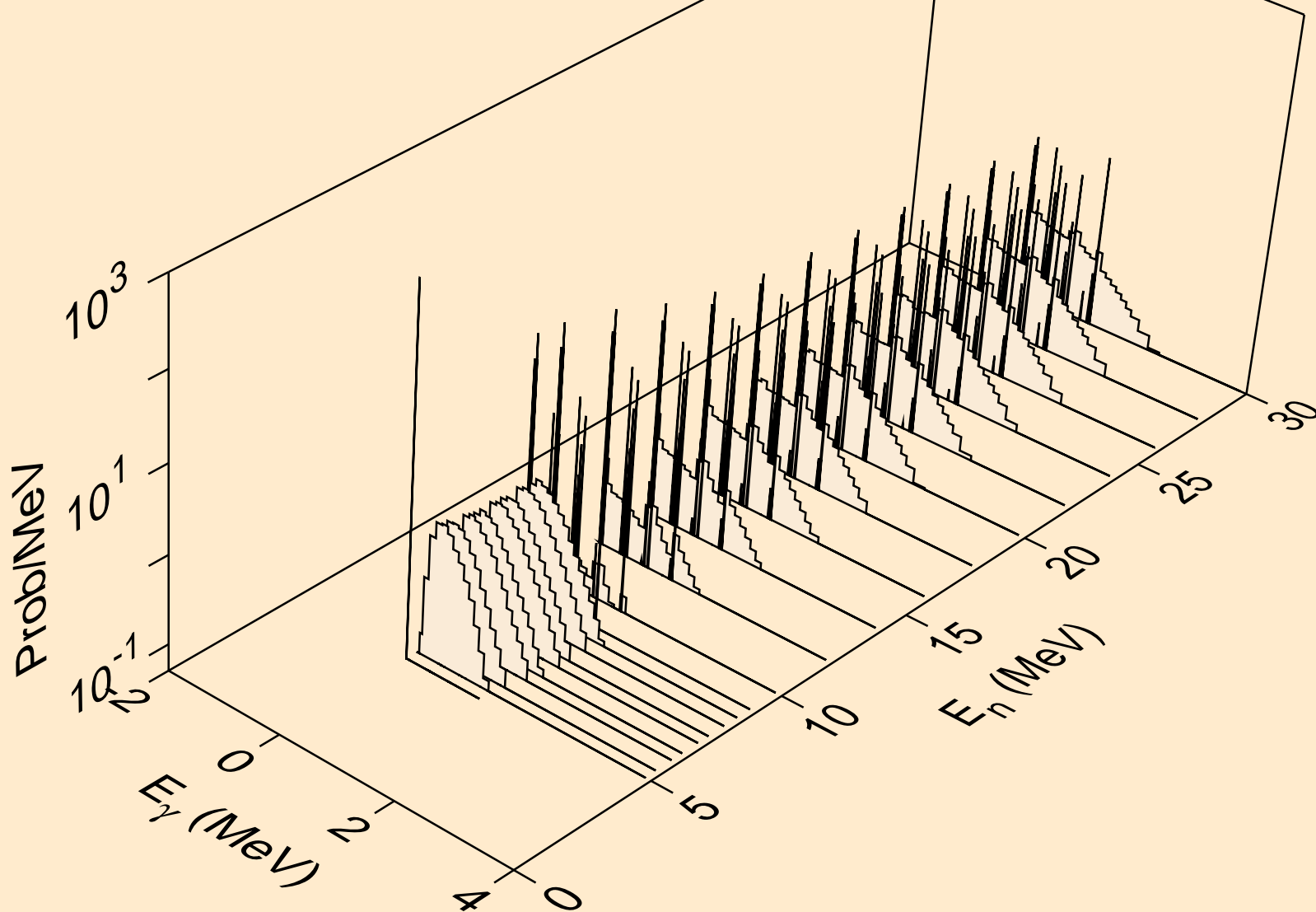

AM235 NEUTRON ACER TENDL-2019 LIBRARY; T=293.16K
Photon emission for (n,pd)

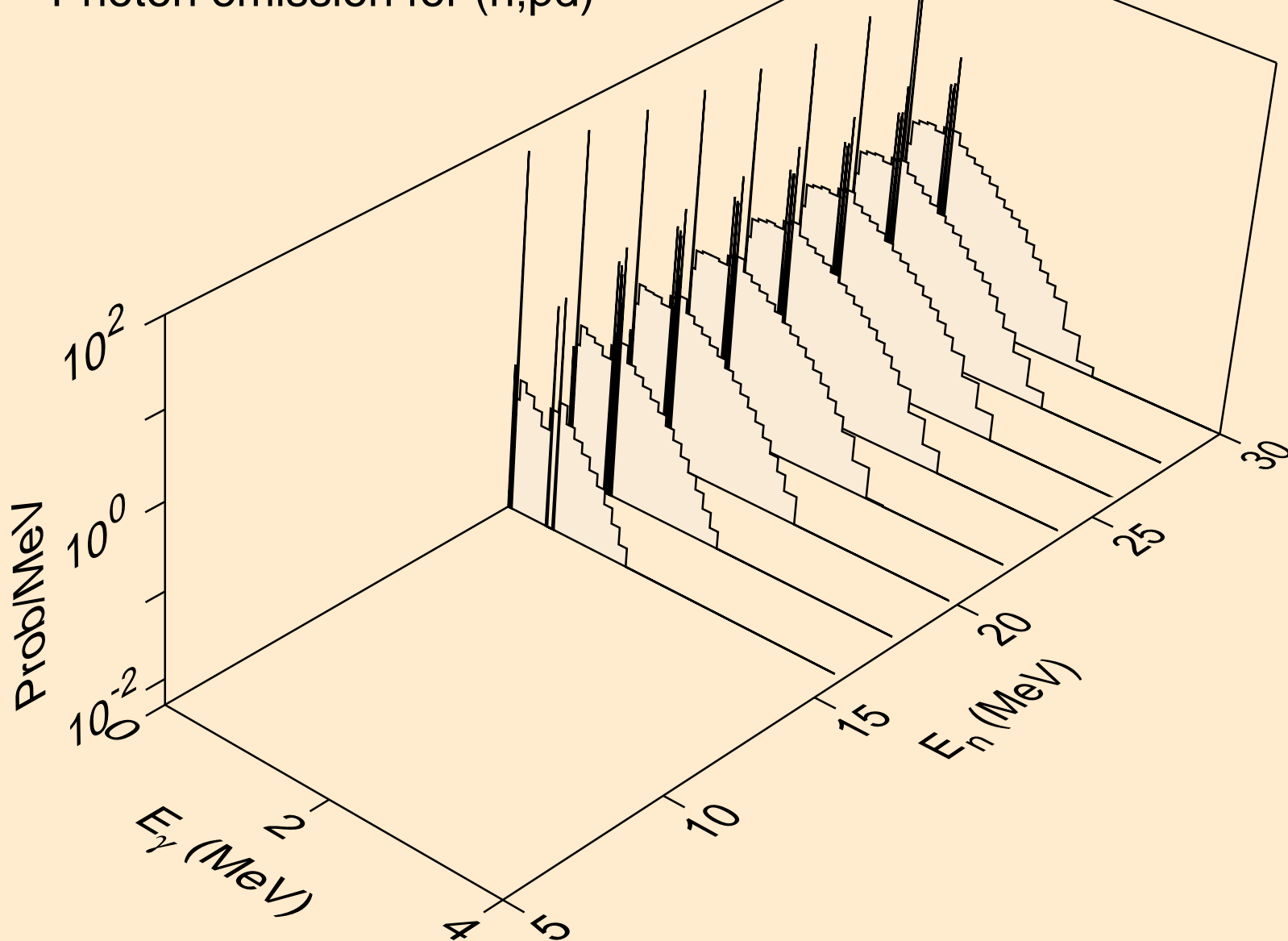

AM235 NEUTRON ACER TENDL-2019 LIBRARY; T=293.16K
Photon emission for (n,pt)

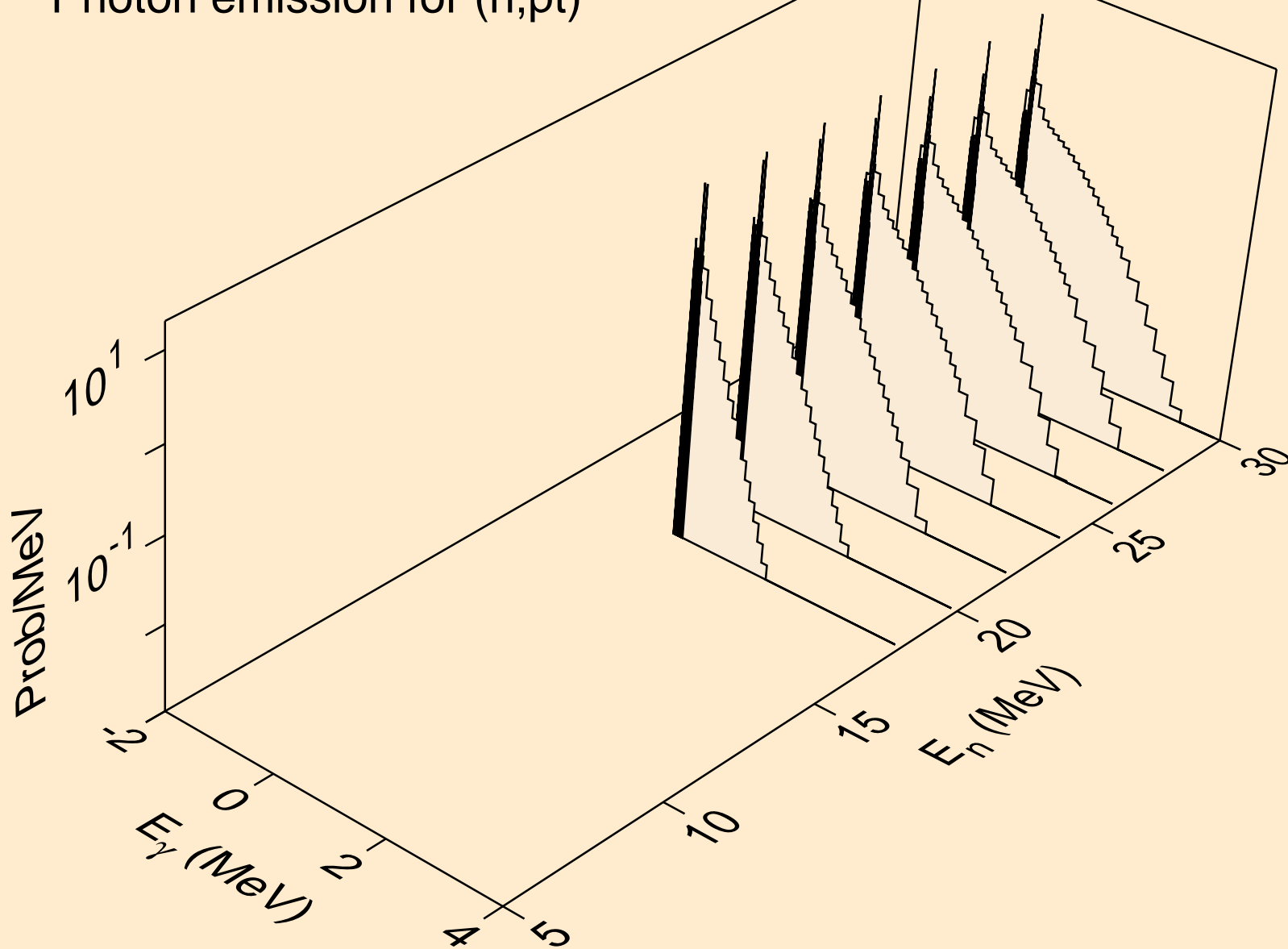

AM235 NEUTRON ACER TENDL-2019 LIBRARY; T=293.16K
thermal capture photon spectrum

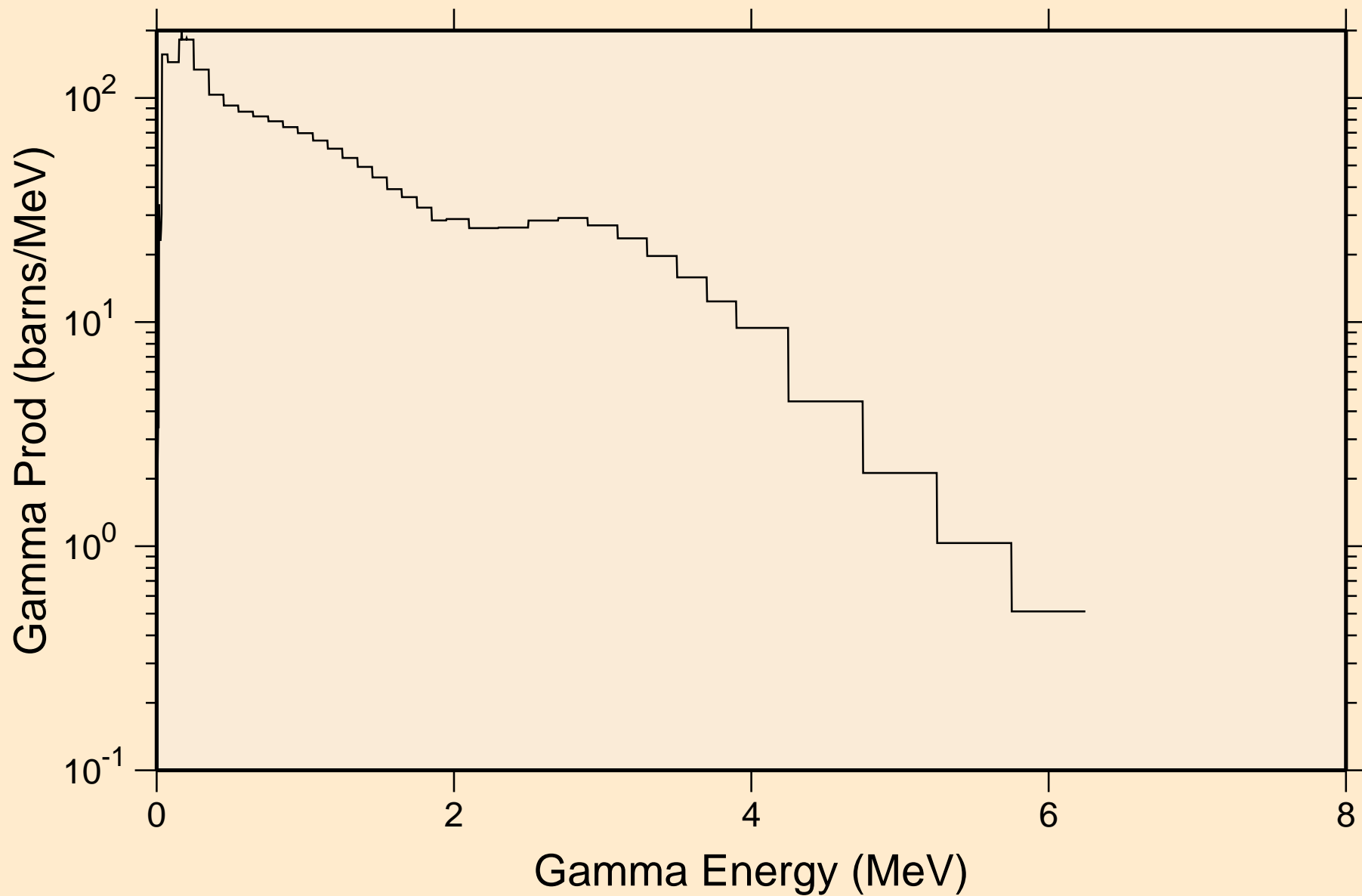

AM235 NEUTRON ACER TENDL-2019 LIBRARY; T=293.16K
14 MeV photon spectrum

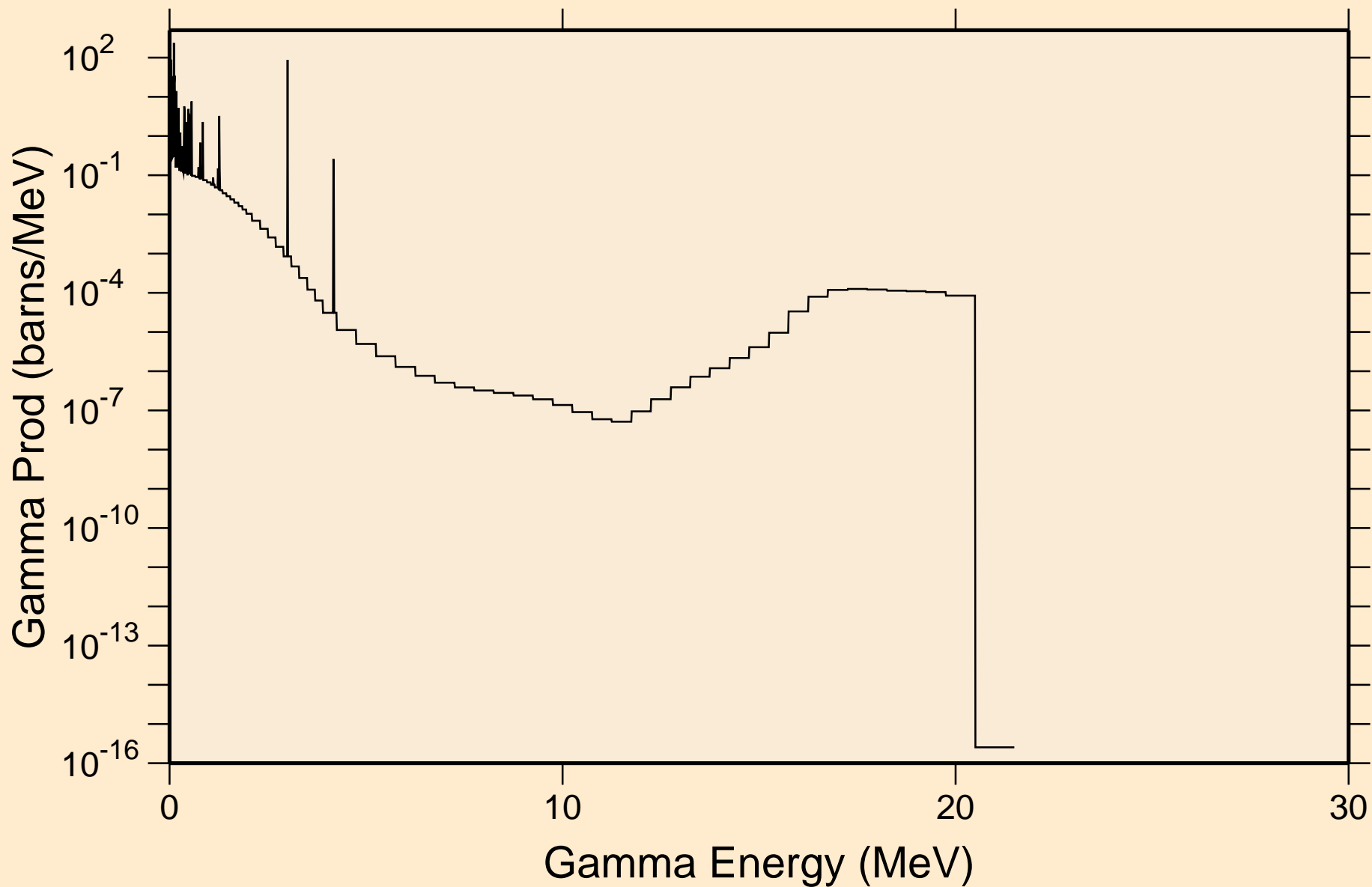

AM235 NEUTRON ACER TENDL-2019 LIBRARY; T=293.16K
Particle heating contributions

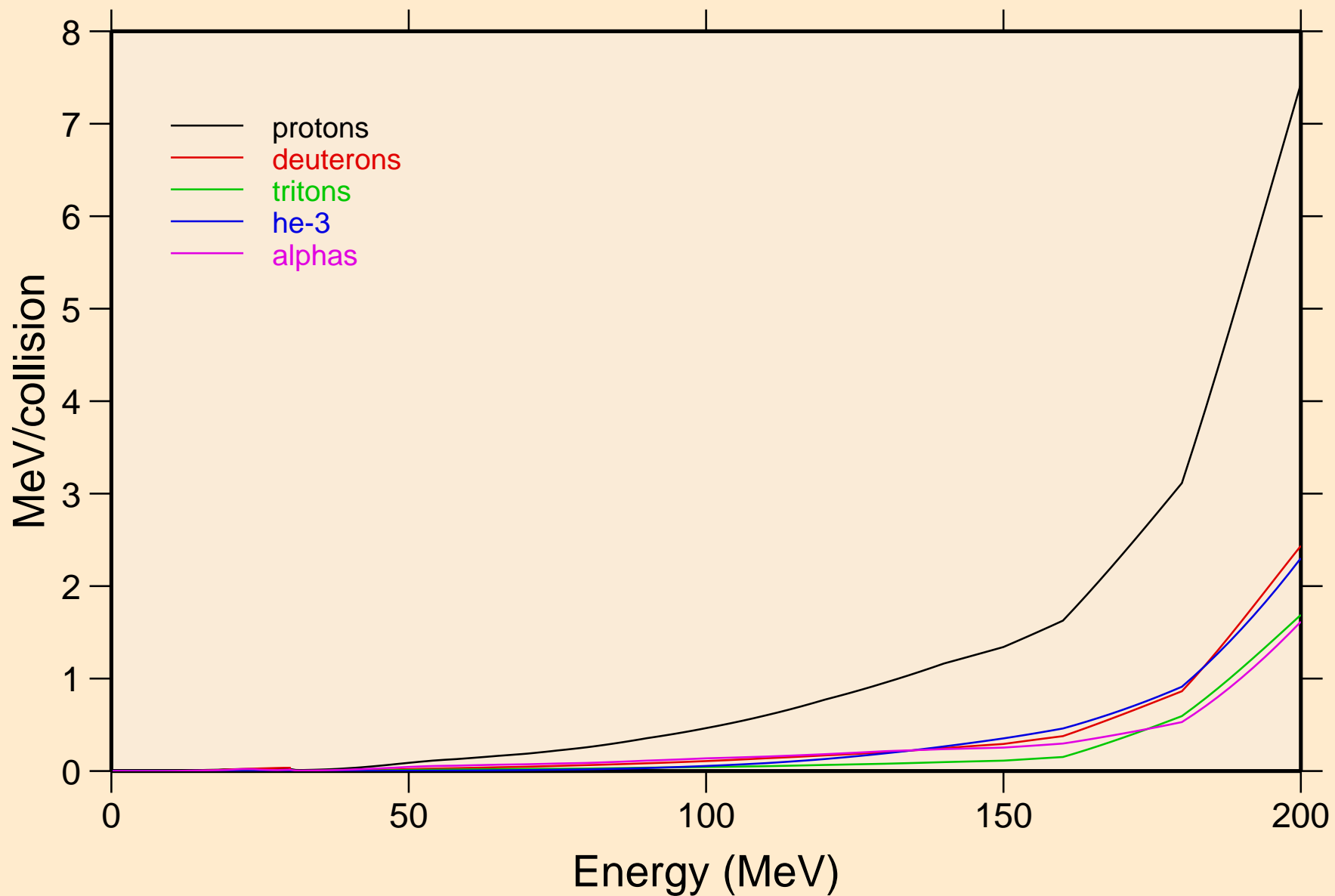

AM235 NEUTRON ACER TENDL-2019 LIBRARY; T=293.16K
Recoil Heating

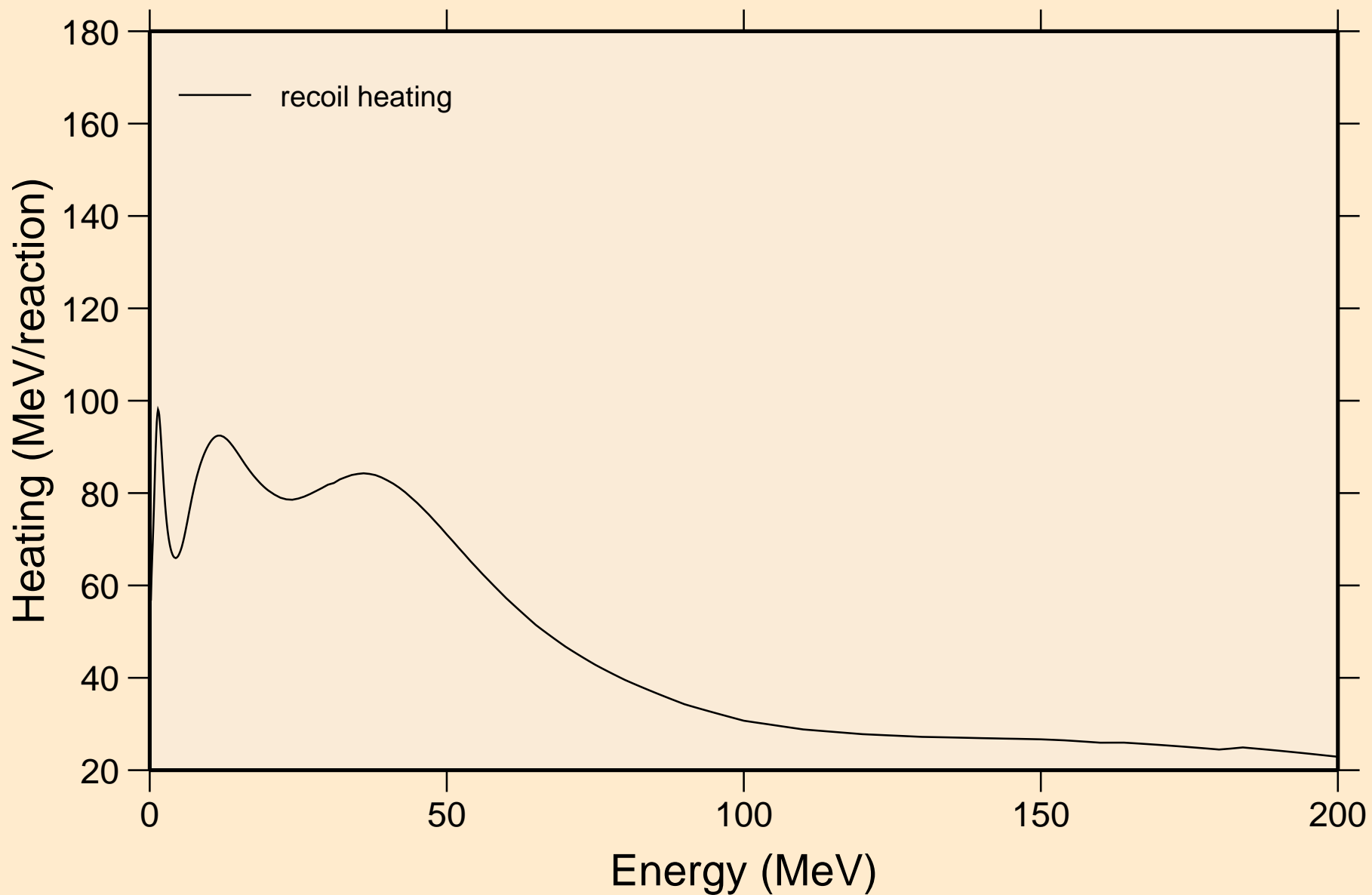

AM235 NEUTRON ACER TENDL-2019 LIBRARY; T=293.16K

Particle production cross sections

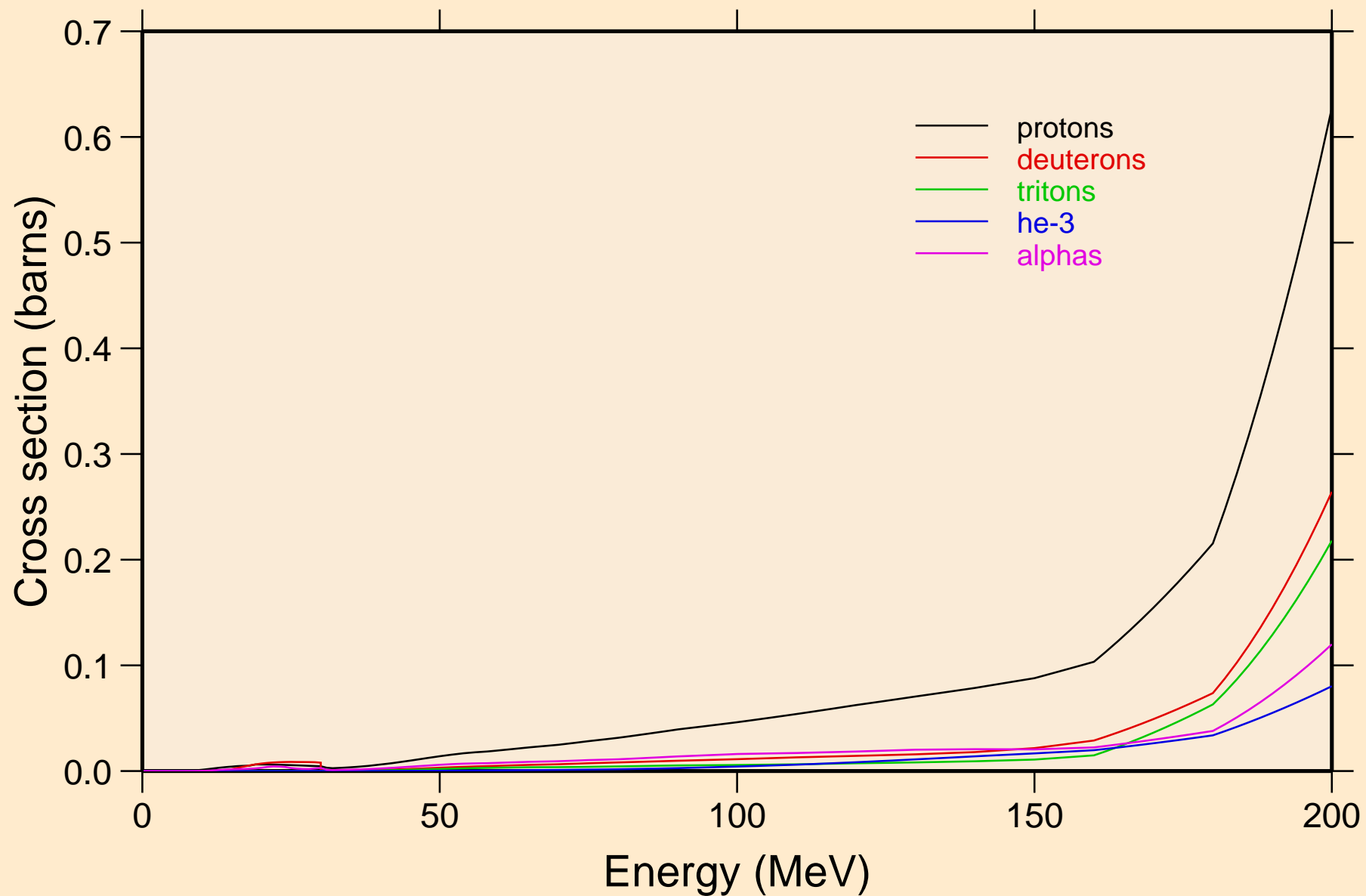

AM235 NEUTRON ACER TENDL-2019 LIBRARY; T=293.16K
protons from (n,x)

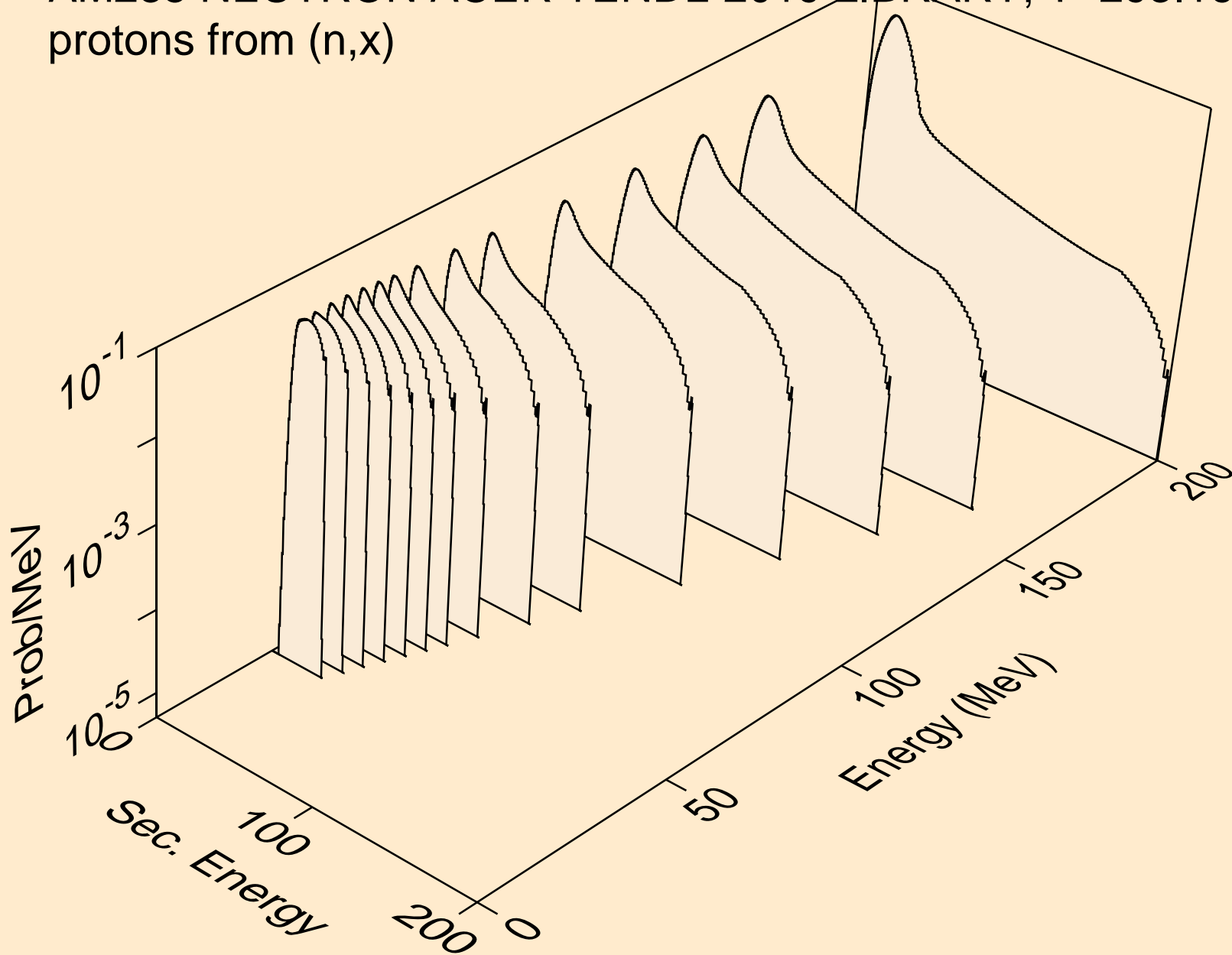

AM235 NEUTRON ACER TENDL-2019 LIBRARY; T=293.16K
protons from (n,n*)p

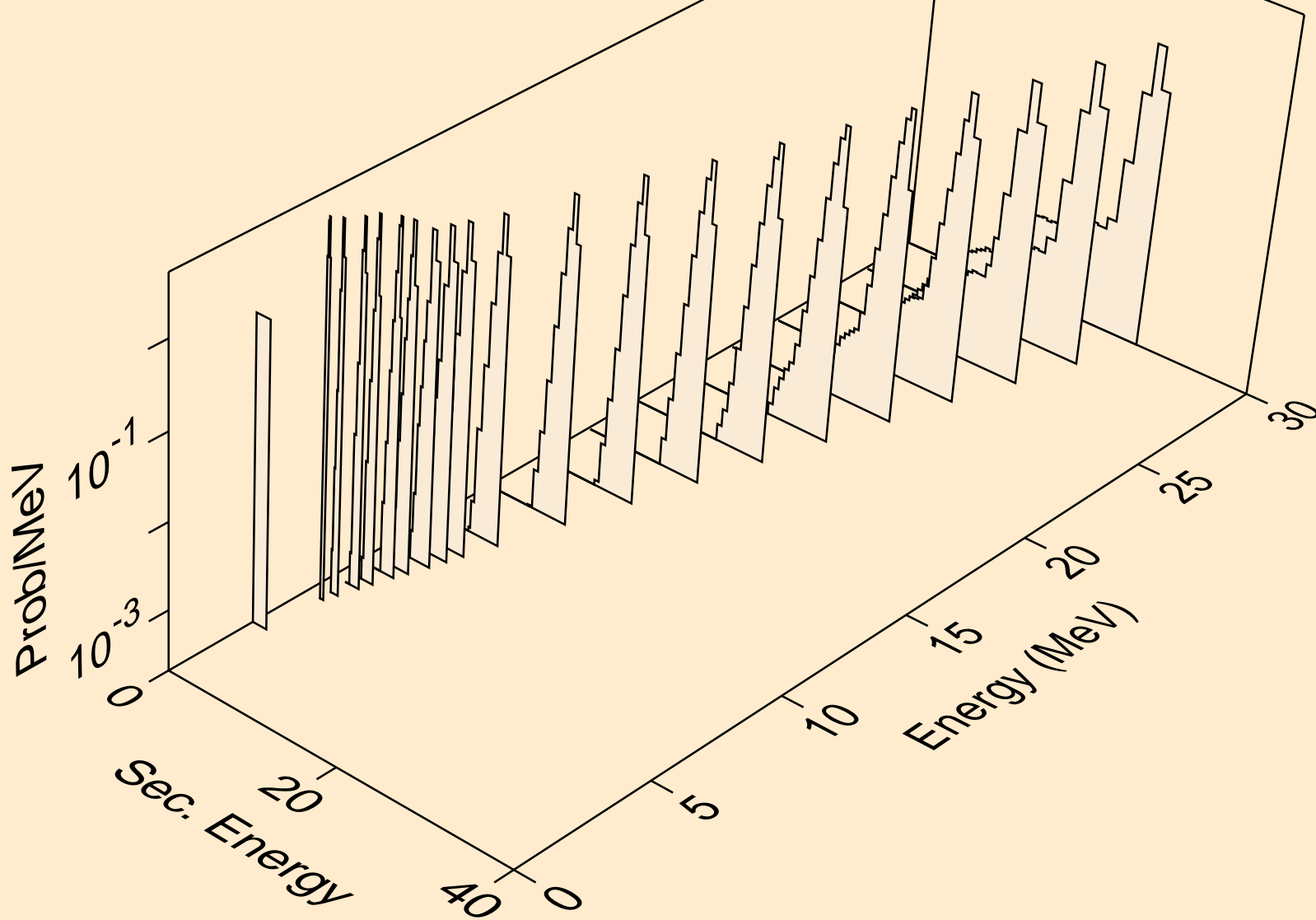

AM235 NEUTRON ACER TENDL-2019 LIBRARY; T=293.16K
protons from (n,2np)

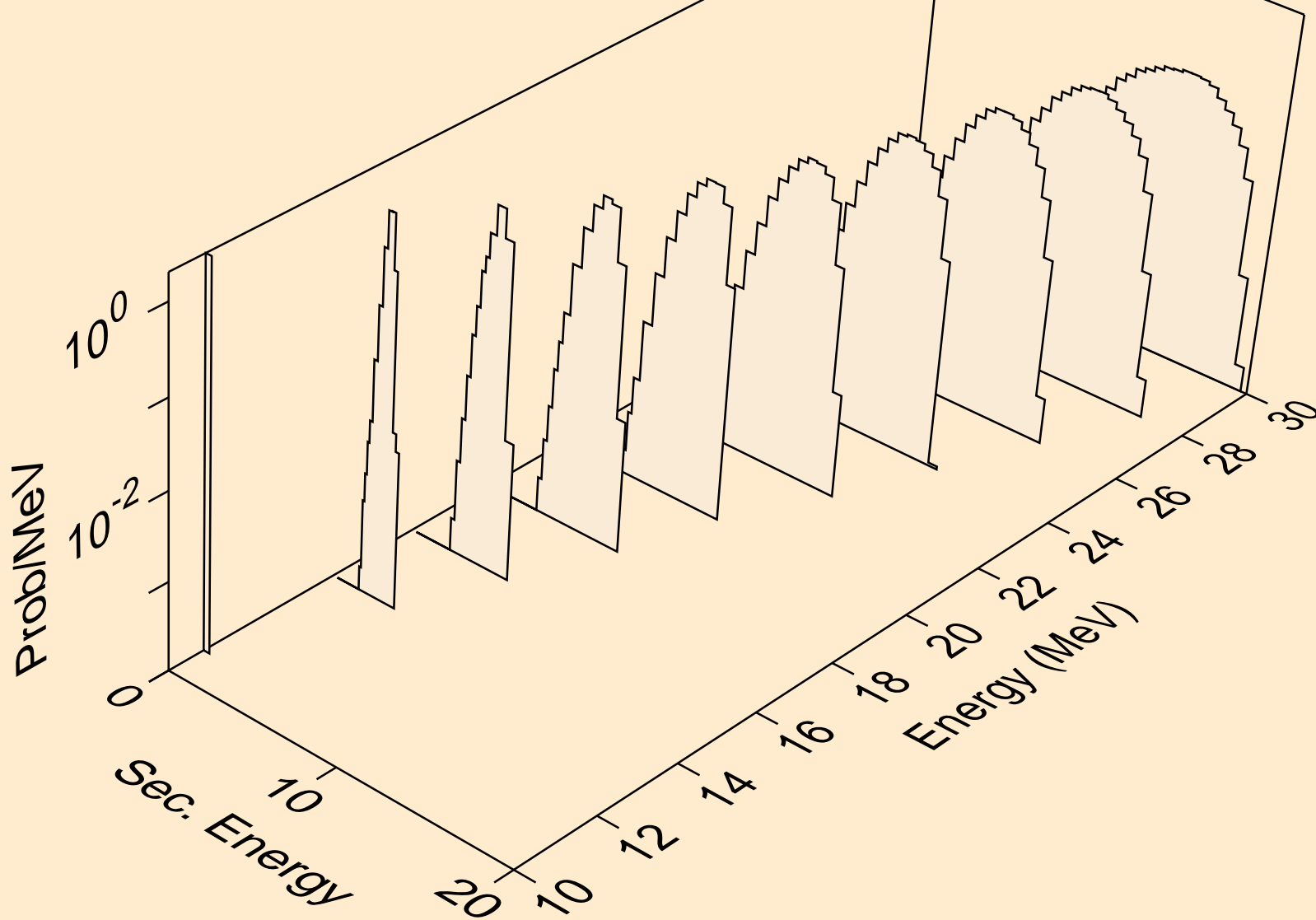

AM235 NEUTRON ACER TENDL-2019 LIBRARY; T=293.16K
protons from (n,3np)

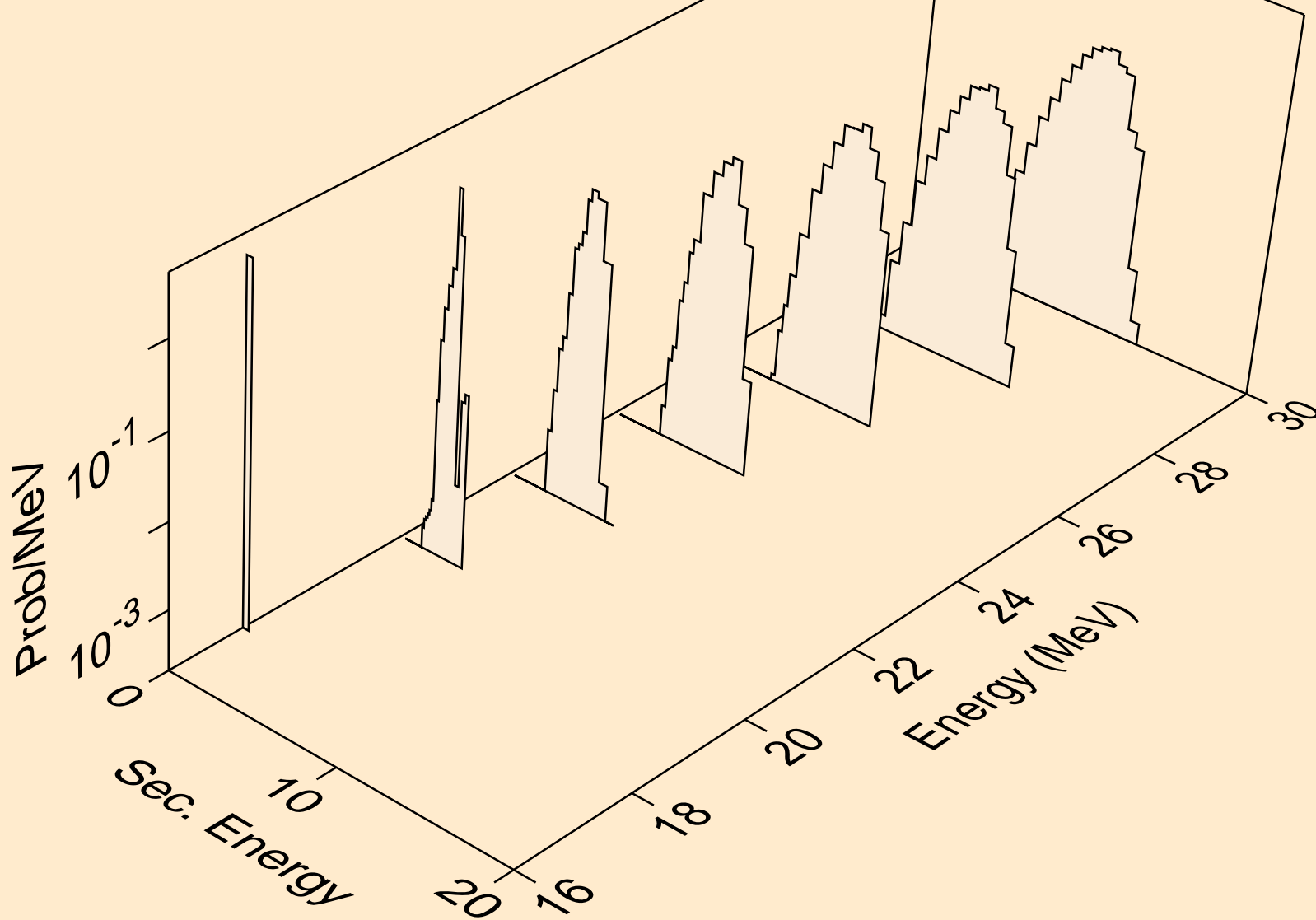

AM235 NEUTRON ACER TENDL-2019 LIBRARY; T=293.16K
protons from (n,2np)

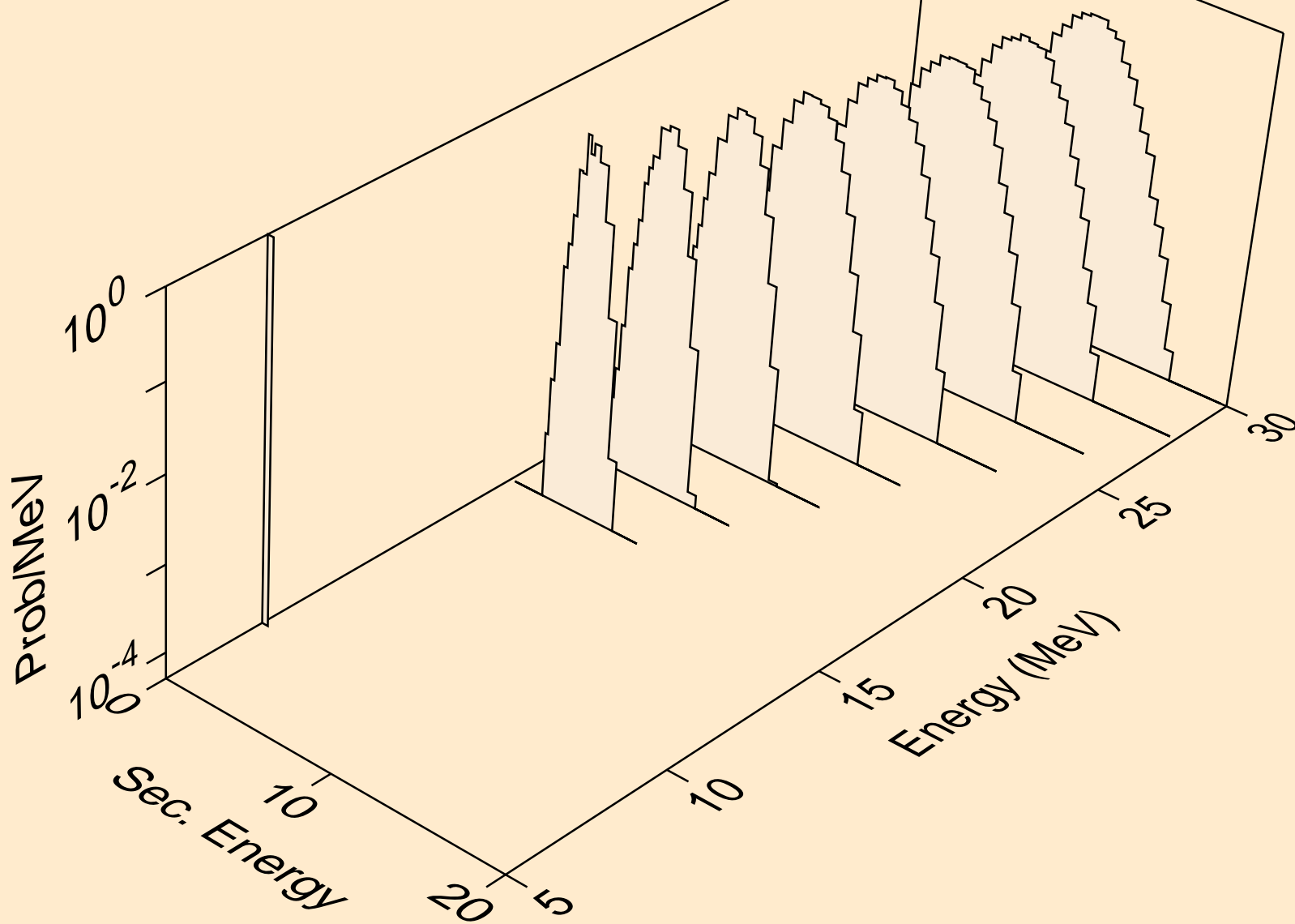

AM235 NEUTRON ACER TENDL-2019 LIBRARY; T=293.16K
protons from (n,npa)

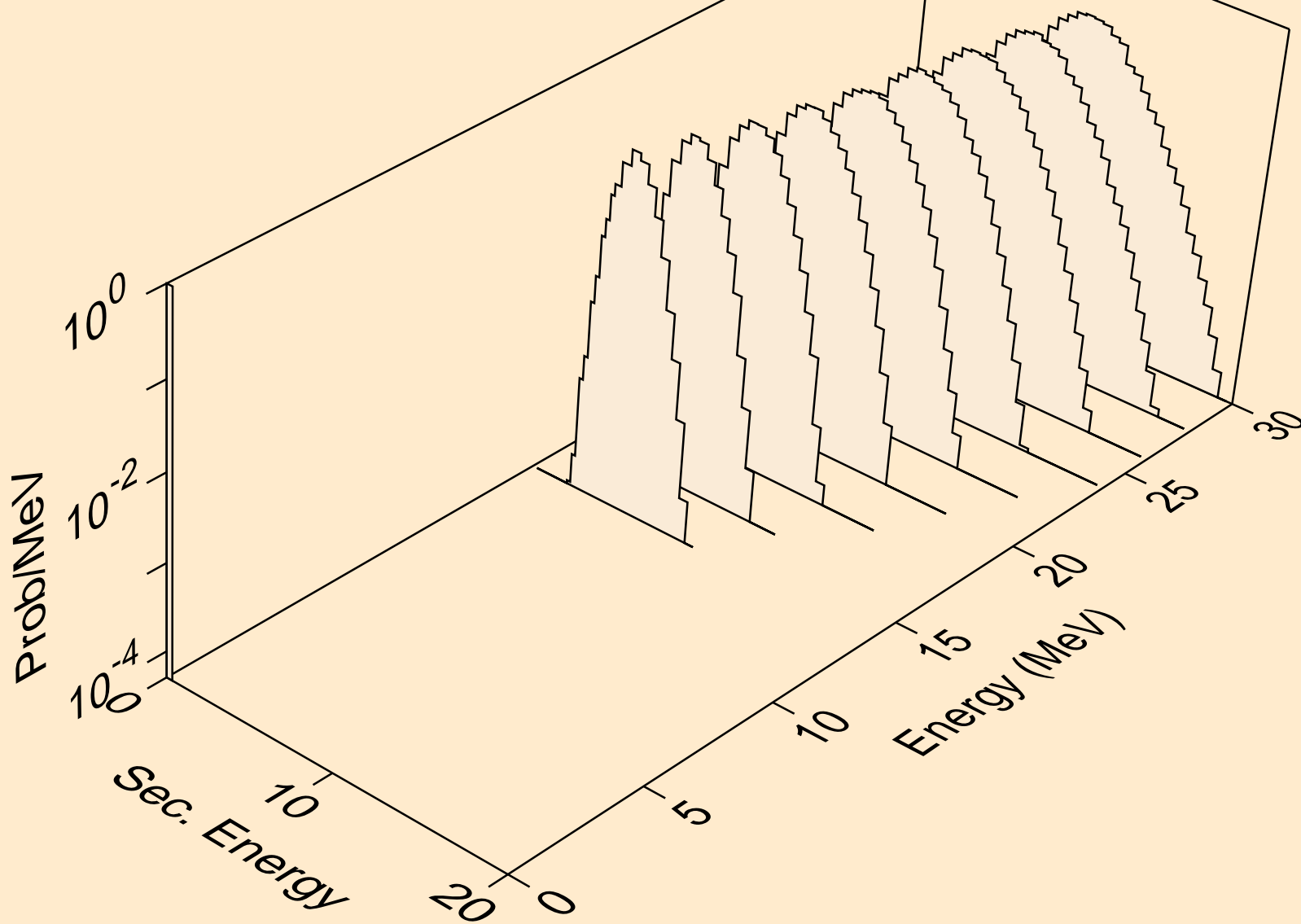

AM235 NEUTRON ACER TENDL-2019 LIBRARY; T=293.16K
protons from (n,p)

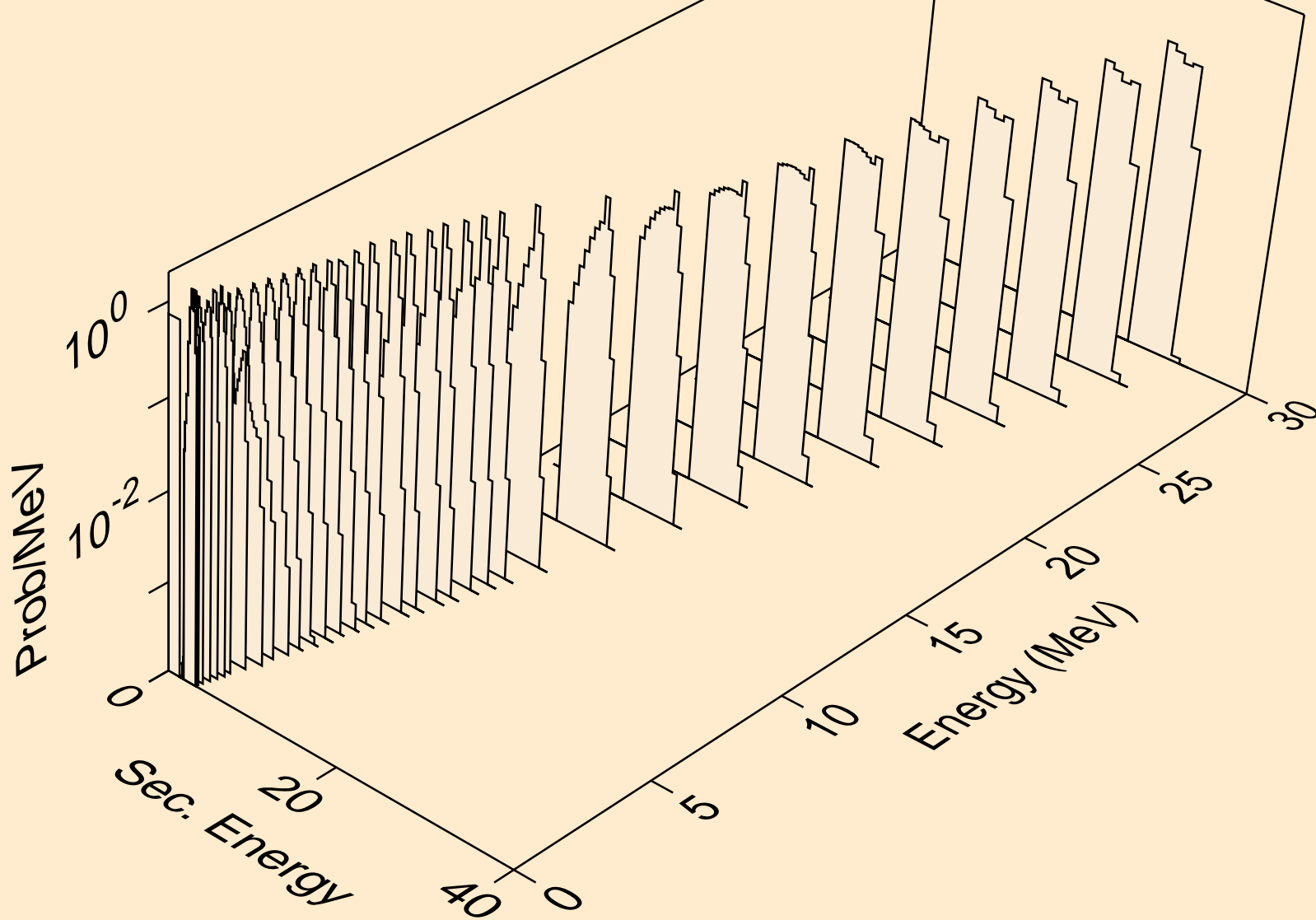

AM235 NEUTRON ACER TENDL-2019 LIBRARY; T=293.16K
protons from (n,2p)

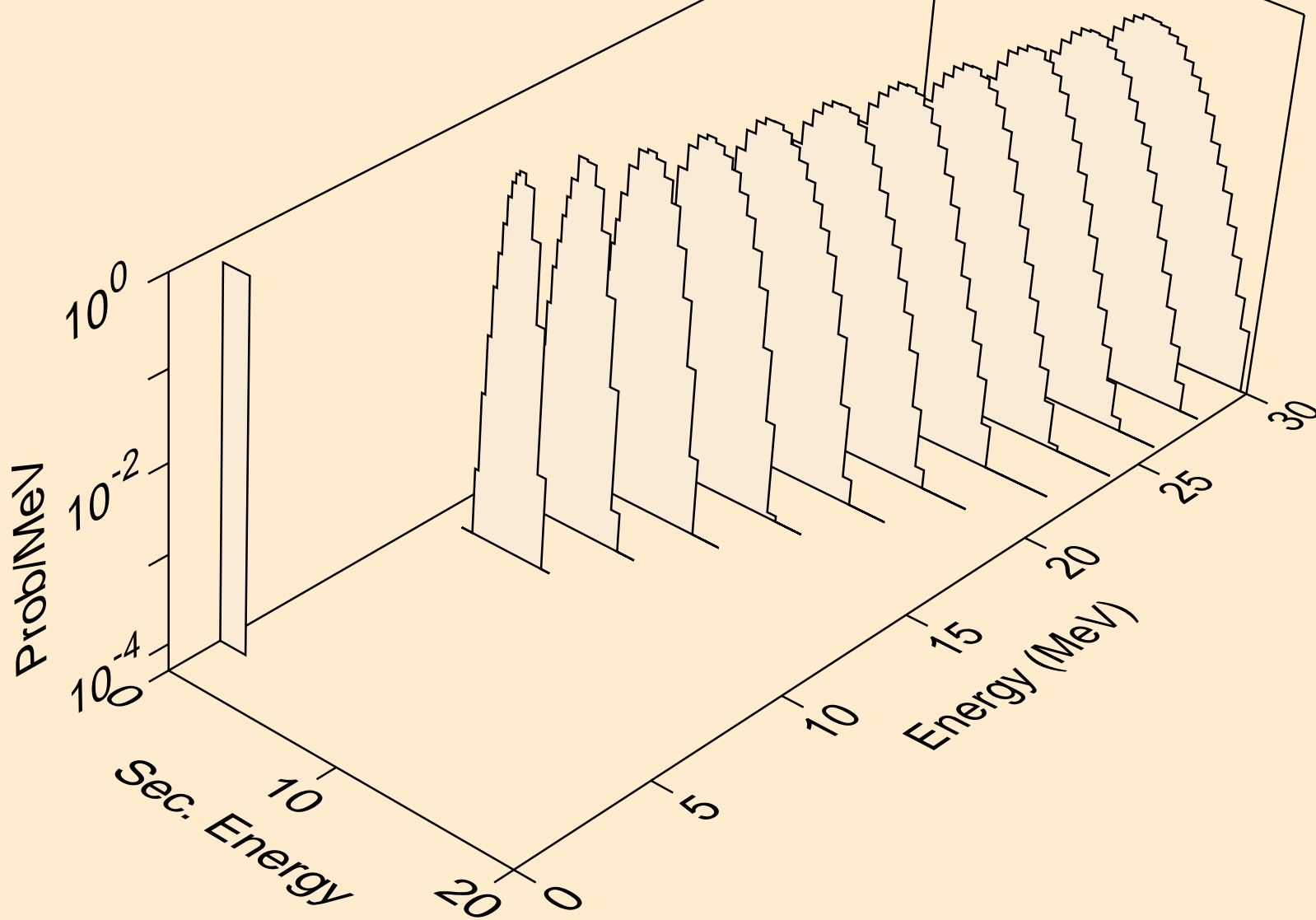

AM235 NEUTRON ACER TENDL-2019 LIBRARY; T=293.16K
protons from (n,p)

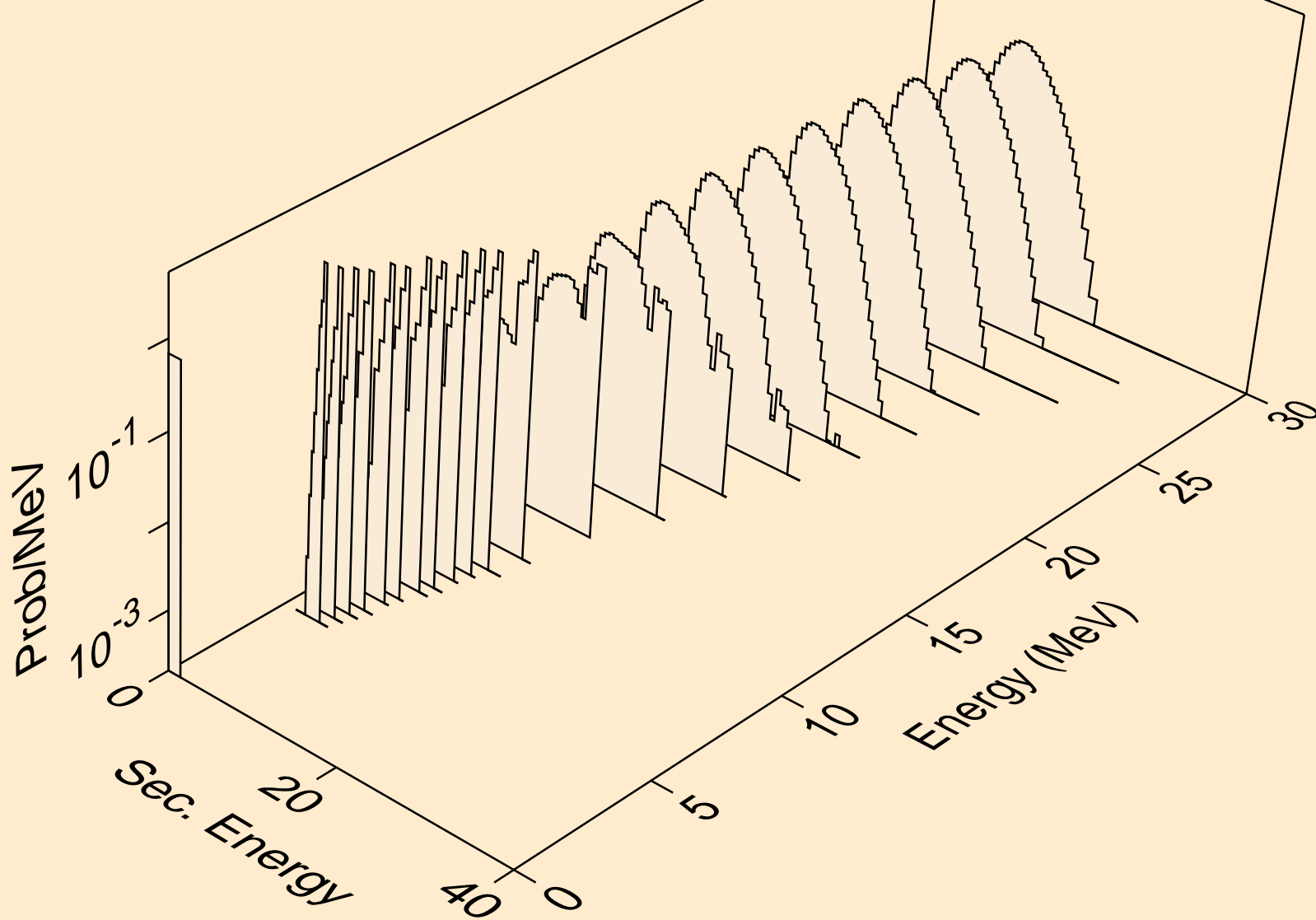

AM235 NEUTRON ACER TENDL-2019 LIBRARY; T=293.16K
protons from (n,pd)

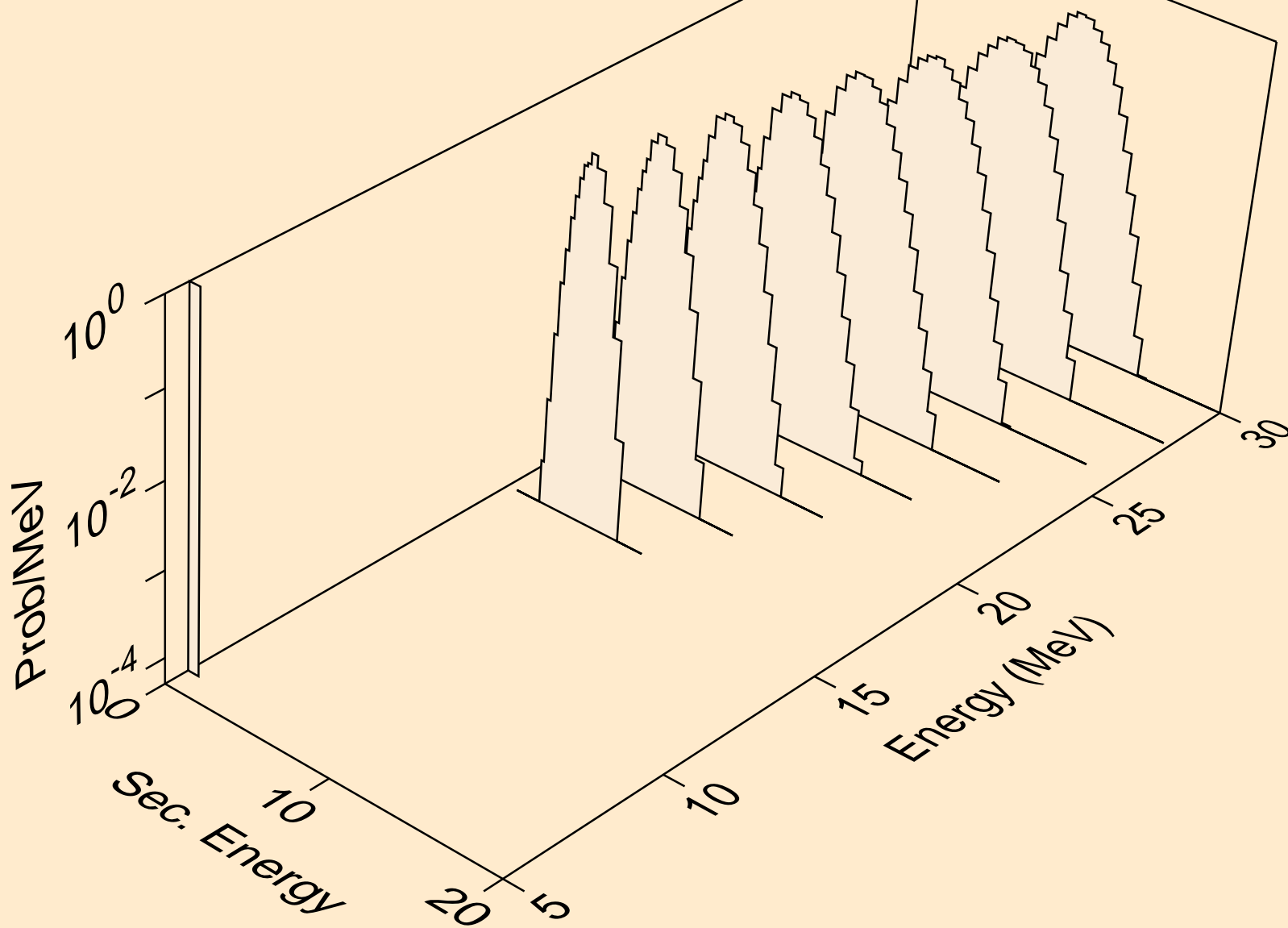

AM235 NEUTRON ACER TENDL-2019 LIBRARY; T=293.16K
protons from (n,pt)

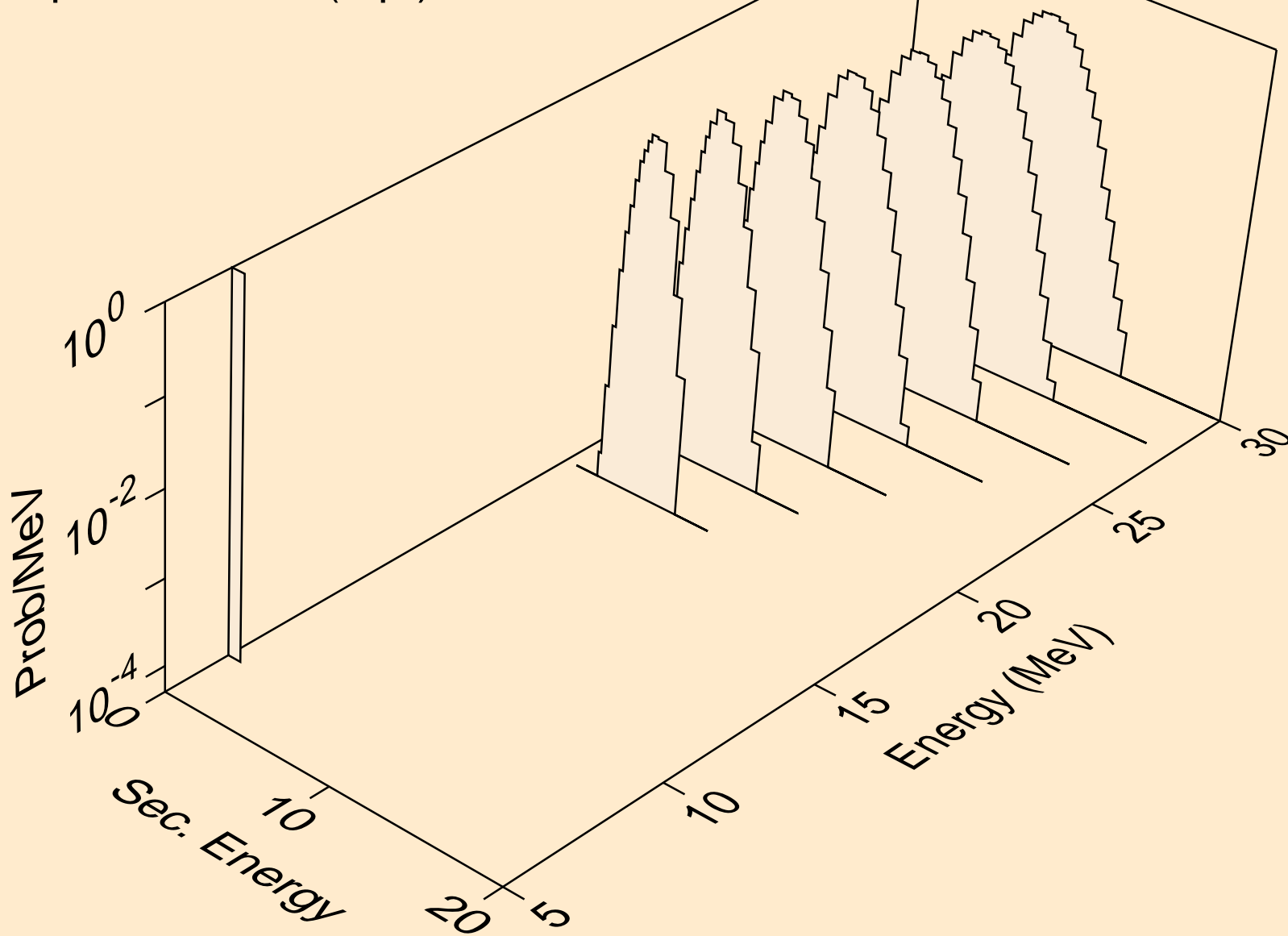

AM235 NEUTRON ACER TENDL-2019 LIBRARY; T=293.16K
deuterons from (n,x)

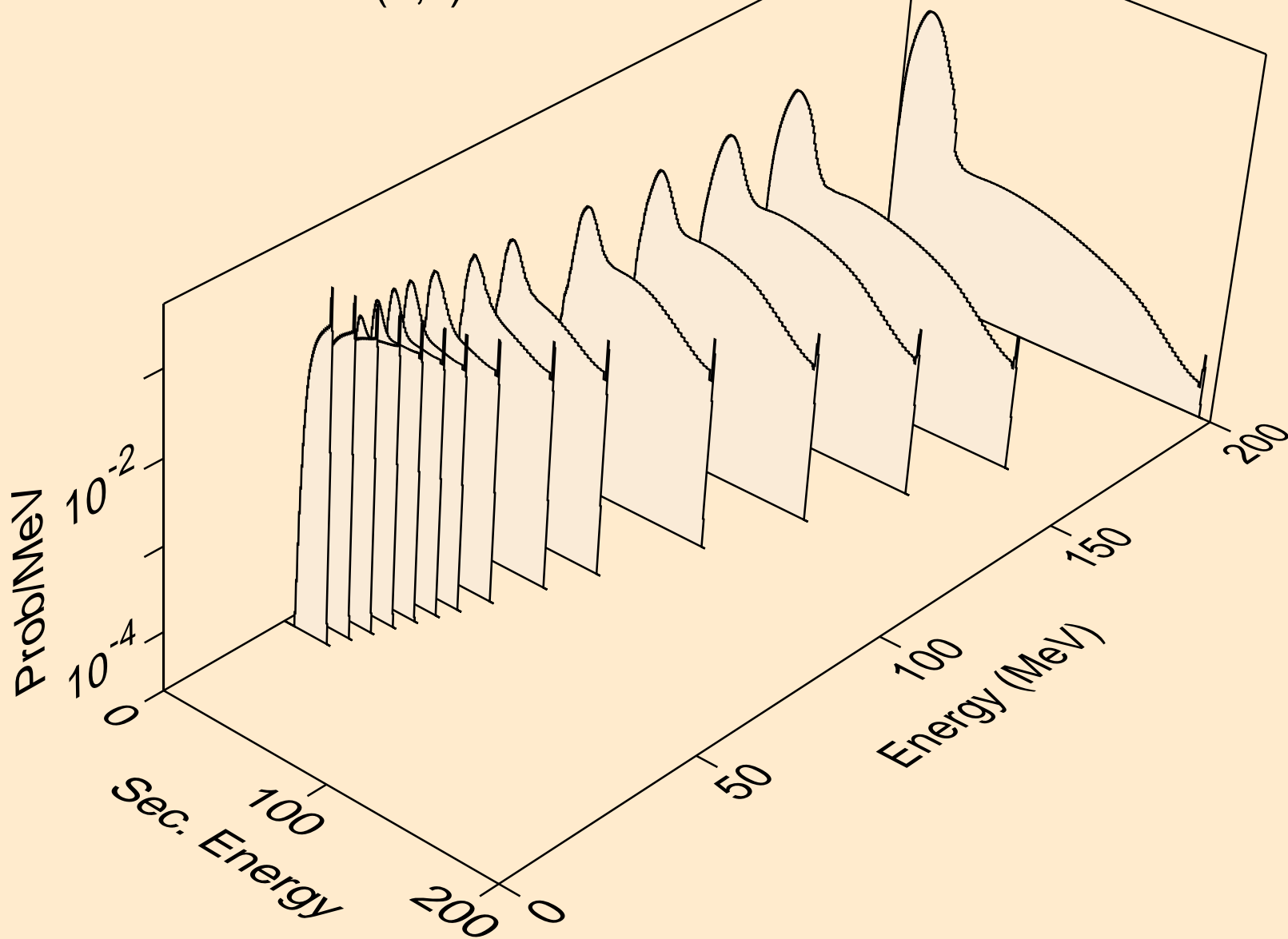

AM235 NEUTRON ACER TENDL-2019 LIBRARY; T=293.16K
deuterons from (n,2nd)

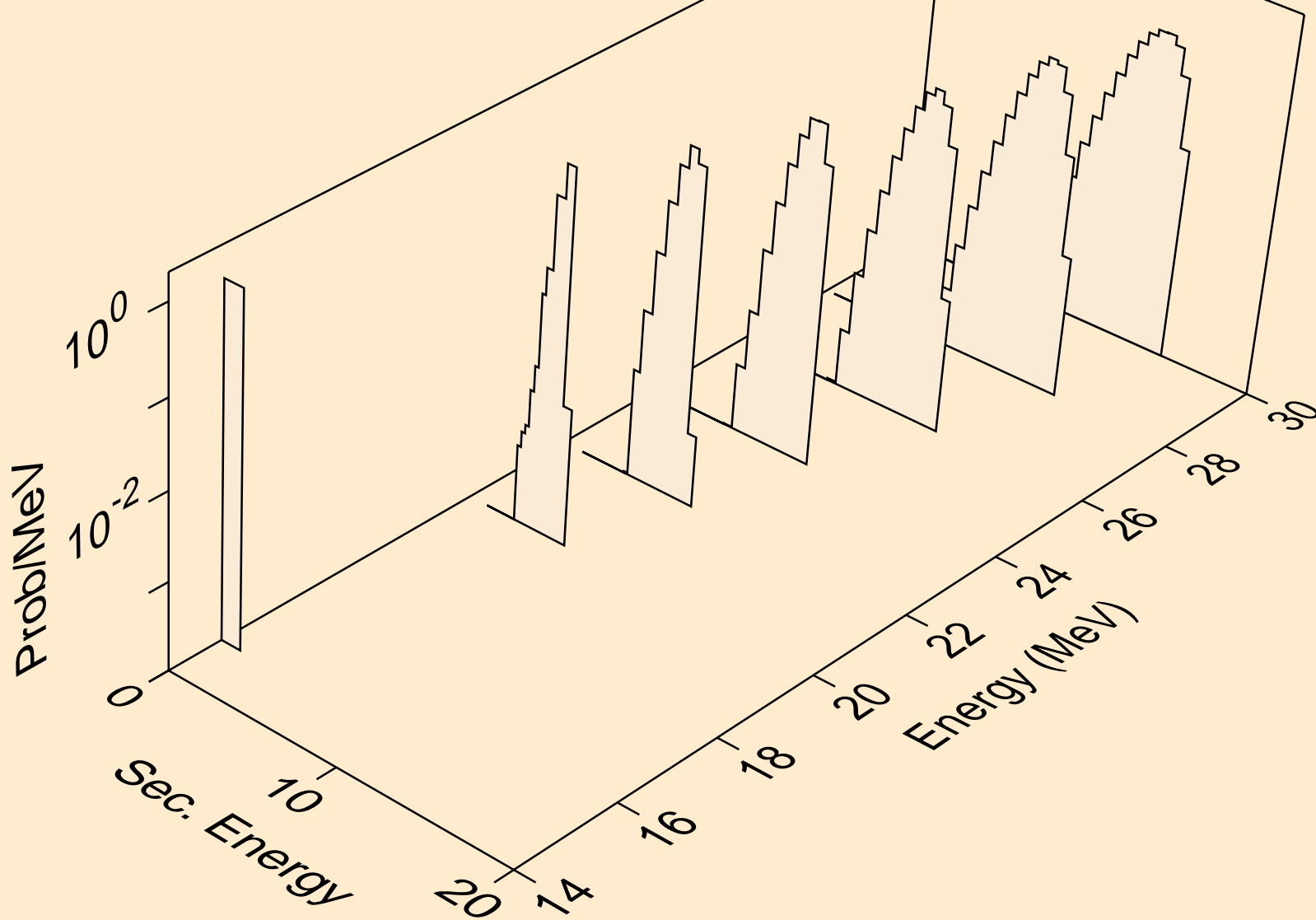

AM235 NEUTRON ACER TENDL-2019 LIBRARY; T=293.16K
deuterons from (n,n*)d

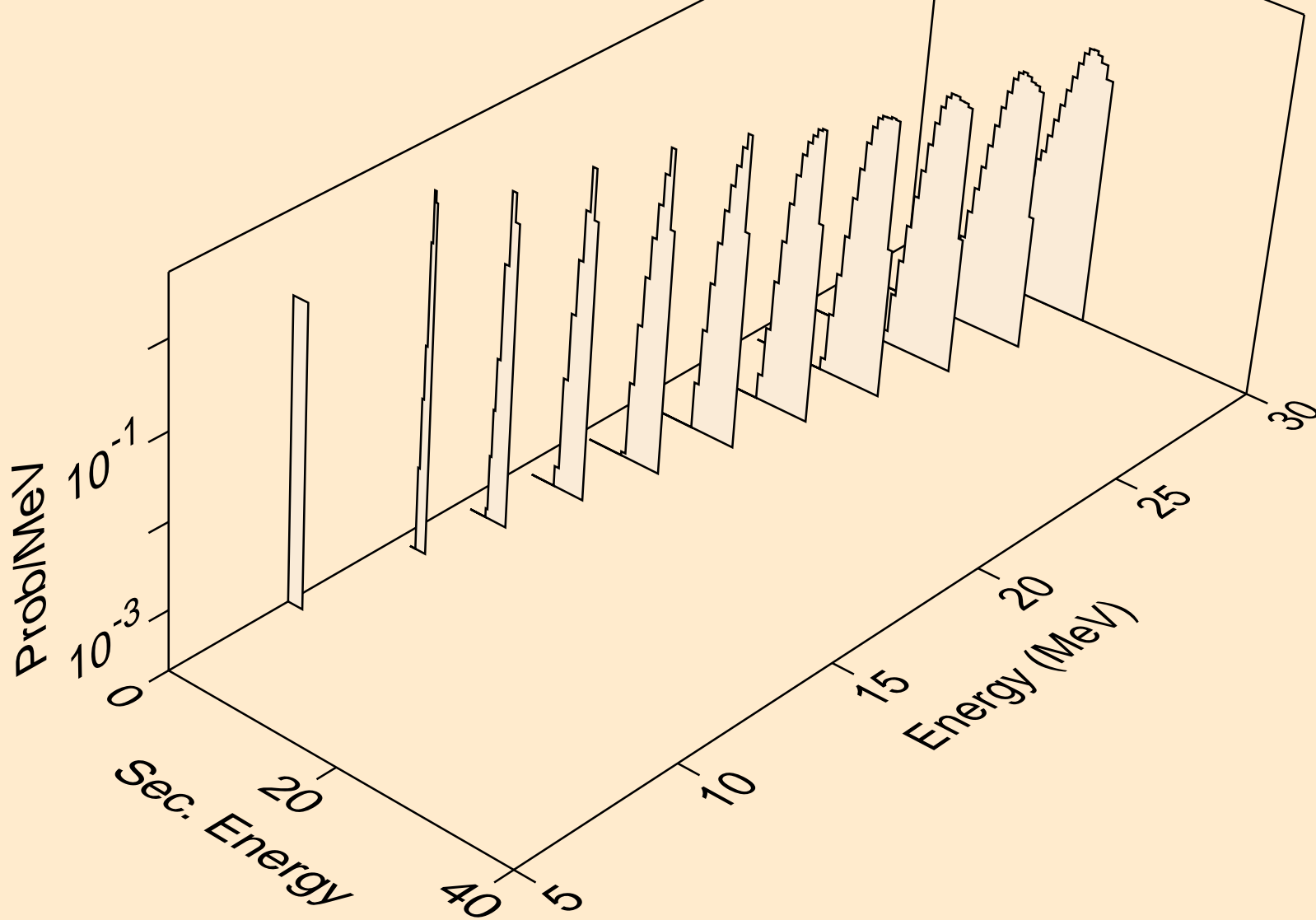

AM235 NEUTRON ACER TENDL-2019 LIBRARY; T=293.16K
deuterons from (n,d)

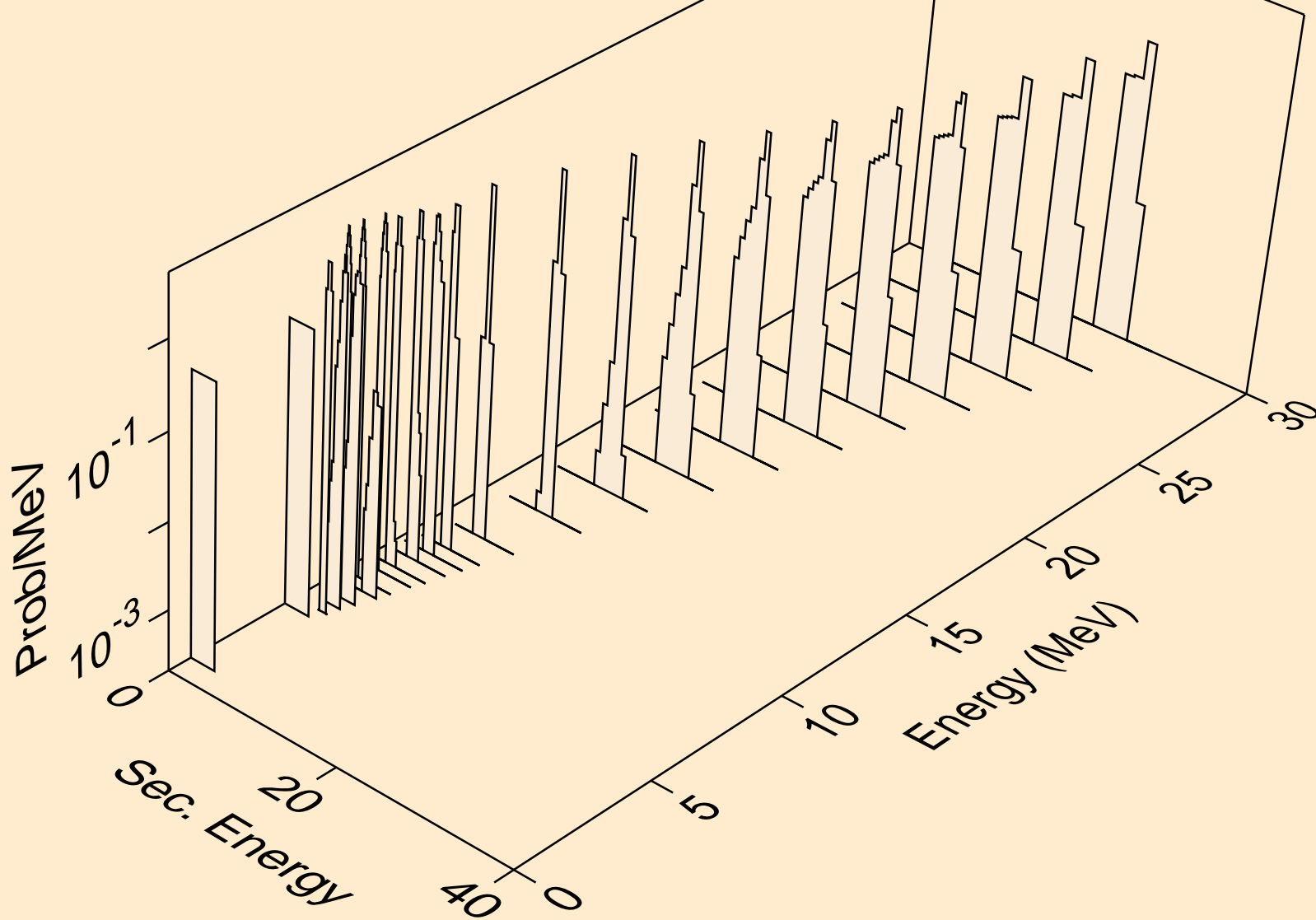

AM235 NEUTRON ACER TENDL-2019 LIBRARY; T=293.16K
deuterons from (n,pd)

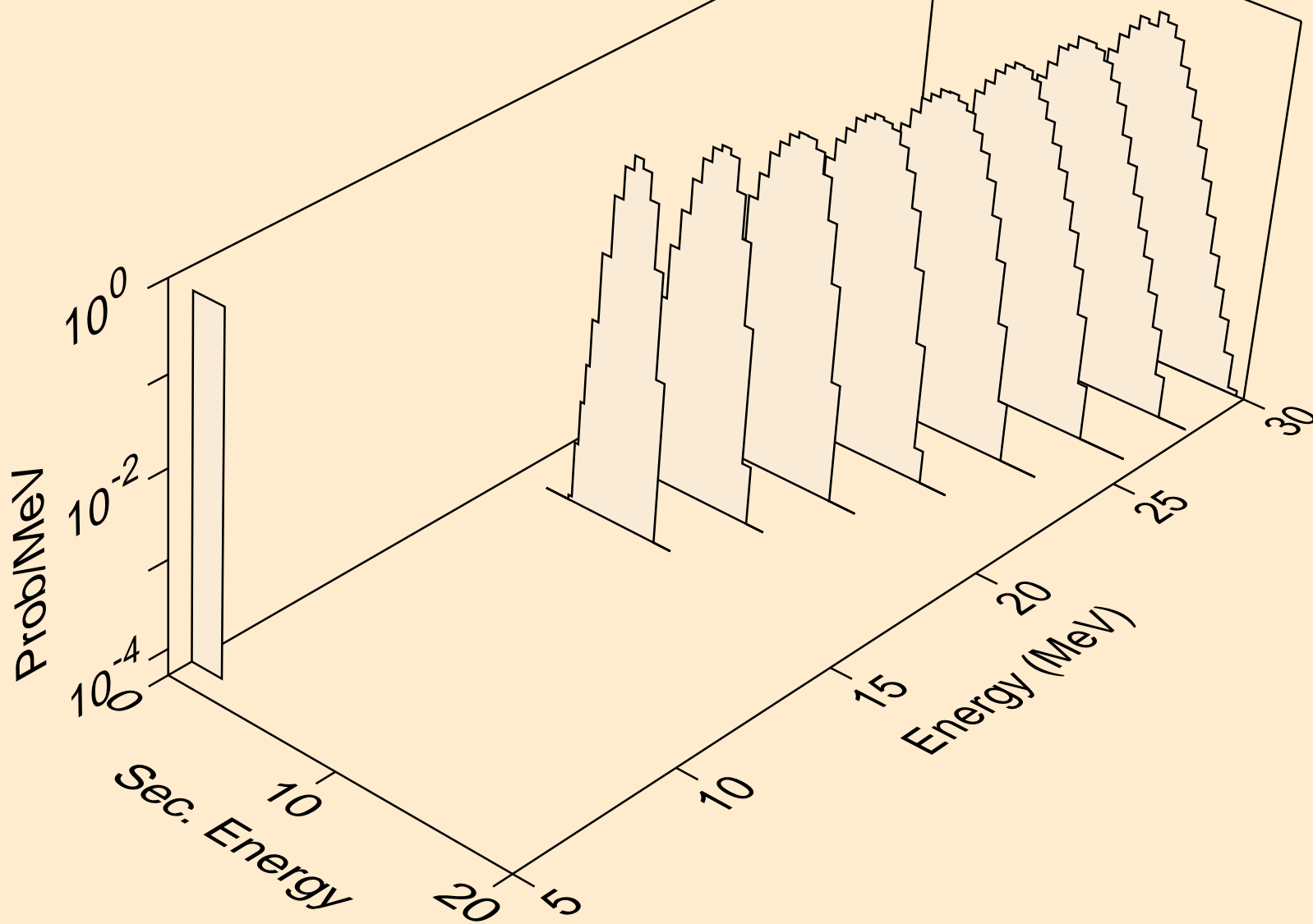

AM235 NEUTRON ACER TENDL-2019 LIBRARY; T=293.16K
tritons from (n,x)

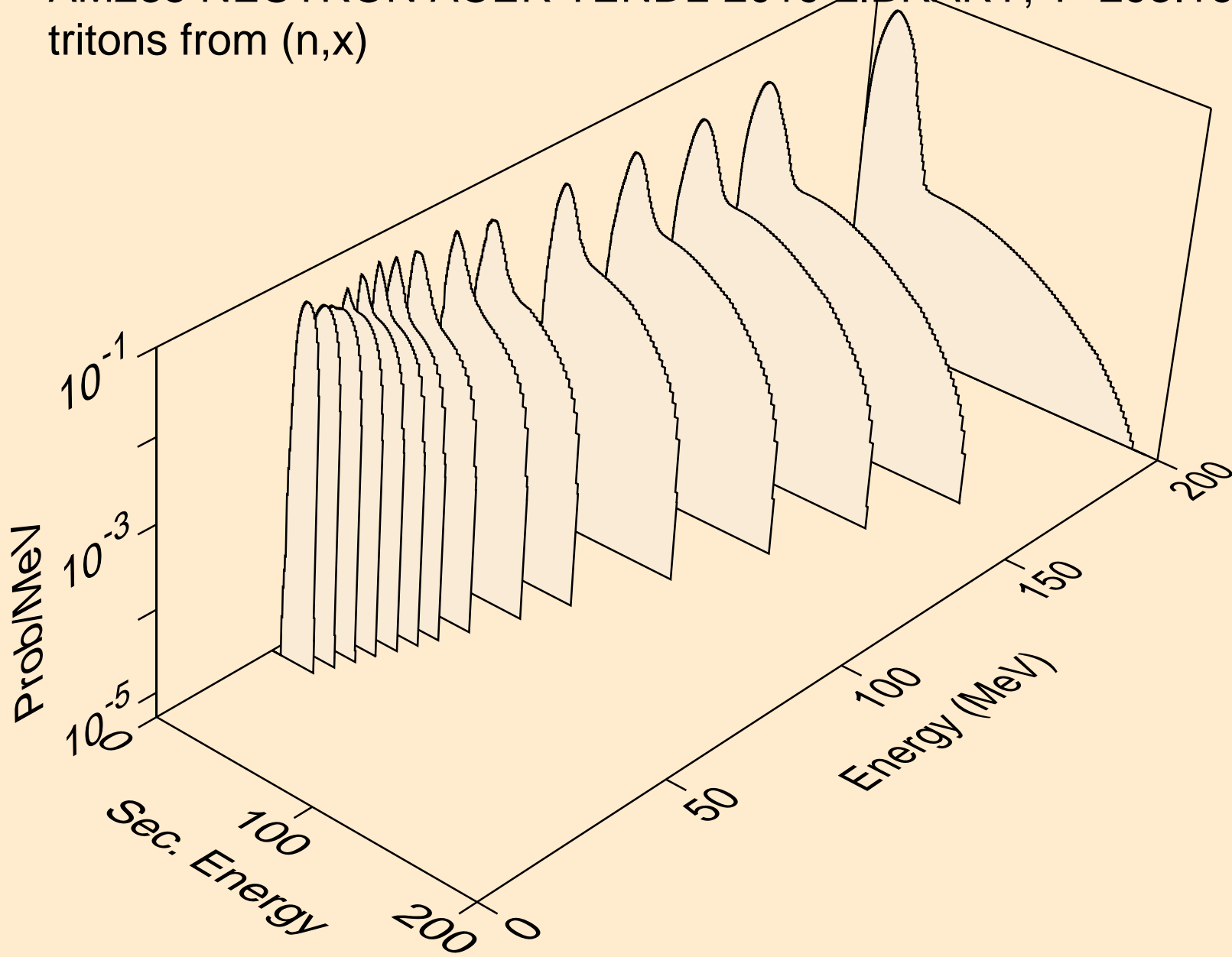

AM235 NEUTRON ACER TENDL-2019 LIBRARY; T=293.16K
tritons from (n,n*)t

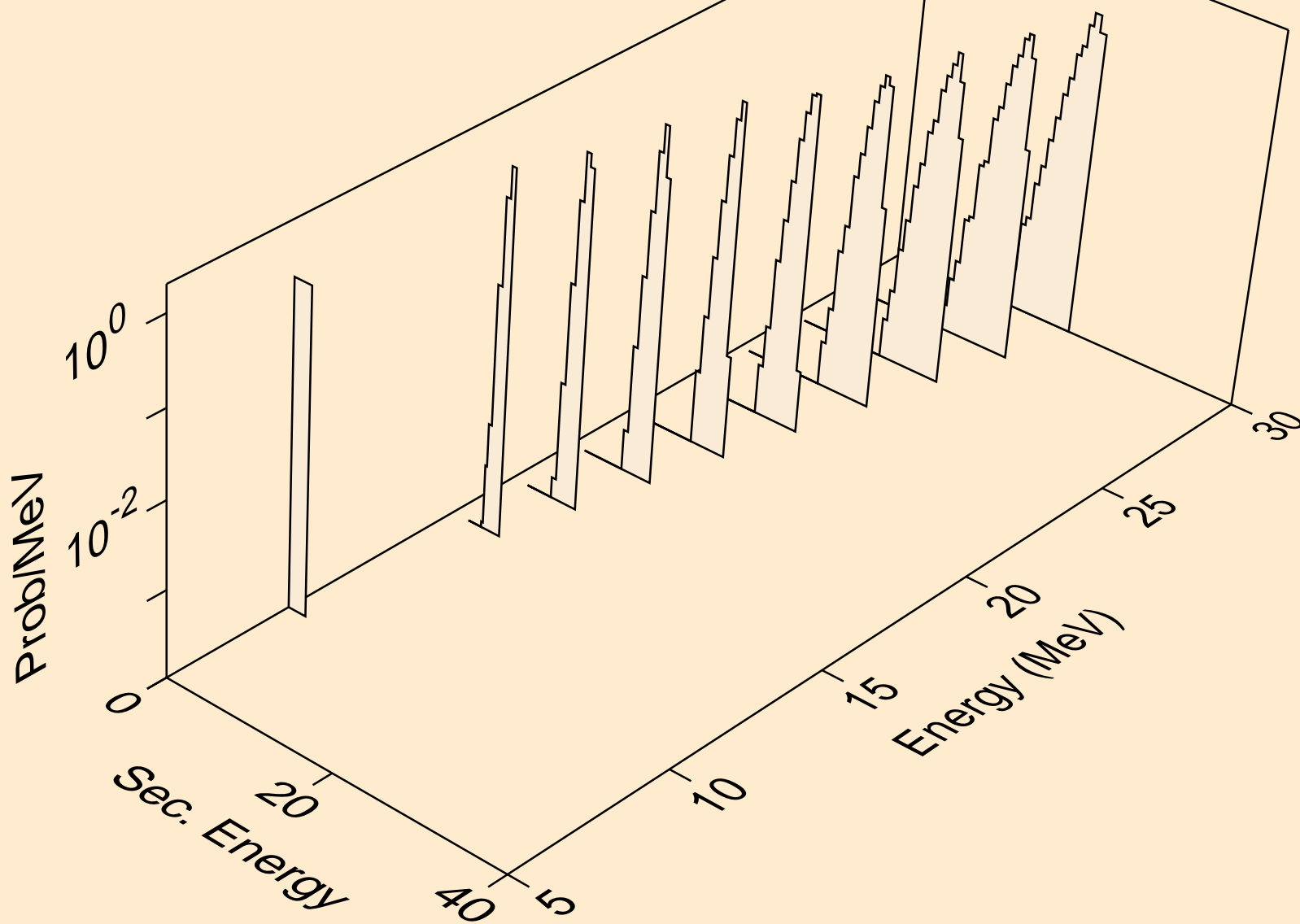

AM235 NEUTRON ACER TENDL-2019 LIBRARY; T=293.16K
tritons from (n,t)

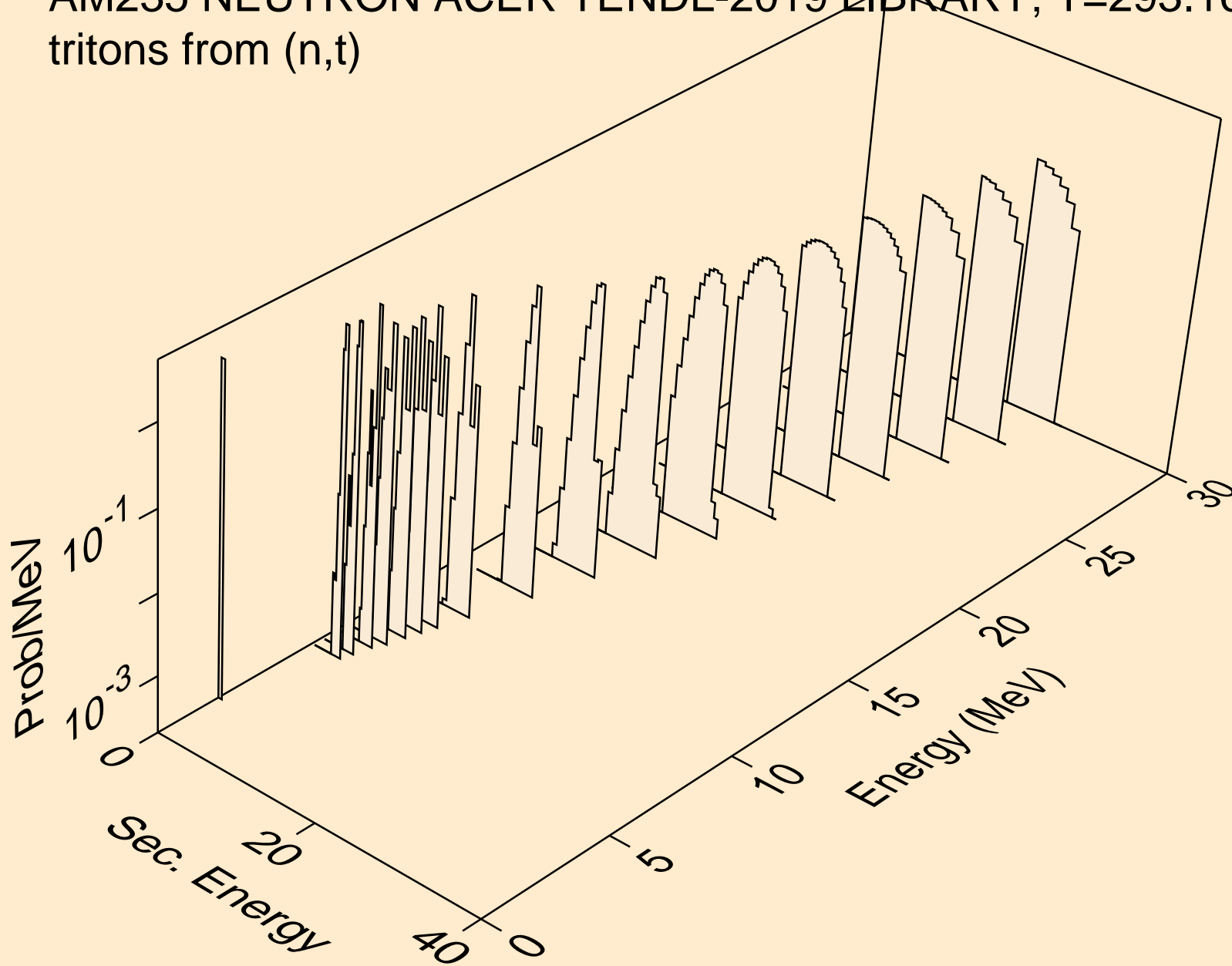

AM235 NEUTRON ACER TENDL-2019 LIBRARY; T=293.16K
tritons from (n,pt)

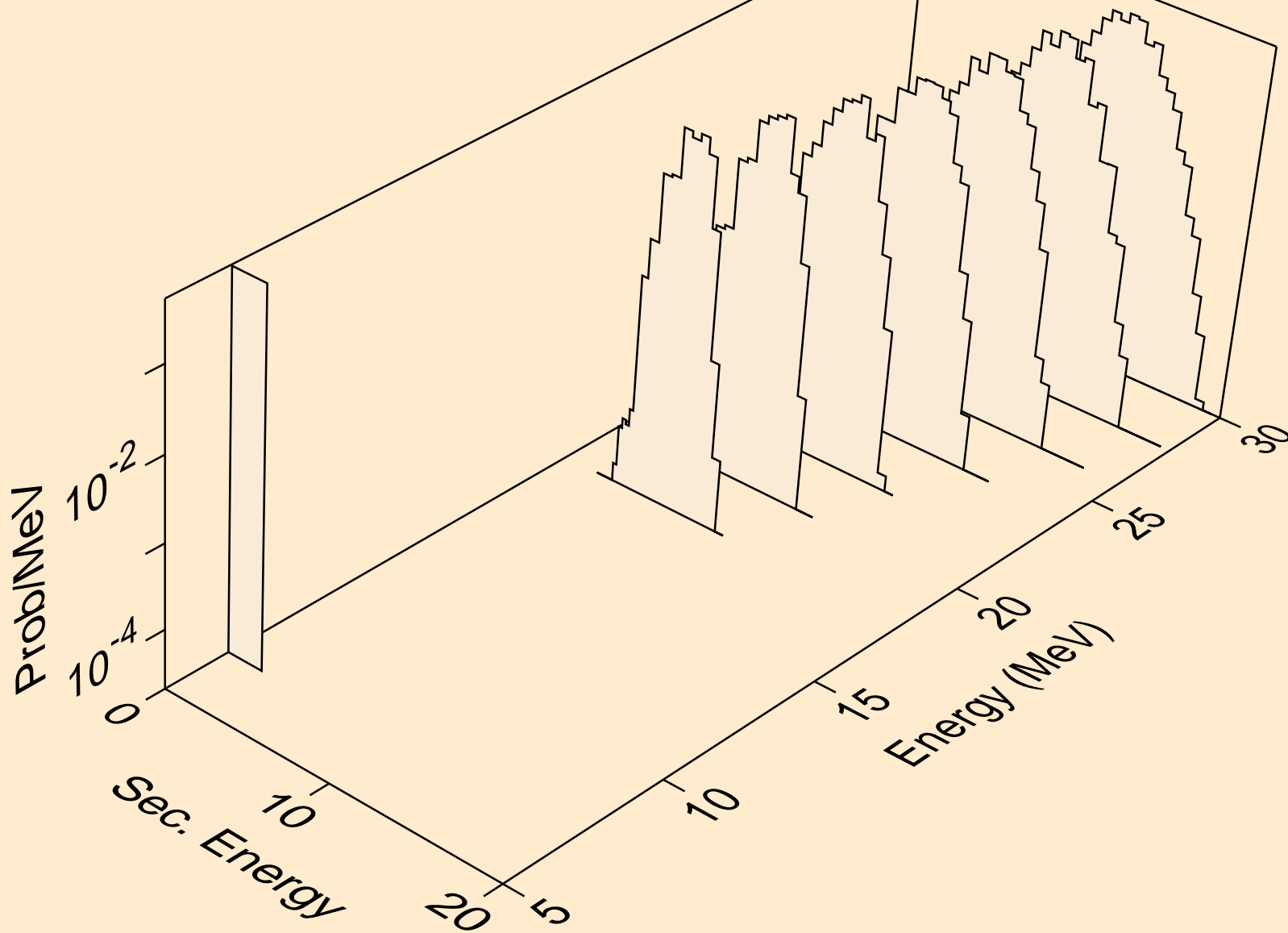

AM235 NEUTRON ACER TENDL-2019 LIBRARY; T=293.16K
he3s from (n,x)

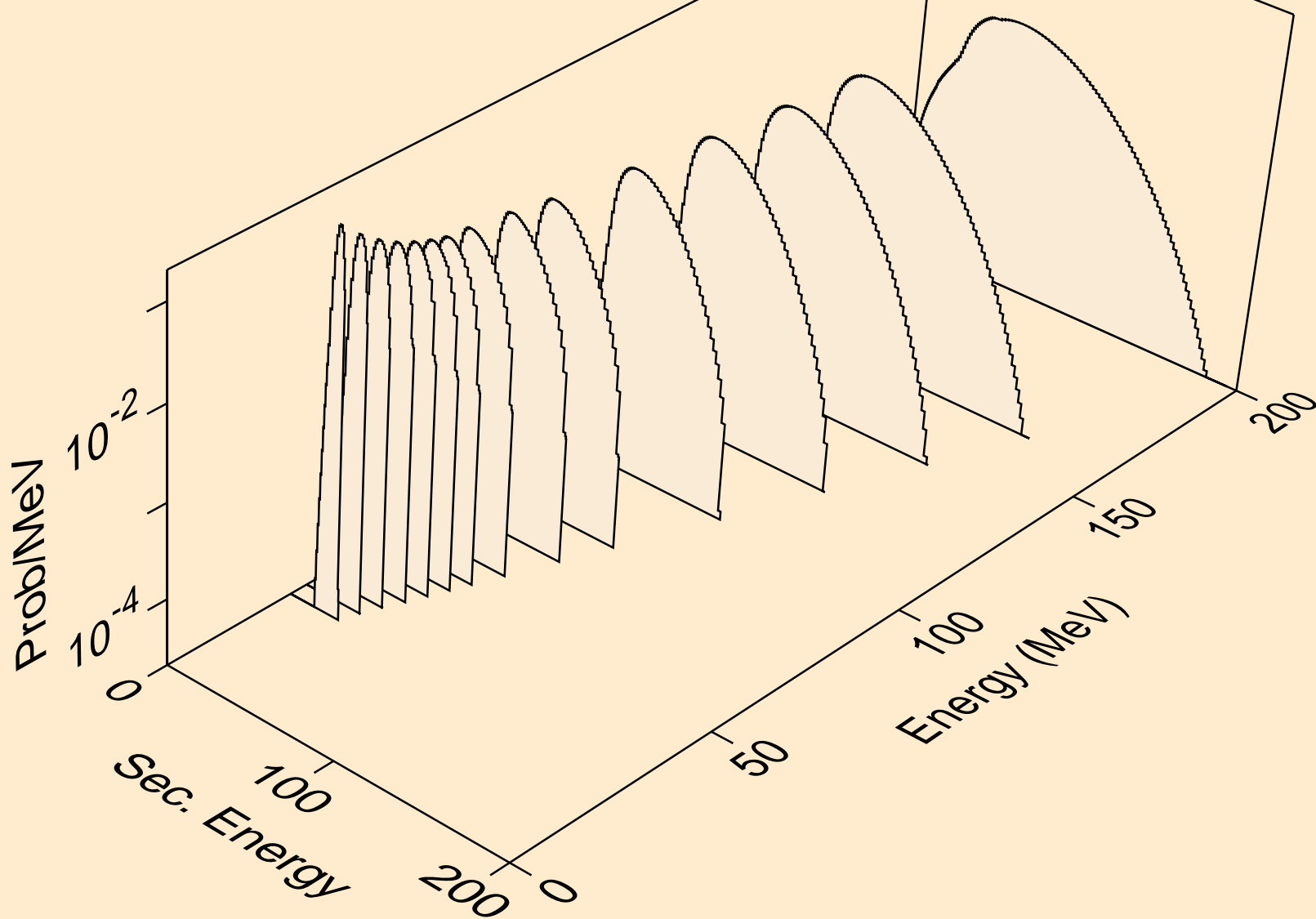

AM235 NEUTRON ACER TENDL-2019 LIBRARY; T=293.16K
he3s from (n,n*)he3

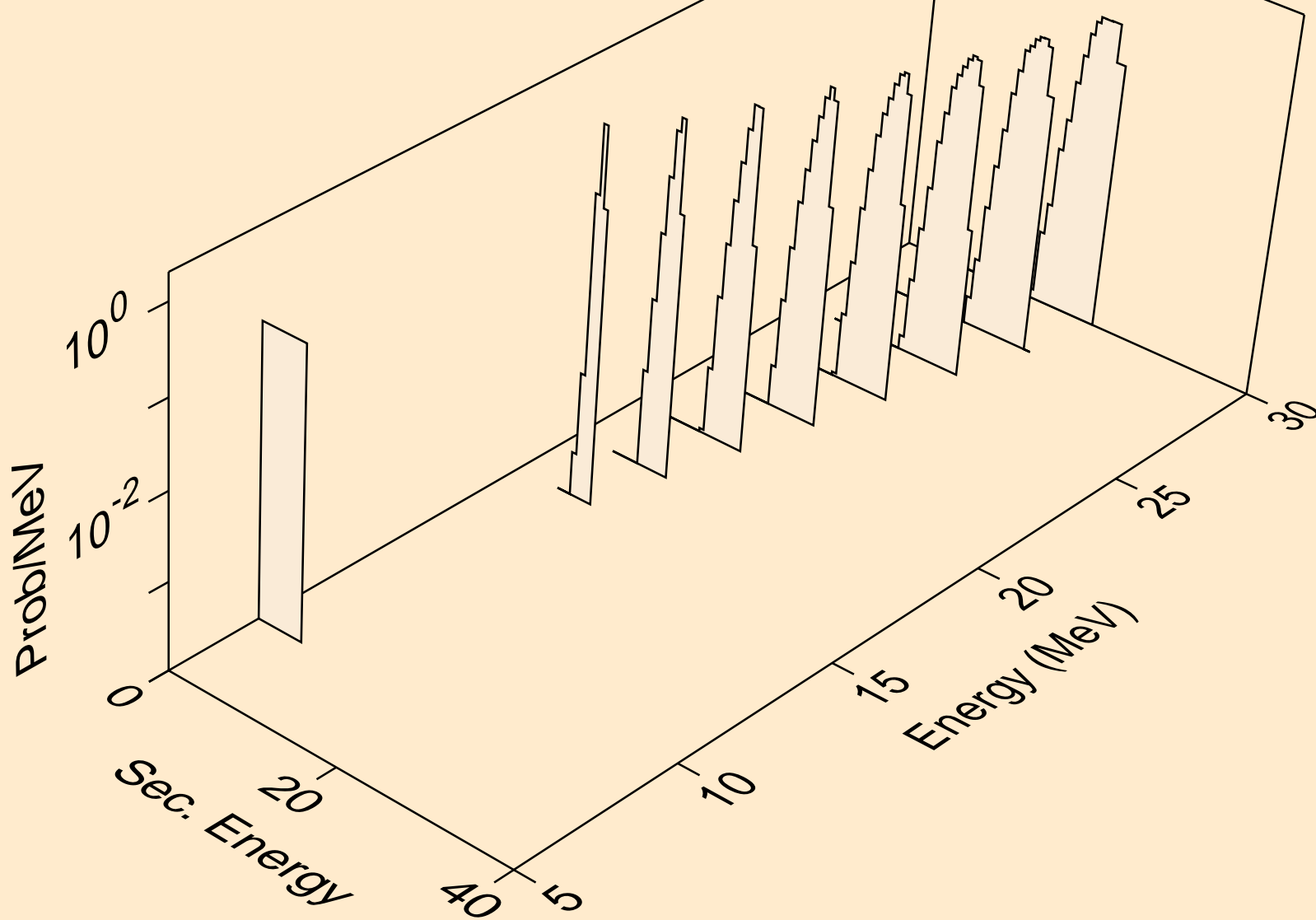

AM235 NEUTRON ACER TENDL-2019 LIBRARY; T=293.16K
he3s from (n,he3)

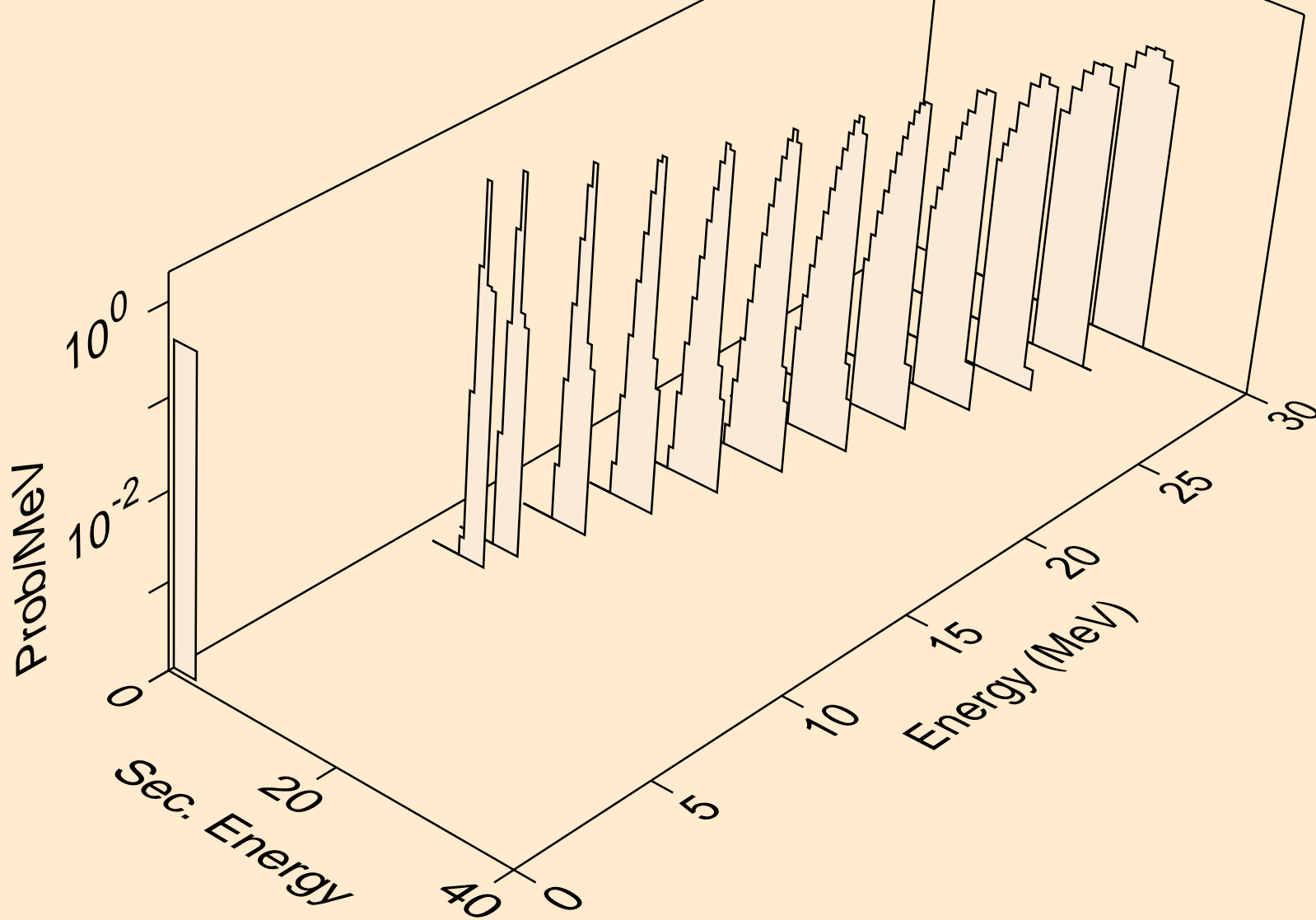

AM235 NEUTRON ACER TENDL-2019 LIBRARY; T=293.16K
alphas from (n,x)

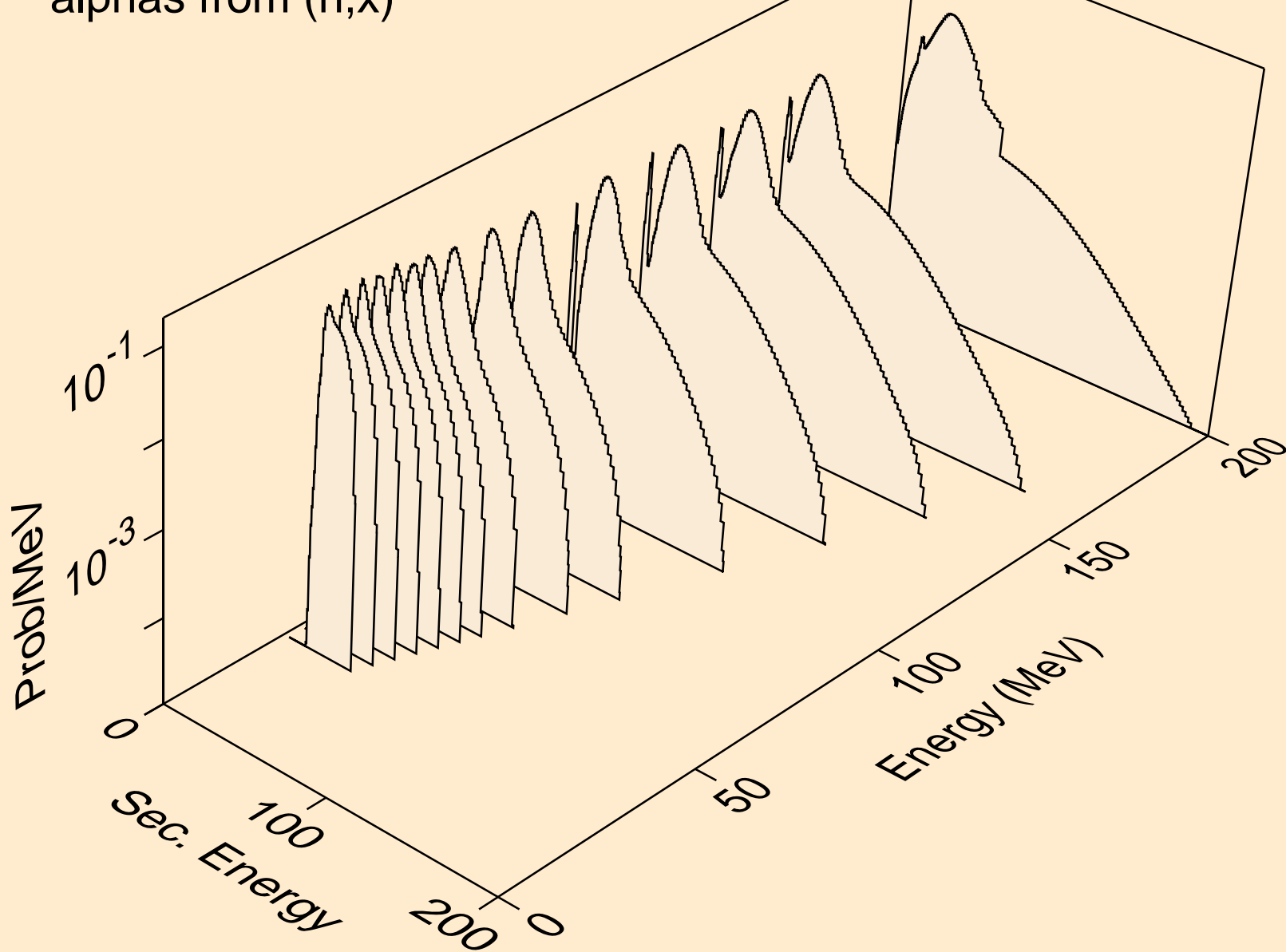

AM235 NEUTRON ACER TENDL-2019 LIBRARY; T=293.16K
alphas from (n,n*)a

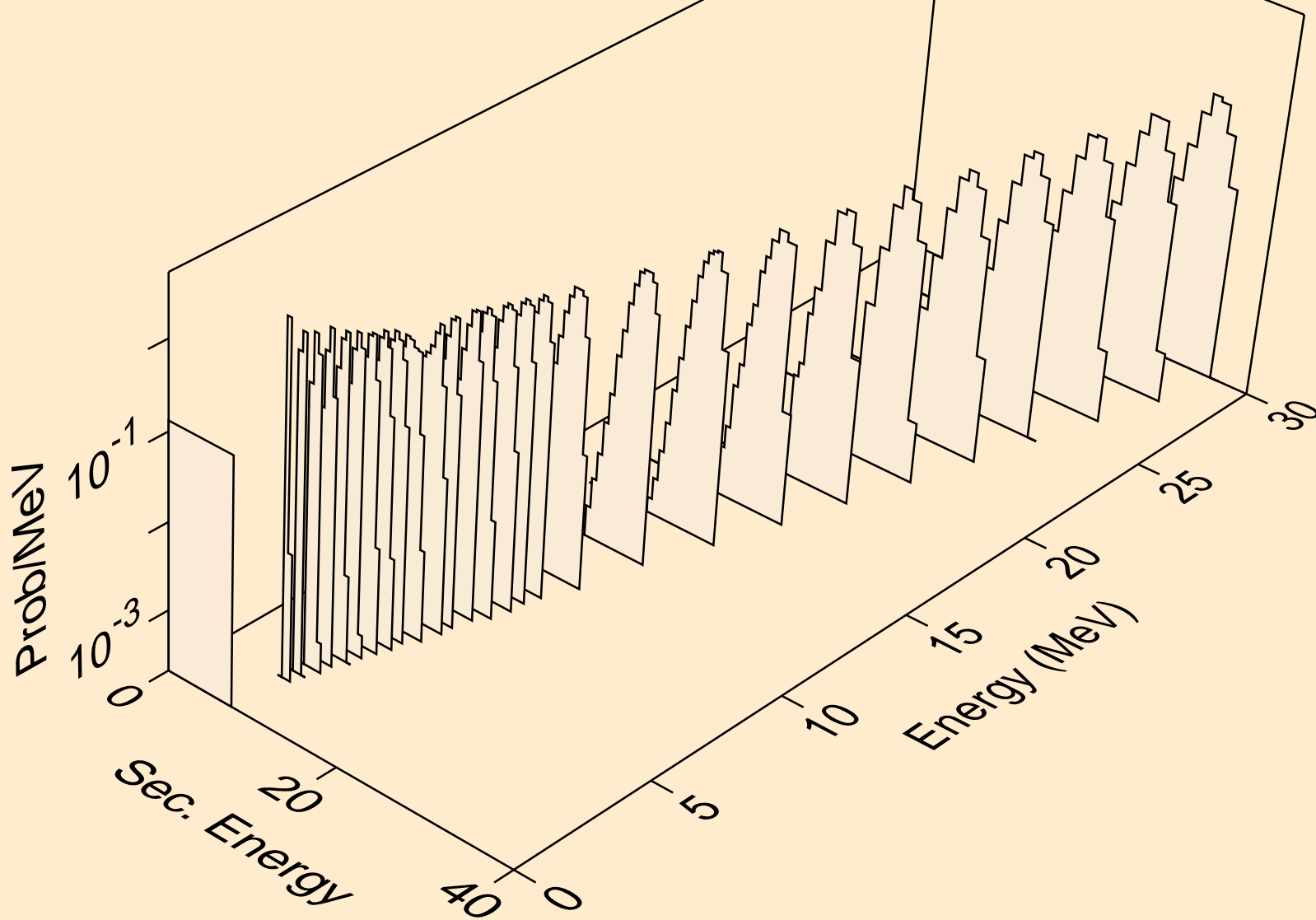

AM235 NEUTRON ACER TENDL-2019 LIBRARY; T=293.16K
alphas from (n,2n)a

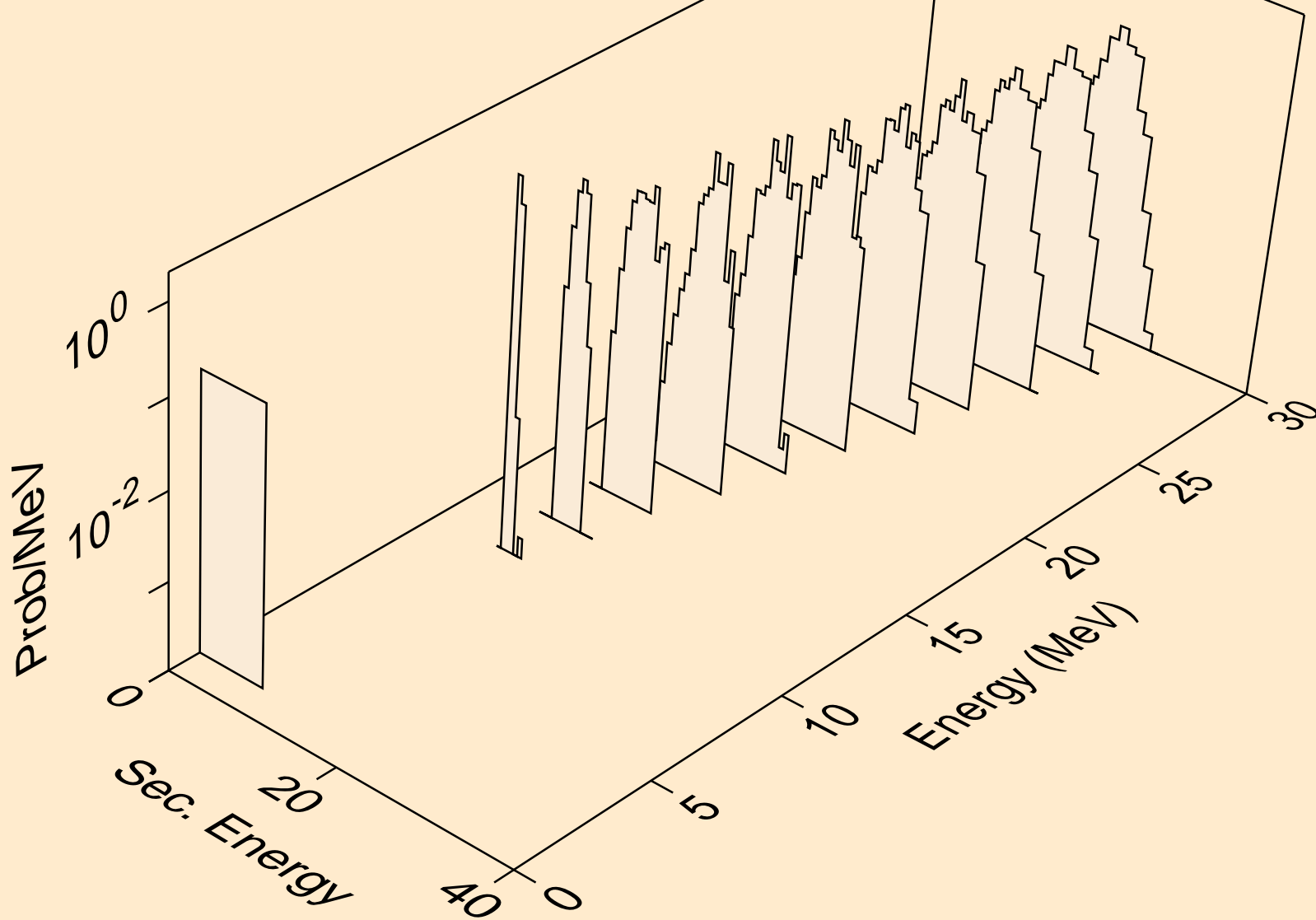

AM235 NEUTRON ACER TENDL-2019 LIBRARY; T=293.16K
alphas from (n,3n)a

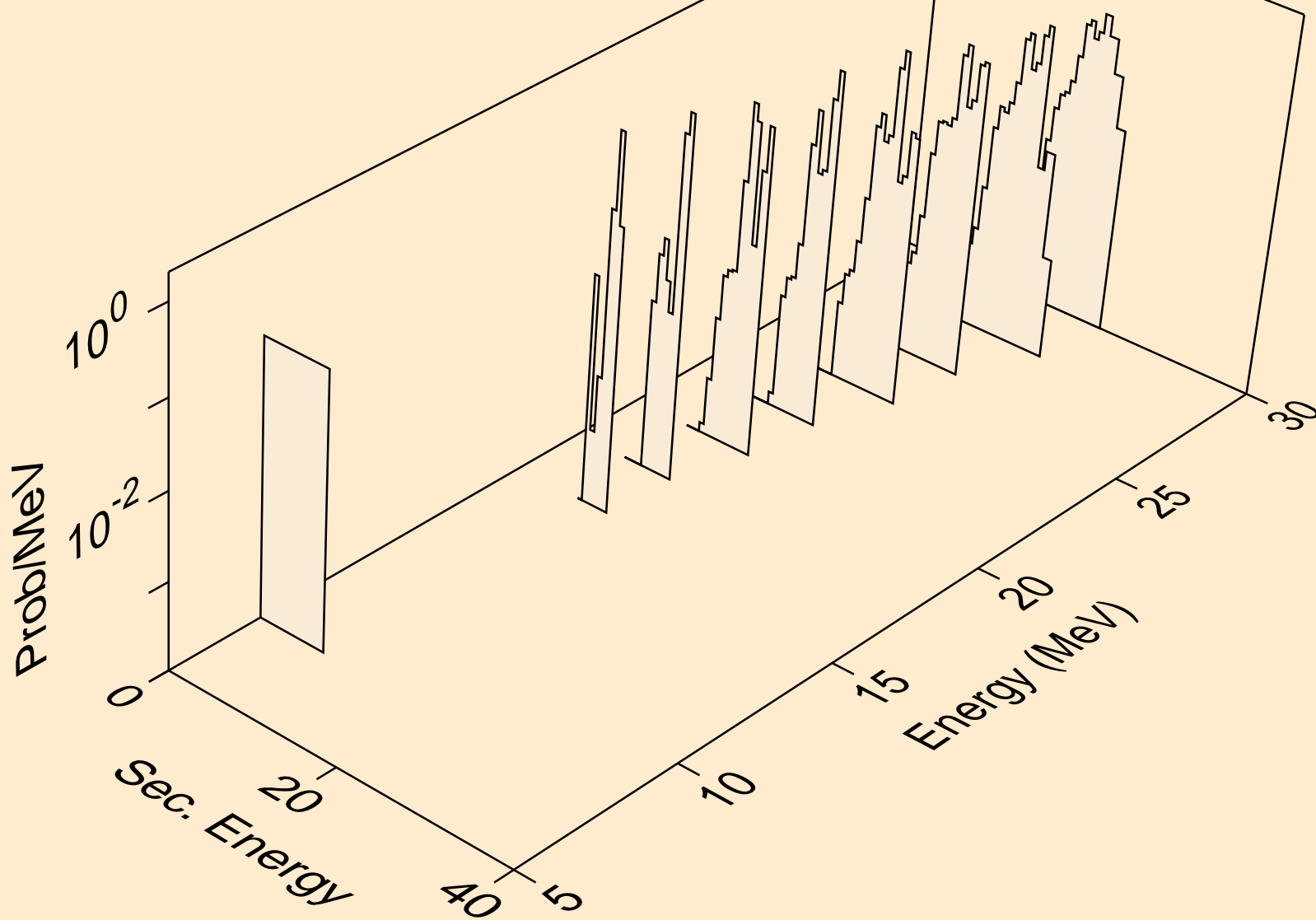

AM235 NEUTRON ACER TENDL-2019 LIBRARY; T=293.16K
alphas from (n,n*)2a

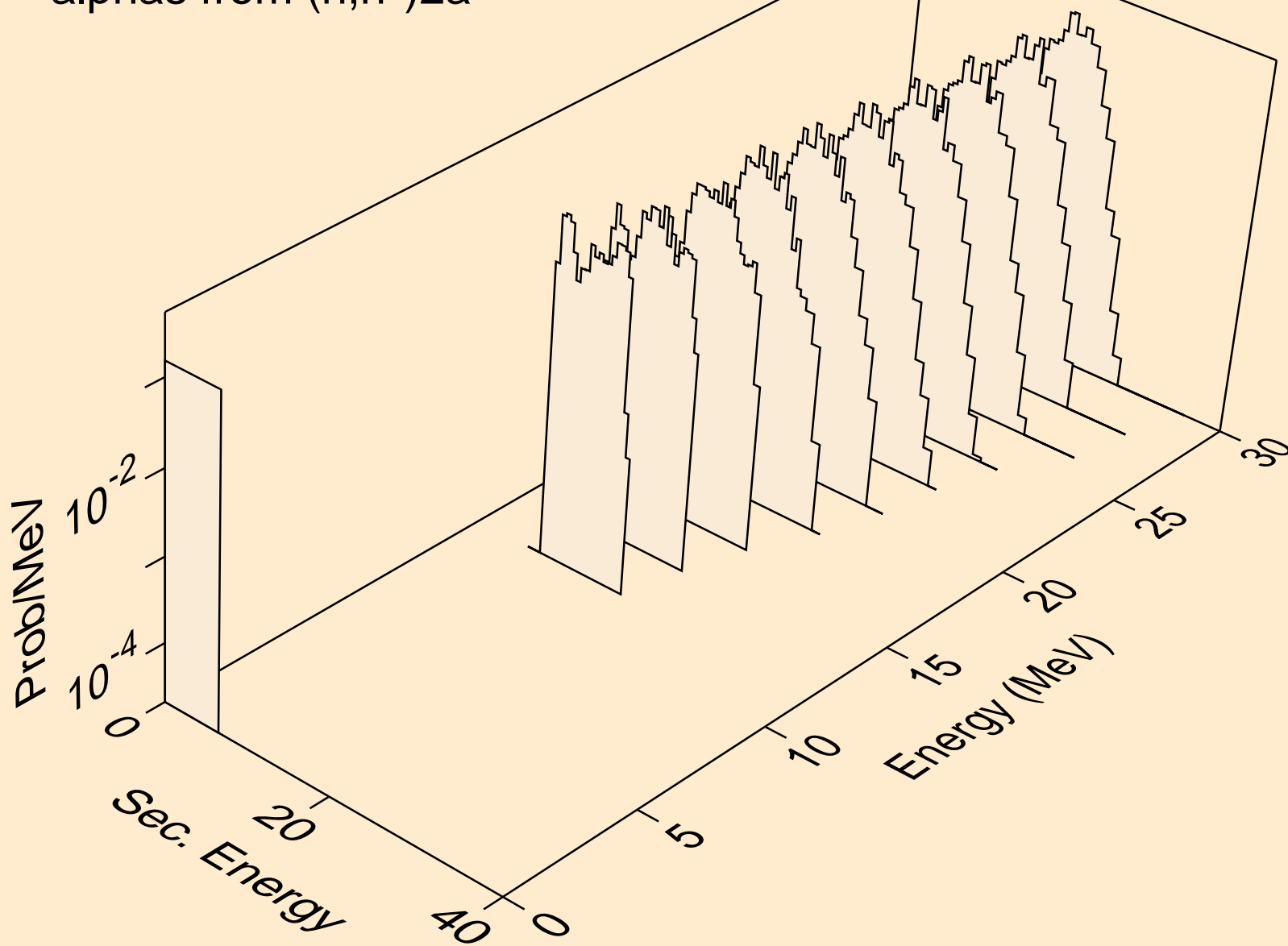

AM235 NEUTRON ACER TENDL-2019 LIBRARY; T=293.16K
alphas from (n,2n)2a

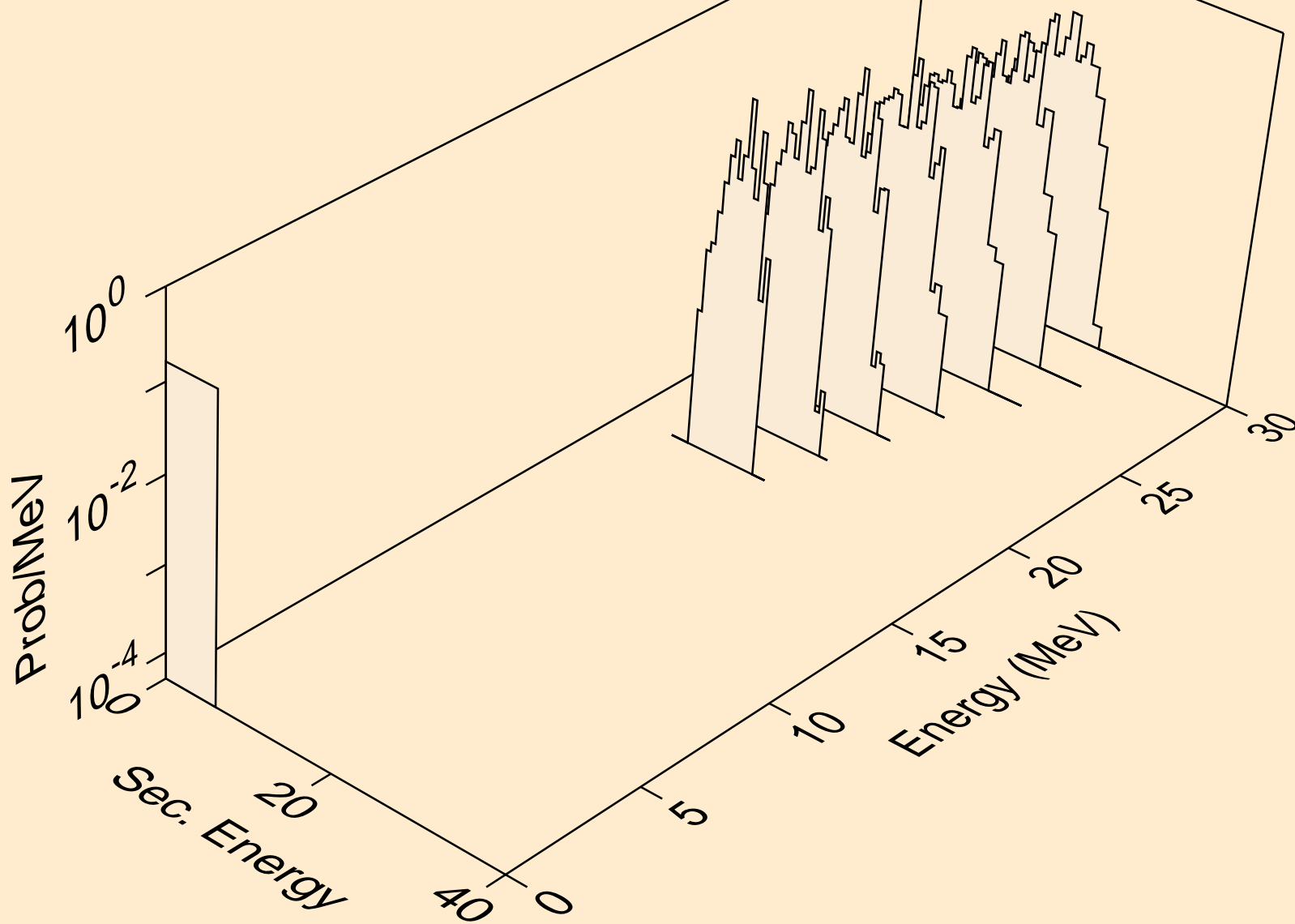

AM235 NEUTRON ACER TENDL-2019 LIBRARY; T=293.16K
alphas from (n,npa)

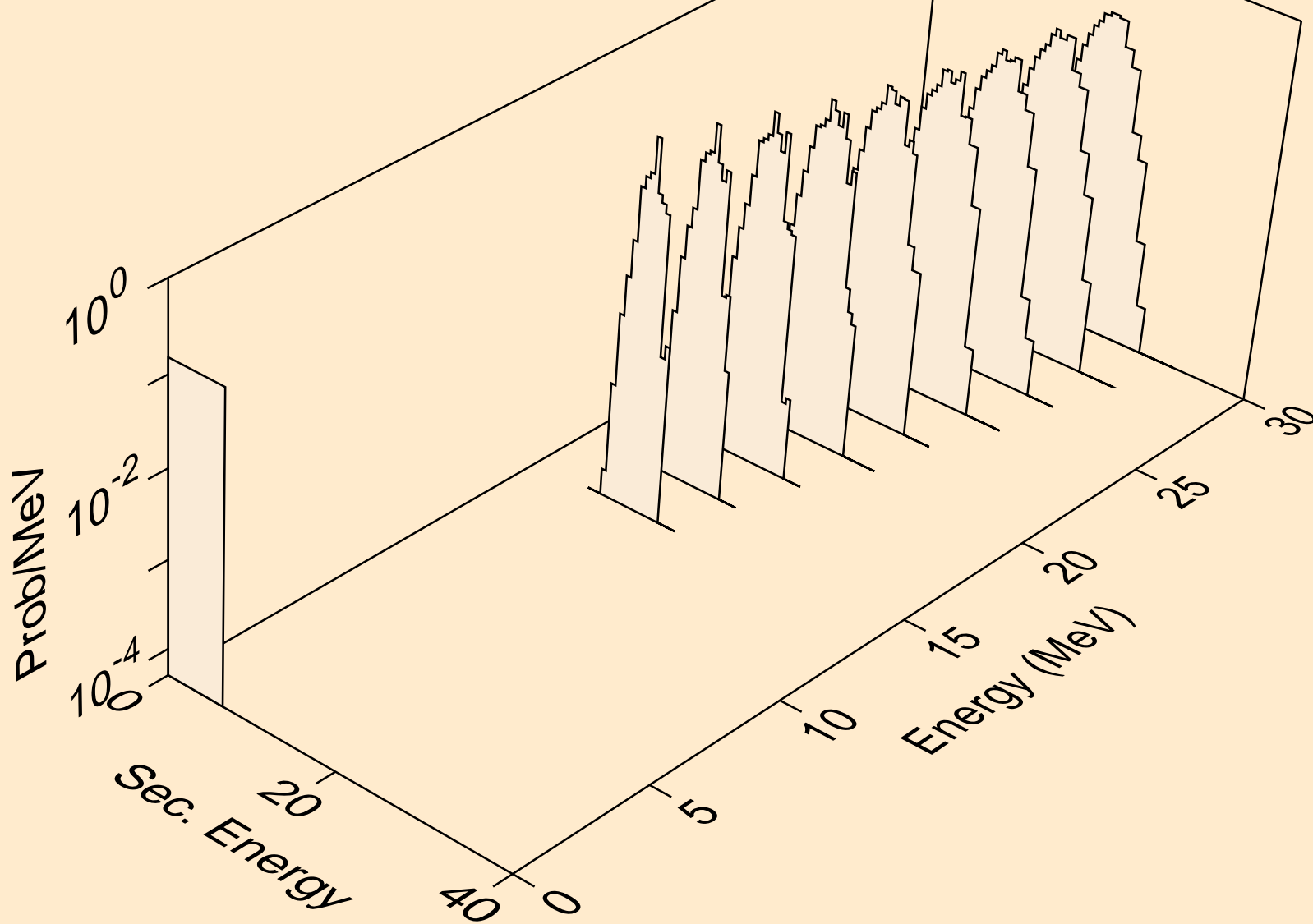

AM235 NEUTRON ACER TENDL-2019 LIBRARY; T=293.16K
alphas from (n,a)

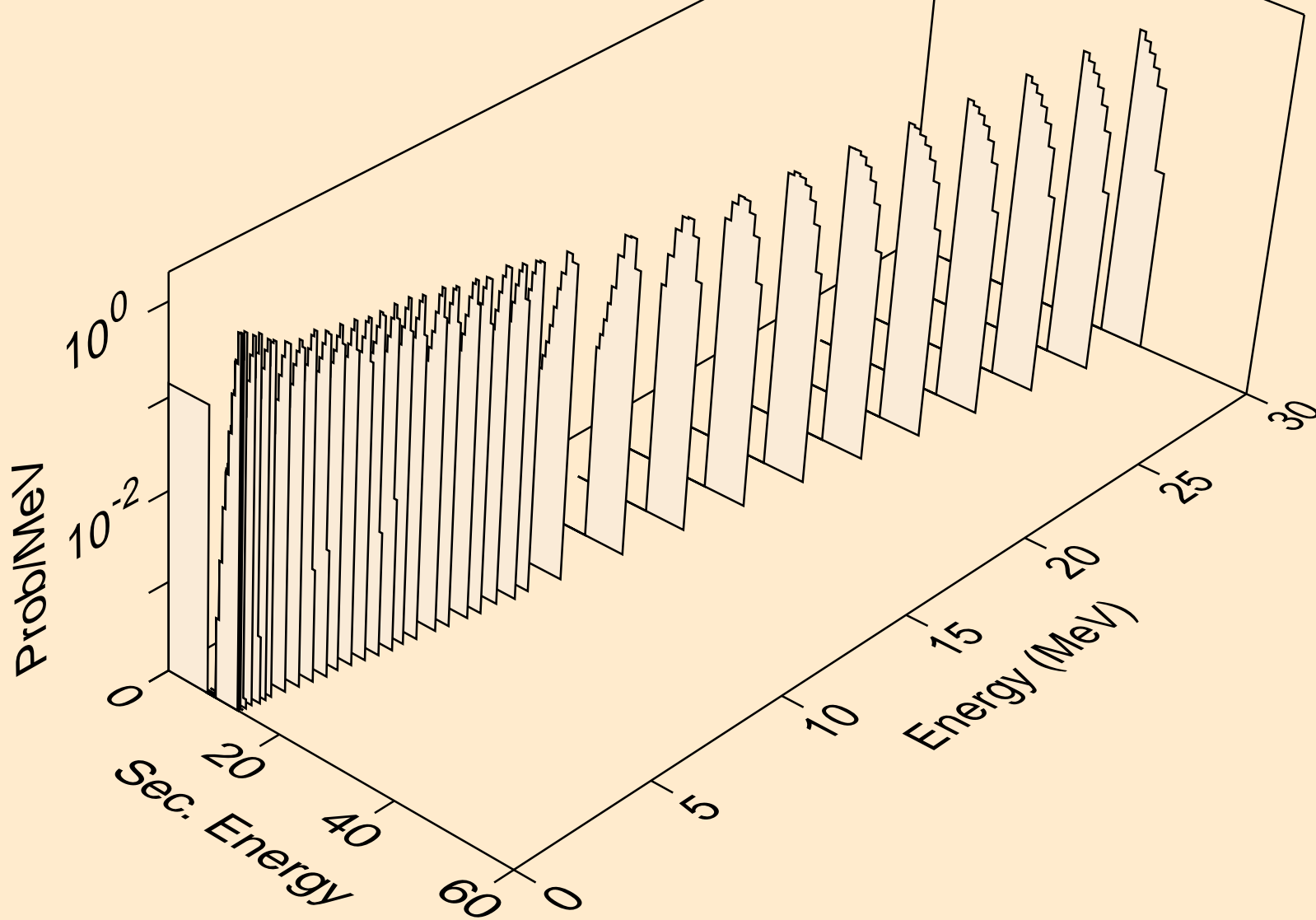

AM235 NEUTRON ACER TENDL-2019 LIBRARY; T=293.16K
alphas from (n,2a)

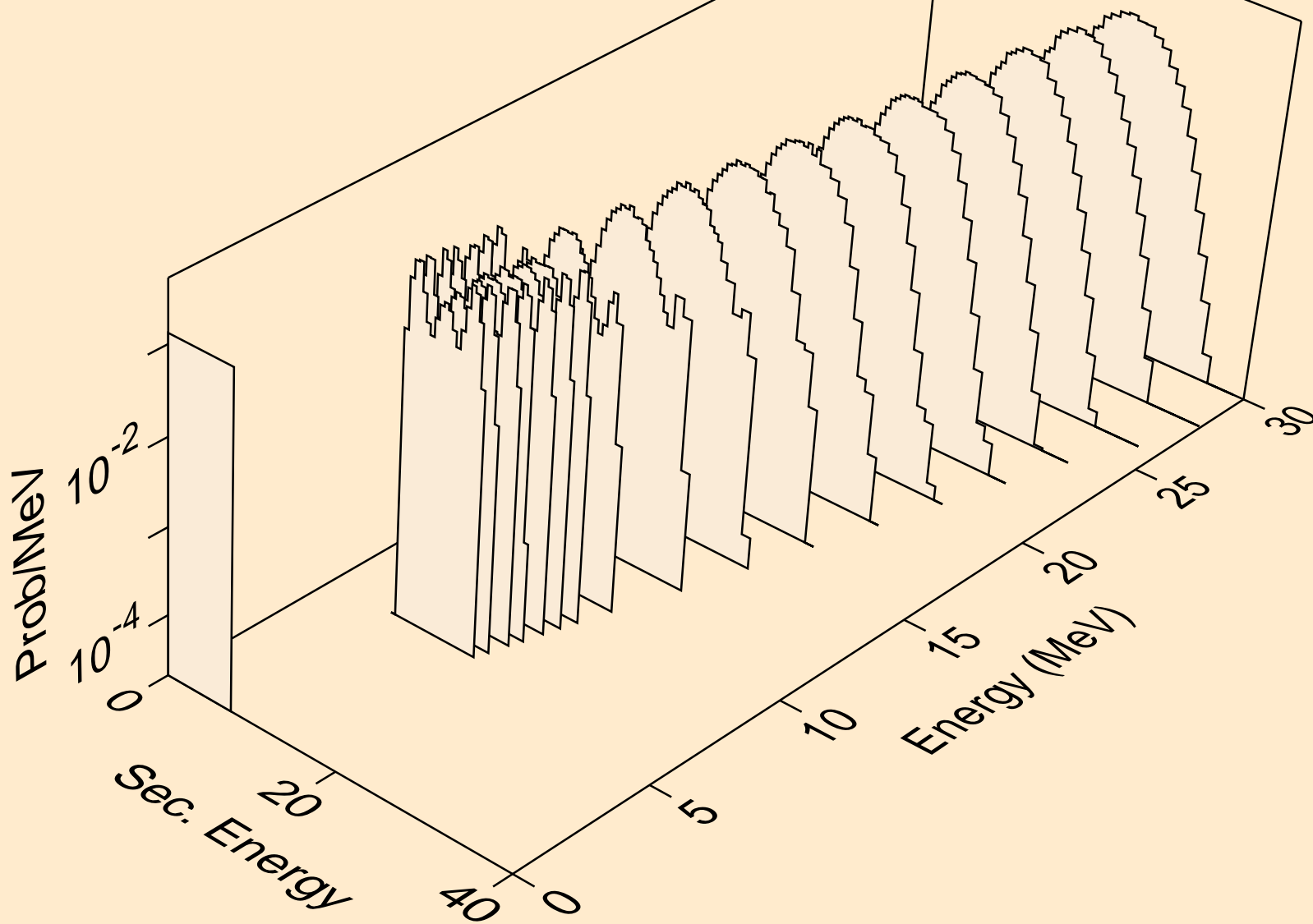

AM235 NEUTRON ACER TENDL-2019 LIBRARY; T=293.16K
alphas from (n,pa)

