

AM236M NEUTRON ACER TENDL-2019 LIBRARY; T=293.16K  
Principal cross sections

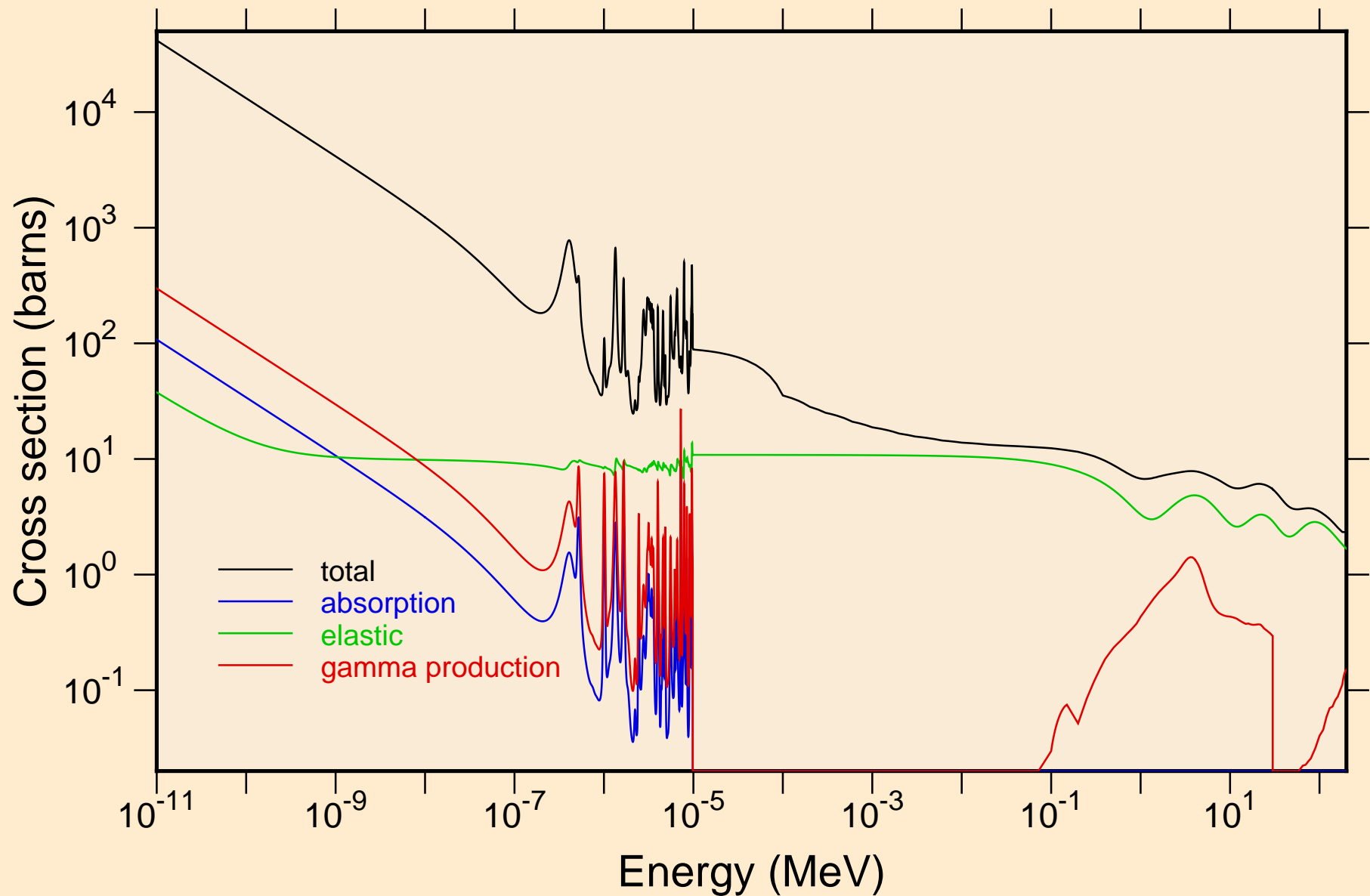

AM236M NEUTRON ACER TENDL-2019 LIBRARY; T=293.16K  
resonance total cross section

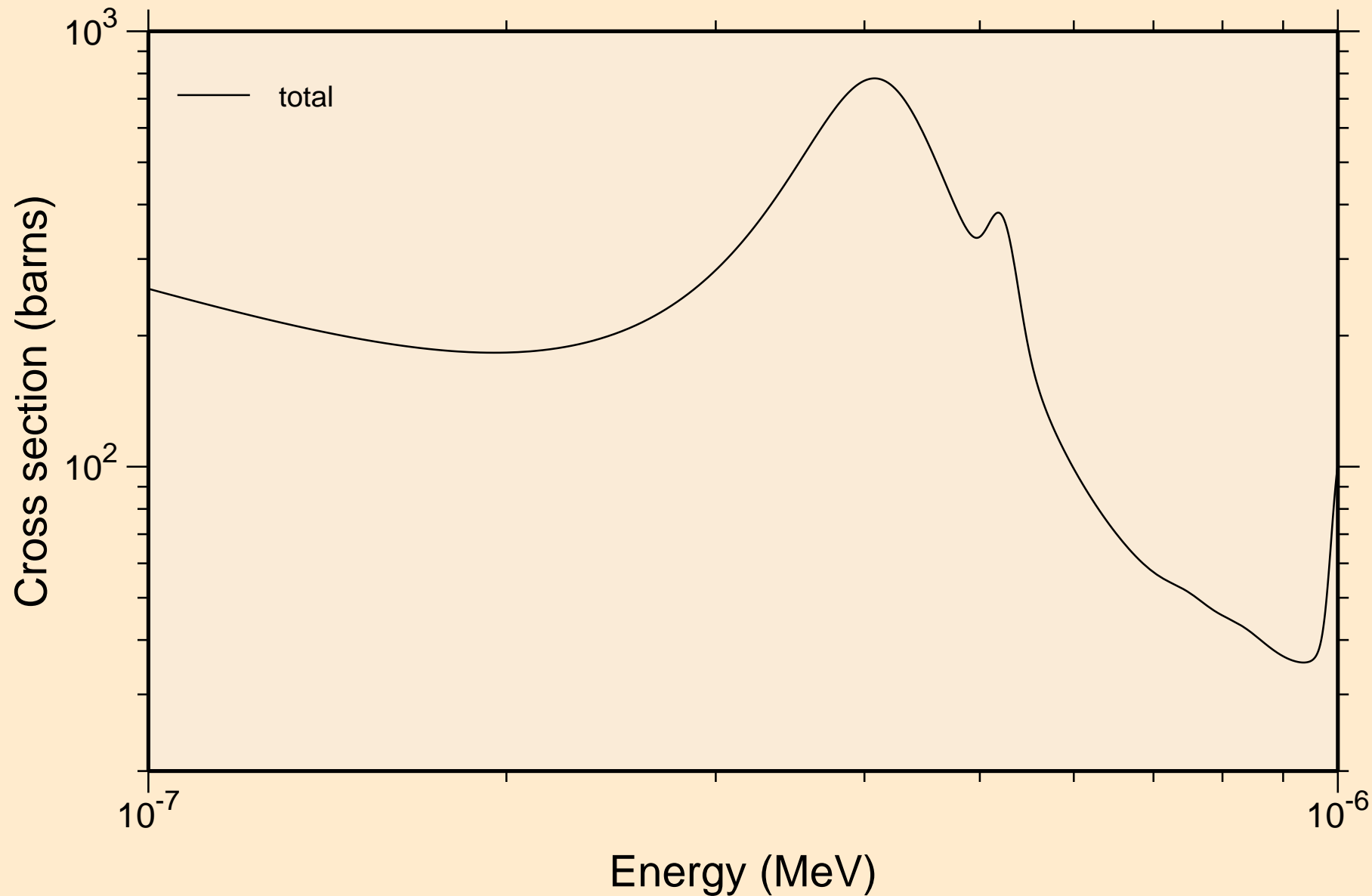

AM236M NEUTRON ACER TENDL-2019 LIBRARY; T=293.16K  
resonance total cross section

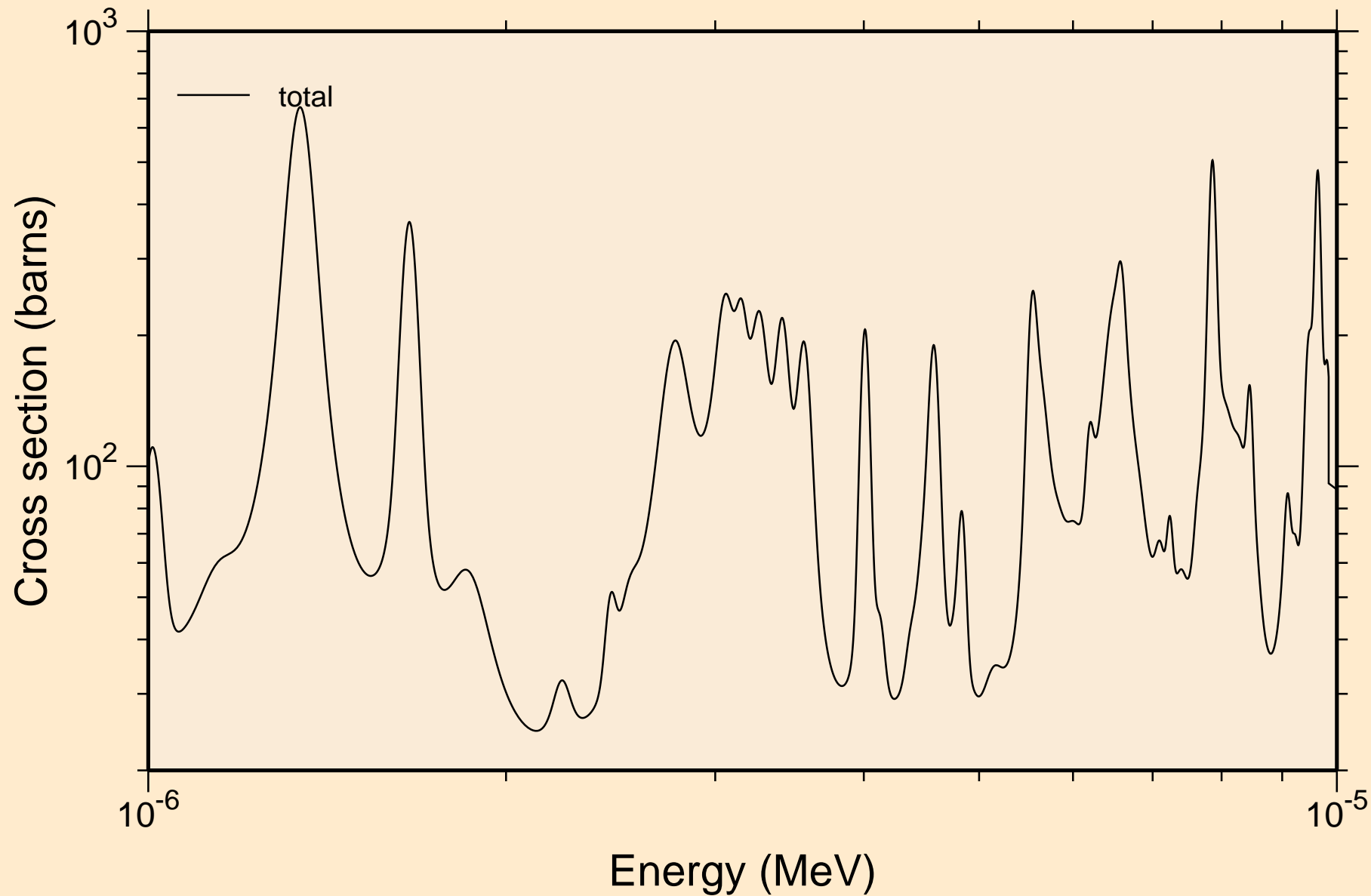

AM236M NEUTRON ACER TENDL-2019 LIBRARY; T=293.16K  
resonance total cross section

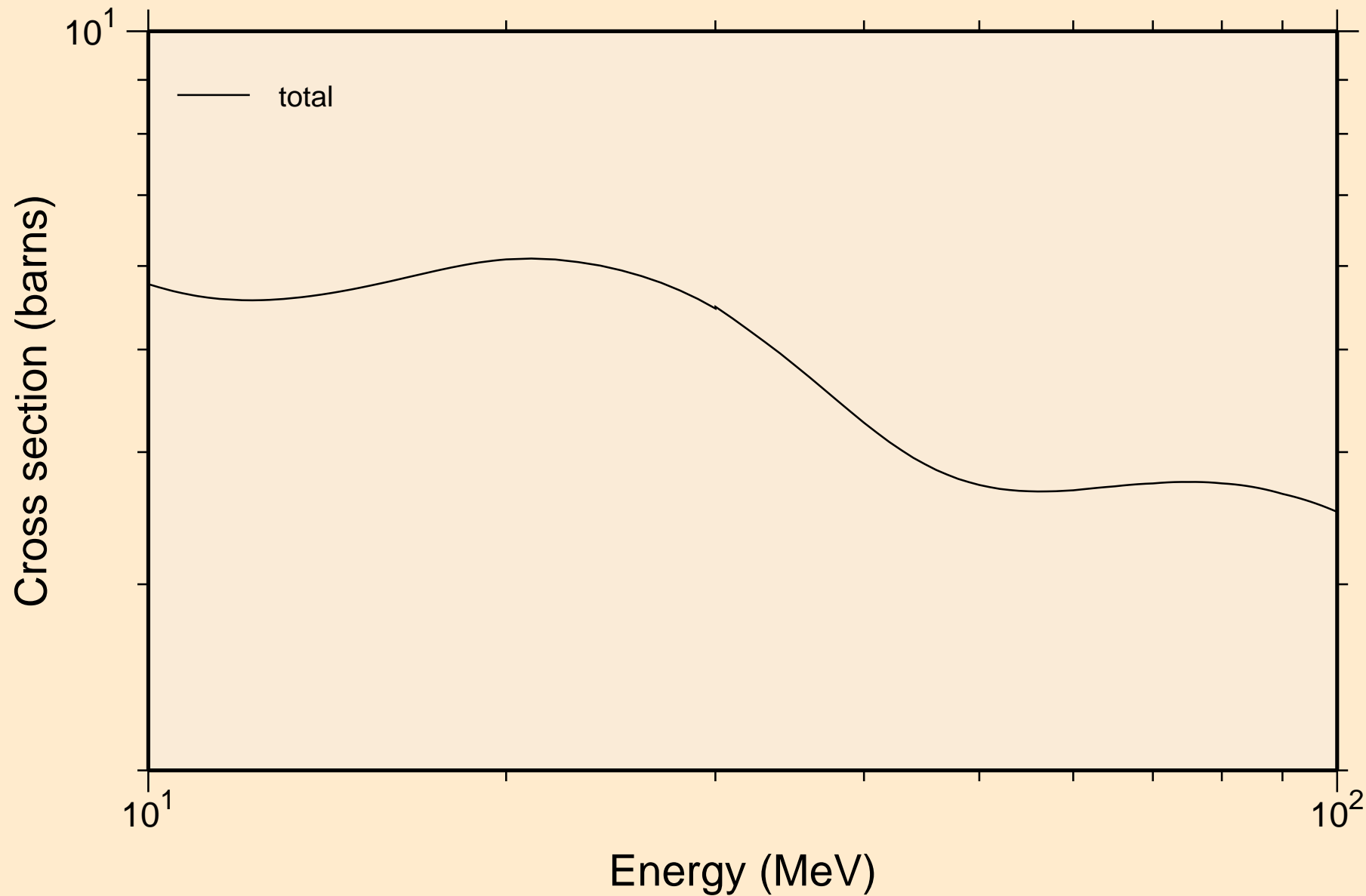

AM236M NEUTRON ACER TENDL-2019 LIBRARY; T=293.16K  
resonance absorption cross sections

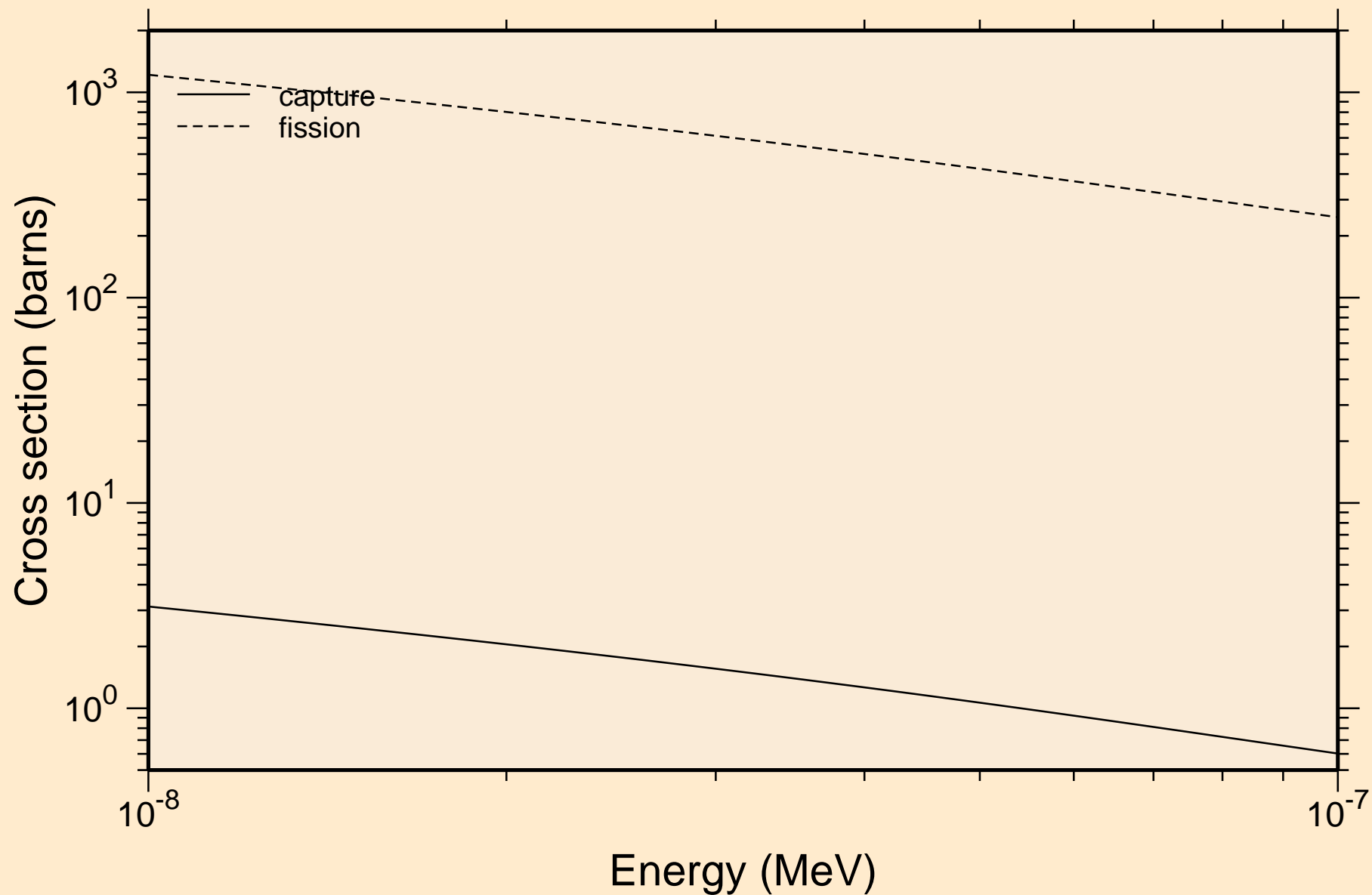

AM236M NEUTRON ACER TENDL-2019 LIBRARY; T=293.16K  
resonance absorption cross sections

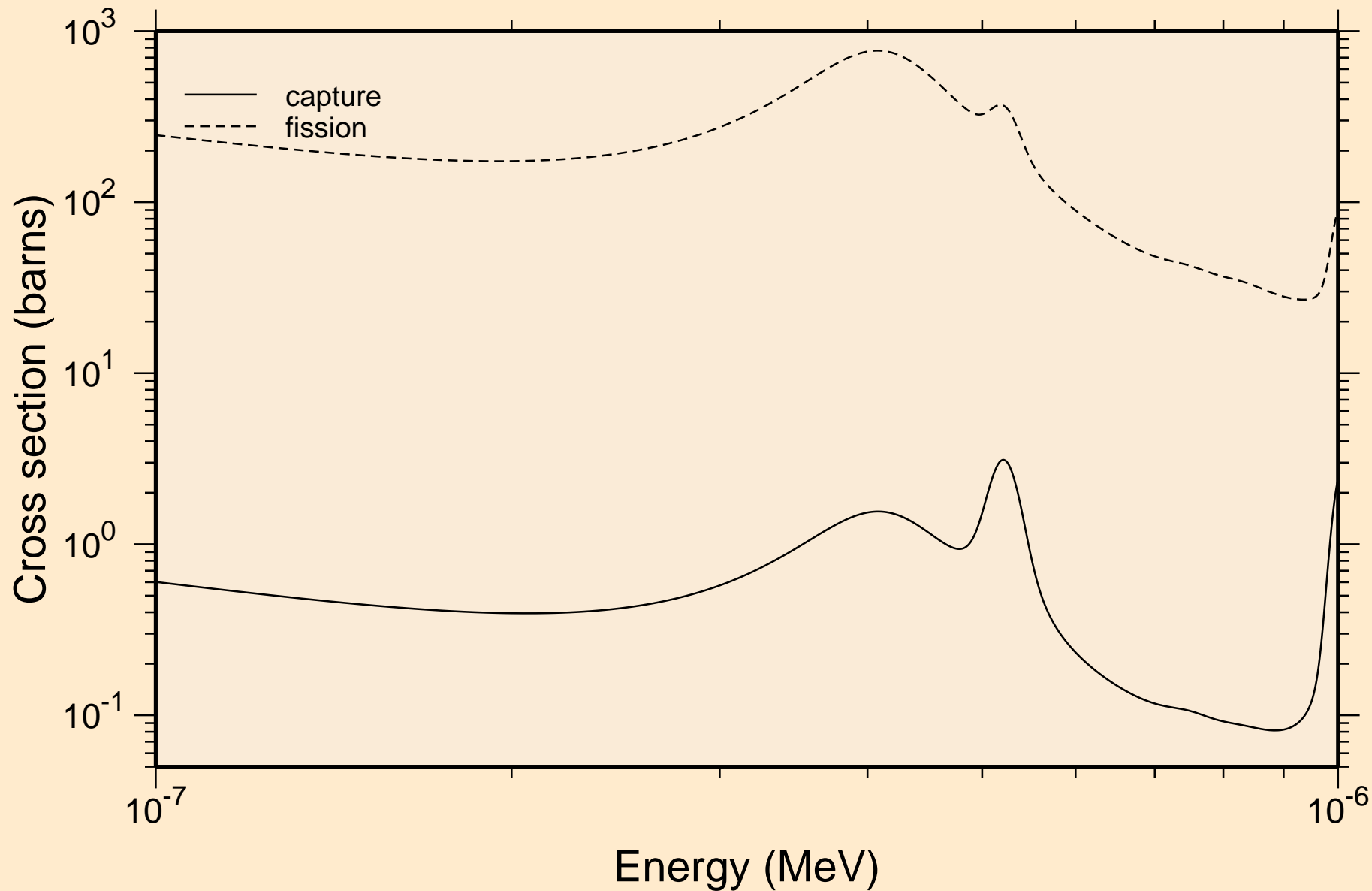

AM236M NEUTRON ACER TENDL-2019 LIBRARY; T=293.16K  
resonance absorption cross sections

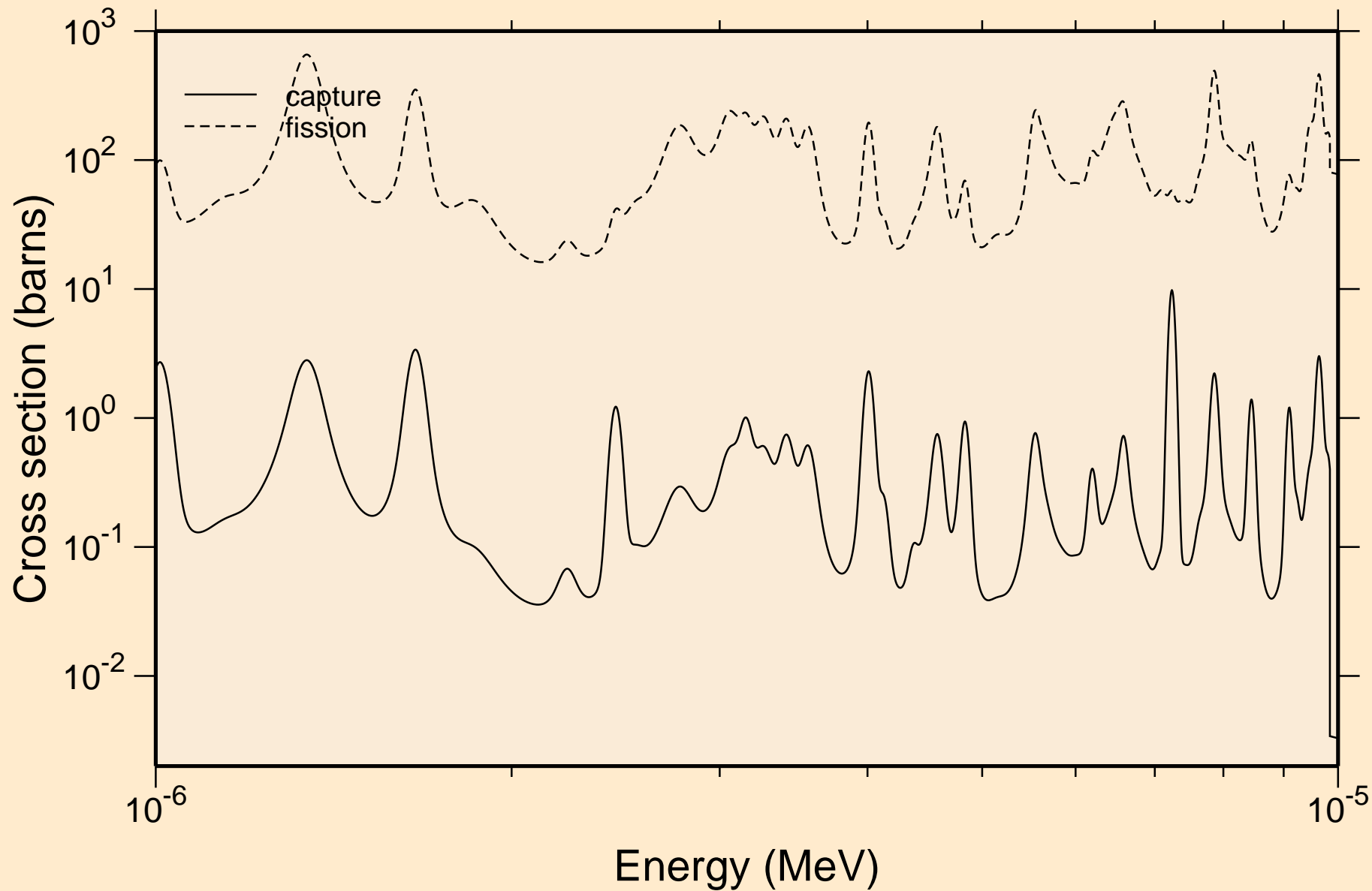

AM236M NEUTRON ACER TENDL-2019 LIBRARY; T=293.16K  
resonance absorption cross sections

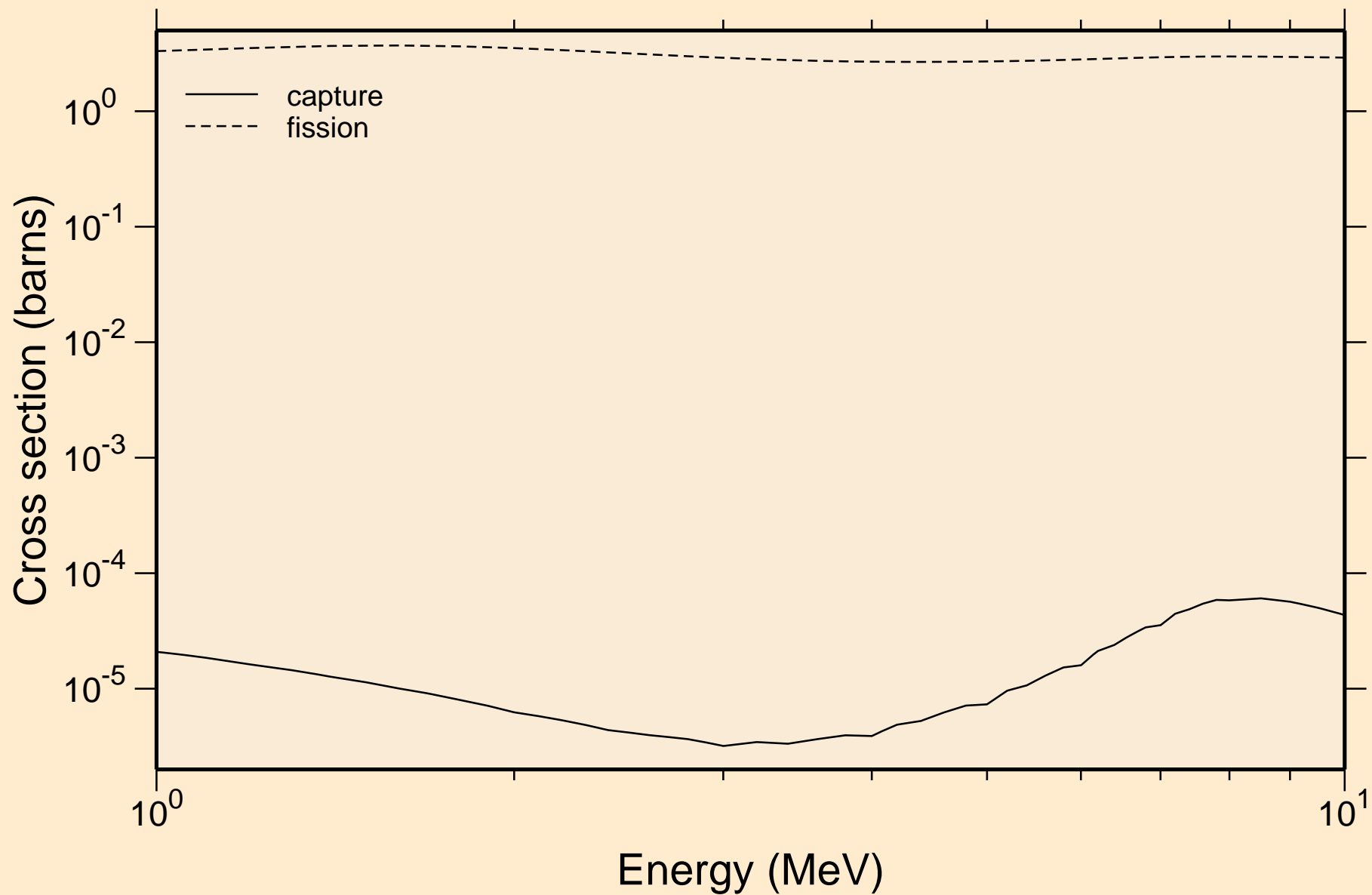



AM236M NEUTRON ACER TENDL-2019 LIBRARY; T=293.16K  
Heating

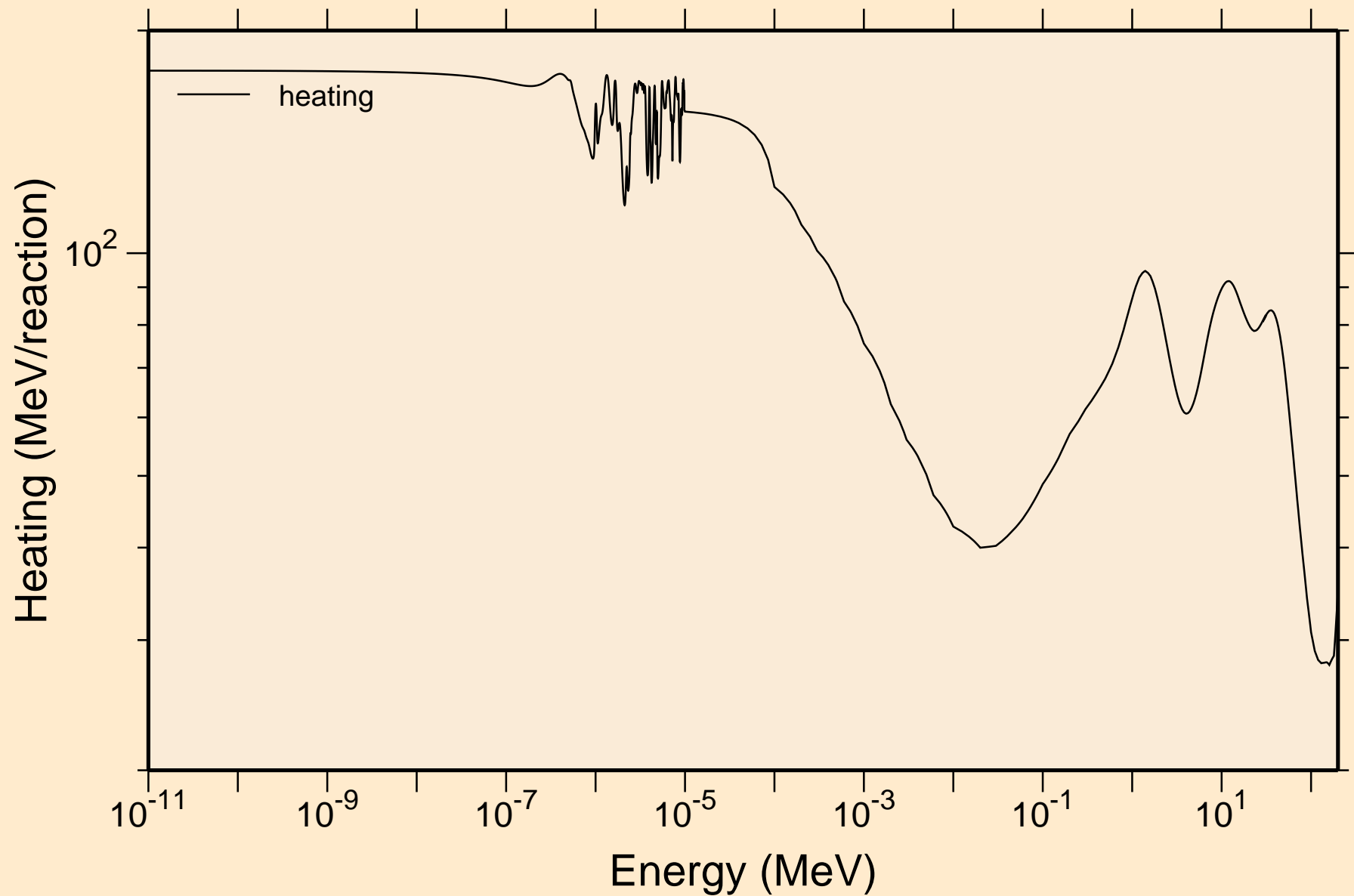

AM236M NEUTRON ACER TENDL-2019 LIBRARY; T=293.16K  
Damage

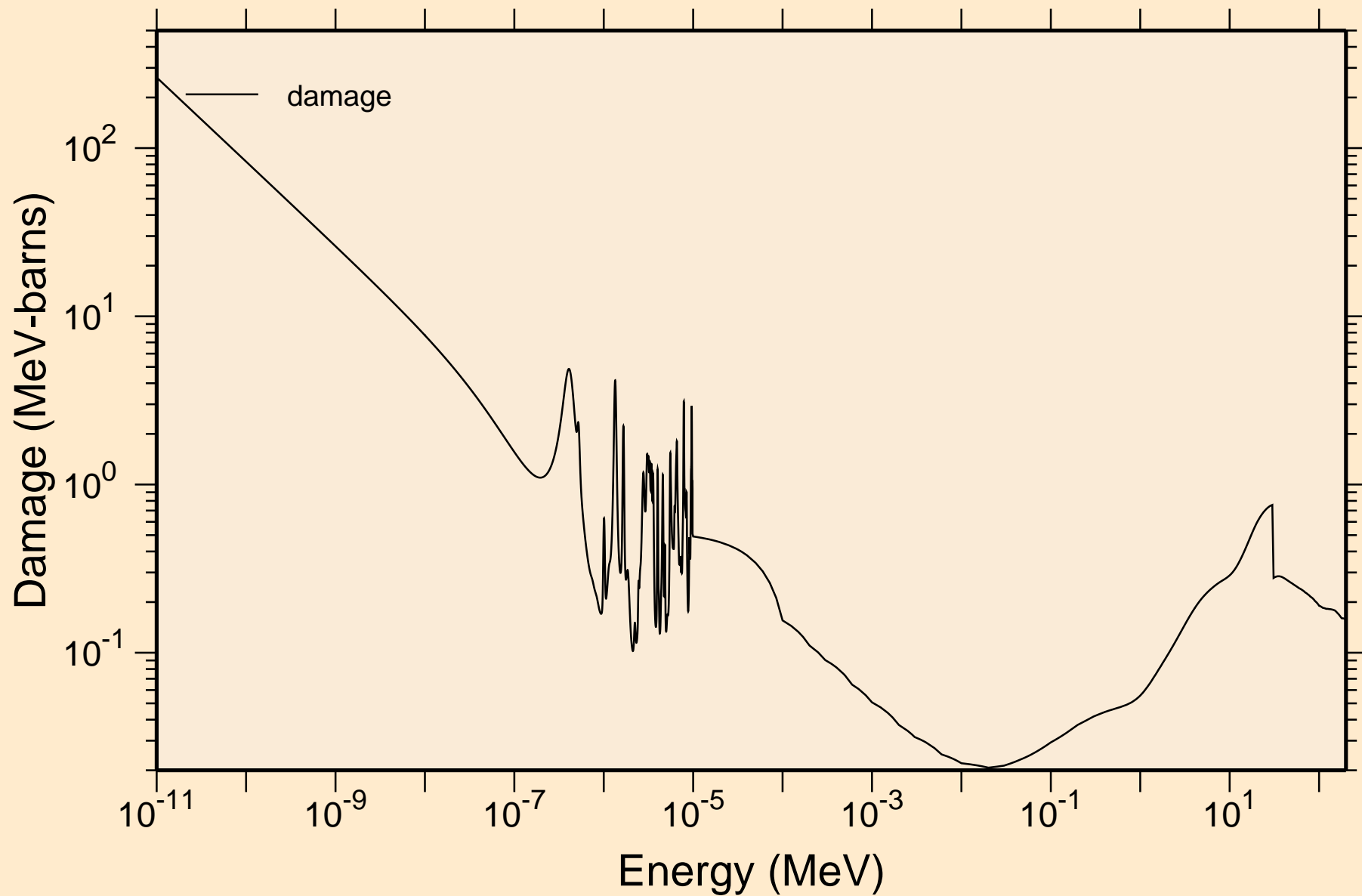

# AM236M NEUTRON ACER TENDL-2019 LIBRARY; T=293.16K

## Non-threshold reactions

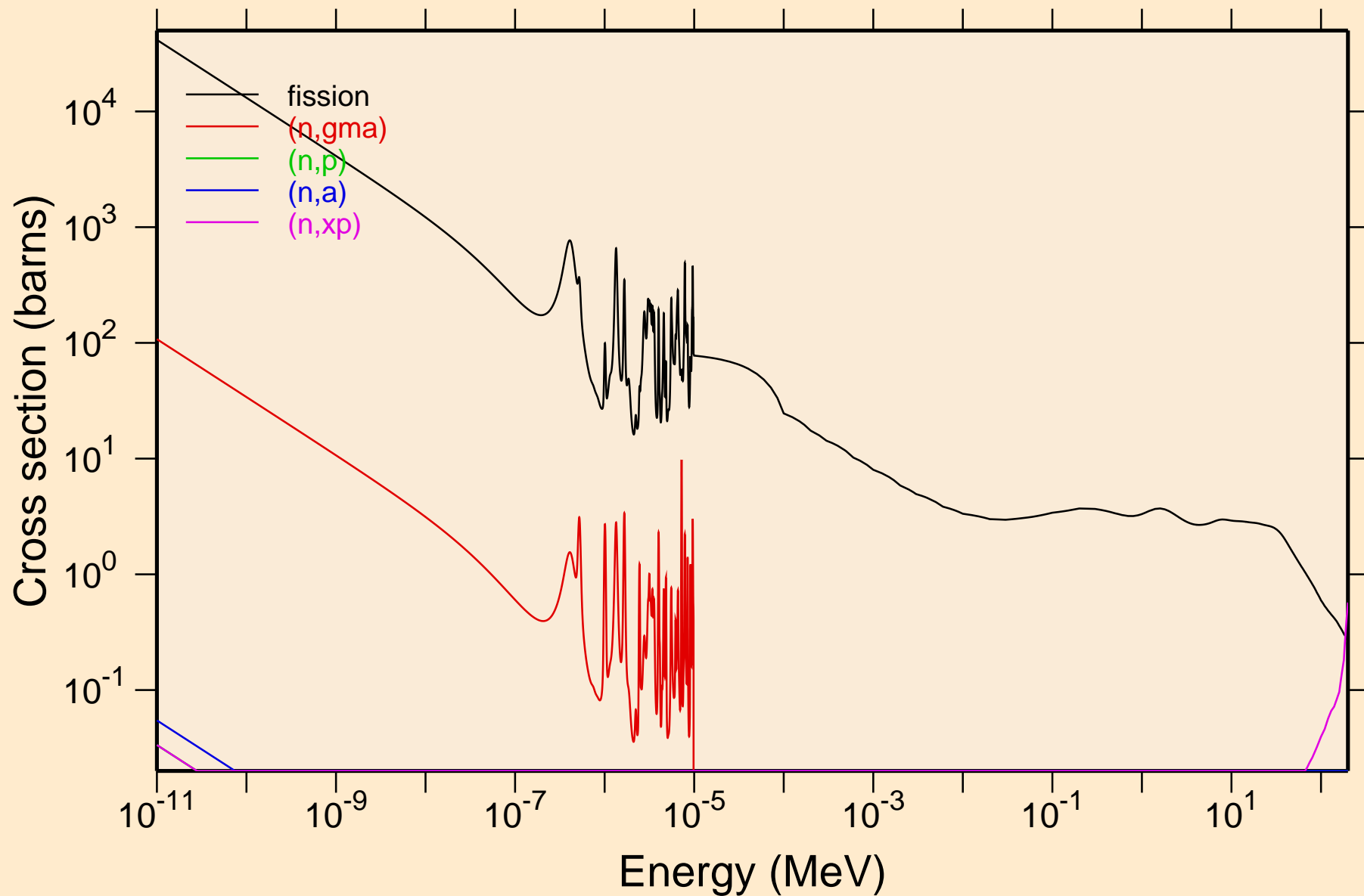

AM236M NEUTRON ACER TENDL-2019 LIBRARY; T=293.16K  
Non-threshold reactions

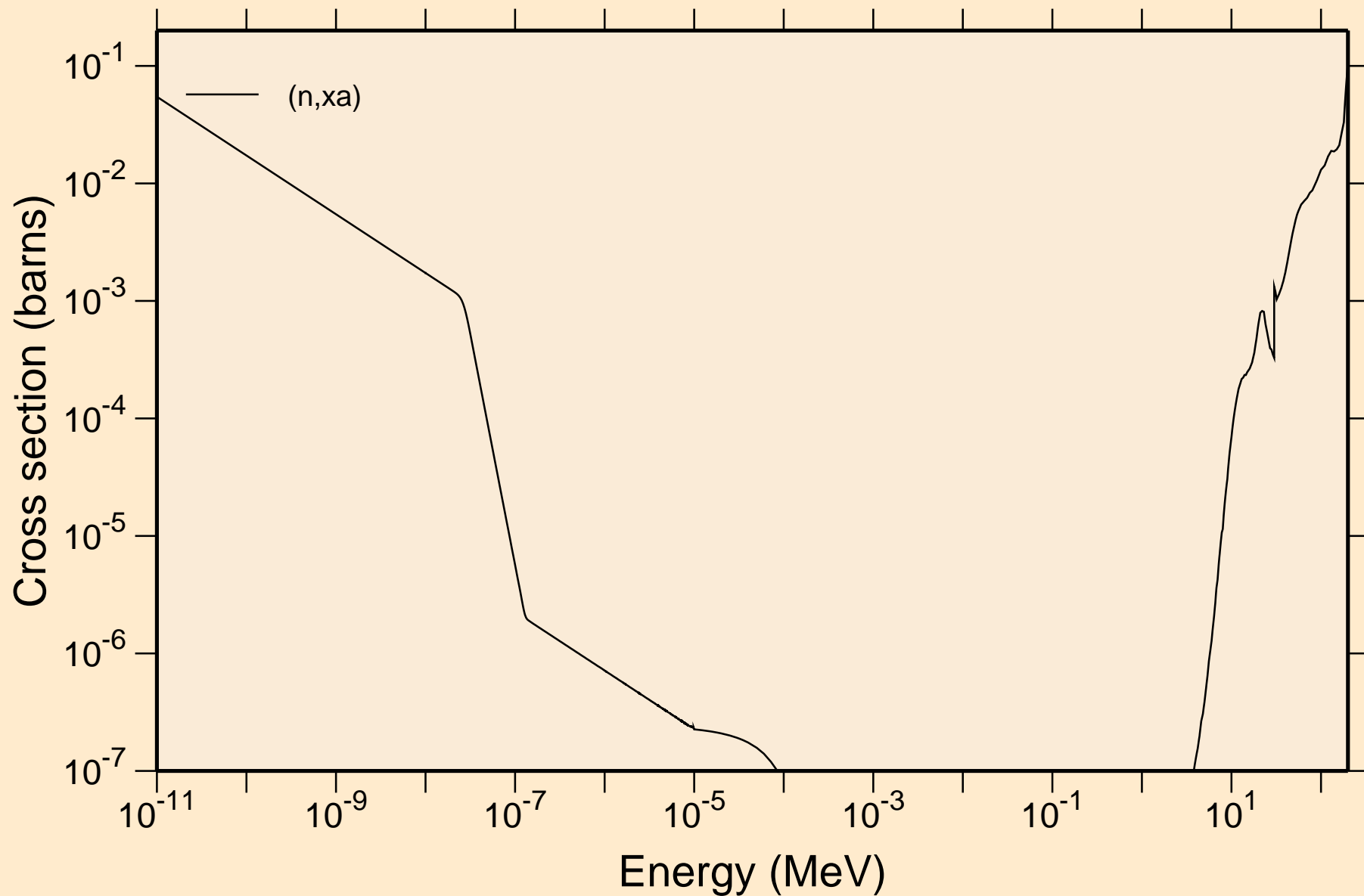

AM236M NEUTRON ACER TENDL-2019 LIBRARY; T=293.16K  
Principal cross sections

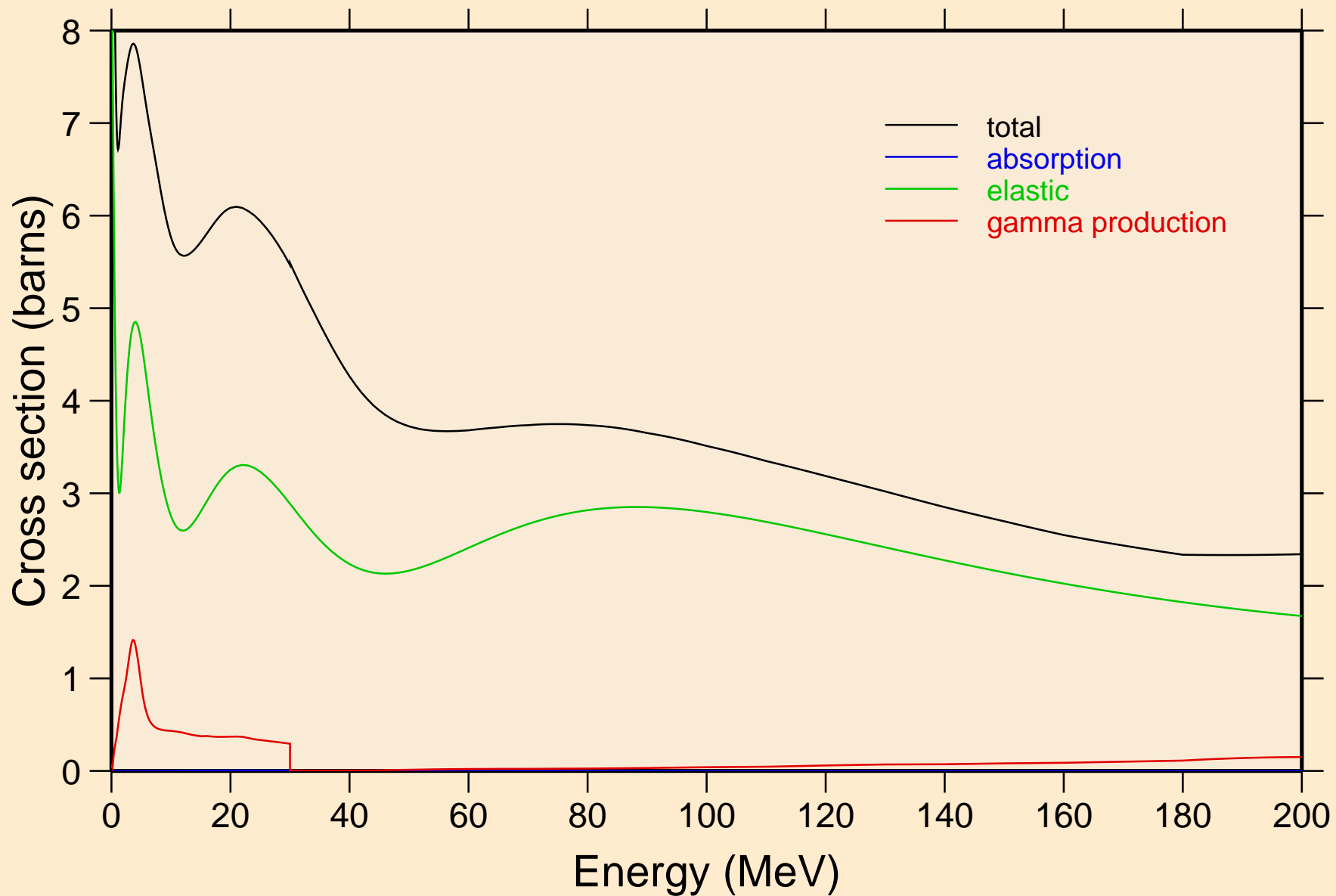

AM236M NEUTRON ACER TENDL-2019 LIBRARY; T=293.16K  
Heating

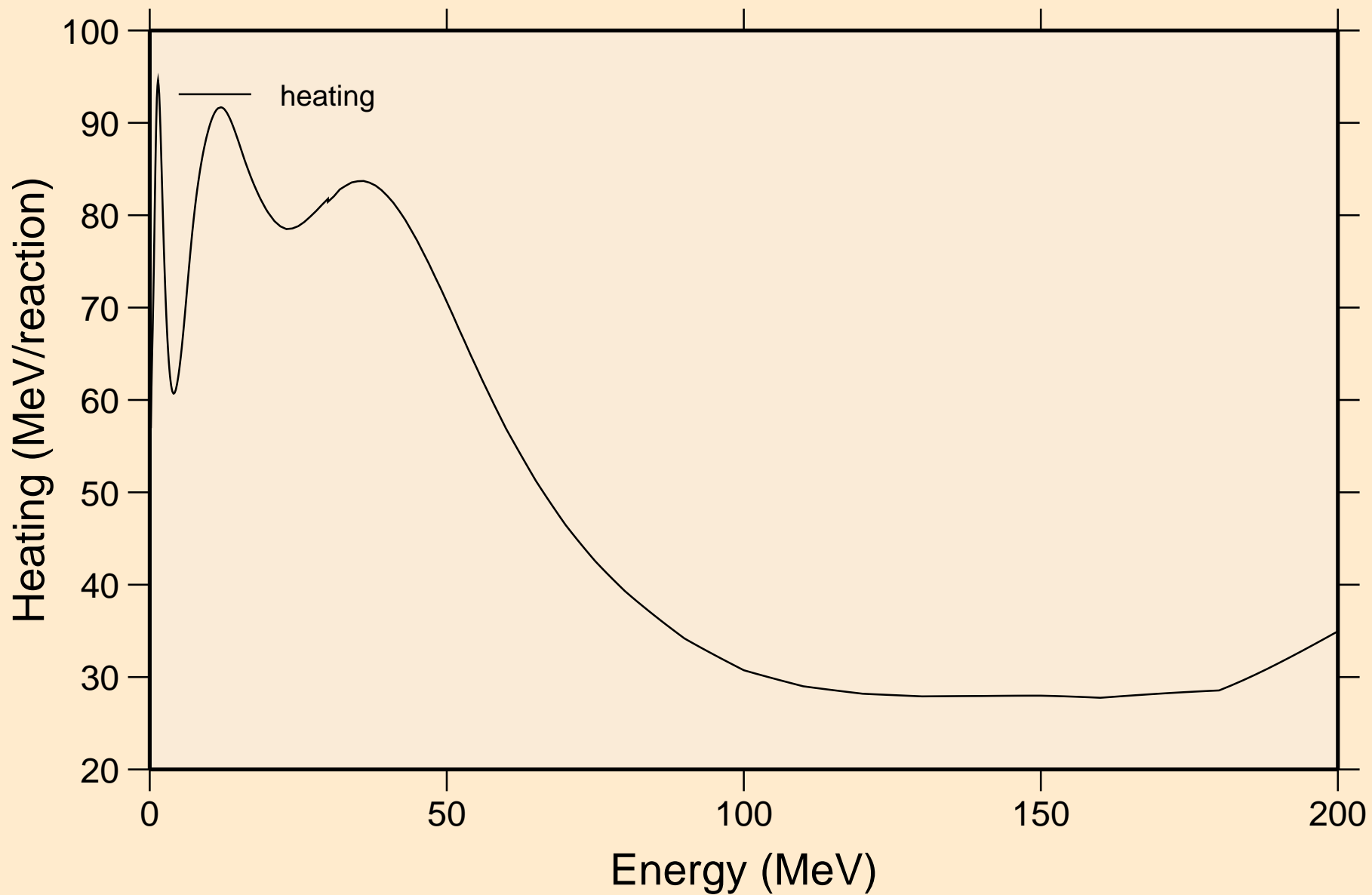

AM236M NEUTRON ACER TENDL-2019 LIBRARY; T=293.16K  
Damage

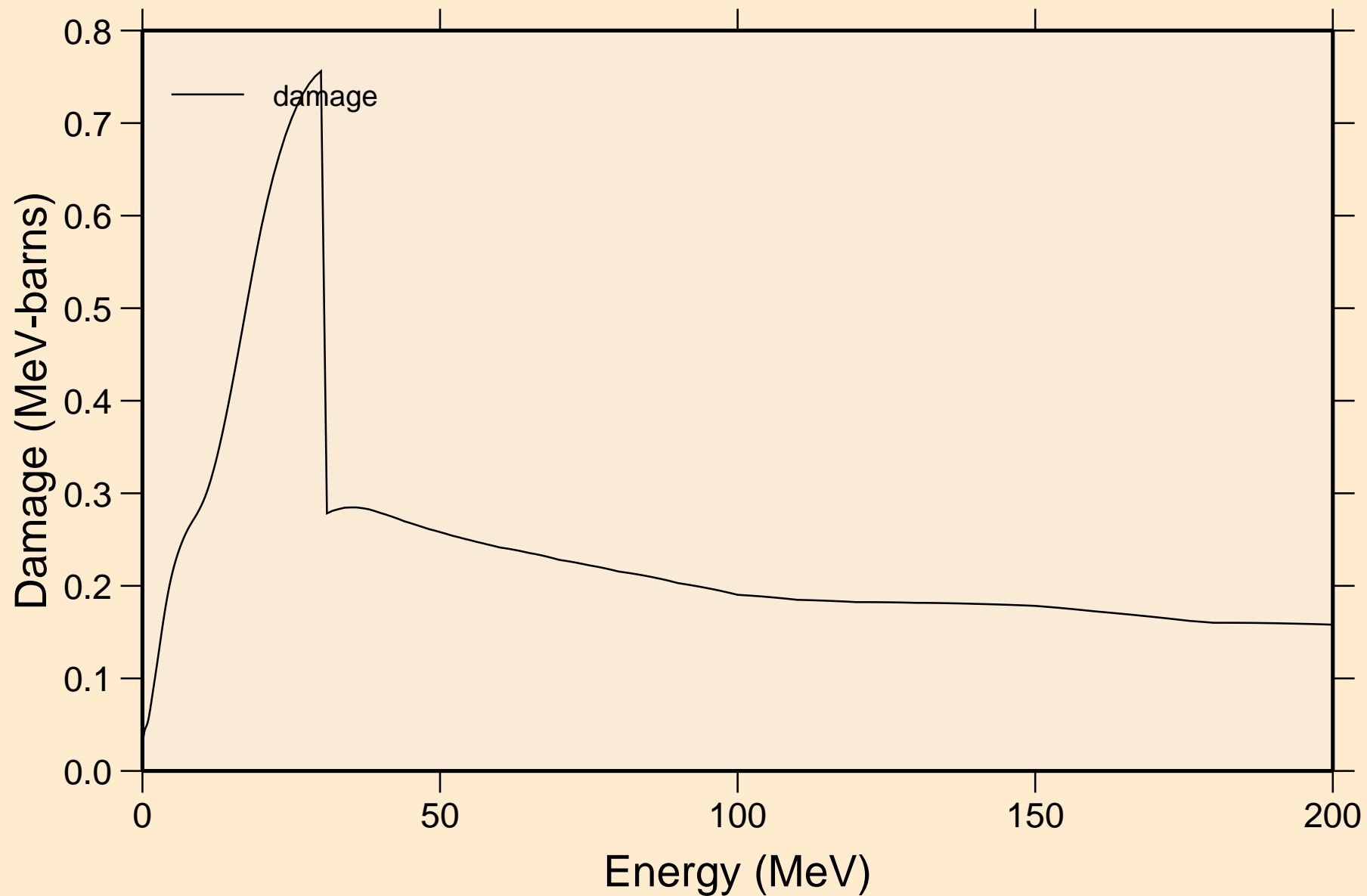

# AM236M NEUTRON ACER TENDL-2019 LIBRARY; T=293.16K

## Non-threshold reactions

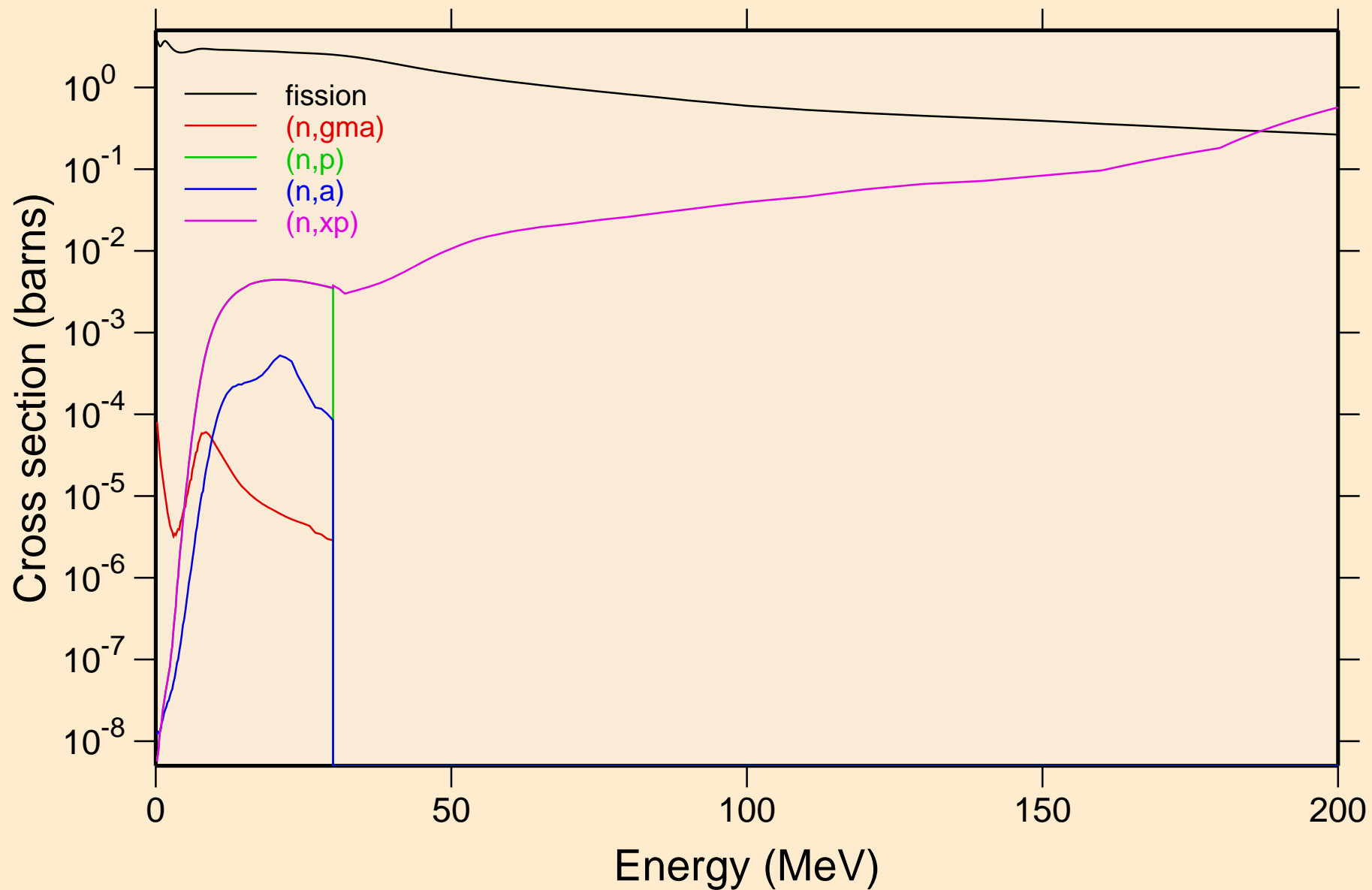



AM236M NEUTRON ACER TENDL-2019 LIBRARY; T=293.16K  
Non-threshold reactions

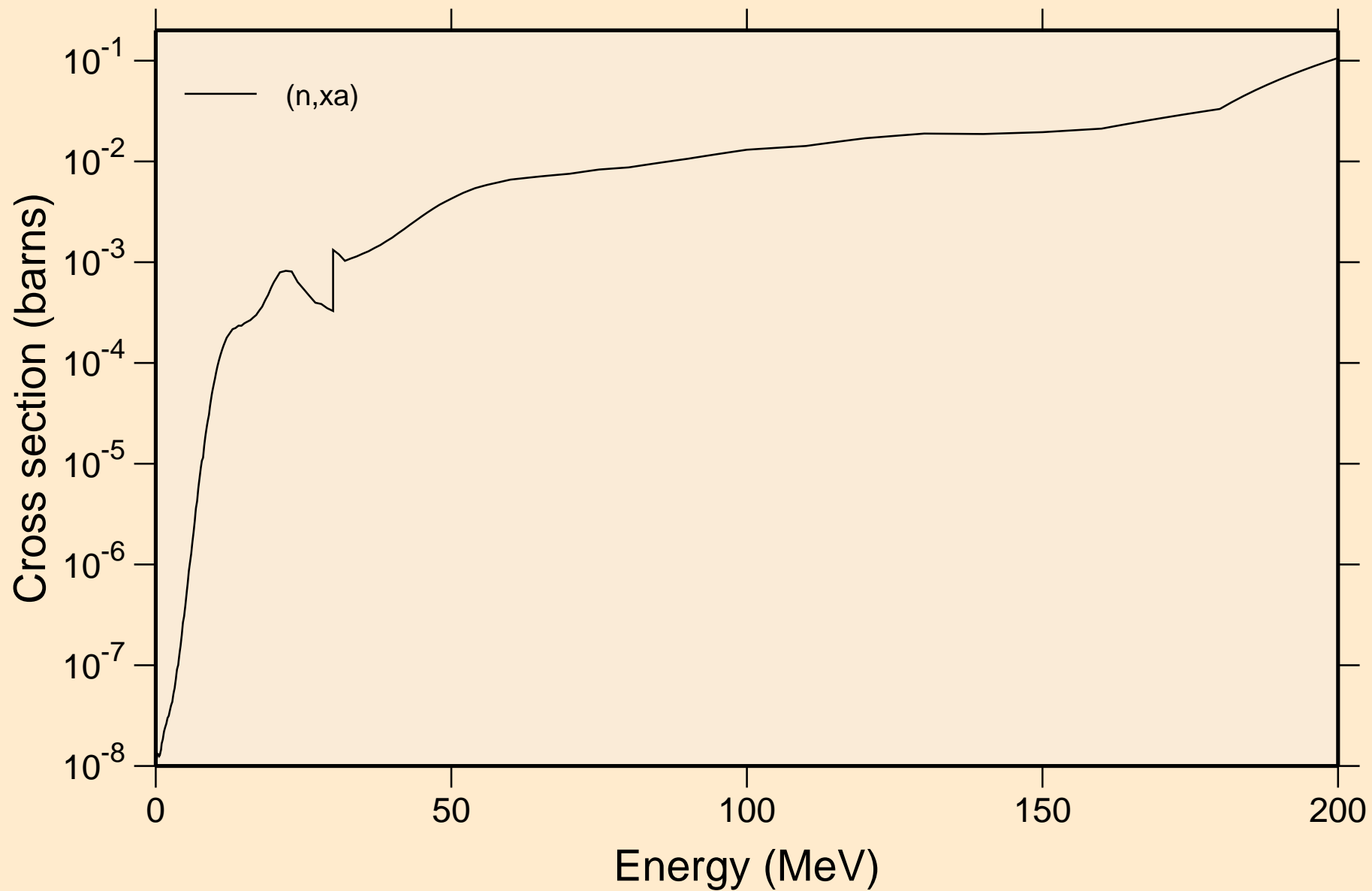

AM236M NEUTRON ACER TENDL-2019 LIBRARY; T=293.16K  
Inelastic levels

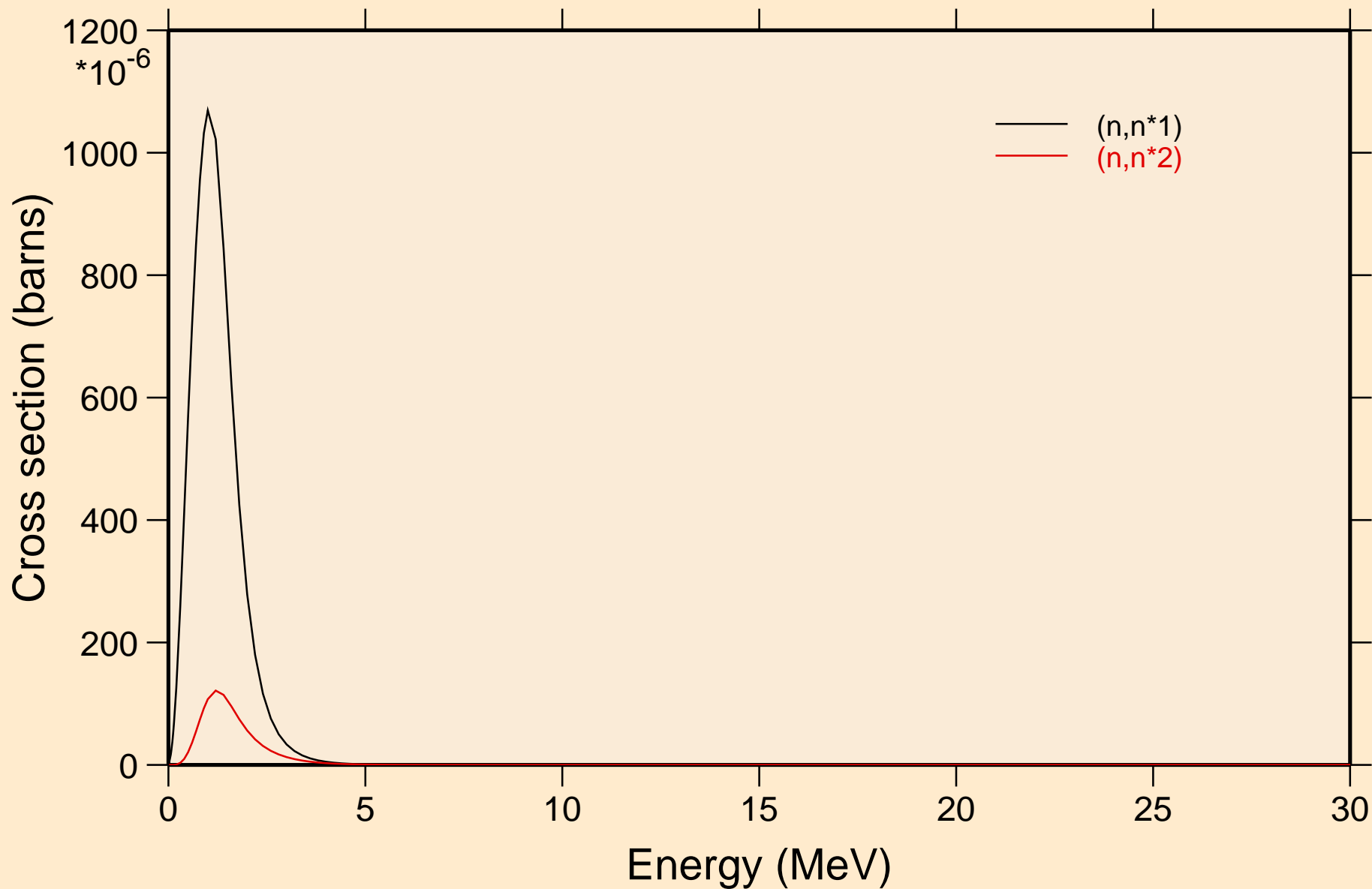

AM236M NEUTRON ACER TENDL-2019 LIBRARY; T=293.16K  
Threshold reactions

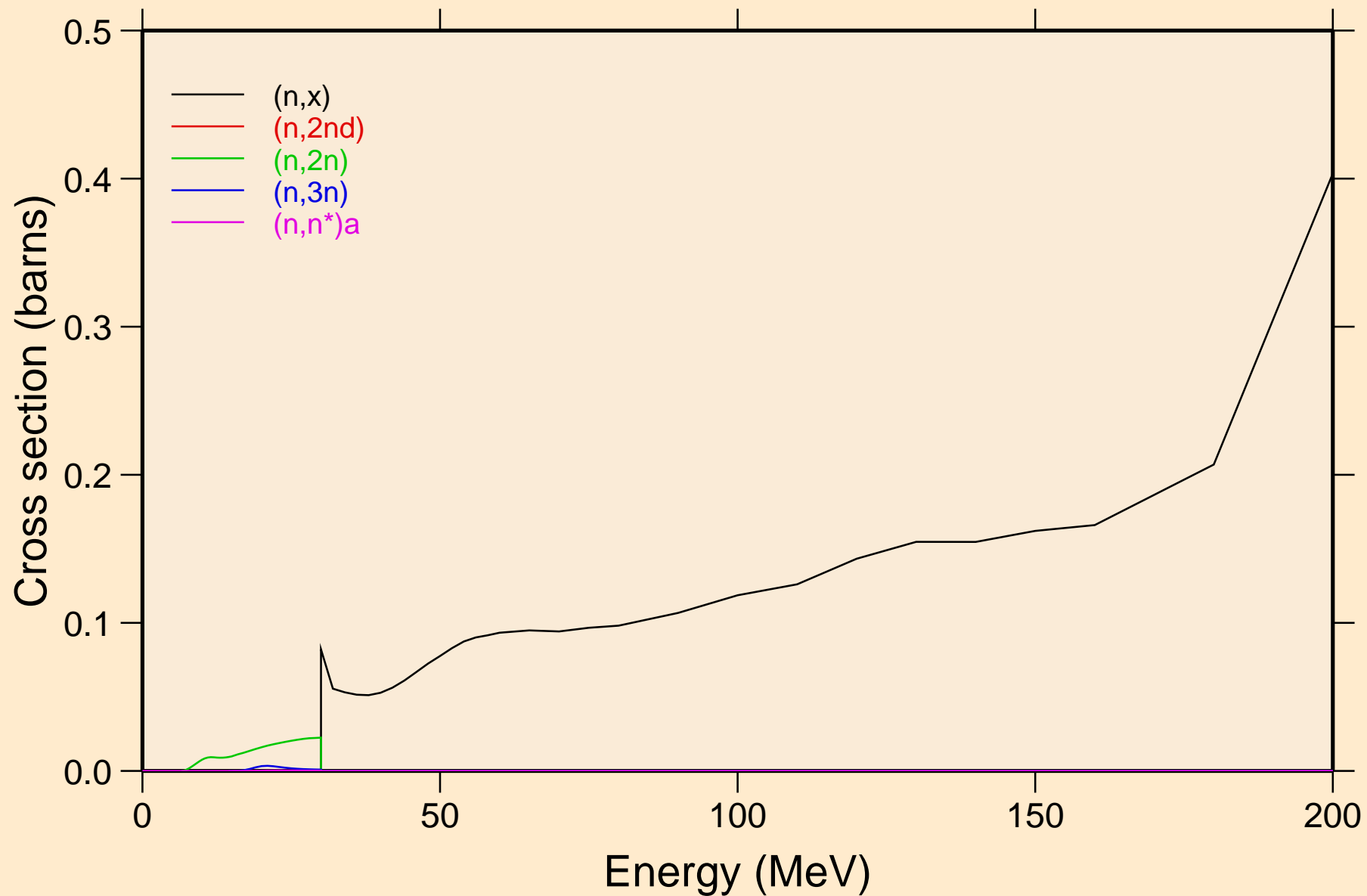

AM236M NEUTRON ACER TENDL-2019 LIBRARY; T=293.16K  
Threshold reactions

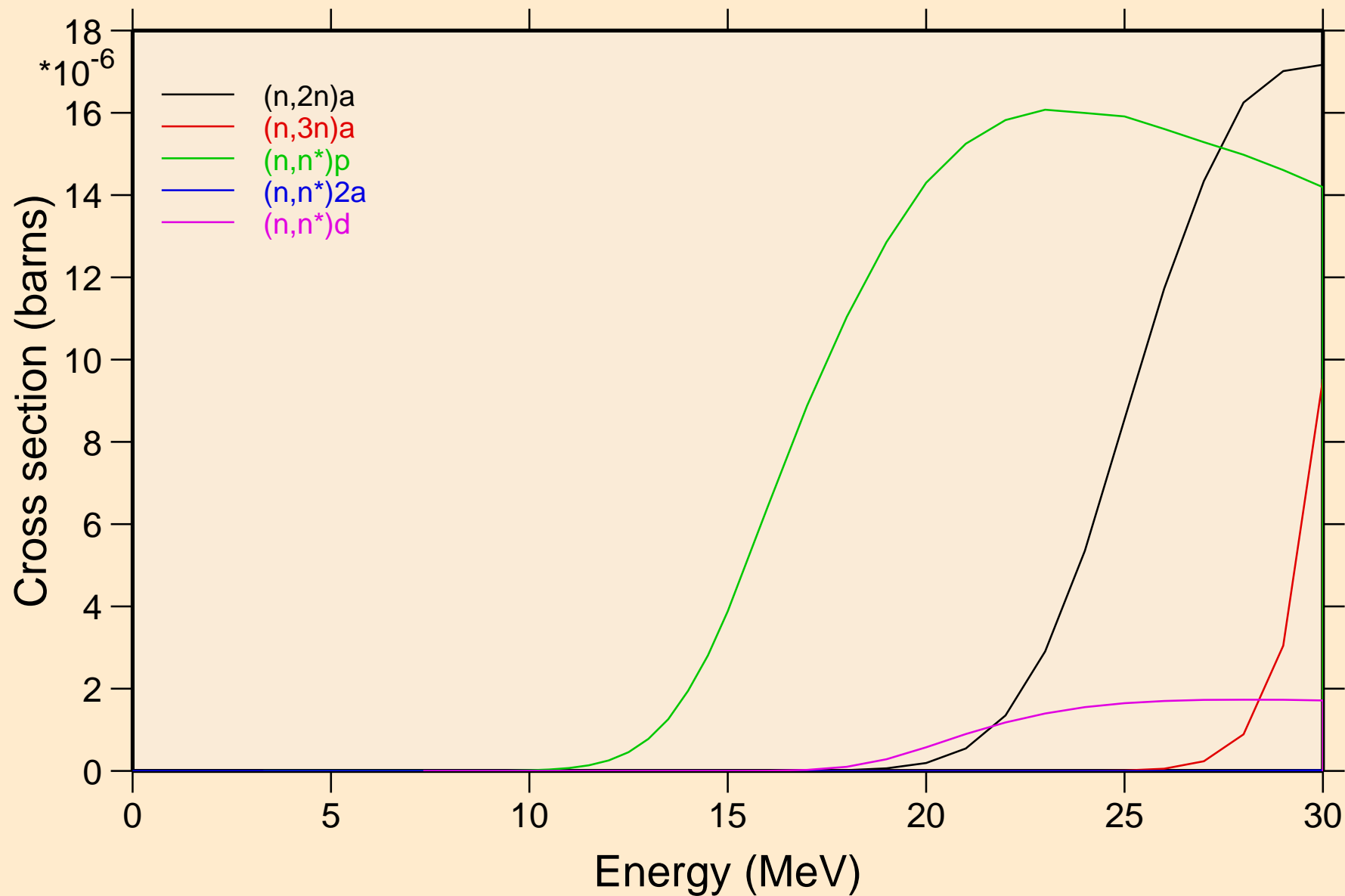

AM236M NEUTRON ACER TENDL-2019 LIBRARY; T=293.16K  
Threshold reactions

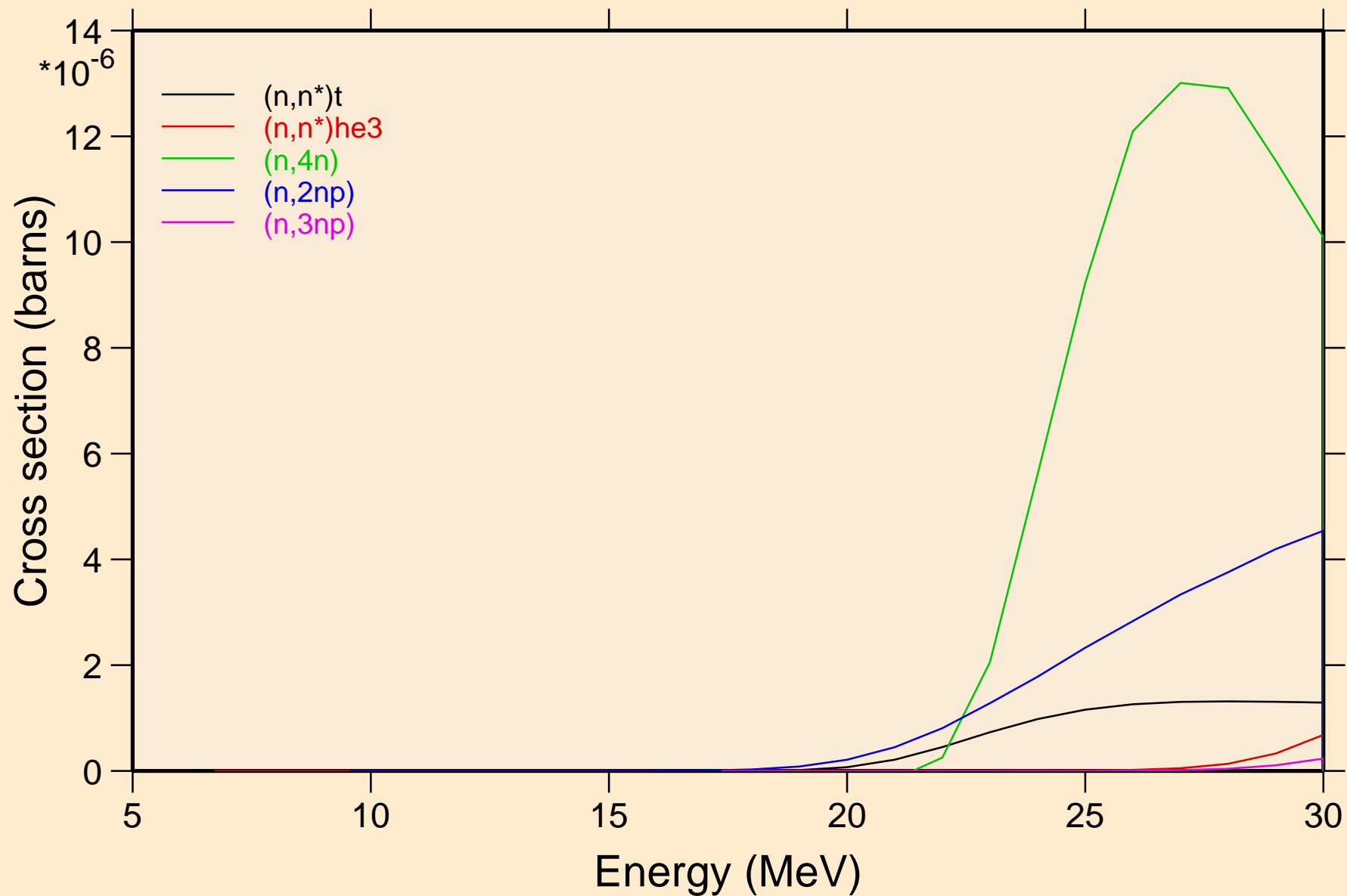

AM236M NEUTRON ACER TENDL-2019 LIBRARY; T=293.16K  
Threshold reactions

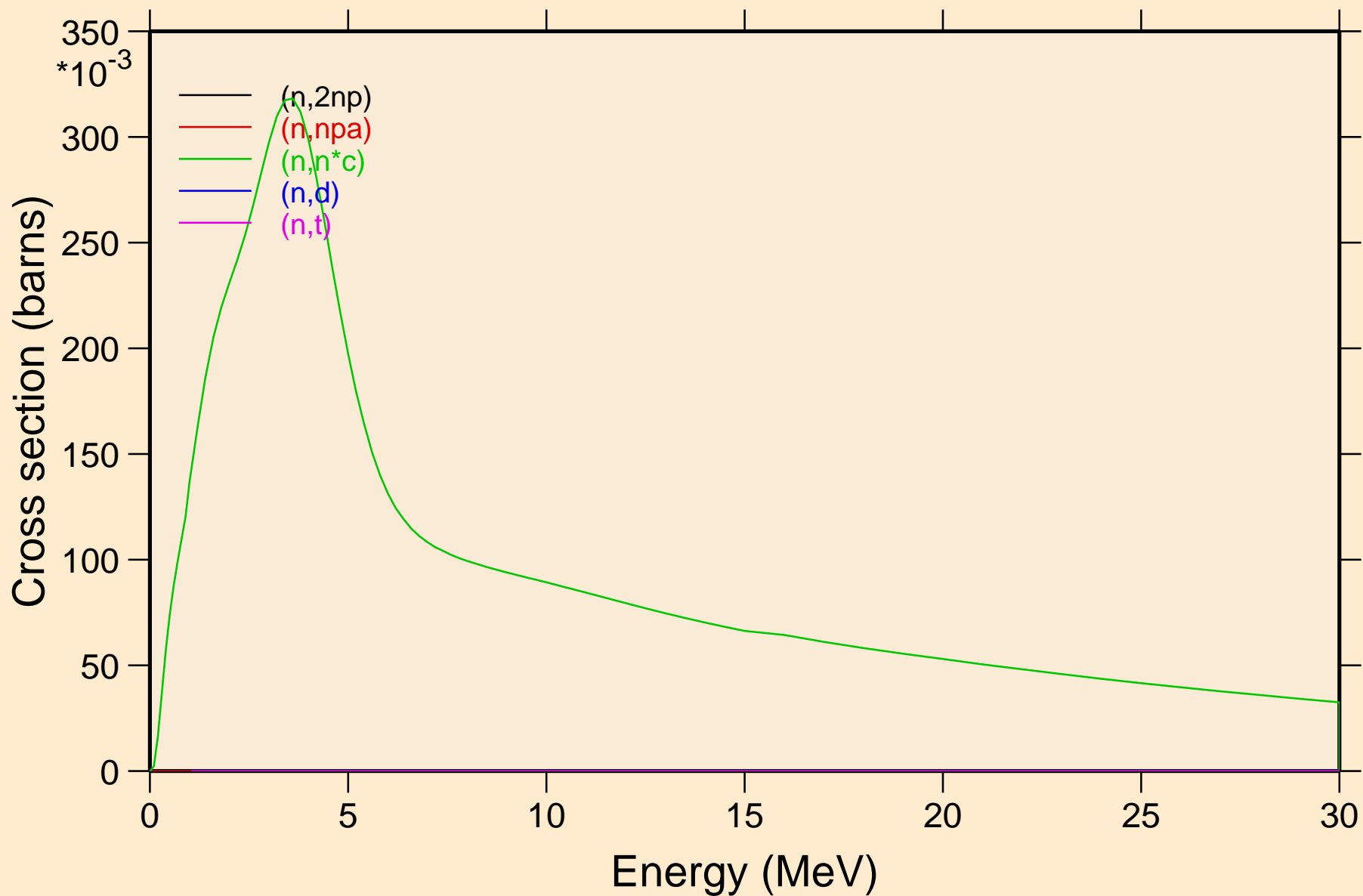

AM236M NEUTRON ACER TENDL-2019 LIBRARY; T=293.16K  
Threshold reactions

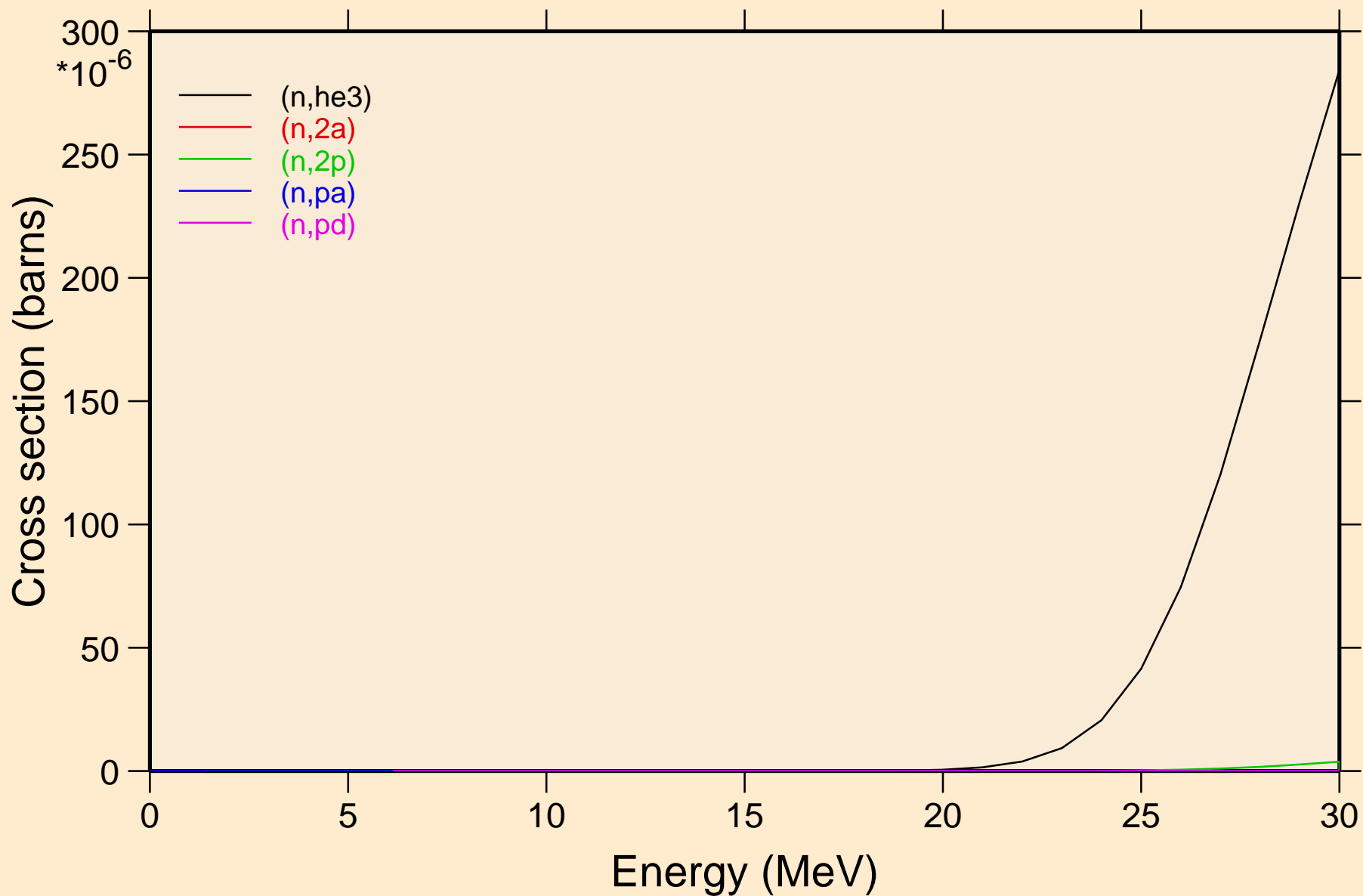

AM236M NEUTRON ACER TENDL-2019 LIBRARY; T=293.16K  
Threshold reactions

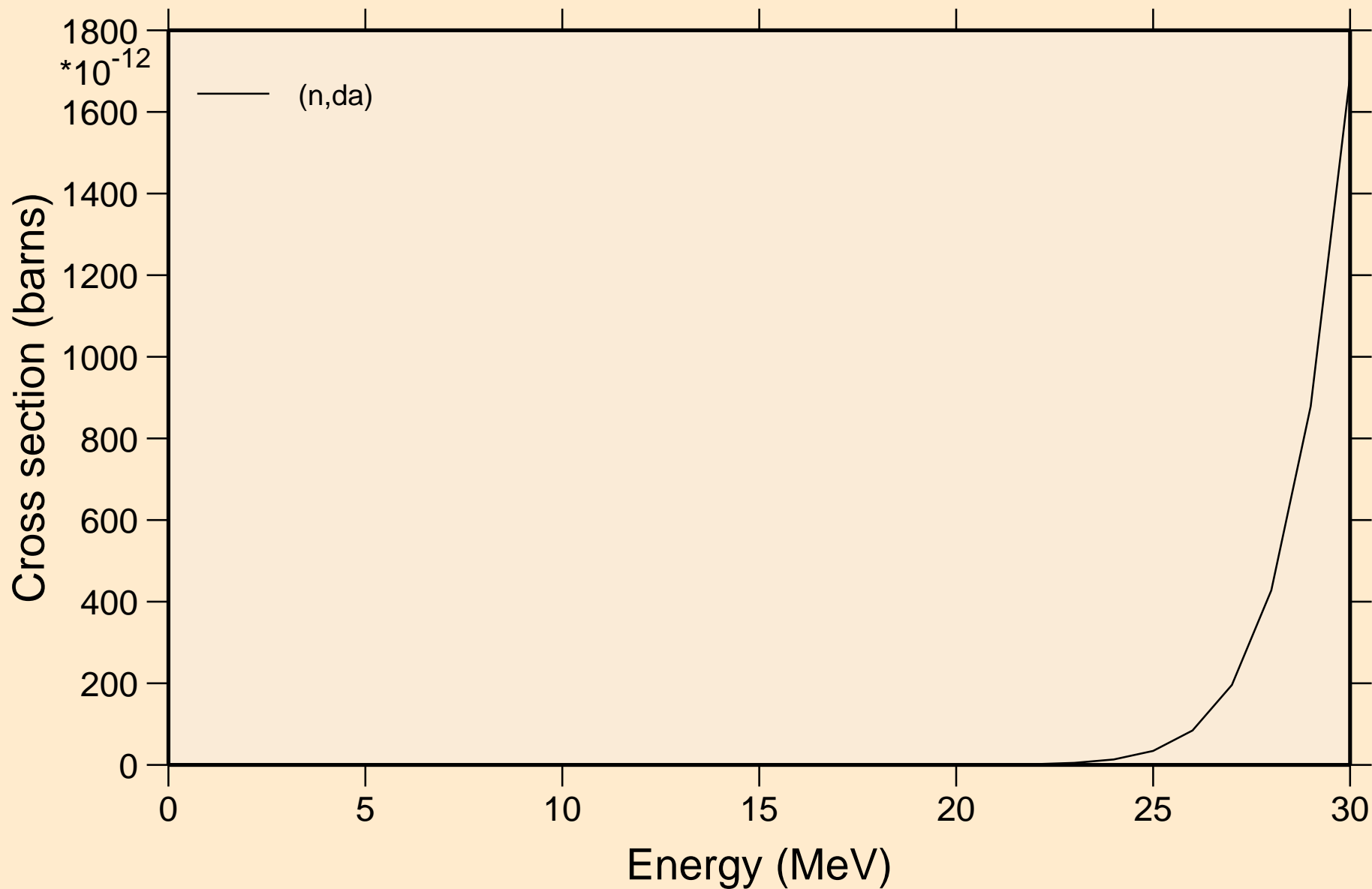



AM236M NEUTRON ACER TENDL-2019 LIBRARY; T=293.16K  
Threshold reactions

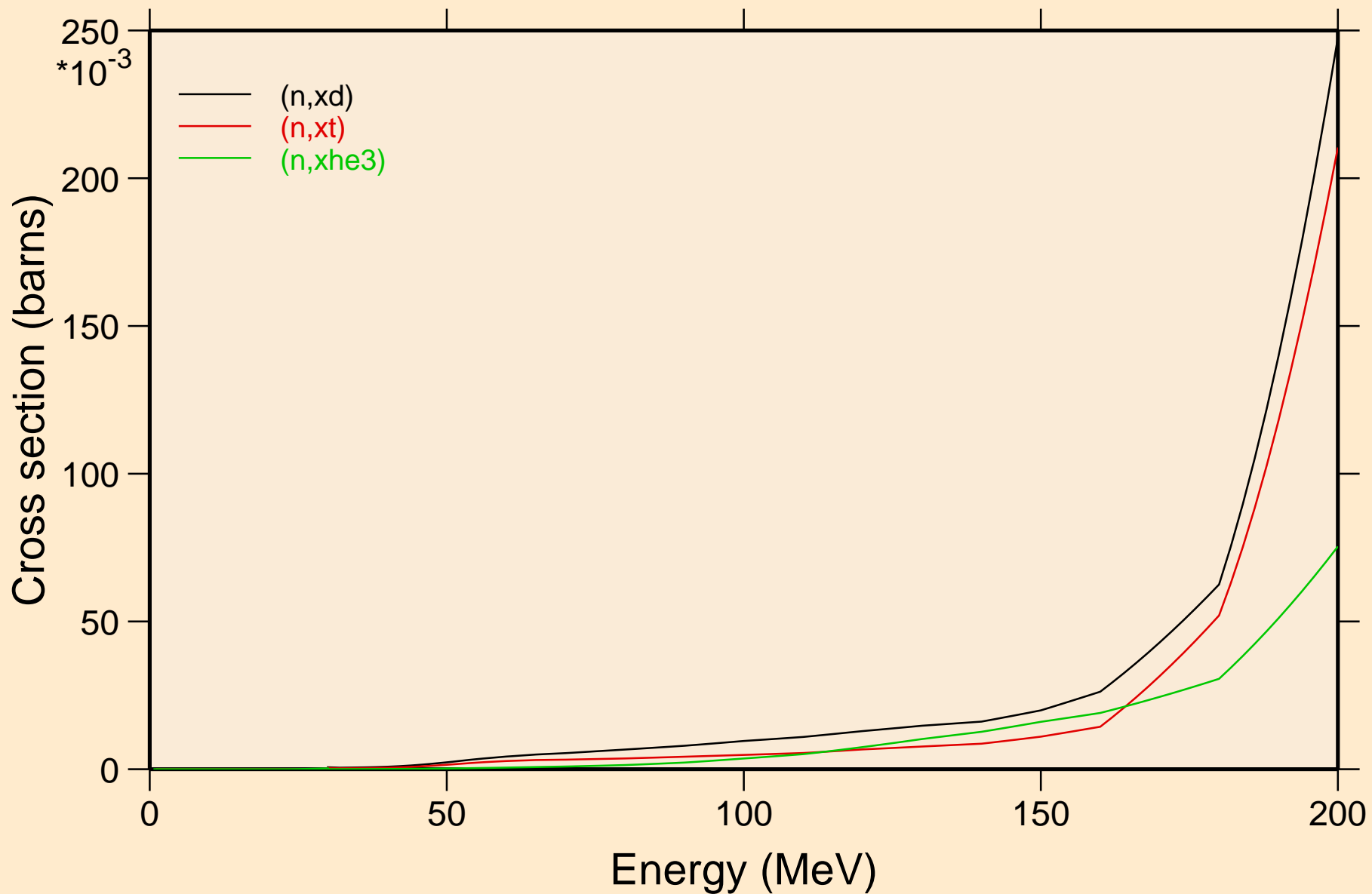

AM236M NEUTRON ACER TENDL-2019 LIBRARY; T=293.16K  
angular distribution for elastic

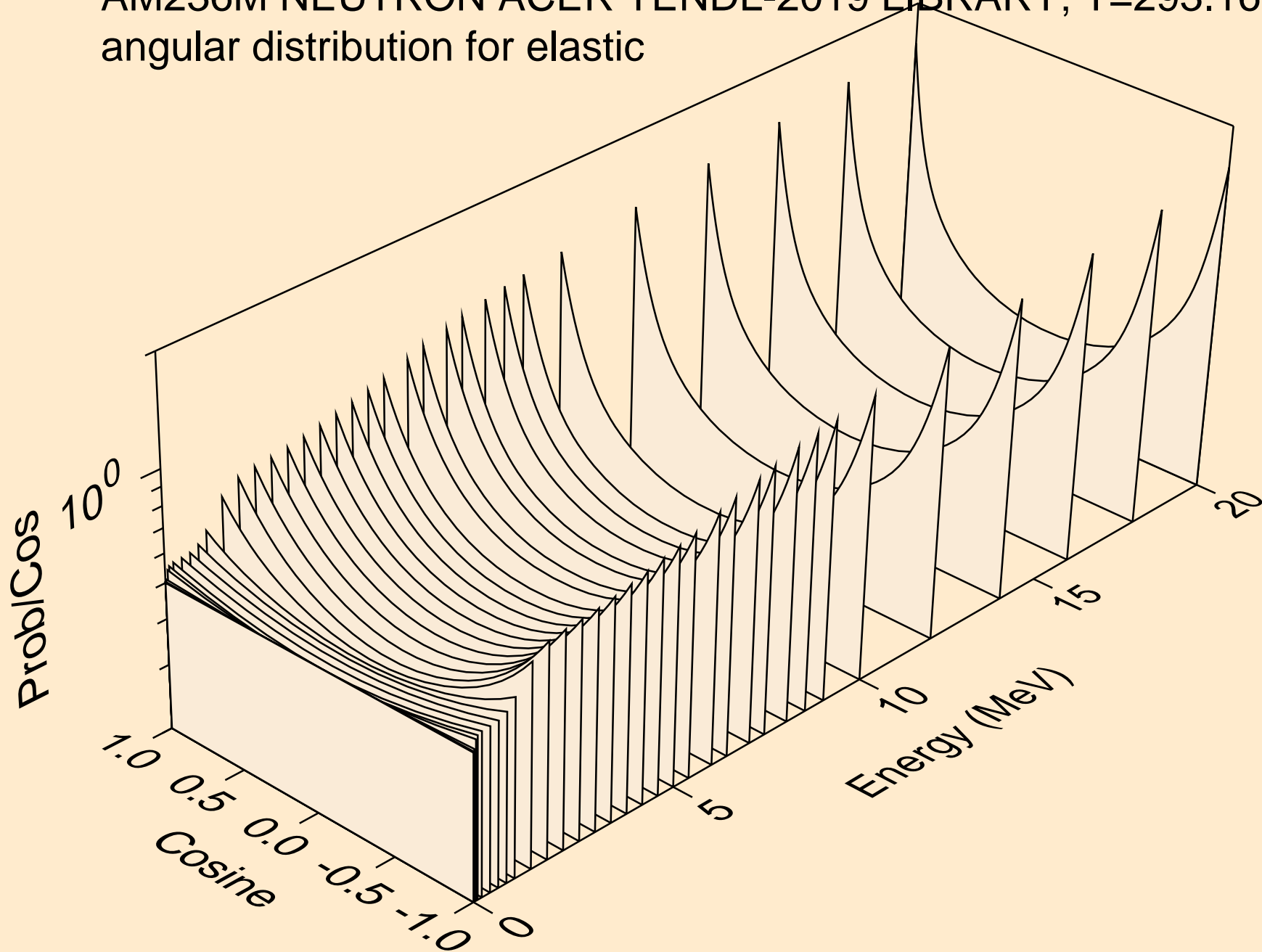

AM236M NEUTRON ACER TENDL-2019 LIBRARY; T=293.16K  
angular distribution for elastic

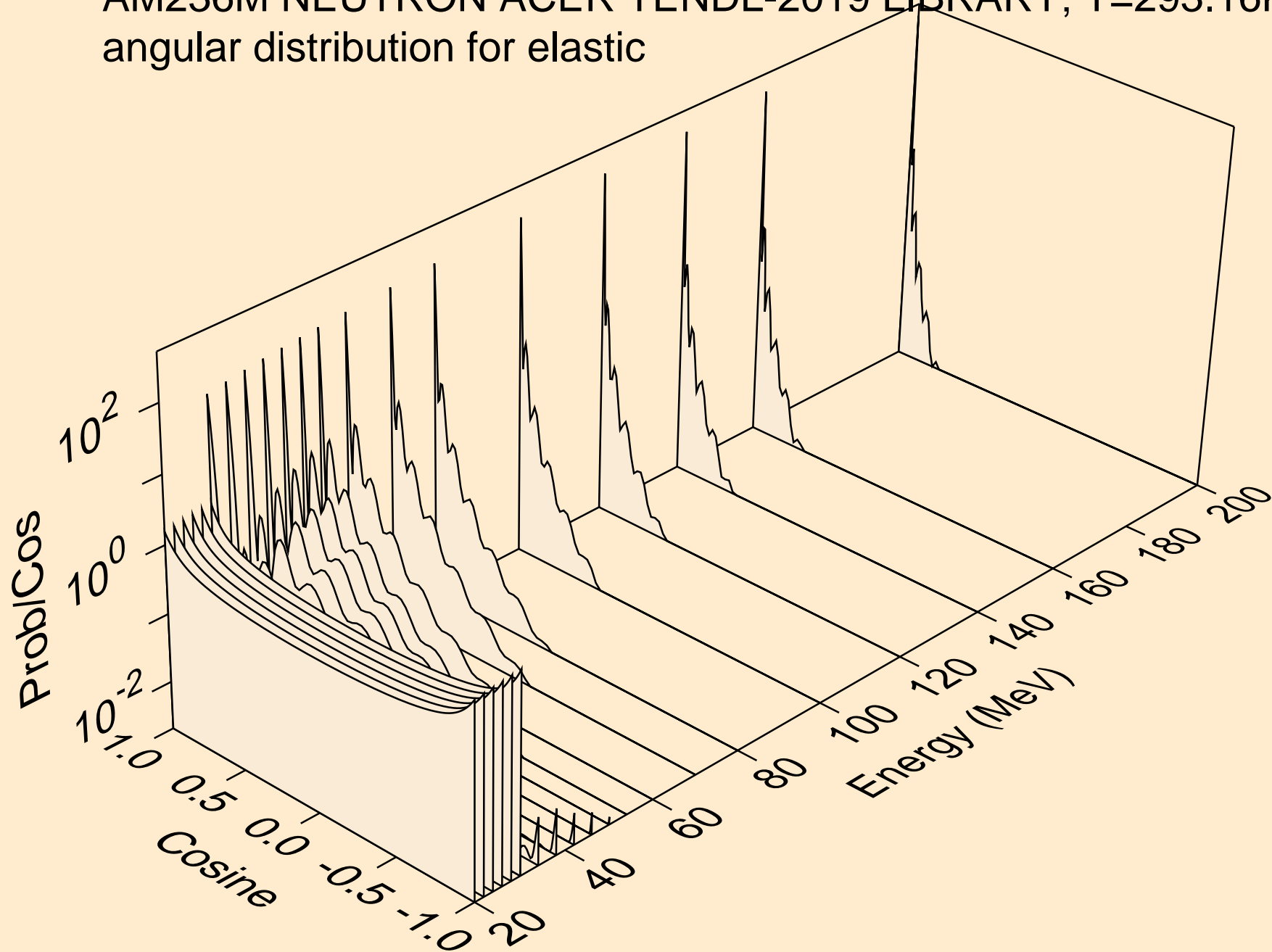

AM236M NEUTRON ACER TENDL-2019 LIBRARY; T=293.16K  
angular distribution for (n,n\*1)

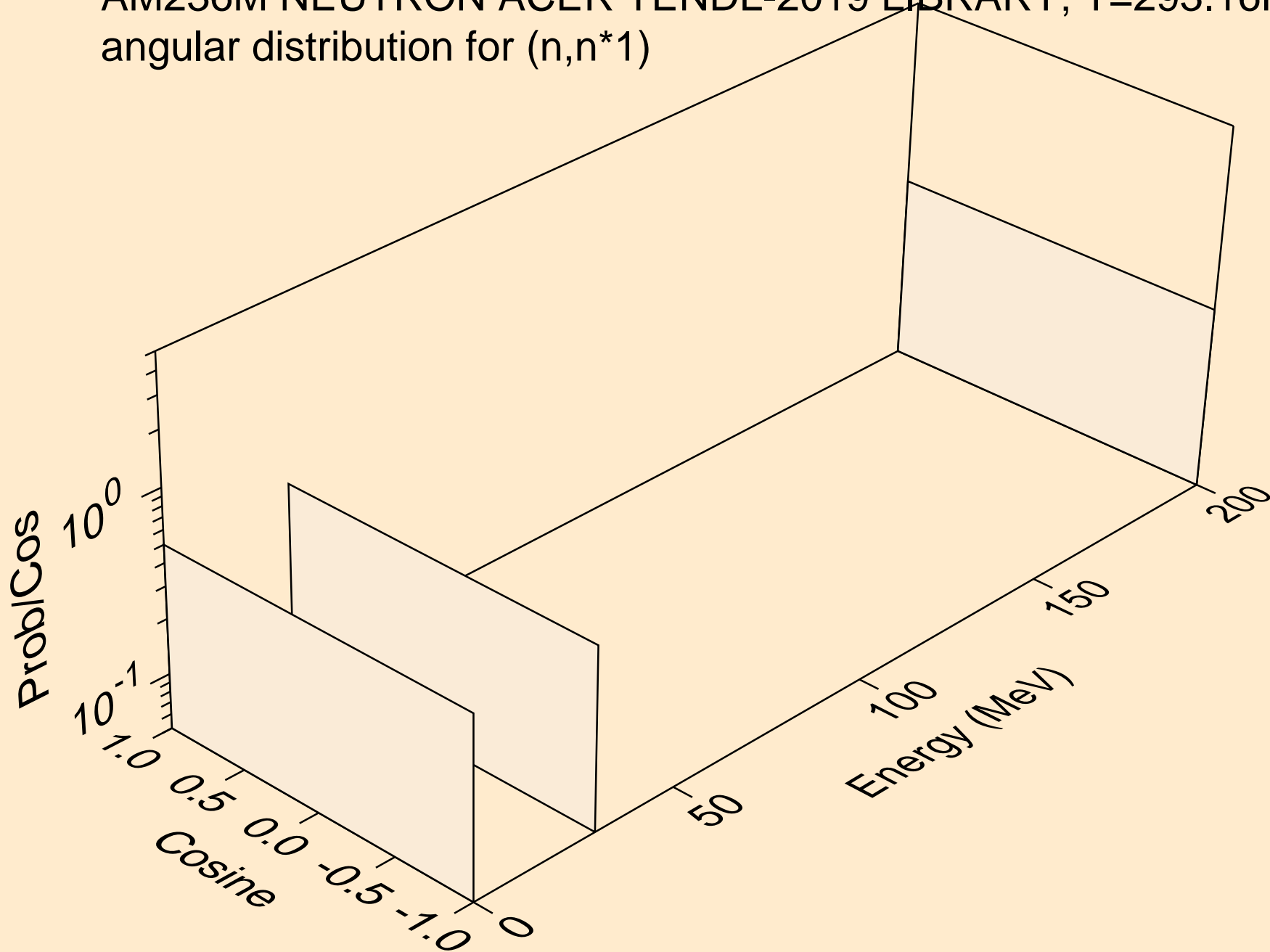

AM236M NEUTRON ACER TENDL-2019 LIBRARY; T=293.16K  
angular distribution for (n,n\*2)

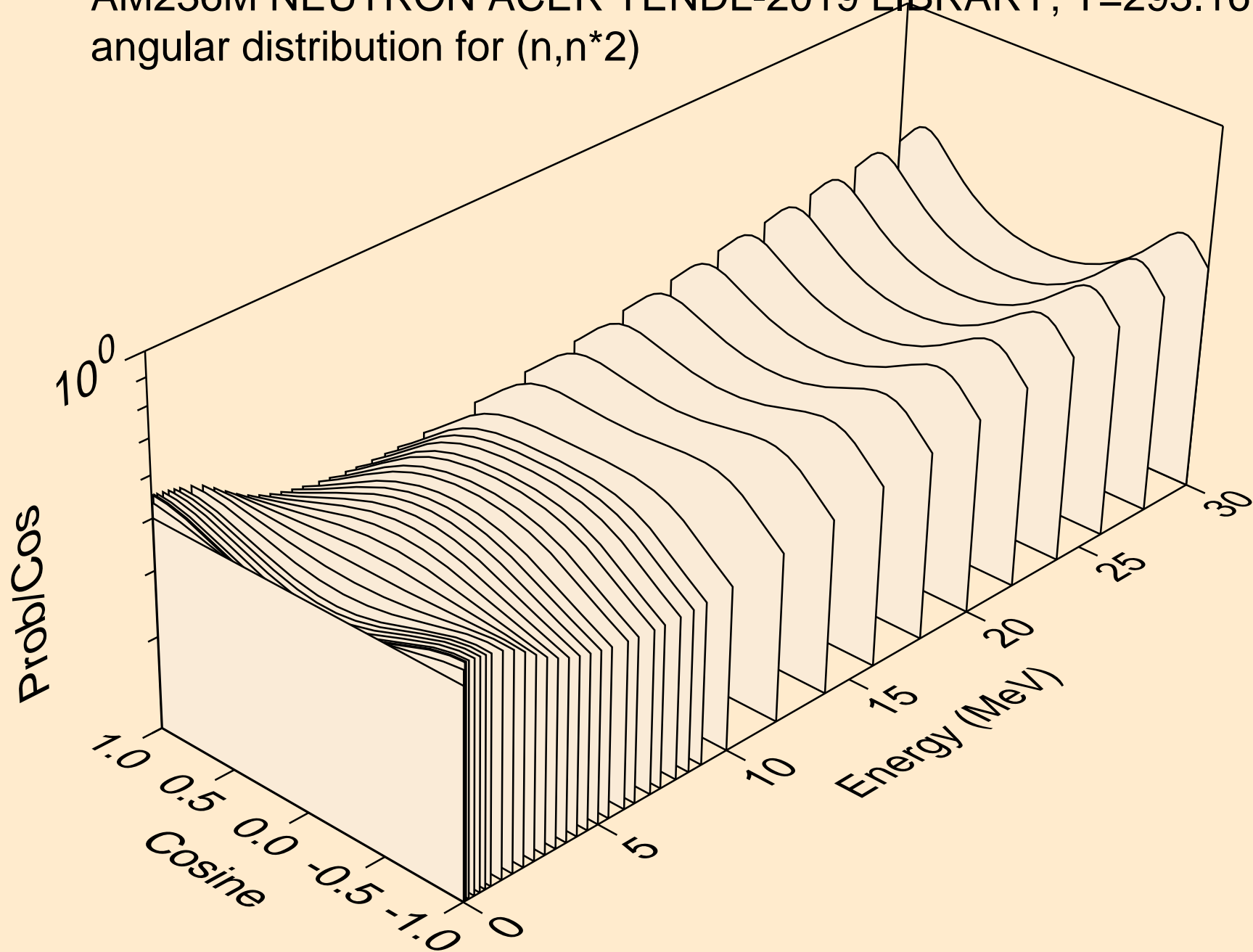

AM236M NEUTRON ACER TENDL-2019 LIBRARY; T=293.16K  
Total fission nubar

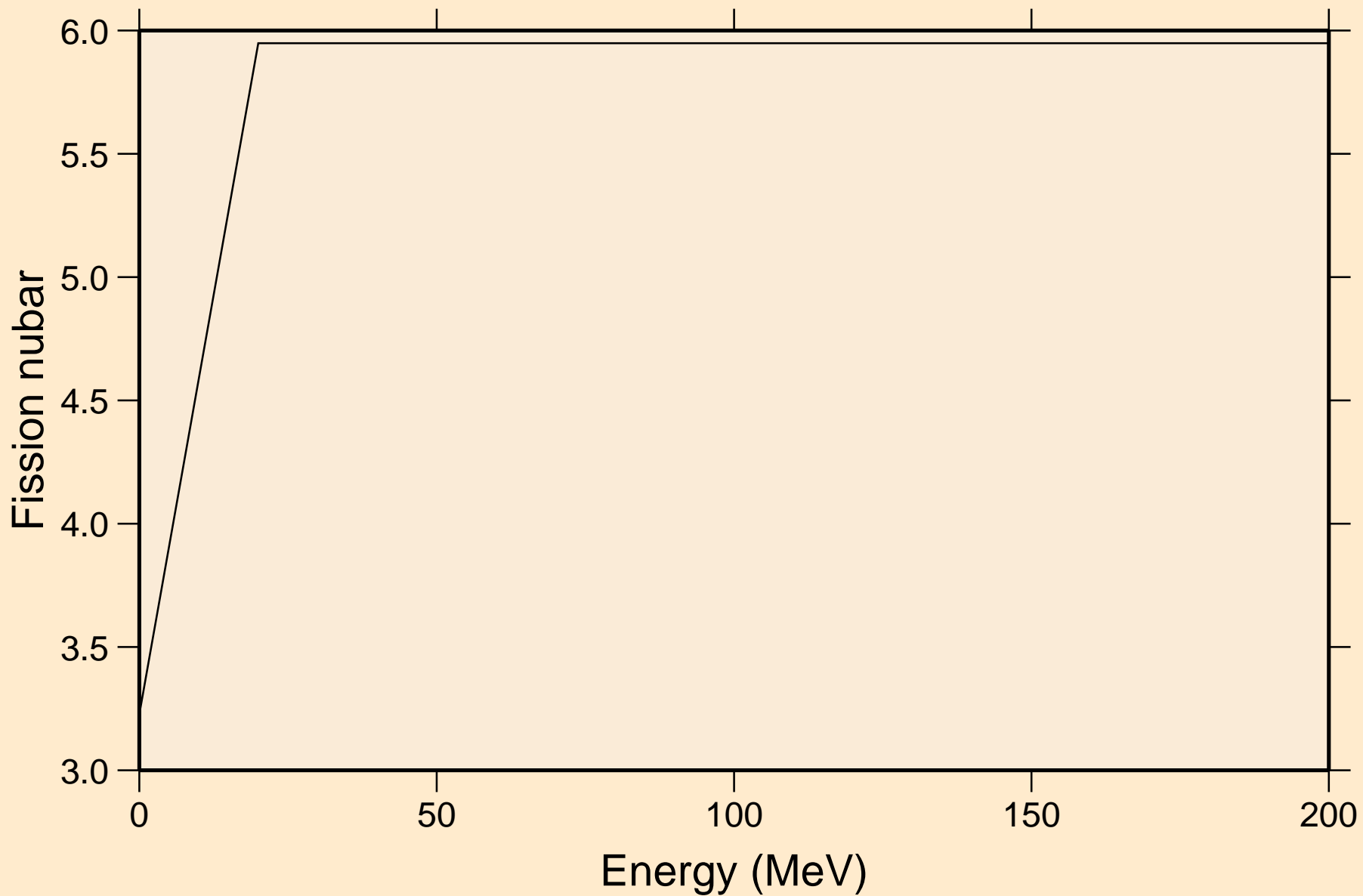

AM236M NEUTRON ACER TENDL-2019 LIBRARY; T=293.16K  
Neutron emission for (n,x)

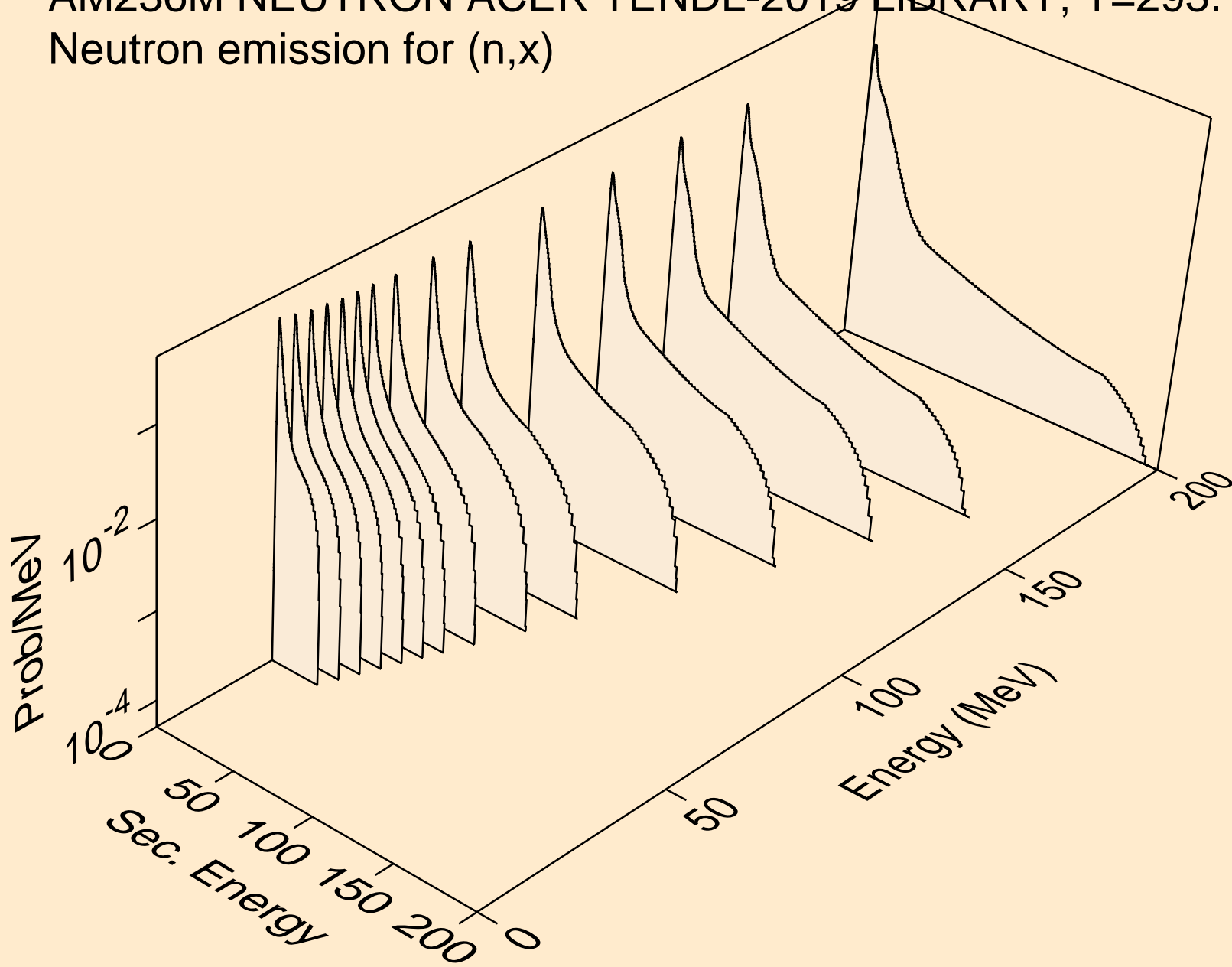

AM236M NEUTRON ACER TENDL-2019 LIBRARY; T=293.16K  
Neutron emission for (n,2nd)

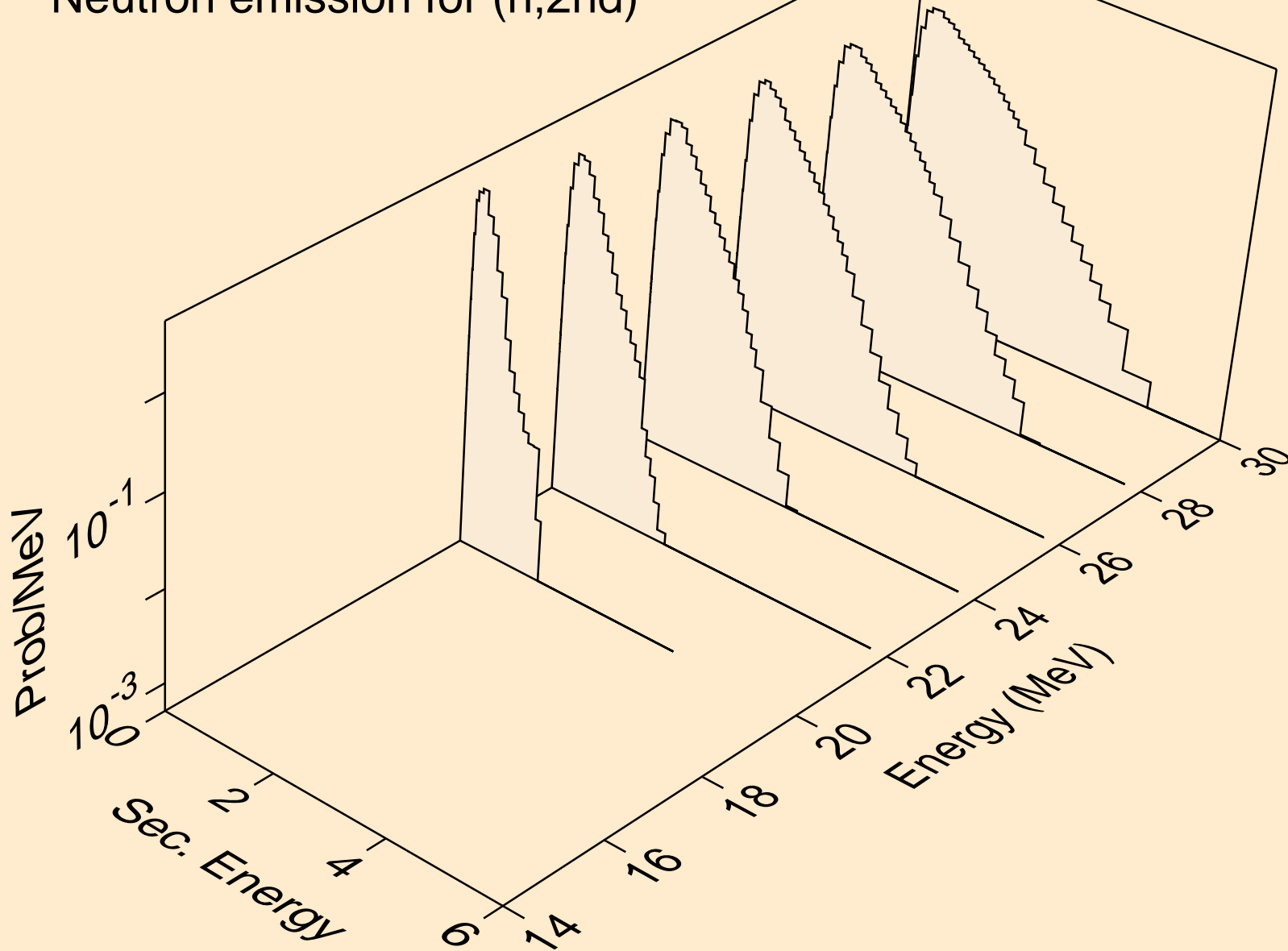



AM236M NEUTRON ACER TENDL-2019 LIBRARY; T=293.16K  
Neutron emission for (n,2n)

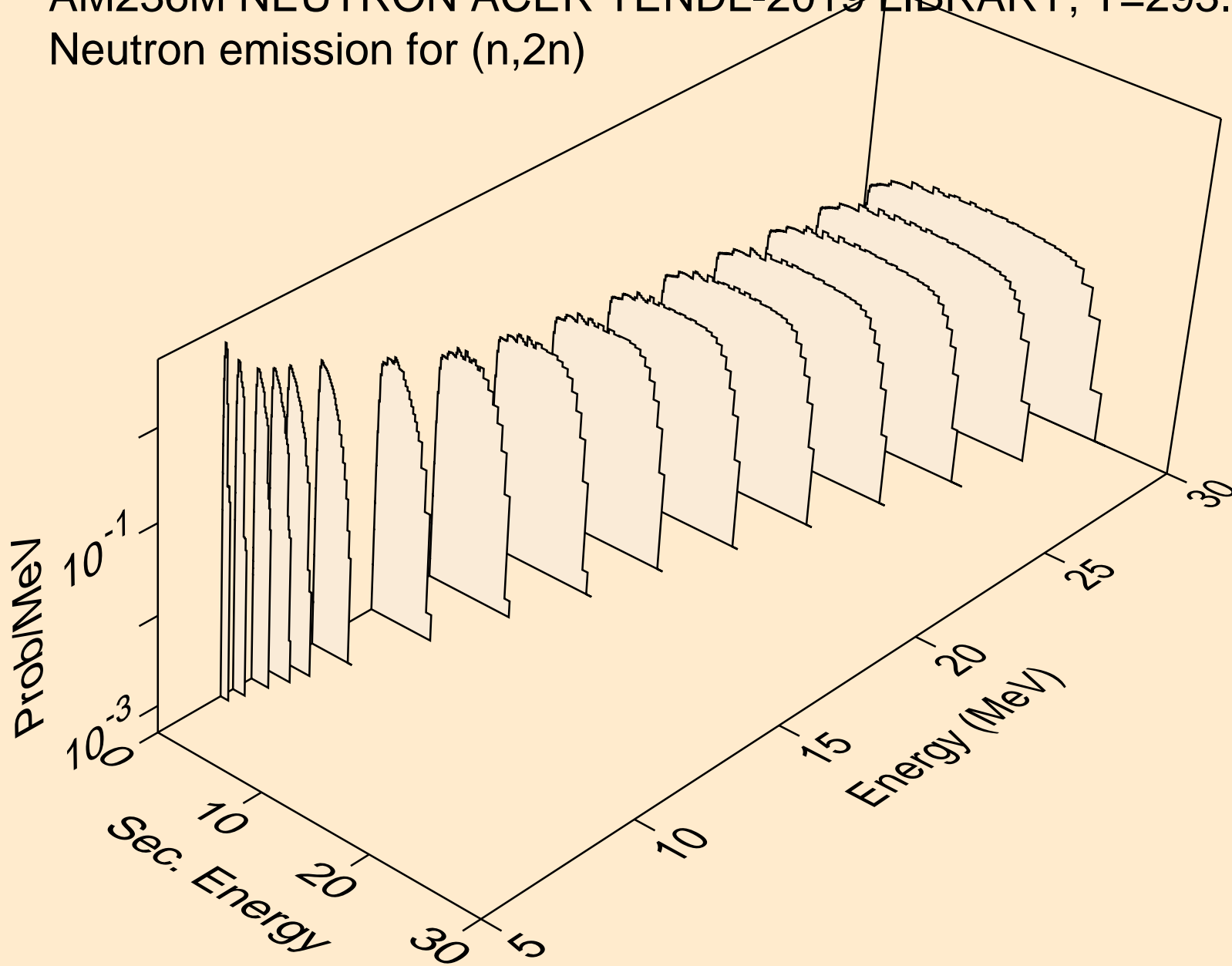

AM236M NEUTRON ACER TENDL-2019 LIBRARY; T=293.16K  
Neutron emission for (n,3n)

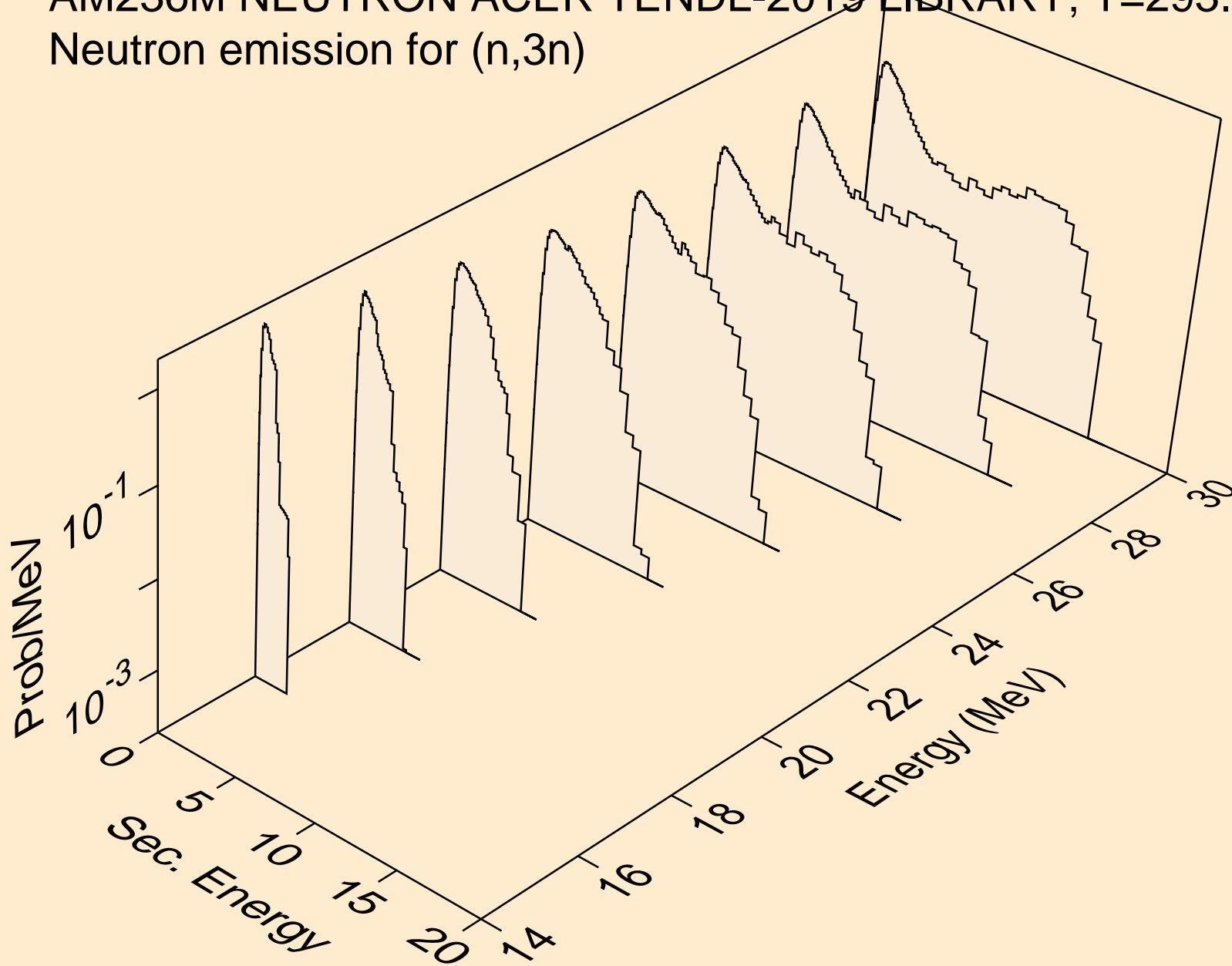

AM236M NEUTRON ACER TENDL-2019 LIBRARY; T=293.16K  
Neutron emission for fission

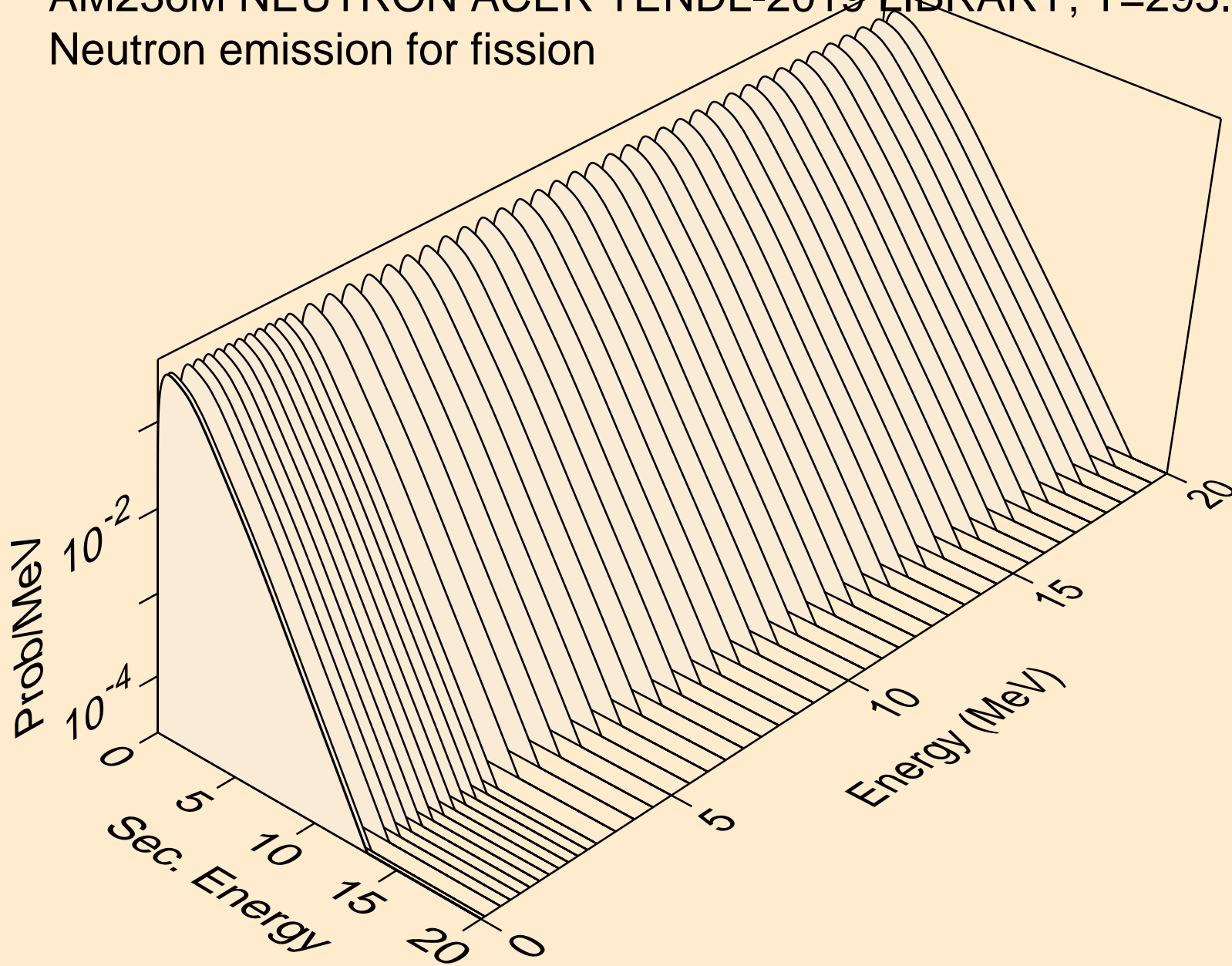

AM236M NEUTRON ACER TENDL-2019 LIBRARY; T=293.16K  
Neutron emission for (n,n\*)a

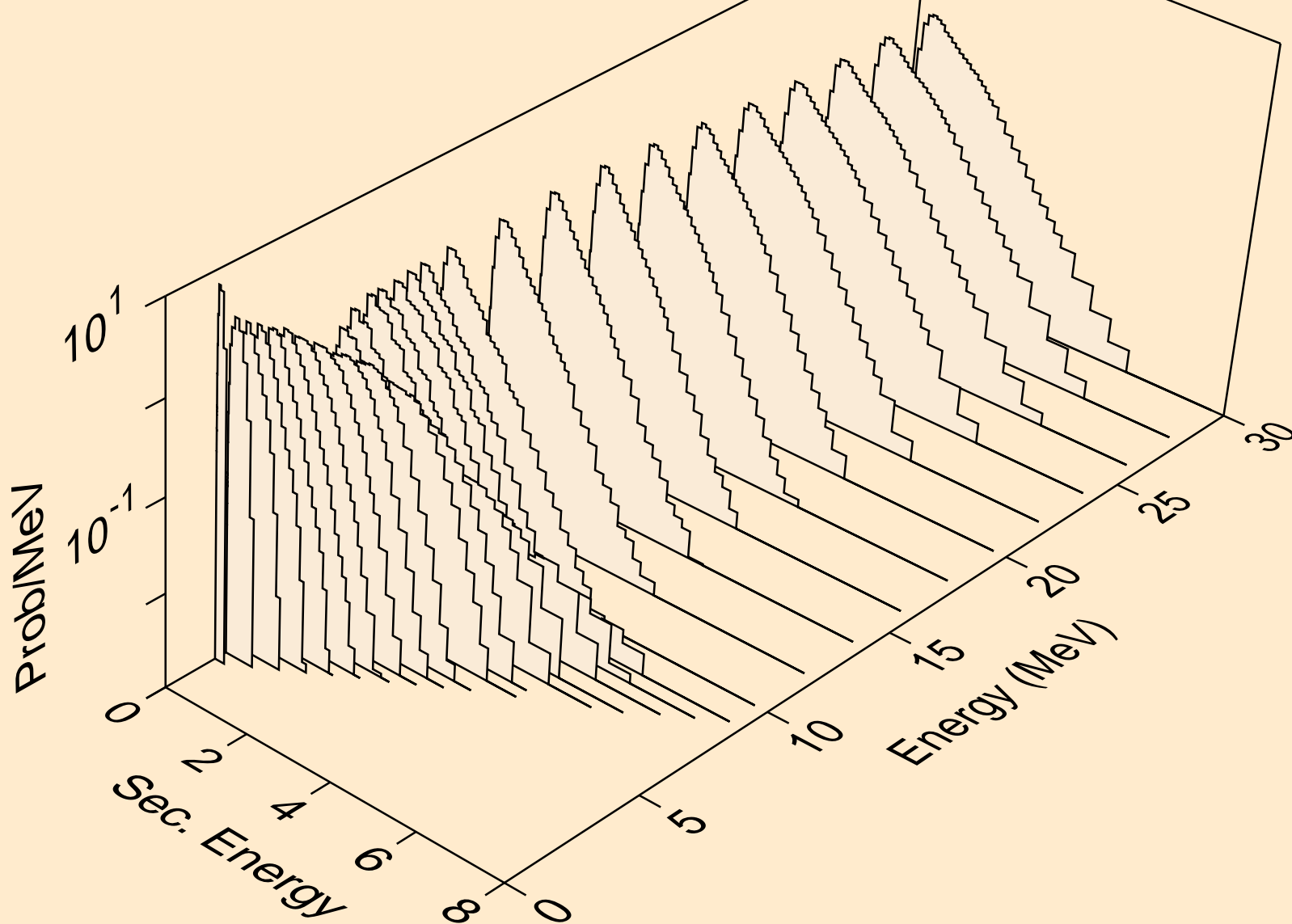

AM236M NEUTRON ACER TENDL-2019 LIBRARY; T=293.16K  
Neutron emission for (n,2n)a

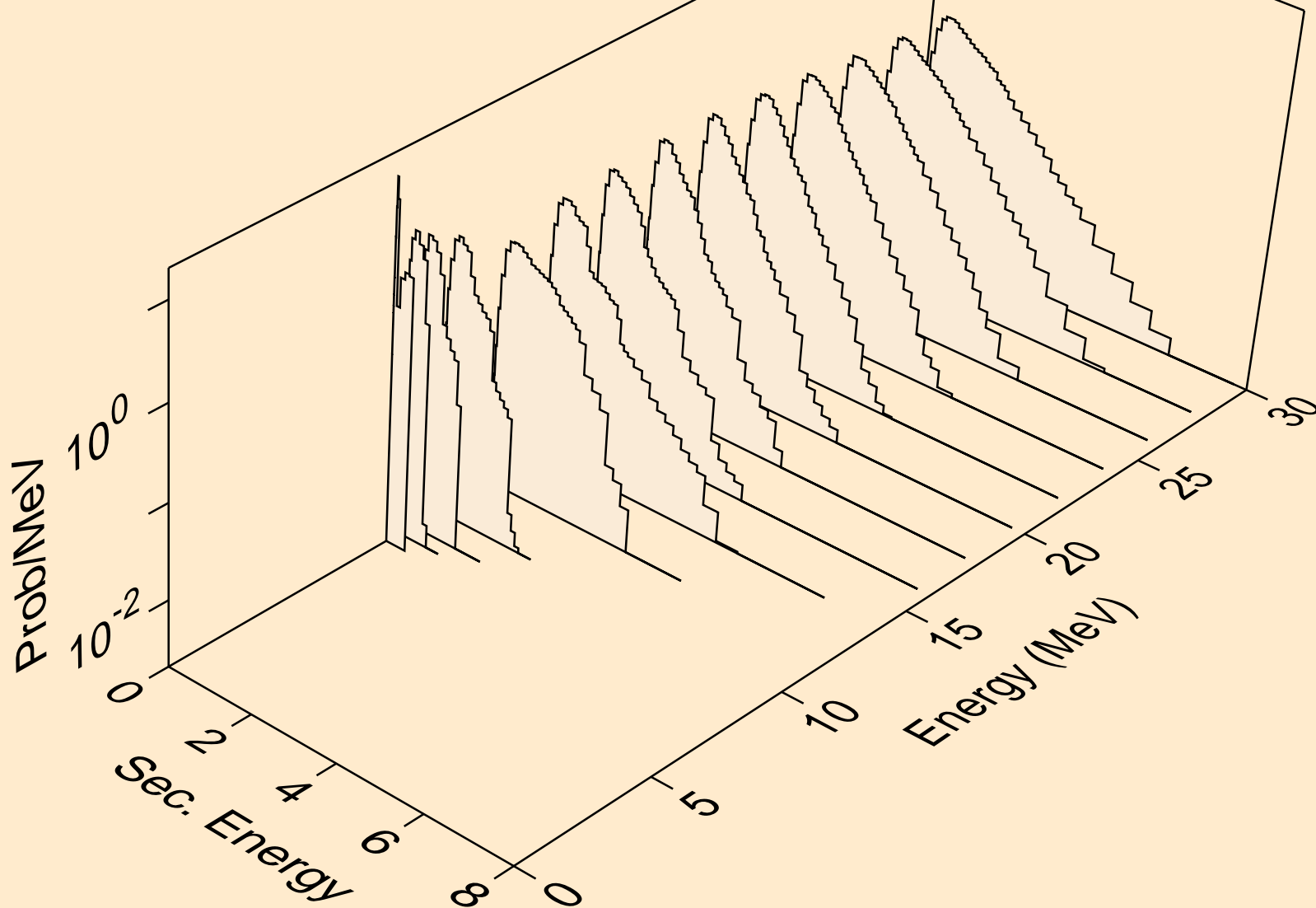

AM236M NEUTRON ACER TENDL-2019 LIBRARY; T=293.16K  
Neutron emission for (n,3n)a

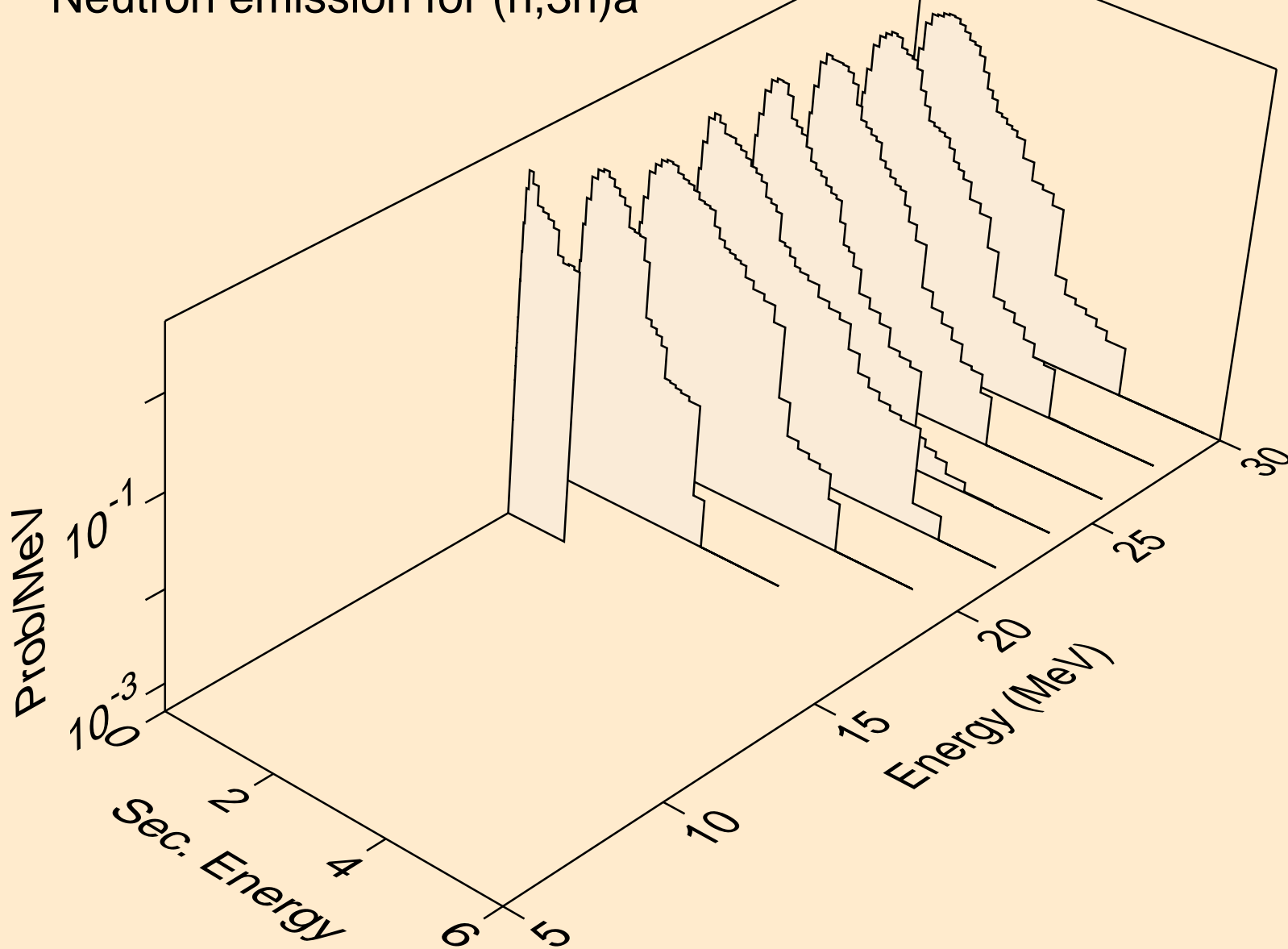

AM236M NEUTRON ACER TENDL-2019 LIBRARY; T=293.16K  
Neutron emission for (n,n\*)p

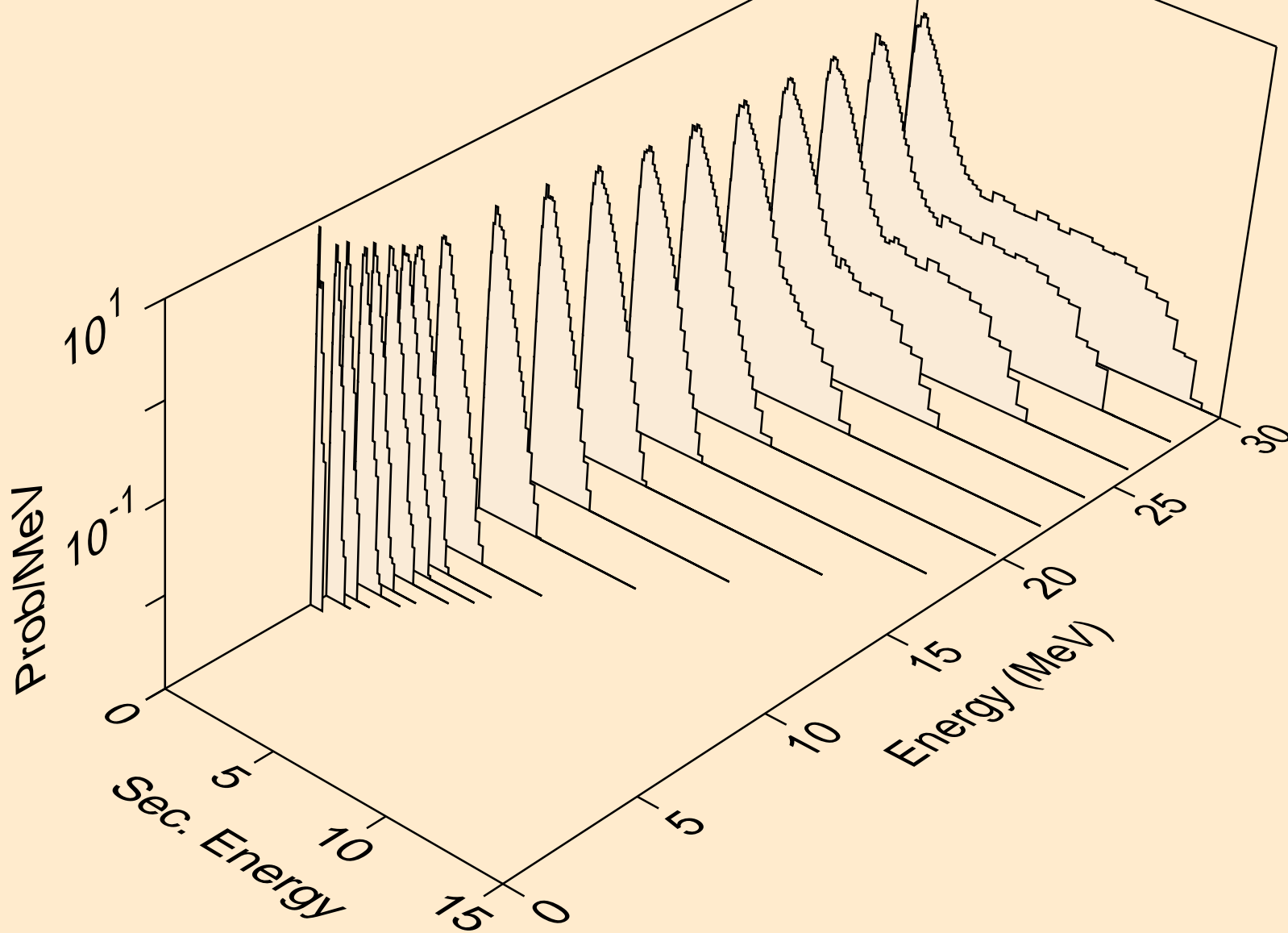

AM236M NEUTRON ACER TENDL-2019 LIBRARY; T=293.16K  
Neutron emission for (n,n\*)2a

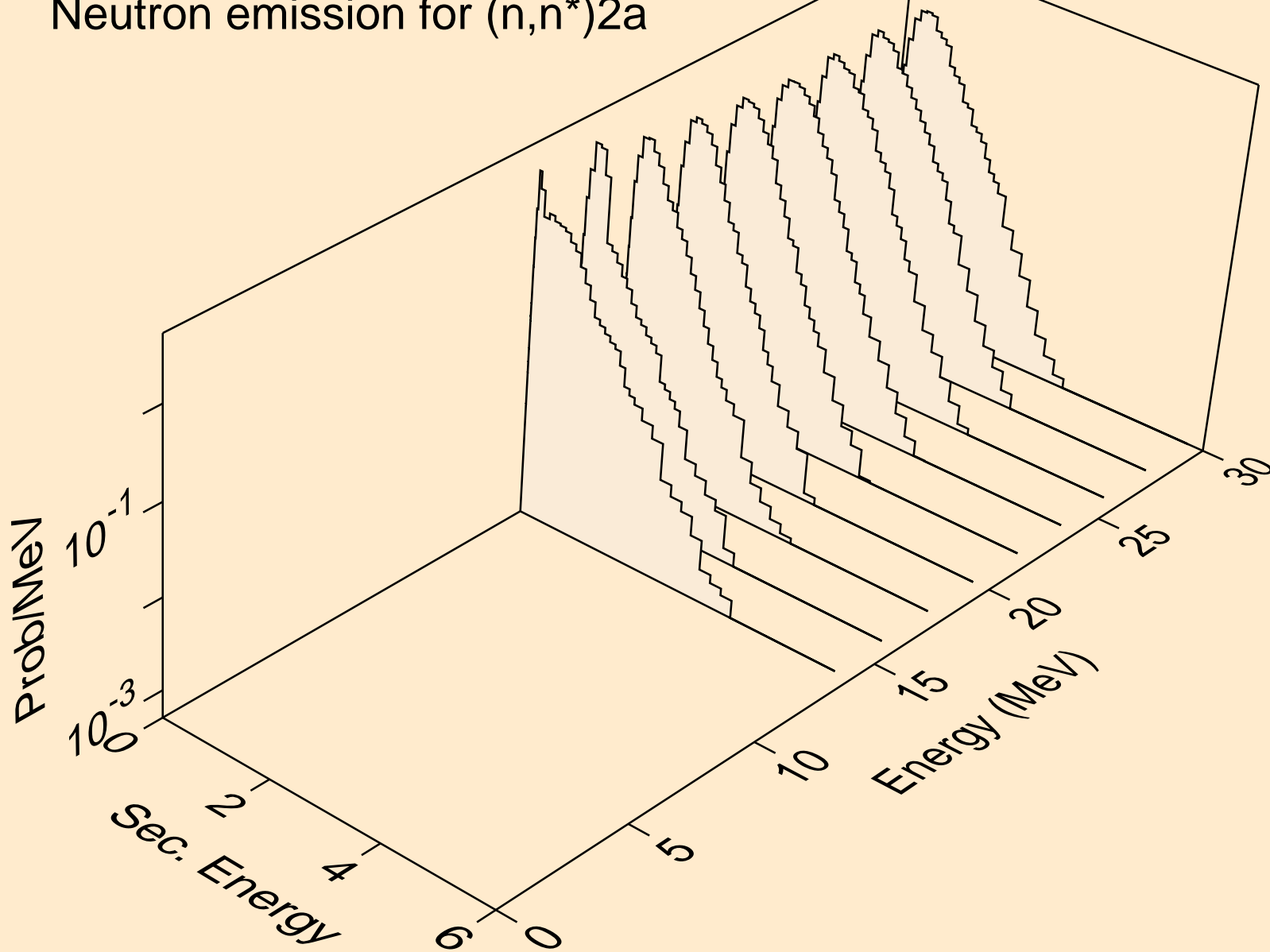



AM236M NEUTRON ACER TENDL-2019 LIBRARY; T=293.16K  
Neutron emission for (n,n\*)d

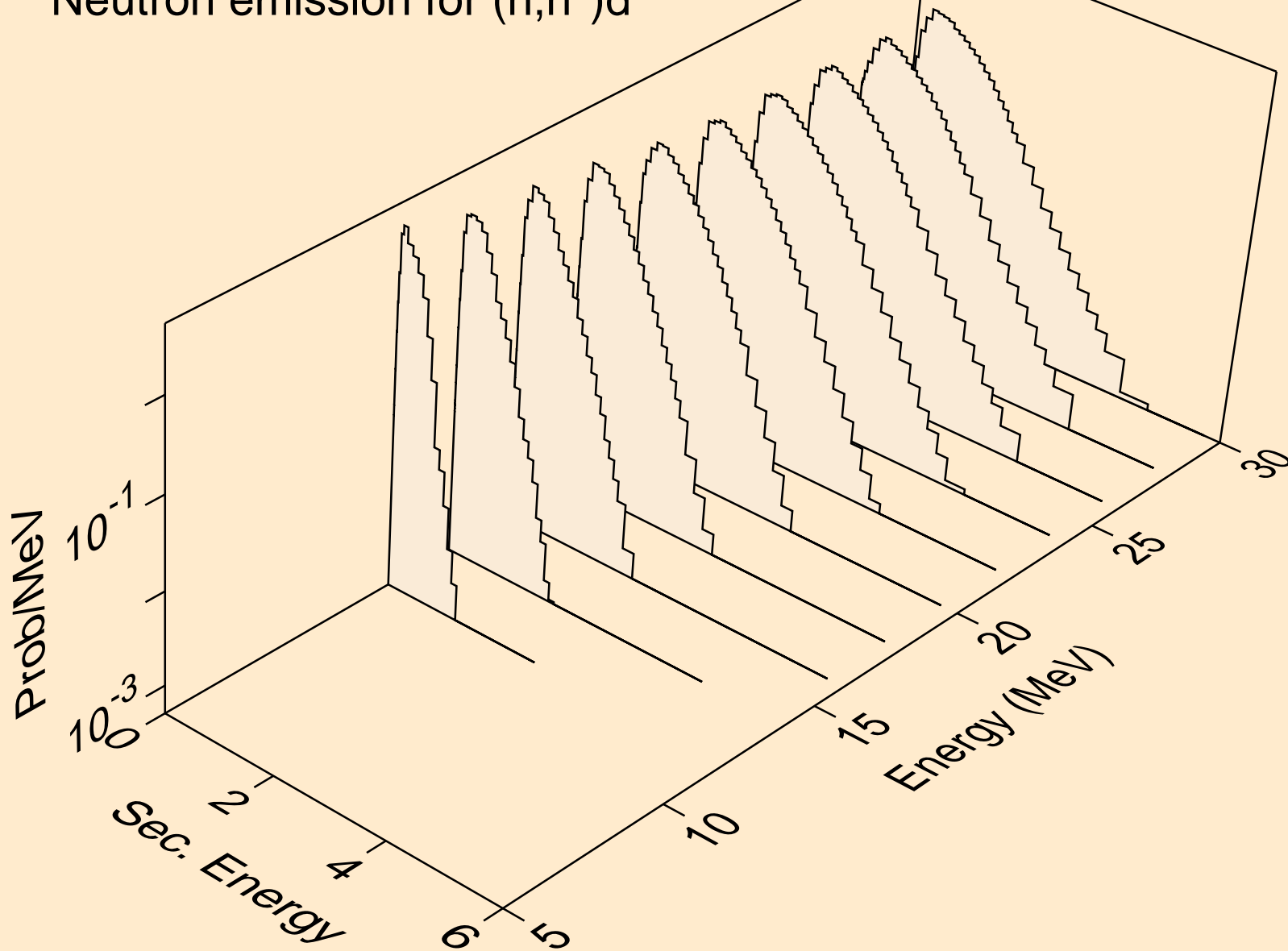

AM236M NEUTRON ACER TENDL-2019 LIBRARY; T=293.16K  
Neutron emission for (n,n\*)t

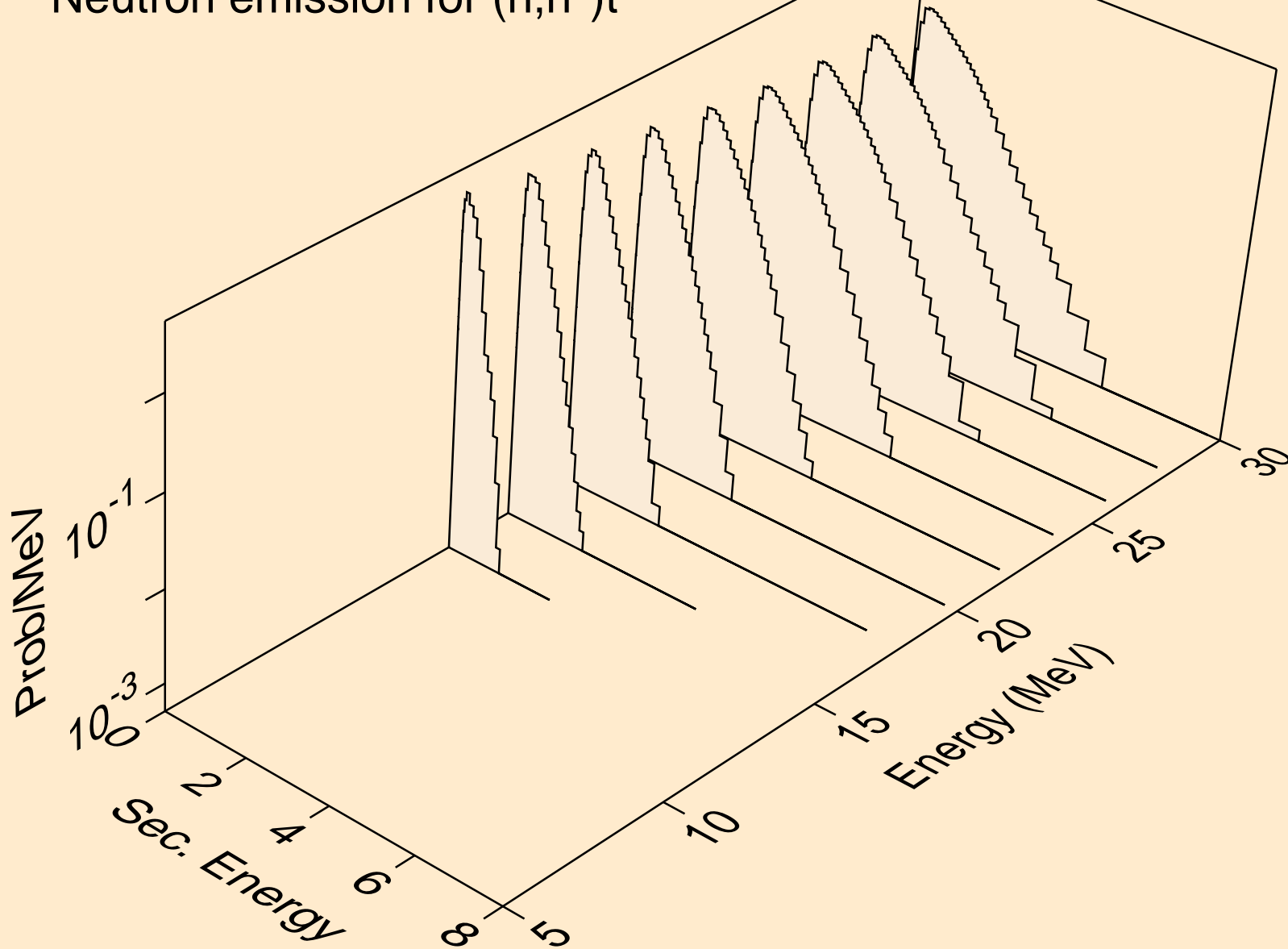

AM236M NEUTRON ACER TENDL-2019 LIBRARY; T=293.16K  
Neutron emission for (n,n\*)he3

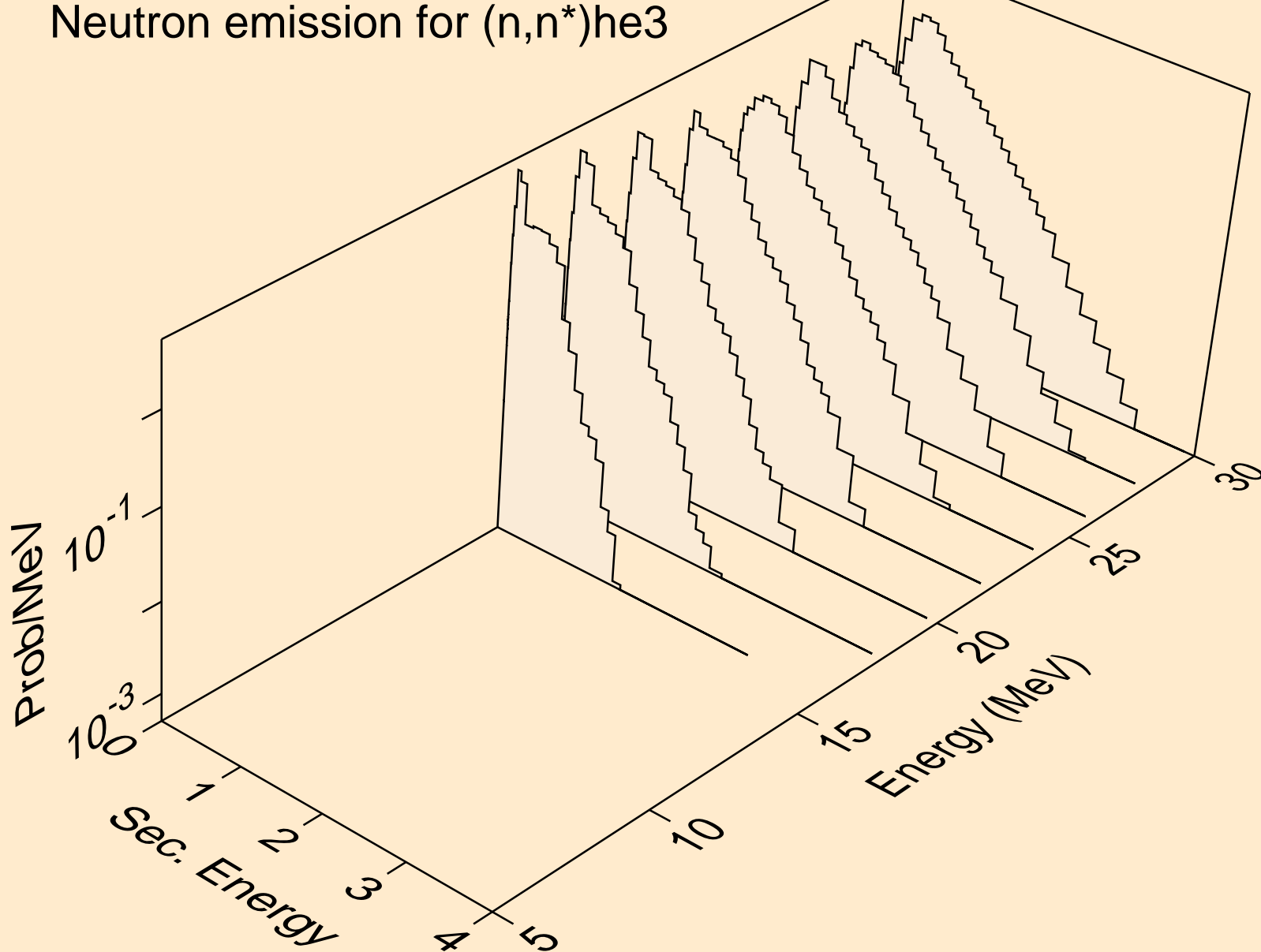

AM236M NEUTRON ACER TENDL-2019 LIBRARY; T=293.16K  
Neutron emission for (n,4n)

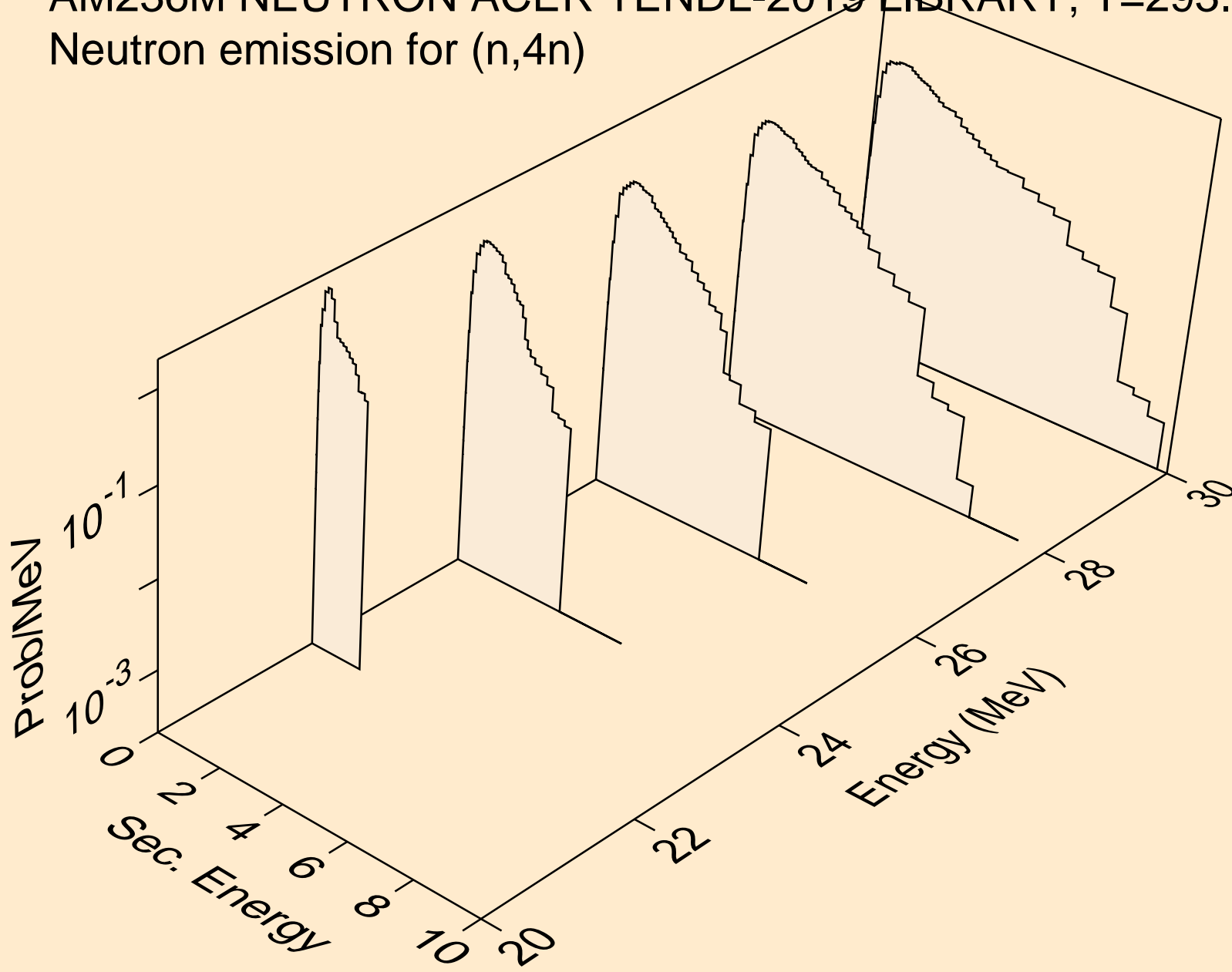

AM236M NEUTRON ACER TENDL-2019 LIBRARY; T=293.16K  
Neutron emission for (n,2np)

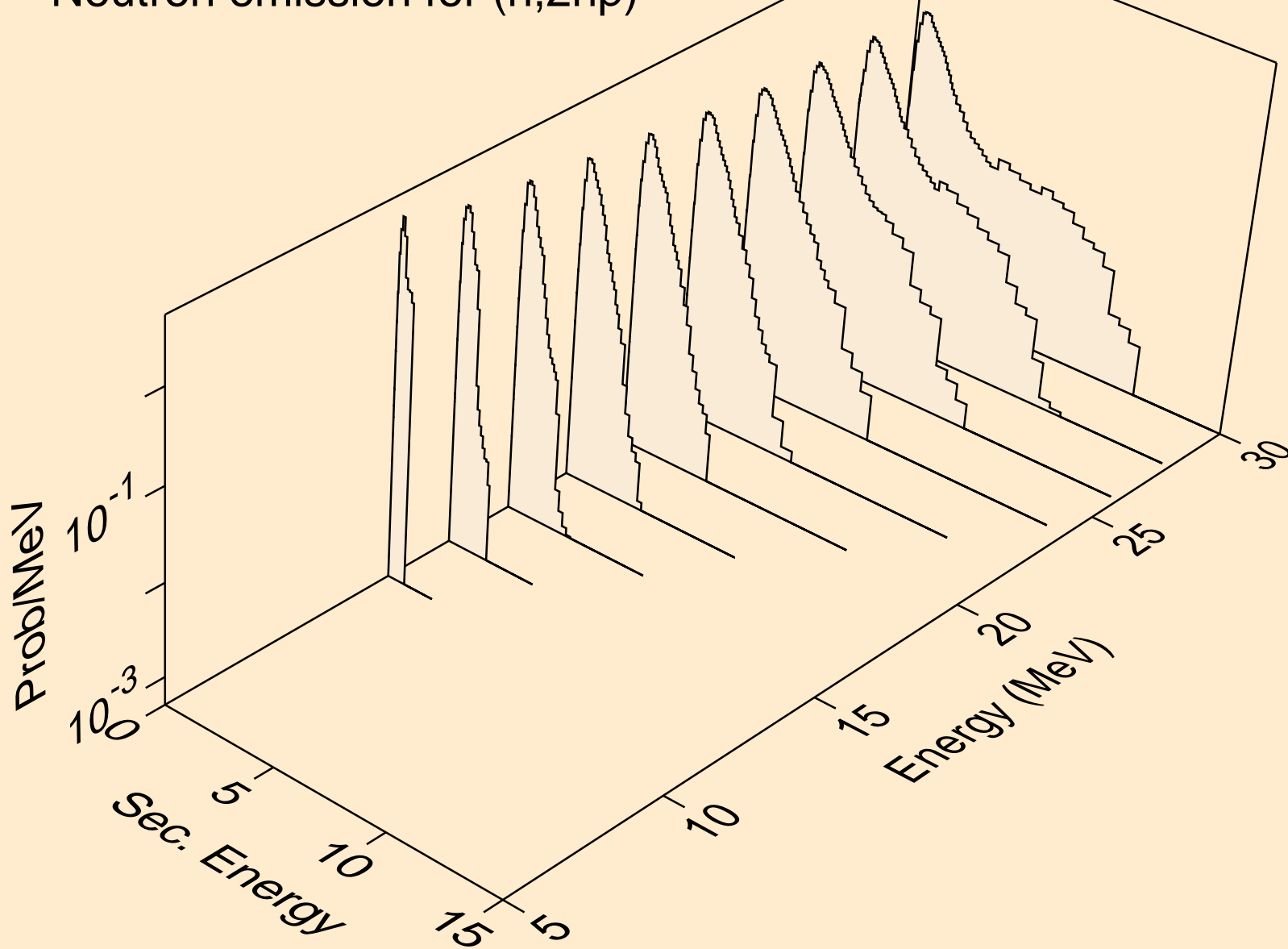

AM236M NEUTRON ACER TENDL-2019 LIBRARY; T=293.16K  
Neutron emission for (n,3np)

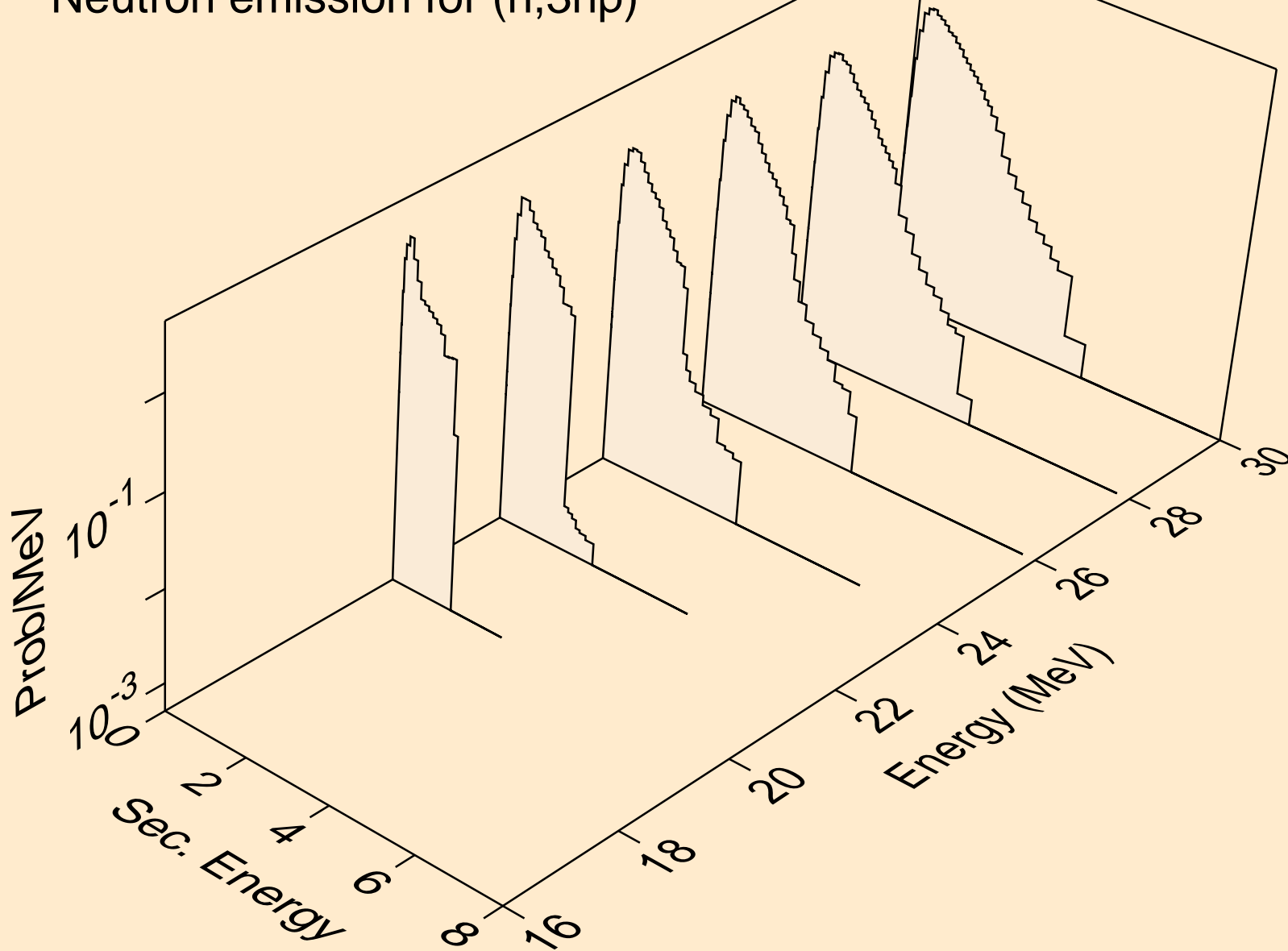

AM236M NEUTRON ACER TENDL-2019 LIBRARY; T=293.16K  
Neutron emission for (n,2np)

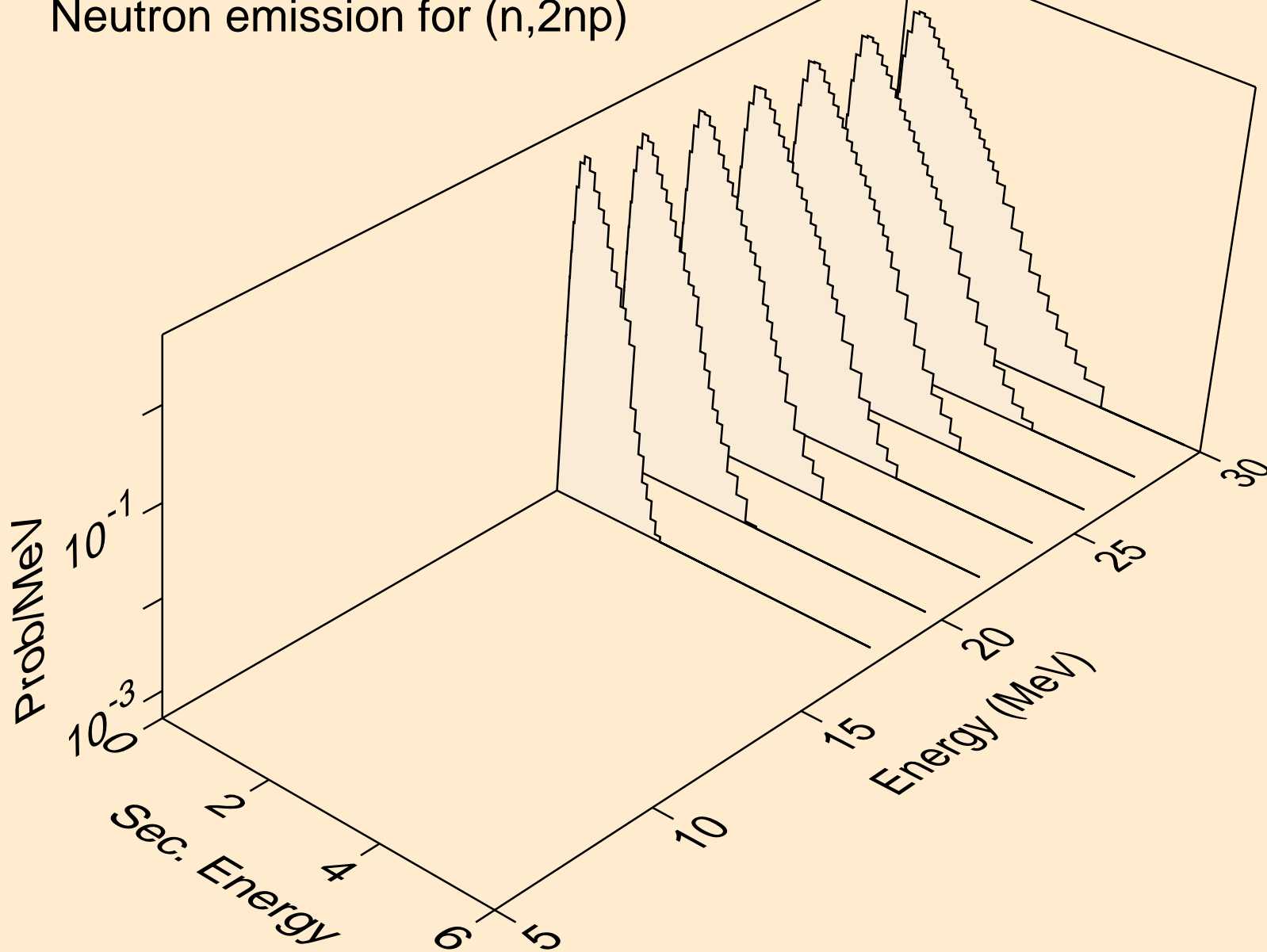

AM236M NEUTRON ACER TENDL-2019 LIBRARY; T=293.16K  
Neutron emission for (n,npa)

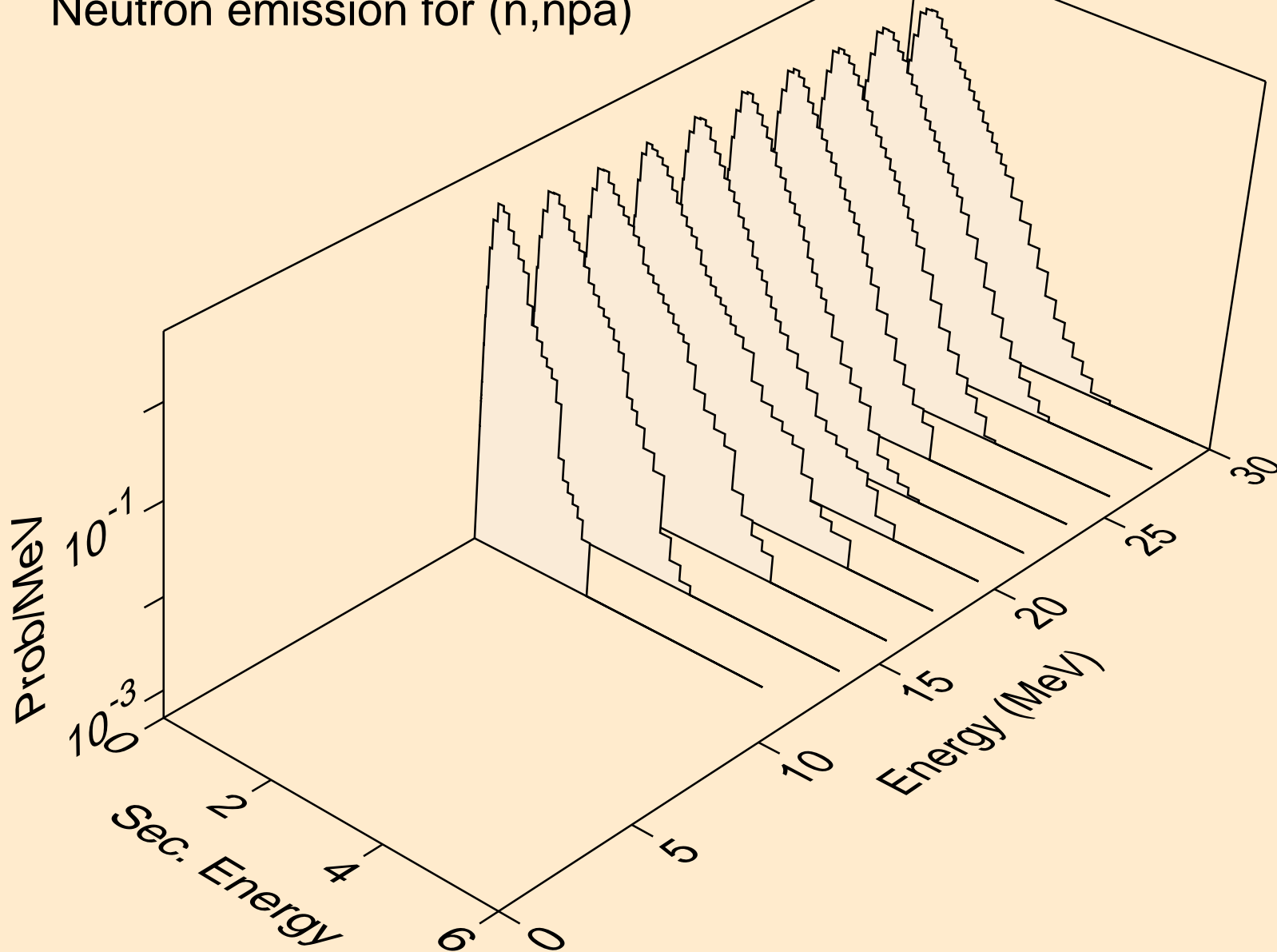



AM236M NEUTRON ACER TENDL-2019 LIBRARY; T=293.16K  
Neutron emission for (n,n\*c)

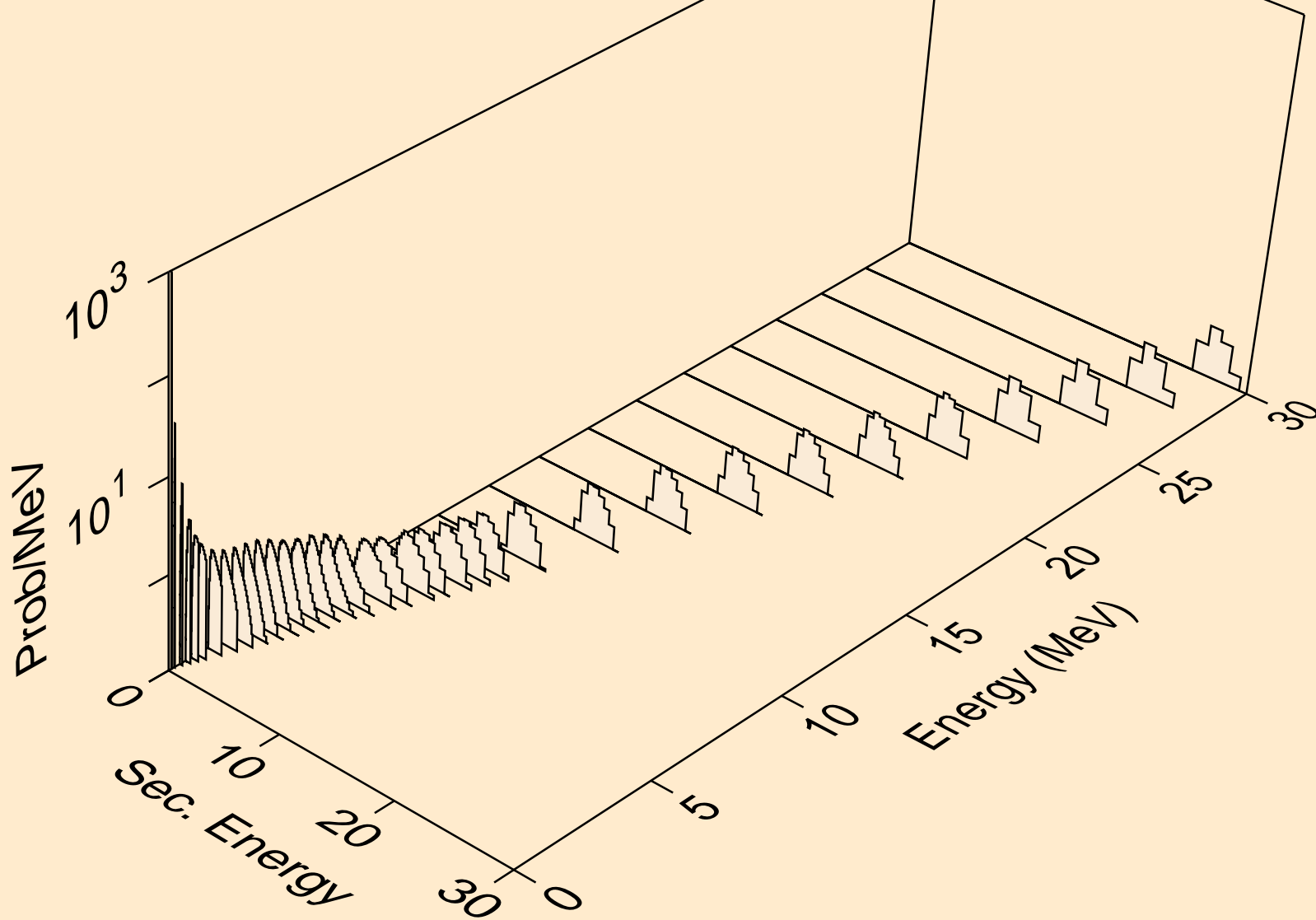

AM236M NEUTRON ACER TENDL-2019 LIBRARY; T=293.16K  
Delayed nubar

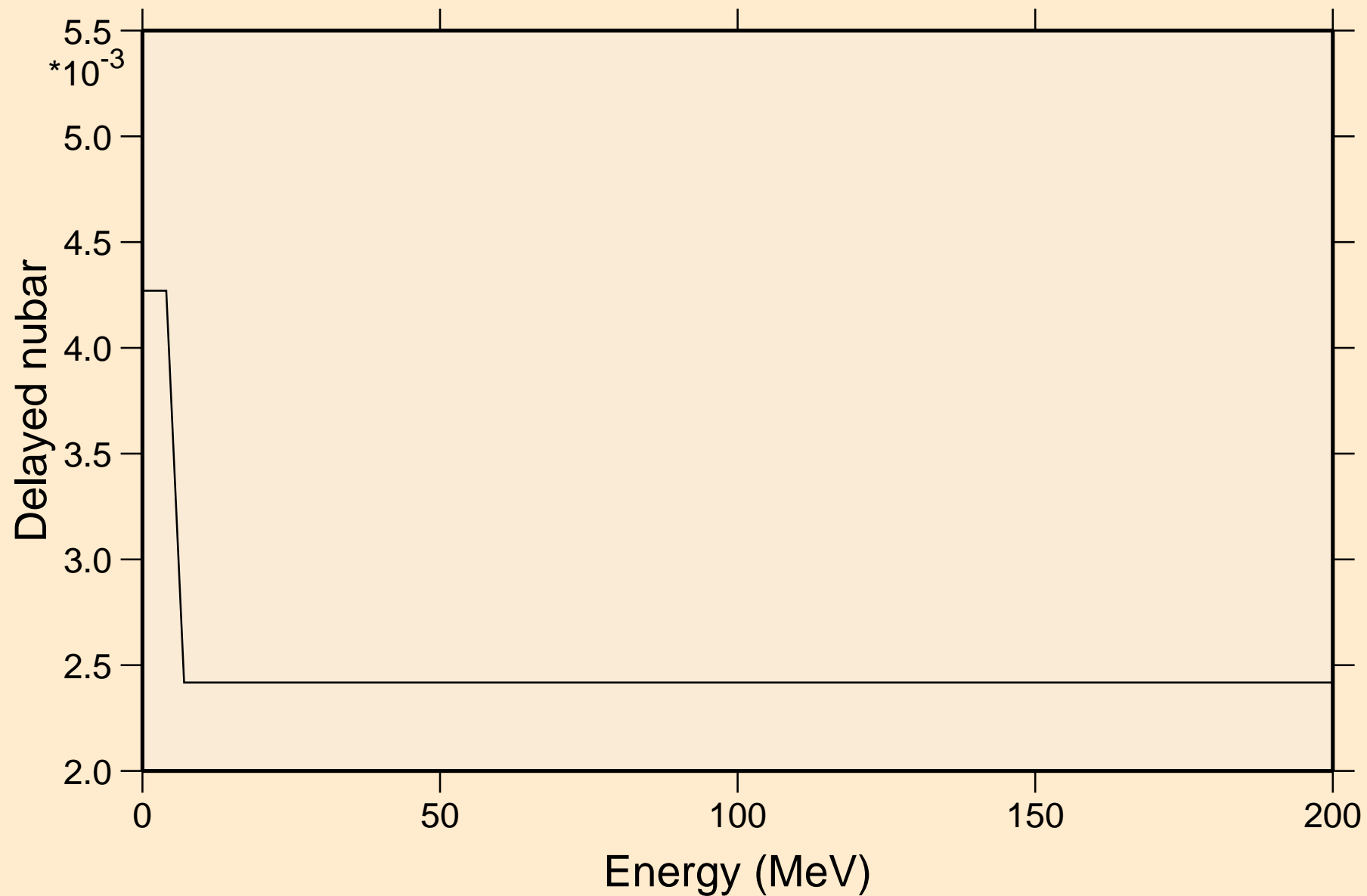

# AM236M NEUTRON ACER TENDL-2019 LIBRARY; T=293.16K

## Delayed neutron spectra

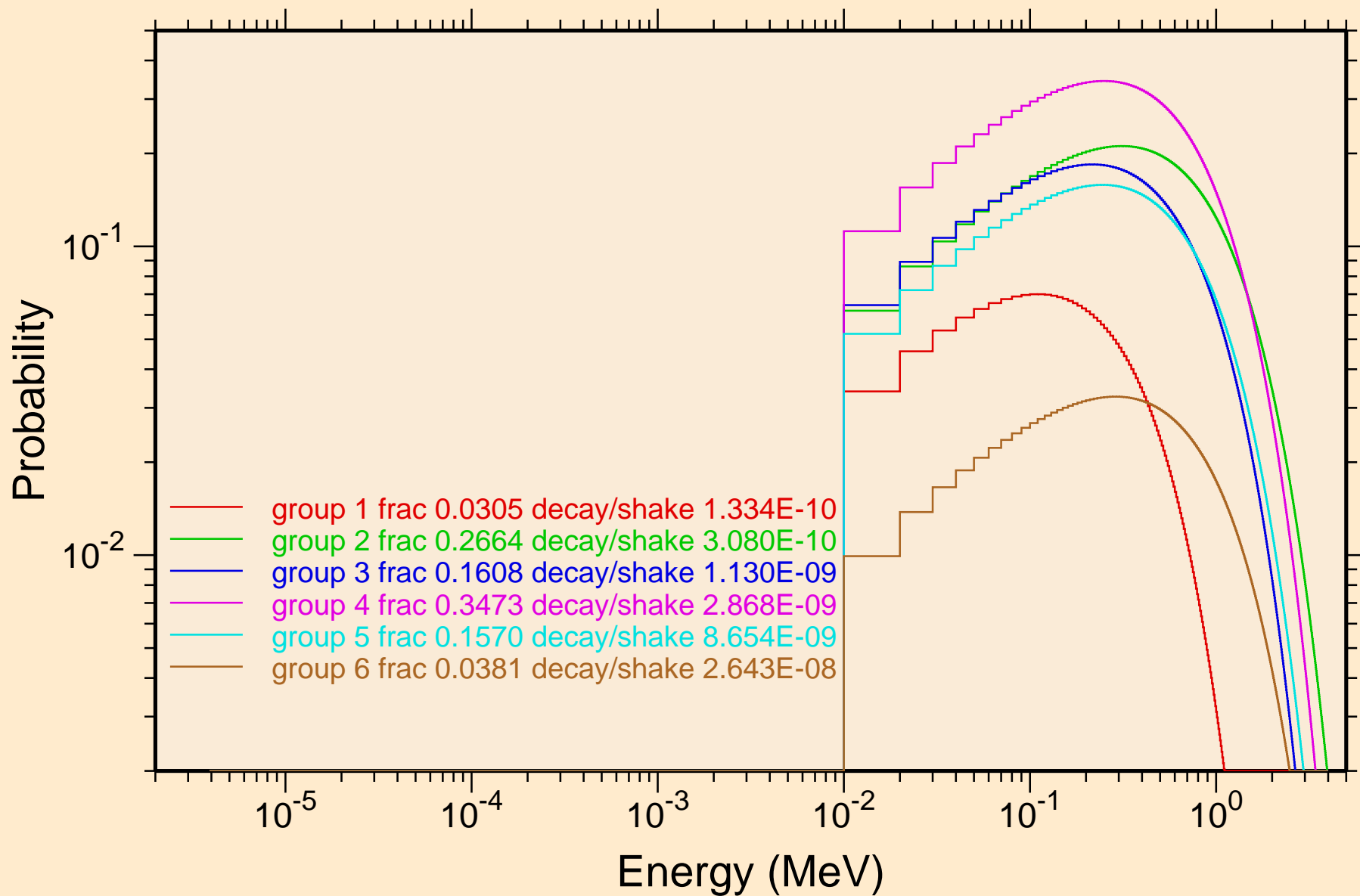

AM236M NEUTRON ACER TENDL-2019 LIBRARY; T=293.16K  
Photon emission for (n,x)

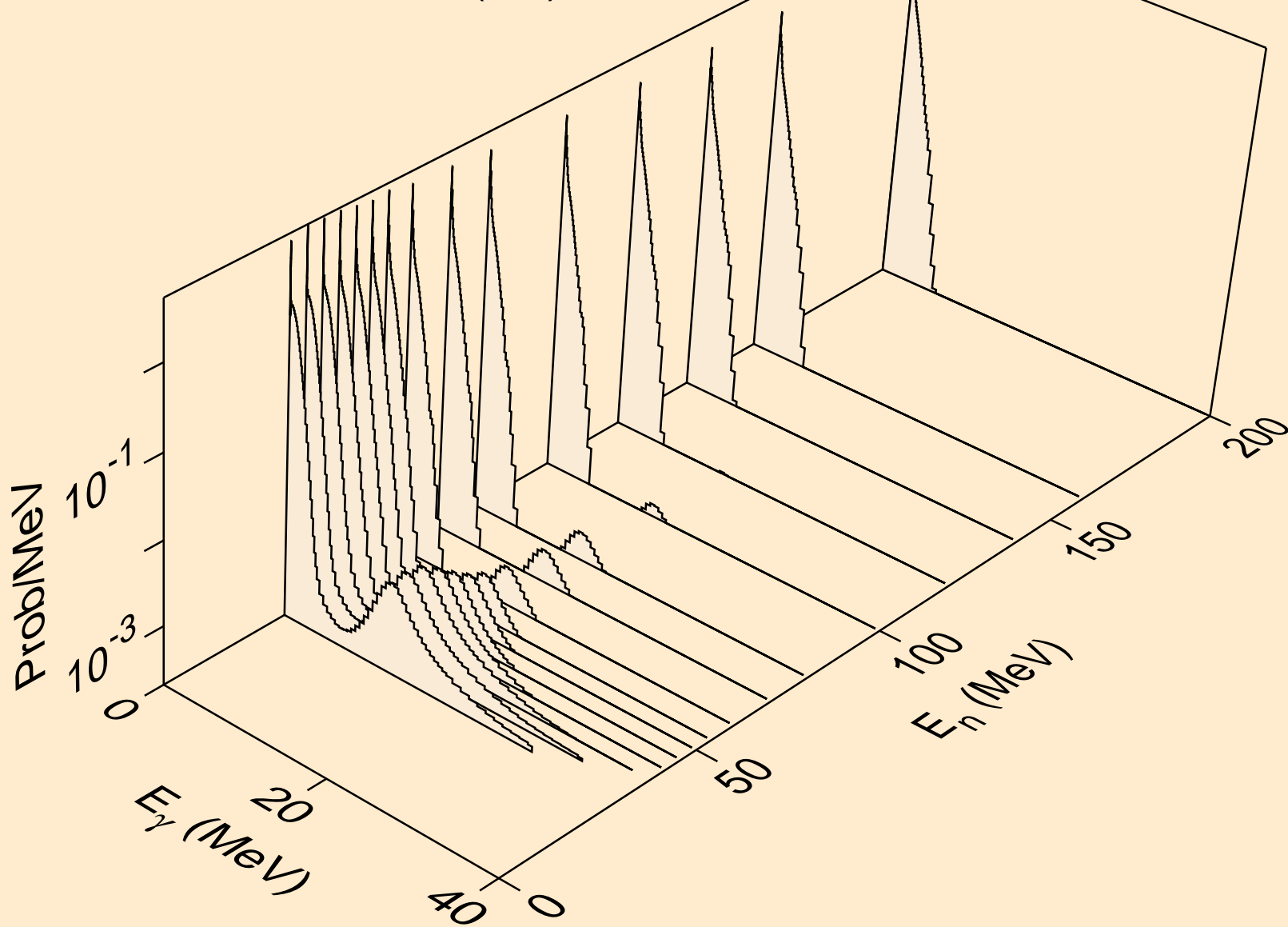

AM236M NEUTRON ACER TENDL-2019 LIBRARY; T=293.16K  
Photon emission for (n,2nd)

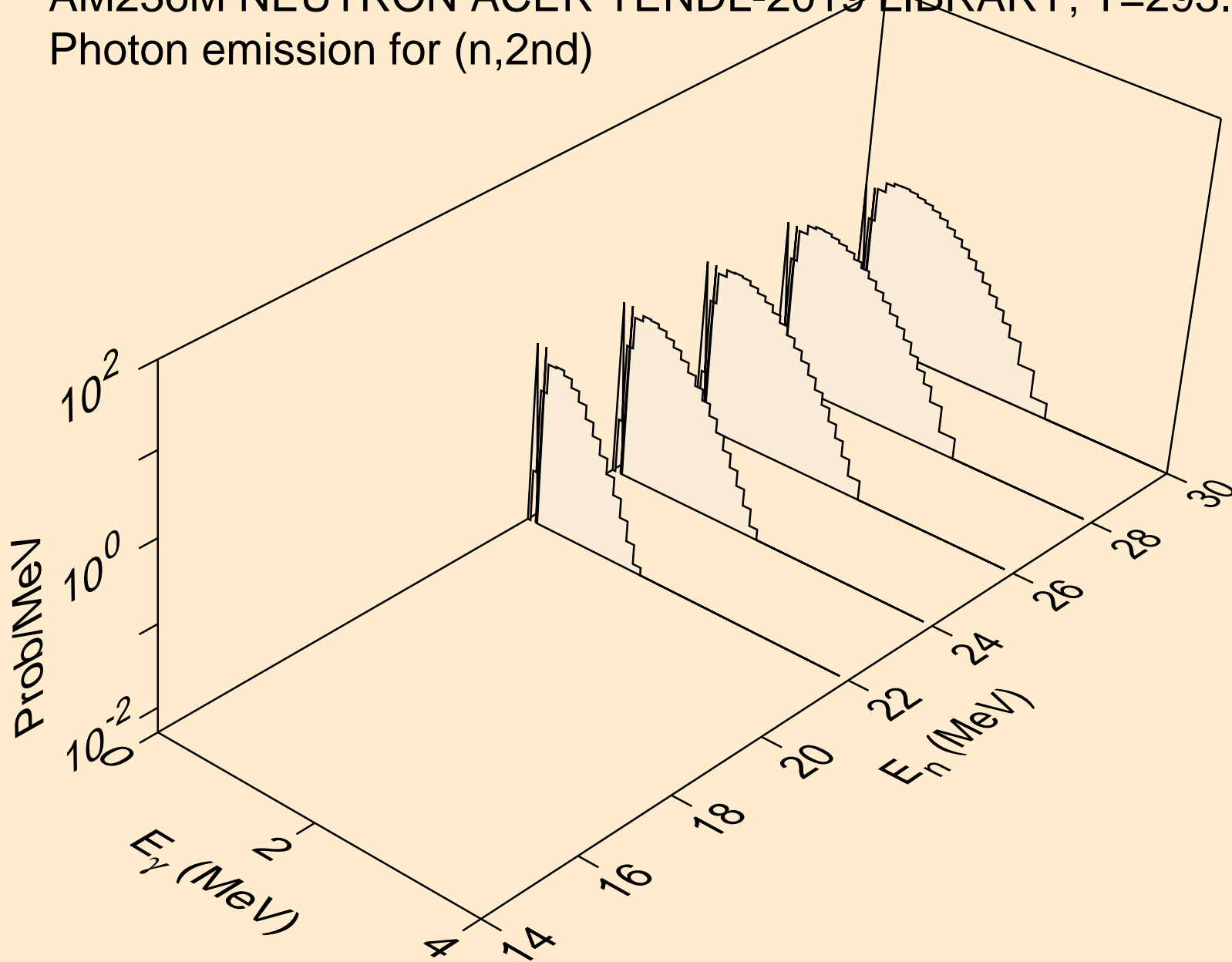

AM236M NEUTRON ACER TENDL-2019 LIBRARY; T=293.16K  
Photon emission for (n,2n)

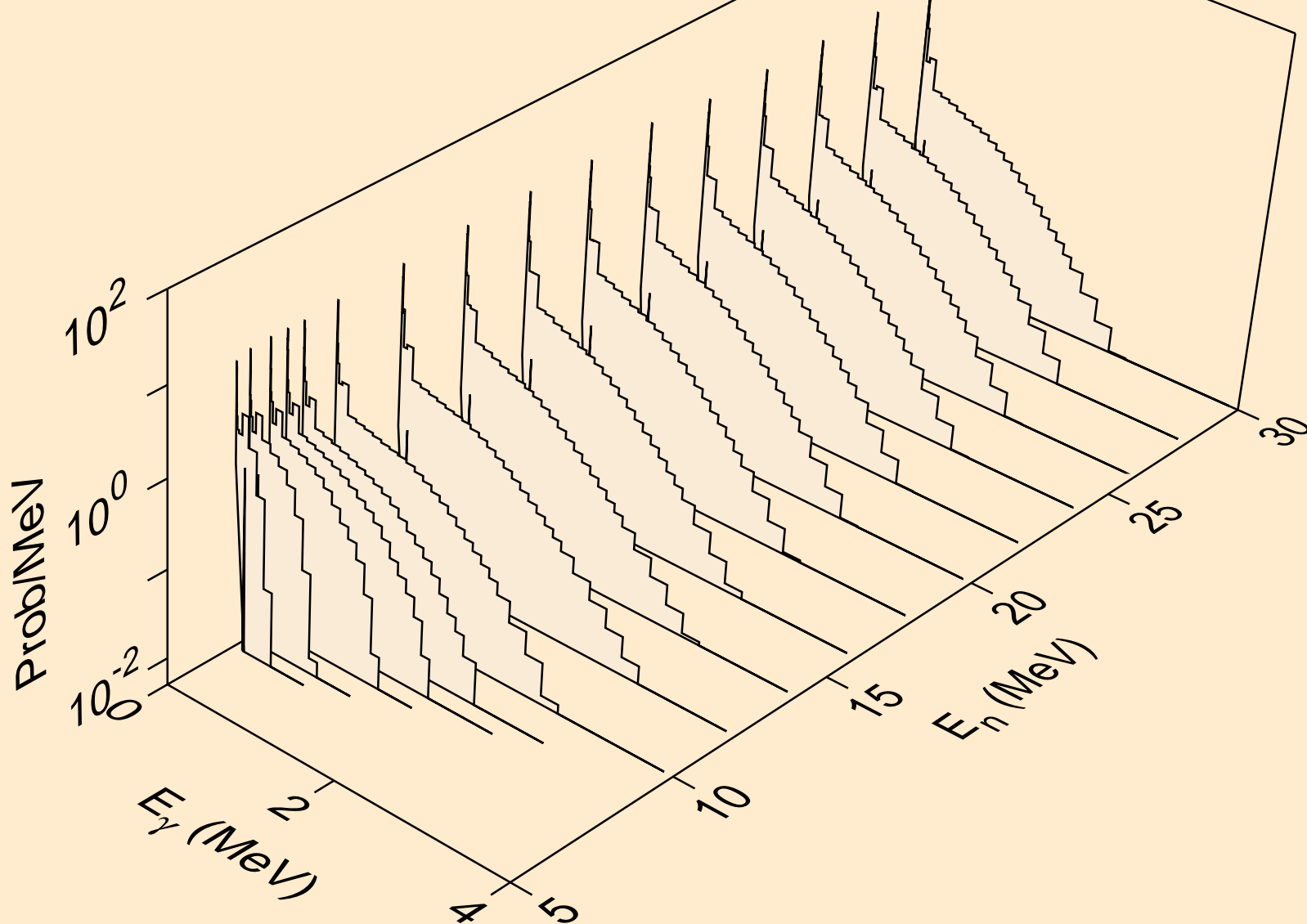

AM236M NEUTRON ACER TENDL-2019 LIBRARY; T=293.16K  
Photon emission for (n,3n)

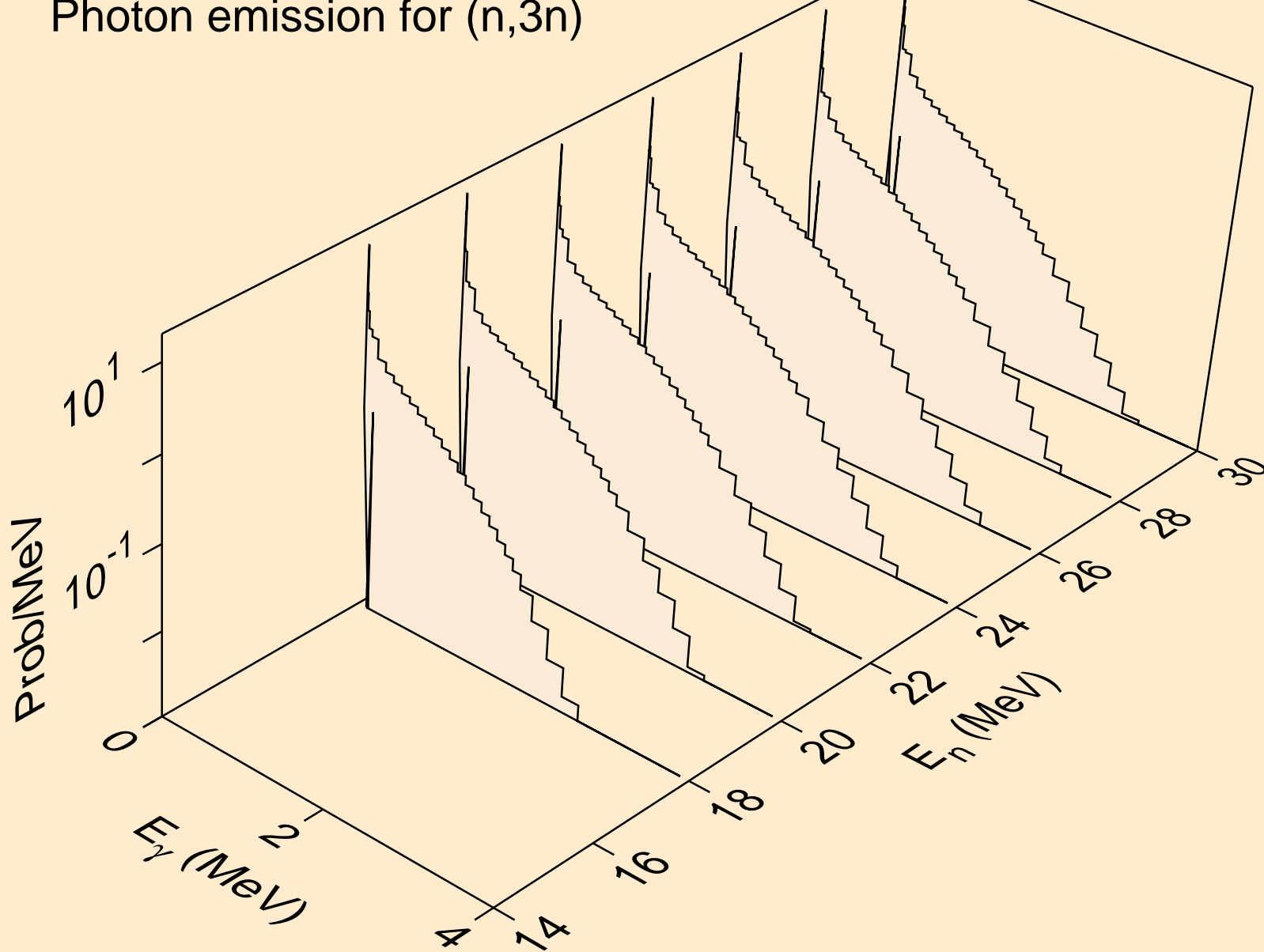

AM236M NEUTRON ACER TENDL-2019 LIBRARY; T=293.16K  
Photon emission for (n,n\*)a

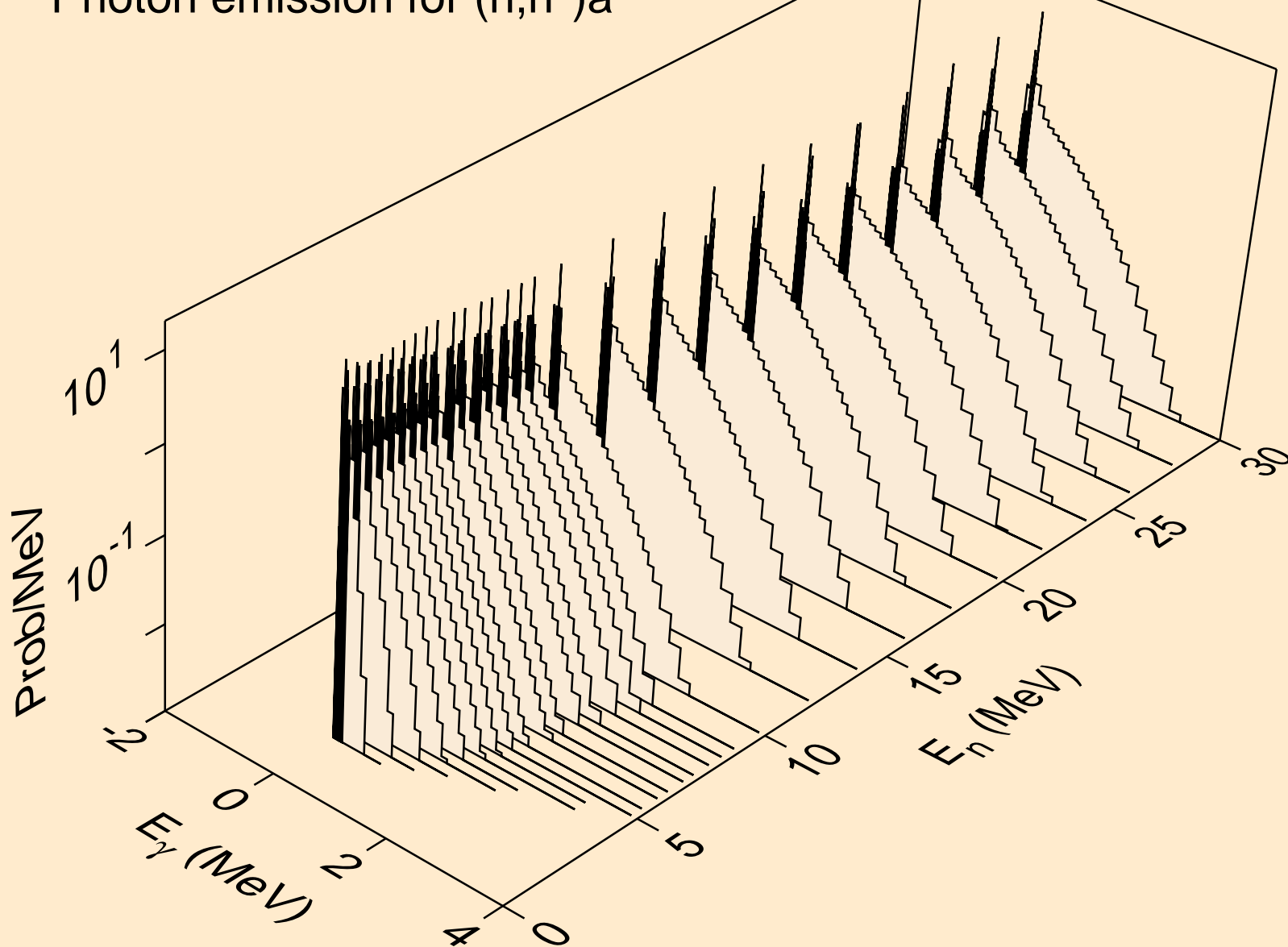



AM236M NEUTRON ACER TENDL-2019 LIBRARY; T=293.16K  
Photon emission for (n,2n)a

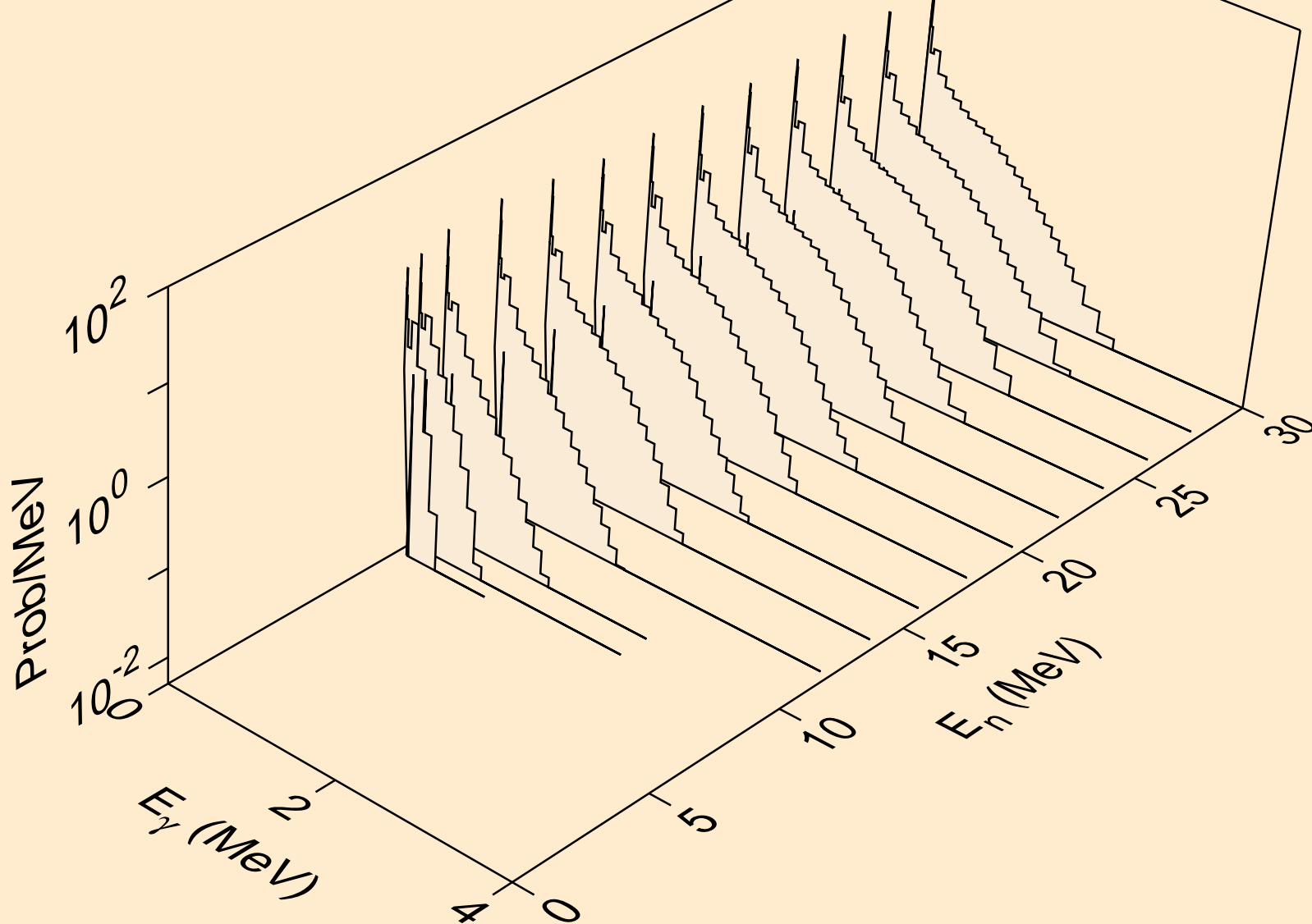

AM236M NEUTRON ACER TENDL-2019 LIBRARY; T=293.16K  
Photon emission for (n,3n)a

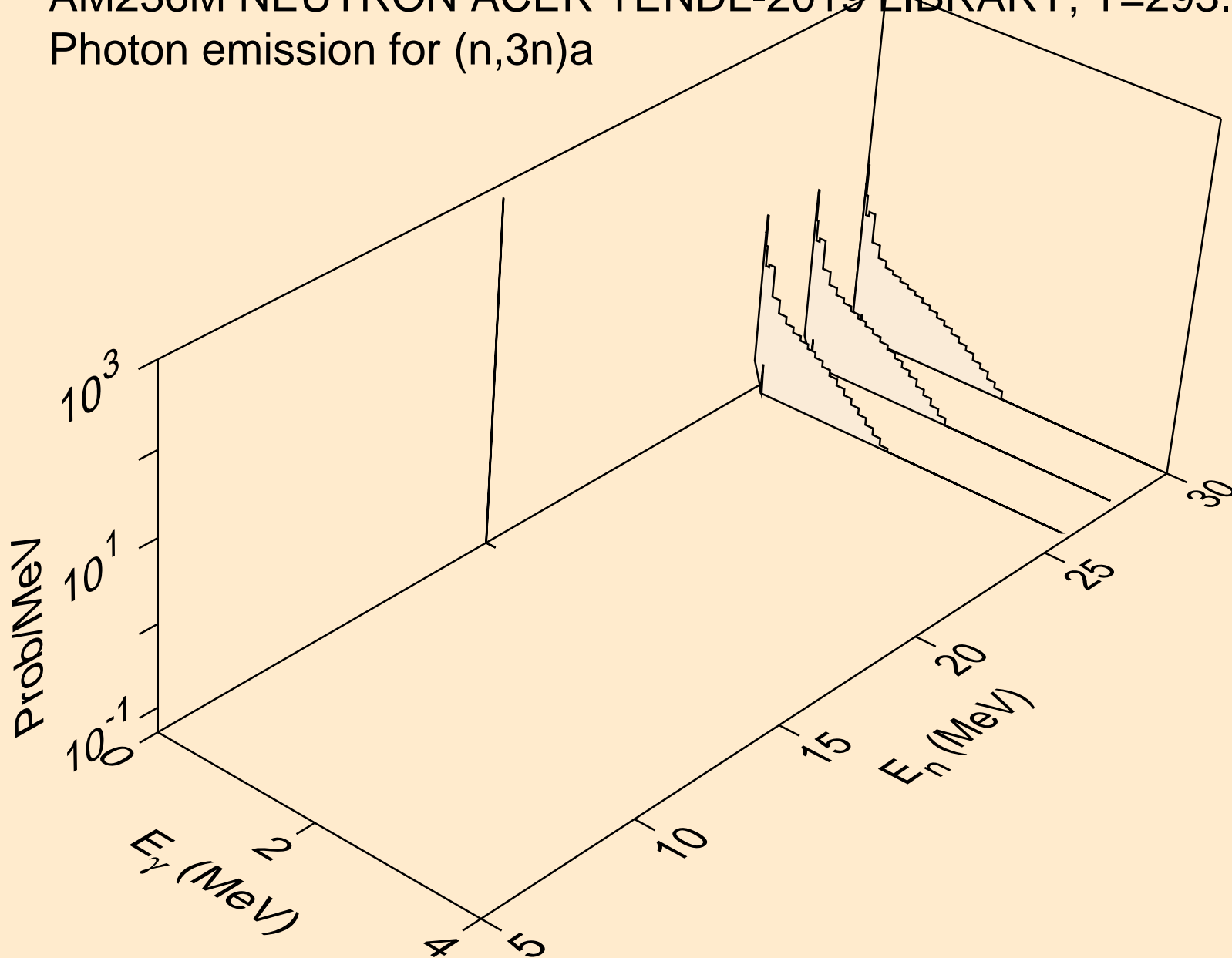

AM236M NEUTRON ACER TENDL-2019 LIBRARY; T=293.16K  
Photon emission for (n,n\*)p

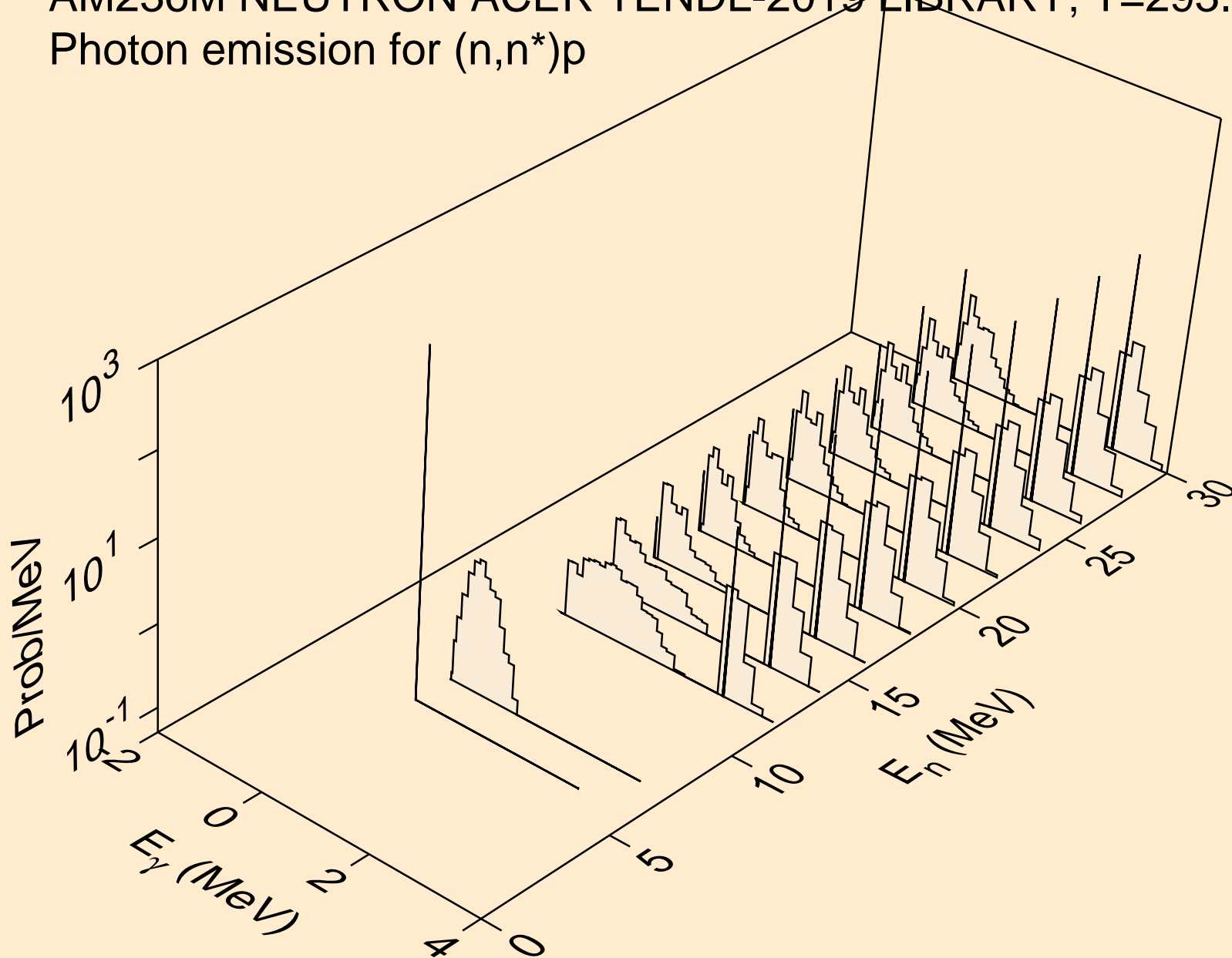

AM236M NEUTRON ACER TENDL-2019 LIBRARY; T=293.16K  
Photon emission for (n,n\*)2a

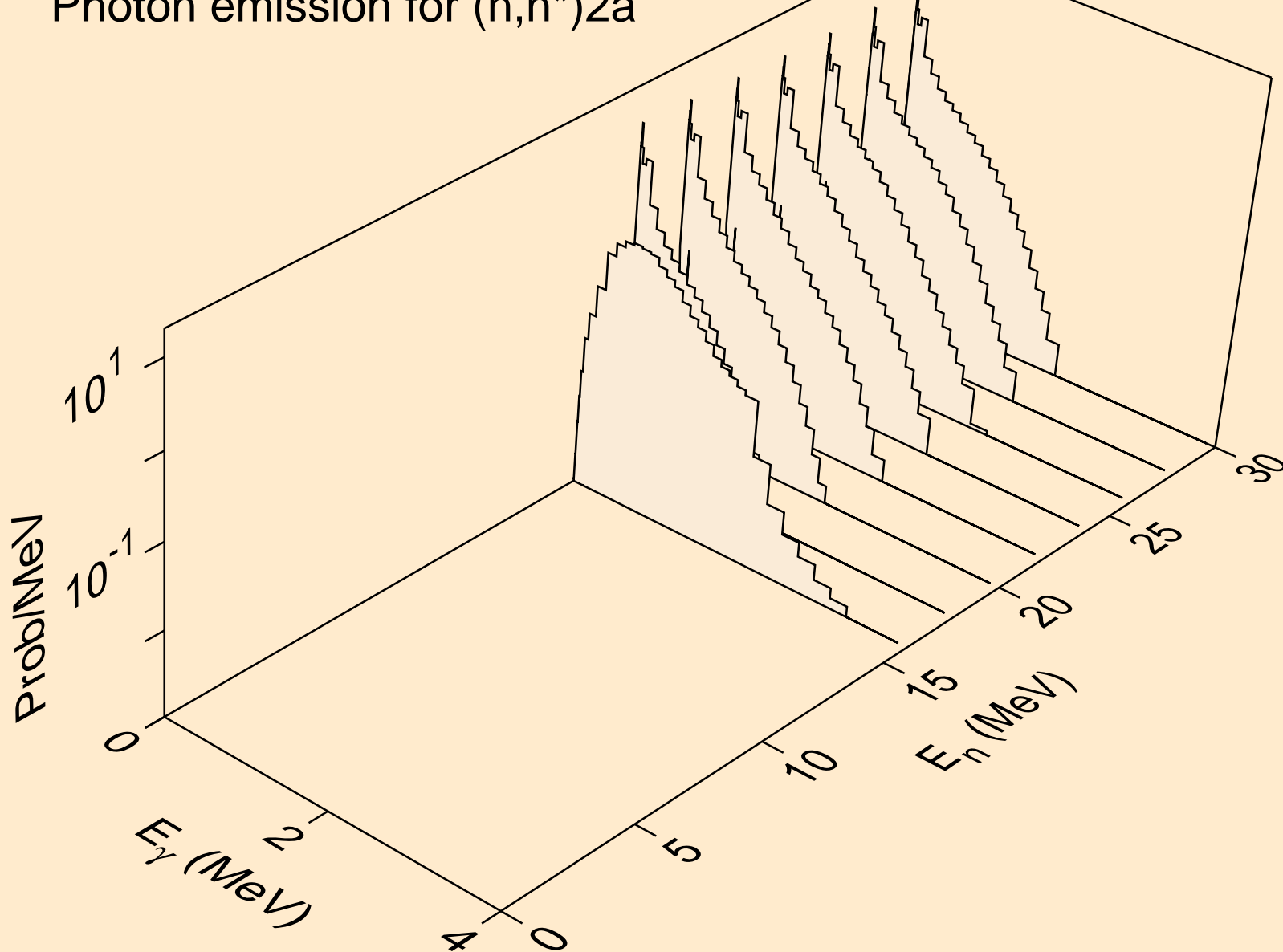

AM236M NEUTRON ACER TENDL-2019 LIBRARY; T=293.16K  
Photon emission for (n,n\*)d

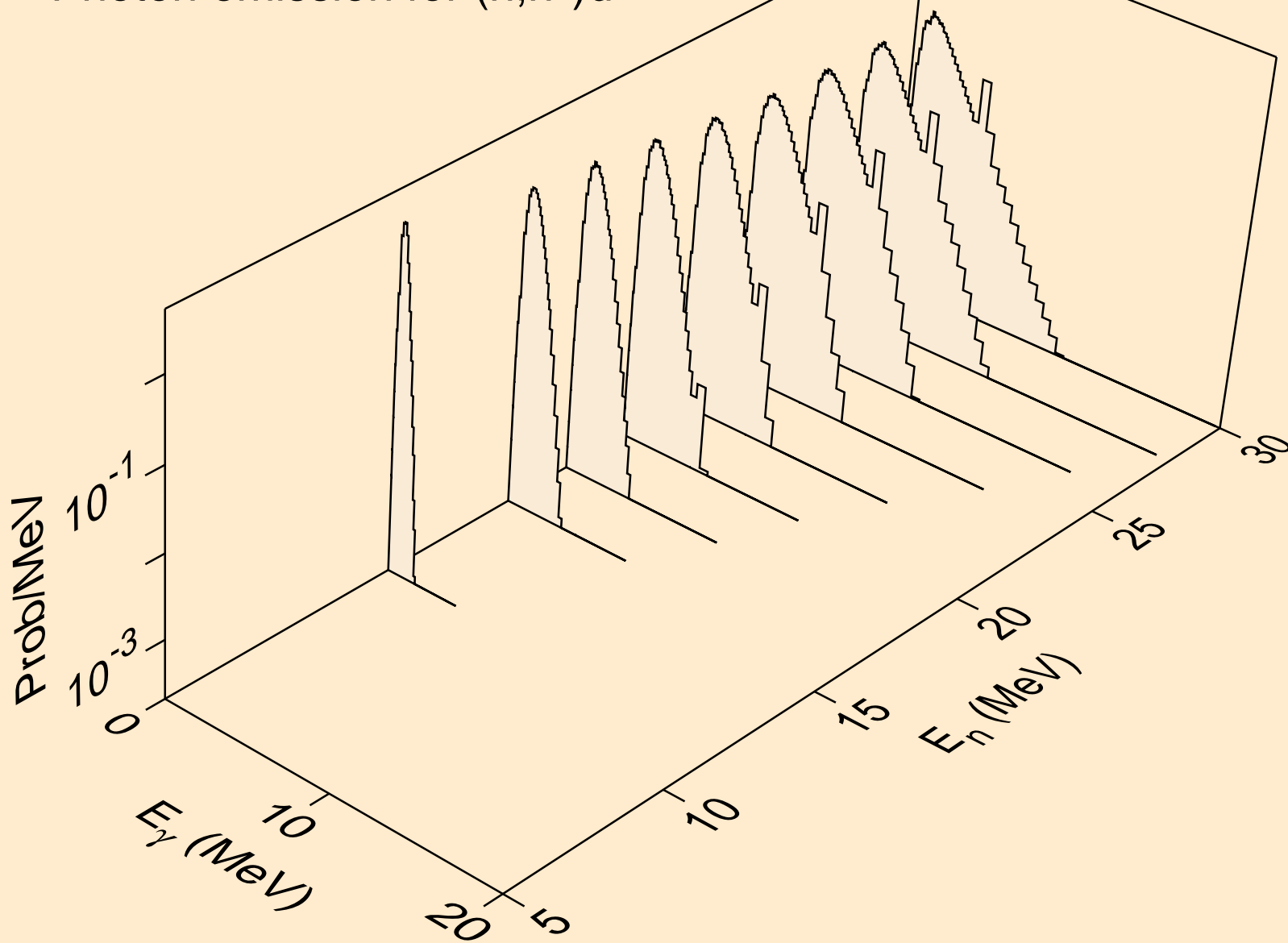

AM236M NEUTRON ACER TENDL-2019 LIBRARY; T=293.16K  
Photon emission for (n,n\*)t

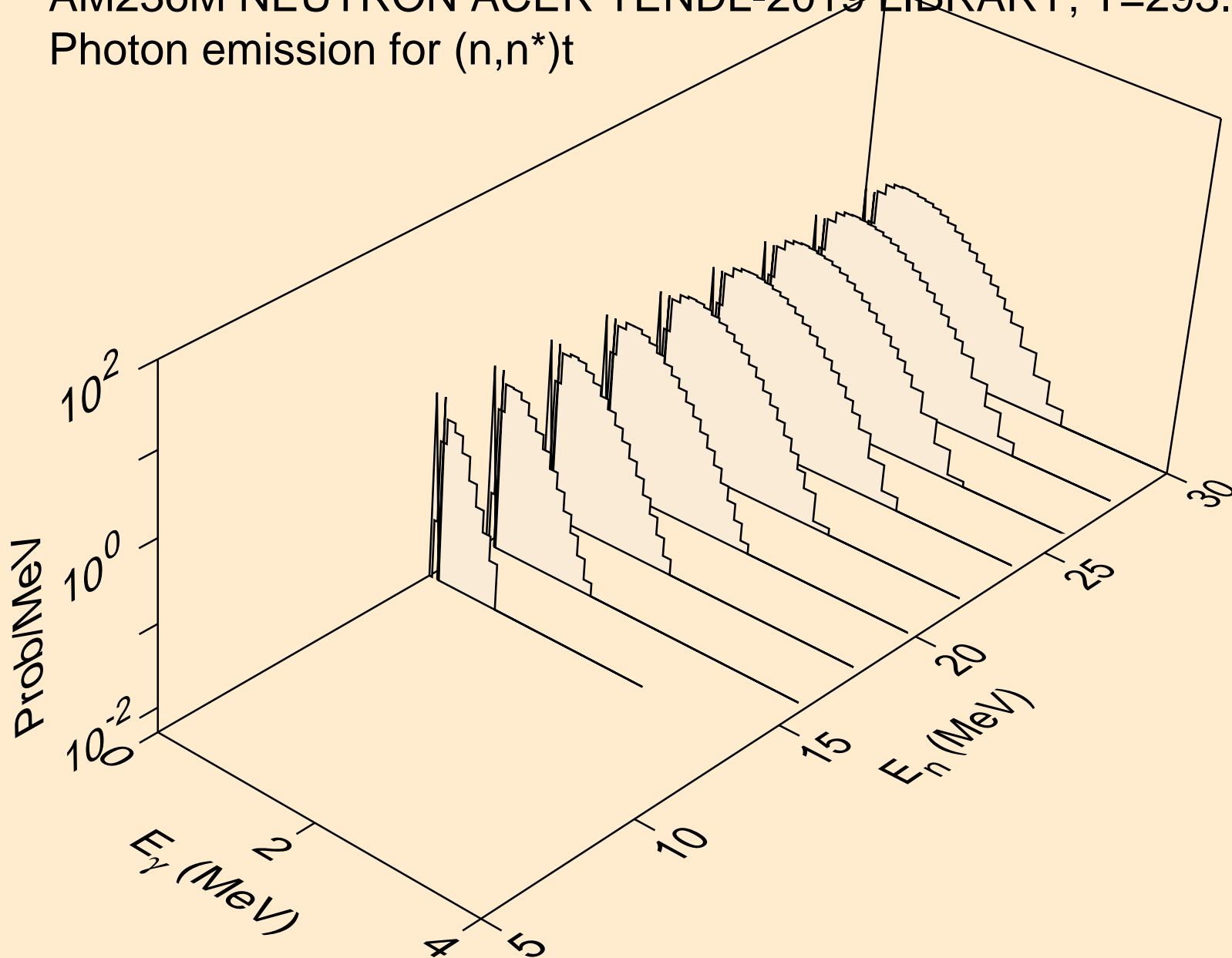

AM236M NEUTRON ACER TENDL-2019 LIBRARY; T=293.16K  
Photon emission for (n,n\*)he3

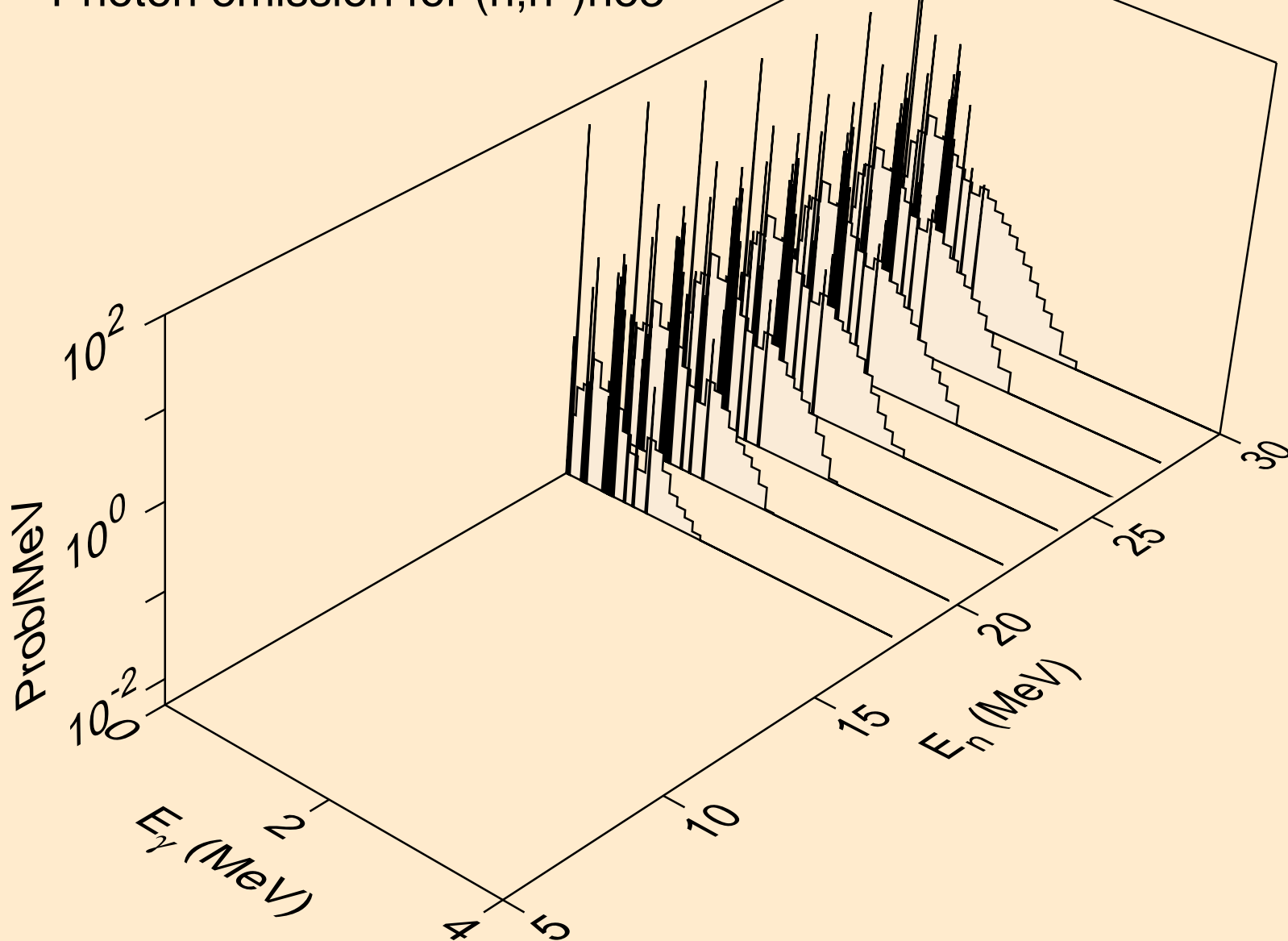

AM236M NEUTRON ACER TENDL-2019 LIBRARY; T=293.16K  
Photon emission for (n,4n)

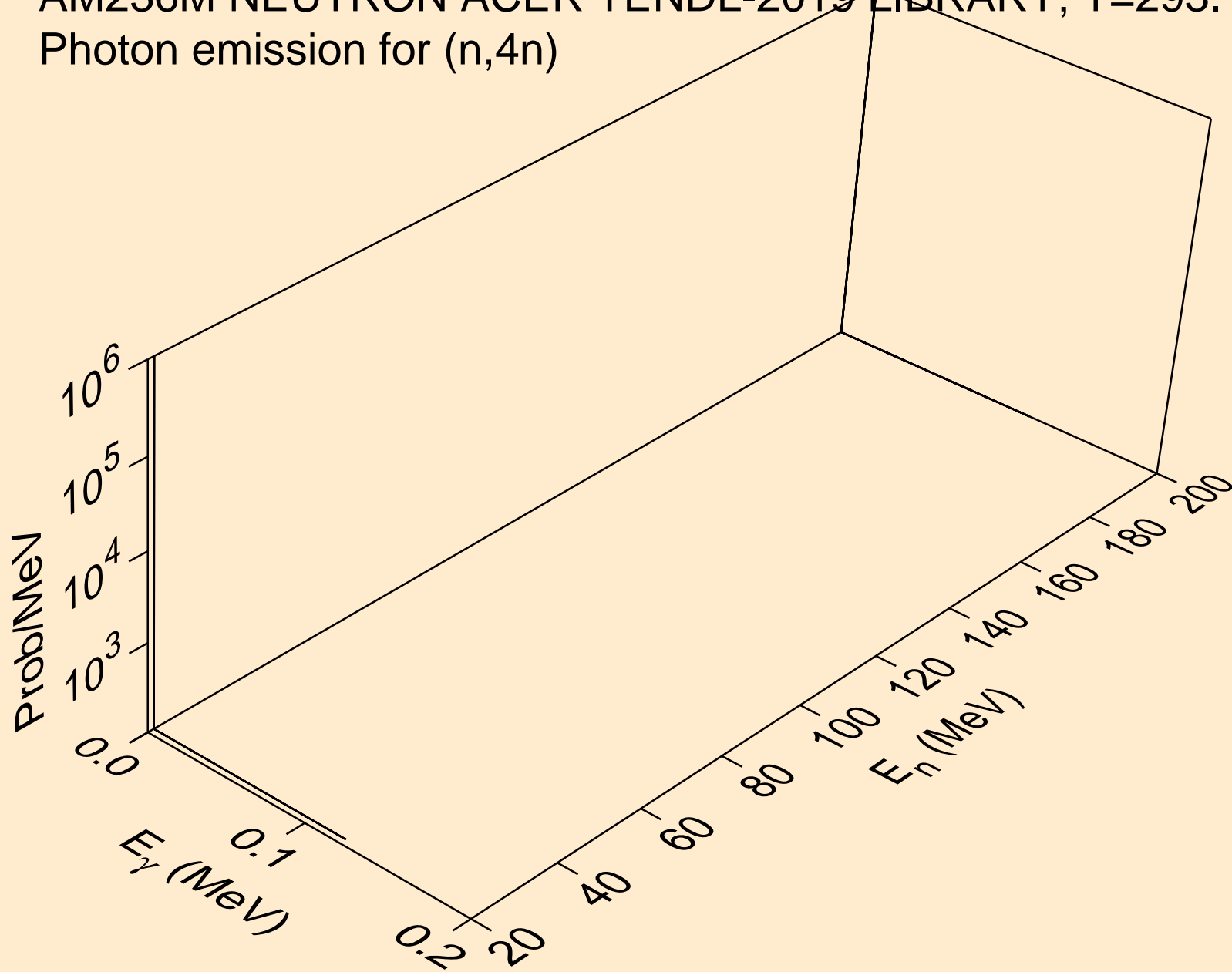



AM236M NEUTRON ACER TENDL-2019 LIBRARY; T=293.16K  
Photon emission for (n,2np)

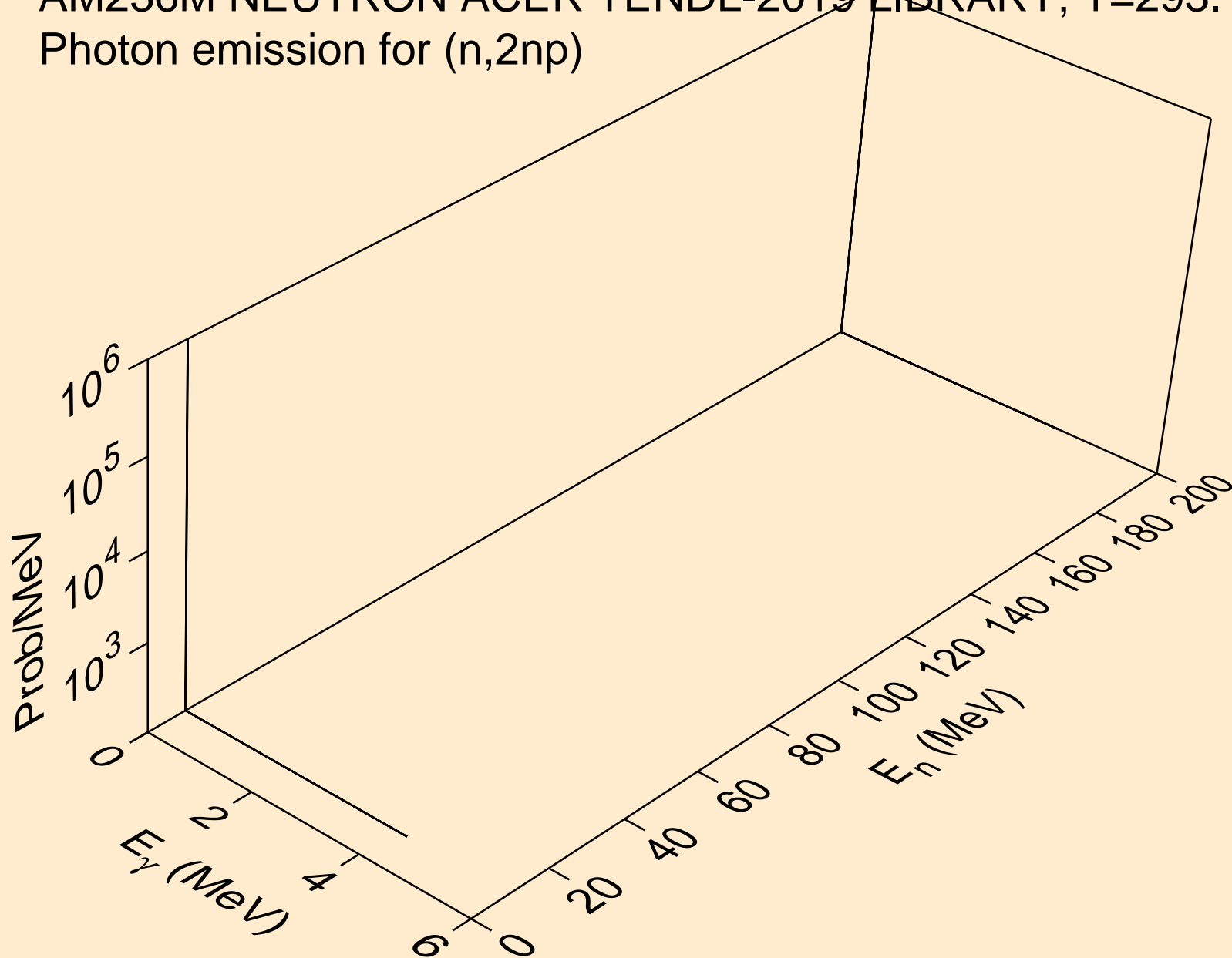

AM236M NEUTRON ACER TENDL-2019 LIBRARY; T=293.16K  
Photon emission for (n,3np)

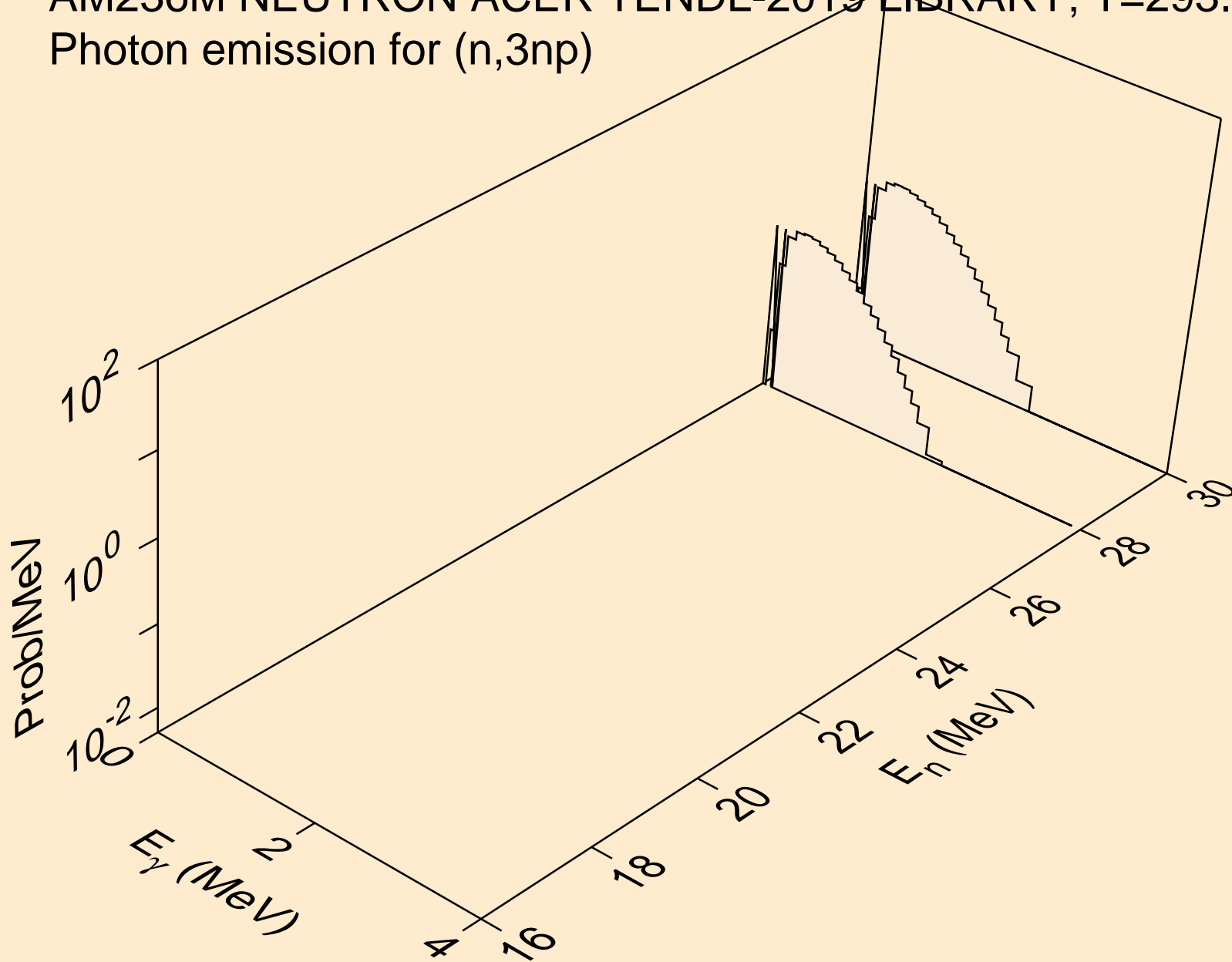

AM236M NEUTRON ACER TENDL-2019 LIBRARY; T=293.16K  
Photon emission for (n,2np)

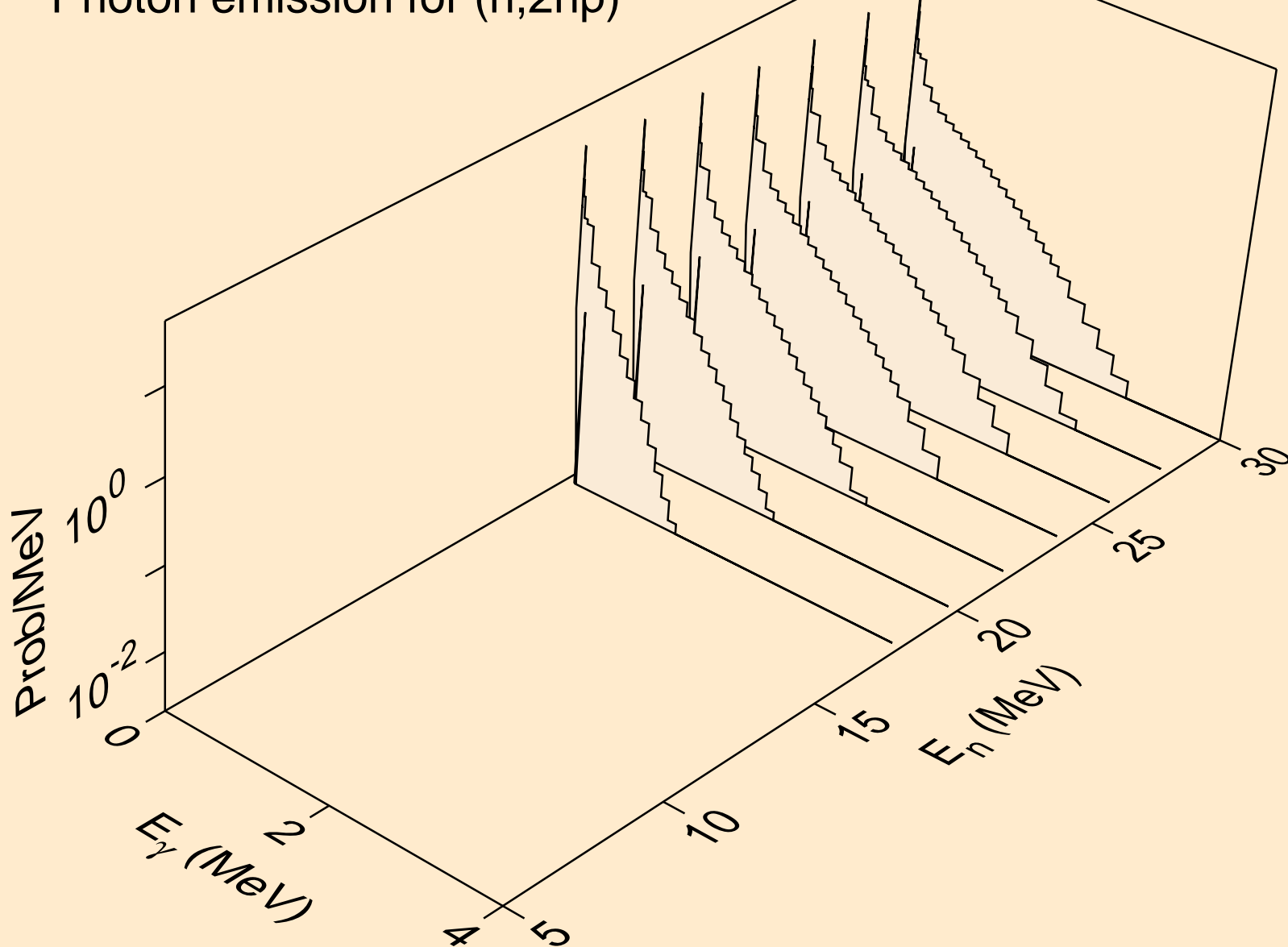

AM236M NEUTRON ACER TENDL-2019 LIBRARY; T=293.16K  
Photon emission for (n,npa)

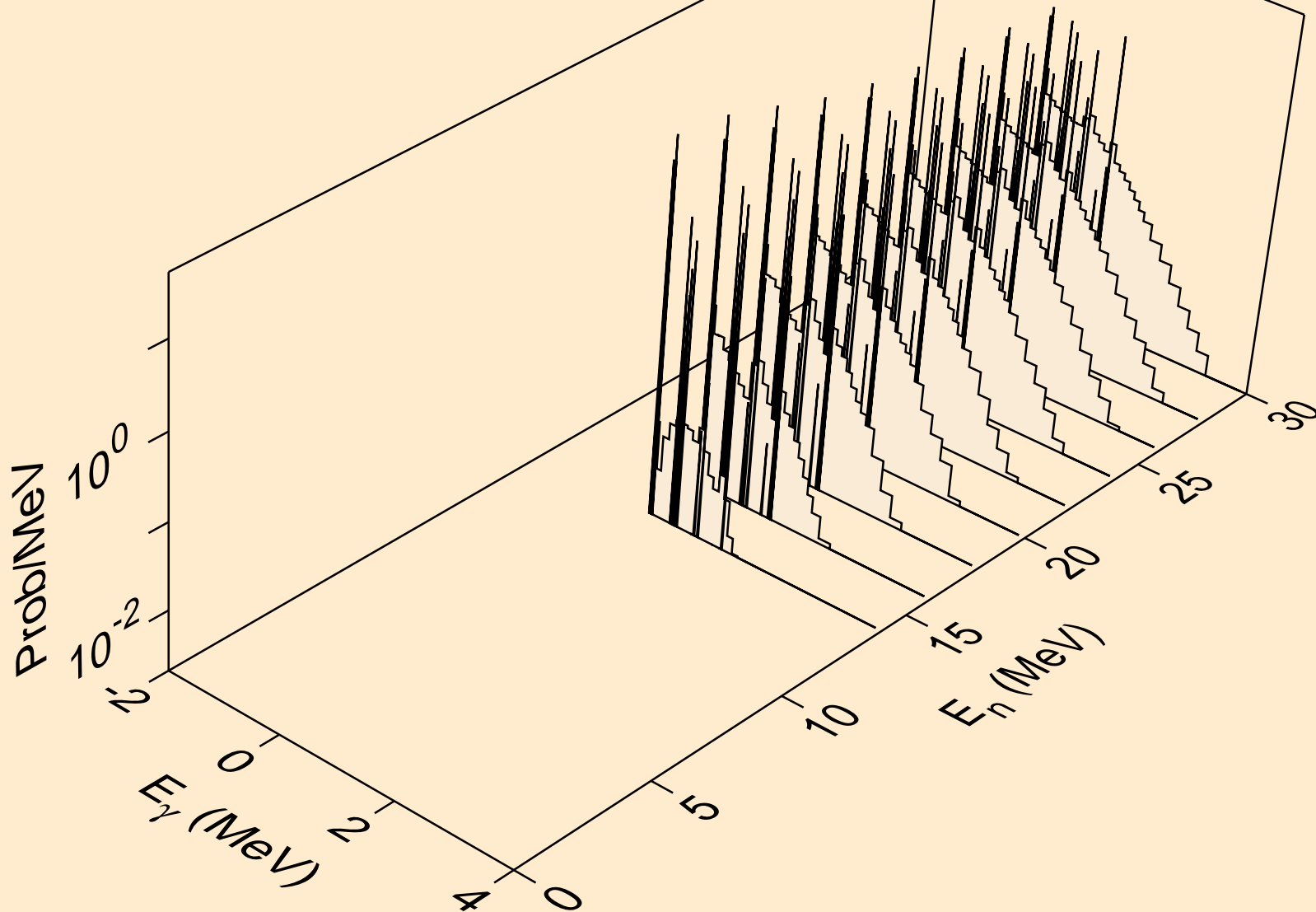

AM236M NEUTRON ACER TENDL-2019 LIBRARY; T=293.16K  
Photon emission for (n,n\*2)

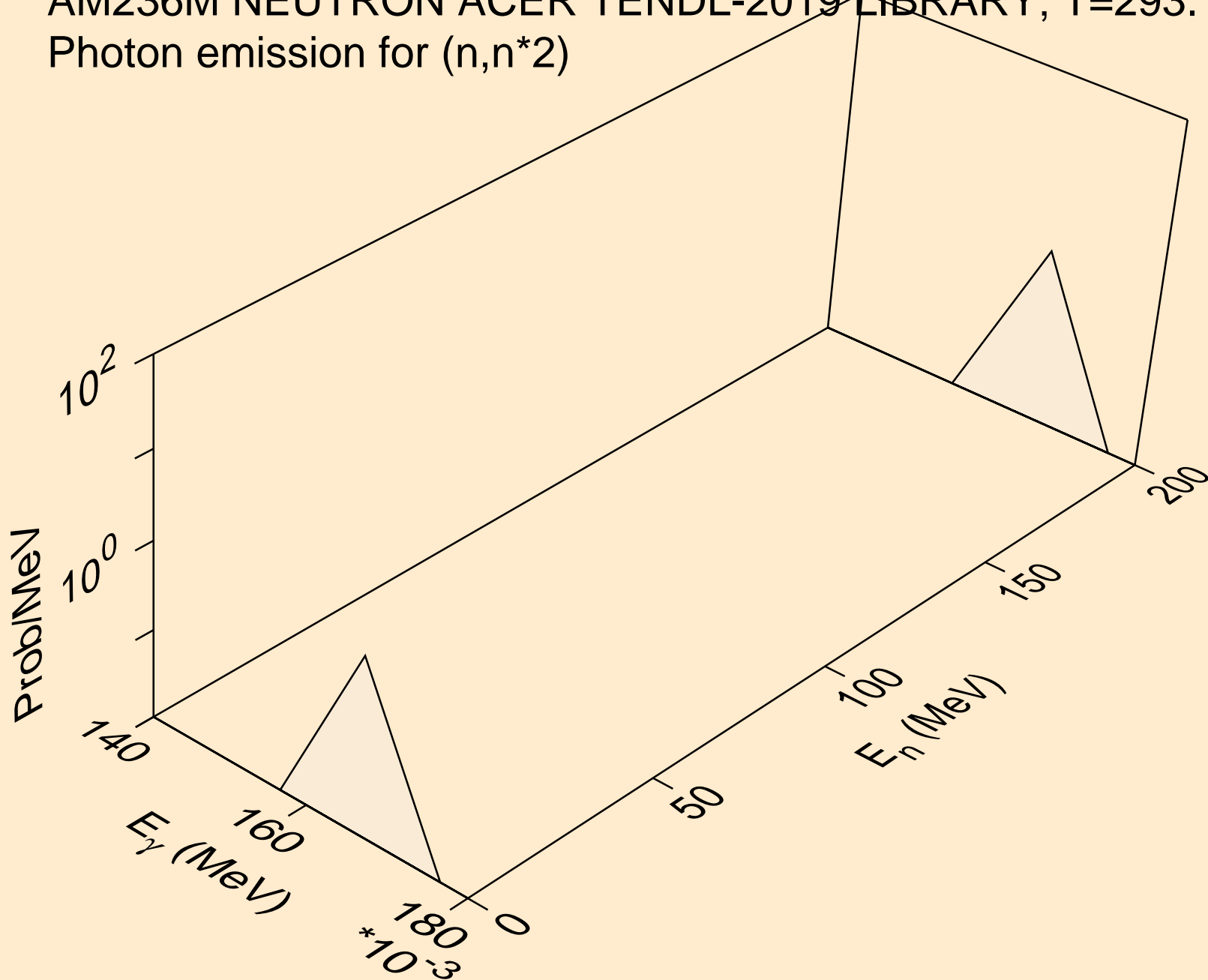

AM236M NEUTRON ACER TENDL-2019 LIBRARY; T=293.16K  
Photon emission for (n,n\*c)

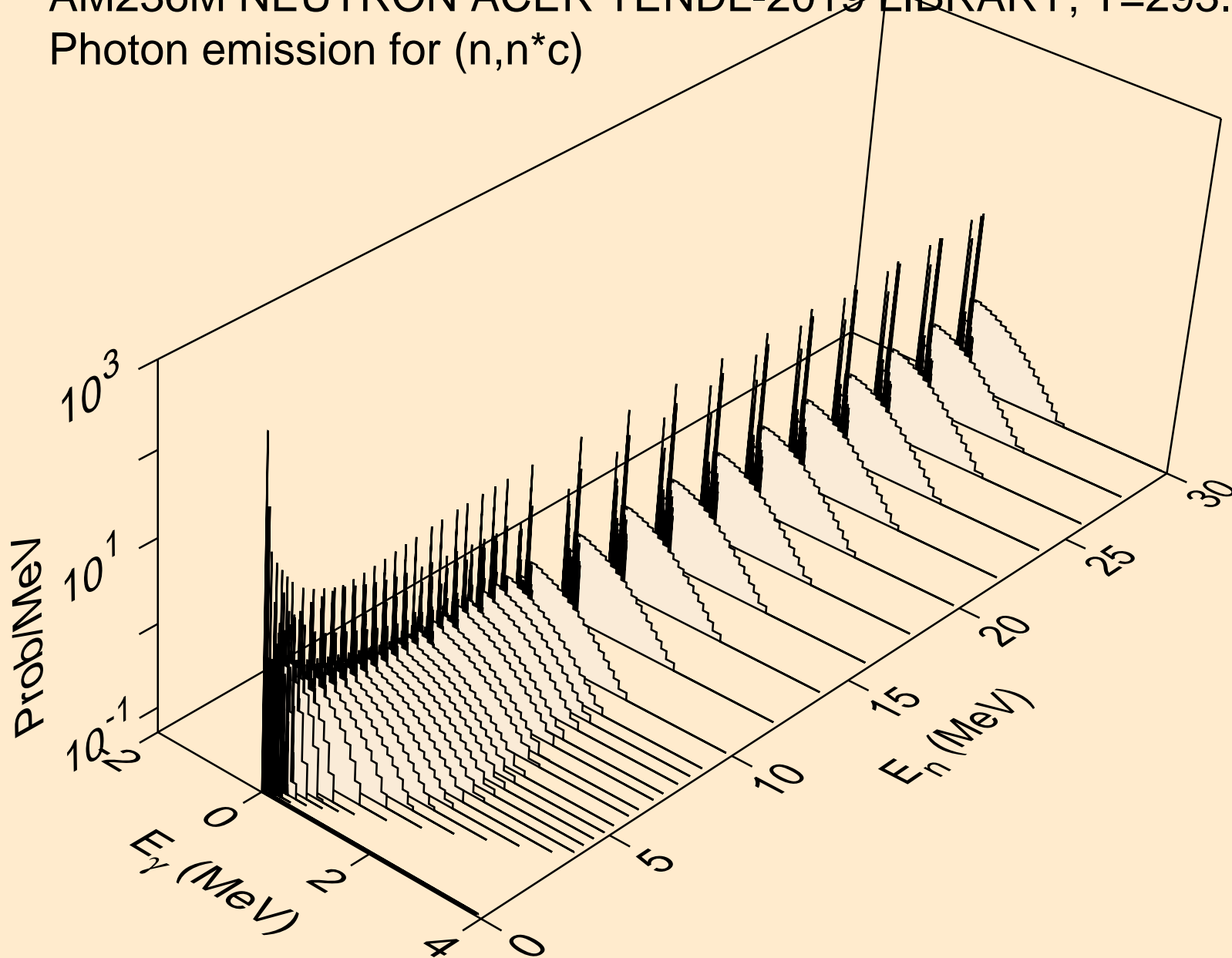

AM236M NEUTRON ACER TENDL-2019 LIBRARY; T=293.16K  
Photon emission for (n,gma)

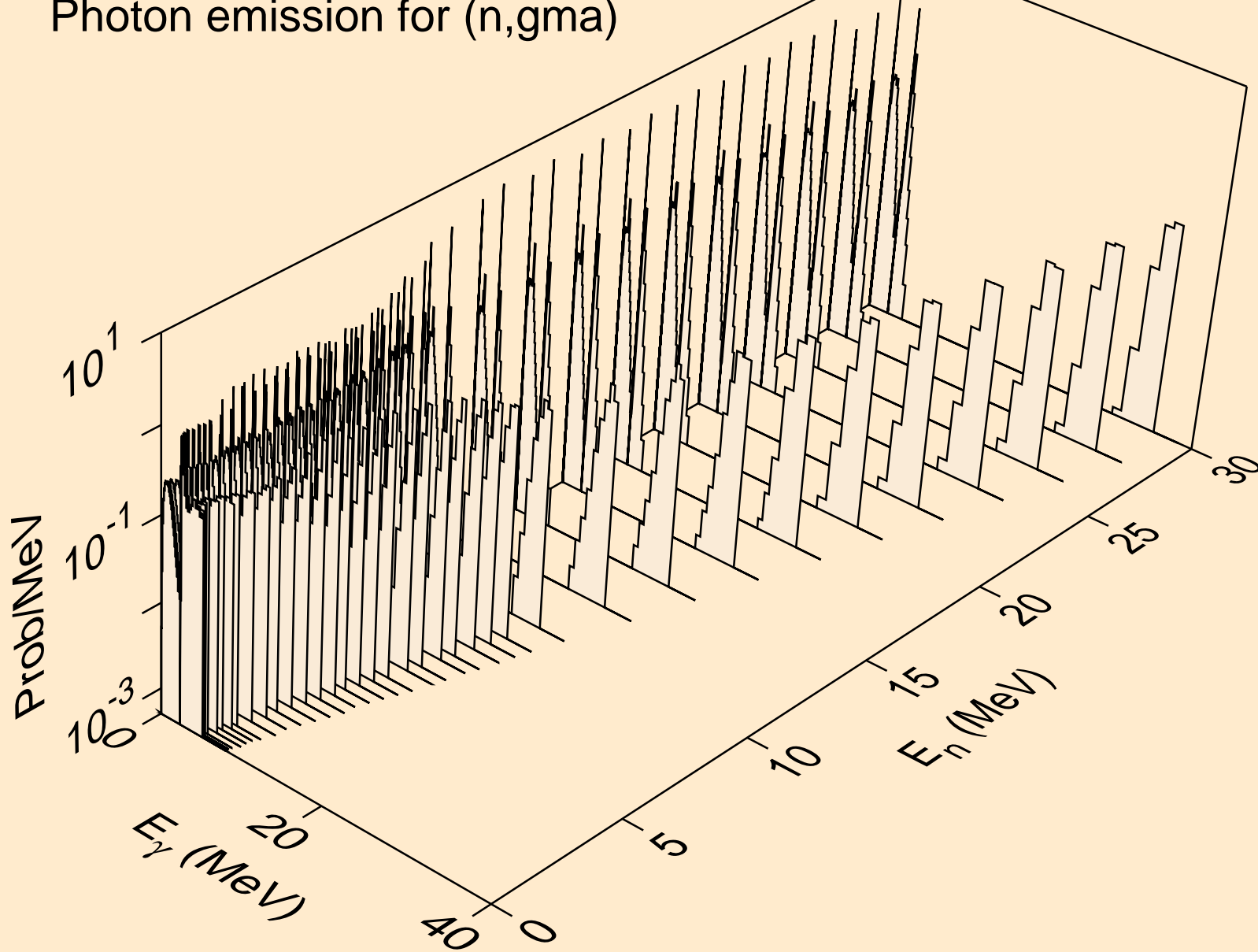

AM236M NEUTRON ACER TENDL-2019 LIBRARY; T=293.16K  
Photon emission for (n,p)

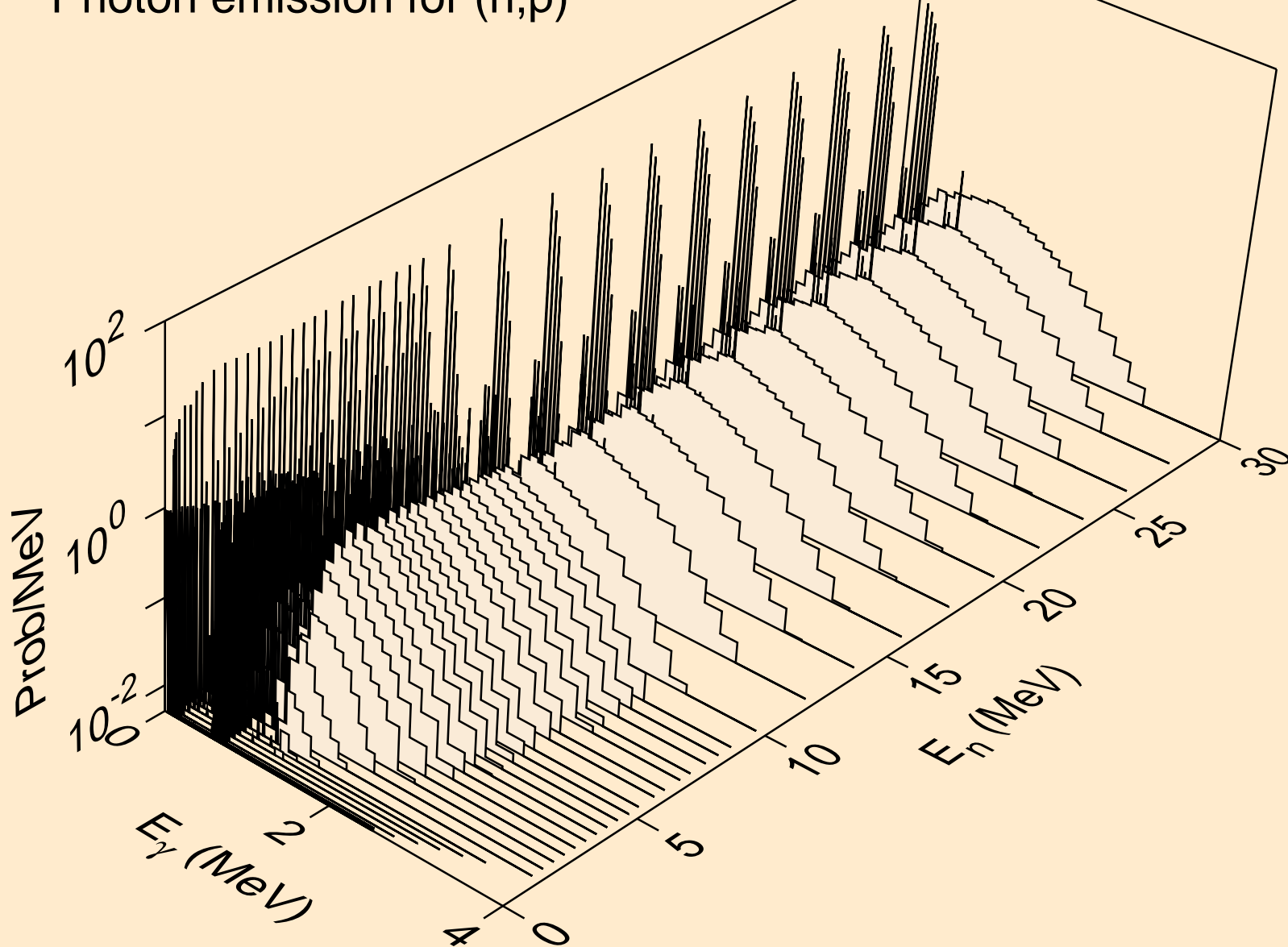



AM236M NEUTRON ACER TENDL-2019 LIBRARY; T=293.16K  
Photon emission for (n,d)

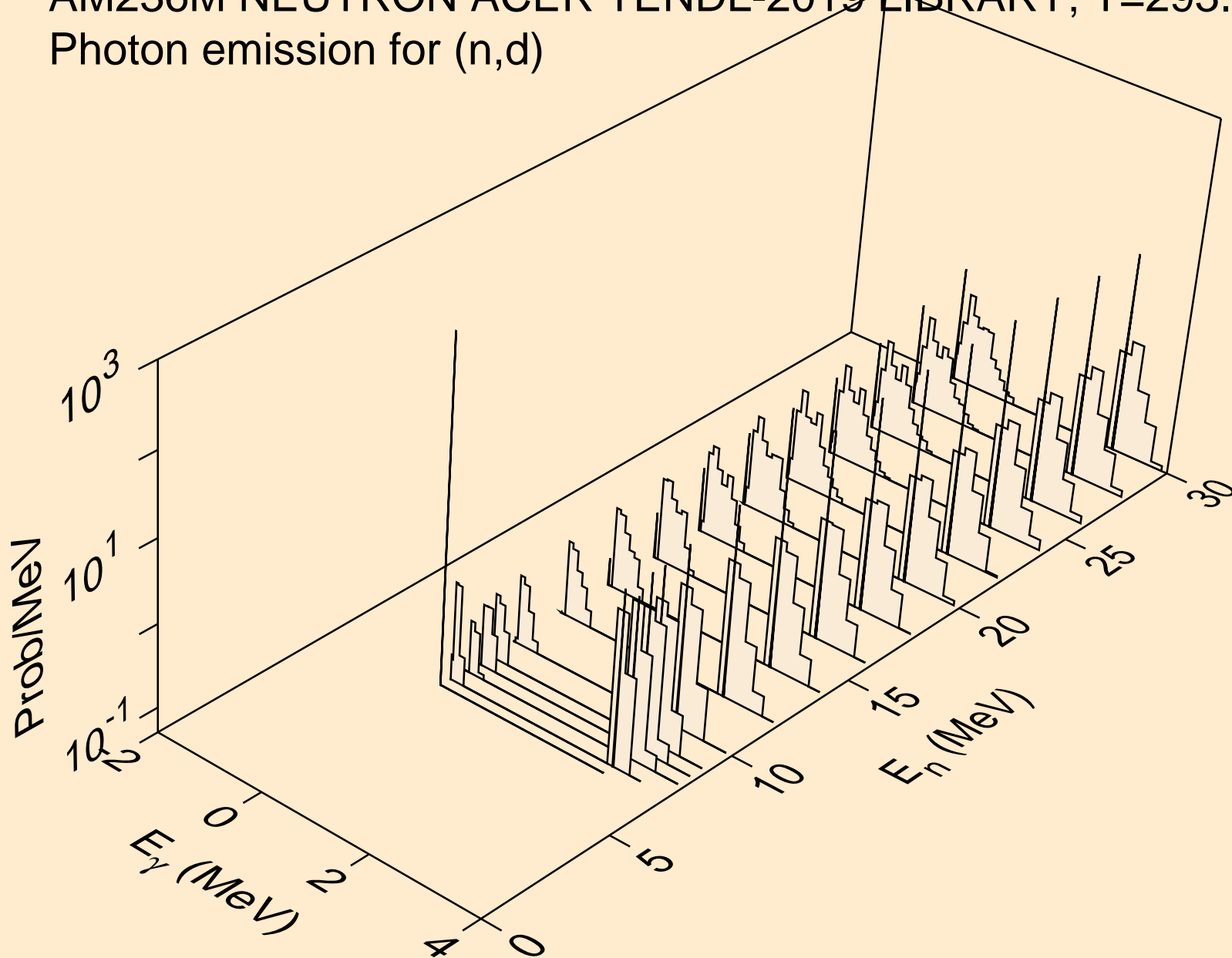

AM236M NEUTRON ACER TENDL-2019 LIBRARY; T=293.16K  
Photon emission for (n,t)

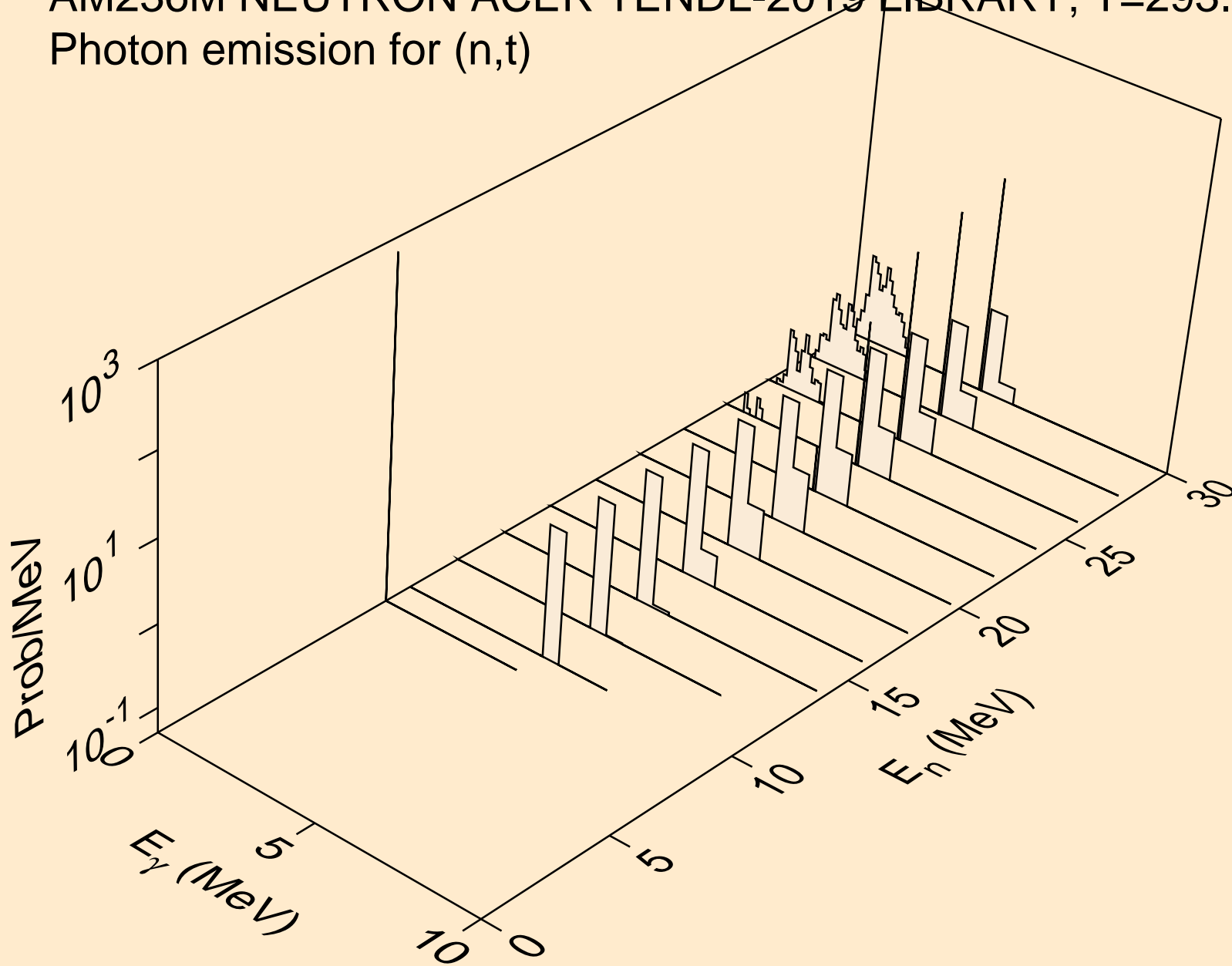

AM236M NEUTRON ACER TENDL-2019 LIBRARY; T=293.16K  
Photon emission for (n,he3)

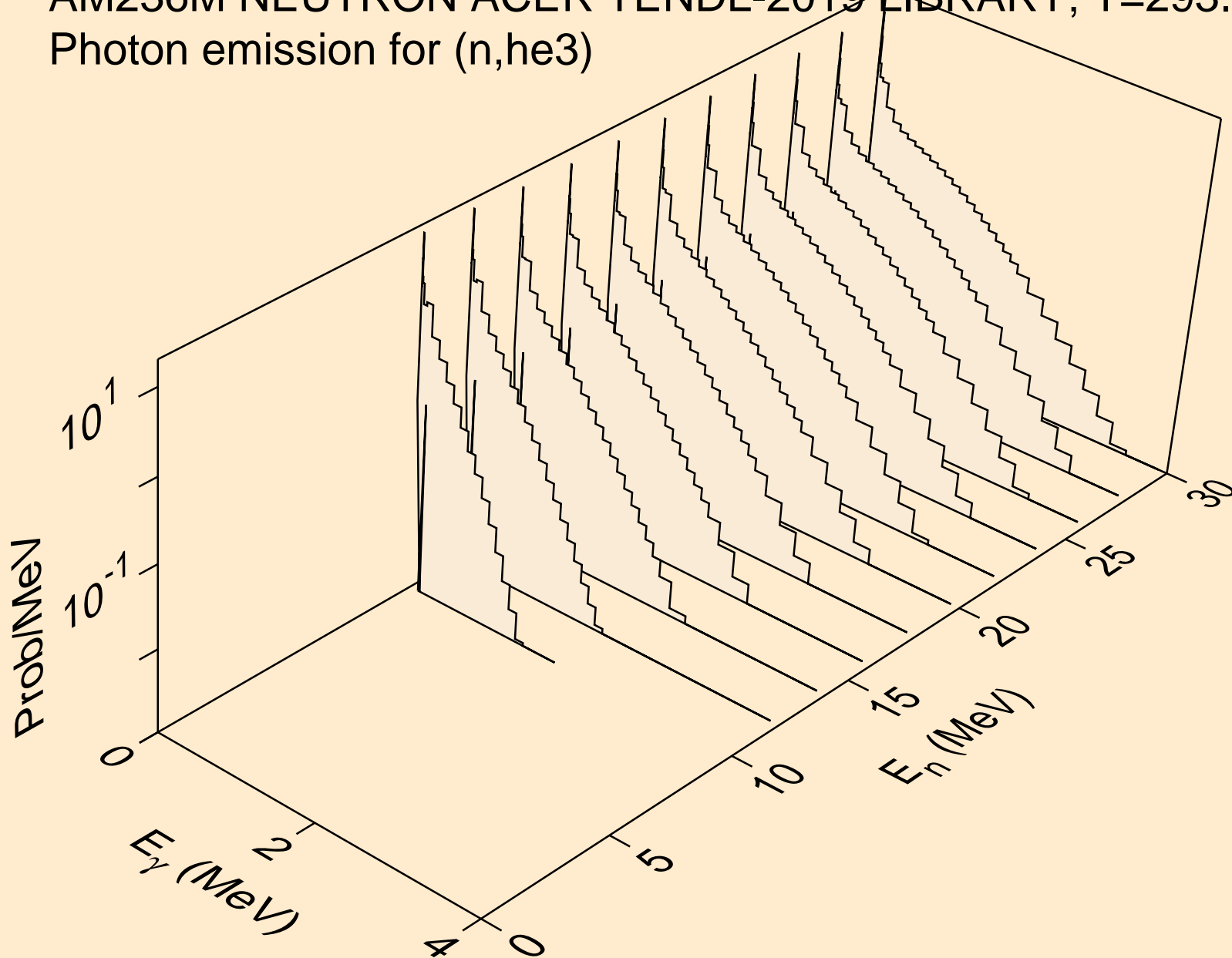

AM236M NEUTRON ACER TENDL-2019 LIBRARY; T=293.16K  
Photon emission for (n,a)

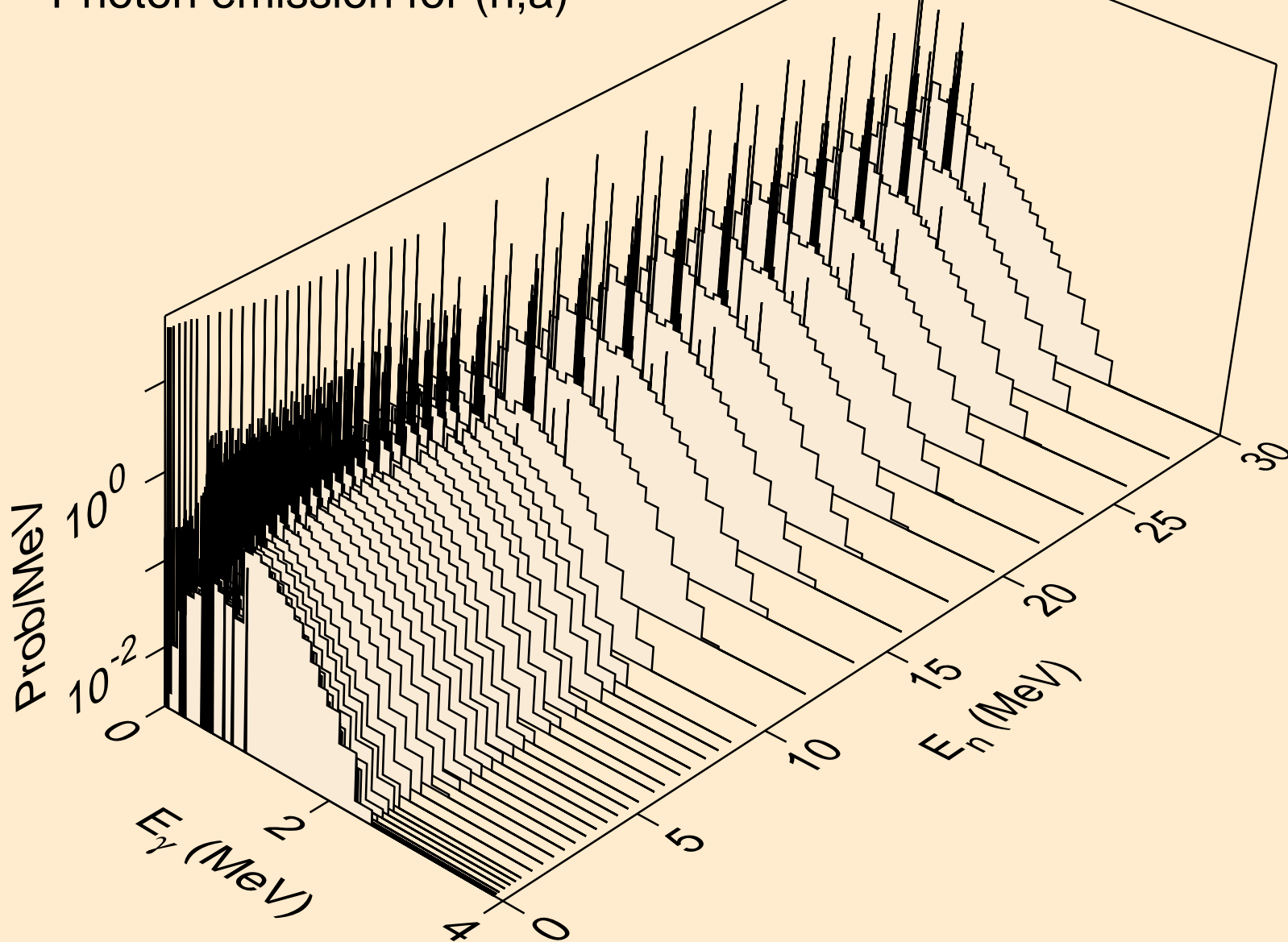

AM236M NEUTRON ACER TENDL-2019 LIBRARY; T=293.16K  
Photon emission for (n,2a)

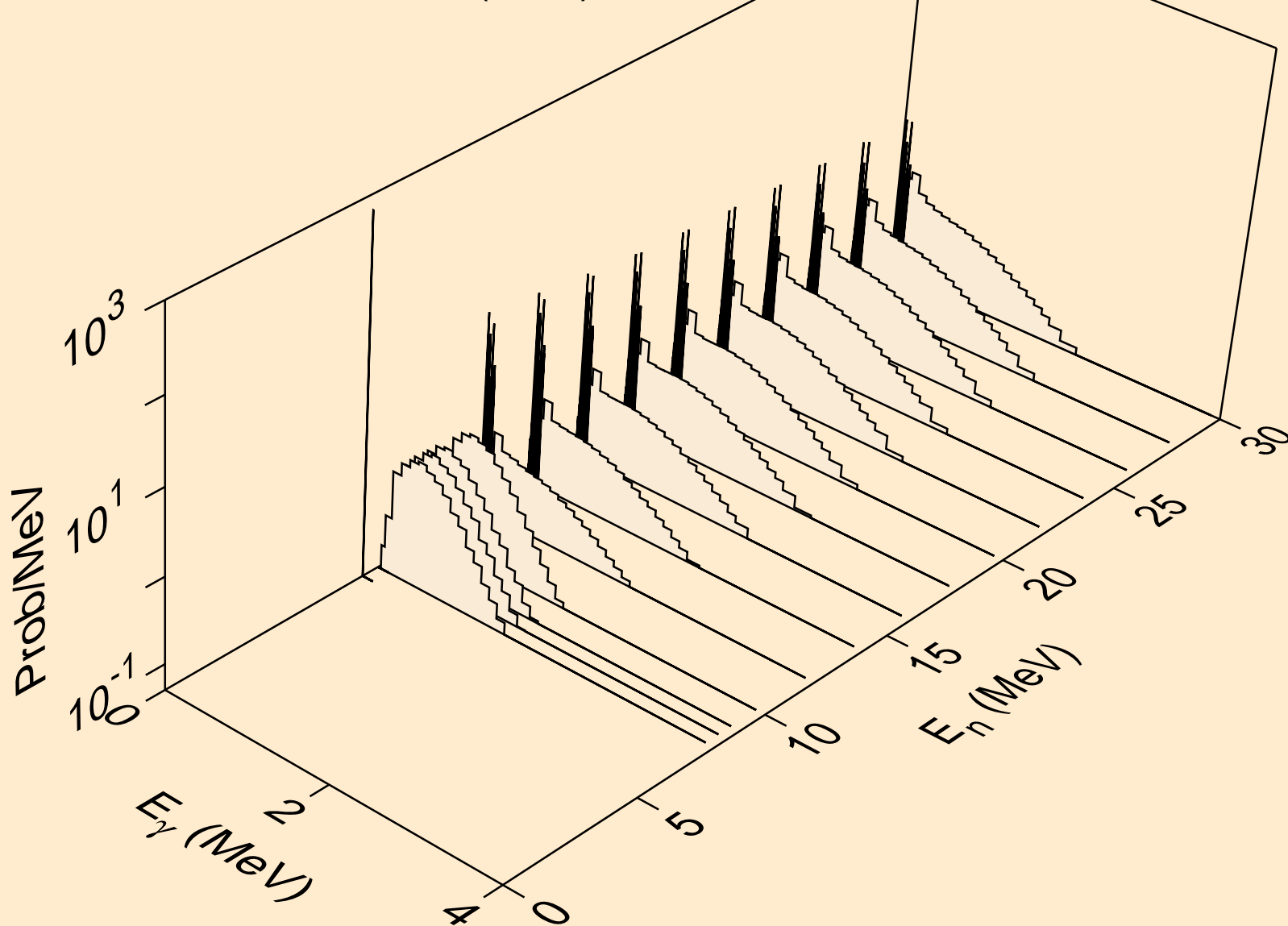

AM236M NEUTRON ACER TENDL-2019 LIBRARY; T=293.16K  
Photon emission for (n,2p)

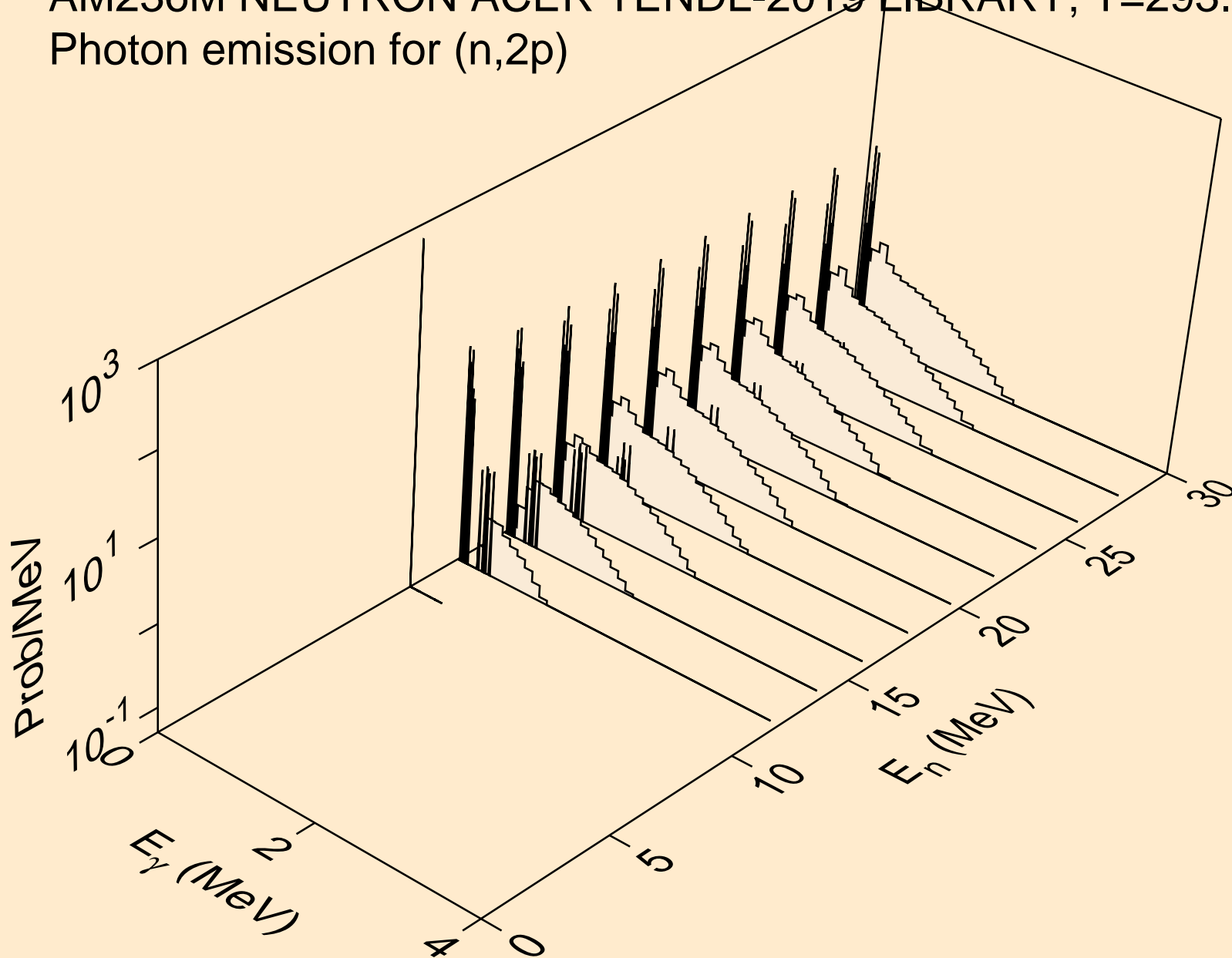

AM236M NEUTRON ACER TENDL-2019 LIBRARY; T=293.16K  
Photon emission for (n,p $\alpha$ )

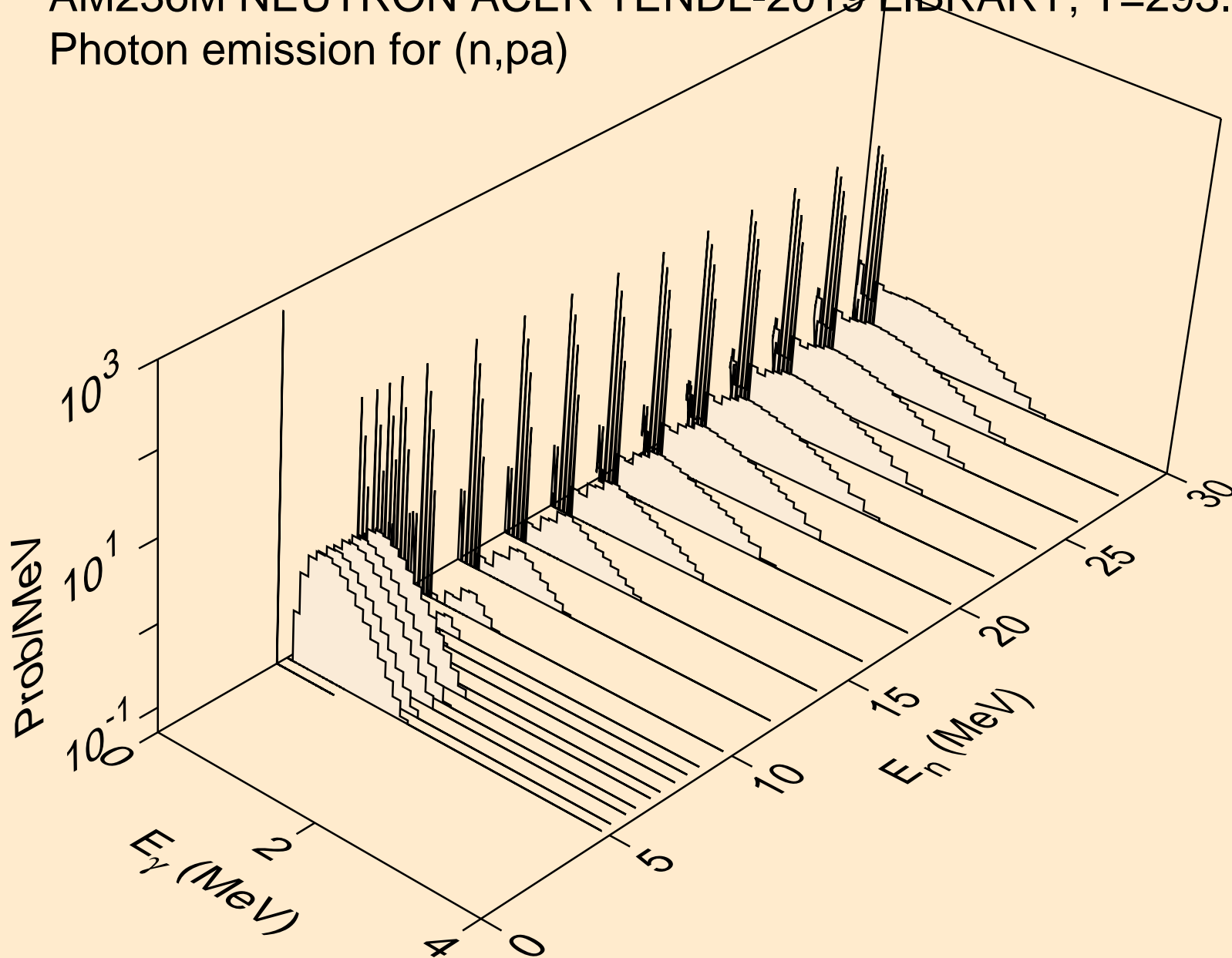

AM236M NEUTRON ACER TENDL-2019 LIBRARY; T=293.16K  
Photon emission for (n,pd)

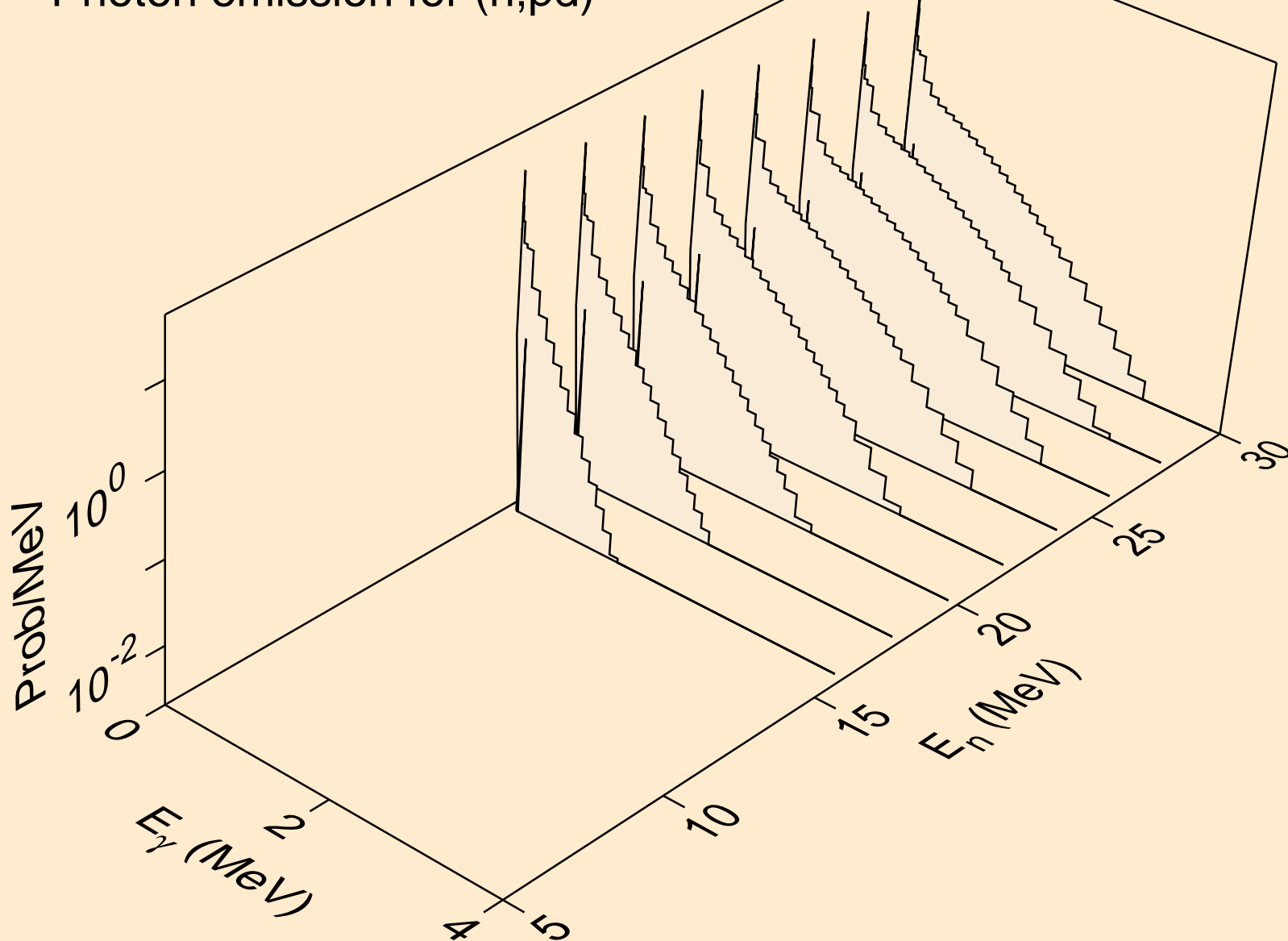



AM236M NEUTRON ACER TENDL-2019 LIBRARY; T=293.16K  
Photon emission for (n,da)

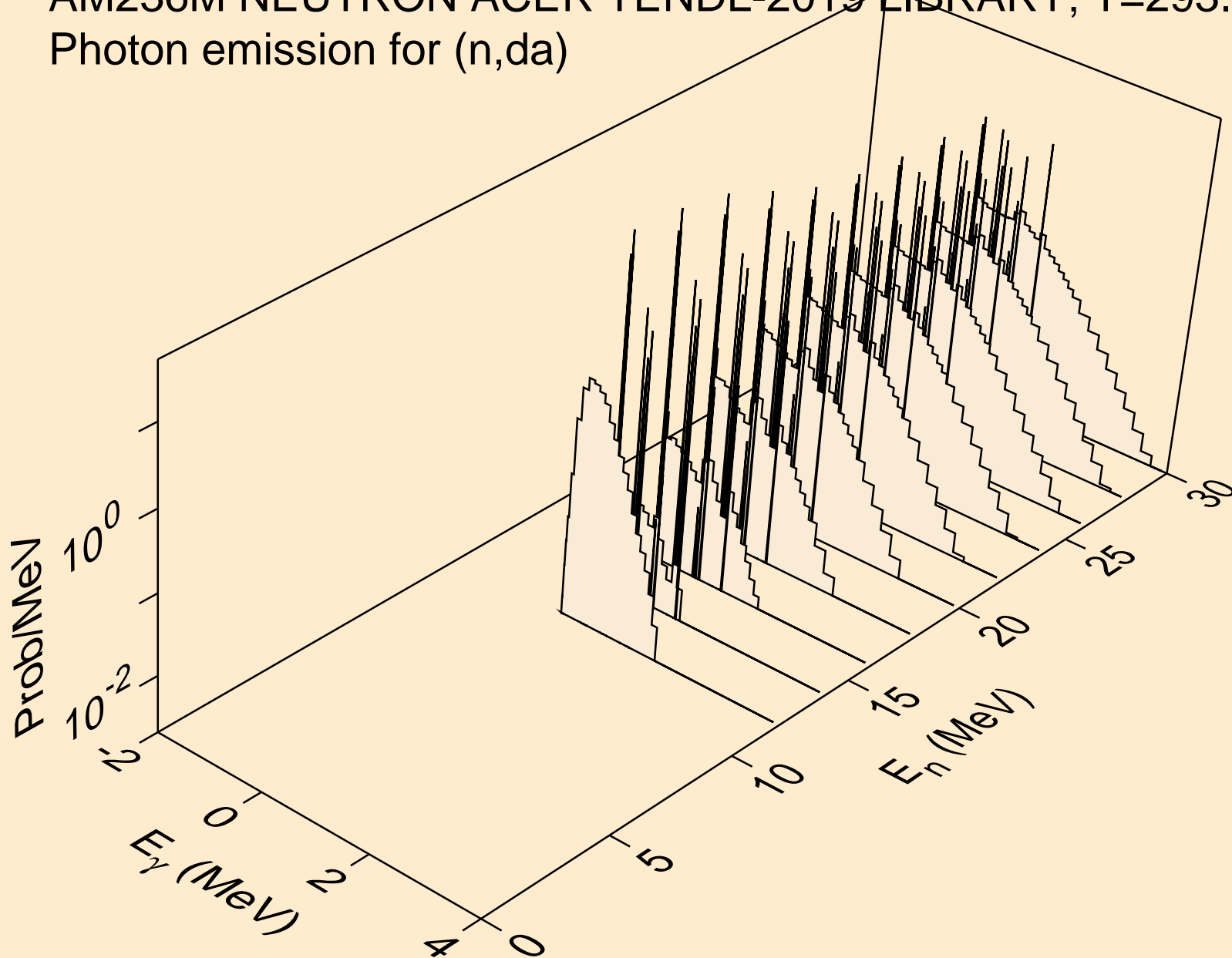

AM236M NEUTRON ACER TENDL-2019 LIBRARY; T=293.16K  
thermal capture photon spectrum

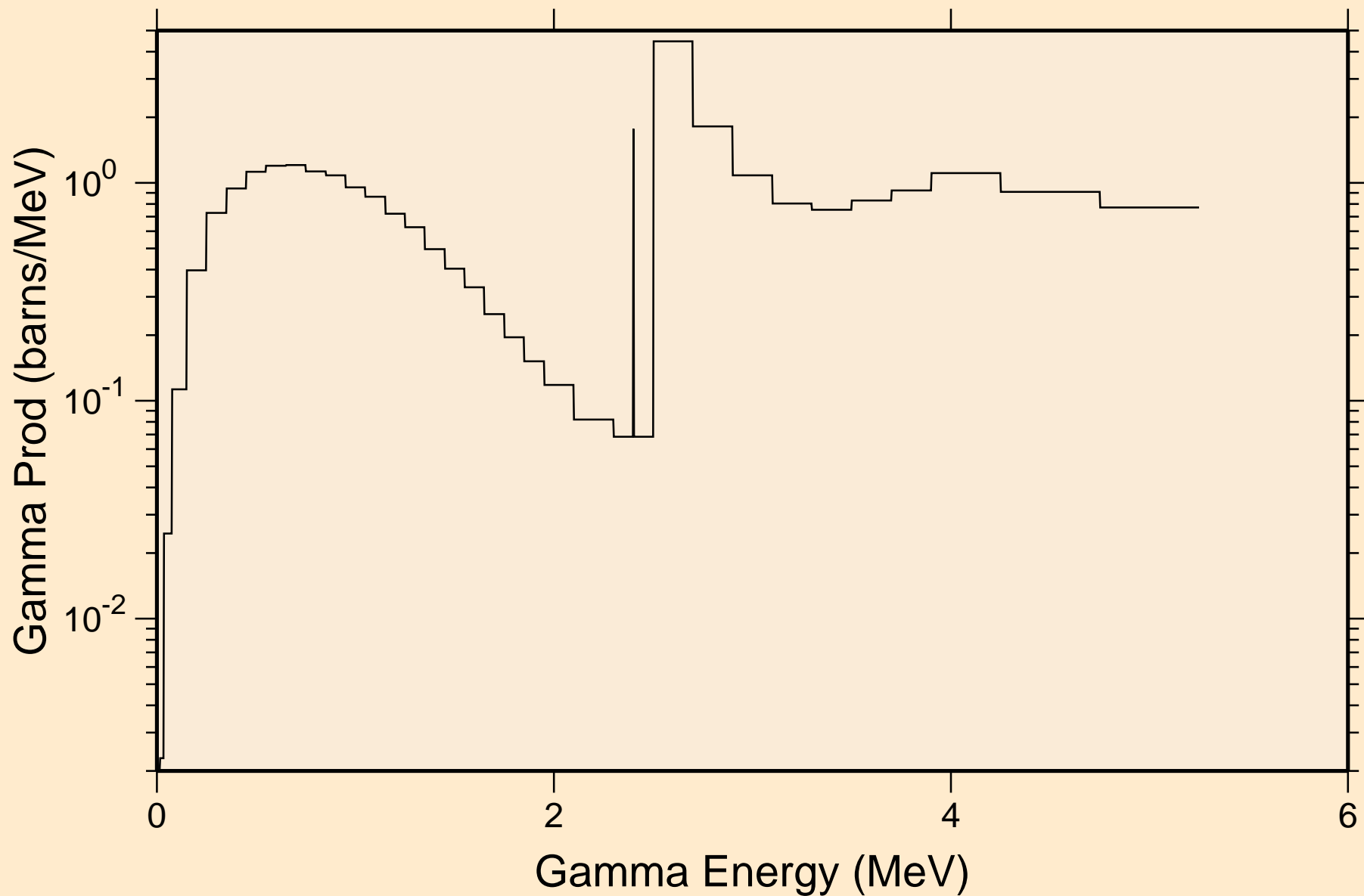

AM236M NEUTRON ACER TENDL-2019 LIBRARY; T=293.16K  
14 MeV photon spectrum

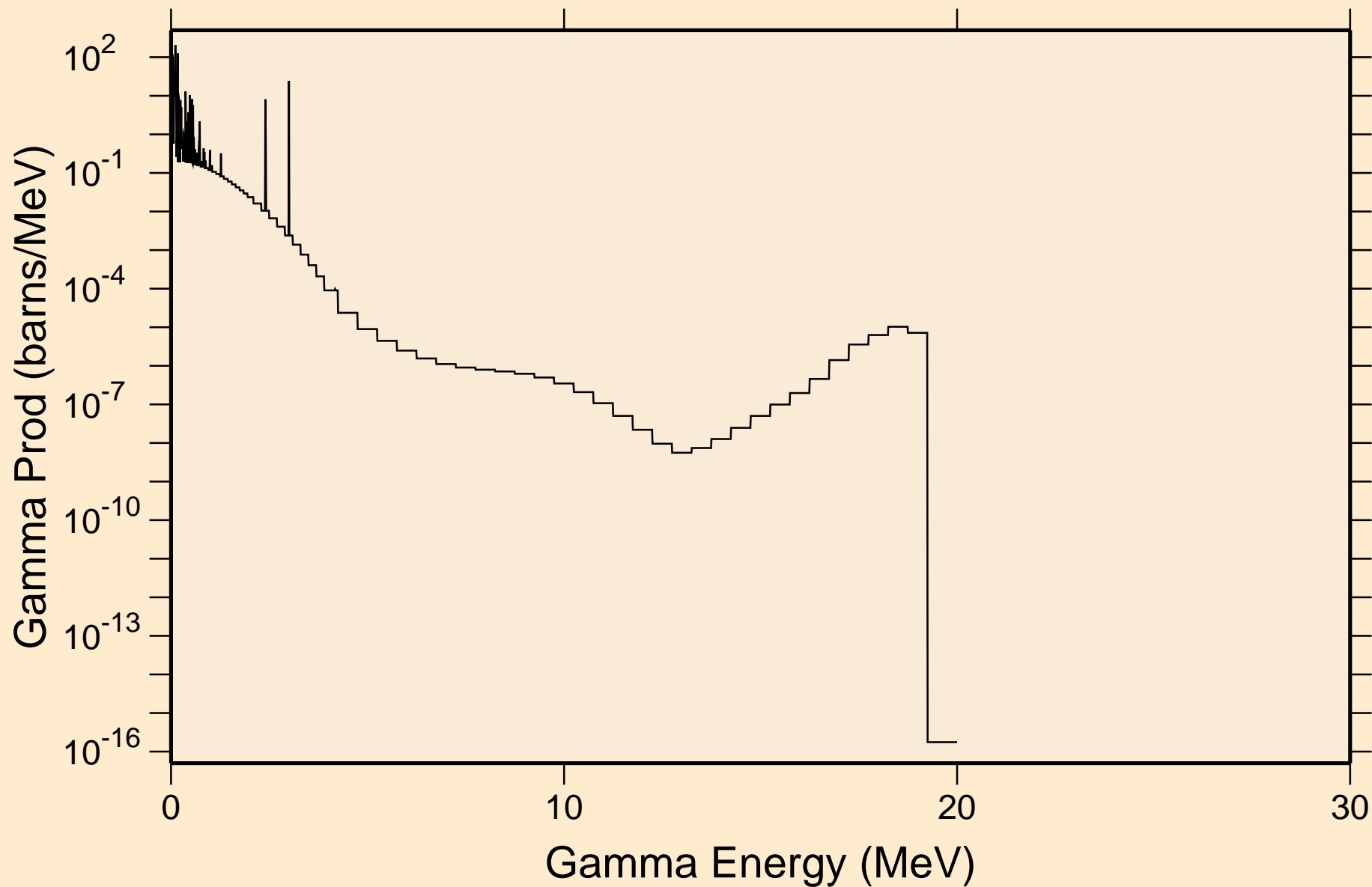

# AM236M NEUTRON ACER TENDL-2019 LIBRARY; T=293.16K

## Particle heating contributions

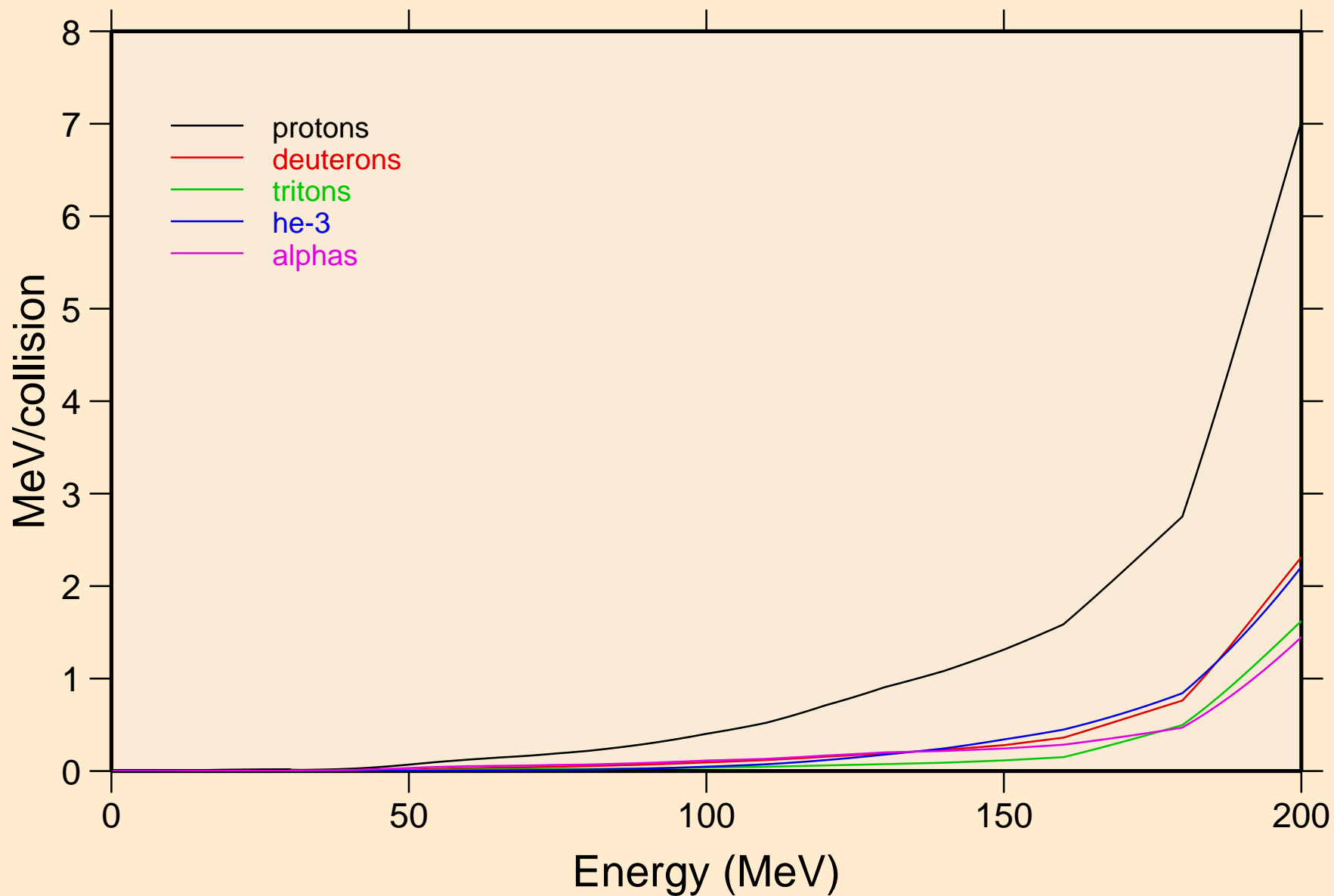

AM236M NEUTRON ACER TENDL-2019 LIBRARY; T=293.16K  
Recoil Heating

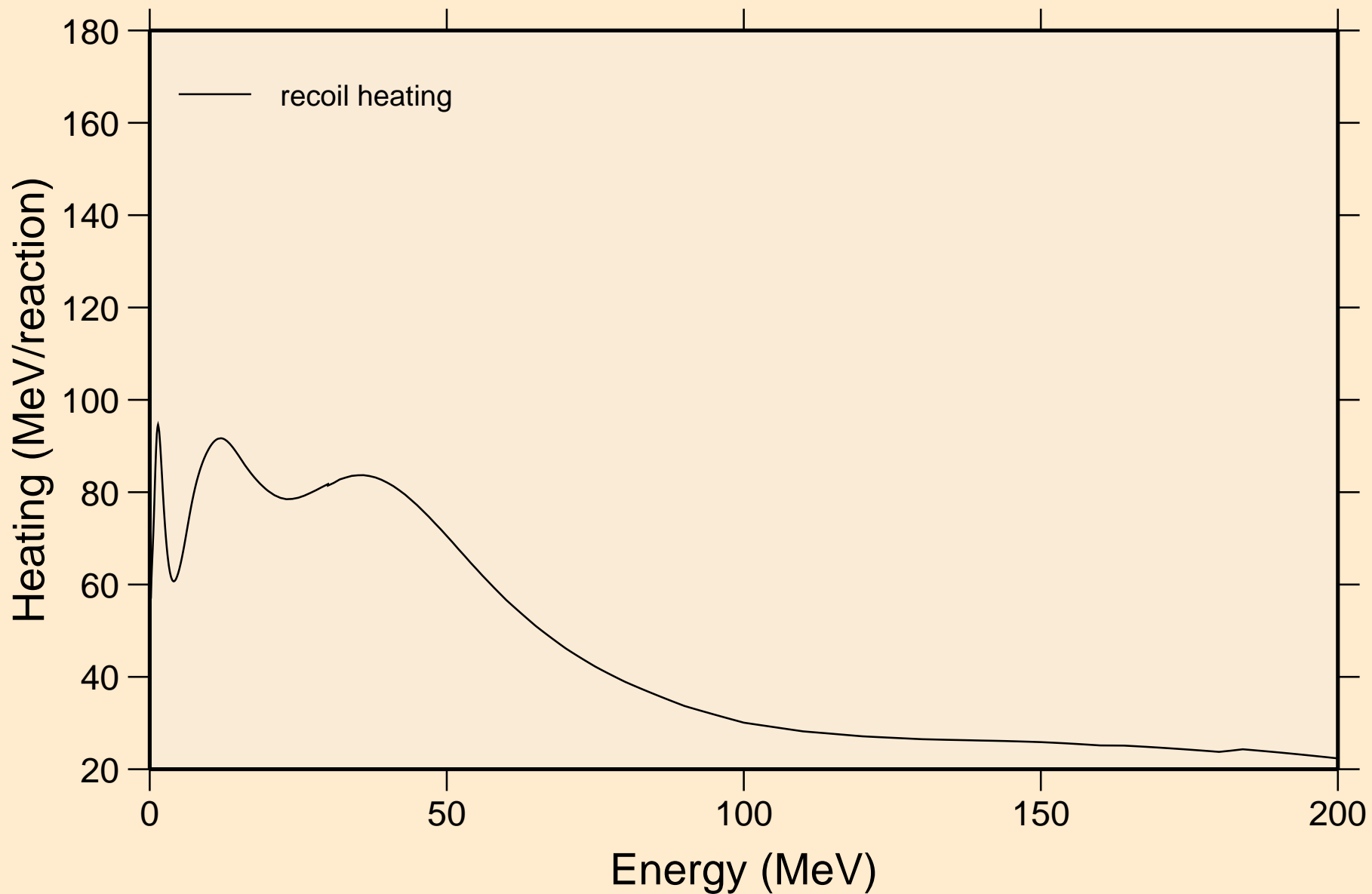

AM236M NEUTRON ACER TENDL-2019 LIBRARY; T=293.16K  
Particle production cross sections

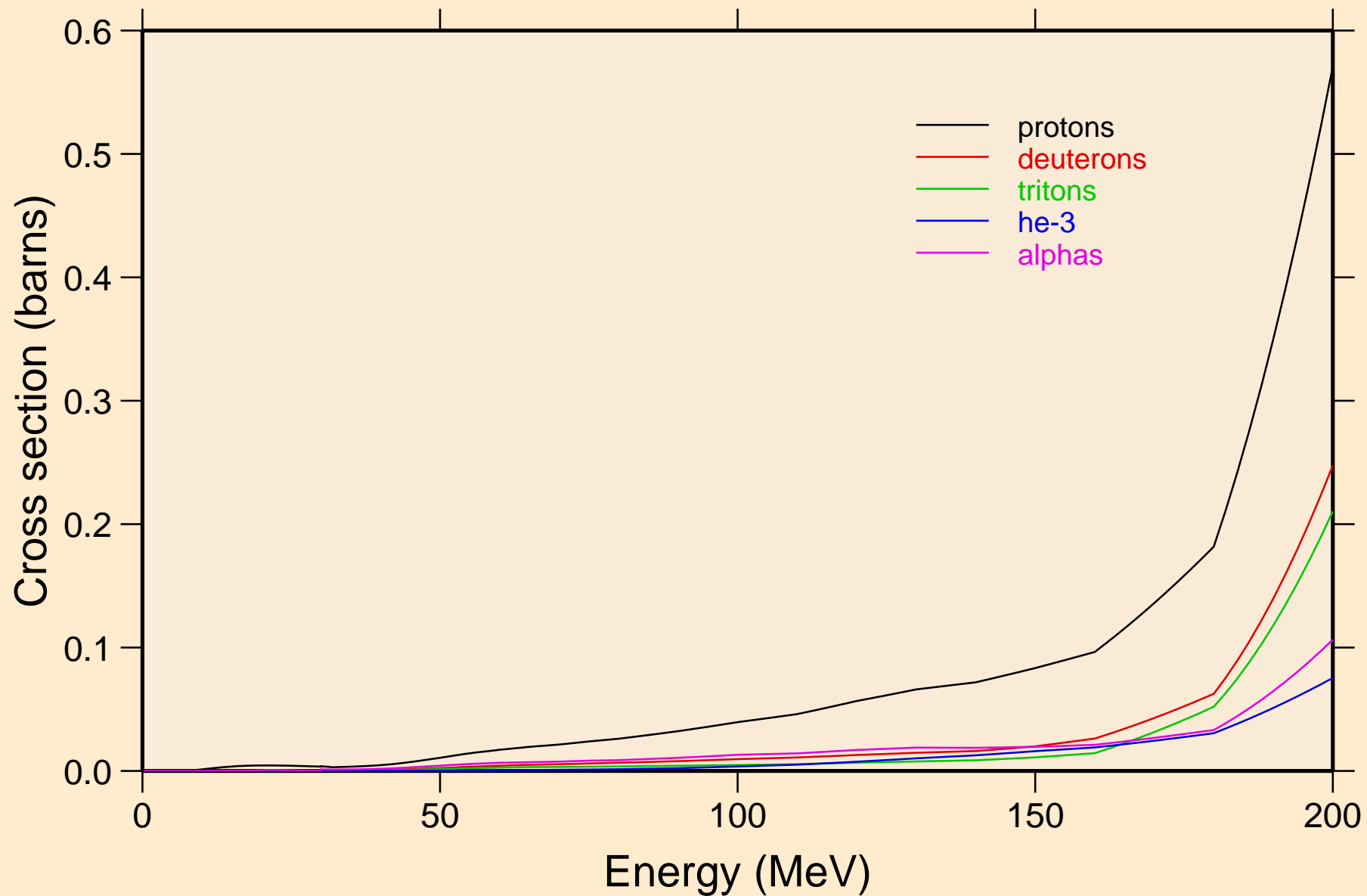

AM236M NEUTRON ACER TENDL-2019 LIBRARY; T=293.16K  
protons from (n,x)

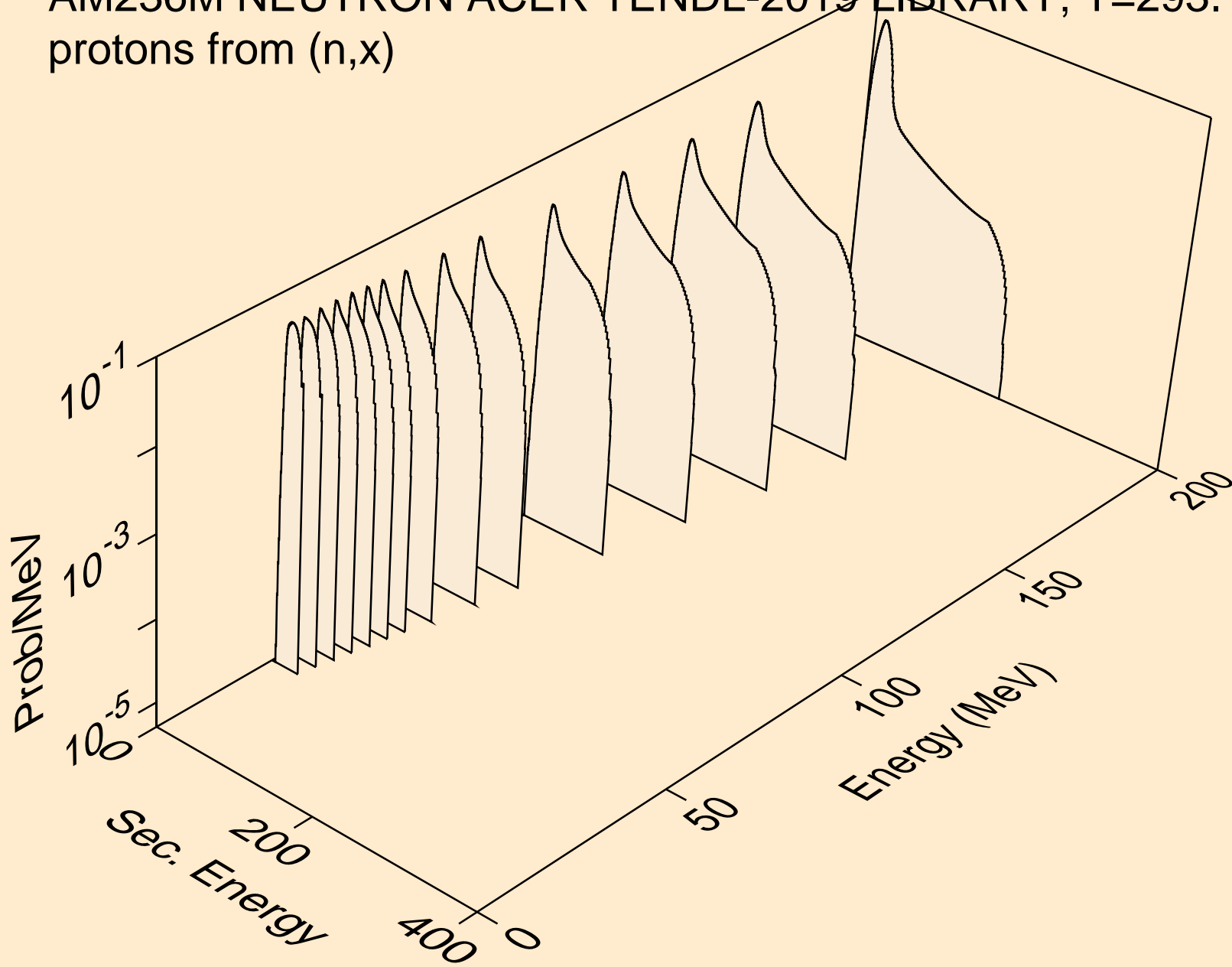

AM236M NEUTRON ACER TENDL-2019 LIBRARY; T=293.16K  
protons from (n,n\*)p

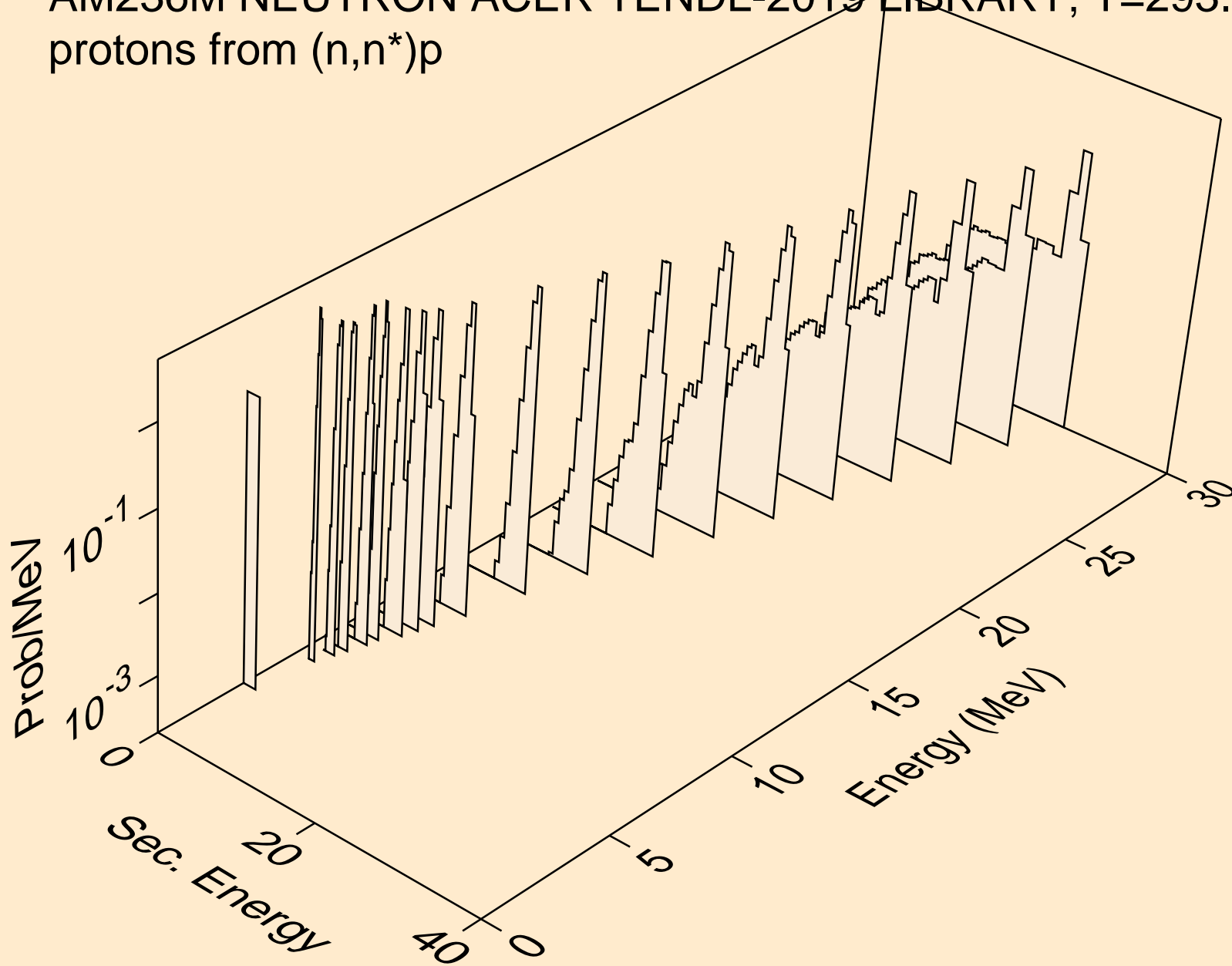



AM236M NEUTRON ACER TENDL-2019 LIBRARY; T=293.16K  
protons from (n,2np)

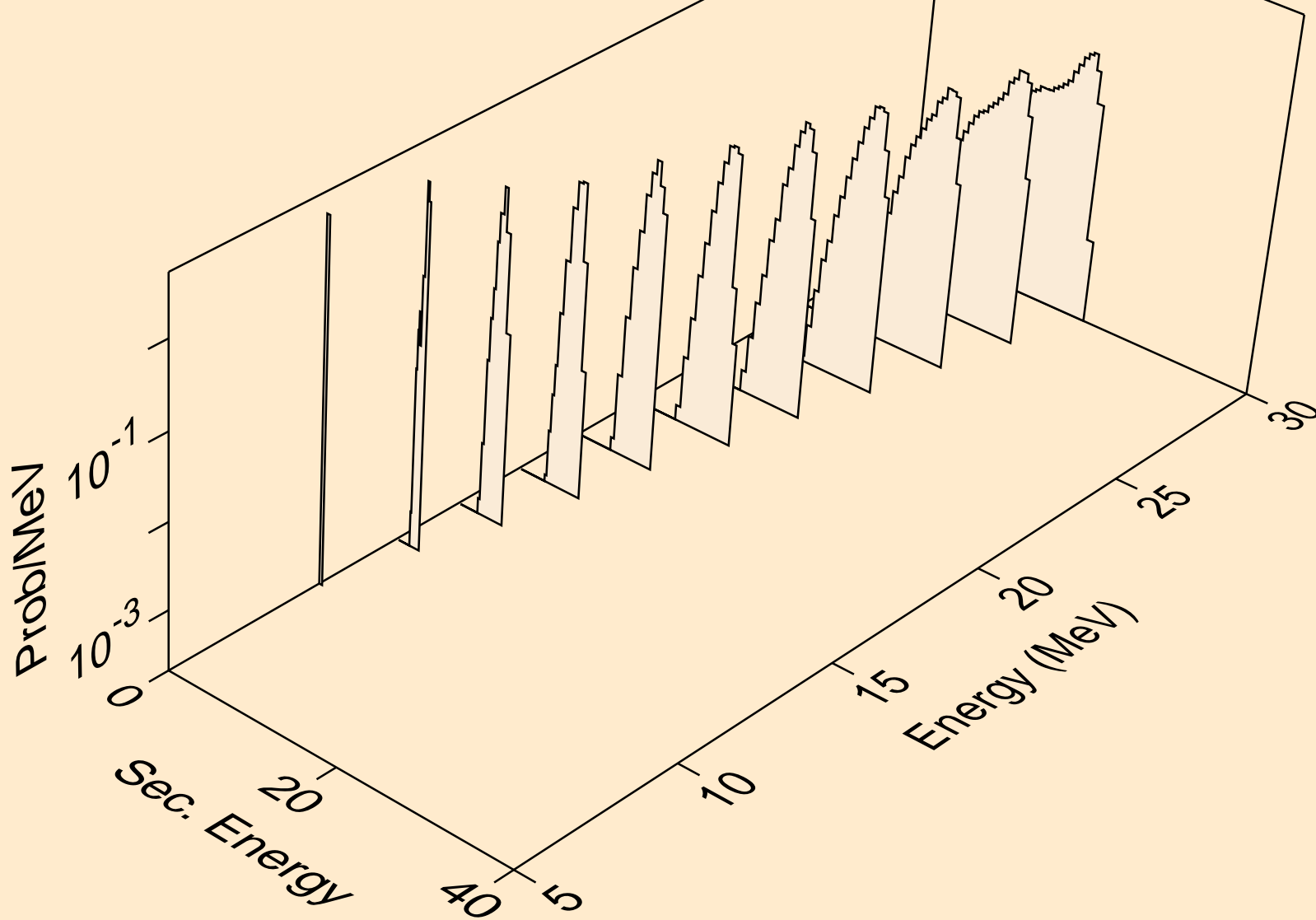

AM236M NEUTRON ACER TENDL-2019 LIBRARY; T=293.16K  
protons from (n,3np)

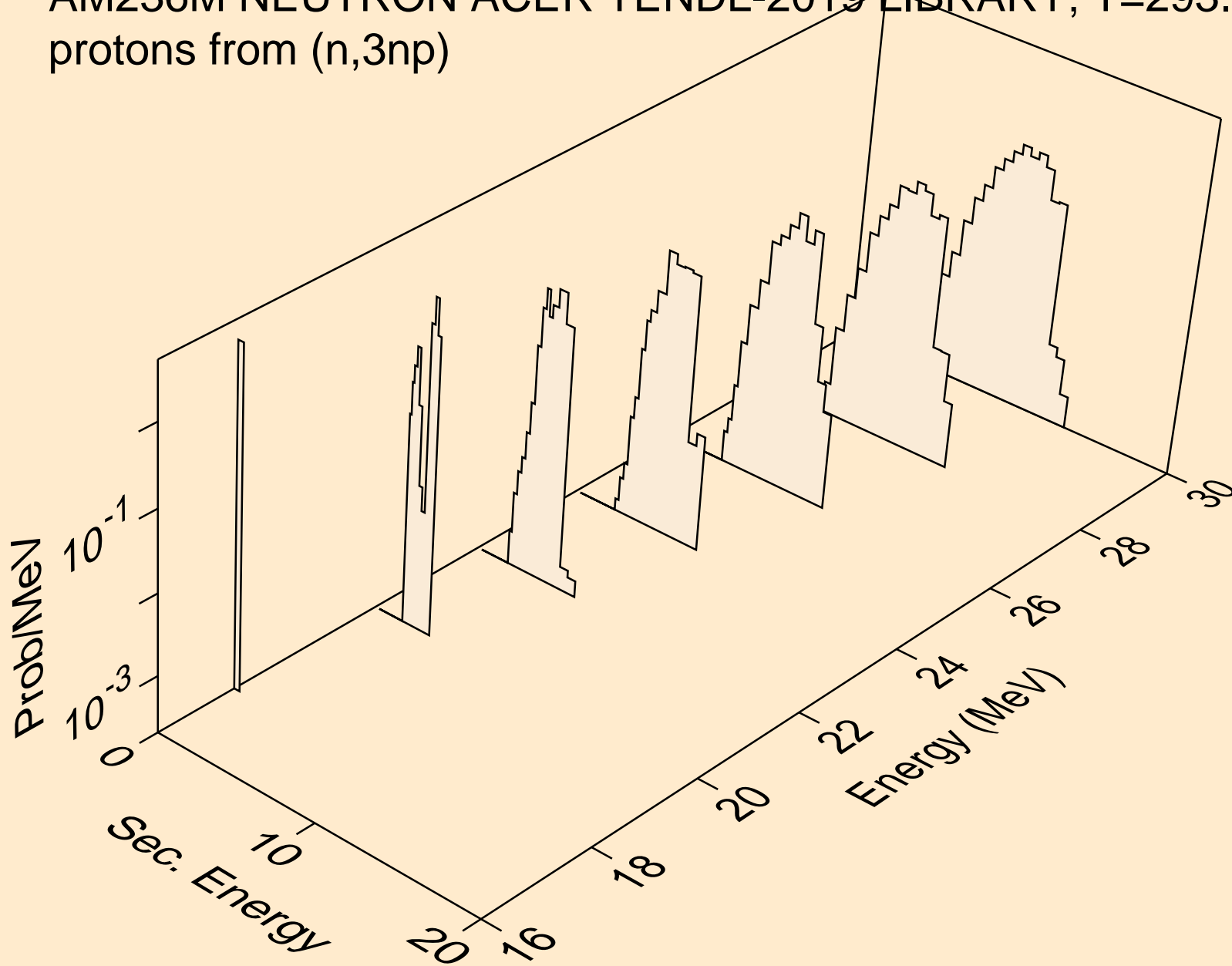

AM236M NEUTRON ACER TENDL-2019 LIBRARY; T=293.16K  
protons from (n,2np)

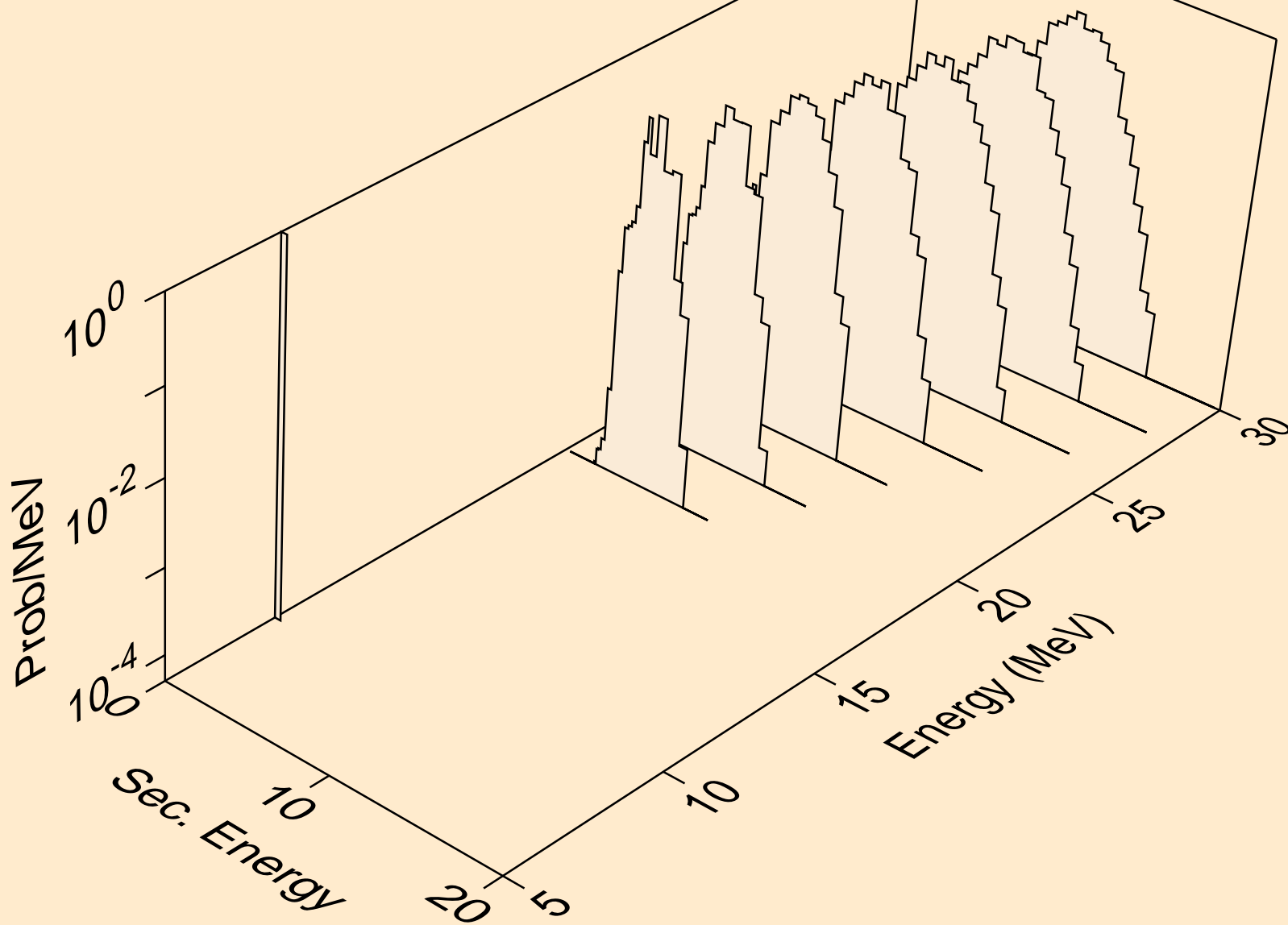

AM236M NEUTRON ACER TENDL-2019 LIBRARY; T=293.16K  
protons from (n,npa)

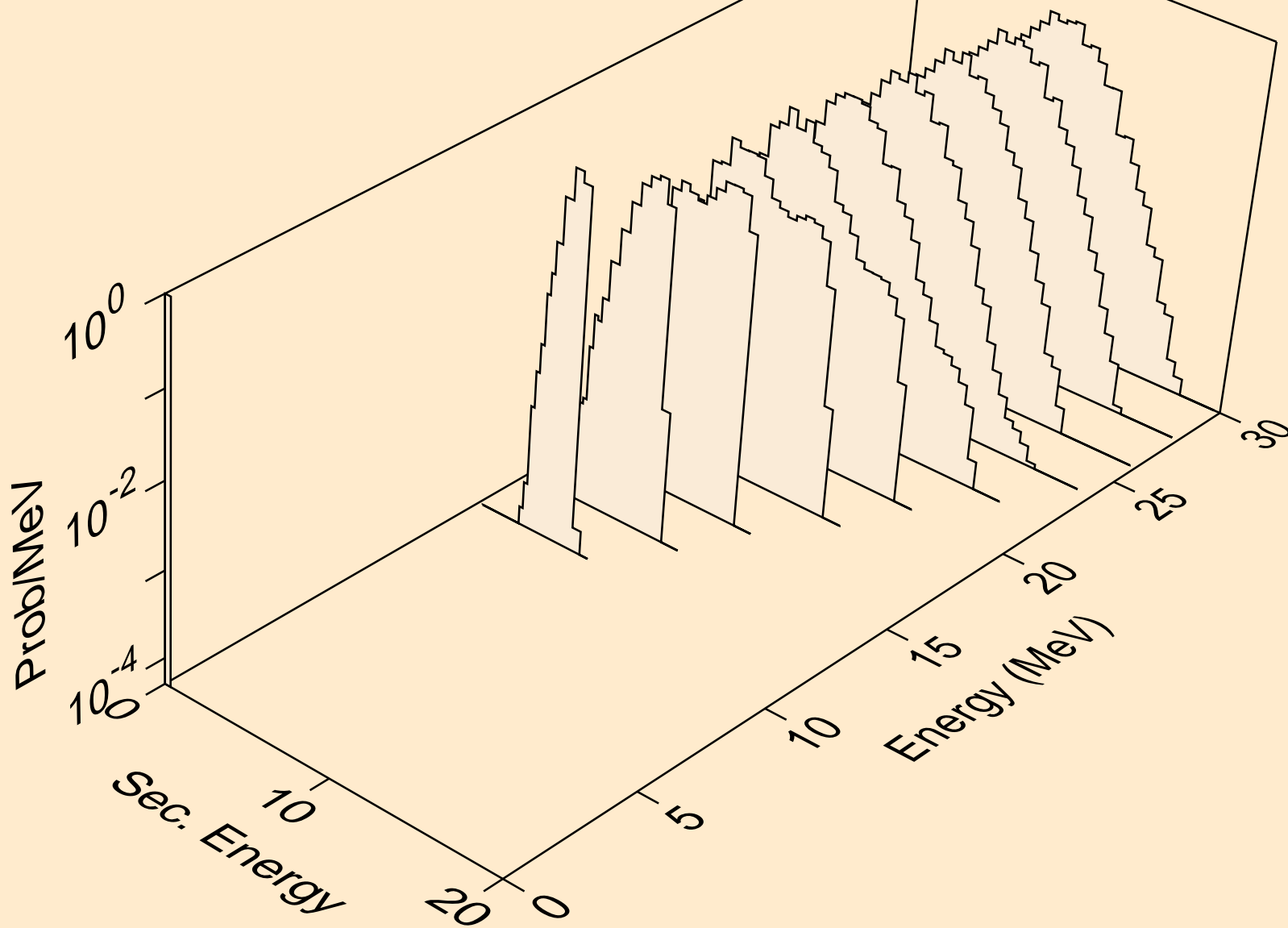

AM236M NEUTRON ACER TENDL-2019 LIBRARY; T=293.16K  
protons from (n,p)

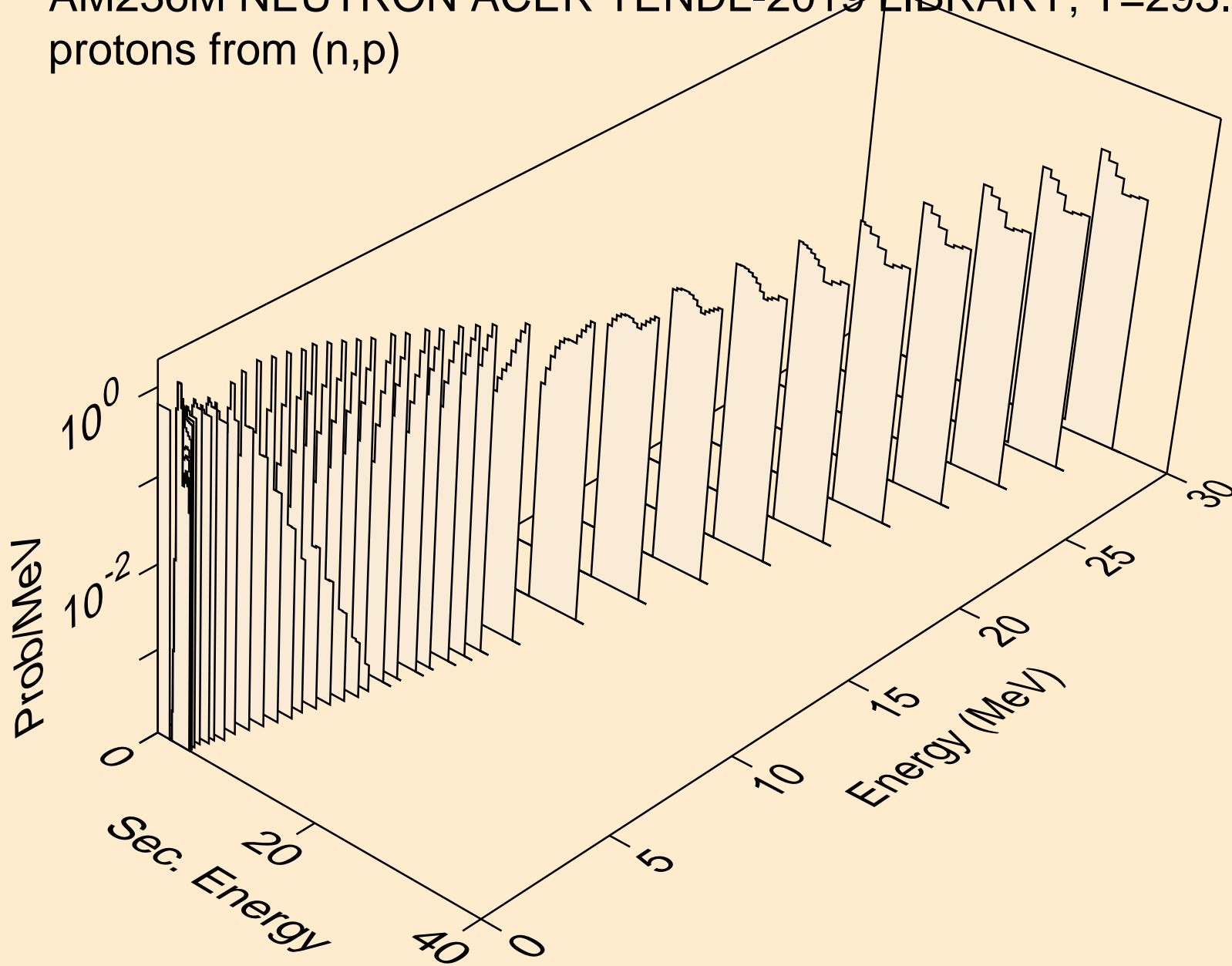

AM236M NEUTRON ACER TENDL-2019 LIBRARY; T=293.16K  
protons from (n,2p)

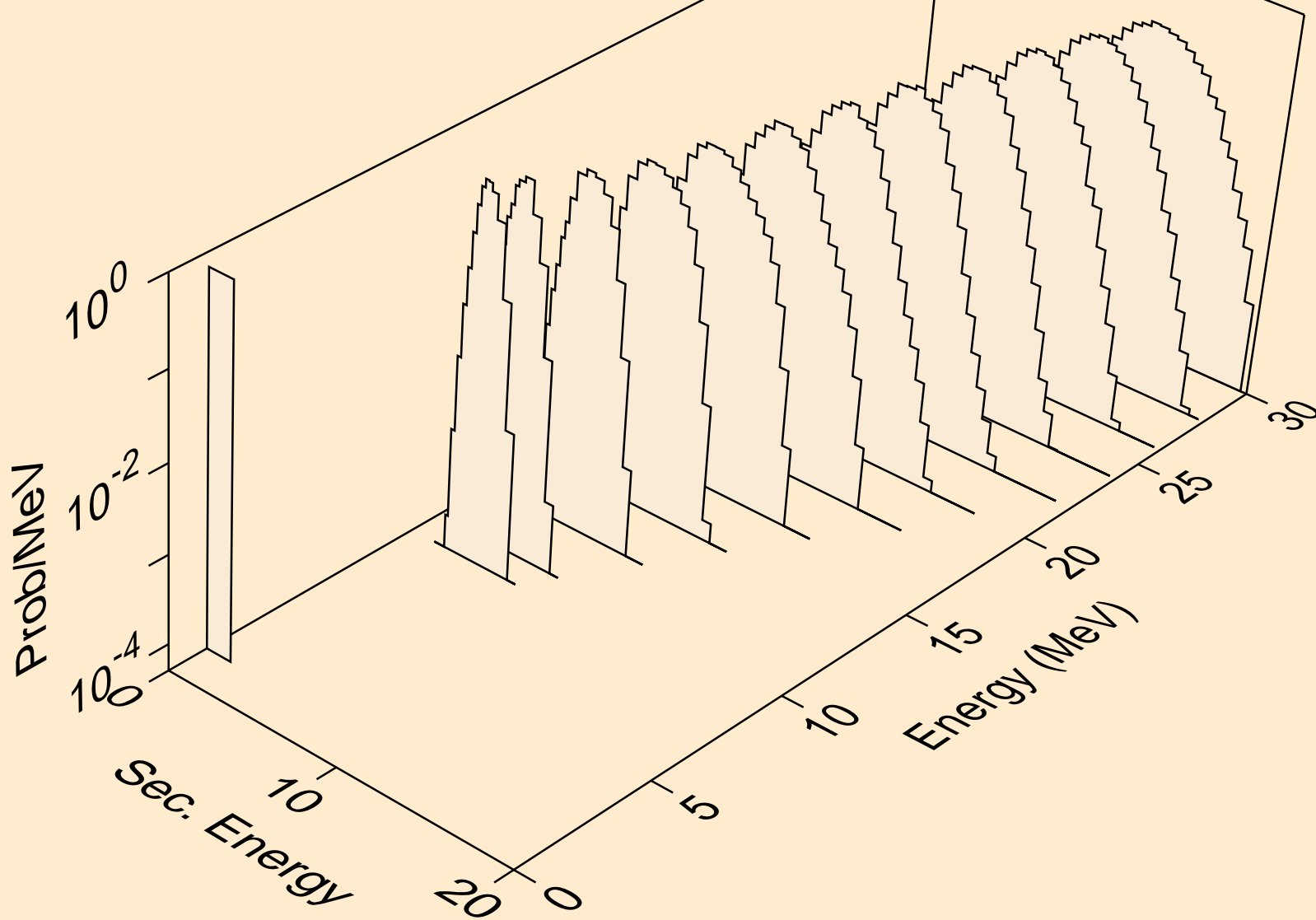

AM236M NEUTRON ACER TENDL-2019 LIBRARY; T=293.16K  
protons from (n,p)

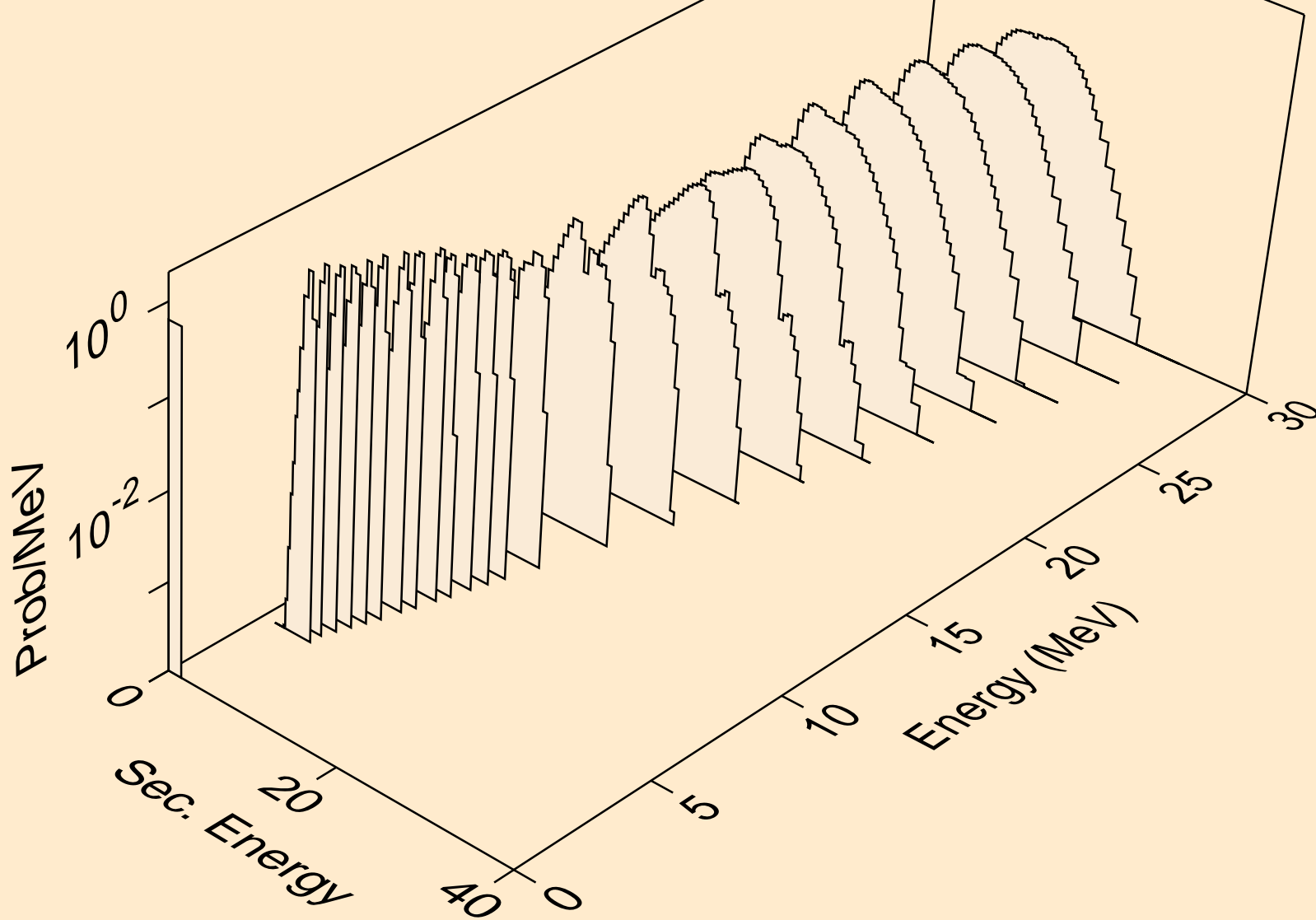

AM236M NEUTRON ACER TENDL-2019 LIBRARY; T=293.16K  
protons from (n,pd)

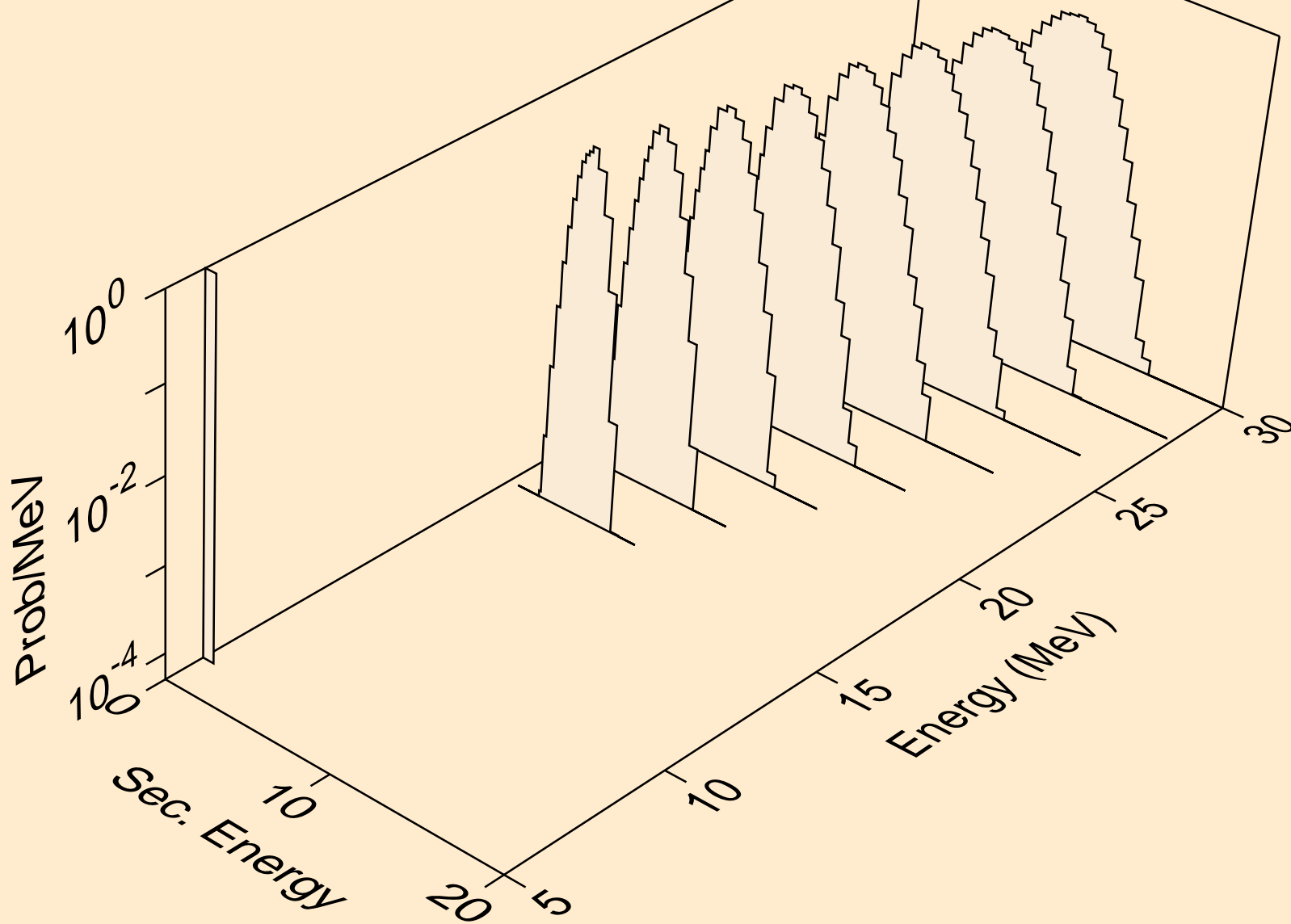



AM236M NEUTRON ACER TENDL-2019 LIBRARY; T=293.16K  
deuterons from (n,x)

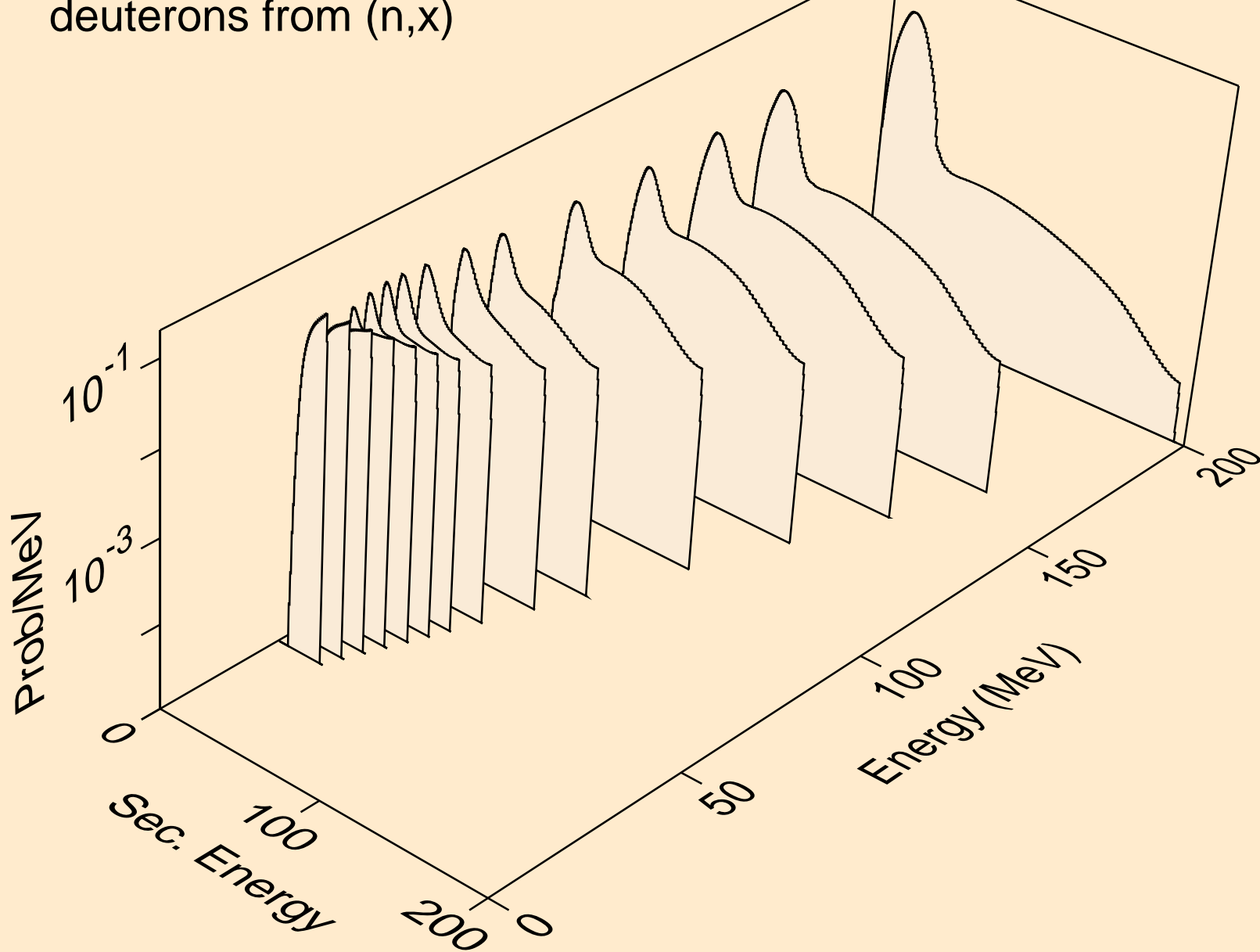

AM236M NEUTRON ACER TENDL-2019 LIBRARY; T=293.16K  
deuterons from (n,2nd)

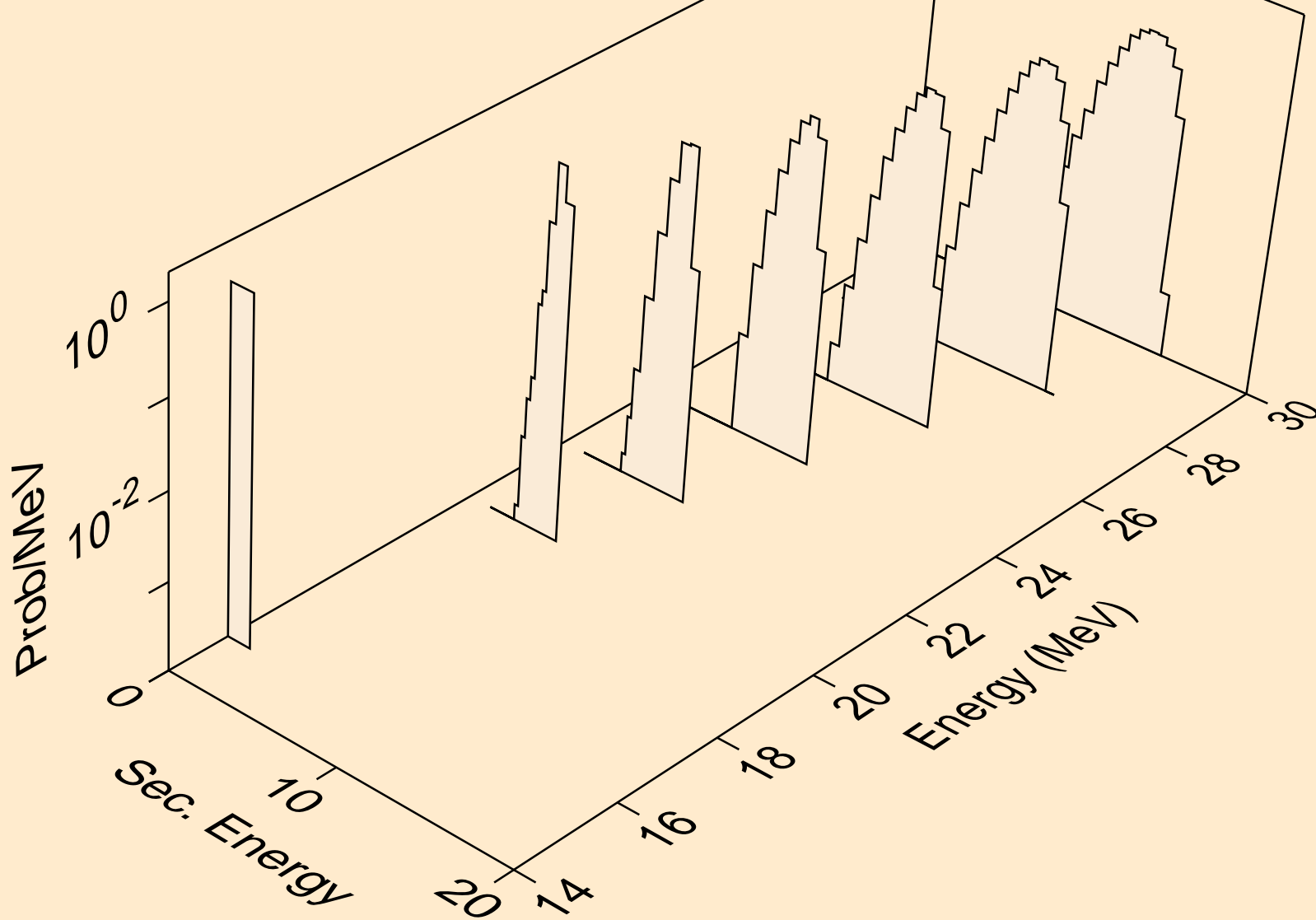

AM236M NEUTRON ACER TENDL-2019 LIBRARY; T=293.16K  
deuterons from (n,n\*)d

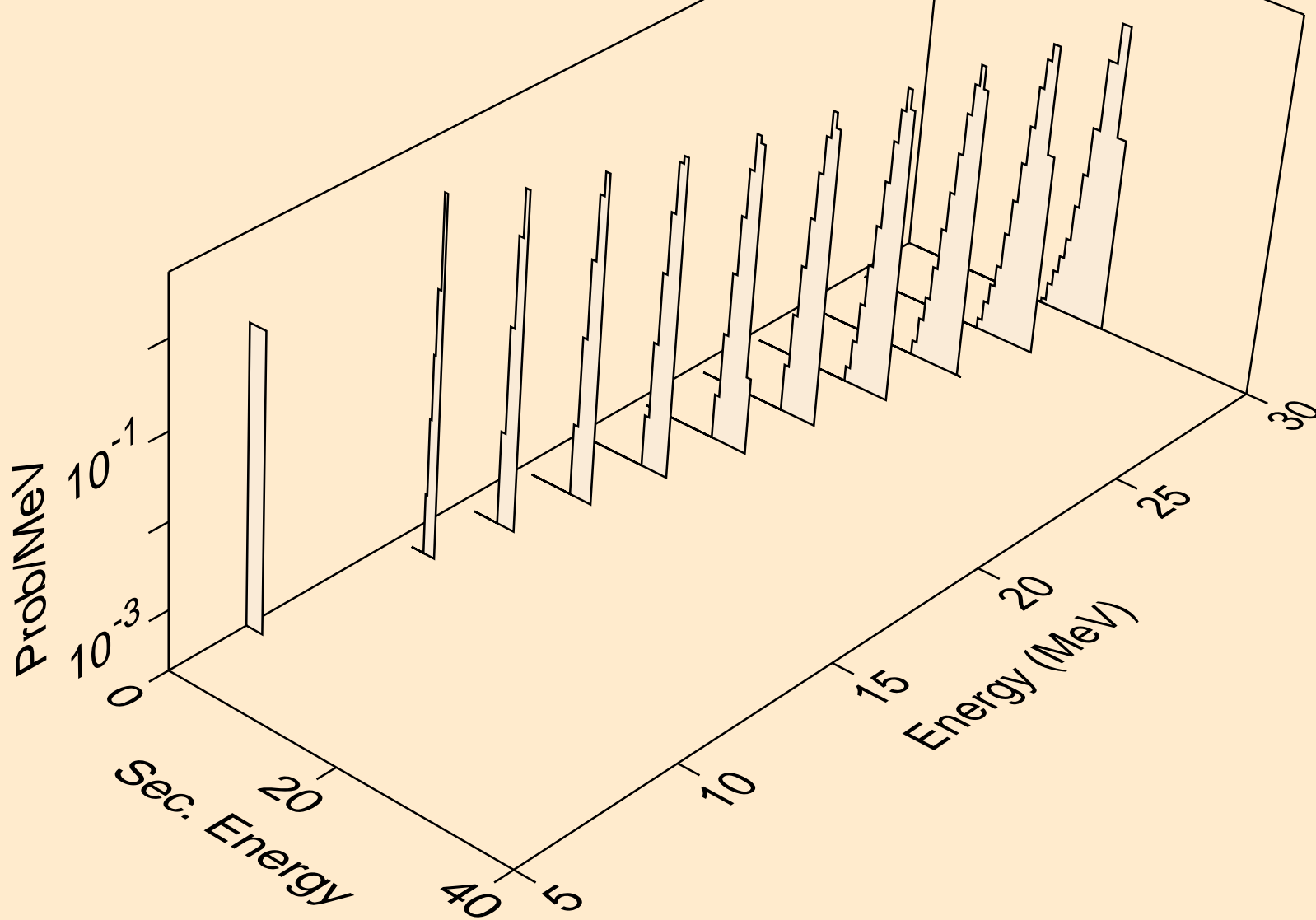

AM236M NEUTRON ACER TENDL-2019 LIBRARY; T=293.16K  
deuterons from (n,d)

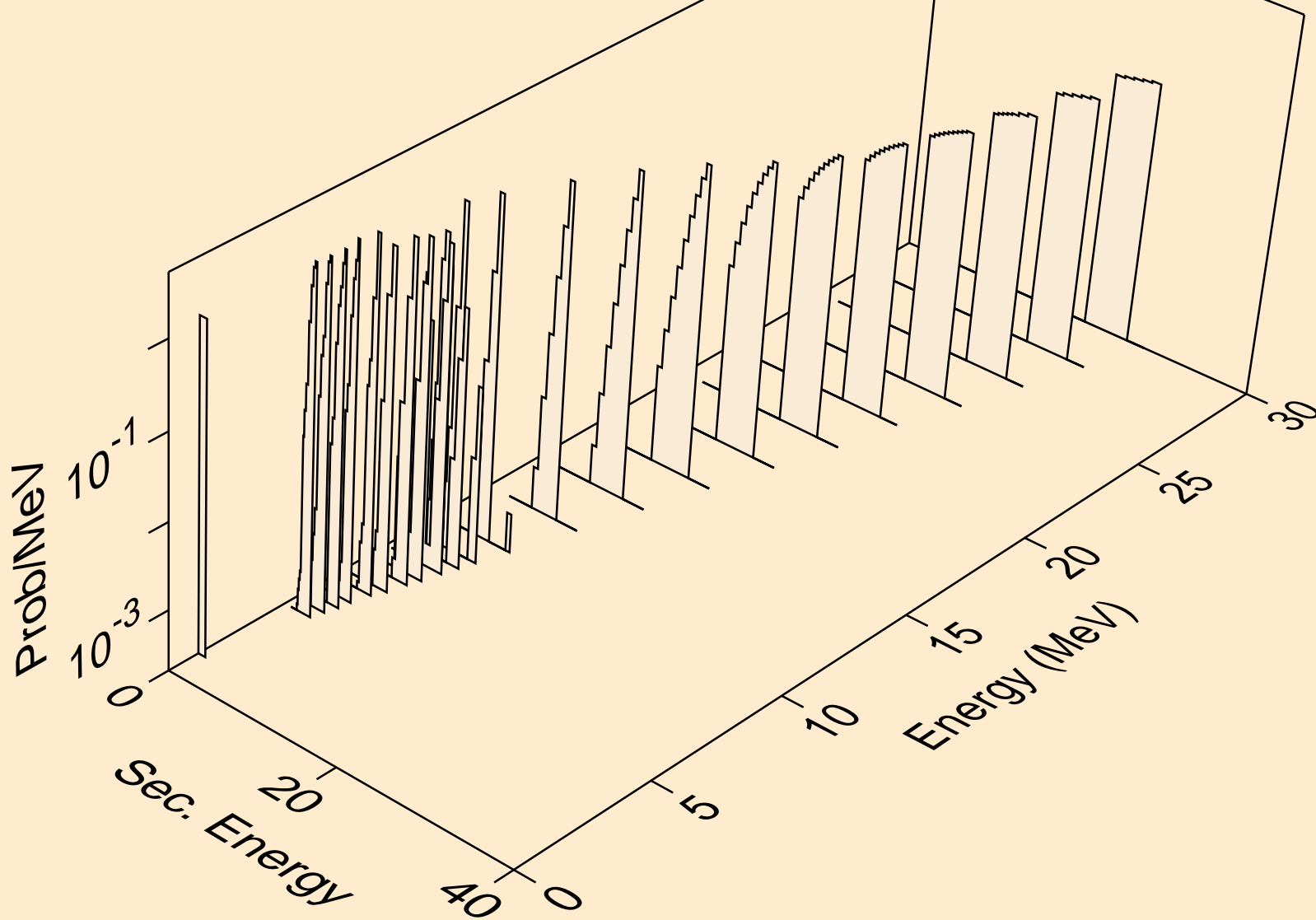

AM236M NEUTRON ACER TENDL-2019 LIBRARY; T=293.16K  
deuterons from (n,pd)

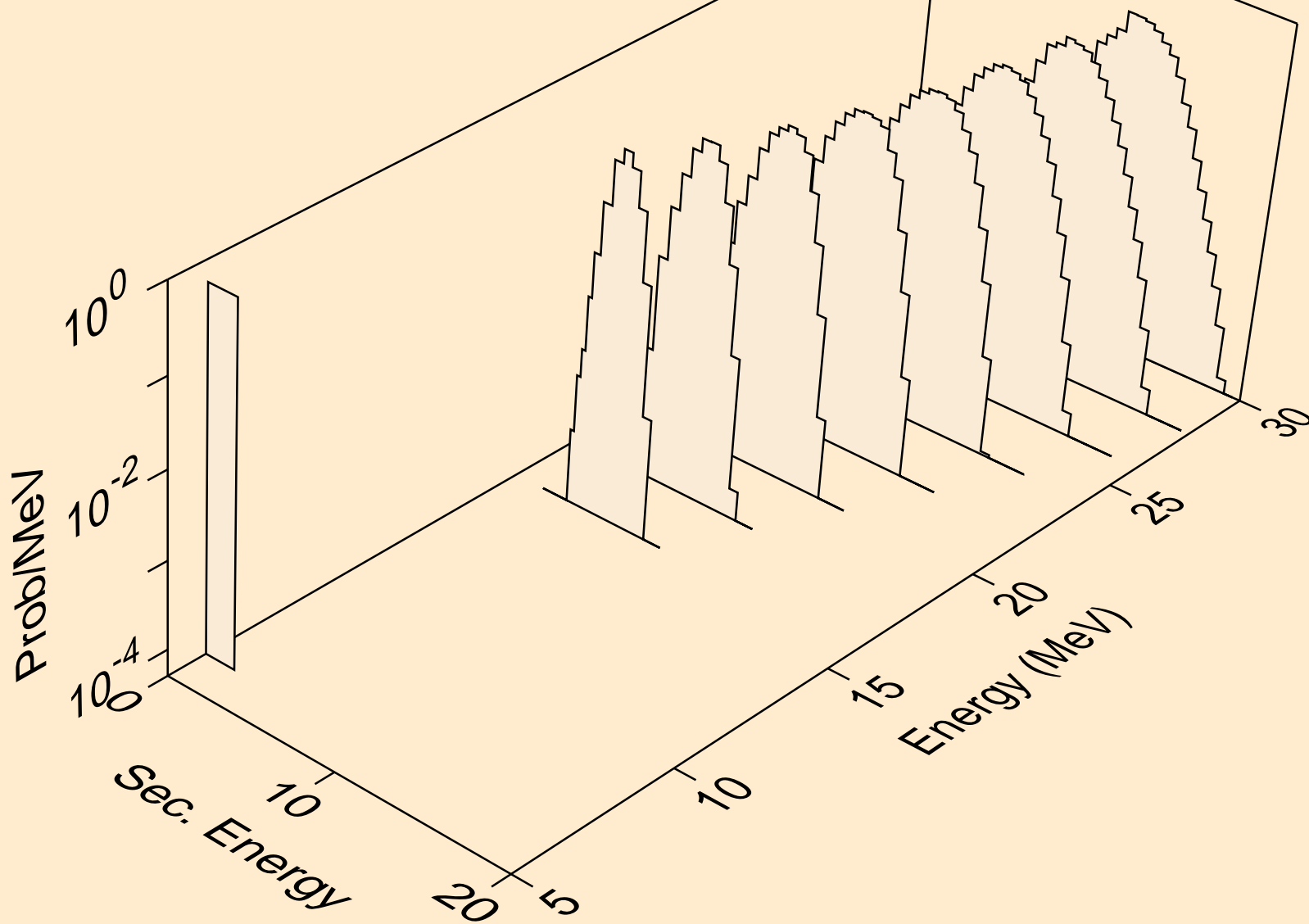

AM236M NEUTRON ACER TENDL-2019 LIBRARY; T=293.16K  
deuterons from (n,da)

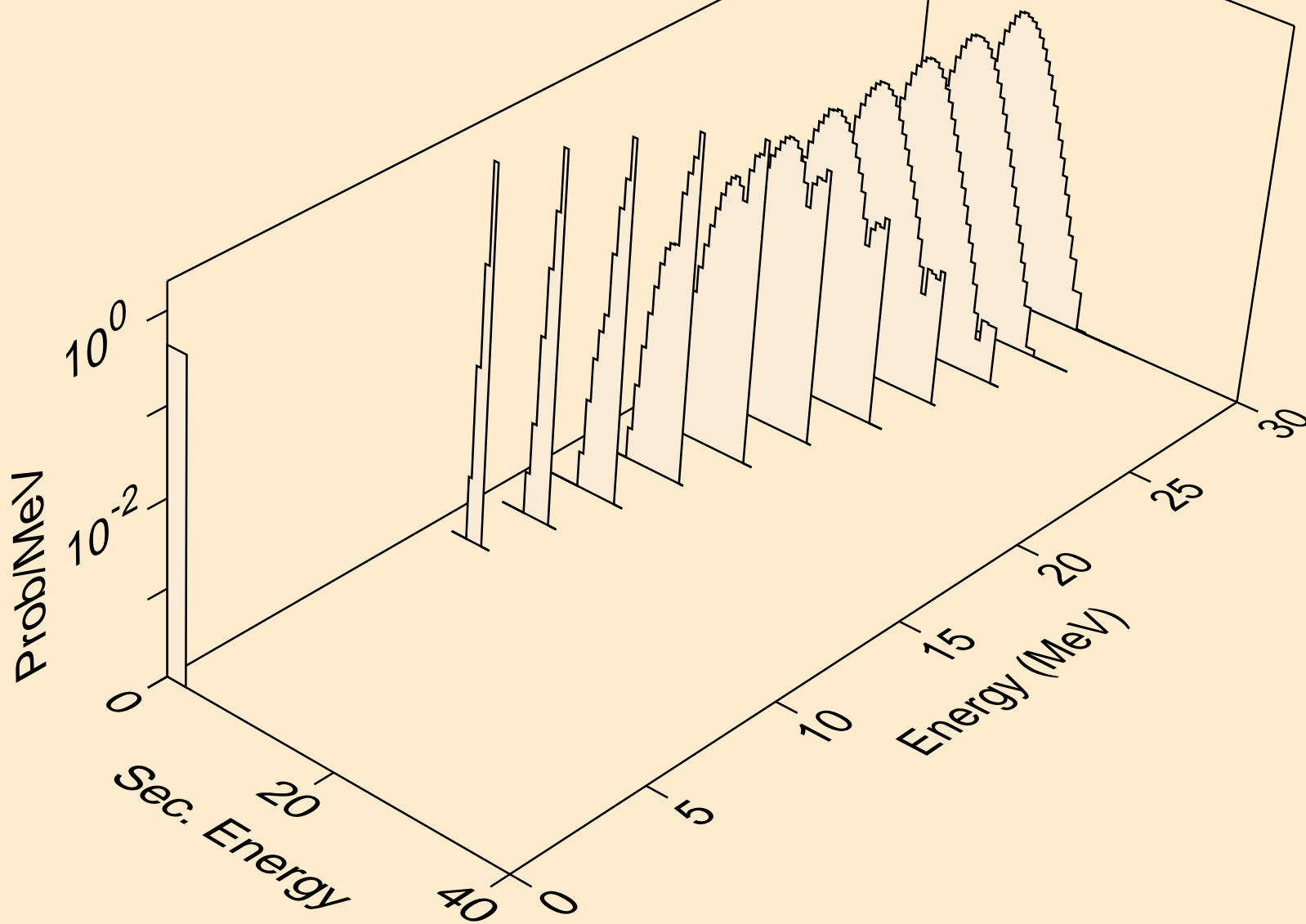

AM236M NEUTRON ACER TENDL-2019 LIBRARY; T=293.16K  
tritons from (n,x)

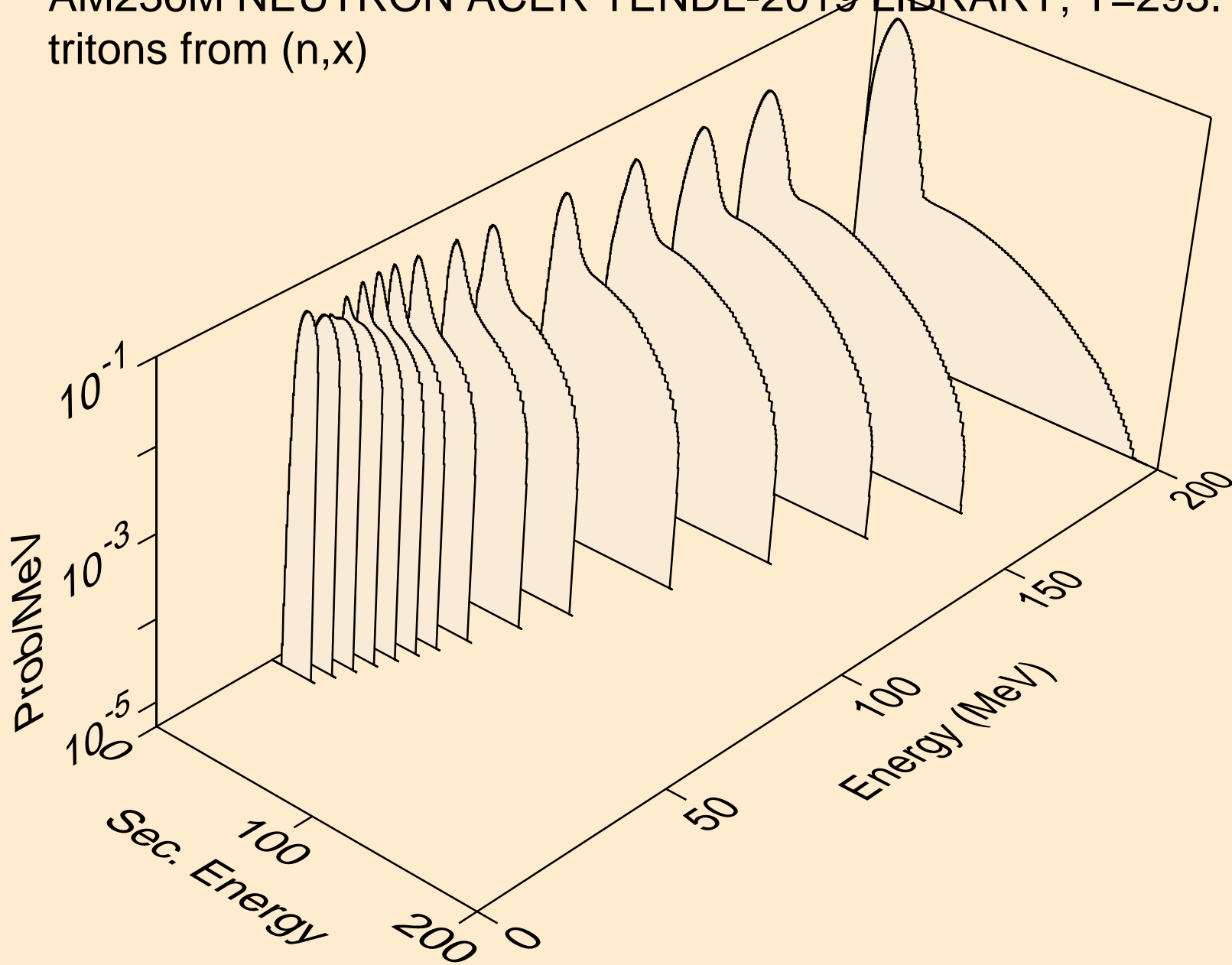

AM236M NEUTRON ACER TENDL-2019 LIBRARY; T=293.16K  
tritons from (n,n\*)t

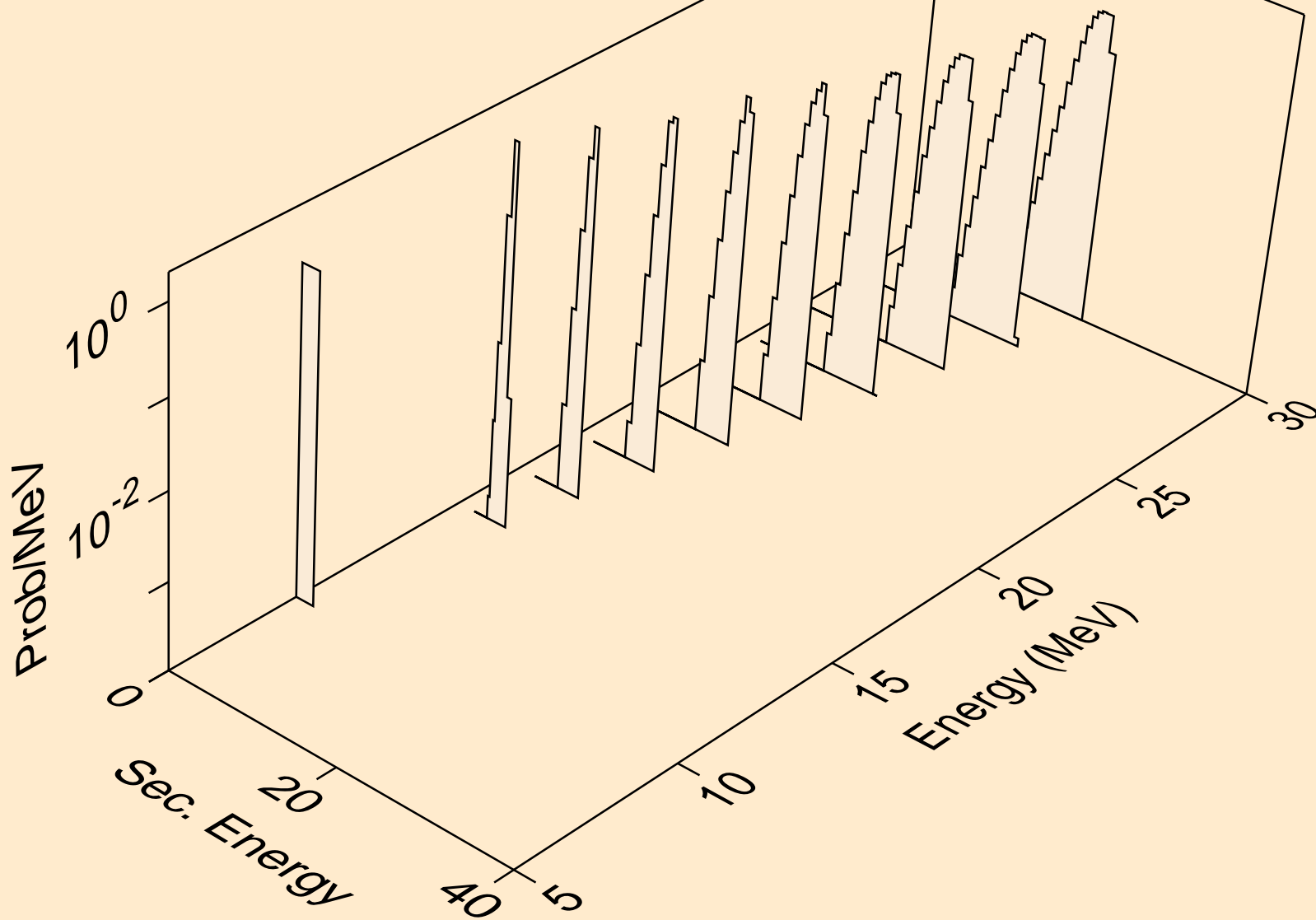



AM236M NEUTRON ACER TENDL-2019 LIBRARY; T=293.16K  
tritons from (n,t)

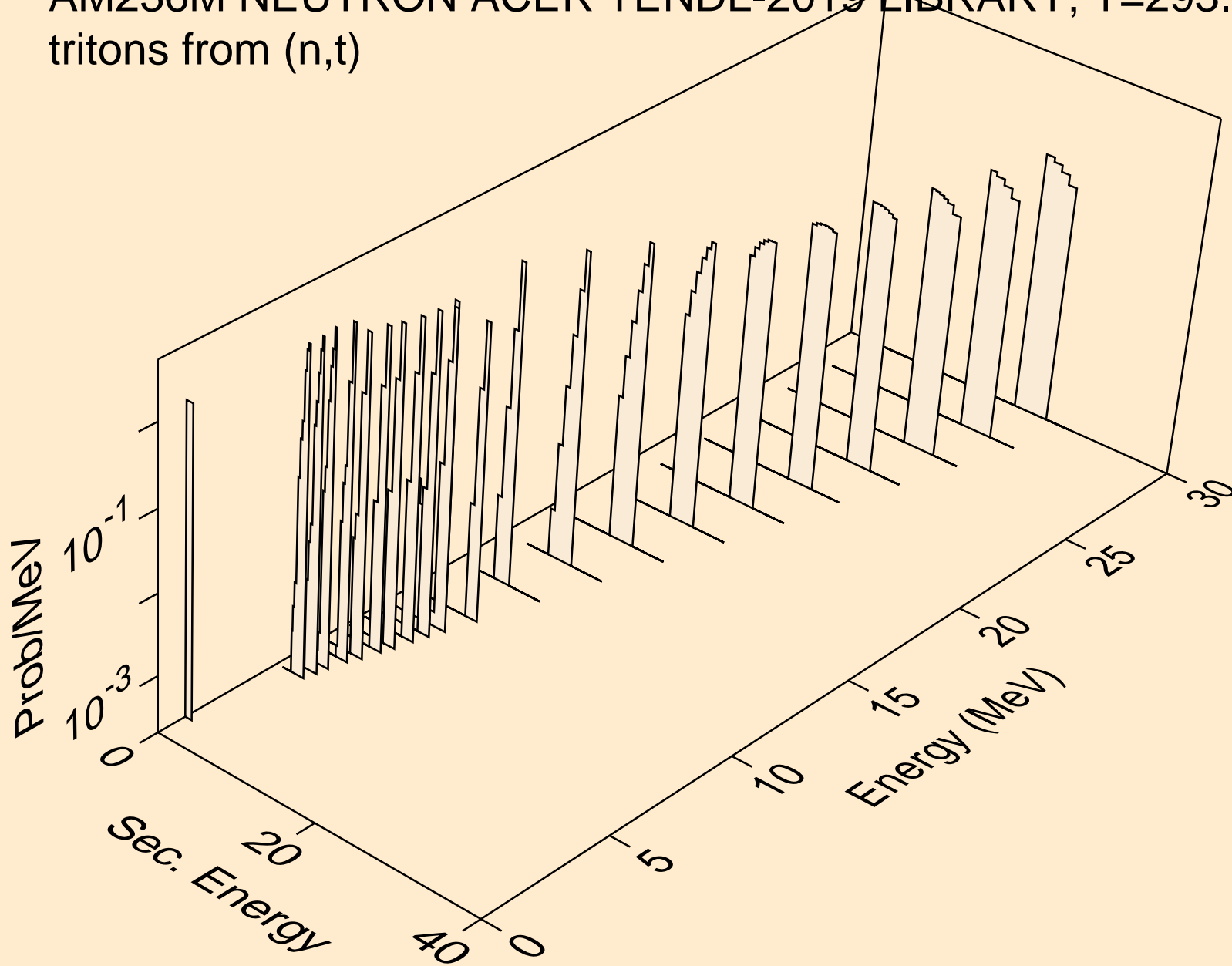

AM236M NEUTRON ACER TENDL-2019 LIBRARY; T=293.16K  
he3s from (n,x)

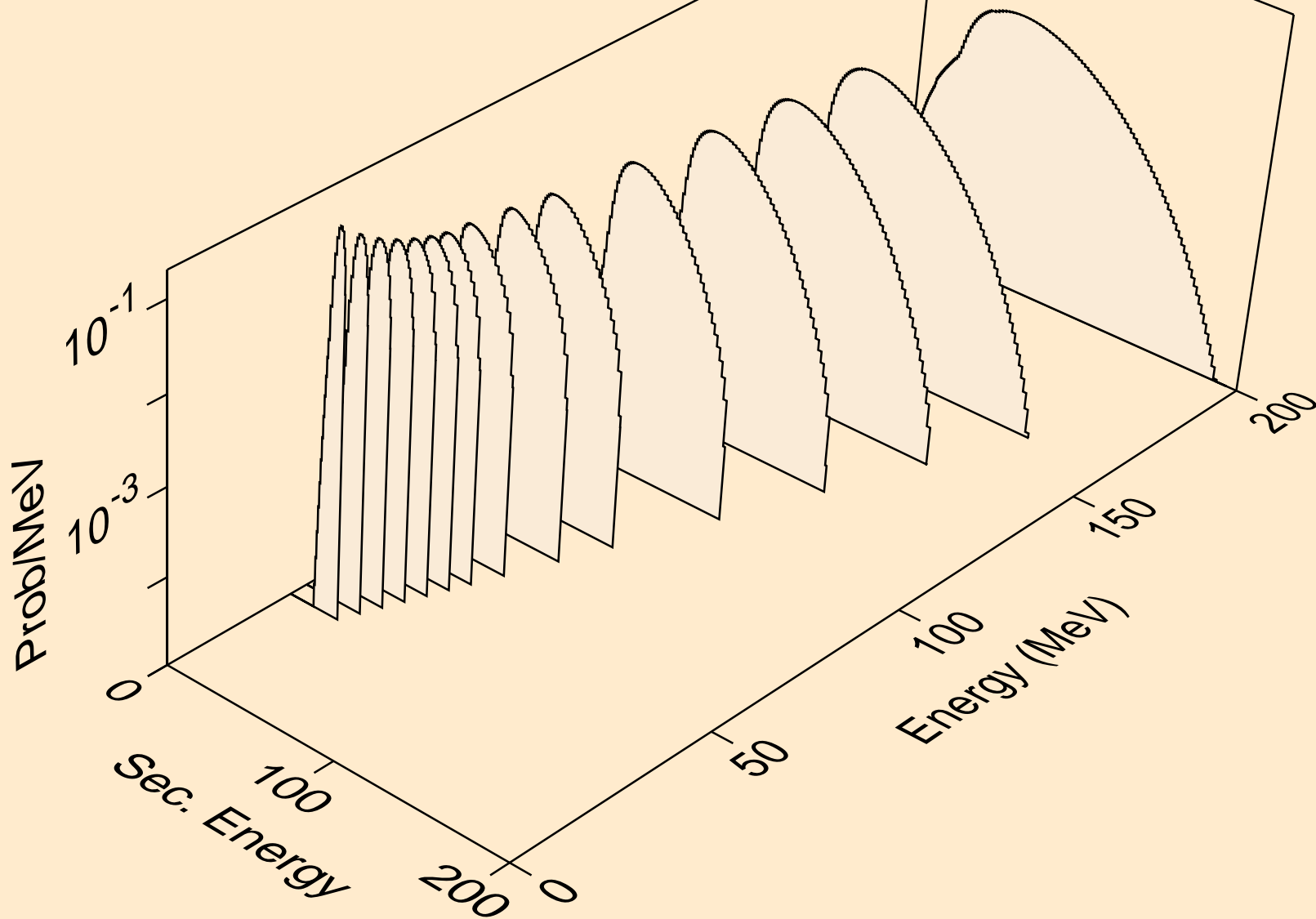

AM236M NEUTRON ACER TENDL-2019 LIBRARY; T=293.16K  
he3s from (n,n\*)he3

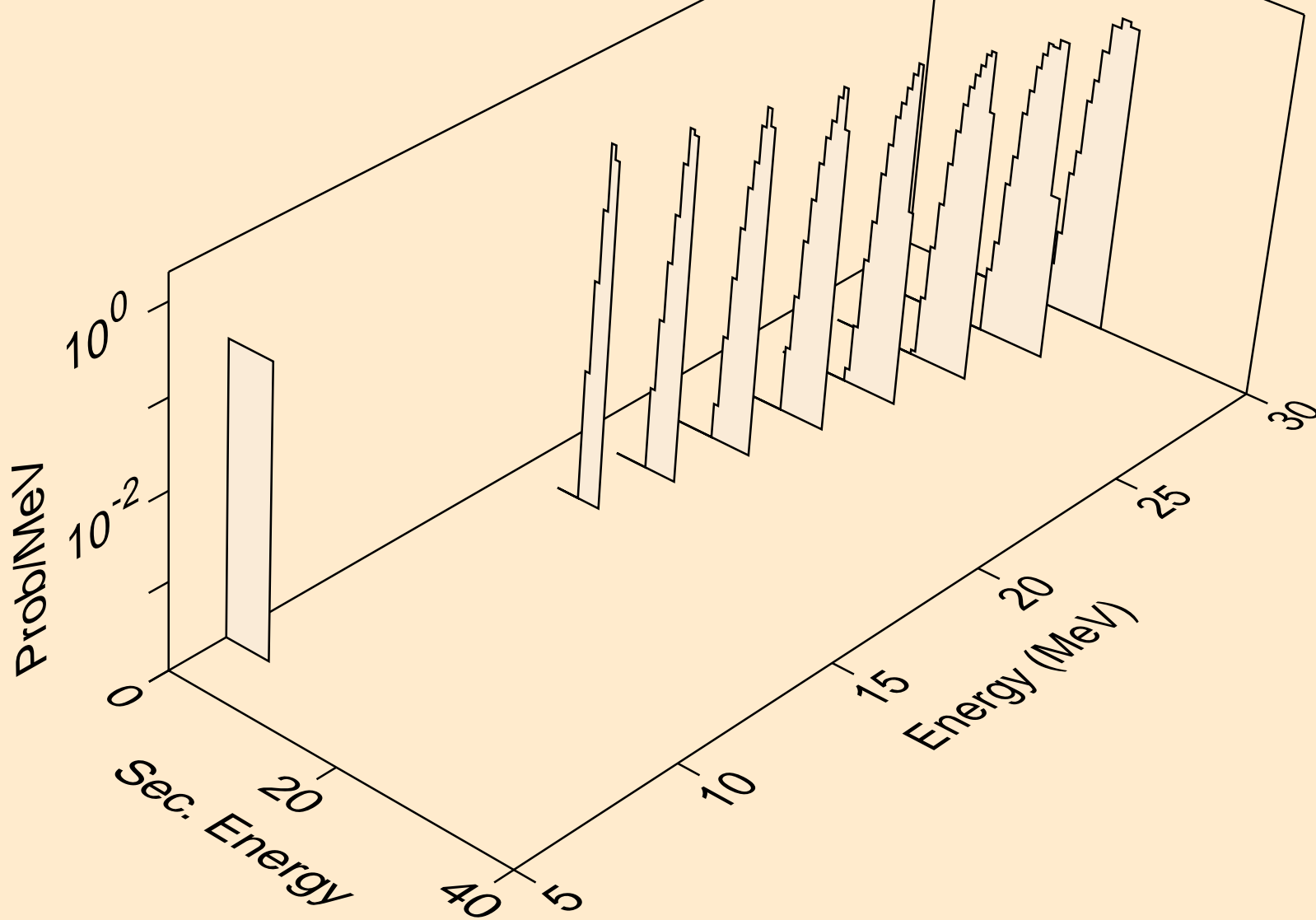

AM236M NEUTRON ACER TENDL-2019 LIBRARY; T=293.16K  
he3s from (n,he3)

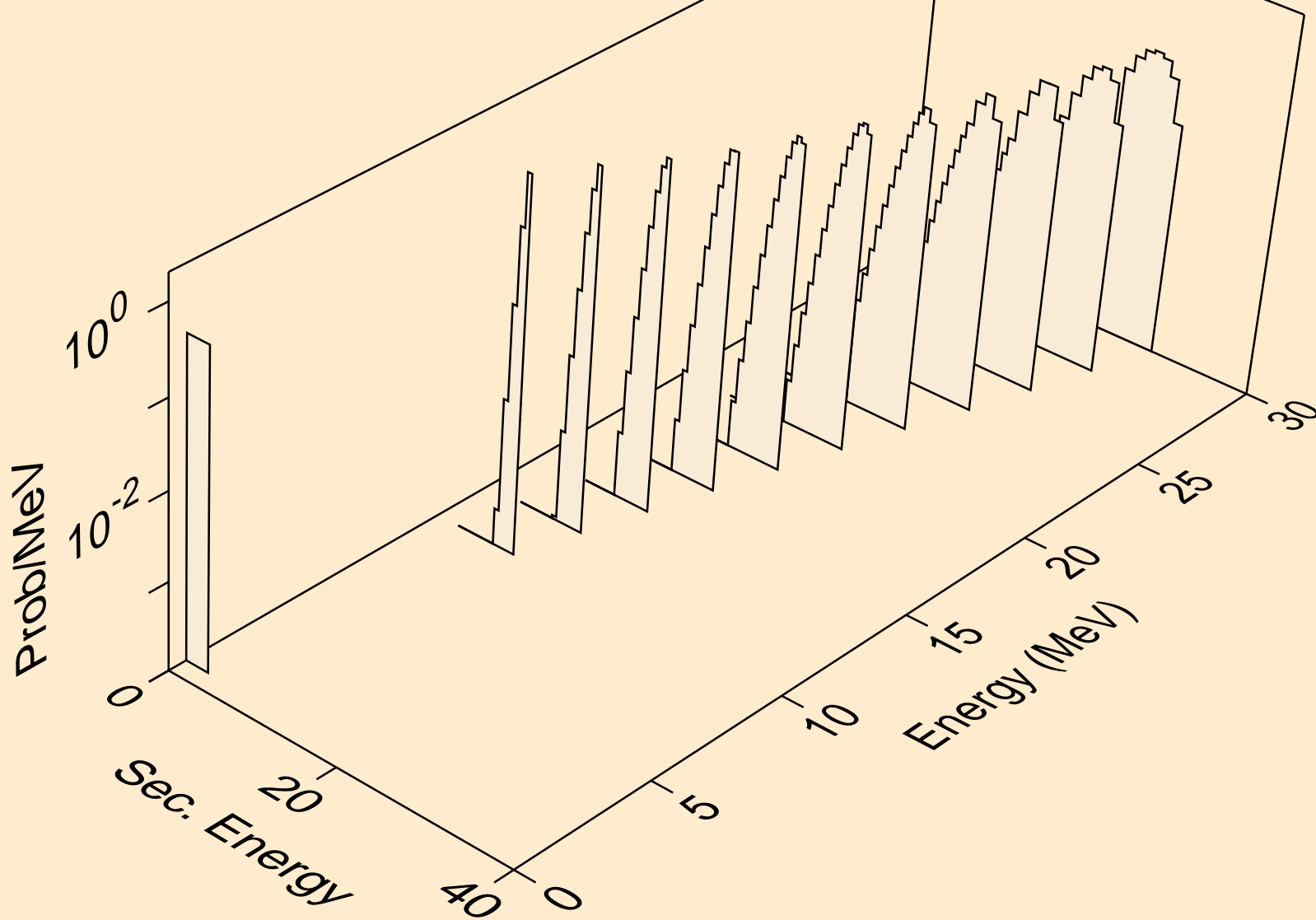

AM236M NEUTRON ACER TENDL-2019 LIBRARY; T=293.16K  
alphas from (n,x)

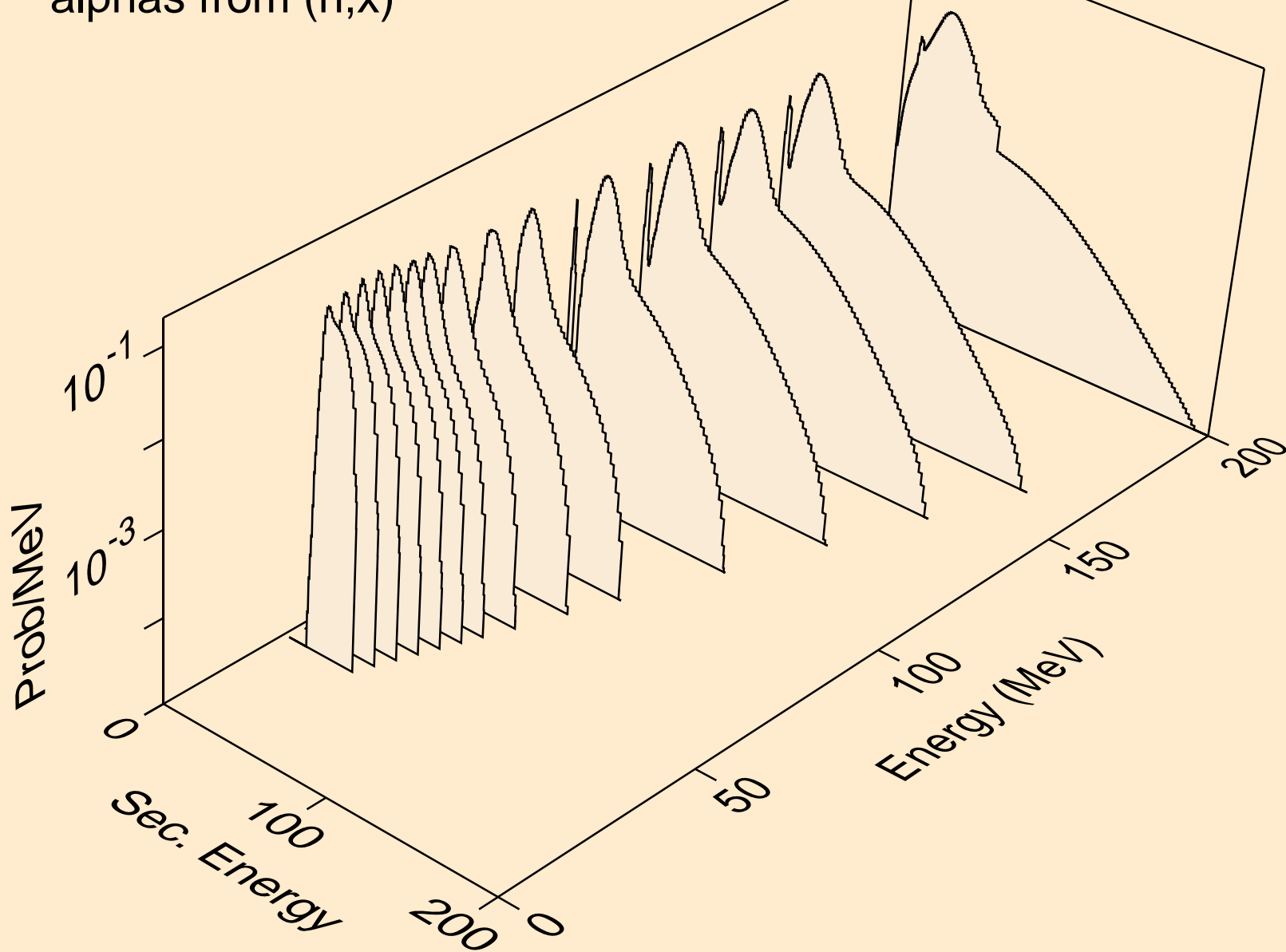

AM236M NEUTRON ACER TENDL-2019 LIBRARY; T=293.16K  
alphas from (n,n\*)a

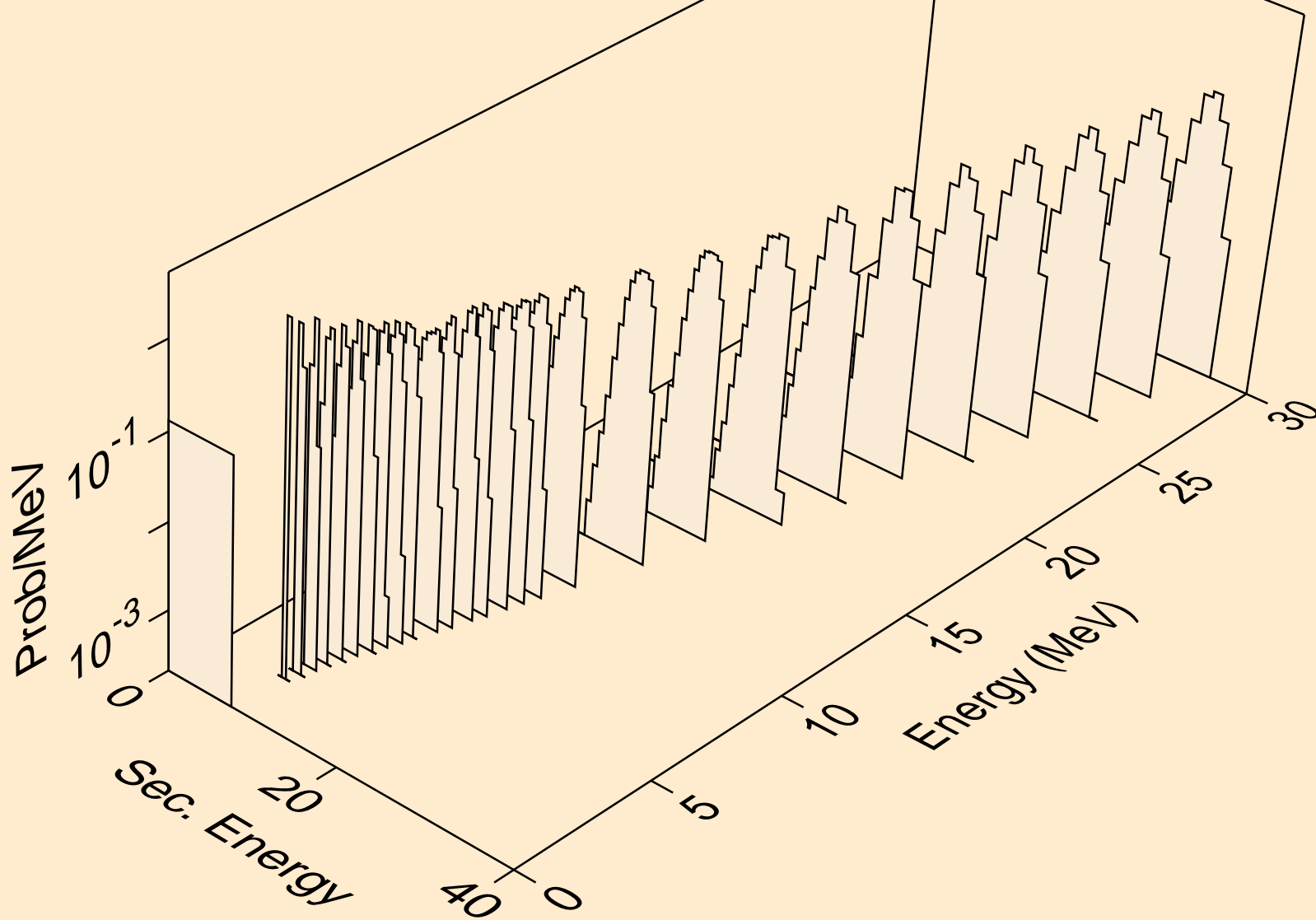

AM236M NEUTRON ACER TENDL-2019 LIBRARY; T=293.16K  
alphas from (n,2n)a

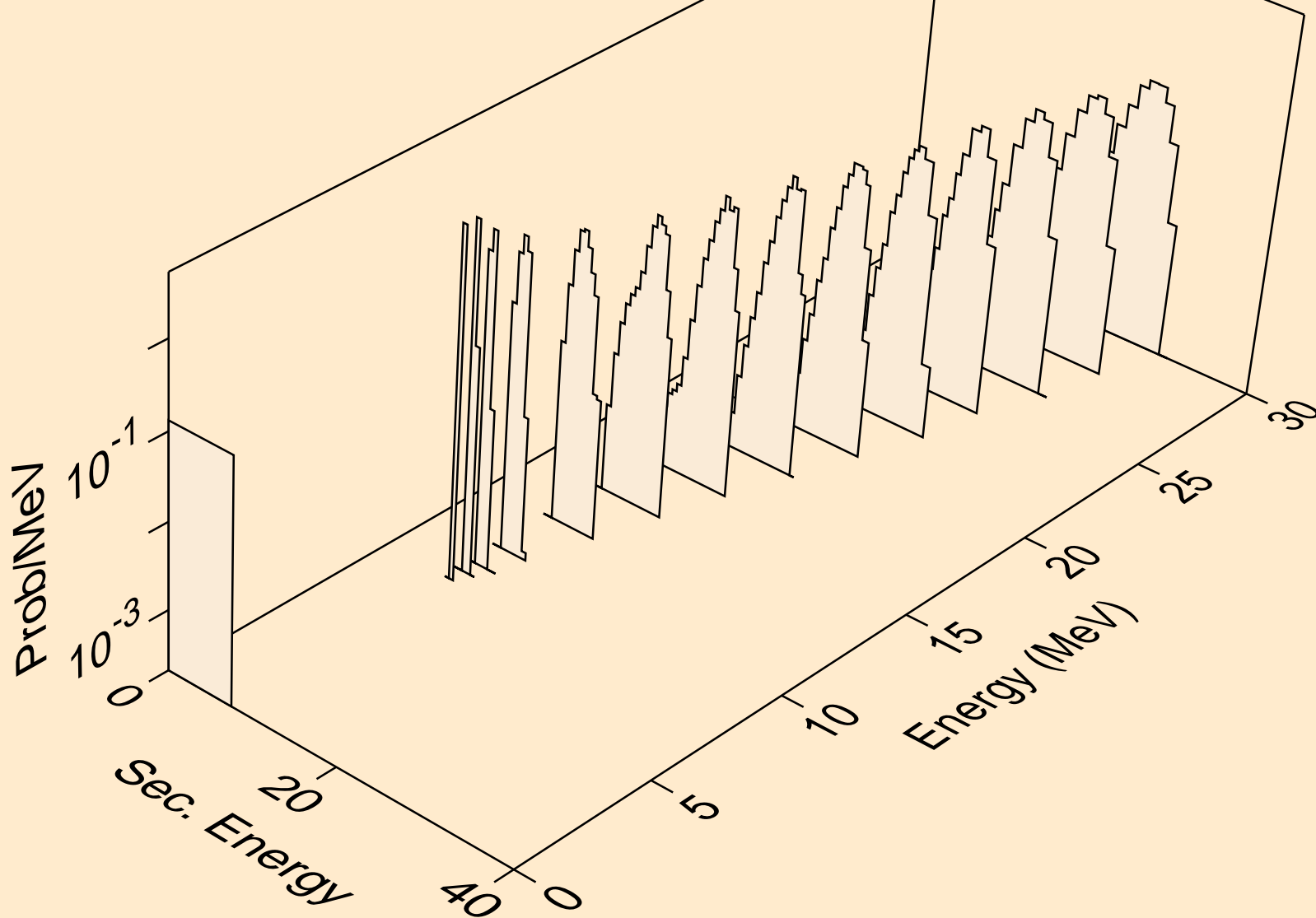

AM236M NEUTRON ACER TENDL-2019 LIBRARY; T=293.16K  
alphas from (n,3n)a

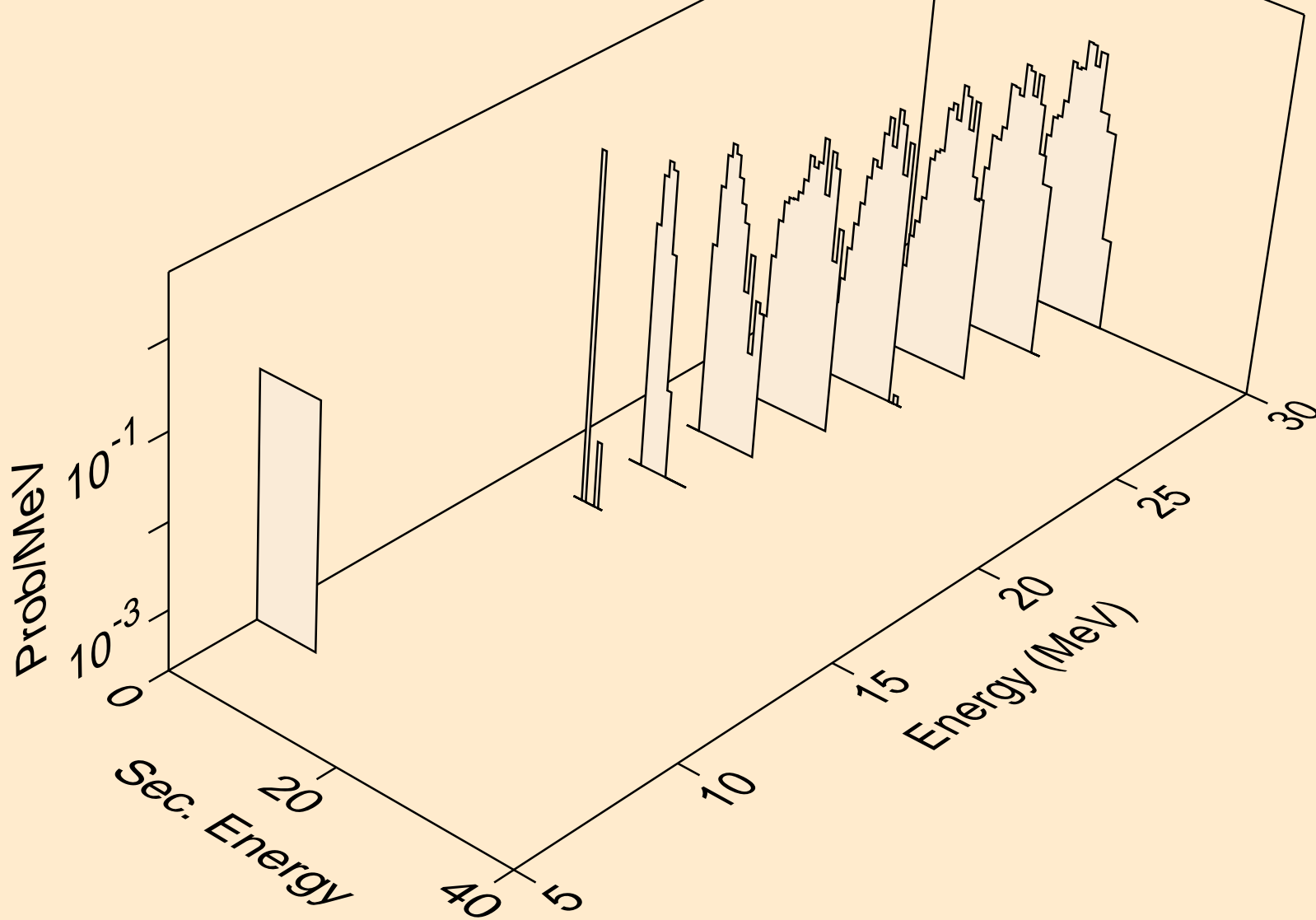



AM236M NEUTRON ACER TENDL-2019 LIBRARY; T=293.16K  
alphas from (n,n\*)2a

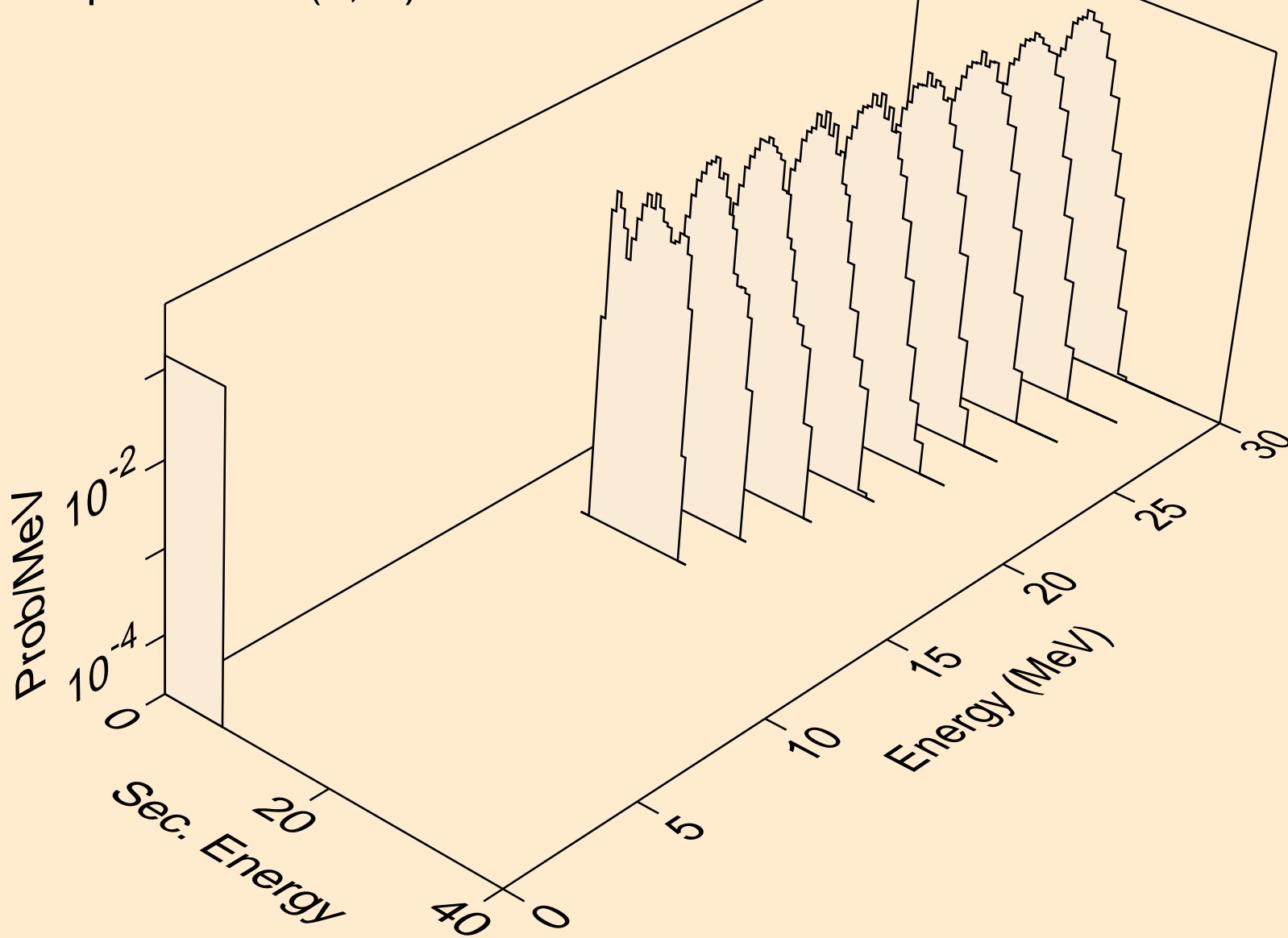

AM236M NEUTRON ACER TENDL-2019 LIBRARY; T=293.16K  
alphas from (n,npa)

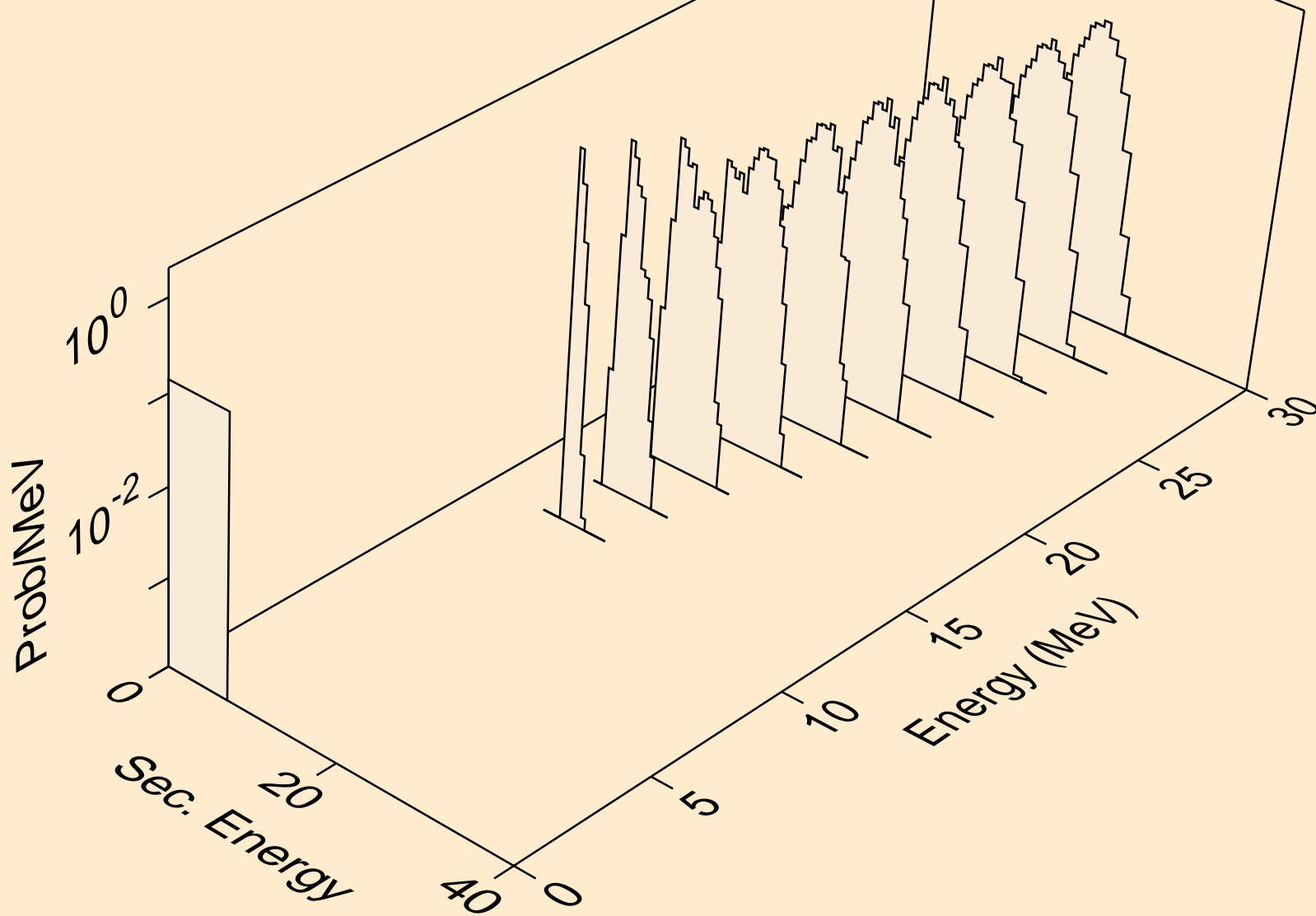

AM236M NEUTRON ACER TENDL-2019 LIBRARY; T=293.16K  
alphas from (n,a)

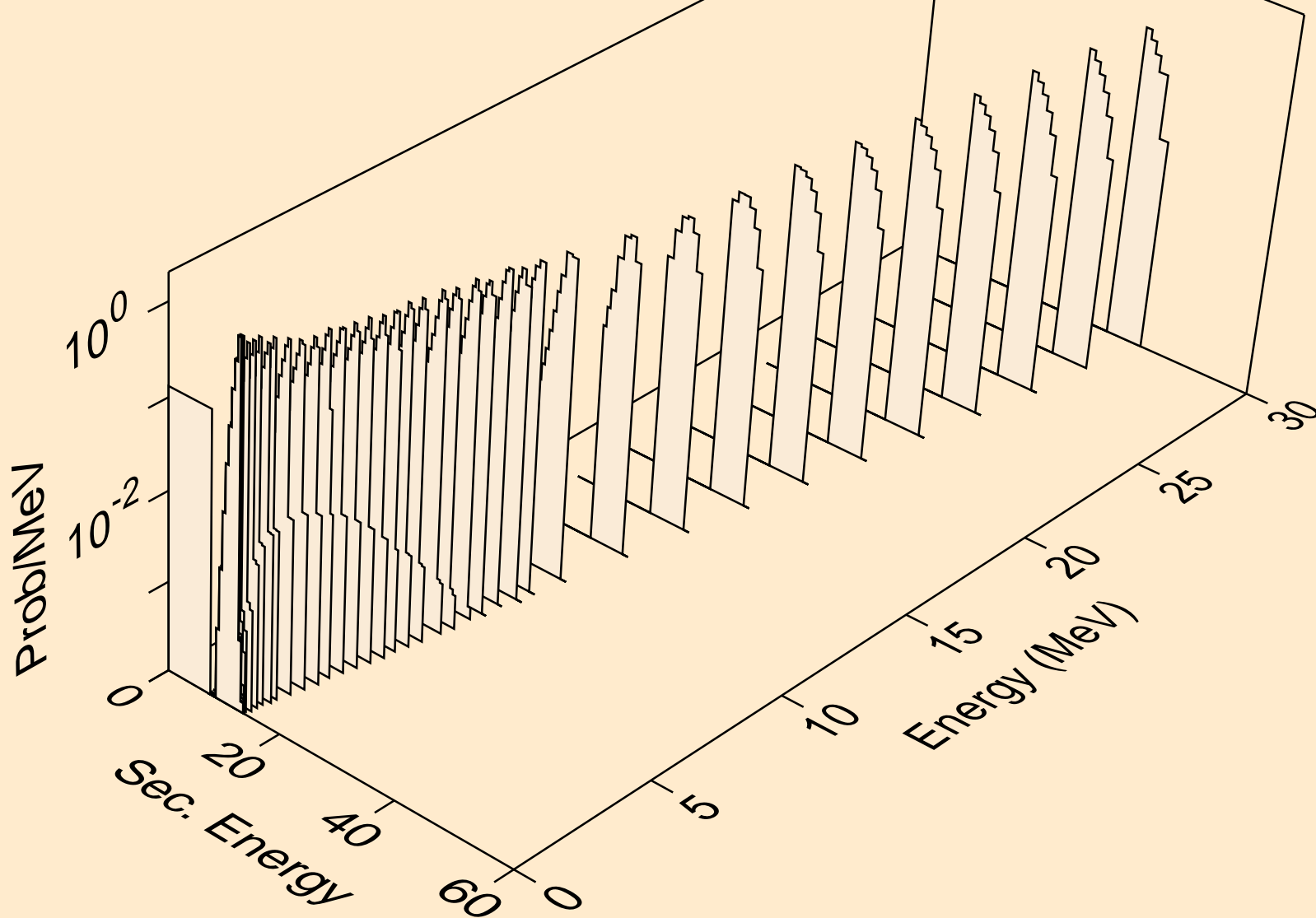

AM236M NEUTRON ACER TENDL-2019 LIBRARY; T=293.16K  
alphas from (n,2a)

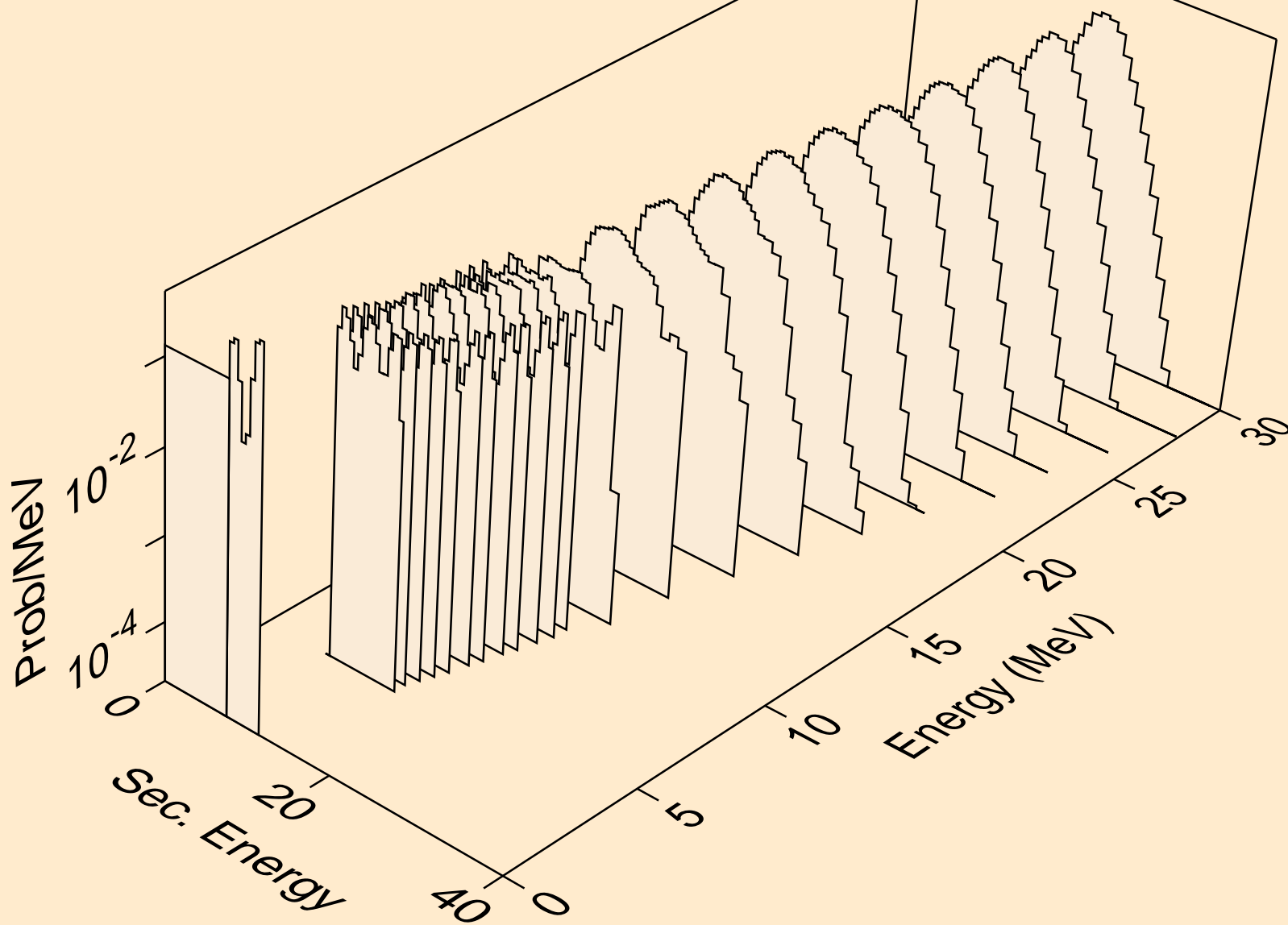

AM236M NEUTRON ACER TENDL-2019 LIBRARY; T=293.16K  
alphas from (n,pa)

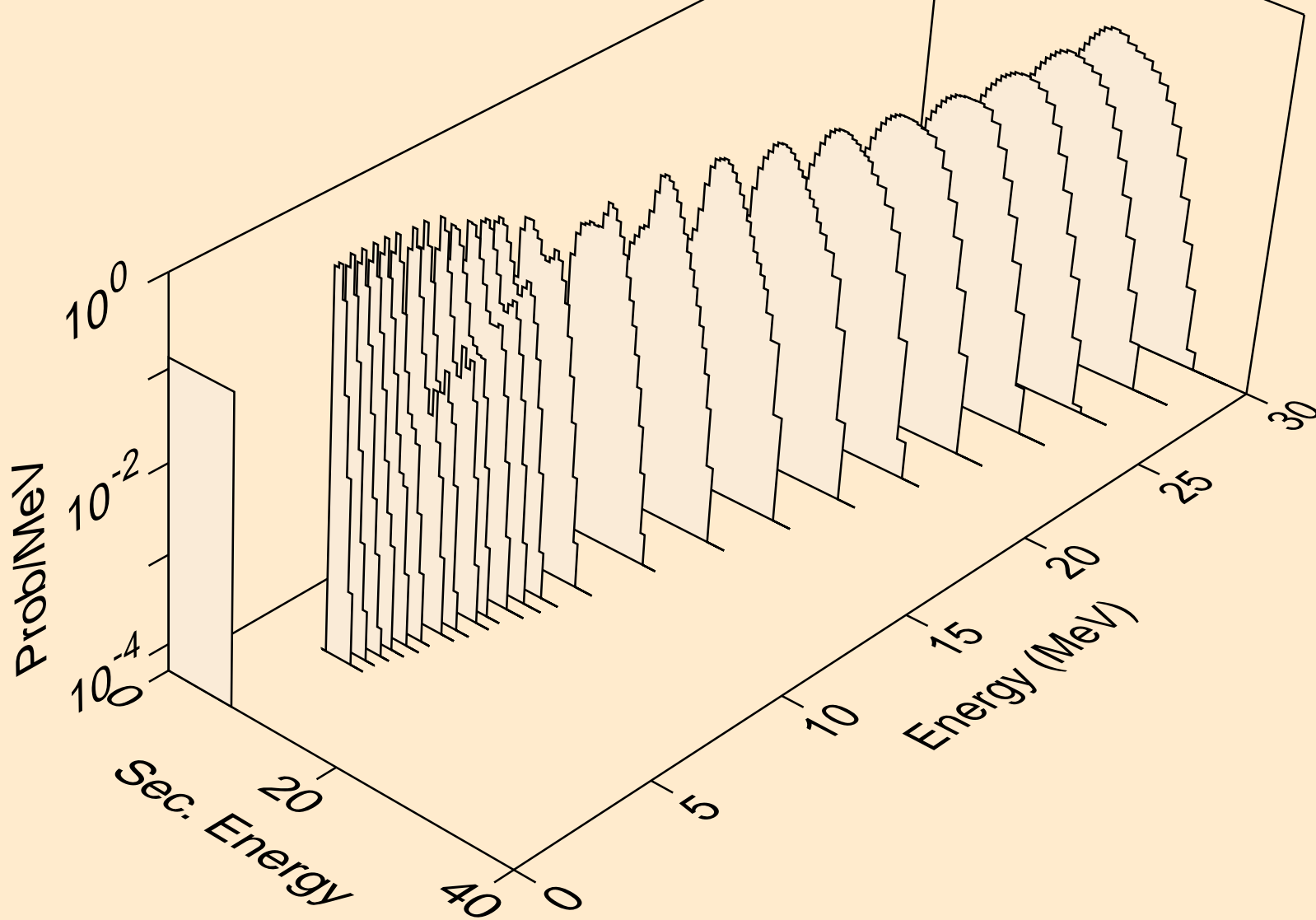

AM236M NEUTRON ACER TENDL-2019 LIBRARY; T=293.16K  
alphas from (n,da)

