

AM242M NEUTRON ACER TENDL-2019 LIBRARY; T=293.16K
Principal cross sections

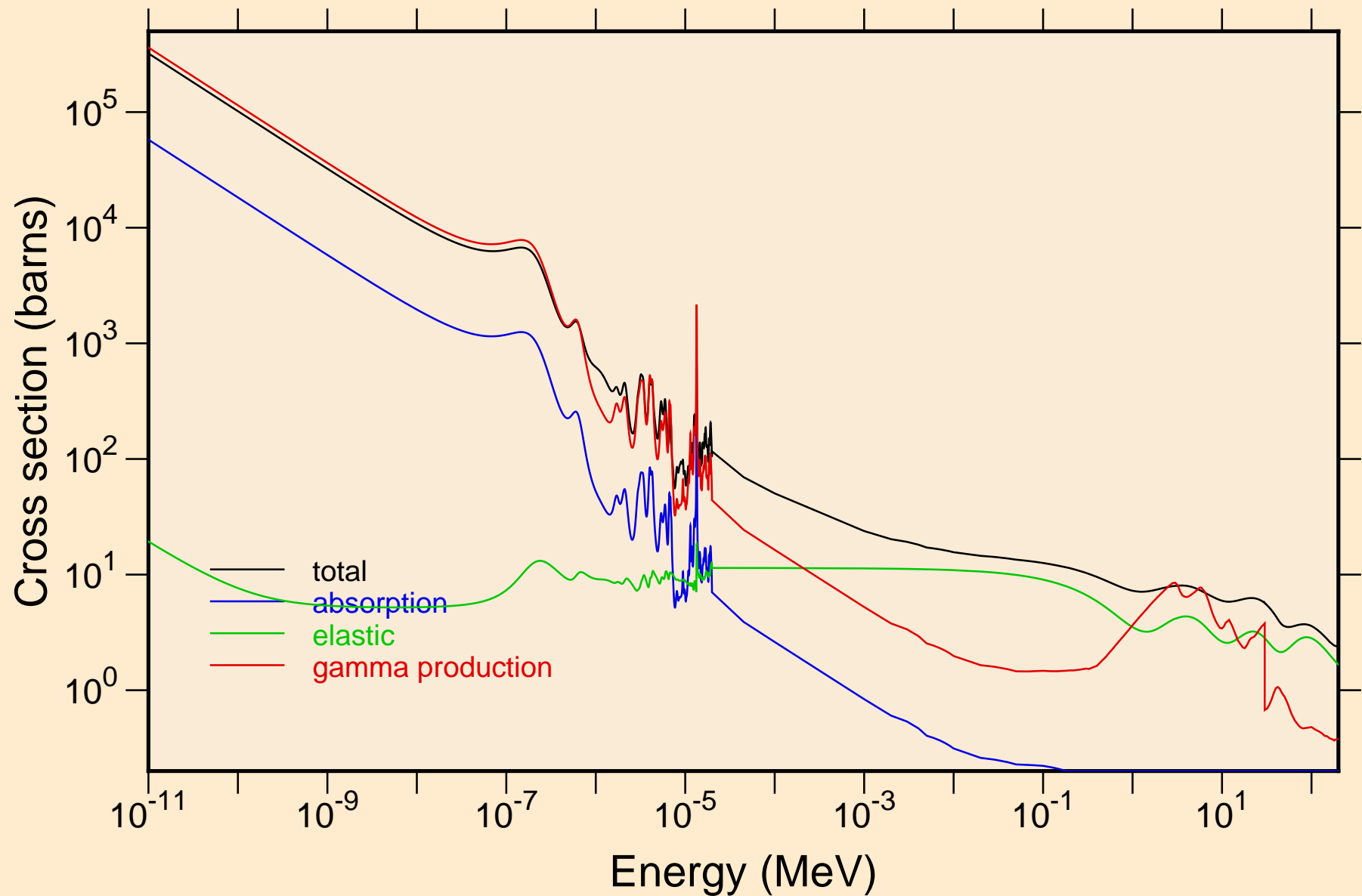

AM242M NEUTRON ACER TENDL-2019 LIBRARY; T=293.16K
resonance total cross section

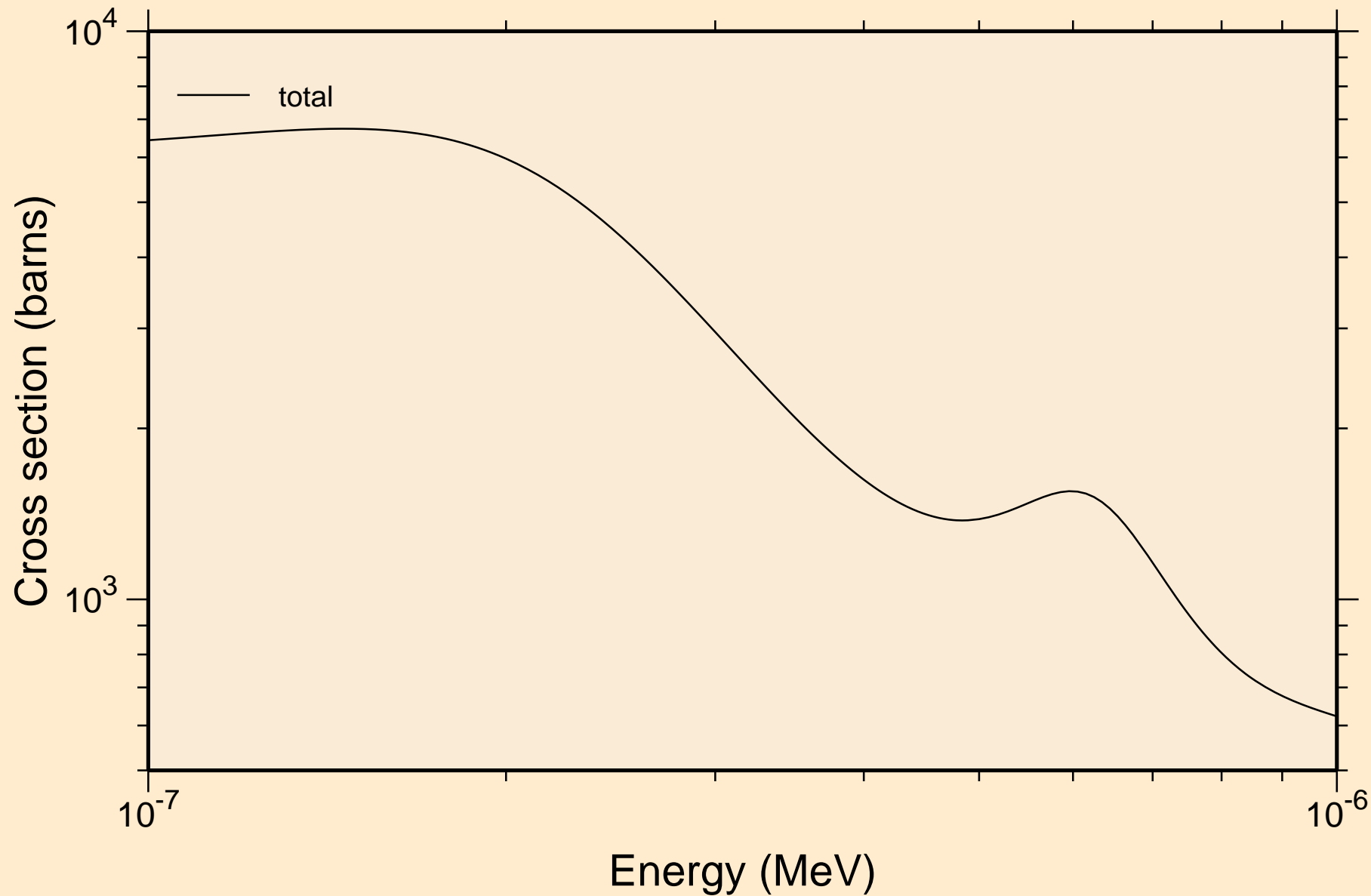

AM242M NEUTRON ACER TENDL-2019 LIBRARY; T=293.16K
resonance total cross section

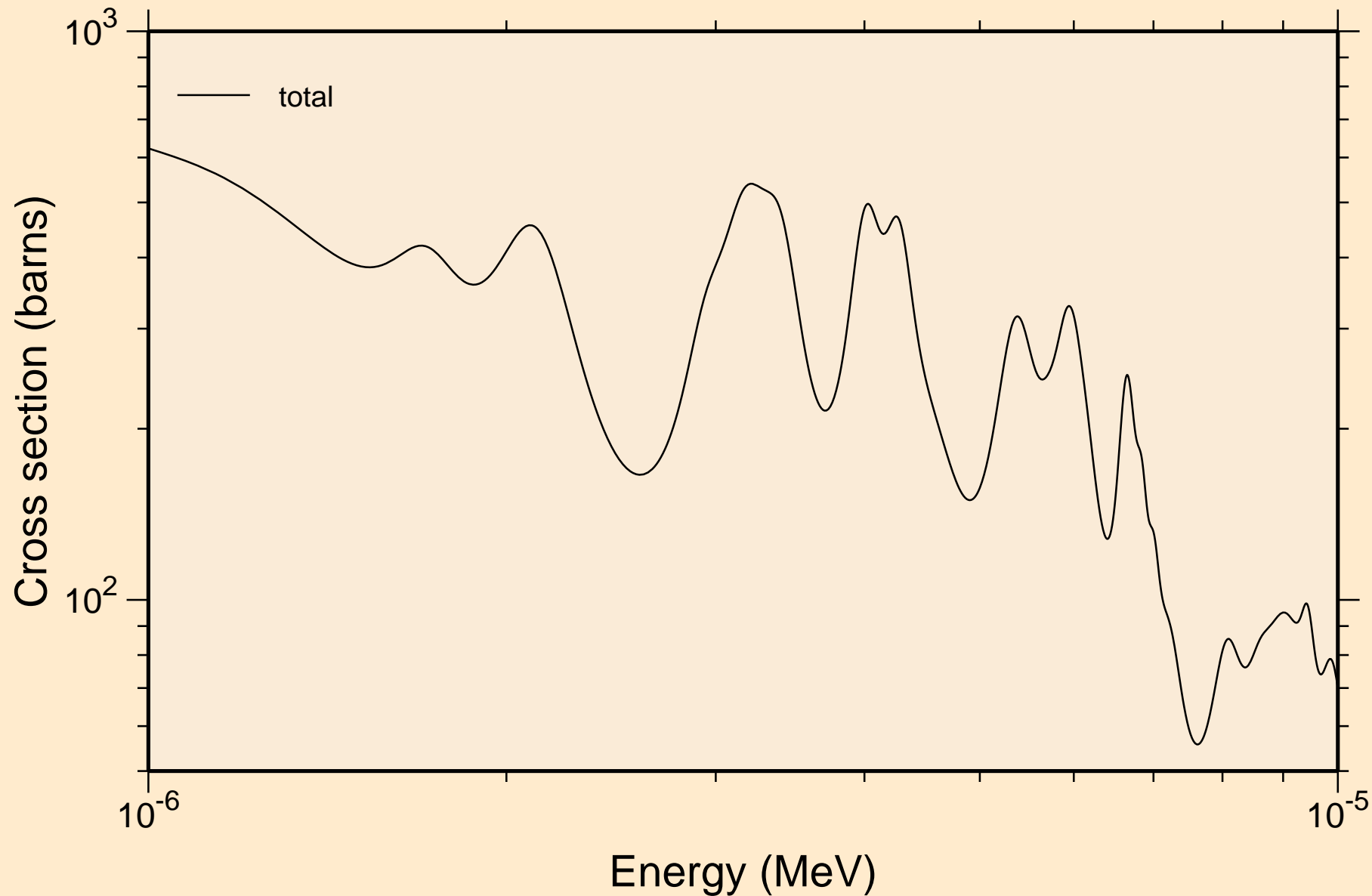

AM242M NEUTRON ACER TENDL-2019 LIBRARY; T=293.16K
resonance total cross section

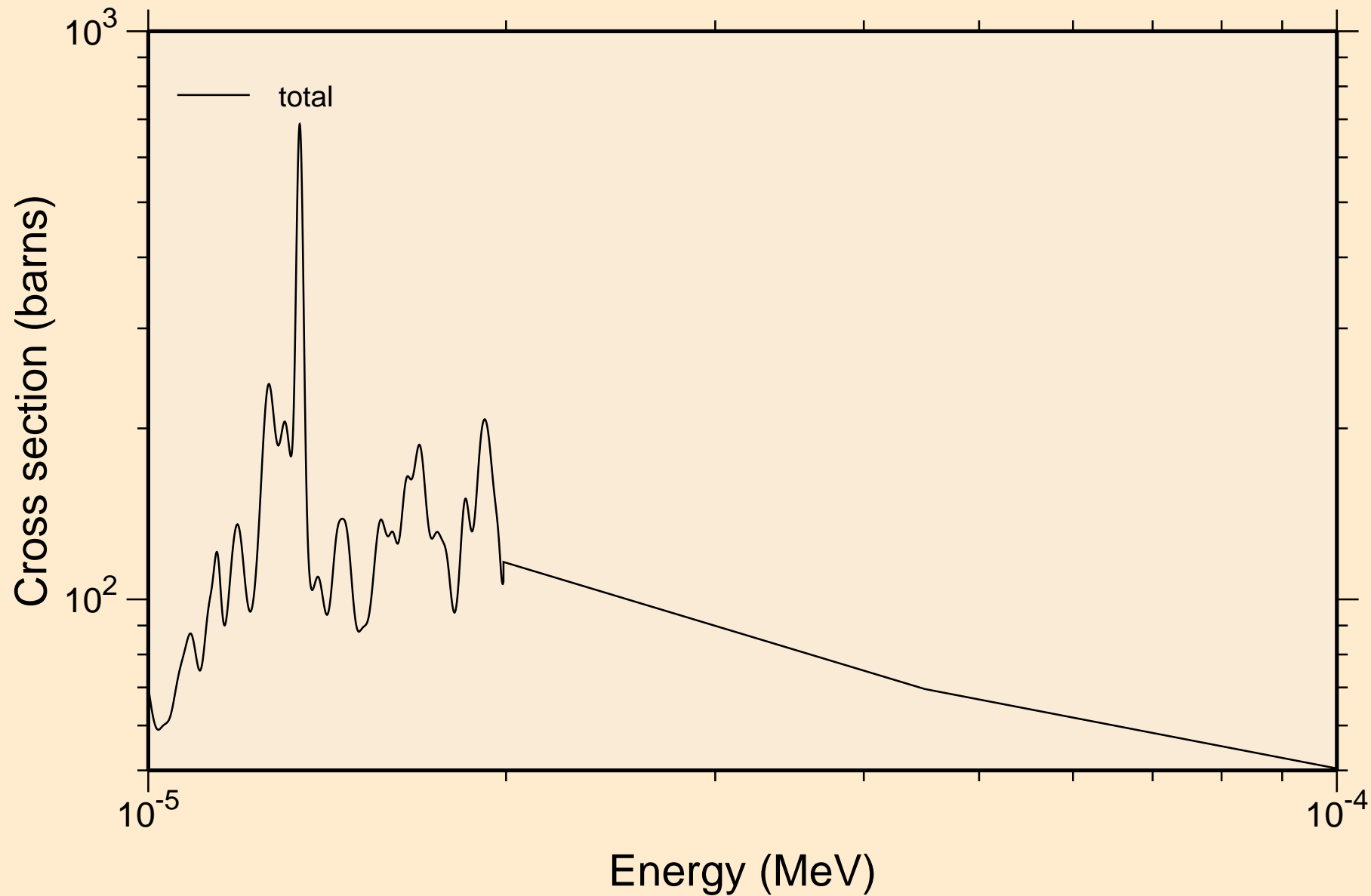

AM242M NEUTRON ACER TENDL-2019 LIBRARY; T=293.16K
resonance total cross section

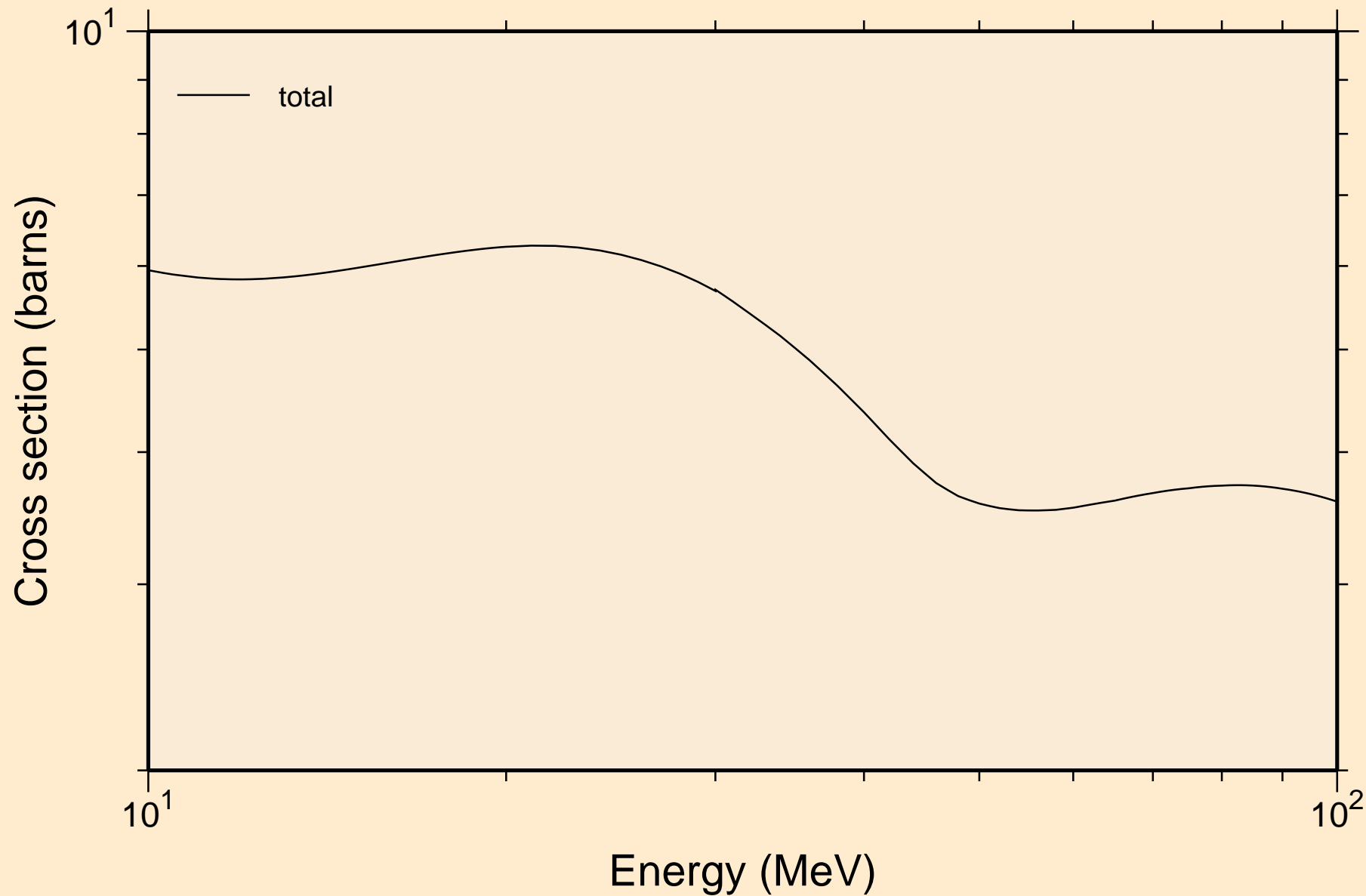

AM242M NEUTRON ACER TENDL-2019 LIBRARY; T=293.16K
resonance absorption cross sections

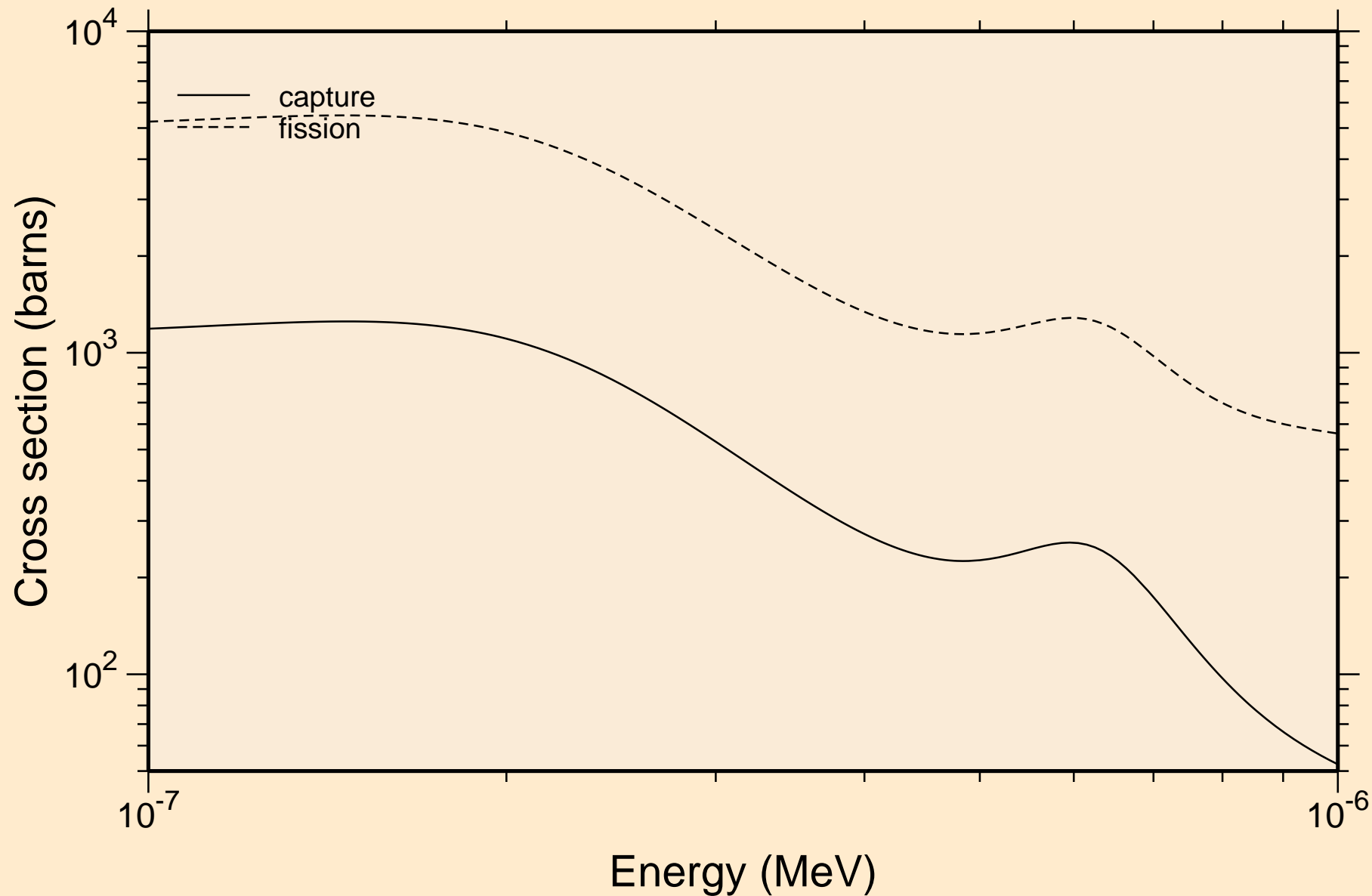

AM242M NEUTRON ACER TENDL-2019 LIBRARY; T=293.16K
resonance absorption cross sections

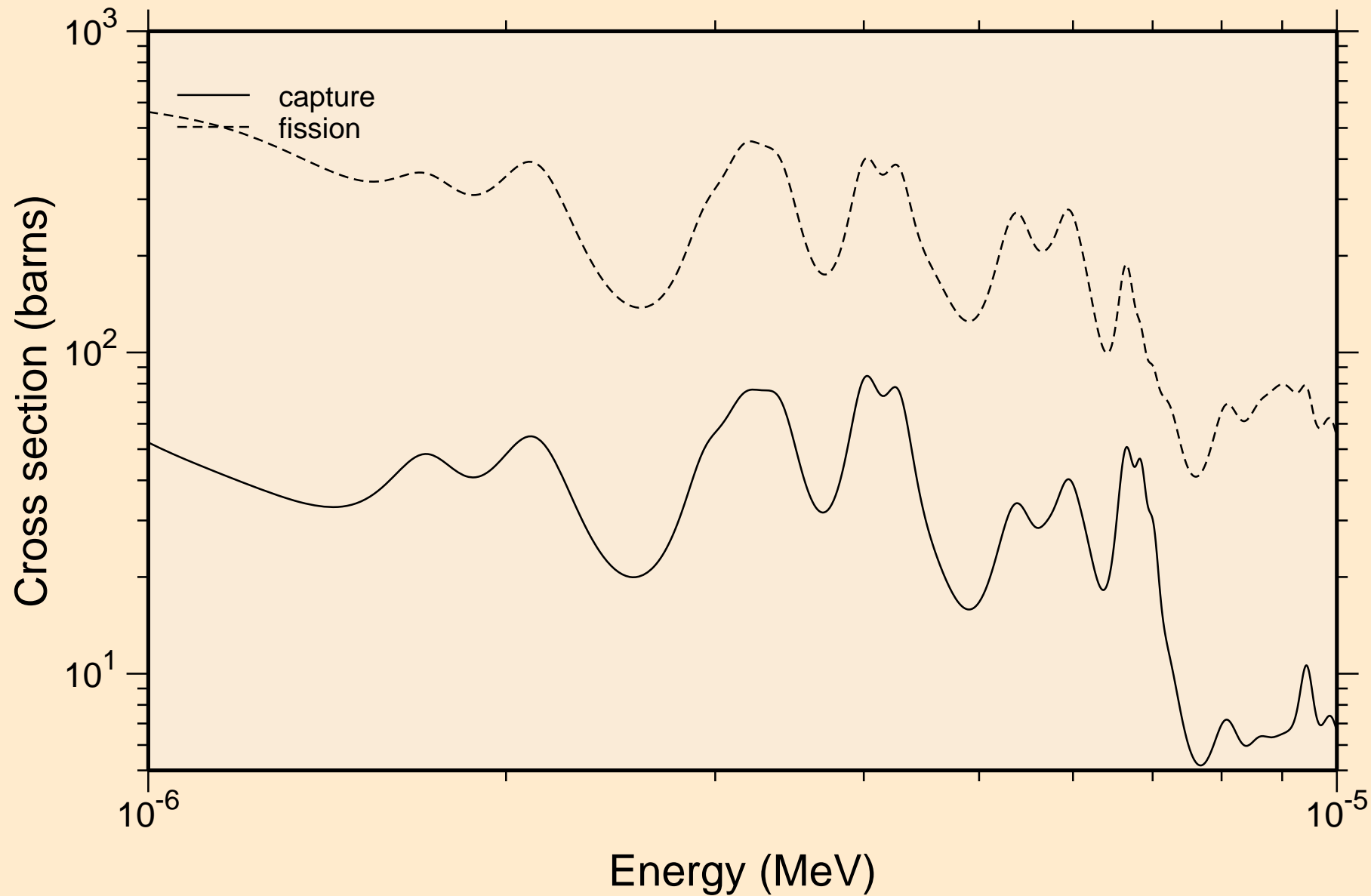

AM242M NEUTRON ACER TENDL-2019 LIBRARY; T=293.16K
resonance absorption cross sections

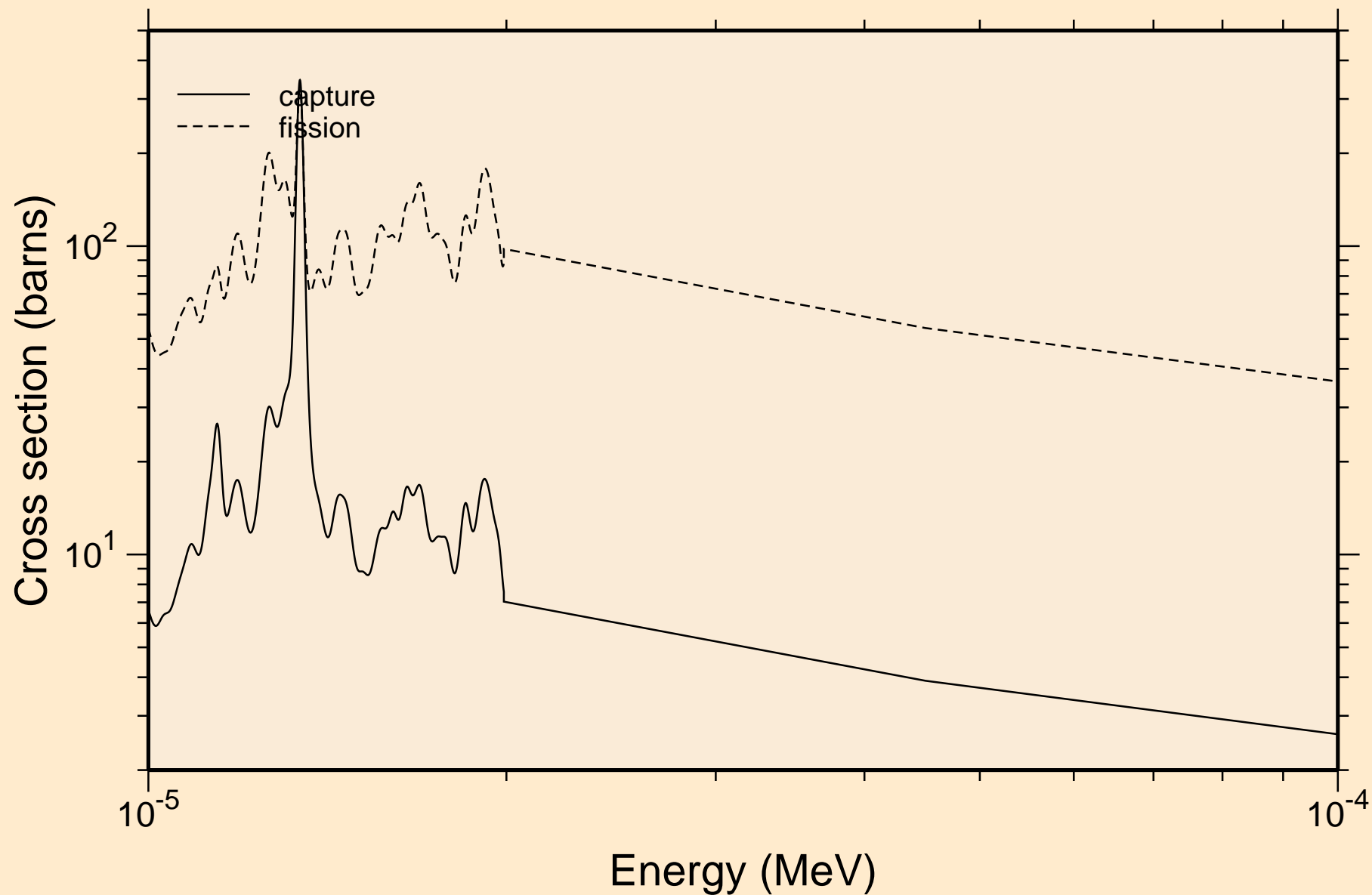

AM242M NEUTRON ACER TENDL-2019 LIBRARY; T=293.16K
resonance absorption cross sections

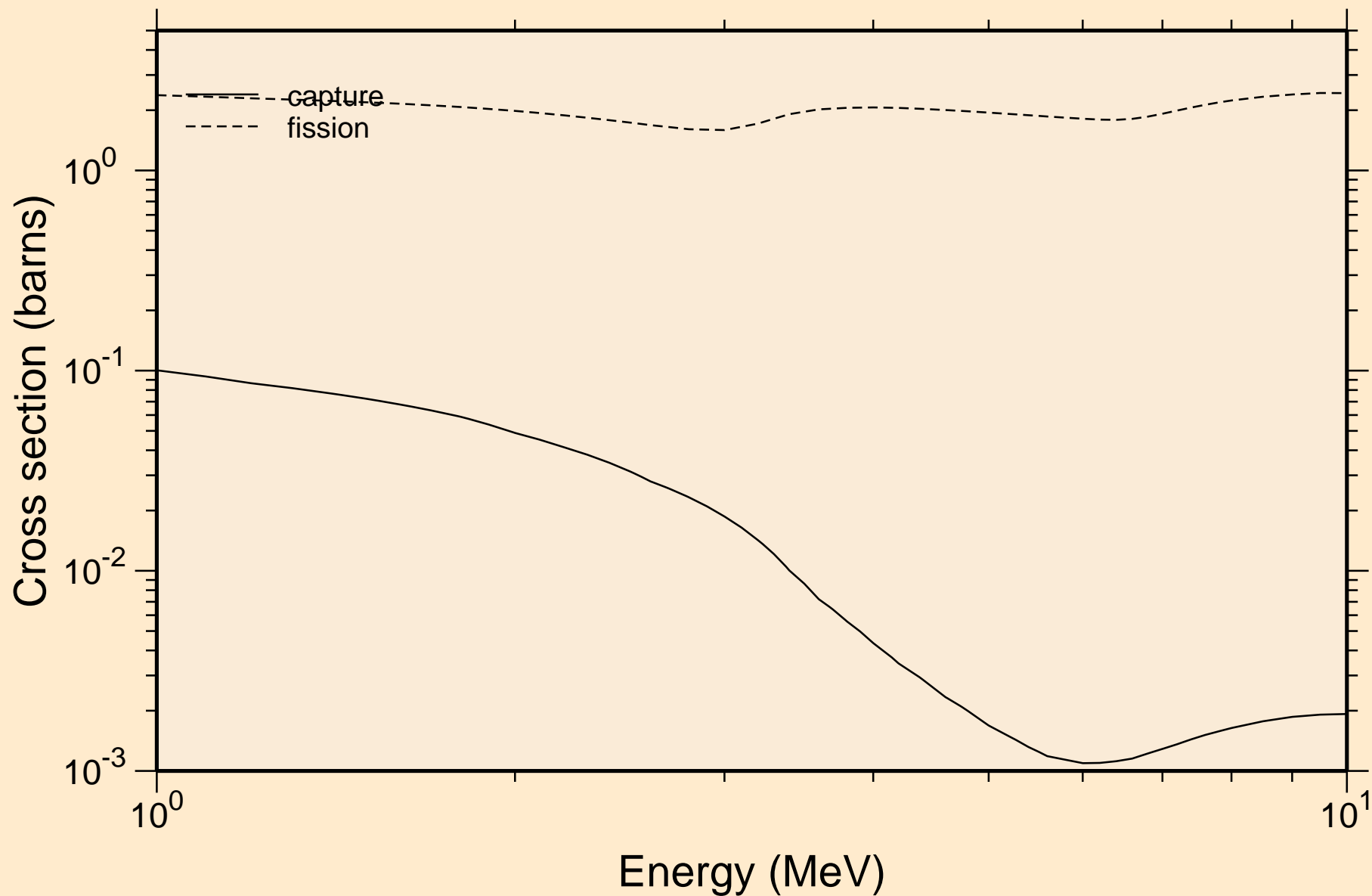

AM242M NEUTRON ACER TENDL-2019 LIBRARY; T=293.16K
Heating

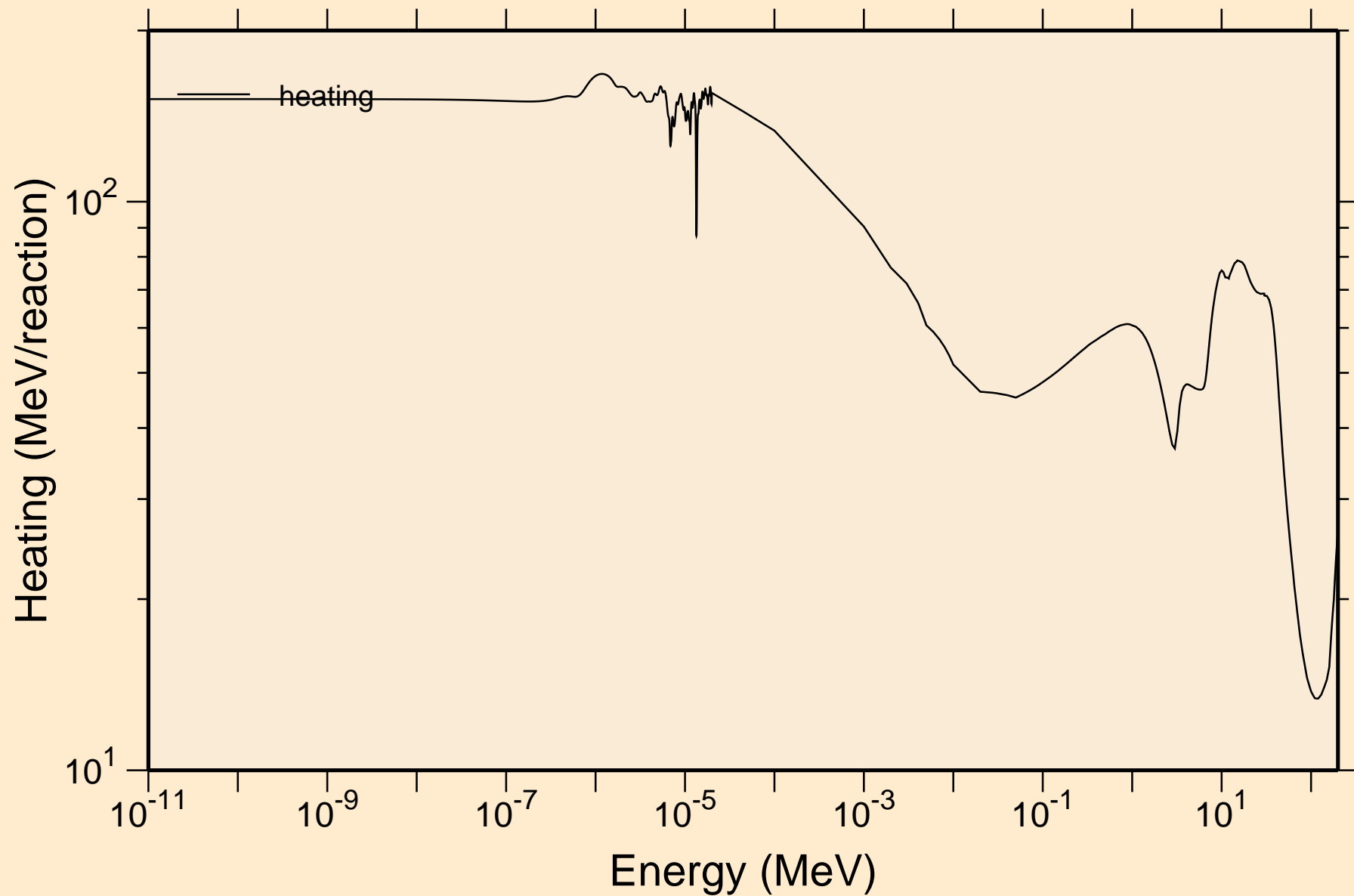

AM242M NEUTRON ACER TENDL-2019 LIBRARY; T=293.16K
Damage

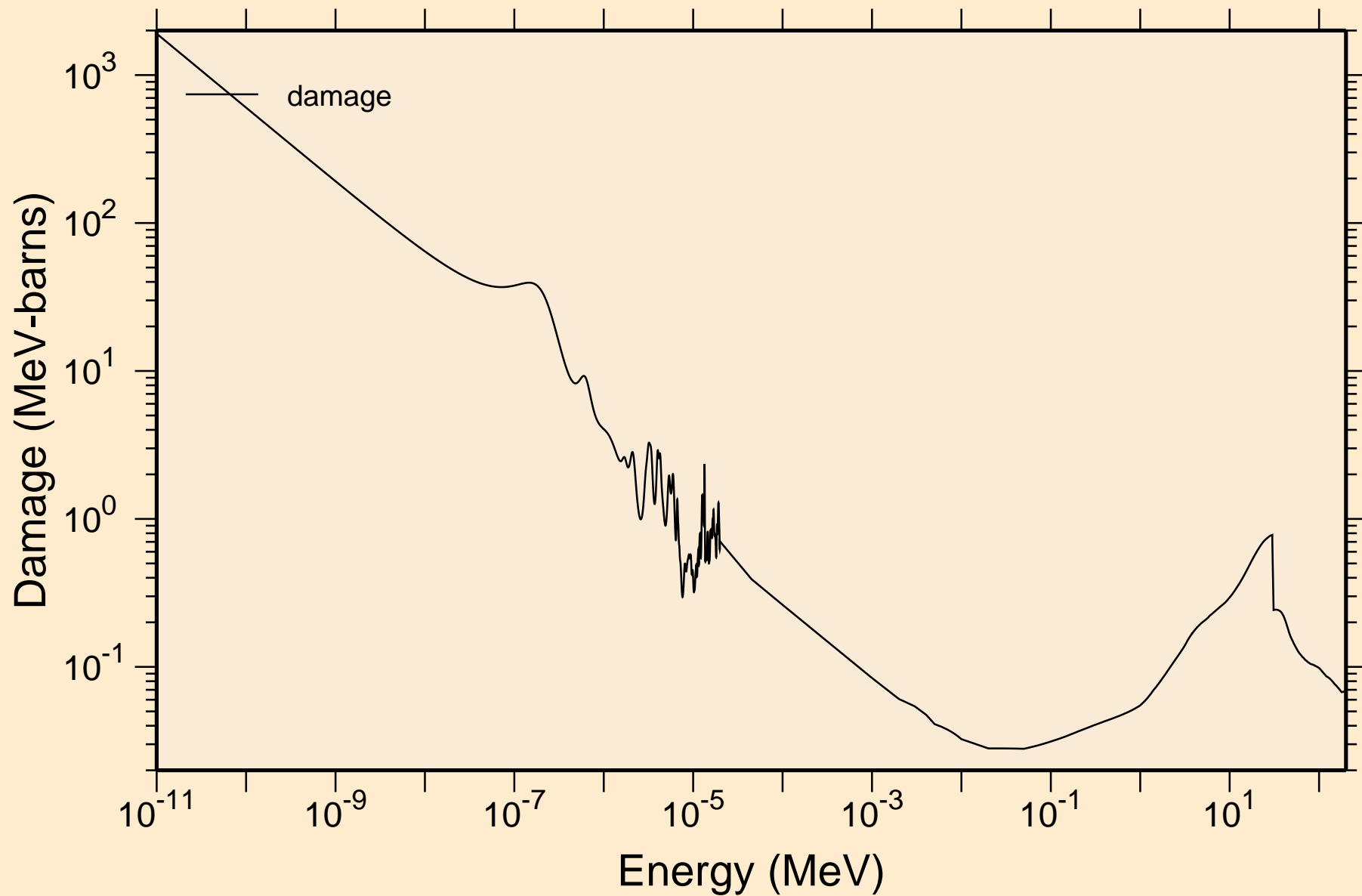

AM242M NEUTRON ACER TENDL-2019 LIBRARY; T=293.16K
Non-threshold reactions

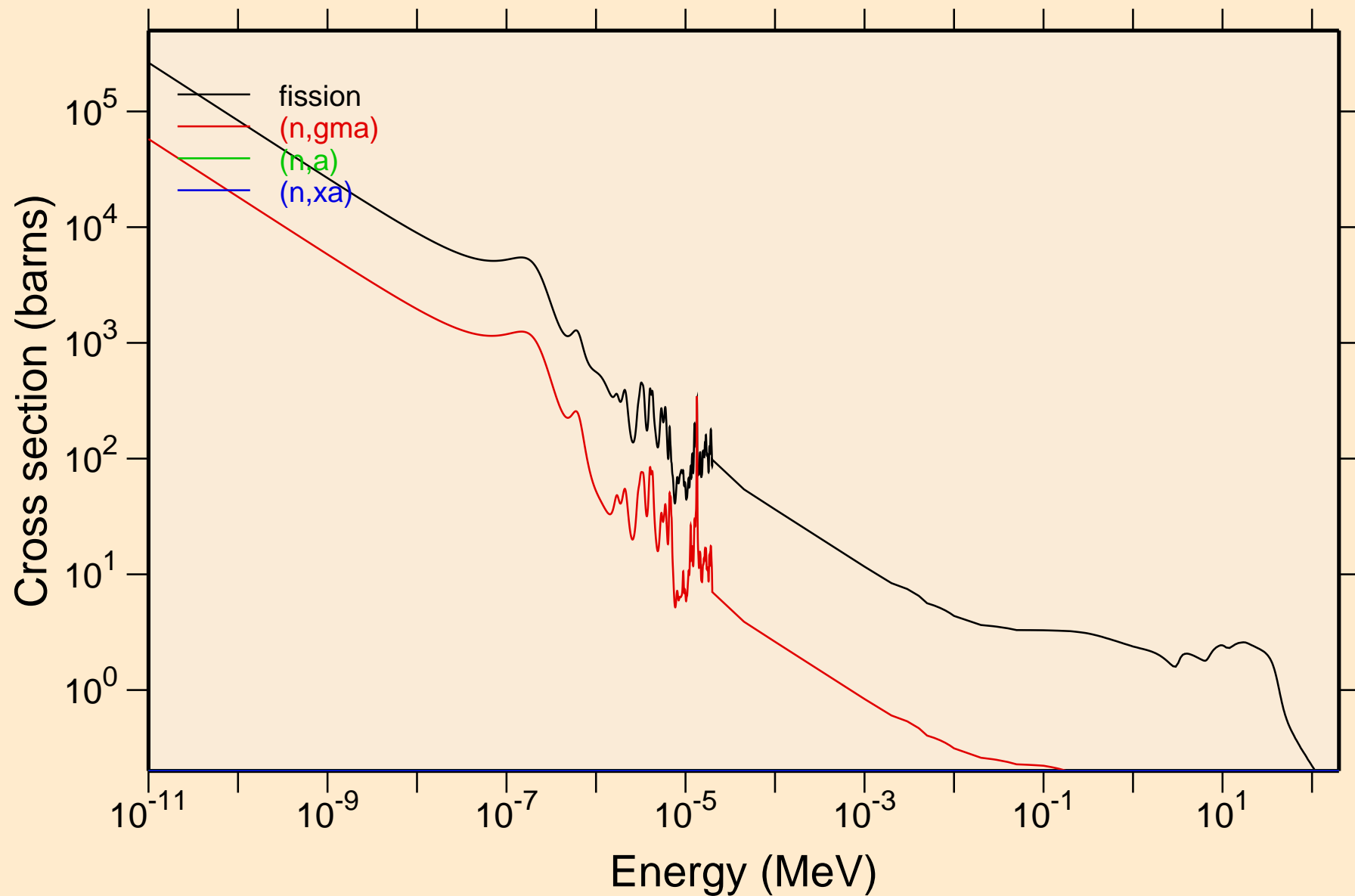

AM242M NEUTRON ACER TENDL-2019 LIBRARY; T=293.16K
Principal cross sections

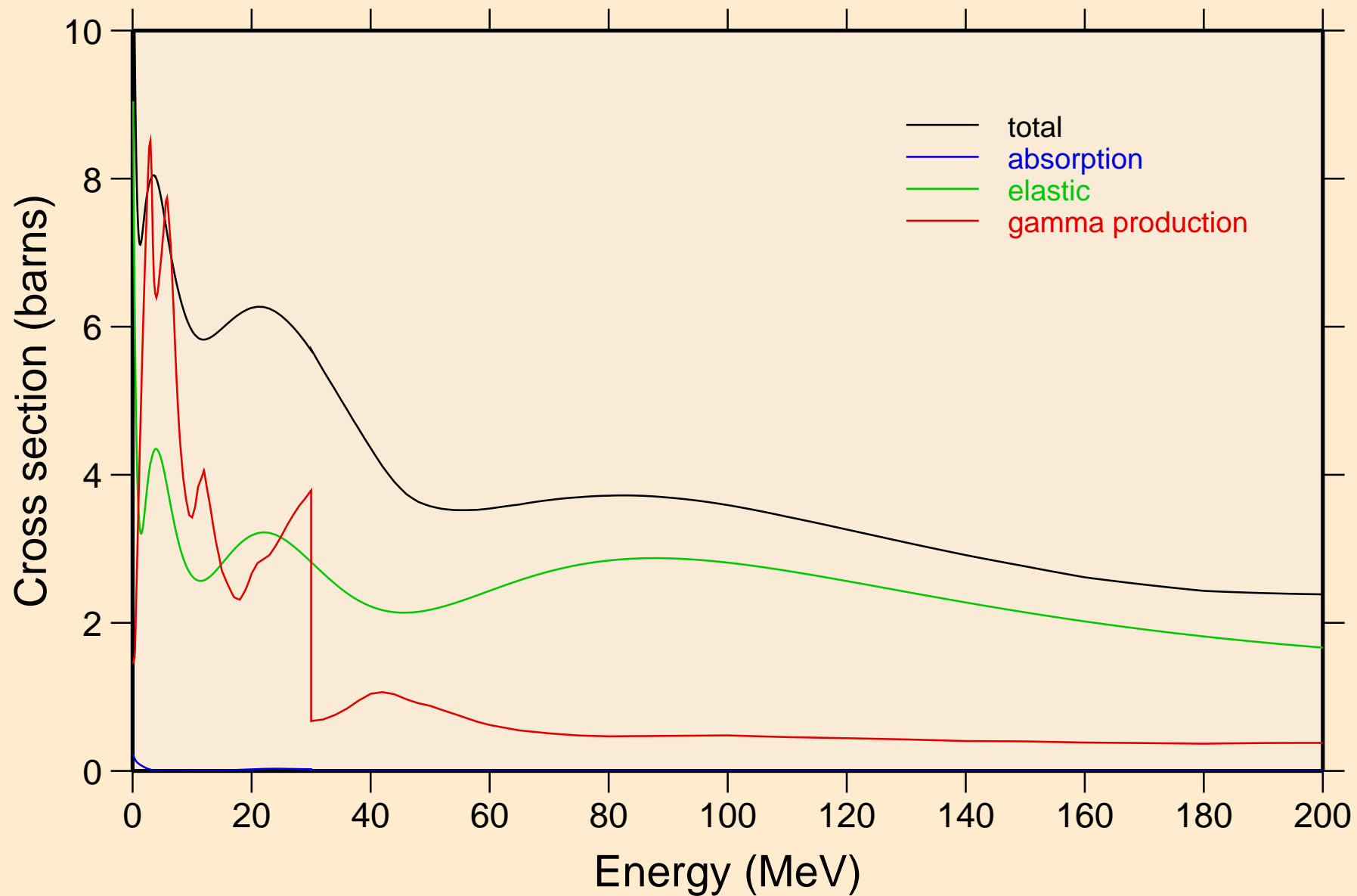

AM242M NEUTRON ACER TENDL-2019 LIBRARY; T=293.16K
Heating

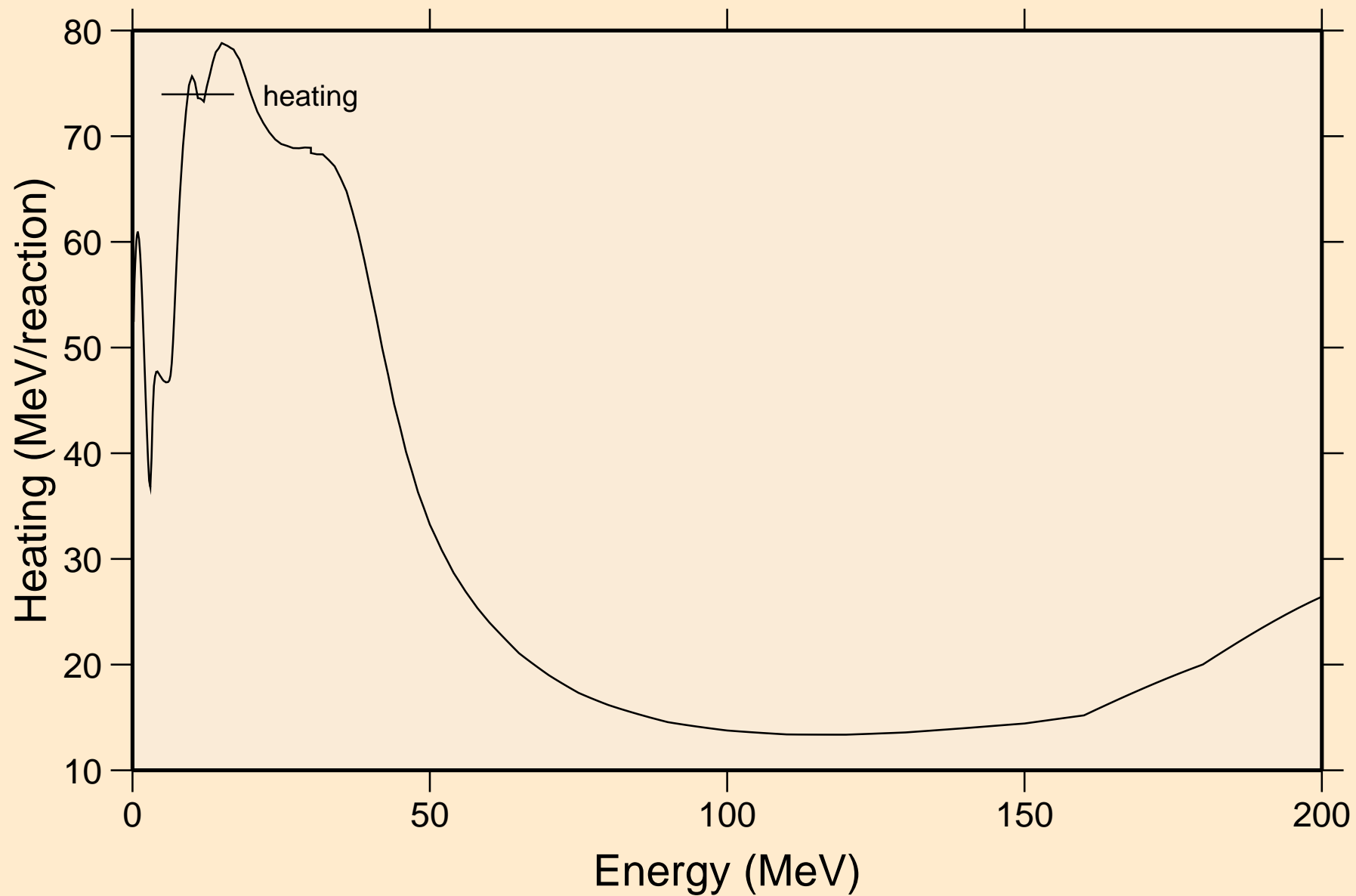

AM242M NEUTRON ACER TENDL-2019 LIBRARY; T=293.16K
Damage

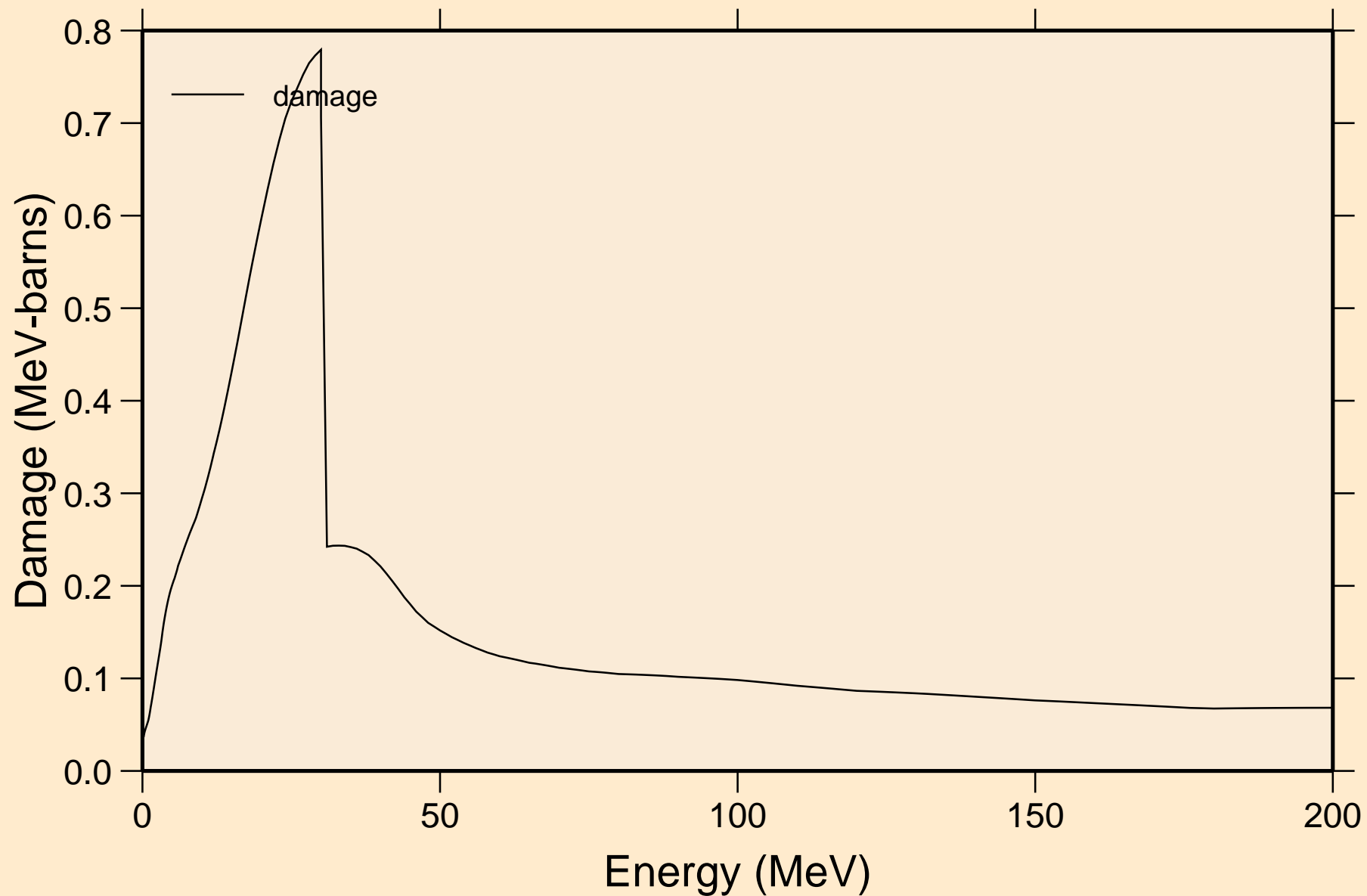

AM242M NEUTRON ACER TENDL-2019 LIBRARY; T=293.16K
Non-threshold reactions

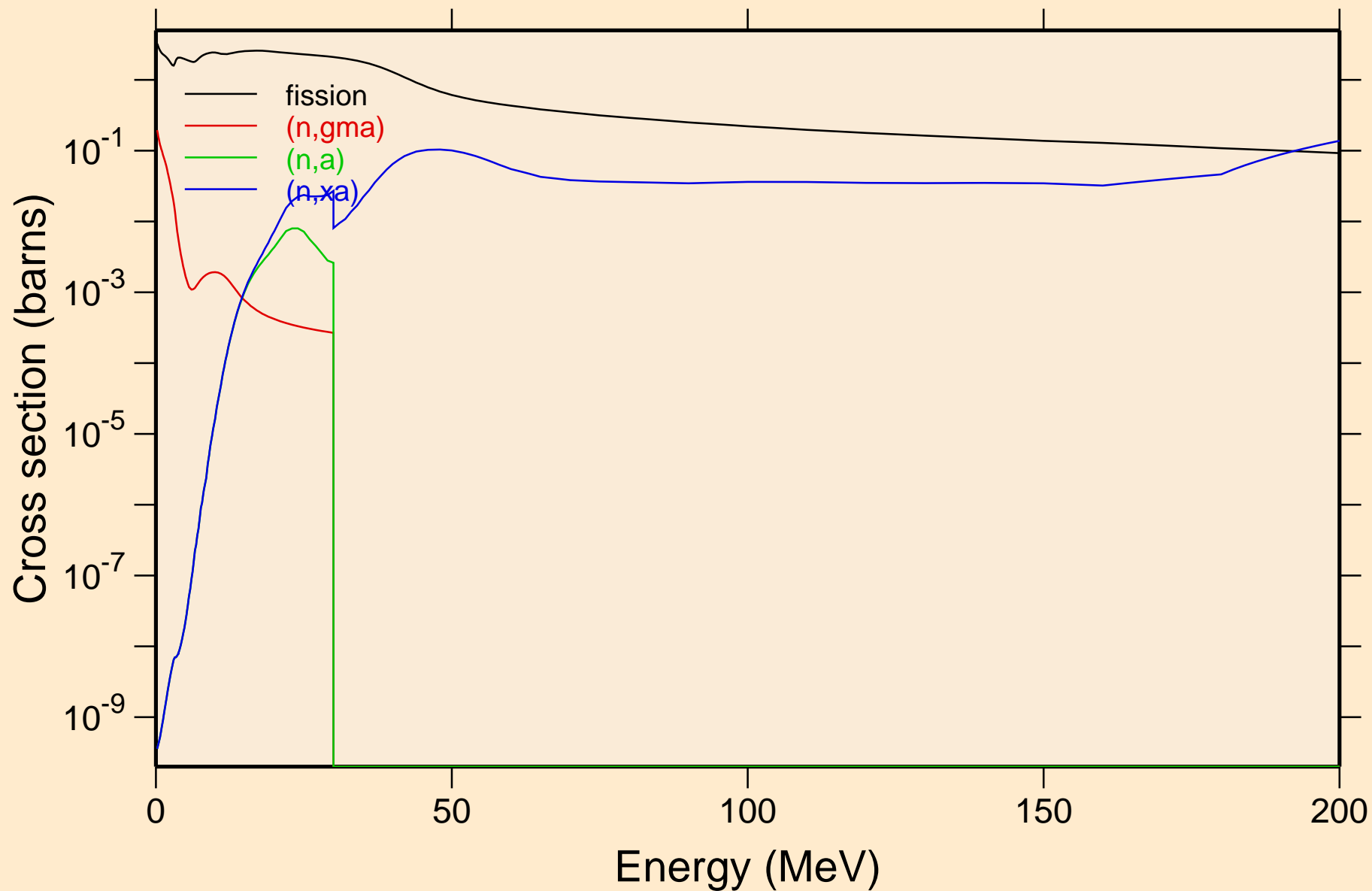

AM242M NEUTRON ACER TENDL-2019 LIBRARY; T=293.16K
Inelastic levels

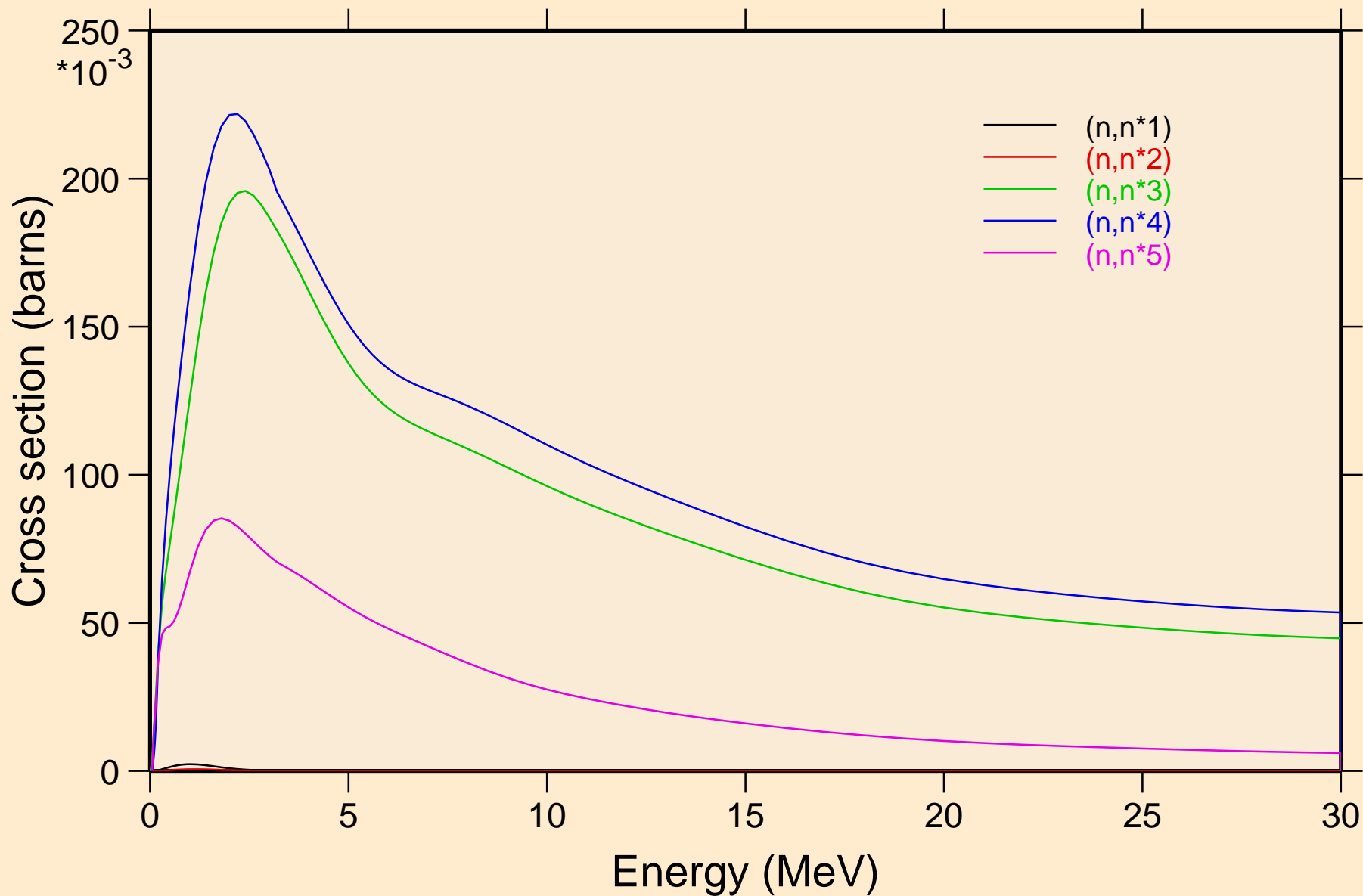

AM242M NEUTRON ACER TENDL-2019 LIBRARY; T=293.16K
Inelastic levels

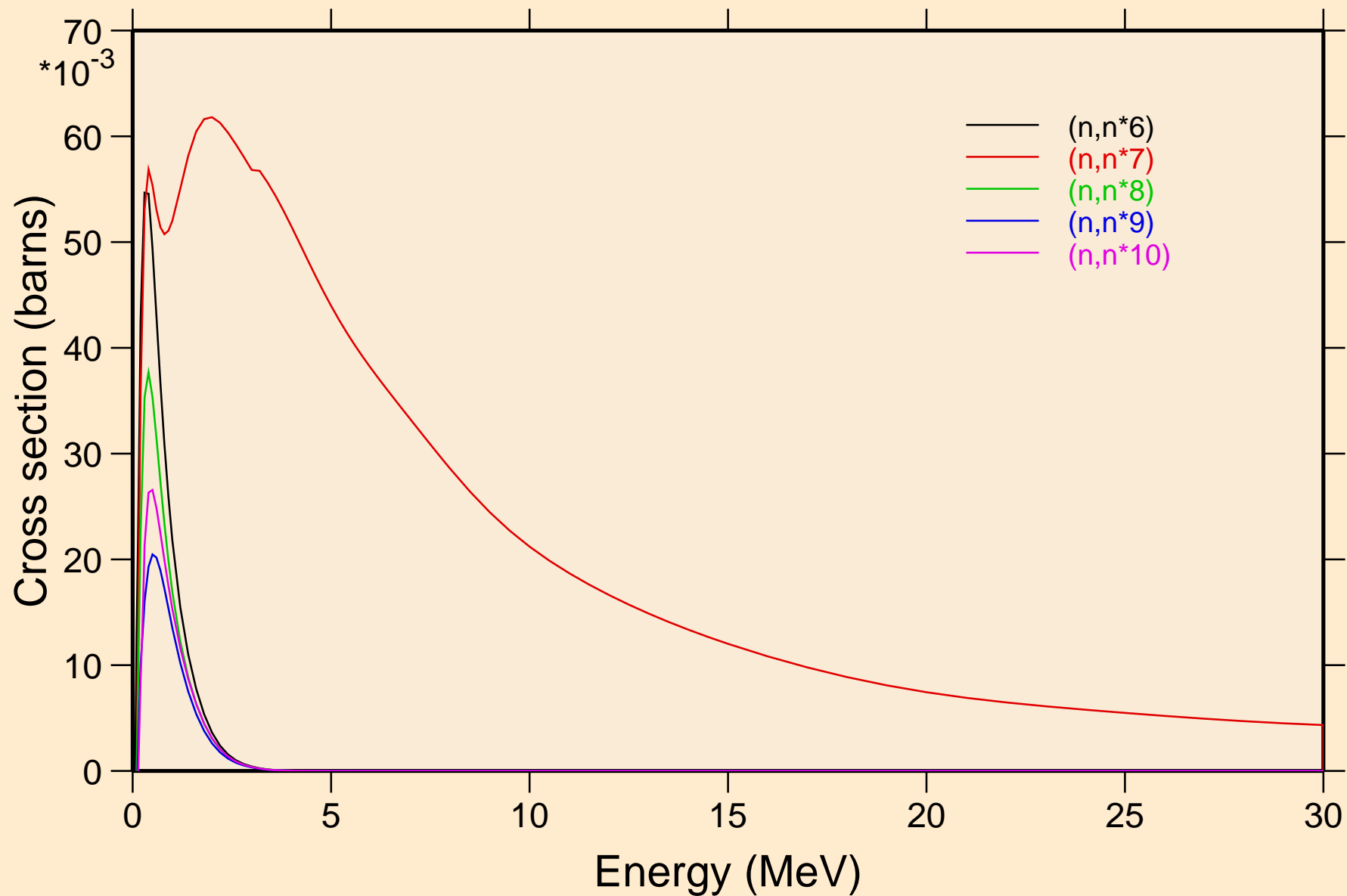

AM242M NEUTRON ACER TENDL-2019 LIBRARY; T=293.16K
Inelastic levels

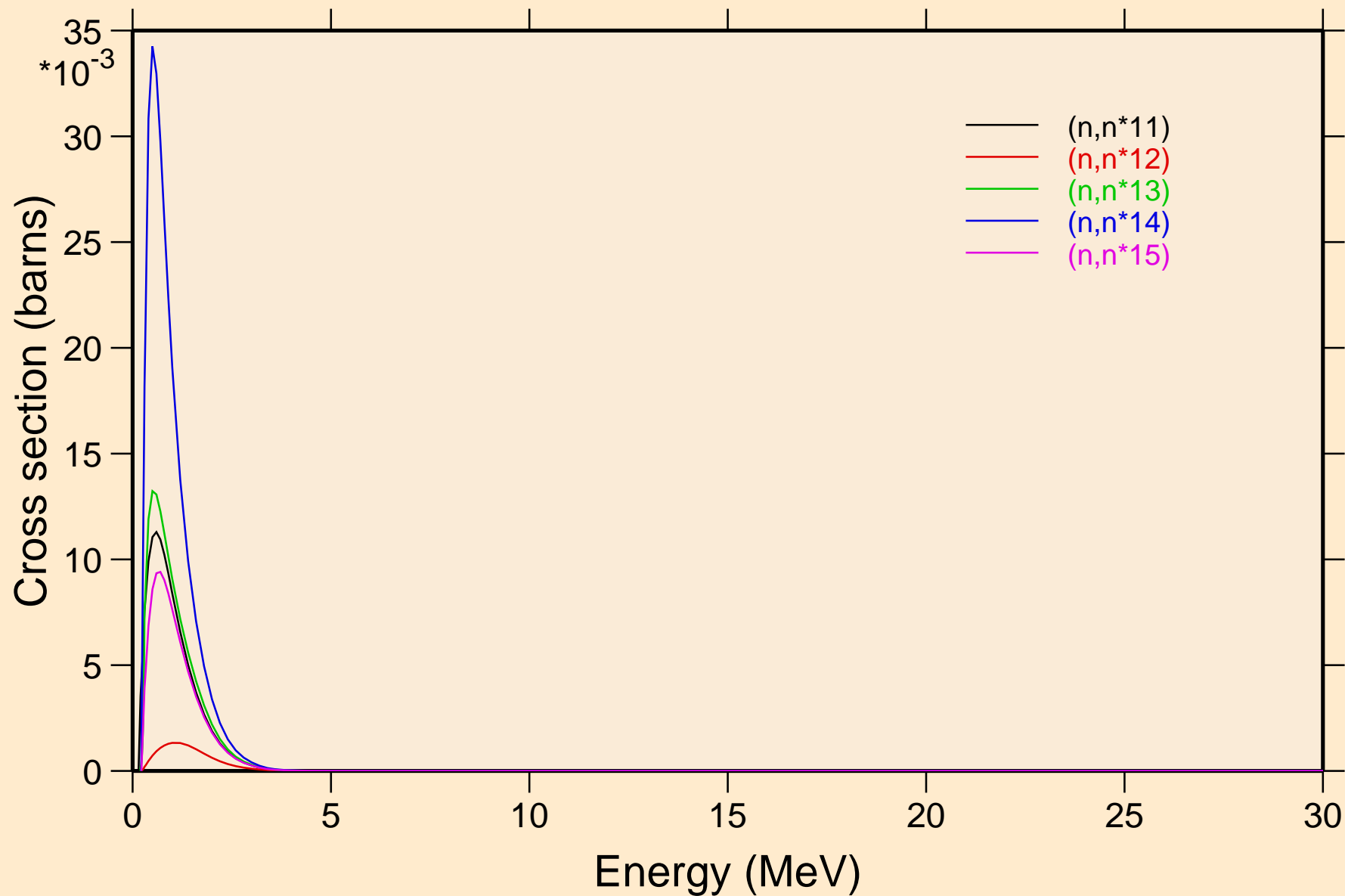

AM242M NEUTRON ACER TENDL-2019 LIBRARY; T=293.16K
Inelastic levels

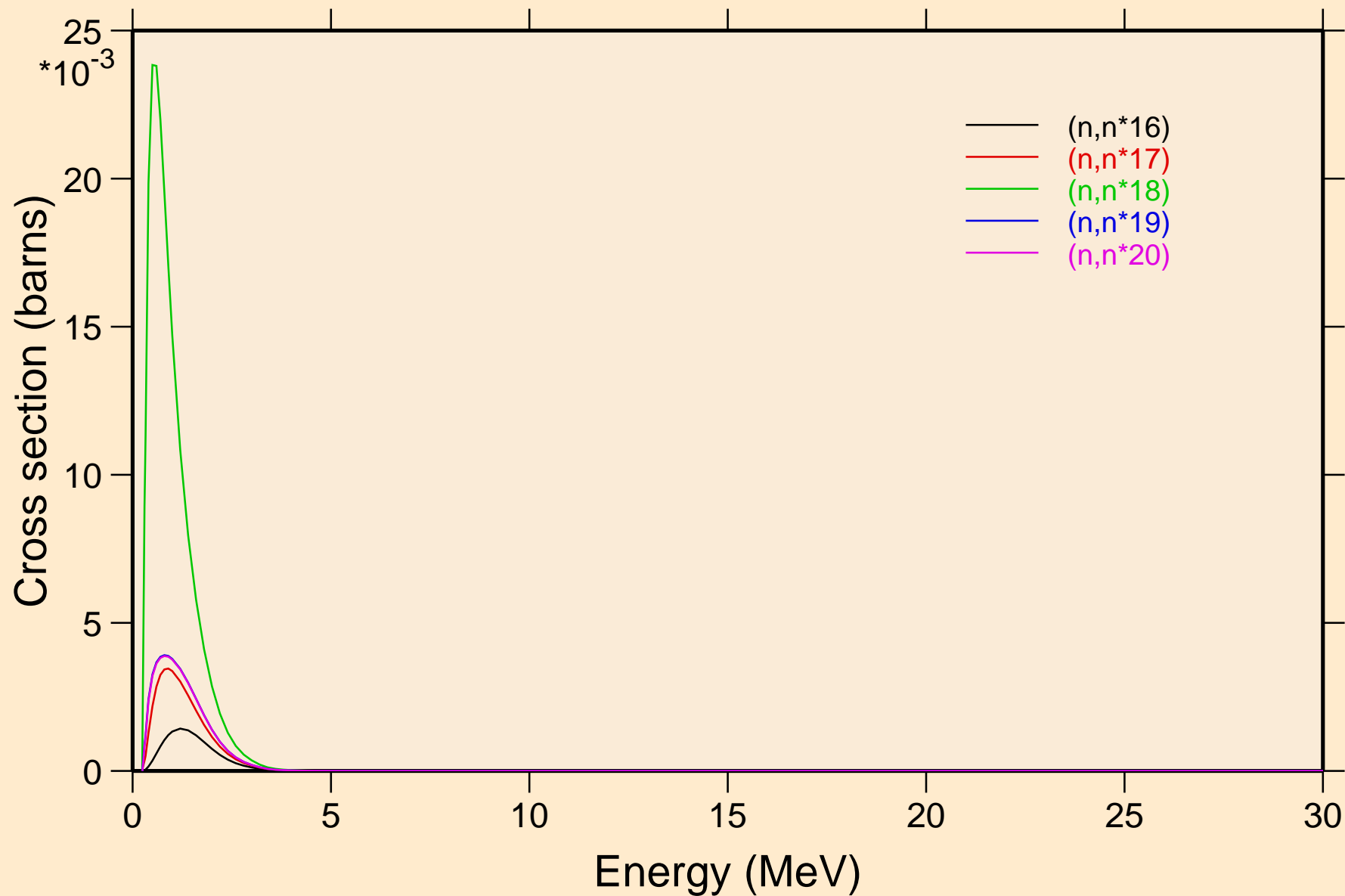

AM242M NEUTRON ACER TENDL-2019 LIBRARY; T=293.16K
Inelastic levels

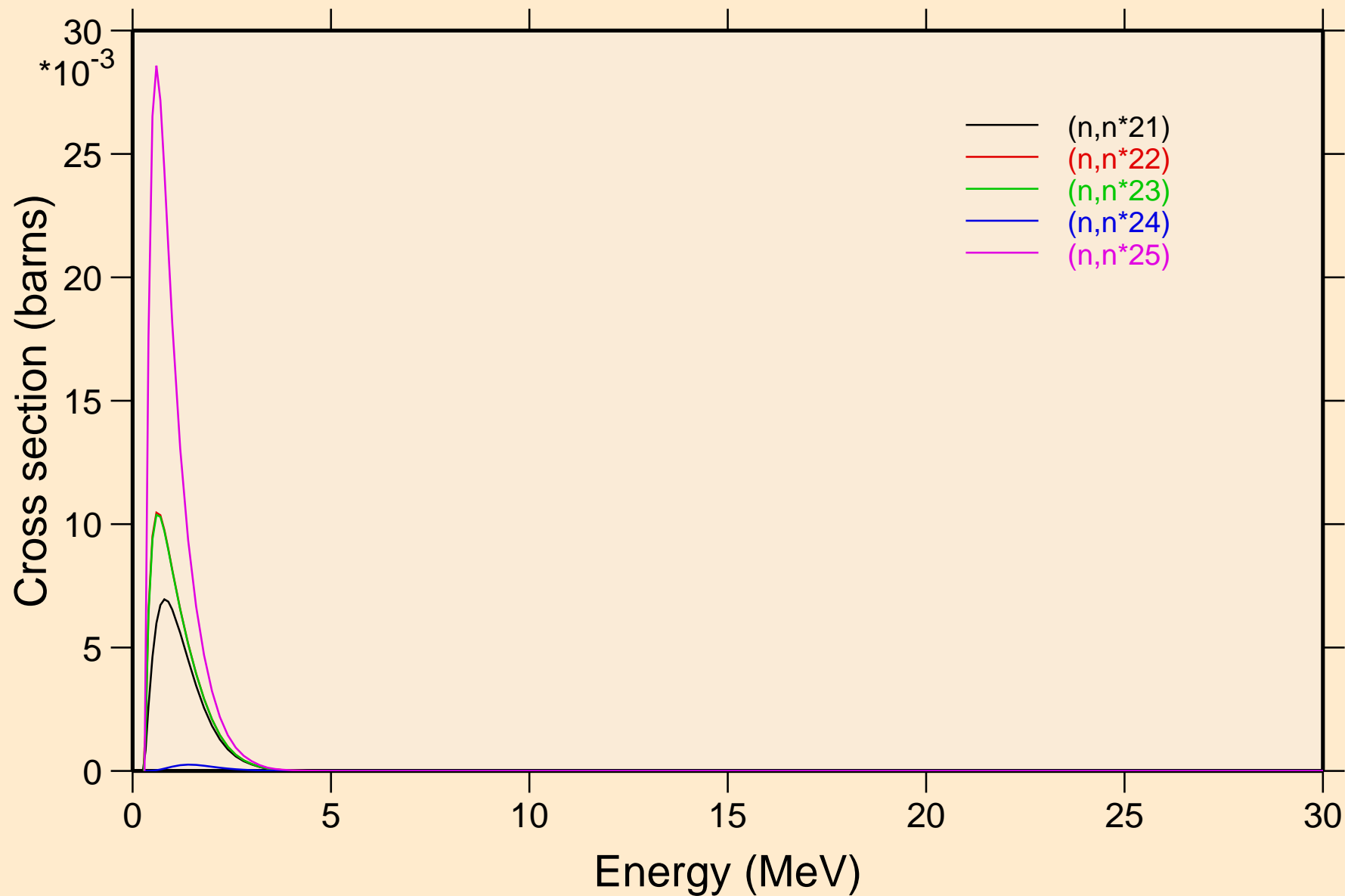

AM242M NEUTRON ACER TENDL-2019 LIBRARY; T=293.16K
Inelastic levels

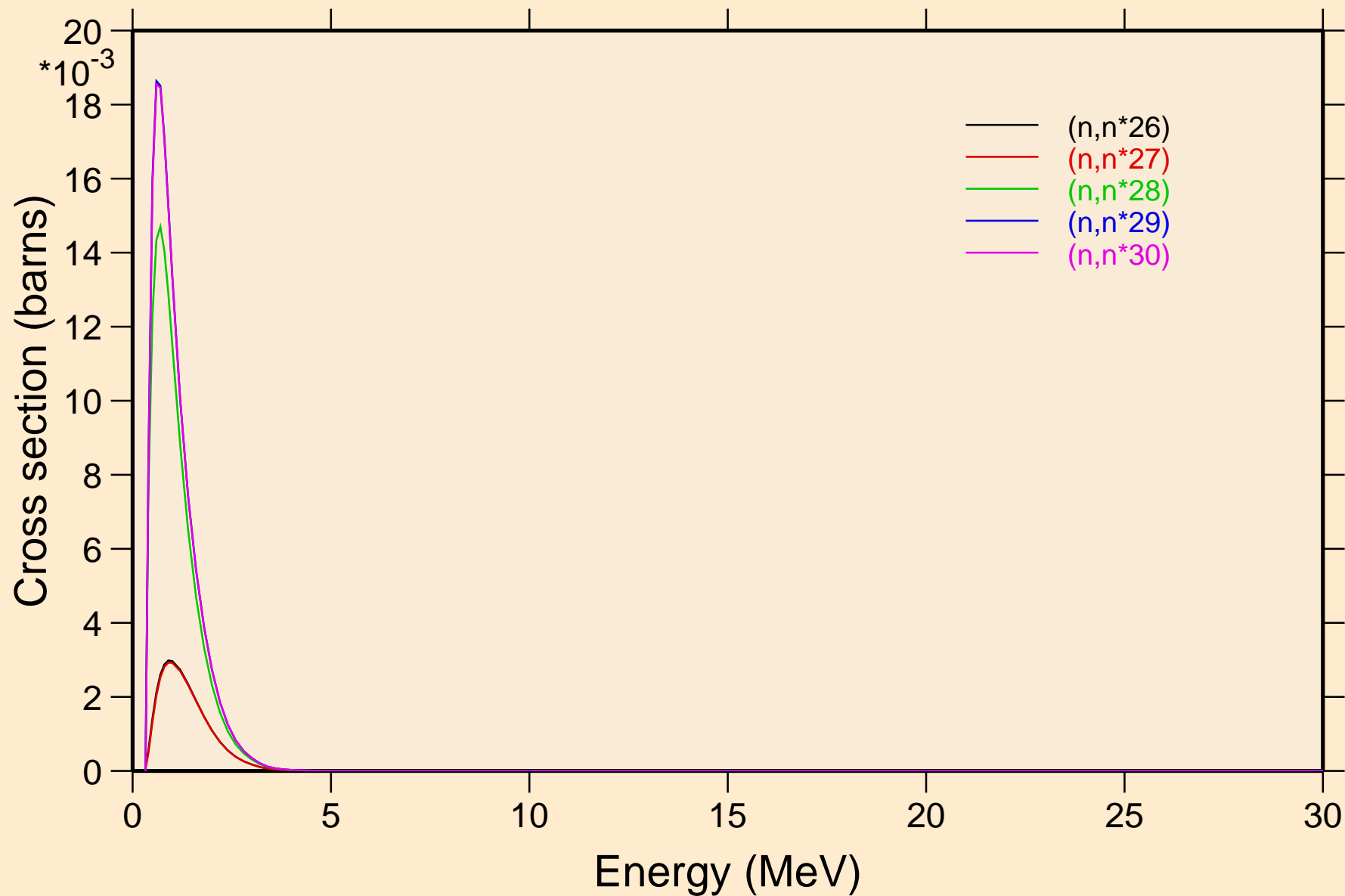

AM242M NEUTRON ACER TENDL-2019 LIBRARY; T=293.16K
Threshold reactions

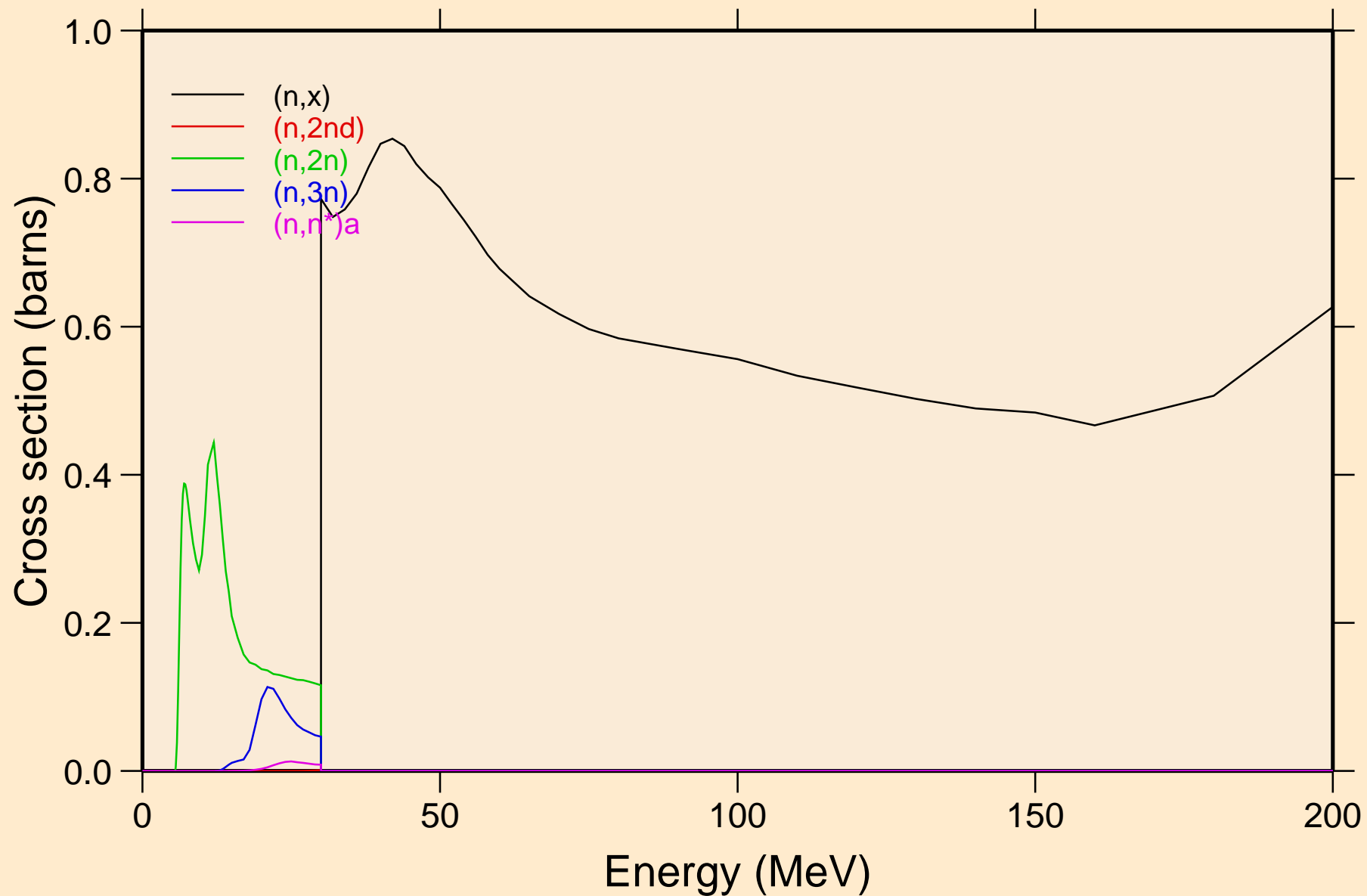

AM242M NEUTRON ACER TENDL-2019 LIBRARY; T=293.16K
Threshold reactions

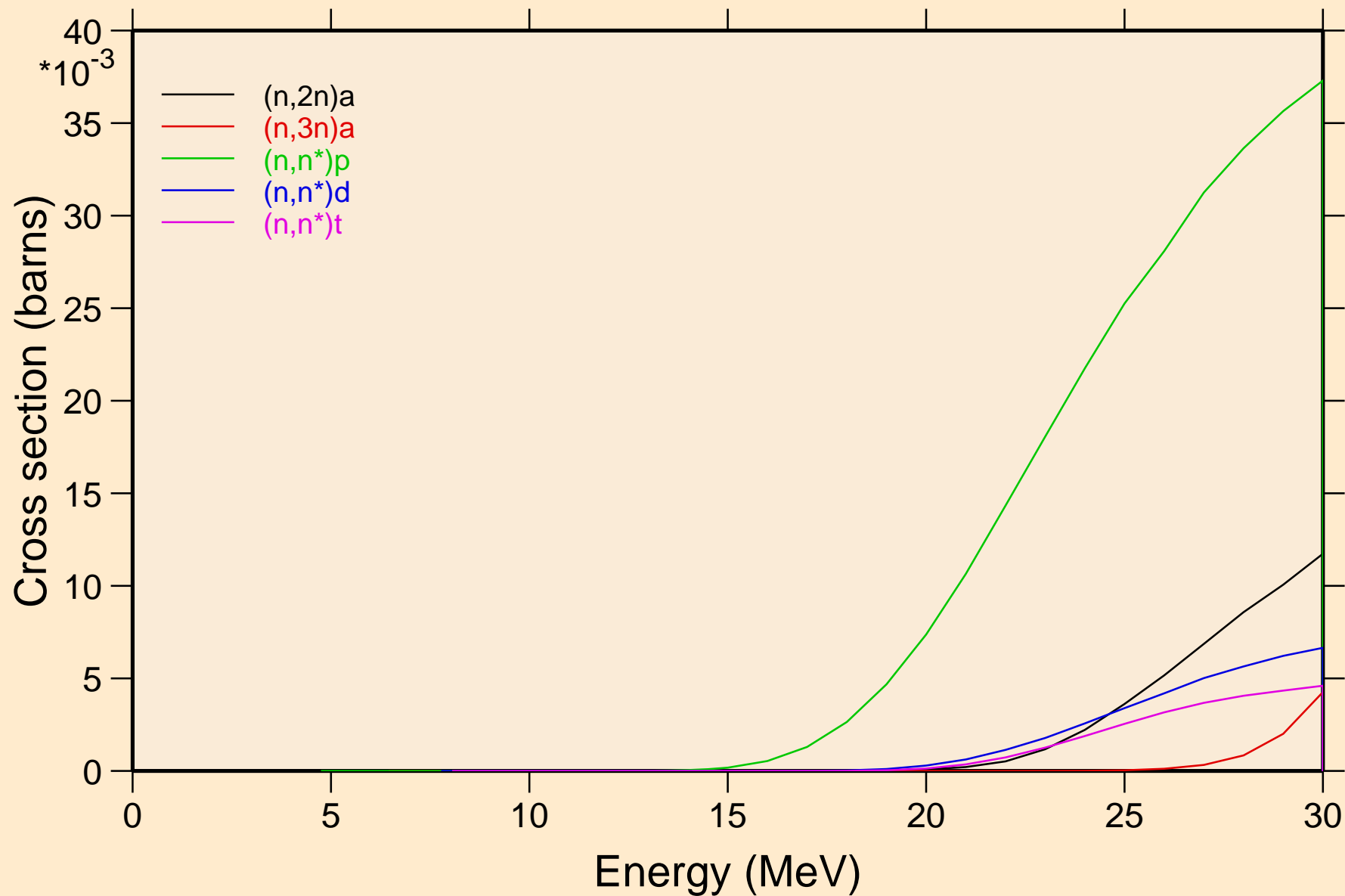

AM242M NEUTRON ACER TENDL-2019 LIBRARY; T=293.16K
Threshold reactions

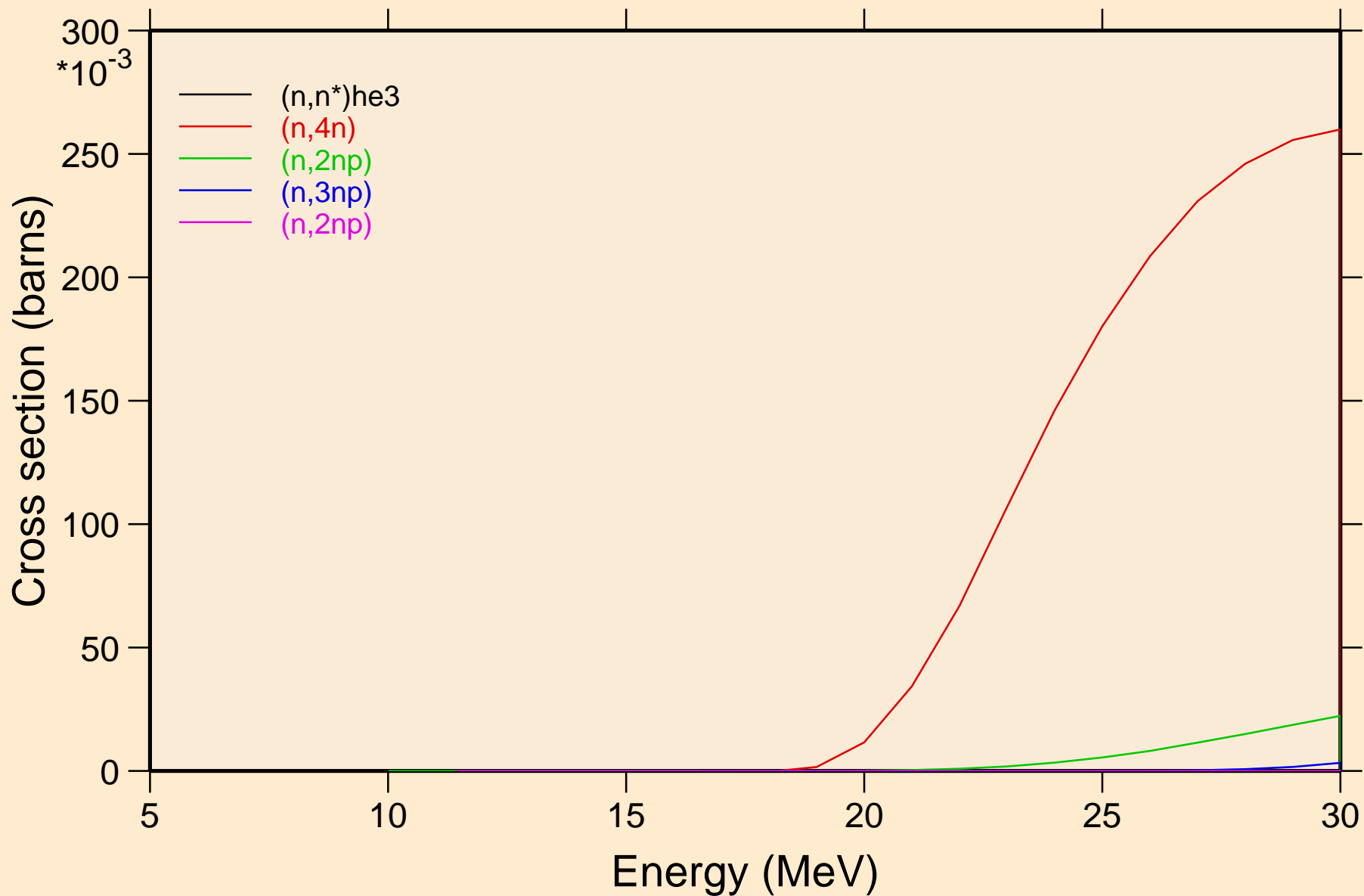

AM242M NEUTRON ACER TENDL-2019 LIBRARY; T=293.16K
Threshold reactions

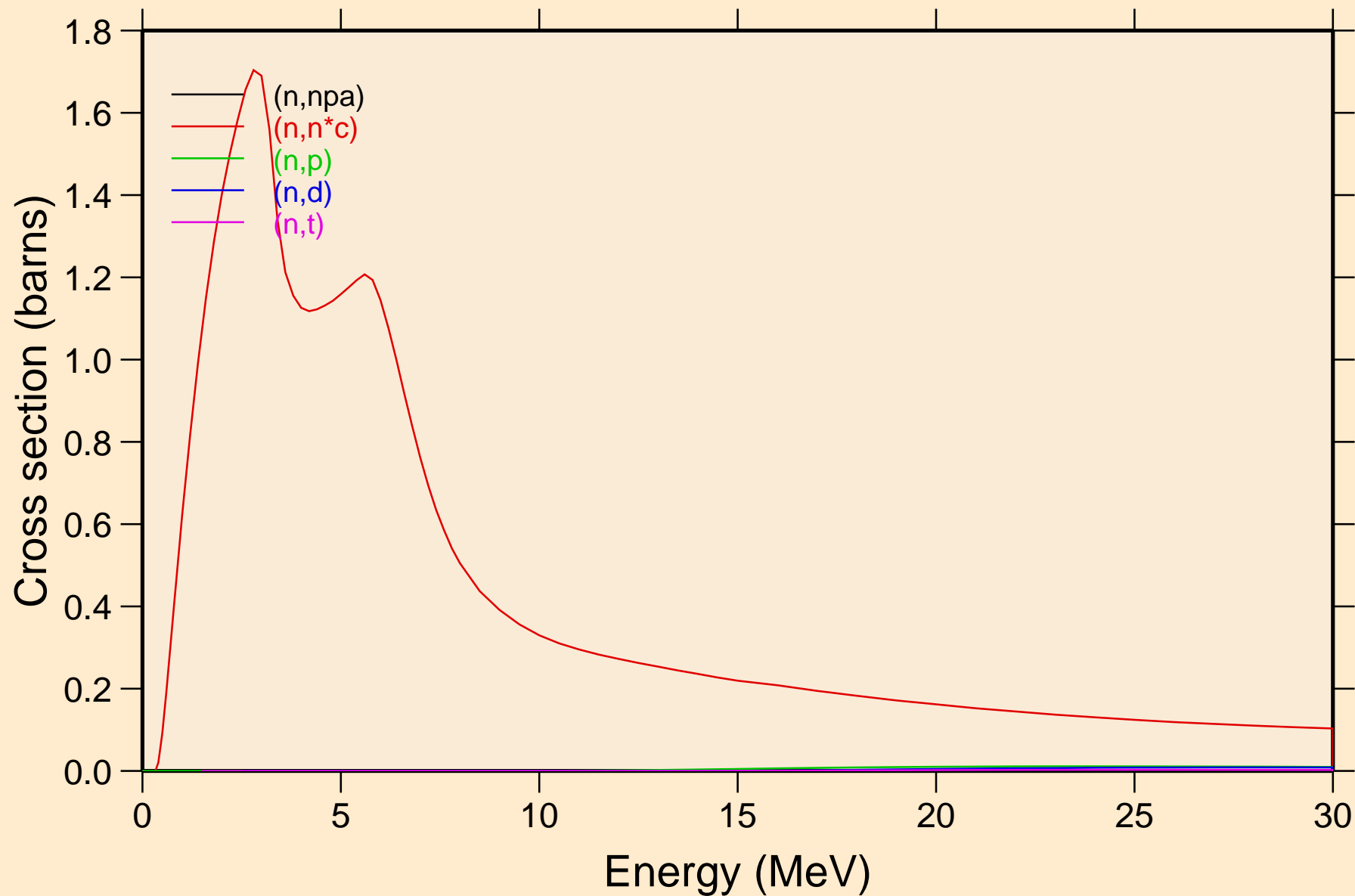

AM242M NEUTRON ACER TENDL-2019 LIBRARY; T=293.16K
Threshold reactions

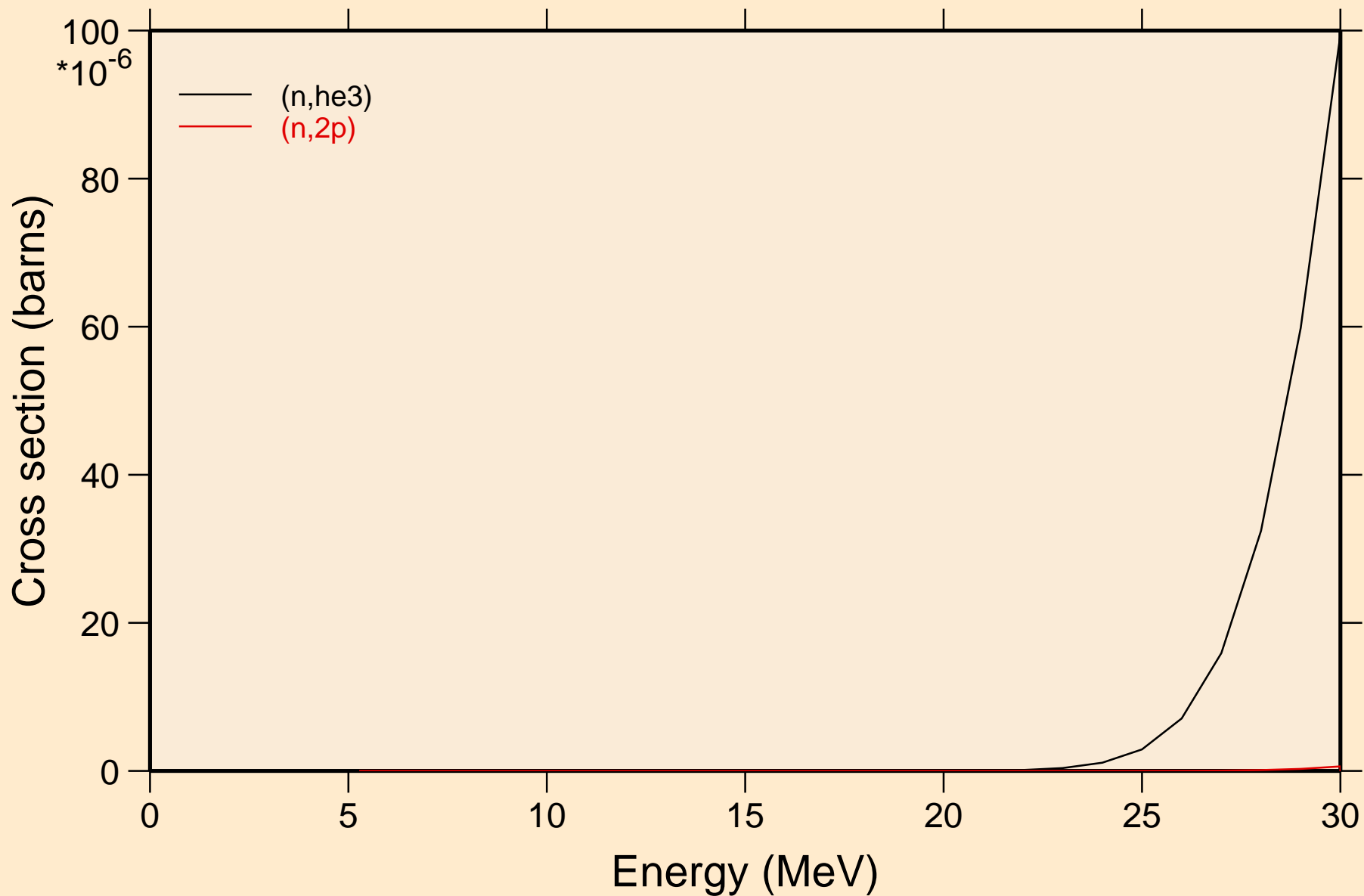

AM242M NEUTRON ACER TENDL-2019 LIBRARY; T=293.16K
Threshold reactions

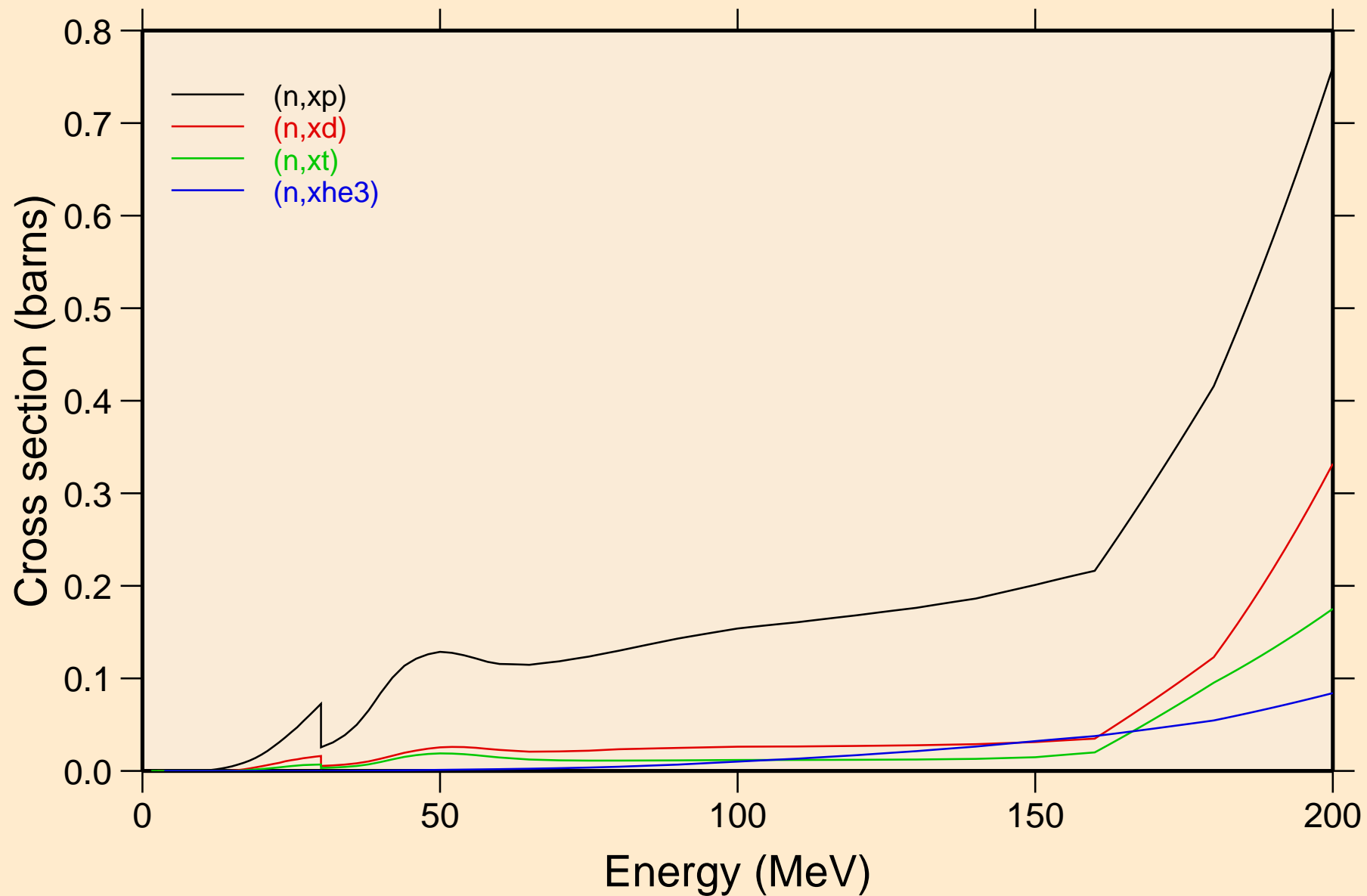

AM242M NEUTRON ACER TENDL-2019 LIBRARY; T=293.16K
angular distribution for elastic

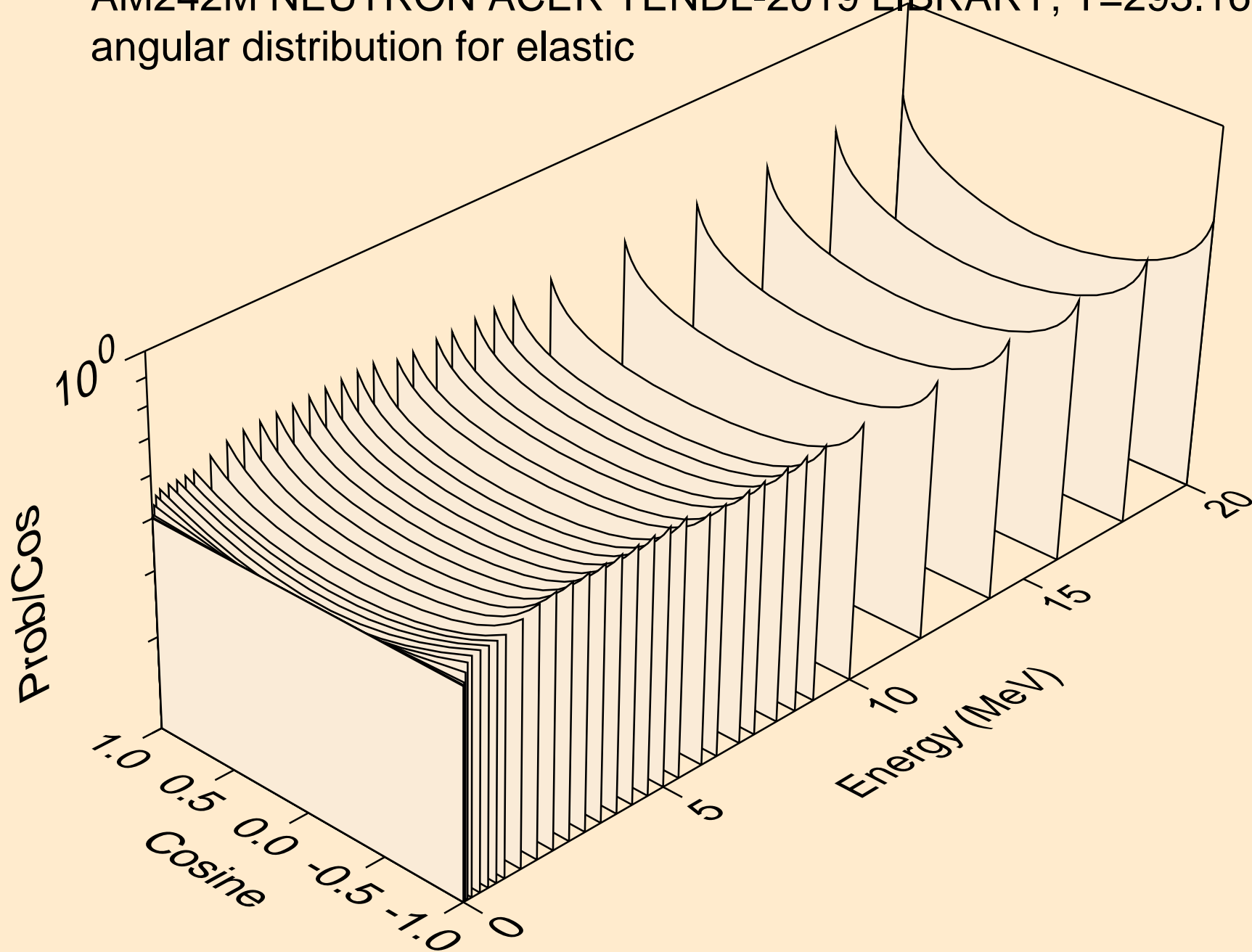

AM242M NEUTRON ACER TENDL-2019 LIBRARY; T=293.16K
angular distribution for elastic

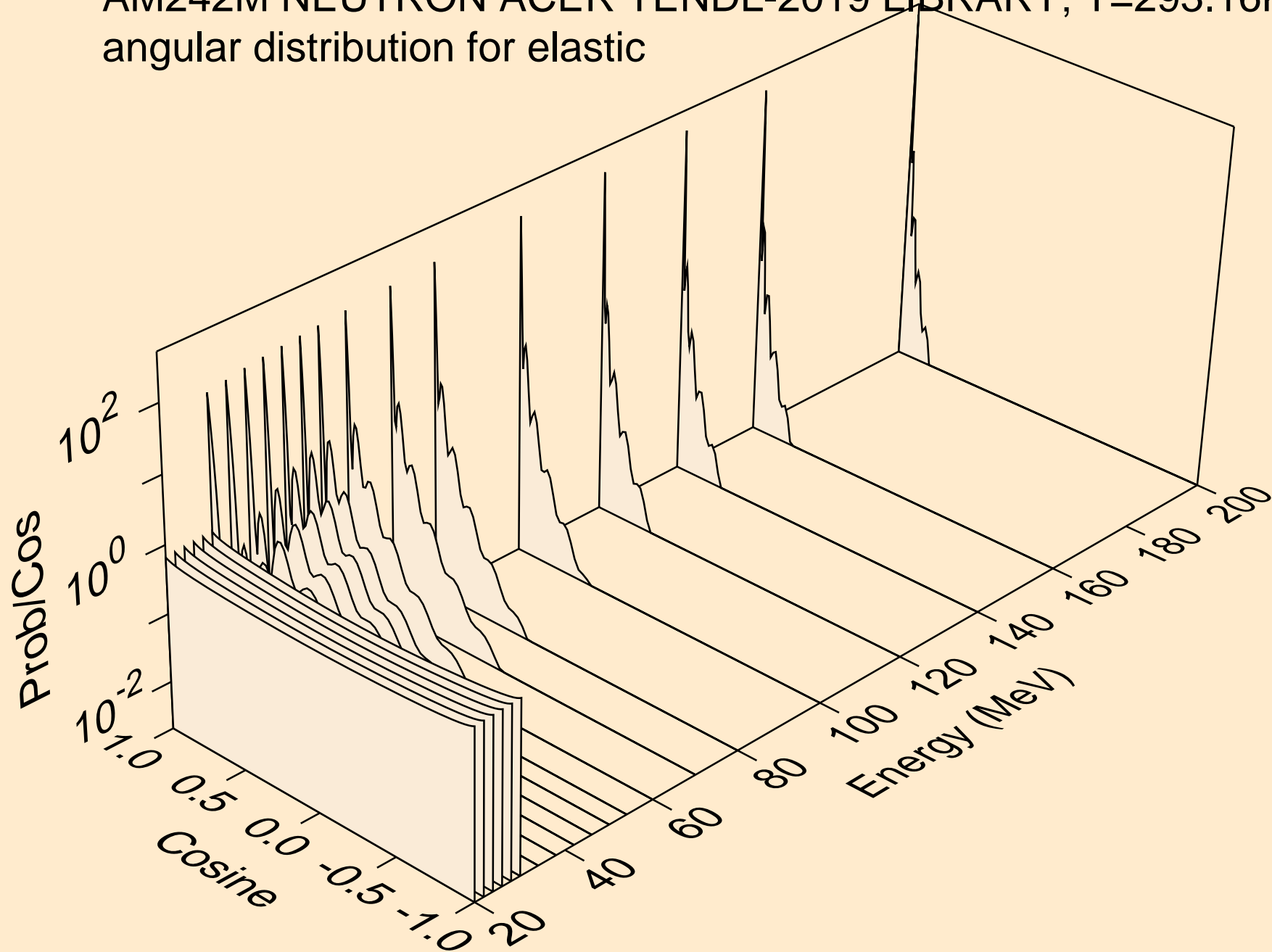

AM242M NEUTRON ACER TENDL-2019 LIBRARY; T=293.16K
angular distribution for (n,n*1)

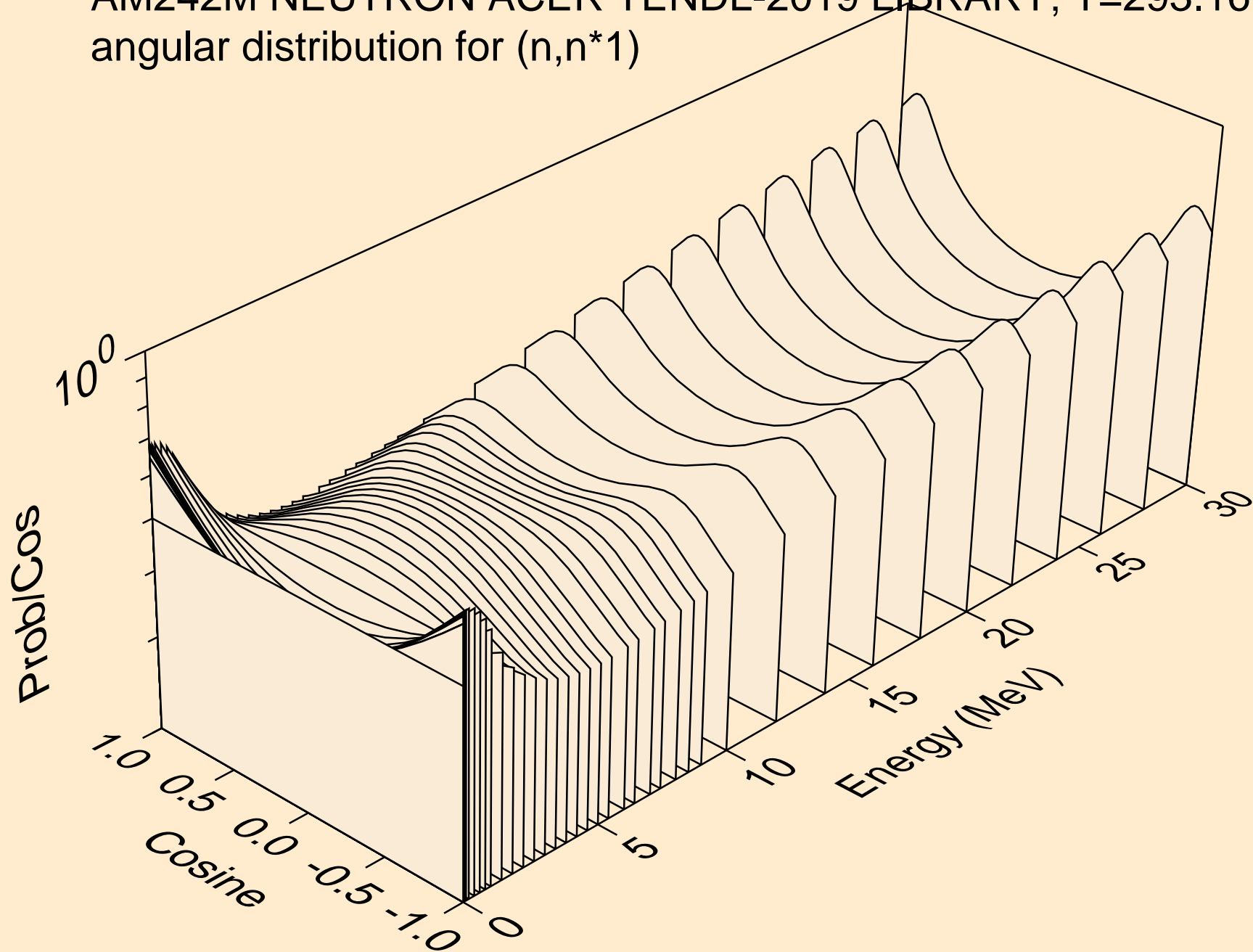

AM242M NEUTRON ACER TENDL-2019 LIBRARY; T=293.16K
angular distribution for (n,n*2)

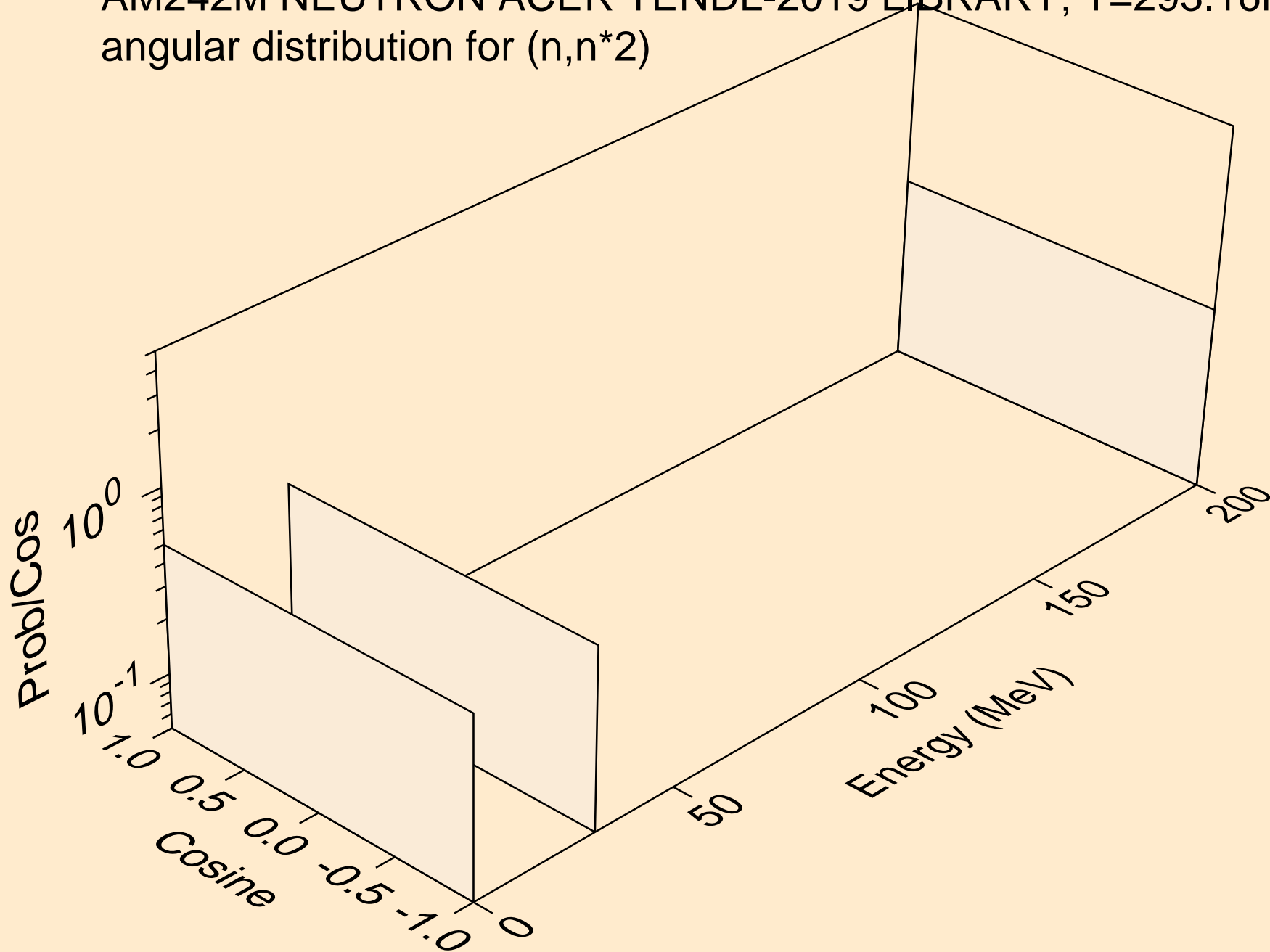

AM242M NEUTRON ACER TENDL-2019 LIBRARY; T=293.16K
angular distribution for (n,n*3)

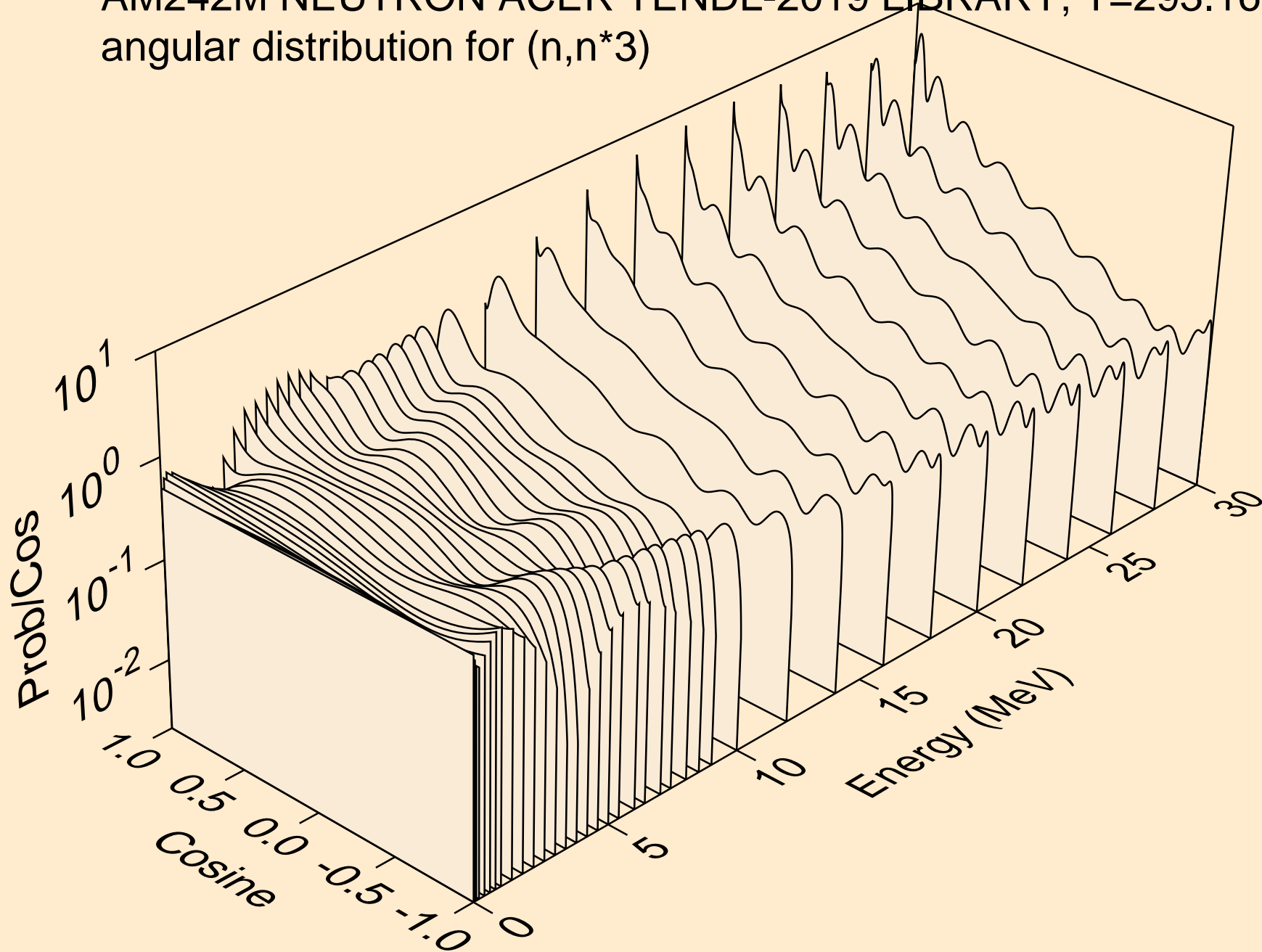

AM242M NEUTRON ACER TENDL-2019 LIBRARY; T=293.16K
angular distribution for (n,n*4)

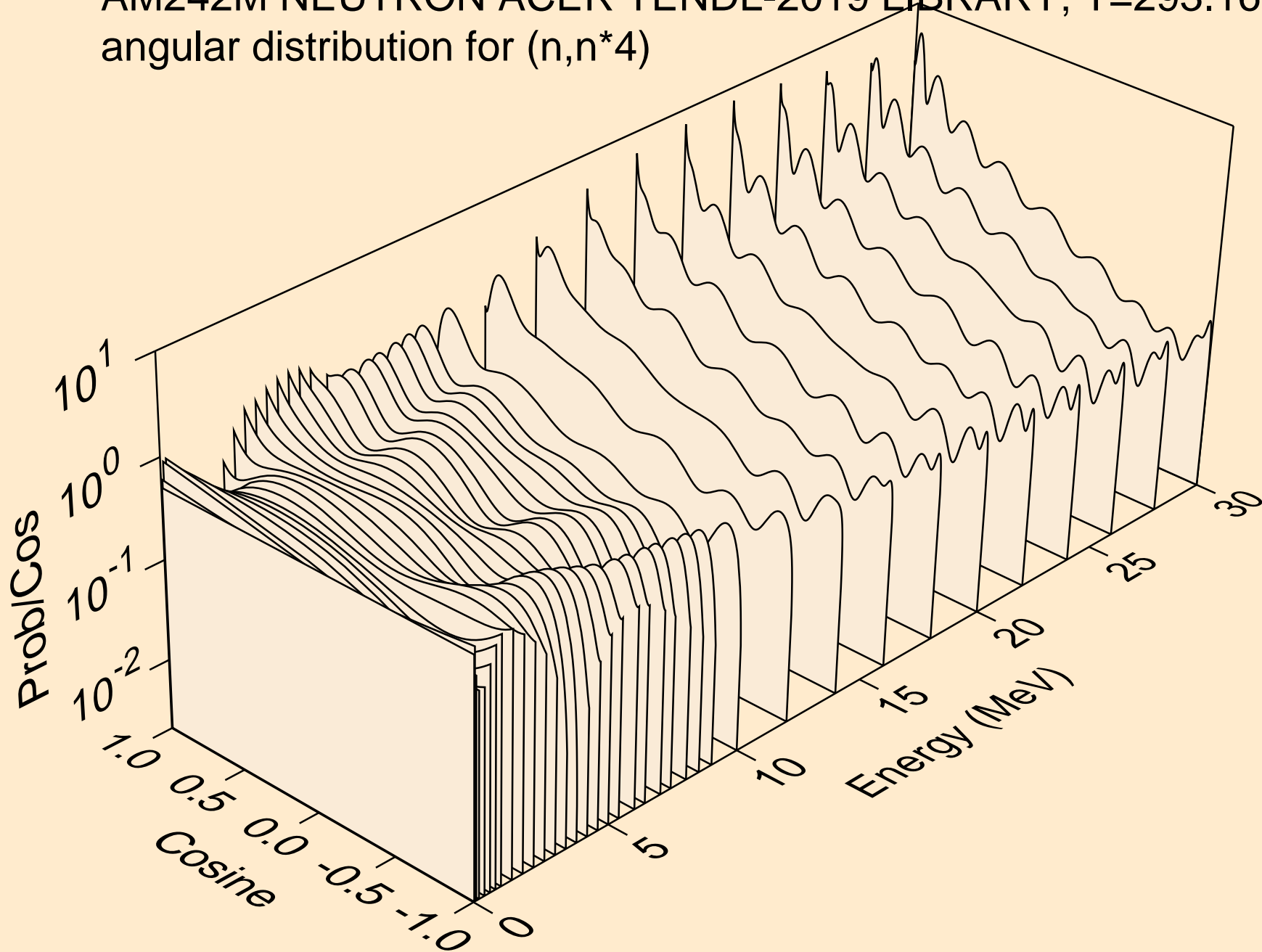

AM242M NEUTRON ACER TENDL-2019 LIBRARY; T=293.16K
angular distribution for (n,n*5)

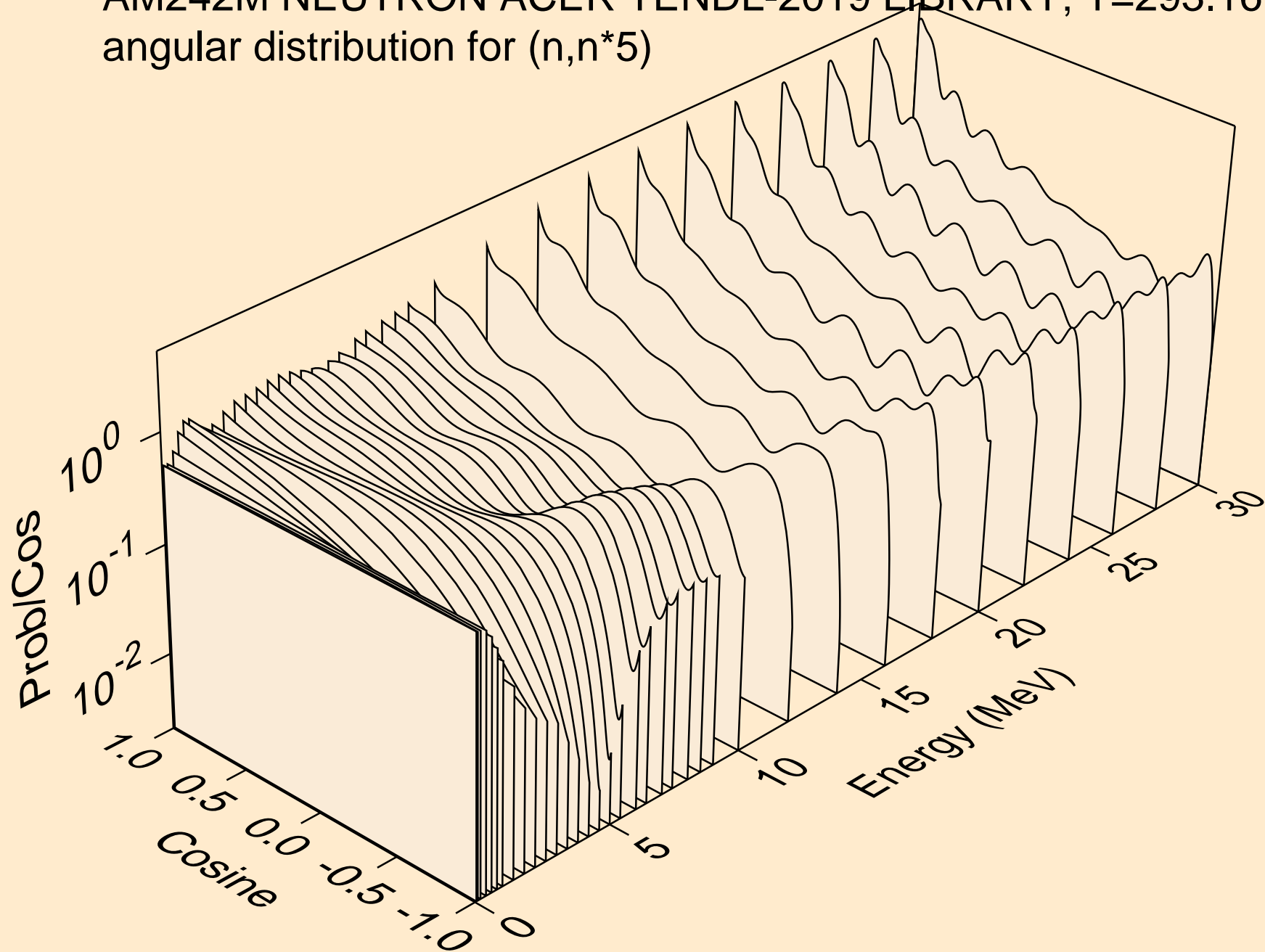

AM242M NEUTRON ACER TENDL-2019 LIBRARY; T=293.16K
angular distribution for (n,n*6)

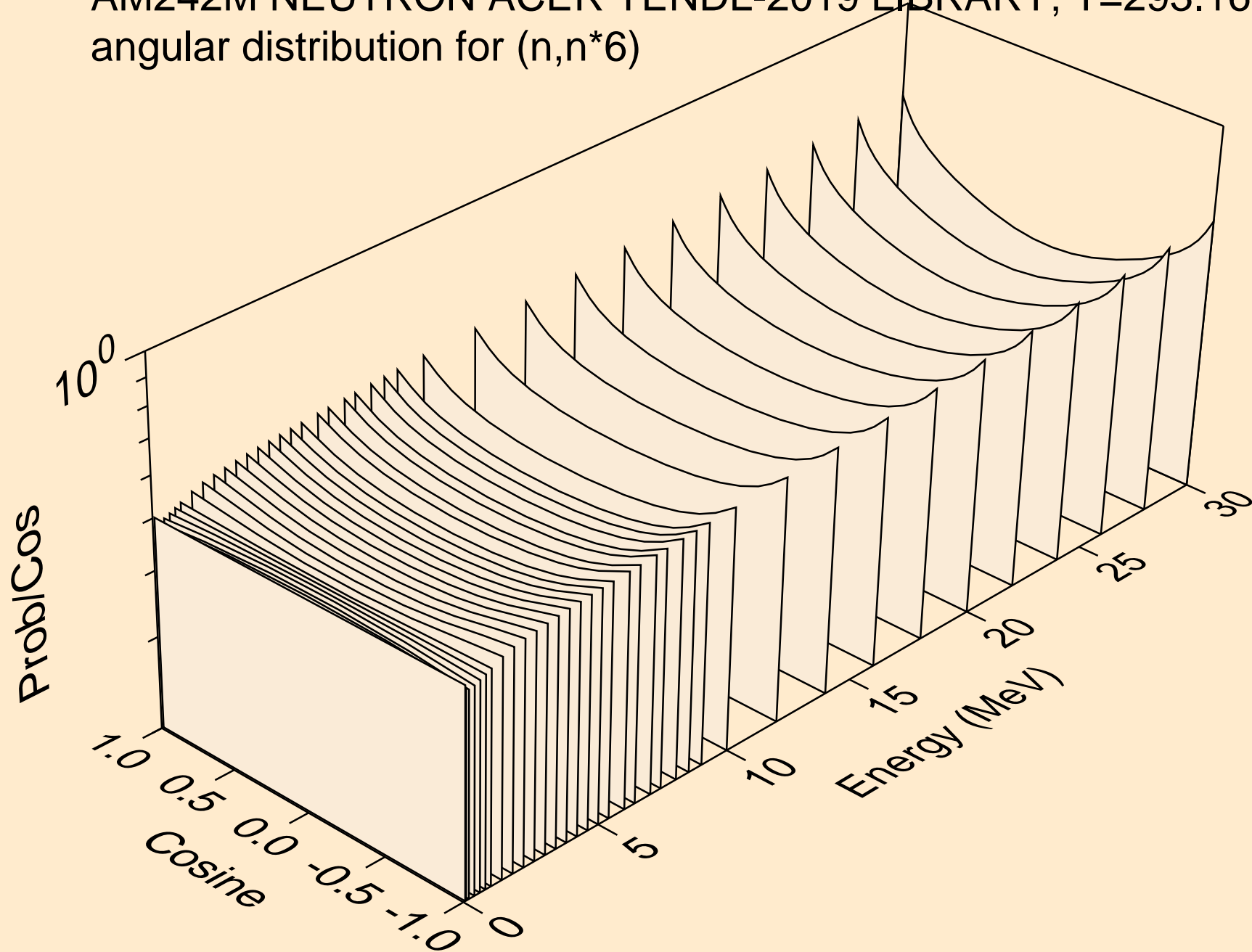

AM242M NEUTRON ACER TENDL-2019 LIBRARY; T=293.16K
angular distribution for (n,n*7)

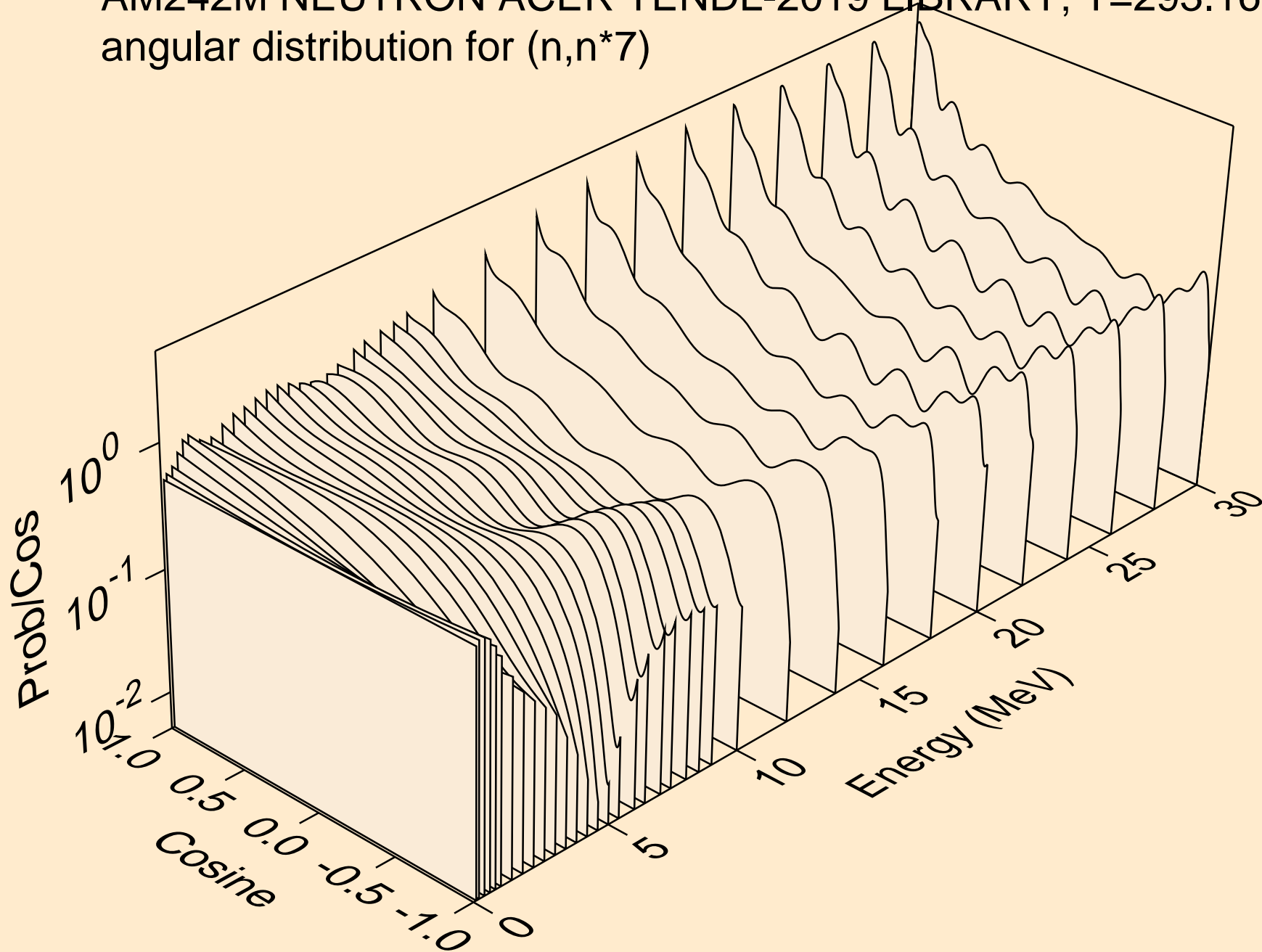

AM242M NEUTRON ACER TENDL-2019 LIBRARY; T=293.16K
angular distribution for (n,n*8)

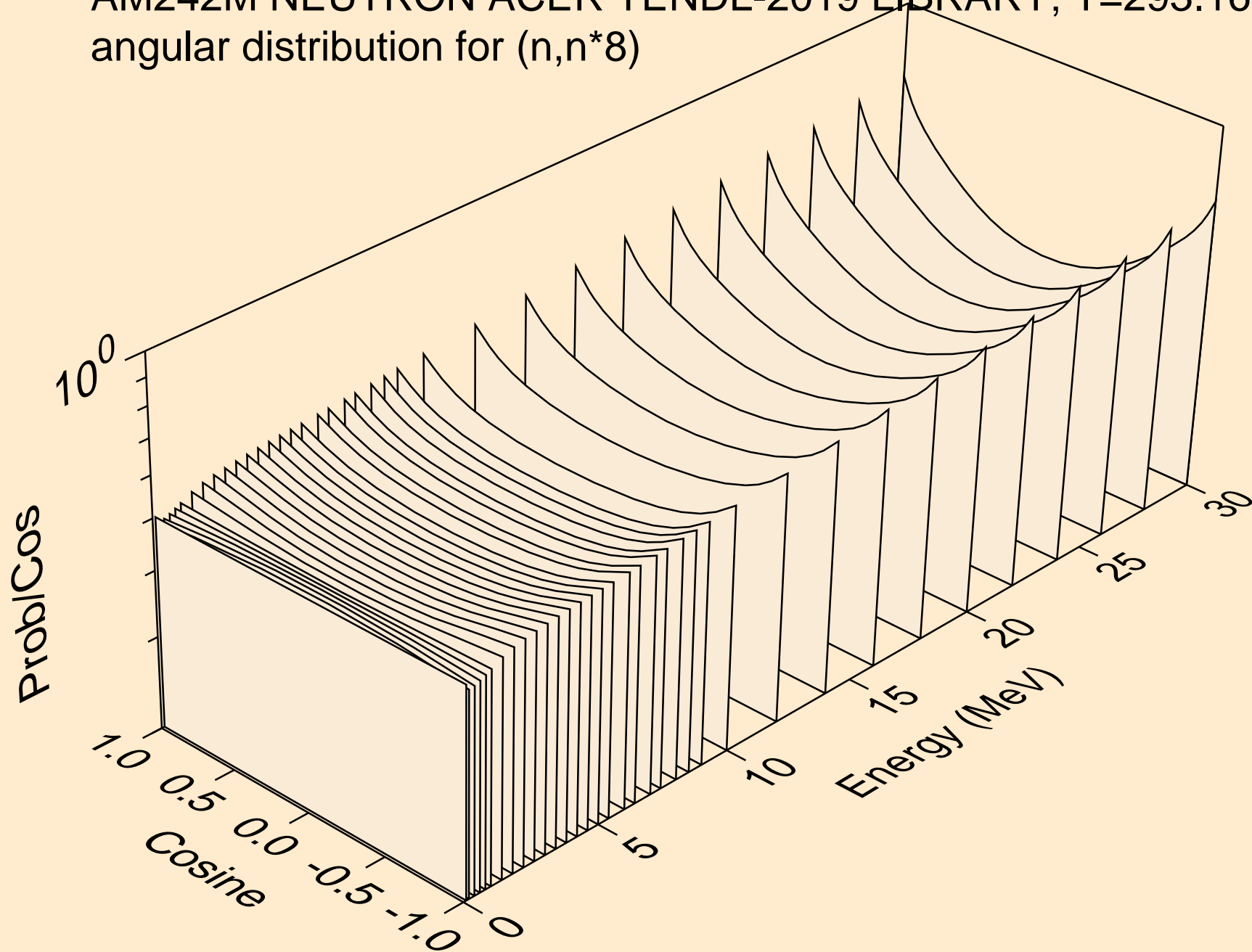

AM242M NEUTRON ACER TENDL-2019 LIBRARY; T=293.16K
angular distribution for (n,n*9)

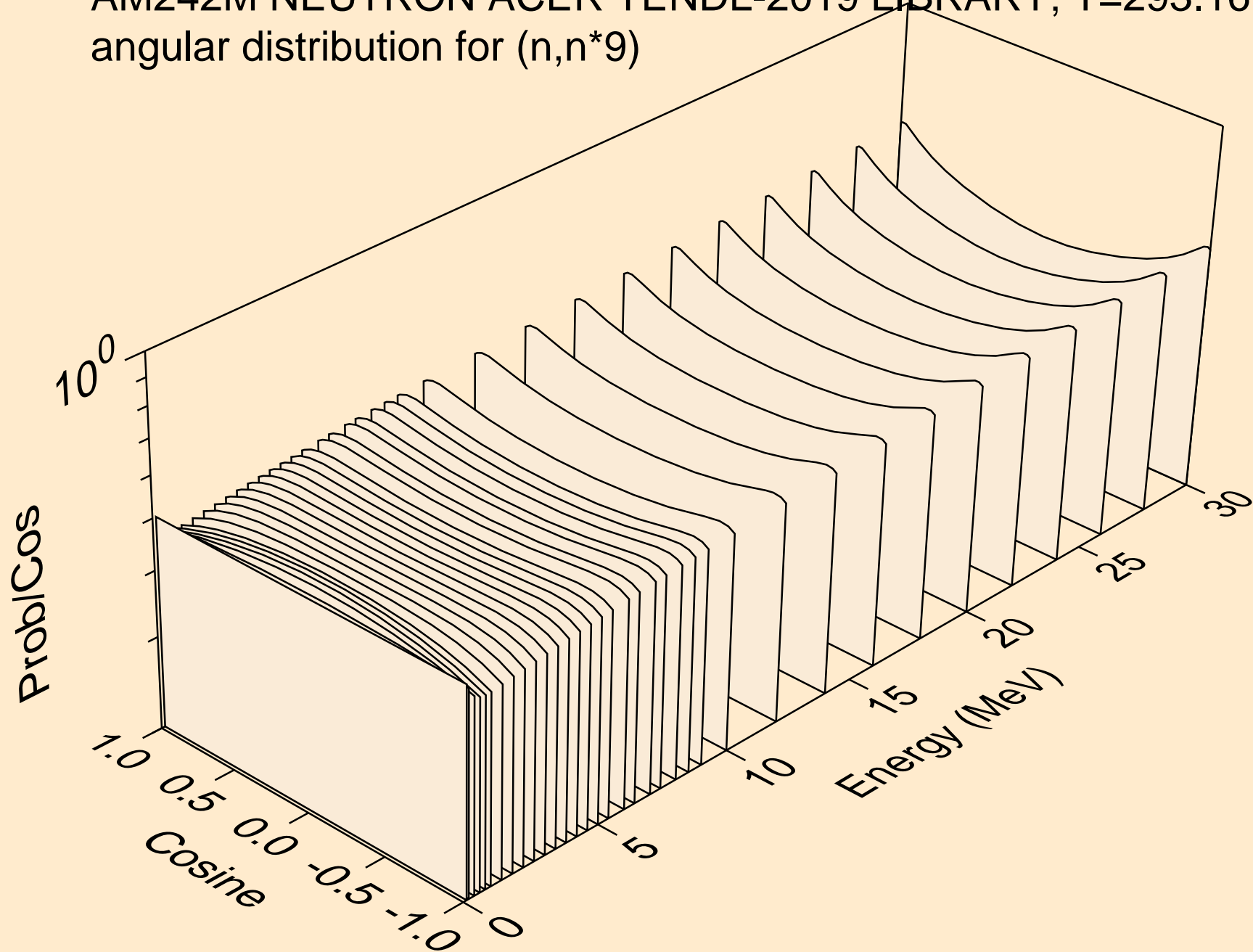

AM242M NEUTRON ACER TENDL-2019 LIBRARY; T=293.16K
angular distribution for (n,n*10)

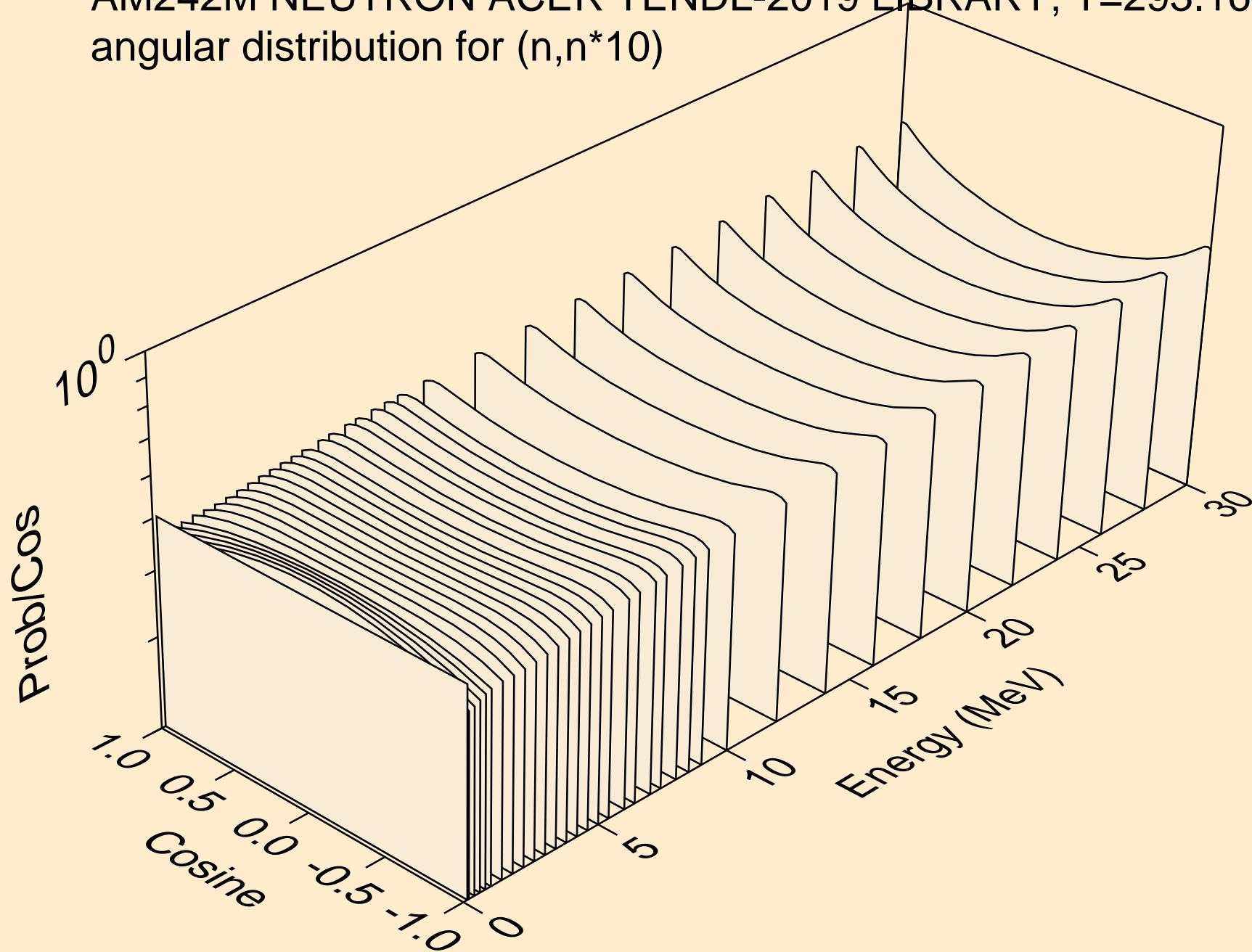

AM242M NEUTRON ACER TENDL-2019 LIBRARY; T=293.16K
angular distribution for (n,n*11)

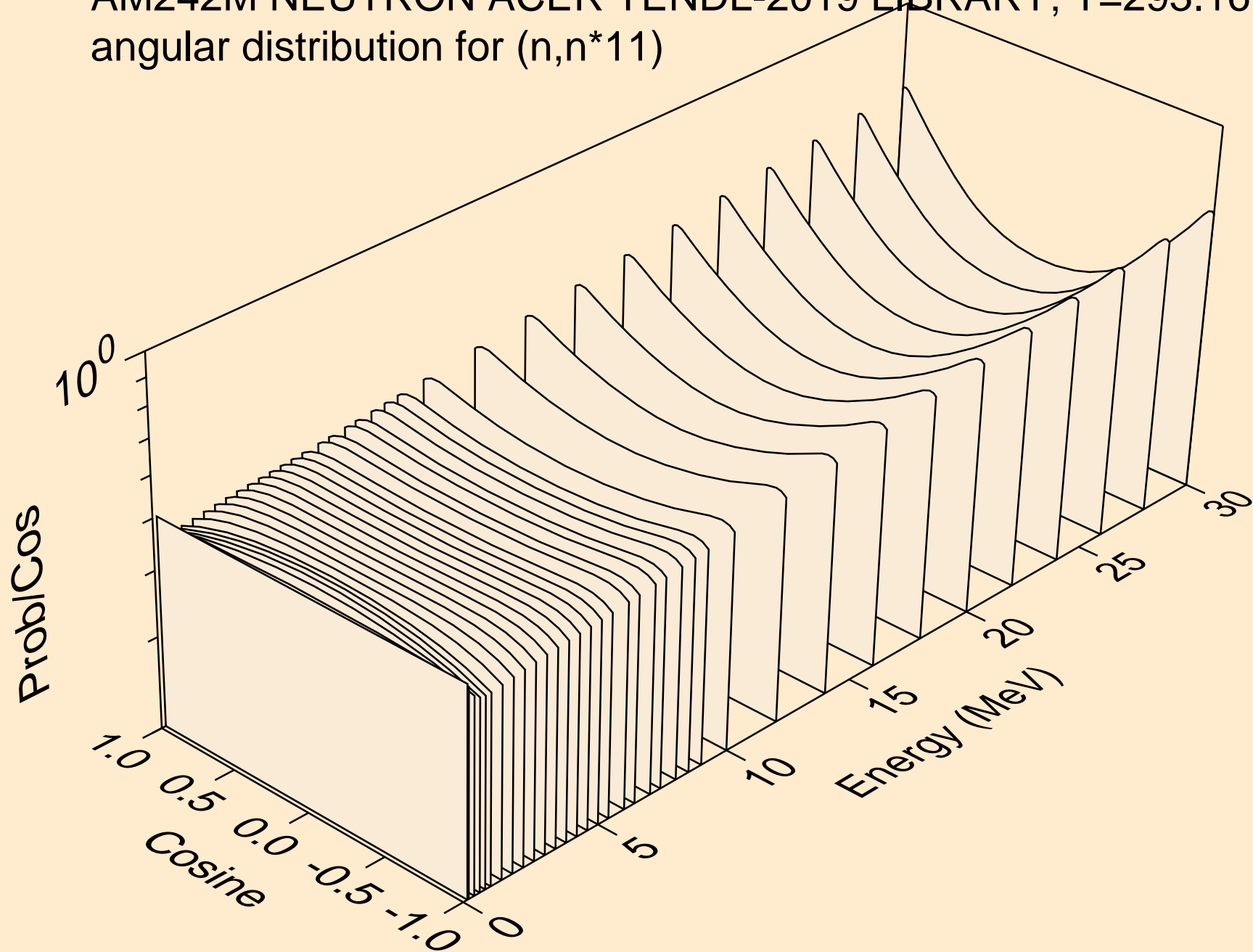

AM242M NEUTRON ACER TENDL-2019 LIBRARY; T=293.16K
angular distribution for (n,n*12)

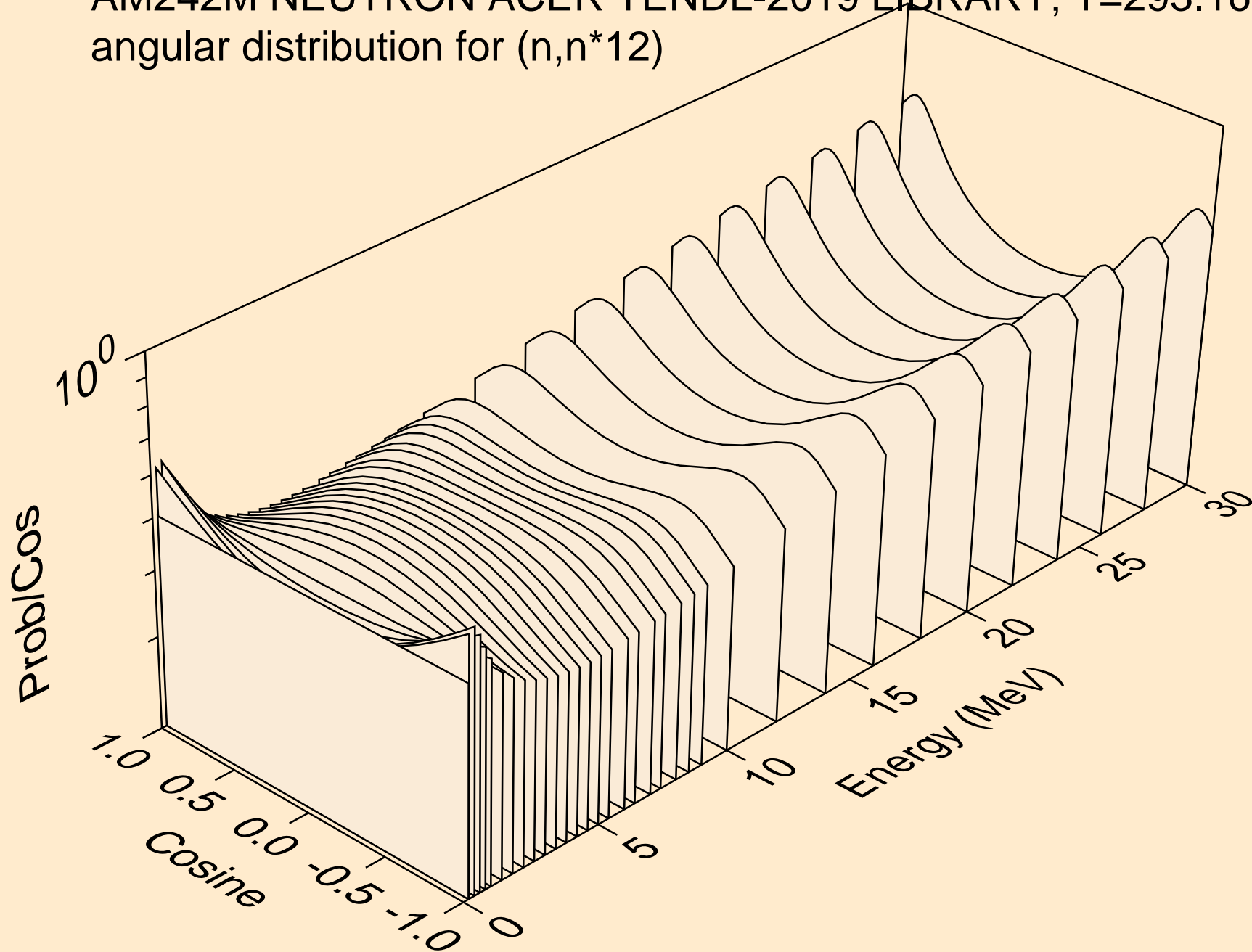

AM242M NEUTRON ACER TENDL-2019 LIBRARY; T=293.16K
angular distribution for (n,n*13)

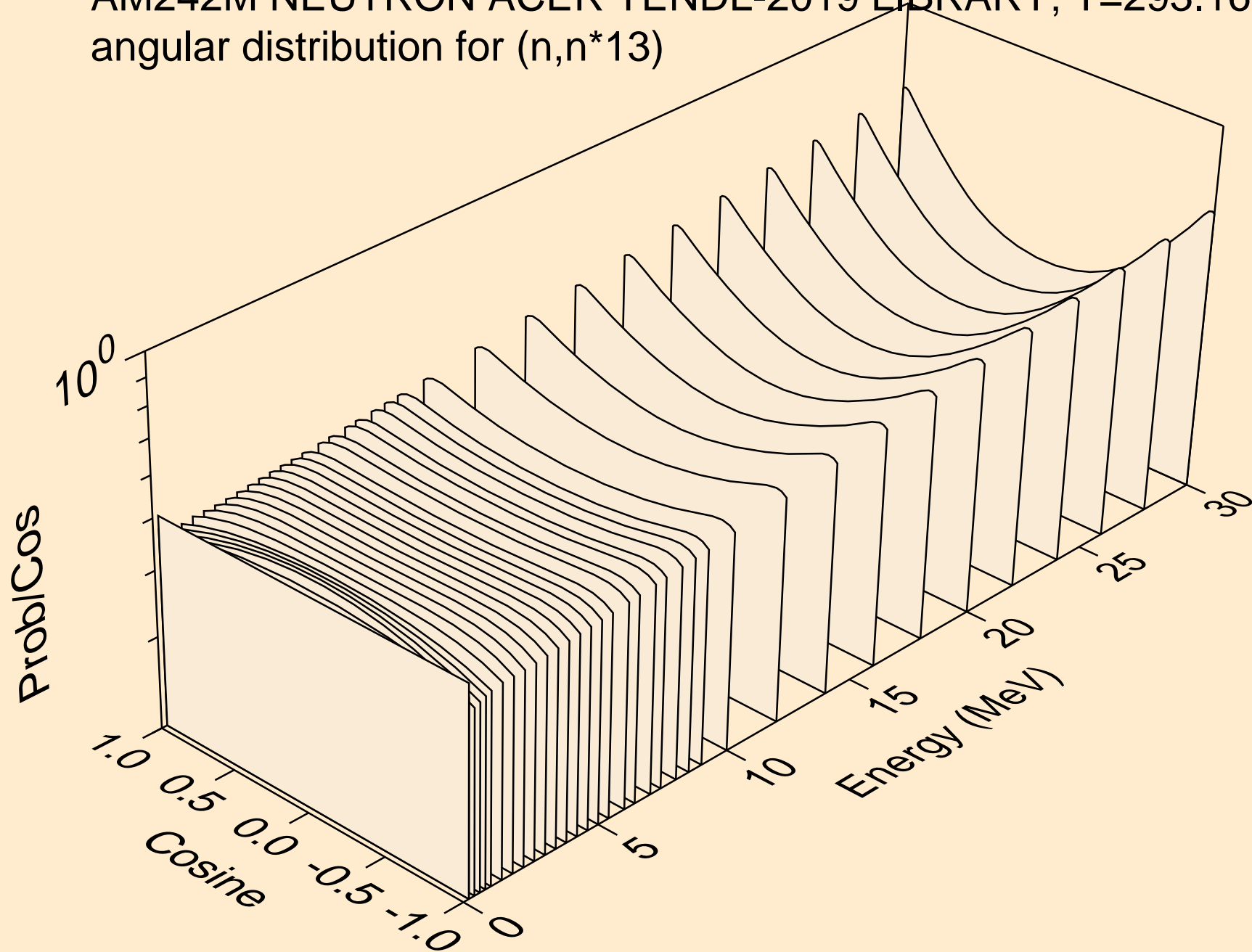

AM242M NEUTRON ACER TENDL-2019 LIBRARY; T=293.16K
angular distribution for (n,n*14)

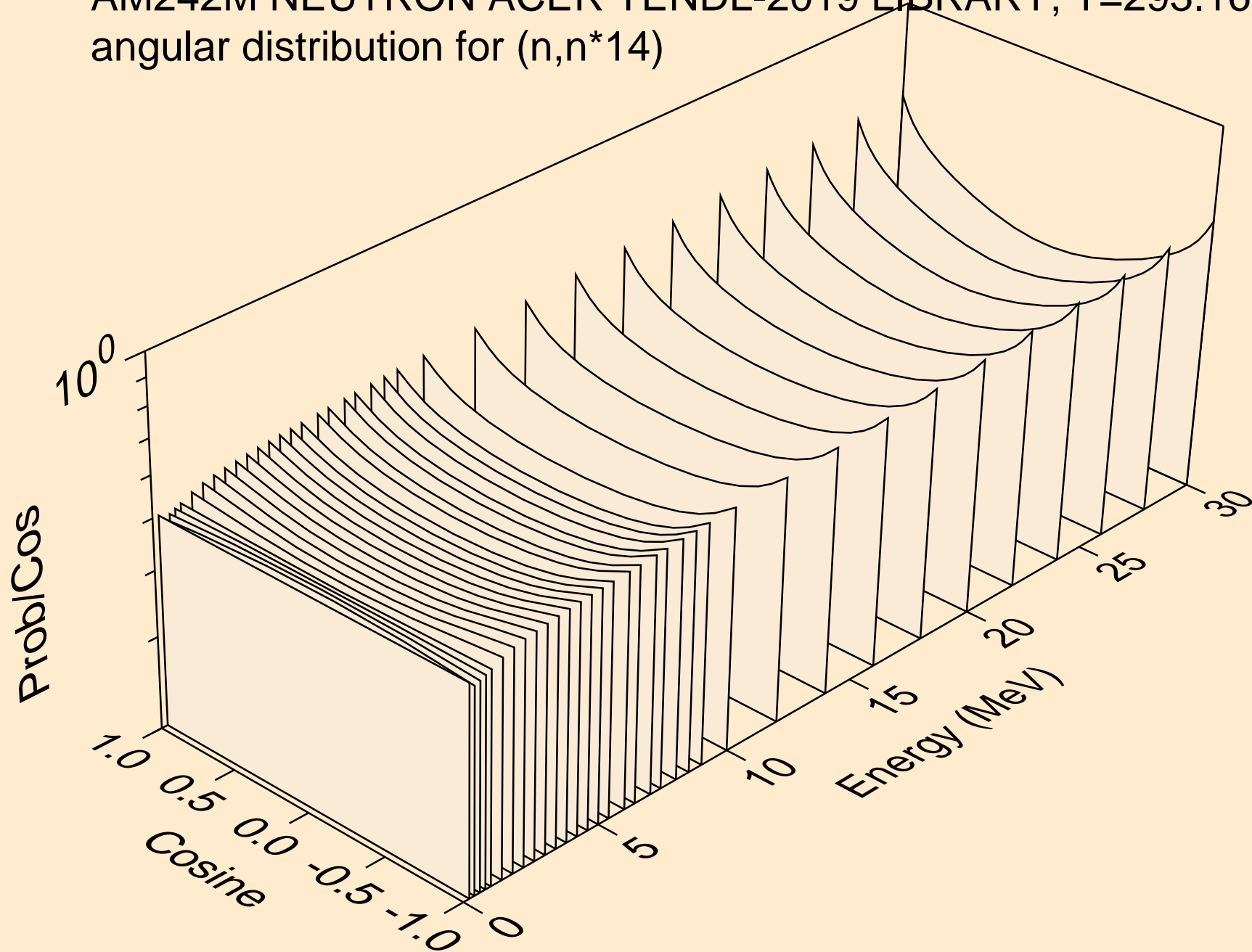

AM242M NEUTRON ACER TENDL-2019 LIBRARY; T=293.16K
angular distribution for (n,n*15)

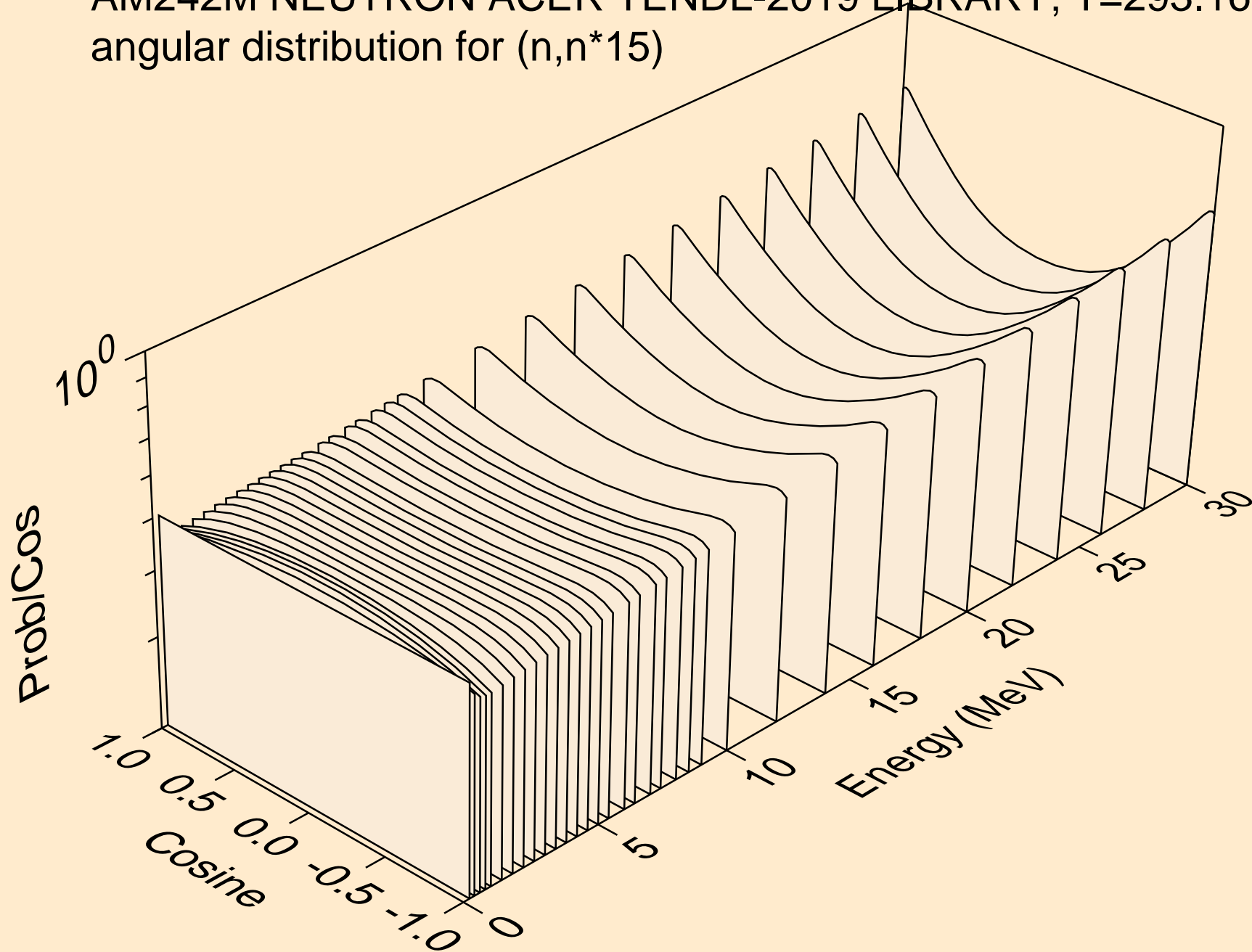

AM242M NEUTRON ACER TENDL-2019 LIBRARY; T=293.16K
angular distribution for (n,n*16)

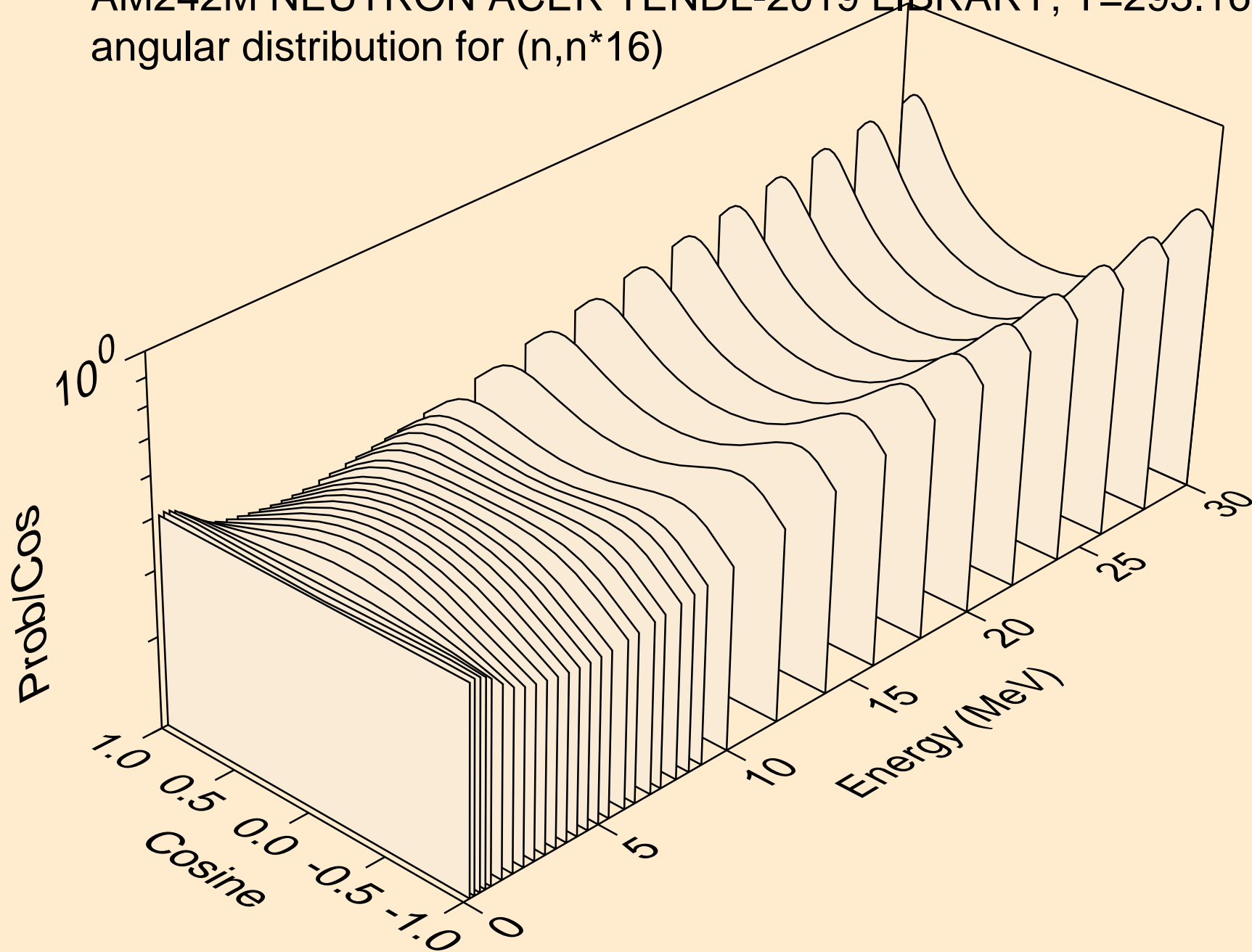

AM242M NEUTRON ACER TENDL-2019 LIBRARY; T=293.16K
angular distribution for (n,n*17)

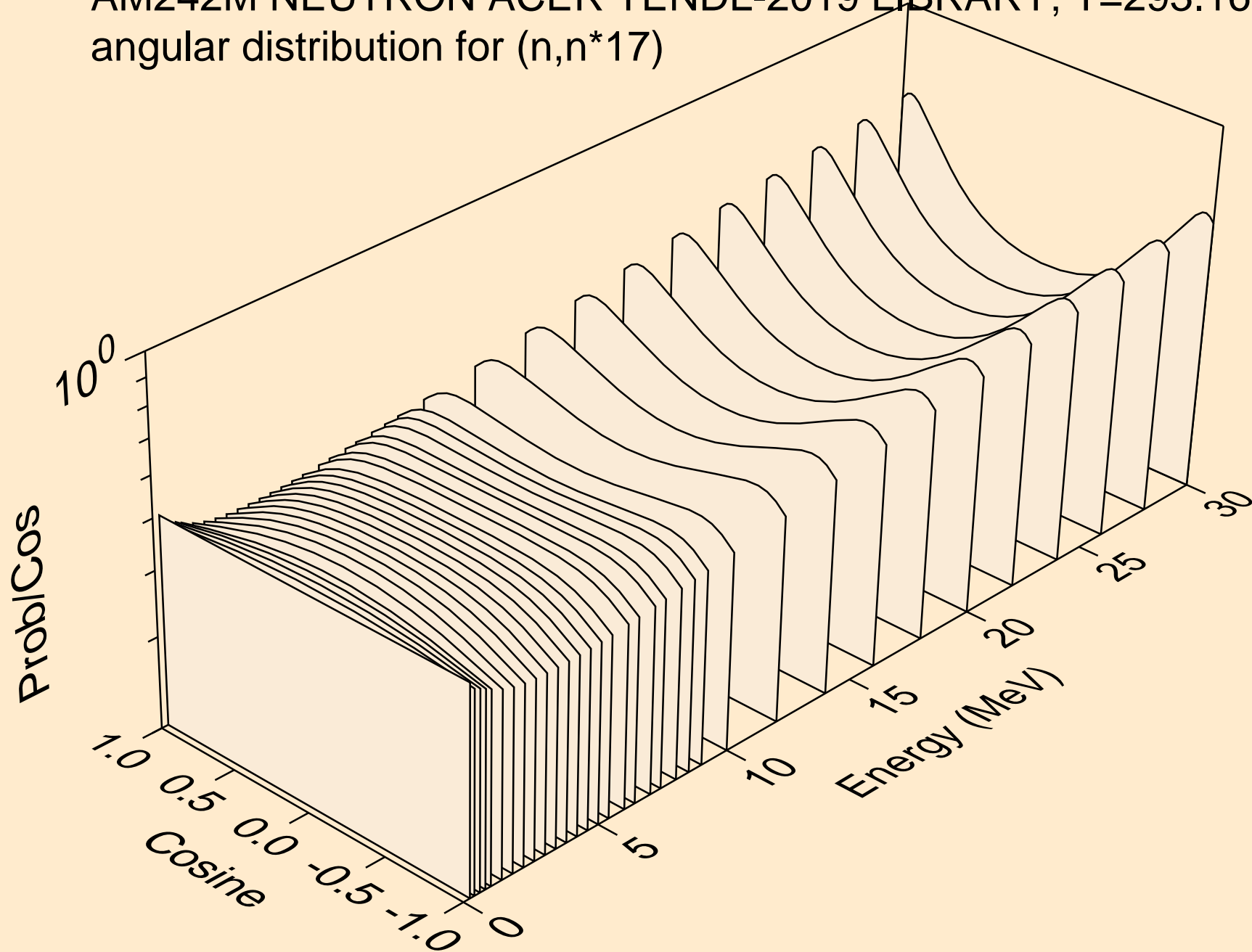

AM242M NEUTRON ACER TENDL-2019 LIBRARY; T=293.16K
angular distribution for (n,n*18)

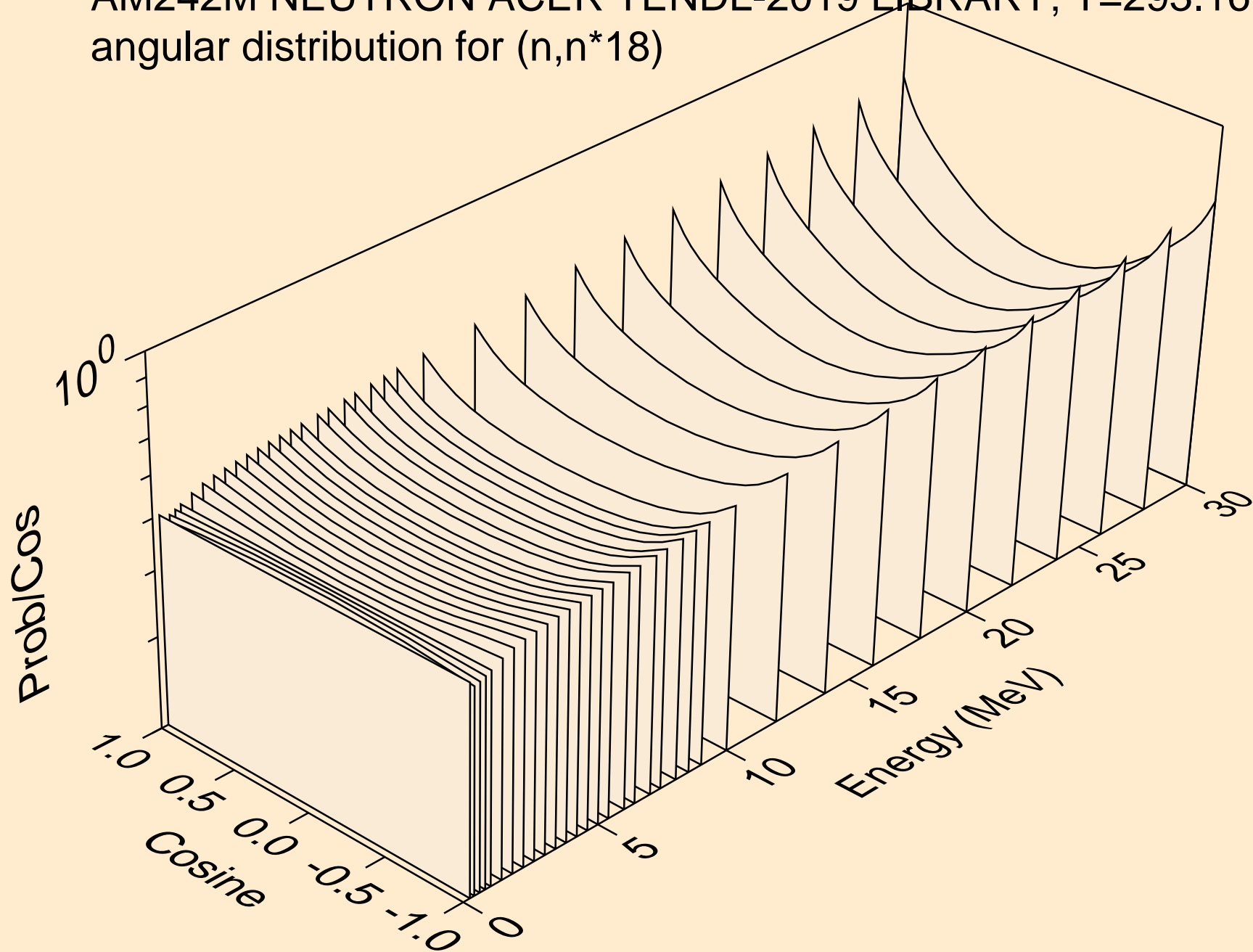

AM242M NEUTRON ACER TENDL-2019 LIBRARY; T=293.16K
angular distribution for (n,n*19)

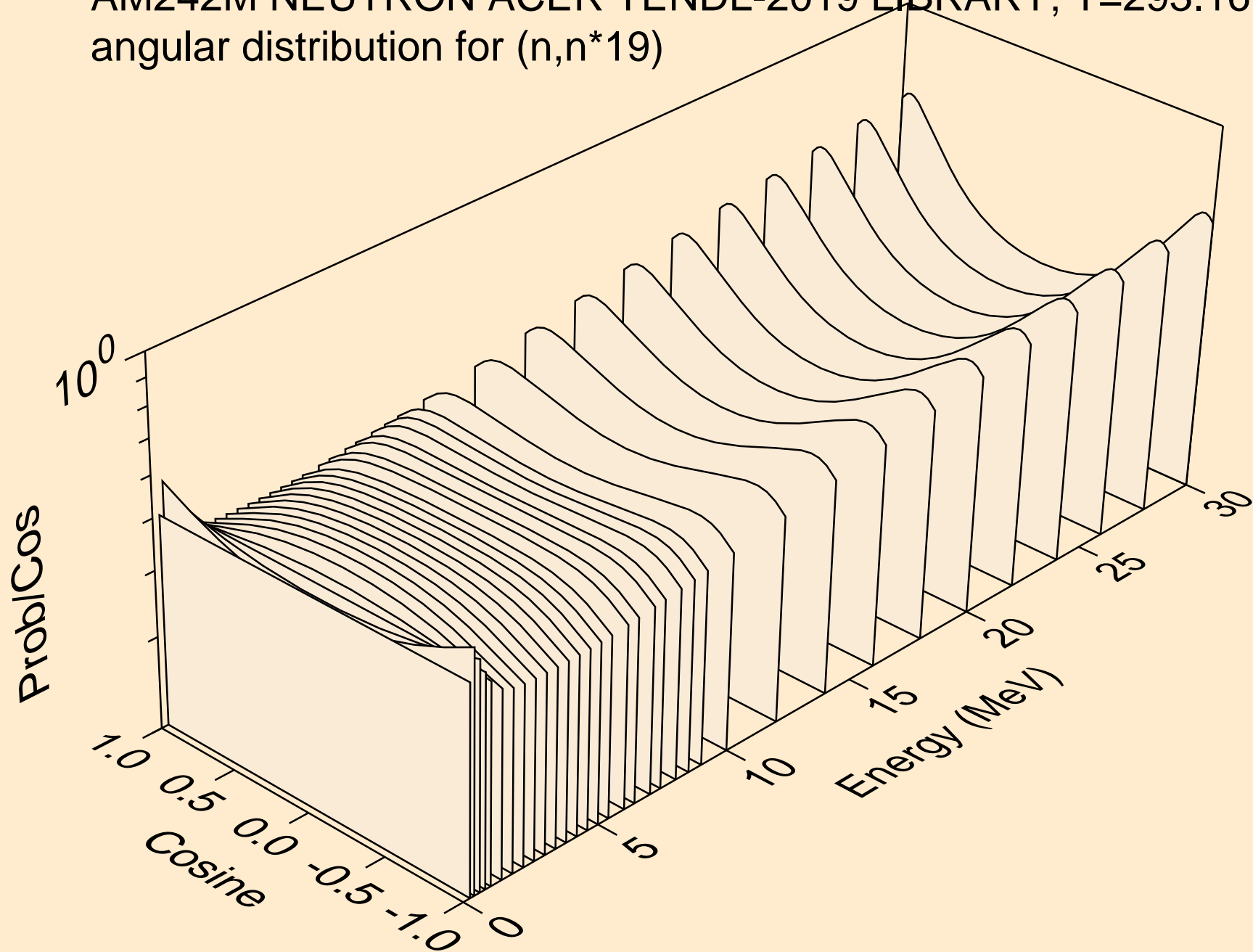

AM242M NEUTRON ACER TENDL-2019 LIBRARY; T=293.16K
angular distribution for (n,n*20)

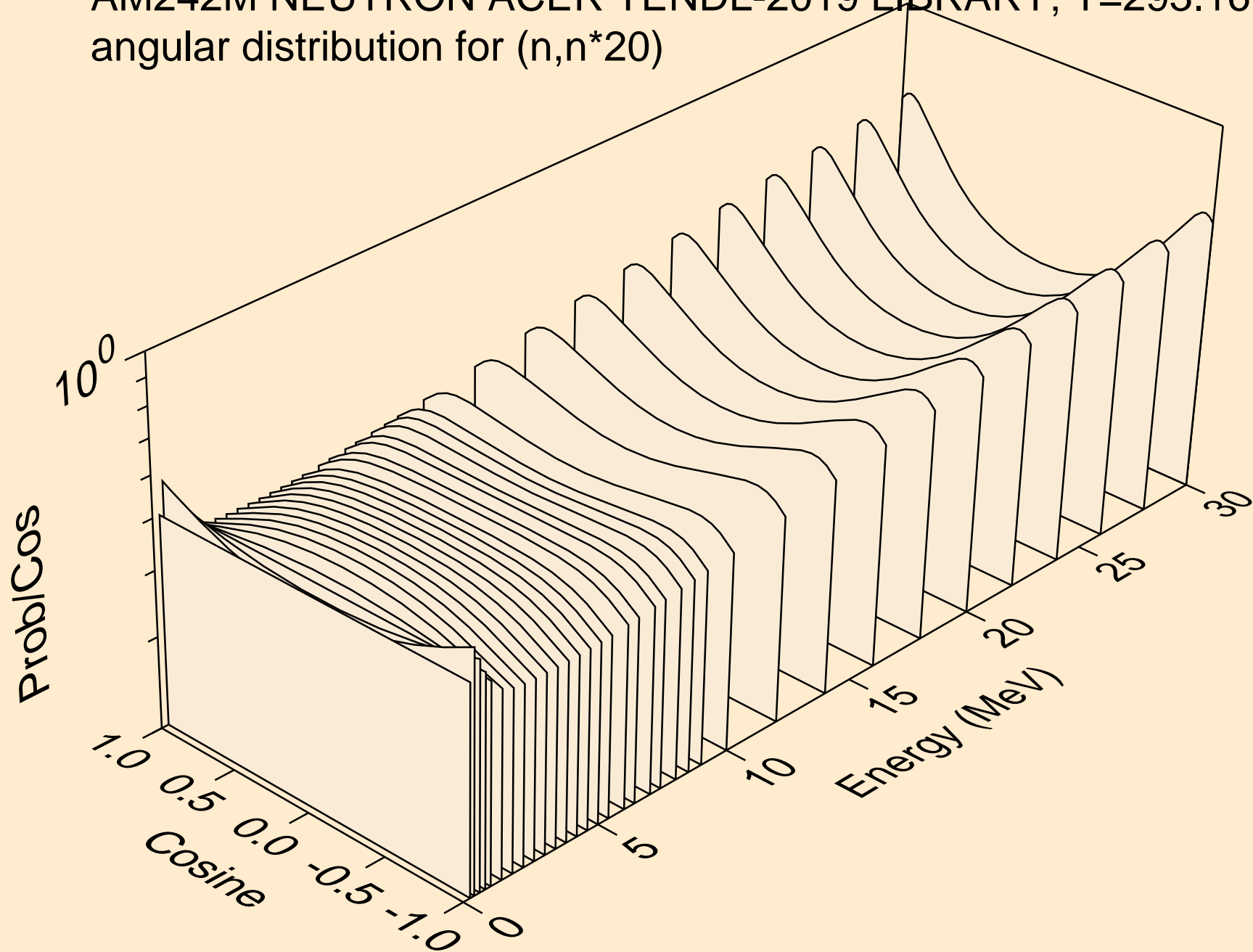

AM242M NEUTRON ACER TENDL-2019 LIBRARY; T=293.16K
angular distribution for (n,n*21)

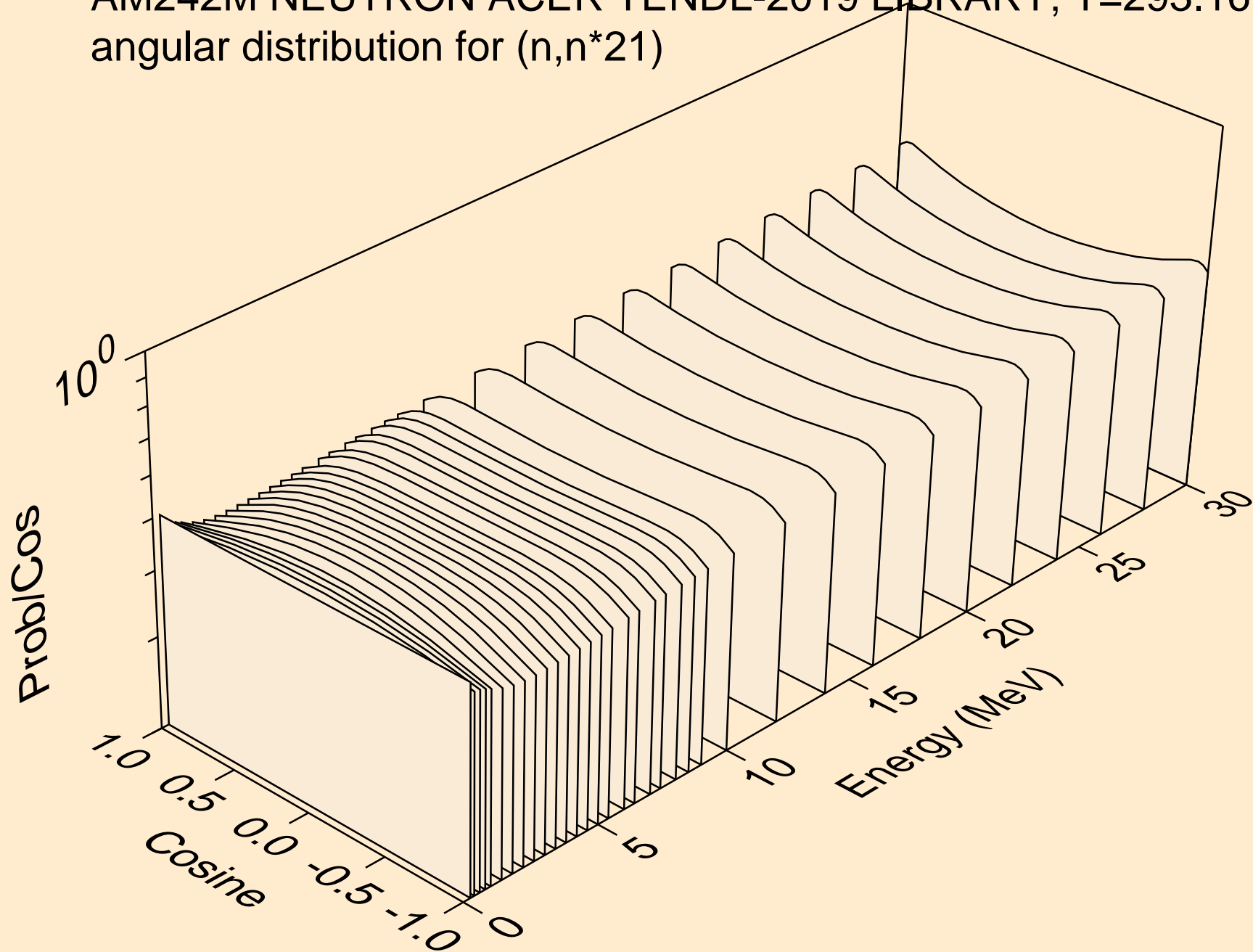

AM242M NEUTRON ACER TENDL-2019 LIBRARY; T=293.16K
angular distribution for (n,n*22)

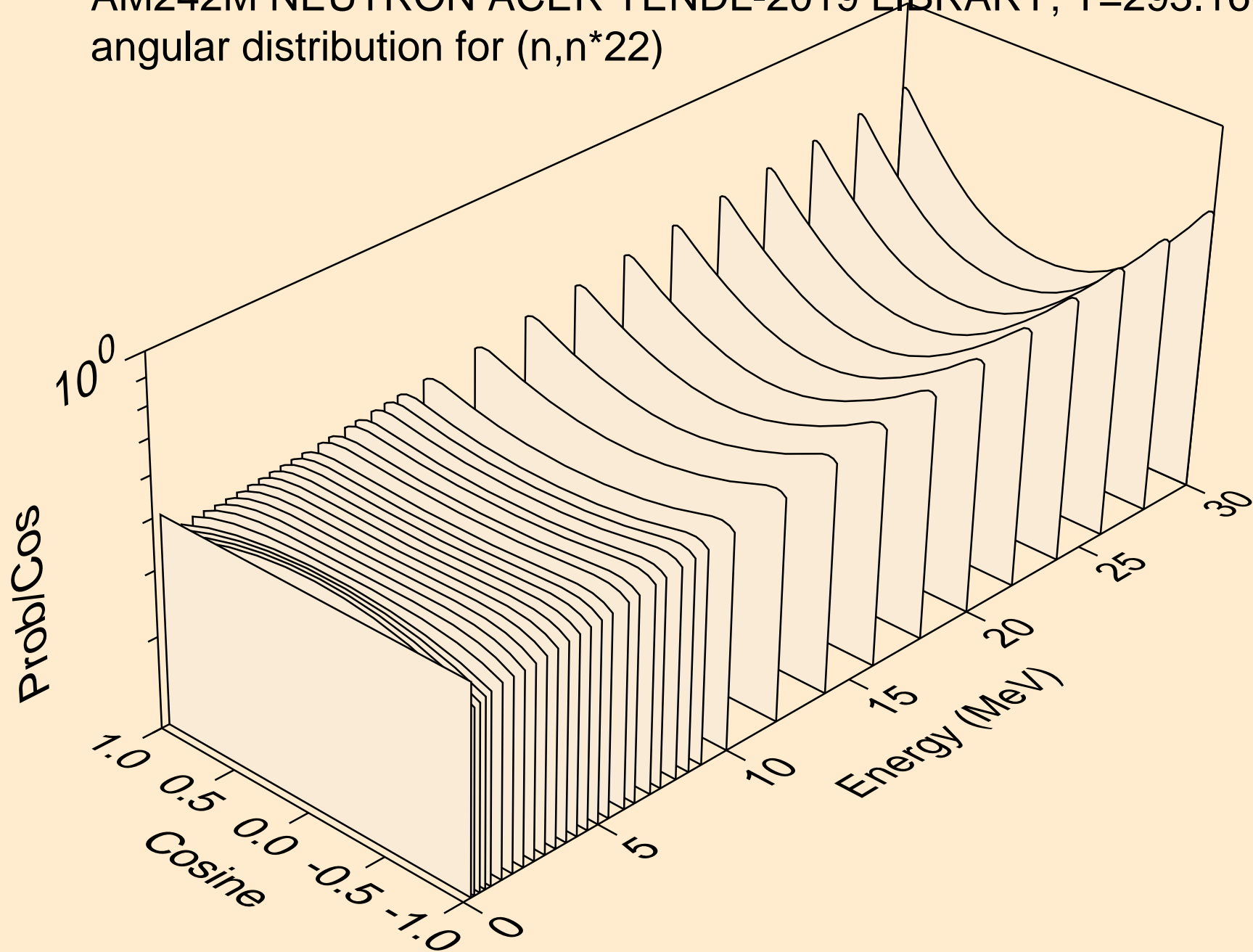

AM242M NEUTRON ACER TENDL-2019 LIBRARY; T=293.16K
angular distribution for (n,n*23)

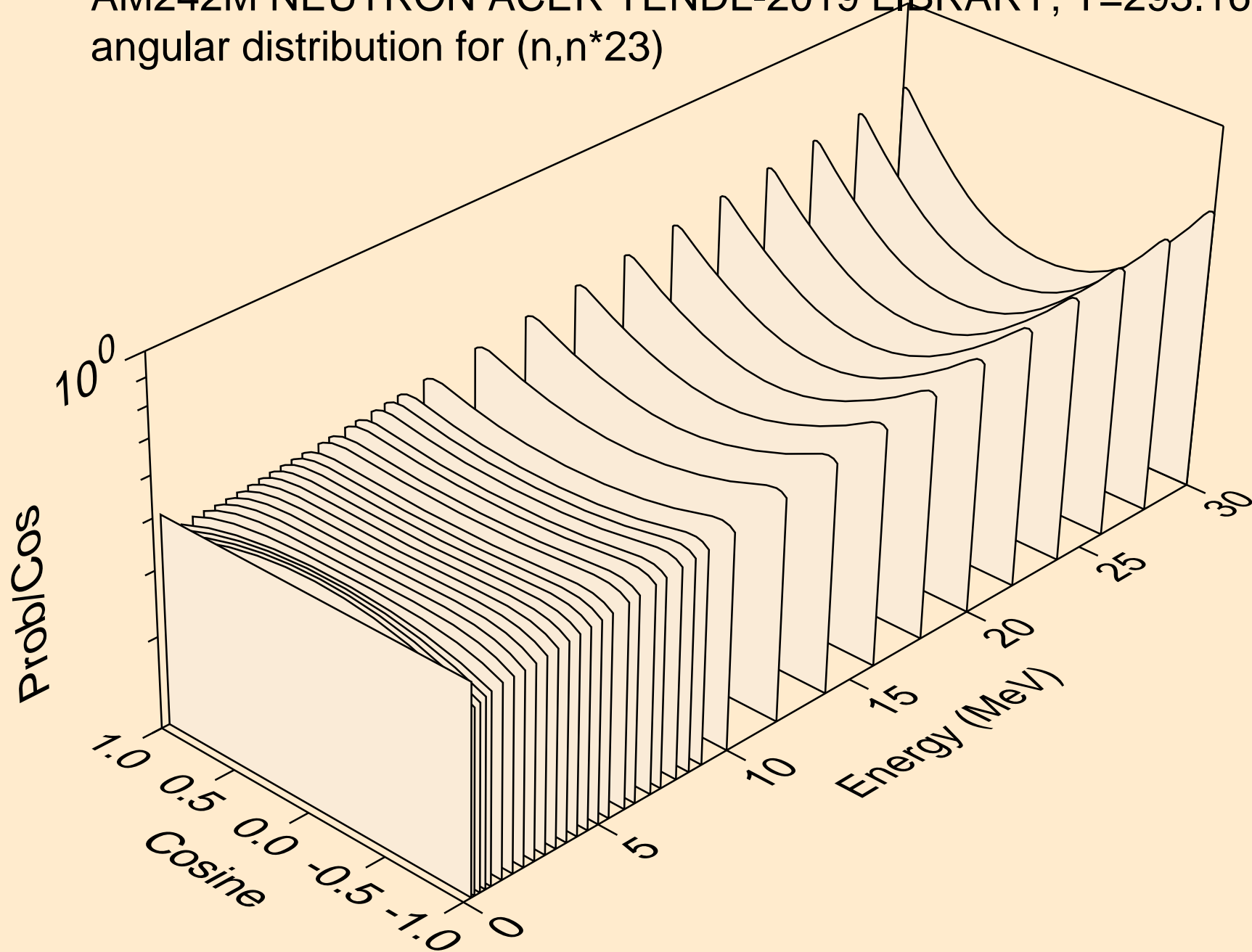

AM242M NEUTRON ACER TENDL-2019 LIBRARY; T=293.16K
angular distribution for (n,n*24)

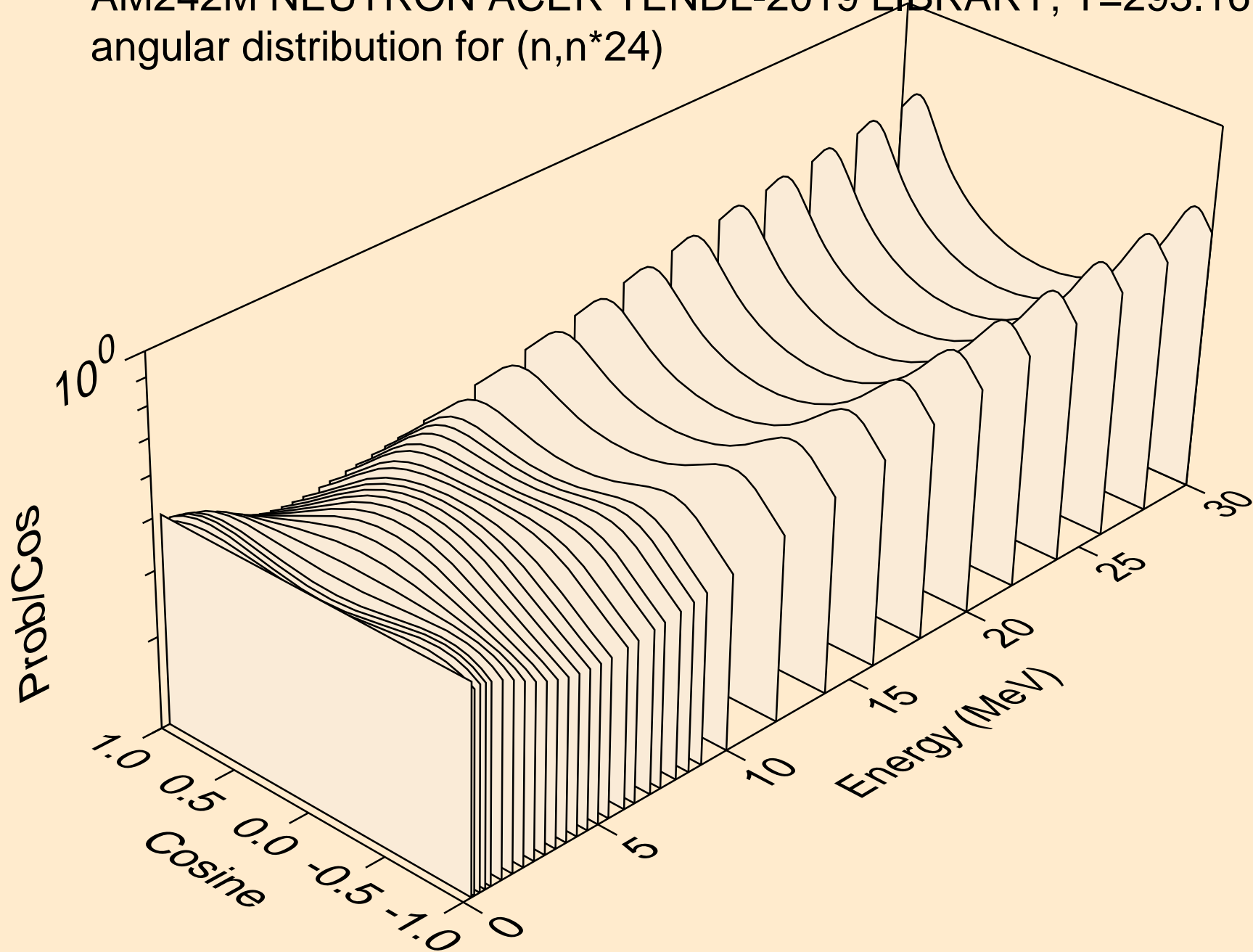

AM242M NEUTRON ACER TENDL-2019 LIBRARY; T=293.16K
angular distribution for (n,n*25)

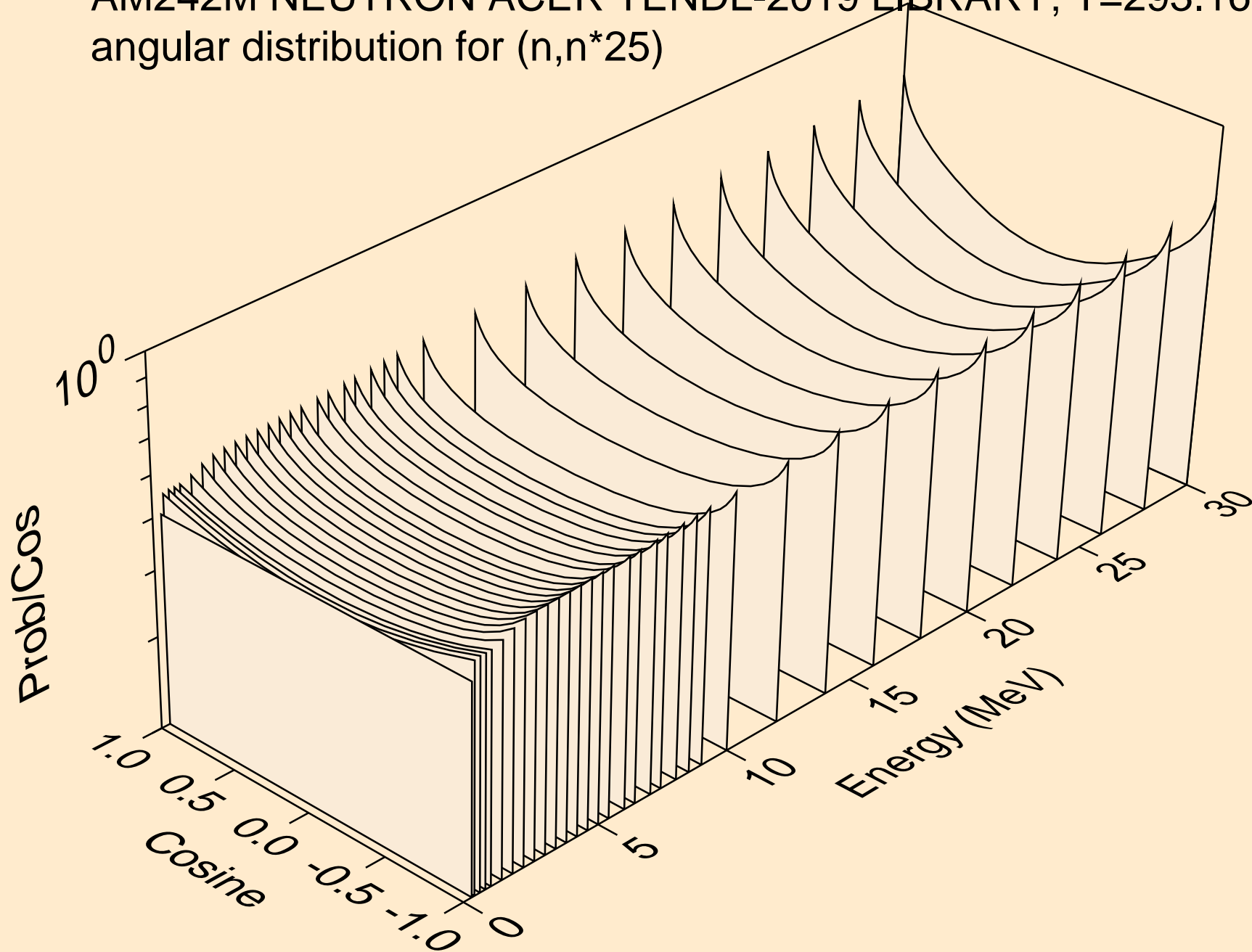

AM242M NEUTRON ACER TENDL-2019 LIBRARY; T=293.16K
angular distribution for (n,n*26)

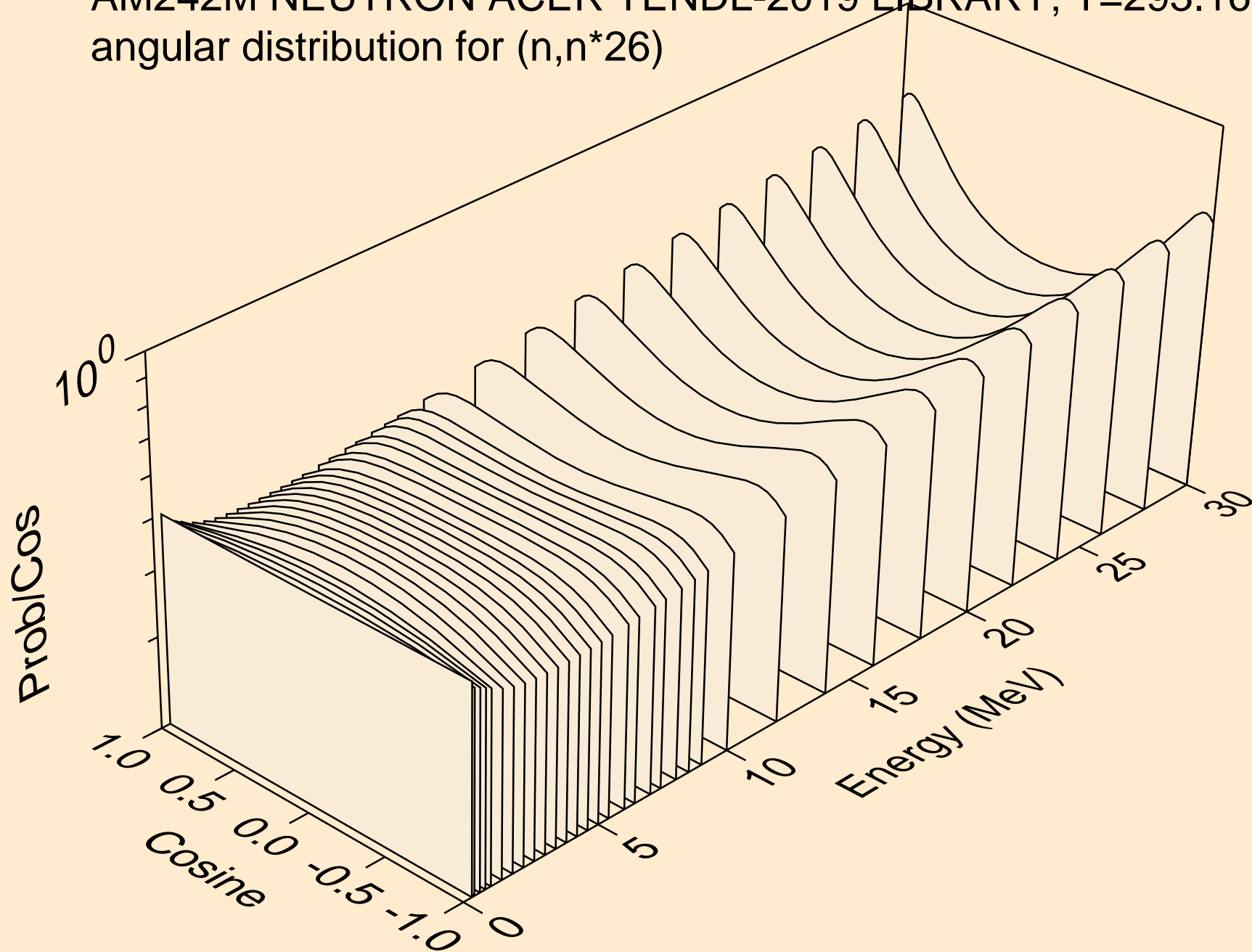

AM242M NEUTRON ACER TENDL-2019 LIBRARY; T=293.16K
angular distribution for (n,n*27)

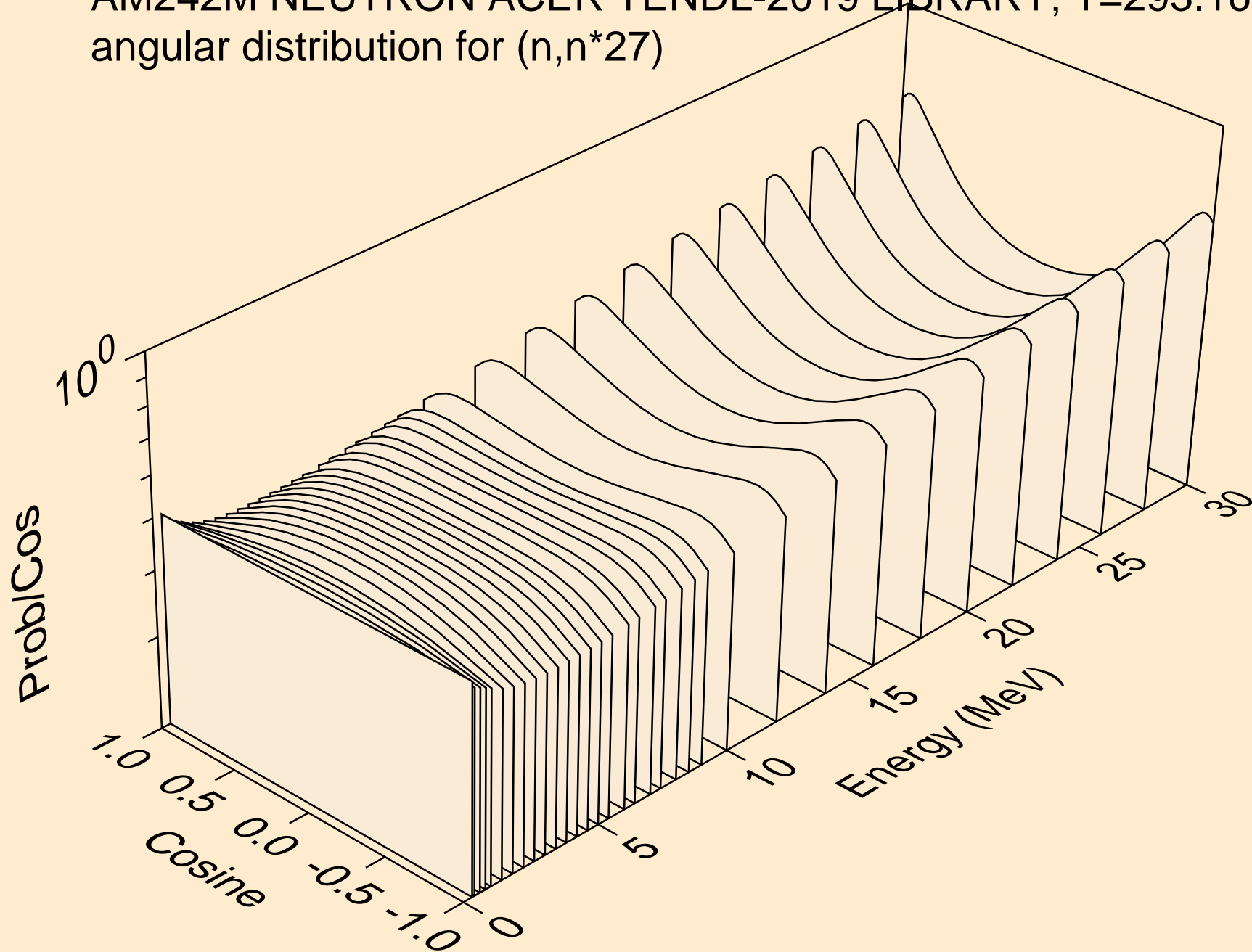

AM242M NEUTRON ACER TENDL-2019 LIBRARY; T=293.16K
angular distribution for (n,n*28)

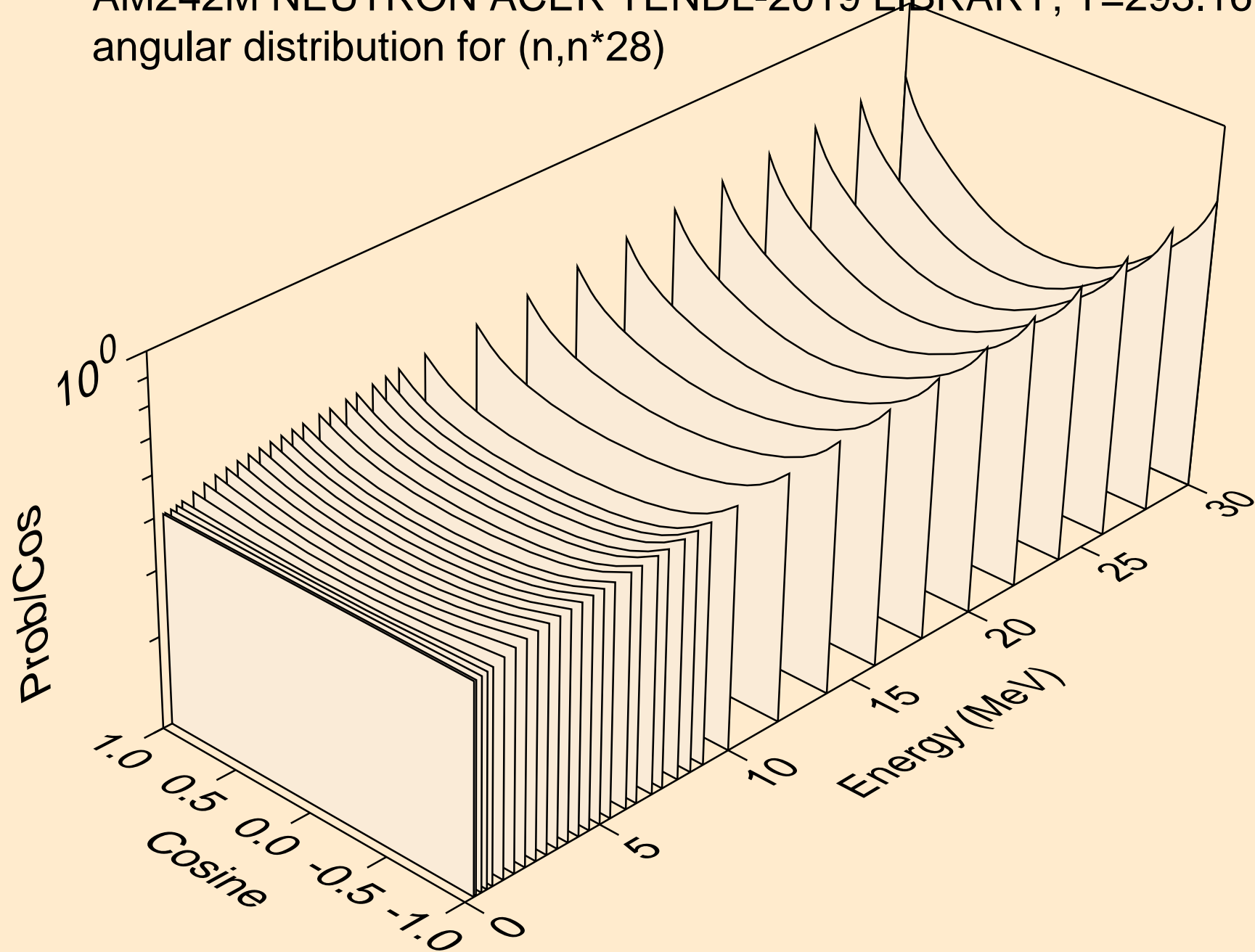

AM242M NEUTRON ACER TENDL-2019 LIBRARY; T=293.16K
angular distribution for (n,n*29)

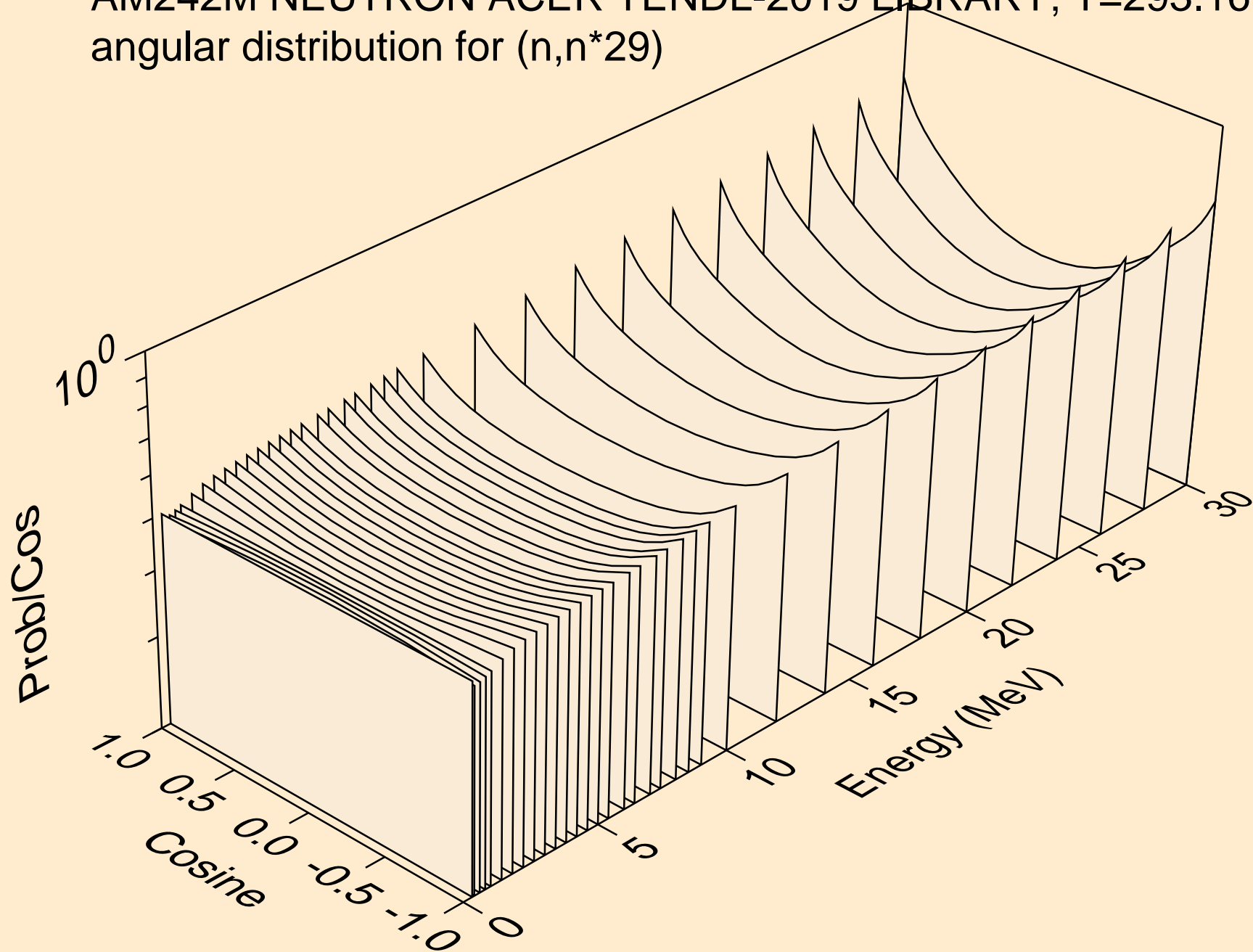

AM242M NEUTRON ACER TENDL-2019 LIBRARY; T=293.16K
angular distribution for (n,n*30)

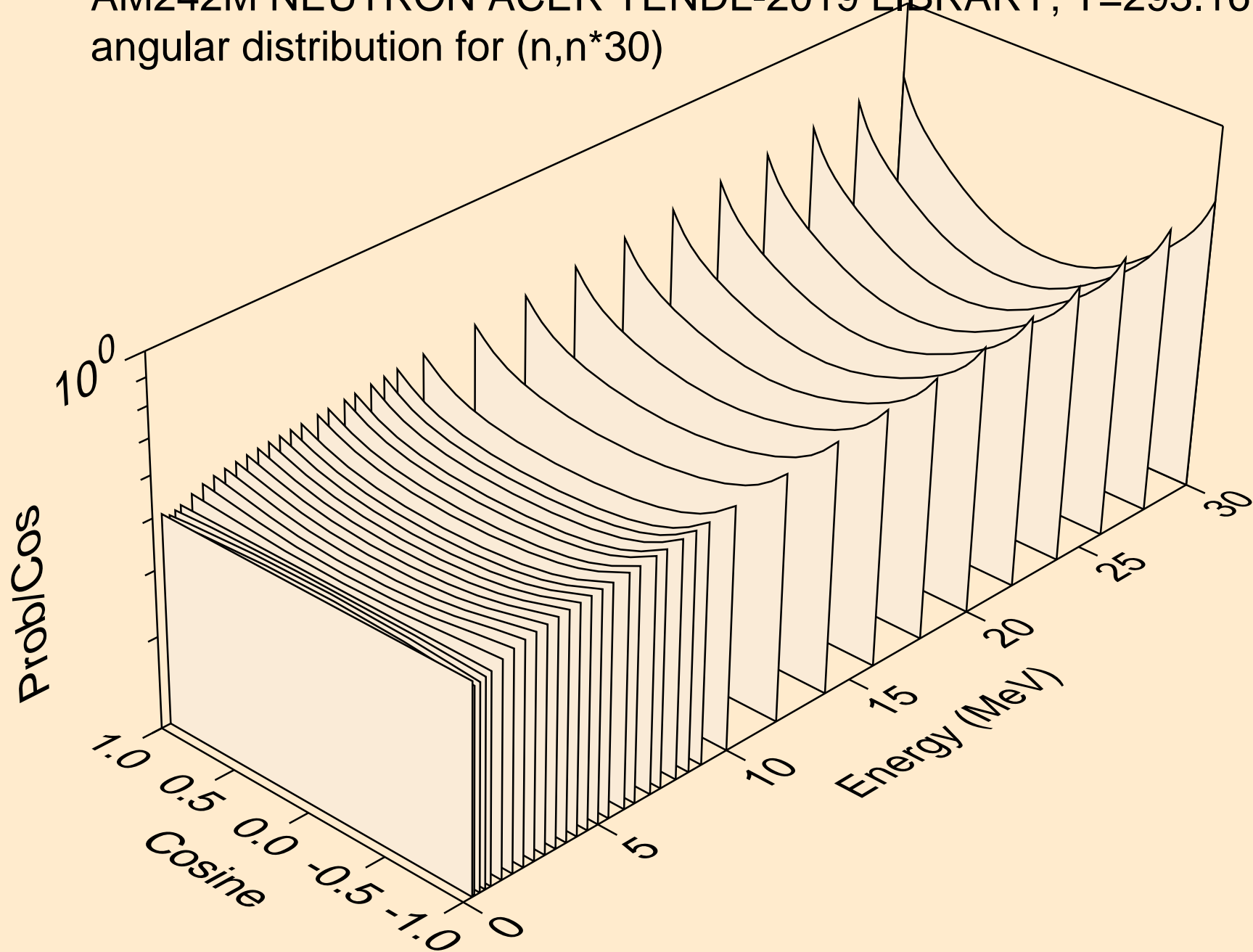

AM242M NEUTRON ACER TENDL-2019 LIBRARY; T=293.16K
Total fission nubar

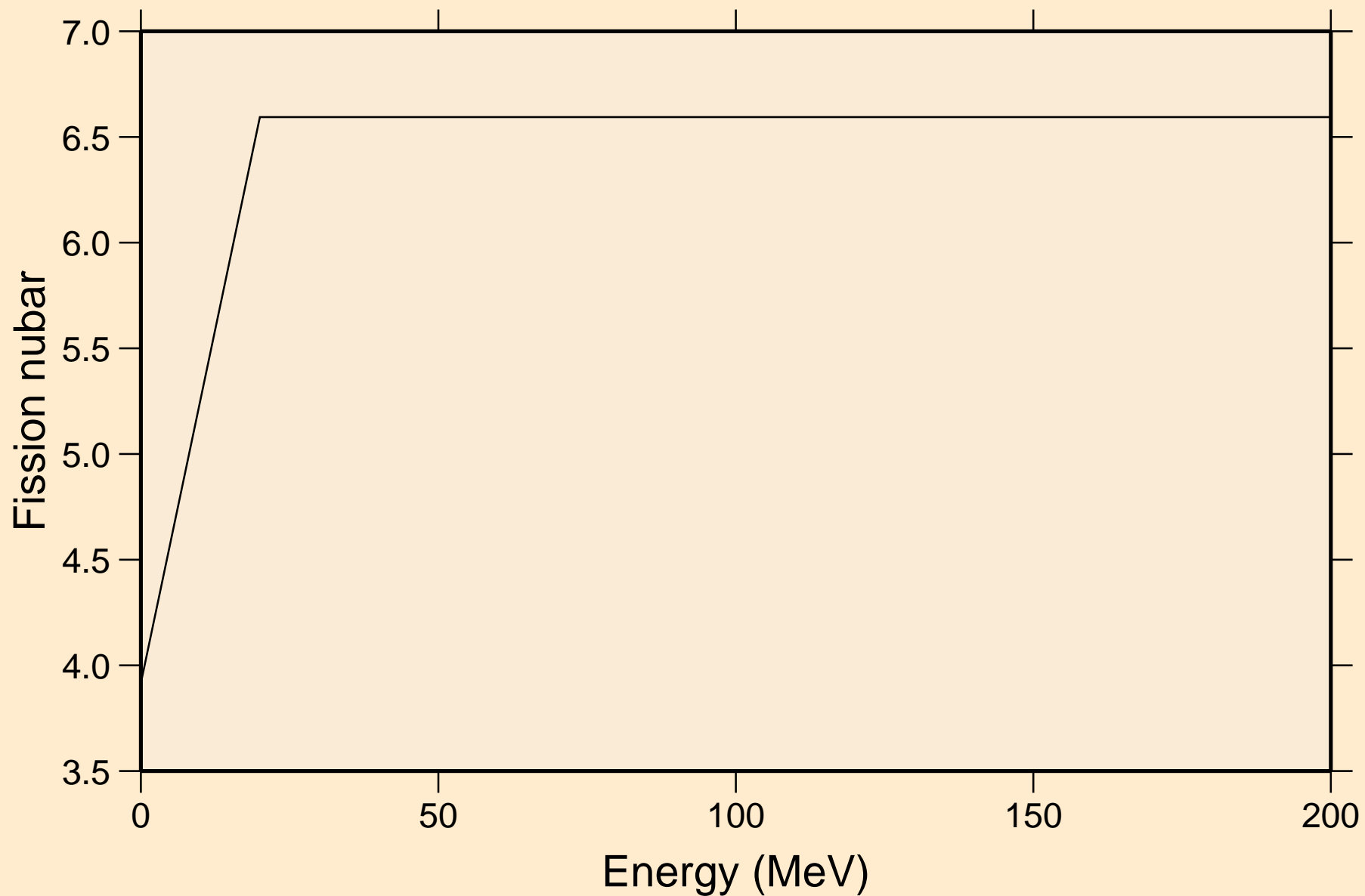

AM242M NEUTRON ACER TENDL-2019 LIBRARY; T=293.16K
Neutron emission for (n,x)

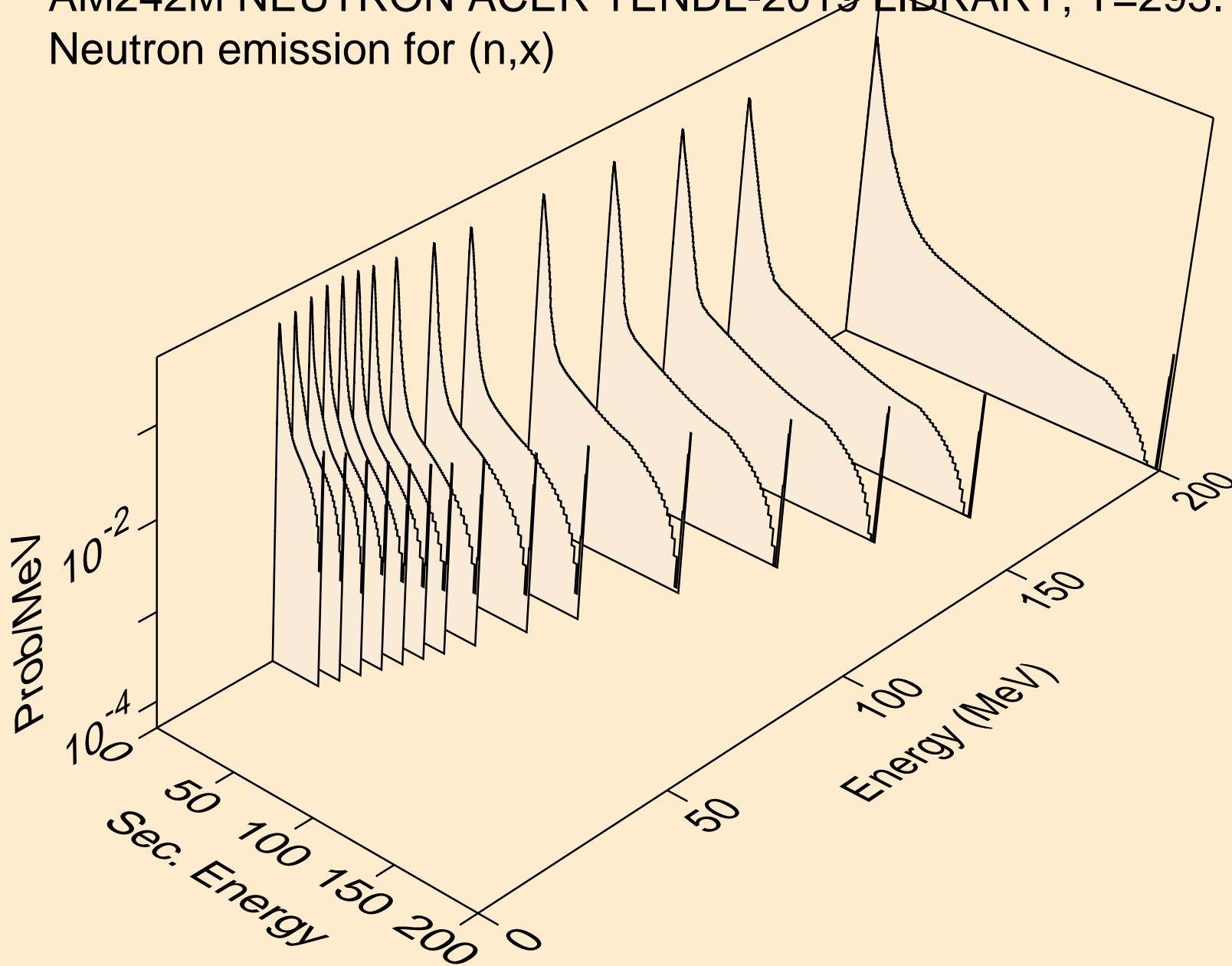

AM242M NEUTRON ACER TENDL-2019 LIBRARY; T=293.16K
Neutron emission for (n,2nd)

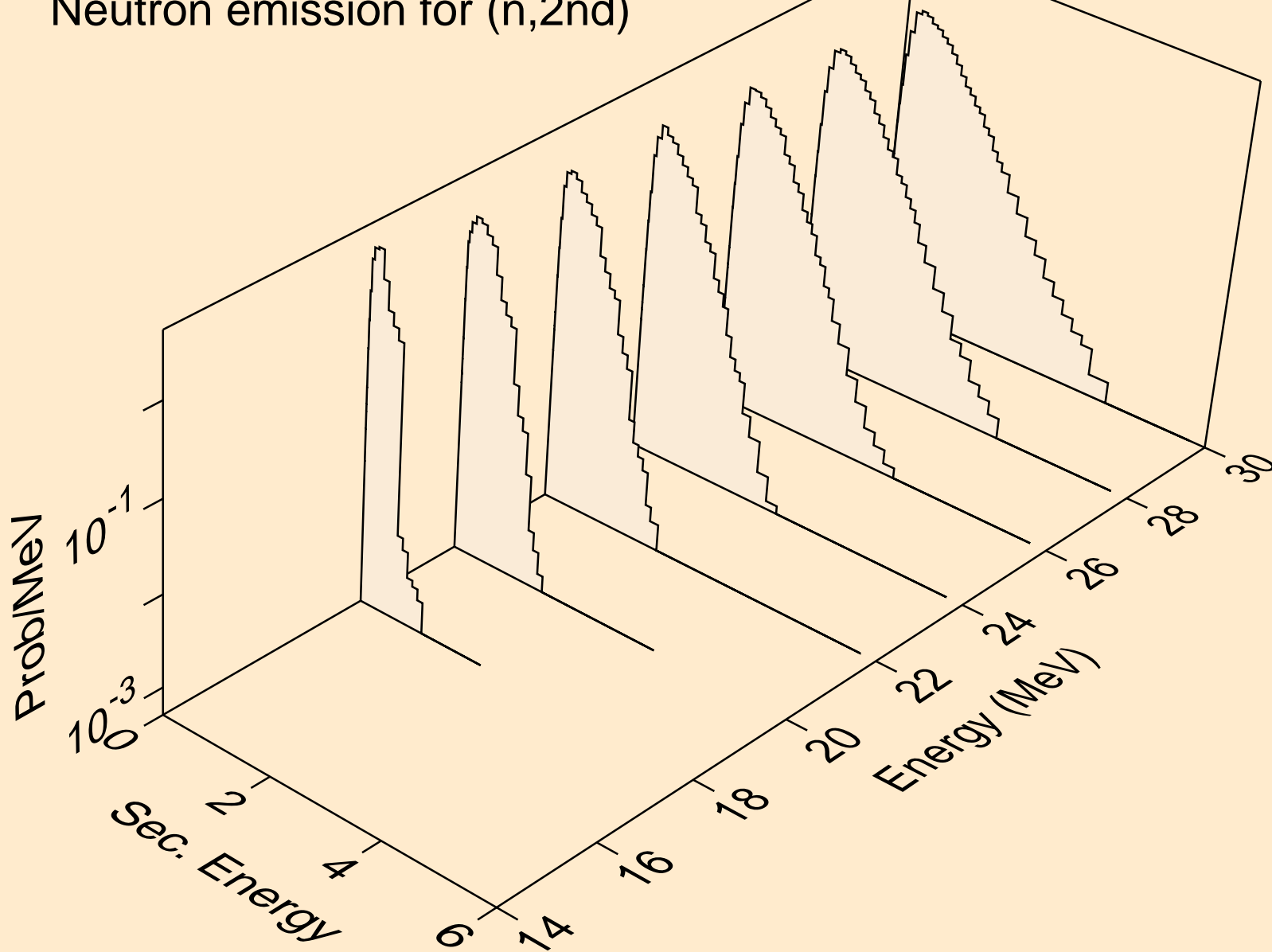

AM242M NEUTRON ACER TENDL-2019 LIBRARY; T=293.16K
Neutron emission for (n,2n)

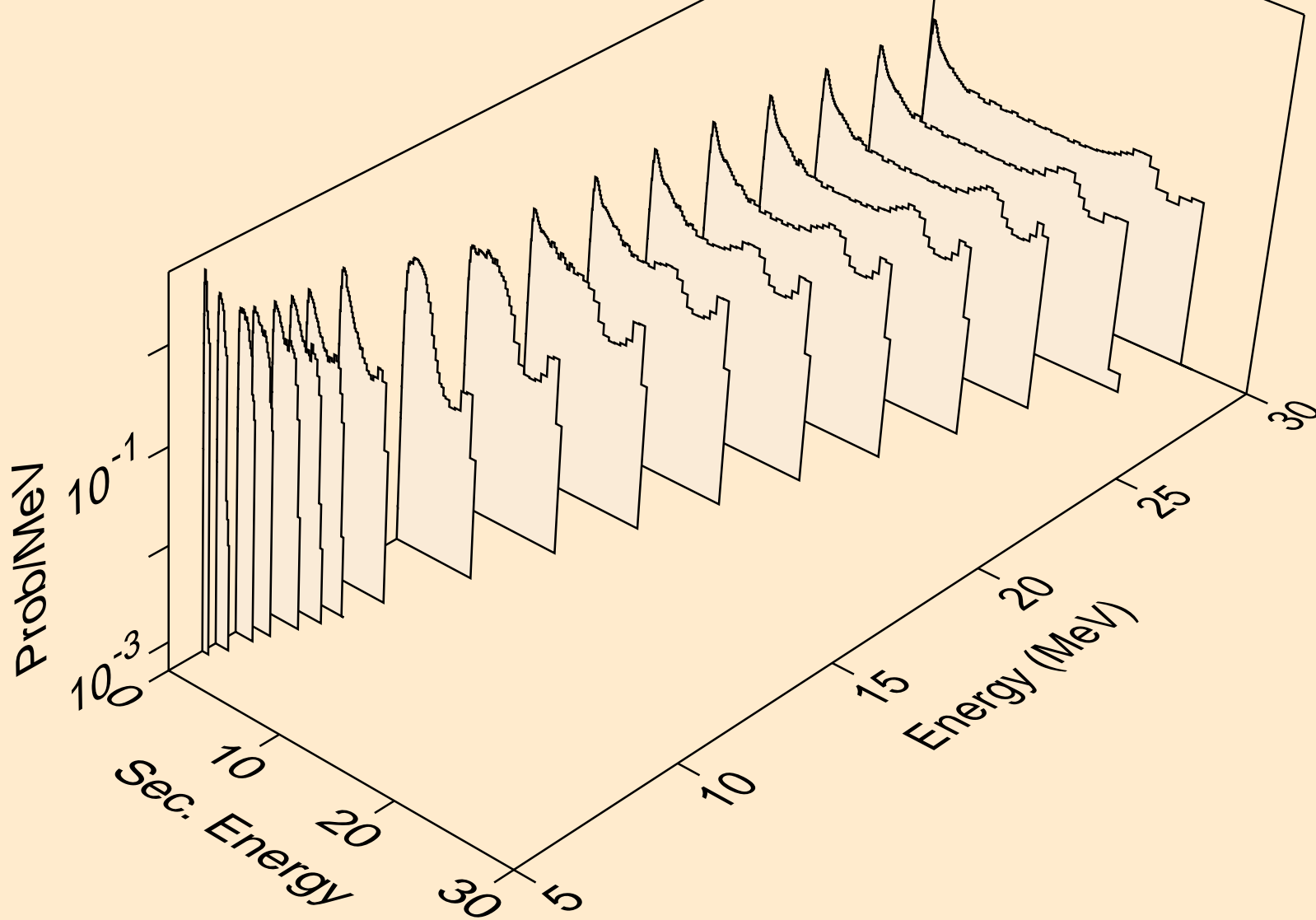

AM242M NEUTRON ACER TENDL-2019 LIBRARY; T=293.16K
Neutron emission for (n,3n)

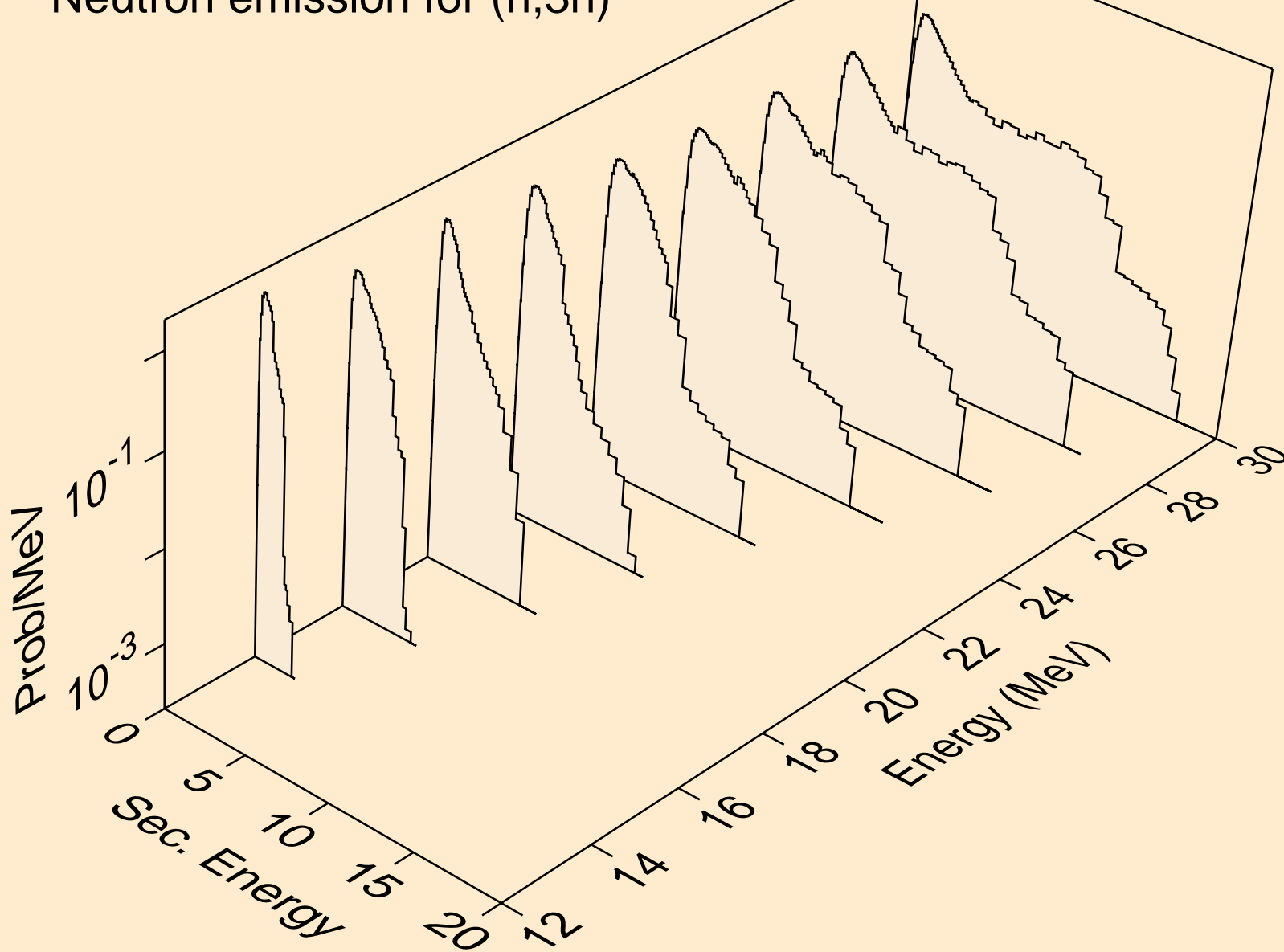

AM242M NEUTRON ACER TENDL-2019 LIBRARY; T=293.16K
Neutron emission for fission

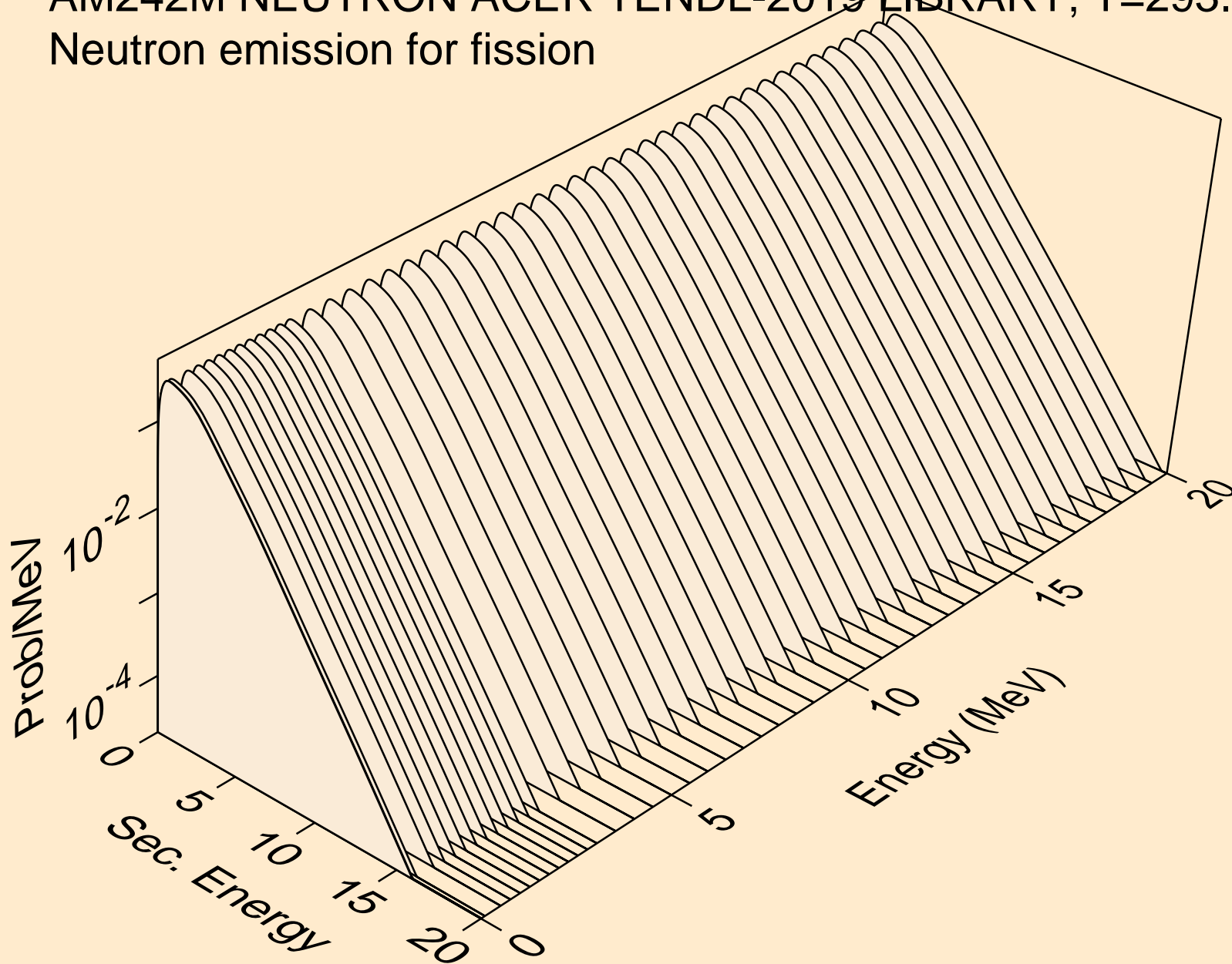

AM242M NEUTRON ACER TENDL-2019 LIBRARY; T=293.16K
Neutron emission for (n,n*)a

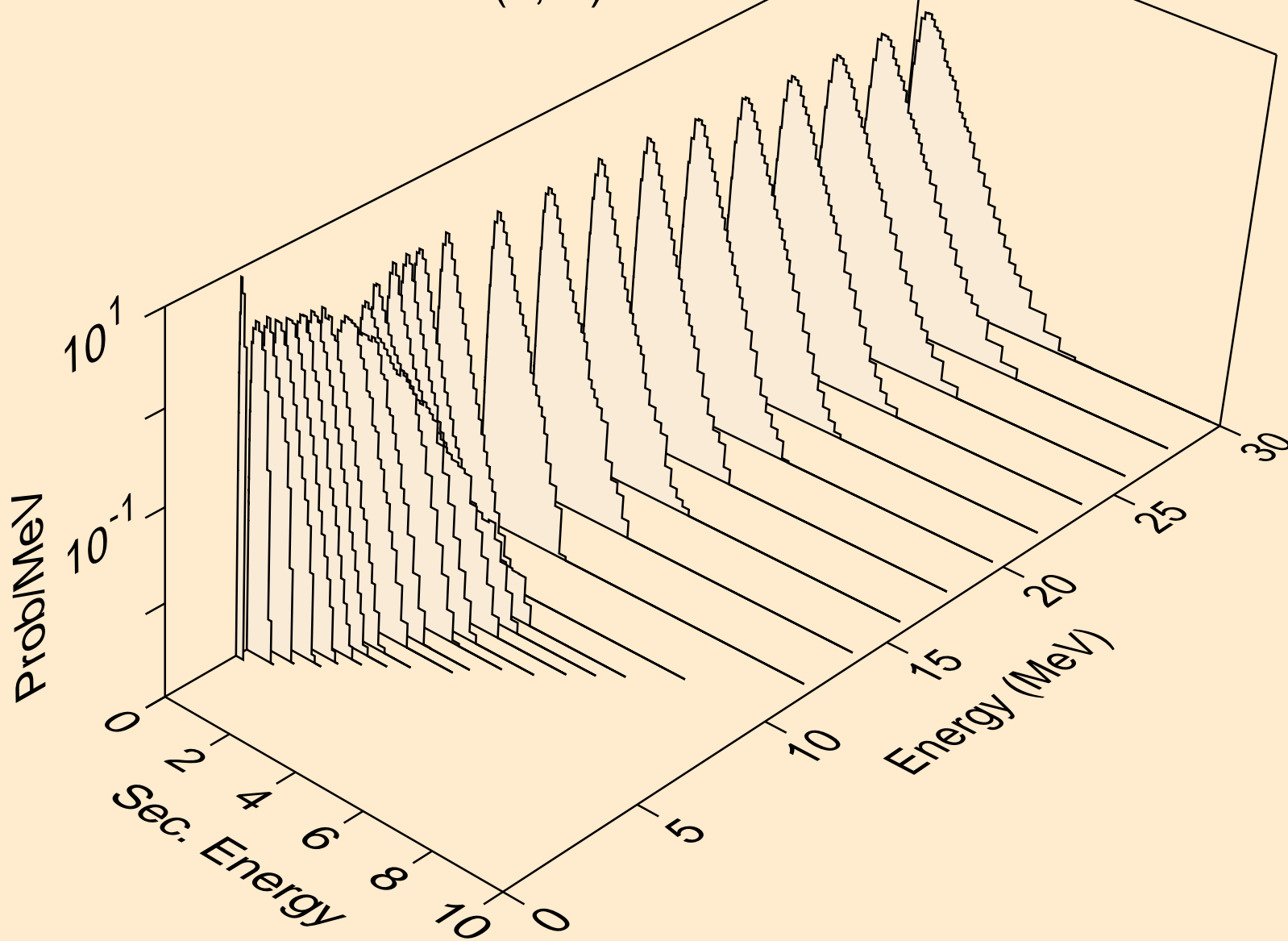

AM242M NEUTRON ACER TENDL-2019 LIBRARY; T=293.16K
Neutron emission for (n,2n)a

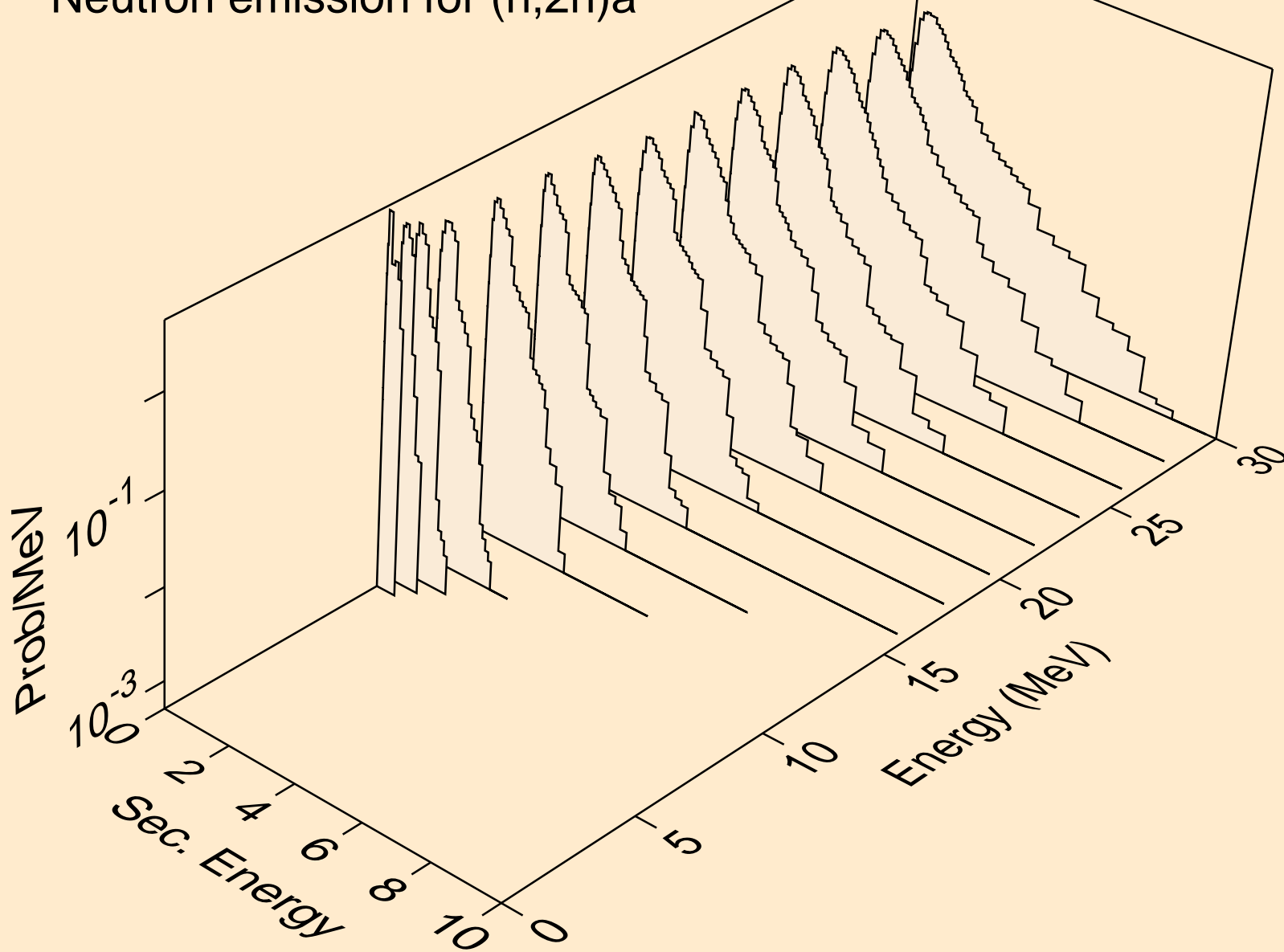

AM242M NEUTRON ACER TENDL-2019 LIBRARY; T=293.16K
Neutron emission for (n,3n)a

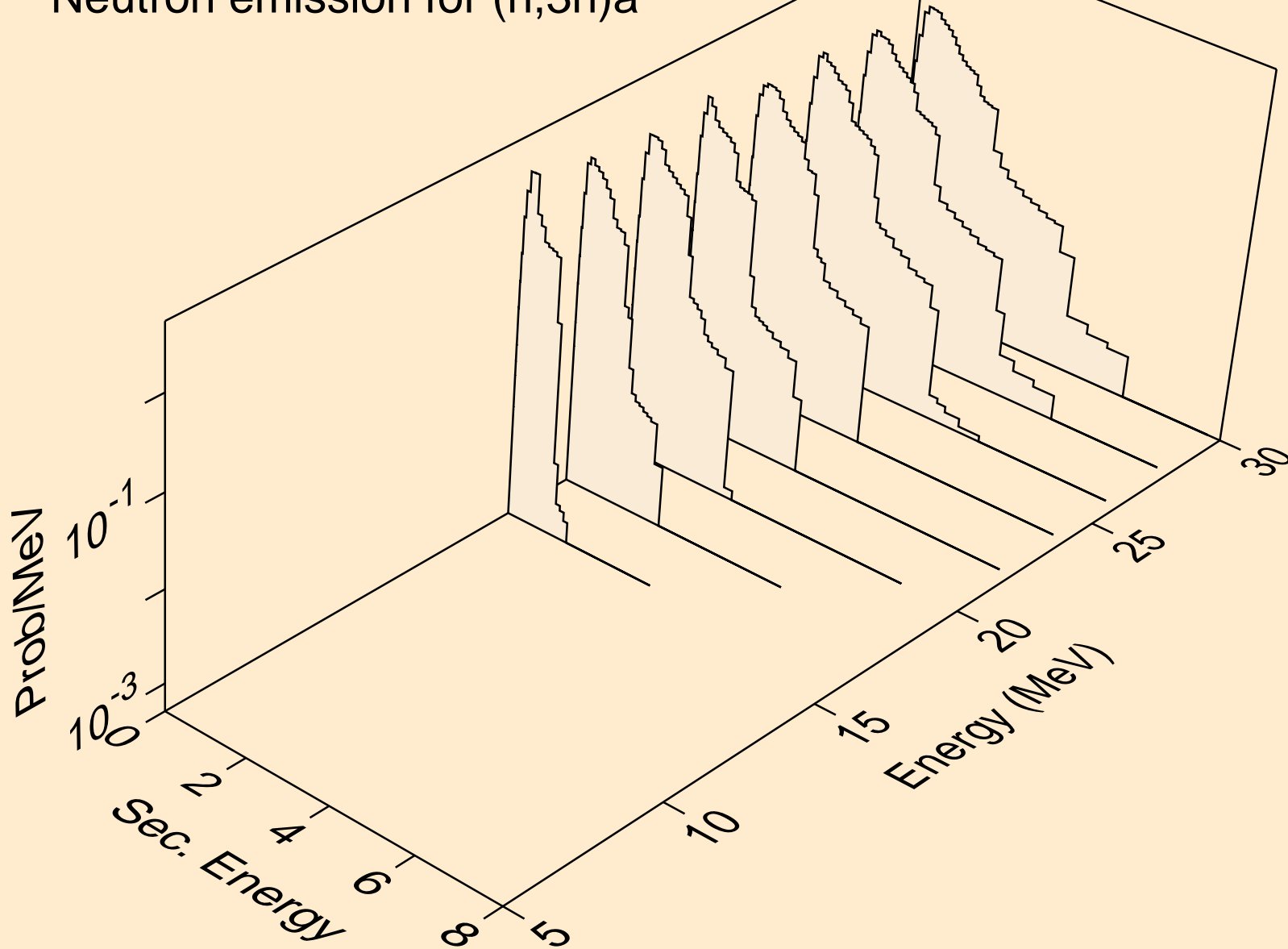

AM242M NEUTRON ACER TENDL-2019 LIBRARY; T=293.16K
Neutron emission for (n,n*)p

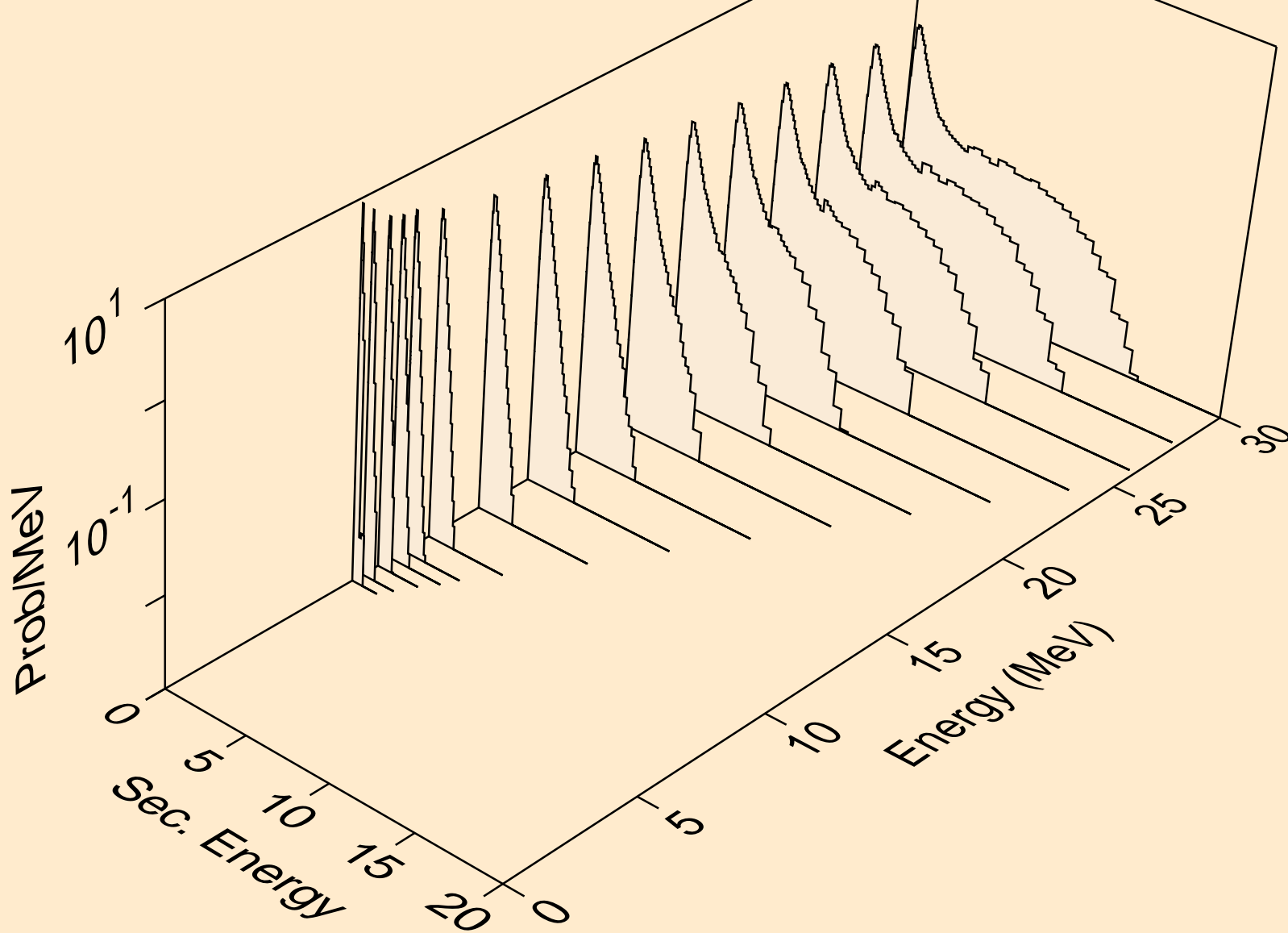

AM242M NEUTRON ACER TENDL-2019 LIBRARY; T=293.16K
Neutron emission for (n,n*)d

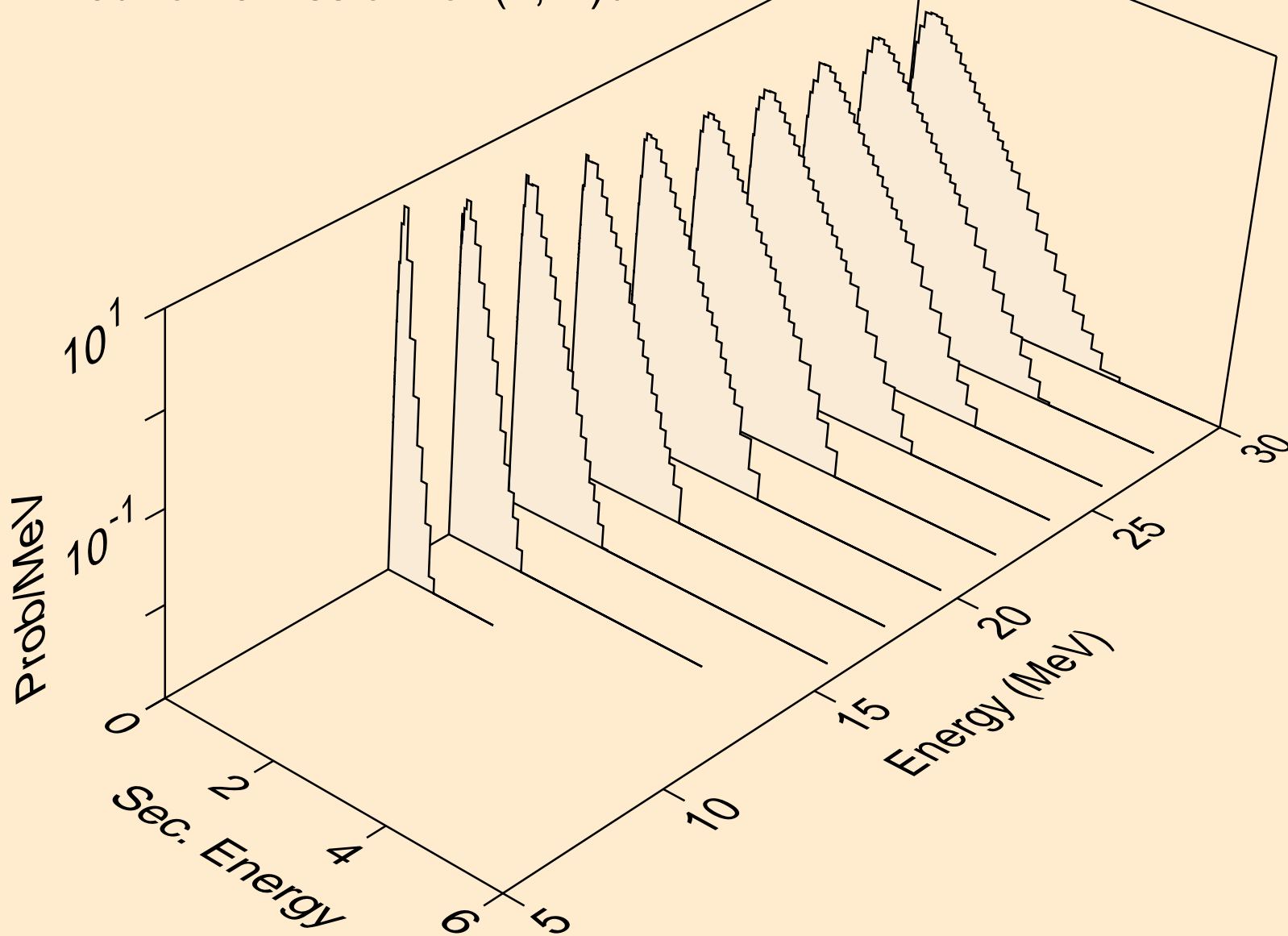

AM242M NEUTRON ACER TENDL-2019 LIBRARY; T=293.16K
Neutron emission for (n,n*)t

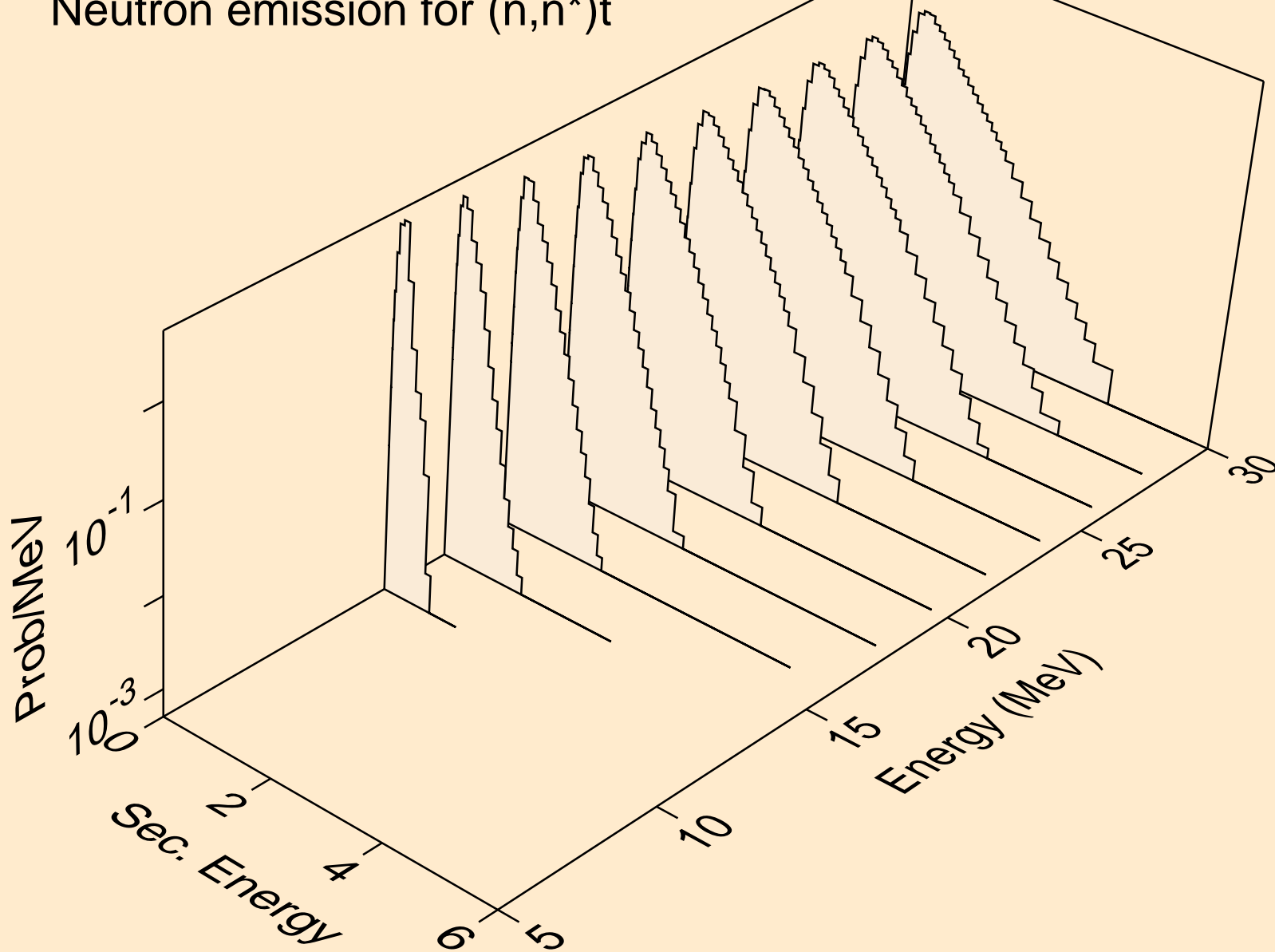

AM242M NEUTRON ACER TENDL-2019 LIBRARY; T=293.16K
Neutron emission for (n,n*)he3

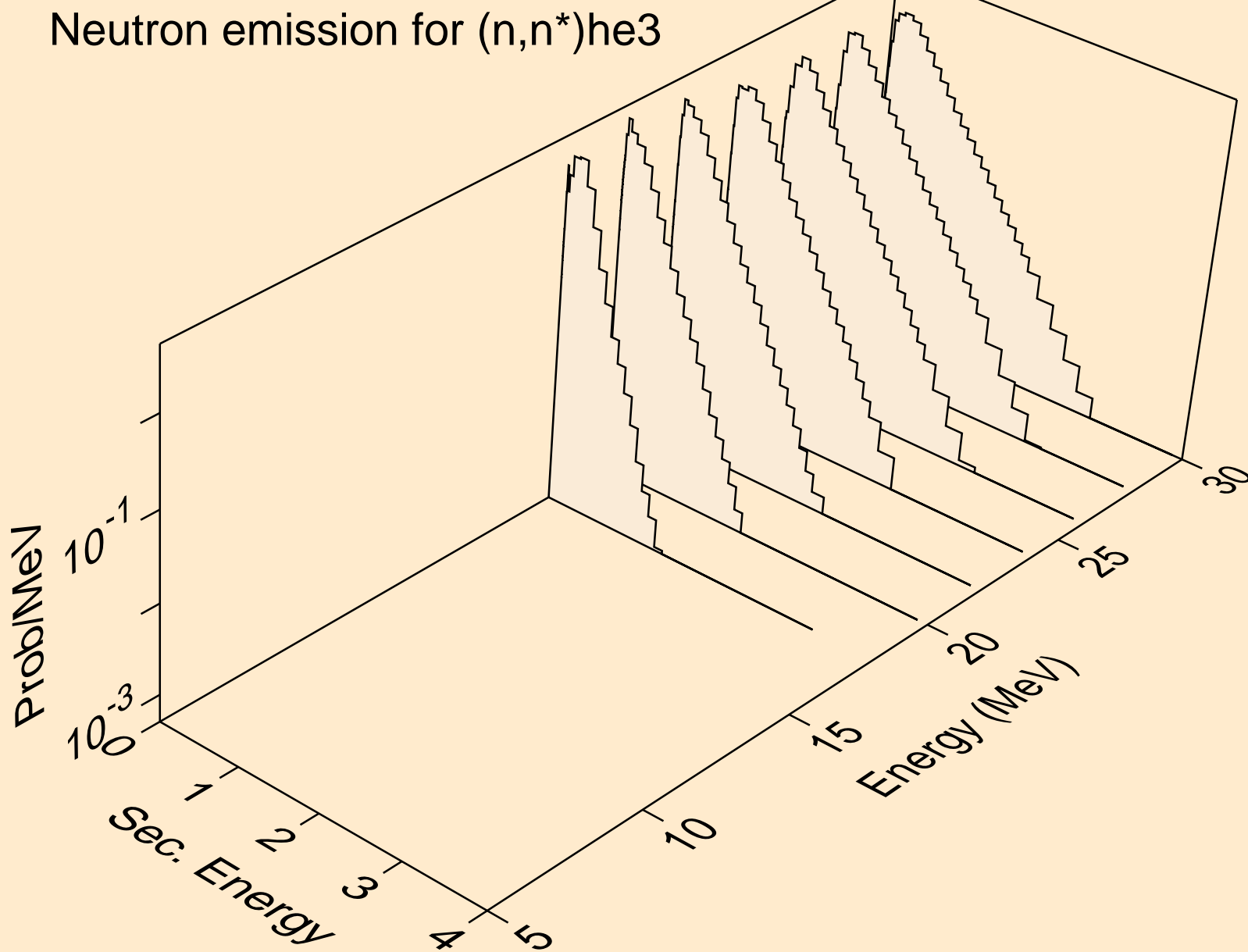

AM242M NEUTRON ACER TENDL-2019 LIBRARY; T=293.16K
Neutron emission for (n,4n)

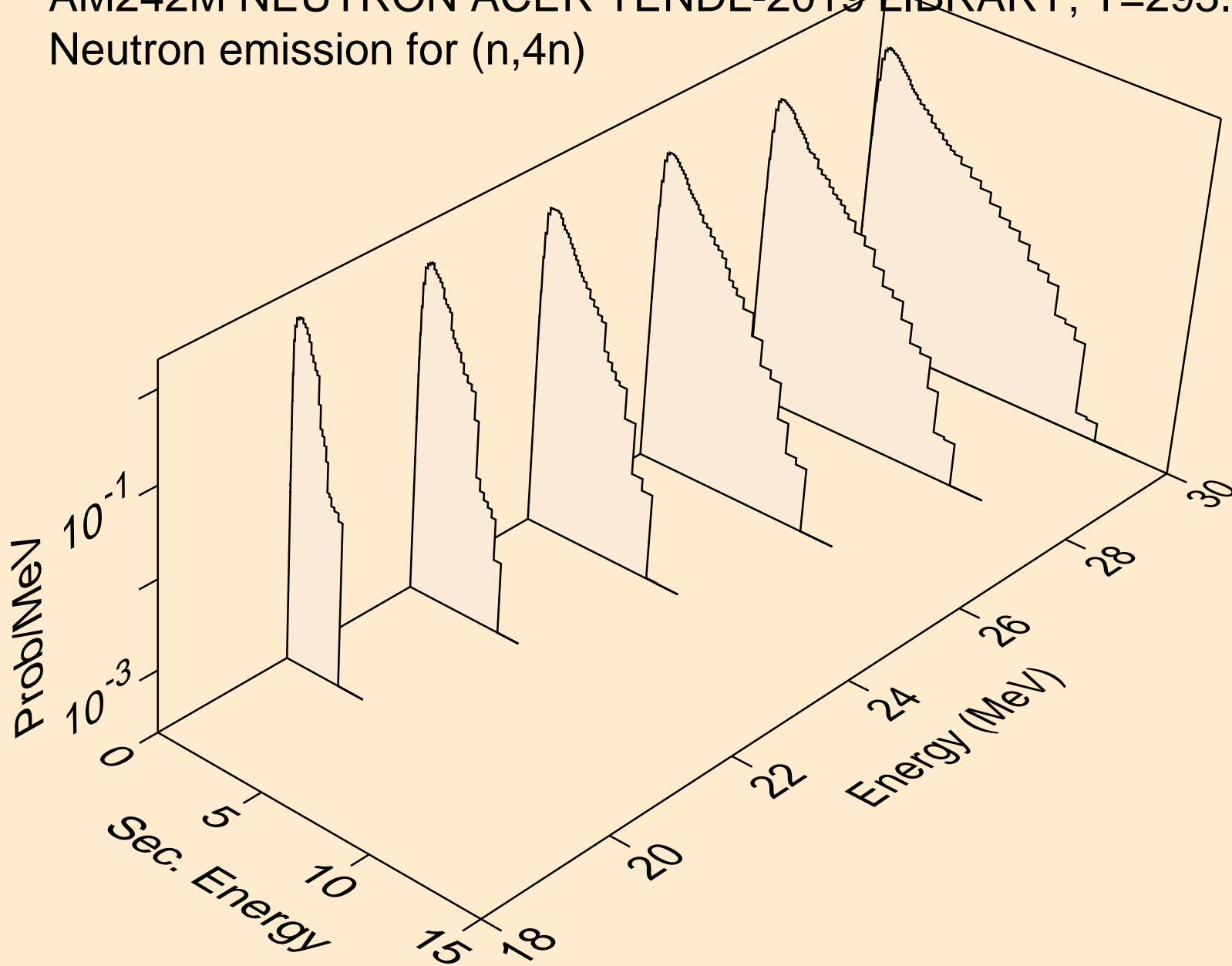

AM242M NEUTRON ACER TENDL-2019 LIBRARY; T=293.16K
Neutron emission for (n,2np)

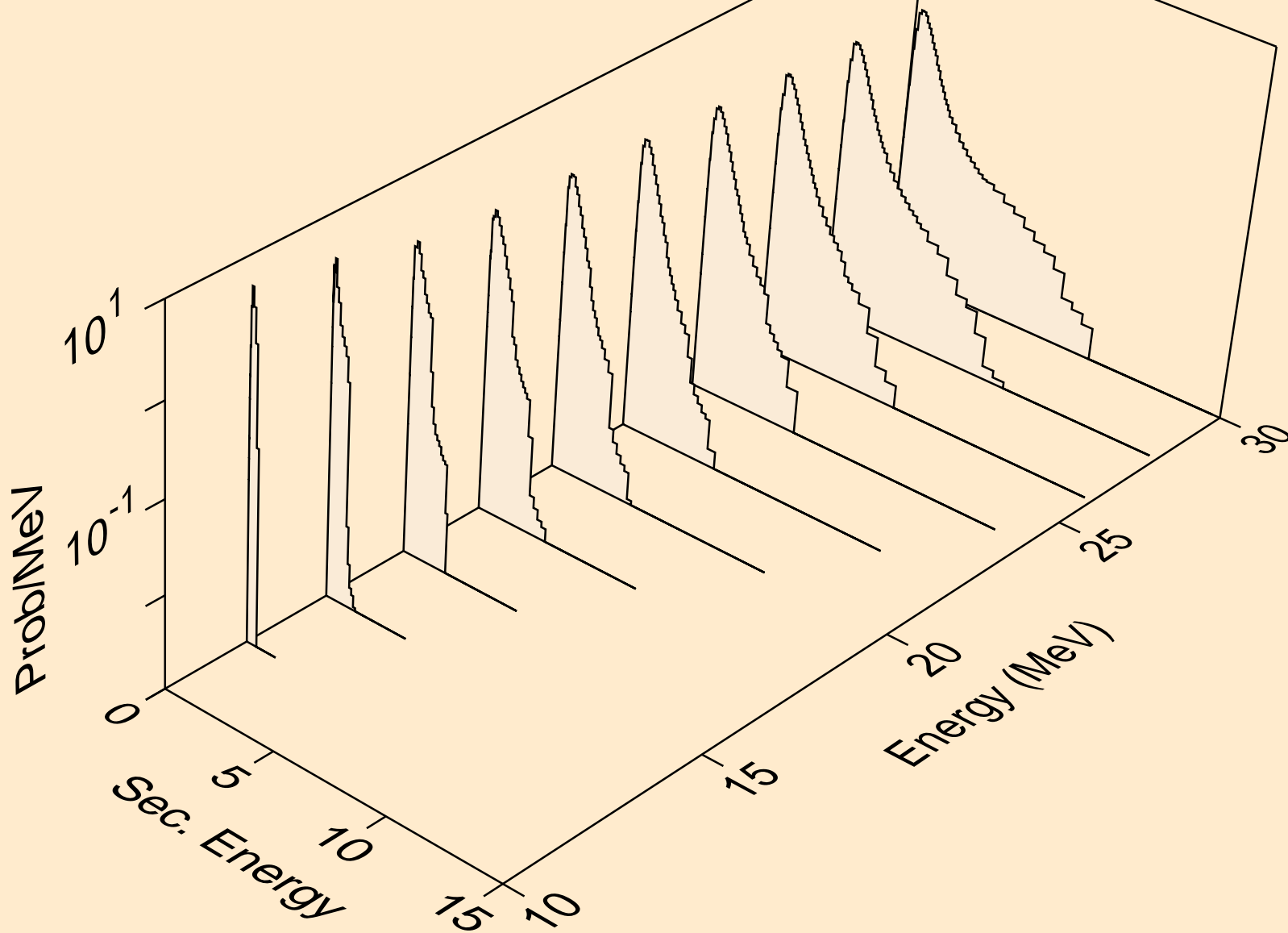

AM242M NEUTRON ACER TENDL-2019 LIBRARY; T=293.16K
Neutron emission for (n,3np)

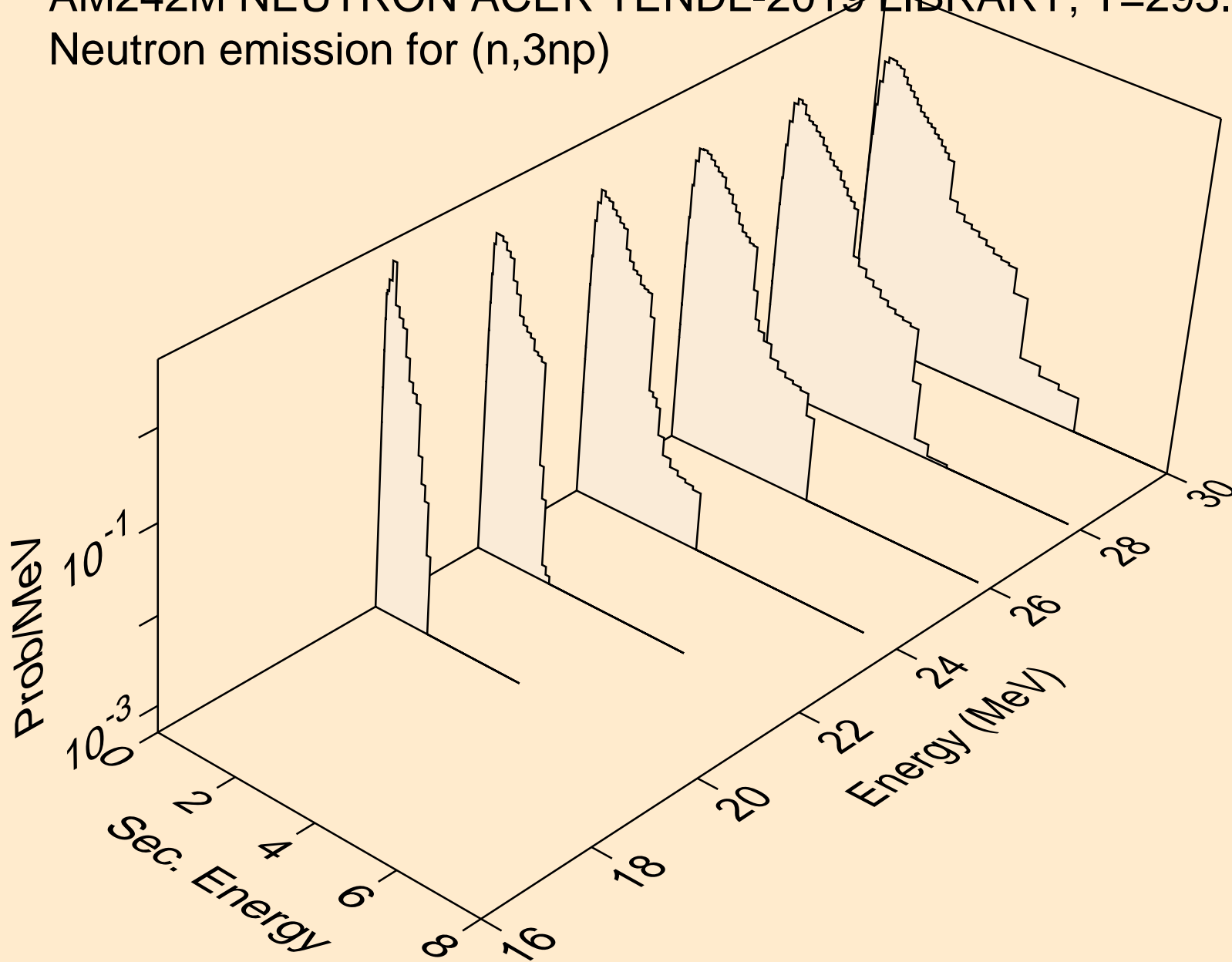

AM242M NEUTRON ACER TENDL-2019 LIBRARY; T=293.16K
Neutron emission for (n,2np)

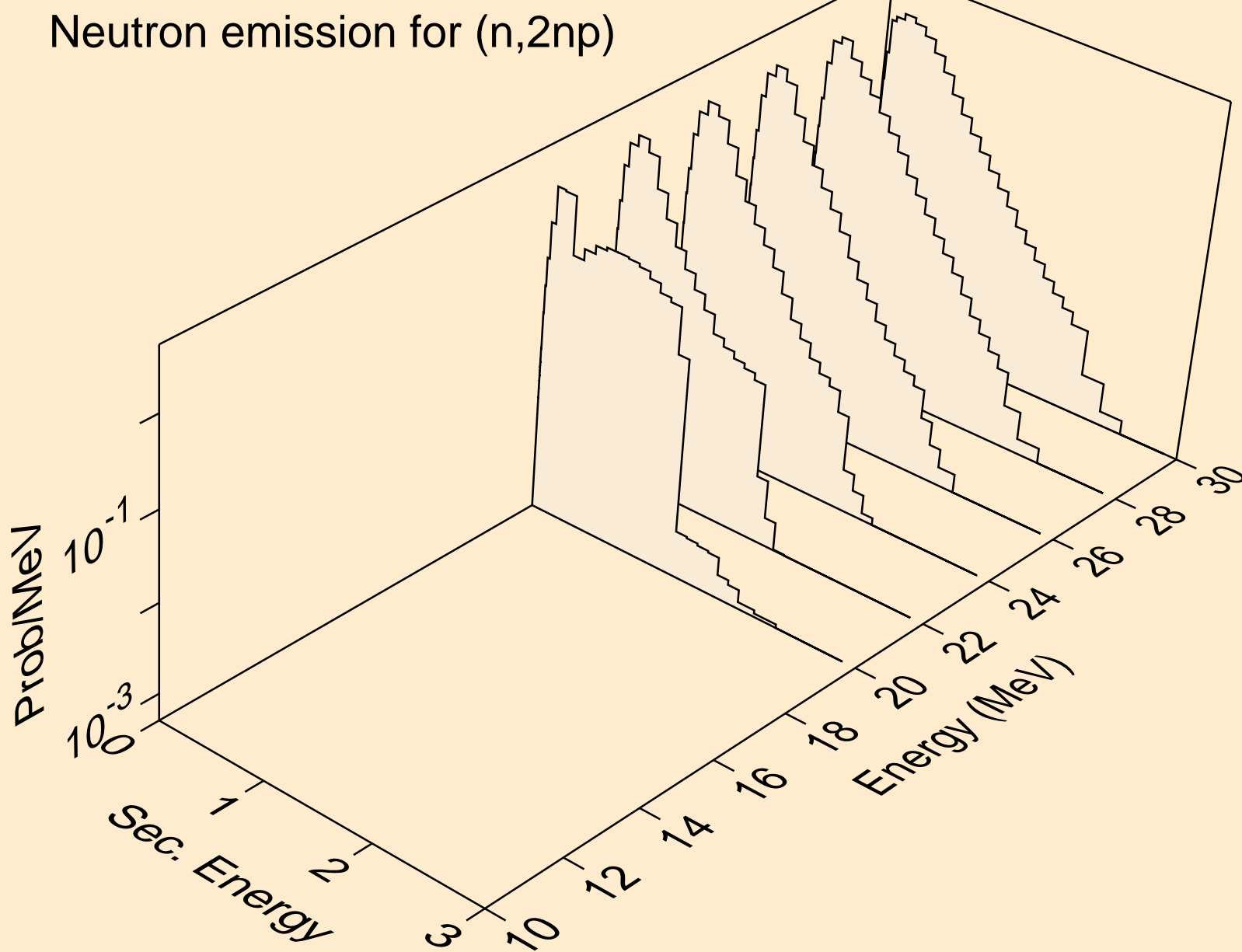

AM242M NEUTRON ACER TENDL-2019 LIBRARY; T=293.16K
Neutron emission for (n,npa)

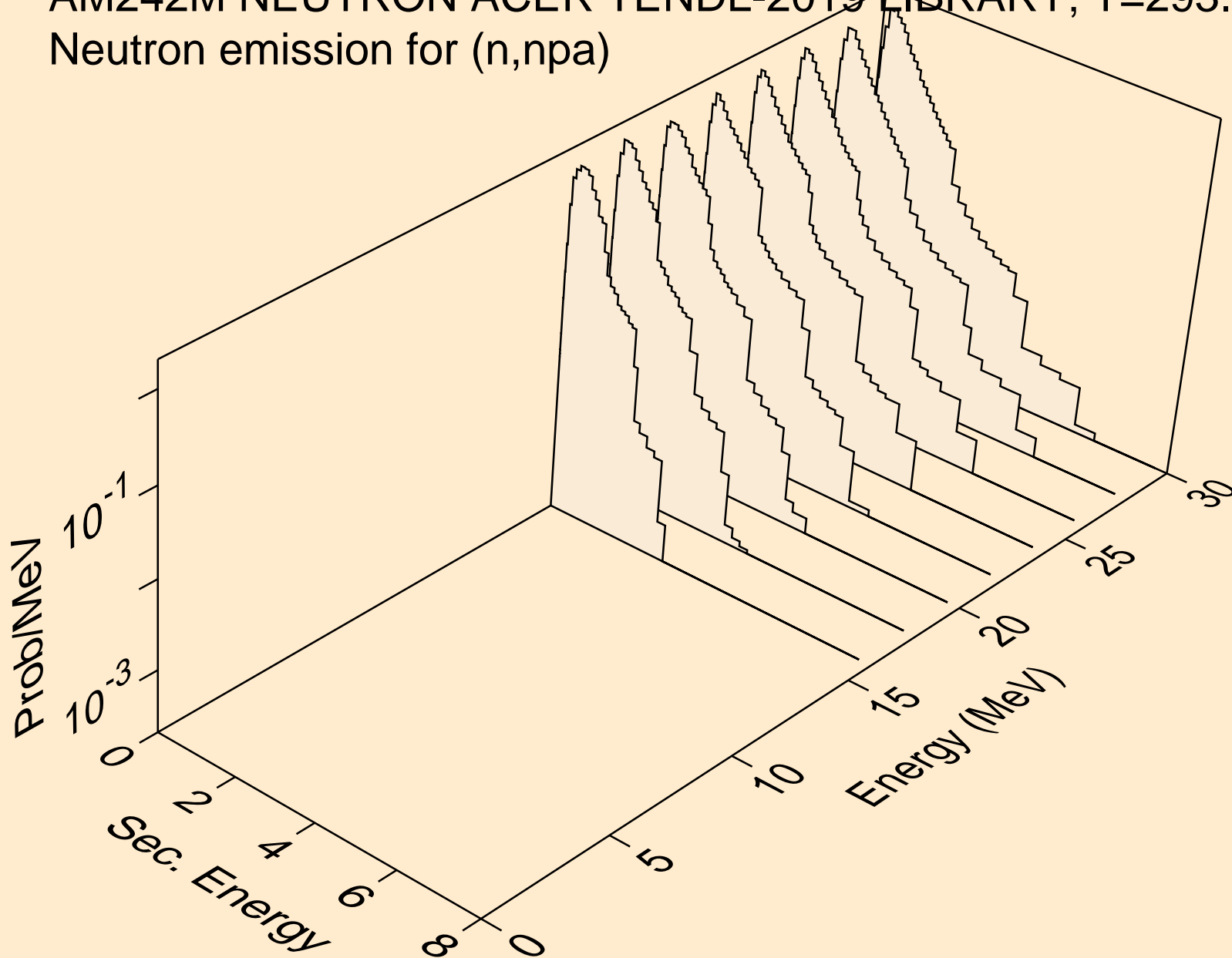

AM242M NEUTRON ACER TENDL-2019 LIBRARY; T=293.16K
Neutron emission for (n,n*c)

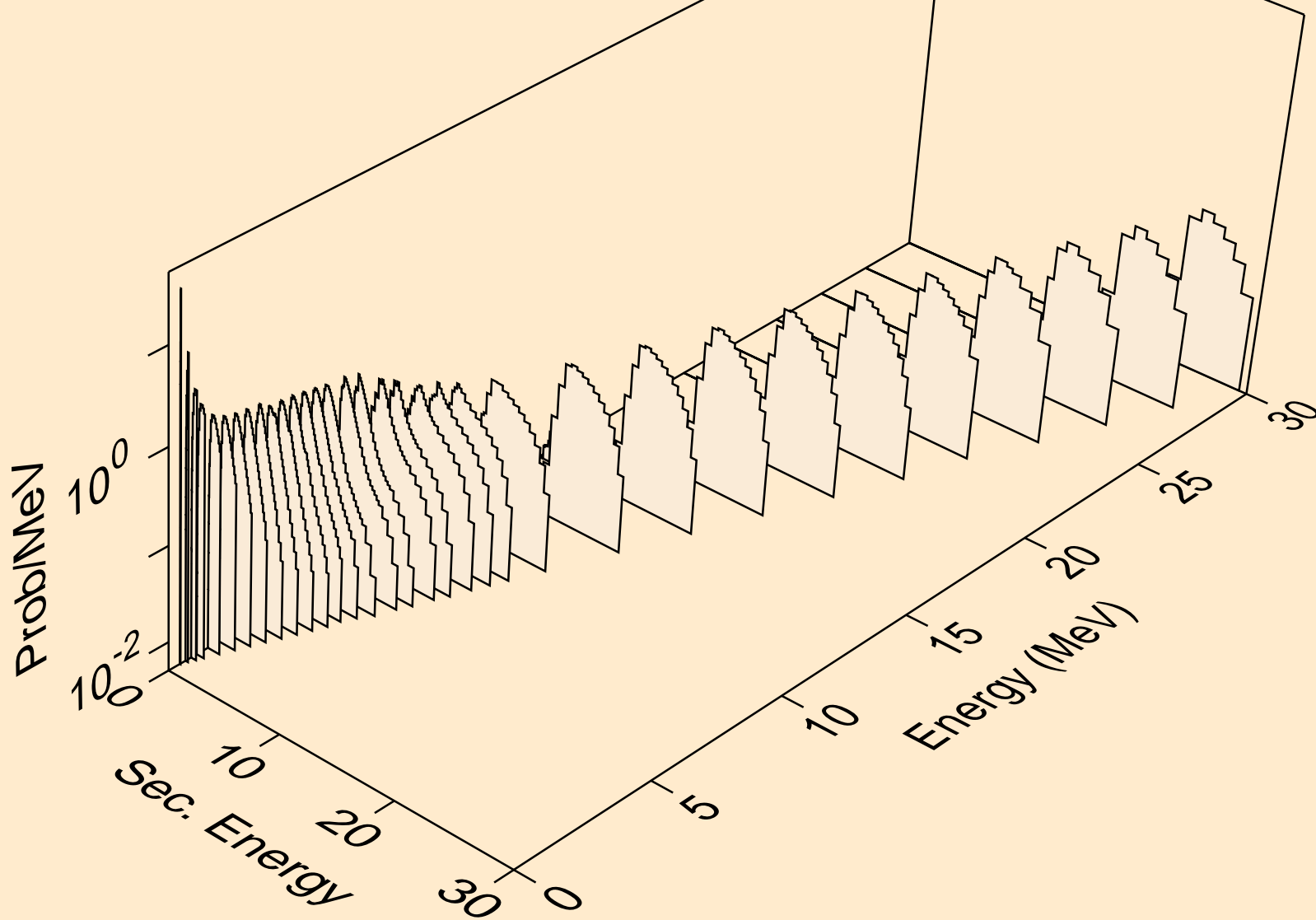

AM242M NEUTRON ACER TENDL-2019 LIBRARY; T=293.16K
Delayed nubar

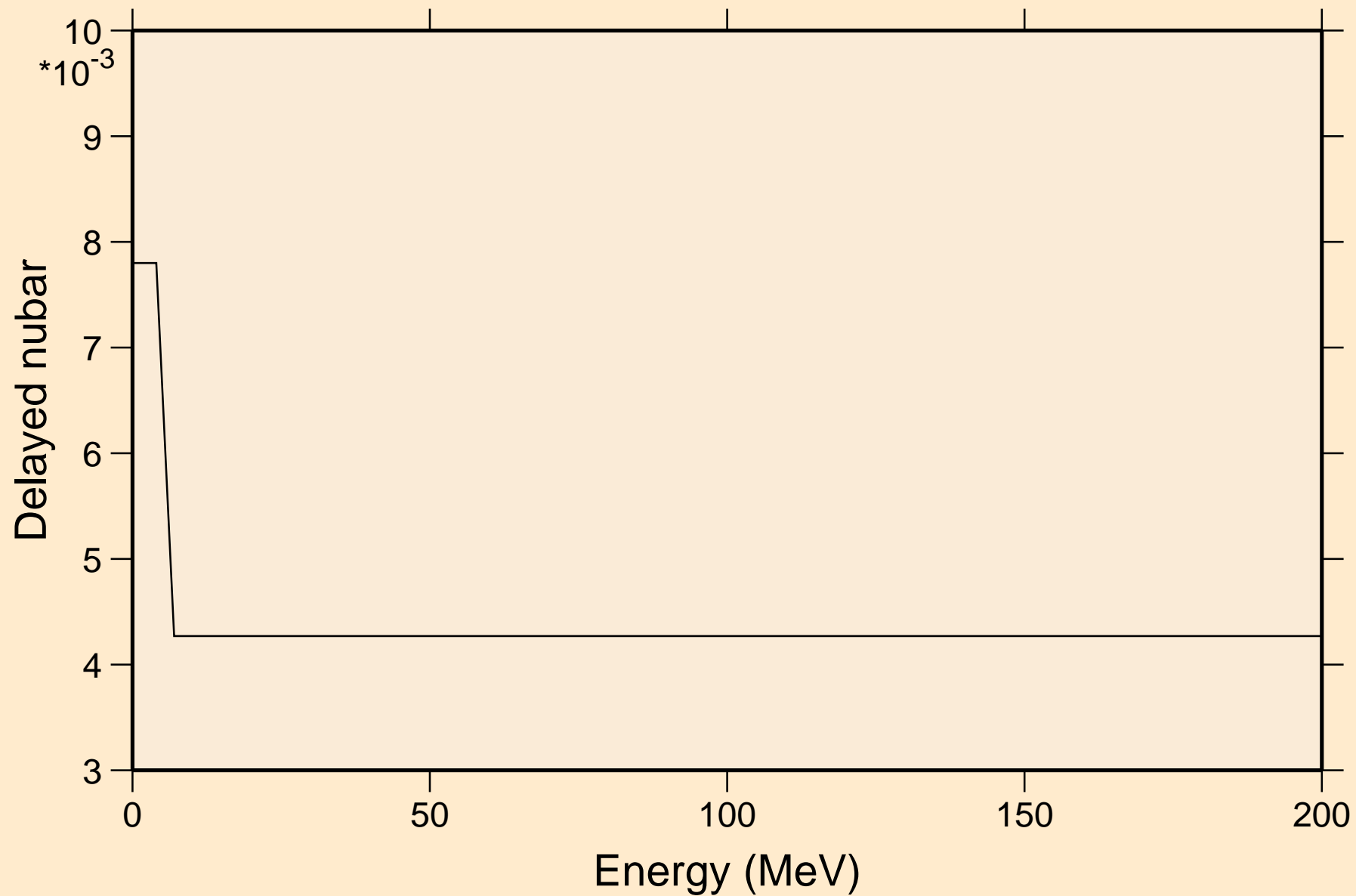

AM242M NEUTRON ACER TENDL-2019 LIBRARY; T=293.16K

Delayed neutron spectra

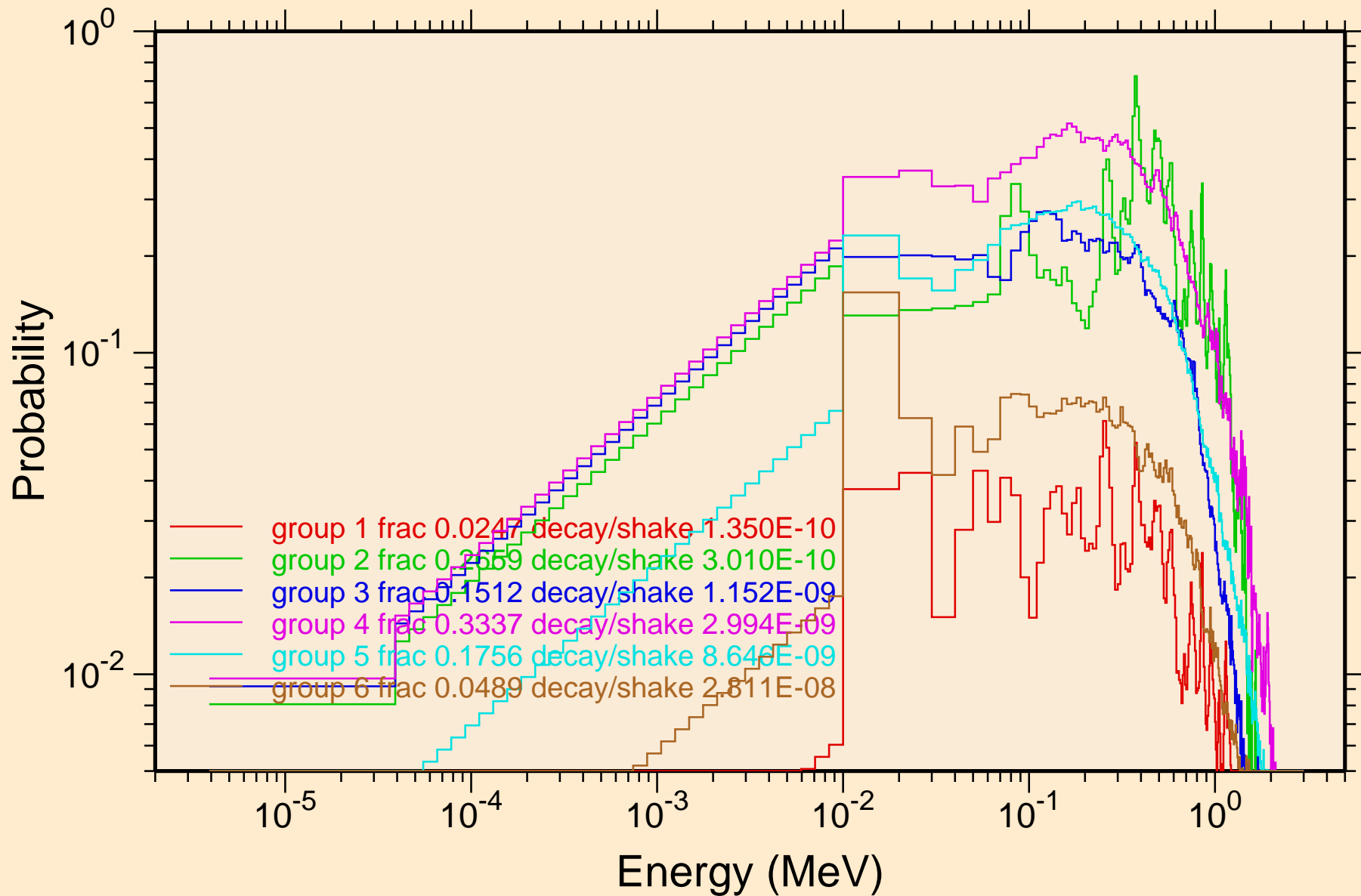

AM242M NEUTRON ACER TENDL-2019 LIBRARY; T=293.16K
Photon emission for (n,x)

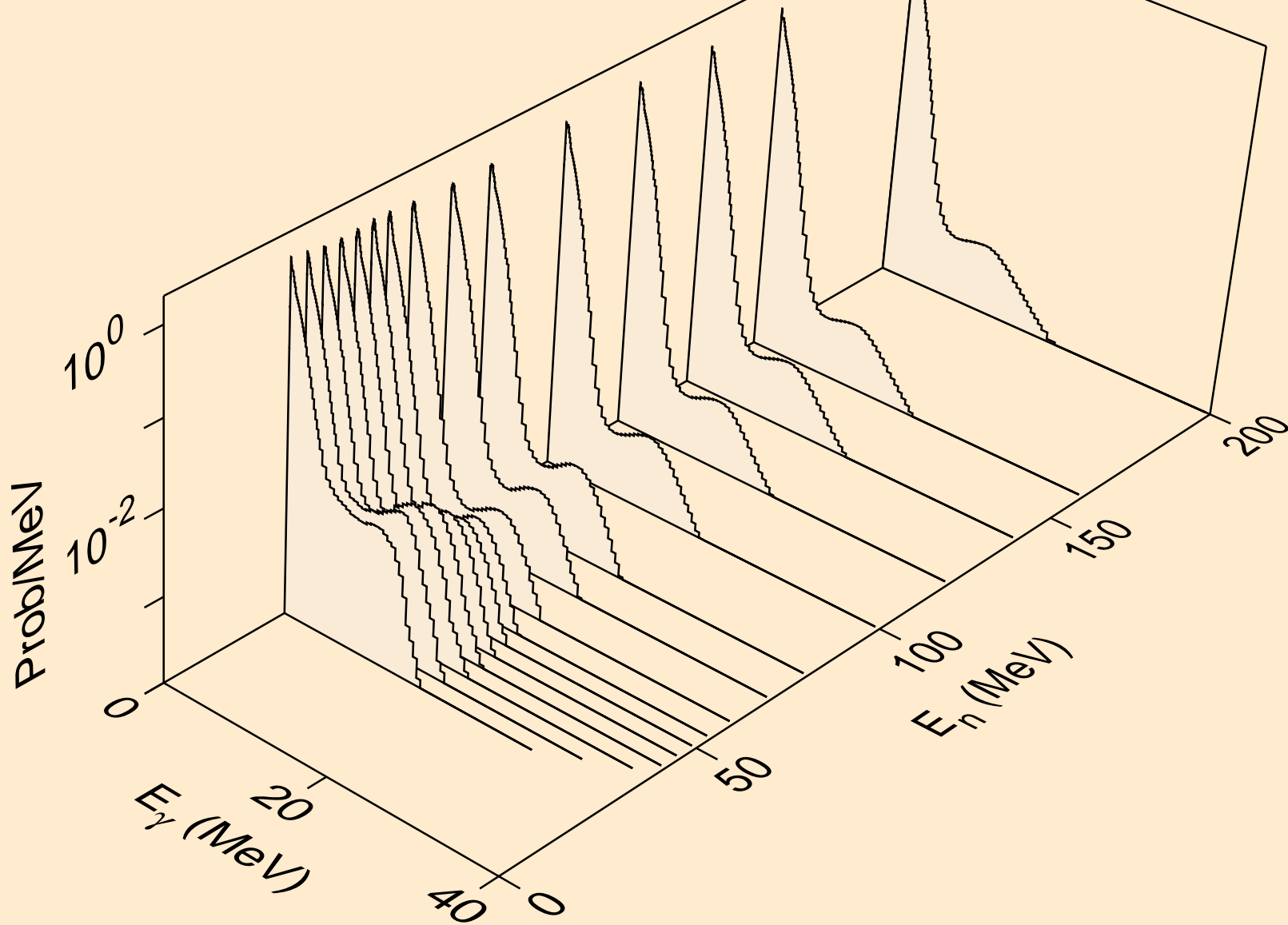

AM242M NEUTRON ACER TENDL-2019 LIBRARY; T=293.16K
Photon emission for (n,2nd)

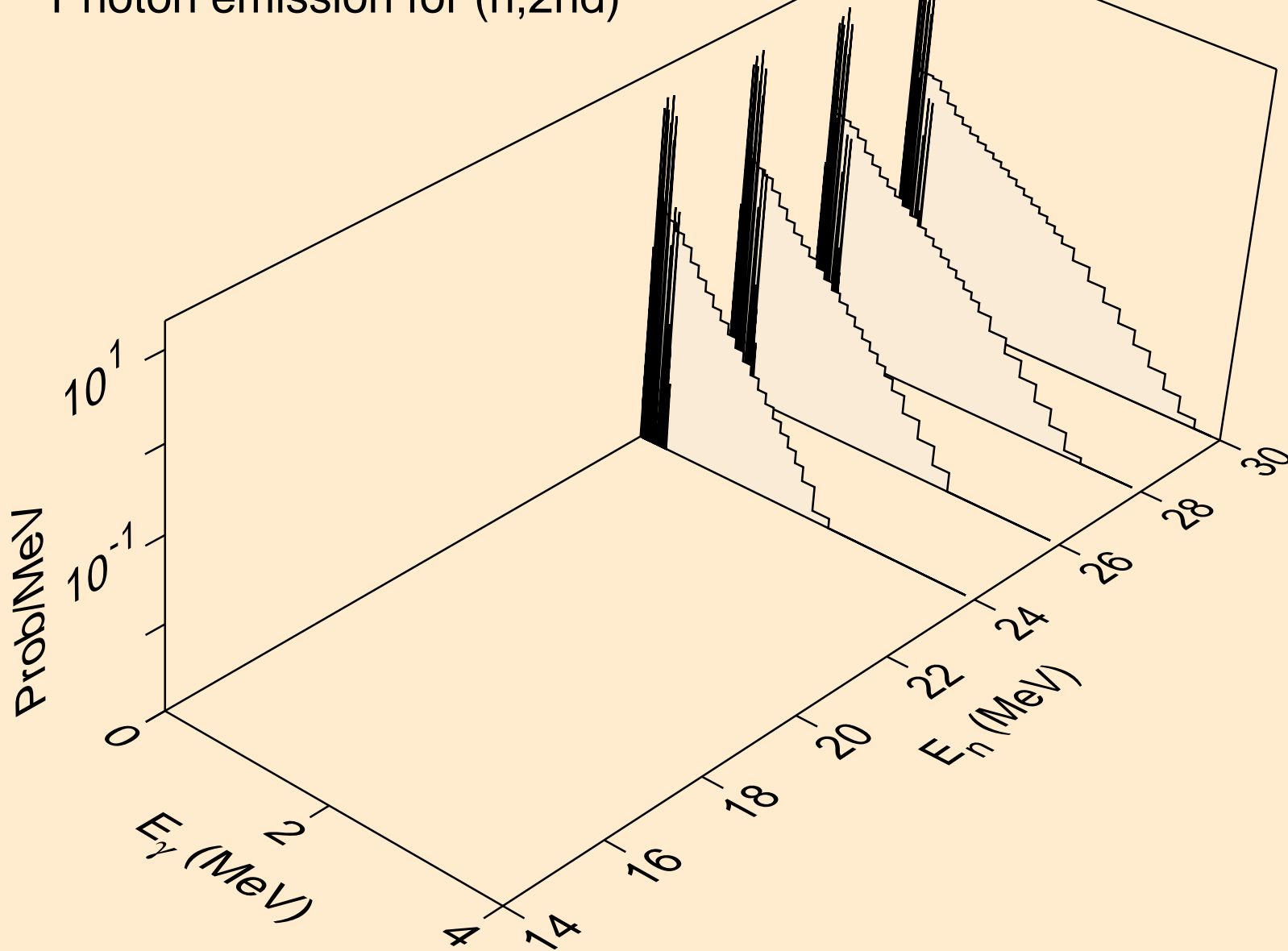

AM242M NEUTRON ACER TENDL-2019 LIBRARY; T=293.16K
Photon emission for (n,2n)

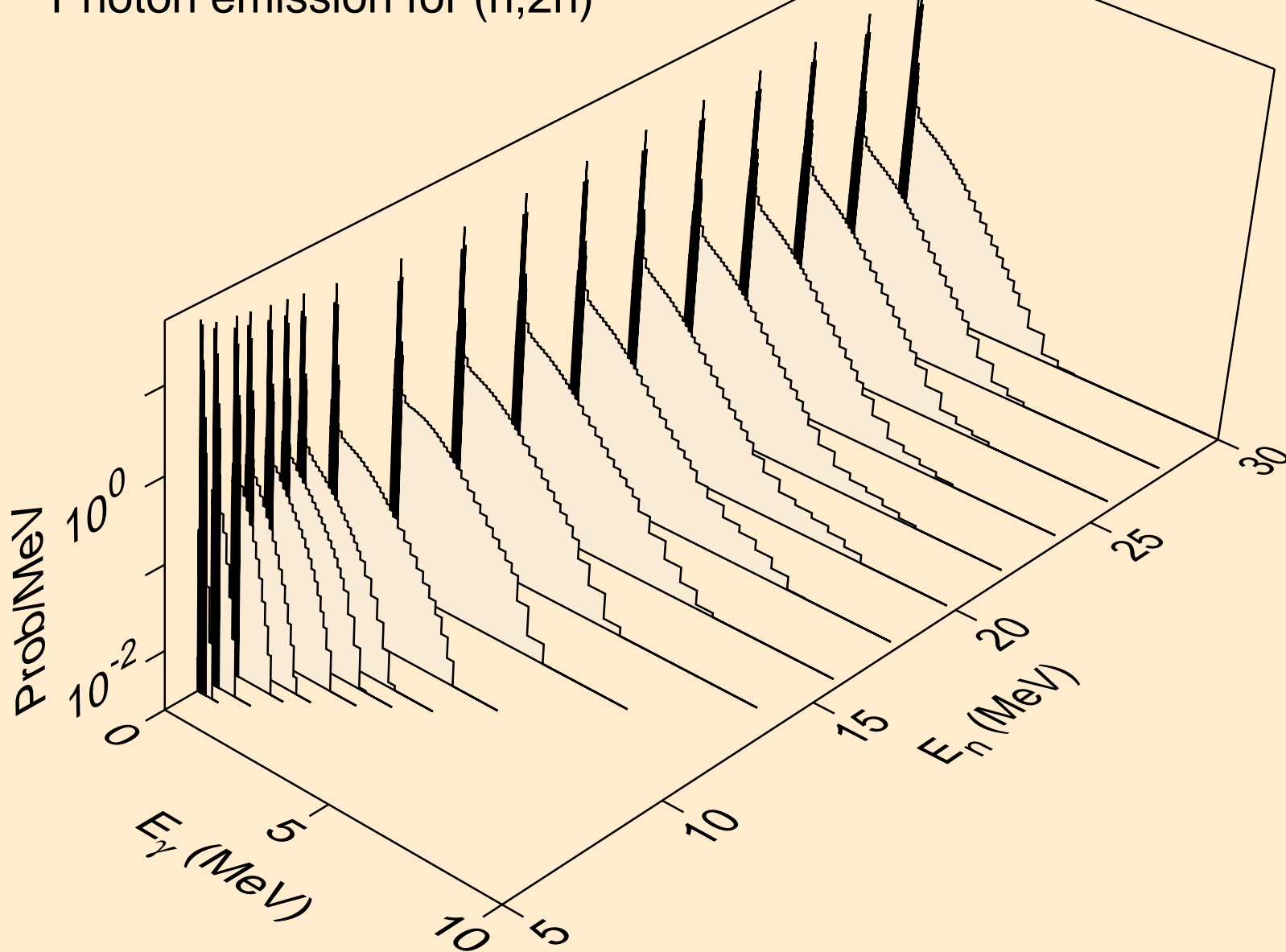

AM242M NEUTRON ACER TENDL-2019 LIBRARY; T=293.16K
Photon emission for (n,3n)

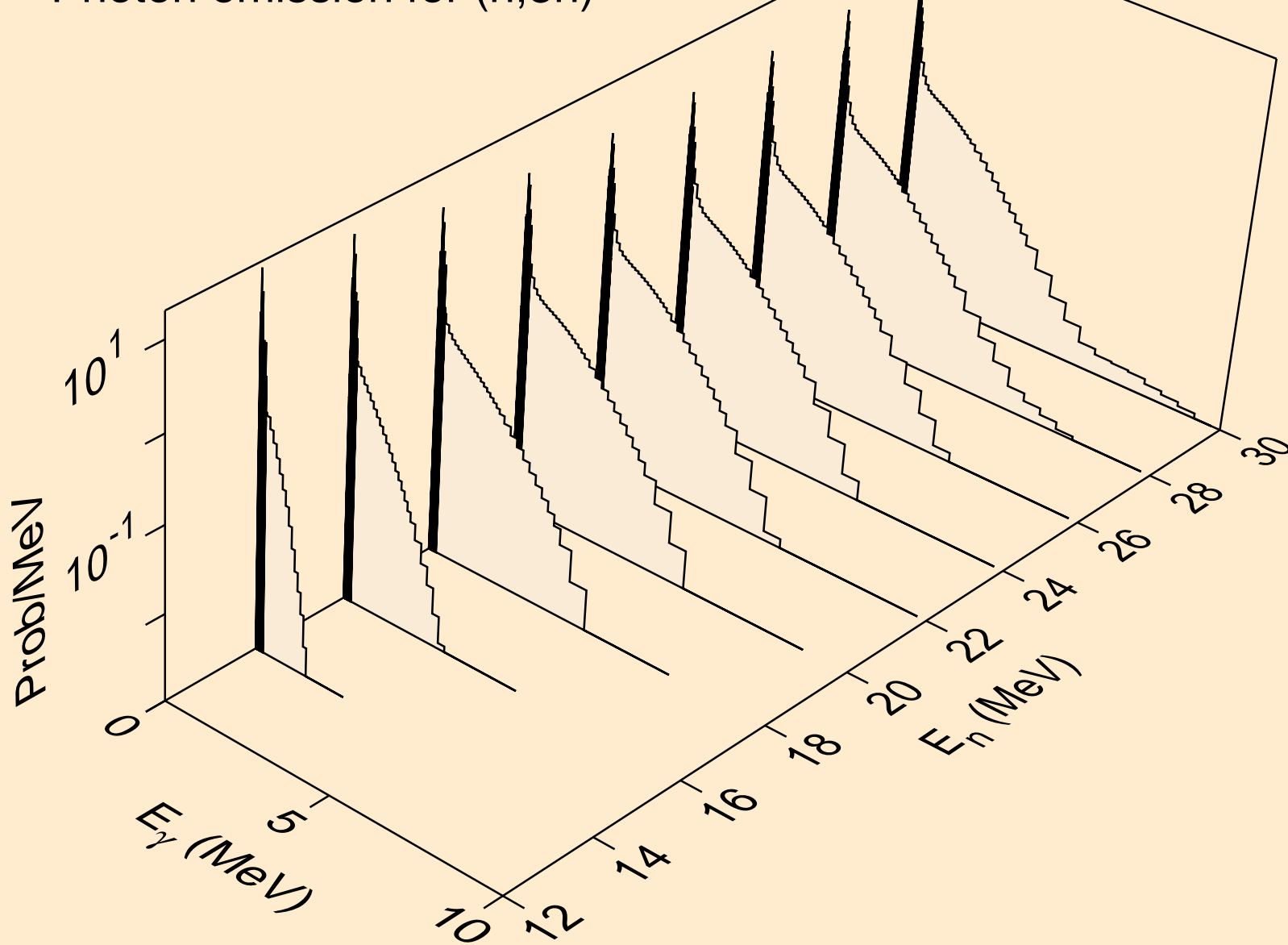

AM242M NEUTRON ACER TENDL-2019 LIBRARY; T=293.16K
Photon emission for (n,n*)a

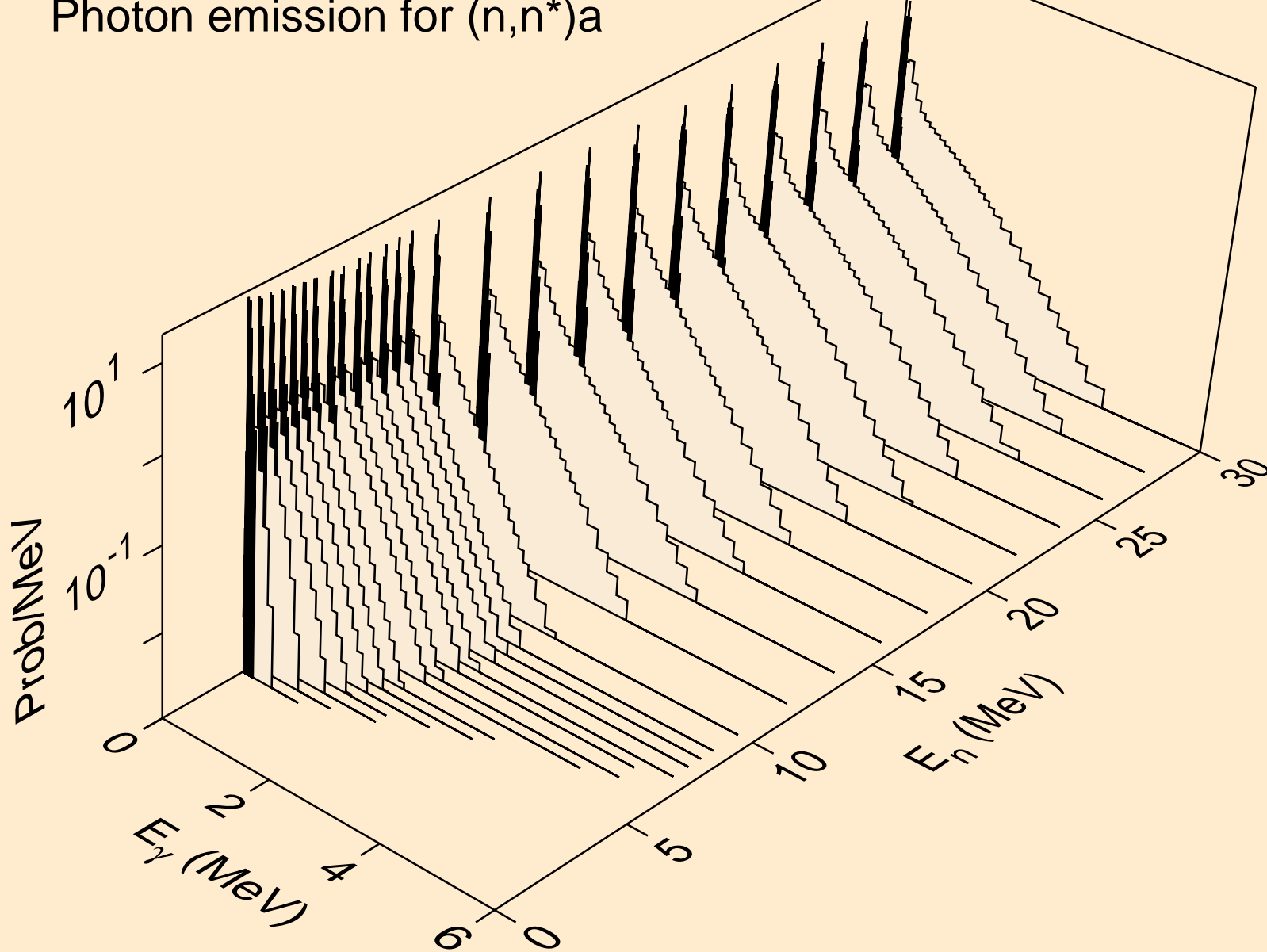

AM242M NEUTRON ACER TENDL-2019 LIBRARY; T=293.16K
Photon emission for (n,2n)a

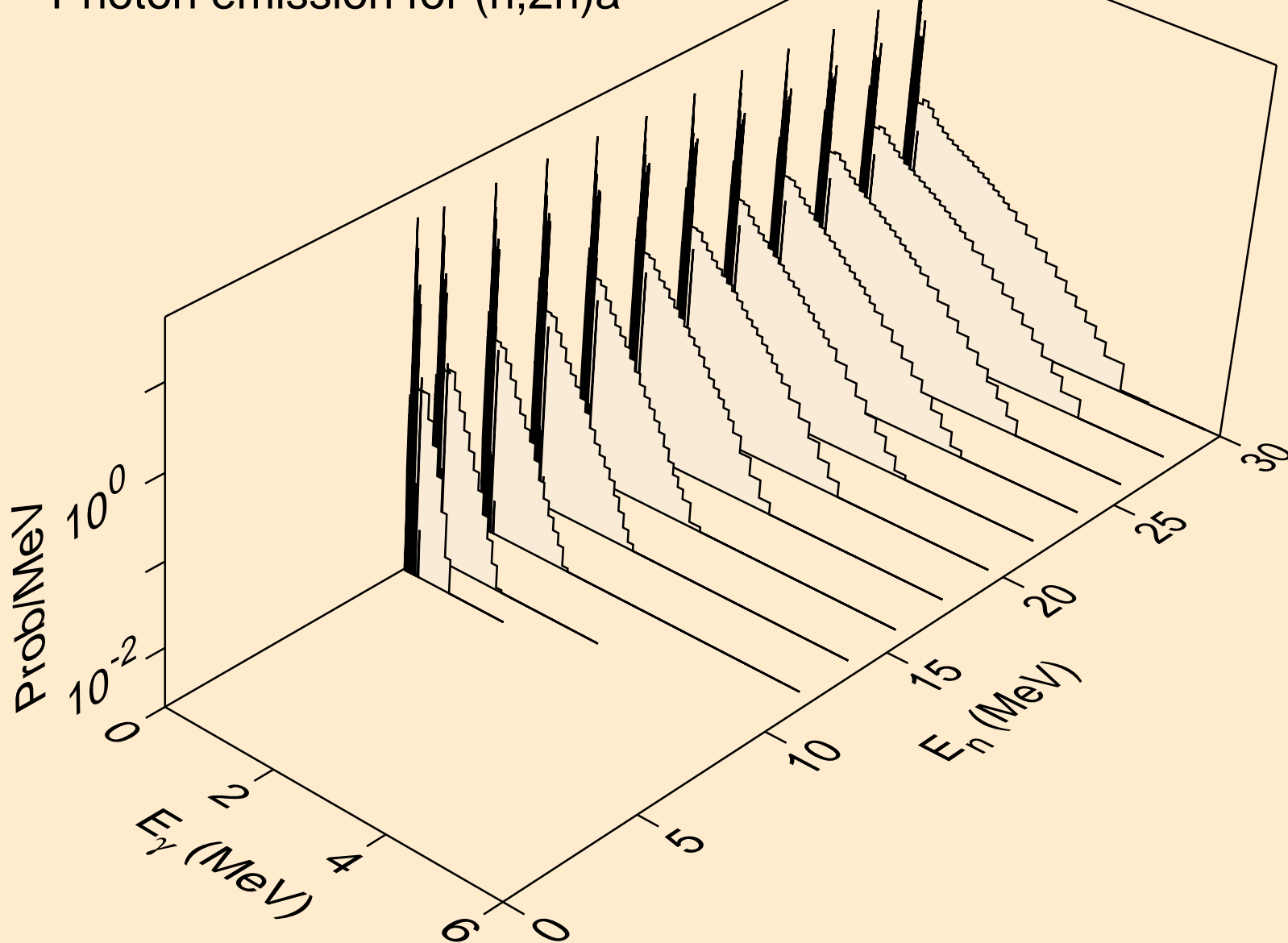

AM242M NEUTRON ACER TENDL-2019 LIBRARY; T=293.16K
Photon emission for (n,3n)a

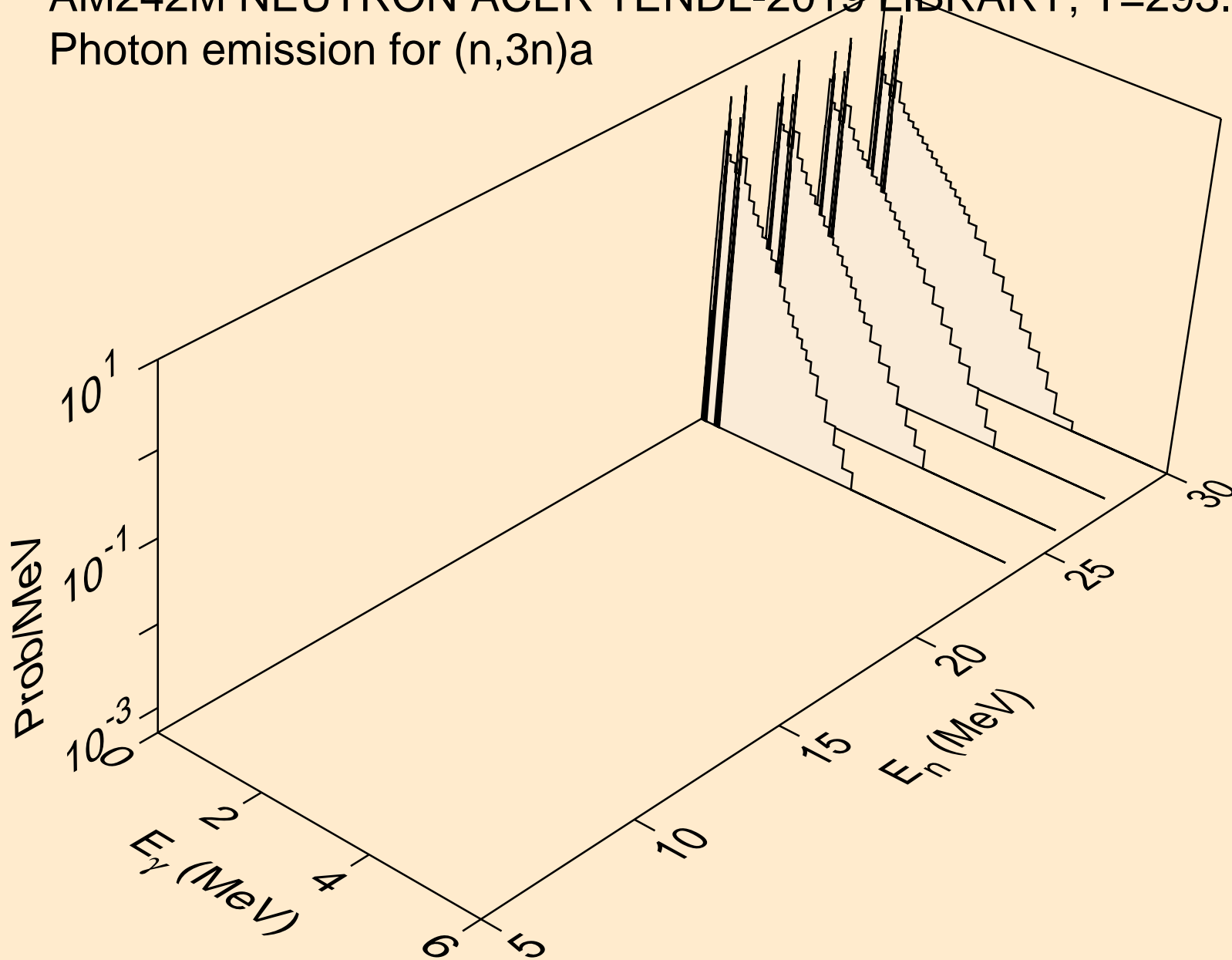

AM242M NEUTRON ACER TENDL-2019 LIBRARY; T=293.16K
Photon emission for (n,n*)p

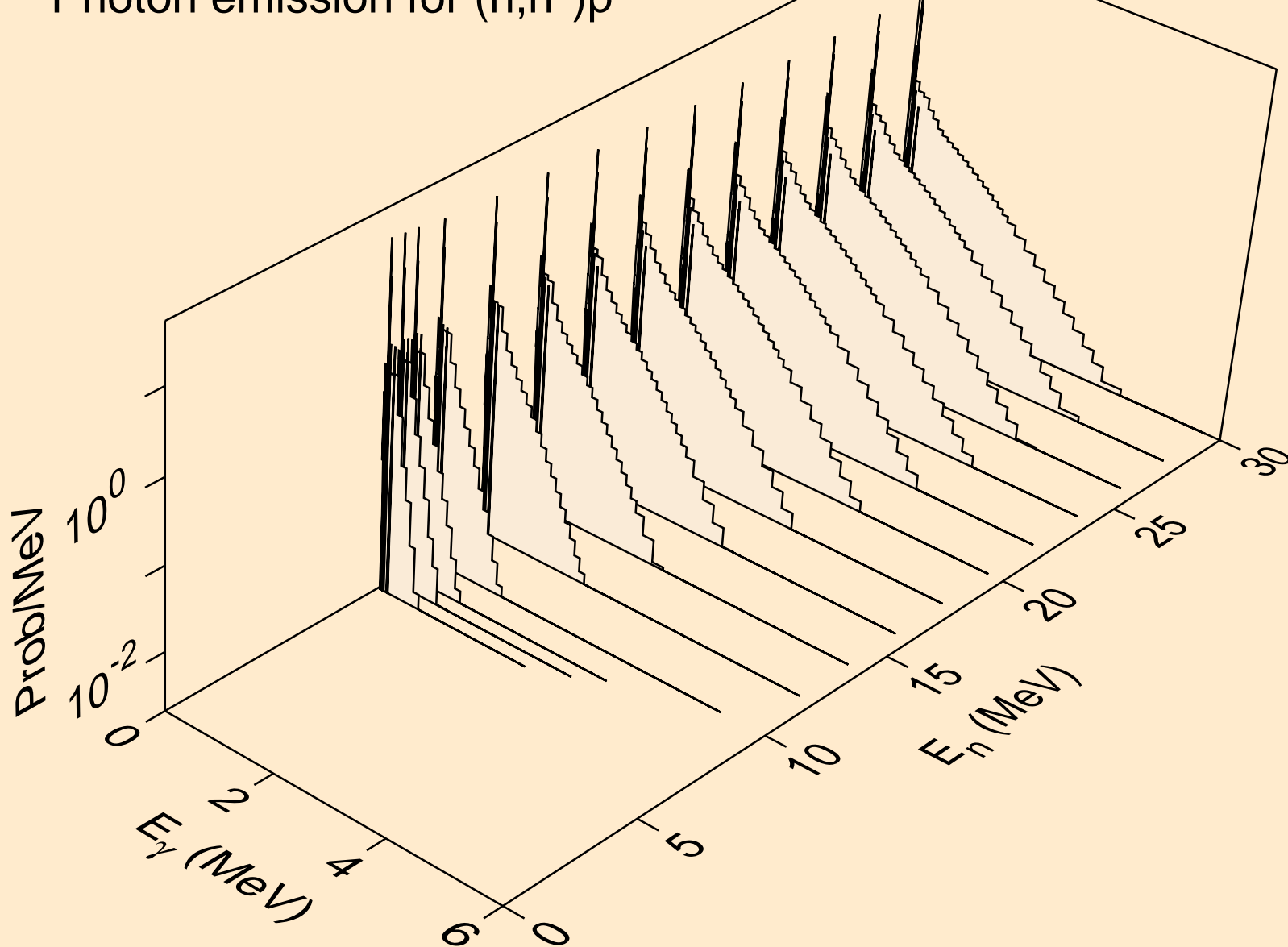

AM242M NEUTRON ACER TENDL-2019 LIBRARY; T=293.16K
Photon emission for (n,n*)d

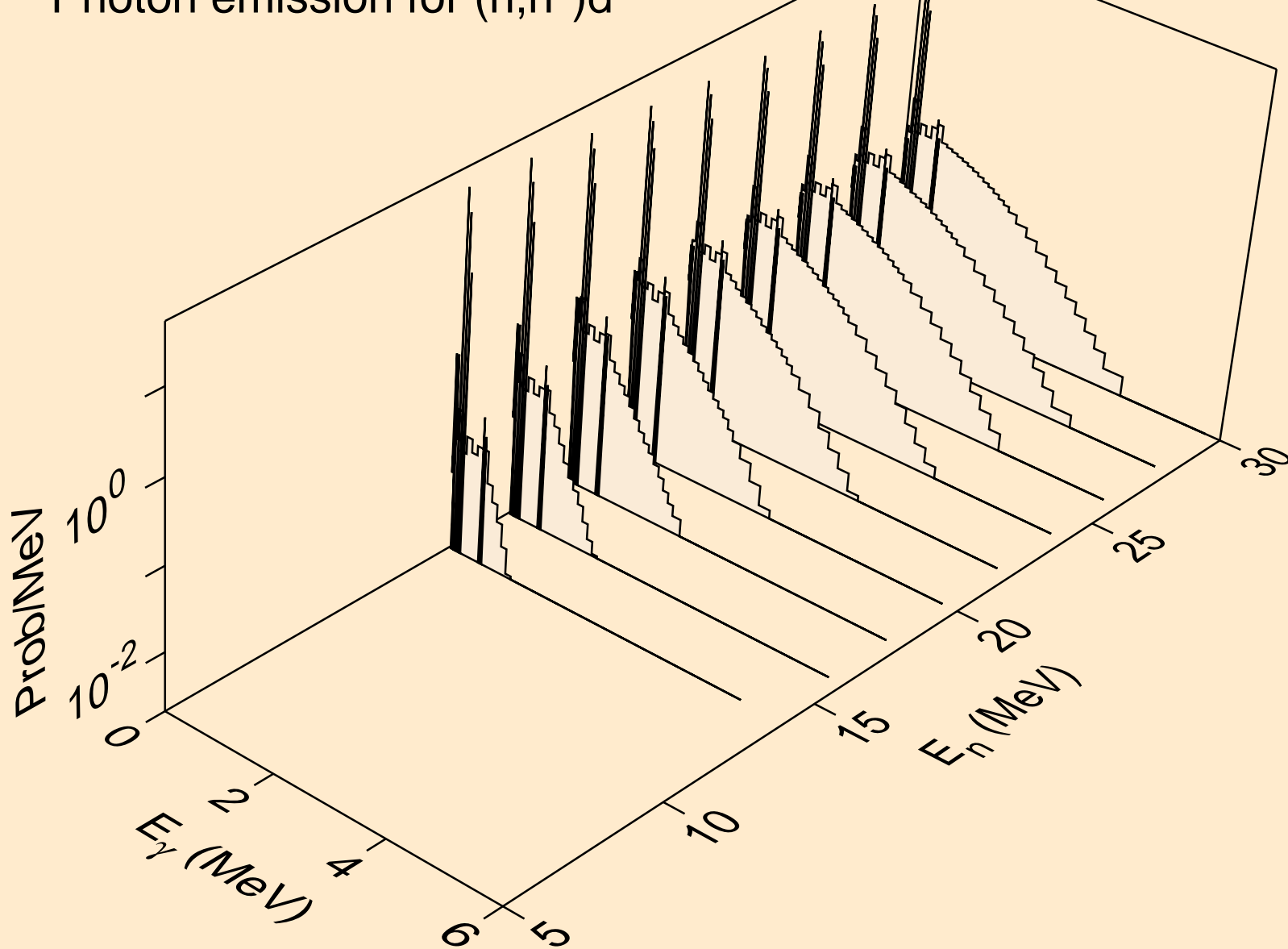

AM242M NEUTRON ACER TENDL-2019 LIBRARY; T=293.16K
Photon emission for (n,n*)t

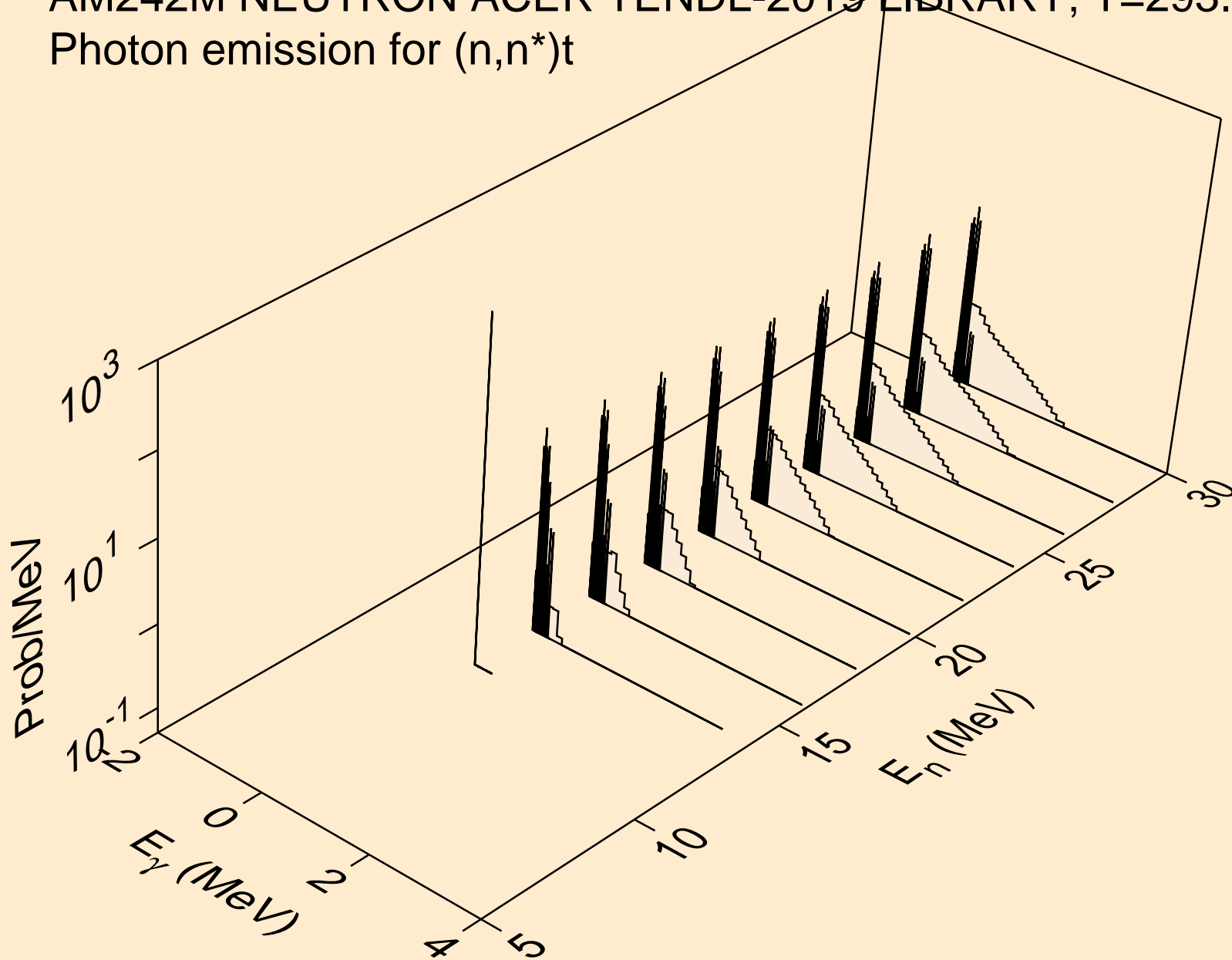

AM242M NEUTRON ACER TENDL-2019 LIBRARY; T=293.16K
Photon emission for (n,n*)he3

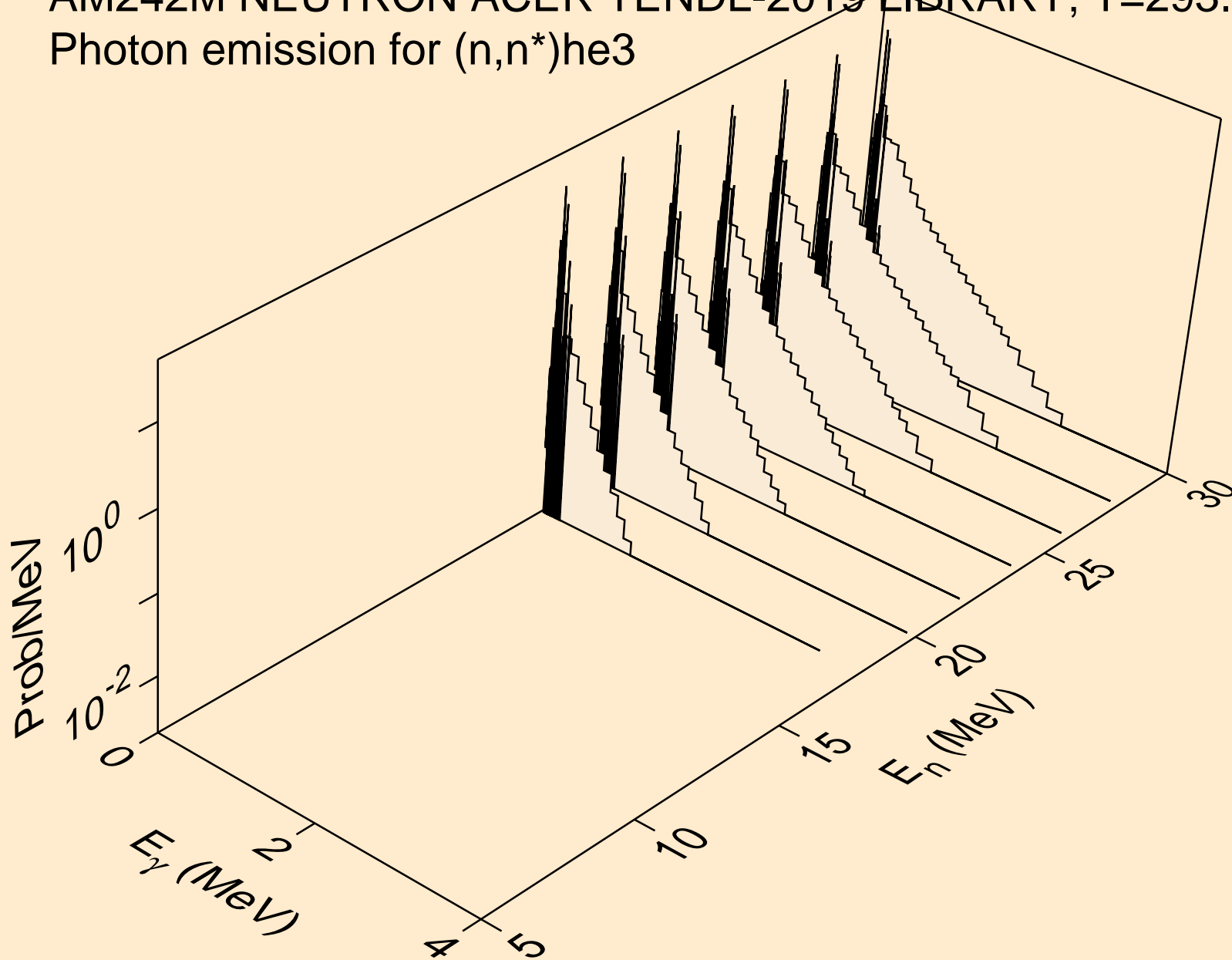

AM242M NEUTRON ACER TENDL-2019 LIBRARY; T=293.16K
Photon emission for (n,4n)

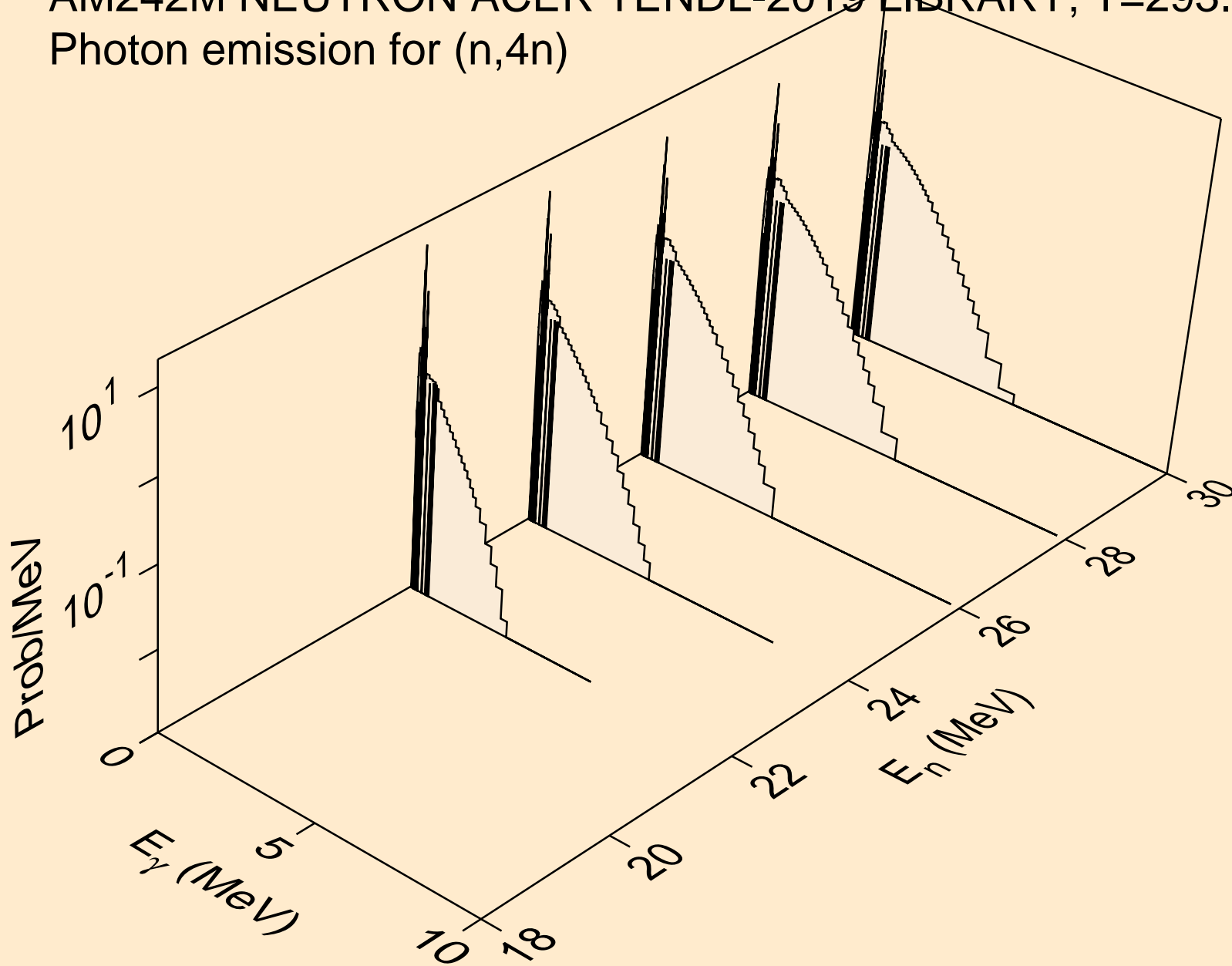

AM242M NEUTRON ACER TENDL-2019 LIBRARY; T=293.16K
Photon emission for (n,2np)

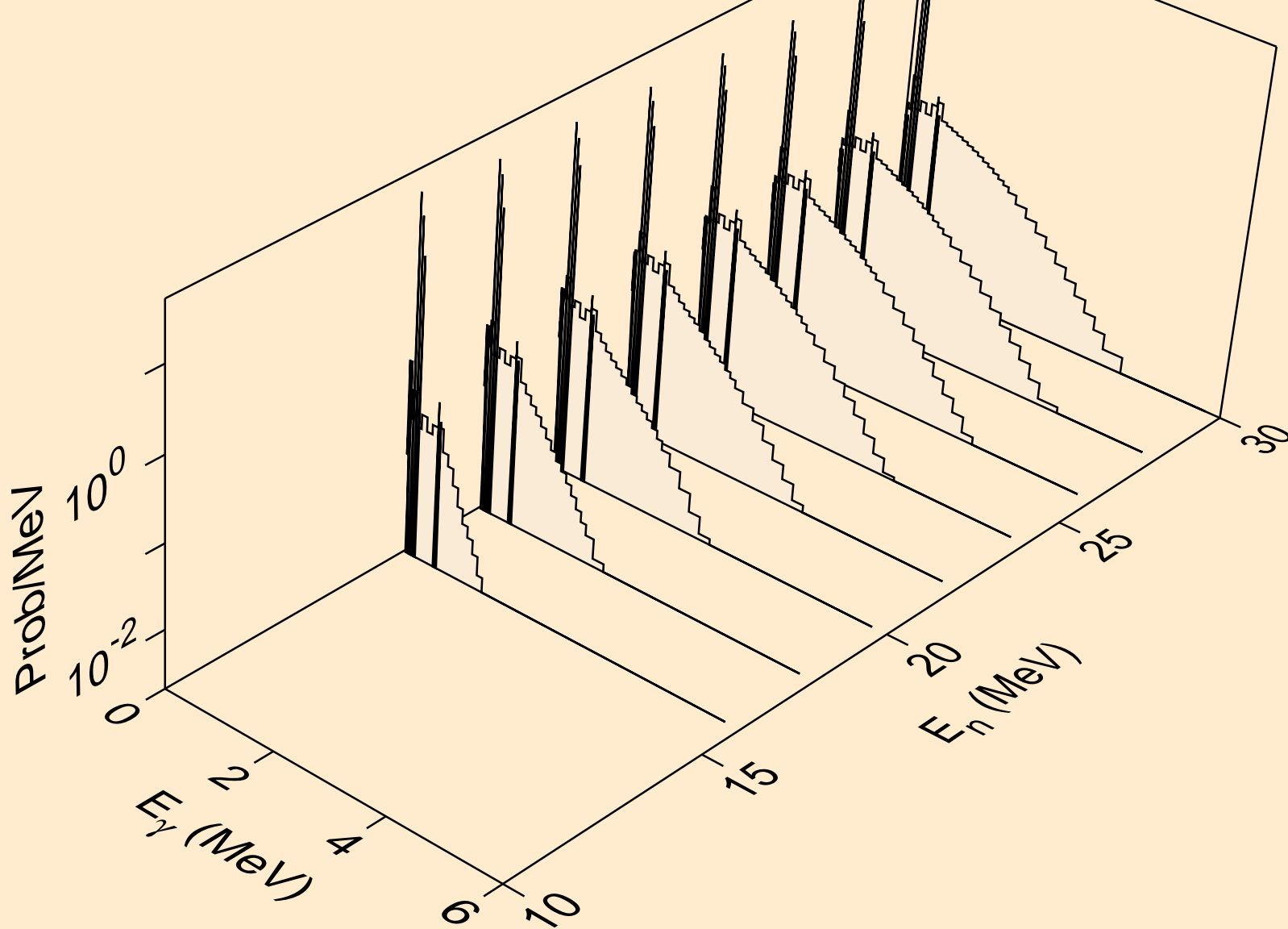

AM242M NEUTRON ACER TENDL-2019 LIBRARY; T=293.16K
Photon emission for (n,3np)

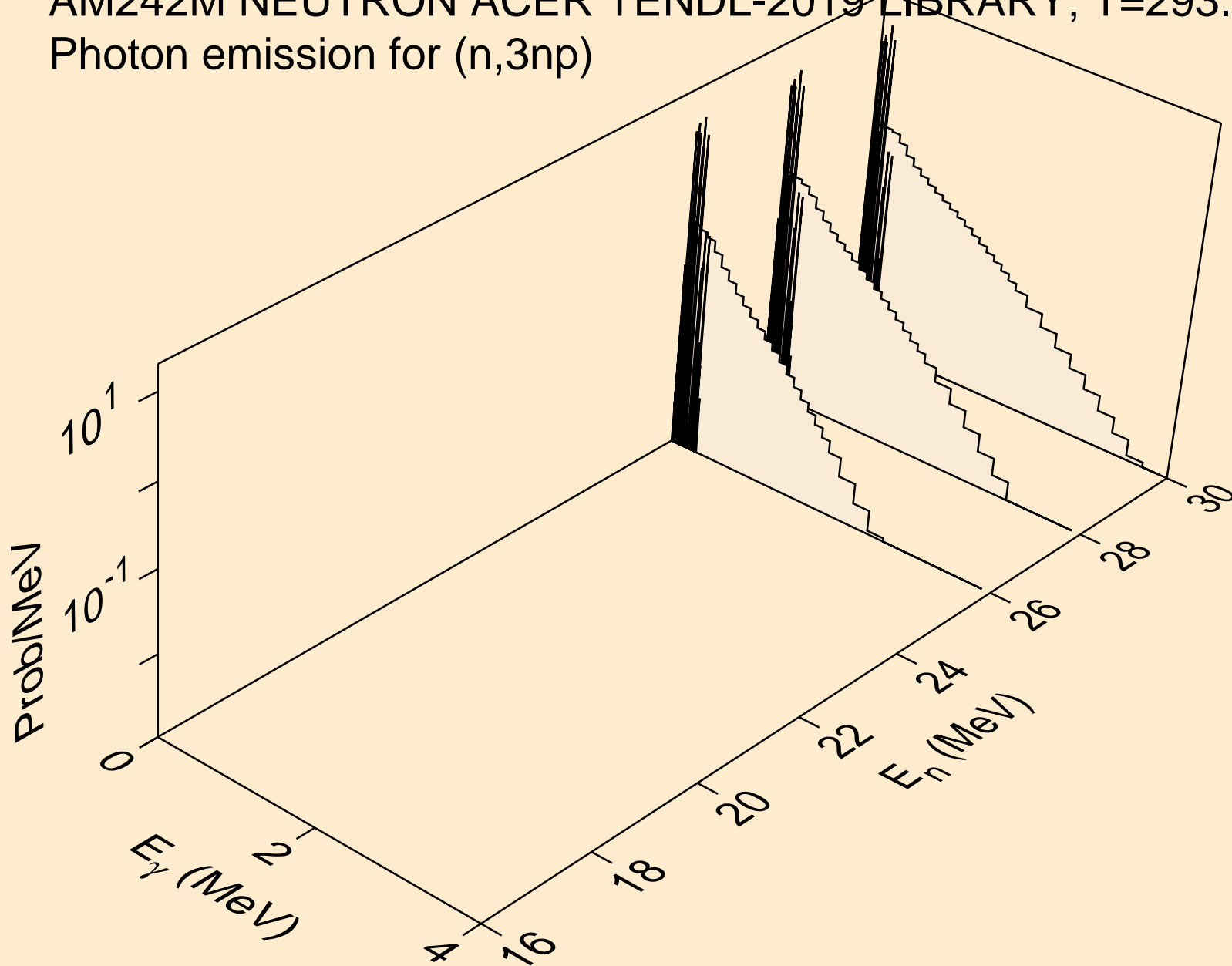

AM242M NEUTRON ACER TENDL-2019 LIBRARY; T=293.16K
Photon emission for (n,2np)

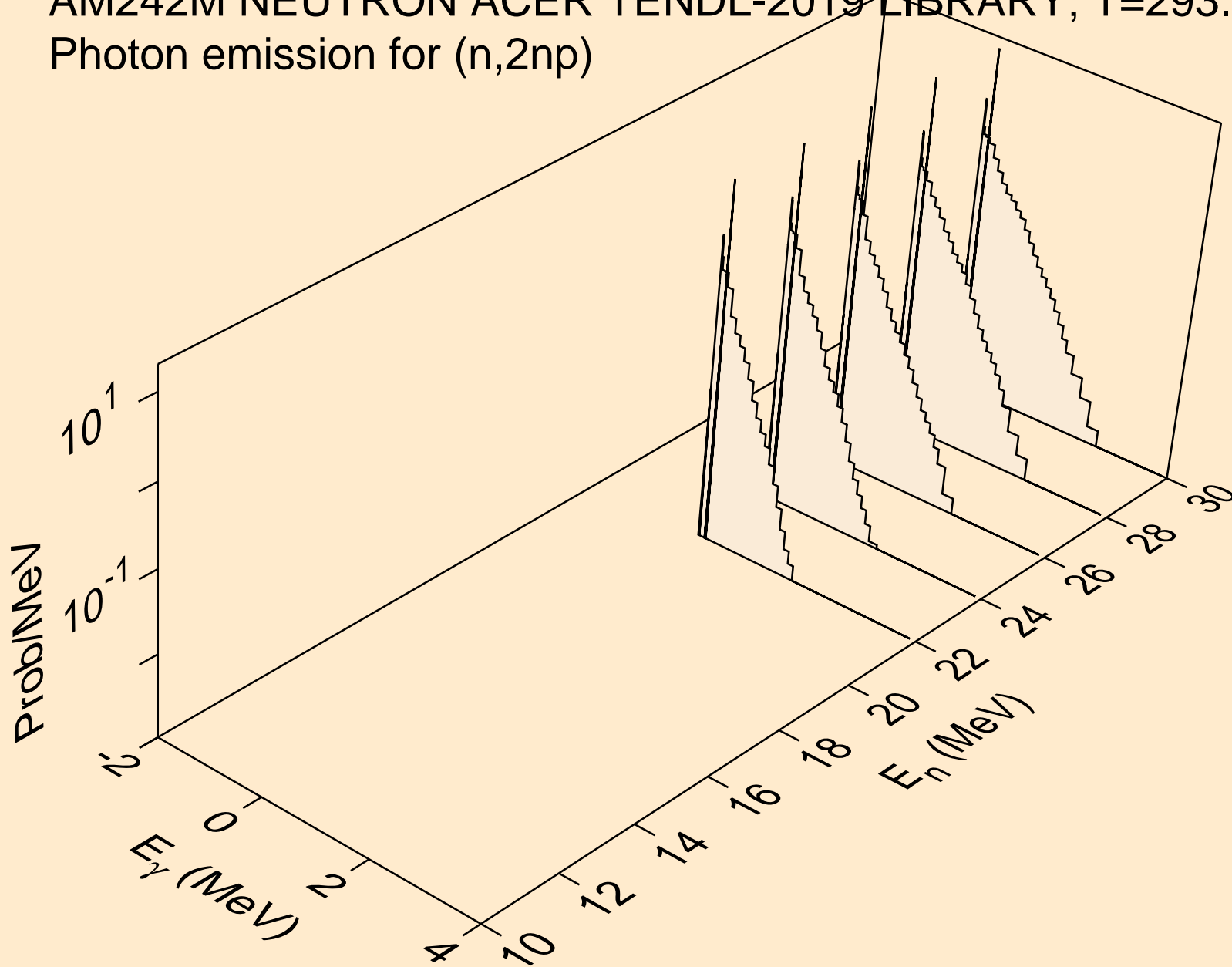

AM242M NEUTRON ACER TENDL-2019 LIBRARY; T=293.16K
Photon emission for (n,npa)

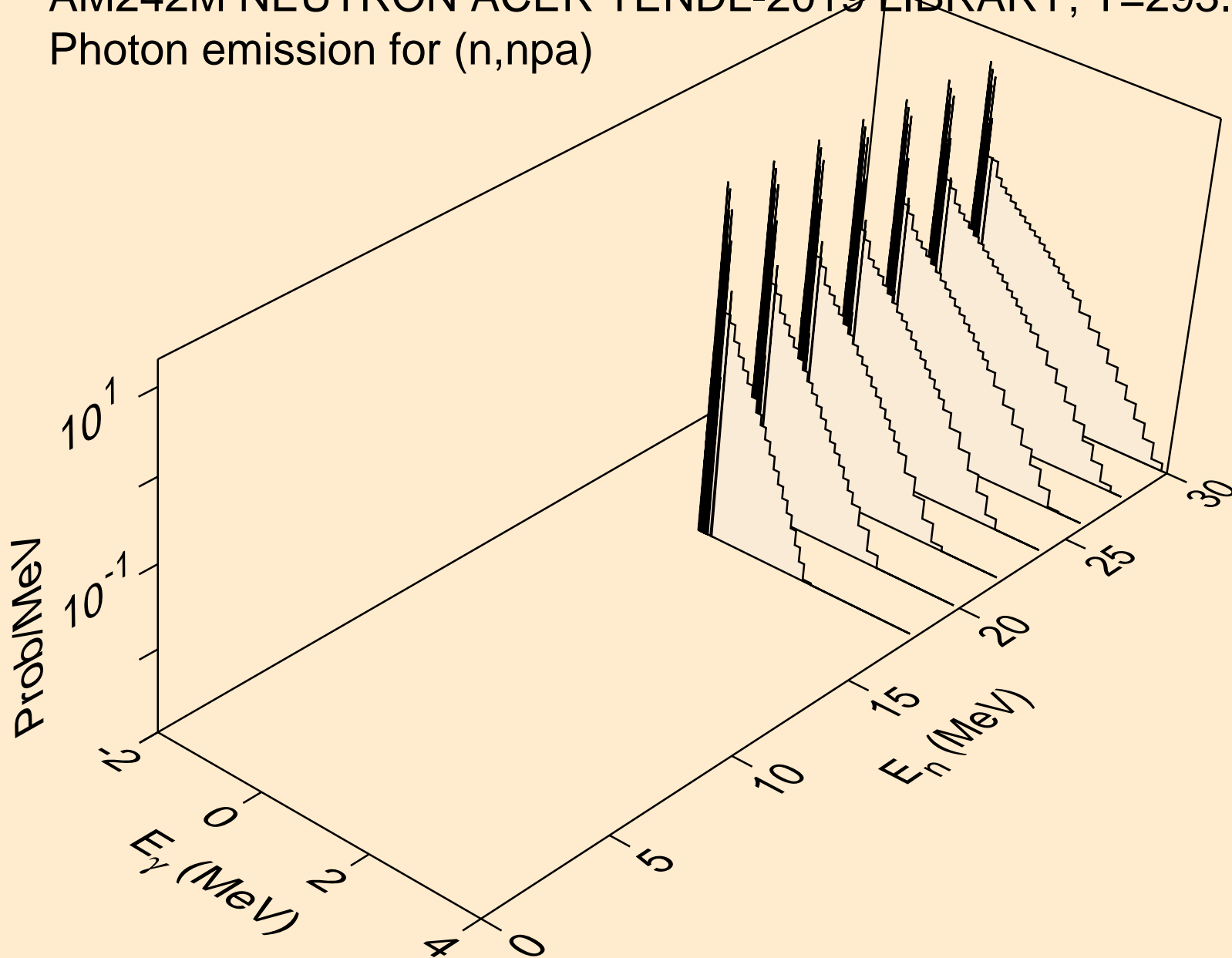

AM242M NEUTRON ACER TENDL-2019 LIBRARY; T=293.16K
Photon emission for (n,n*1)

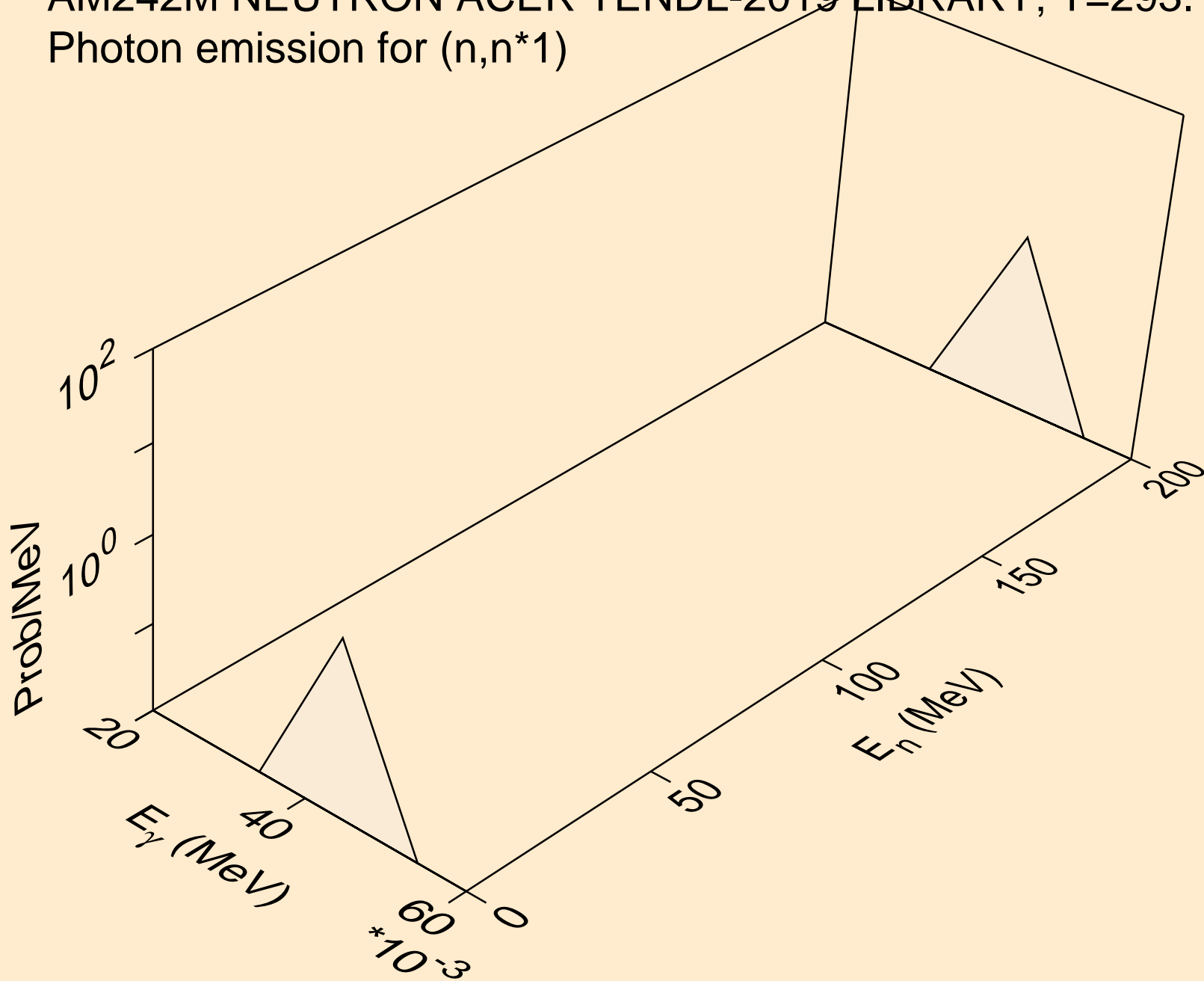

AM242M NEUTRON ACER TENDL-2019 LIBRARY; T=293.16K
Photon emission for (n,n*3)

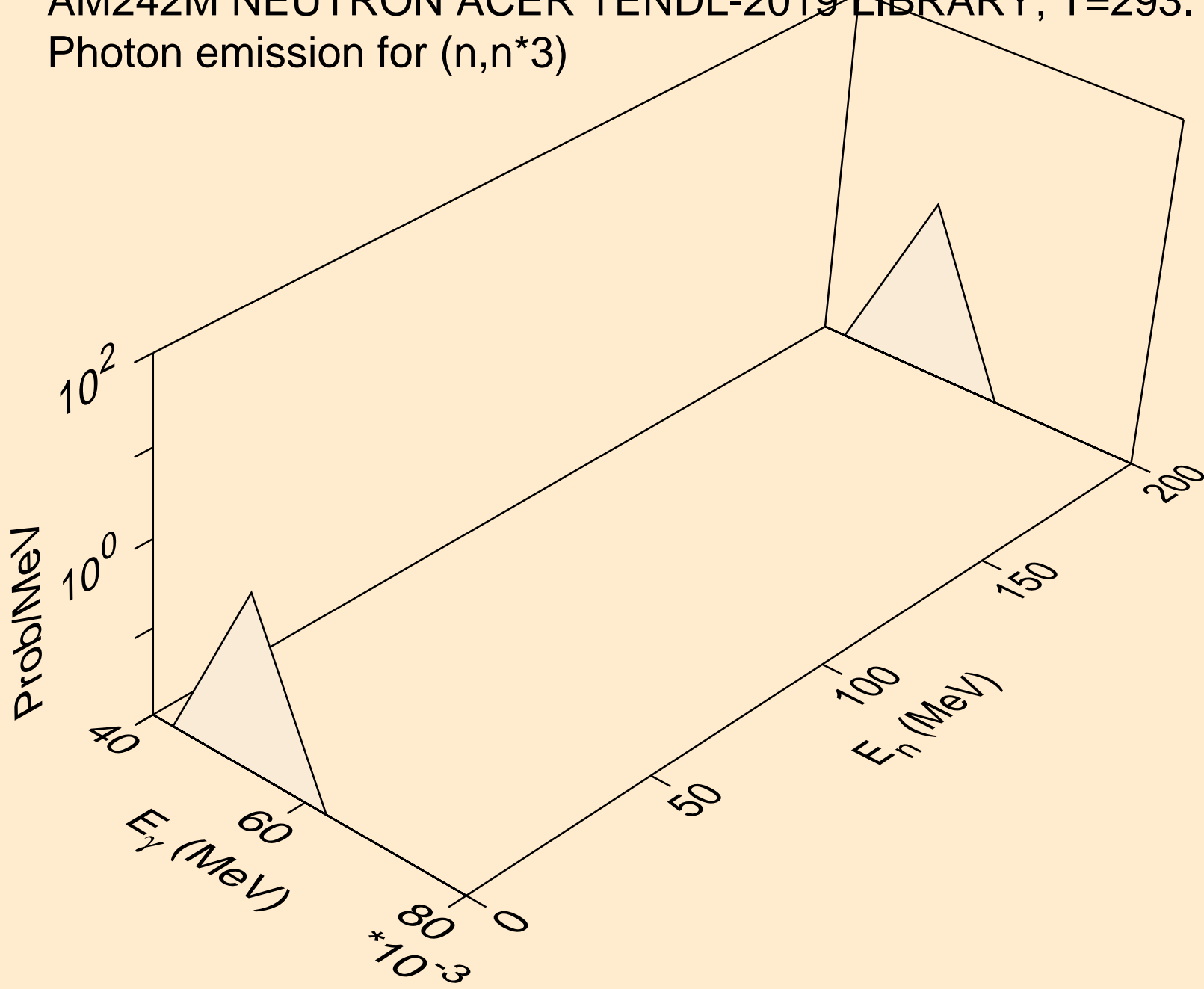

AM242M NEUTRON ACER TENDL-2019 LIBRARY; T=293.16K
Photon emission for (n,n*4)

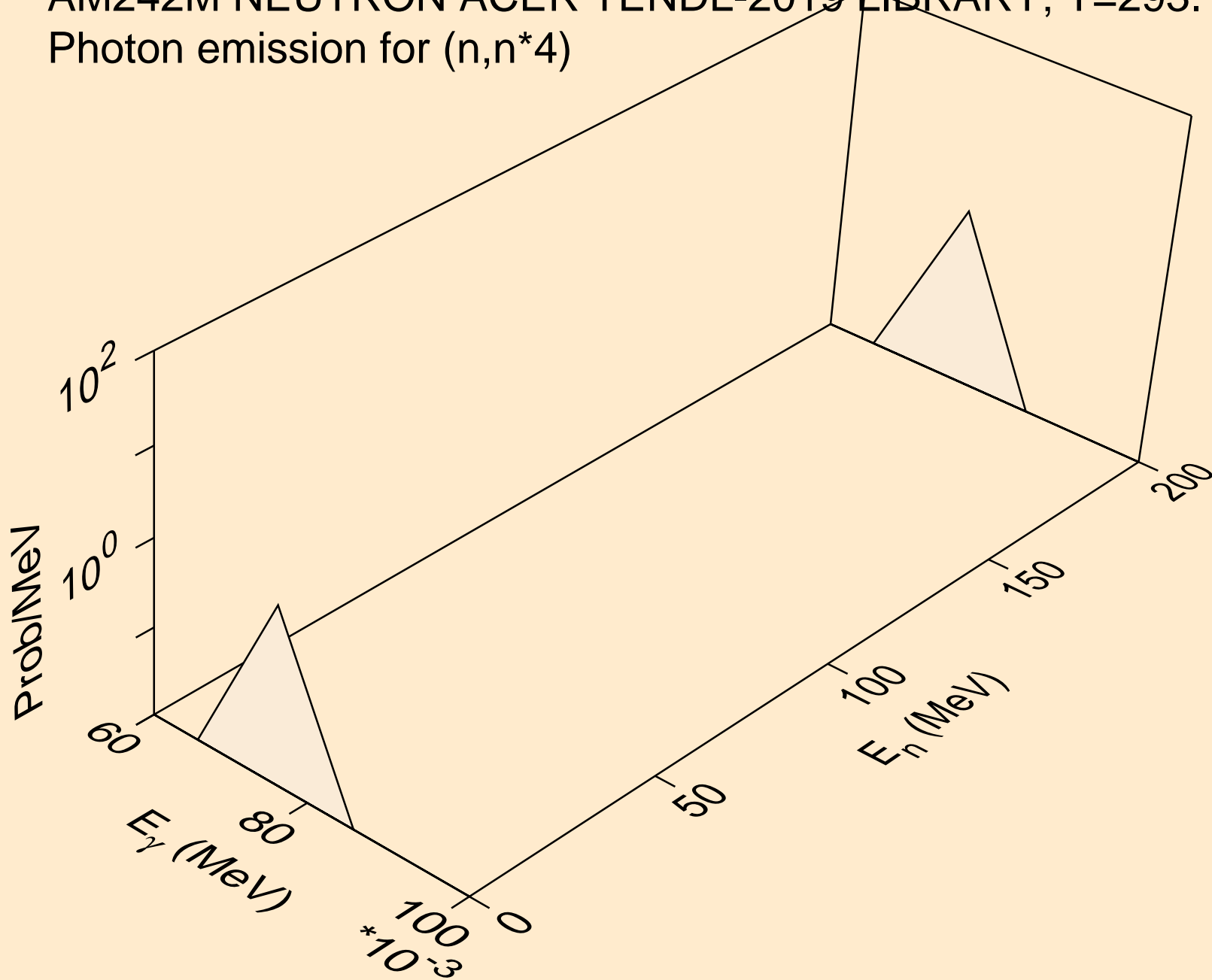

AM242M NEUTRON ACER TENDL-2019 LIBRARY; T=293.16K
Photon emission for (n,n*5)

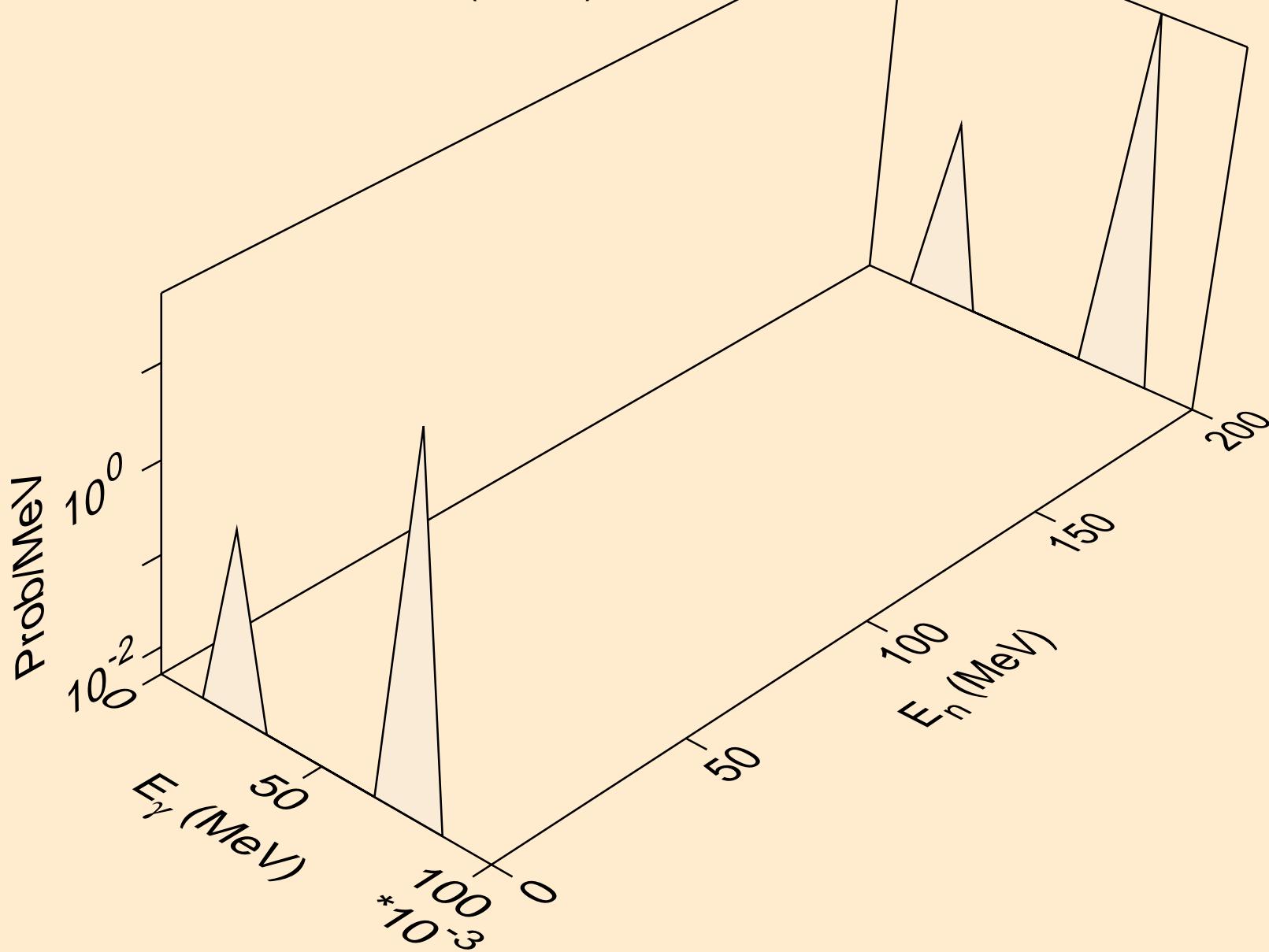

AM242M NEUTRON ACER TENDL-2019 LIBRARY; T=293.16K
Photon emission for (n,n*6)

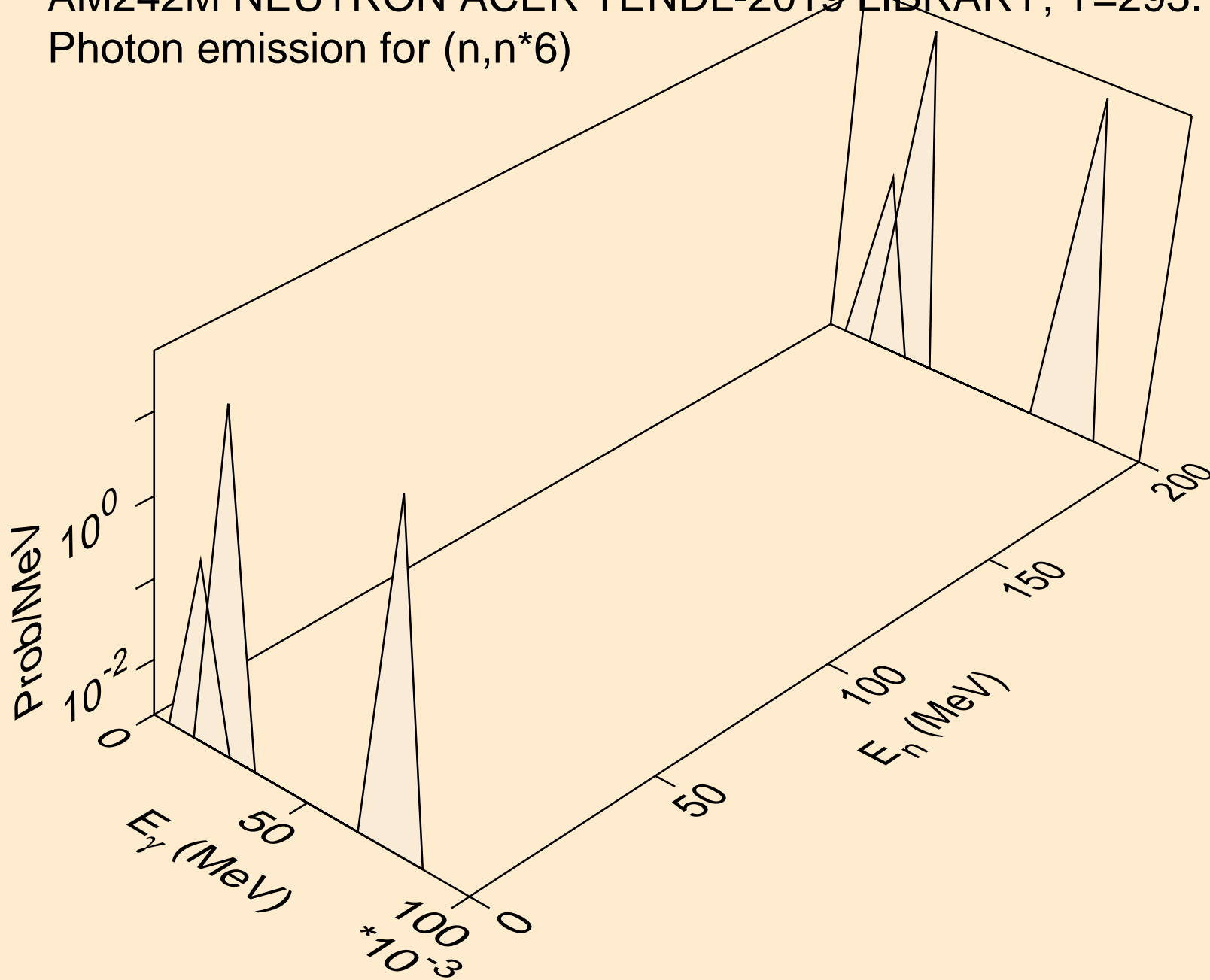

AM242M NEUTRON ACER TENDL-2019 LIBRARY; T=293.16K
Photon emission for (n,n*7)

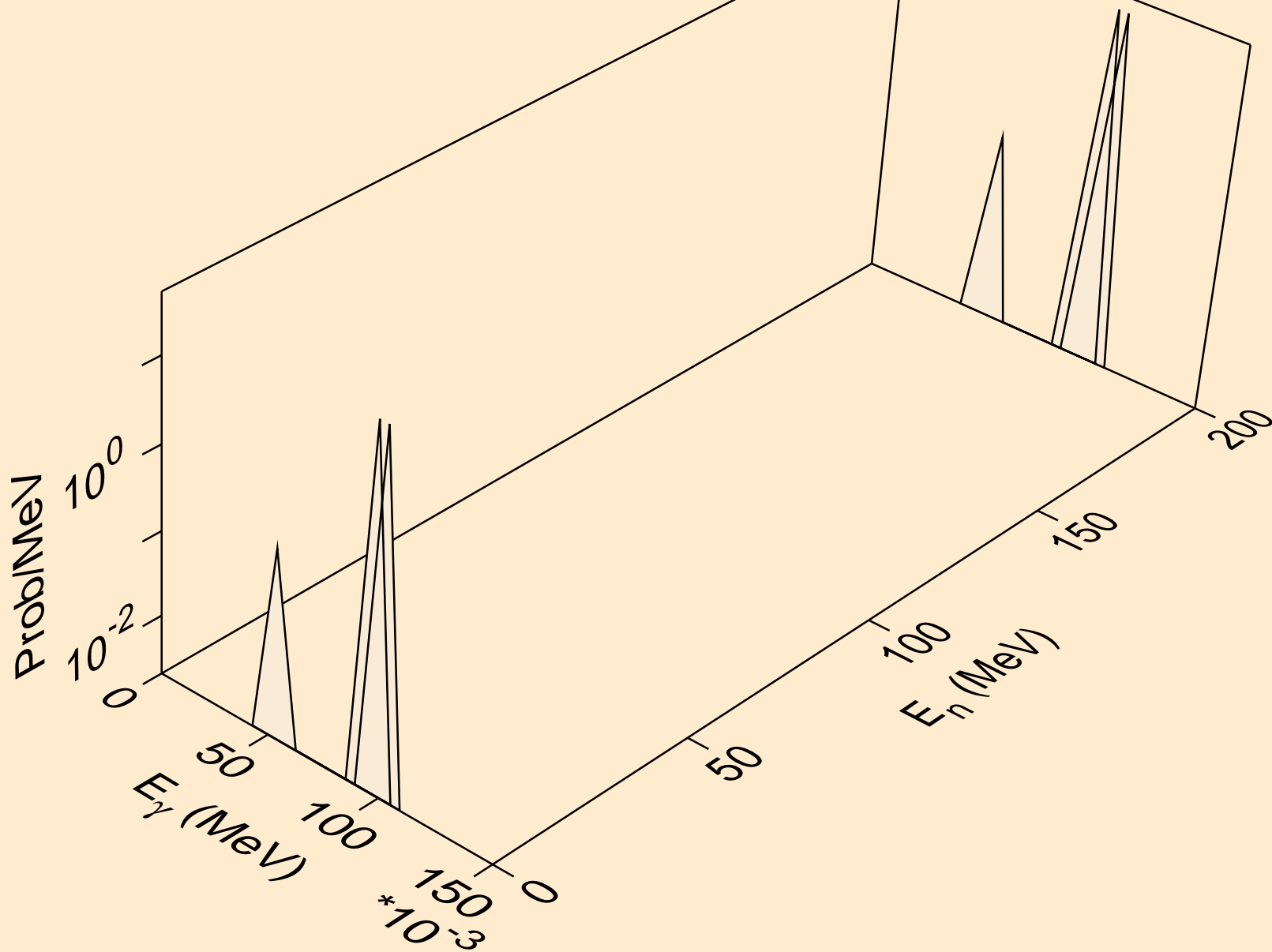

AM242M NEUTRON ACER TENDL-2019 LIBRARY; T=293.16K
Photon emission for (n,n*8)

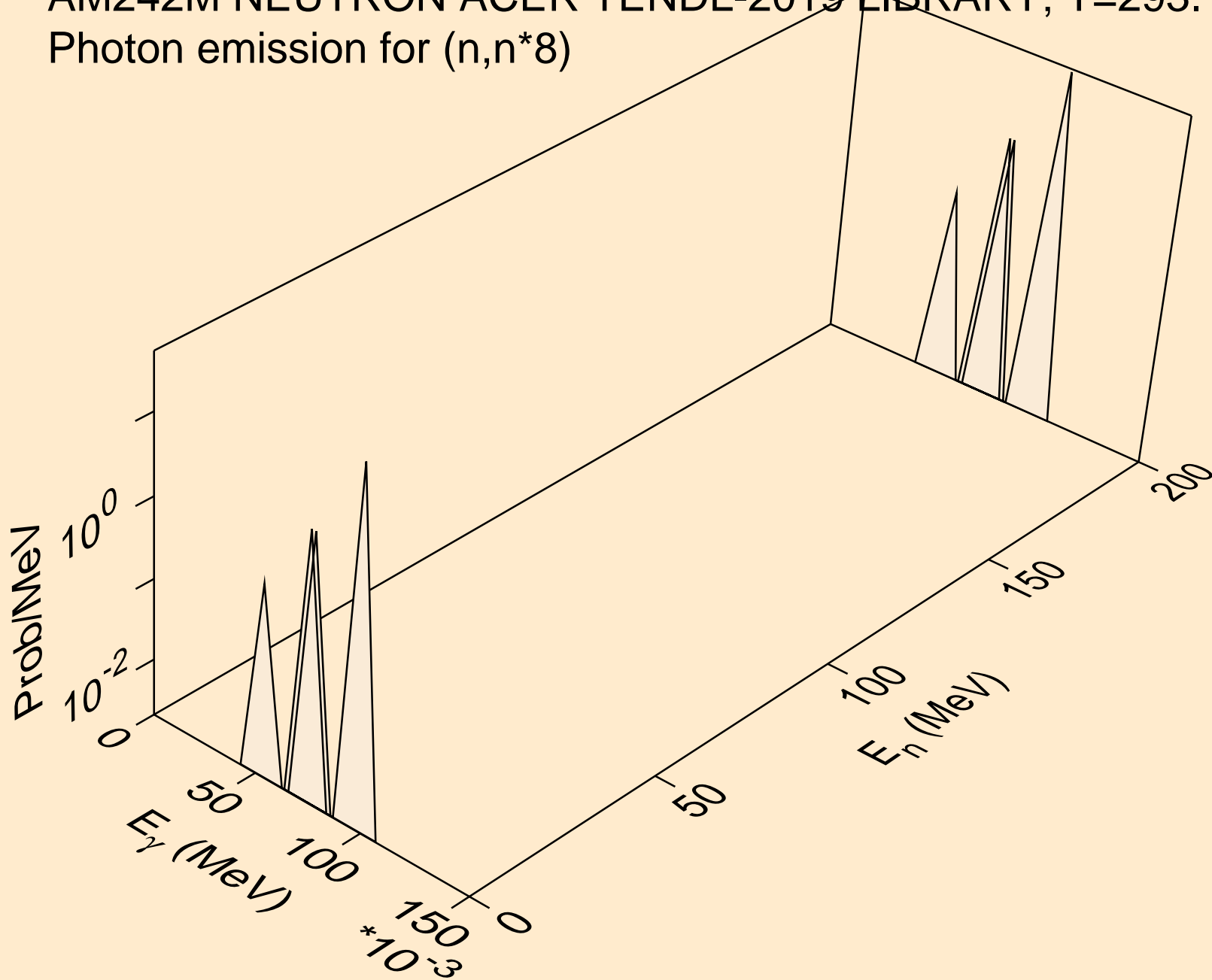

AM242M NEUTRON ACER TENDL-2019 LIBRARY; T=293.16K
Photon emission for (n,n*9)

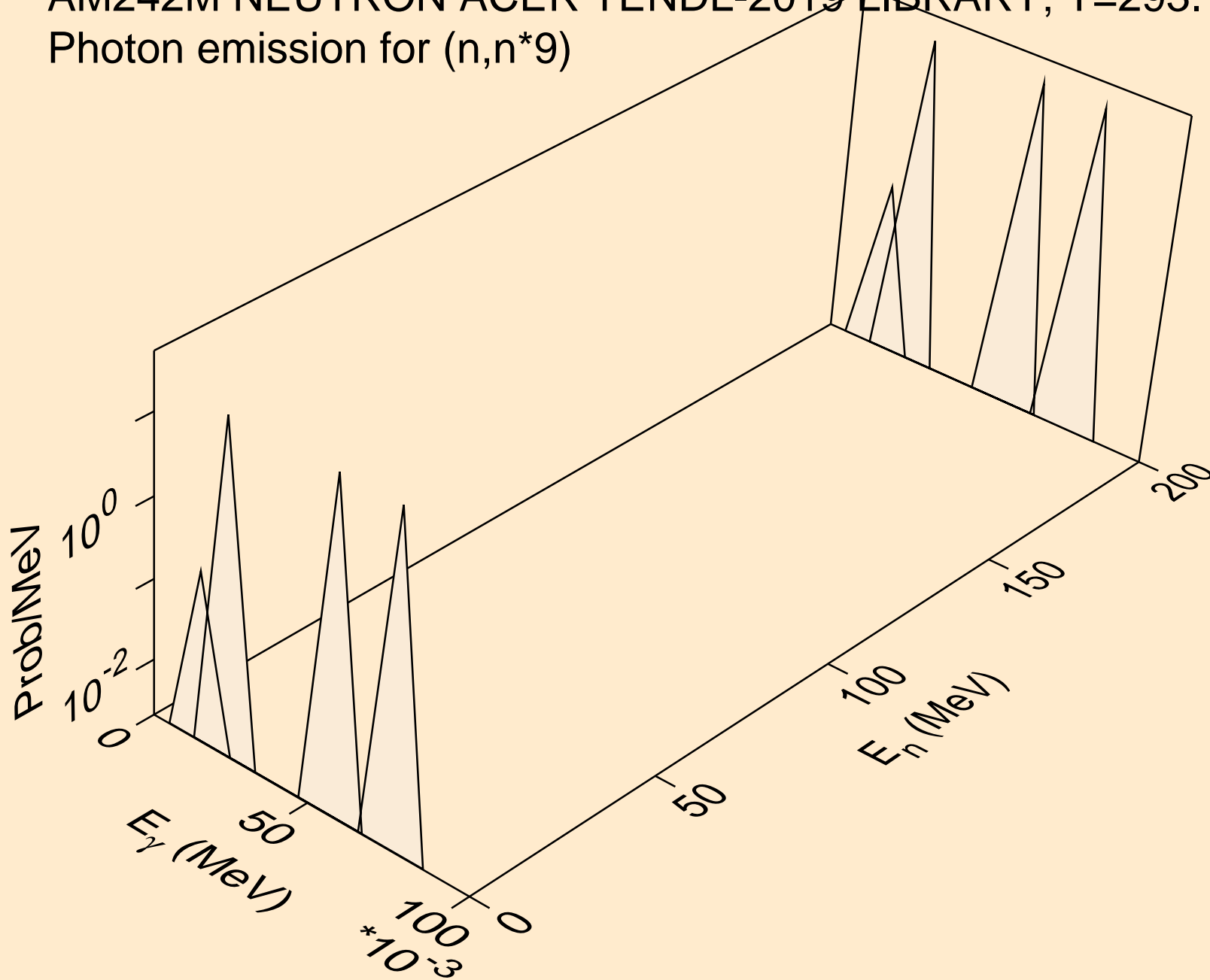

AM242M NEUTRON ACER TENDL-2019 LIBRARY; T=293.16K
Photon emission for (n,n*10)

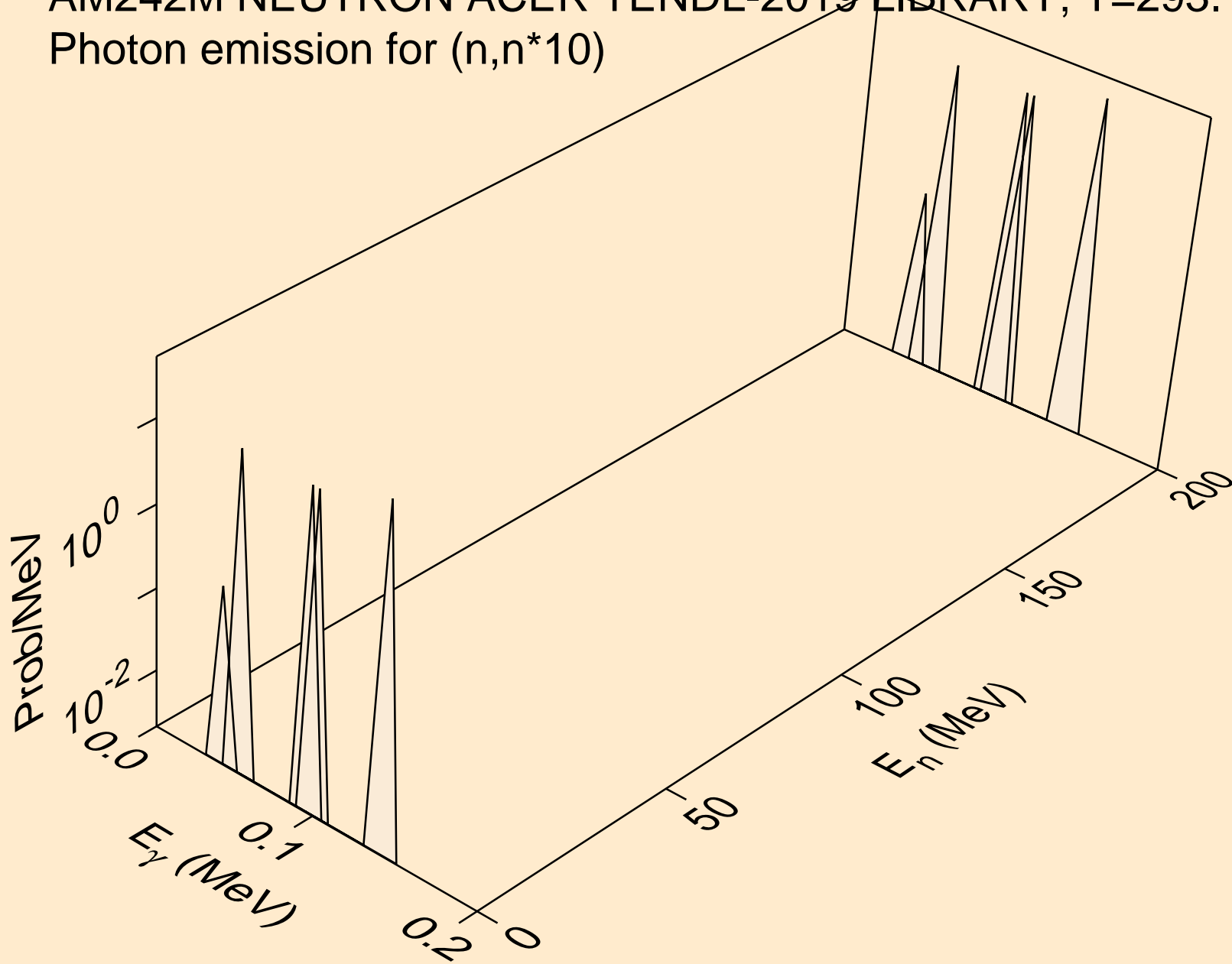

AM242M NEUTRON ACER TENDL-2019 LIBRARY; T=293.16K
Photon emission for (n,n*11)

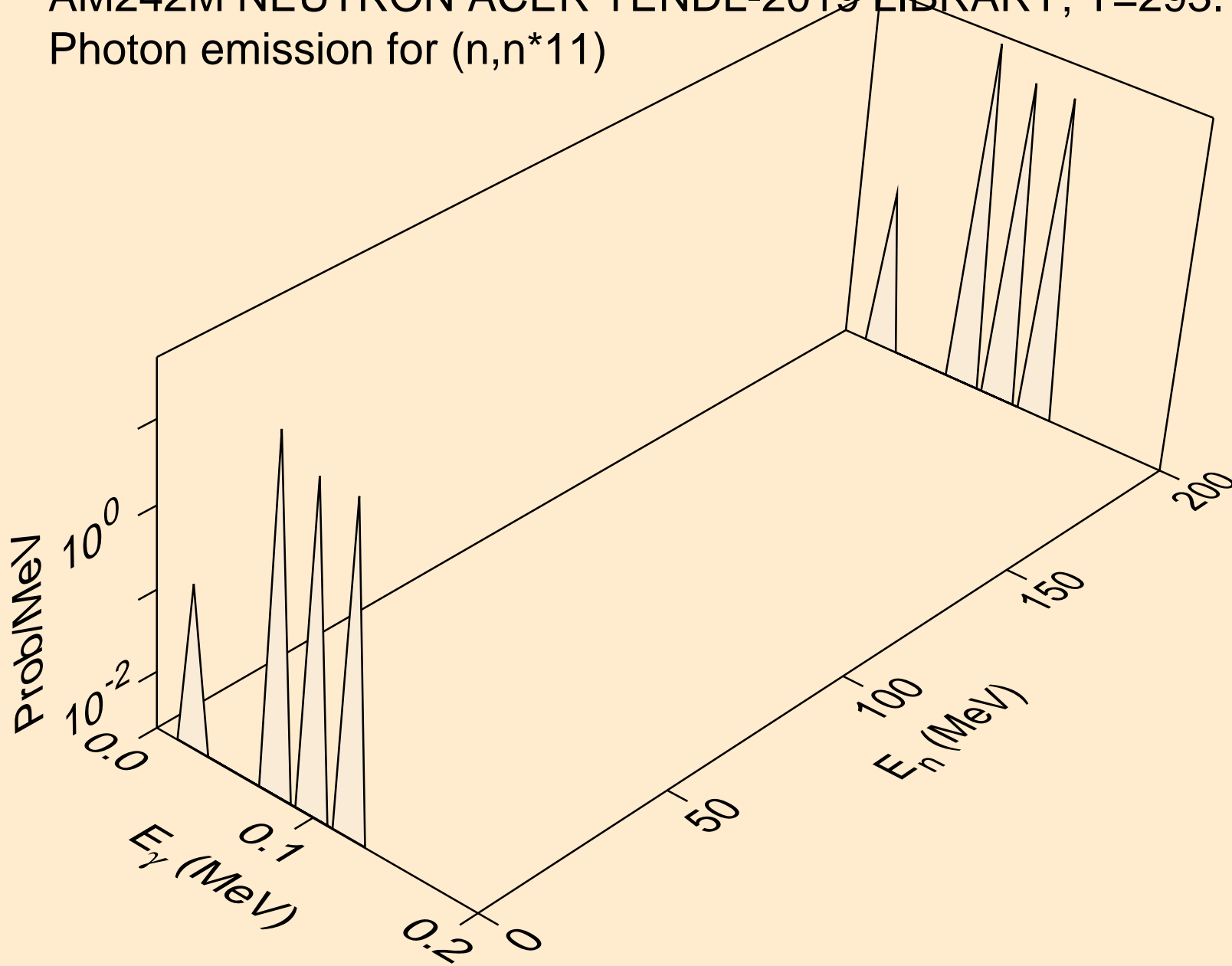

AM242M NEUTRON ACER TENDL-2019 LIBRARY; T=293.16K
Photon emission for (n,n*12)

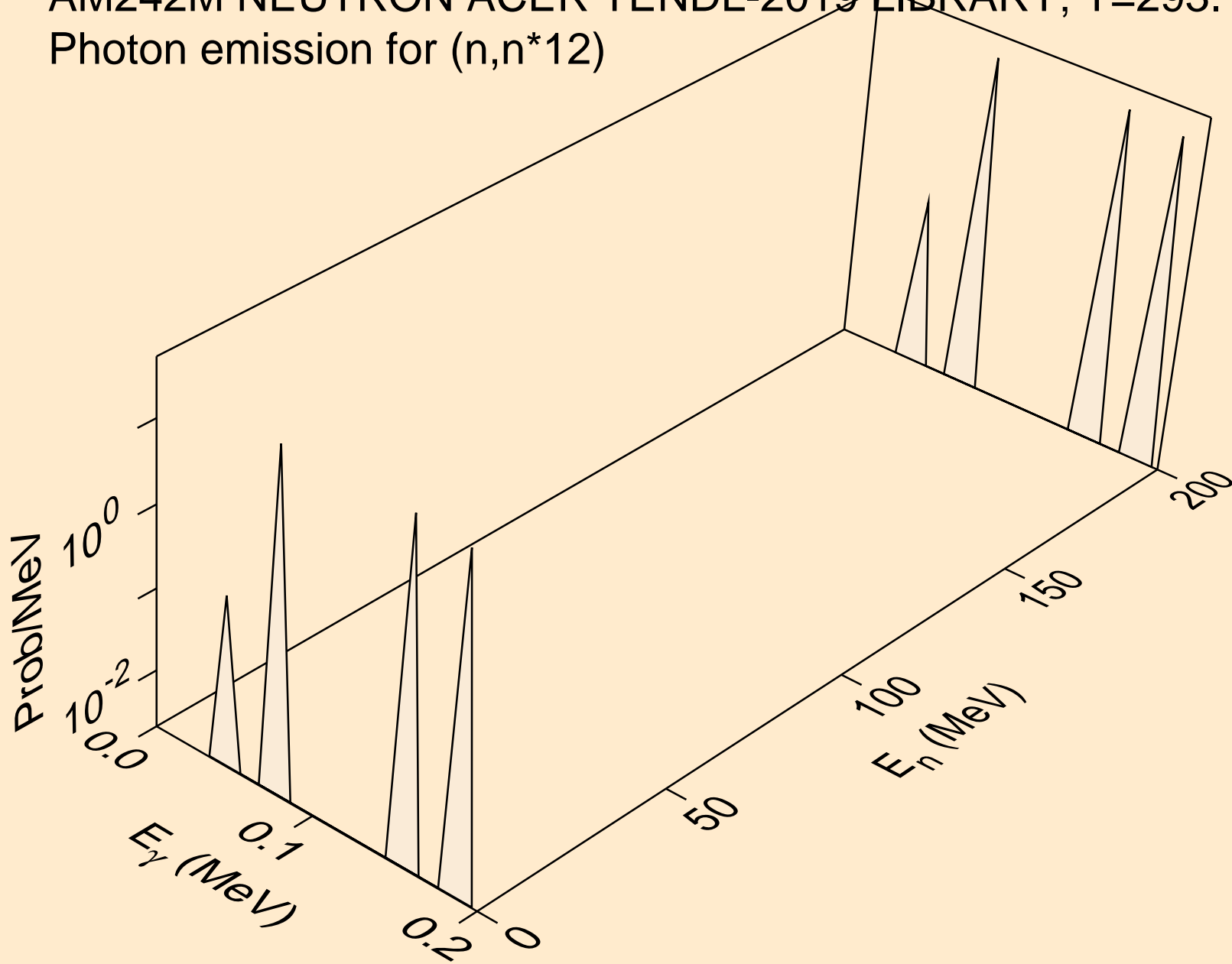

AM242M NEUTRON ACER TENDL-2019 LIBRARY; T=293.16K
Photon emission for (n,n*13)

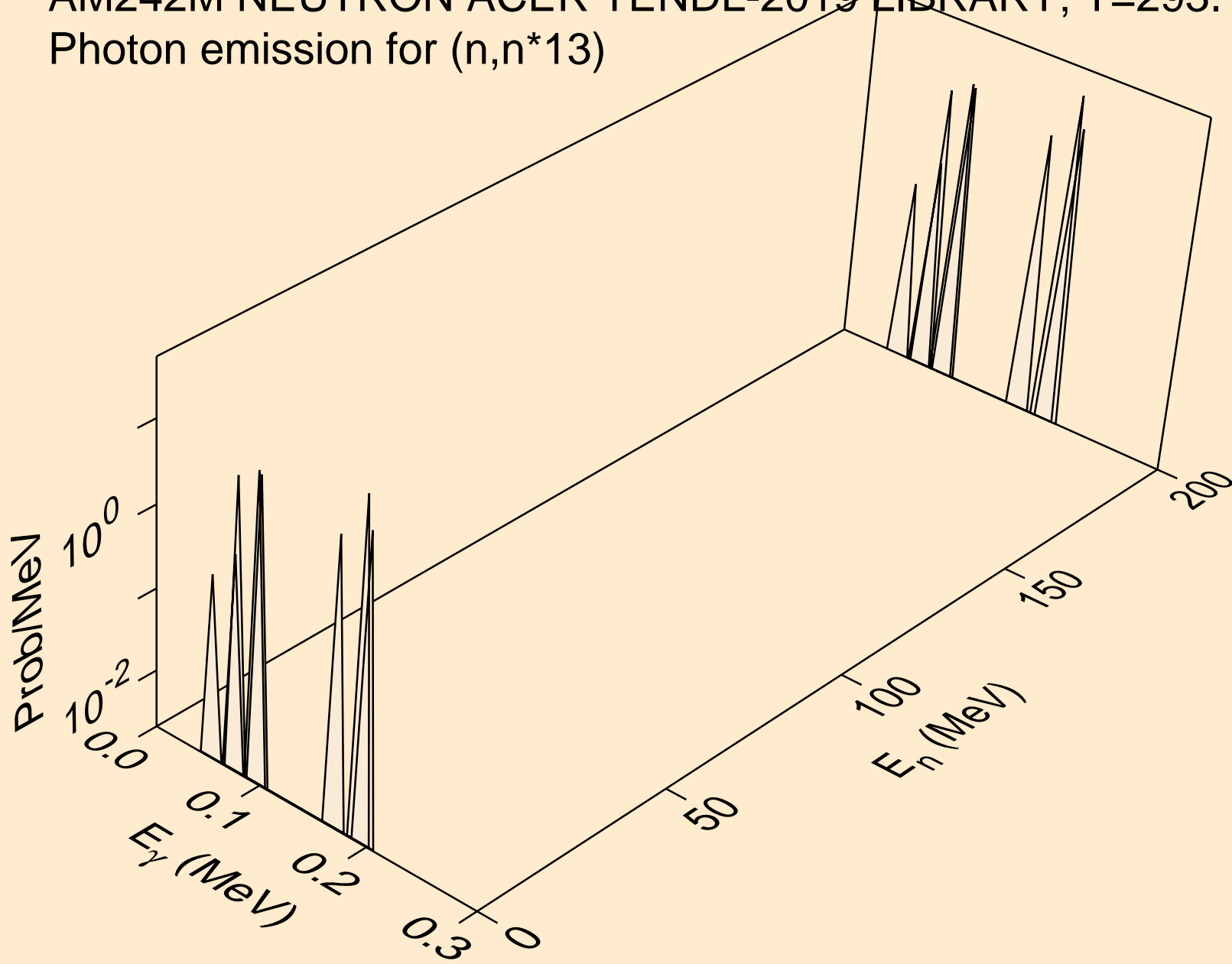

AM242M NEUTRON ACER TENDL-2019 LIBRARY; T=293.16K
Photon emission for (n,n*14)

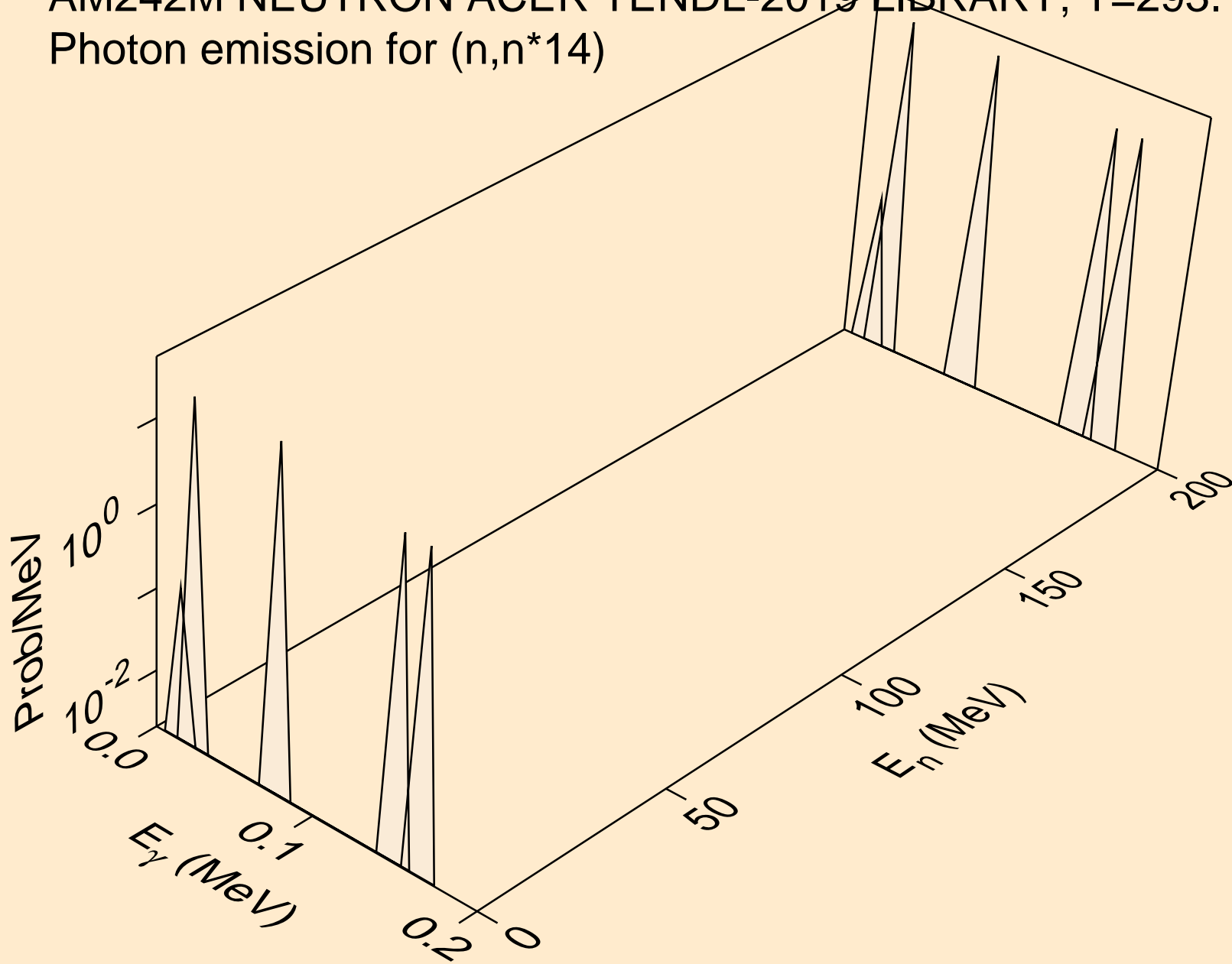

AM242M NEUTRON ACER TENDL-2019 LIBRARY; T=293.16K
Photon emission for (n,n*15)

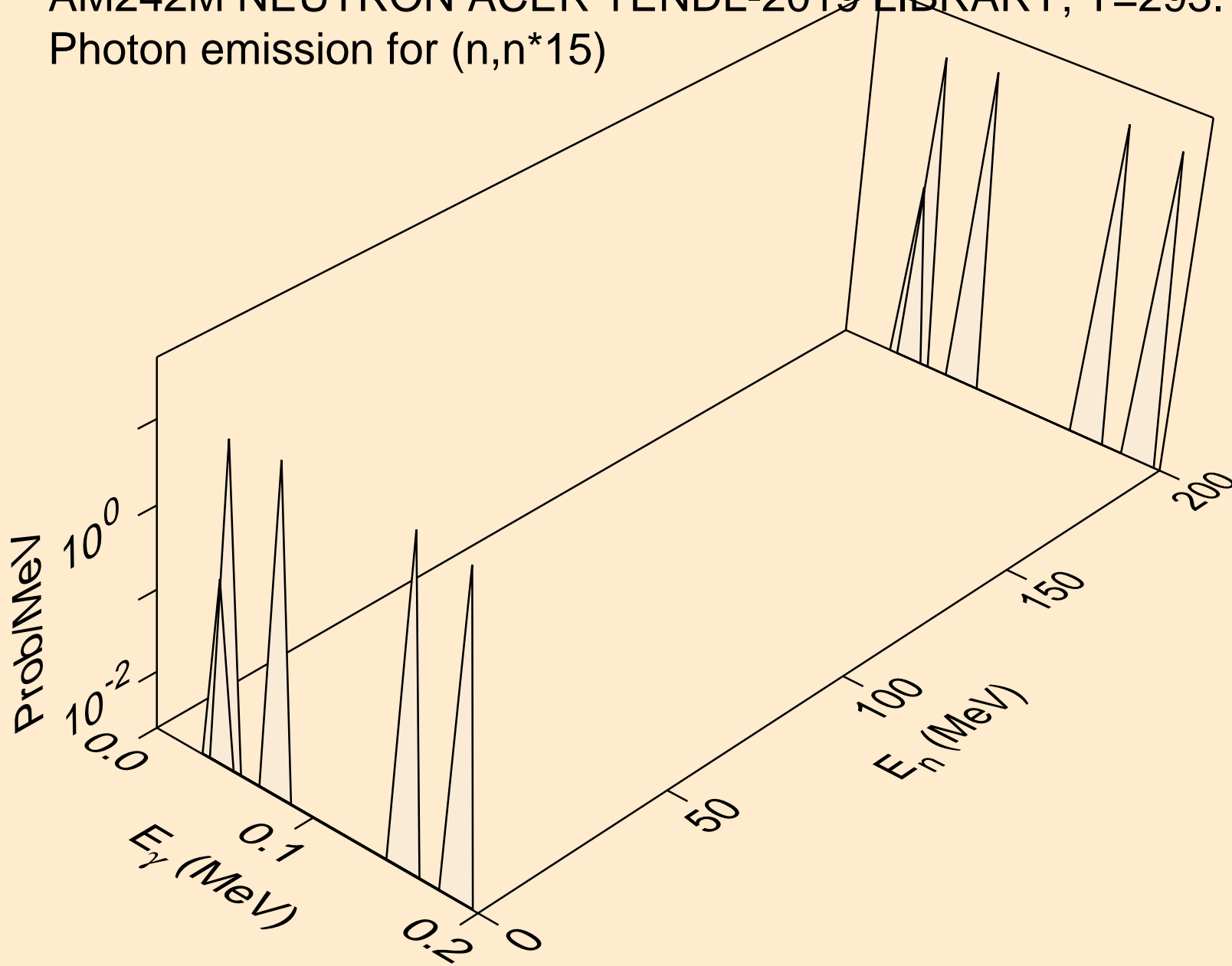

AM242M NEUTRON ACER TENDL-2019 LIBRARY; T=293.16K
Photon emission for (n,n*16)

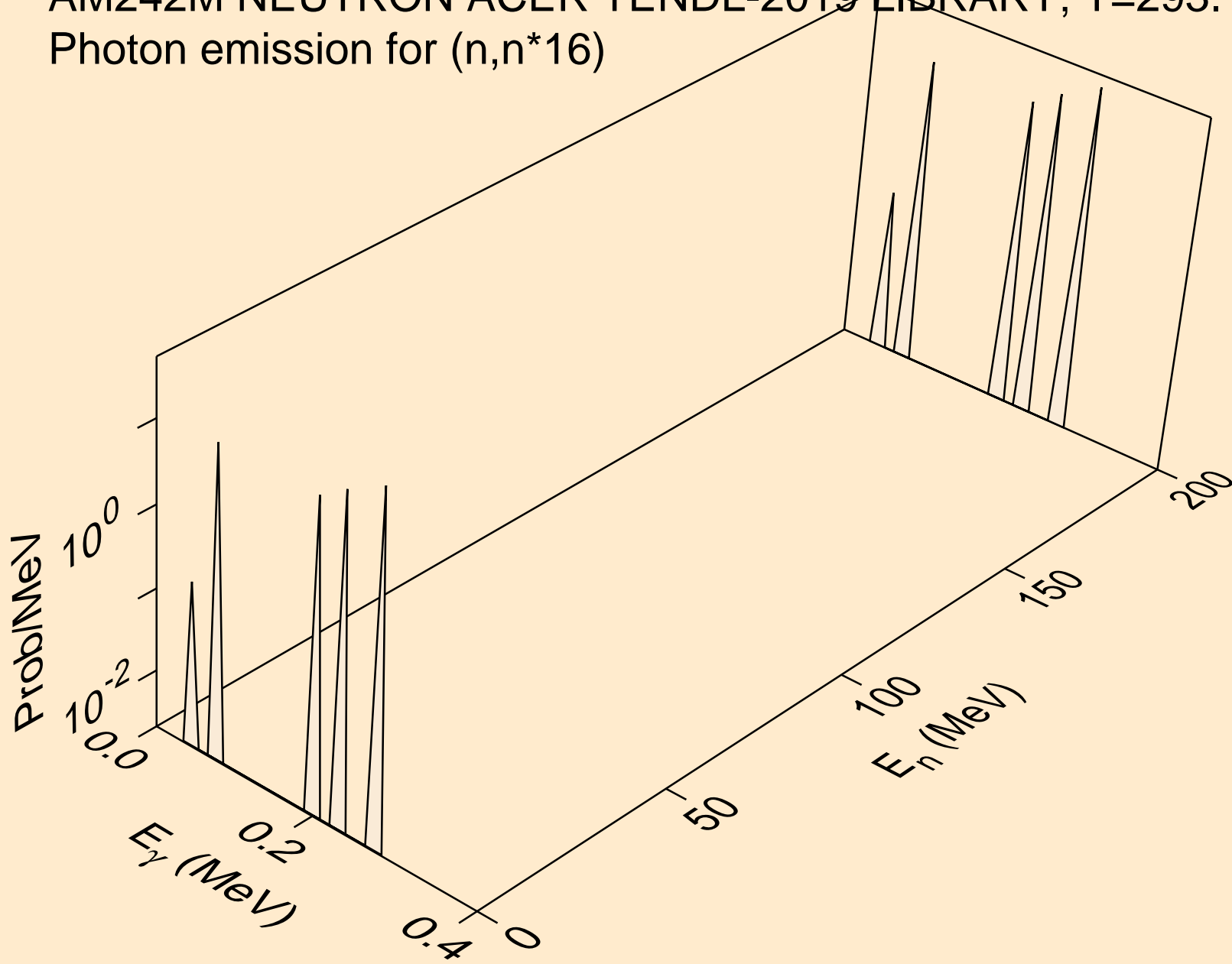

AM242M NEUTRON ACER TENDL-2019 LIBRARY; T=293.16K
Photon emission for (n,n*17)

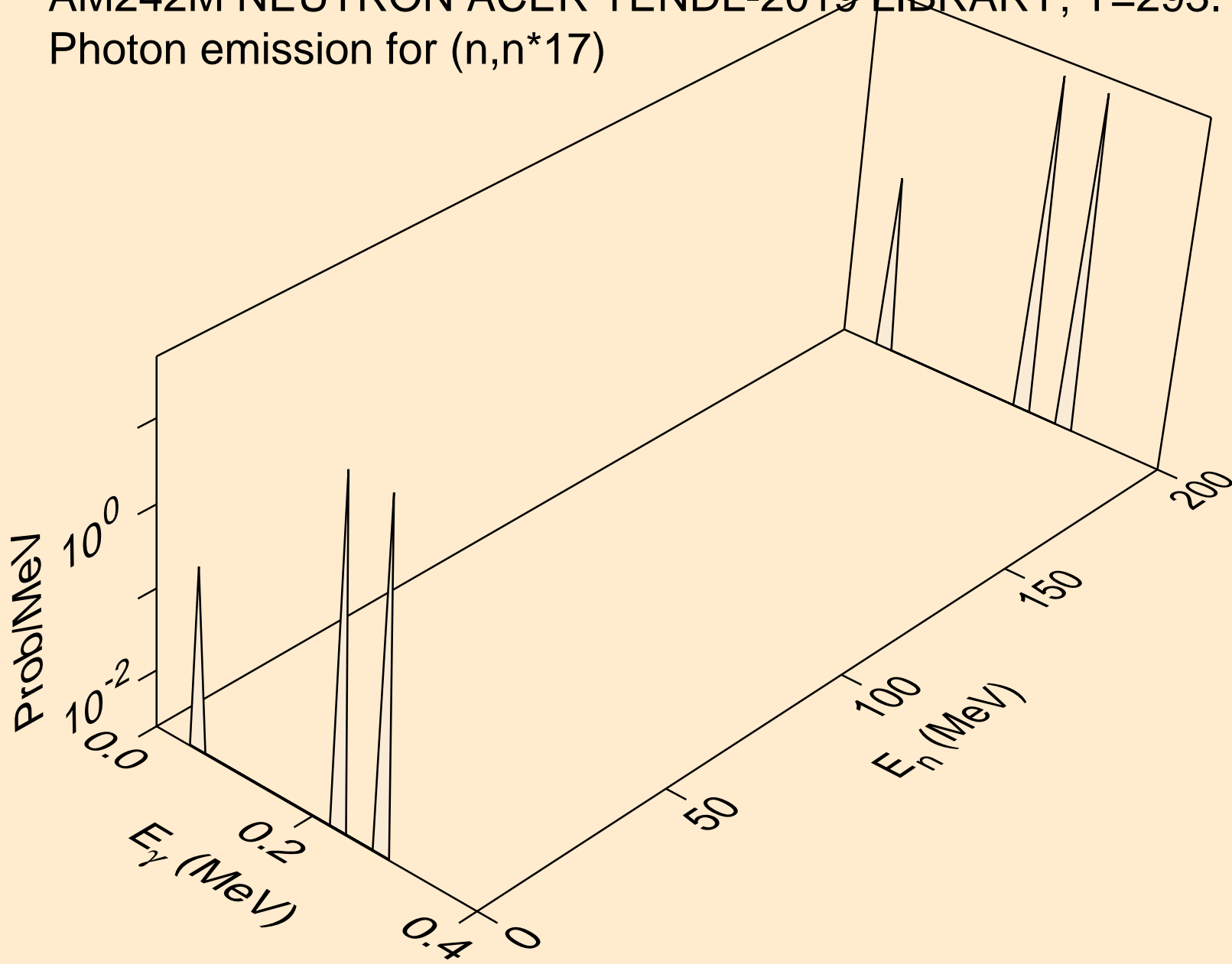

AM242M NEUTRON ACER TENDL-2019 LIBRARY; T=293.16K
Photon emission for (n,n*18)

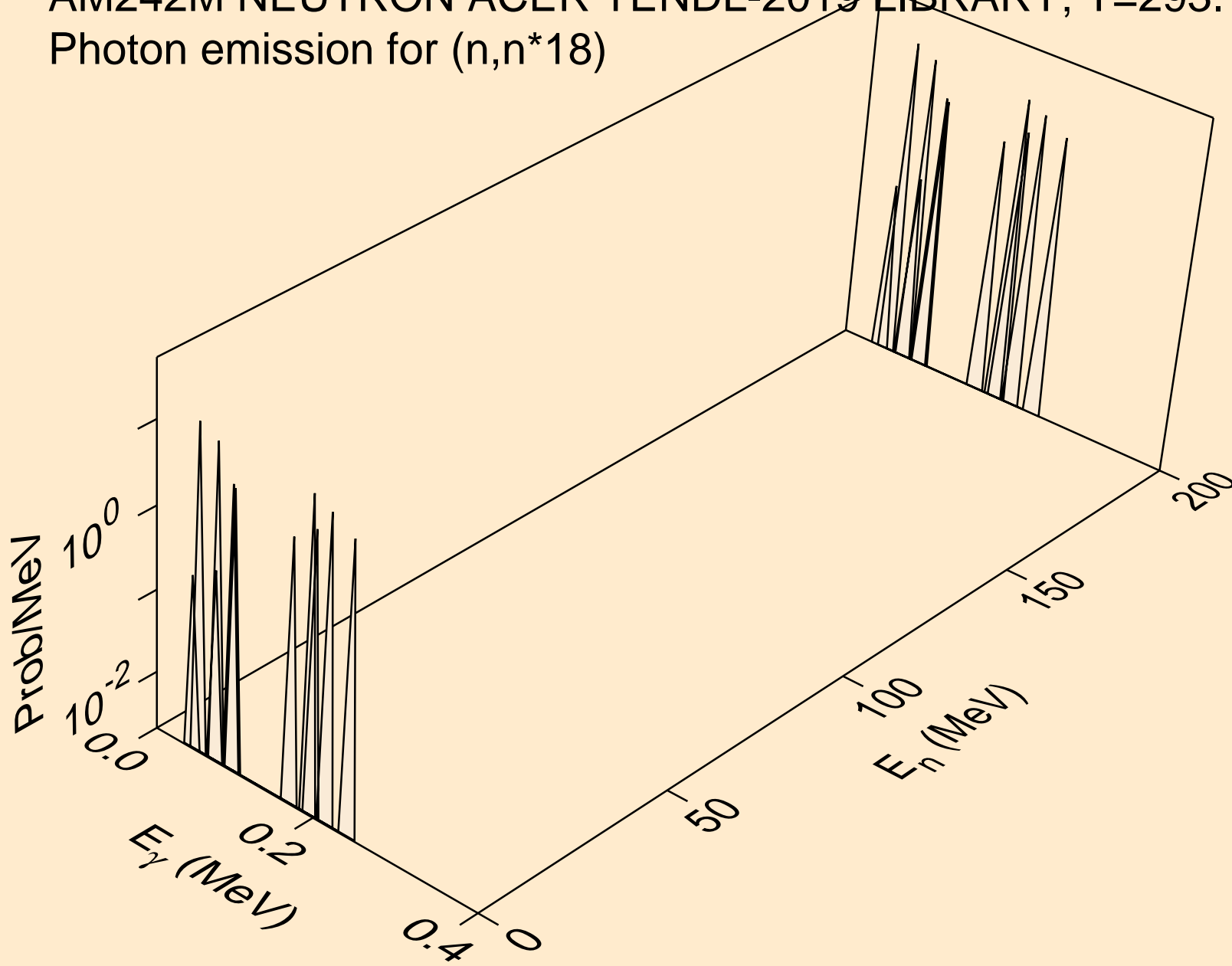

AM242M NEUTRON ACER TENDL-2019 LIBRARY; T=293.16K
Photon emission for (n,n*19)

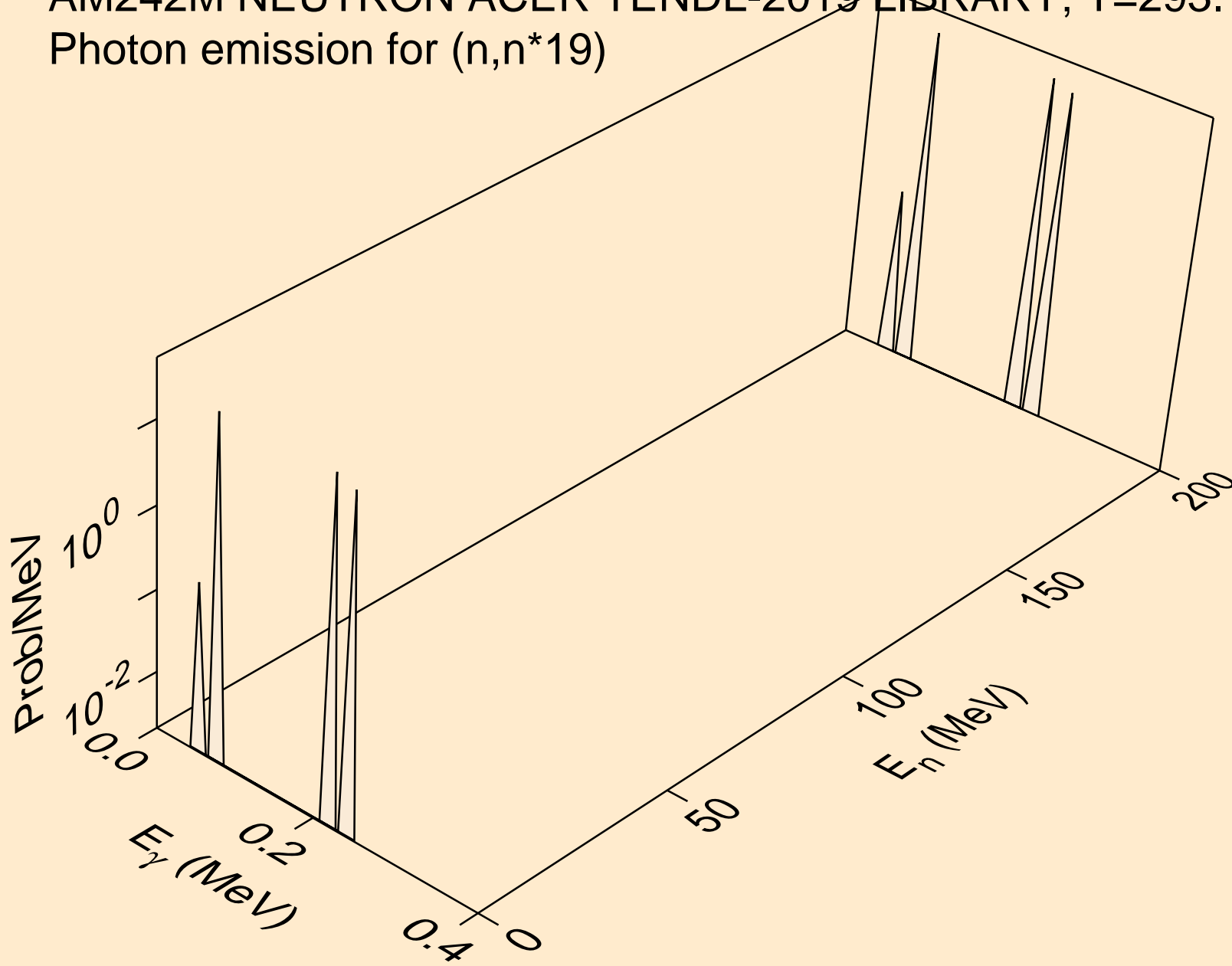

AM242M NEUTRON ACER TENDL-2019 LIBRARY; T=293.16K
Photon emission for (n,n*20)

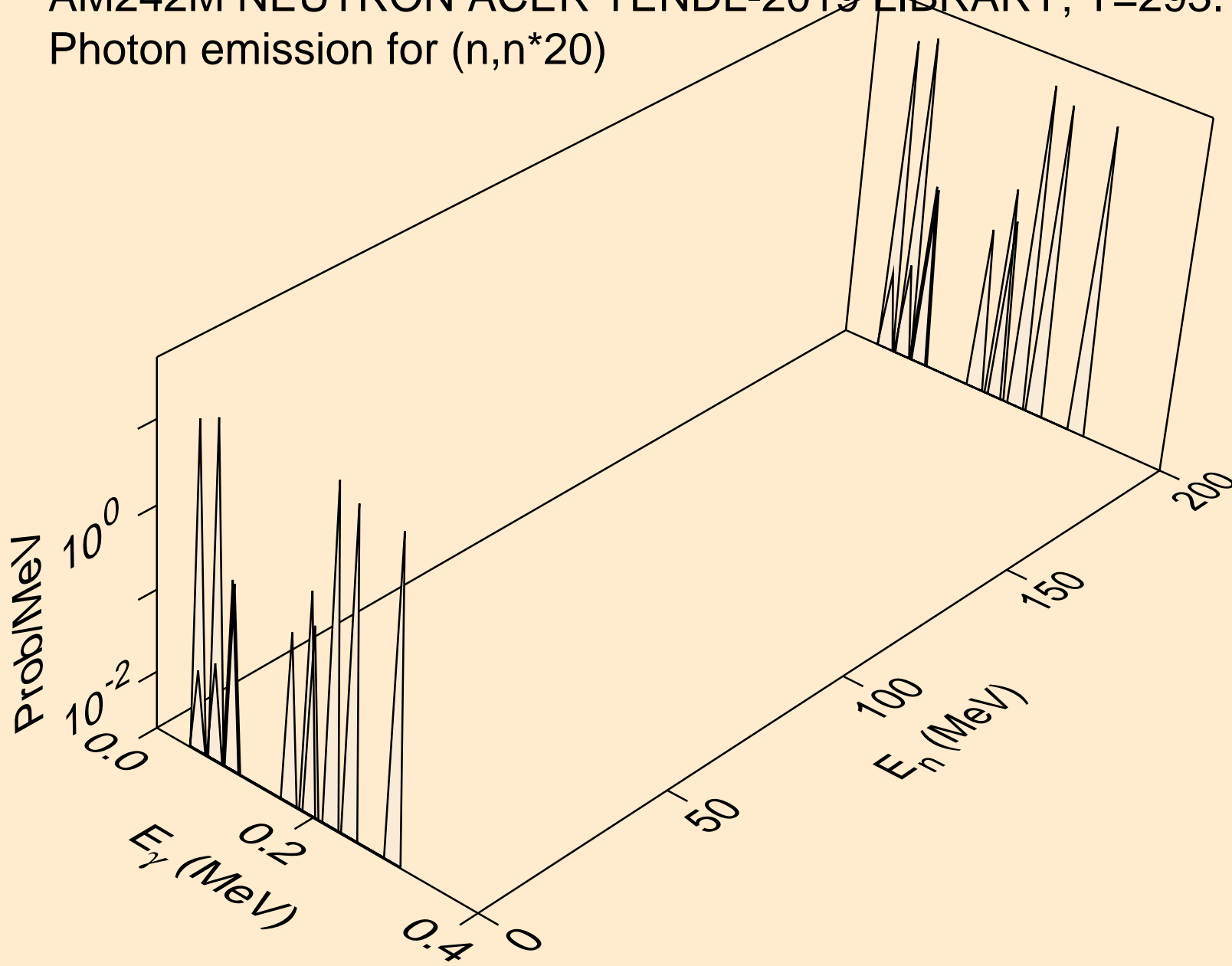

AM242M NEUTRON ACER TENDL-2019 LIBRARY; T=293.16K
Photon emission for (n,n*21)

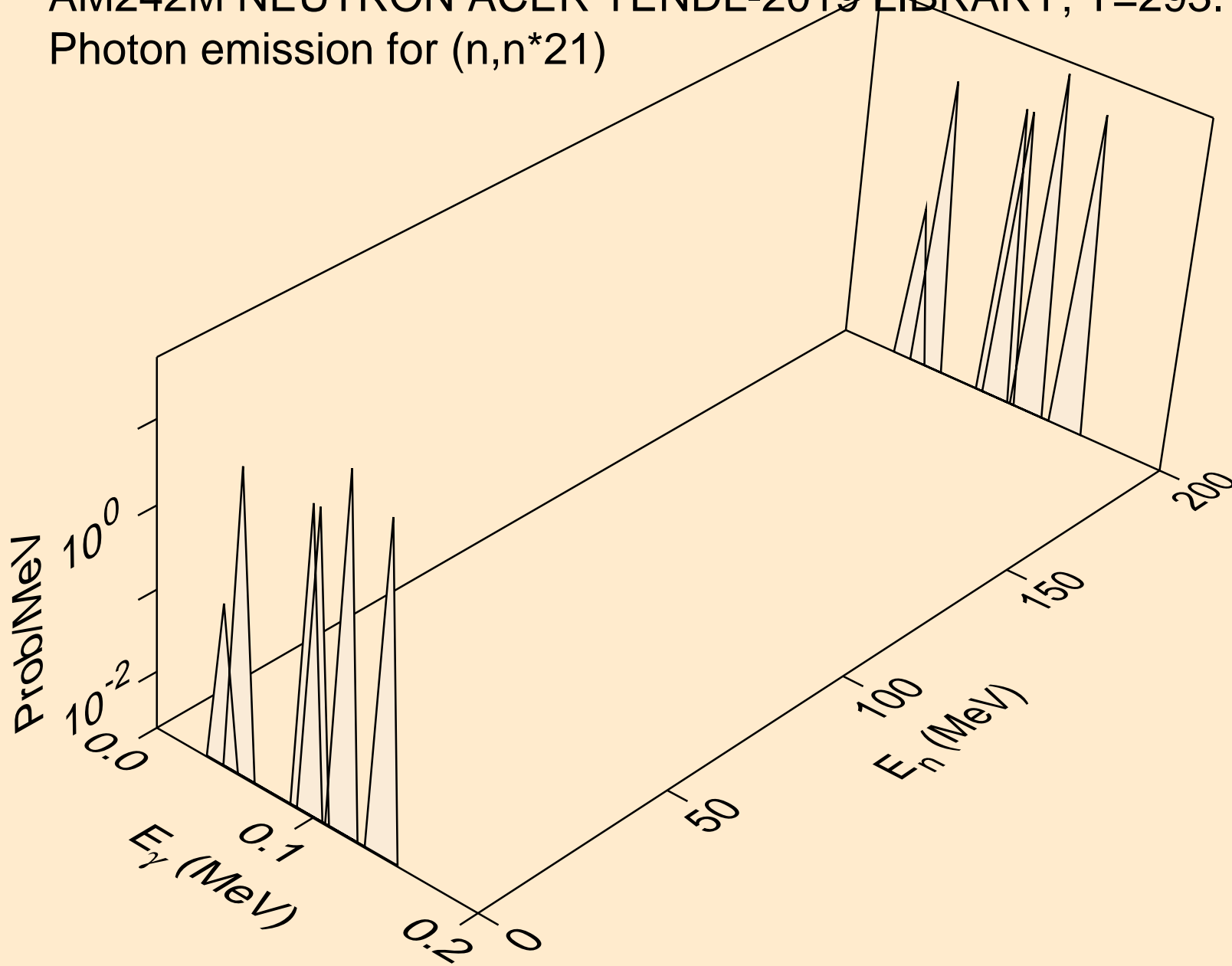

AM242M NEUTRON ACER TENDL-2019 LIBRARY; T=293.16K
Photon emission for (n,n*22)

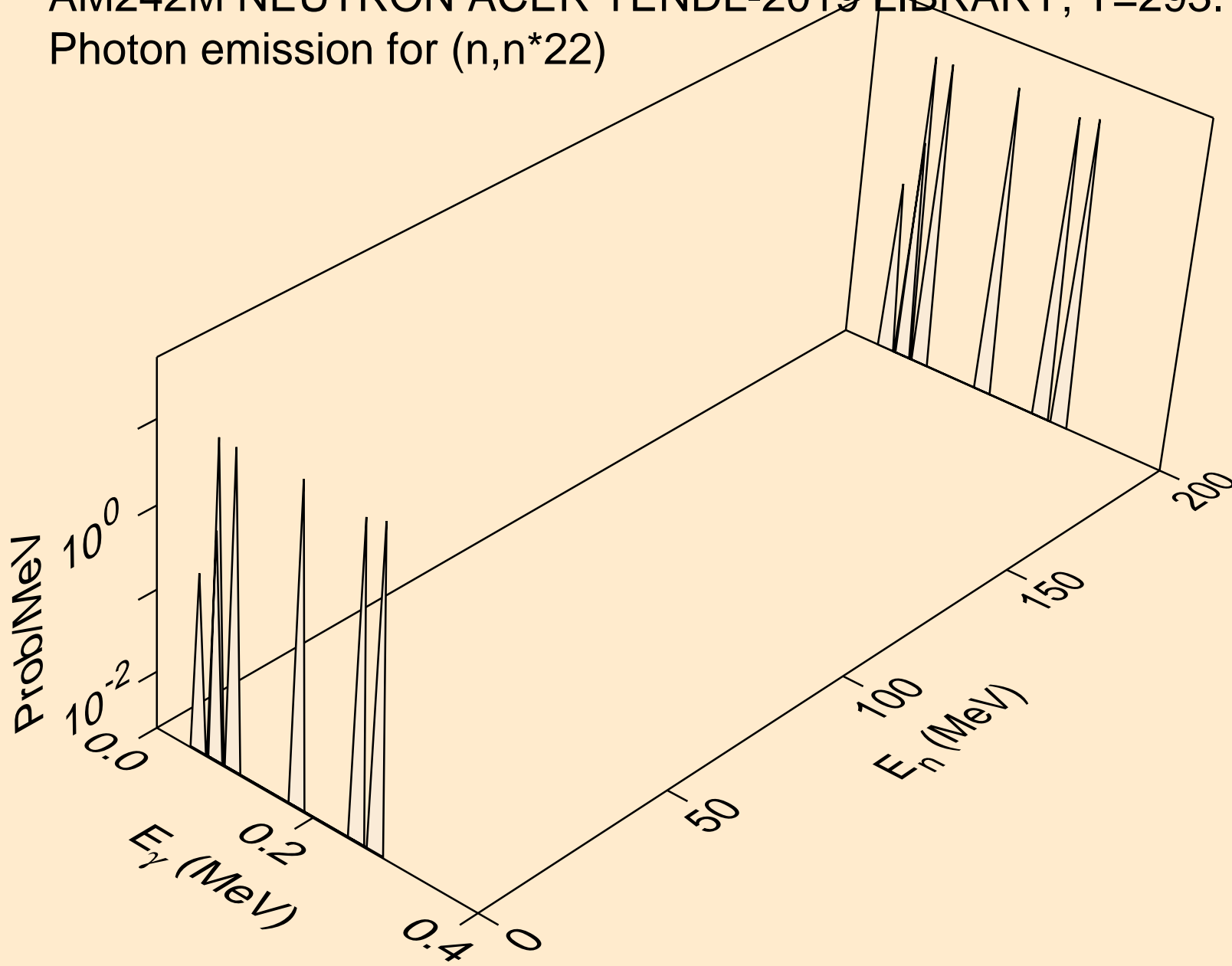

AM242M NEUTRON ACER TENDL-2019 LIBRARY; T=293.16K
Photon emission for (n,n*23)

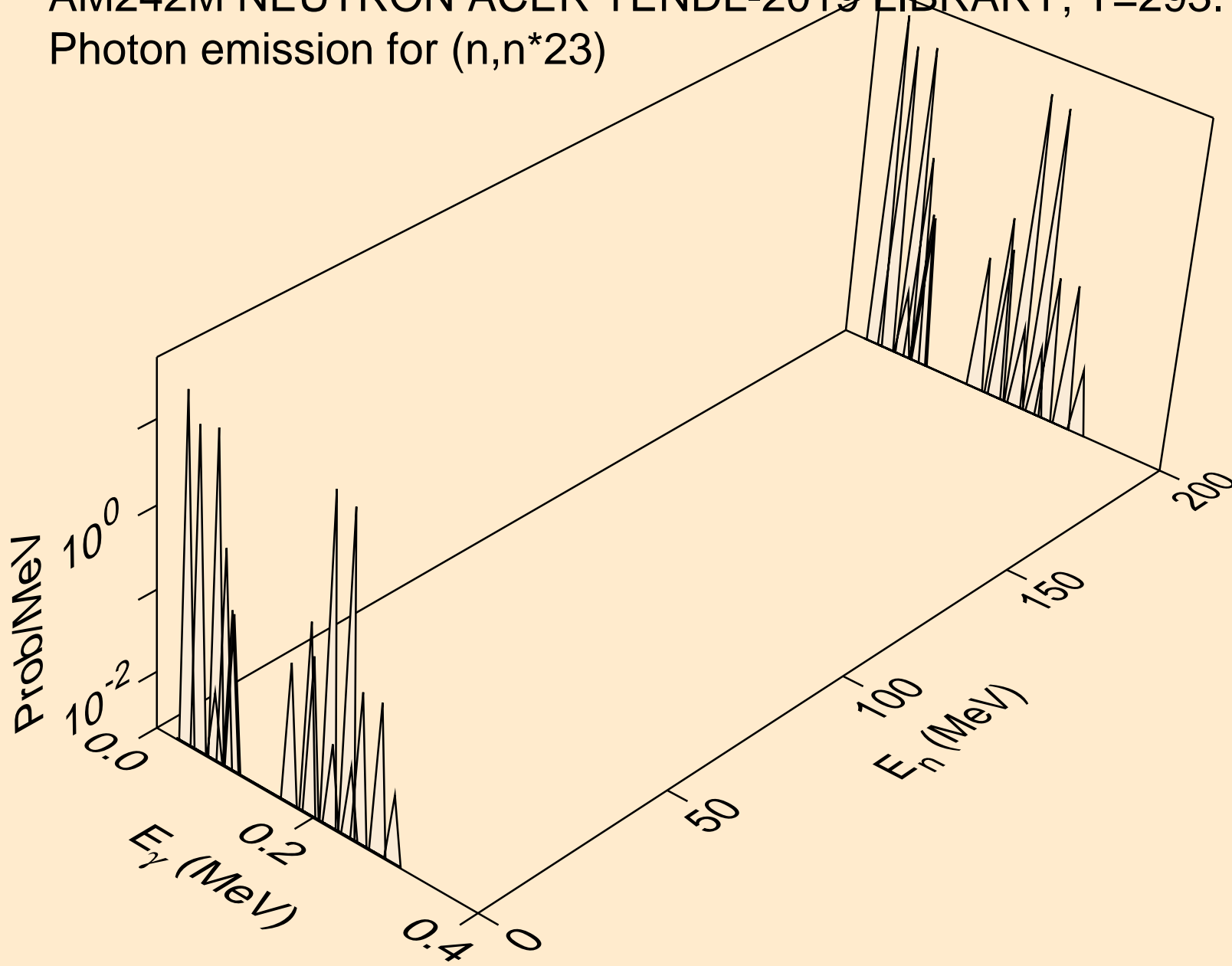

AM242M NEUTRON ACER TENDL-2019 LIBRARY; T=293.16K
Photon emission for (n,n*24)

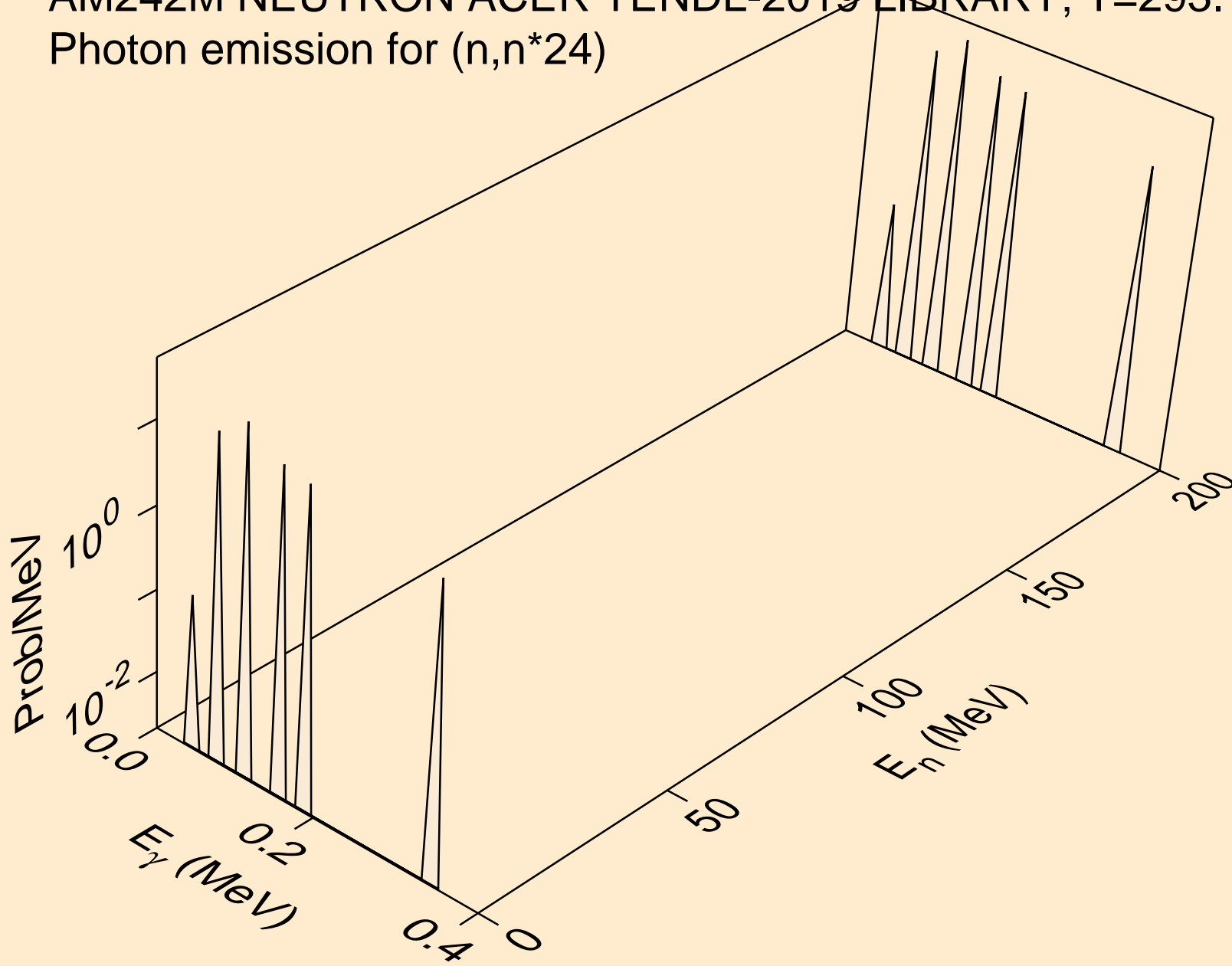

AM242M NEUTRON ACER TENDL-2019 LIBRARY; T=293.16K
Photon emission for (n,n*25)

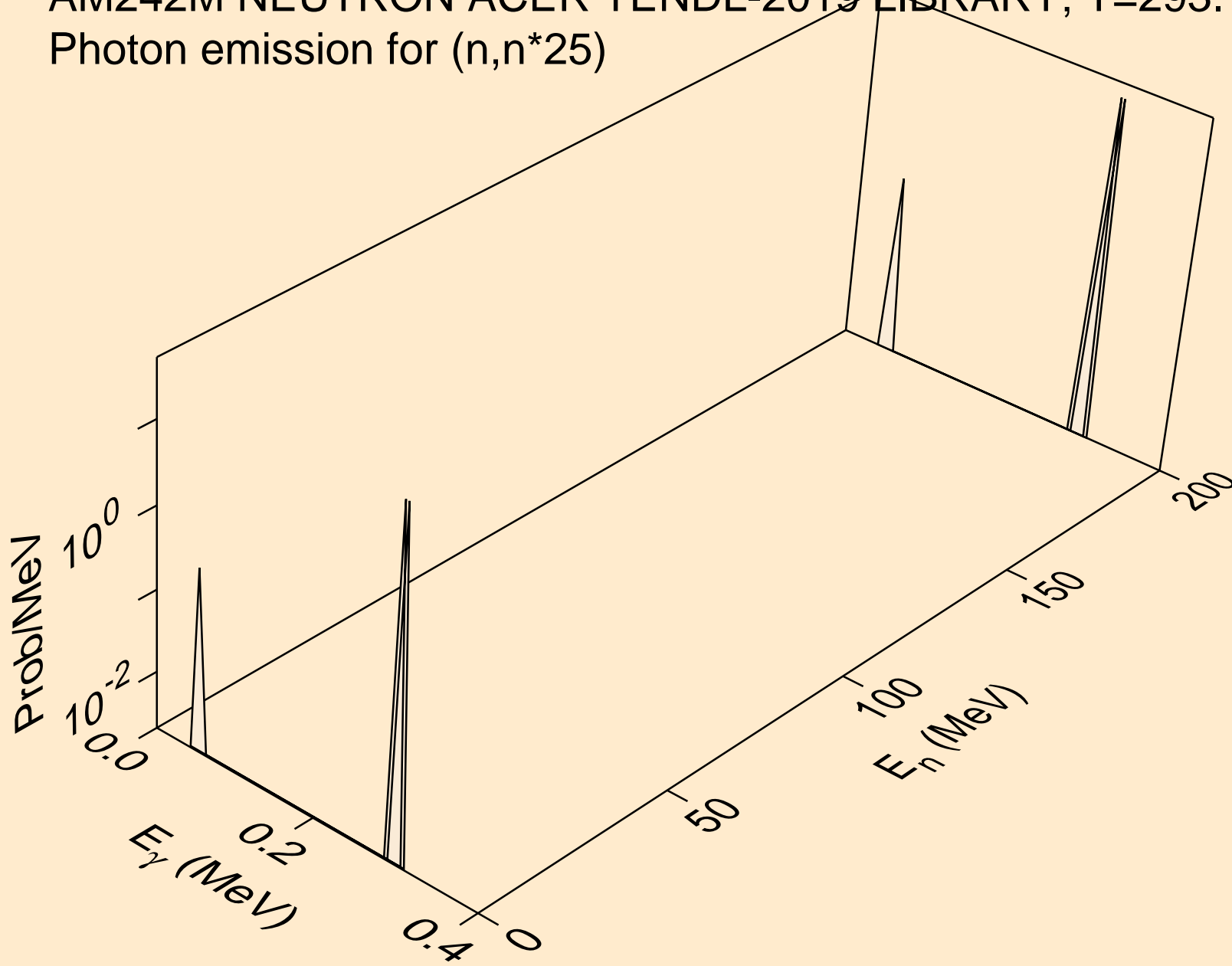

AM242M NEUTRON ACER TENDL-2019 LIBRARY; T=293.16K
Photon emission for (n,n*26)

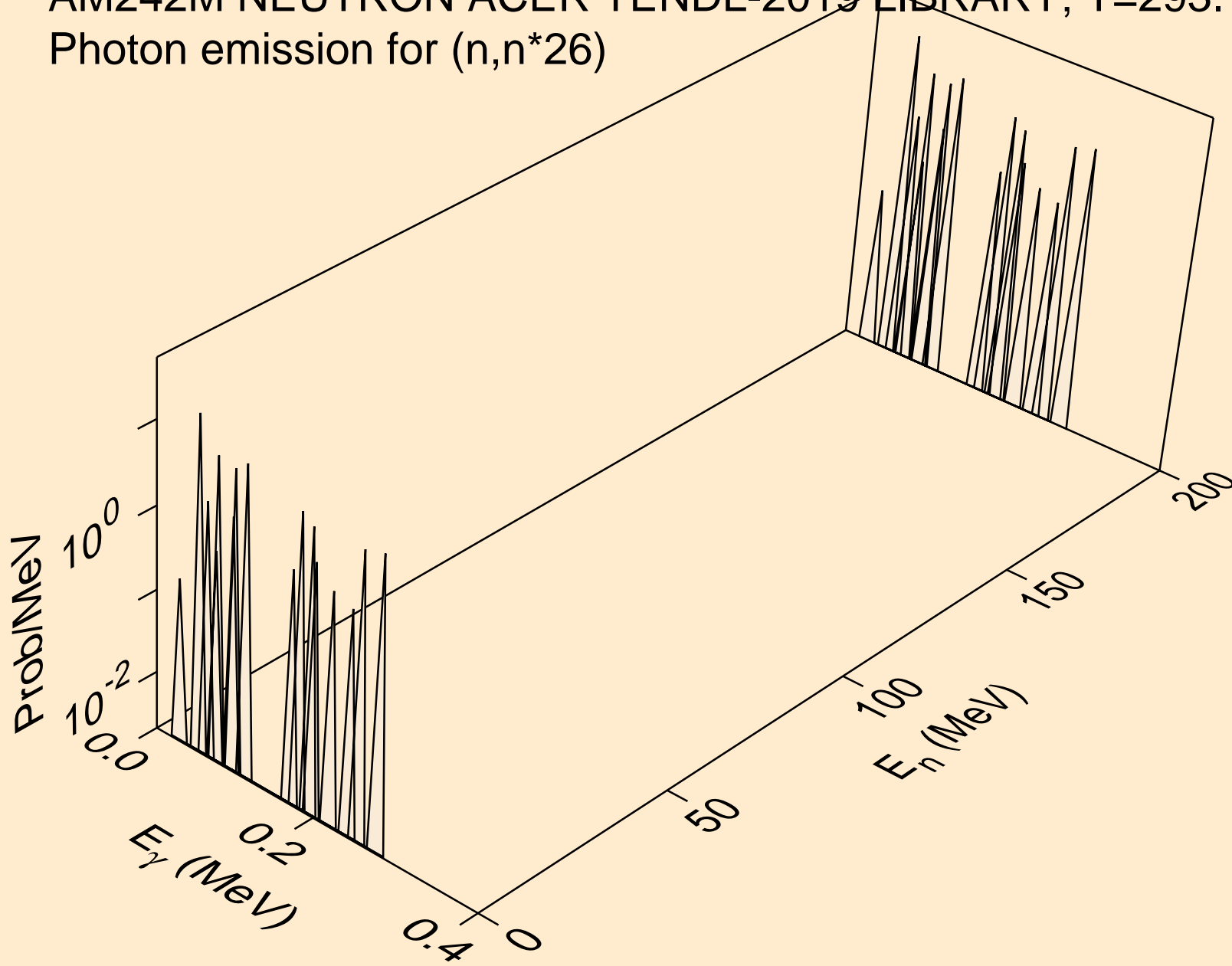

AM242M NEUTRON ACER TENDL-2019 LIBRARY; T=293.16K
Photon emission for (n,n*27)

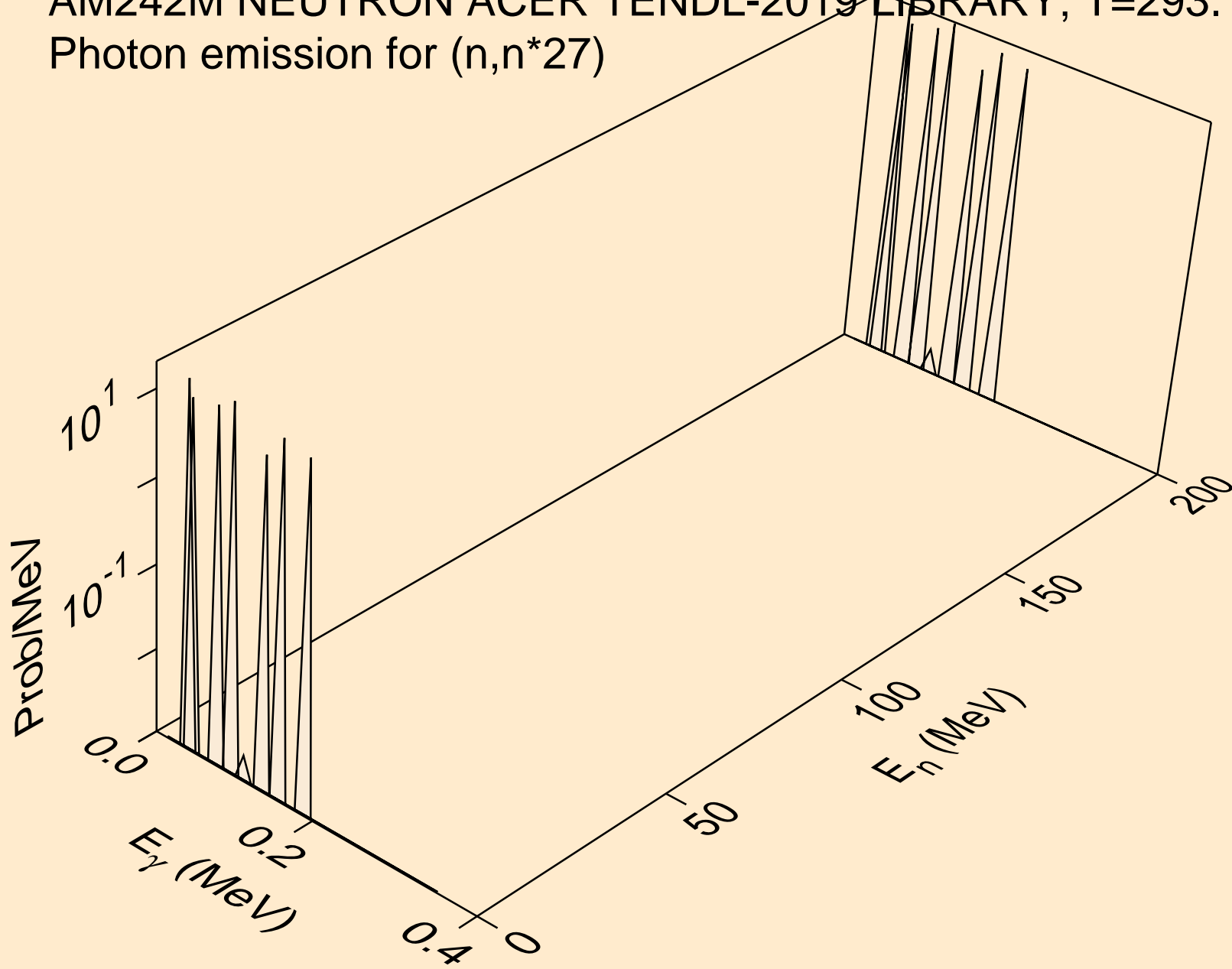

AM242M NEUTRON ACER TENDL-2019 LIBRARY; T=293.16K
Photon emission for (n,n*28)

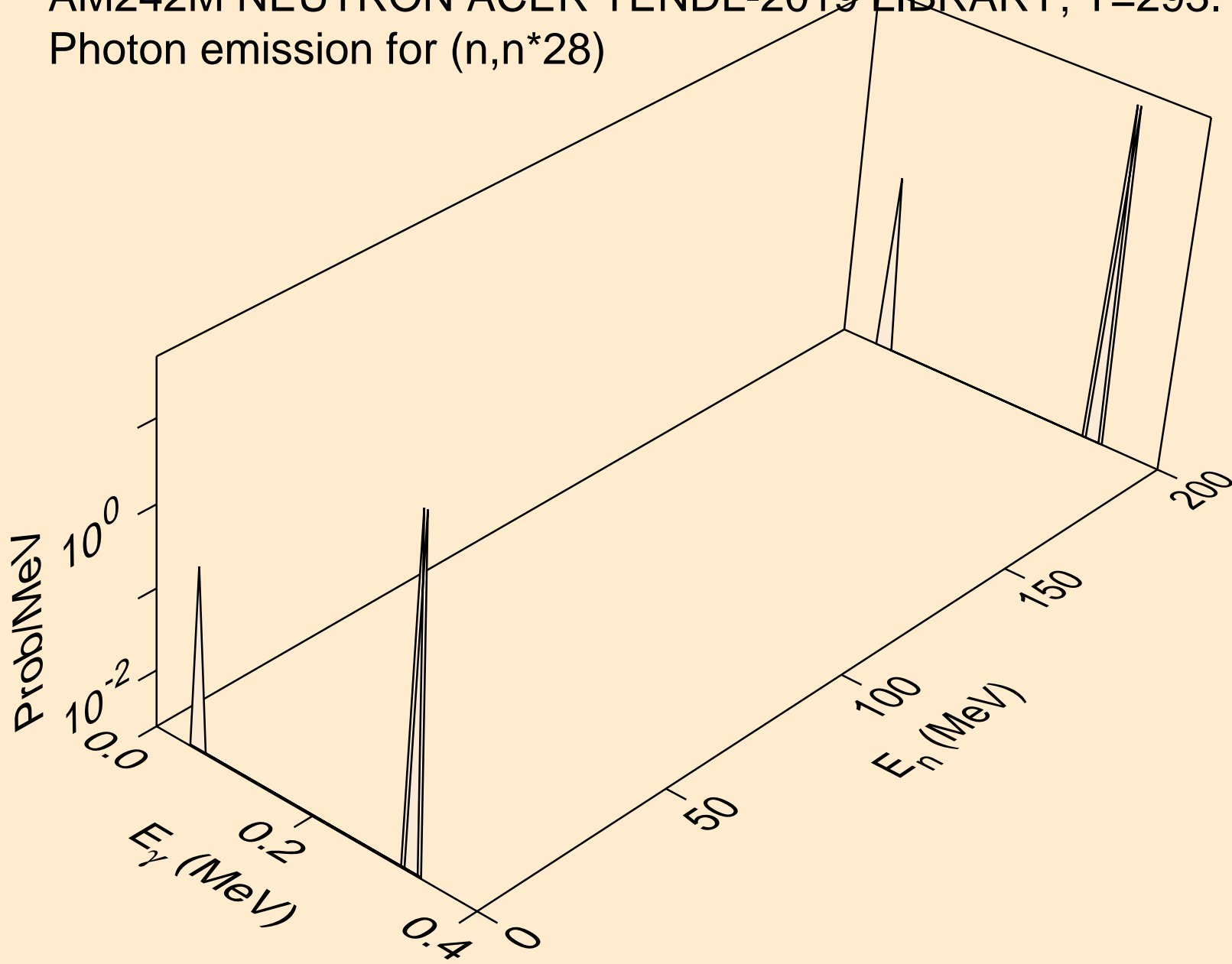

AM242M NEUTRON ACER TENDL-2019 LIBRARY; T=293.16K
Photon emission for (n,n*29)

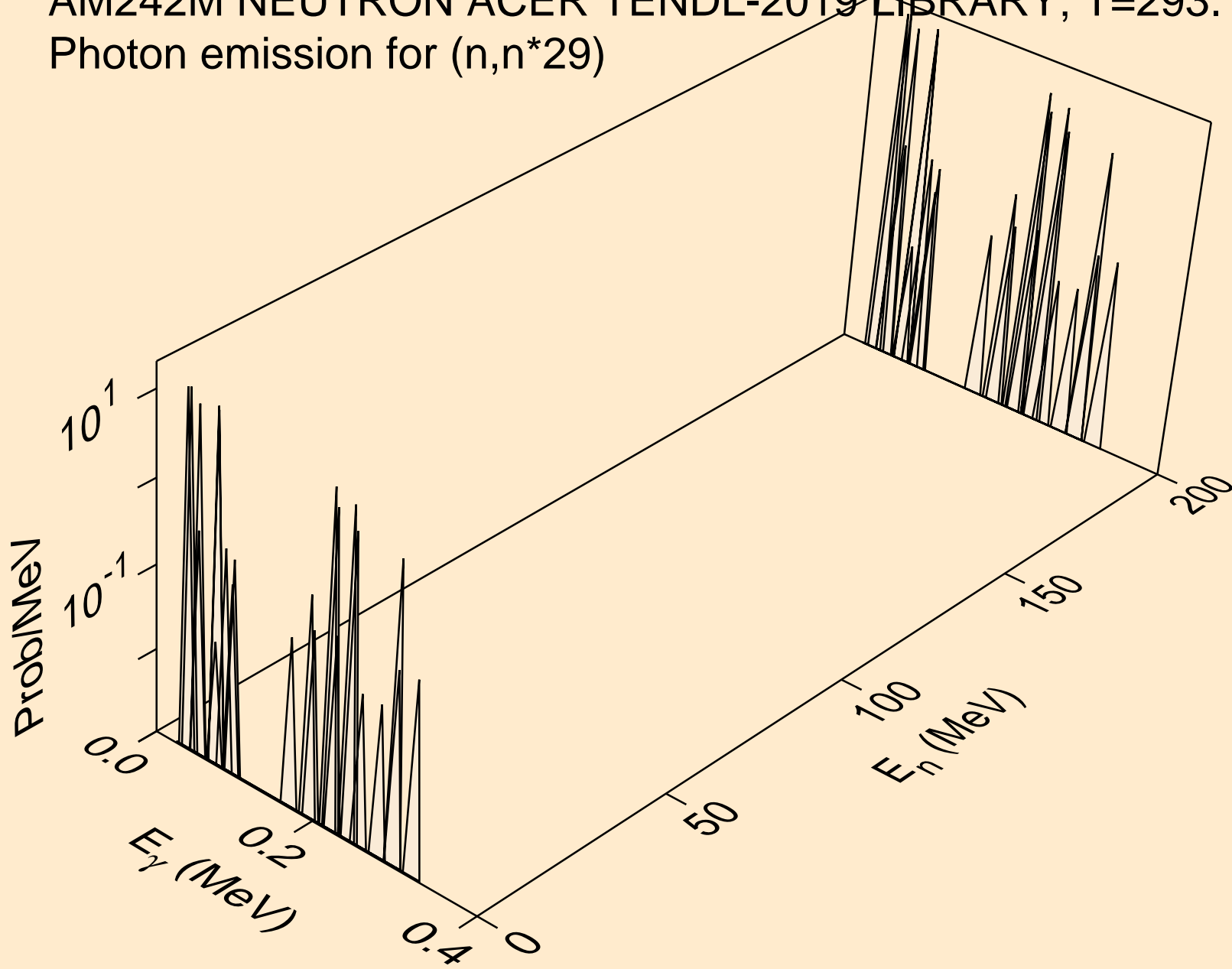

AM242M NEUTRON ACER TENDL-2019 LIBRARY; T=293.16K
Photon emission for (n,n*30)

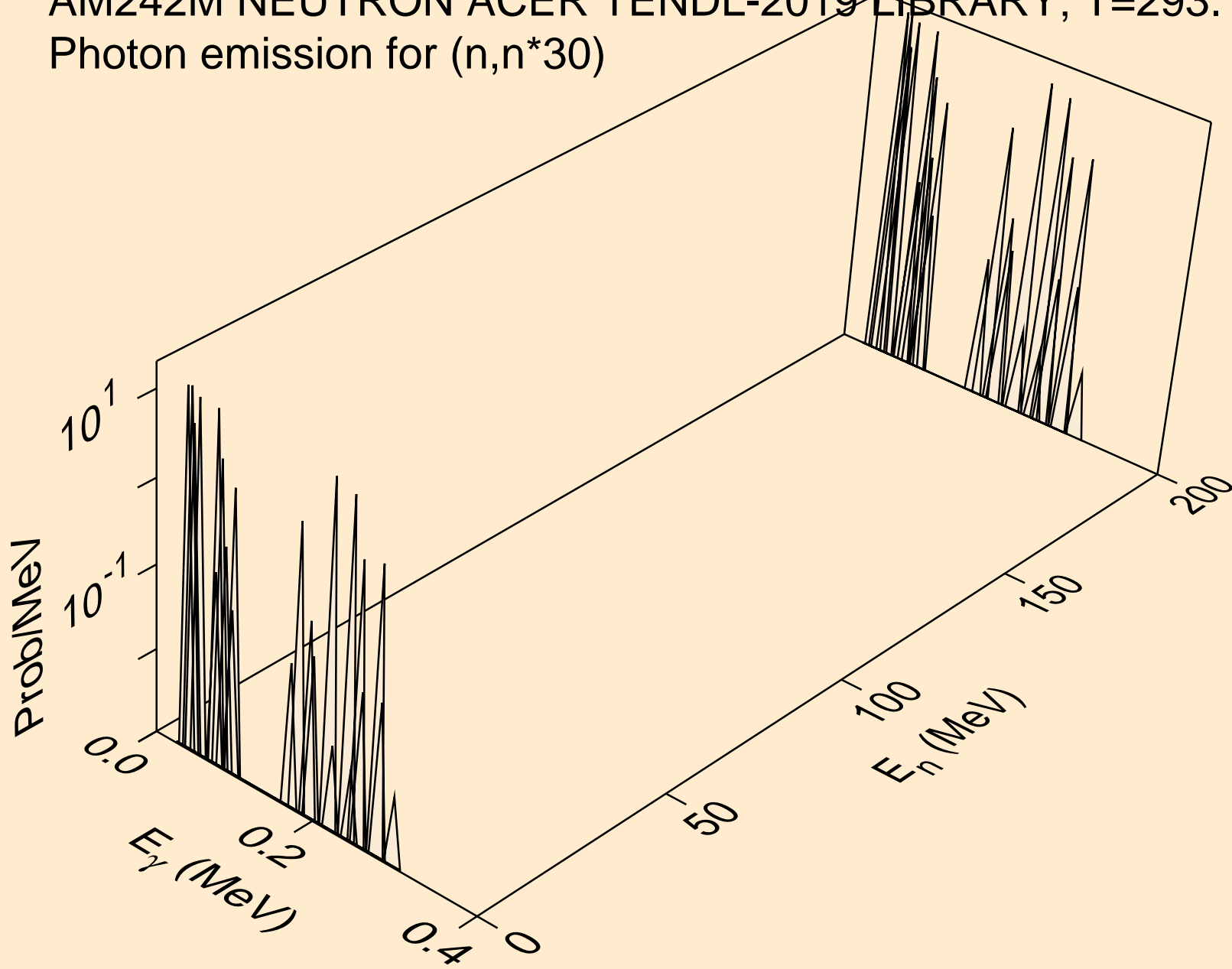

AM242M NEUTRON ACER TENDL-2019 LIBRARY; T=293.16K
Photon emission for (n,n*c)

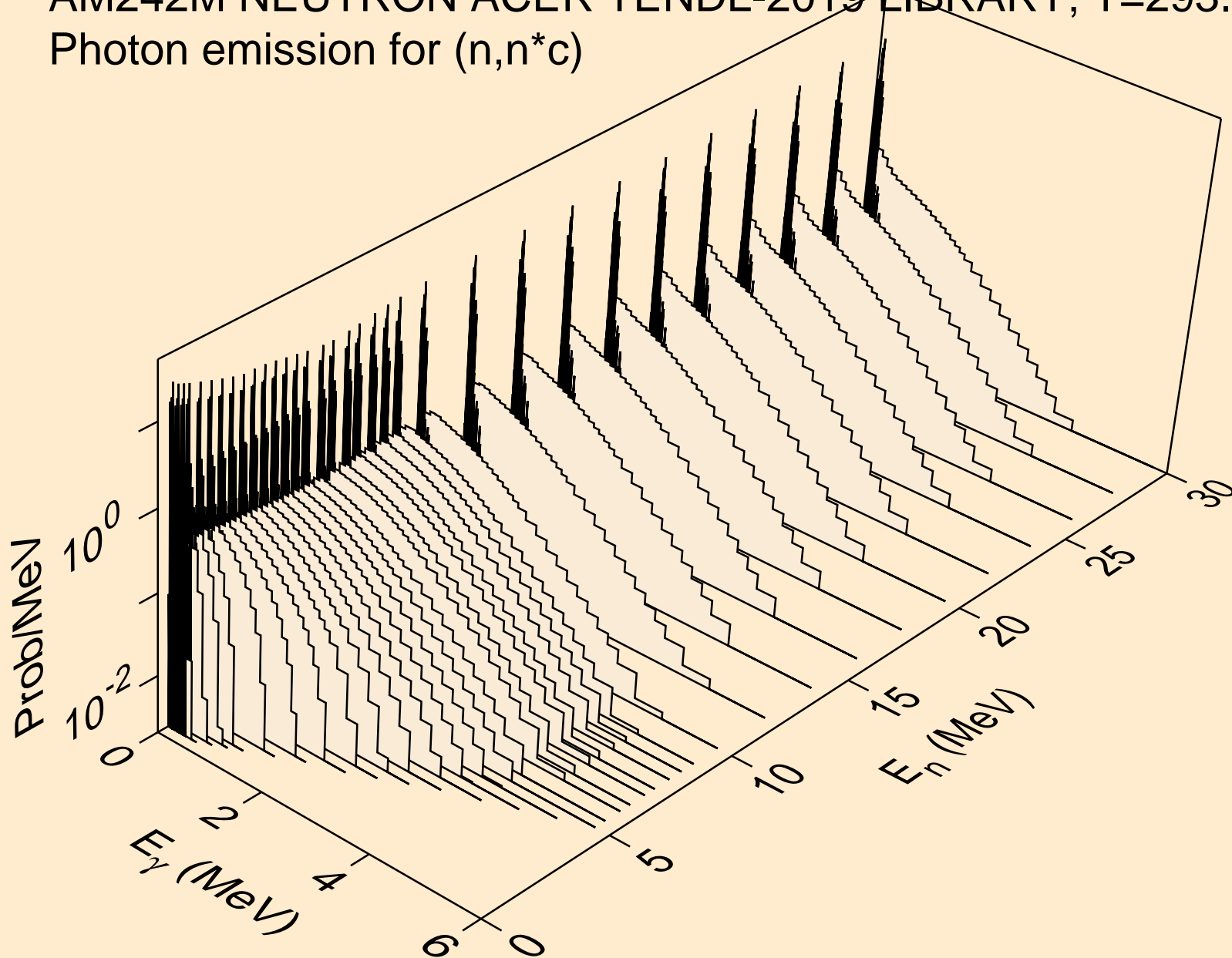

AM242M NEUTRON ACER TENDL-2019 LIBRARY; T=293.16K
Photon emission for (n,gma)

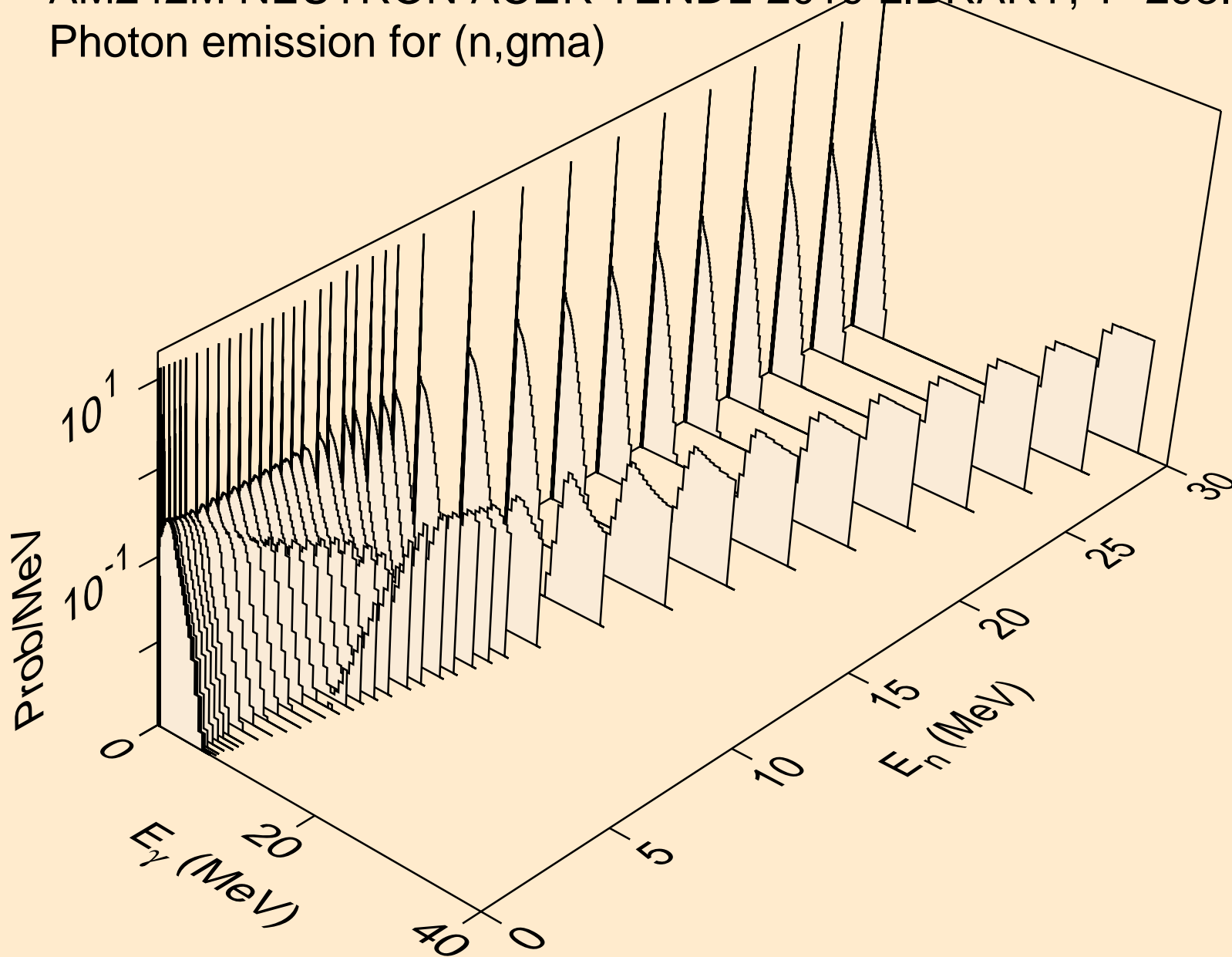

AM242M NEUTRON ACER TENDL-2019 LIBRARY; T=293.16K
Photon emission for (n,p)

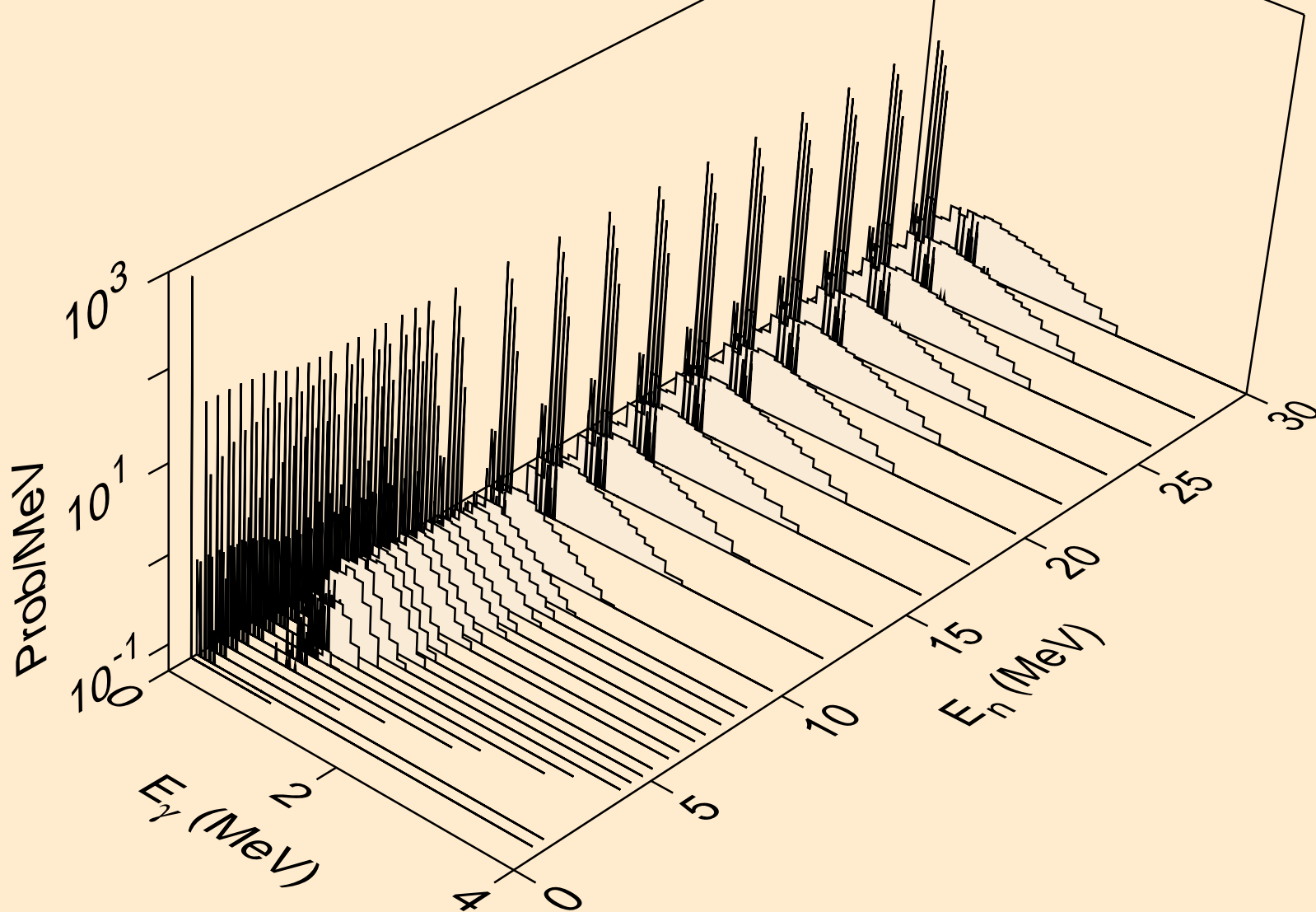

AM242M NEUTRON ACER TENDL-2019 LIBRARY; T=293.16K
Photon emission for (n,d)

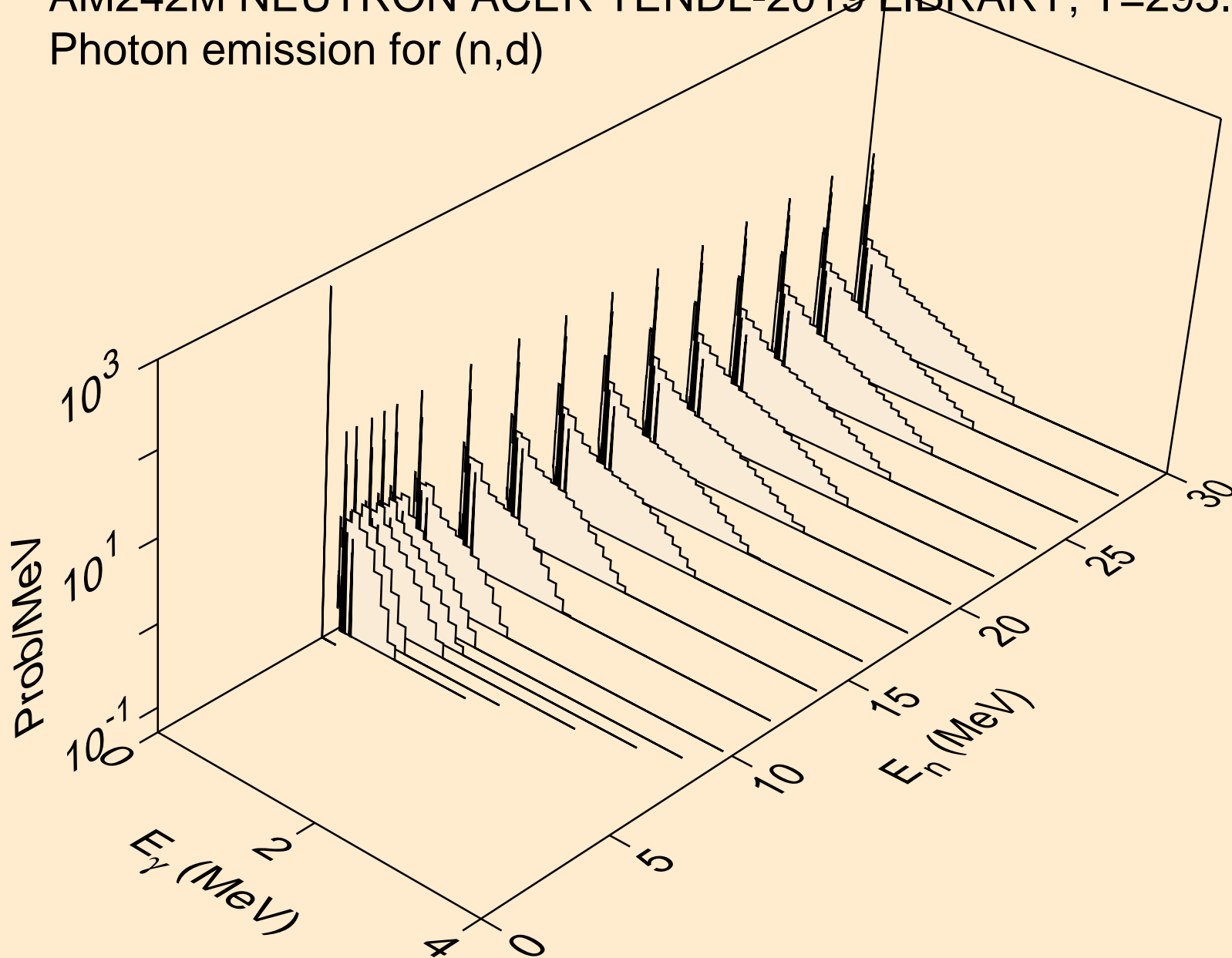

AM242M NEUTRON ACER TENDL-2019 LIBRARY; T=293.16K
Photon emission for (n,t)

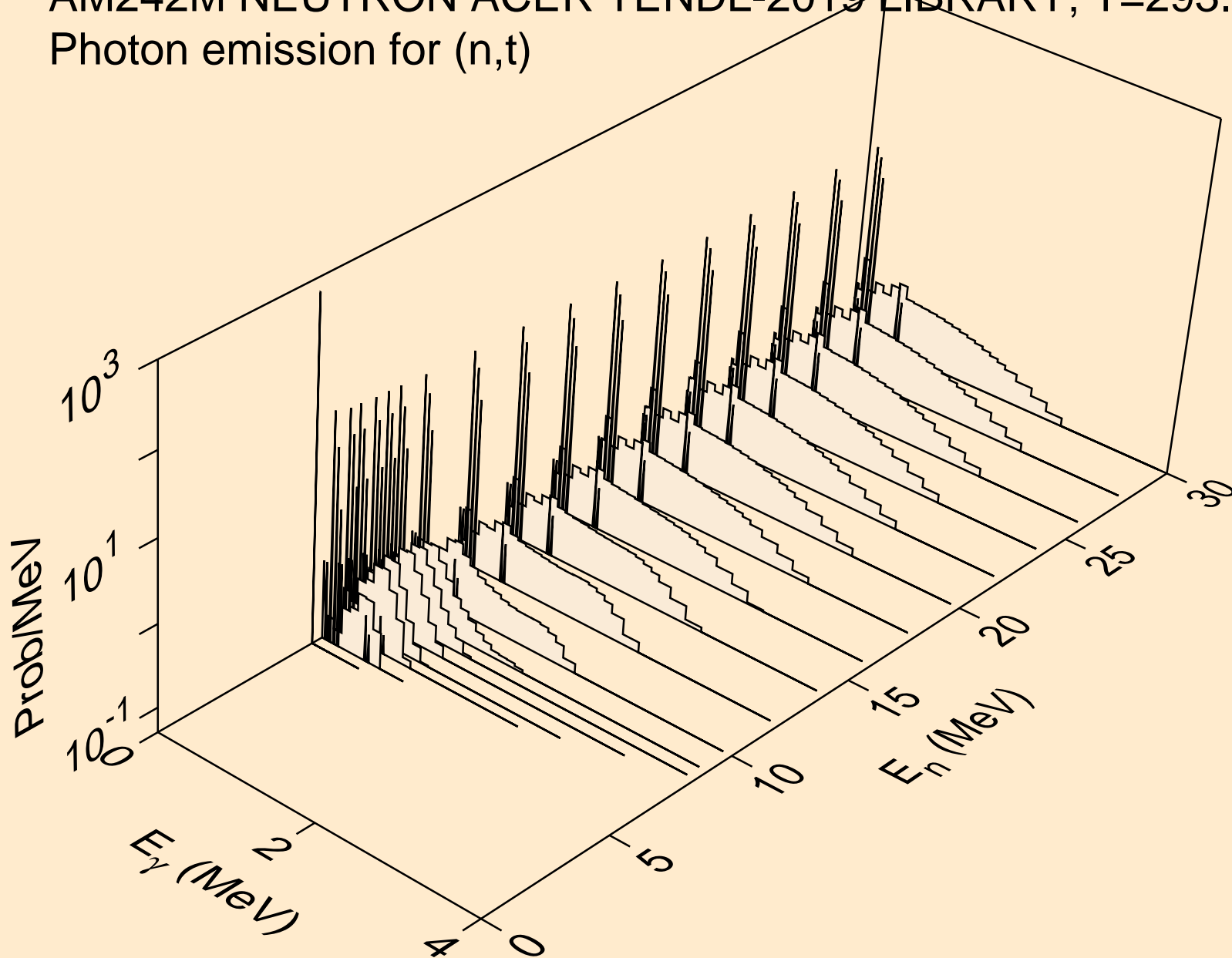

AM242M NEUTRON ACER TENDL-2019 LIBRARY; T=293.16K
Photon emission for (n,he3)

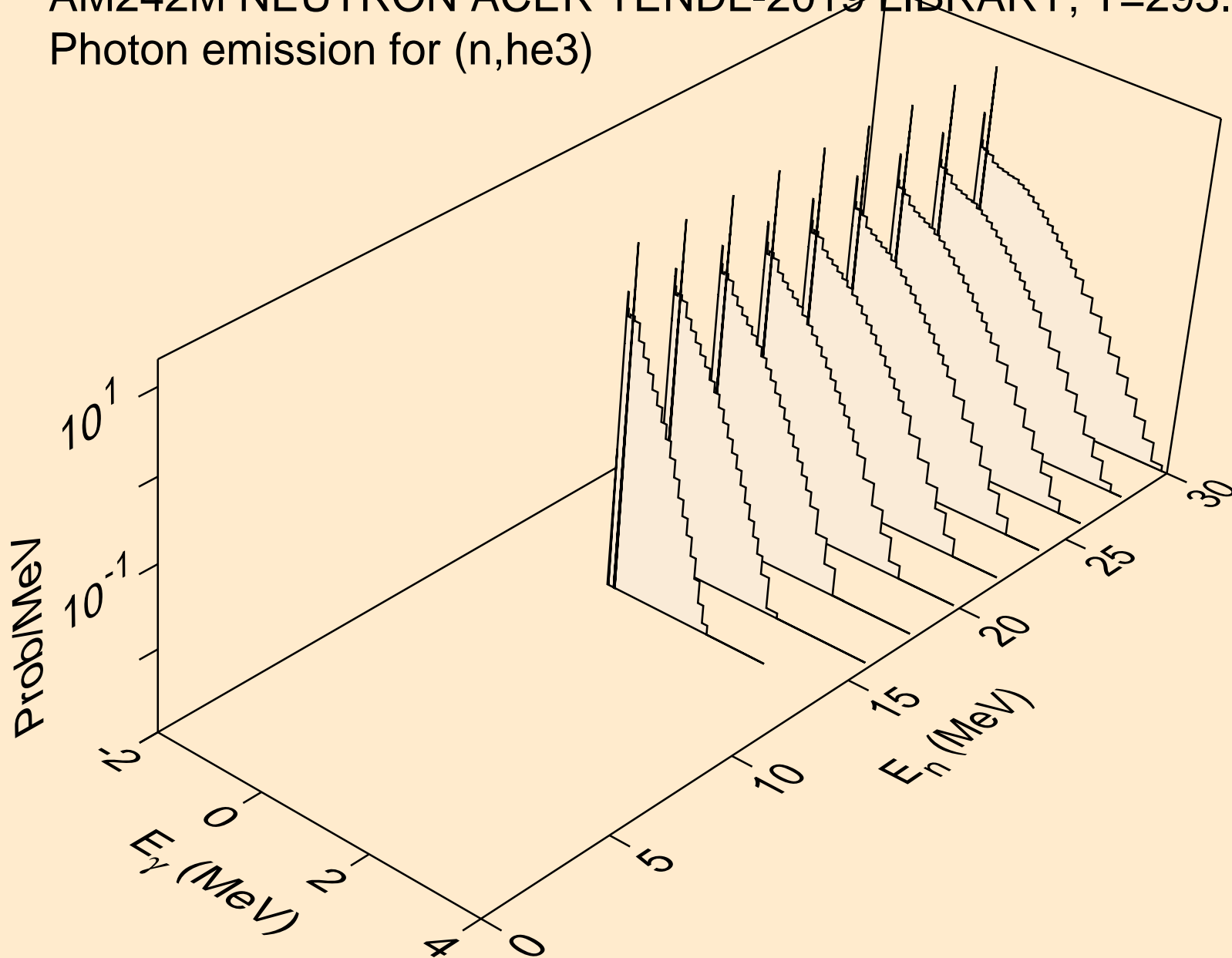

AM242M NEUTRON ACER TENDL-2019 LIBRARY; T=293.16K
Photon emission for (n,a)

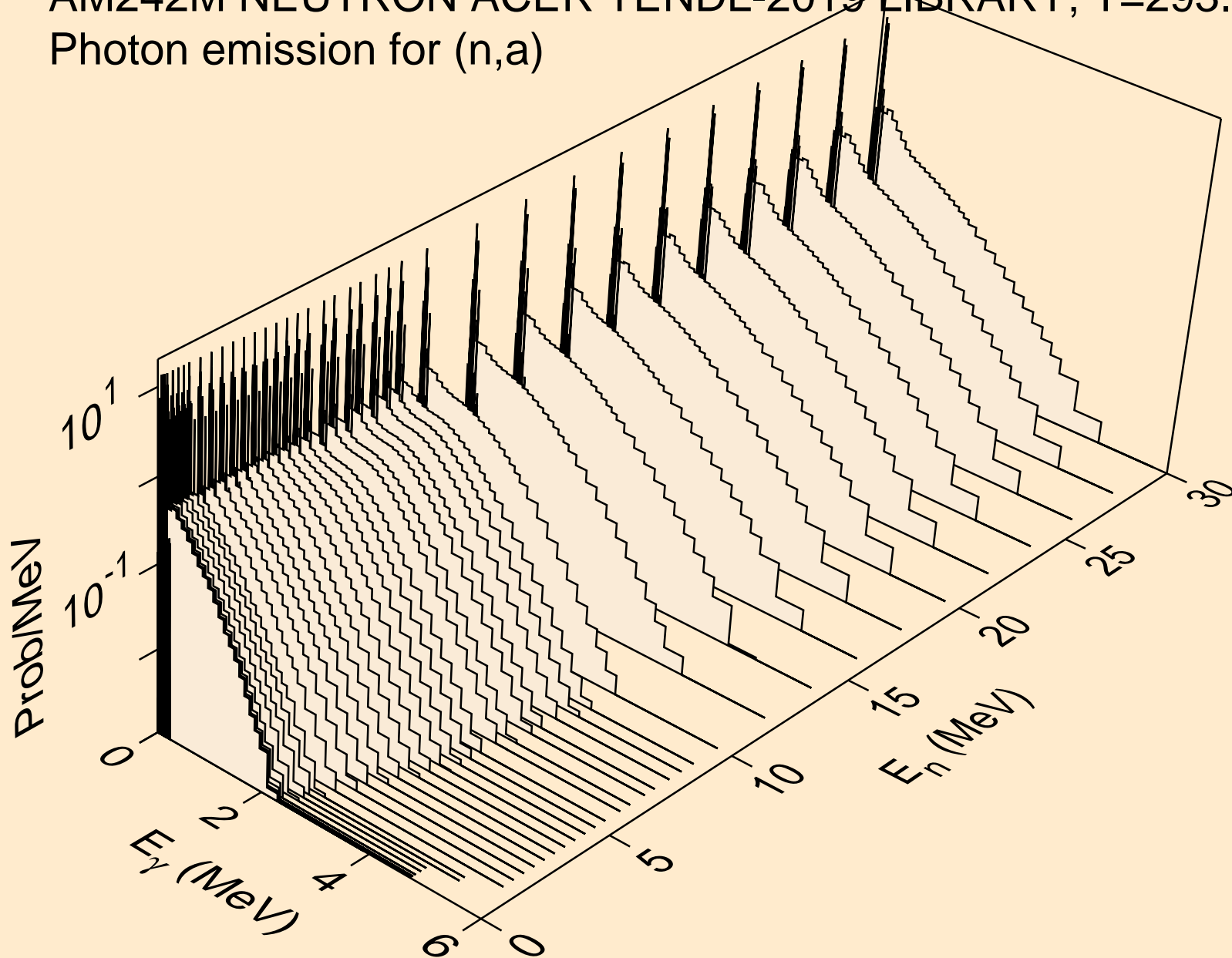

AM242M NEUTRON ACER TENDL-2019 LIBRARY; T=293.16K
Photon emission for (n,2p)

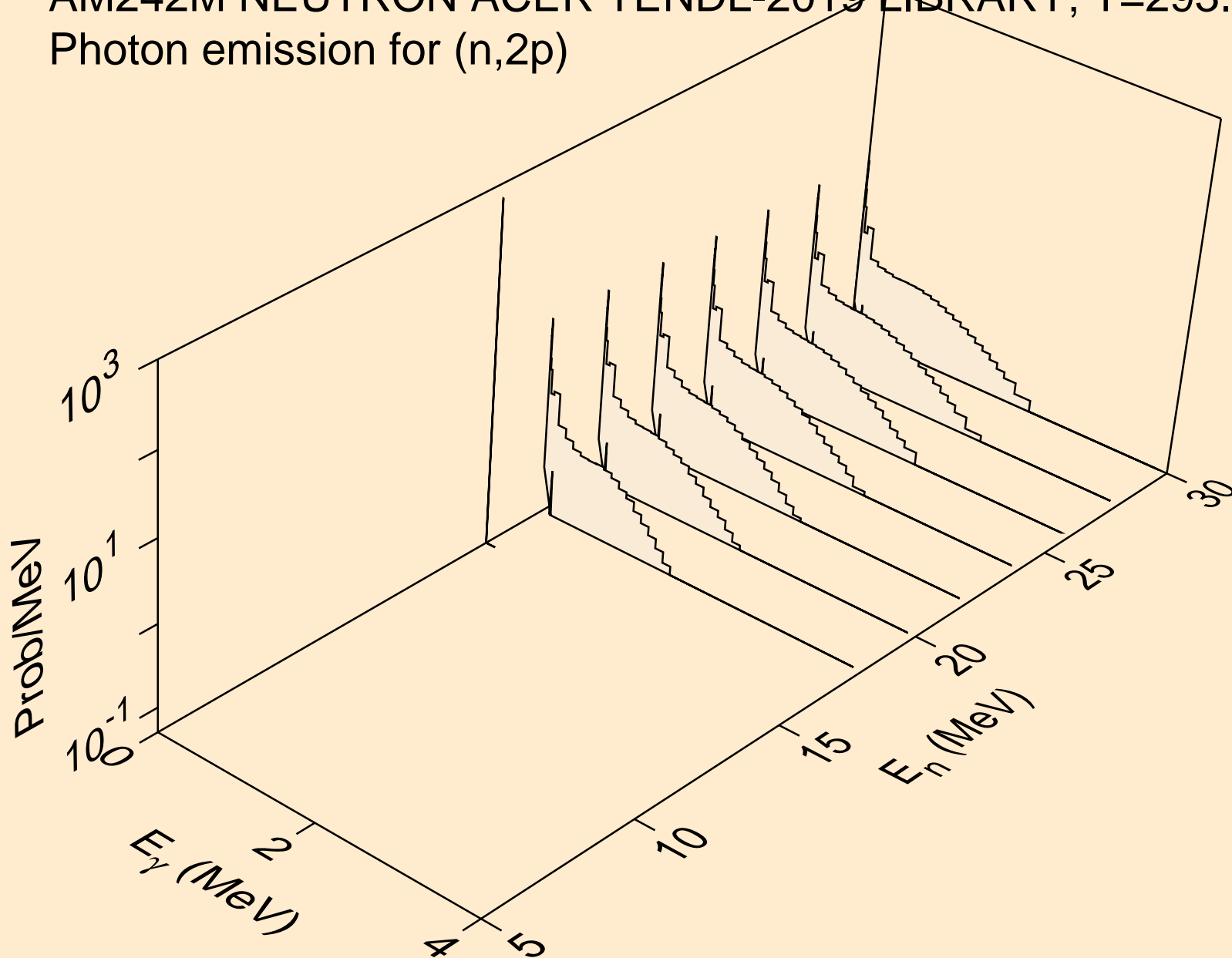

AM242M NEUTRON ACER TENDL-2019 LIBRARY; T=293.16K
thermal capture photon spectrum

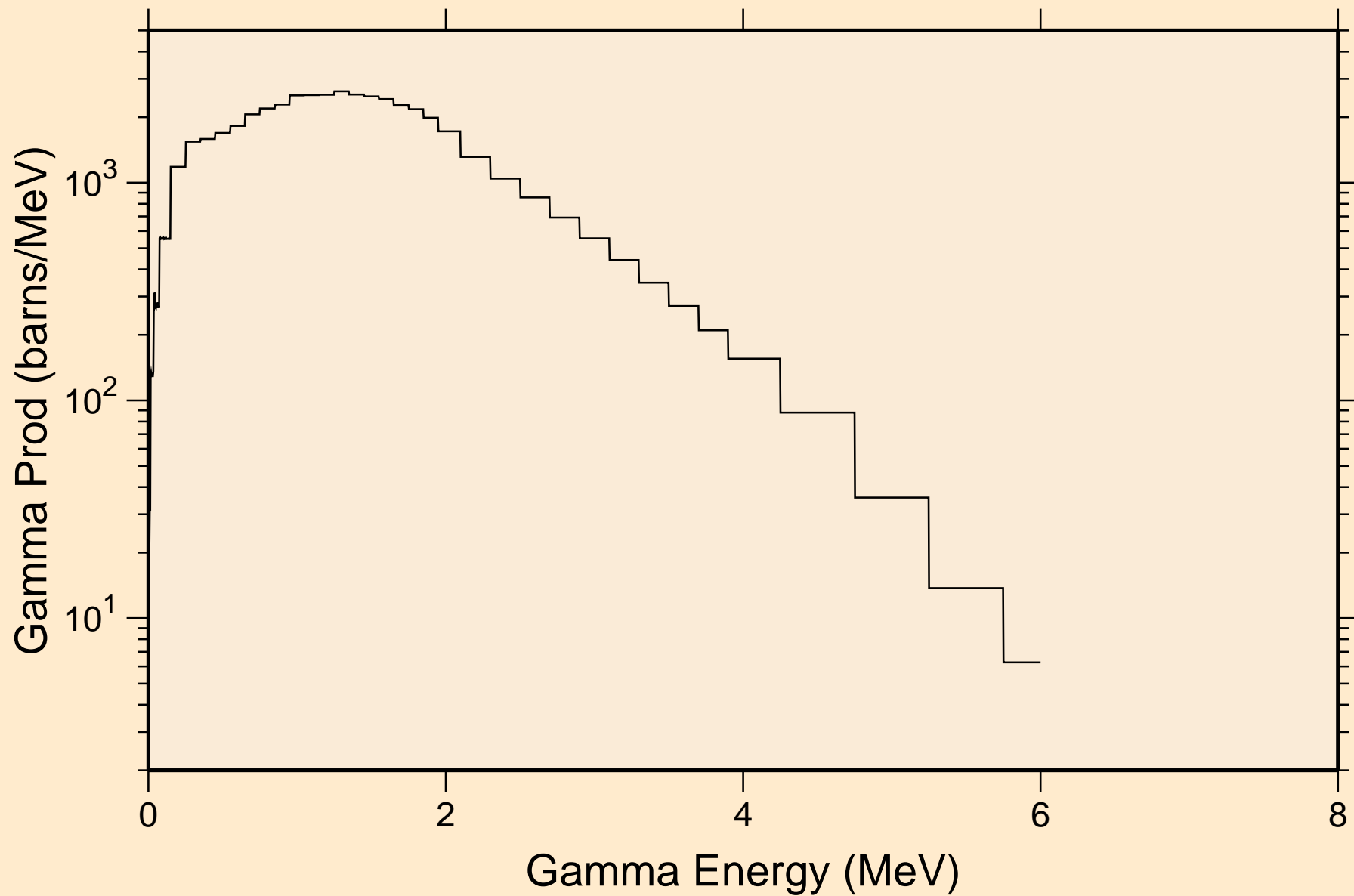

AM242M NEUTRON ACER TENDL-2019 LIBRARY; T=293.16K
14 MeV photon spectrum

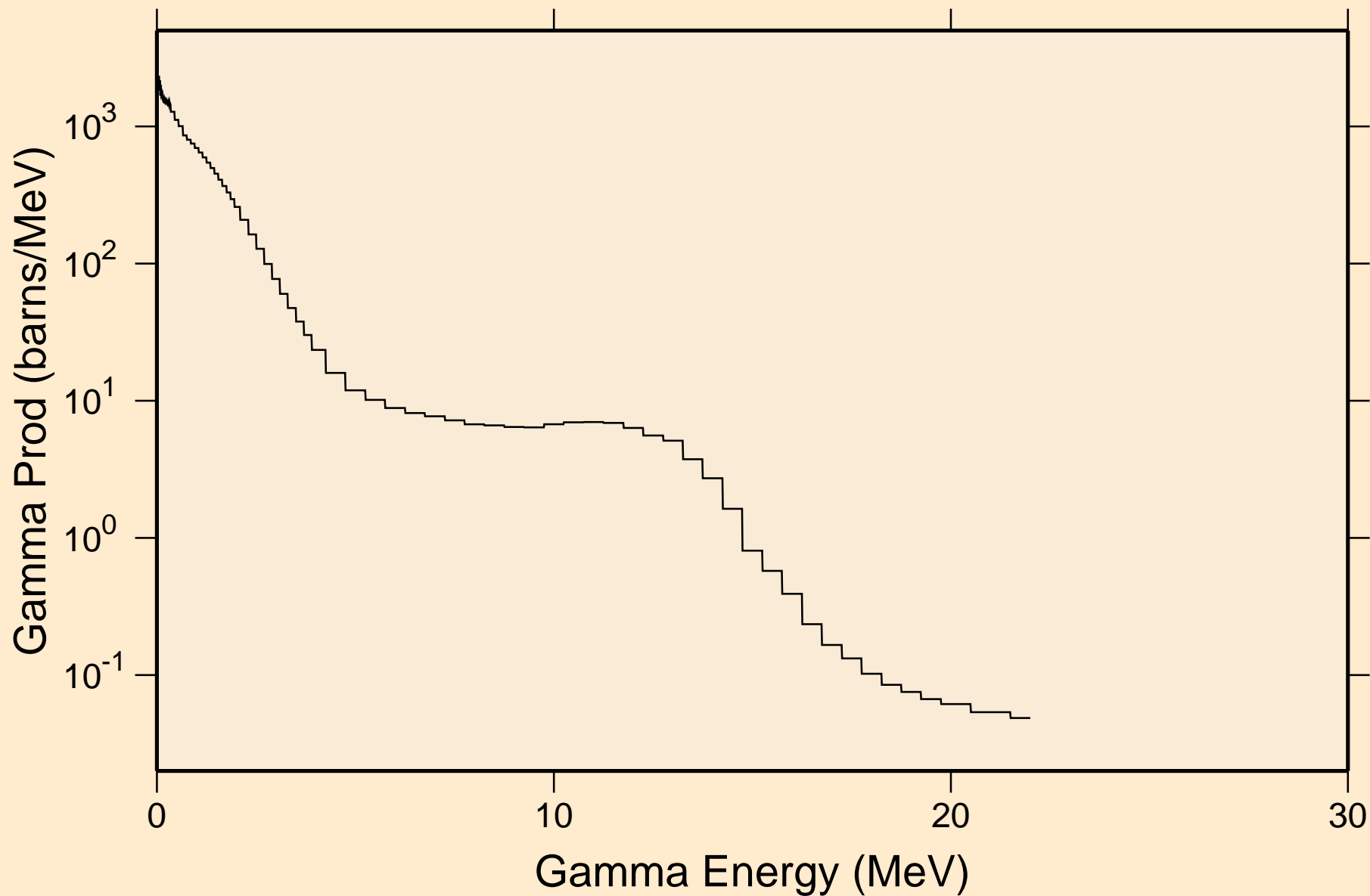

AM242M NEUTRON ACER TENDL-2019 LIBRARY; T=293.16K
Particle heating contributions

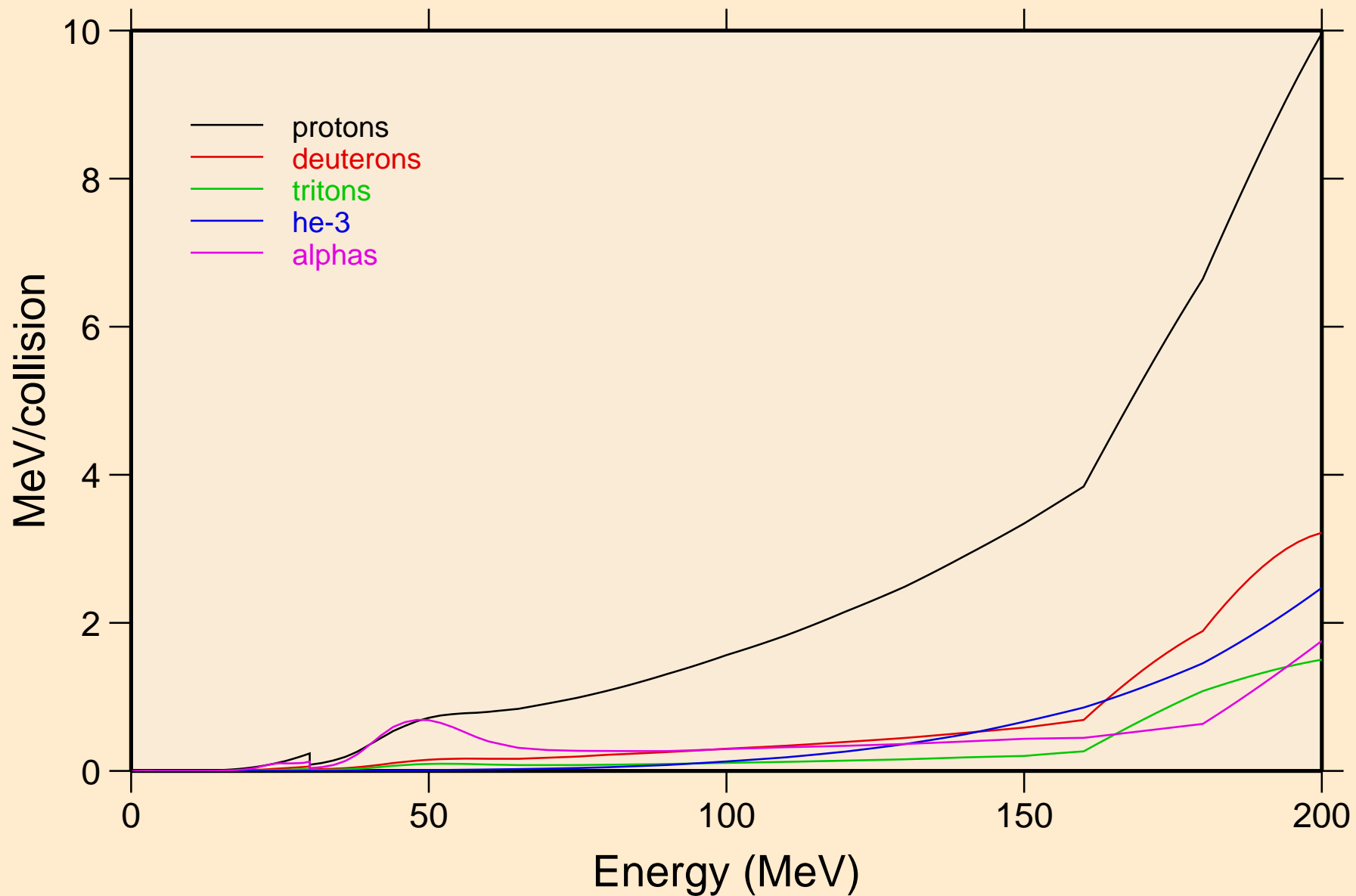

AM242M NEUTRON ACER TENDL-2019 LIBRARY; T=293.16K
Recoil Heating

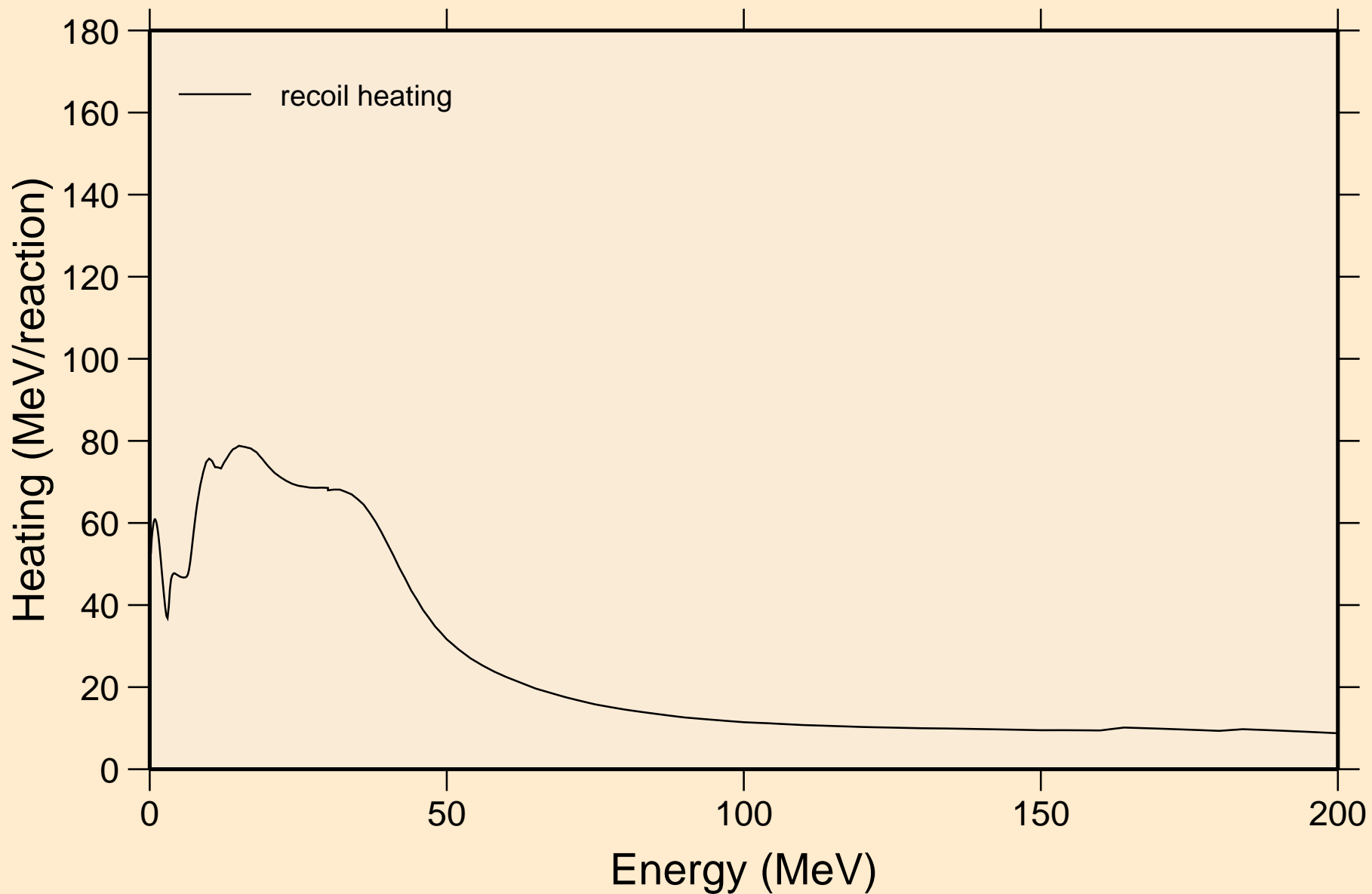

AM242M NEUTRON ACER TENDL-2019 LIBRARY; T=293.16K
Particle production cross sections

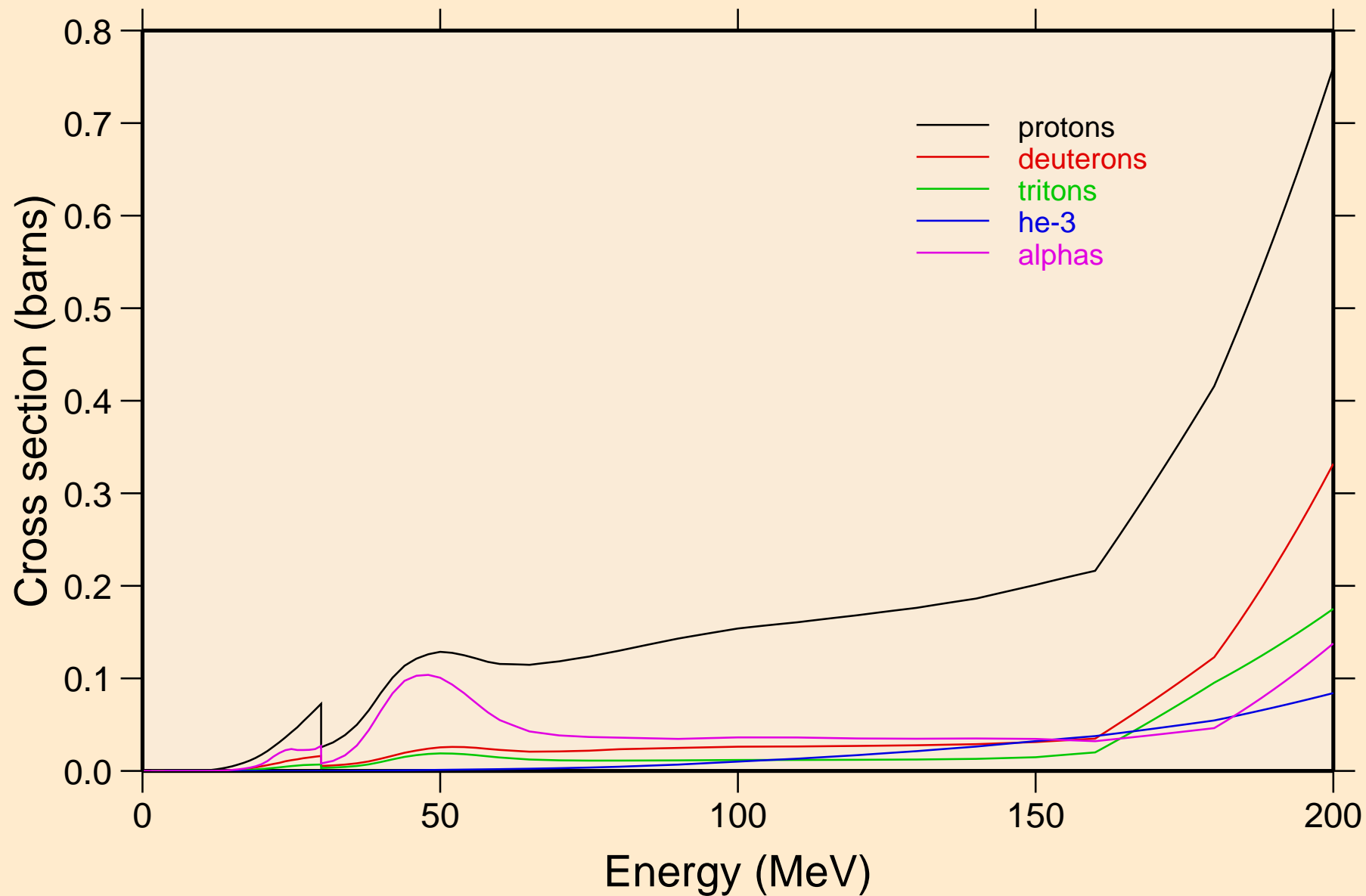

AM242M NEUTRON ACER TENDL-2019 LIBRARY; T=293.16K
protons from (n,x)

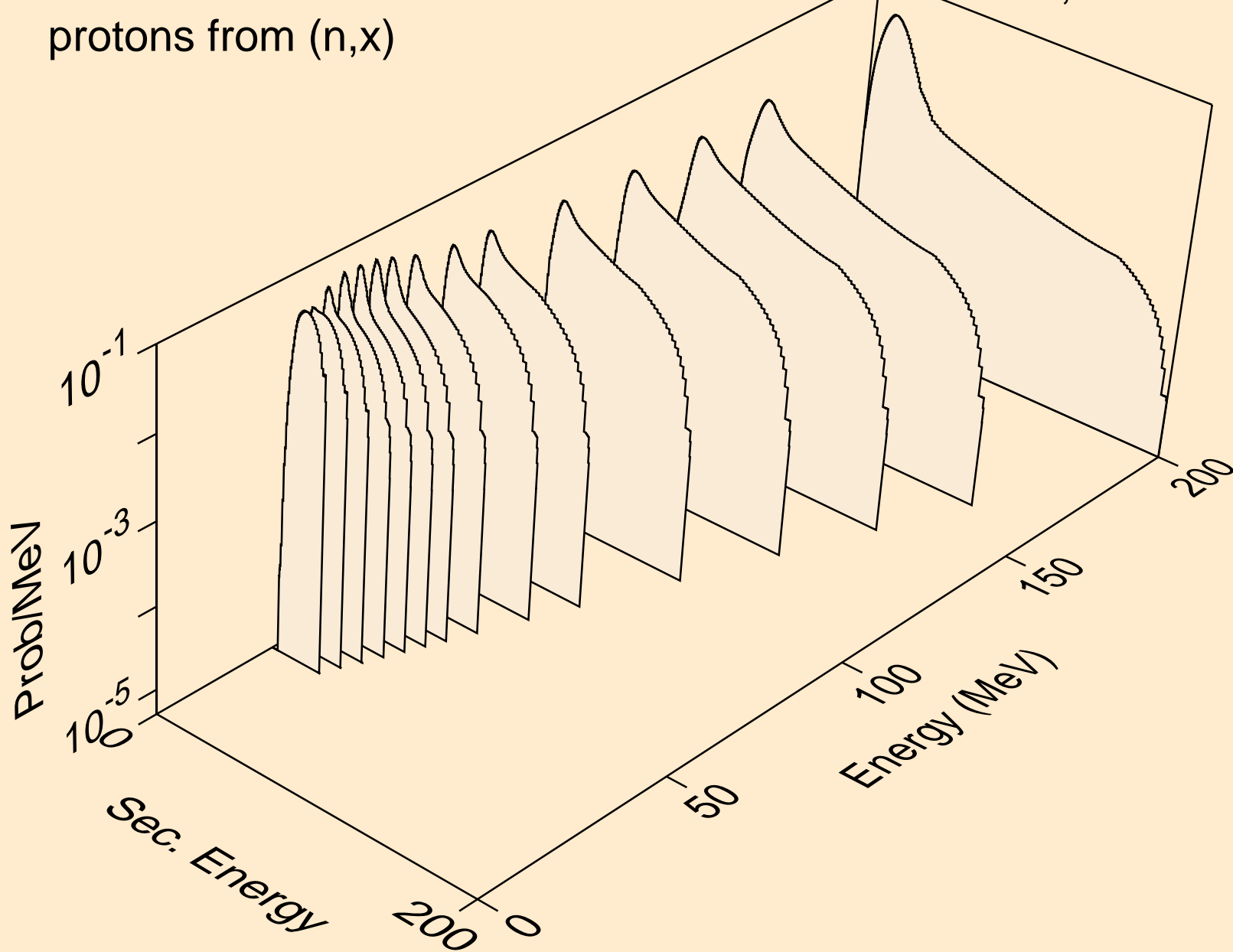

AM242M NEUTRON ACER TENDL-2019 LIBRARY; T=293.16K
protons from (n,n*)p

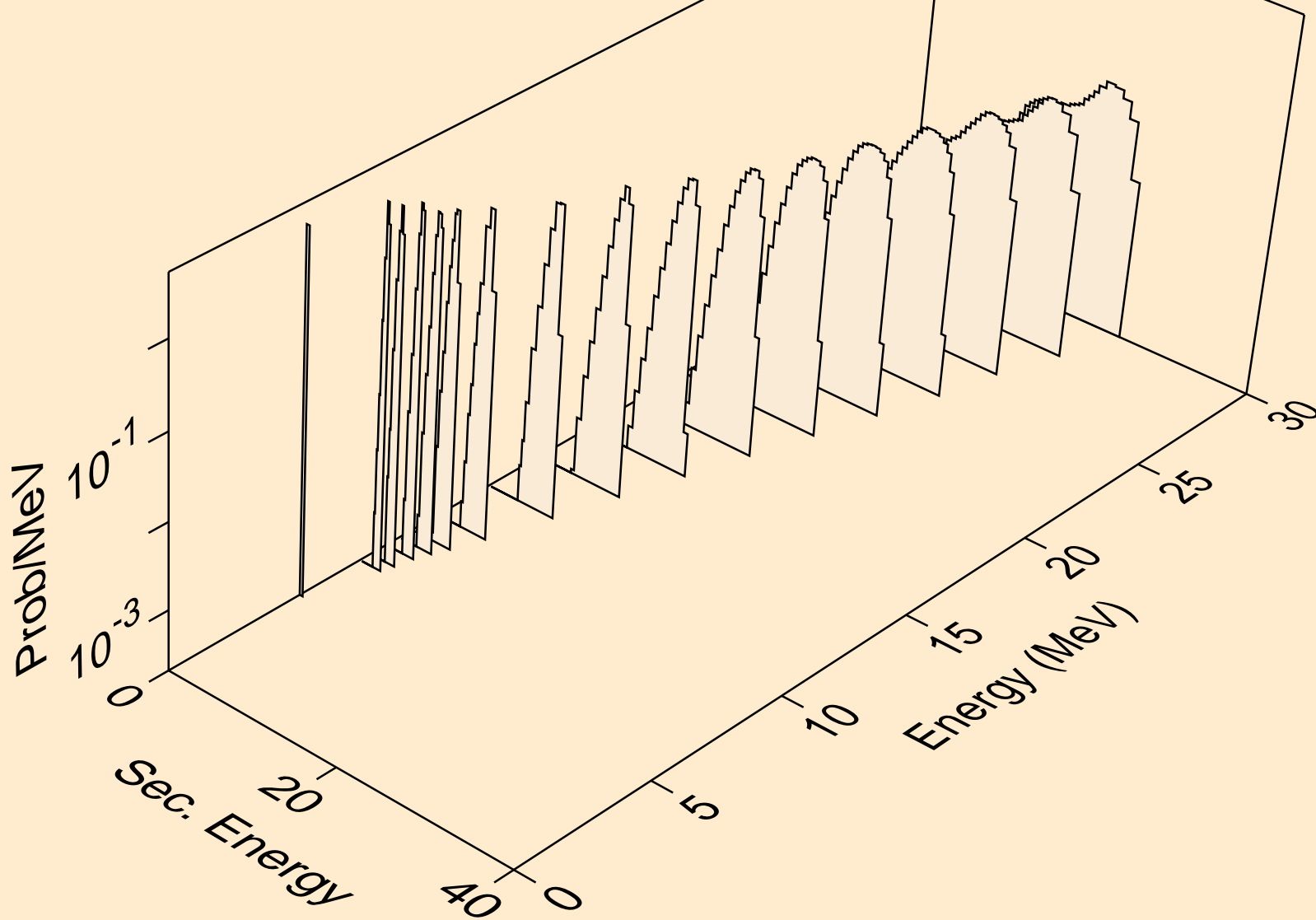

AM242M NEUTRON ACER TENDL-2019 LIBRARY; T=293.16K
protons from (n,2np)

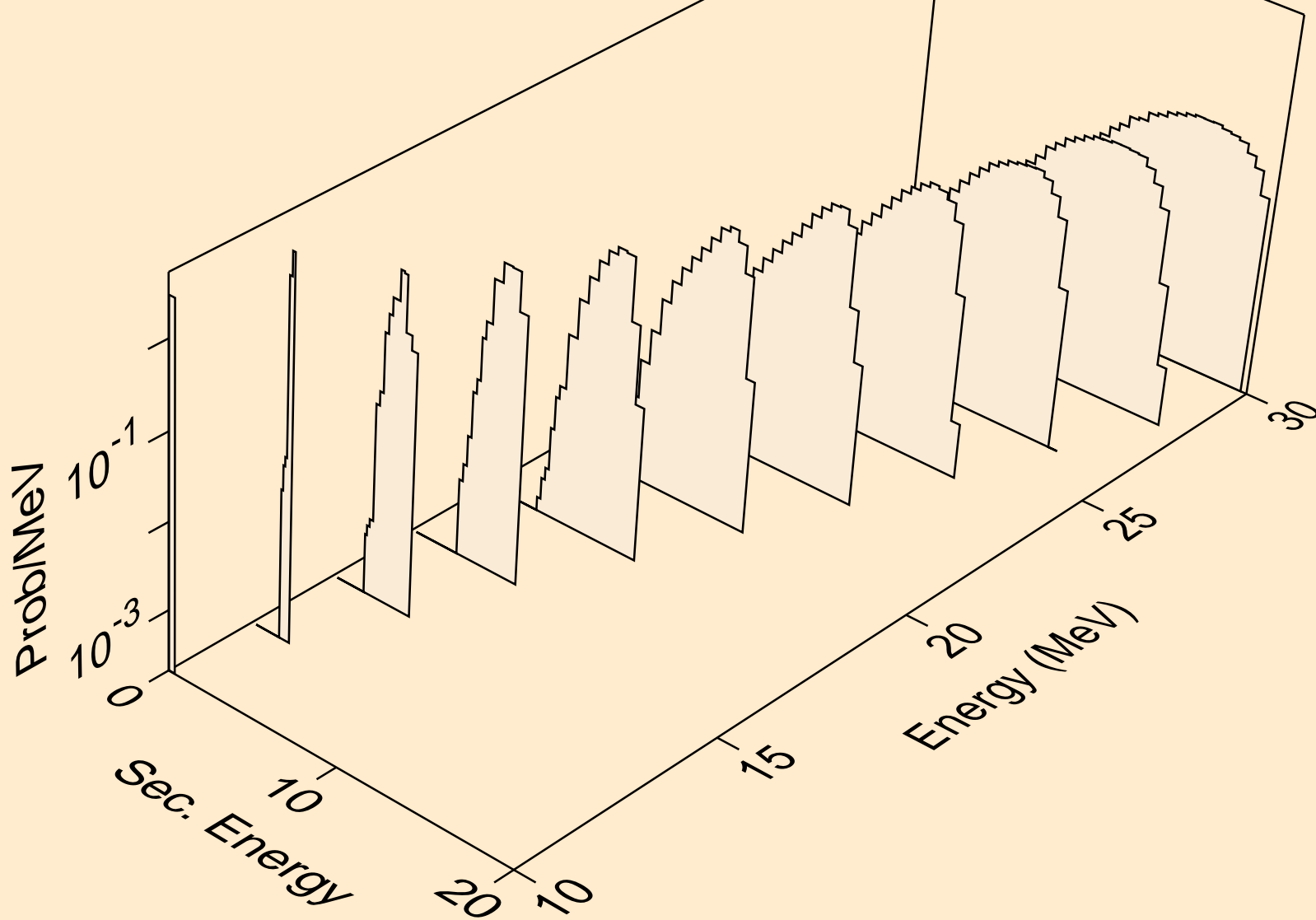

AM242M NEUTRON ACER TENDL-2019 LIBRARY; T=293.16K
protons from (n,3np)

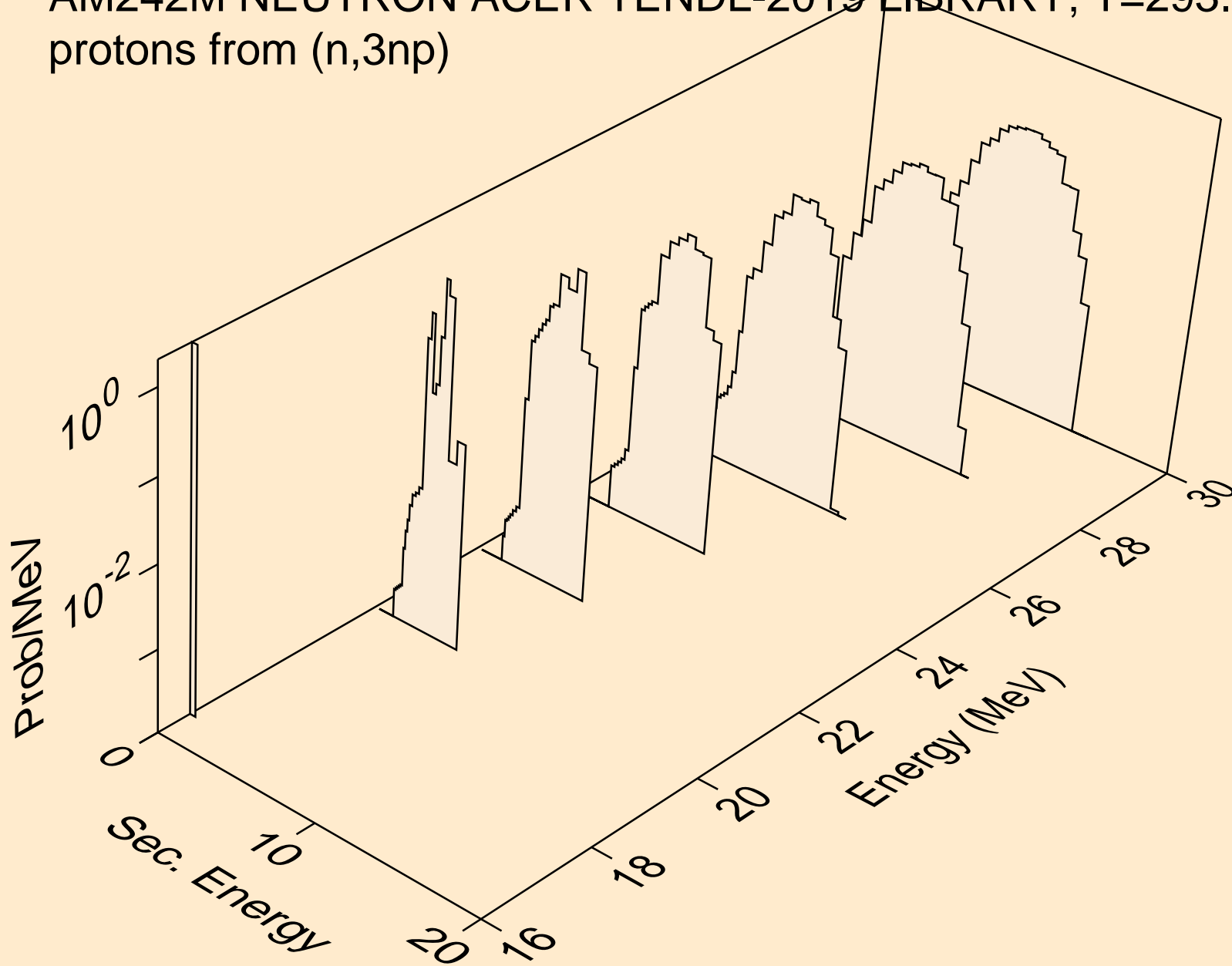

AM242M NEUTRON ACER TENDL-2019 LIBRARY; T=293.16K
protons from (n,2np)

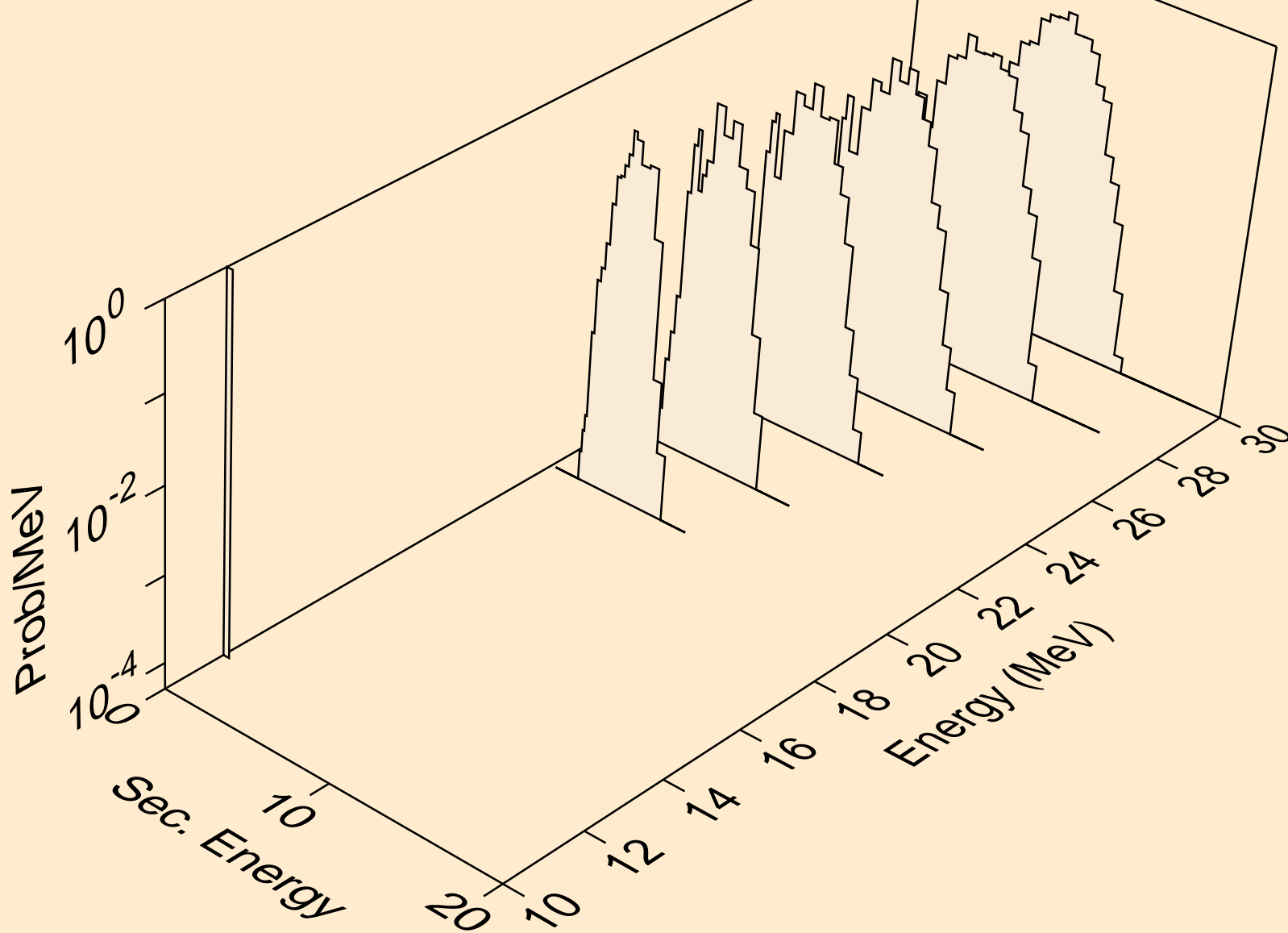

AM242M NEUTRON ACER TENDL-2019 LIBRARY; T=293.16K
protons from (n,npa)

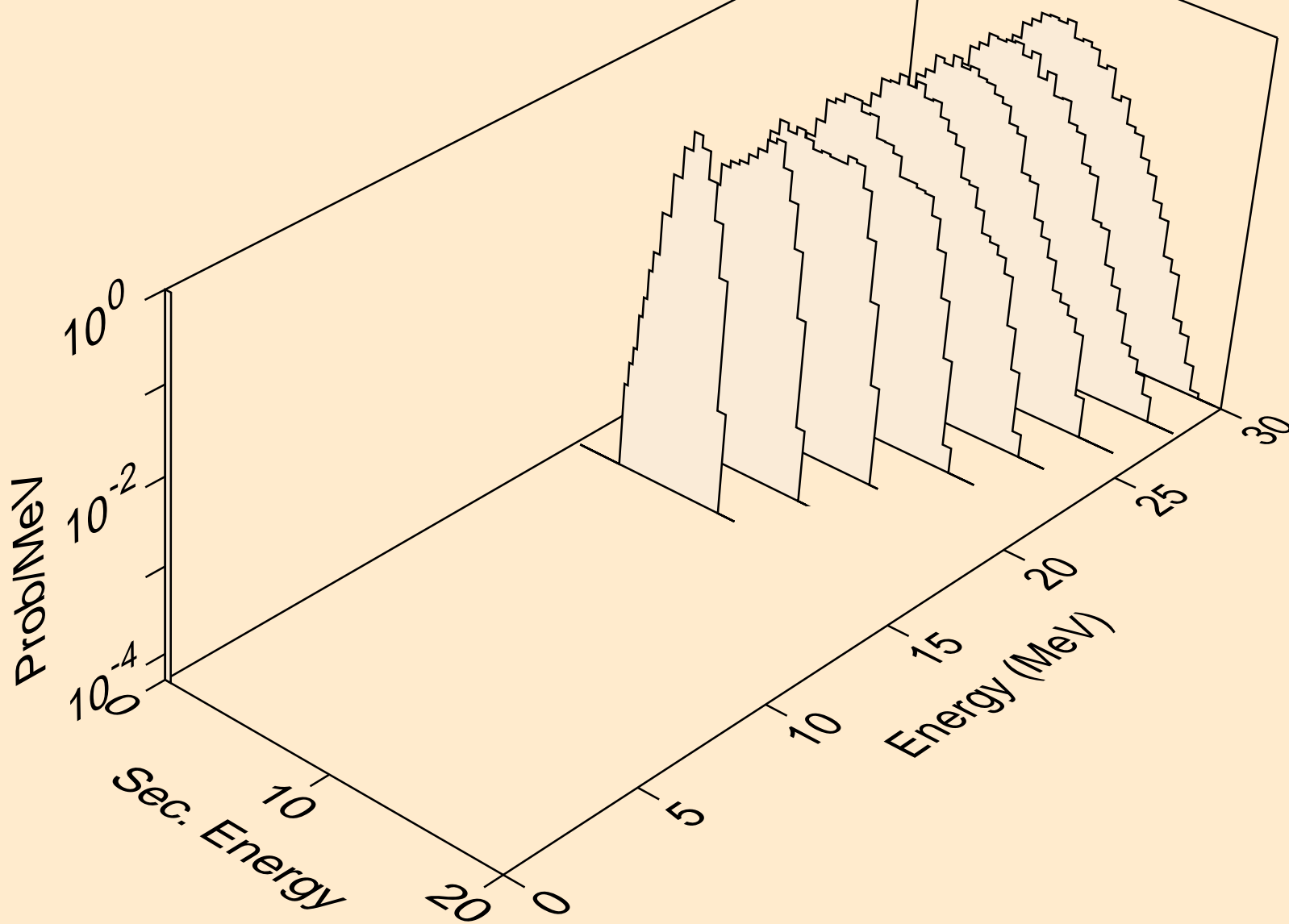

AM242M NEUTRON ACER TENDL-2019 LIBRARY; T=293.16K
protons from (n,p)

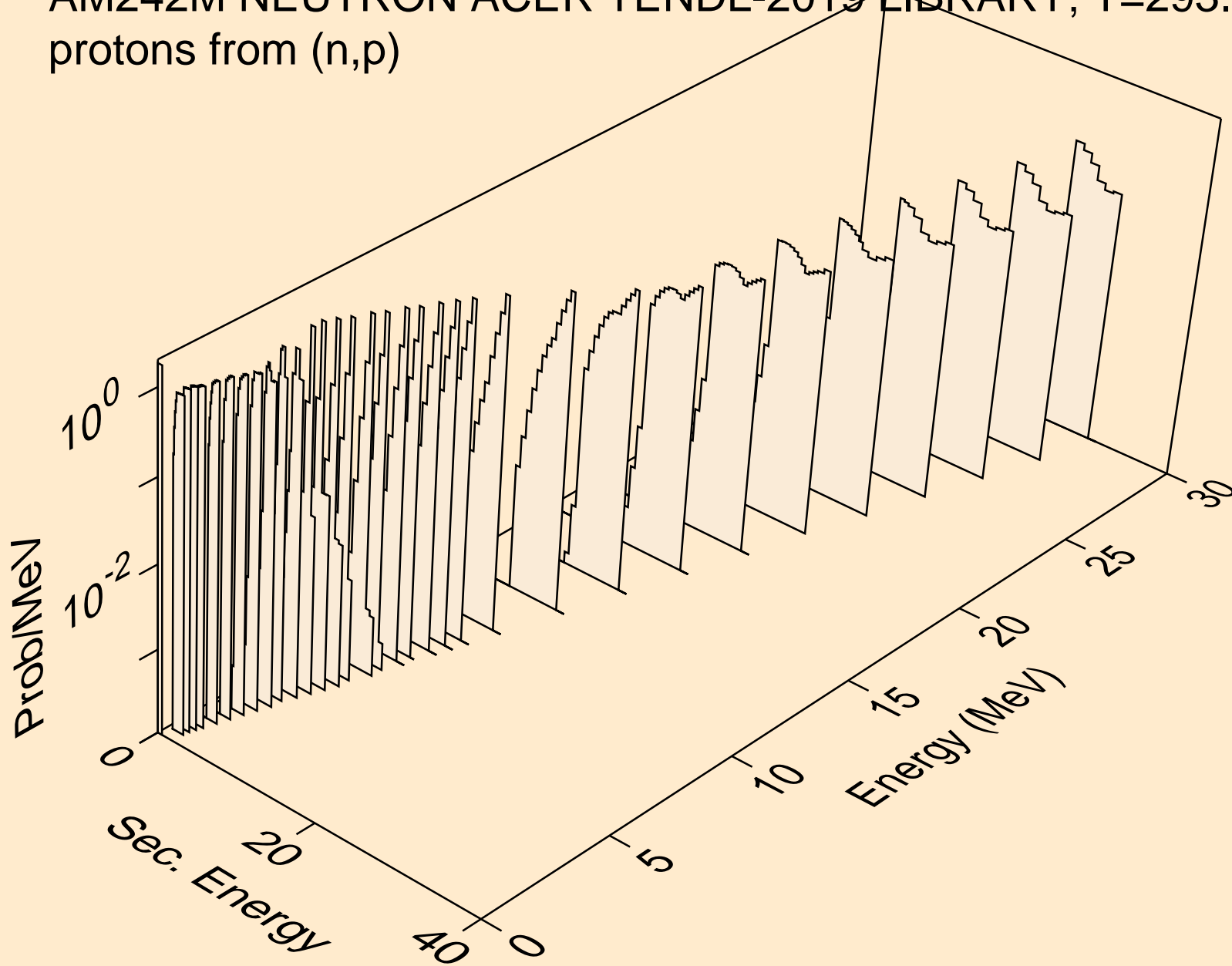

AM242M NEUTRON ACER TENDL-2019 LIBRARY; T=293.16K
protons from (n,2p)

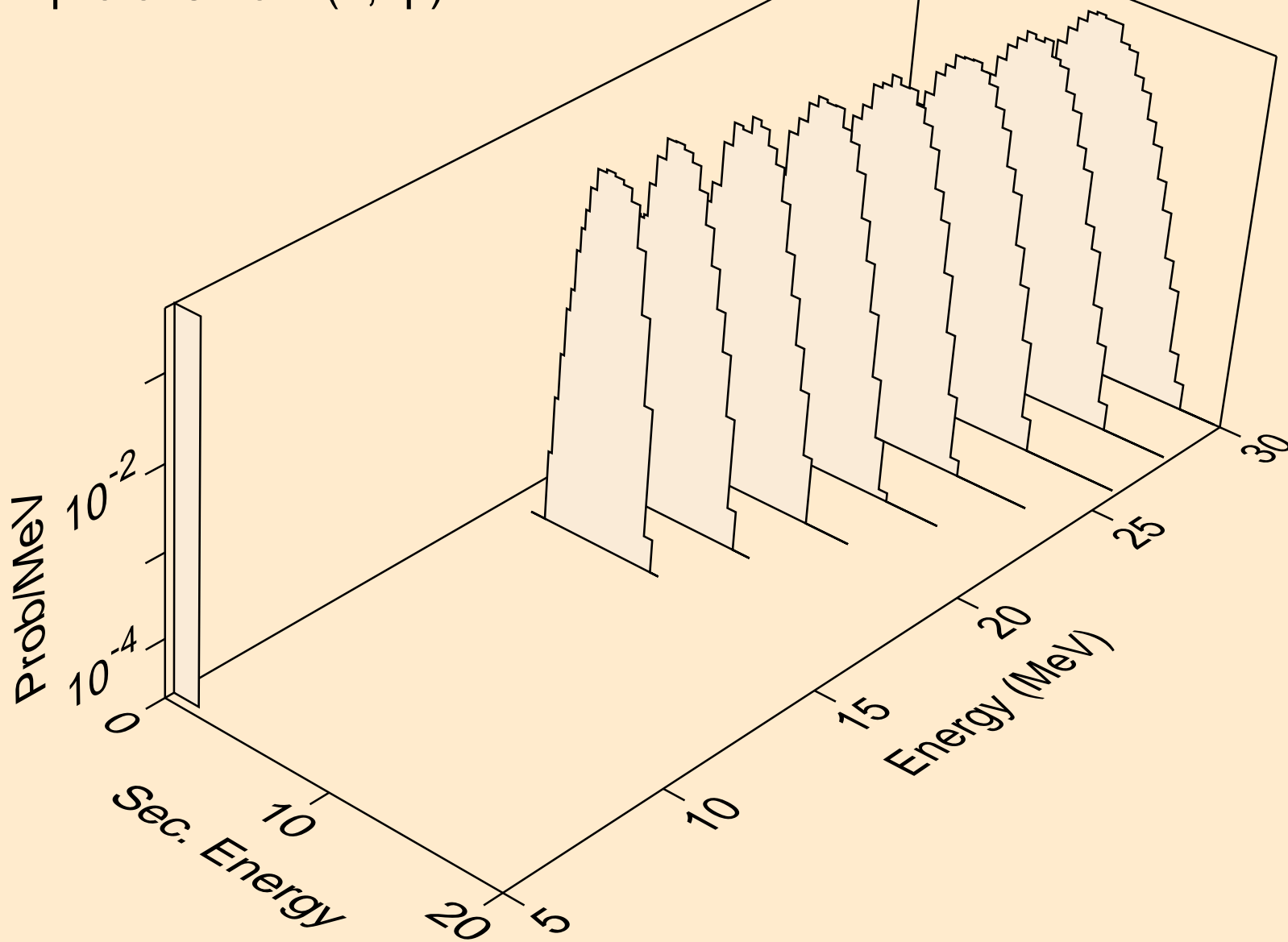

AM242M NEUTRON ACER TENDL-2019 LIBRARY; T=293.16K
deuterons from (n,x)

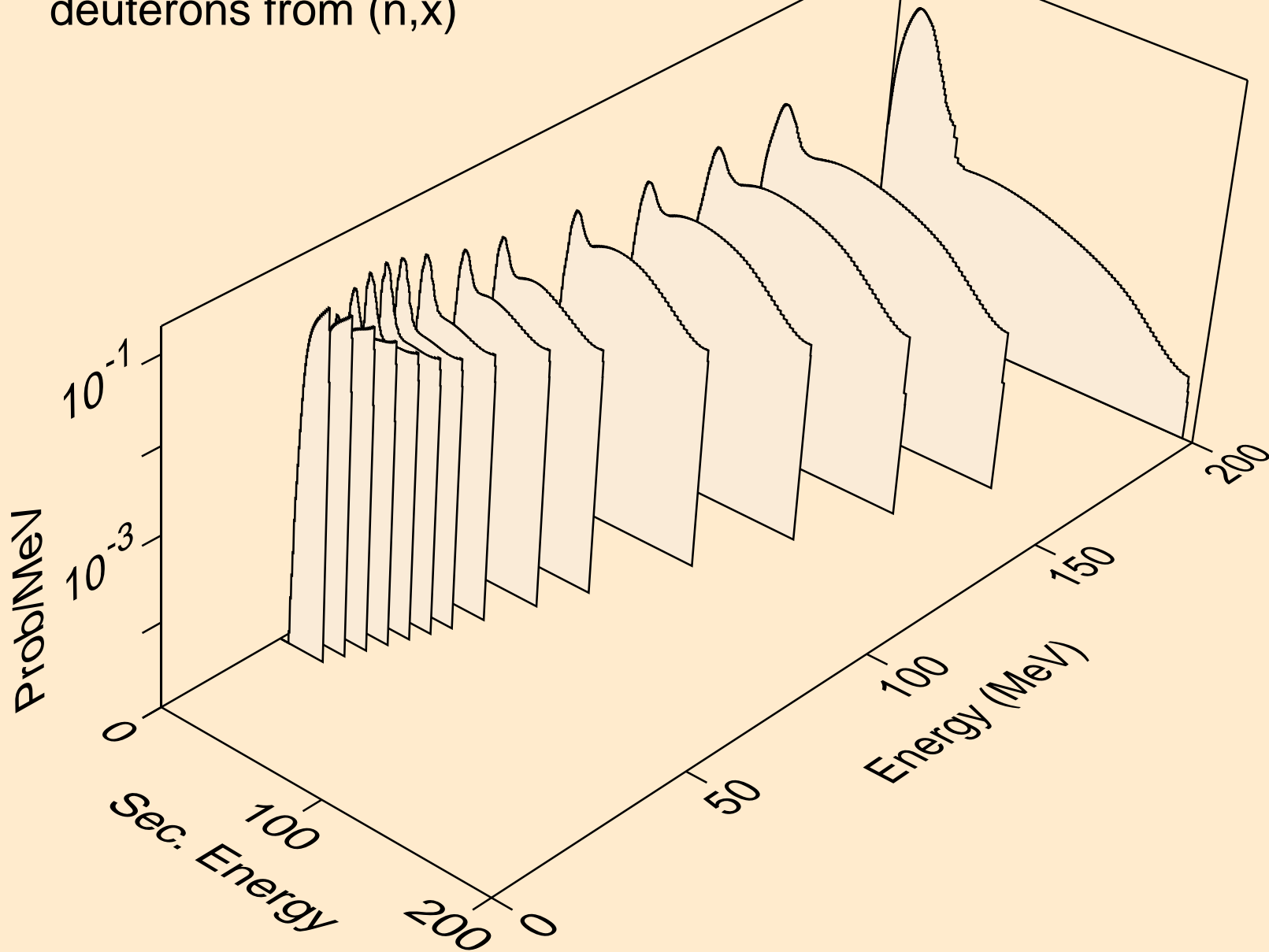

AM242M NEUTRON ACER TENDL-2019 LIBRARY; T=293.16K
deuterons from (n,2nd)

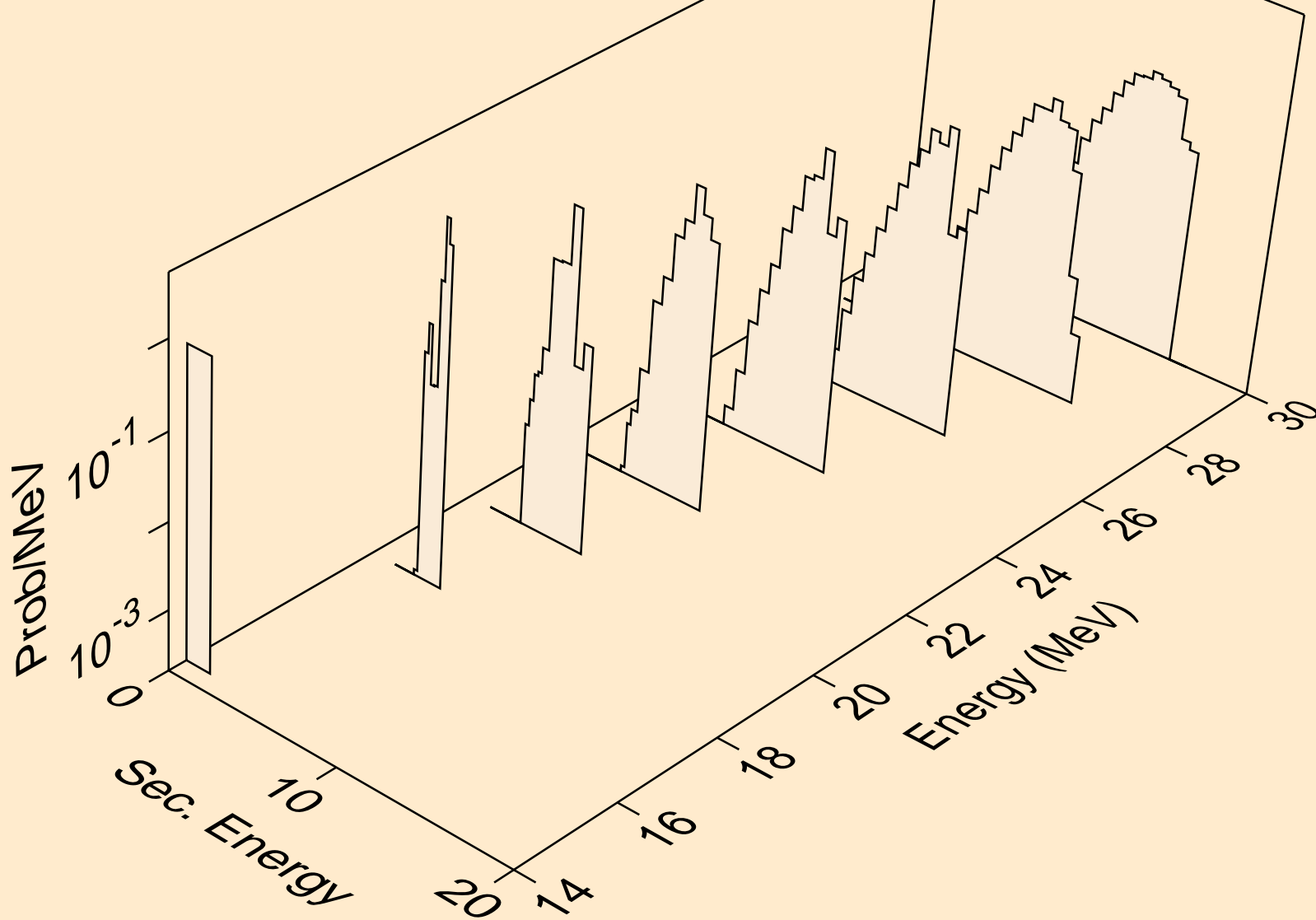

AM242M NEUTRON ACER TENDL-2019 LIBRARY; T=293.16K
deuterons from (n,n*)d

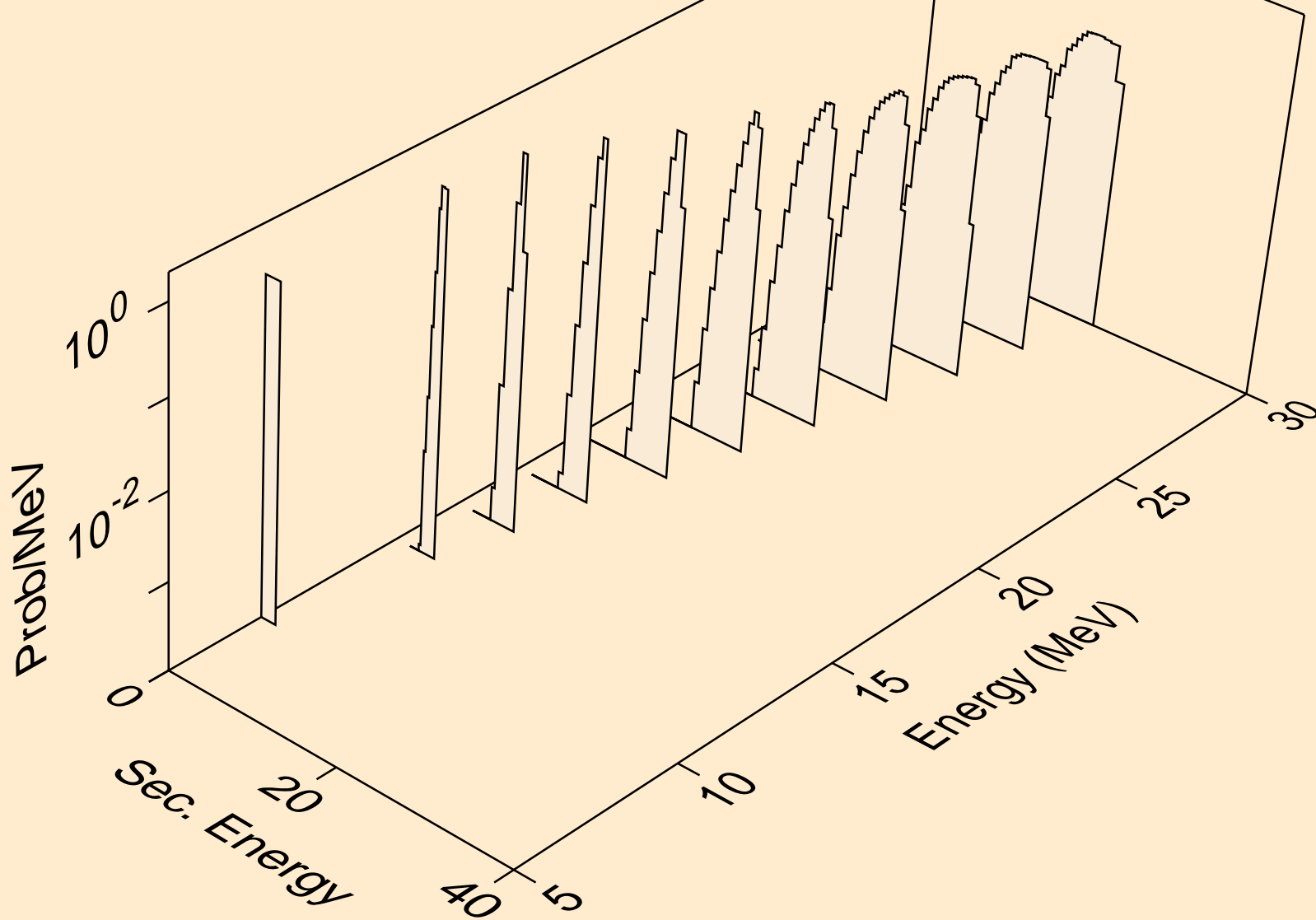

AM242M NEUTRON ACER TENDL-2019 LIBRARY; T=293.16K
deuterons from (n,d)

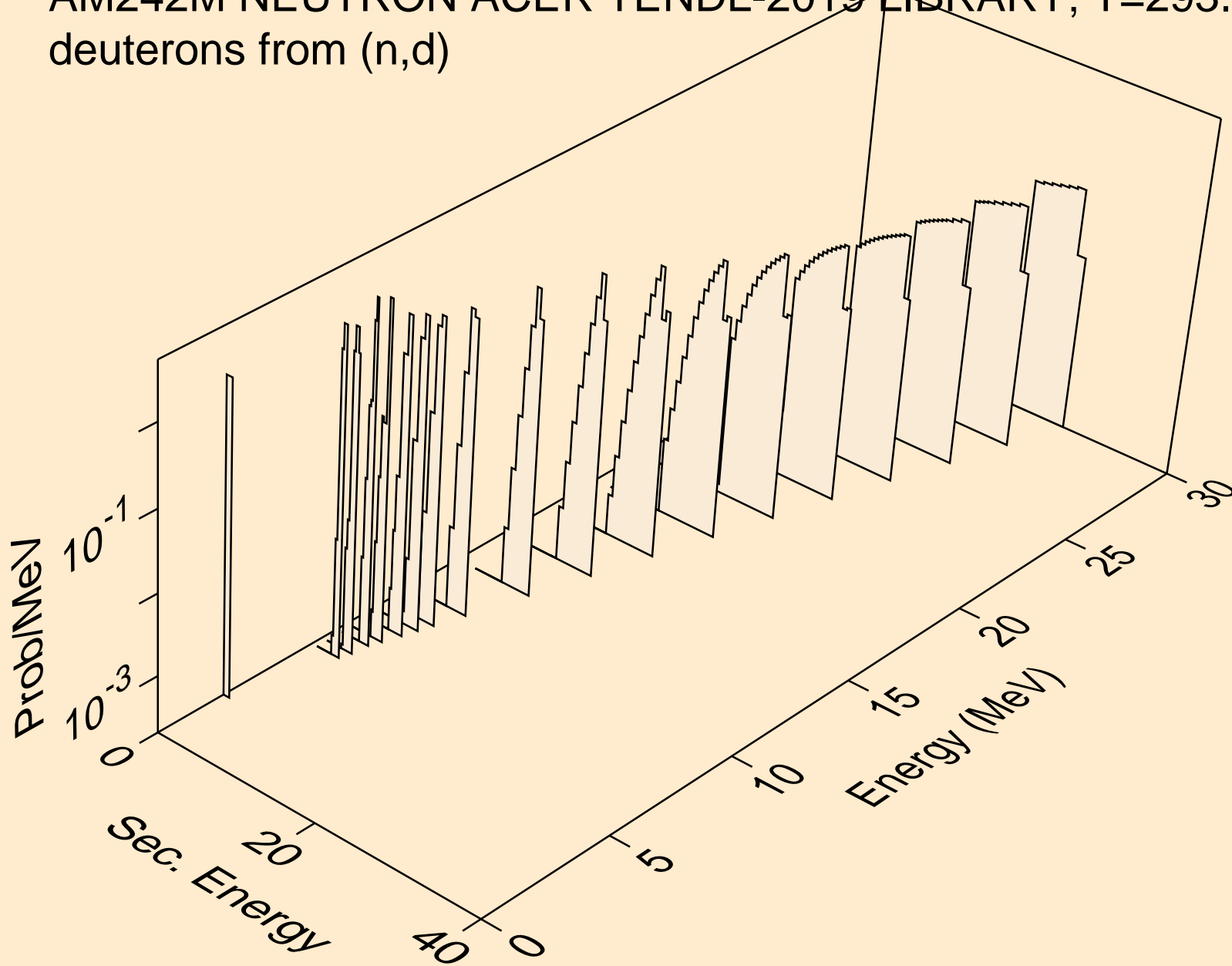

AM242M NEUTRON ACER TENDL-2019 LIBRARY; T=293.16K
tritons from (n,x)

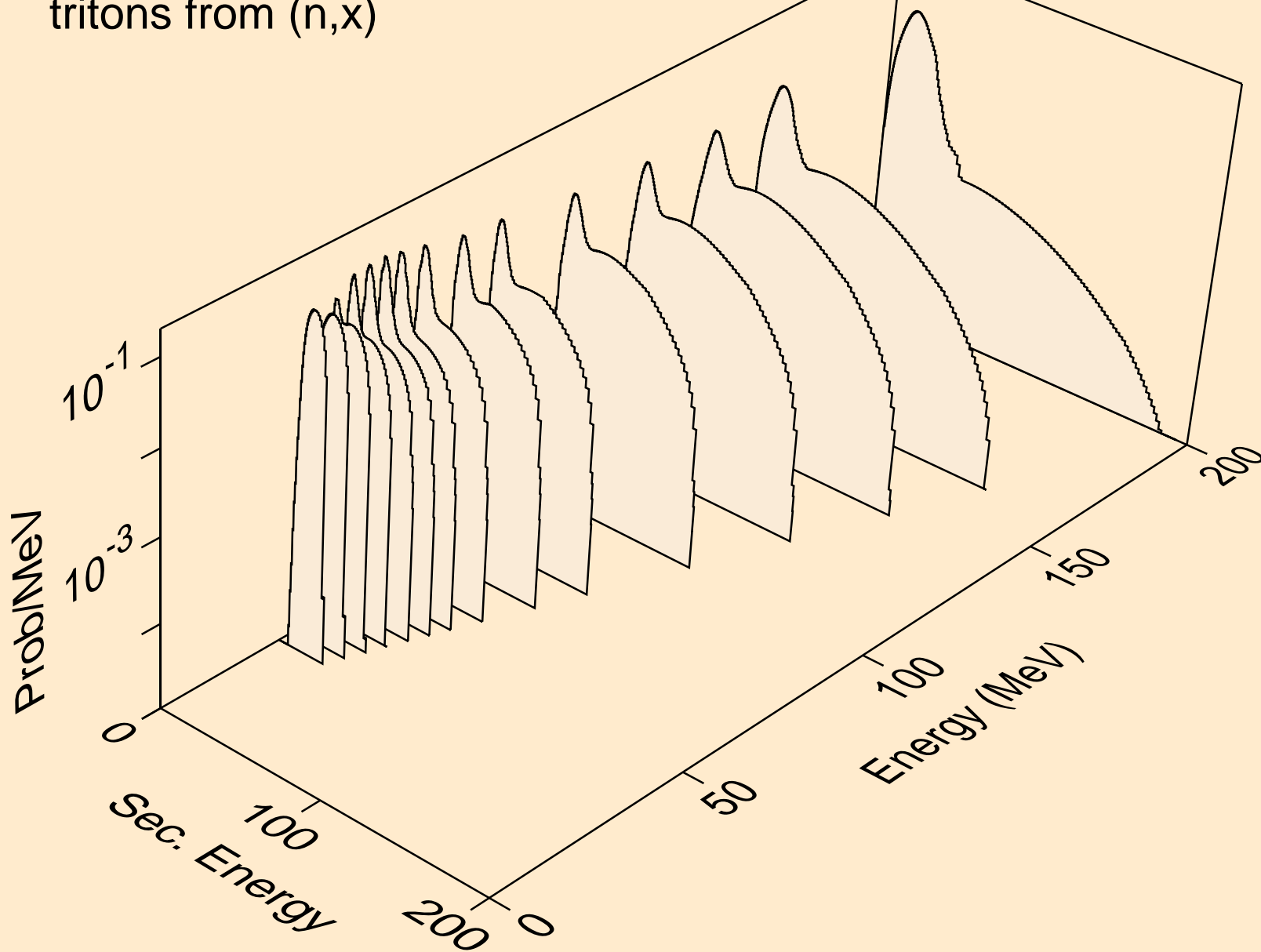

AM242M NEUTRON ACER TENDL-2019 LIBRARY; T=293.16K
tritons from (n,n*)t

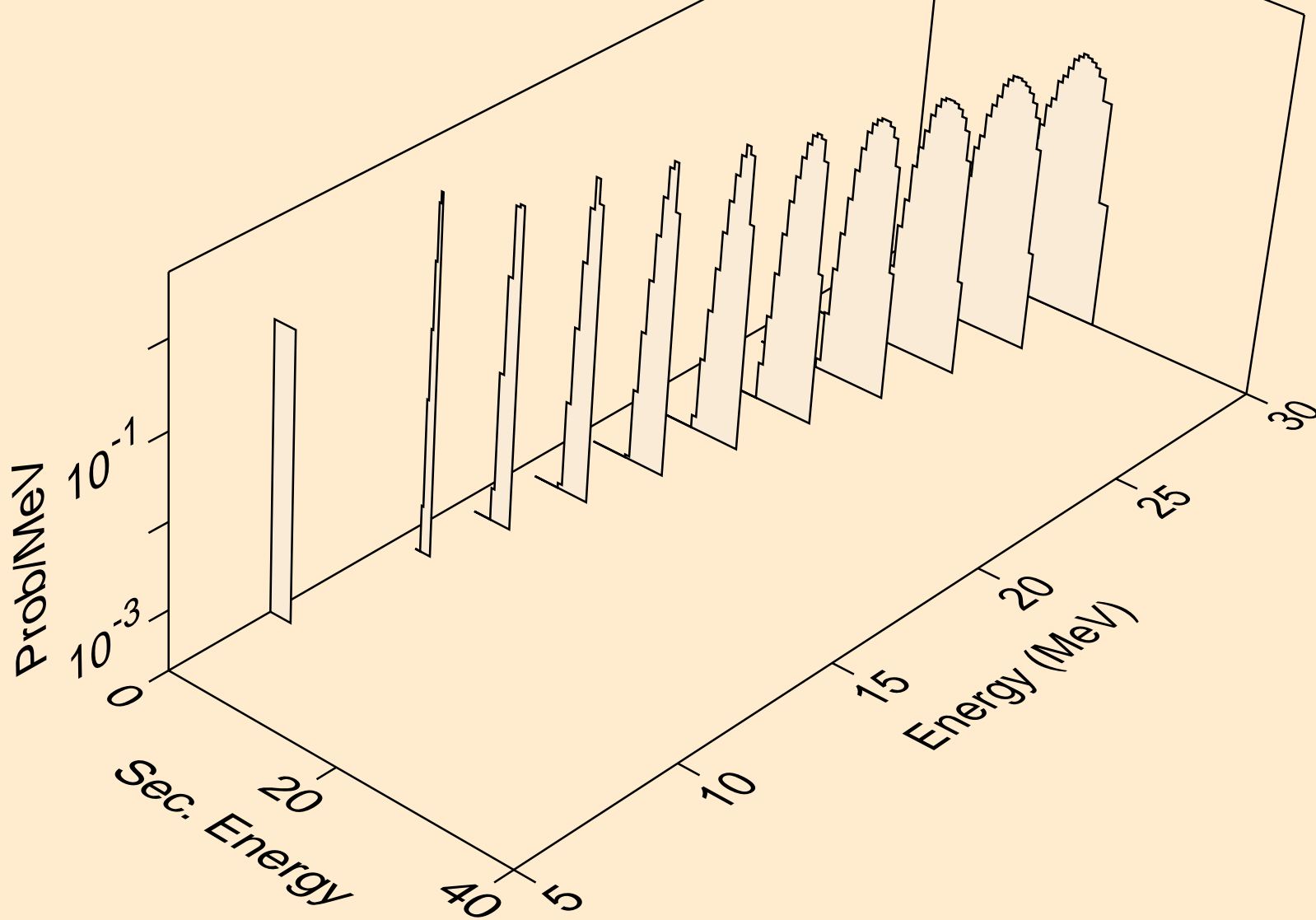

AM242M NEUTRON ACER TENDL-2019 LIBRARY; T=293.16K
tritons from (n,t)

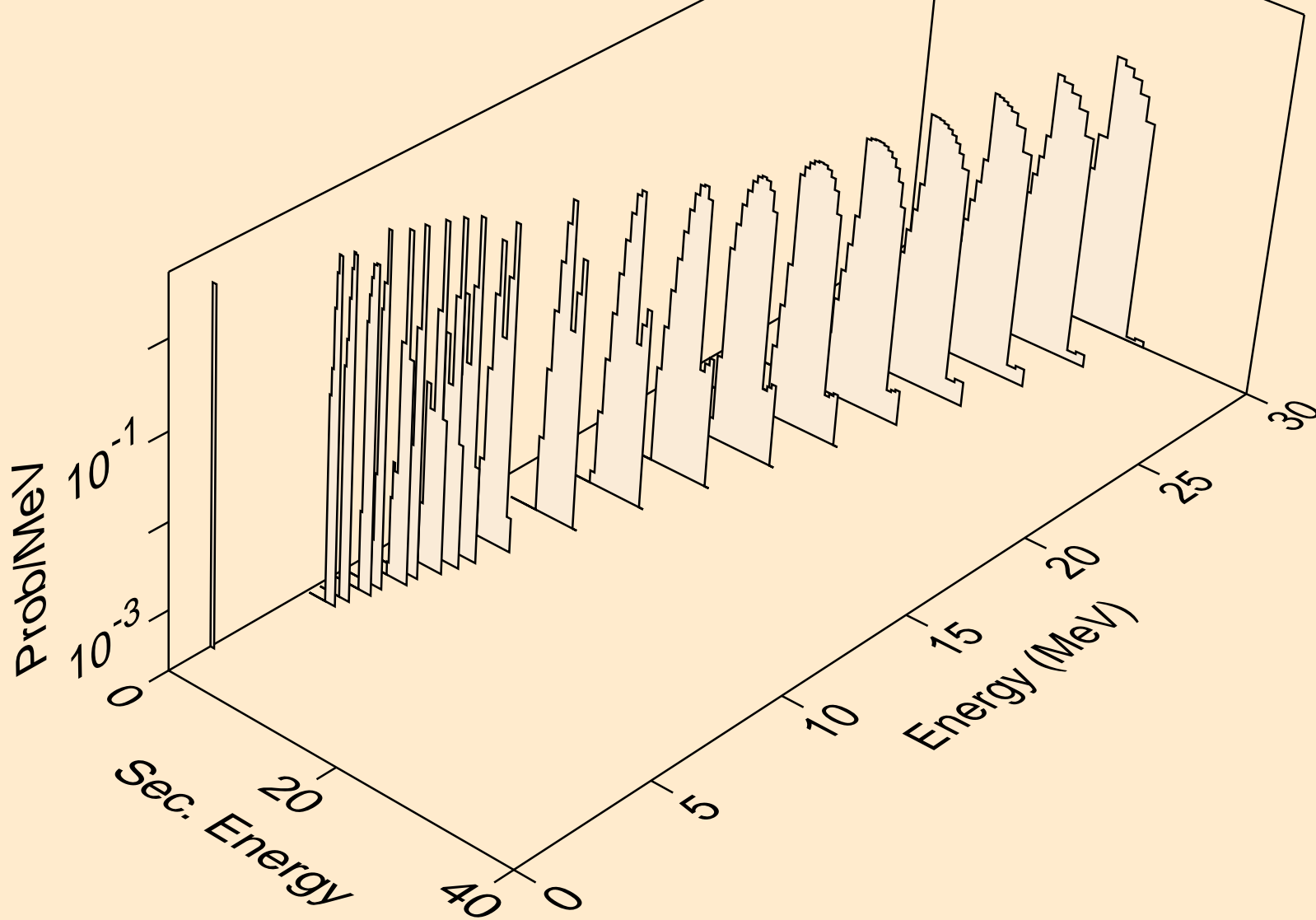

AM242M NEUTRON ACER TENDL-2019 LIBRARY; T=293.16K
he3s from (n,x)

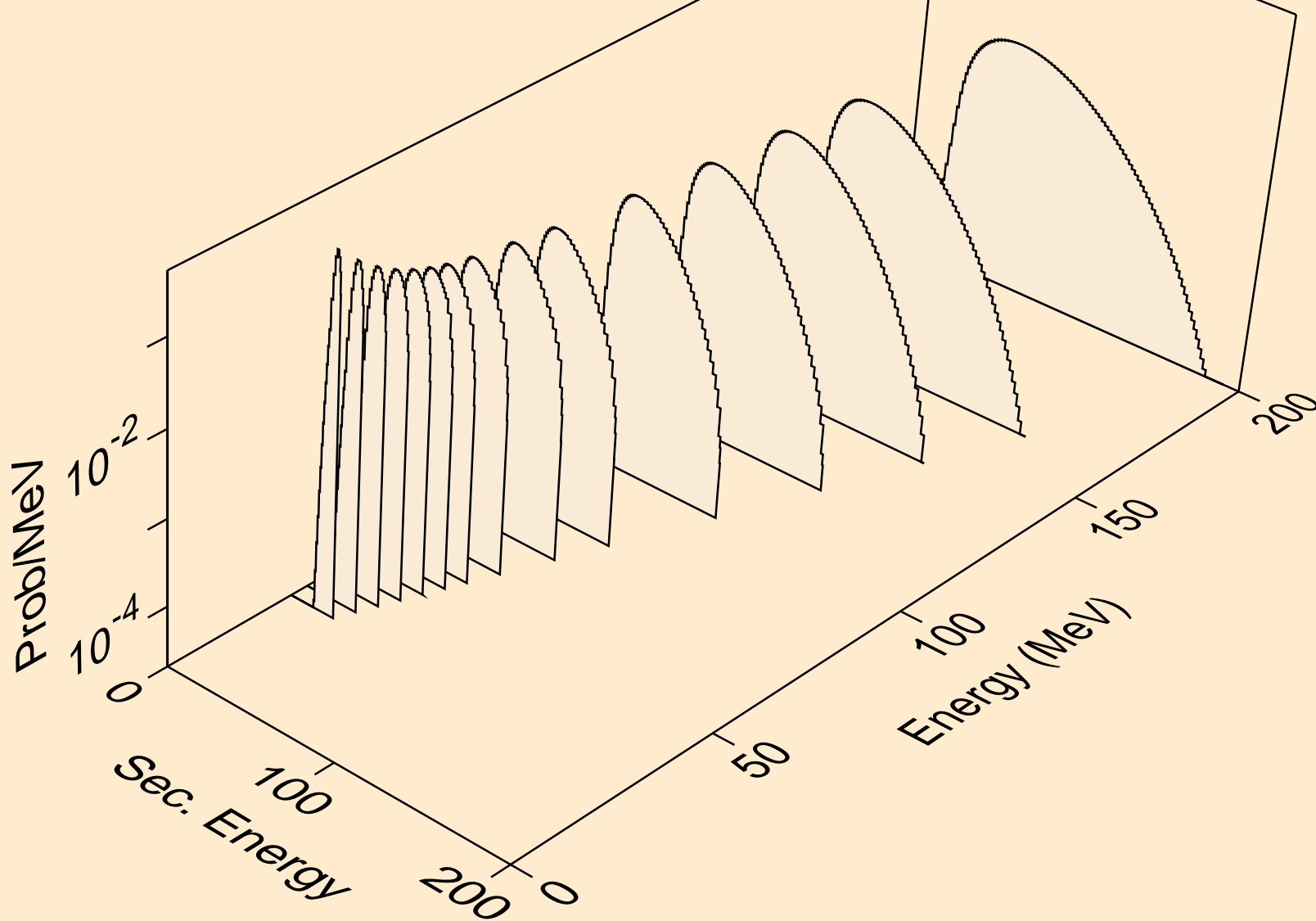

AM242M NEUTRON ACER TENDL-2019 LIBRARY; T=293.16K
he3s from (n,n*)he3

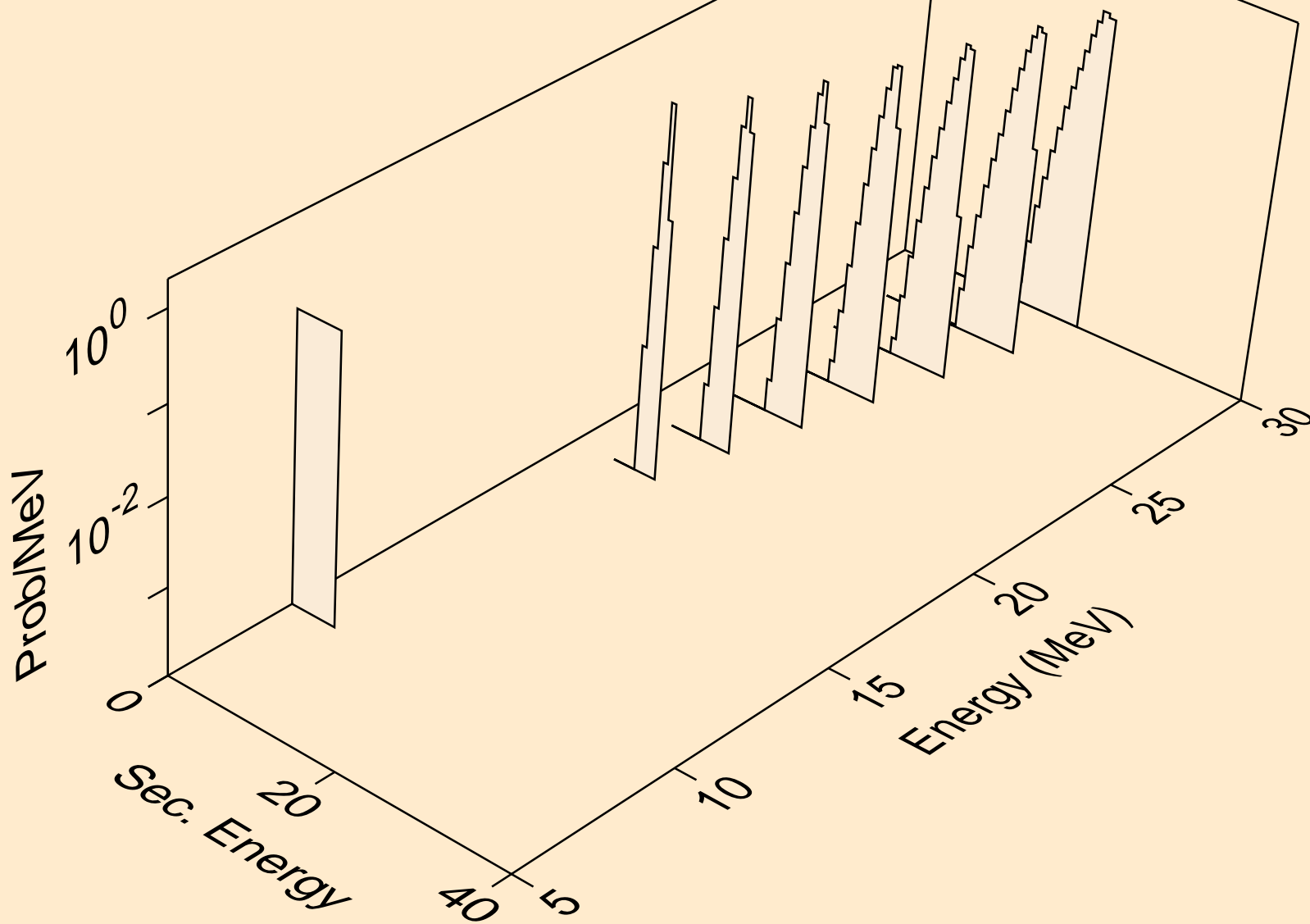

AM242M NEUTRON ACER TENDL-2019 LIBRARY; T=293.16K
he3s from (n,he3)

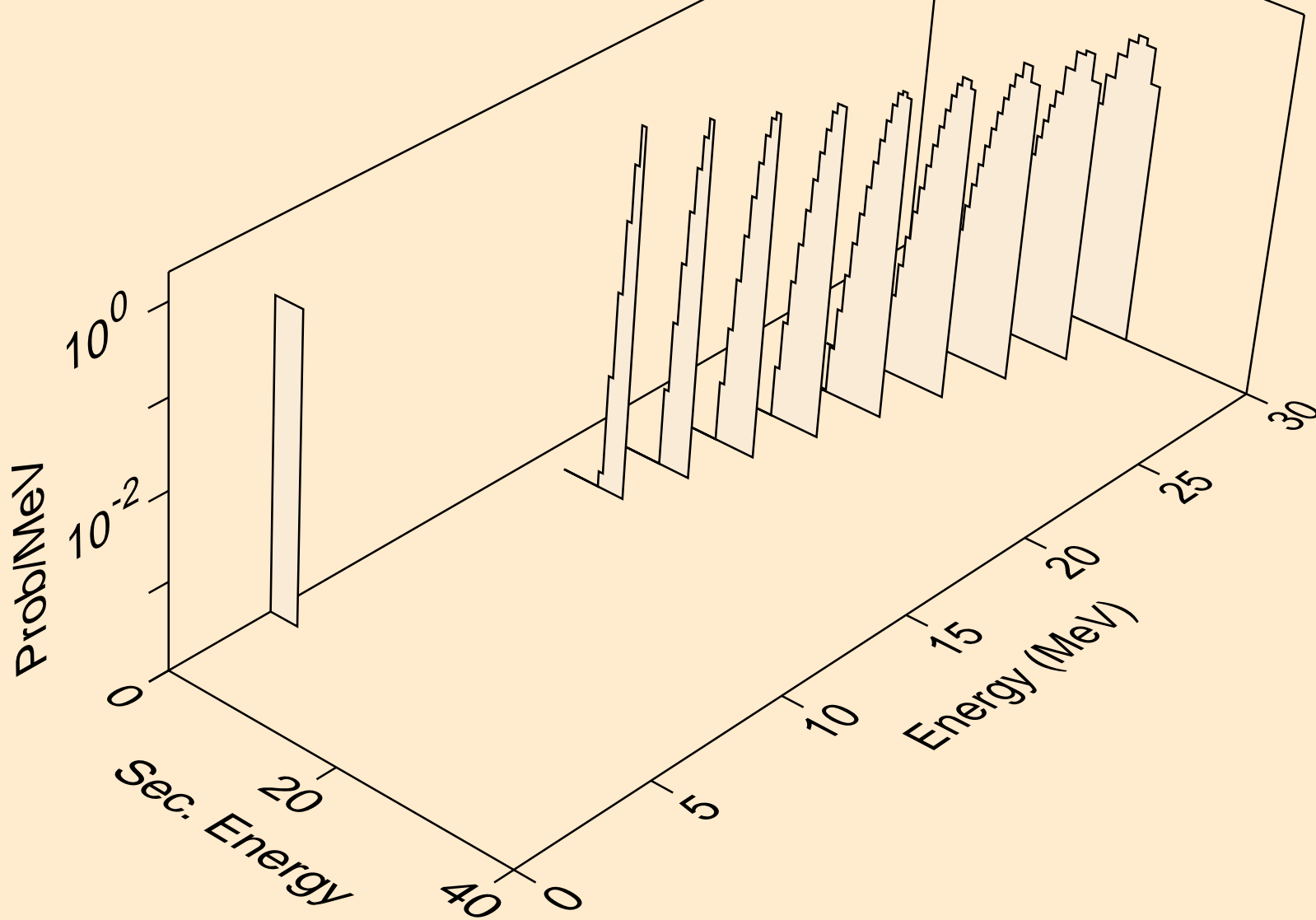

AM242M NEUTRON ACER TENDL-2019 LIBRARY; T=293.16K
alphas from (n,x)

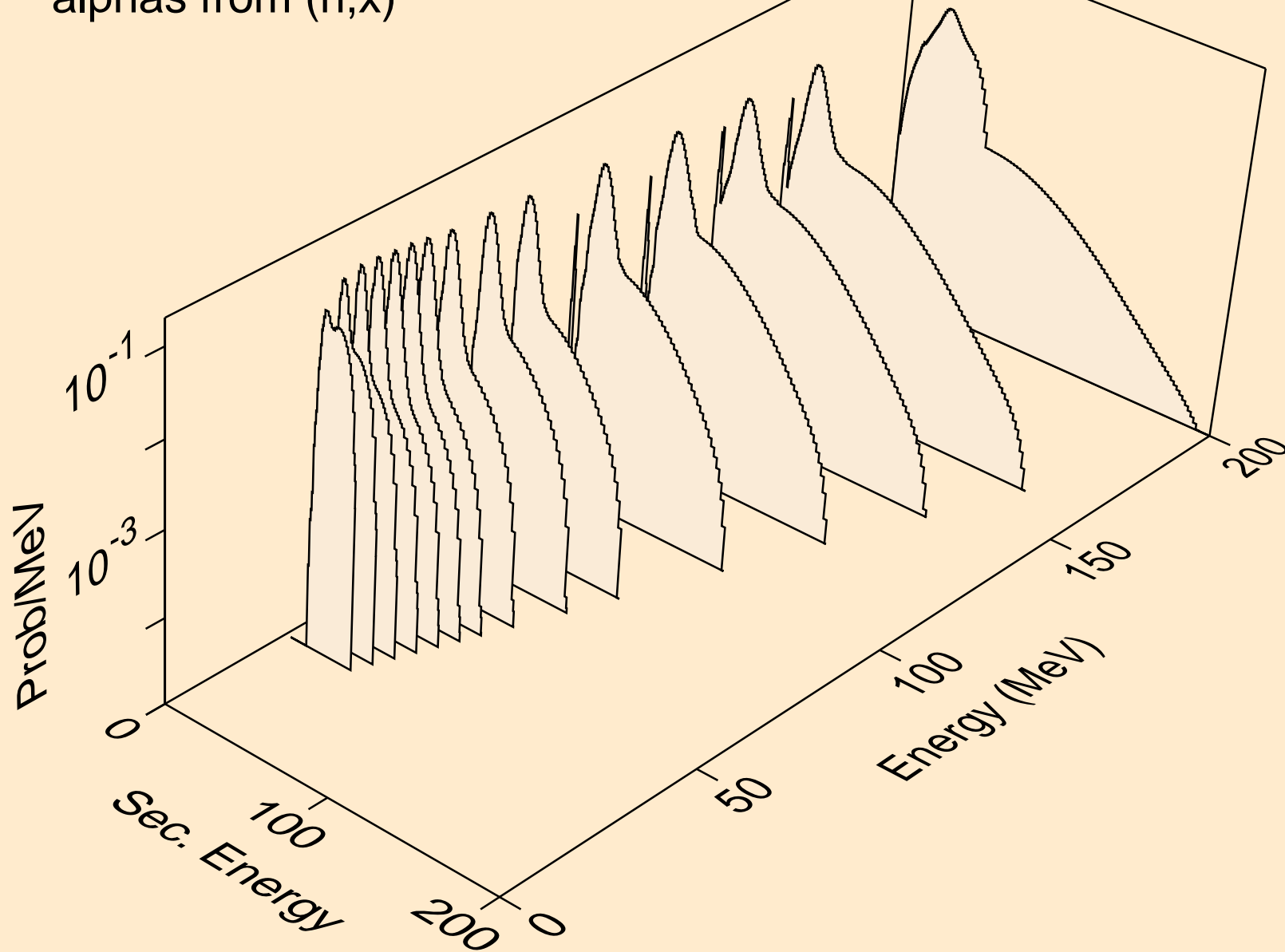

AM242M NEUTRON ACER TENDL-2019 LIBRARY; T=293.16K
alphas from (n,n*)a

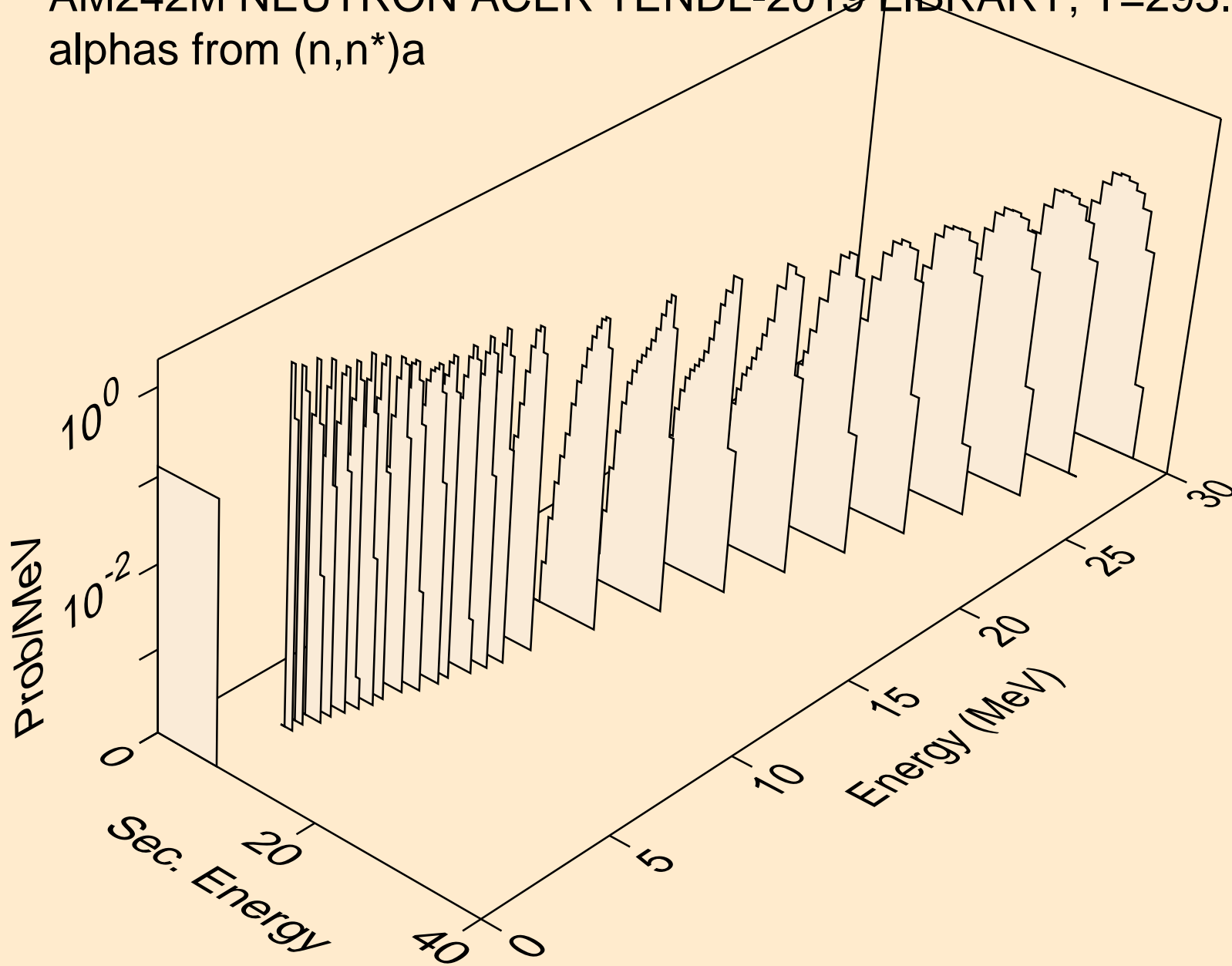

AM242M NEUTRON ACER TENDL-2019 LIBRARY; T=293.16K
alphas from (n,2n)a

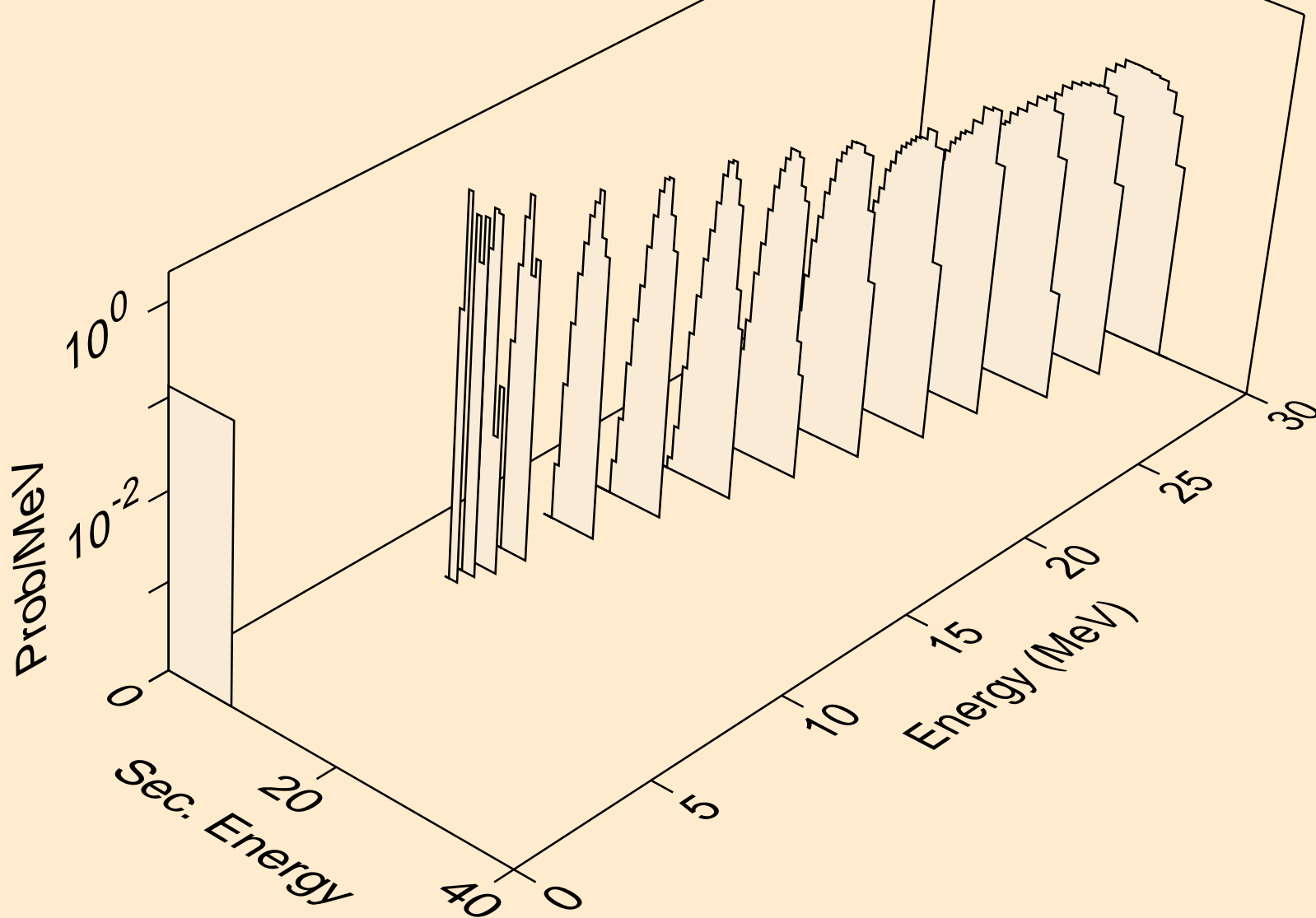

AM242M NEUTRON ACER TENDL-2019 LIBRARY; T=293.16K
alphas from (n,3n)a

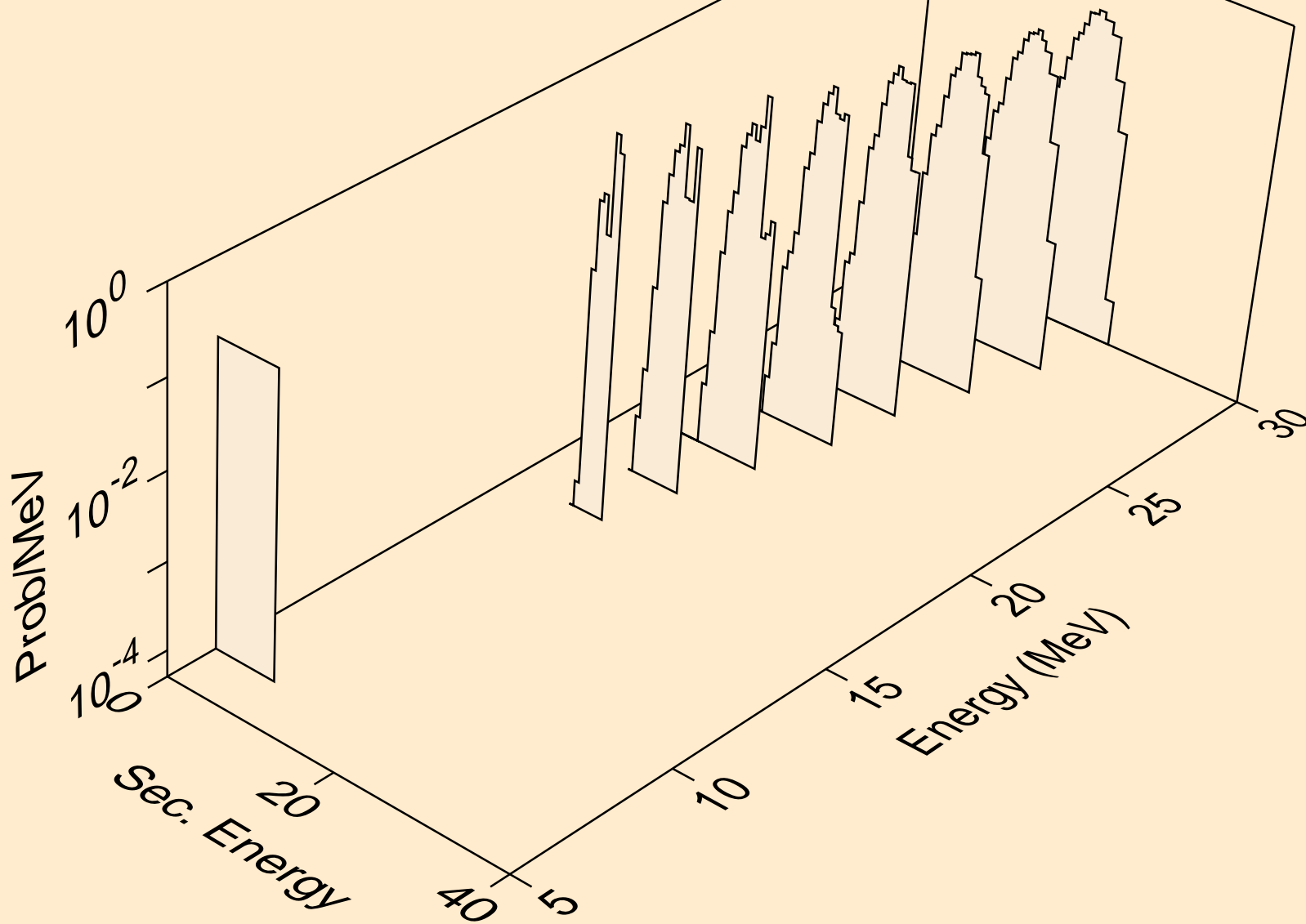

AM242M NEUTRON ACER TENDL-2019 LIBRARY; T=293.16K
alphas from (n,npa)

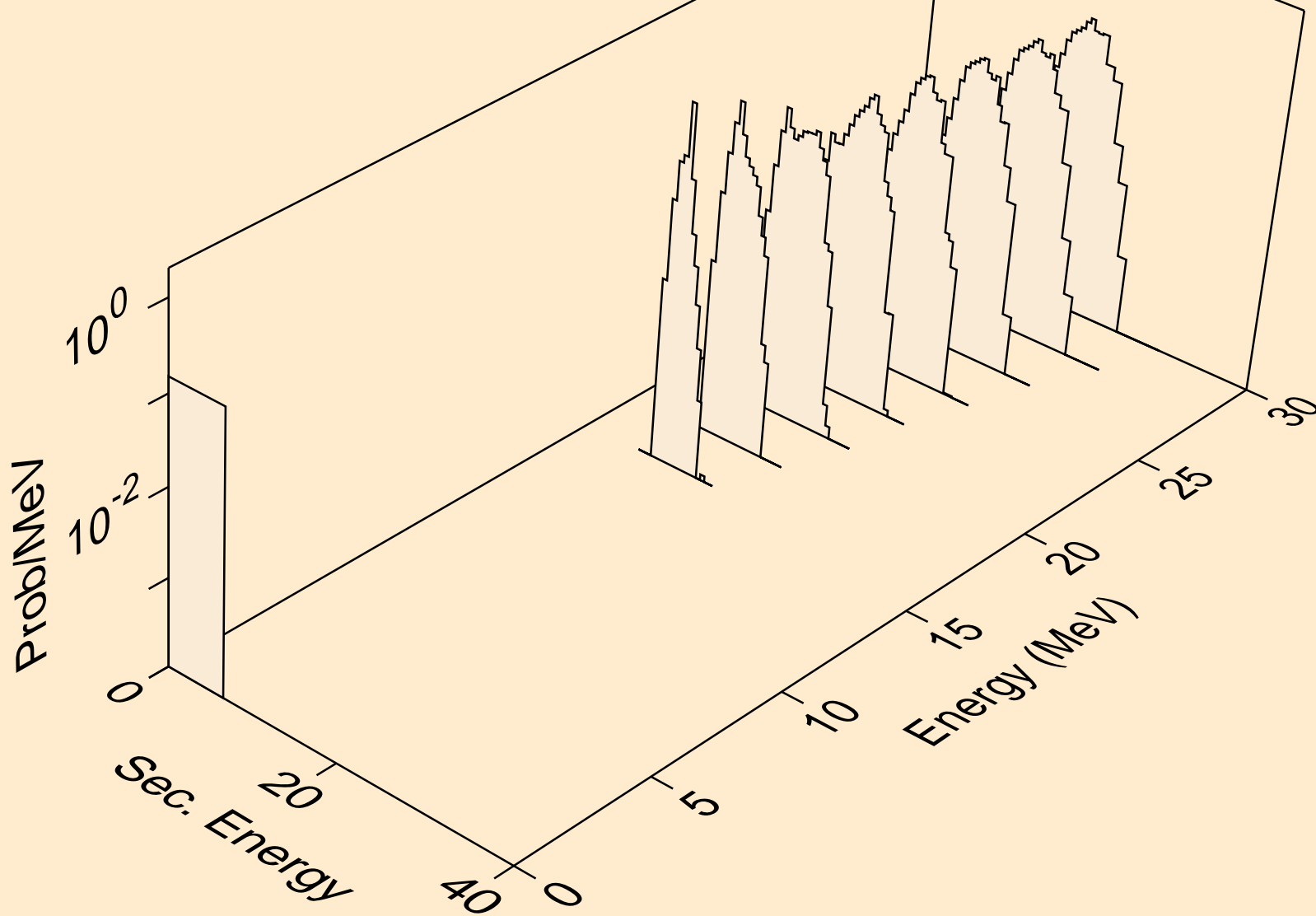

AM242M NEUTRON ACER TENDL-2019 LIBRARY; T=293.16K
alphas from (n,a)

