

BK237 NEUTRON ACER TENDL-2019 LIBRARY; T=293.16K
Principal cross sections

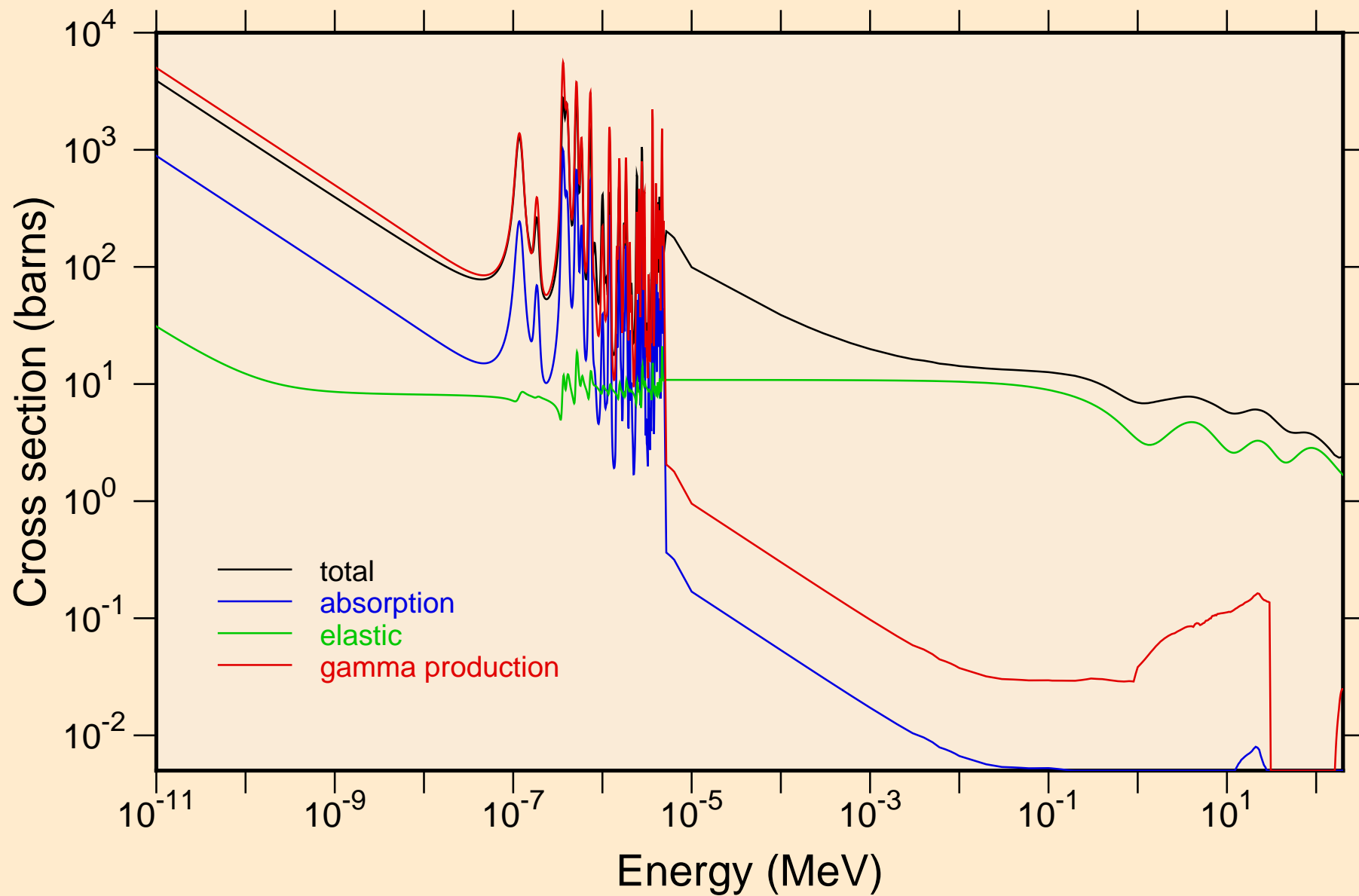

BK237 NEUTRON ACER TENDL-2019 LIBRARY; T=293.16K
resonance total cross section

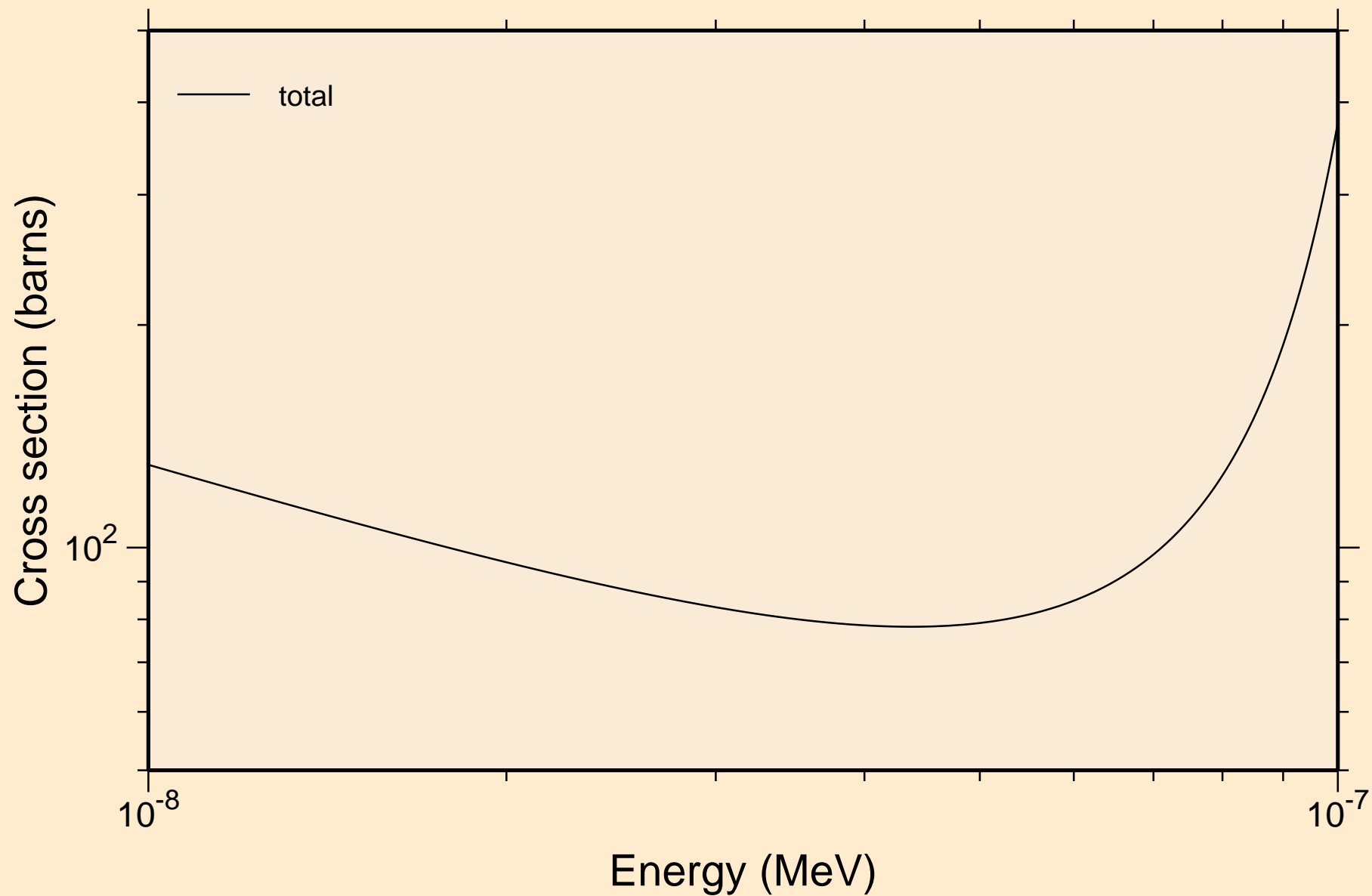

BK237 NEUTRON ACER TENDL-2019 LIBRARY; T=293.16K
resonance total cross section

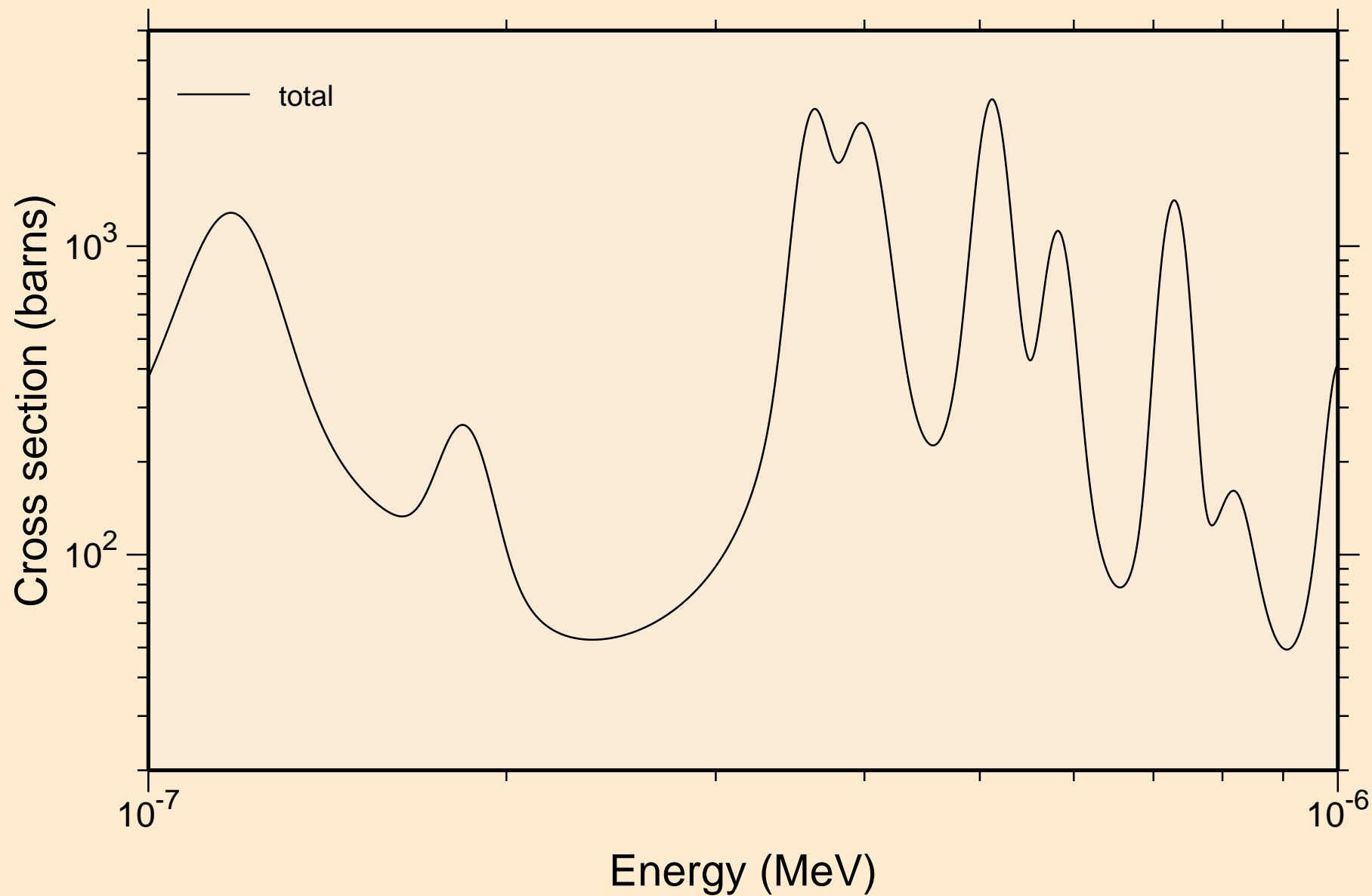

BK237 NEUTRON ACER TENDL-2019 LIBRARY; T=293.16K
resonance total cross section

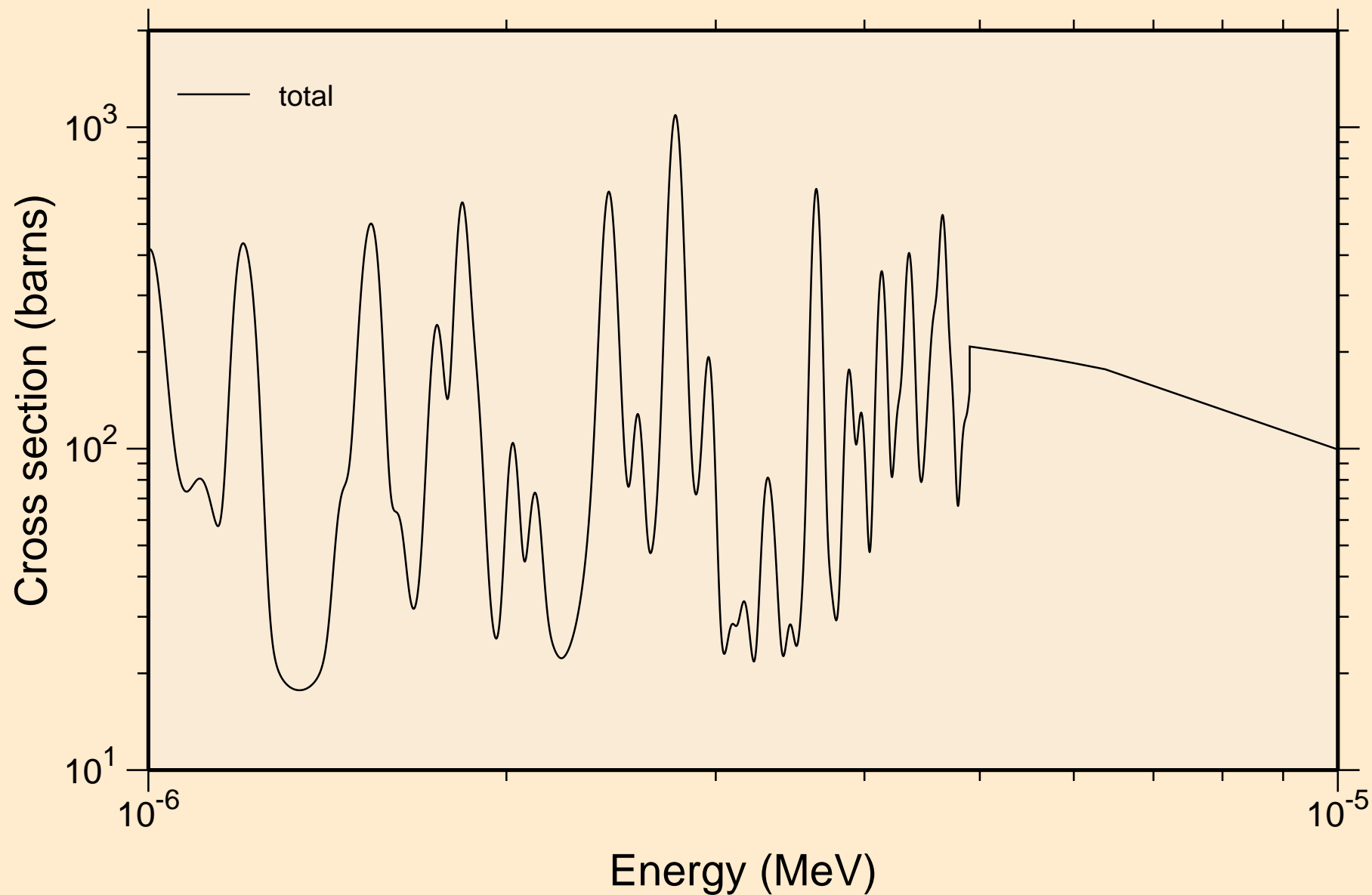

BK237 NEUTRON ACER TENDL-2019 LIBRARY; T=293.16K
resonance total cross section

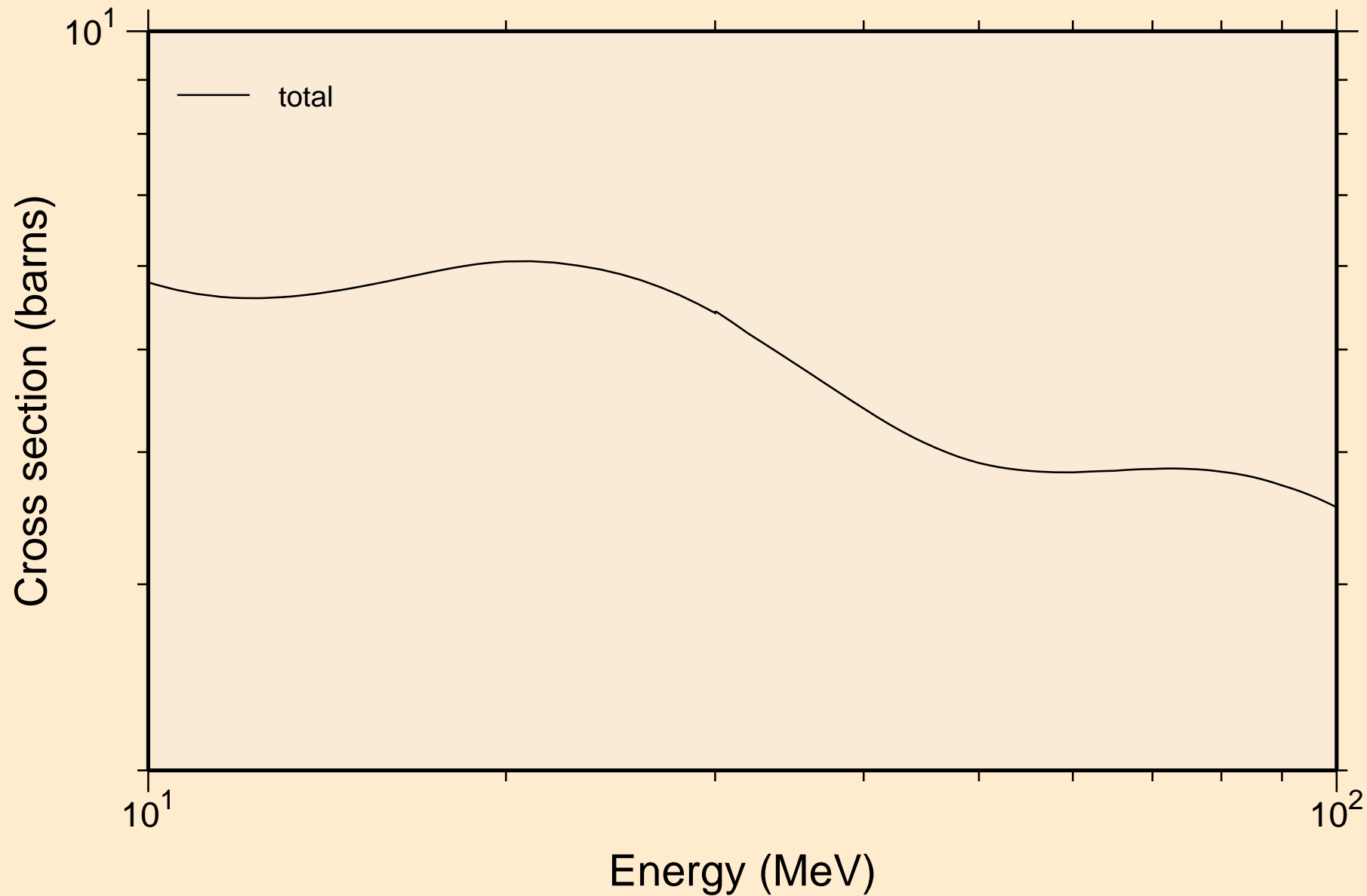

BK237 NEUTRON ACER TENDL-2019 LIBRARY; T=293.16K
resonance absorption cross sections

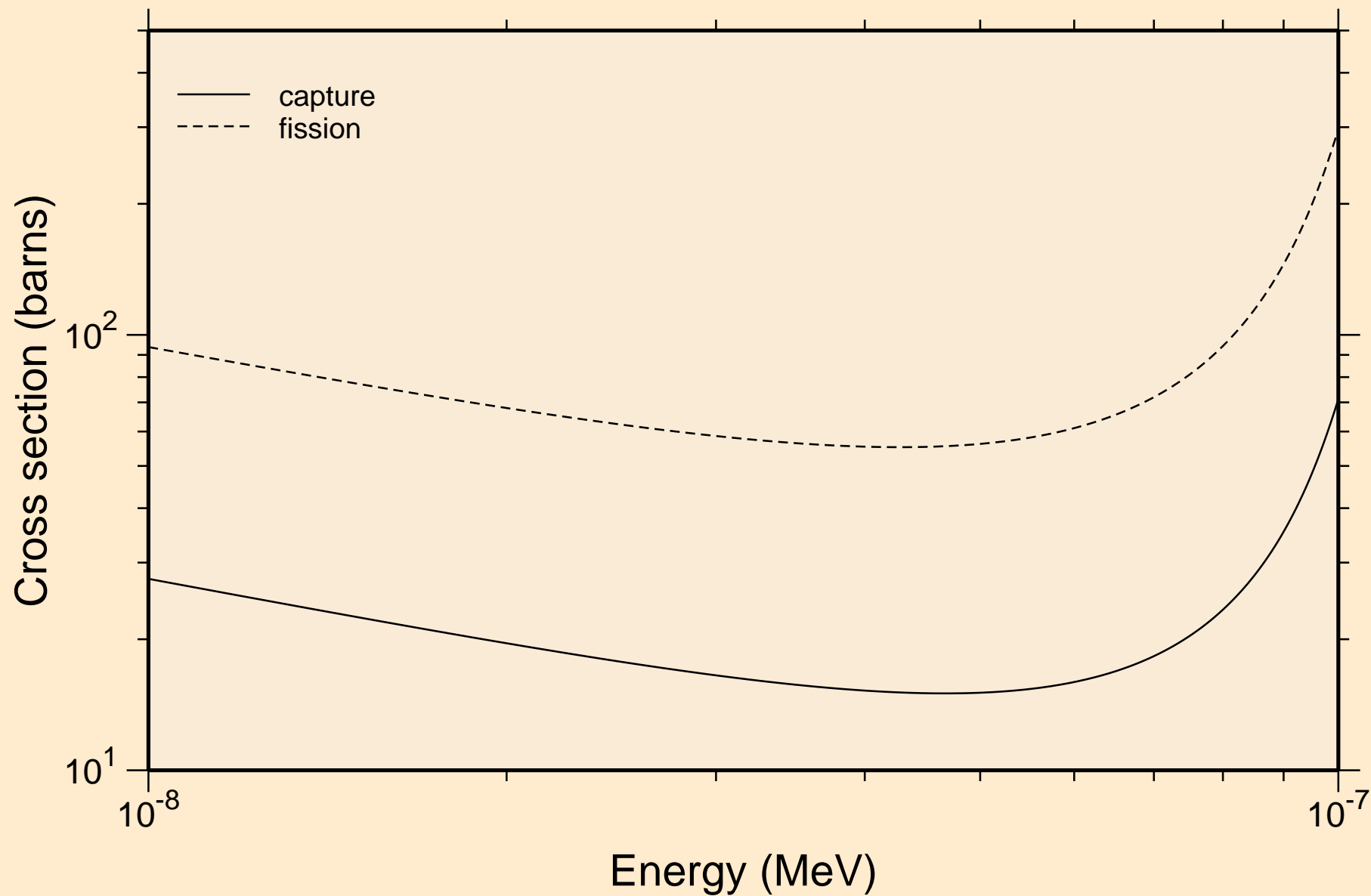

BK237 NEUTRON ACER TENDL-2019 LIBRARY; T=293.16K
resonance absorption cross sections

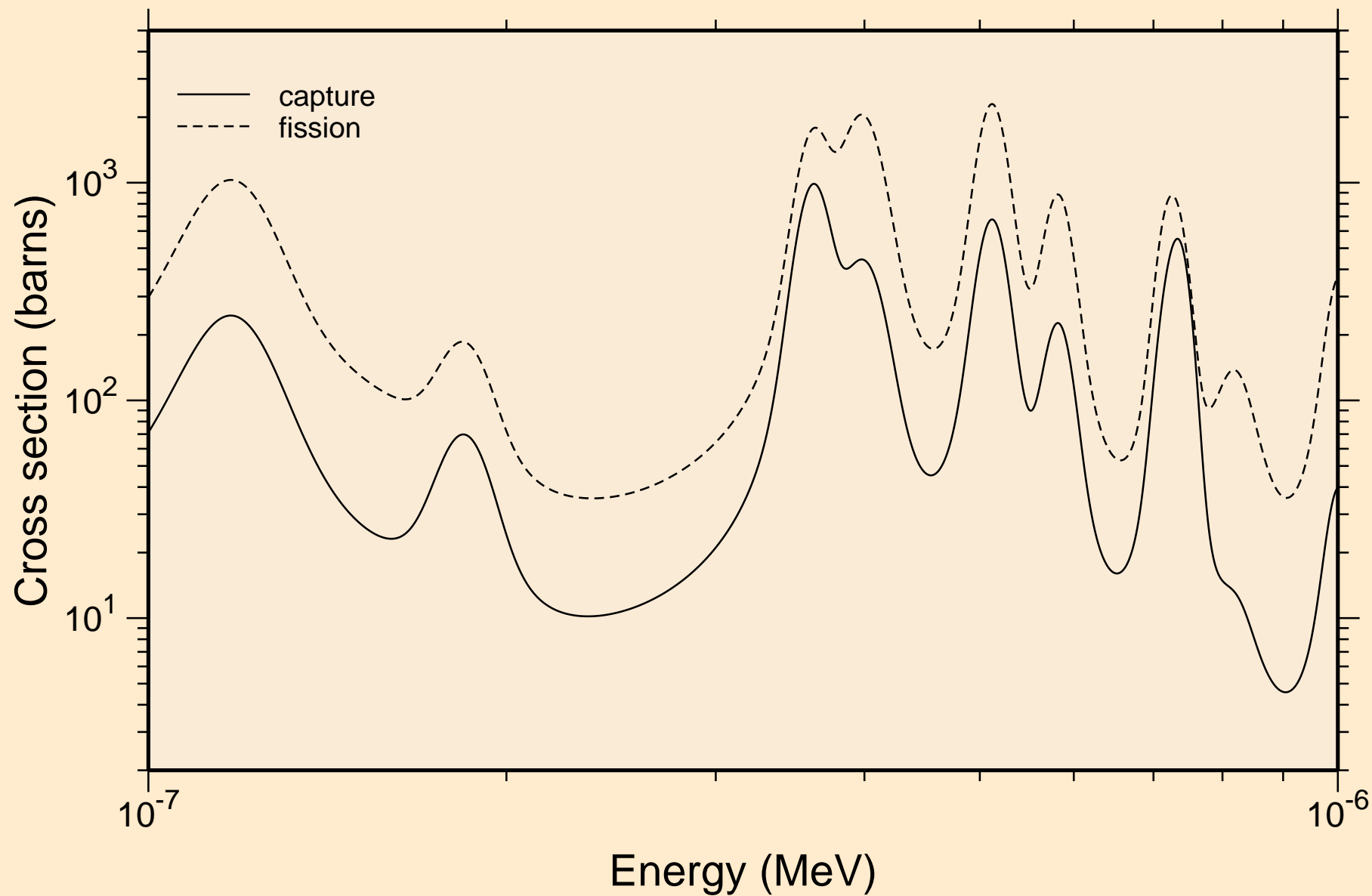

BK237 NEUTRON ACER TENDL-2019 LIBRARY; T=293.16K
resonance absorption cross sections

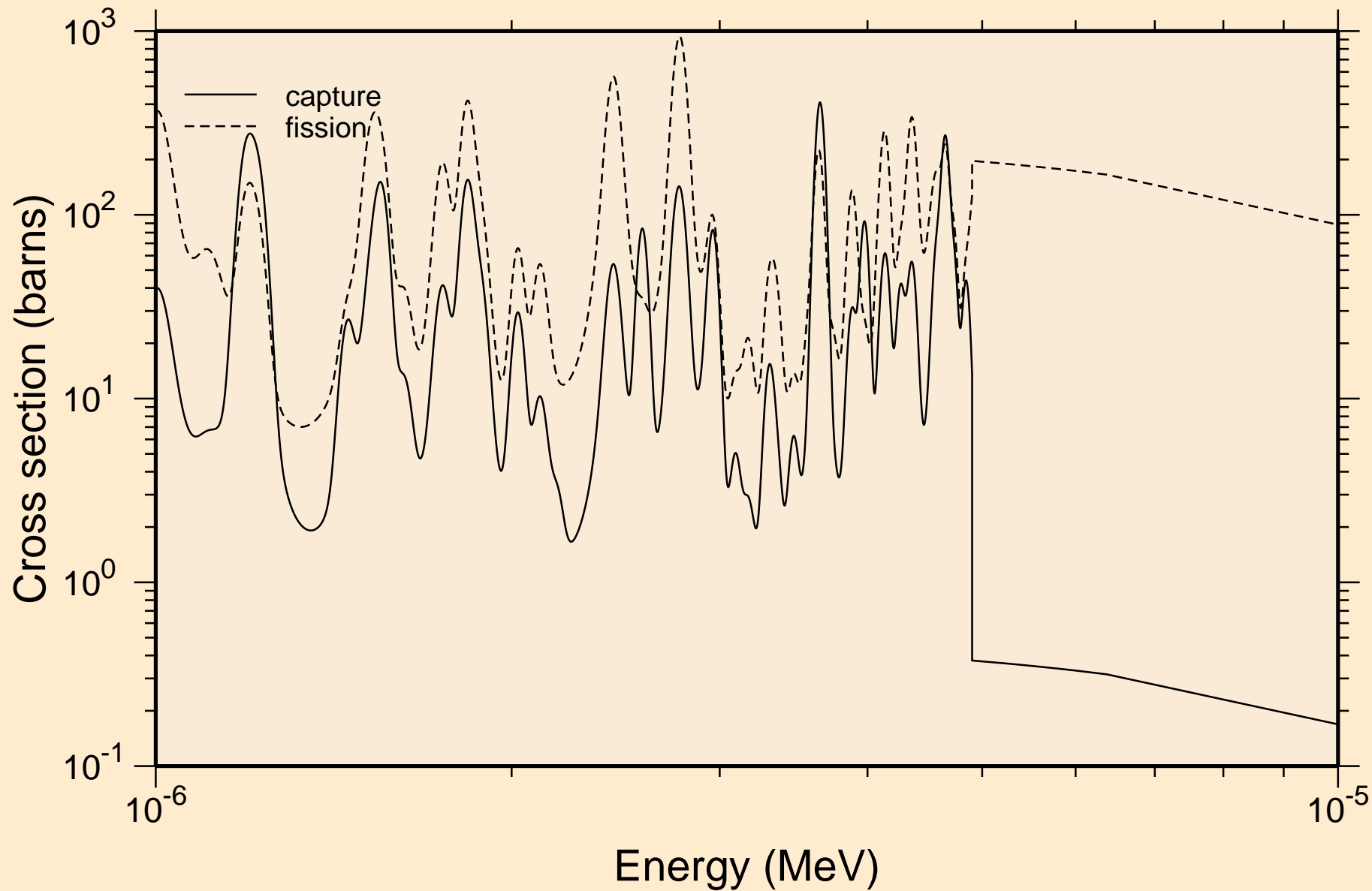

BK237 NEUTRON ACER TENDL-2019 LIBRARY; T=293.16K
resonance absorption cross sections

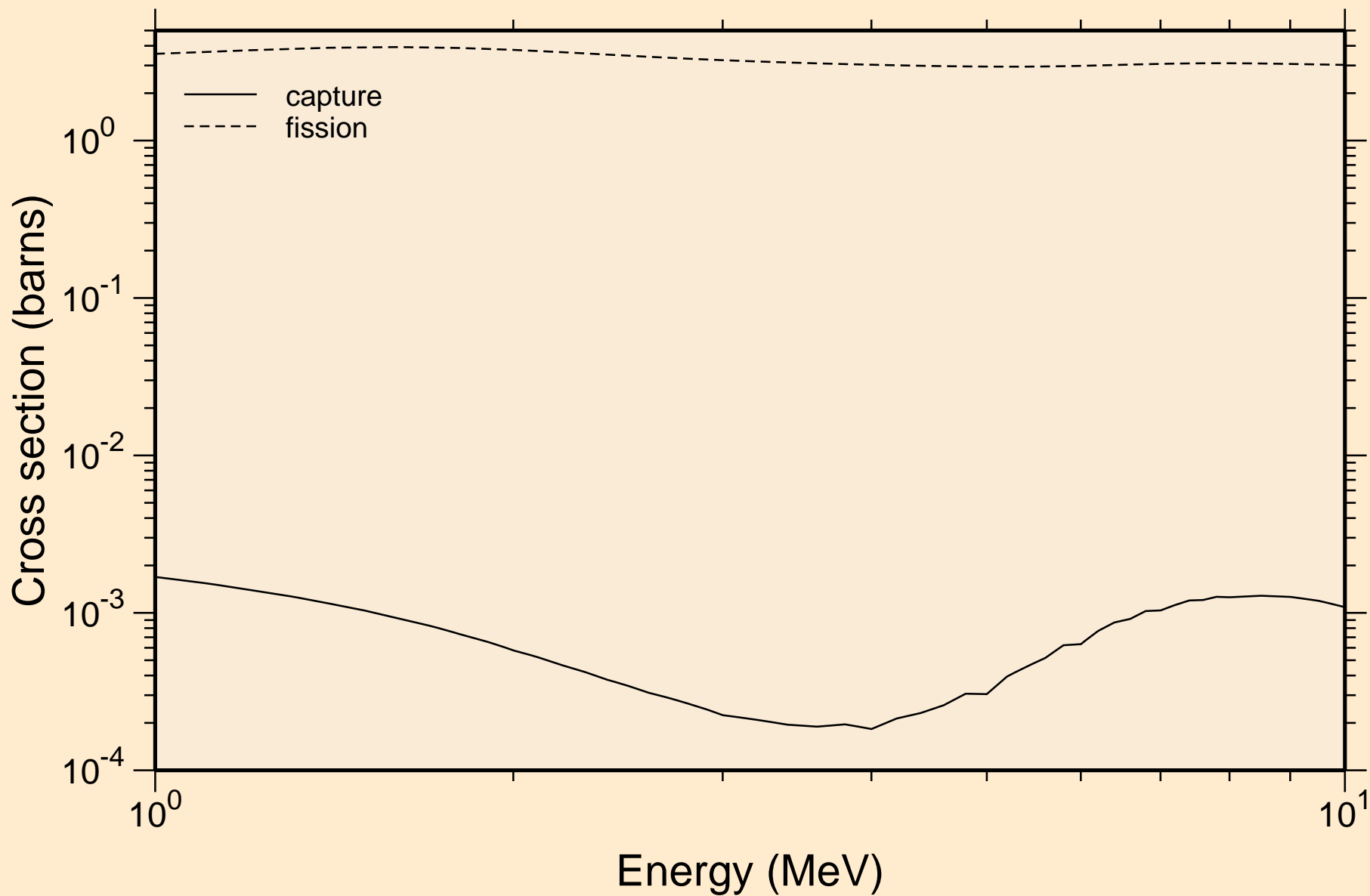

BK237 NEUTRON ACER TENDL-2019 LIBRARY; T=293.16K
Heating

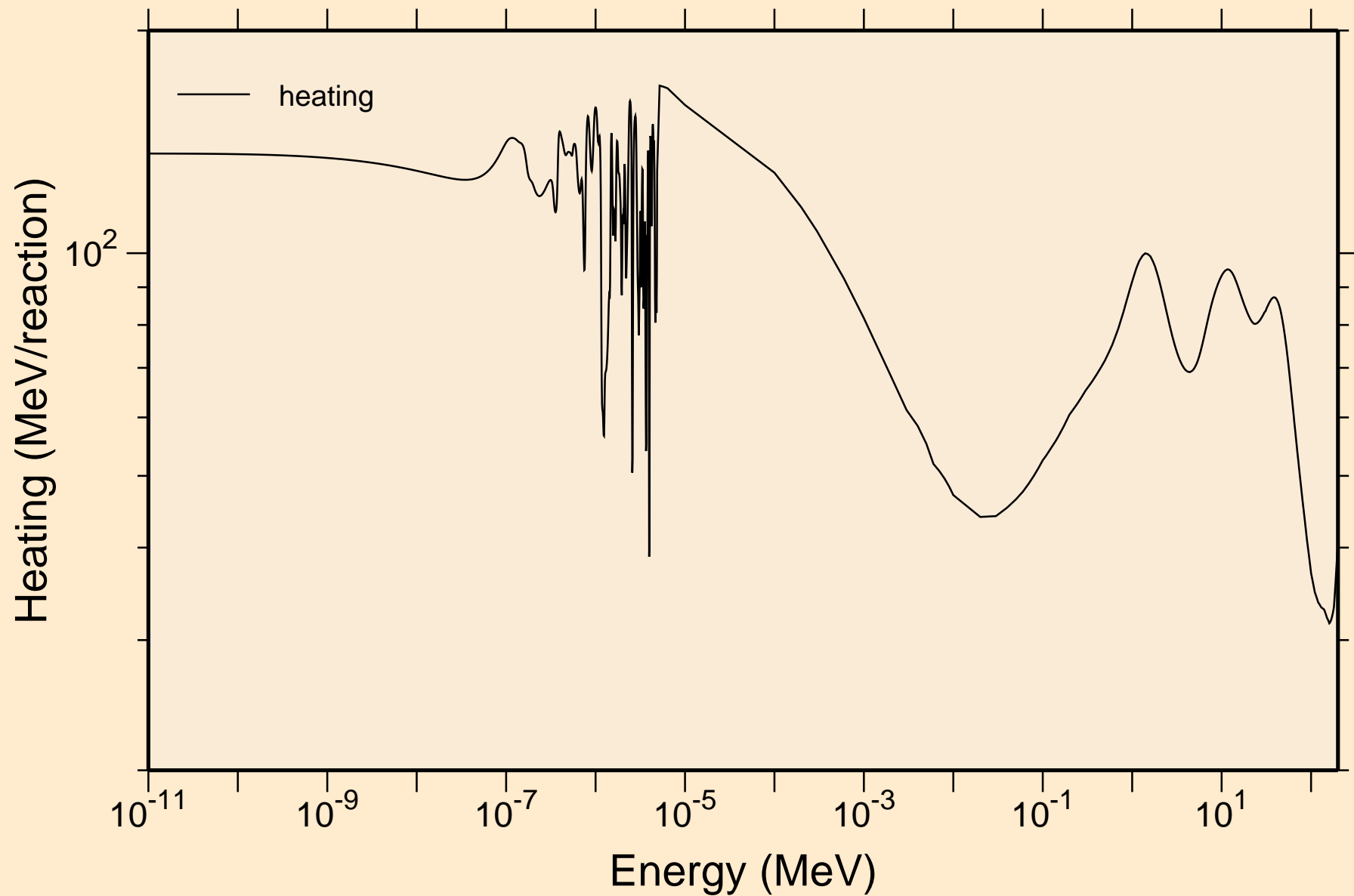

BK237 NEUTRON ACER TENDL-2019 LIBRARY; T=293.16K
Damage

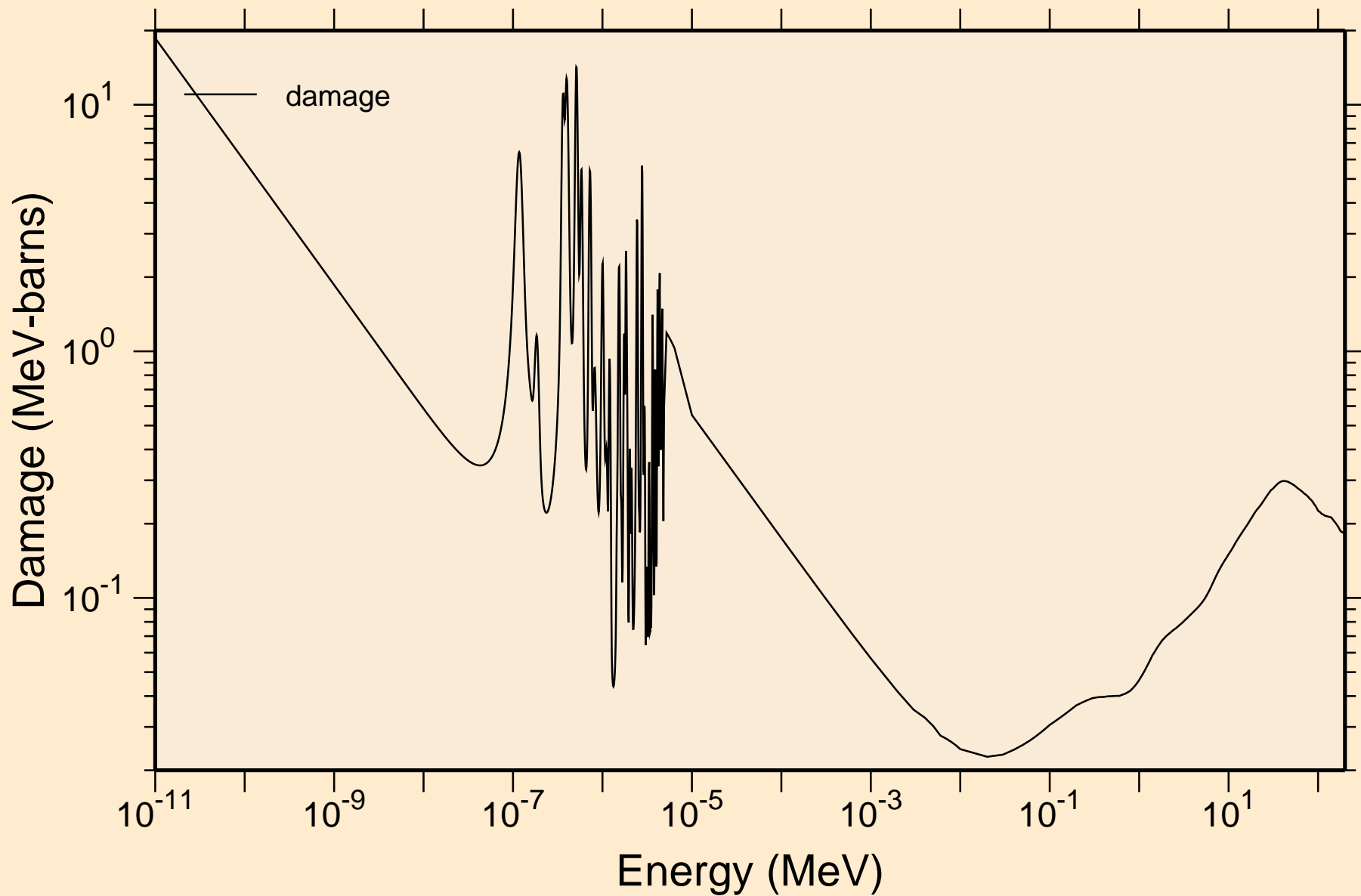

BK237 NEUTRON ACER TENDL-2019 LIBRARY; T=293.16K
Non-threshold reactions

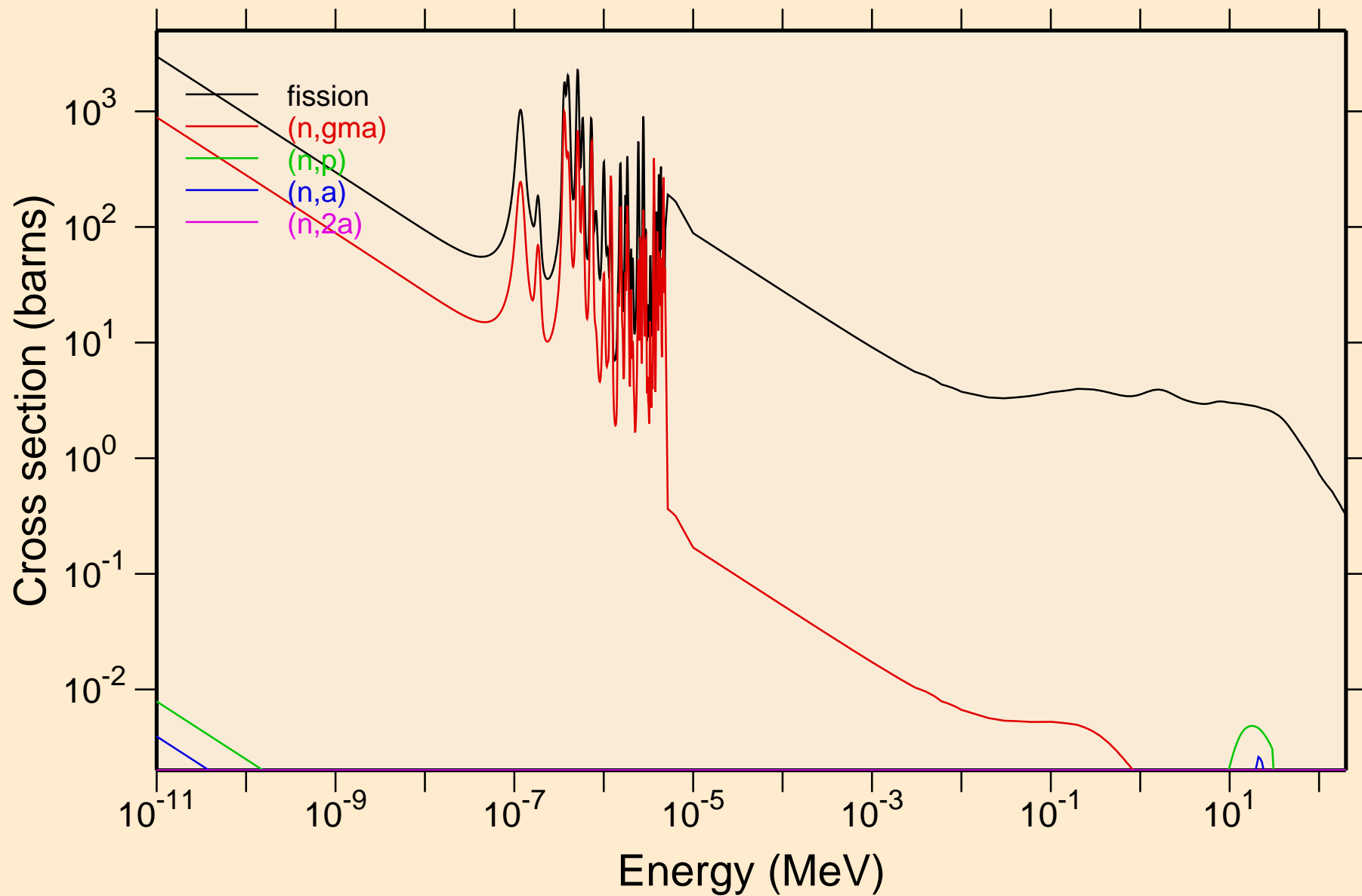

BK237 NEUTRON ACER TENDL-2019 LIBRARY; T=293.16K
Non-threshold reactions

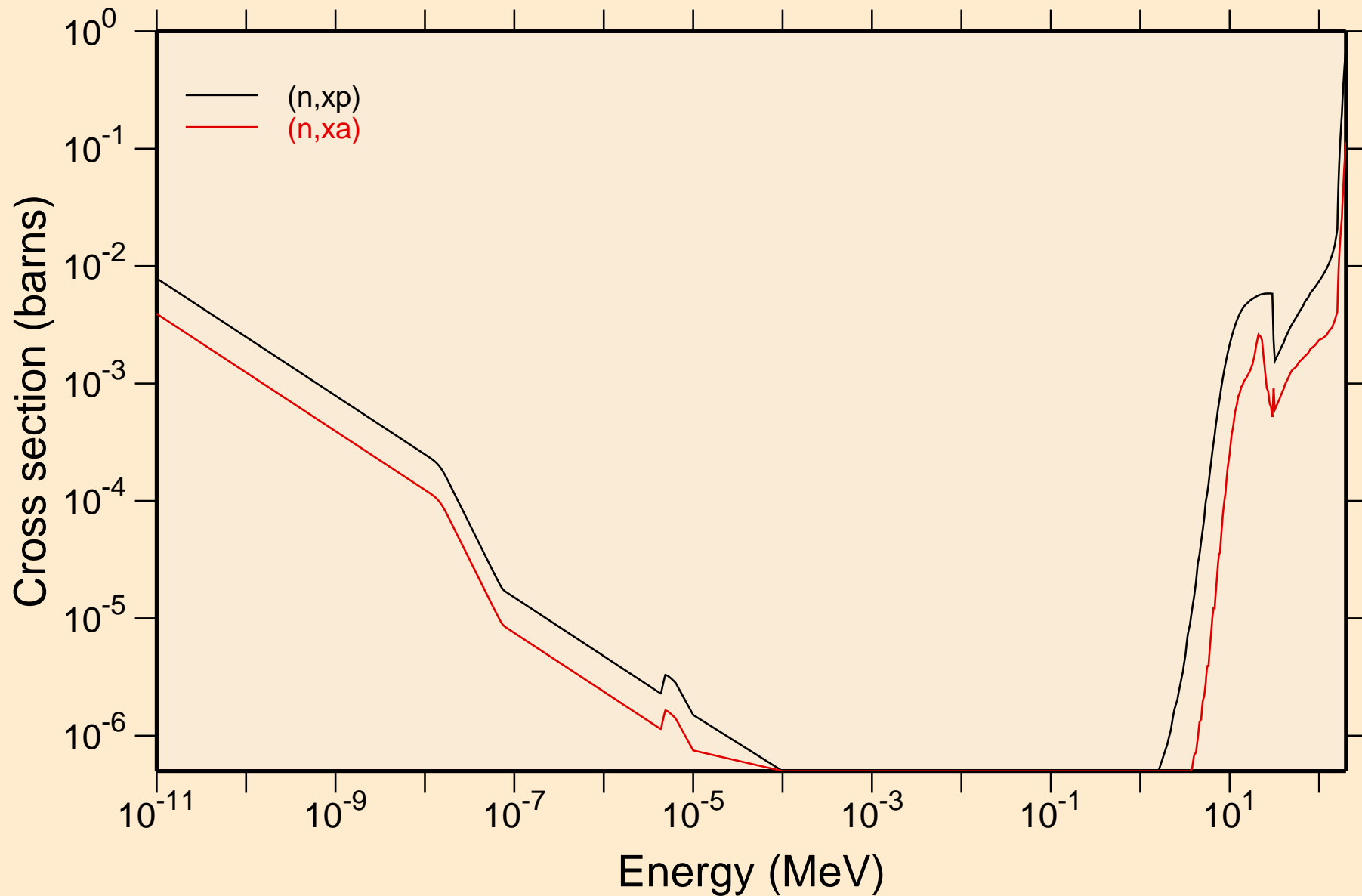

BK237 NEUTRON ACER TENDL-2019 LIBRARY; T=293.16K

Principal cross sections

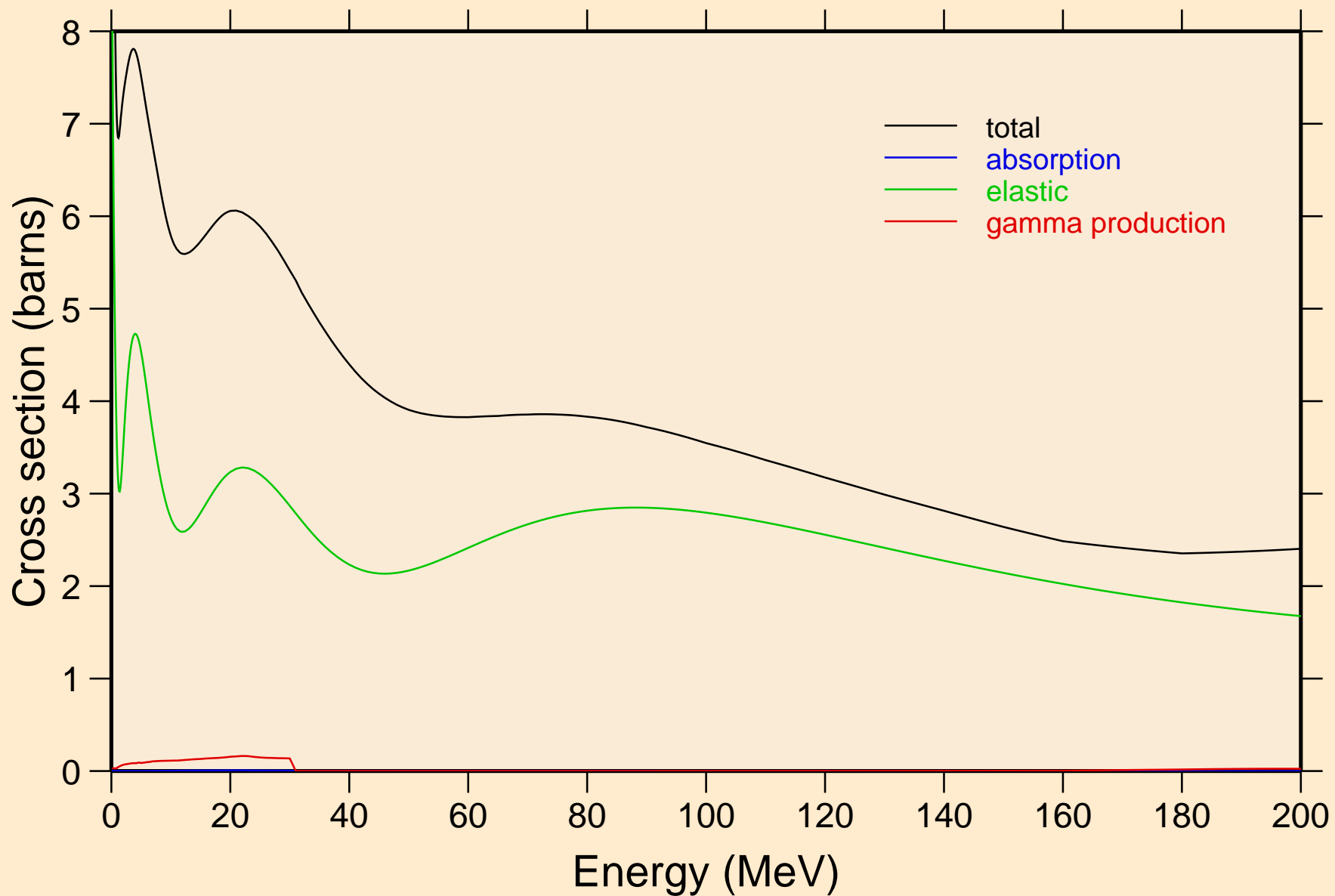

BK237 NEUTRON ACER TENDL-2019 LIBRARY; T=293.16K
Heating

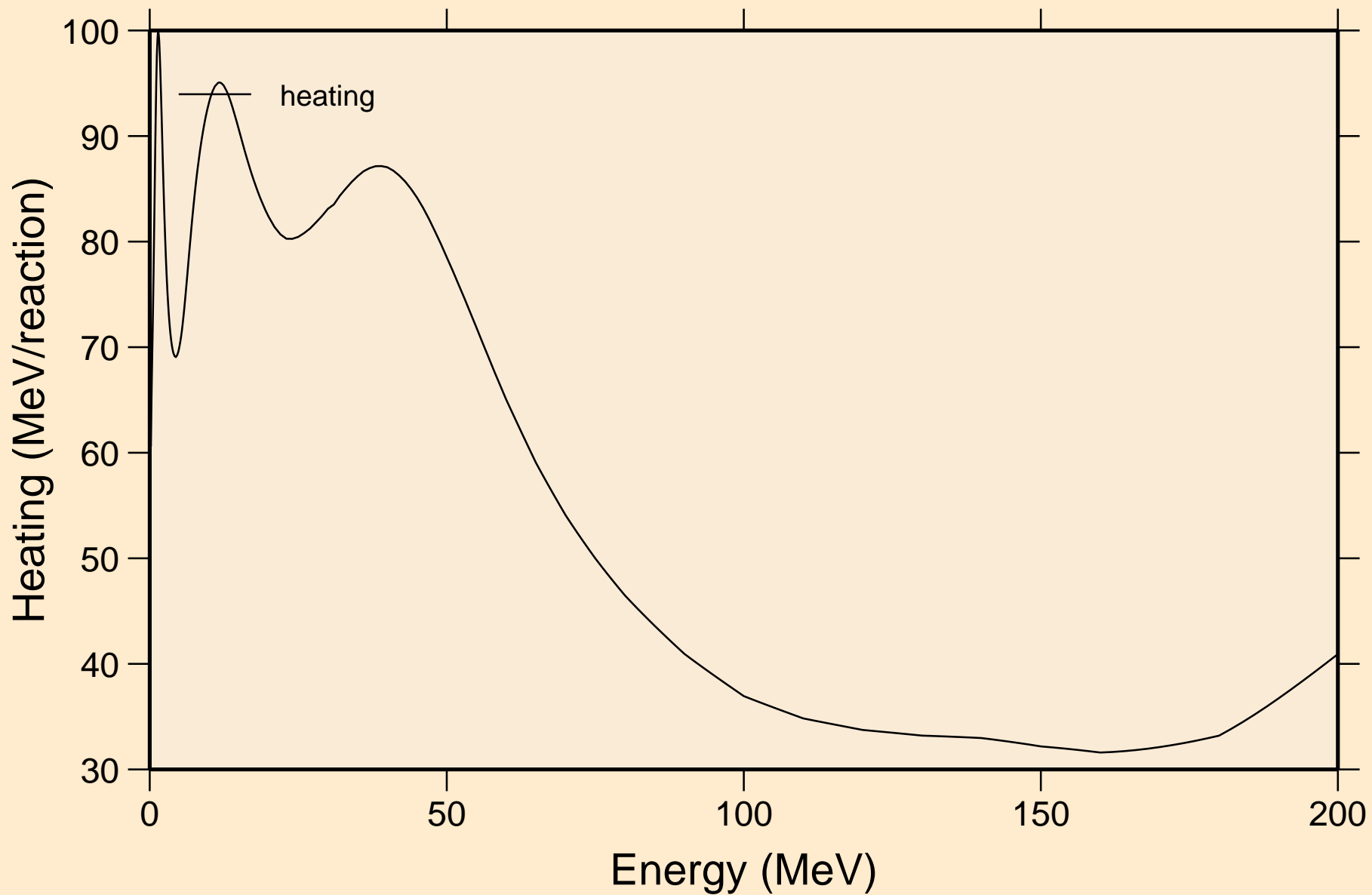

BK237 NEUTRON ACER TENDL-2019 LIBRARY; T=293.16K
Damage

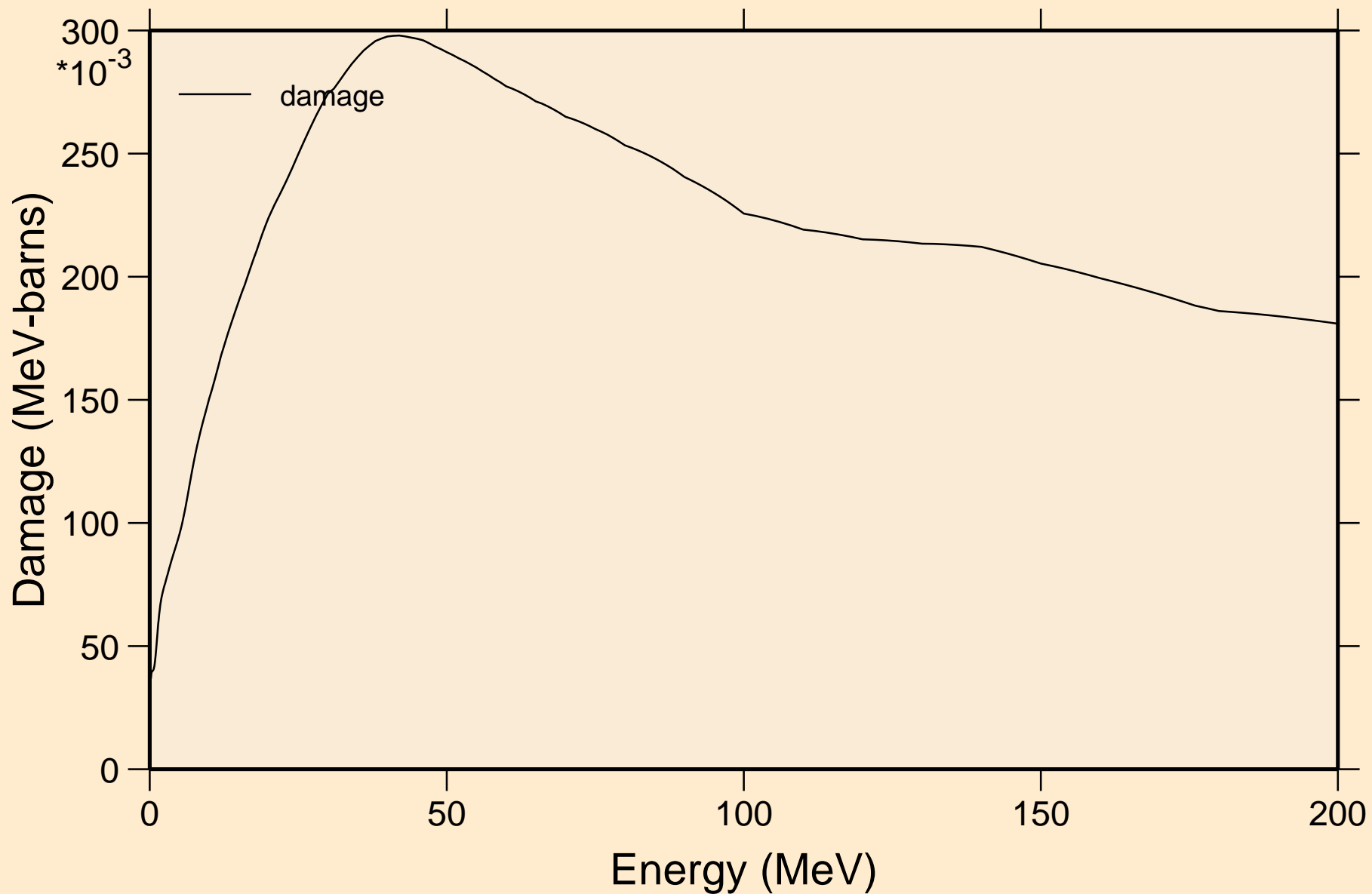

BK237 NEUTRON ACER TENDL-2019 LIBRARY; T=293.16K
Non-threshold reactions

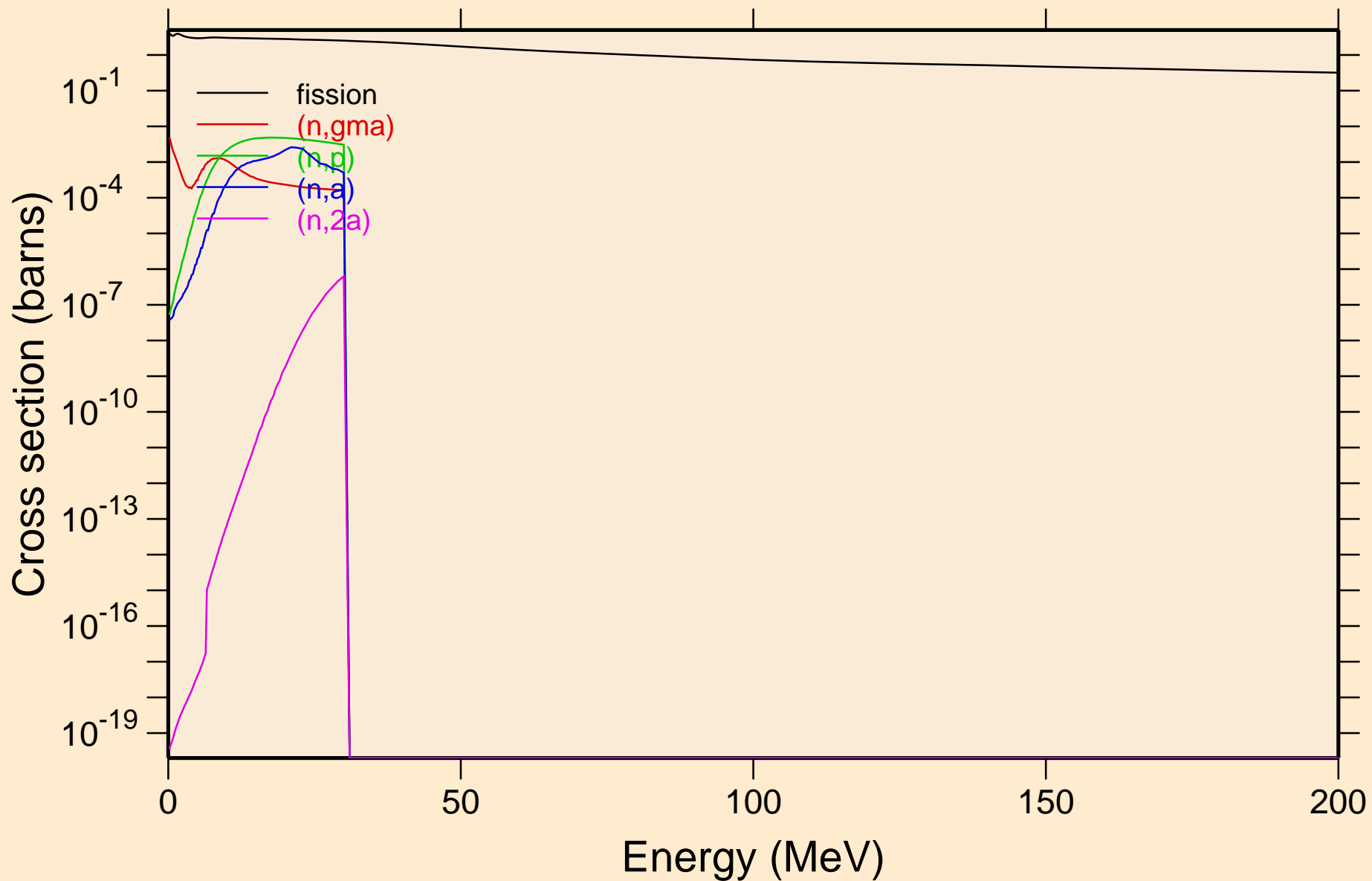

BK237 NEUTRON ACER TENDL-2019 LIBRARY; T=293.16K
Non-threshold reactions

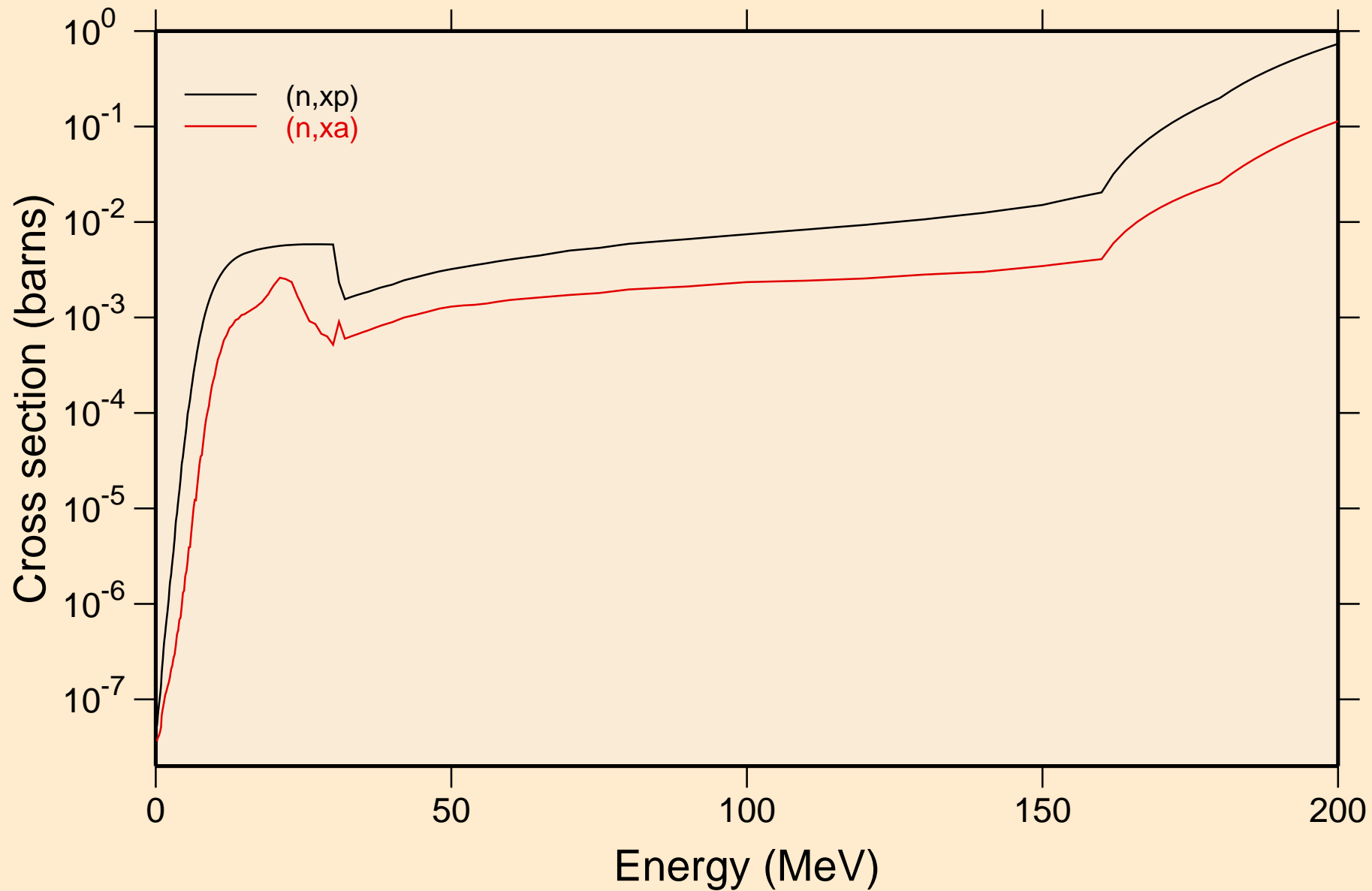

BK237 NEUTRON ACER TENDL-2019 LIBRARY; T=293.16K
Inelastic levels

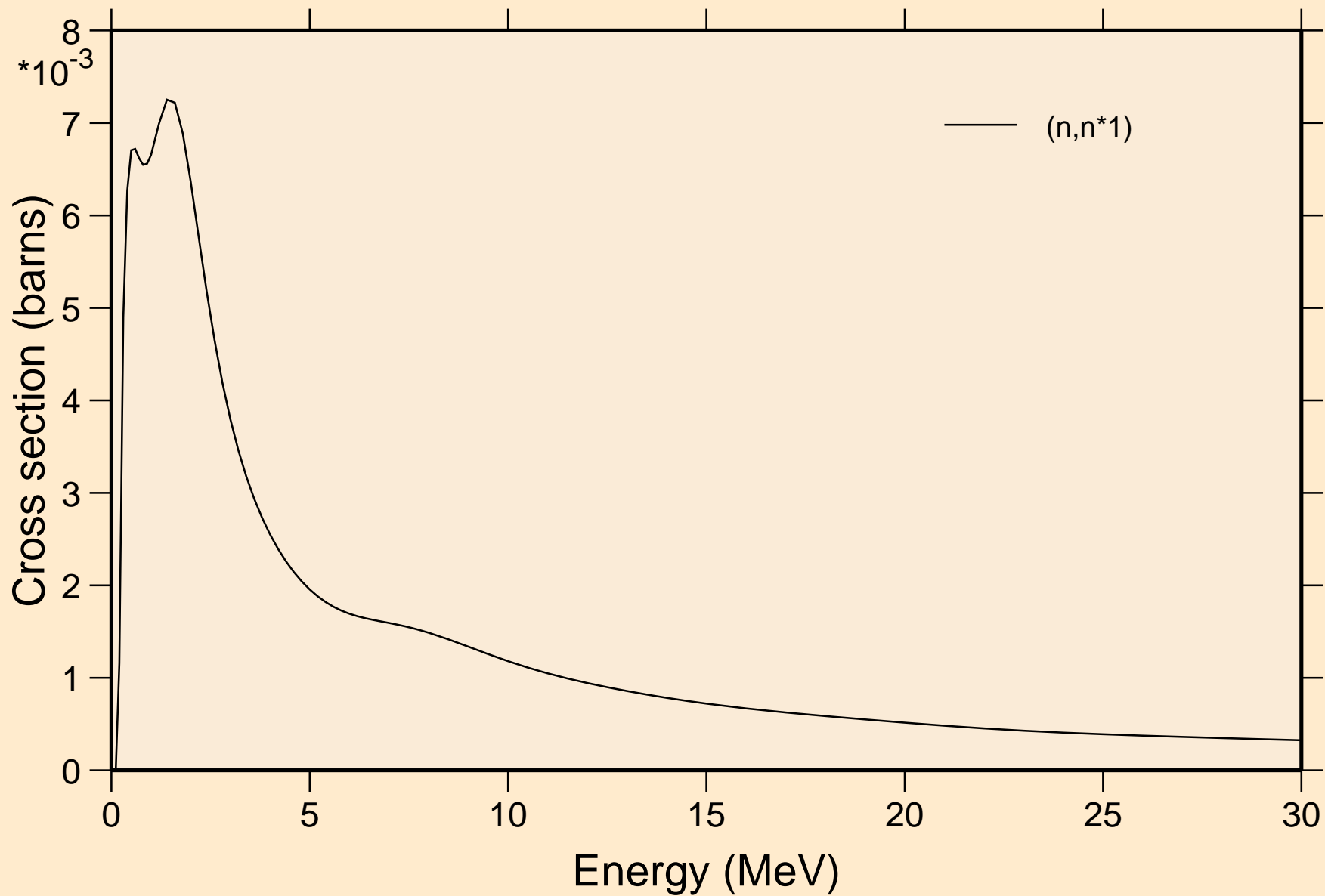

BK237 NEUTRON ACER TENDL-2019 LIBRARY; T=293.16K
Threshold reactions

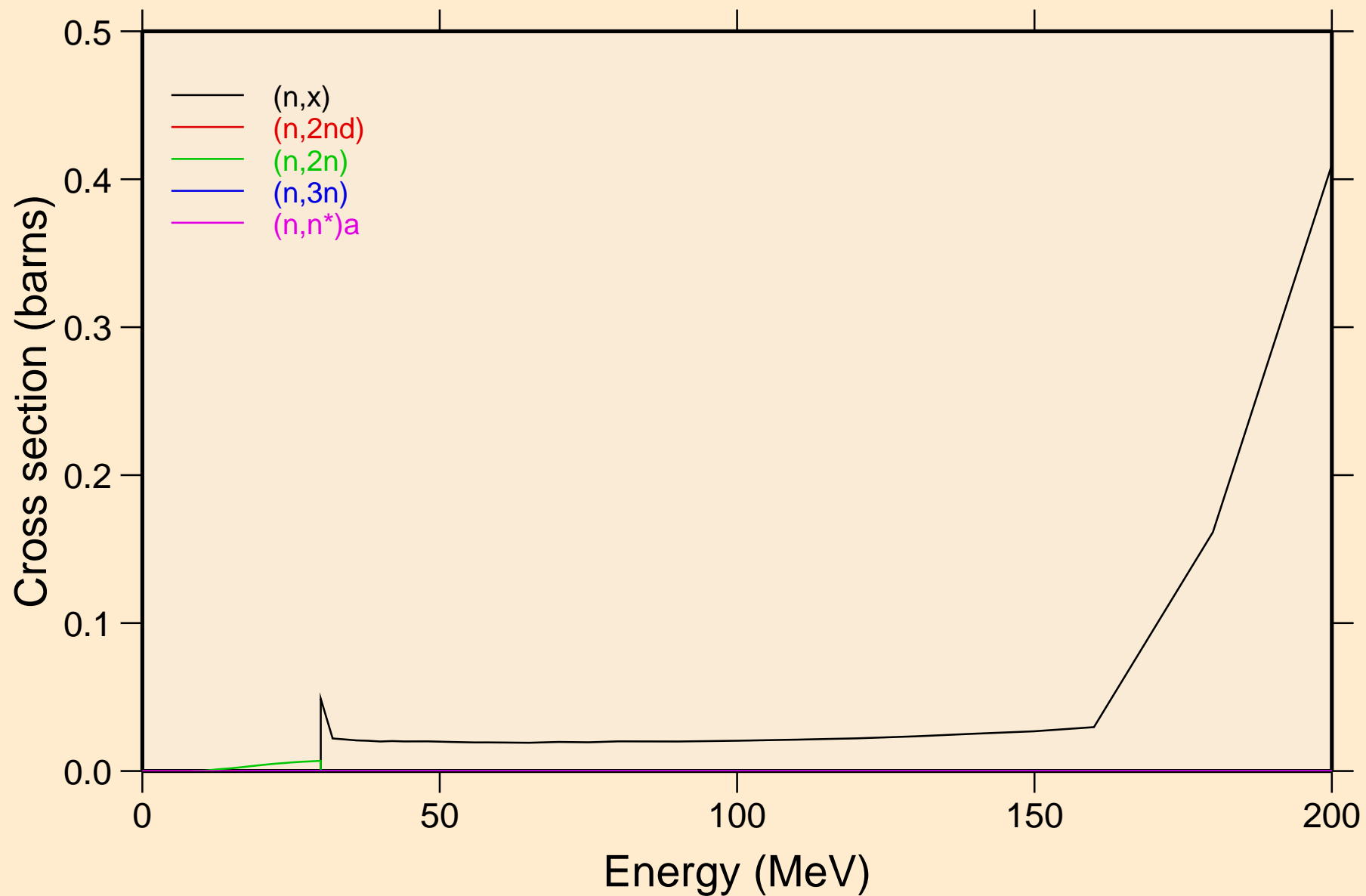

BK237 NEUTRON ACER TENDL-2019 LIBRARY; T=293.16K
Threshold reactions

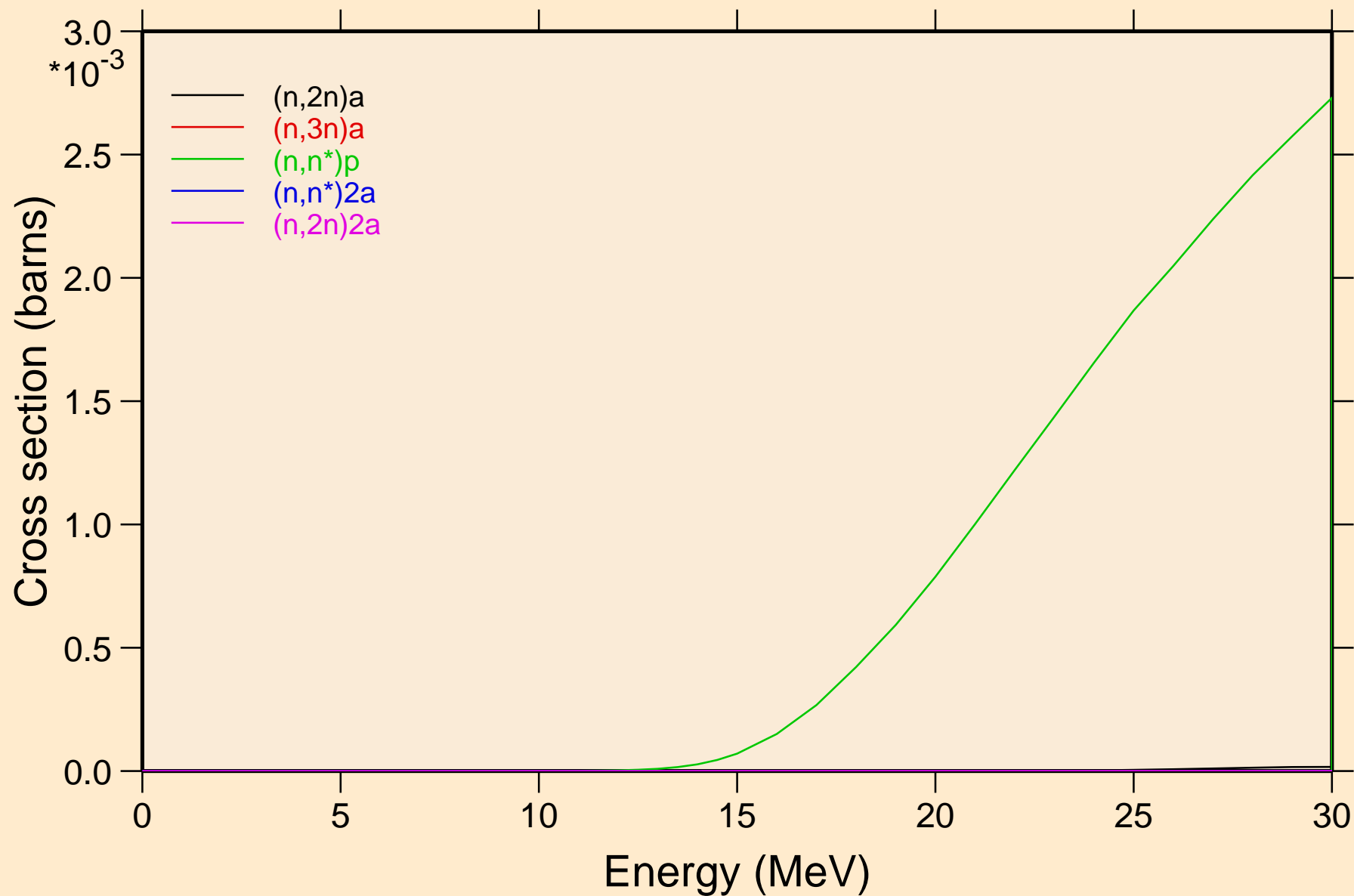

BK237 NEUTRON ACER TENDL-2019 LIBRARY; T=293.16K
Threshold reactions

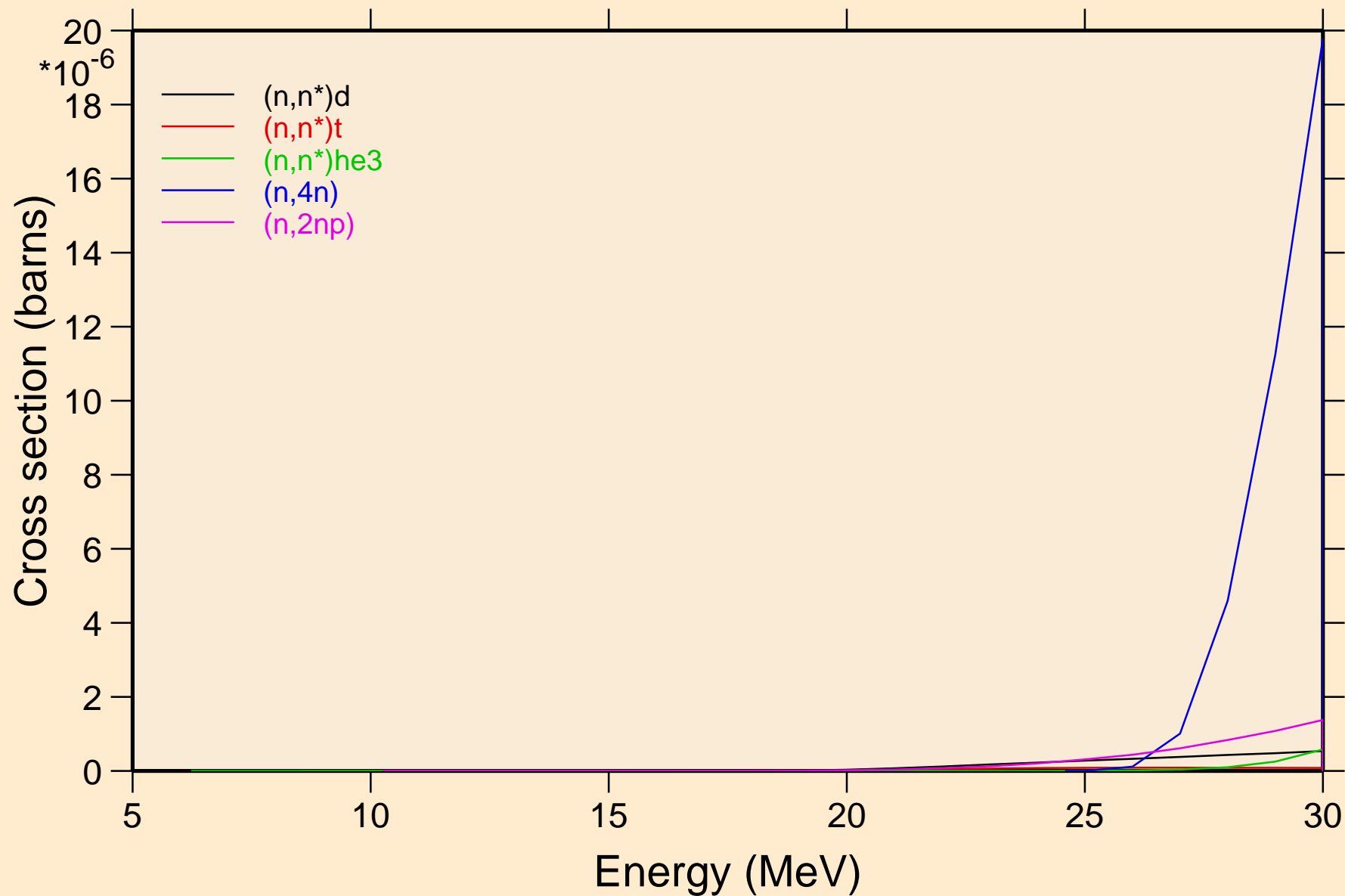

BK237 NEUTRON ACER TENDL-2019 LIBRARY; T=293.16K

Threshold reactions

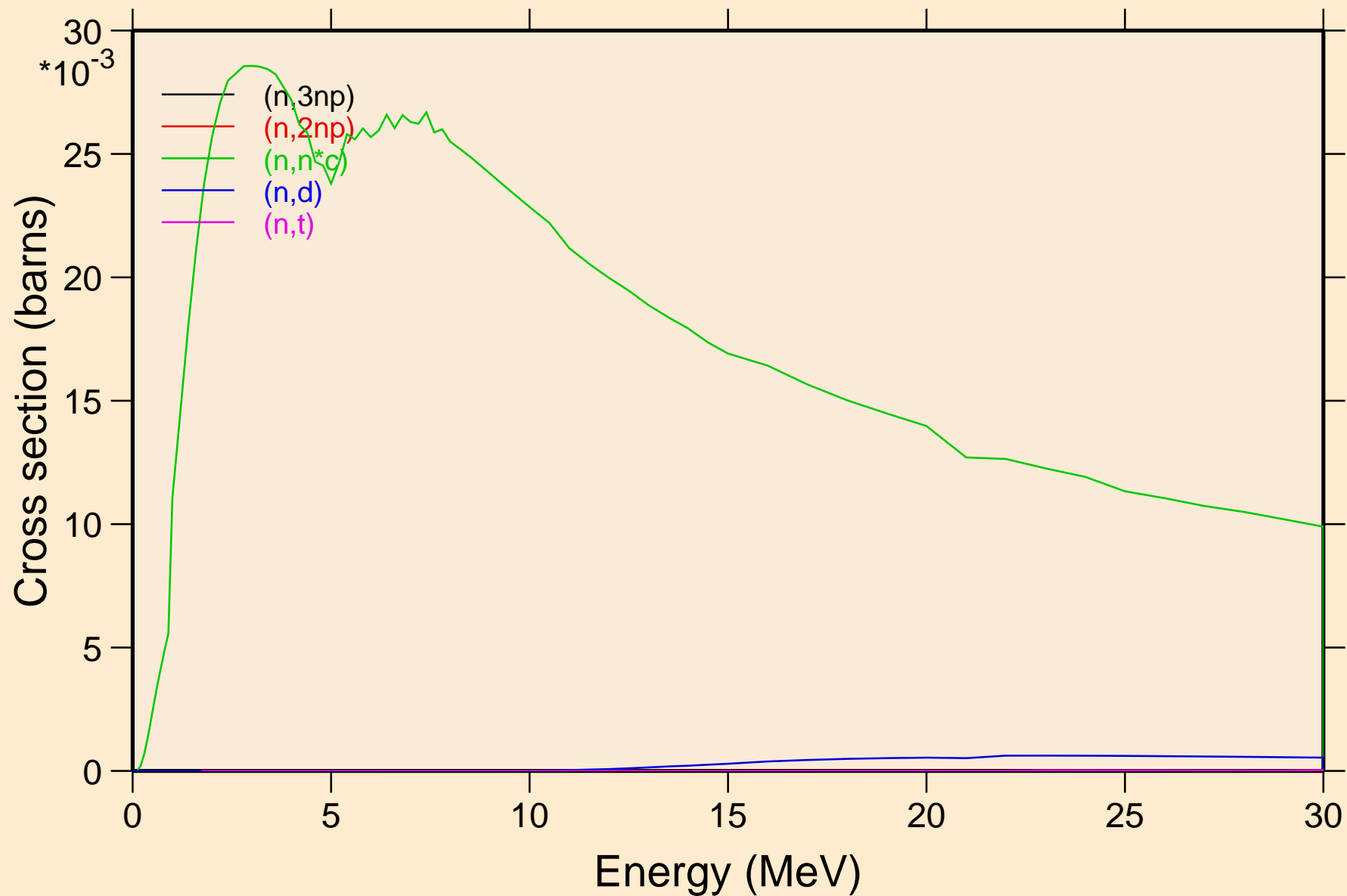

BK237 NEUTRON ACER TENDL-2019 LIBRARY; T=293.16K
Threshold reactions

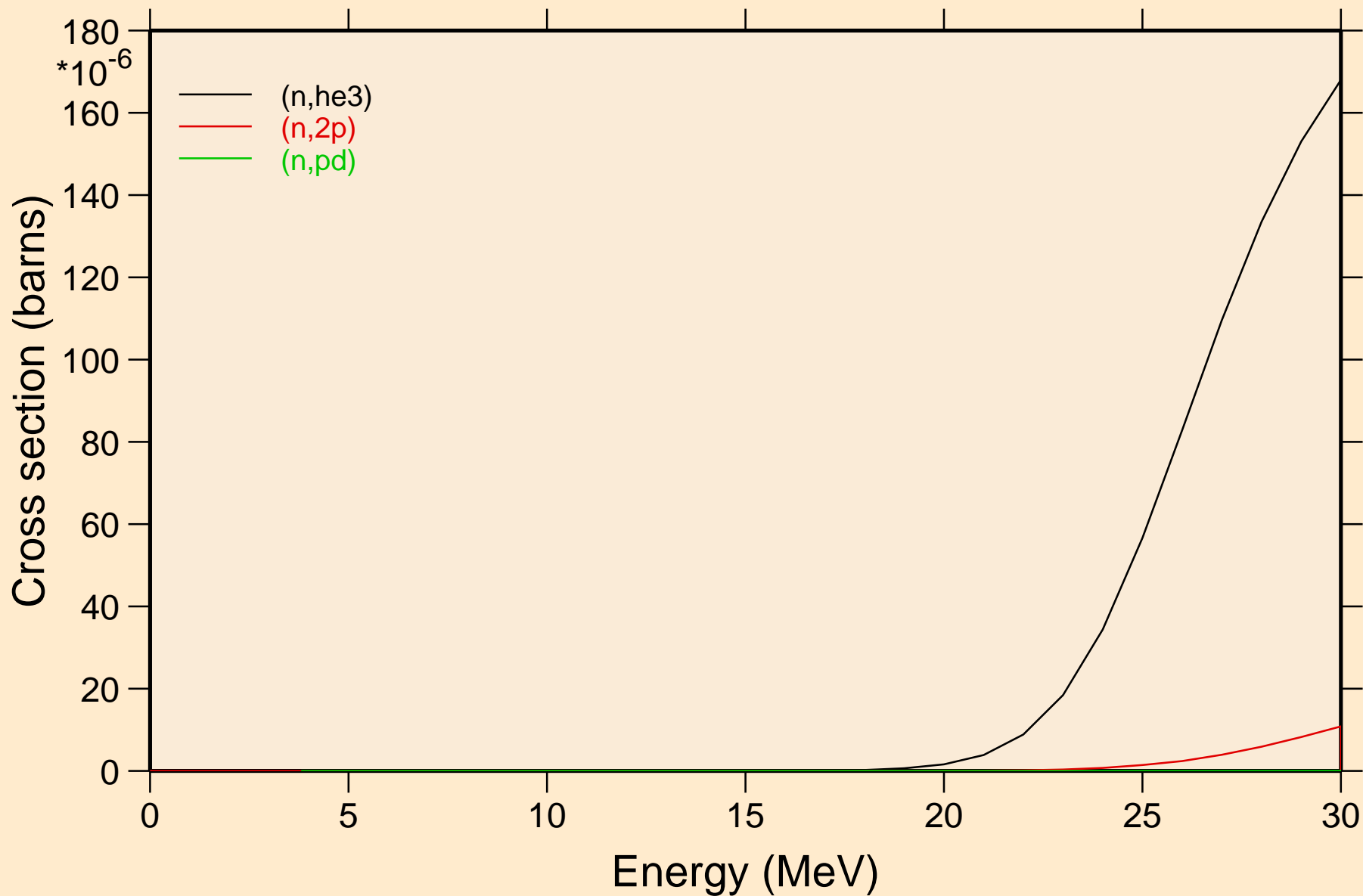

BK237 NEUTRON ACER TENDL-2019 LIBRARY; T=293.16K
Threshold reactions

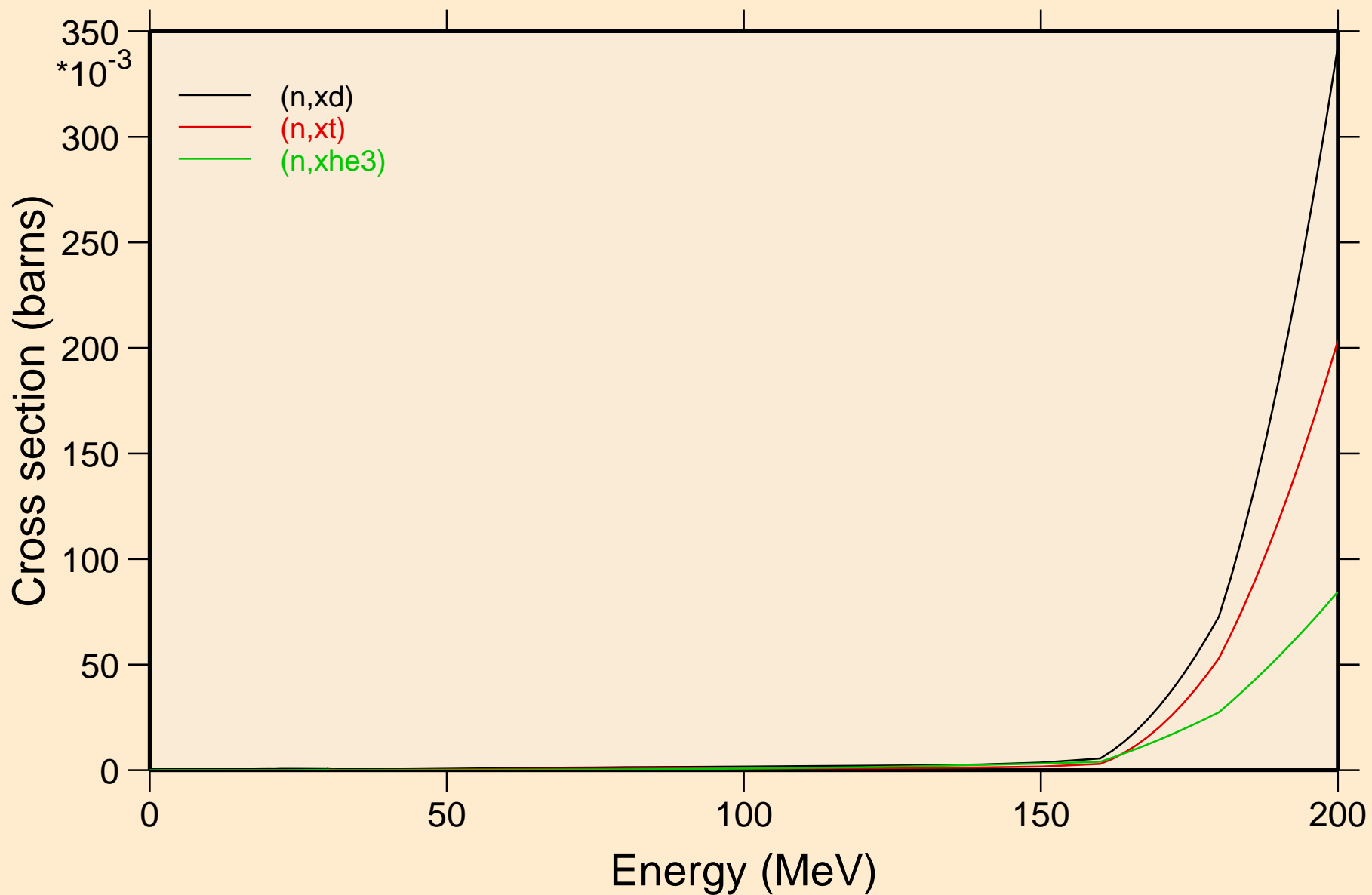

BK237 NEUTRON ACER TENDL-2019 LIBRARY; T=293.16K
angular distribution for elastic

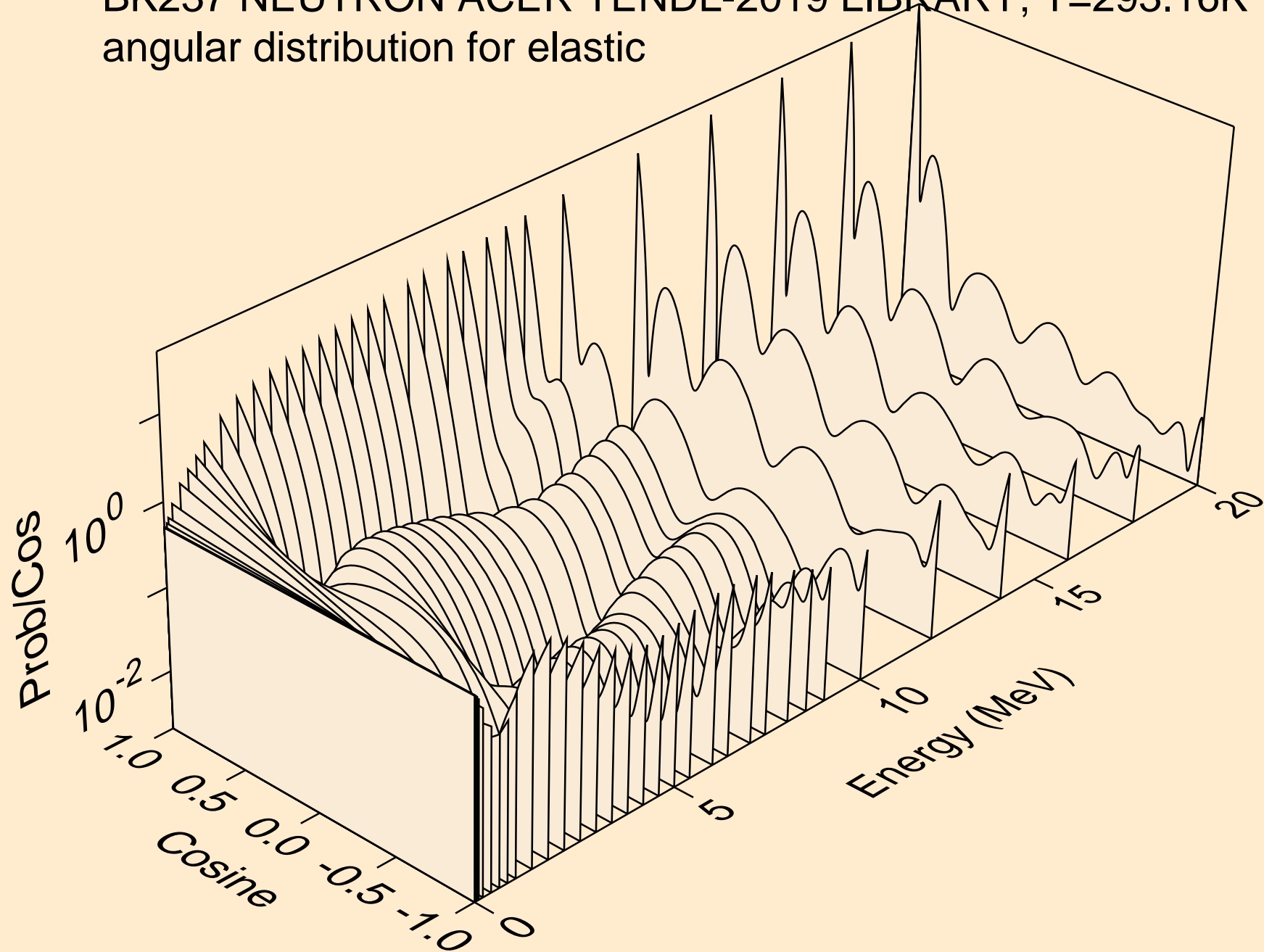

BK237 NEUTRON ACER TENDL-2019 LIBRARY; T=293.16K
angular distribution for elastic

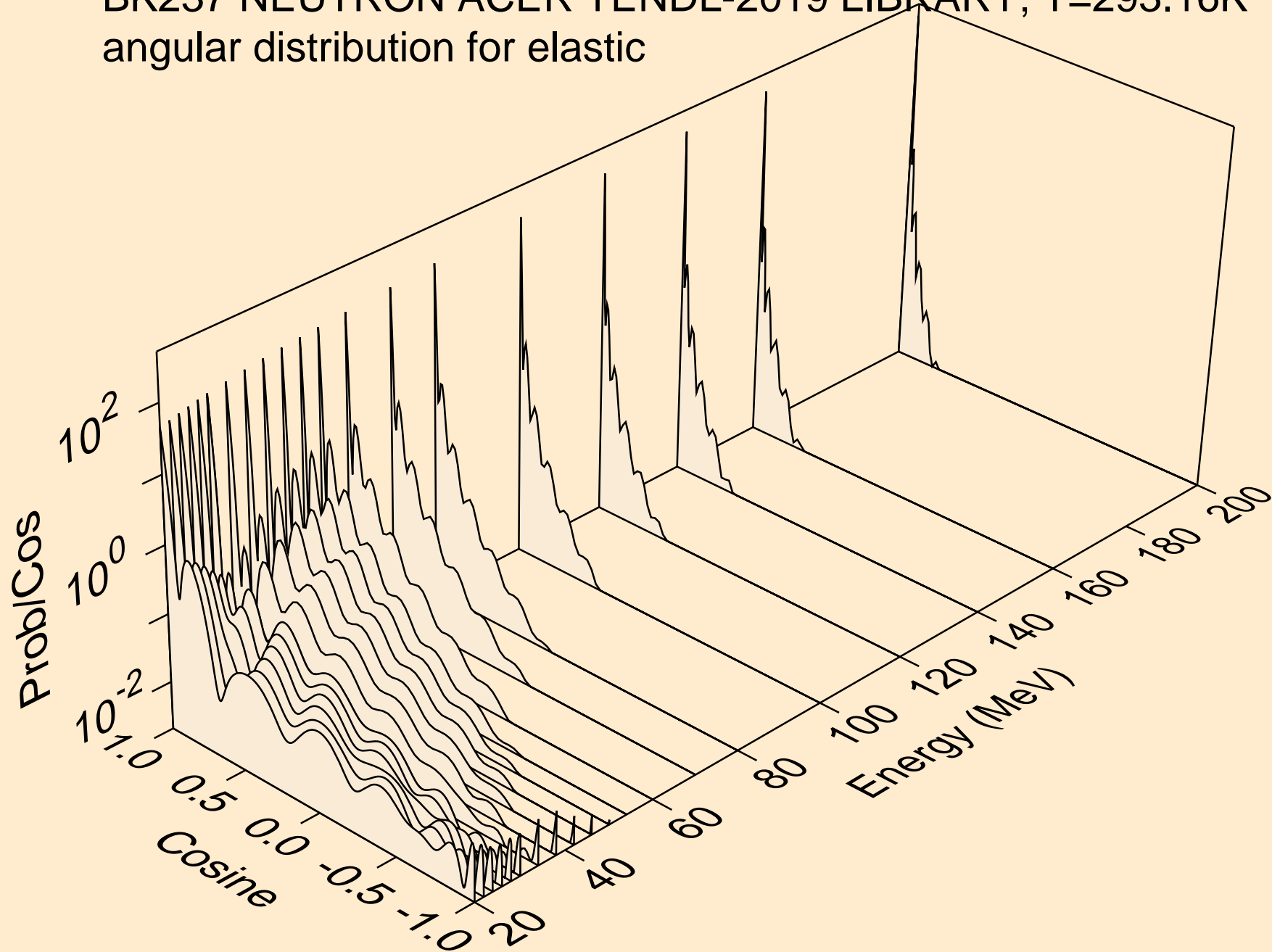

BK237 NEUTRON ACER TENDL-2019 LIBRARY; T=293.16K
angular distribution for (n,n*1)

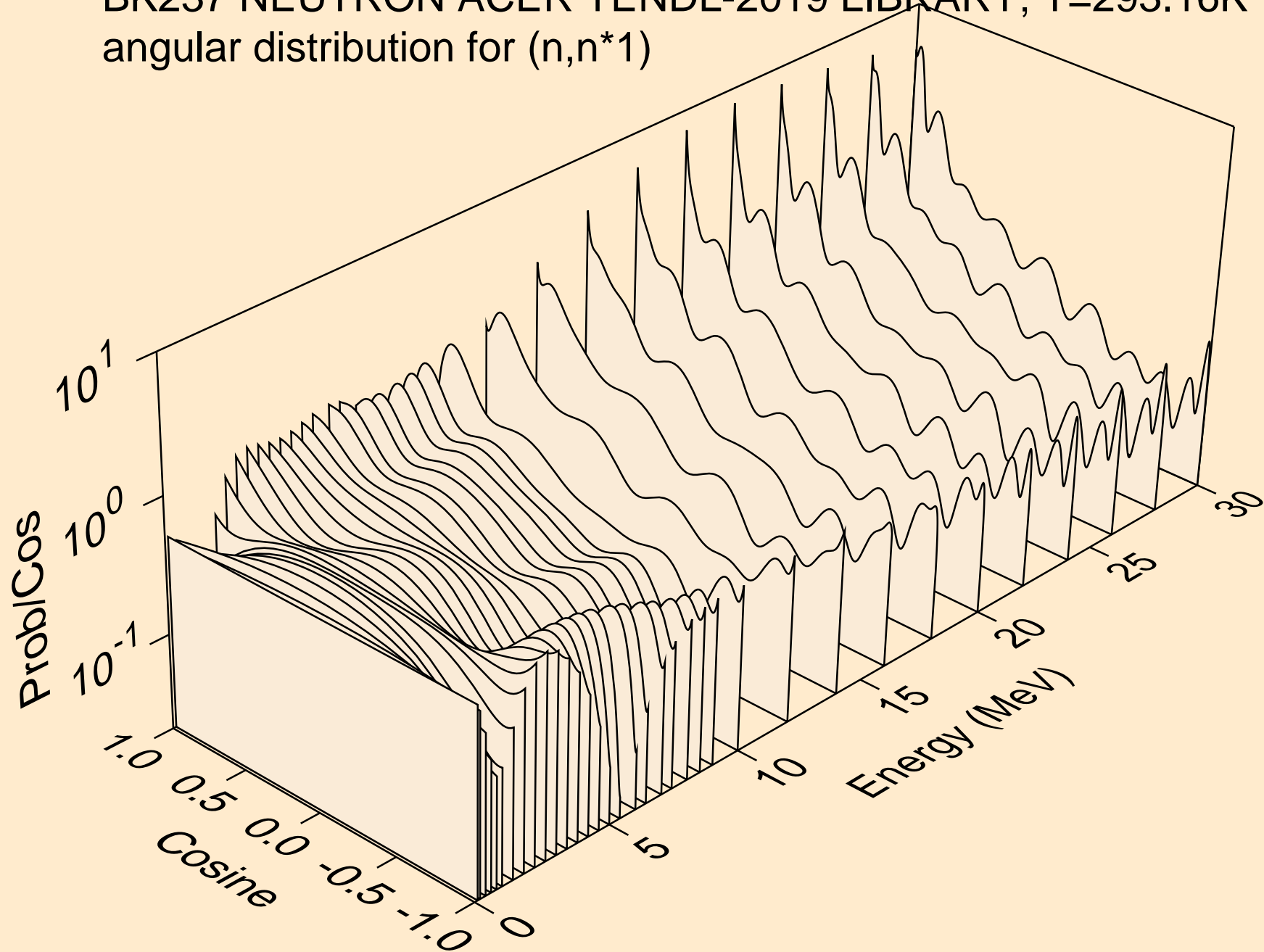

BK237 NEUTRON ACER TENDL-2019 LIBRARY; T=293.16K
Total fission nubar

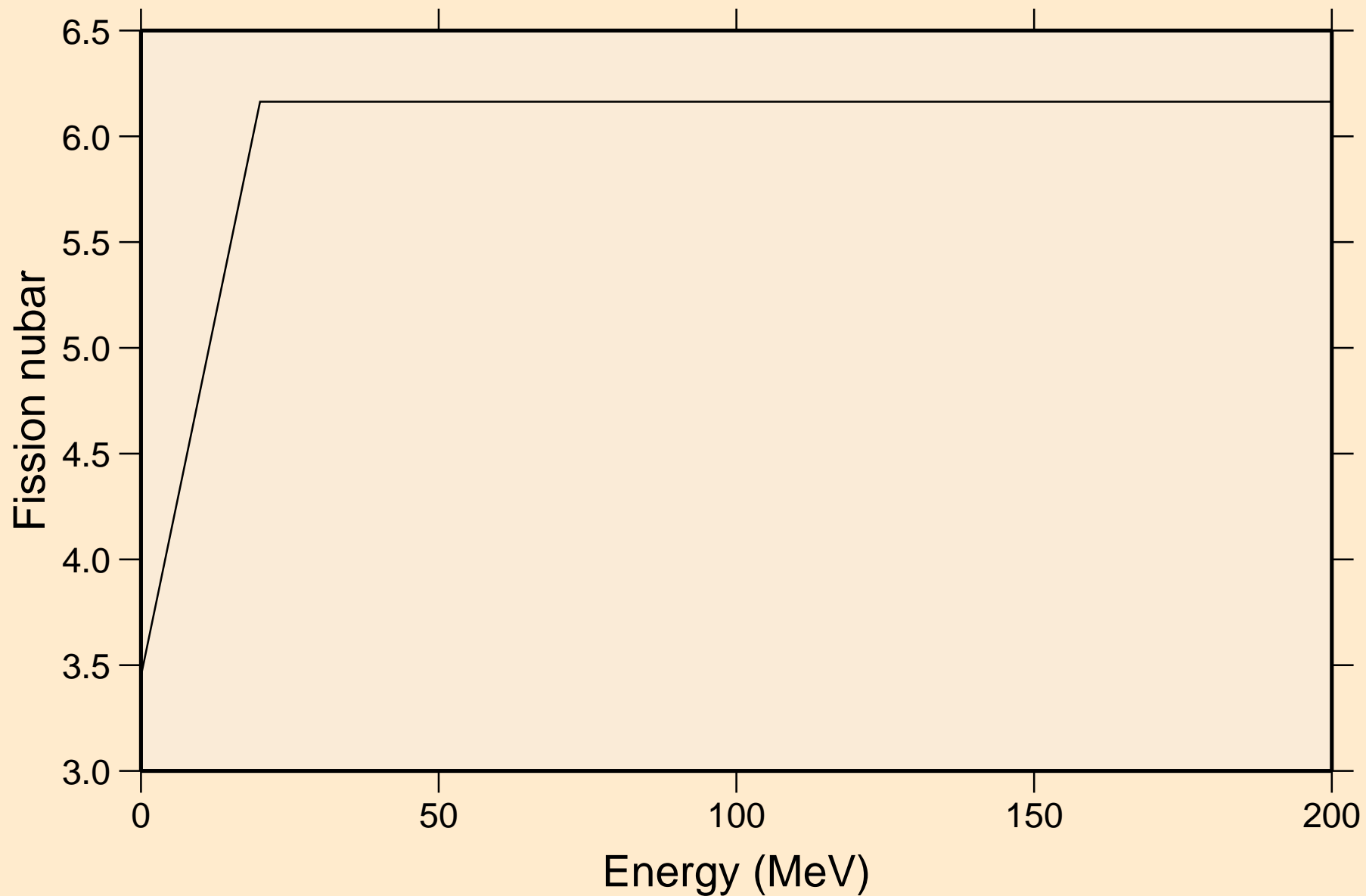

BK237 NEUTRON ACER TENDL-2019 LIBRARY; T=293.16K
Neutron emission for (n,x)

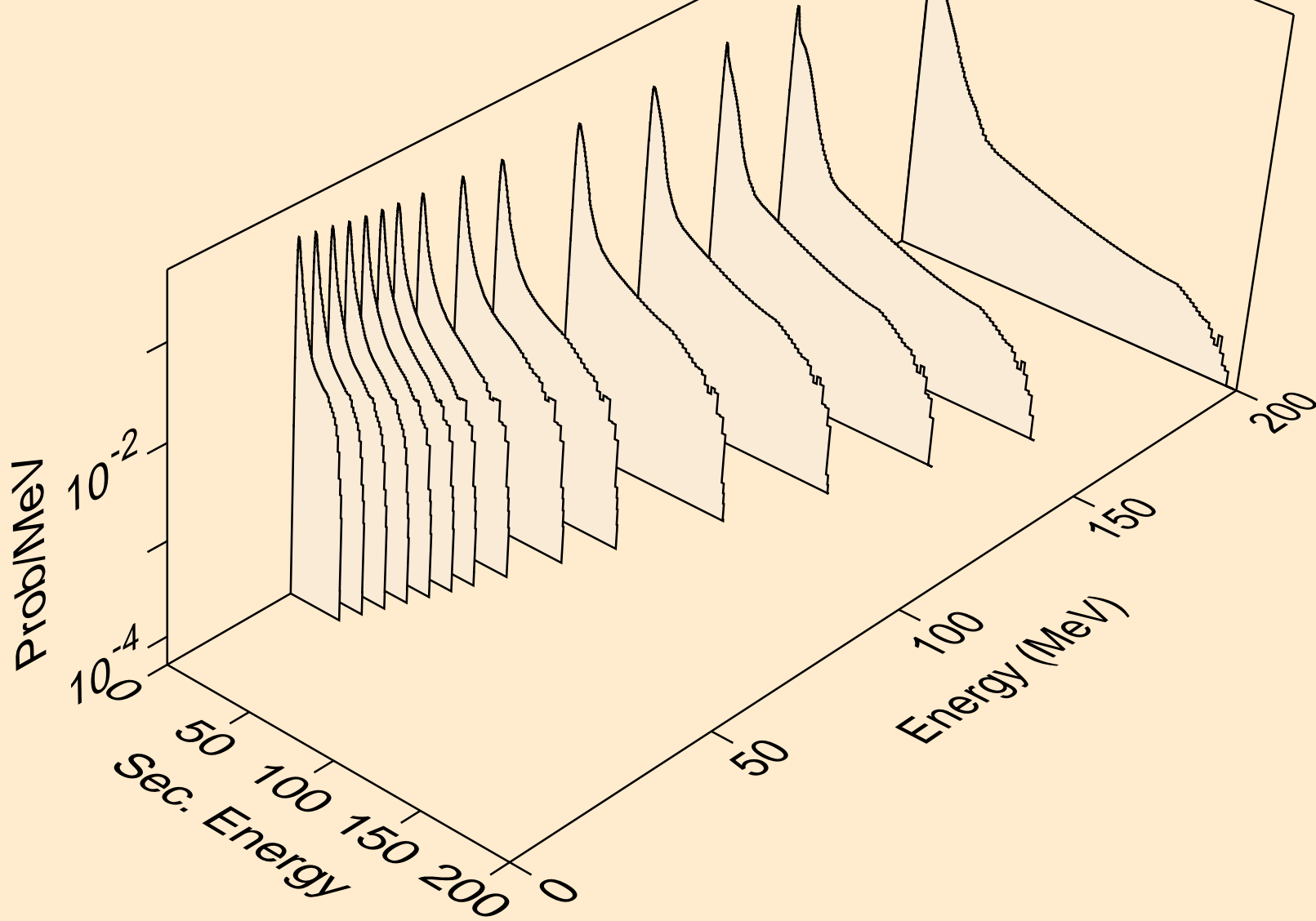

BK237 NEUTRON ACER TENDL-2019 LIBRARY; T=293.16K
Neutron emission for (n,2nd)

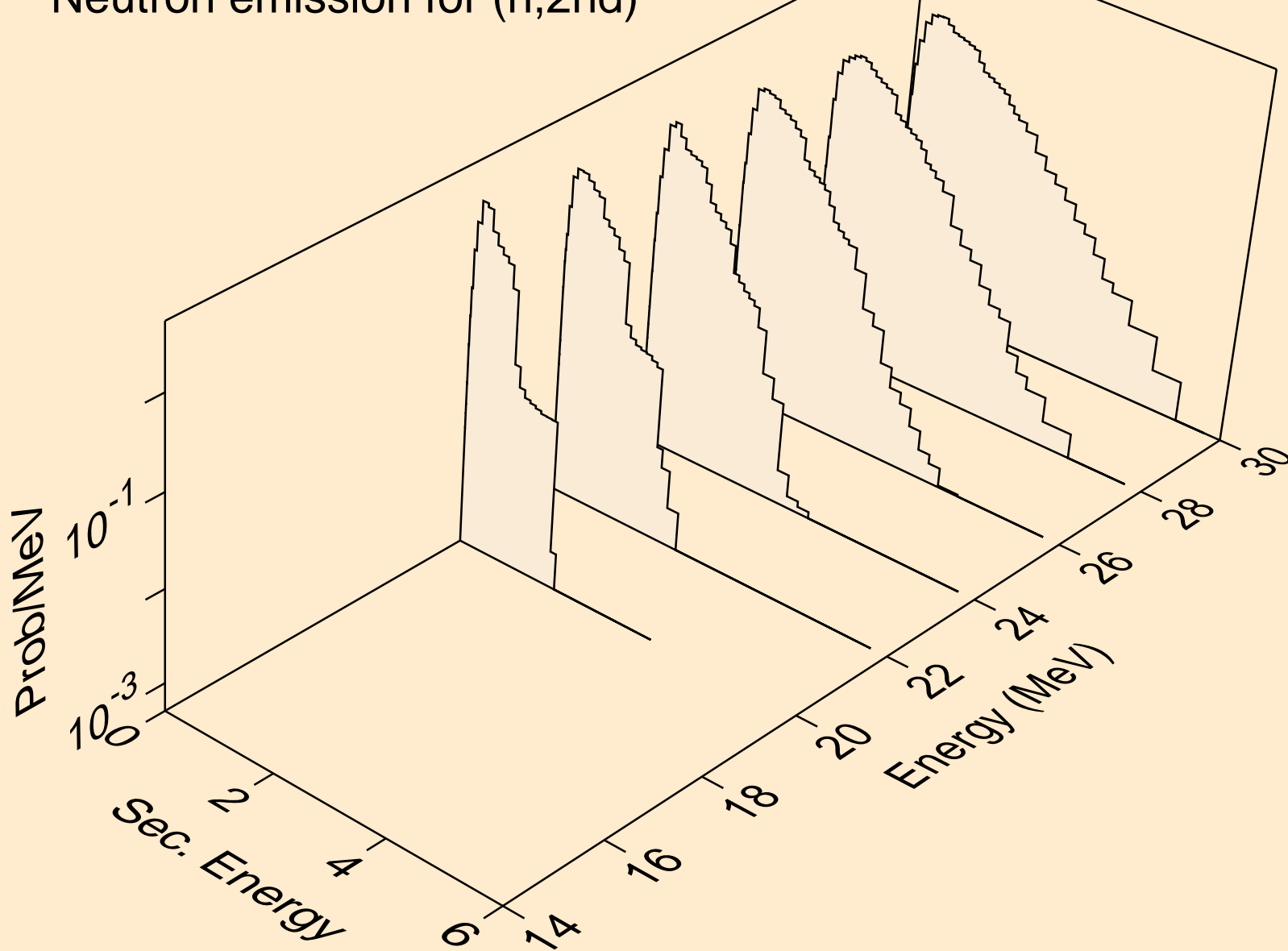

BK237 NEUTRON ACER TENDL-2019 LIBRARY; T=293.16K
Neutron emission for (n,2n)

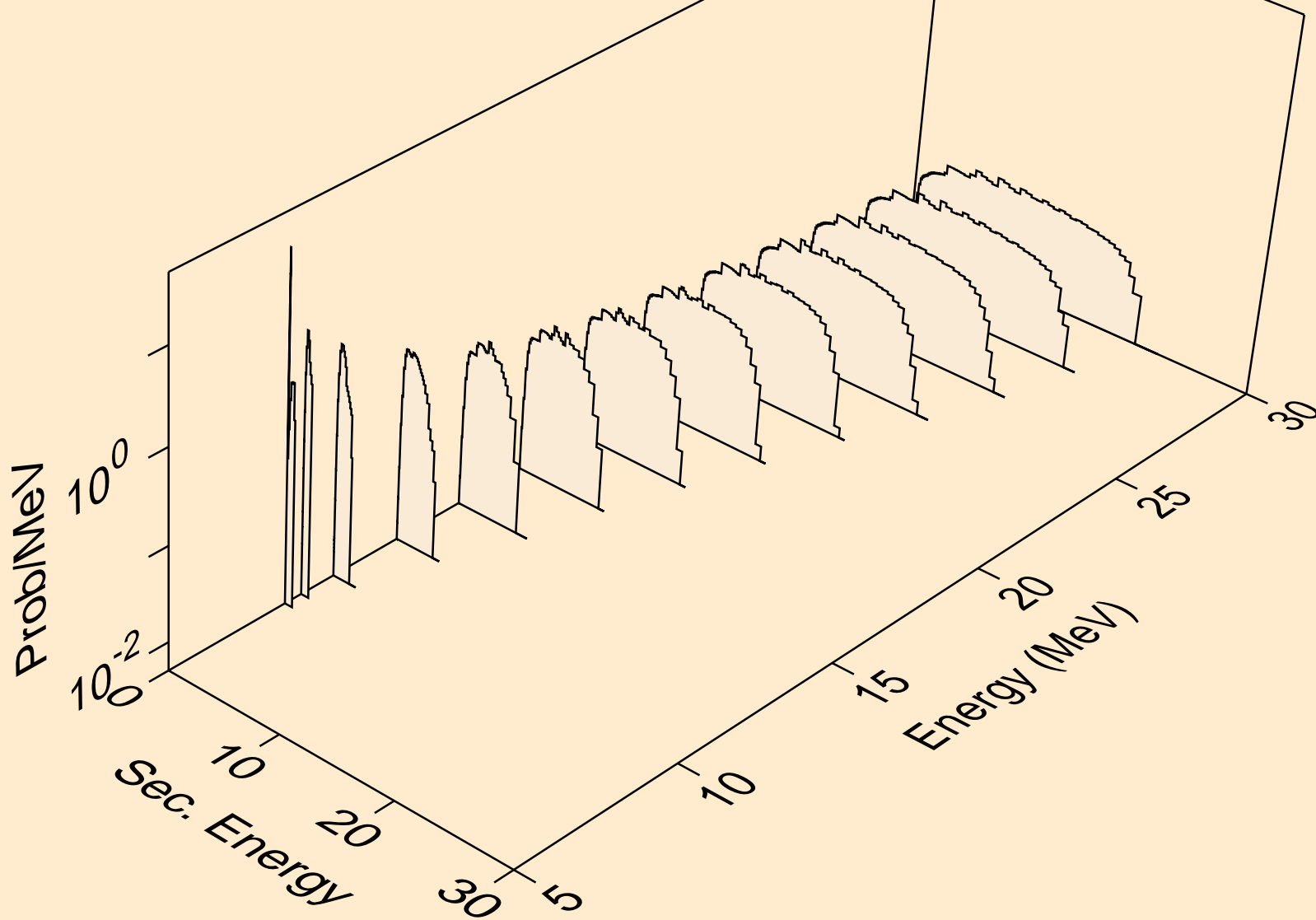

BK237 NEUTRON ACER TENDL-2019 LIBRARY; T=293.16K
Neutron emission for (n,3n)

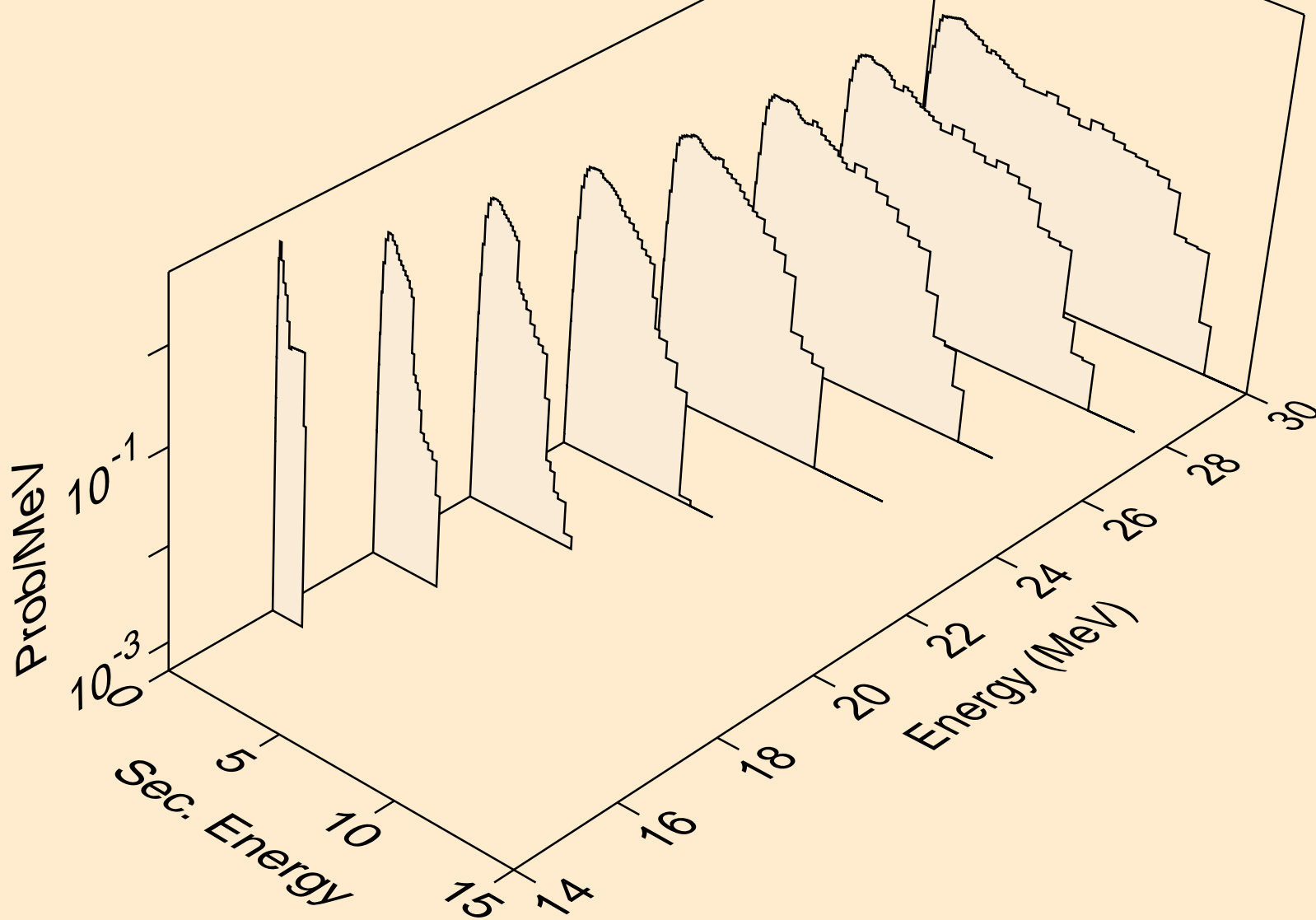

BK237 NEUTRON ACER TENDL-2019 LIBRARY; T=293.16K
Neutron emission for fission

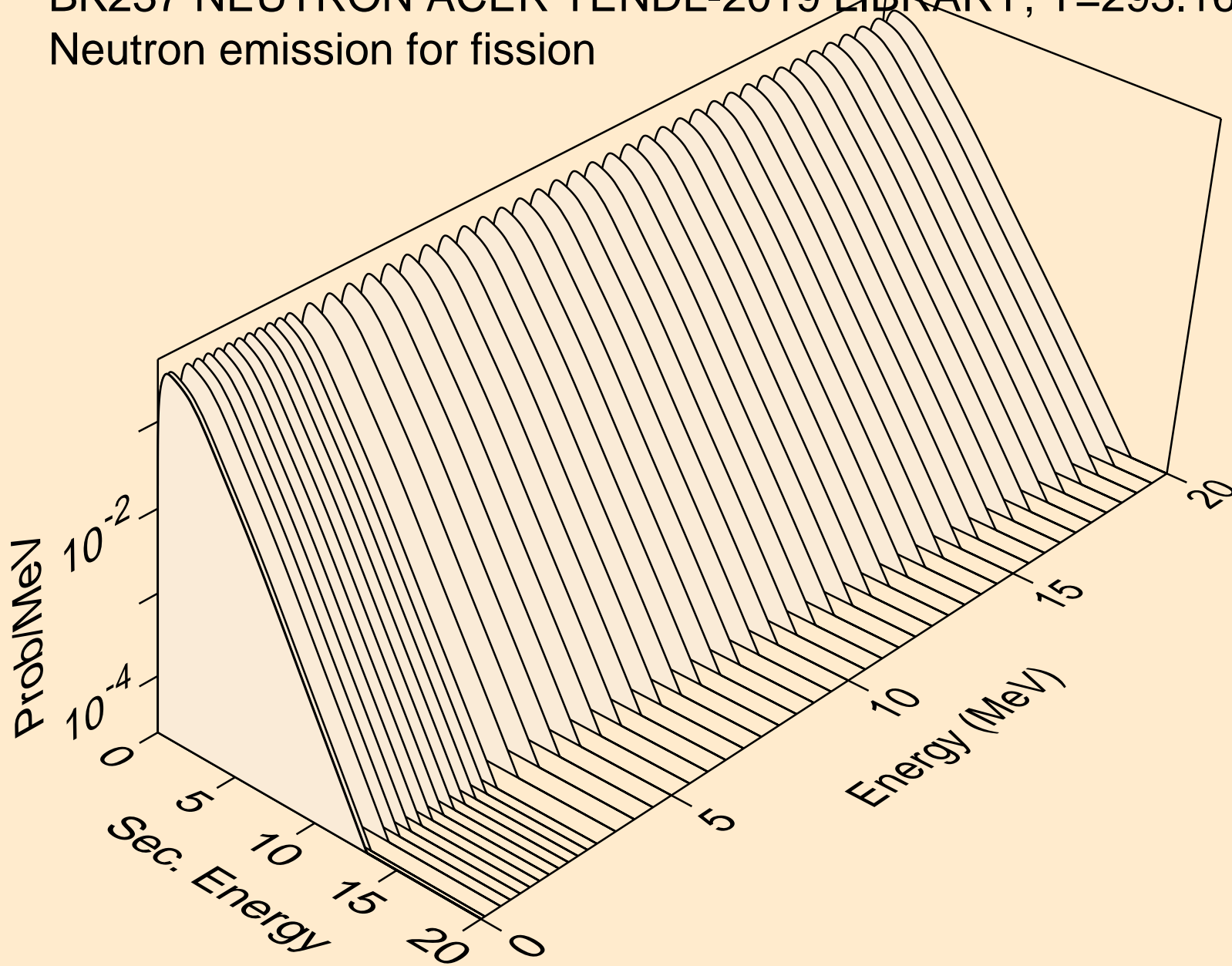

BK237 NEUTRON ACER TENDL-2019 LIBRARY; T=293.16K
Neutron emission for (n,n*)a

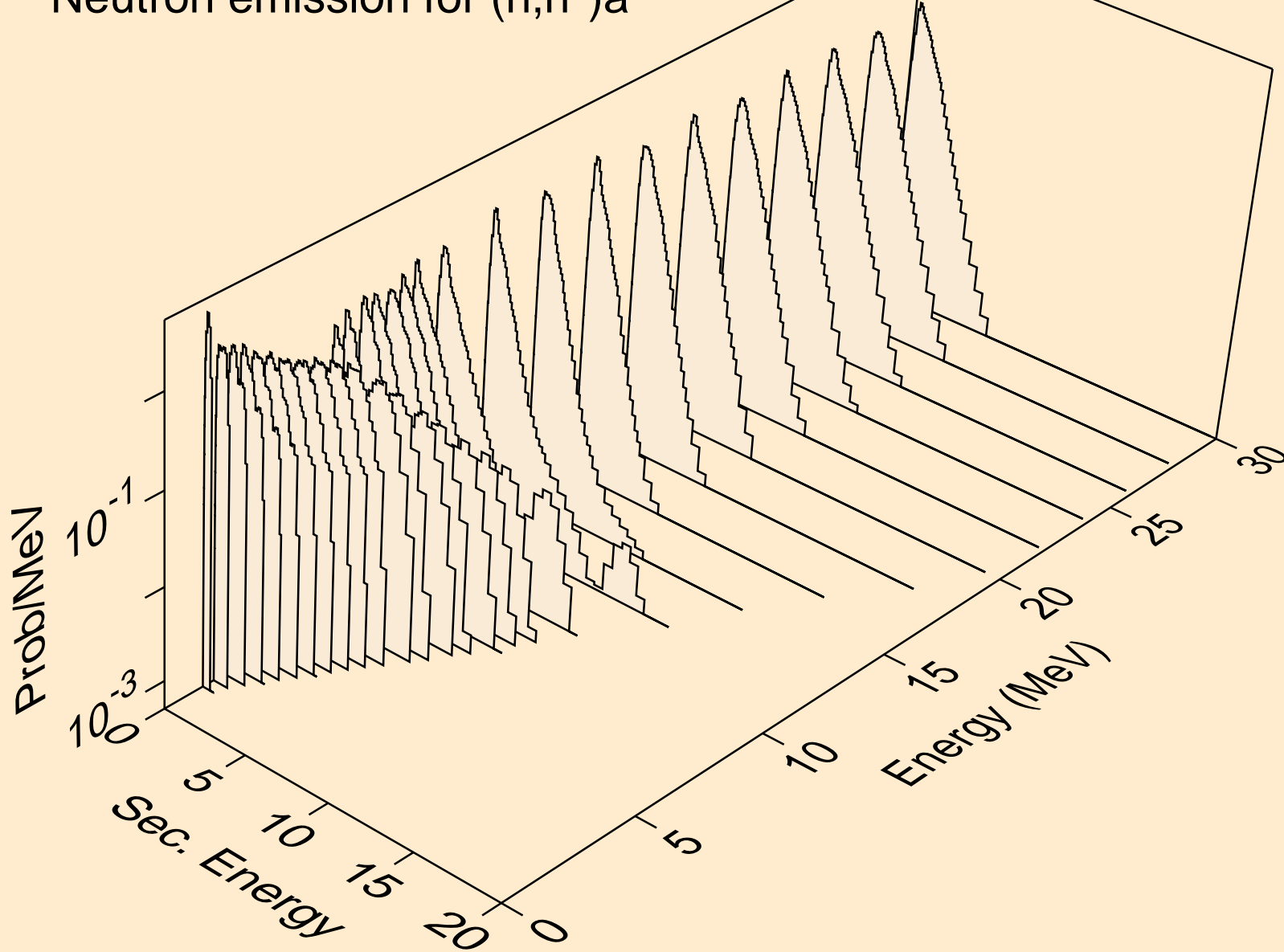

BK237 NEUTRON ACER TENDL-2019 LIBRARY; T=293.16K
Neutron emission for (n,2n)a

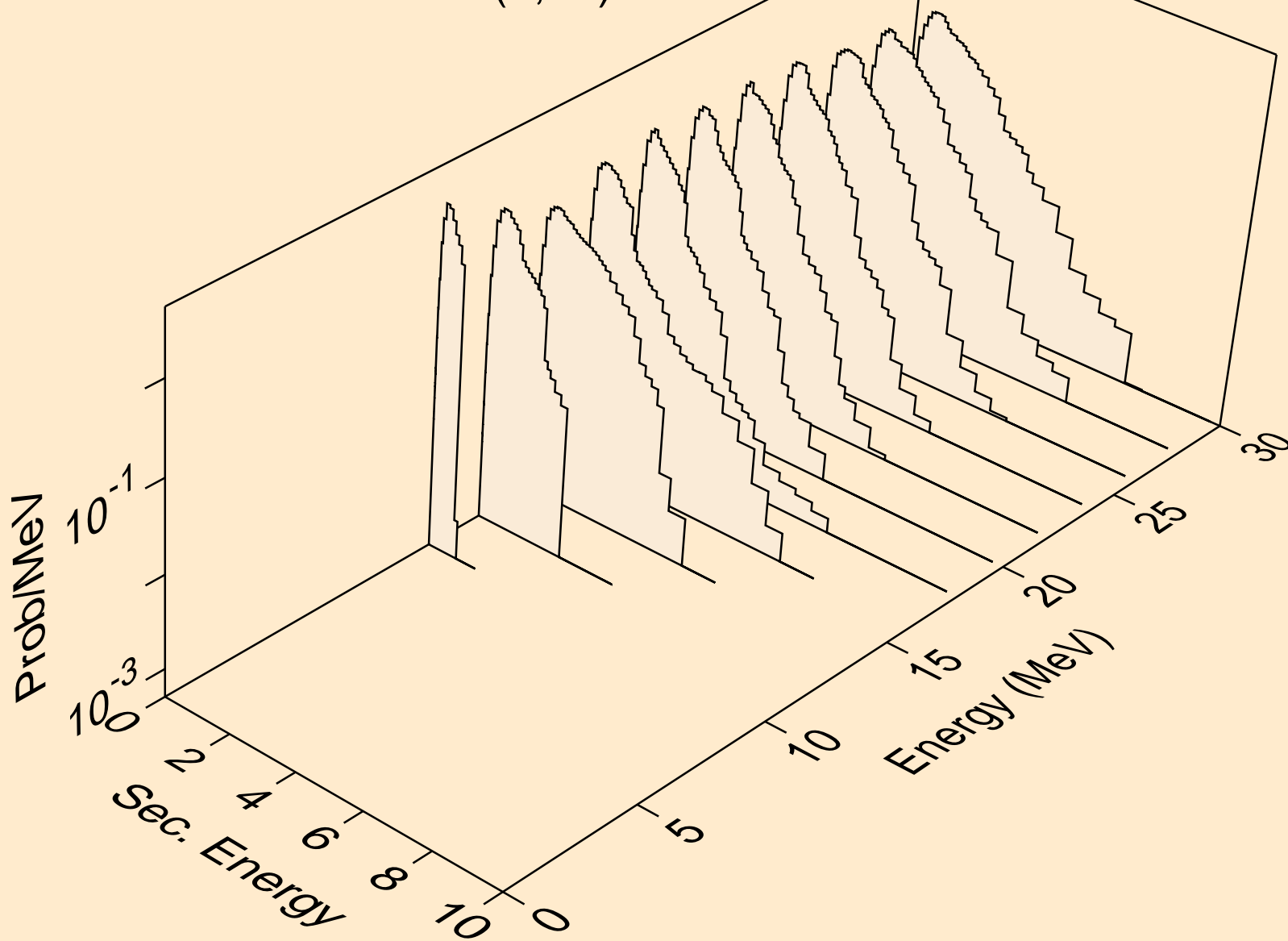

BK237 NEUTRON ACER TENDL-2019 LIBRARY; T=293.16K
Neutron emission for (n,3n)a

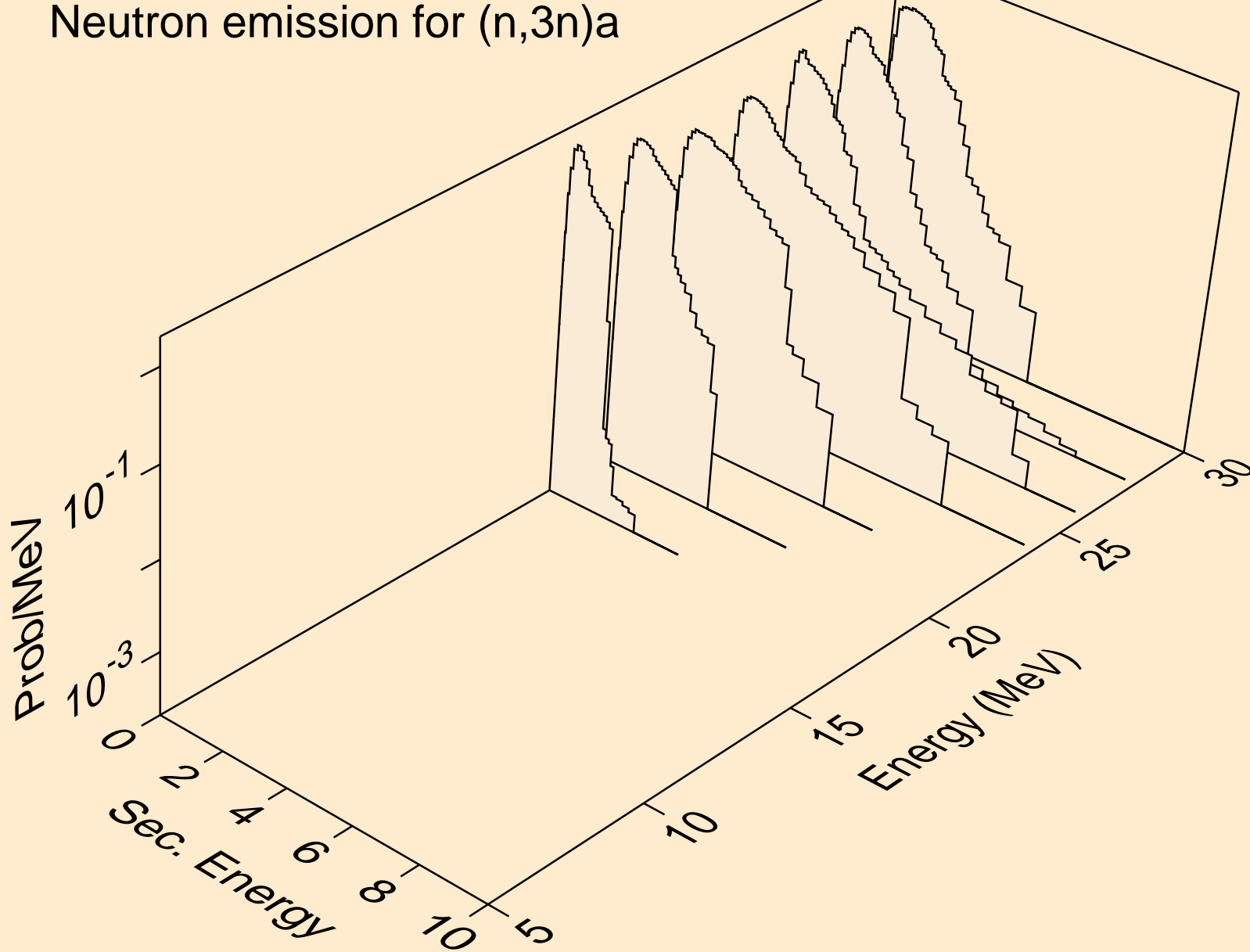

BK237 NEUTRON ACER TENDL-2019 LIBRARY; T=293.16K
Neutron emission for (n,n*)p

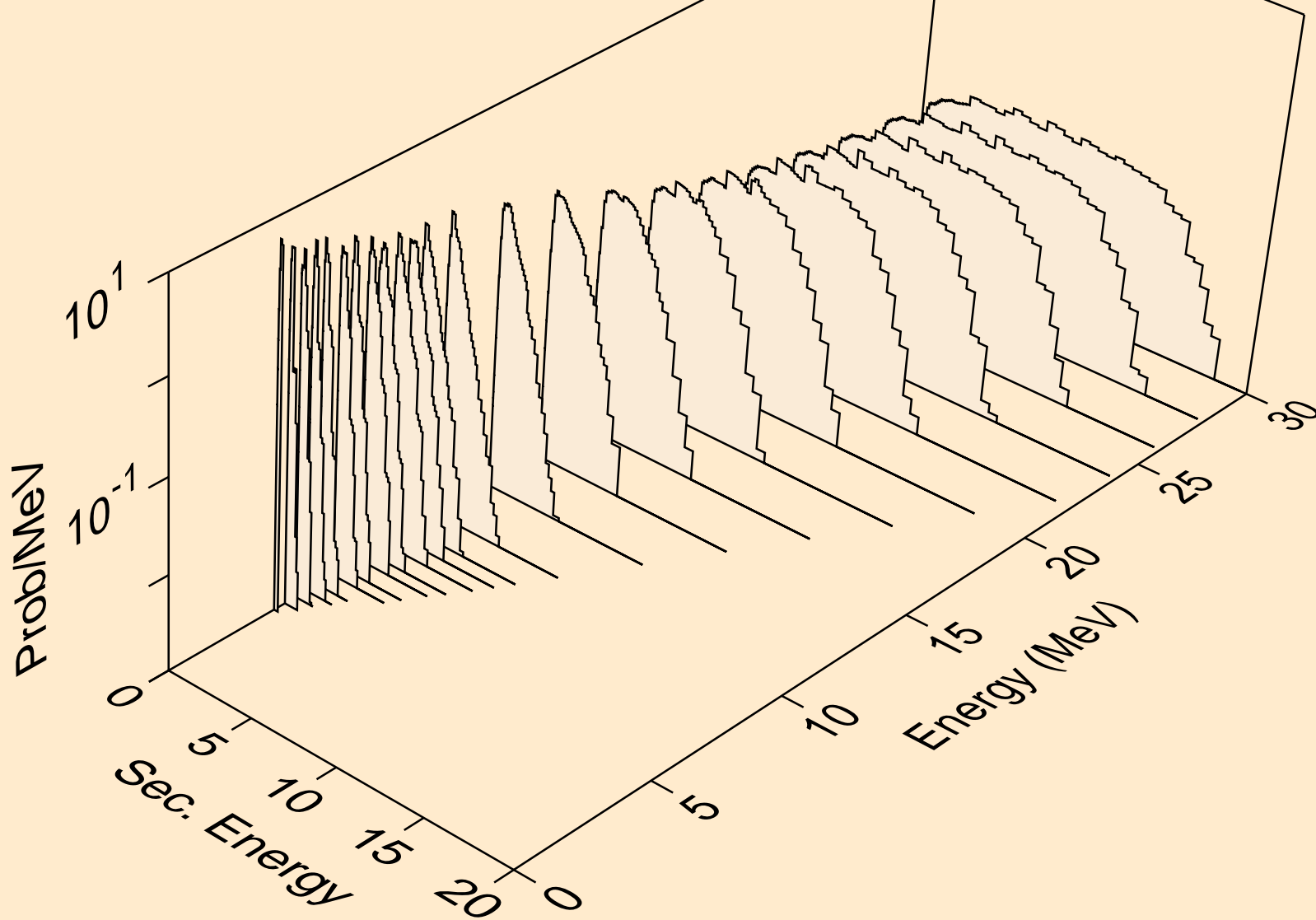

BK237 NEUTRON ACER TENDL-2019 LIBRARY; T=293.16K
Neutron emission for (n,n*)2a

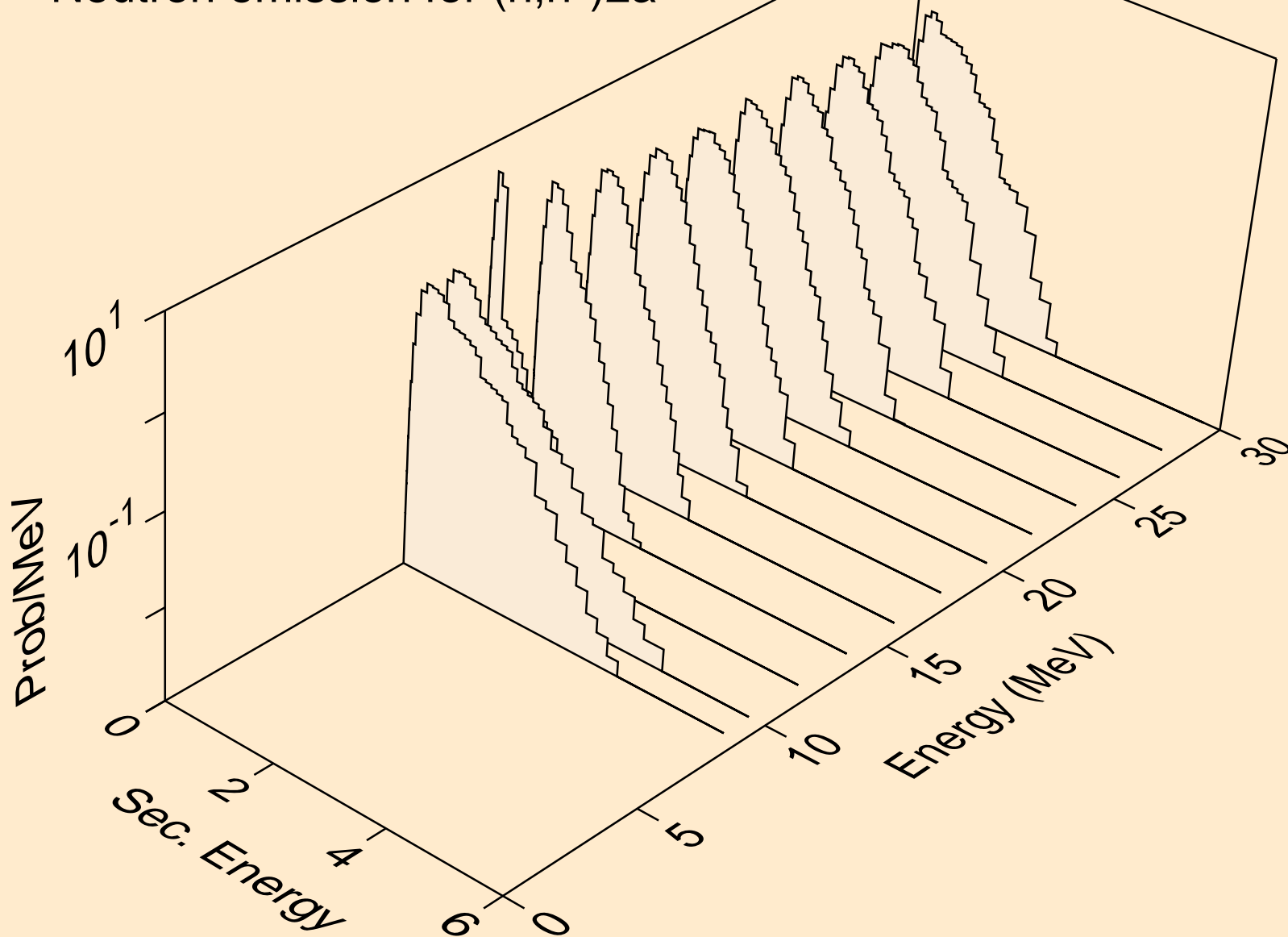

BK237 NEUTRON ACER TENDL-2019 LIBRARY; T=293.16K
Neutron emission for (n,2n)2a

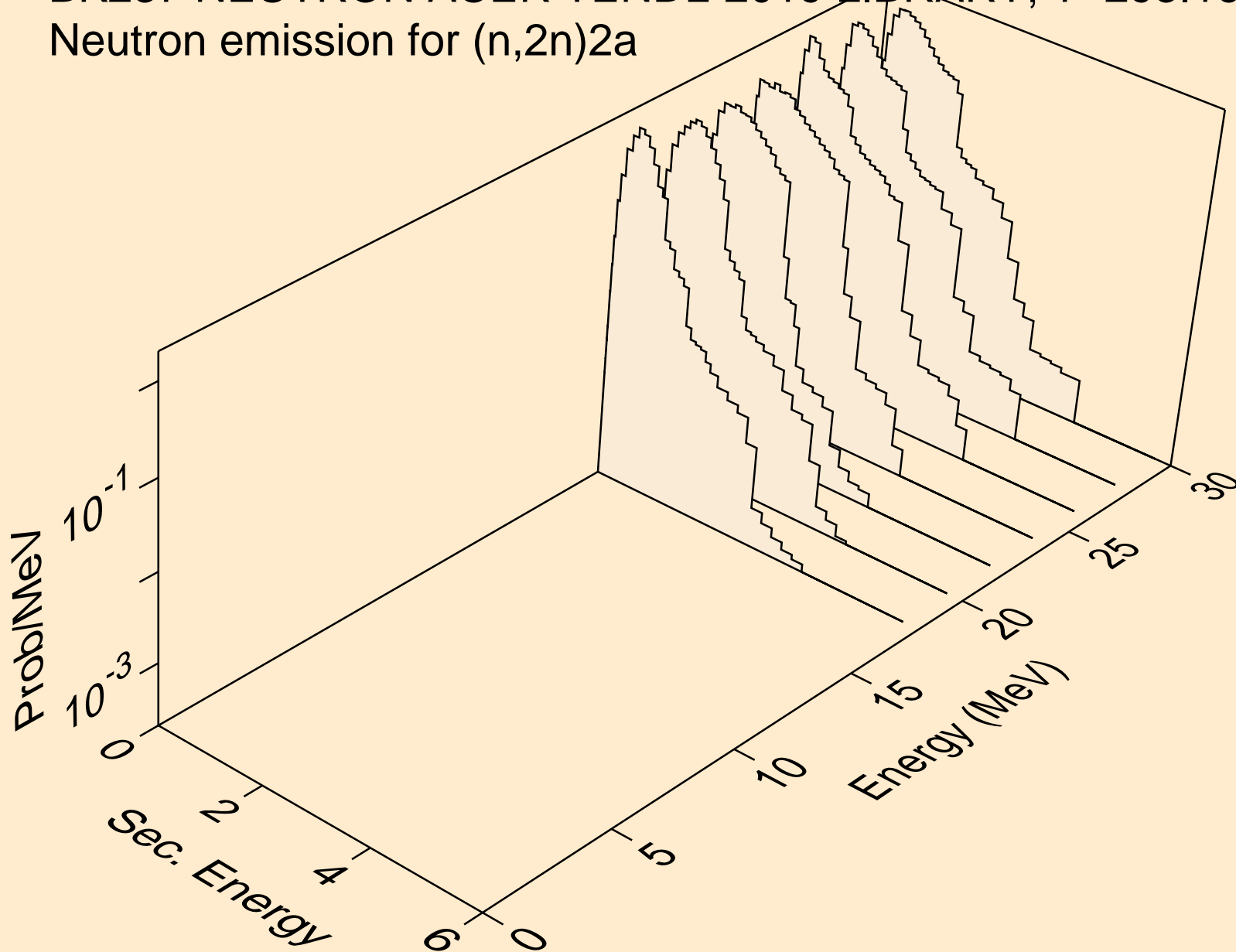

BK237 NEUTRON ACER TENDL-2019 LIBRARY; T=293.16K
Neutron emission for (n,n*)d

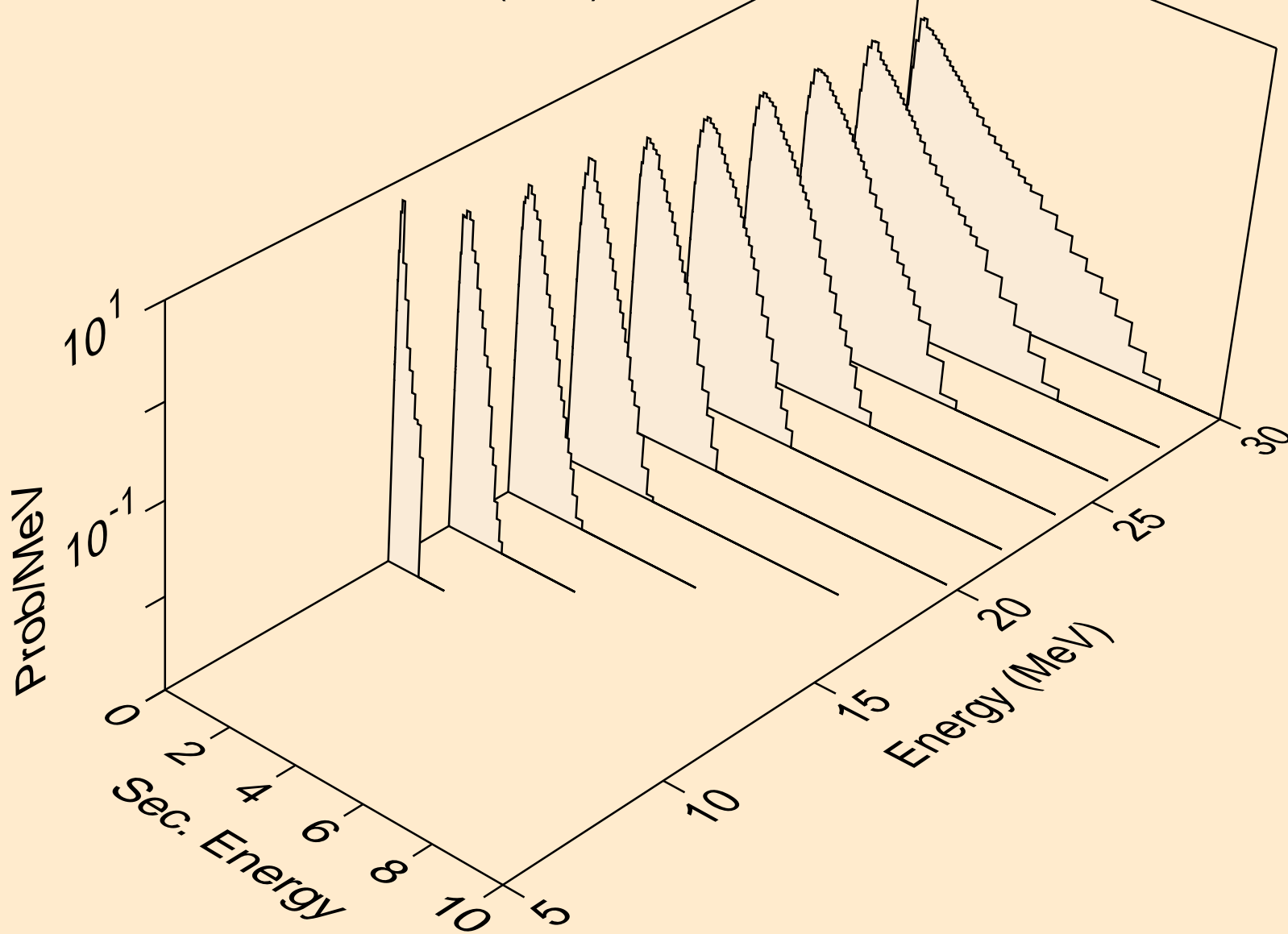

BK237 NEUTRON ACER TENDL-2019 LIBRARY; T=293.16K
Neutron emission for (n,n*)t

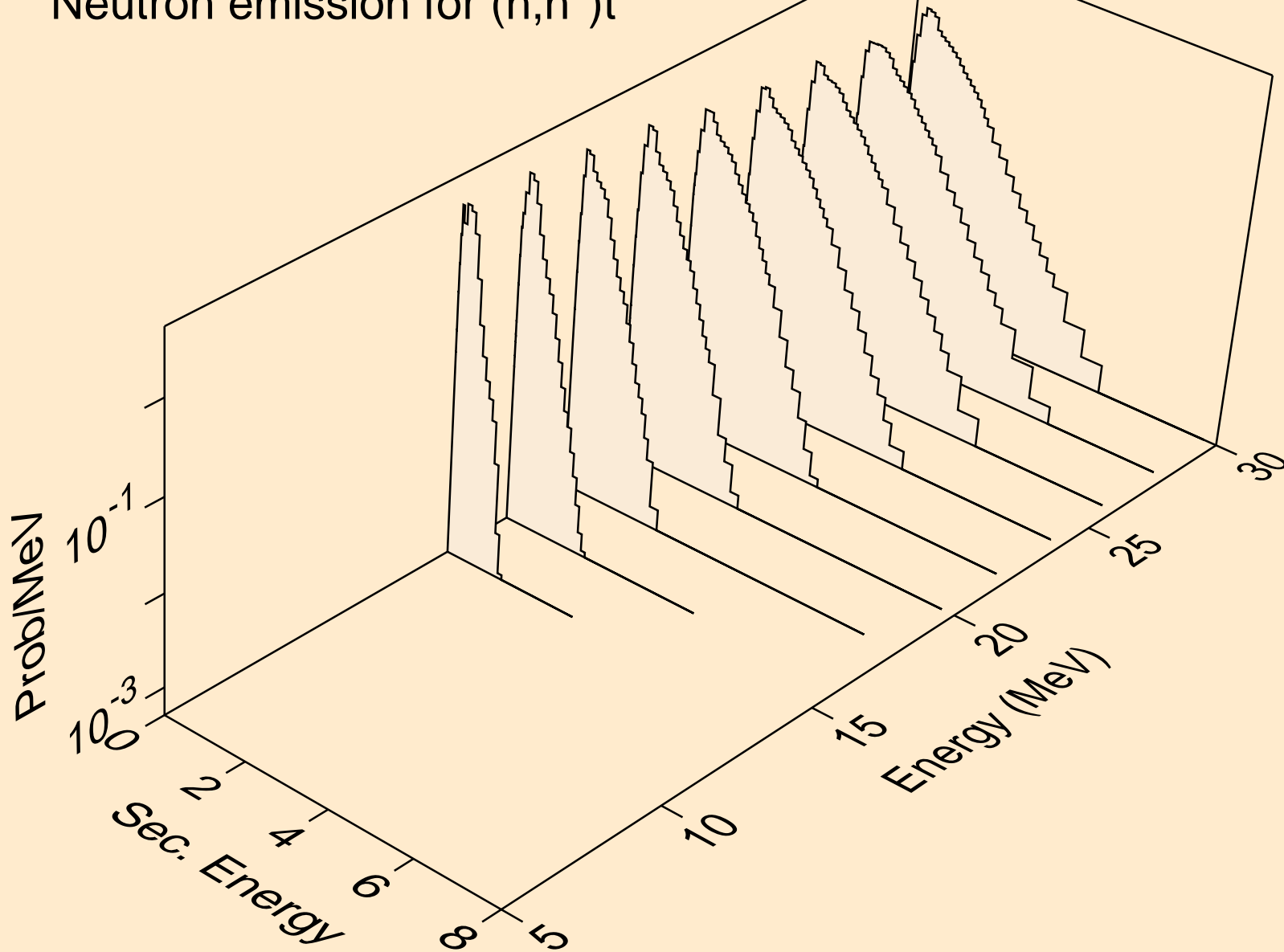

BK237 NEUTRON ACER TENDL-2019 LIBRARY; T=293.16K
Neutron emission for (n,n*)he3

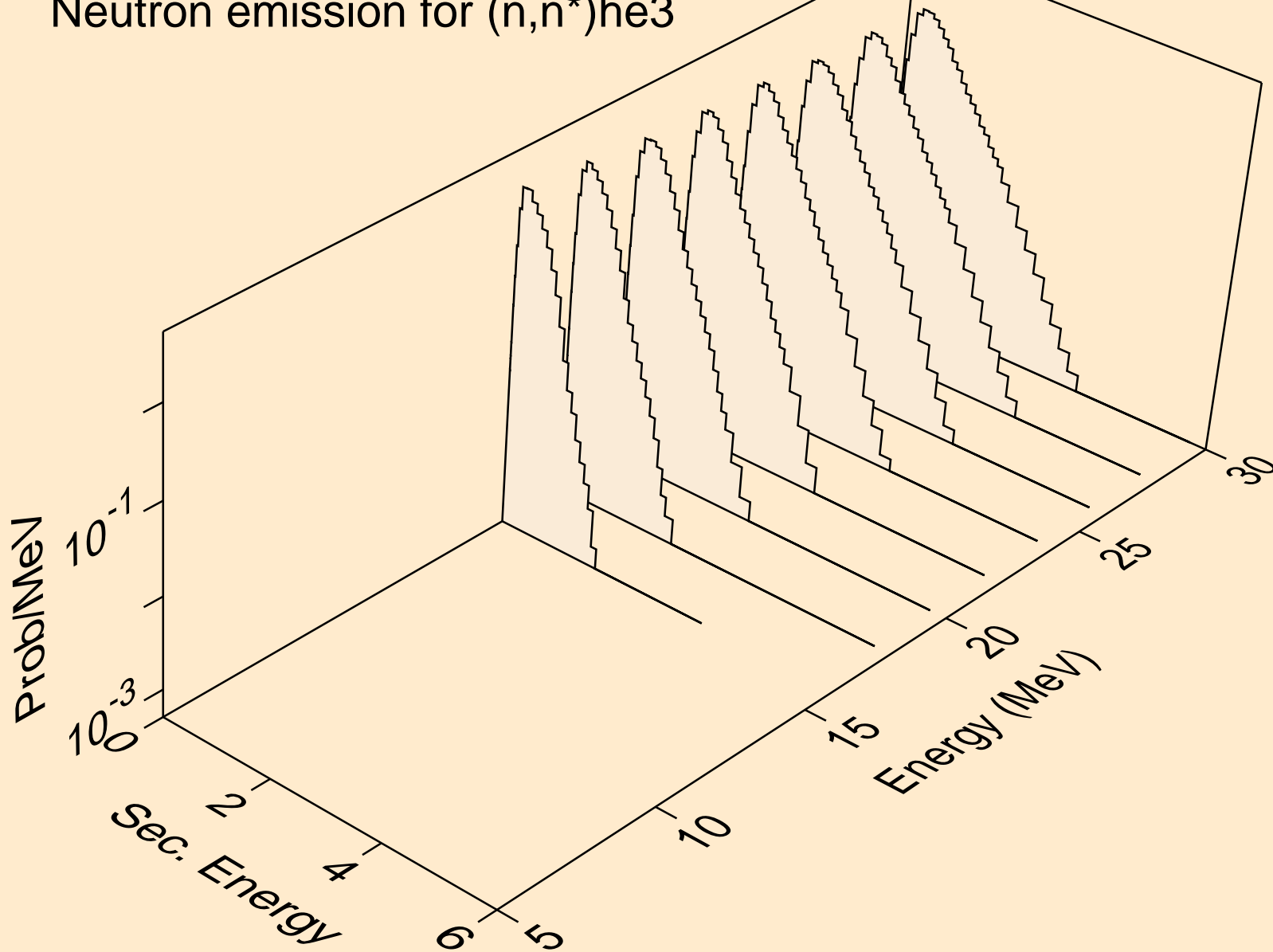

BK237 NEUTRON ACER TENDL-2019 LIBRARY; T=293.16K
Neutron emission for (n,4n)

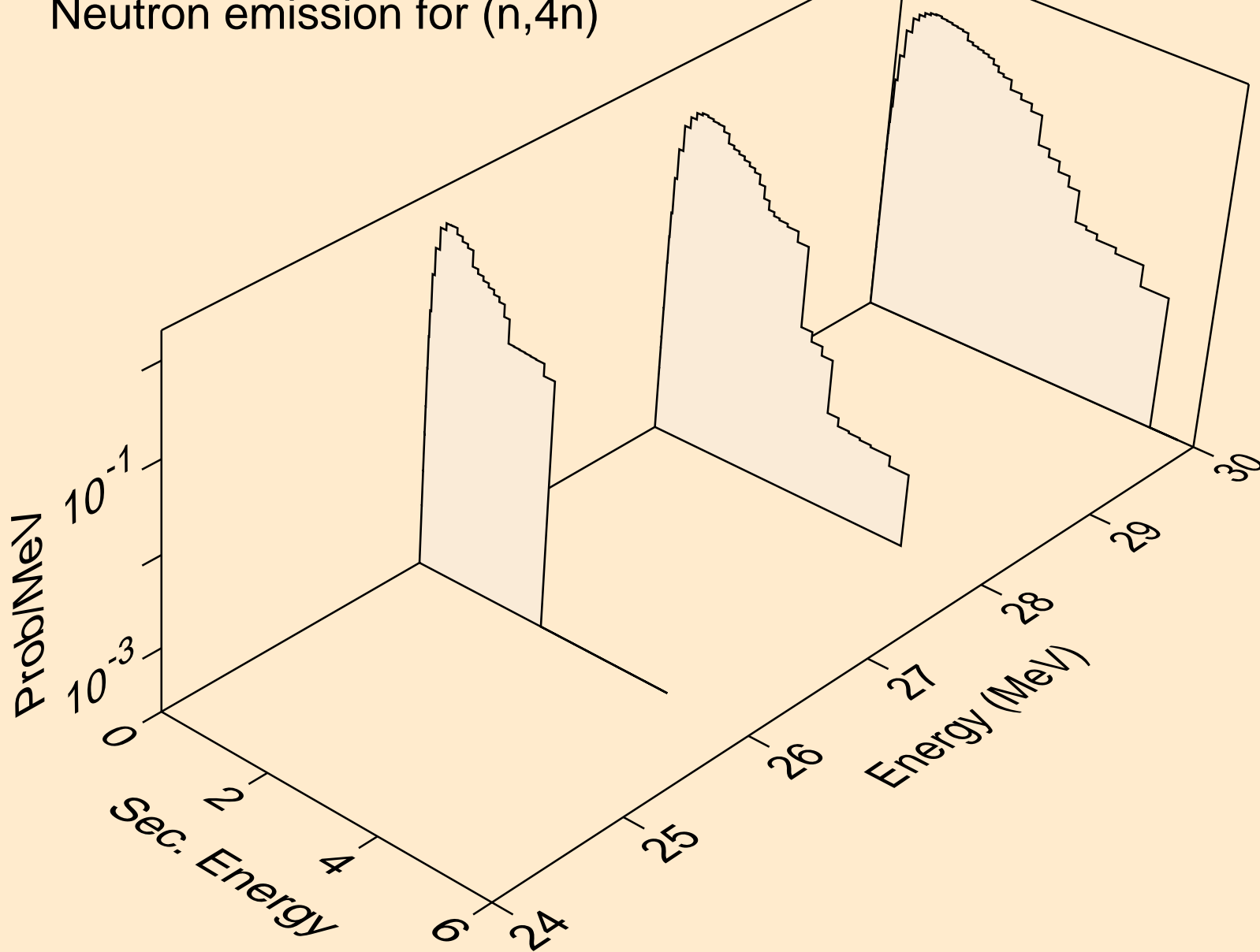

BK237 NEUTRON ACER TENDL-2019 LIBRARY; T=293.16K
Neutron emission for (n,2np)

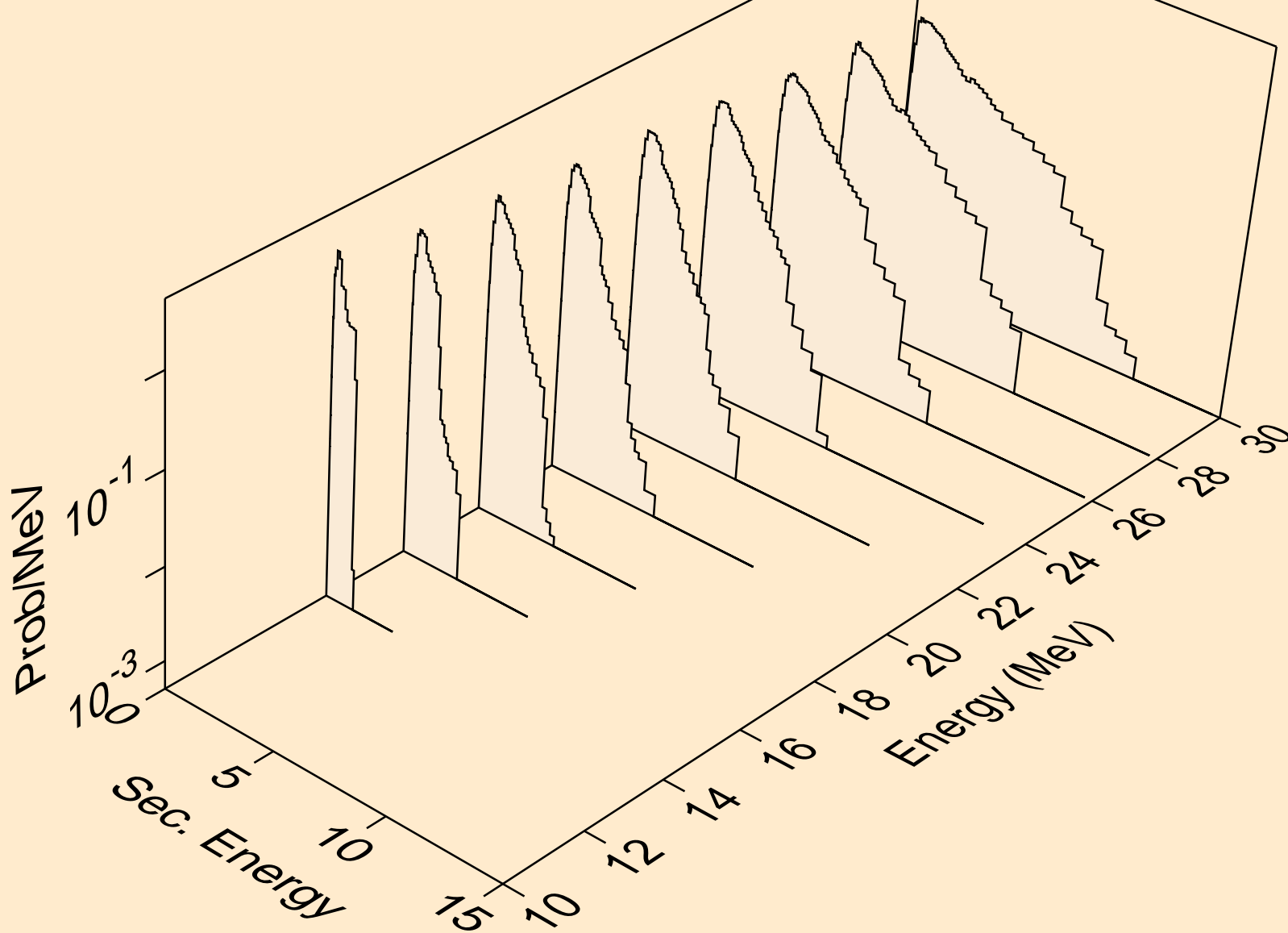

BK237 NEUTRON ACER TENDL-2019 LIBRARY; T=293.16K
Neutron emission for (n,3np)

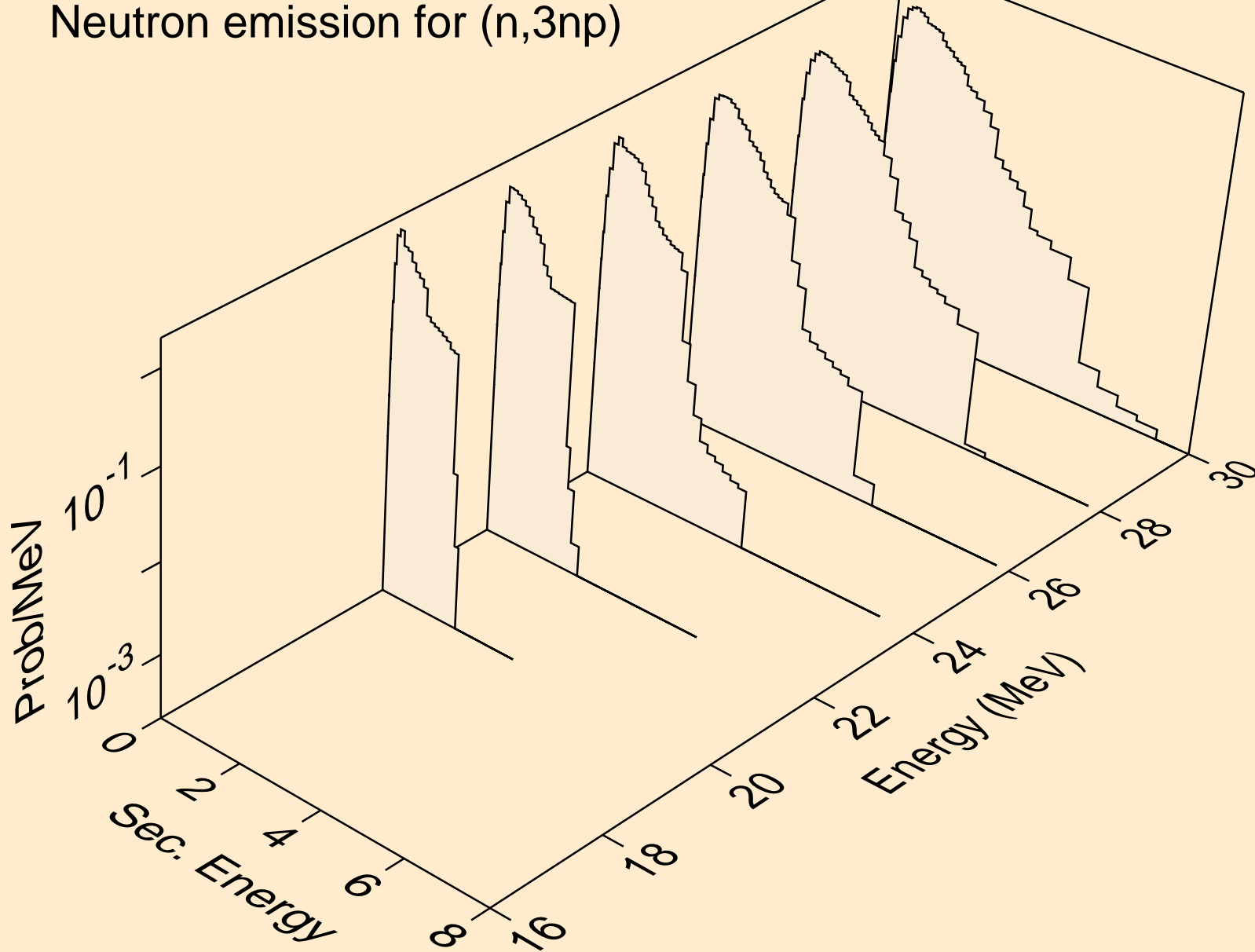

BK237 NEUTRON ACER TENDL-2019 LIBRARY; T=293.16K
Neutron emission for (n,2np)

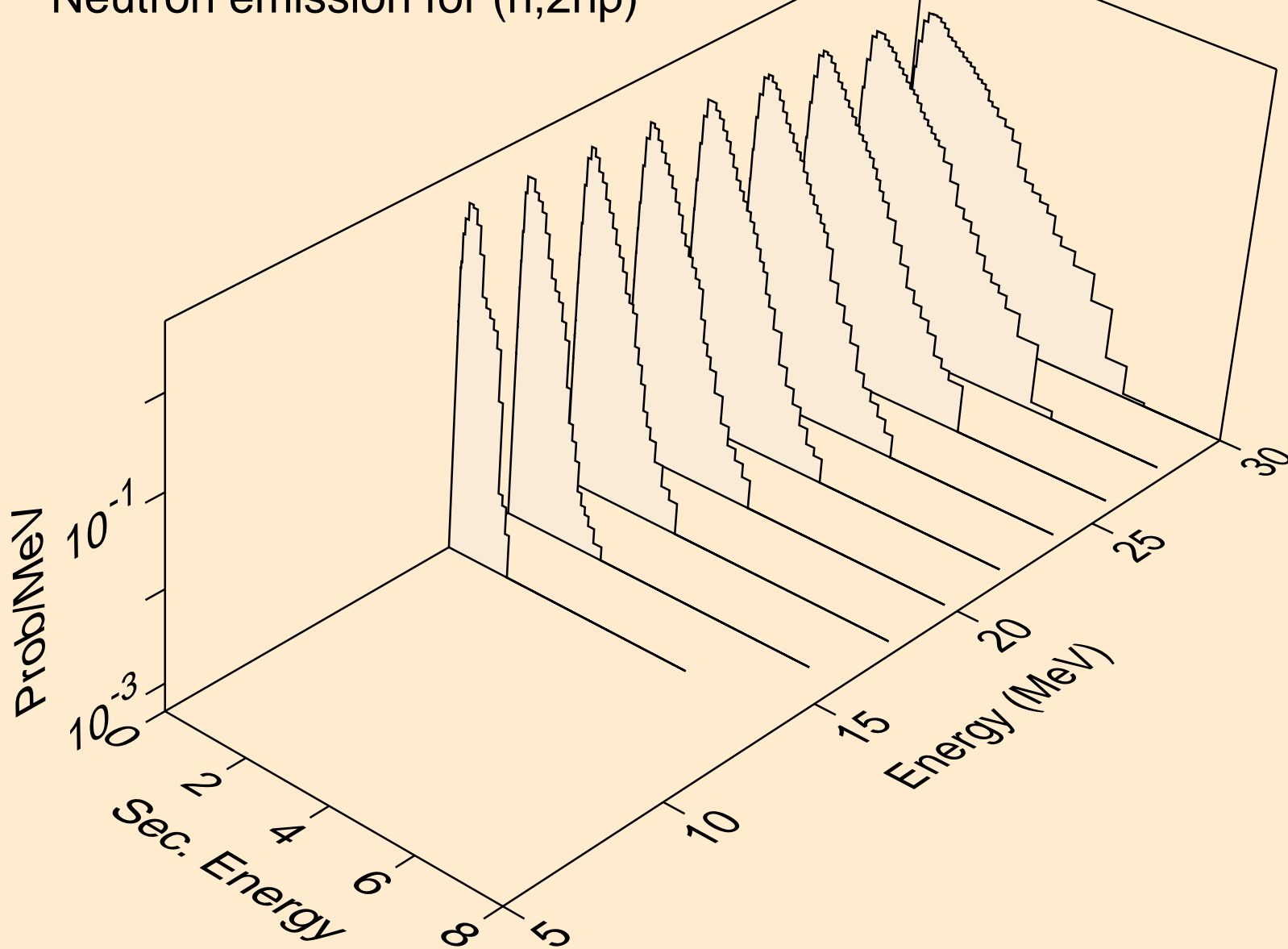

BK237 NEUTRON ACER TENDL-2019 LIBRARY; T=293.16K
Neutron emission for (n,n*c)

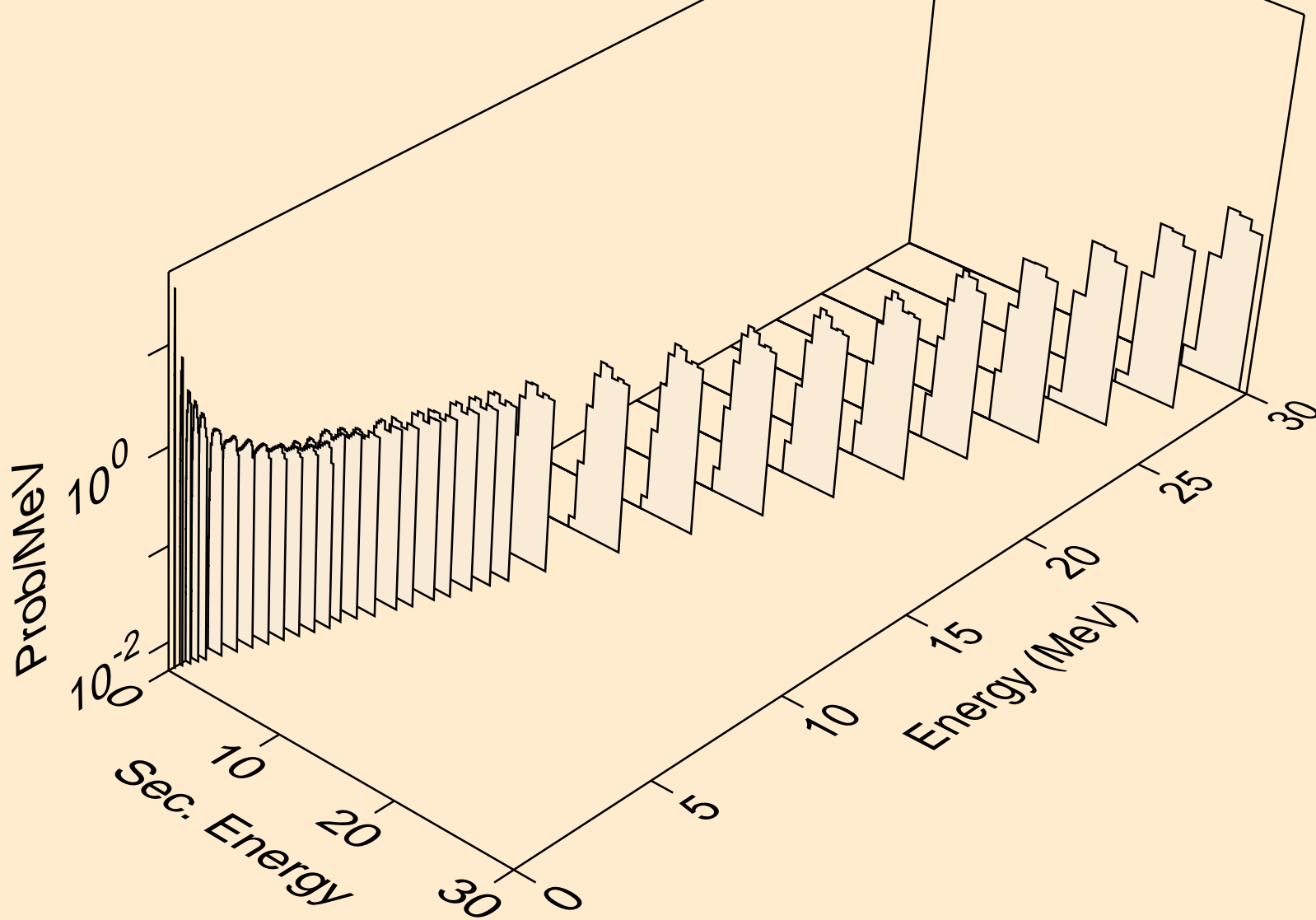

BK237 NEUTRON ACER TENDL-2019 LIBRARY; T=293.16K
Delayed nubar

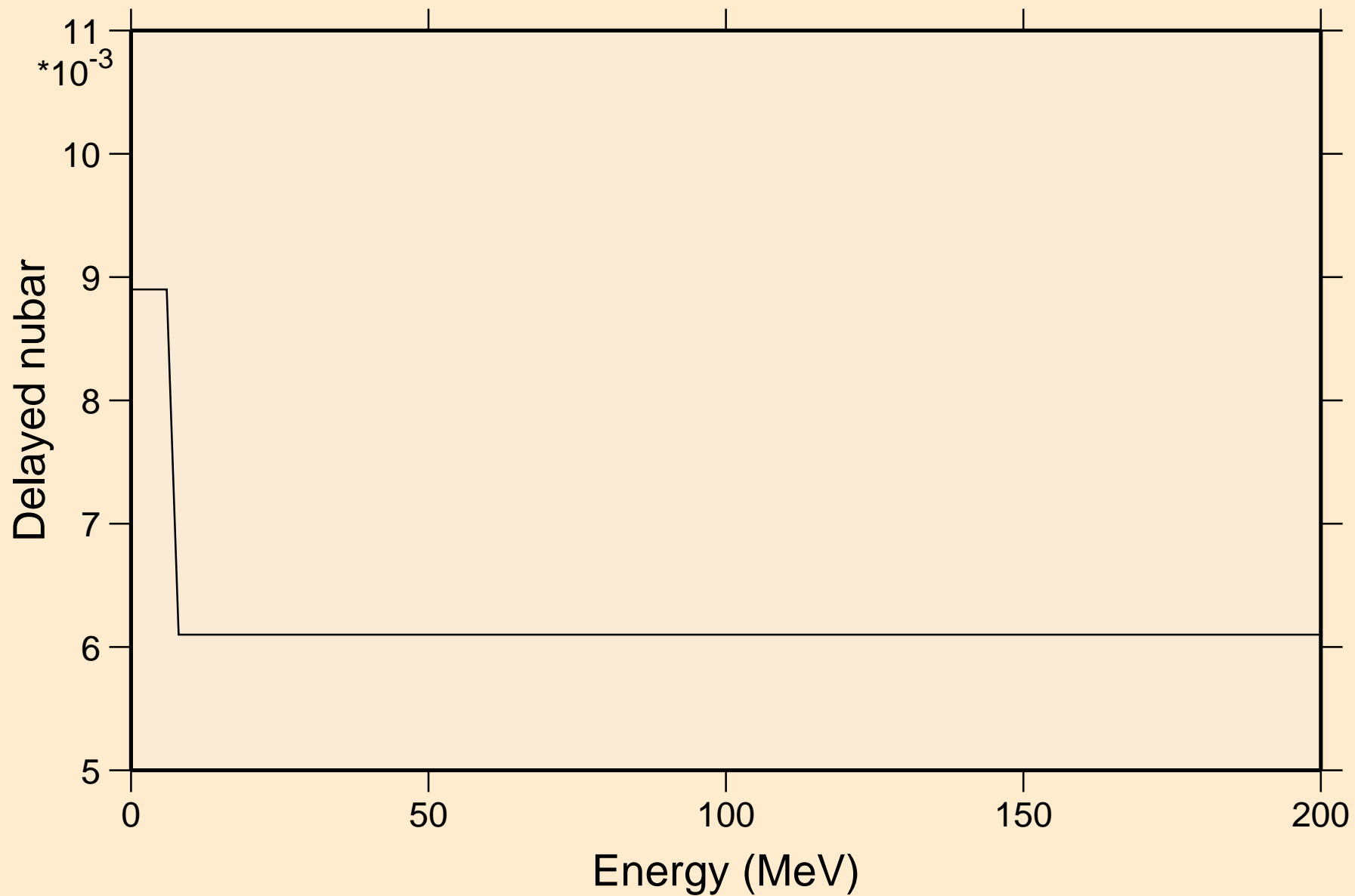

BK237 NEUTRON ACER TENDL-2019 LIBRARY; T=293.16K

Delayed neutron spectra

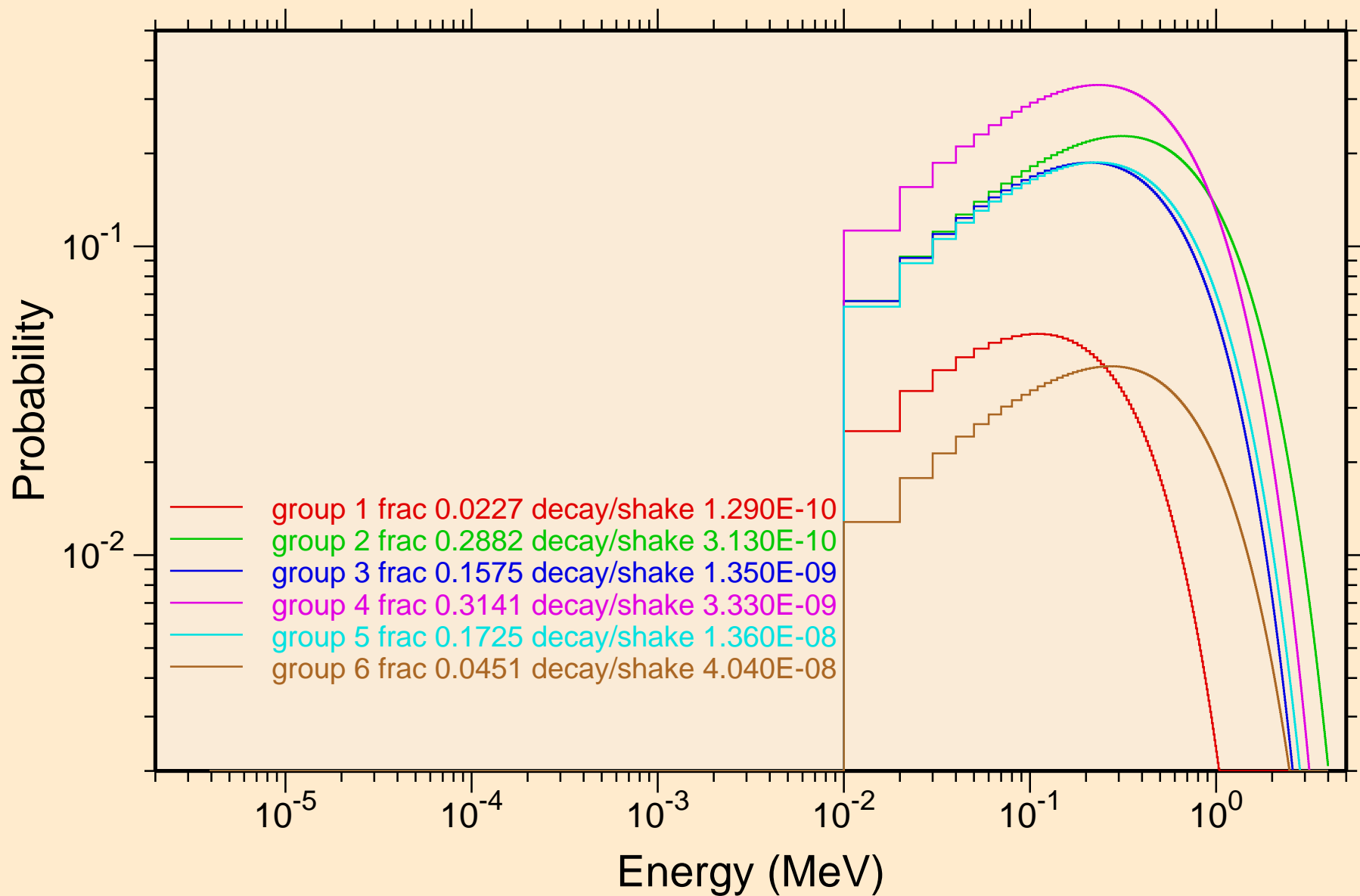

BK237 NEUTRON ACER TENDL-2019 LIBRARY; T=293.16K
Photon emission for (n,x)

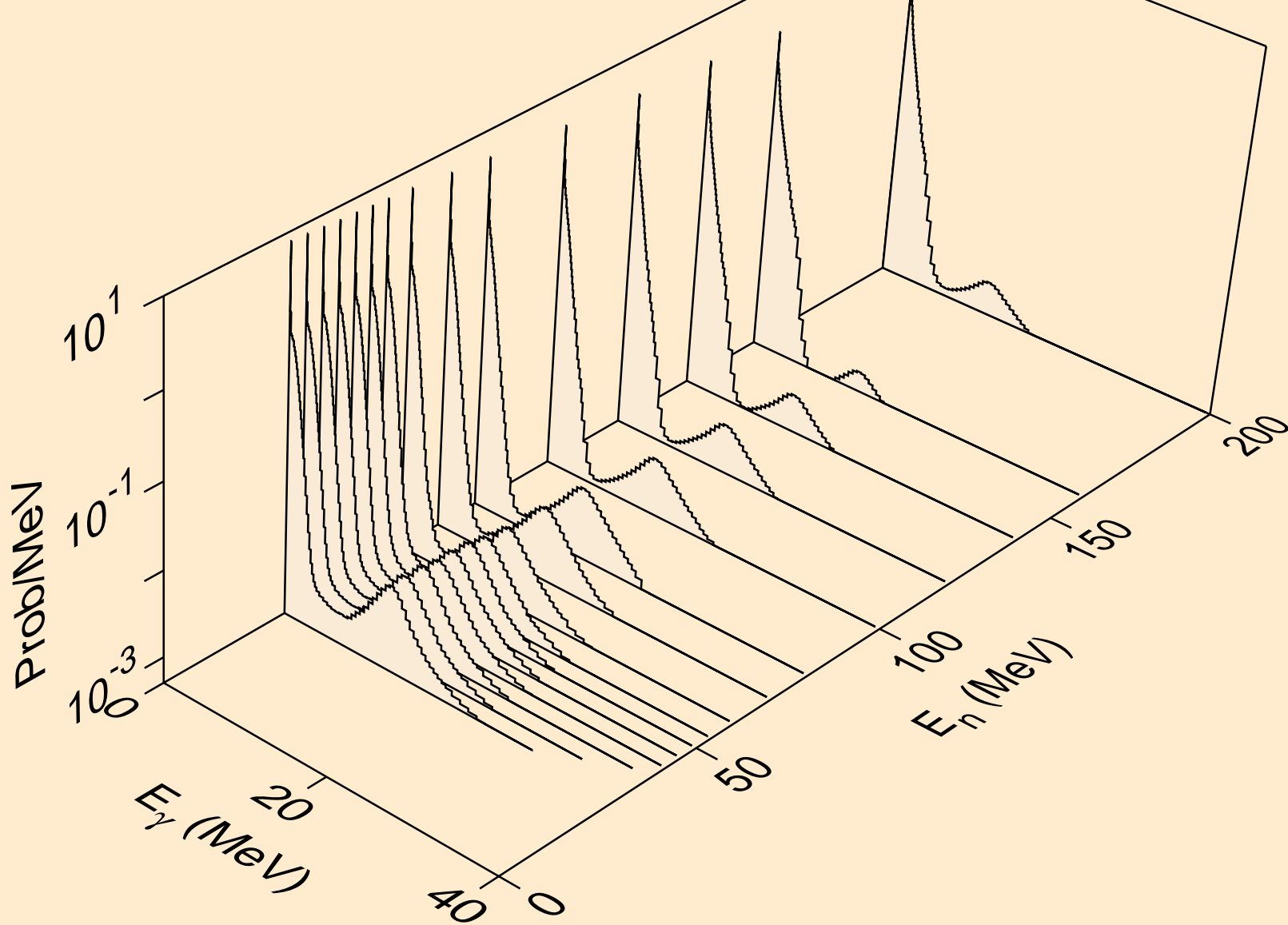

BK237 NEUTRON ACER TENDL-2019 LIBRARY; T=293.16K
Photon emission for (n,2nd)

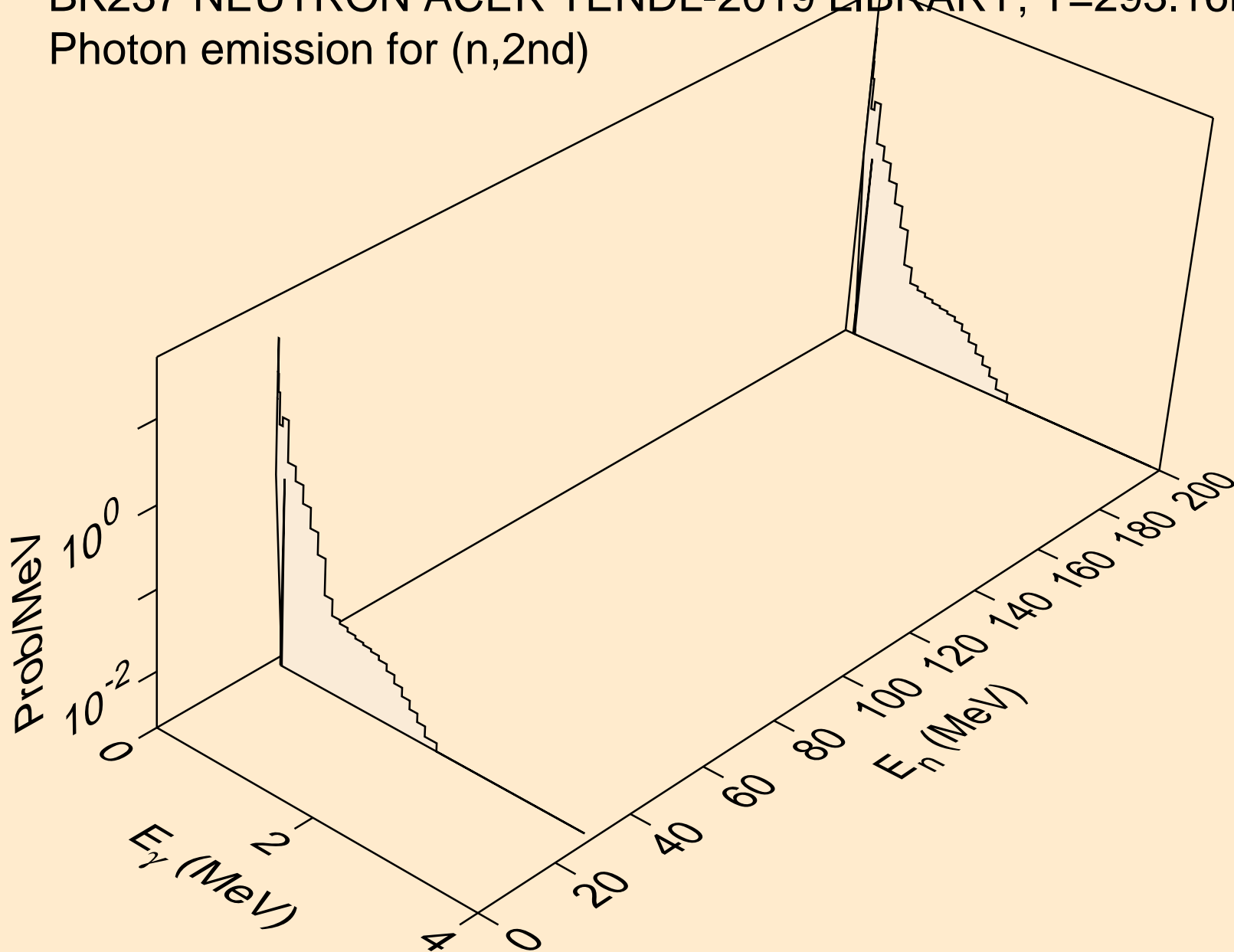

BK237 NEUTRON ACER TENDL-2019 LIBRARY; T=293.16K
Photon emission for (n,2n)

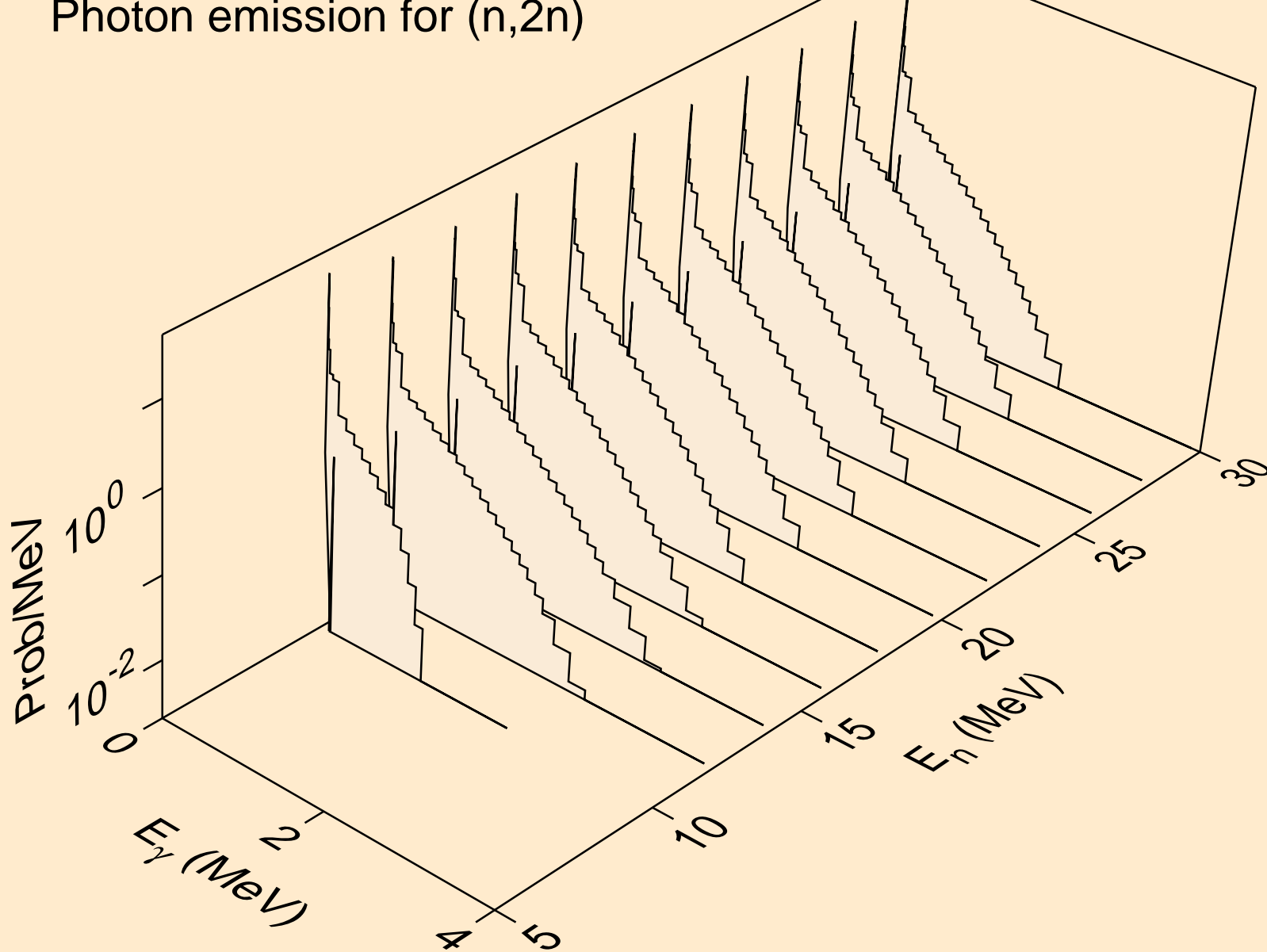

BK237 NEUTRON ACER TENDL-2019 LIBRARY; T=293.16K
Photon emission for (n,3n)

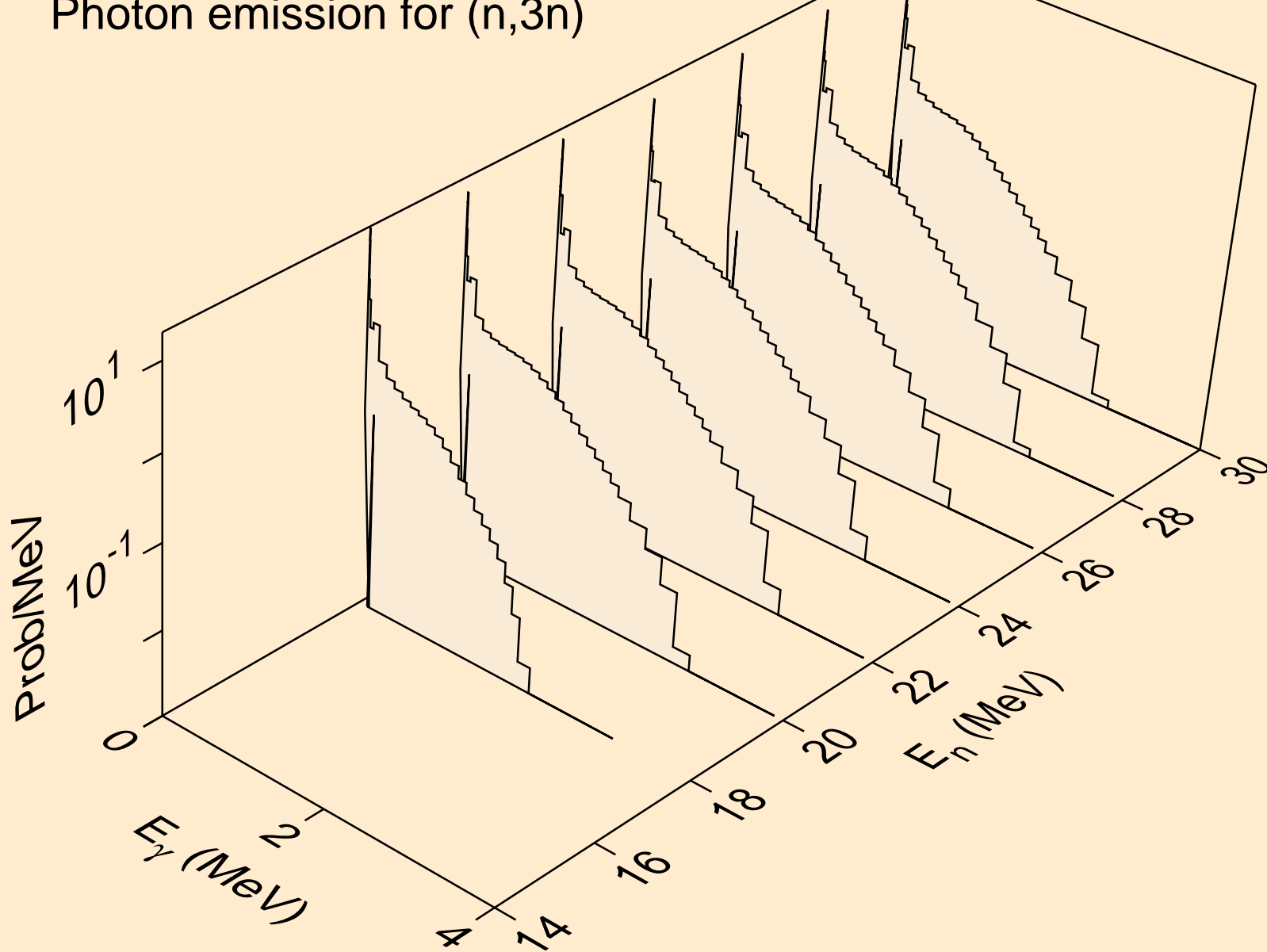

BK237 NEUTRON ACER TENDL-2019 LIBRARY; T=293.16K
Photon emission for (n,n*)a

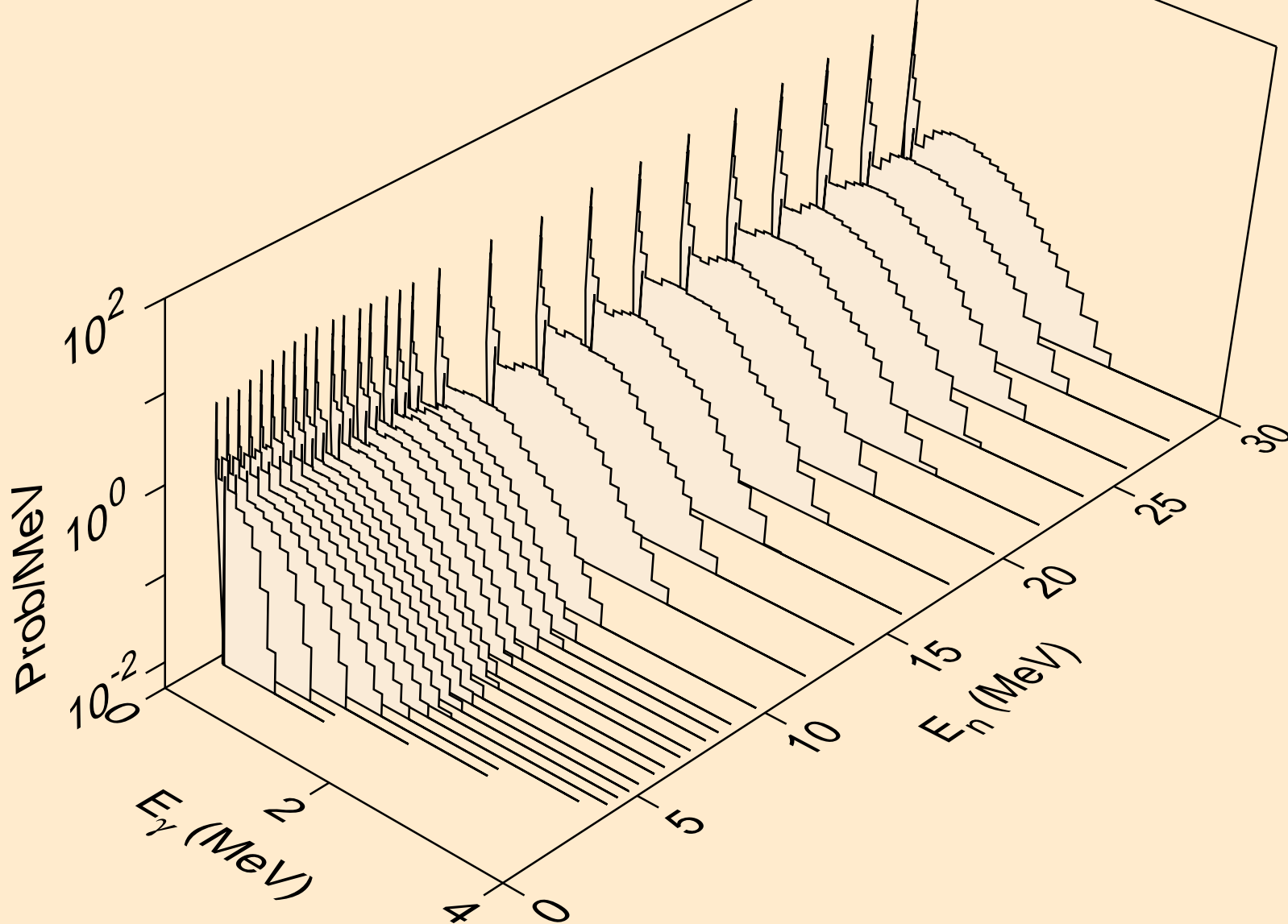

BK237 NEUTRON ACER TENDL-2019 LIBRARY; T=293.16K
Photon emission for (n,2n)a

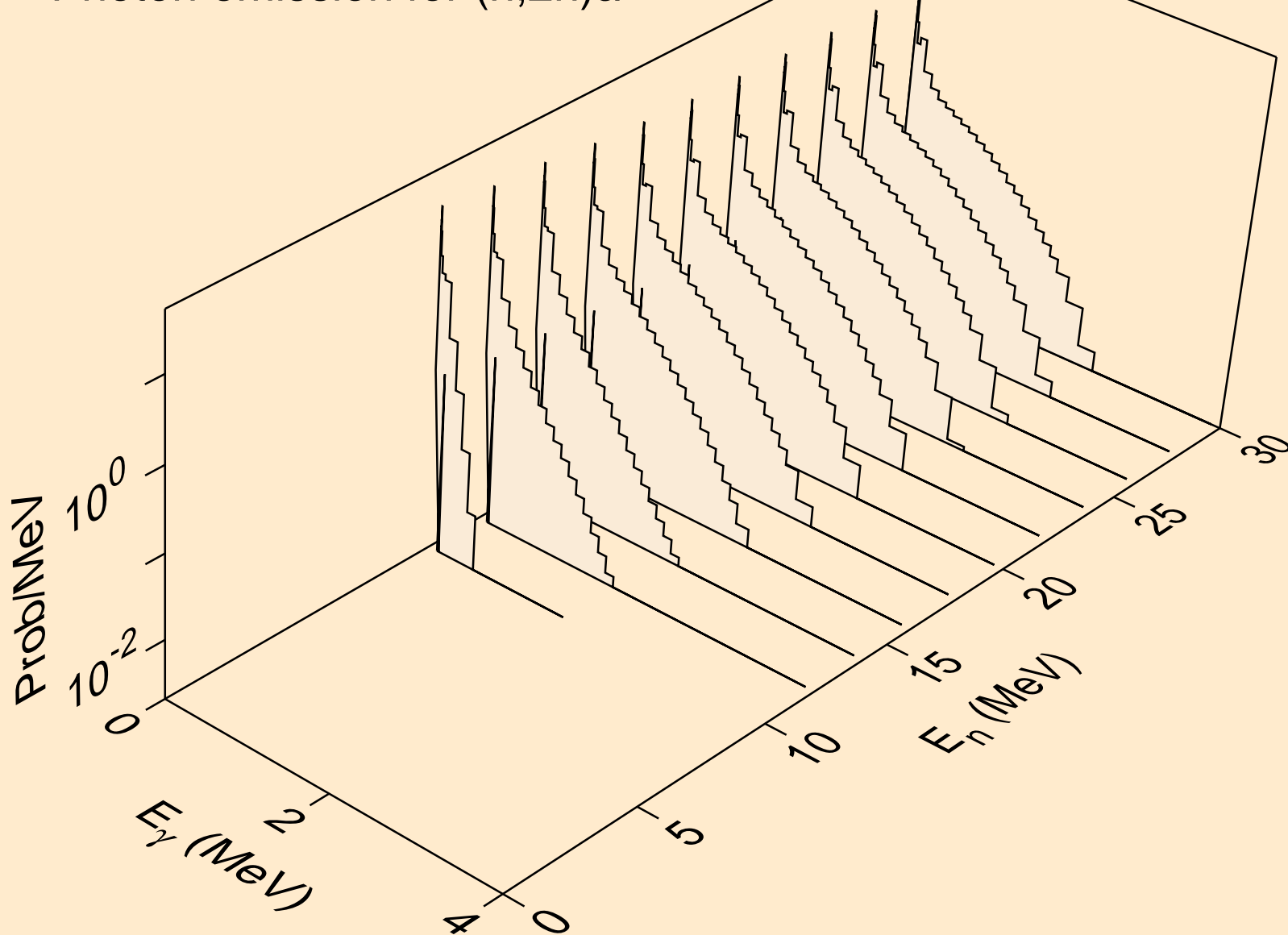

BK237 NEUTRON ACER TENDL-2019 LIBRARY; T=293.16K
Photon emission for (n,3n)a

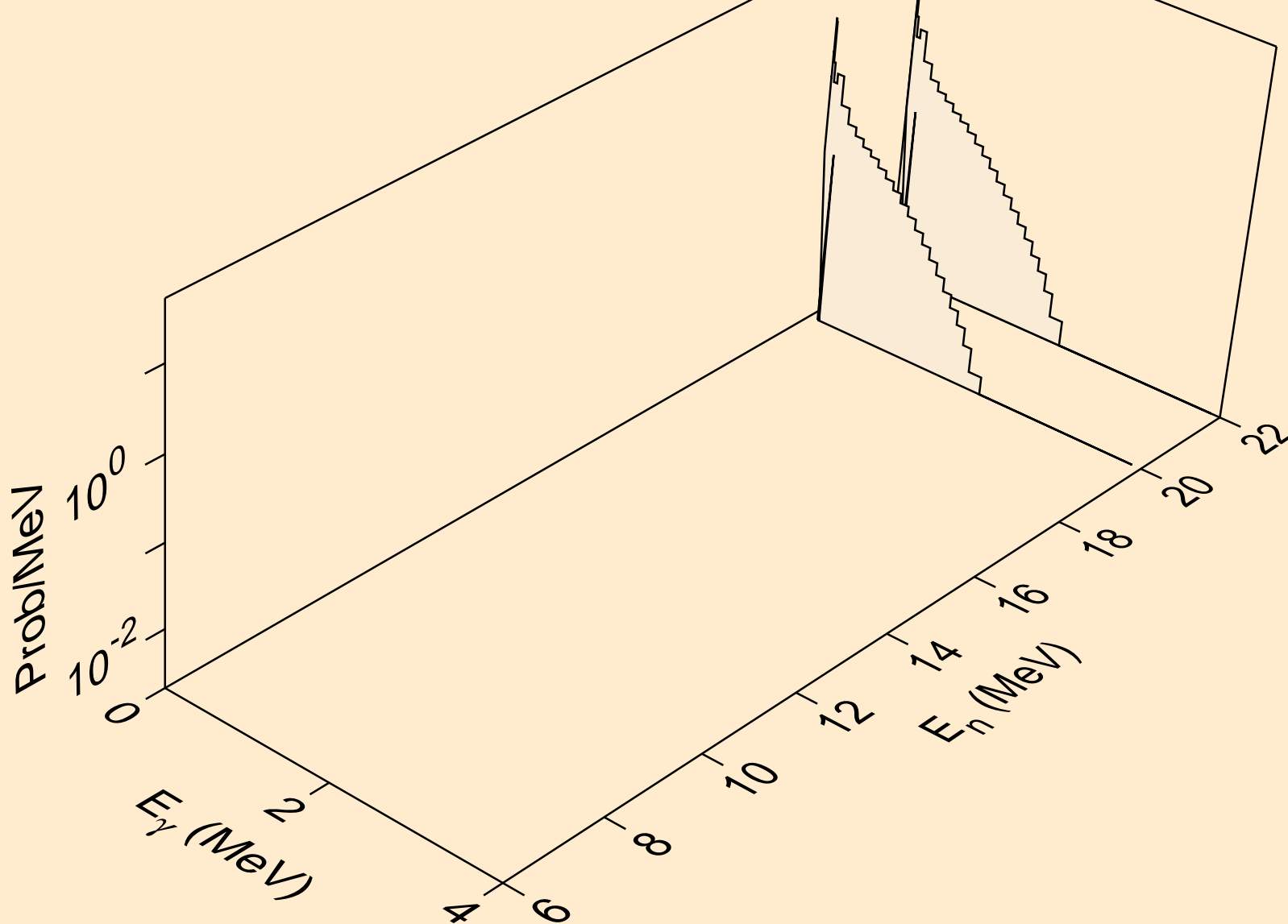

BK237 NEUTRON ACER TENDL-2019 LIBRARY; T=293.16K
Photon emission for (n,n*)p

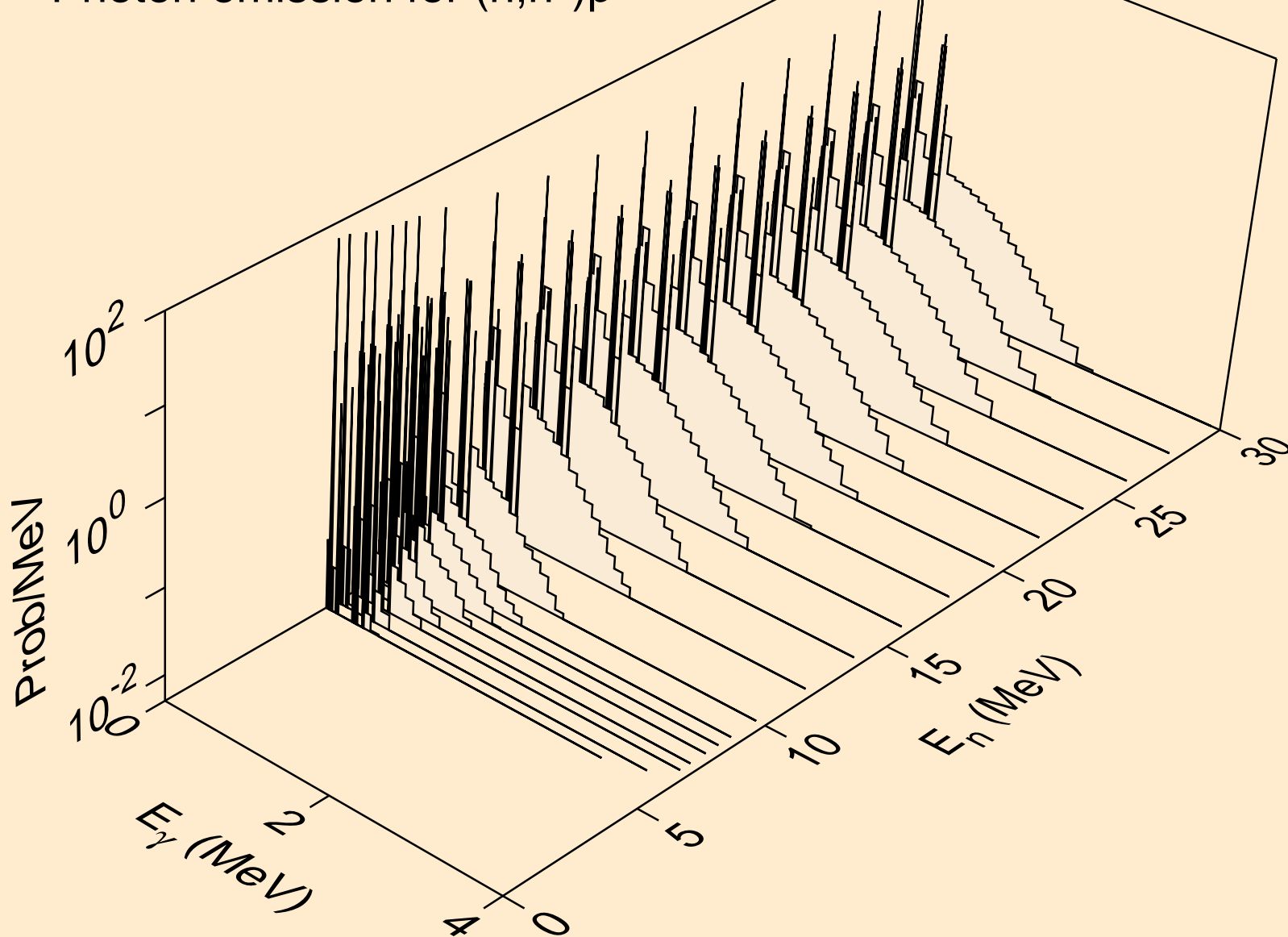

BK237 NEUTRON ACER TENDL-2019 LIBRARY; T=293.16K
Photon emission for (n,n*)2a

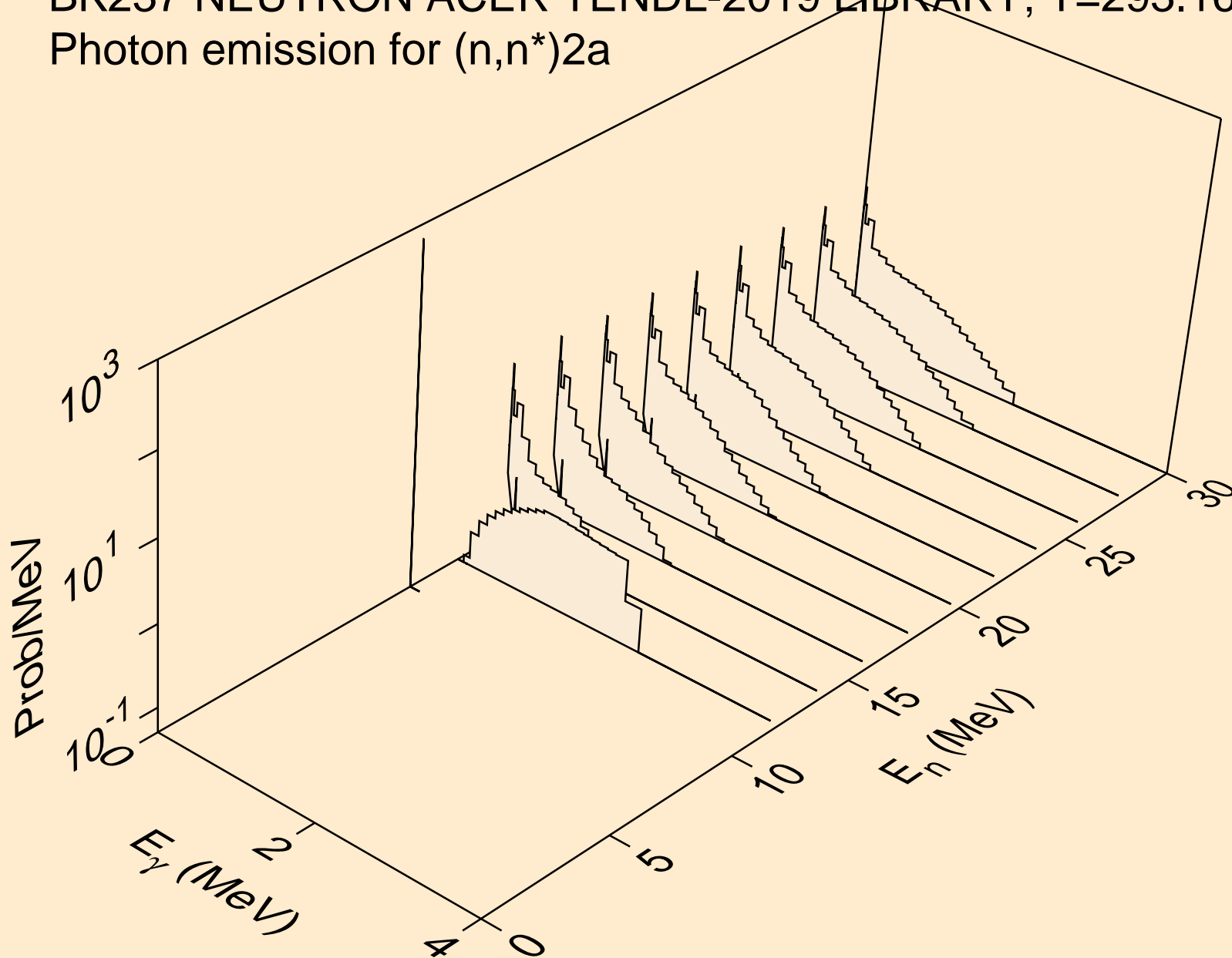

BK237 NEUTRON ACER TENDL-2019 LIBRARY; T=293.16K
Photon emission for (n,2n)2a

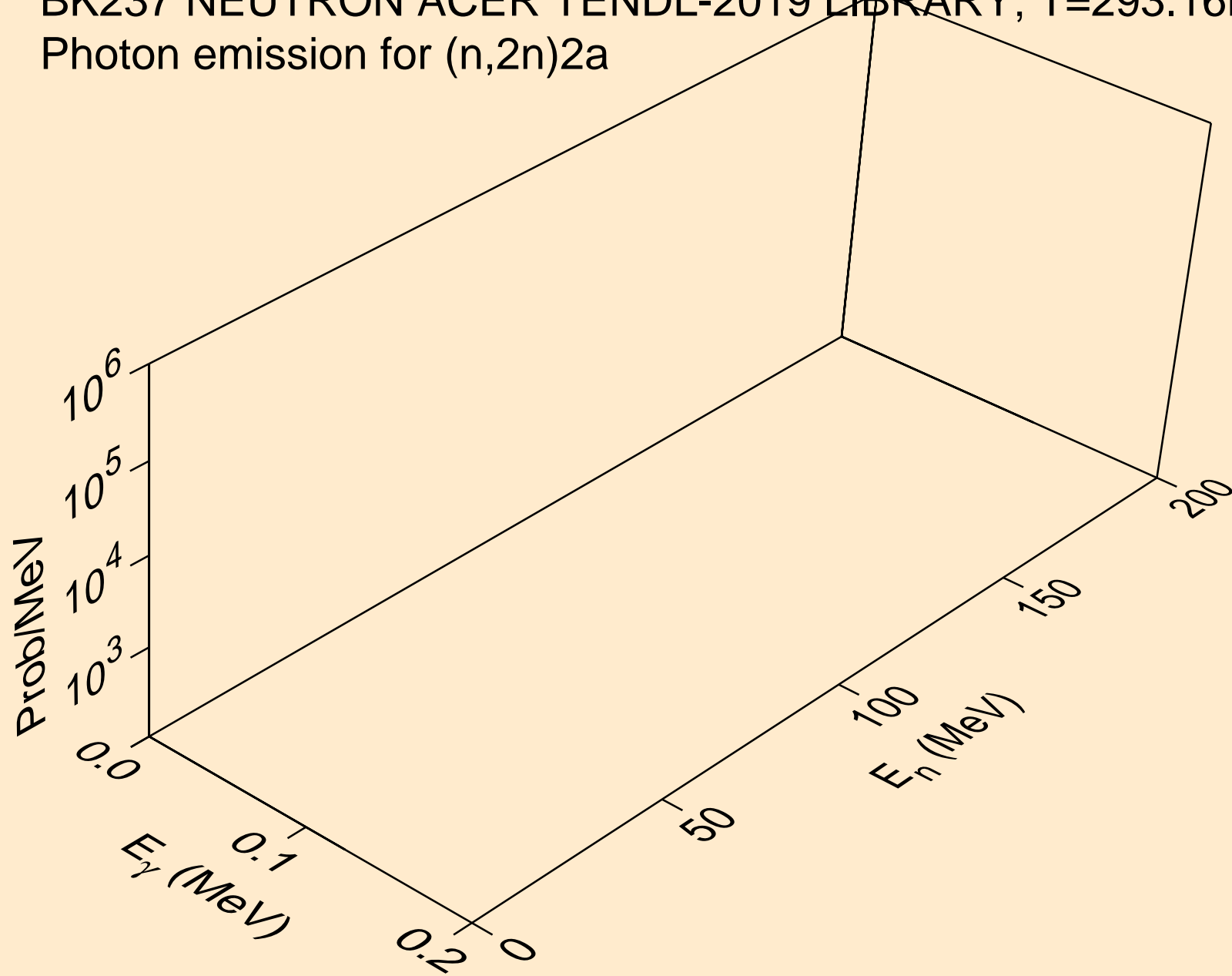

BK237 NEUTRON ACER TENDL-2019 LIBRARY; T=293.16K
Photon emission for (n,n*)d

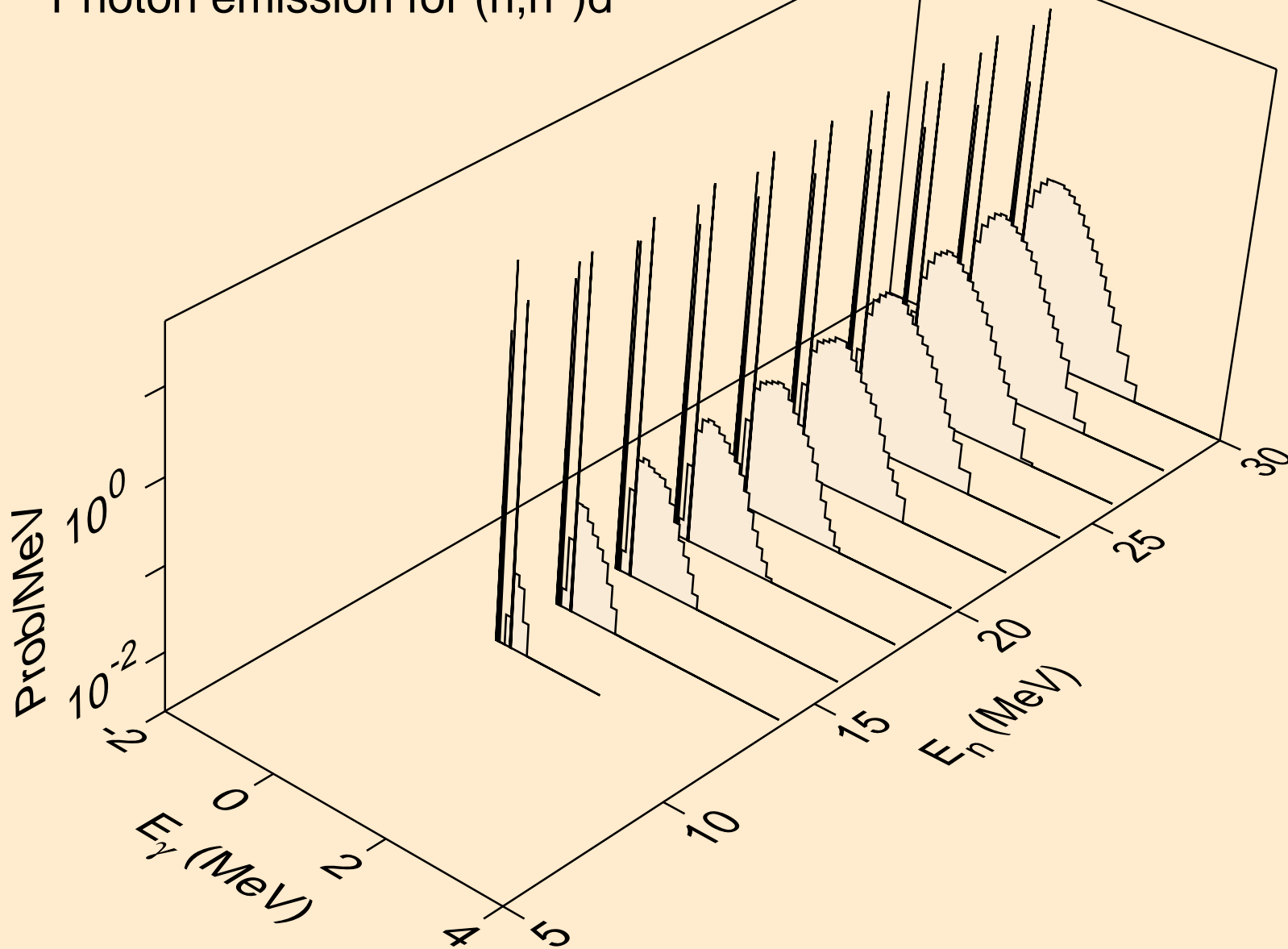

BK237 NEUTRON ACER TENDL-2019 LIBRARY; T=293.16K
Photon emission for (n,n*)t

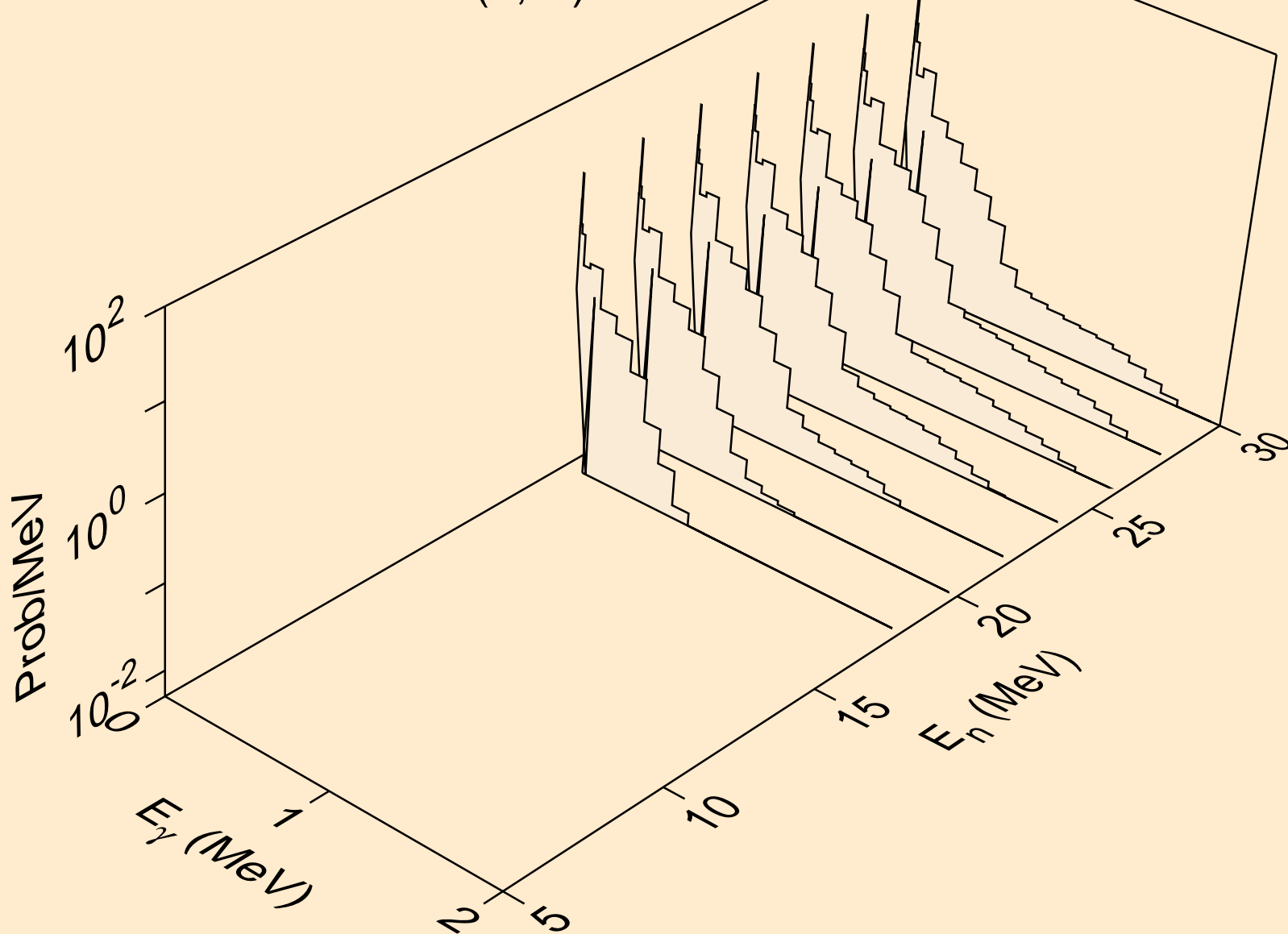

BK237 NEUTRON ACER TENDL-2019 LIBRARY; T=293.16K
Photon emission for (n,n*)he3

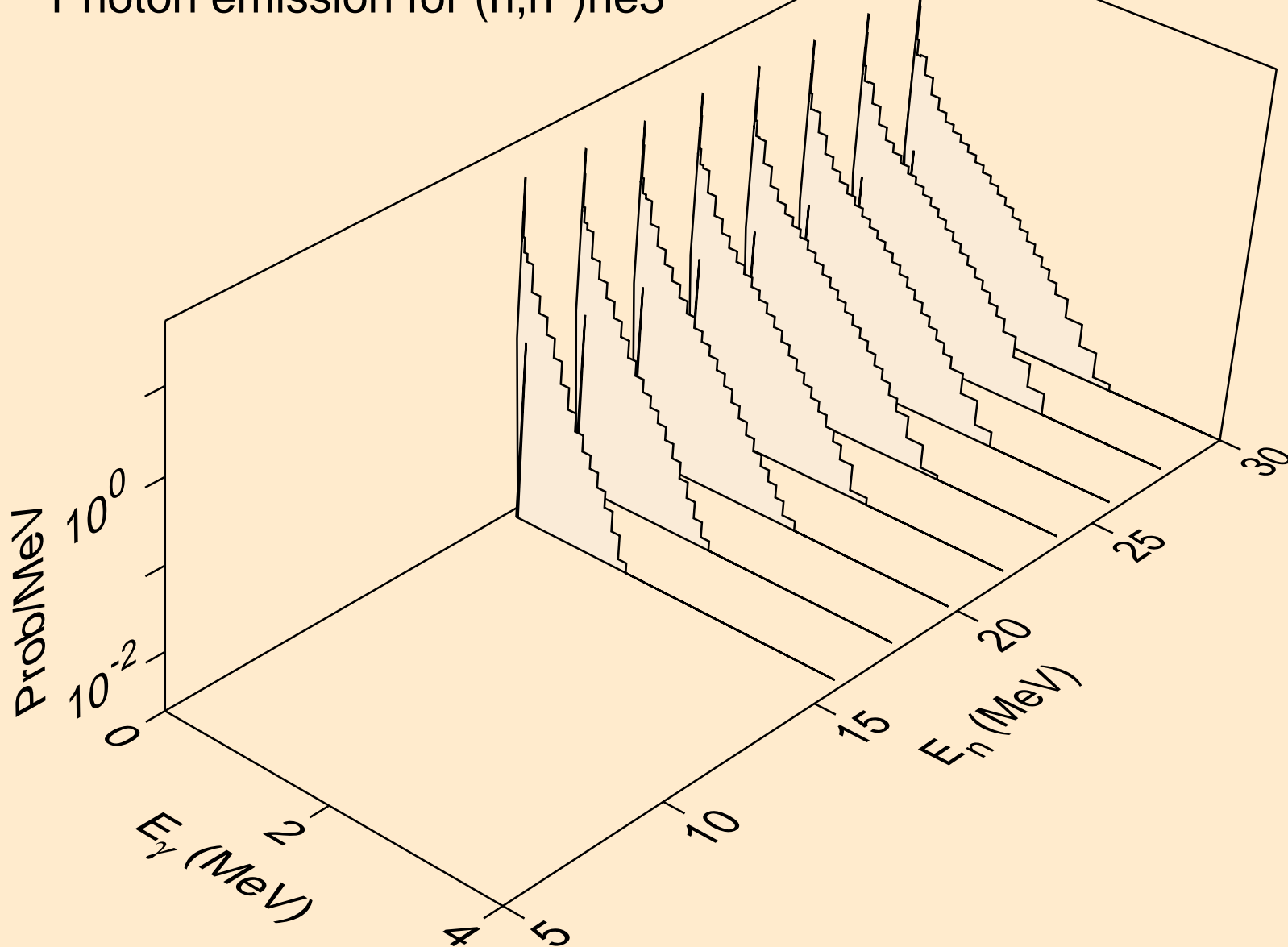

BK237 NEUTRON ACER TENDL-2019 LIBRARY; T=293.16K
Photon emission for (n,4n)

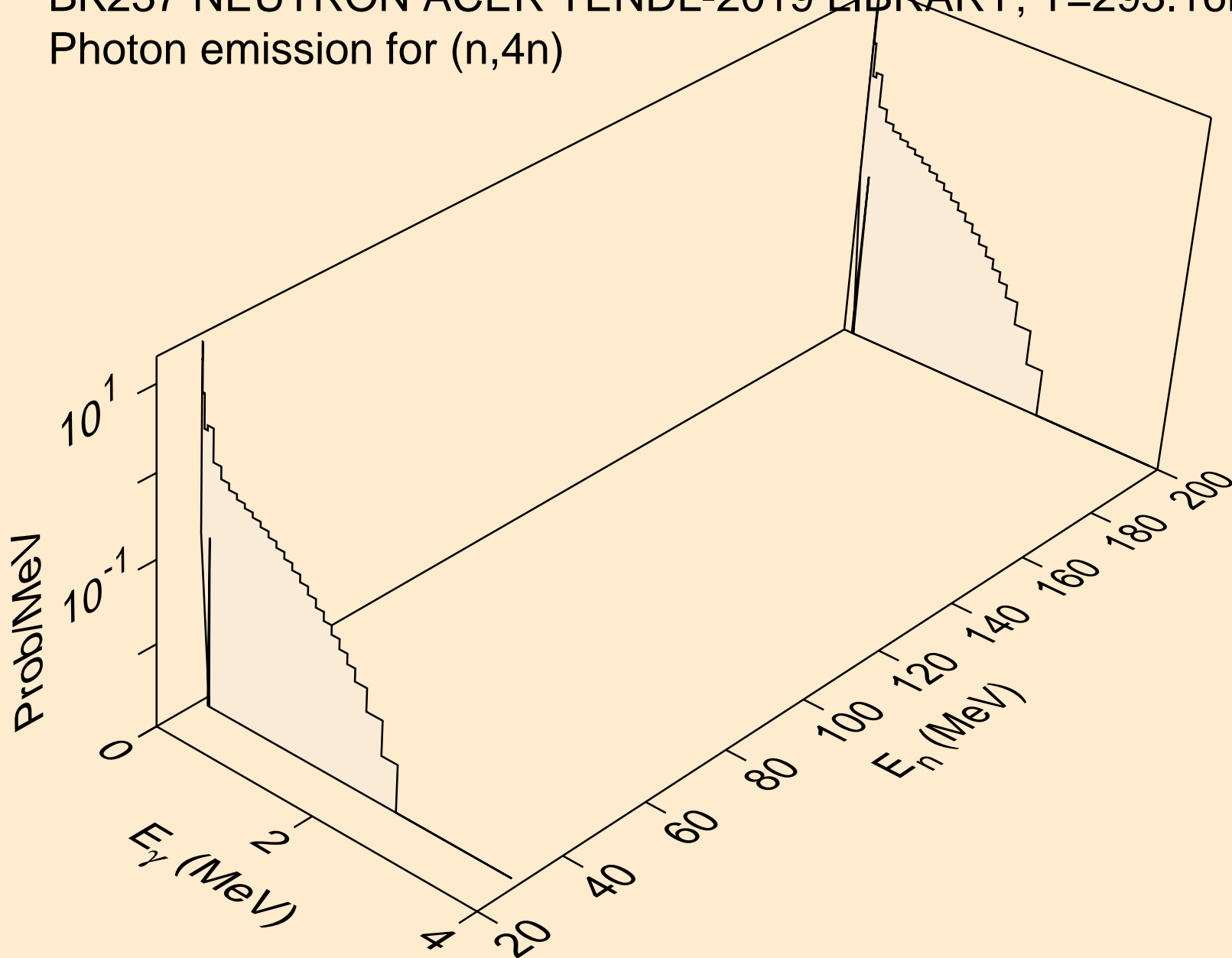

BK237 NEUTRON ACER TENDL-2019 LIBRARY; T=293.16K
Photon emission for (n,2np)

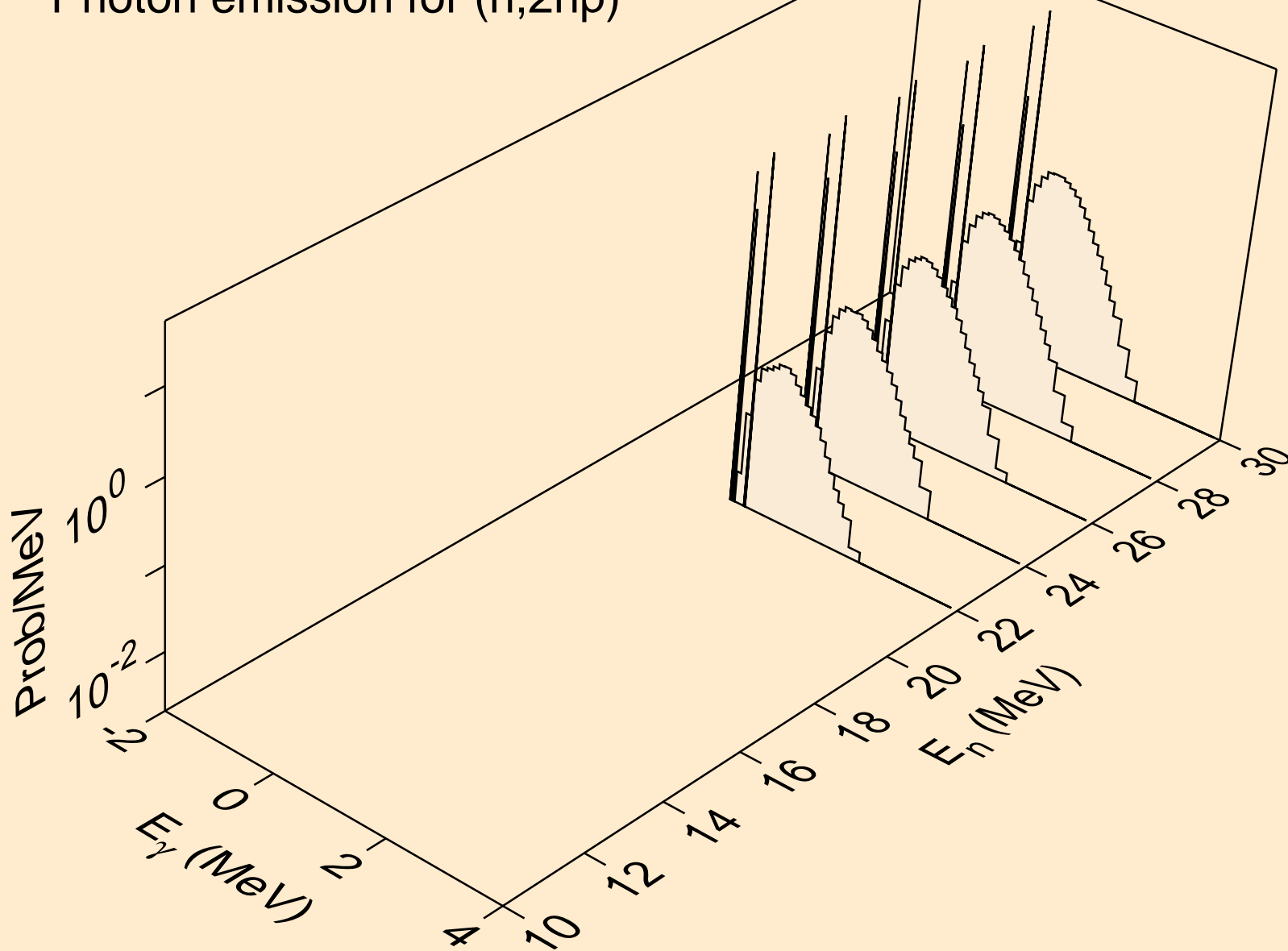

BK237 NEUTRON ACER TENDL-2019 LIBRARY; T=293.16K
Photon emission for (n,3np)

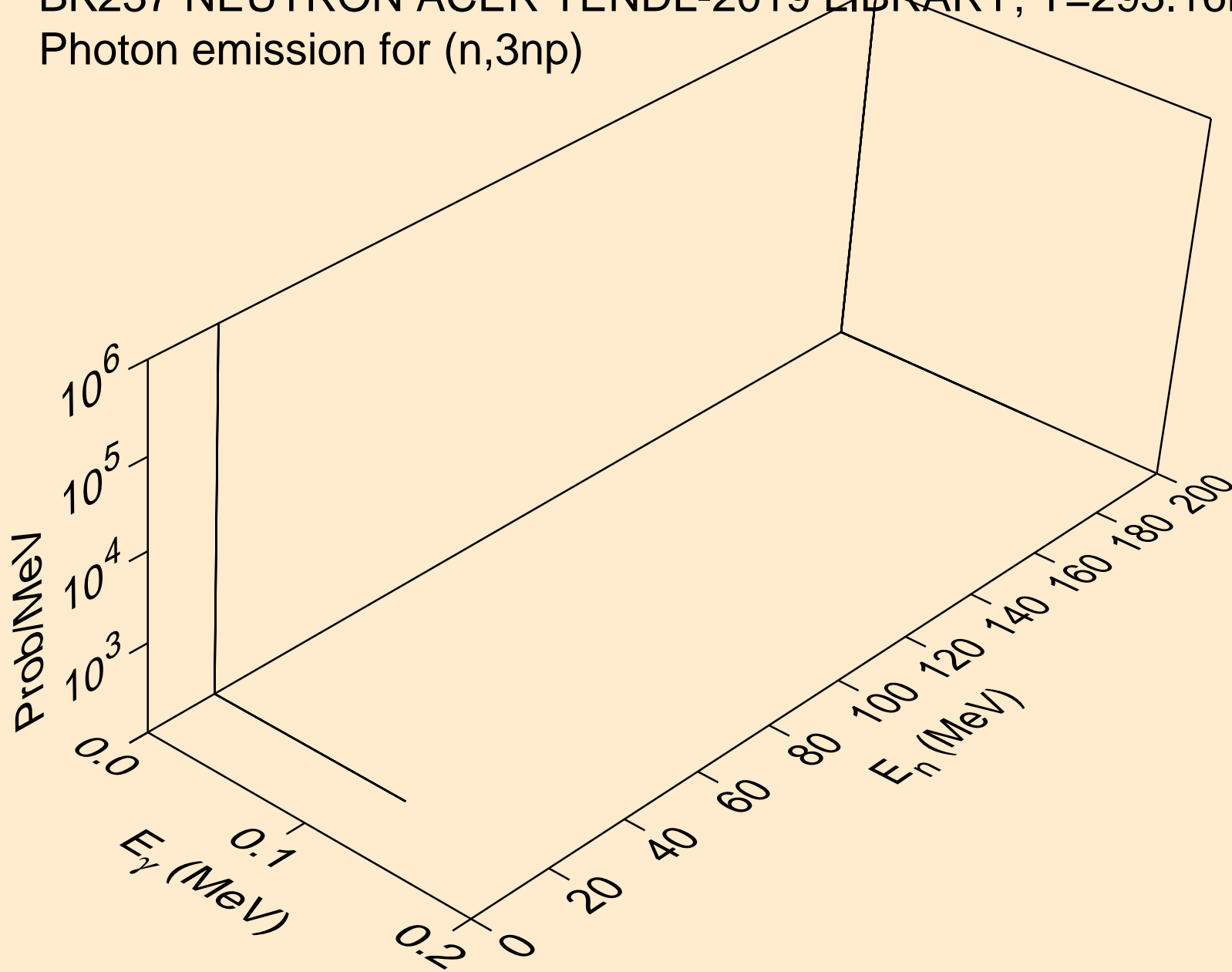

BK237 NEUTRON ACER TENDL-2019 LIBRARY; T=293.16K
Photon emission for (n,2np)

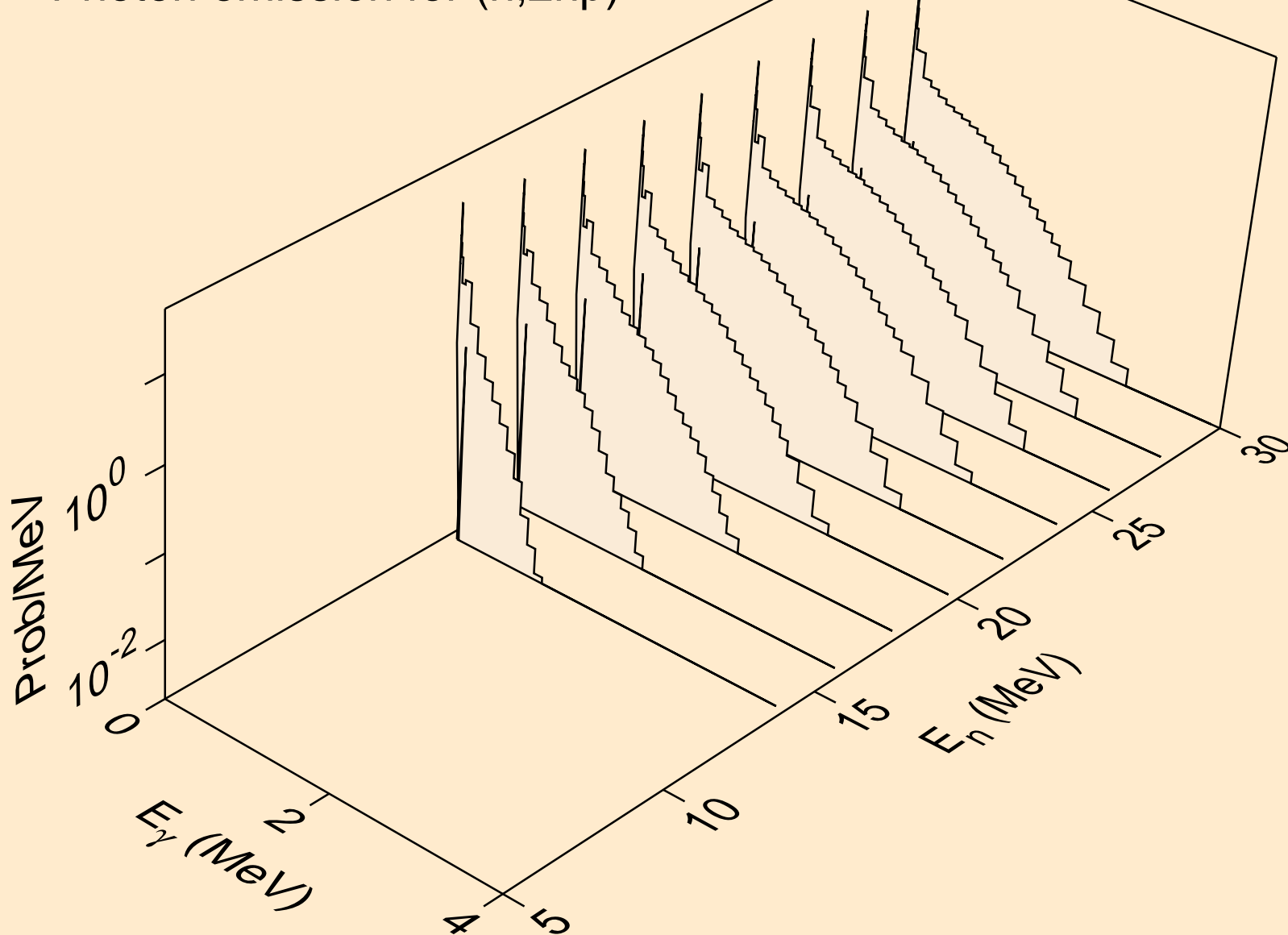

BK237 NEUTRON ACER TENDL-2019 LIBRARY; T=293.16K
Photon emission for (n,n*c)

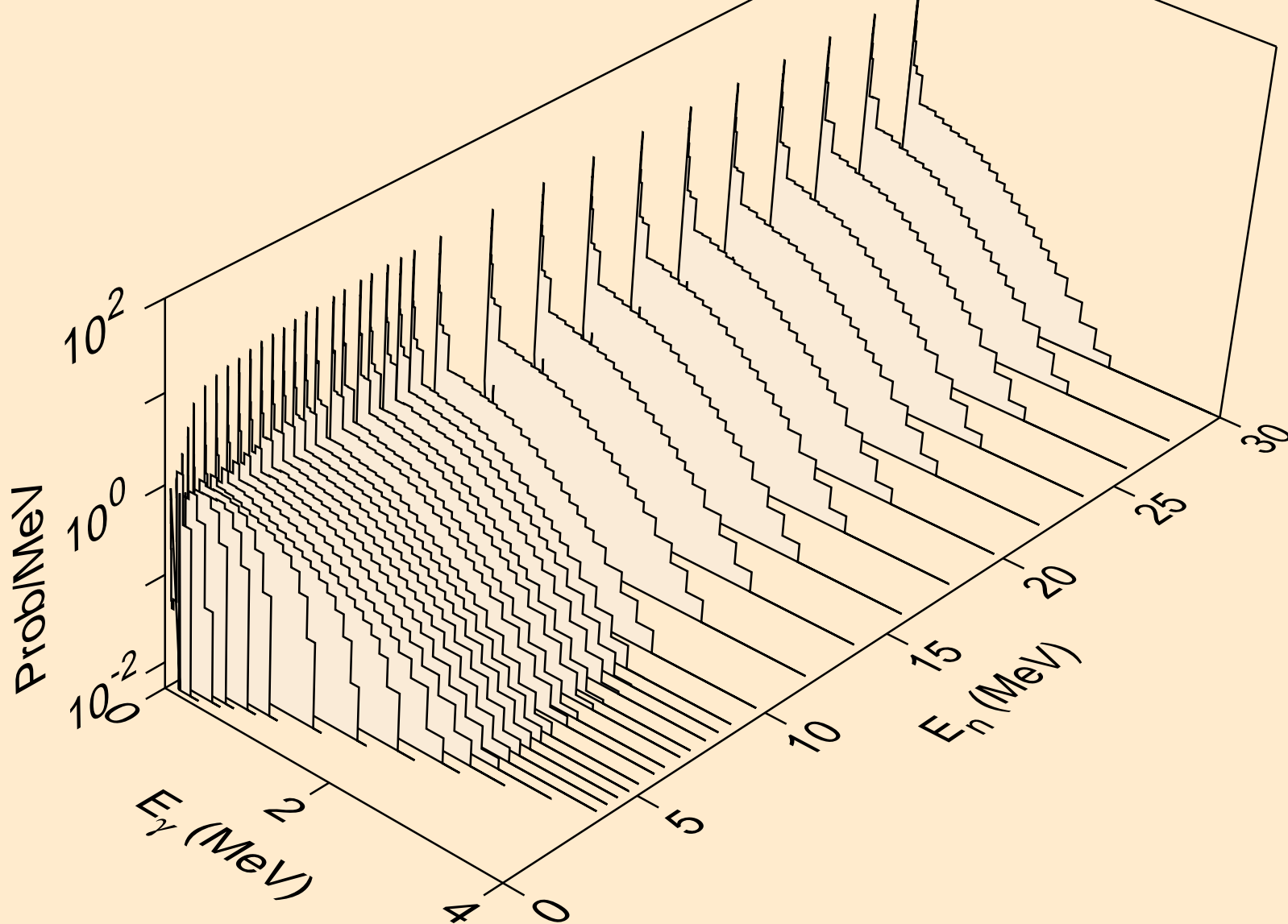

BK237 NEUTRON ACER TENDL-2019 LIBRARY; T=293.16K
Photon emission for (n,gma)

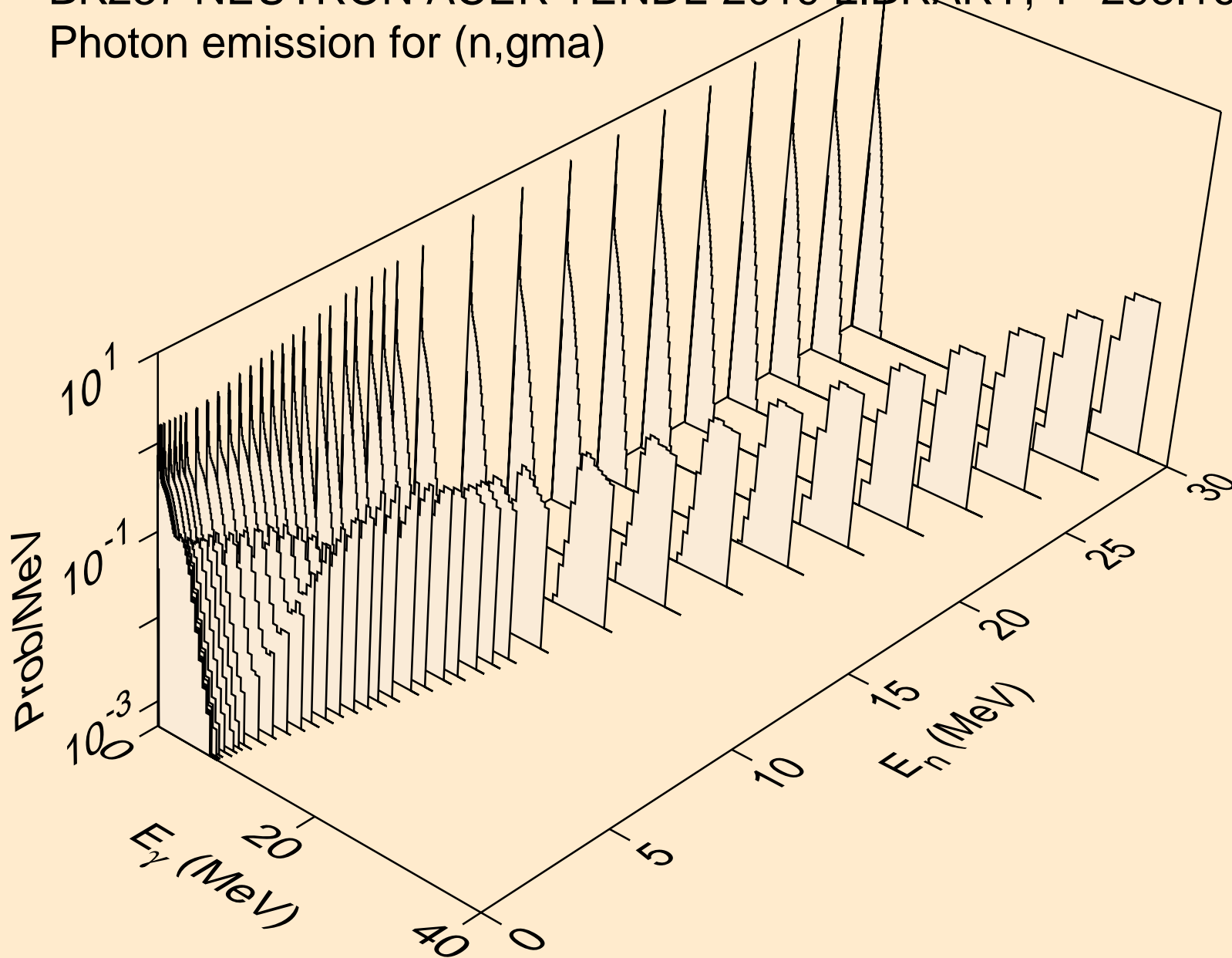

BK237 NEUTRON ACER TENDL-2019 LIBRARY; T=293.16K
Photon emission for (n,p)

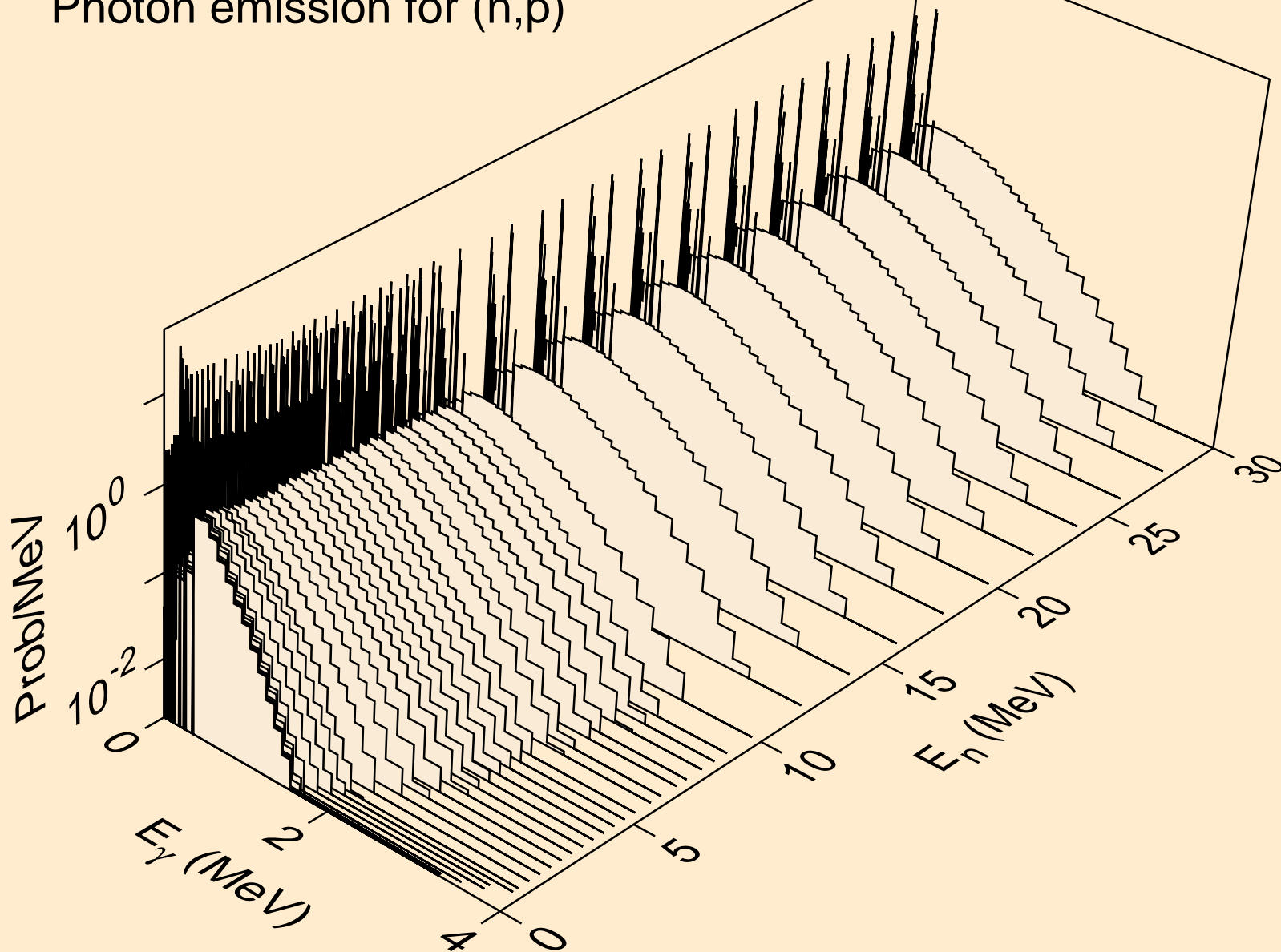

BK237 NEUTRON ACER TENDL-2019 LIBRARY; T=293.16K
Photon emission for (n,d)

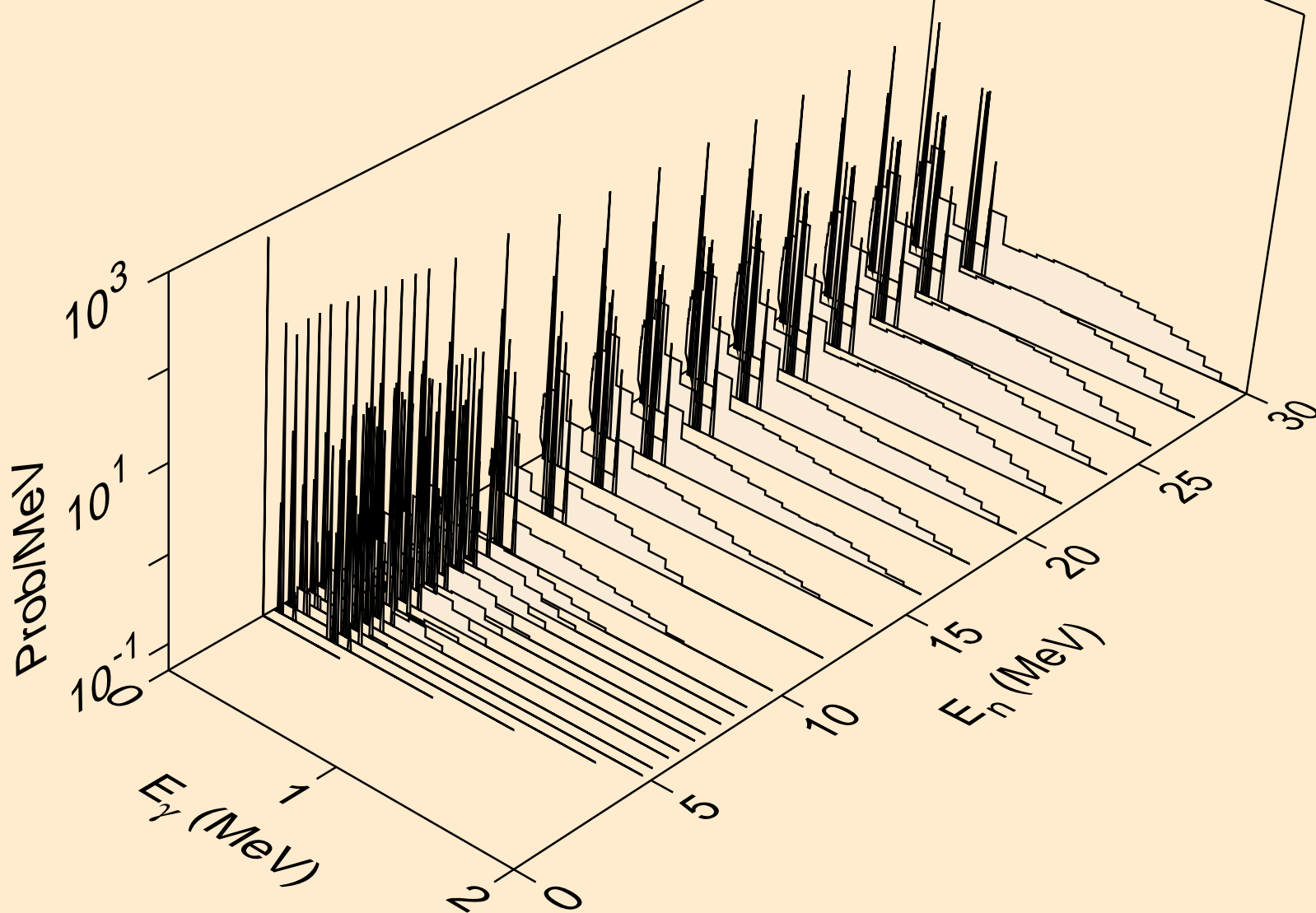

BK237 NEUTRON ACER TENDL-2019 LIBRARY; T=293.16K
Photon emission for (n,t)

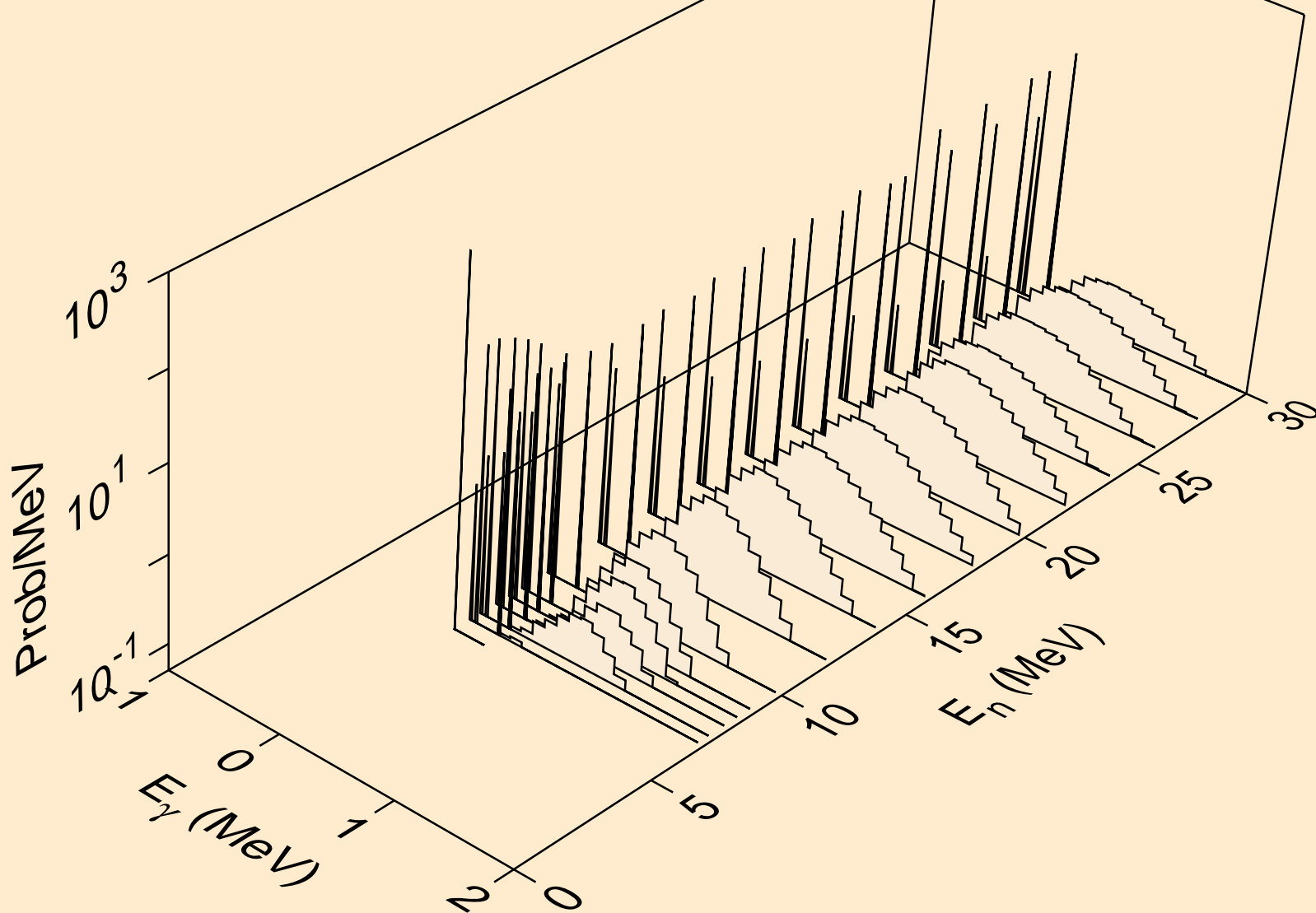

BK237 NEUTRON ACER TENDL-2019 LIBRARY; T=293.16K
Photon emission for (n,he3)

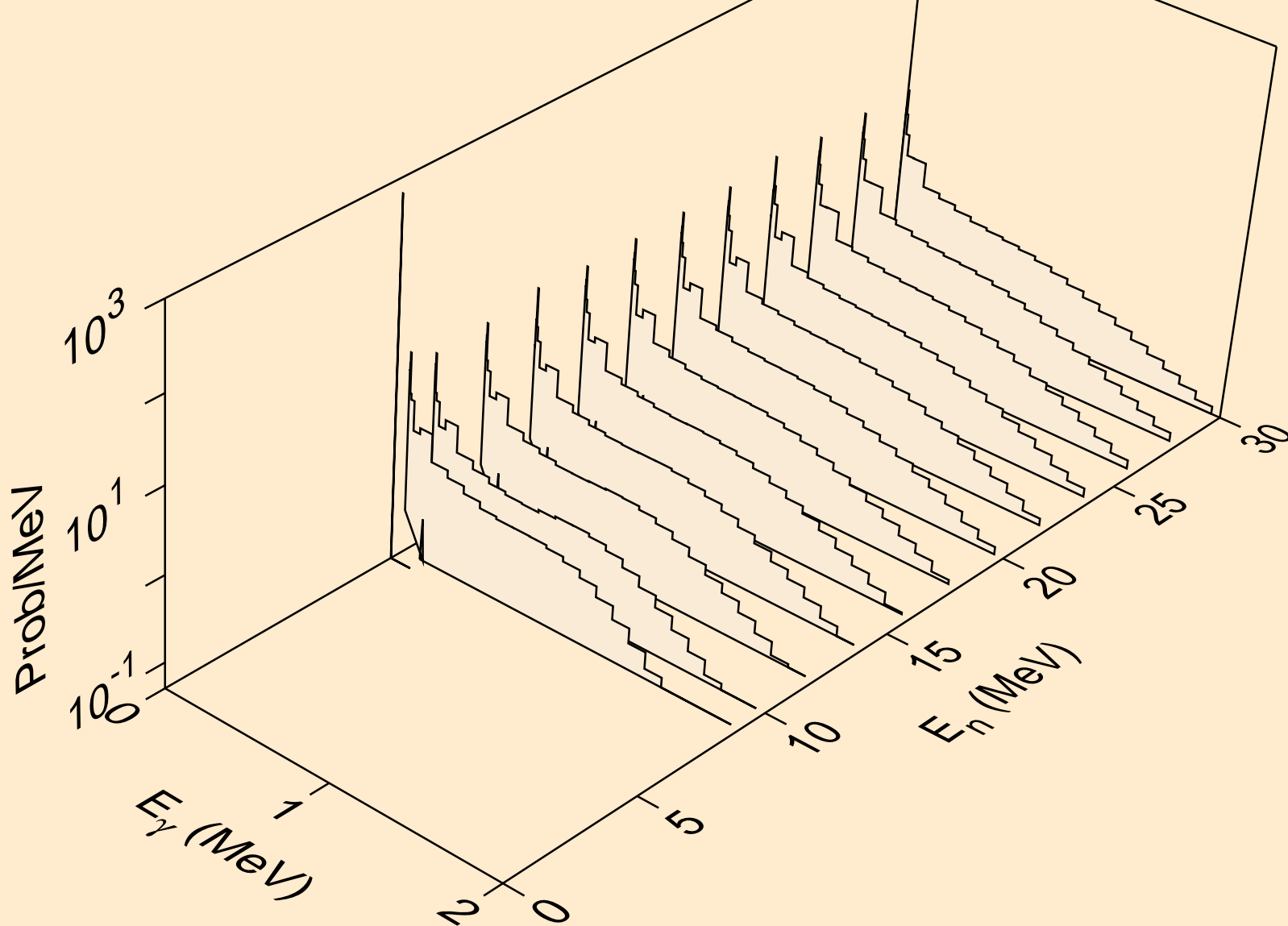

BK237 NEUTRON ACER TENDL-2019 LIBRARY; T=293.16K
Photon emission for (n,a)

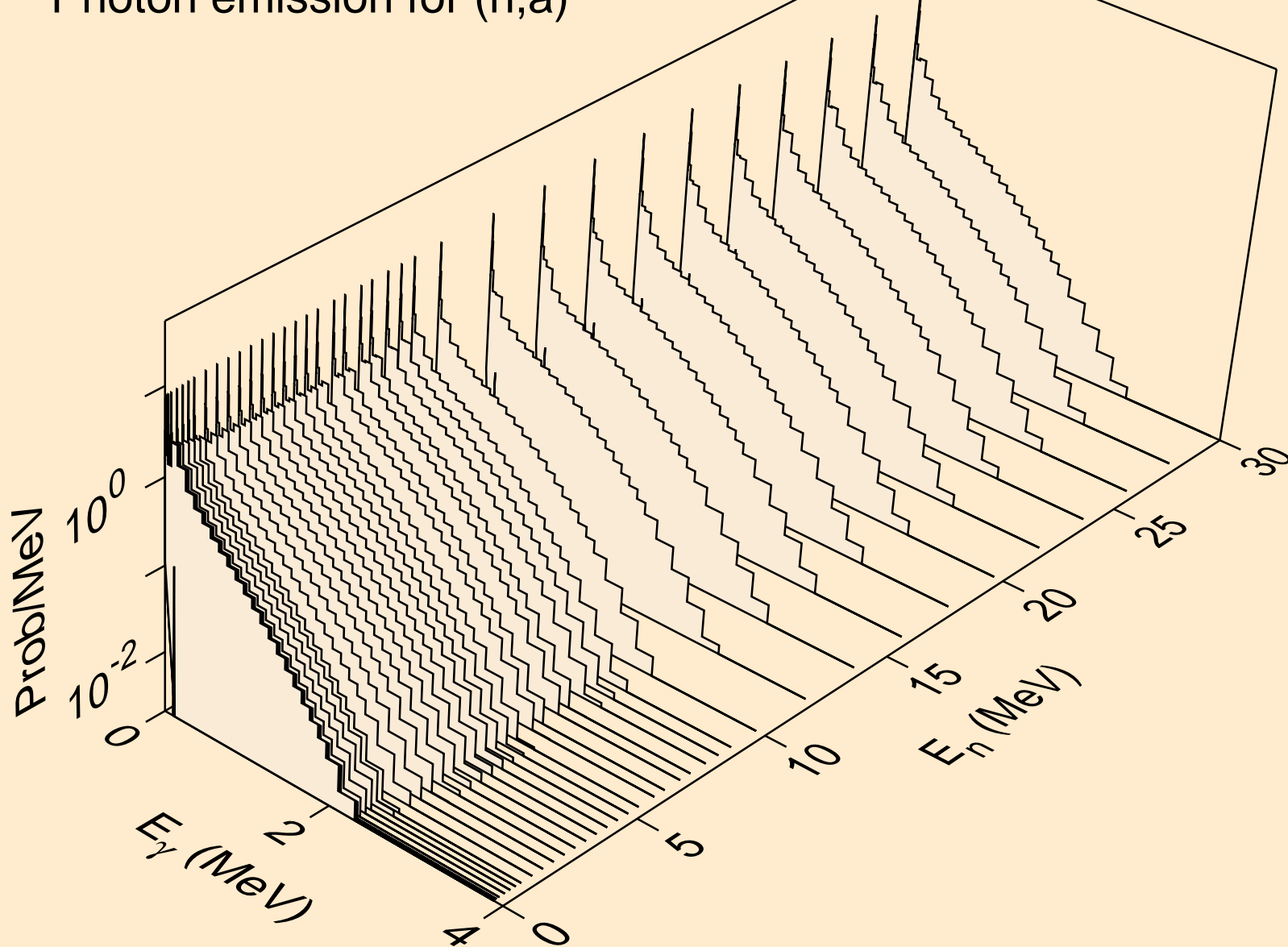

BK237 NEUTRON ACER TENDL-2019 LIBRARY; T=293.16K
Photon emission for (n,2a)

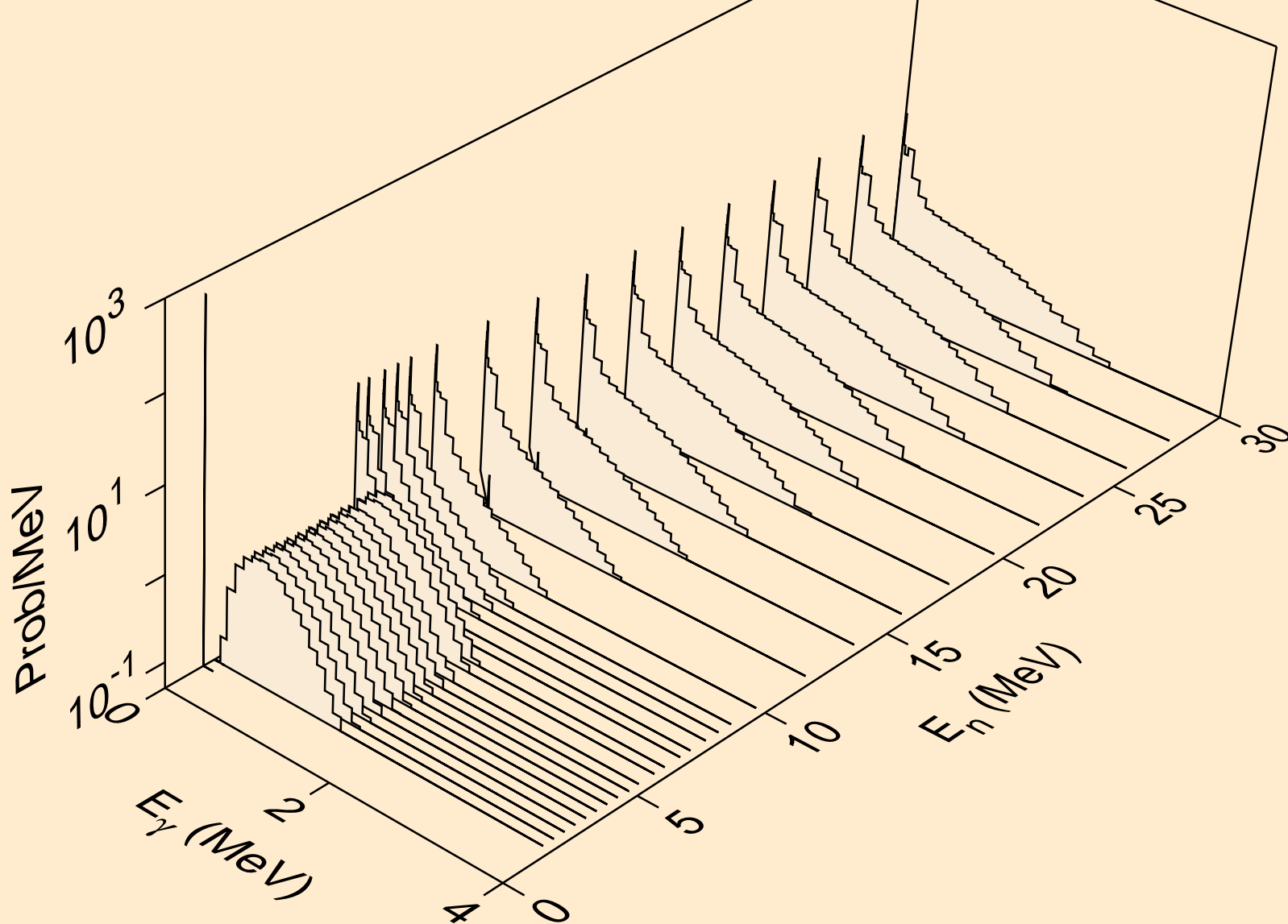

BK237 NEUTRON ACER TENDL-2019 LIBRARY; T=293.16K
Photon emission for (n,2p)

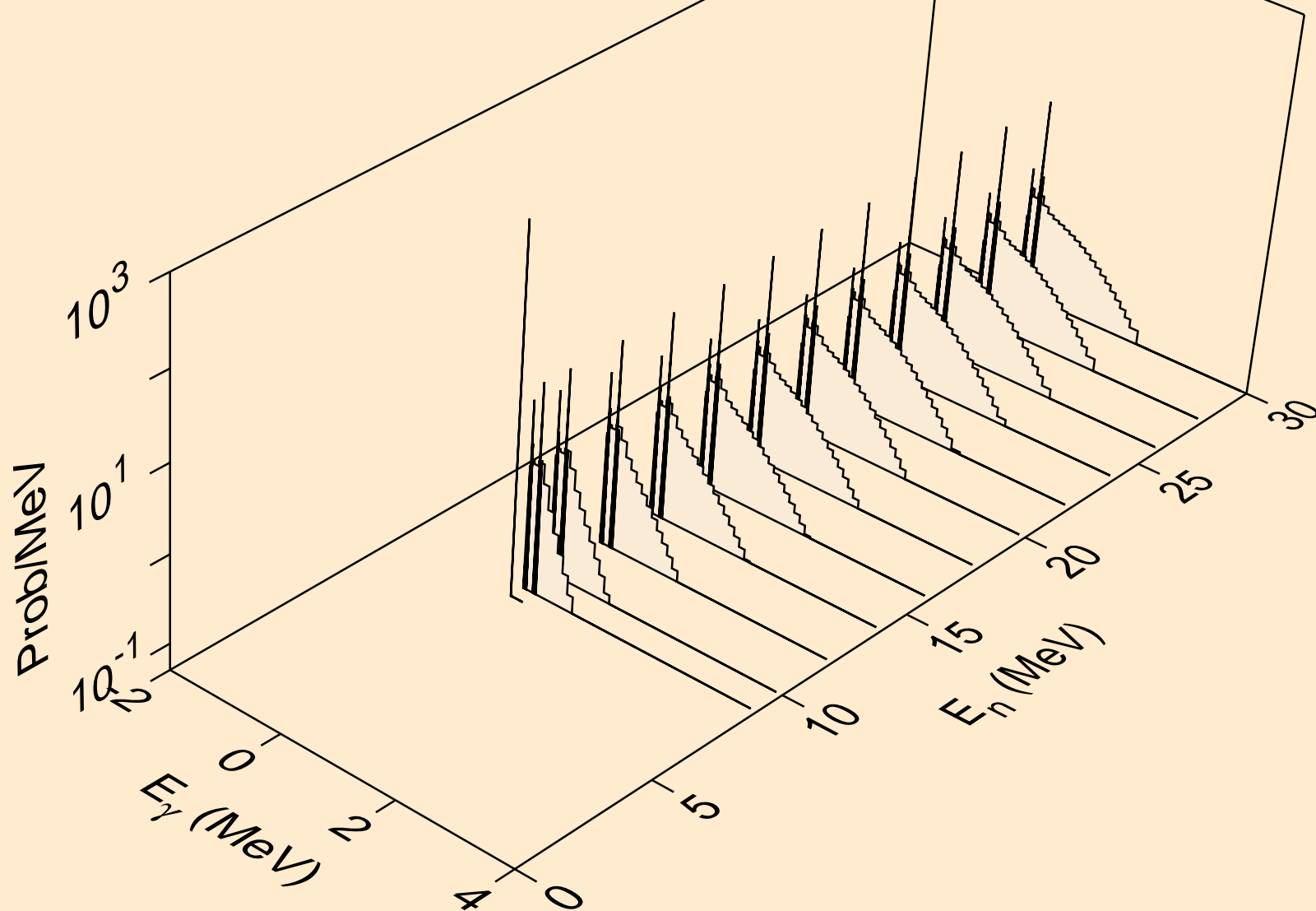

BK237 NEUTRON ACER TENDL-2019 LIBRARY; T=293.16K
Photon emission for (n,pd)

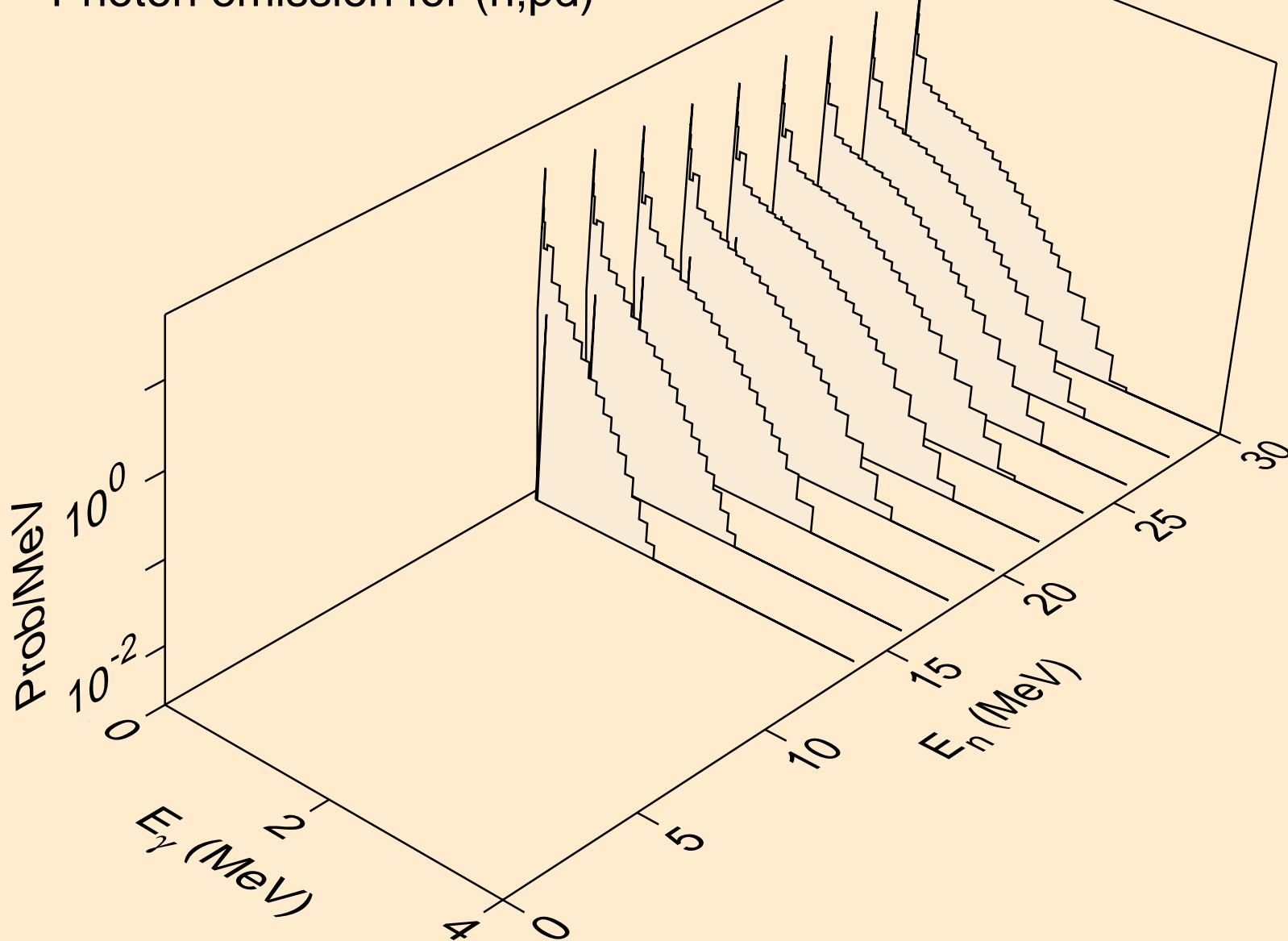

BK237 NEUTRON ACER TENDL-2019 LIBRARY; T=293.16K
thermal capture photon spectrum

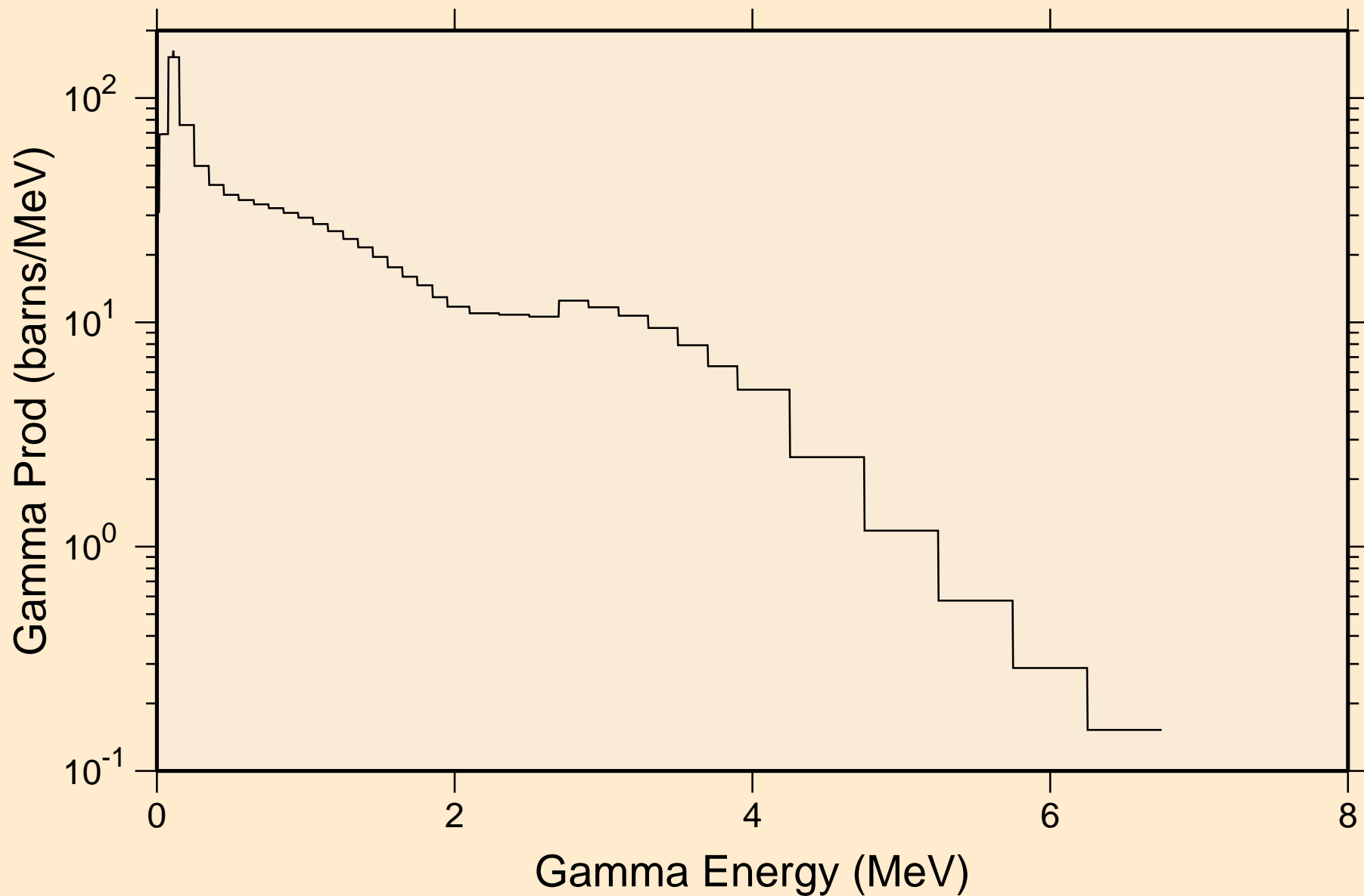

BK237 NEUTRON ACER TENDL-2019 LIBRARY; T=293.16K
14 MeV photon spectrum

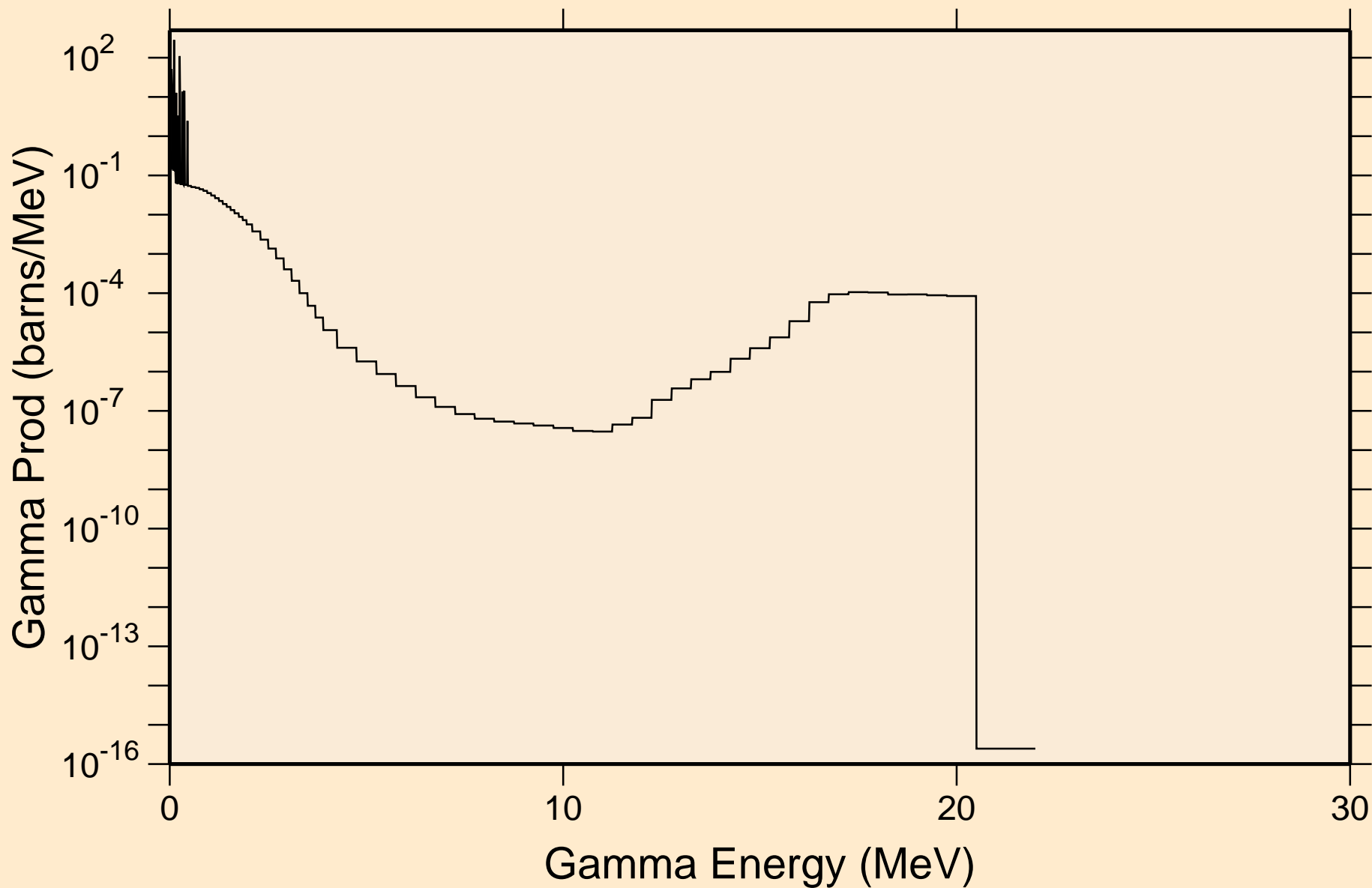

BK237 NEUTRON ACER TENDL-2019 LIBRARY; T=293.16K
Particle heating contributions

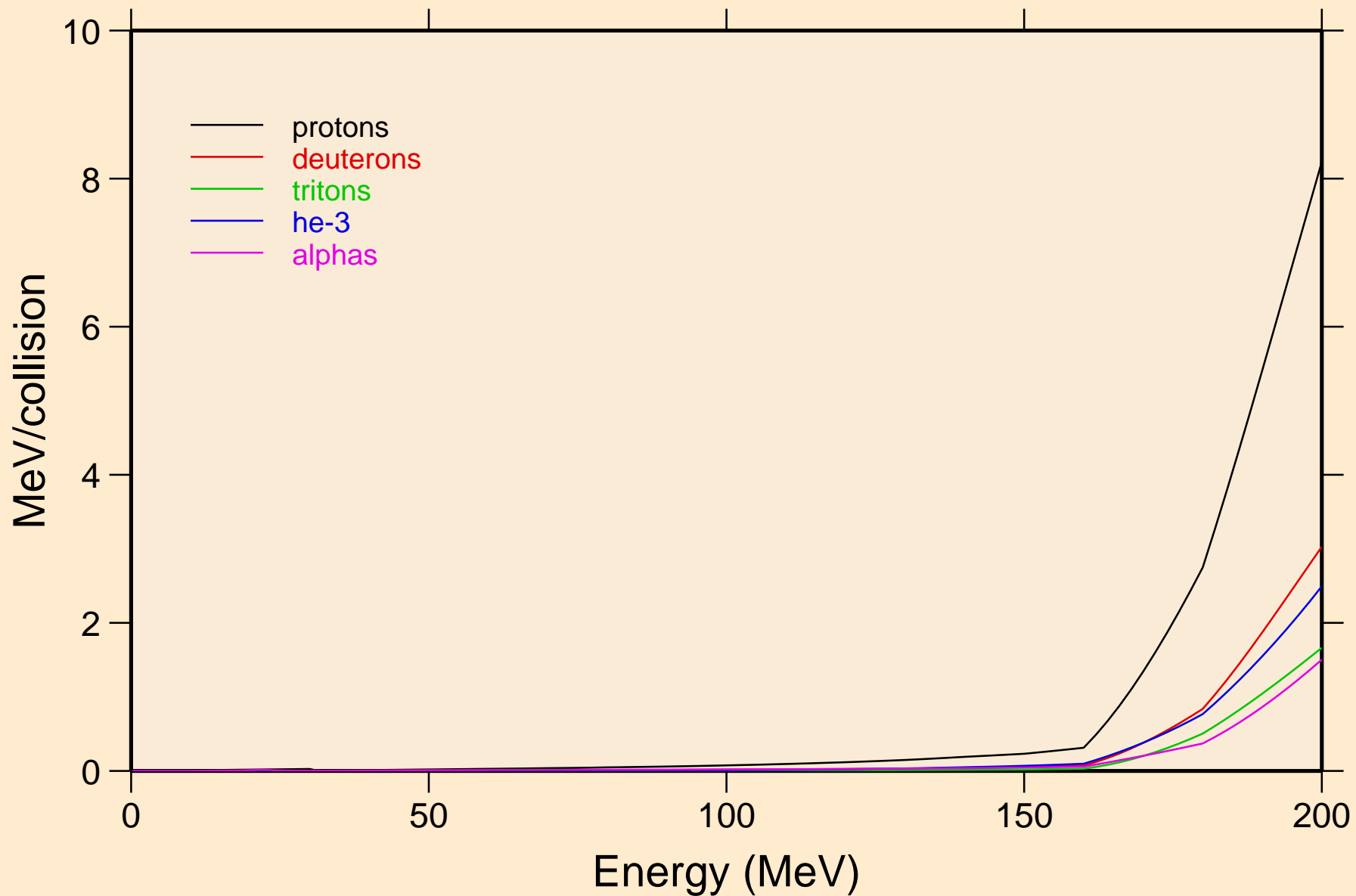

BK237 NEUTRON ACER TENDL-2019 LIBRARY; T=293.16K
Recoil Heating

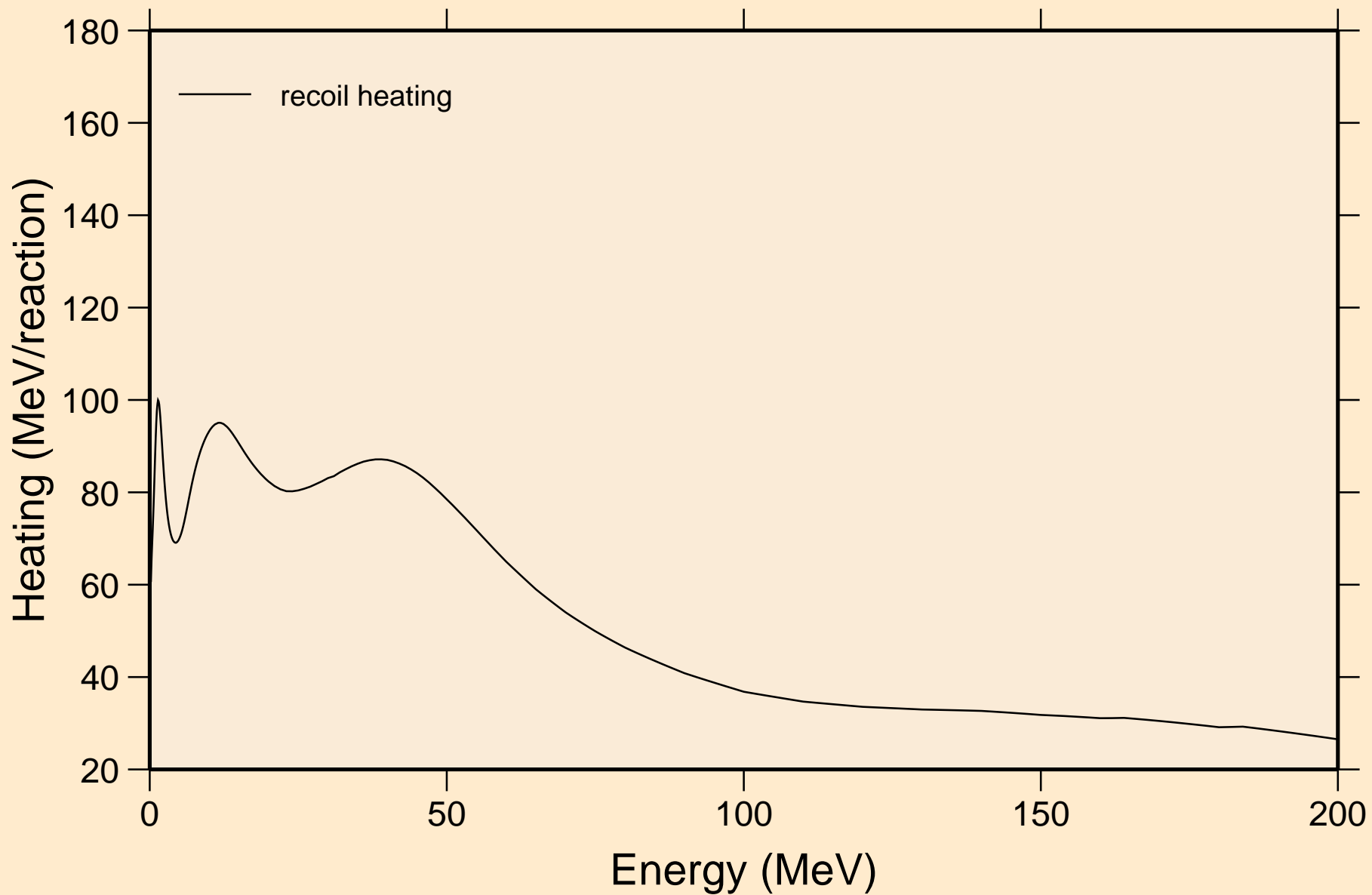

BK237 NEUTRON ACER TENDL-2019 LIBRARY; T=293.16K
Particle production cross sections

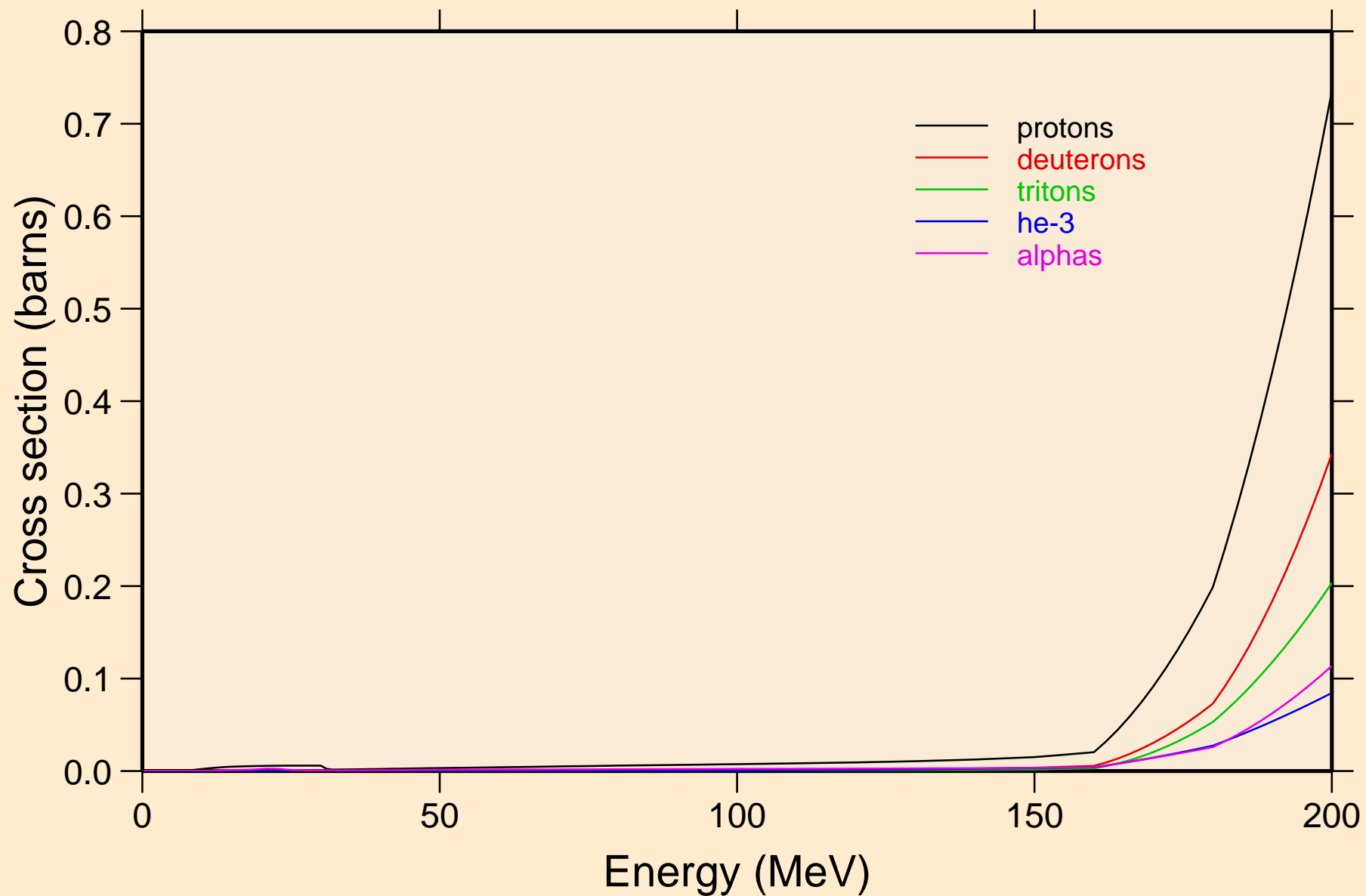

BK237 NEUTRON ACER TENDL-2019 LIBRARY; T=293.16K
protons from (n,x)

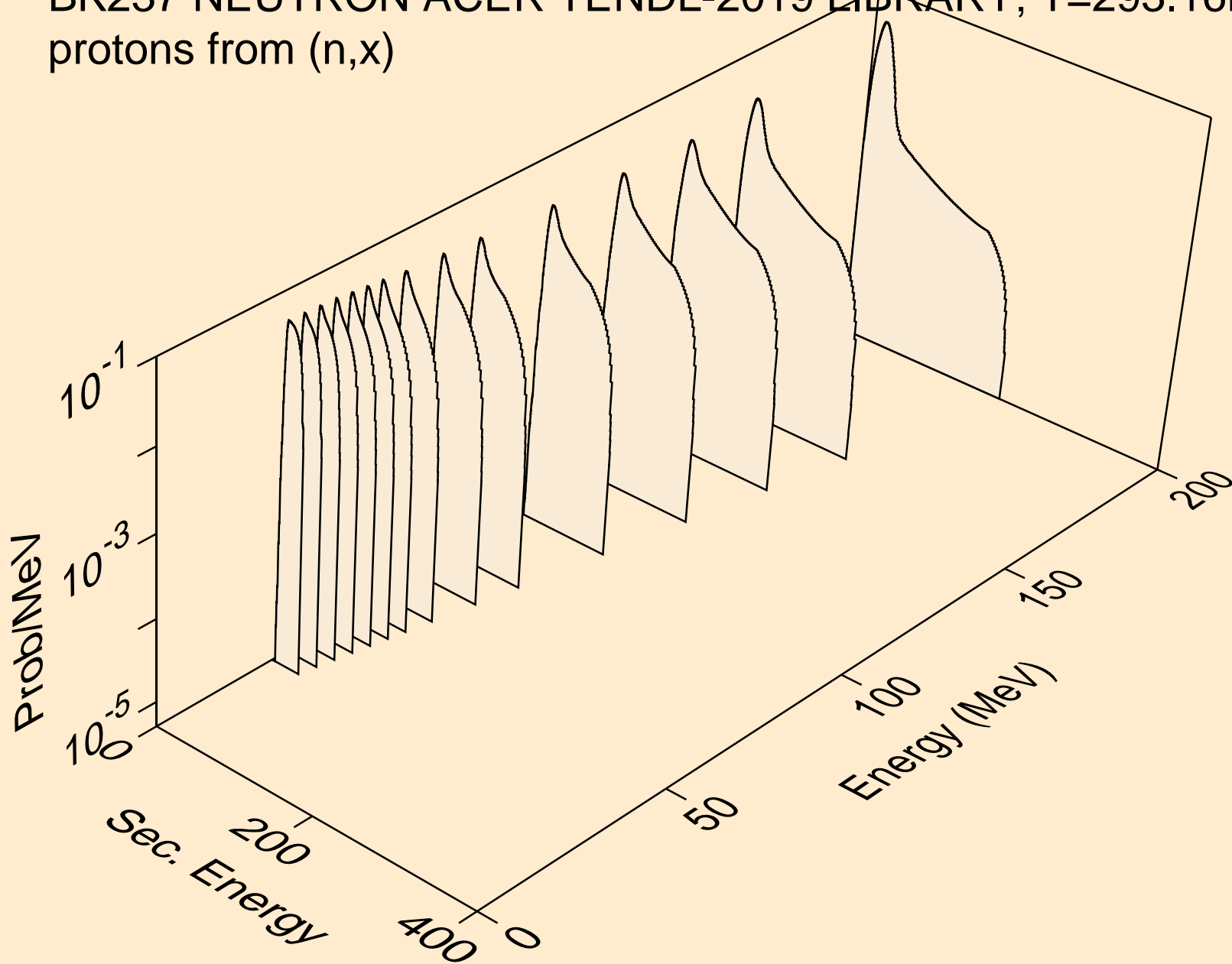

BK237 NEUTRON ACER TENDL-2019 LIBRARY; T=293.16K
protons from (n,n*)p

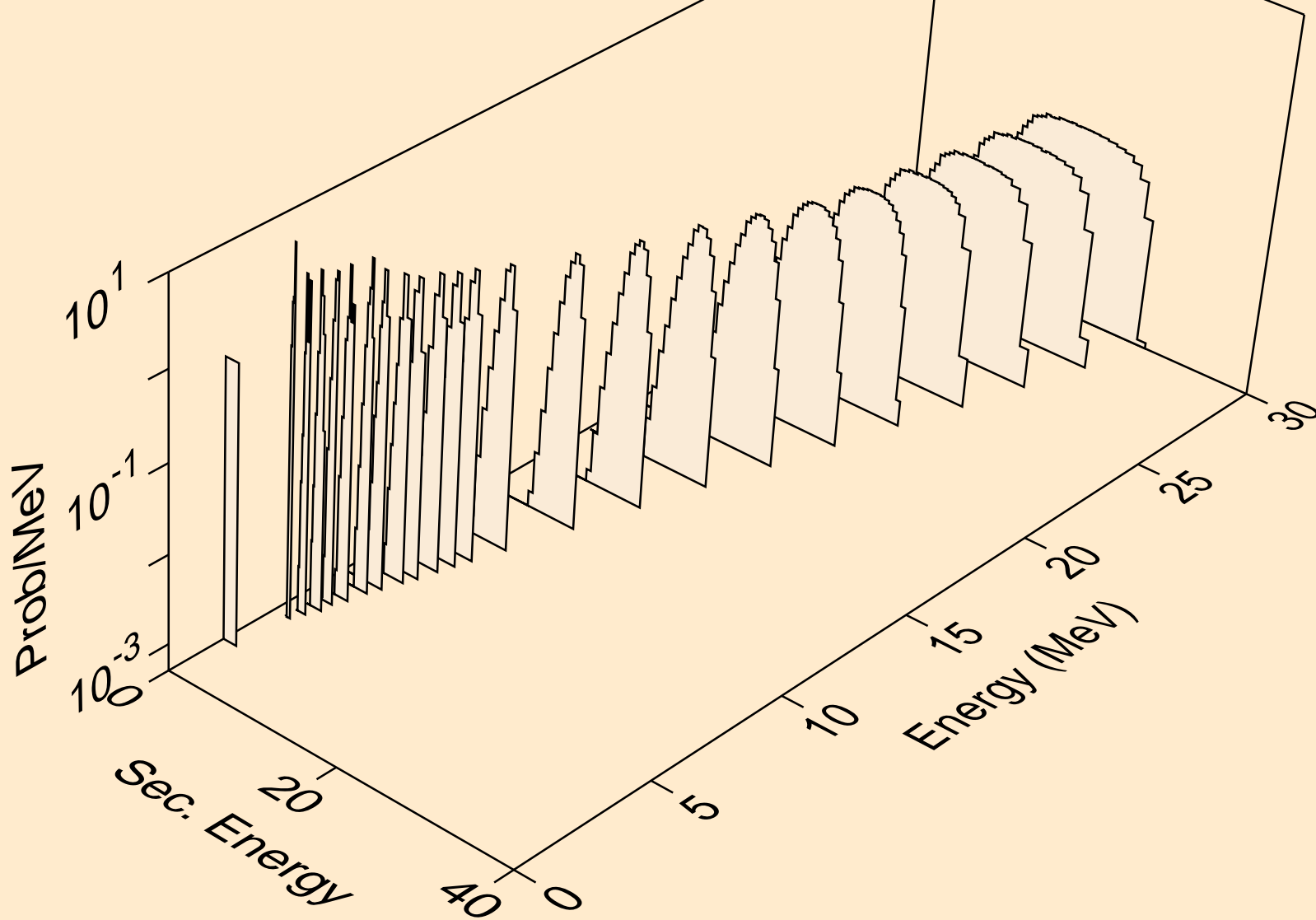

BK237 NEUTRON ACER TENDL-2019 LIBRARY; T=293.16K
protons from (n,2np)

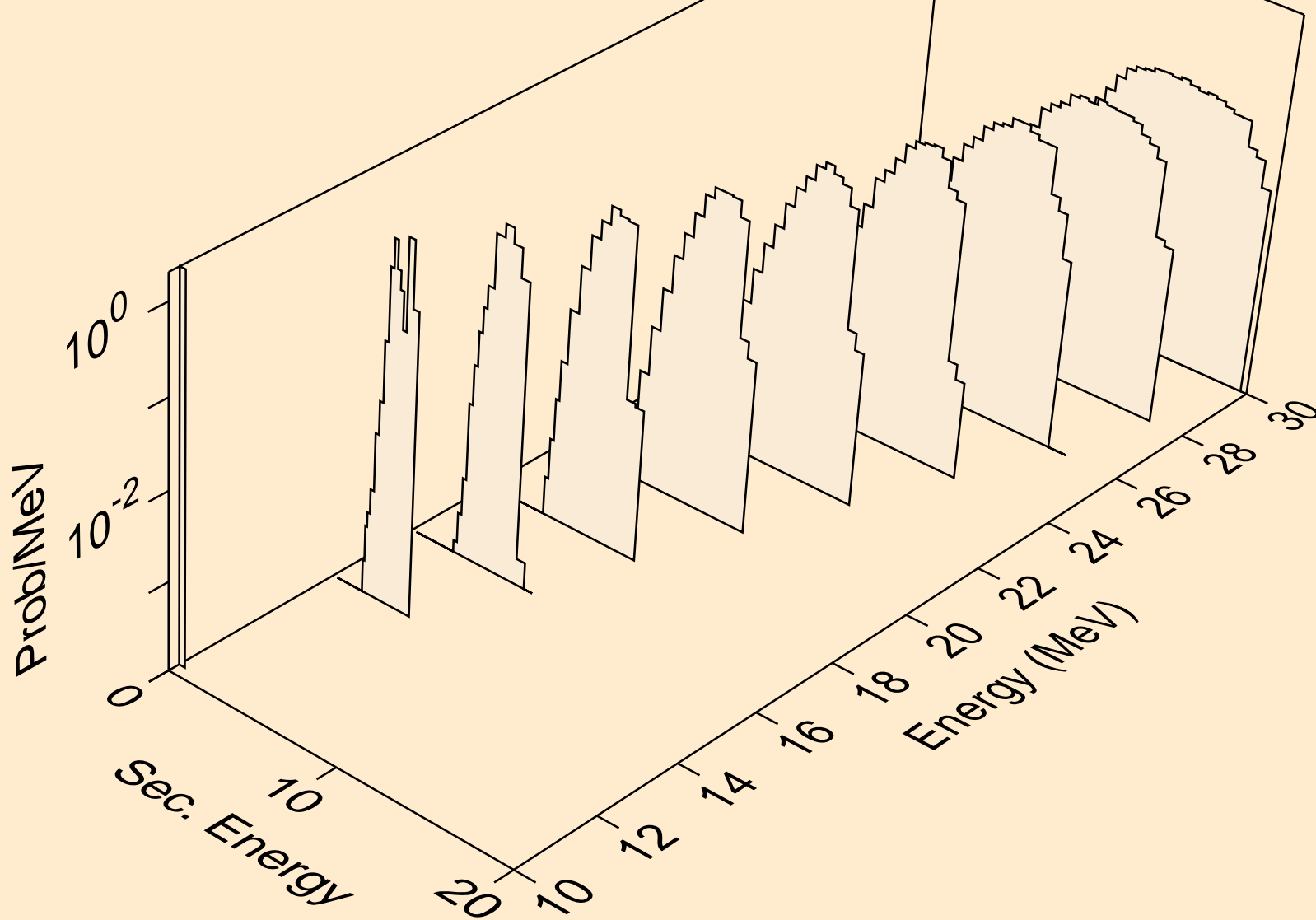

BK237 NEUTRON ACER TENDL-2019 LIBRARY; T=293.16K
protons from (n,3np)

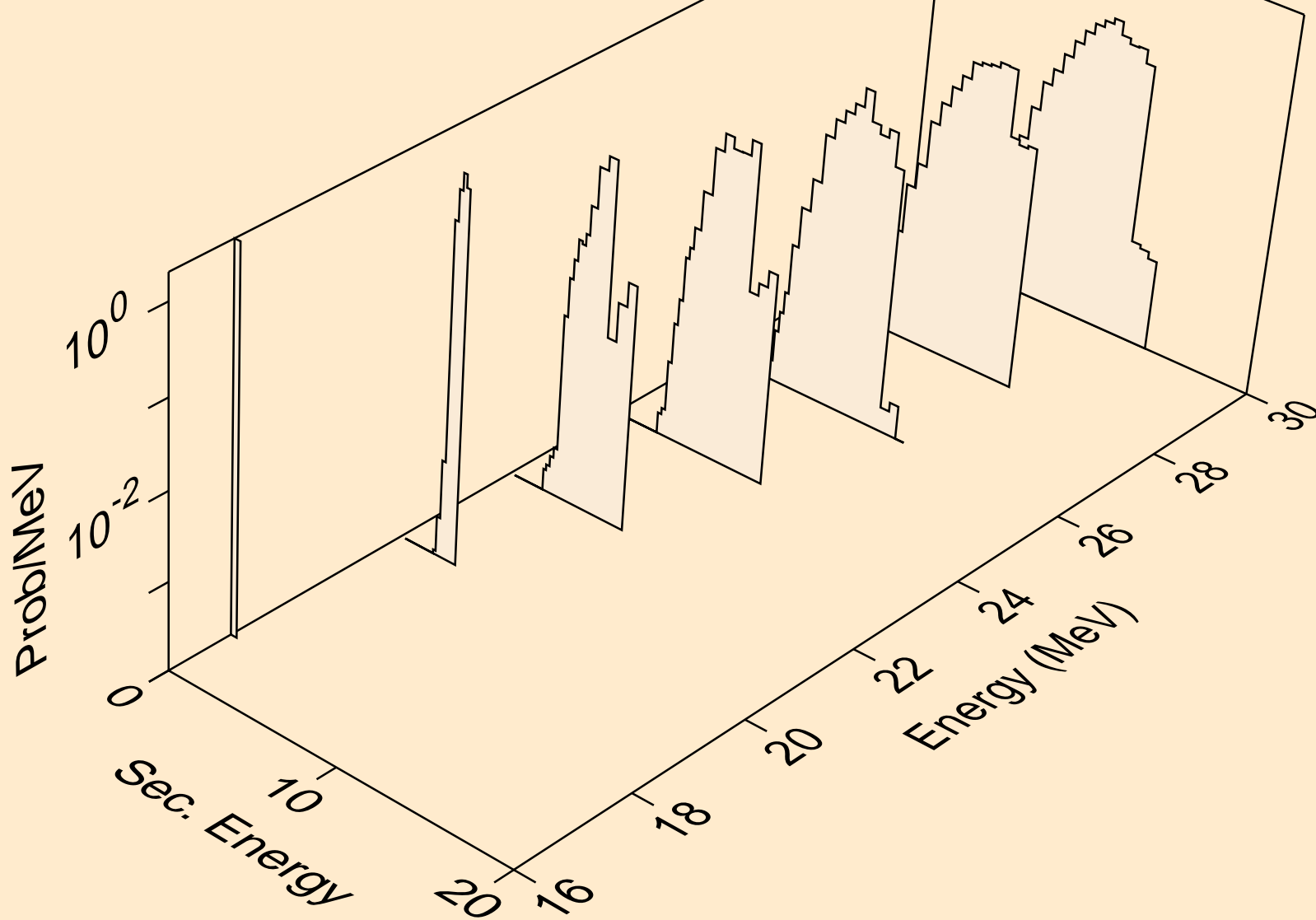

BK237 NEUTRON ACER TENDL-2019 LIBRARY; T=293.16K
protons from (n,2np)

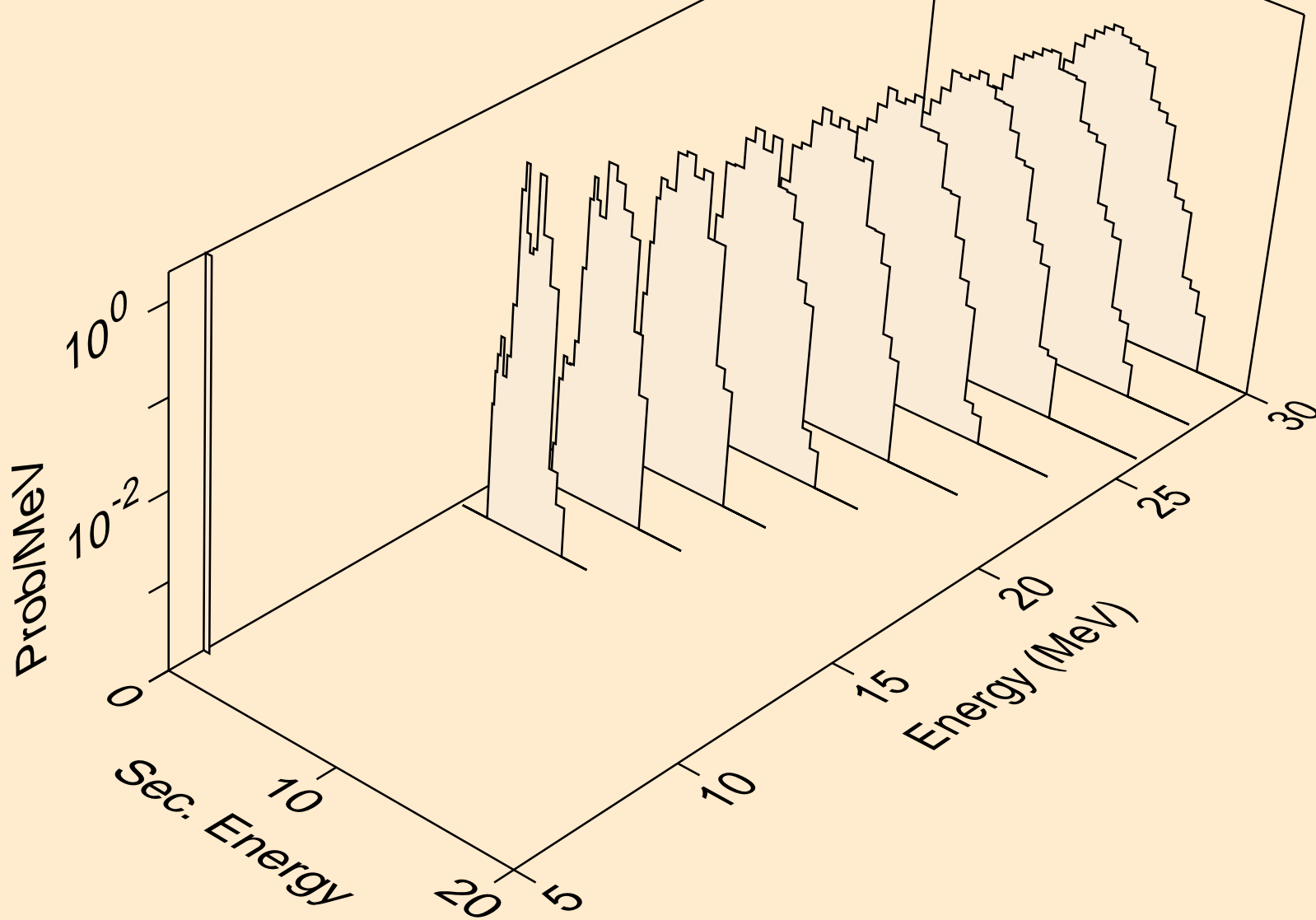

BK237 NEUTRON ACER TENDL-2019 LIBRARY; T=293.16K
protons from (n,p)

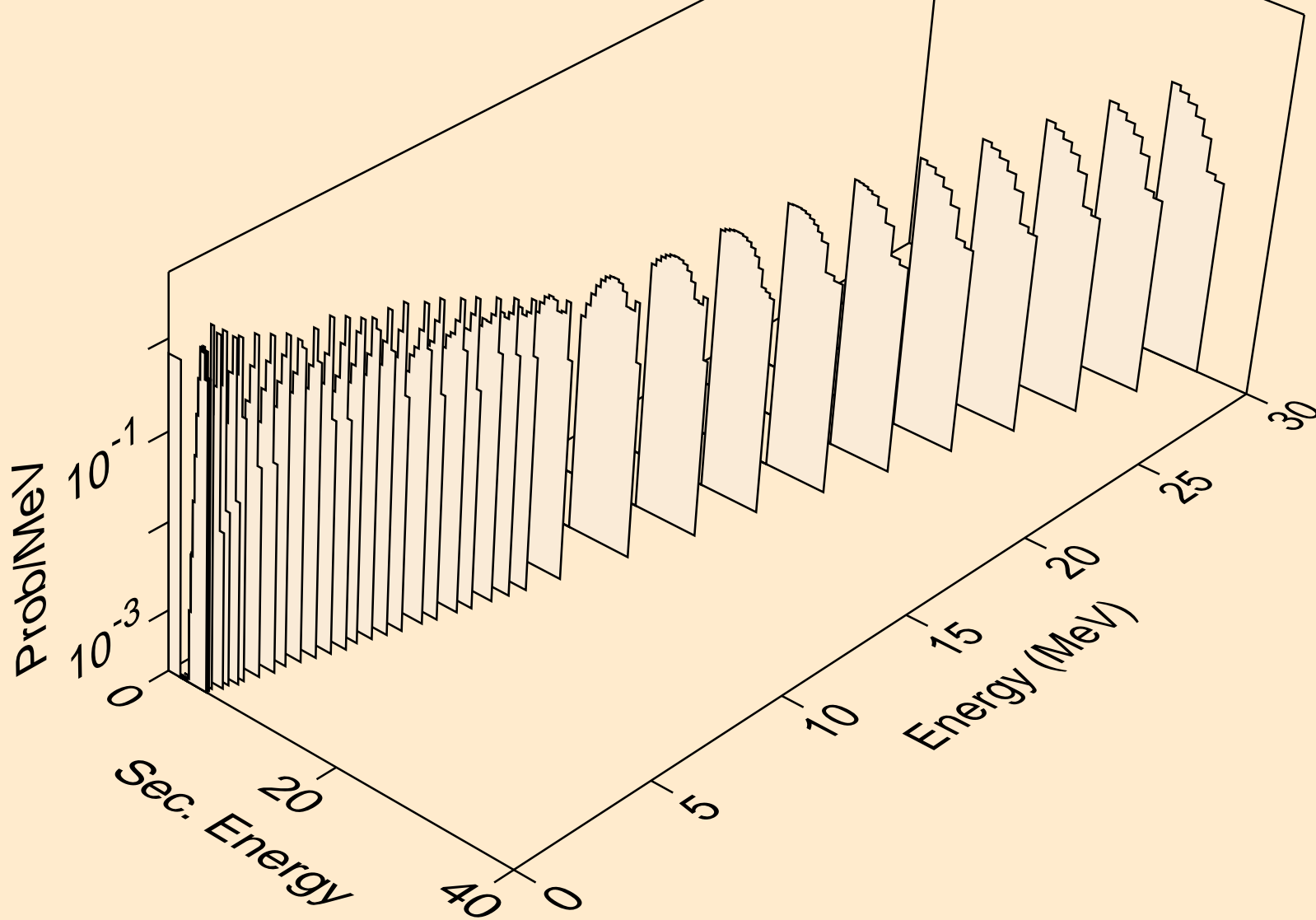

BK237 NEUTRON ACER TENDL-2019 LIBRARY; T=293.16K
protons from (n,2p)

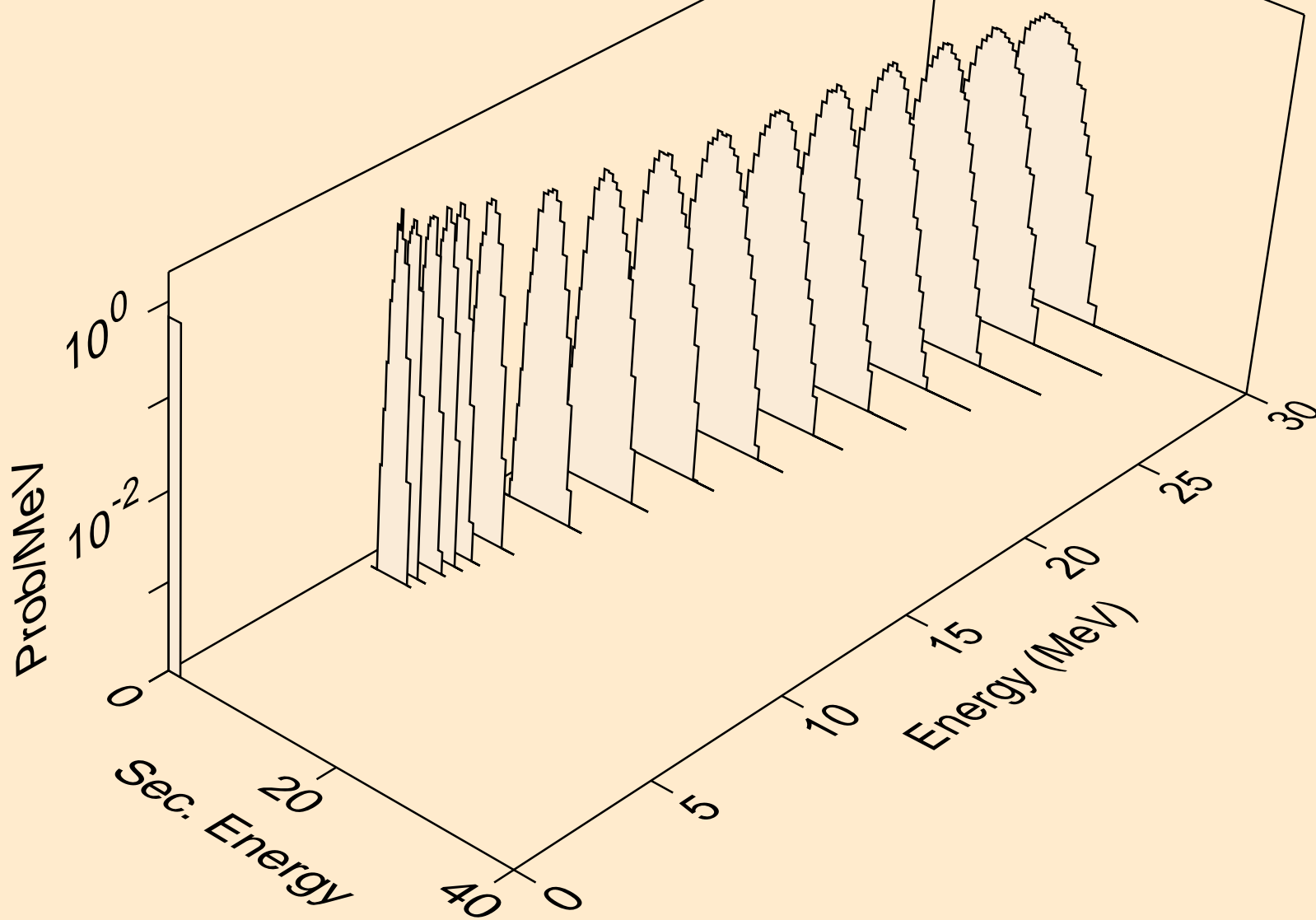

BK237 NEUTRON ACER TENDL-2019 LIBRARY; T=293.16K
protons from (n,pd)

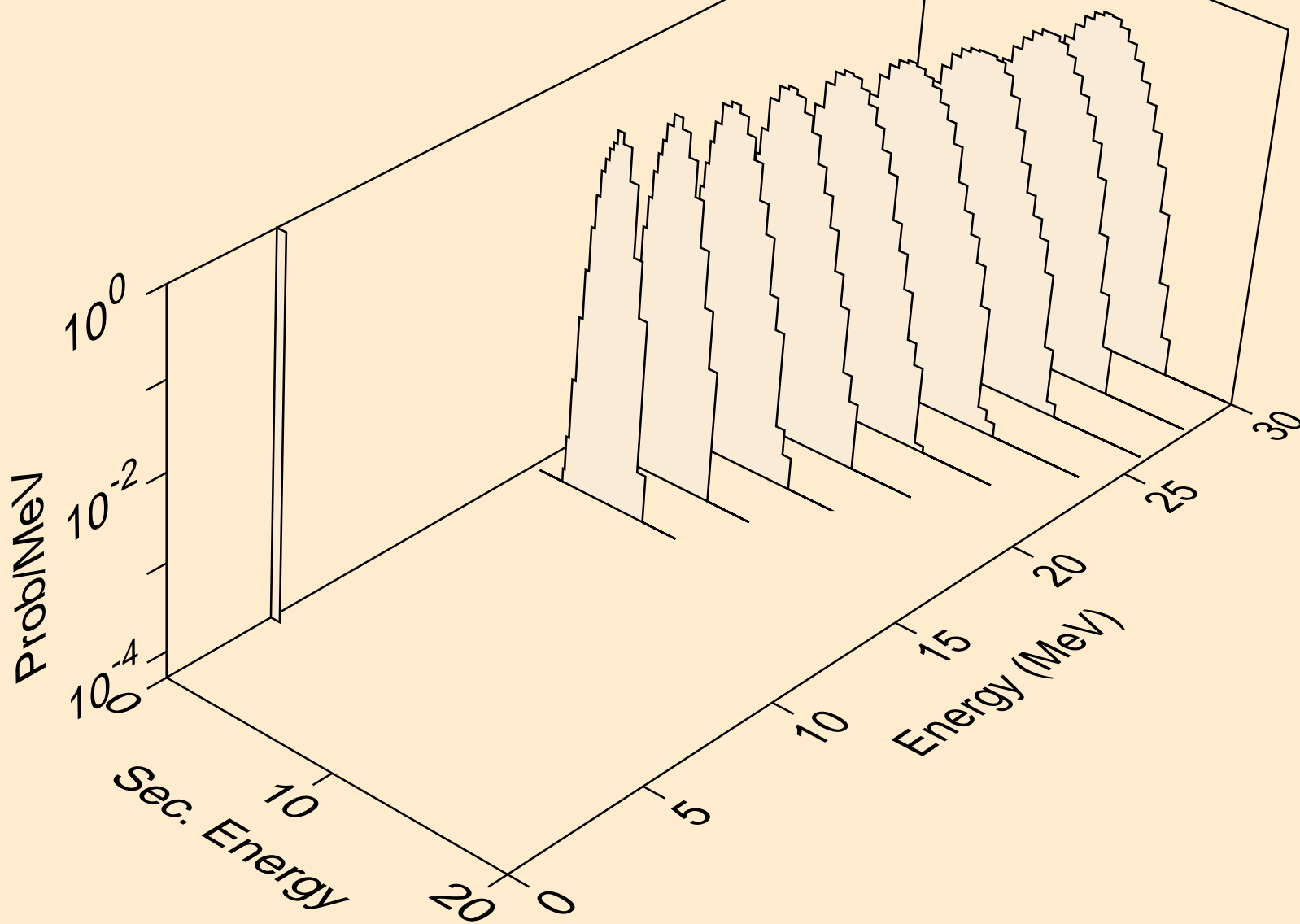

BK237 NEUTRON ACER TENDL-2019 LIBRARY; T=293.16K
deuterons from (n,x)

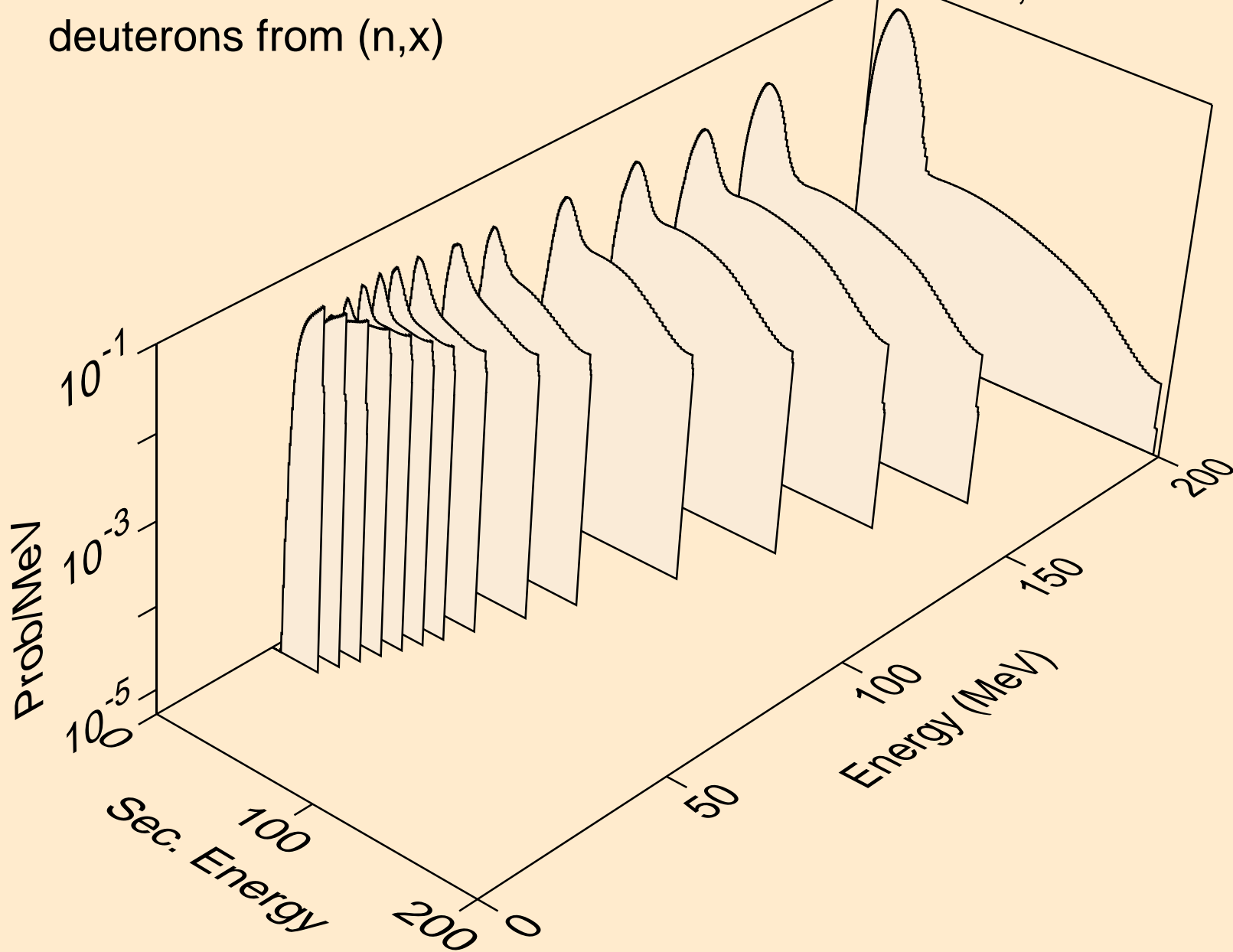

BK237 NEUTRON ACER TENDL-2019 LIBRARY; T=293.16K
deuterons from (n,2nd)

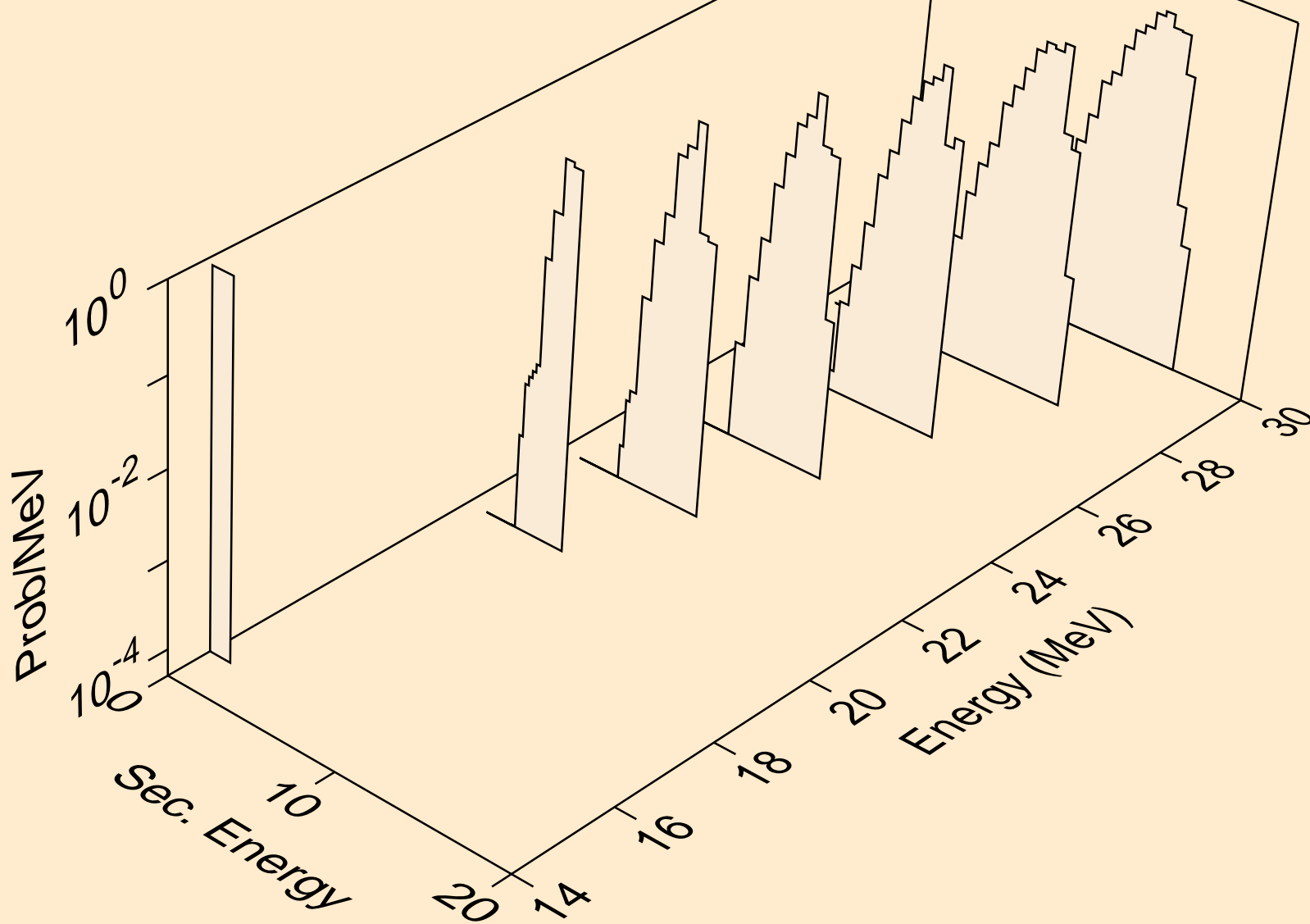

BK237 NEUTRON ACER TENDL-2019 LIBRARY; T=293.16K
deuterons from (n,n*)d

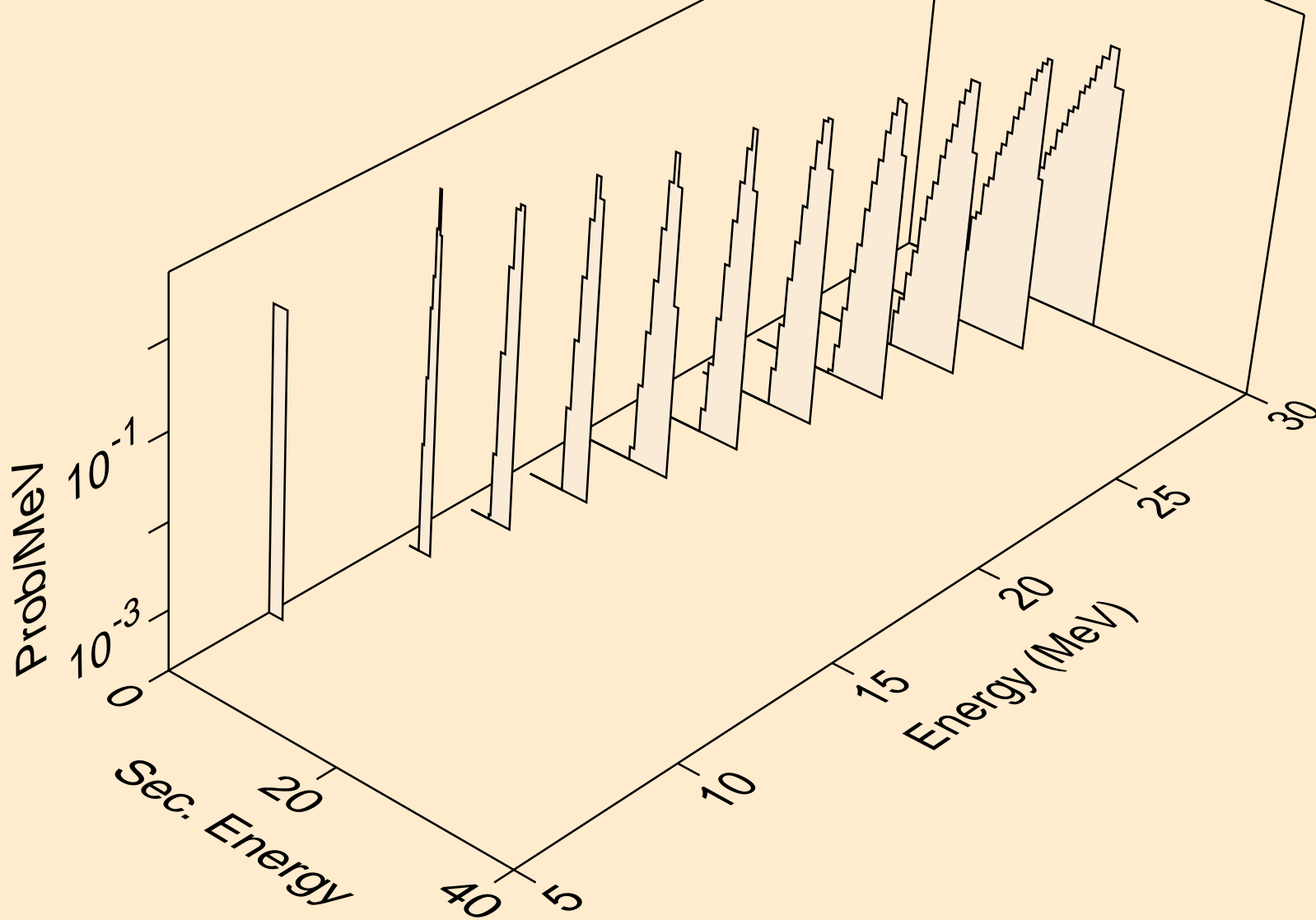

BK237 NEUTRON ACER TENDL-2019 LIBRARY; T=293.16K
deuterons from (n,d)

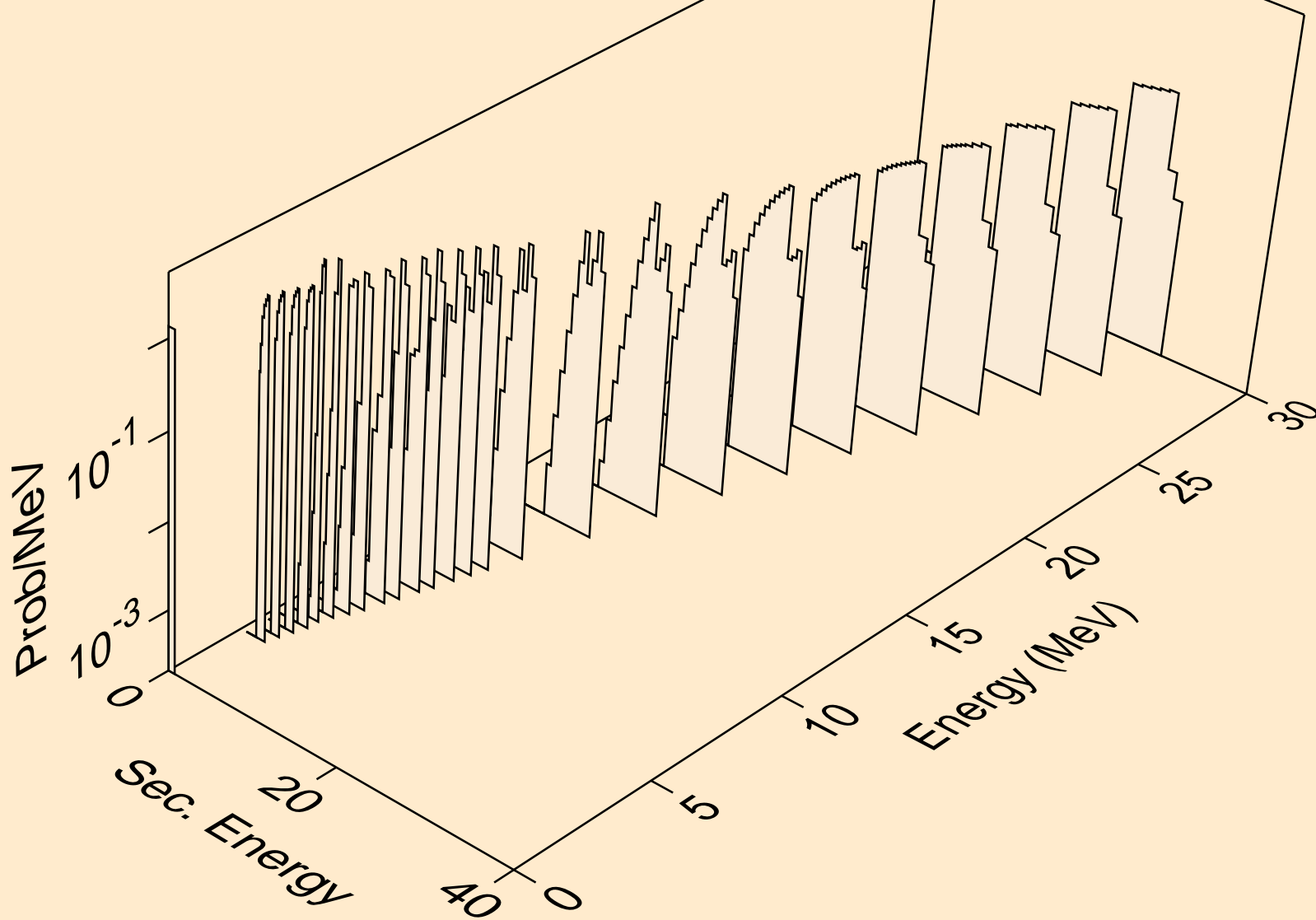

BK237 NEUTRON ACER TENDL-2019 LIBRARY; T=293.16K
deuterons from (n,pd)

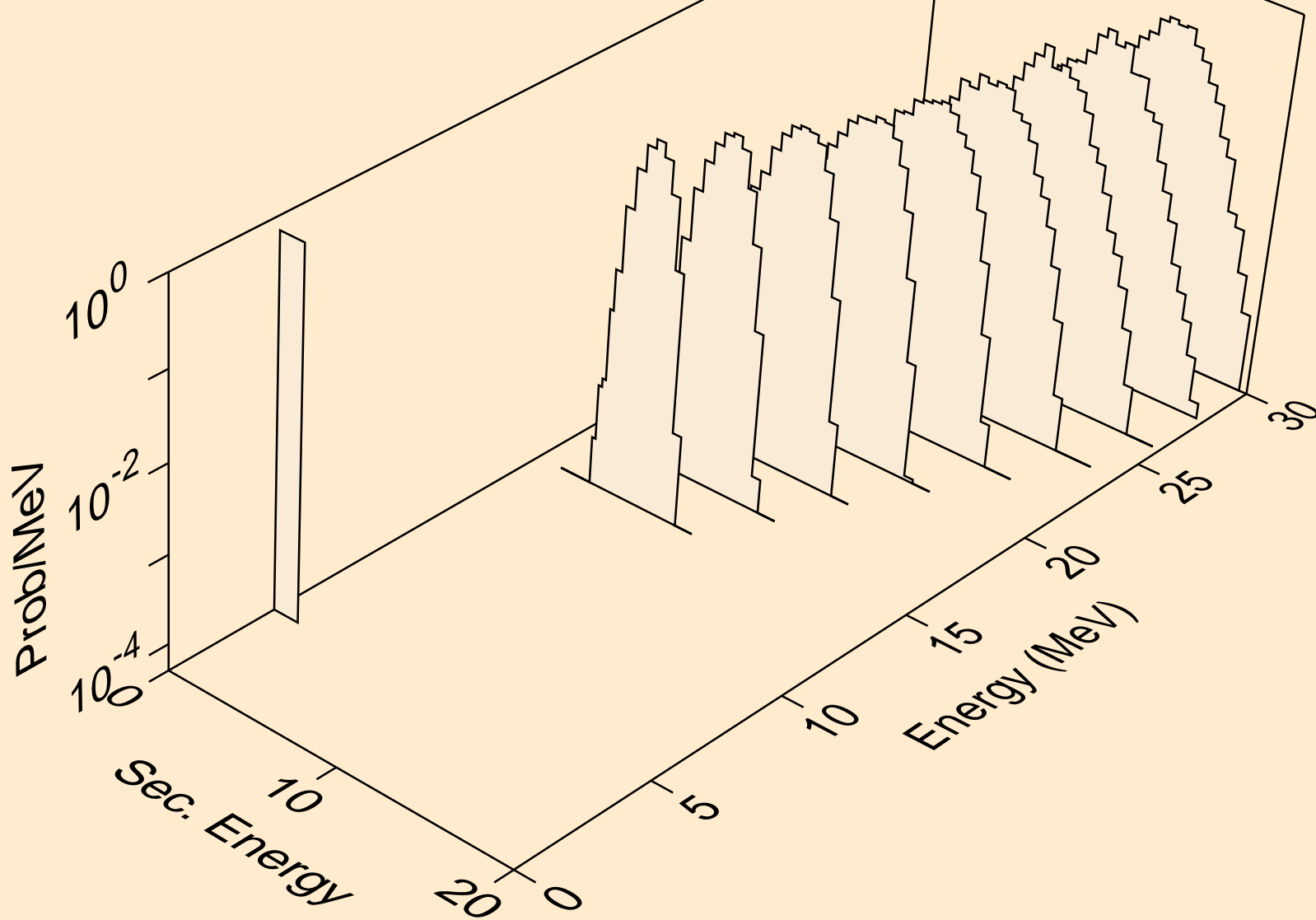

BK237 NEUTRON ACER TENDL-2019 LIBRARY; T=293.16K
tritons from (n,x)

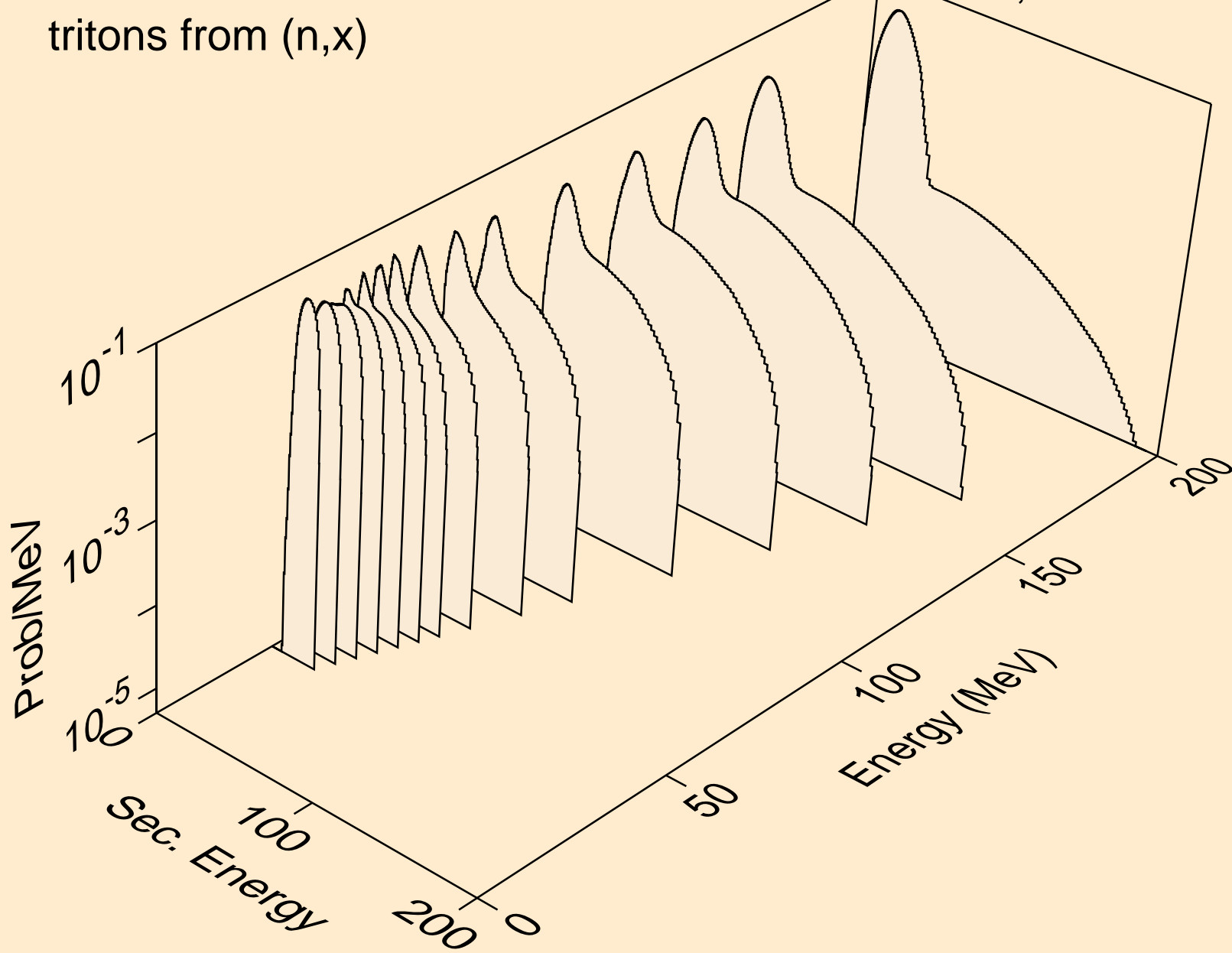

BK237 NEUTRON ACER TENDL-2019 LIBRARY; T=293.16K
tritons from (n,n*)t

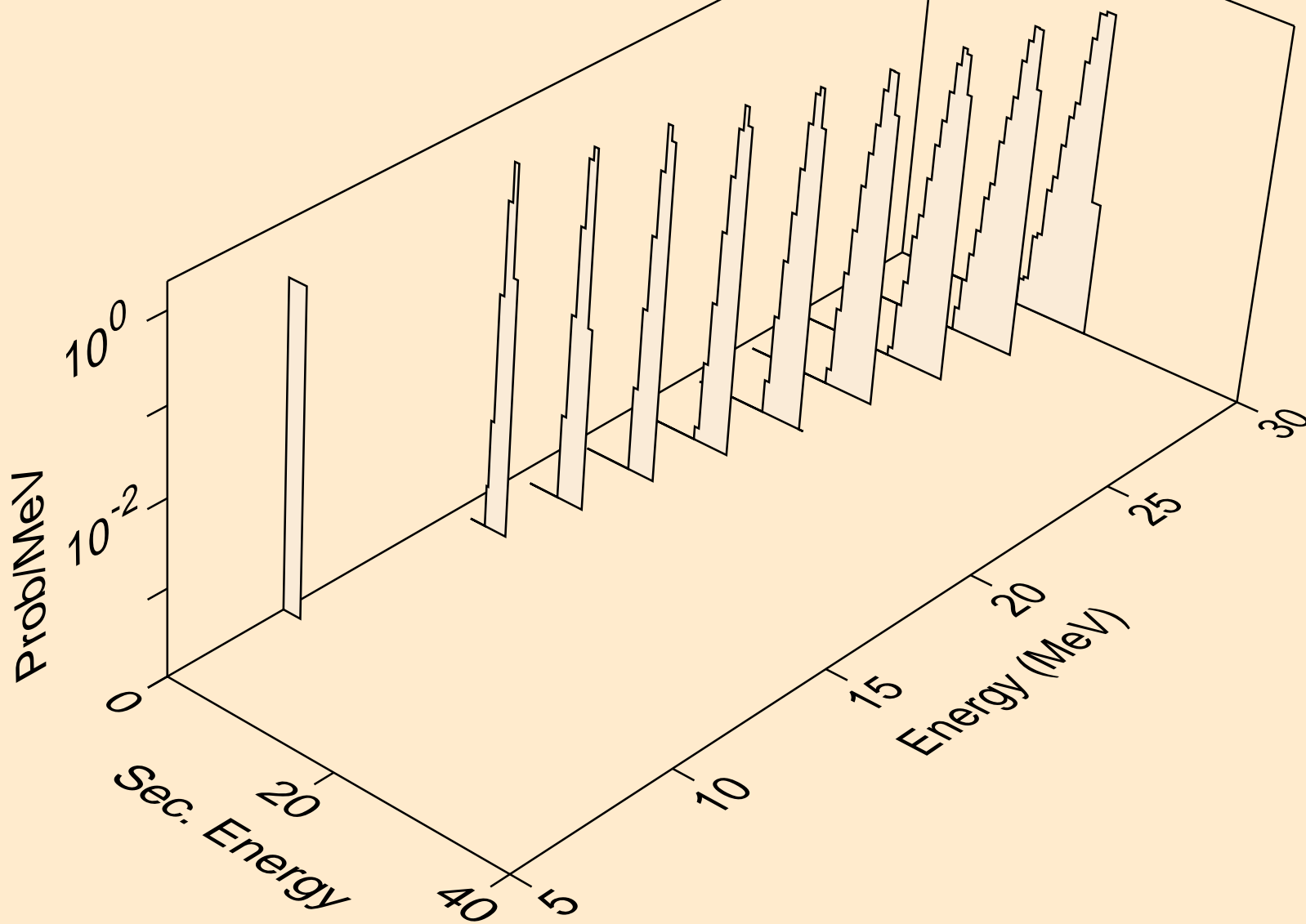

BK237 NEUTRON ACER TENDL-2019 LIBRARY; T=293.16K
tritons from (n,t)

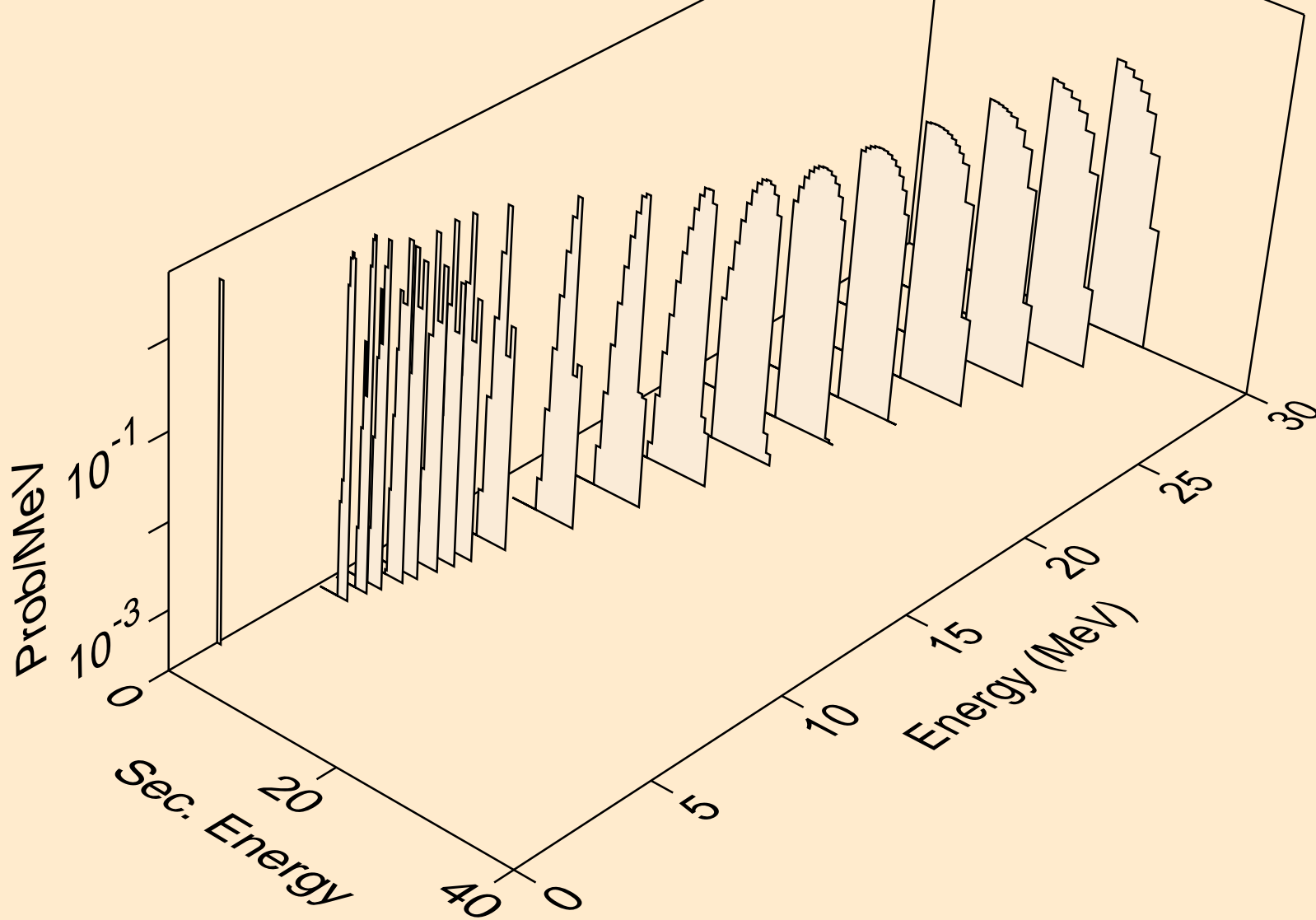

BK237 NEUTRON ACER TENDL-2019 LIBRARY; T=293.16K
he3s from (n,x)

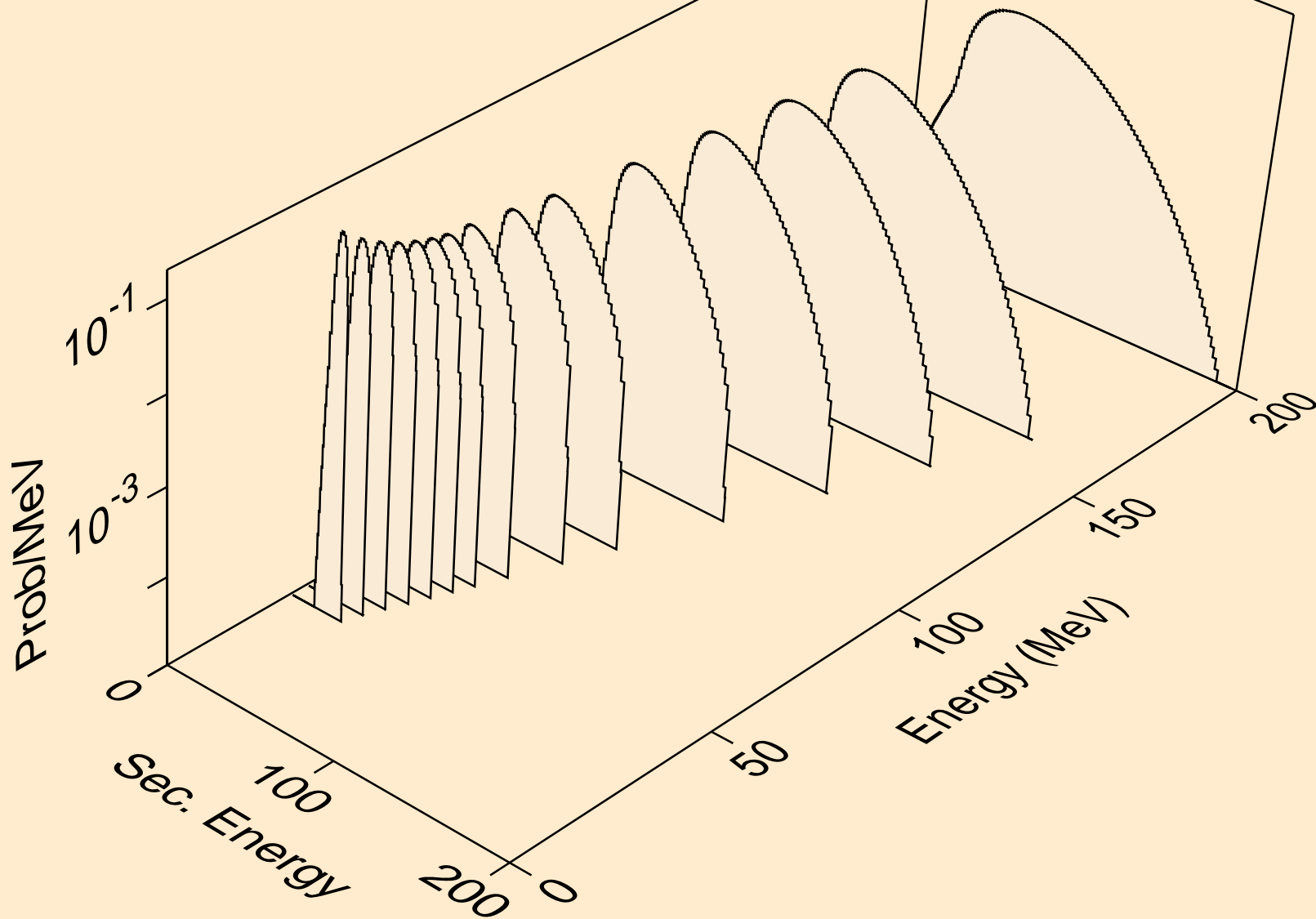

BK237 NEUTRON ACER TENDL-2019 LIBRARY; T=293.16K
he3s from (n,n*)he3

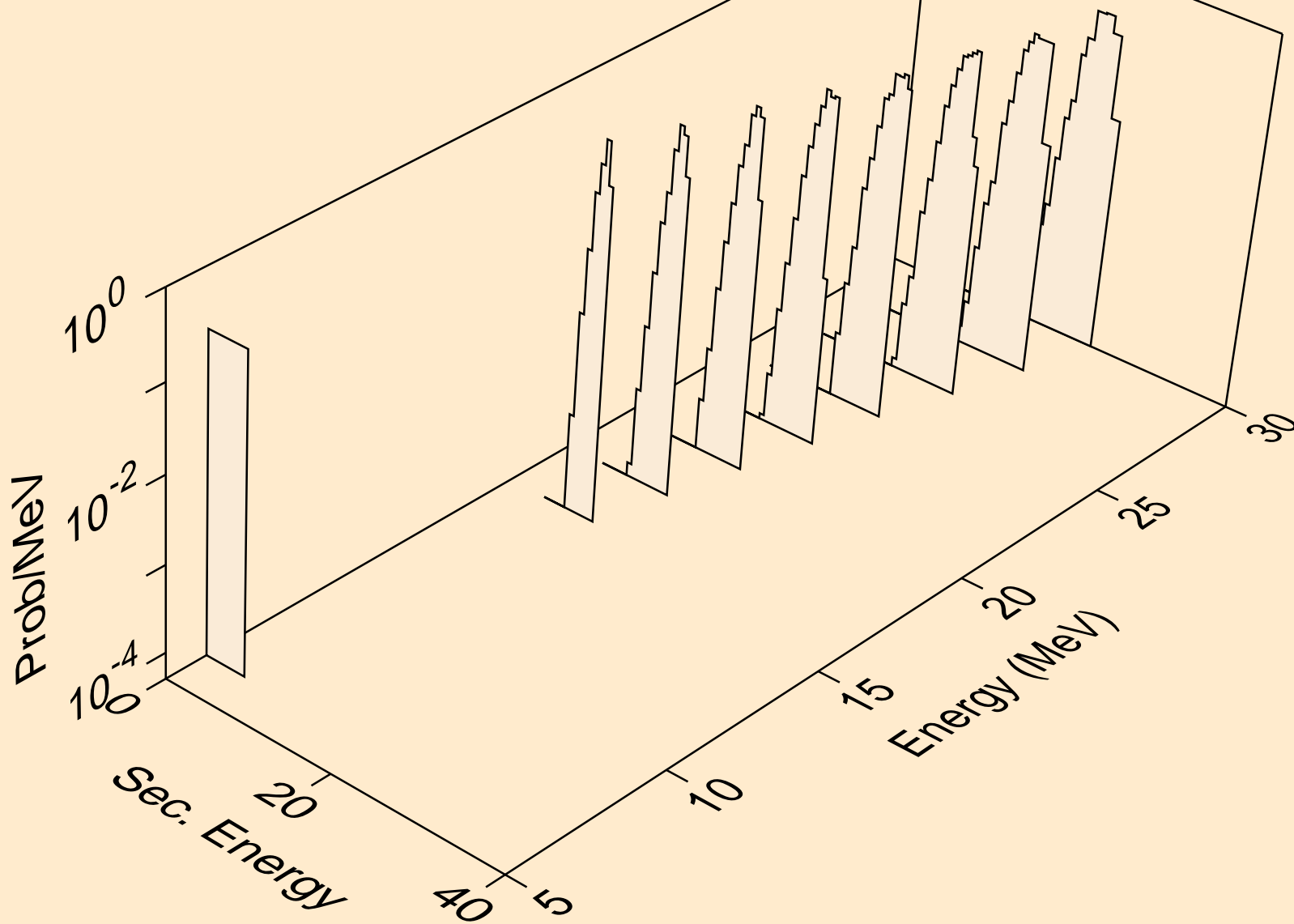

BK237 NEUTRON ACER TENDL-2019 LIBRARY; T=293.16K
he3s from (n,he3)

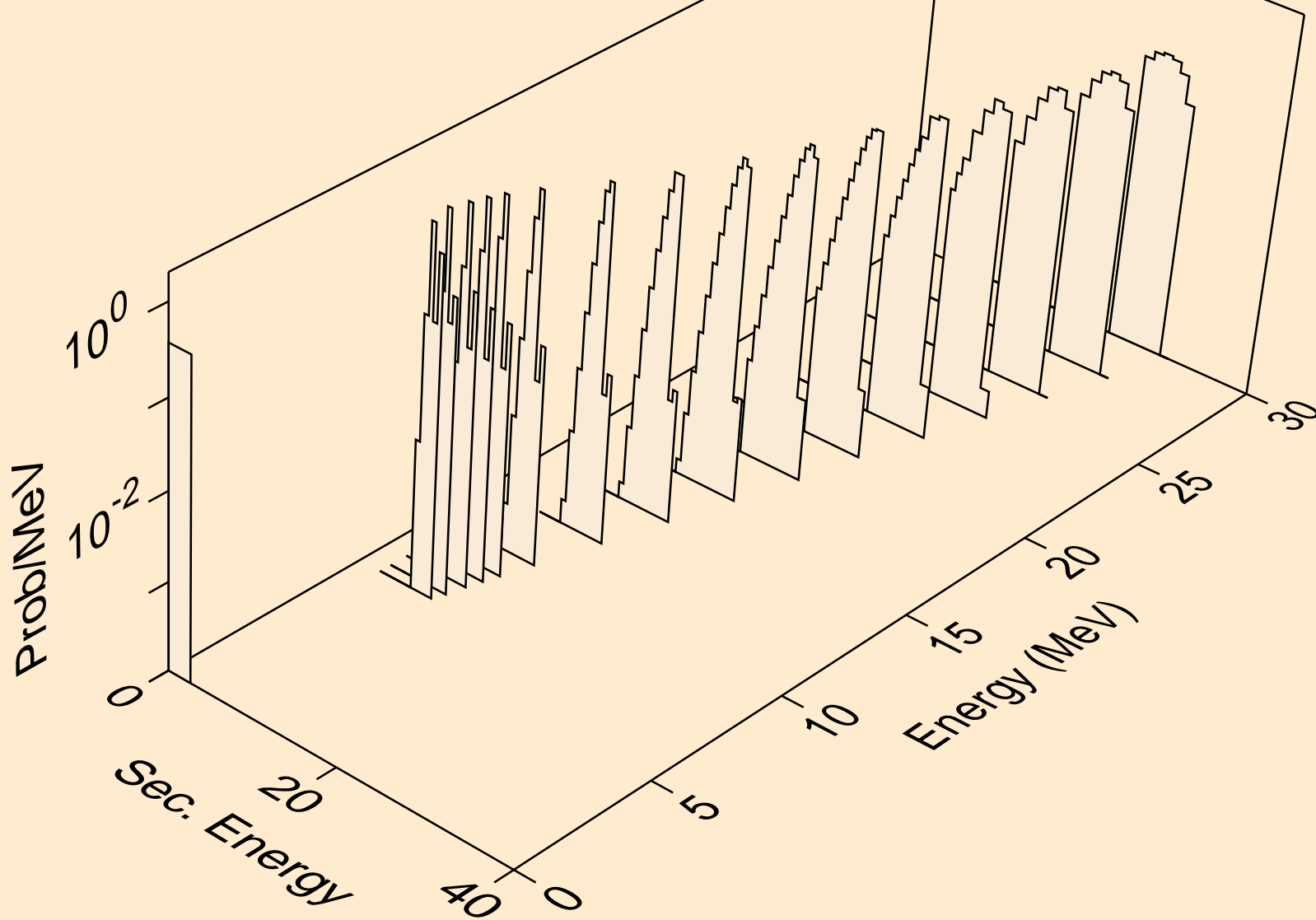

BK237 NEUTRON ACER TENDL-2019 LIBRARY; T=293.16K
alphas from (n,x)

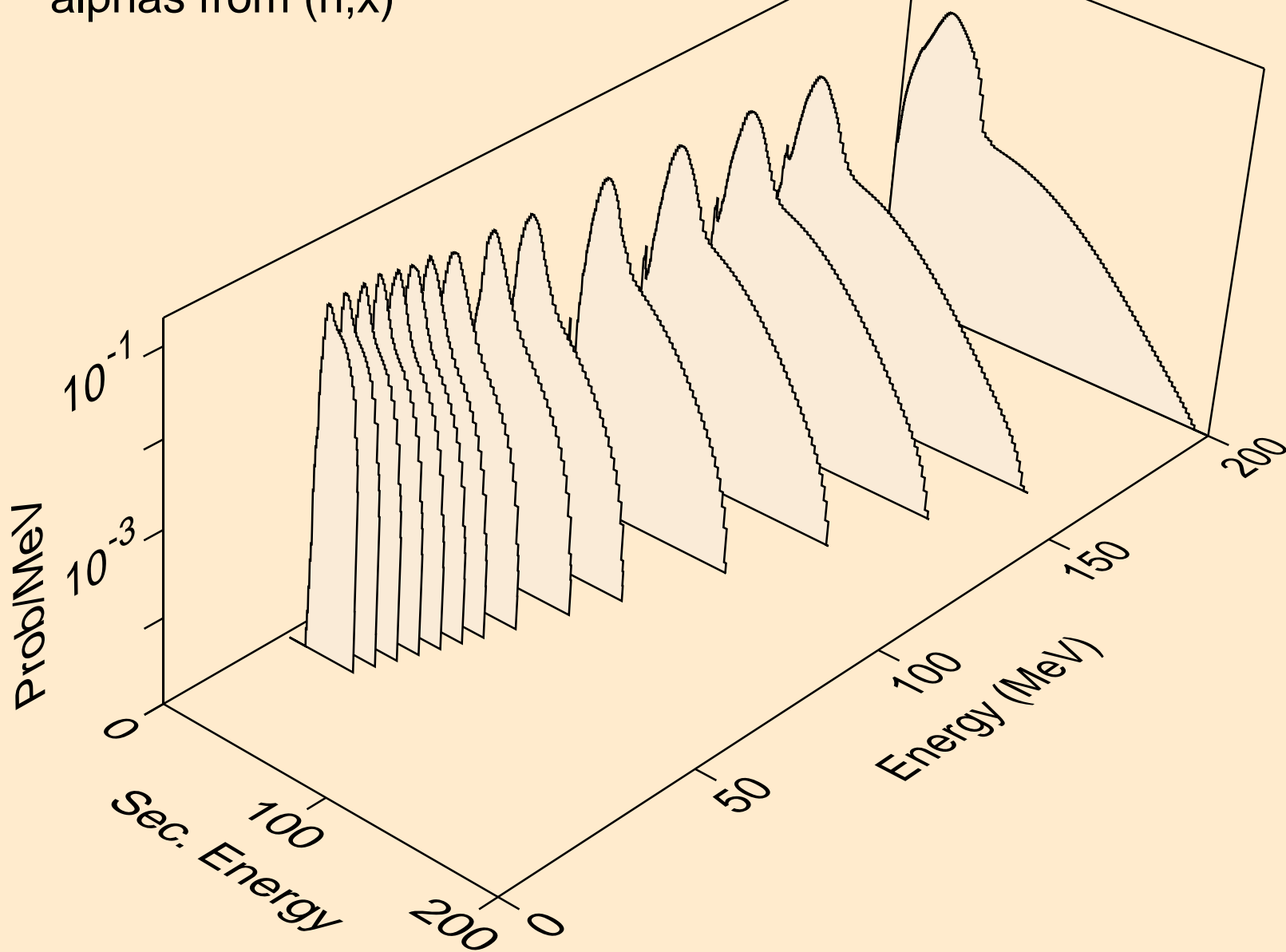

BK237 NEUTRON ACER TENDL-2019 LIBRARY; T=293.16K
alphas from (n,n*)a

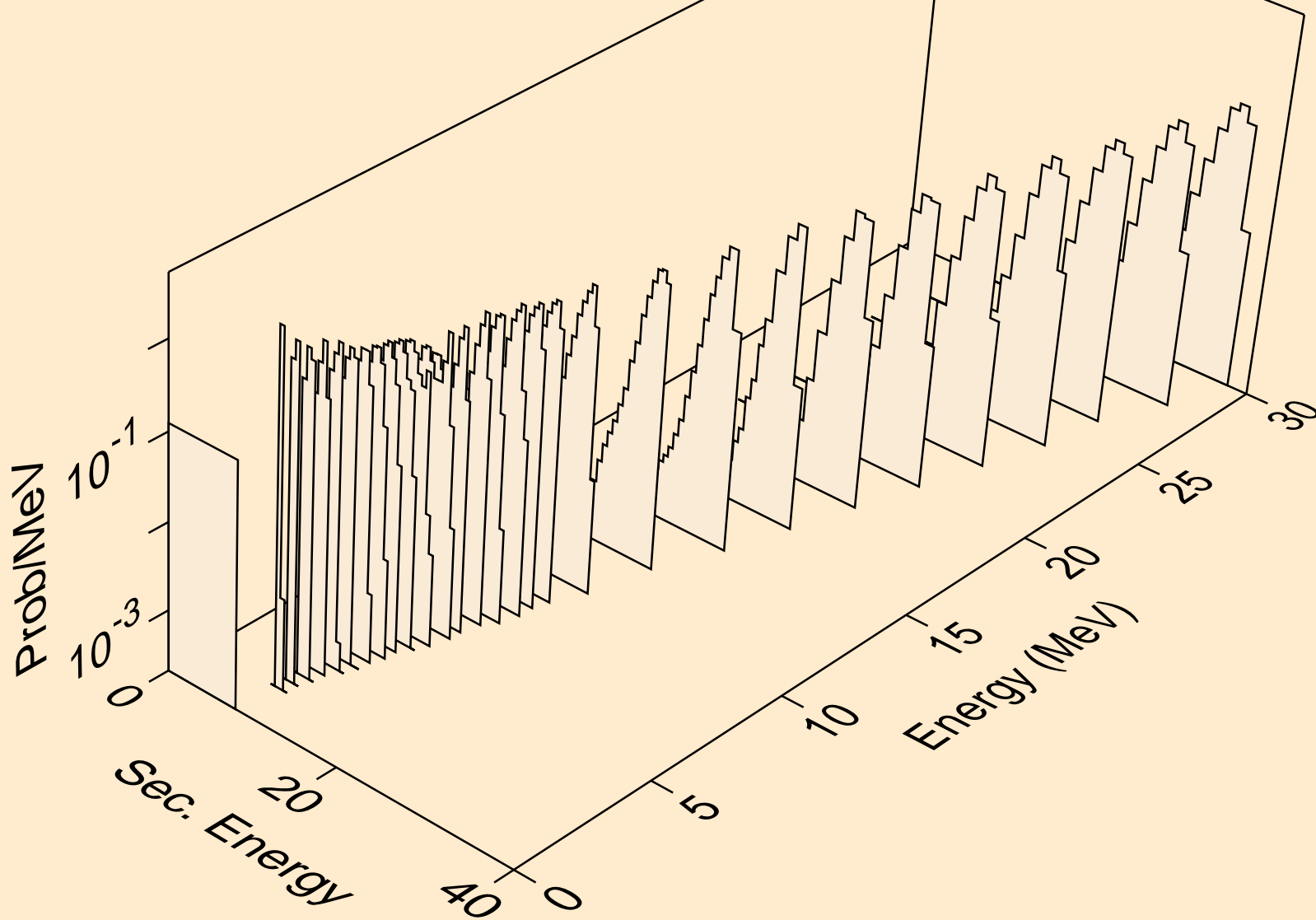

BK237 NEUTRON ACER TENDL-2019 LIBRARY; T=293.16K
alphas from (n,2n)a

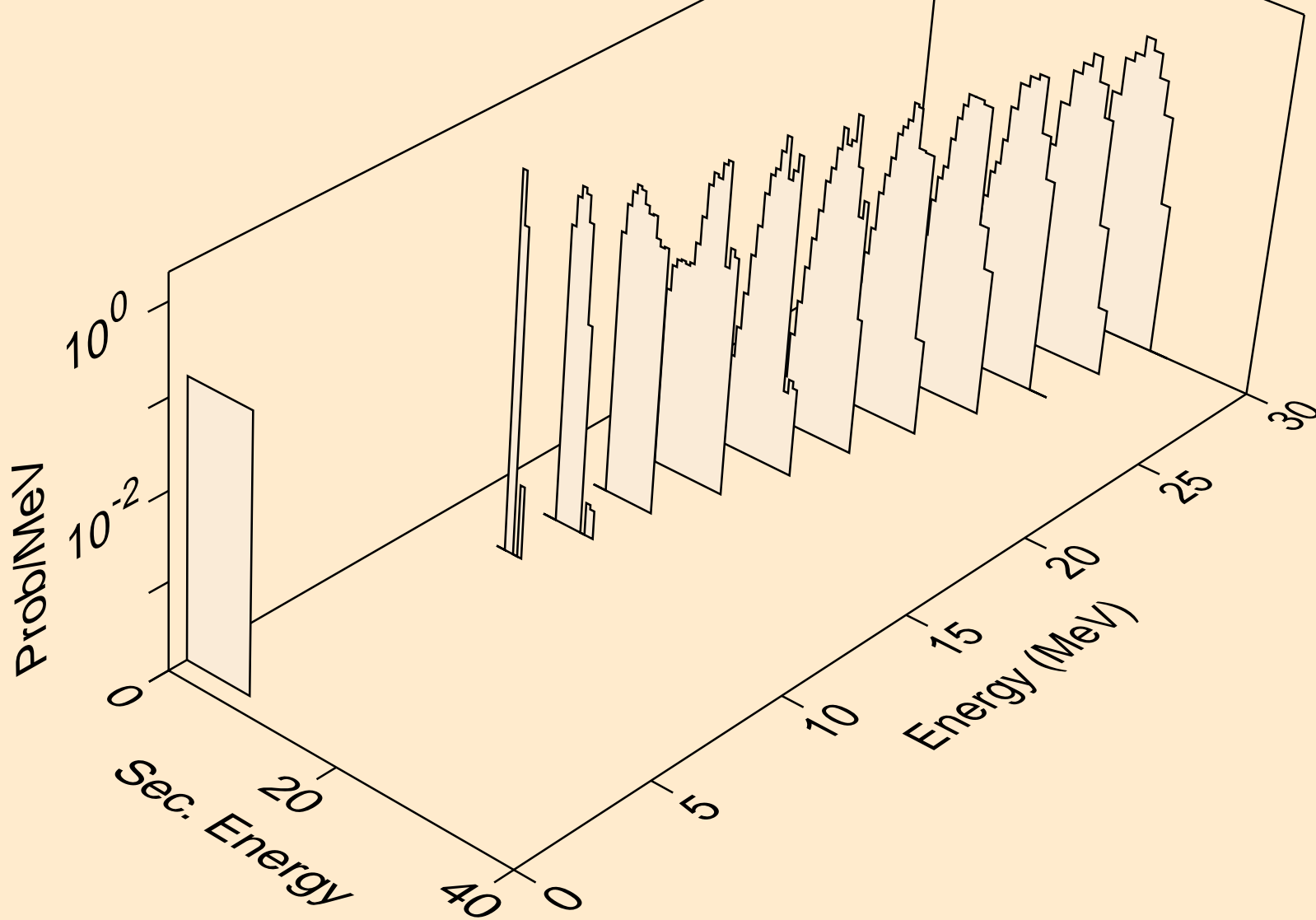

BK237 NEUTRON ACER TENDL-2019 LIBRARY; T=293.16K
alphas from (n,3n)a

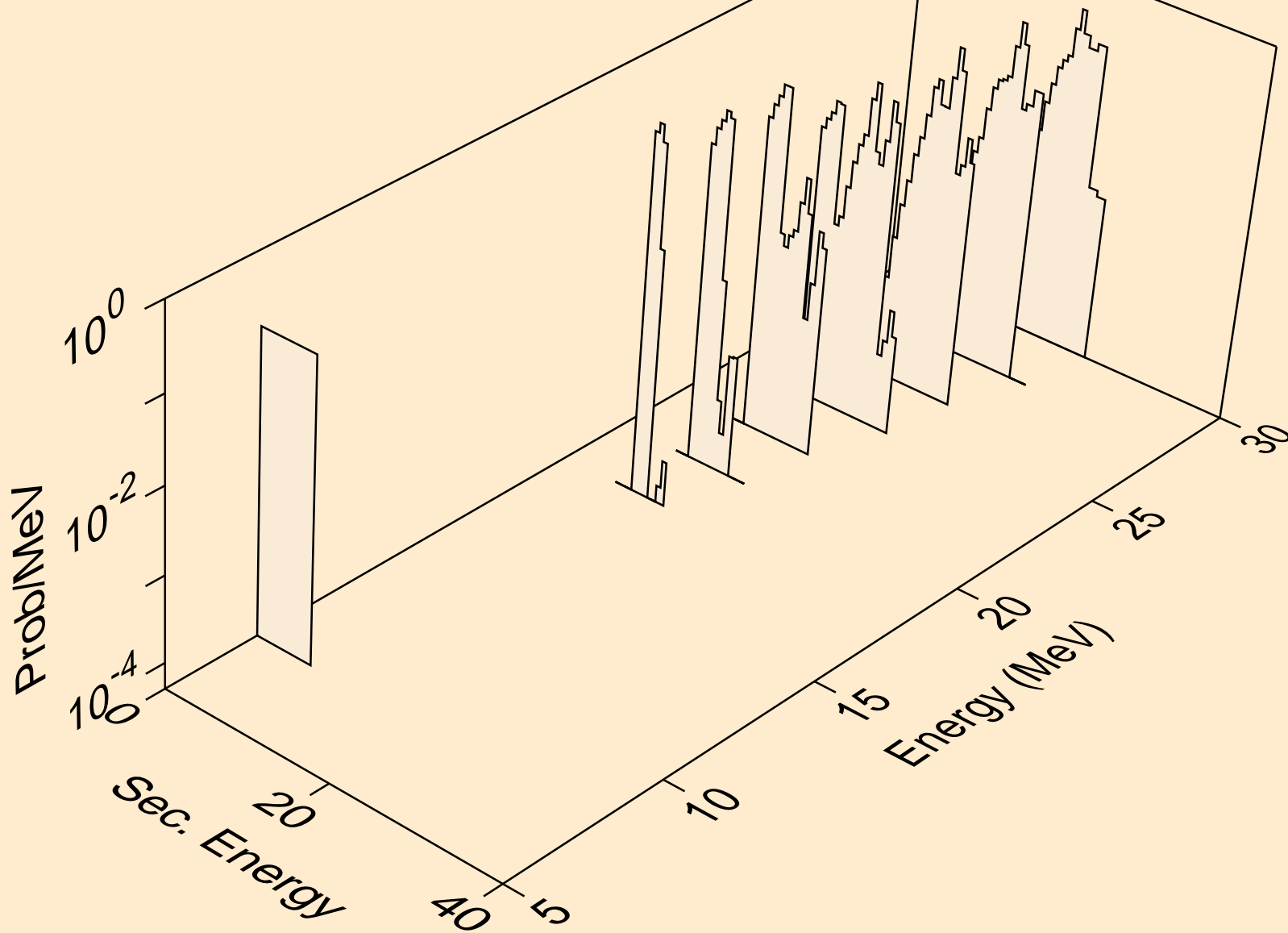

BK237 NEUTRON ACER TENDL-2019 LIBRARY; T=293.16K
alphas from (n,n*)2a

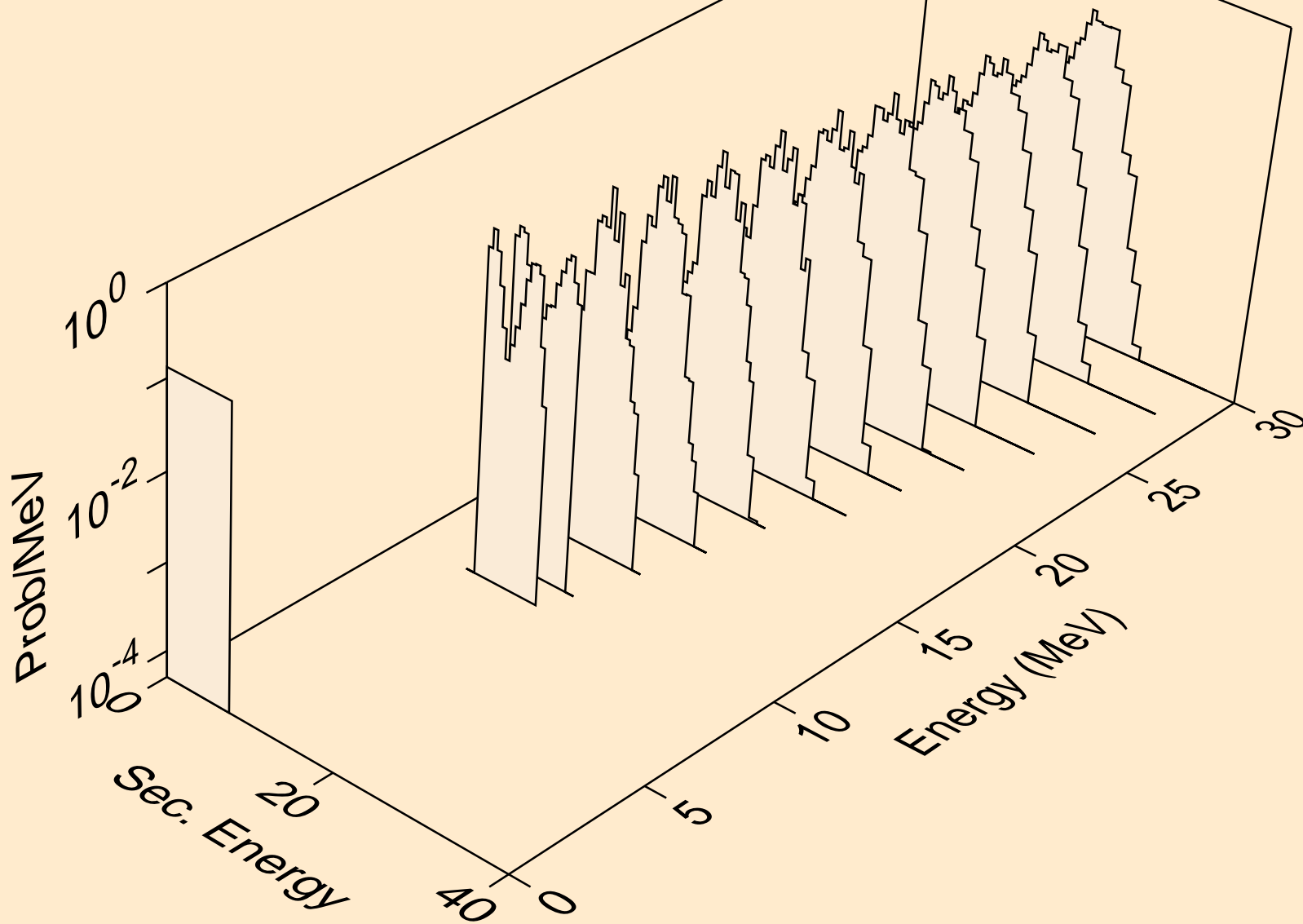

BK237 NEUTRON ACER TENDL-2019 LIBRARY; T=293.16K
alphas from (n,2n)2a

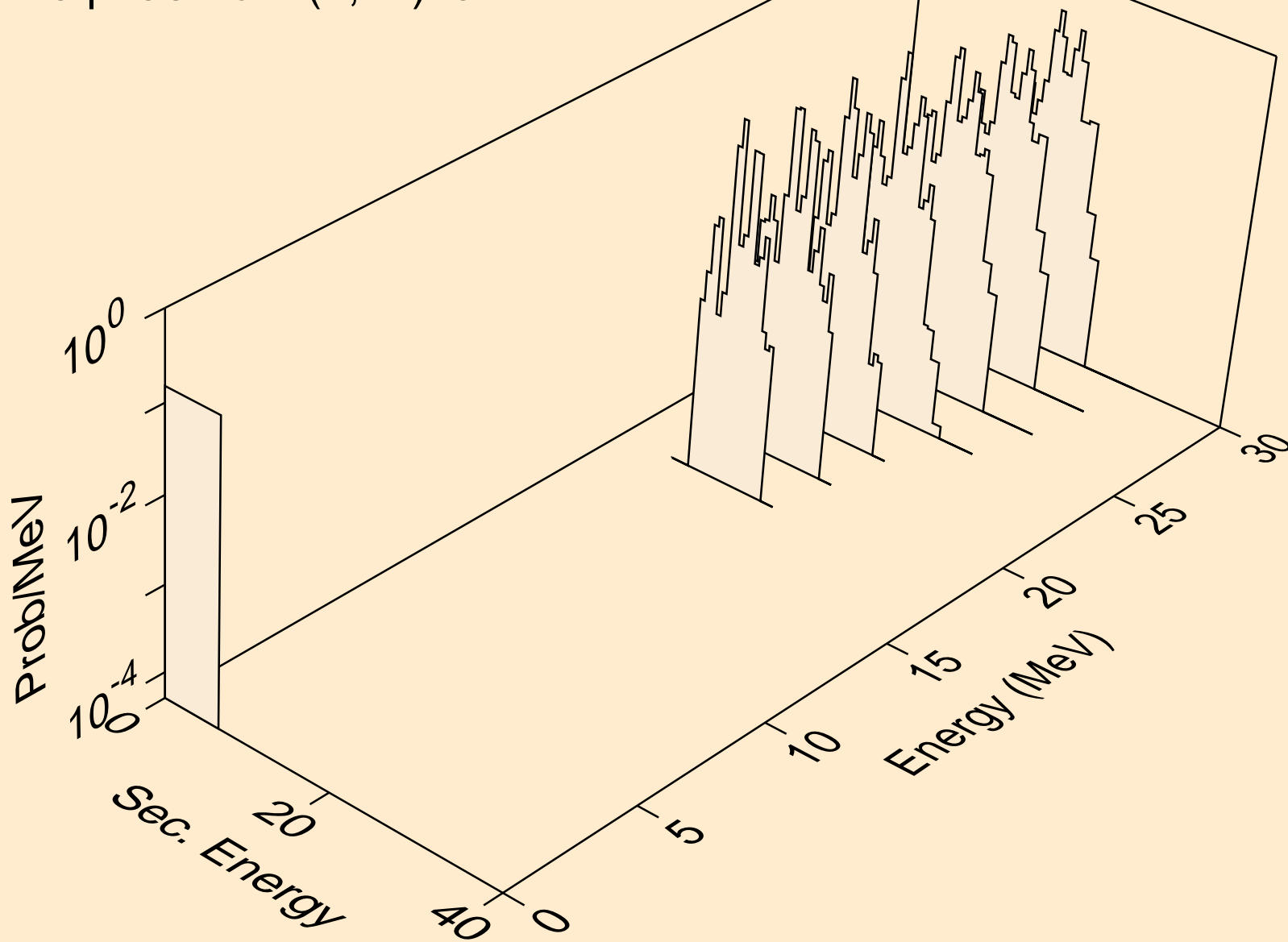

BK237 NEUTRON ACER TENDL-2019 LIBRARY; T=293.16K
alphas from (n,a)

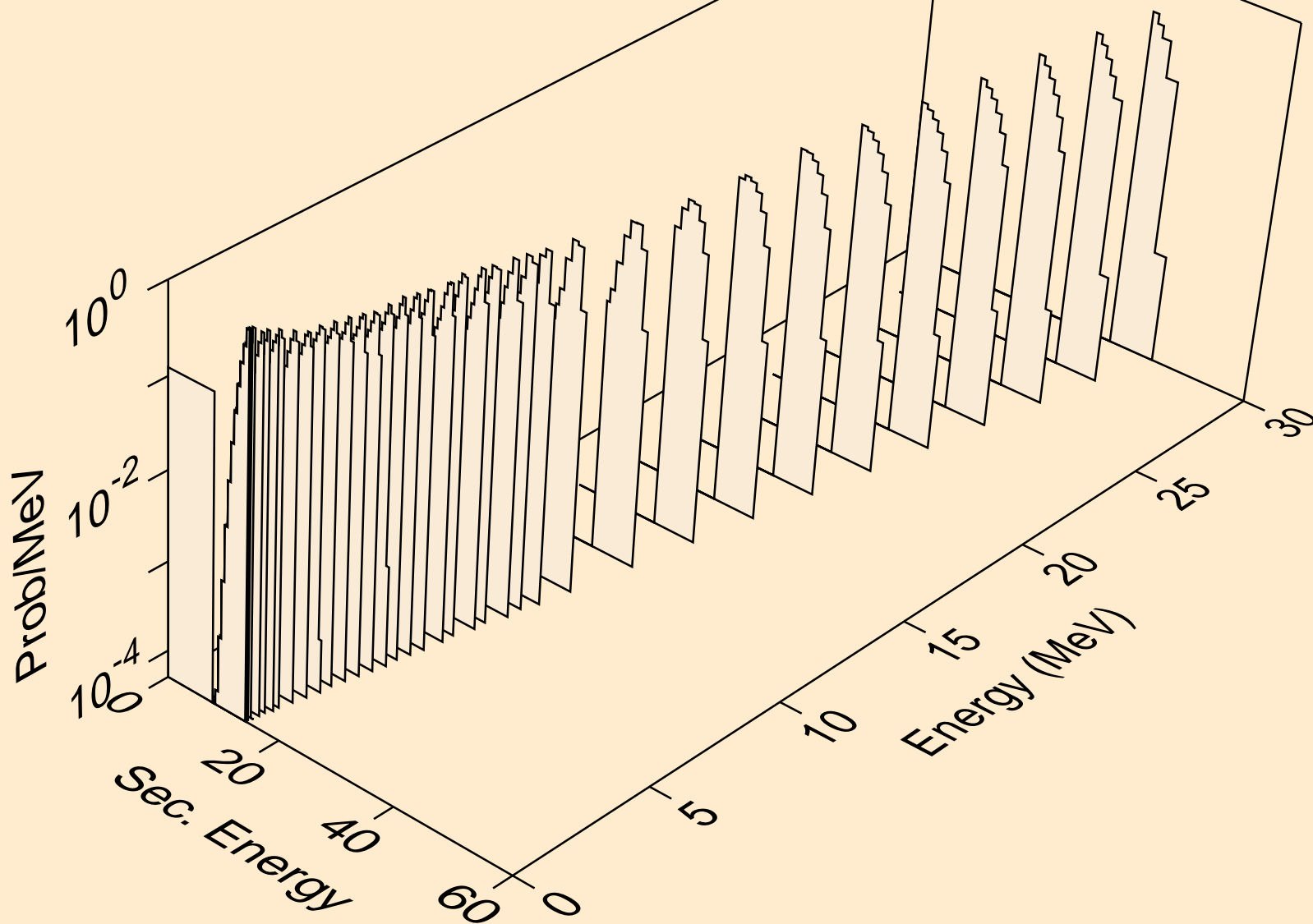

BK237 NEUTRON ACER TENDL-2019 LIBRARY; T=293.16K
alphas from (n,2a)

