

BK240 NEUTRON ACER TENDL-2019 LIBRARY; T=293.16K
Principal cross sections

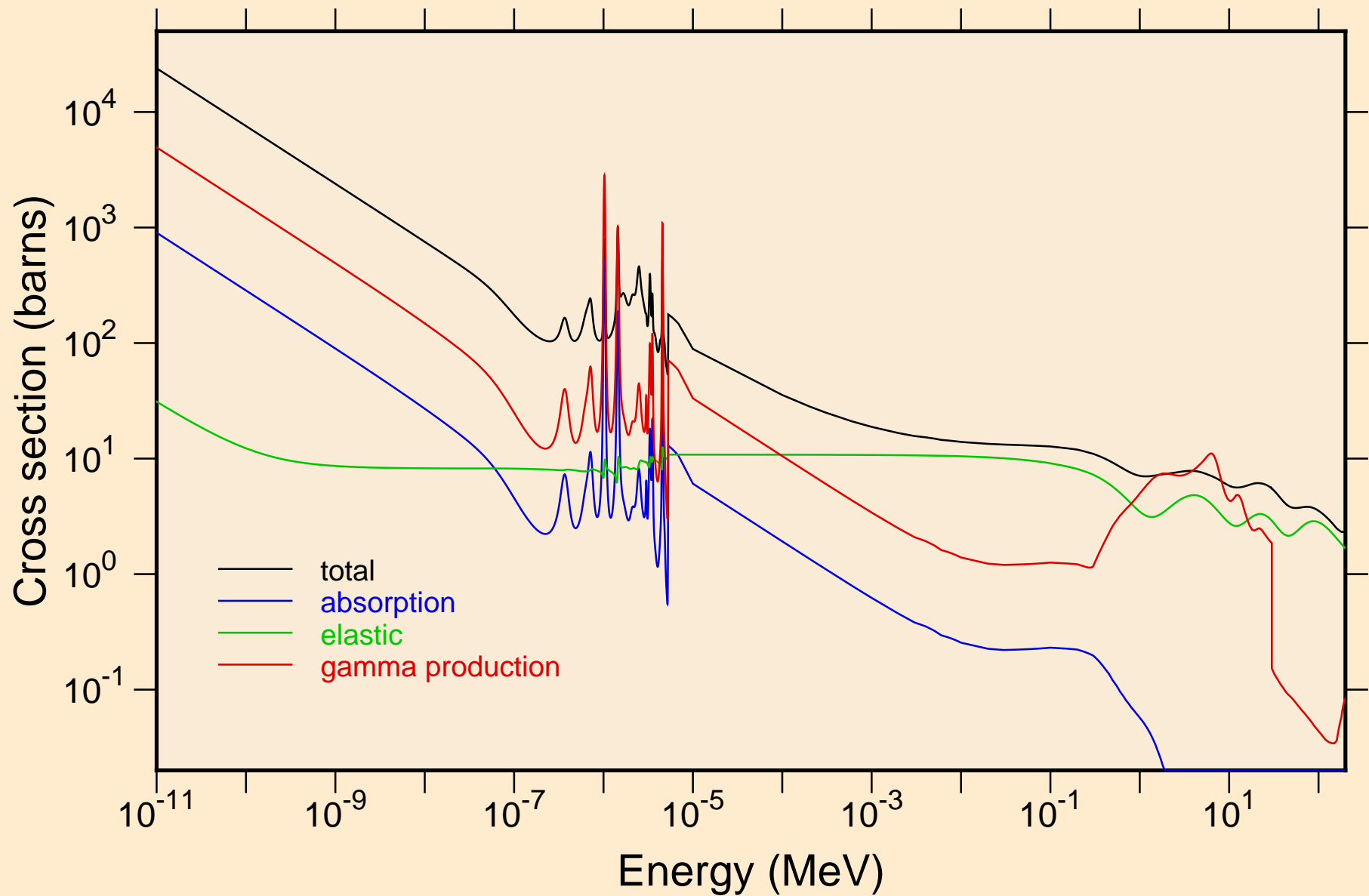

BK240 NEUTRON ACER TENDL-2019 LIBRARY; T=293.16K
resonance total cross section

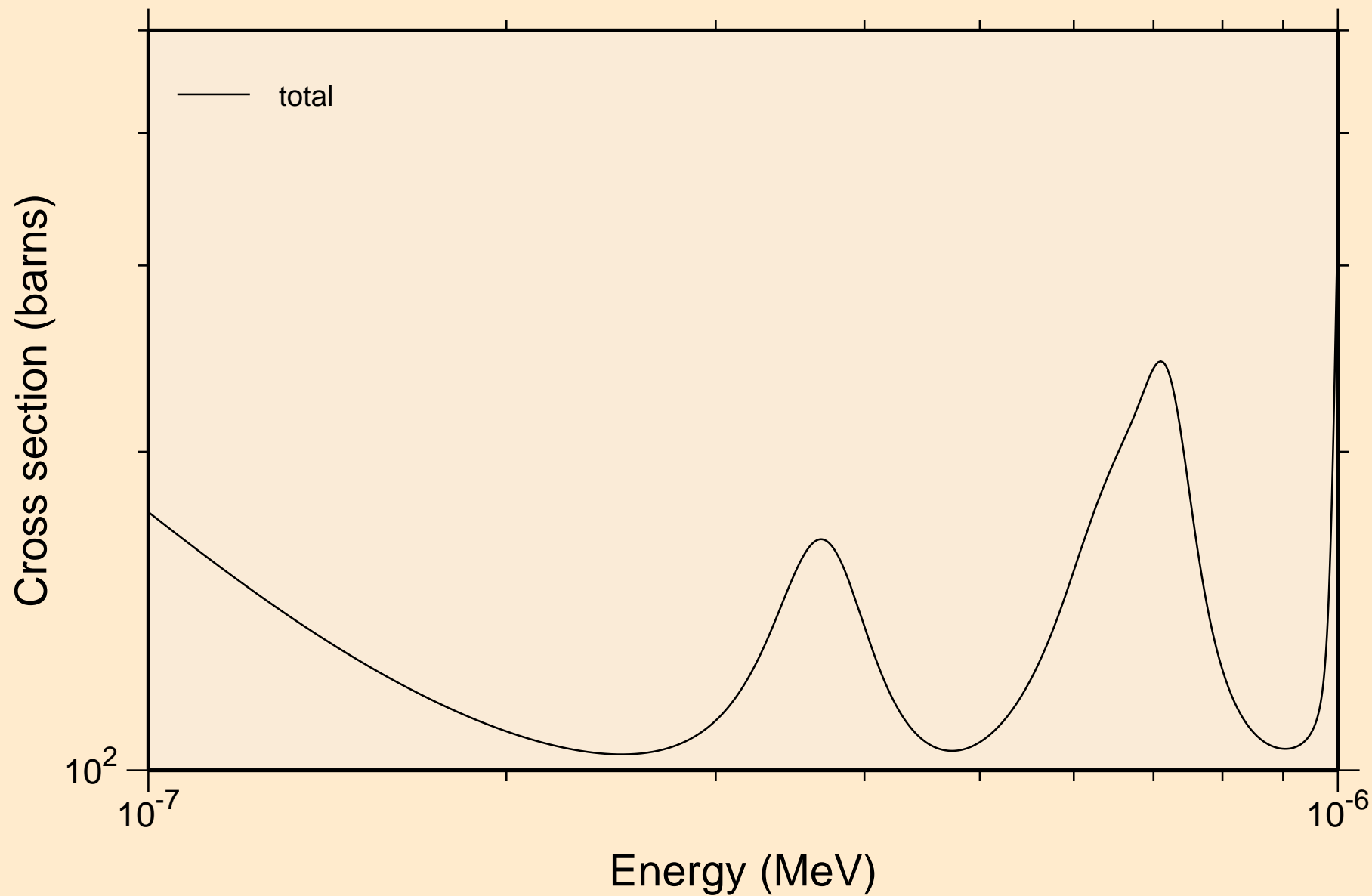

BK240 NEUTRON ACER TENDL-2019 LIBRARY; T=293.16K
resonance total cross section

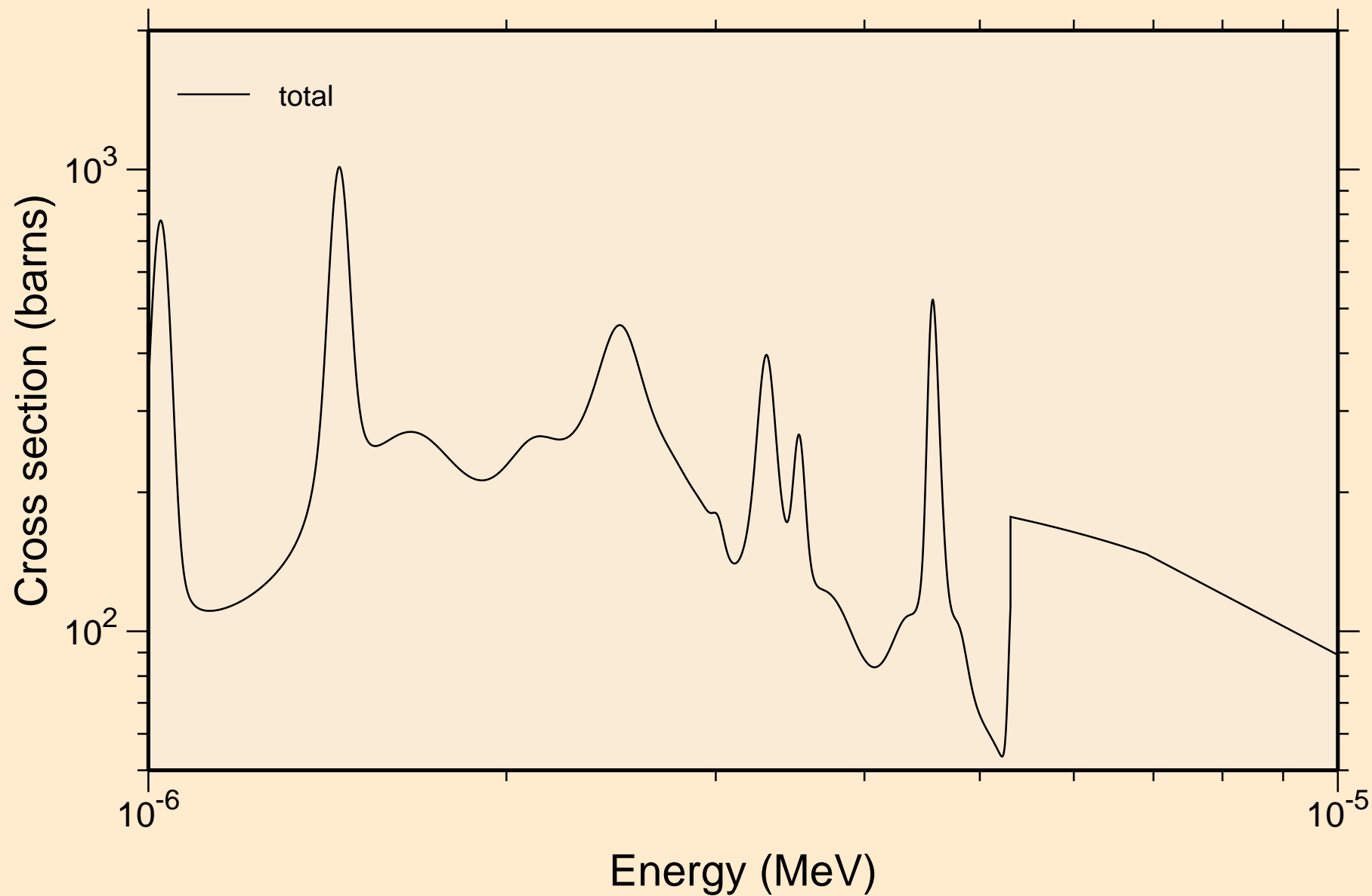

BK240 NEUTRON ACER TENDL-2019 LIBRARY; T=293.16K
resonance total cross section

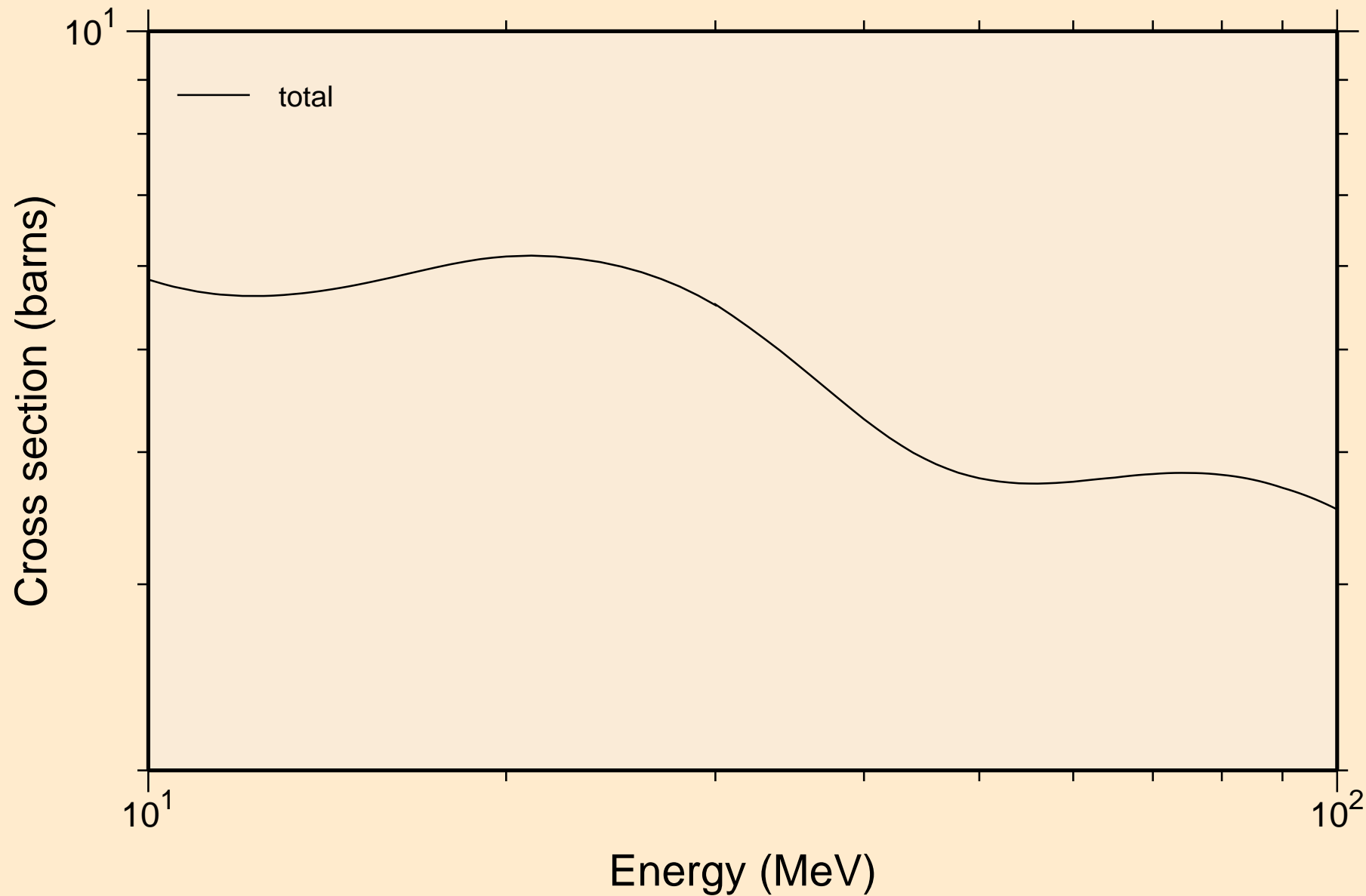

BK240 NEUTRON ACER TENDL-2019 LIBRARY; T=293.16K
resonance absorption cross sections

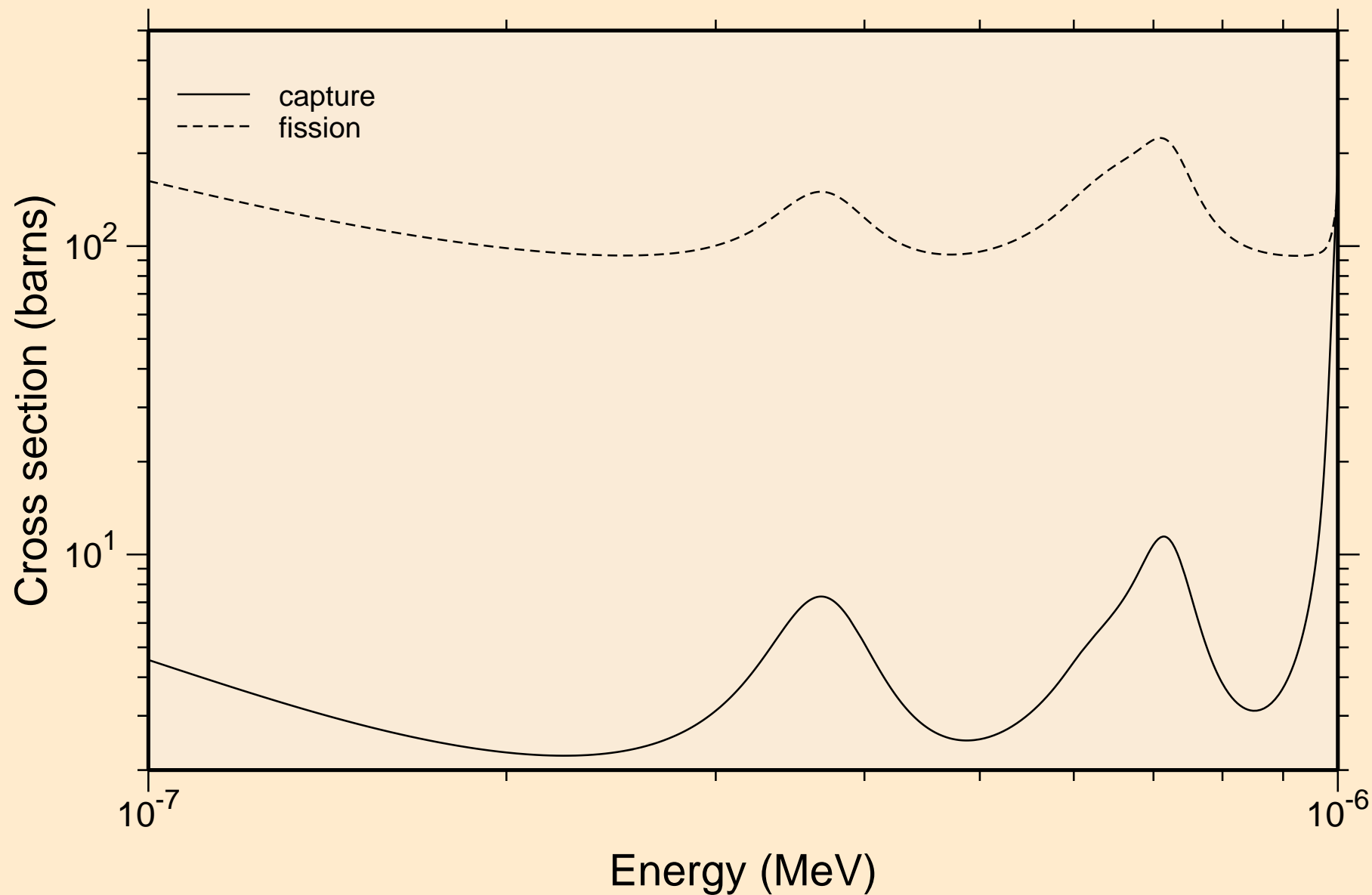

BK240 NEUTRON ACER TENDL-2019 LIBRARY; T=293.16K
resonance absorption cross sections

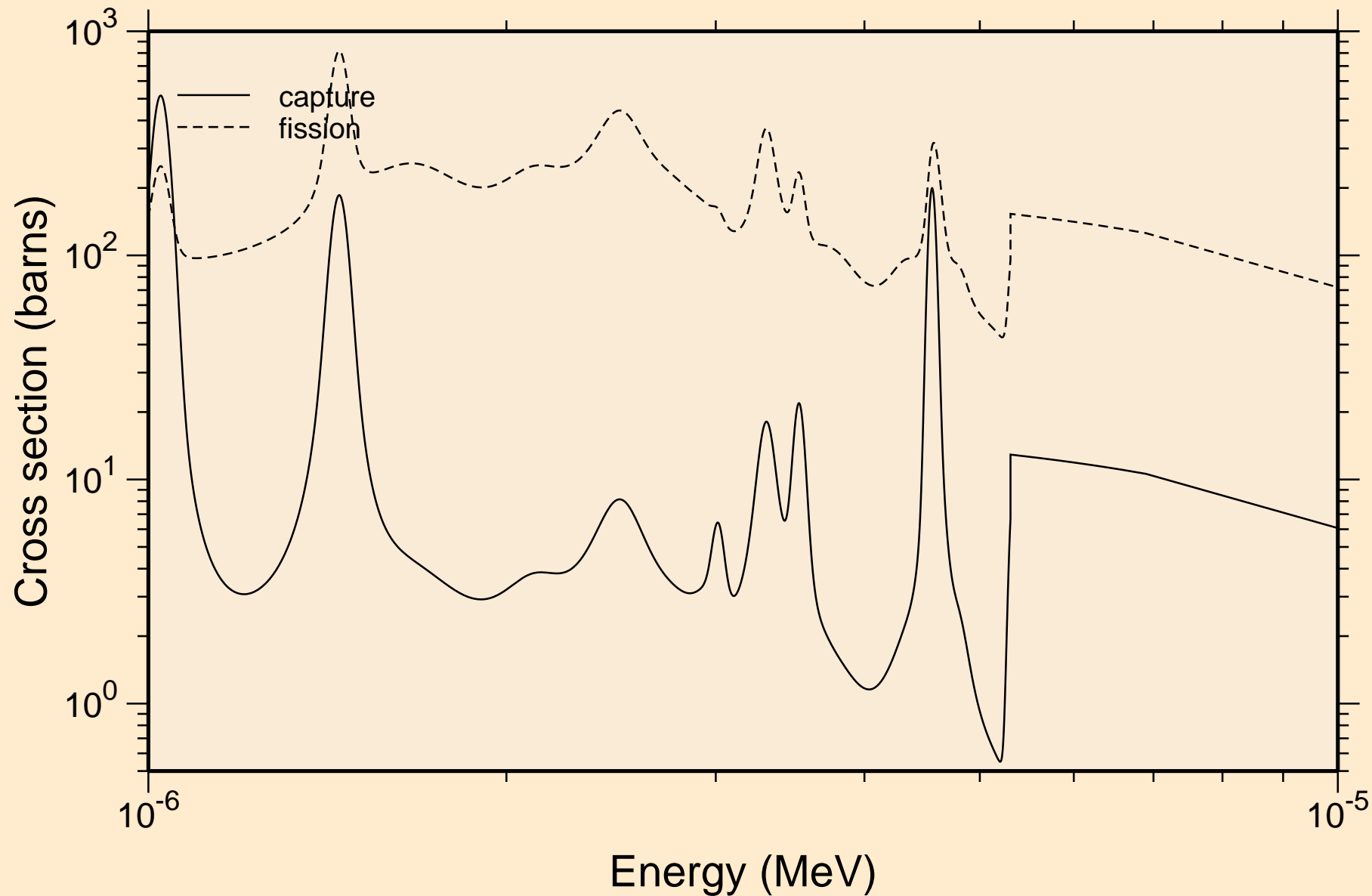

BK240 NEUTRON ACER TENDL-2019 LIBRARY; T=293.16K
resonance absorption cross sections

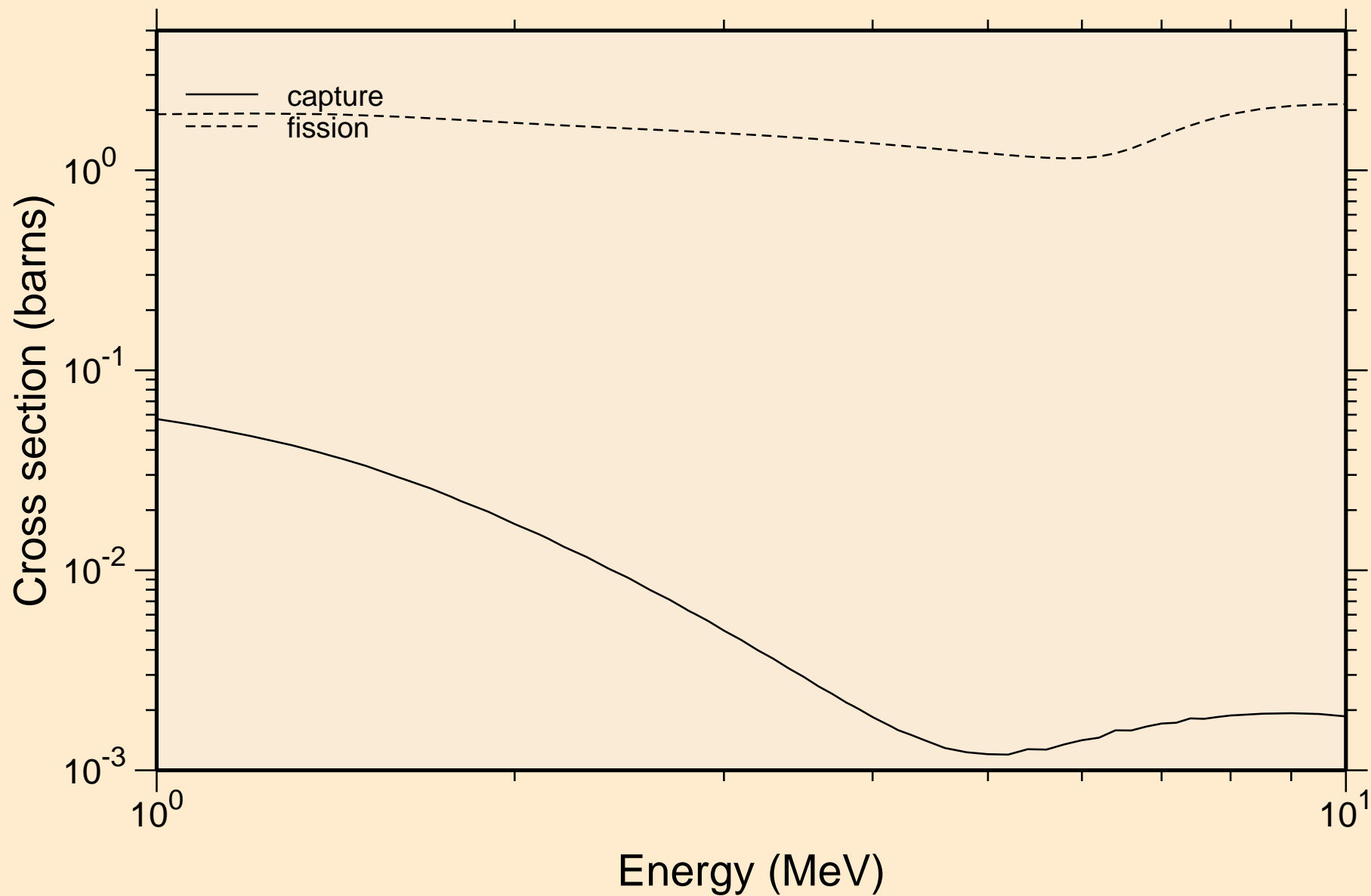

BK240 NEUTRON ACER TENDL-2019 LIBRARY; T=293.16K
Heating

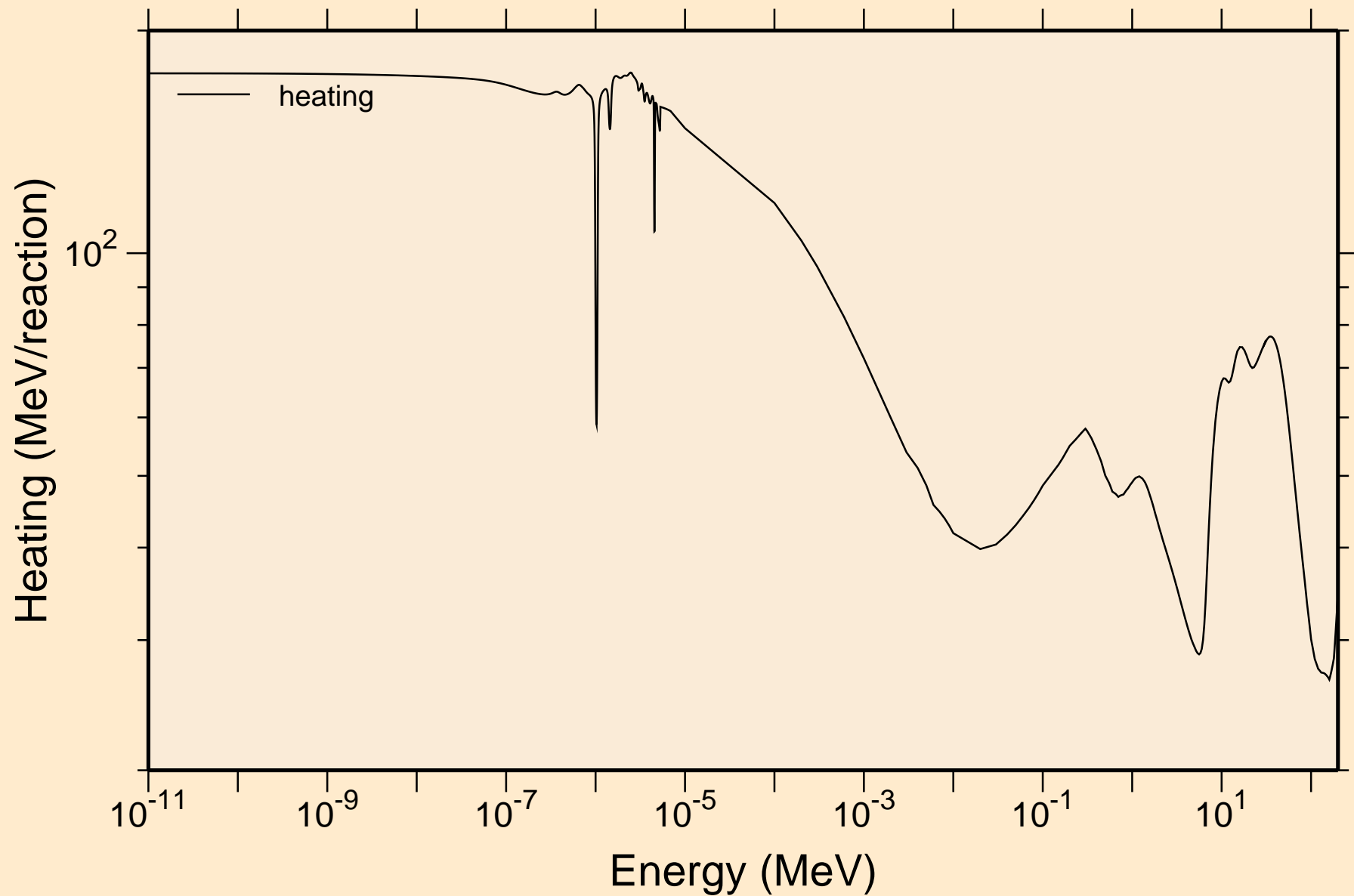

BK240 NEUTRON ACER TENDL-2019 LIBRARY; T=293.16K
Damage

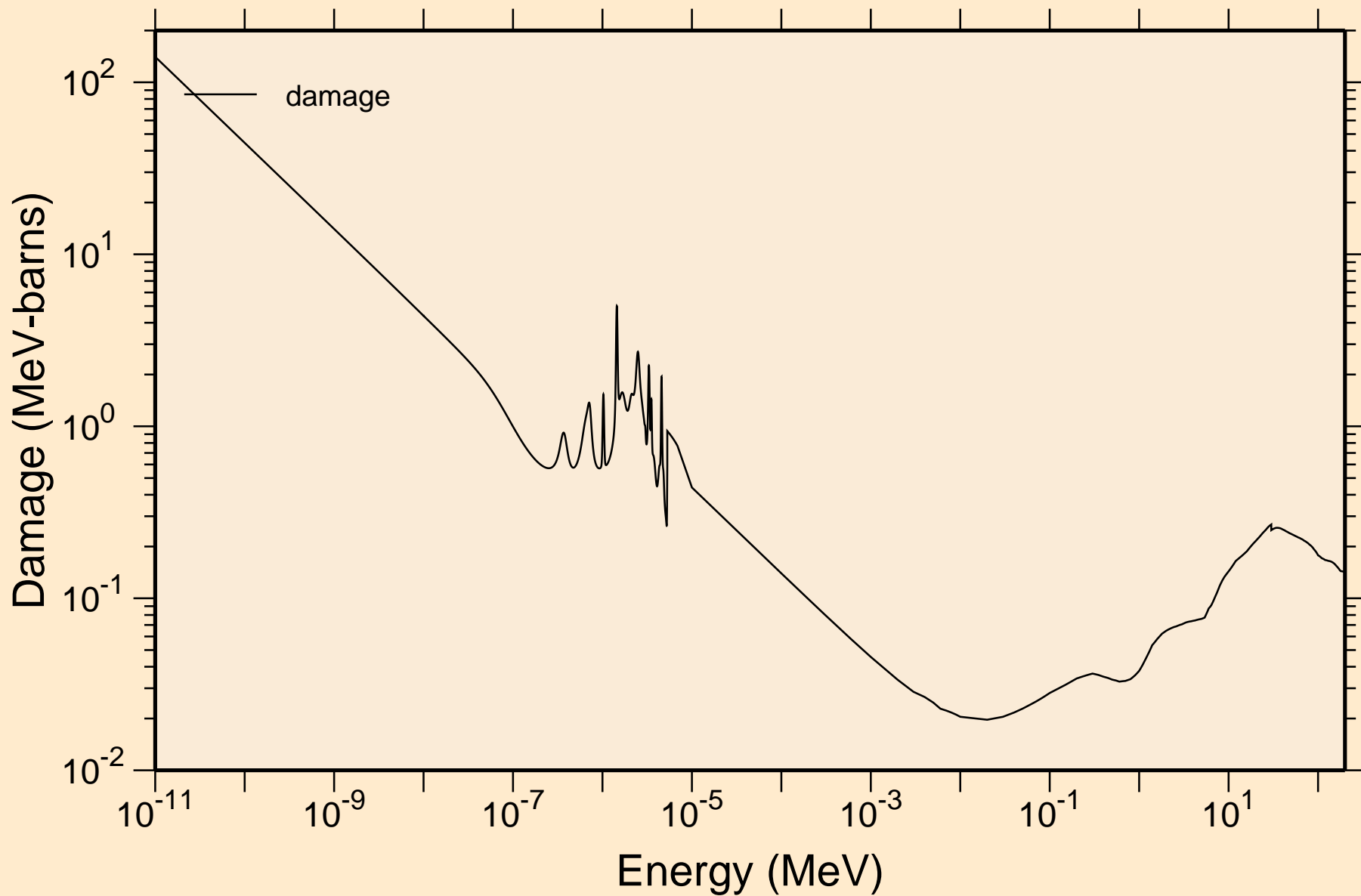

BK240 NEUTRON ACER TENDL-2019 LIBRARY; T=293.16K
Non-threshold reactions

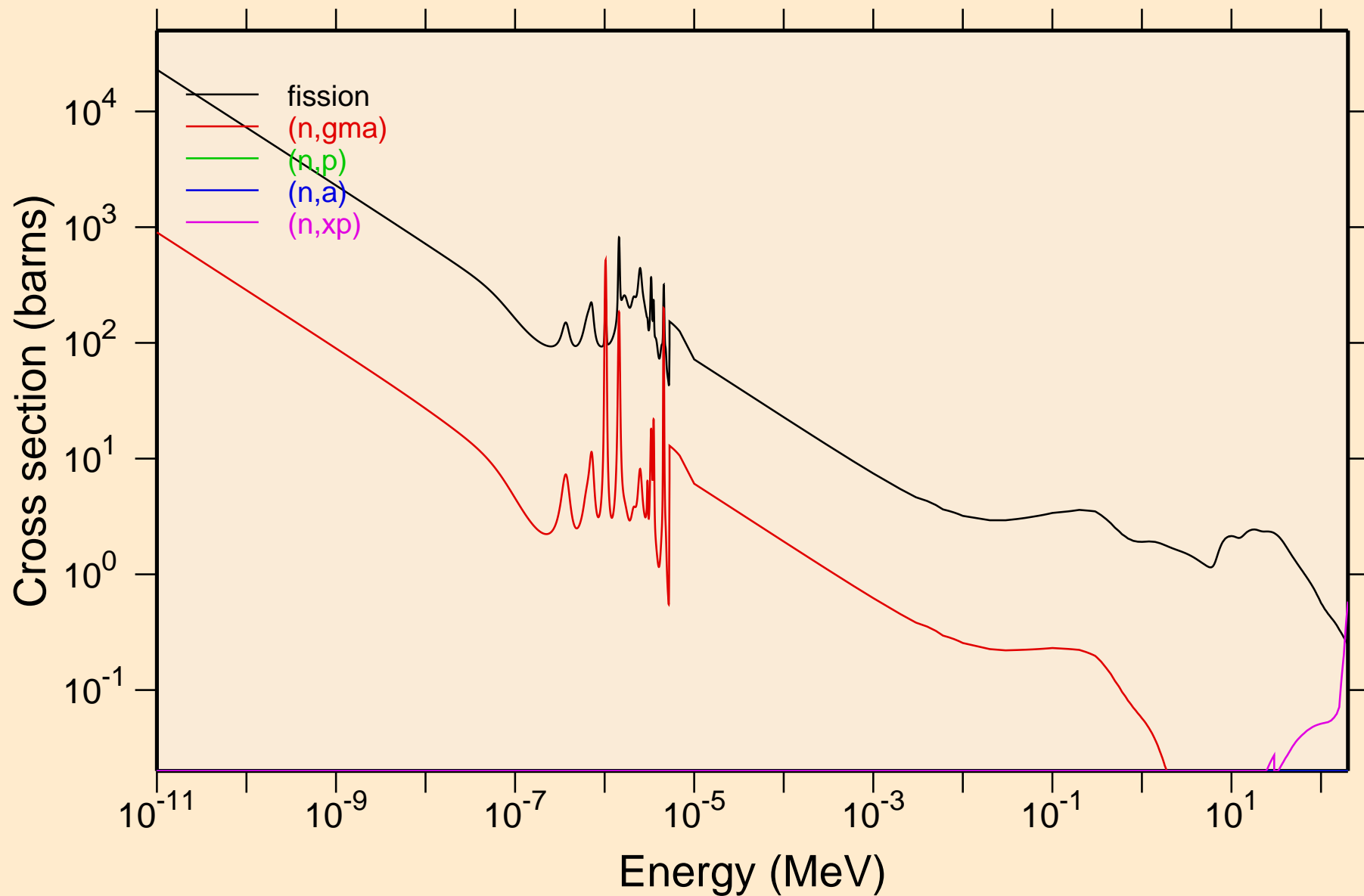

BK240 NEUTRON ACER TENDL-2019 LIBRARY; T=293.16K
Non-threshold reactions

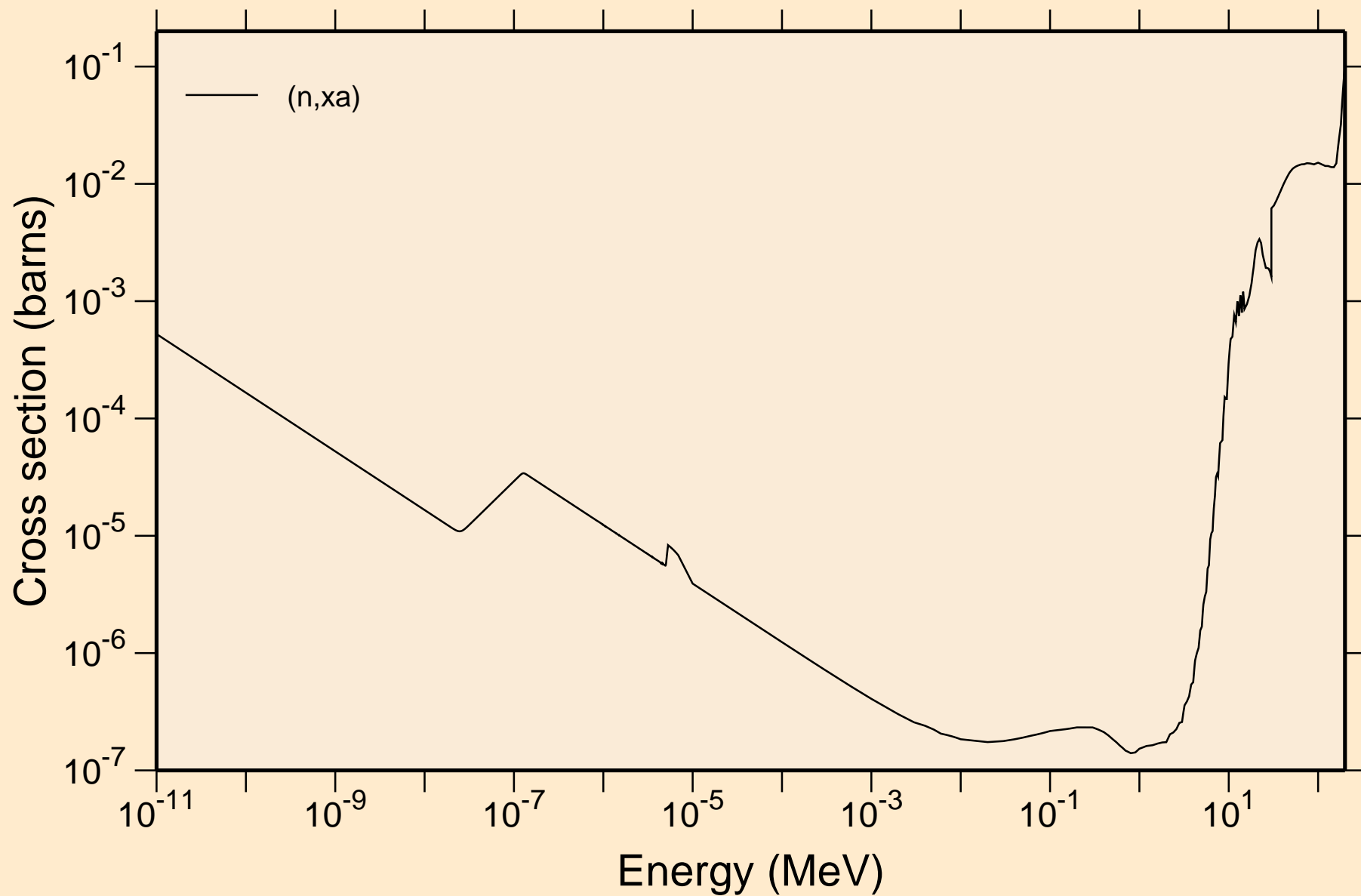

BK240 NEUTRON ACER TENDL-2019 LIBRARY; T=293.16K
Principal cross sections

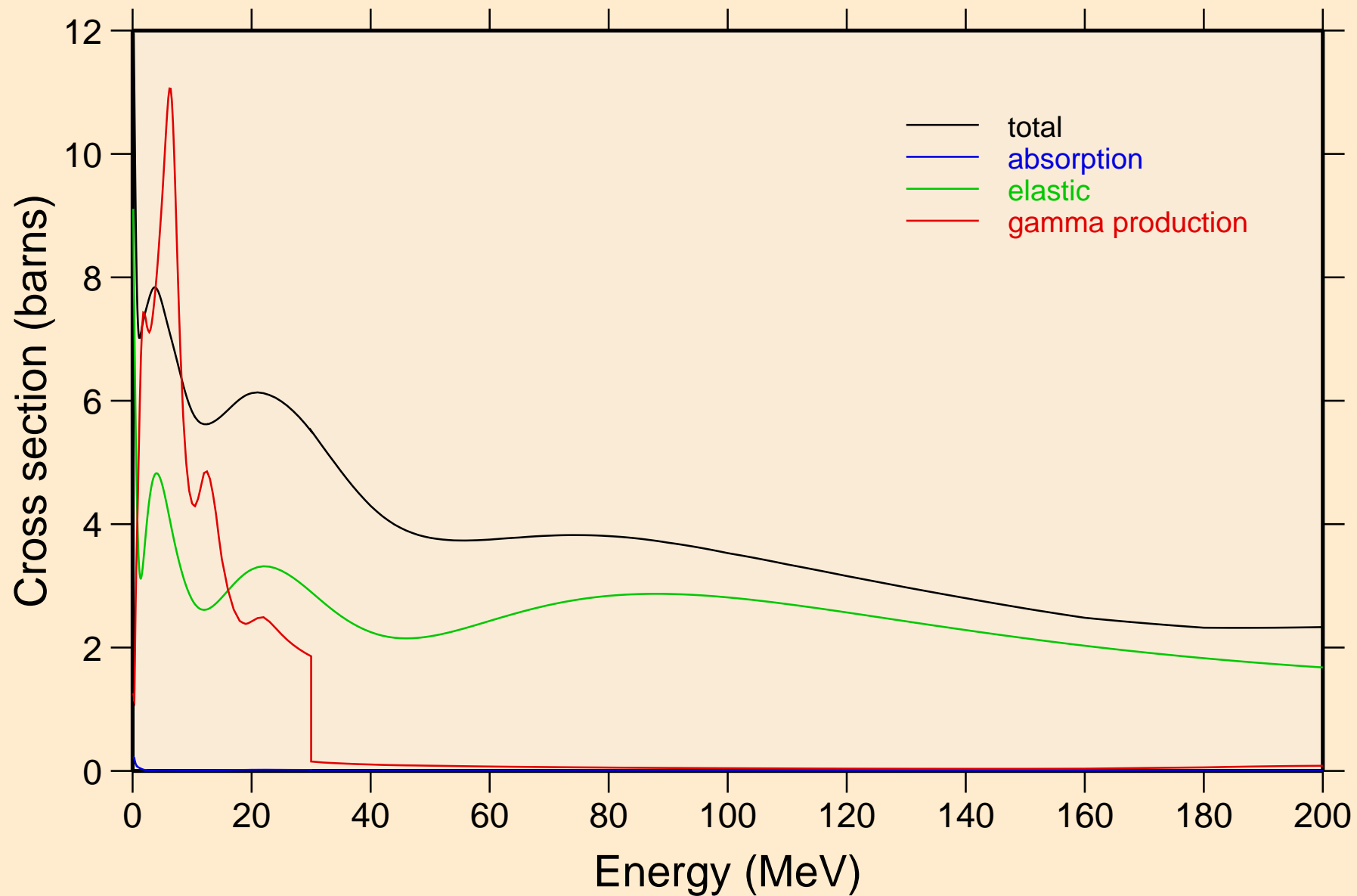

BK240 NEUTRON ACER TENDL-2019 LIBRARY; T=293.16K
Heating

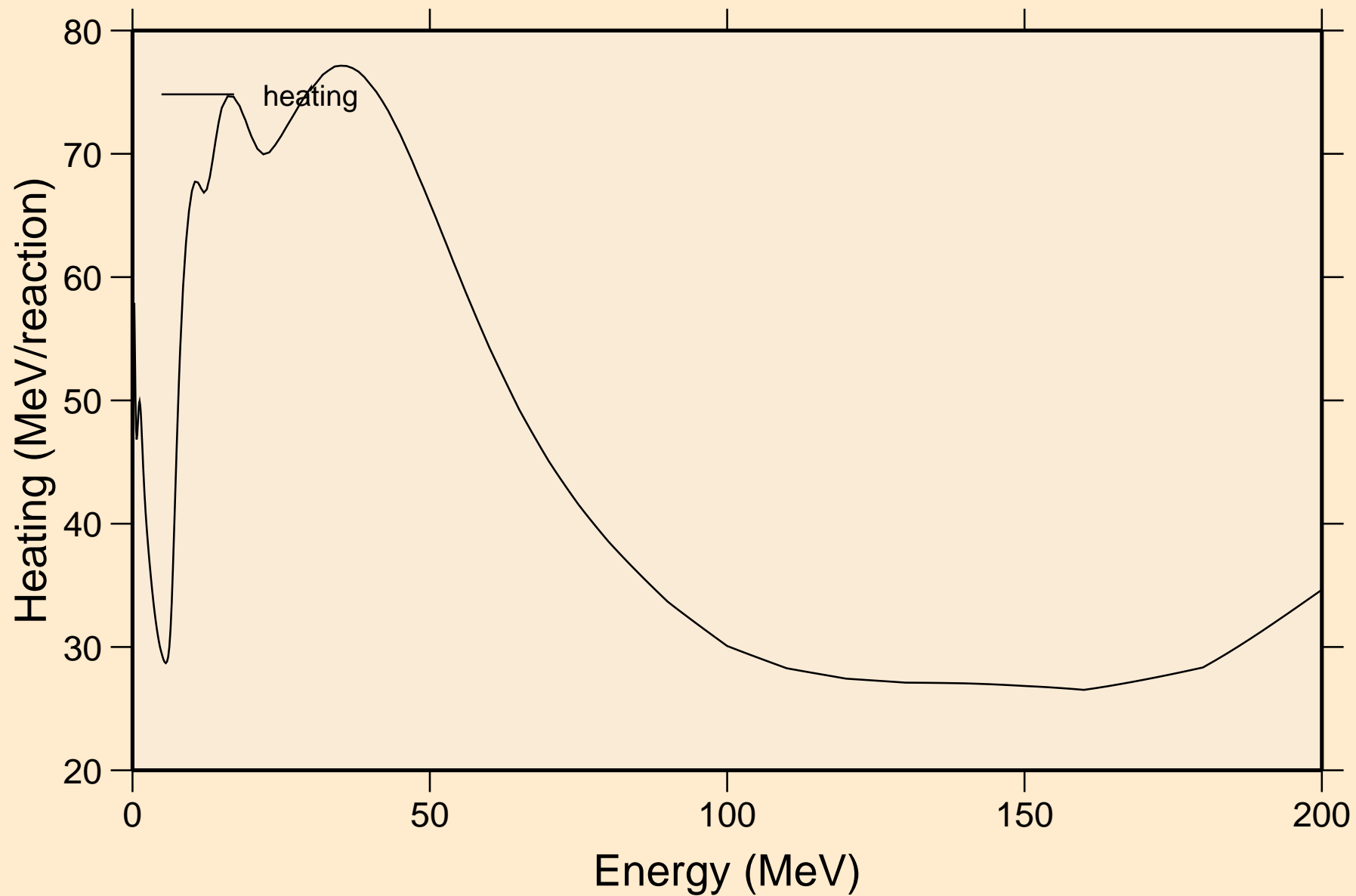

BK240 NEUTRON ACER TENDL-2019 LIBRARY; T=293.16K
Damage

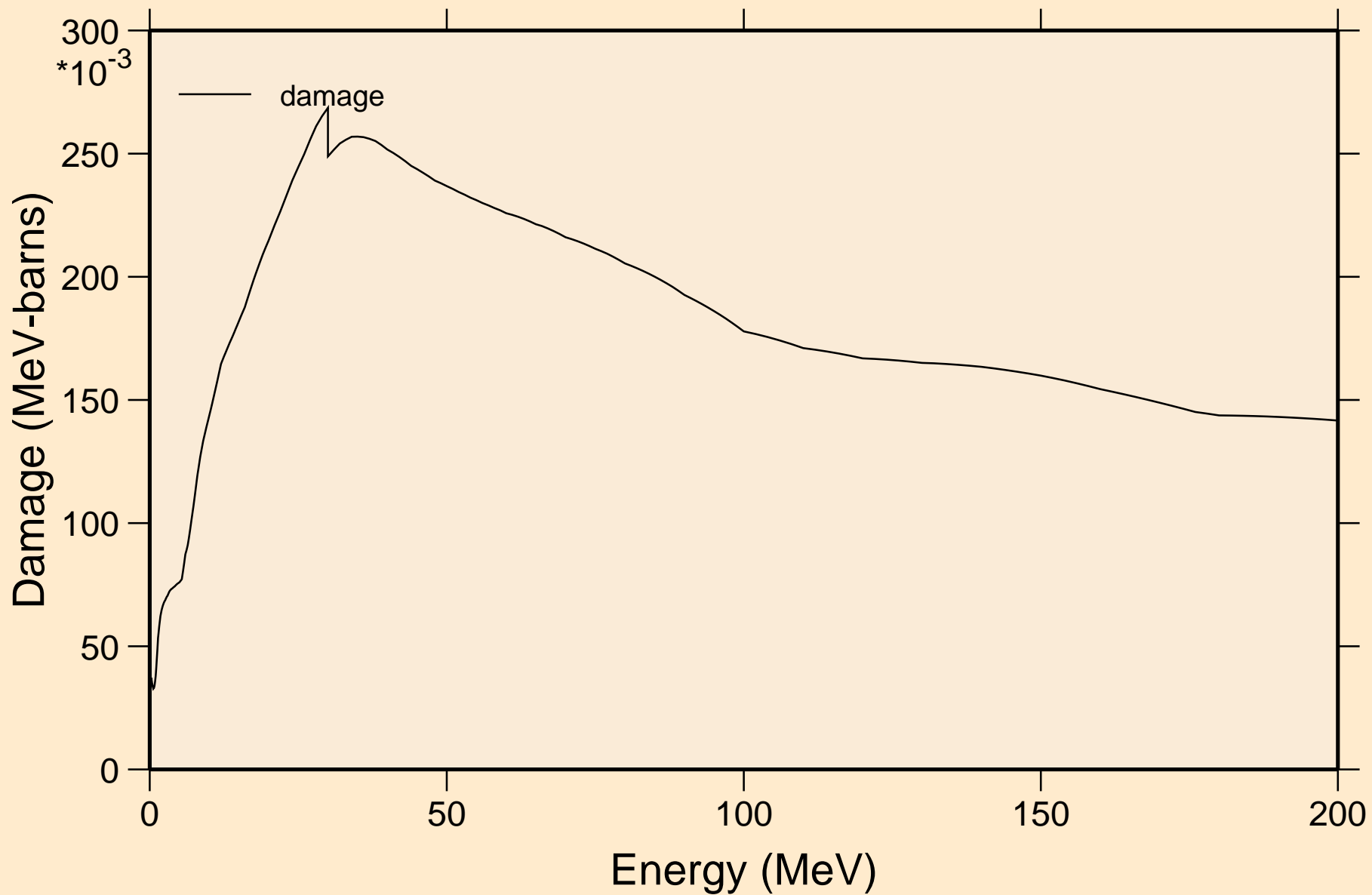

BK240 NEUTRON ACER TENDL-2019 LIBRARY; T=293.16K
Non-threshold reactions

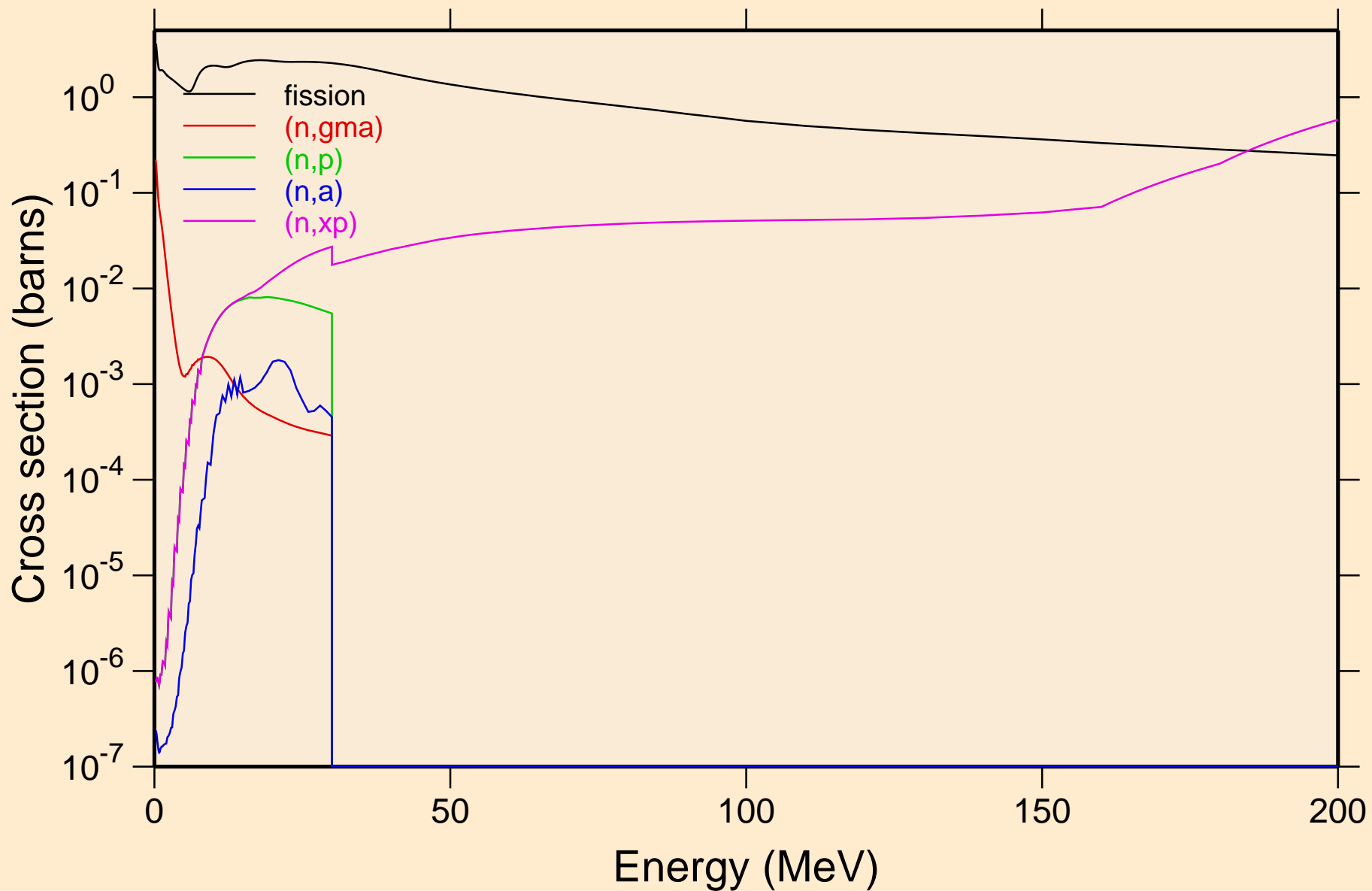

BK240 NEUTRON ACER TENDL-2019 LIBRARY; T=293.16K
Non-threshold reactions

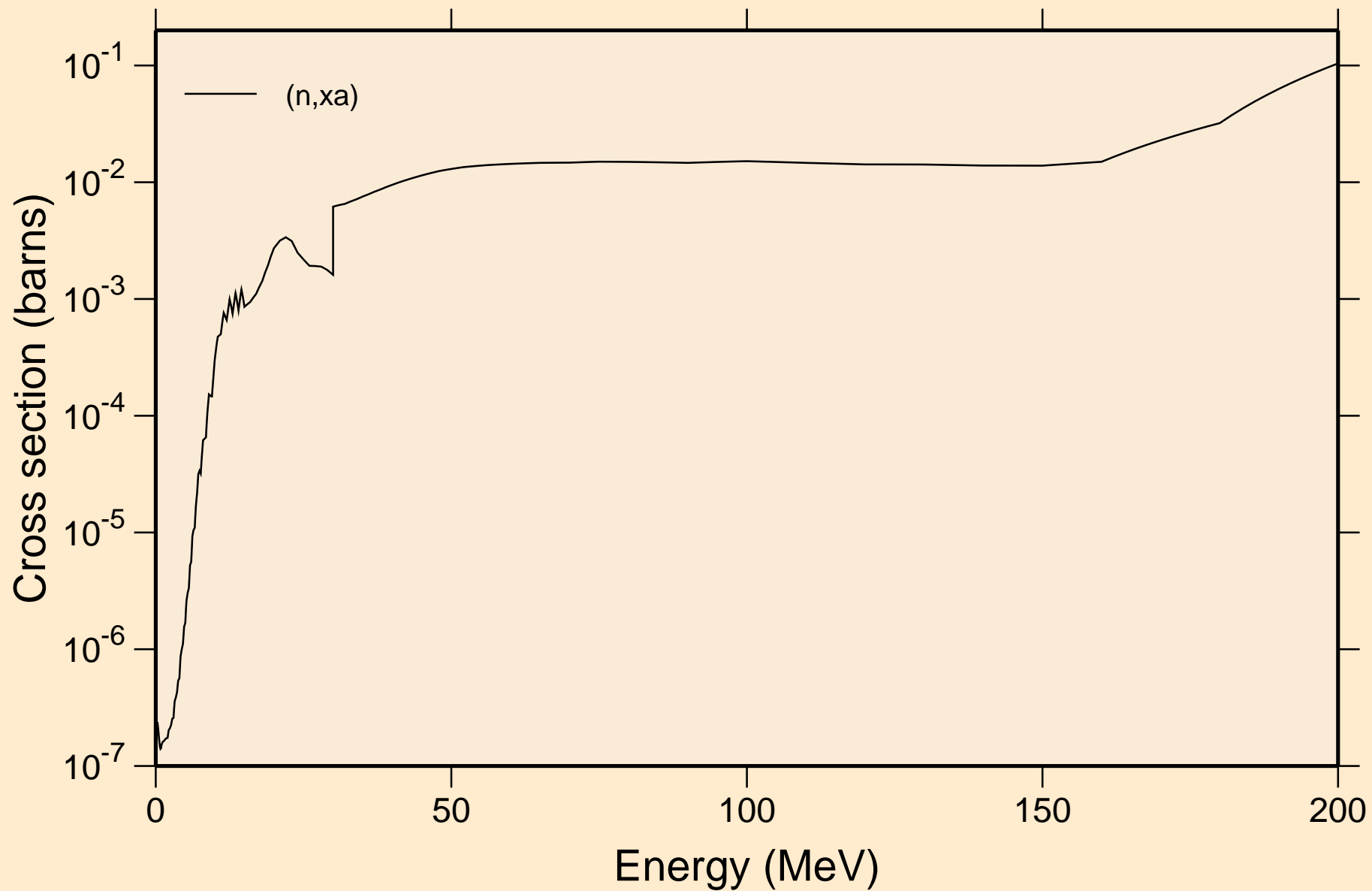

BK240 NEUTRON ACER TENDL-2019 LIBRARY; T=293.16K
Inelastic levels

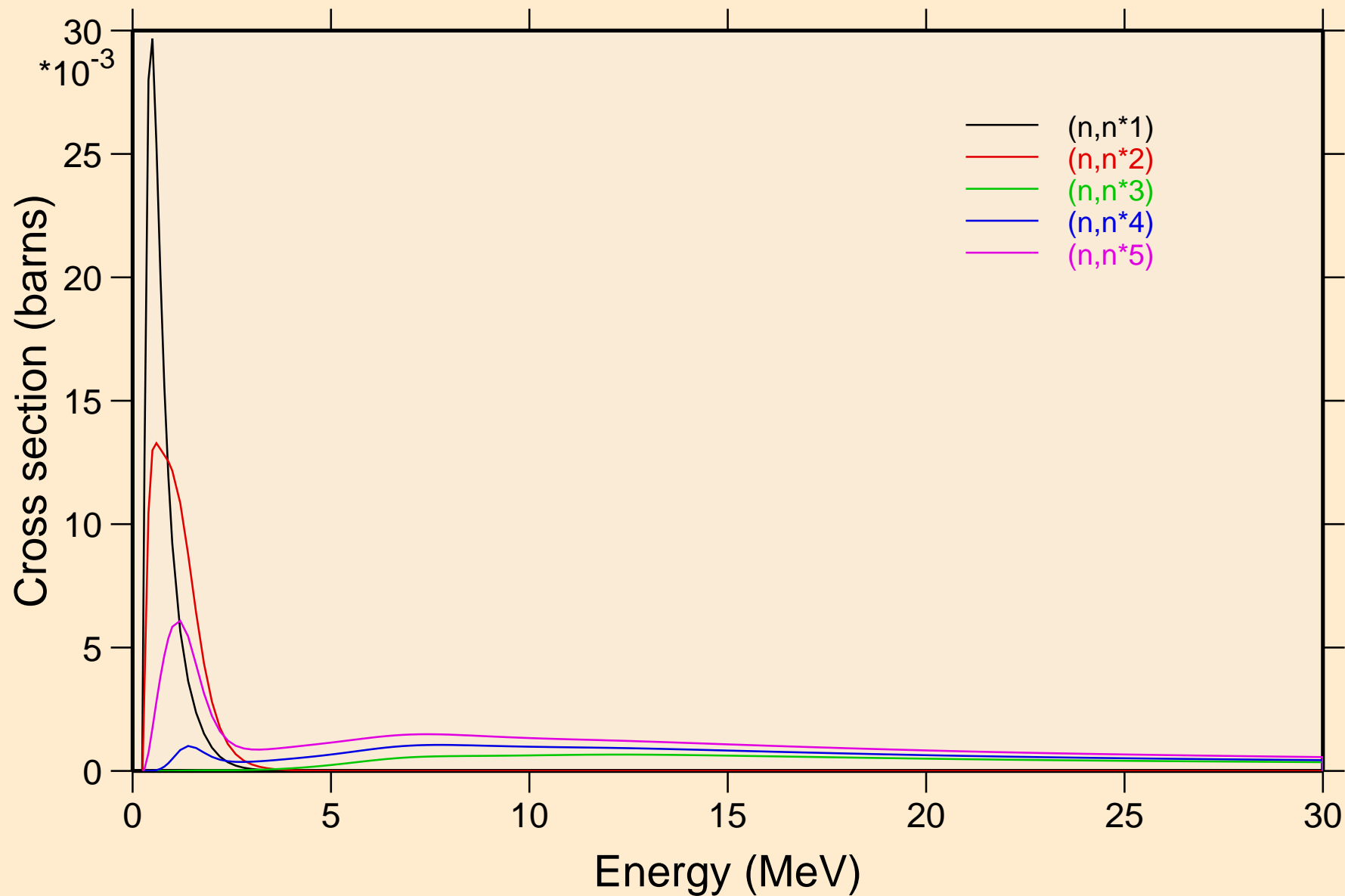

BK240 NEUTRON ACER TENDL-2019 LIBRARY; T=293.16K
Inelastic levels

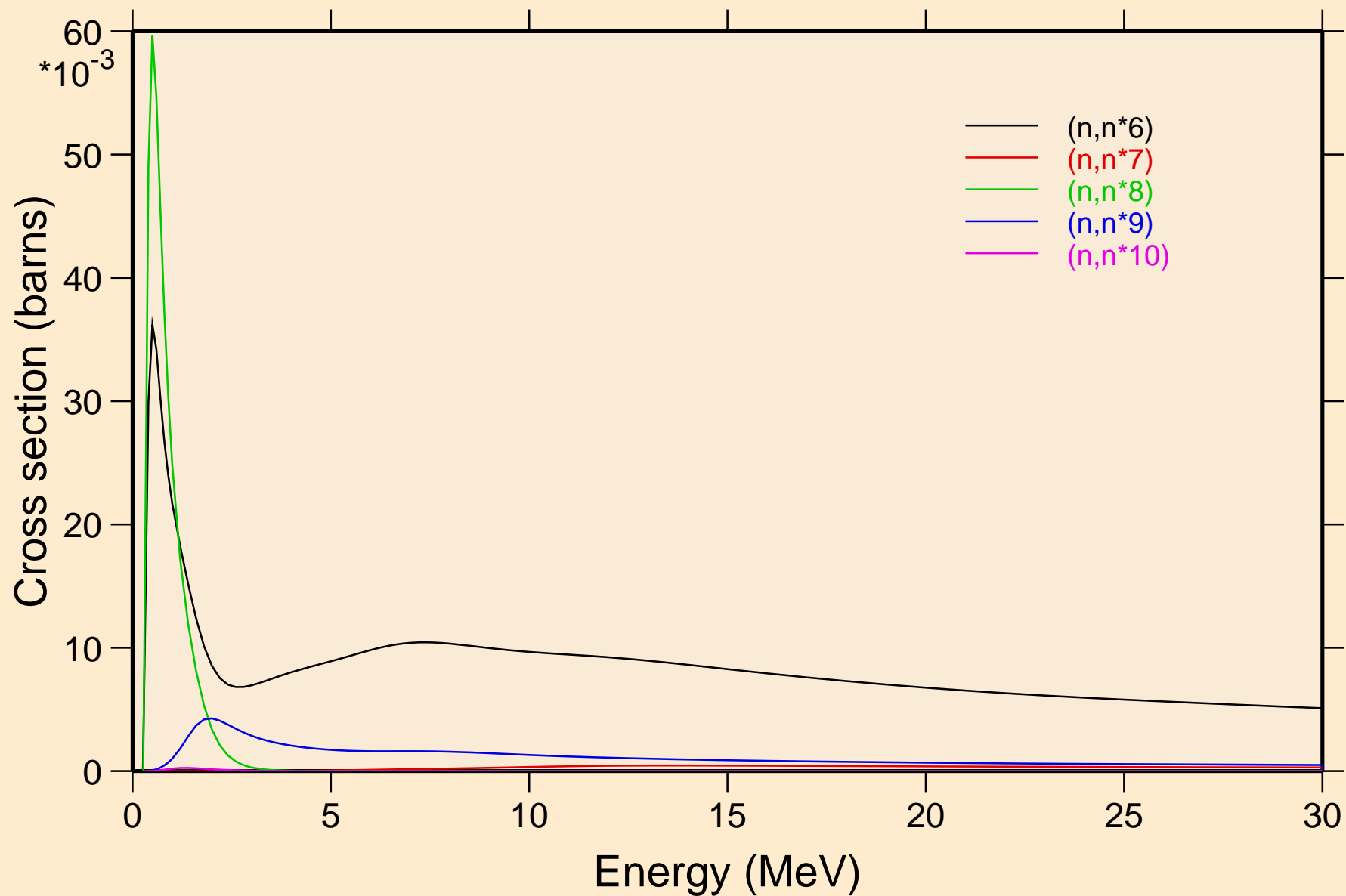

BK240 NEUTRON ACER TENDL-2019 LIBRARY; T=293.16K
Inelastic levels

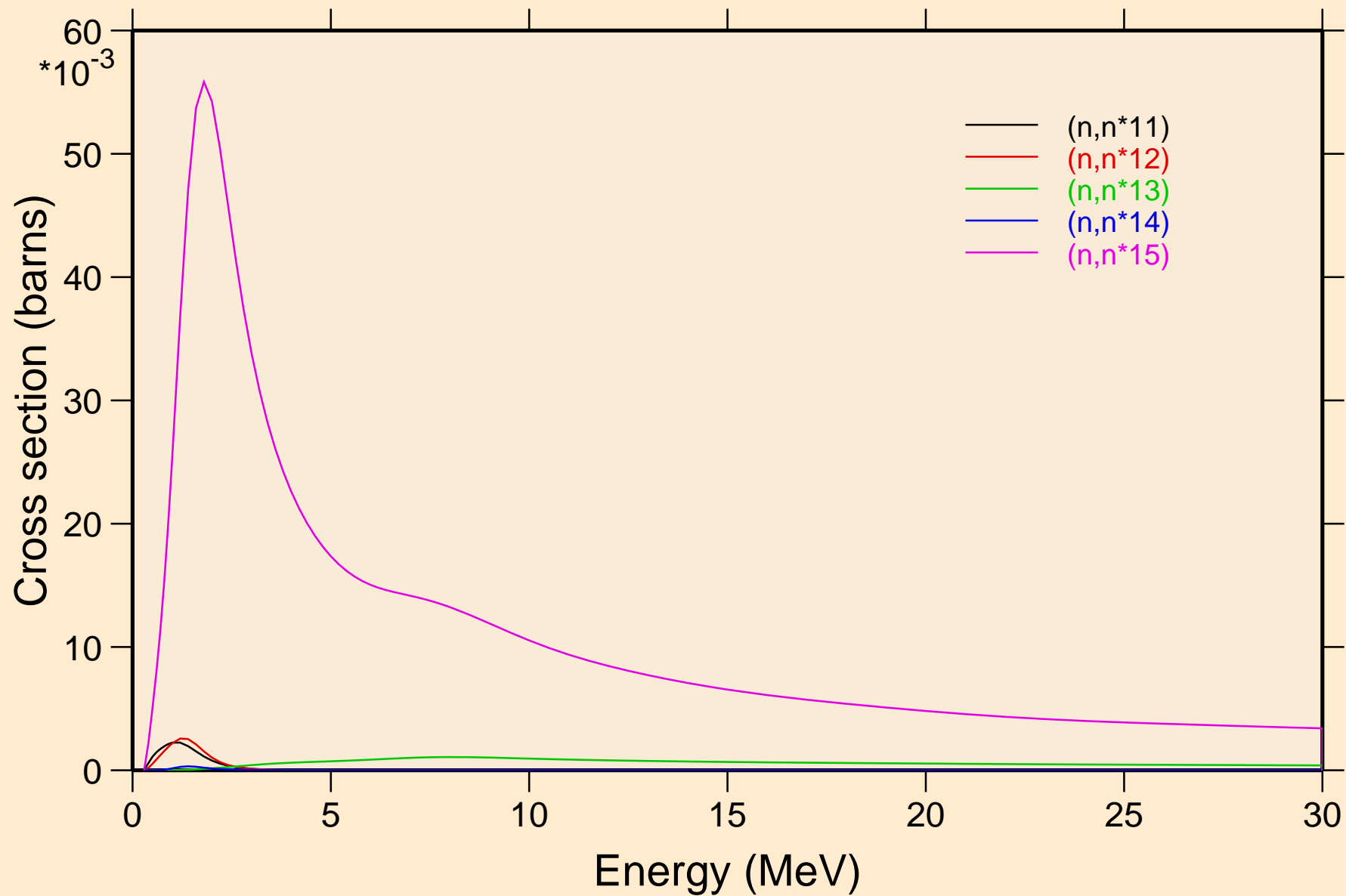

BK240 NEUTRON ACER TENDL-2019 LIBRARY; T=293.16K
Inelastic levels

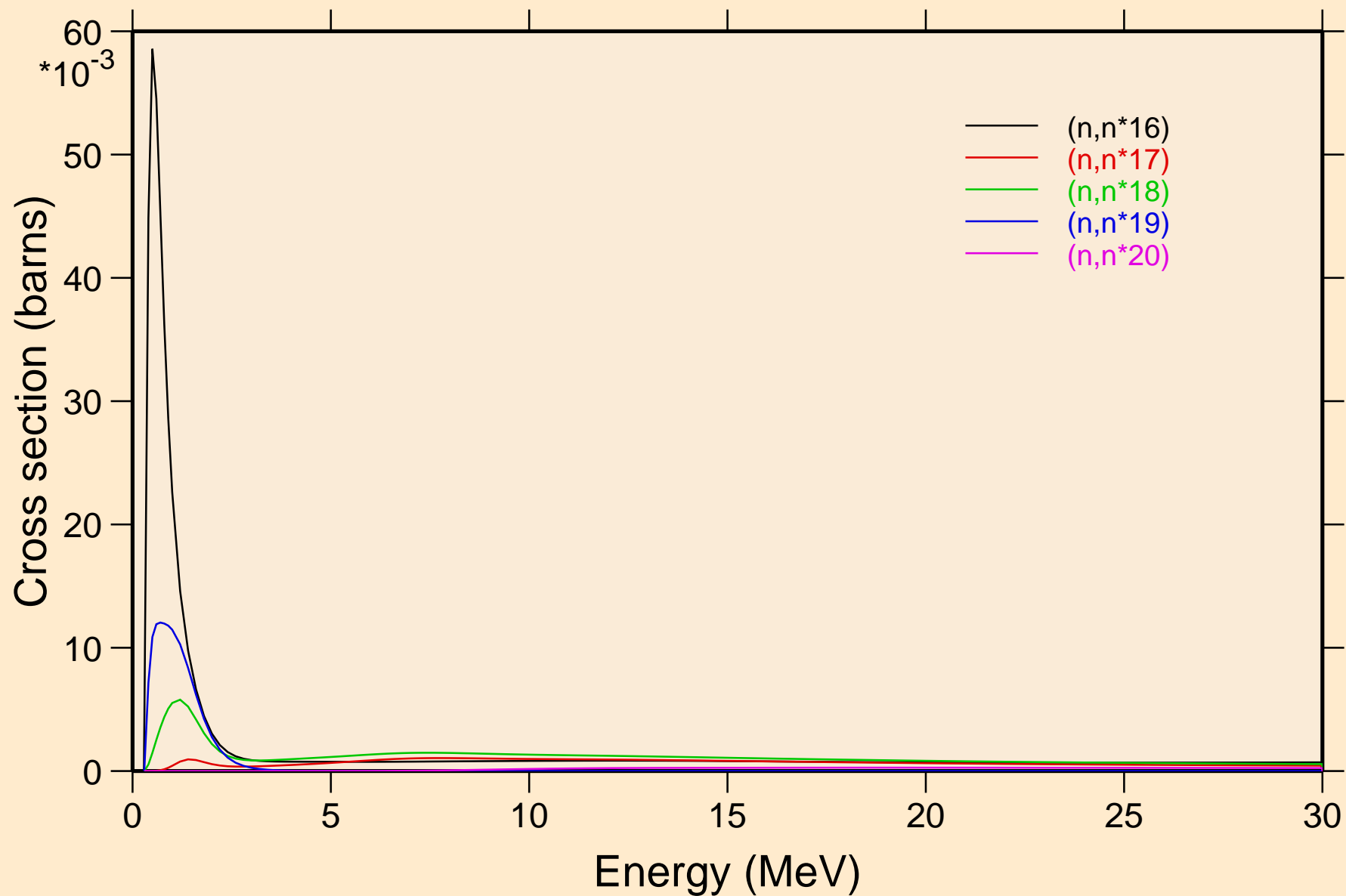

BK240 NEUTRON ACER TENDL-2019 LIBRARY; T=293.16K
Inelastic levels

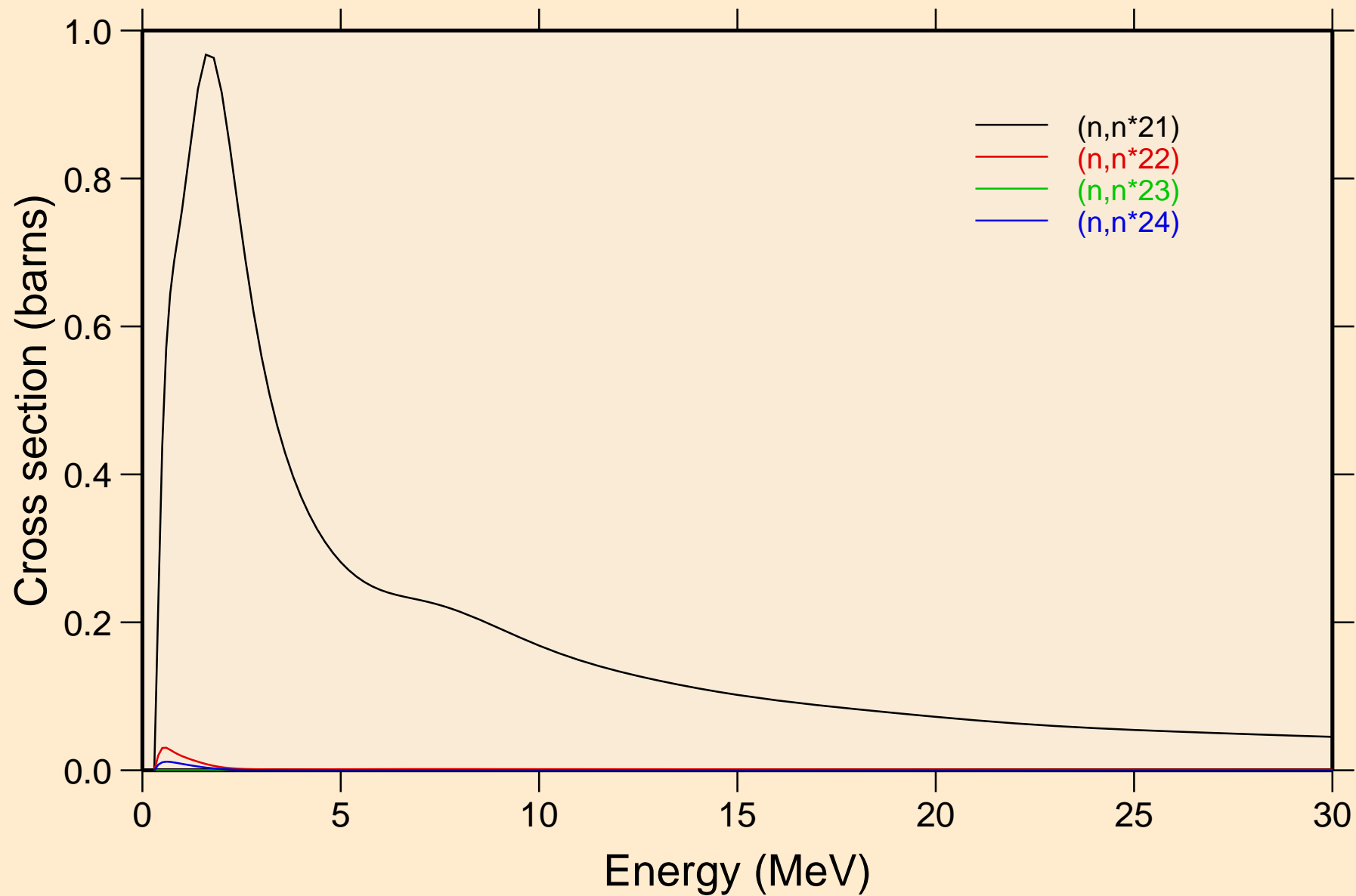

BK240 NEUTRON ACER TENDL-2019 LIBRARY; T=293.16K
Threshold reactions

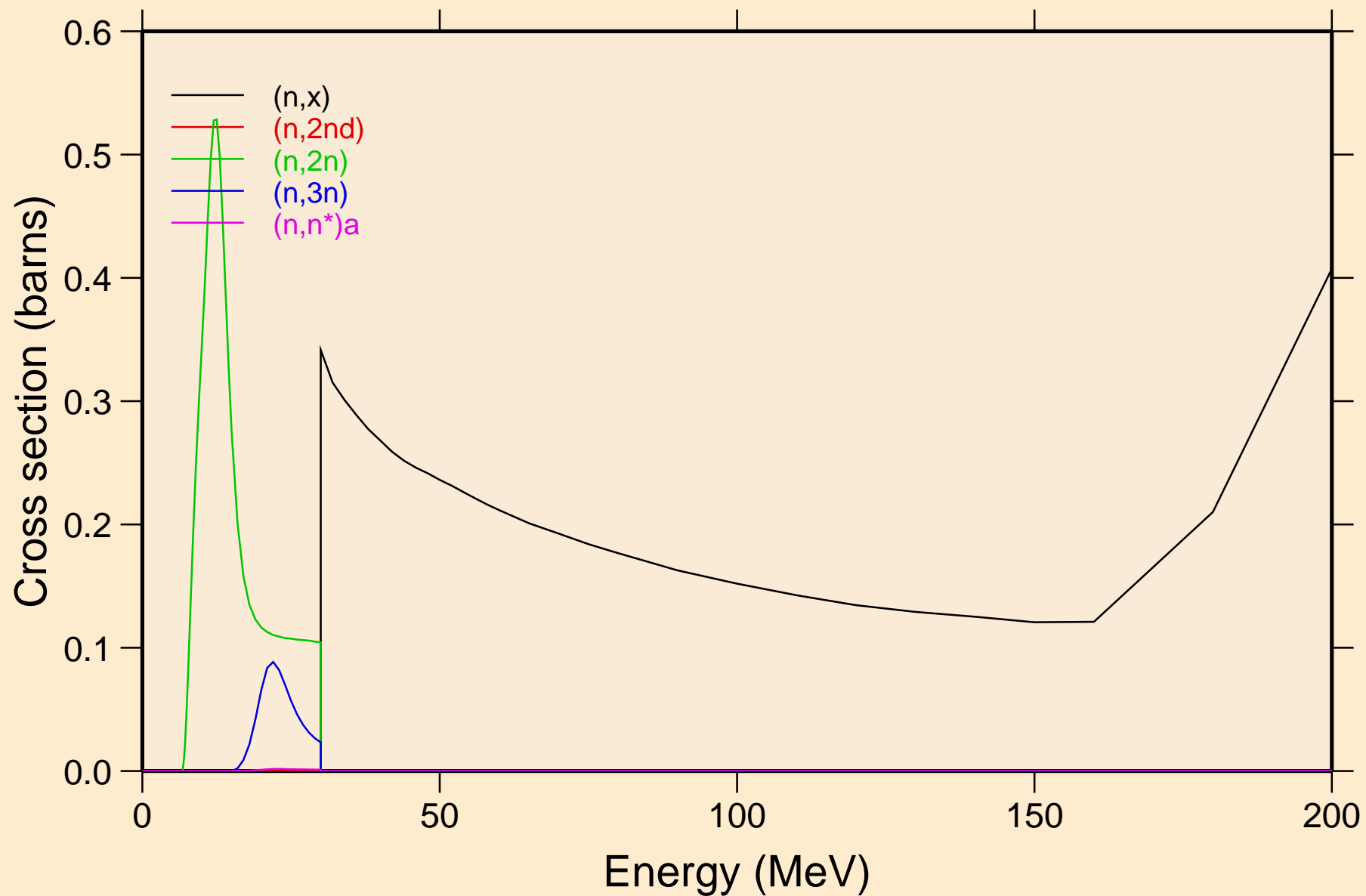

BK240 NEUTRON ACER TENDL-2019 LIBRARY; T=293.16K
Threshold reactions

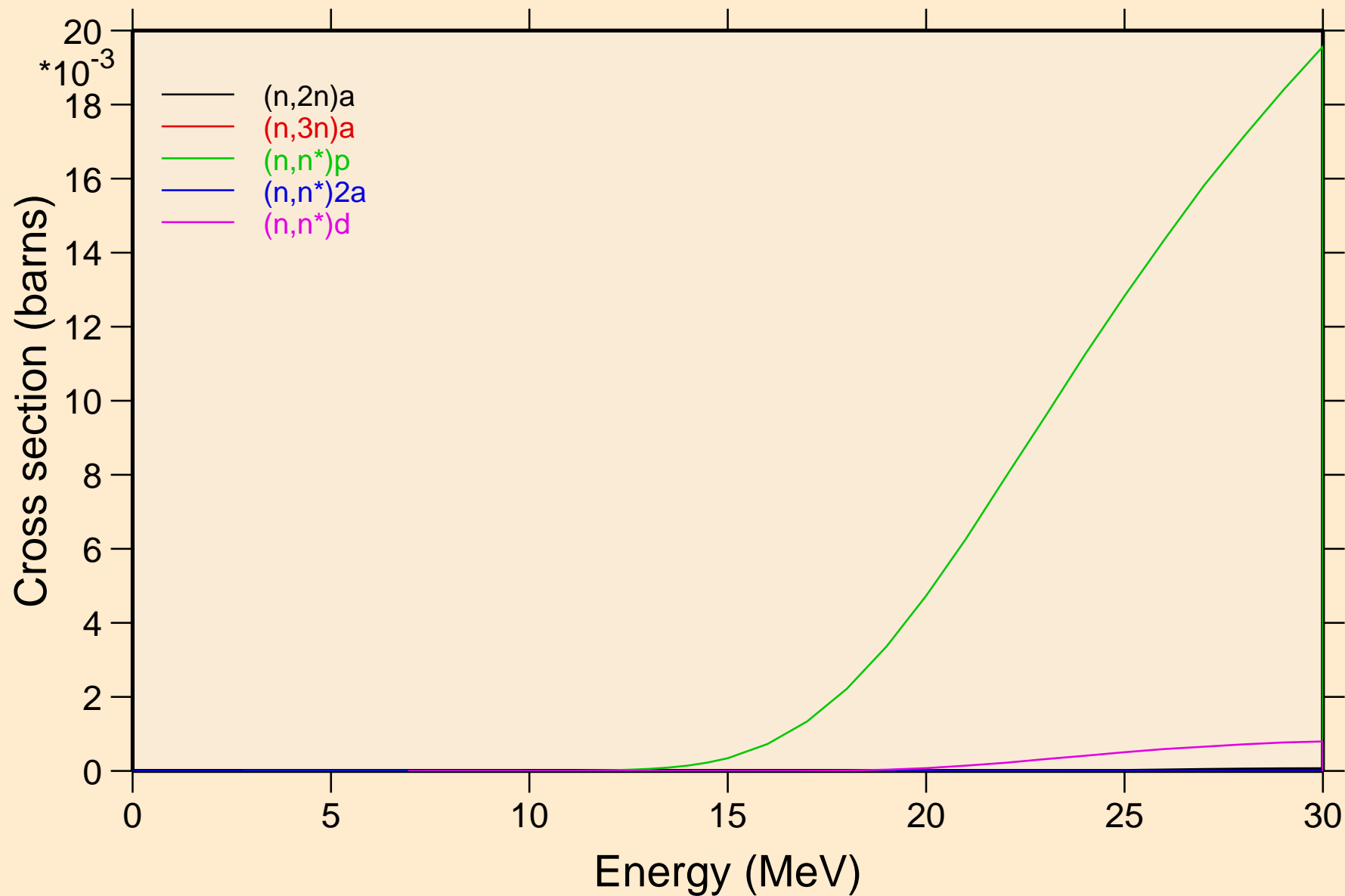

BK240 NEUTRON ACER TENDL-2019 LIBRARY; T=293.16K
Threshold reactions

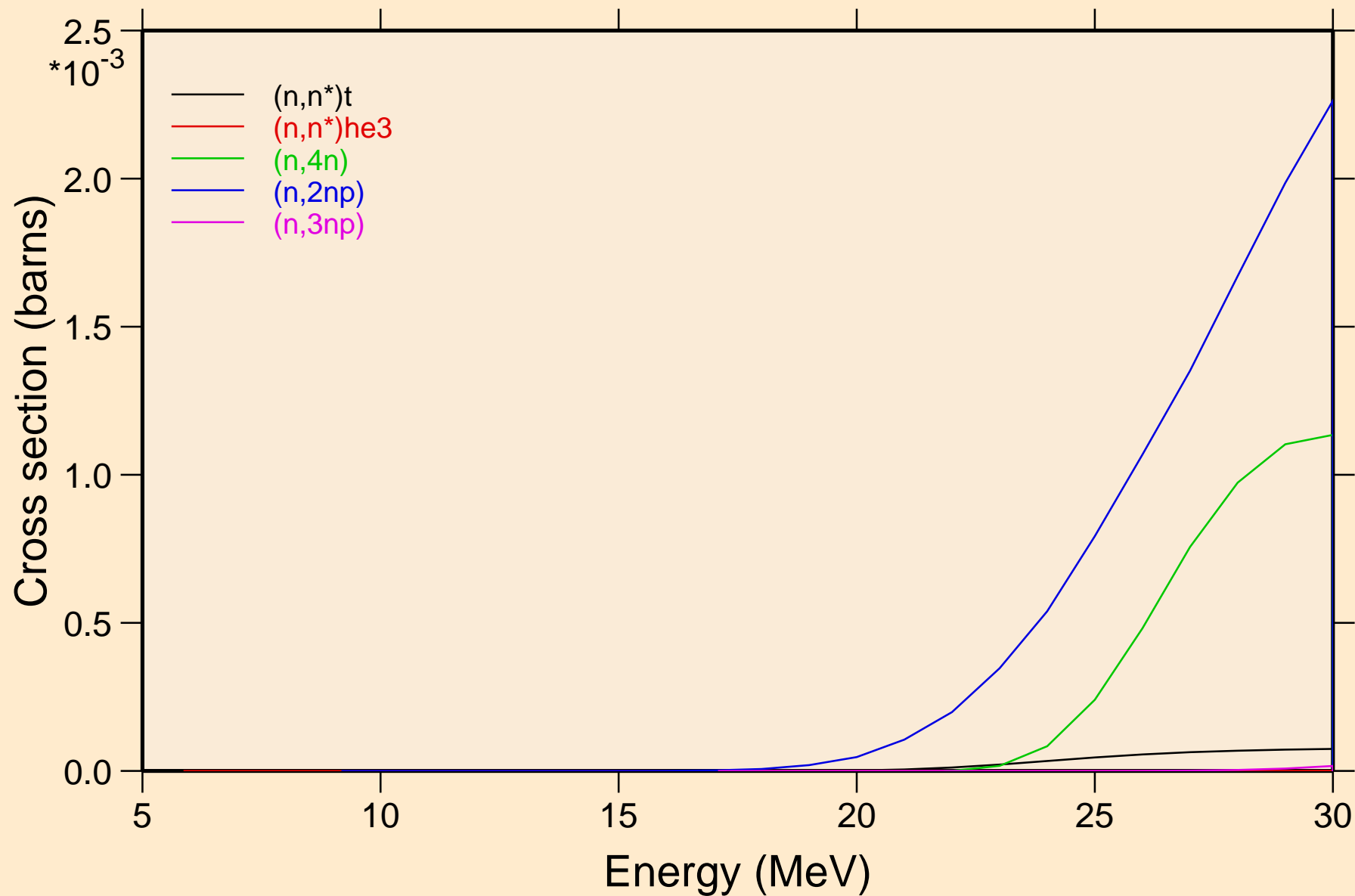

BK240 NEUTRON ACER TENDL-2019 LIBRARY; T=293.16K
Threshold reactions

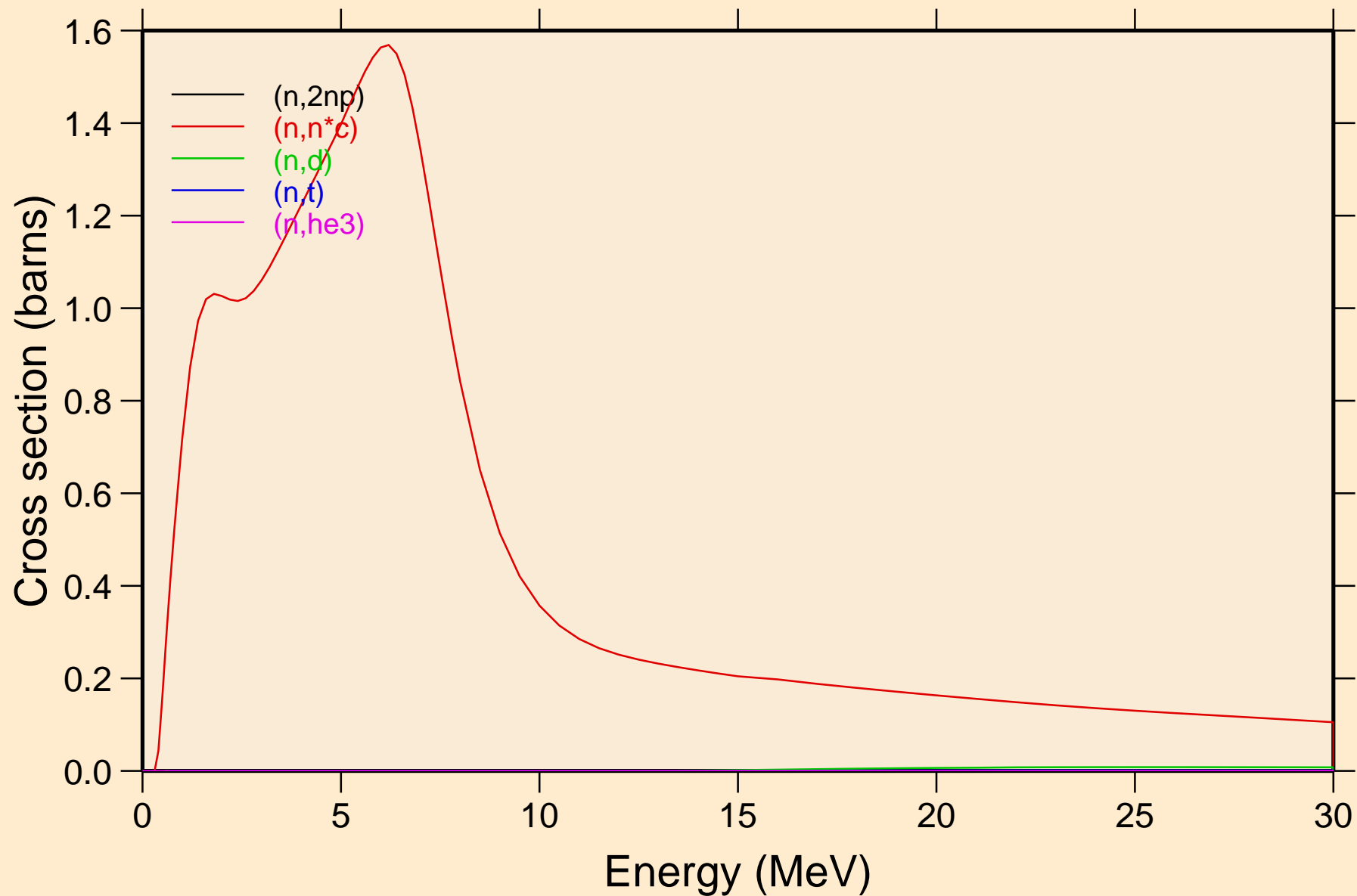

BK240 NEUTRON ACER TENDL-2019 LIBRARY; T=293.16K
Threshold reactions

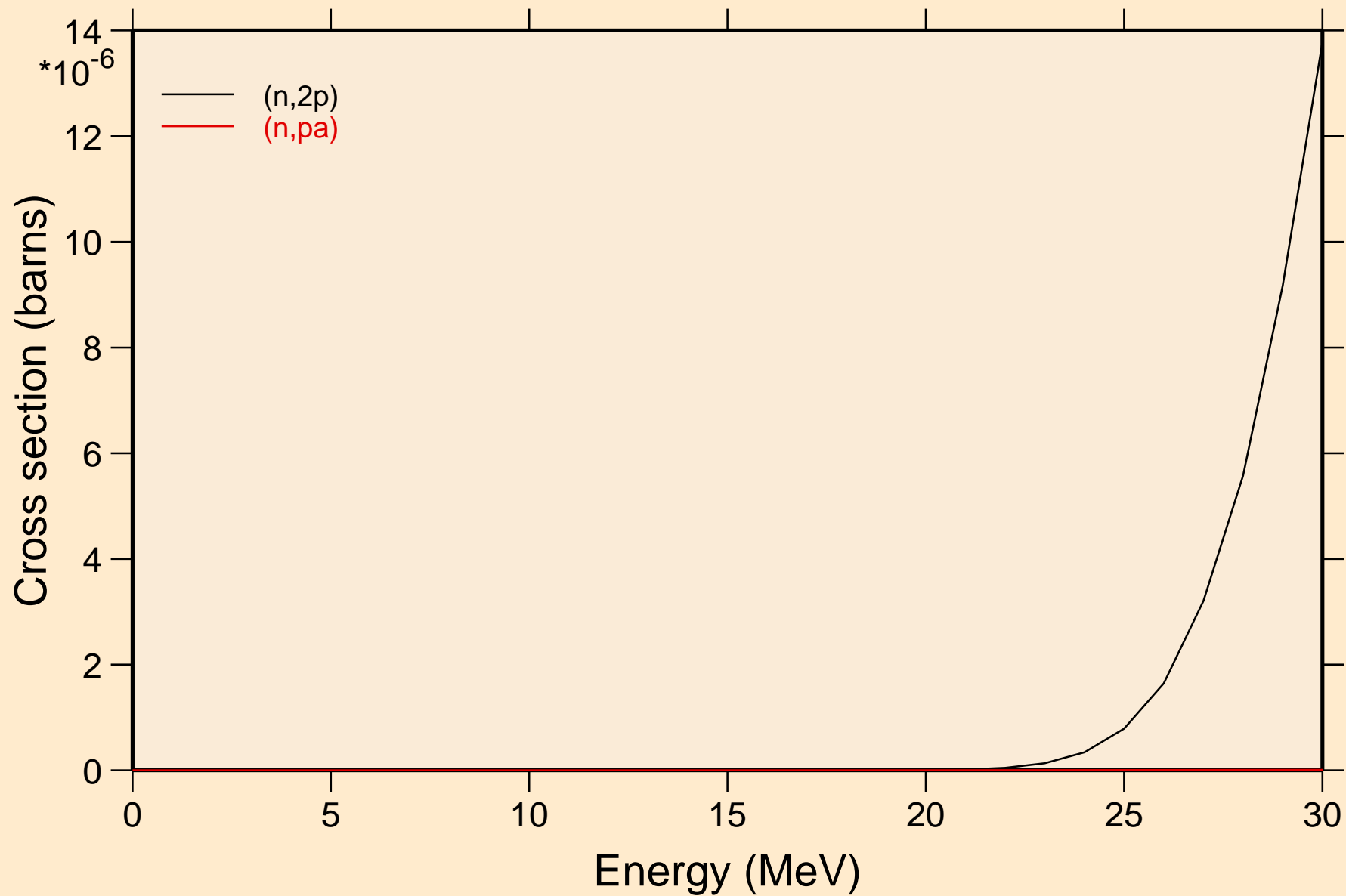

BK240 NEUTRON ACER TENDL-2019 LIBRARY; T=293.16K
Threshold reactions

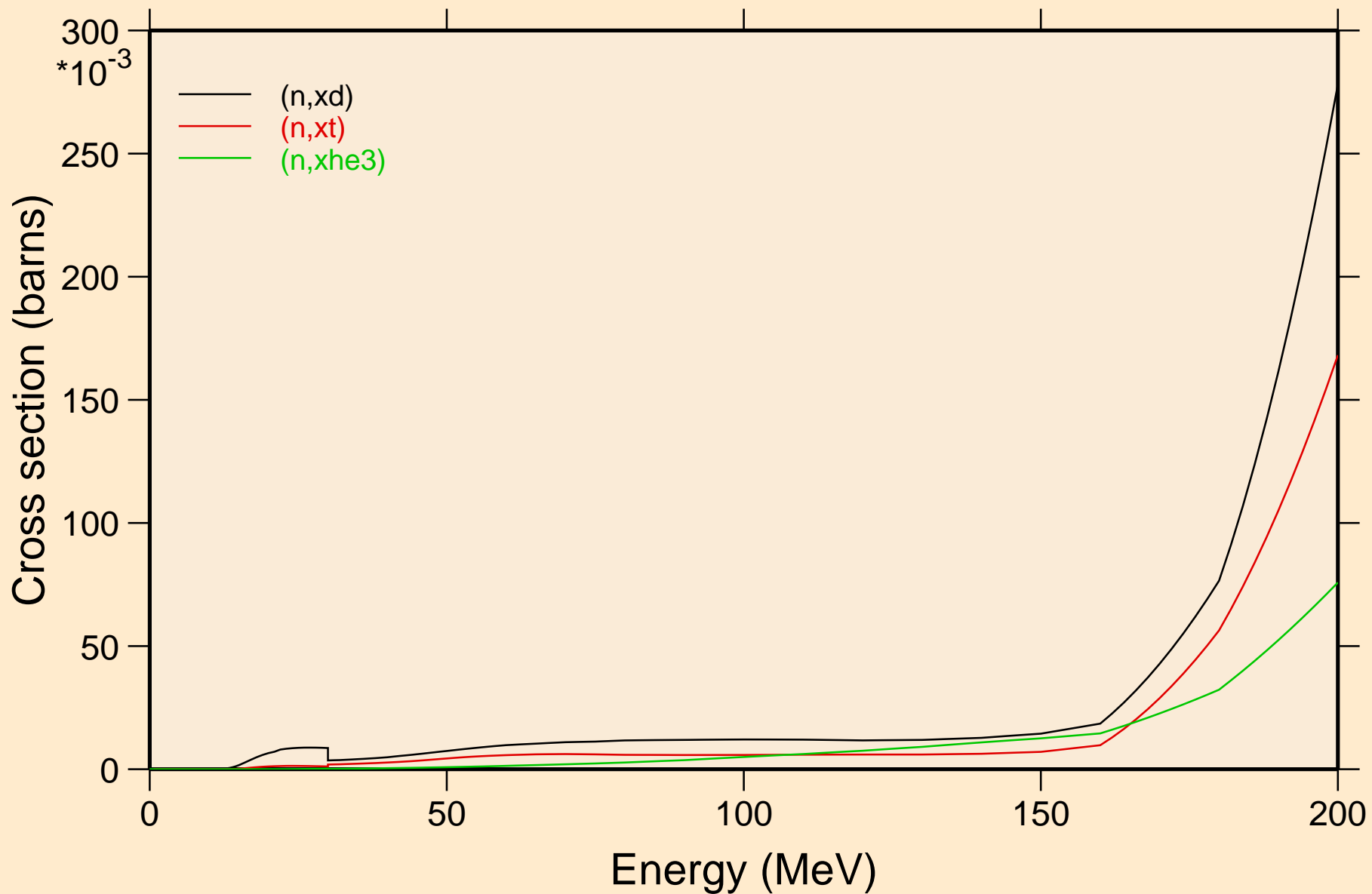

BK240 NEUTRON ACER TENDL-2019 LIBRARY; T=293.16K
angular distribution for elastic

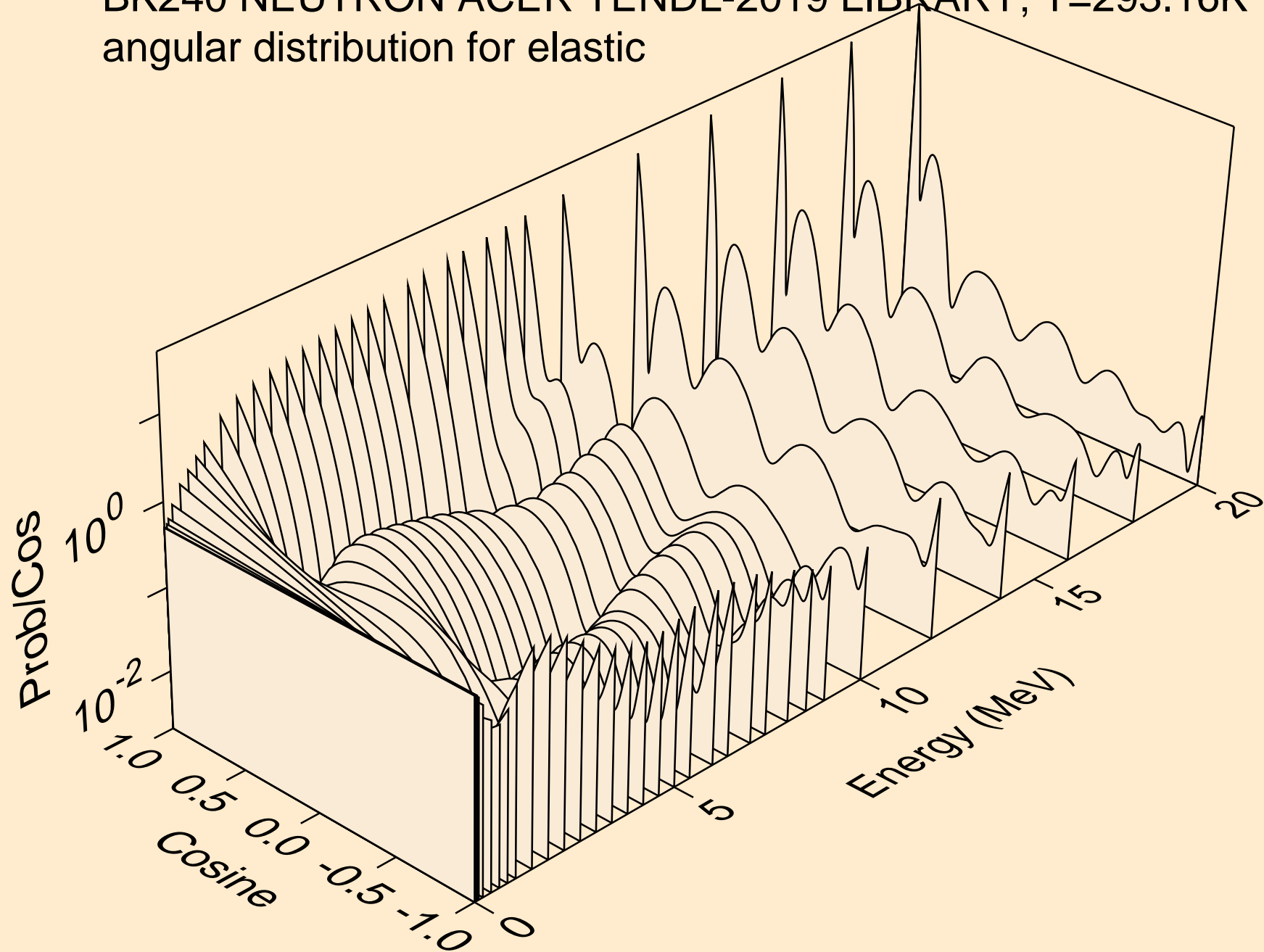

BK240 NEUTRON ACER TENDL-2019 LIBRARY; T=293.16K
angular distribution for elastic

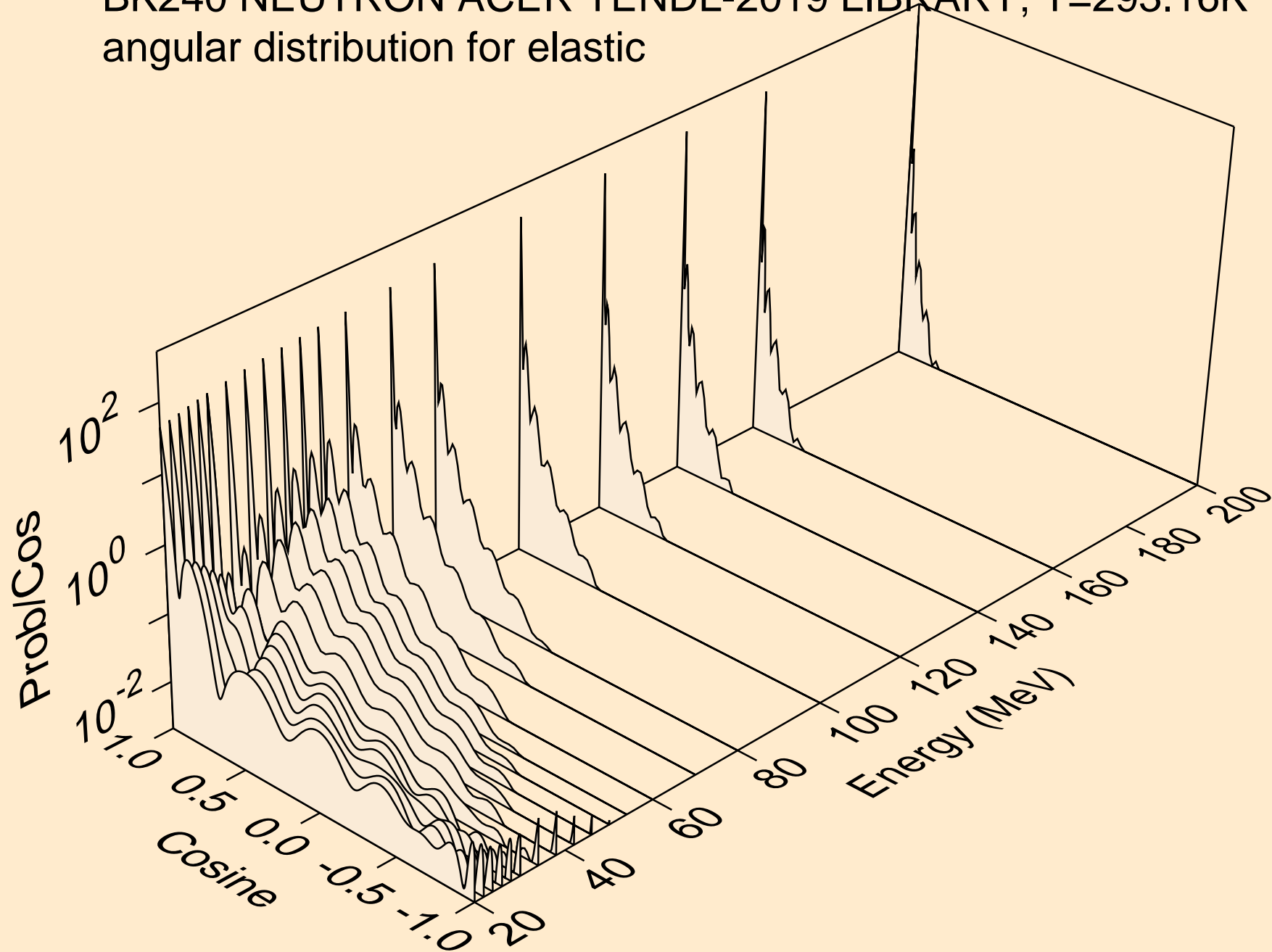

BK240 NEUTRON ACER TENDL-2019 LIBRARY; T=293.16K
angular distribution for (n,n*1)

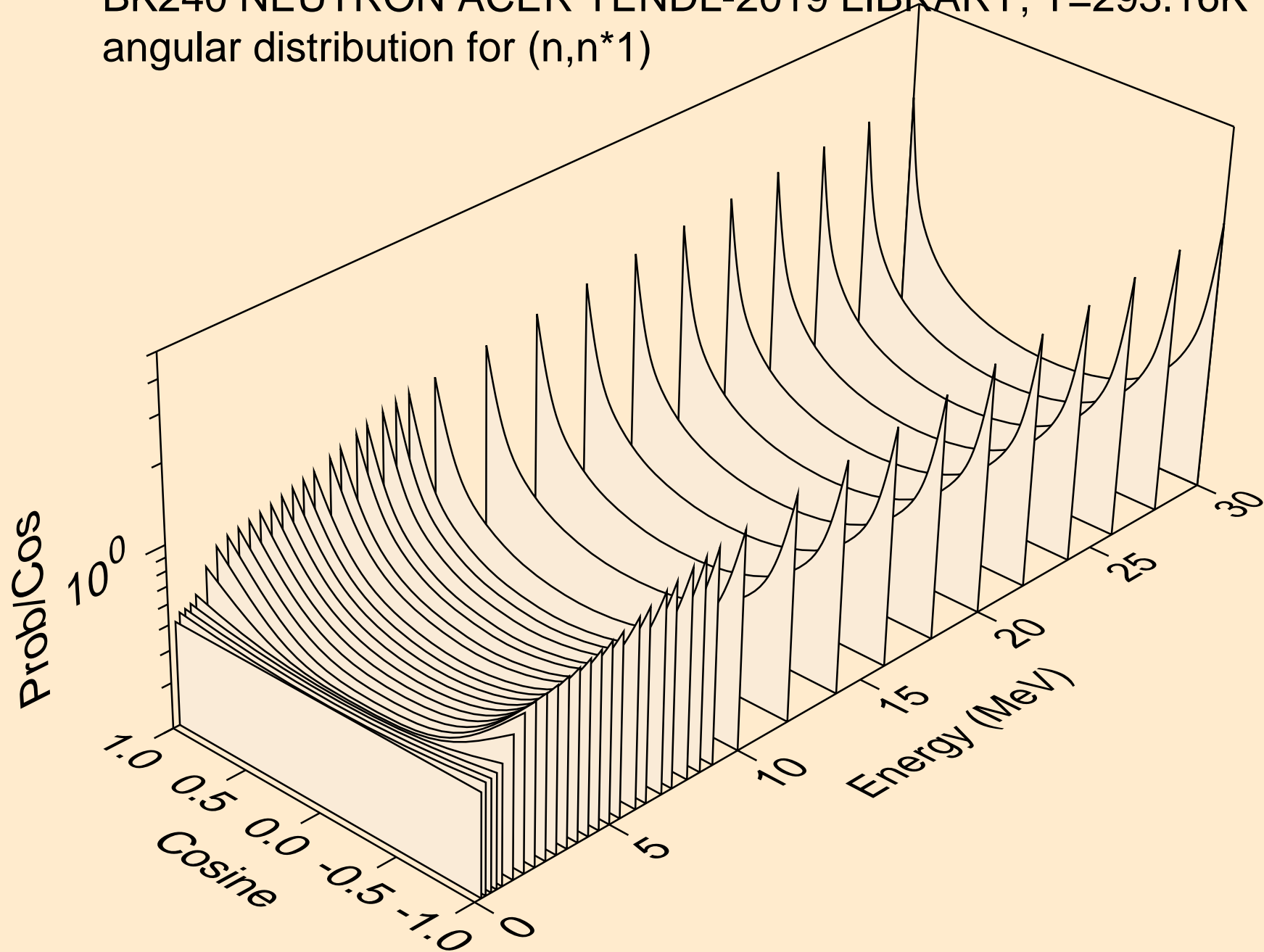

BK240 NEUTRON ACER TENDL-2019 LIBRARY; T=293.16K
angular distribution for (n,n*2)

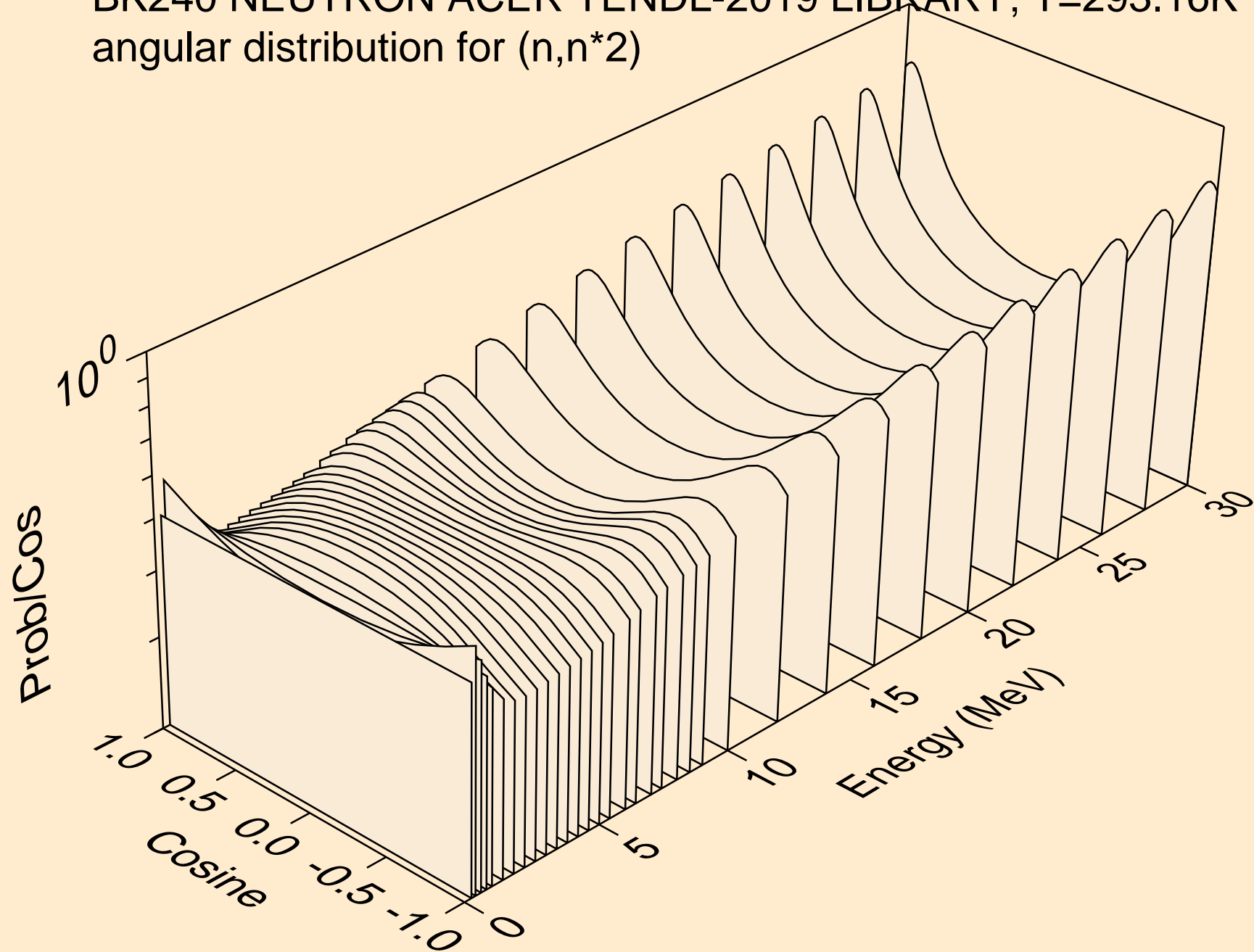

BK240 NEUTRON ACER TENDL-2019 LIBRARY; T=293.16K
angular distribution for (n,n*3)

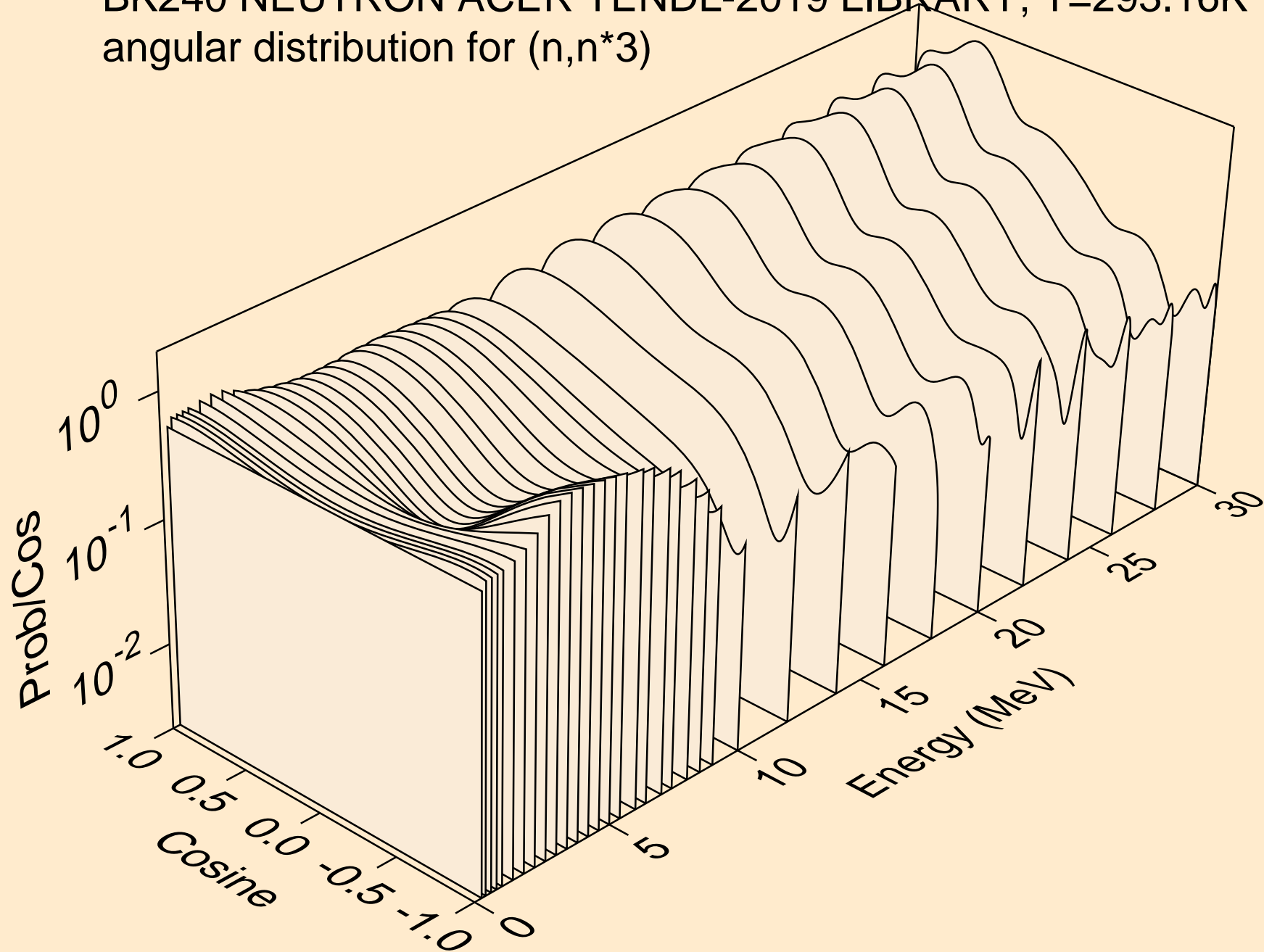

BK240 NEUTRON ACER TENDL-2019 LIBRARY; T=293.16K
angular distribution for (n,n*4)

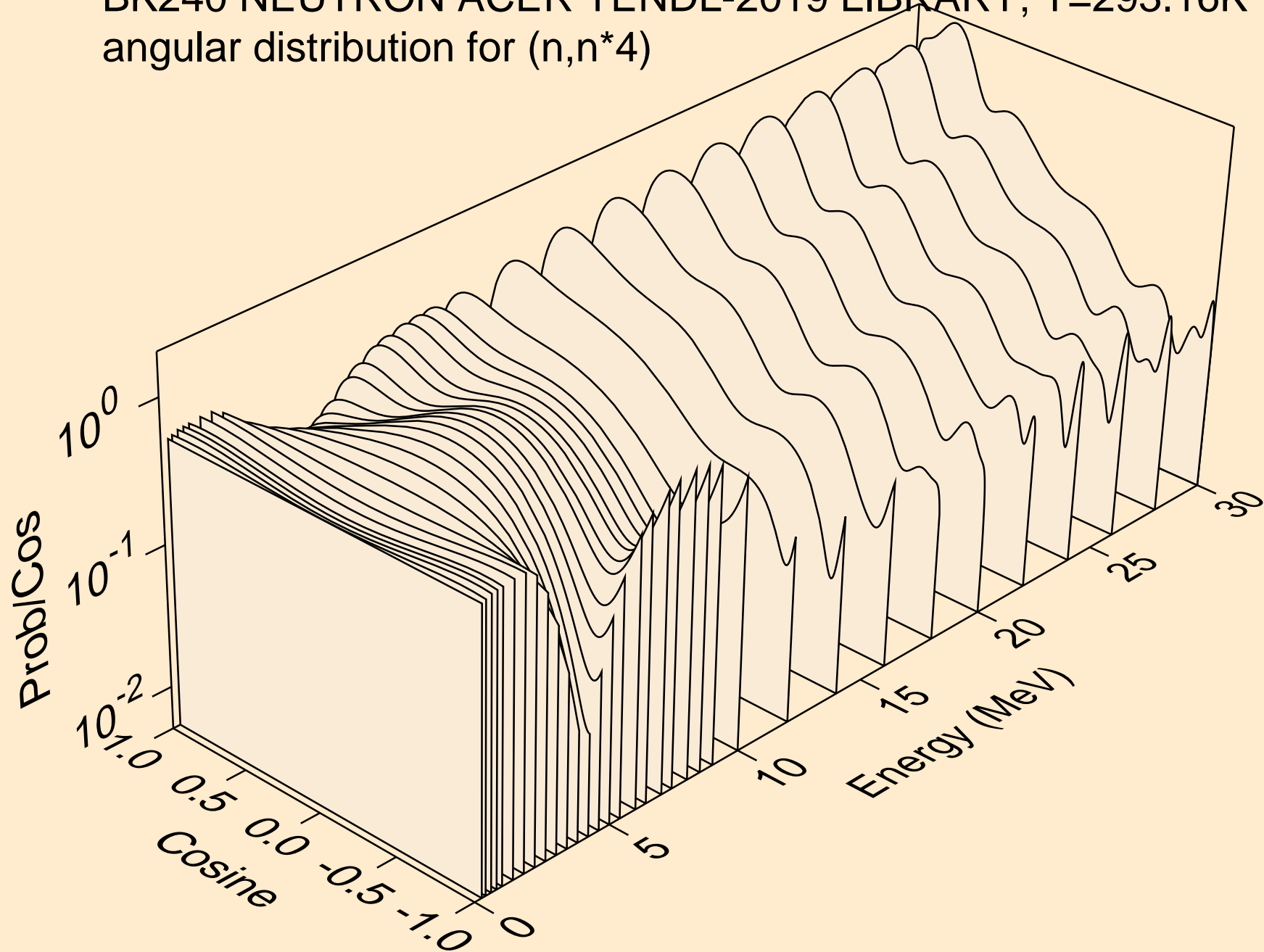

BK240 NEUTRON ACER TENDL-2019 LIBRARY; T=293.16K
angular distribution for (n,n*5)

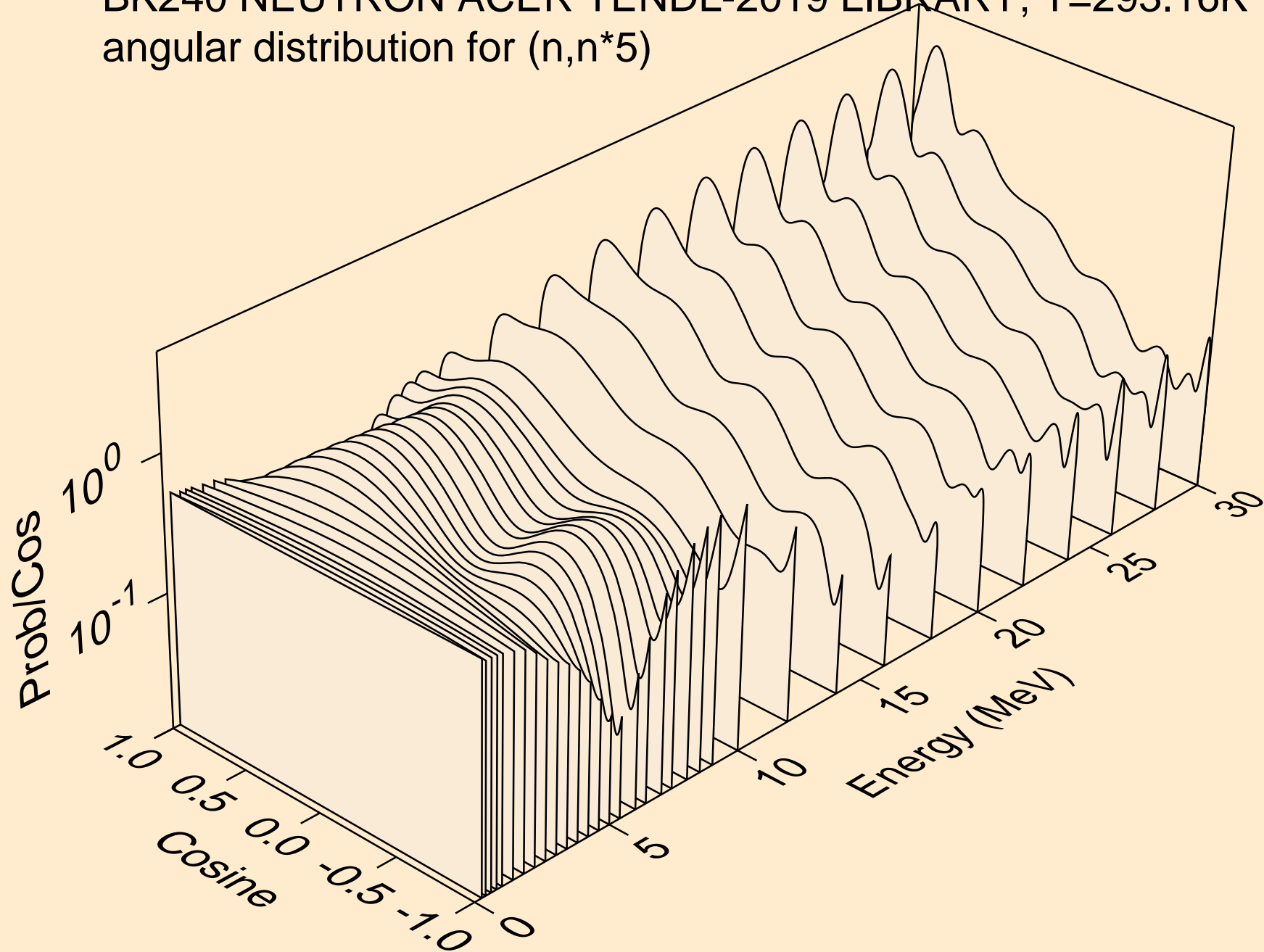

BK240 NEUTRON ACER TENDL-2019 LIBRARY; T=293.16K
angular distribution for (n,n*6)

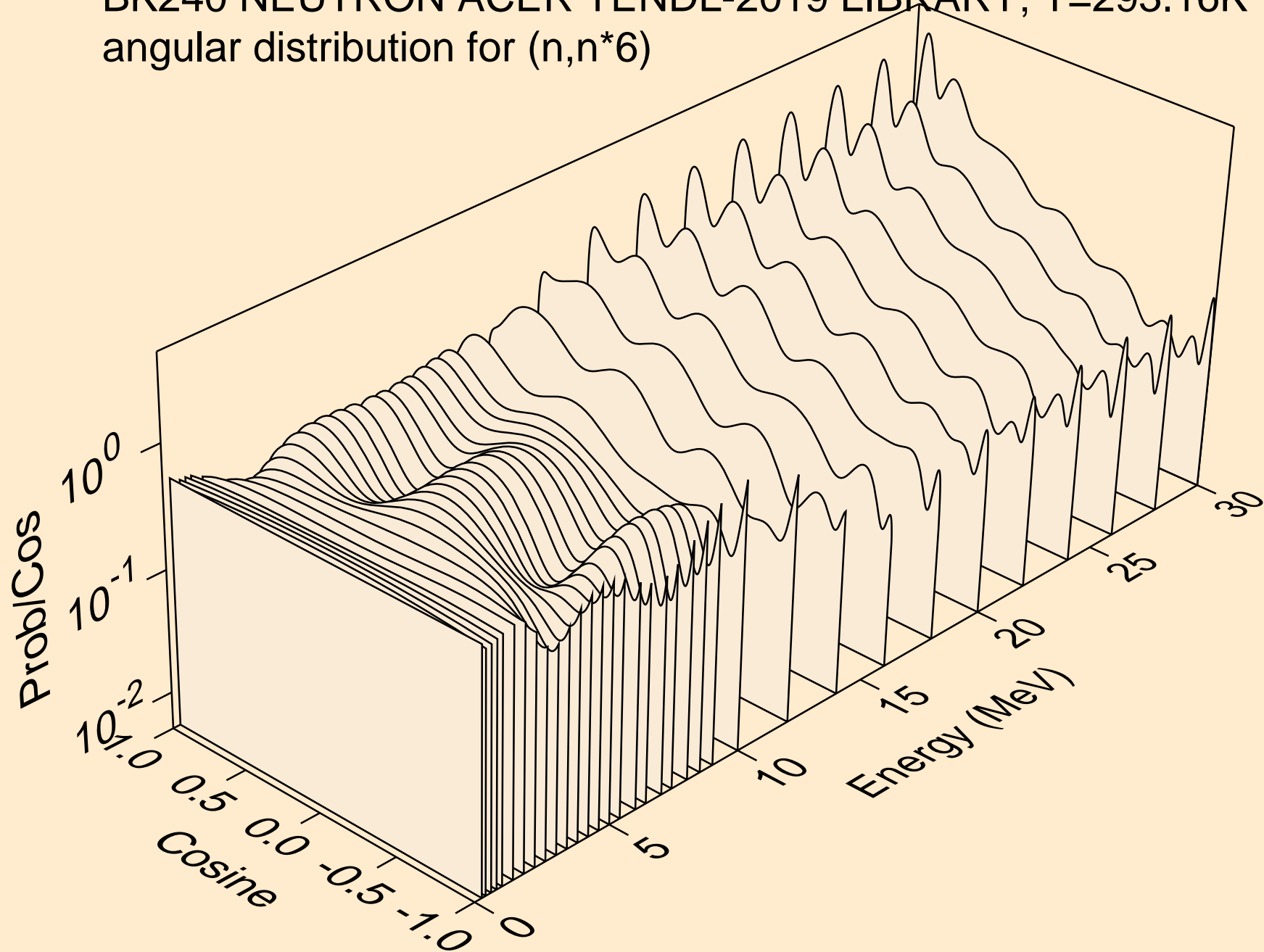

BK240 NEUTRON ACER TENDL-2019 LIBRARY; T=293.16K
angular distribution for (n,n*7)

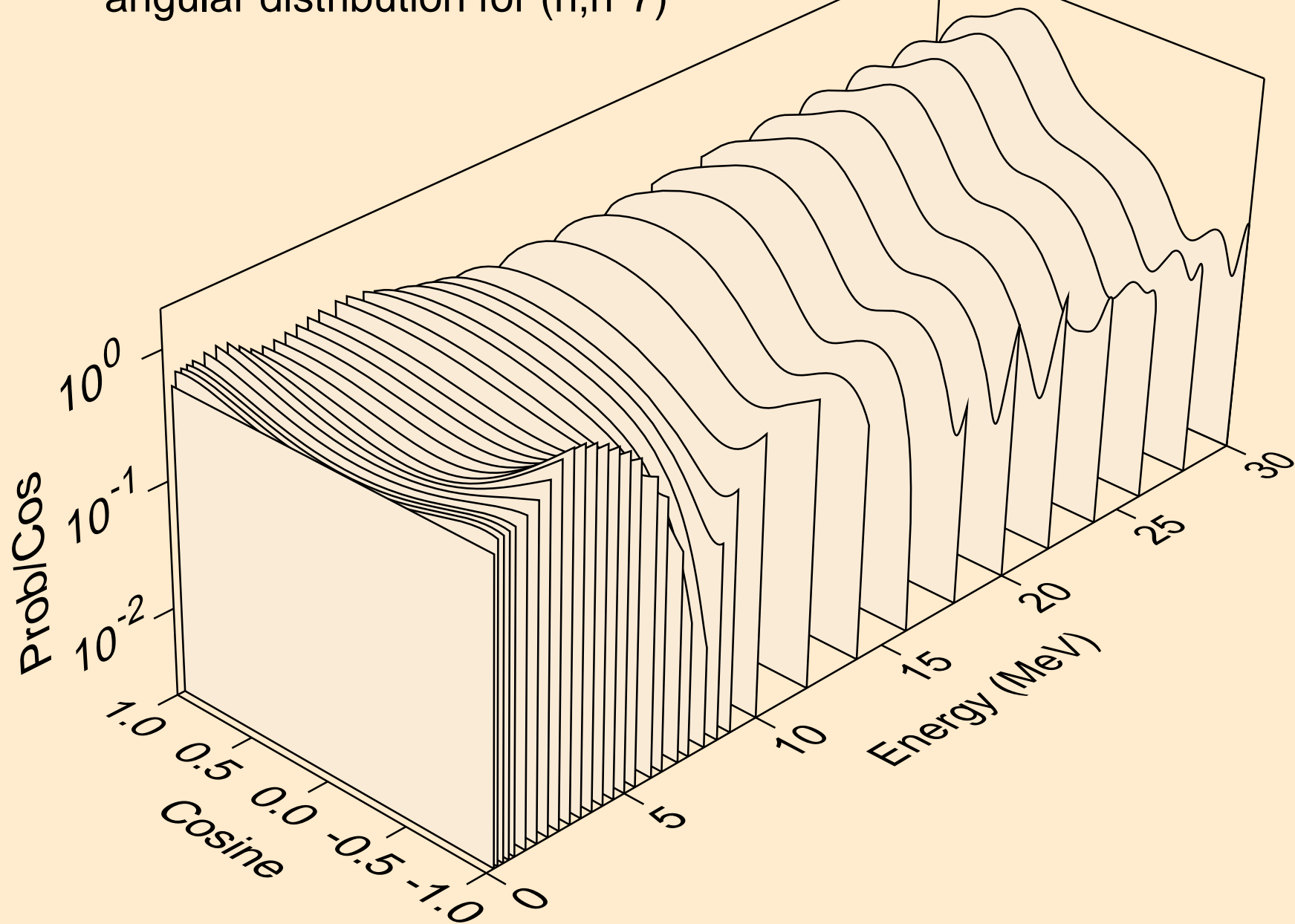

BK240 NEUTRON ACER TENDL-2019 LIBRARY; T=293.16K
angular distribution for (n,n*8)

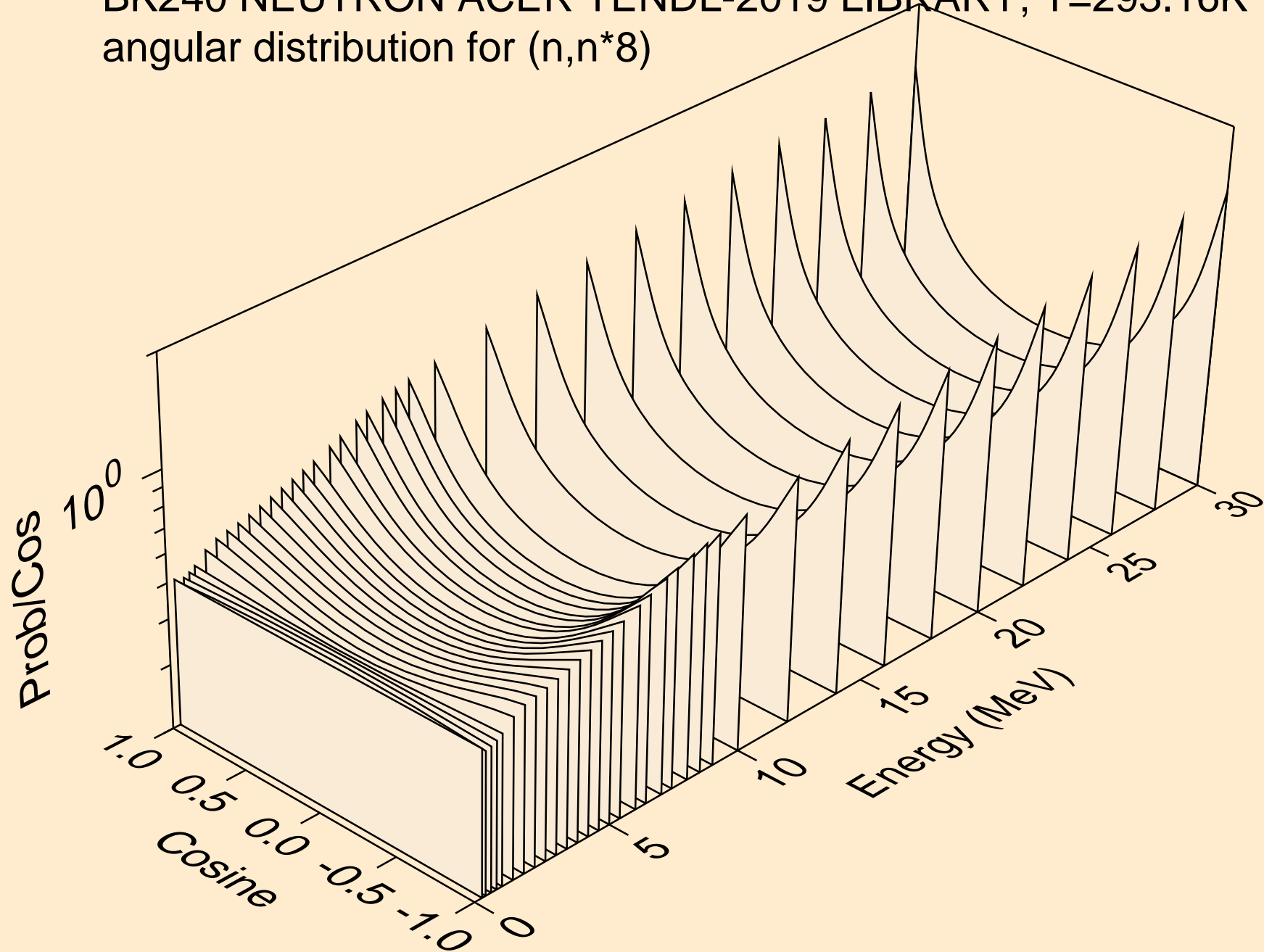

BK240 NEUTRON ACER TENDL-2019 LIBRARY; T=293.16K
angular distribution for (n,n*9)

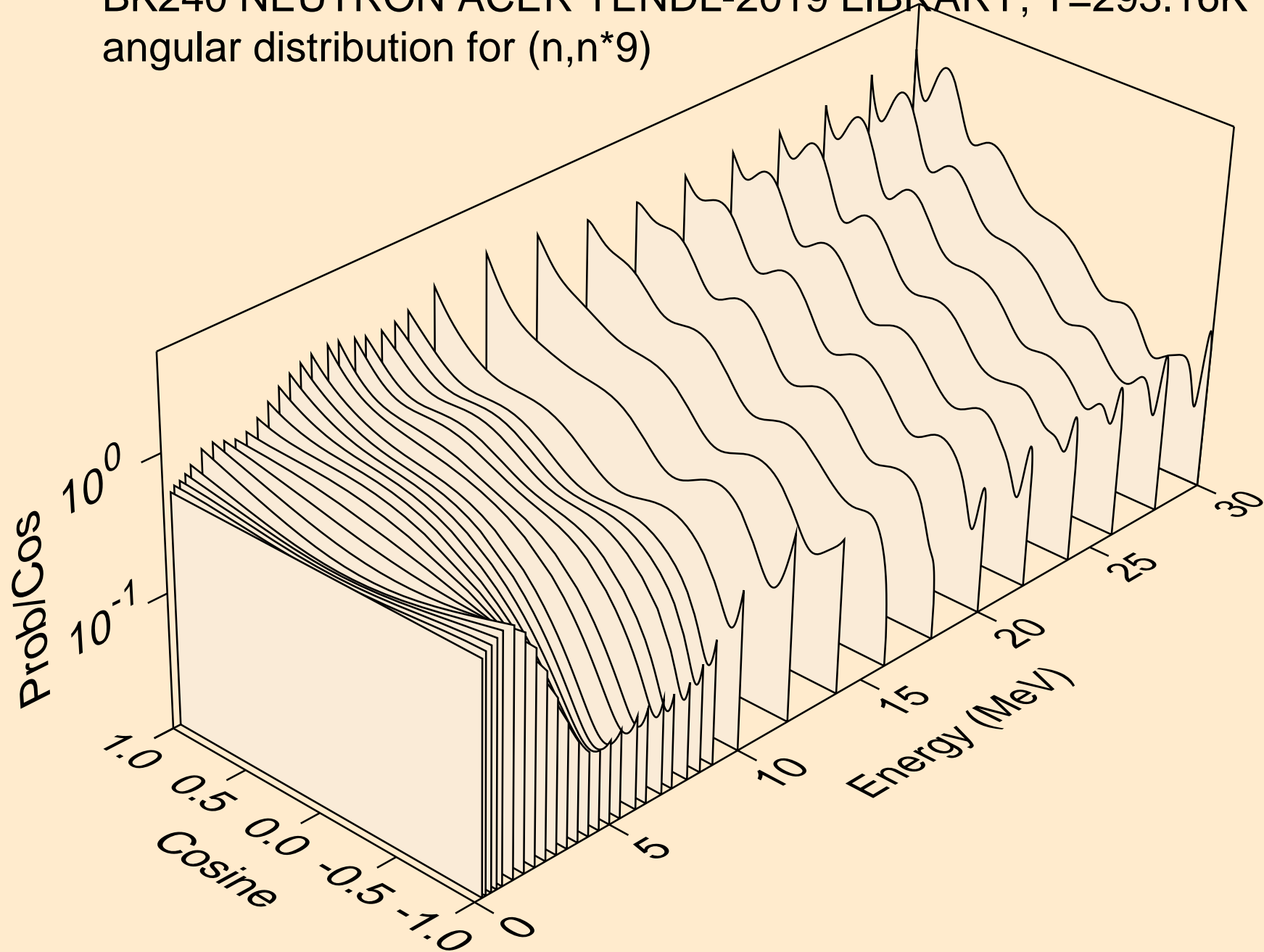

BK240 NEUTRON ACER TENDL-2019 LIBRARY; T=293.16K
angular distribution for (n,n*10)

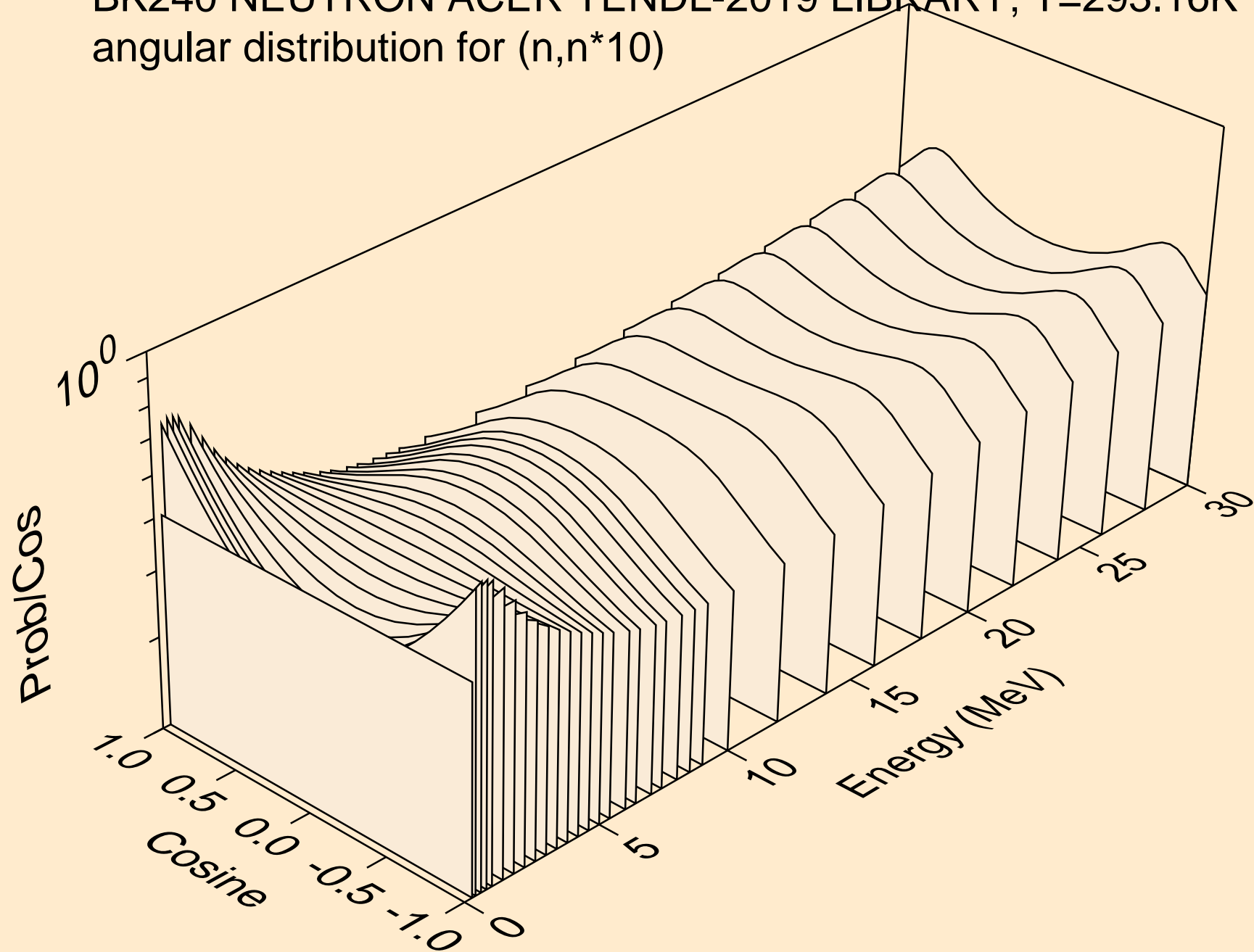

BK240 NEUTRON ACER TENDL-2019 LIBRARY; T=293.16K
angular distribution for (n,n*11)

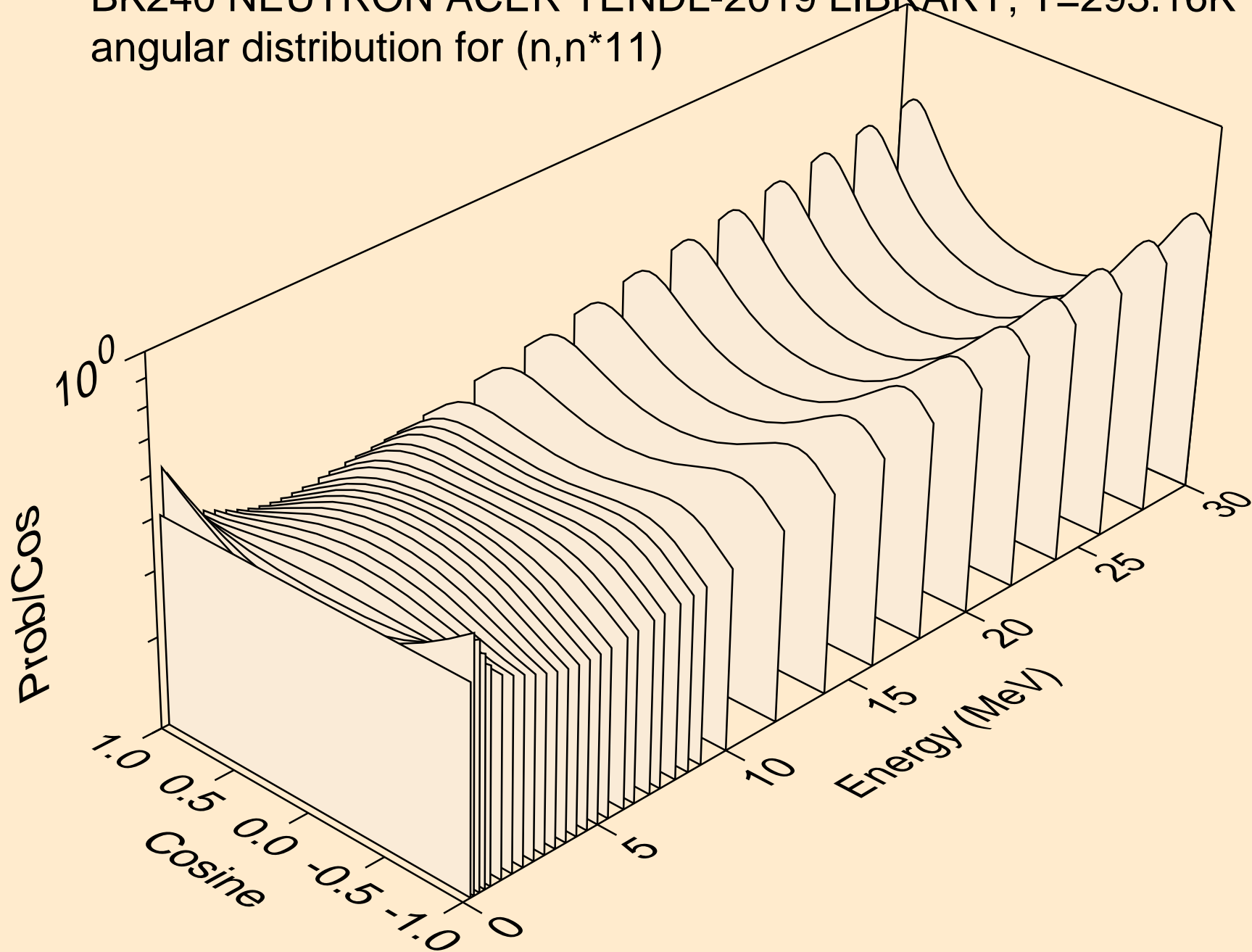

BK240 NEUTRON ACER TENDL-2019 LIBRARY; T=293.16K
angular distribution for (n,n*12)

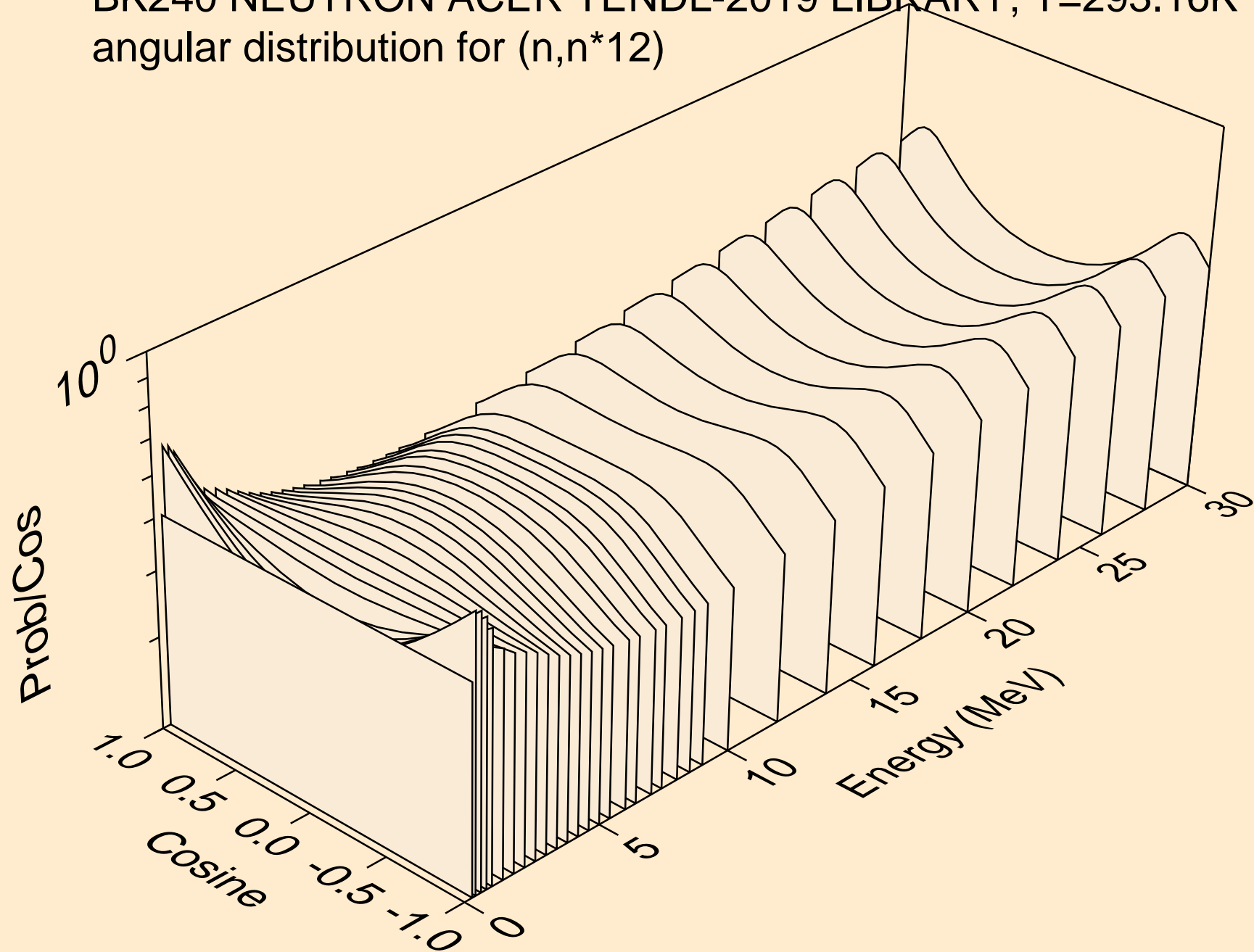

BK240 NEUTRON ACER TENDL-2019 LIBRARY; T=293.16K
angular distribution for (n,n*13)

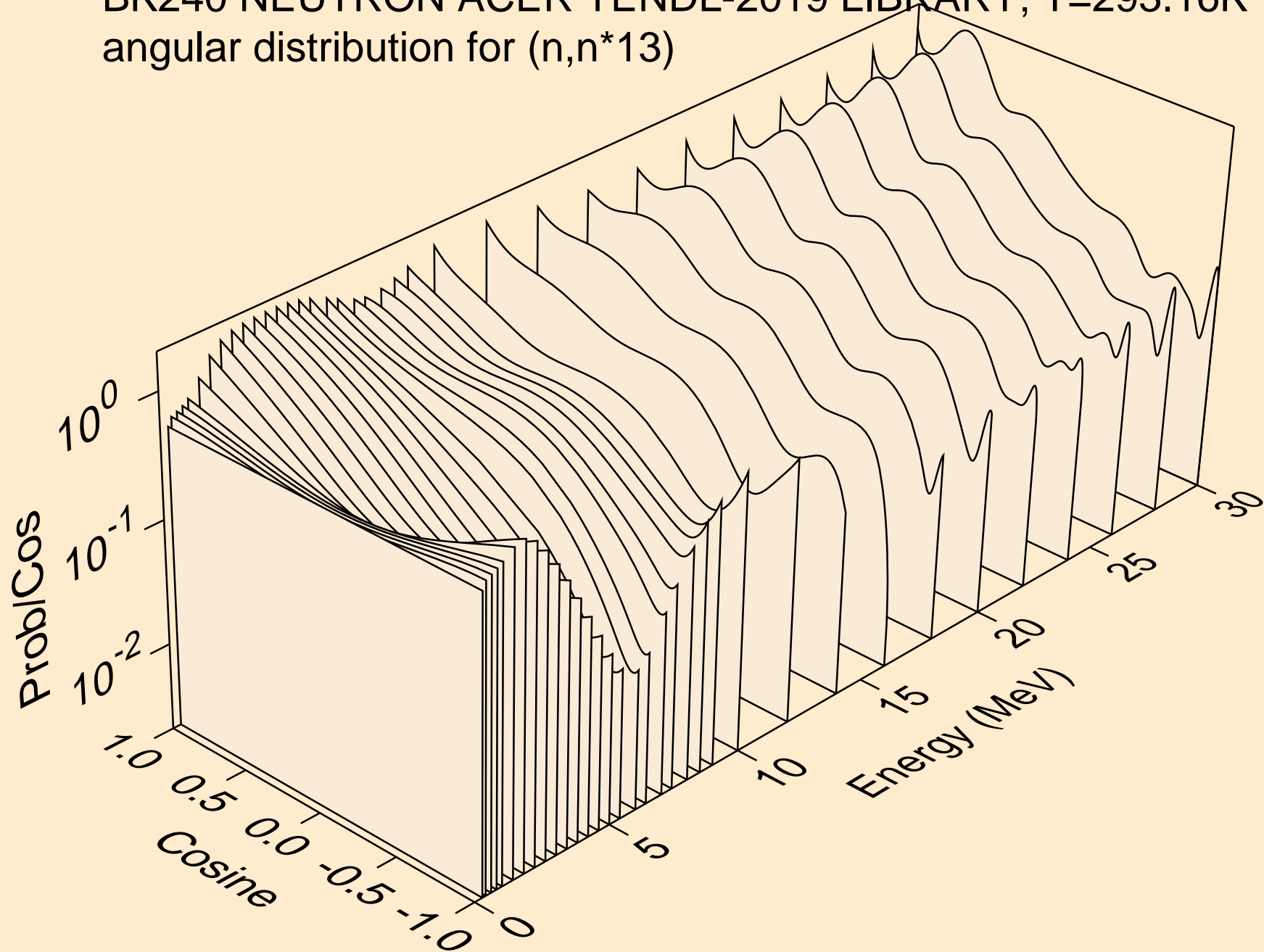

BK240 NEUTRON ACER TENDL-2019 LIBRARY; T=293.16K
angular distribution for (n,n*14)

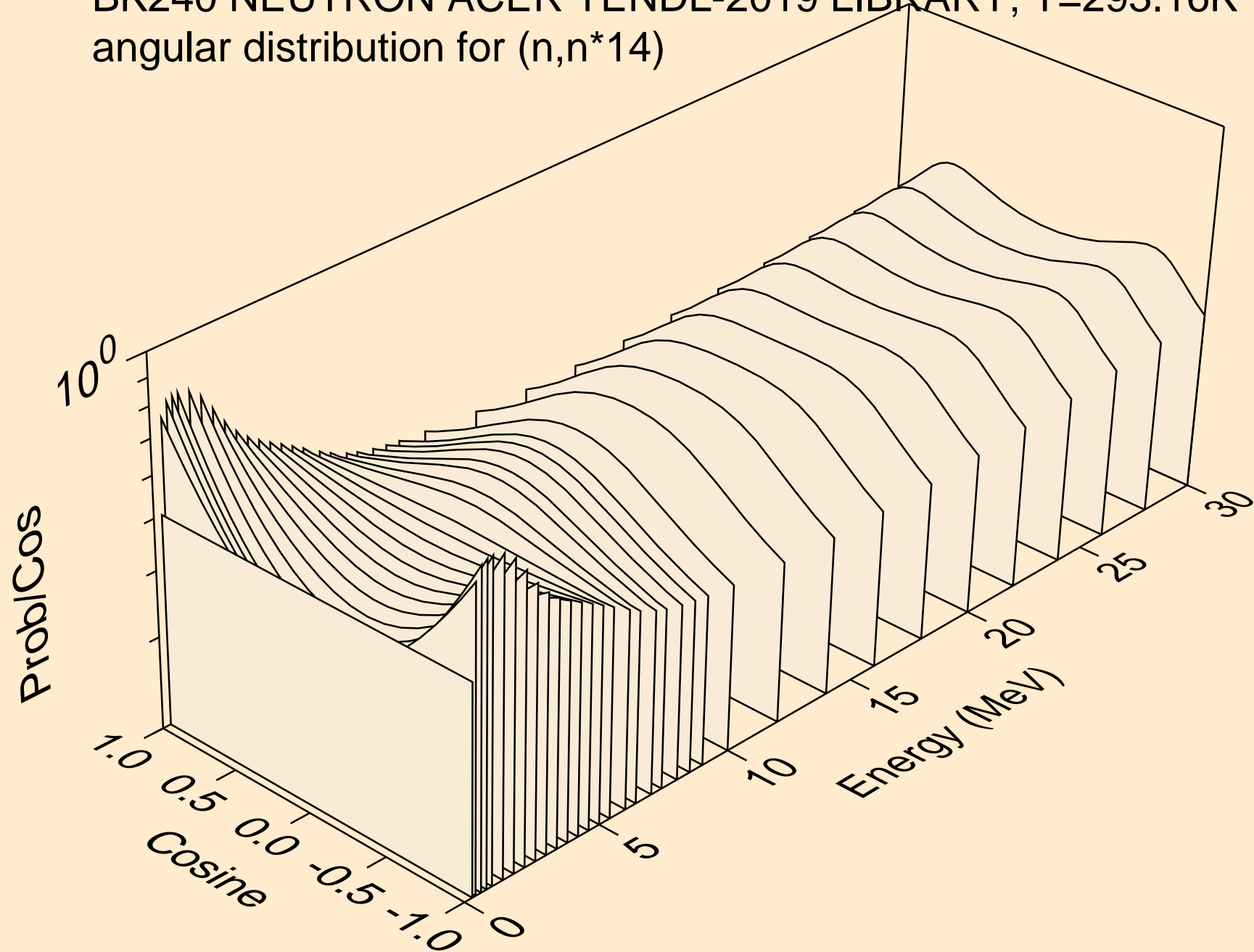

BK240 NEUTRON ACER TENDL-2019 LIBRARY; T=293.16K
angular distribution for (n,n*15)

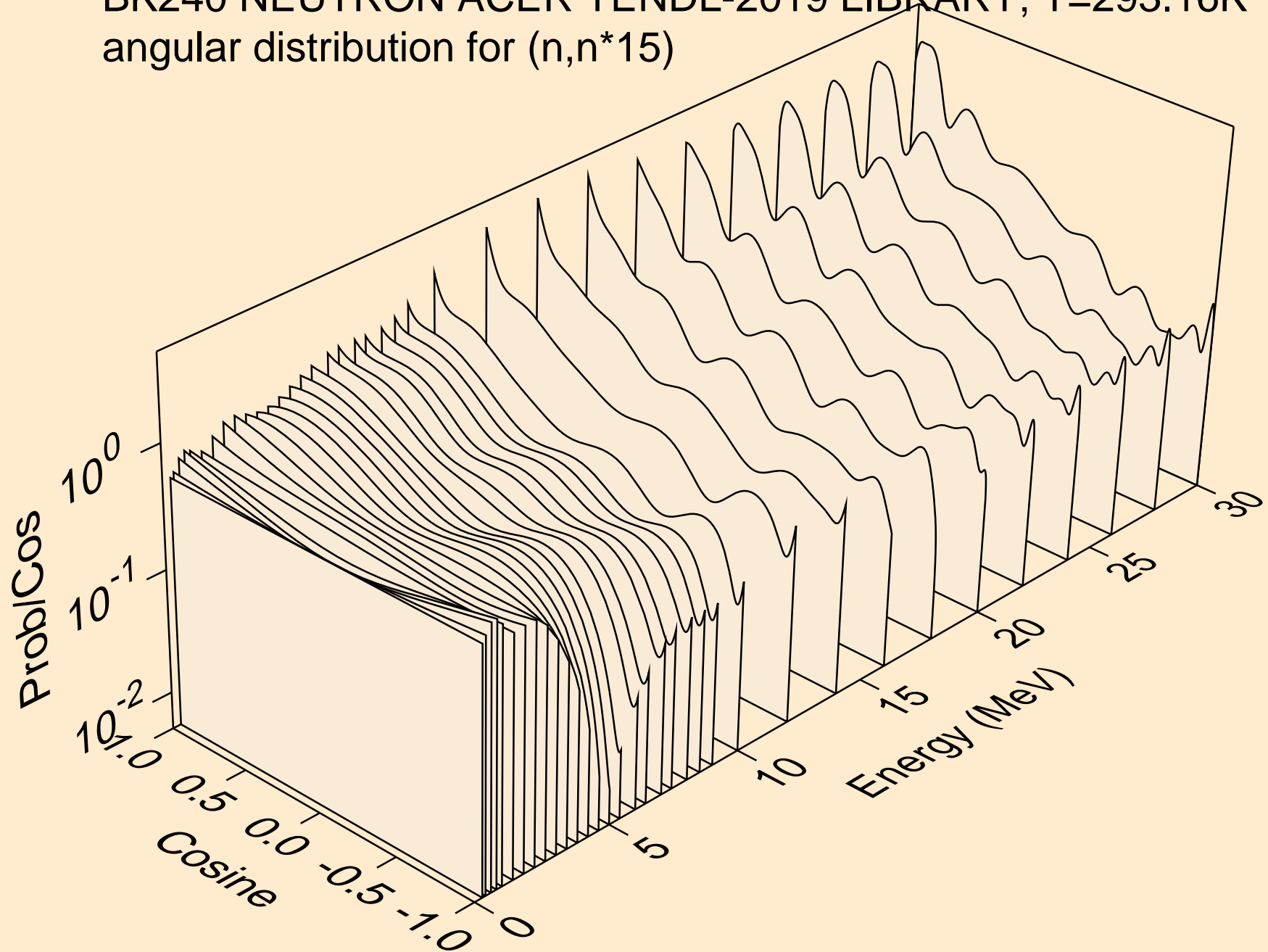

BK240 NEUTRON ACER TENDL-2019 LIBRARY; T=293.16K
angular distribution for (n,n*16)

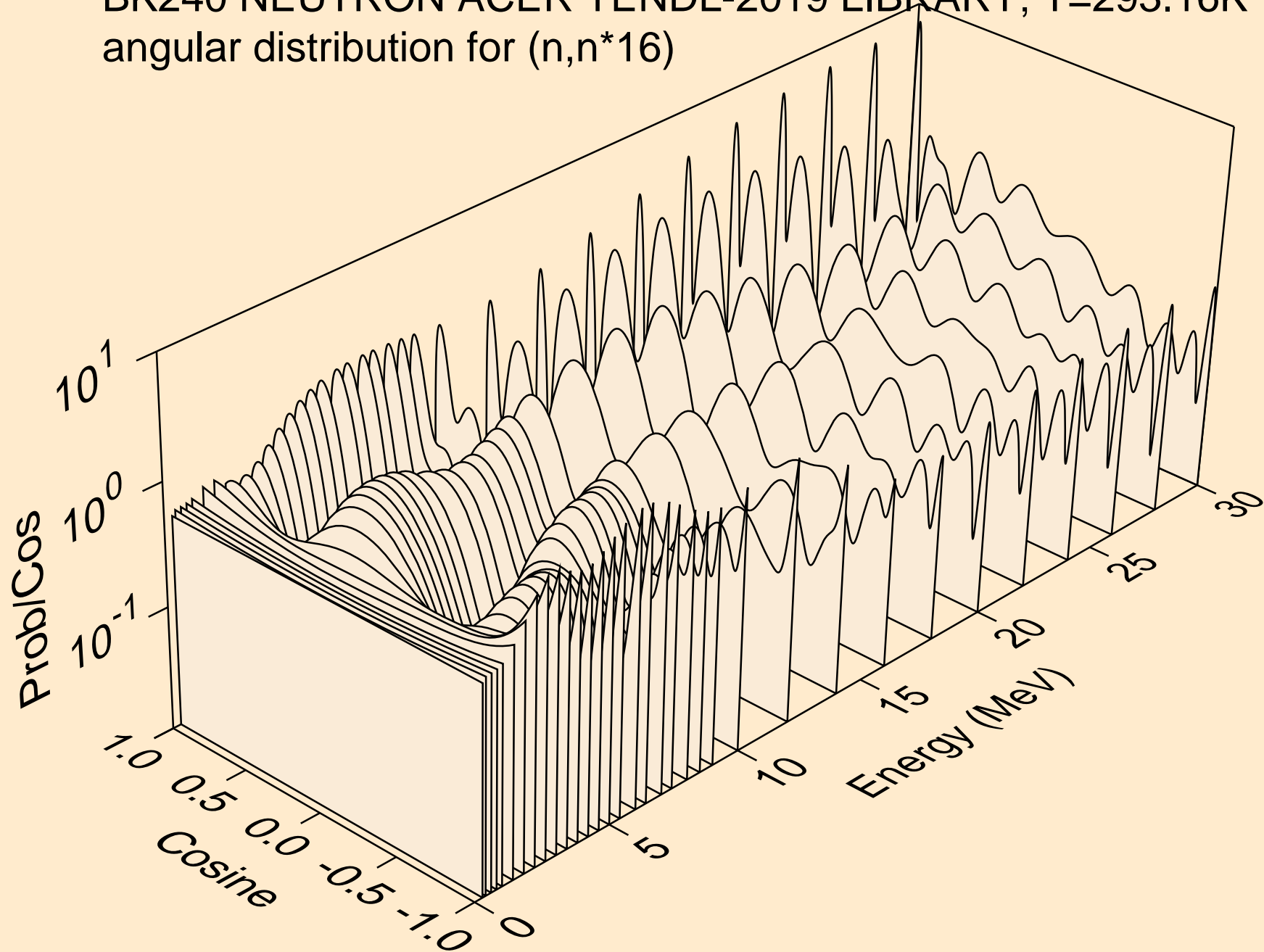

BK240 NEUTRON ACER TENDL-2019 LIBRARY; T=293.16K
angular distribution for (n,n*17)

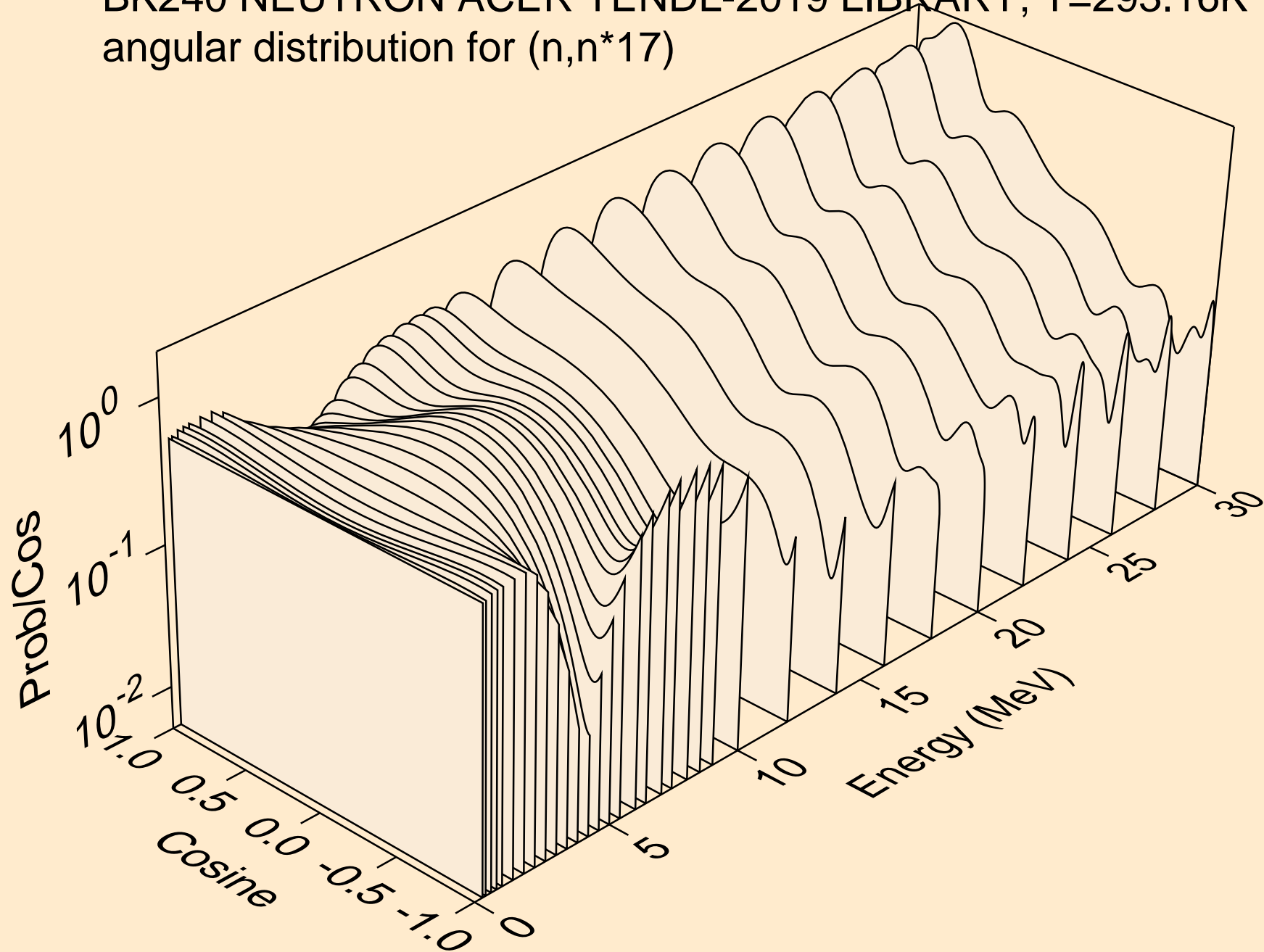

BK240 NEUTRON ACER TENDL-2019 LIBRARY; T=293.16K
angular distribution for (n,n*18)

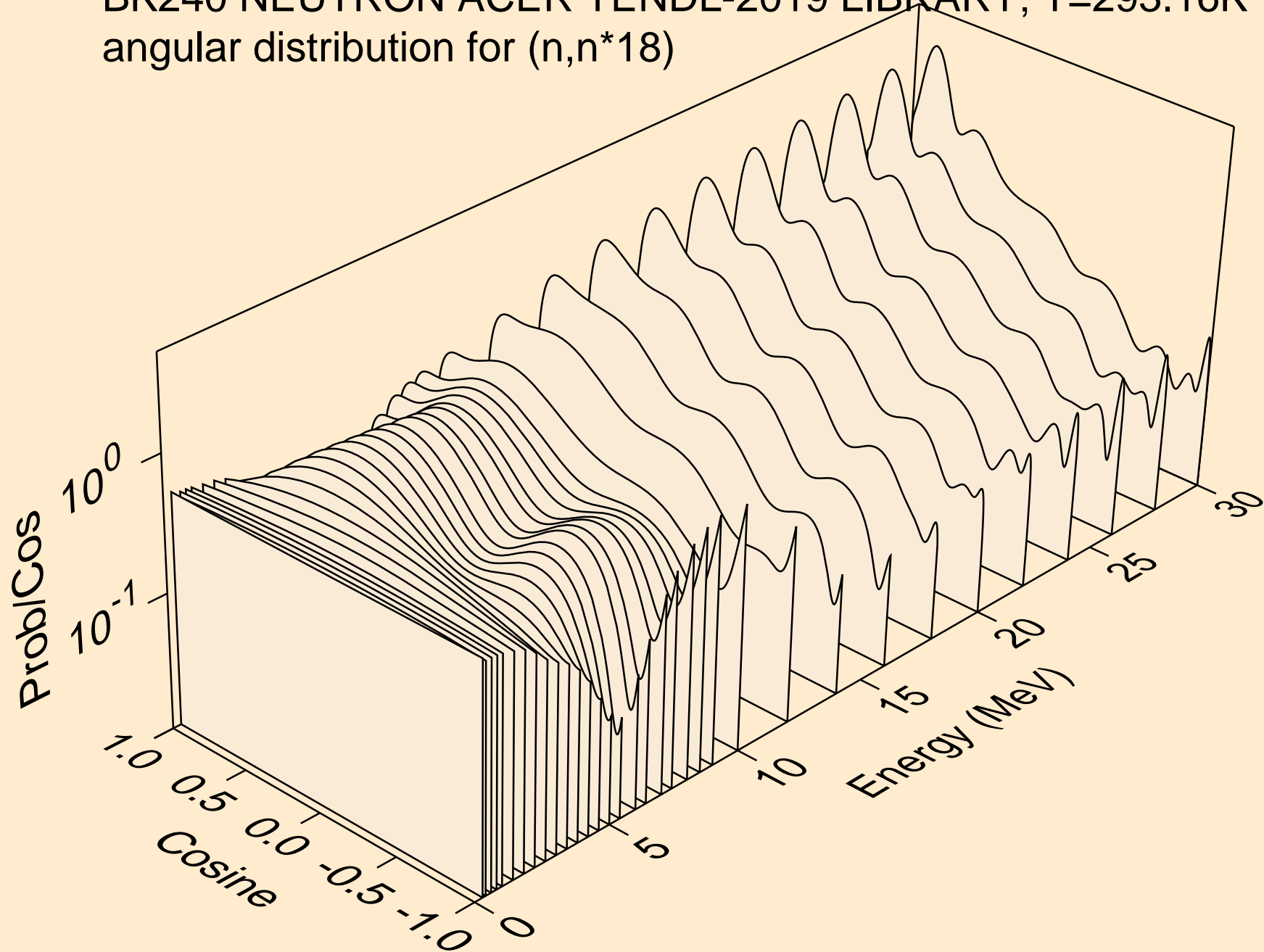

BK240 NEUTRON ACER TENDL-2019 LIBRARY; T=293.16K
angular distribution for (n,n*19)

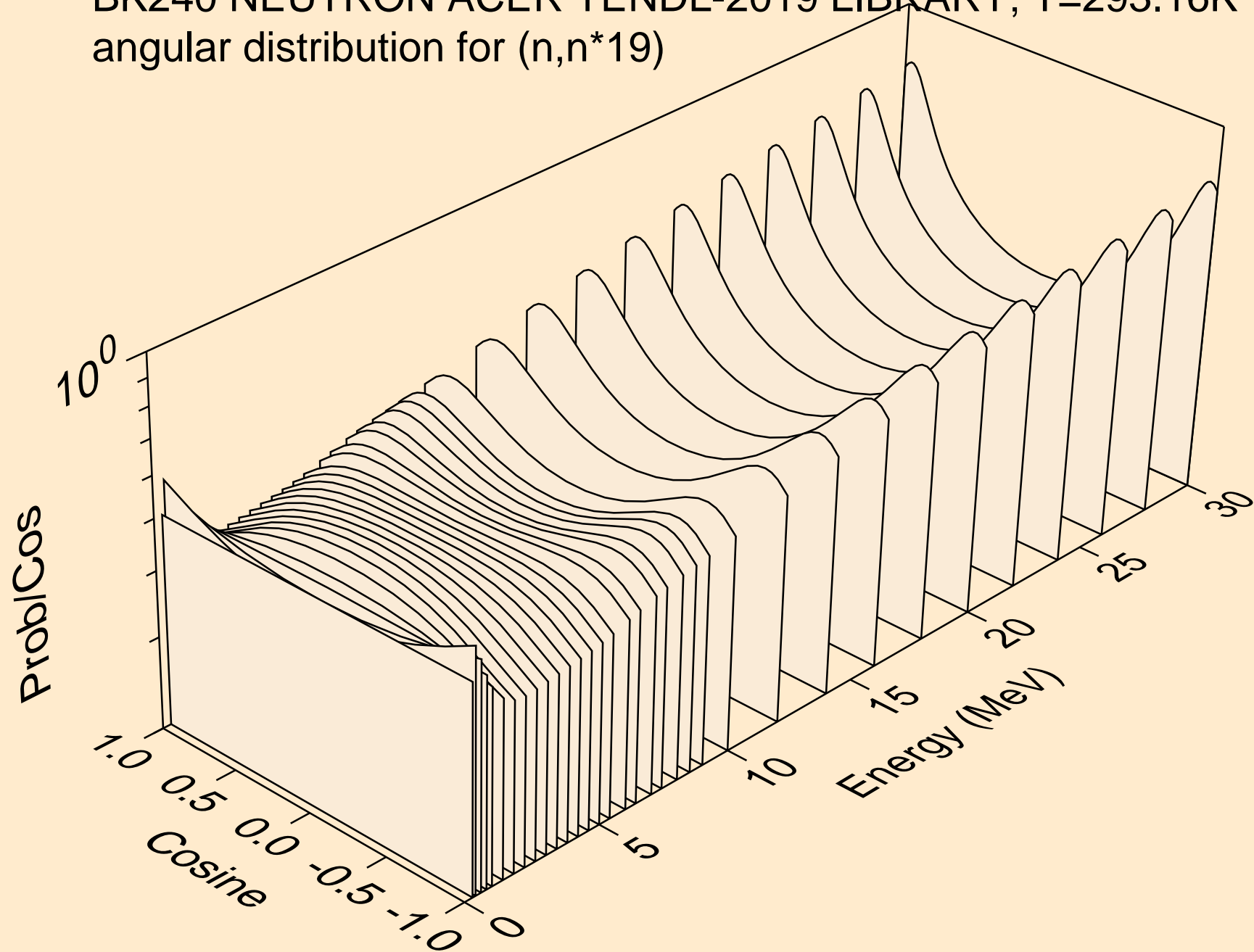

BK240 NEUTRON ACER TENDL-2019 LIBRARY; T=293.16K
angular distribution for (n,n*20)

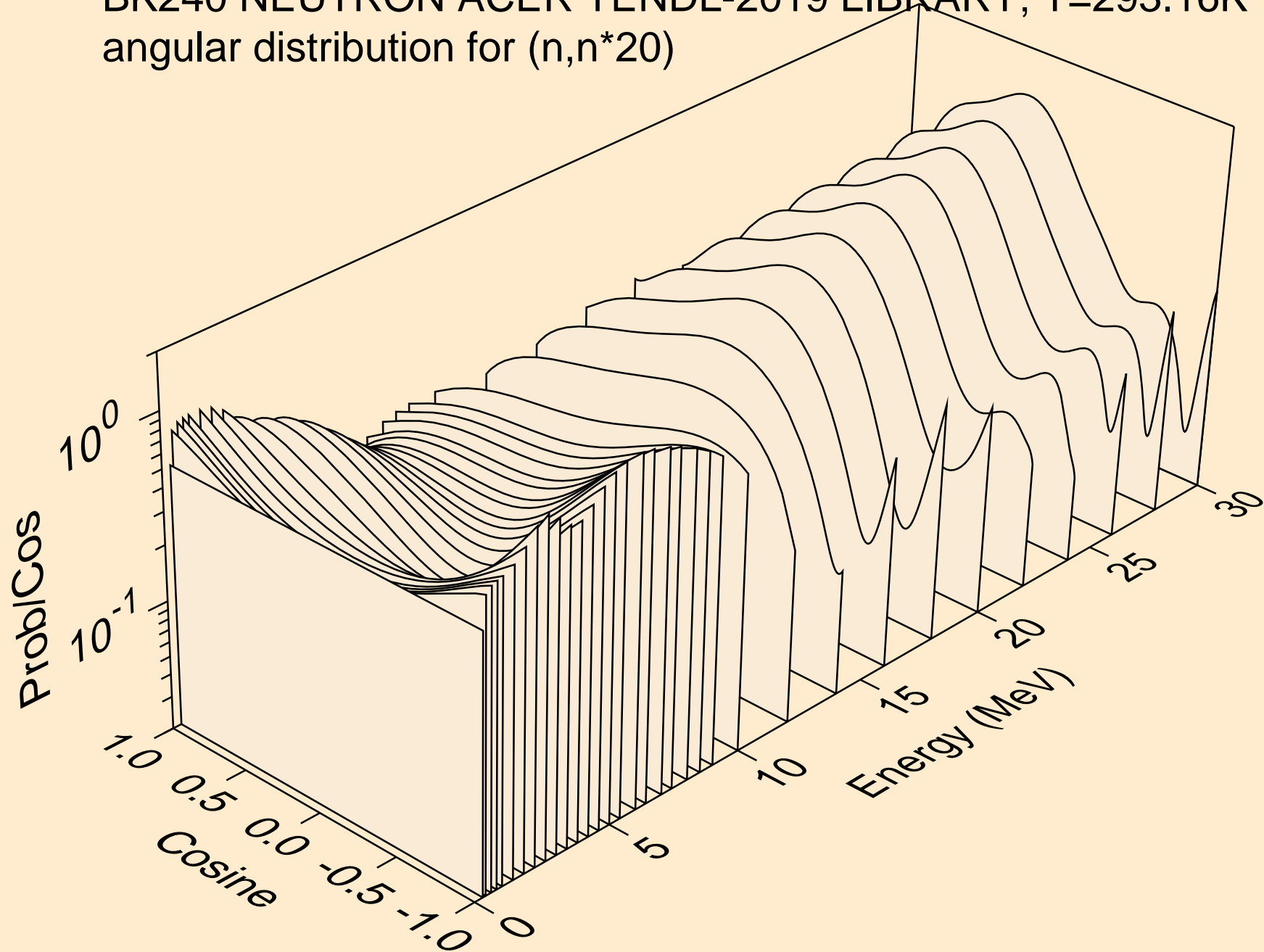

BK240 NEUTRON ACER TENDL-2019 LIBRARY; T=293.16K
angular distribution for (n,n*21)

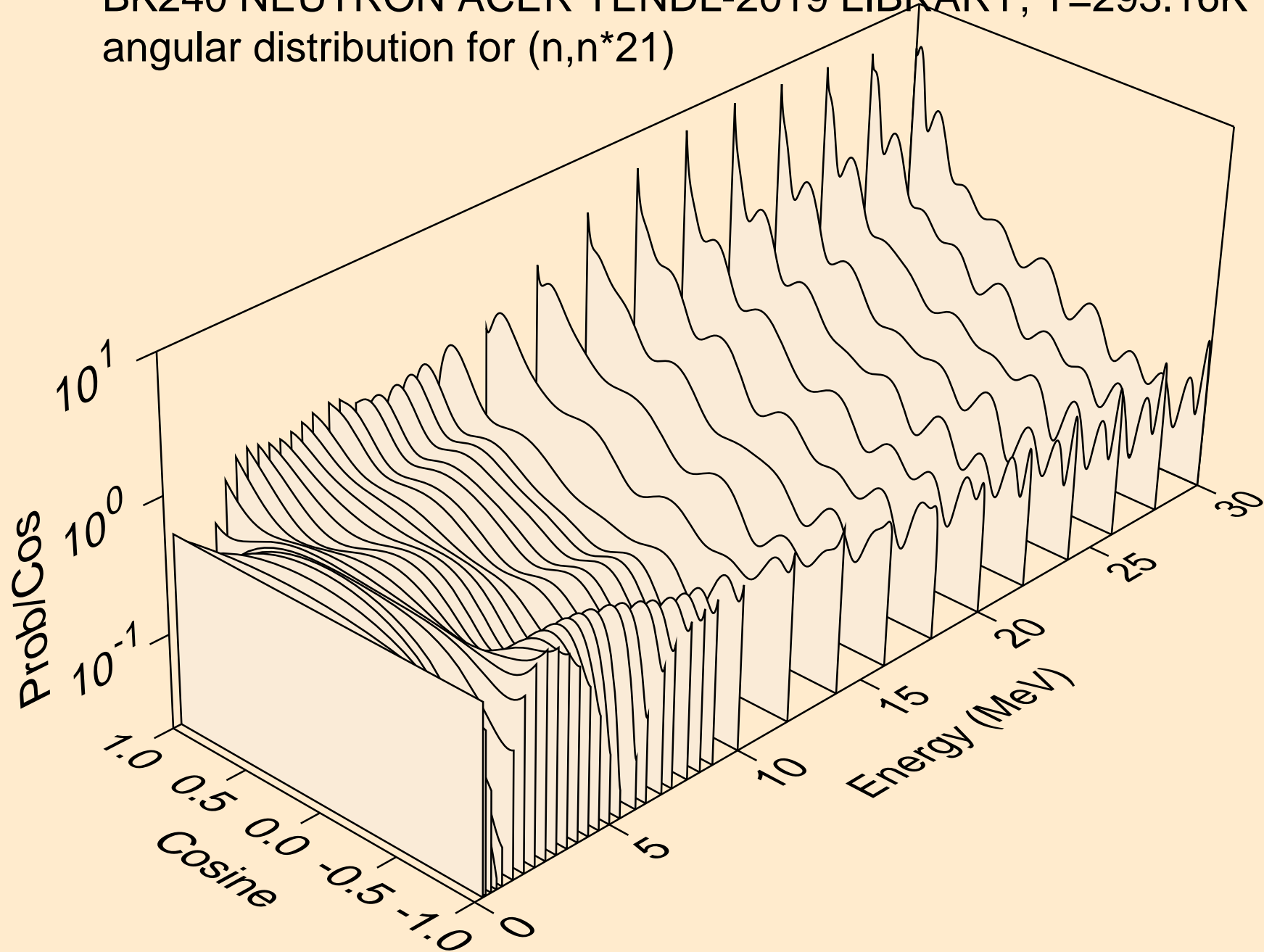

BK240 NEUTRON ACER TENDL-2019 LIBRARY; T=293.16K
angular distribution for (n,n*22)

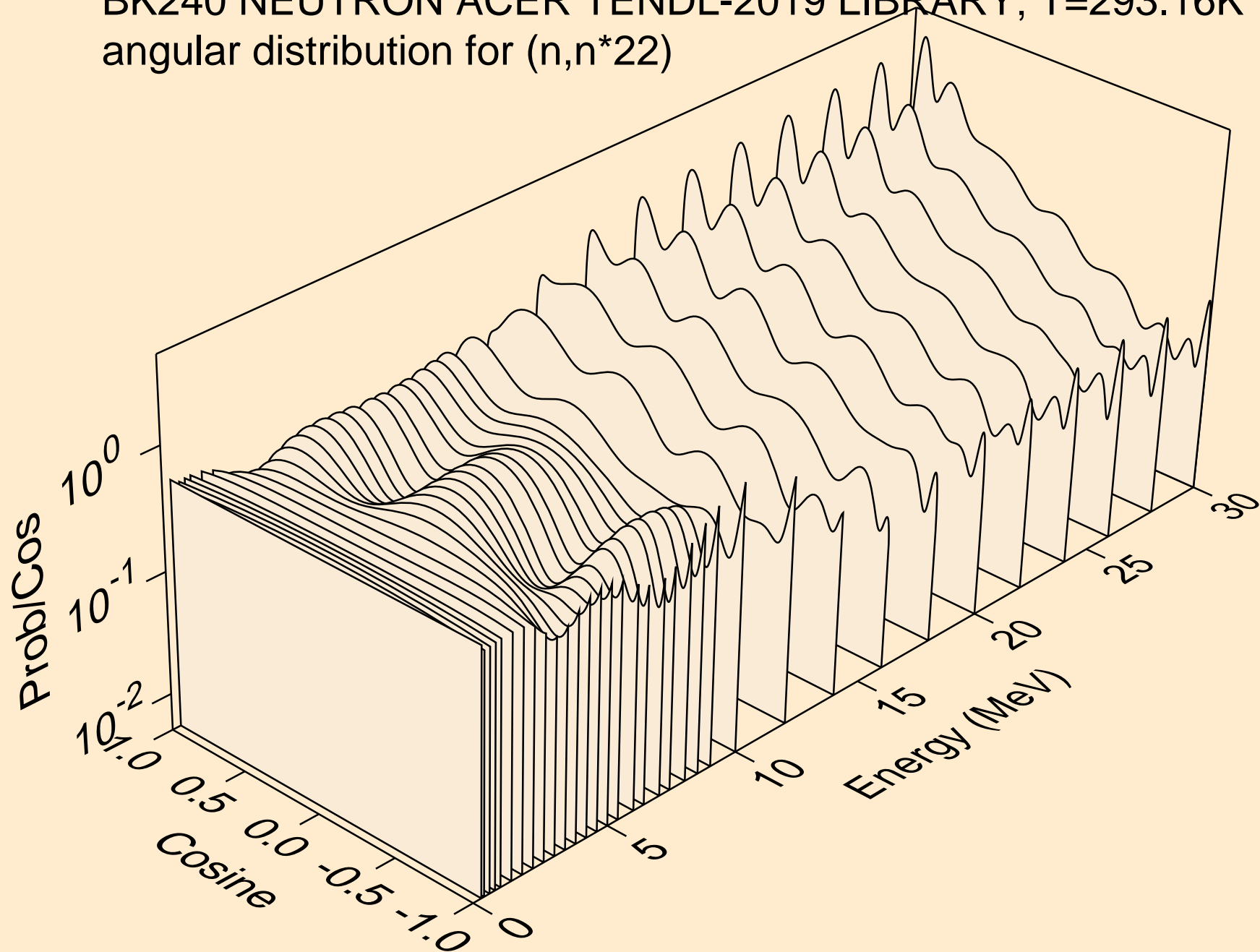

BK240 NEUTRON ACER TENDL-2019 LIBRARY; T=293.16K
angular distribution for (n,n*23)

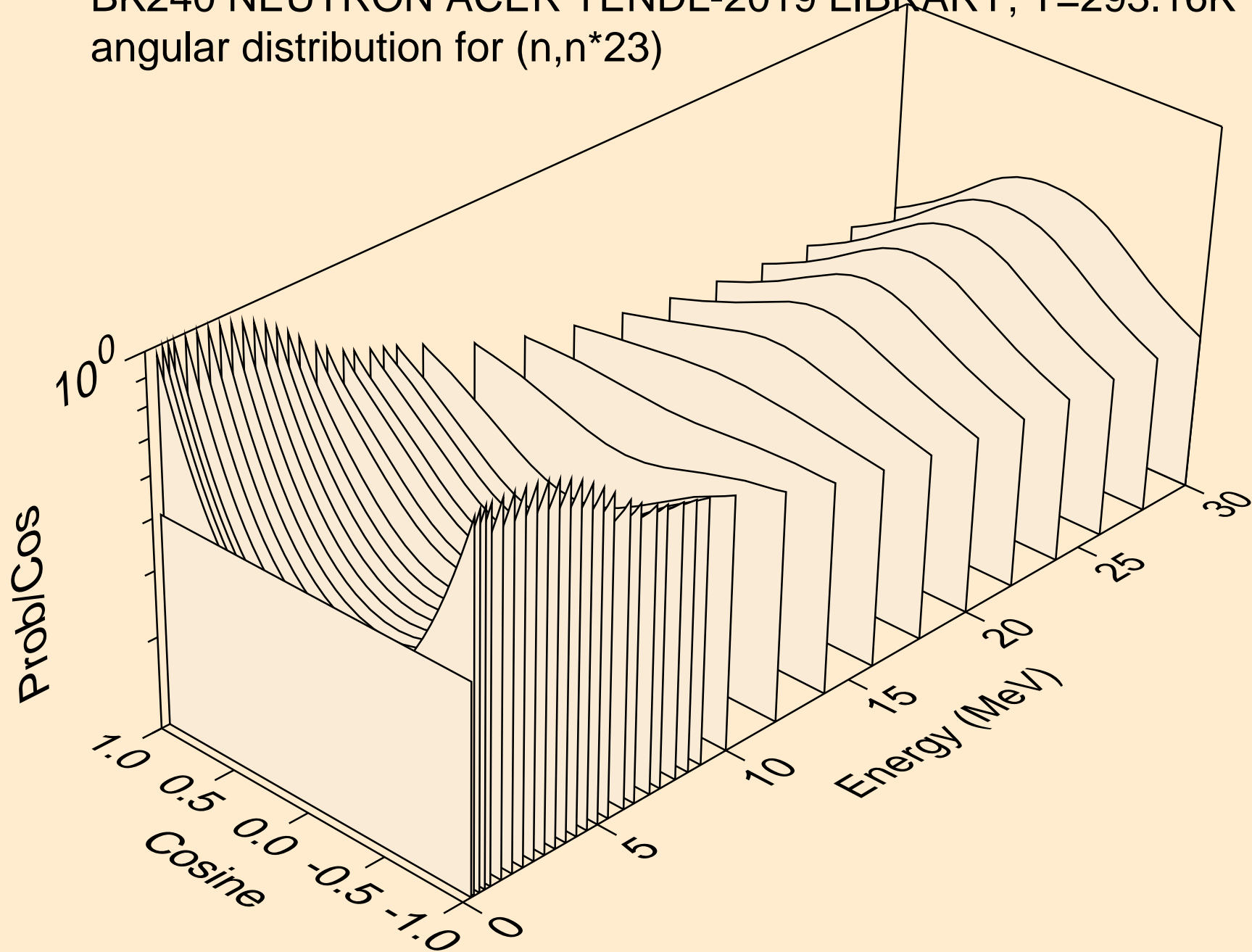

BK240 NEUTRON ACER TENDL-2019 LIBRARY; T=293.16K
angular distribution for (n,n*24)

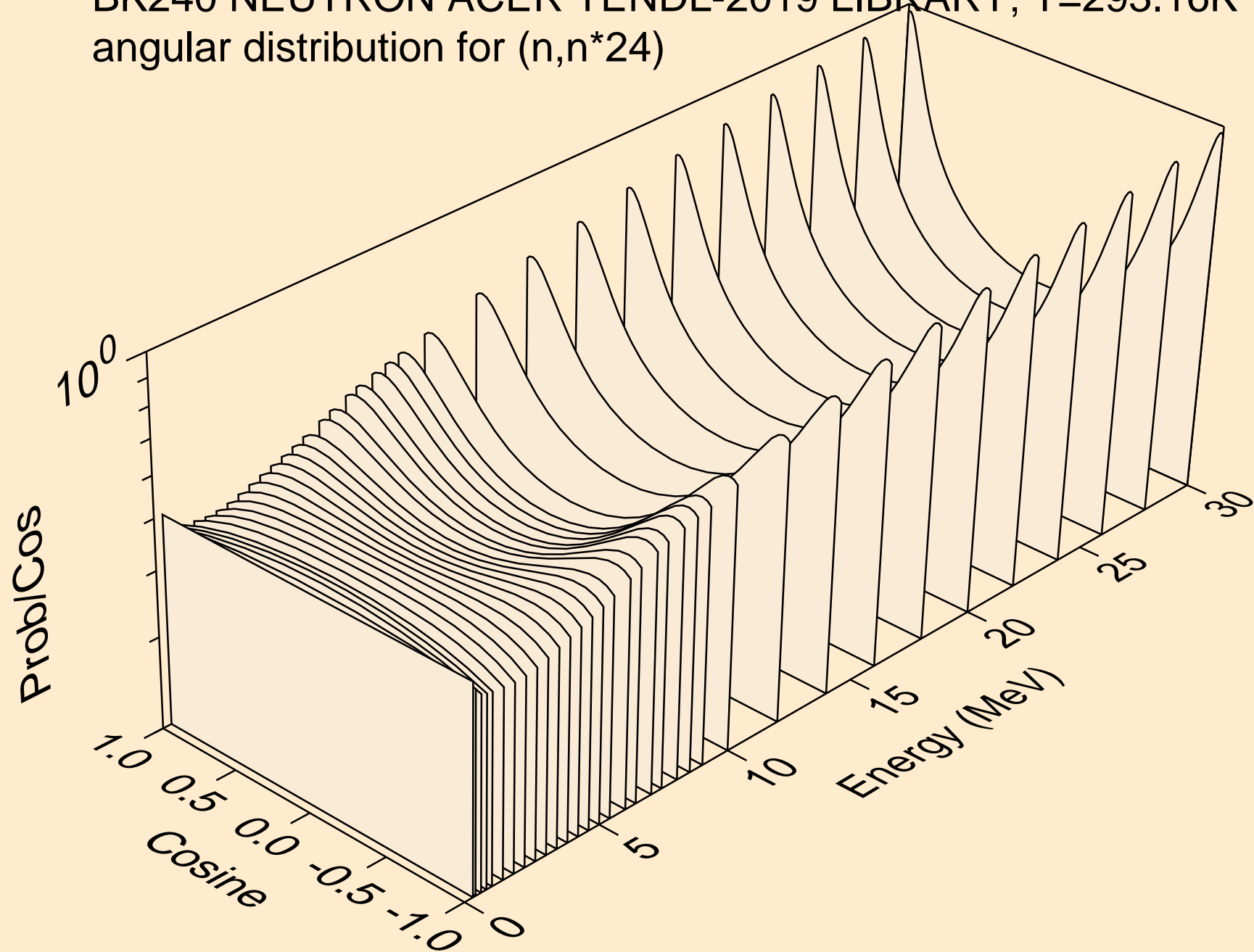

BK240 NEUTRON ACER TENDL-2019 LIBRARY; T=293.16K
Total fission nubar

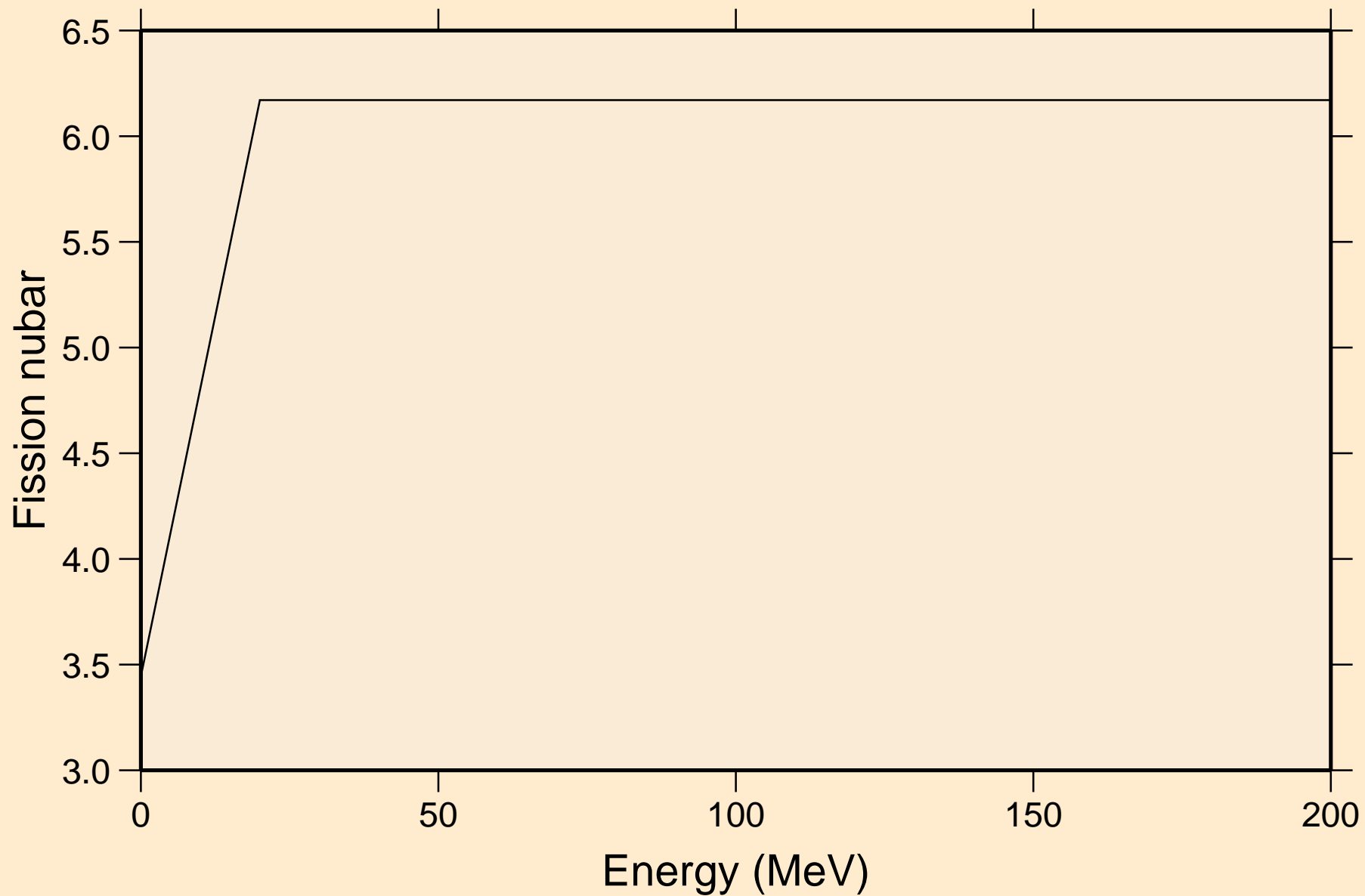

BK240 NEUTRON ACER TENDL-2019 LIBRARY; T=293.16K
Neutron emission for (n,x)

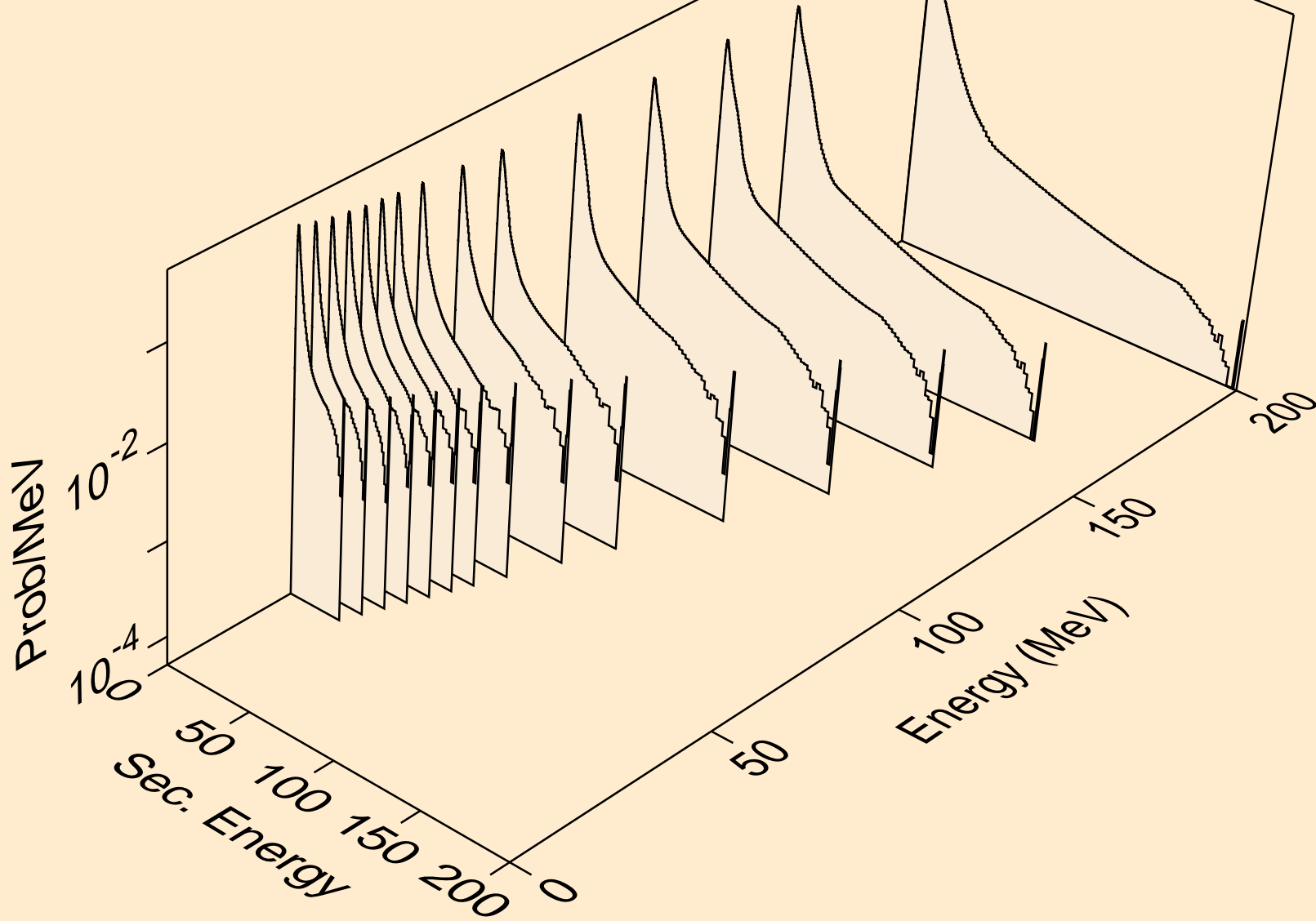

BK240 NEUTRON ACER TENDL-2019 LIBRARY; T=293.16K
Neutron emission for (n,2nd)

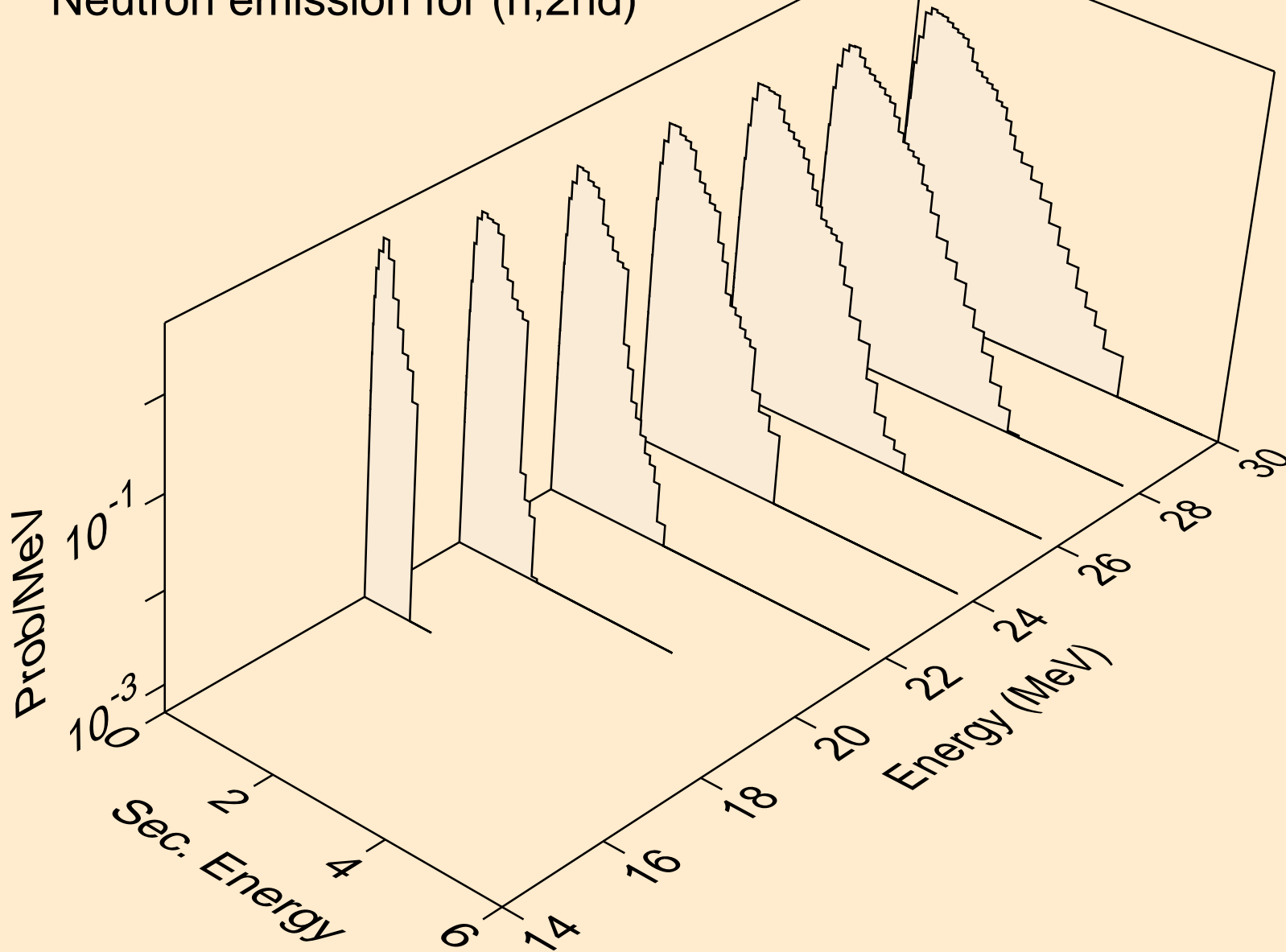

BK240 NEUTRON ACER TENDL-2019 LIBRARY; T=293.16K
Neutron emission for (n,2n)

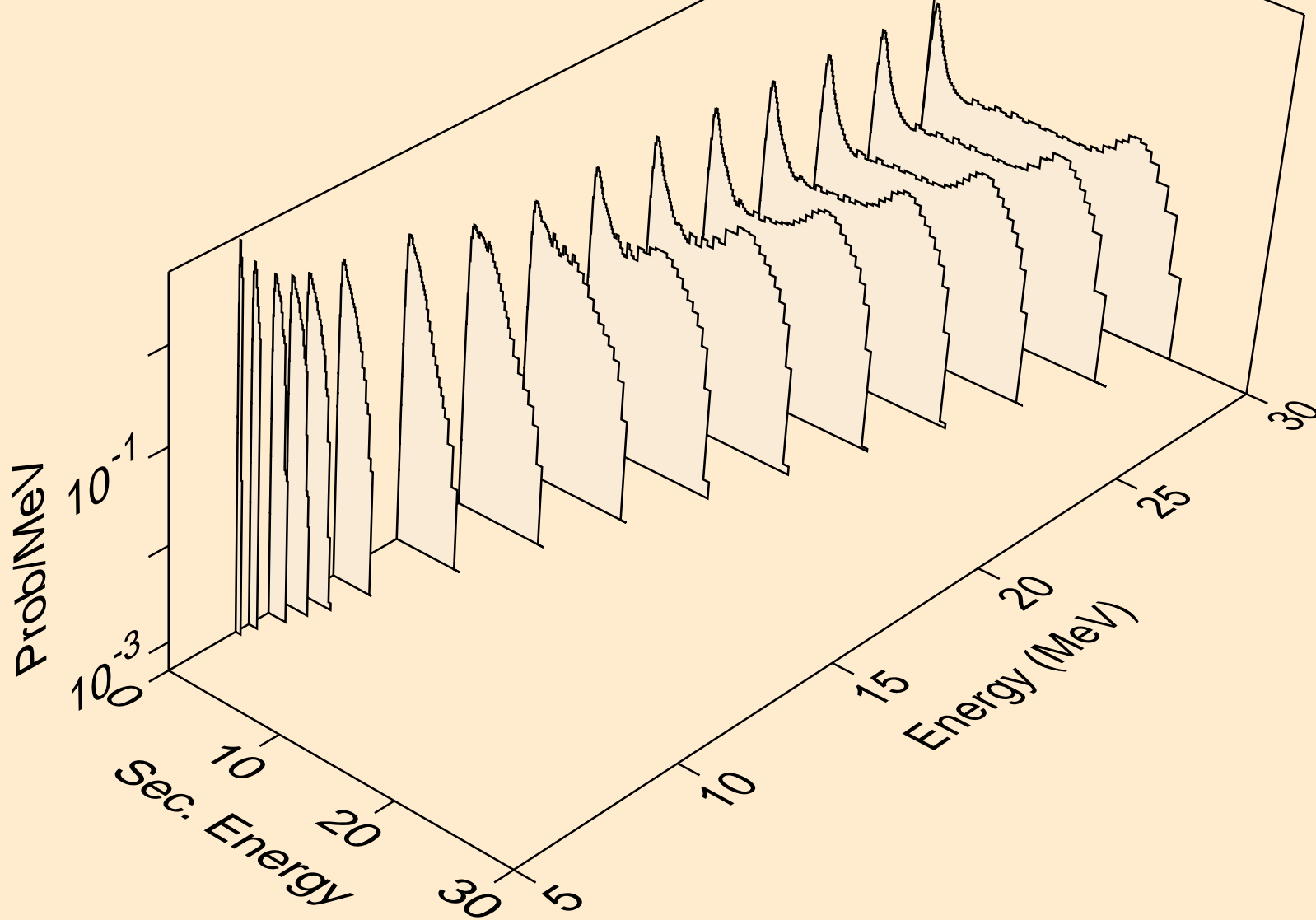

BK240 NEUTRON ACER TENDL-2019 LIBRARY; T=293.16K
Neutron emission for (n,3n)

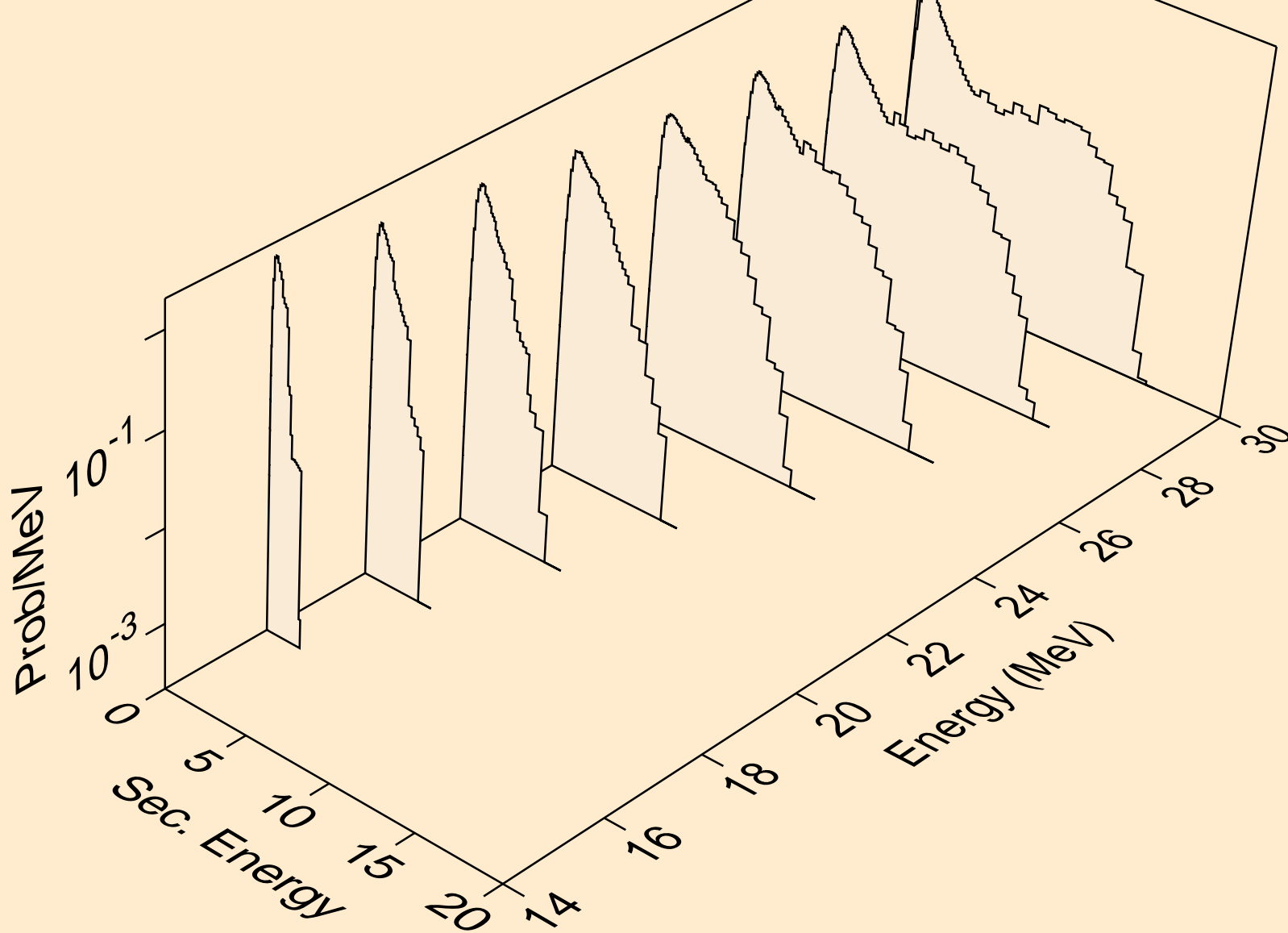

BK240 NEUTRON ACER TENDL-2019 LIBRARY; T=293.16K
Neutron emission for fission

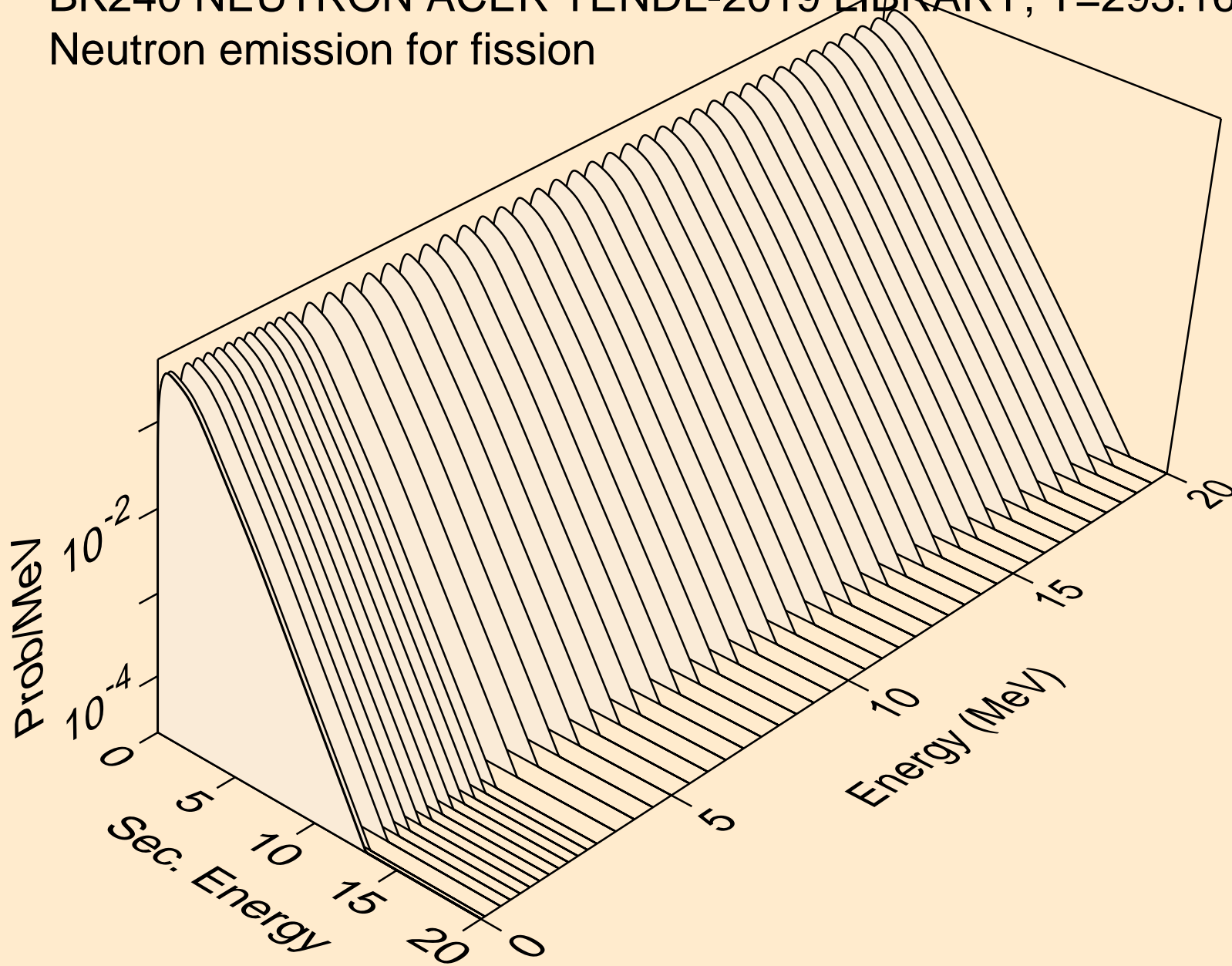

BK240 NEUTRON ACER TENDL-2019 LIBRARY; T=293.16K
Neutron emission for (n,n*)a

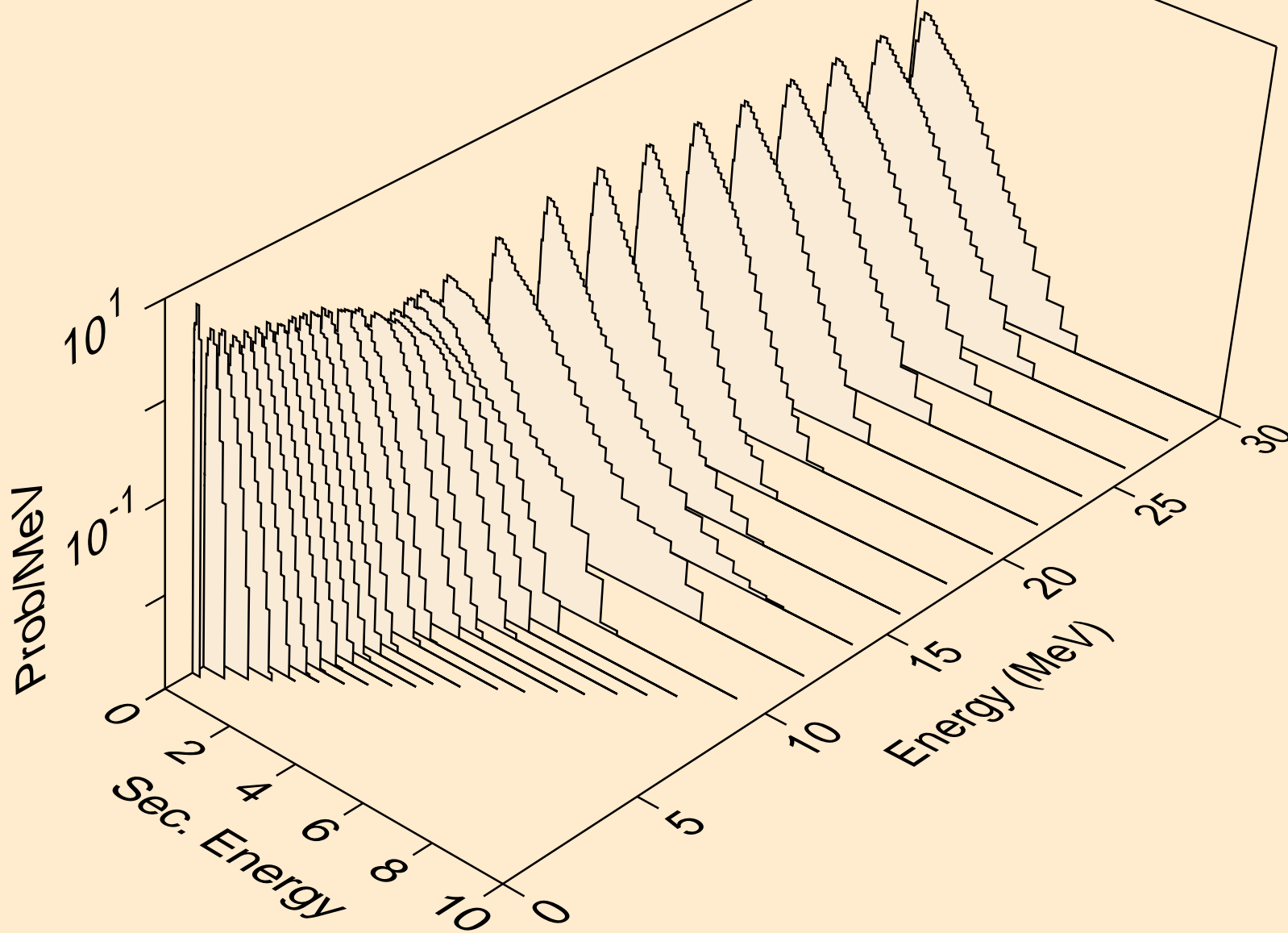

BK240 NEUTRON ACER TENDL-2019 LIBRARY; T=293.16K
Neutron emission for (n,2n)a

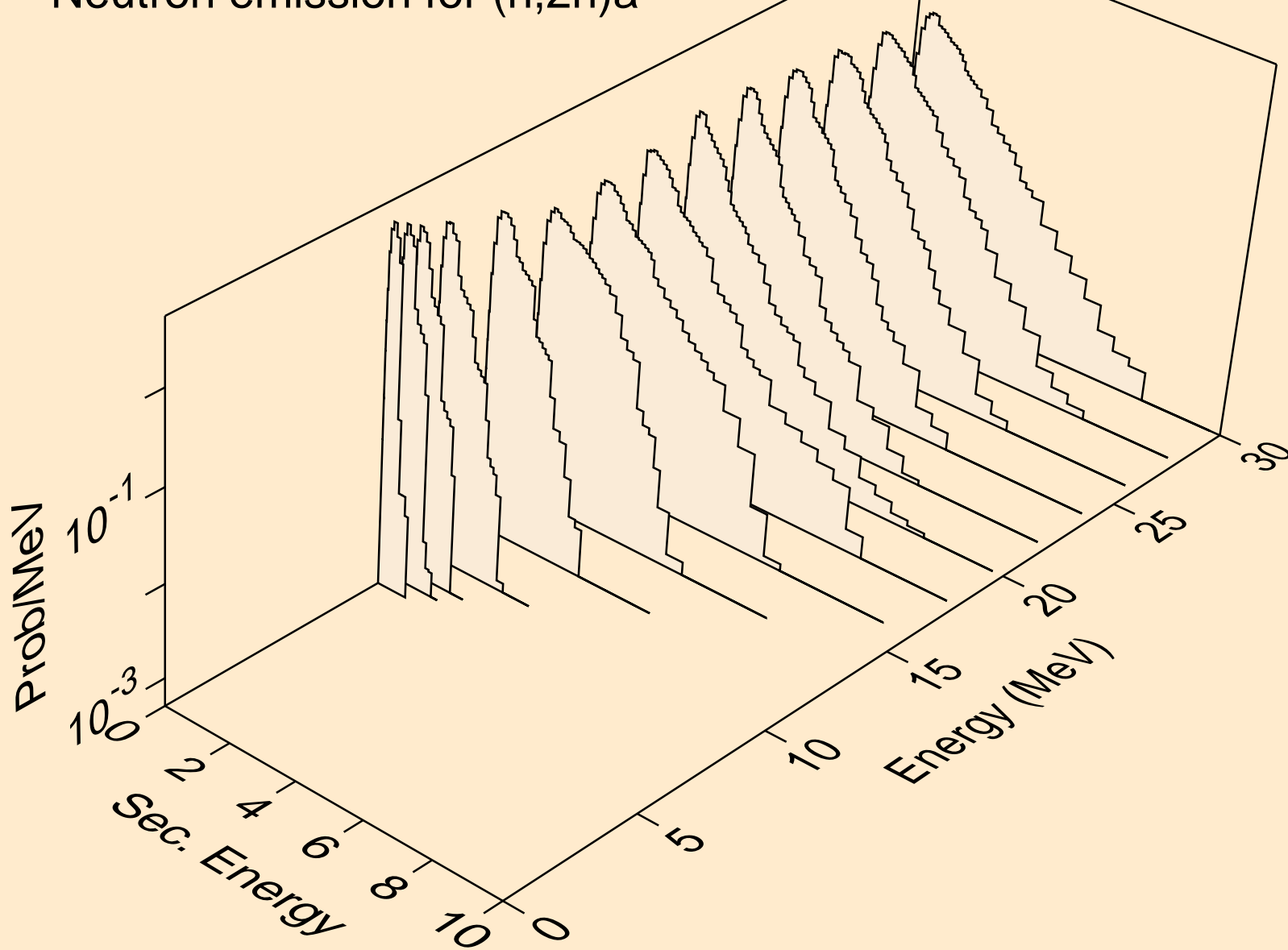

BK240 NEUTRON ACER TENDL-2019 LIBRARY; T=293.16K
Neutron emission for (n,3n)a

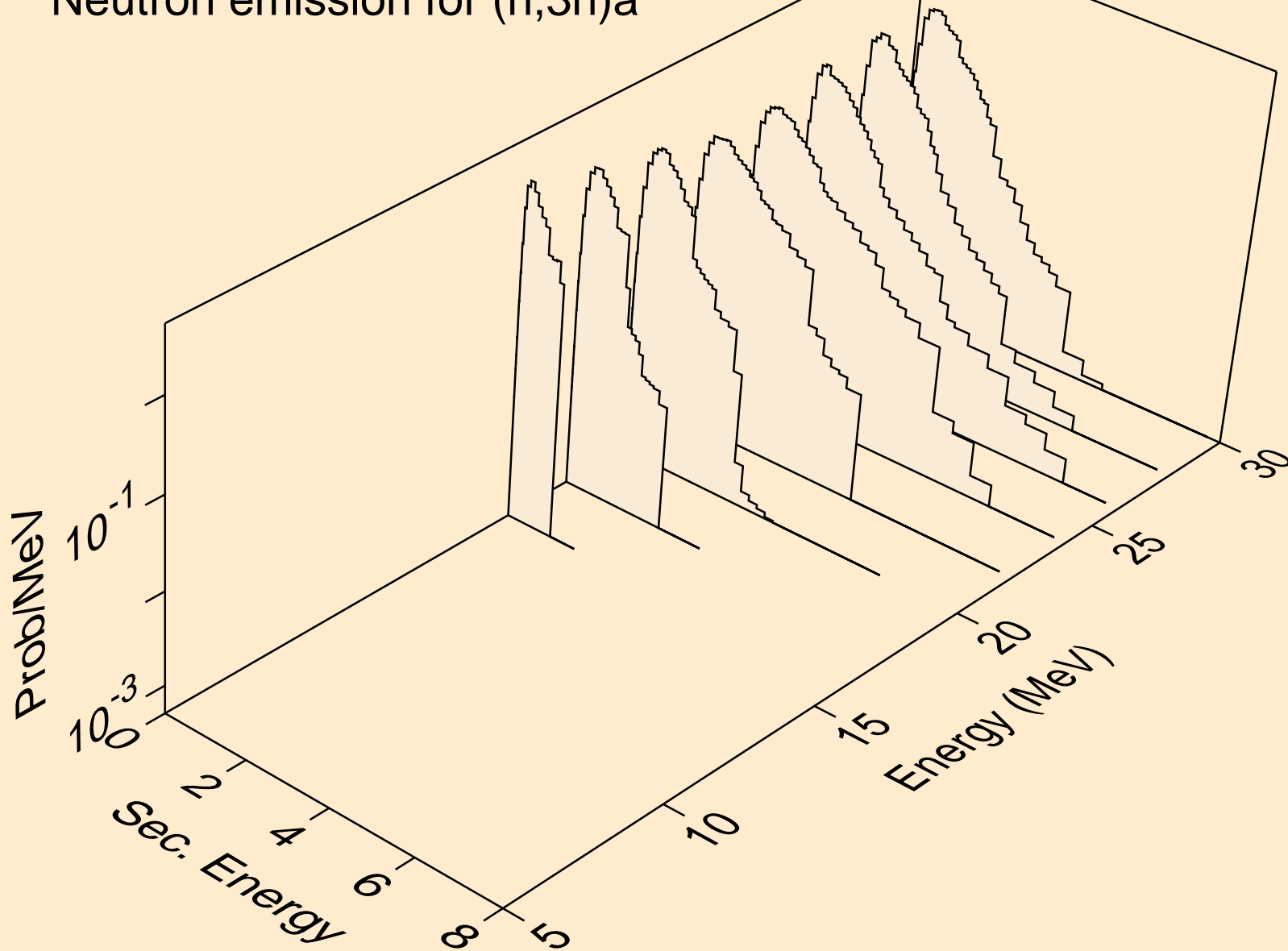

BK240 NEUTRON ACER TENDL-2019 LIBRARY; T=293.16K
Neutron emission for (n,n*)p

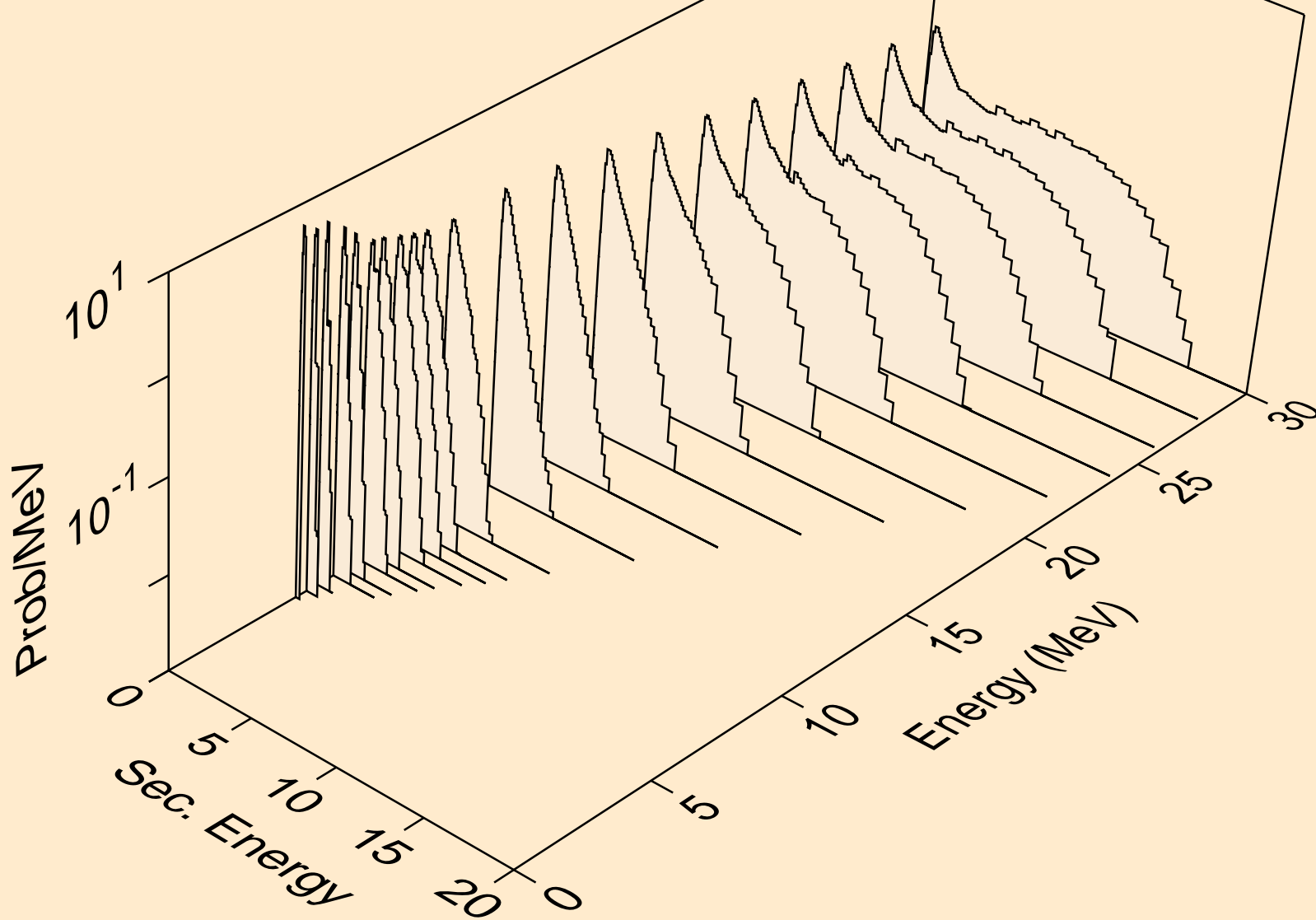

BK240 NEUTRON ACER TENDL-2019 LIBRARY; T=293.16K
Neutron emission for (n,n*)2a

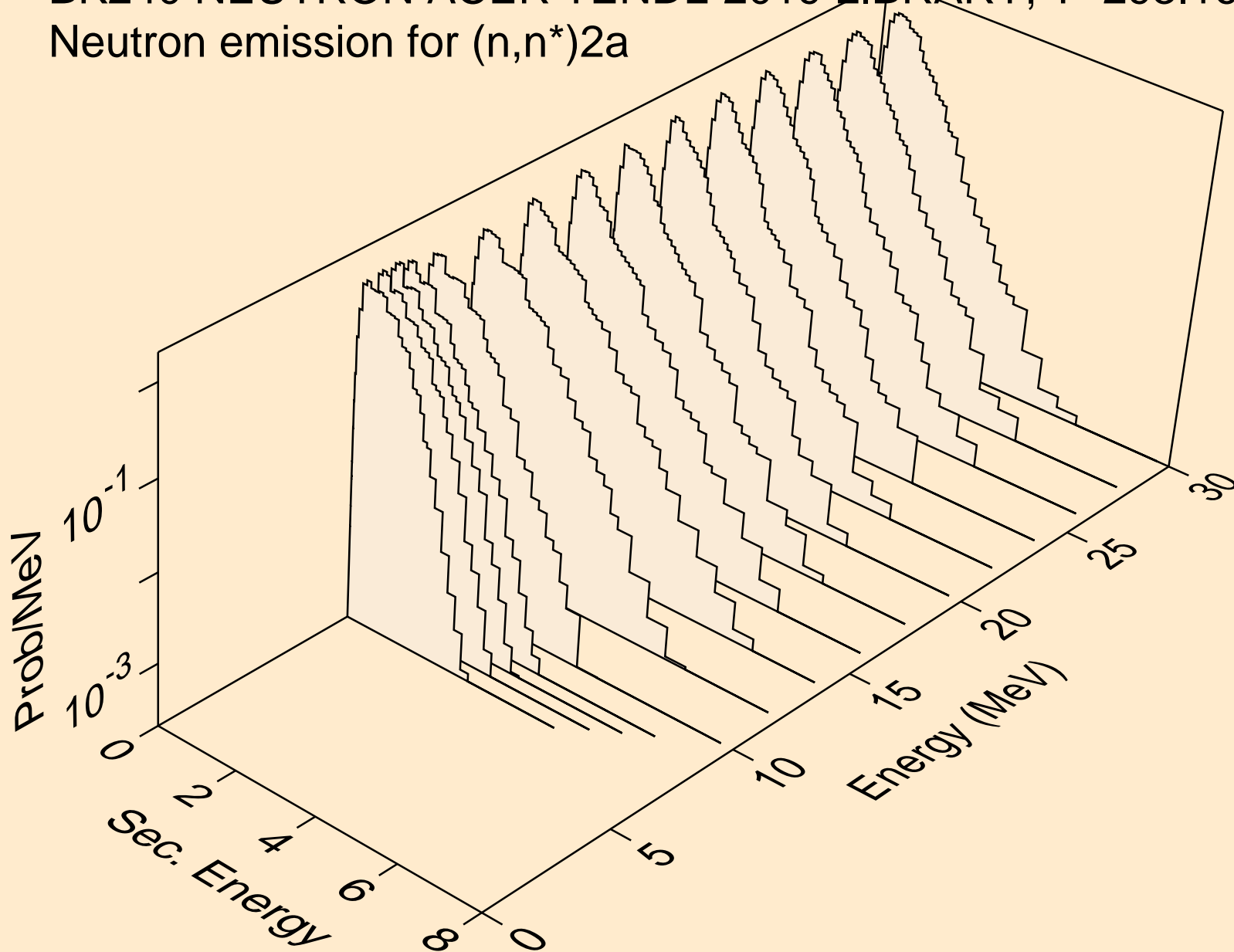

BK240 NEUTRON ACER TENDL-2019 LIBRARY; T=293.16K
Neutron emission for (n,n*)d

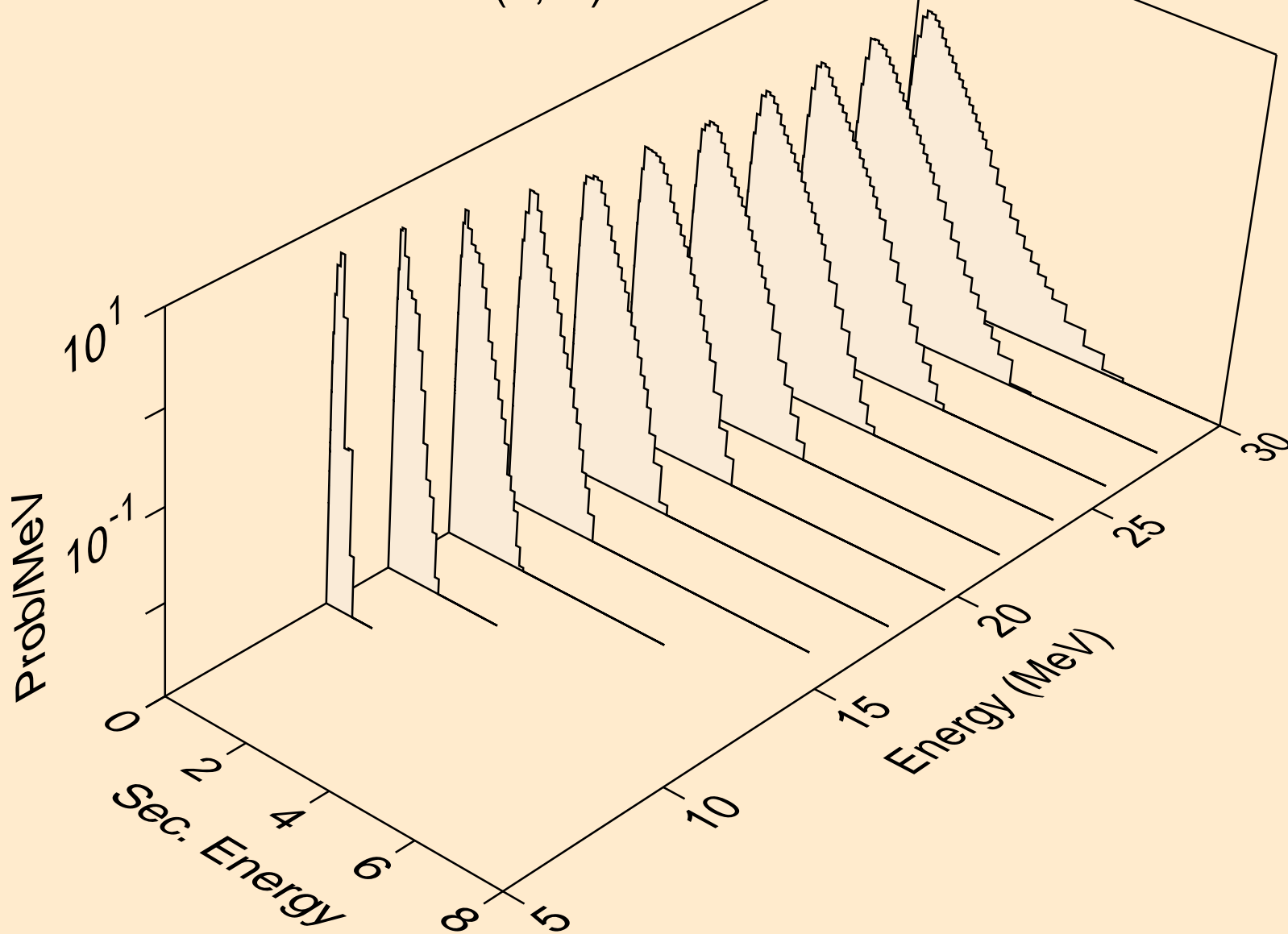

BK240 NEUTRON ACER TENDL-2019 LIBRARY; T=293.16K
Neutron emission for (n,n*)t

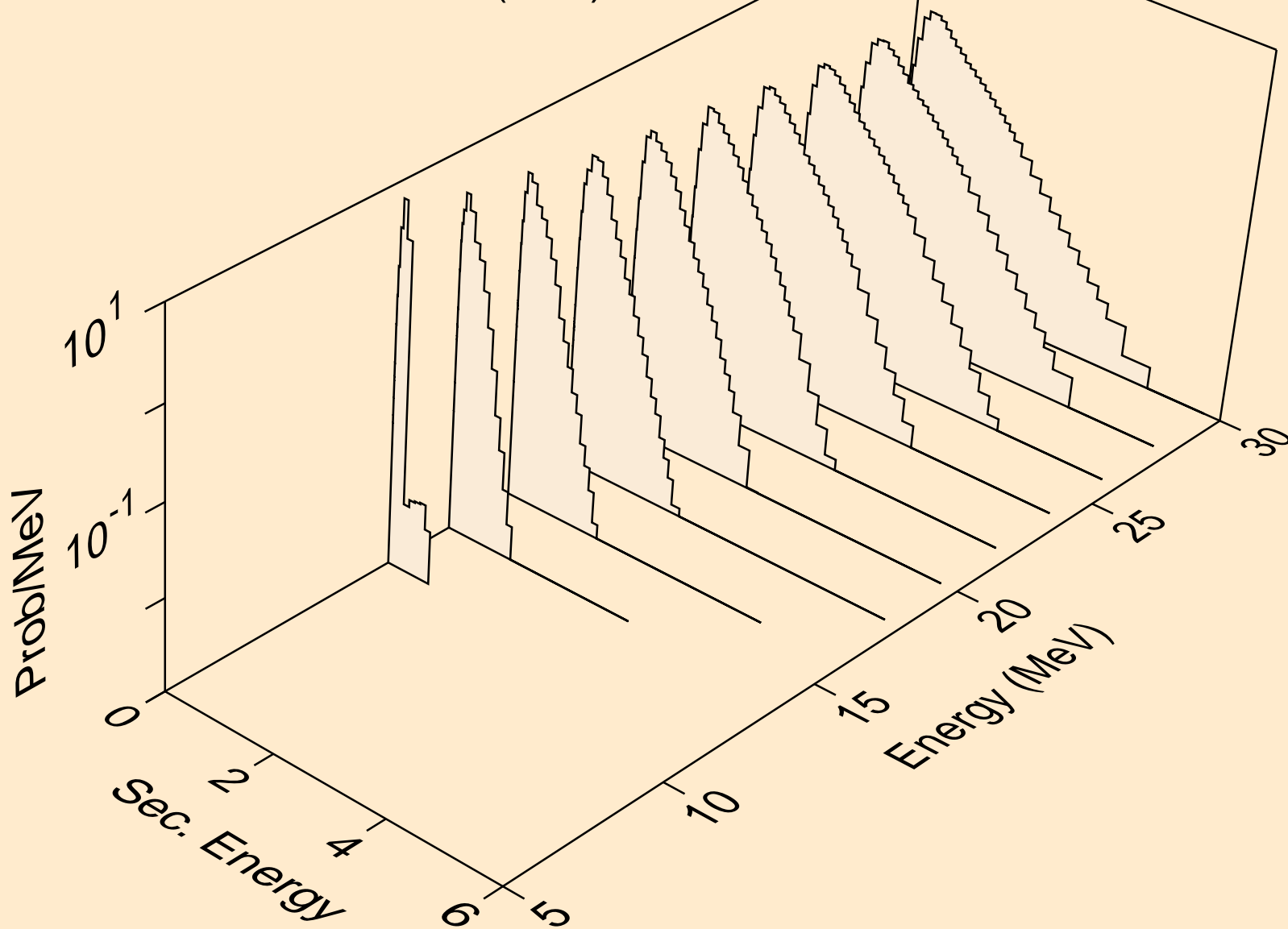

BK240 NEUTRON ACER TENDL-2019 LIBRARY; T=293.16K
Neutron emission for (n,n*)he3

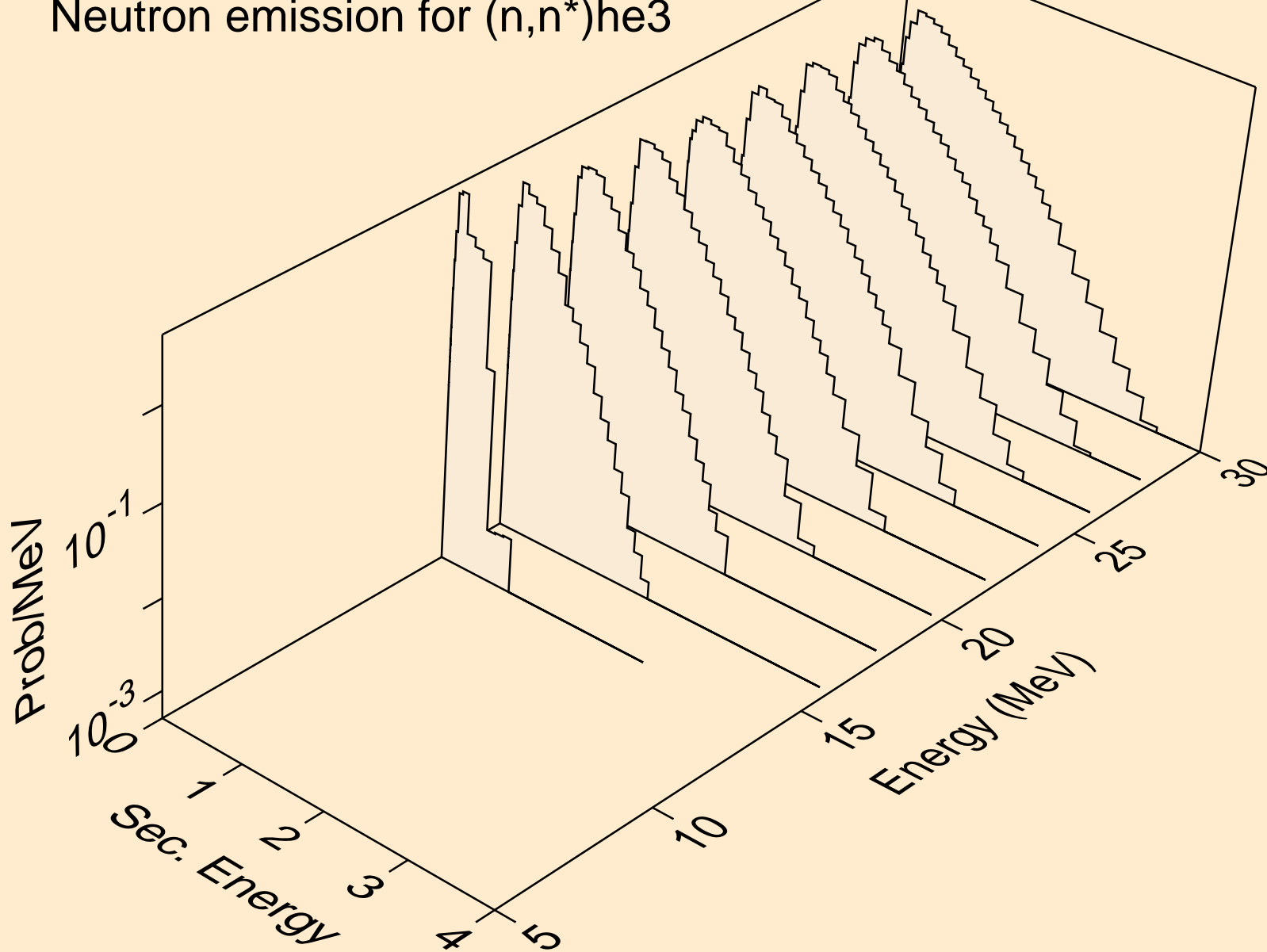

BK240 NEUTRON ACER TENDL-2019 LIBRARY; T=293.16K
Neutron emission for (n,4n)

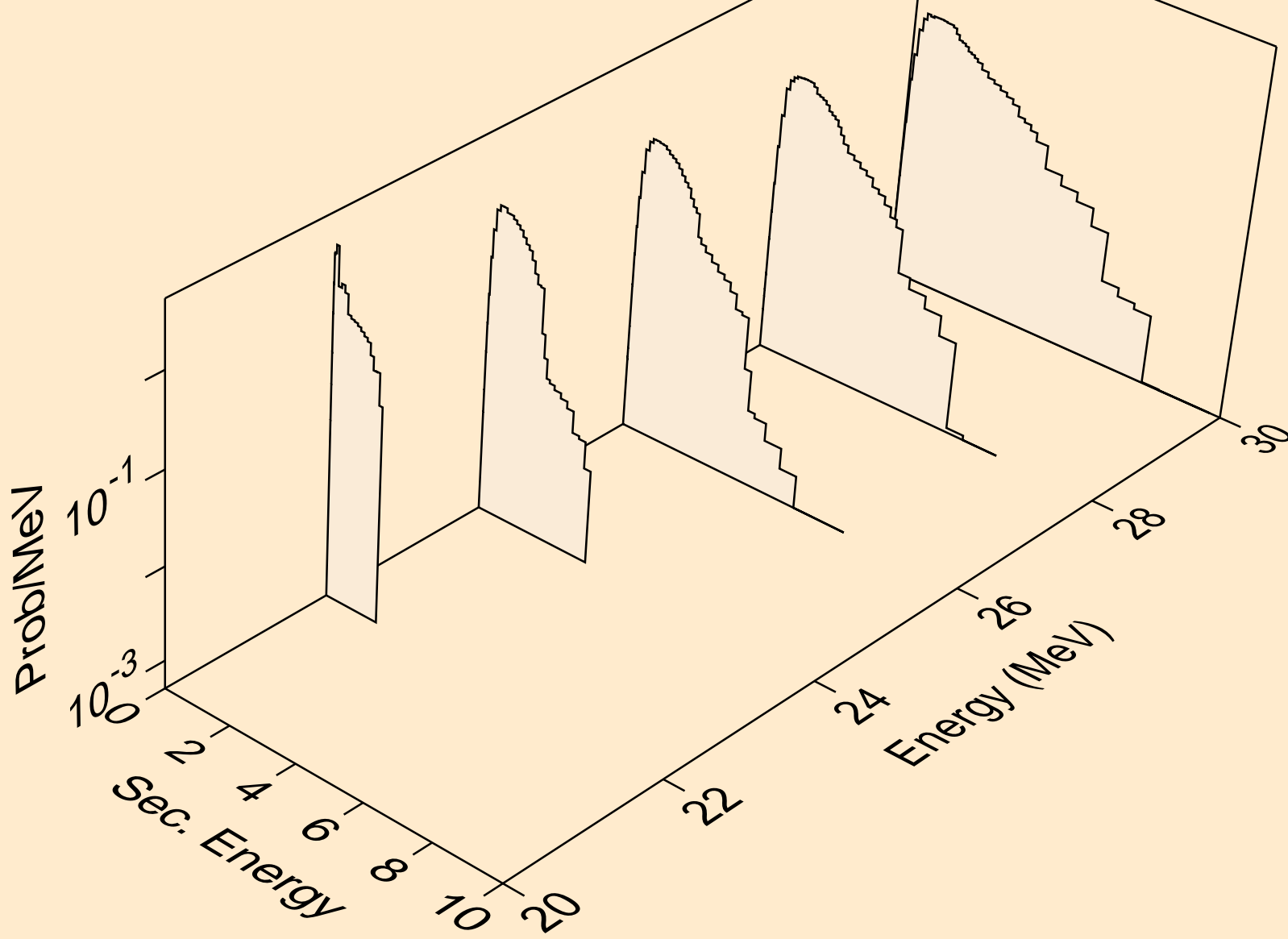

BK240 NEUTRON ACER TENDL-2019 LIBRARY; T=293.16K
Neutron emission for (n,2np)

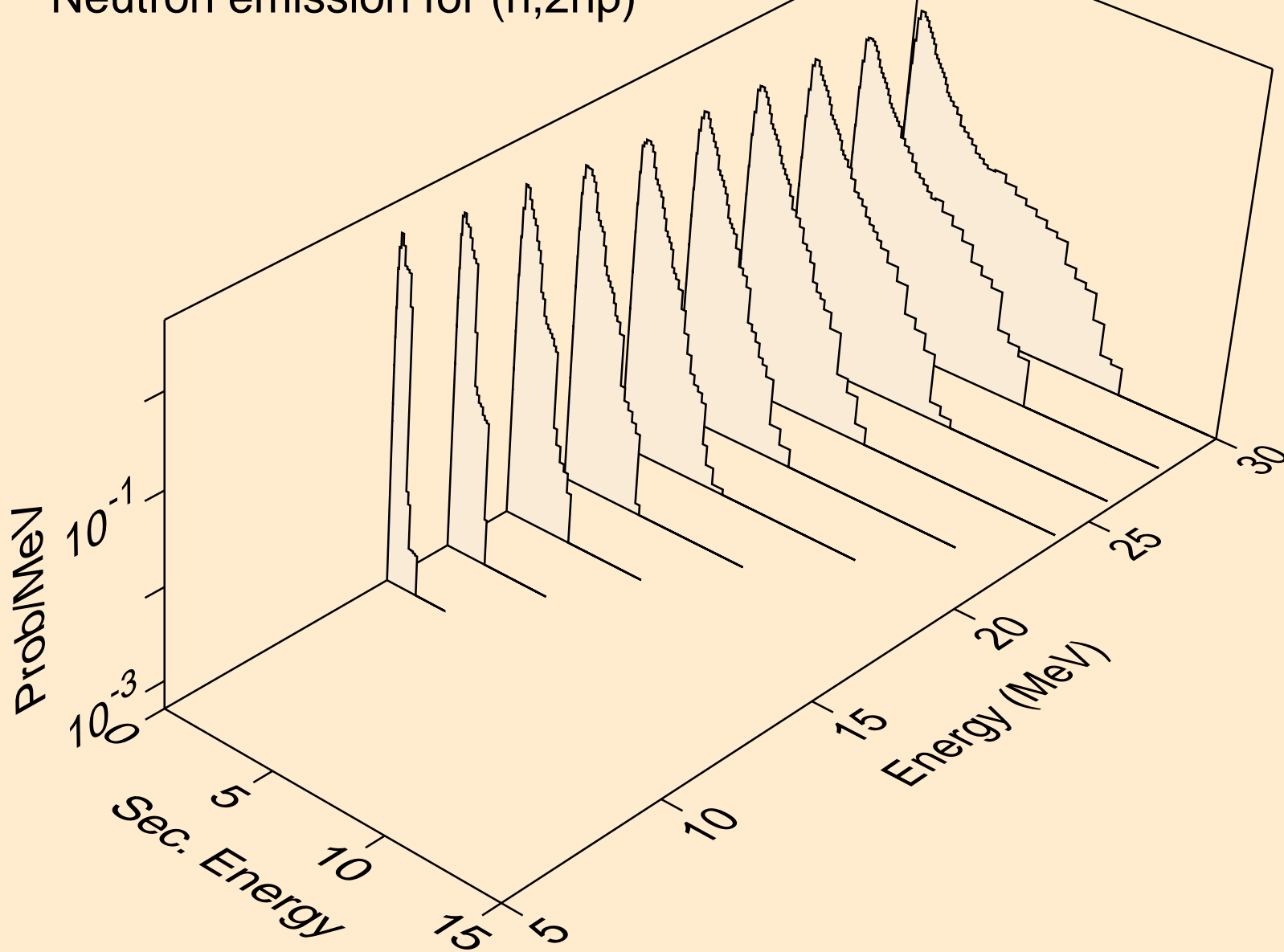

BK240 NEUTRON ACER TENDL-2019 LIBRARY; T=293.16K
Neutron emission for (n,3np)

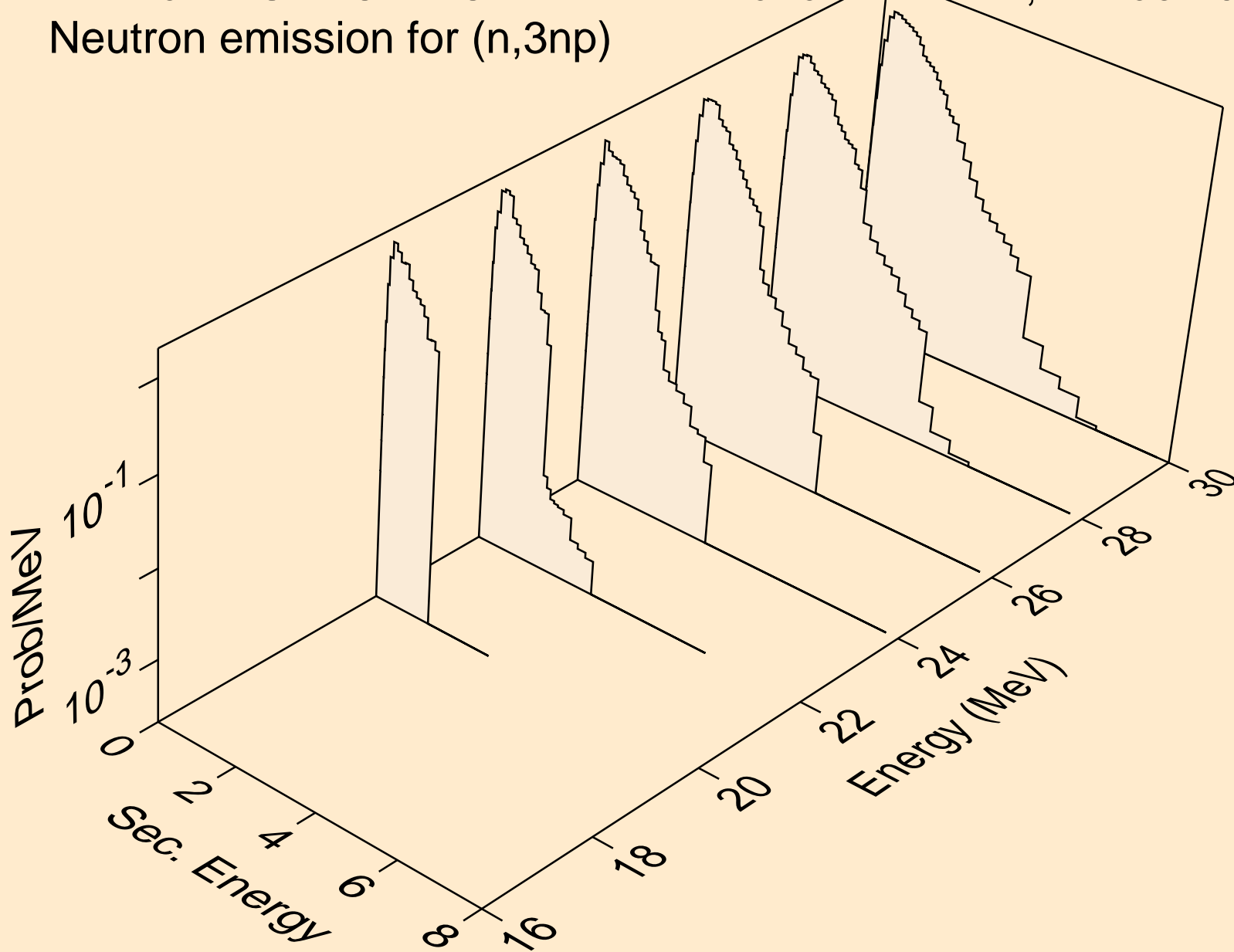

BK240 NEUTRON ACER TENDL-2019 LIBRARY; T=293.16K
Neutron emission for (n,2np)

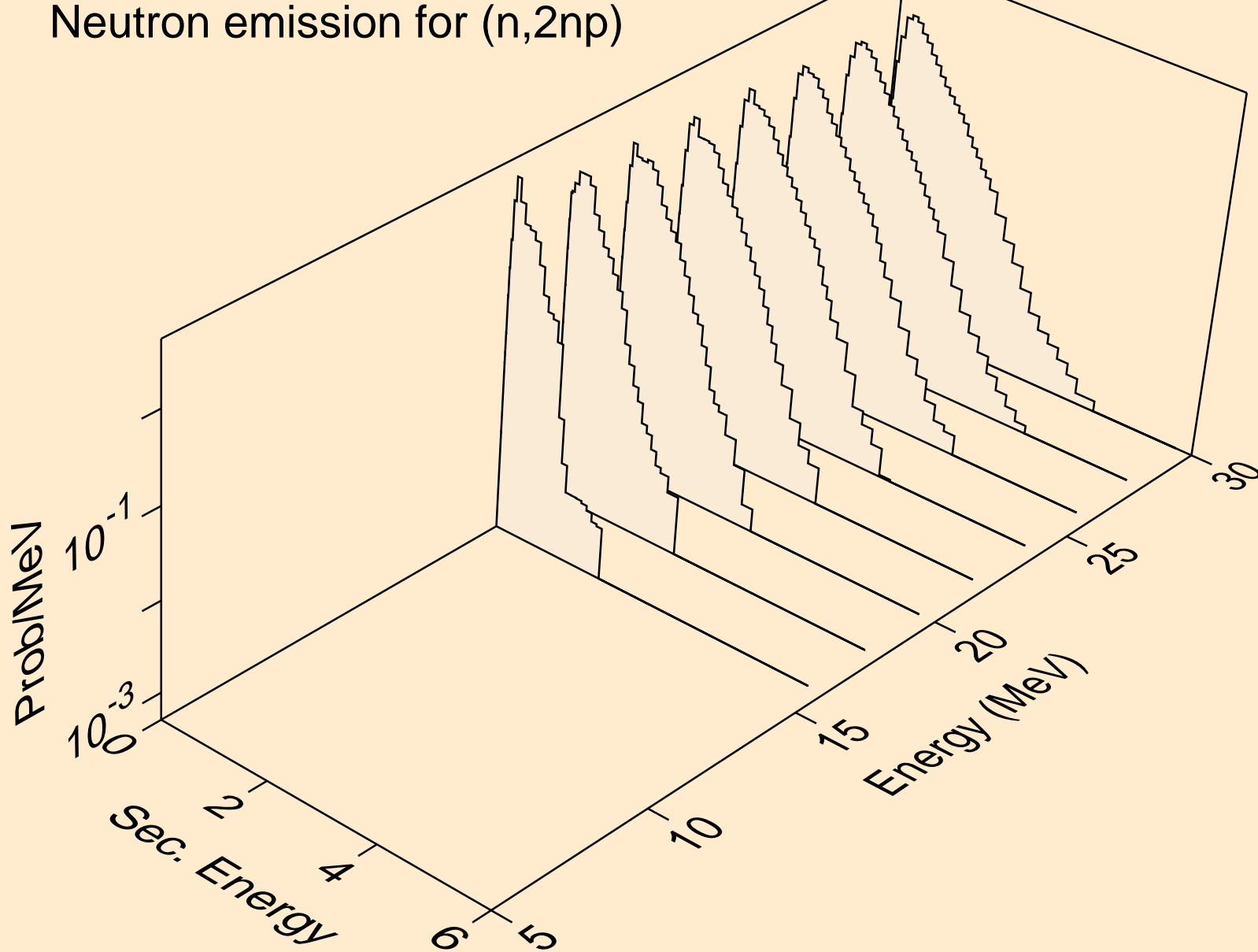

BK240 NEUTRON ACER TENDL-2019 LIBRARY; T=293.16K
Neutron emission for (n,n*c)

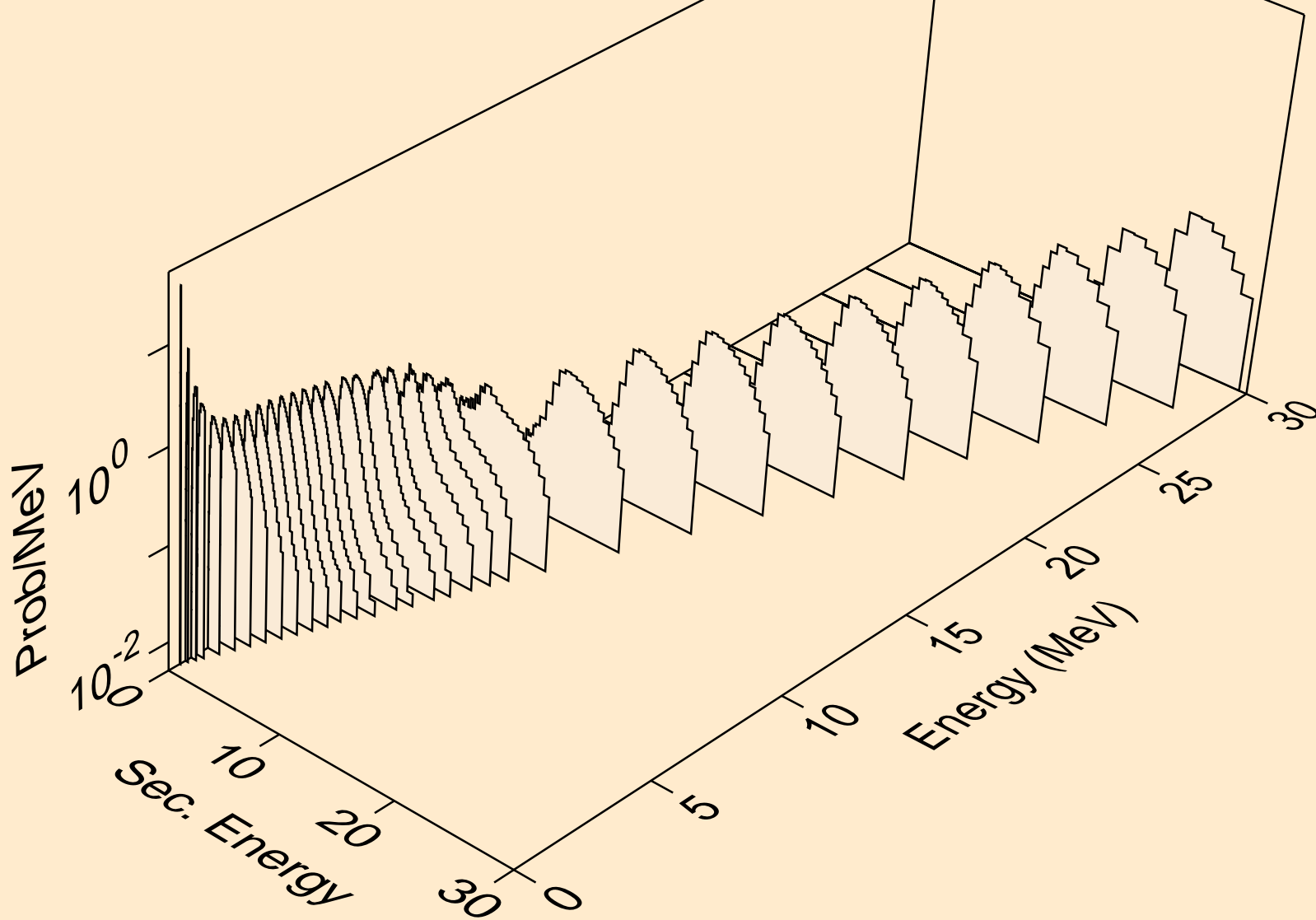

BK240 NEUTRON ACER TENDL-2019 LIBRARY; T=293.16K
Delayed nubar

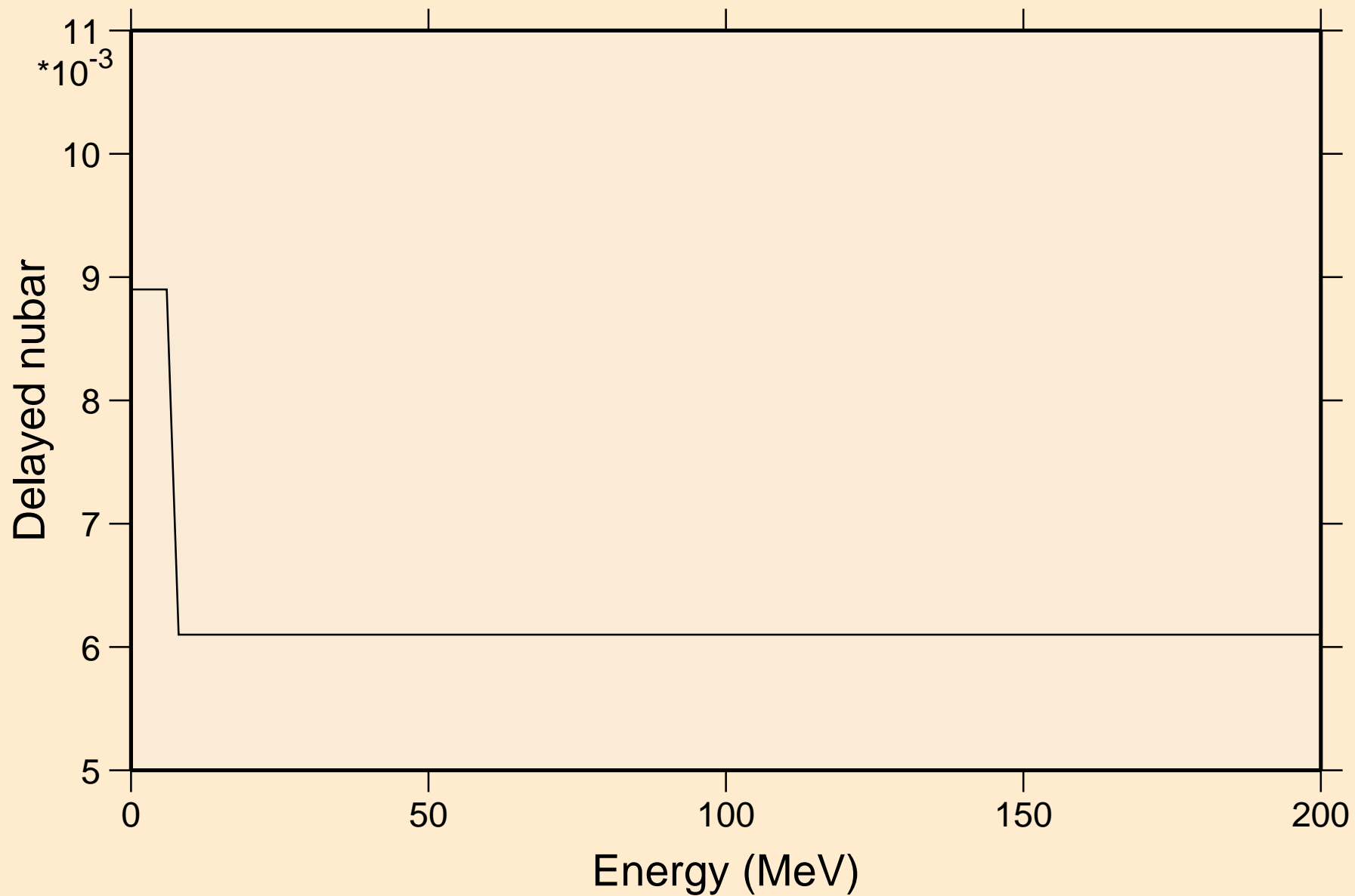

BK240 NEUTRON ACER TENDL-2019 LIBRARY; T=293.16K

Delayed neutron spectra

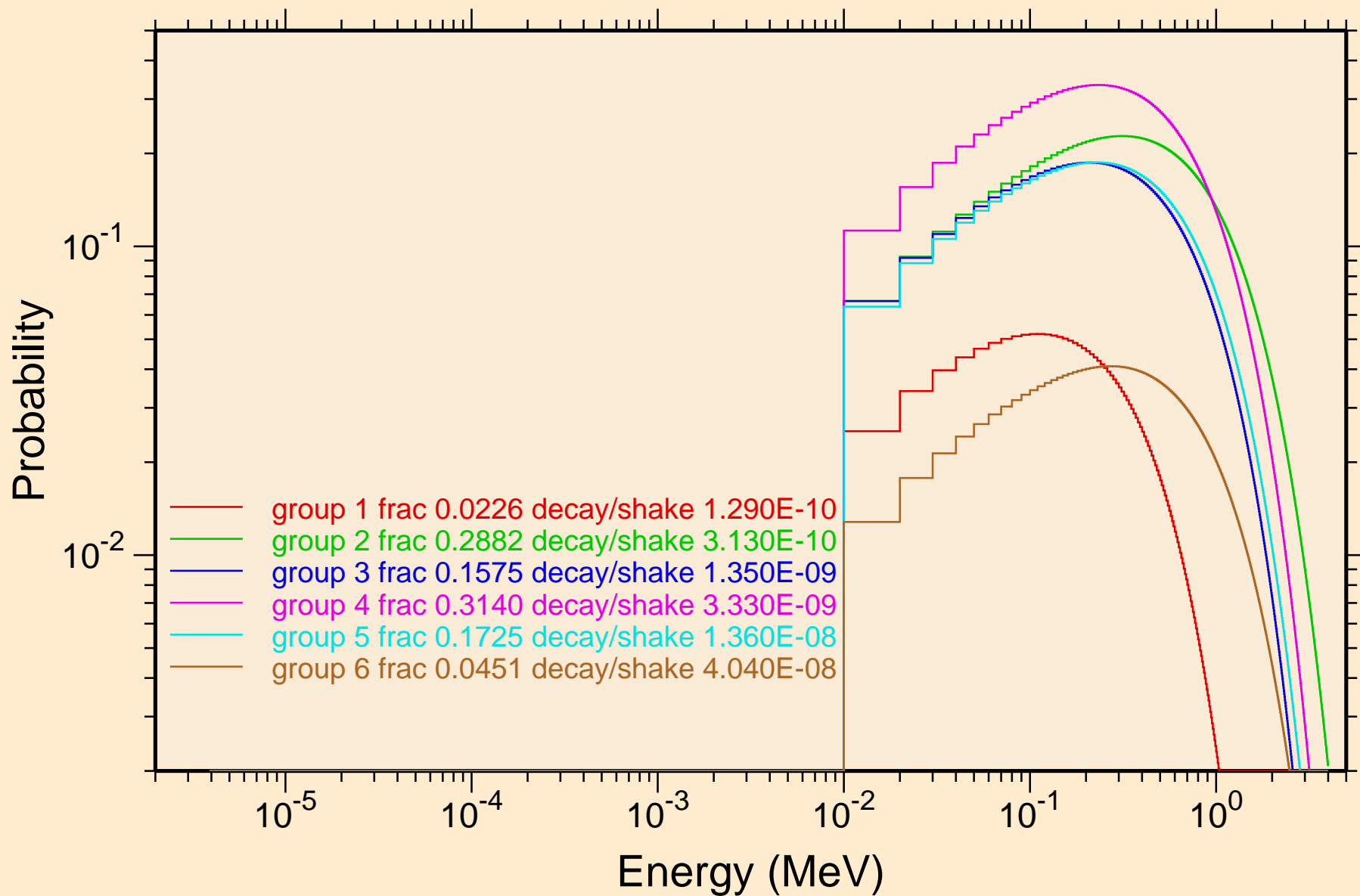

BK240 NEUTRON ACER TENDL-2019 LIBRARY; T=293.16K
Photon emission for (n,x)

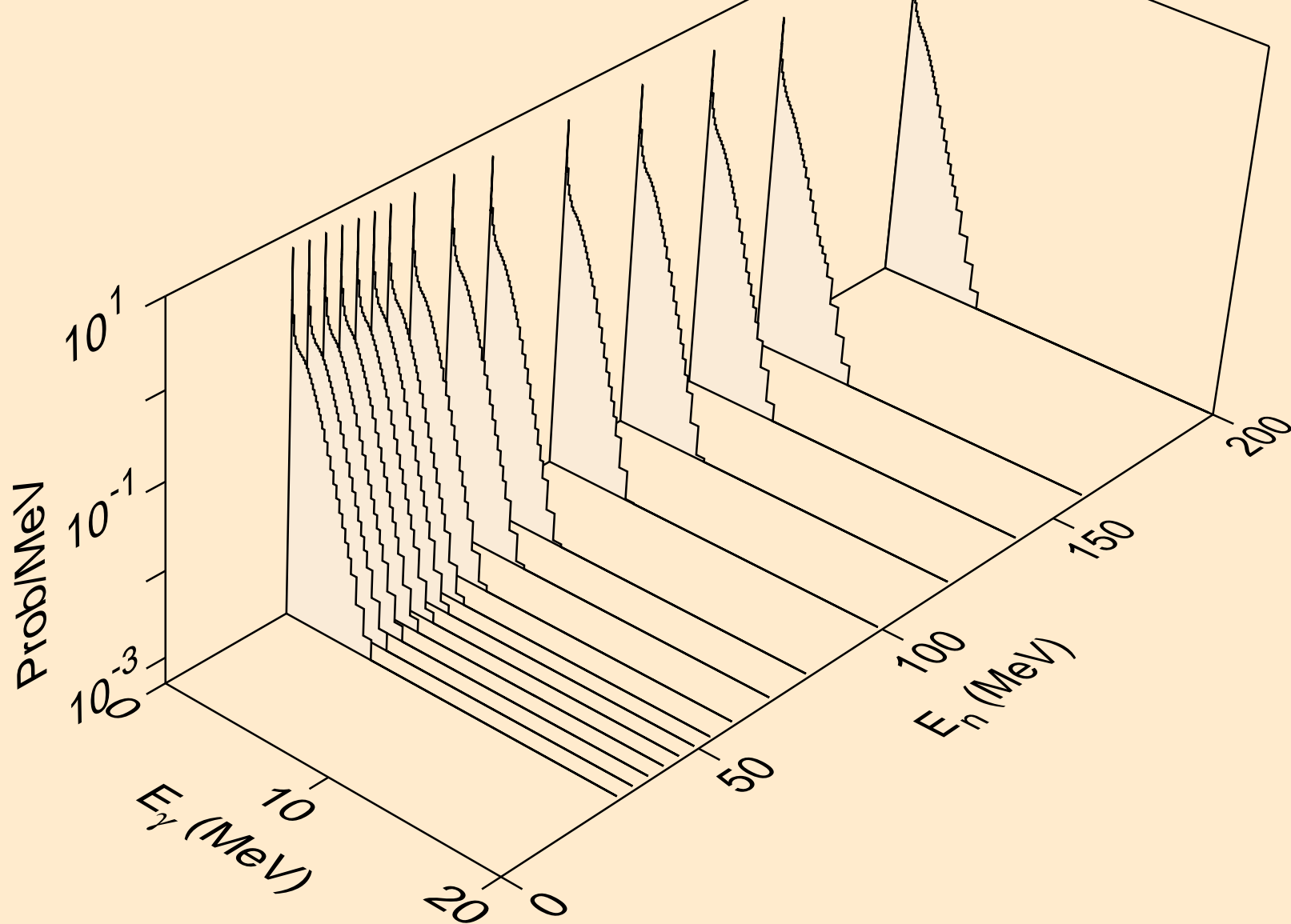

BK240 NEUTRON ACER TENDL-2019 LIBRARY; T=293.16K
Photon emission for (n,2nd)

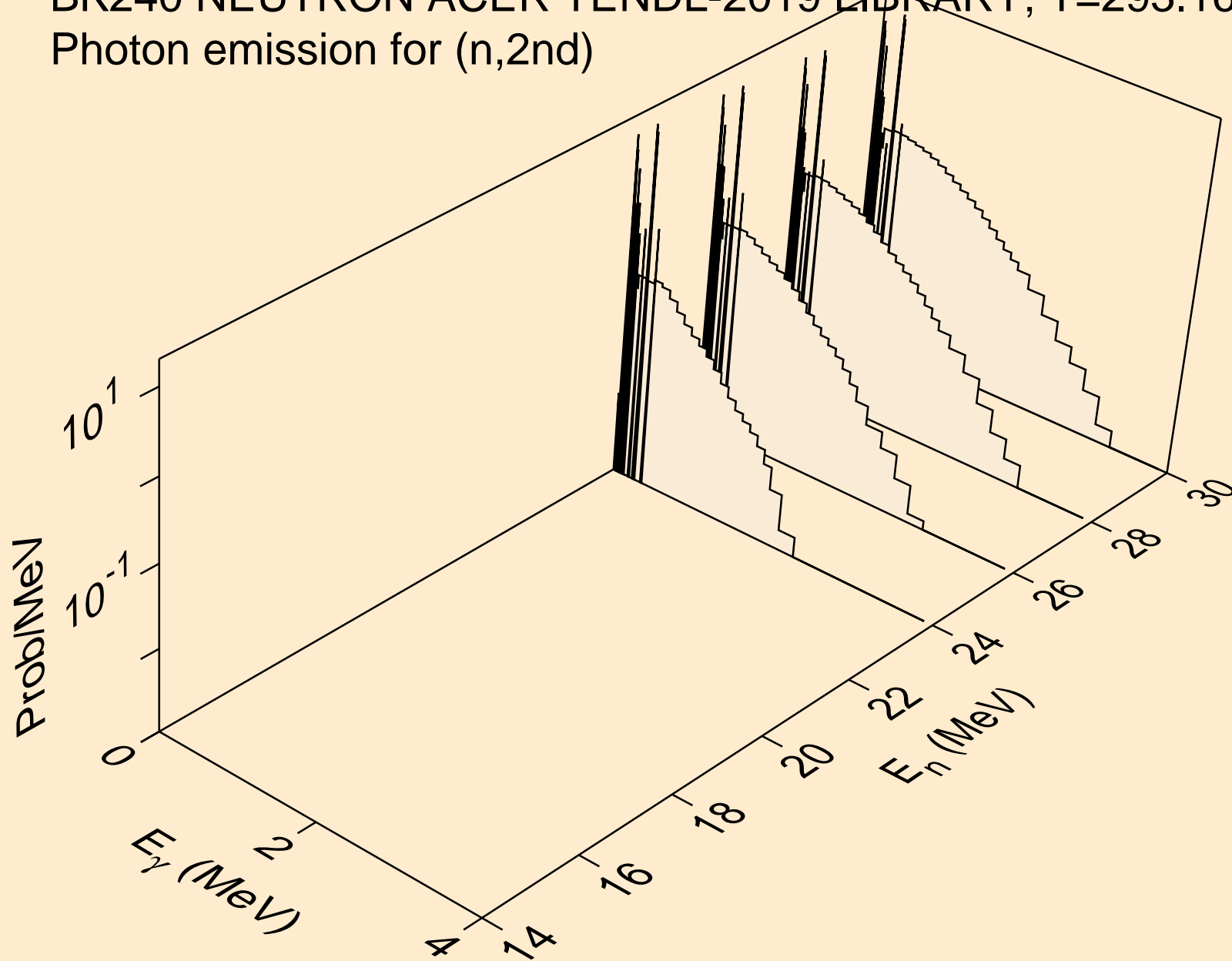

BK240 NEUTRON ACER TENDL-2019 LIBRARY; T=293.16K
Photon emission for (n,2n)

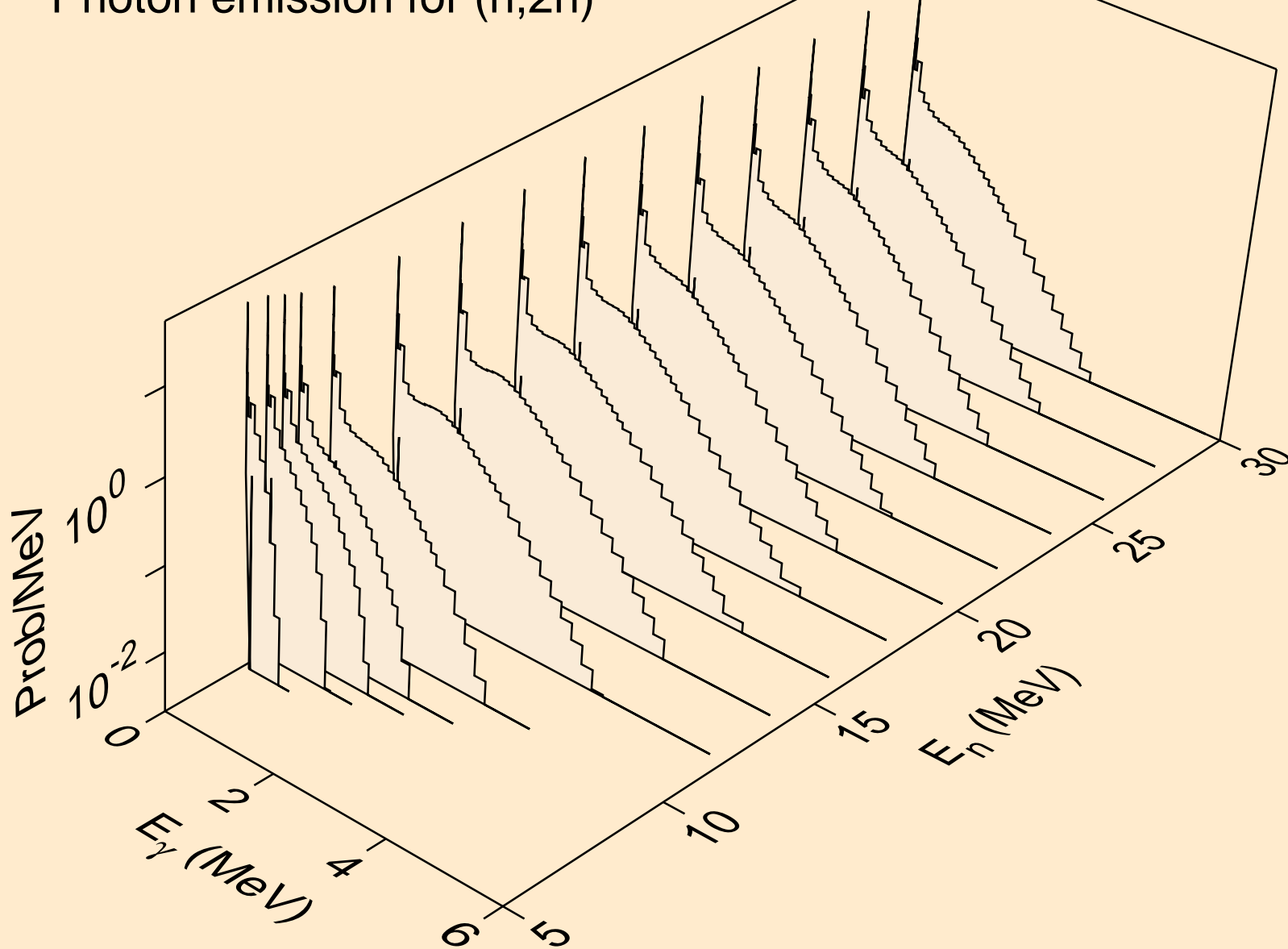

BK240 NEUTRON ACER TENDL-2019 LIBRARY; T=293.16K
Photon emission for (n,3n)

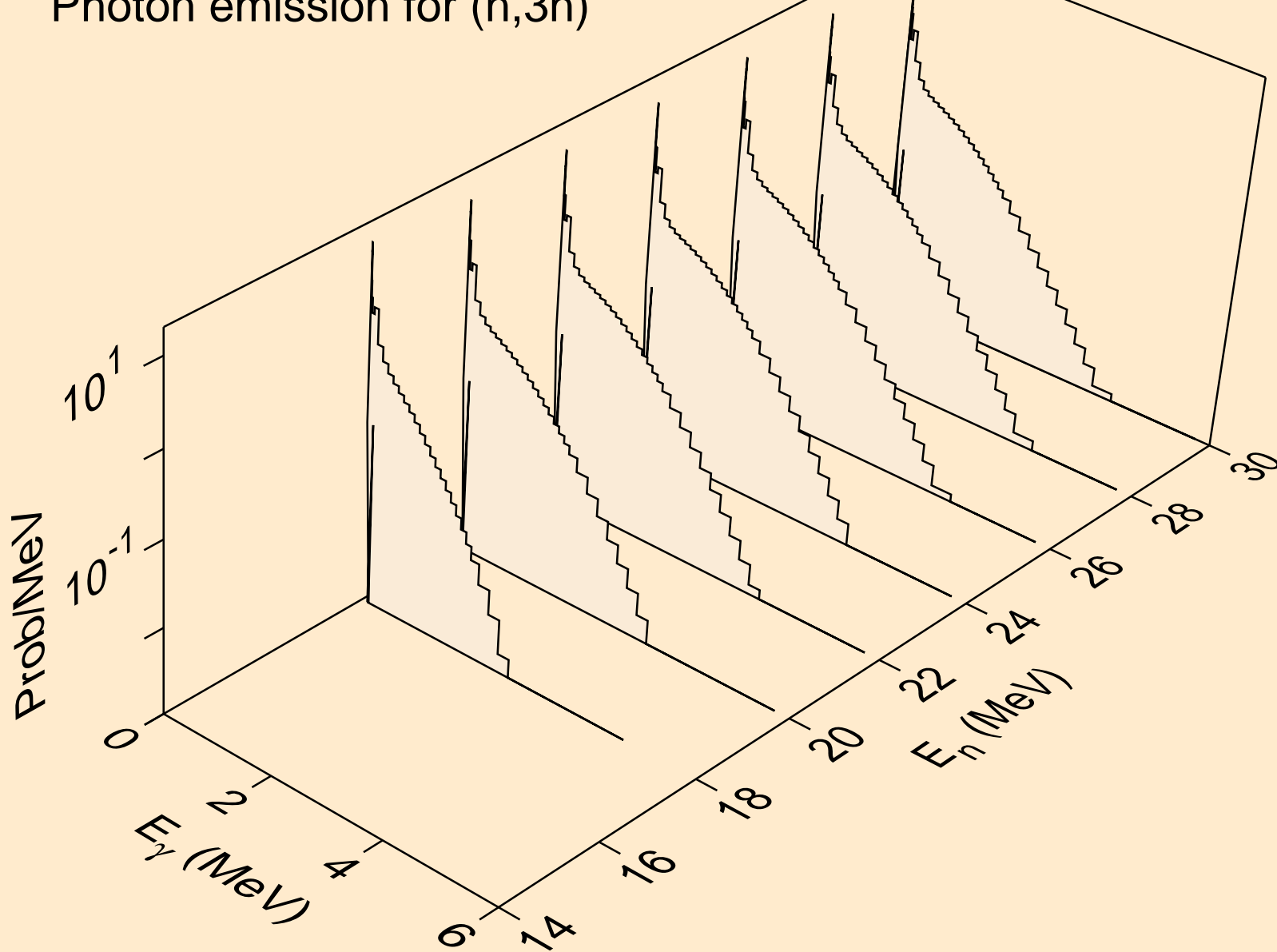

BK240 NEUTRON ACER TENDL-2019 LIBRARY; T=293.16K
Photon emission for (n,n*)a

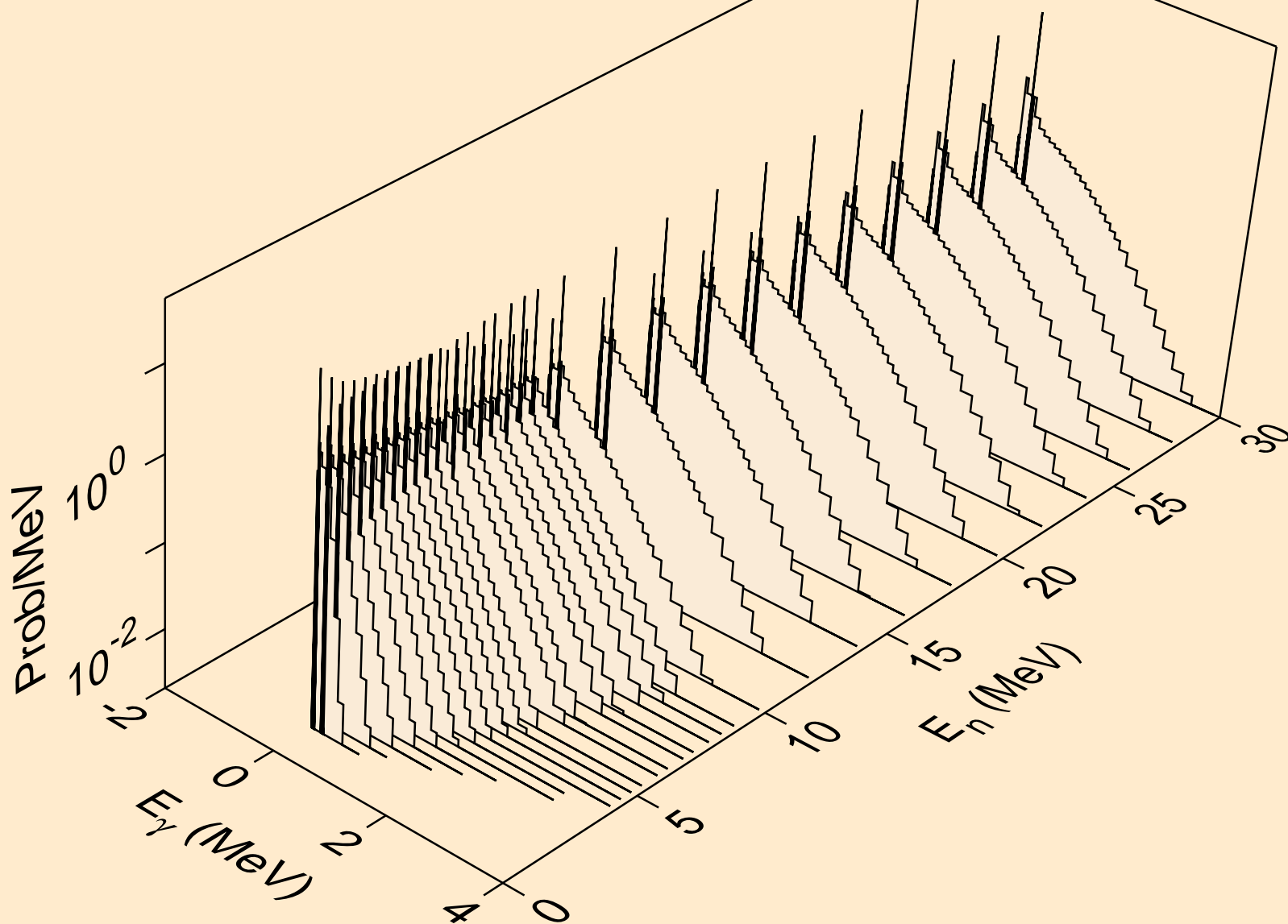

BK240 NEUTRON ACER TENDL-2019 LIBRARY; T=293.16K
Photon emission for (n,2n)a

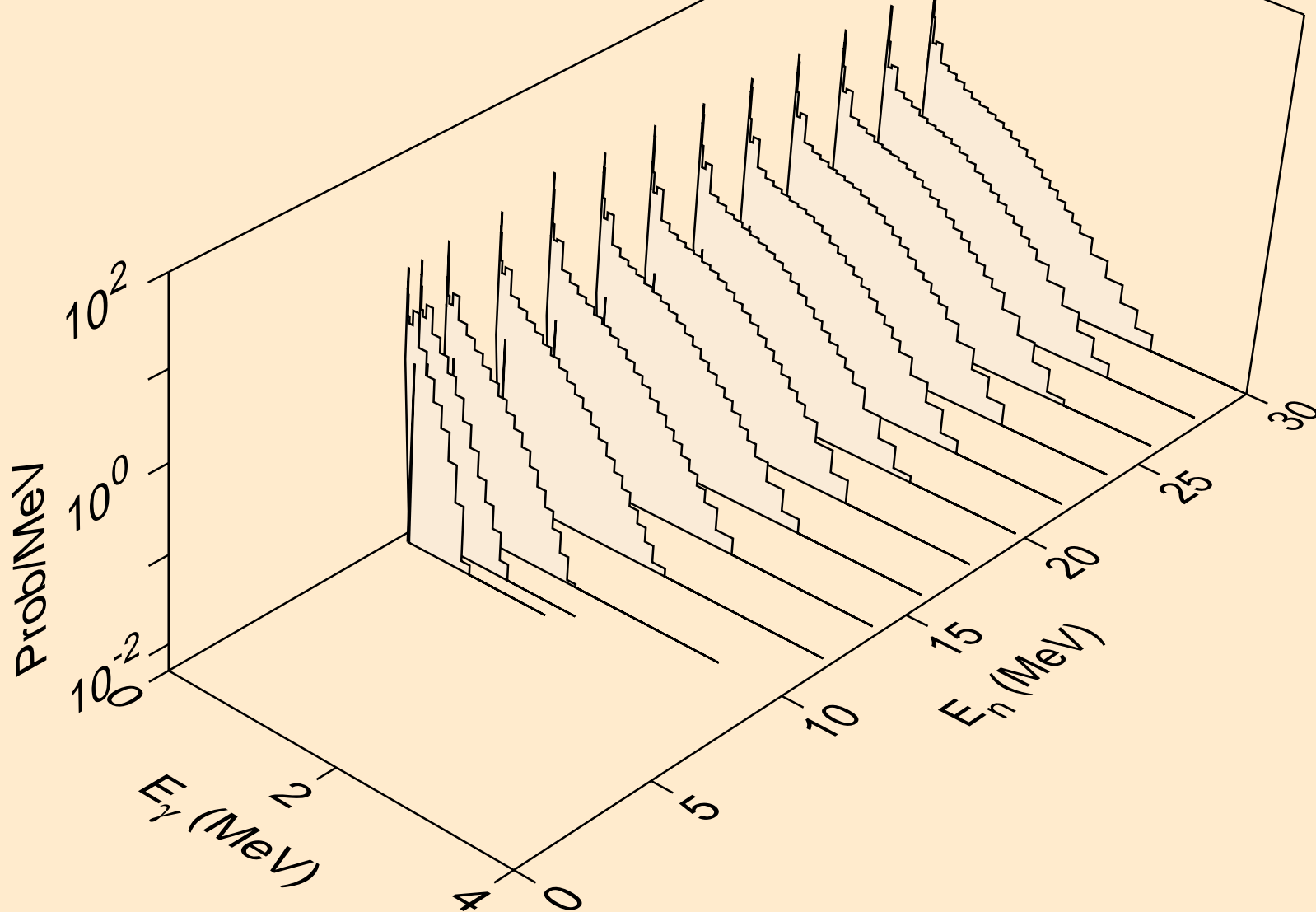

BK240 NEUTRON ACER TENDL-2019 LIBRARY; T=293.16K
Photon emission for (n,3n)a

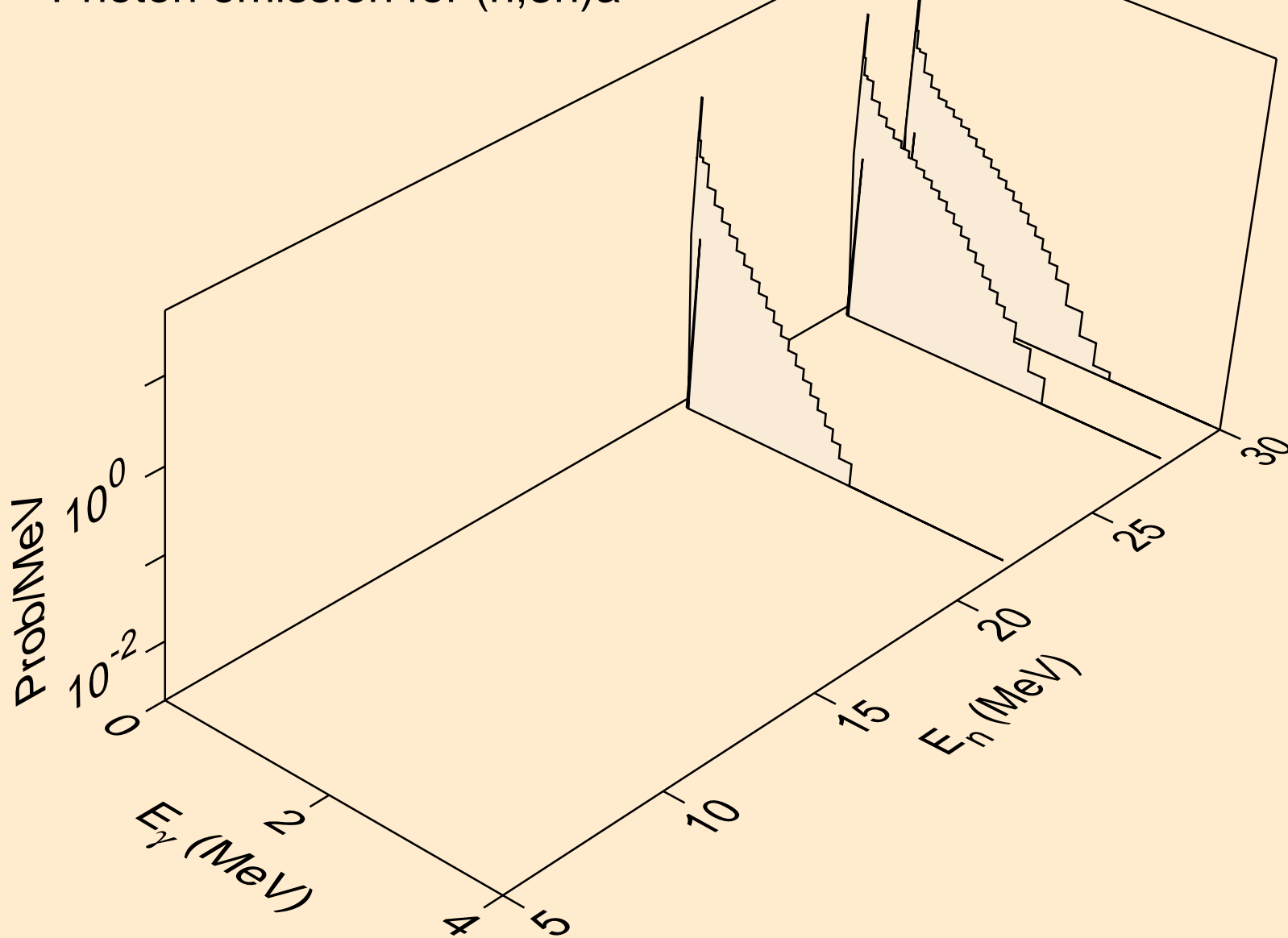

BK240 NEUTRON ACER TENDL-2019 LIBRARY; T=293.16K
Photon emission for (n,n*)p

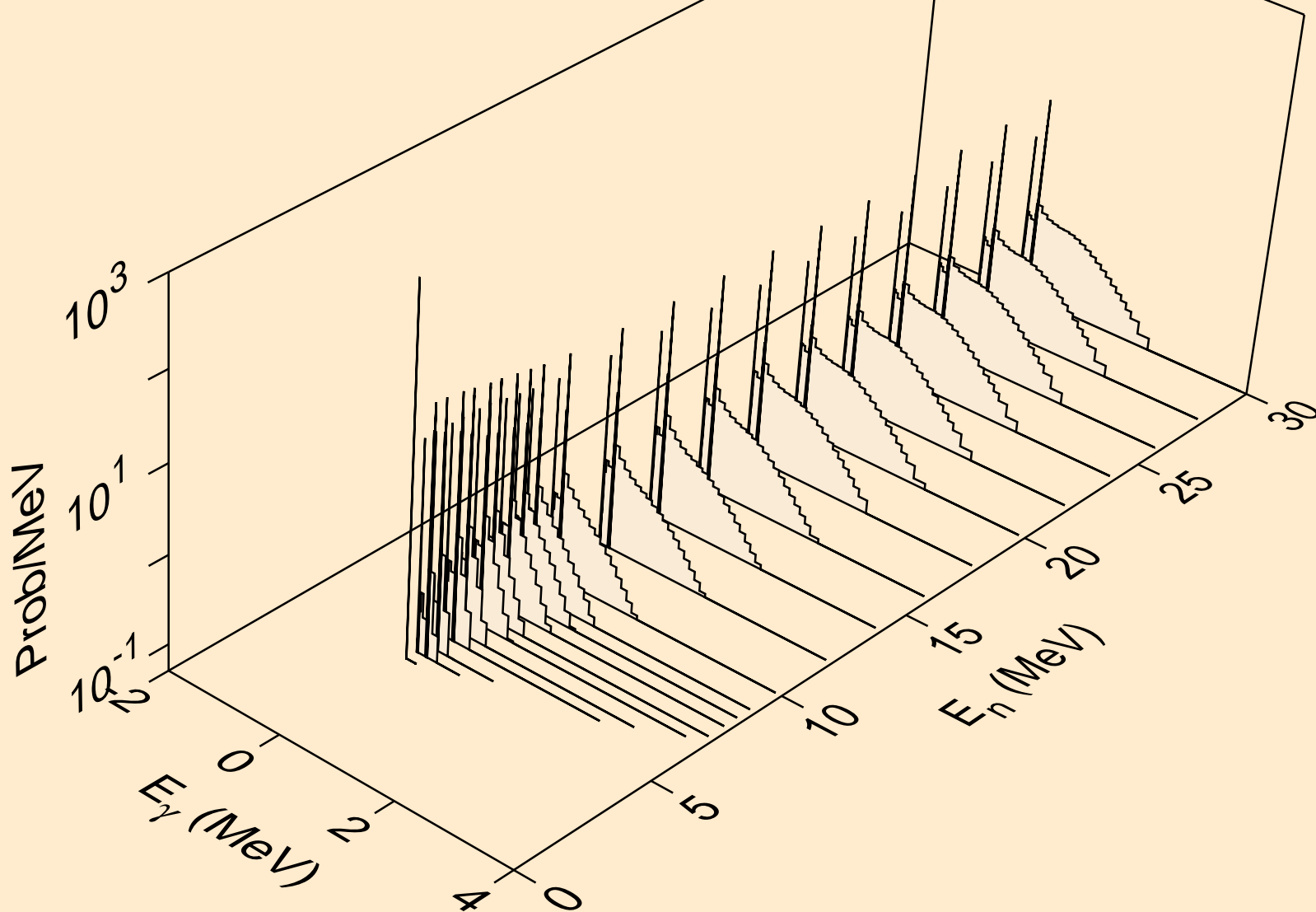

BK240 NEUTRON ACER TENDL-2019 LIBRARY; T=293.16K
Photon emission for (n,n*)2a

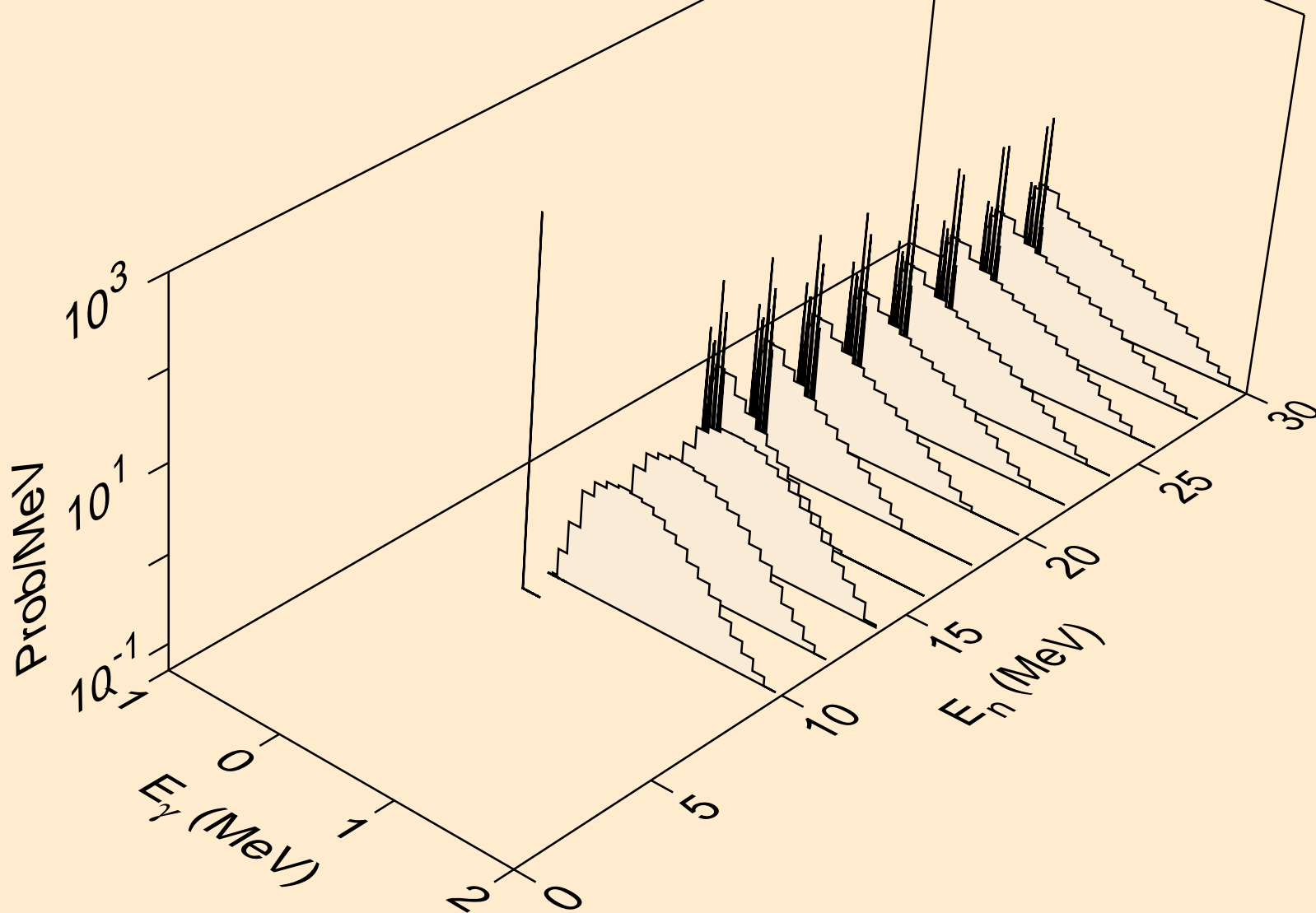

BK240 NEUTRON ACER TENDL-2019 LIBRARY; T=293.16K
Photon emission for (n,n*)d

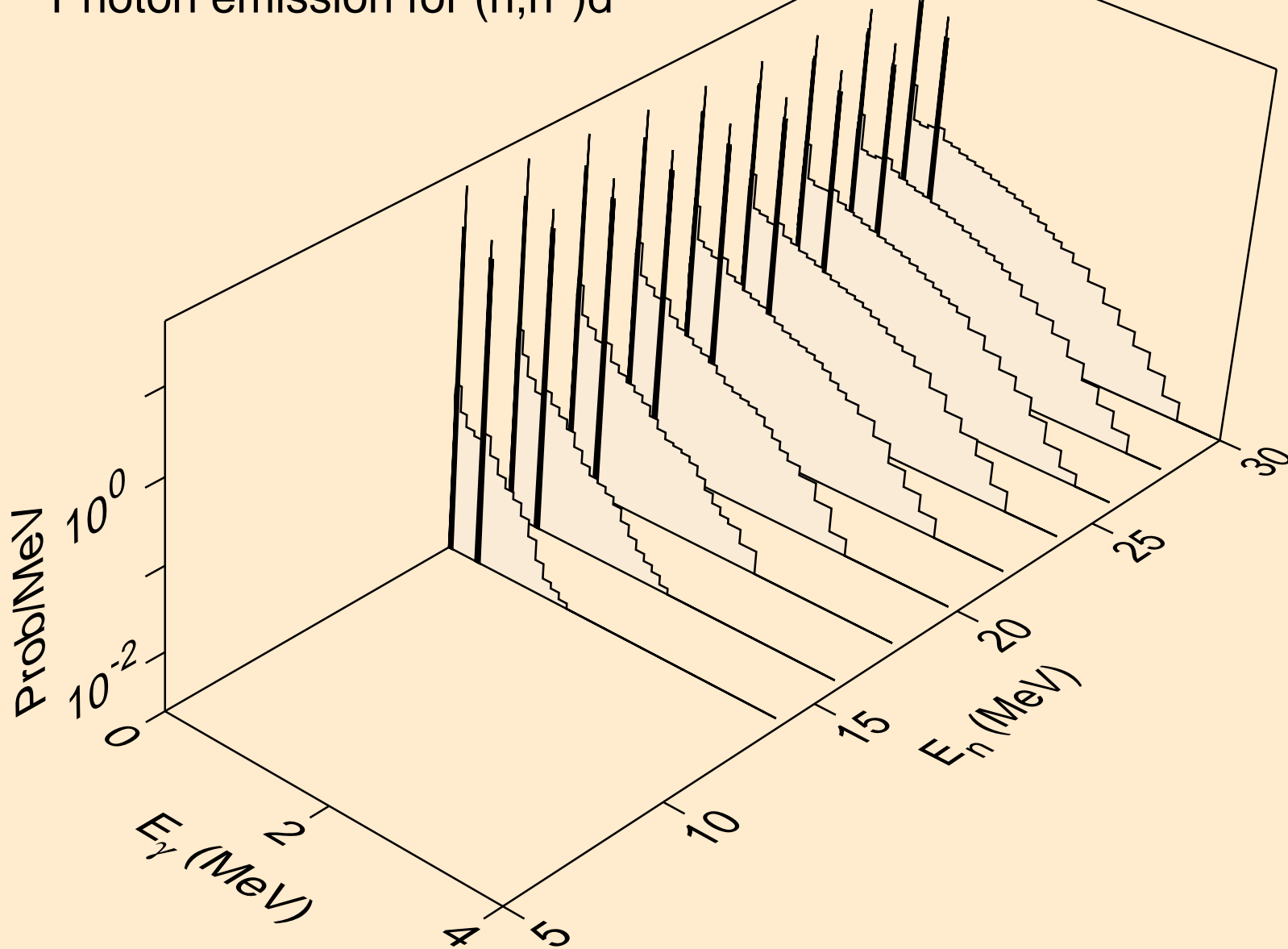

BK240 NEUTRON ACER TENDL-2019 LIBRARY; T=293.16K
Photon emission for (n,n*)t

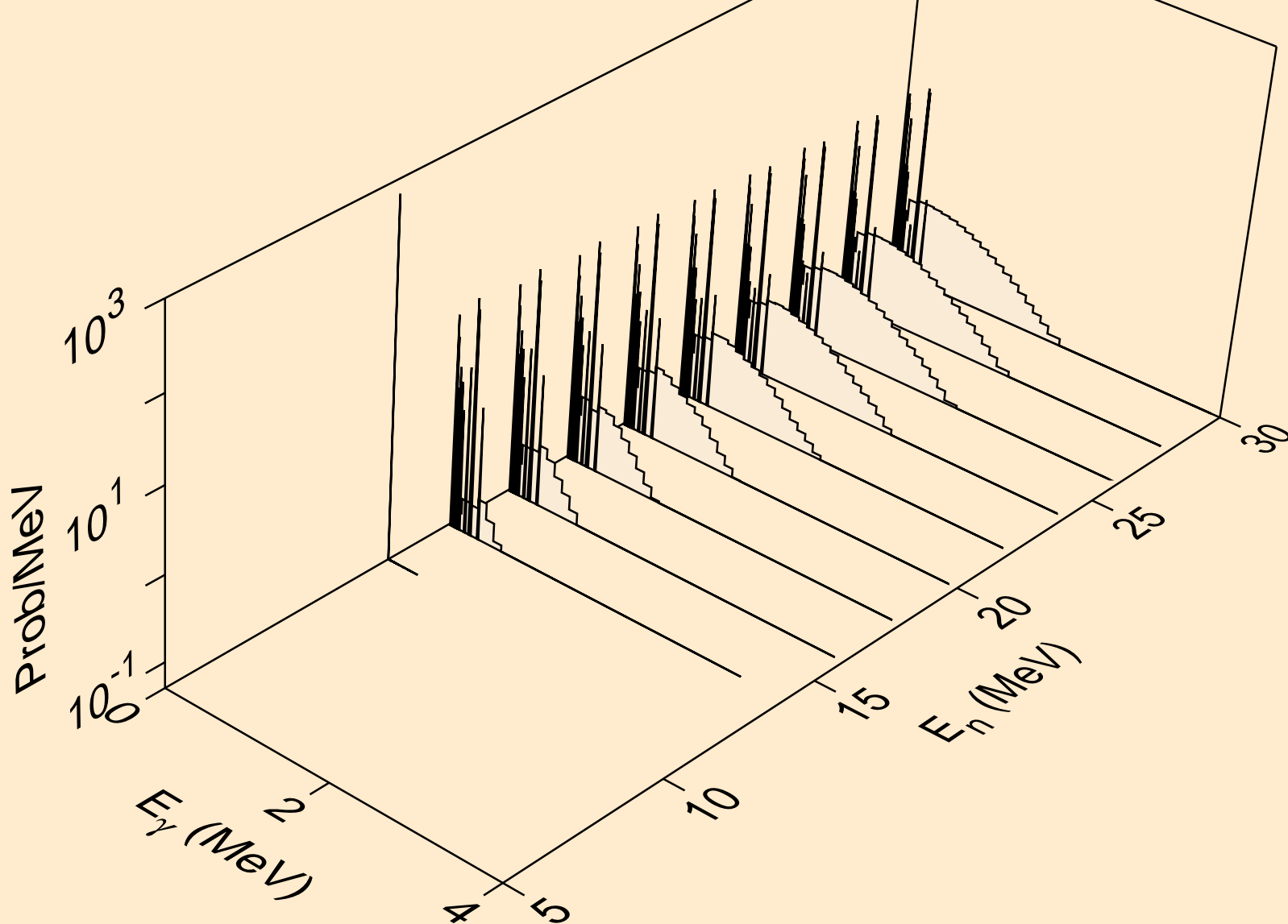

BK240 NEUTRON ACER TENDL-2019 LIBRARY; T=293.16K
Photon emission for (n,n*)he3

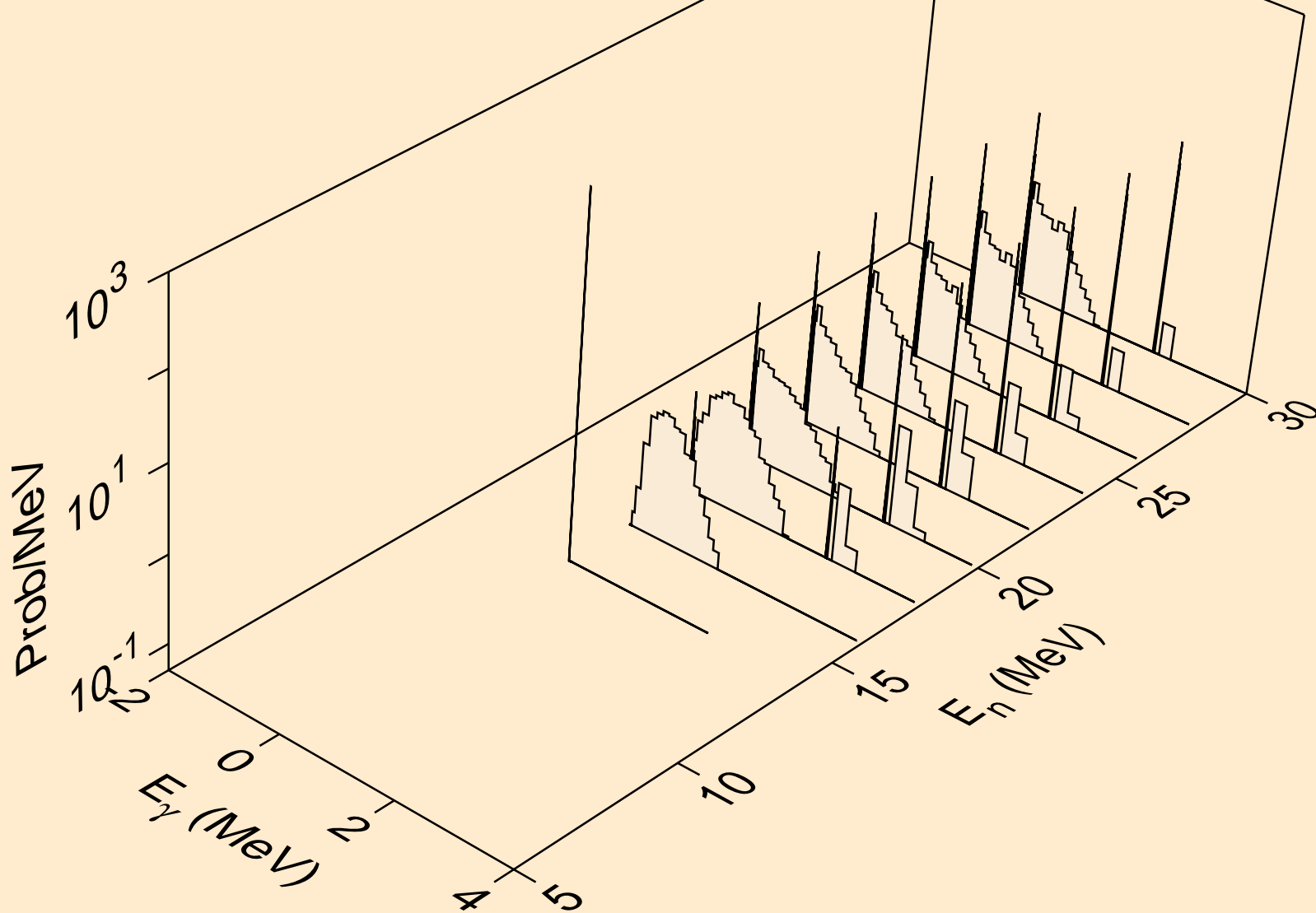

BK240 NEUTRON ACER TENDL-2019 LIBRARY; T=293.16K
Photon emission for (n,4n)

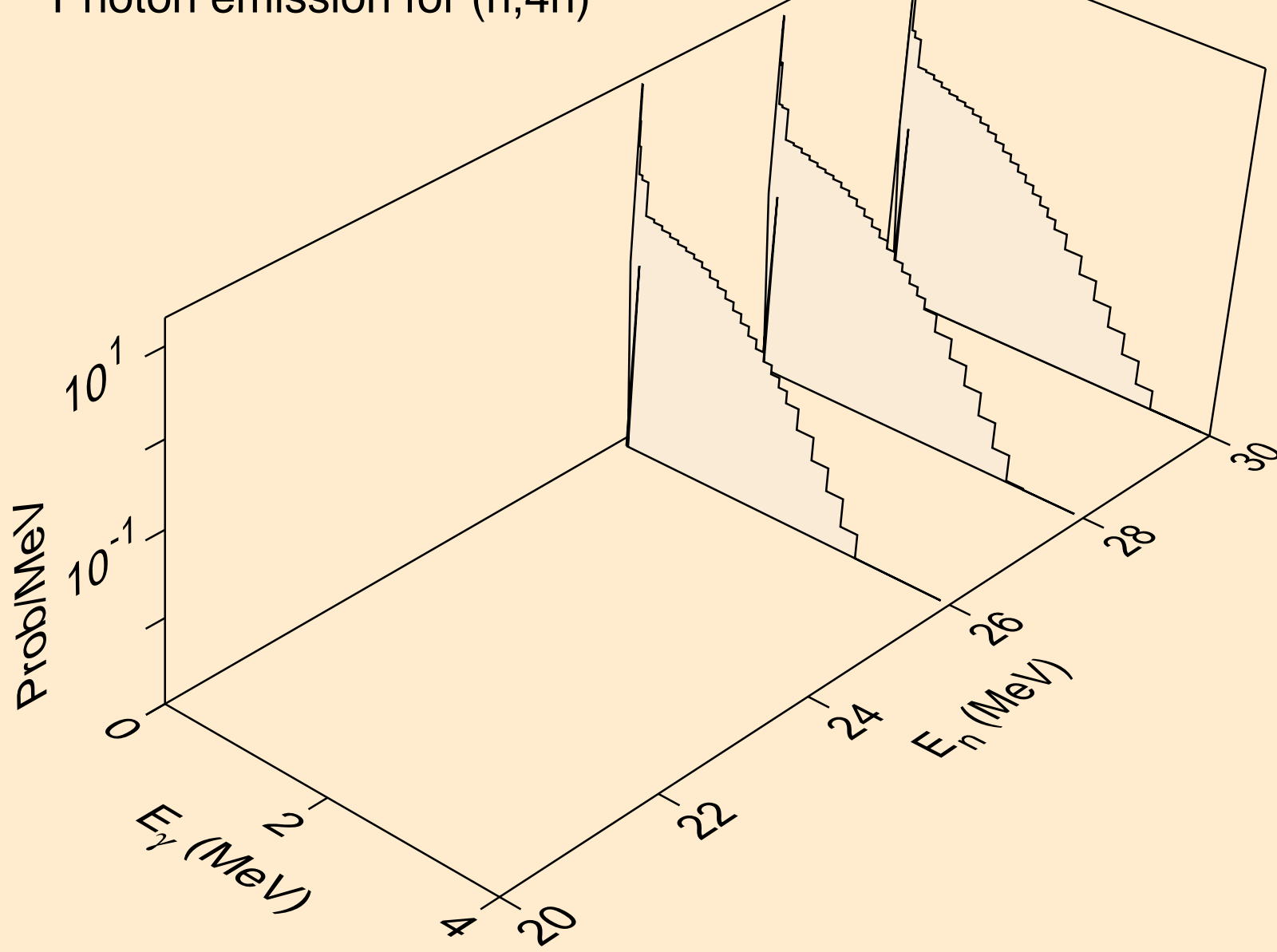

BK240 NEUTRON ACER TENDL-2019 LIBRARY; T=293.16K
Photon emission for (n,2np)

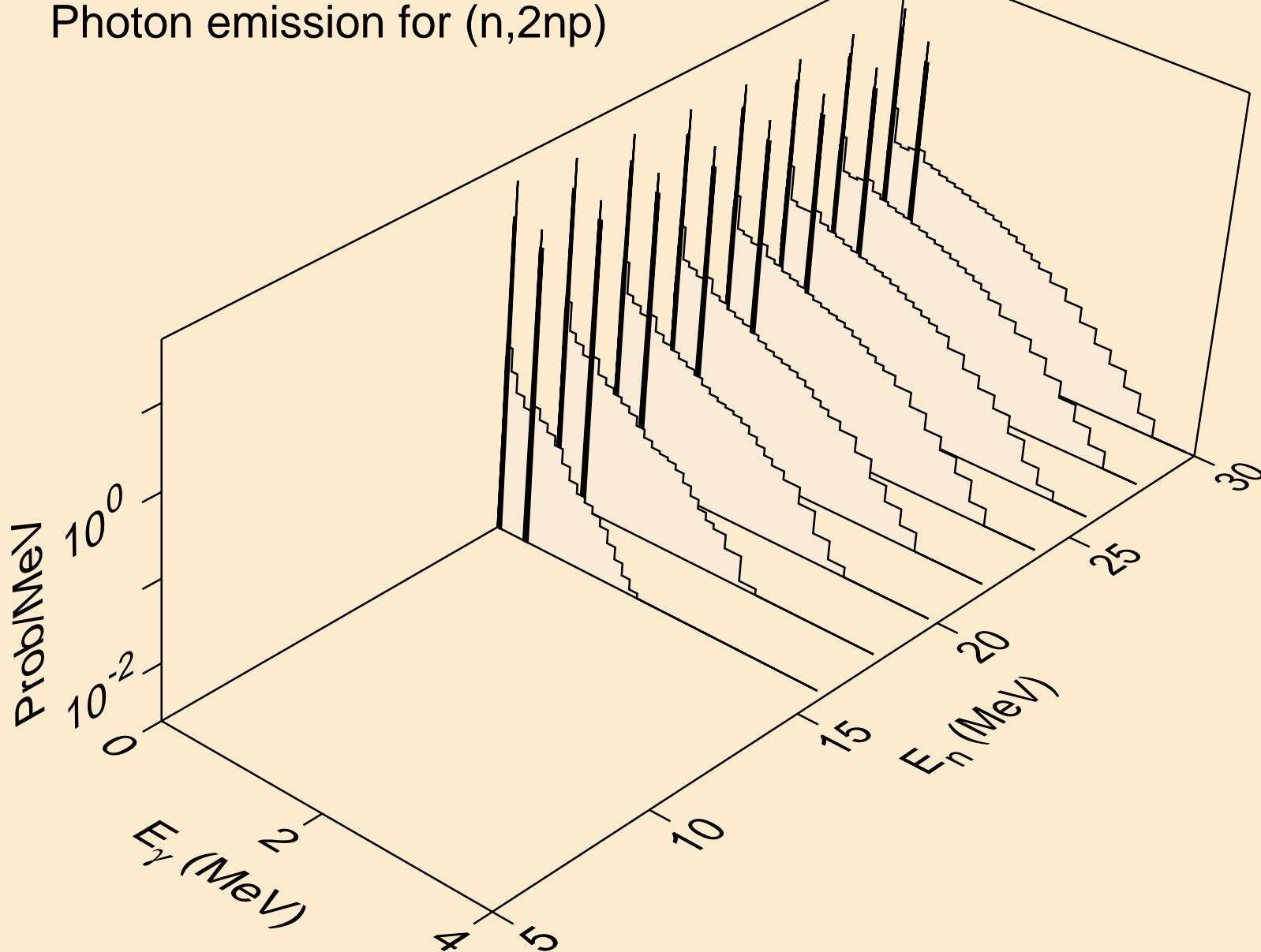

BK240 NEUTRON ACER TENDL-2019 LIBRARY; T=293.16K
Photon emission for (n,3np)

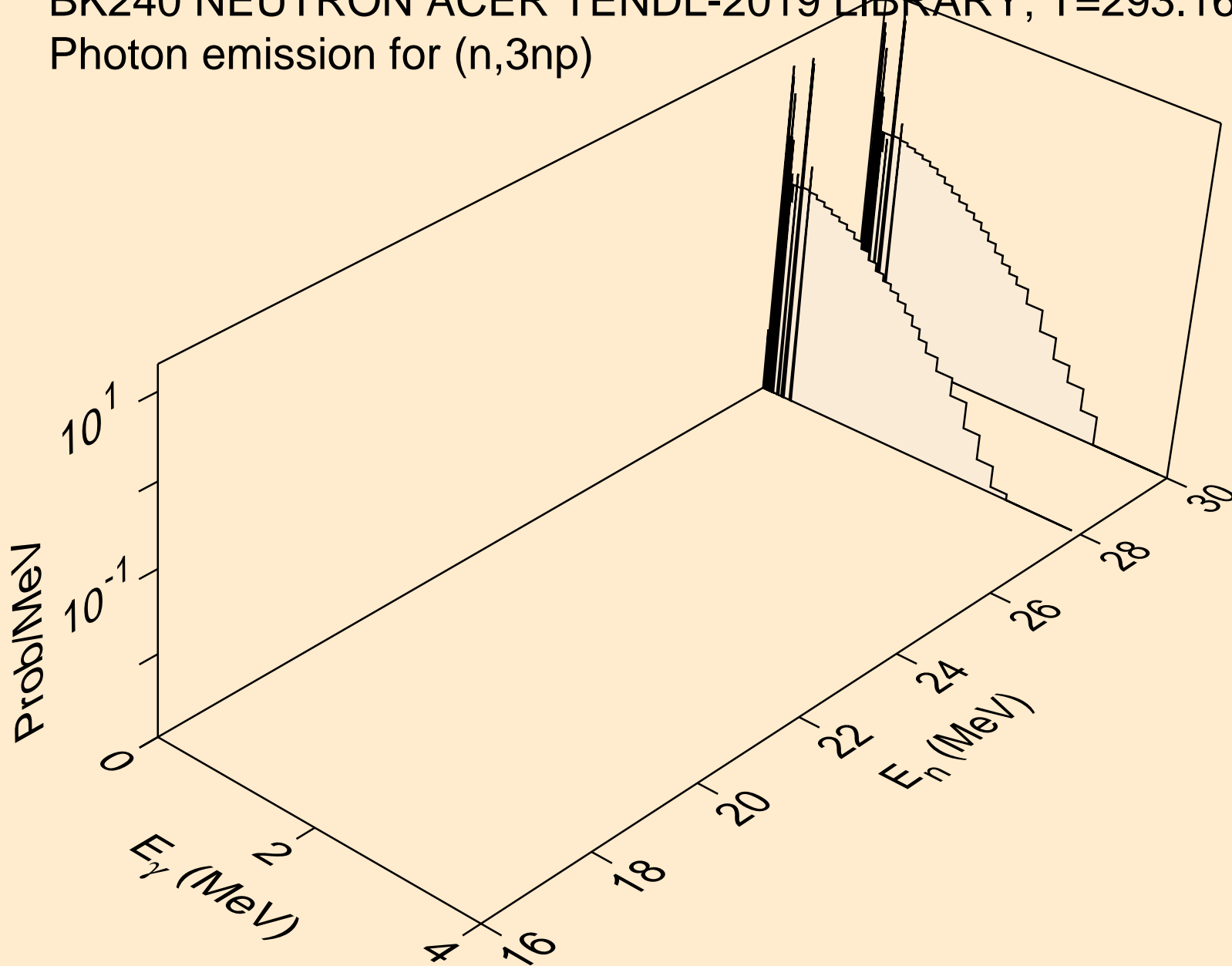

BK240 NEUTRON ACER TENDL-2019 LIBRARY; T=293.16K
Photon emission for (n,2np)

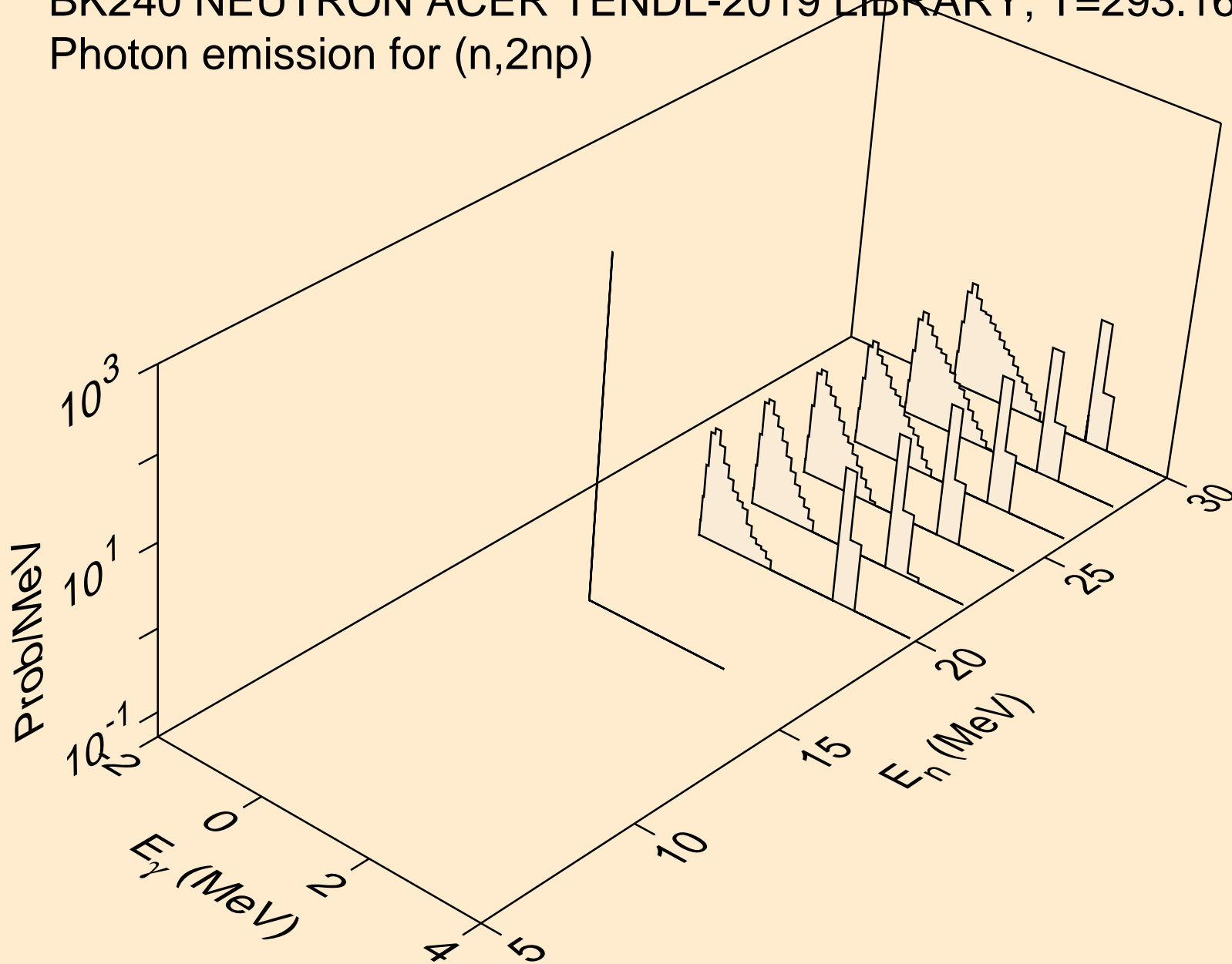

BK240 NEUTRON ACER TENDL-2019 LIBRARY; T=293.16K
Photon emission for (n,n*c)

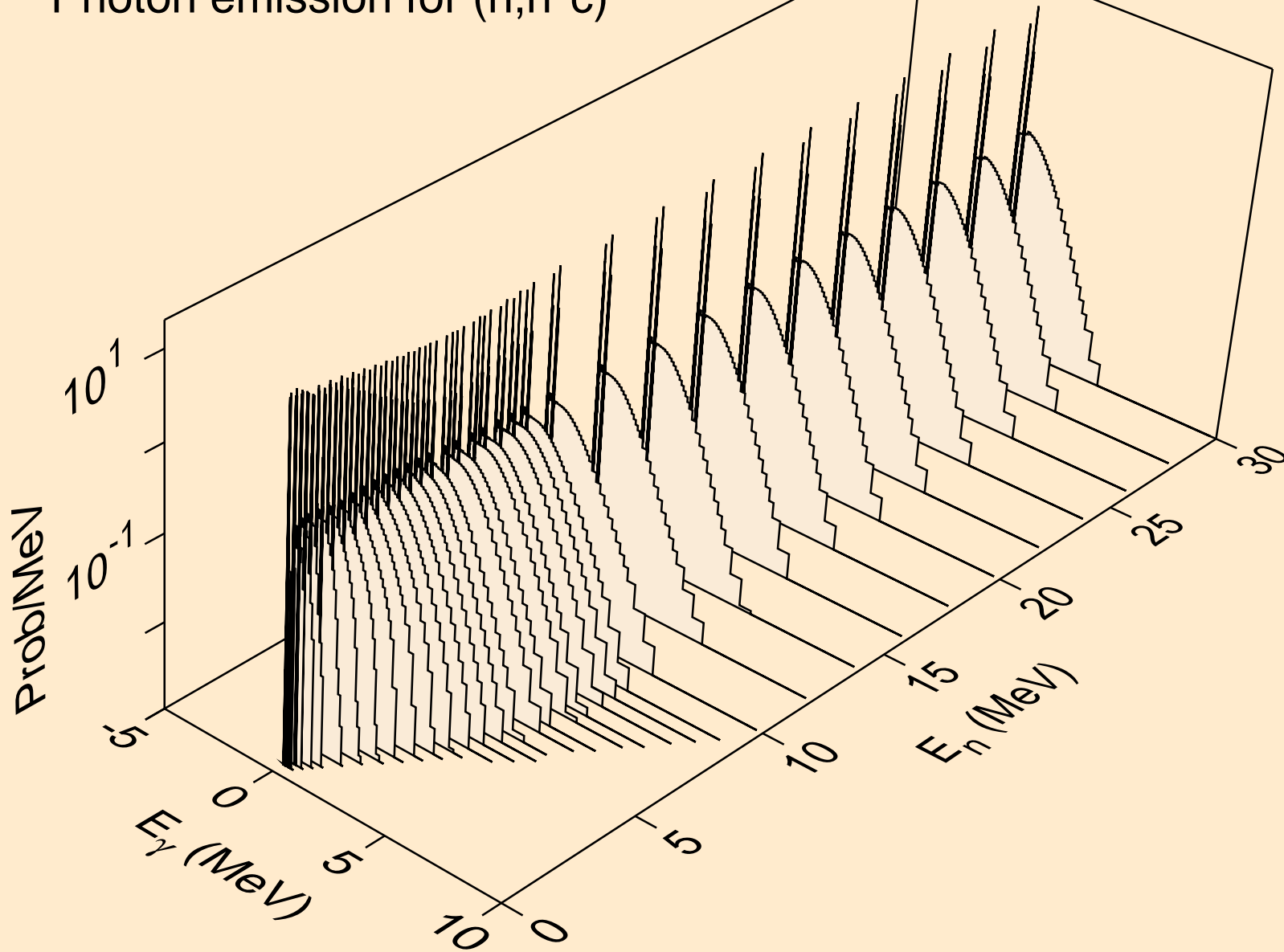

BK240 NEUTRON ACER TENDL-2019 LIBRARY; T=293.16K
Photon emission for (n,gma)

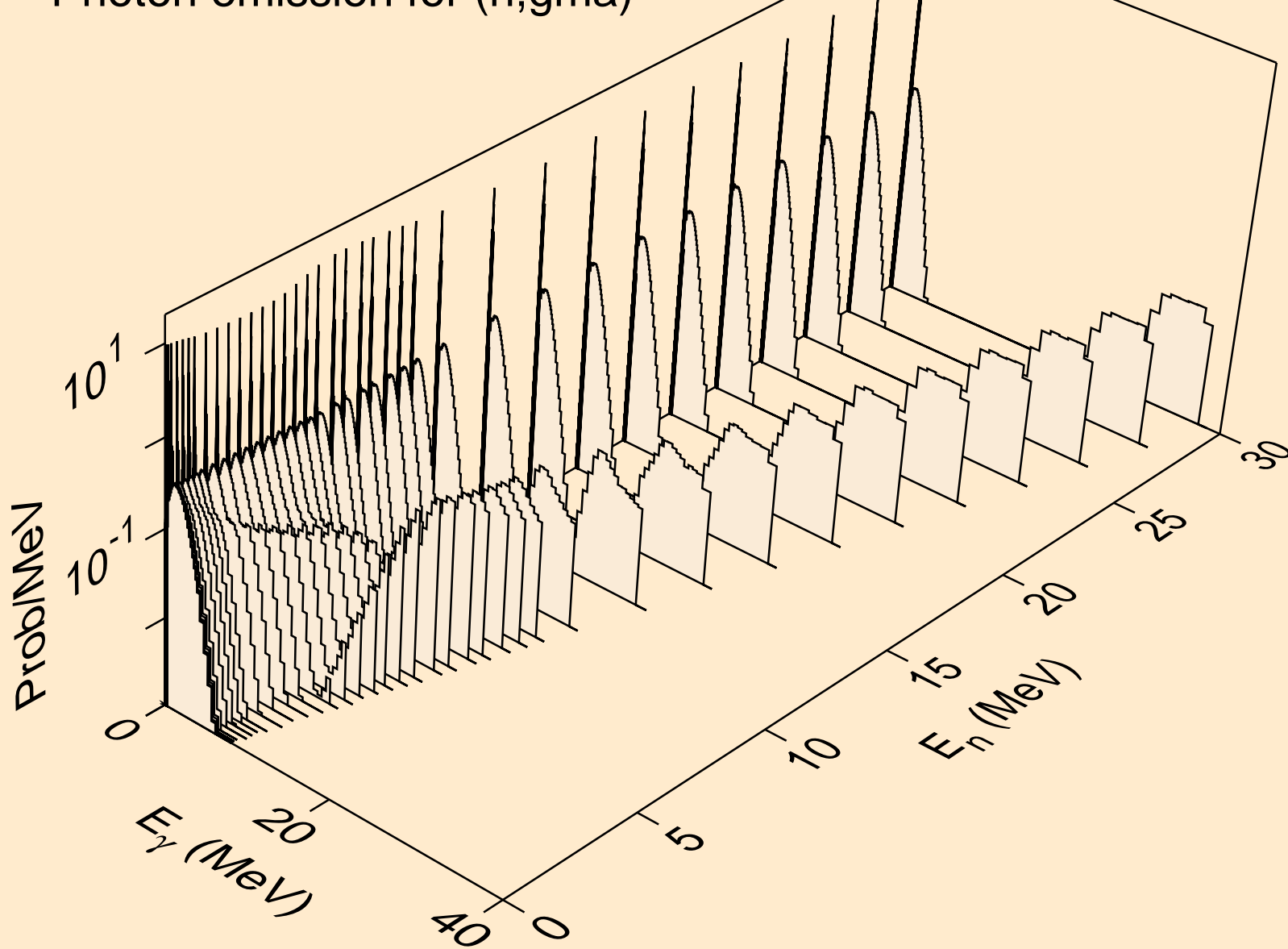

BK240 NEUTRON ACER TENDL-2019 LIBRARY; T=293.16K
Photon emission for (n,p)

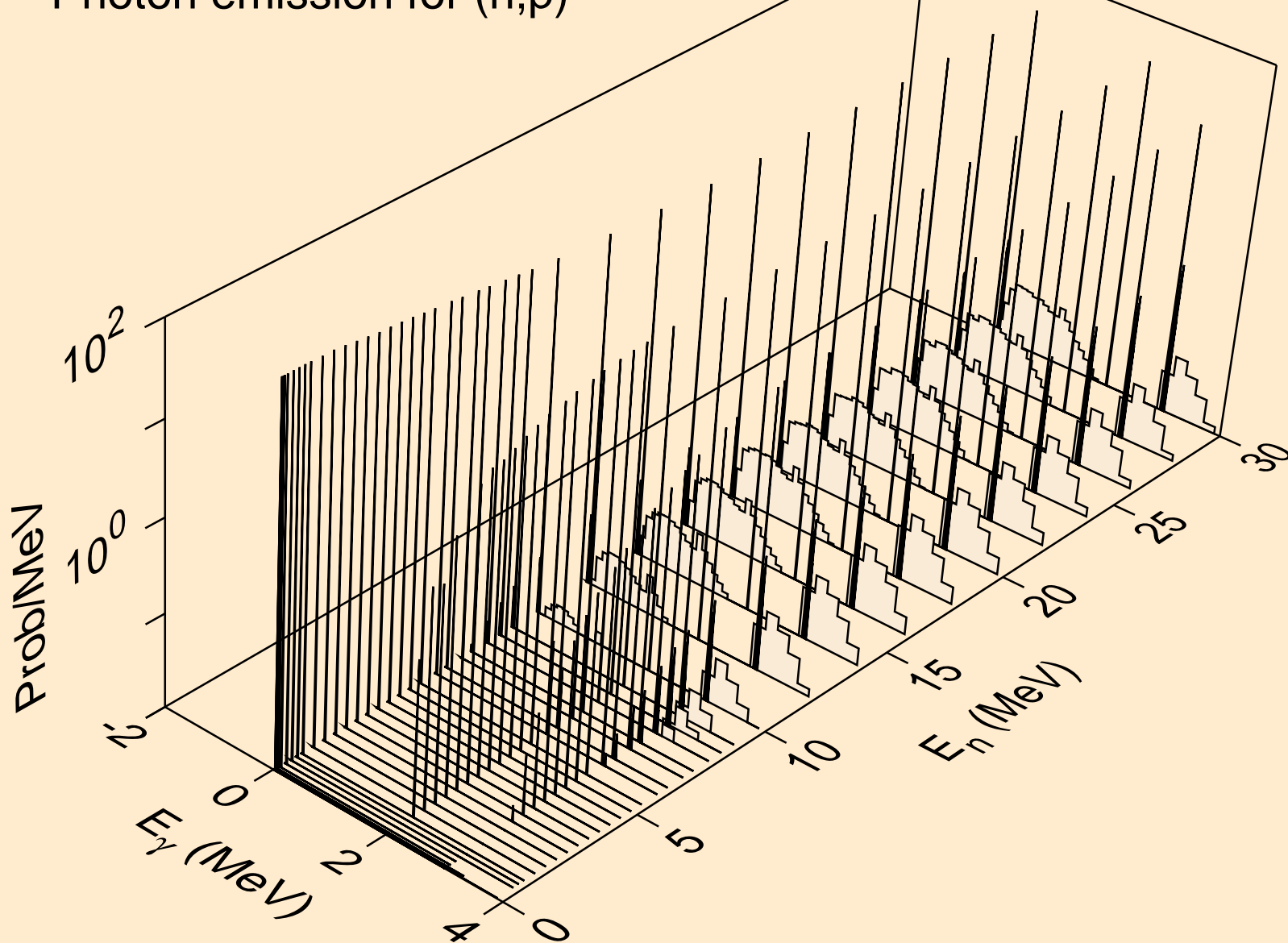

BK240 NEUTRON ACER TENDL-2019 LIBRARY; T=293.16K
Photon emission for (n,d)

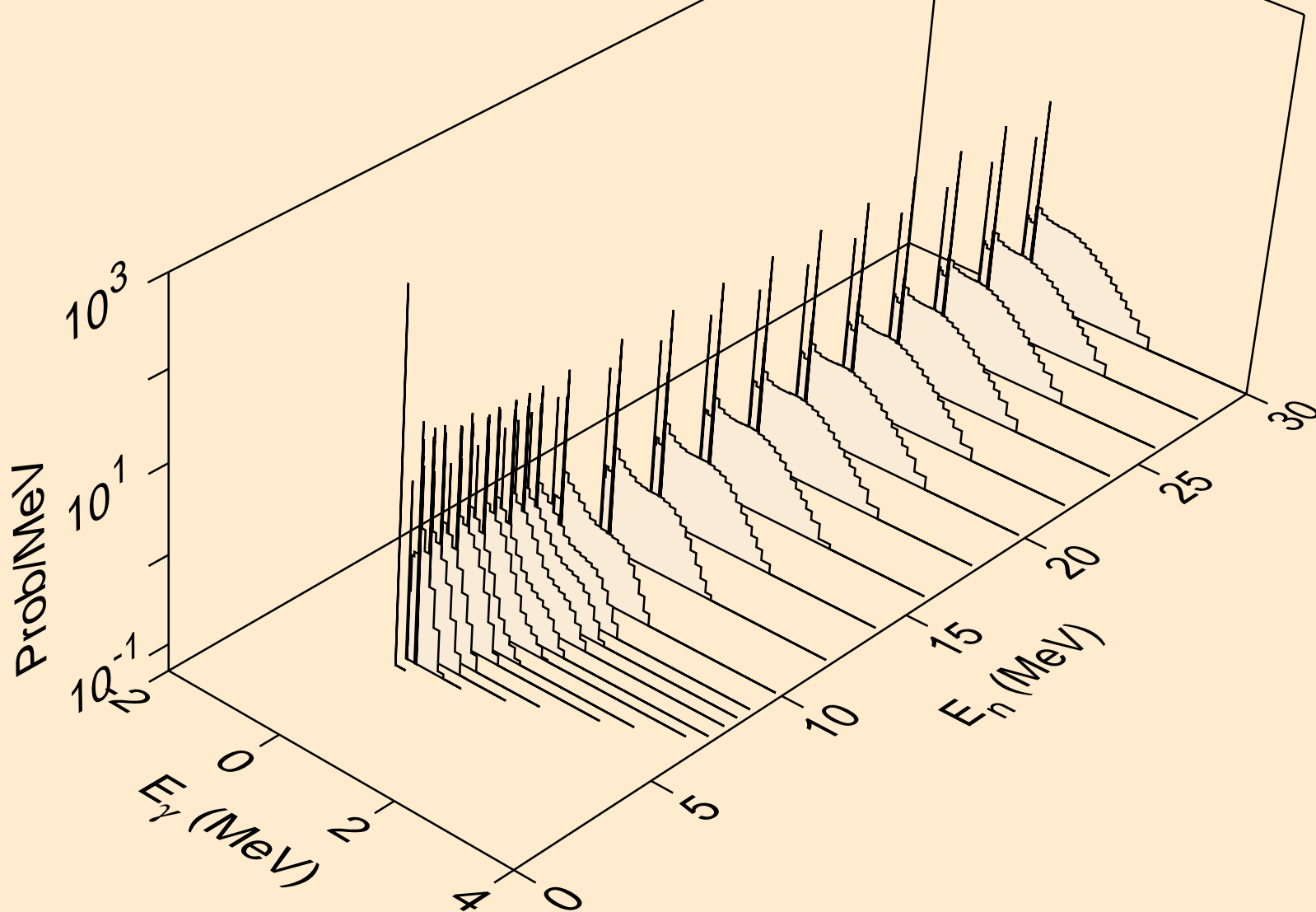

BK240 NEUTRON ACER TENDL-2019 LIBRARY; T=293.16K
Photon emission for (n,t)

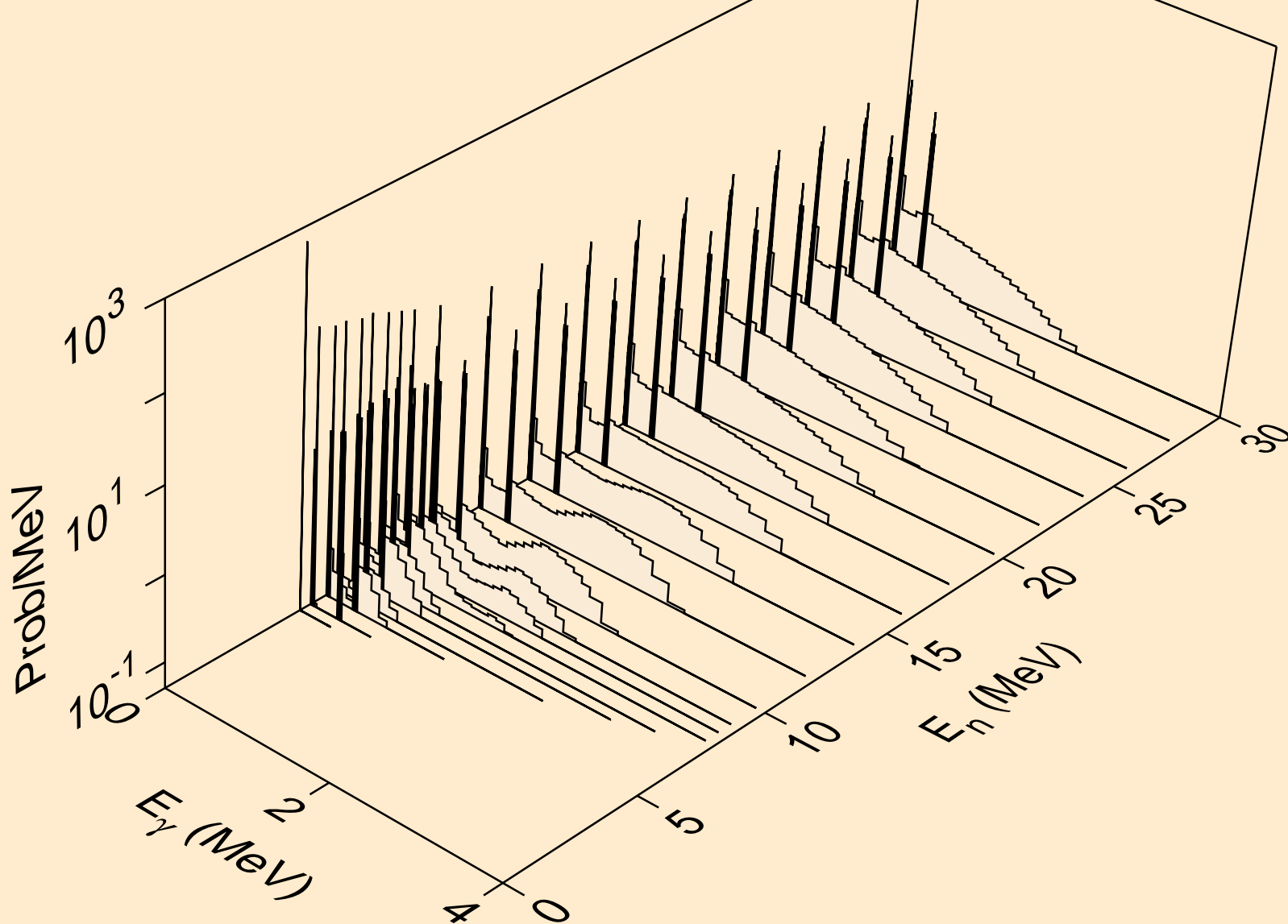

BK240 NEUTRON ACER TENDL-2019 LIBRARY; T=293.16K
Photon emission for (n,he3)

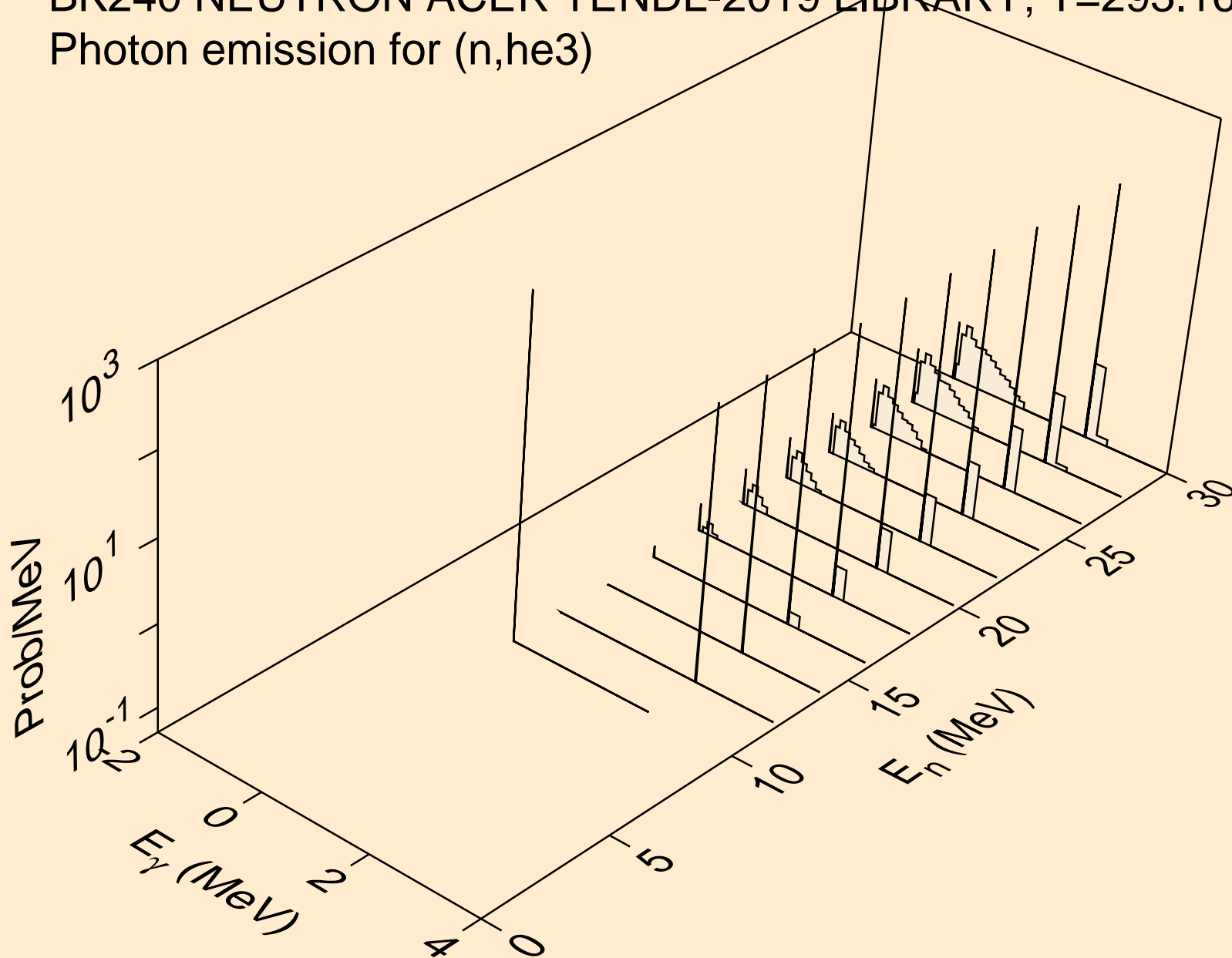

BK240 NEUTRON ACER TENDL-2019 LIBRARY; T=293.16K
Photon emission for (n,a)

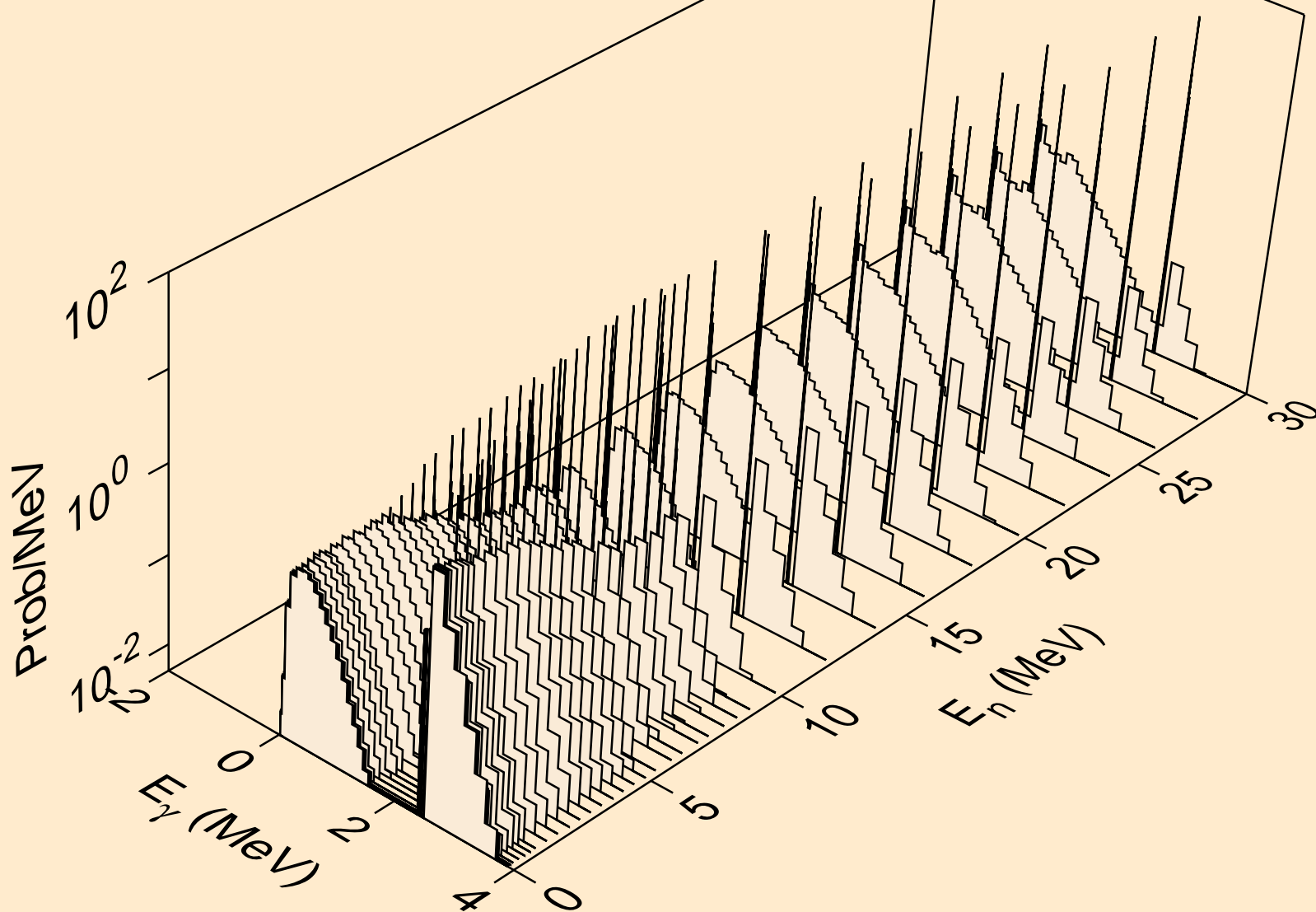

BK240 NEUTRON ACER TENDL-2019 LIBRARY; T=293.16K
Photon emission for (n,2p)

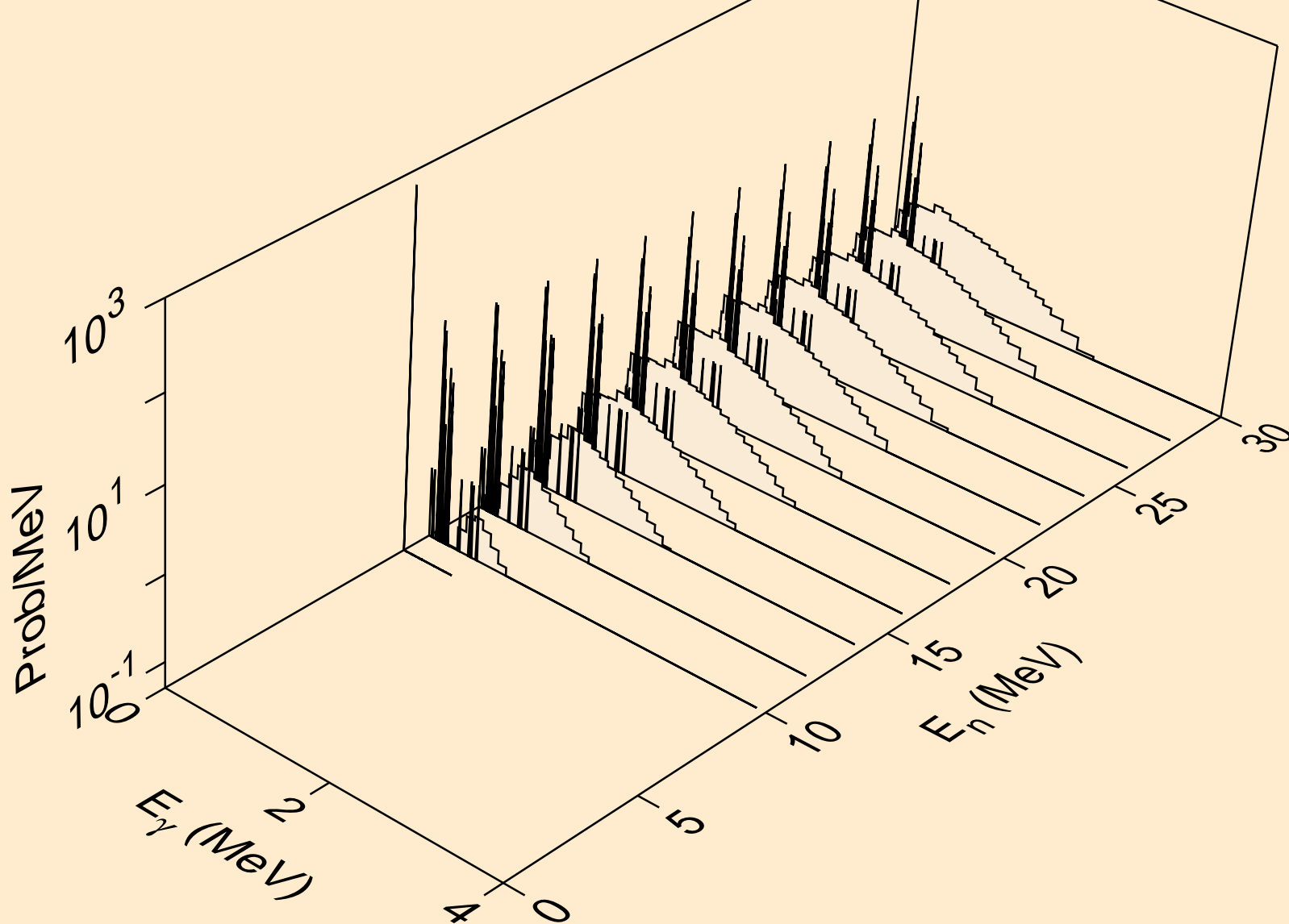

BK240 NEUTRON ACER TENDL-2019 LIBRARY; T=293.16K
Photon emission for (n,p α)

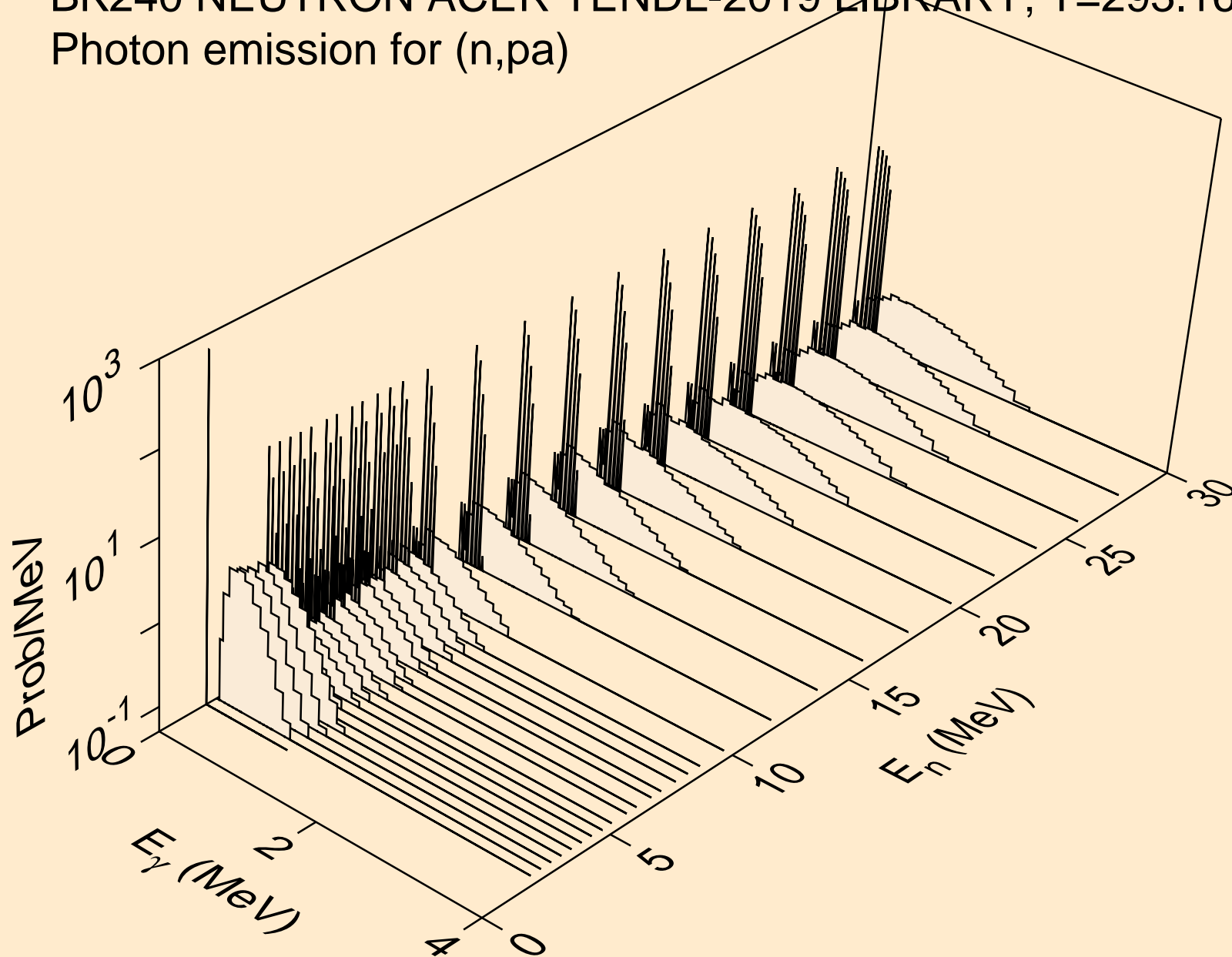

BK240 NEUTRON ACER TENDL-2019 LIBRARY; T=293.16K
thermal capture photon spectrum

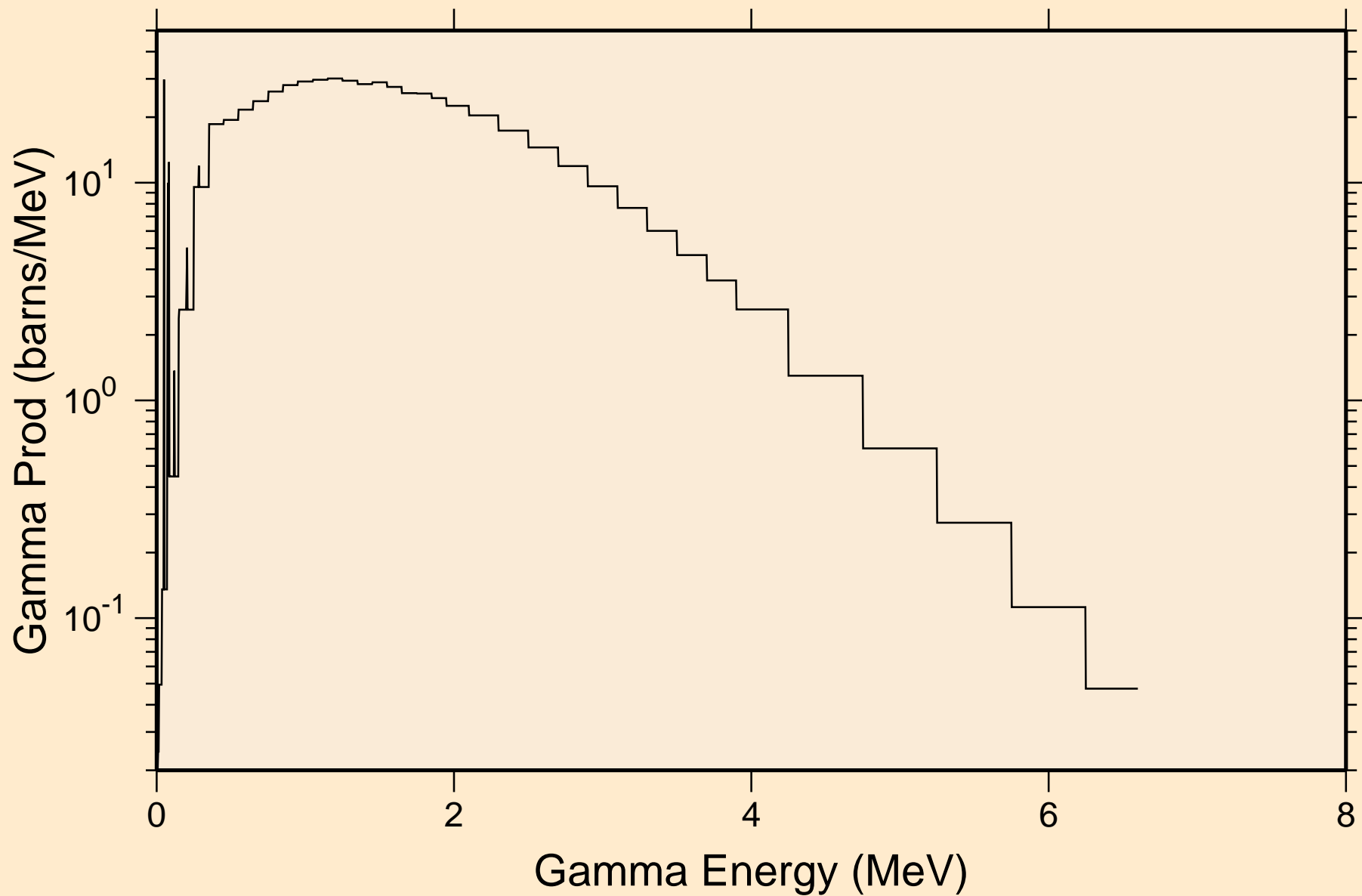

BK240 NEUTRON ACER TENDL-2019 LIBRARY; T=293.16K
14 MeV photon spectrum

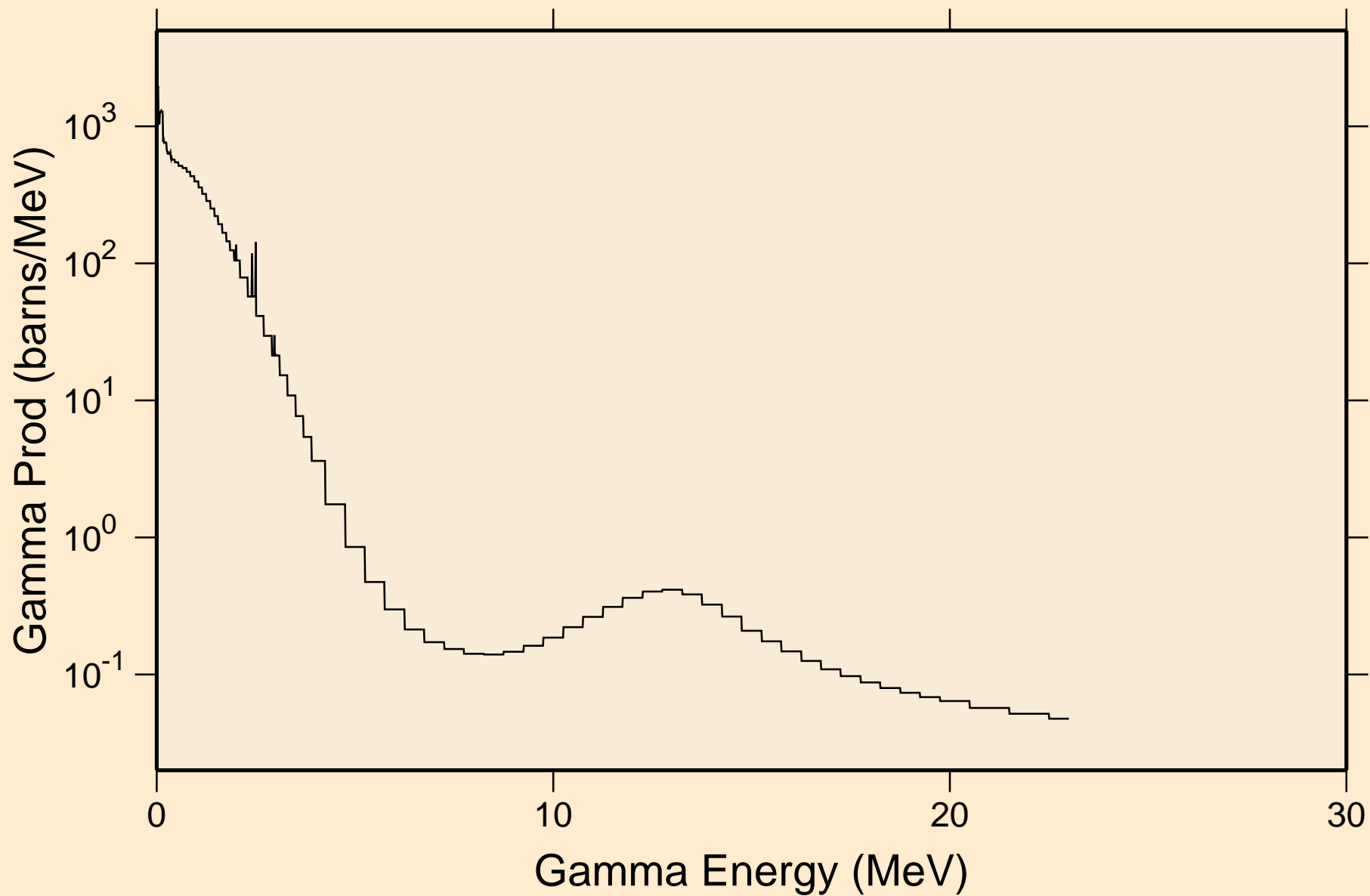

BK240 NEUTRON ACER TENDL-2019 LIBRARY; T=293.16K
Particle heating contributions

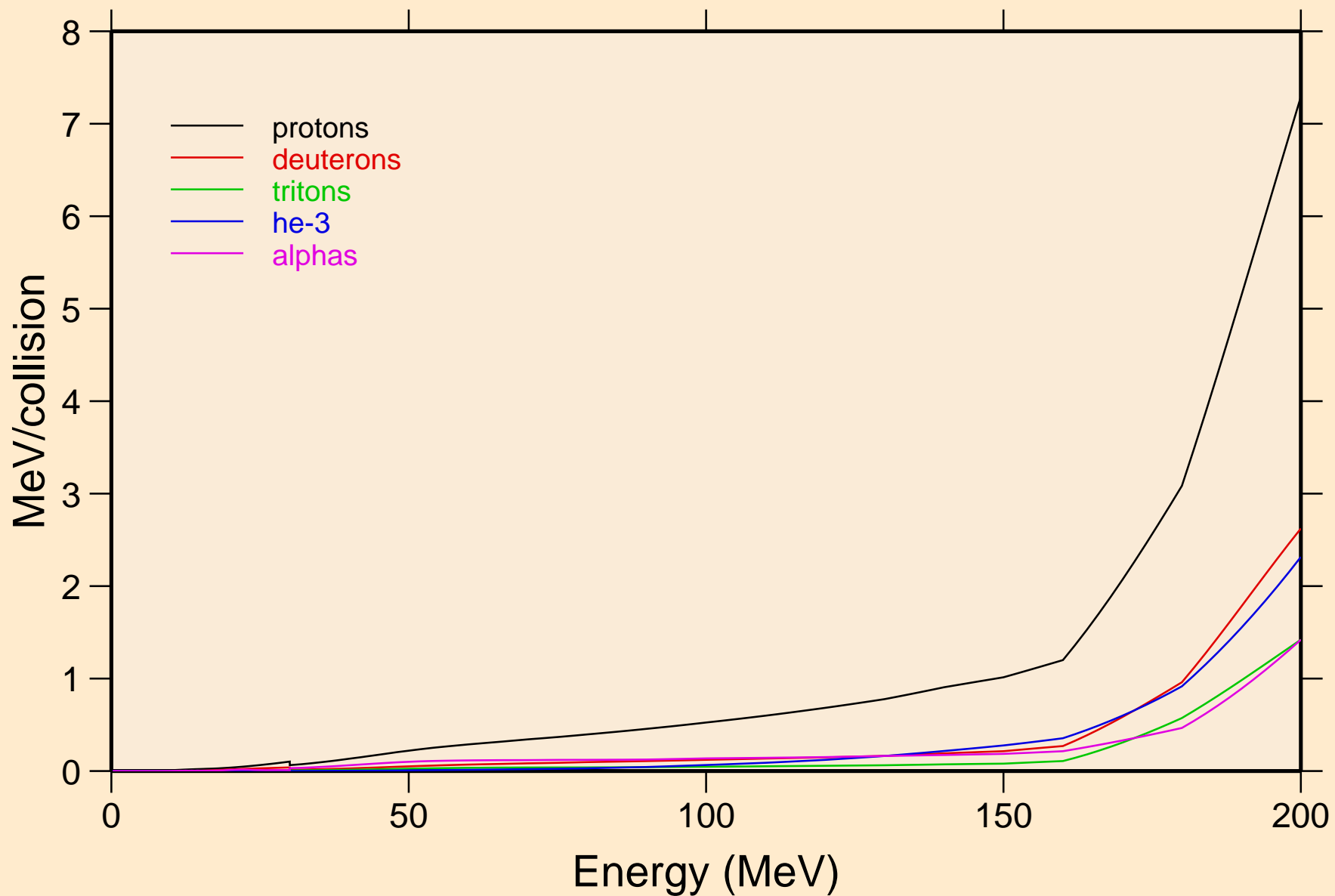

BK240 NEUTRON ACER TENDL-2019 LIBRARY; T=293.16K
Recoil Heating

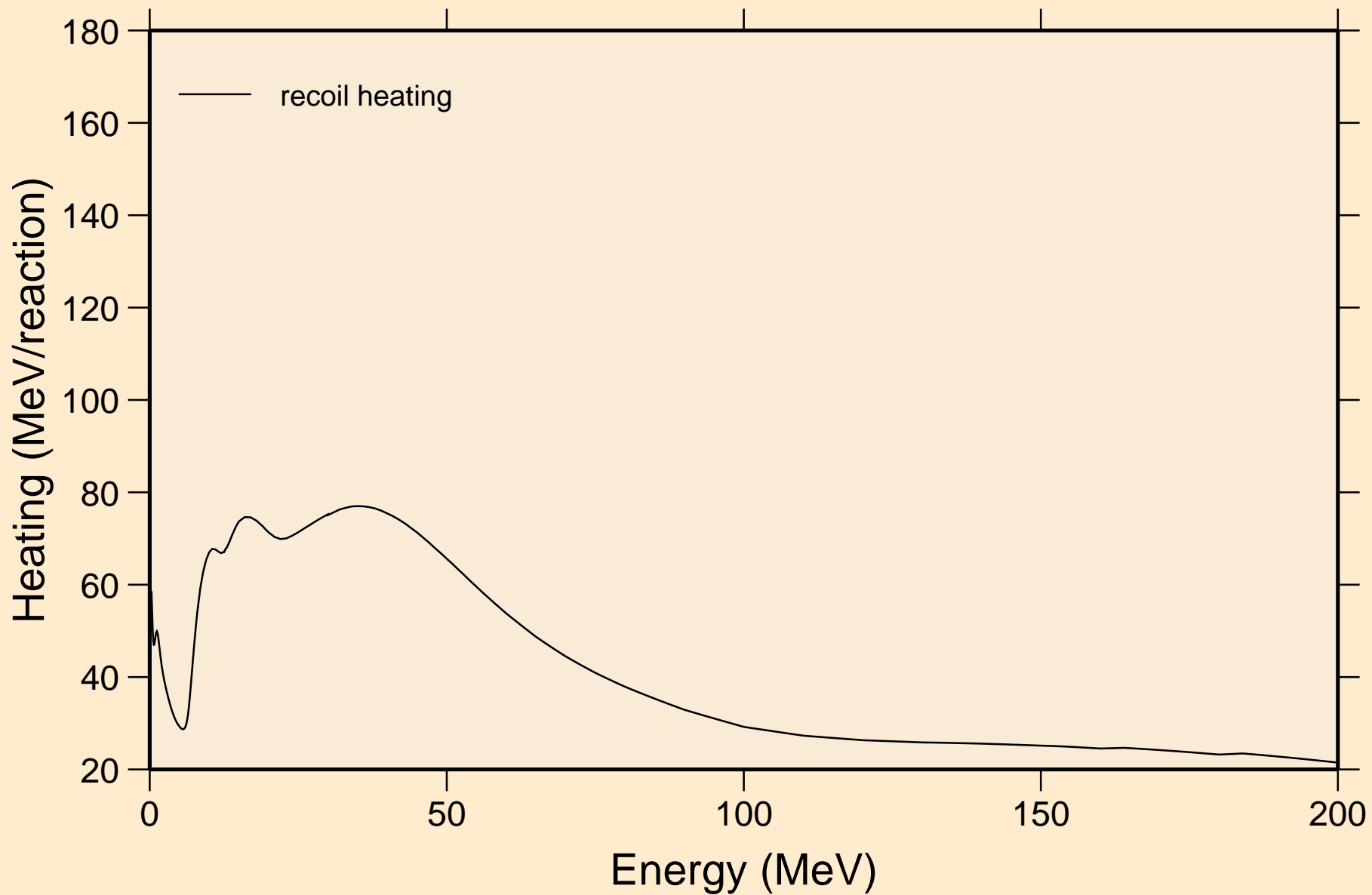

BK240 NEUTRON ACER TENDL-2019 LIBRARY; T=293.16K

Particle production cross sections

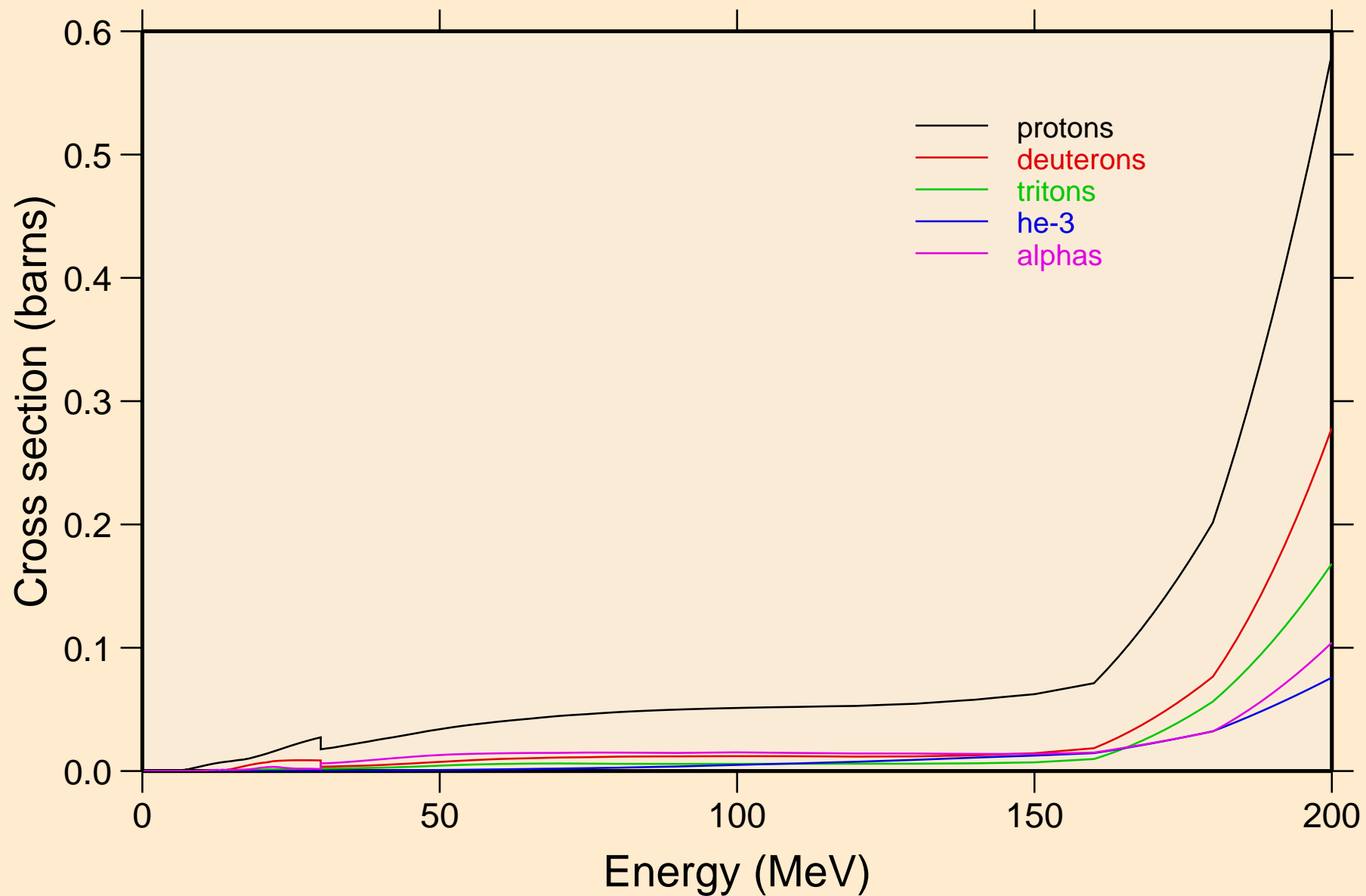

BK240 NEUTRON ACER TENDL-2019 LIBRARY; T=293.16K
protons from (n,x)

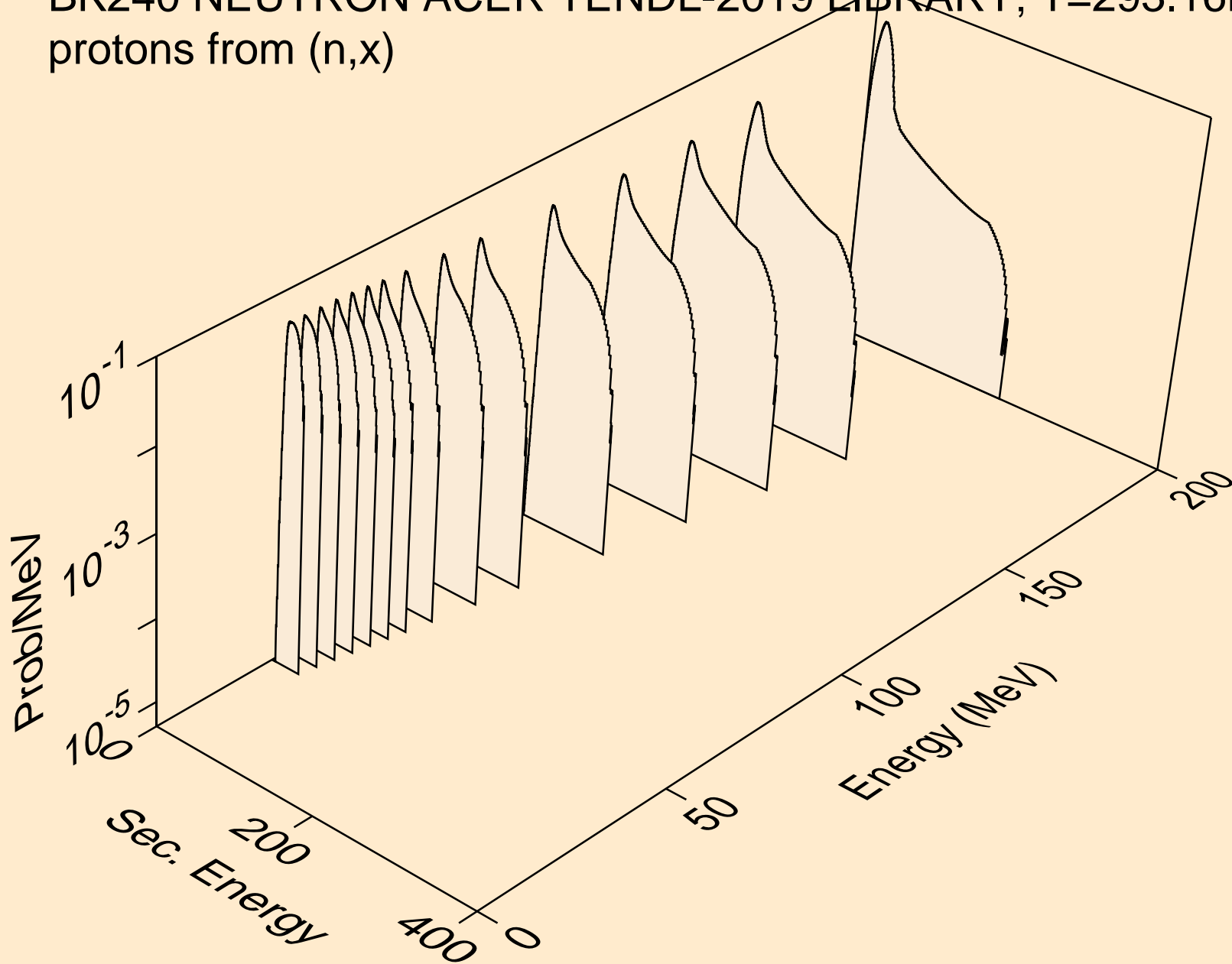

BK240 NEUTRON ACER TENDL-2019 LIBRARY; T=293.16K
protons from (n,n*)p

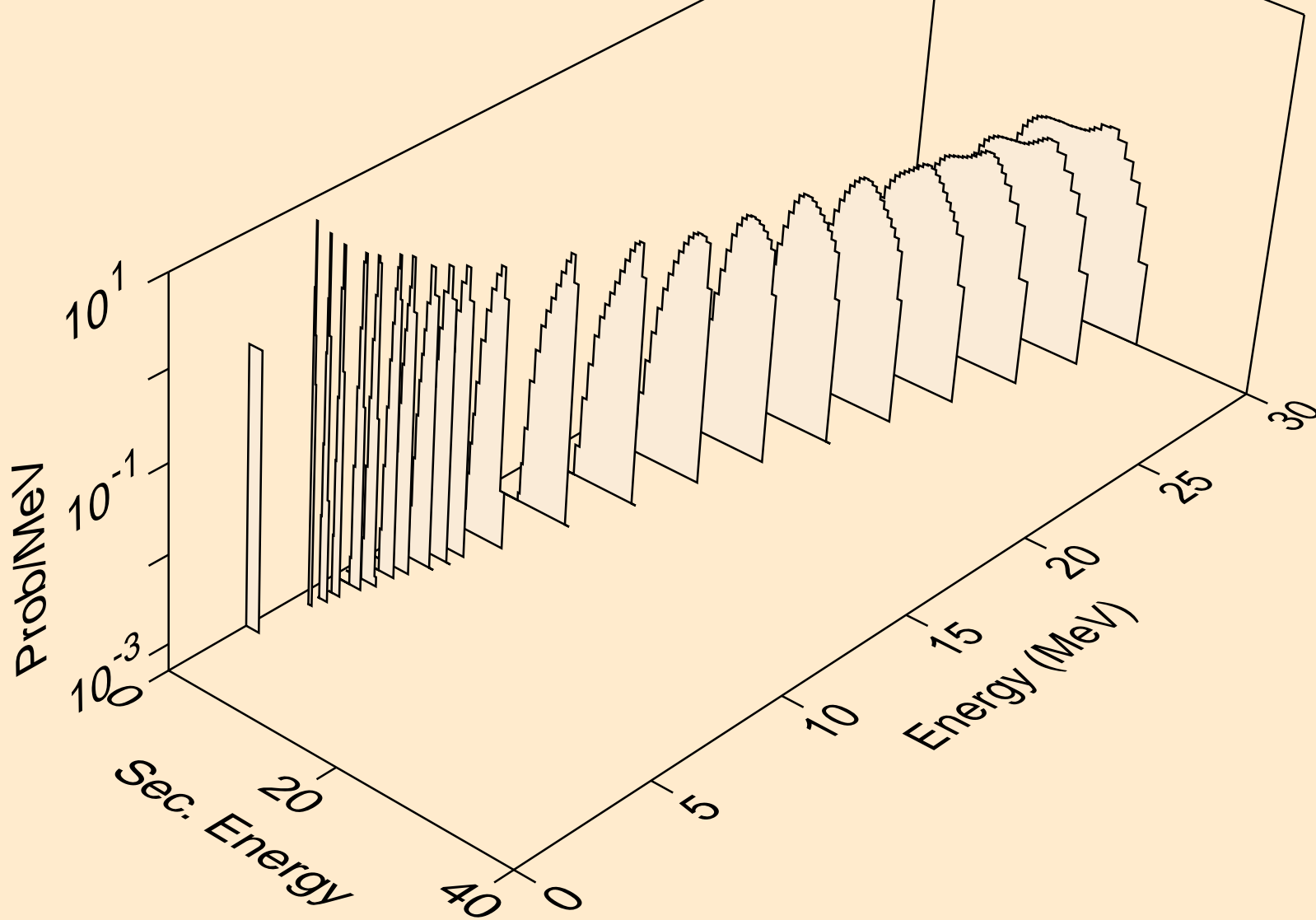

BK240 NEUTRON ACER TENDL-2019 LIBRARY; T=293.16K
protons from (n,2np)

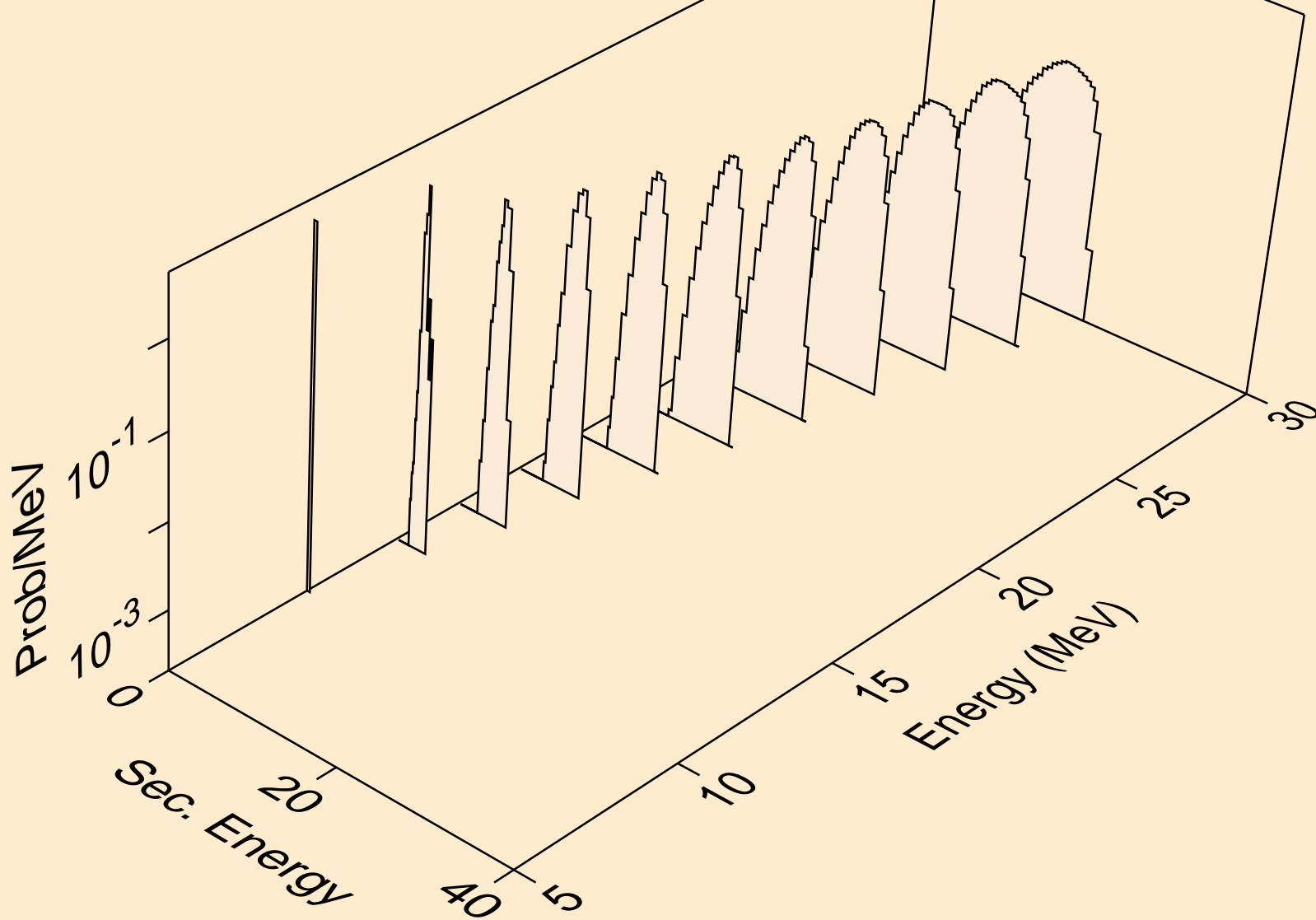

BK240 NEUTRON ACER TENDL-2019 LIBRARY; T=293.16K
protons from (n,3np)

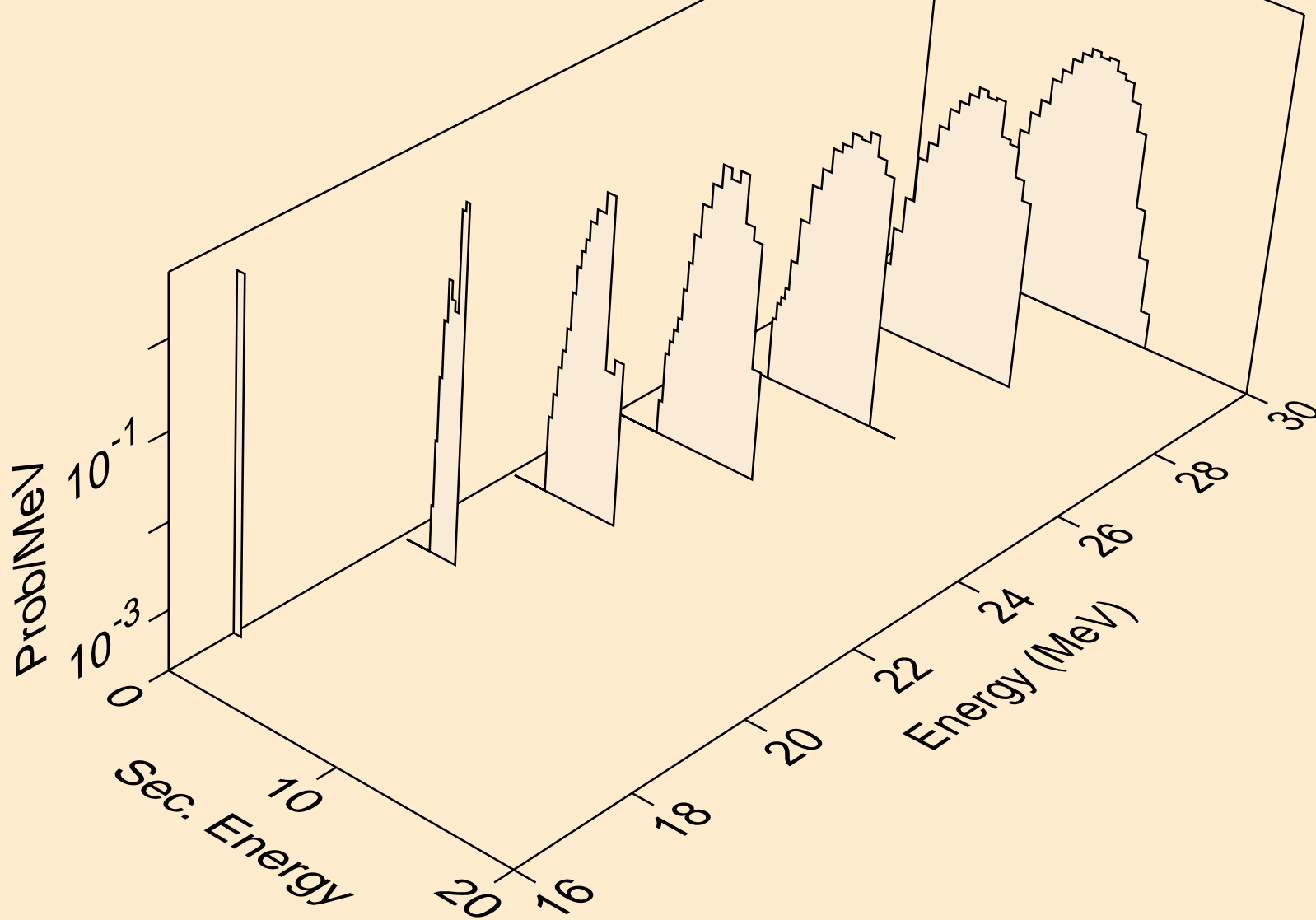

BK240 NEUTRON ACER TENDL-2019 LIBRARY; T=293.16K
protons from (n,2np)

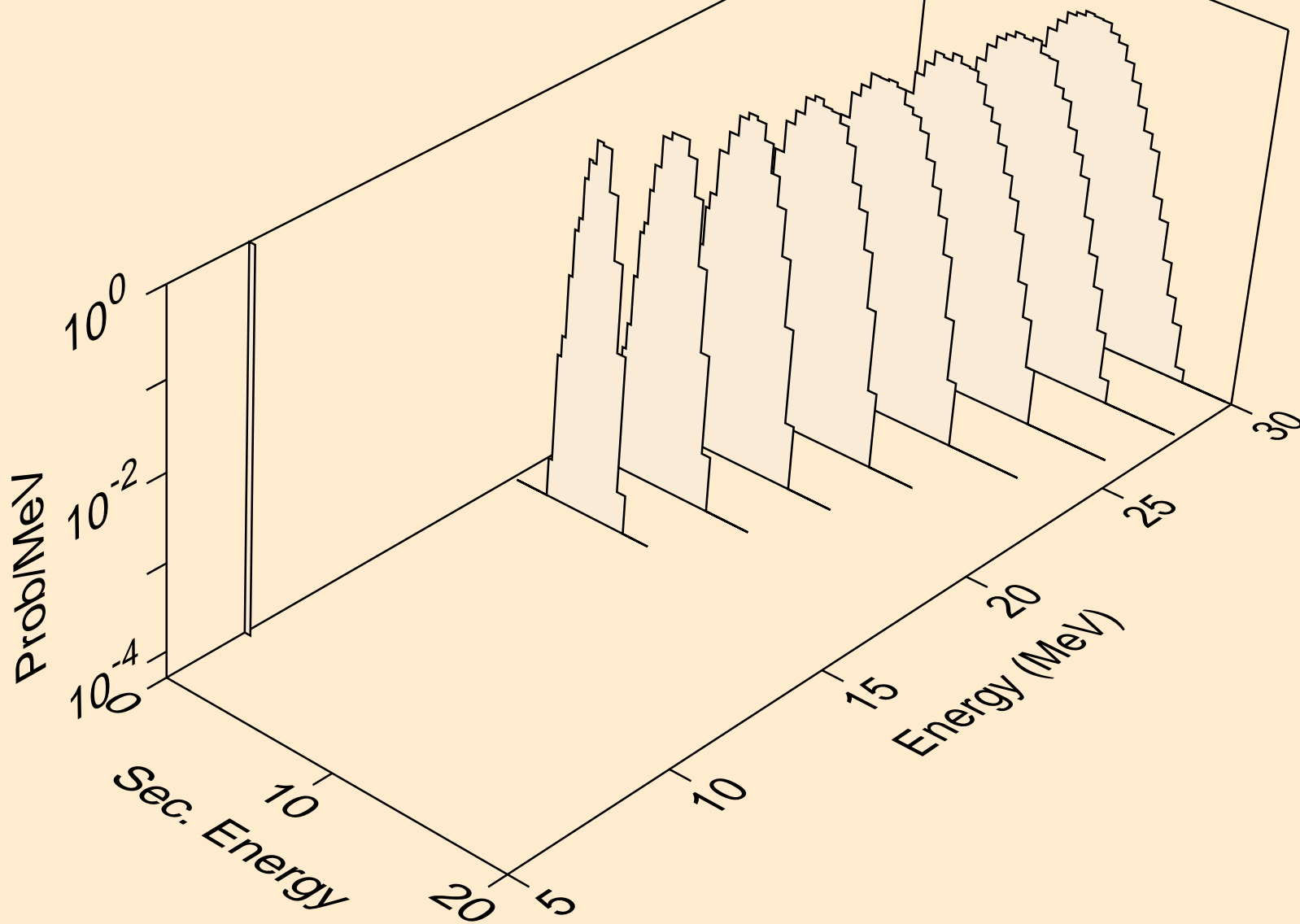

BK240 NEUTRON ACER TENDL-2019 LIBRARY; T=293.16K
protons from (n,p)

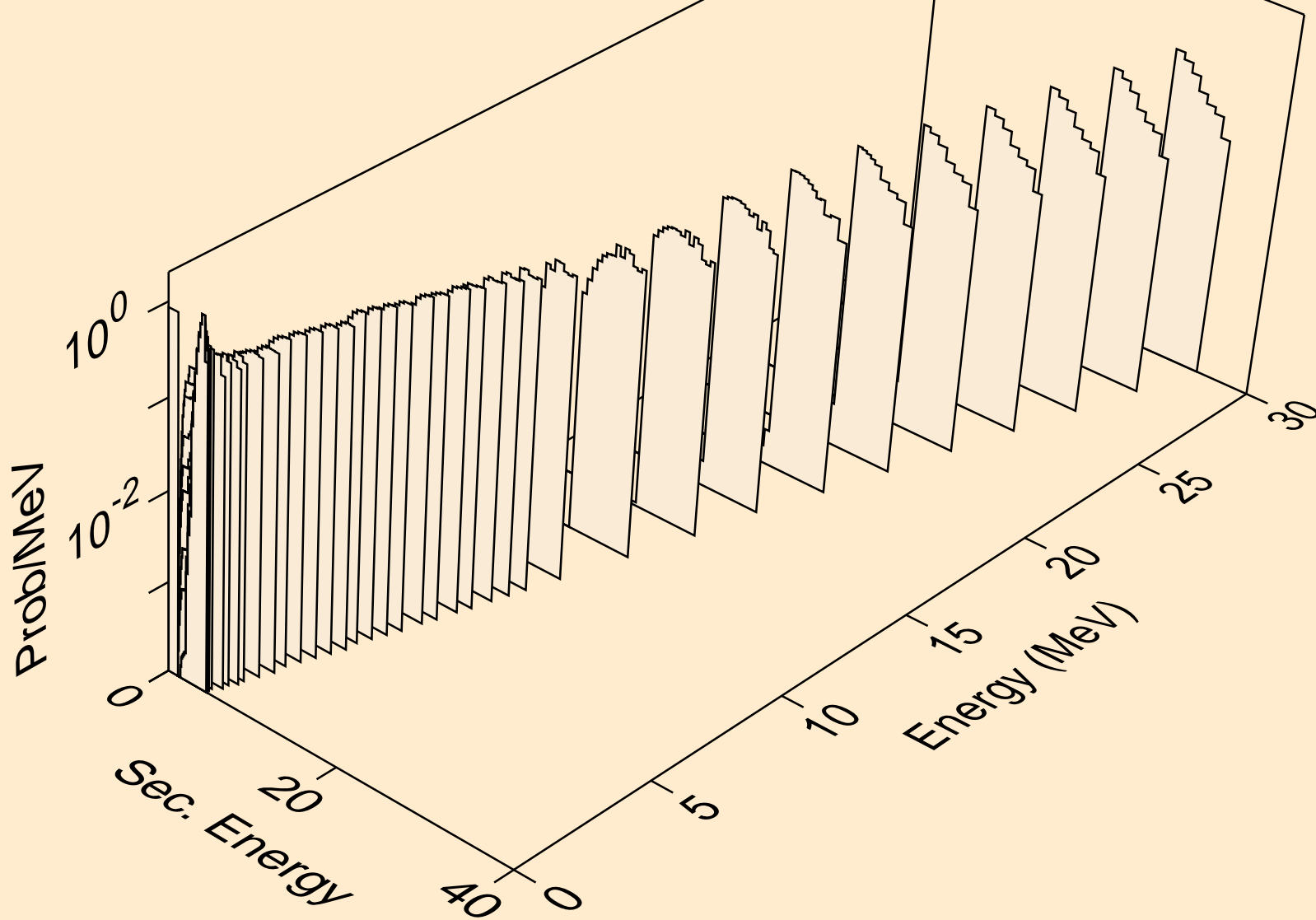

BK240 NEUTRON ACER TENDL-2019 LIBRARY; T=293.16K
protons from (n,2p)

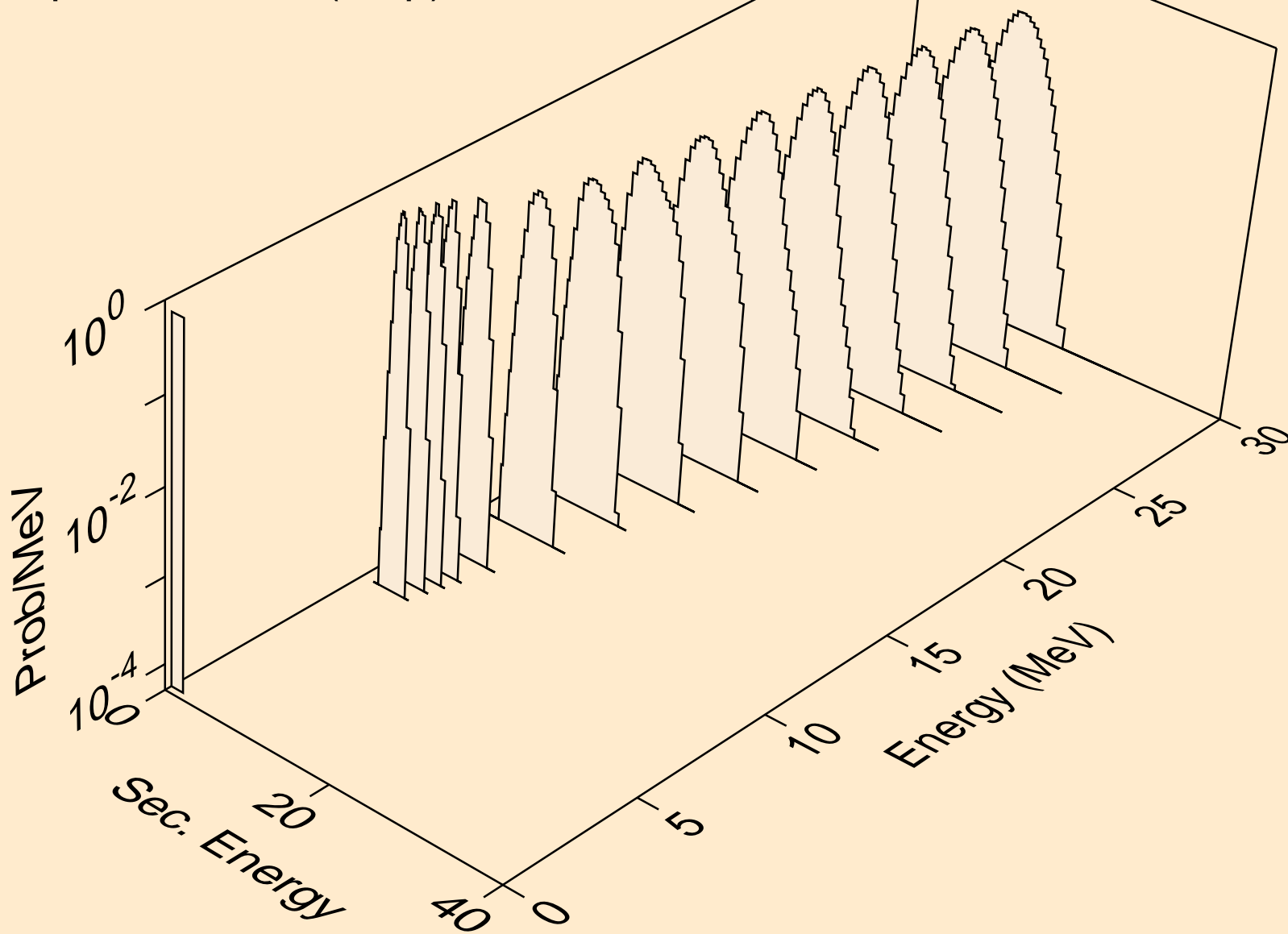

BK240 NEUTRON ACER TENDL-2019 LIBRARY; T=293.16K
protons from (n,p)

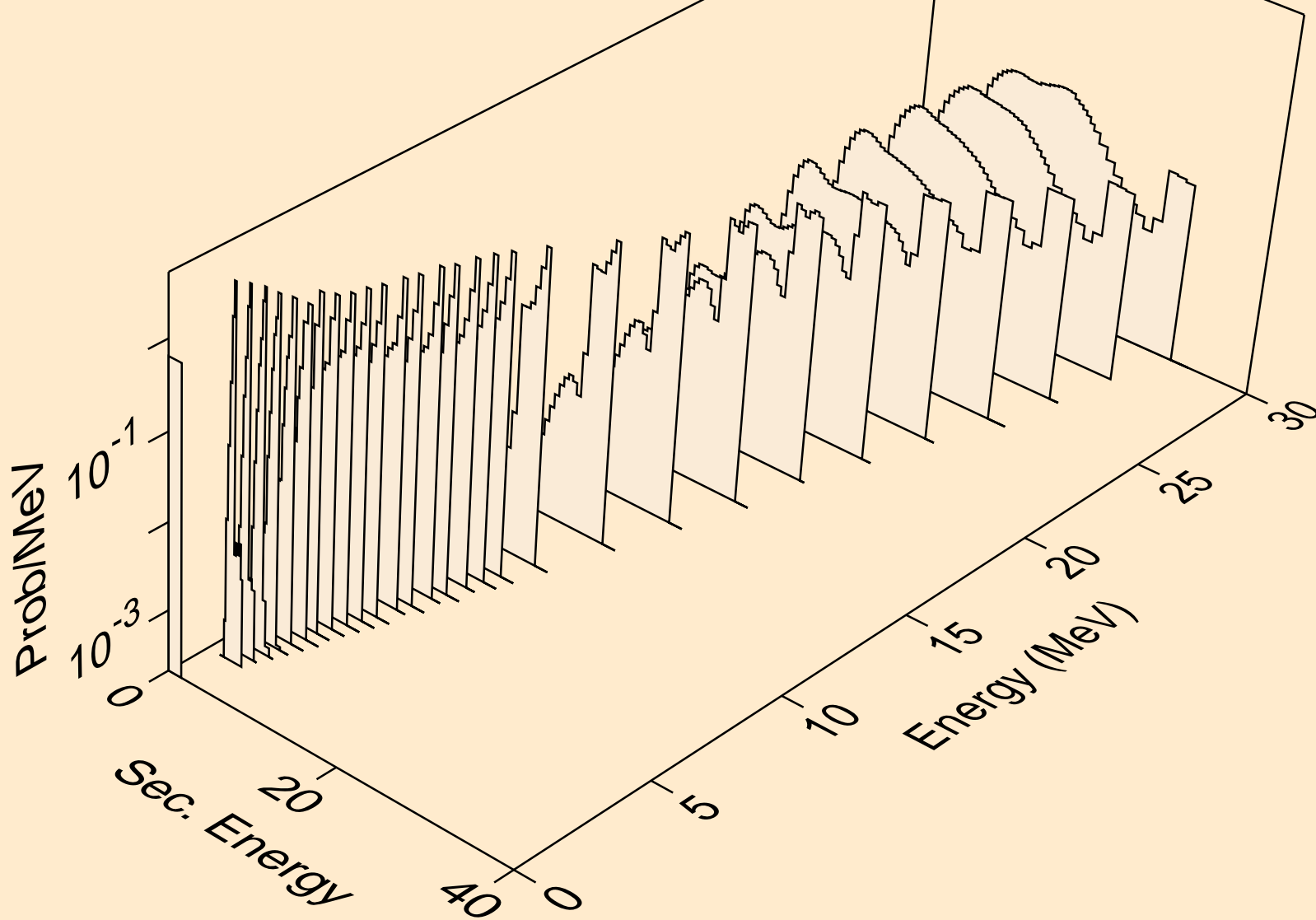

BK240 NEUTRON ACER TENDL-2019 LIBRARY; T=293.16K
deuterons from (n,x)

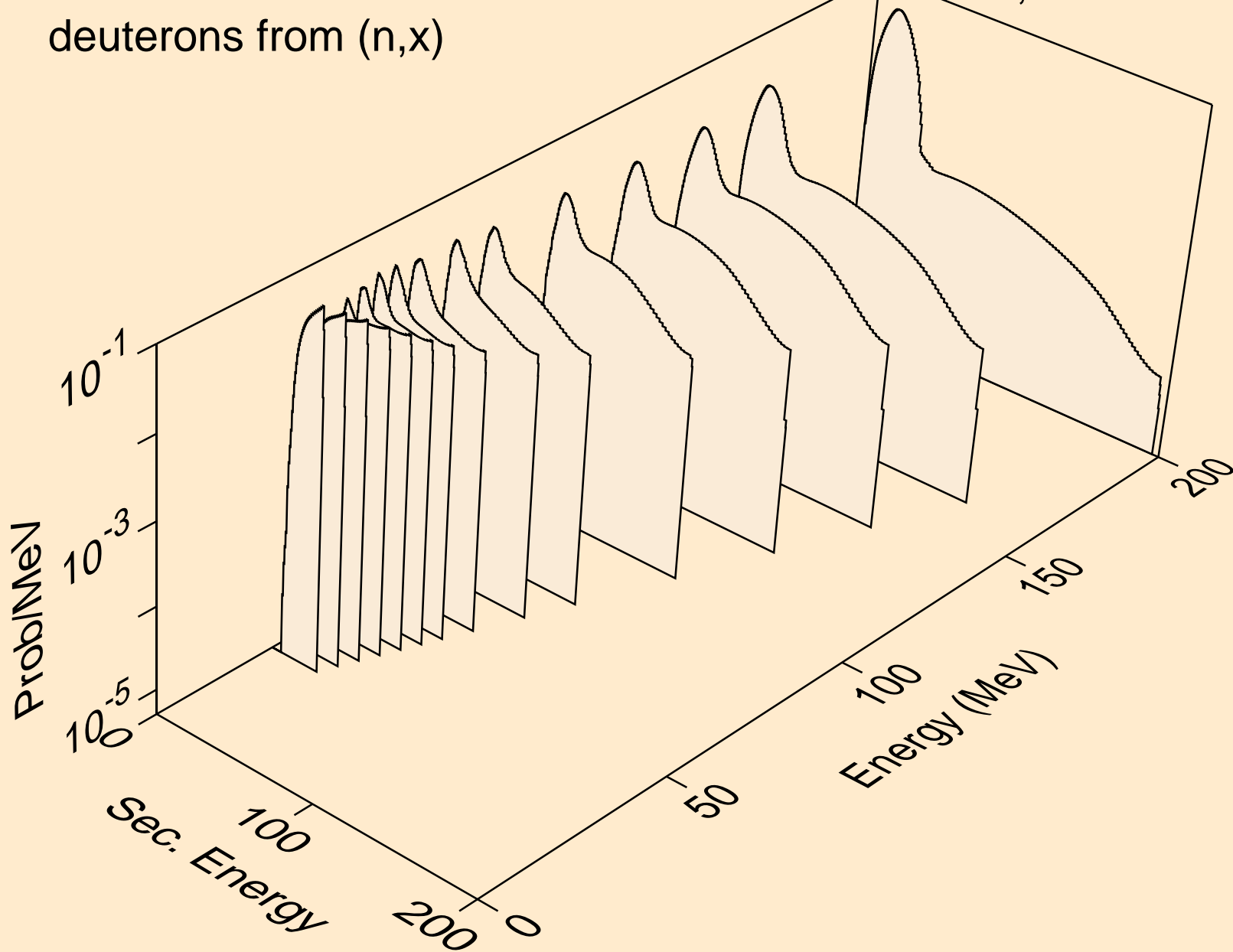

BK240 NEUTRON ACER TENDL-2019 LIBRARY; T=293.16K
deuterons from (n,2nd)

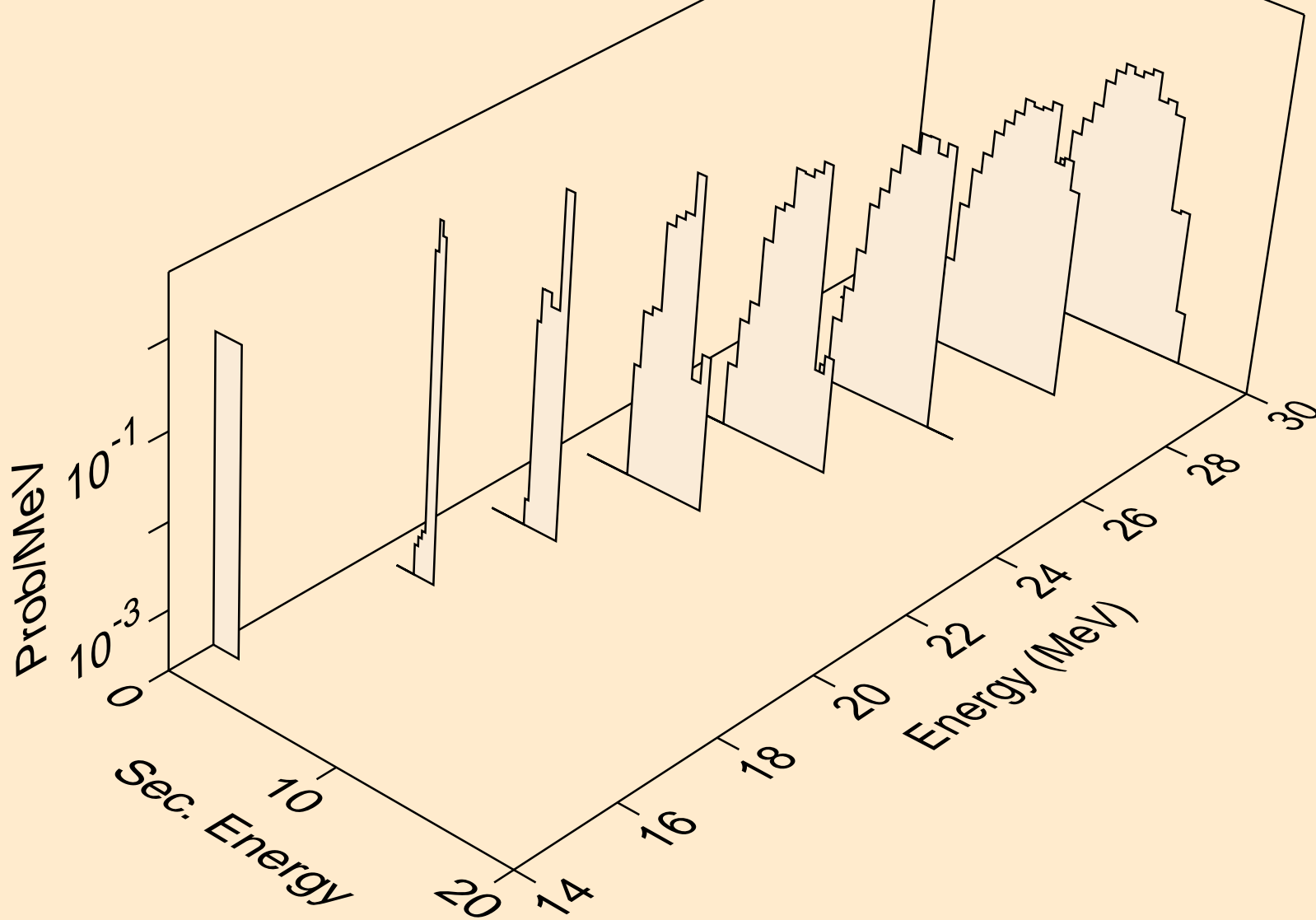

BK240 NEUTRON ACER TENDL-2019 LIBRARY; T=293.16K
deuterons from (n,n*)d

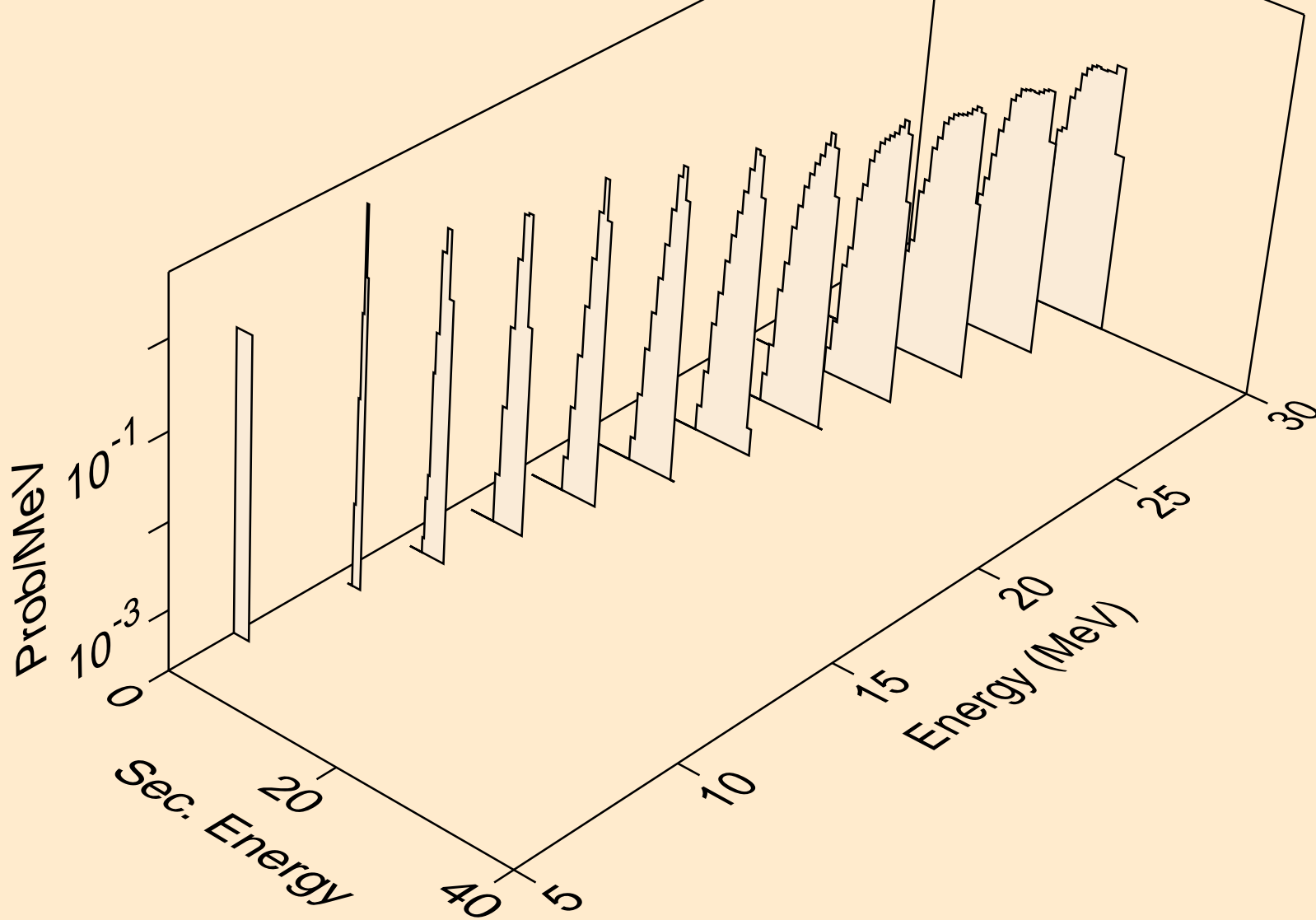

BK240 NEUTRON ACER TENDL-2019 LIBRARY; T=293.16K
deuterons from (n,d)

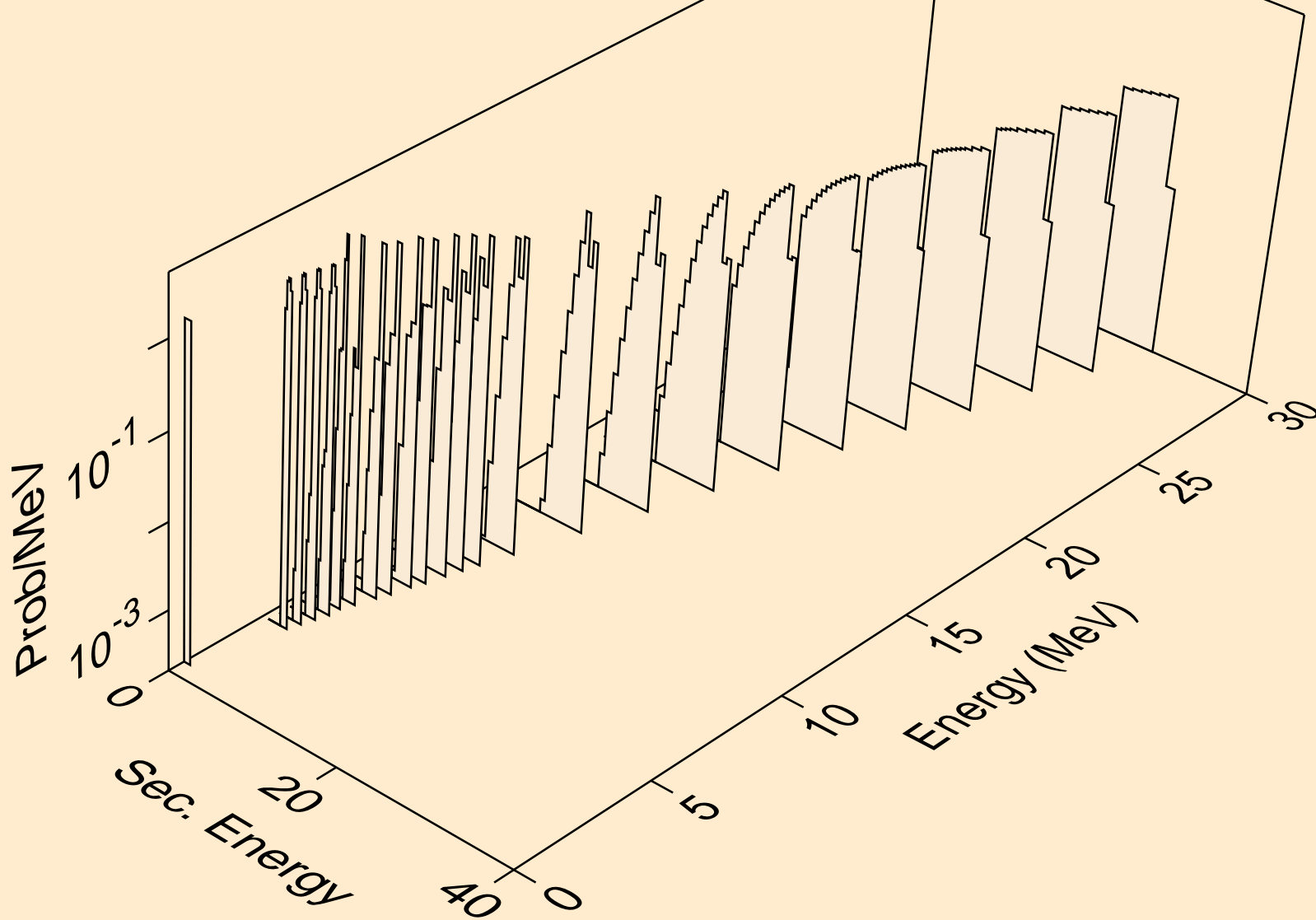

BK240 NEUTRON ACER TENDL-2019 LIBRARY; T=293.16K
tritons from (n,x)

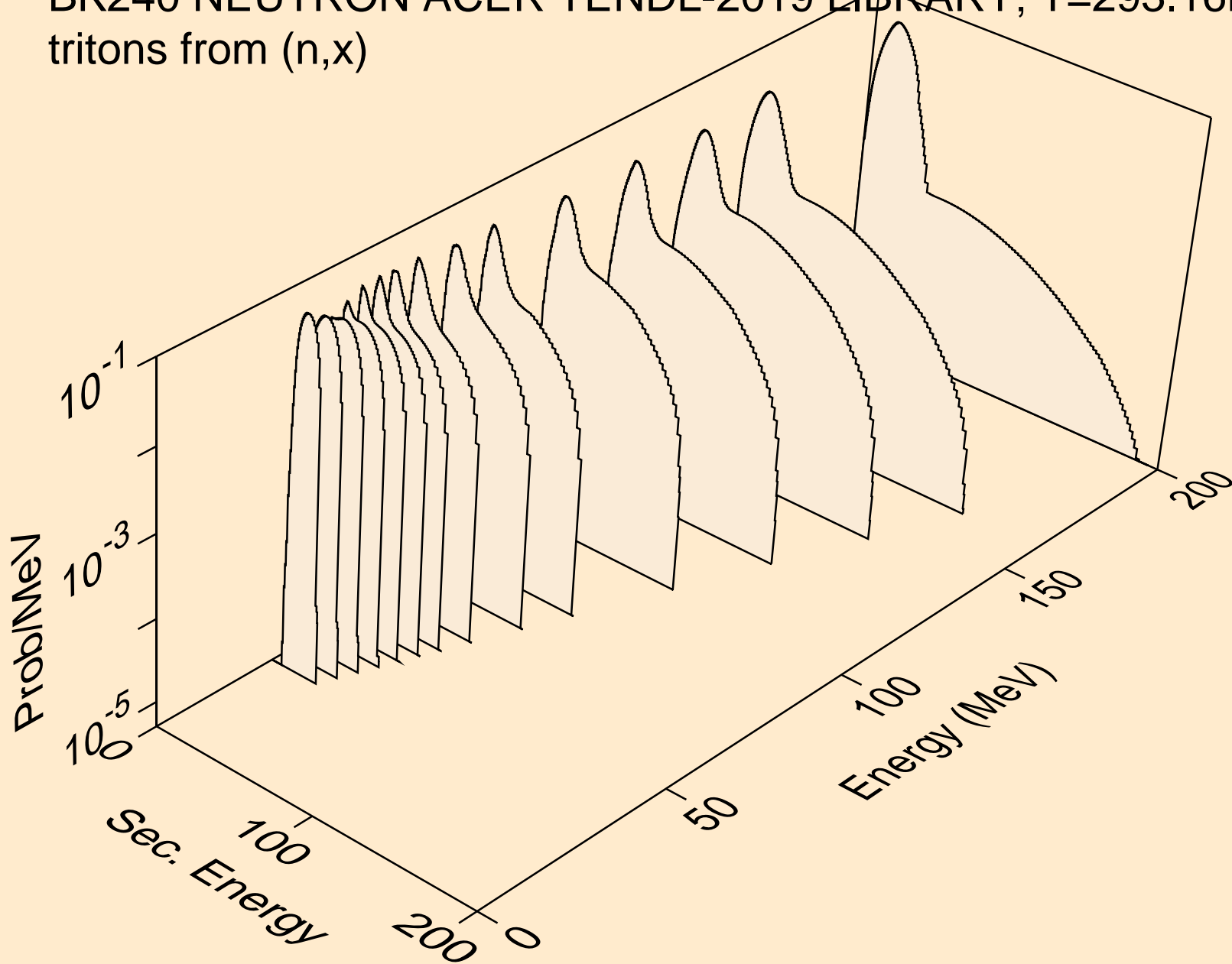

BK240 NEUTRON ACER TENDL-2019 LIBRARY; T=293.16K
tritons from (n,n*)t

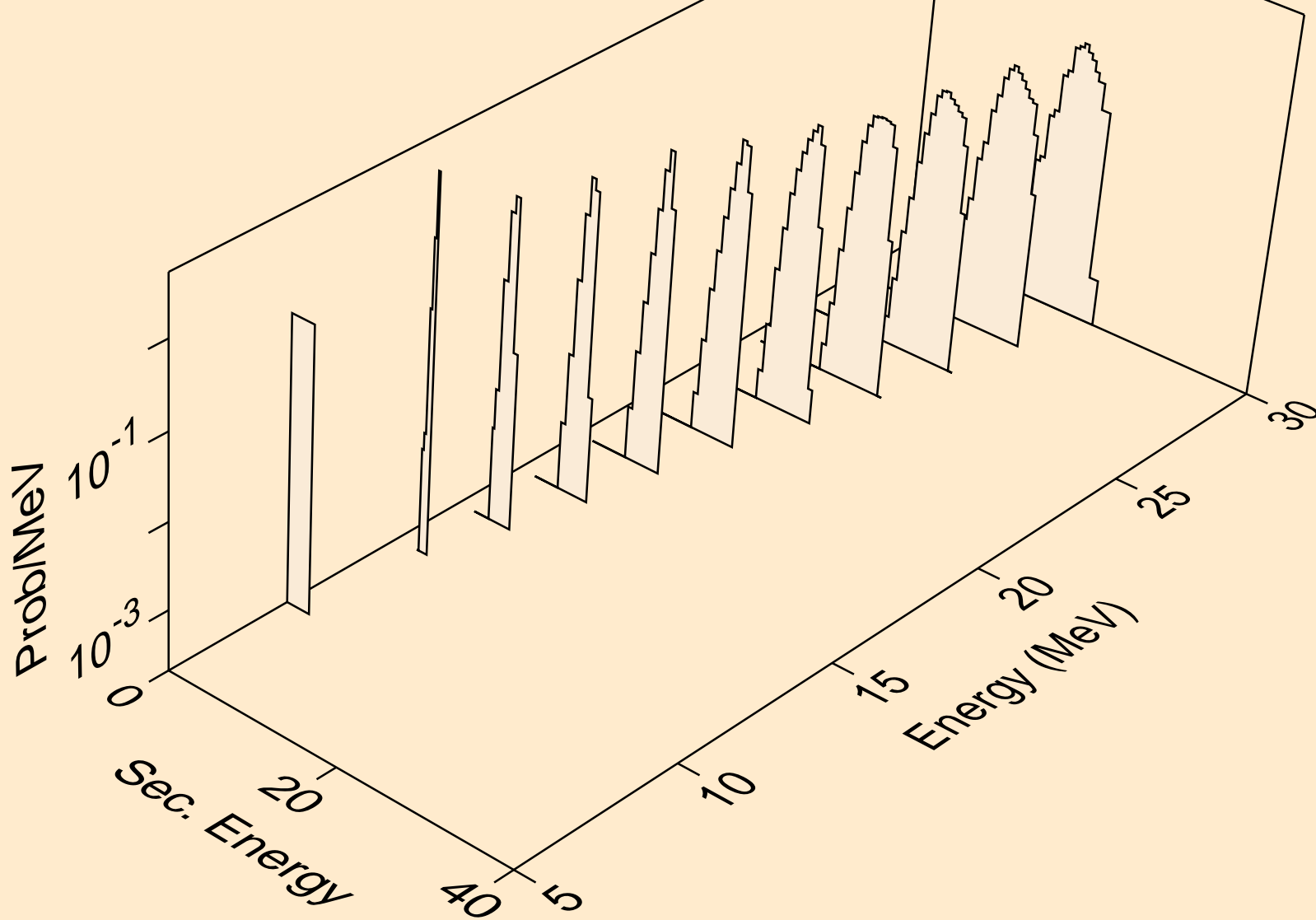

BK240 NEUTRON ACER TENDL-2019 LIBRARY; T=293.16K
tritons from (n,t)

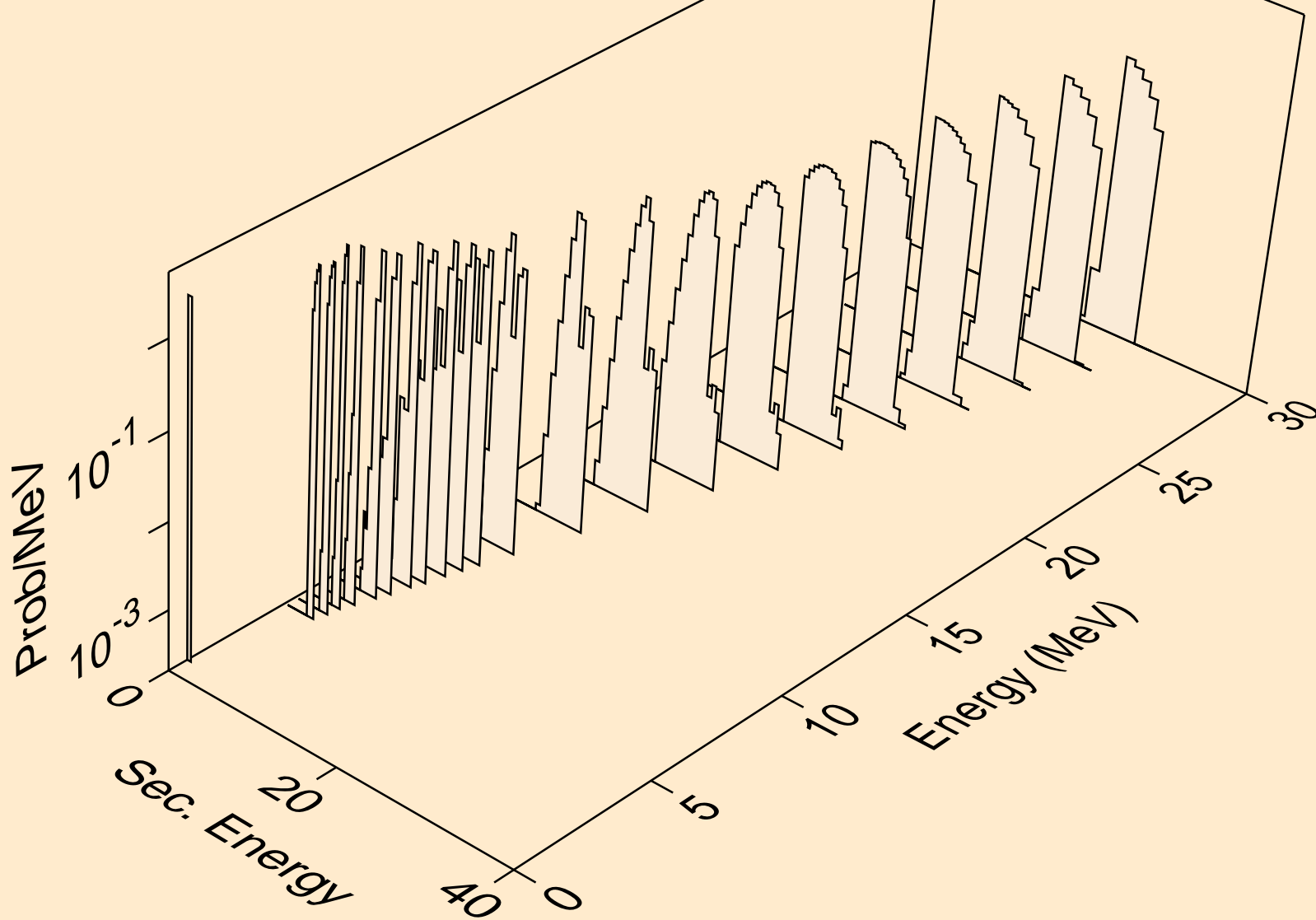

BK240 NEUTRON ACER TENDL-2019 LIBRARY; T=293.16K
he3s from (n,x)

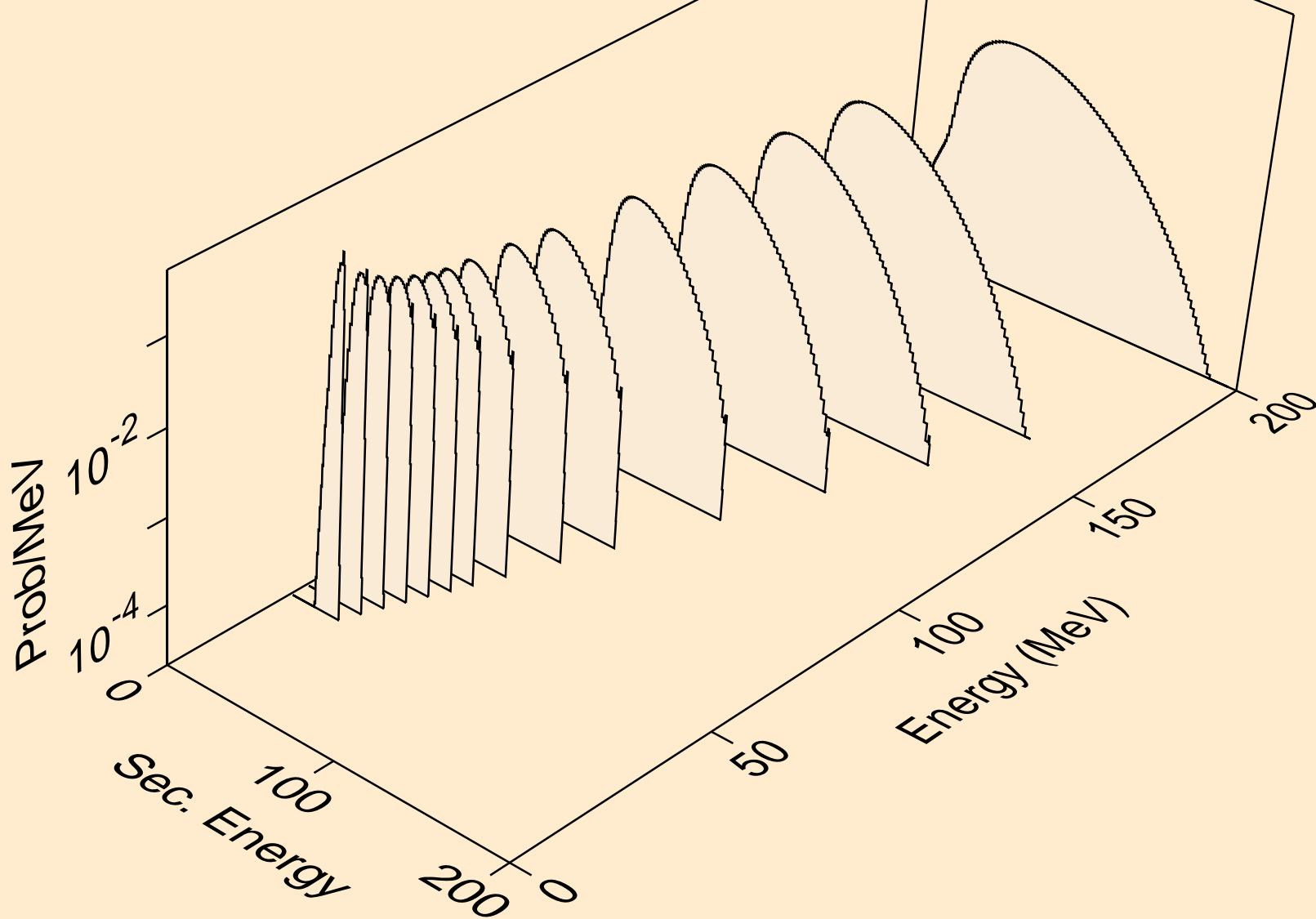

BK240 NEUTRON ACER TENDL-2019 LIBRARY; T=293.16K
he3s from (n,n*)he3

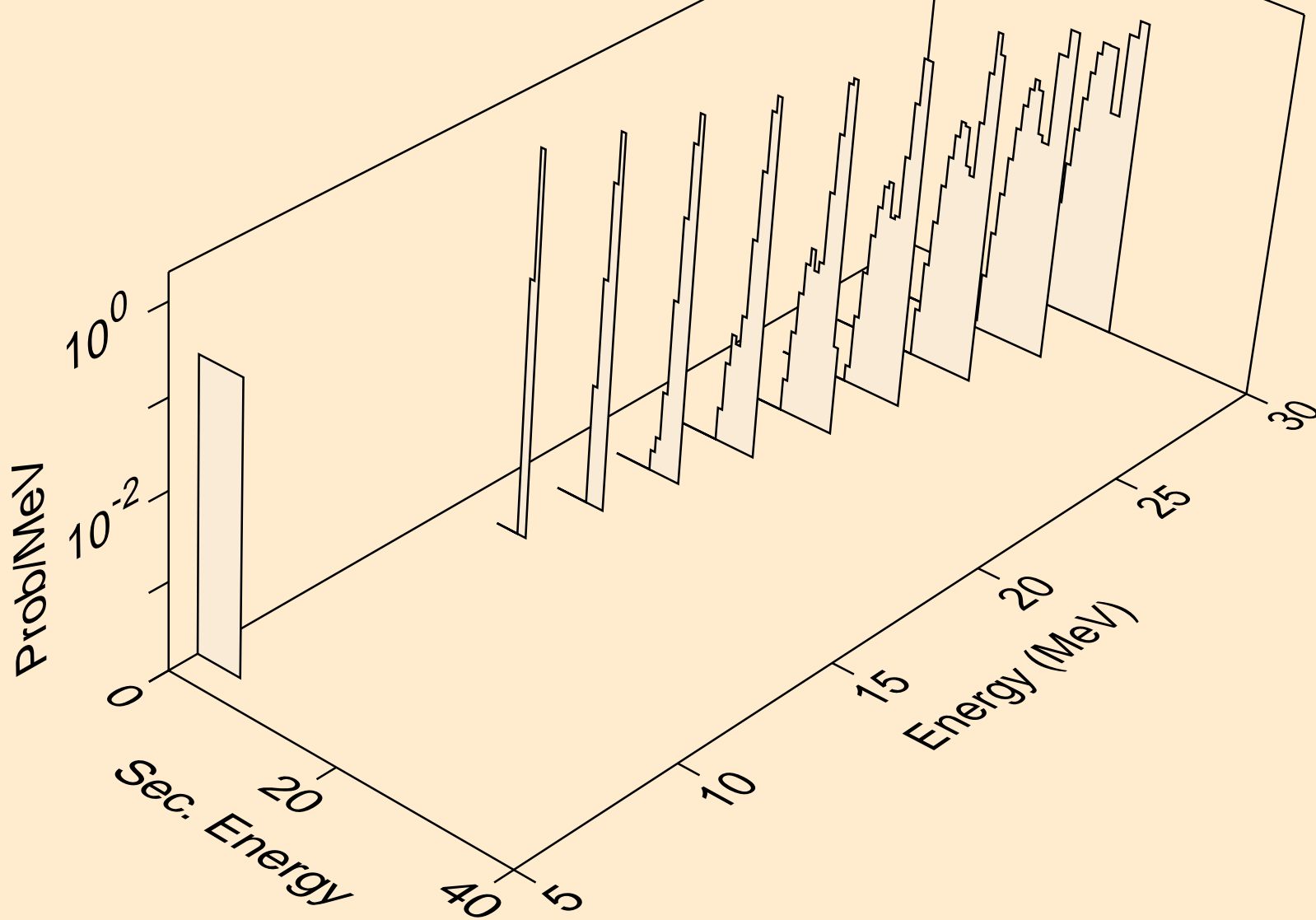

BK240 NEUTRON ACER TENDL-2019 LIBRARY; T=293.16K
he3s from (n,he3)

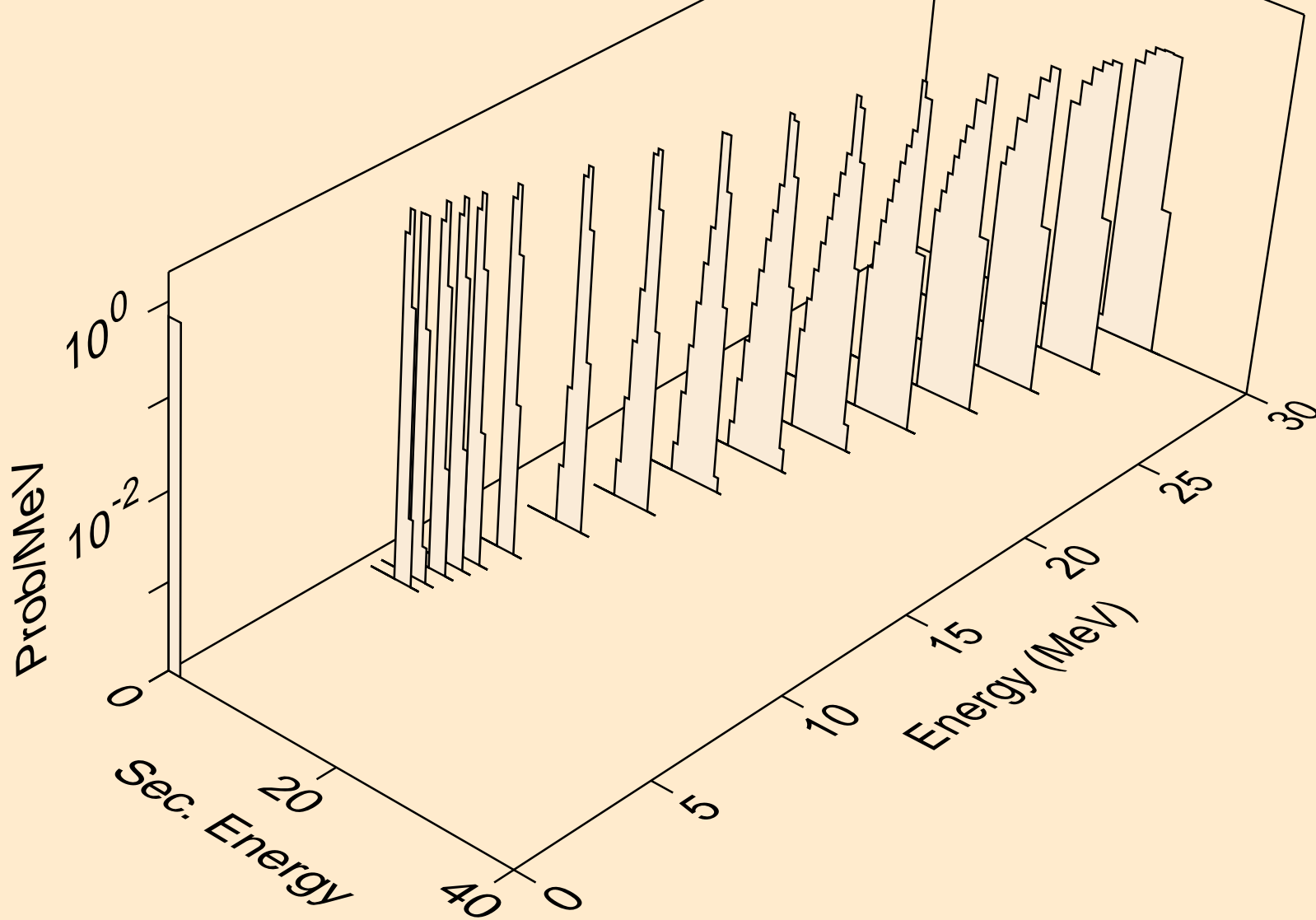

BK240 NEUTRON ACER TENDL-2019 LIBRARY; T=293.16K
alphas from (n,x)

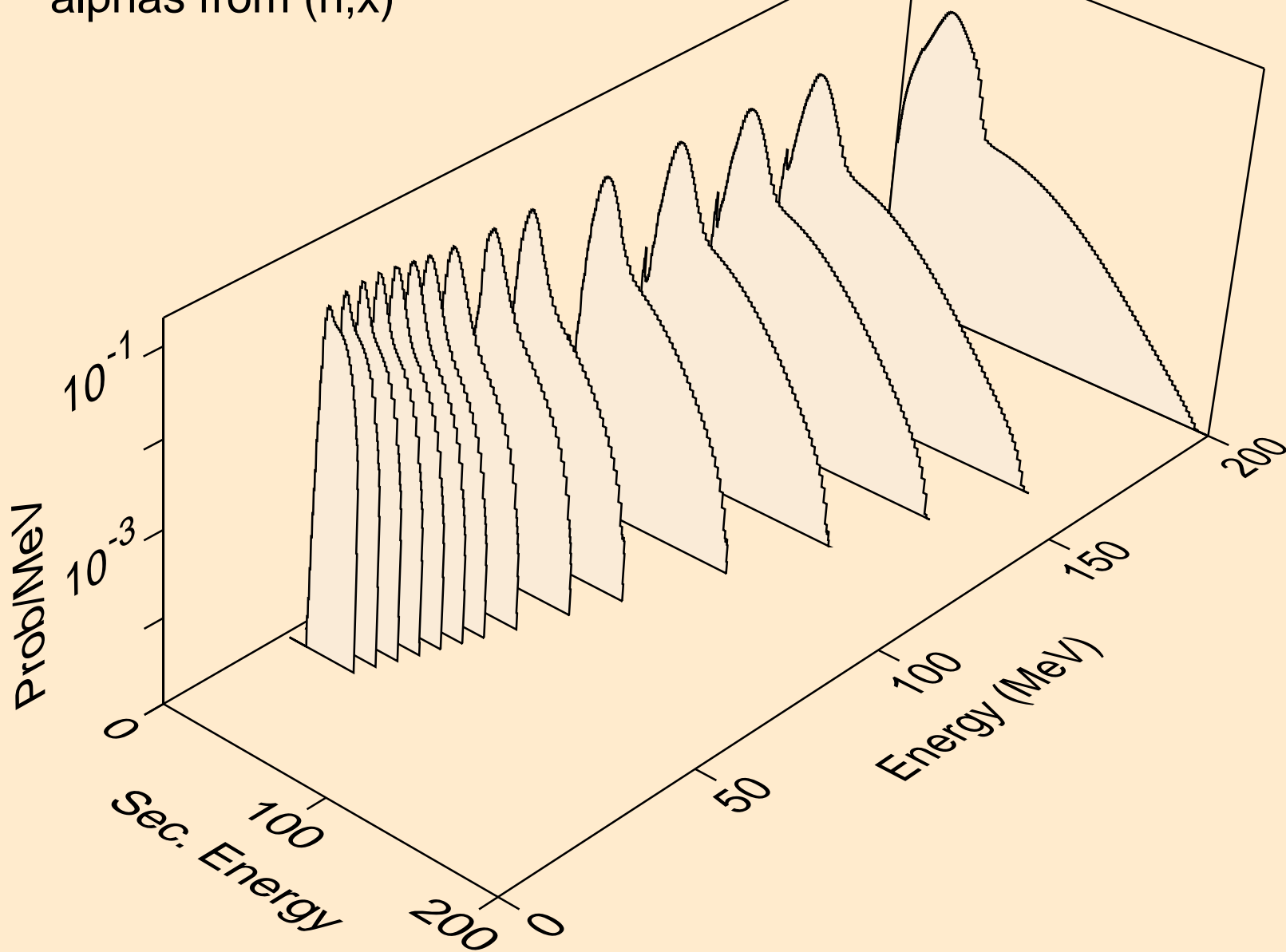

BK240 NEUTRON ACER TENDL-2019 LIBRARY; T=293.16K
alphas from (n,n*)a

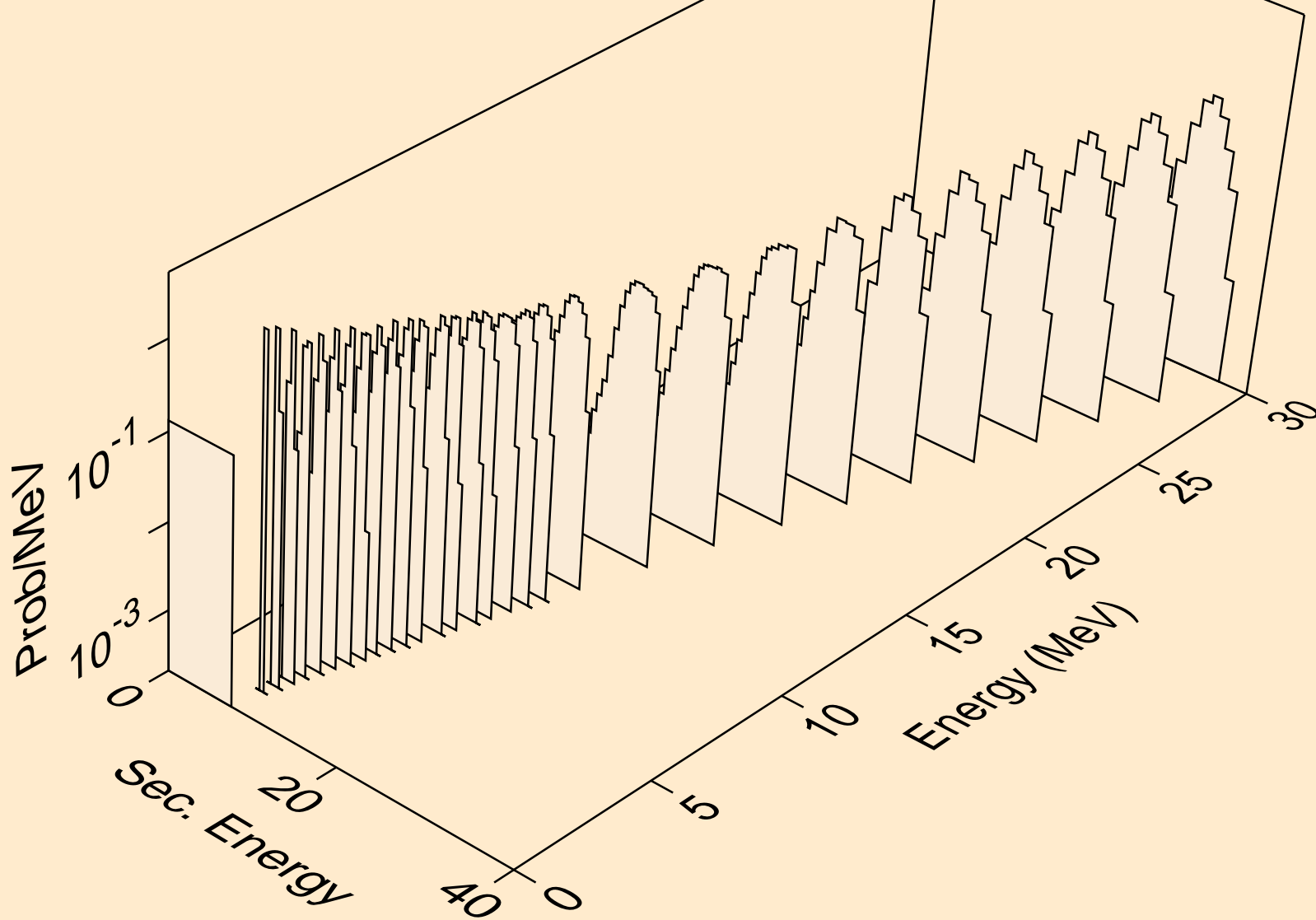

BK240 NEUTRON ACER TENDL-2019 LIBRARY; T=293.16K
alphas from (n,2n)a

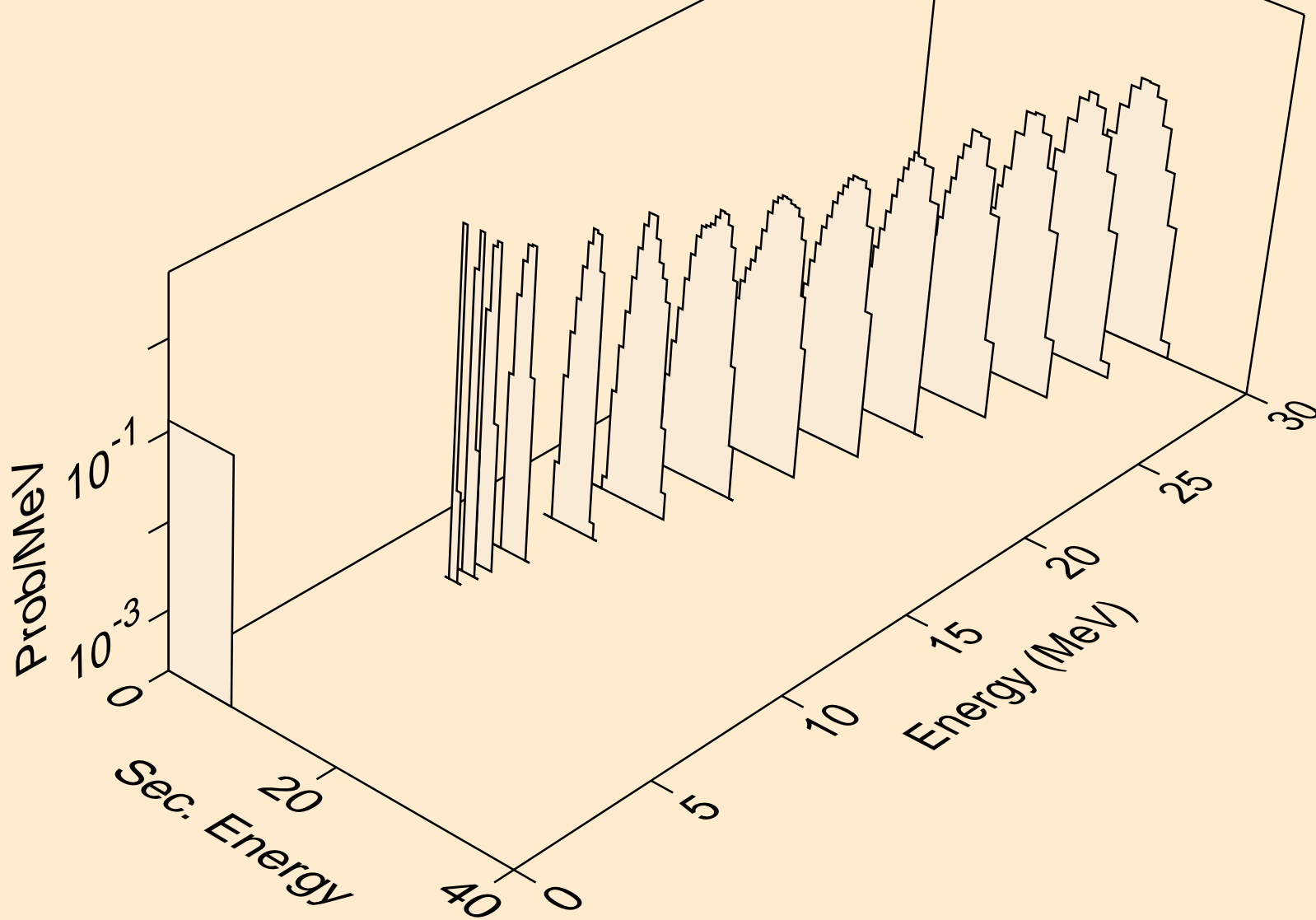

BK240 NEUTRON ACER TENDL-2019 LIBRARY; T=293.16K
alphas from (n,3n)a

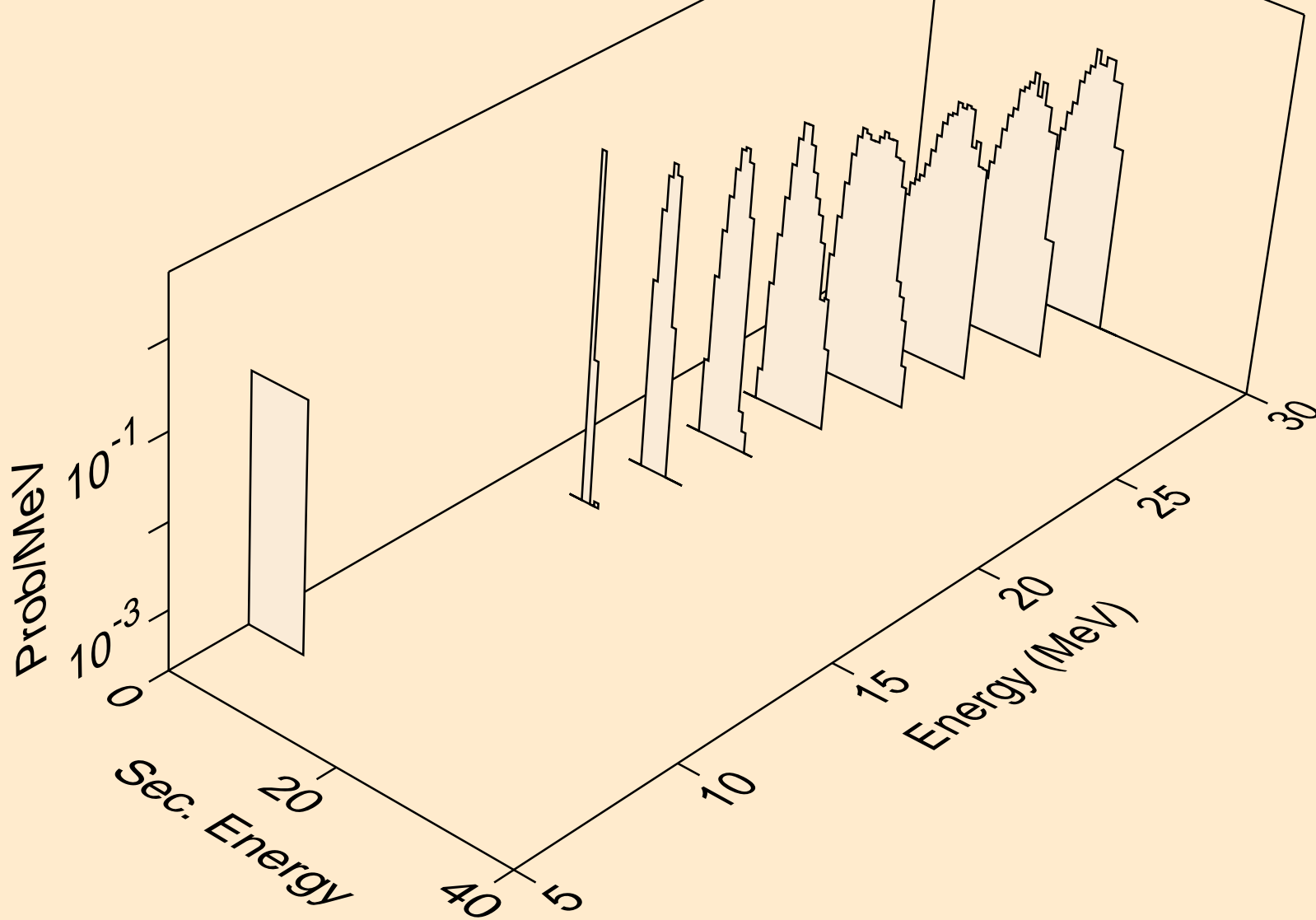

BK240 NEUTRON ACER TENDL-2019 LIBRARY; T=293.16K
alphas from (n,n*)2a

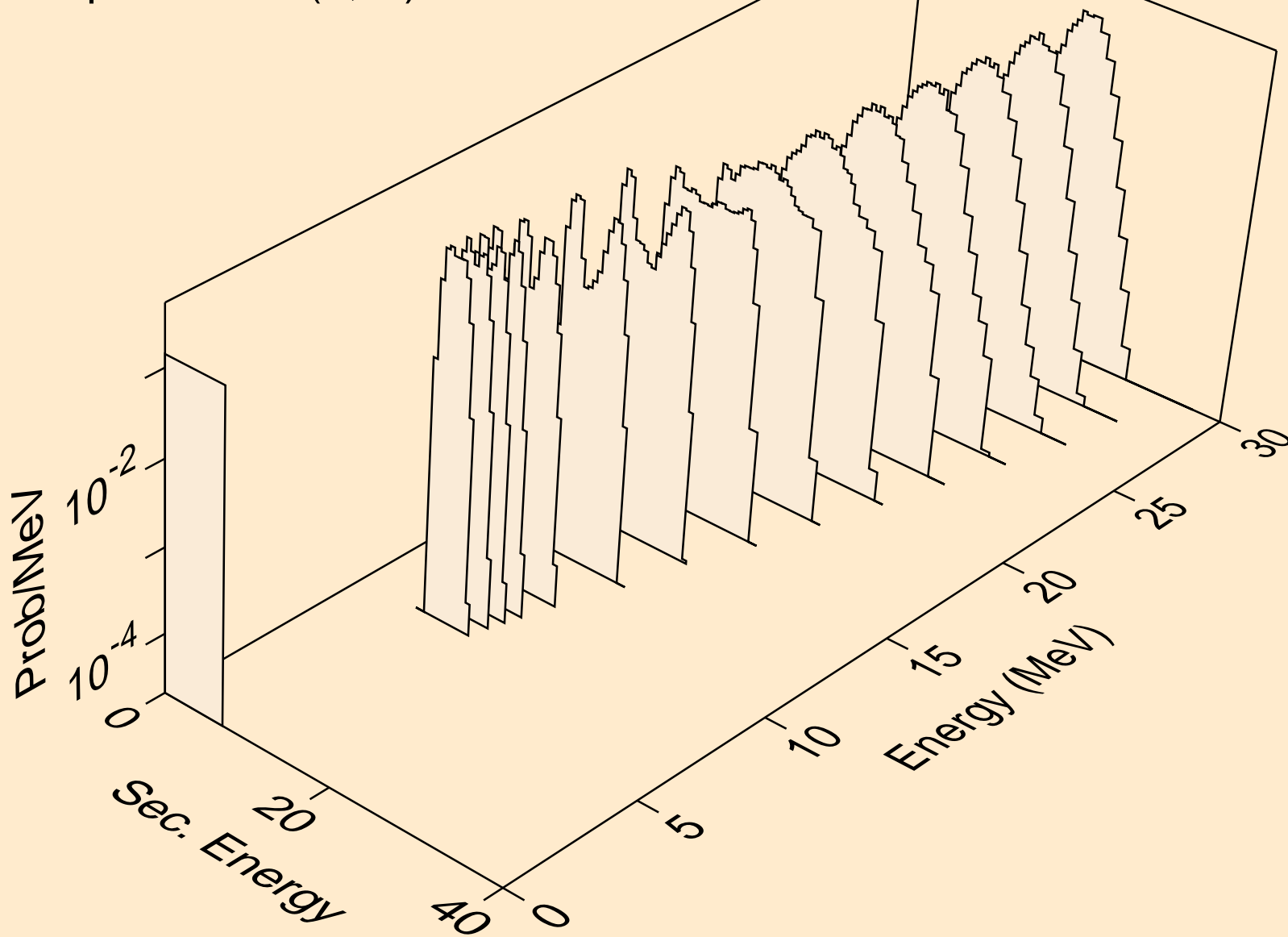

BK240 NEUTRON ACER TENDL-2019 LIBRARY; T=293.16K
alphas from (n,a)

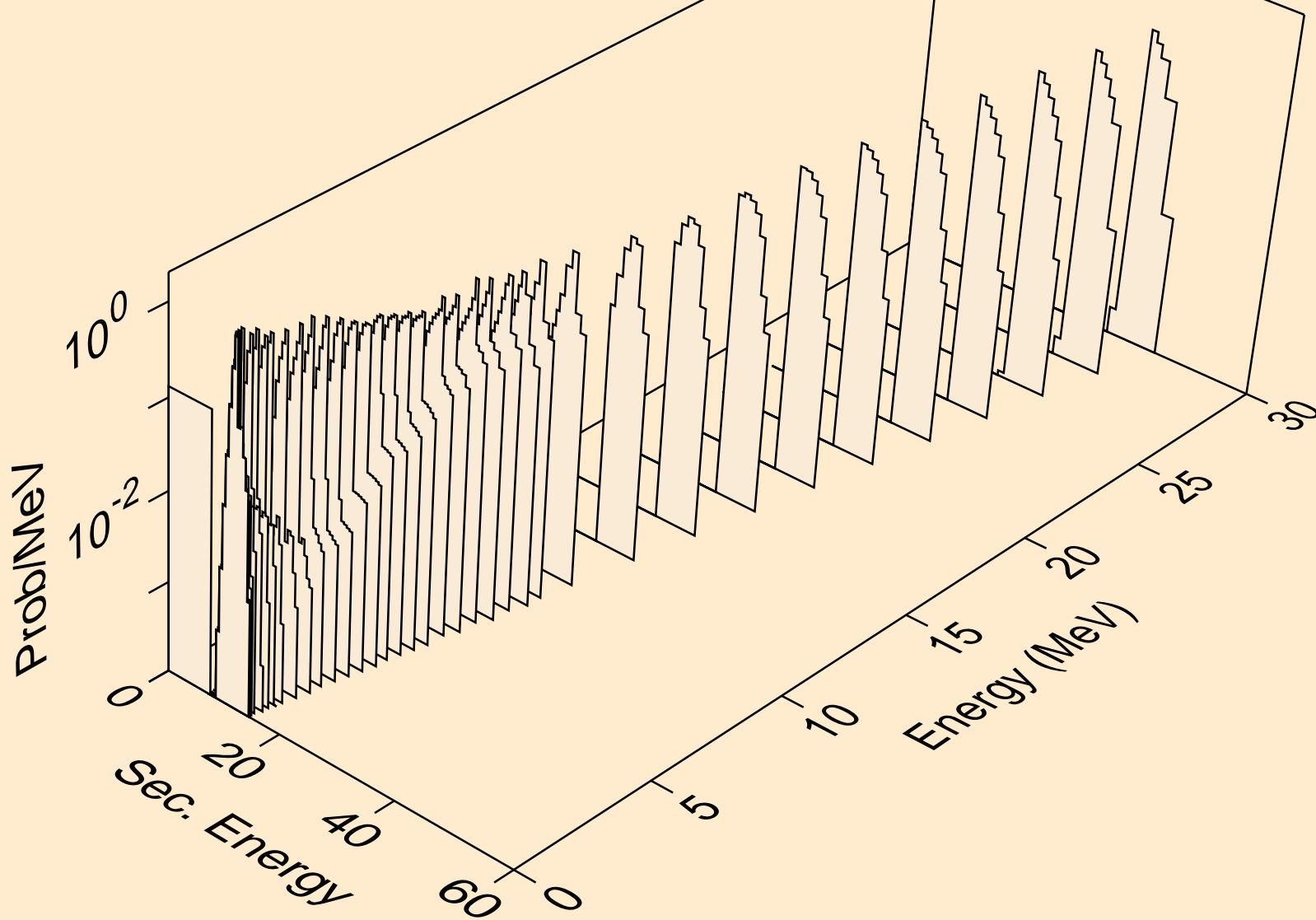

BK240 NEUTRON ACER TENDL-2019 LIBRARY; T=293.16K
alphas from (n,pa)

