

BK243 NEUTRON ACER TENDL-2019 LIBRARY; T=293.16K
Principal cross sections

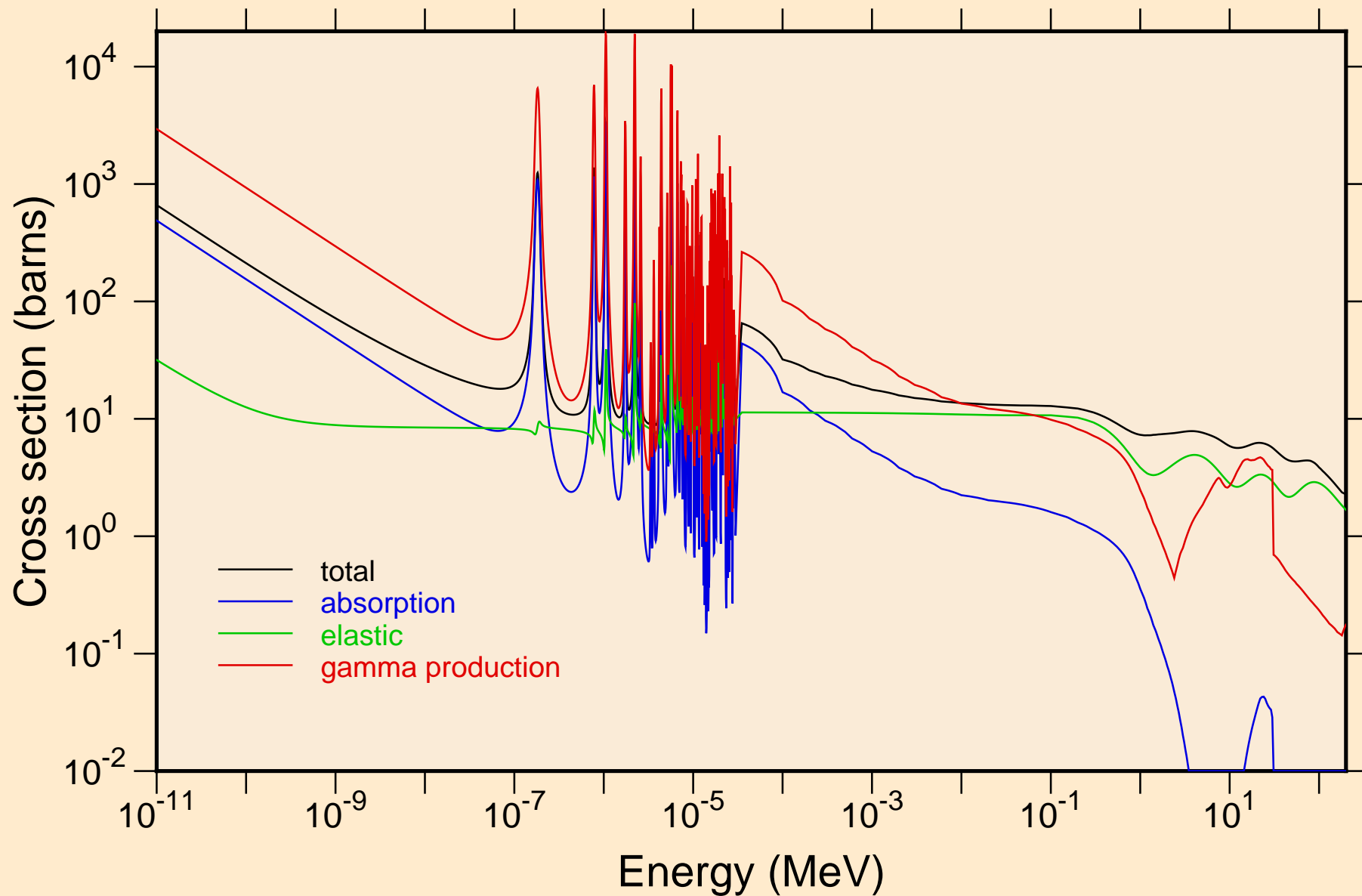

BK243 NEUTRON ACER TENDL-2019 LIBRARY; T=293.16K
resonance total cross section

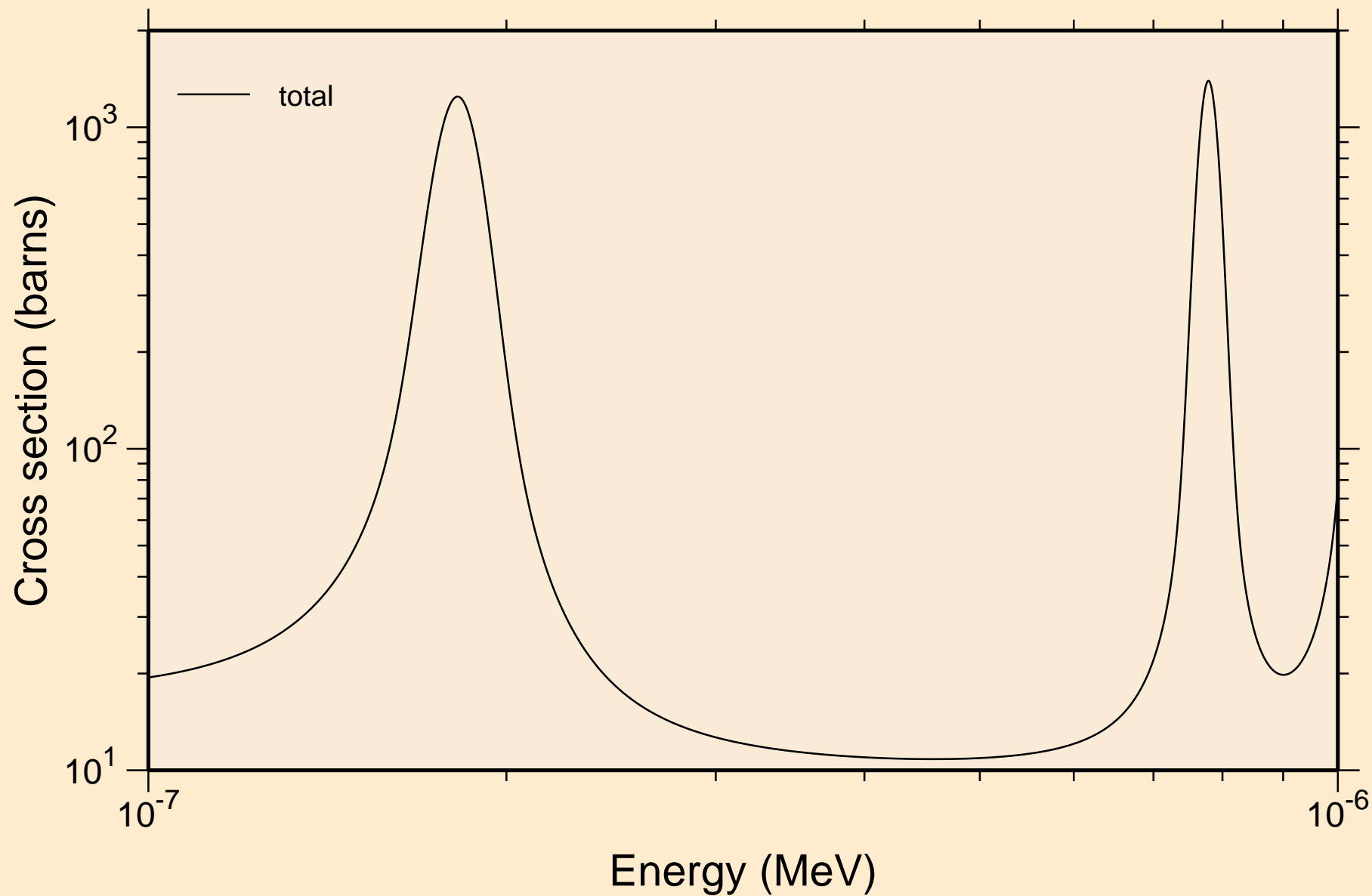

BK243 NEUTRON ACER TENDL-2019 LIBRARY; T=293.16K
resonance total cross section

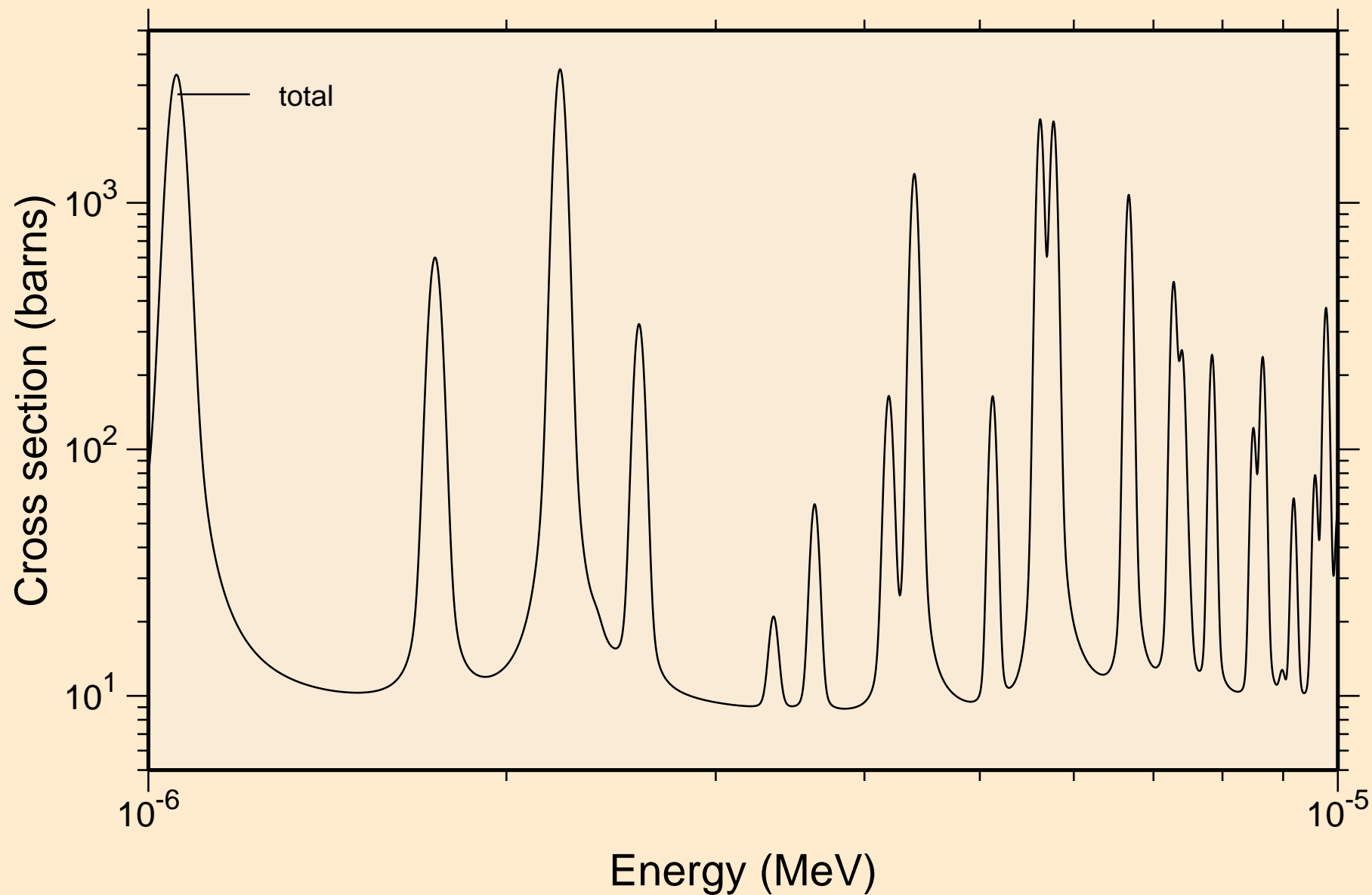

BK243 NEUTRON ACER TENDL-2019 LIBRARY; T=293.16K
resonance total cross section

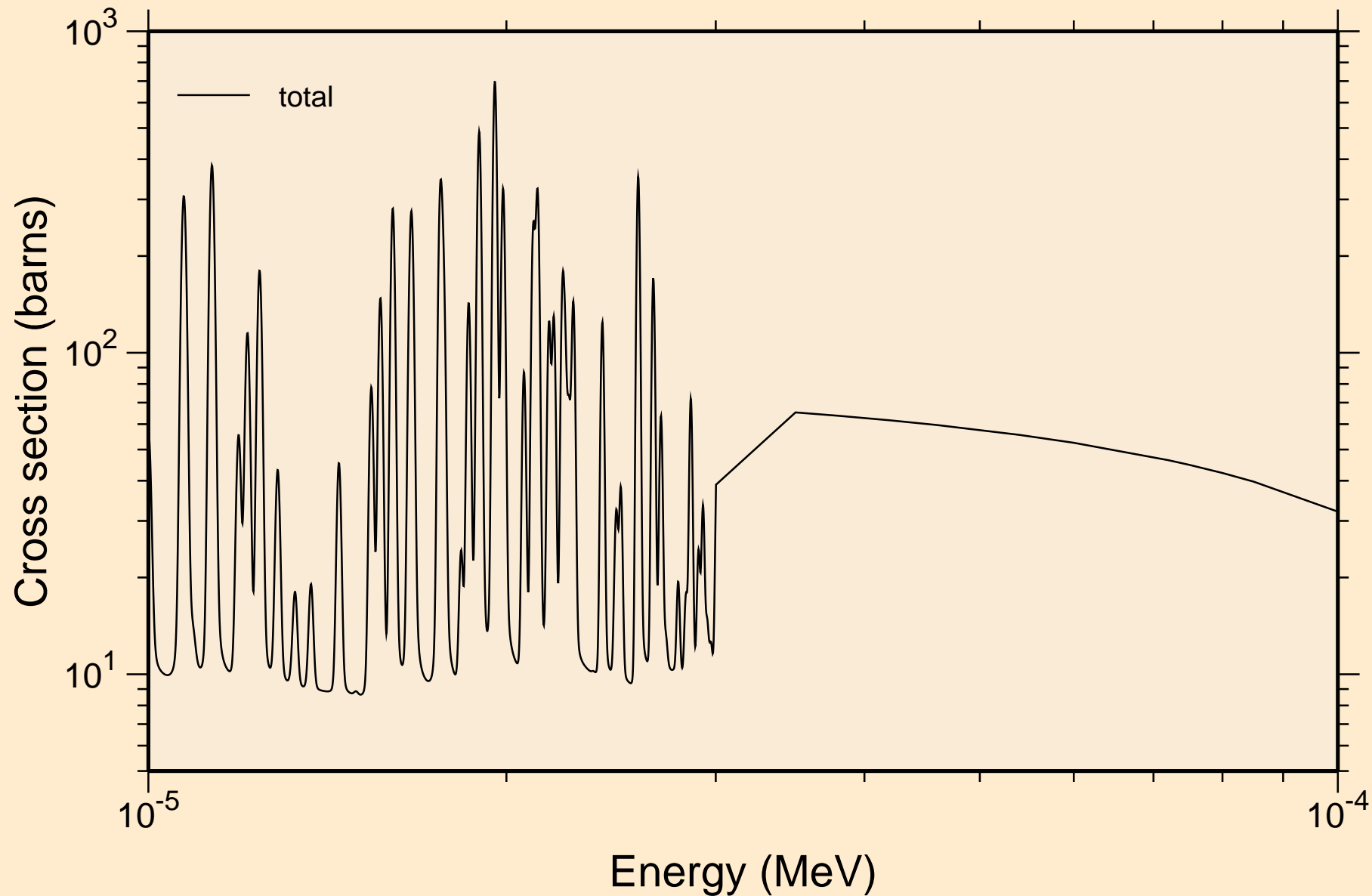

BK243 NEUTRON ACER TENDL-2019 LIBRARY; T=293.16K
resonance total cross section

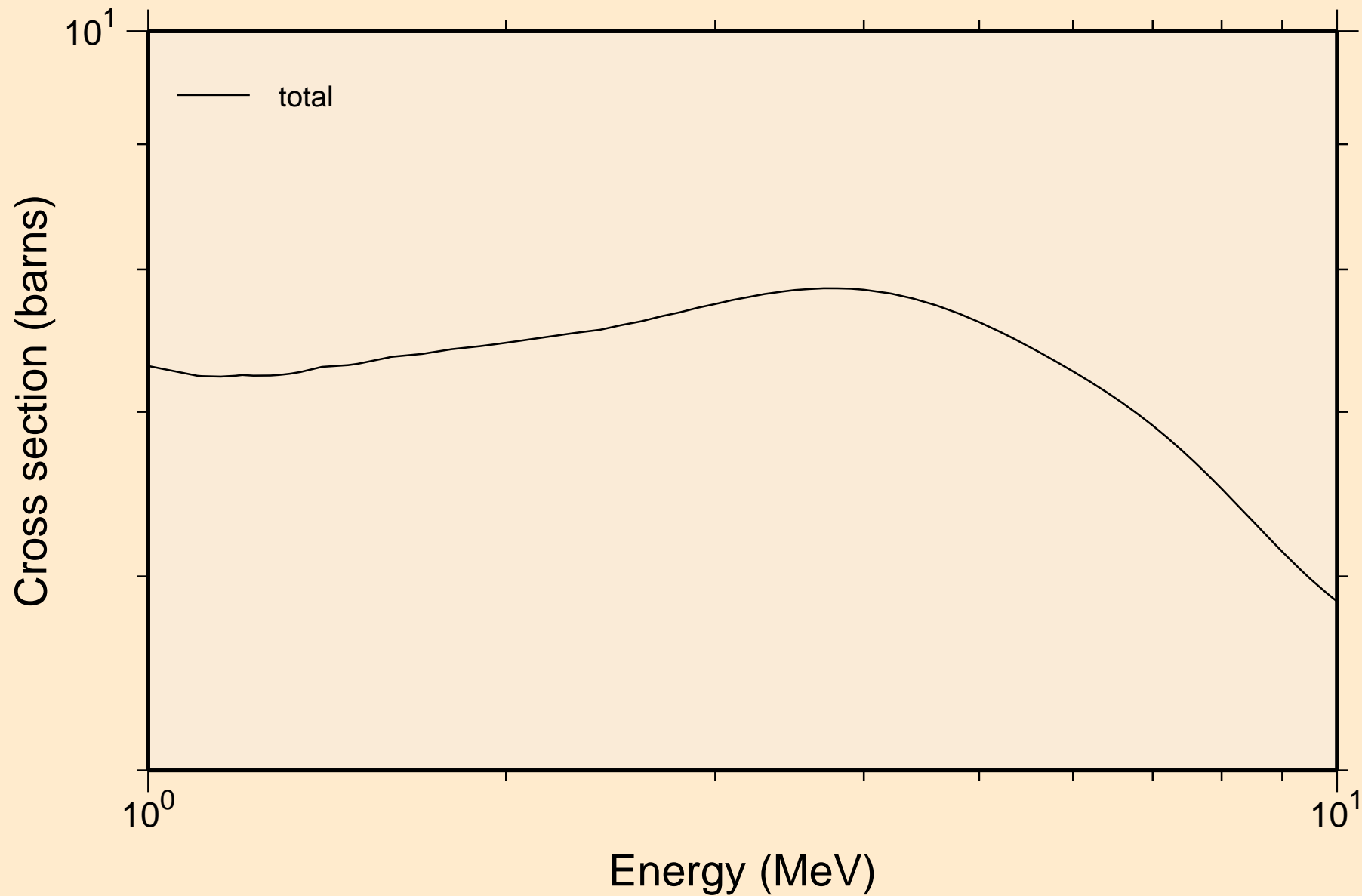

BK243 NEUTRON ACER TENDL-2019 LIBRARY; T=293.16K
resonance absorption cross sections

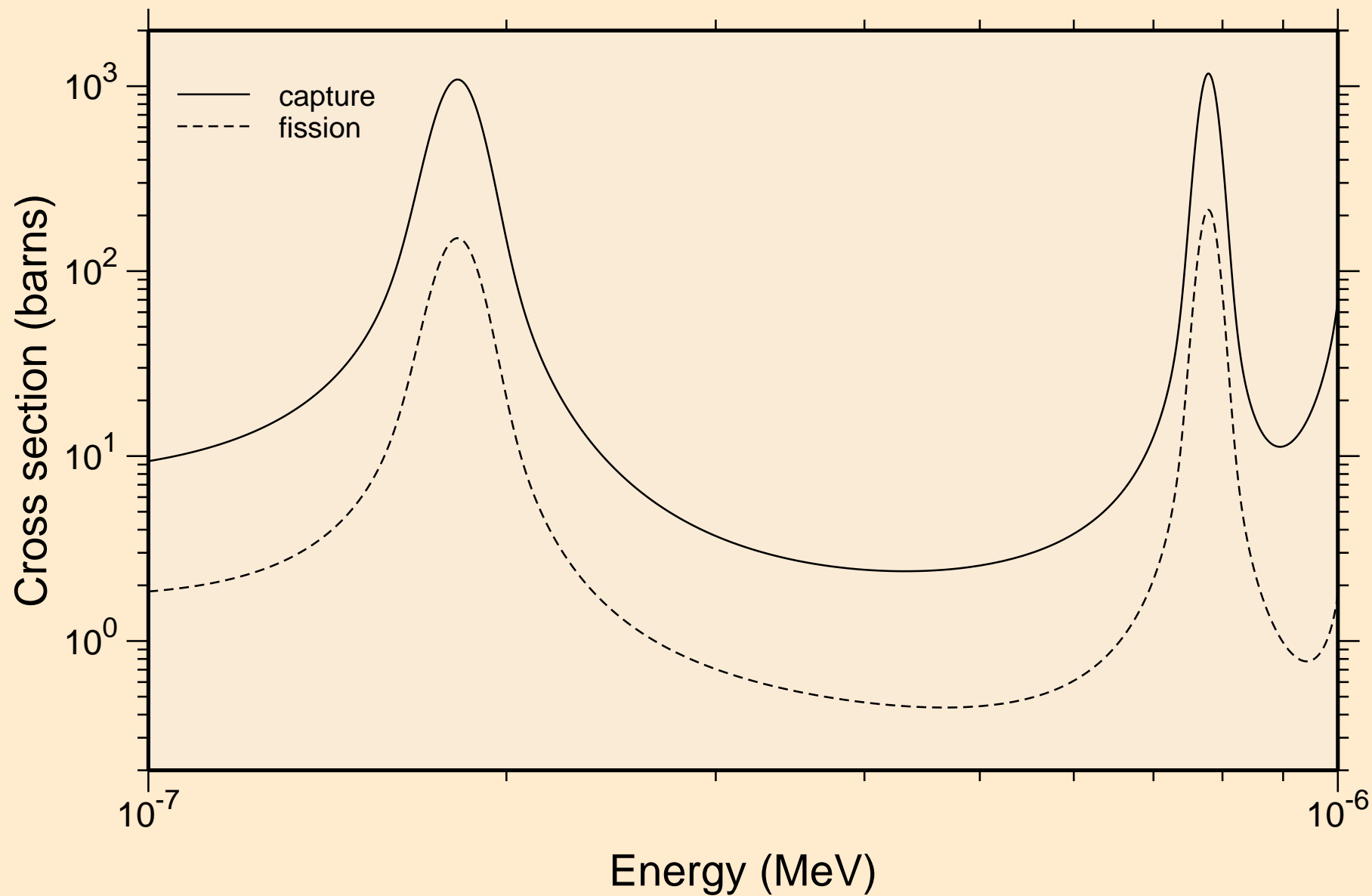

BK243 NEUTRON ACER TENDL-2019 LIBRARY; T=293.16K
resonance absorption cross sections

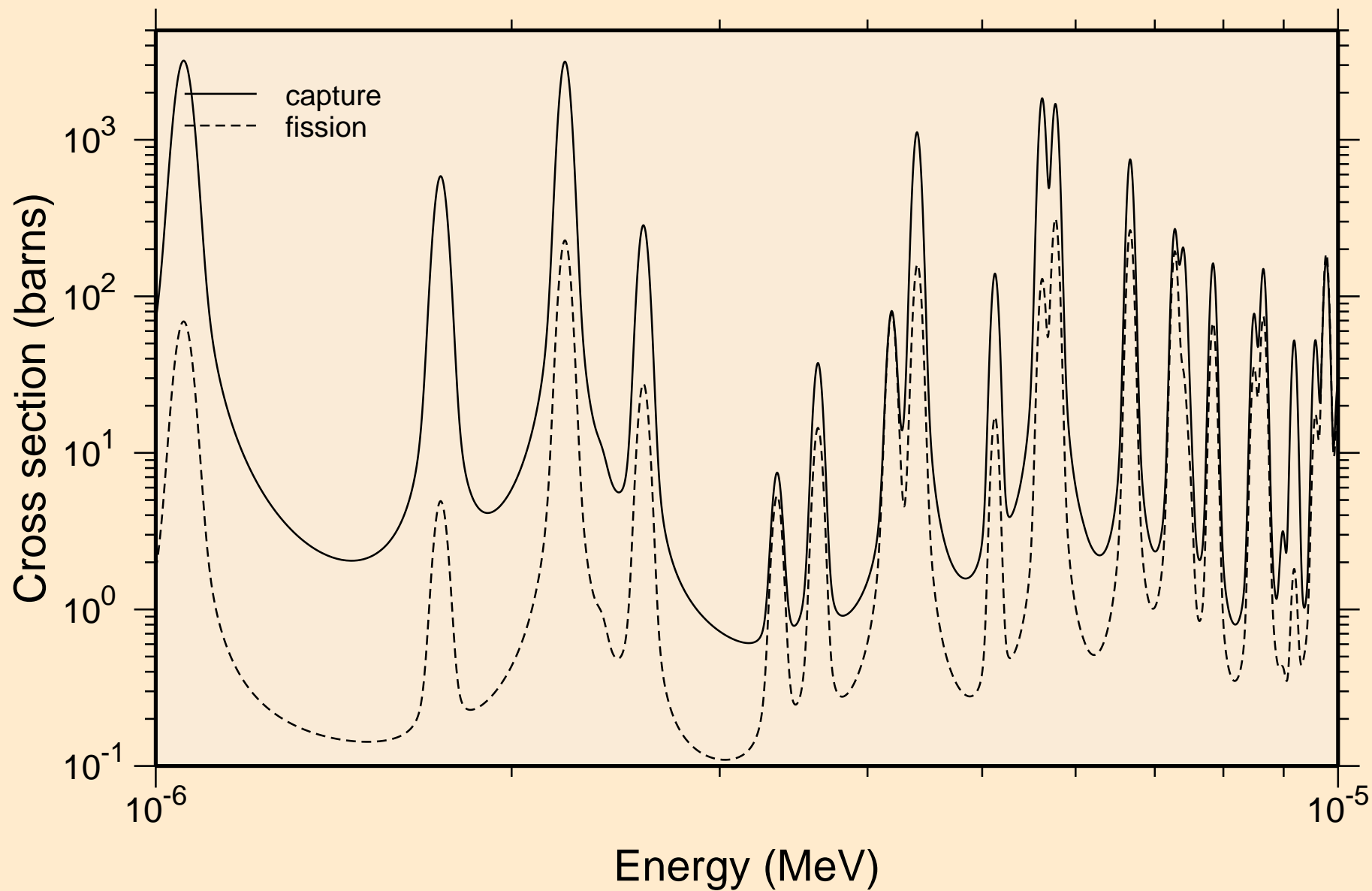

BK243 NEUTRON ACER TENDL-2019 LIBRARY; T=293.16K
resonance absorption cross sections

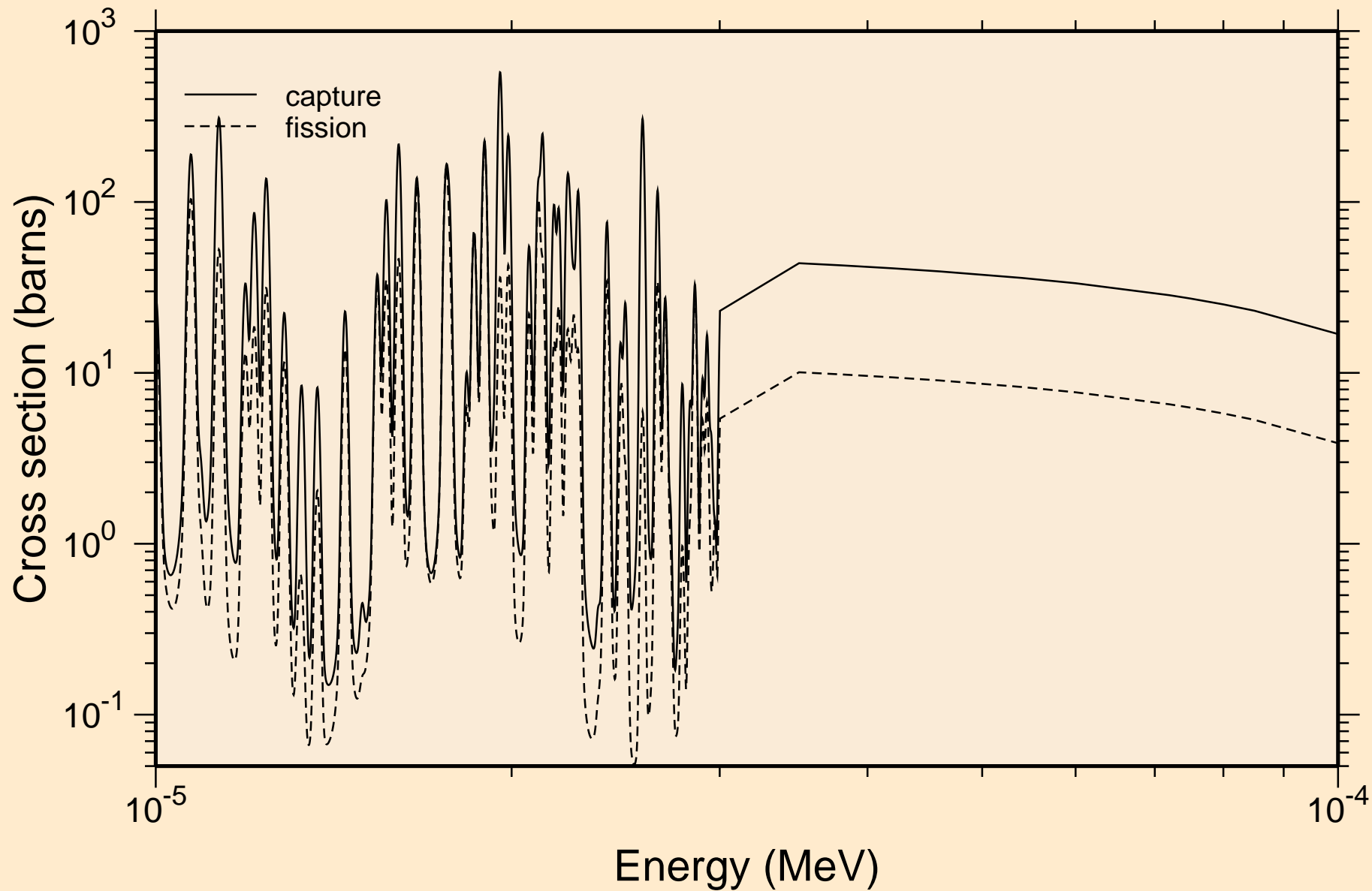

BK243 NEUTRON ACER TENDL-2019 LIBRARY; T=293.16K
resonance absorption cross sections

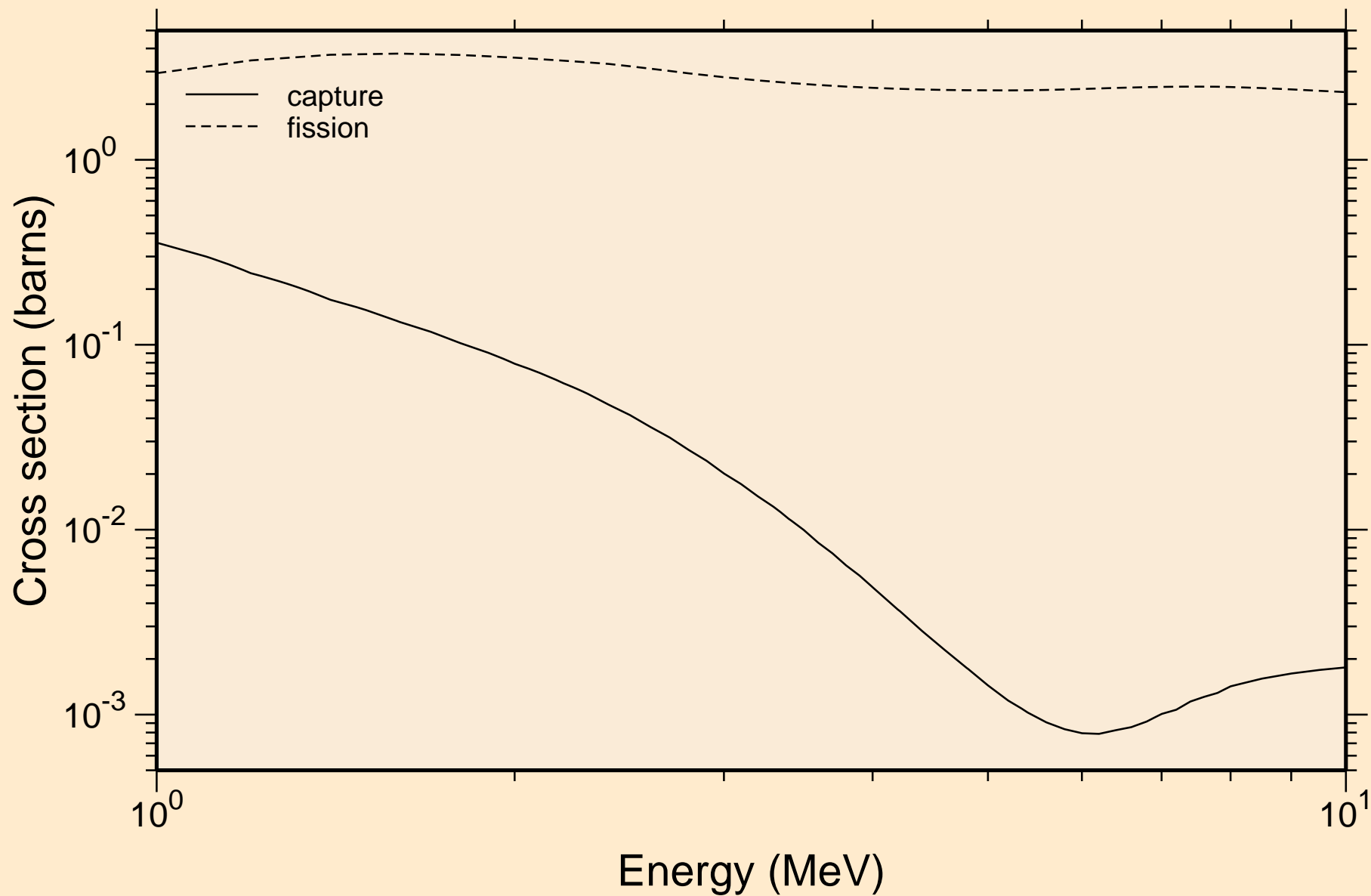

BK243 NEUTRON ACER TENDL-2019 LIBRARY; T=293.16K
Heating

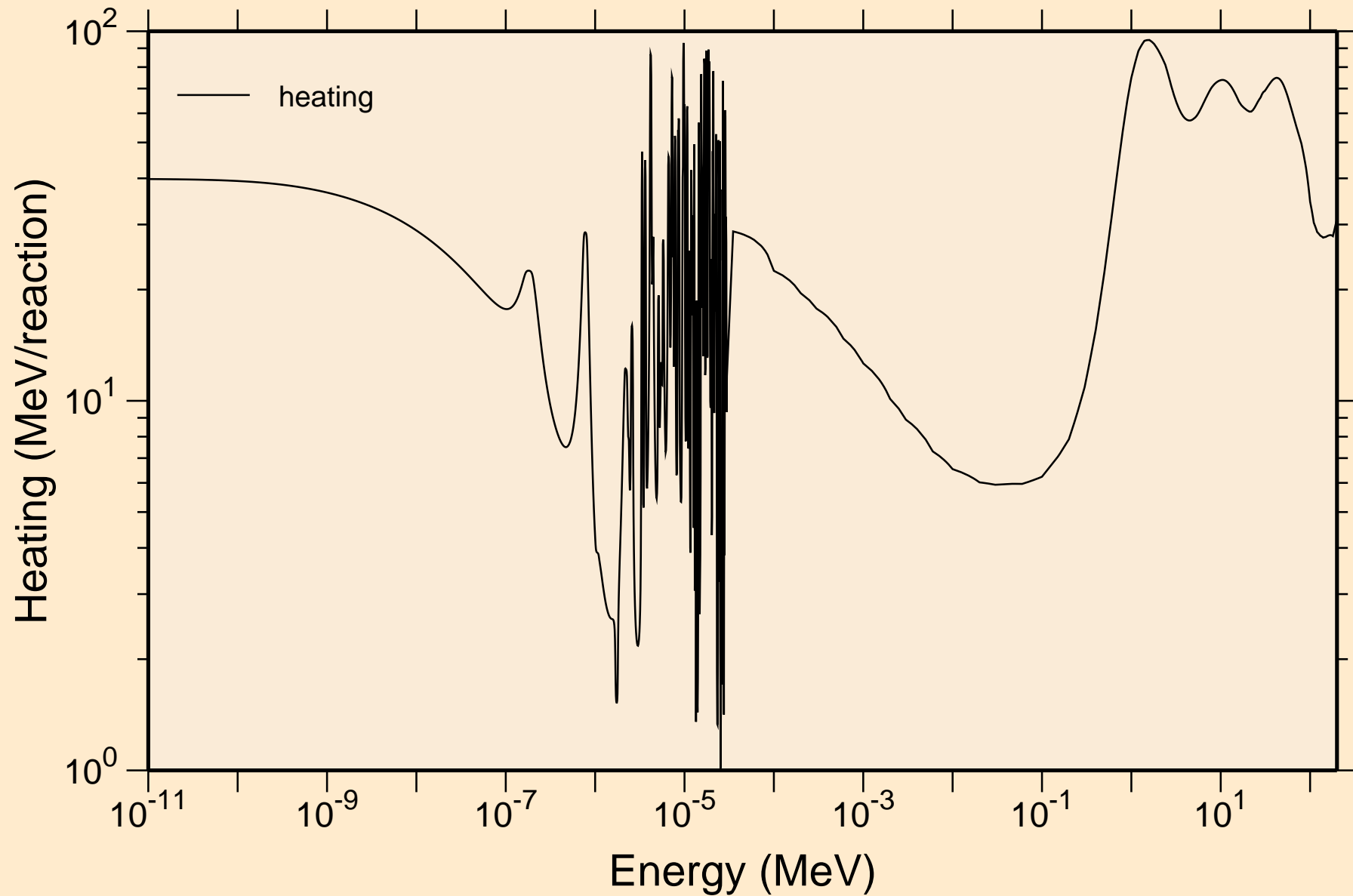

BK243 NEUTRON ACER TENDL-2019 LIBRARY; T=293.16K
Damage

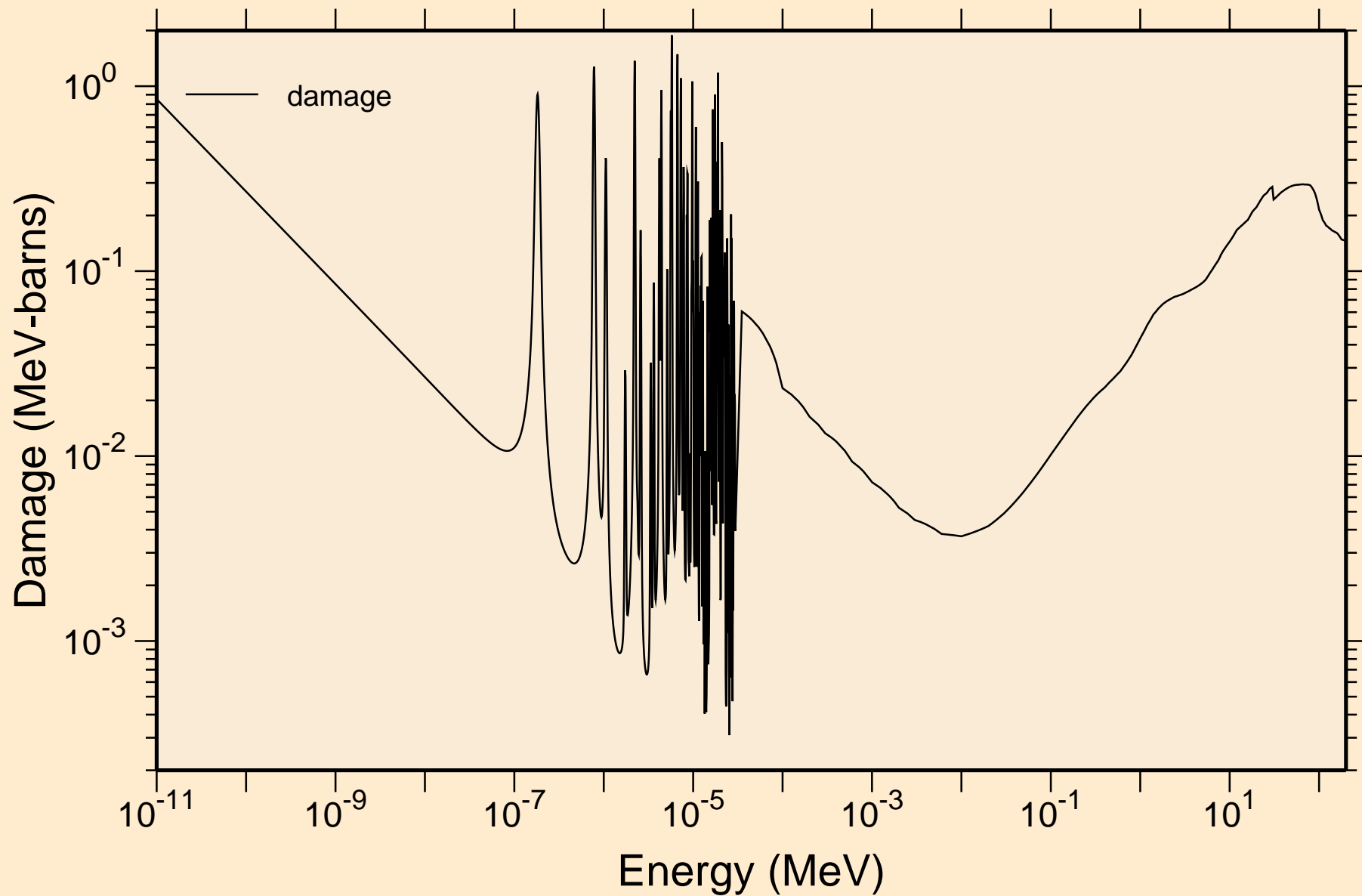

BK243 NEUTRON ACER TENDL-2019 LIBRARY; T=293.16K
Non-threshold reactions

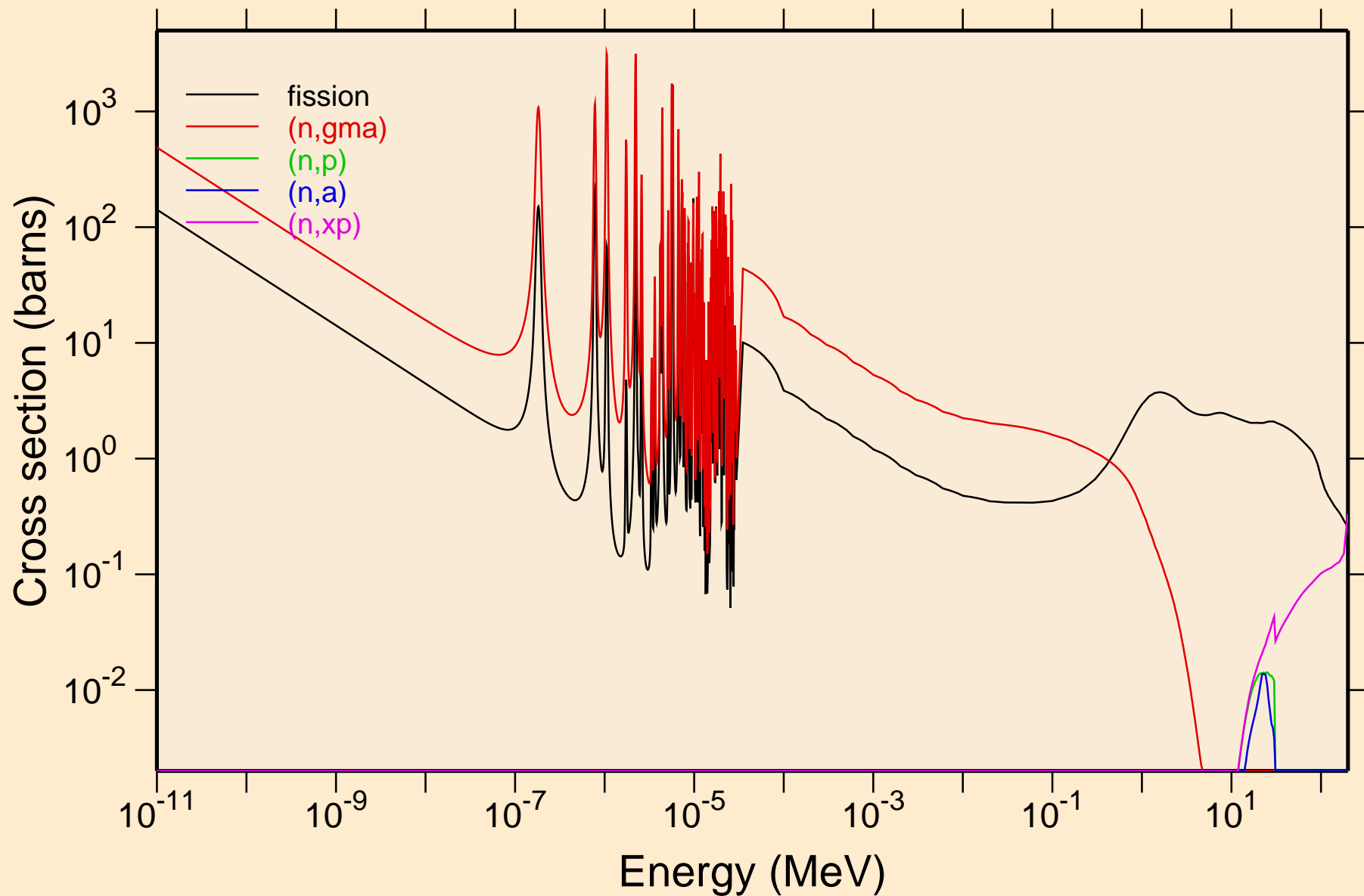

BK243 NEUTRON ACER TENDL-2019 LIBRARY; T=293.16K
Non-threshold reactions

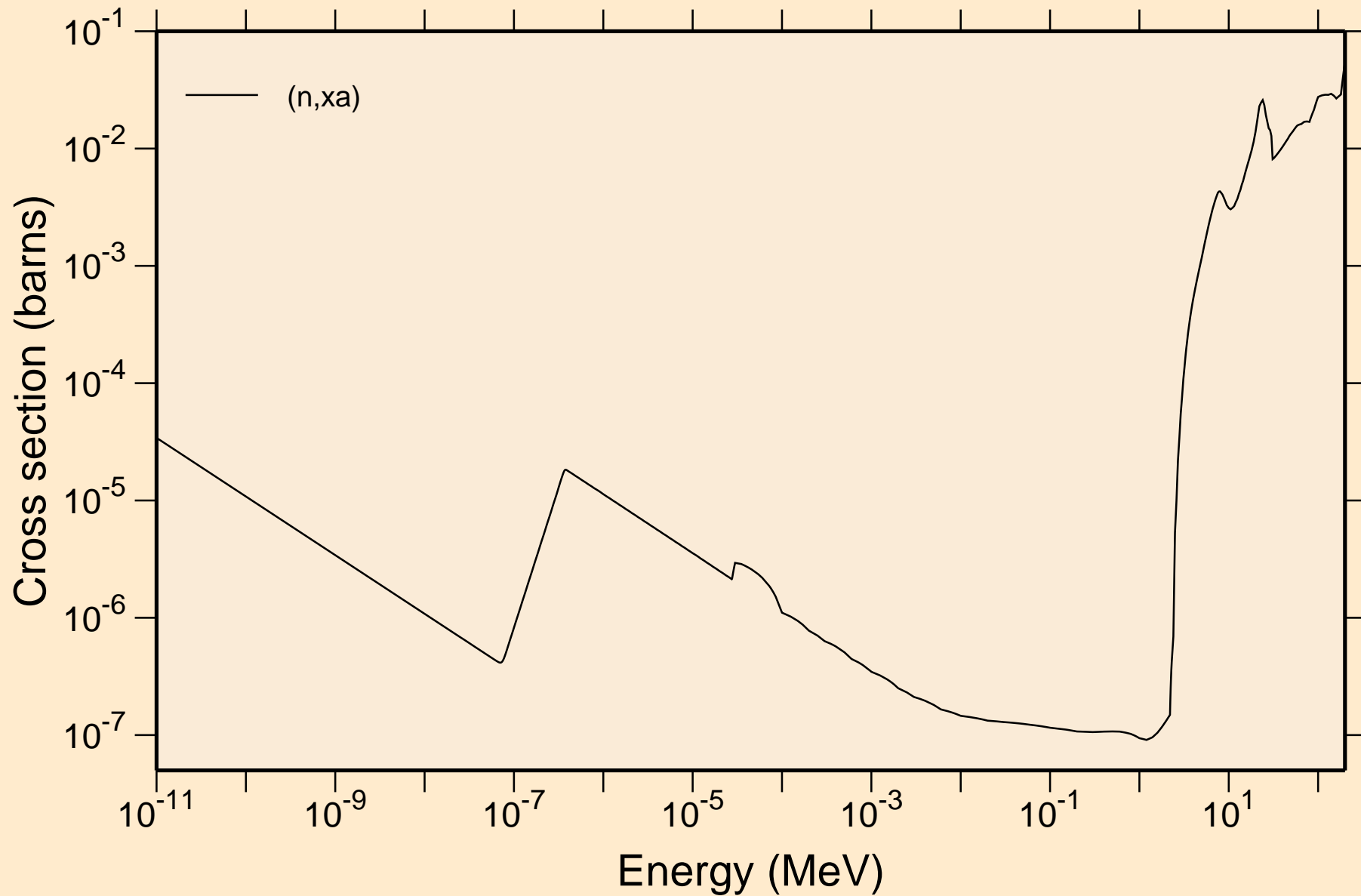

BK243 NEUTRON ACER TENDL-2019 LIBRARY; T=293.16K
Principal cross sections

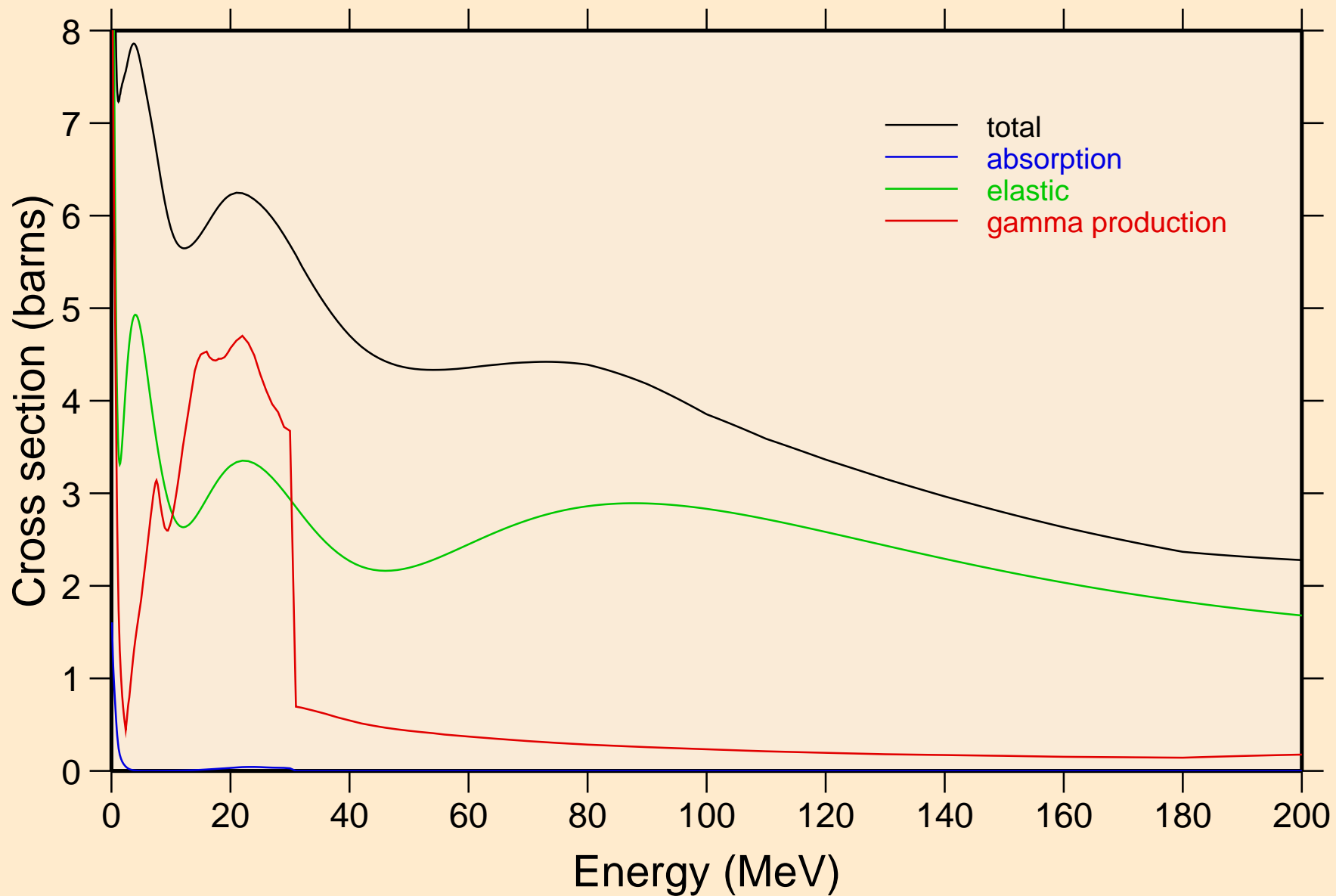

BK243 NEUTRON ACER TENDL-2019 LIBRARY; T=293.16K
Heating

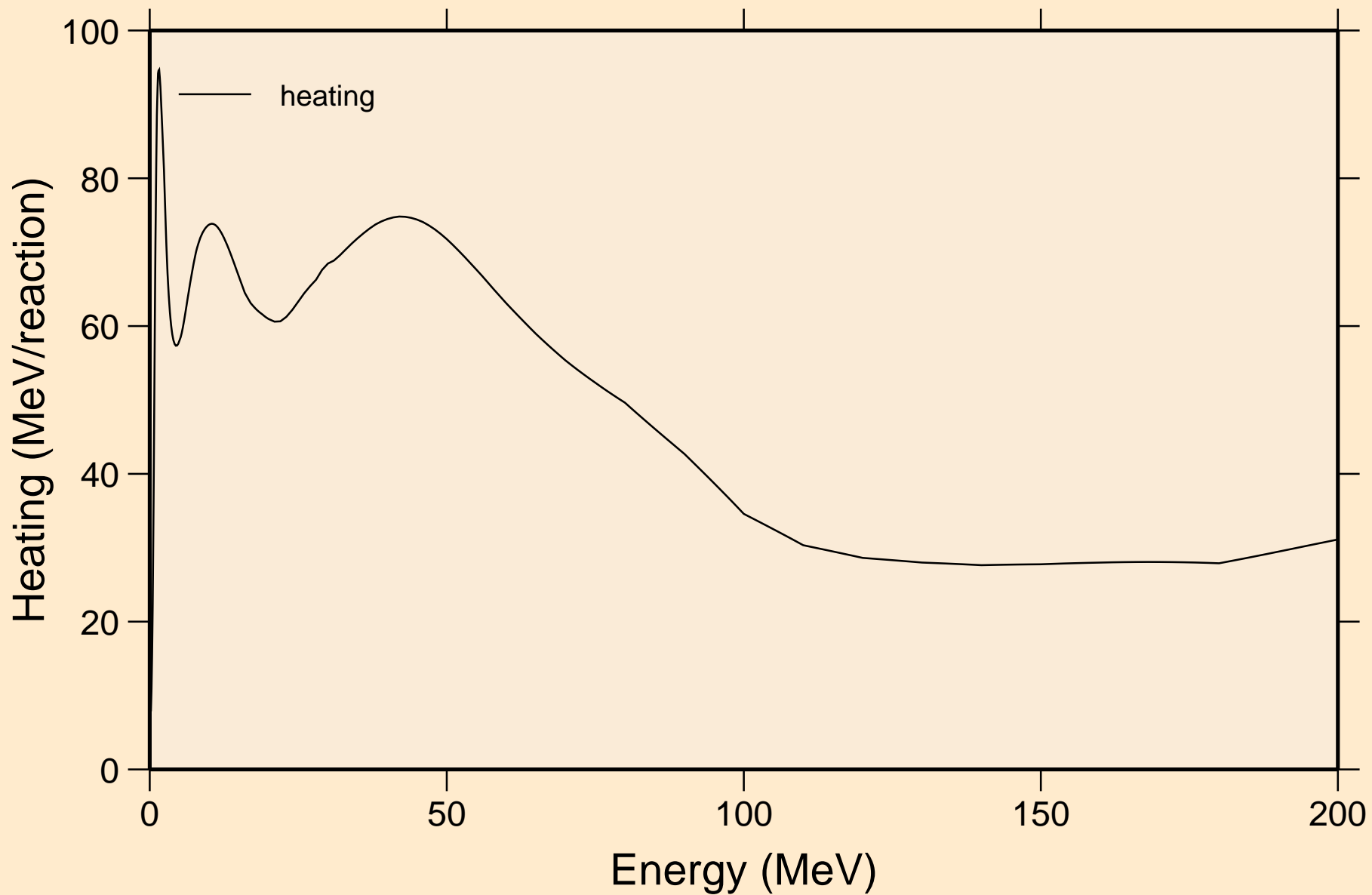

BK243 NEUTRON ACER TENDL-2019 LIBRARY; T=293.16K
Damage

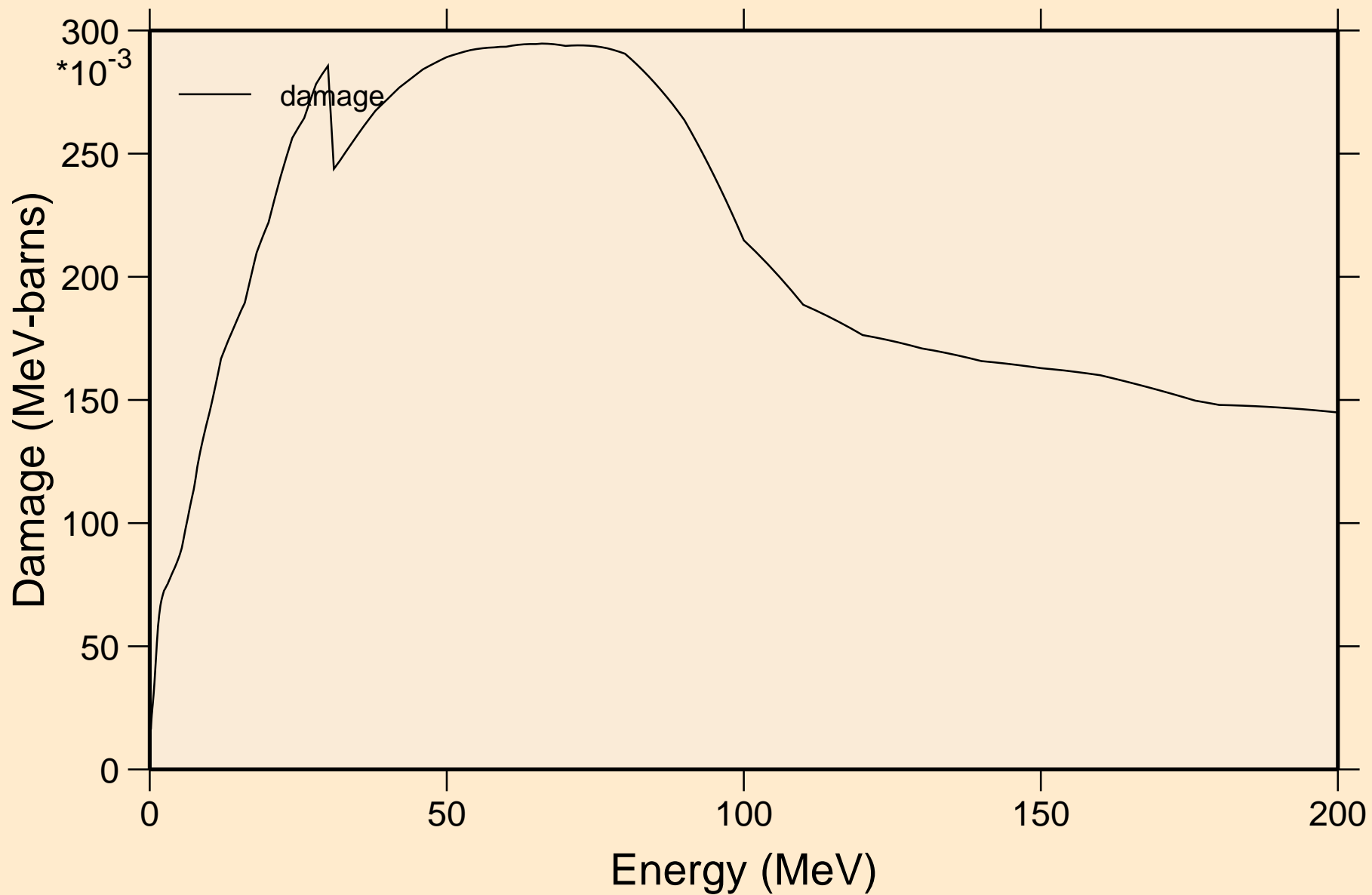

BK243 NEUTRON ACER TENDL-2019 LIBRARY; T=293.16K

Non-threshold reactions

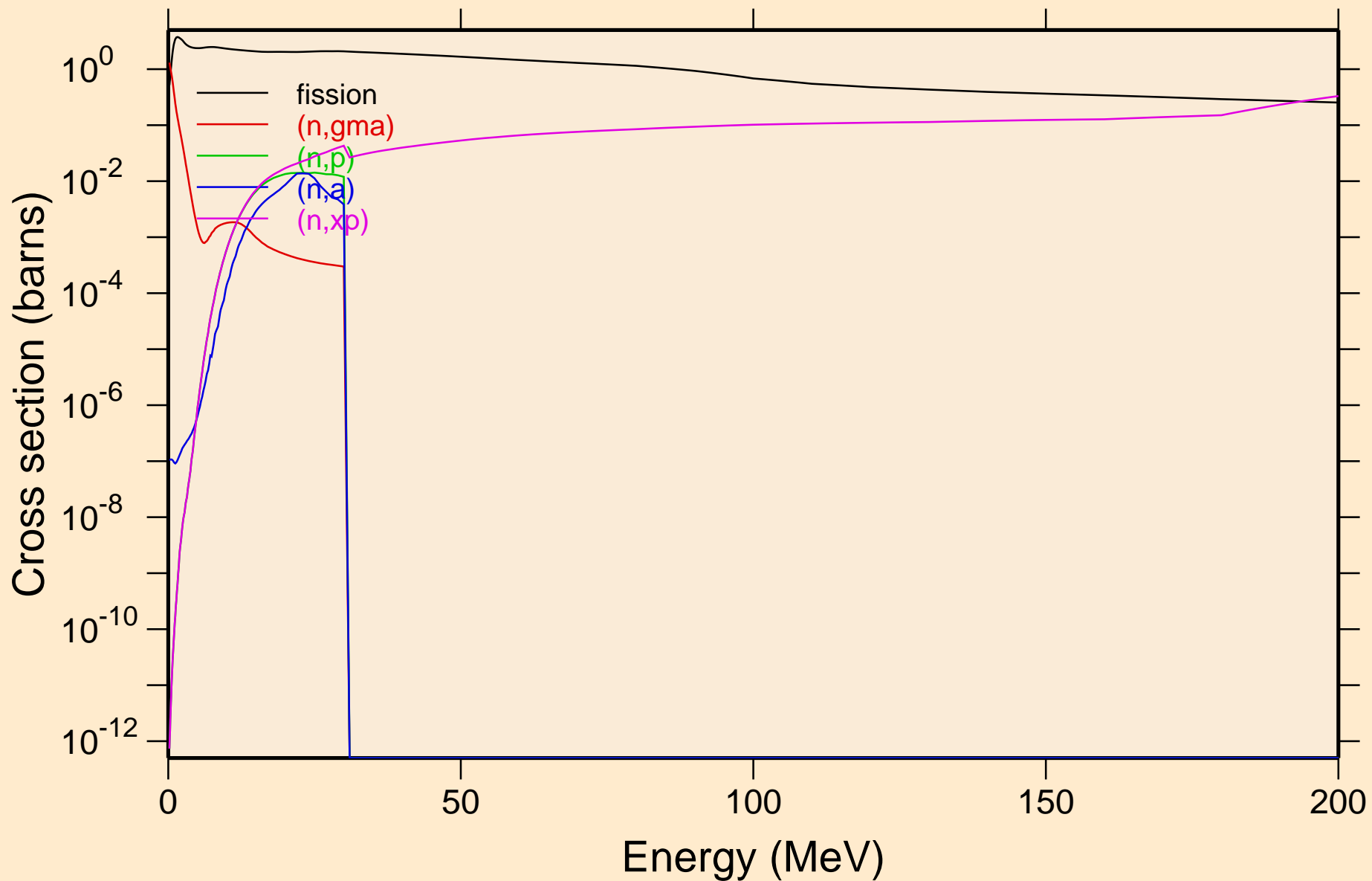

BK243 NEUTRON ACER TENDL-2019 LIBRARY; T=293.16K
Non-threshold reactions

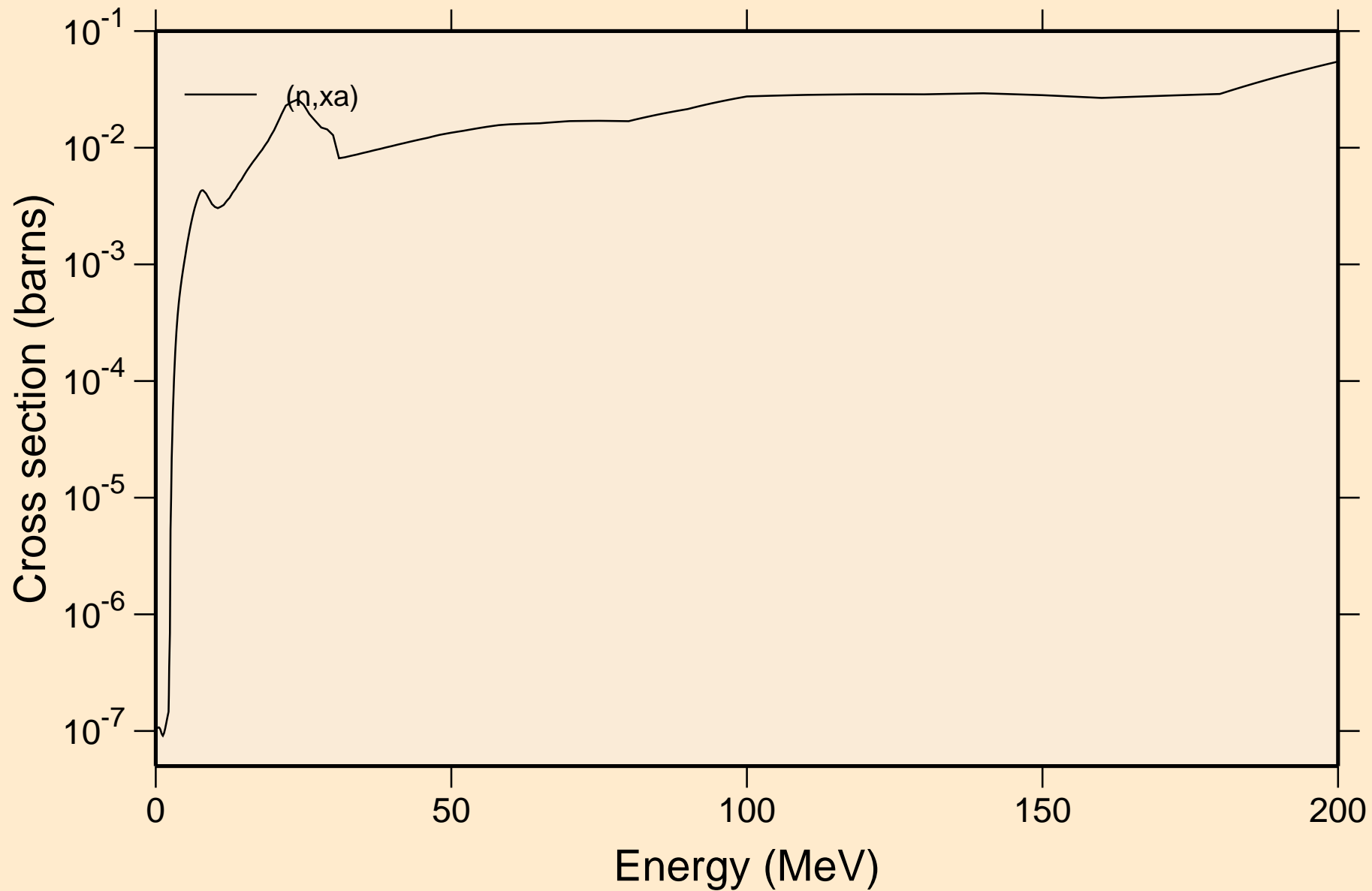

BK243 NEUTRON ACER TENDL-2019 LIBRARY; T=293.16K
Inelastic levels

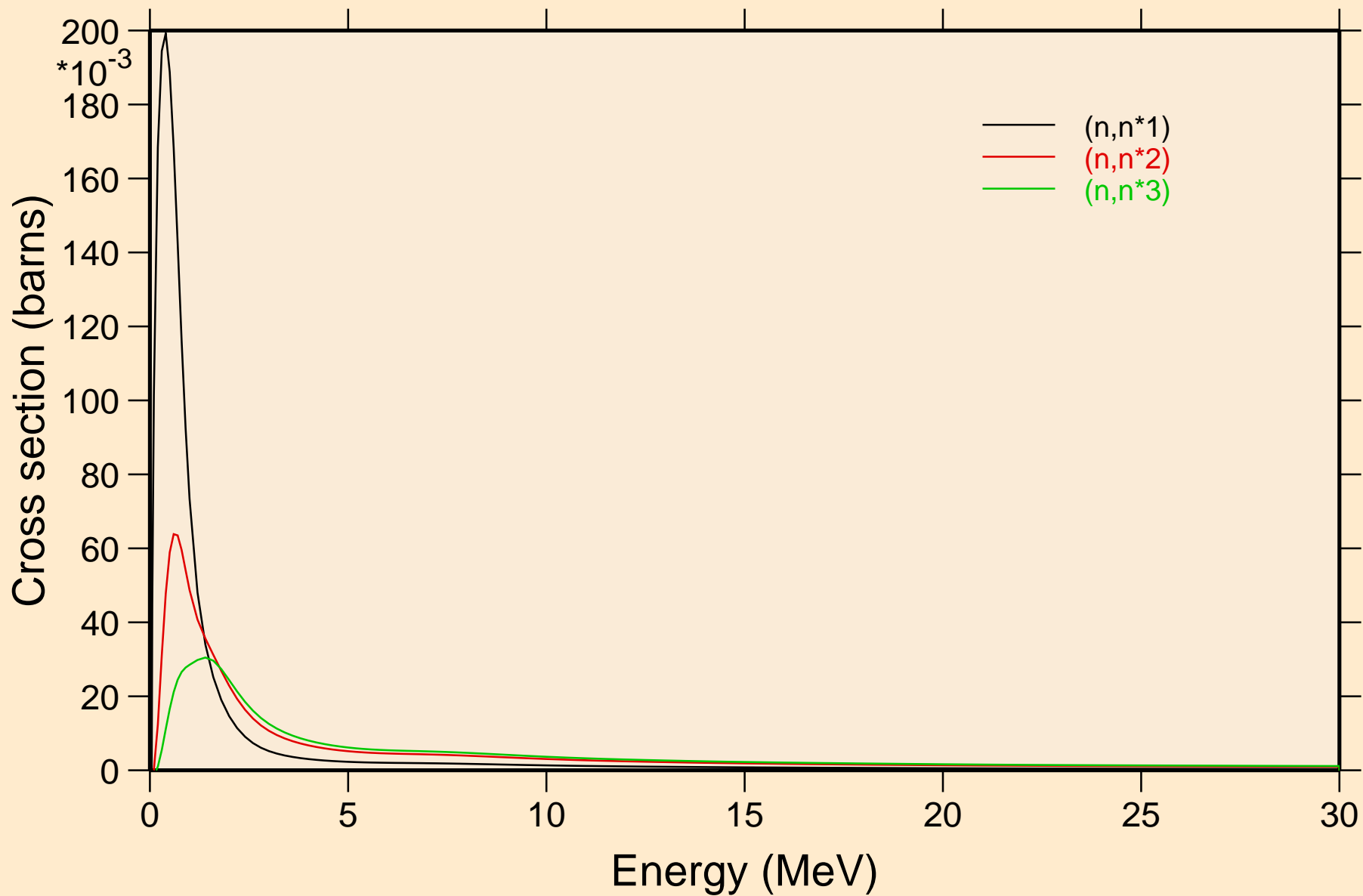

BK243 NEUTRON ACER TENDL-2019 LIBRARY; T=293.16K
Threshold reactions

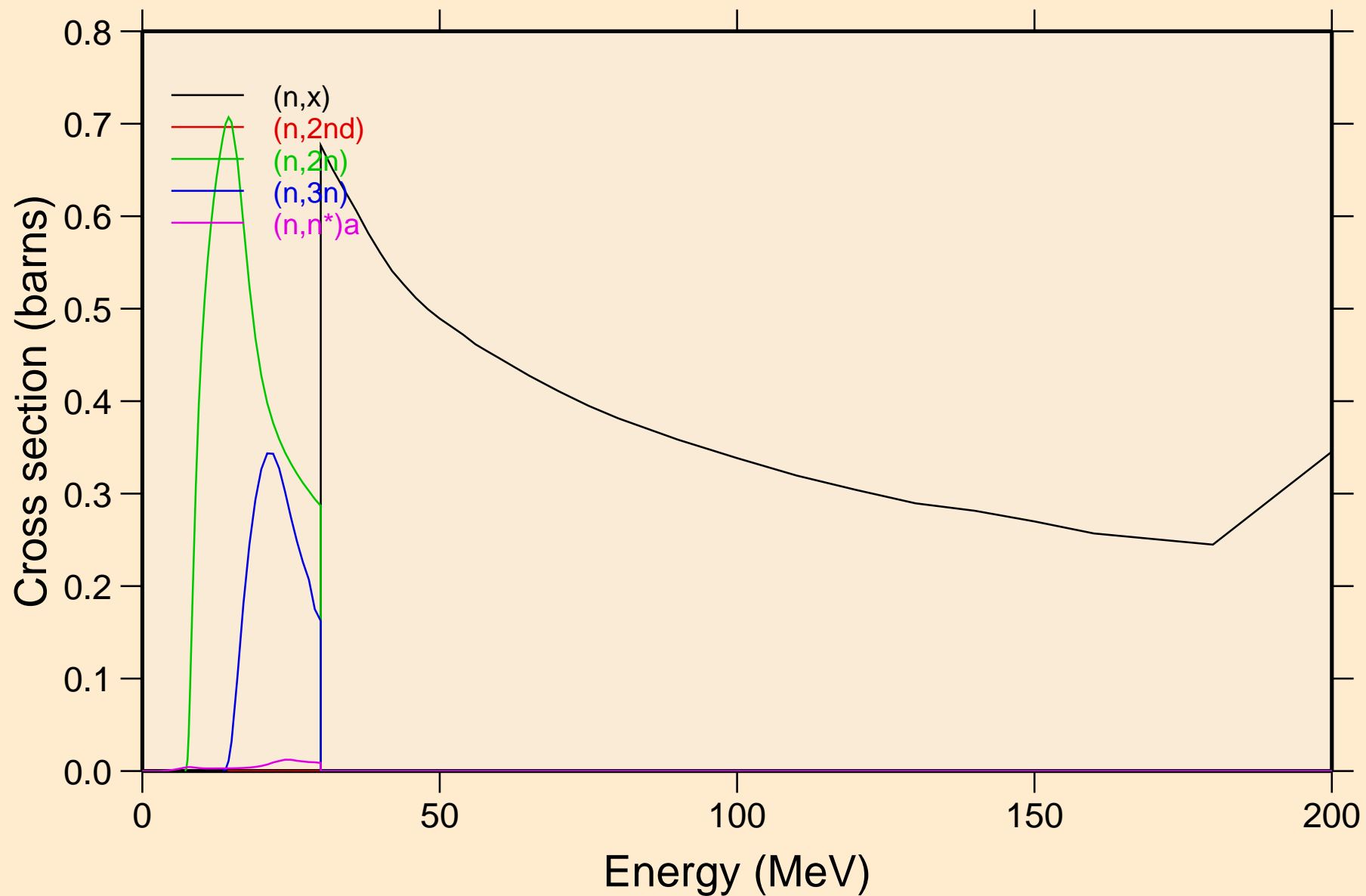

BK243 NEUTRON ACER TENDL-2019 LIBRARY; T=293.16K
Threshold reactions

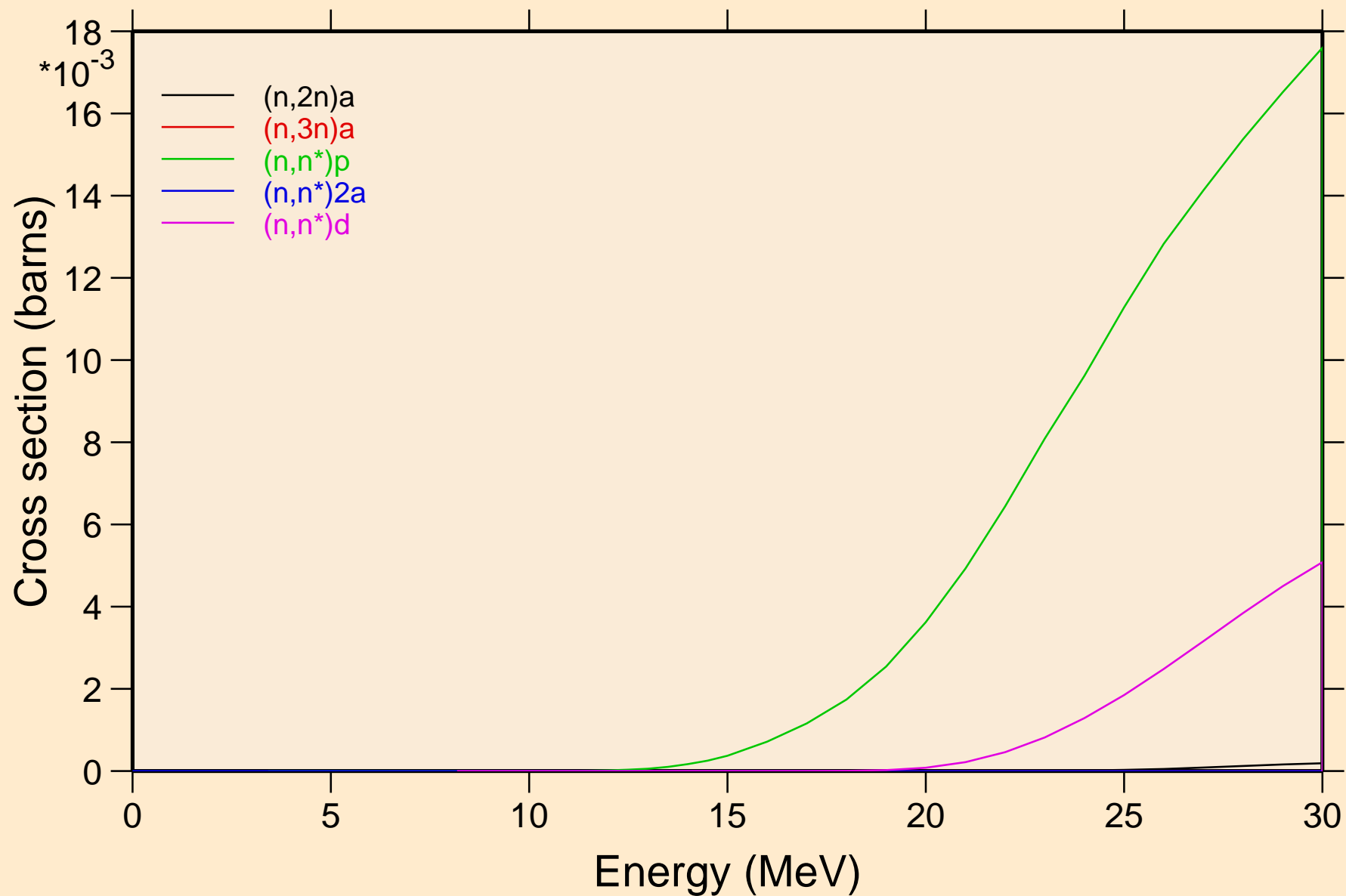

BK243 NEUTRON ACER TENDL-2019 LIBRARY; T=293.16K
Threshold reactions

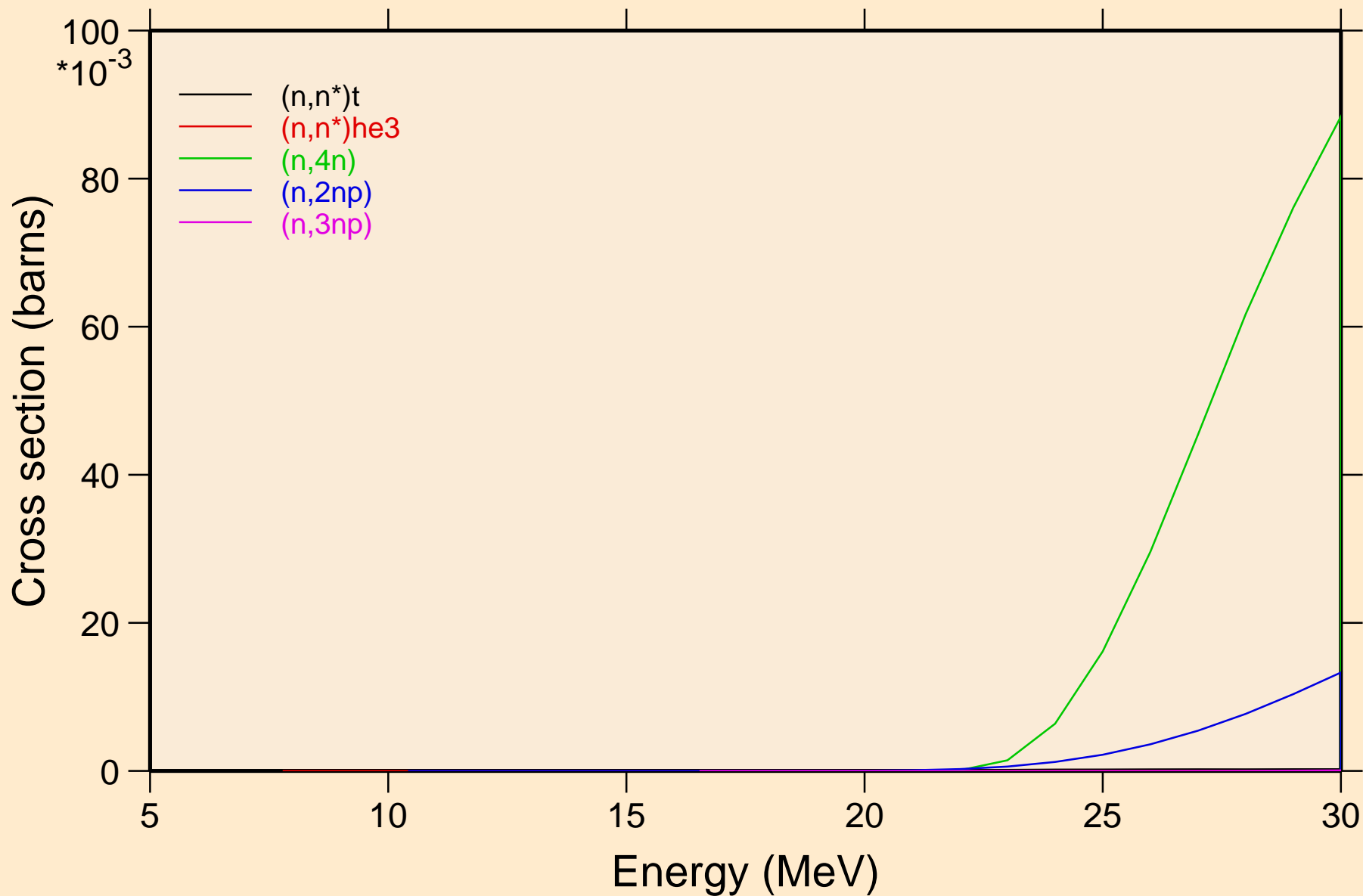

BK243 NEUTRON ACER TENDL-2019 LIBRARY; T=293.16K
Threshold reactions

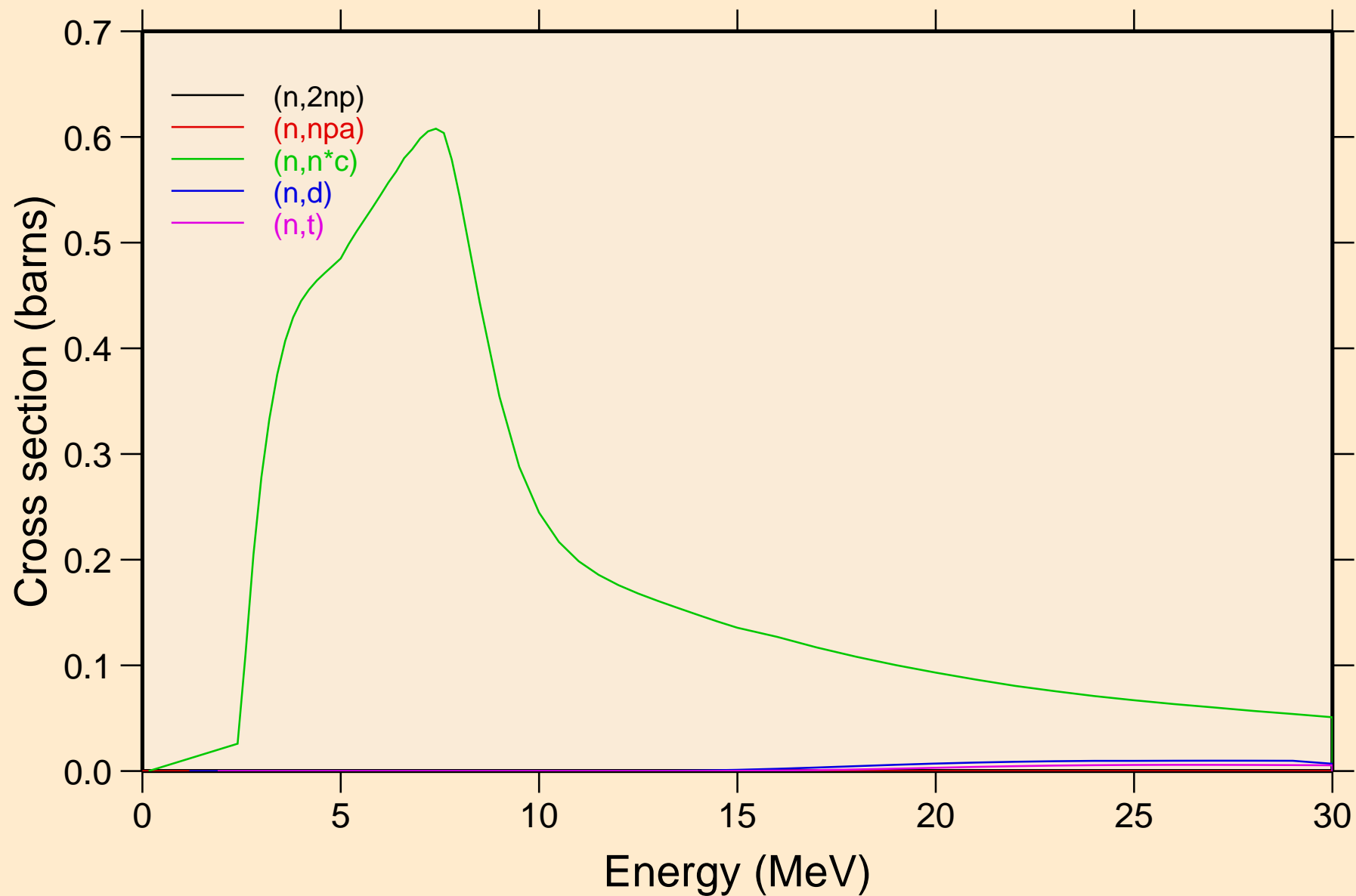

BK243 NEUTRON ACER TENDL-2019 LIBRARY; T=293.16K
Threshold reactions

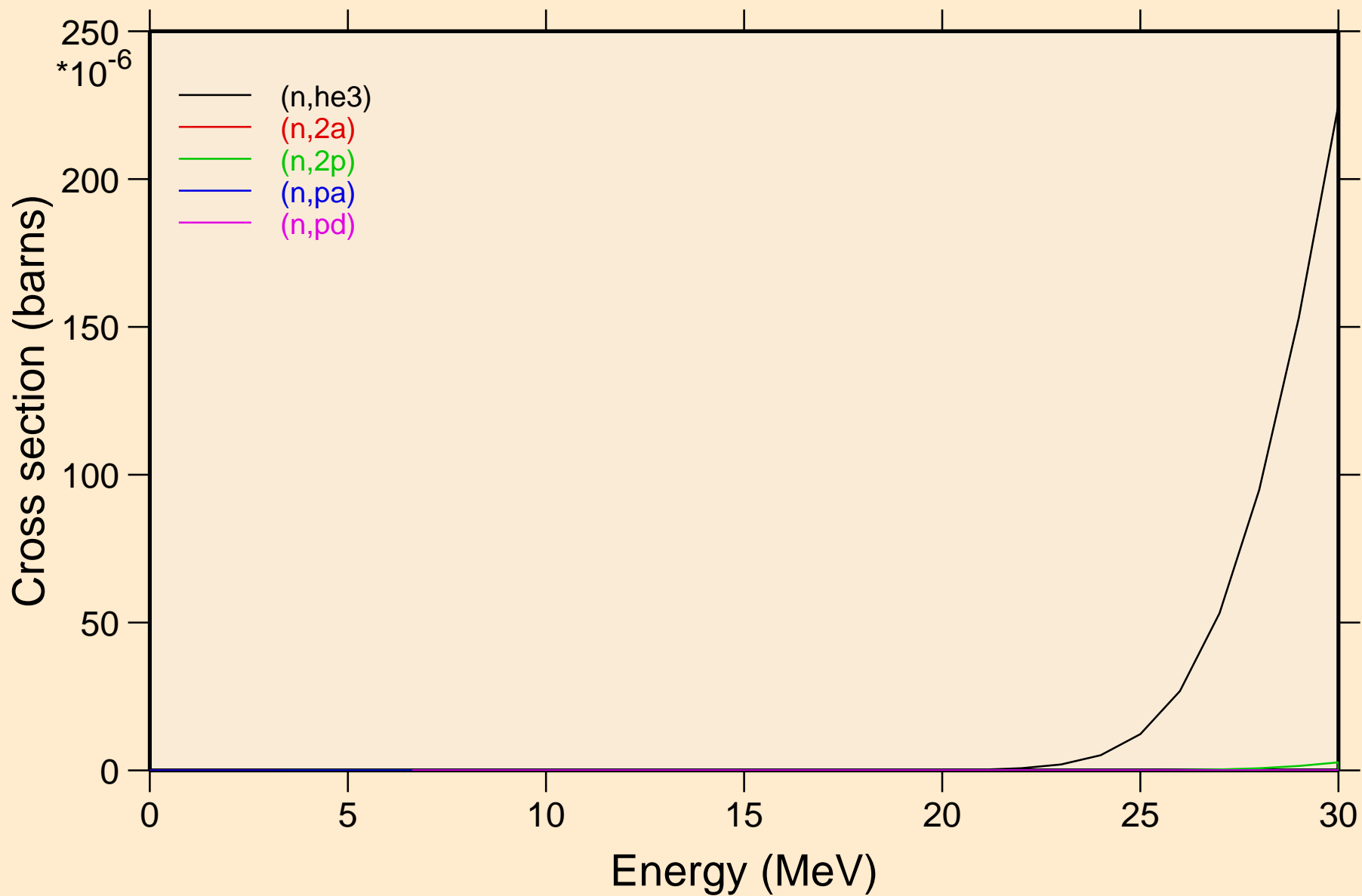

BK243 NEUTRON ACER TENDL-2019 LIBRARY; T=293.16K
Threshold reactions

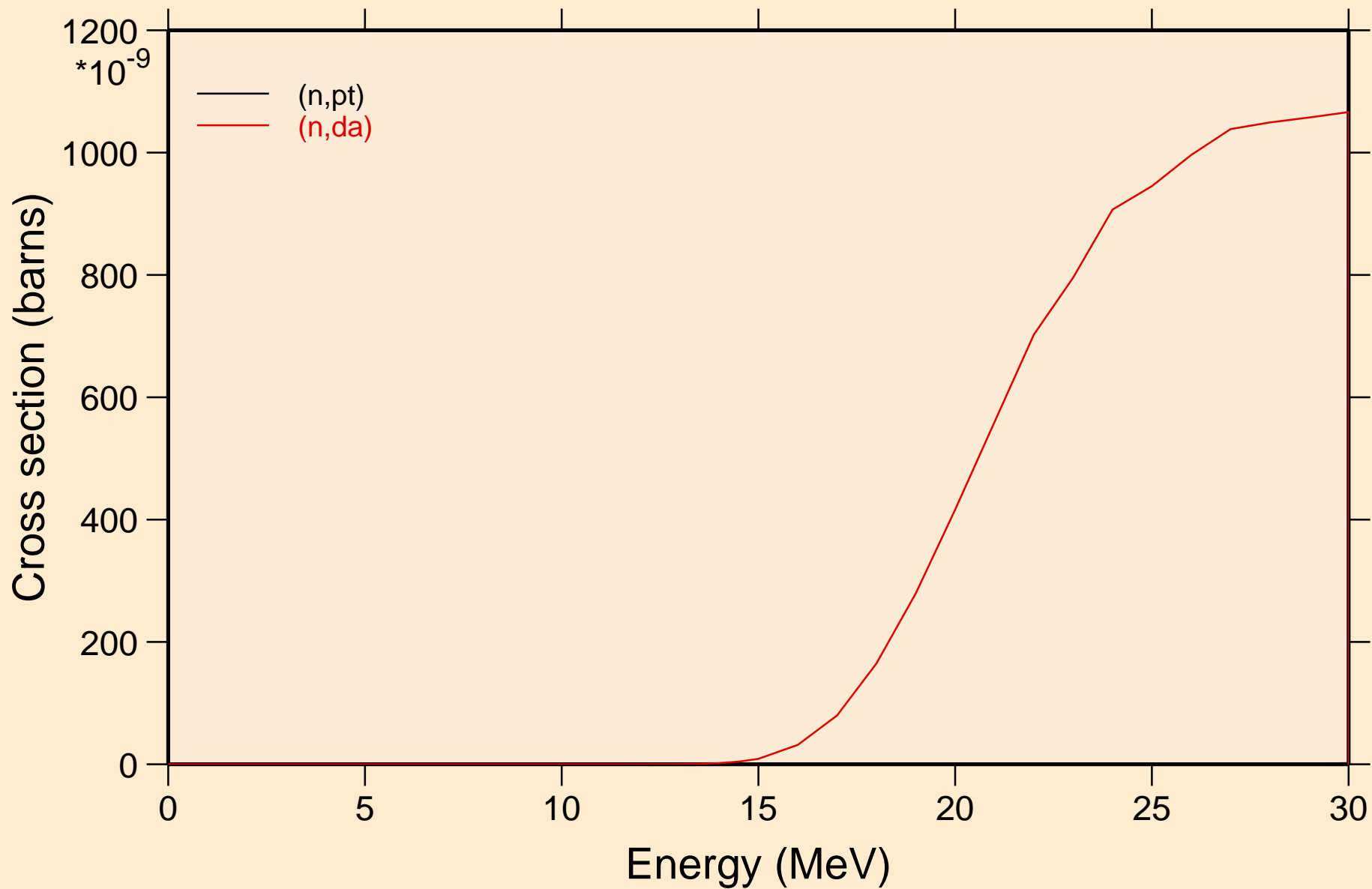

BK243 NEUTRON ACER TENDL-2019 LIBRARY; T=293.16K
Threshold reactions

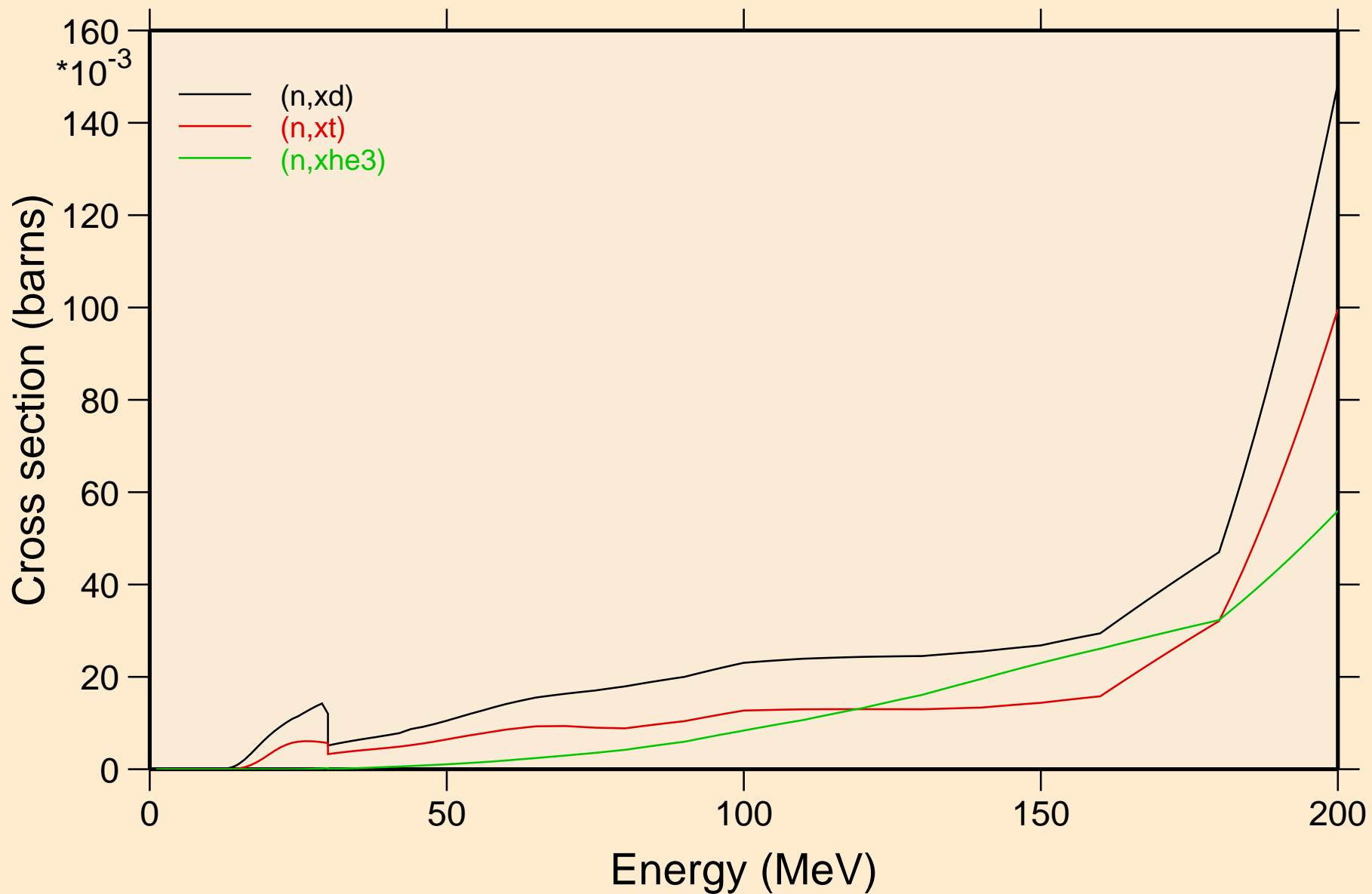

BK243 NEUTRON ACER TENDL-2019 LIBRARY; T=293.16K
angular distribution for elastic

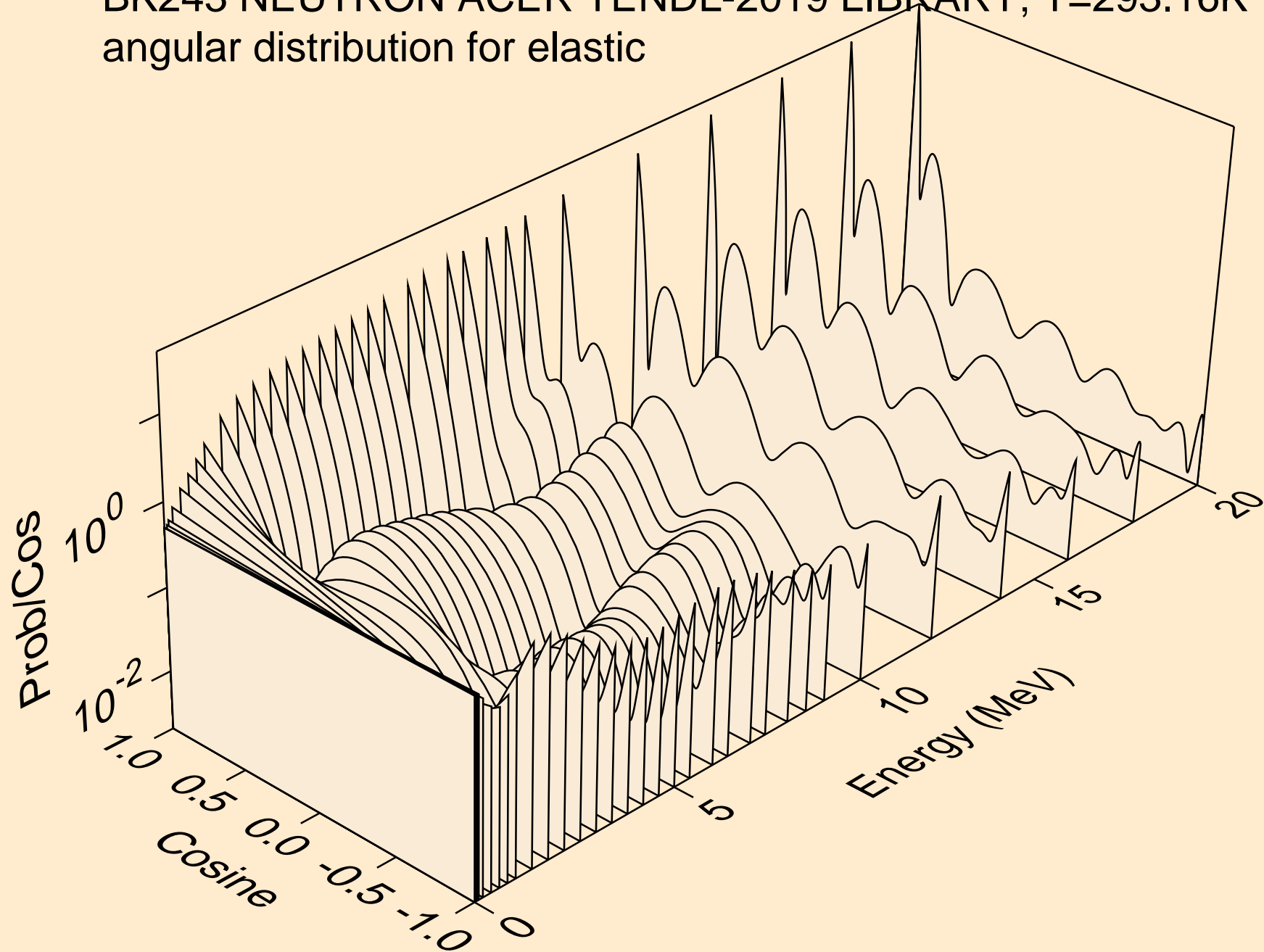

BK243 NEUTRON ACER TENDL-2019 LIBRARY; T=293.16K
angular distribution for elastic

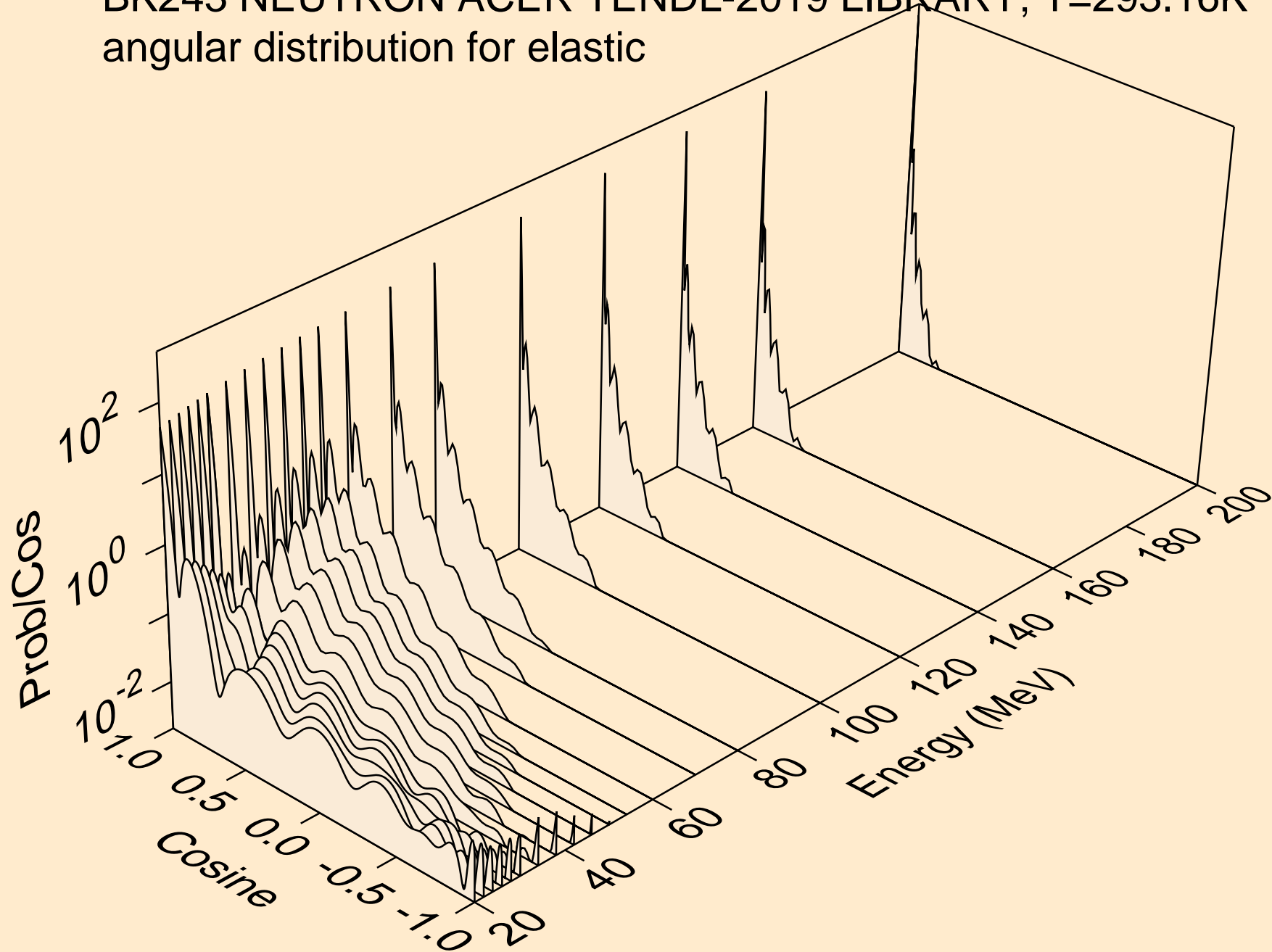

BK243 NEUTRON ACER TENDL-2019 LIBRARY; T=293.16K
angular distribution for (n,n*1)

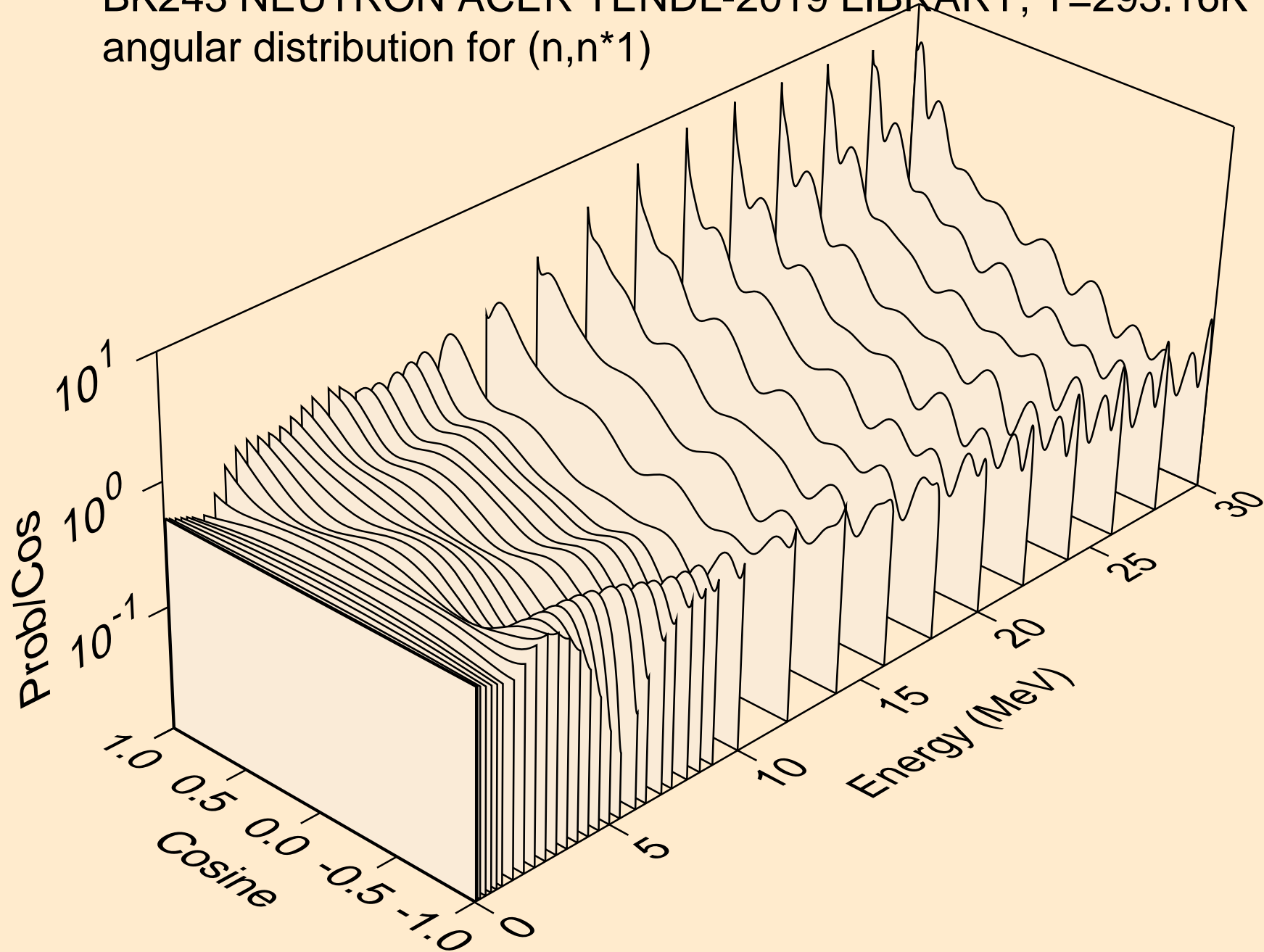

BK243 NEUTRON ACER TENDL-2019 LIBRARY; T=293.16K
angular distribution for (n,n*2)

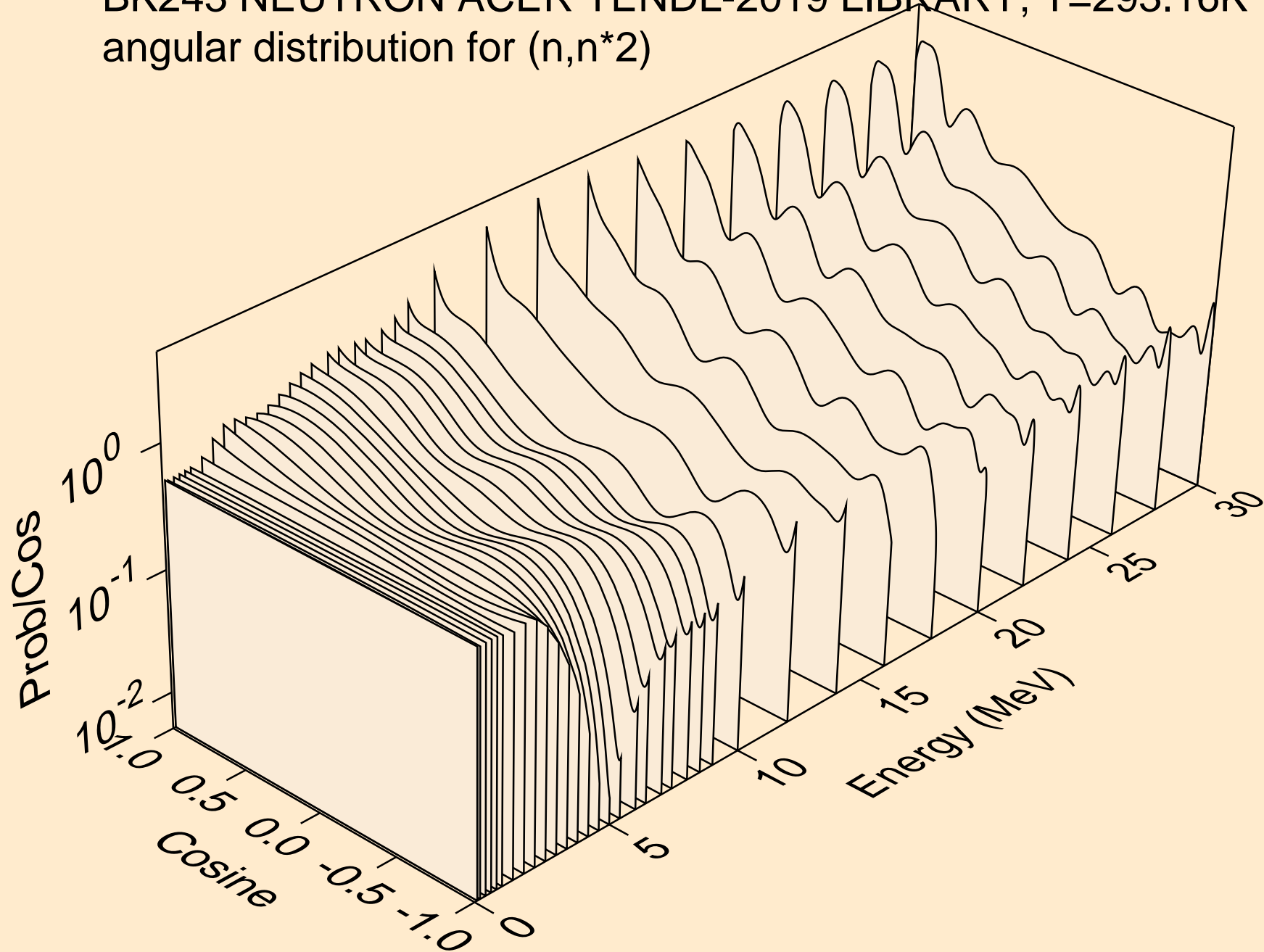

BK243 NEUTRON ACER TENDL-2019 LIBRARY; T=293.16K
angular distribution for (n,n*3)

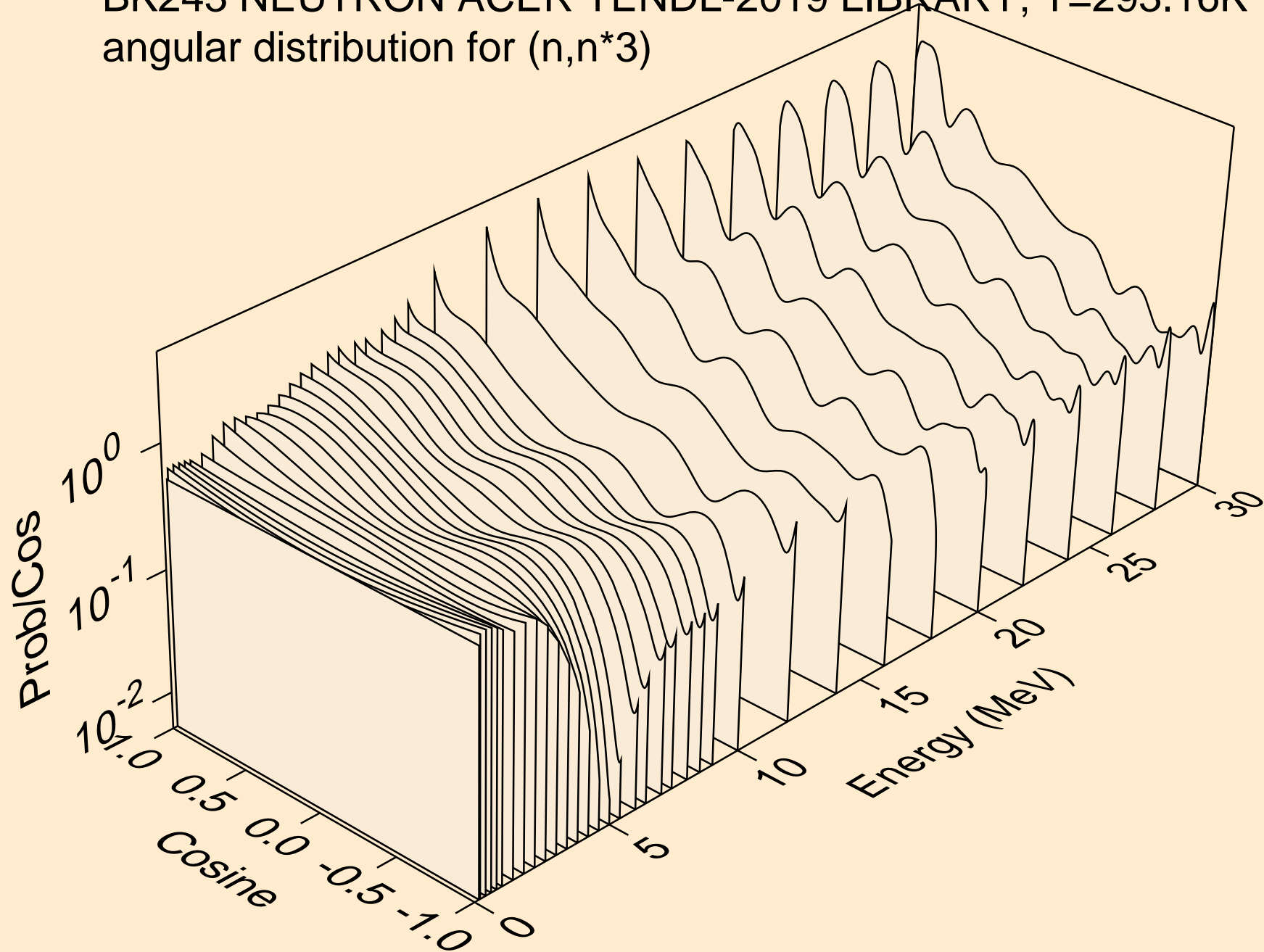

BK243 NEUTRON ACER TENDL-2019 LIBRARY; T=293.16K
Total fission nubar

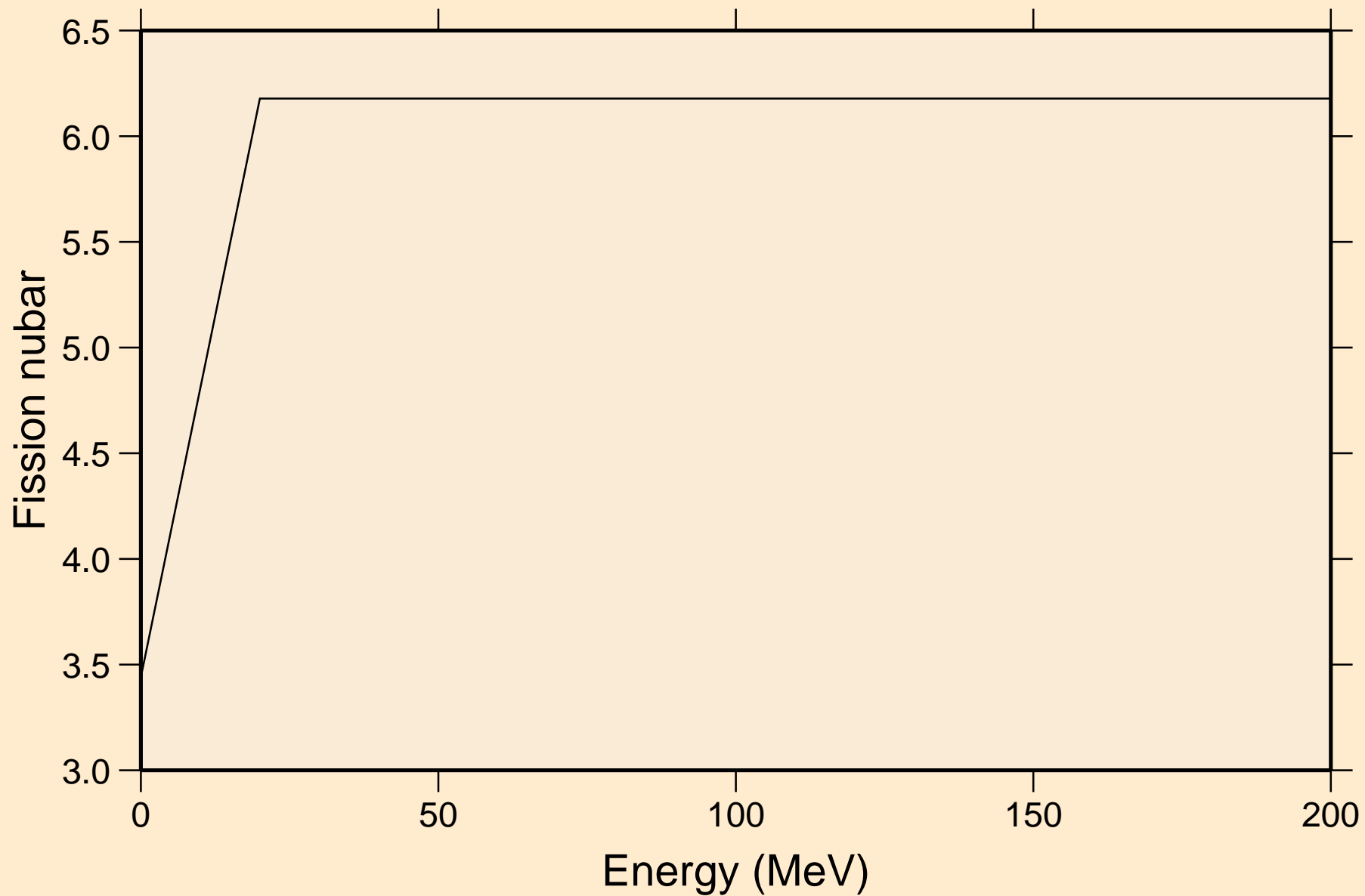

BK243 NEUTRON ACER TENDL-2019 LIBRARY; T=293.16K
Neutron emission for (n,x)

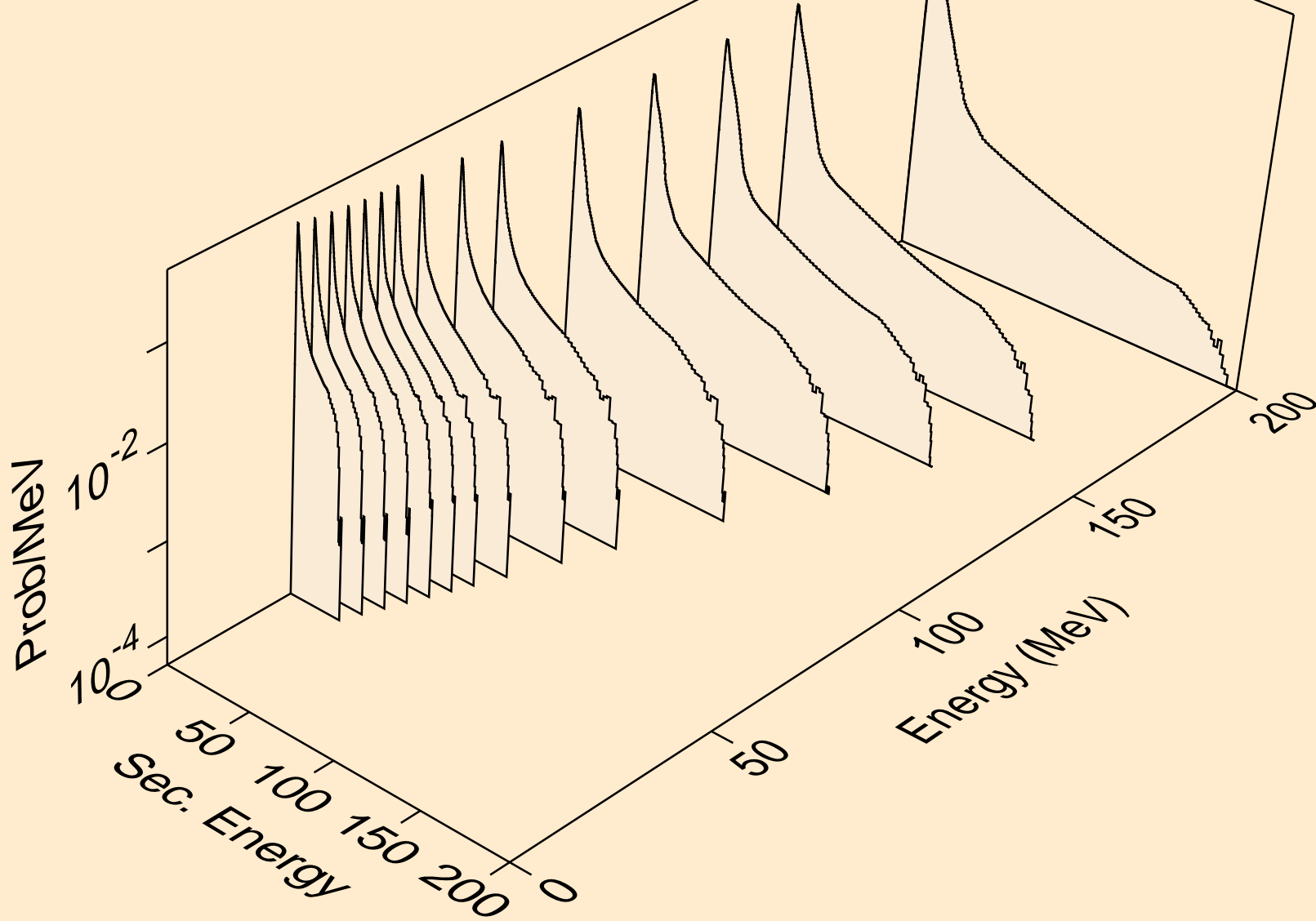

BK243 NEUTRON ACER TENDL-2019 LIBRARY; T=293.16K
Neutron emission for (n,2nd)

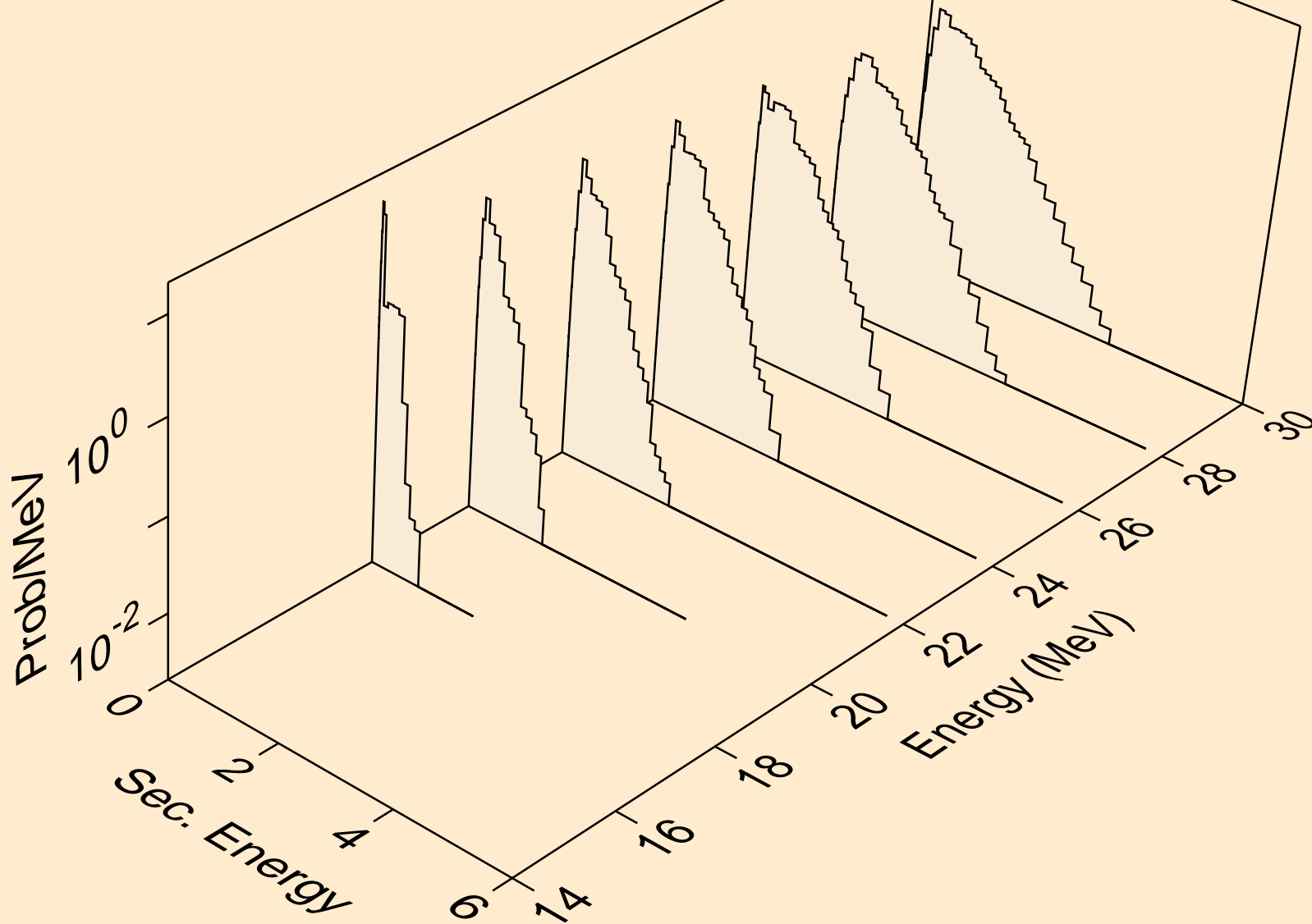

BK243 NEUTRON ACER TENDL-2019 LIBRARY; T=293.16K
Neutron emission for (n,2n)

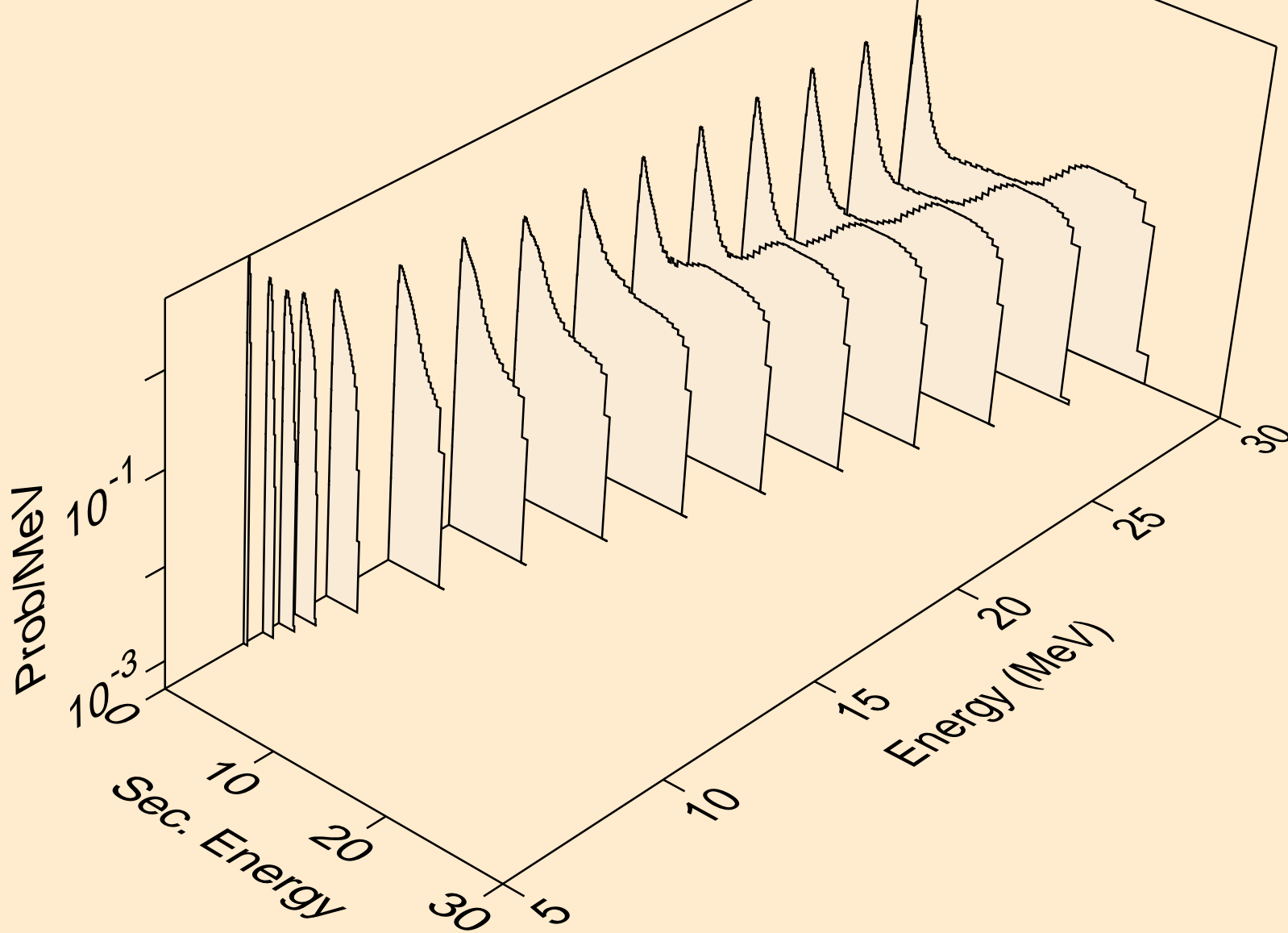

BK243 NEUTRON ACER TENDL-2019 LIBRARY; T=293.16K
Neutron emission for (n,3n)

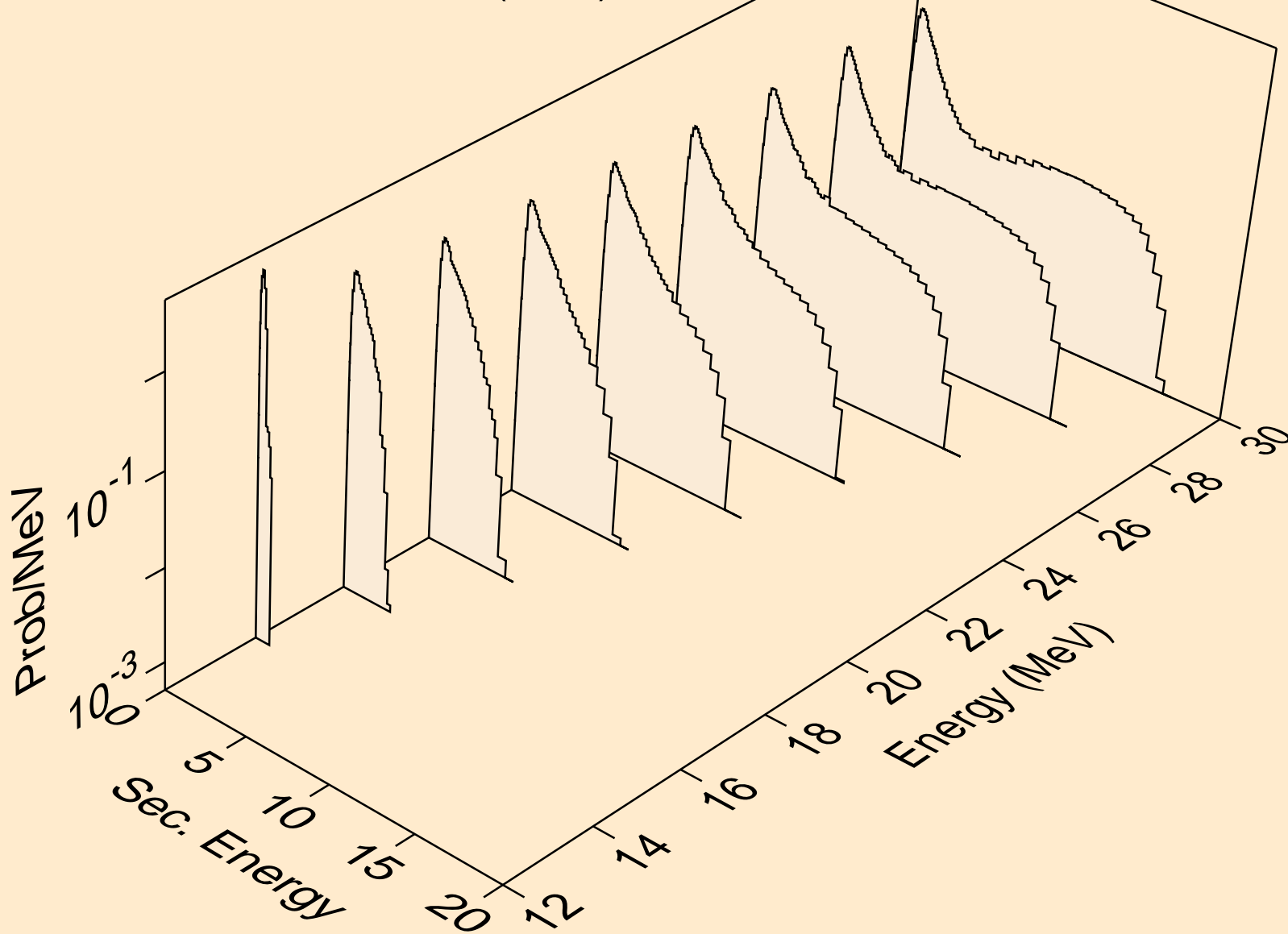

BK243 NEUTRON ACER TENDL-2019 LIBRARY; T=293.16K
Neutron emission for fission

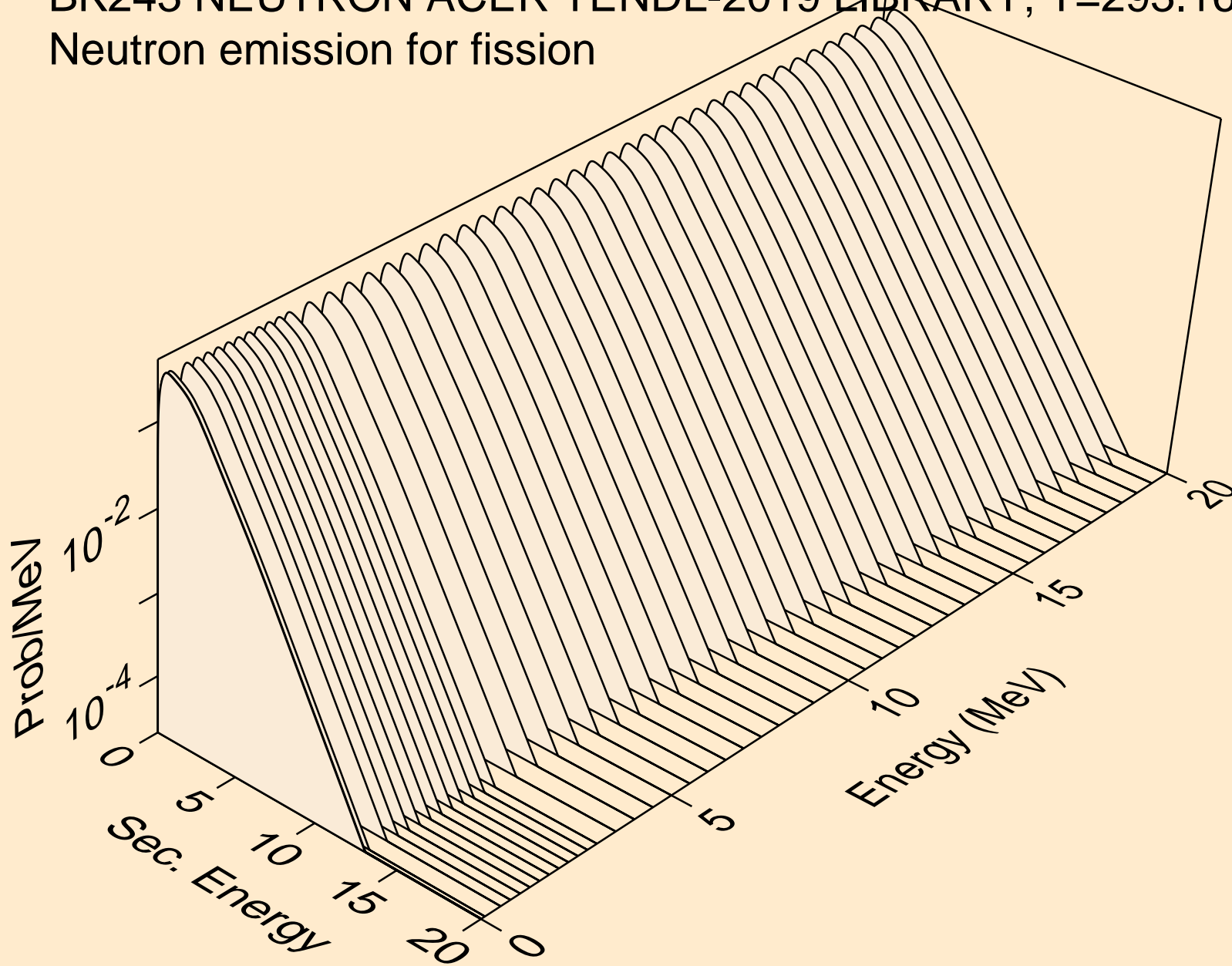

BK243 NEUTRON ACER TENDL-2019 LIBRARY; T=293.16K
Neutron emission for (n,n*)a

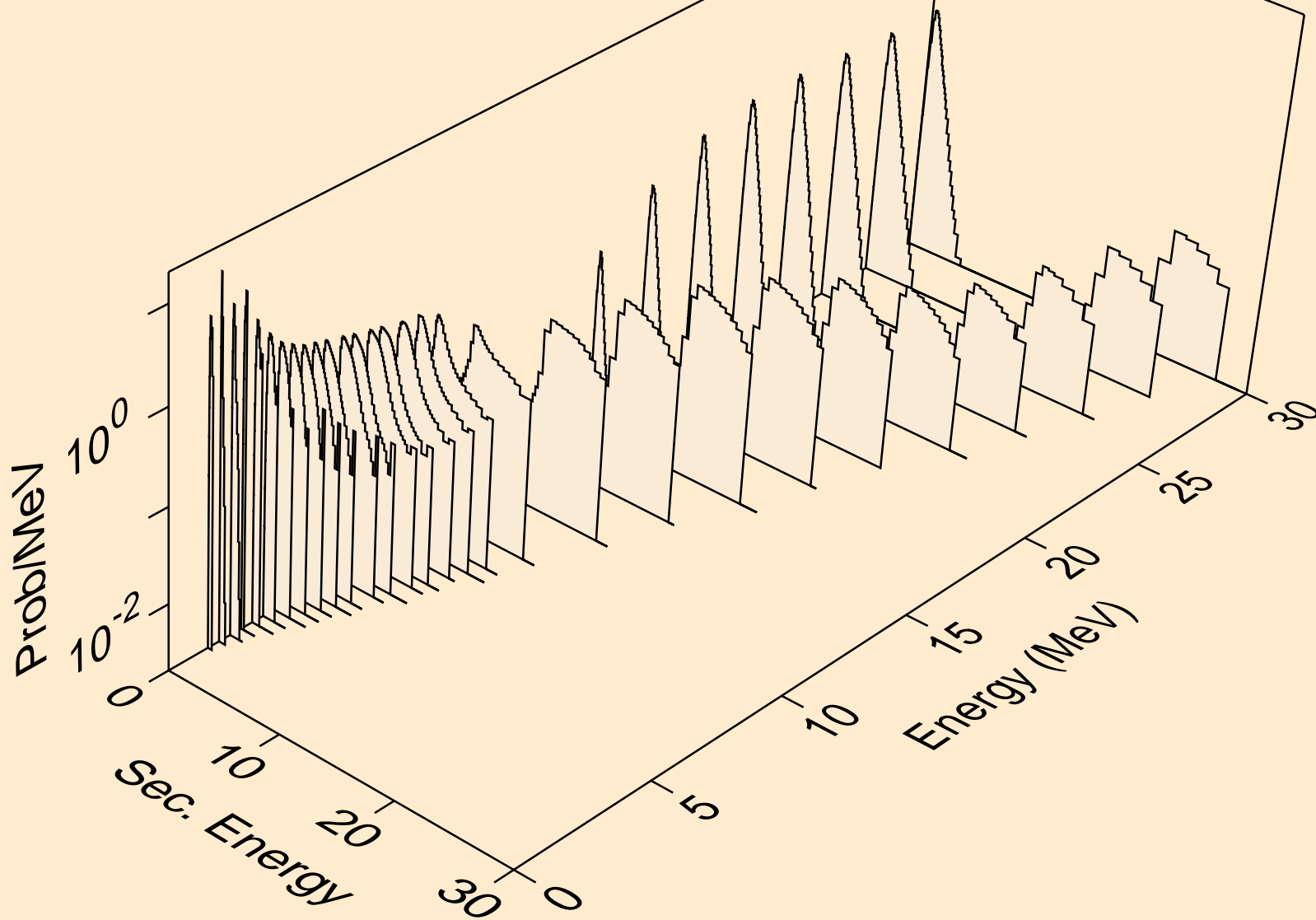

BK243 NEUTRON ACER TENDL-2019 LIBRARY; T=293.16K
Neutron emission for (n,2n)a

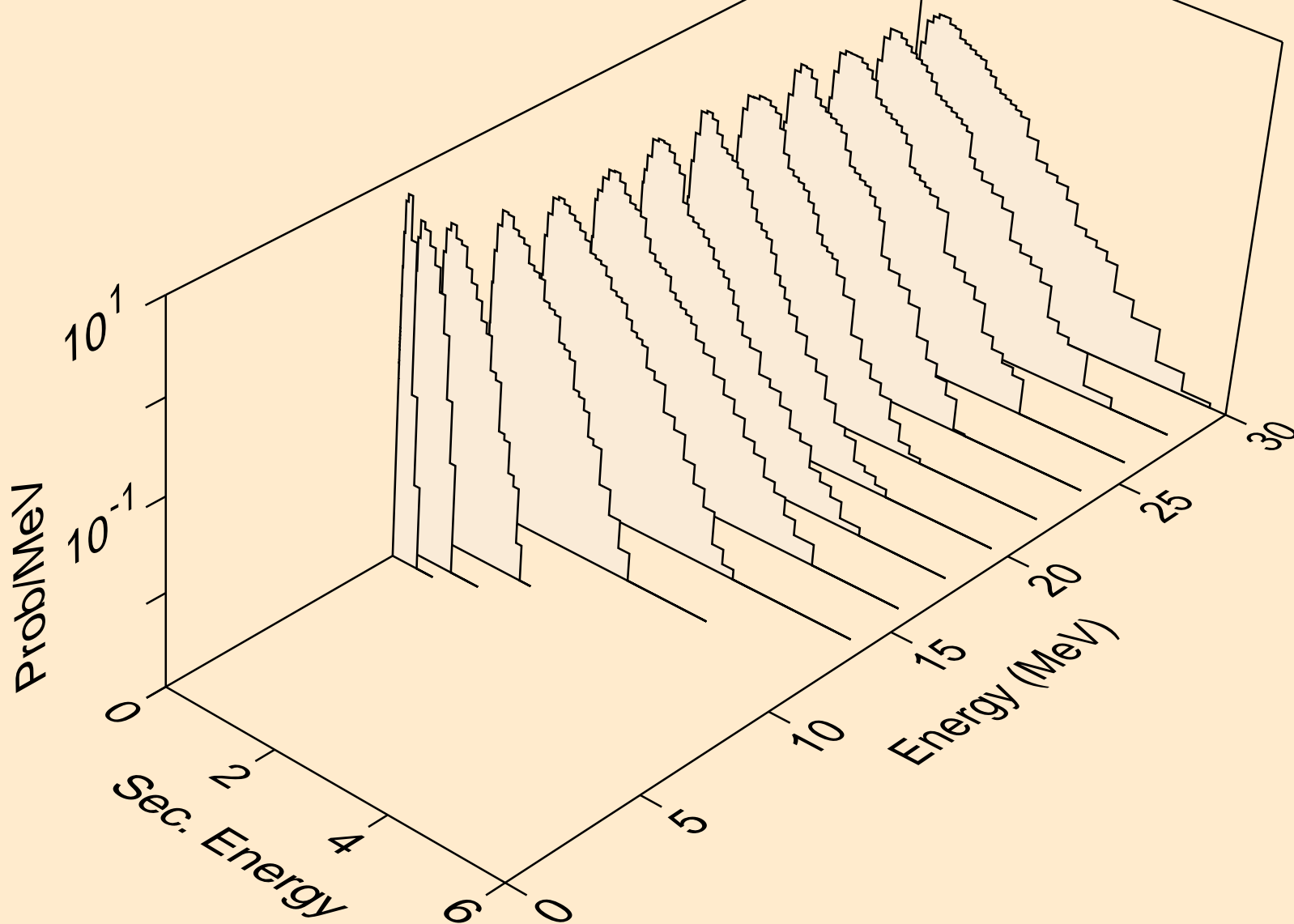

BK243 NEUTRON ACER TENDL-2019 LIBRARY; T=293.16K
Neutron emission for (n,3n)a

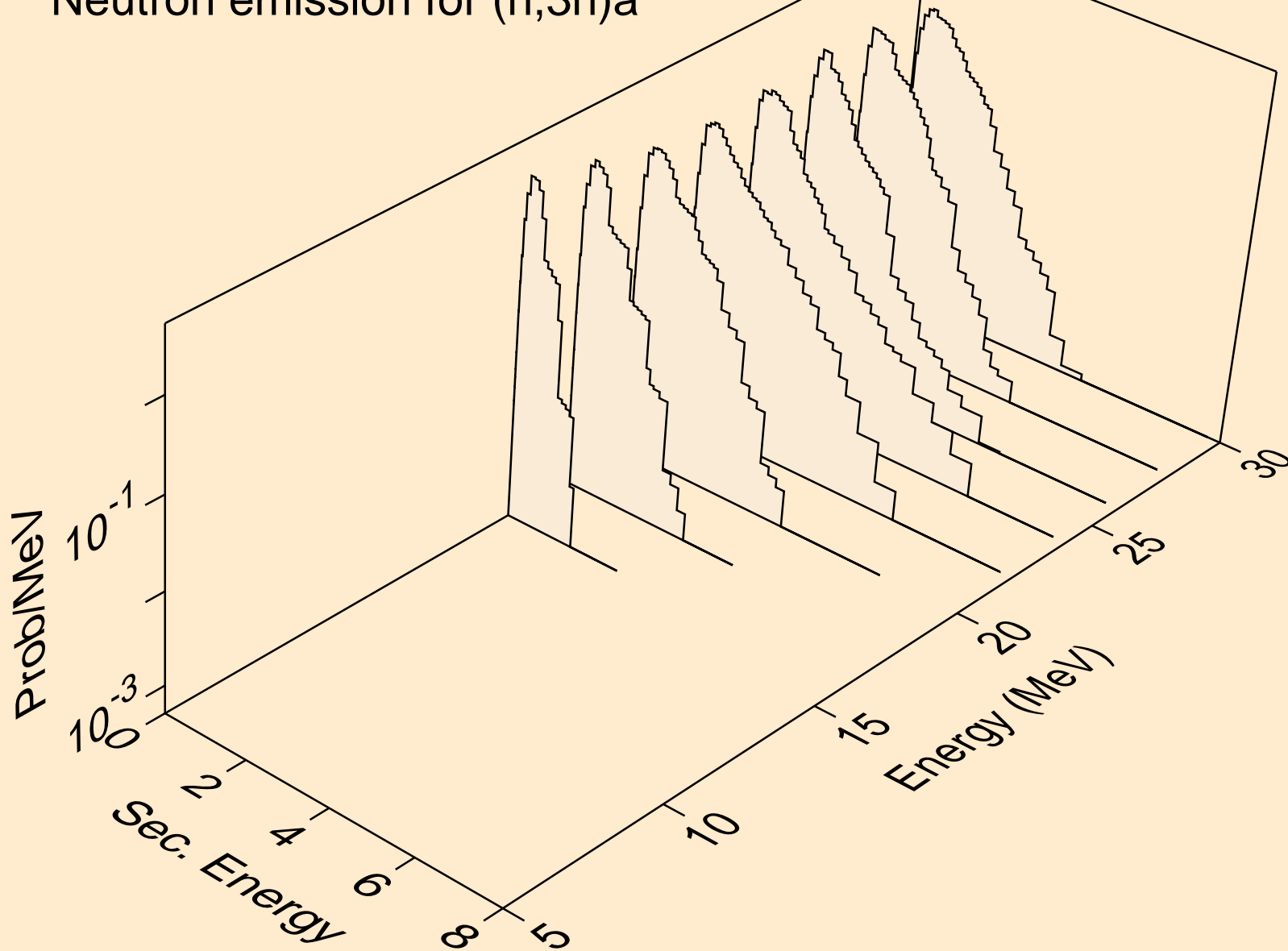

BK243 NEUTRON ACER TENDL-2019 LIBRARY; T=293.16K
Neutron emission for (n,n*)p

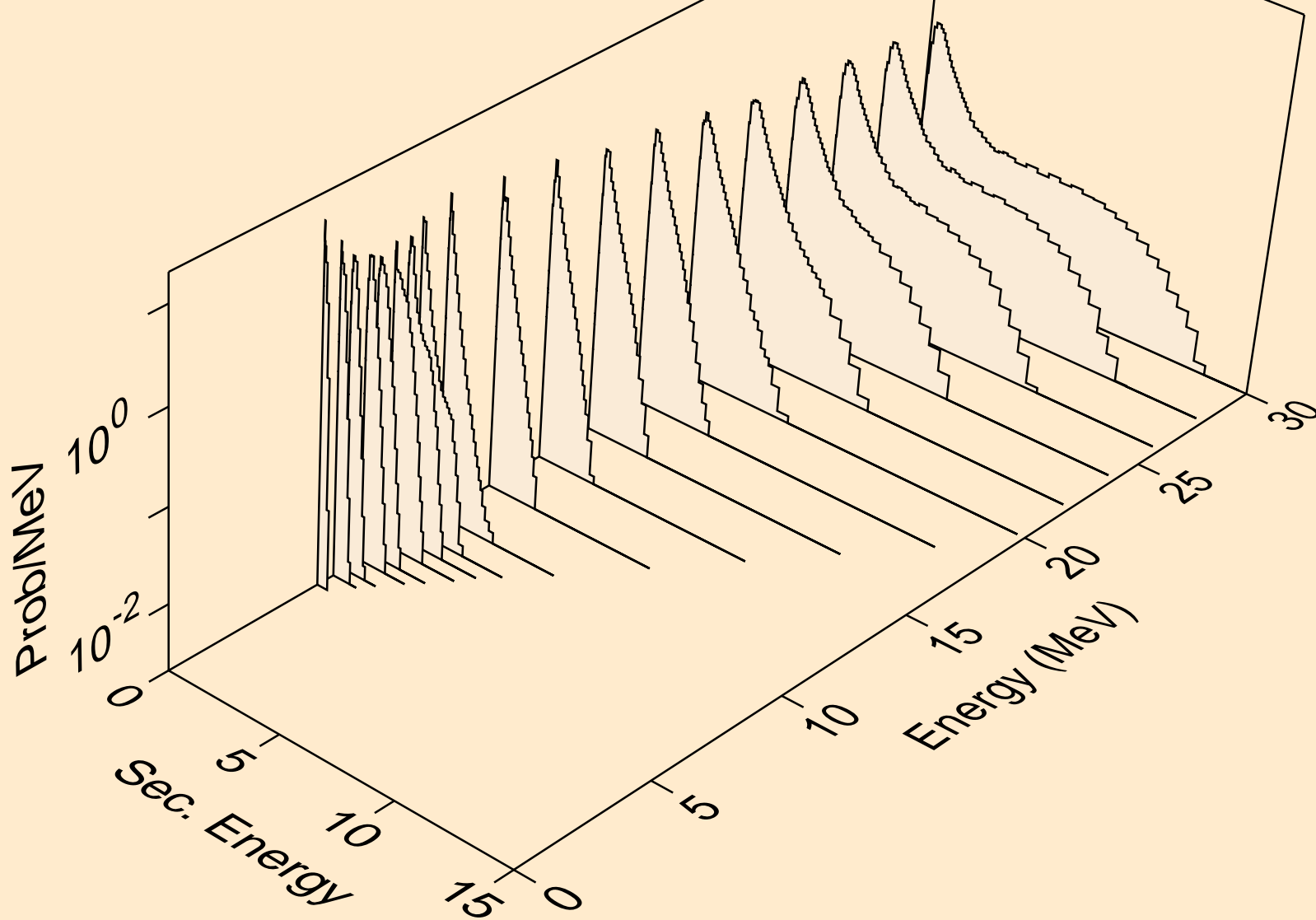

BK243 NEUTRON ACER TENDL-2019 LIBRARY; T=293.16K
Neutron emission for (n,n*)2a

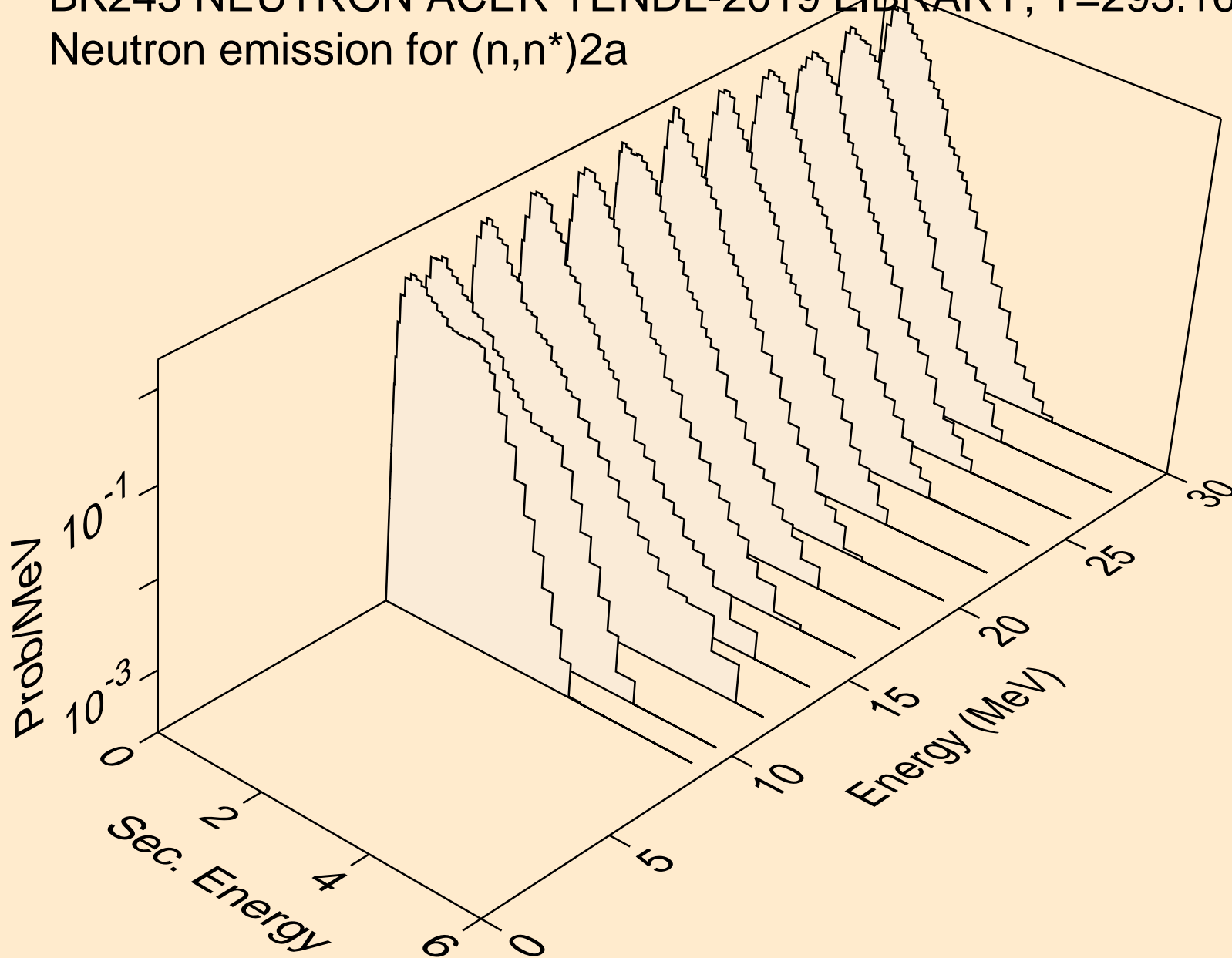

BK243 NEUTRON ACER TENDL-2019 LIBRARY; T=293.16K
Neutron emission for (n,n*)d

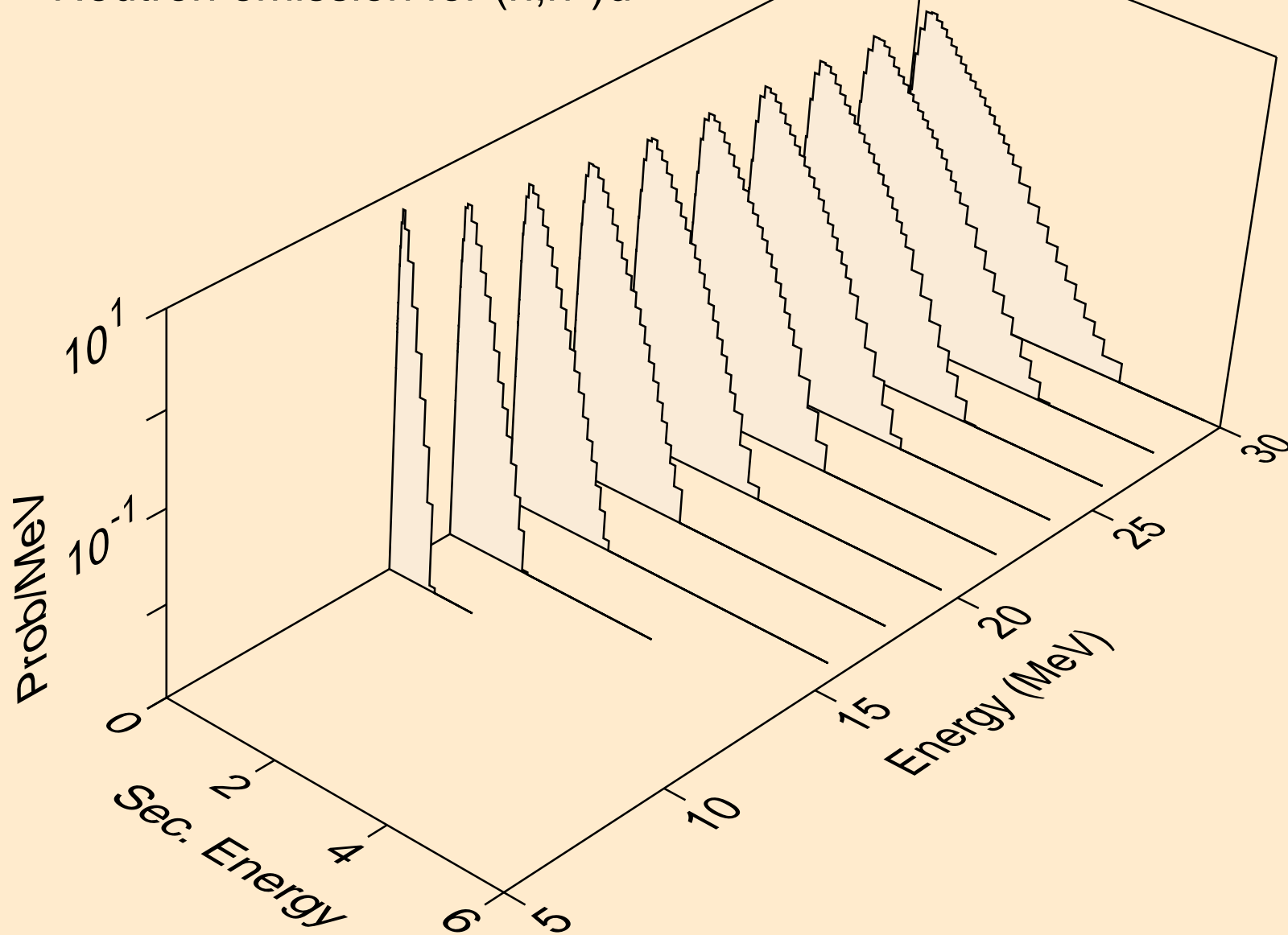

BK243 NEUTRON ACER TENDL-2019 LIBRARY; T=293.16K
Neutron emission for (n,n*)t

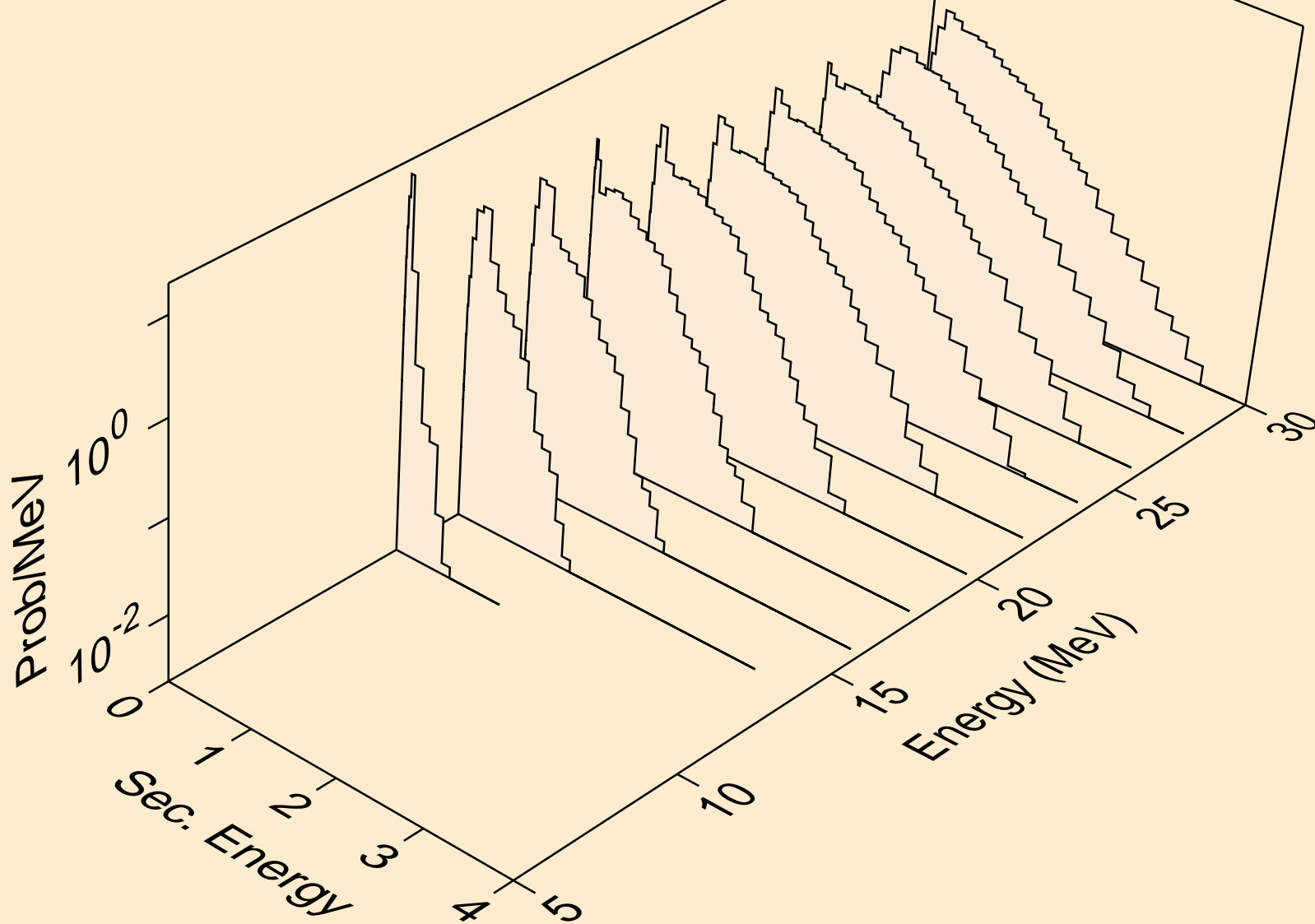

BK243 NEUTRON ACER TENDL-2019 LIBRARY; T=293.16K
Neutron emission for (n,n*)he3

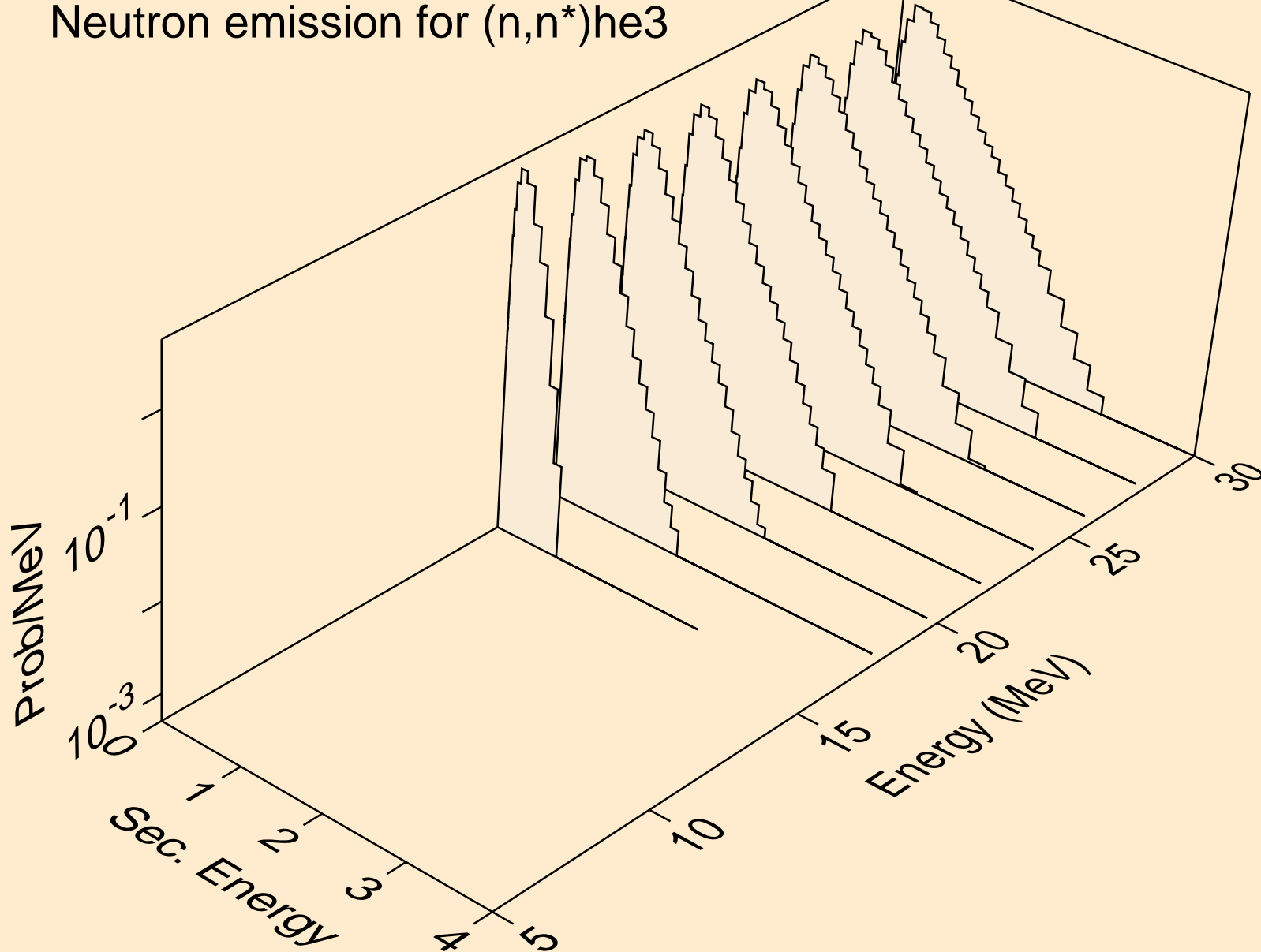

BK243 NEUTRON ACER TENDL-2019 LIBRARY; T=293.16K
Neutron emission for (n,4n)

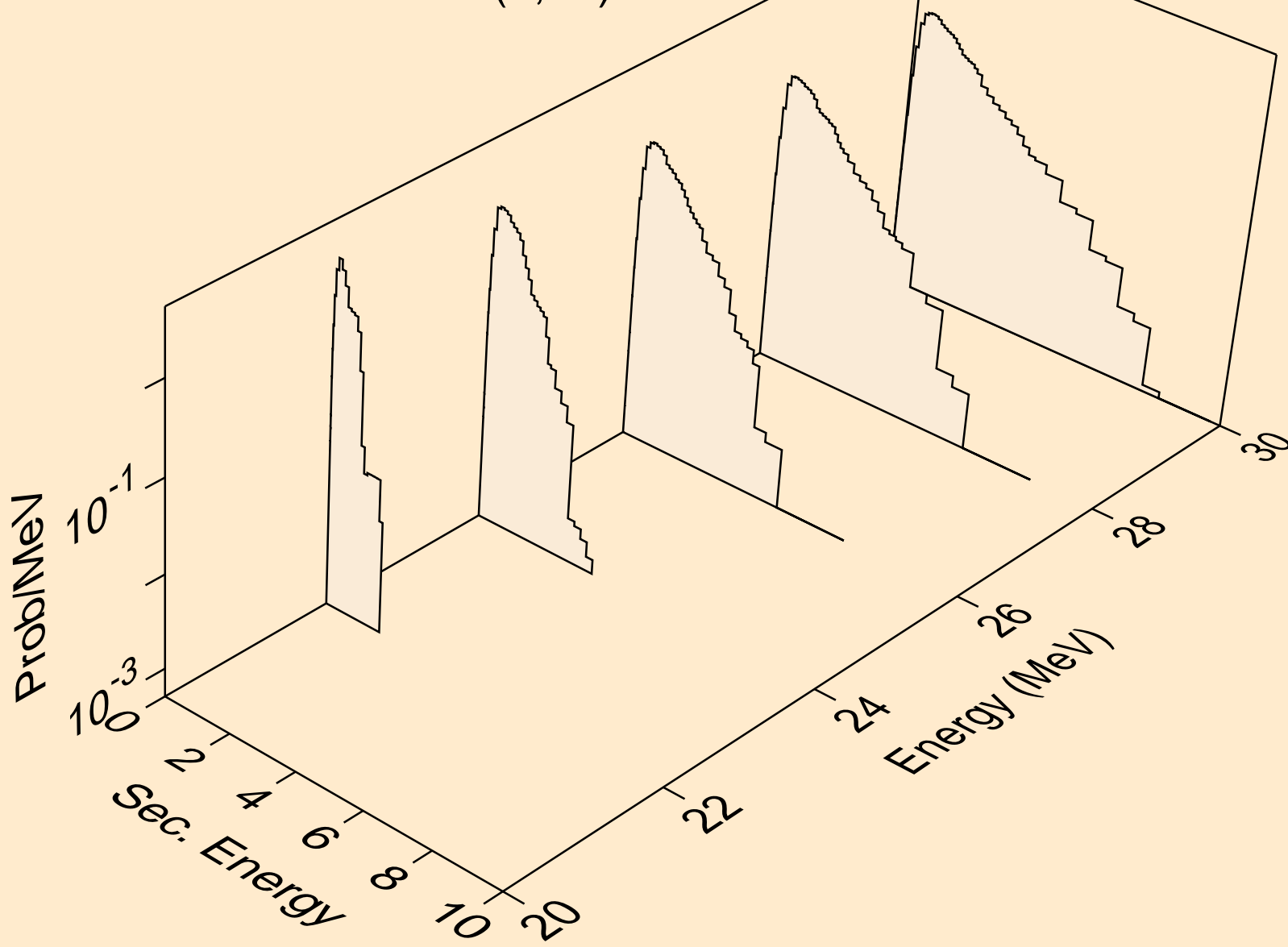

BK243 NEUTRON ACER TENDL-2019 LIBRARY; T=293.16K
Neutron emission for (n,2np)

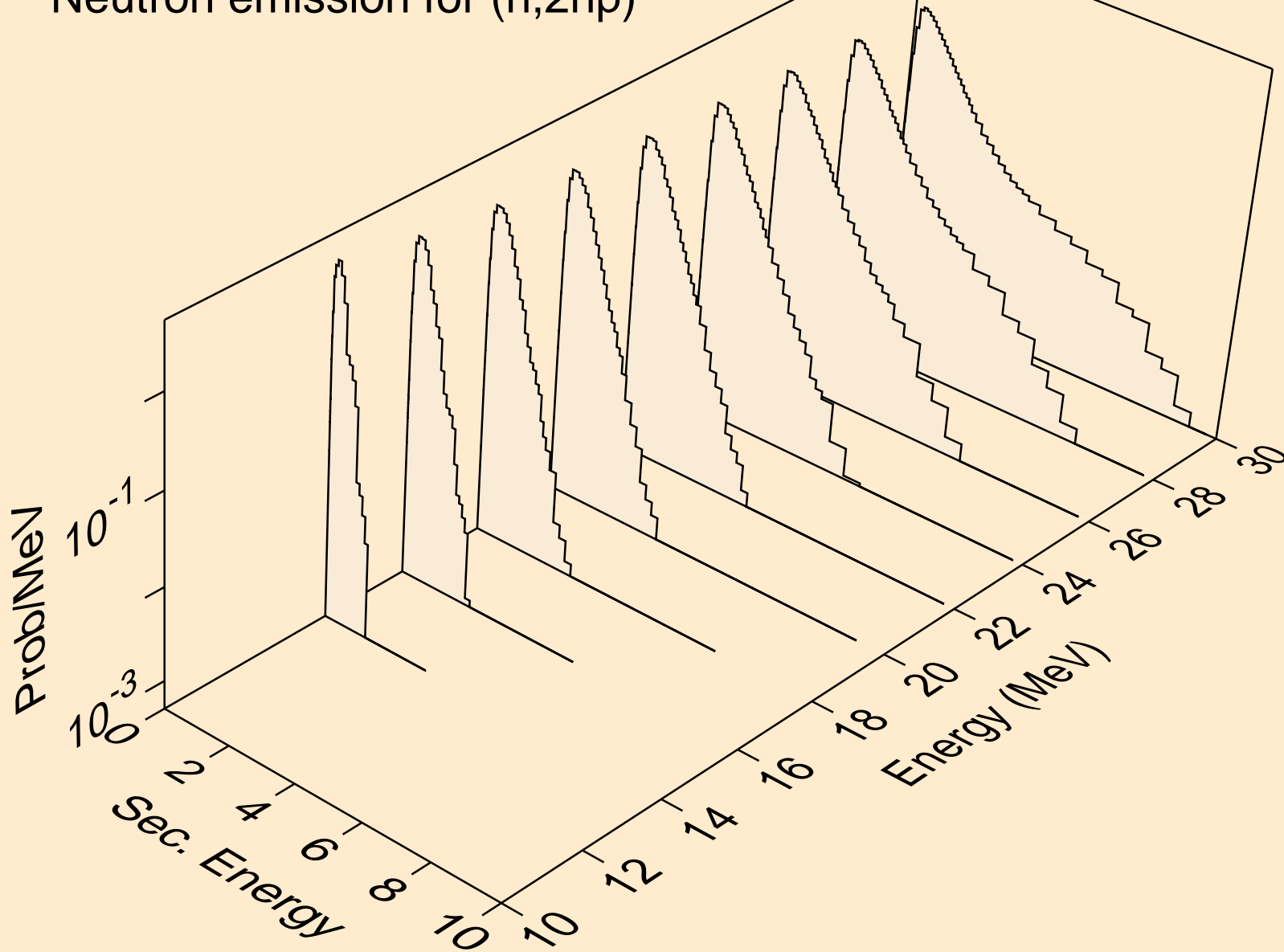

BK243 NEUTRON ACER TENDL-2019 LIBRARY; T=293.16K
Neutron emission for (n,3np)

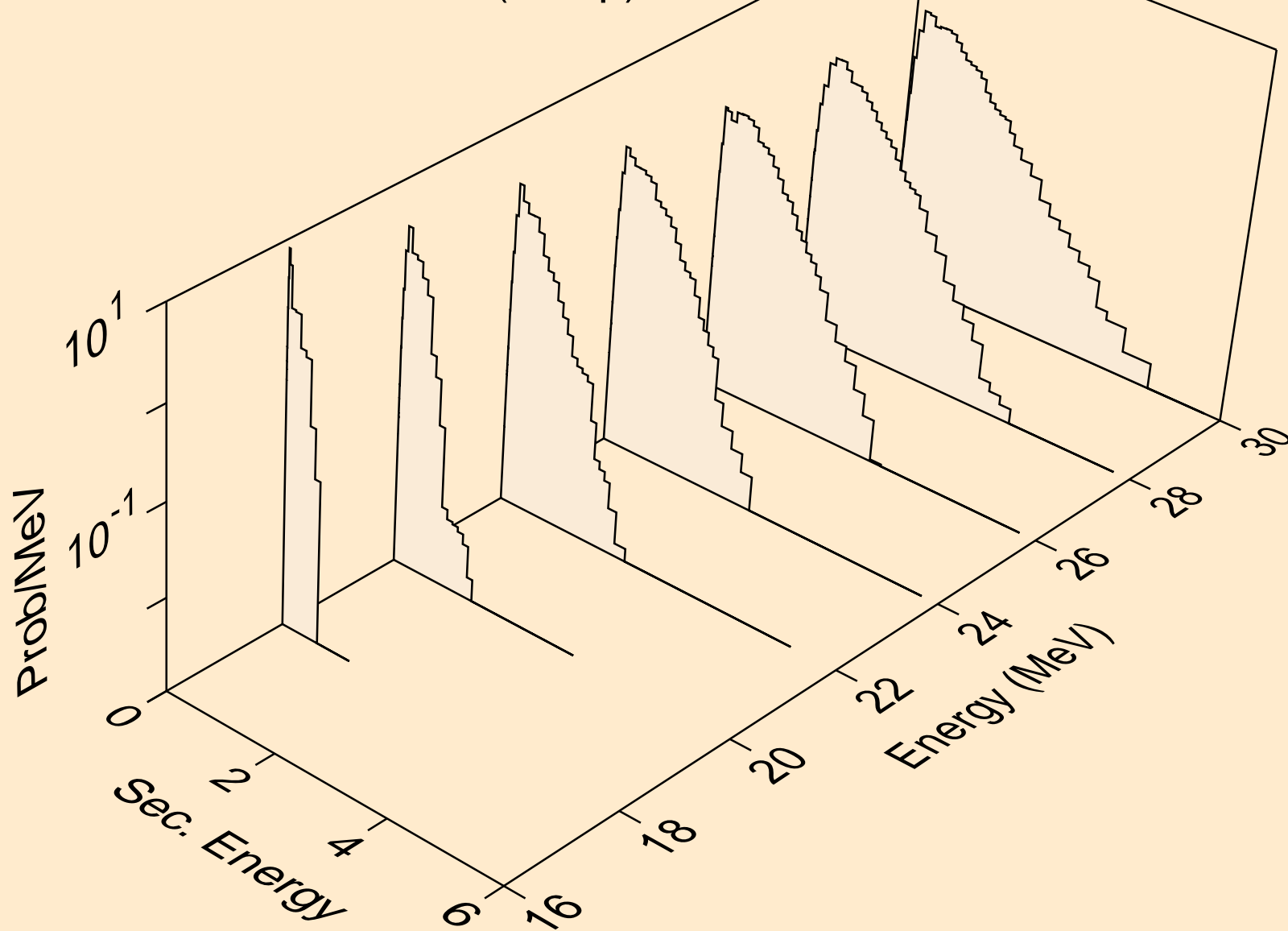

BK243 NEUTRON ACER TENDL-2019 LIBRARY; T=293.16K
Neutron emission for (n,2np)

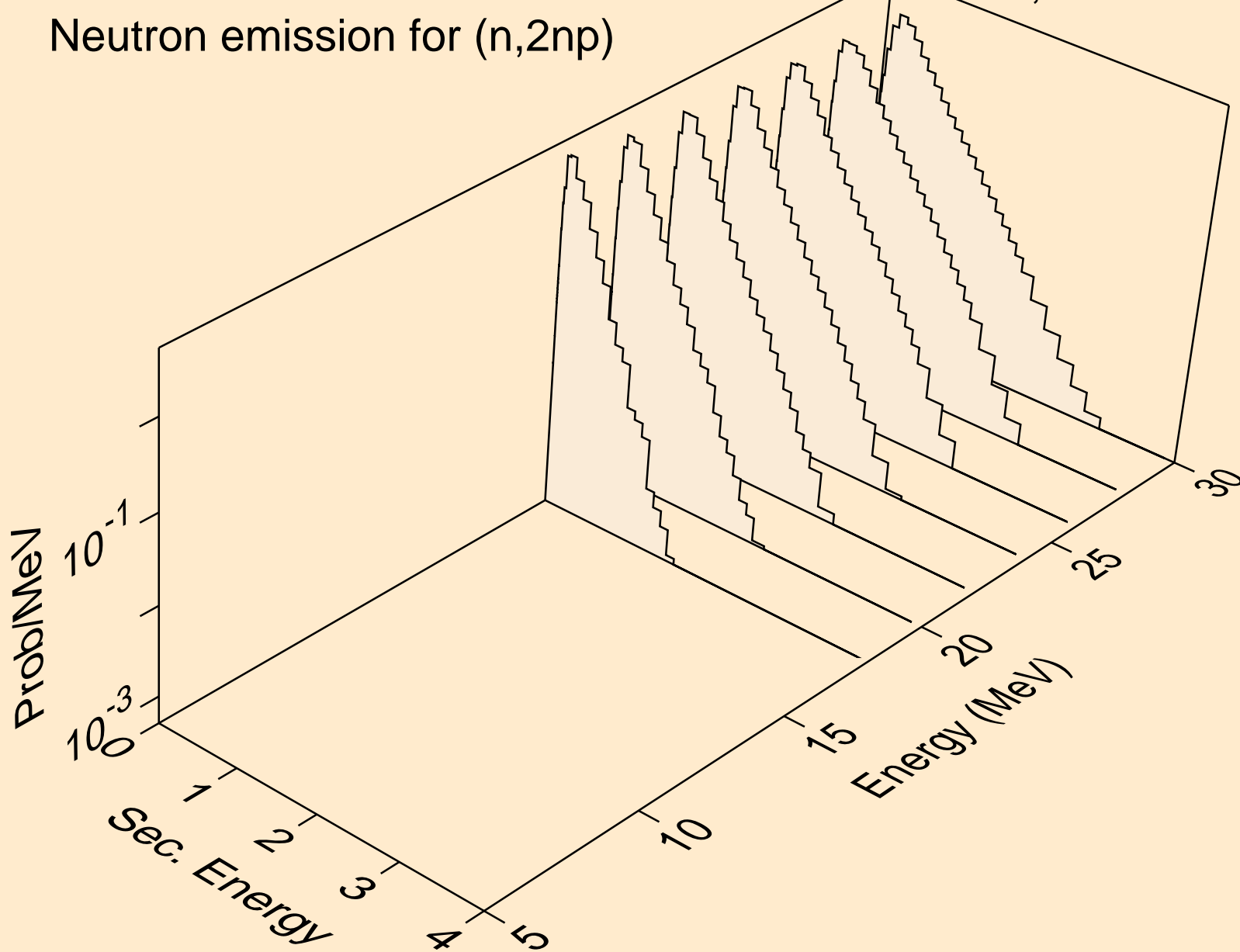

BK243 NEUTRON ACER TENDL-2019 LIBRARY; T=293.16K
Neutron emission for (n,npa)

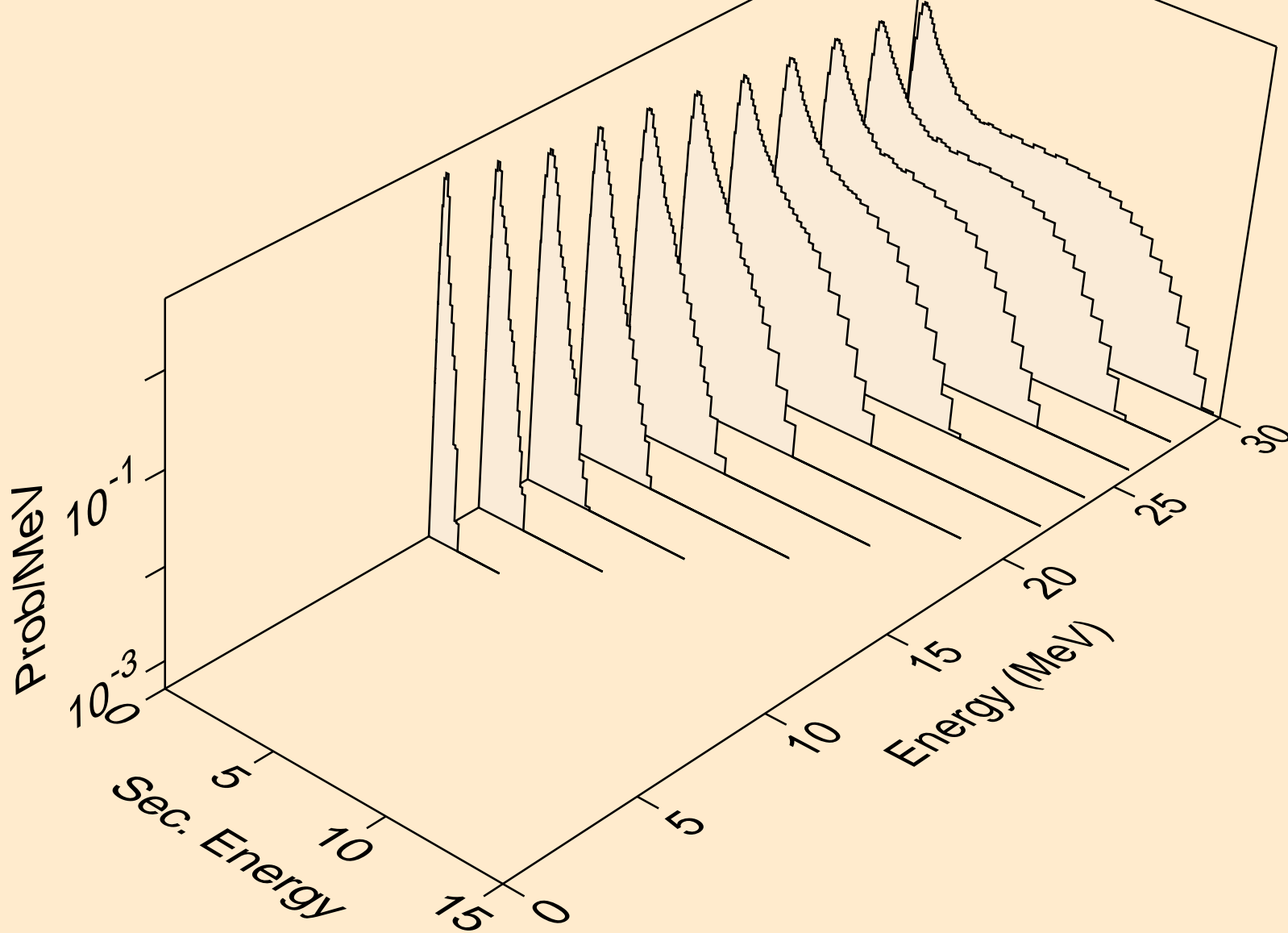

BK243 NEUTRON ACER TENDL-2019 LIBRARY; T=293.16K
Neutron emission for (n,n*c)

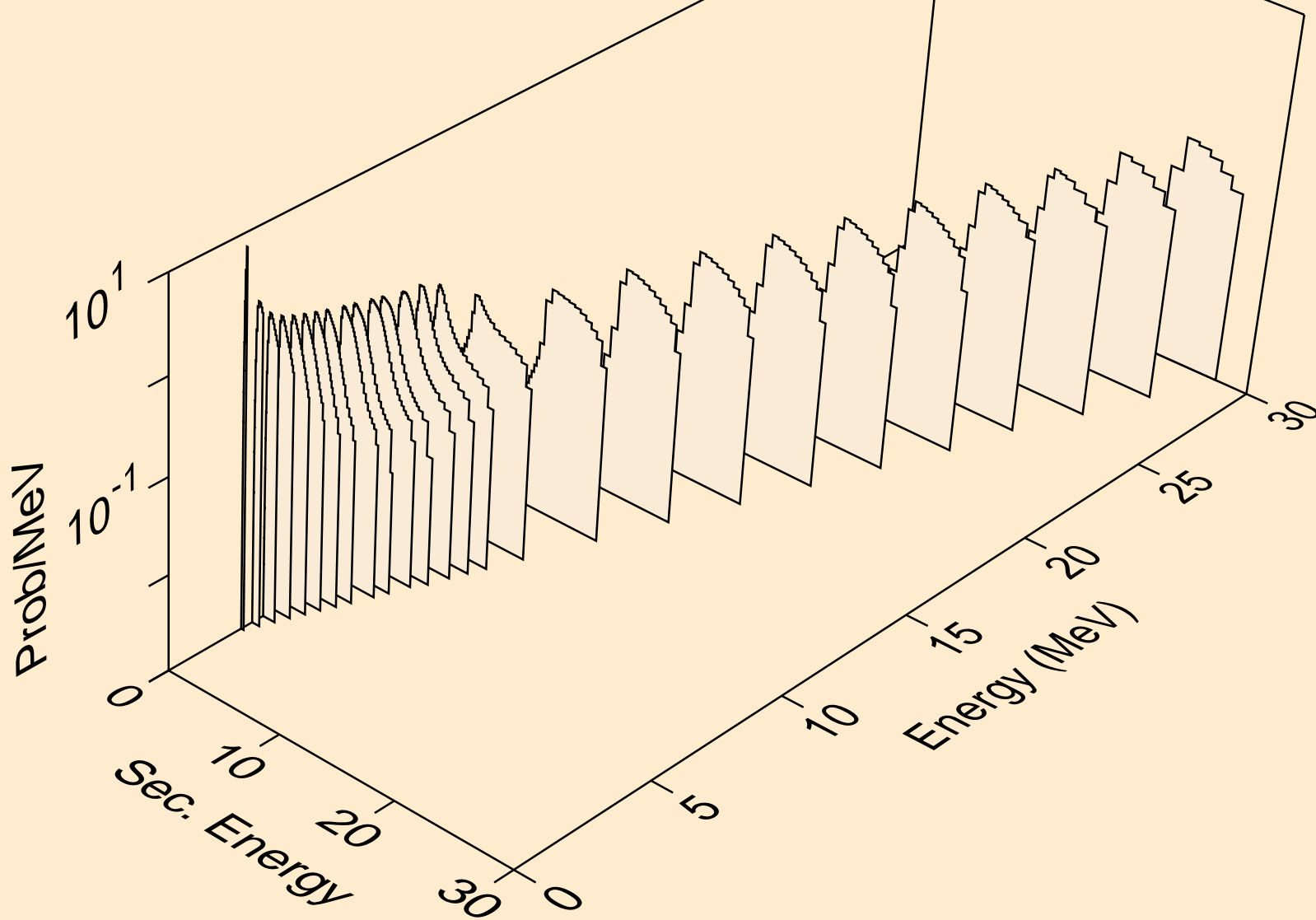

BK243 NEUTRON ACER TENDL-2019 LIBRARY; T=293.16K
Delayed nubar

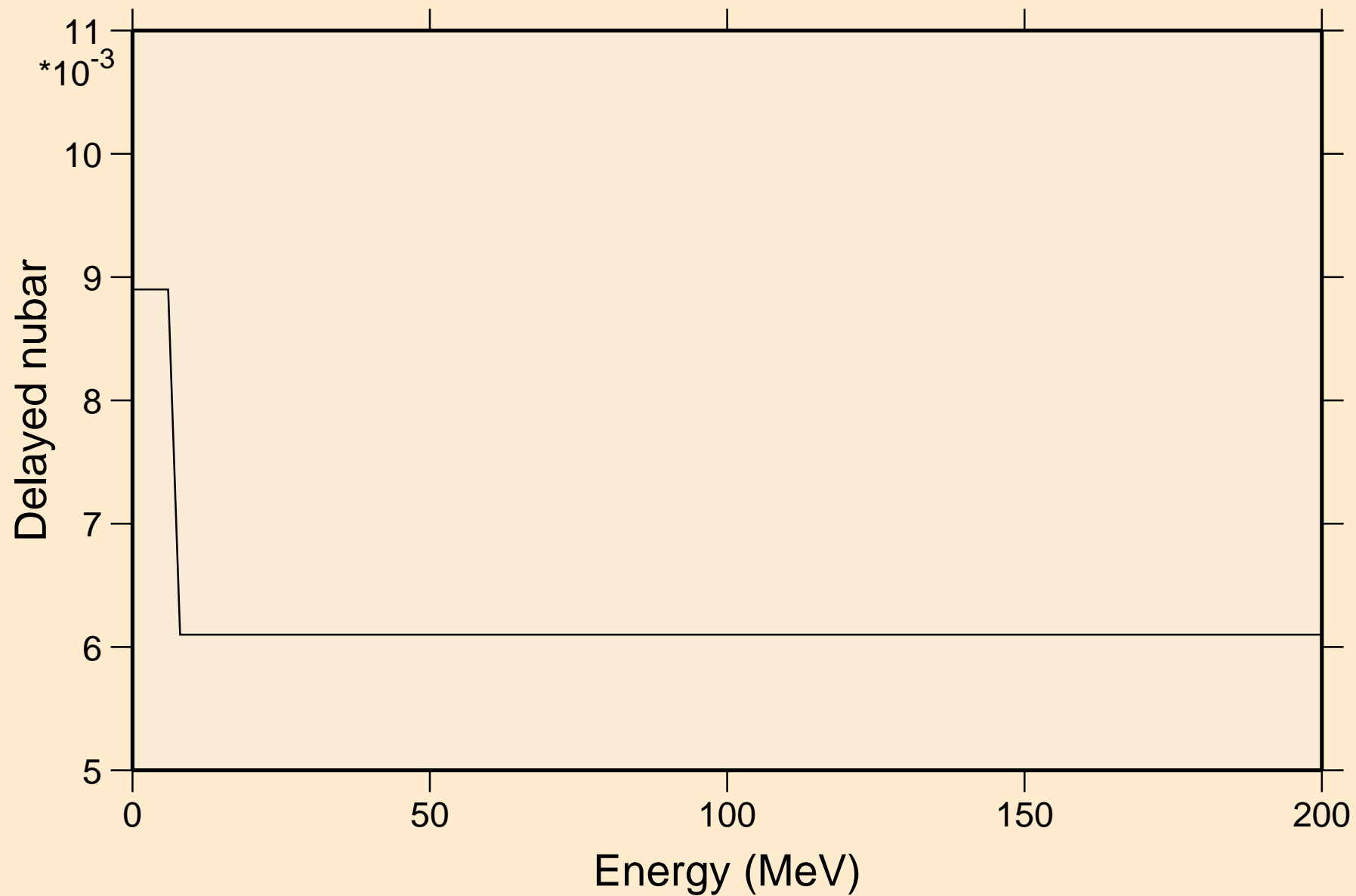

BK243 NEUTRON ACER TENDL-2019 LIBRARY; T=293.16K

Delayed neutron spectra

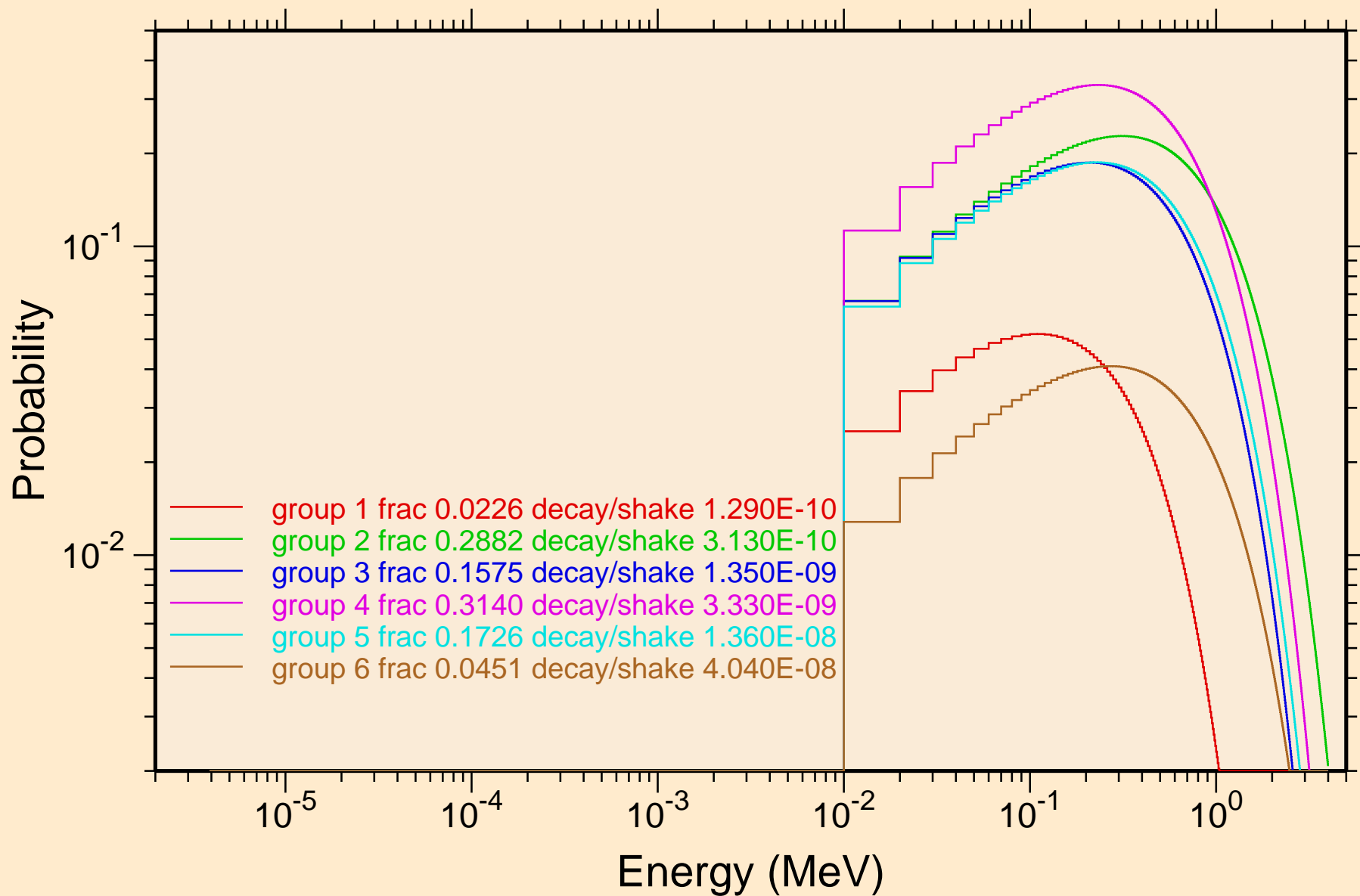

BK243 NEUTRON ACER TENDL-2019 LIBRARY; T=293.16K
Photon emission for (n,x)

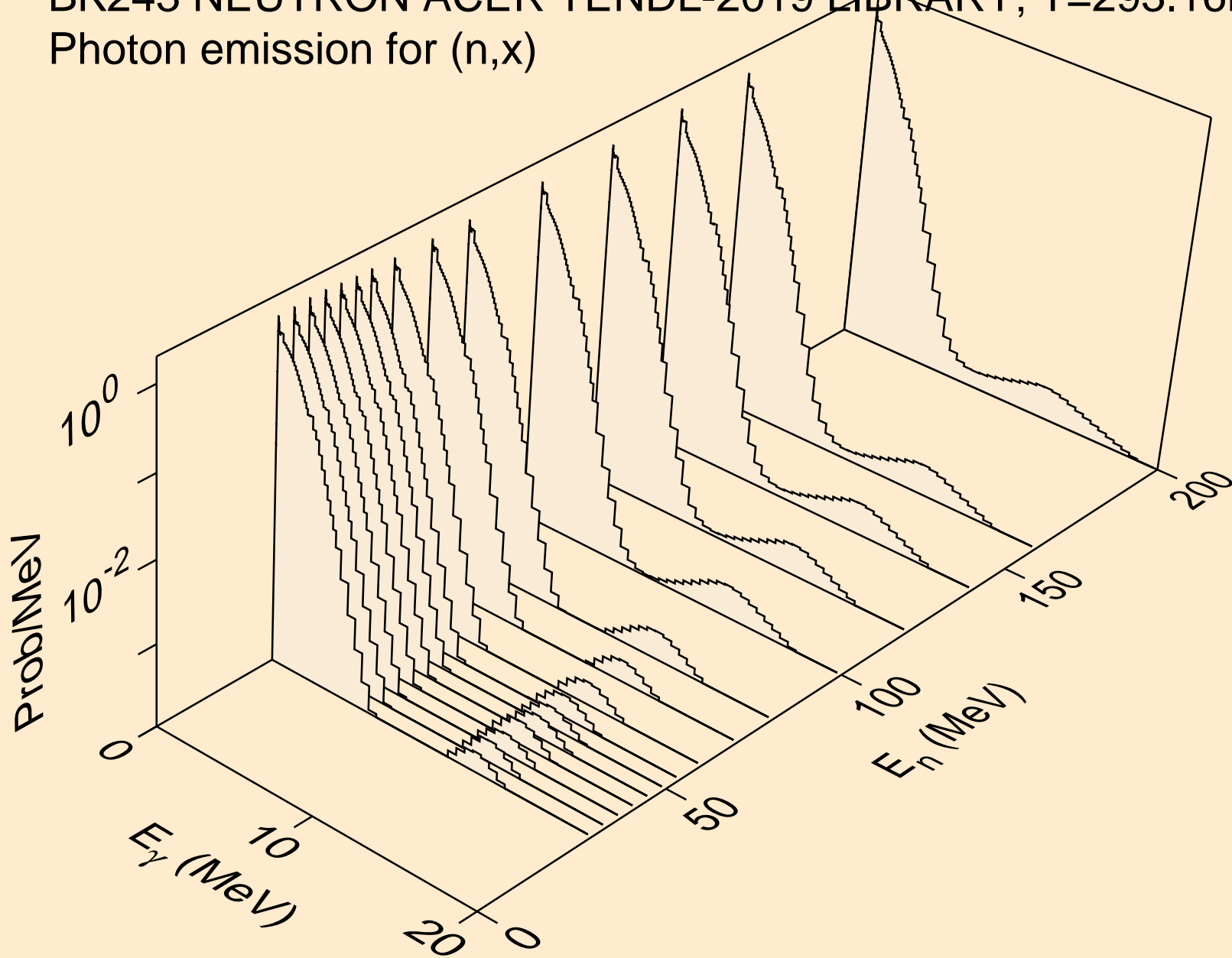

BK243 NEUTRON ACER TENDL-2019 LIBRARY; T=293.16K
Photon emission for (n,2nd)

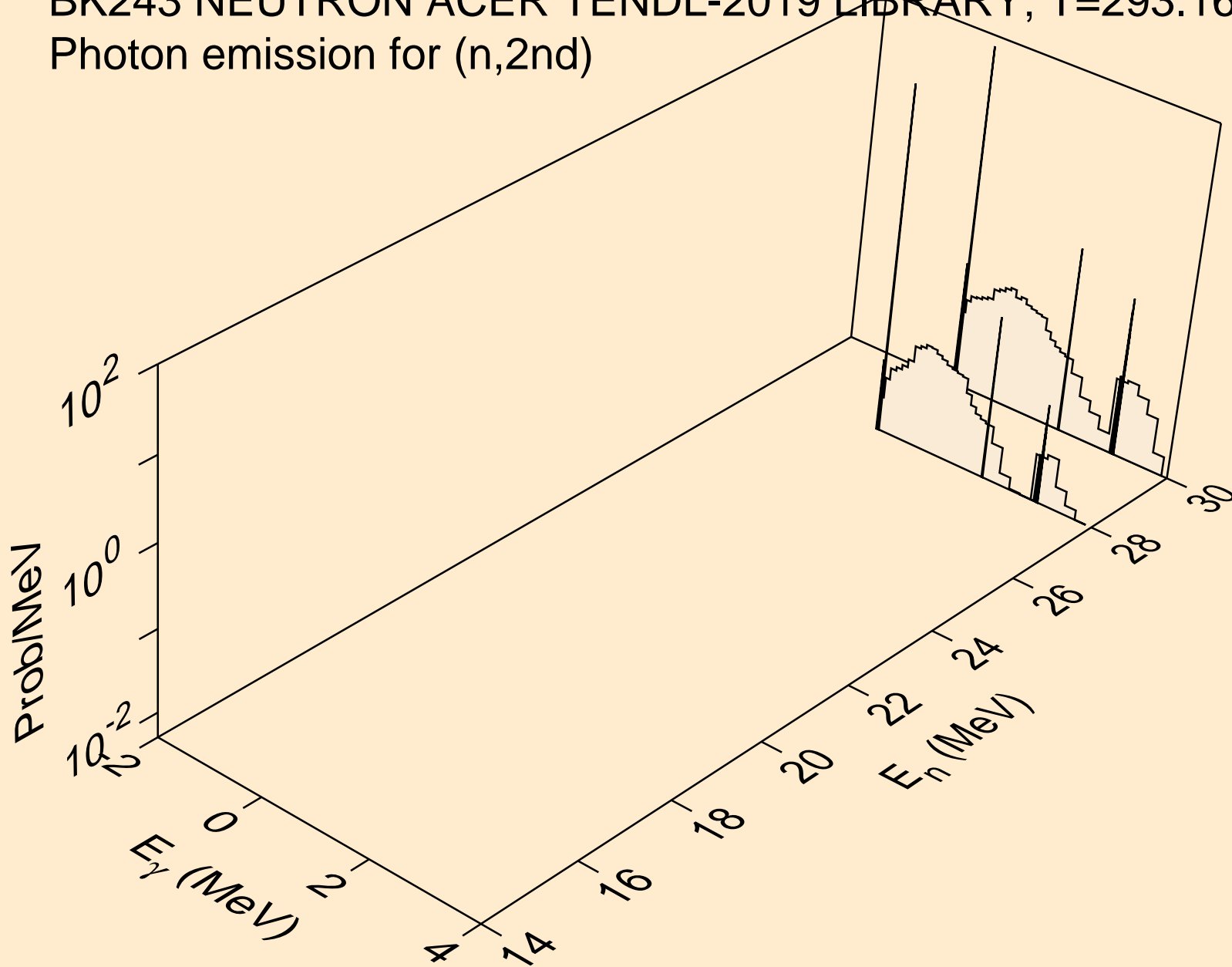

BK243 NEUTRON ACER TENDL-2019 LIBRARY; T=293.16K
Photon emission for (n,2n)

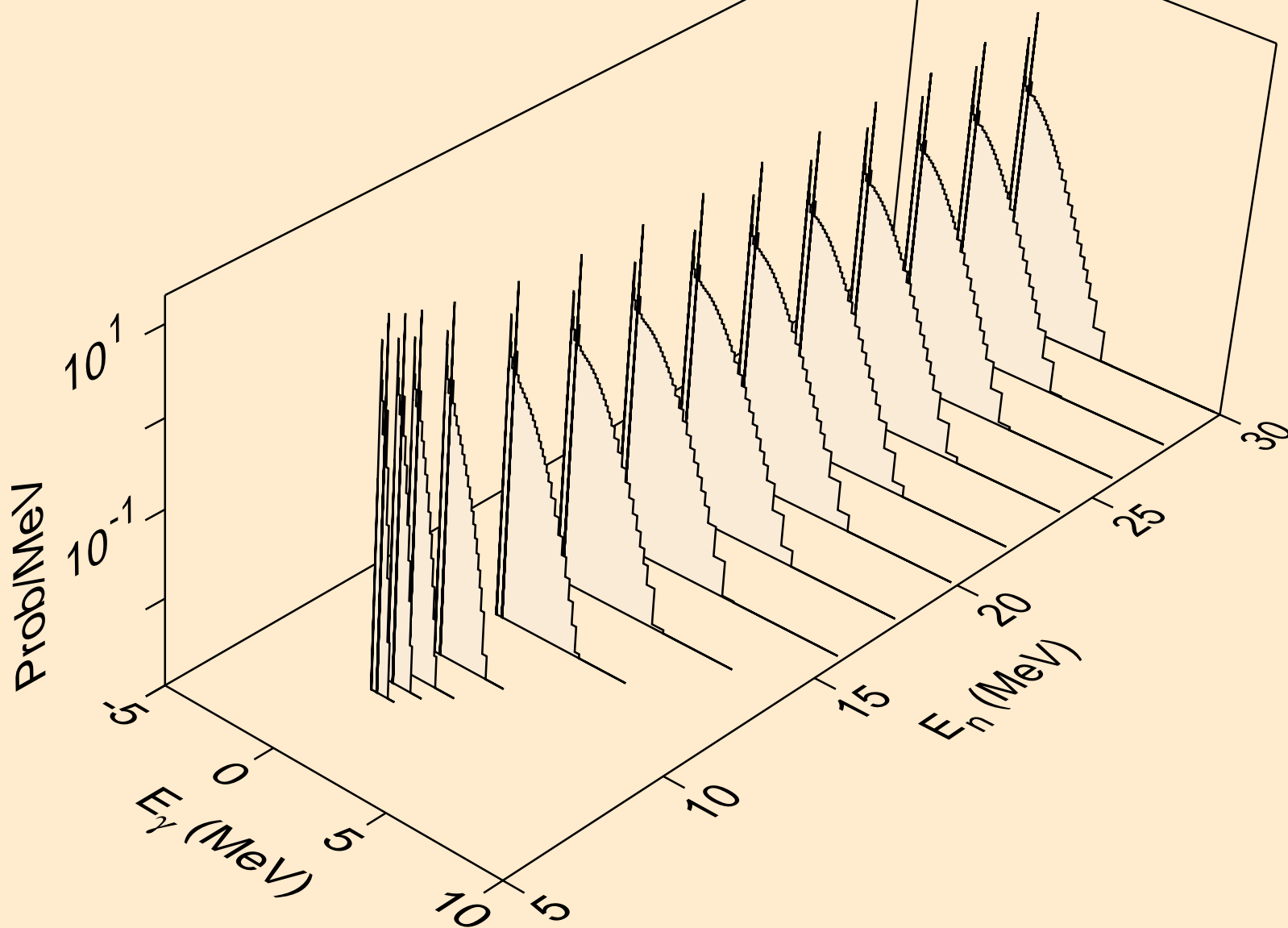

BK243 NEUTRON ACER TENDL-2019 LIBRARY; T=293.16K
Photon emission for (n,3n)

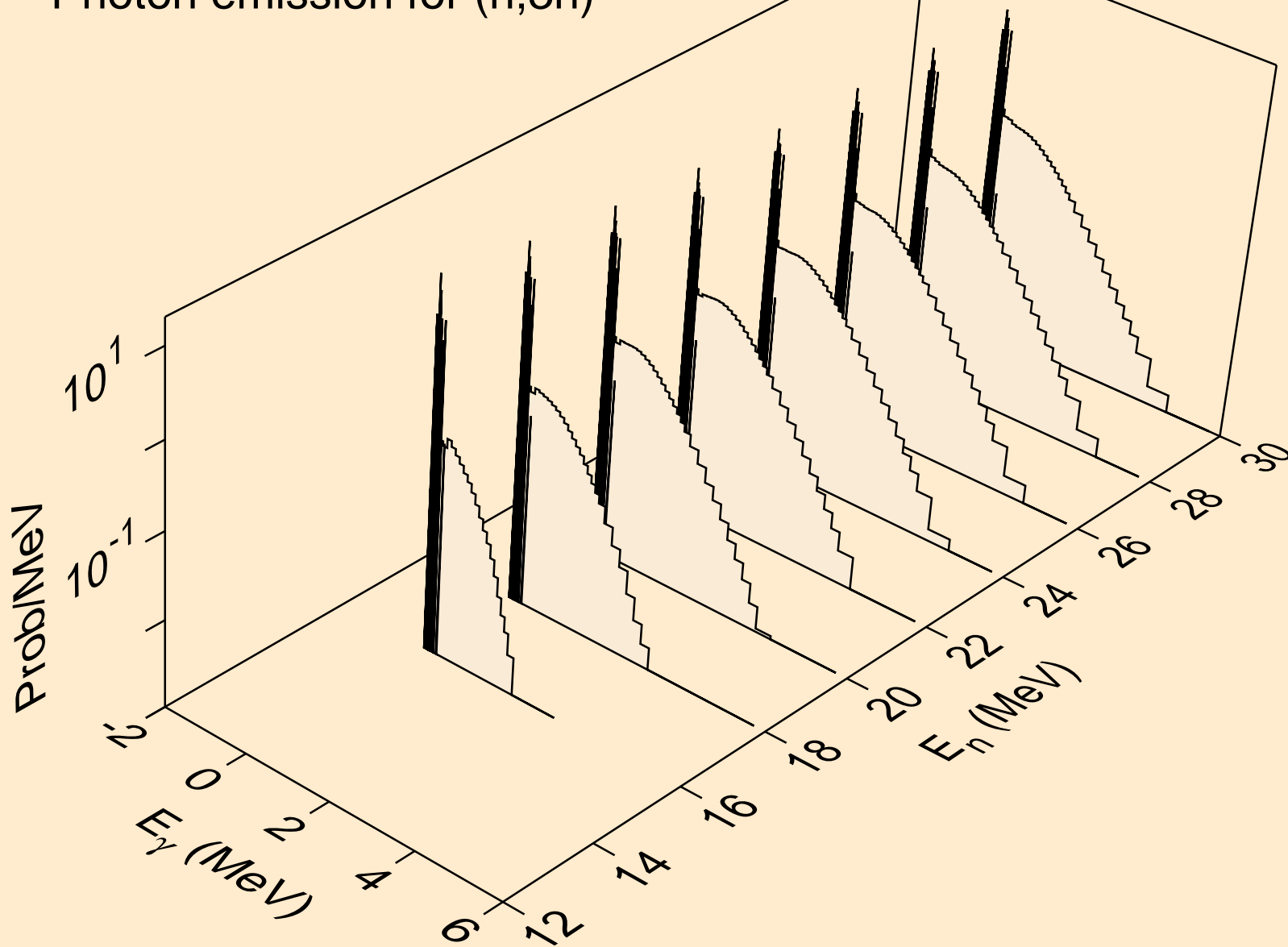

BK243 NEUTRON ACER TENDL-2019 LIBRARY; T=293.16K
Photon emission for (n,n*)a

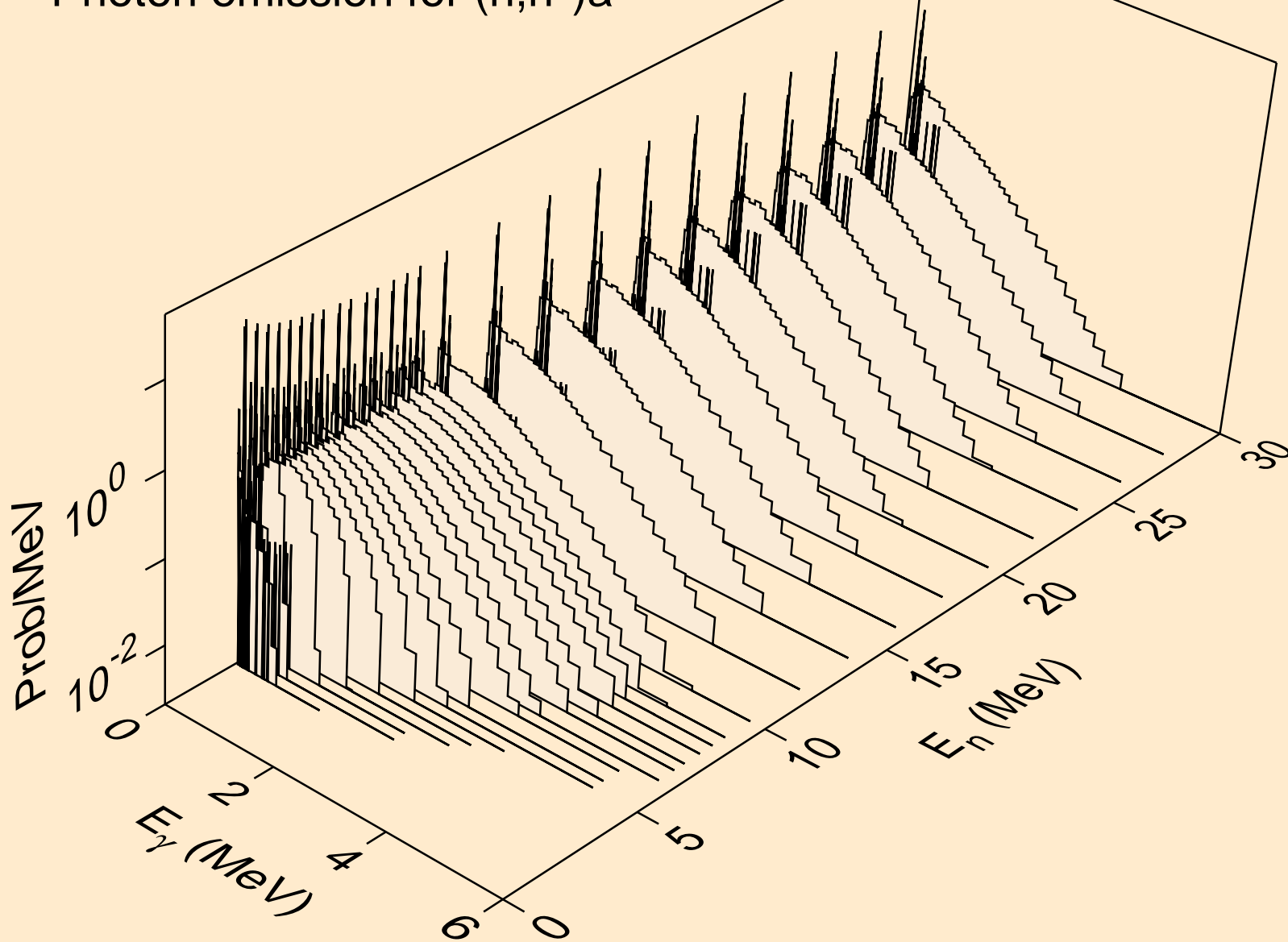

BK243 NEUTRON ACER TENDL-2019 LIBRARY; T=293.16K
Photon emission for (n,2n)a

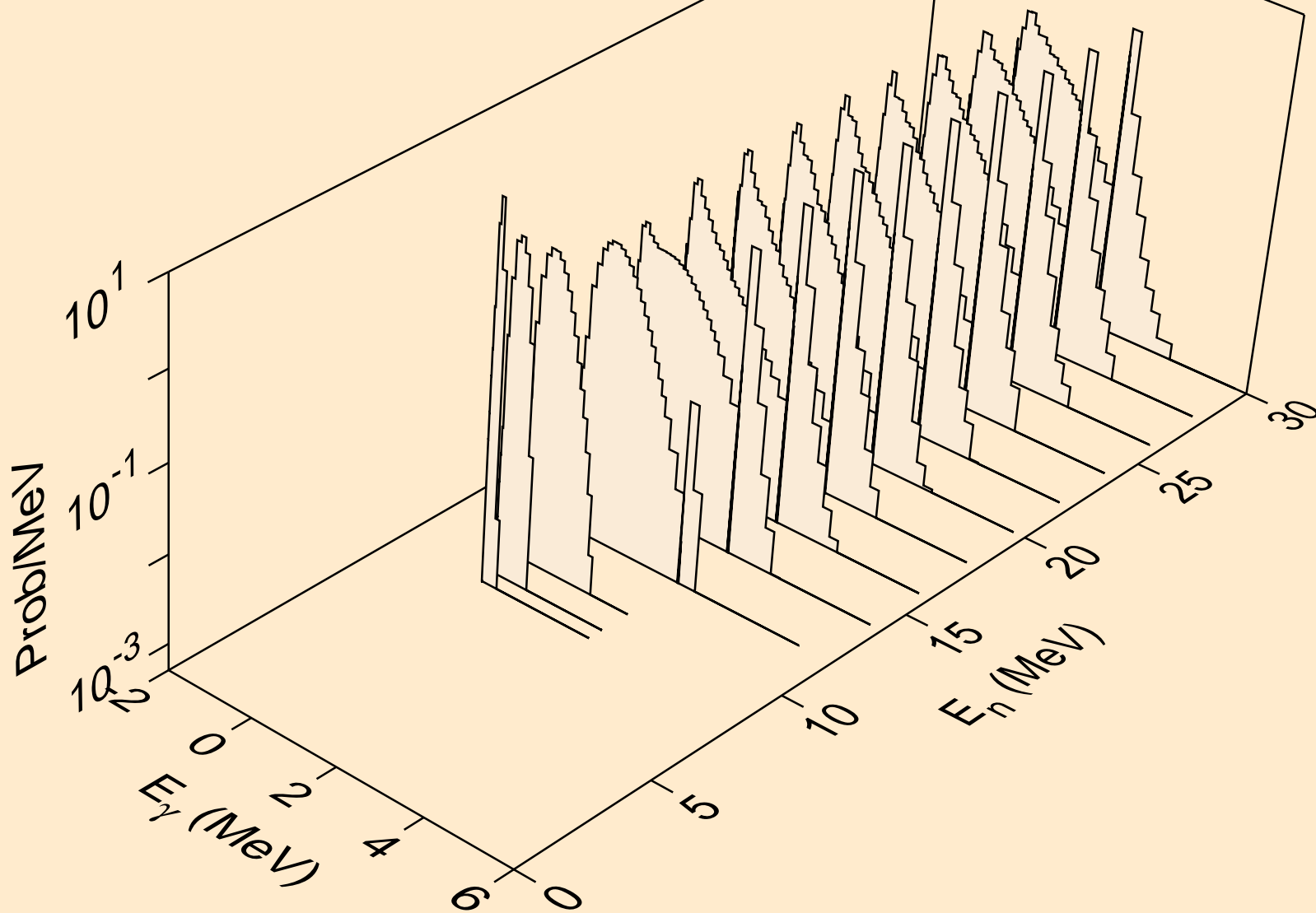

BK243 NEUTRON ACER TENDL-2019 LIBRARY; T=293.16K
Photon emission for (n,3n)a

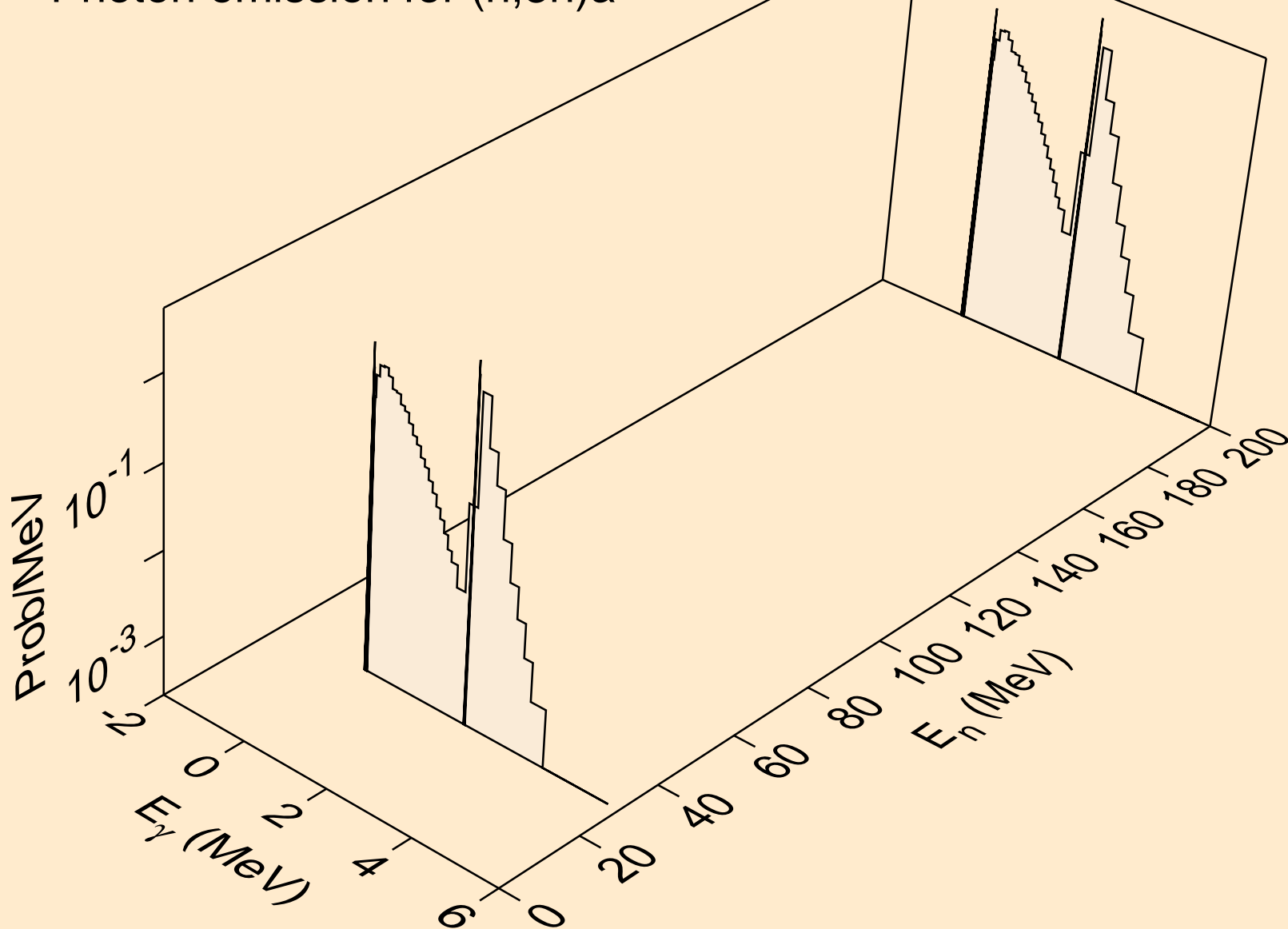

BK243 NEUTRON ACER TENDL-2019 LIBRARY; T=293.16K
Photon emission for (n,n*)p

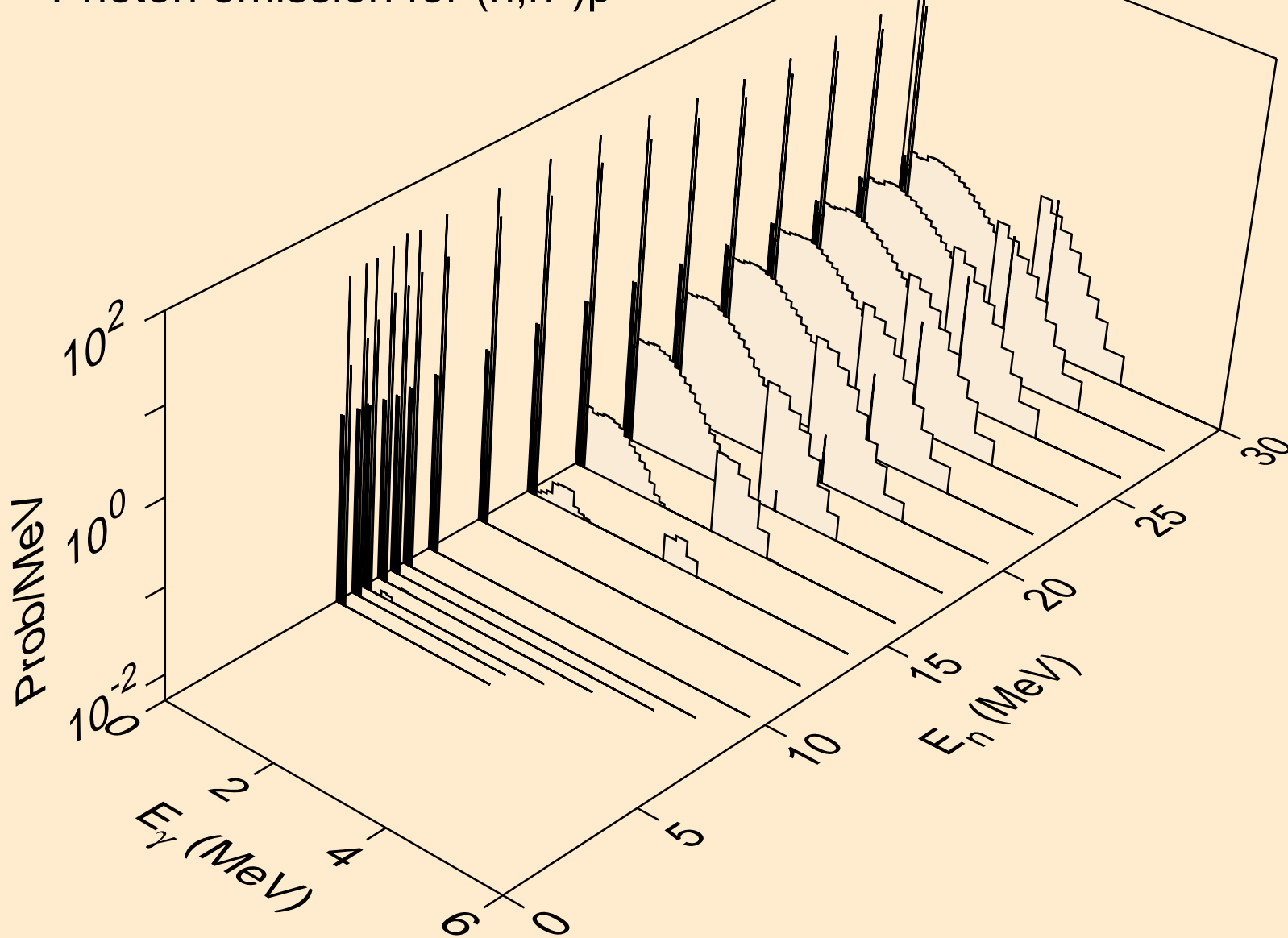

BK243 NEUTRON ACER TENDL-2019 LIBRARY; T=293.16K
Photon emission for (n,n*)2a

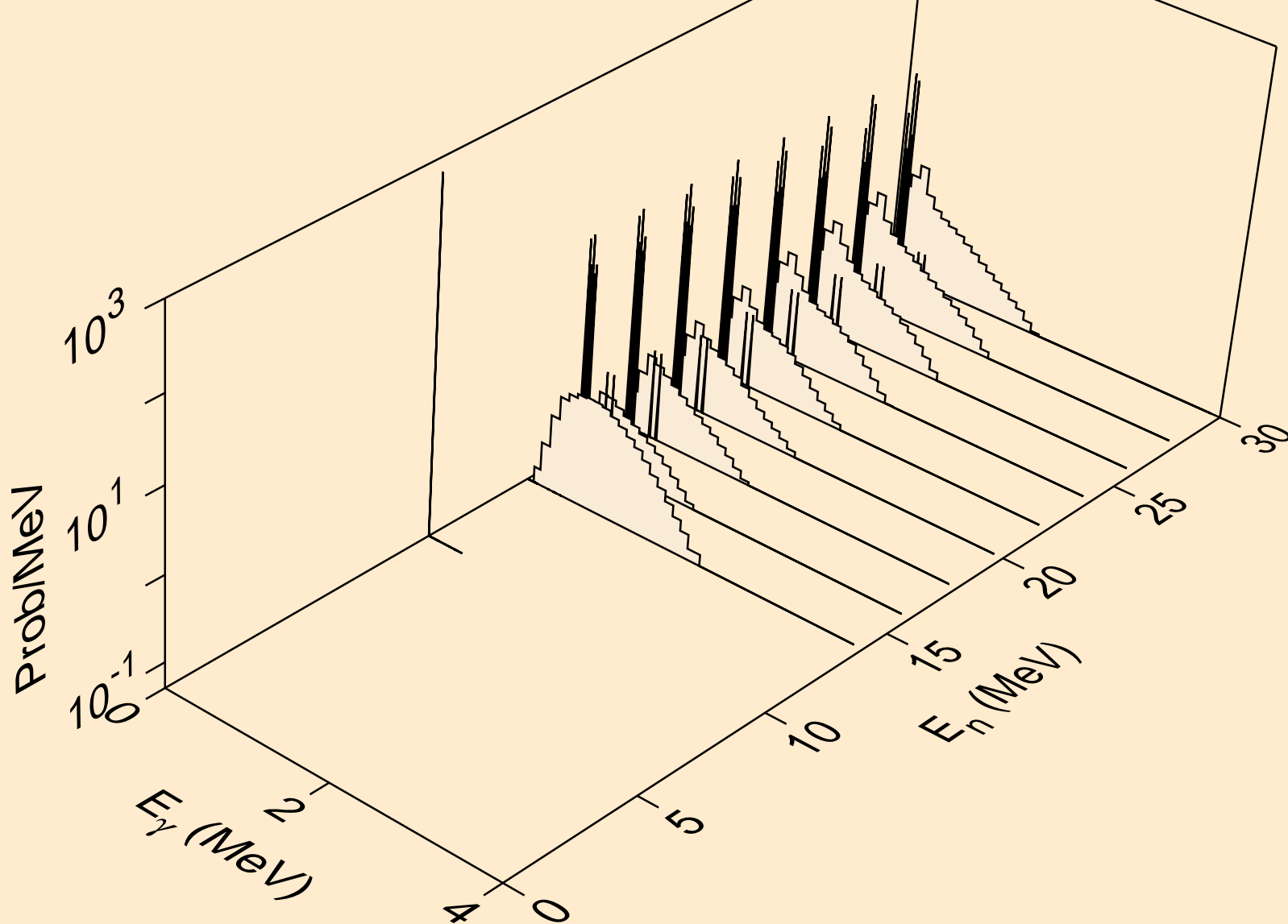

BK243 NEUTRON ACER TENDL-2019 LIBRARY; T=293.16K
Photon emission for (n,n*)d

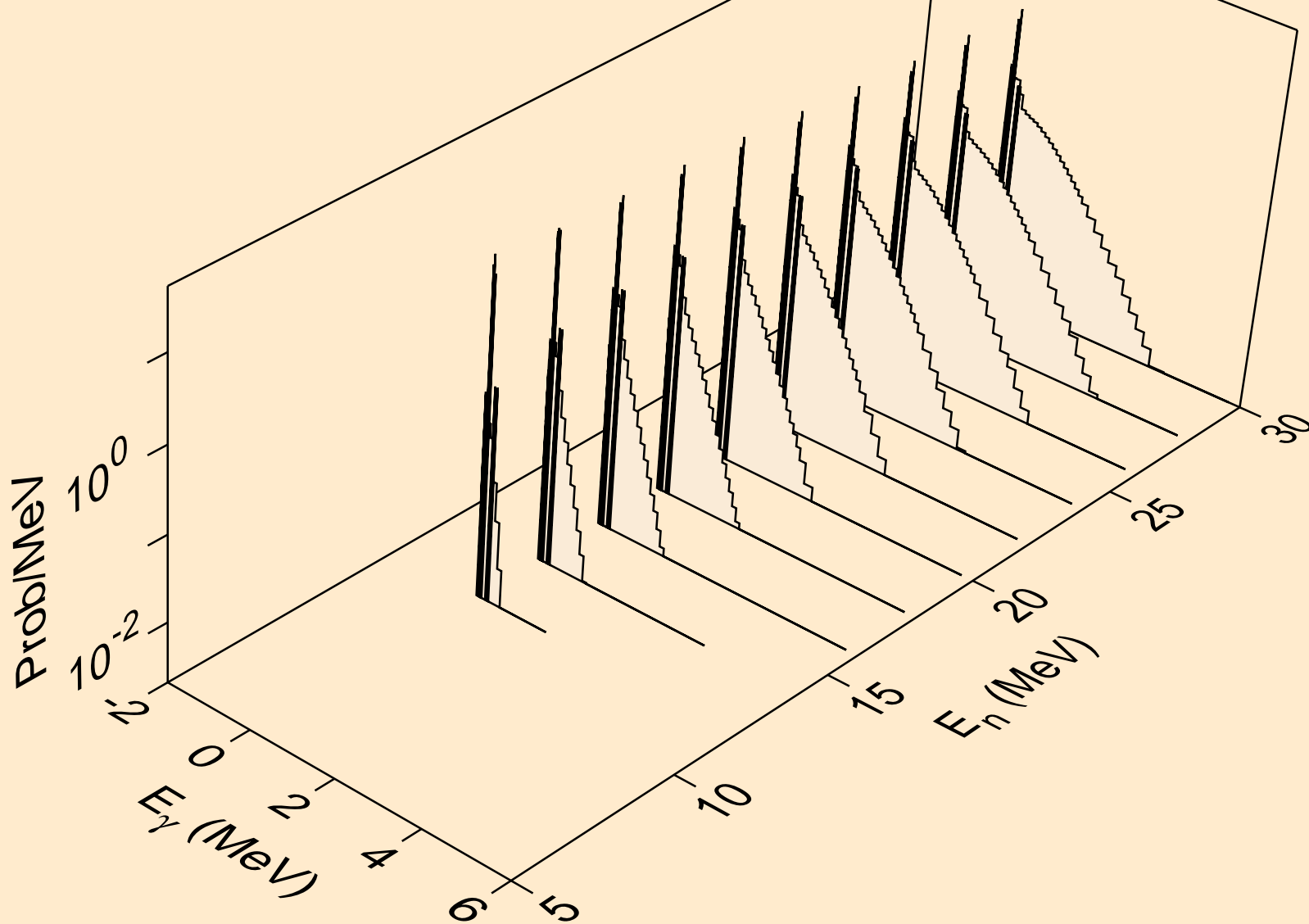

BK243 NEUTRON ACER TENDL-2019 LIBRARY; T=293.16K
Photon emission for (n,n*)t

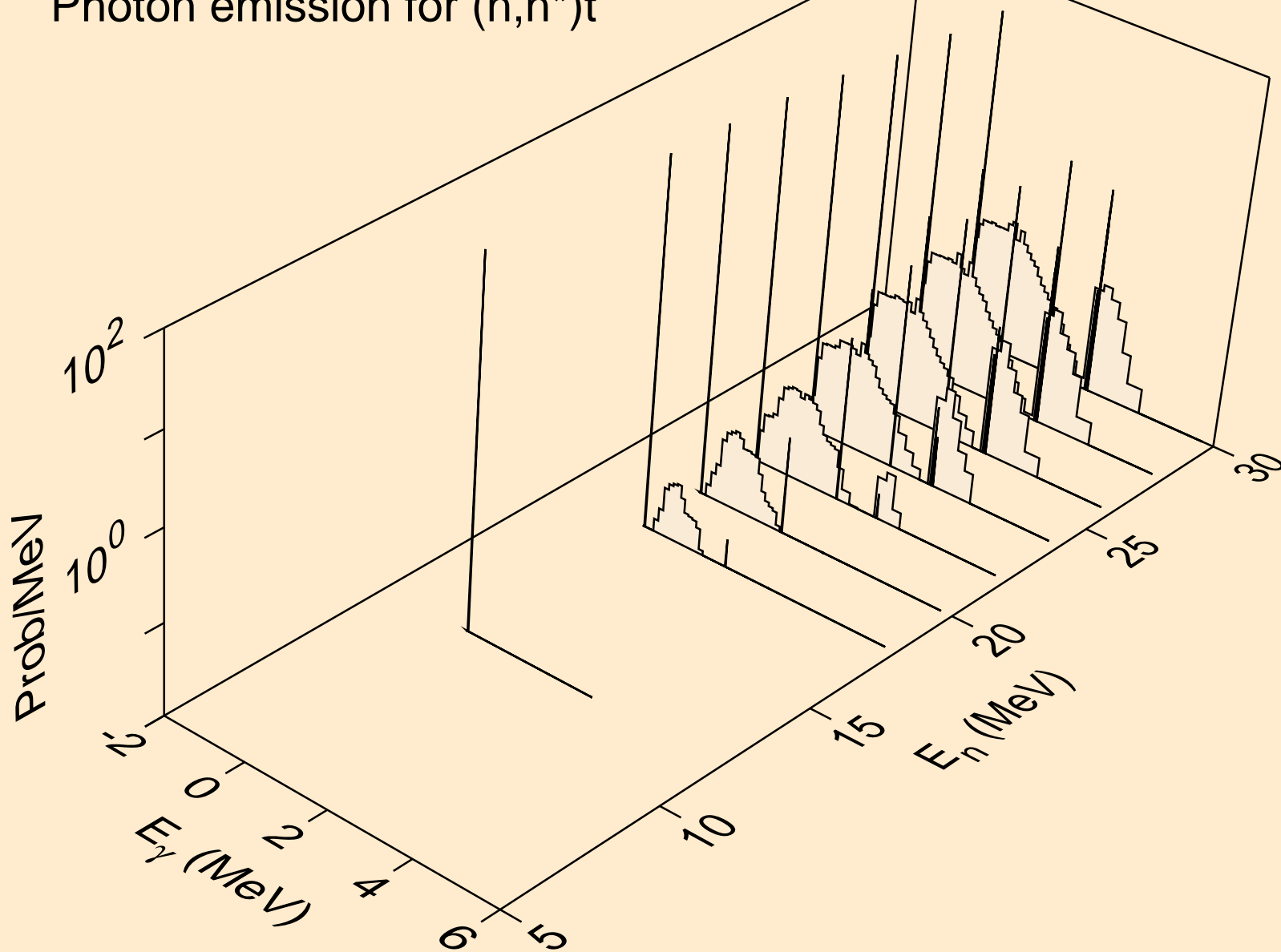

BK243 NEUTRON ACER TENDL-2019 LIBRARY; T=293.16K
Photon emission for (n,n*)he3

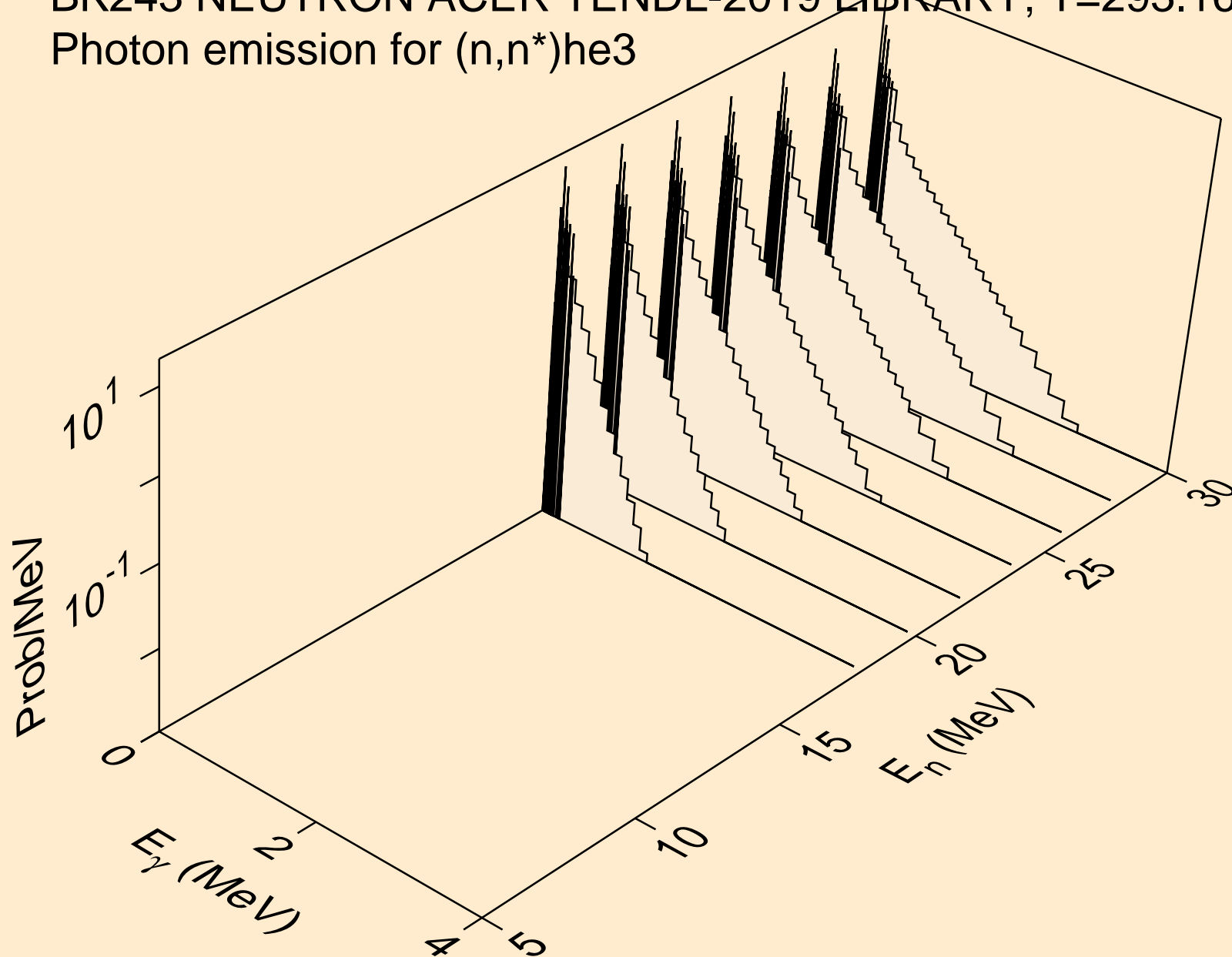

BK243 NEUTRON ACER TENDL-2019 LIBRARY; T=293.16K
Photon emission for (n,4n)

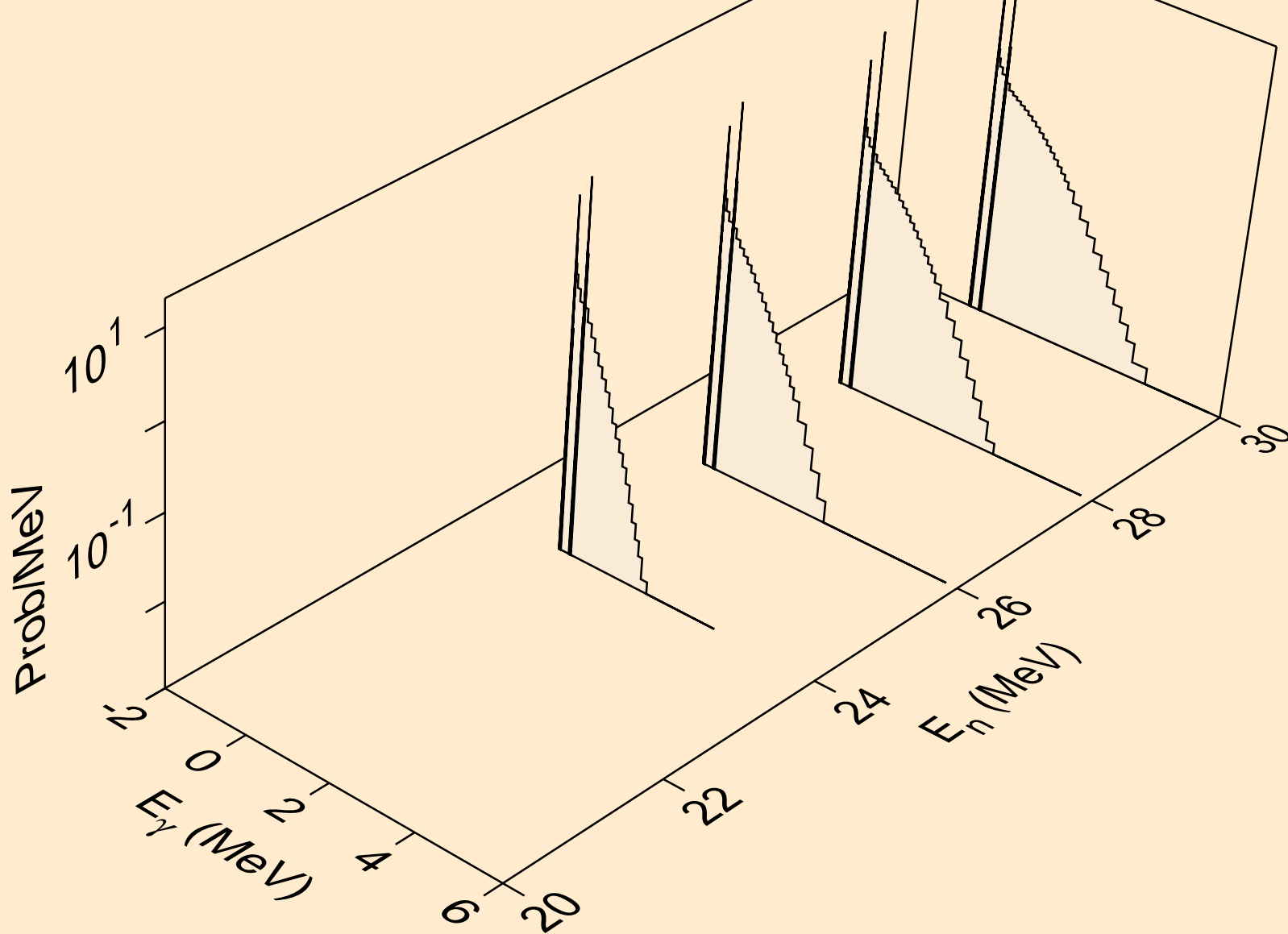

BK243 NEUTRON ACER TENDL-2019 LIBRARY; T=293.16K
Photon emission for (n,2np)

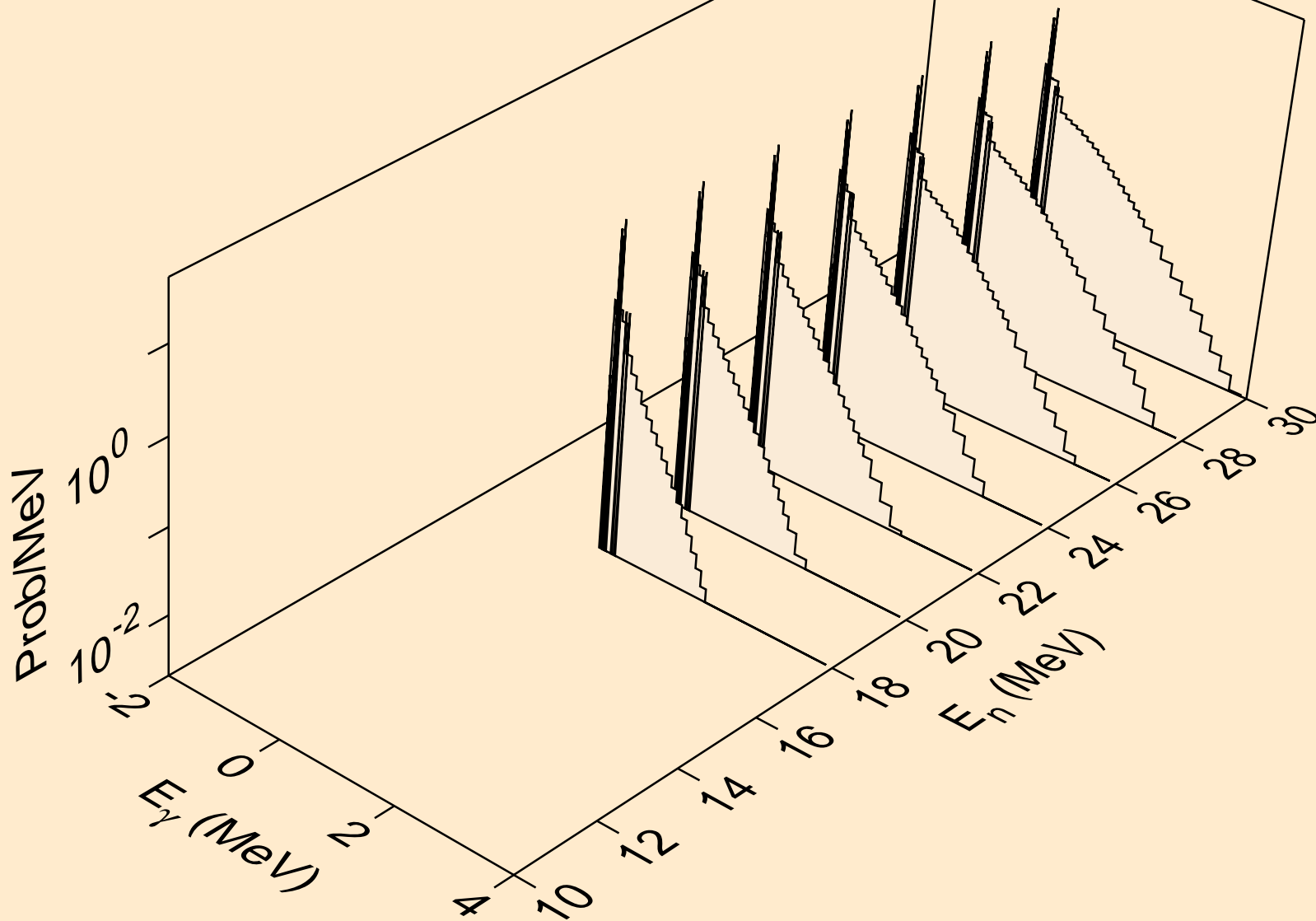

BK243 NEUTRON ACER TENDL-2019 LIBRARY; T=293.16K
Photon emission for (n,3np)

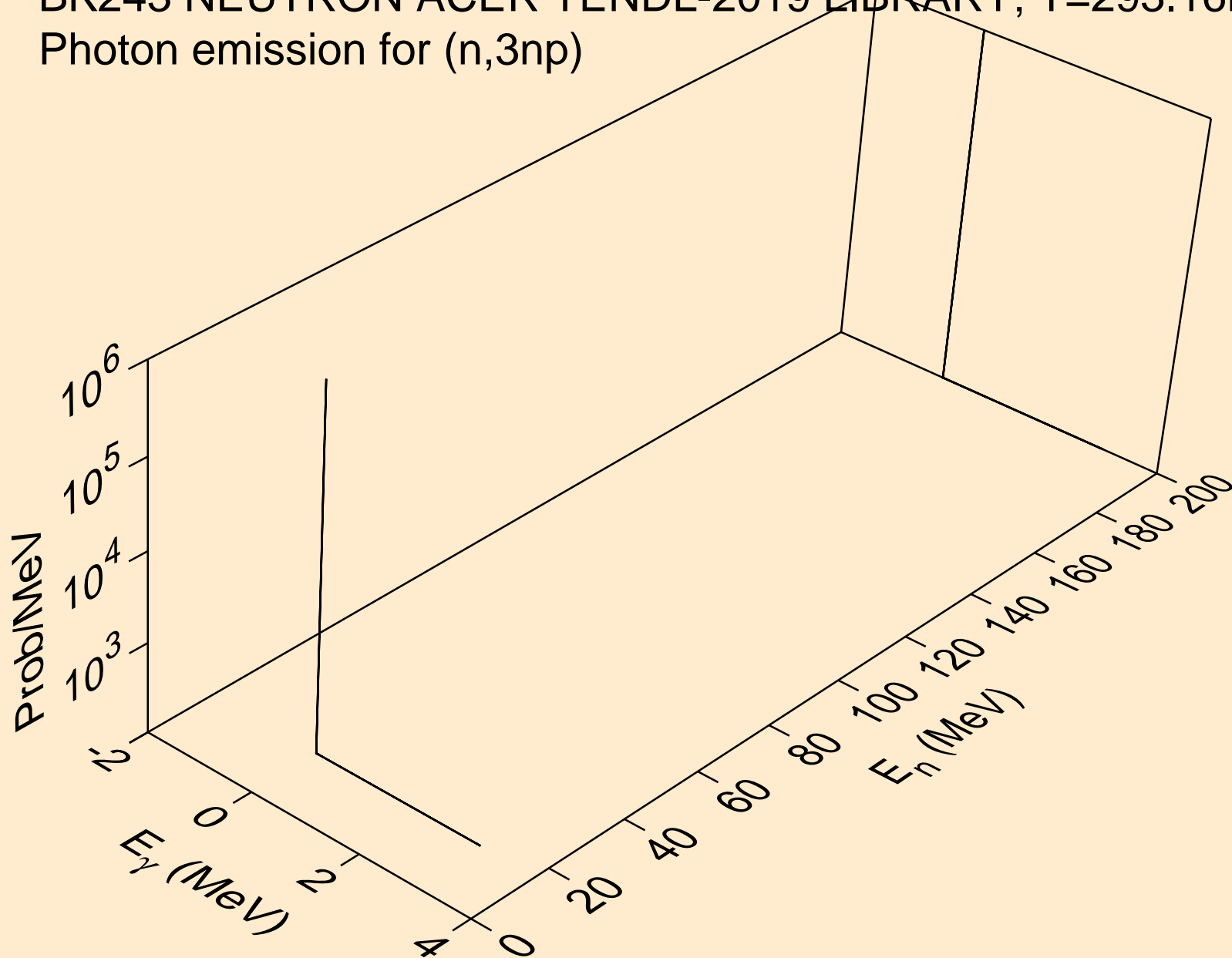

BK243 NEUTRON ACER TENDL-2019 LIBRARY; T=293.16K
Photon emission for (n,2np)

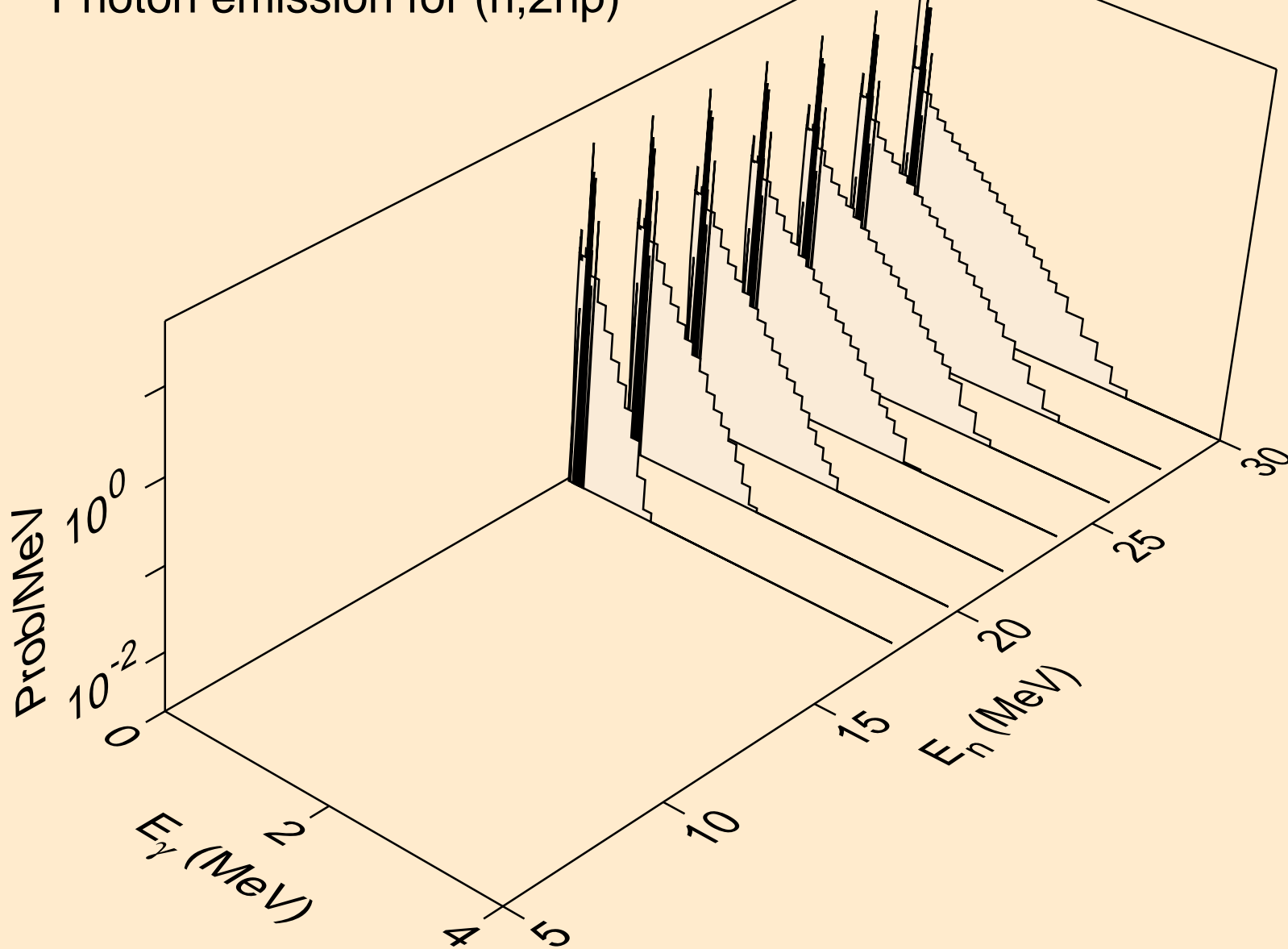

BK243 NEUTRON ACER TENDL-2019 LIBRARY; T=293.16K
Photon emission for (n,npa)

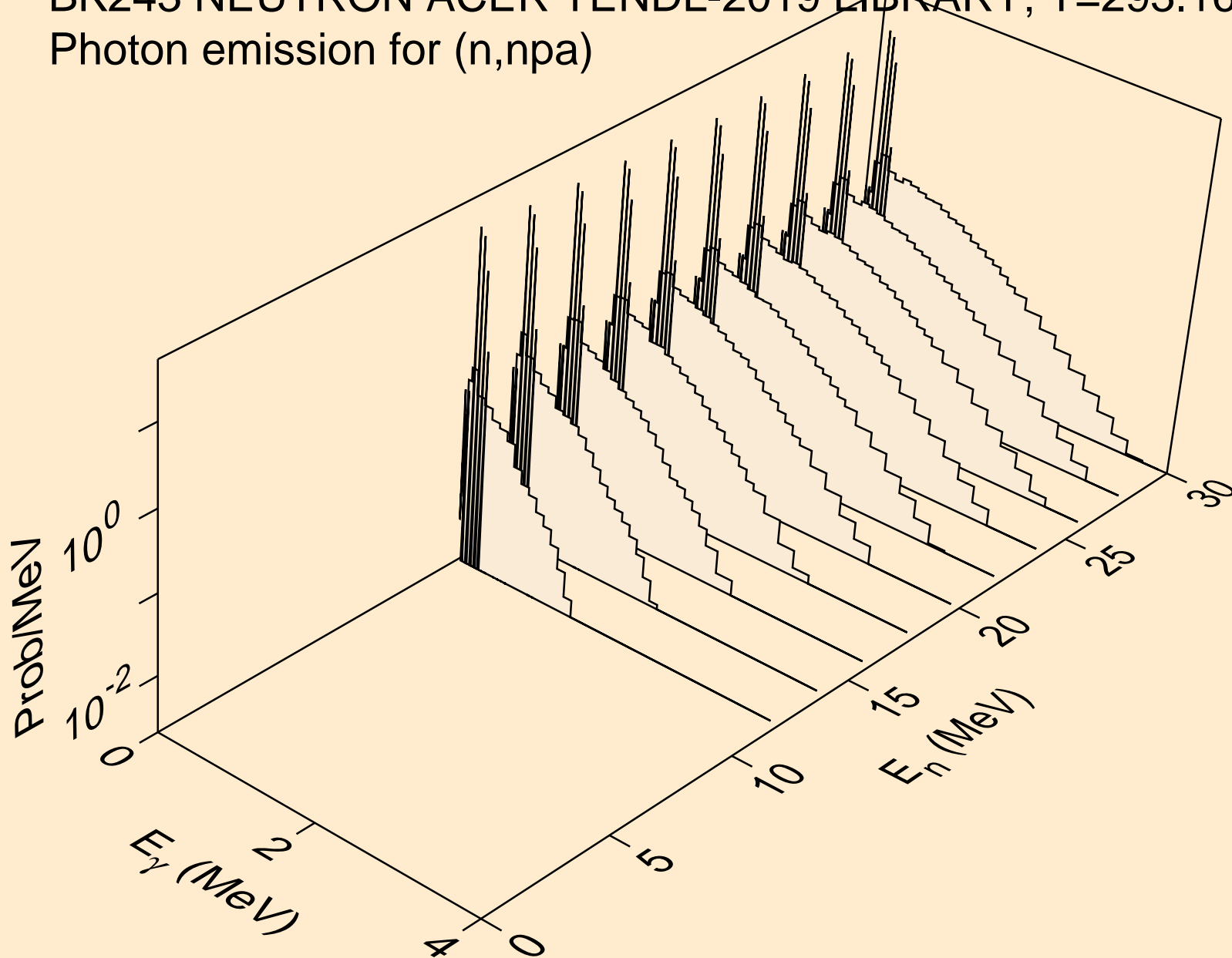

BK243 NEUTRON ACER TENDL-2019 LIBRARY; T=293.16K
Photon emission for (n,n*c)

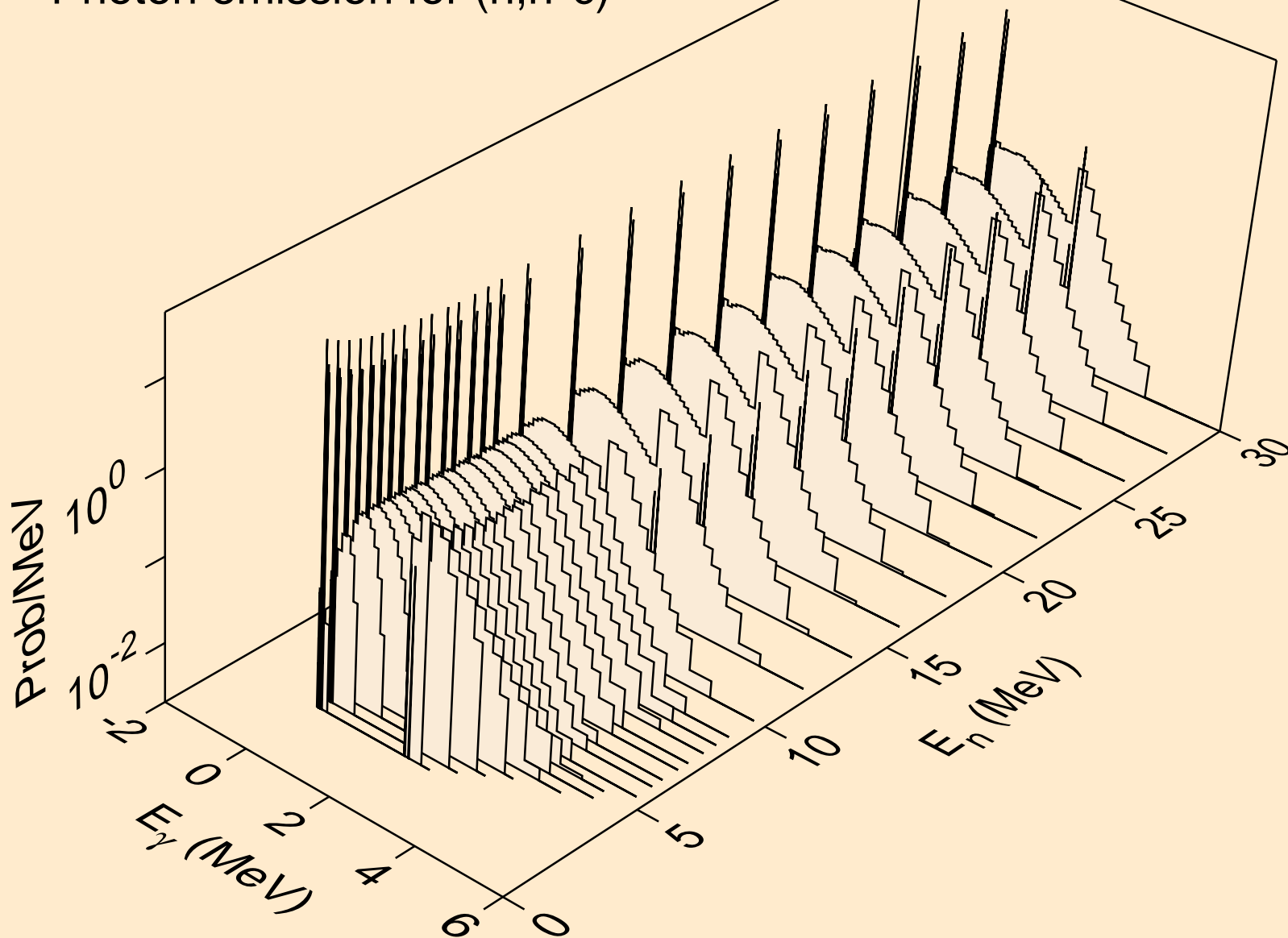

BK243 NEUTRON ACER TENDL-2019 LIBRARY; T=293.16K
Photon emission for (n,gma)

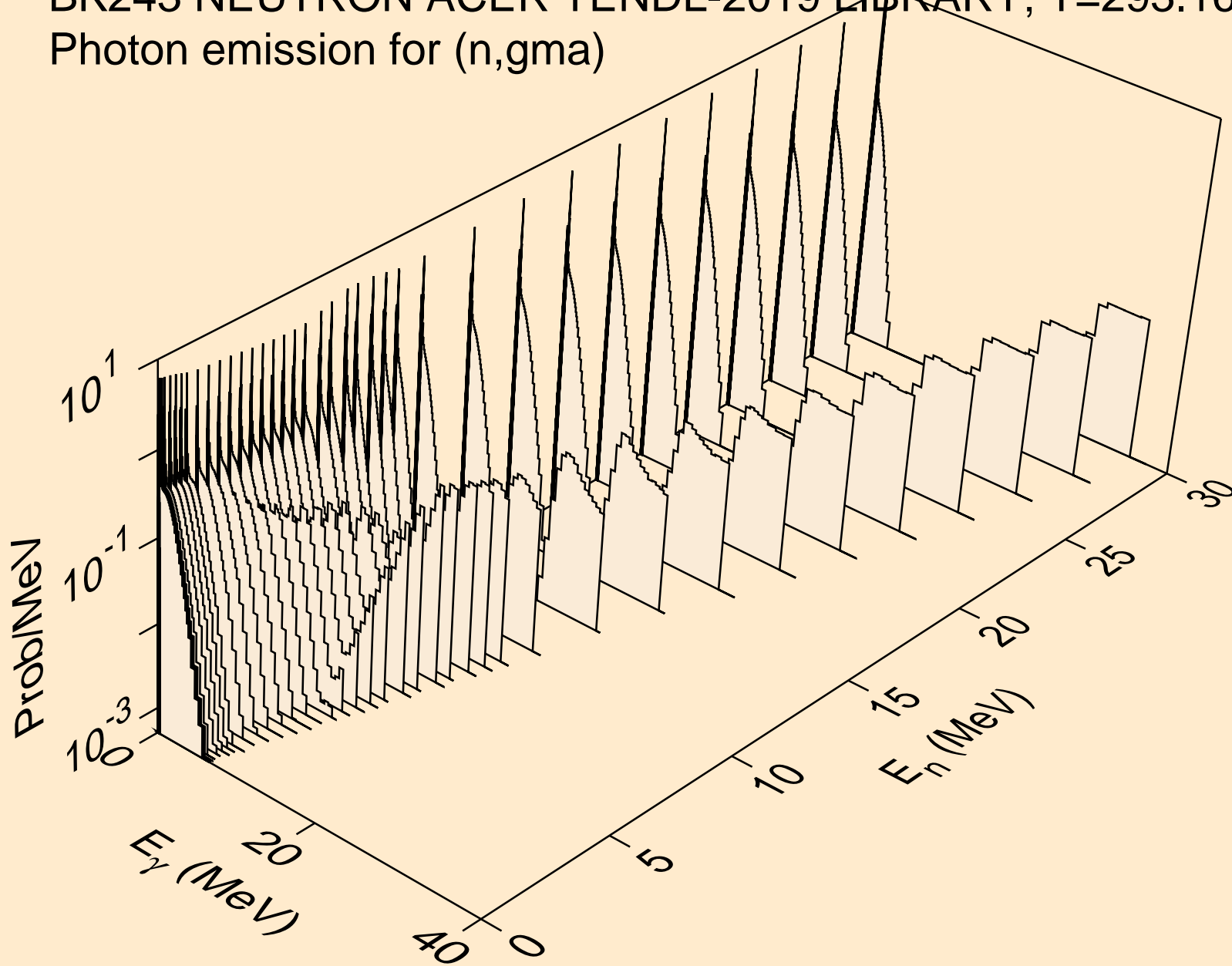

BK243 NEUTRON ACER TENDL-2019 LIBRARY; T=293.16K
Photon emission for (n,p)

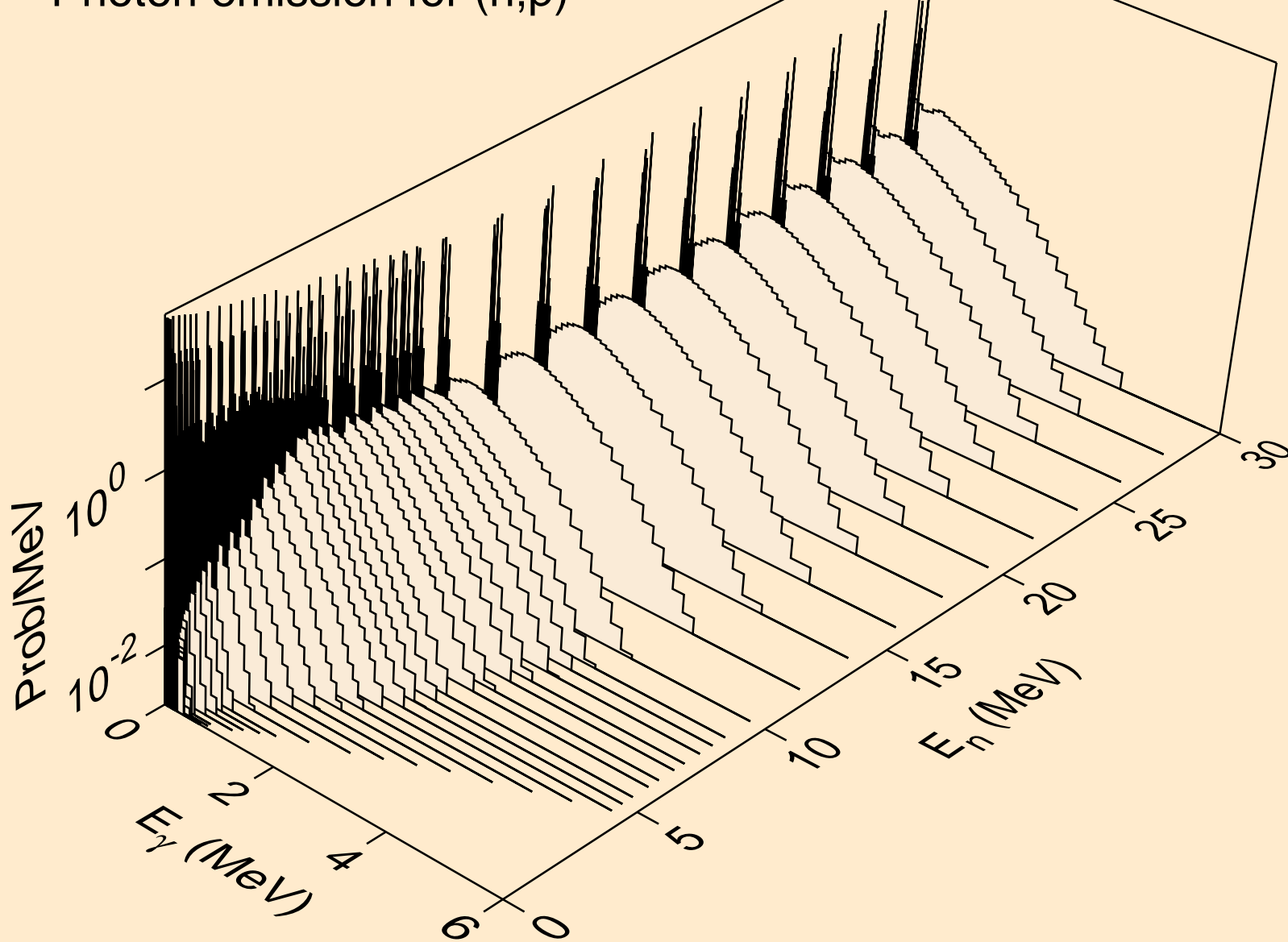

BK243 NEUTRON ACER TENDL-2019 LIBRARY; T=293.16K
Photon emission for (n,d)

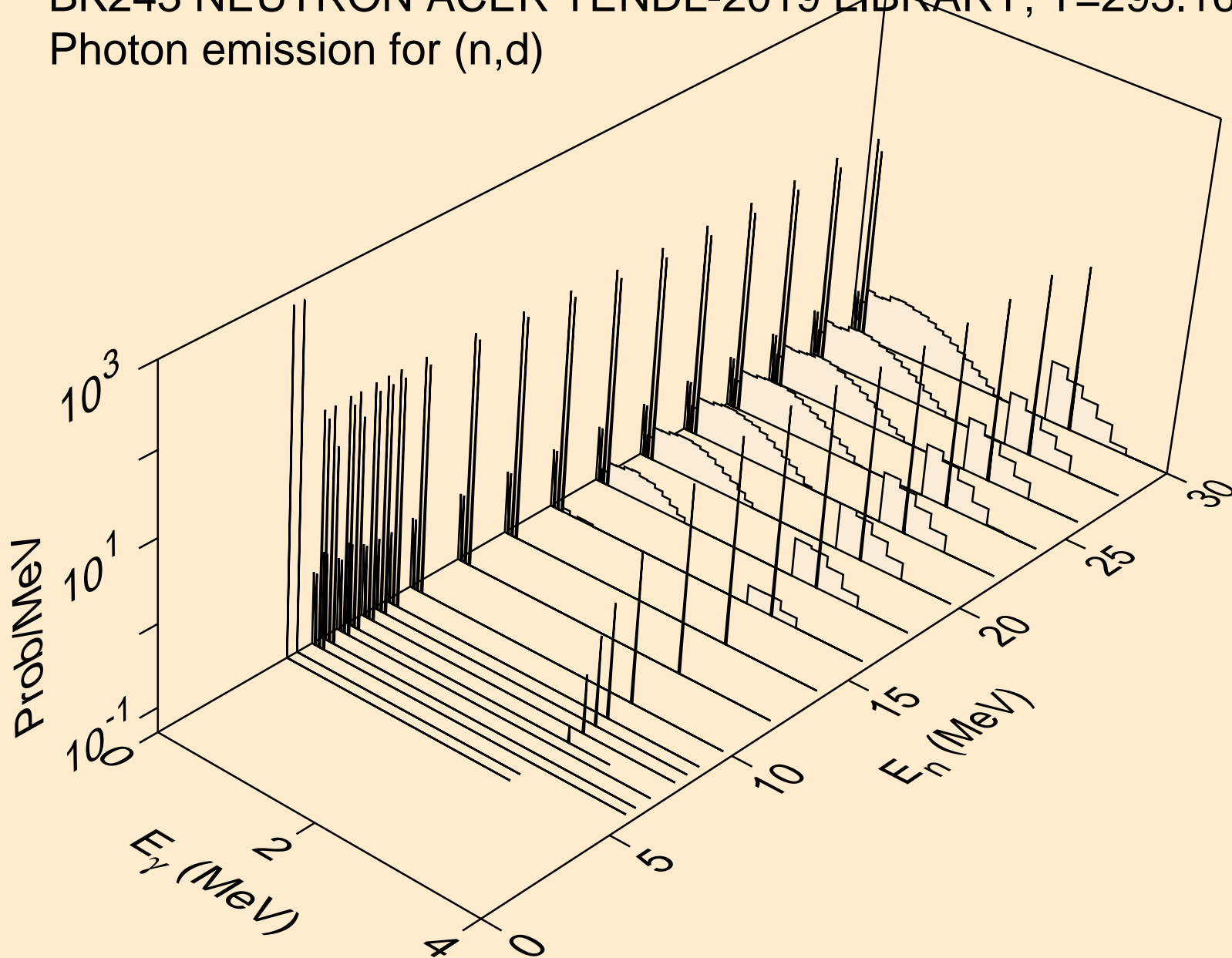

BK243 NEUTRON ACER TENDL-2019 LIBRARY; T=293.16K
Photon emission for (n,t)

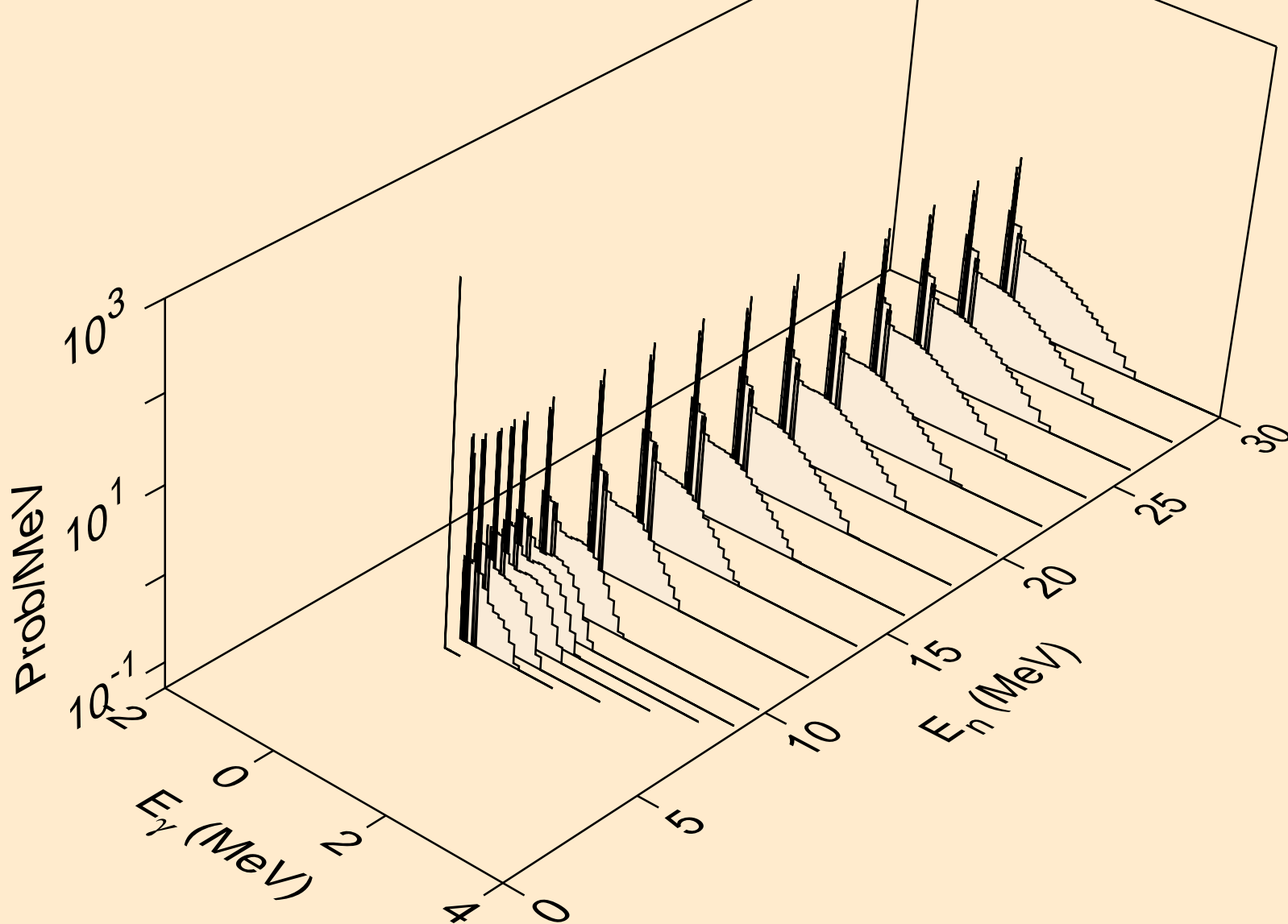

BK243 NEUTRON ACER TENDL-2019 LIBRARY; T=293.16K
Photon emission for (n,he3)

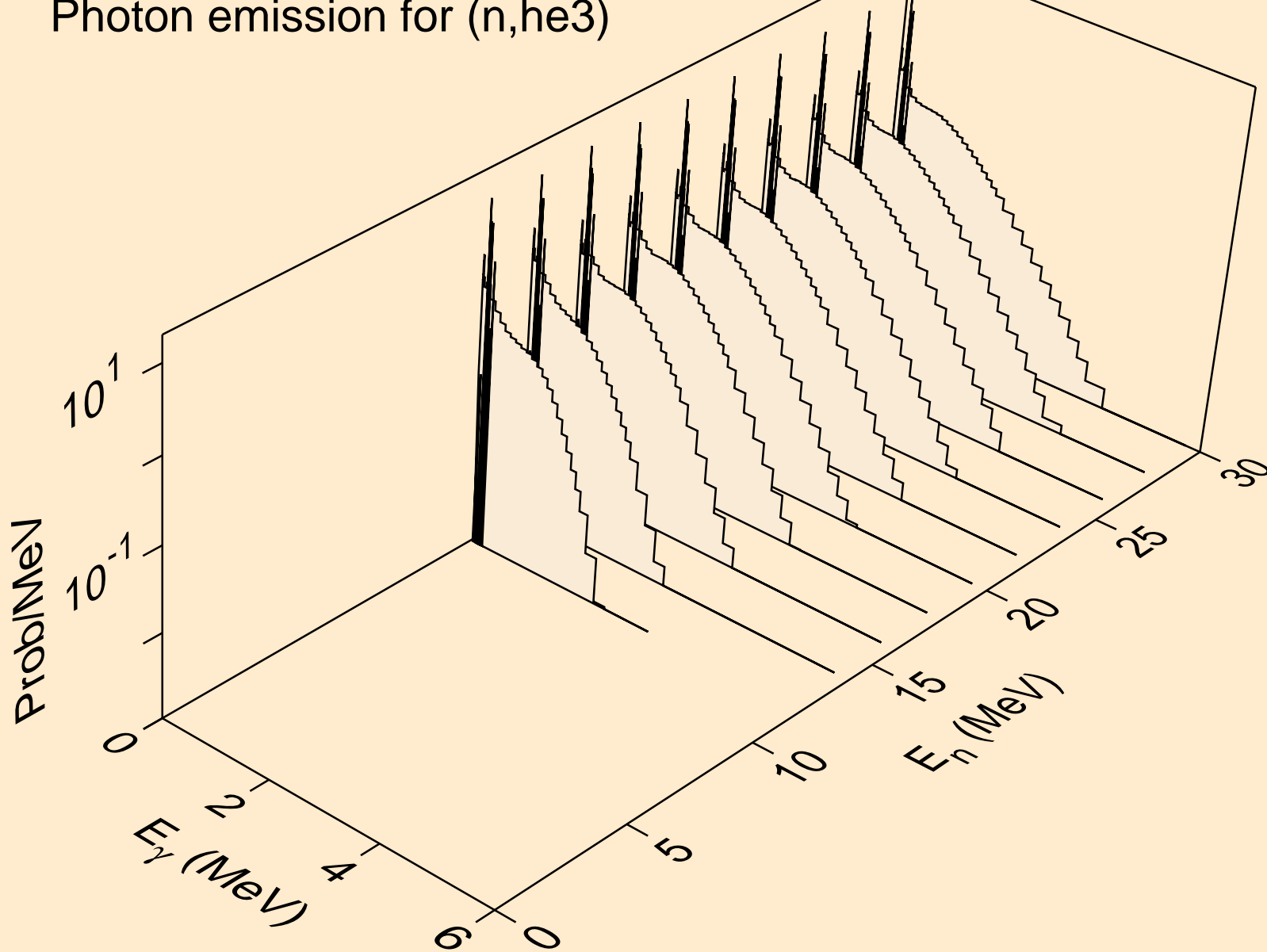

BK243 NEUTRON ACER TENDL-2019 LIBRARY; T=293.16K
Photon emission for (n,a)

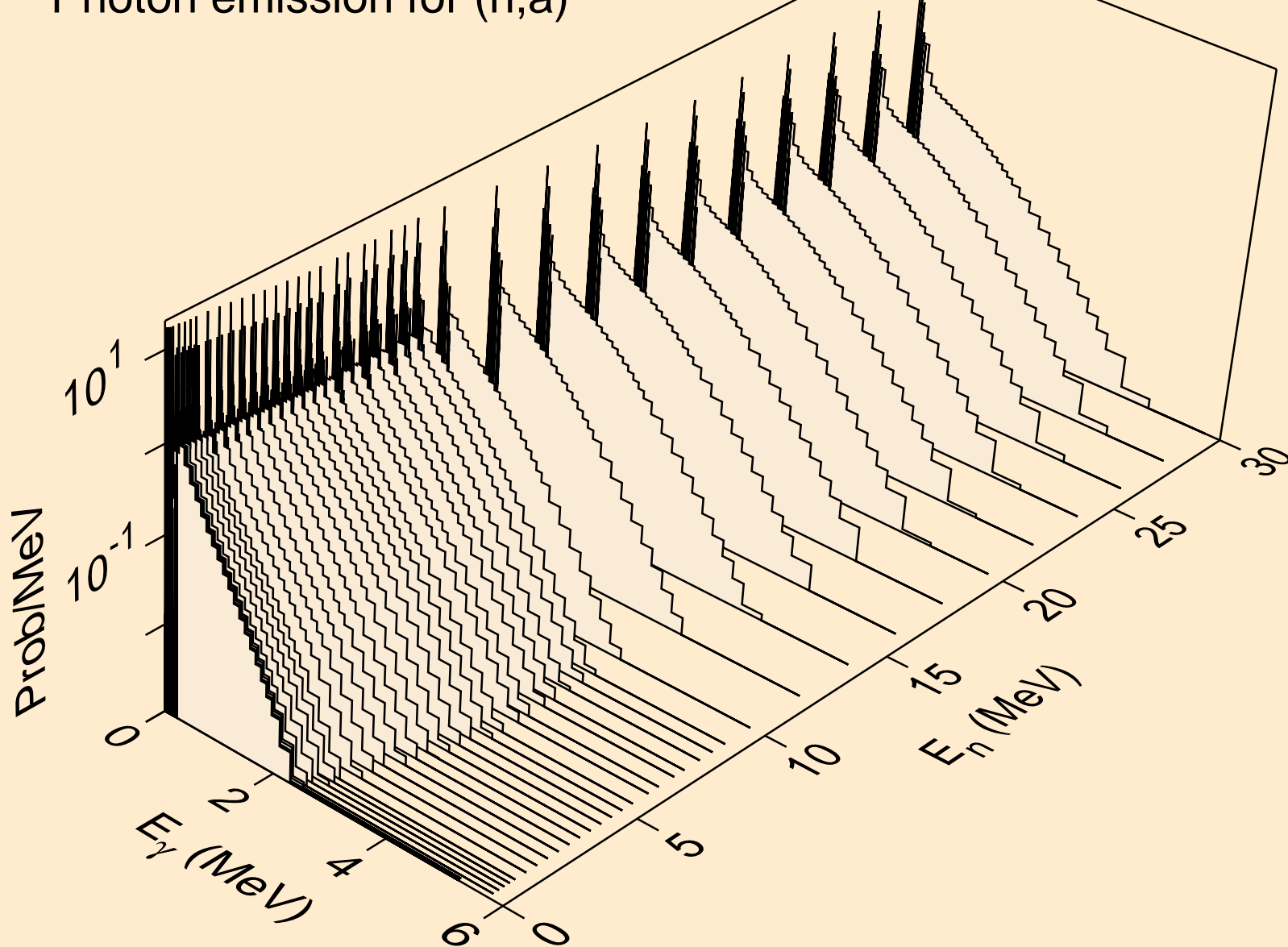

BK243 NEUTRON ACER TENDL-2019 LIBRARY; T=293.16K
Photon emission for (n,2a)

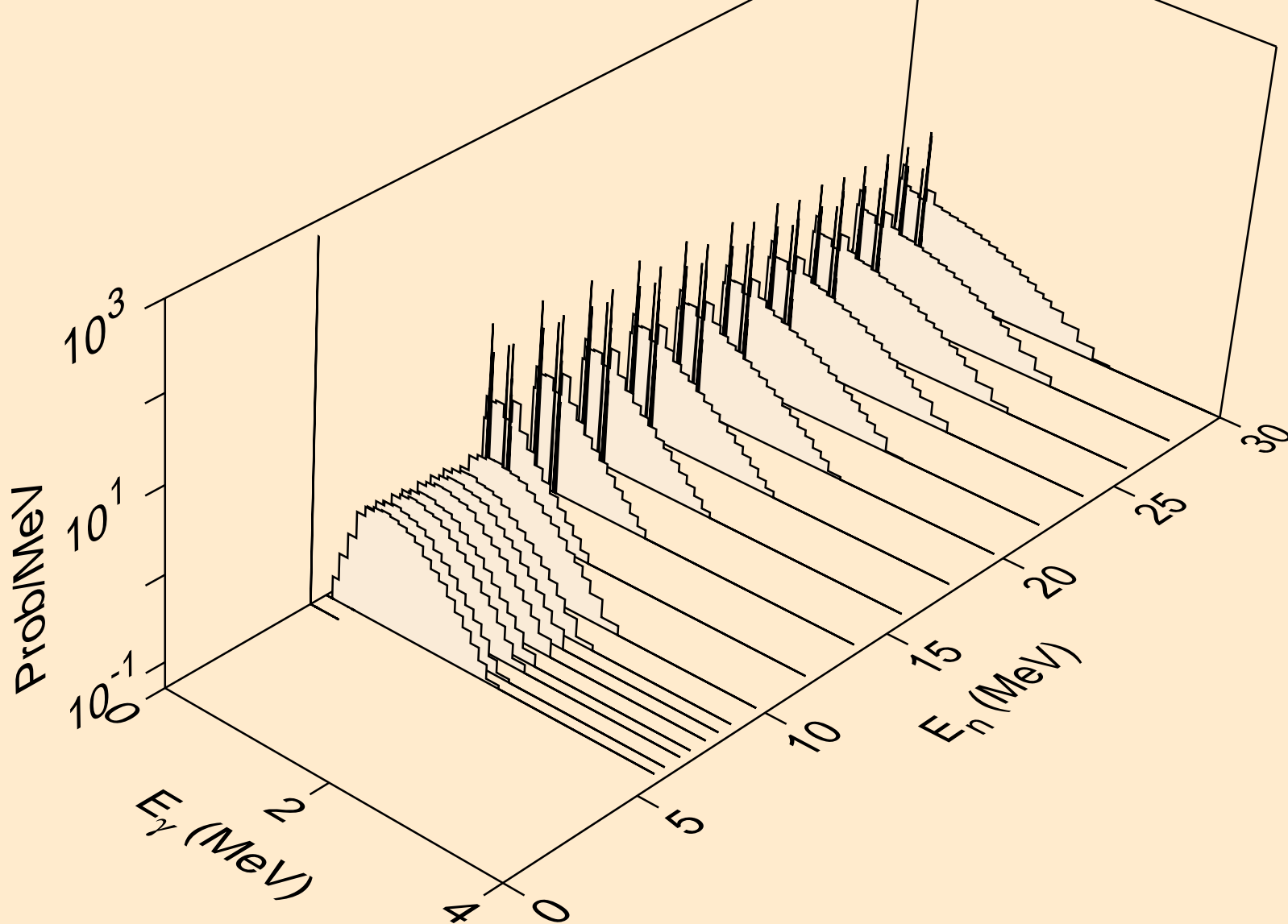

BK243 NEUTRON ACER TENDL-2019 LIBRARY; T=293.16K
Photon emission for (n,2p)

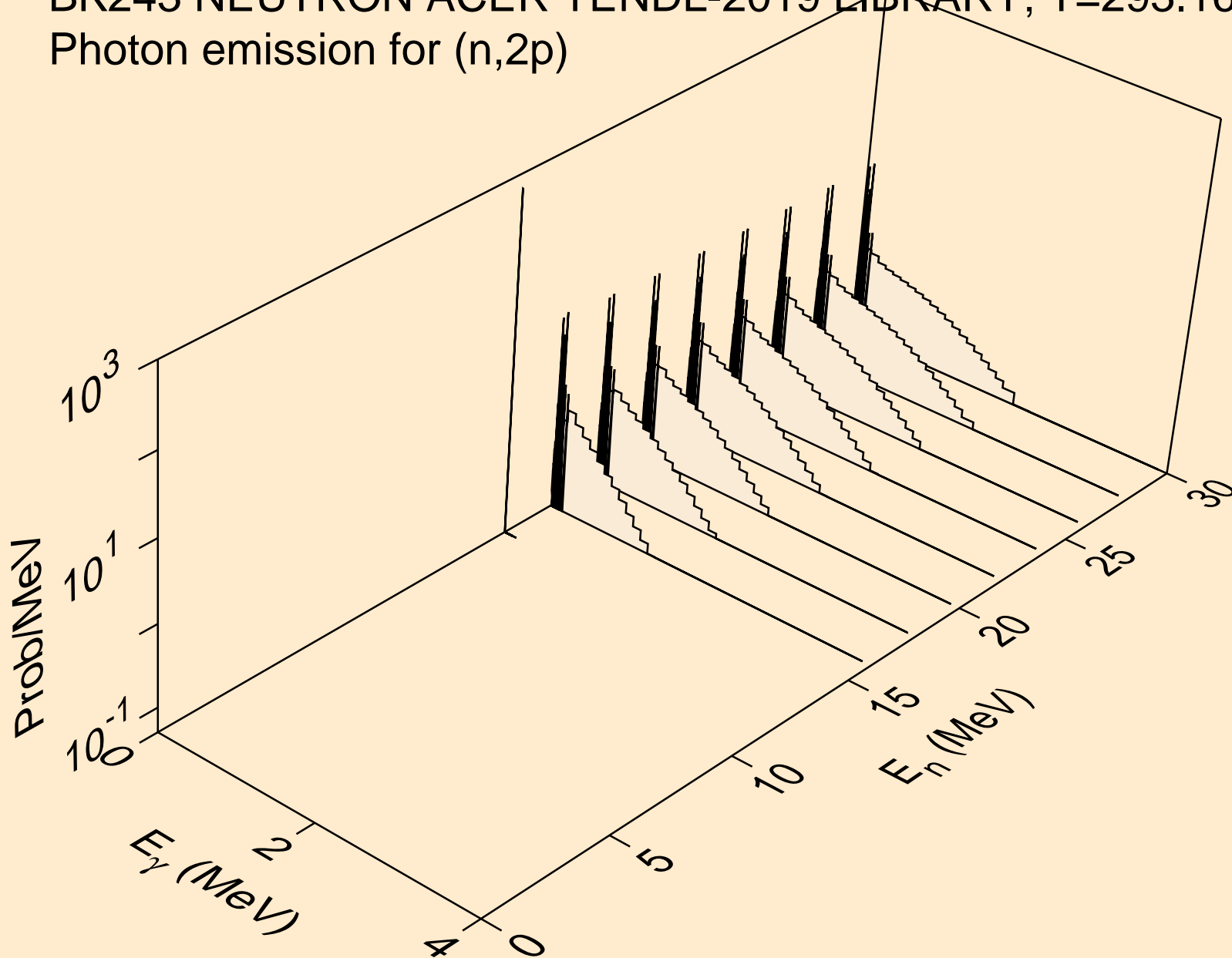

BK243 NEUTRON ACER TENDL-2019 LIBRARY; T=293.16K
Photon emission for (n,p α)

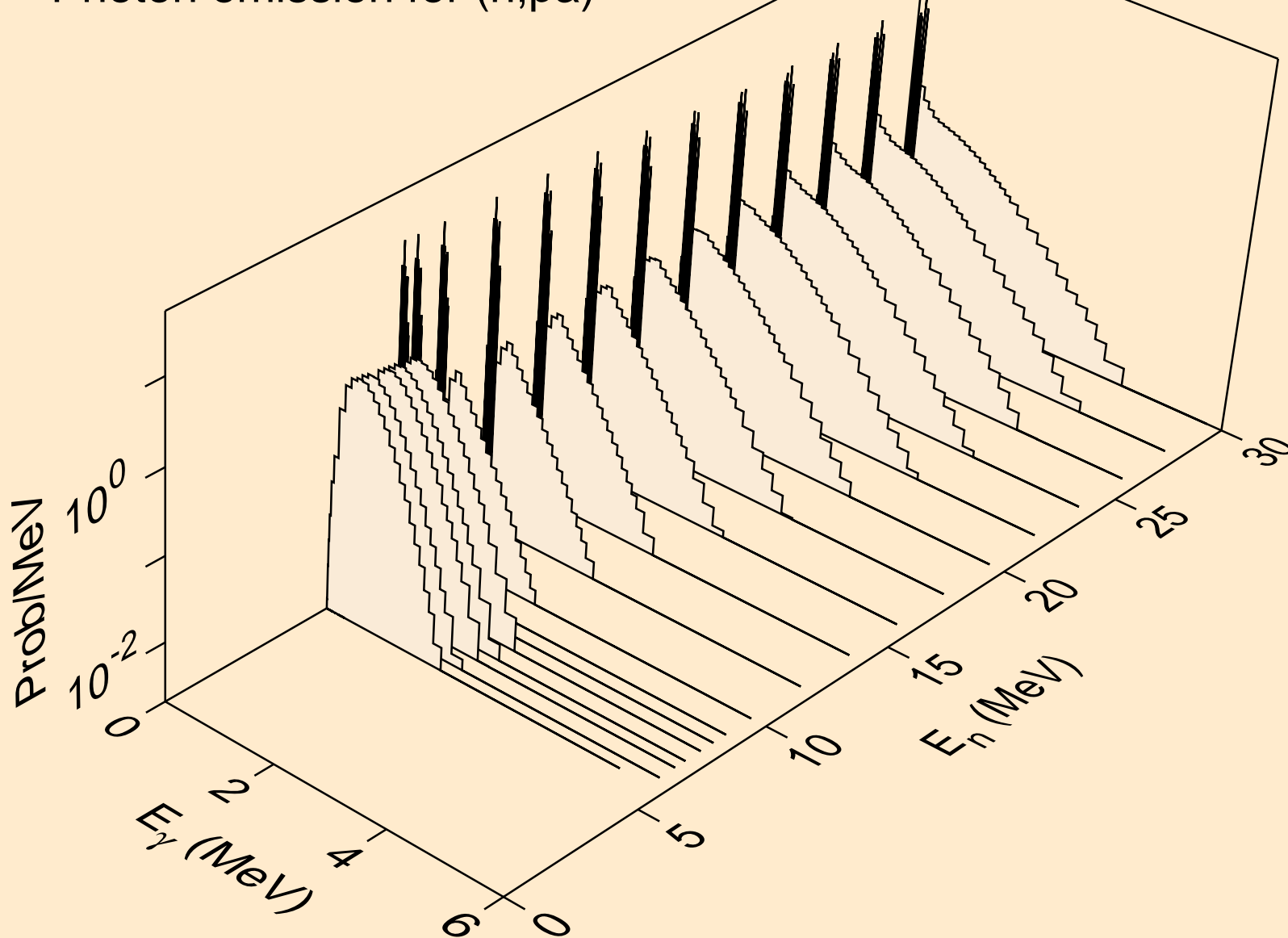

BK243 NEUTRON ACER TENDL-2019 LIBRARY; T=293.16K
Photon emission for (n,pd)

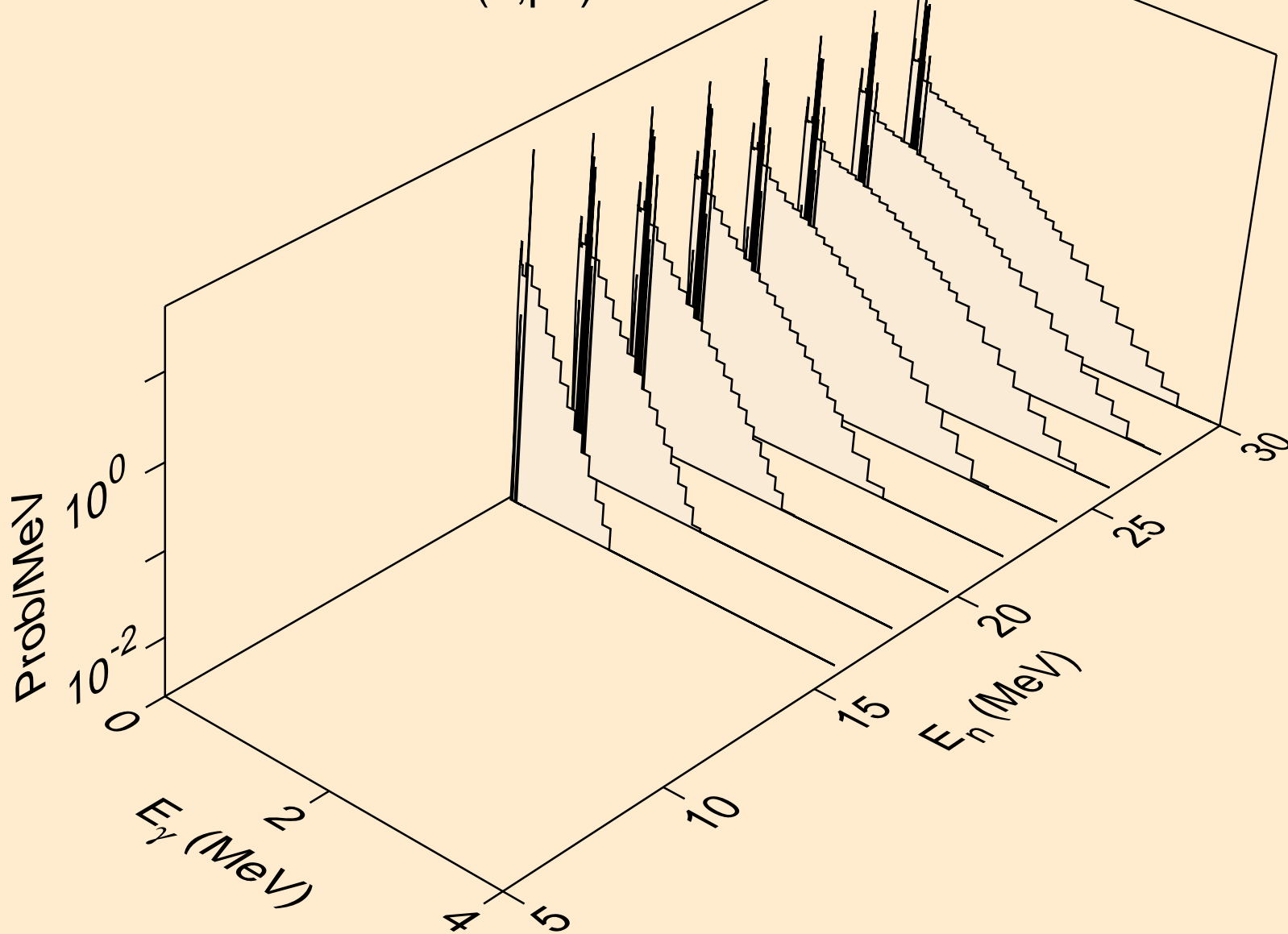

BK243 NEUTRON ACER TENDL-2019 LIBRARY; T=293.16K
Photon emission for (n,pt)

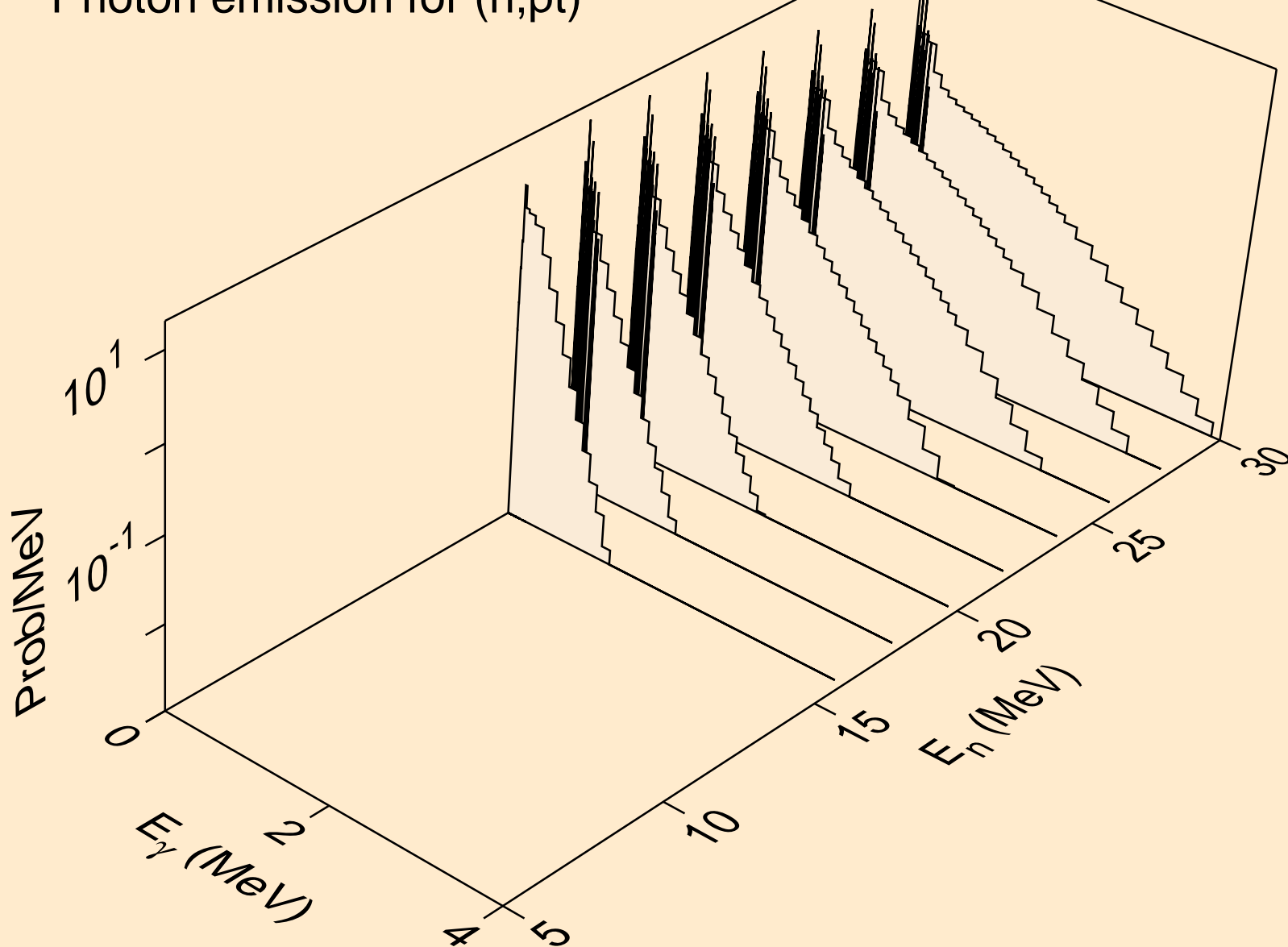

BK243 NEUTRON ACER TENDL-2019 LIBRARY; T=293.16K
Photon emission for (n,da)

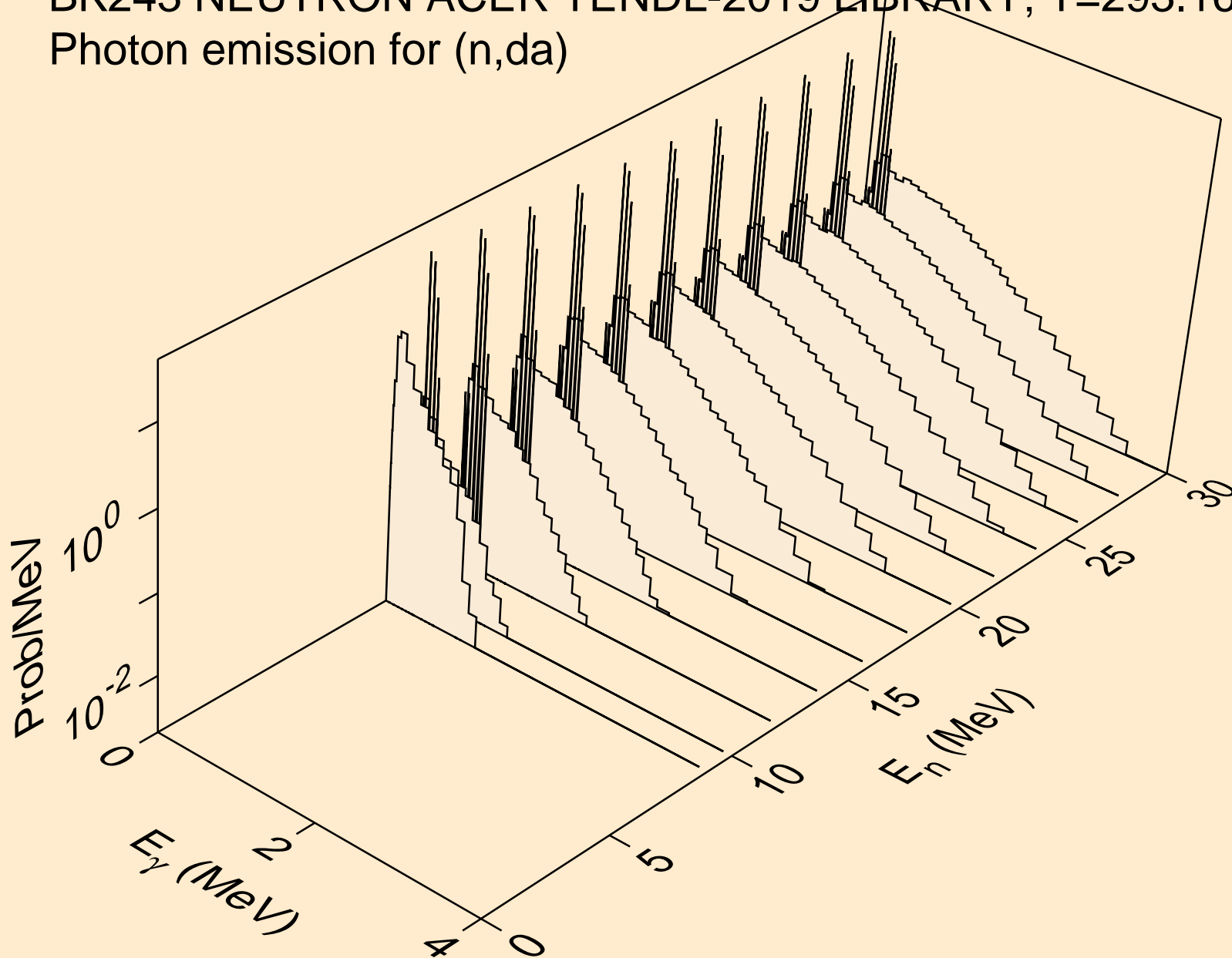

BK243 NEUTRON ACER TENDL-2019 LIBRARY; T=293.16K
thermal capture photon spectrum

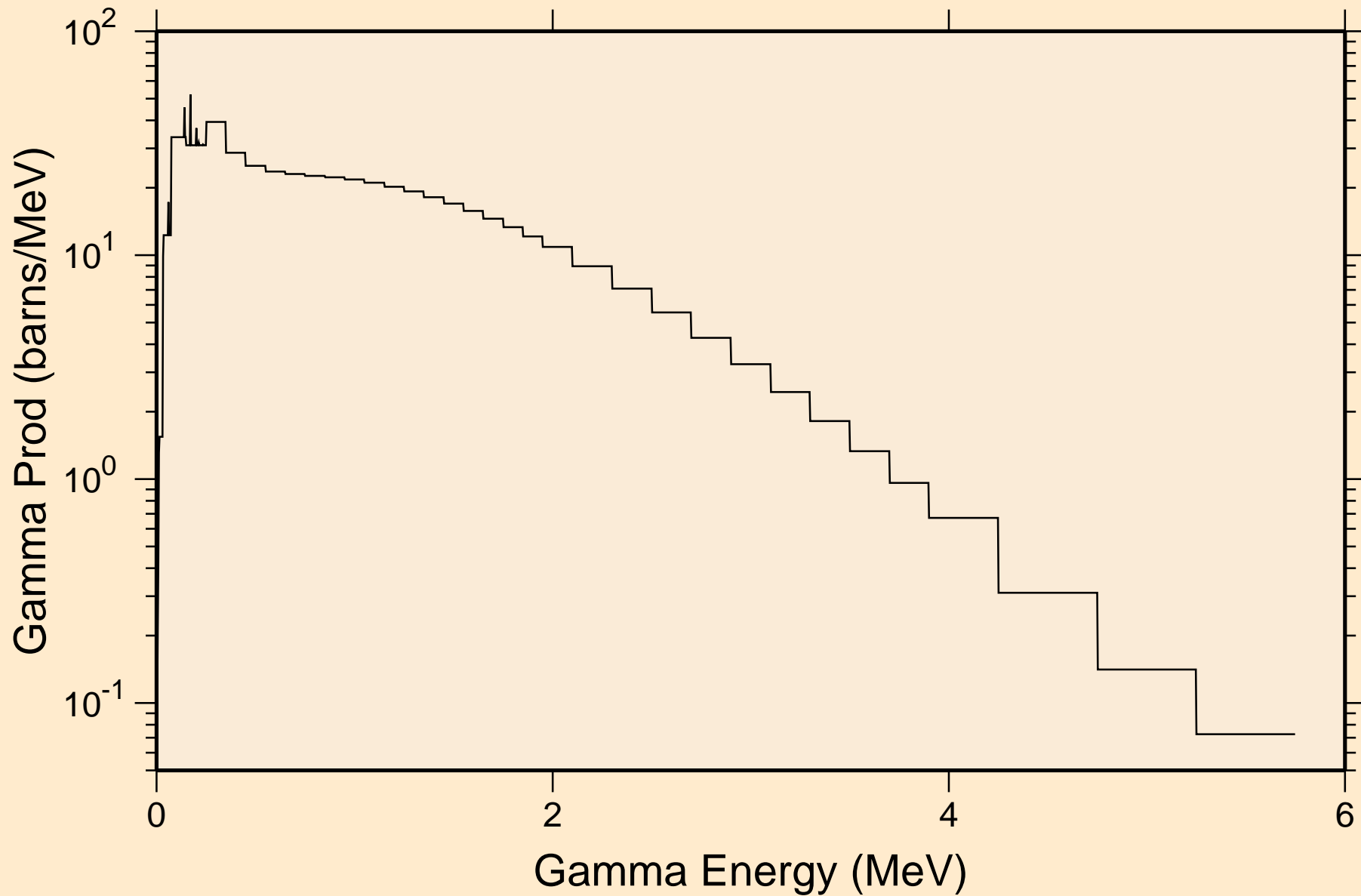

BK243 NEUTRON ACER TENDL-2019 LIBRARY; T=293.16K
14 MeV photon spectrum

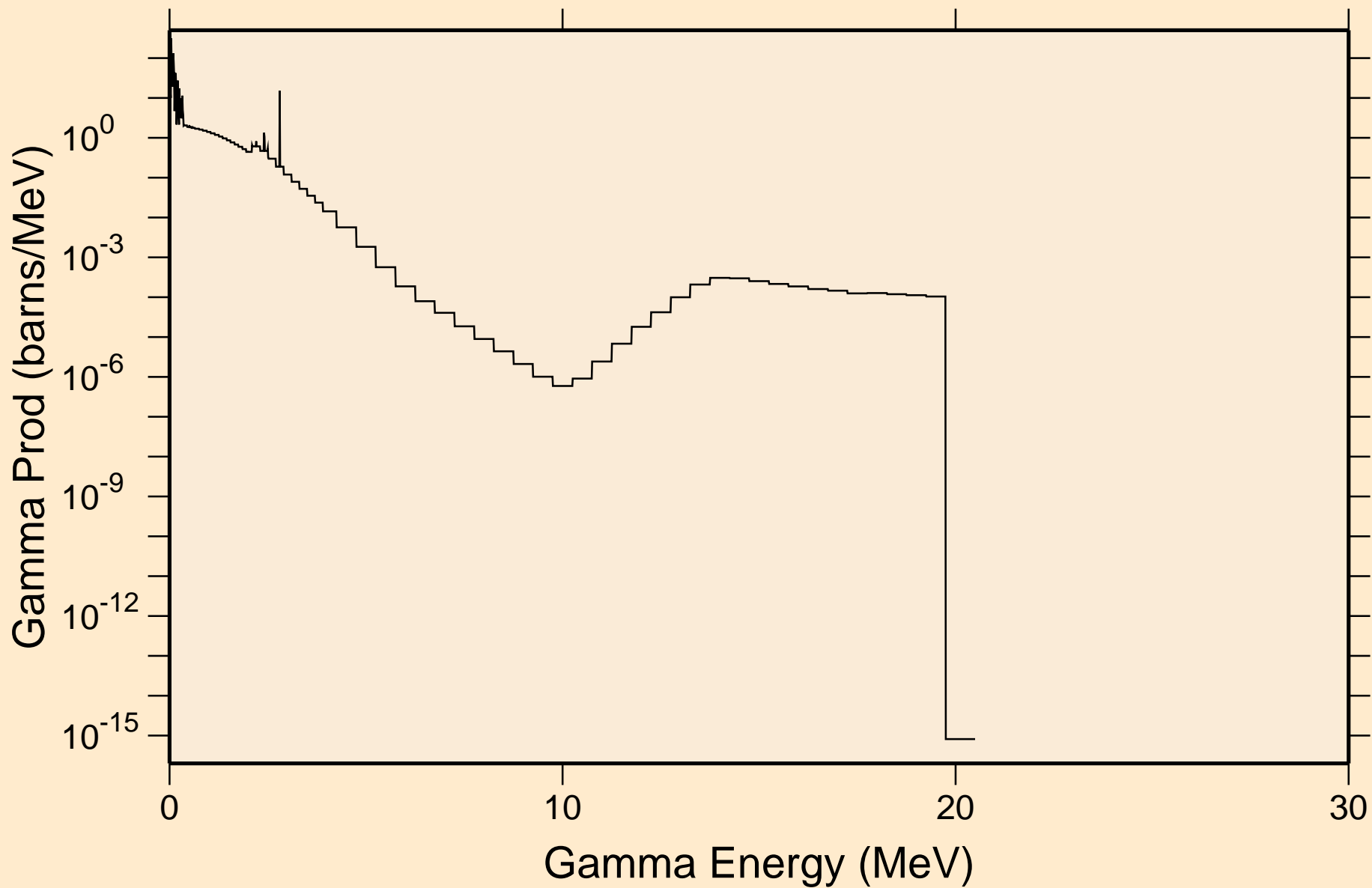

BK243 NEUTRON ACER TENDL-2019 LIBRARY; T=293.16K

Particle heating contributions

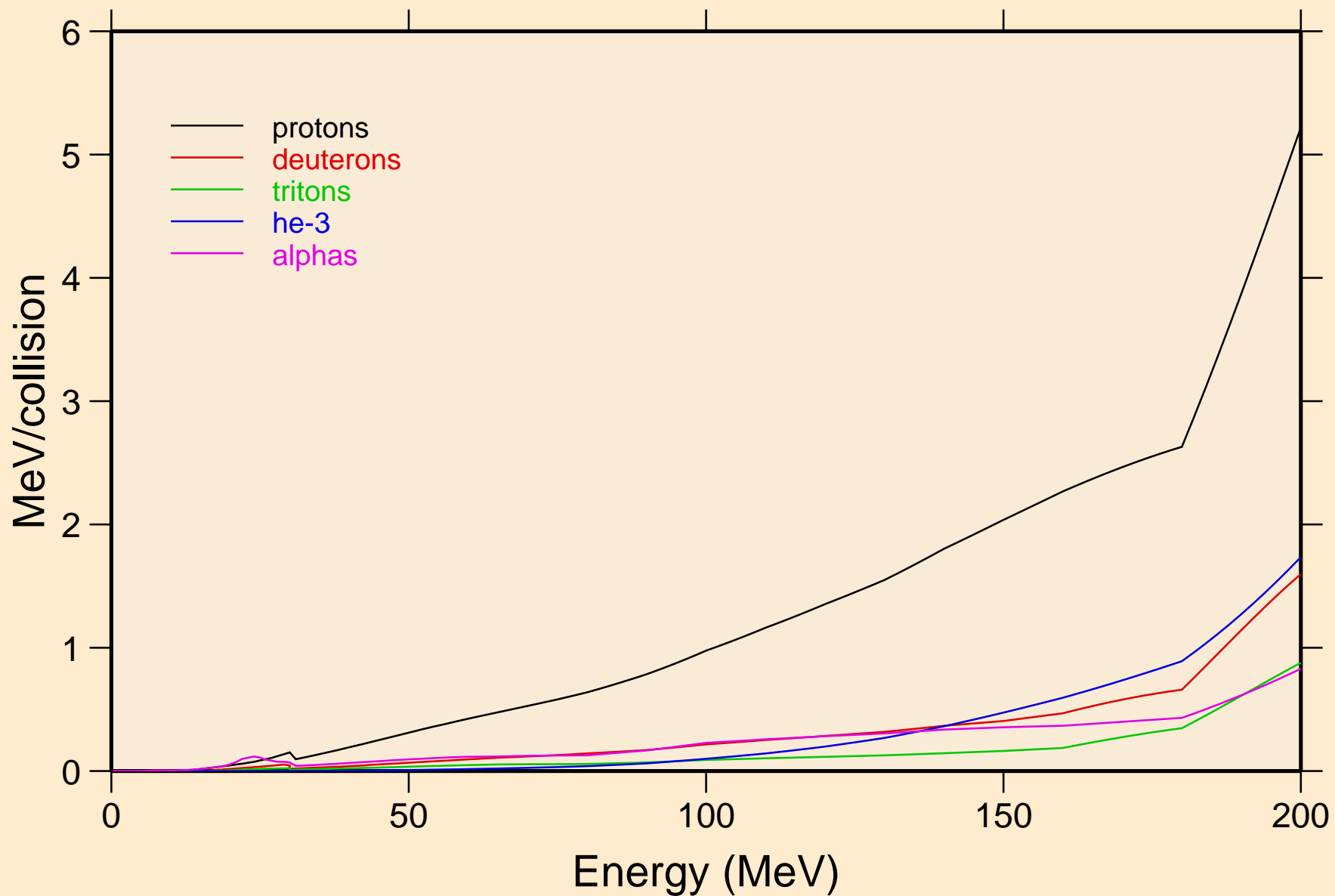

BK243 NEUTRON ACER TENDL-2019 LIBRARY; T=293.16K
Recoil Heating

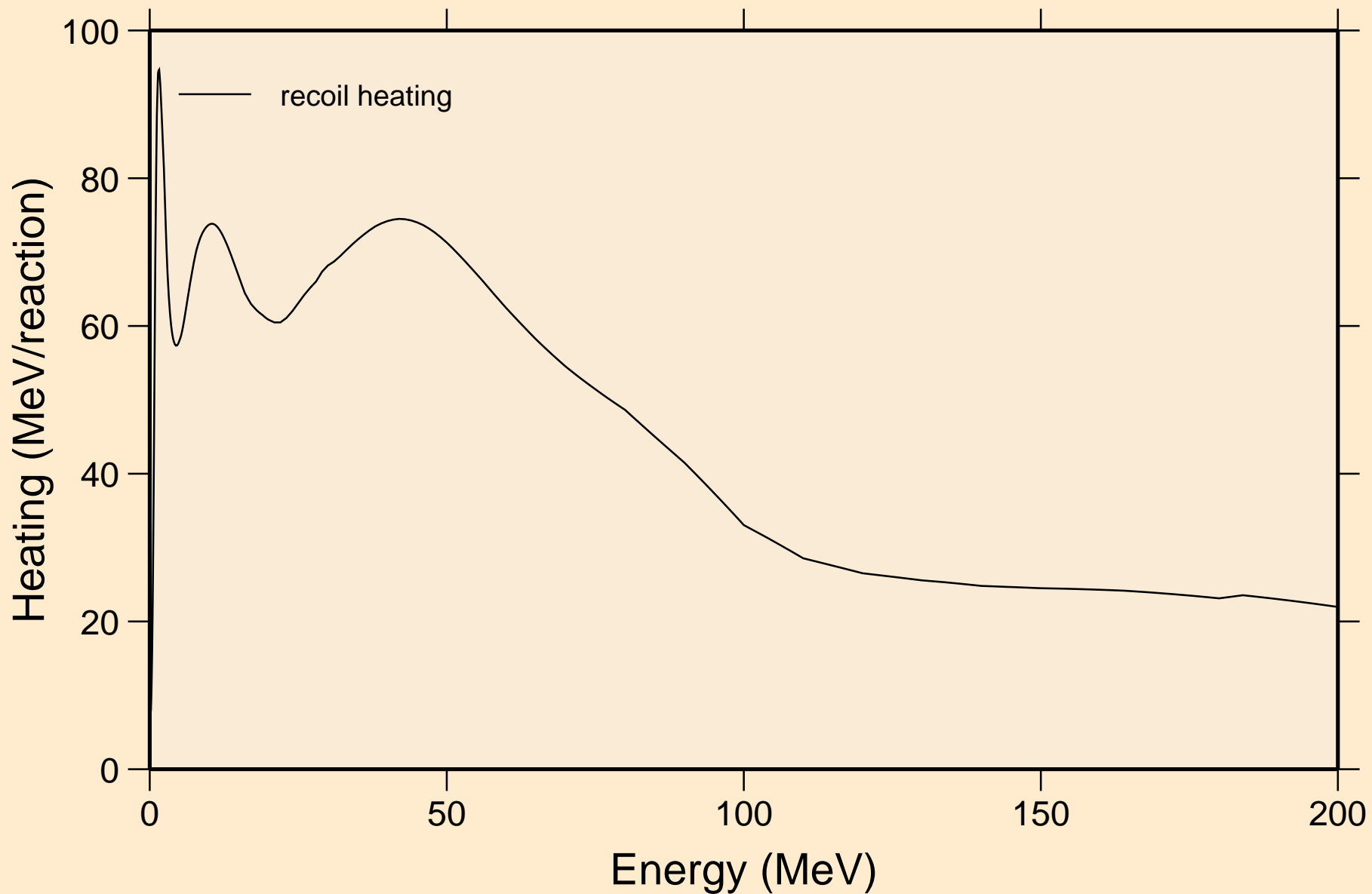

BK243 NEUTRON ACER TENDL-2019 LIBRARY; T=293.16K
Particle production cross sections

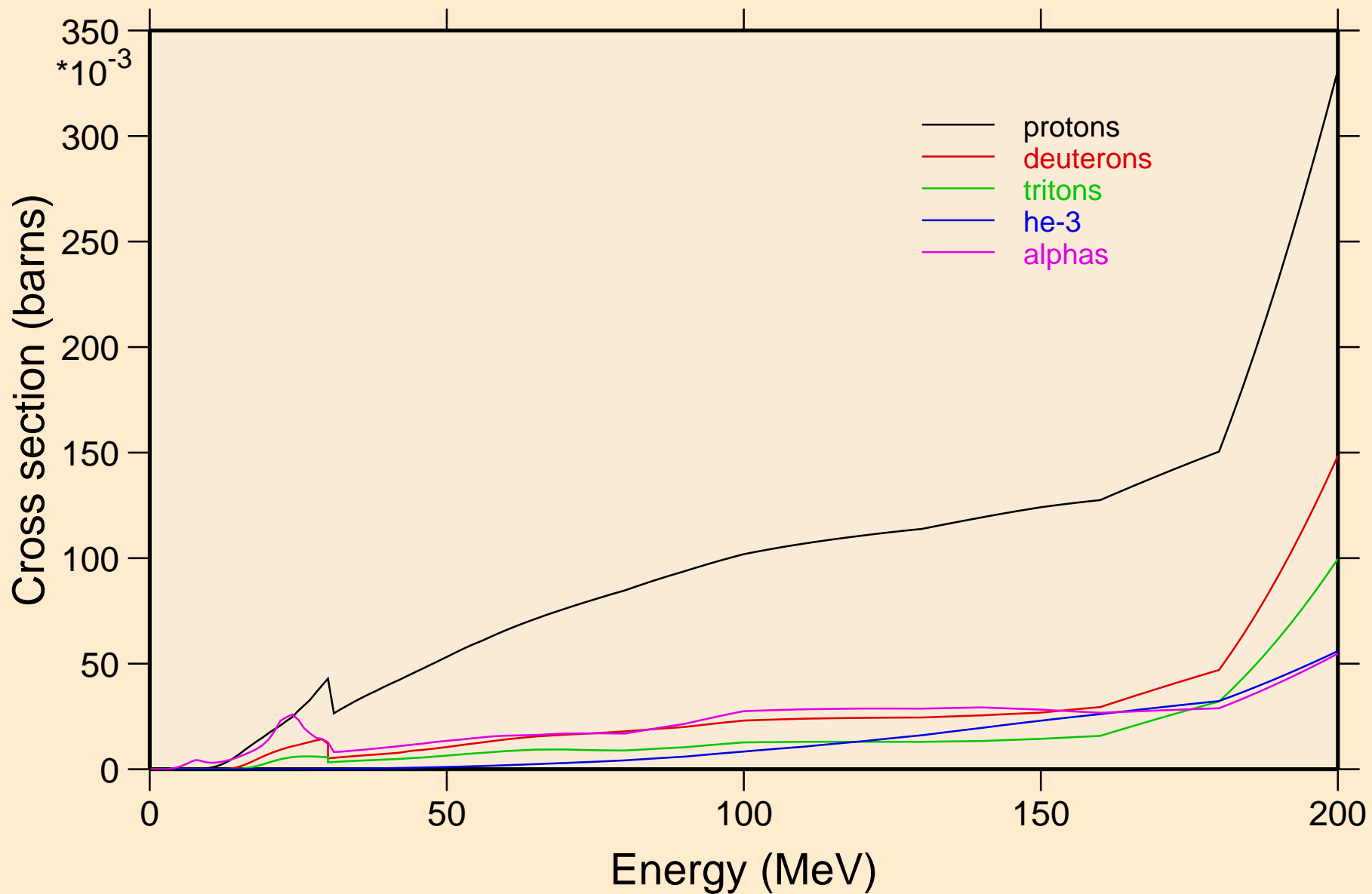

BK243 NEUTRON ACER TENDL-2019 LIBRARY; T=293.16K
protons from (n,x)

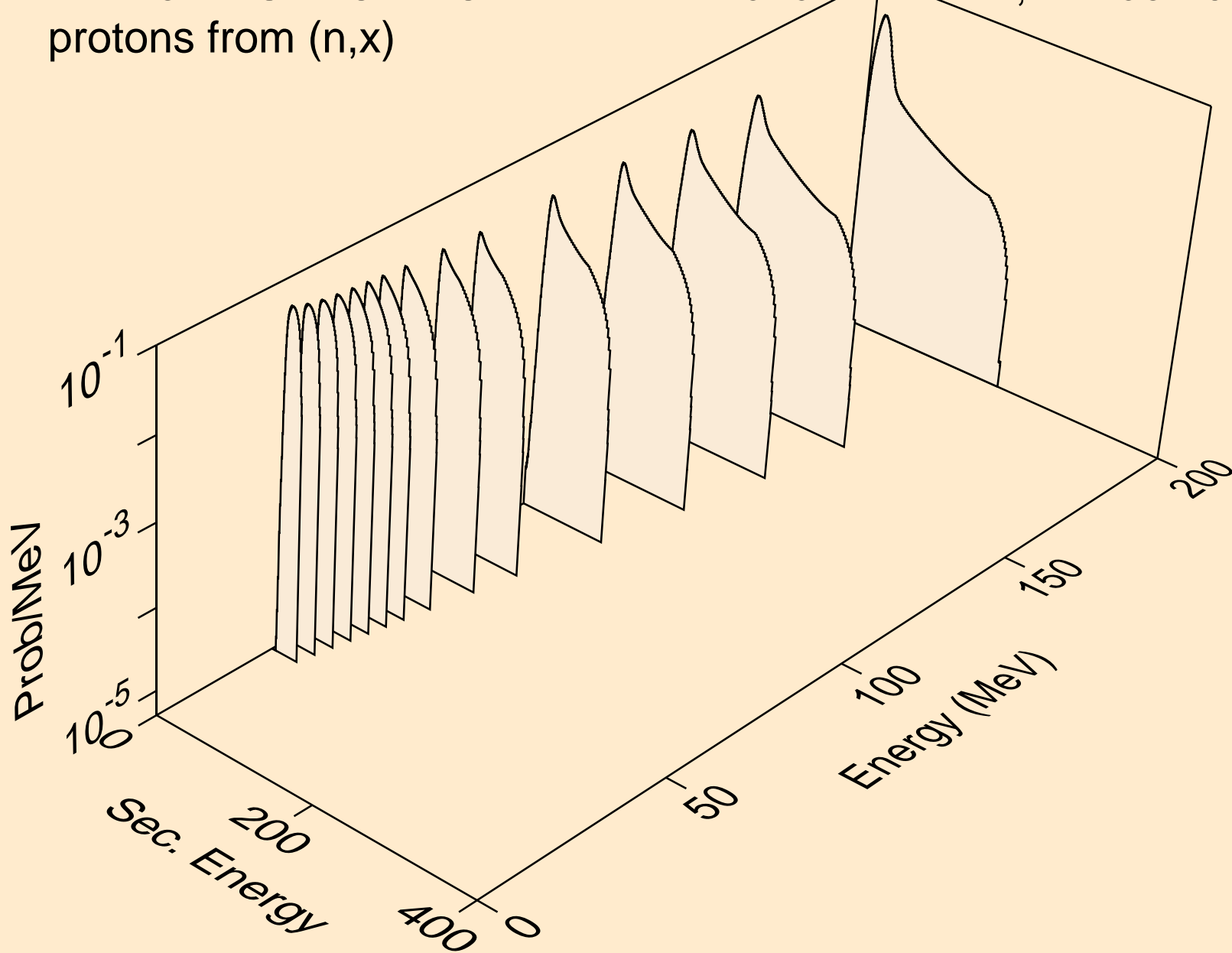

BK243 NEUTRON ACER TENDL-2019 LIBRARY; T=293.16K
protons from (n,n*)p

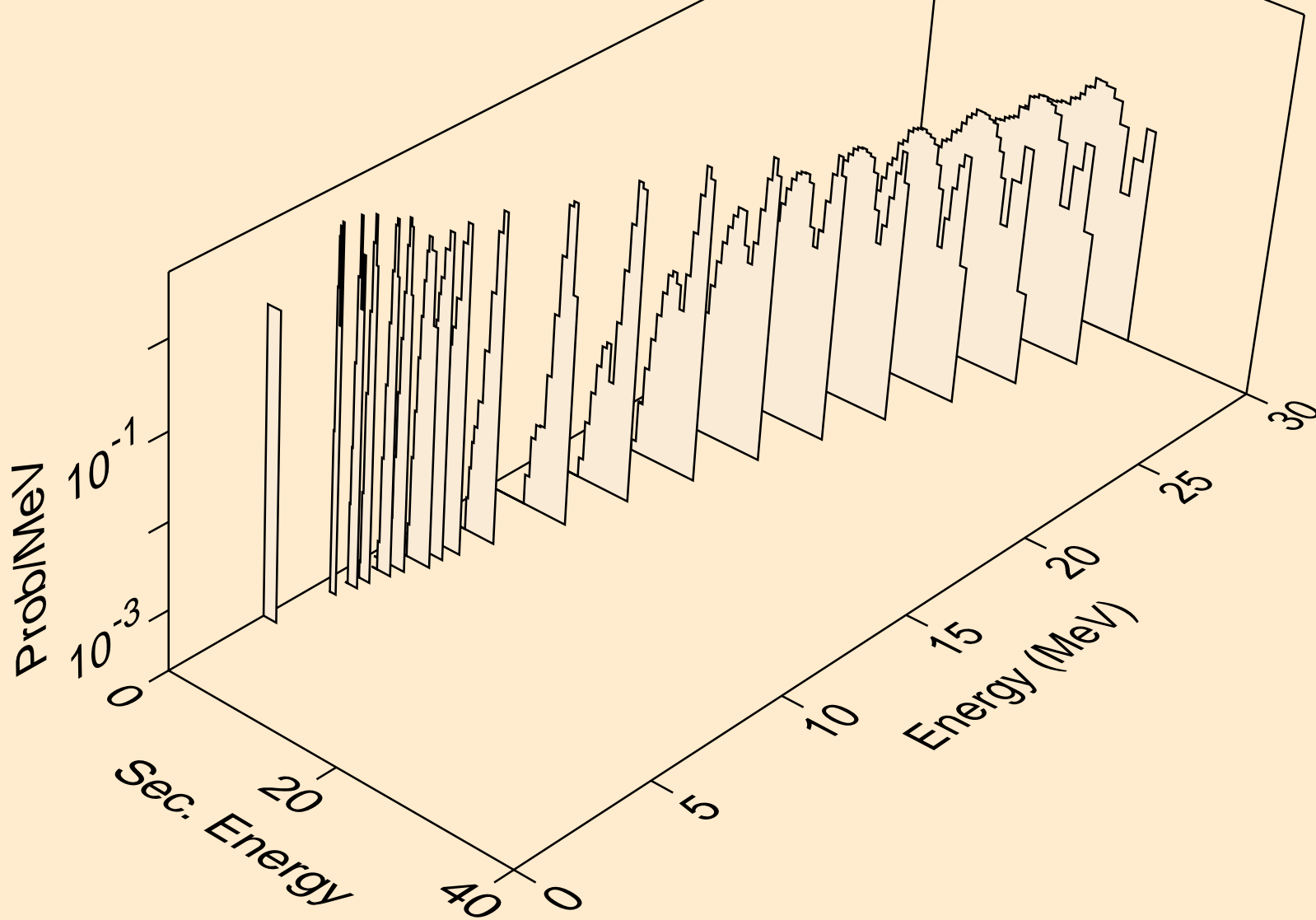

BK243 NEUTRON ACER TENDL-2019 LIBRARY; T=293.16K
protons from (n,2np)

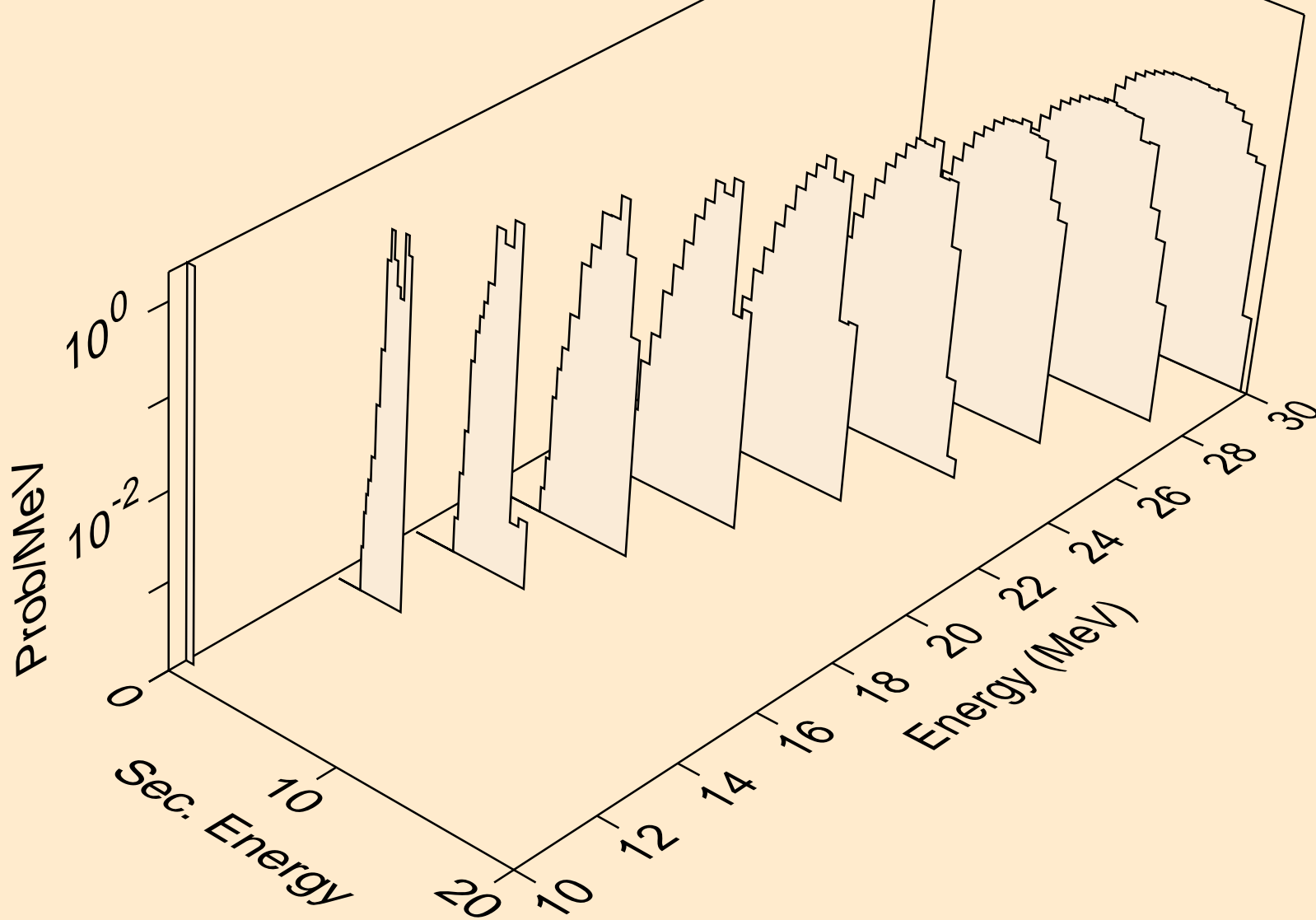

BK243 NEUTRON ACER TENDL-2019 LIBRARY; T=293.16K
protons from (n,3np)

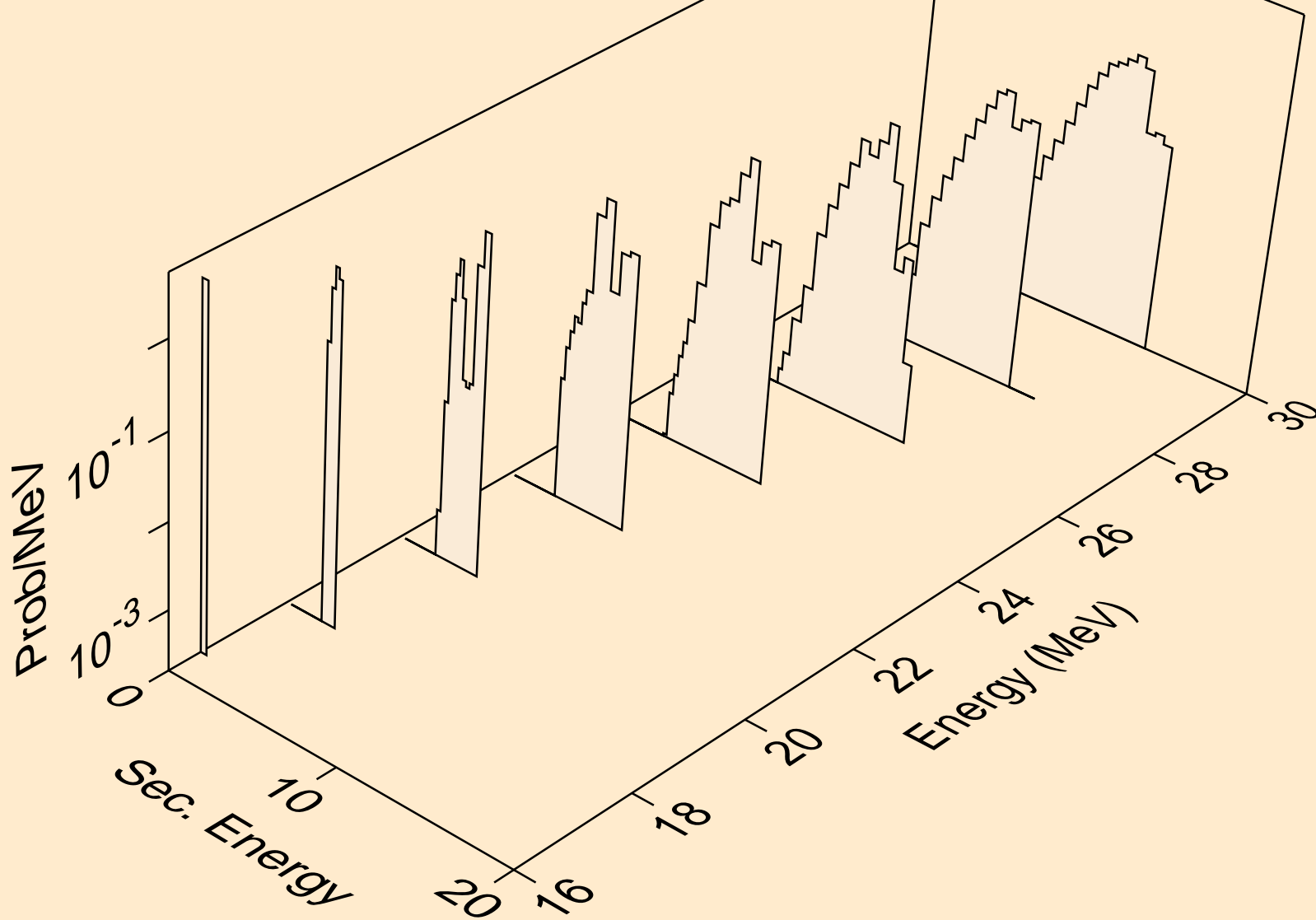

BK243 NEUTRON ACER TENDL-2019 LIBRARY; T=293.16K
protons from (n,2np)

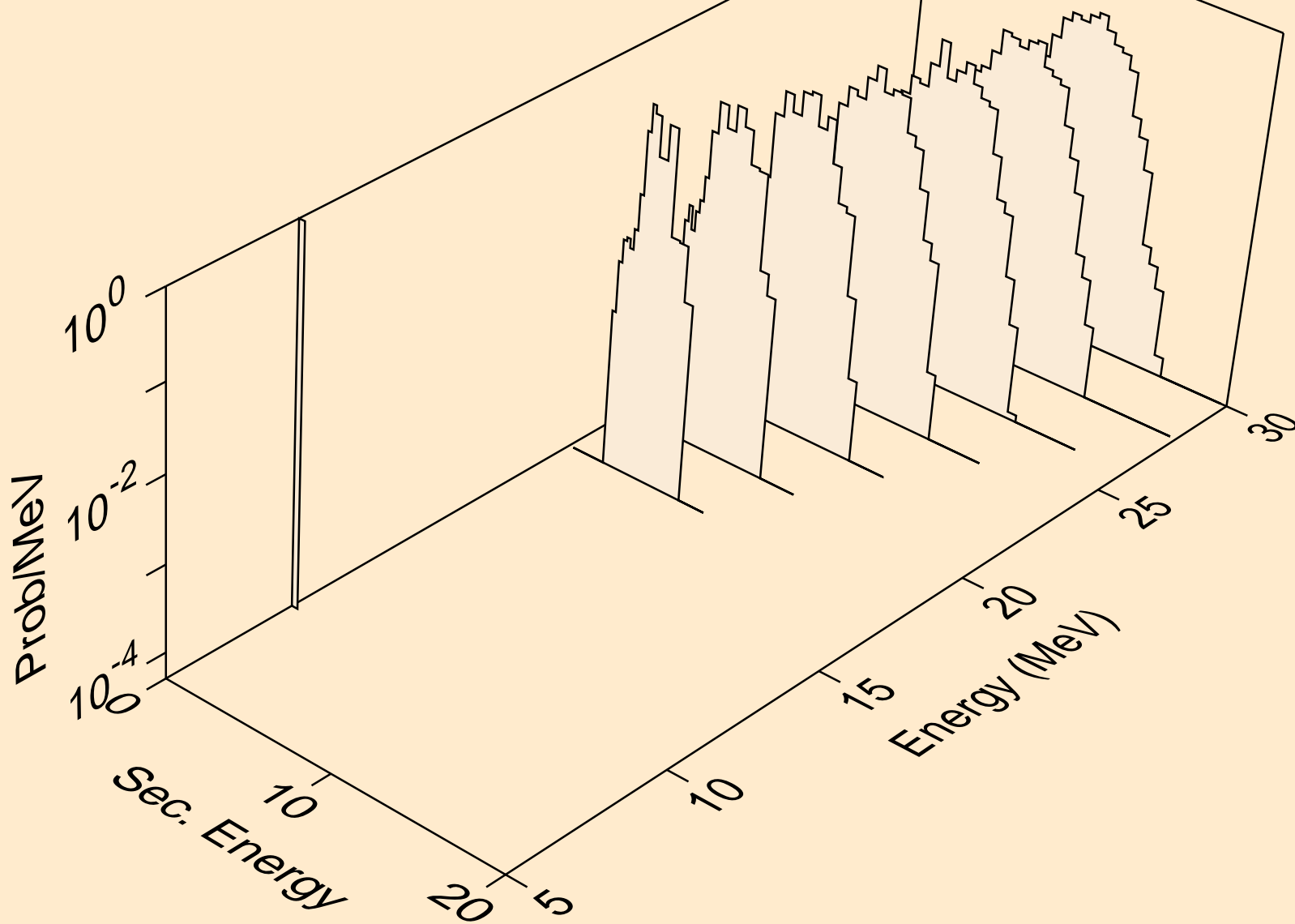

BK243 NEUTRON ACER TENDL-2019 LIBRARY; T=293.16K
protons from (n,npa)

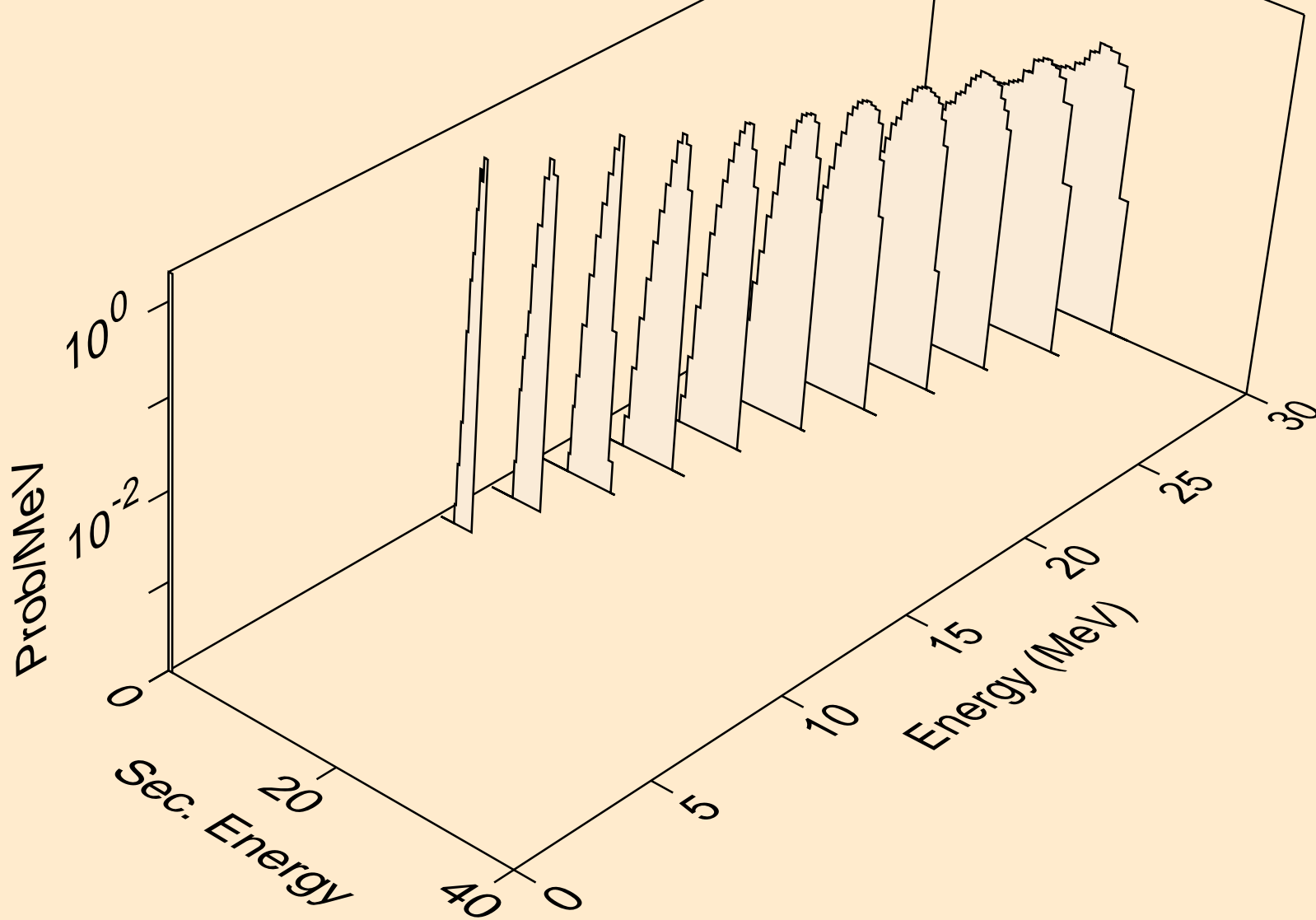

BK243 NEUTRON ACER TENDL-2019 LIBRARY; T=293.16K
protons from (n,p)

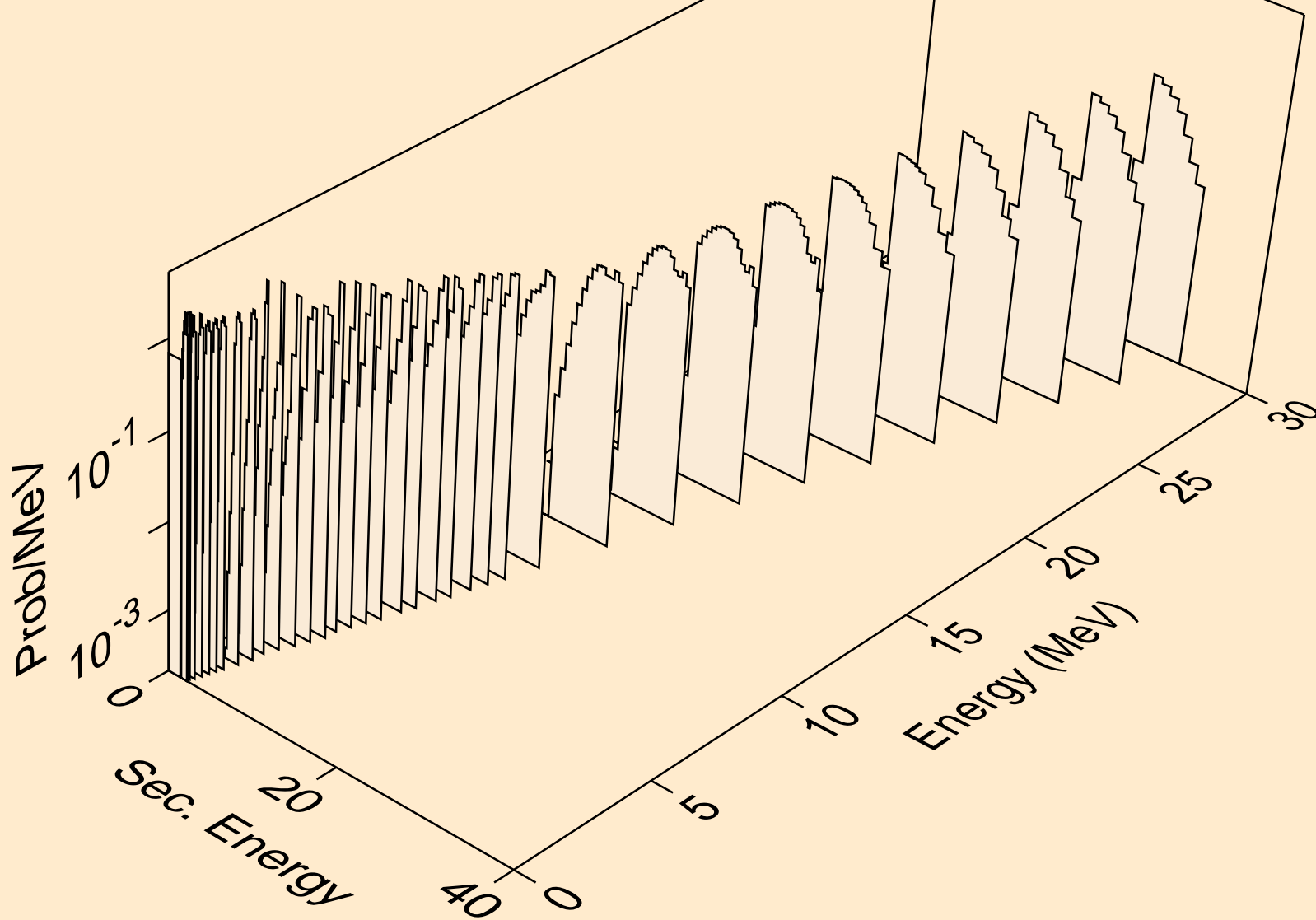

BK243 NEUTRON ACER TENDL-2019 LIBRARY; T=293.16K
protons from (n,2p)

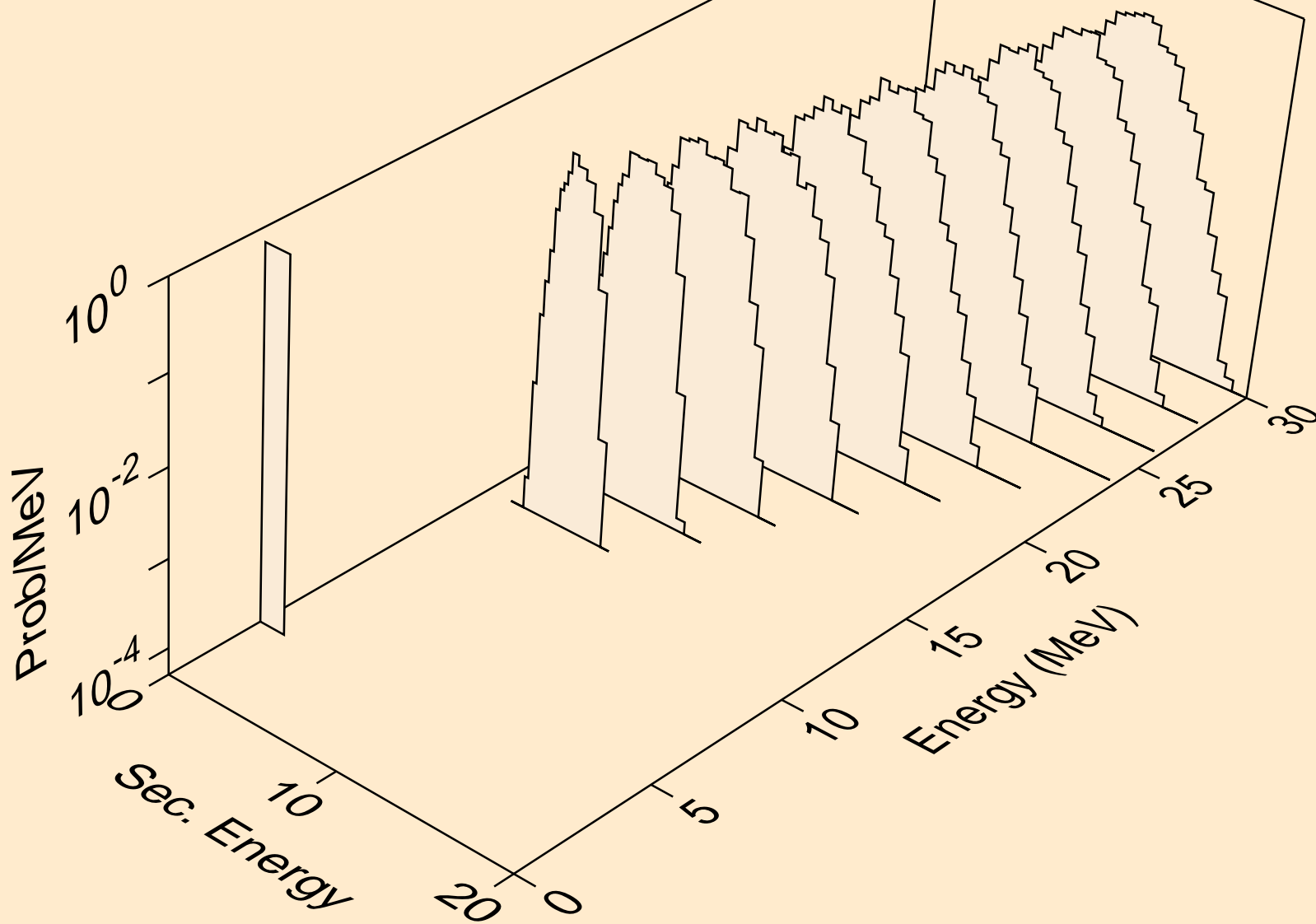

BK243 NEUTRON ACER TENDL-2019 LIBRARY; T=293.16K
protons from (n,p)

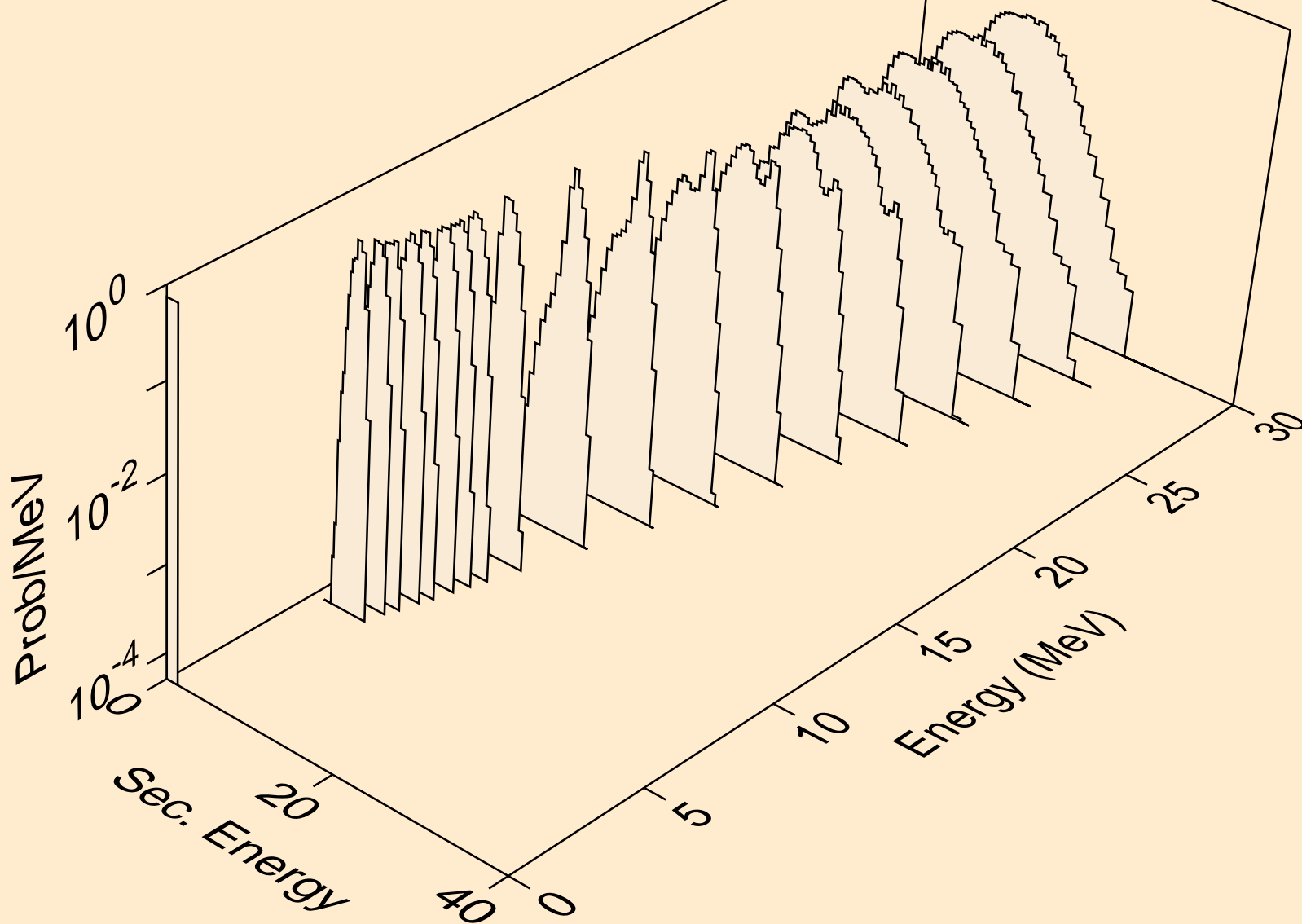

BK243 NEUTRON ACER TENDL-2019 LIBRARY; T=293.16K
protons from (n,pd)

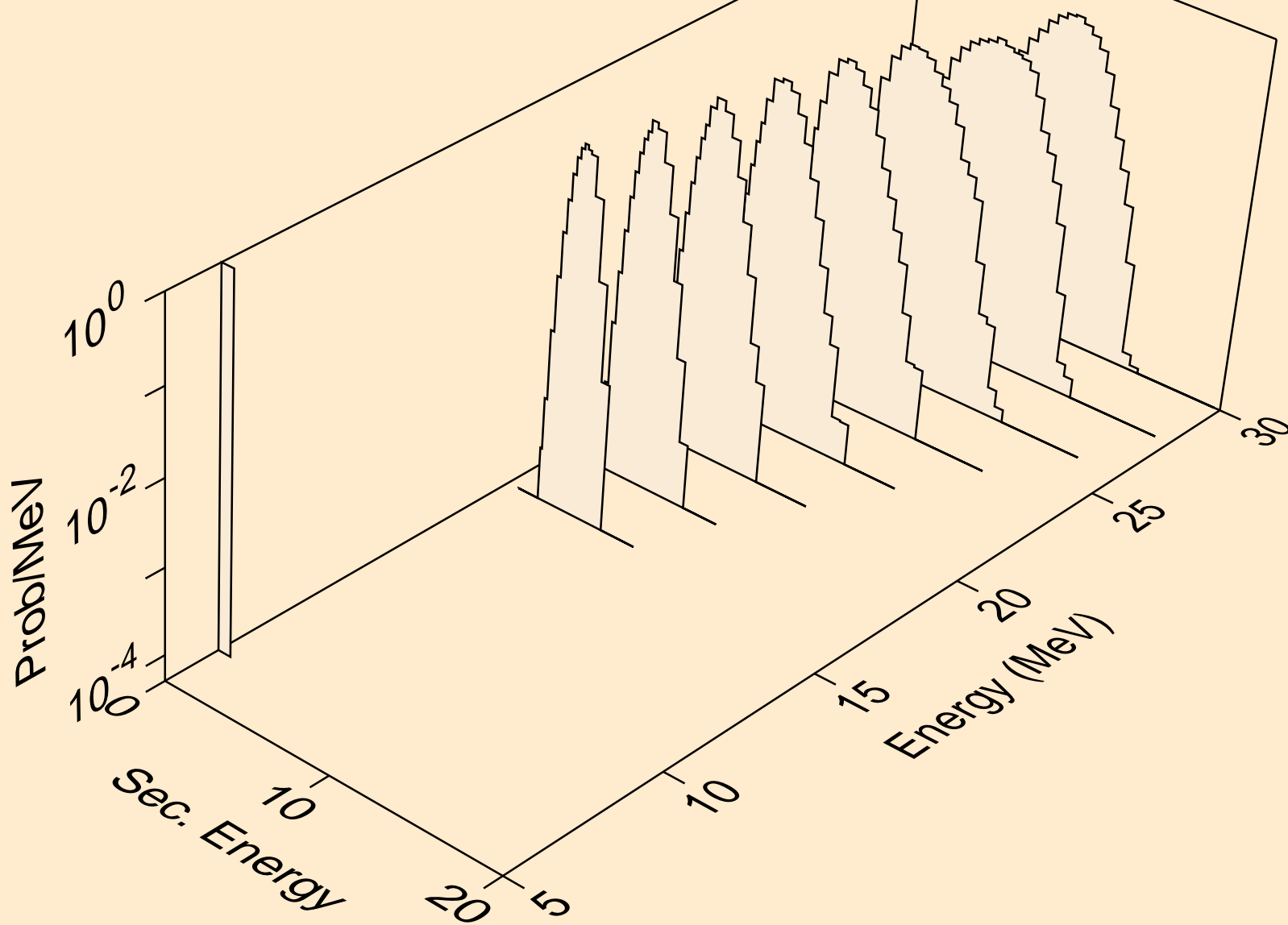

BK243 NEUTRON ACER TENDL-2019 LIBRARY; T=293.16K
protons from (n,pt)

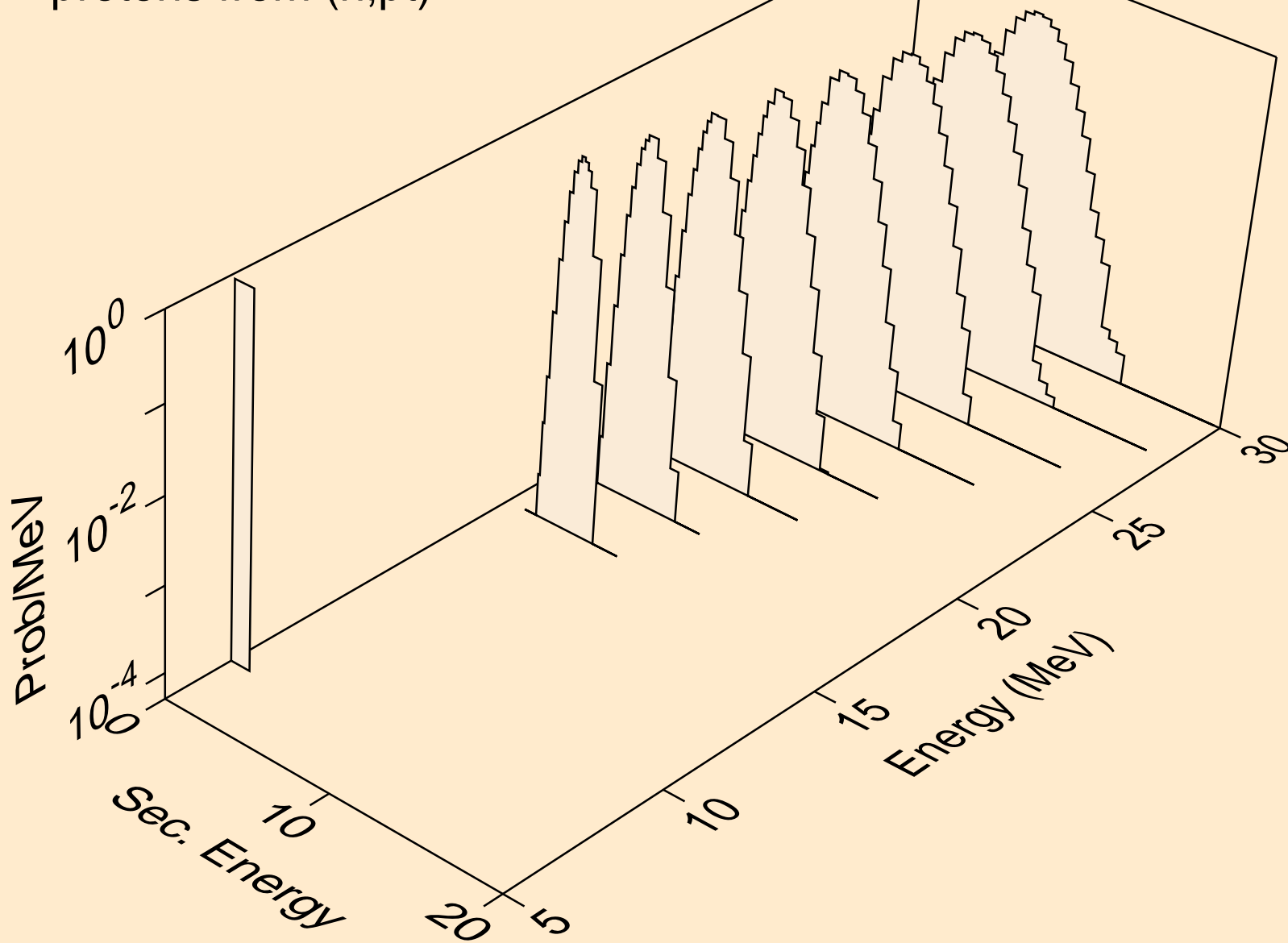

BK243 NEUTRON ACER TENDL-2019 LIBRARY; T=293.16K
deuterons from (n,x)

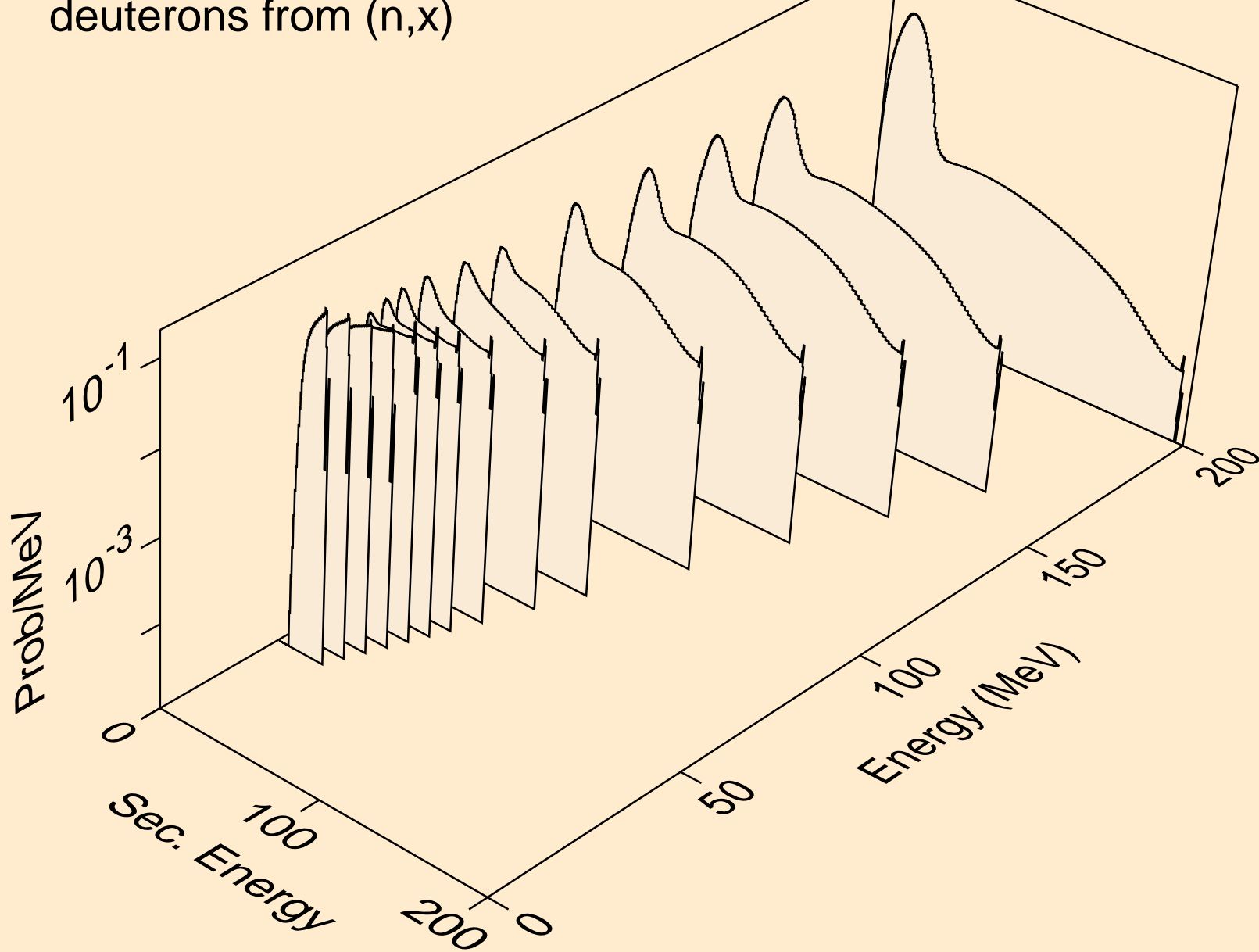

BK243 NEUTRON ACER TENDL-2019 LIBRARY; T=293.16K
deuterons from (n,2nd)

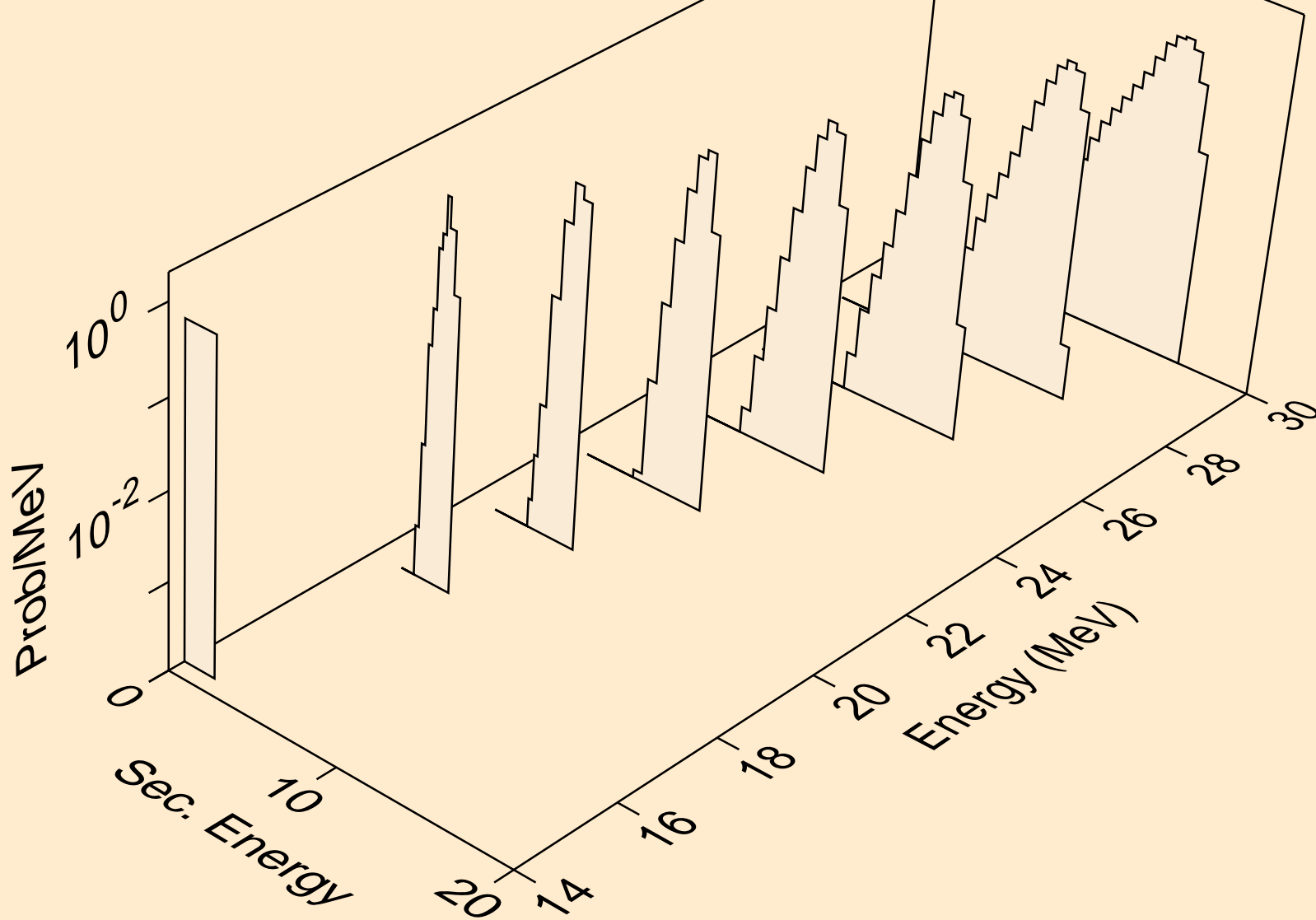

BK243 NEUTRON ACER TENDL-2019 LIBRARY; T=293.16K
deuterons from (n,n*)d

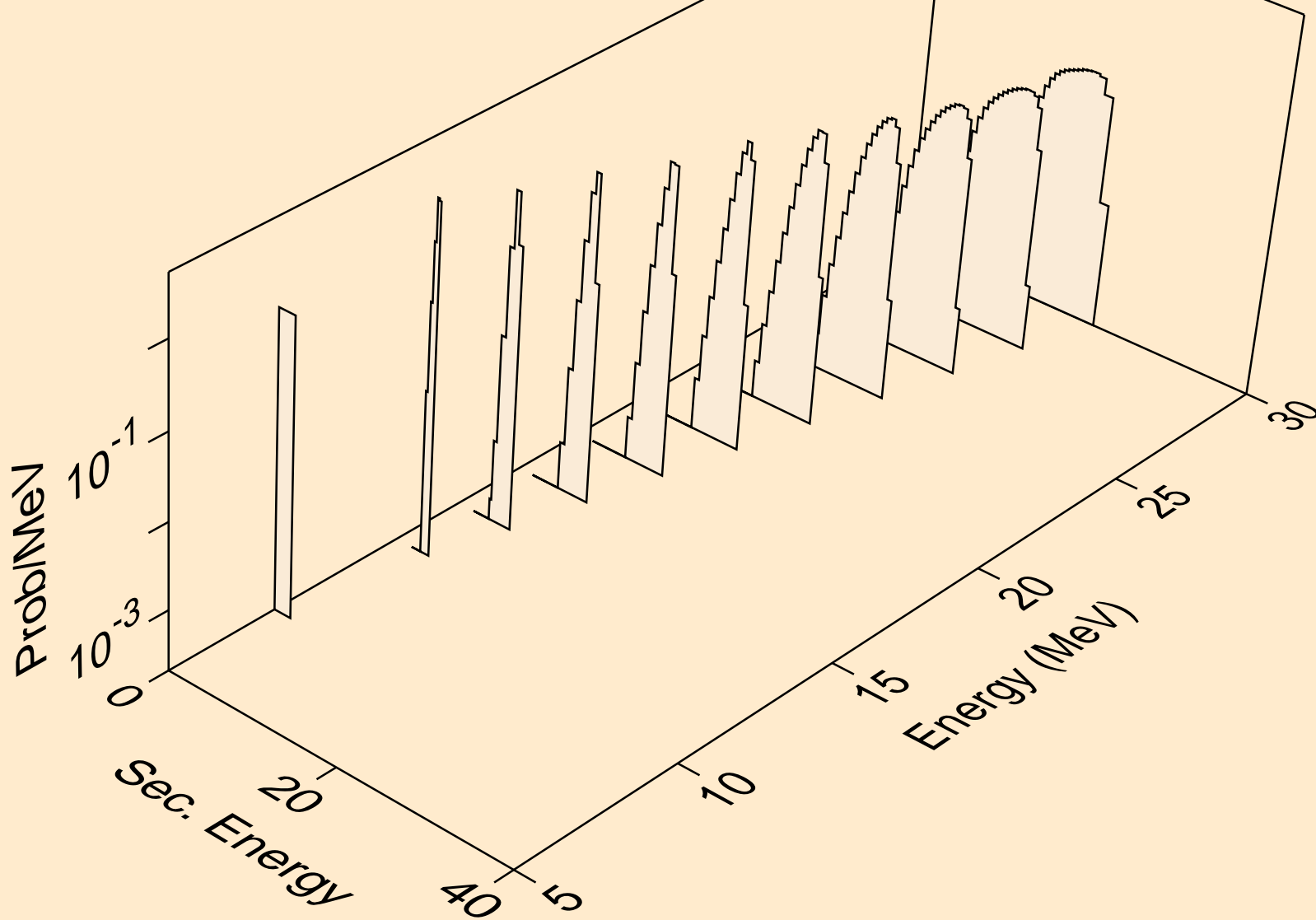

BK243 NEUTRON ACER TENDL-2019 LIBRARY; T=293.16K
deuterons from (n,d)

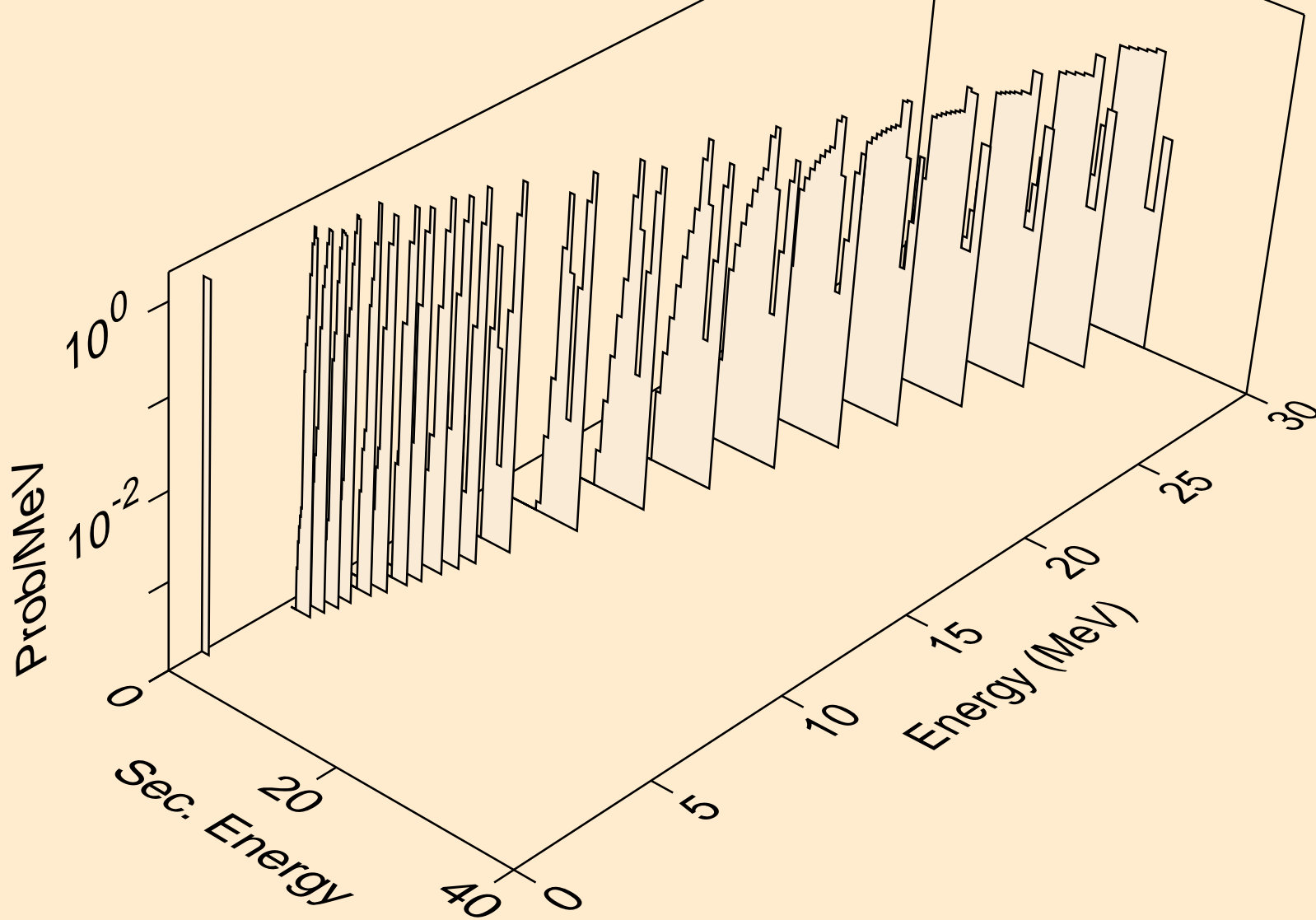

BK243 NEUTRON ACER TENDL-2019 LIBRARY; T=293.16K
deuterons from (n,pd)

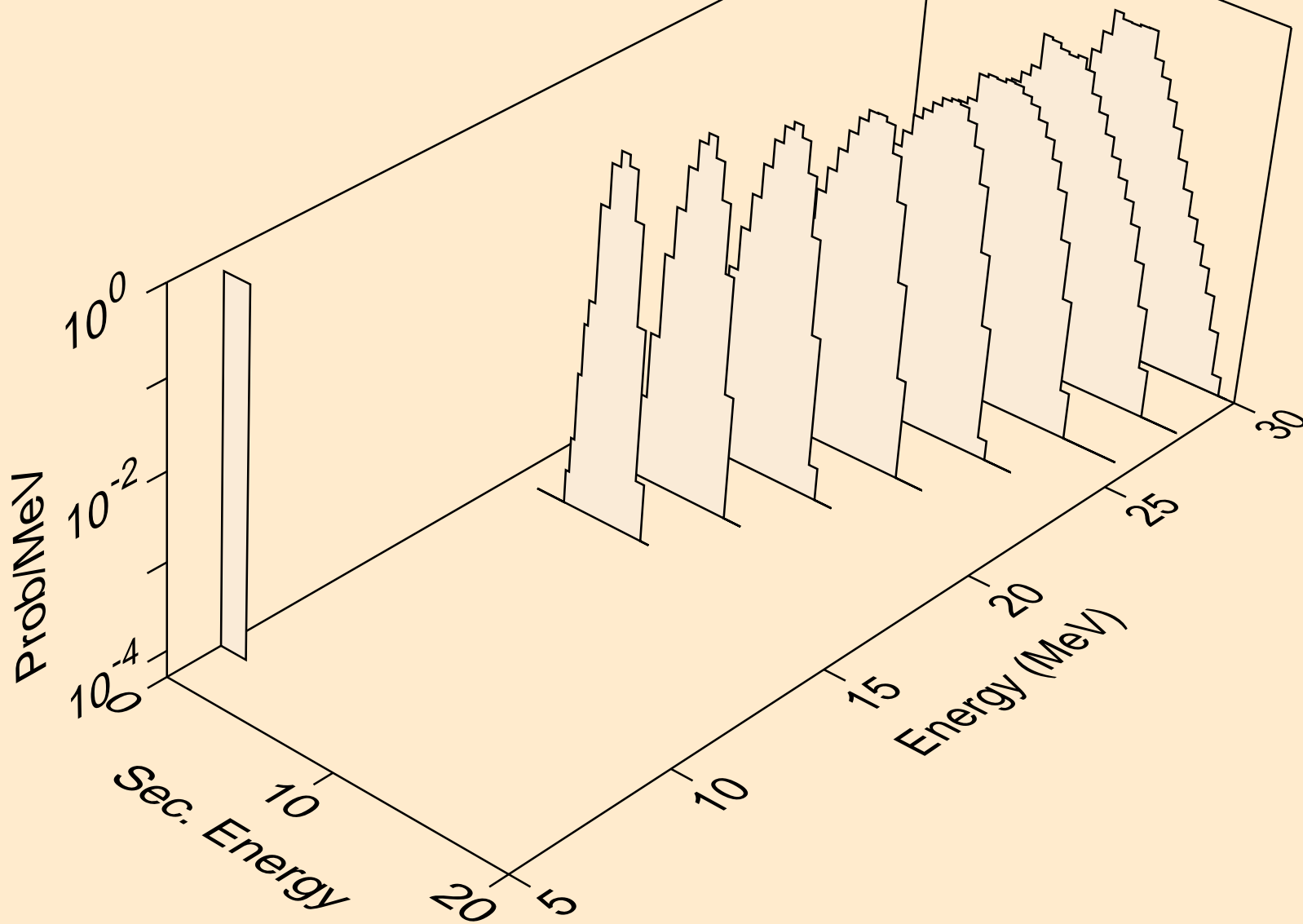

BK243 NEUTRON ACER TENDL-2019 LIBRARY; T=293.16K
deuterons from (n,da)

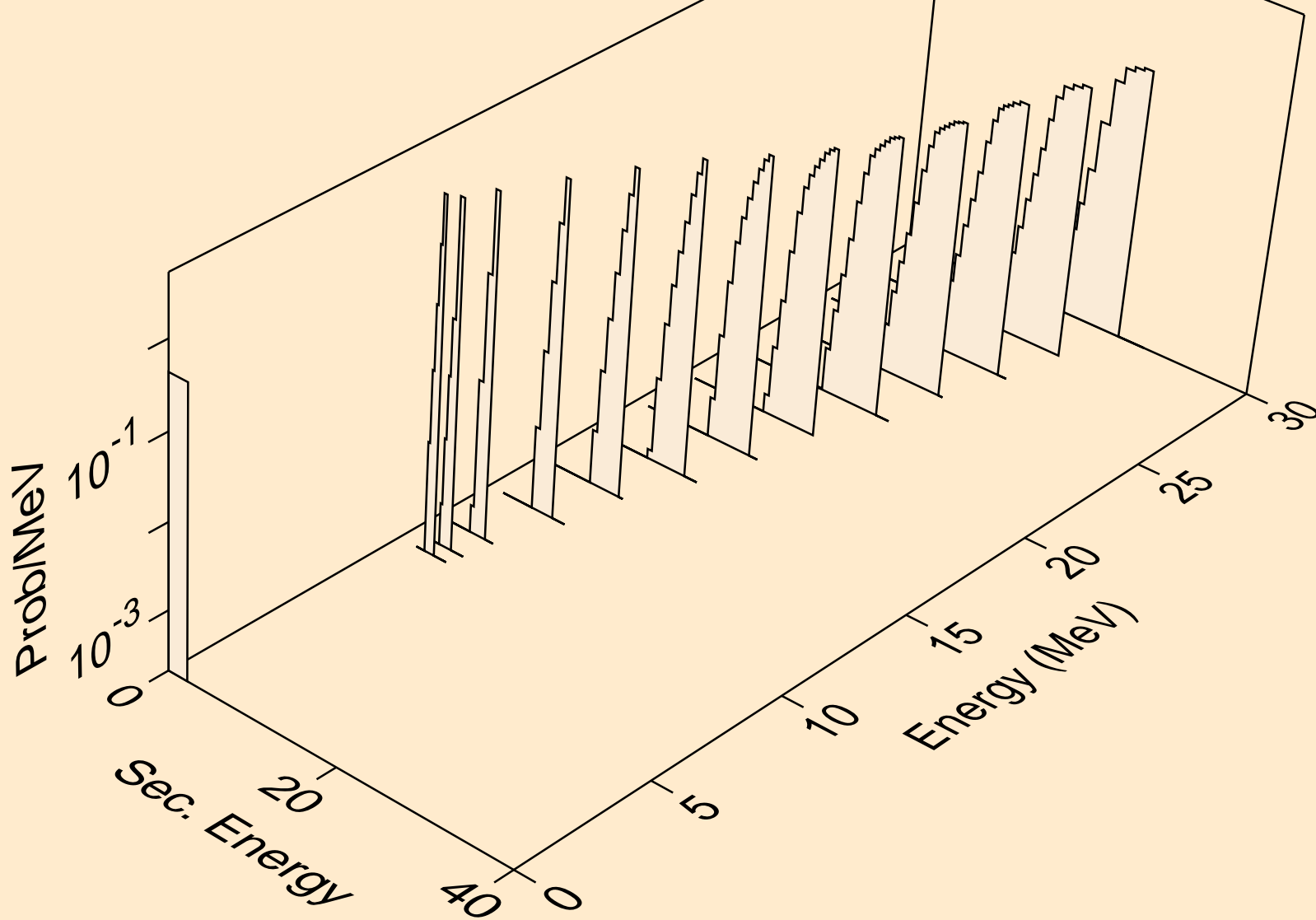

BK243 NEUTRON ACER TENDL-2019 LIBRARY; T=293.16K
tritons from (n,x)

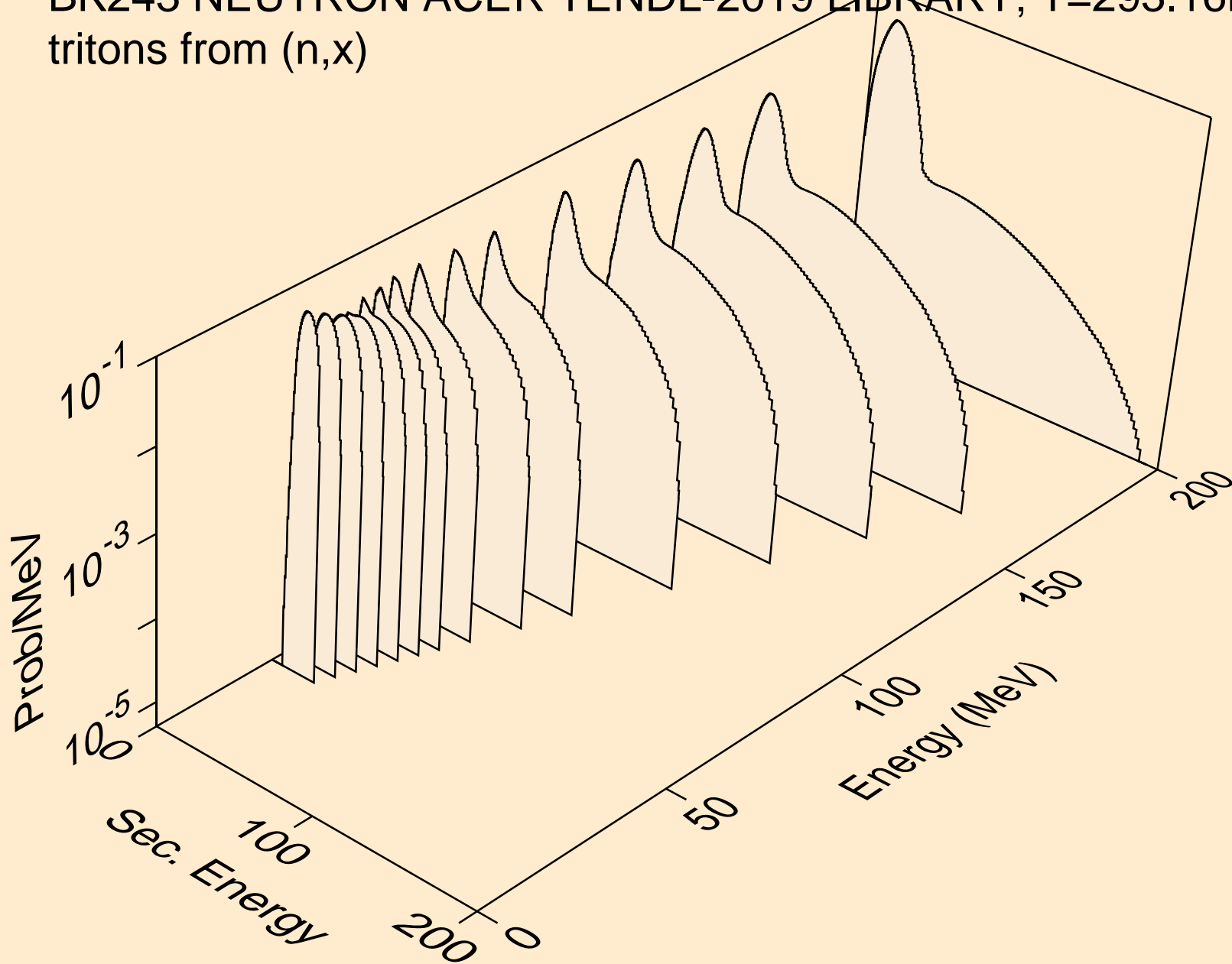

BK243 NEUTRON ACER TENDL-2019 LIBRARY; T=293.16K
tritons from (n,n*)t

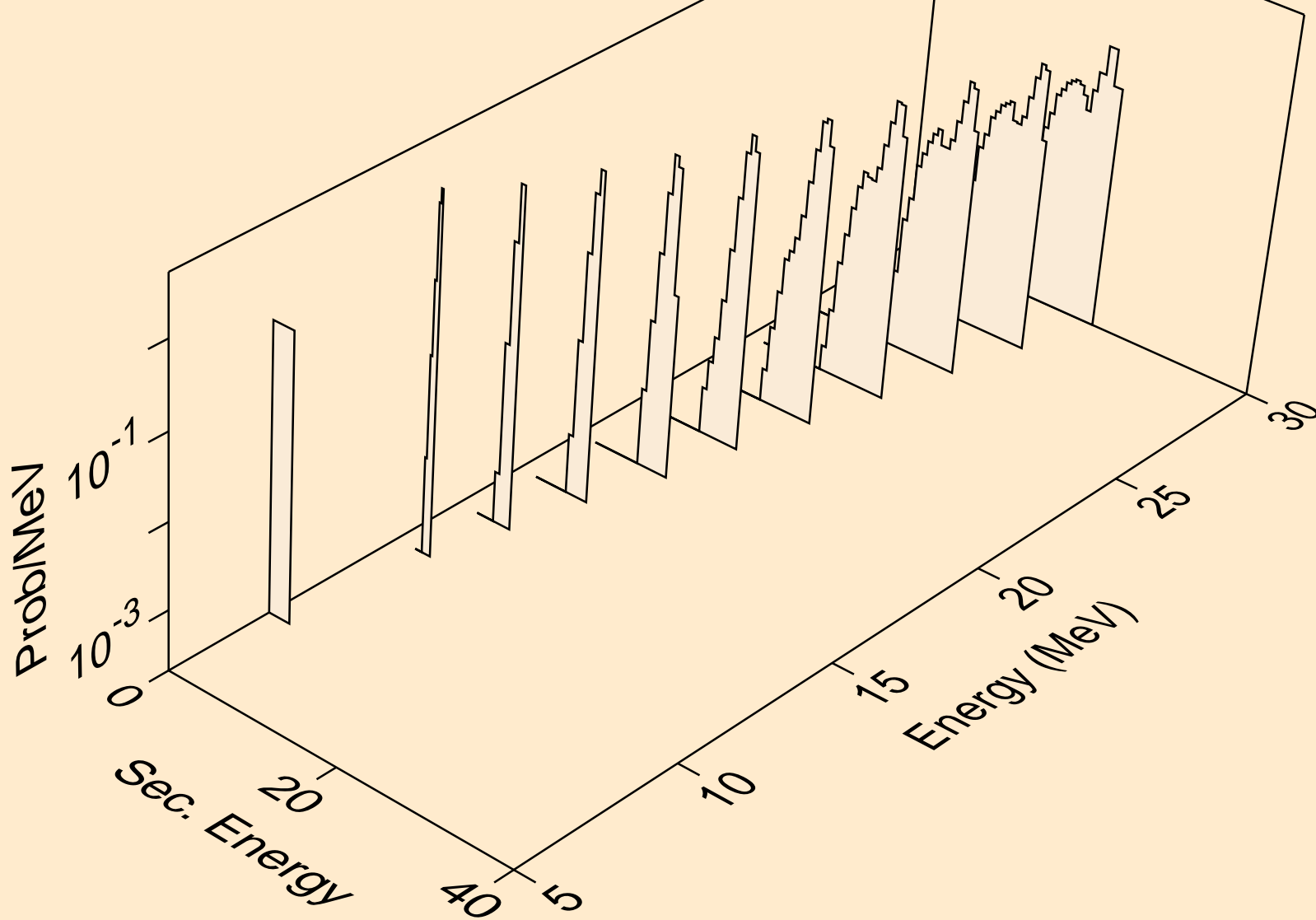

BK243 NEUTRON ACER TENDL-2019 LIBRARY; T=293.16K
tritons from (n,t)

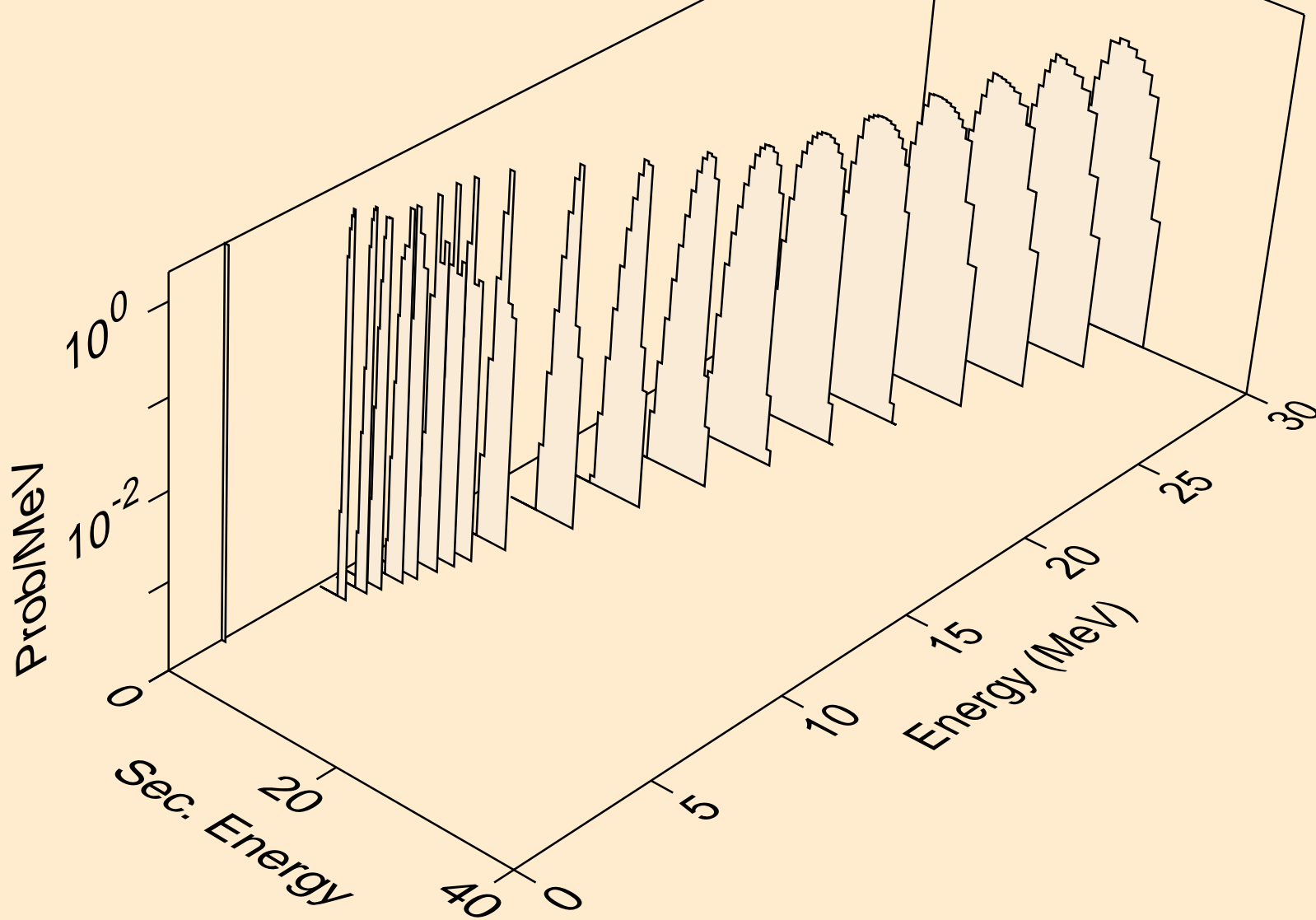

BK243 NEUTRON ACER TENDL-2019 LIBRARY; T=293.16K
tritons from (n,pt)

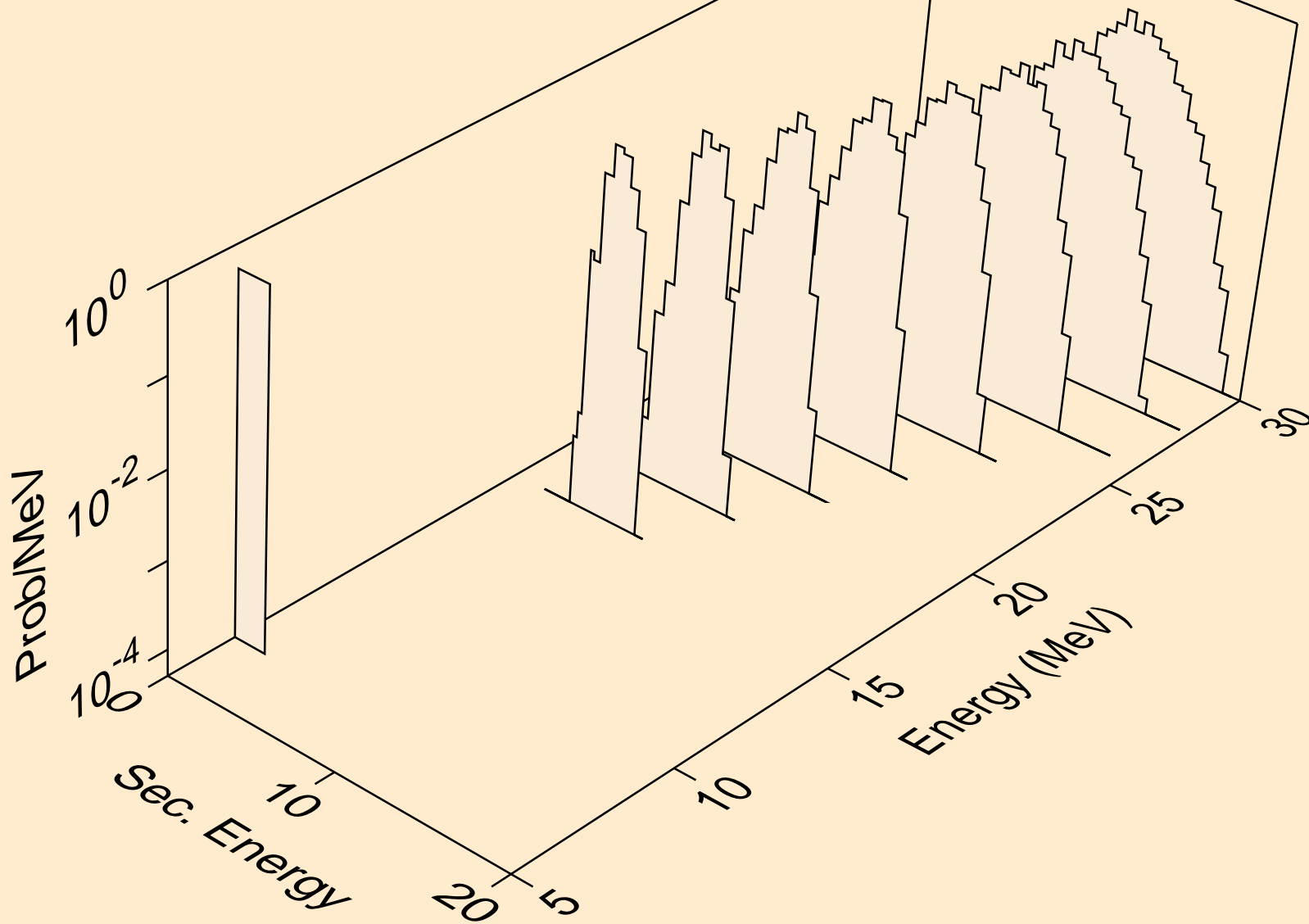

BK243 NEUTRON ACER TENDL-2019 LIBRARY; T=293.16K
he3s from (n,x)

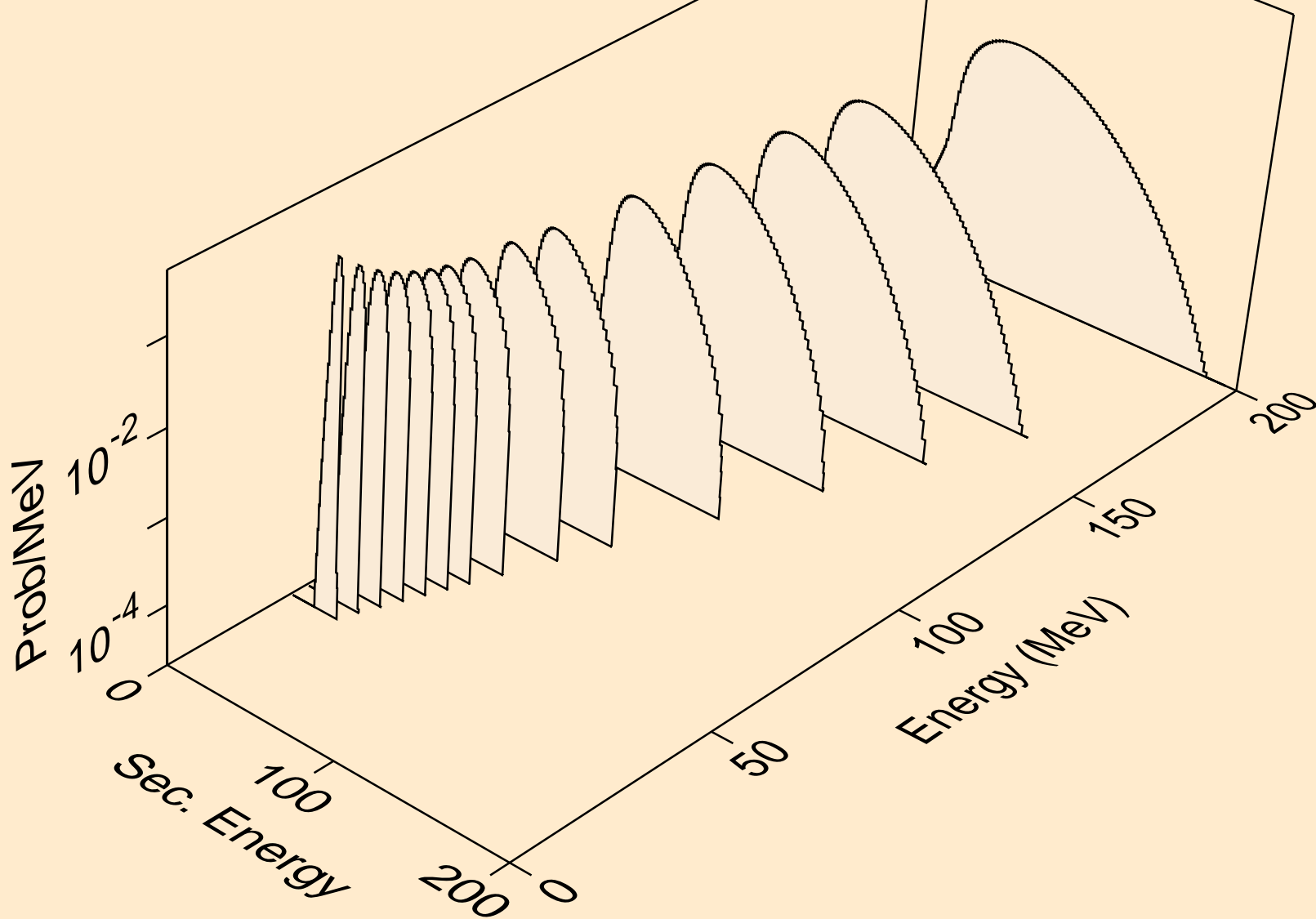

BK243 NEUTRON ACER TENDL-2019 LIBRARY; T=293.16K
he3s from (n,n*)he3

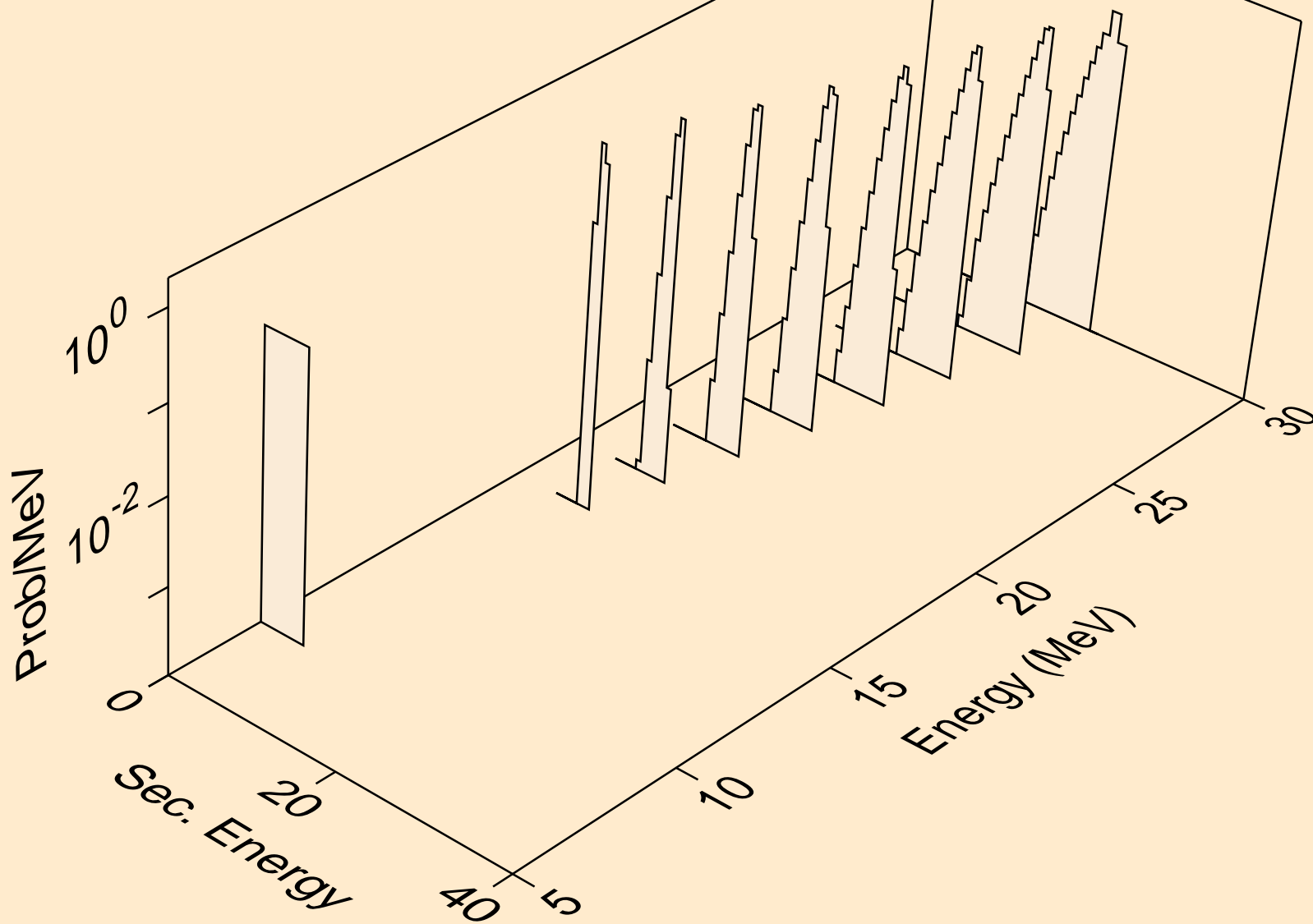

BK243 NEUTRON ACER TENDL-2019 LIBRARY; T=293.16K
he3s from (n,he3)

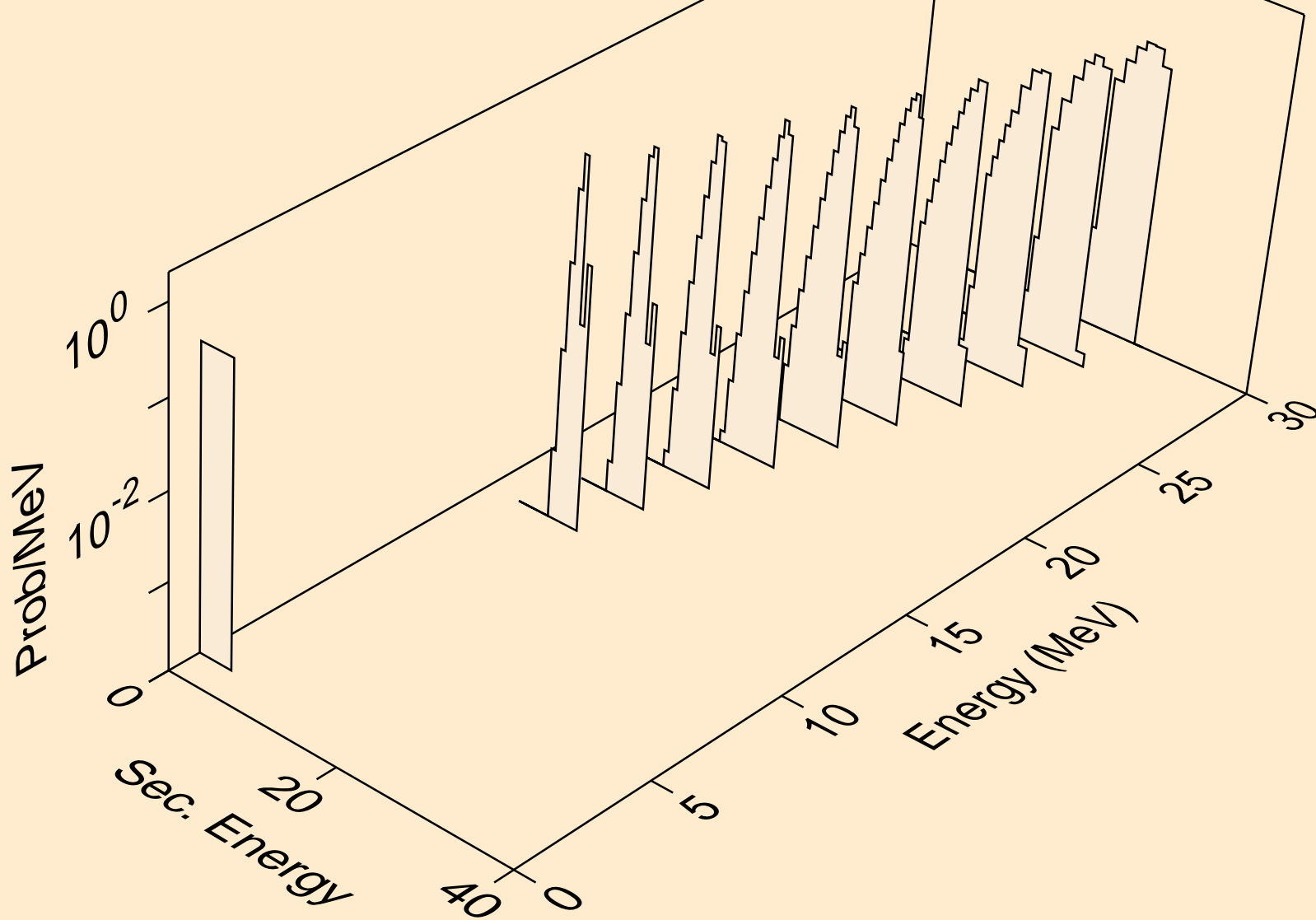

BK243 NEUTRON ACER TENDL-2019 LIBRARY; T=293.16K
alphas from (n,x)

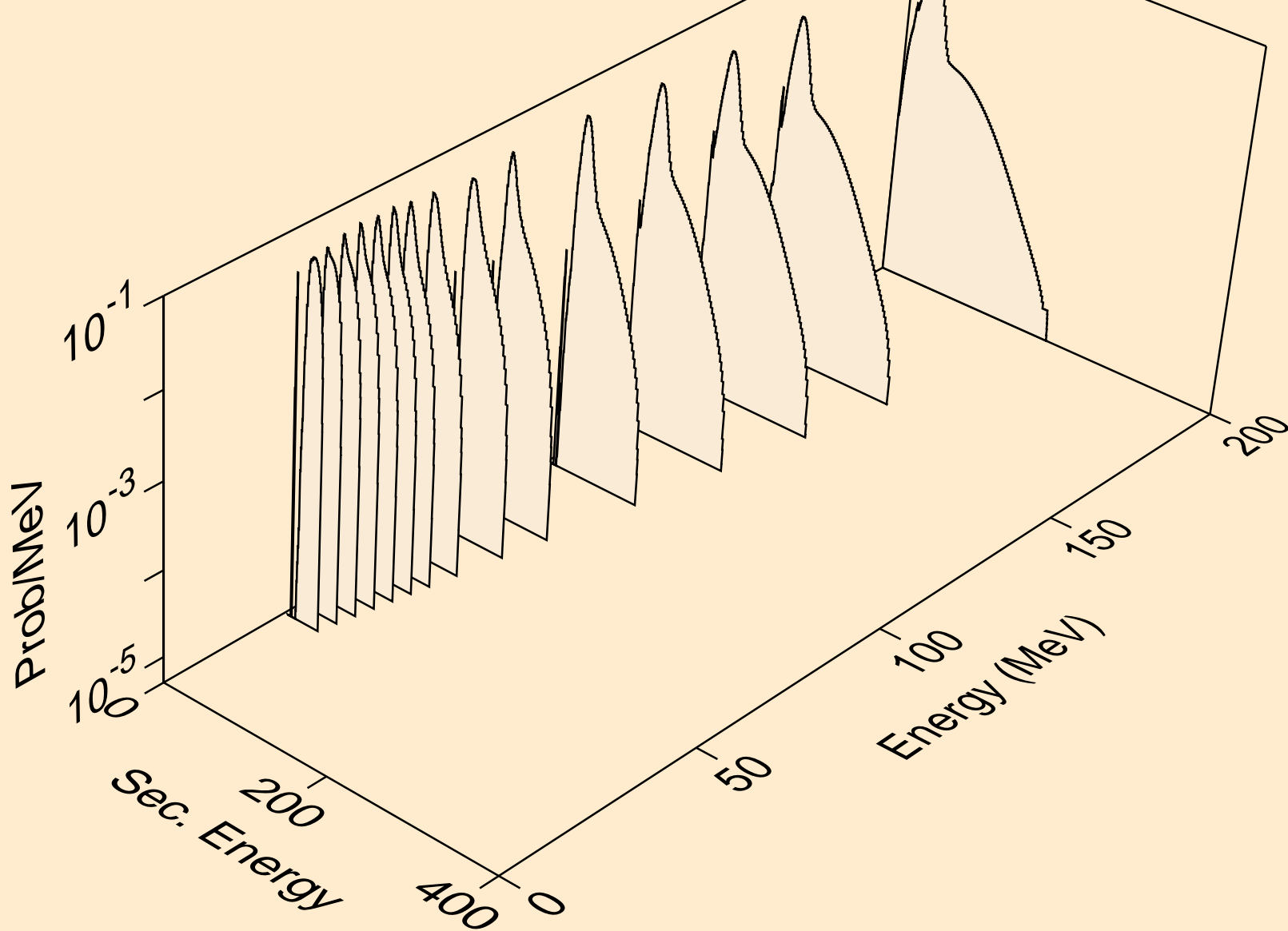

BK243 NEUTRON ACER TENDL-2019 LIBRARY; T=293.16K
alphas from (n,n*)a

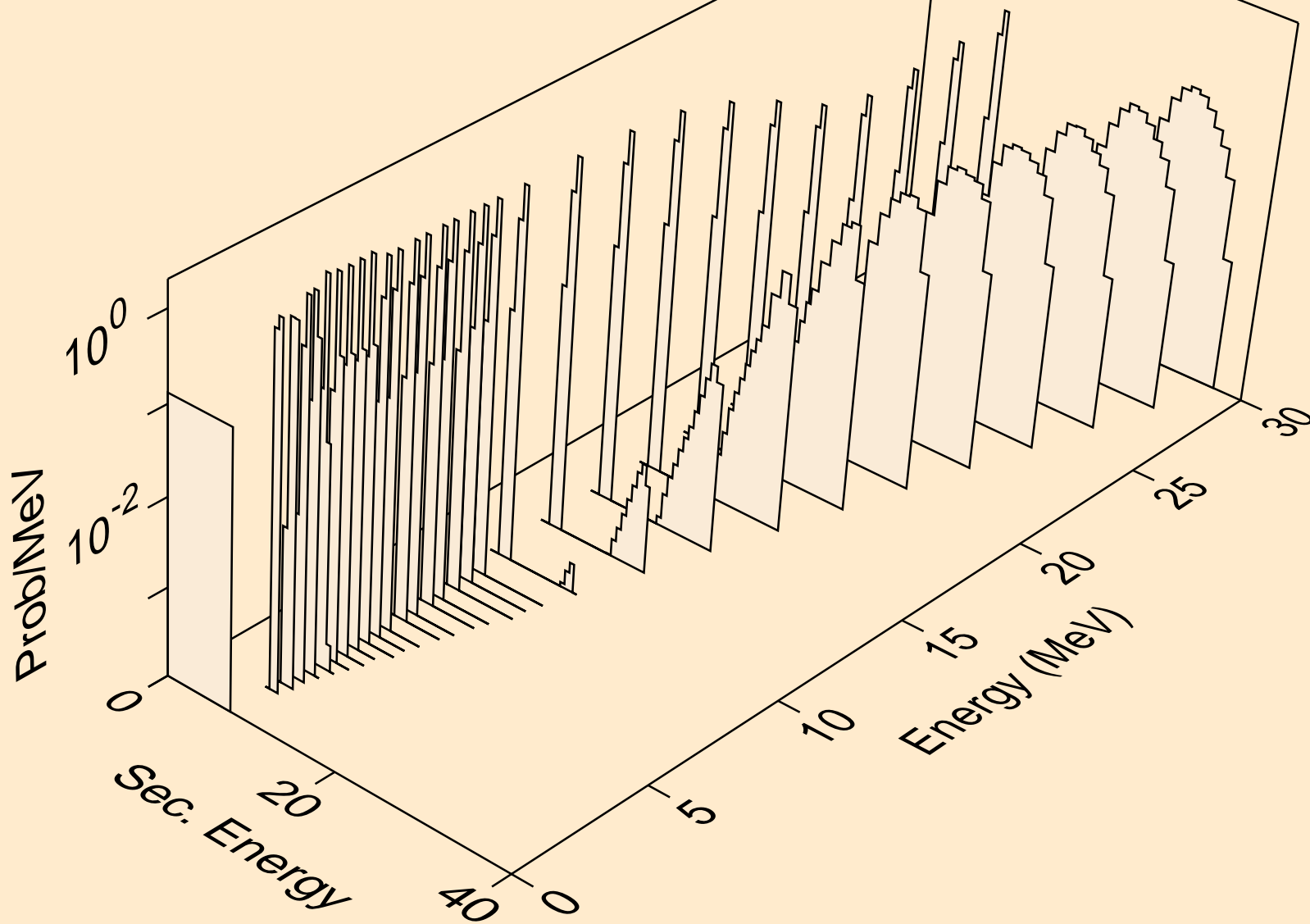

BK243 NEUTRON ACER TENDL-2019 LIBRARY; T=293.16K
alphas from (n,2n)a

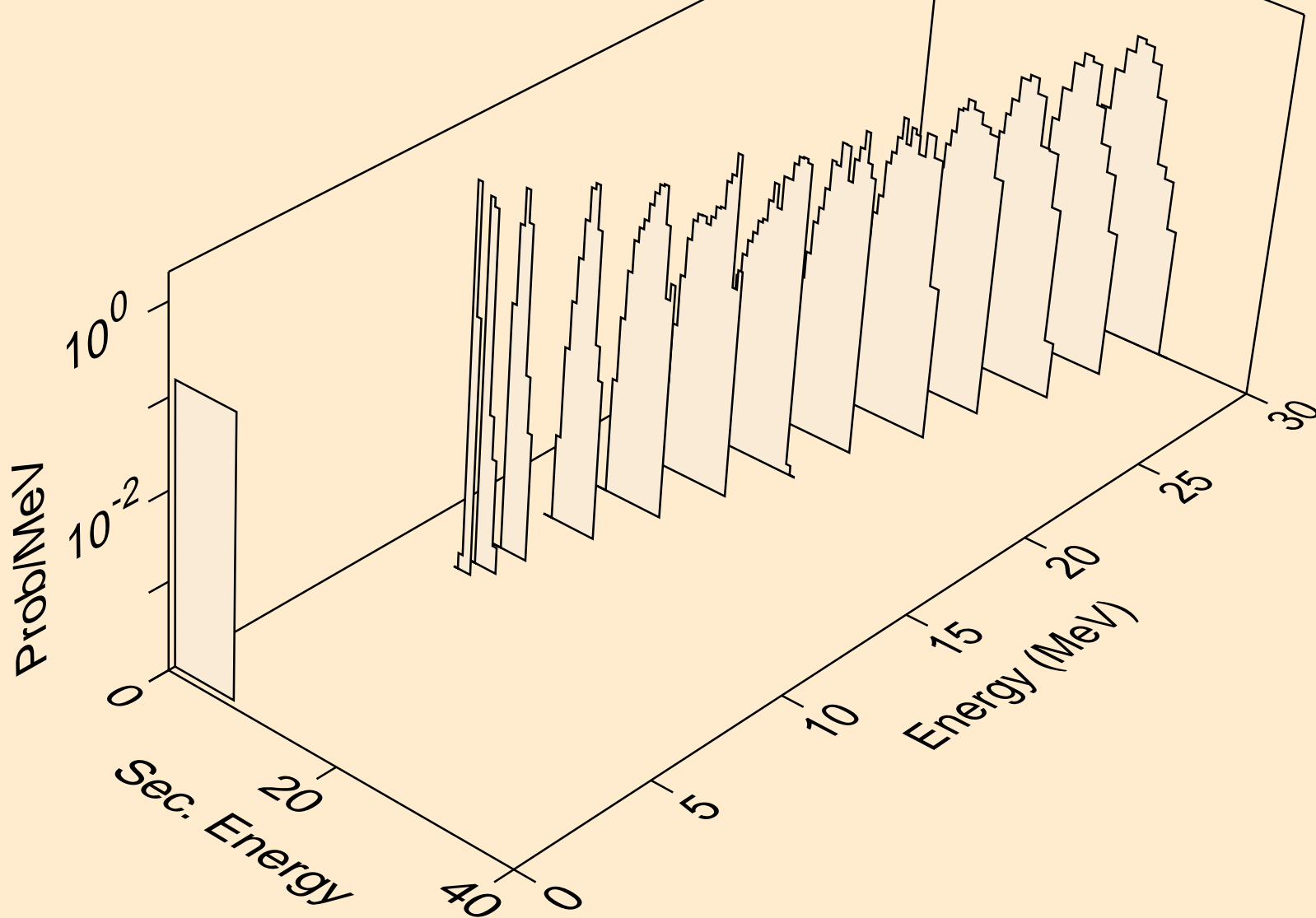

BK243 NEUTRON ACER TENDL-2019 LIBRARY; T=293.16K
alphas from (n,3n)a

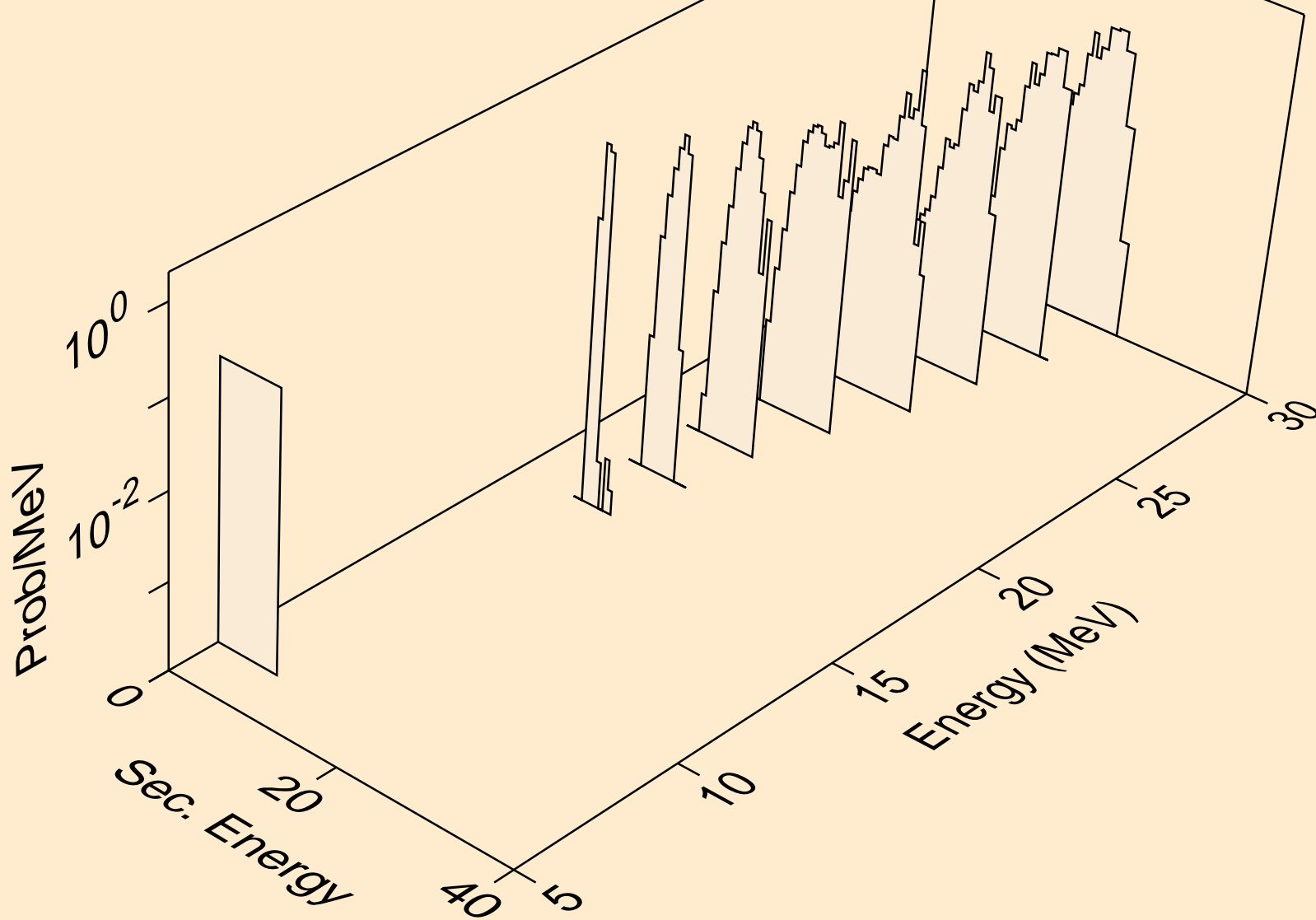

BK243 NEUTRON ACER TENDL-2019 LIBRARY; T=293.16K
alphas from (n,n*)2a

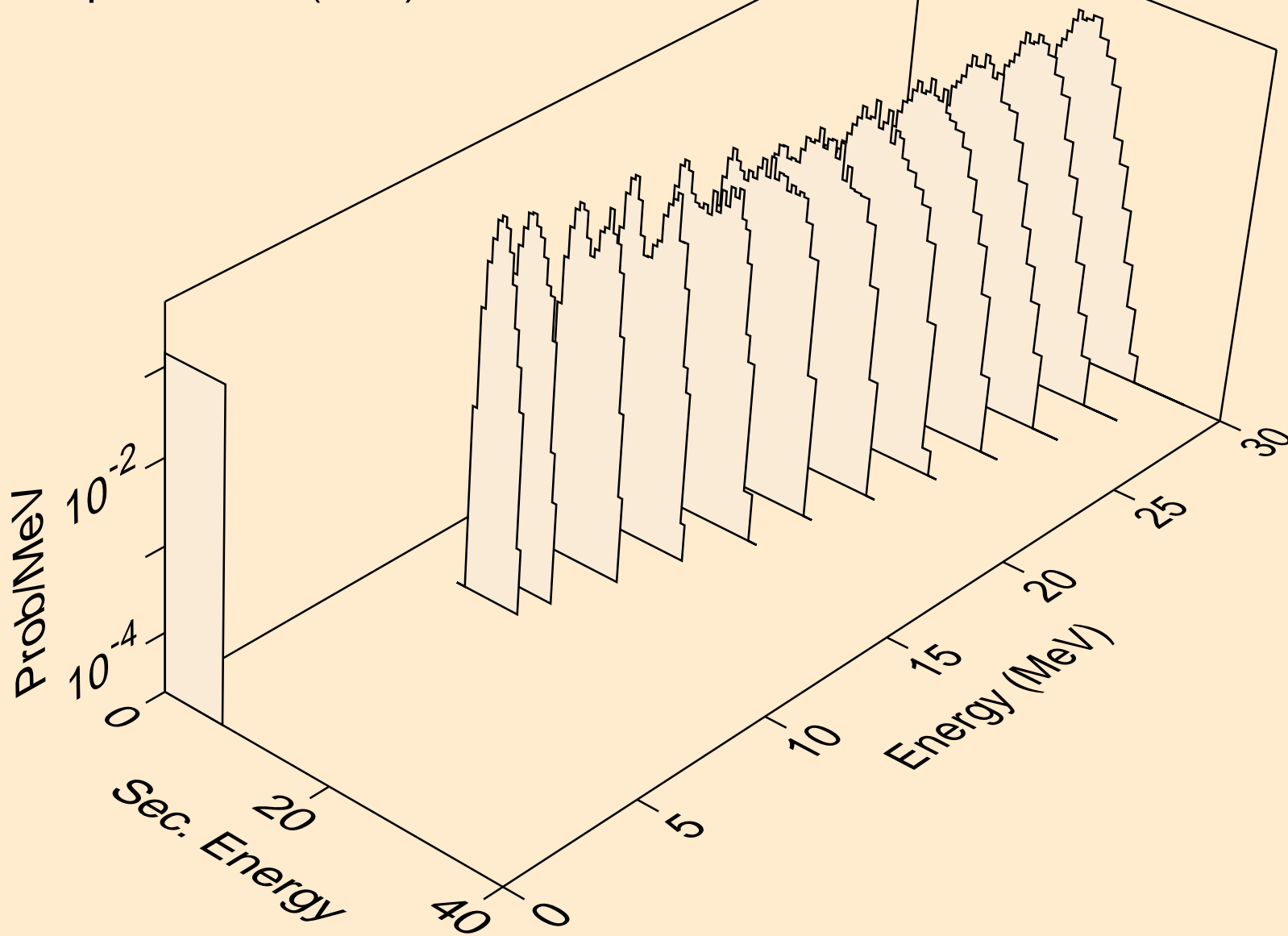

BK243 NEUTRON ACER TENDL-2019 LIBRARY; T=293.16K
alphas from (n,npa)

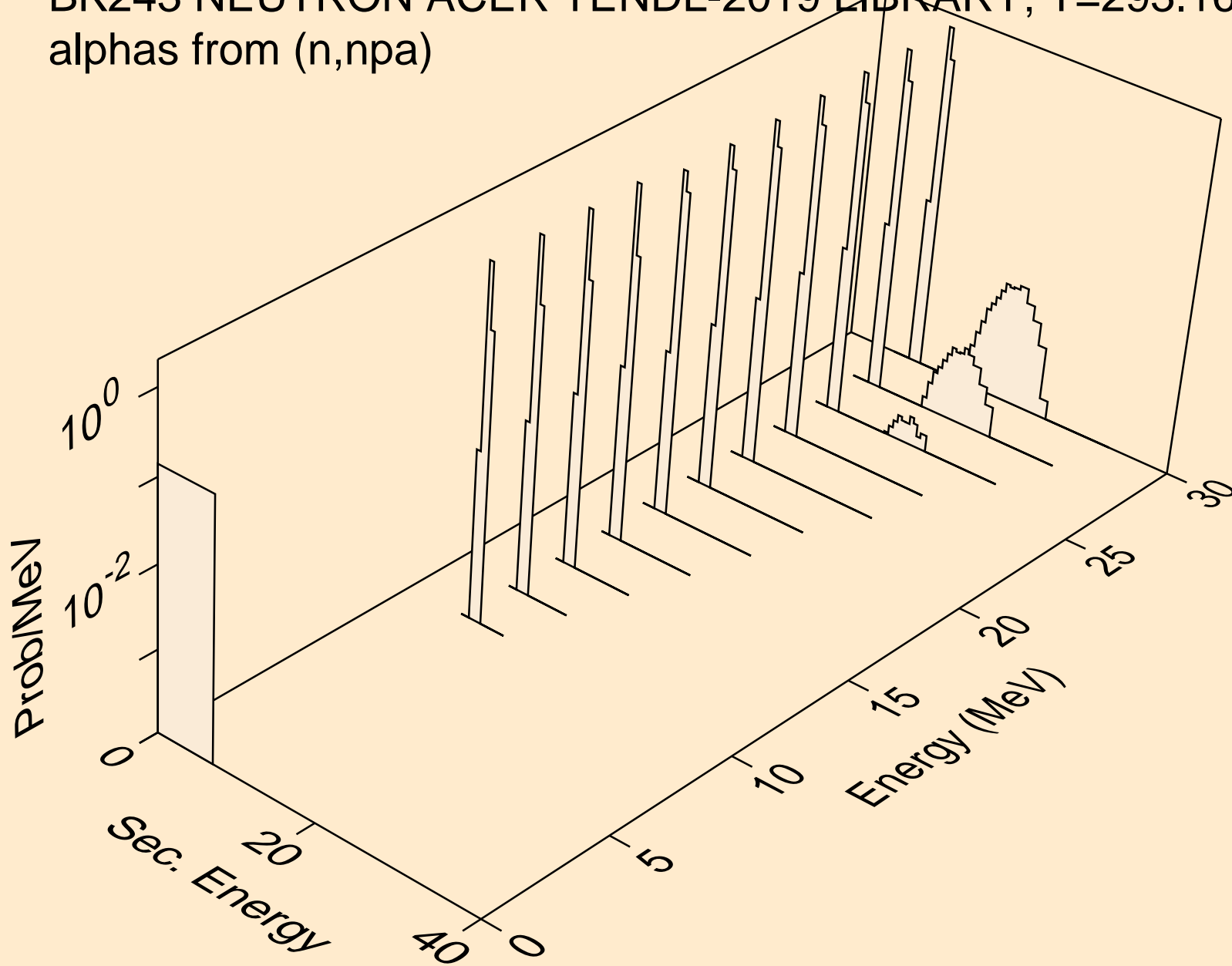

BK243 NEUTRON ACER TENDL-2019 LIBRARY; T=293.16K
alphas from (n,a)

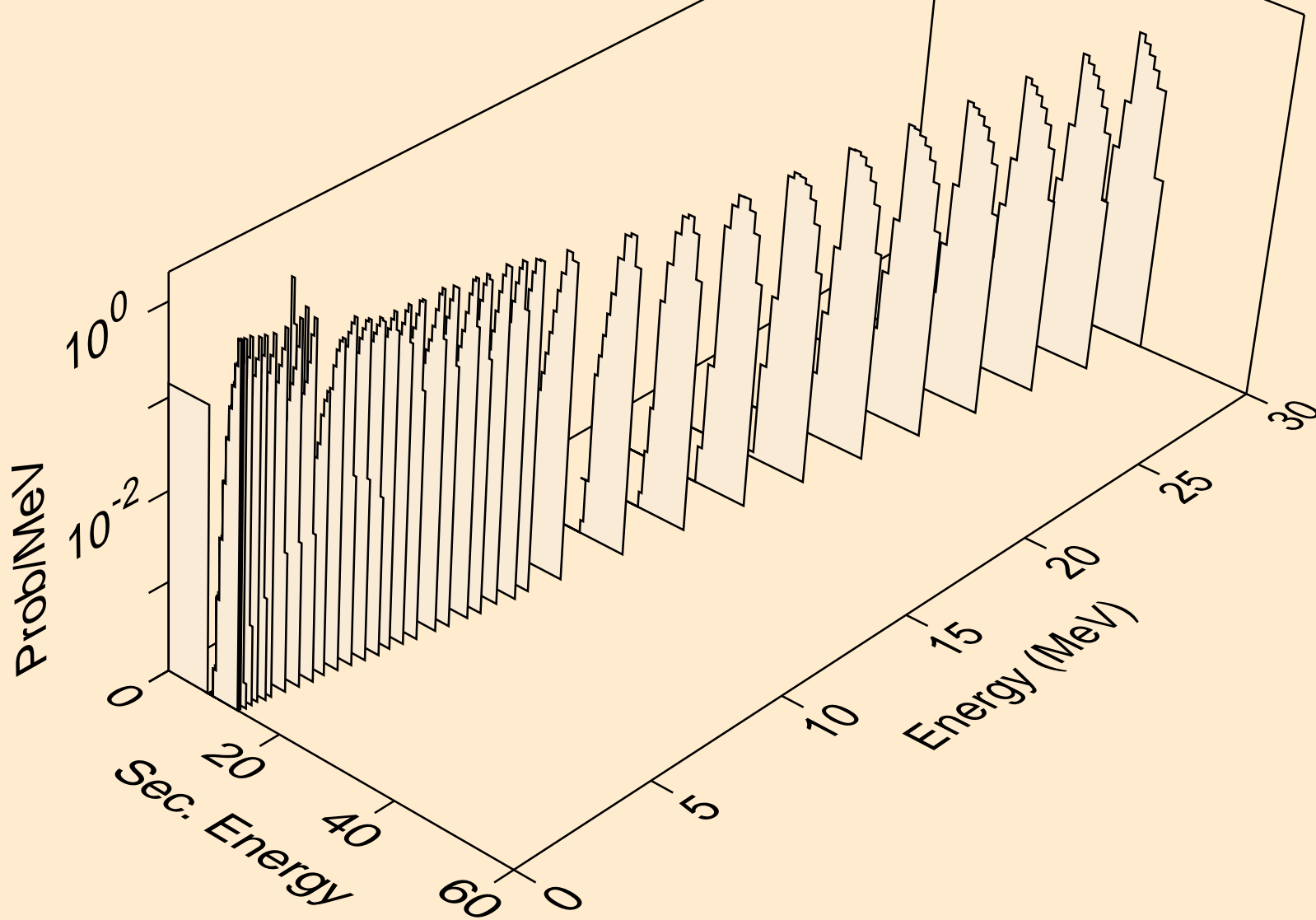

BK243 NEUTRON ACER TENDL-2019 LIBRARY; T=293.16K
alphas from (n,2a)

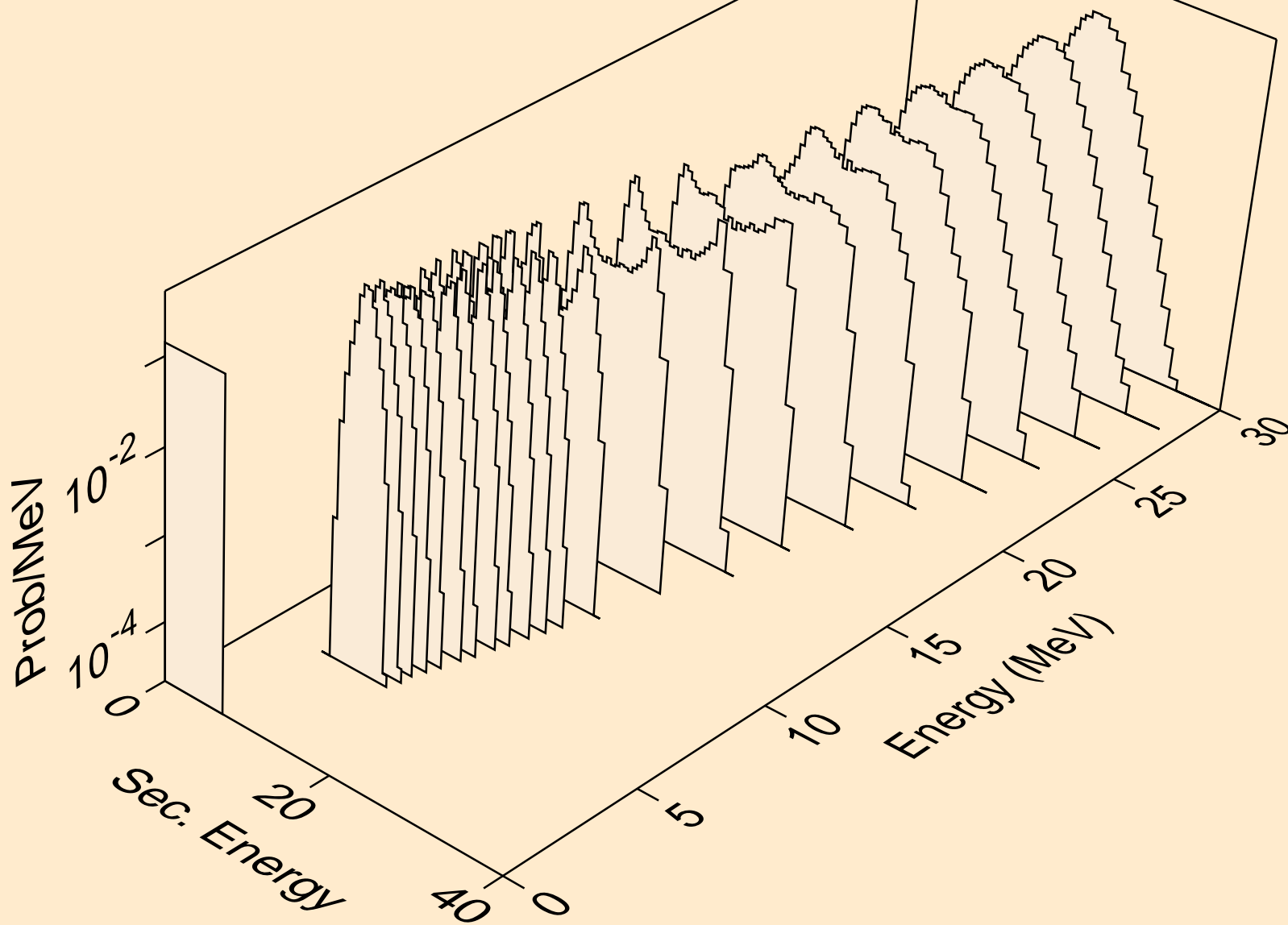

BK243 NEUTRON ACER TENDL-2019 LIBRARY; T=293.16K
alphas from (n,p)

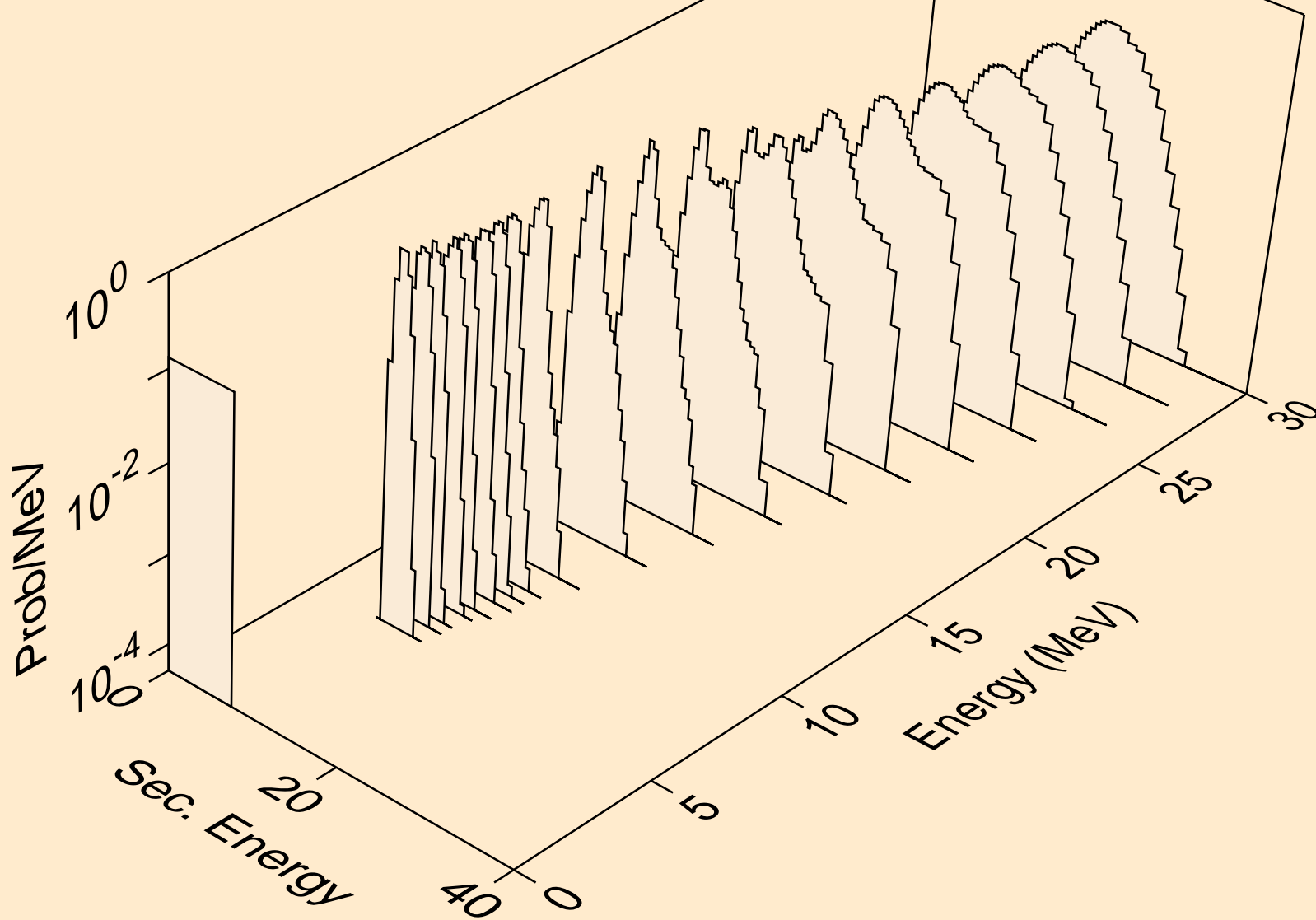

BK243 NEUTRON ACER TENDL-2019 LIBRARY; T=293.16K
alphas from (n,da)

