

CE122 NEUTRON ACER TENDL-2019 LIBRARY; T=293.16K

Principal cross sections

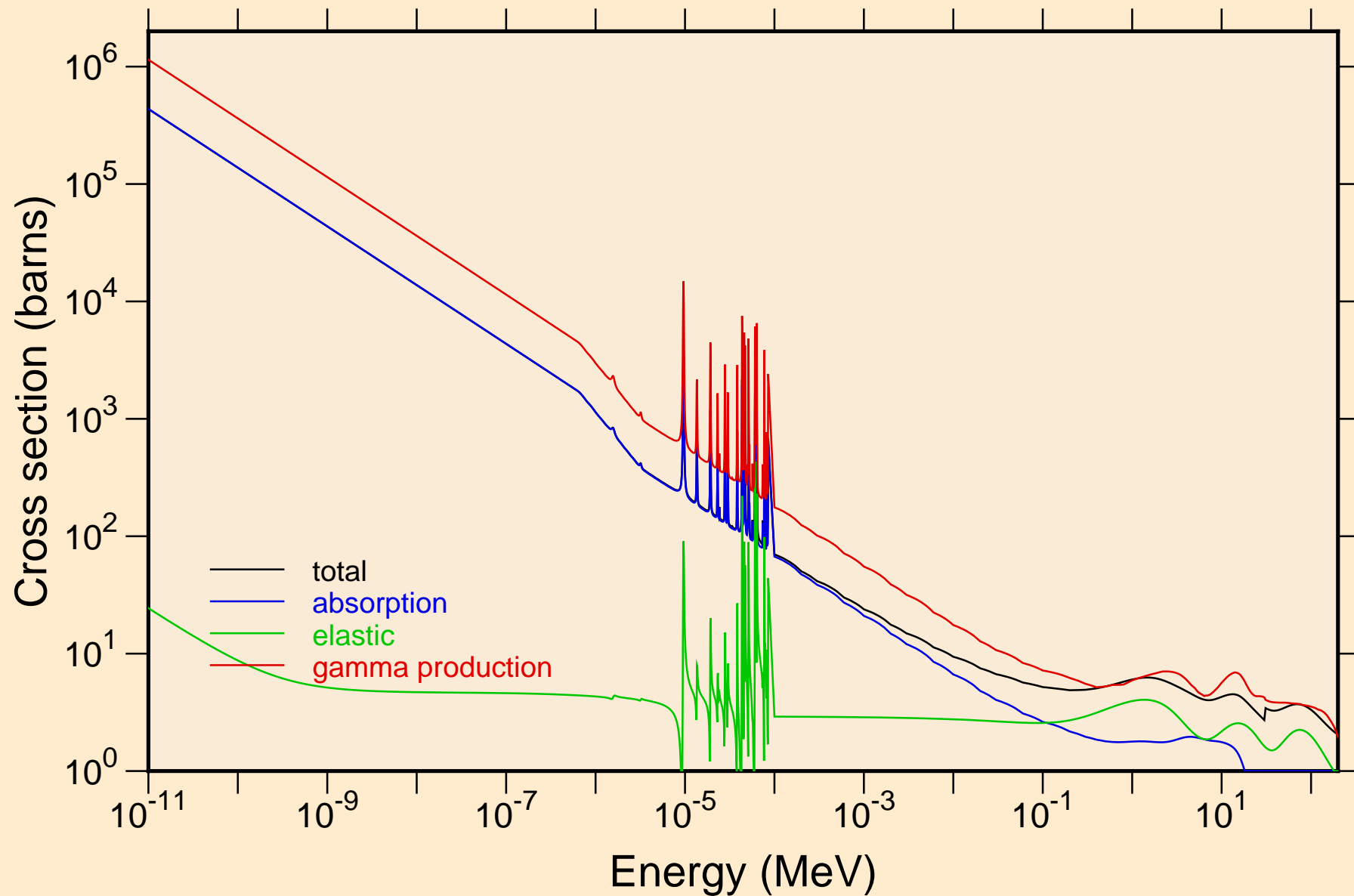

CE122 NEUTRON ACER TENDL-2019 LIBRARY; T=293.16K
resonance total cross section

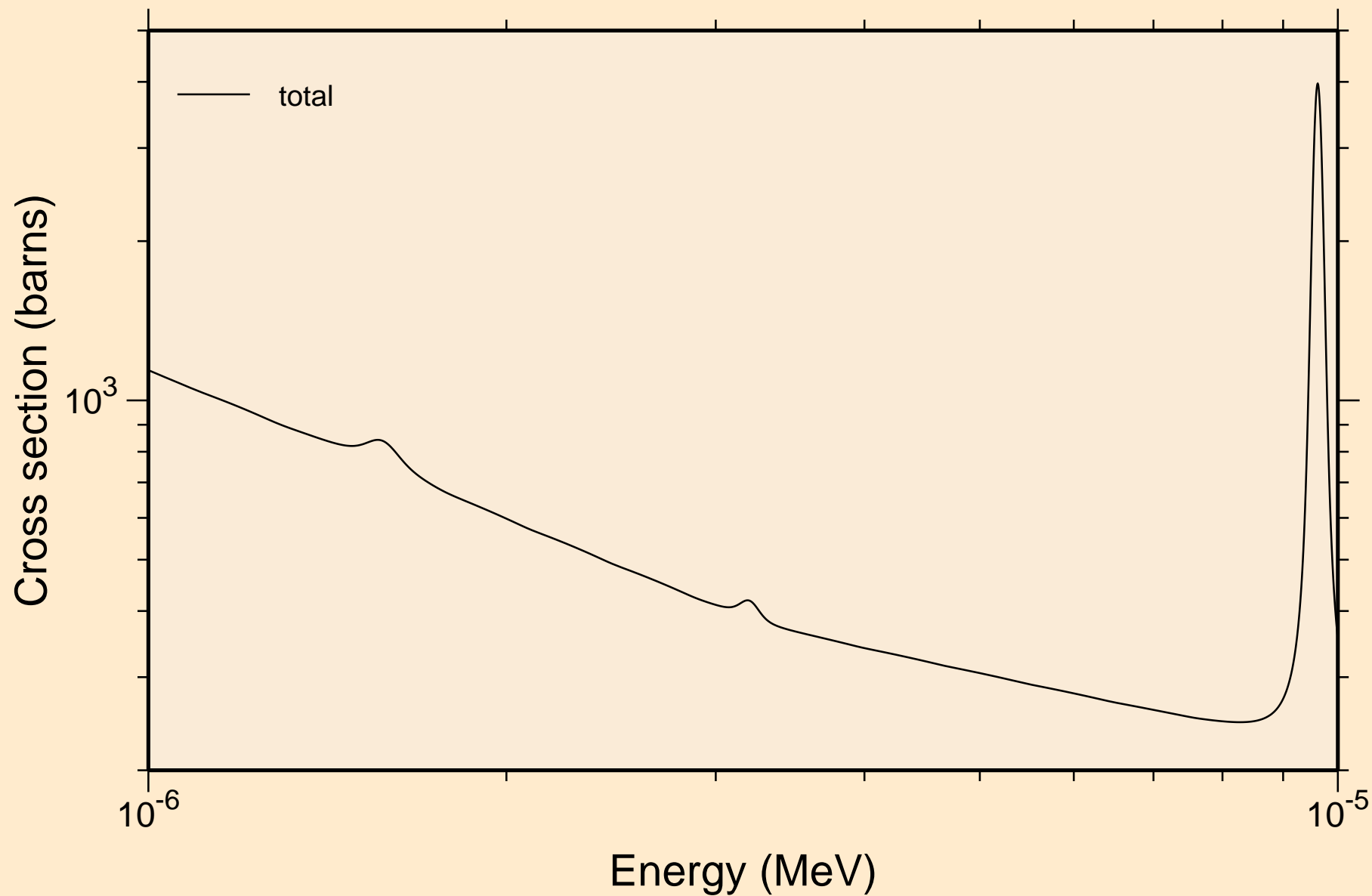

CE122 NEUTRON ACER TENDL-2019 LIBRARY; T=293.16K
resonance total cross section

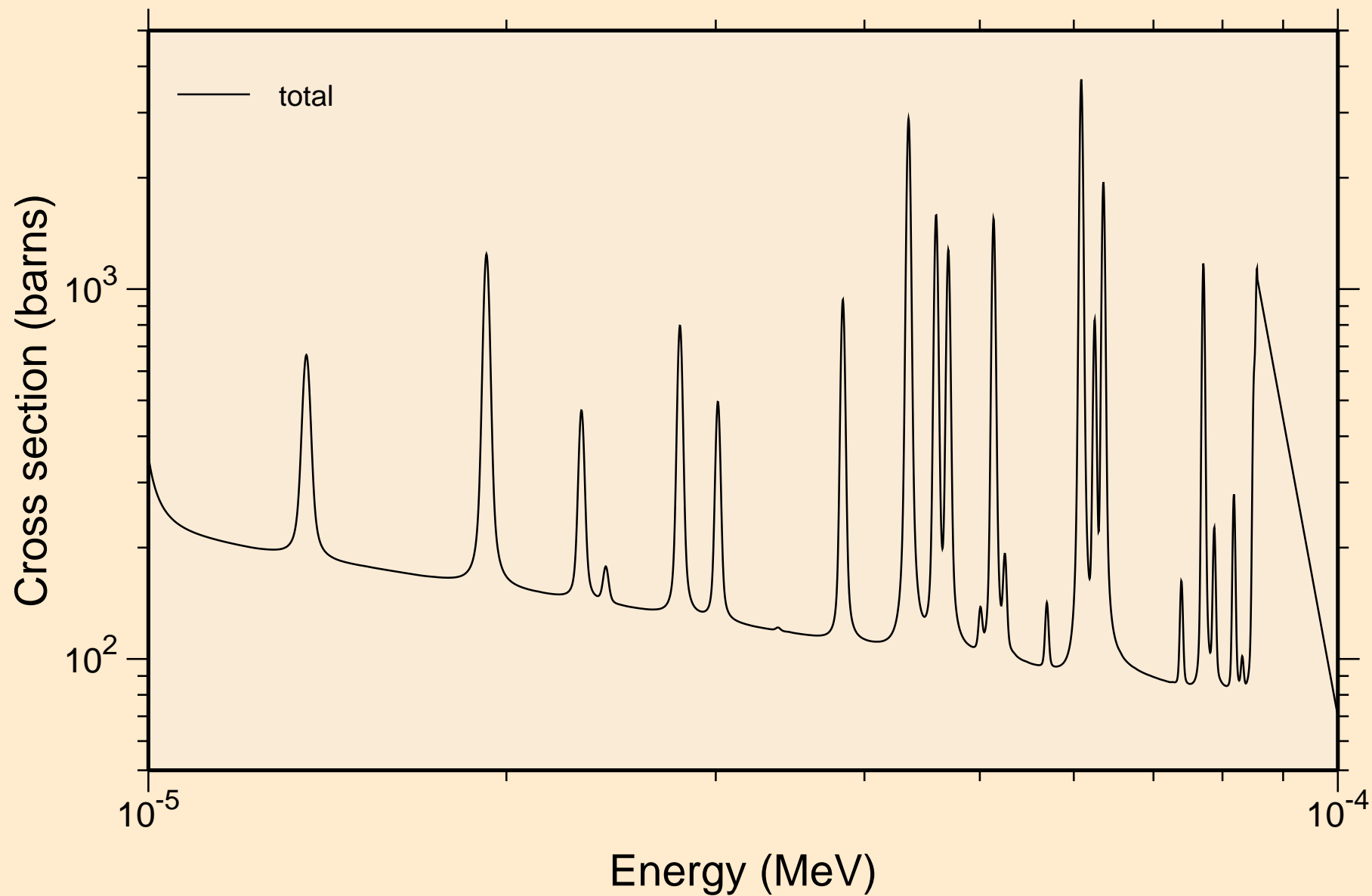

CE122 NEUTRON ACER TENDL-2019 LIBRARY; T=293.16K
resonance total cross section

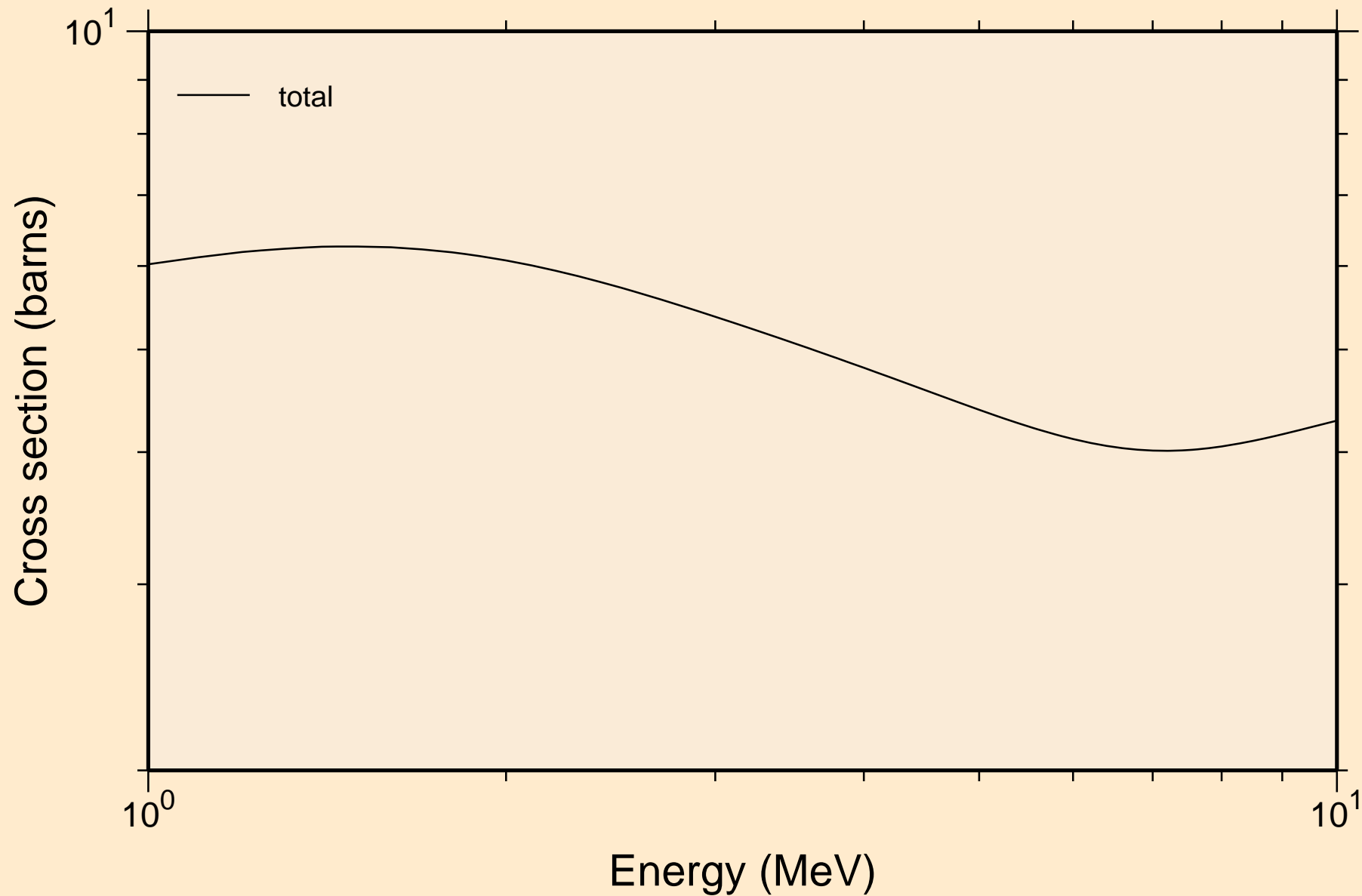

CE122 NEUTRON ACER TENDL-2019 LIBRARY; T=293.16K
resonance absorption cross sections

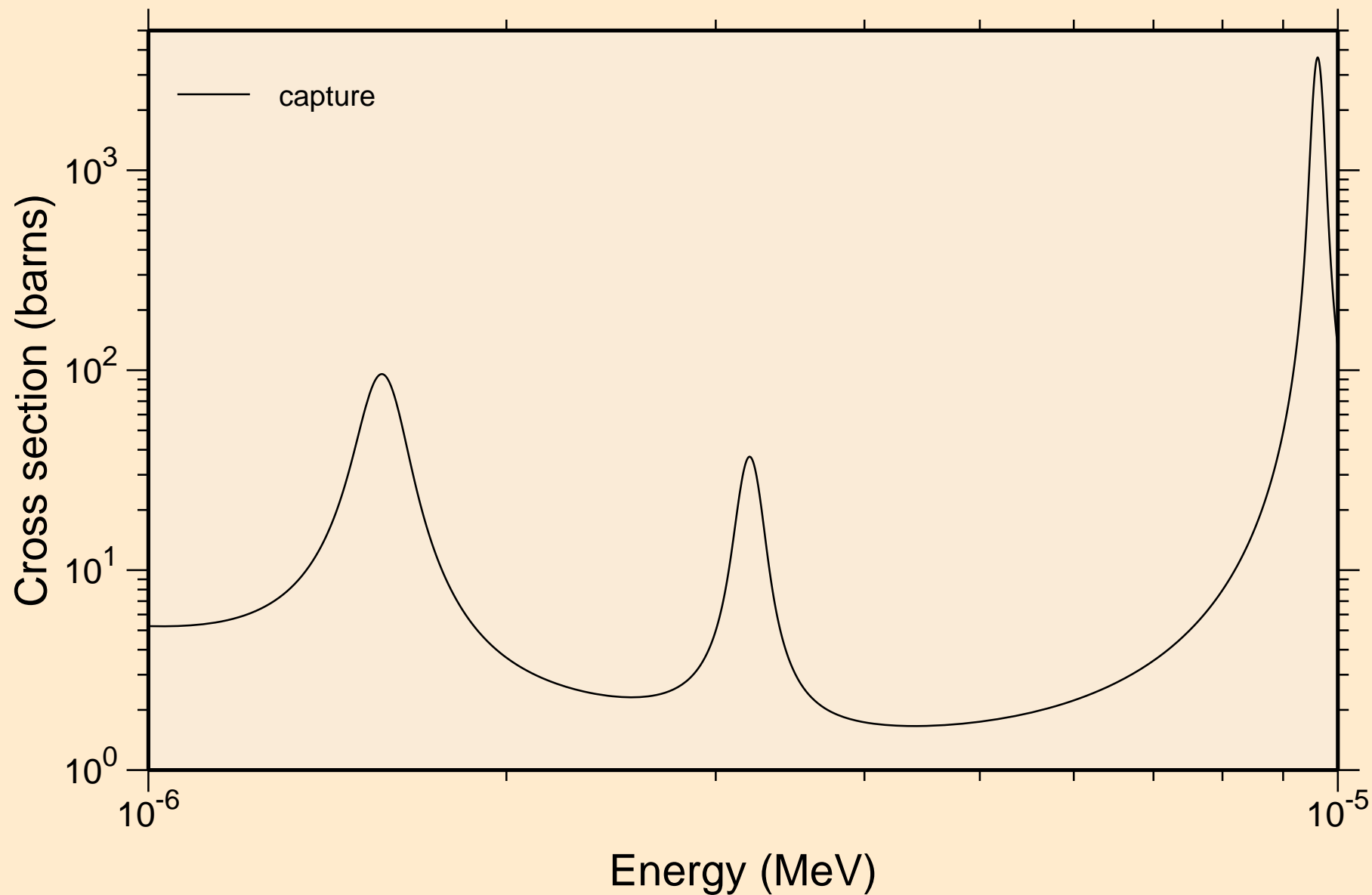

CE122 NEUTRON ACER TENDL-2019 LIBRARY; T=293.16K
resonance absorption cross sections

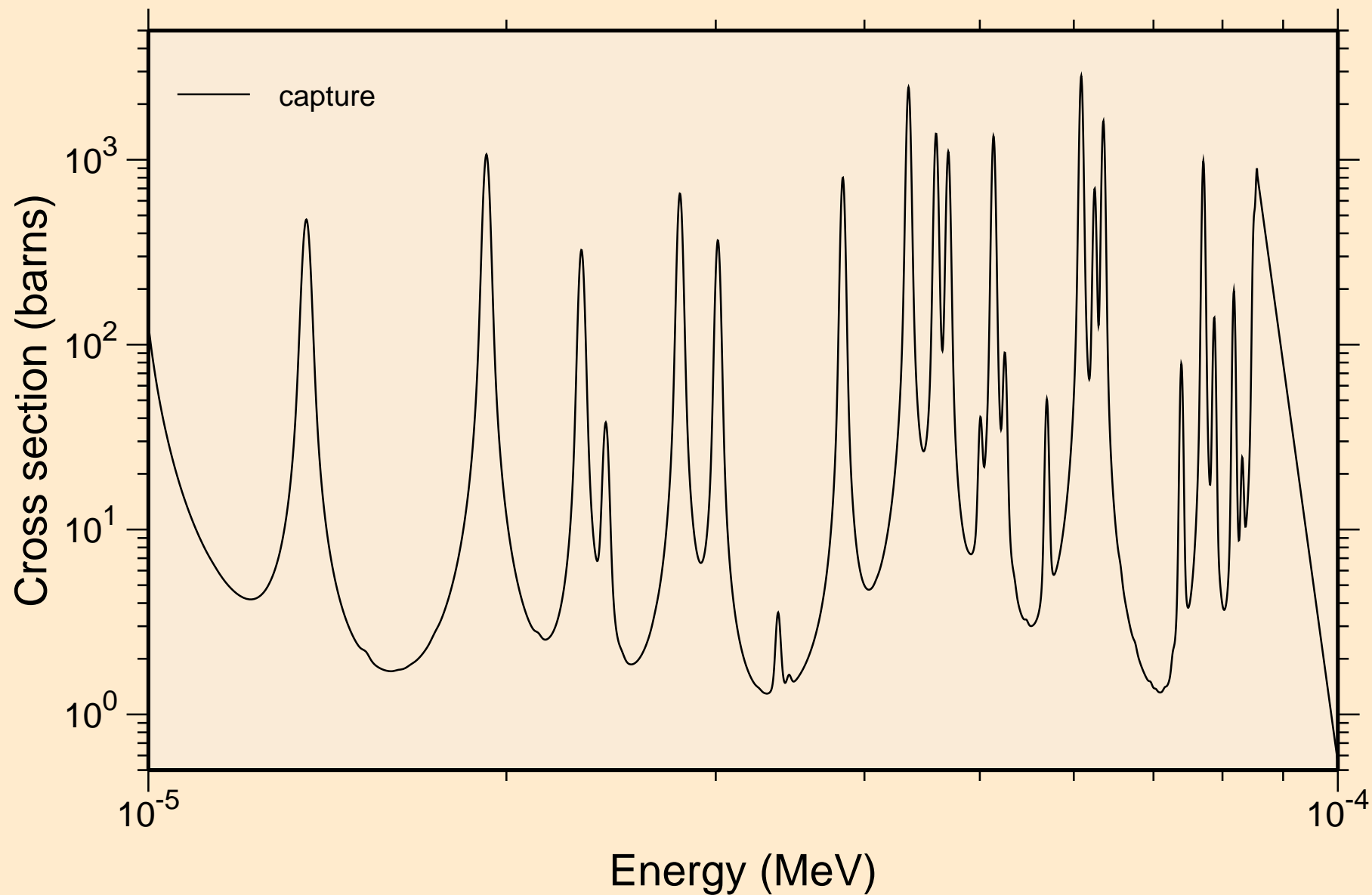

CE122 NEUTRON ACER TENDL-2019 LIBRARY; T=293.16K
resonance absorption cross sections

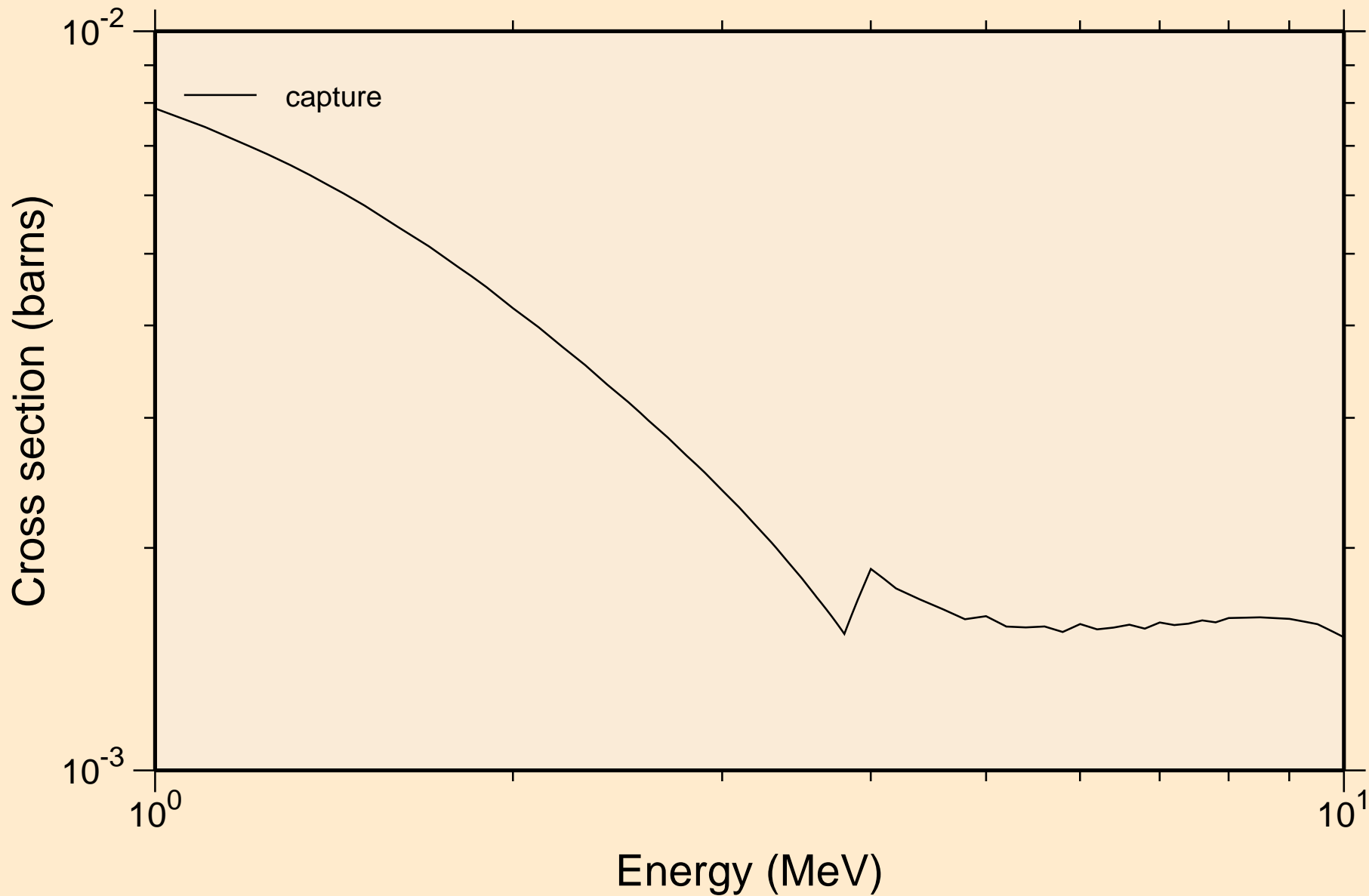

CE122 NEUTRON ACER TENDL-2019 LIBRARY; T=293.16K
Heating

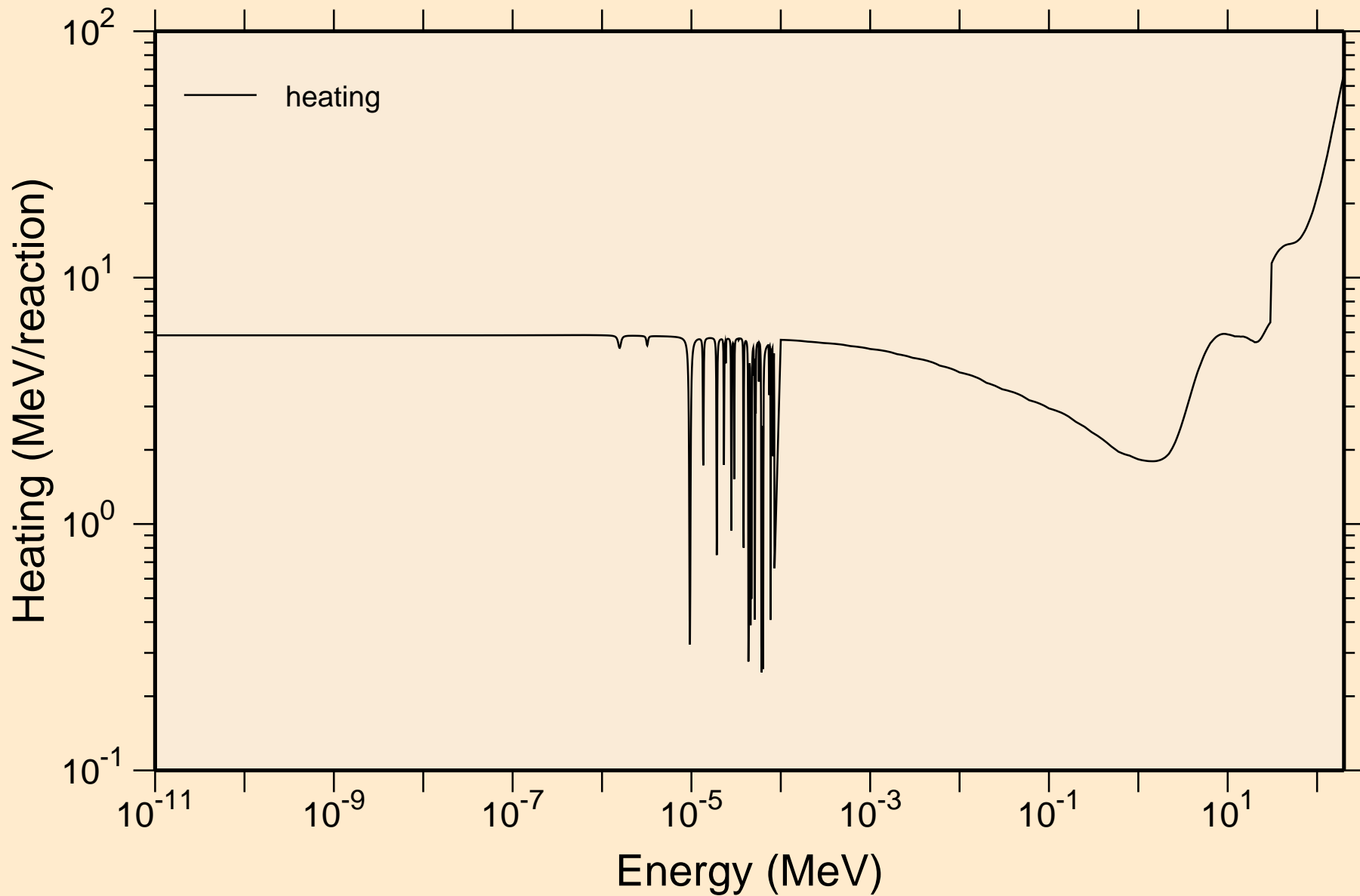

CE122 NEUTRON ACER TENDL-2019 LIBRARY; T=293.16K
Damage

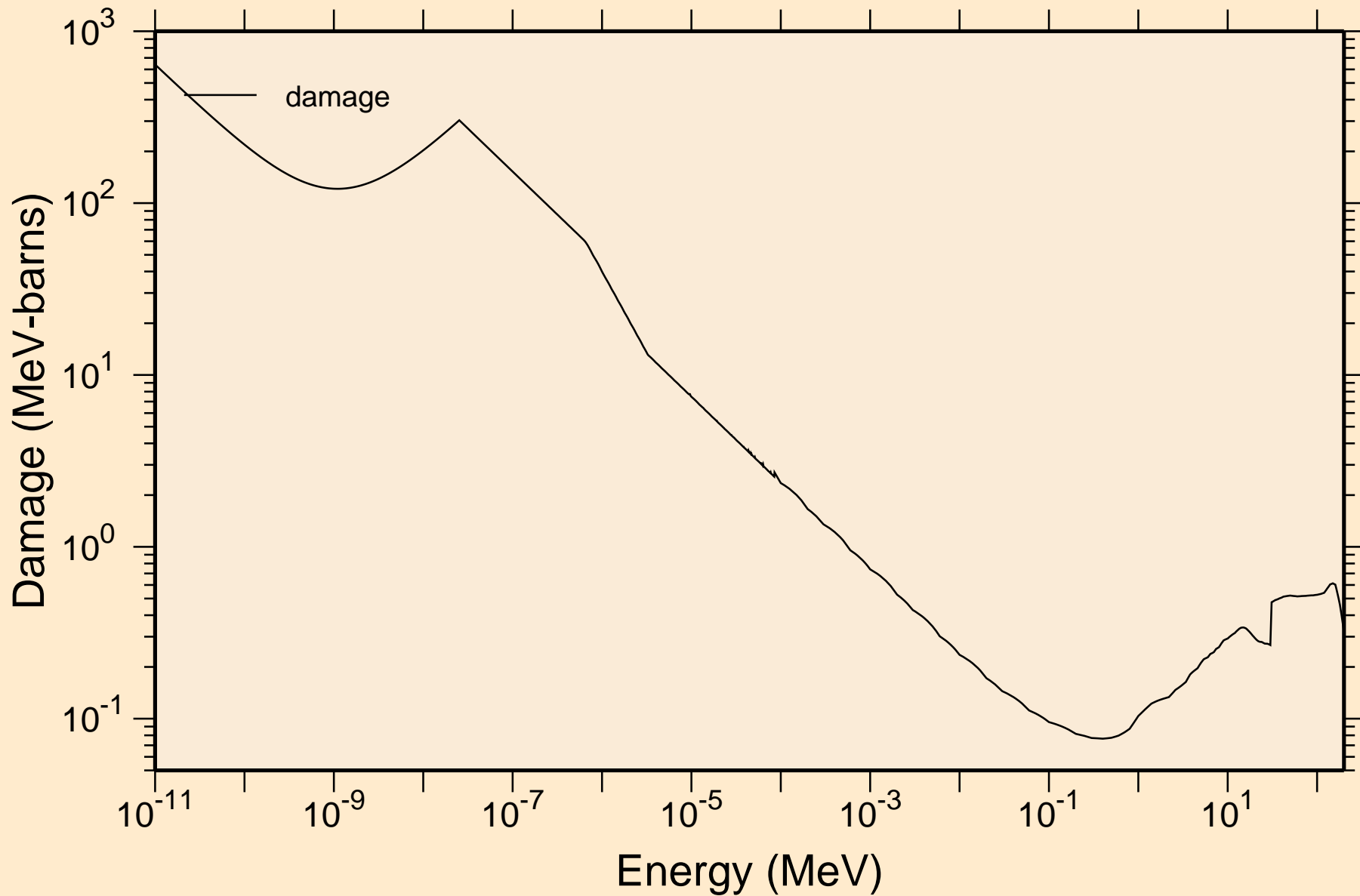

CE122 NEUTRON ACER TENDL-2019 LIBRARY; T=293.16K
Non-threshold reactions

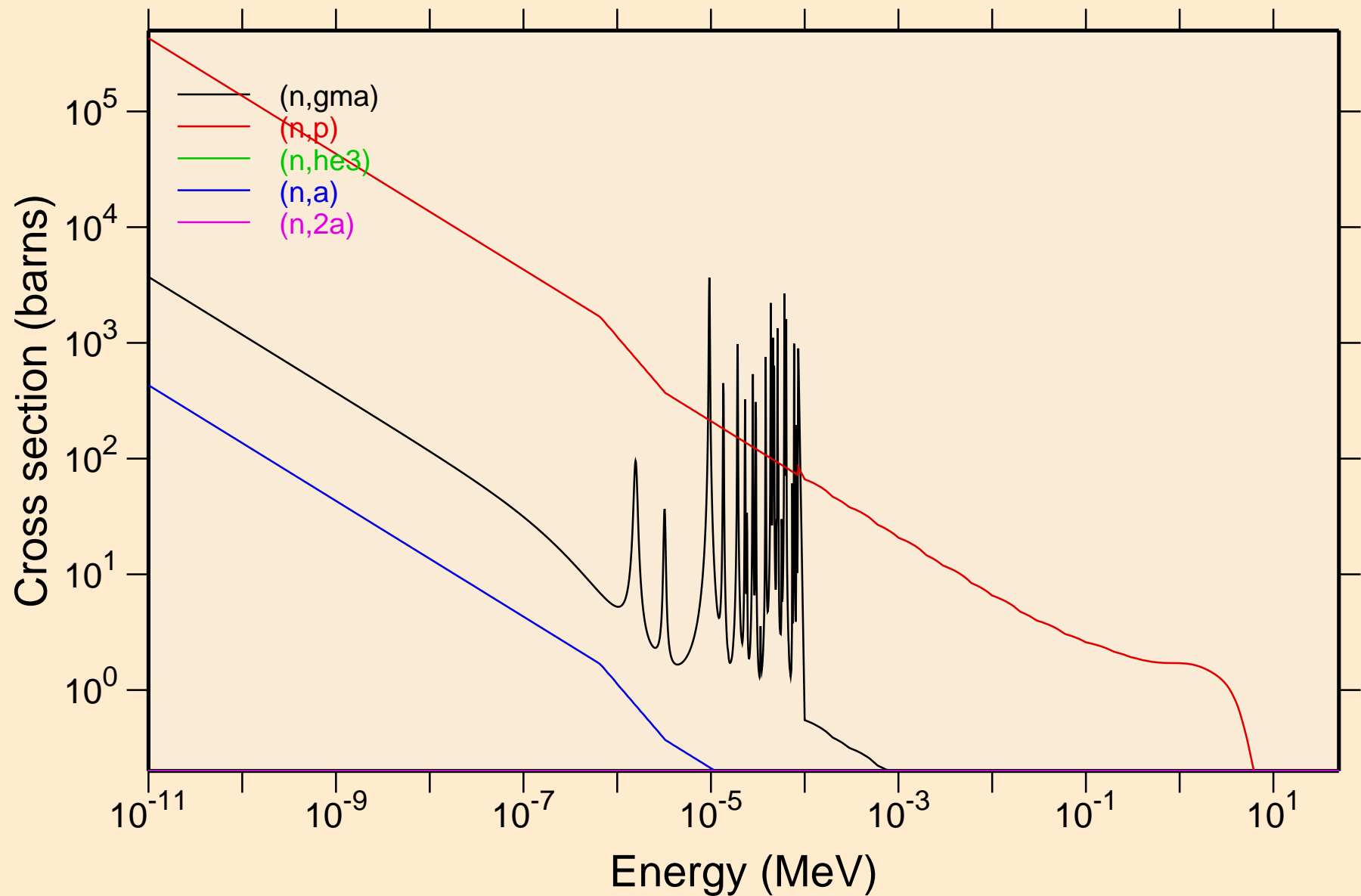

CE122 NEUTRON ACER TENDL-2019 LIBRARY; T=293.16K
Non-threshold reactions

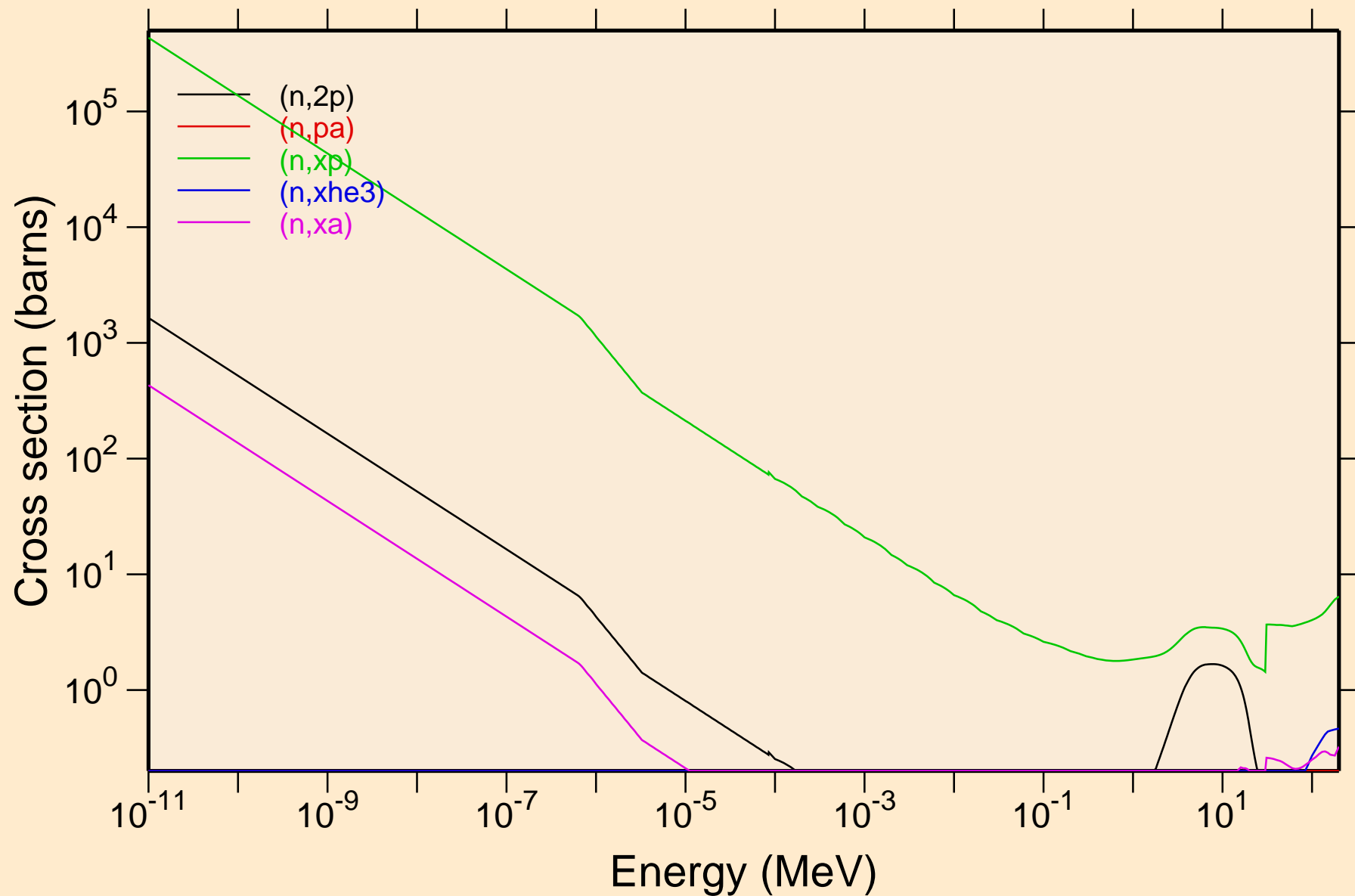

CE122 NEUTRON ACER TENDL-2019 LIBRARY; T=293.16K
Principal cross sections

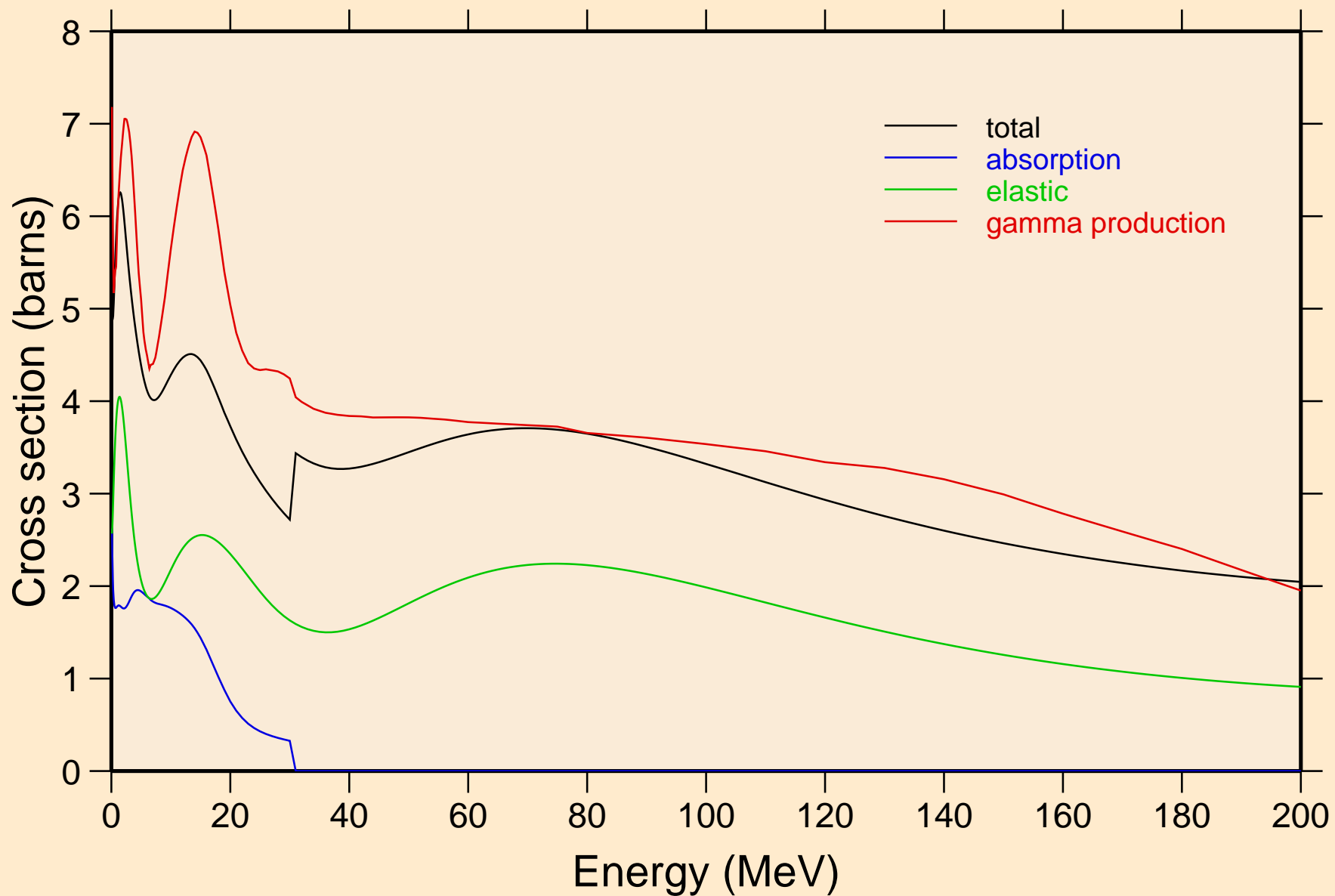

CE122 NEUTRON ACER TENDL-2019 LIBRARY; T=293.16K
Heating

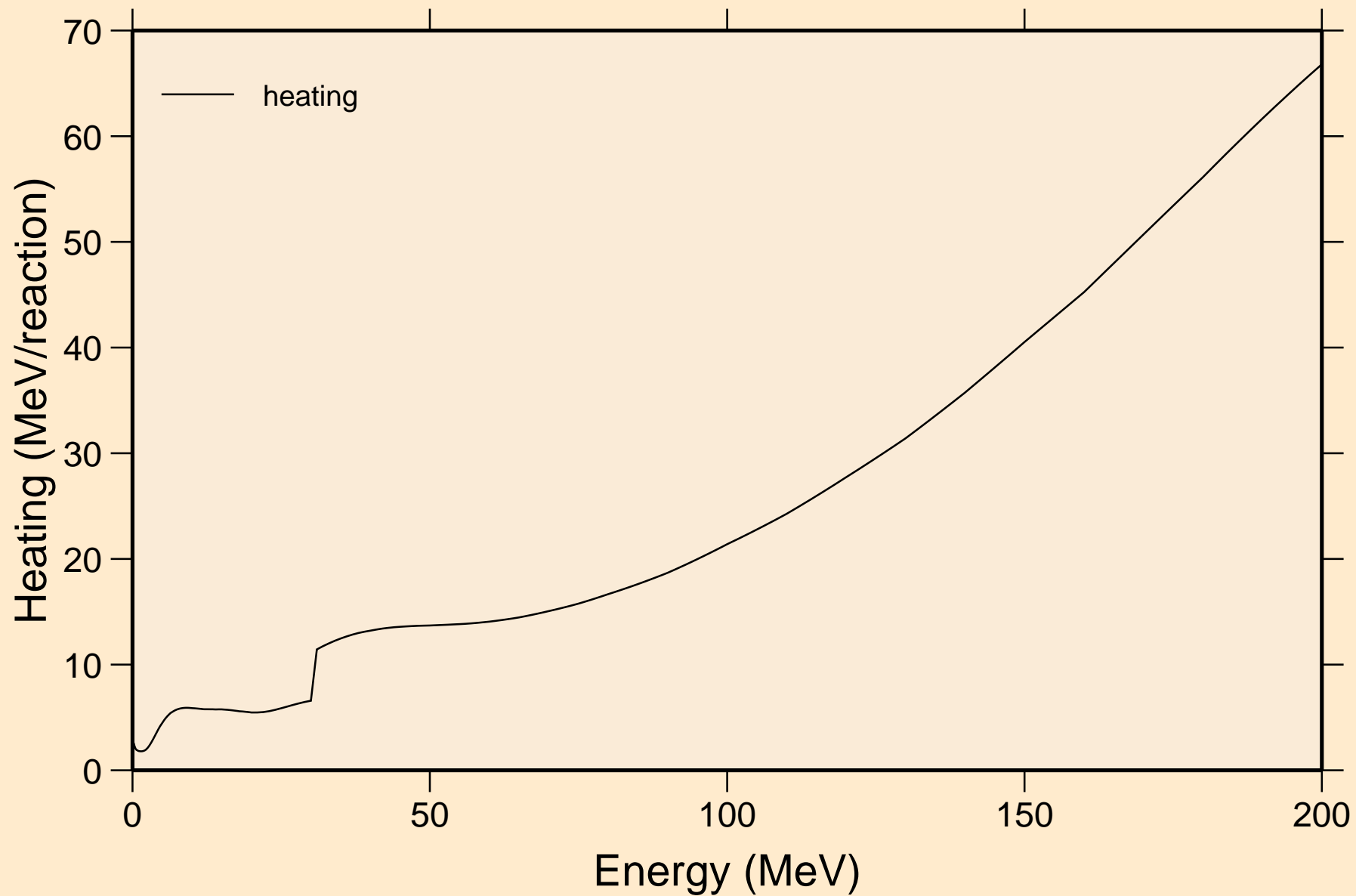

CE122 NEUTRON ACER TENDL-2019 LIBRARY; T=293.16K
Damage

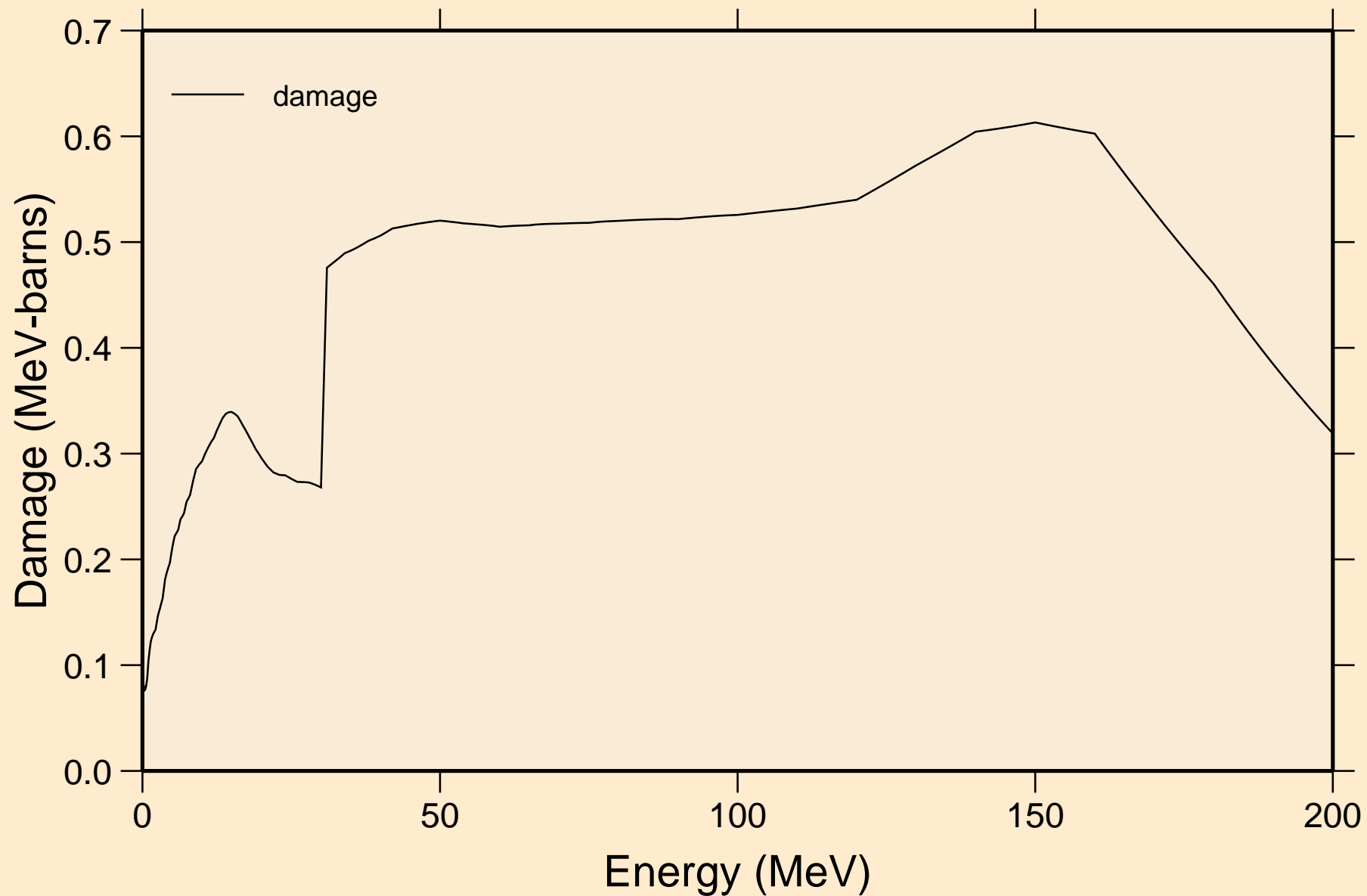

CE122 NEUTRON ACER TENDL-2019 LIBRARY; T=293.16K
Non-threshold reactions

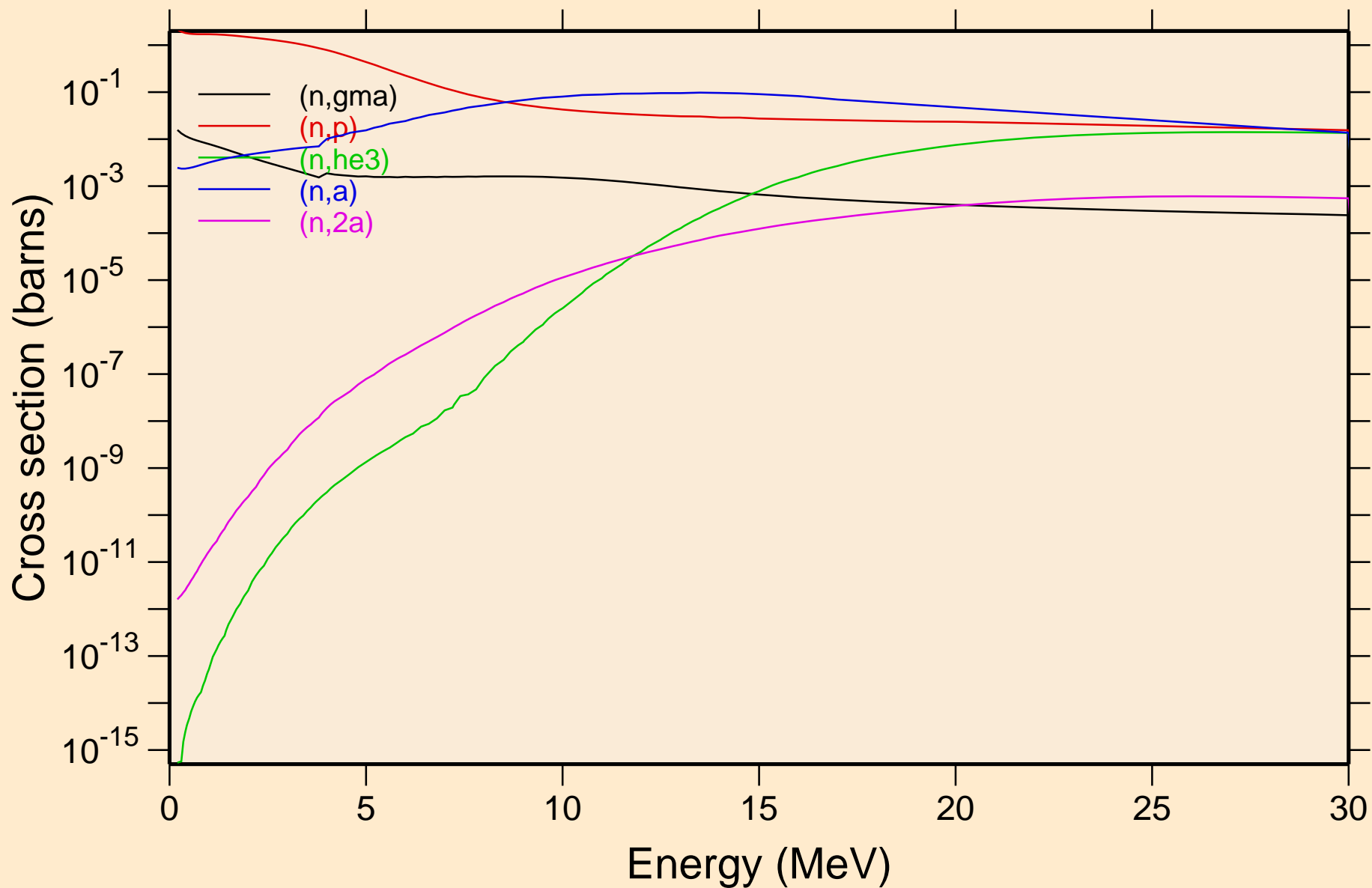

CE122 NEUTRON ACER TENDL-2019 LIBRARY; T=293.16K
Non-threshold reactions

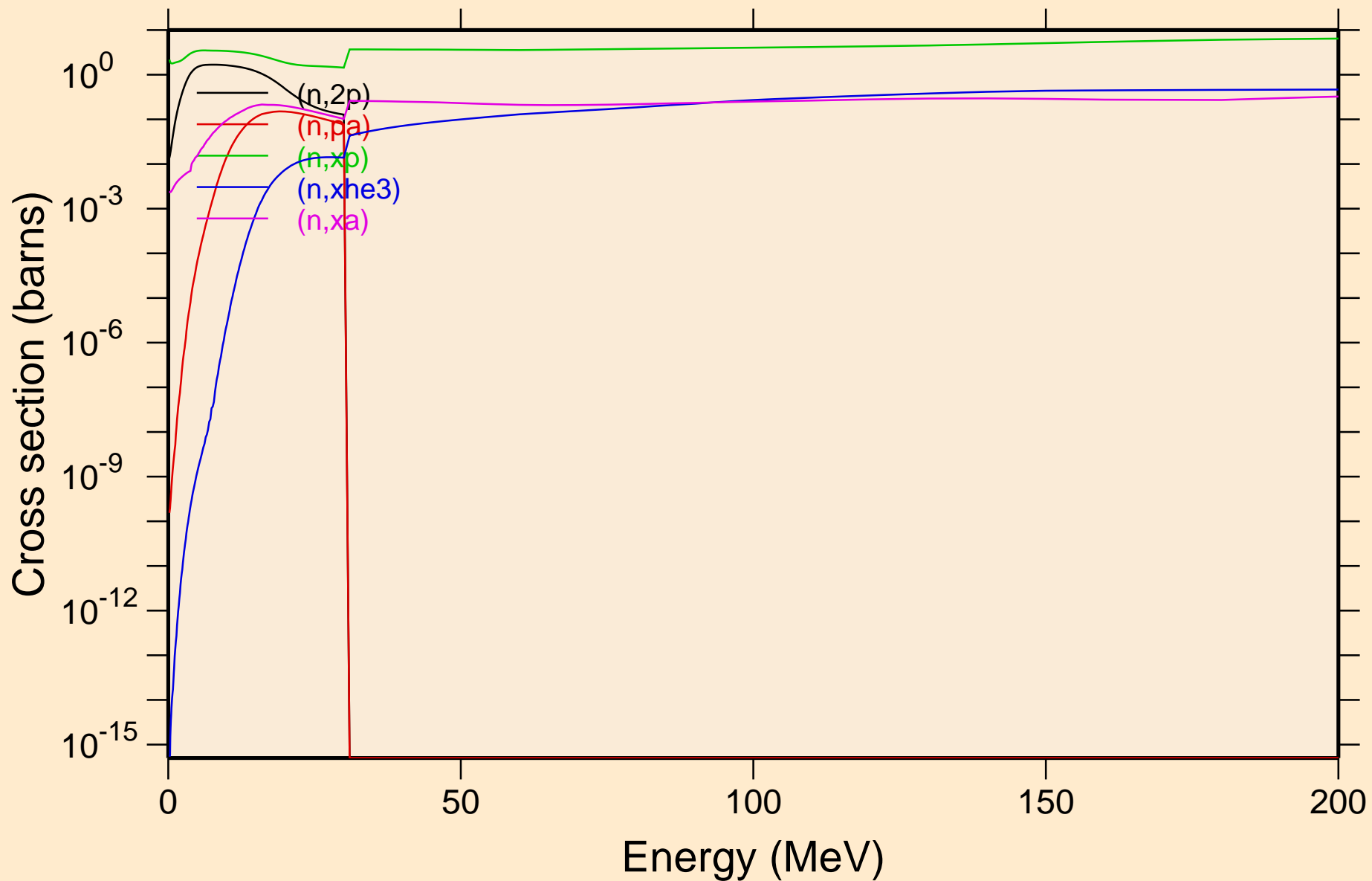

CE122 NEUTRON ACER TENDL-2019 LIBRARY; T=293.16K
Inelastic levels

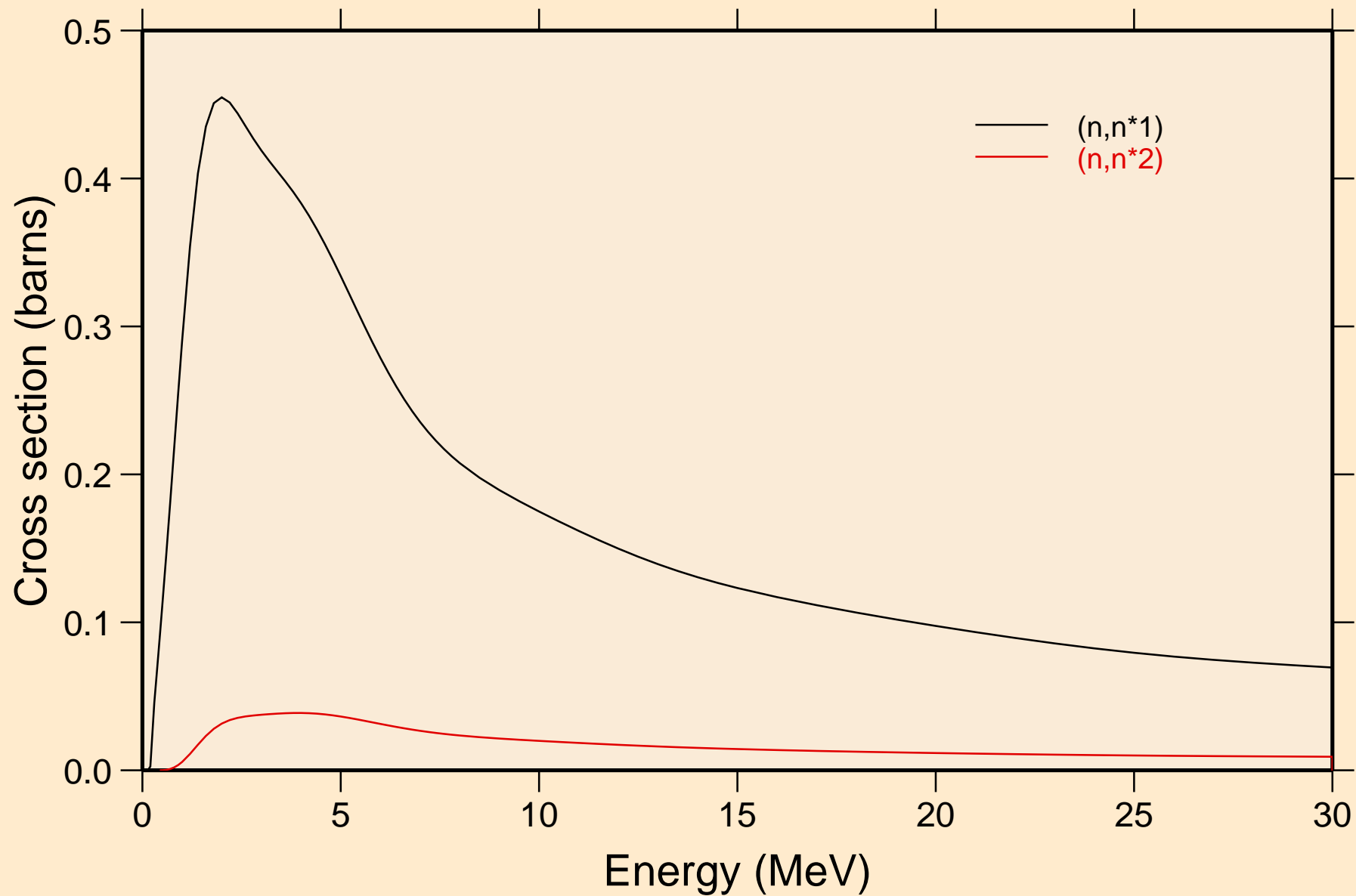

CE122 NEUTRON ACER TENDL-2019 LIBRARY; T=293.16K
Threshold reactions

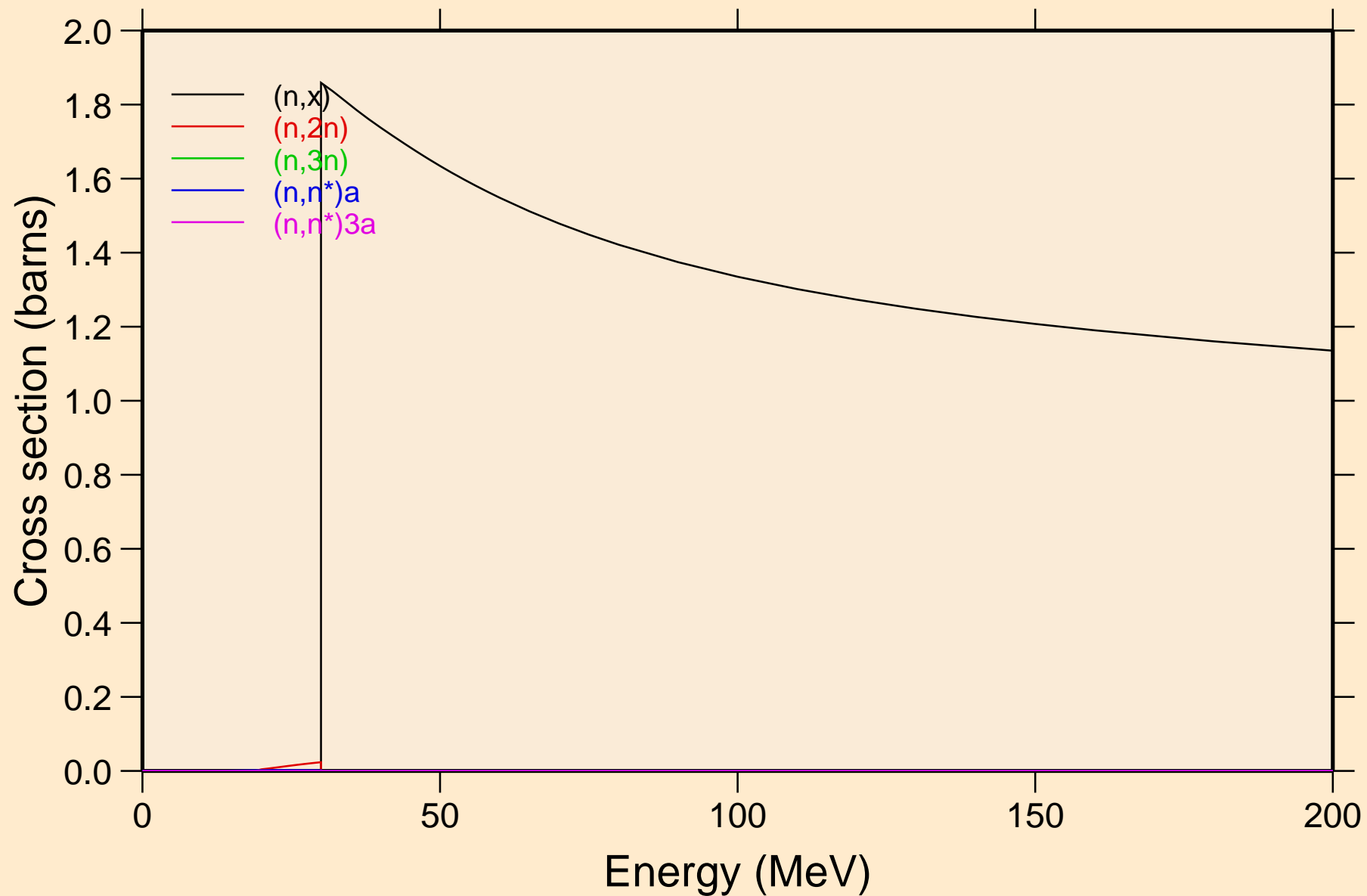

CE122 NEUTRON ACER TENDL-2019 LIBRARY; T=293.16K
Threshold reactions

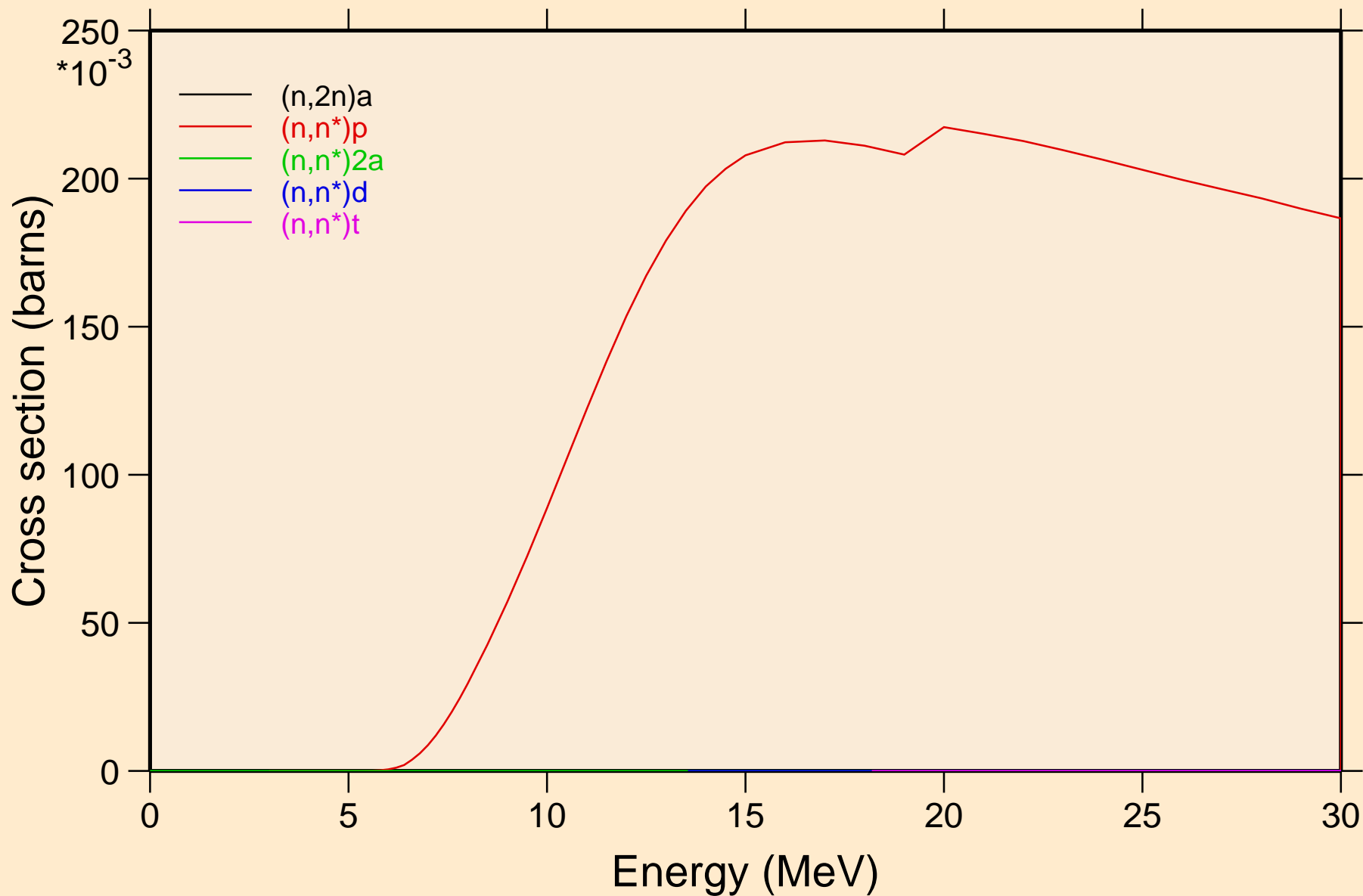

CE122 NEUTRON ACER TENDL-2019 LIBRARY; T=293.16K
Threshold reactions

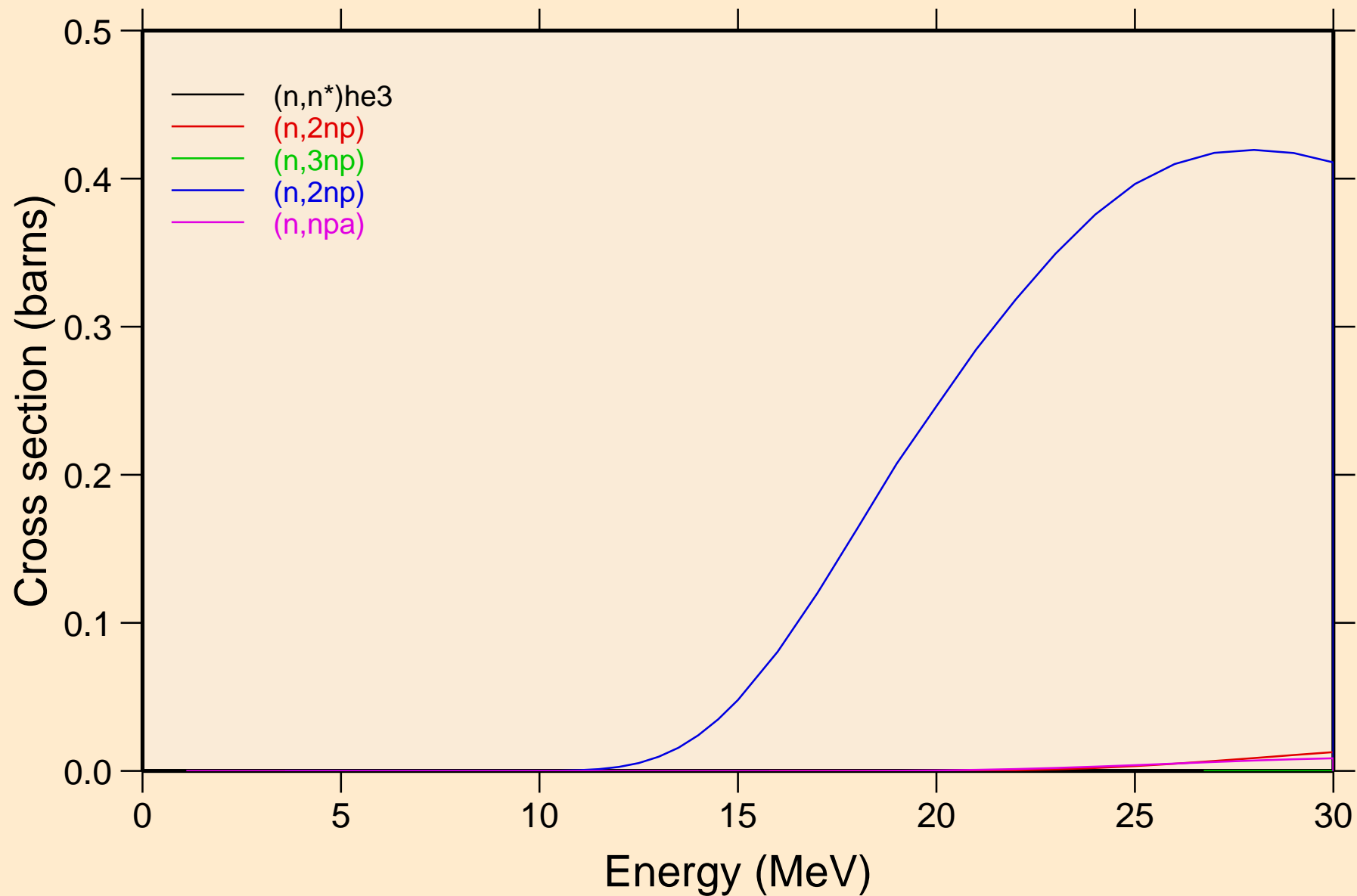

CE122 NEUTRON ACER TENDL-2019 LIBRARY; T=293.16K
Threshold reactions

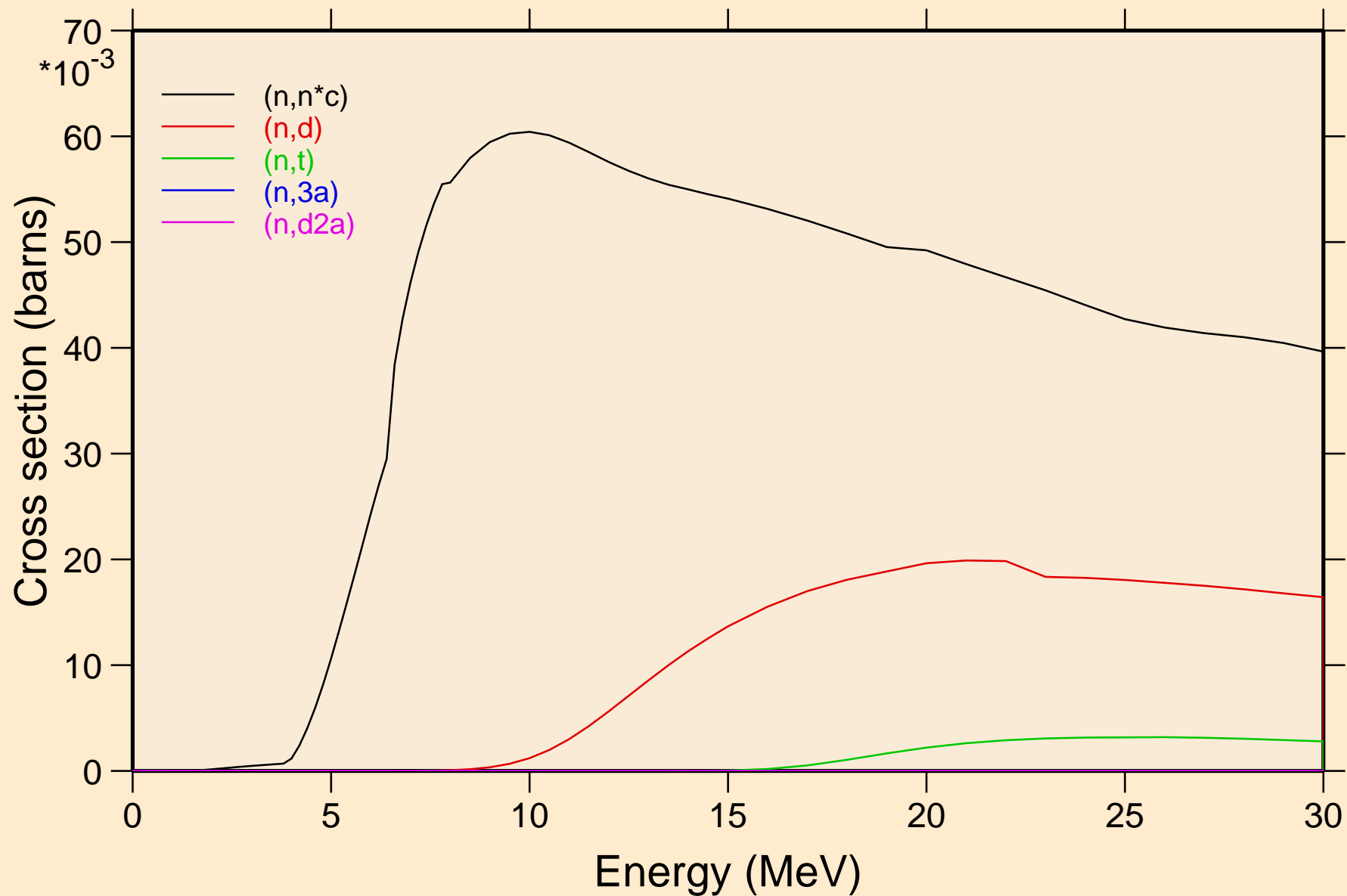

CE122 NEUTRON ACER TENDL-2019 LIBRARY; T=293.16K
Threshold reactions

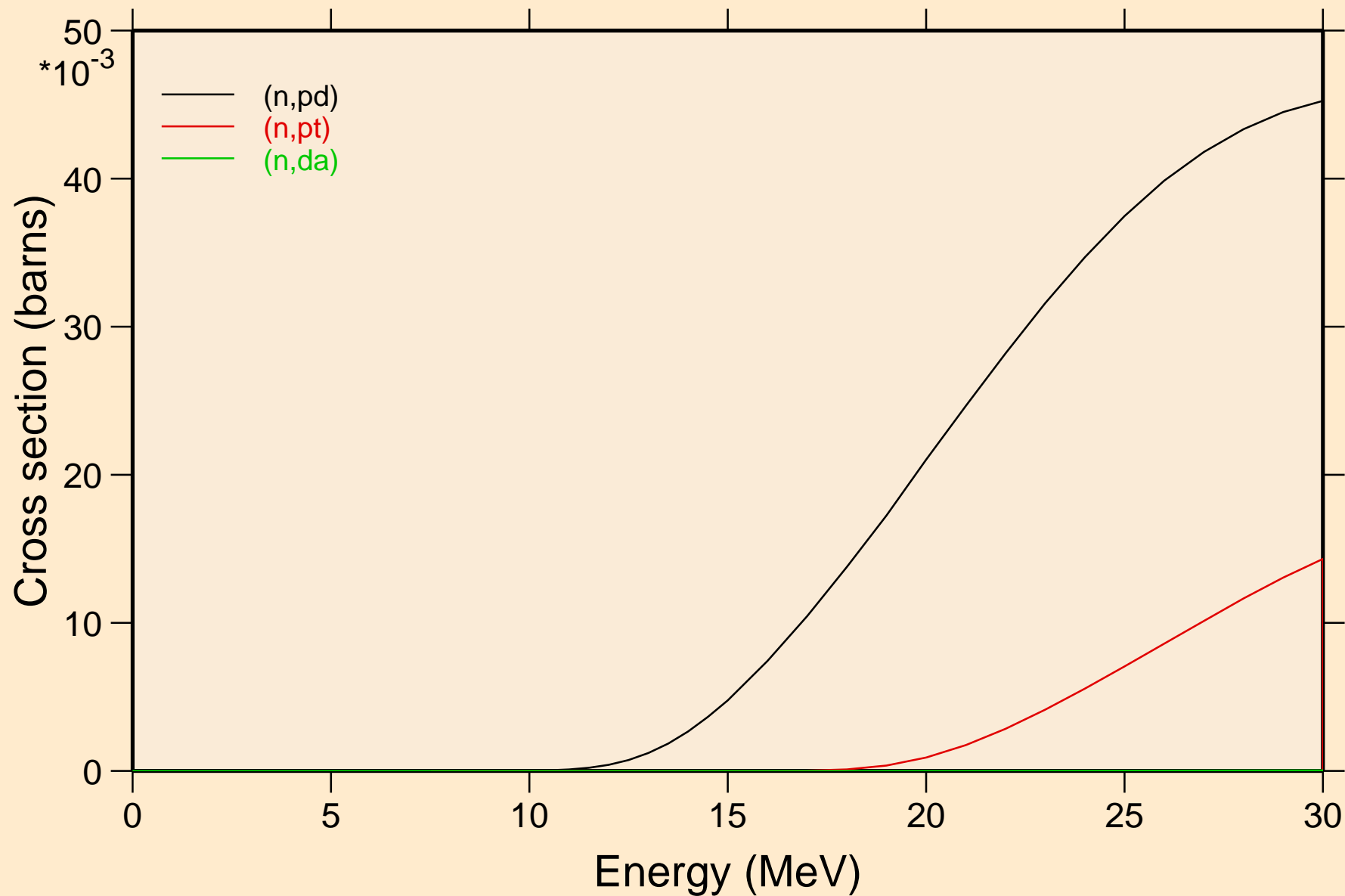

CE122 NEUTRON ACER TENDL-2019 LIBRARY; T=293.16K
Threshold reactions

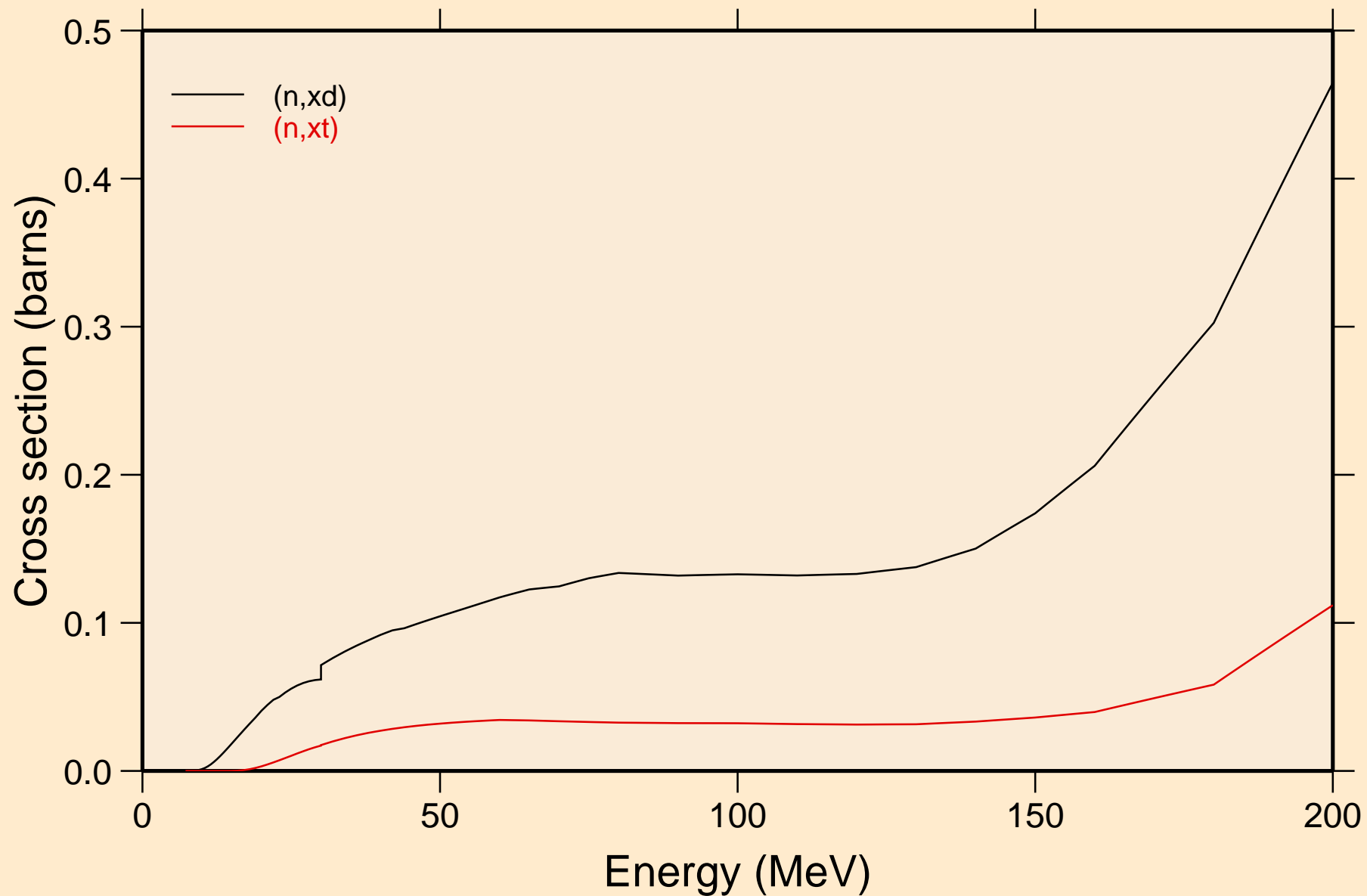

CE122 NEUTRON ACER TENDL-2019 LIBRARY; T=293.16K
angular distribution for elastic

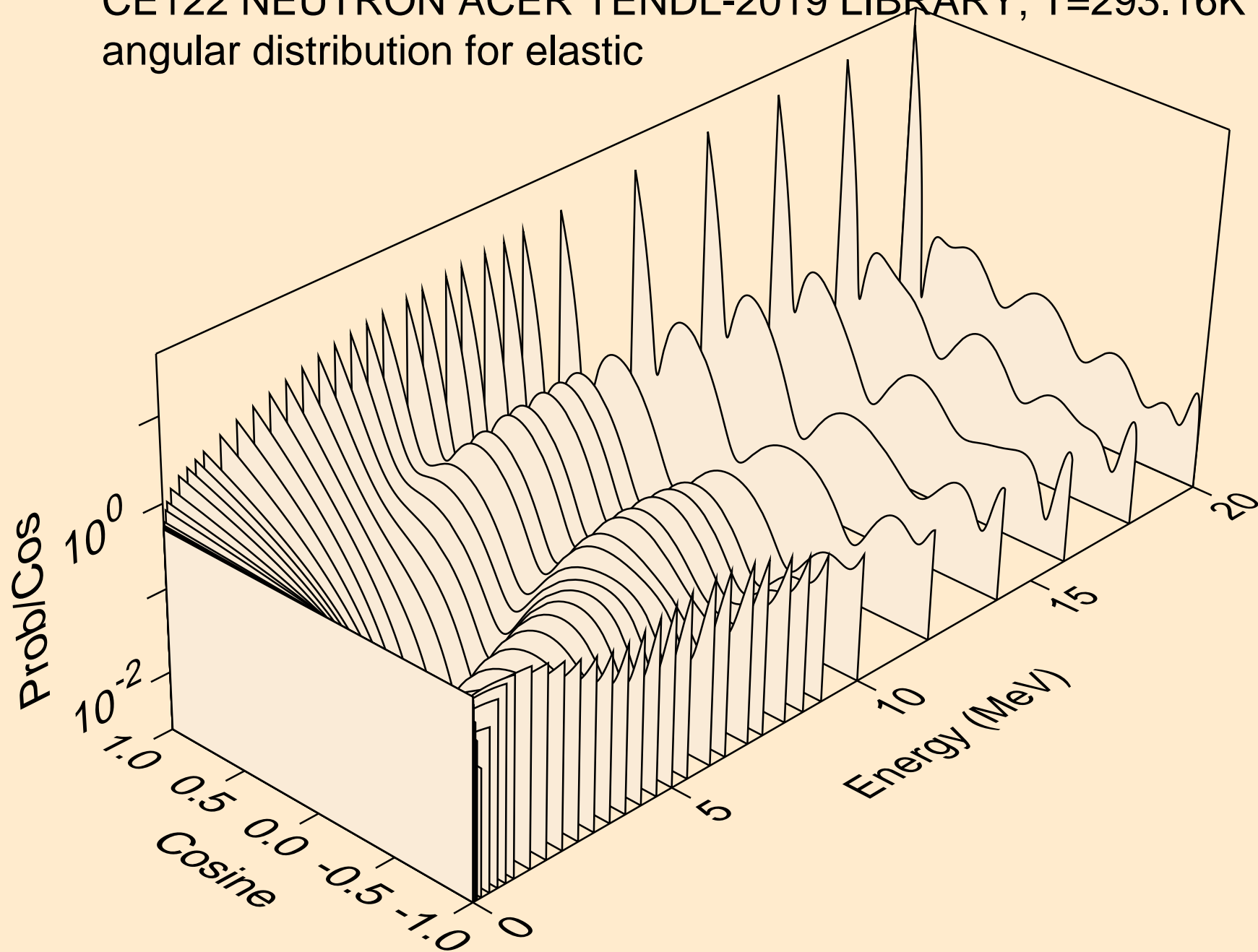

CE122 NEUTRON ACER TENDL-2019 LIBRARY; T=293.16K
angular distribution for elastic

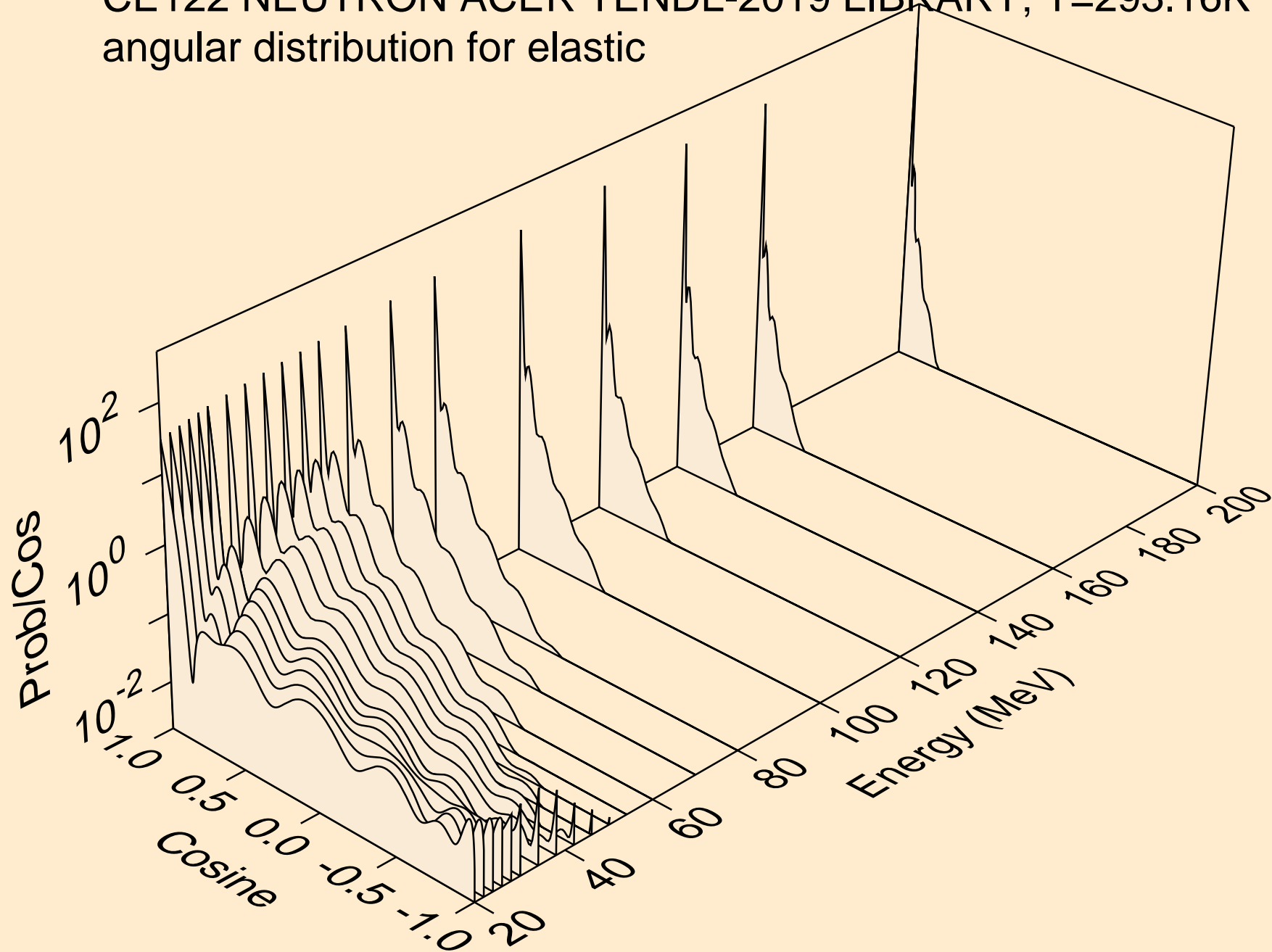

CE122 NEUTRON ACER TENDL-2019 LIBRARY; T=293.16K
angular distribution for (n,n*1)

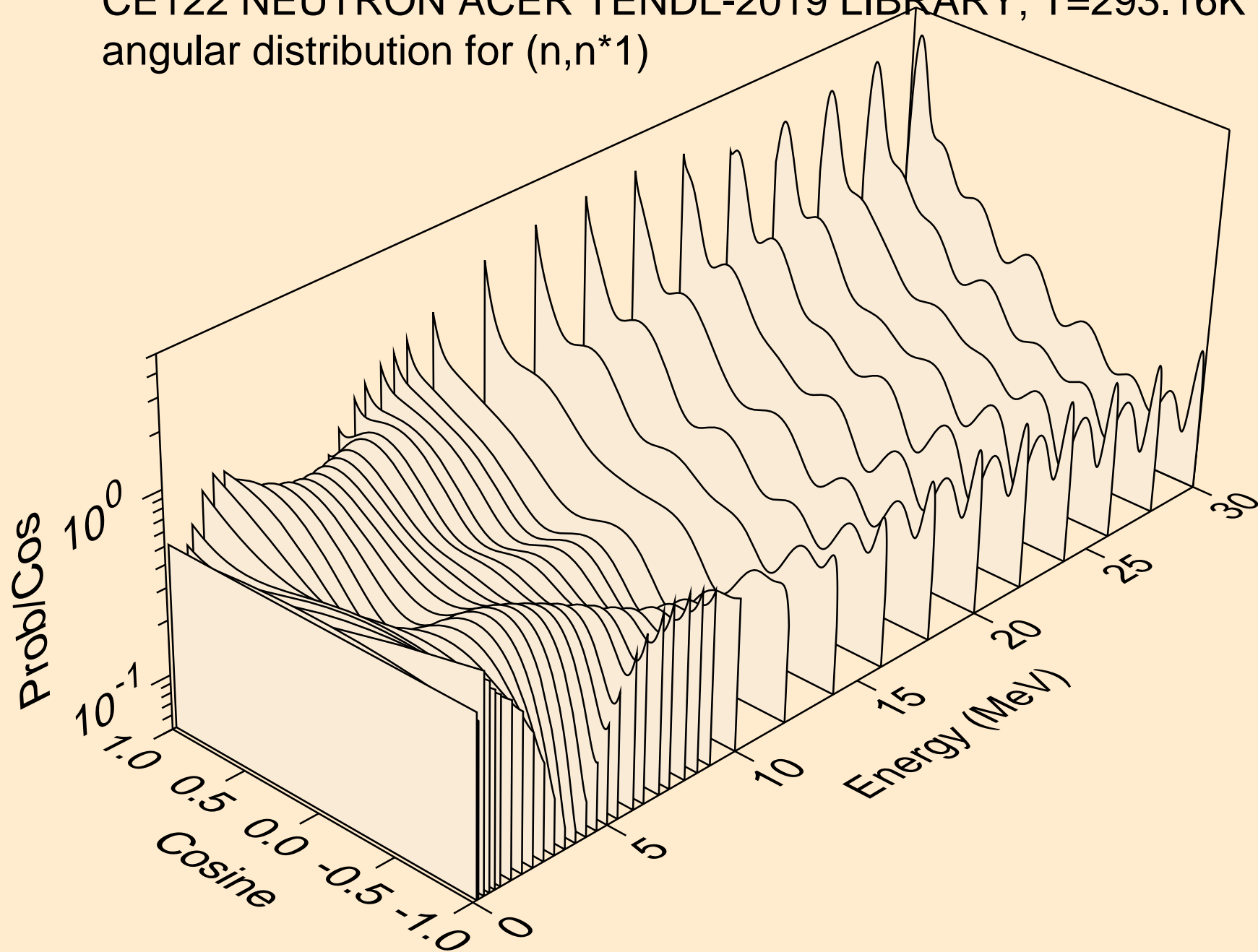

CE122 NEUTRON ACER TENDL-2019 LIBRARY; T=293.16K
angular distribution for (n,n*2)

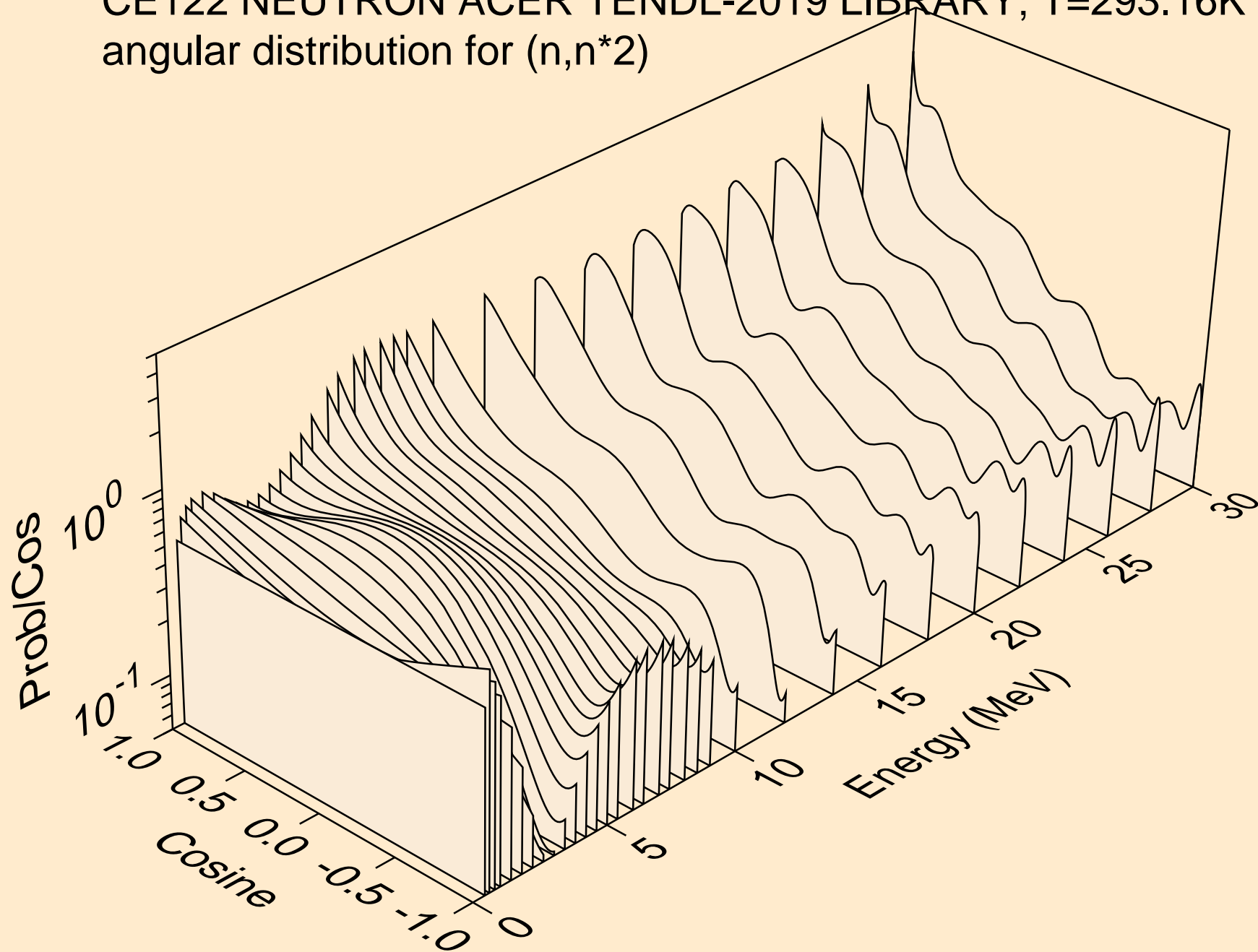

CE122 NEUTRON ACER TENDL-2019 LIBRARY; T=293.16K
Neutron emission for (n,x)

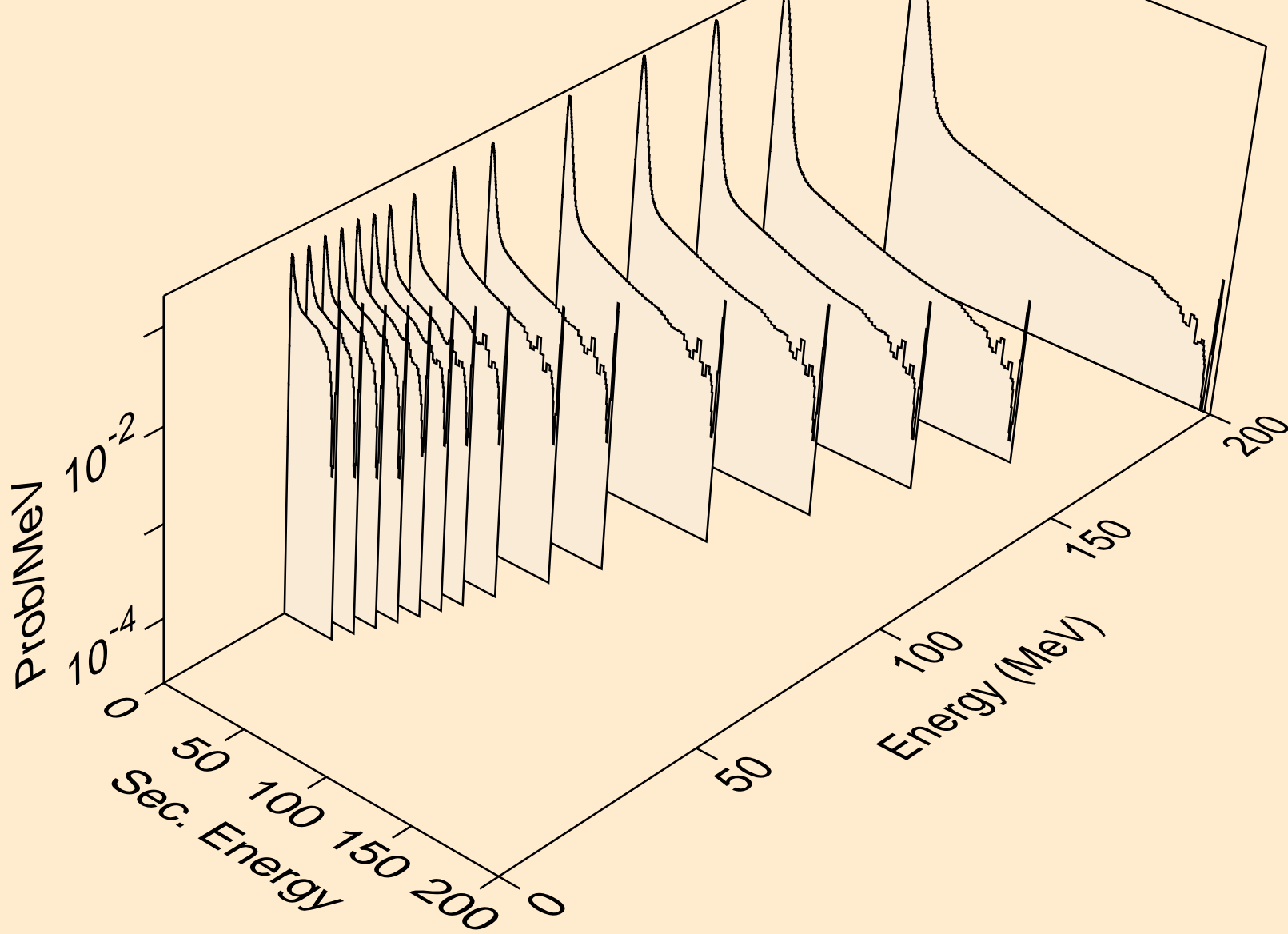

CE122 NEUTRON ACER TENDL-2019 LIBRARY; T=293.16K
Neutron emission for (n,2n)

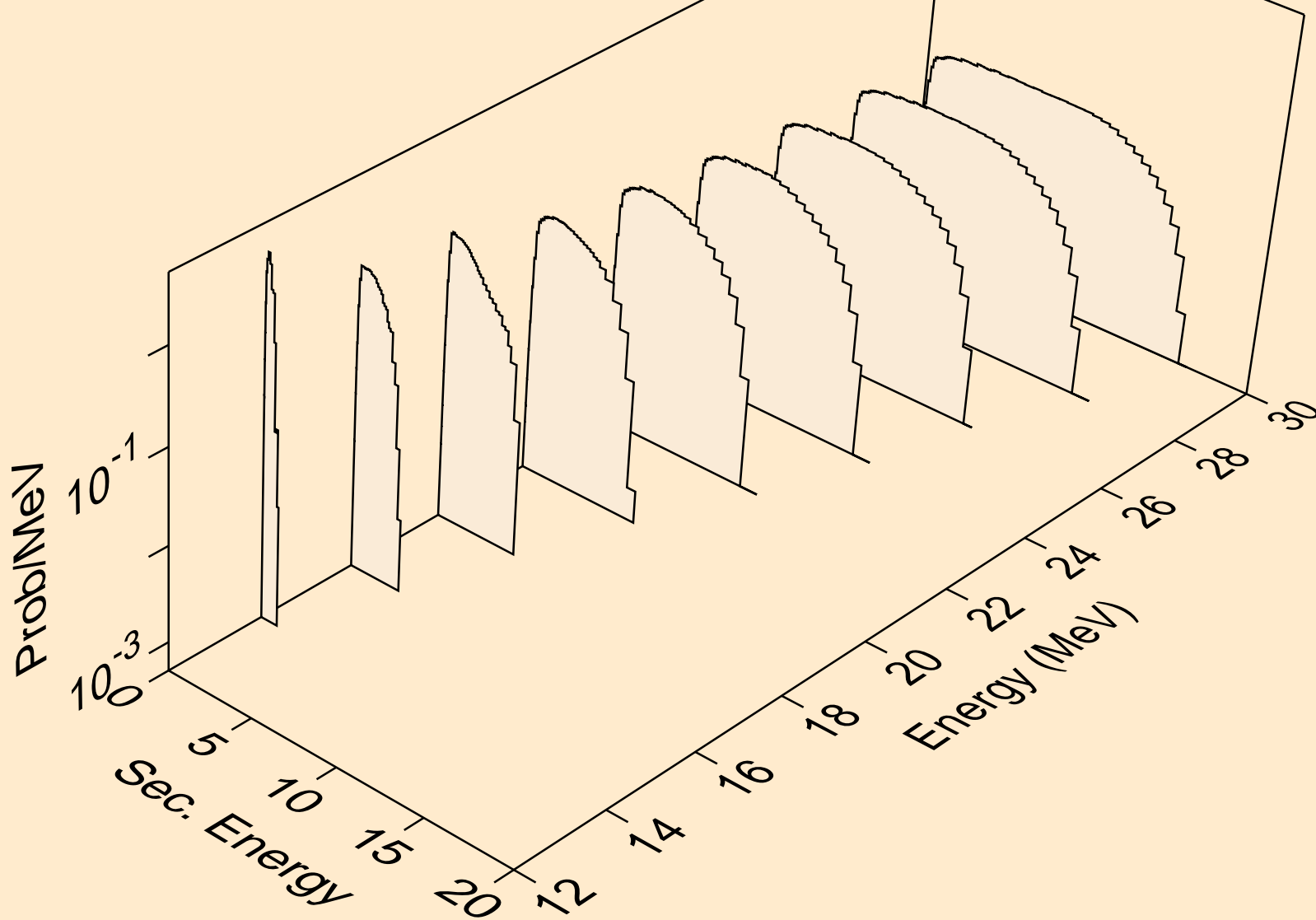

CE122 NEUTRON ACER TENDL-2019 LIBRARY; T=293.16K
Neutron emission for (n,3n)

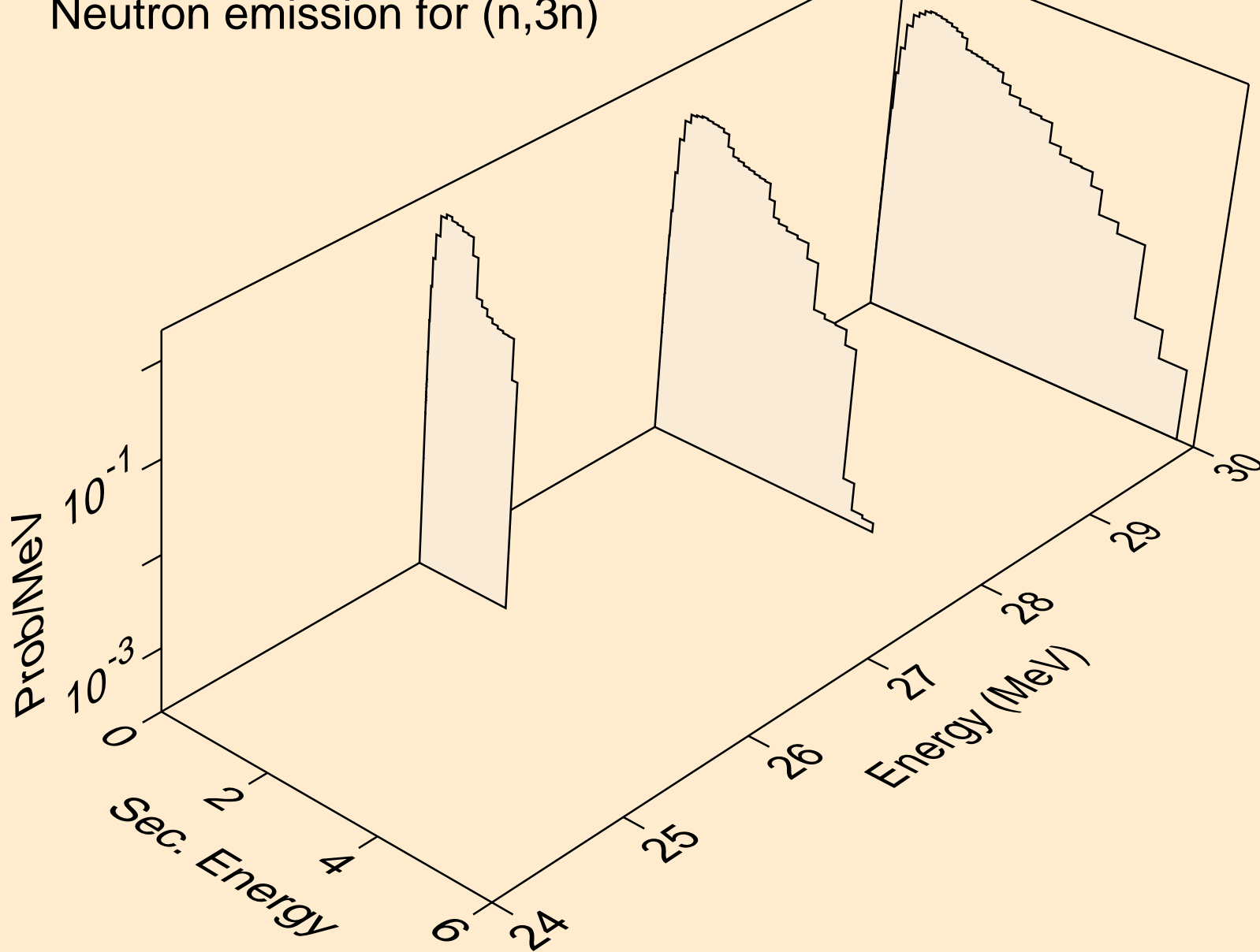

CE122 NEUTRON ACER TENDL-2019 LIBRARY; T=293.16K
Neutron emission for (n,n*)a

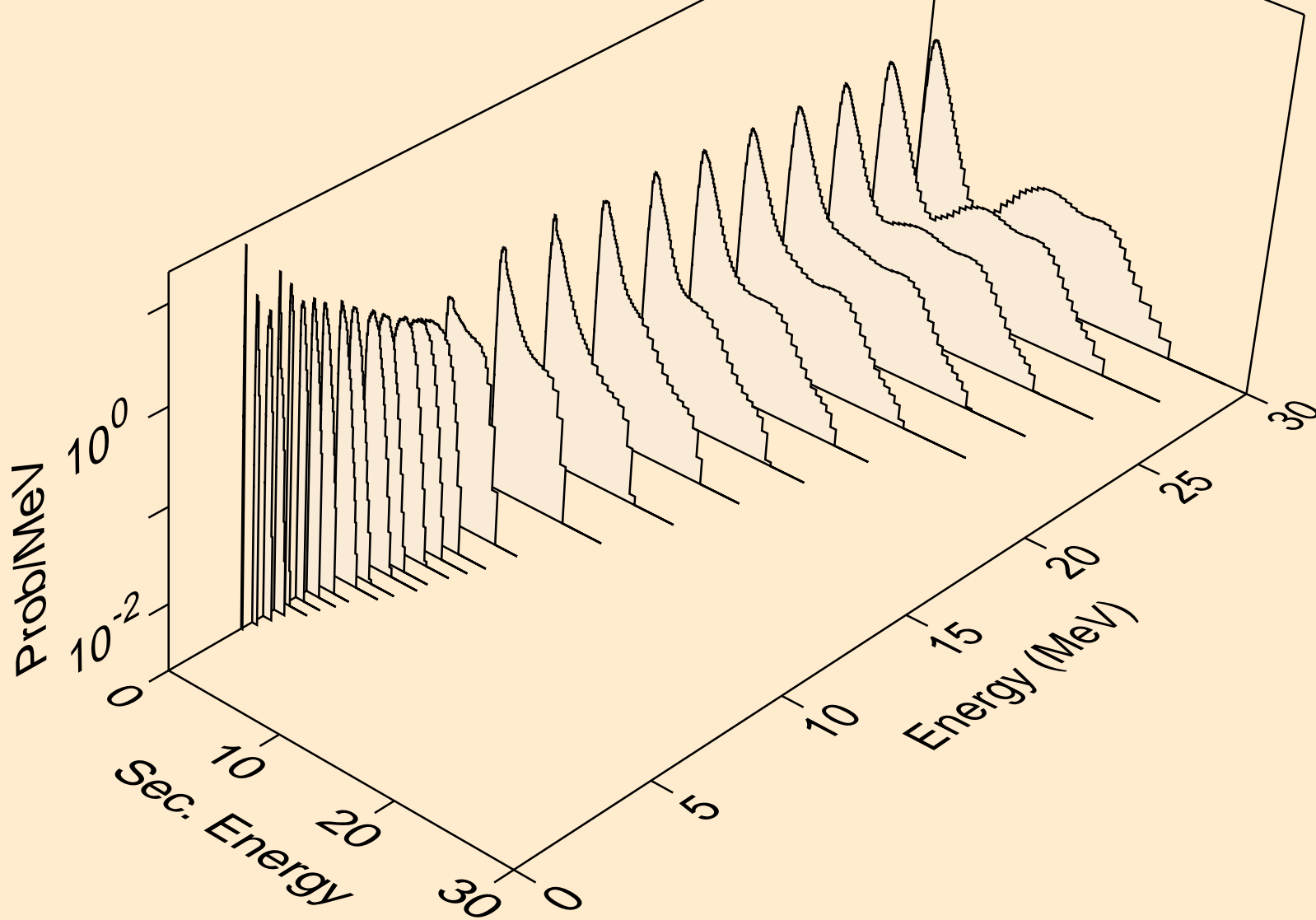

CE122 NEUTRON ACER TENDL-2019 LIBRARY; T=293.16K
Neutron emission for (n,n*)3a

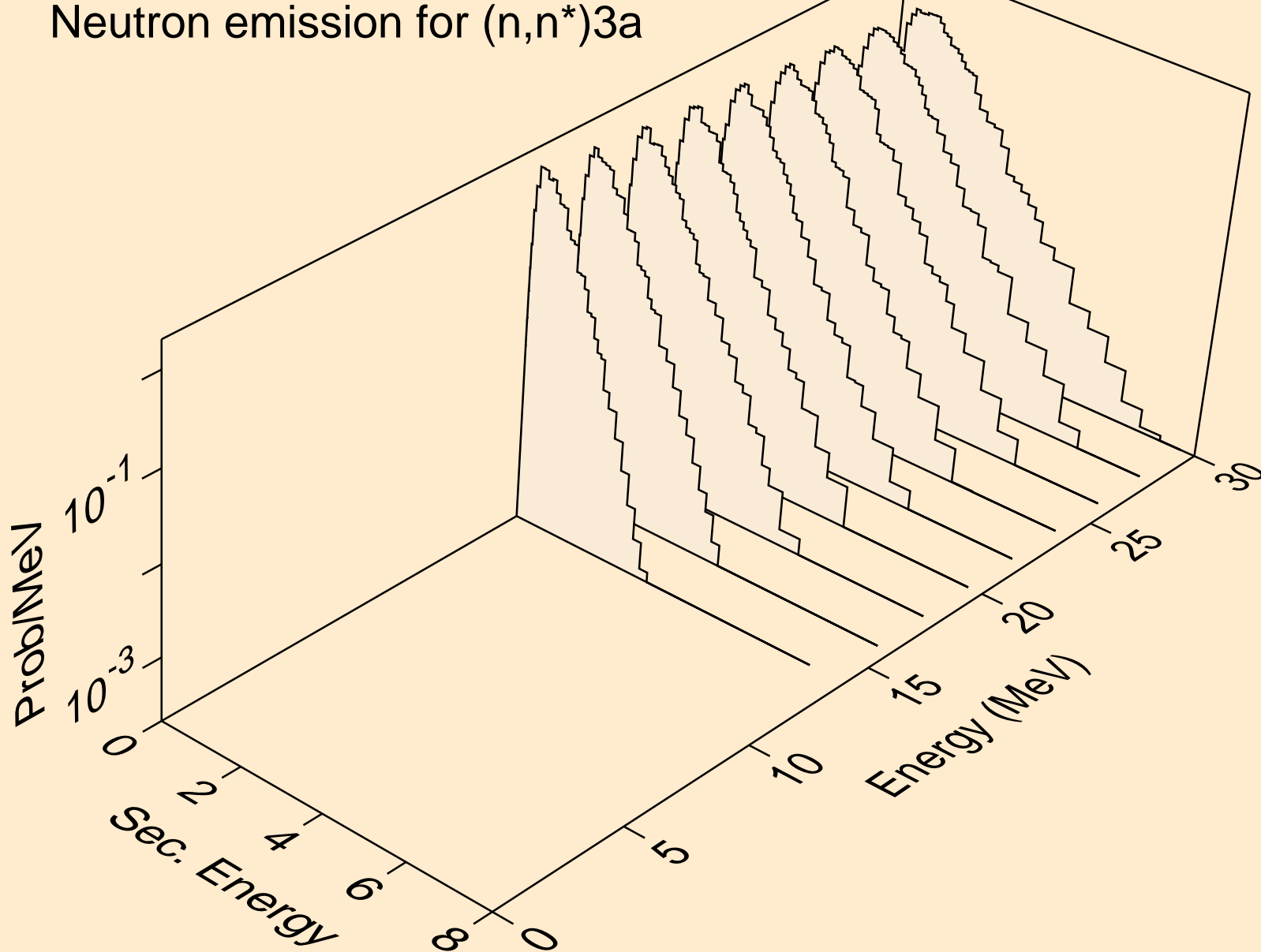

CE122 NEUTRON ACER TENDL-2019 LIBRARY; T=293.16K
Neutron emission for (n,2n)a

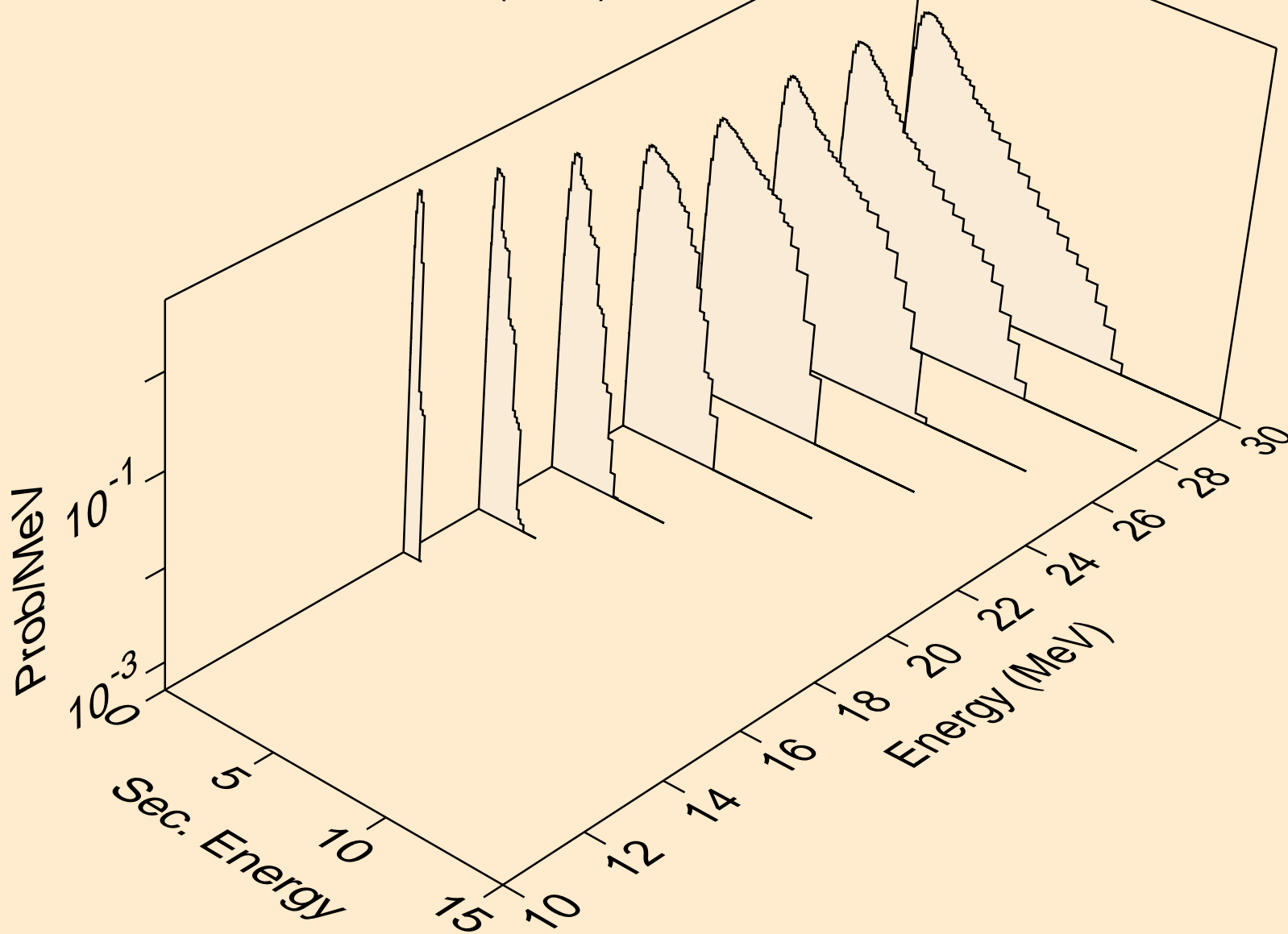

CE122 NEUTRON ACER TENDL-2019 LIBRARY; T=293.16K
Neutron emission for (n,n*)p

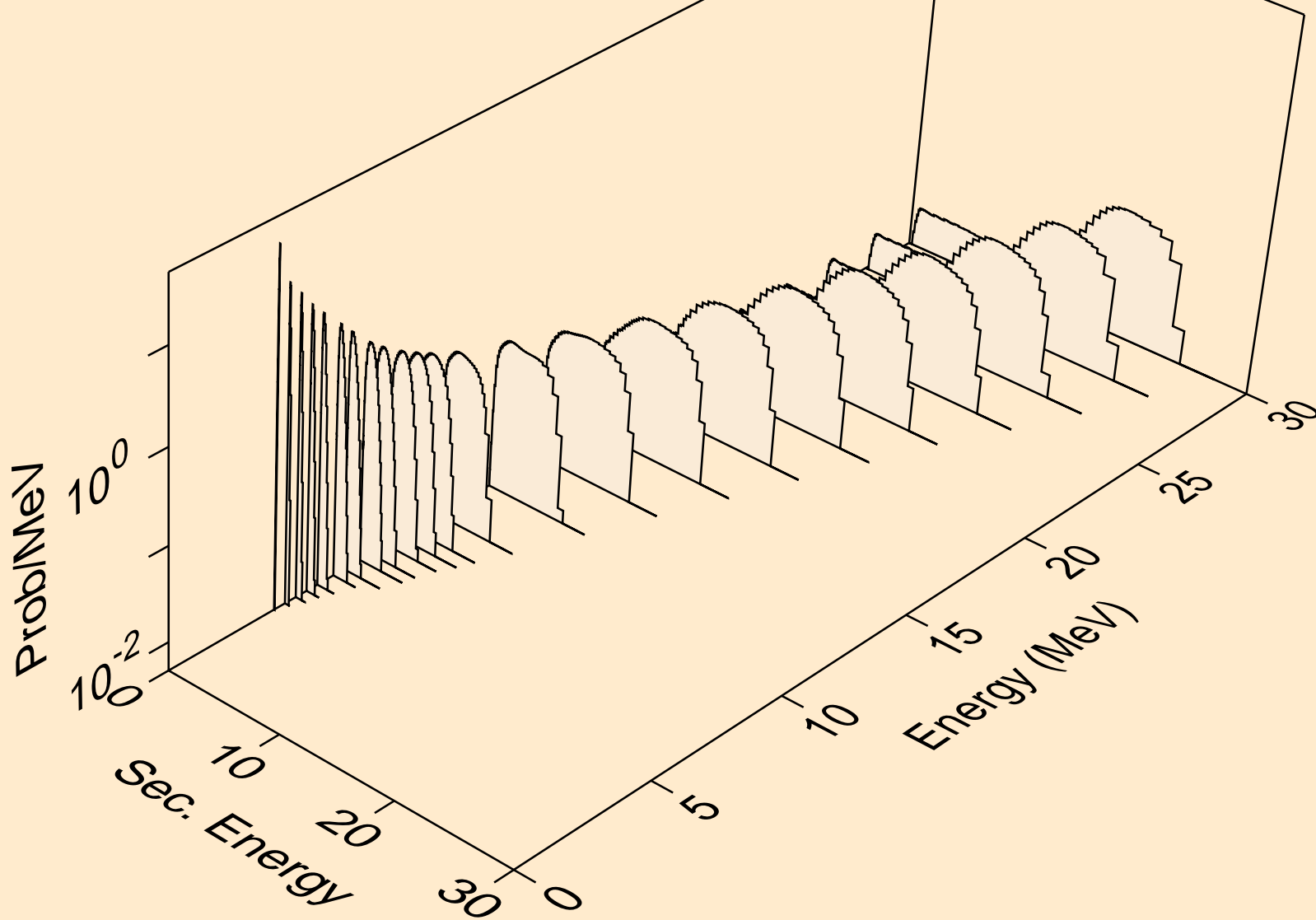

CE122 NEUTRON ACER TENDL-2019 LIBRARY; T=293.16K
Neutron emission for (n,n*)2a

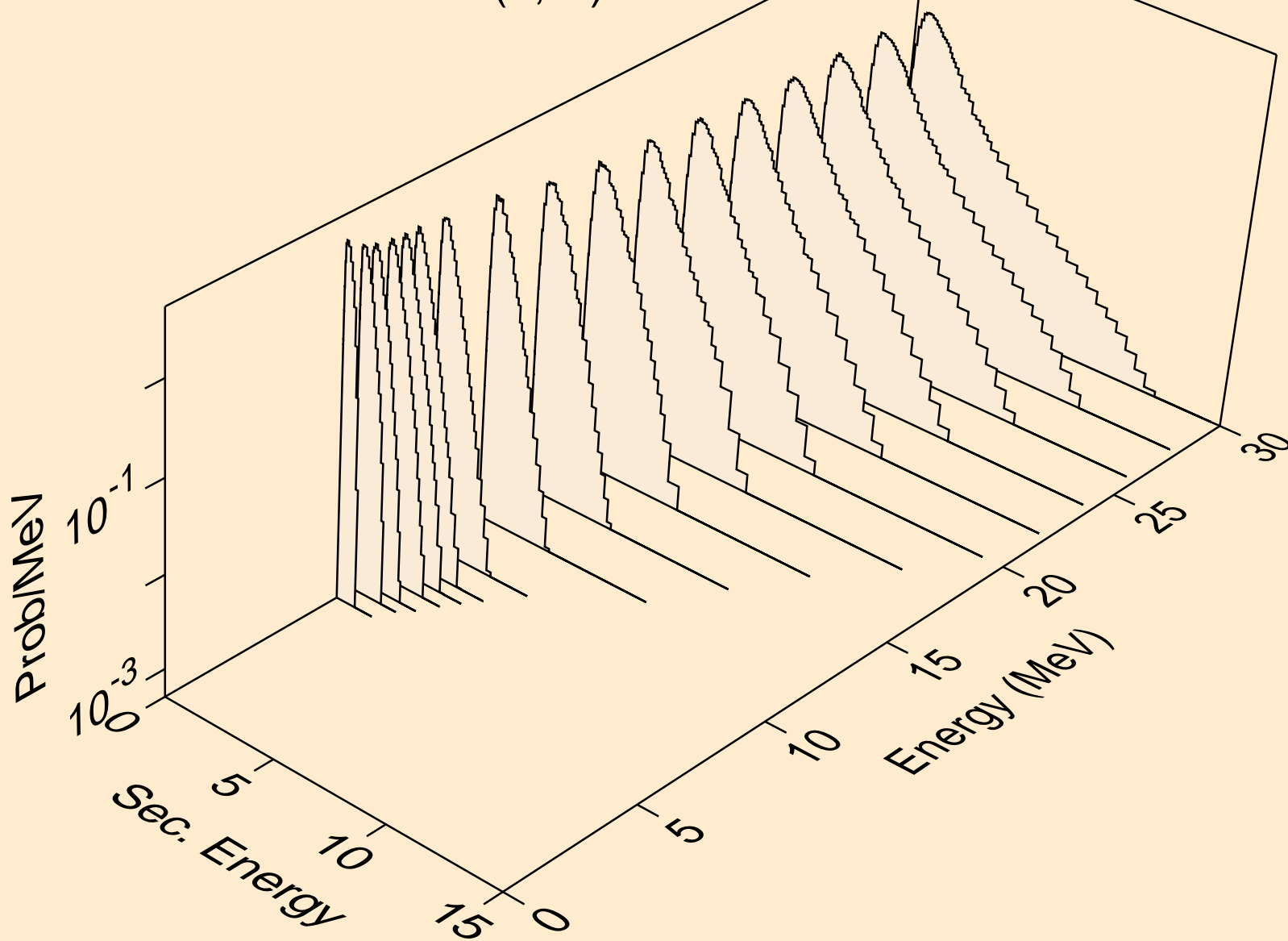

CE122 NEUTRON ACER TENDL-2019 LIBRARY; T=293.16K
Neutron emission for (n,n*)d

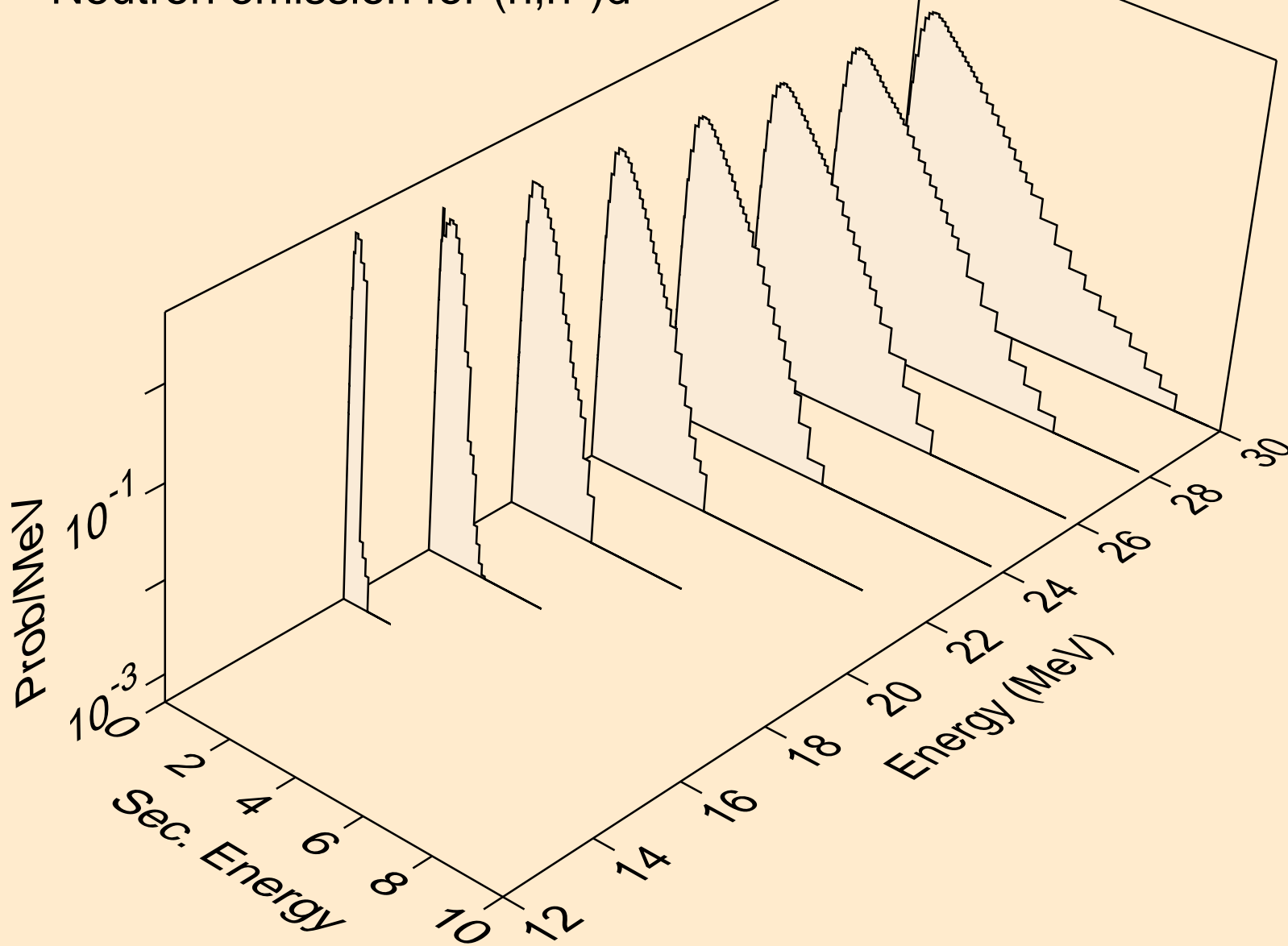

CE122 NEUTRON ACER TENDL-2019 LIBRARY; T=293.16K
Neutron emission for (n,n*)t

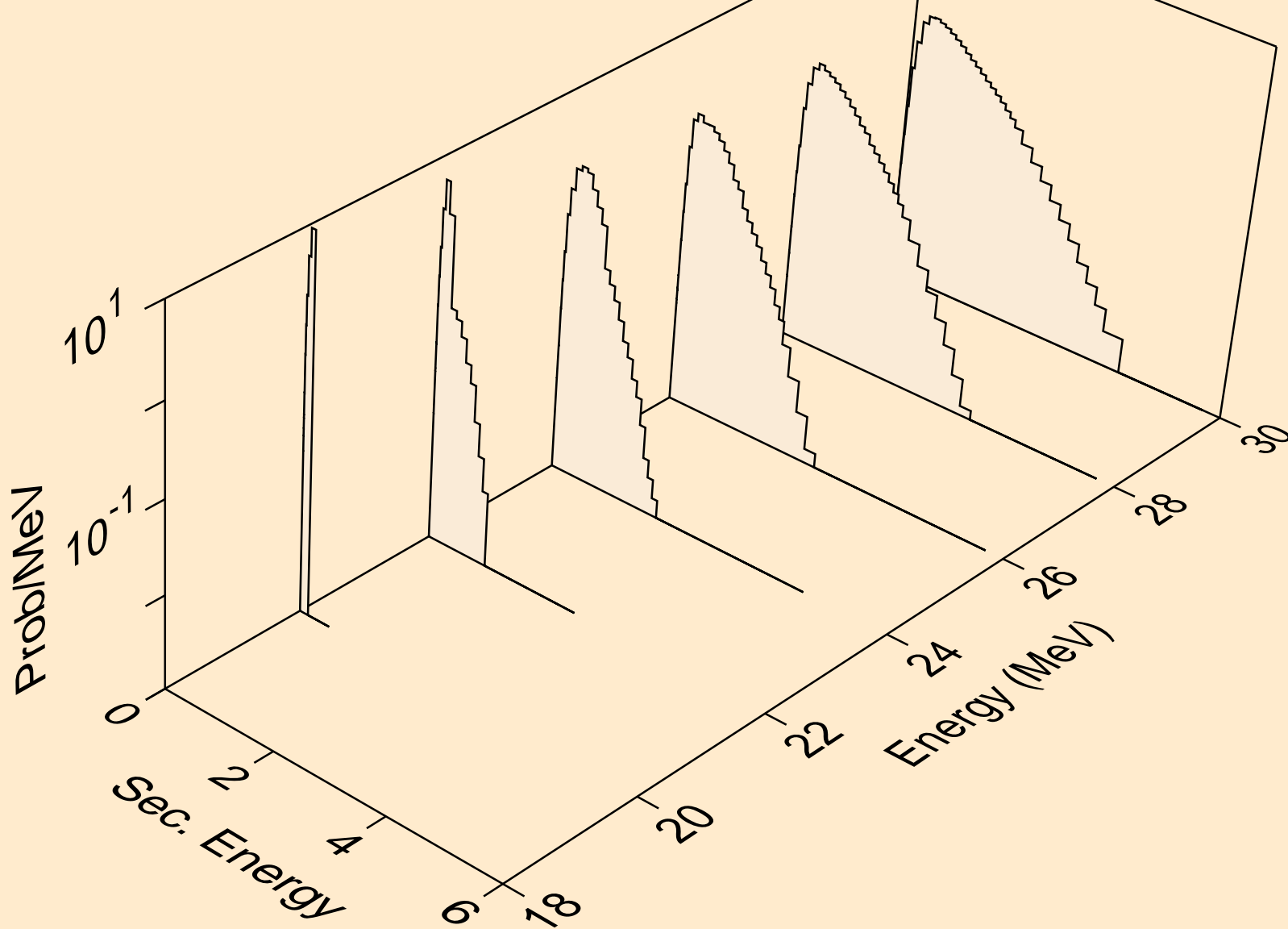

CE122 NEUTRON ACER TENDL-2019 LIBRARY; T=293.16K
Neutron emission for (n,n*)he3

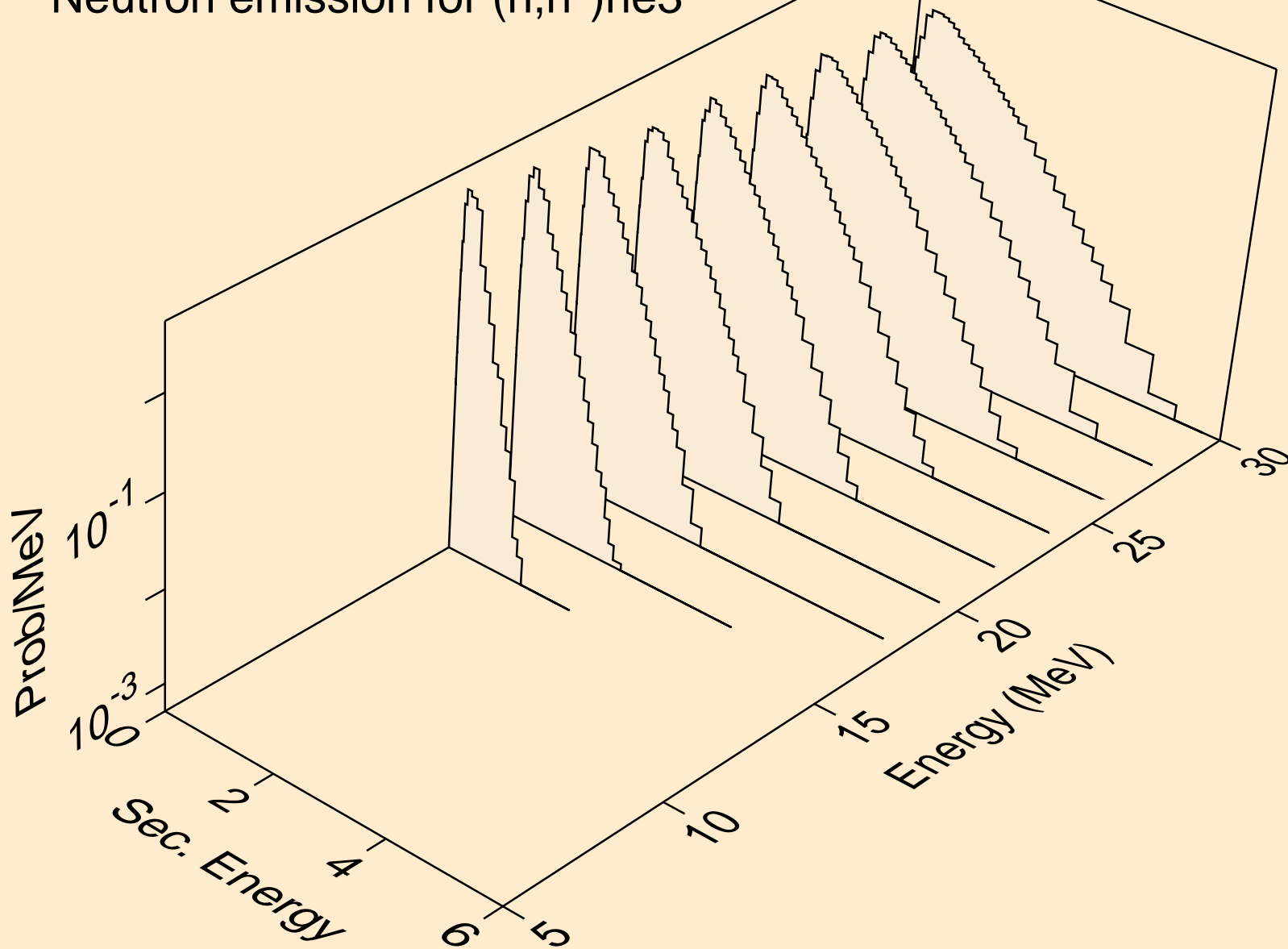

CE122 NEUTRON ACER TENDL-2019 LIBRARY; T=293.16K
Neutron emission for (n,2np)

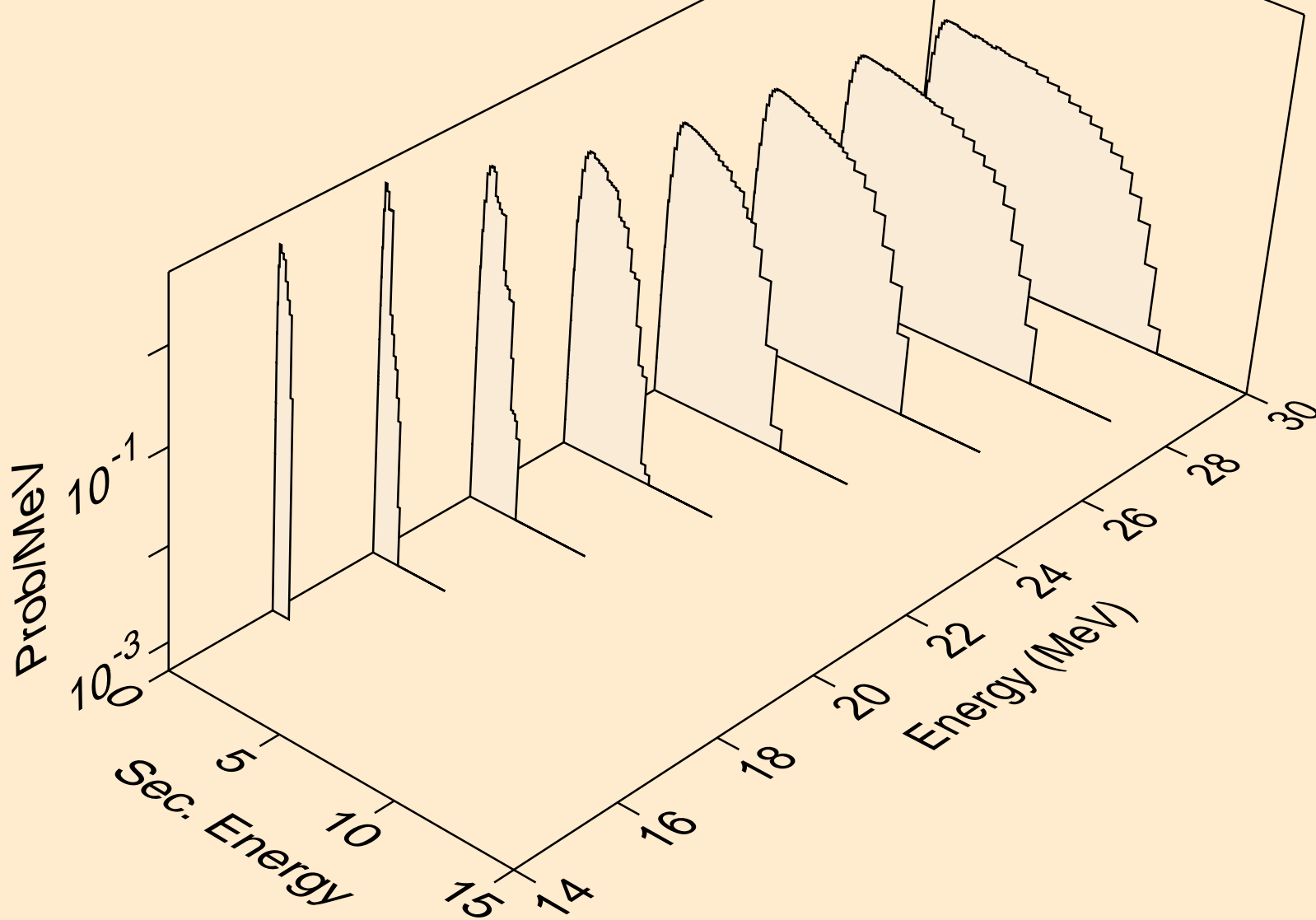

CE122 NEUTRON ACER TENDL-2019 LIBRARY; T=293.16K
Neutron emission for (n,3np)

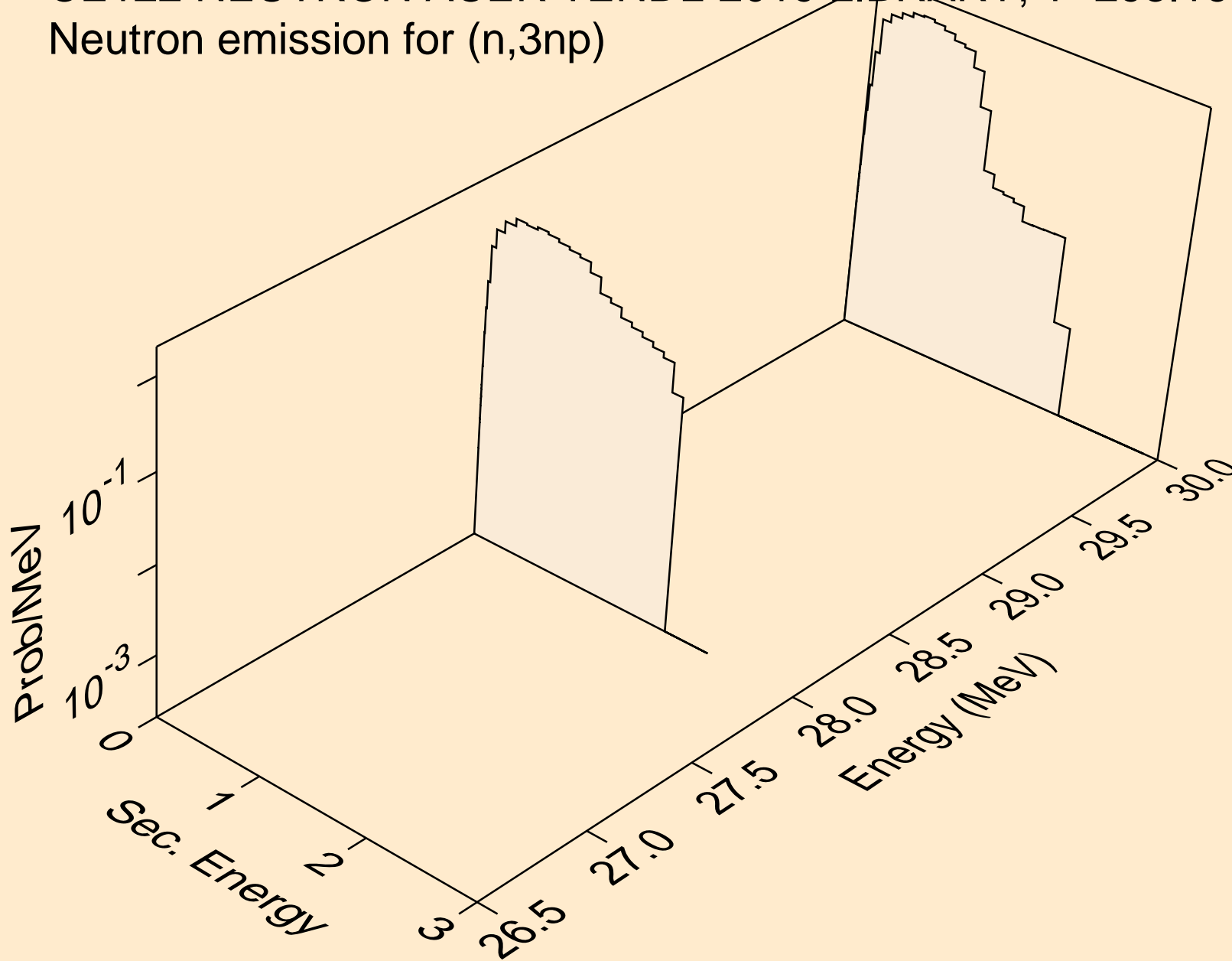

CE122 NEUTRON ACER TENDL-2019 LIBRARY; T=293.16K
Neutron emission for (n,2np)

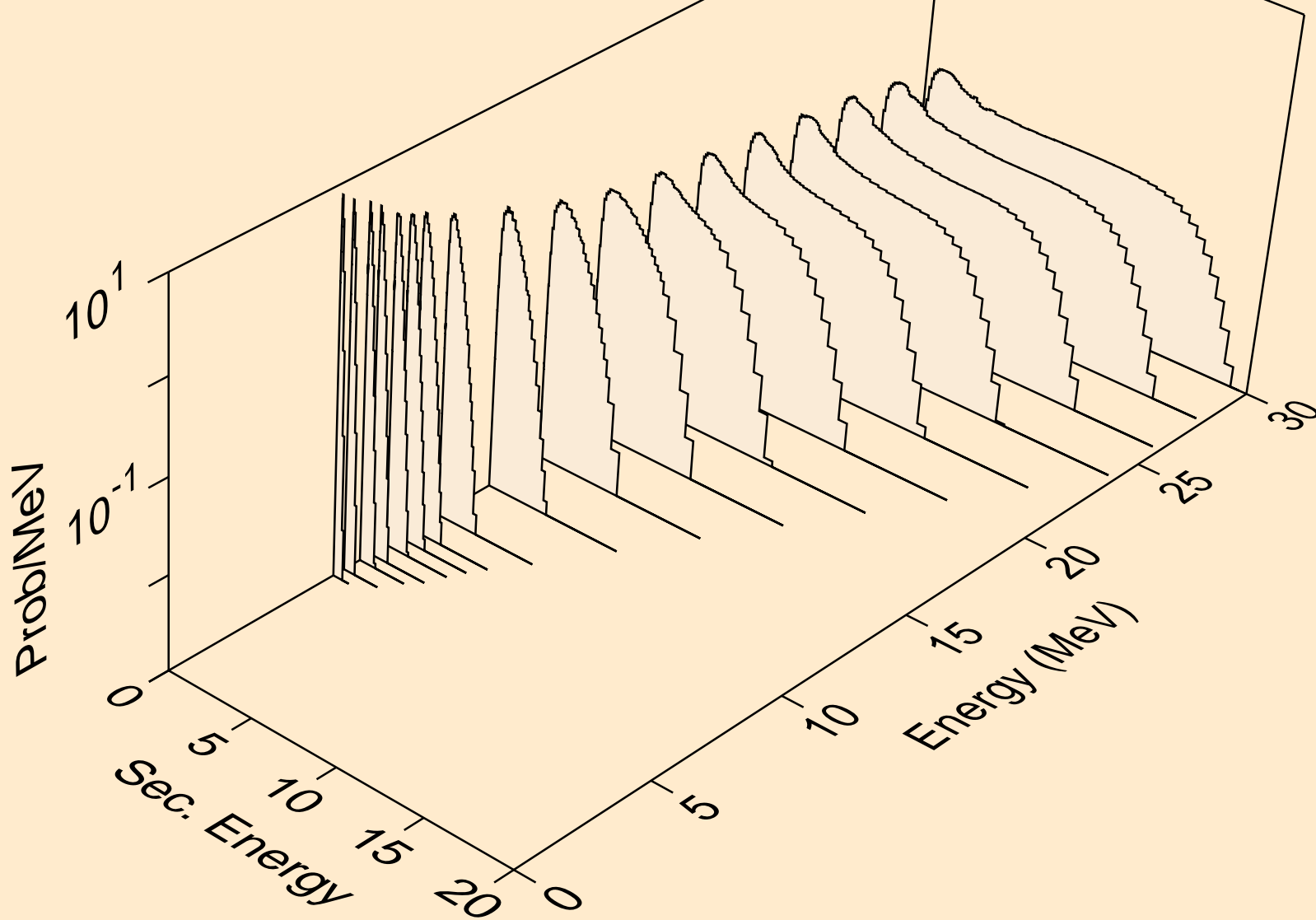

CE122 NEUTRON ACER TENDL-2019 LIBRARY; T=293.16K
Neutron emission for (n,npa)

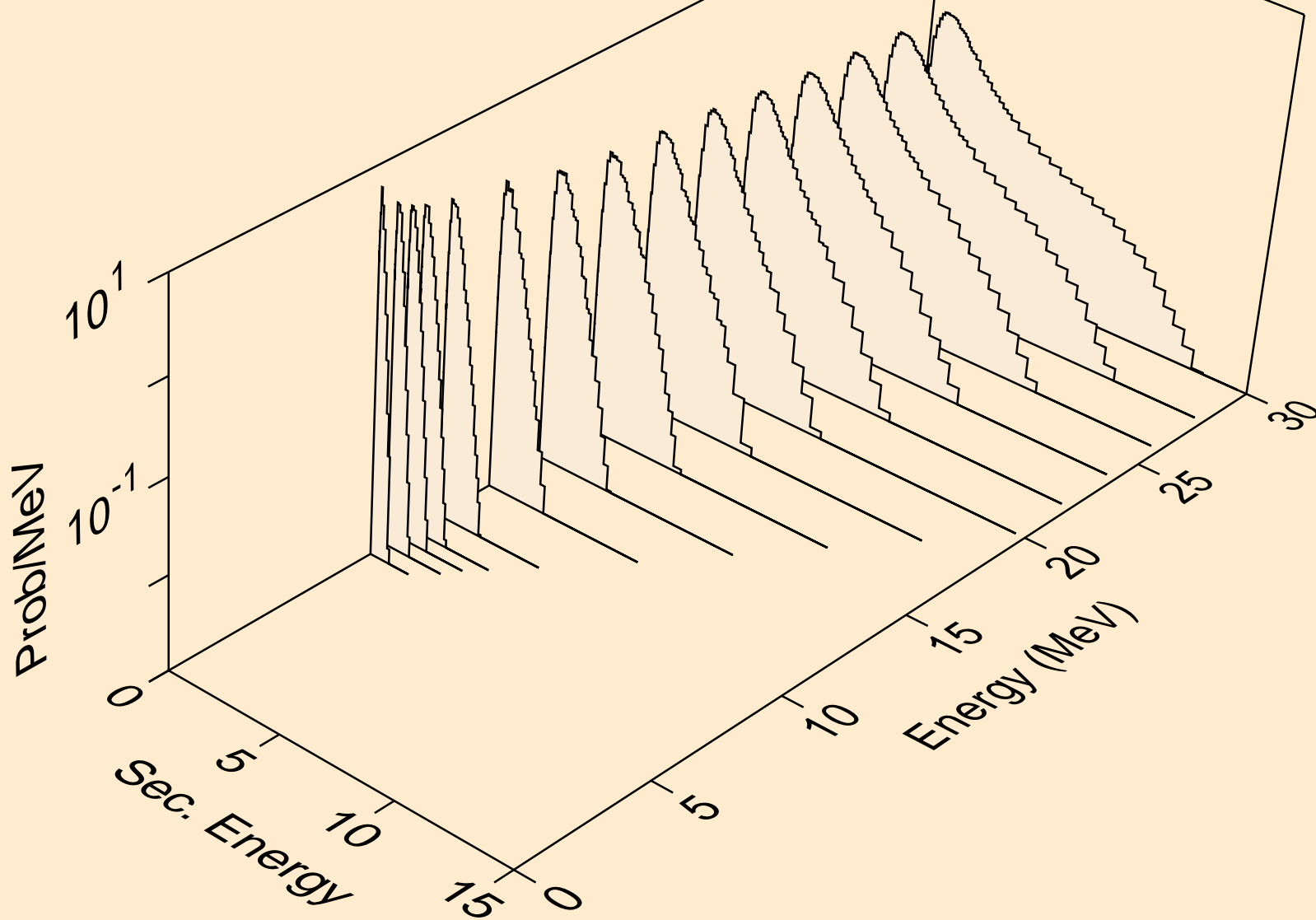

CE122 NEUTRON ACER TENDL-2019 LIBRARY; T=293.16K
Neutron emission for (n,n*c)

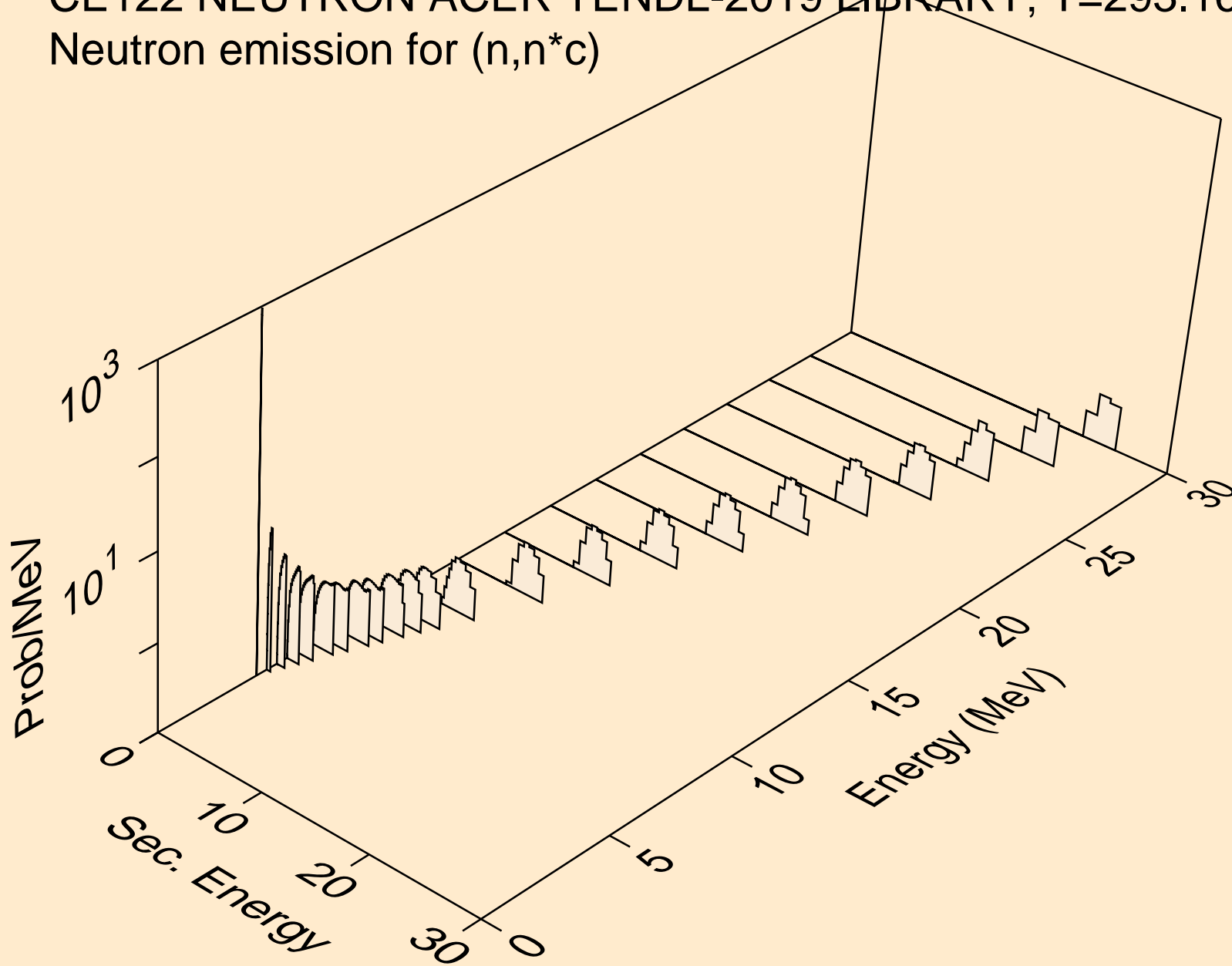

CE122 NEUTRON ACER TENDL-2019 LIBRARY; T=293.16K
Photon emission for (n,x)

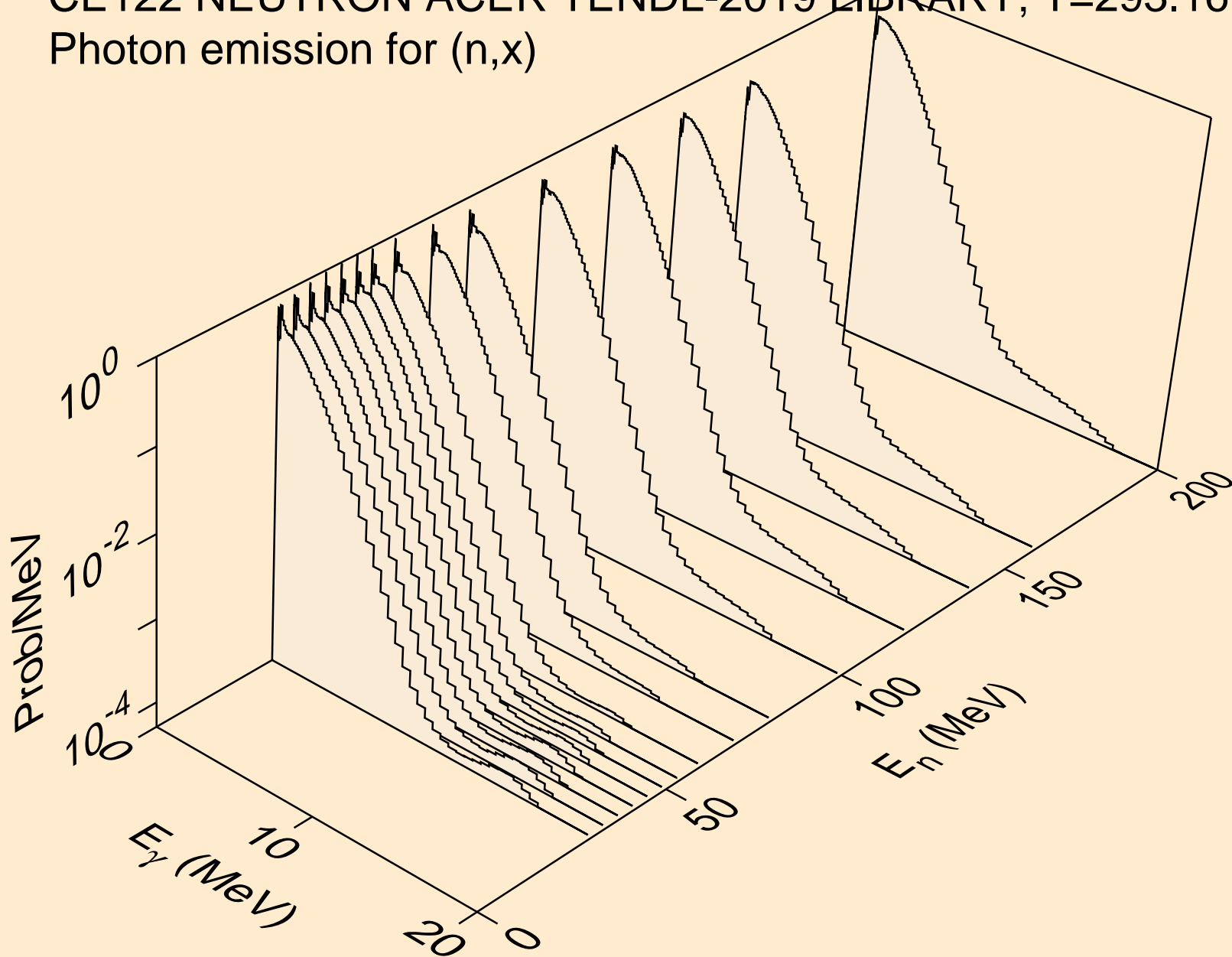

CE122 NEUTRON ACER TENDL-2019 LIBRARY; T=293.16K
Photon emission for (n,2n)

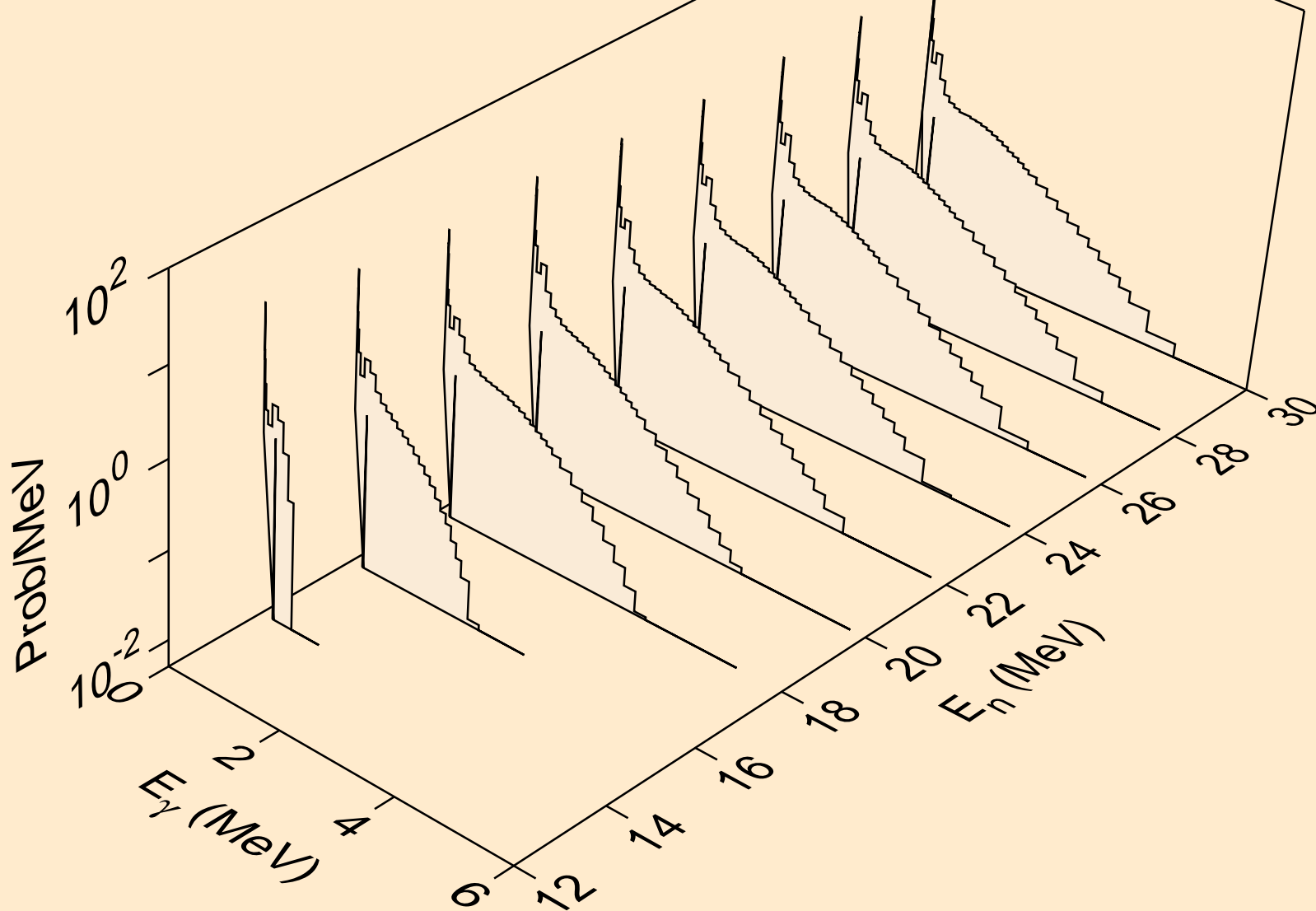

CE122 NEUTRON ACER TENDL-2019 LIBRARY; T=293.16K
Photon emission for (n,3n)

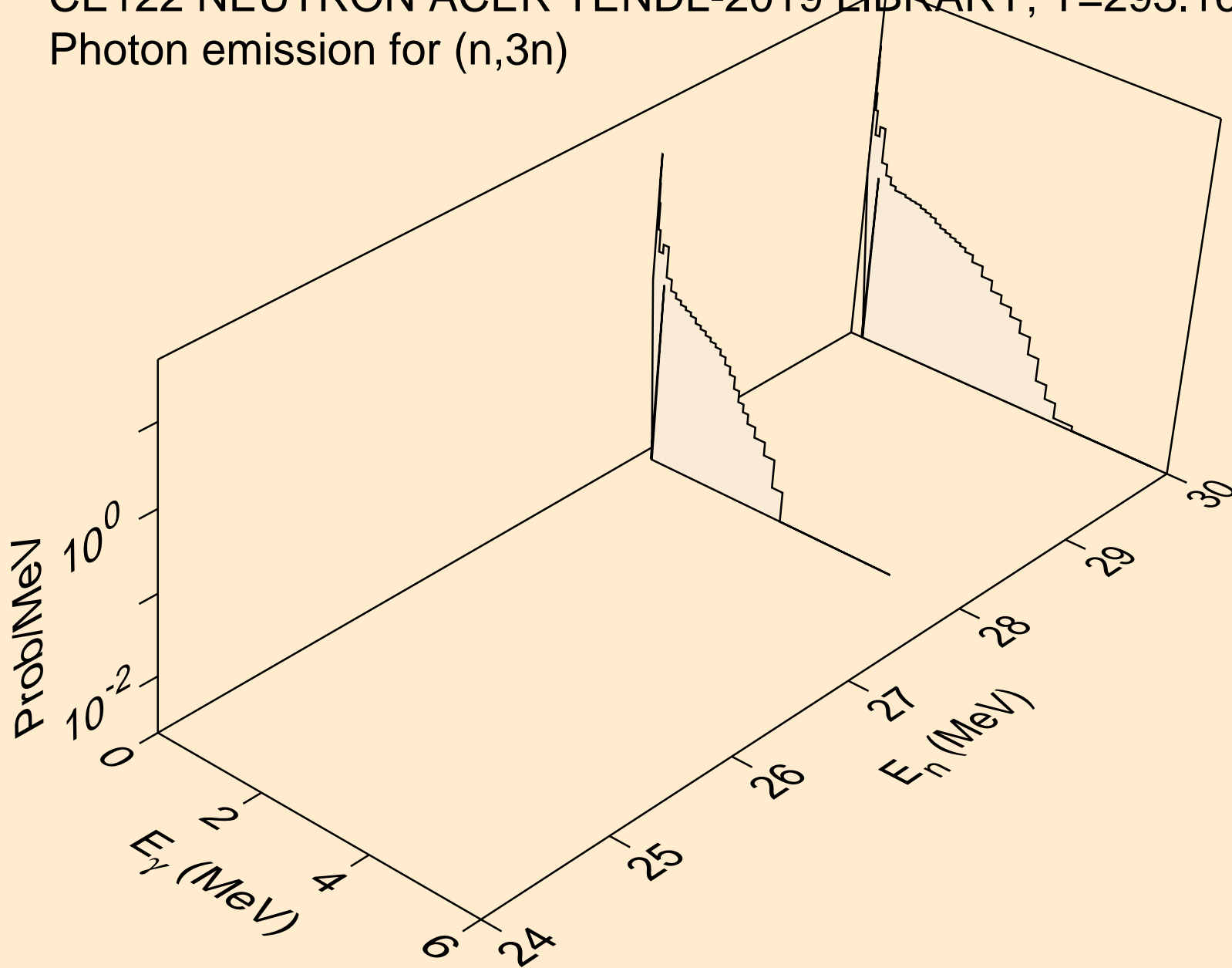

CE122 NEUTRON ACER TENDL-2019 LIBRARY; T=293.16K
Photon emission for (n,n*)a

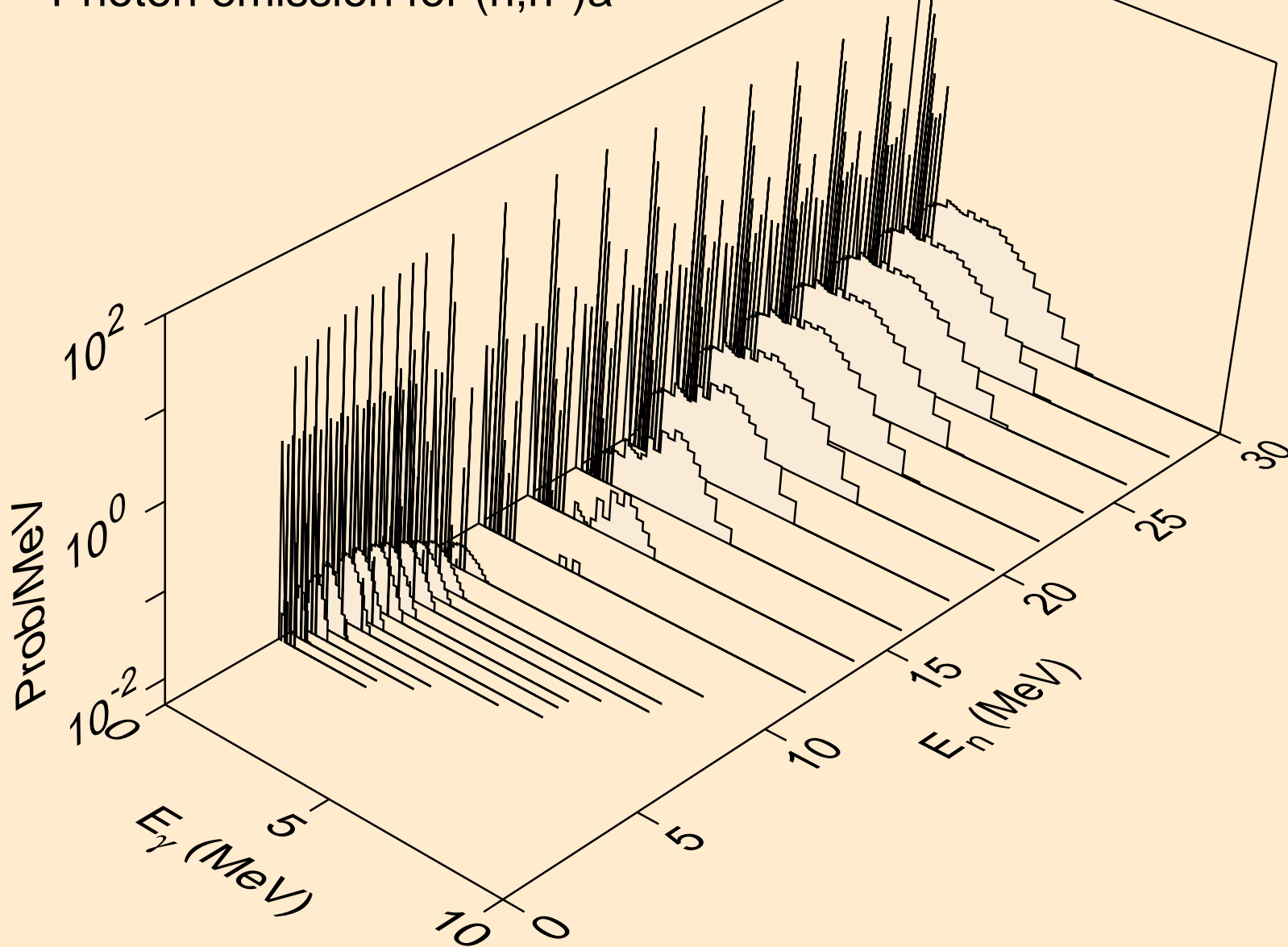

CE122 NEUTRON ACER TENDL-2019 LIBRARY; T=293.16K
Photon emission for (n,n*)3a

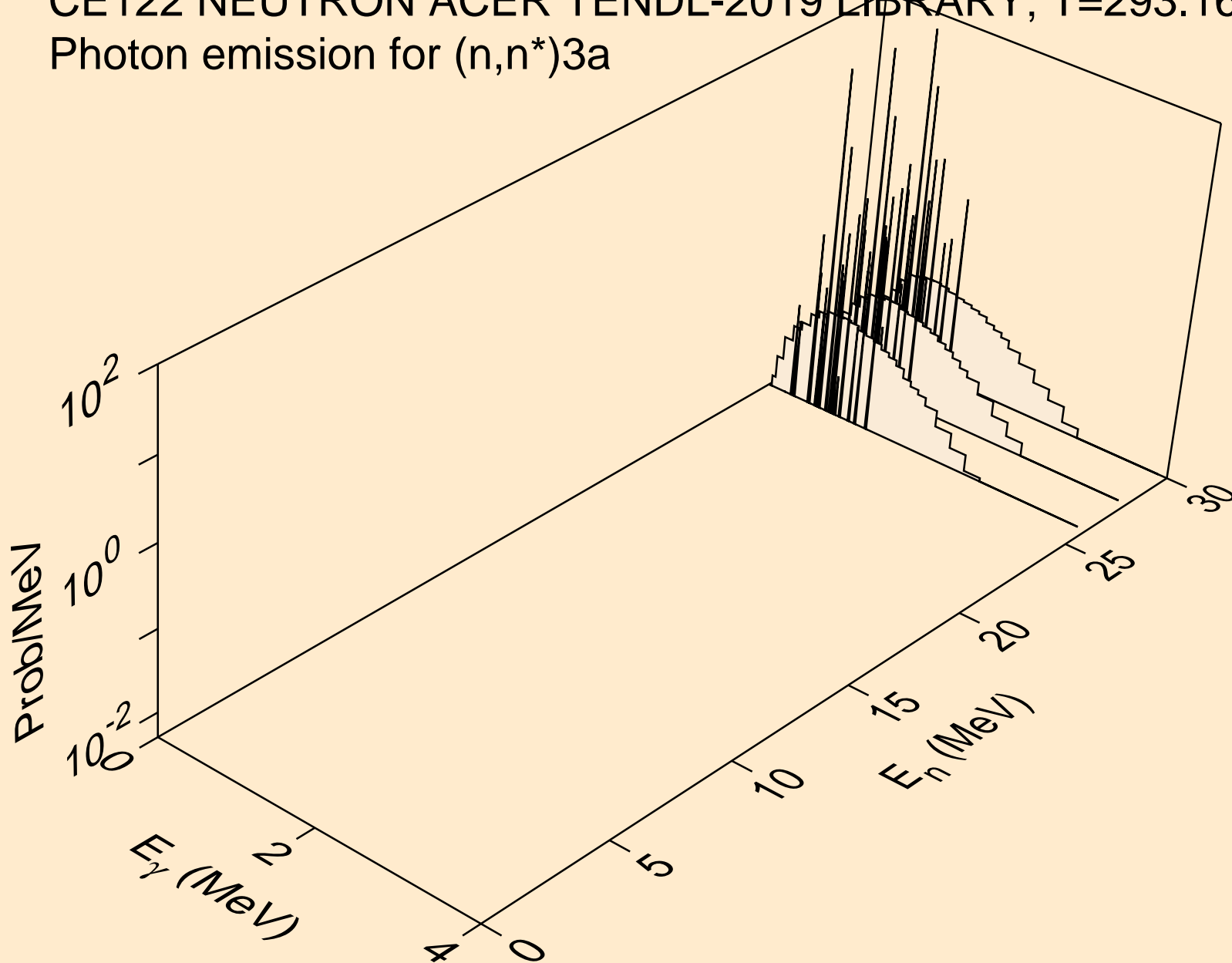

CE122 NEUTRON ACER TENDL-2019 LIBRARY; T=293.16K
Photon emission for (n,2n)a

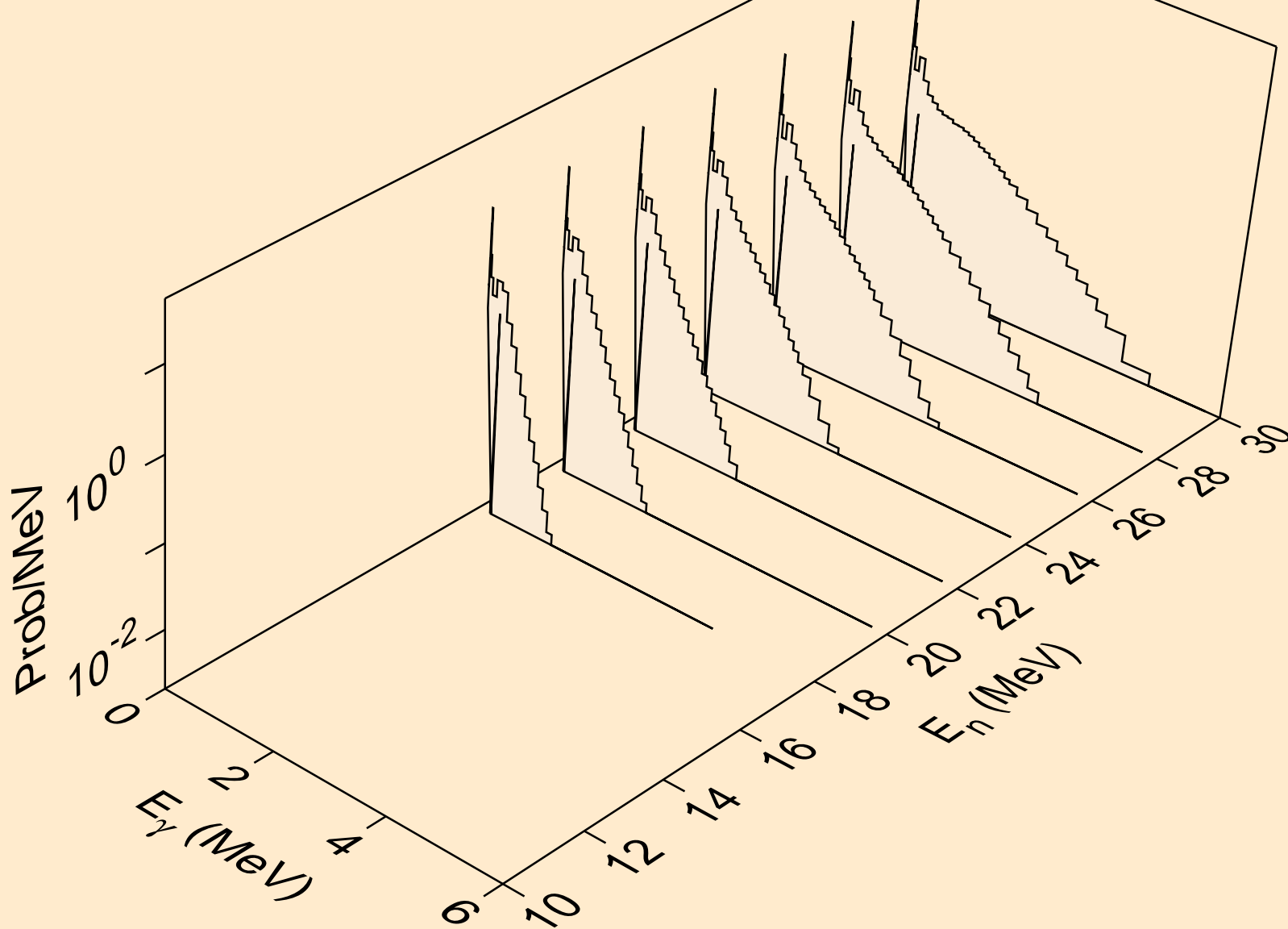

CE122 NEUTRON ACER TENDL-2019 LIBRARY; T=293.16K
Photon emission for (n,n*)p

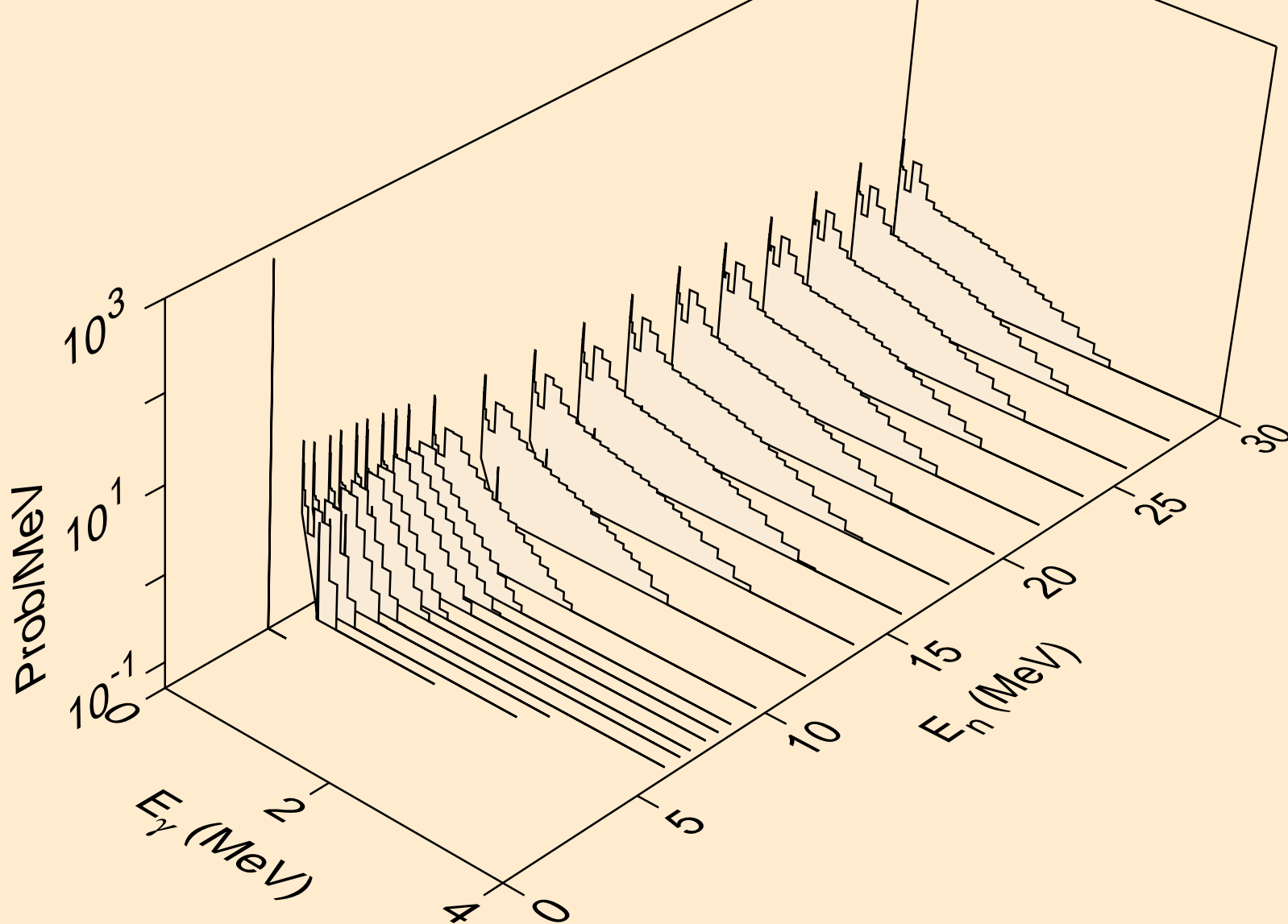

CE122 NEUTRON ACER TENDL-2019 LIBRARY; T=293.16K
Photon emission for (n,n*)2a

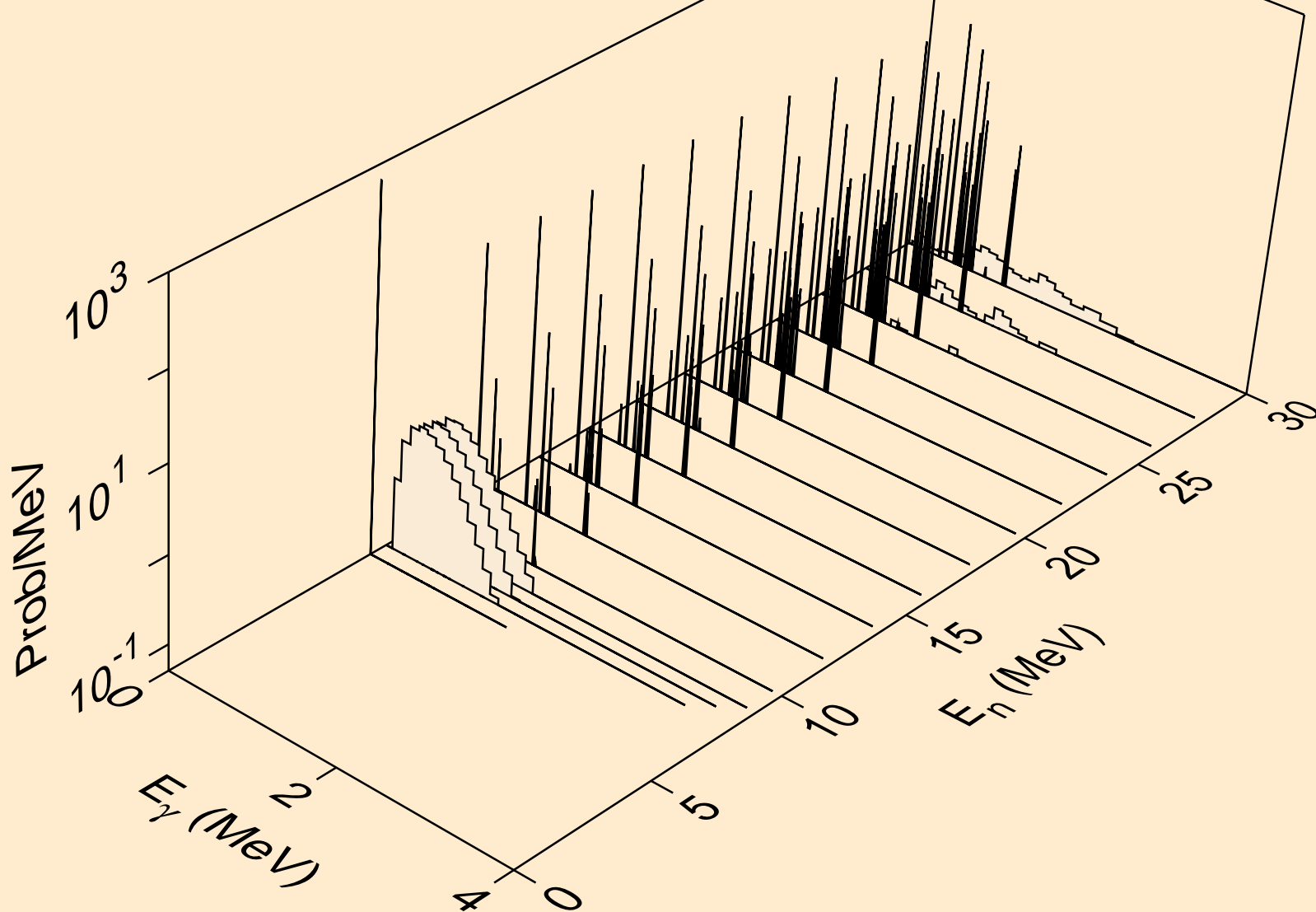

CE122 NEUTRON ACER TENDL-2019 LIBRARY; T=293.16K
Photon emission for (n,n*)d

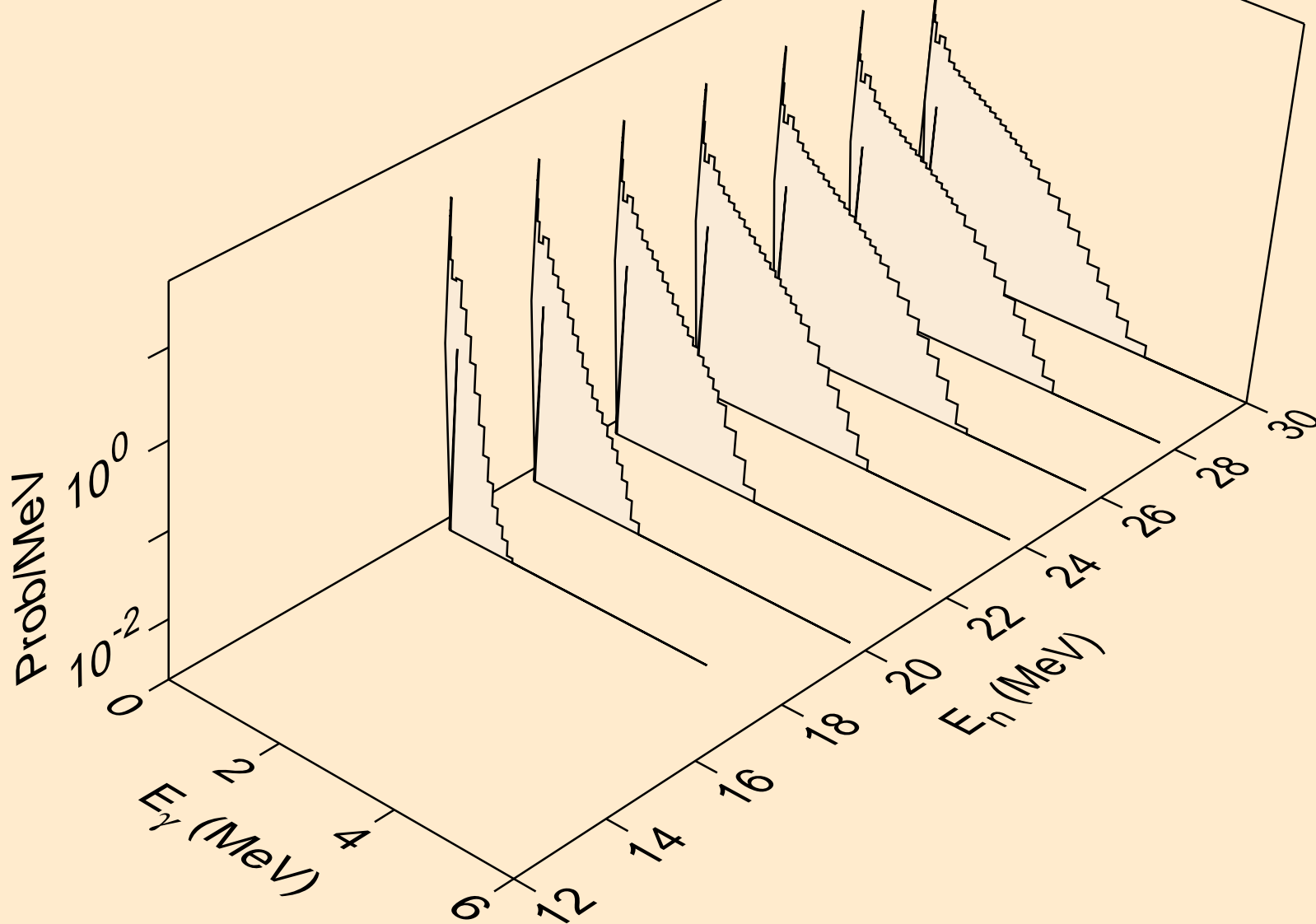

CE122 NEUTRON ACER TENDL-2019 LIBRARY; T=293.16K
Photon emission for (n,n*)t

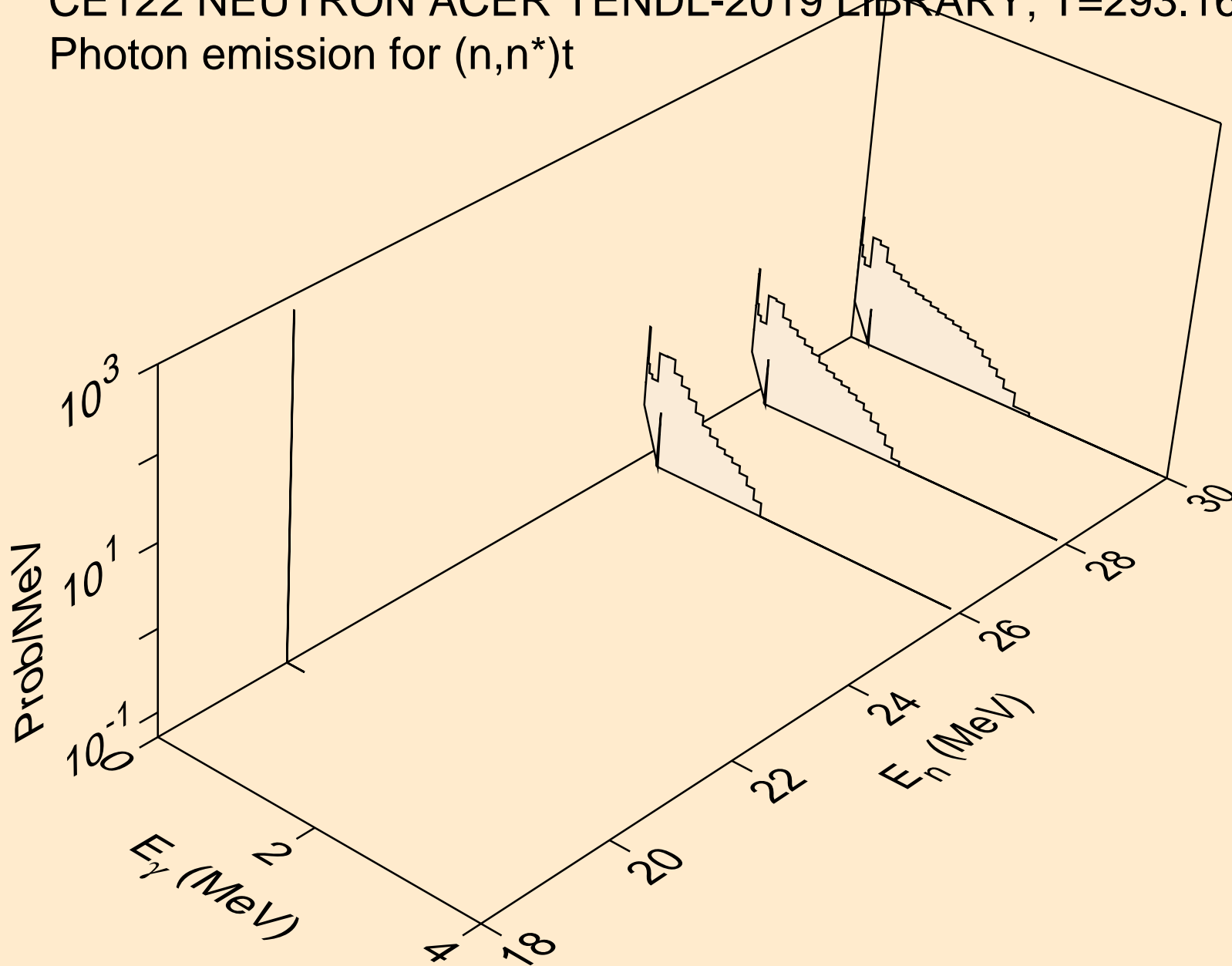

CE122 NEUTRON ACER TENDL-2019 LIBRARY; T=293.16K
Photon emission for (n,n*)he3

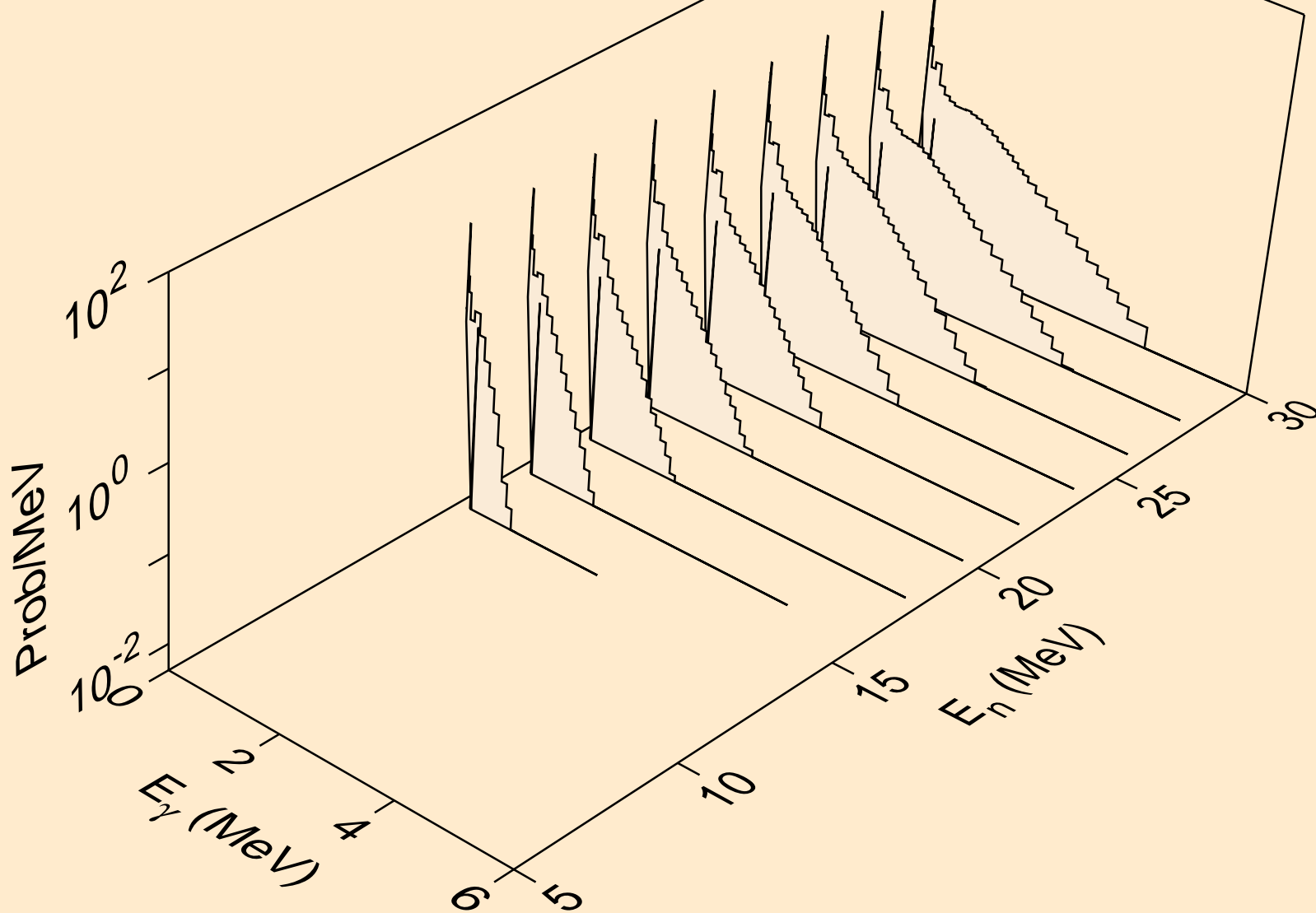

CE122 NEUTRON ACER TENDL-2019 LIBRARY; T=293.16K
Photon emission for (n,2np)

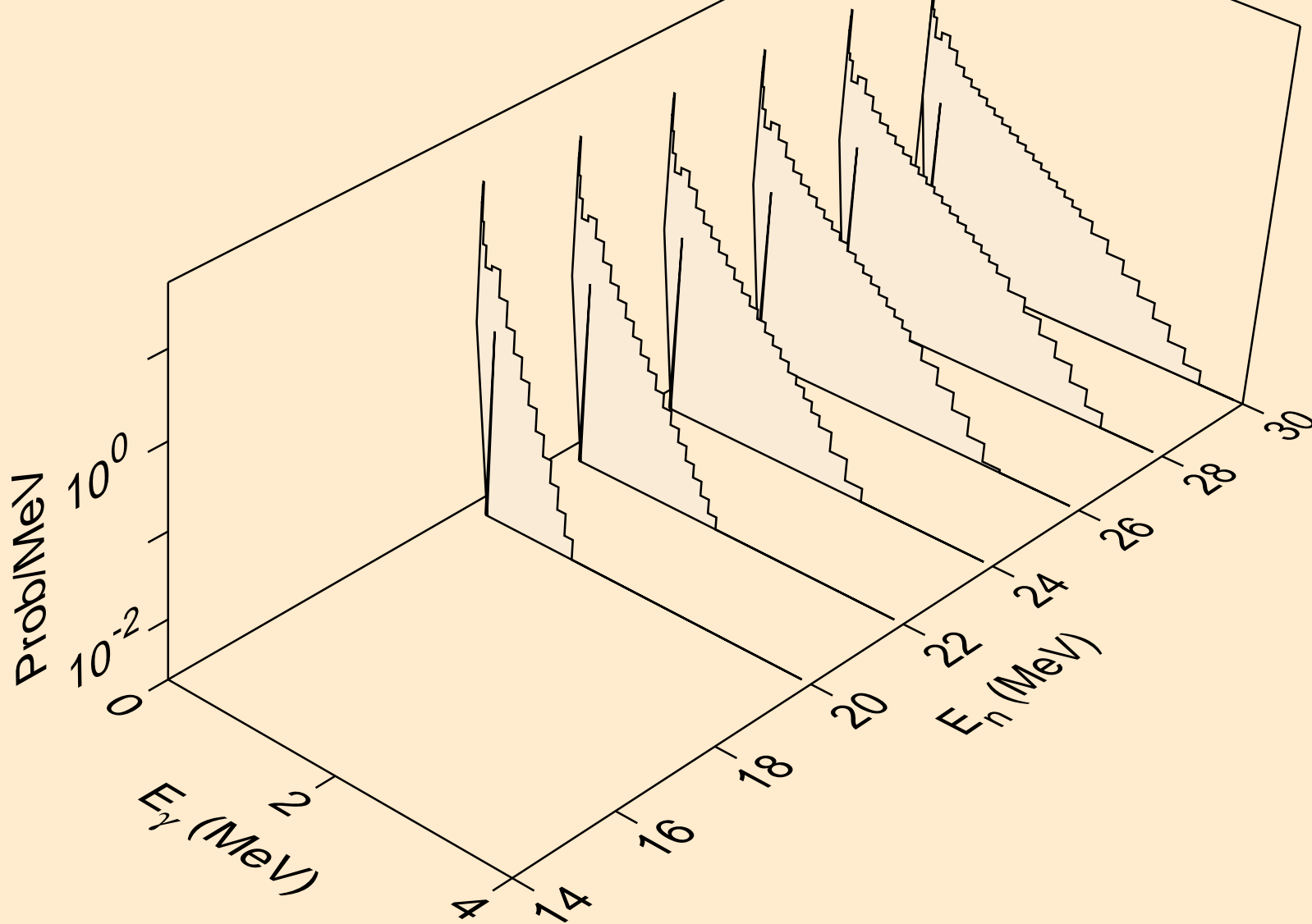

CE122 NEUTRON ACER TENDL-2019 LIBRARY; T=293.16K
Photon emission for (n,3np)

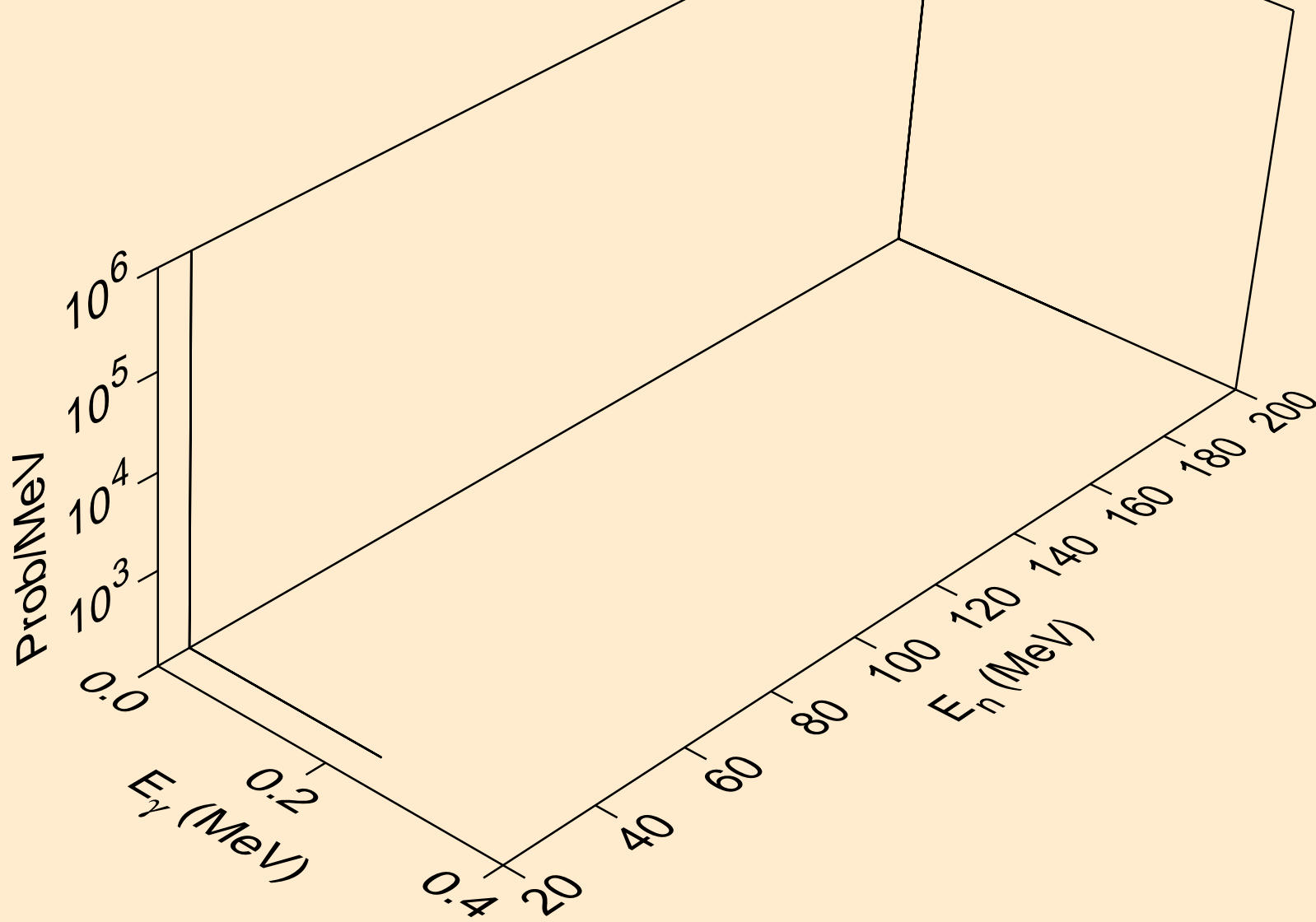

CE122 NEUTRON ACER TENDL-2019 LIBRARY; T=293.16K
Photon emission for (n,2np)

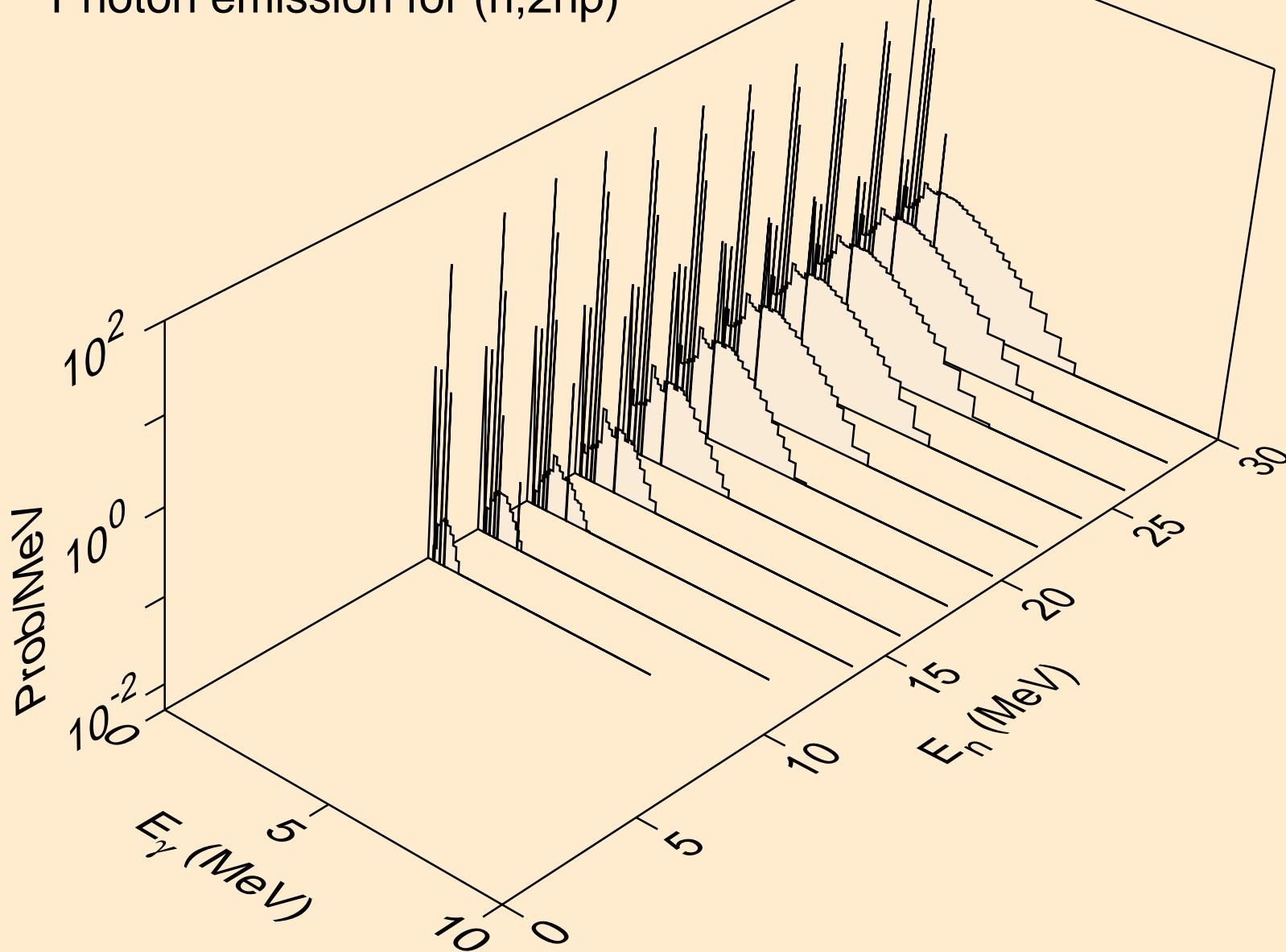

CE122 NEUTRON ACER TENDL-2019 LIBRARY; T=293.16K
Photon emission for (n,npa)

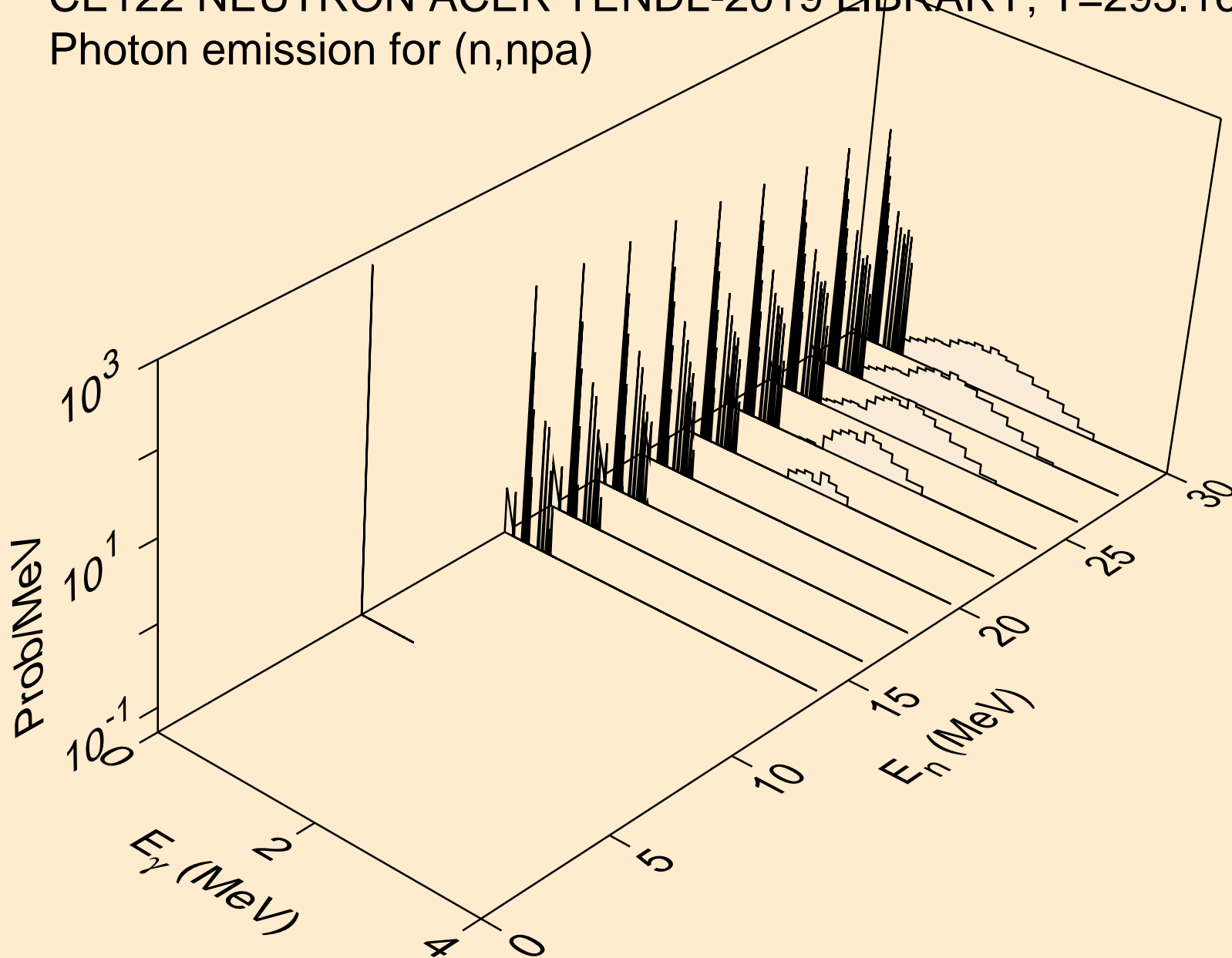

CE122 NEUTRON ACER TENDL-2019 LIBRARY; T=293.16K
Photon emission for (n,n*c)

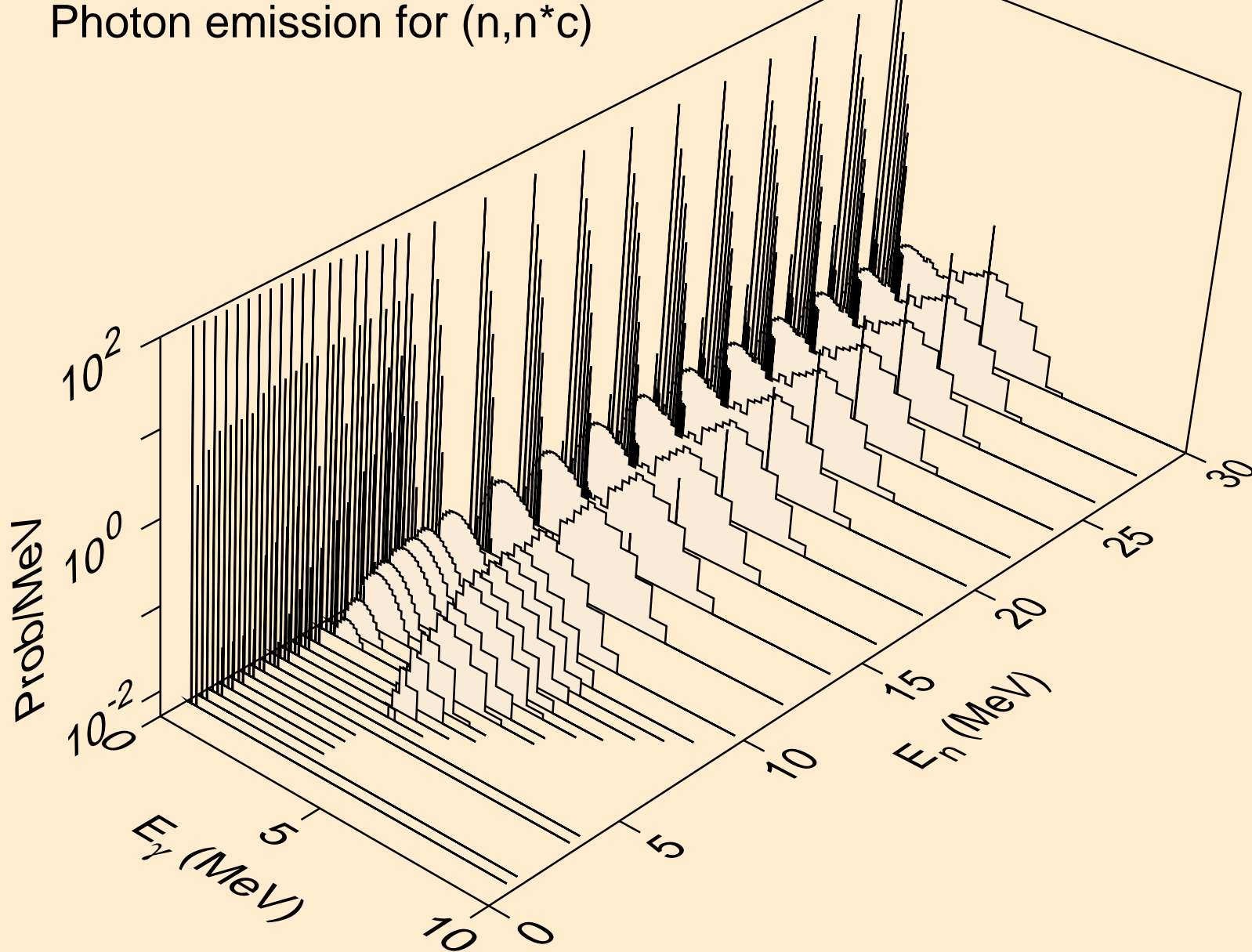

CE122 NEUTRON ACER TENDL-2019 LIBRARY; T=293.16K
Photon emission for (n,gma)

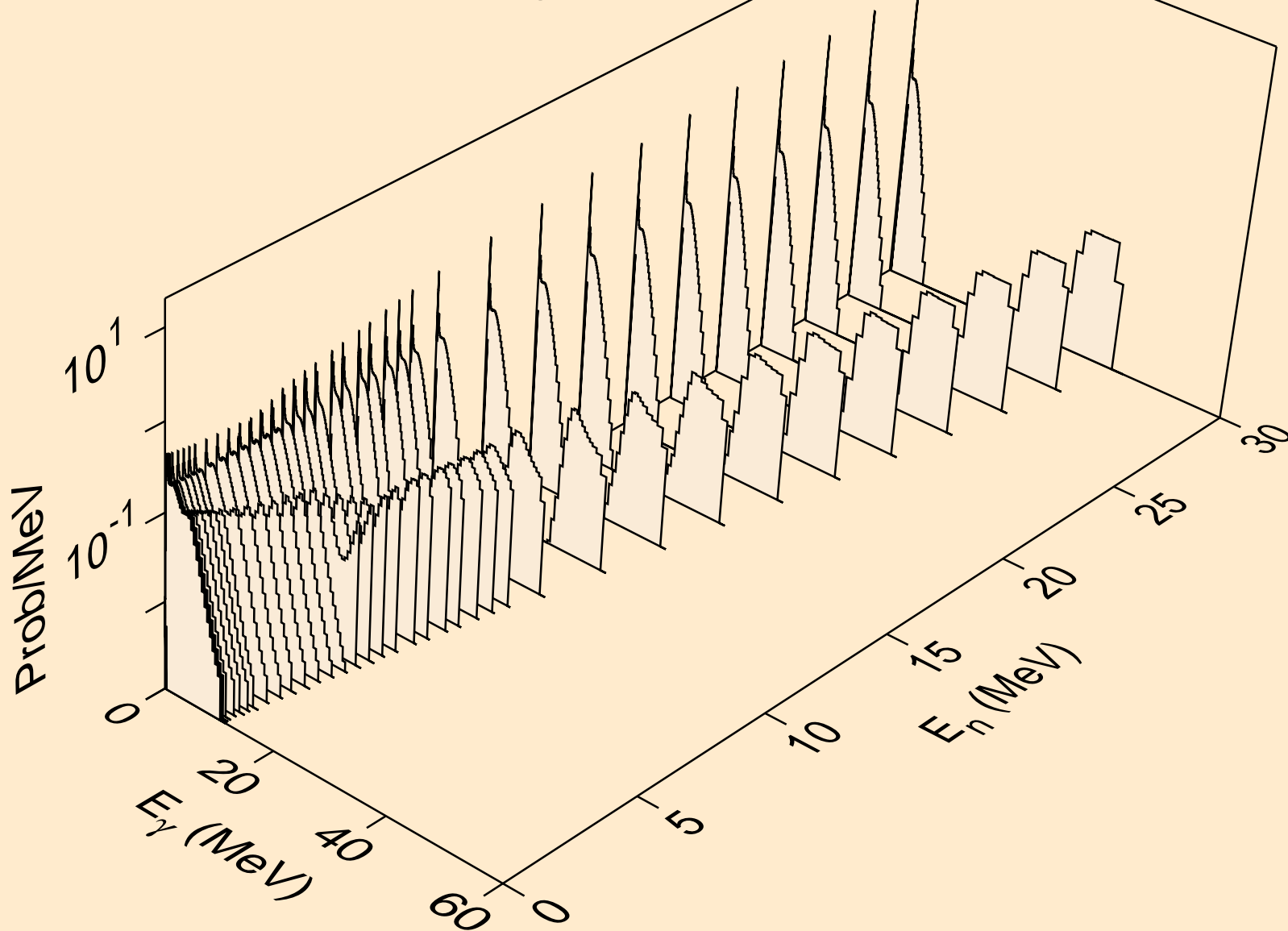

CE122 NEUTRON ACER TENDL-2019 LIBRARY; T=293.16K
Photon emission for (n,p)

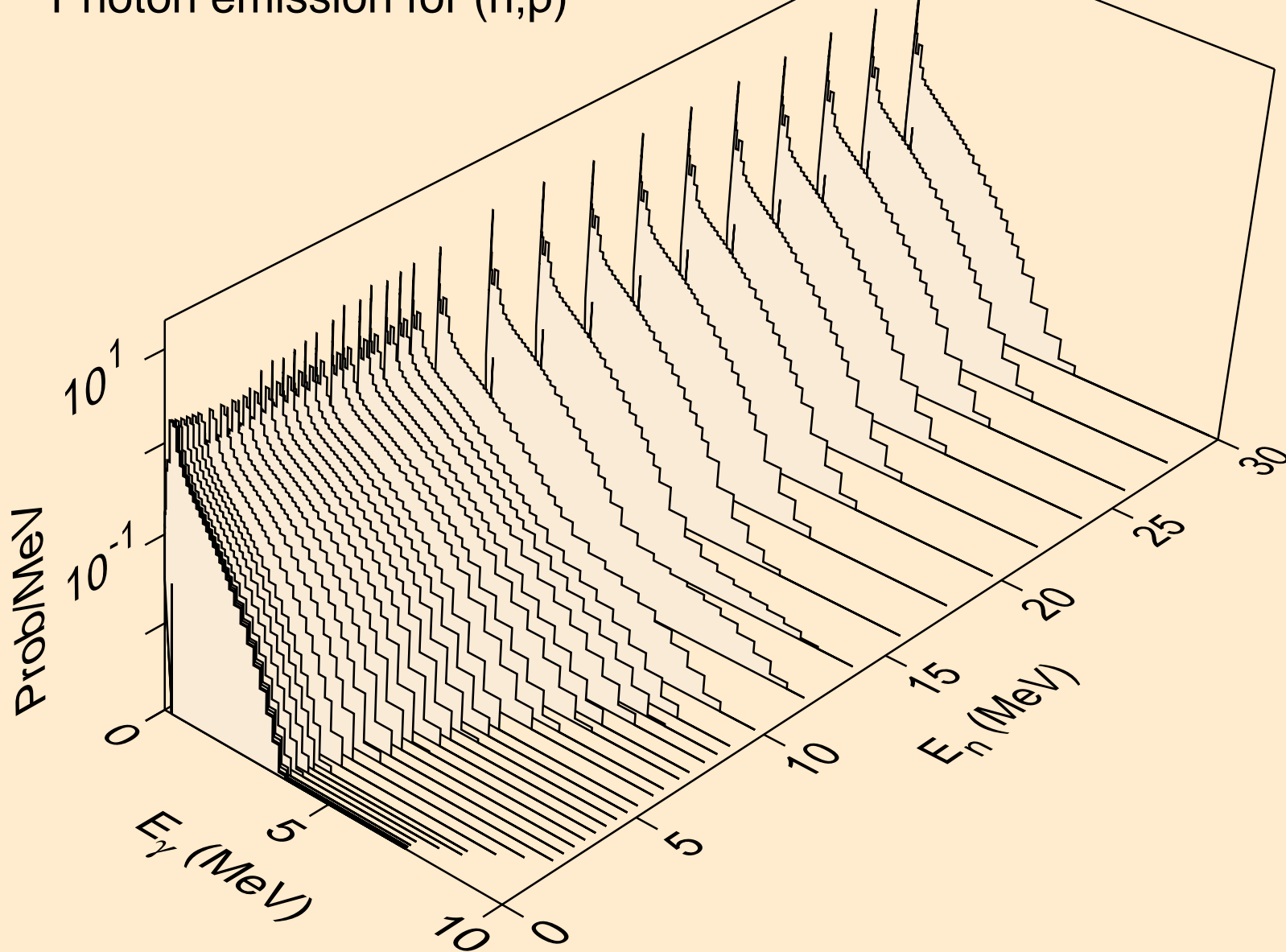

CE122 NEUTRON ACER TENDL-2019 LIBRARY; T=293.16K
Photon emission for (n,d)

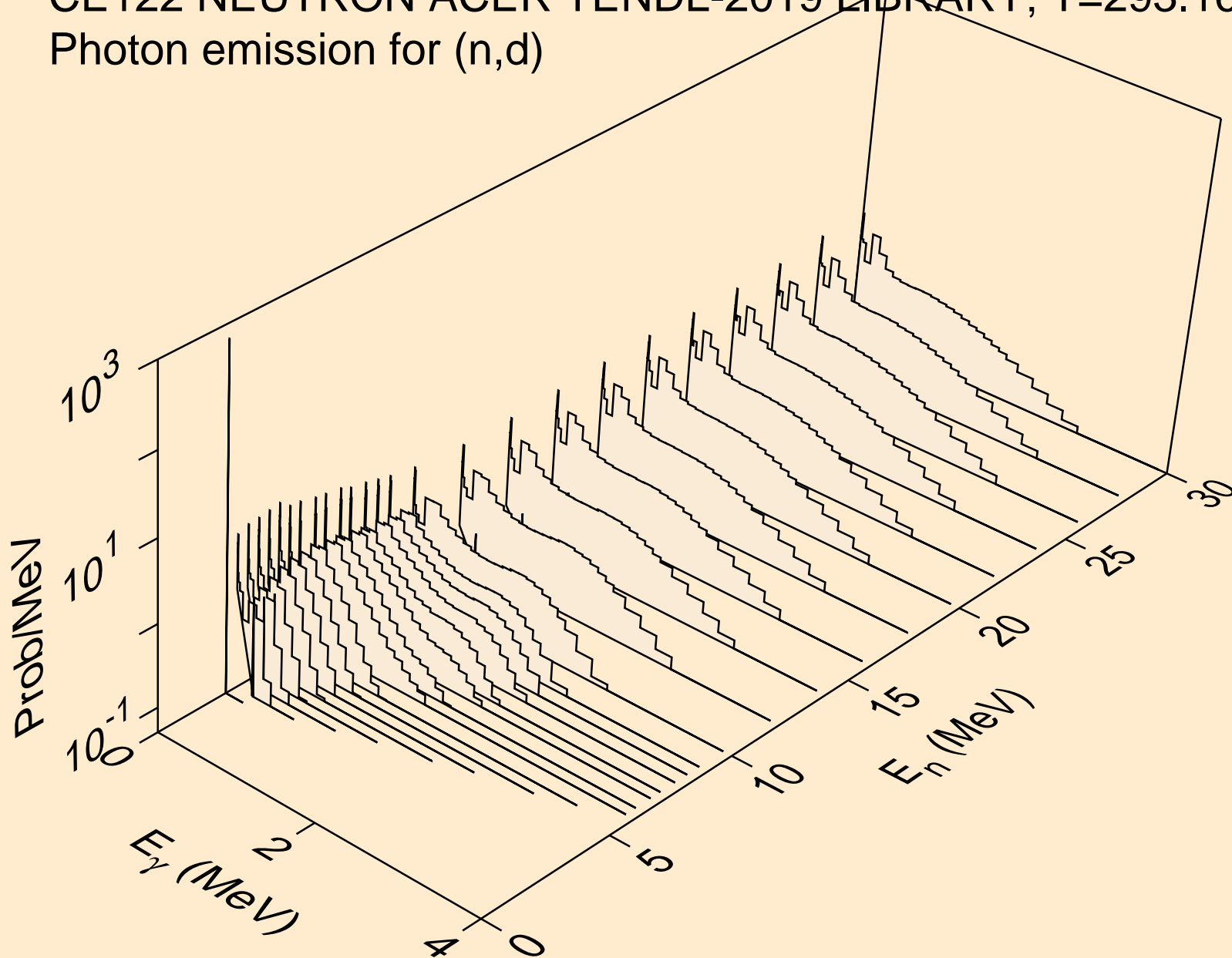

CE122 NEUTRON ACER TENDL-2019 LIBRARY; T=293.16K
Photon emission for (n,t)

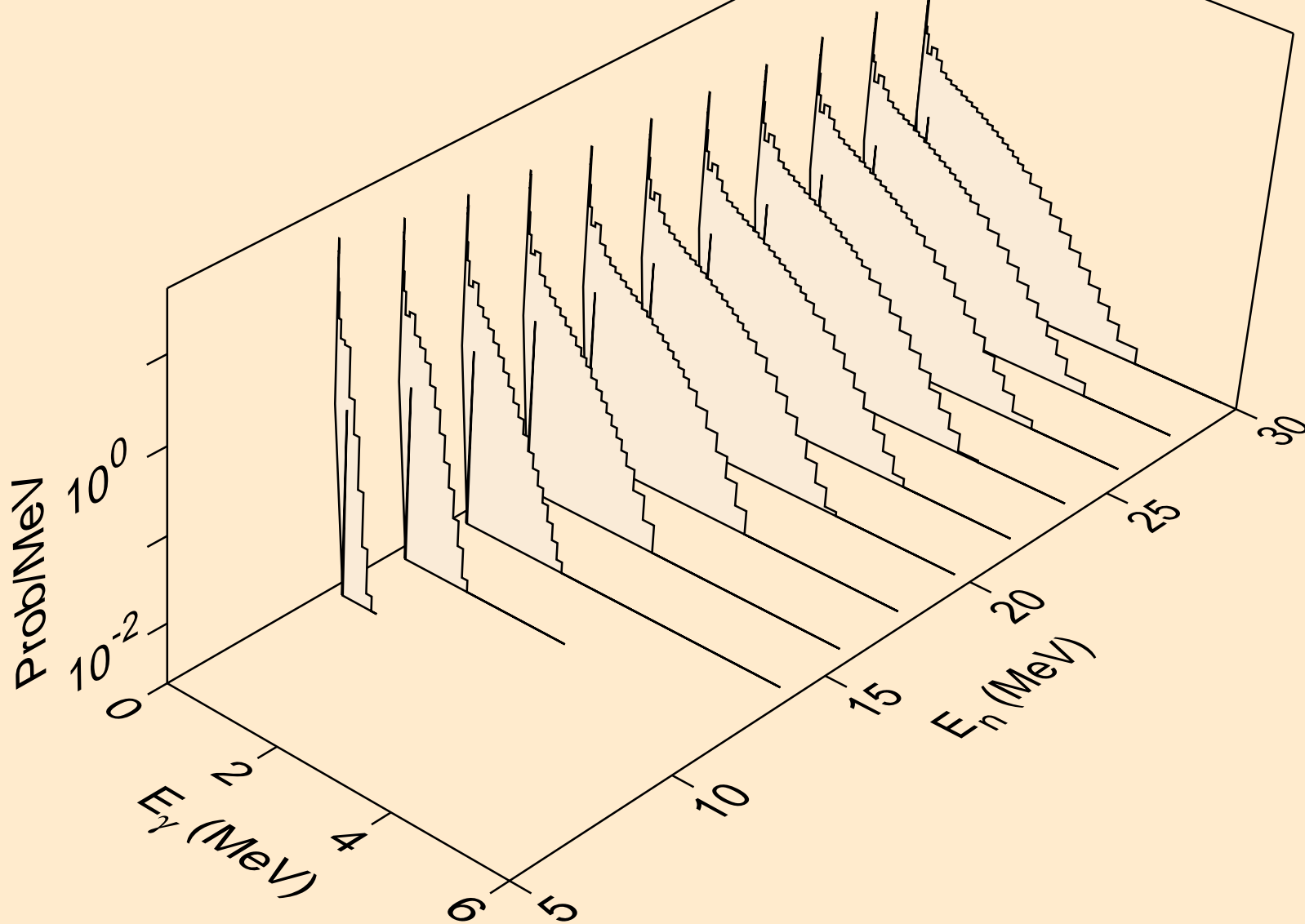

CE122 NEUTRON ACER TENDL-2019 LIBRARY; T=293.16K
Photon emission for (n,he3)

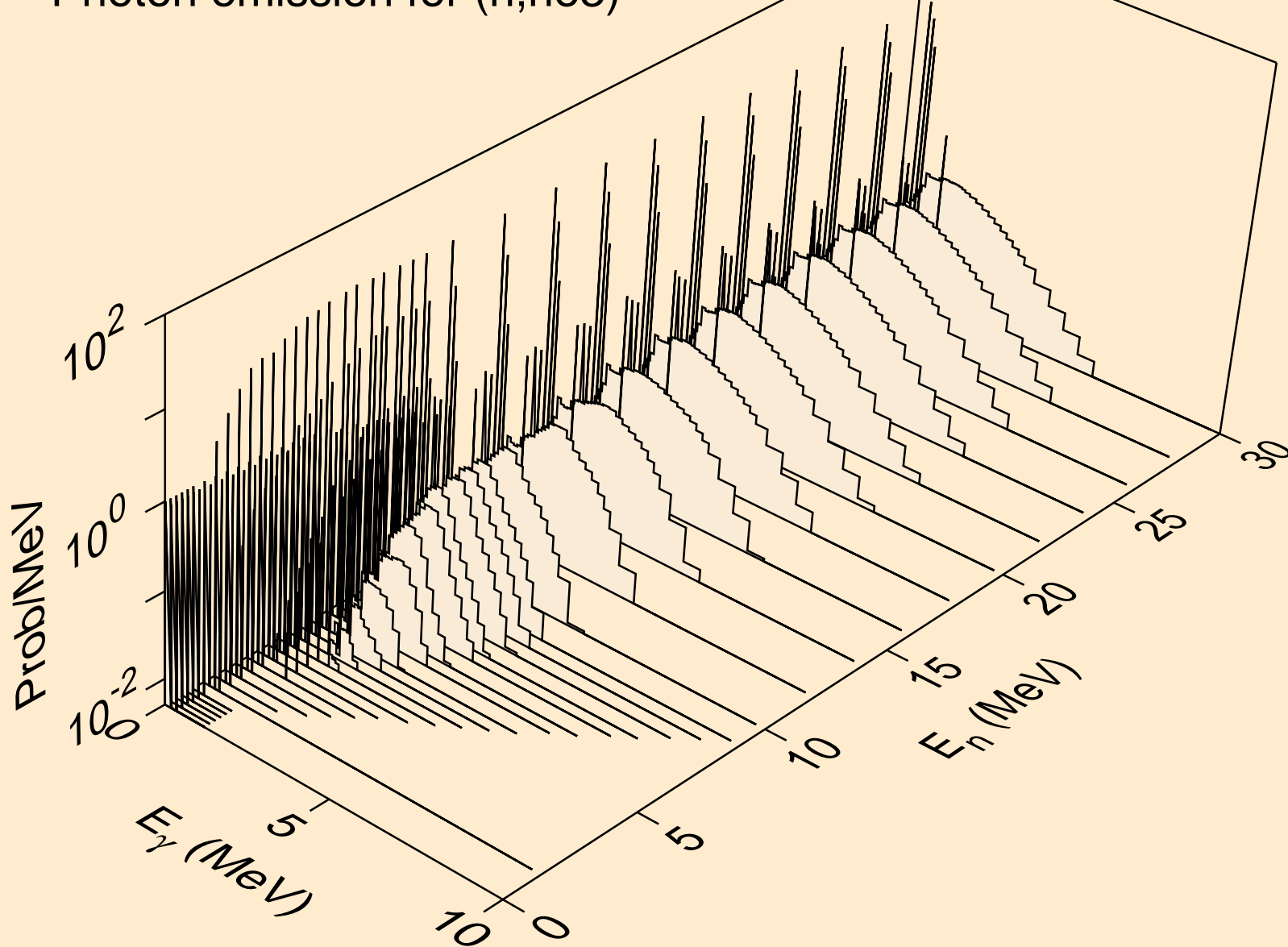

CE122 NEUTRON ACER TENDL-2019 LIBRARY; T=293.16K
Photon emission for (n,a)

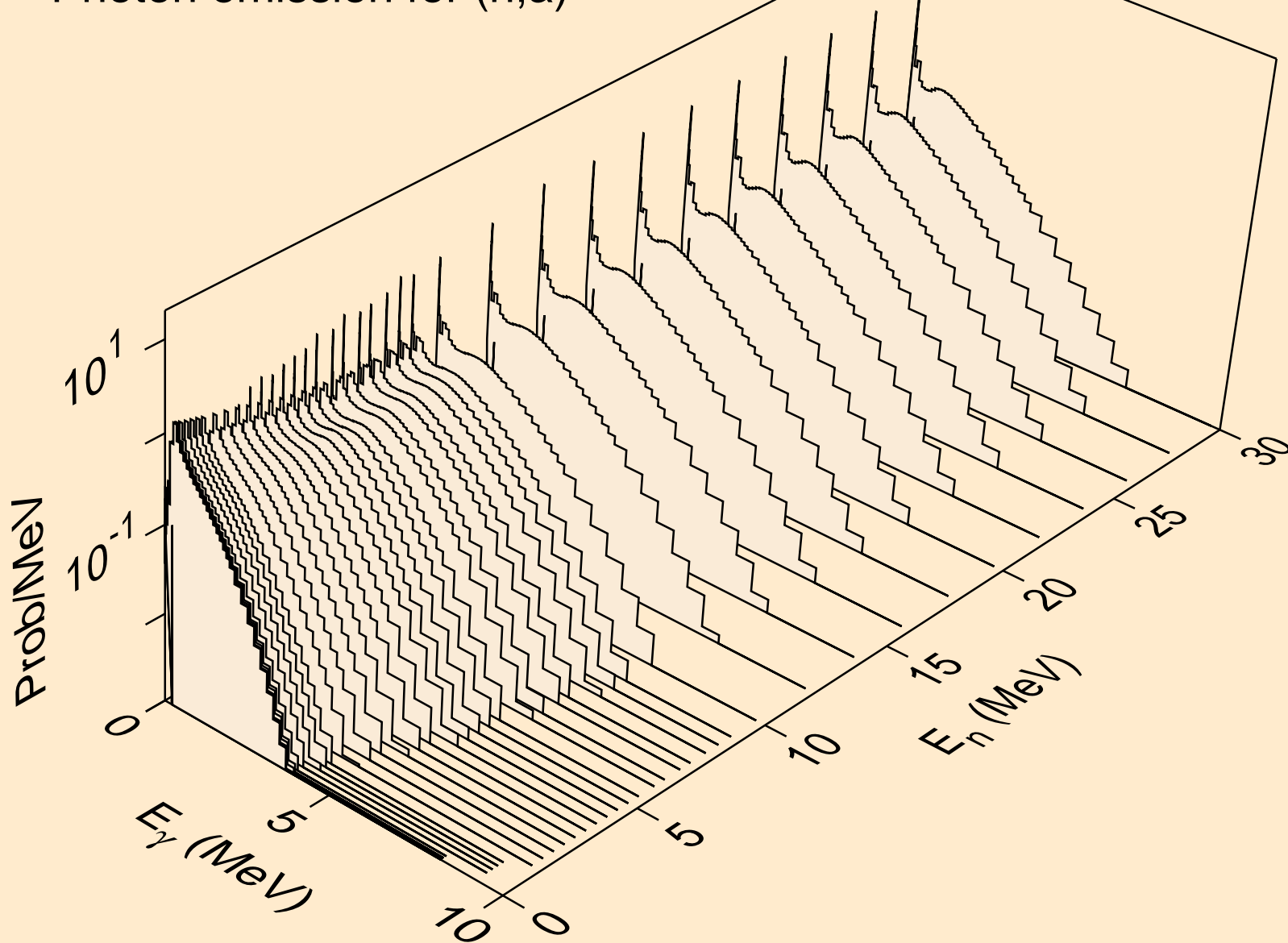

CE122 NEUTRON ACER TENDL-2019 LIBRARY; T=293.16K
Photon emission for (n,2a)

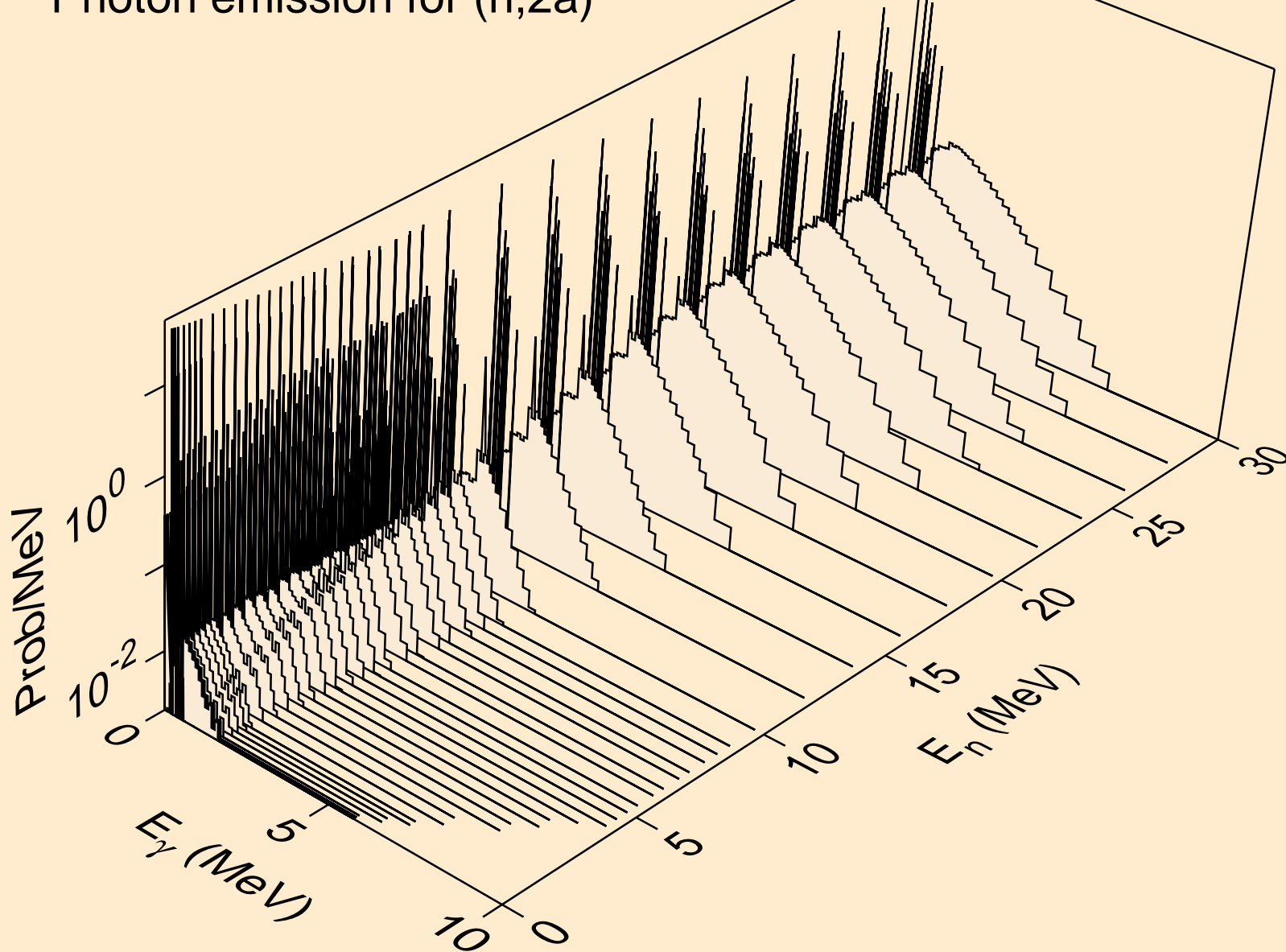

CE122 NEUTRON ACER TENDL-2019 LIBRARY; T=293.16K
Photon emission for (n,3a)

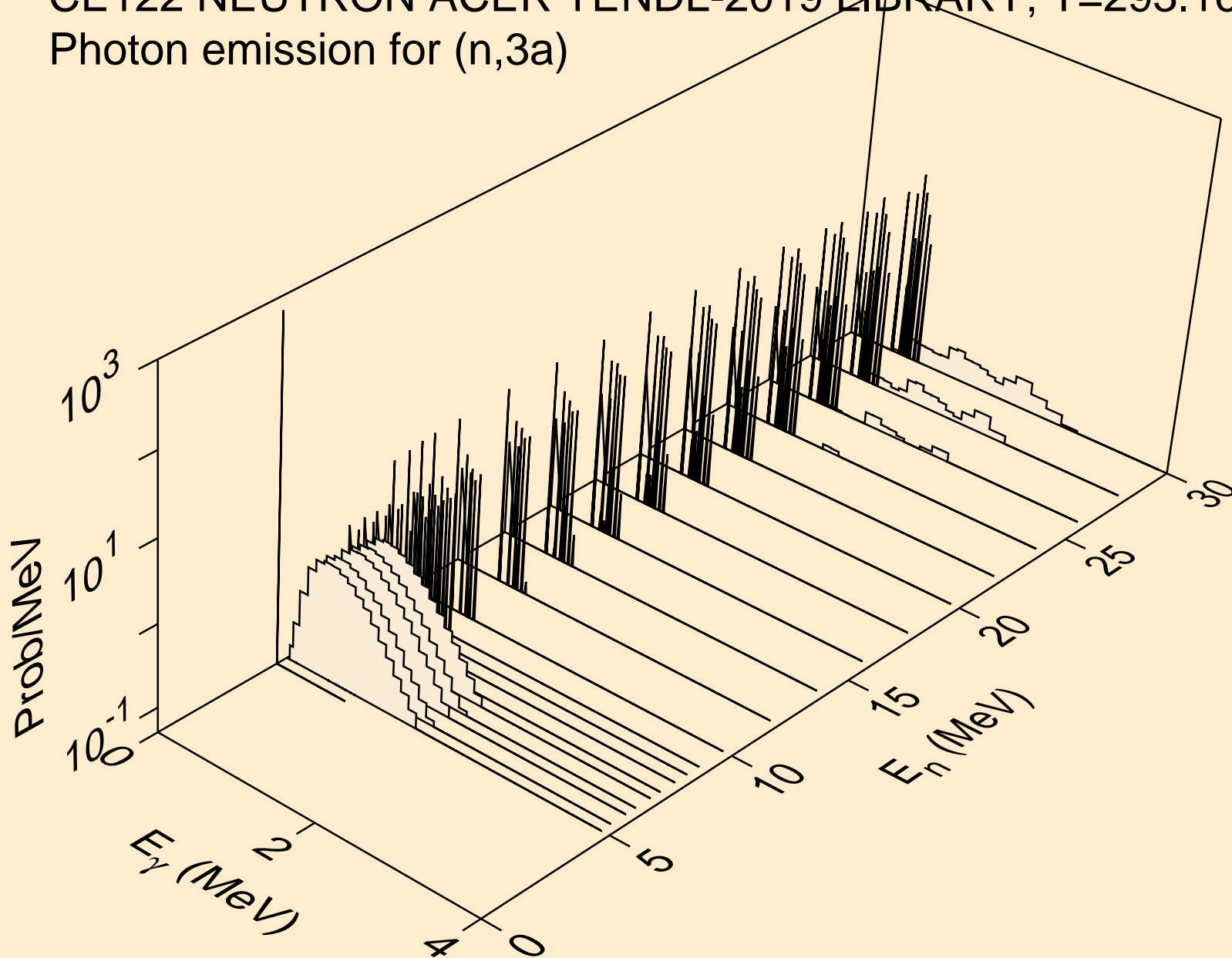

CE122 NEUTRON ACER TENDL-2019 LIBRARY; T=293.16K
Photon emission for (n,2p)

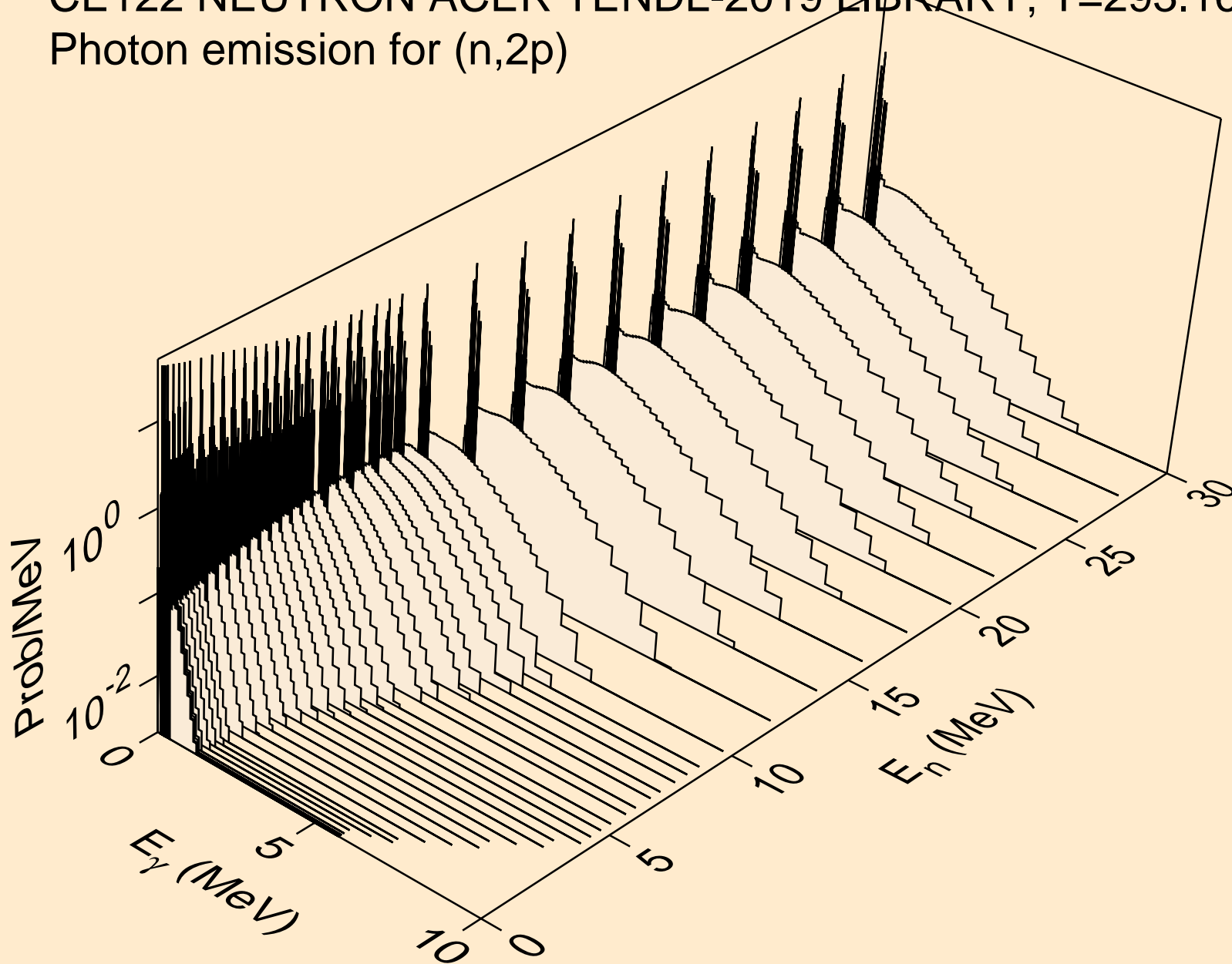

CE122 NEUTRON ACER TENDL-2019 LIBRARY; T=293.16K
Photon emission for (n,p α)

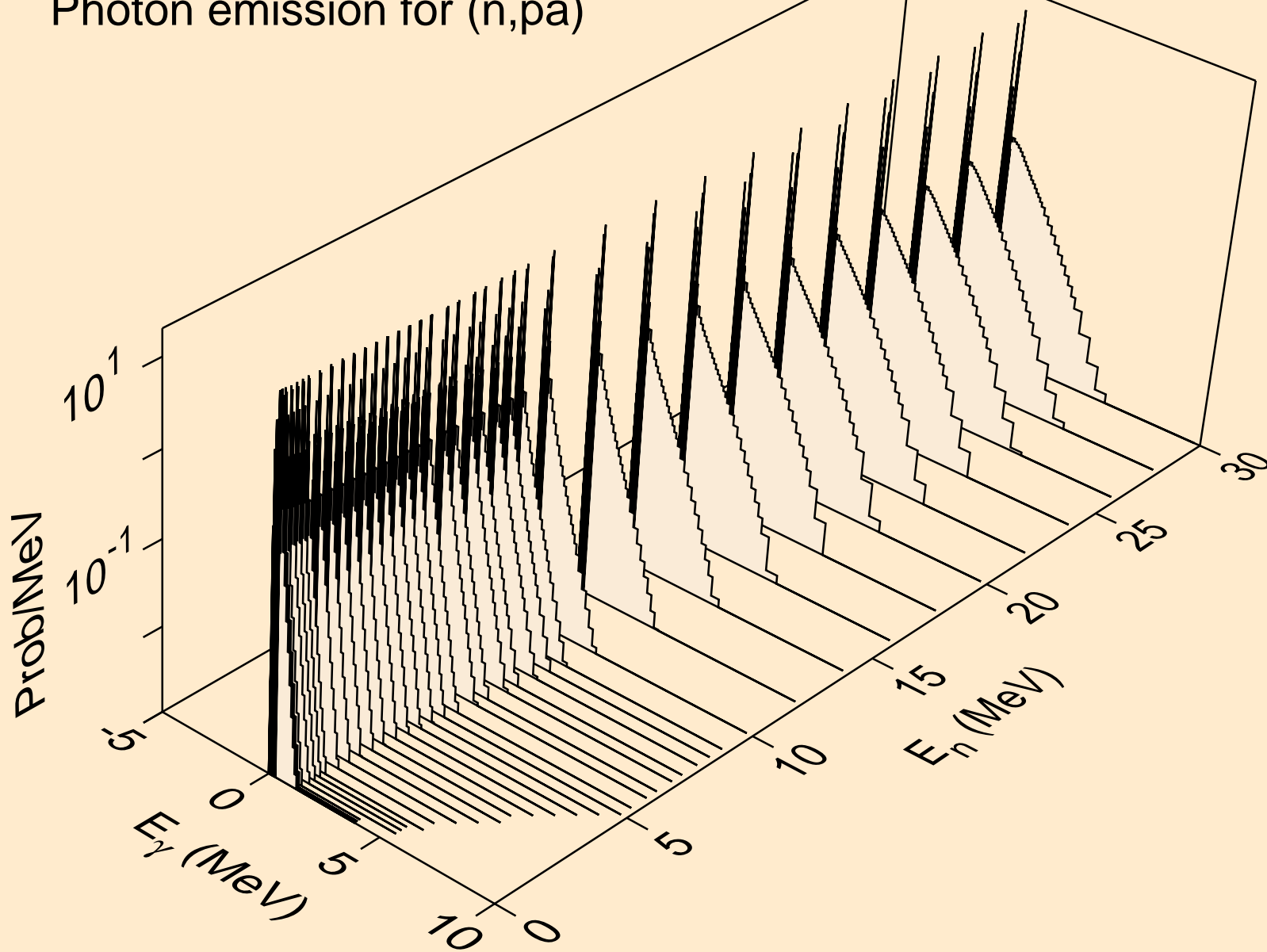

CE122 NEUTRON ACER TENDL-2019 LIBRARY; T=293.16K
Photon emission for (n,d2a)

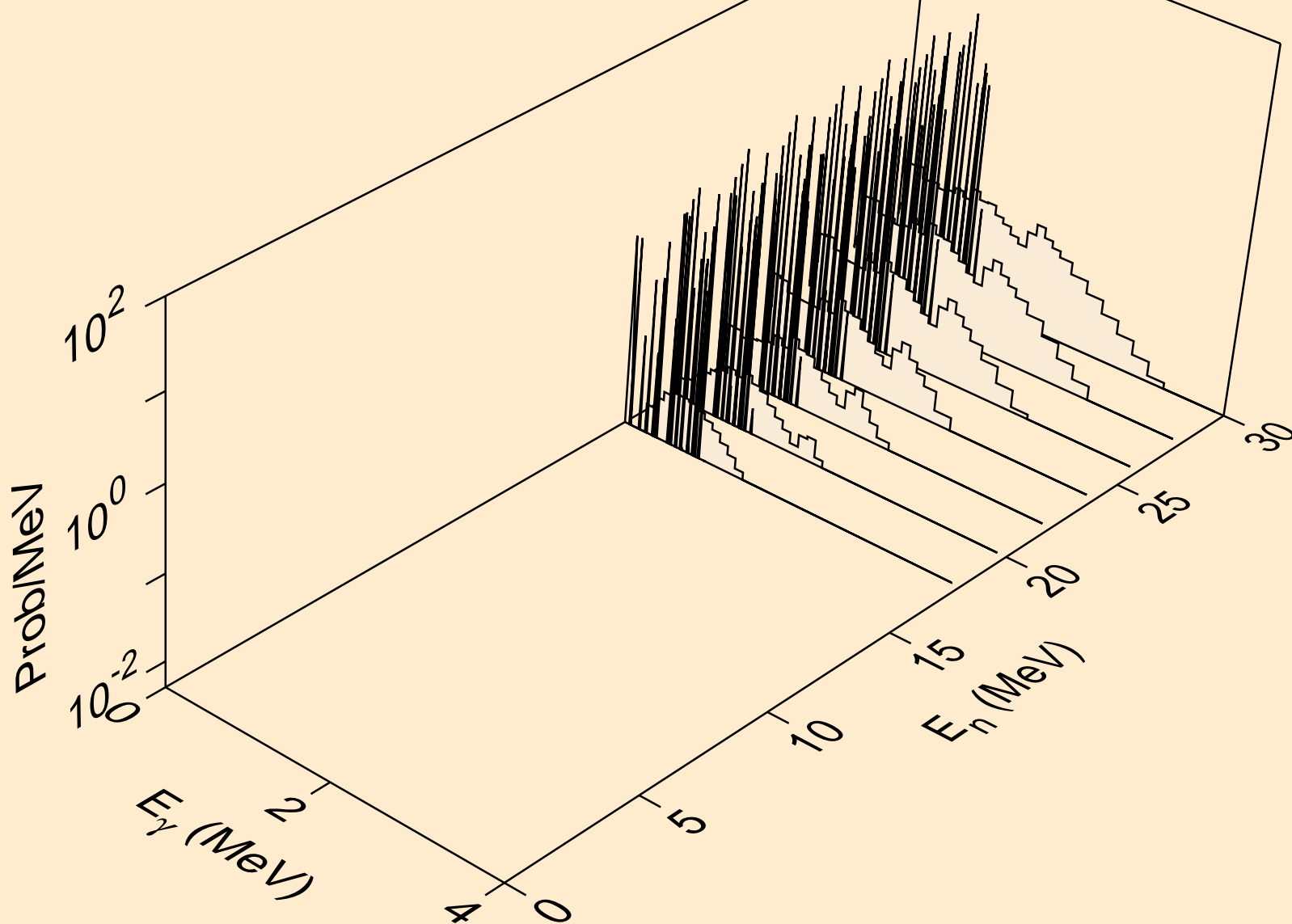

CE122 NEUTRON ACER TENDL-2019 LIBRARY; T=293.16K
Photon emission for (n,pd)

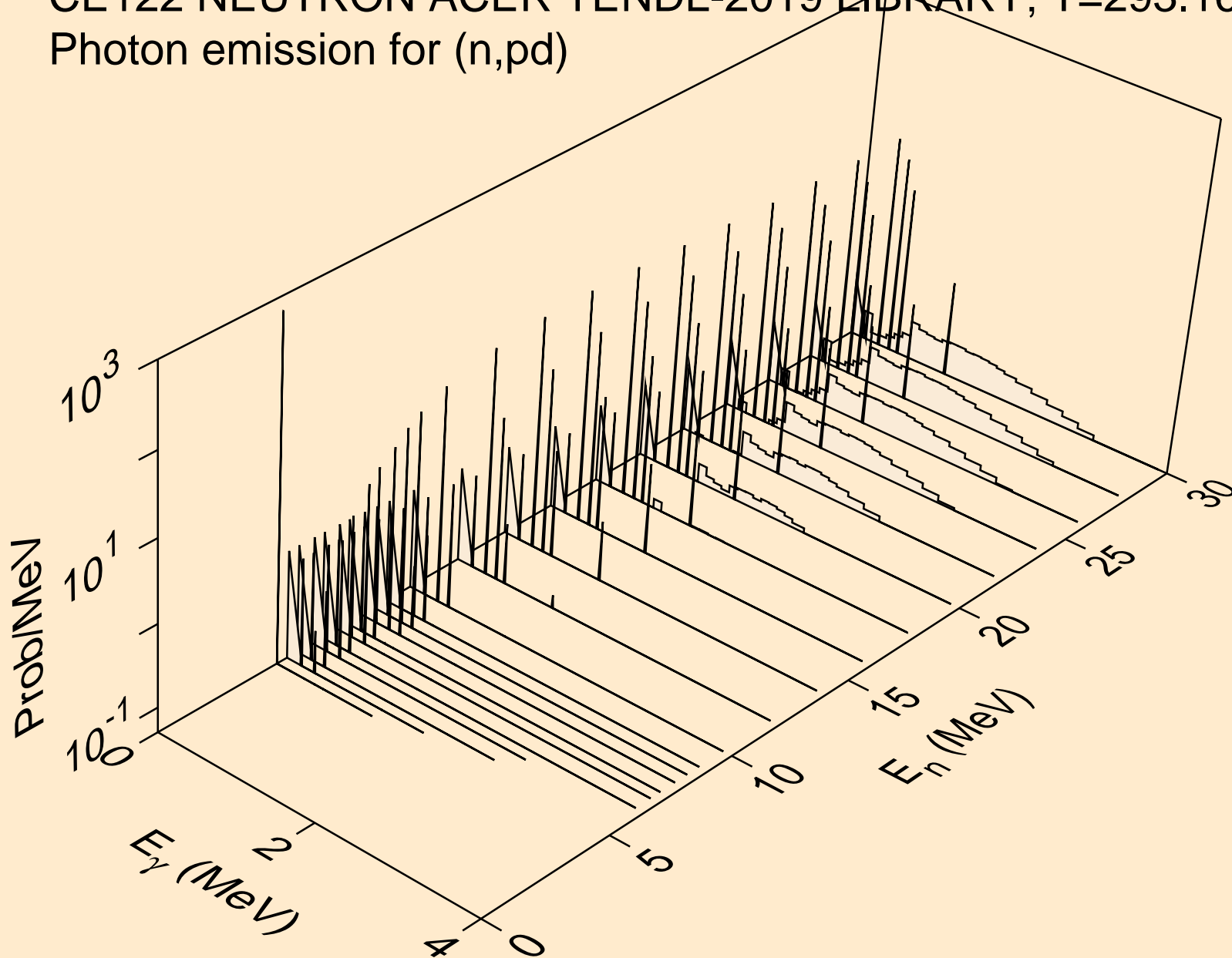

CE122 NEUTRON ACER TENDL-2019 LIBRARY; T=293.16K
Photon emission for (n,pt)

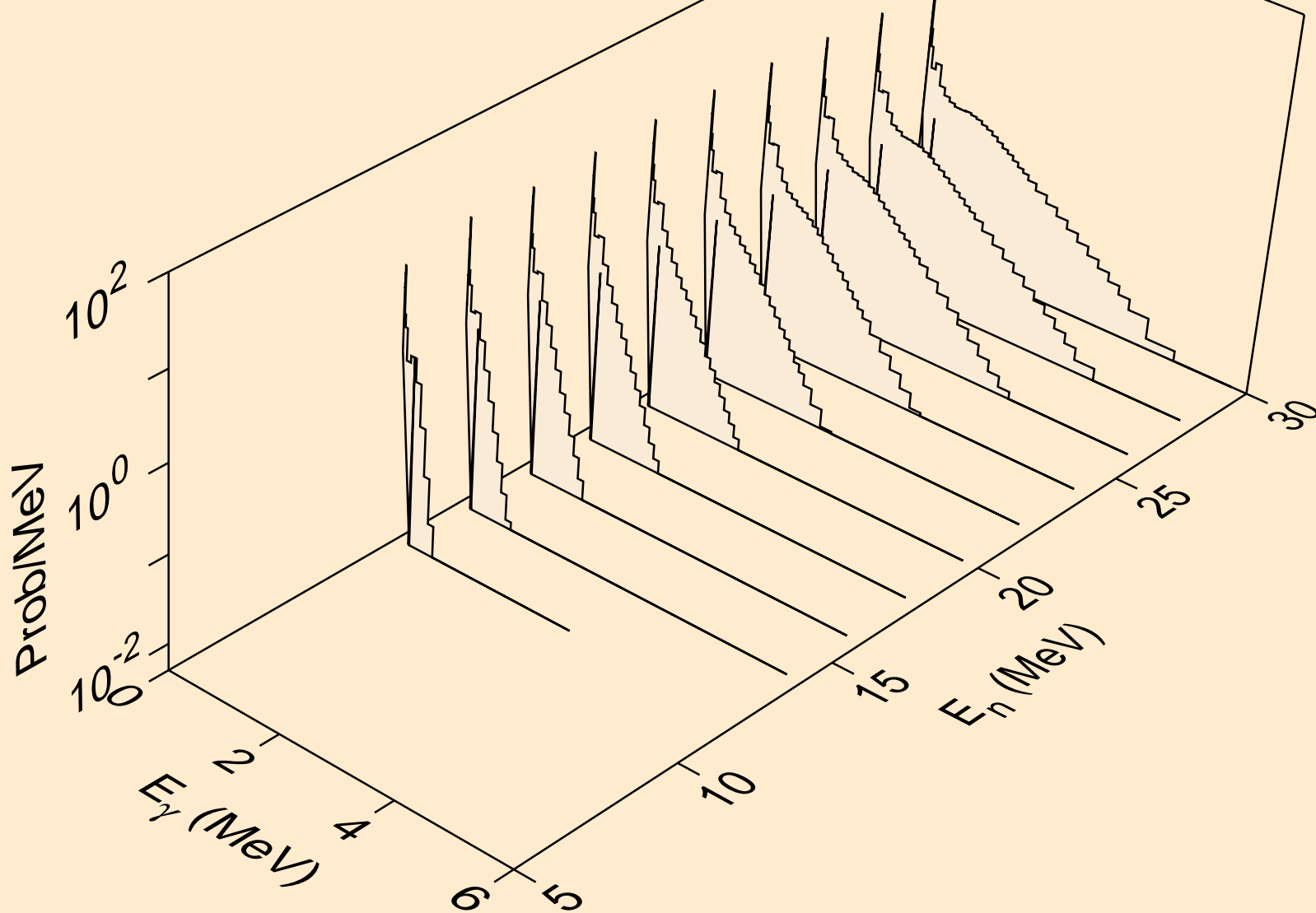

CE122 NEUTRON ACER TENDL-2019 LIBRARY; T=293.16K
Photon emission for (n,da)

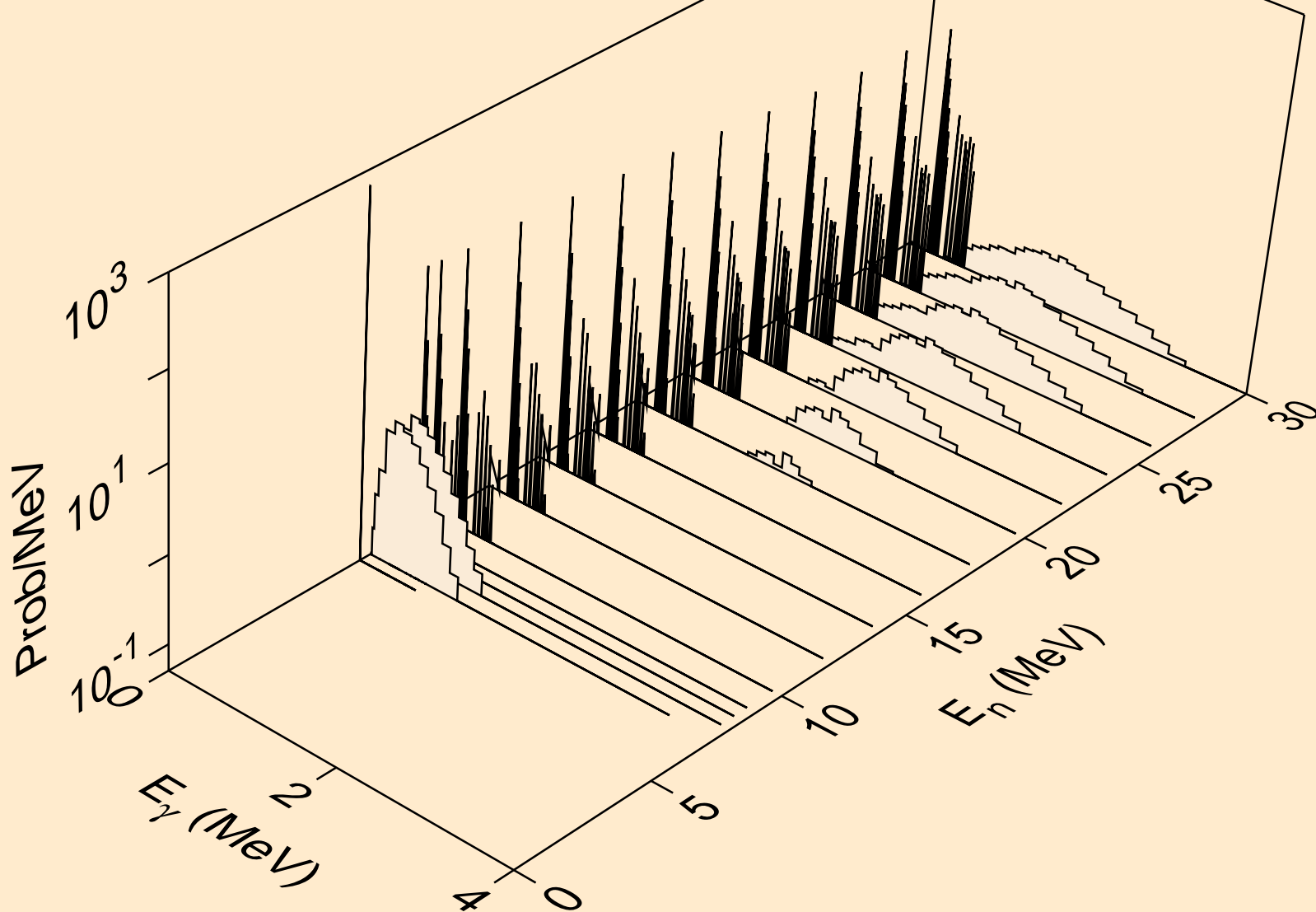

CE122 NEUTRON ACER TENDL-2019 LIBRARY; T=293.16K
thermal capture photon spectrum

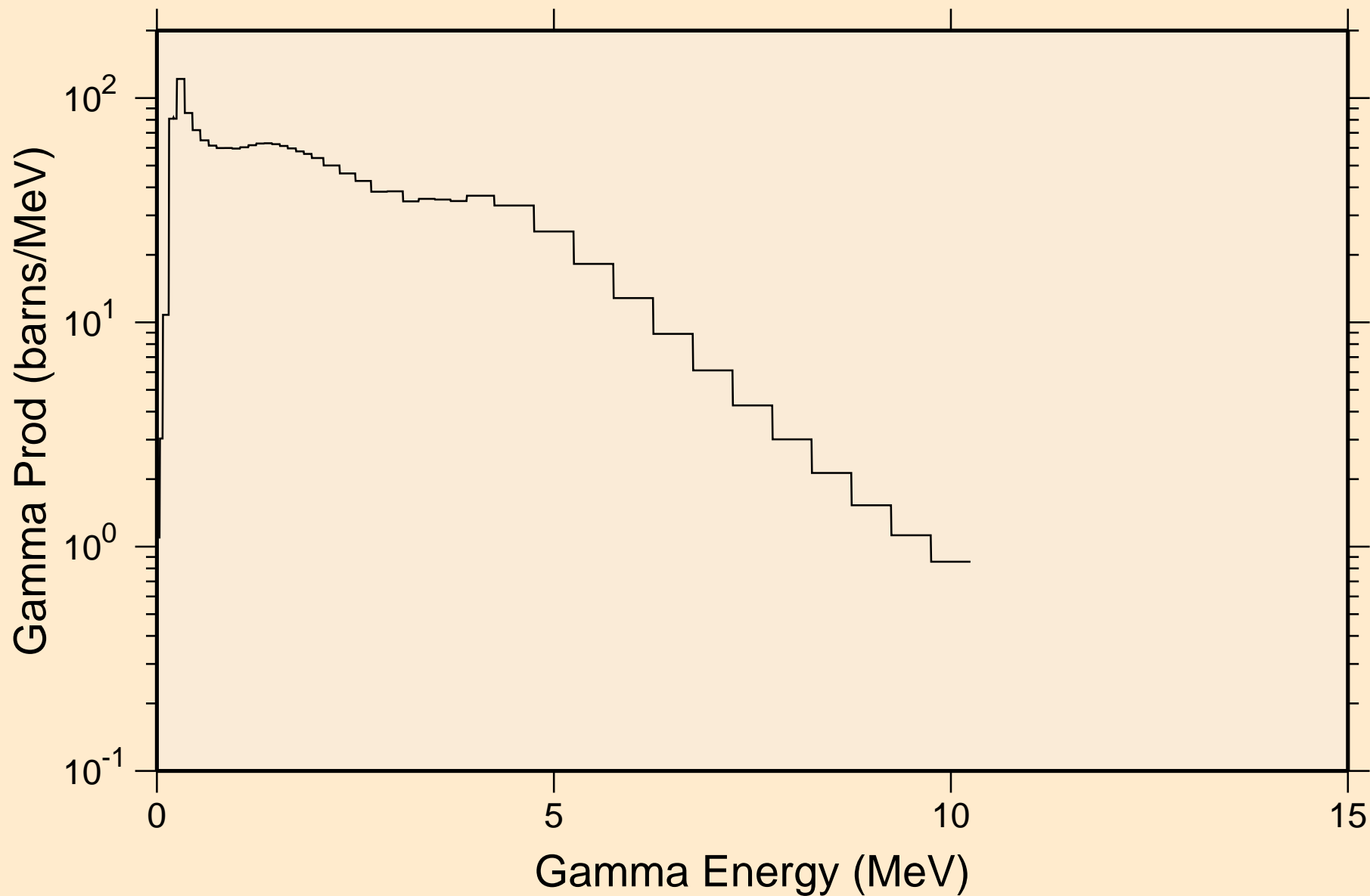

CE122 NEUTRON ACER TENDL-2019 LIBRARY; T=293.16K
14 MeV photon spectrum

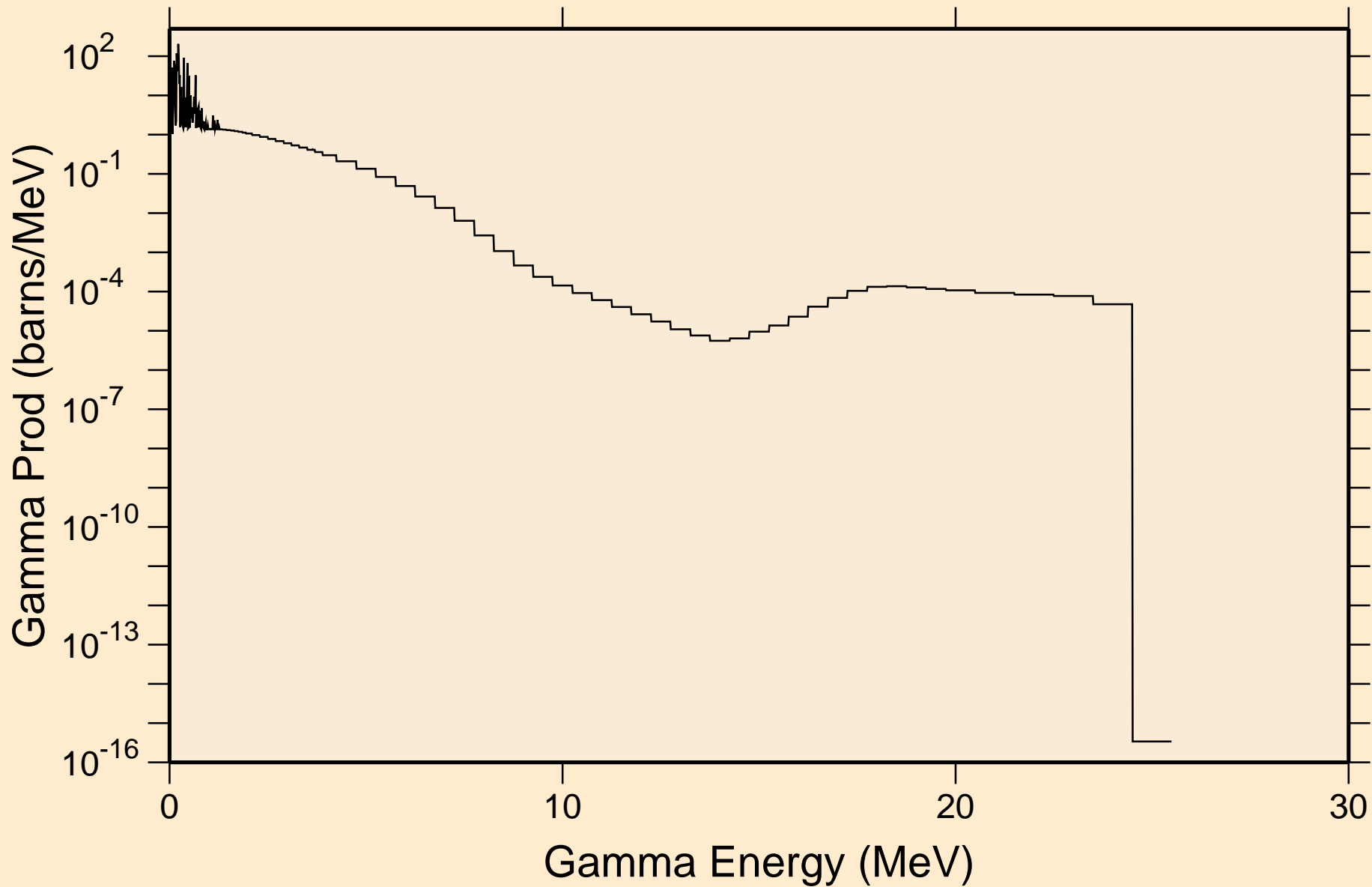

CE122 NEUTRON ACER TENDL-2019 LIBRARY; T=293.16K

Particle heating contributions

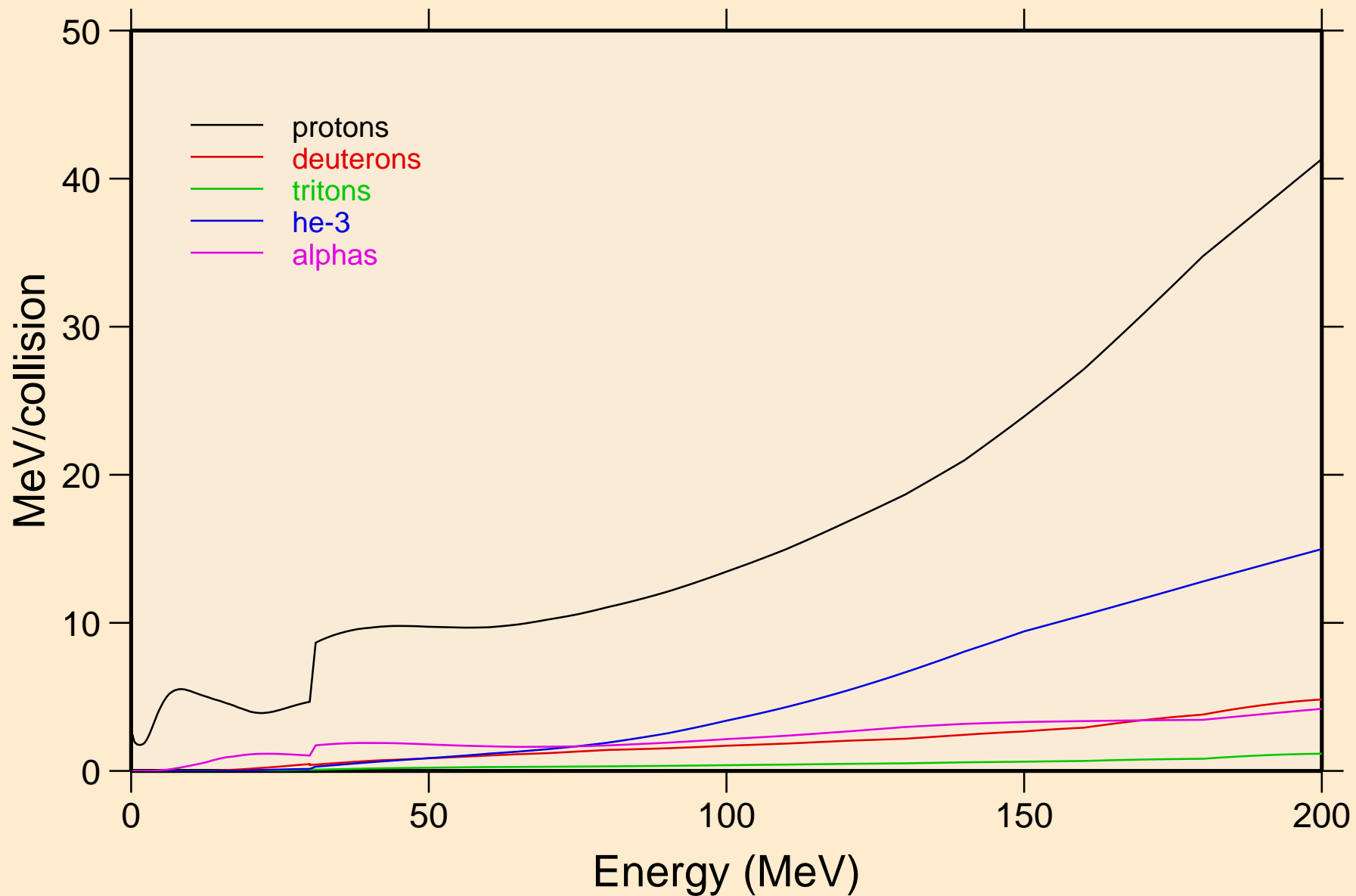

CE122 NEUTRON ACER TENDL-2019 LIBRARY; T=293.16K
Recoil Heating

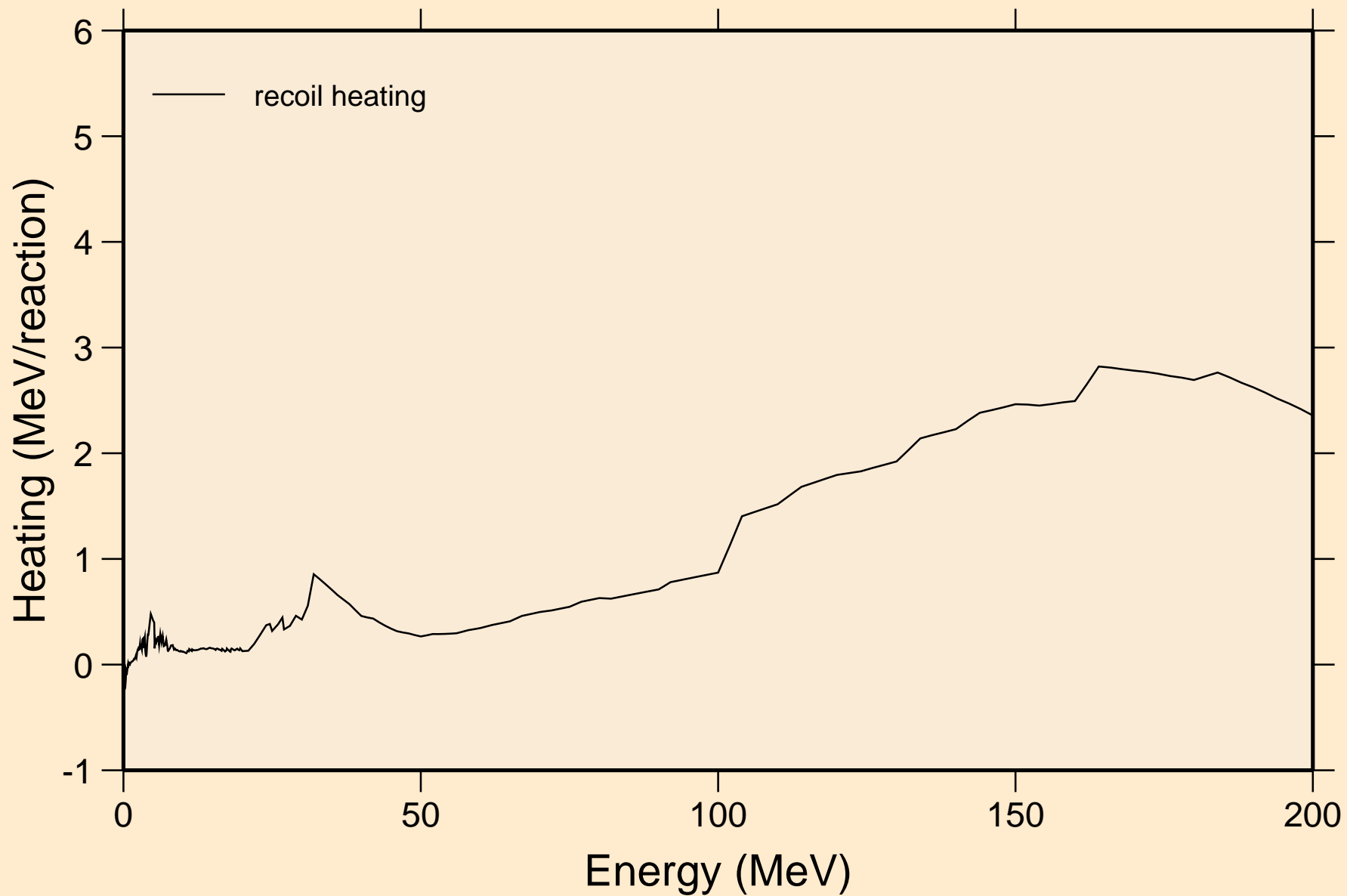

CE122 NEUTRON ACER TENDL-2019 LIBRARY; T=293.16K
Particle production cross sections

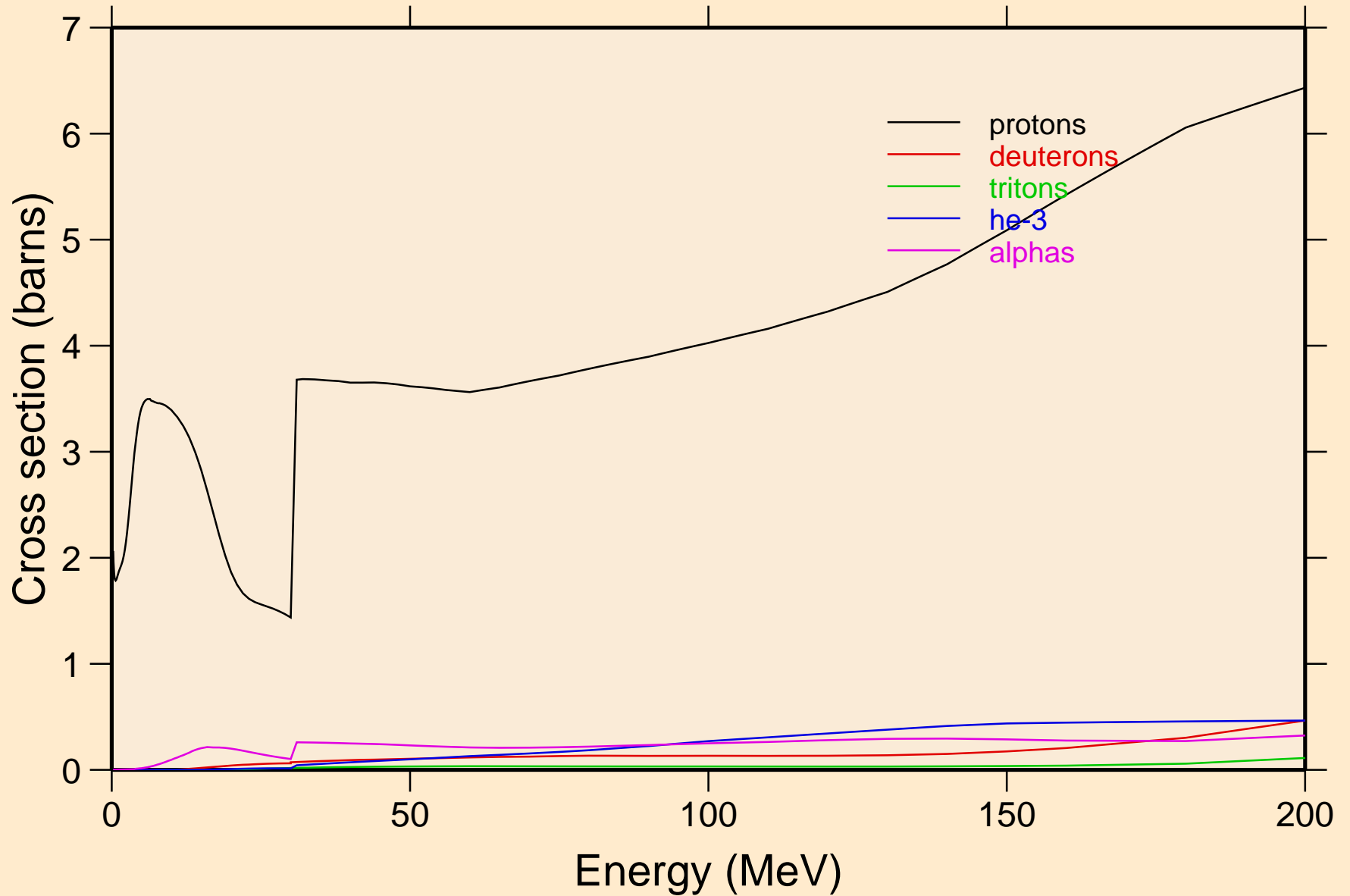

CE122 NEUTRON ACER TENDL-2019 LIBRARY; T=293.16K
protons from (n,x)

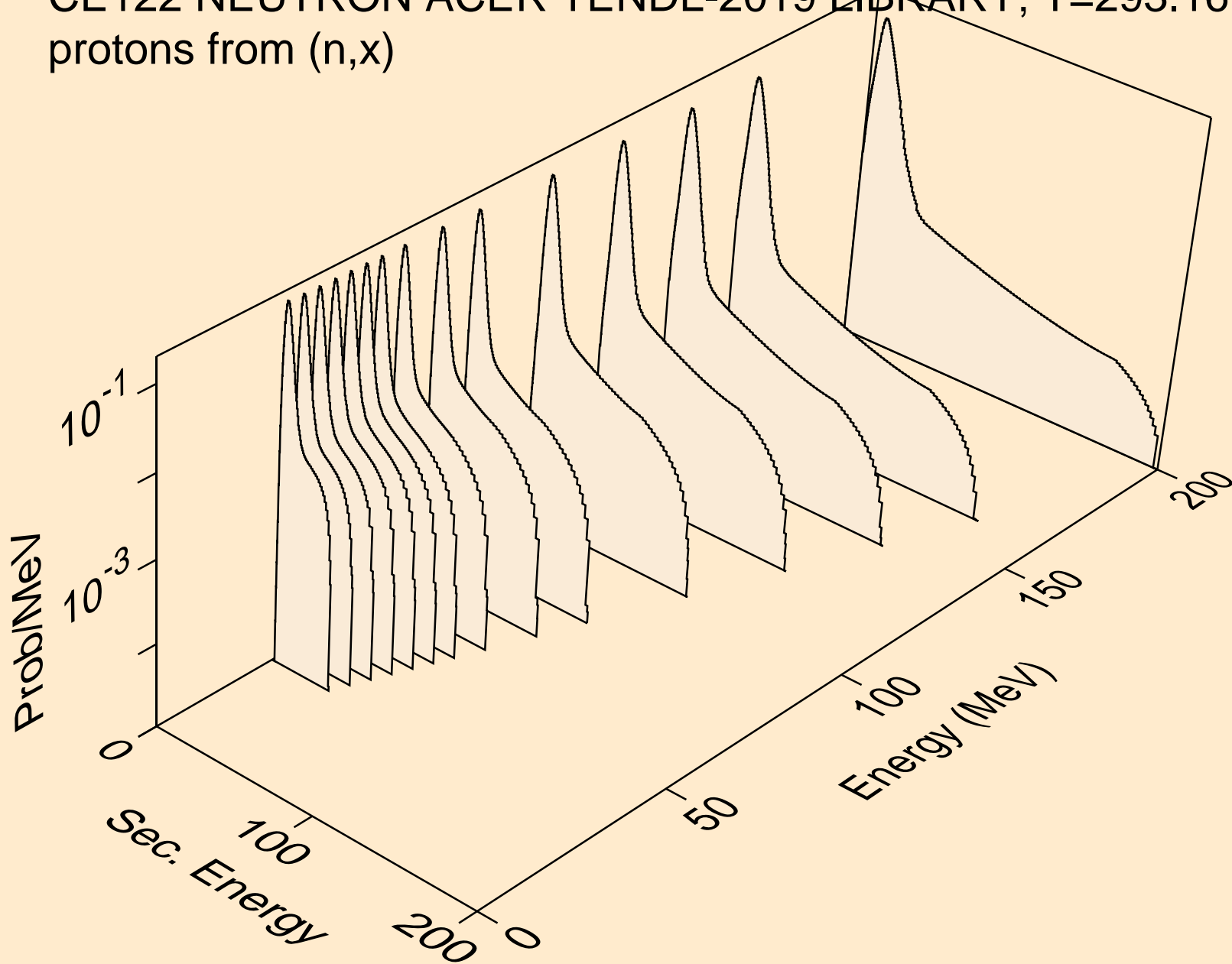

CE122 NEUTRON ACER TENDL-2019 LIBRARY; T=293.16K
protons from (n,n*)p

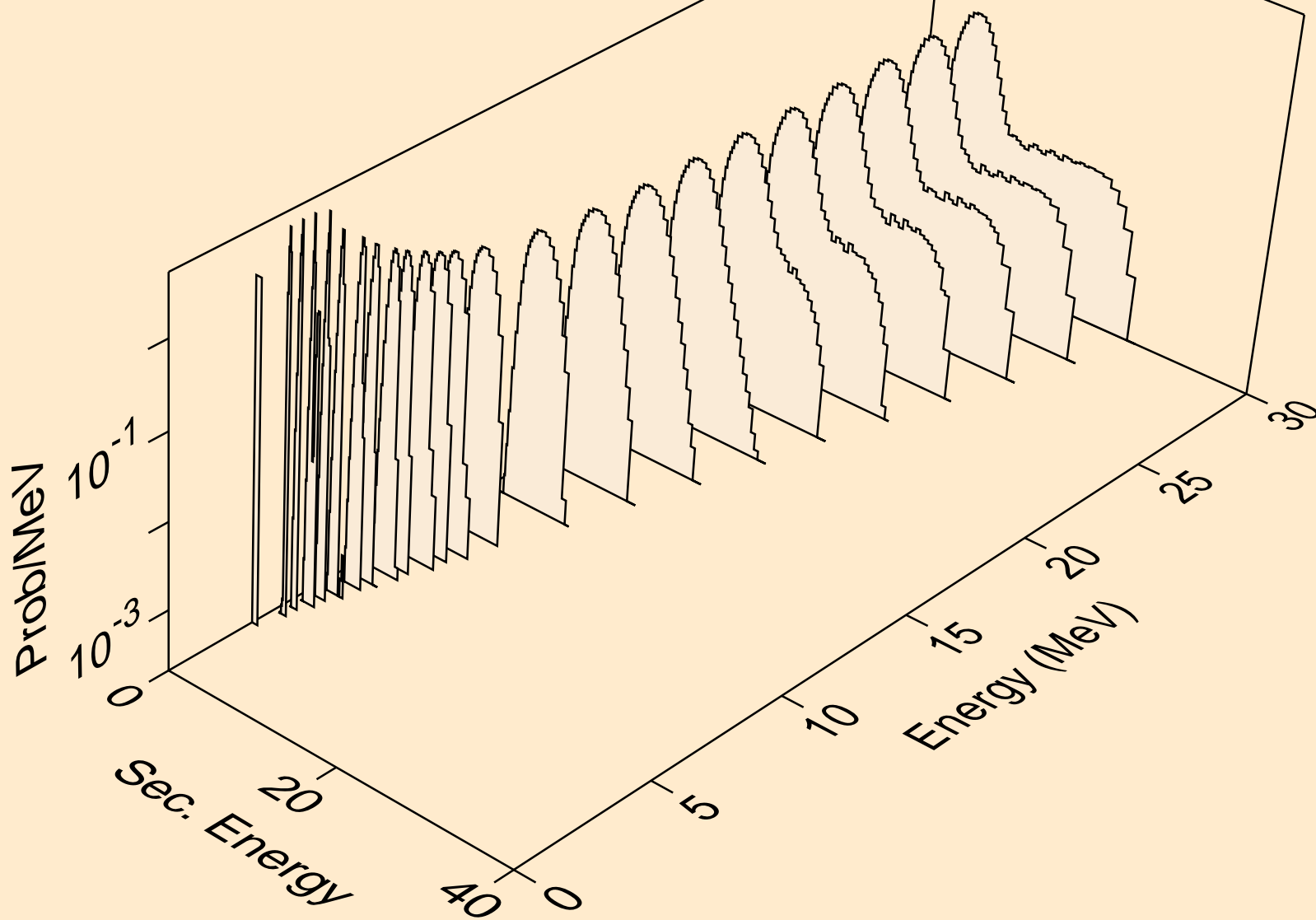

CE122 NEUTRON ACER TENDL-2019 LIBRARY; T=293.16K
protons from (n,2np)

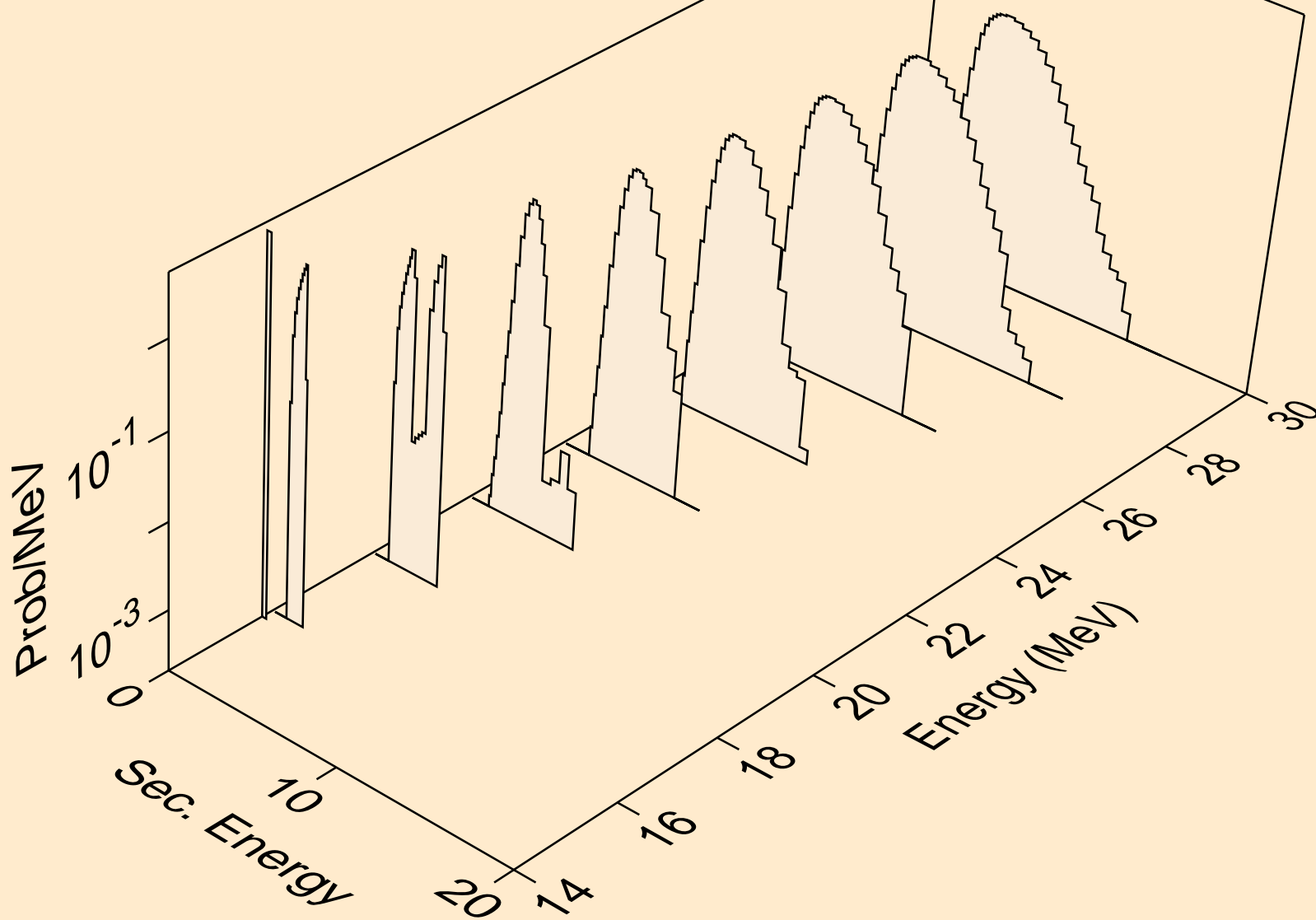

CE122 NEUTRON ACER TENDL-2019 LIBRARY; T=293.16K
protons from (n,3np)

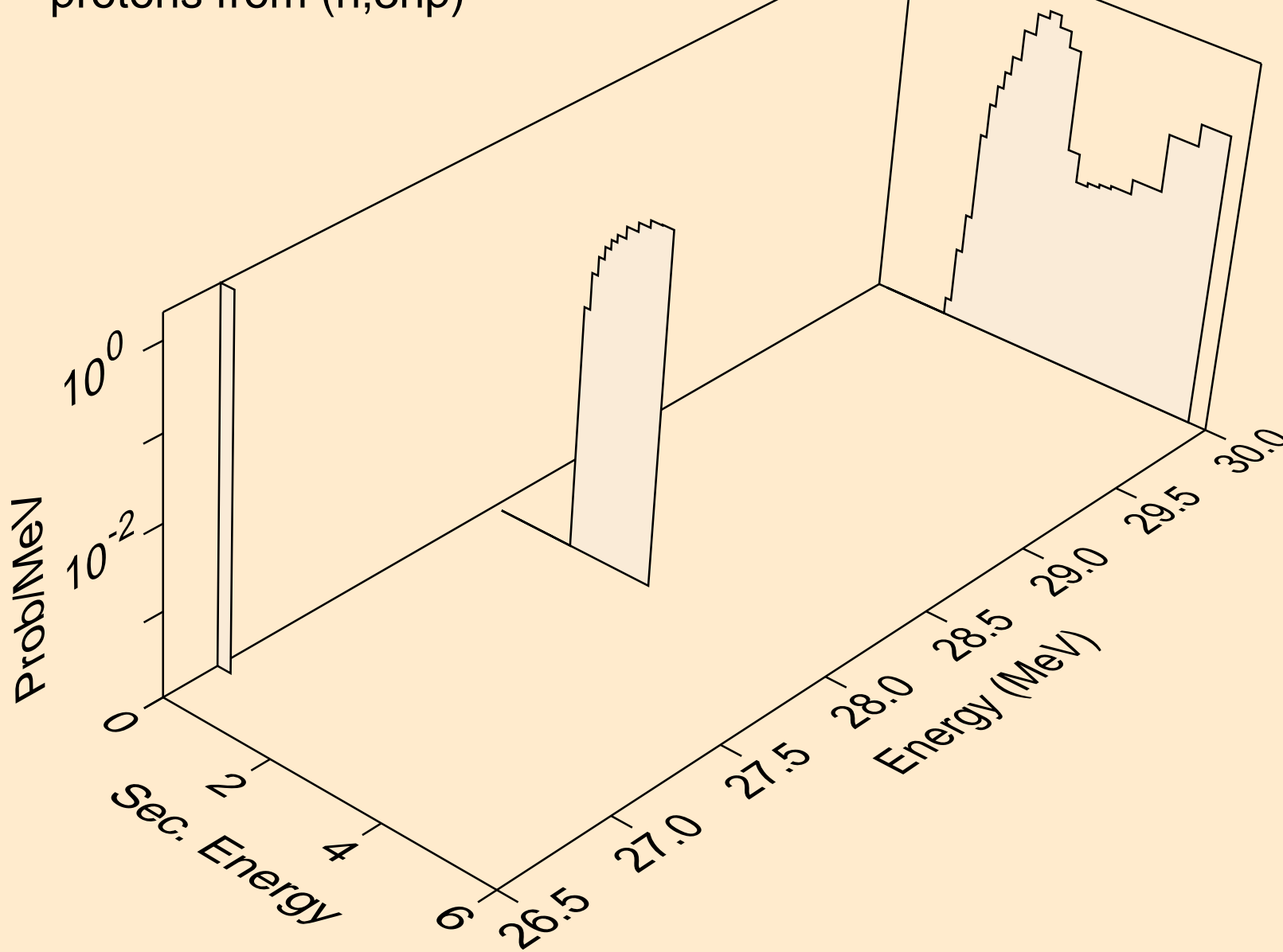

CE122 NEUTRON ACER TENDL-2019 LIBRARY; T=293.16K
protons from (n,2np)

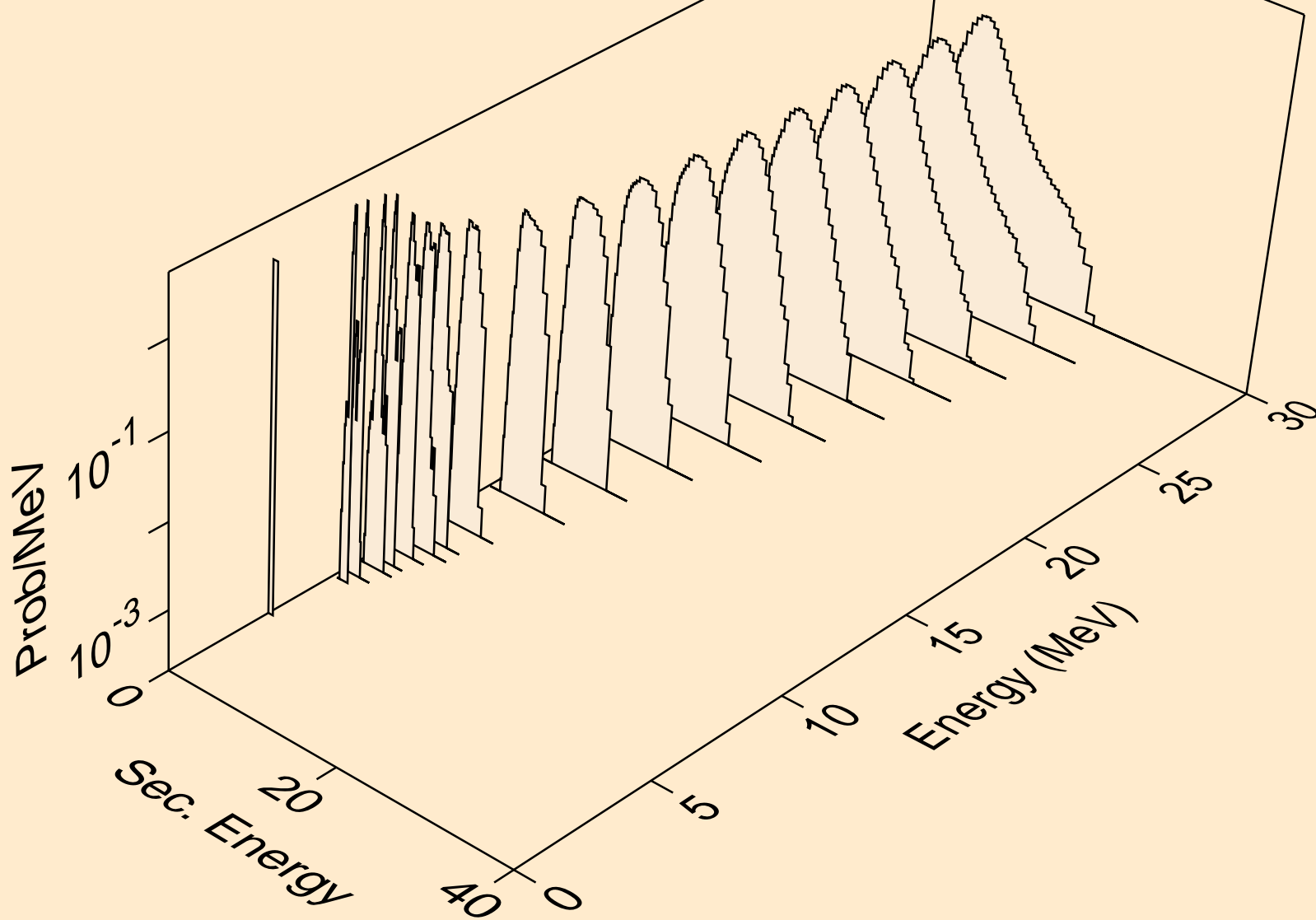

CE122 NEUTRON ACER TENDL-2019 LIBRARY; T=293.16K
protons from (n,npa)

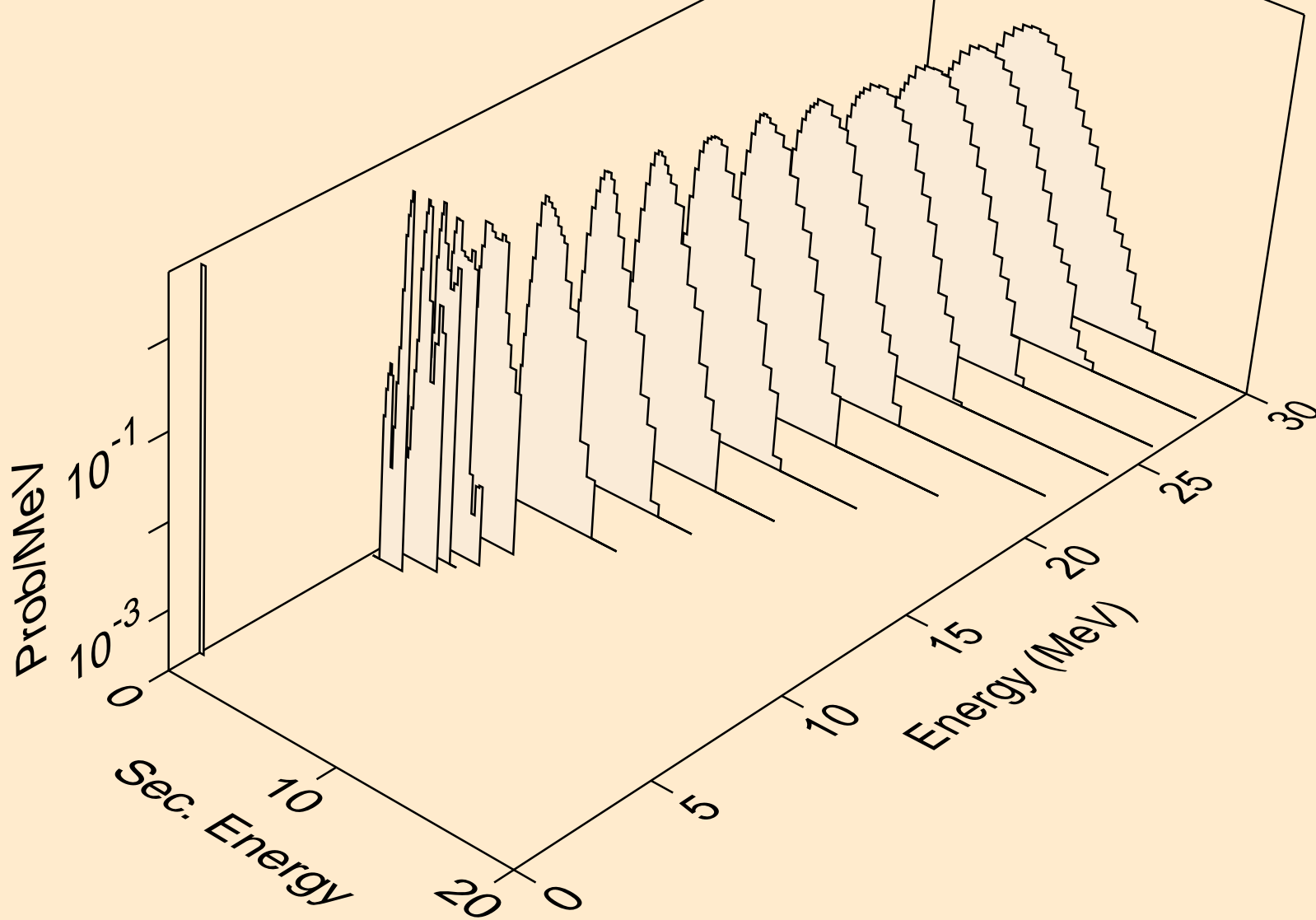

CE122 NEUTRON ACER TENDL-2019 LIBRARY; T=293.16K
protons from (n,p)

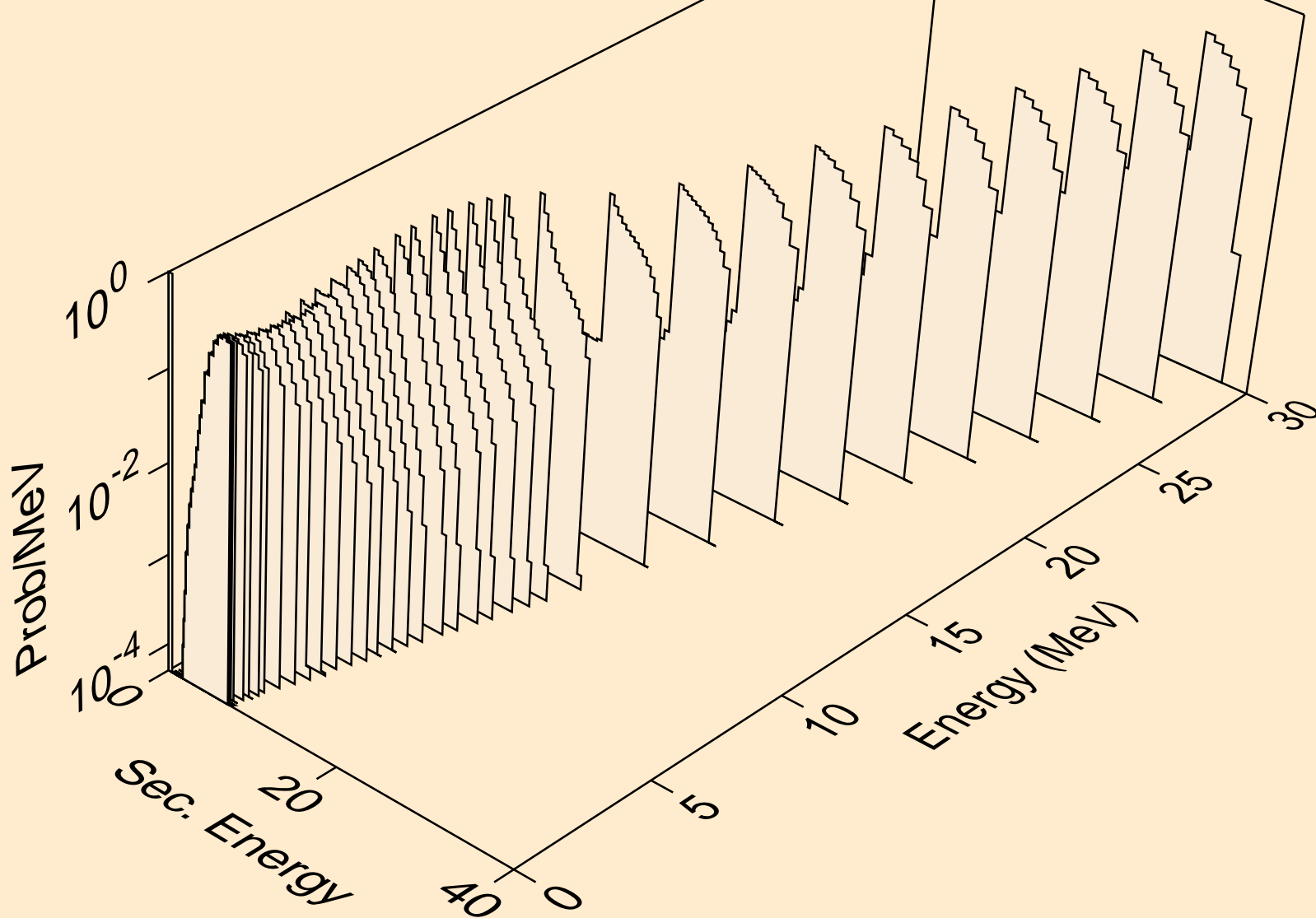

CE122 NEUTRON ACER TENDL-2019 LIBRARY; T=293.16K
protons from (n,2p)

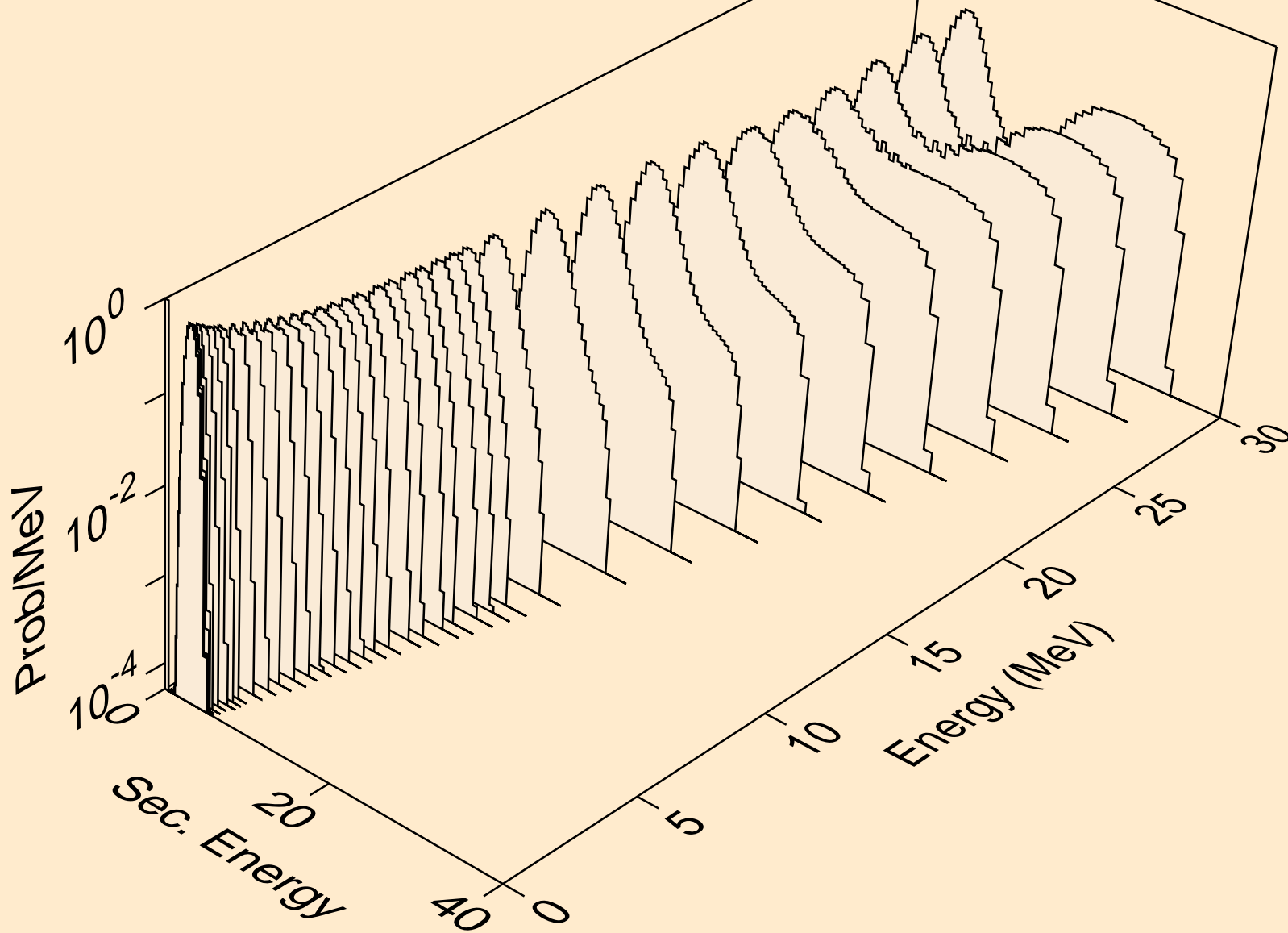

CE122 NEUTRON ACER TENDL-2019 LIBRARY; T=293.16K
protons from (n,p)

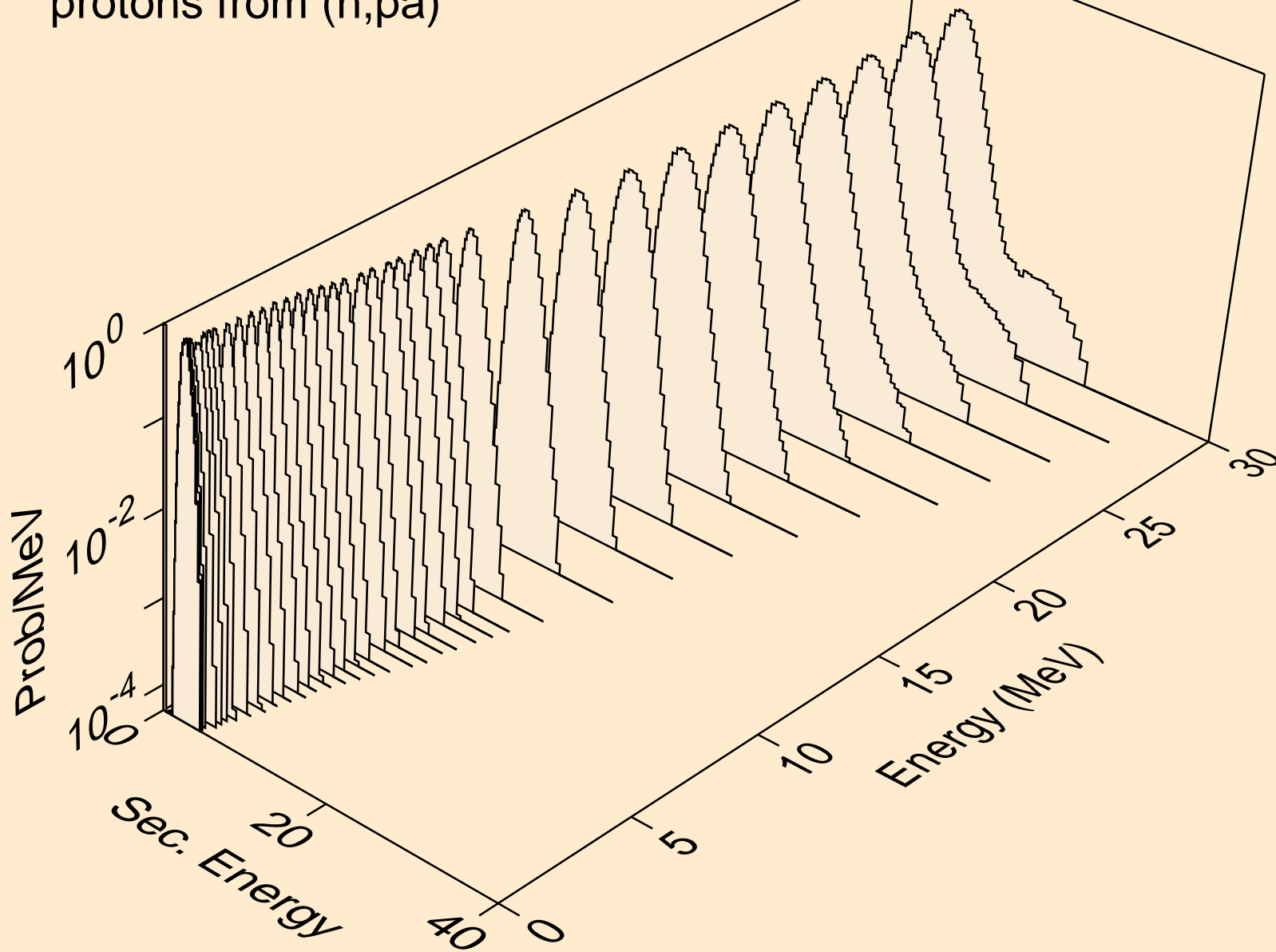

CE122 NEUTRON ACER TENDL-2019 LIBRARY; T=293.16K
protons from (n,pd)

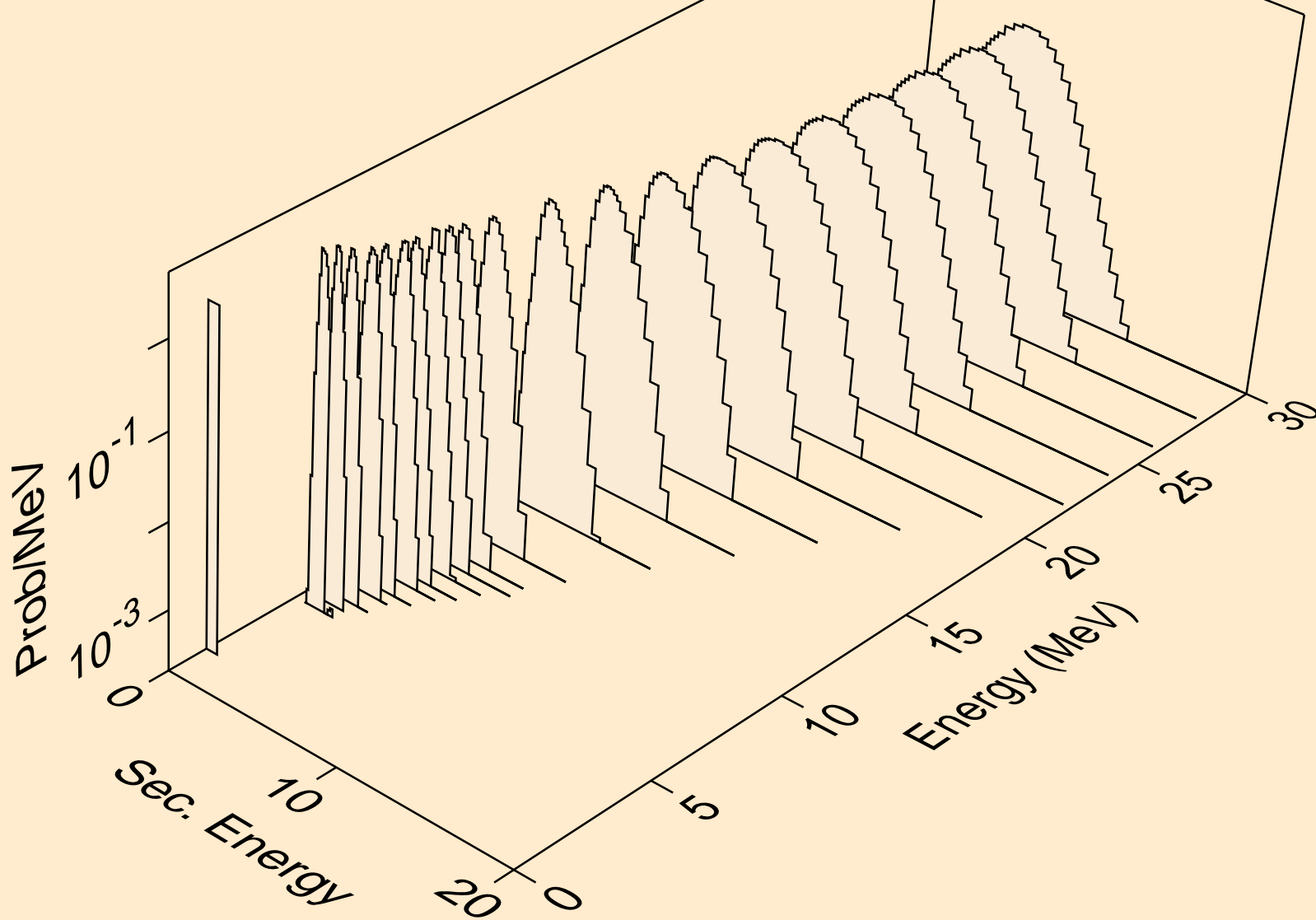

CE122 NEUTRON ACER TENDL-2019 LIBRARY; T=293.16K
protons from (n,pt)

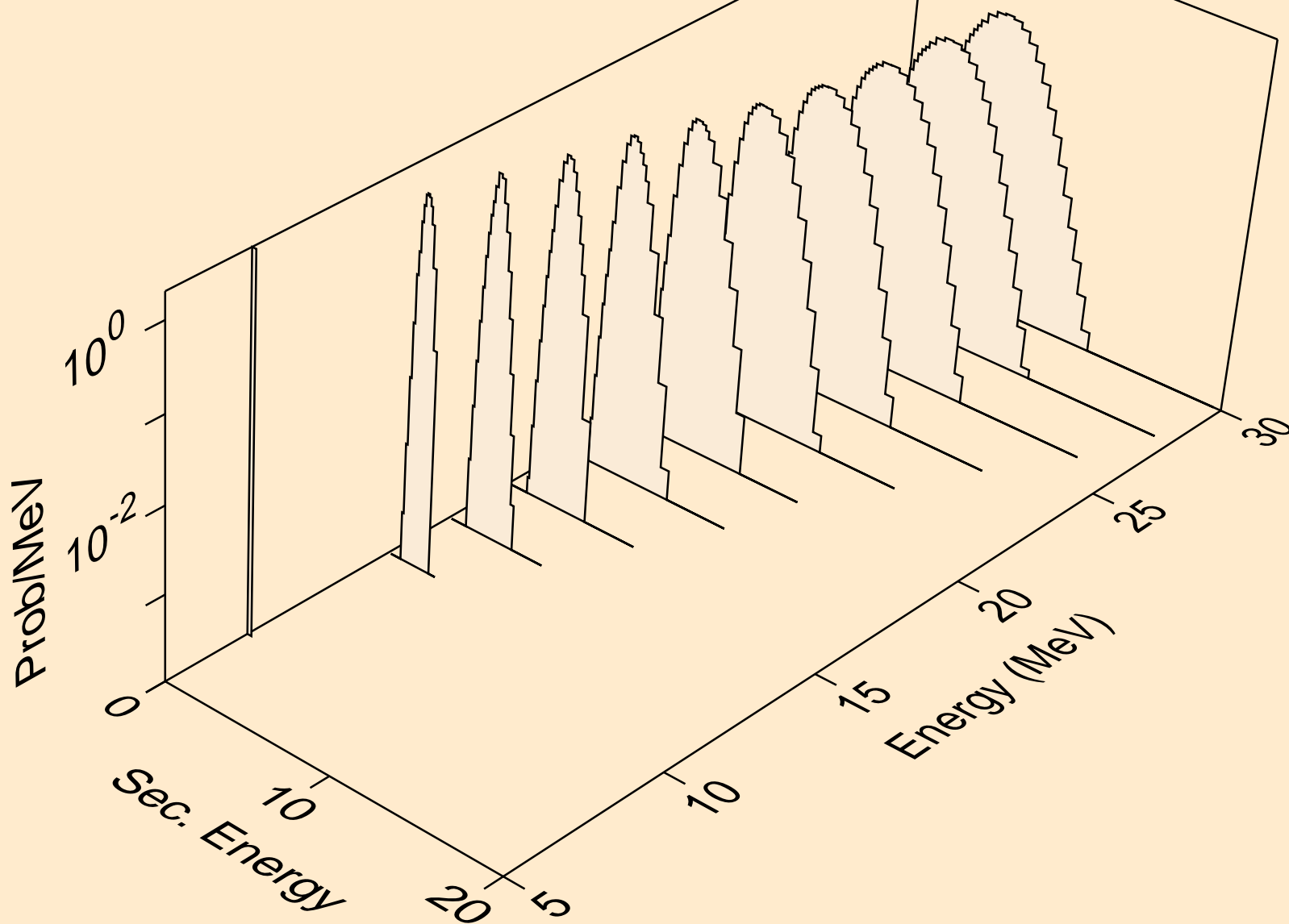

CE122 NEUTRON ACER TENDL-2019 LIBRARY; T=293.16K
deuterons from (n,x)

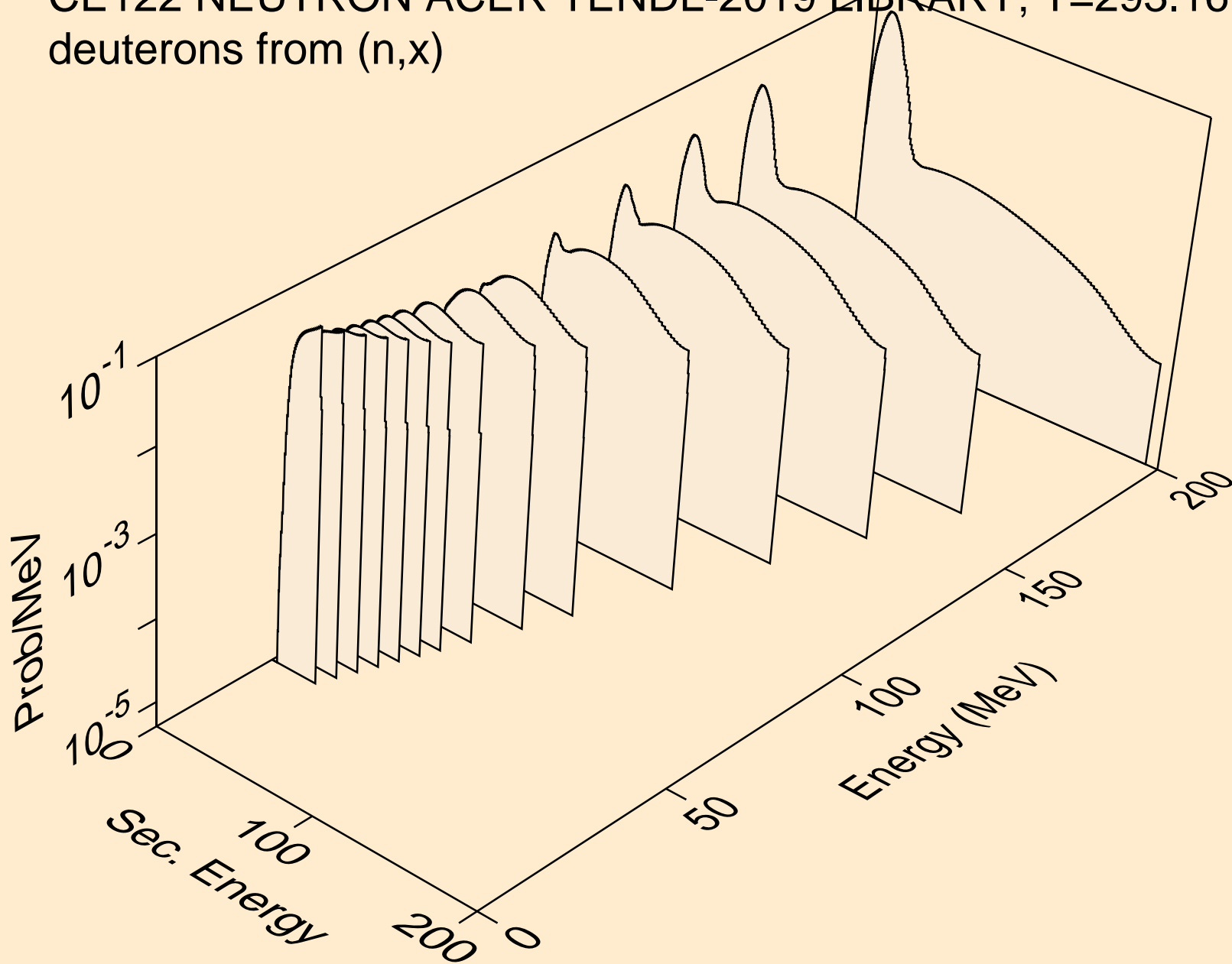

CE122 NEUTRON ACER TENDL-2019 LIBRARY; T=293.16K
deuterons from (n,n*)d

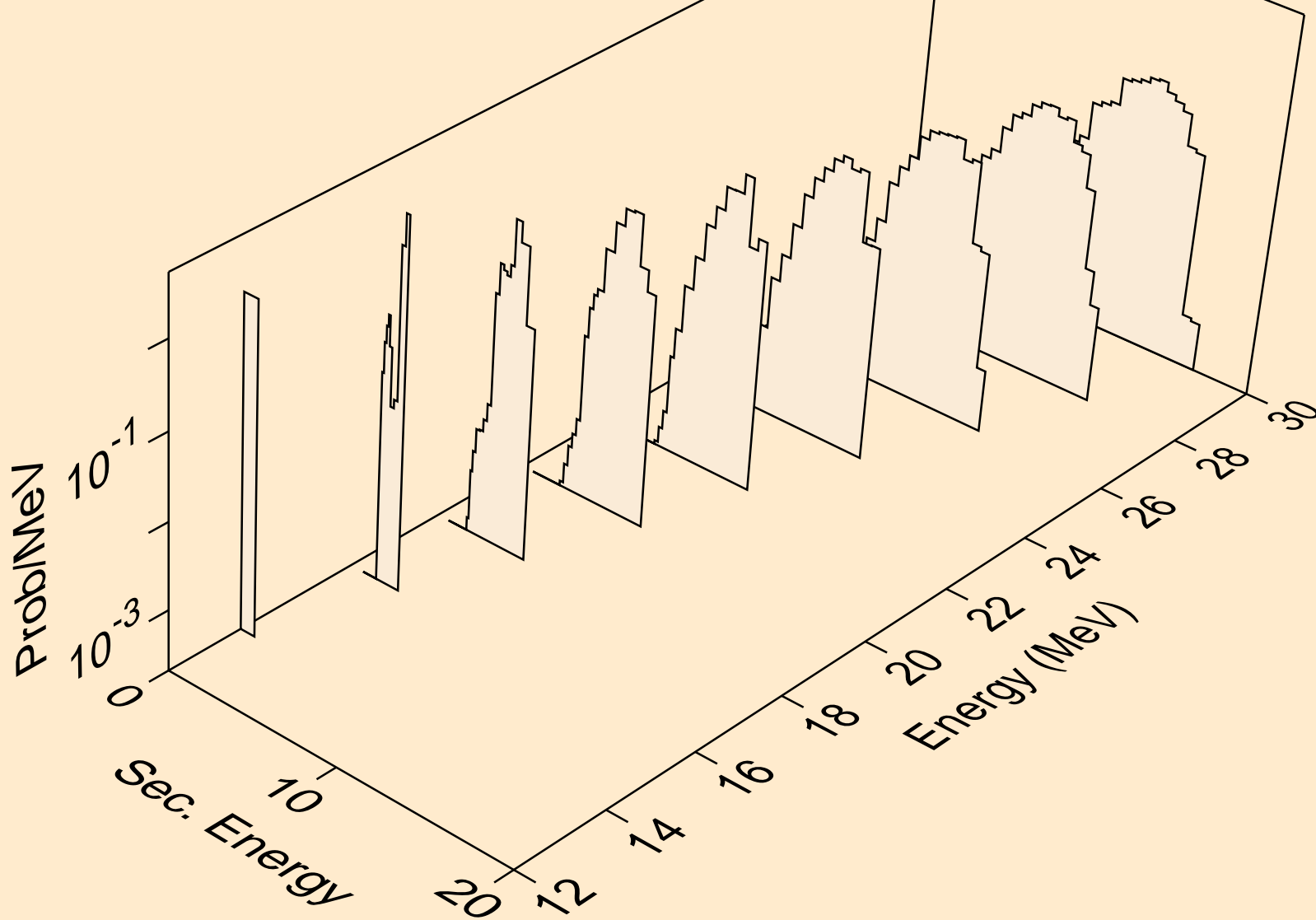

CE122 NEUTRON ACER TENDL-2019 LIBRARY; T=293.16K
deuterons from (n,d)

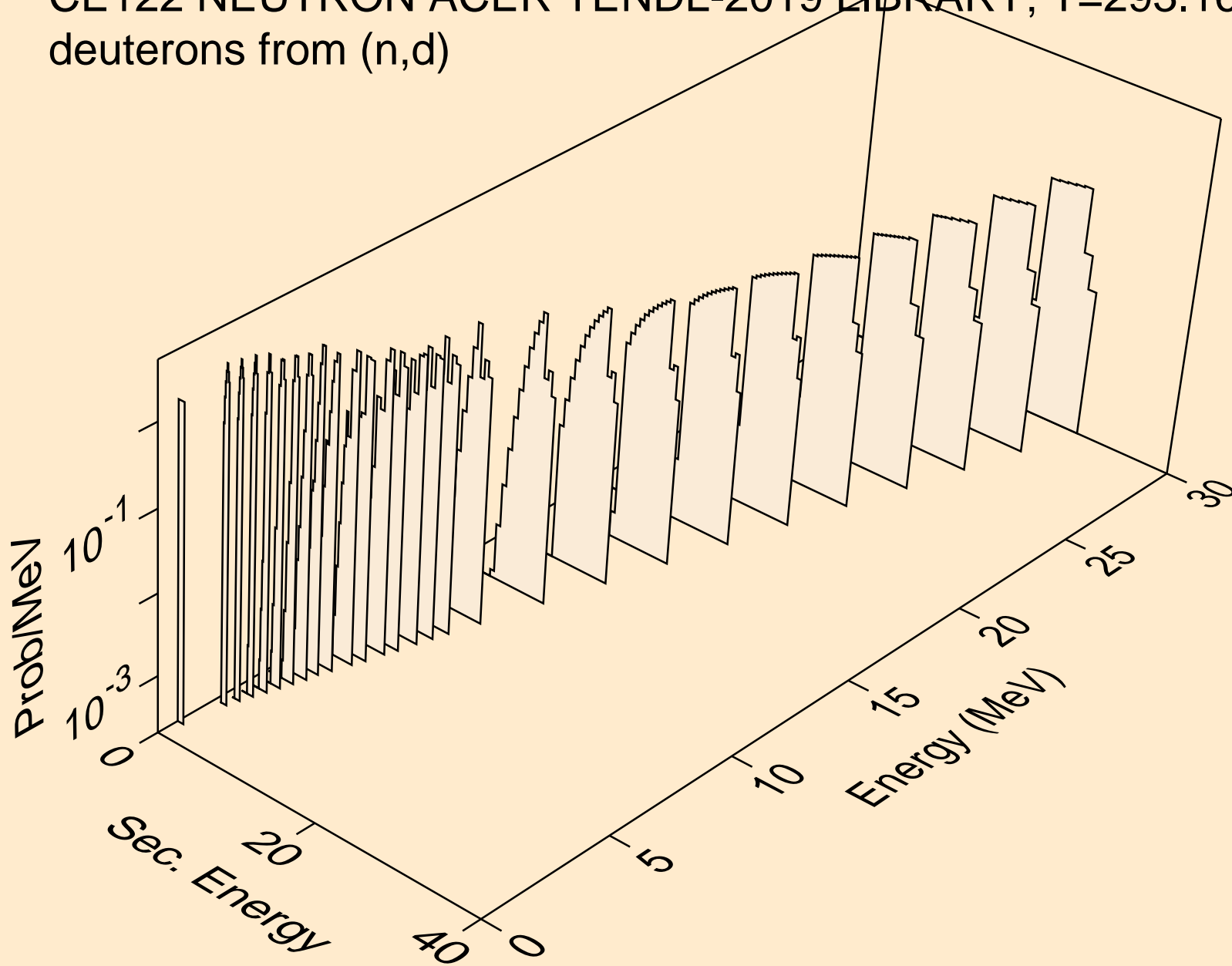

CE122 NEUTRON ACER TENDL-2019 LIBRARY; T=293.16K
deuterons from (n,d2a)

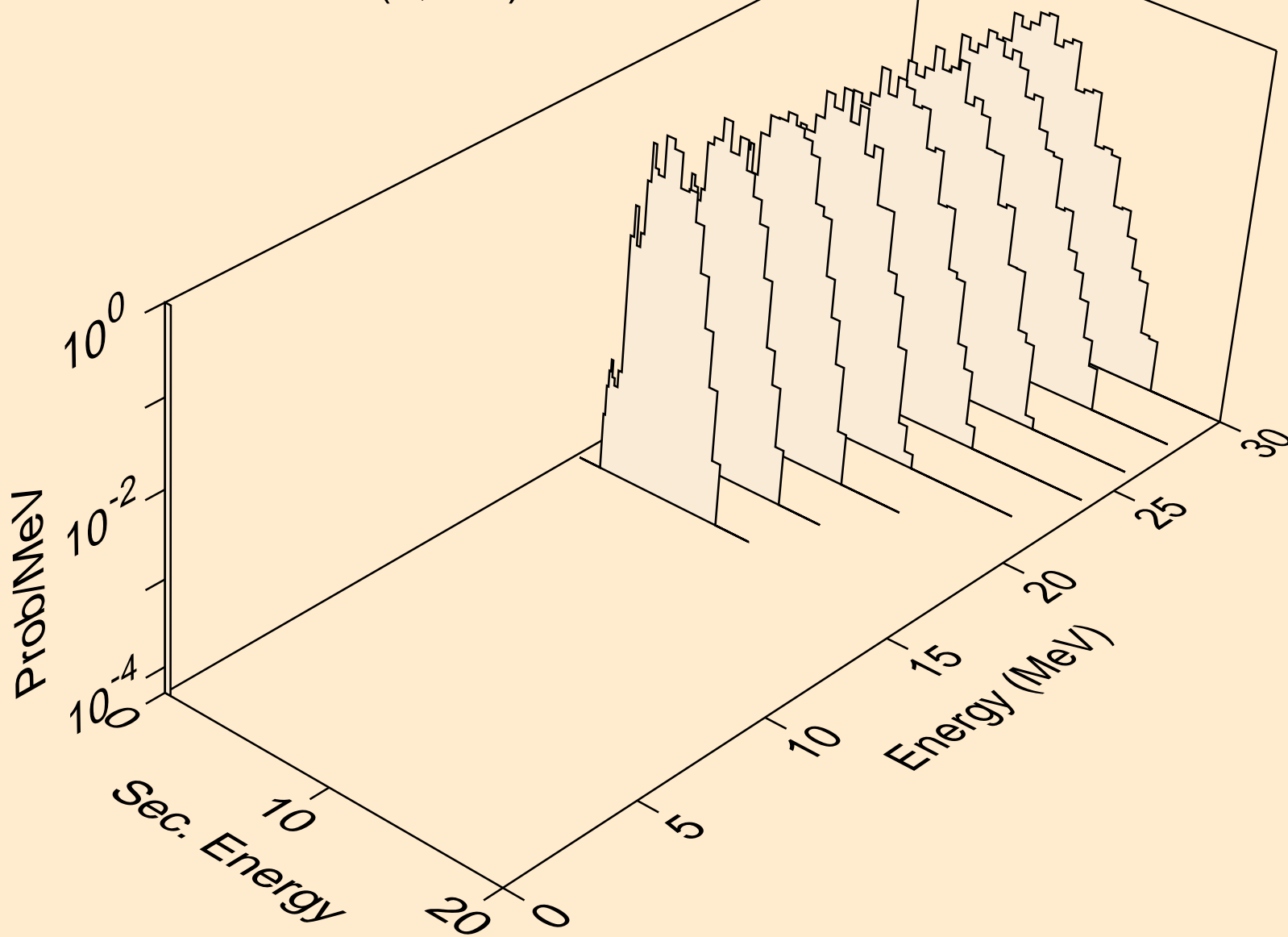

CE122 NEUTRON ACER TENDL-2019 LIBRARY; T=293.16K
deuterons from (n,pd)

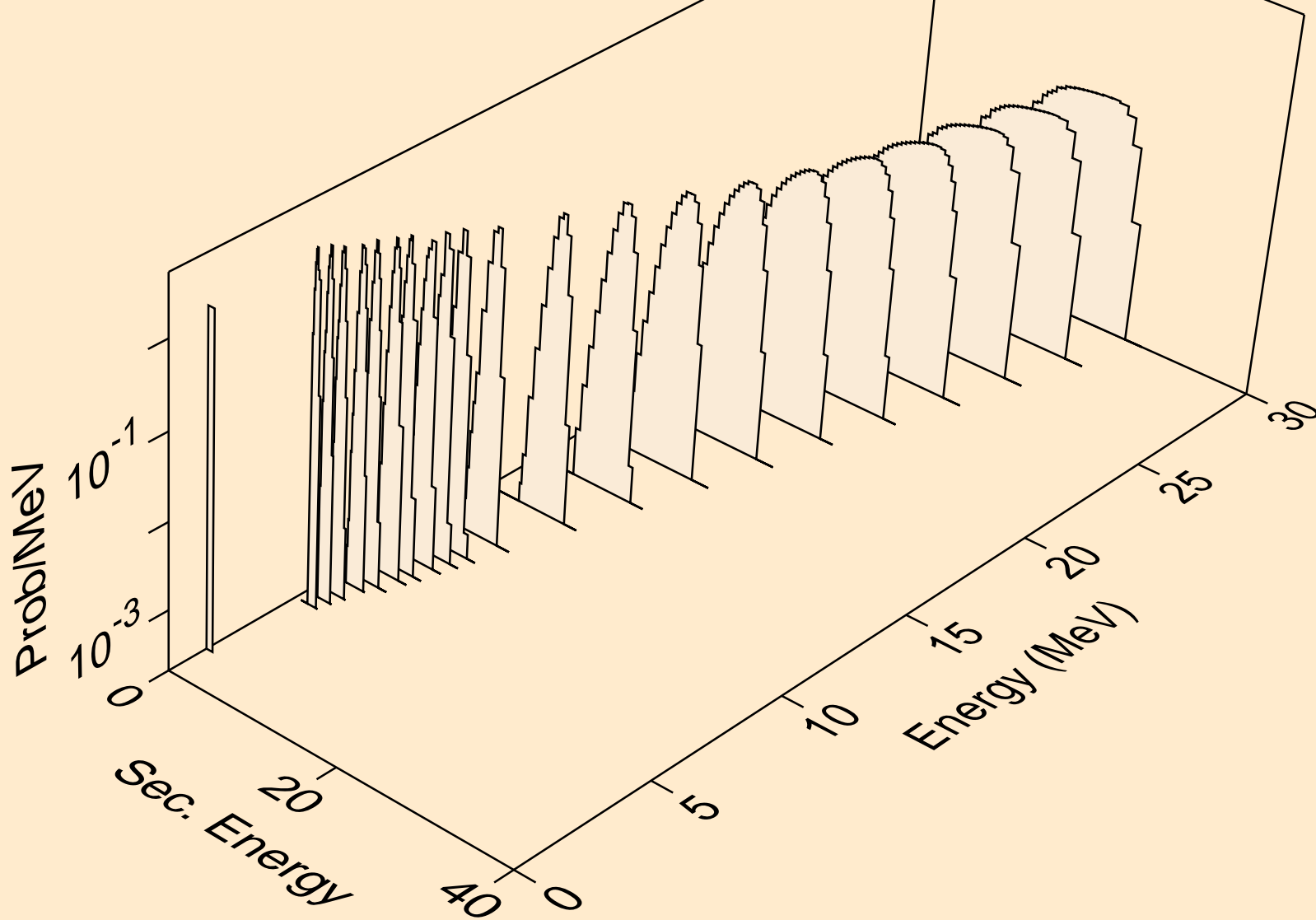

CE122 NEUTRON ACER TENDL-2019 LIBRARY; T=293.16K
deuterons from (n,da)

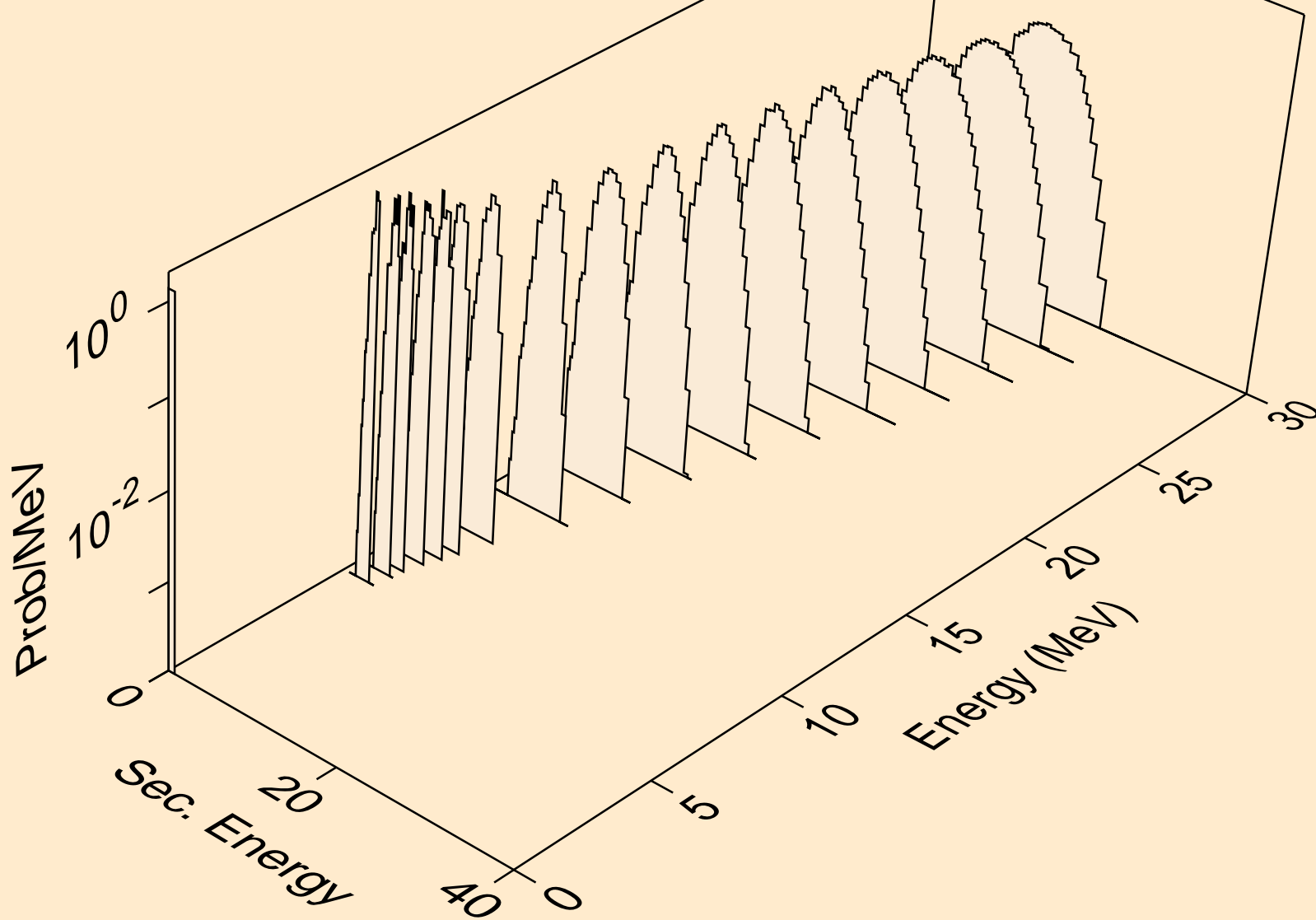

CE122 NEUTRON ACER TENDL-2019 LIBRARY; T=293.16K
tritons from (n,x)

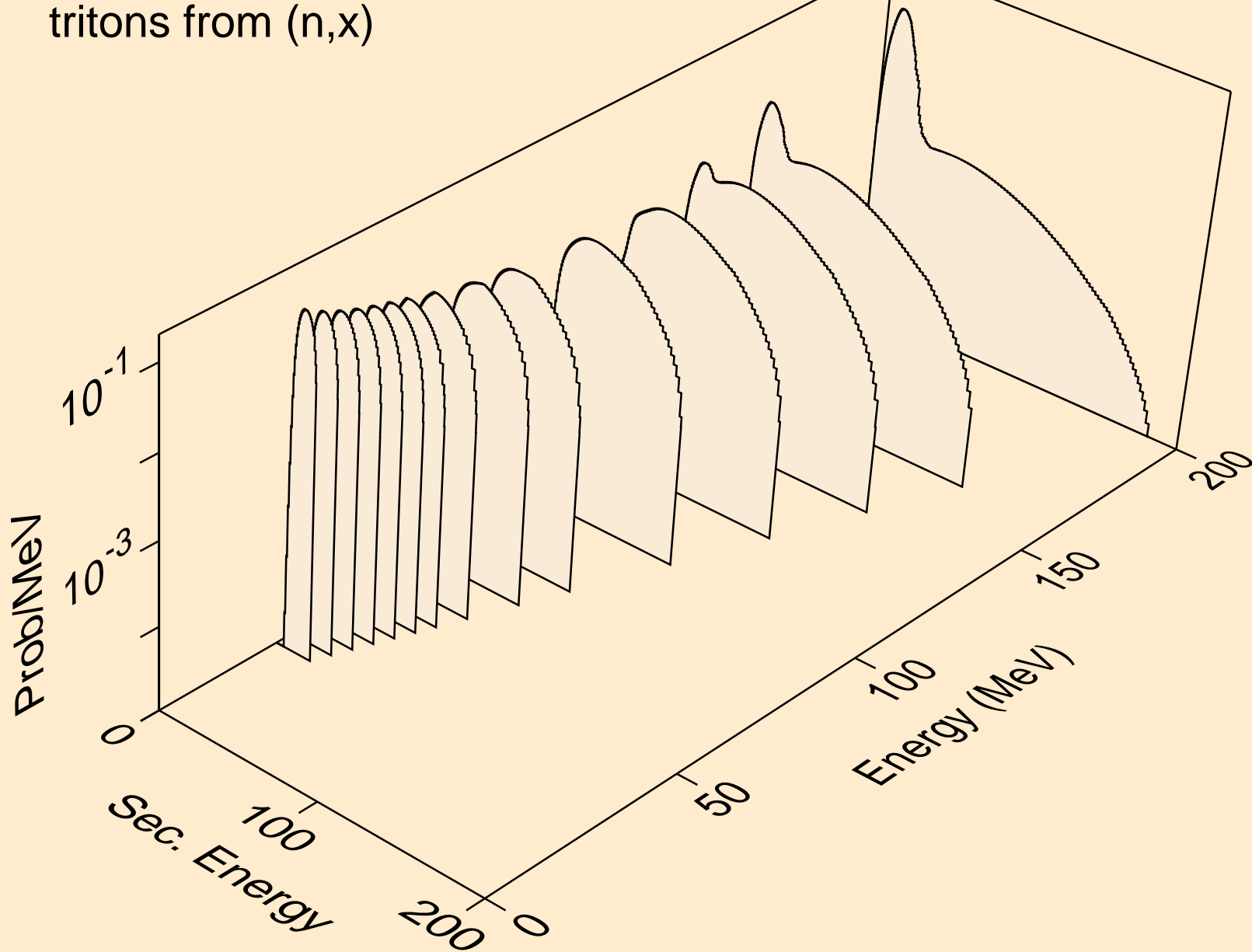

CE122 NEUTRON ACER TENDL-2019 LIBRARY; T=293.16K
tritons from (n,n*)t

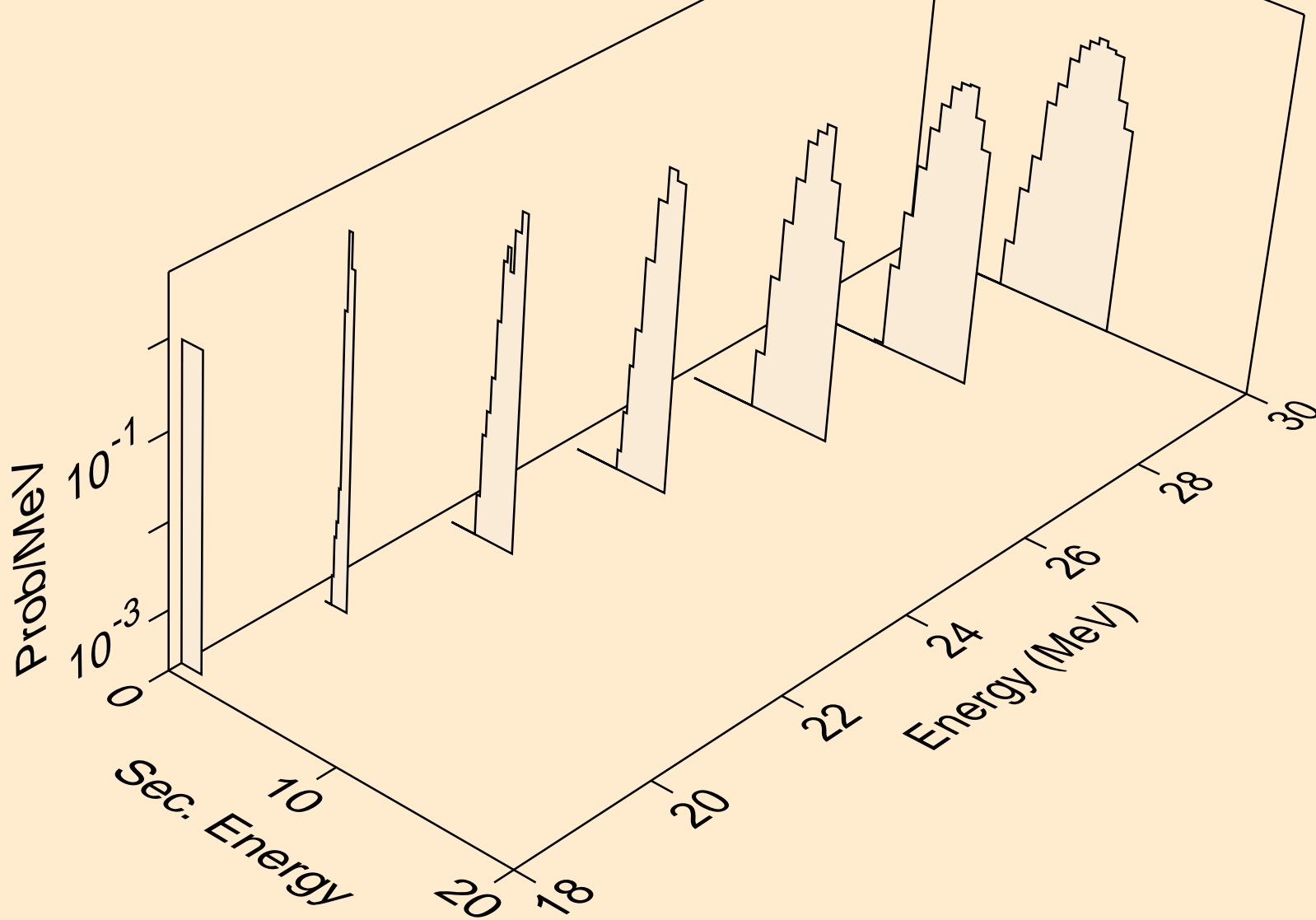

CE122 NEUTRON ACER TENDL-2019 LIBRARY; T=293.16K
tritons from (n,t)

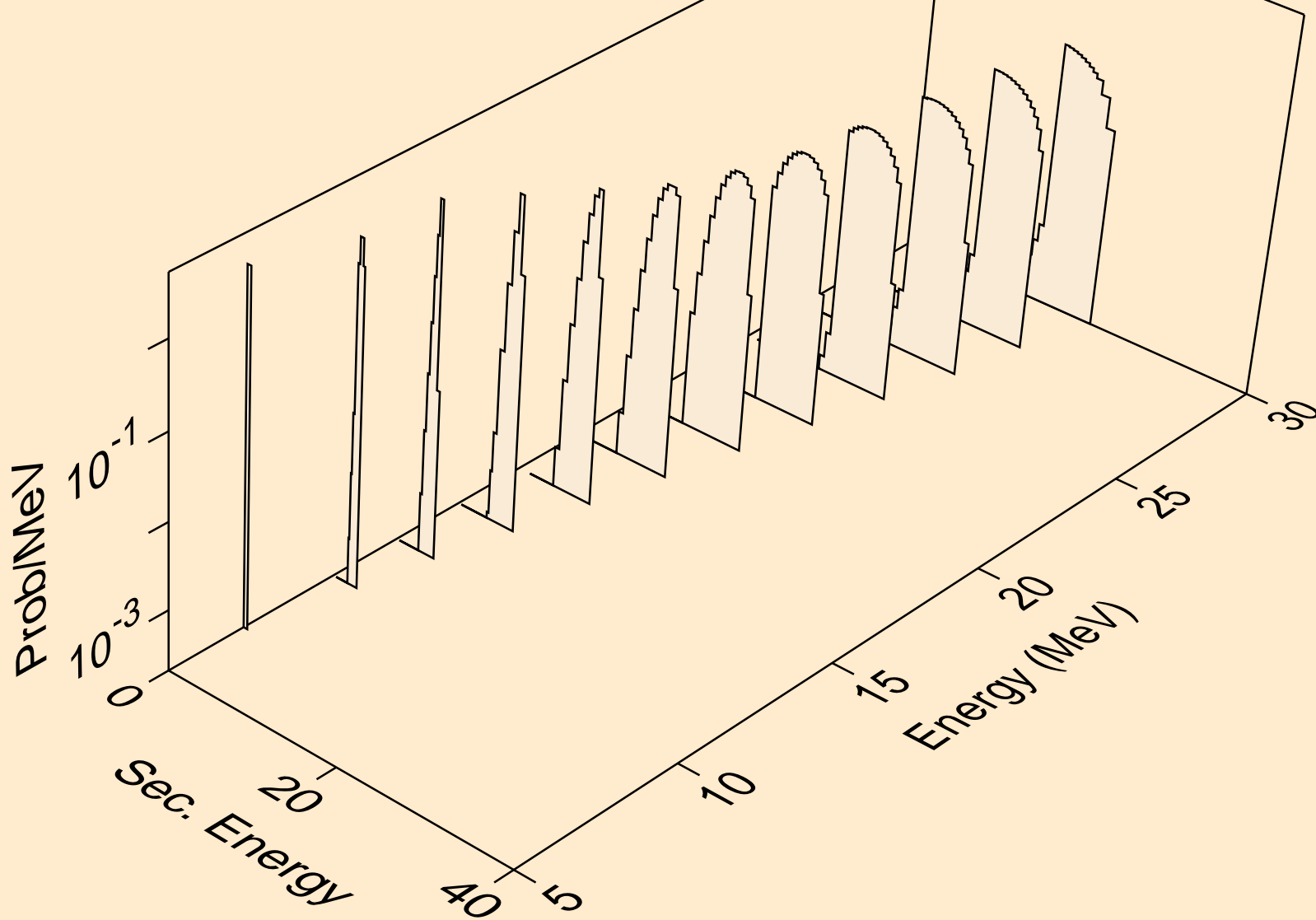

CE122 NEUTRON ACER TENDL-2019 LIBRARY; T=293.16K
tritons from (n,pt)

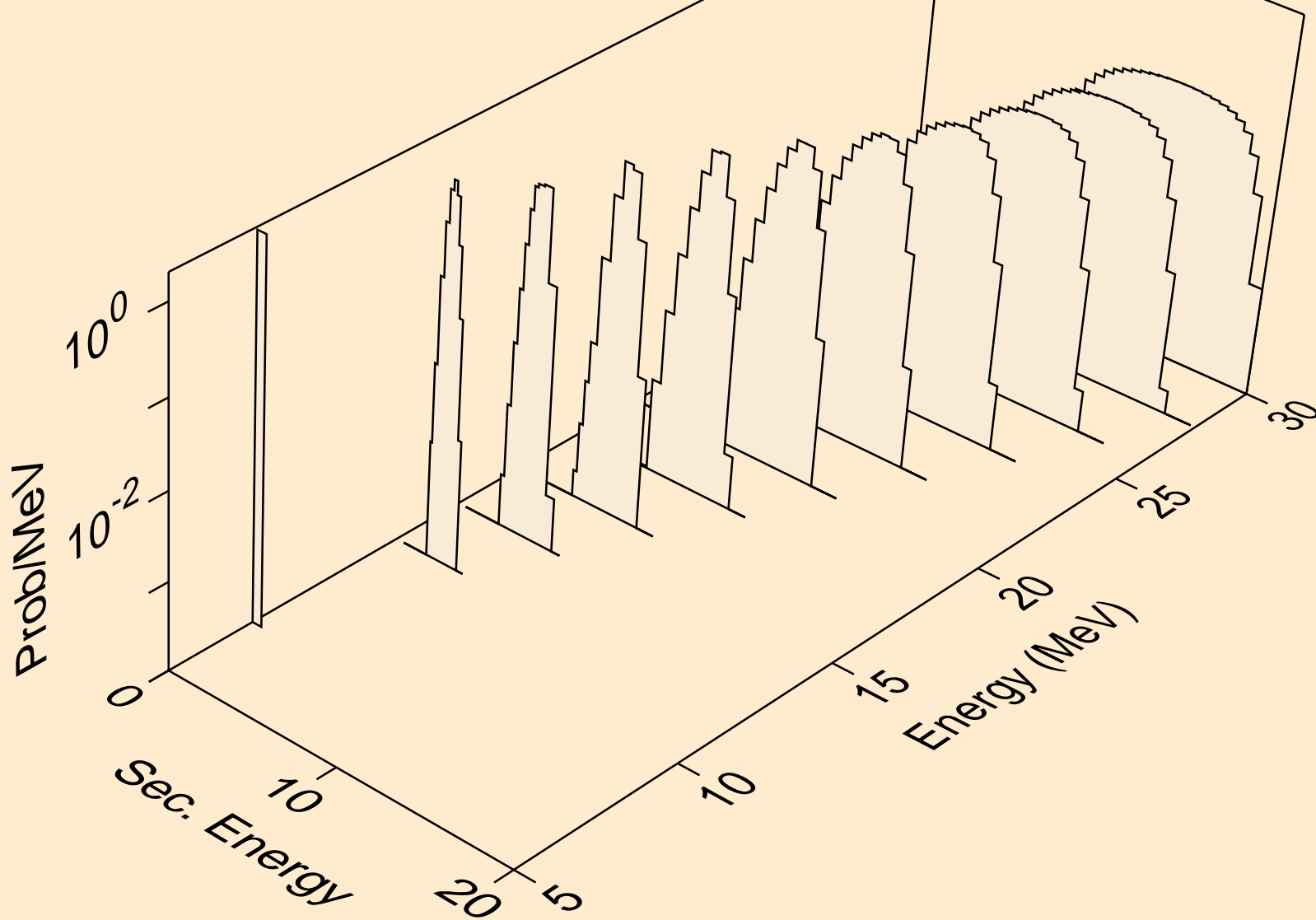

CE122 NEUTRON ACER TENDL-2019 LIBRARY; T=293.16K
he3s from (n,x)

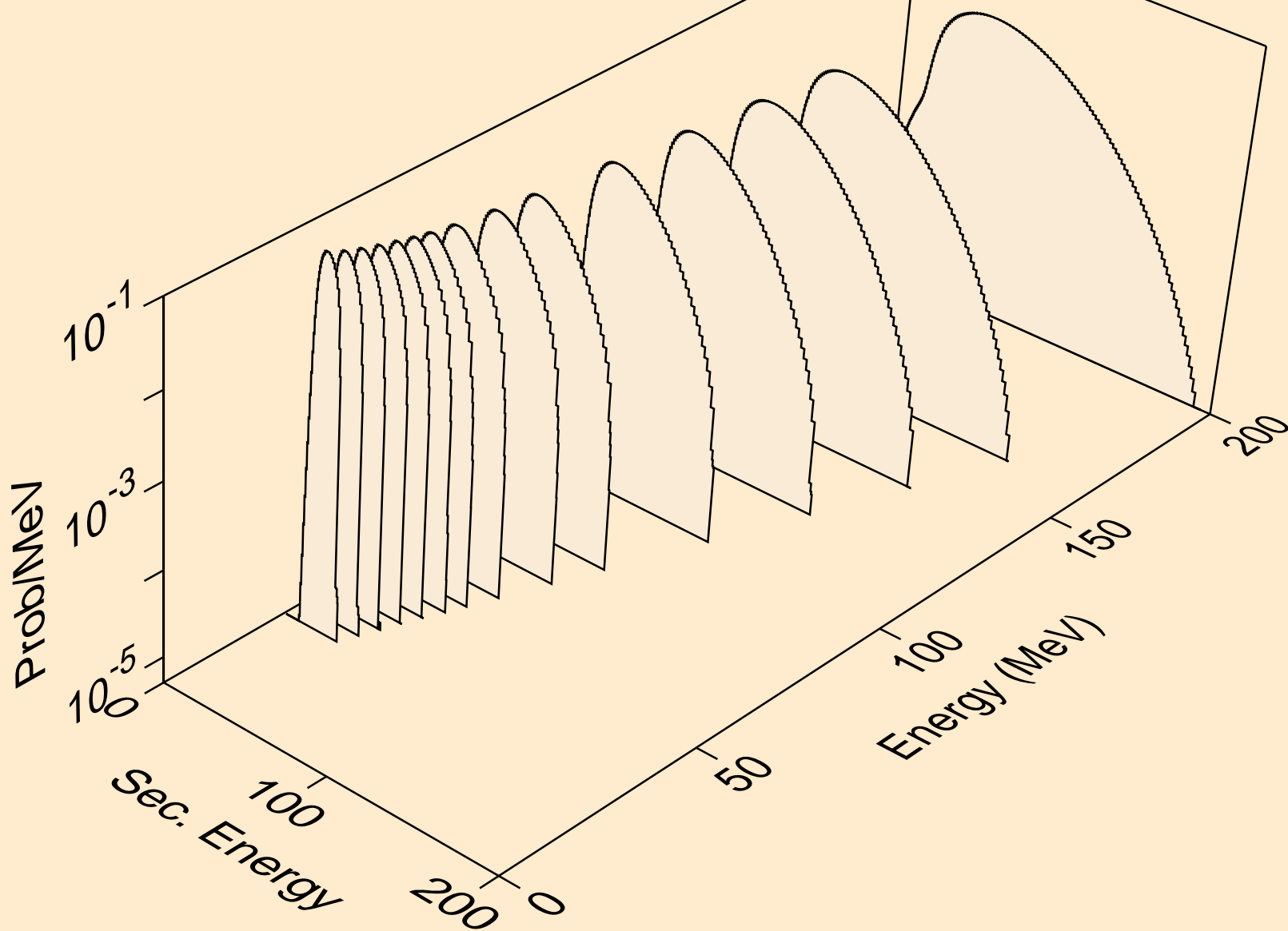

CE122 NEUTRON ACER TENDL-2019 LIBRARY; T=293.16K
he3s from (n,n*)he3

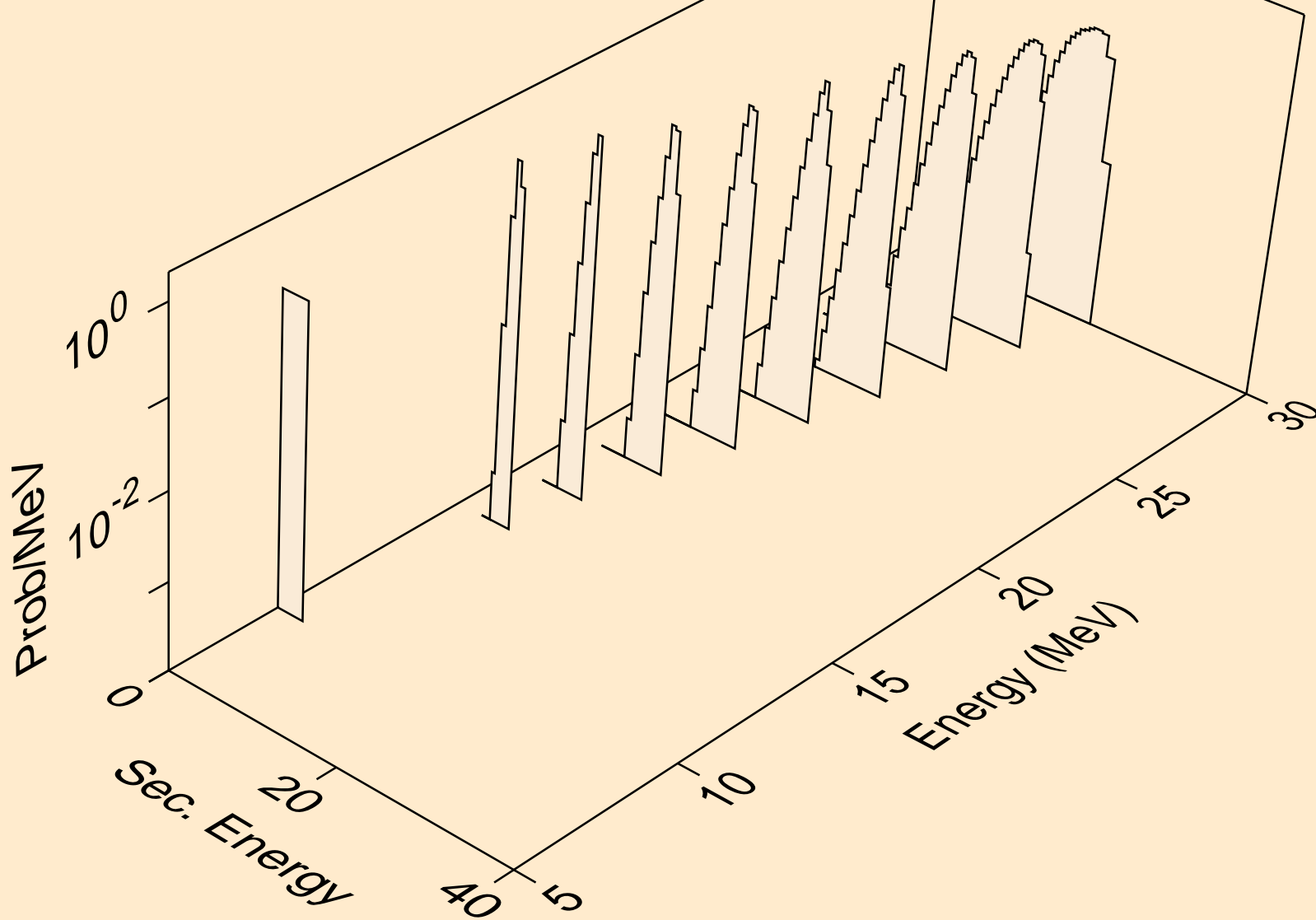

CE122 NEUTRON ACER TENDL-2019 LIBRARY; T=293.16K
he3s from (n,he3)

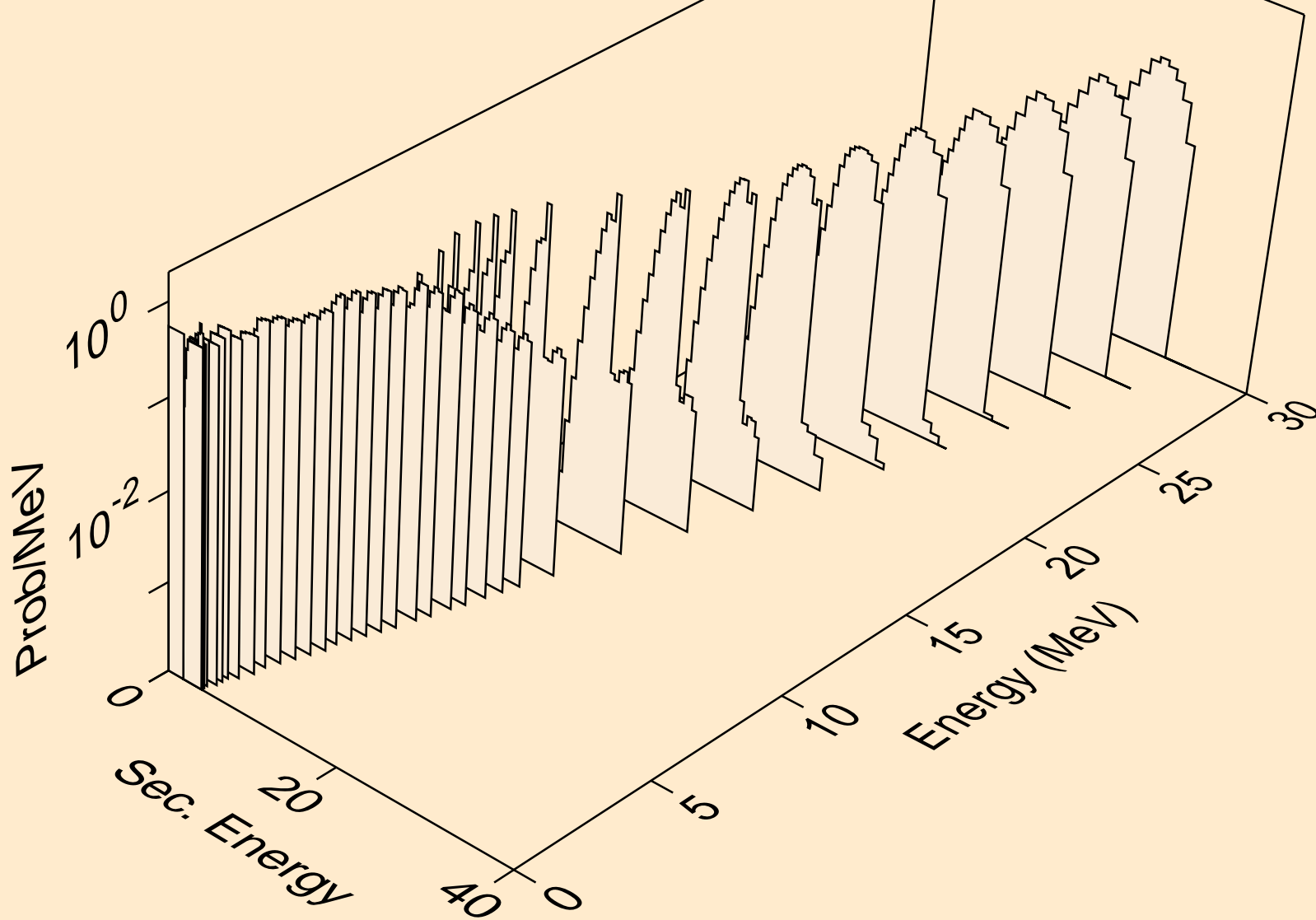

CE122 NEUTRON ACER TENDL-2019 LIBRARY; T=293.16K
alphas from (n,x)

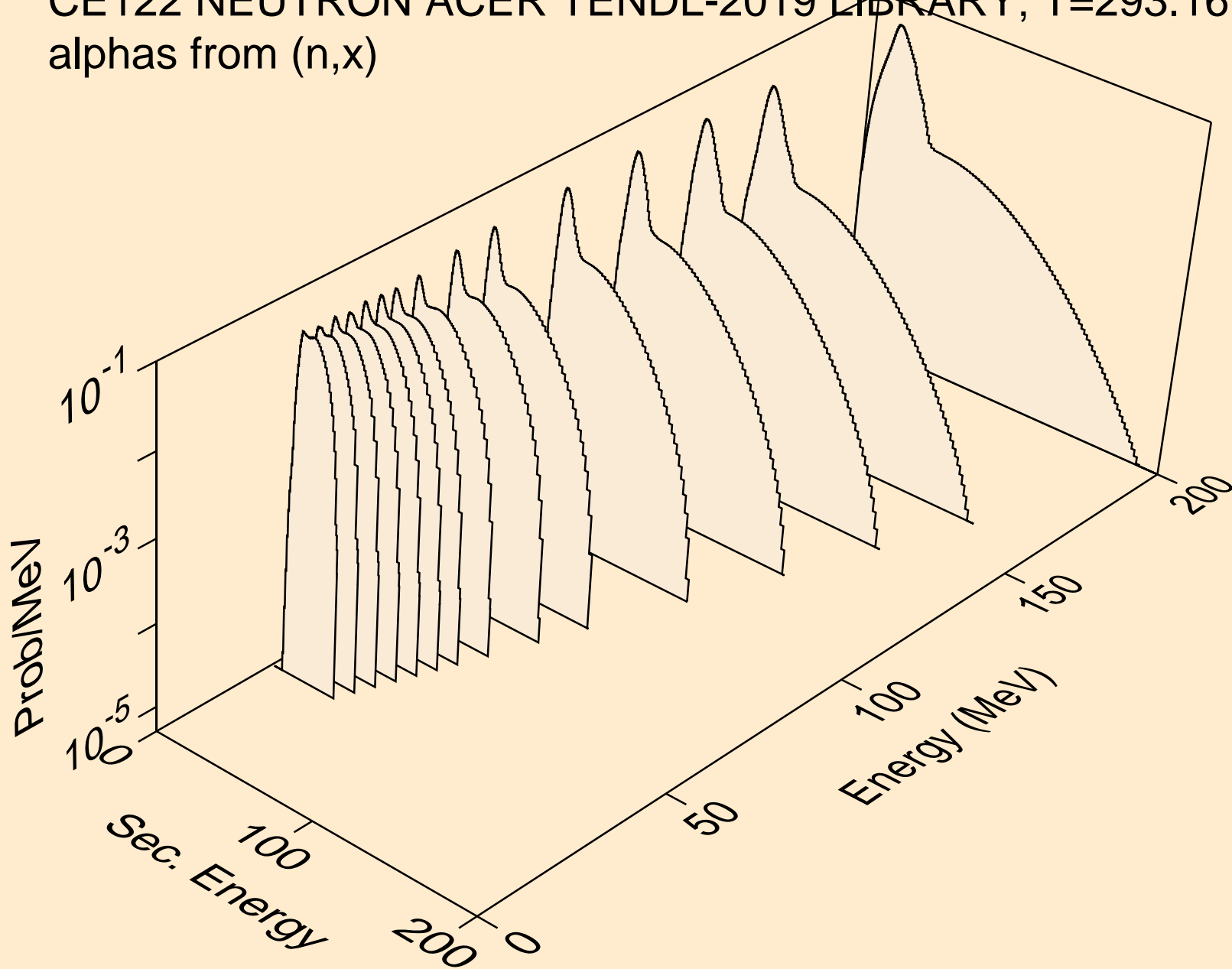

CE122 NEUTRON ACER TENDL-2019 LIBRARY; T=293.16K
alphas from (n,n*)a

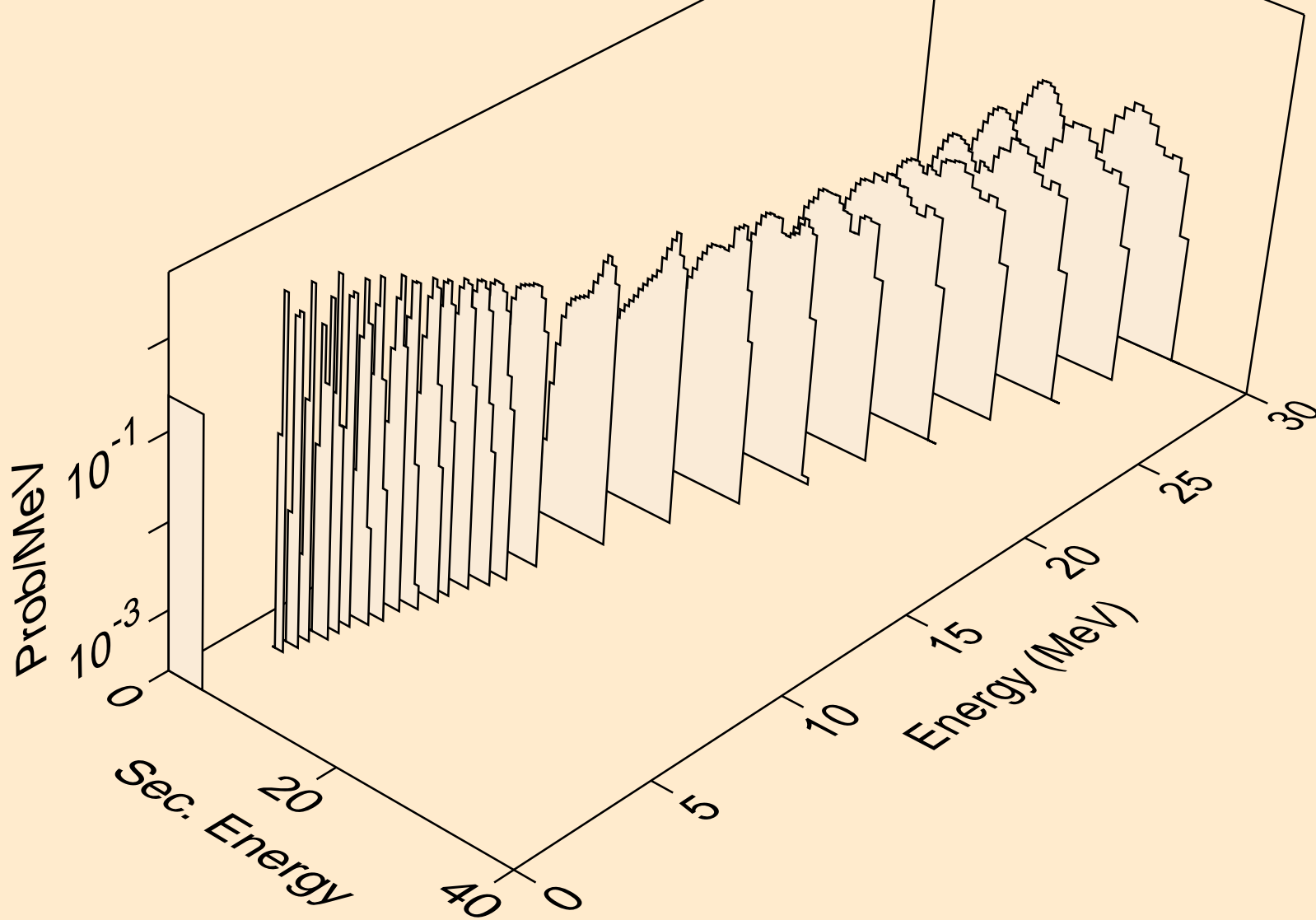

CE122 NEUTRON ACER TENDL-2019 LIBRARY; T=293.16K
alphas from (n,n*)3a

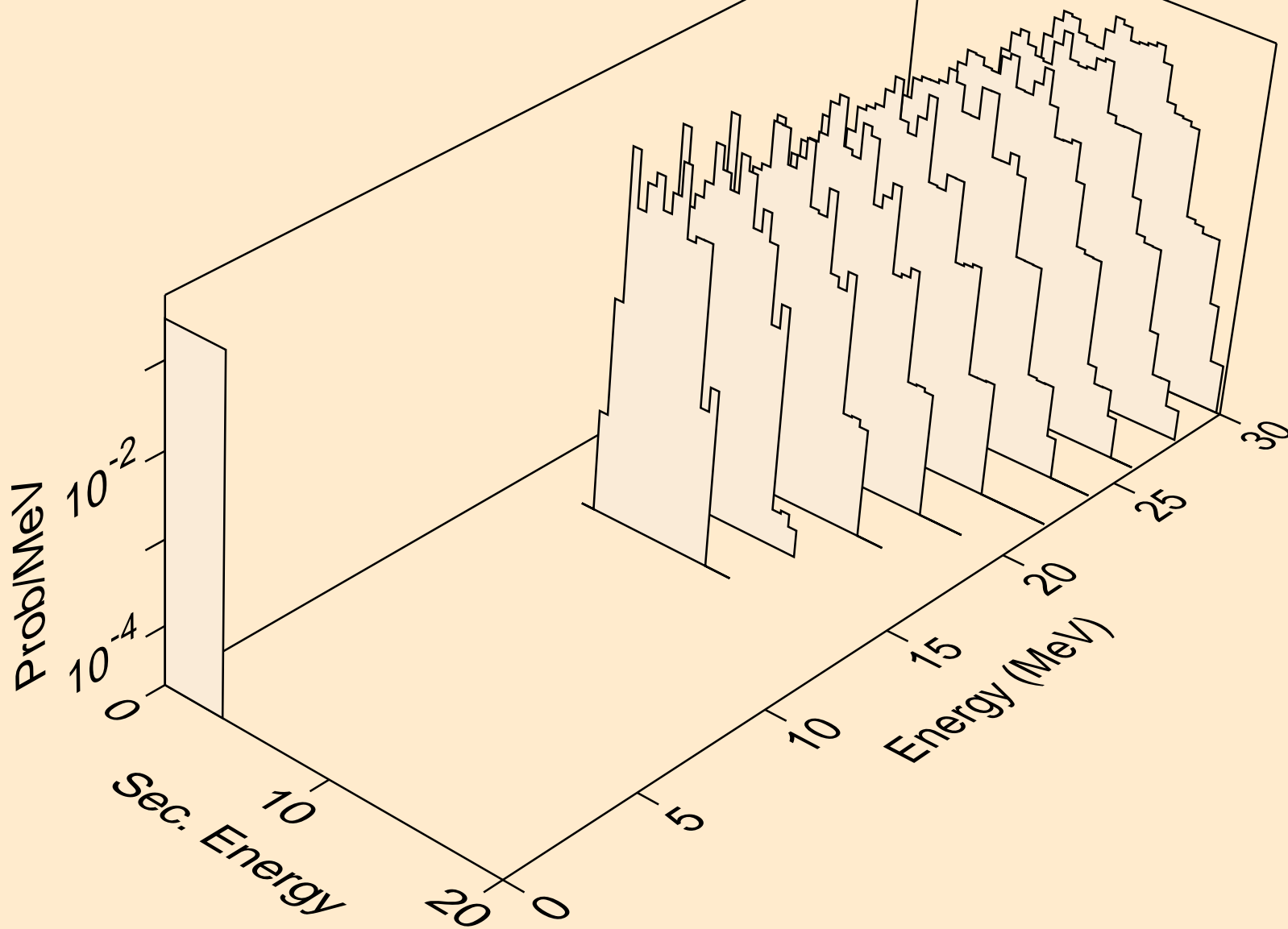

CE122 NEUTRON ACER TENDL-2019 LIBRARY; T=293.16K
alphas from (n,2n)a

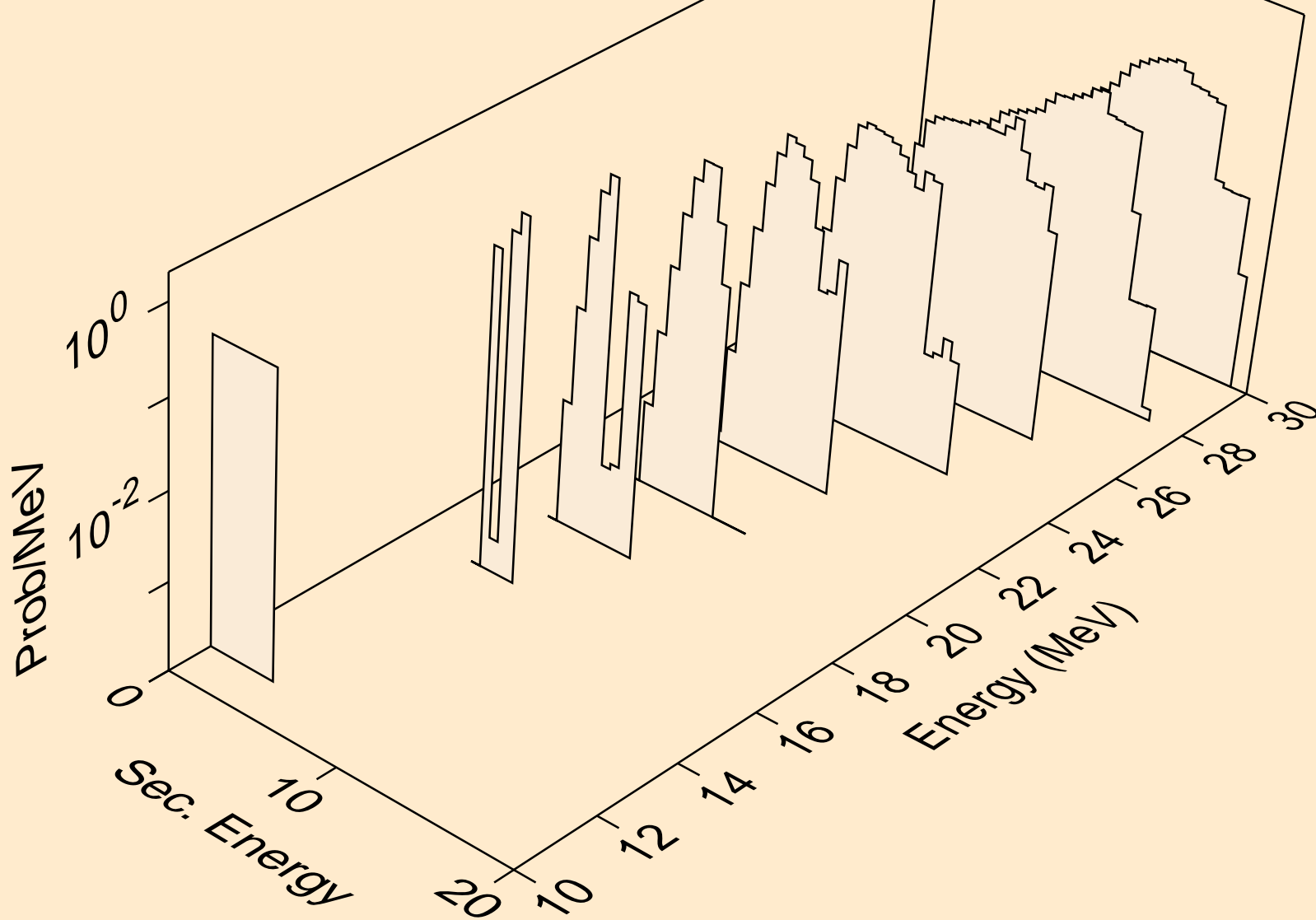

CE122 NEUTRON ACER TENDL-2019 LIBRARY; T=293.16K
alphas from (n,n*)2a

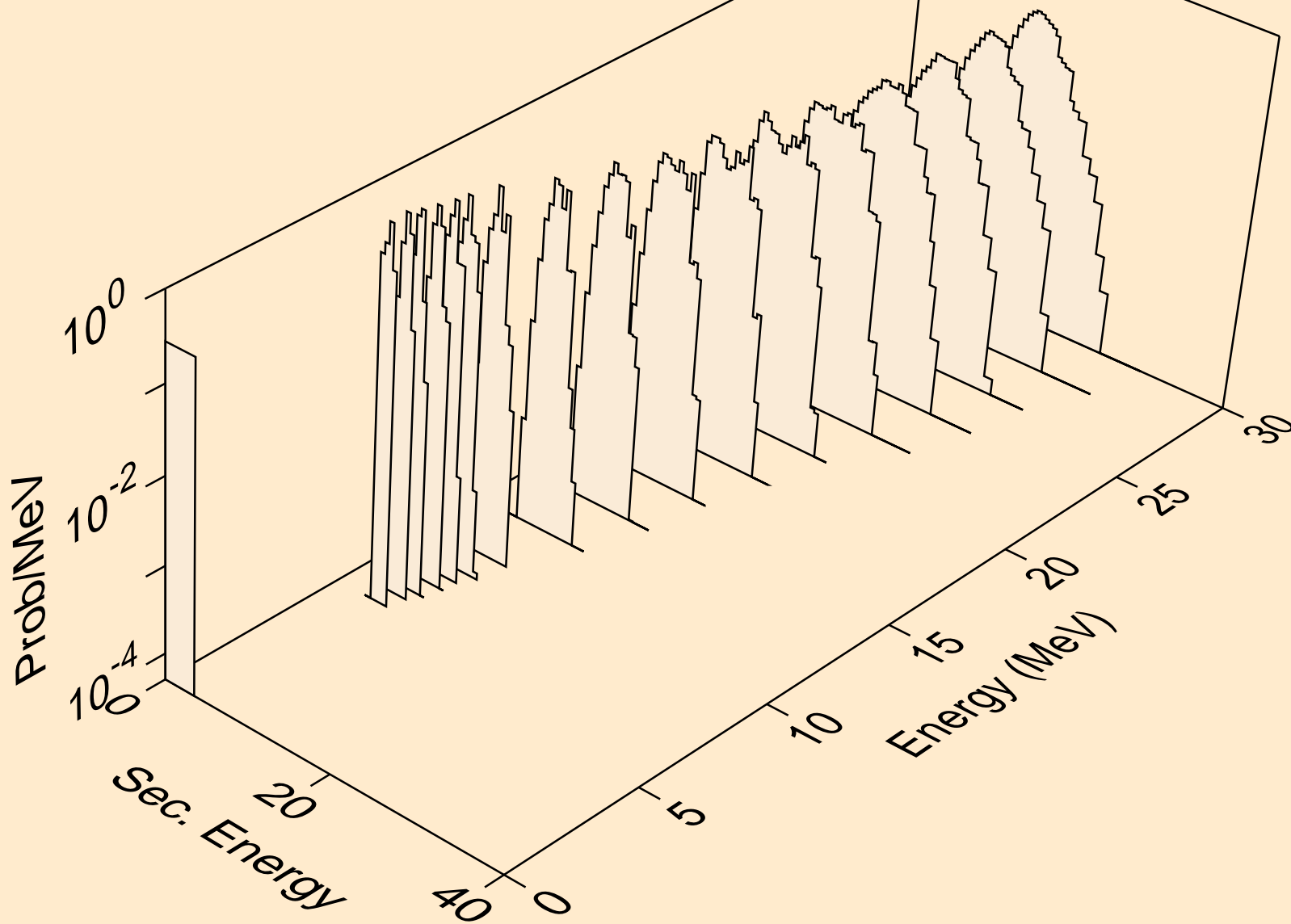

CE122 NEUTRON ACER TENDL-2019 LIBRARY; T=293.16K
alphas from (n,npa)

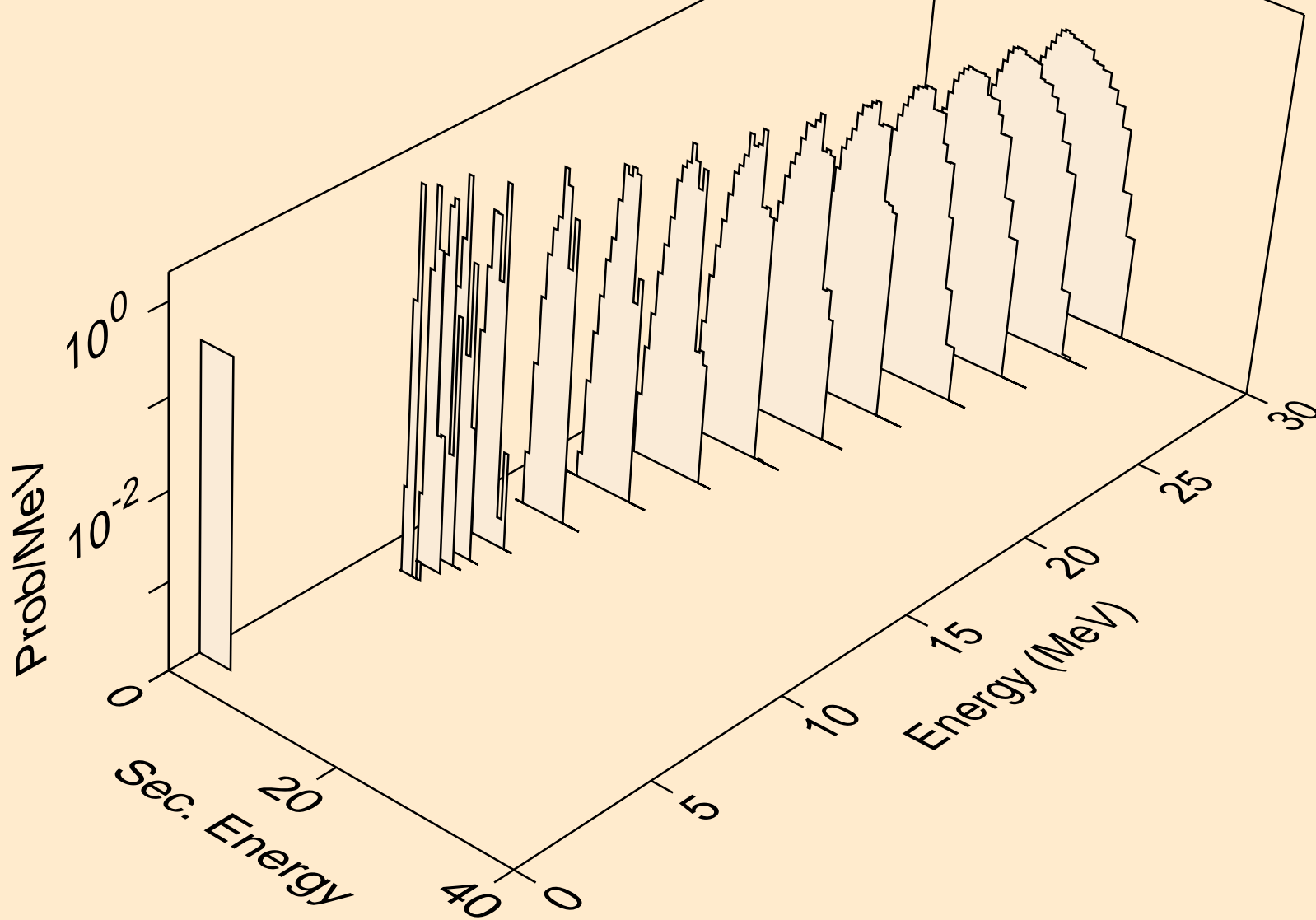

CE122 NEUTRON ACER TENDL-2019 LIBRARY; T=293.16K
alphas from (n,a)

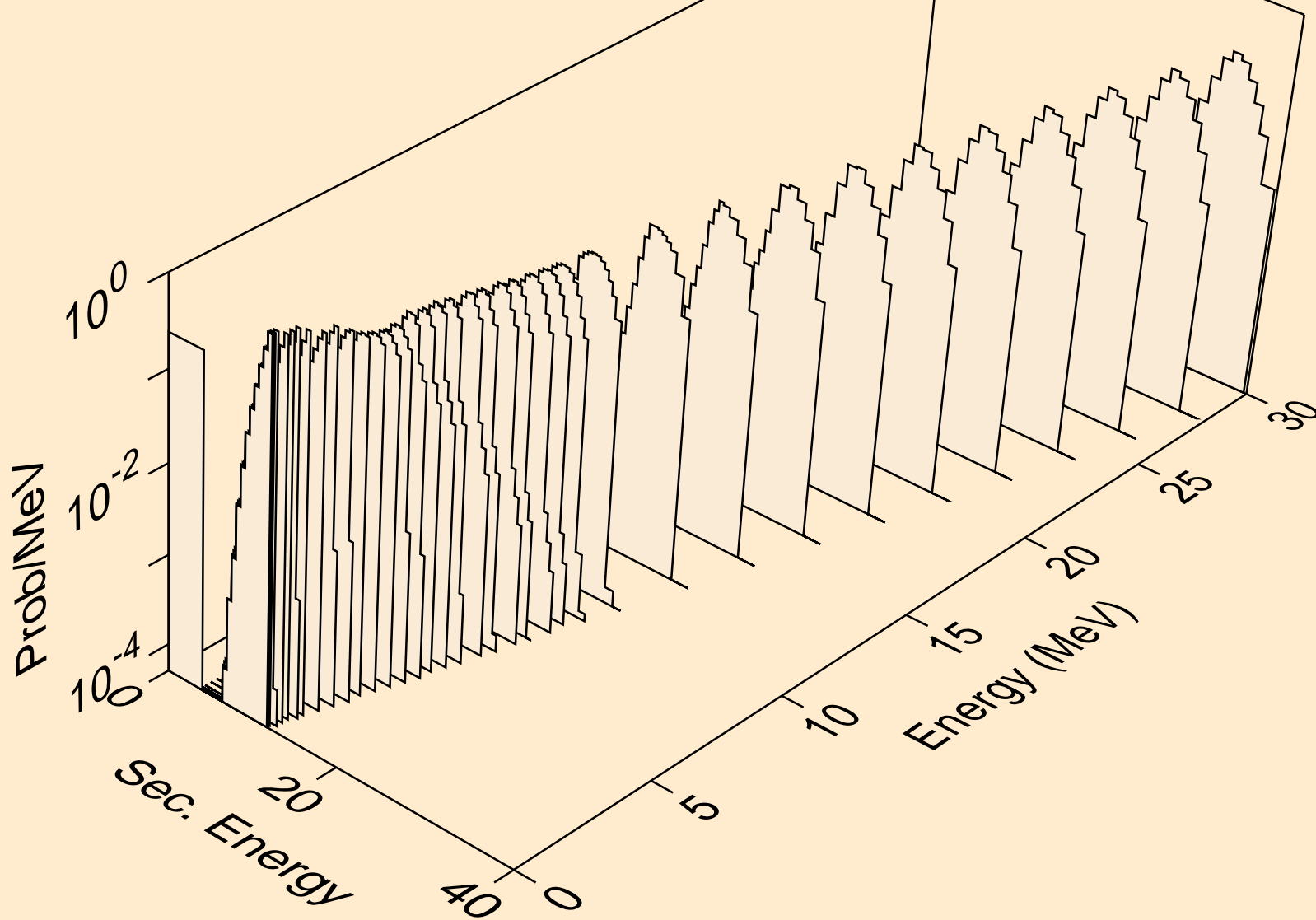

CE122 NEUTRON ACER TENDL-2019 LIBRARY; T=293.16K
alphas from (n,2a)

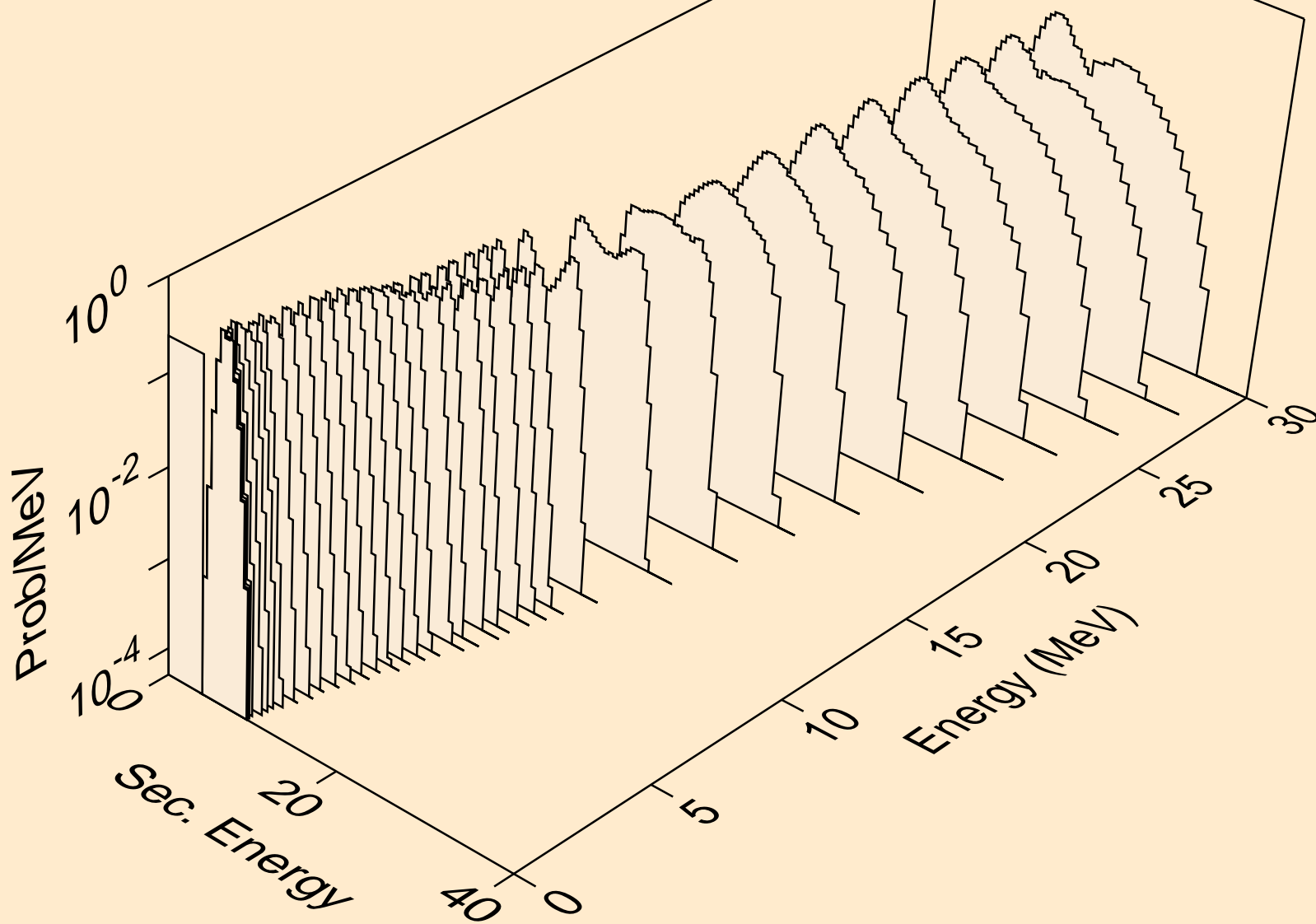

CE122 NEUTRON ACER TENDL-2019 LIBRARY; T=293.16K
alphas from (n,3a)

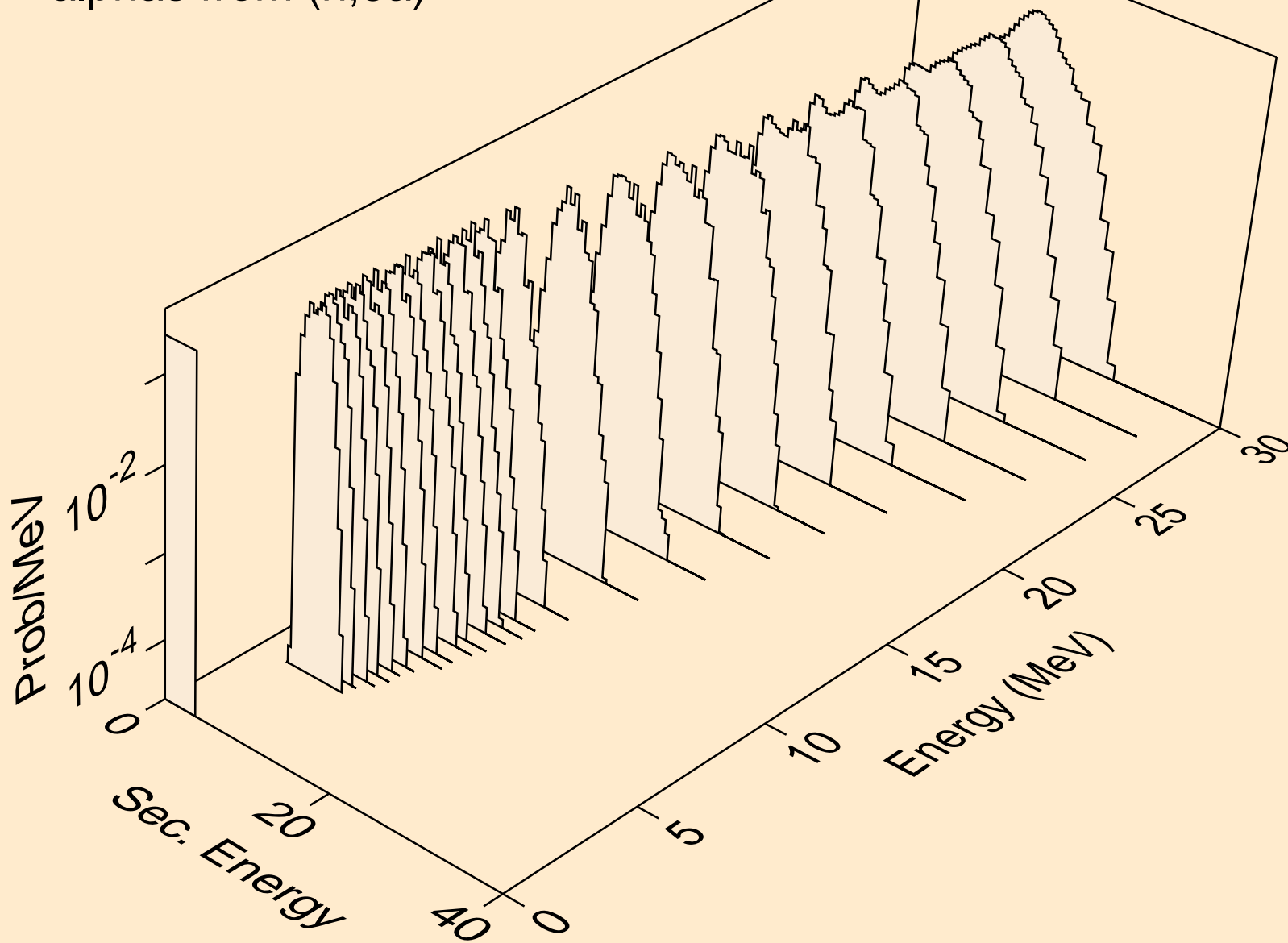

CE122 NEUTRON ACER TENDL-2019 LIBRARY; T=293.16K
alphas from (n,pa)

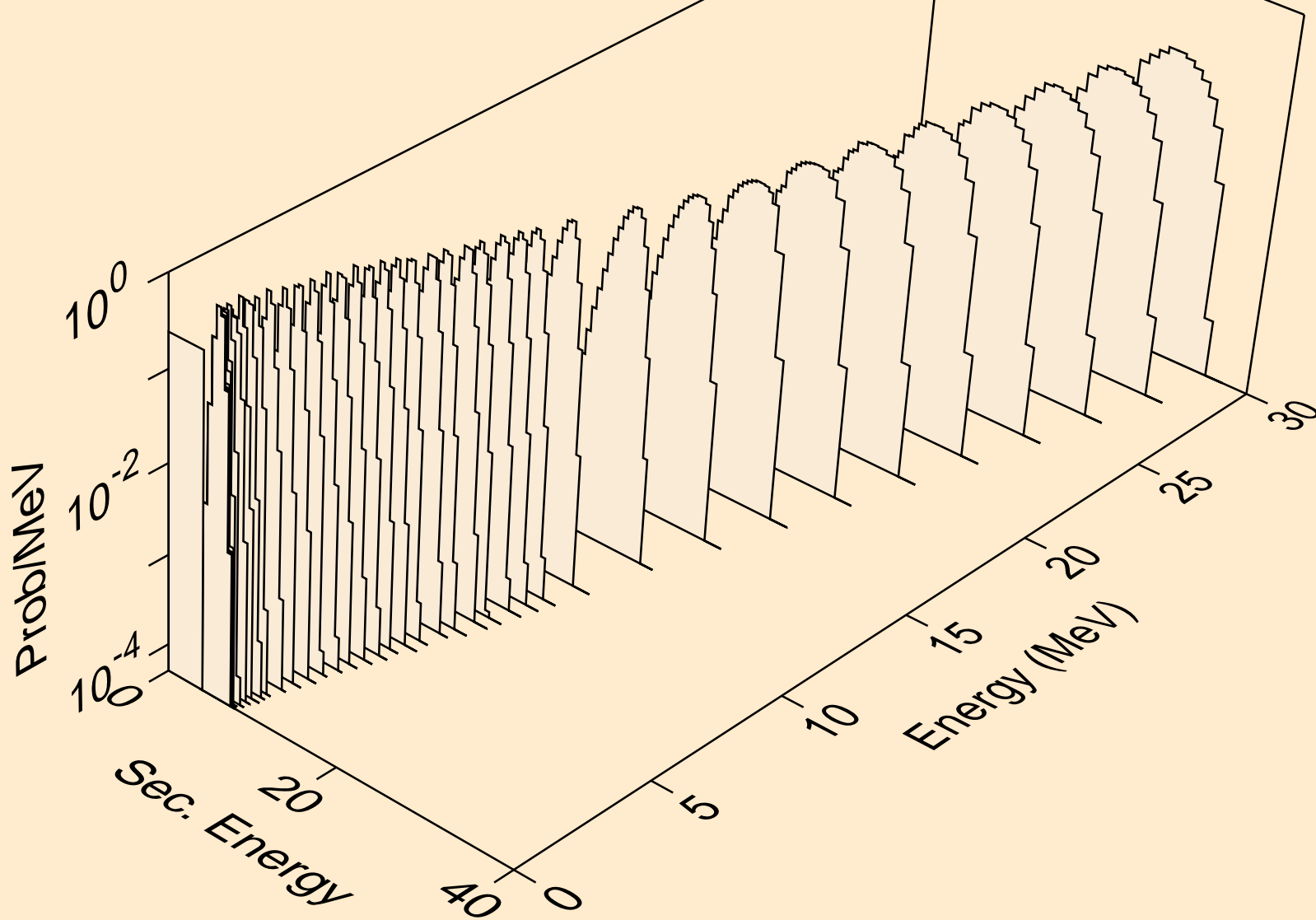

CE122 NEUTRON ACER TENDL-2019 LIBRARY; T=293.16K
alphas from (n,d2a)

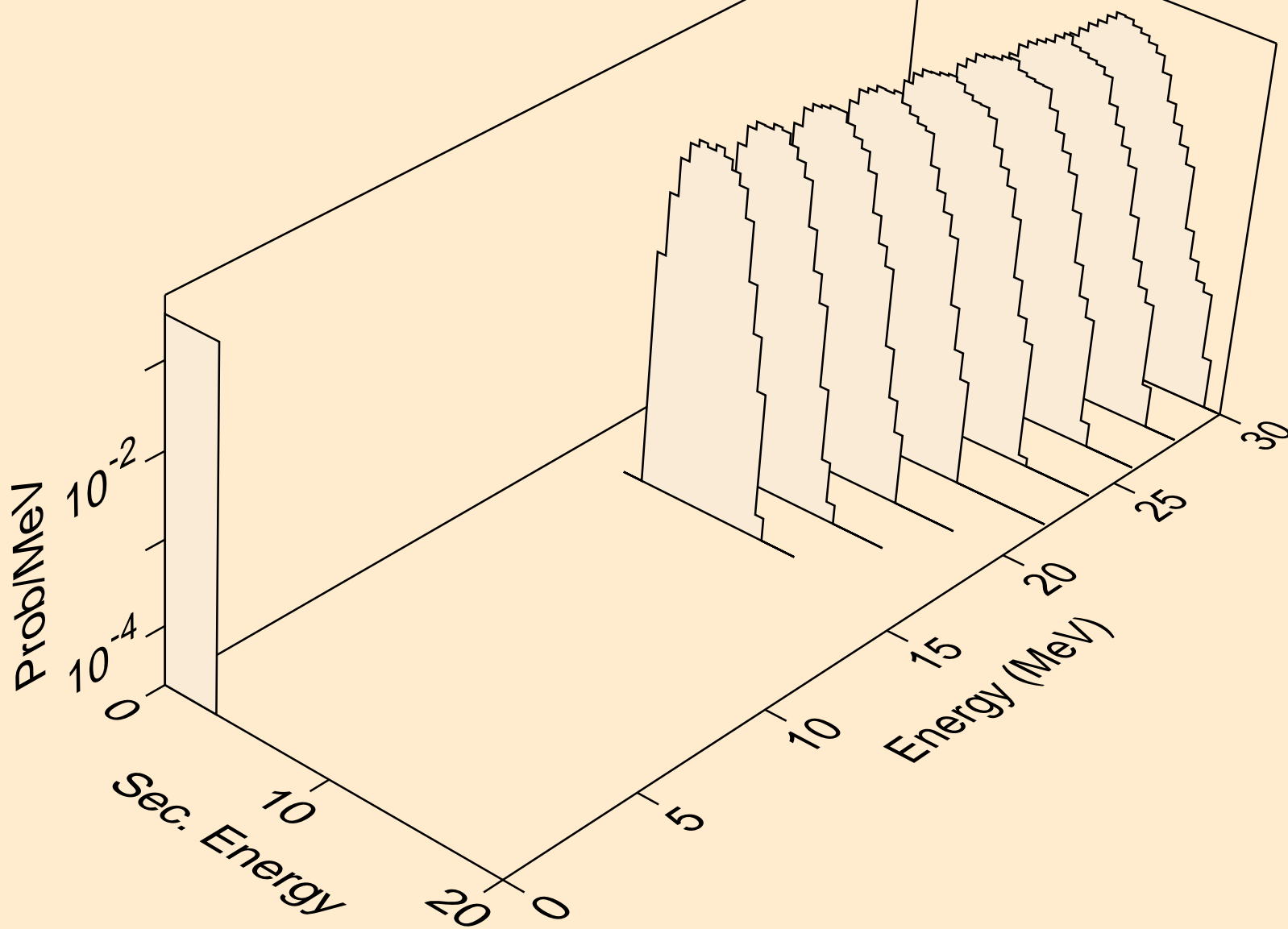

CE122 NEUTRON ACER TENDL-2019 LIBRARY; T=293.16K
alphas from (n,da)

