

CE133M NEUTRON ACER TENDL-2019 LIBRARY; T=293.16K
Principal cross sections

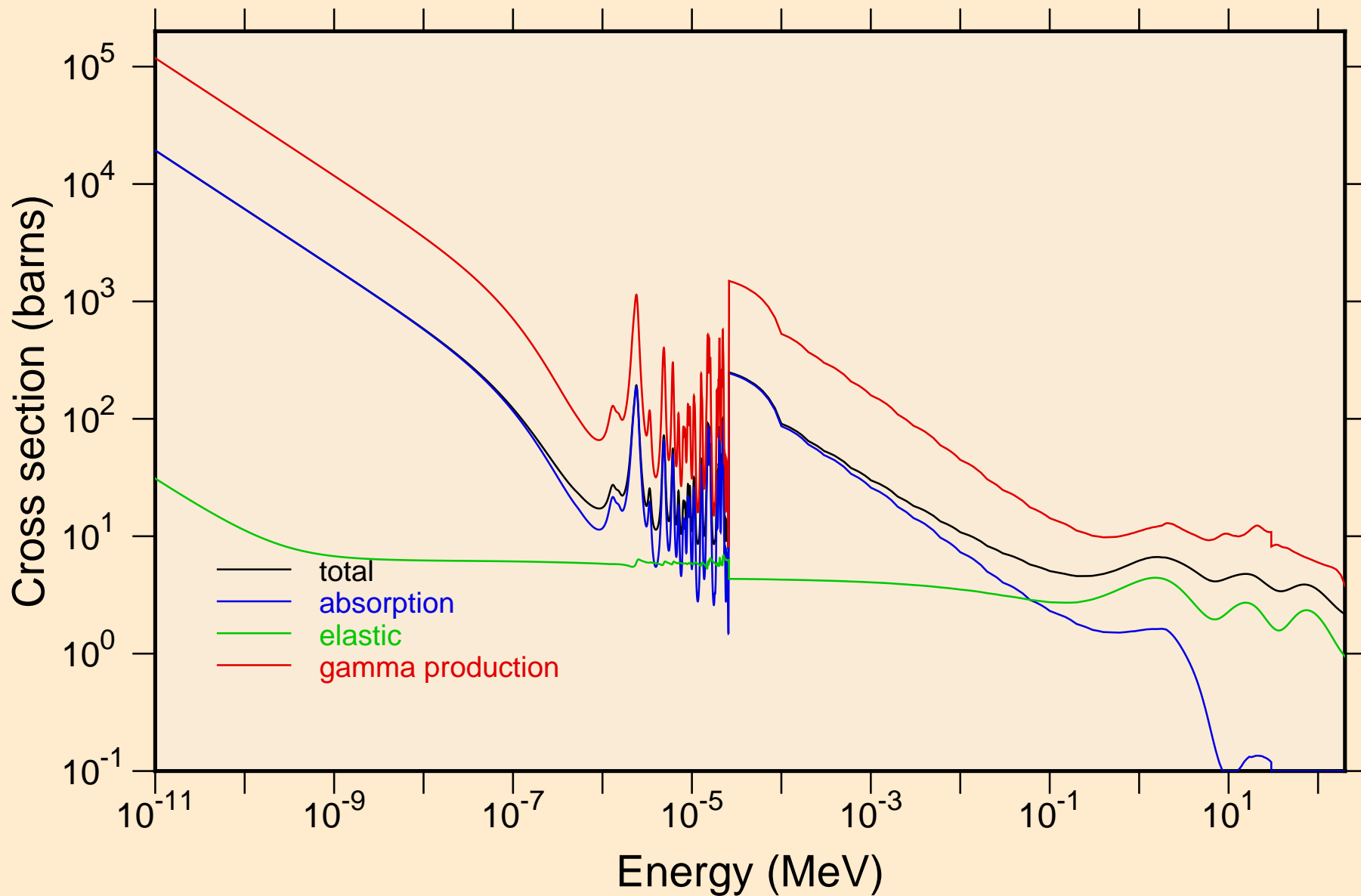

CE133M NEUTRON ACER TENDL-2019 LIBRARY; T=293.16K
resonance total cross section

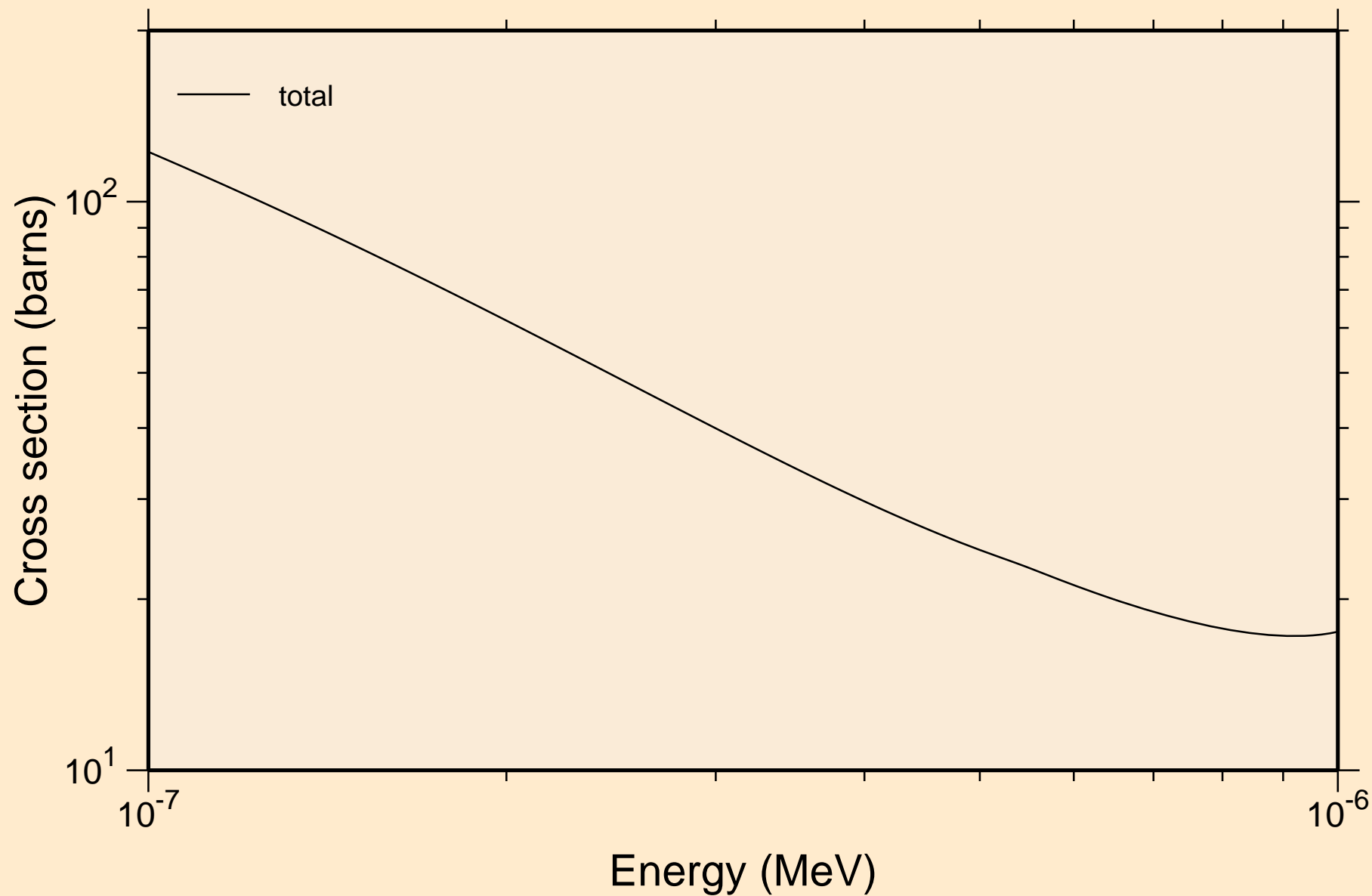

CE133M NEUTRON ACER TENDL-2019 LIBRARY; T=293.16K
resonance total cross section

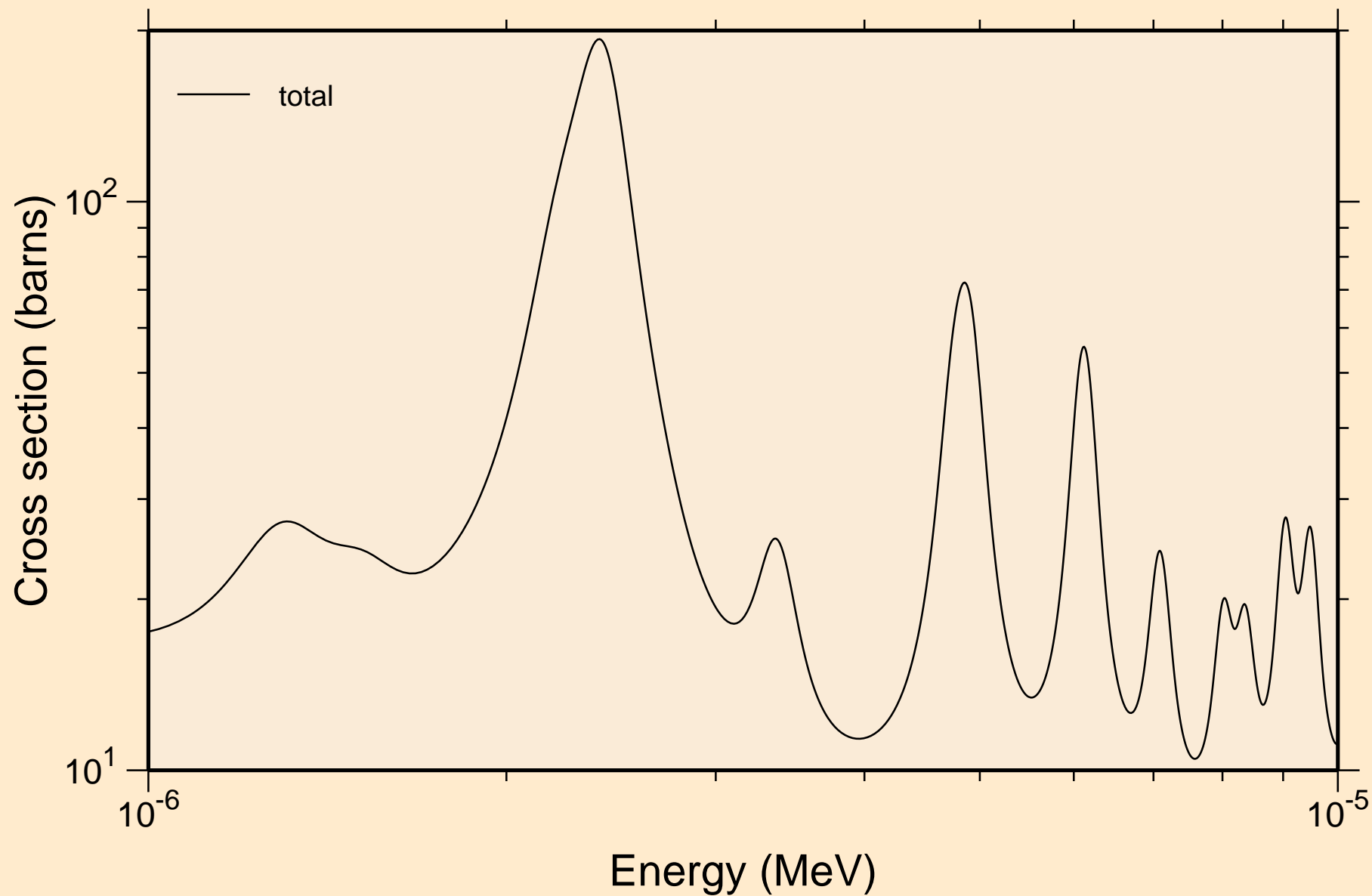

CE133M NEUTRON ACER TENDL-2019 LIBRARY; T=293.16K
resonance total cross section

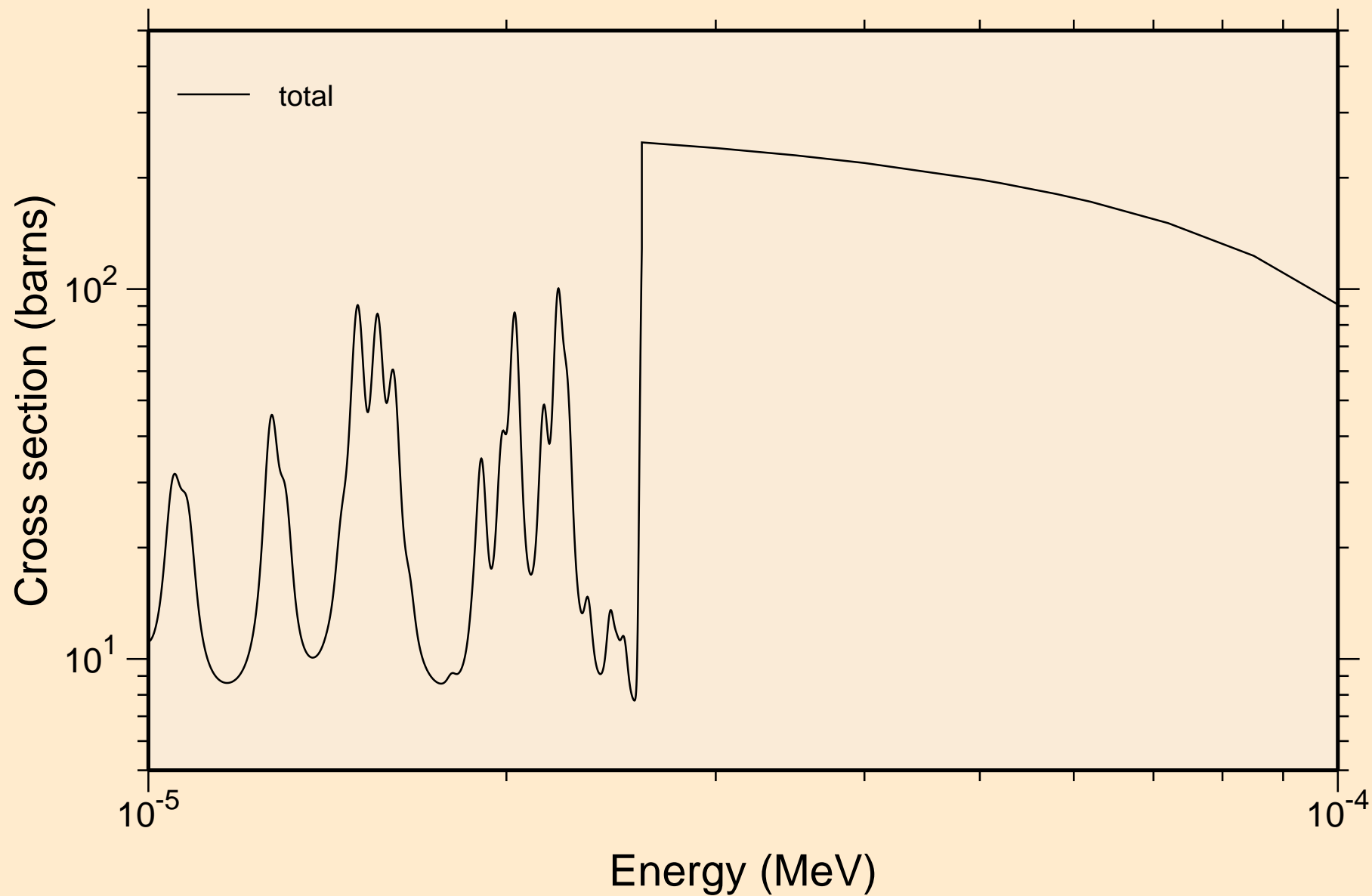

C¹³³M NEUTRON ACER TENDL-2019 LIBRARY; T=293.16K
resonance total cross section

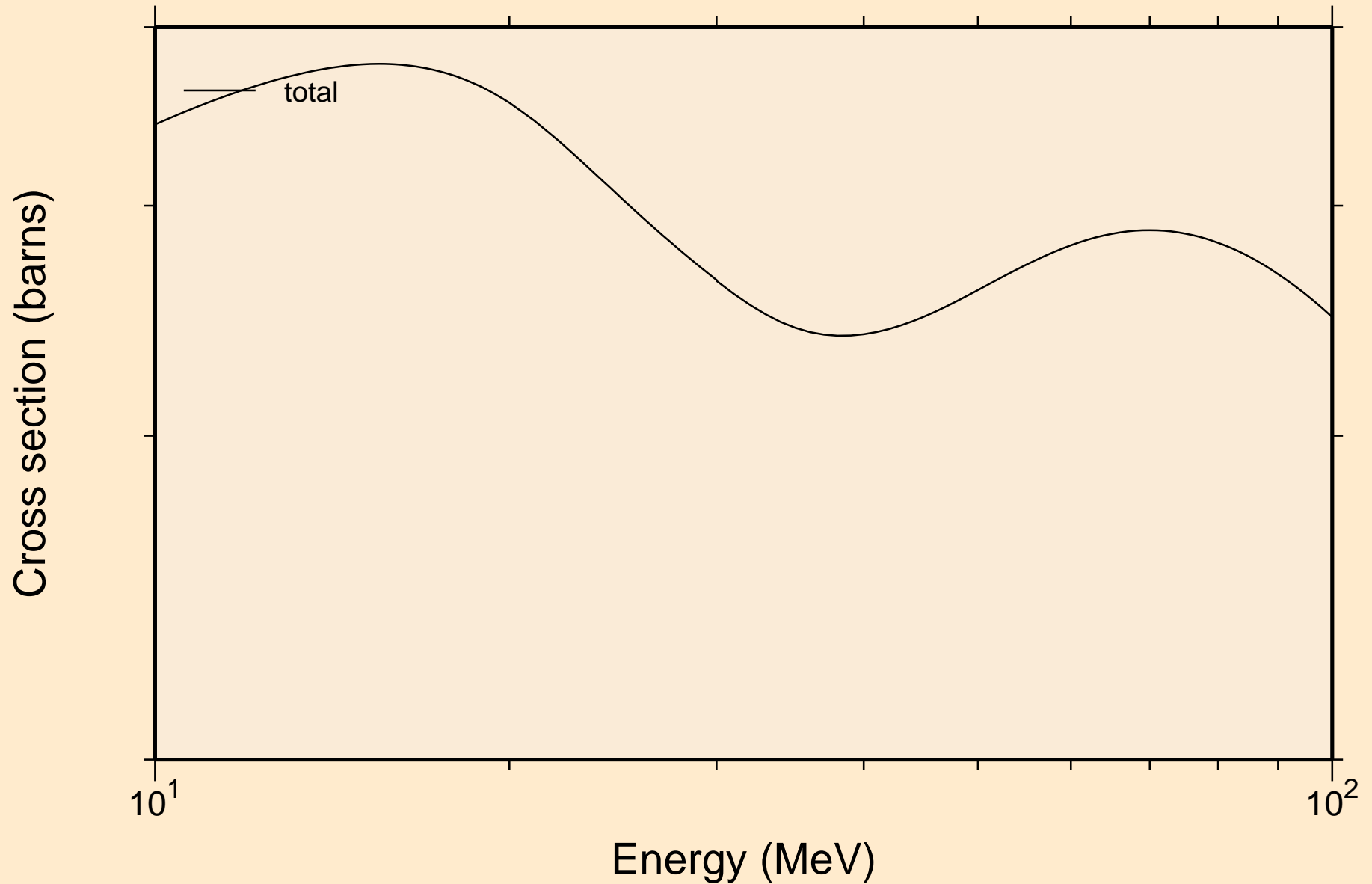

CE133M NEUTRON ACER TENDL-2019 LIBRARY; T=293.16K
resonance absorption cross sections

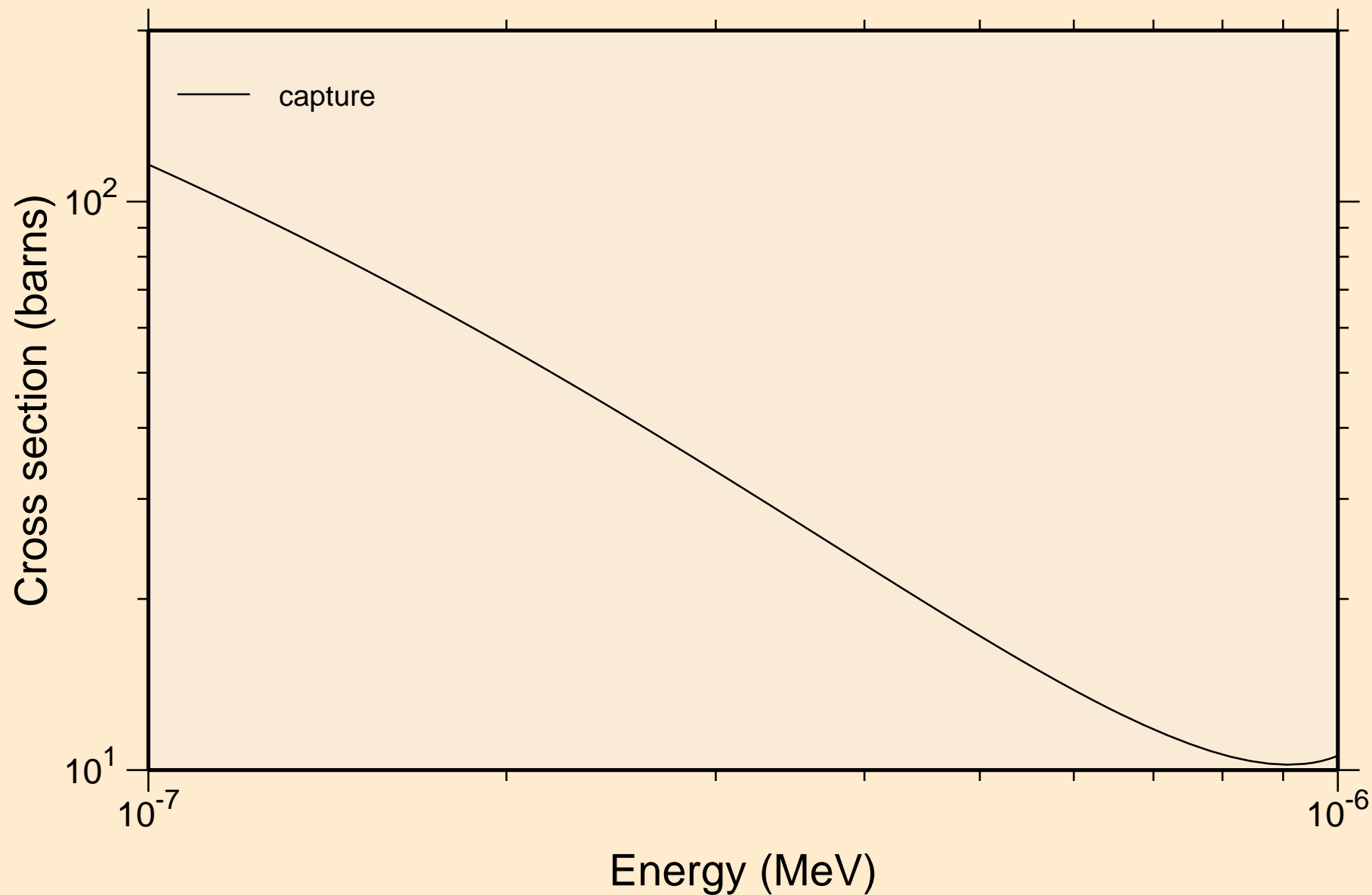

CE133M NEUTRON ACER TENDL-2019 LIBRARY; T=293.16K
resonance absorption cross sections

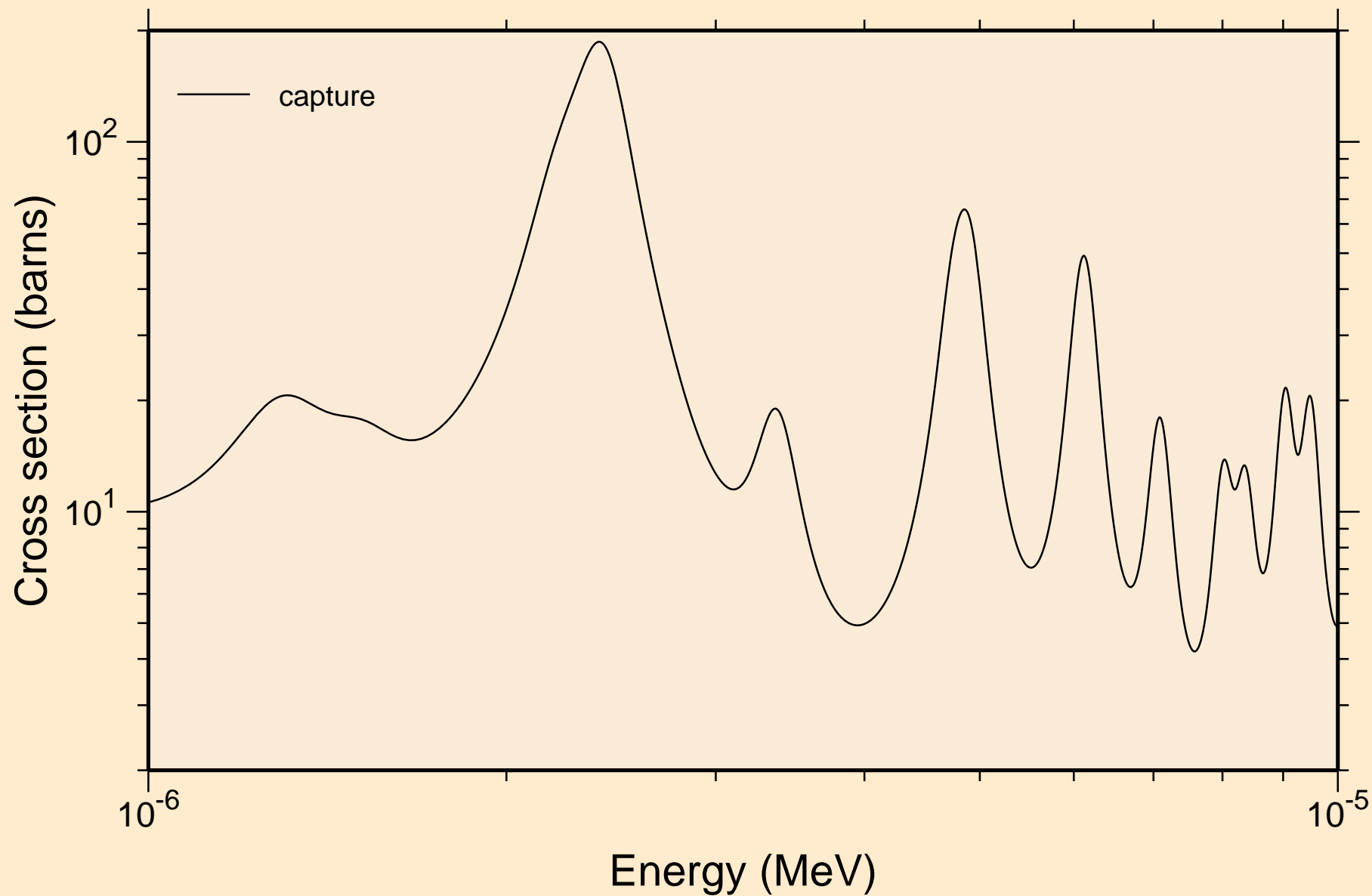

CE133M NEUTRON ACER TENDL-2019 LIBRARY; T=293.16K
resonance absorption cross sections

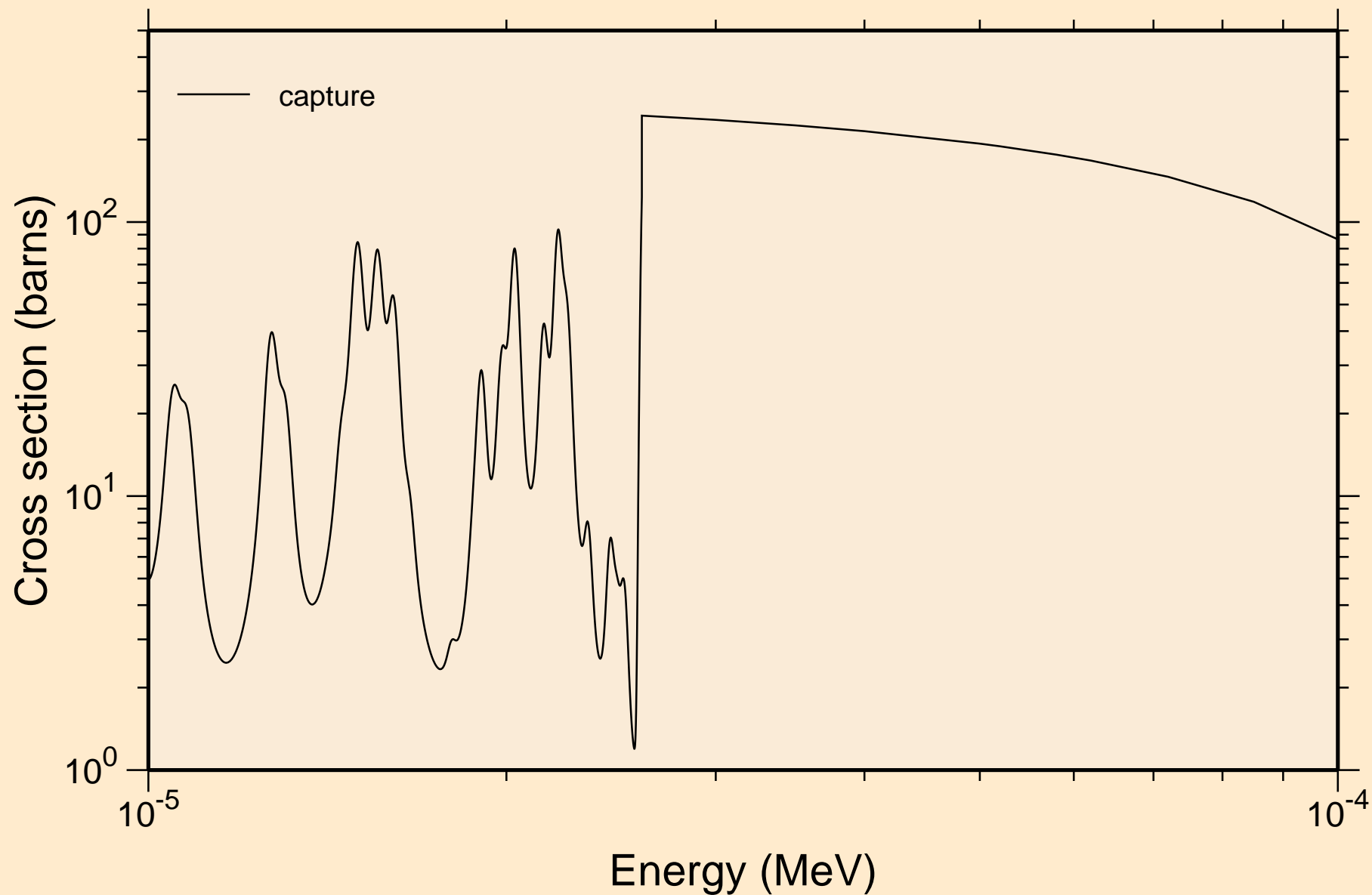

CE133M NEUTRON ACER TENDL-2019 LIBRARY; T=293.16K
resonance absorption cross sections

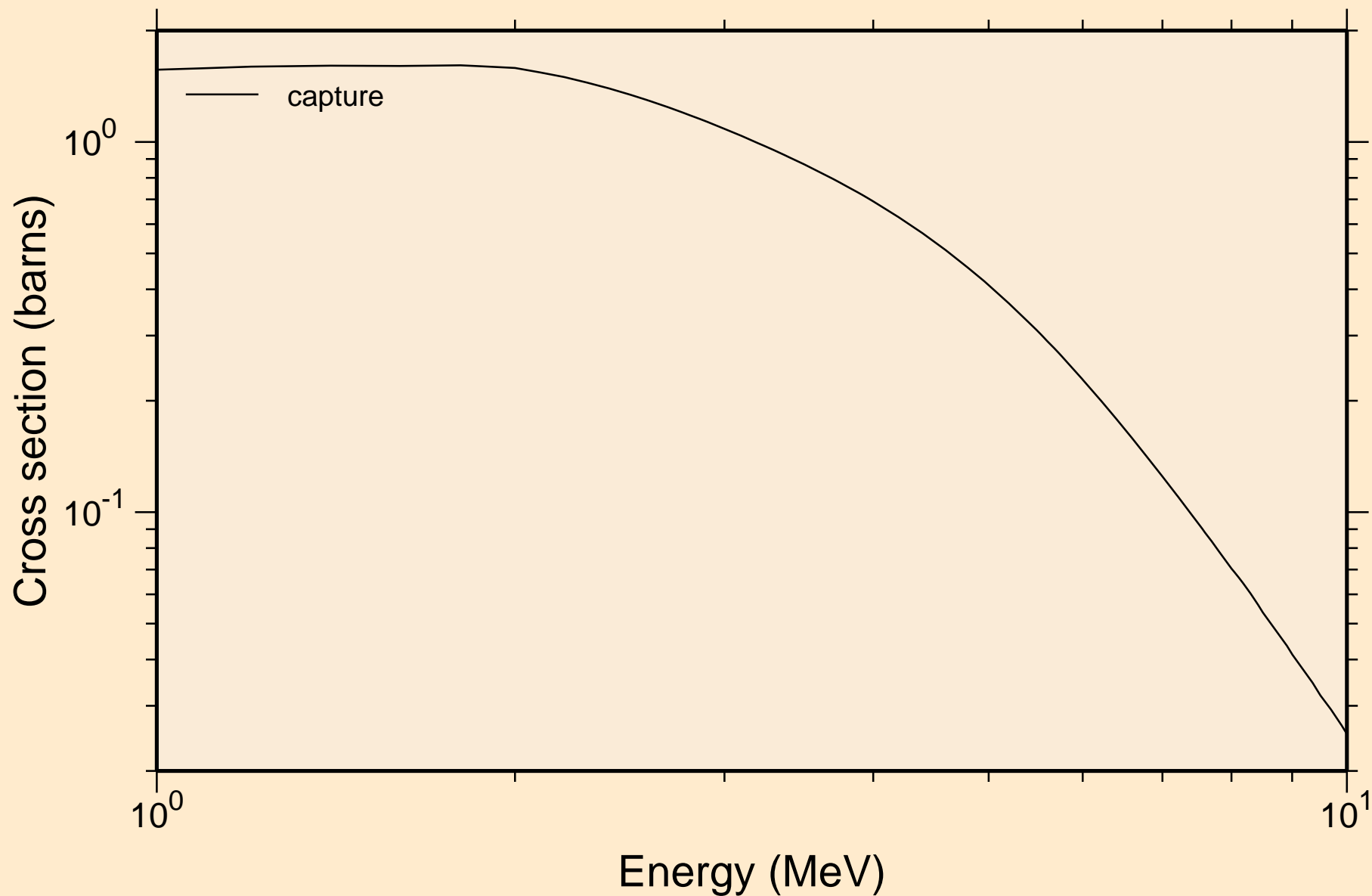

CE133M NEUTRON ACER TENDL-2019 LIBRARY; T=293.16K
Heating

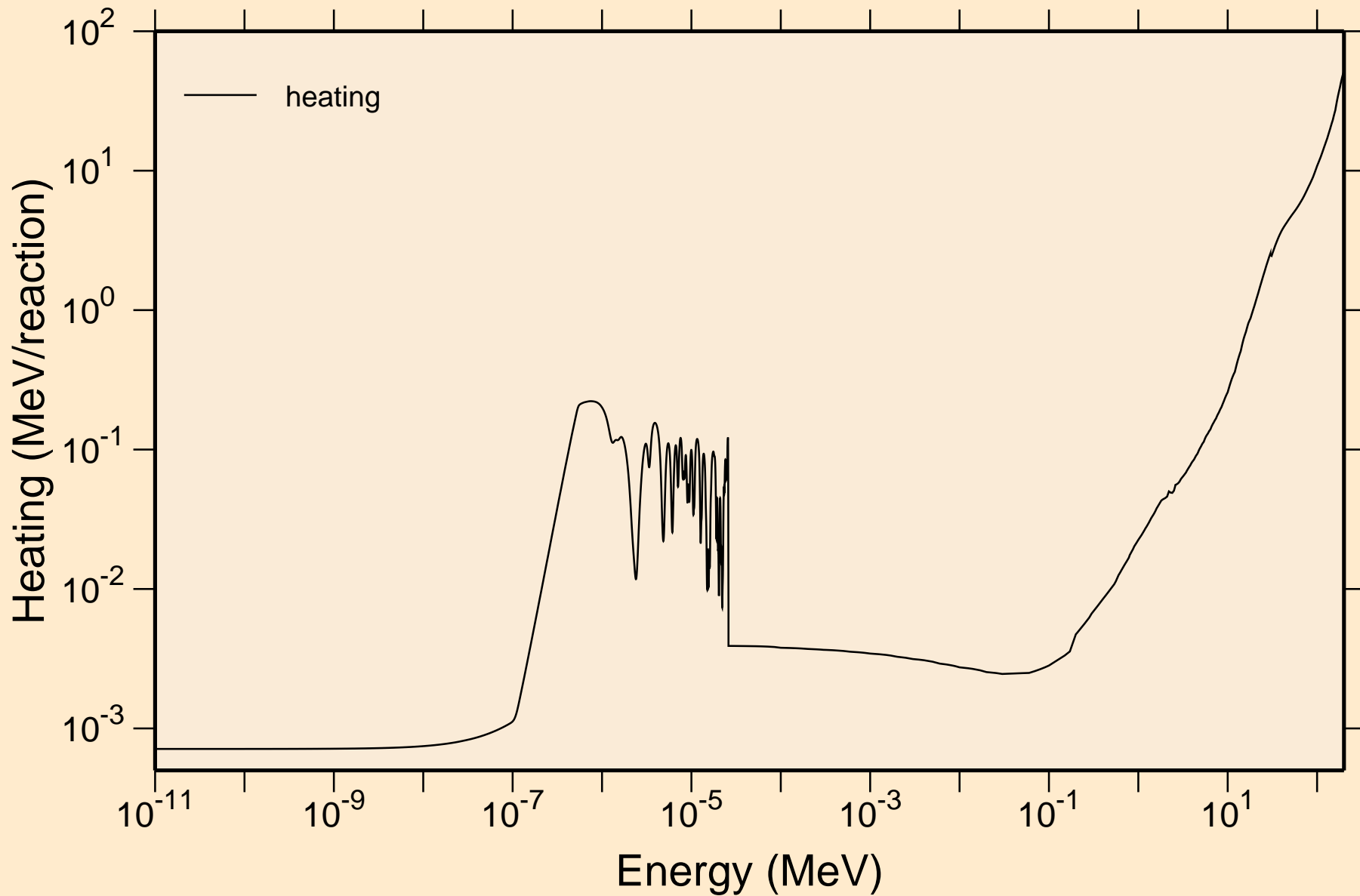

CE133M NEUTRON ACER TENDL-2019 LIBRARY; T=293.16K
Damage

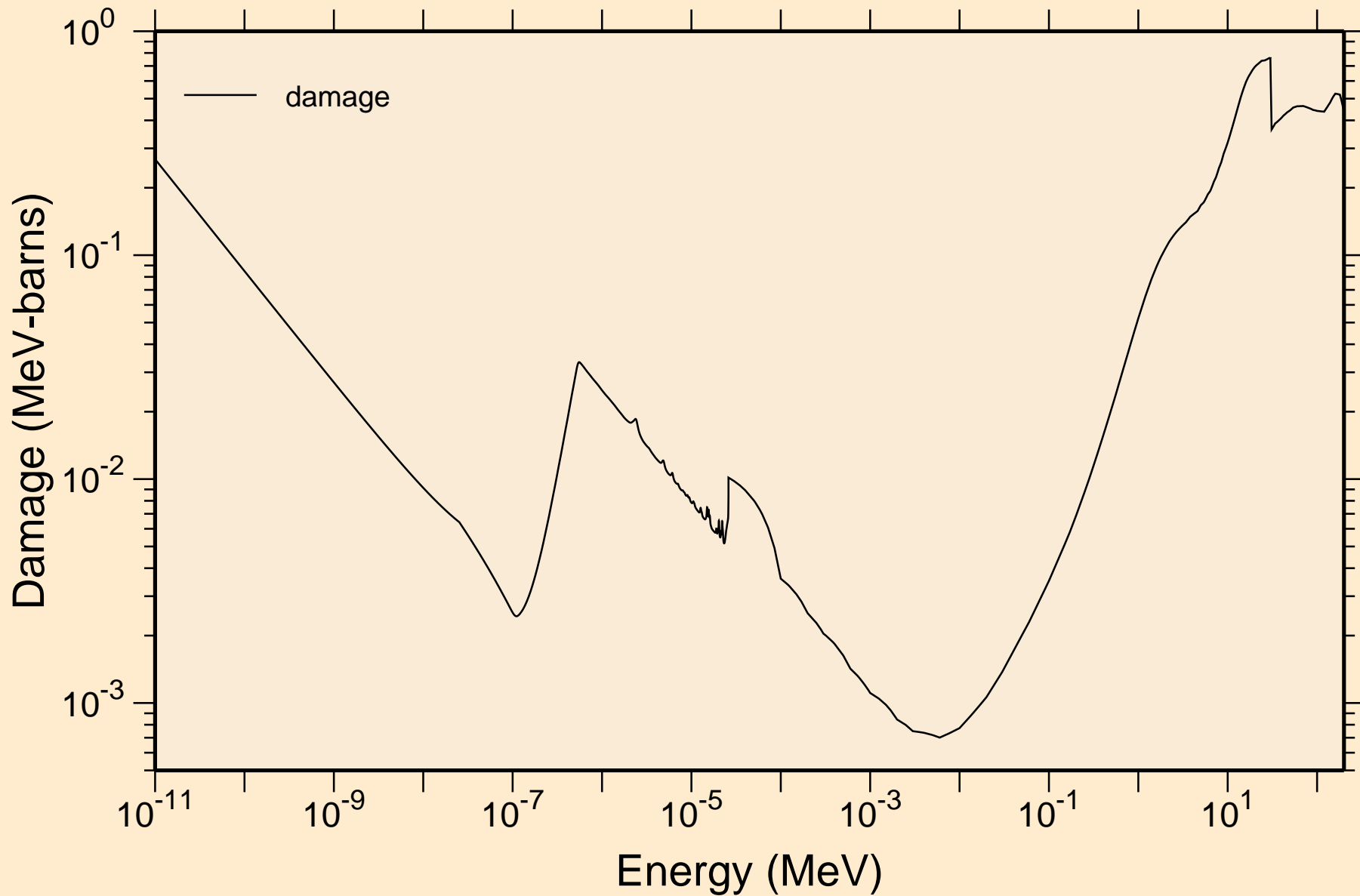

CE133M NEUTRON ACER TENDL-2019 LIBRARY; T=293.16K
Non-threshold reactions

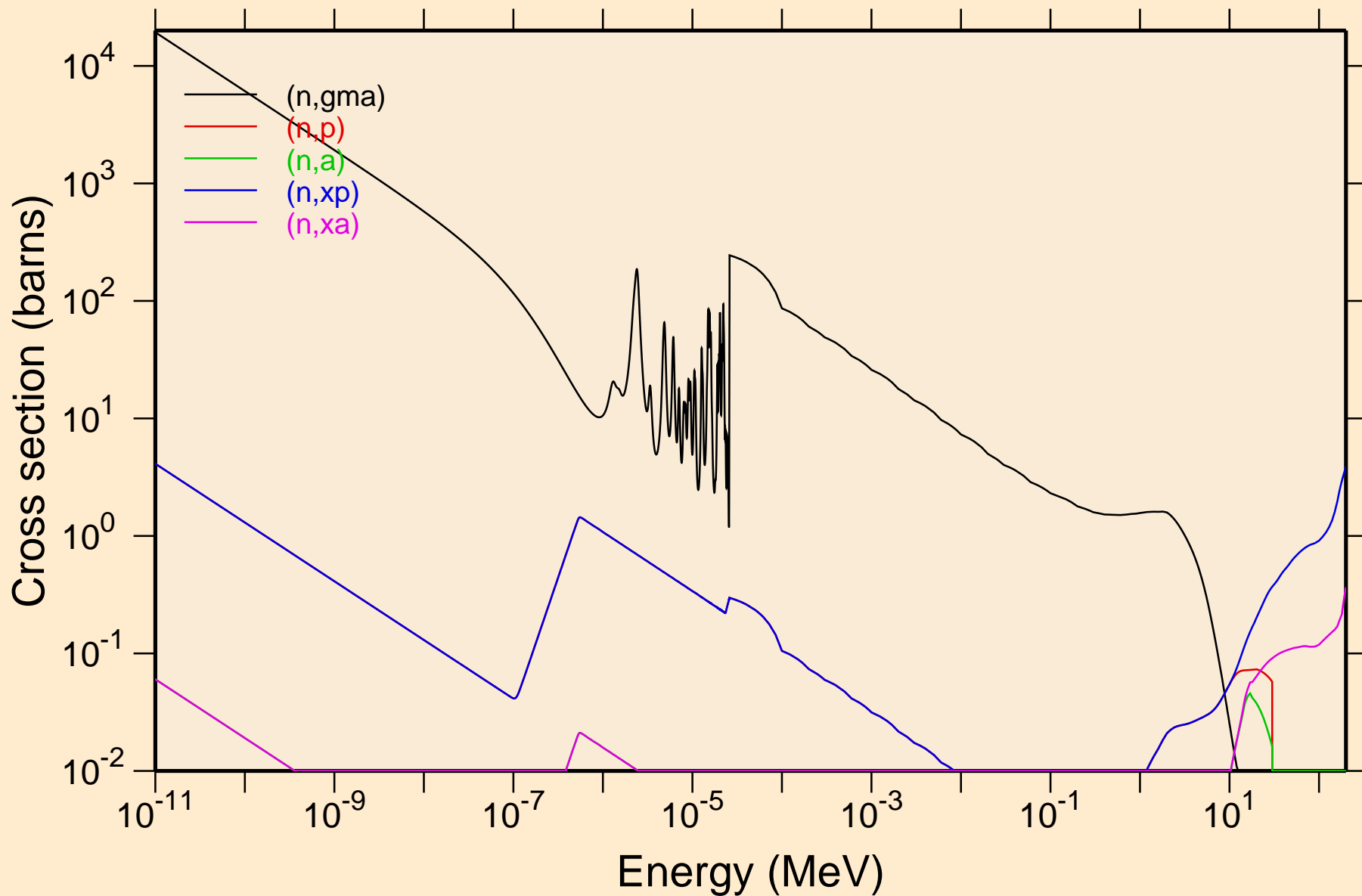

CE133M NEUTRON ACER TENDL-2019 LIBRARY; T=293.16K
Principal cross sections

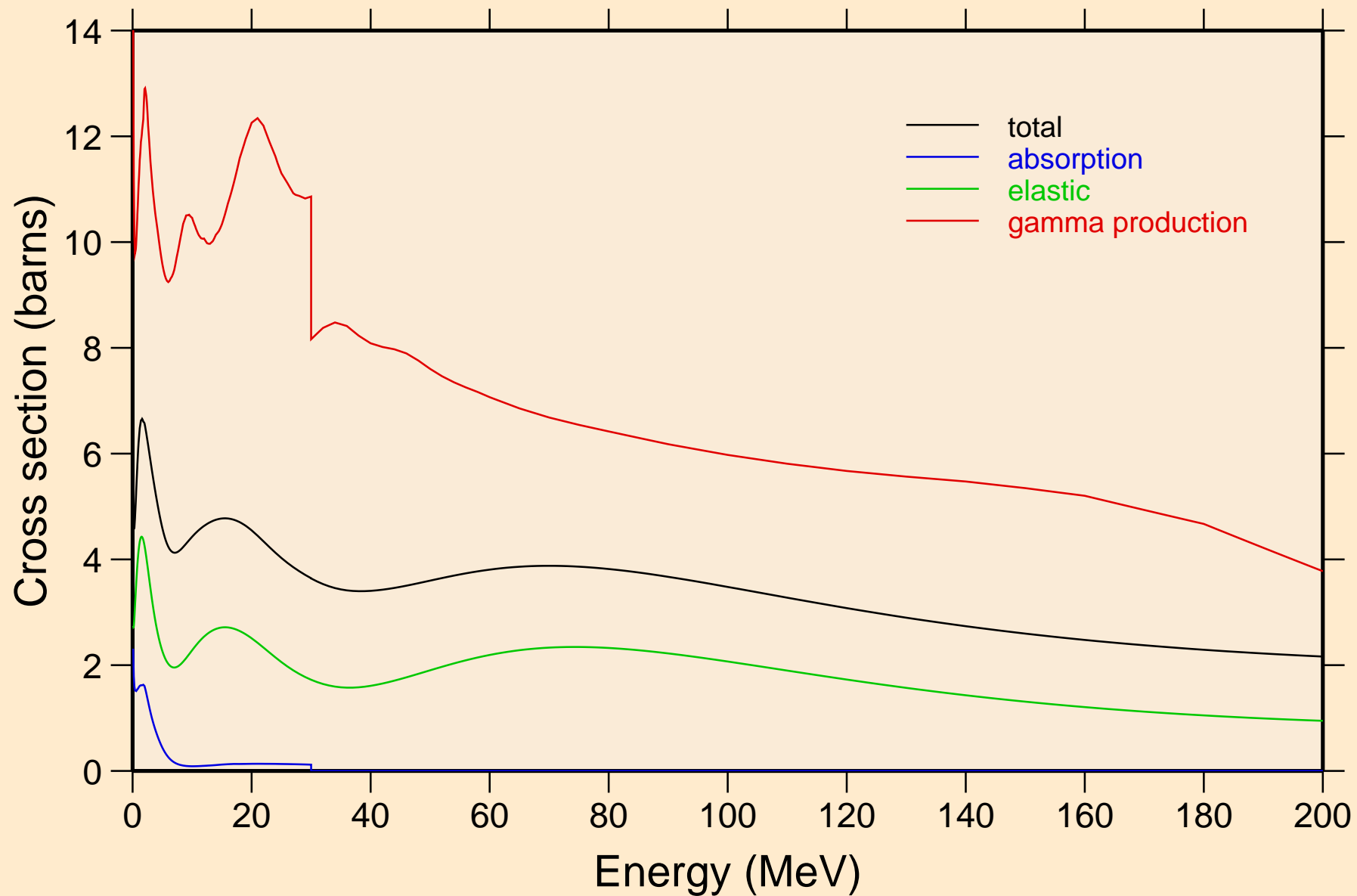

CE133M NEUTRON ACER TENDL-2019 LIBRARY; T=293.16K
Heating

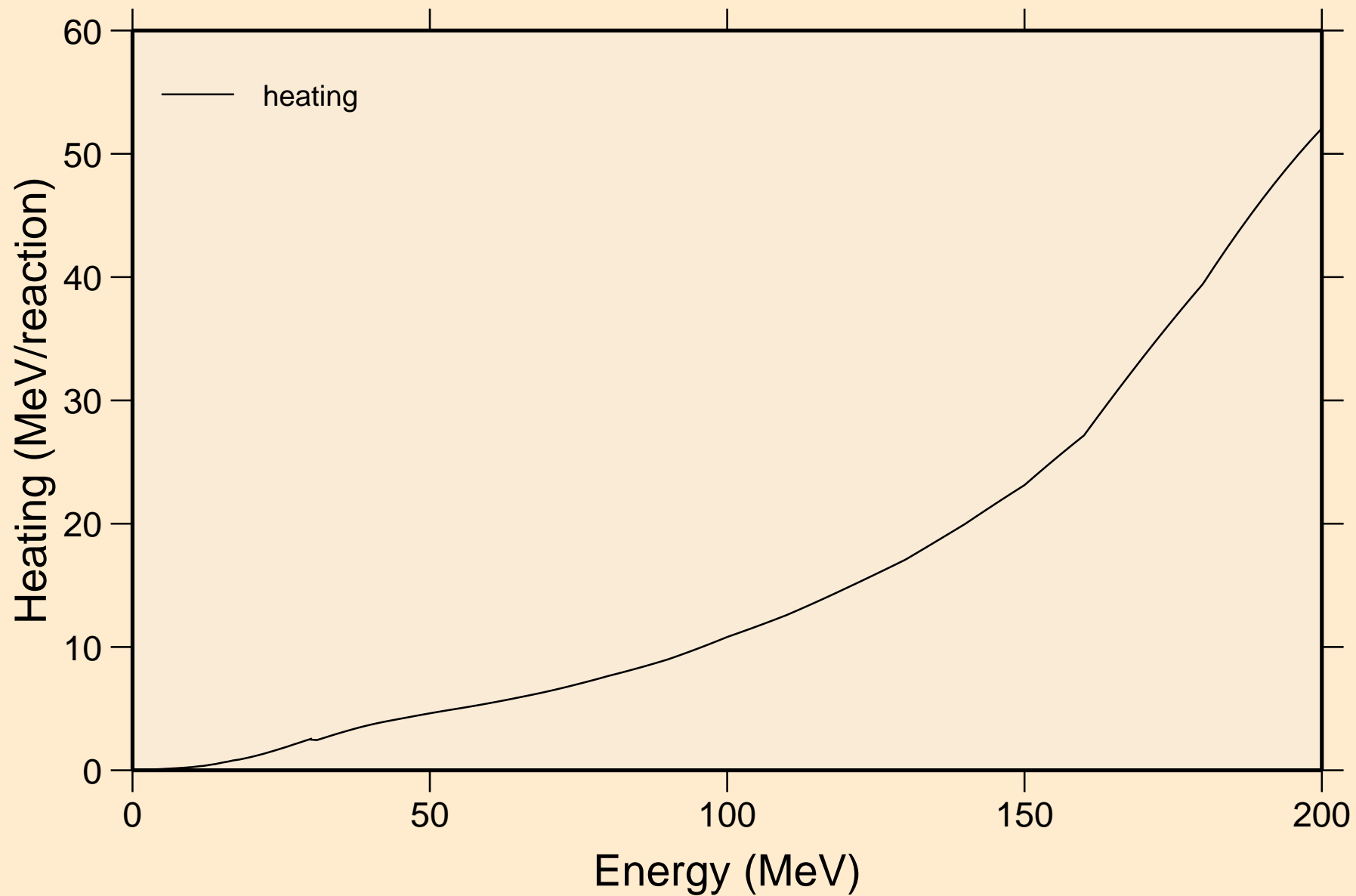

CE133M NEUTRON ACER TENDL-2019 LIBRARY; T=293.16K
Damage

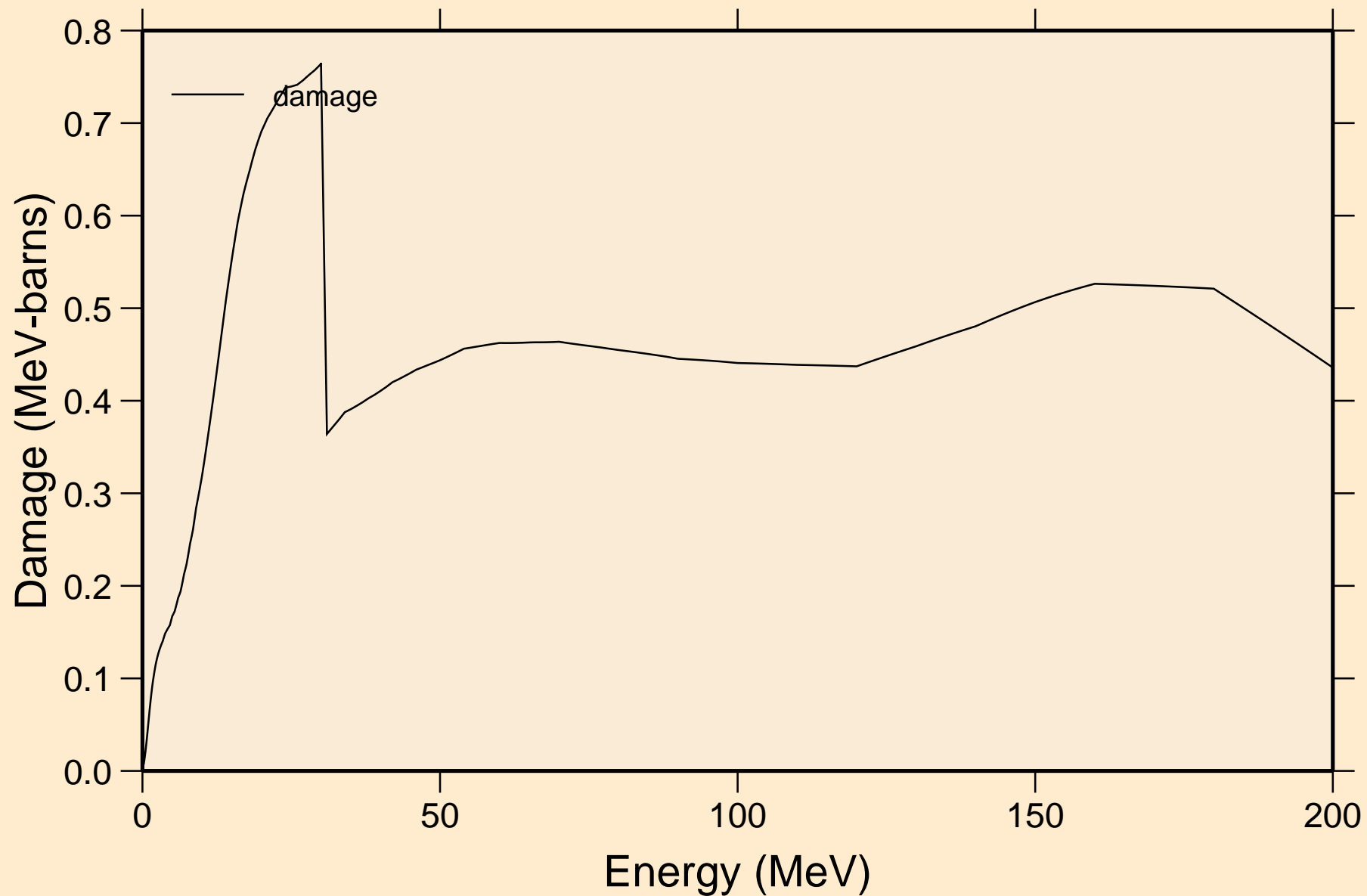

CE133M NEUTRON ACER TENDL-2019 LIBRARY; T=293.16K
Non-threshold reactions

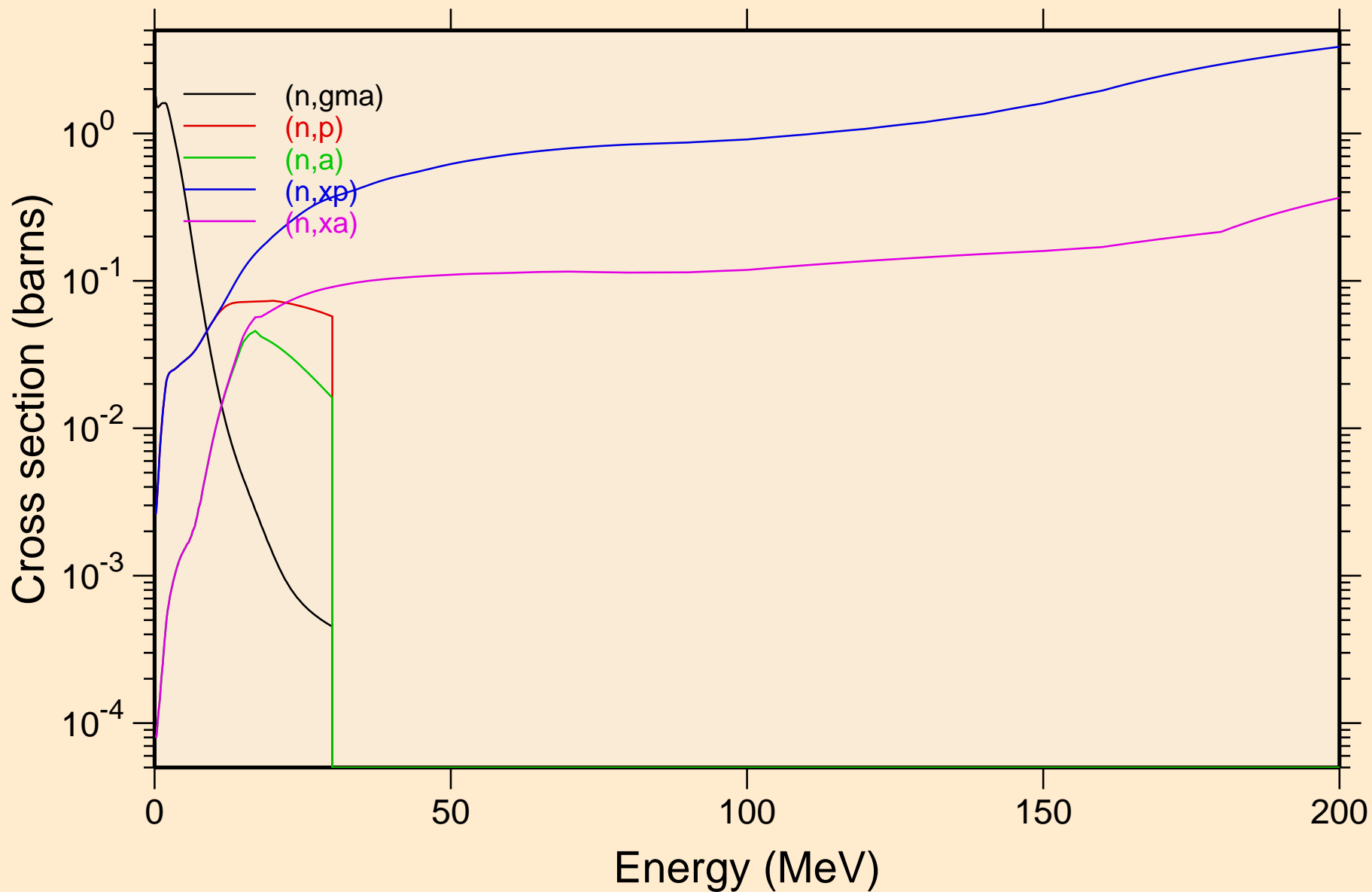

CE133M NEUTRON ACER TENDL-2019 LIBRARY; T=293.16K
Inelastic levels

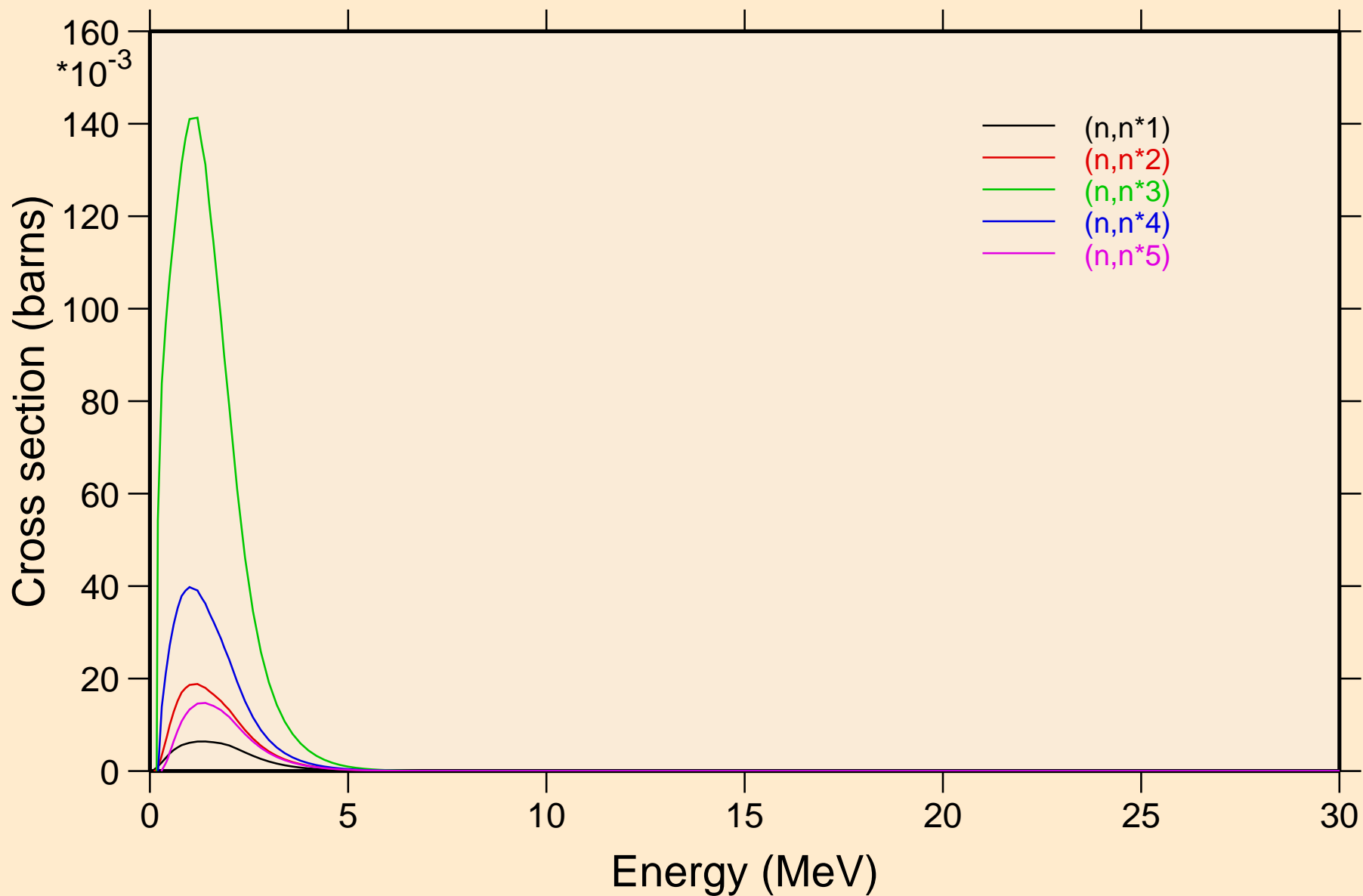

CE133M NEUTRON ACER TENDL-2019 LIBRARY; T=293.16K
Inelastic levels

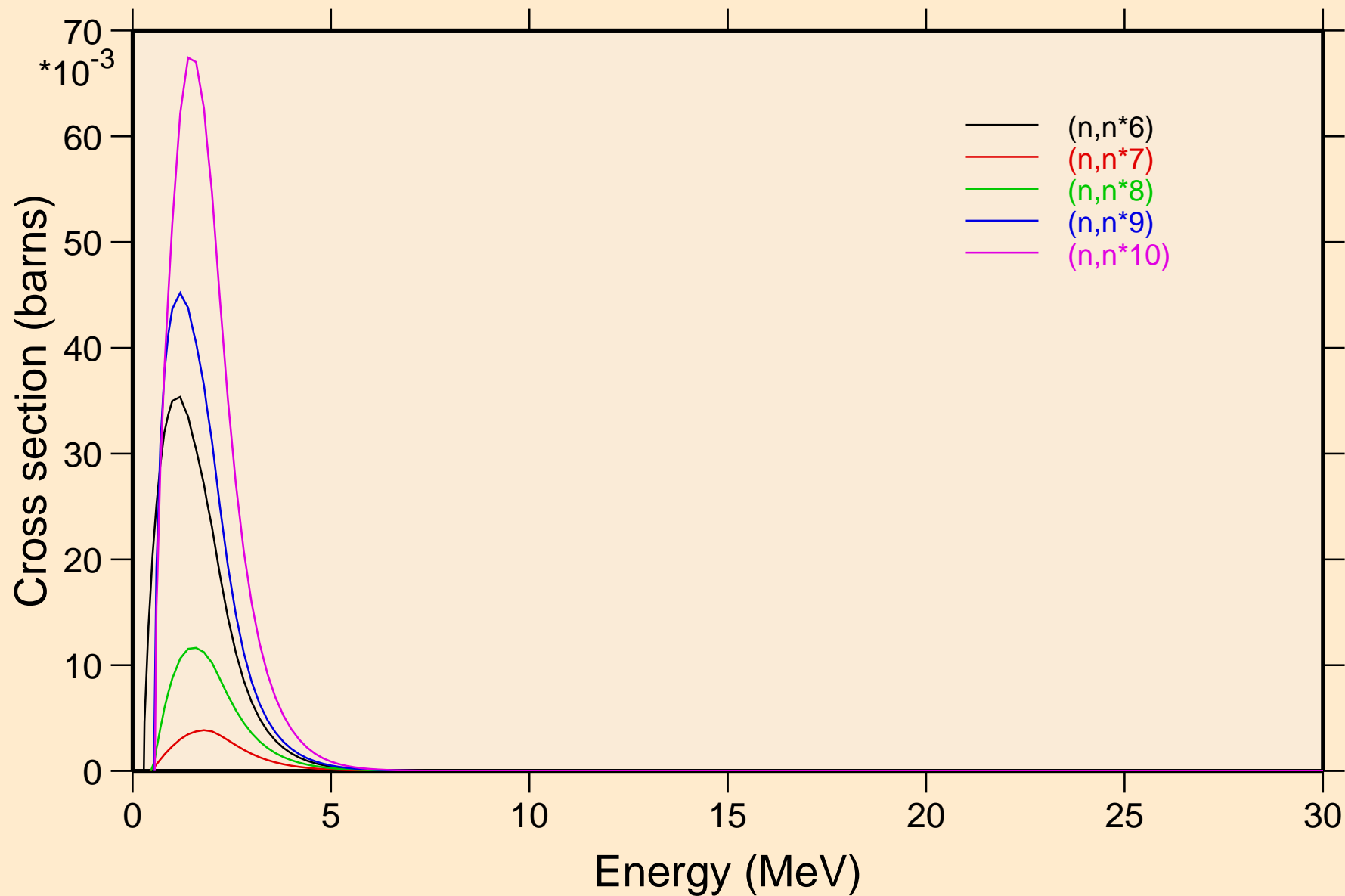

CE133M NEUTRON ACER TENDL-2019 LIBRARY; T=293.16K
Inelastic levels

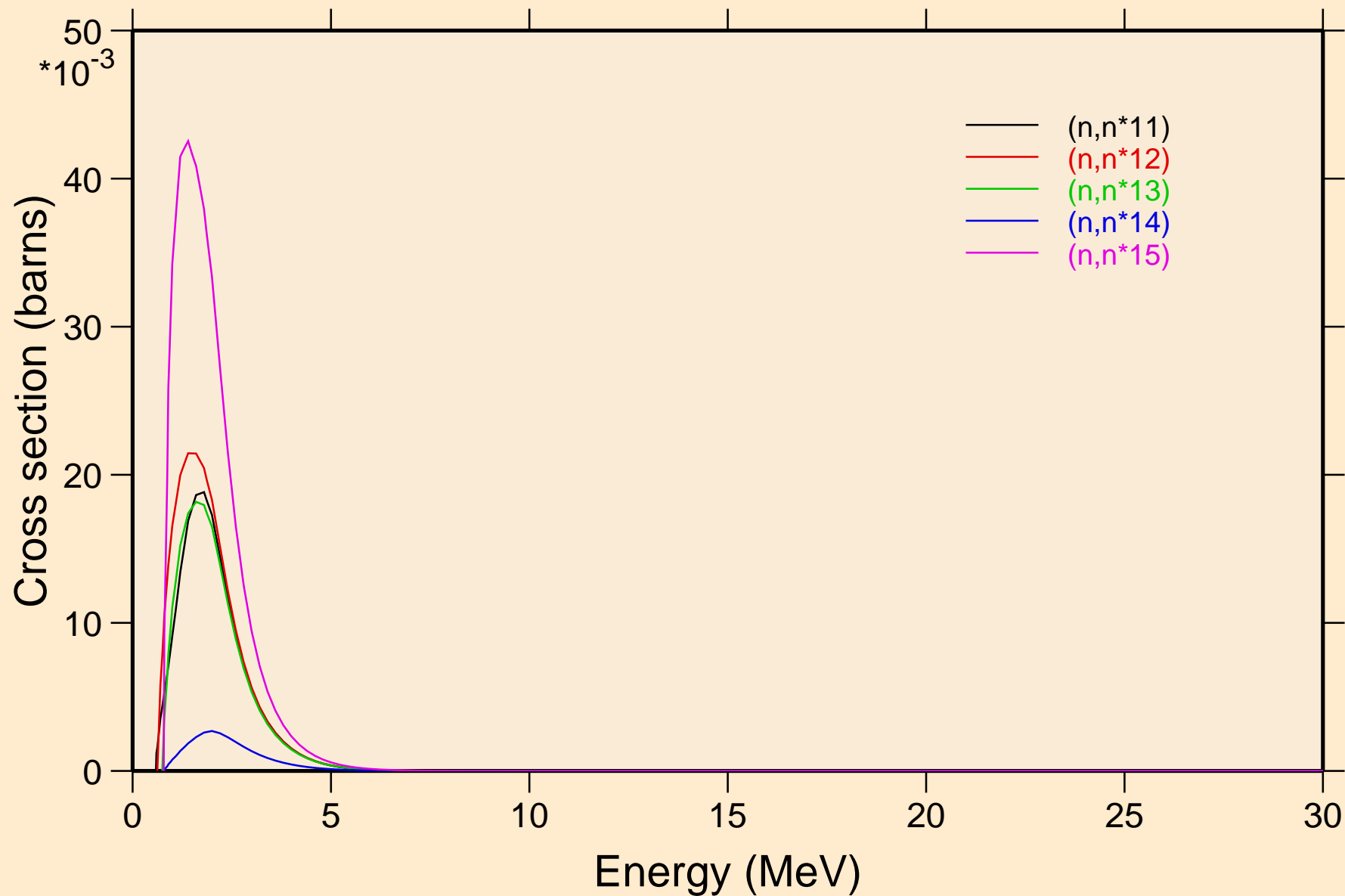

CE133M NEUTRON ACER TENDL-2019 LIBRARY; T=293.16K
Inelastic levels

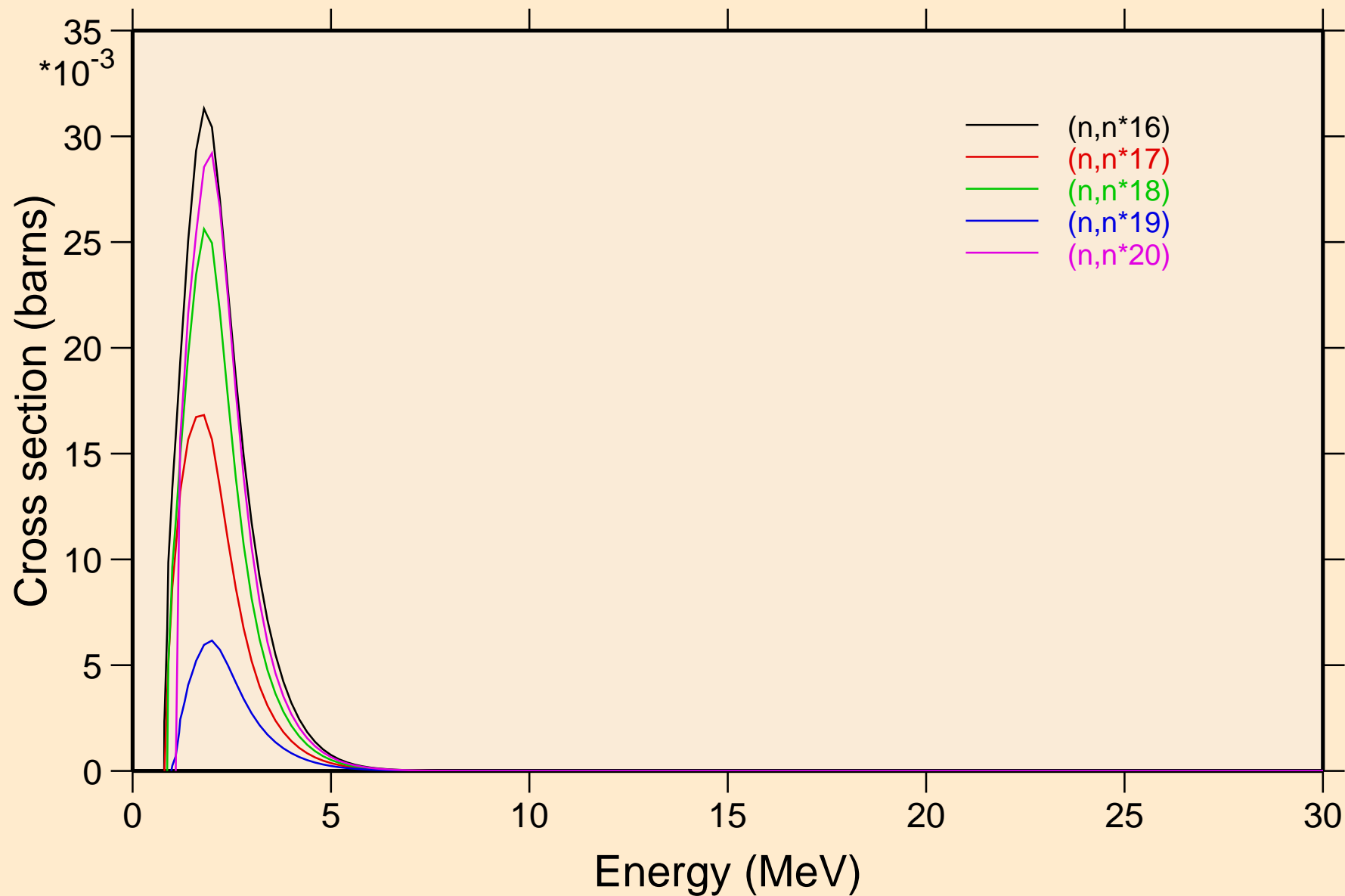

CE133M NEUTRON ACER TENDL-2019 LIBRARY; T=293.16K
Inelastic levels

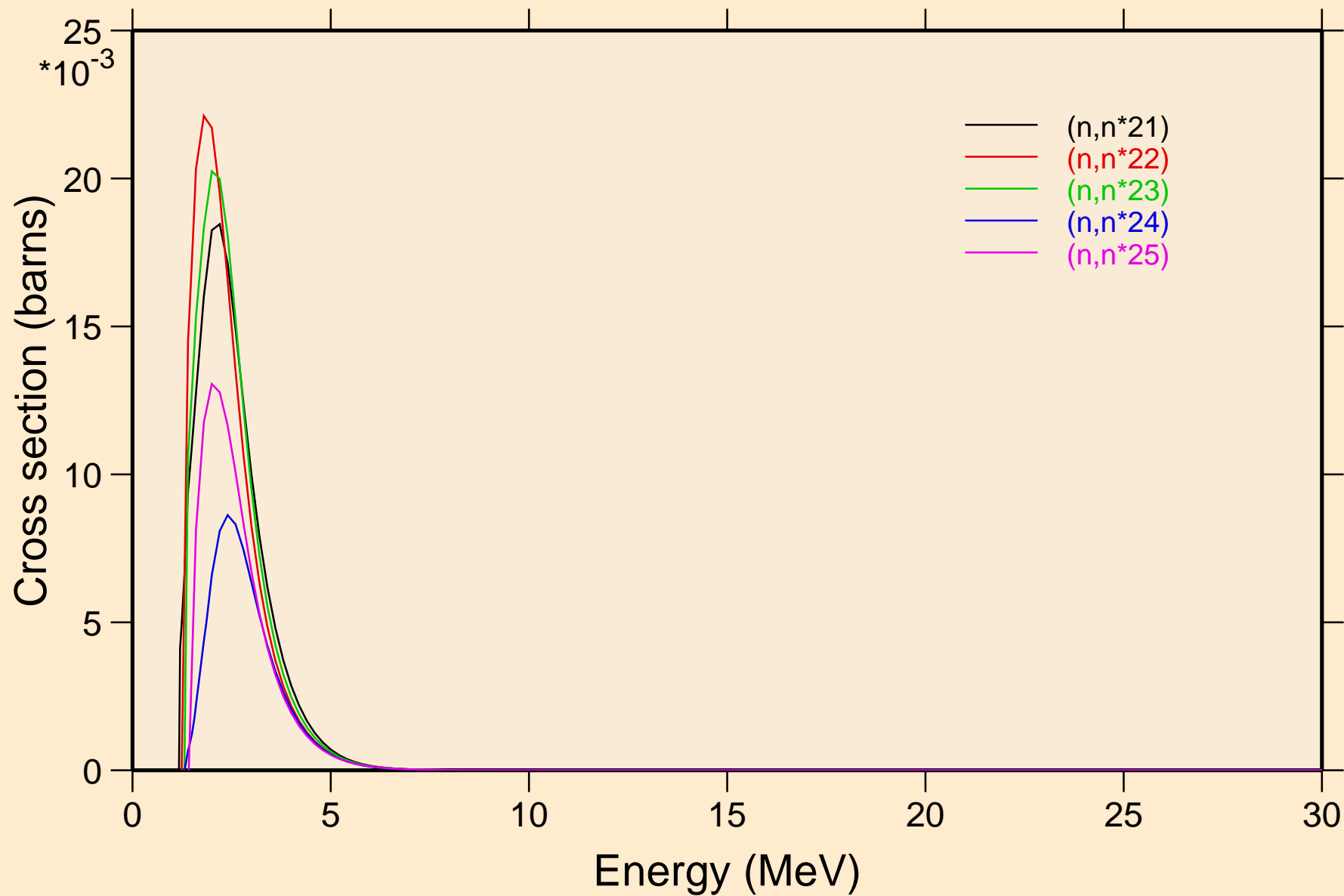

CE133M NEUTRON ACER TENDL-2019 LIBRARY; T=293.16K
Inelastic levels

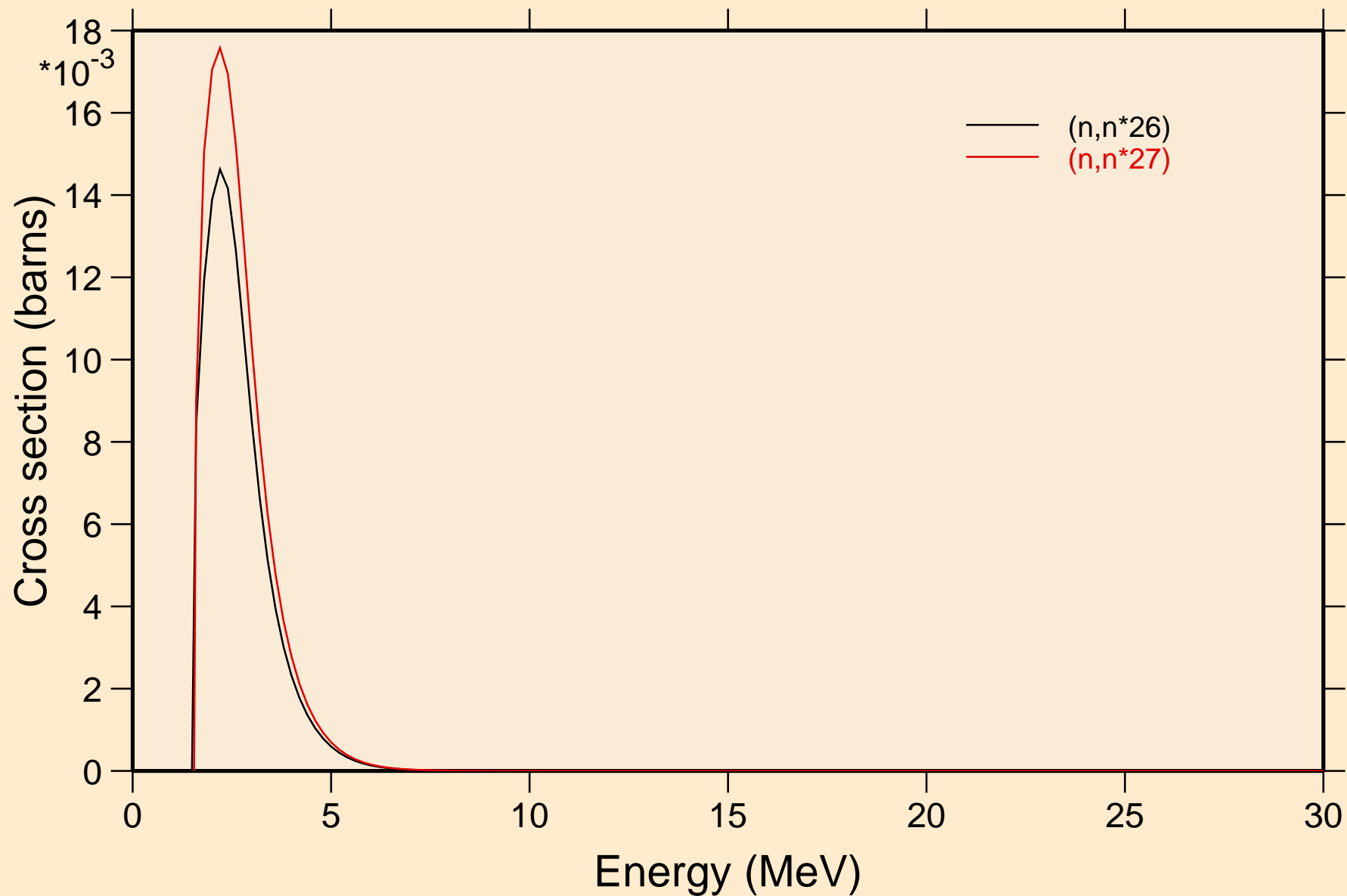

CE133M NEUTRON ACER TENDL-2019 LIBRARY; T=293.16K
Threshold reactions

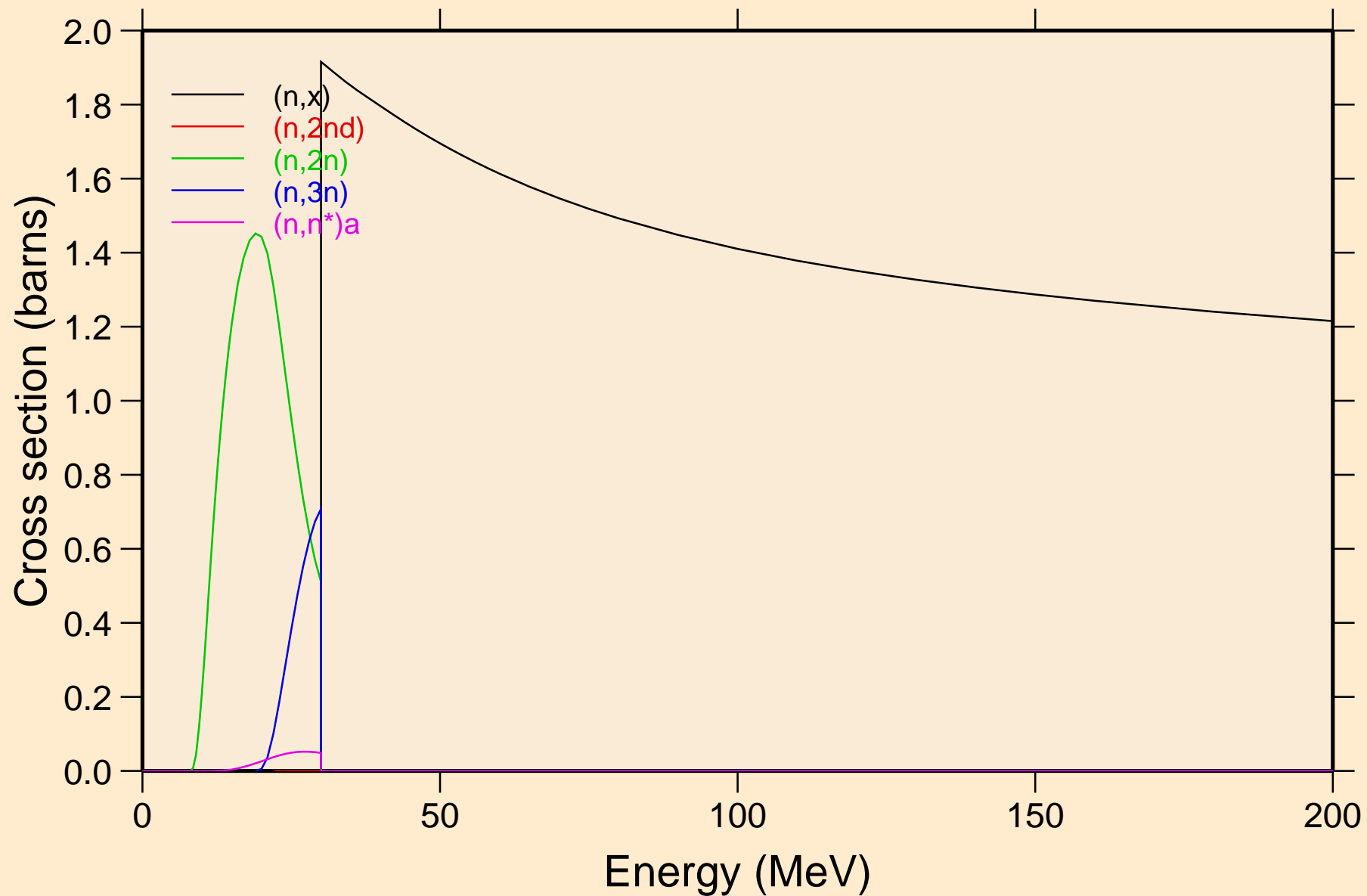

CE133M NEUTRON ACER TENDL-2019 LIBRARY; T=293.16K
Threshold reactions

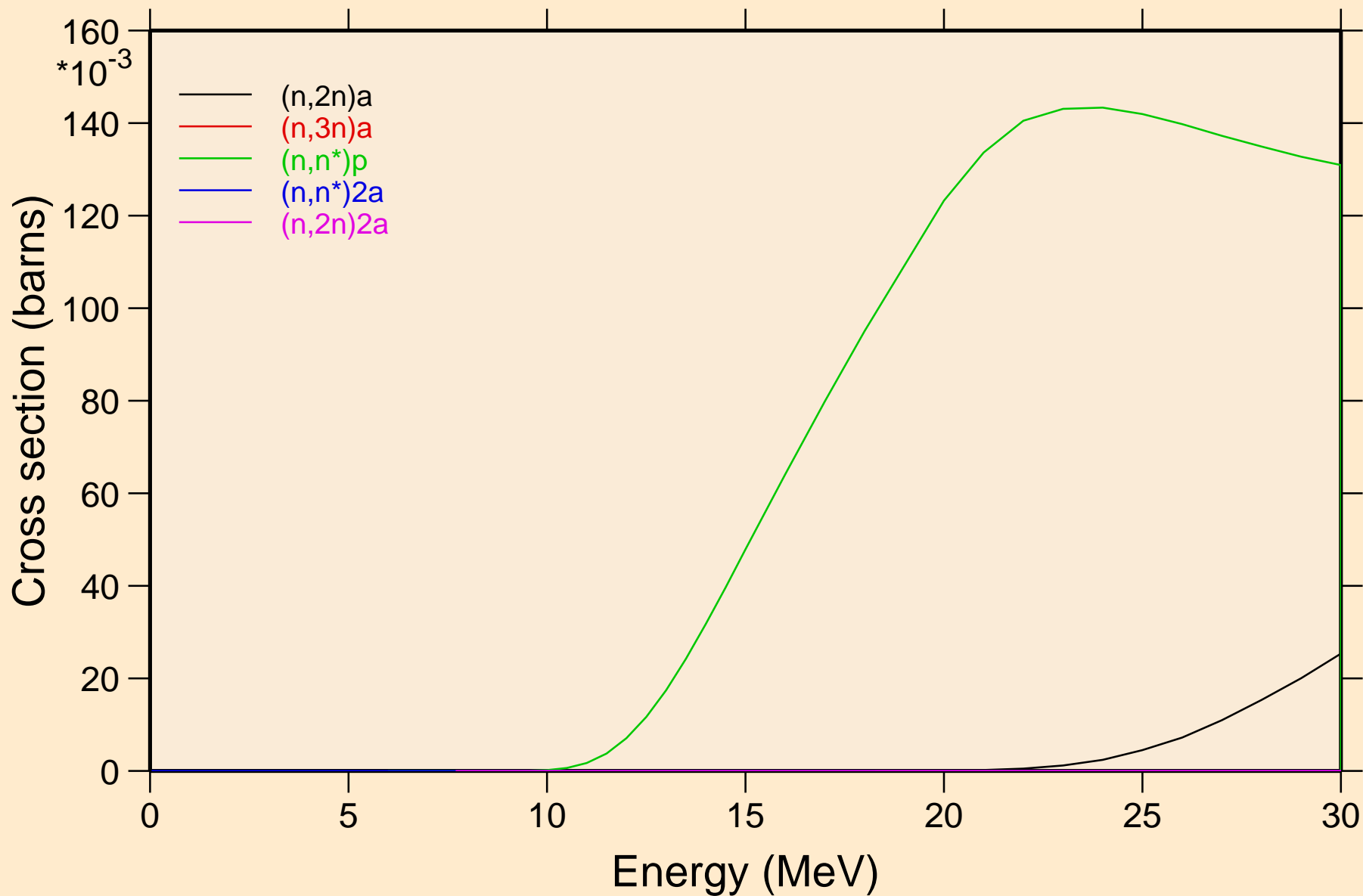

CE133M NEUTRON ACER TENDL-2019 LIBRARY; T=293.16K
Threshold reactions

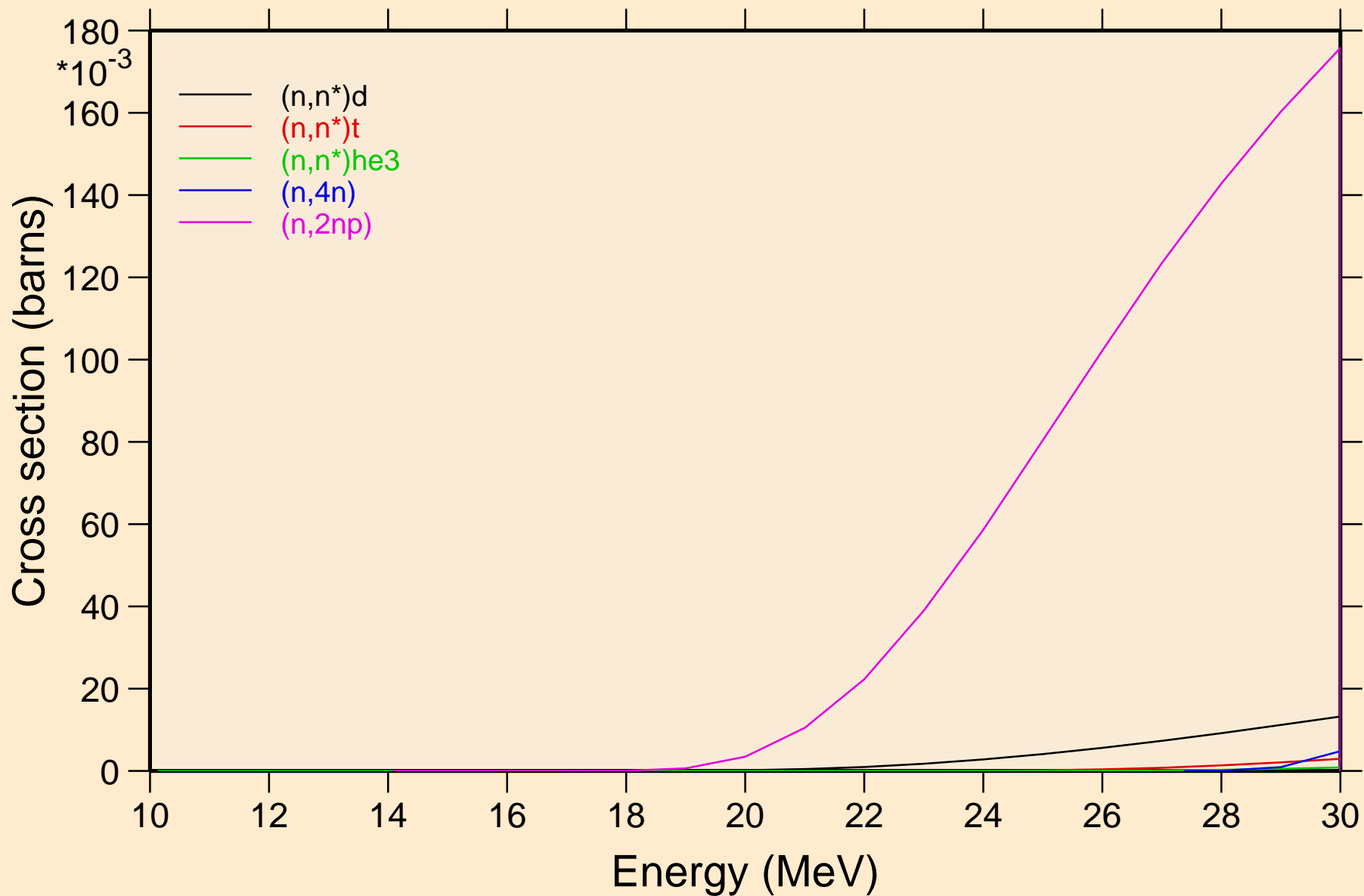

CE133M NEUTRON ACER TENDL-2019 LIBRARY; T=293.16K
Threshold reactions

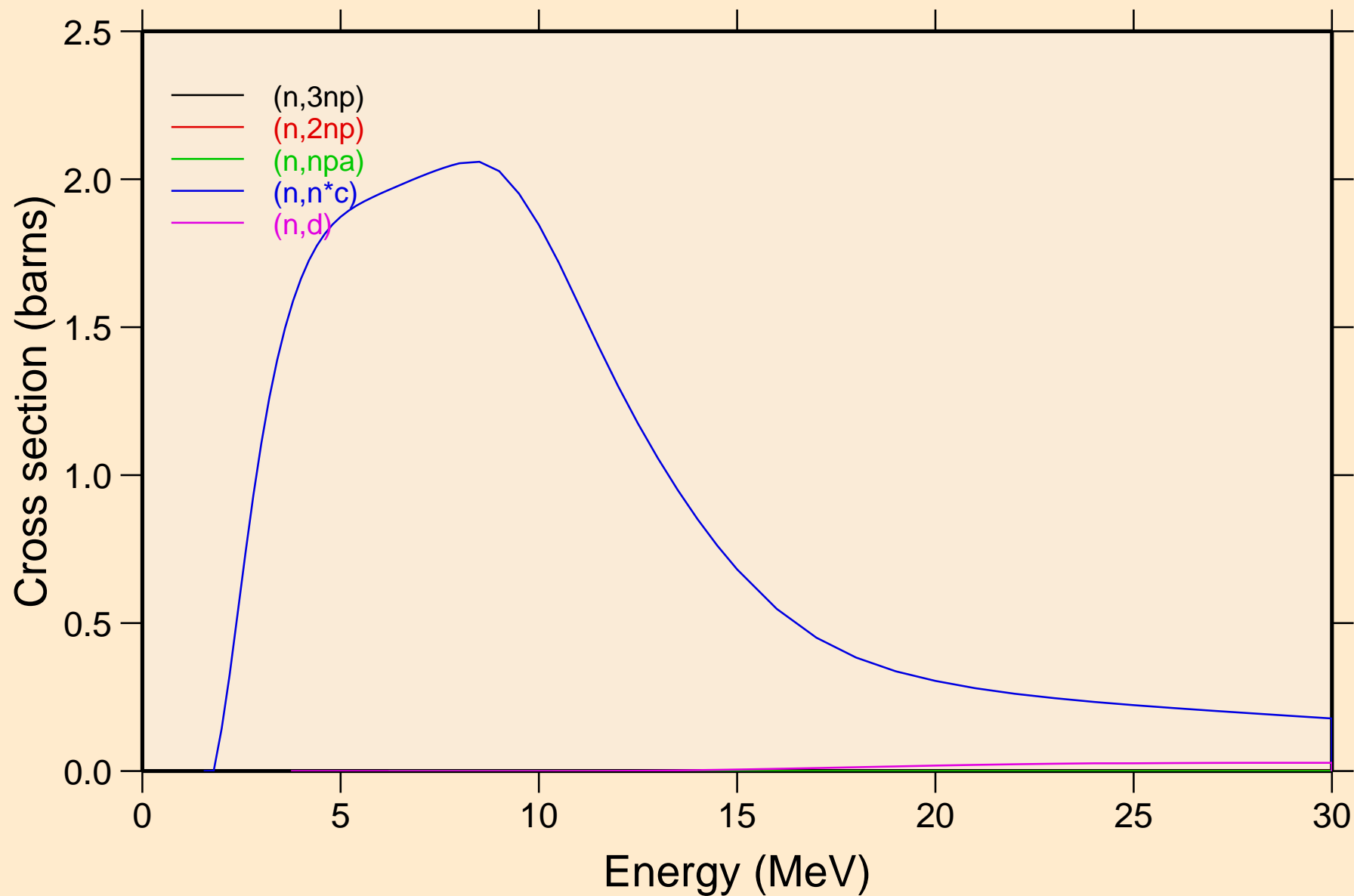

CE133M NEUTRON ACER TENDL-2019 LIBRARY; T=293.16K
Threshold reactions

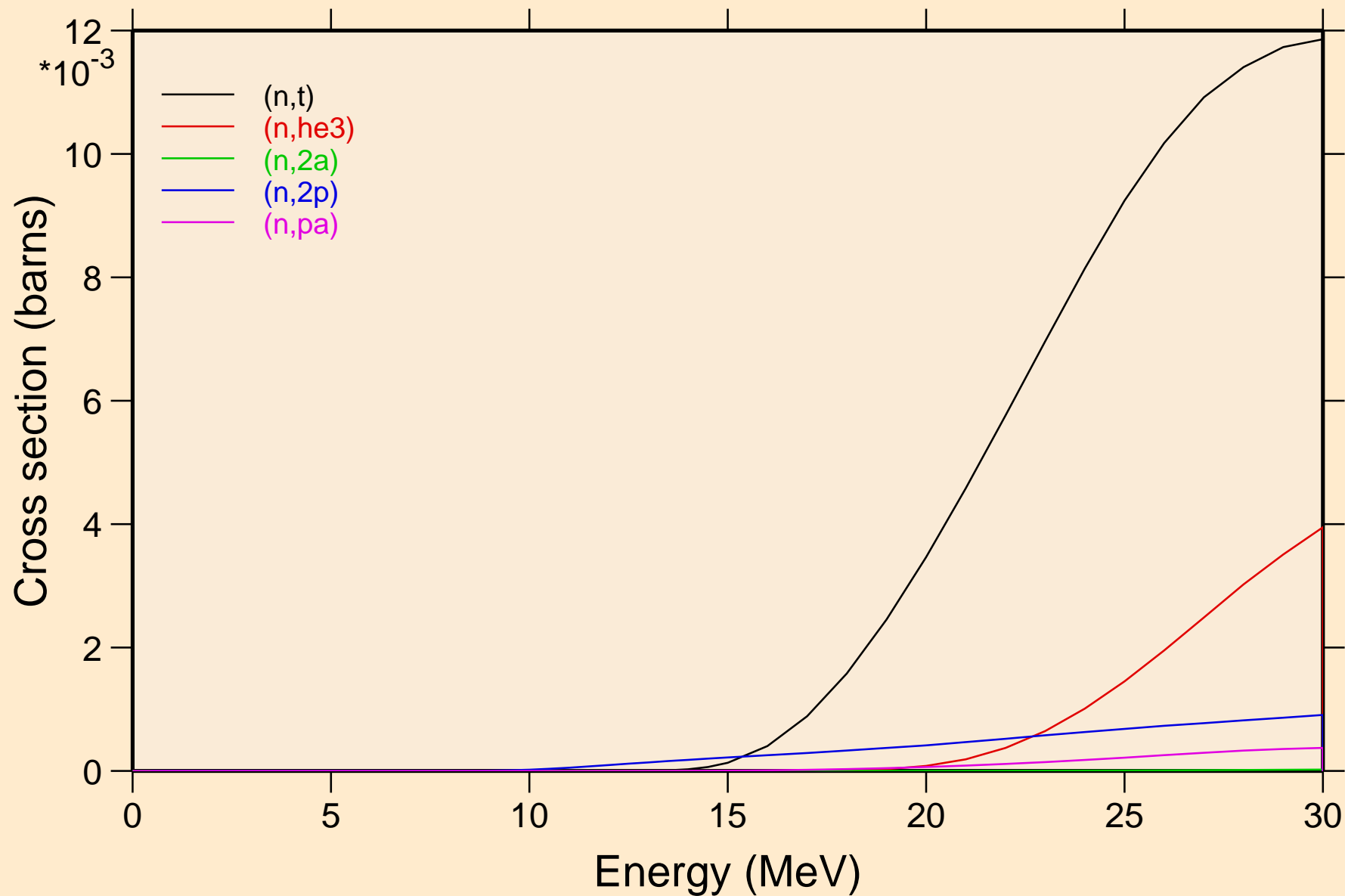

CE133M NEUTRON ACER TENDL-2019 LIBRARY; T=293.16K
Threshold reactions

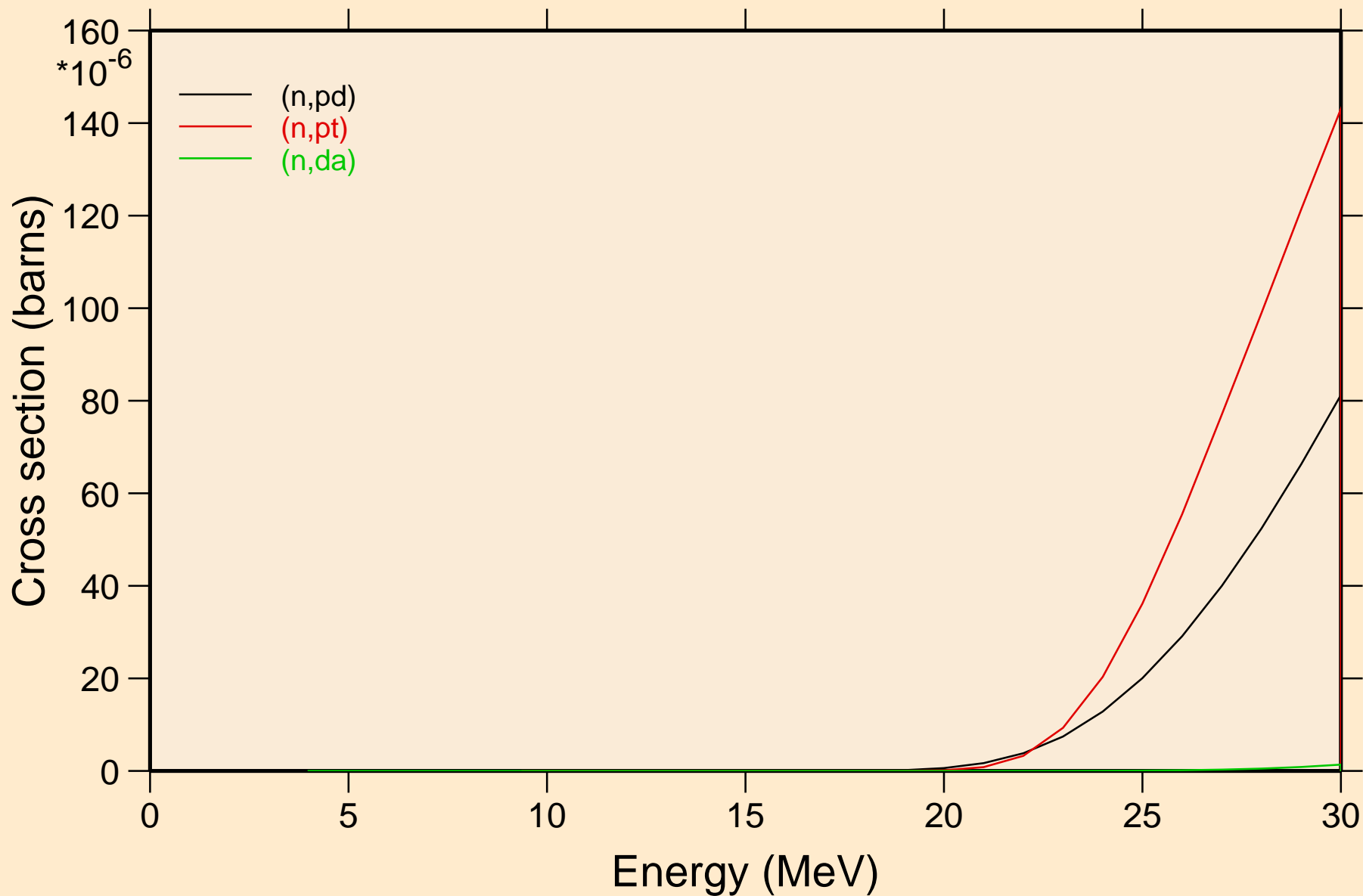

CE133M NEUTRON ACER TENDL-2019 LIBRARY; T=293.16K
Threshold reactions

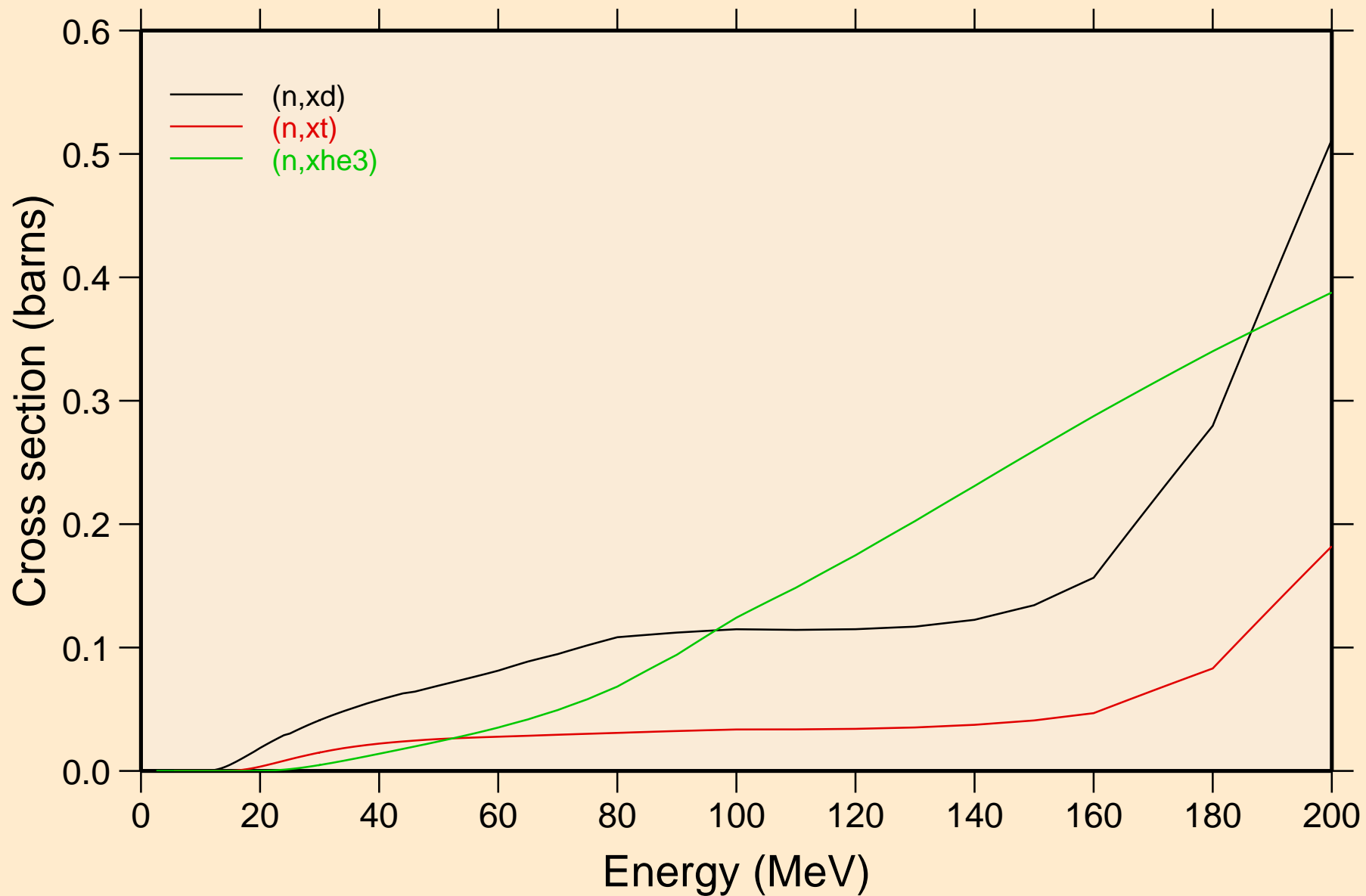

CE133M NEUTRON ACER TENDL-2019 LIBRARY; T=293.16K
angular distribution for elastic

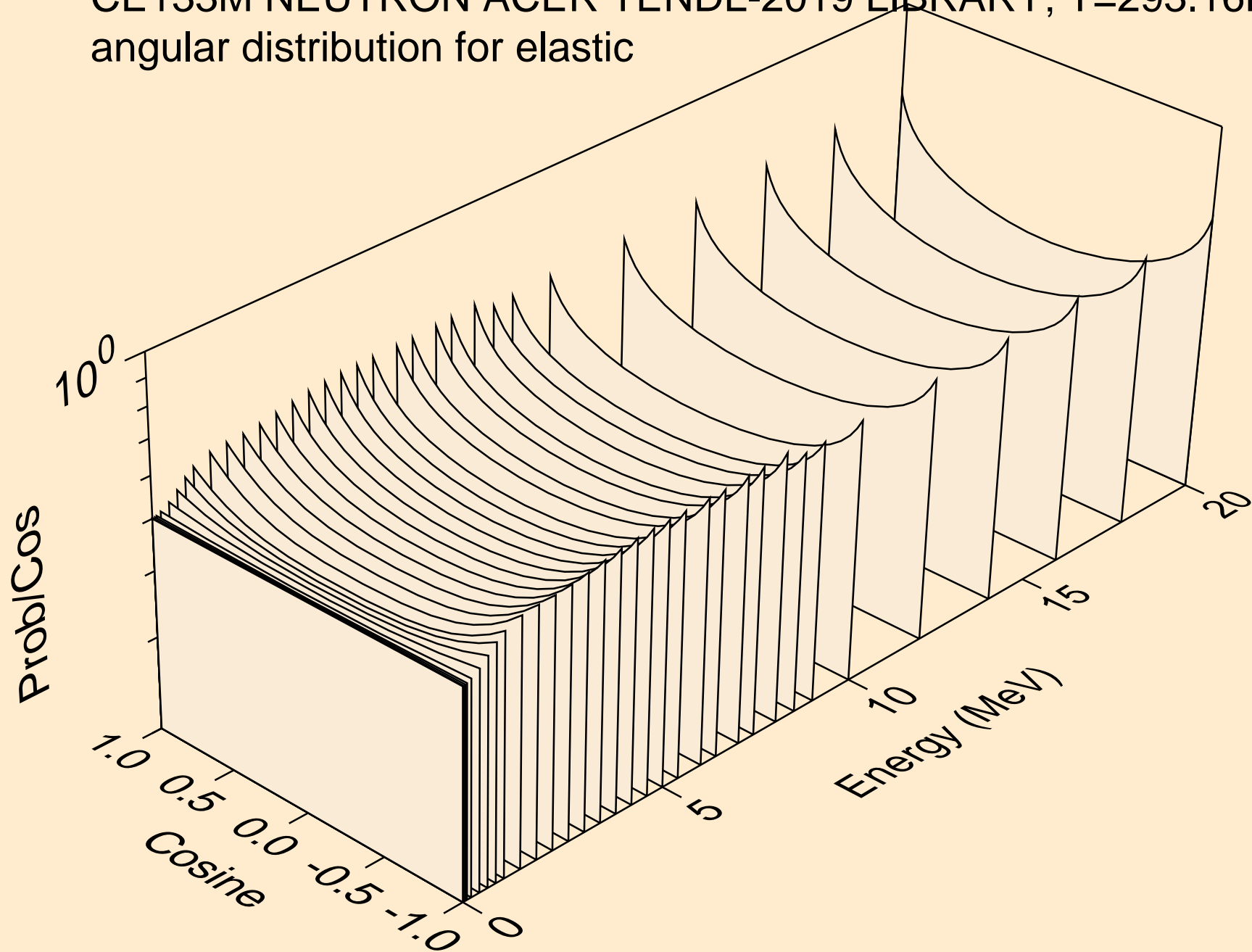

CE133M NEUTRON ACER TENDL-2019 LIBRARY; T=293.16K
angular distribution for elastic

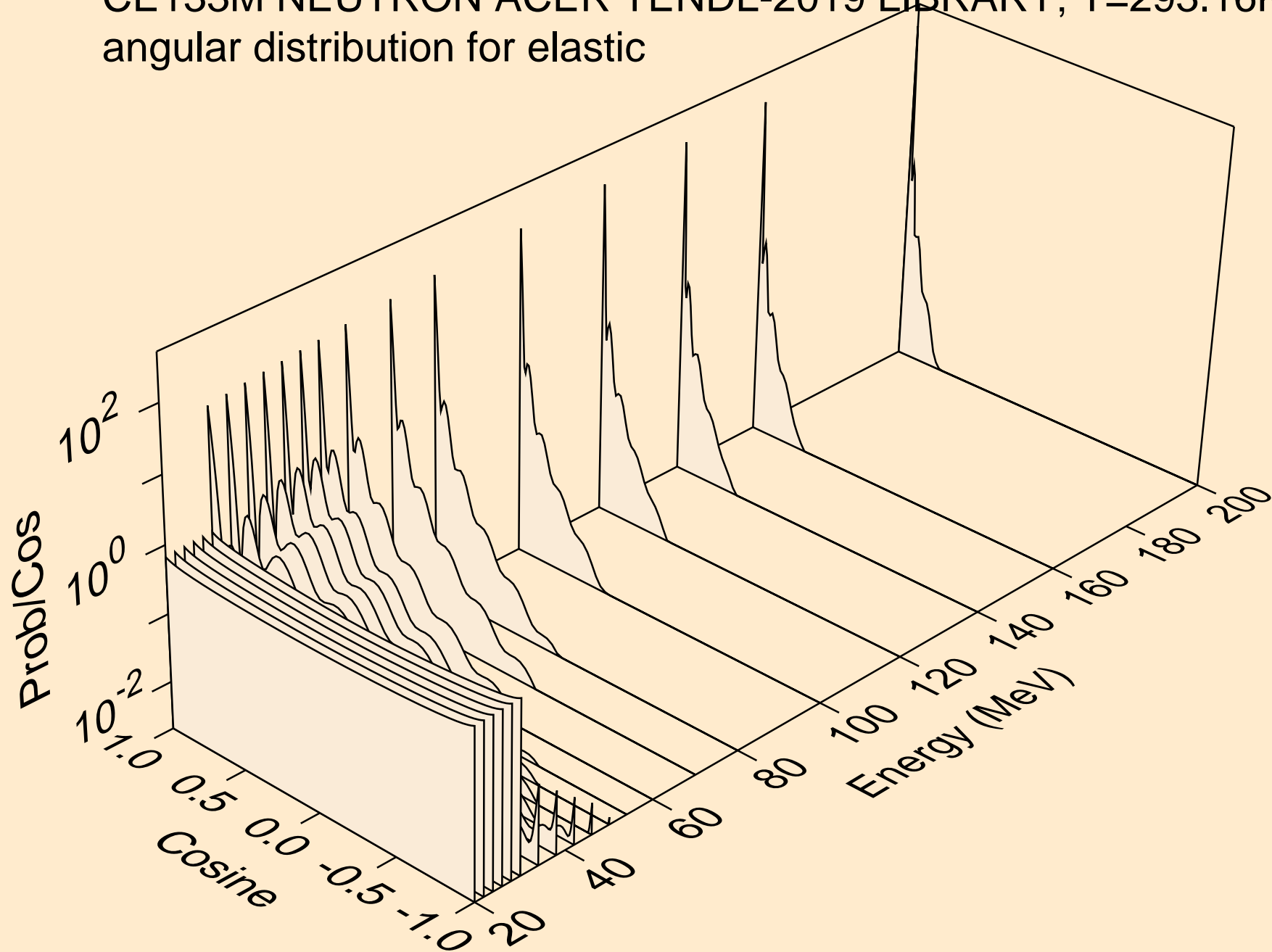

CE133M NEUTRON ACER TENDL-2019 LIBRARY; T=293.16K
angular distribution for (n,n*1)

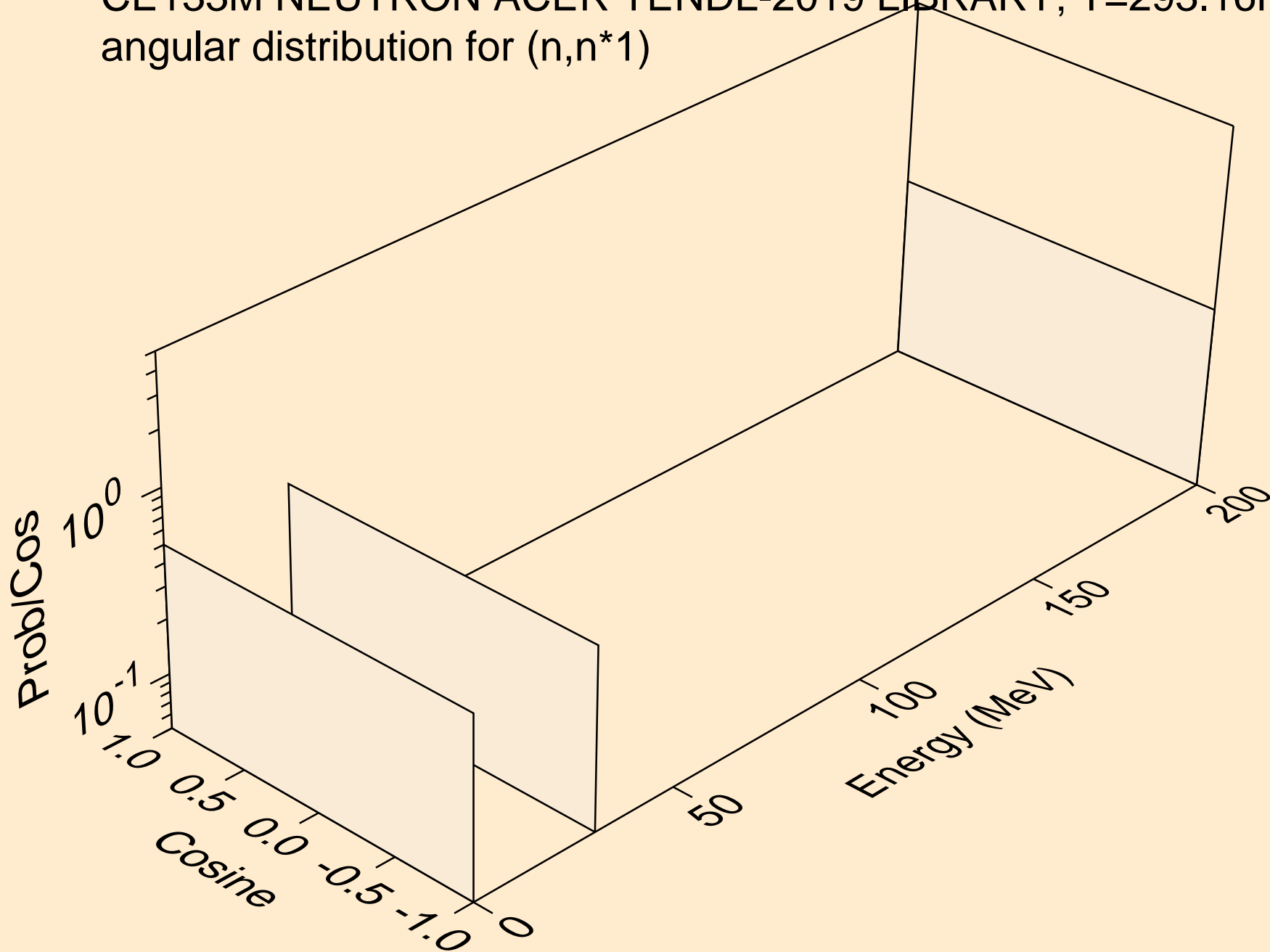

CE133M NEUTRON ACER TENDL-2019 LIBRARY; T=293.16K
angular distribution for (n,n*2)

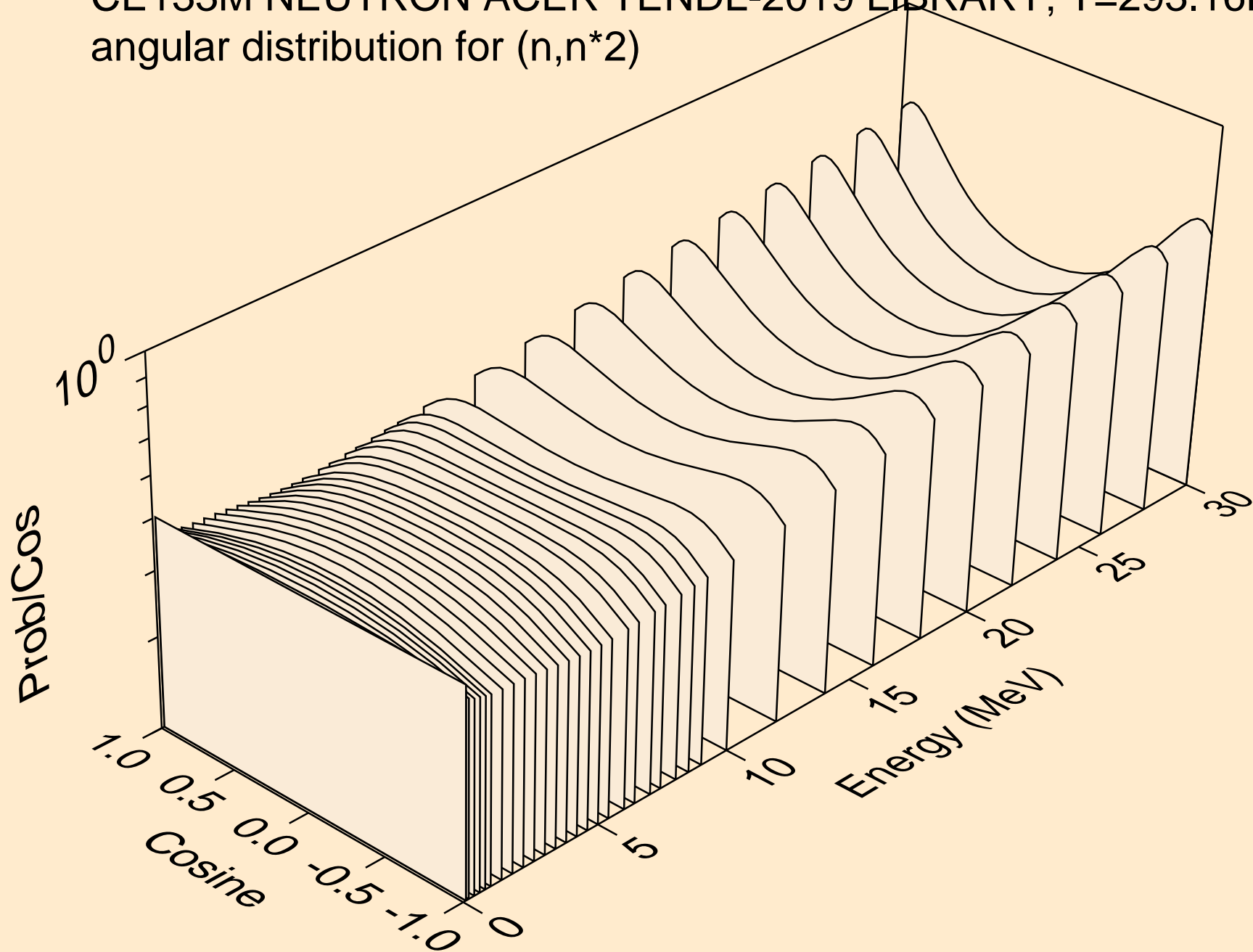

CE133M NEUTRON ACER TENDL-2019 LIBRARY; T=293.16K
angular distribution for (n,n*3)

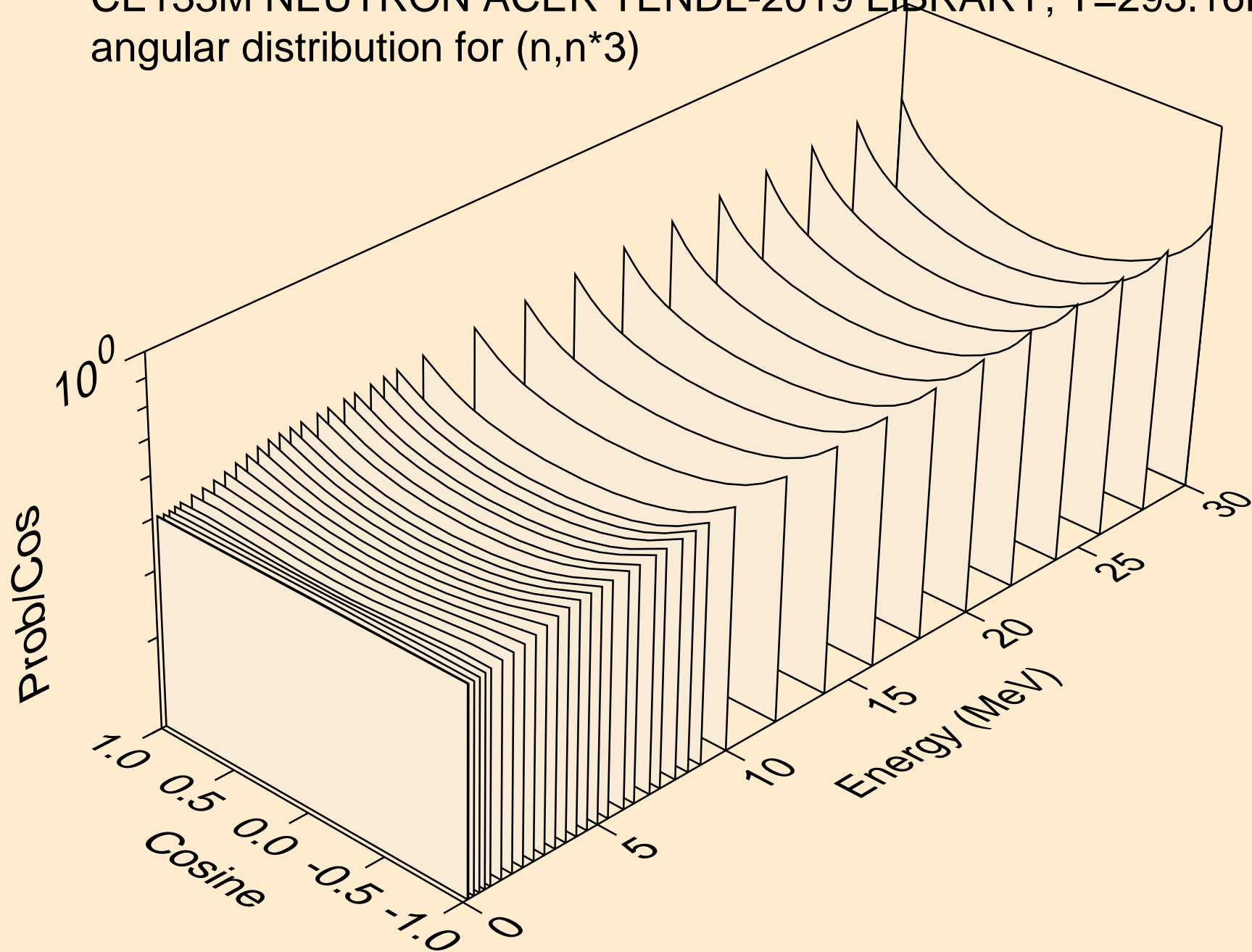

CE133M NEUTRON ACER TENDL-2019 LIBRARY; T=293.16K
angular distribution for (n,n*4)

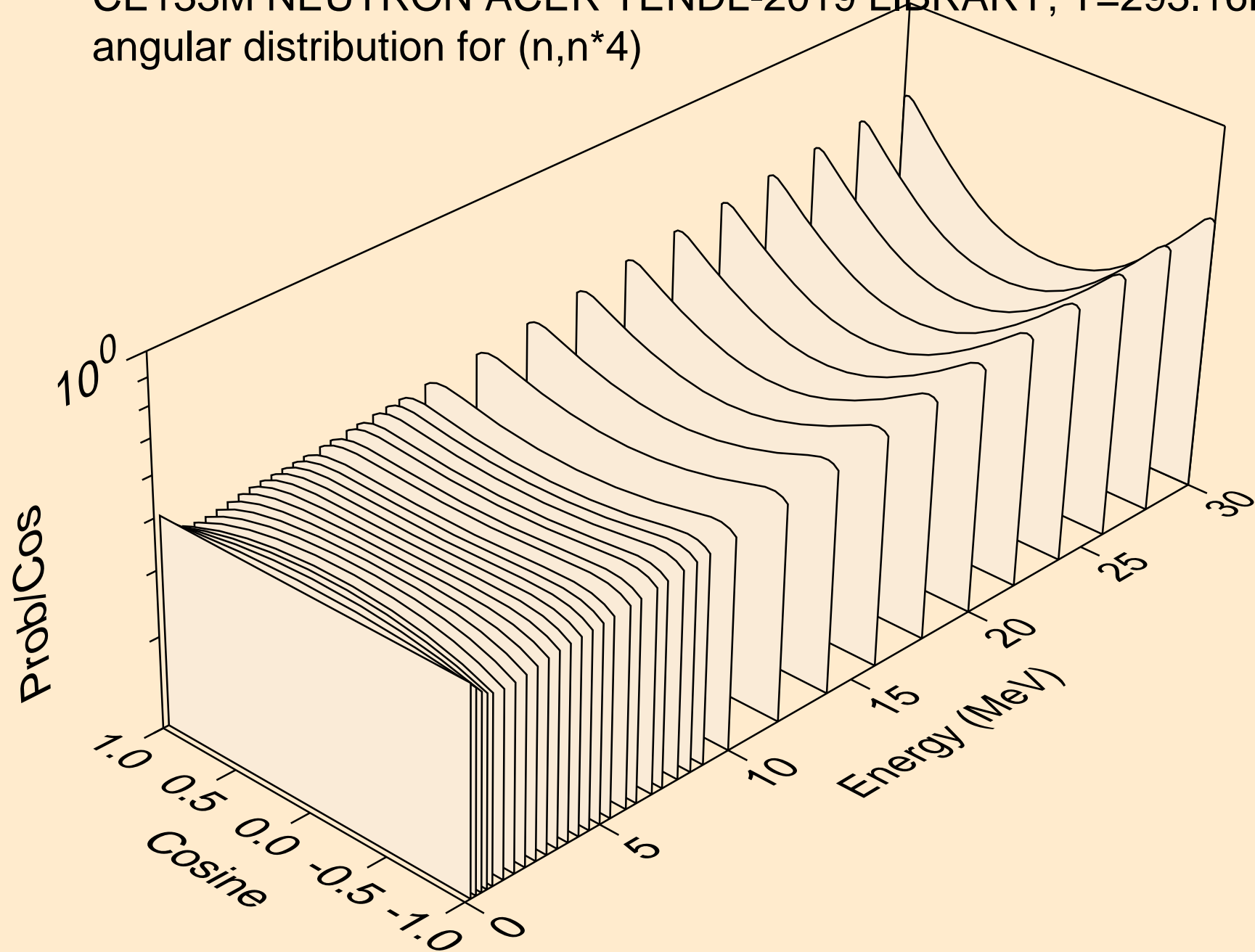

CE133M NEUTRON ACER TENDL-2019 LIBRARY; T=293.16K
angular distribution for (n,n*5)

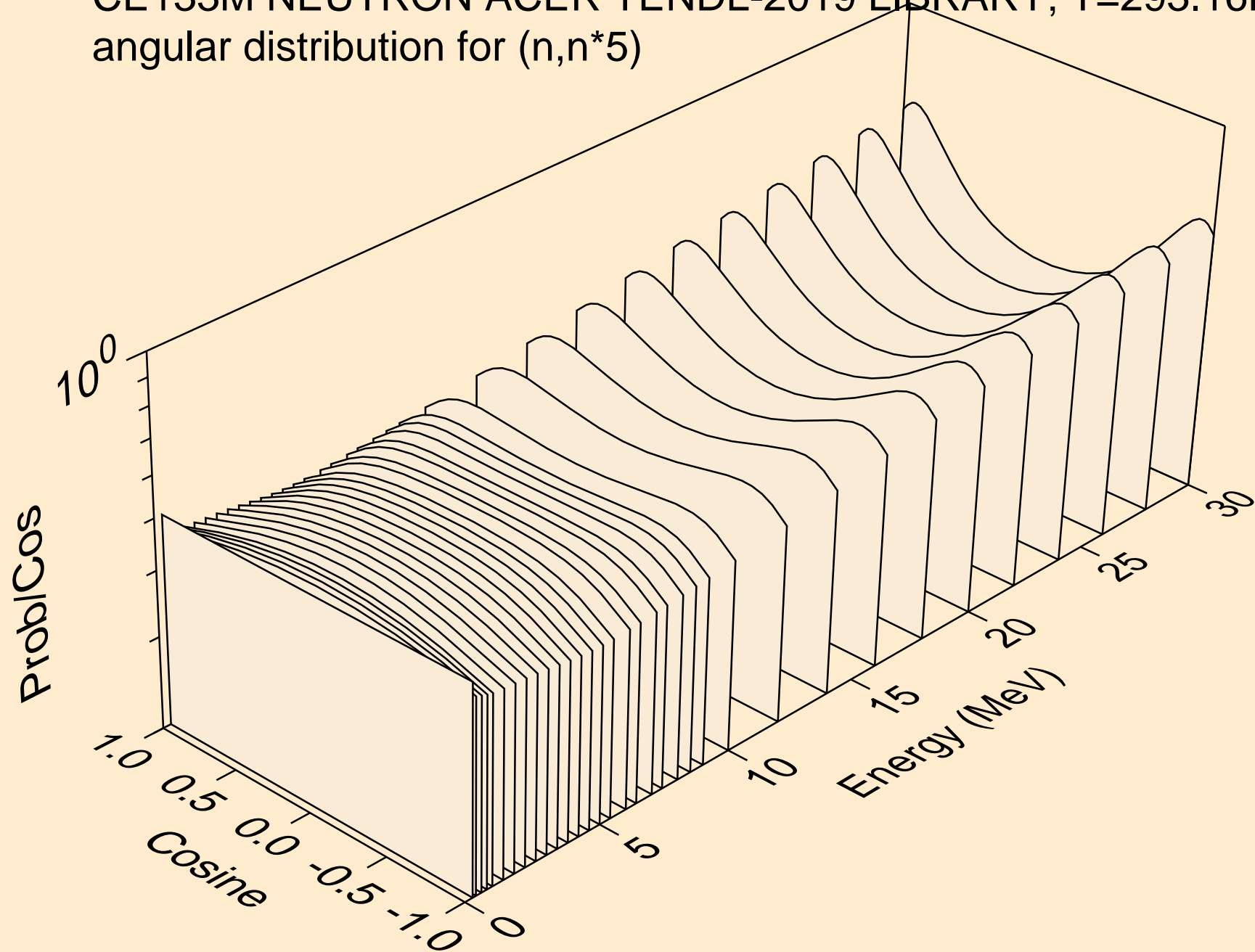

CE133M NEUTRON ACER TENDL-2019 LIBRARY; T=293.16K
angular distribution for (n,n*6)

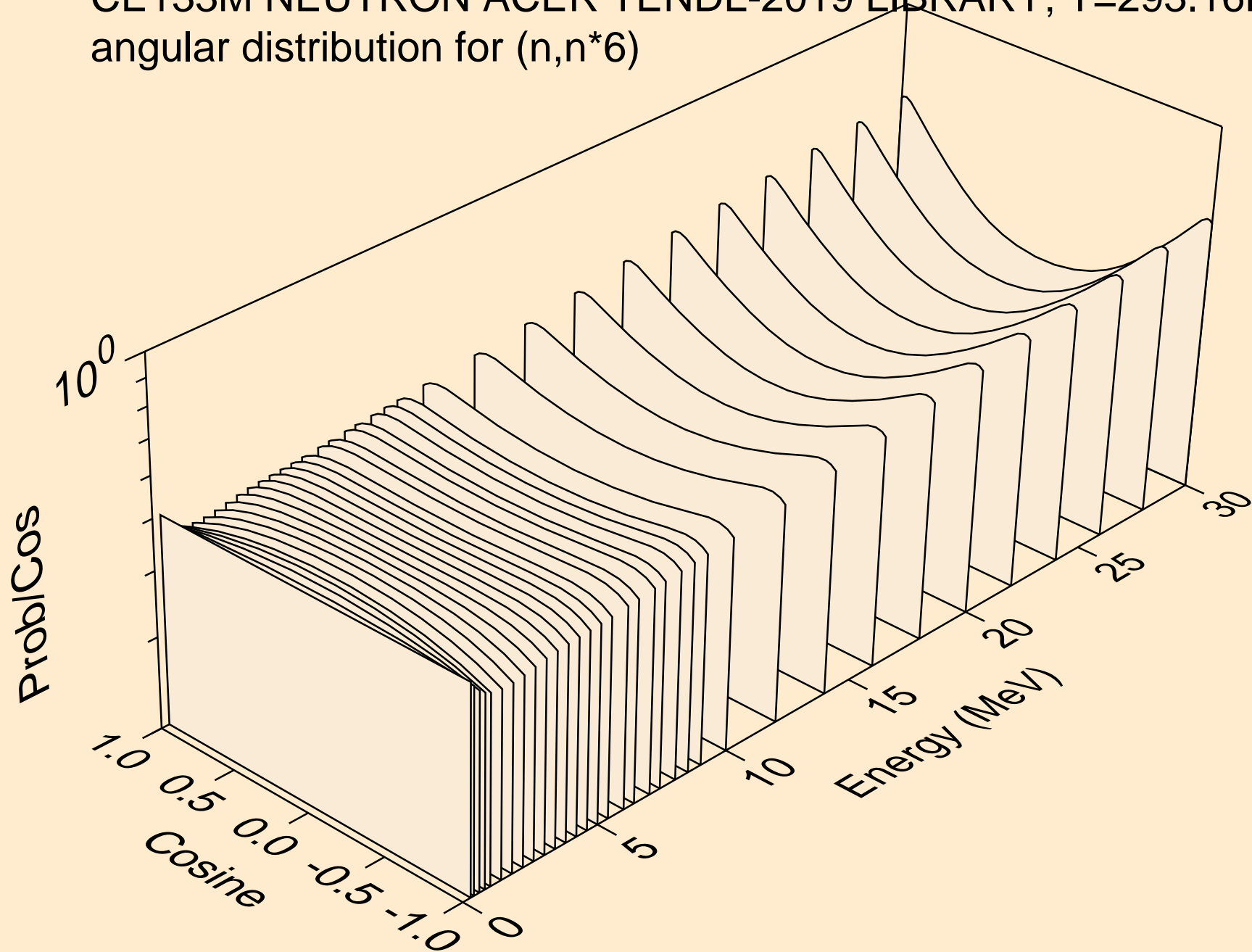

CE133M NEUTRON ACER TENDL-2019 LIBRARY; T=293.16K
angular distribution for (n,n*7)

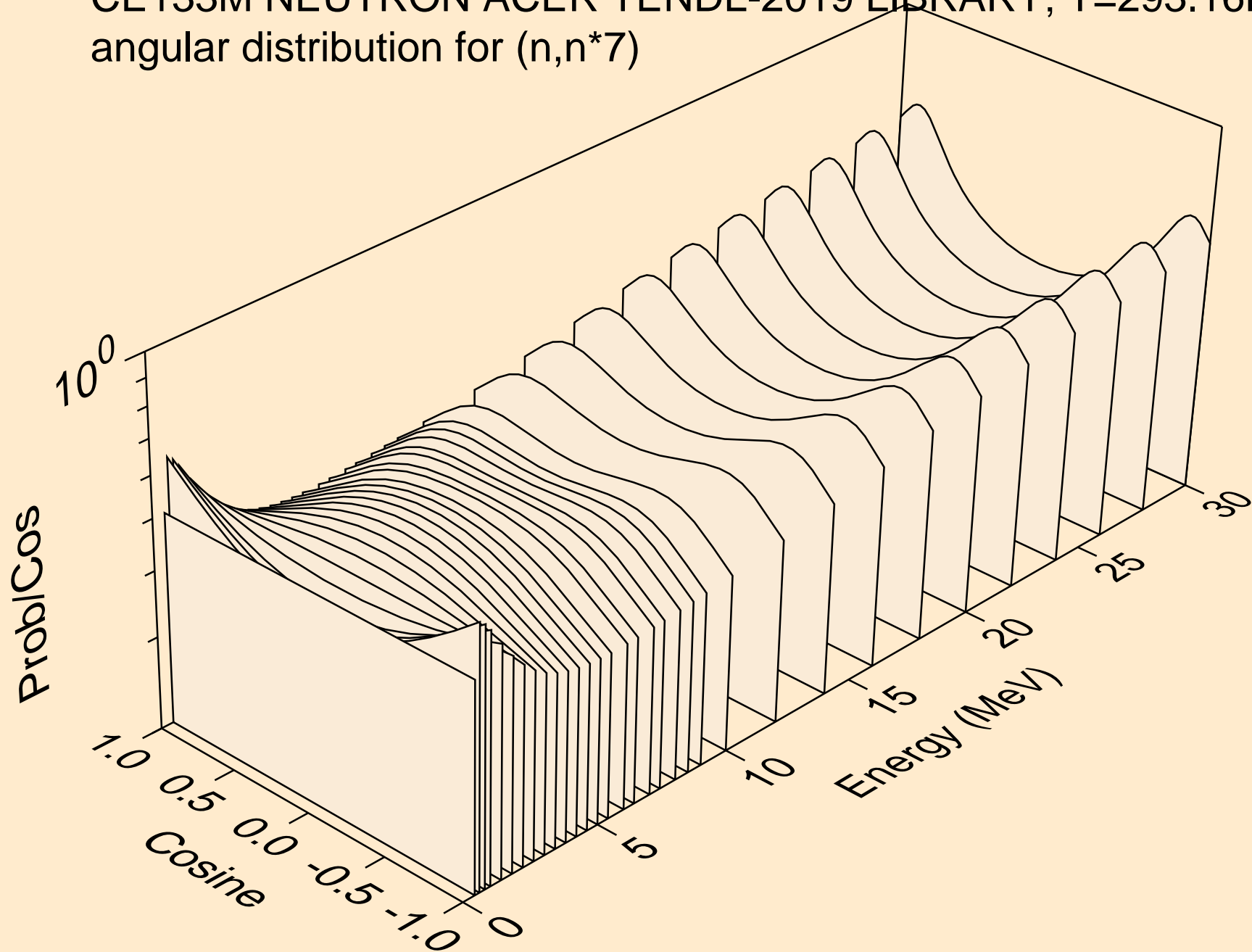

CE133M NEUTRON ACER TENDL-2019 LIBRARY; T=293.16K
angular distribution for (n,n*8)

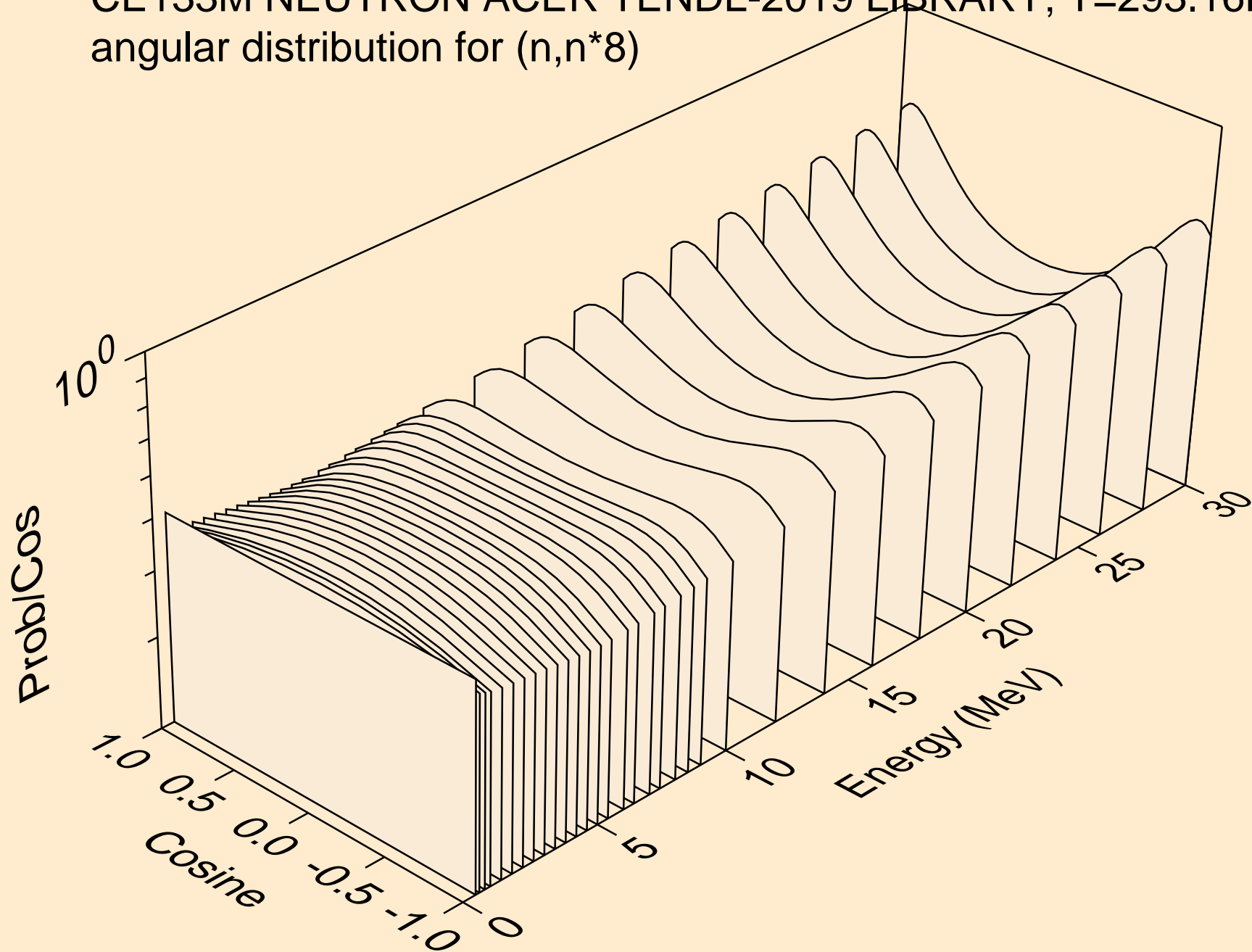

CE133M NEUTRON ACER TENDL-2019 LIBRARY; T=293.16K
angular distribution for (n,n*9)

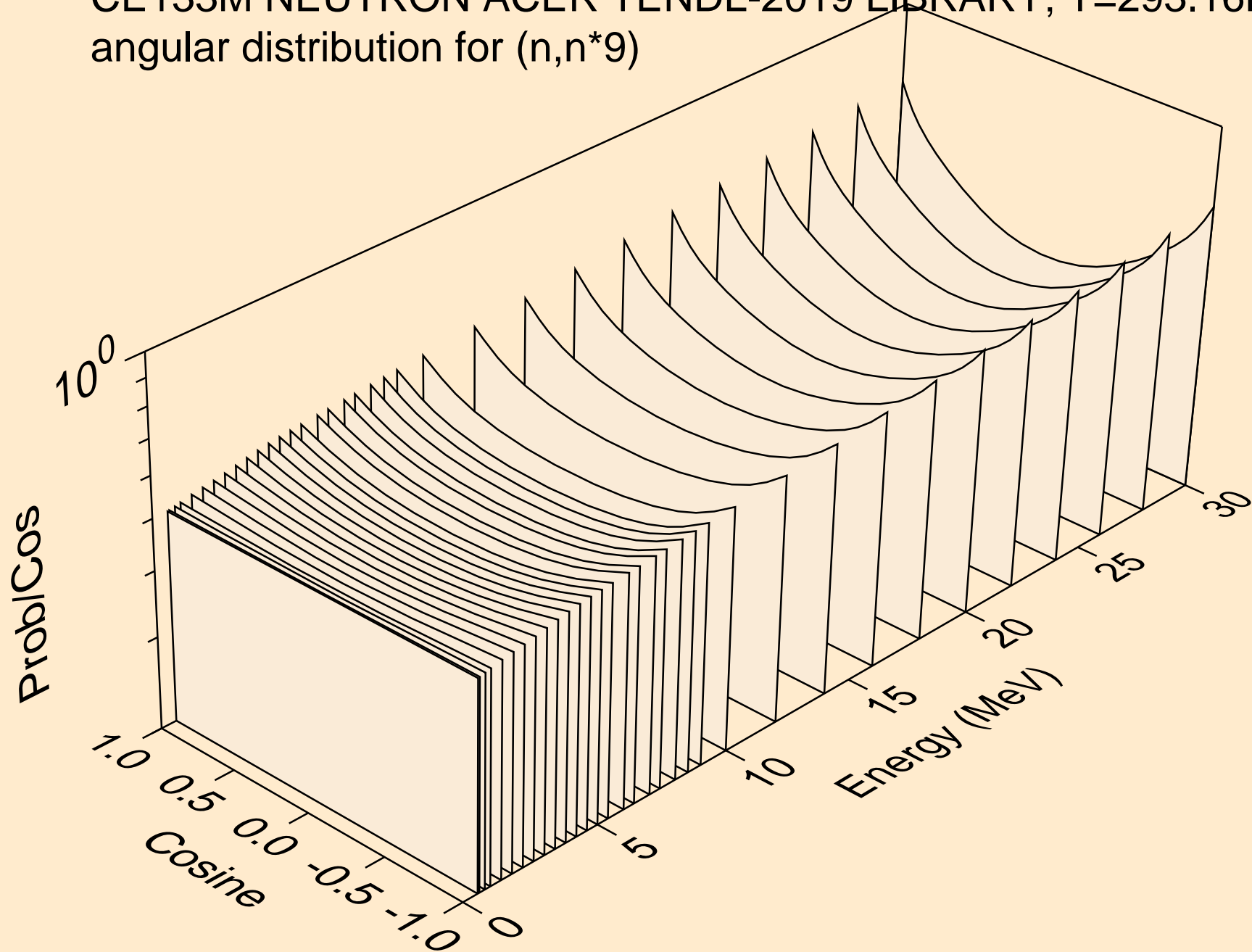

CE133M NEUTRON ACER TENDL-2019 LIBRARY; T=293.16K
angular distribution for (n,n*10)

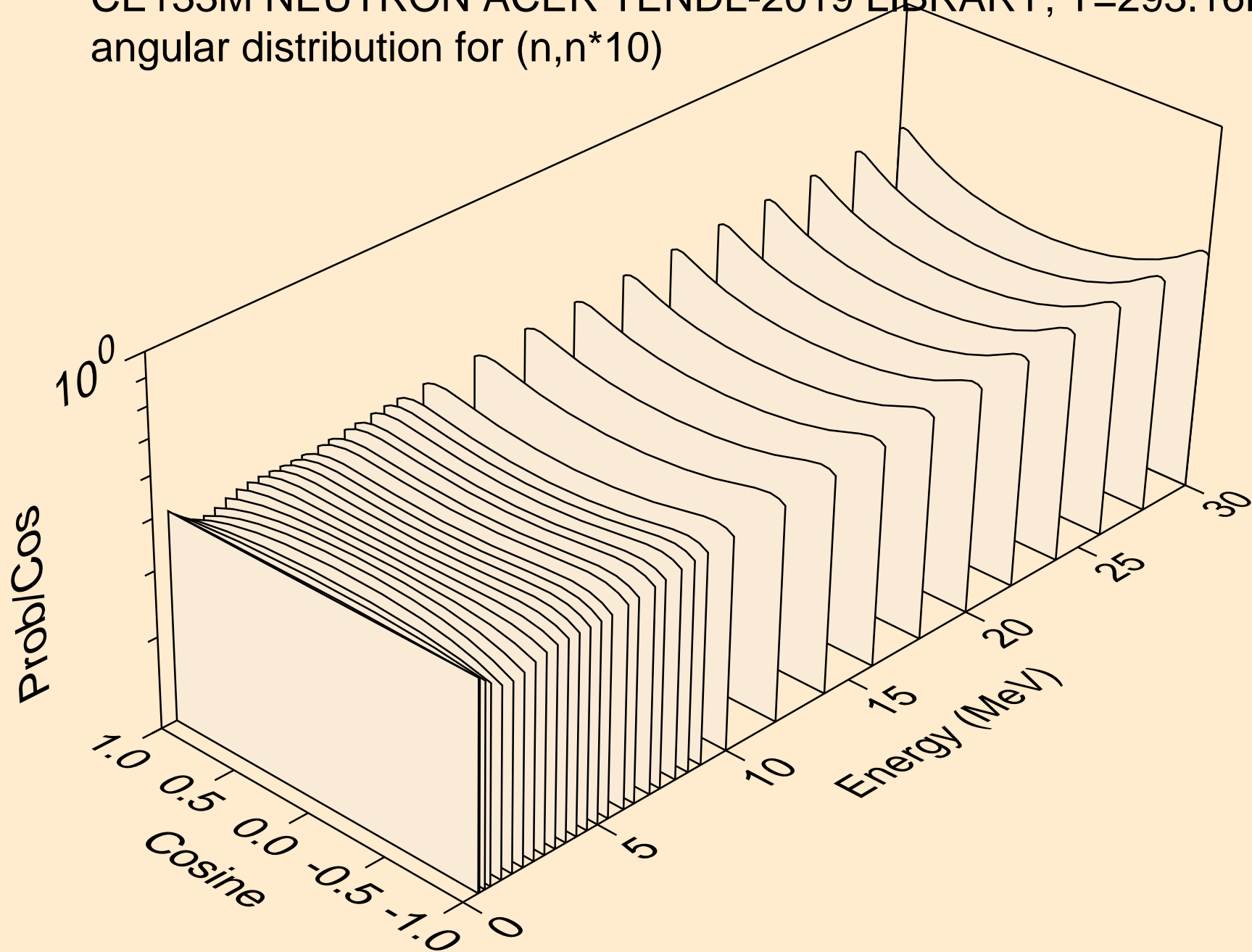

CE133M NEUTRON ACER TENDL-2019 LIBRARY; T=293.16K
angular distribution for (n,n*11)

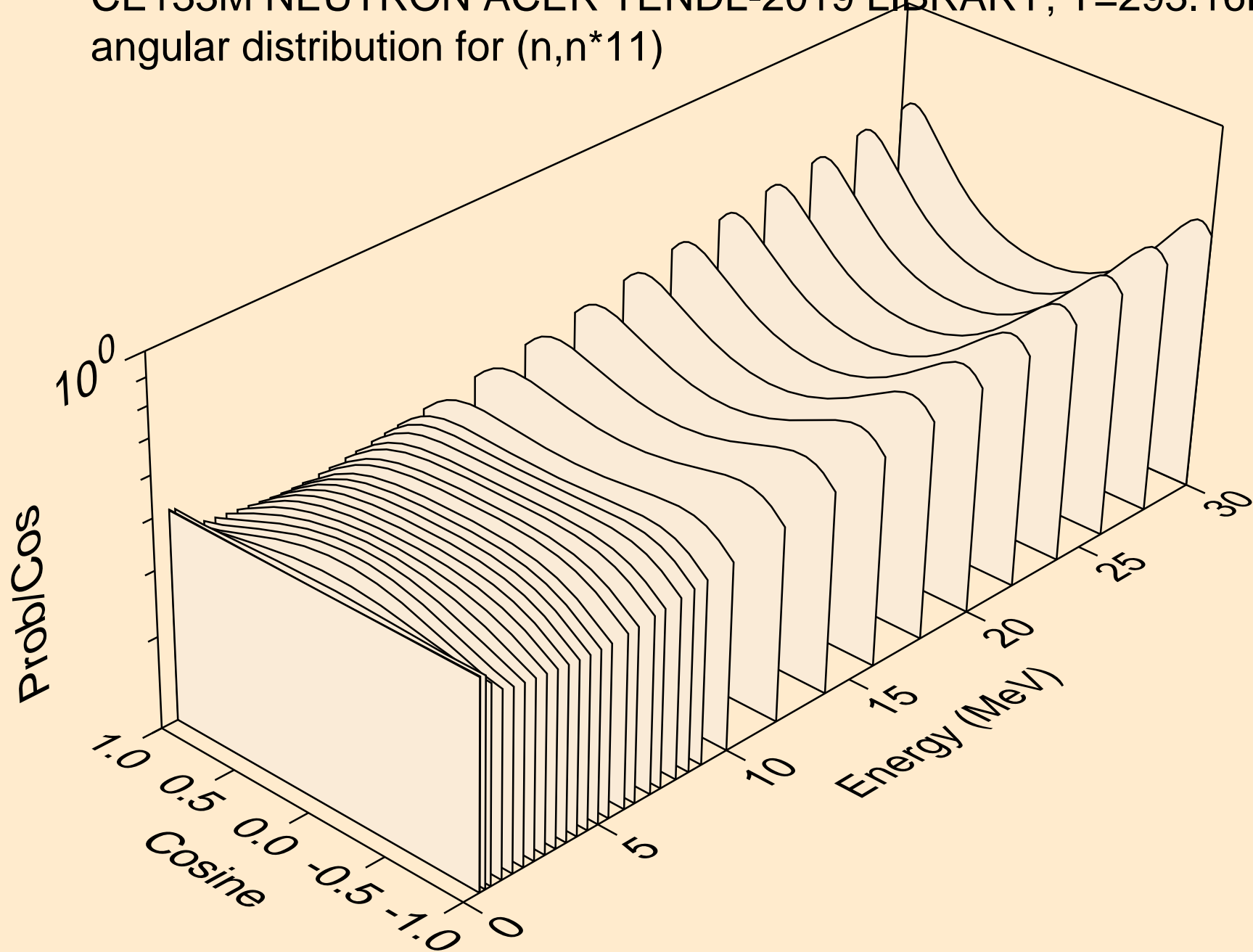

CE133M NEUTRON ACER TENDL-2019 LIBRARY; T=293.16K
angular distribution for (n,n*12)

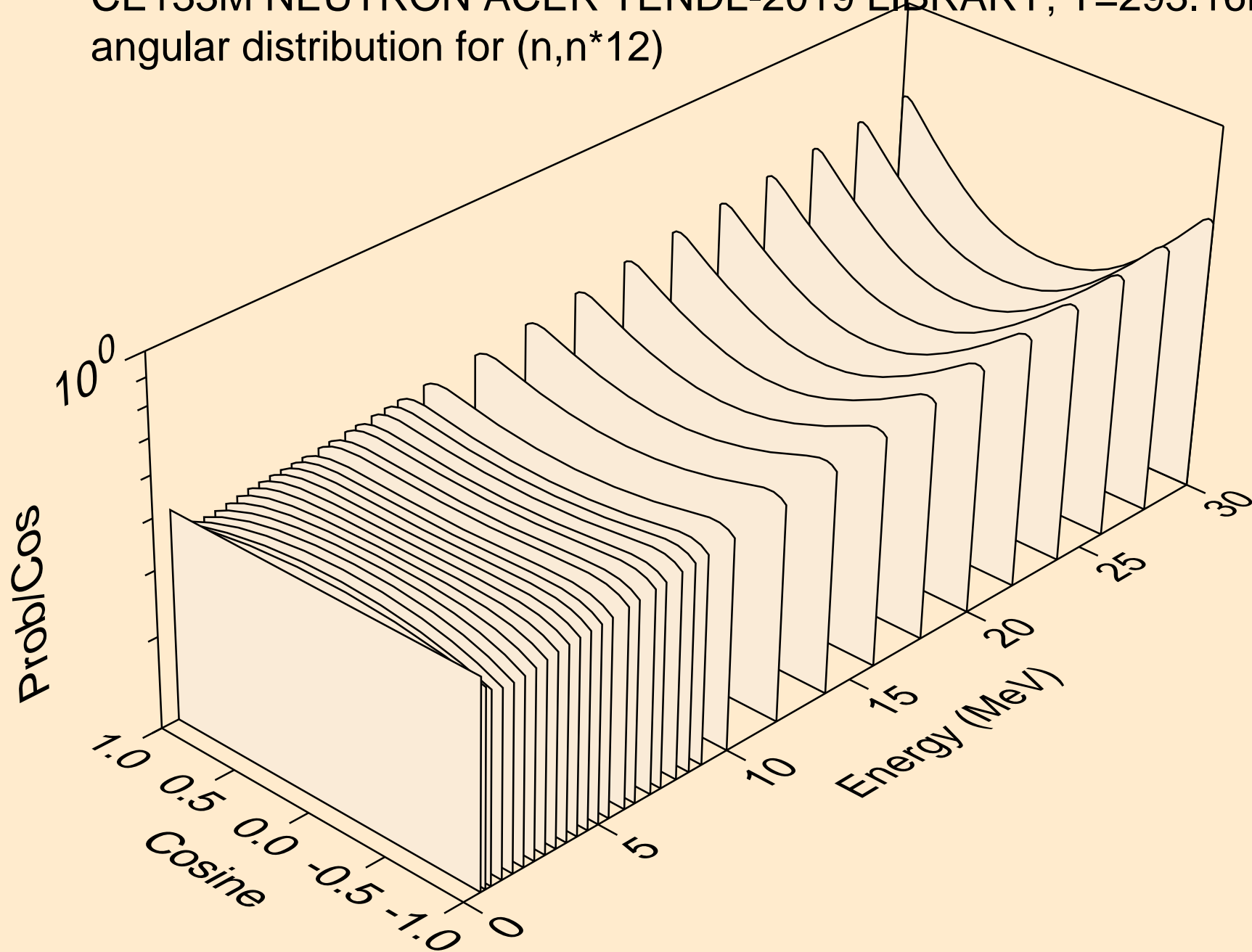

CE133M NEUTRON ACER TENDL-2019 LIBRARY; T=293.16K
angular distribution for (n,n*13)

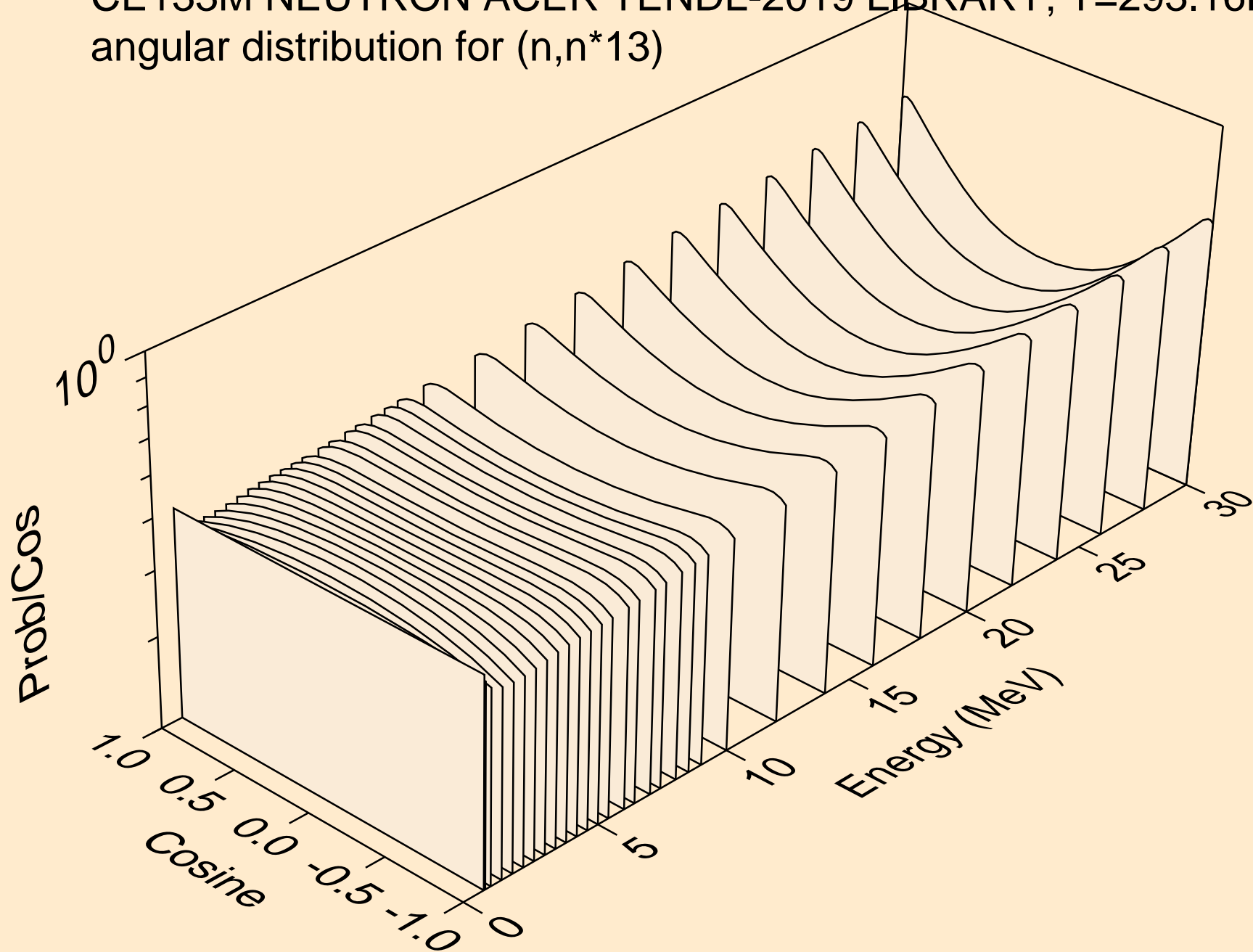

CE133M NEUTRON ACER TENDL-2019 LIBRARY; T=293.16K
angular distribution for (n,n*14)

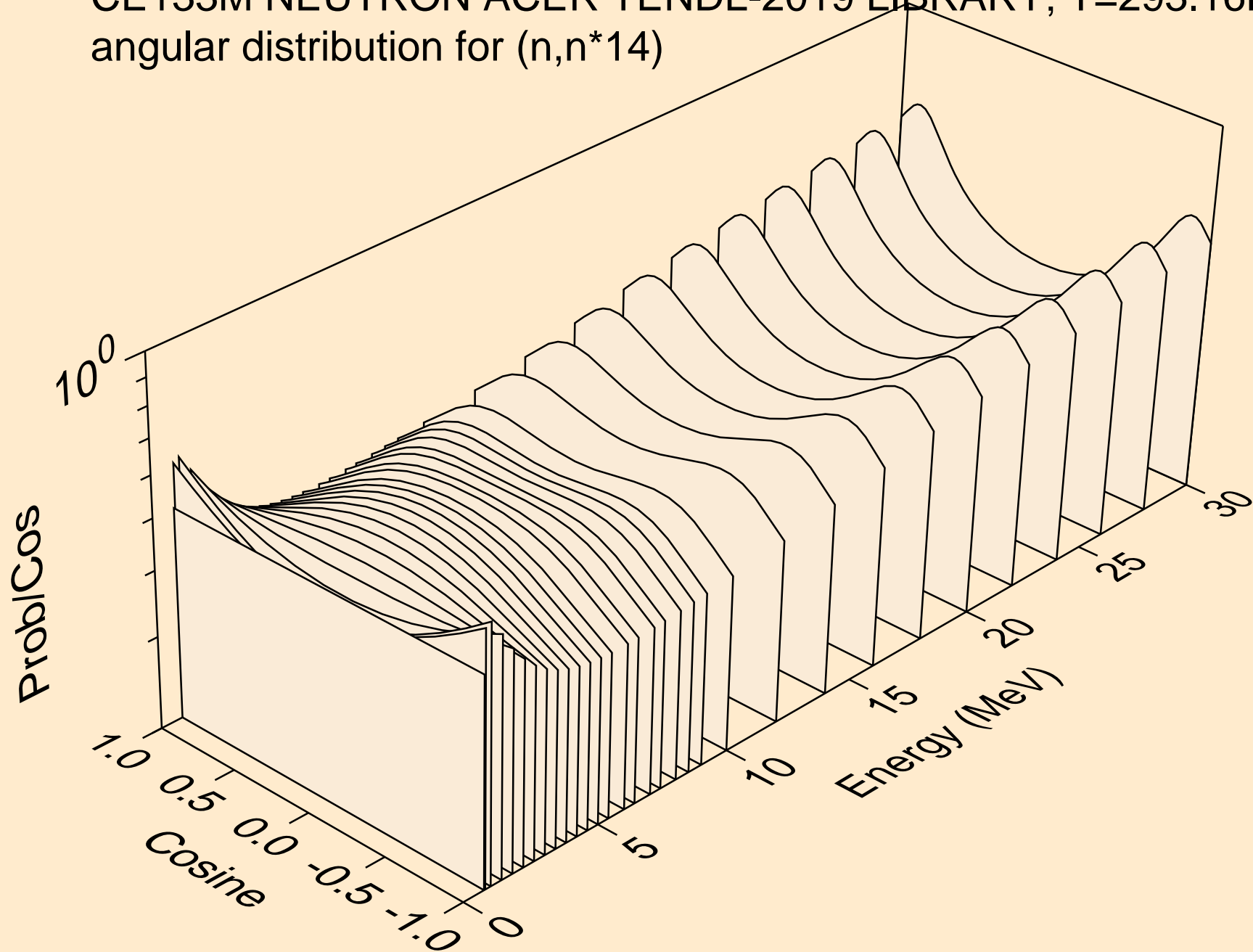

CE133M NEUTRON ACER TENDL-2019 LIBRARY; T=293.16K
angular distribution for (n,n*15)

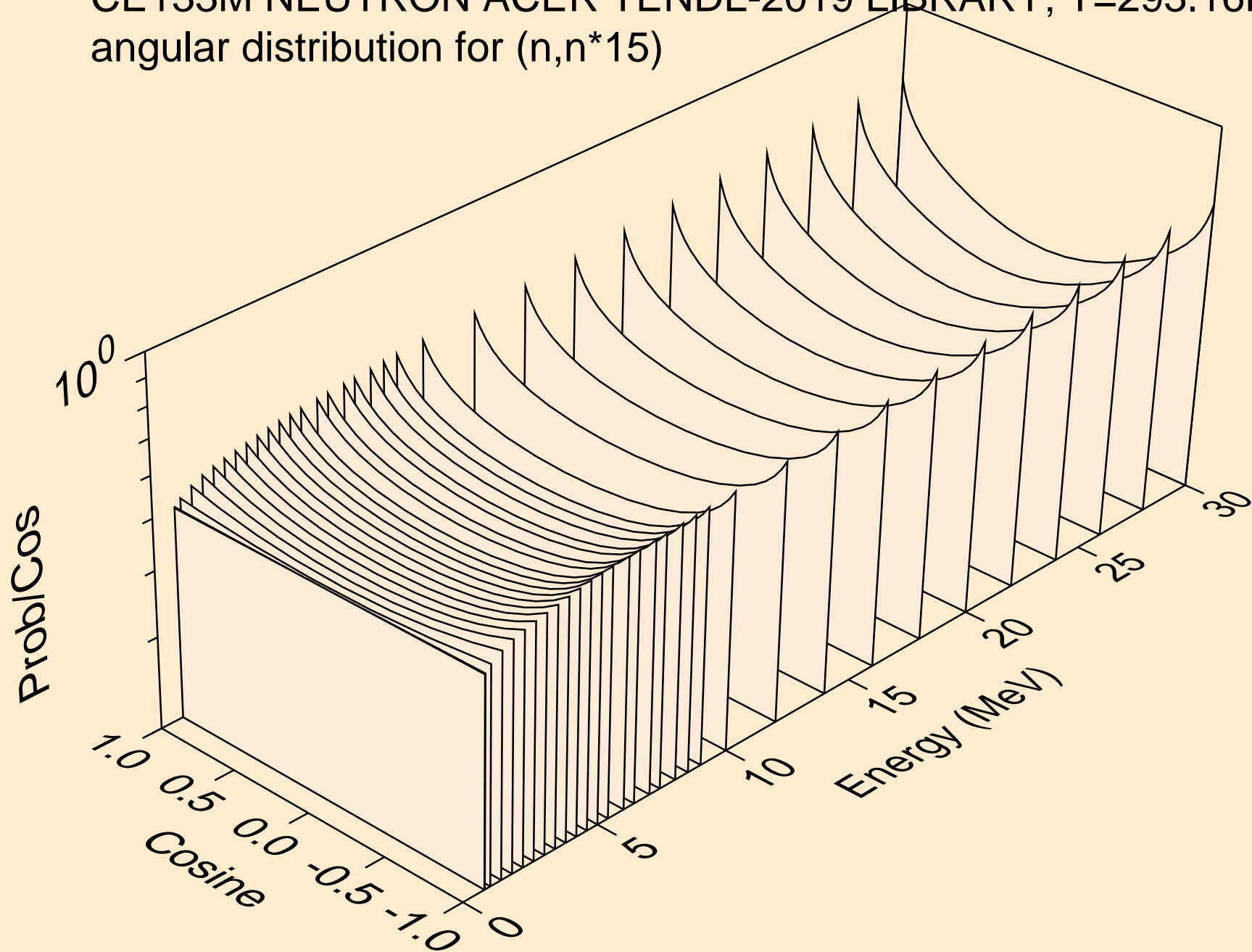

CE133M NEUTRON ACER TENDL-2019 LIBRARY; T=293.16K
angular distribution for (n,n*16)

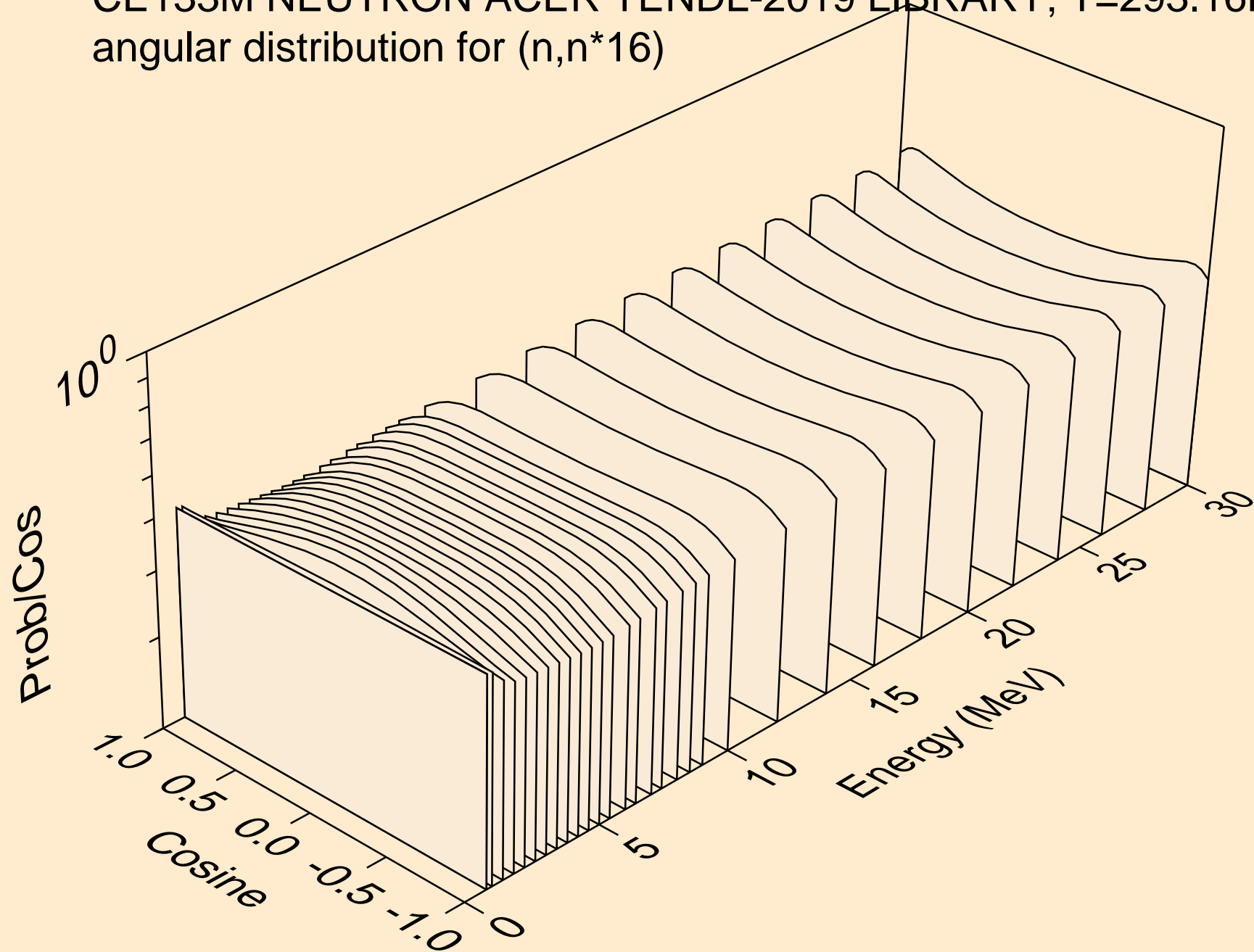

CE133M NEUTRON ACER TENDL-2019 LIBRARY; T=293.16K
angular distribution for (n,n*17)

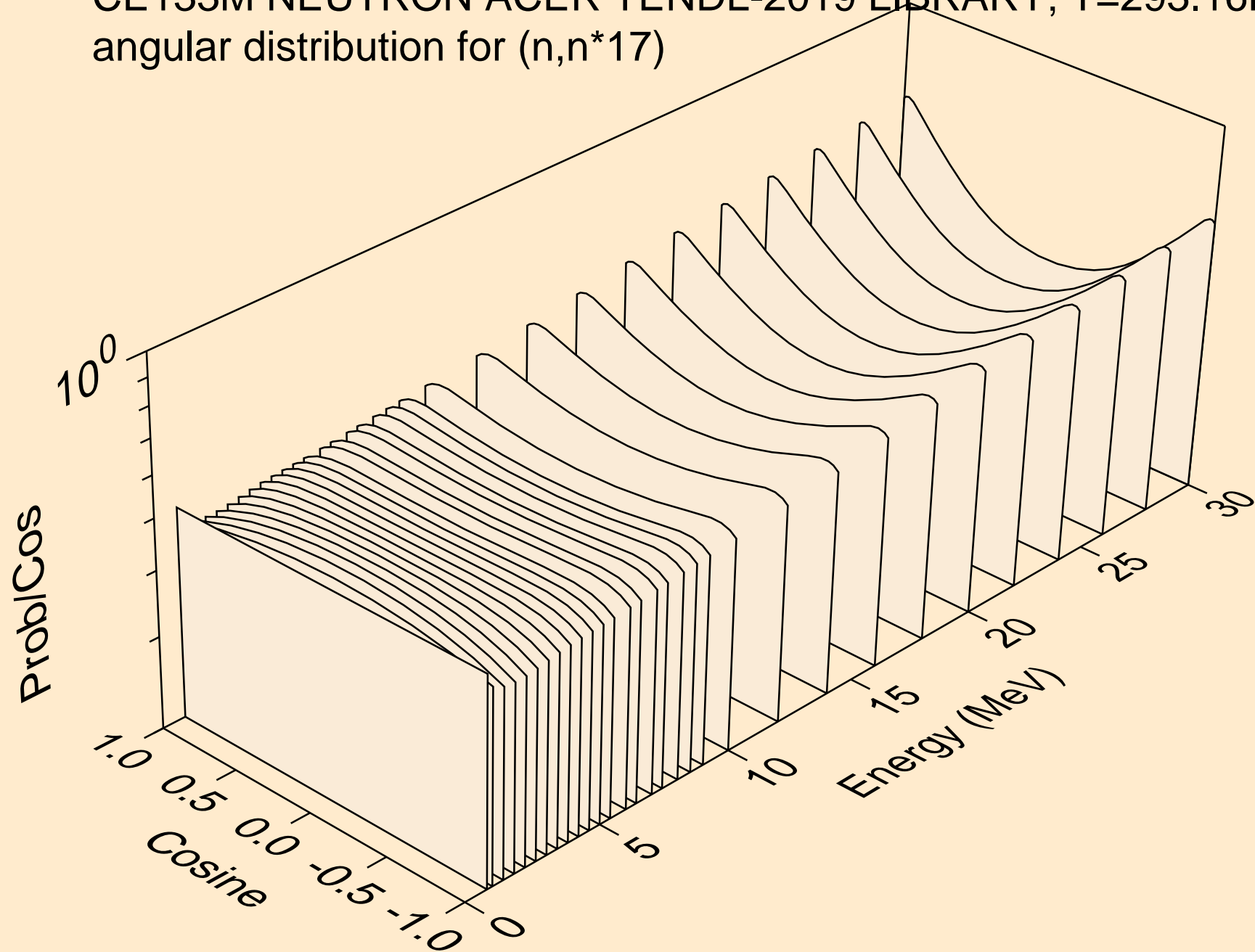

CE133M NEUTRON ACER TENDL-2019 LIBRARY; T=293.16K
angular distribution for (n,n*18)

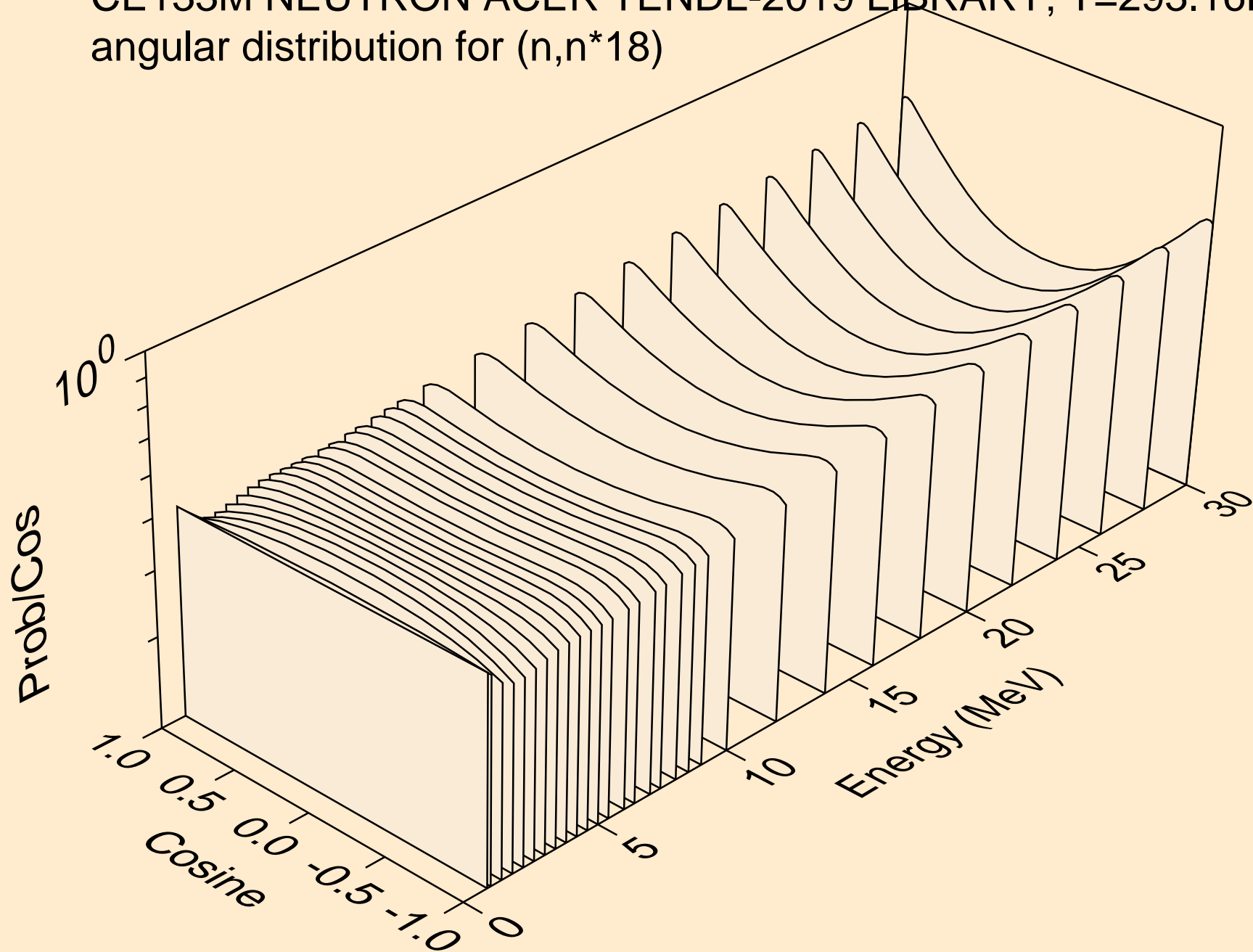

CE133M NEUTRON ACER TENDL-2019 LIBRARY; T=293.16K
angular distribution for (n,n*19)

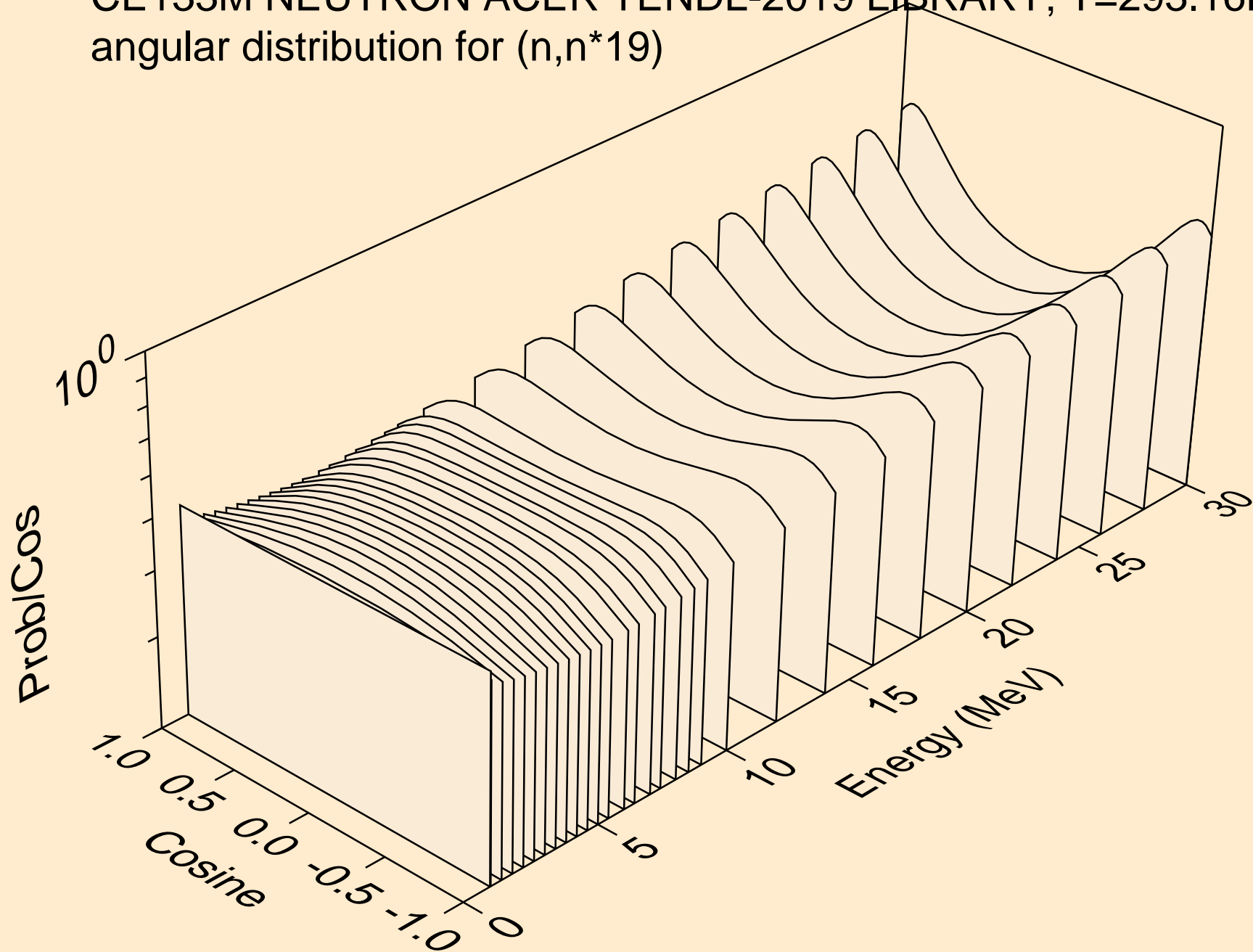

CE133M NEUTRON ACER TENDL-2019 LIBRARY; T=293.16K
angular distribution for (n,n*20)

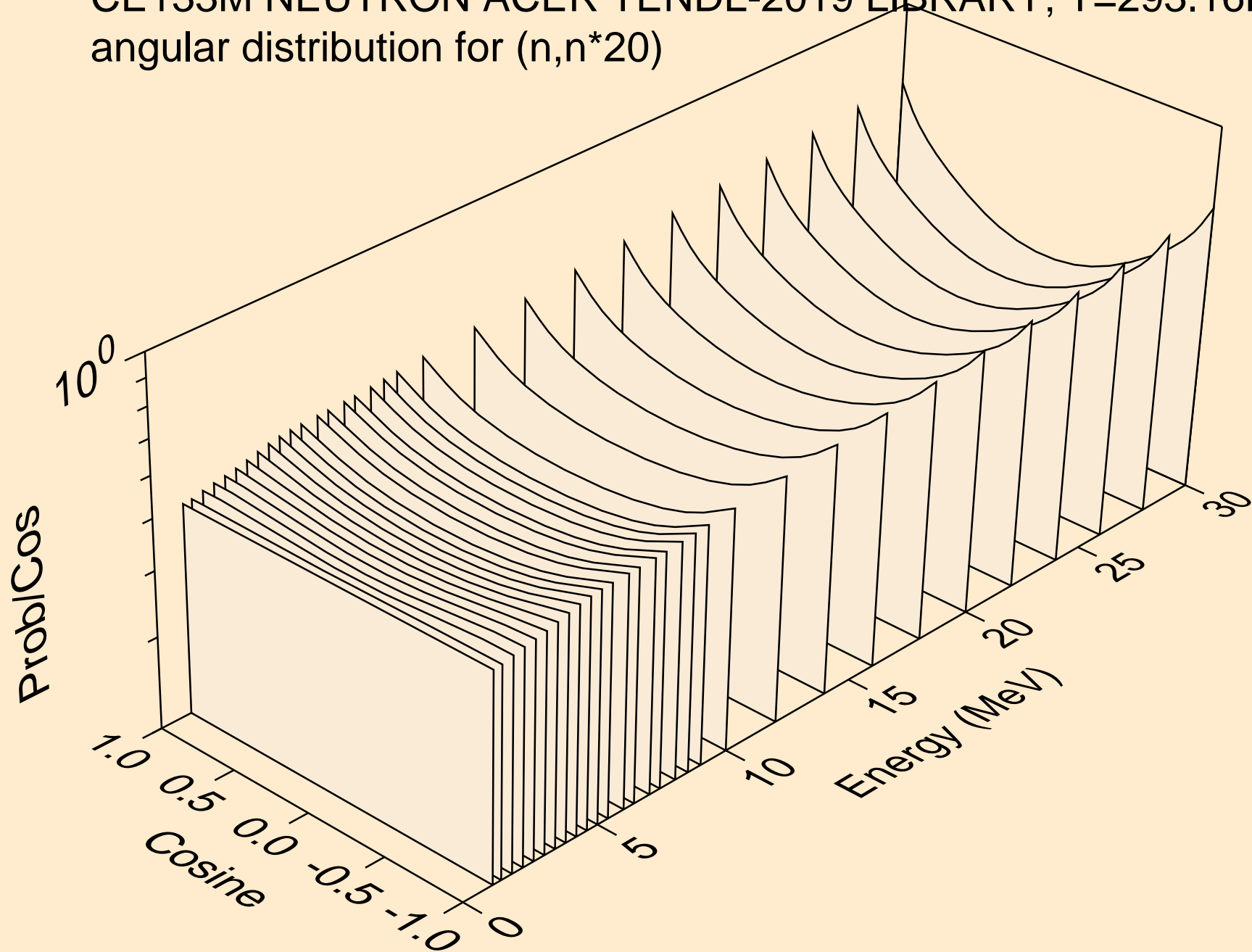

CE133M NEUTRON ACER TENDL-2019 LIBRARY; T=293.16K
angular distribution for (n,n*21)

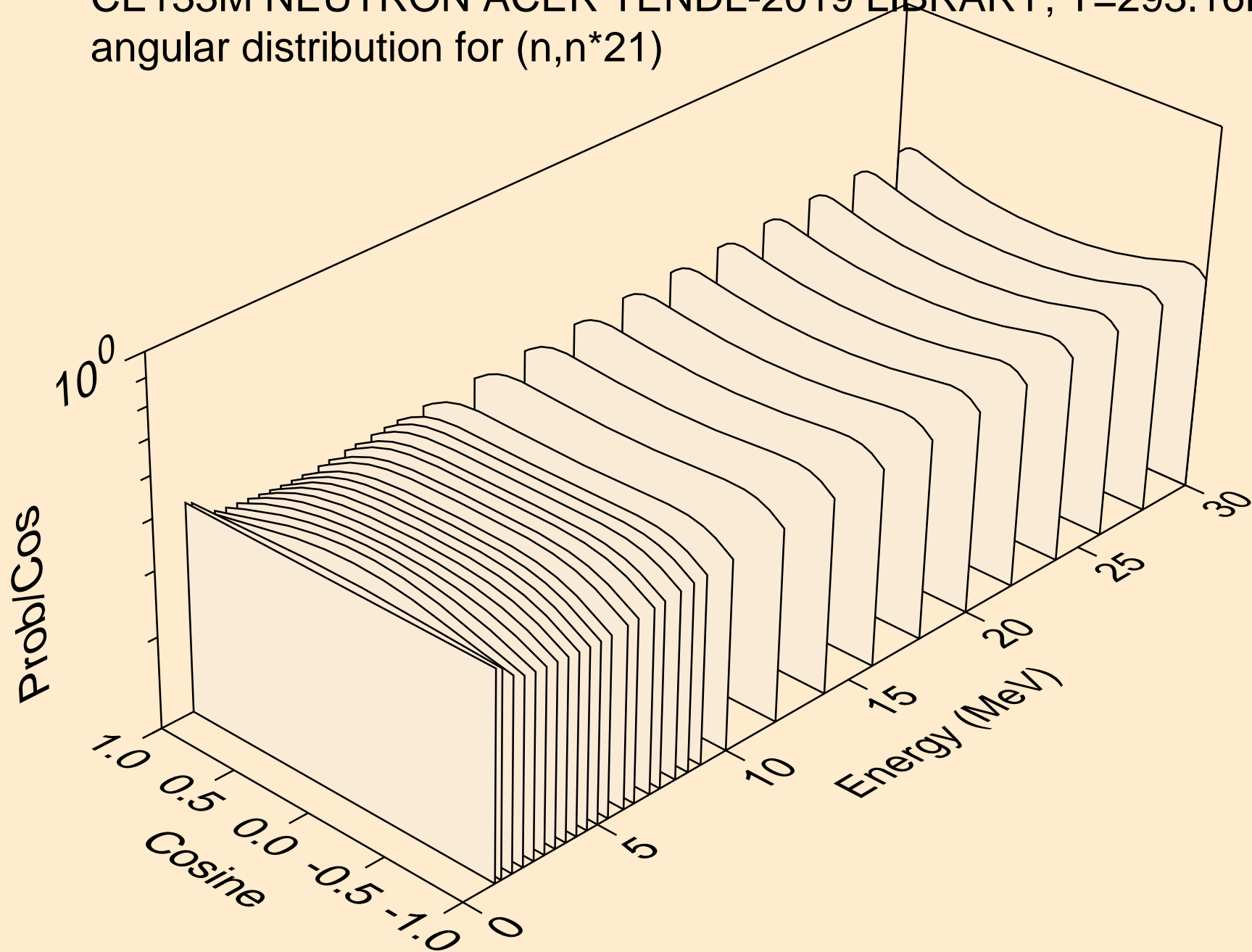

CE133M NEUTRON ACER TENDL-2019 LIBRARY; T=293.16K
angular distribution for (n,n*22)

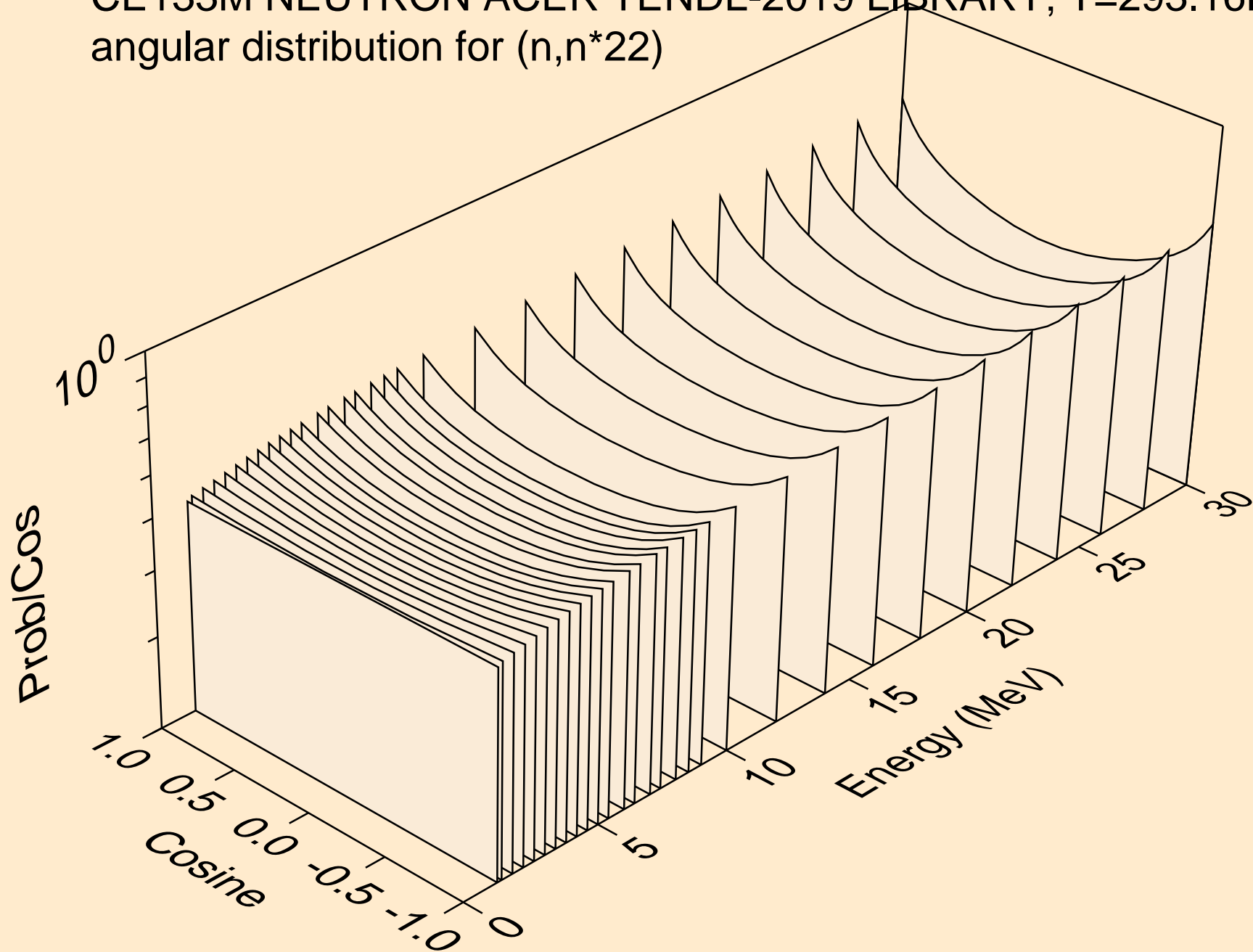

CE133M NEUTRON ACER TENDL-2019 LIBRARY; T=293.16K
angular distribution for (n,n*23)

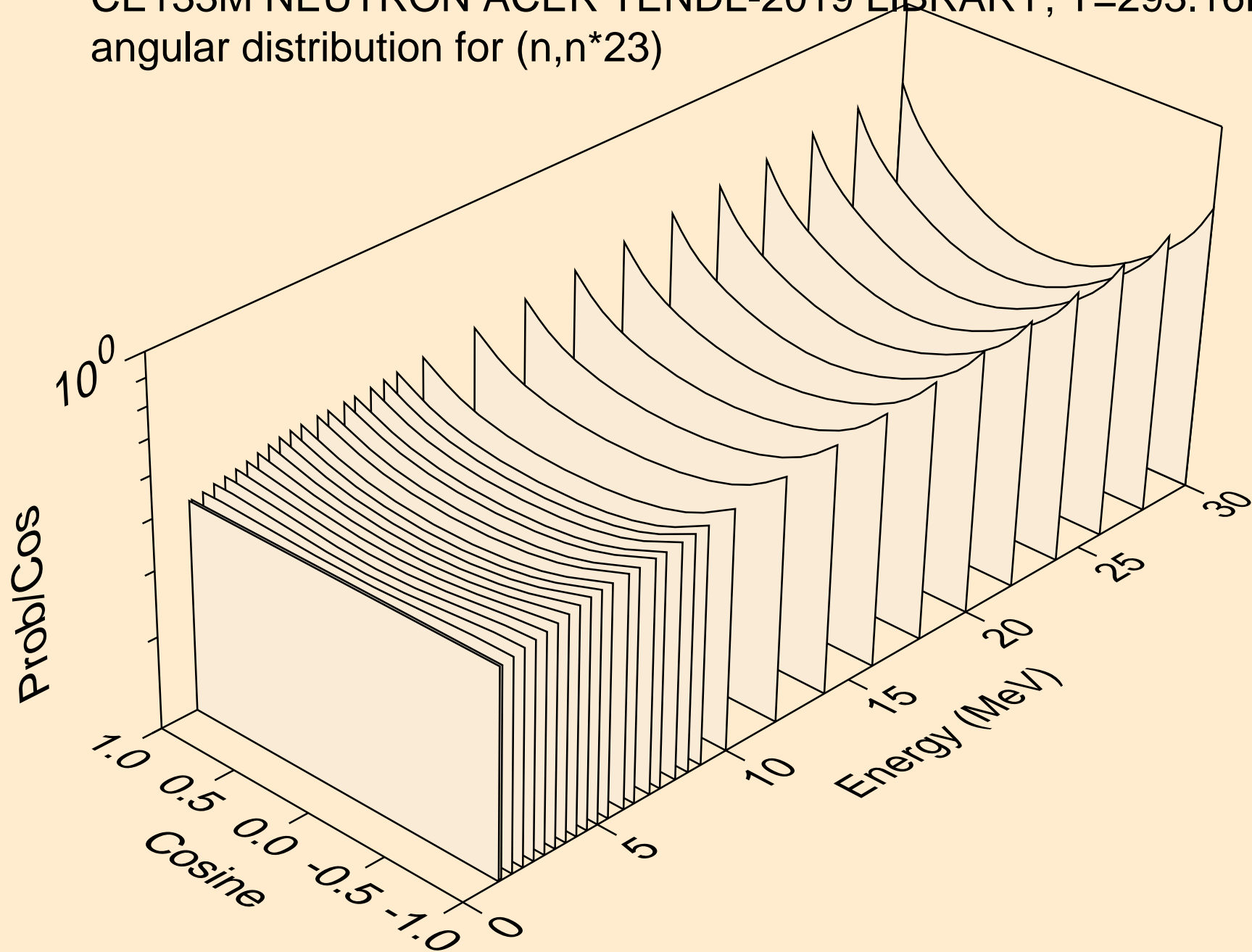

CE133M NEUTRON ACER TENDL-2019 LIBRARY; T=293.16K
angular distribution for (n,n*24)

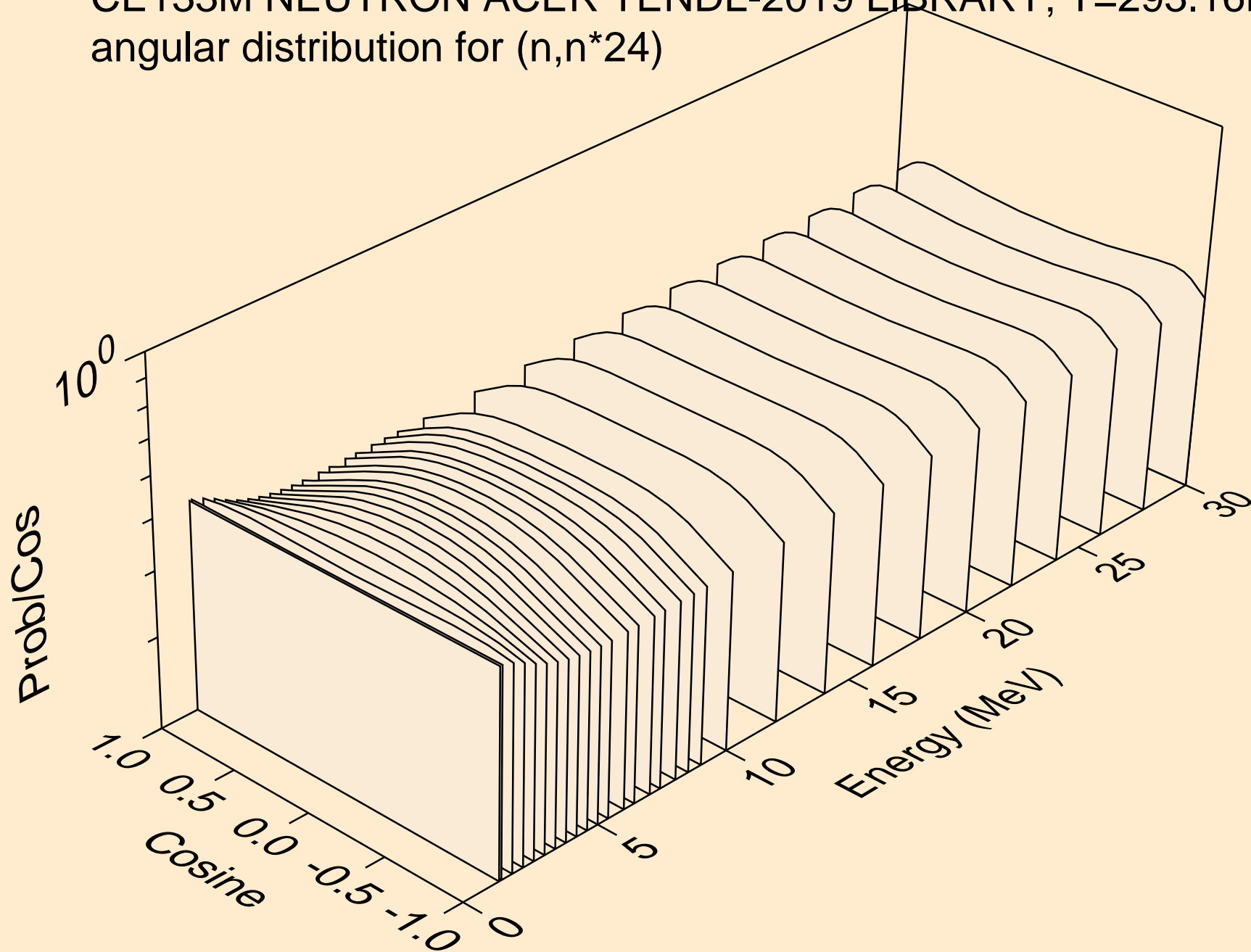

CE133M NEUTRON ACER TENDL-2019 LIBRARY; T=293.16K
angular distribution for (n,n*25)

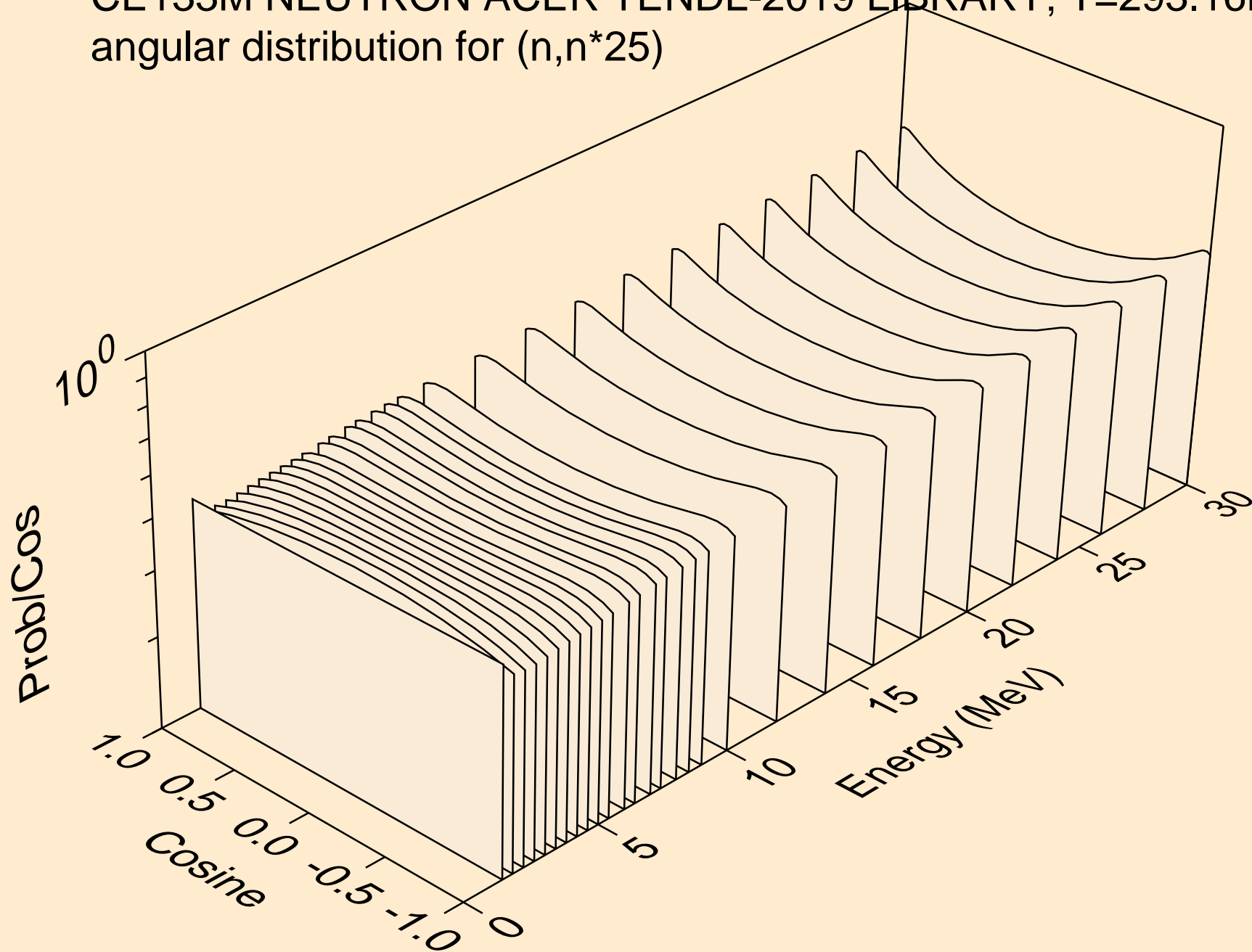

CE133M NEUTRON ACER TENDL-2019 LIBRARY; T=293.16K
angular distribution for (n,n*26)

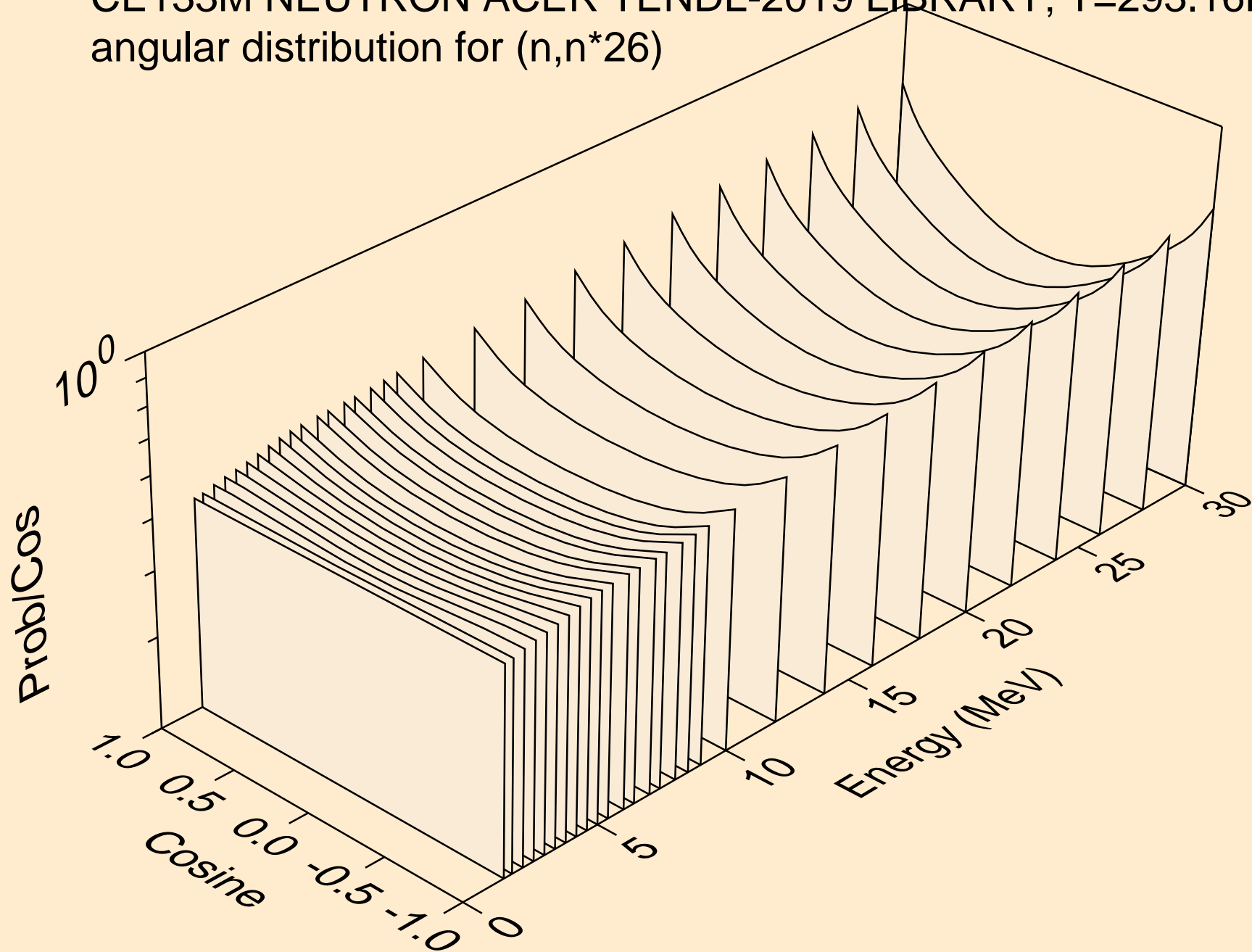

CE133M NEUTRON ACER TENDL-2019 LIBRARY; T=293.16K
angular distribution for (n,n*27)

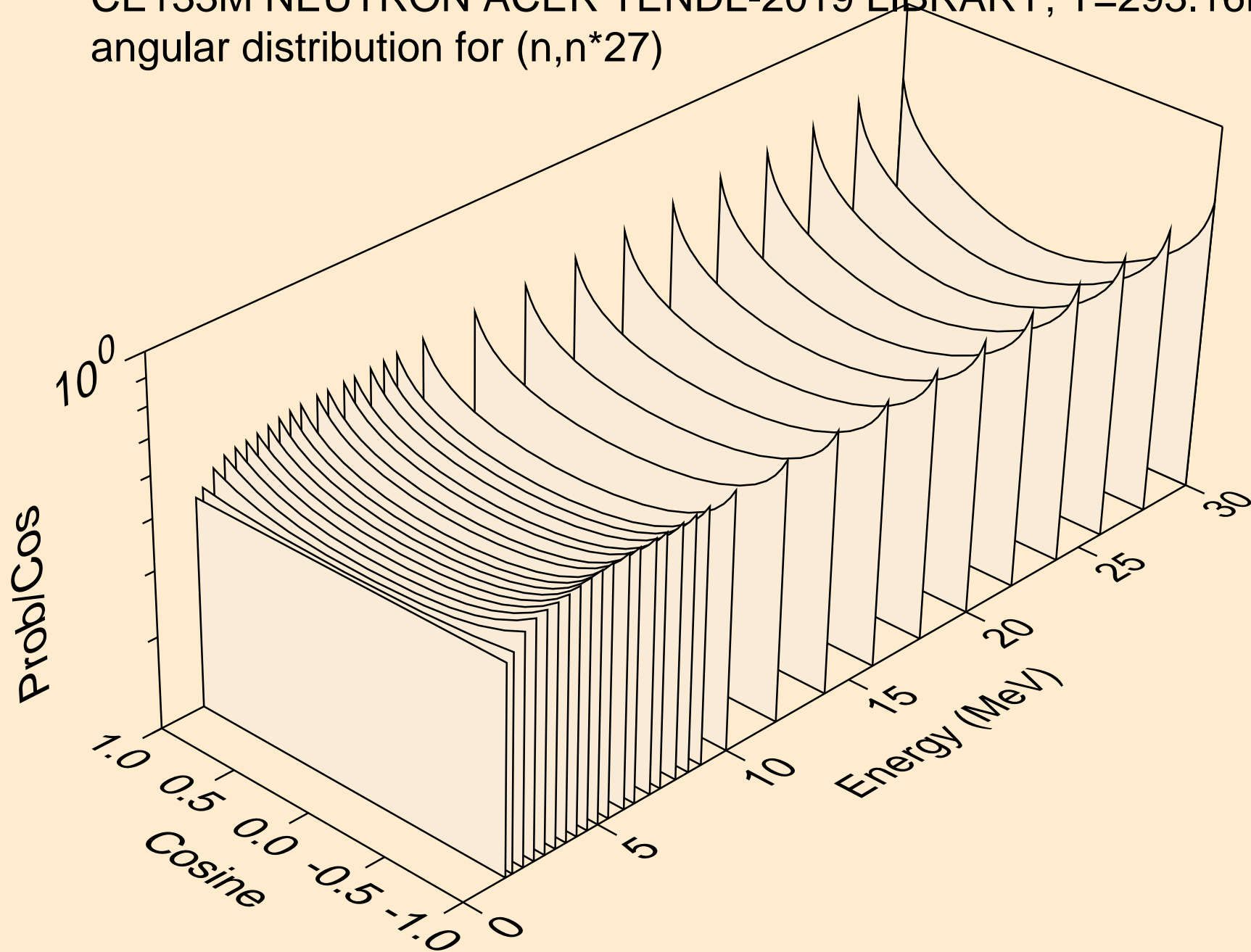

CE133M NEUTRON ACER TENDL-2019 LIBRARY; T=293.16K
Neutron emission for (n,x)

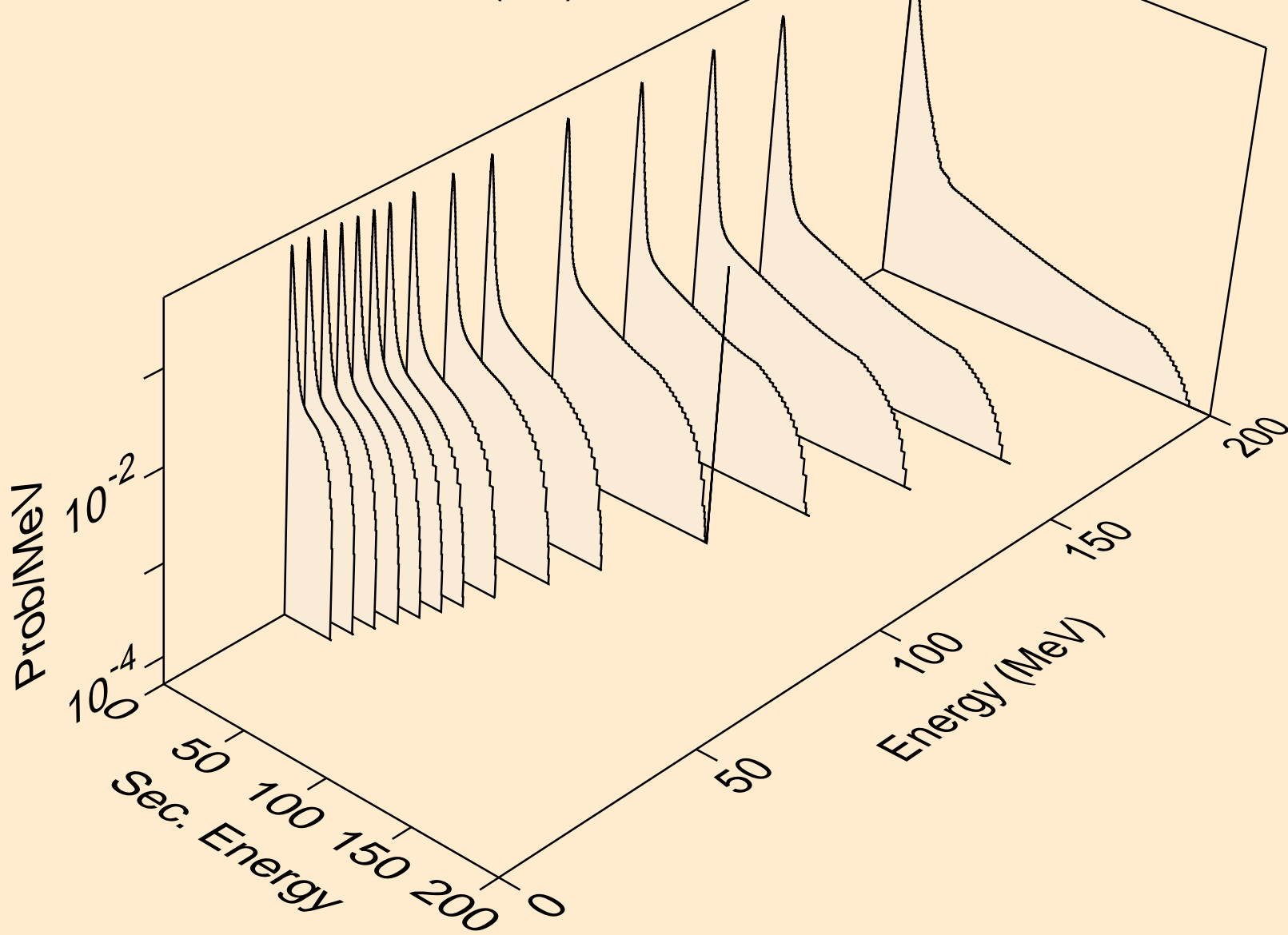

CE133M NEUTRON ACER TENDL-2019 LIBRARY; T=293.16K
Neutron emission for (n,2nd)

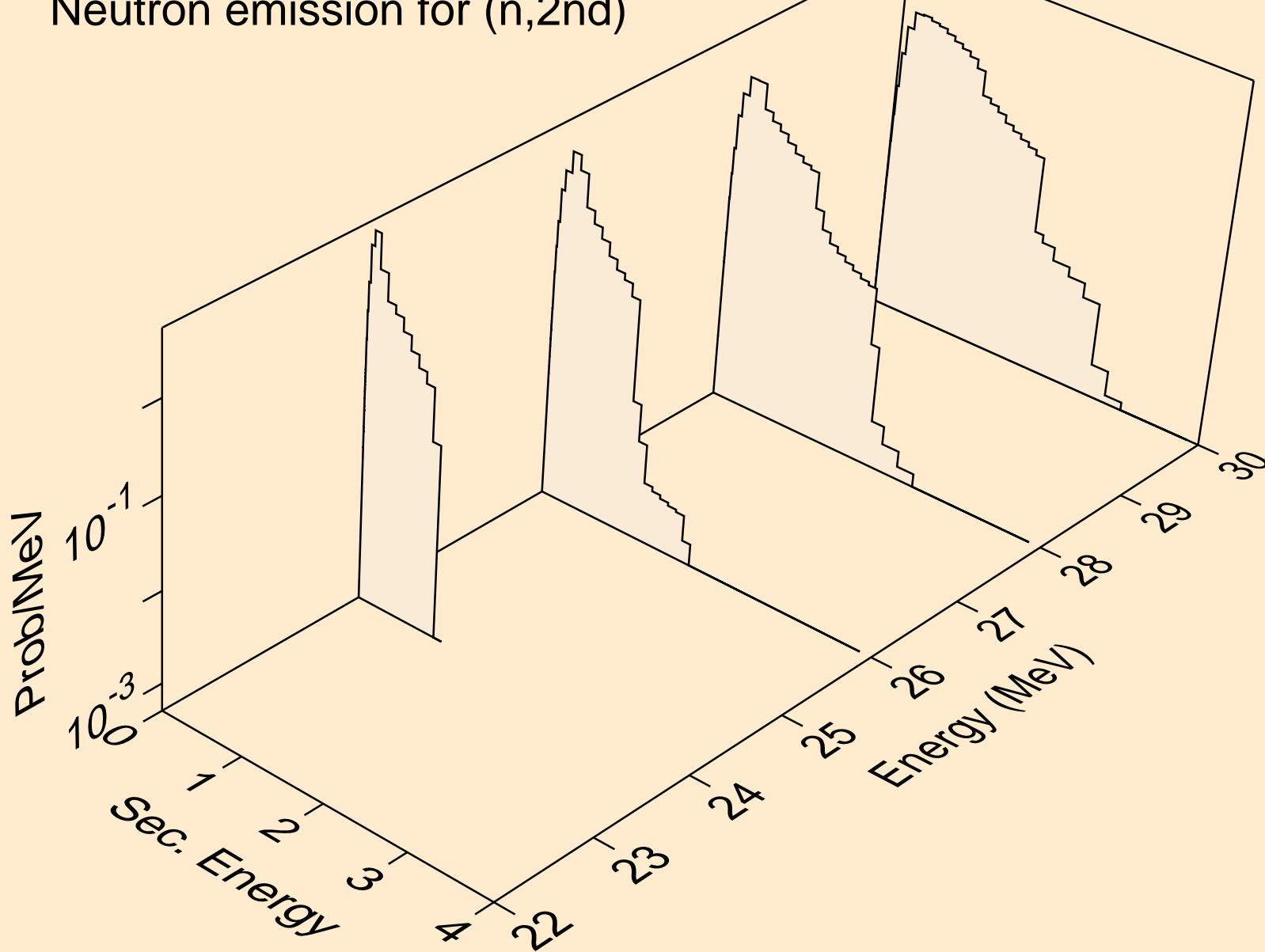

CE133M NEUTRON ACER TENDL-2019 LIBRARY; T=293.16K
Neutron emission for (n,2n)

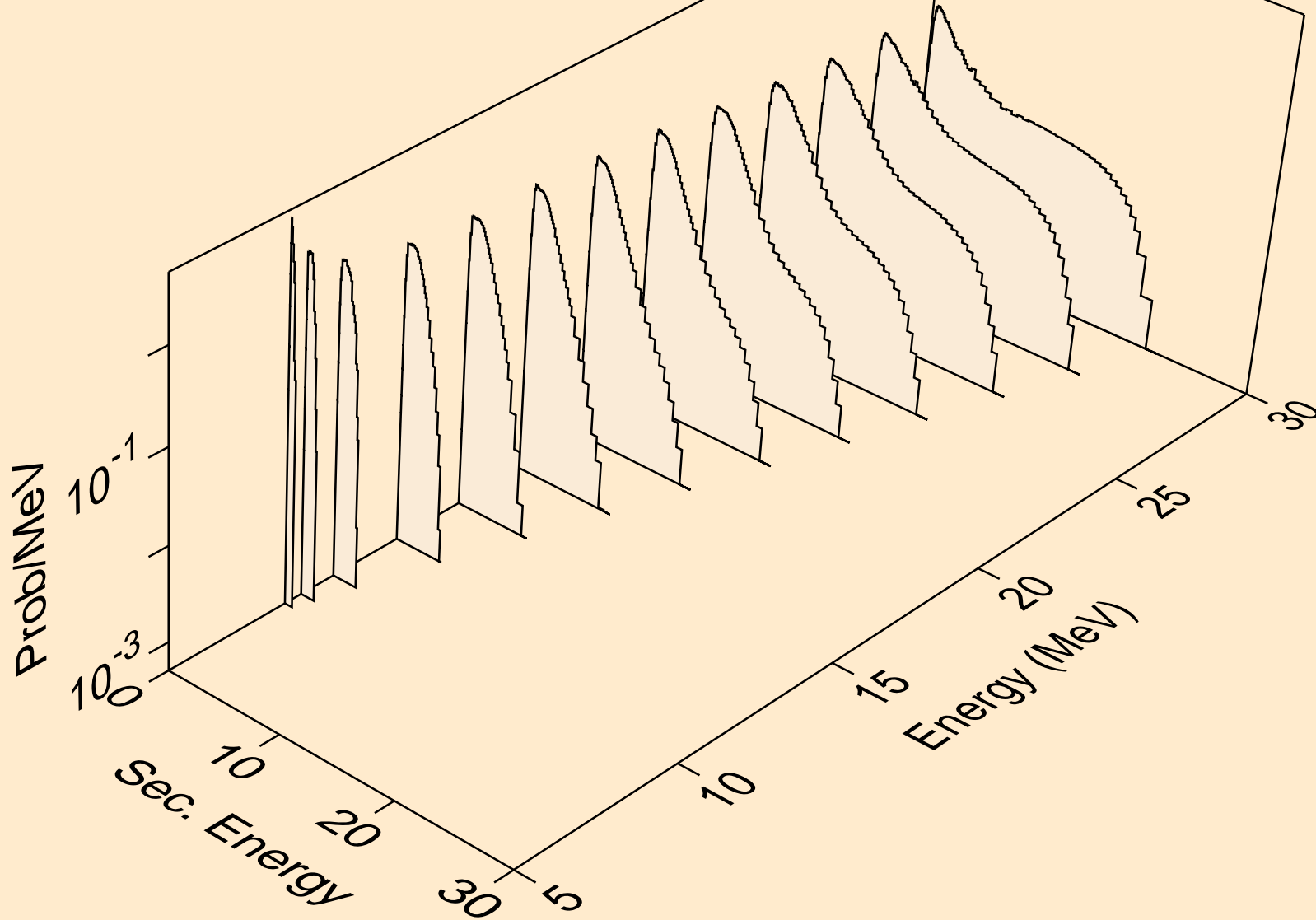

CE133M NEUTRON ACER TENDL-2019 LIBRARY; T=293.16K
Neutron emission for (n,3n)

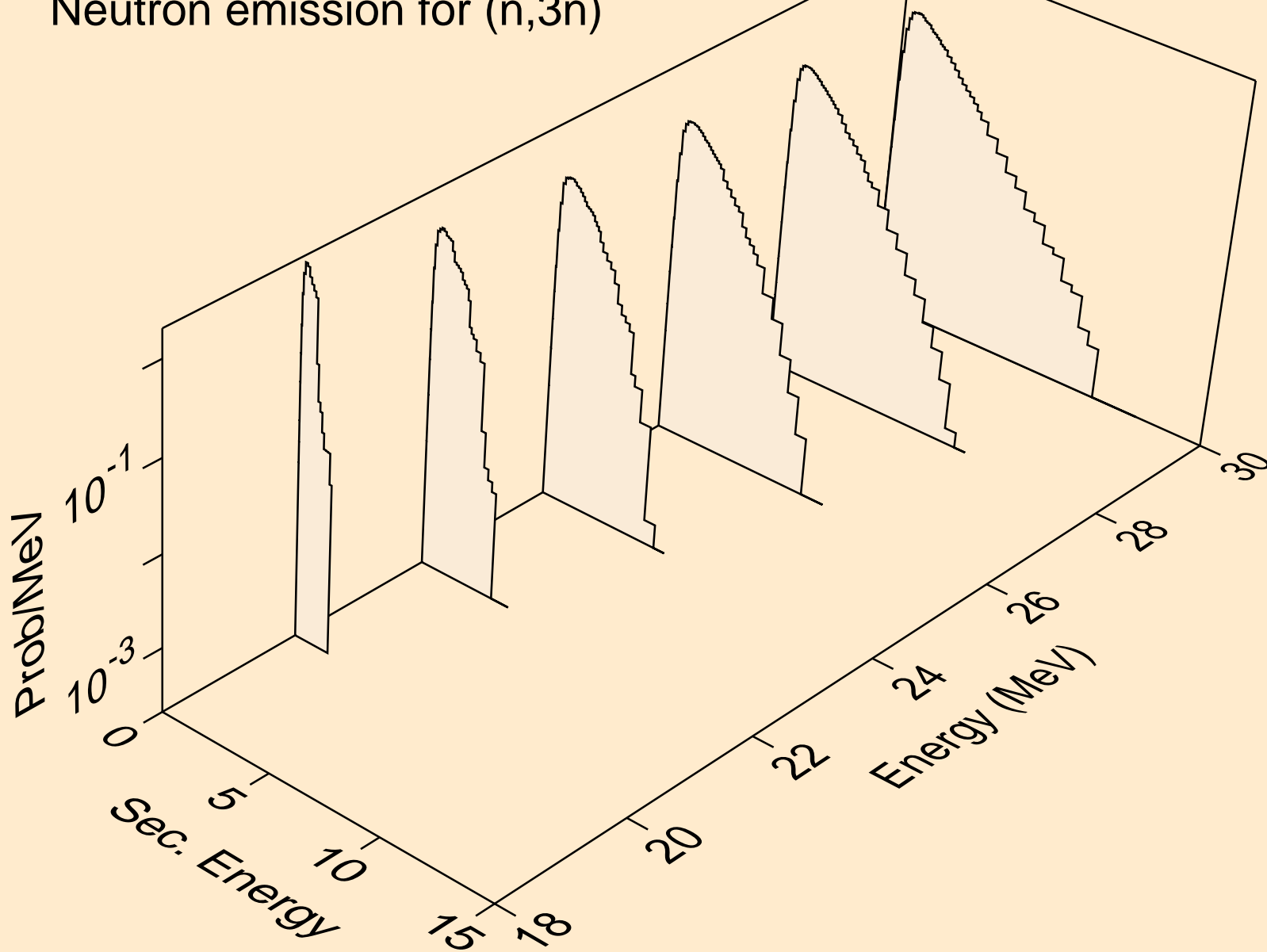

CE133M NEUTRON ACER TENDL-2019 LIBRARY; T=293.16K
Neutron emission for (n,n*)a

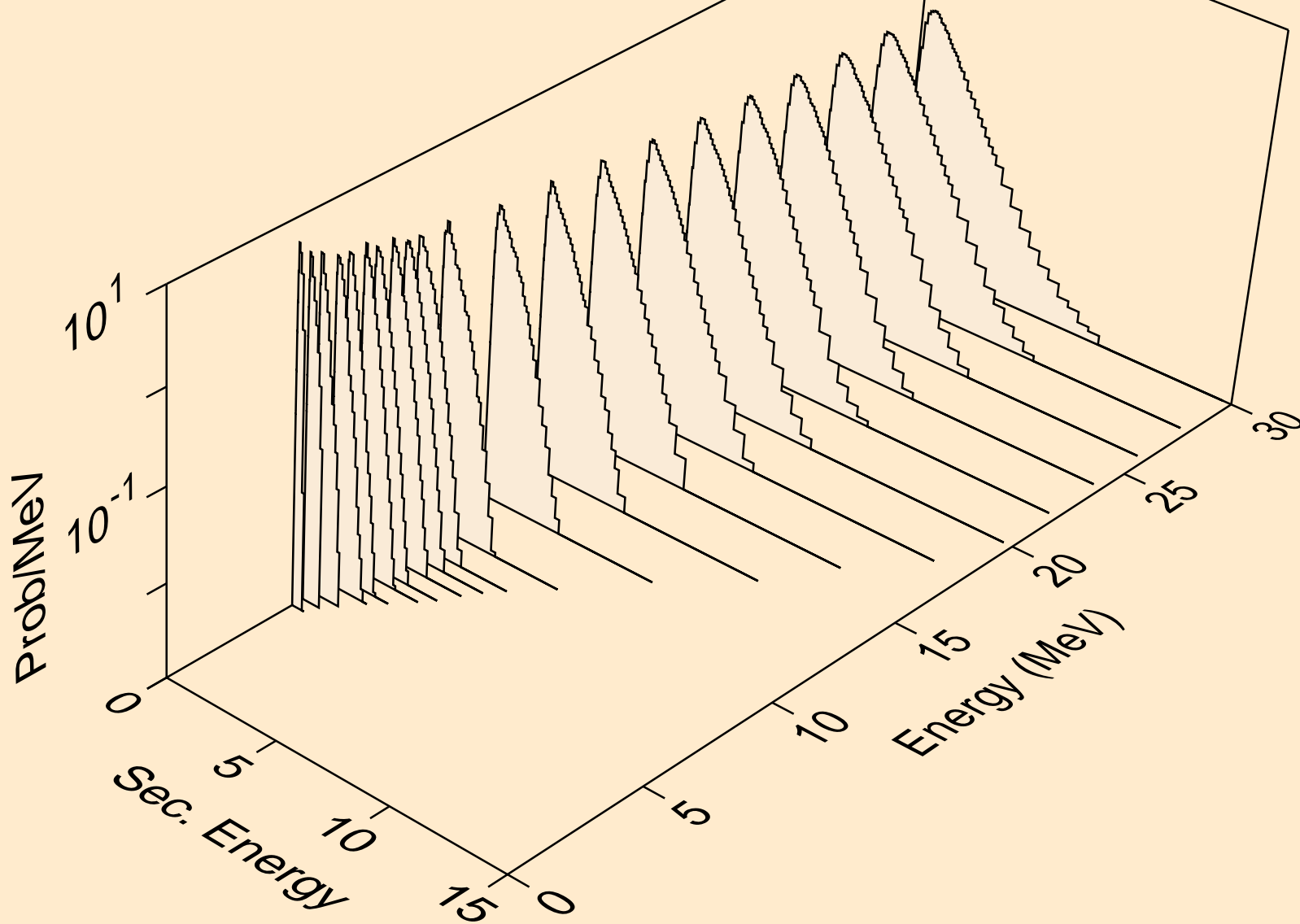

CE133M NEUTRON ACER TENDL-2019 LIBRARY; T=293.16K
Neutron emission for (n,2n)a

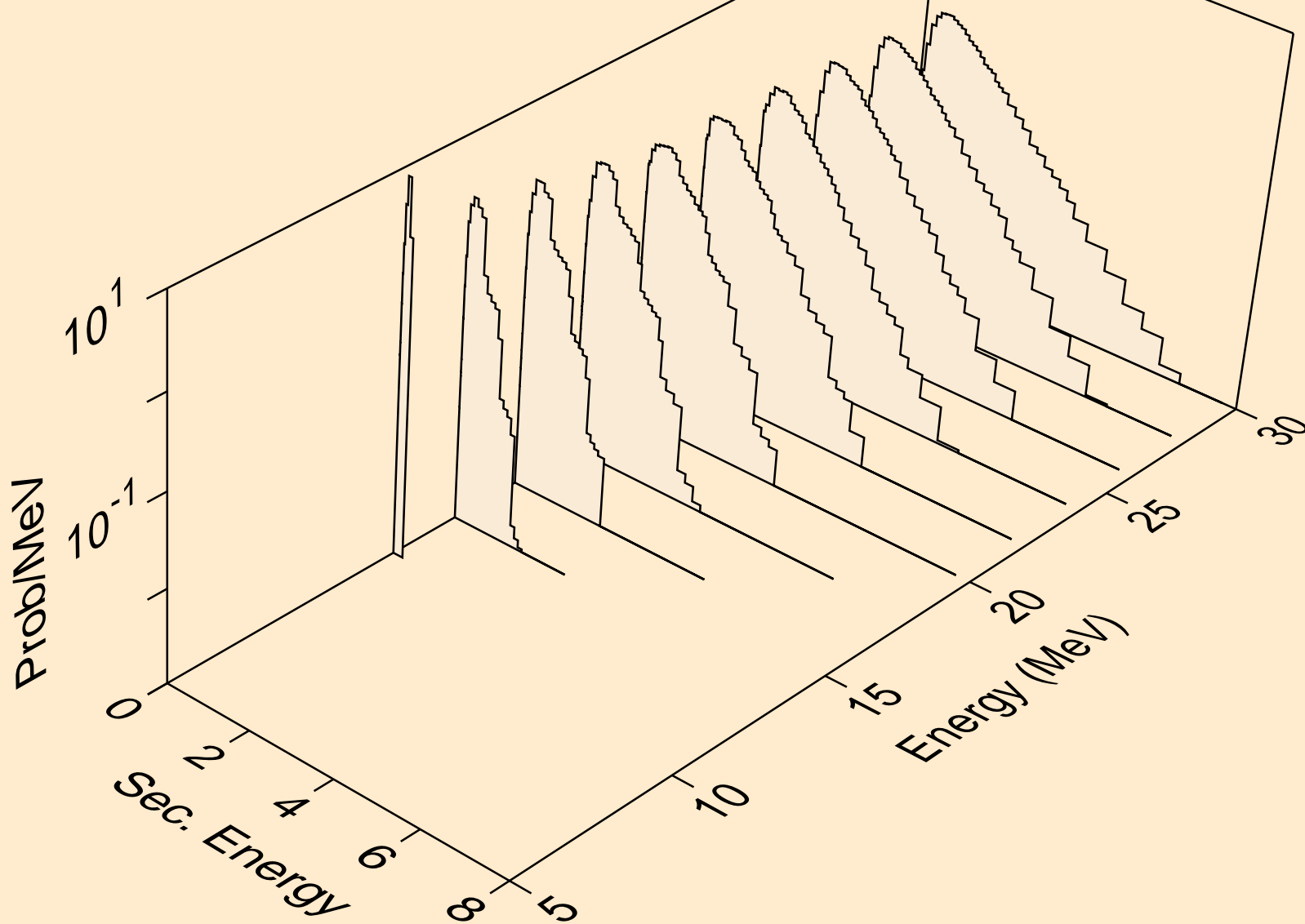

CE133M NEUTRON ACER TENDL-2019 LIBRARY; T=293.16K
Neutron emission for (n,3n)a

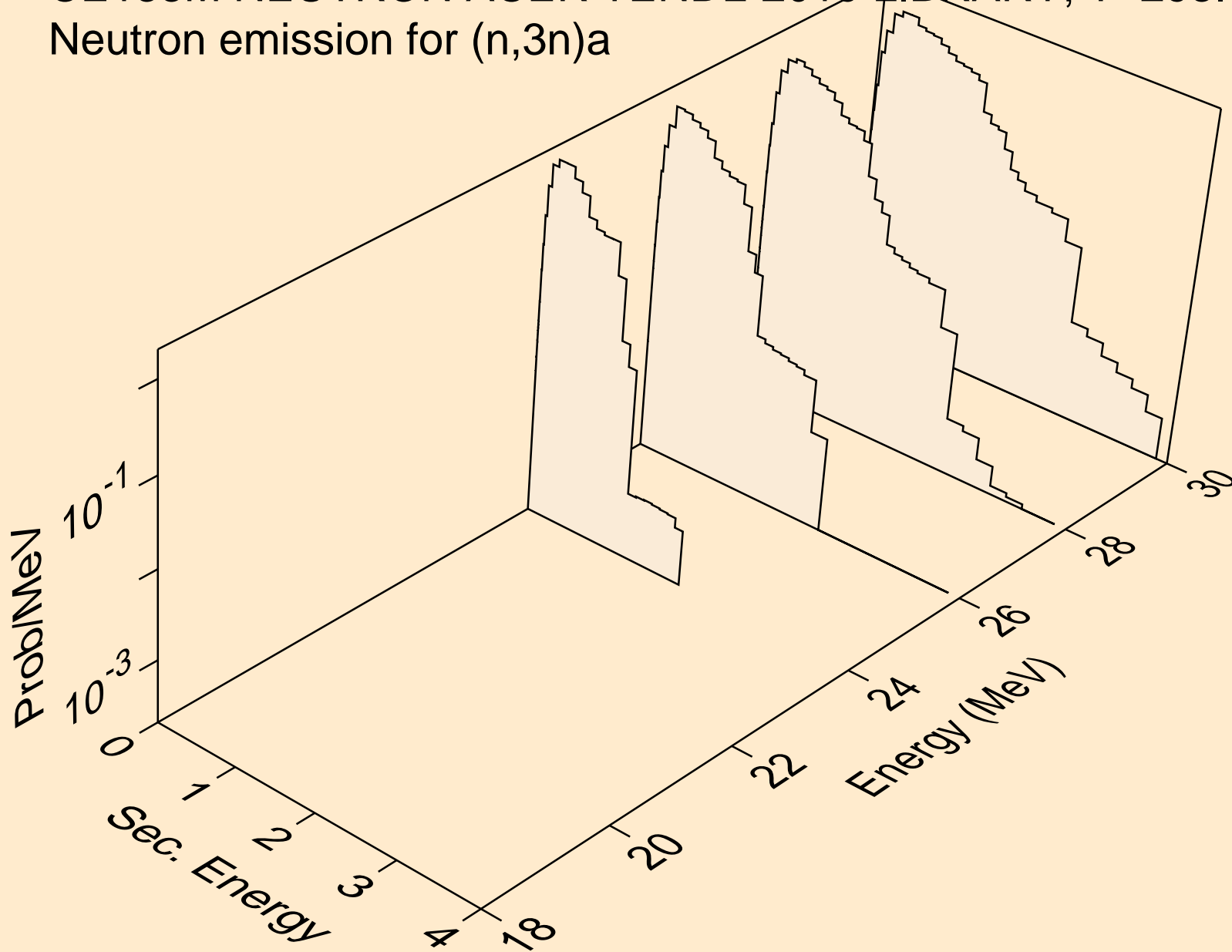

CE133M NEUTRON ACER TENDL-2019 LIBRARY; T=293.16K
Neutron emission for (n,n*)p

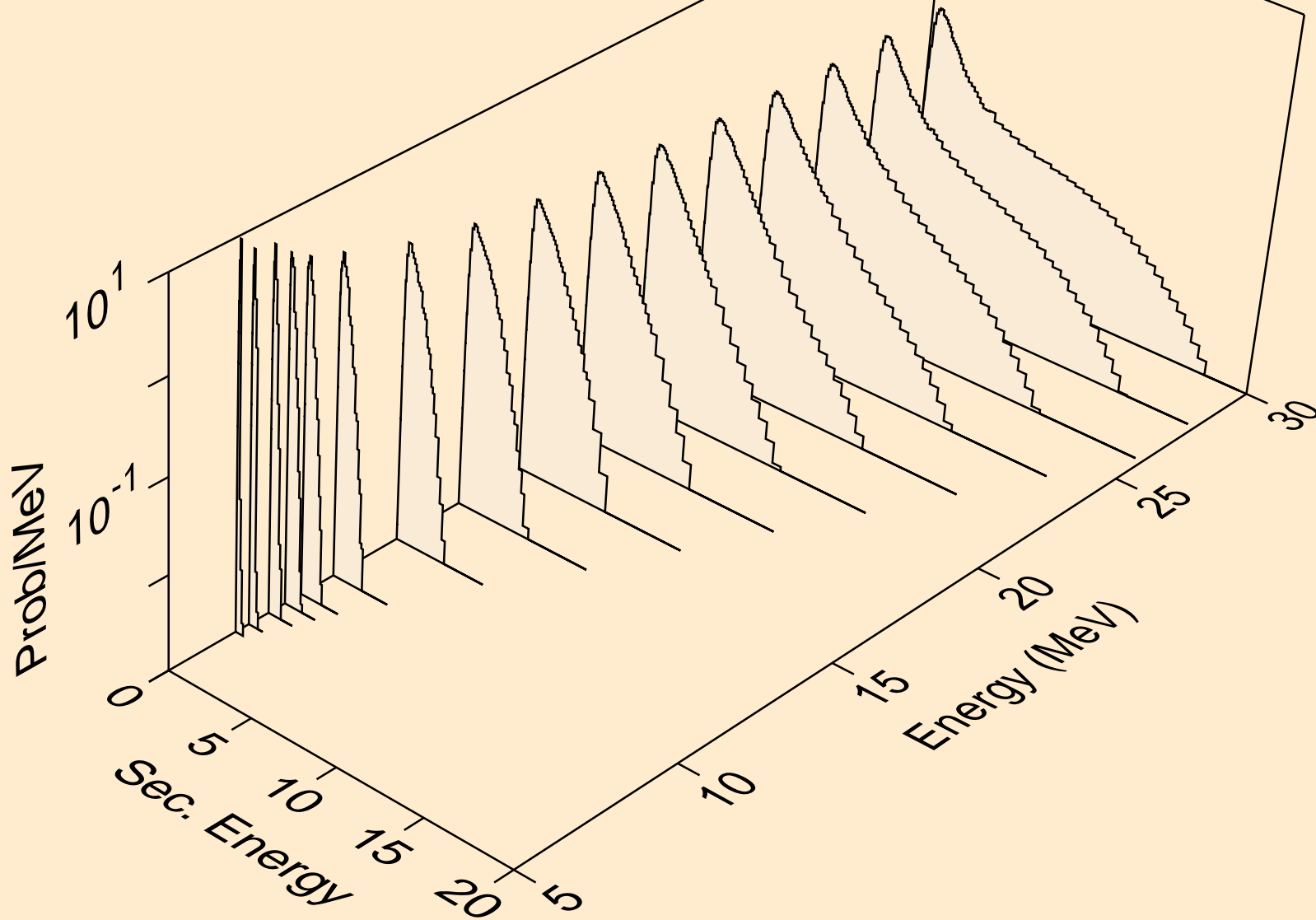

CE133M NEUTRON ACER TENDL-2019 LIBRARY; T=293.16K
Neutron emission for (n,n*)2a

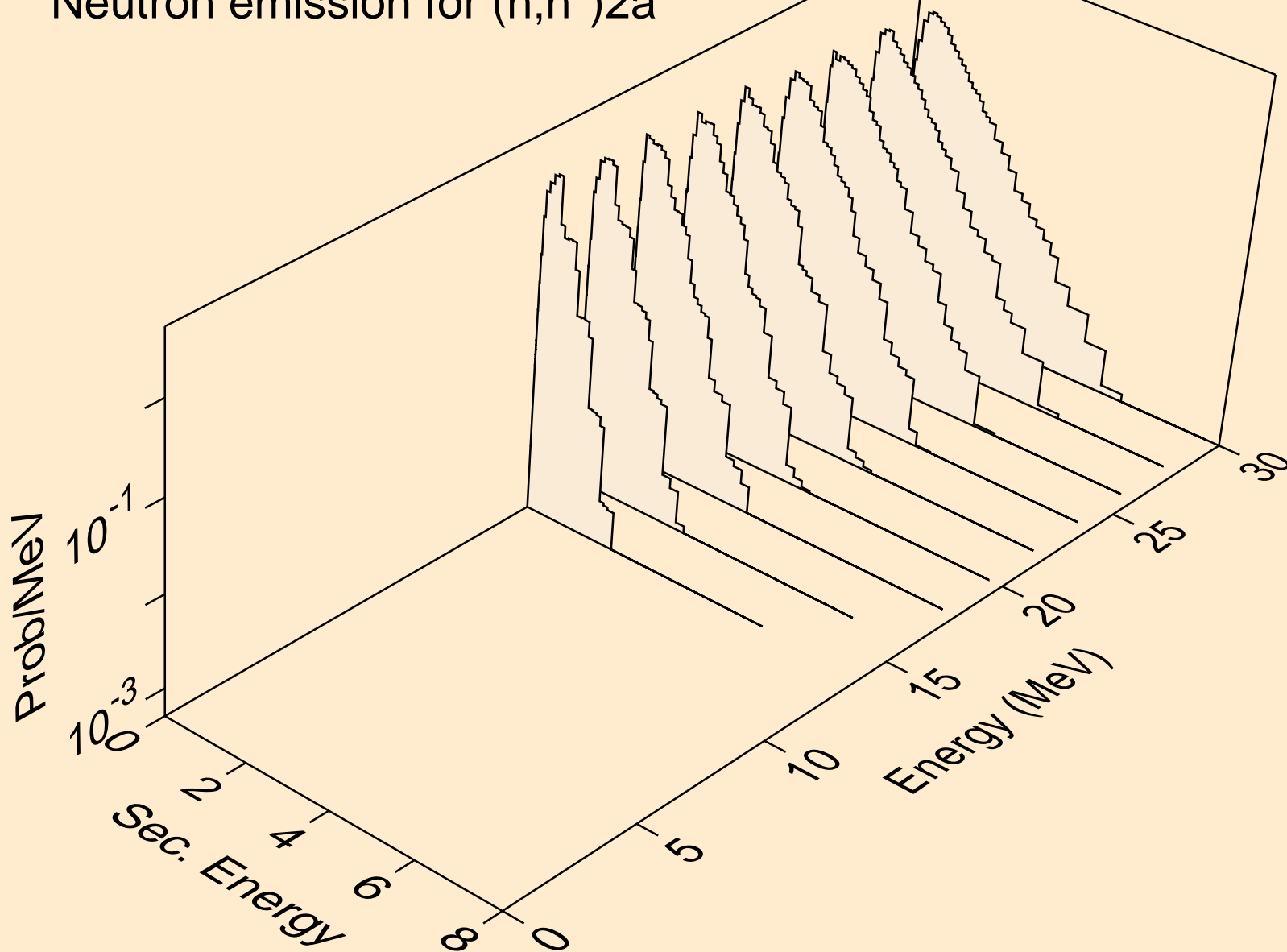

CE133M NEUTRON ACER TENDL-2019 LIBRARY; T=293.16K
Neutron emission for (n,2n)2a

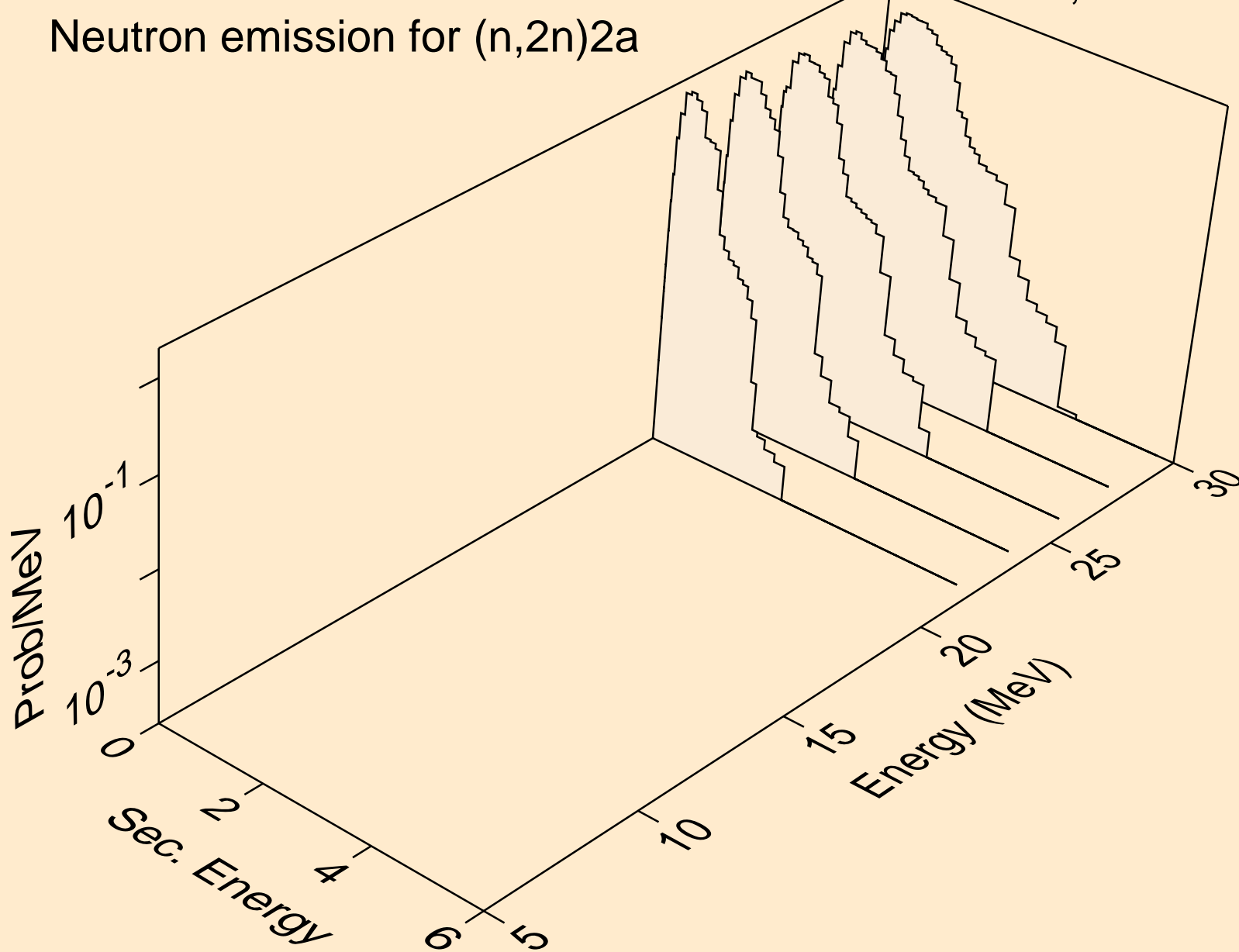

CE133M NEUTRON ACER TENDL-2019 LIBRARY; T=293.16K
Neutron emission for (n,n*)d

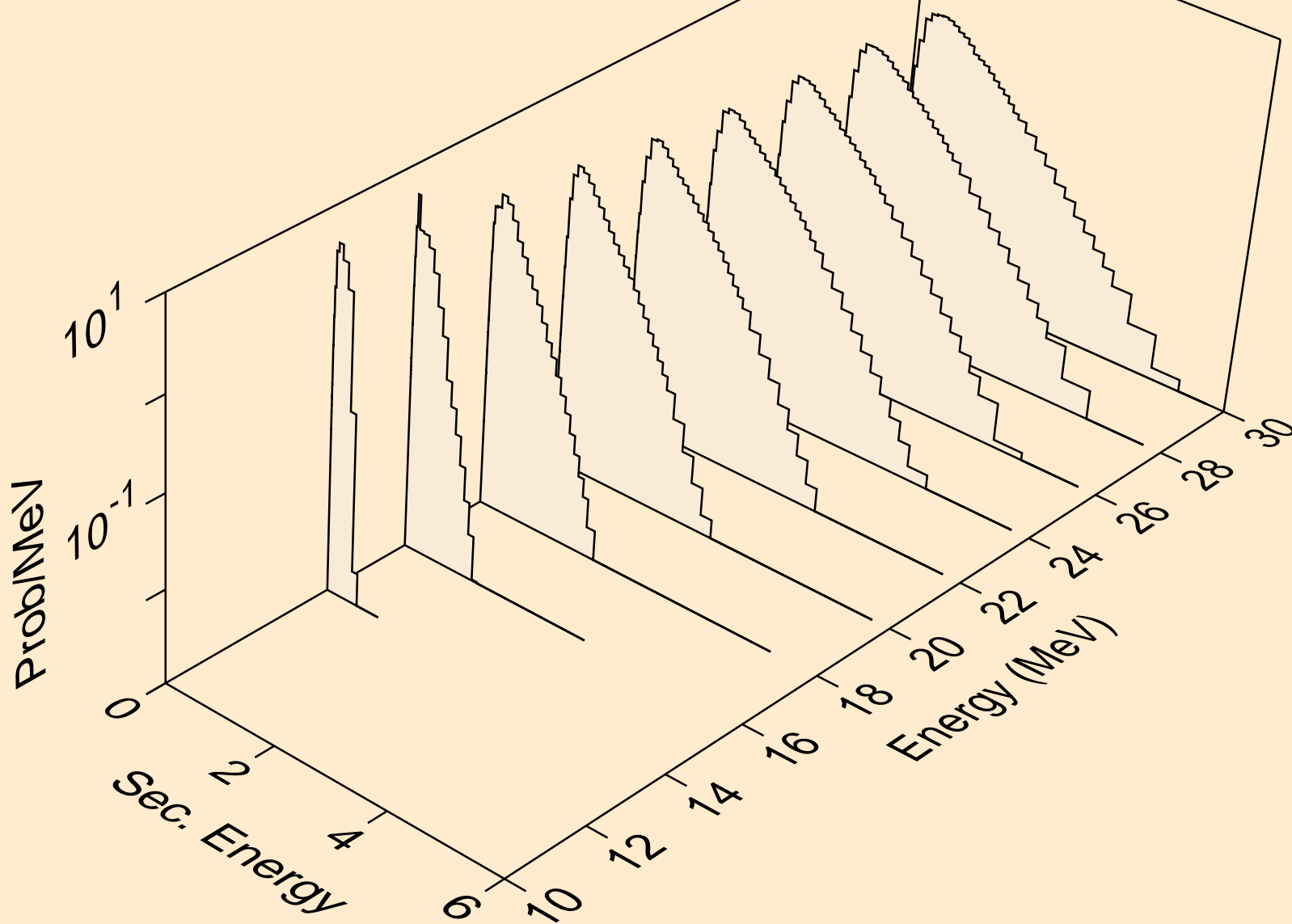

CE133M NEUTRON ACER TENDL-2019 LIBRARY; T=293.16K
Neutron emission for (n,n*)t

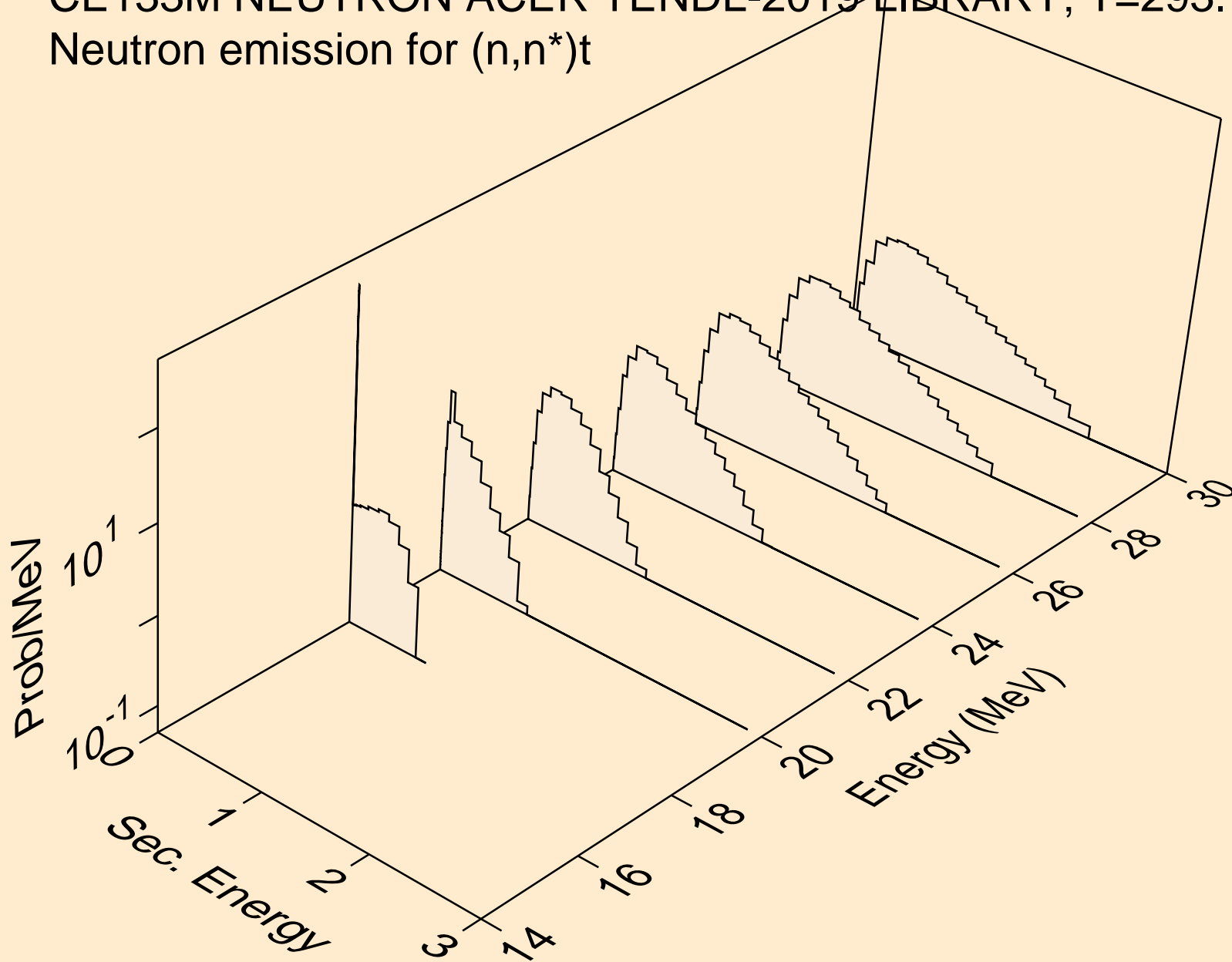

CE133M NEUTRON ACER TENDL-2019 LIBRARY; T=293.16K
Neutron emission for (n,n*)he3

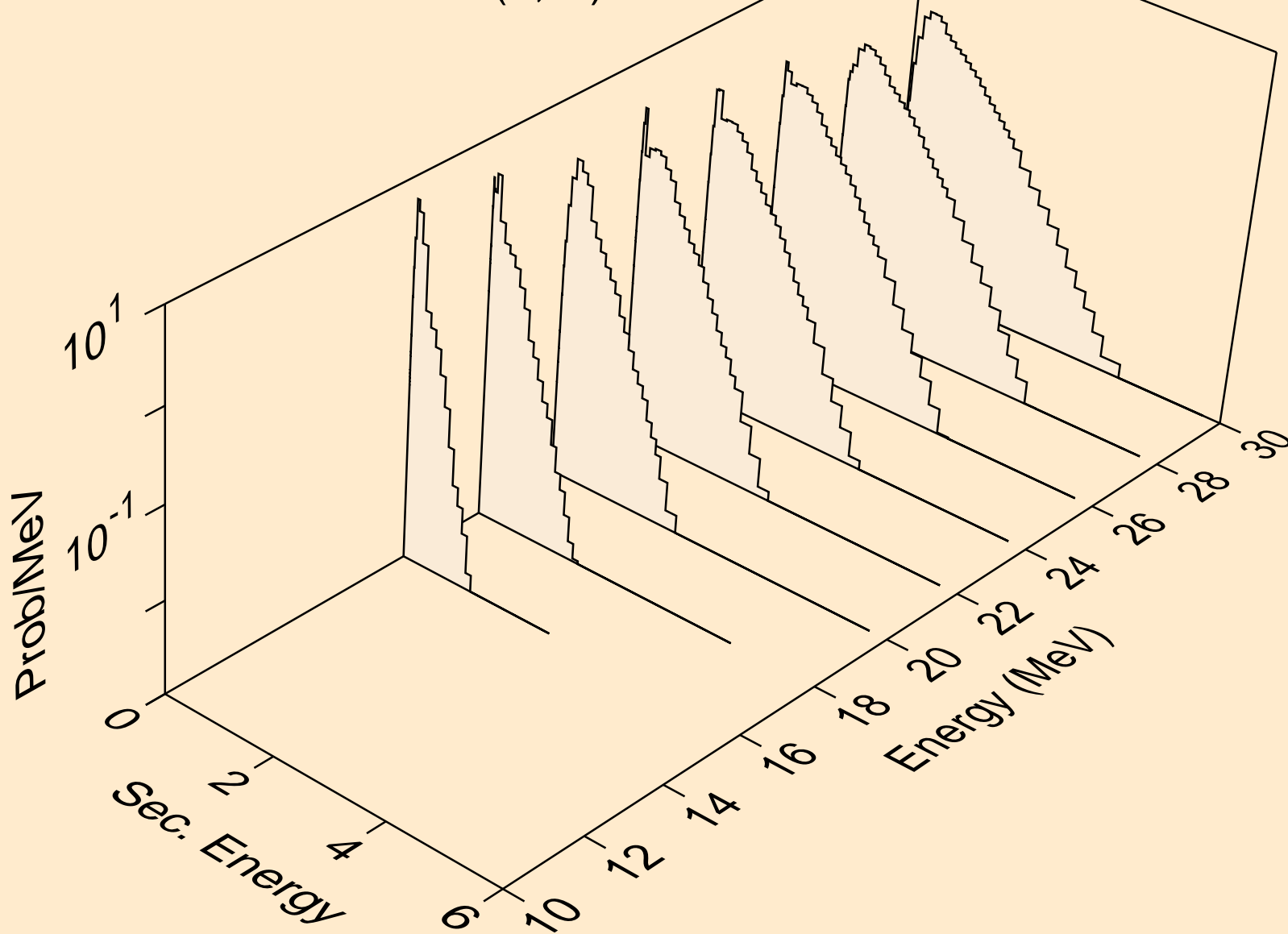

CE133M NEUTRON ACER TENDL-2019 LIBRARY; T=293.16K
Neutron emission for (n,4n)

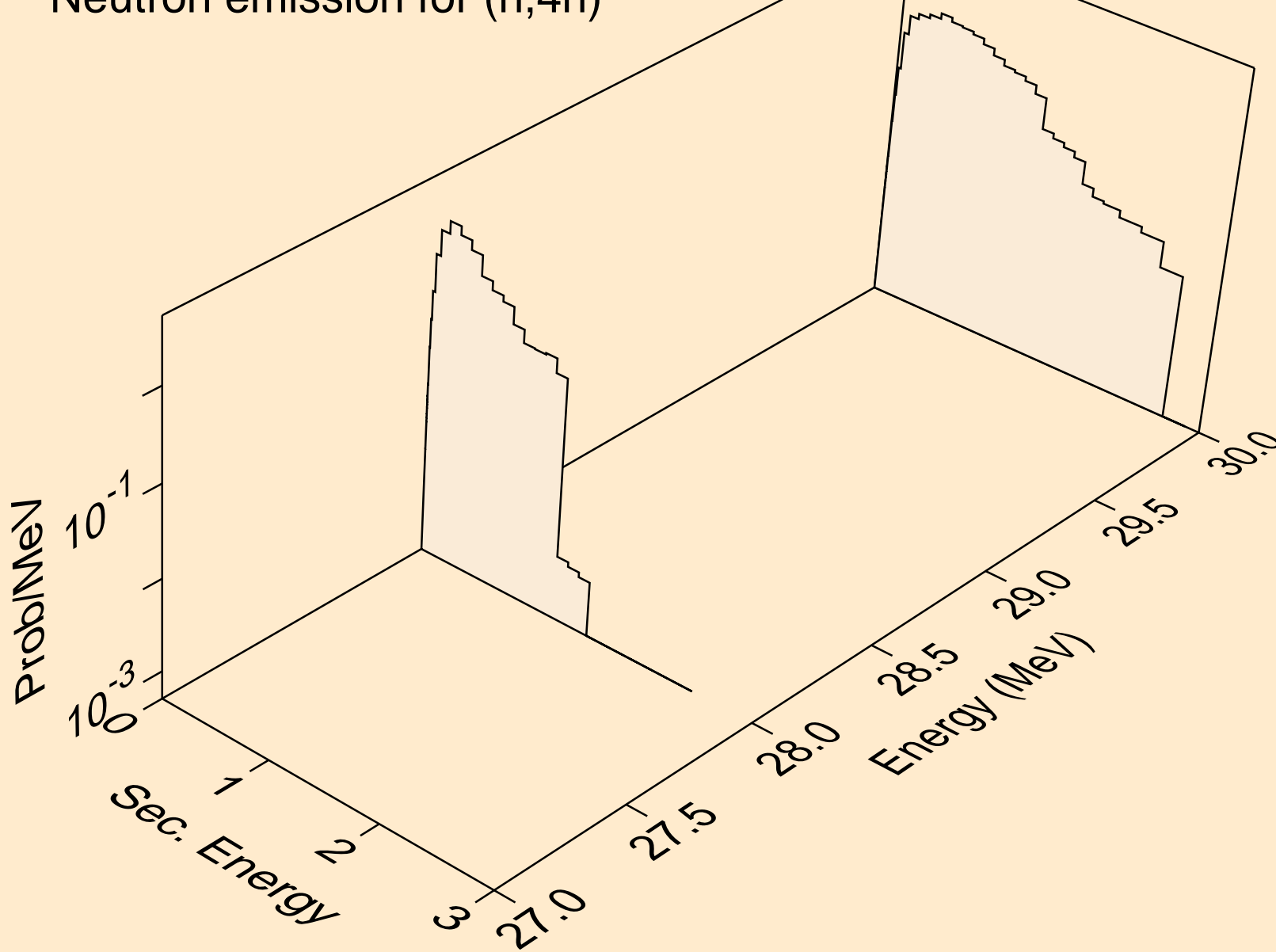

CE133M NEUTRON ACER TENDL-2019 LIBRARY; T=293.16K
Neutron emission for (n,2np)

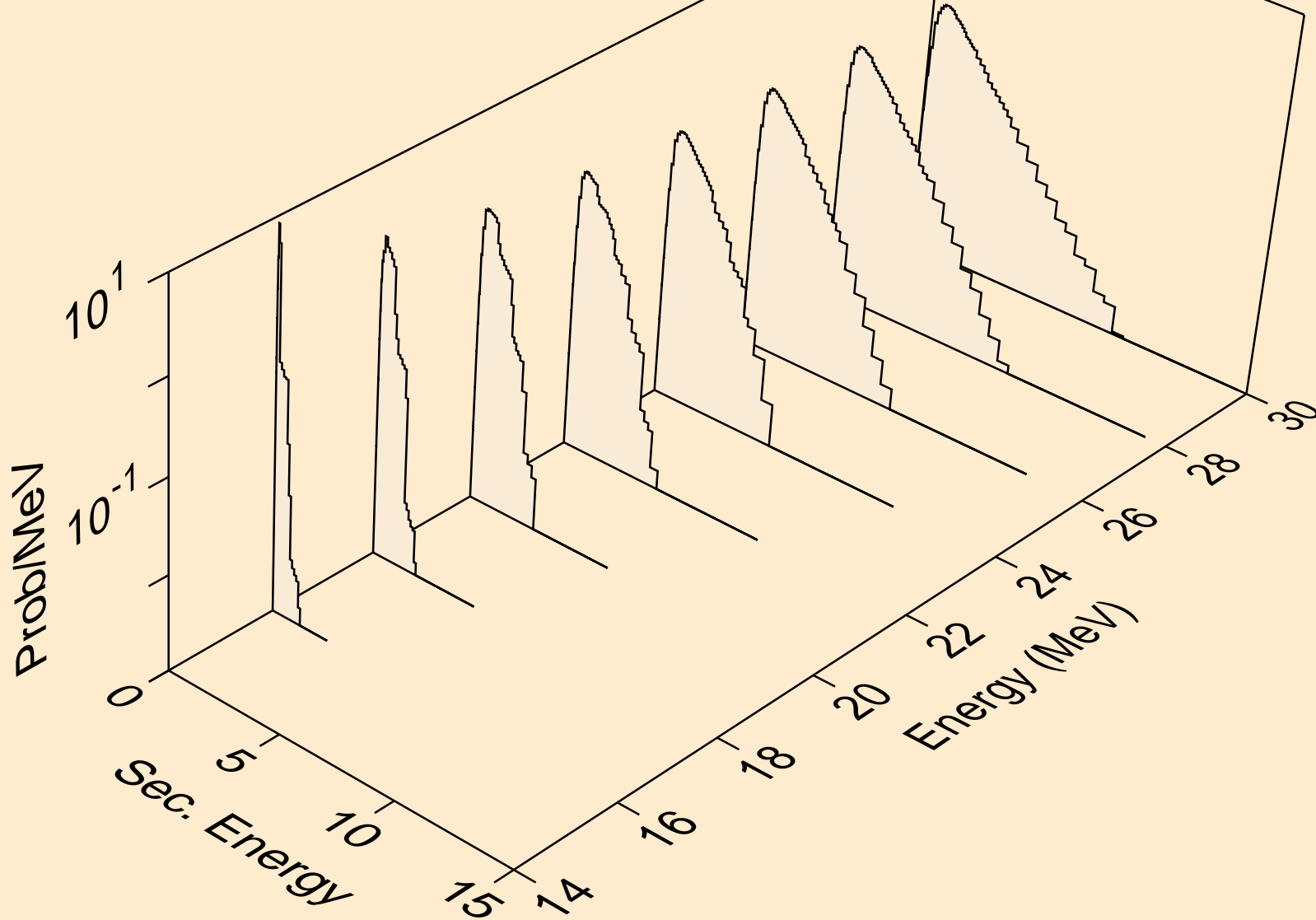

CE133M NEUTRON ACER TENDL-2019 LIBRARY; T=293.16K
Neutron emission for (n,3np)

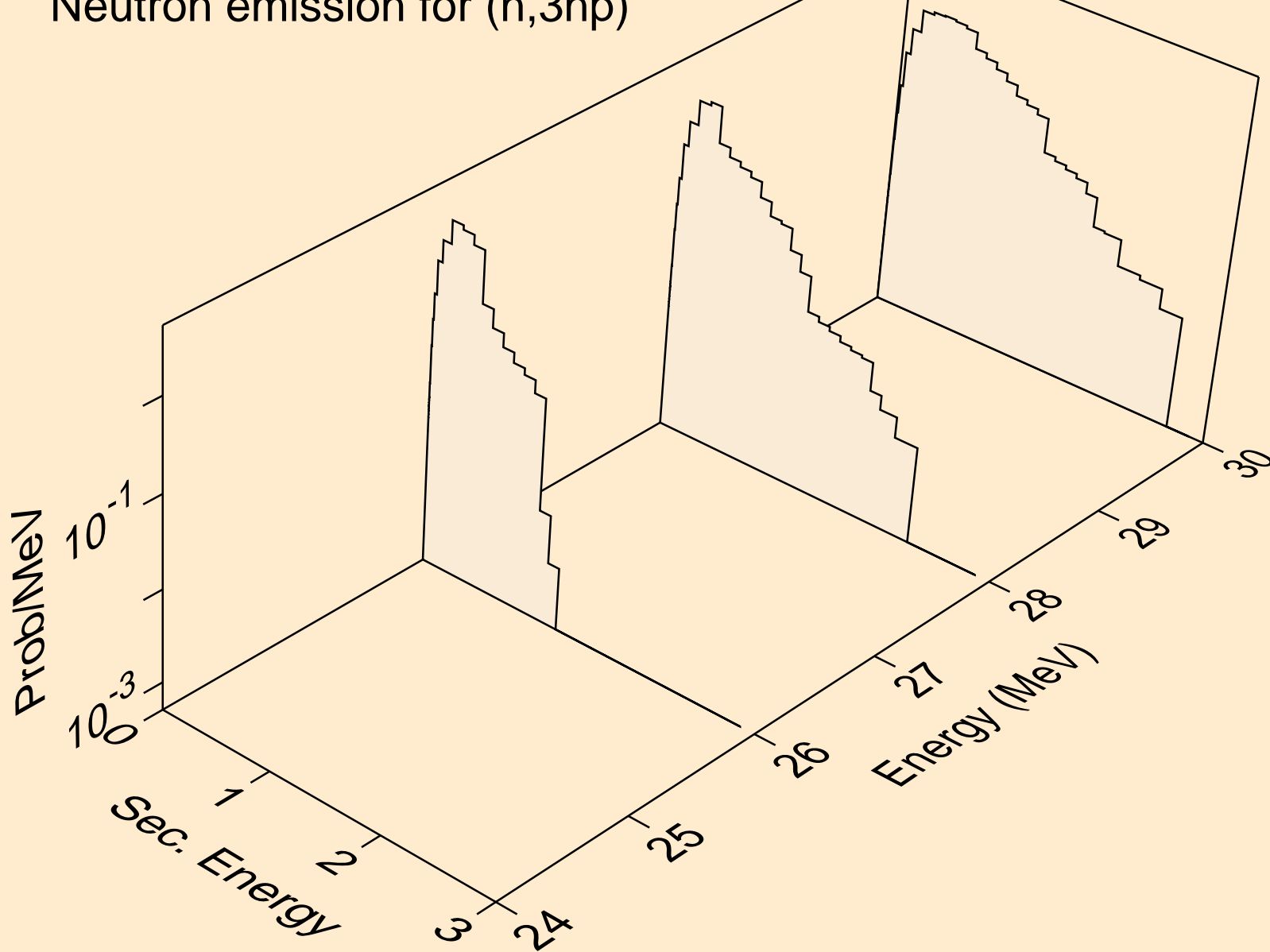

CE133M NEUTRON ACER TENDL-2019 LIBRARY; T=293.16K
Neutron emission for (n,2np)

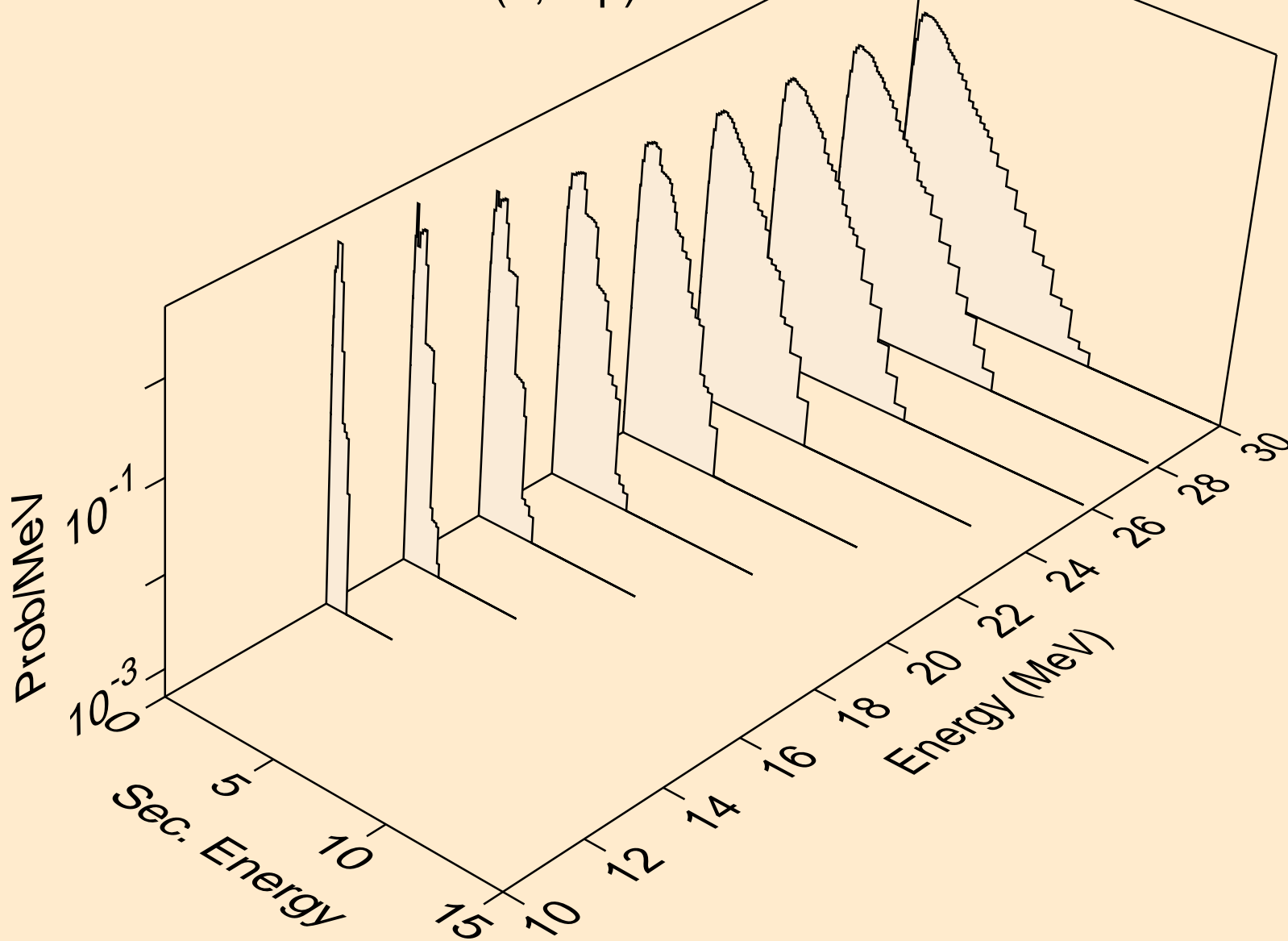

CE133M NEUTRON ACER TENDL-2019 LIBRARY; T=293.16K
Neutron emission for (n,npa)

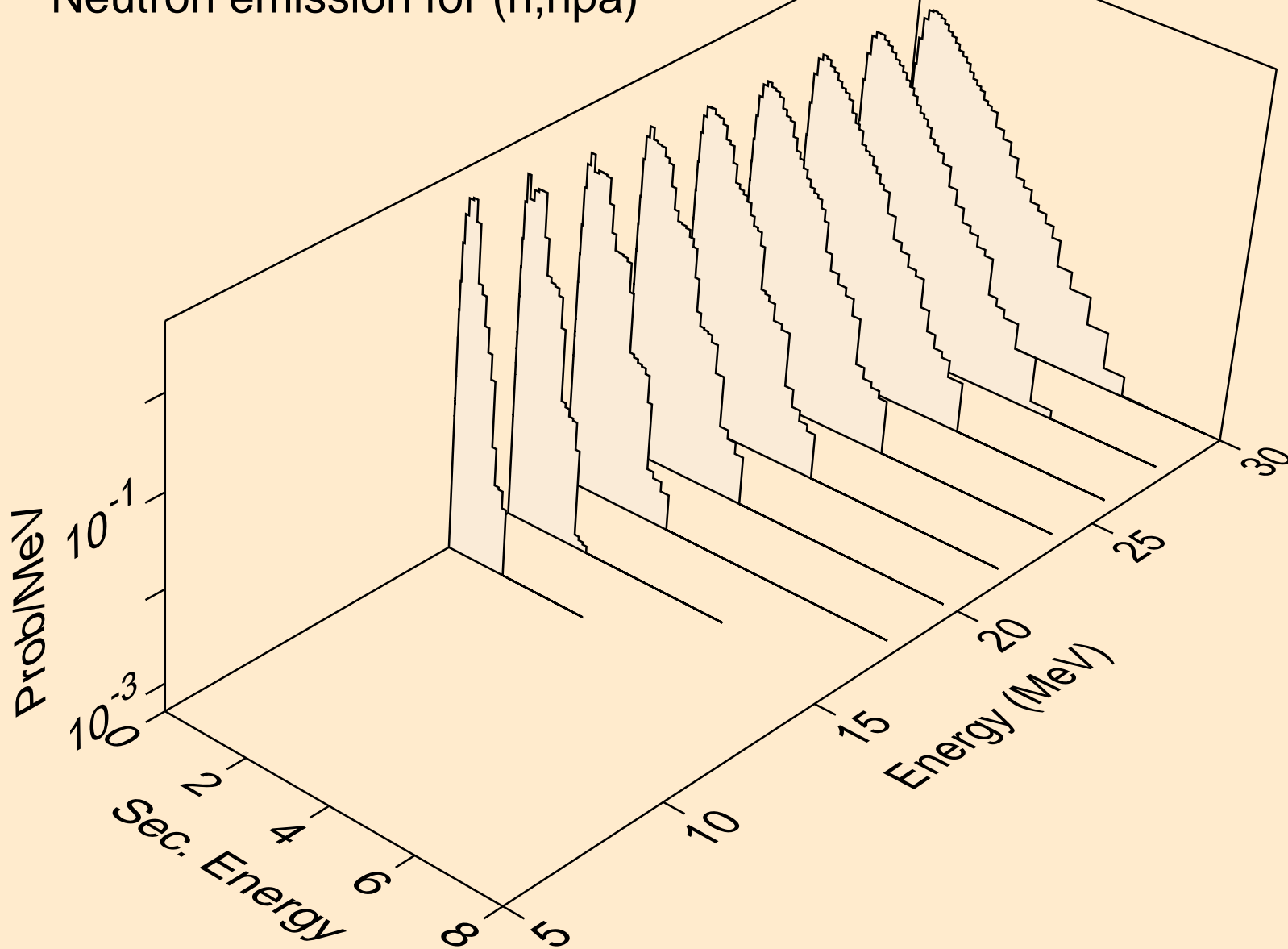

CE133M NEUTRON ACER TENDL-2019 LIBRARY; T=293.16K
Neutron emission for (n,n*c)

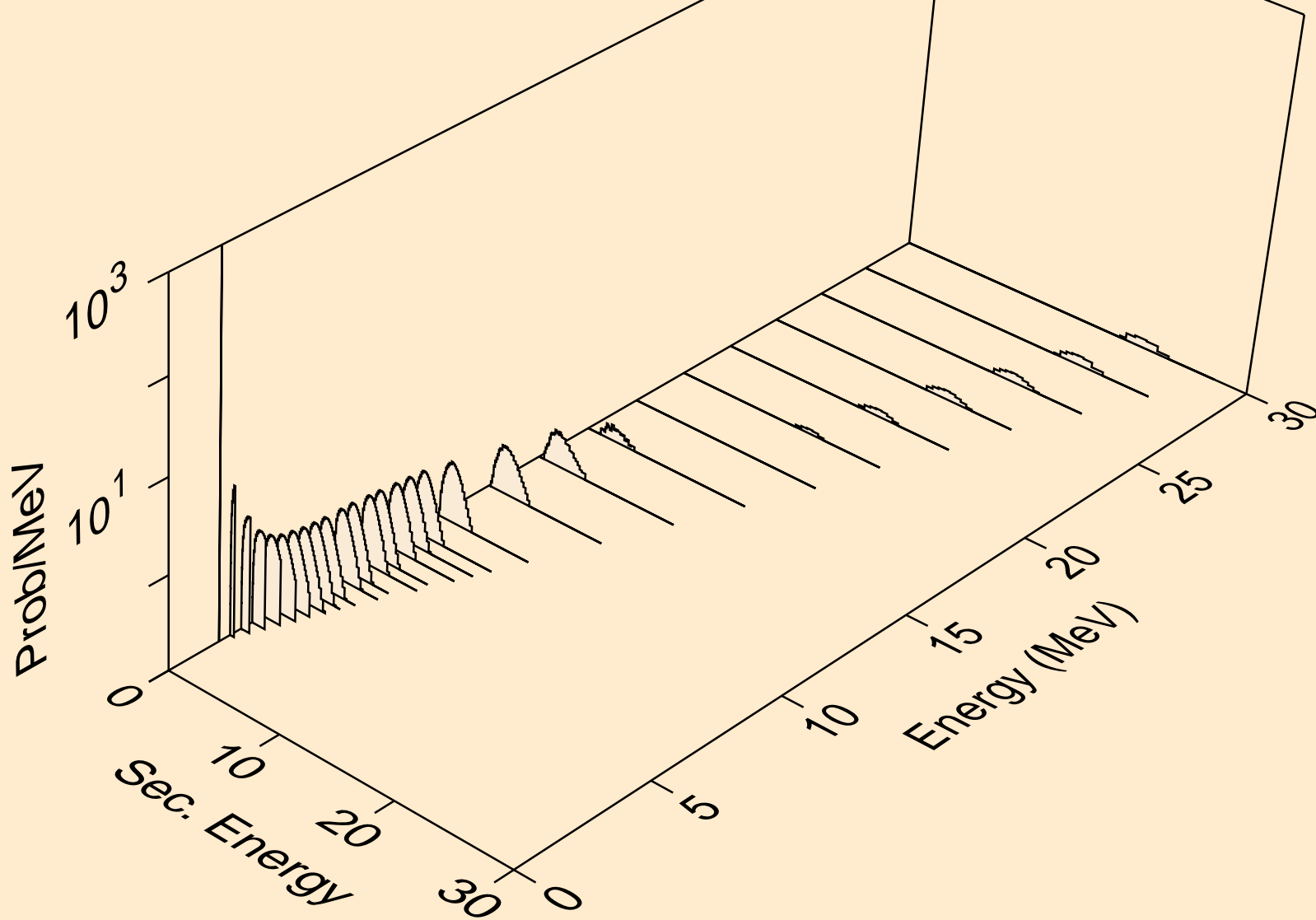

CE133M NEUTRON ACER TENDL-2019 LIBRARY; T=293.16K
Photon emission for (n,x)

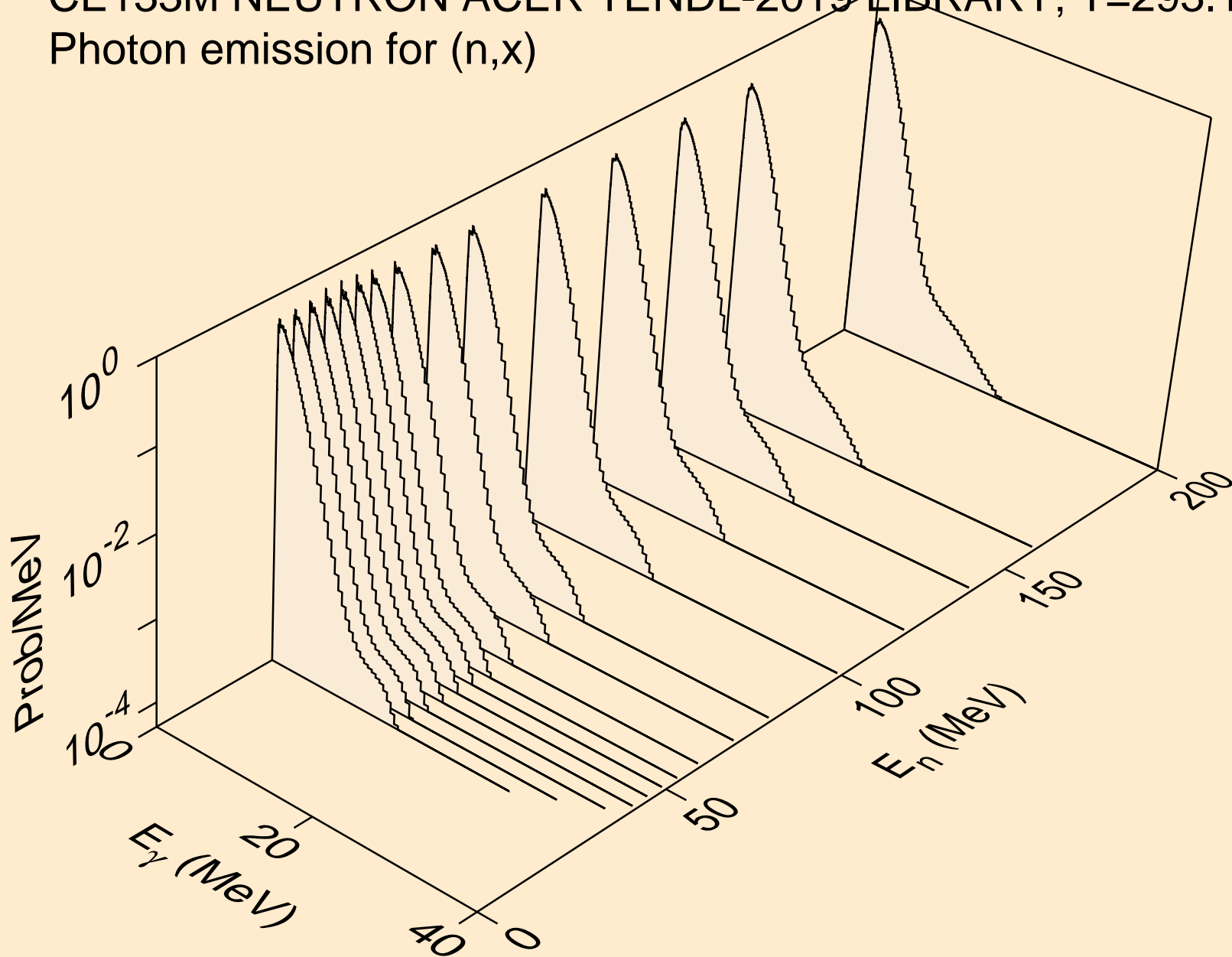

CE133M NEUTRON ACER TENDL-2019 LIBRARY; T=293.16K
Photon emission for (n,2nd)

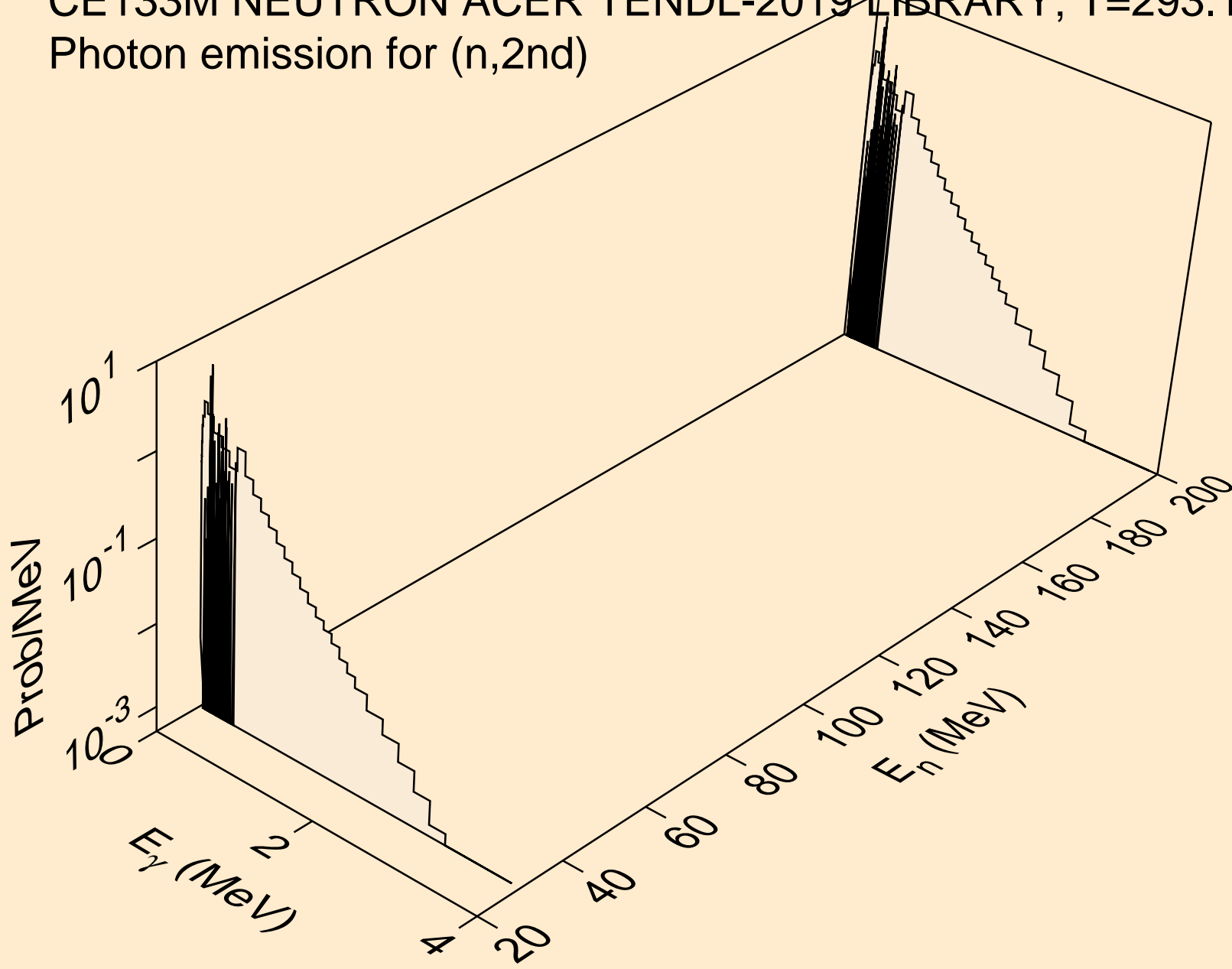

CE133M NEUTRON ACER TENDL-2019 LIBRARY; T=293.16K
Photon emission for (n,2n)

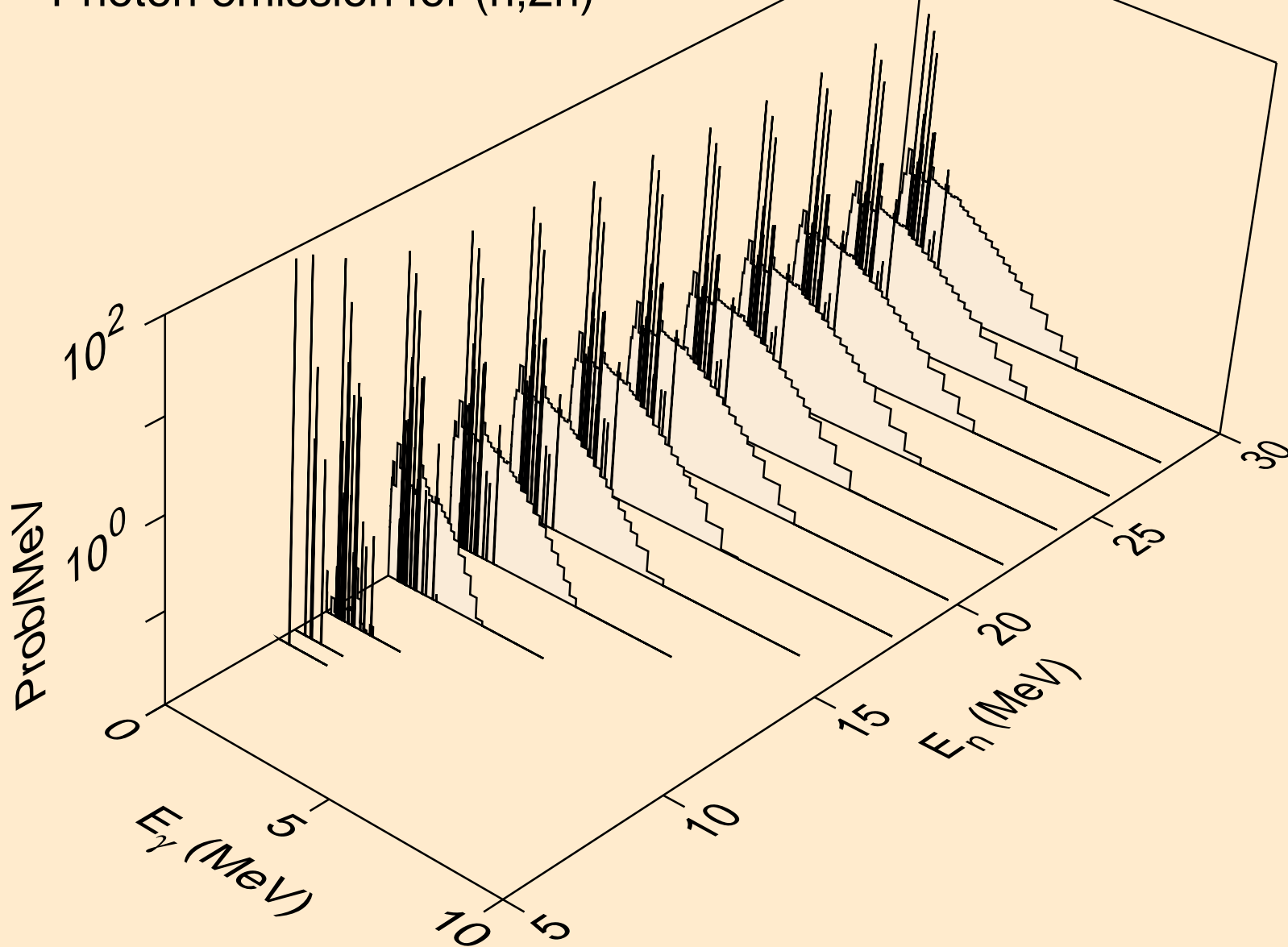

CE133M NEUTRON ACER TENDL-2019 LIBRARY; T=293.16K
Photon emission for (n,3n)

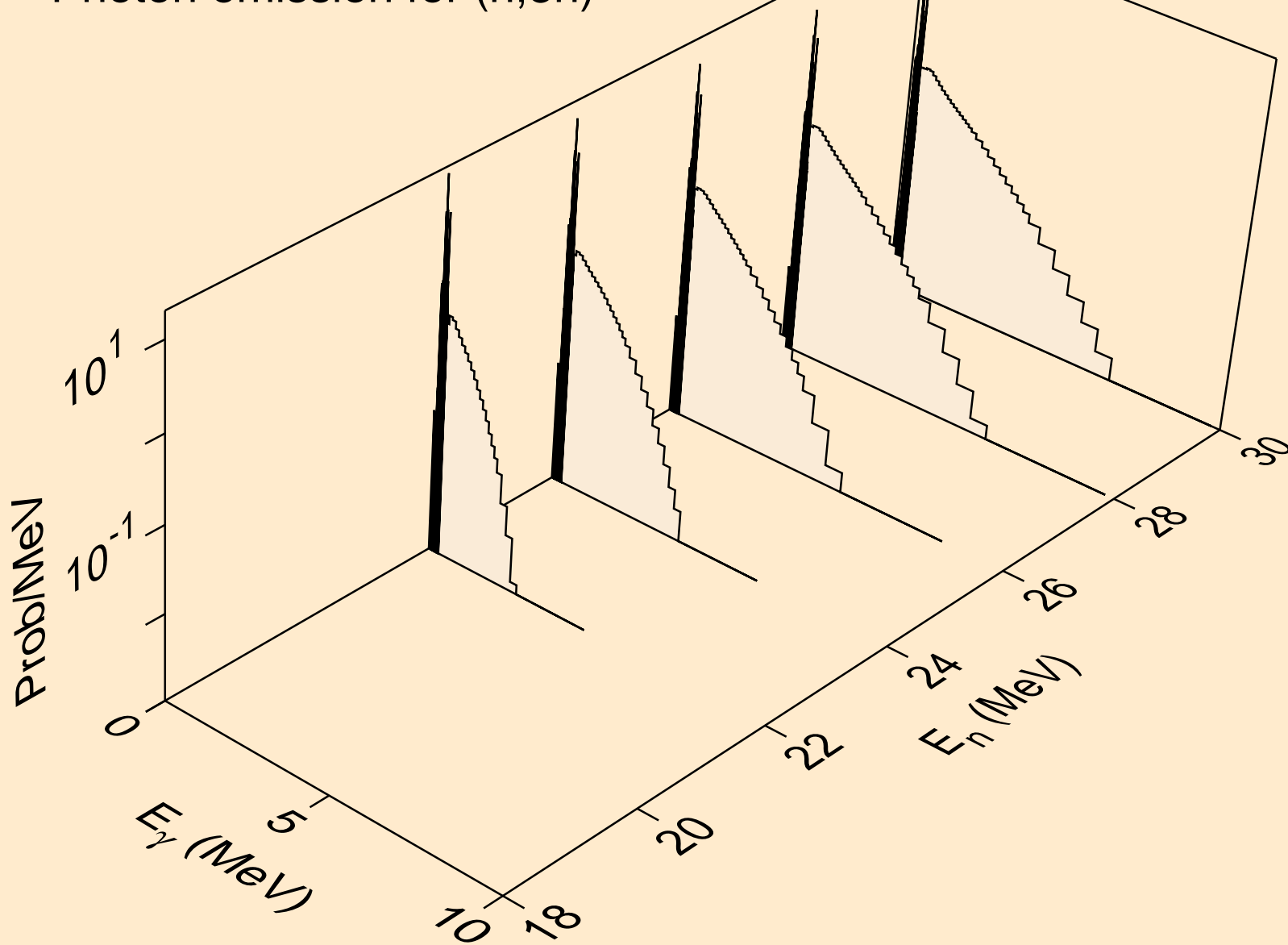

CE133M NEUTRON ACER TENDL-2019 LIBRARY; T=293.16K
Photon emission for (n,n*)a

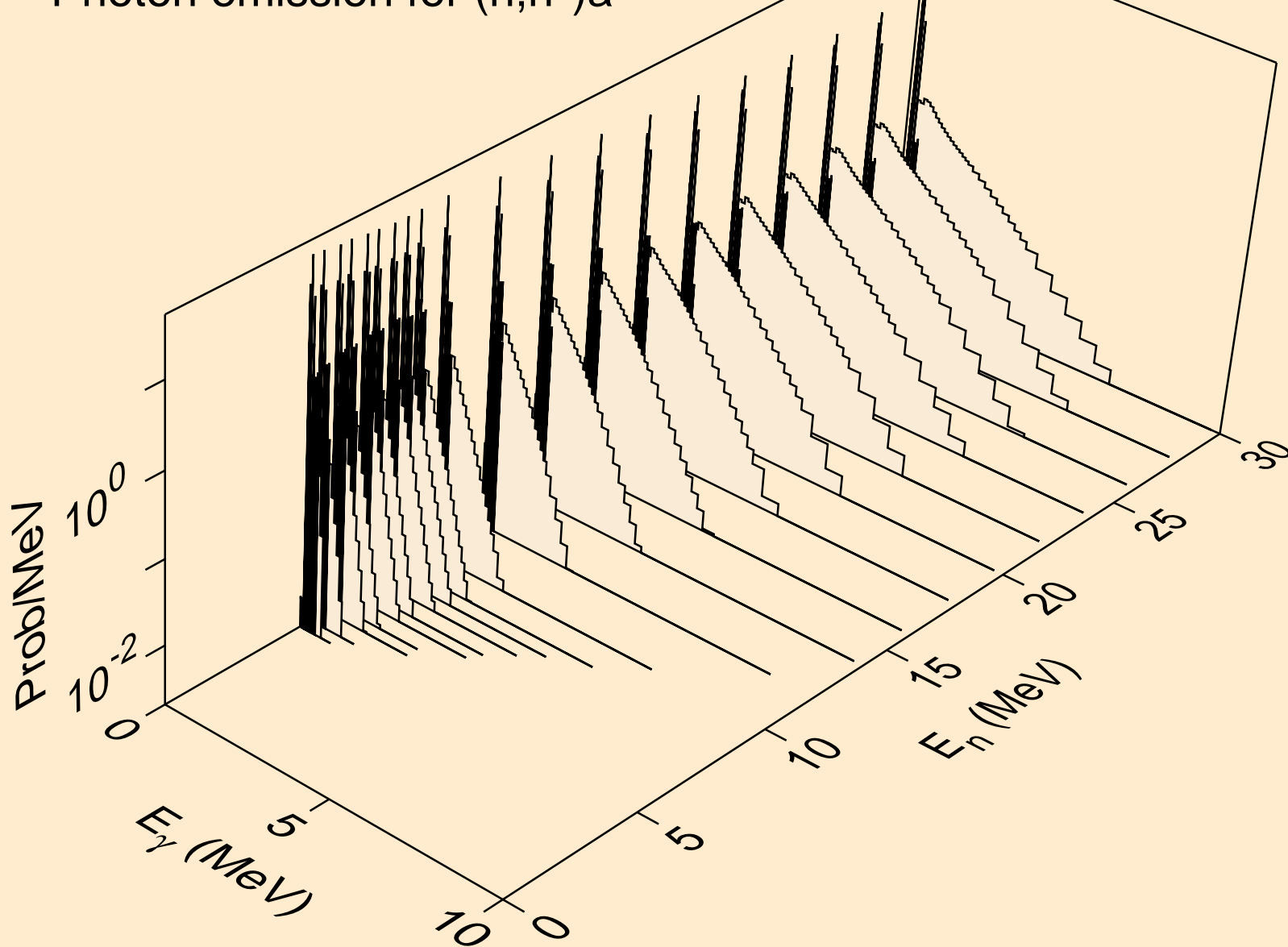

CE133M NEUTRON ACER TENDL-2019 LIBRARY; T=293.16K
Photon emission for (n,2n)a

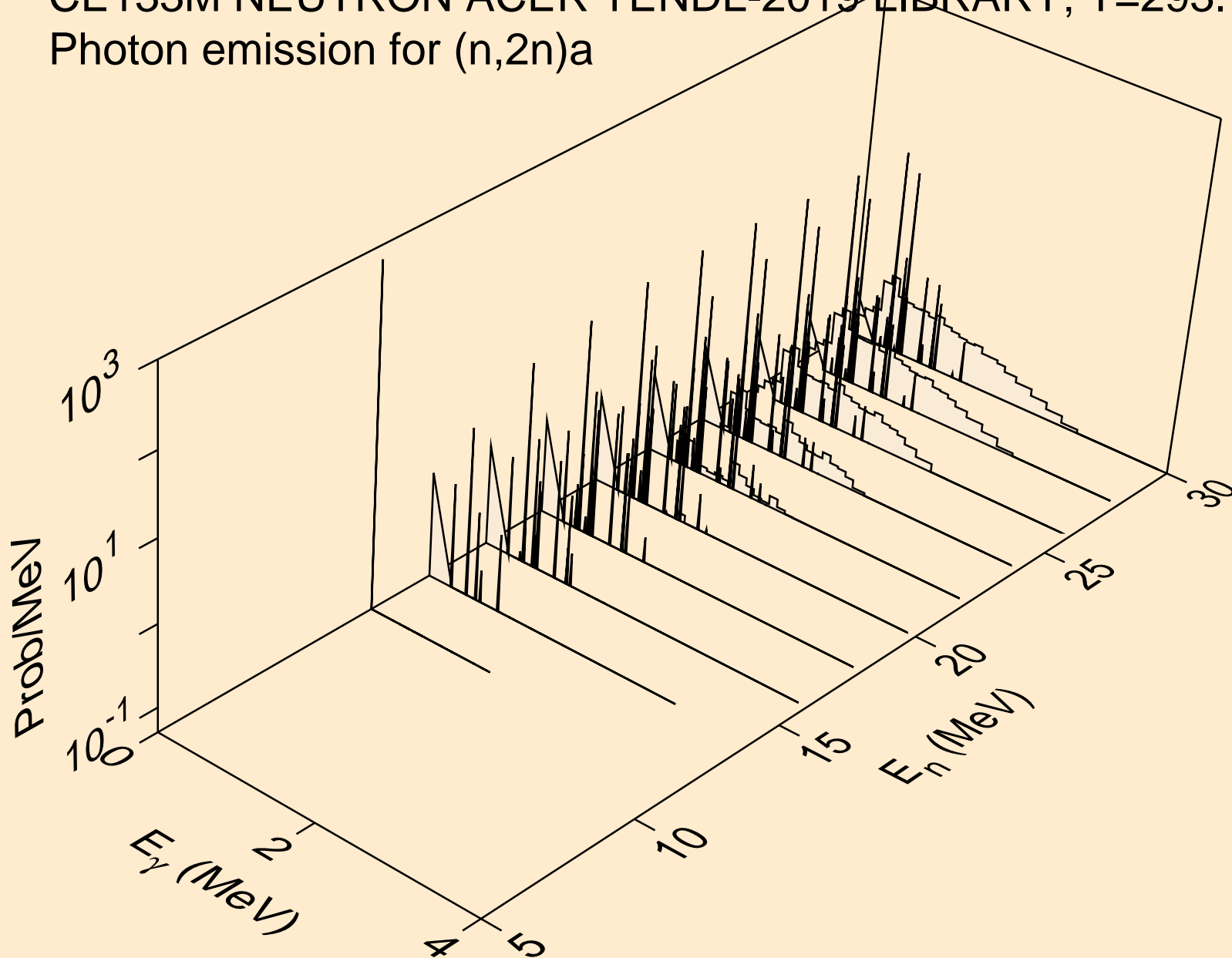

CE133M NEUTRON ACER TENDL-2019 LIBRARY; T=293.16K
Photon emission for (n,3n)a

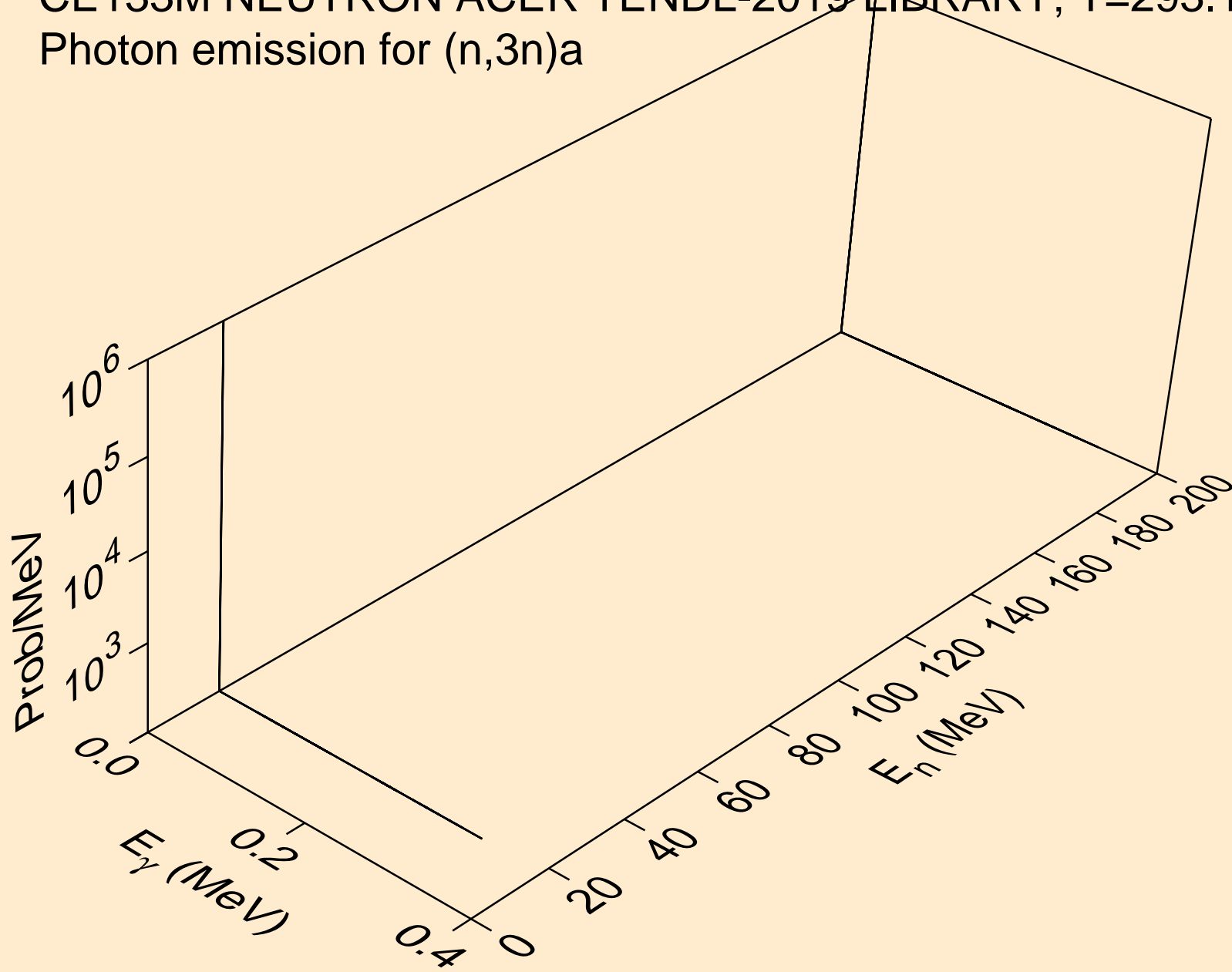

CE133M NEUTRON ACER TENDL-2019 LIBRARY; T=293.16K
Photon emission for (n,n*)p

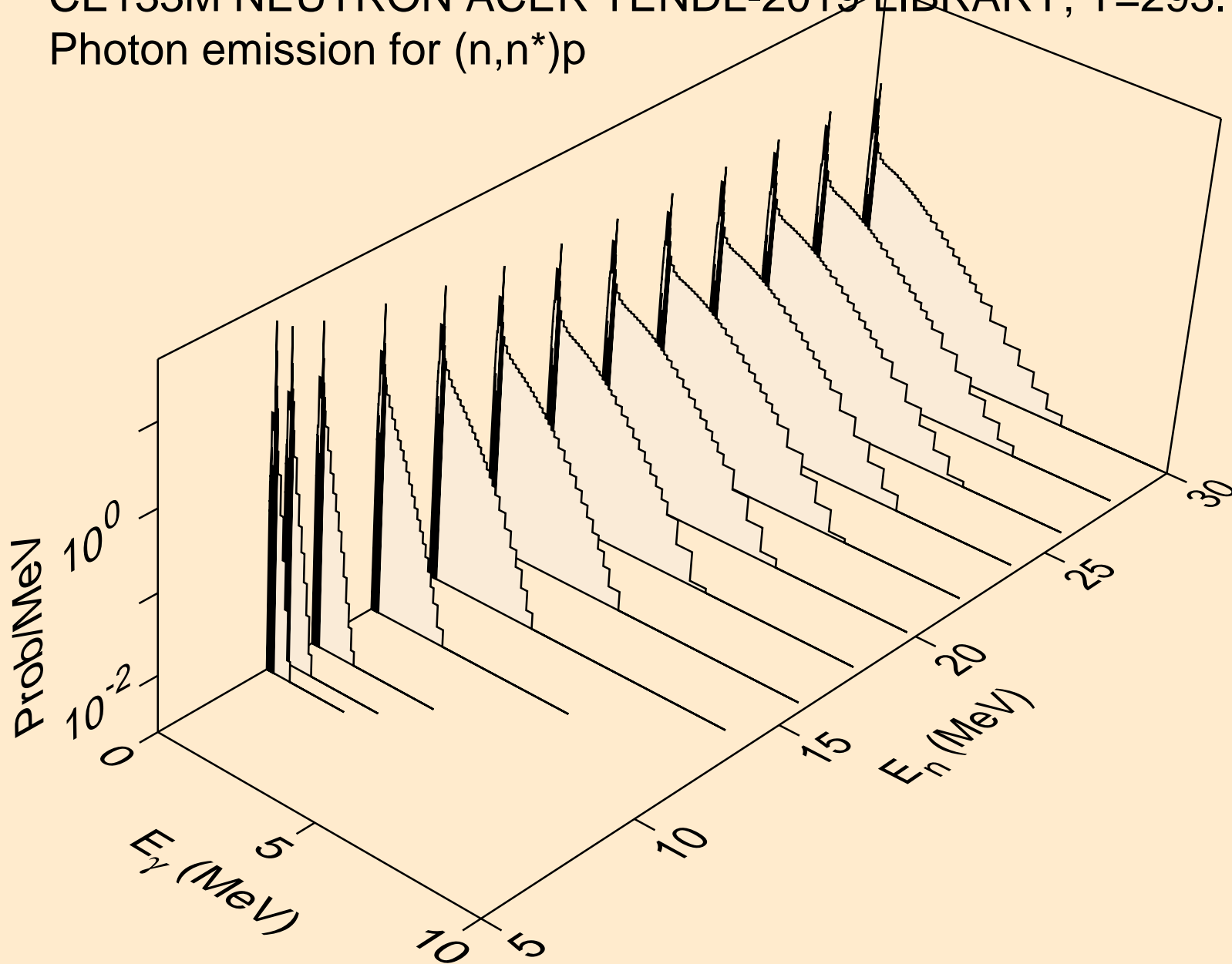

CE133M NEUTRON ACER TENDL-2019 LIBRARY; T=293.16K
Photon emission for (n,n*)2a

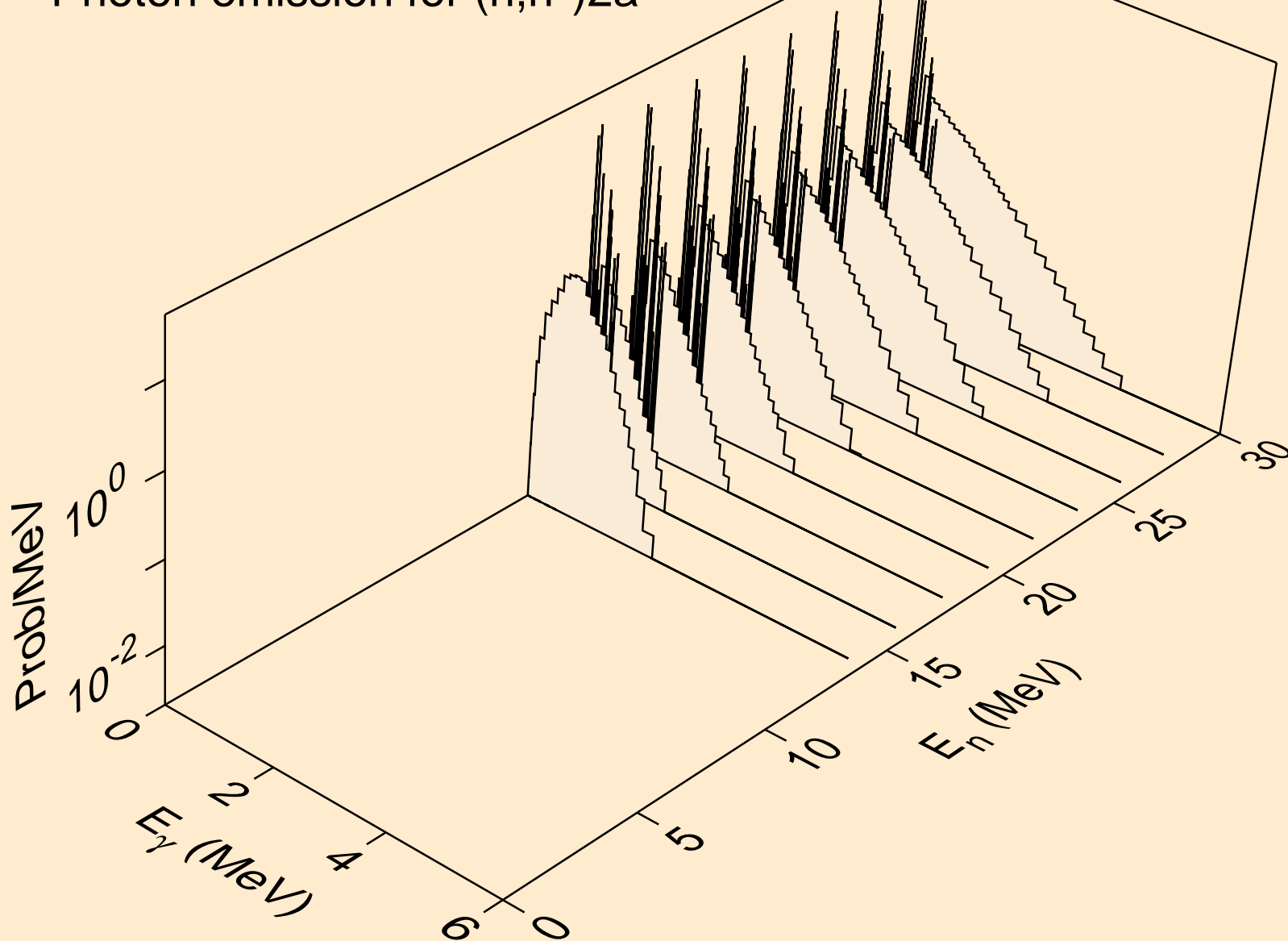

CE133M NEUTRON ACER TENDL-2019 LIBRARY; T=293.16K
Photon emission for (n,2n)2a

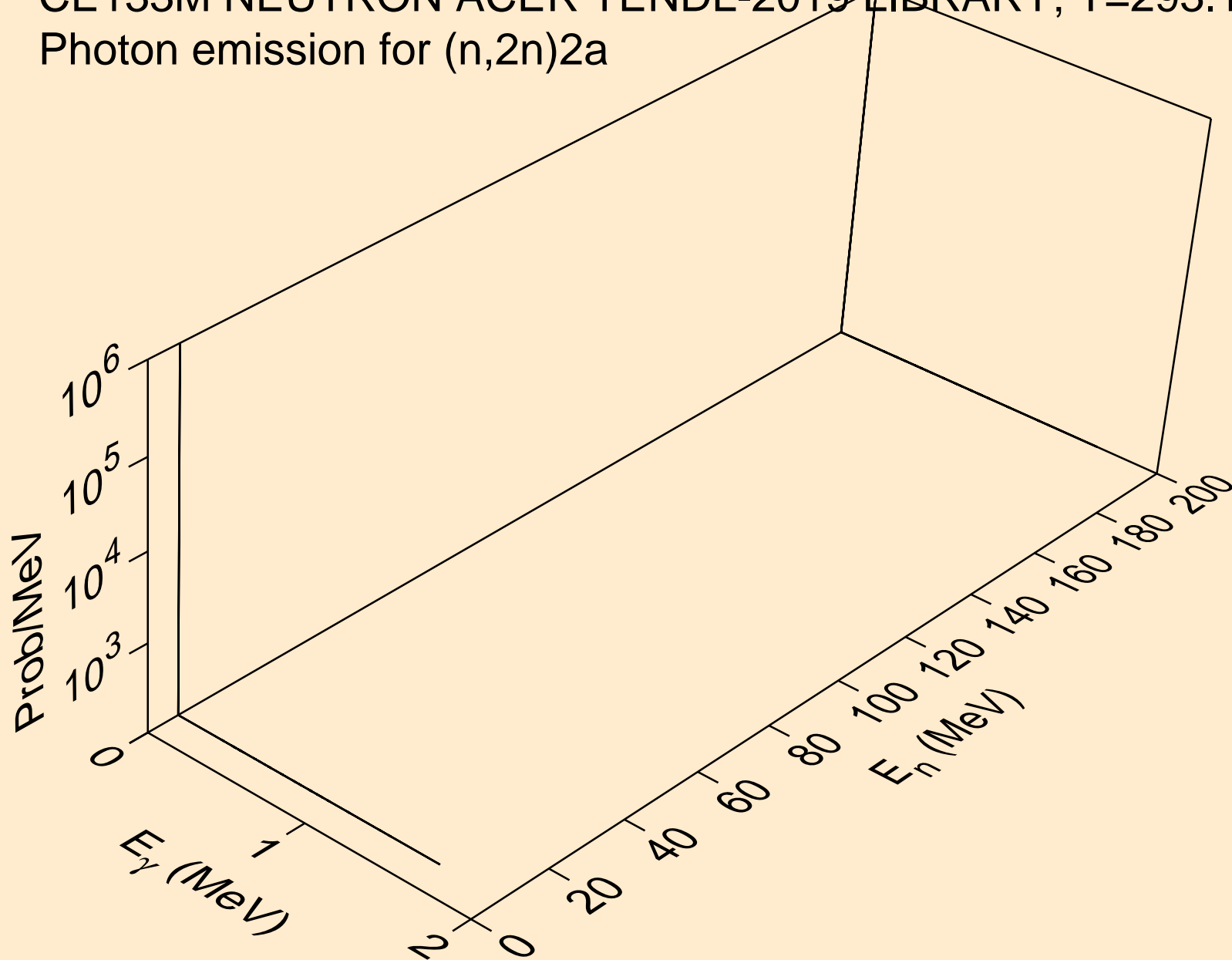

CE133M NEUTRON ACER TENDL-2019 LIBRARY; T=293.16K
Photon emission for (n,n*)d

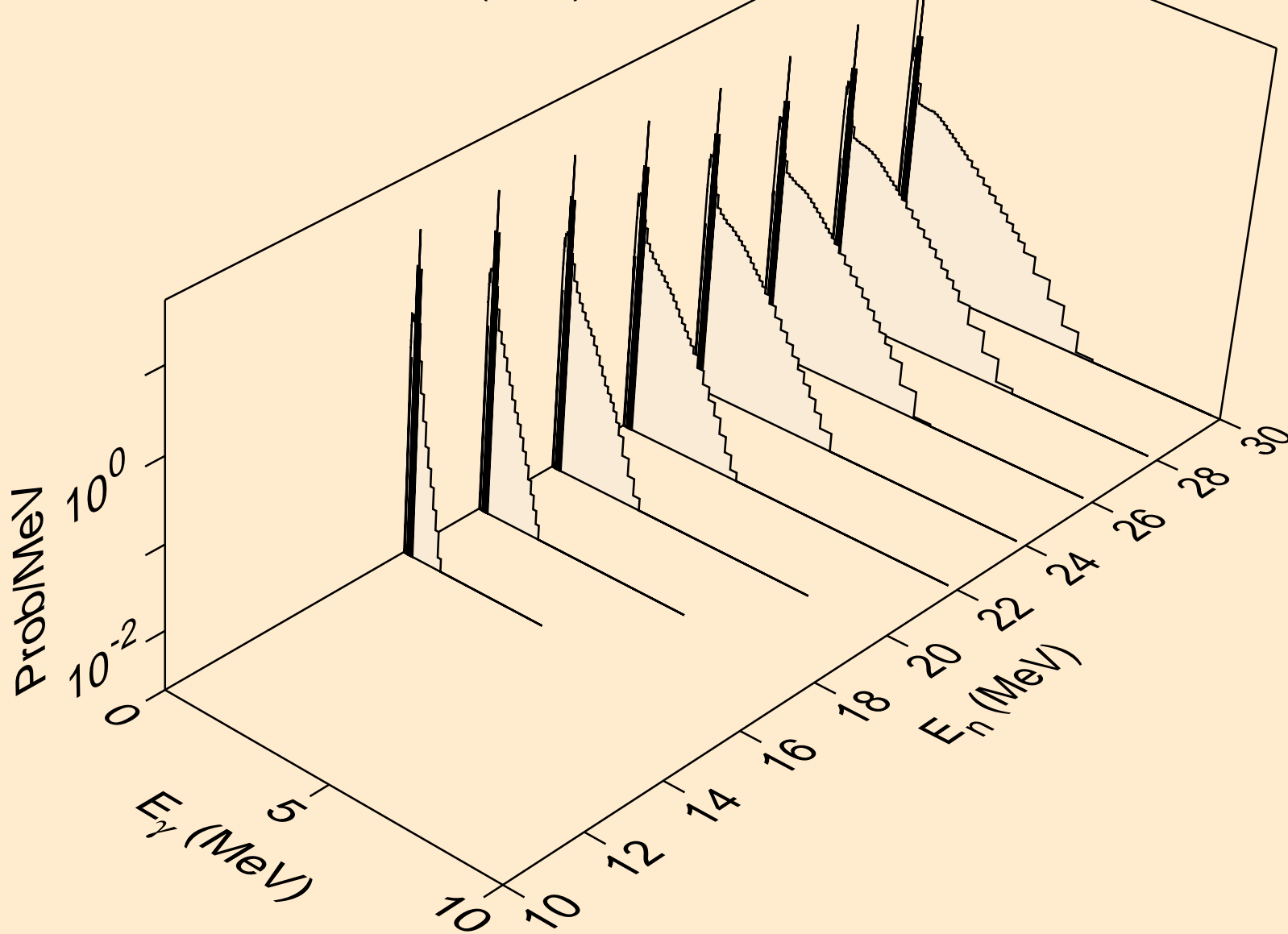

CE133M NEUTRON ACER TENDL-2019 LIBRARY; T=293.16K
Photon emission for (n,n*)t

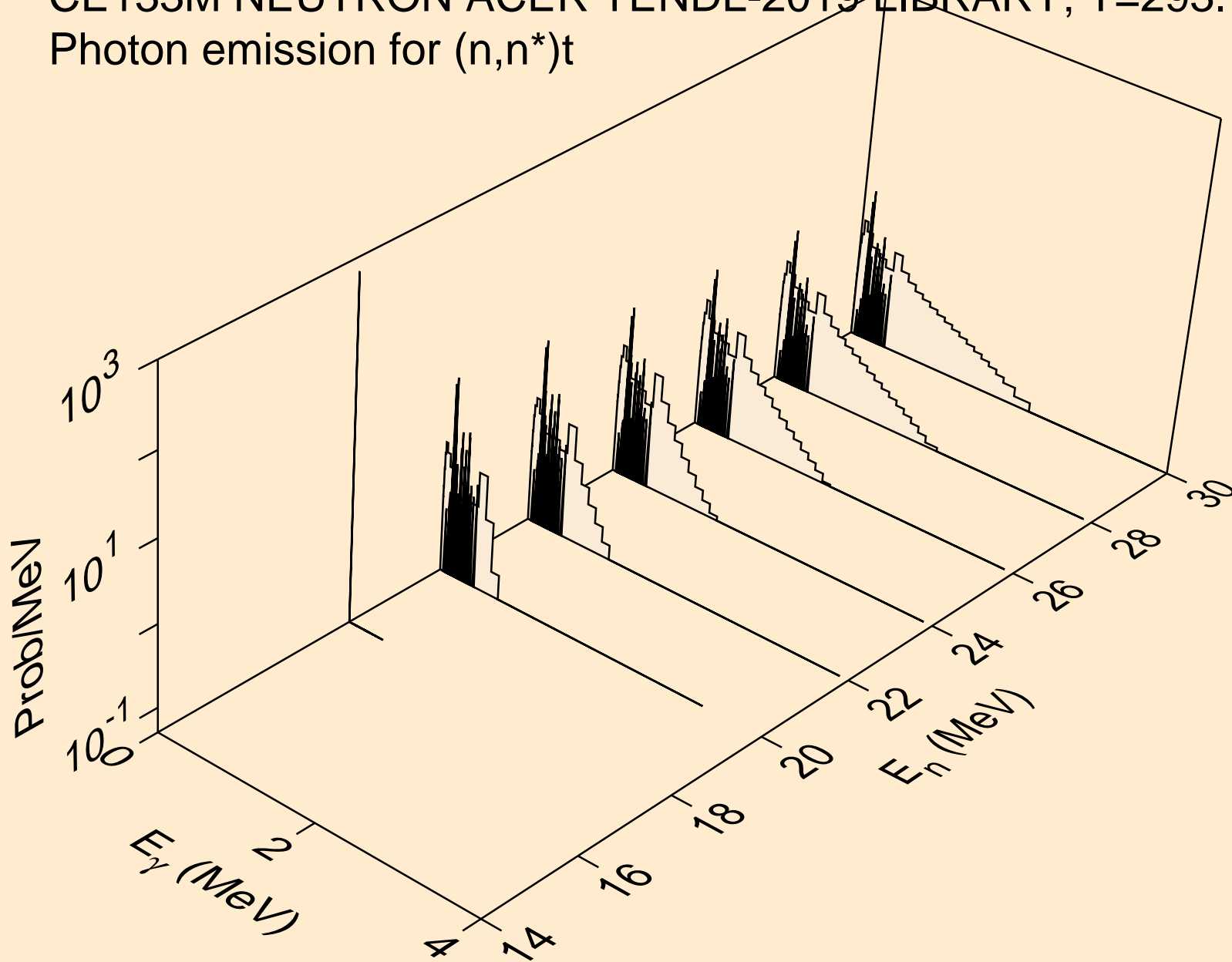

CE133M NEUTRON ACER TENDL-2019 LIBRARY; T=293.16K
Photon emission for (n,n*)he3

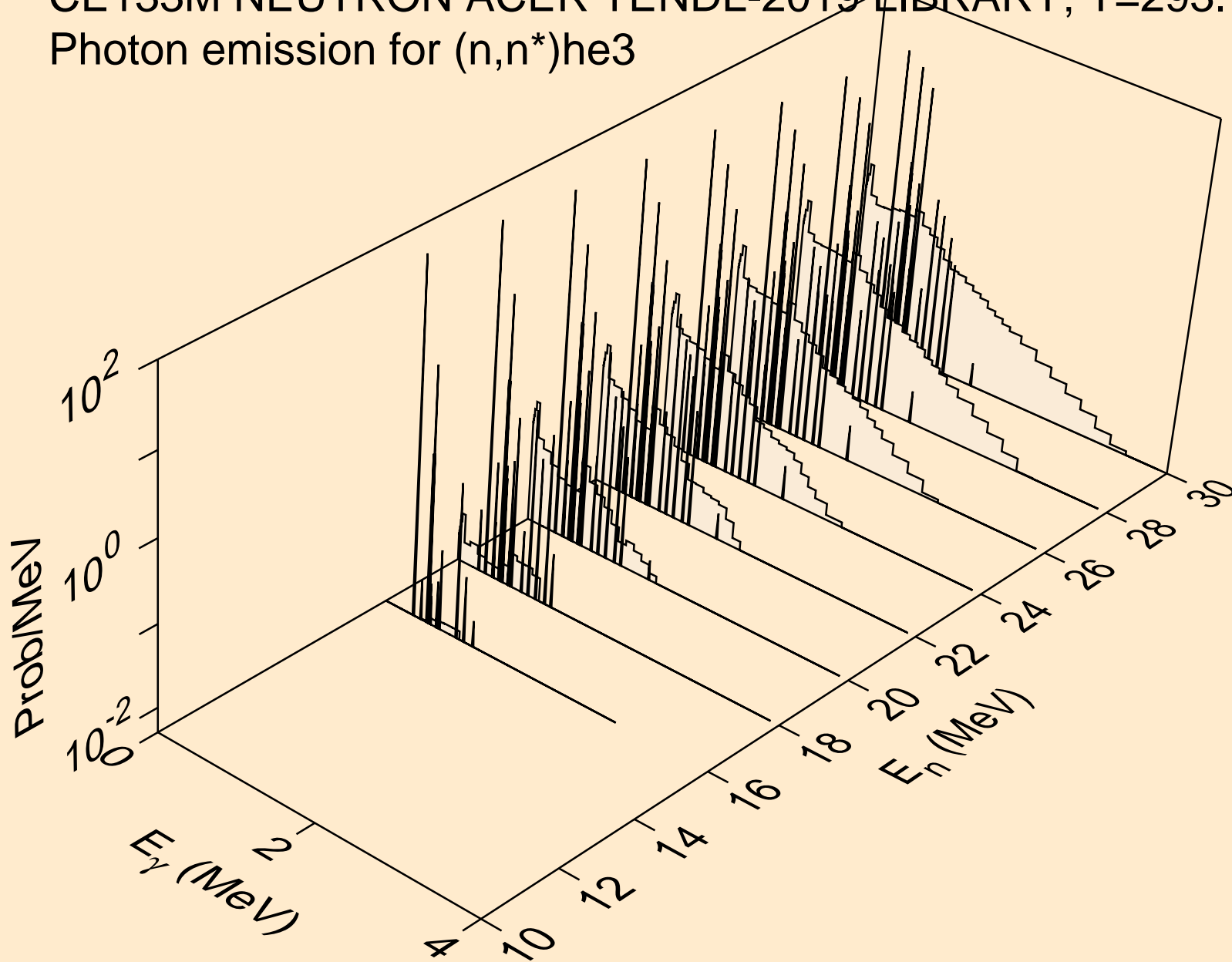

CE133M NEUTRON ACER TENDL-2019 LIBRARY; T=293.16K
Photon emission for (n,4n)

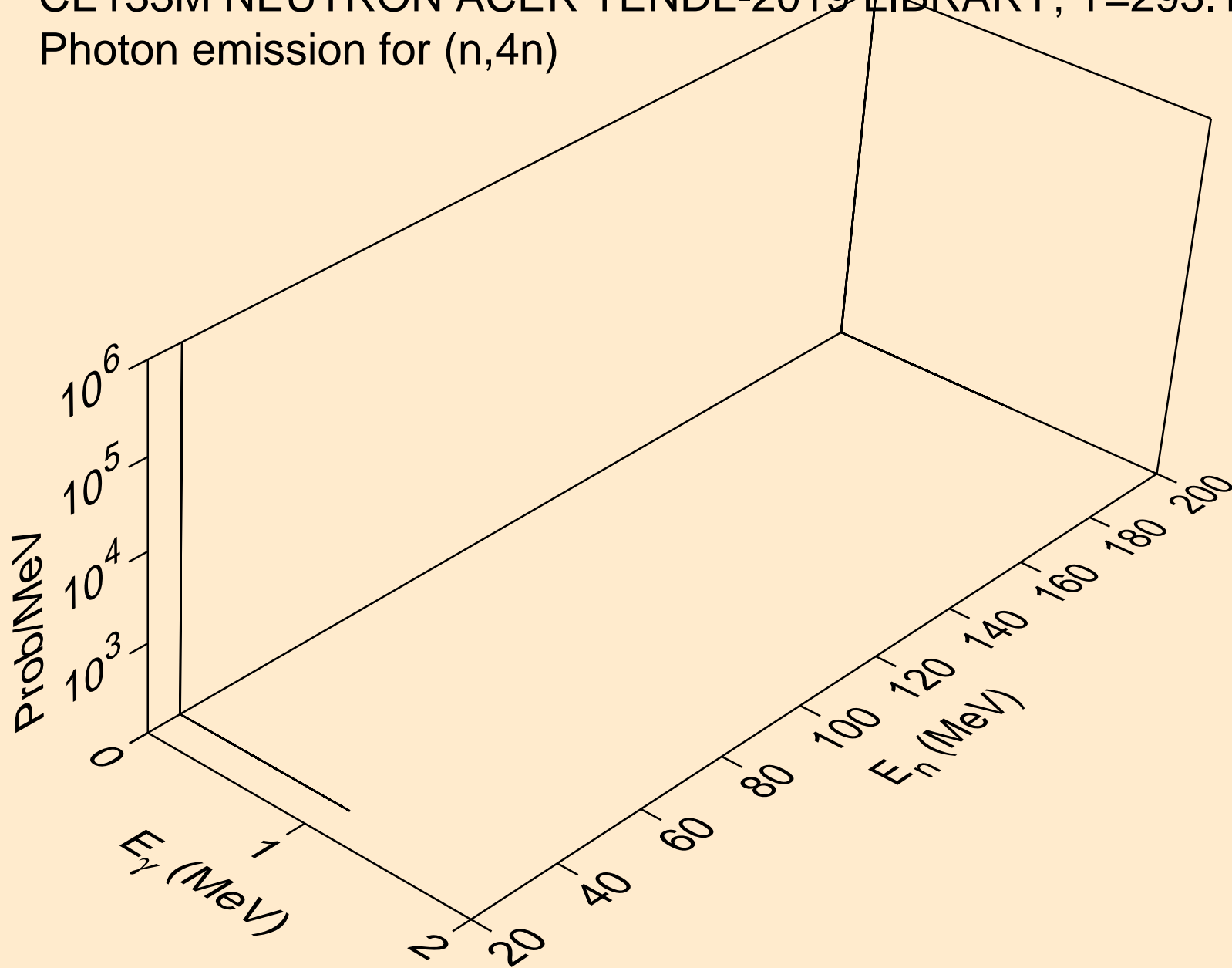

CE133M NEUTRON ACER TENDL-2019 LIBRARY; T=293.16K
Photon emission for (n,2np)

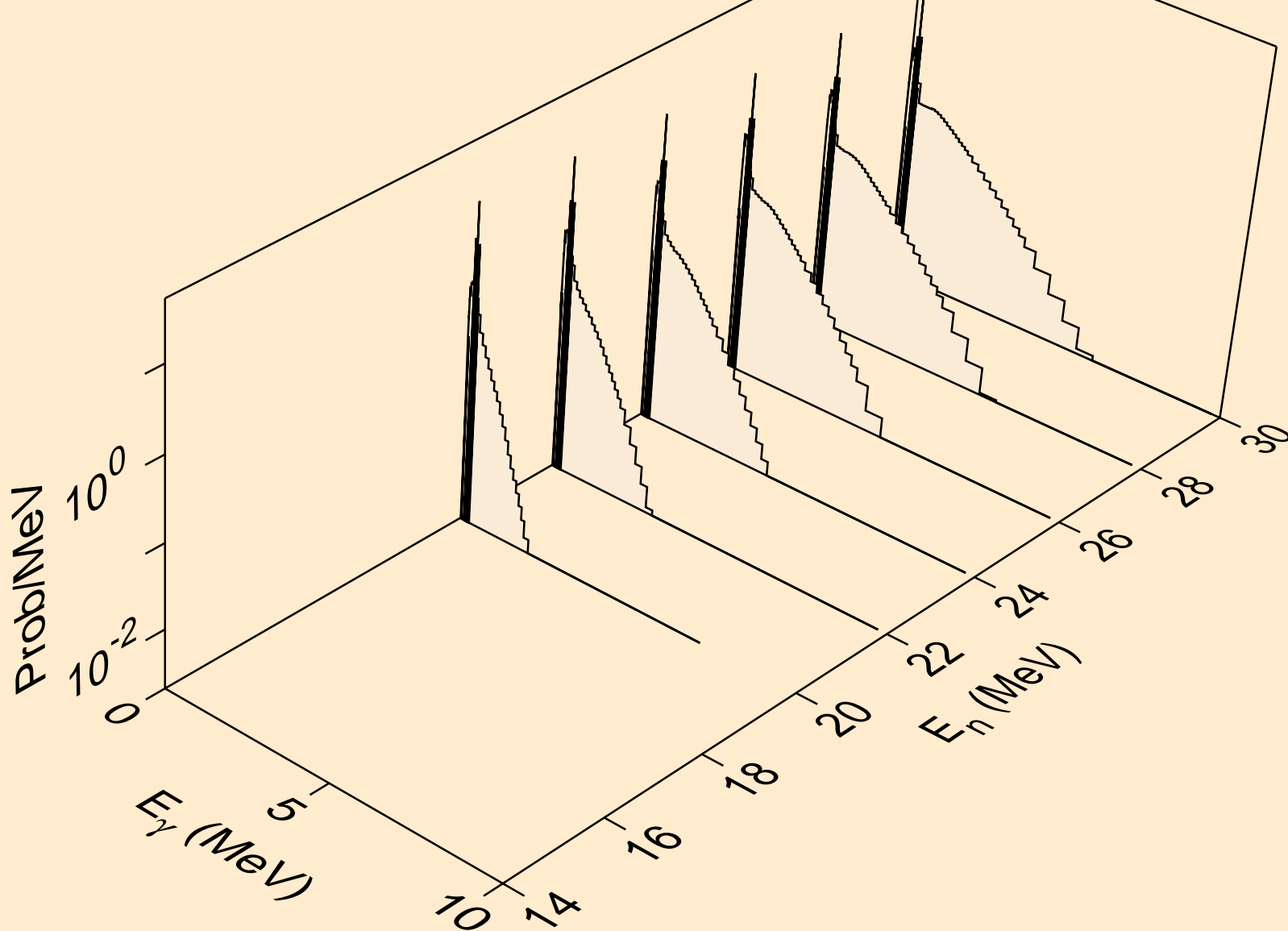

CE133M NEUTRON ACER TENDL-2019 LIBRARY; T=293.16K
Photon emission for (n,3np)

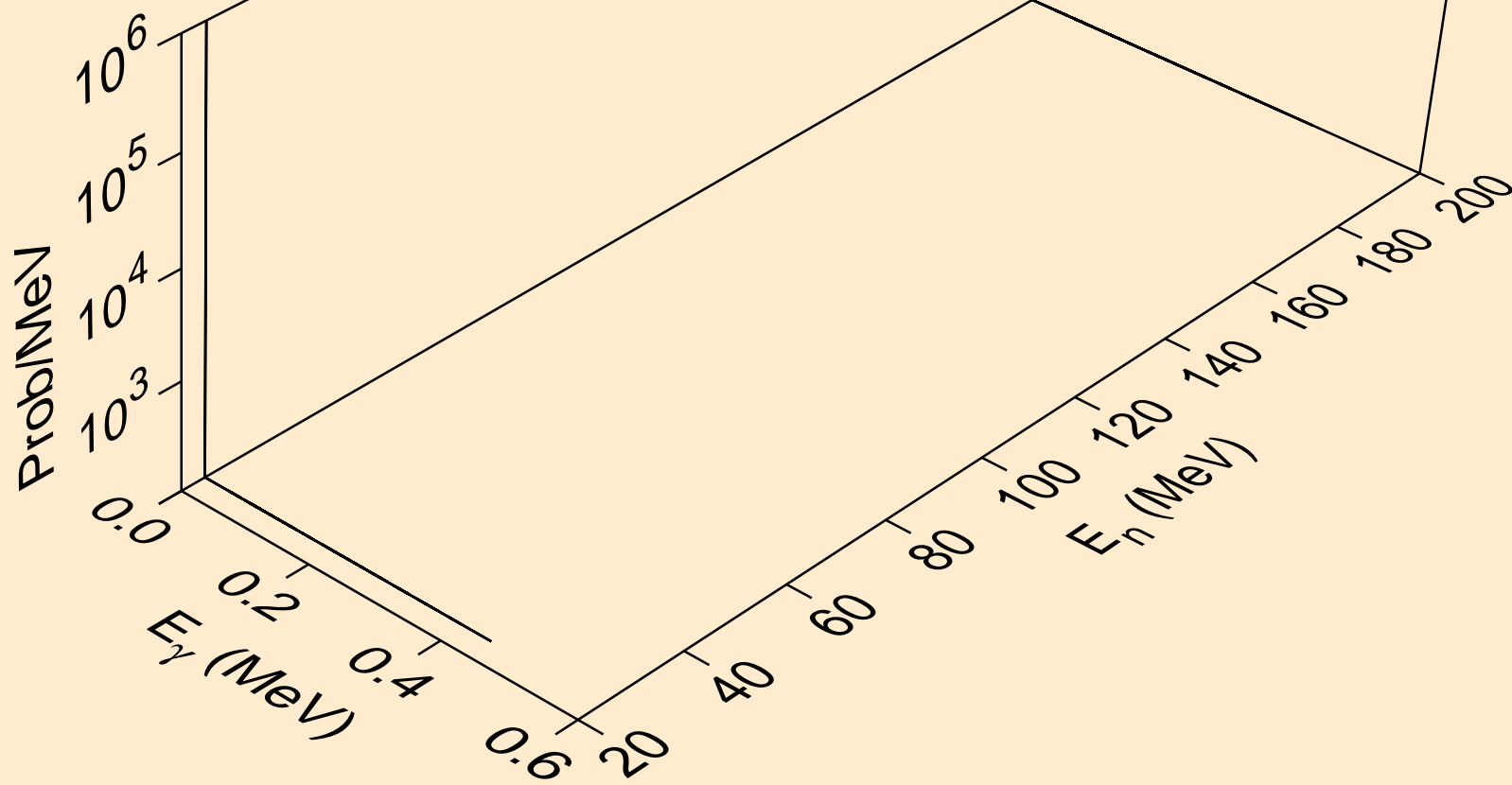

CE133M NEUTRON ACER TENDL-2019 LIBRARY; T=293.16K
Photon emission for (n,2np)

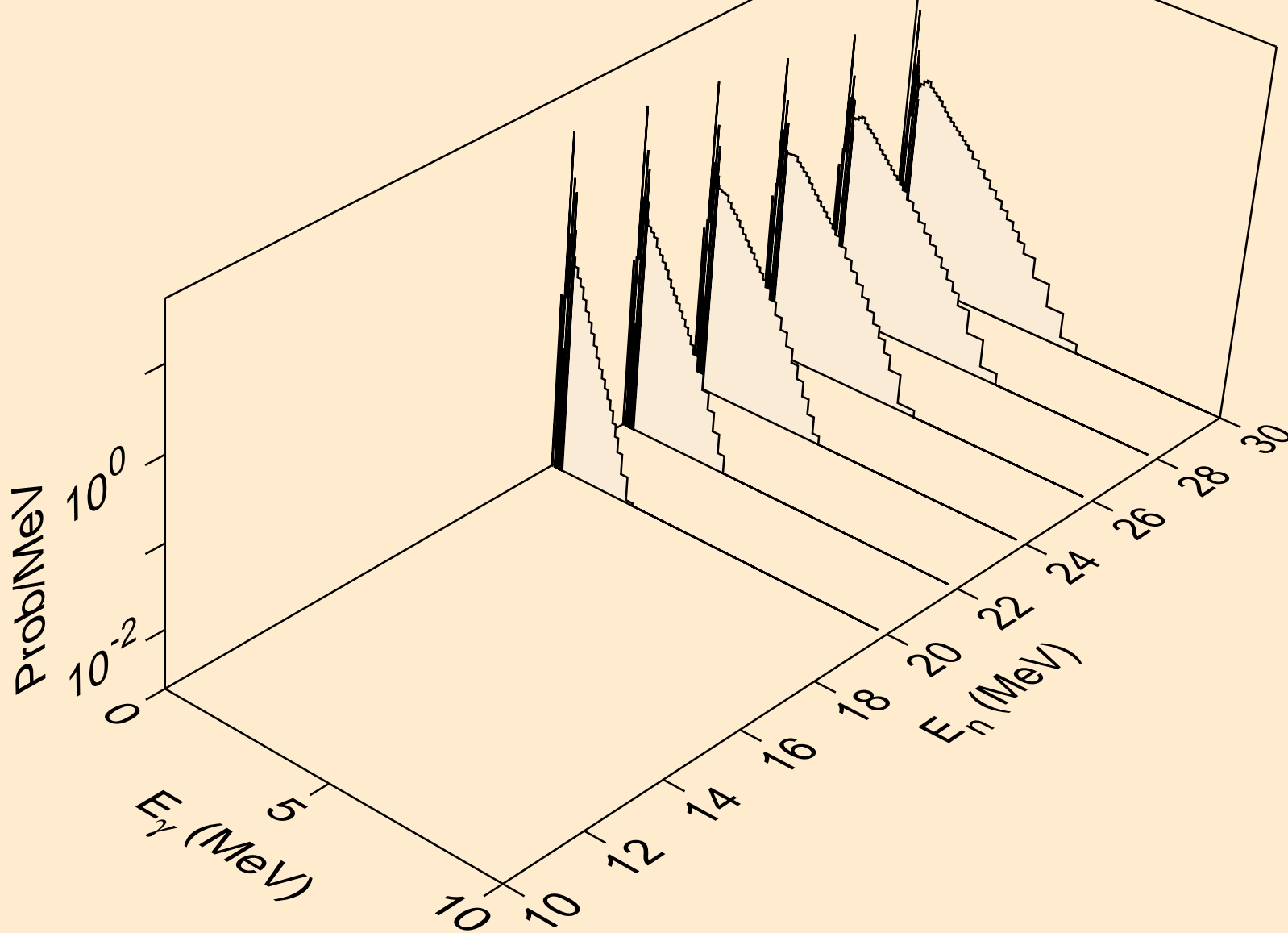

CE133M NEUTRON ACER TENDL-2019 LIBRARY; T=293.16K
Photon emission for (n,npa)

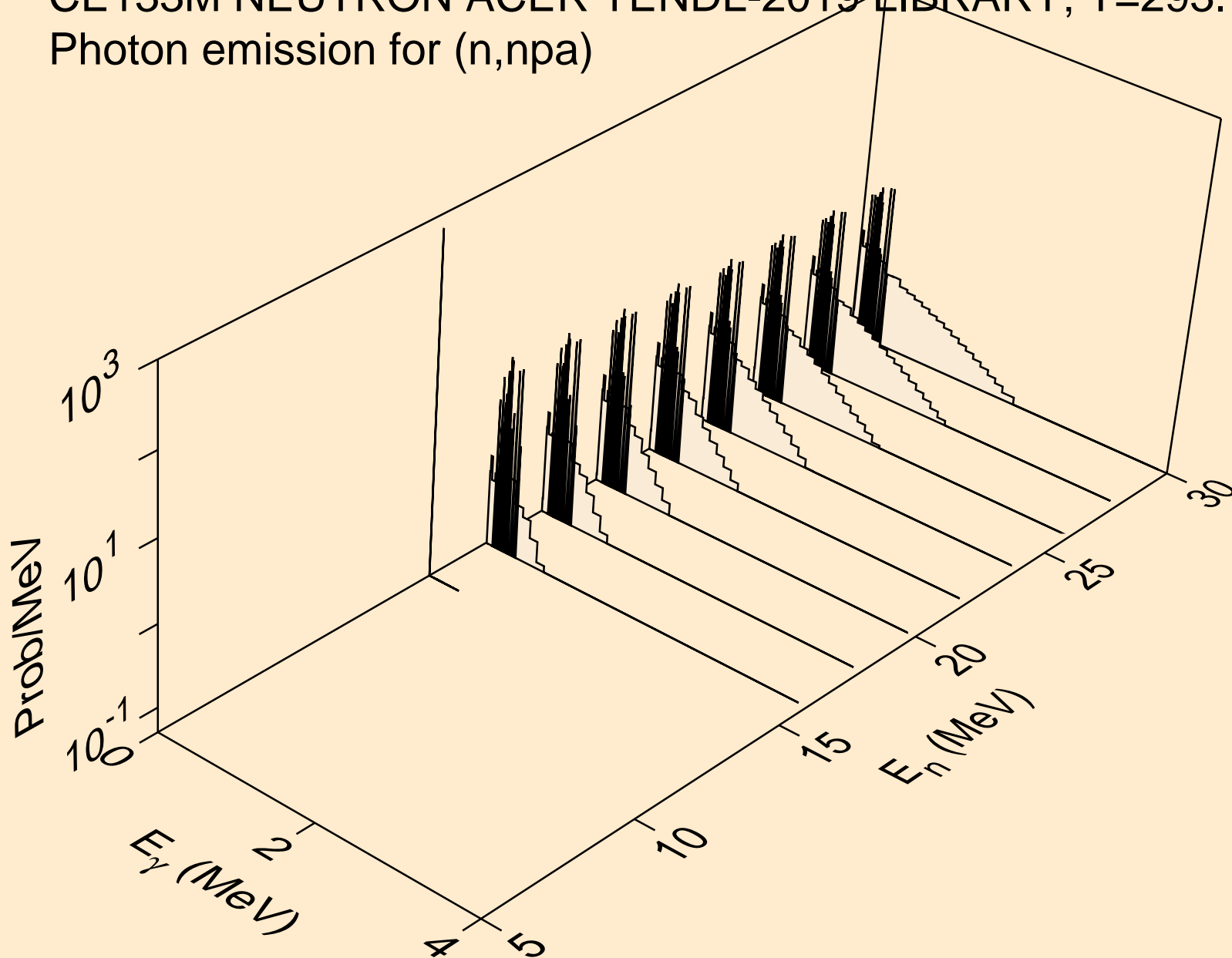

CE133M NEUTRON ACER TENDL-2019 LIBRARY; T=293.16K
Photon emission for (n,n*2)

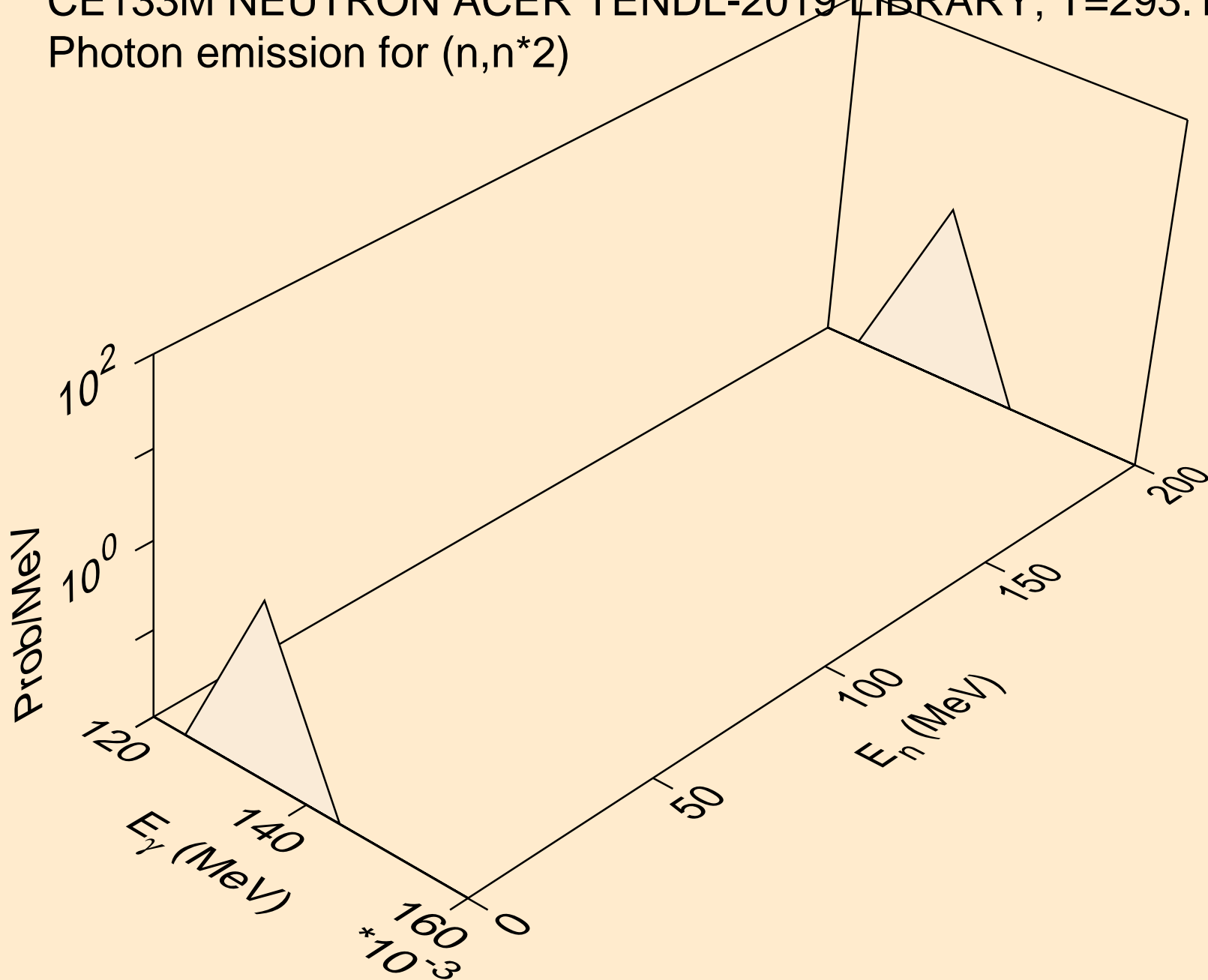

CE133M NEUTRON ACER TENDL-2019 LIBRARY; T=293.16K
Photon emission for (n,n*3)

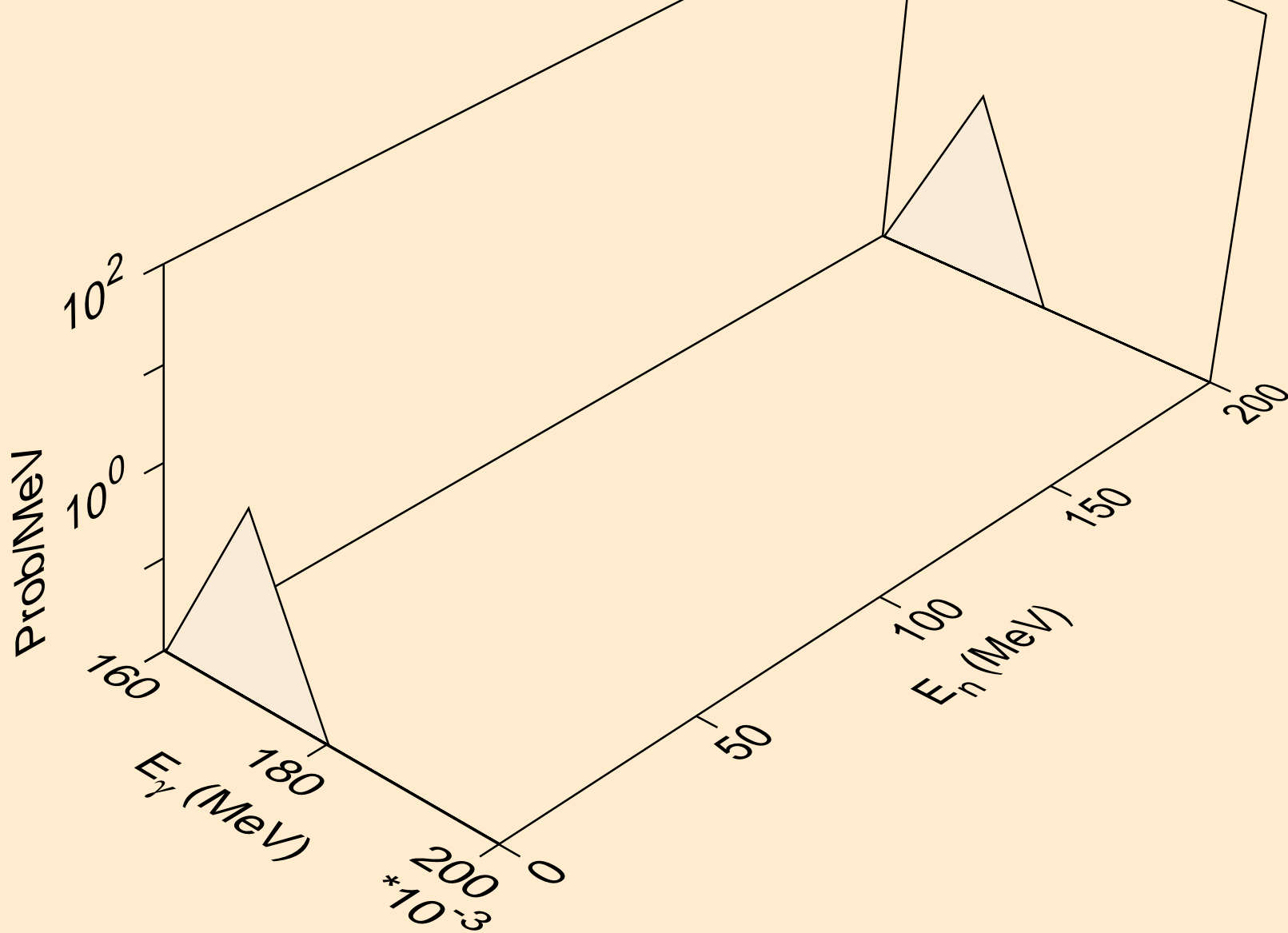

CE133M NEUTRON ACER TENDL-2019 LIBRARY; T=293.16K
Photon emission for (n,n*4)

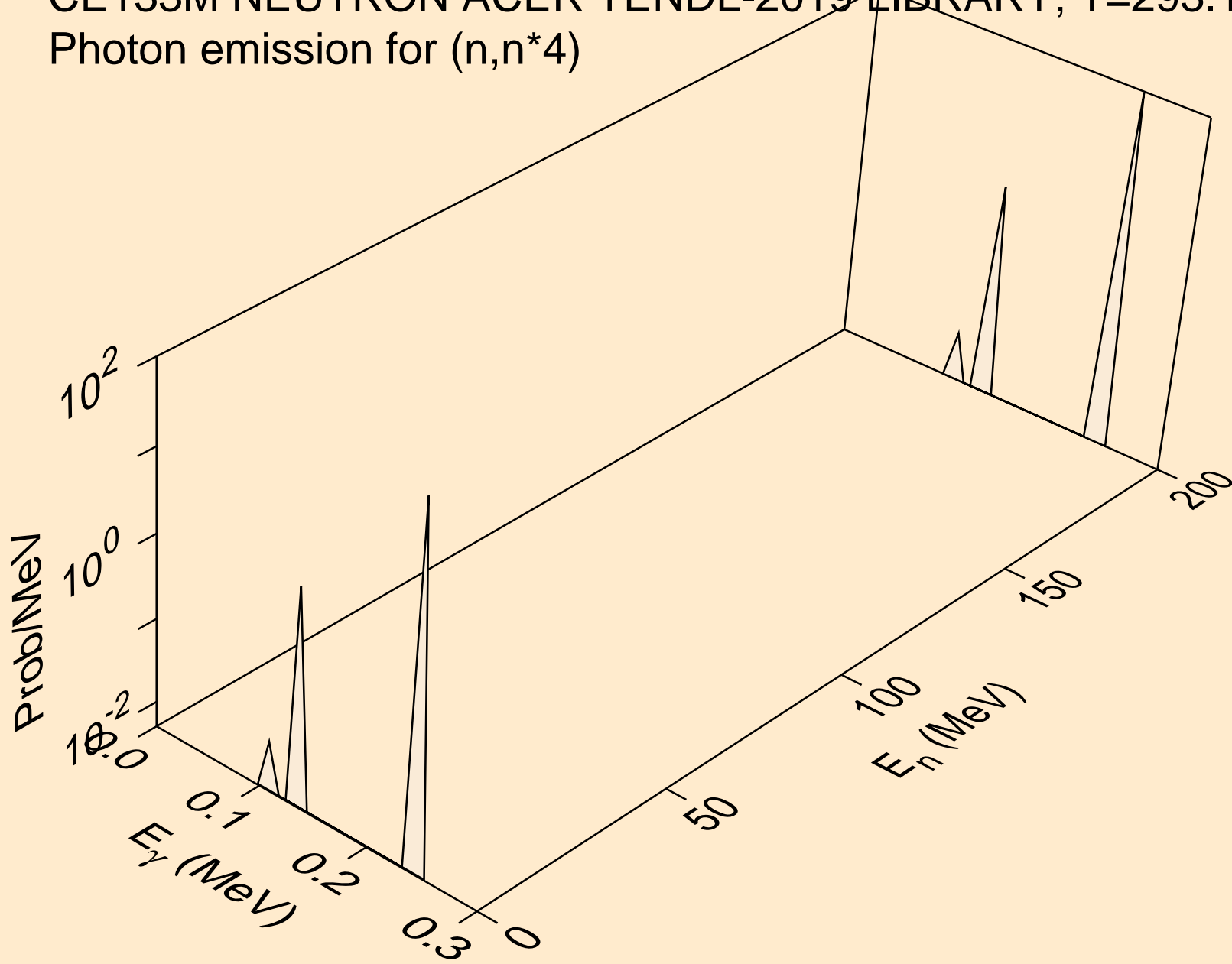

CE133M NEUTRON ACER TENDL-2019 LIBRARY; T=293.16K
Photon emission for (n,n*5)

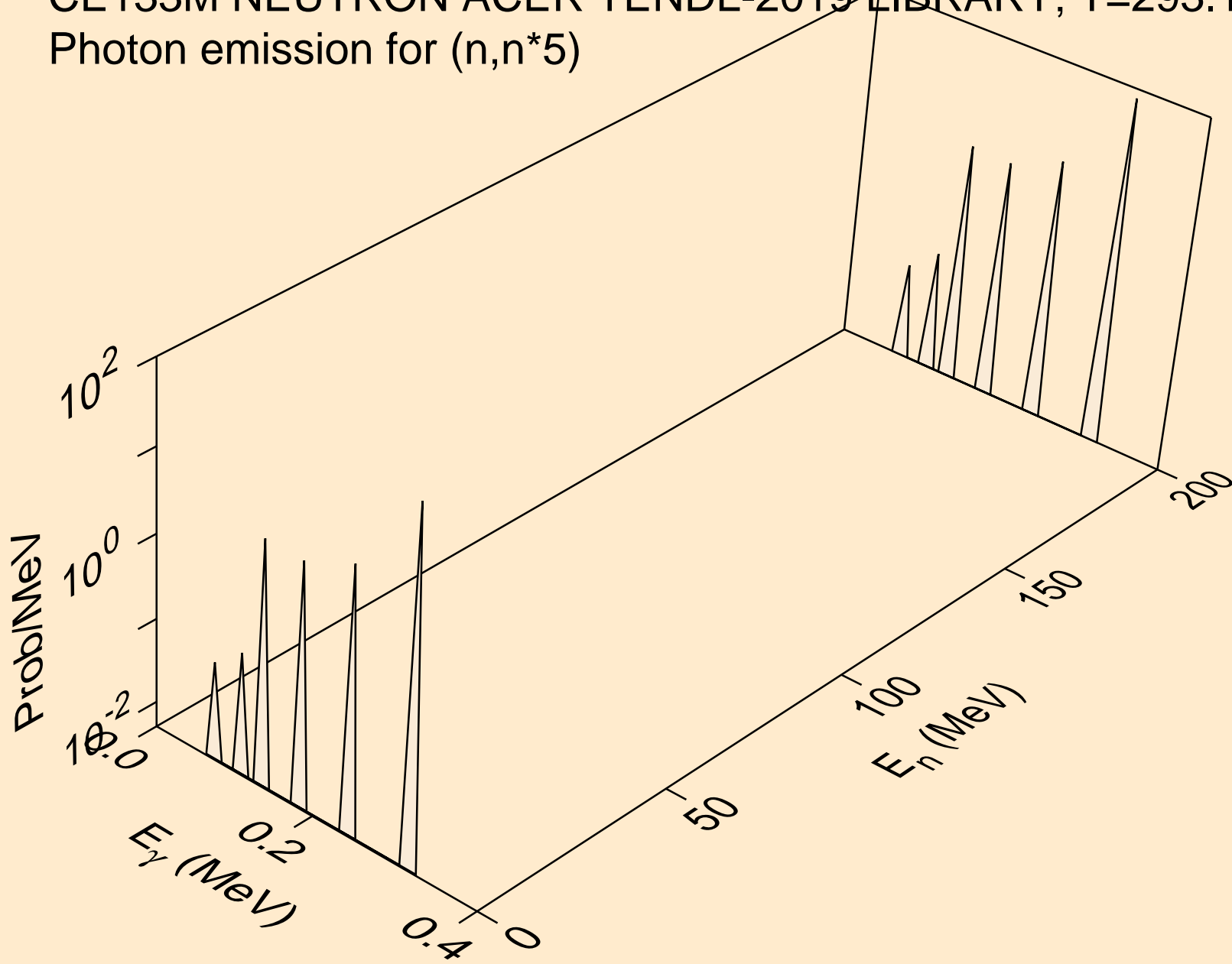

CE133M NEUTRON ACER TENDL-2019 LIBRARY; T=293.16K
Photon emission for (n,n*6)

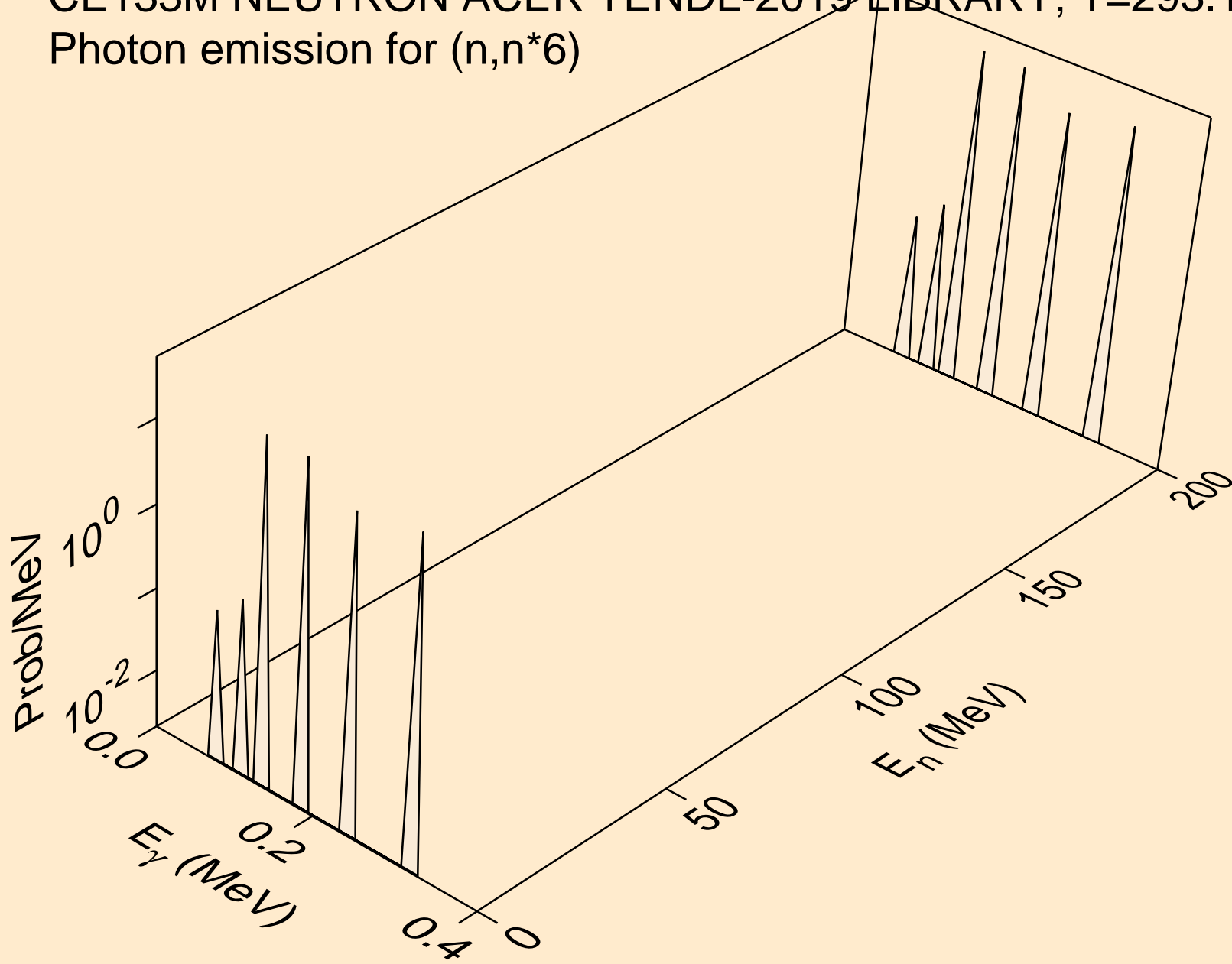

CE133M NEUTRON ACER TENDL-2019 LIBRARY; T=293.16K
Photon emission for (n,n*7)

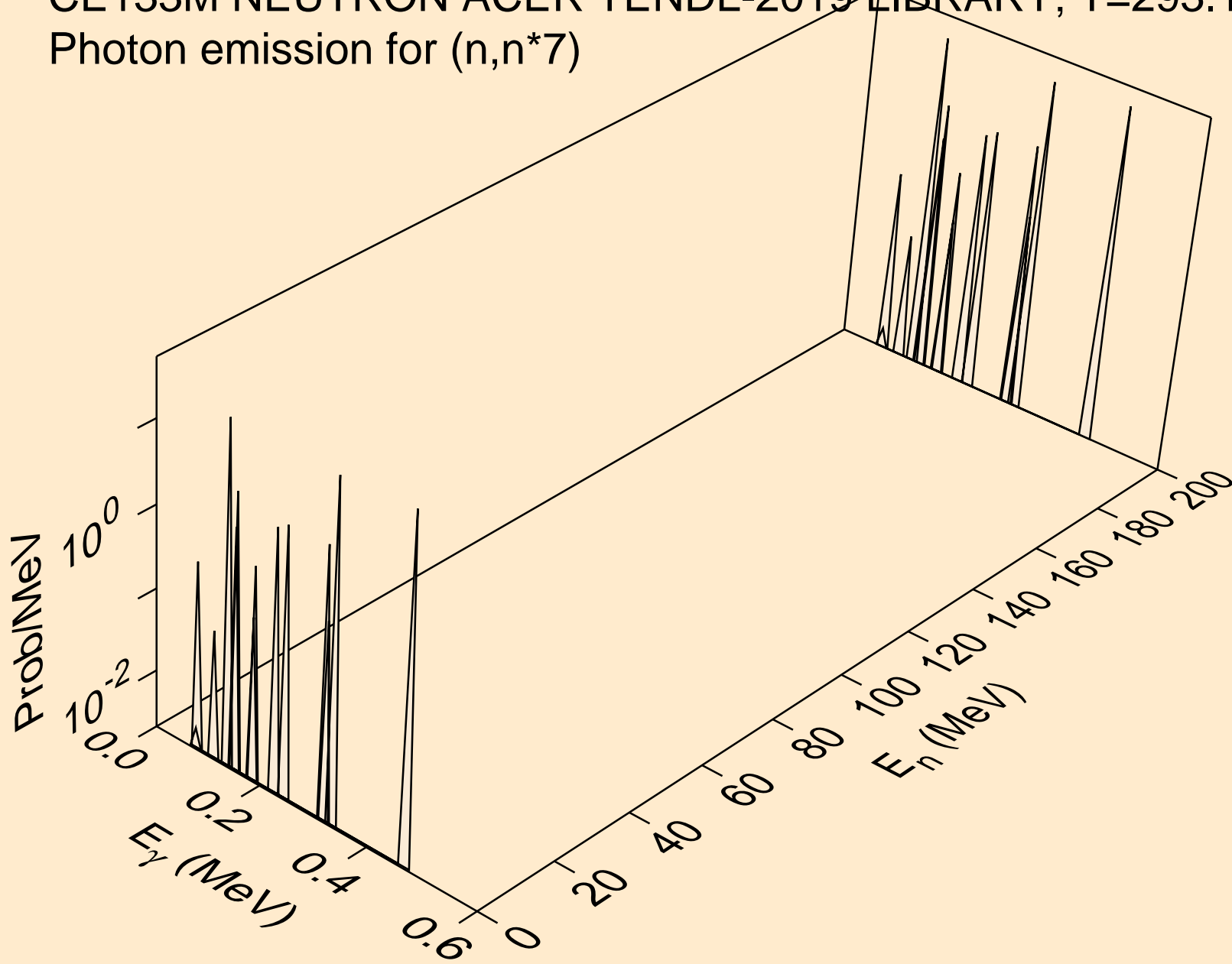

CE133M NEUTRON ACER TENDL-2019 LIBRARY; T=293.16K
Photon emission for (n,n*8)

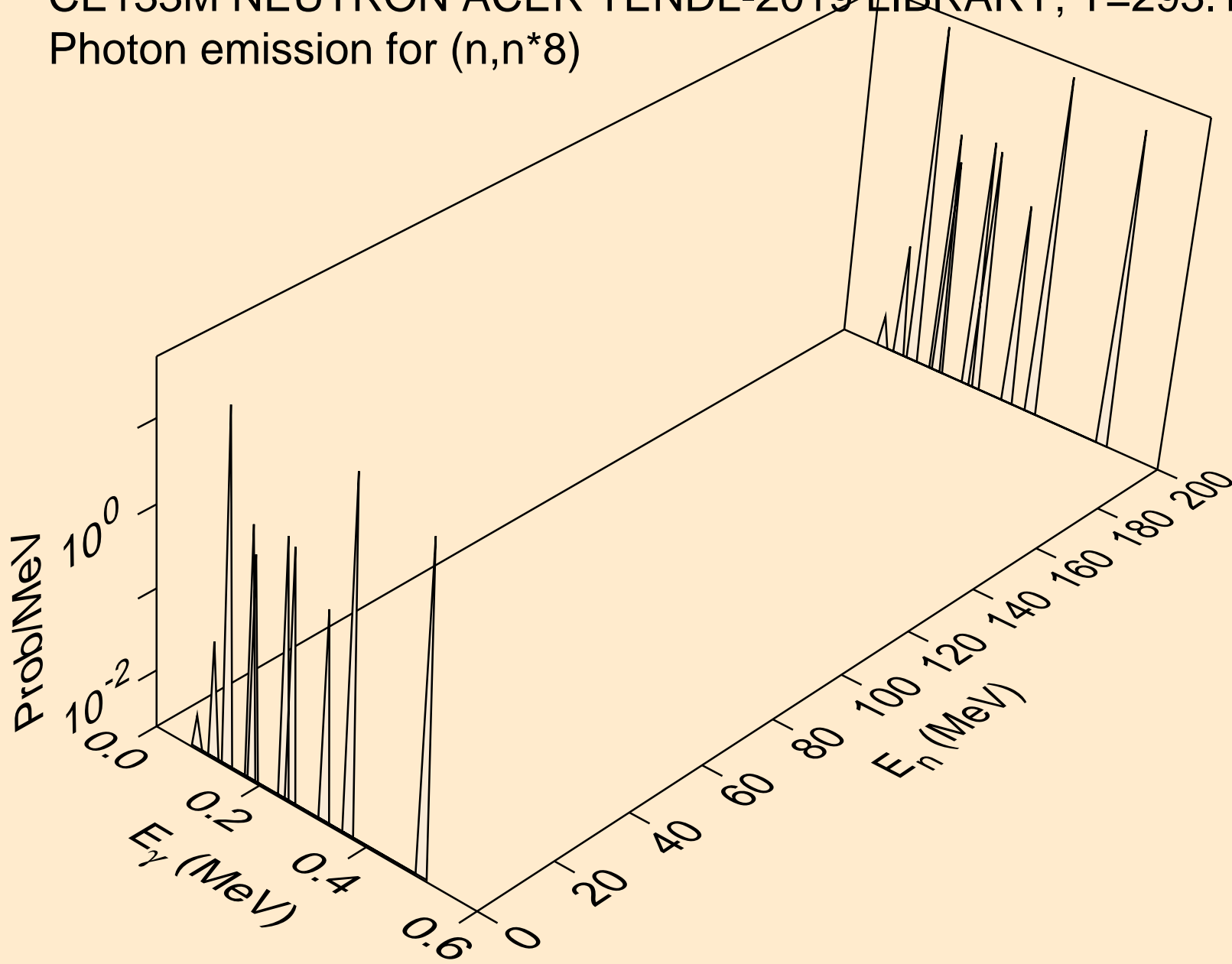

CE133M NEUTRON ACER TENDL-2019 LIBRARY; T=293.16K
Photon emission for (n,n*9)

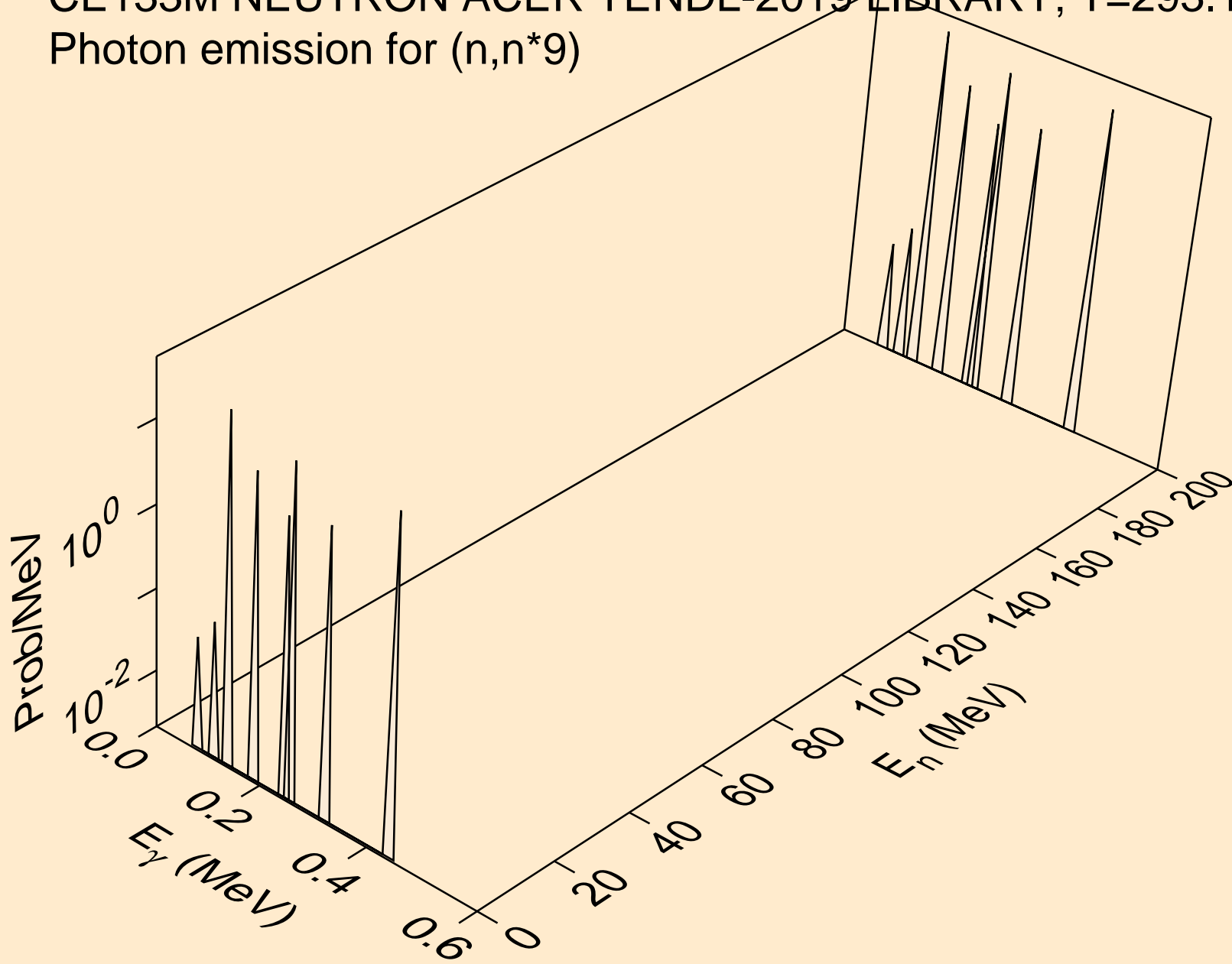

CE133M NEUTRON ACER TENDL-2019 LIBRARY; T=293.16K
Photon emission for (n,n*10)

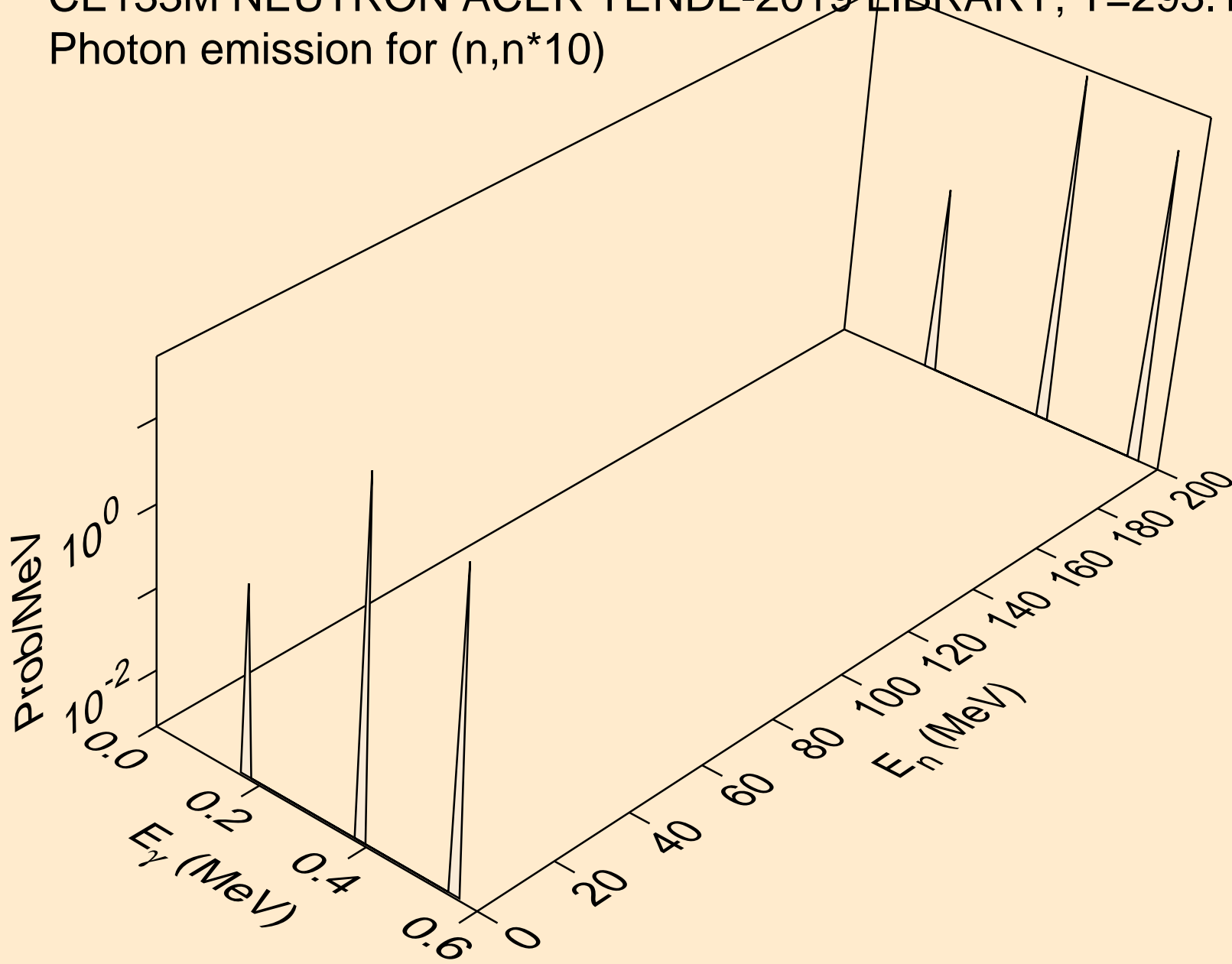

CE133M NEUTRON ACER TENDL-2019 LIBRARY; T=293.16K
Photon emission for (n,n*11)

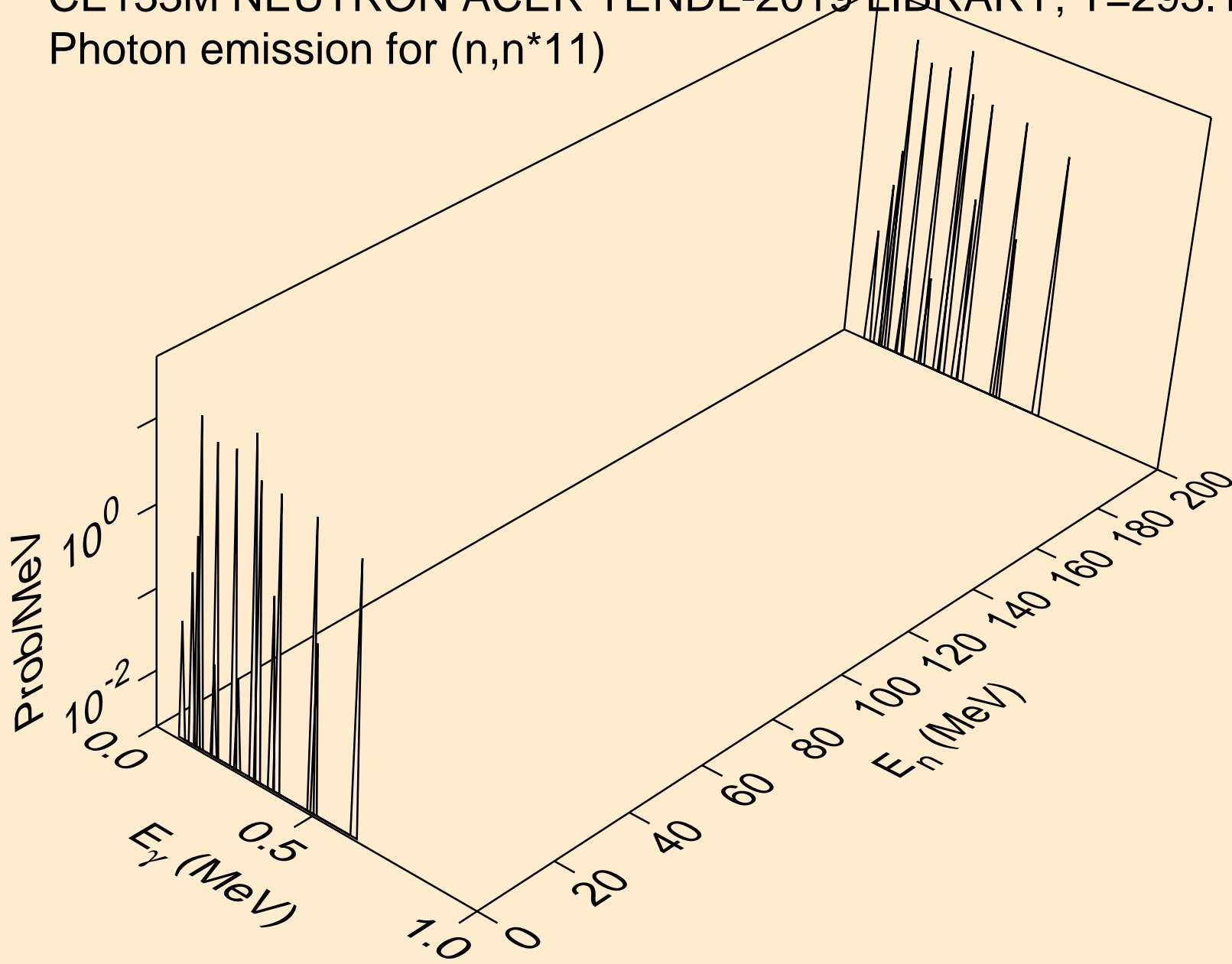

CE133M NEUTRON ACER TENDL-2019 LIBRARY; T=293.16K
Photon emission for (n,n*12)

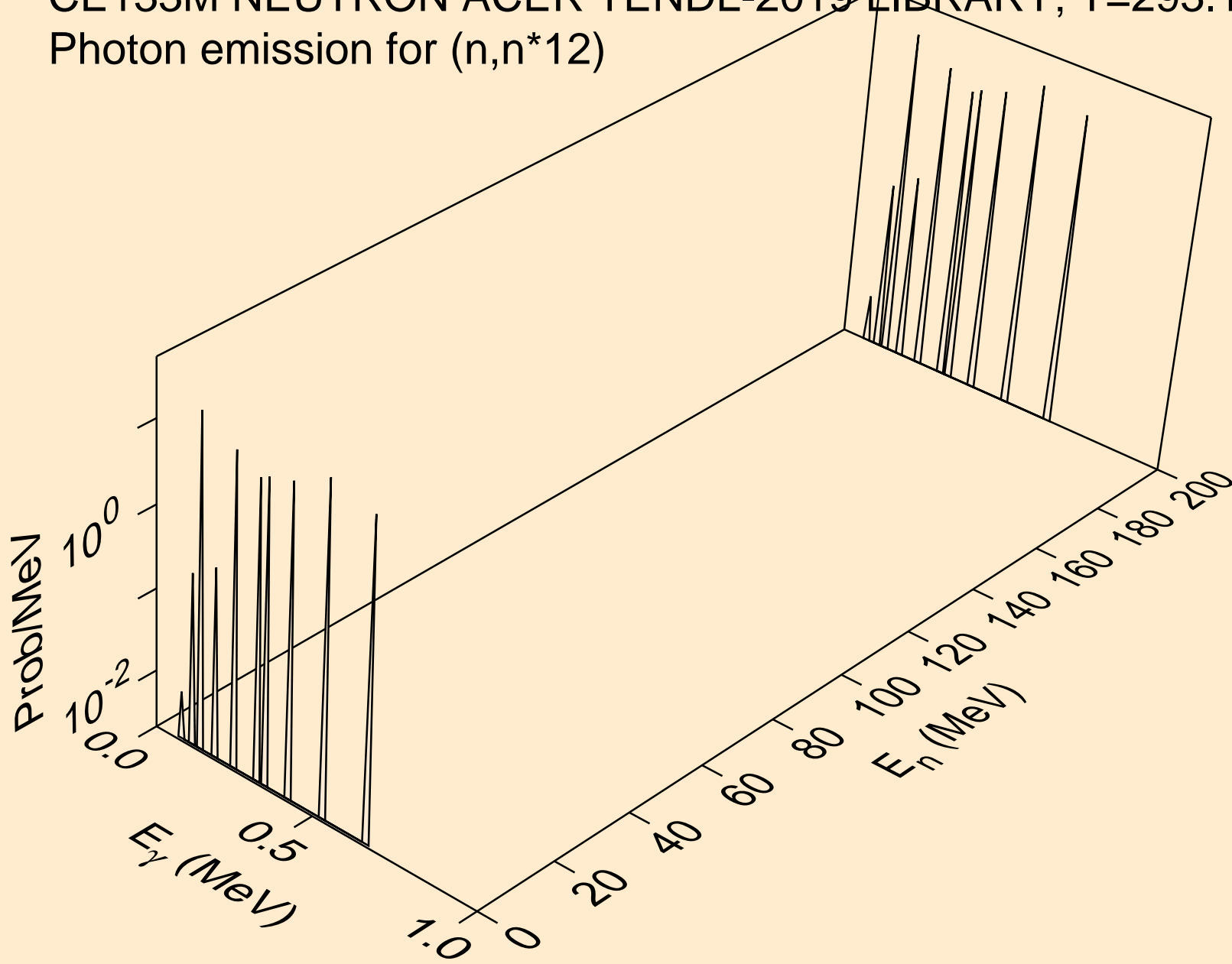

CE133M NEUTRON ACER TENDL-2019 LIBRARY; T=293.16K
Photon emission for (n,n*13)

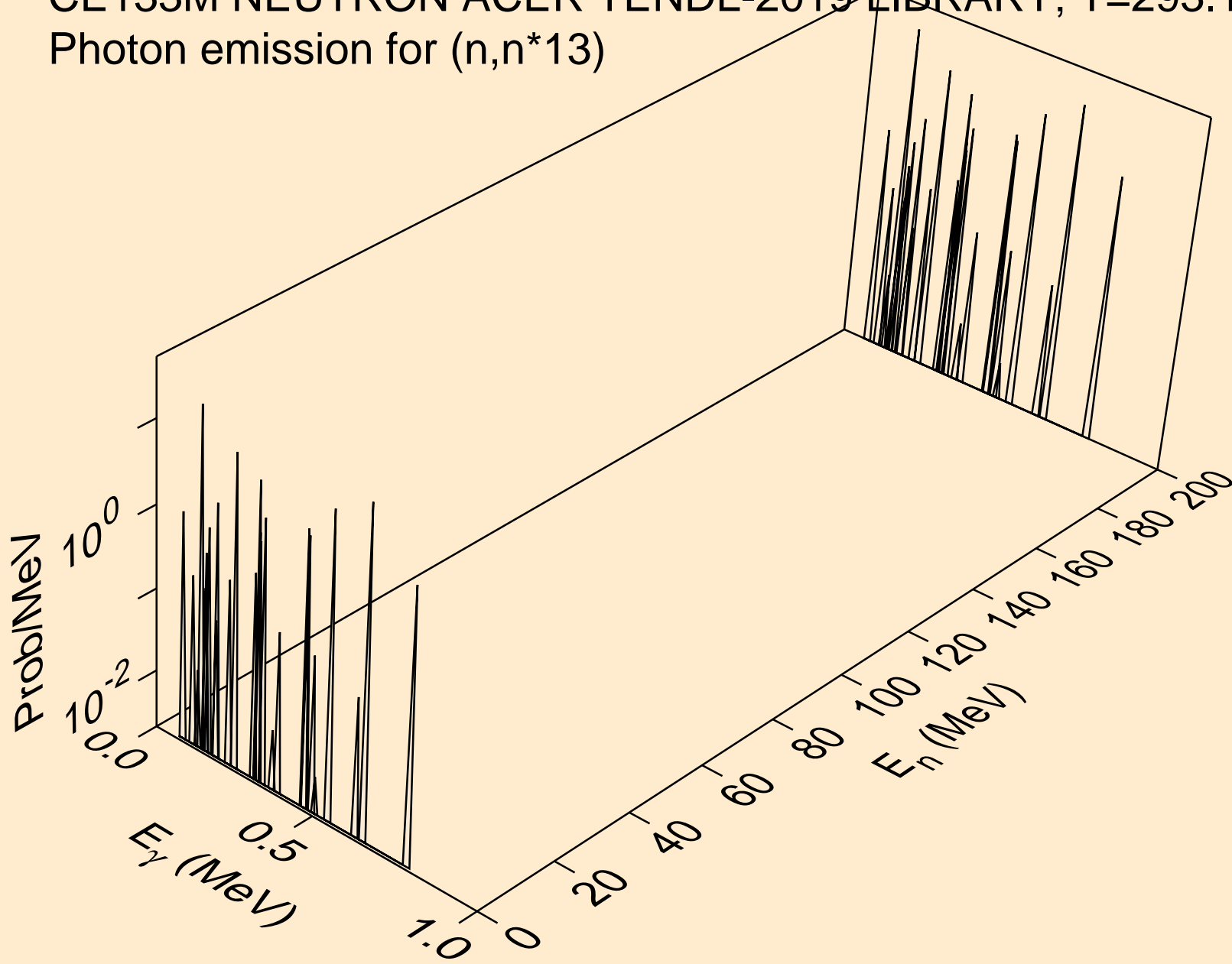

CE133M NEUTRON ACER TENDL-2019 LIBRARY; T=293.16K
Photon emission for (n,n*14)

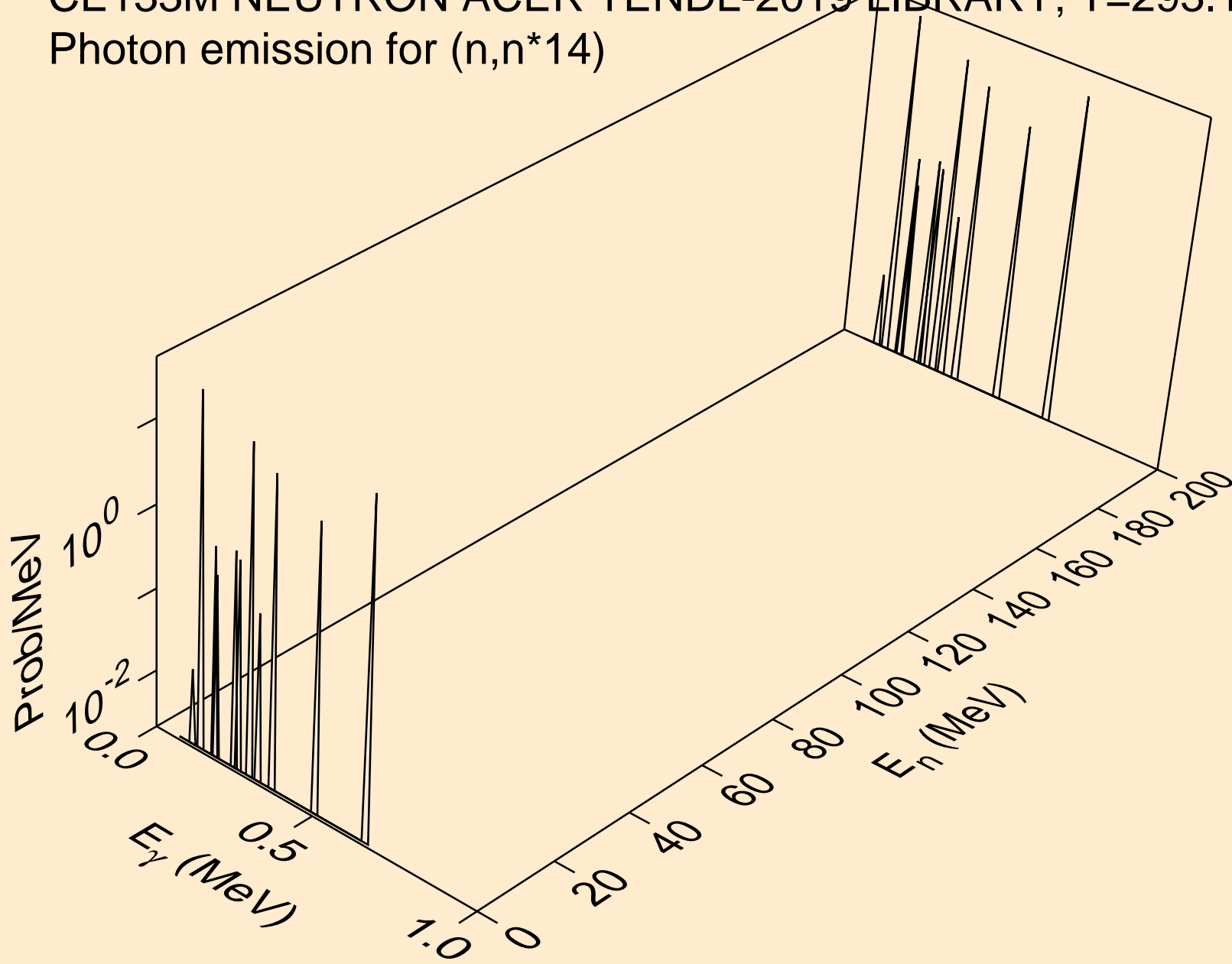

CE133M NEUTRON ACER TENDL-2019 LIBRARY; T=293.16K
Photon emission for (n,n*15)

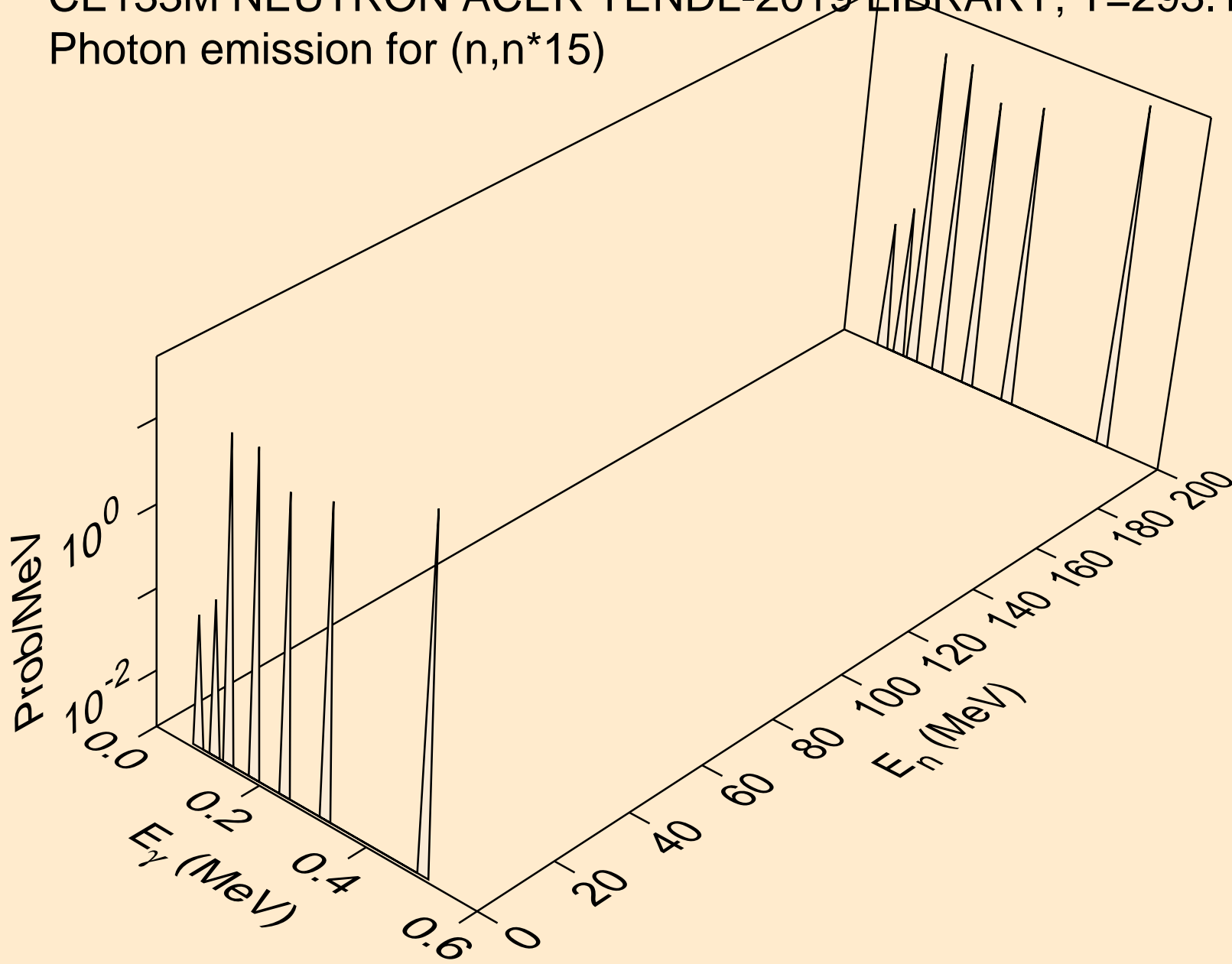

CE133M NEUTRON ACER TENDL-2019 LIBRARY; T=293.16K
Photon emission for (n,n*16)

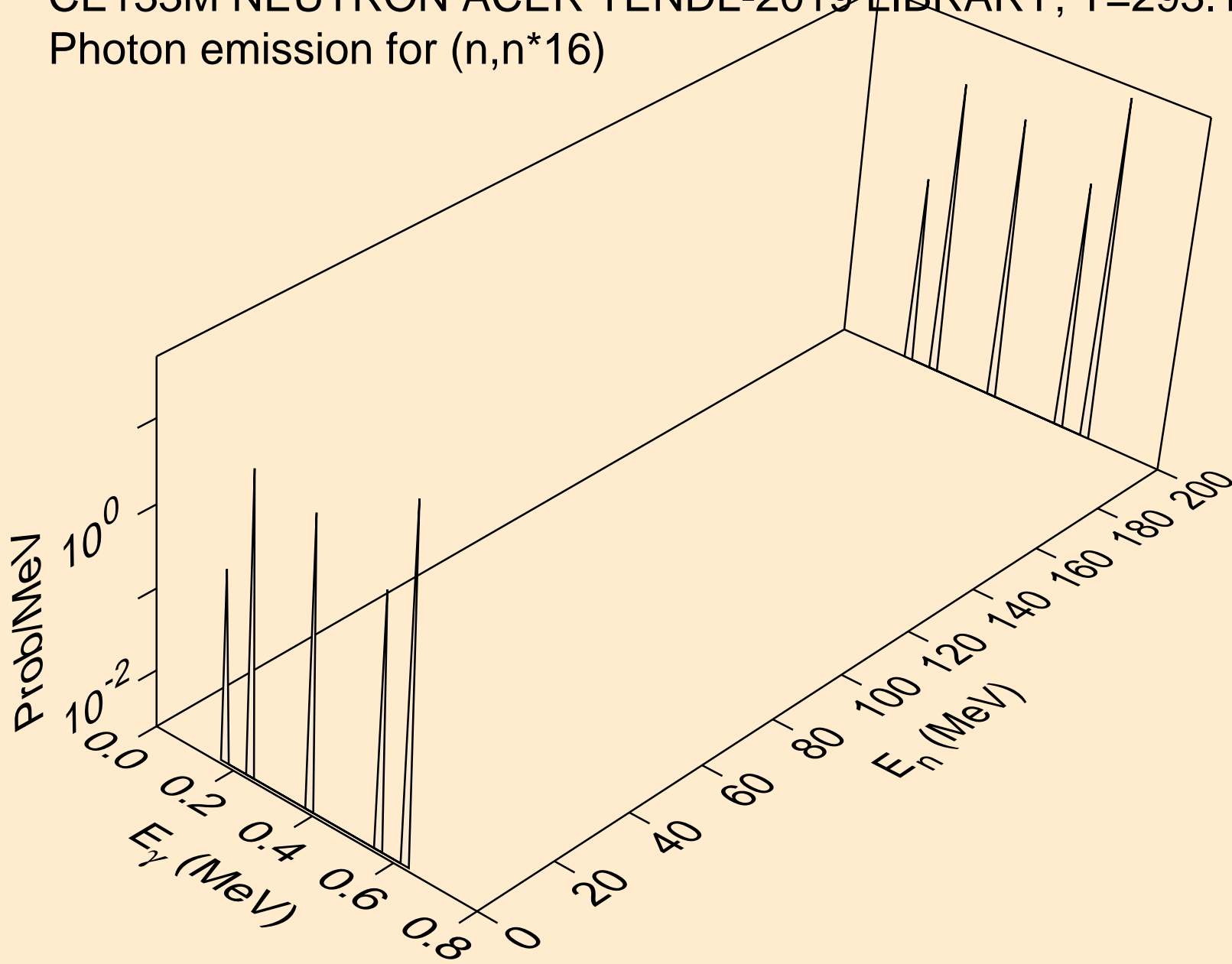

CE133M NEUTRON ACER TENDL-2019 LIBRARY; T=293.16K
Photon emission for (n,n*17)

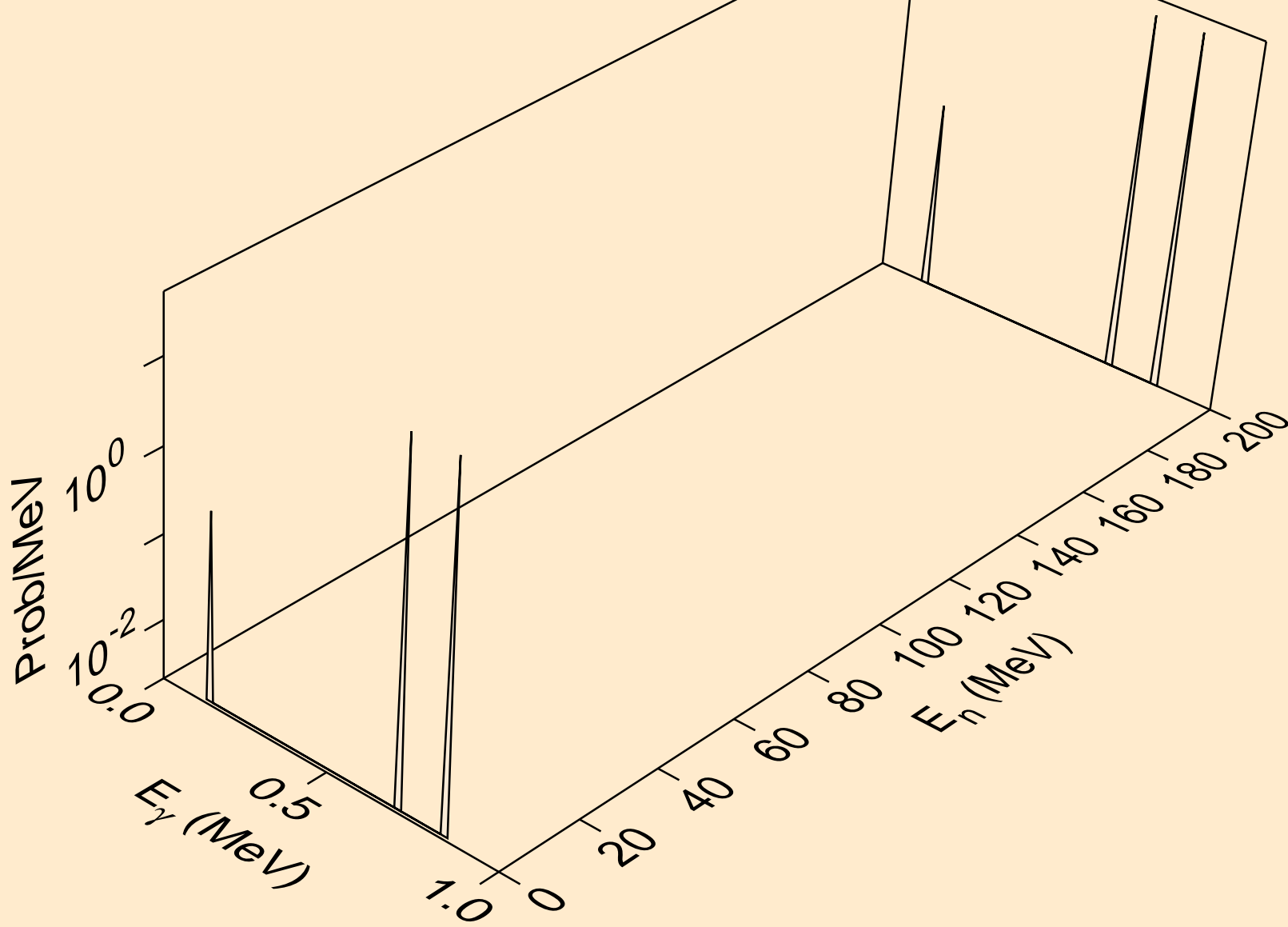

CE133M NEUTRON ACER TENDL-2019 LIBRARY; T=293.16K
Photon emission for (n,n*18)

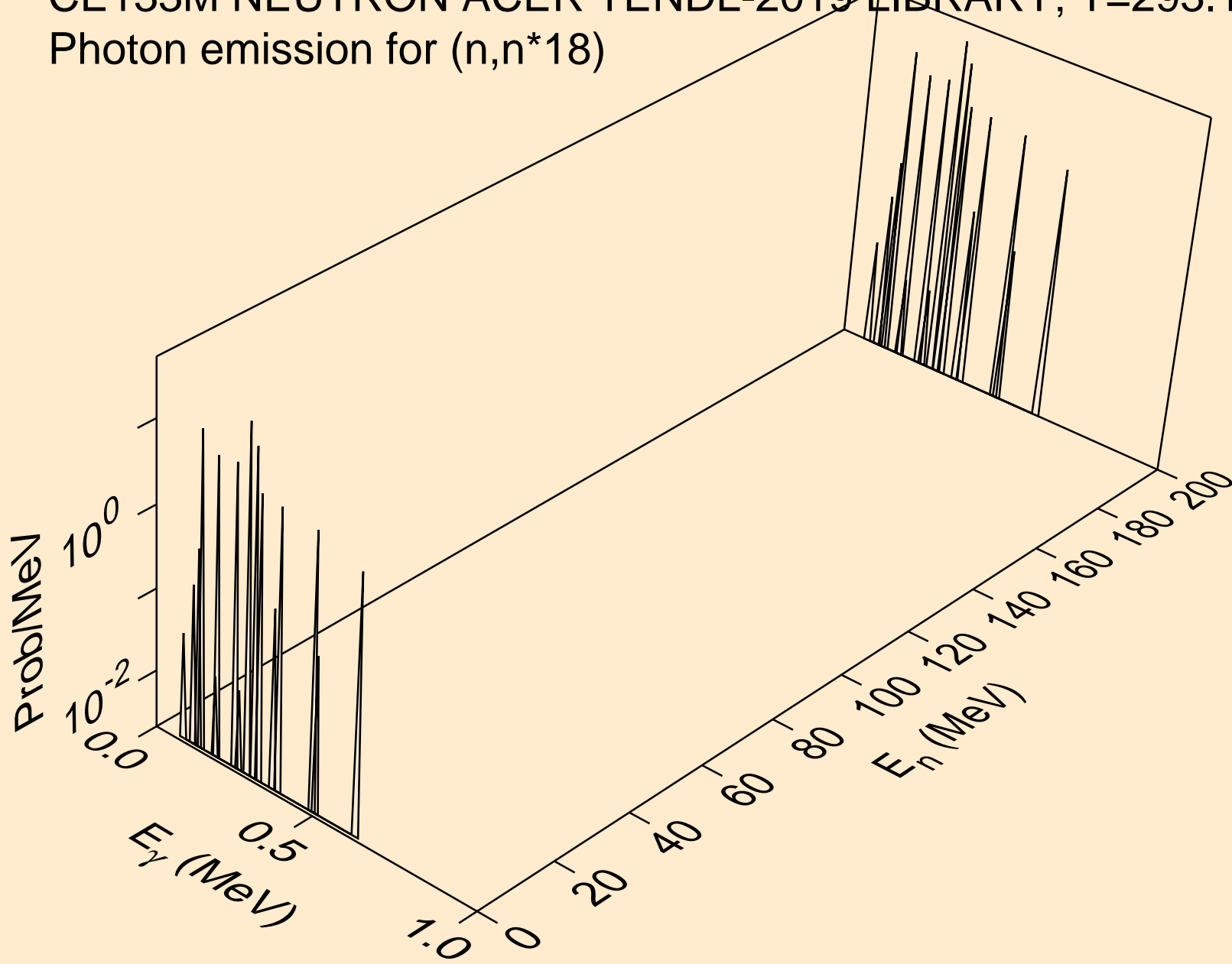

CE133M NEUTRON ACER TENDL-2019 LIBRARY; T=293.16K
Photon emission for (n,n*19)

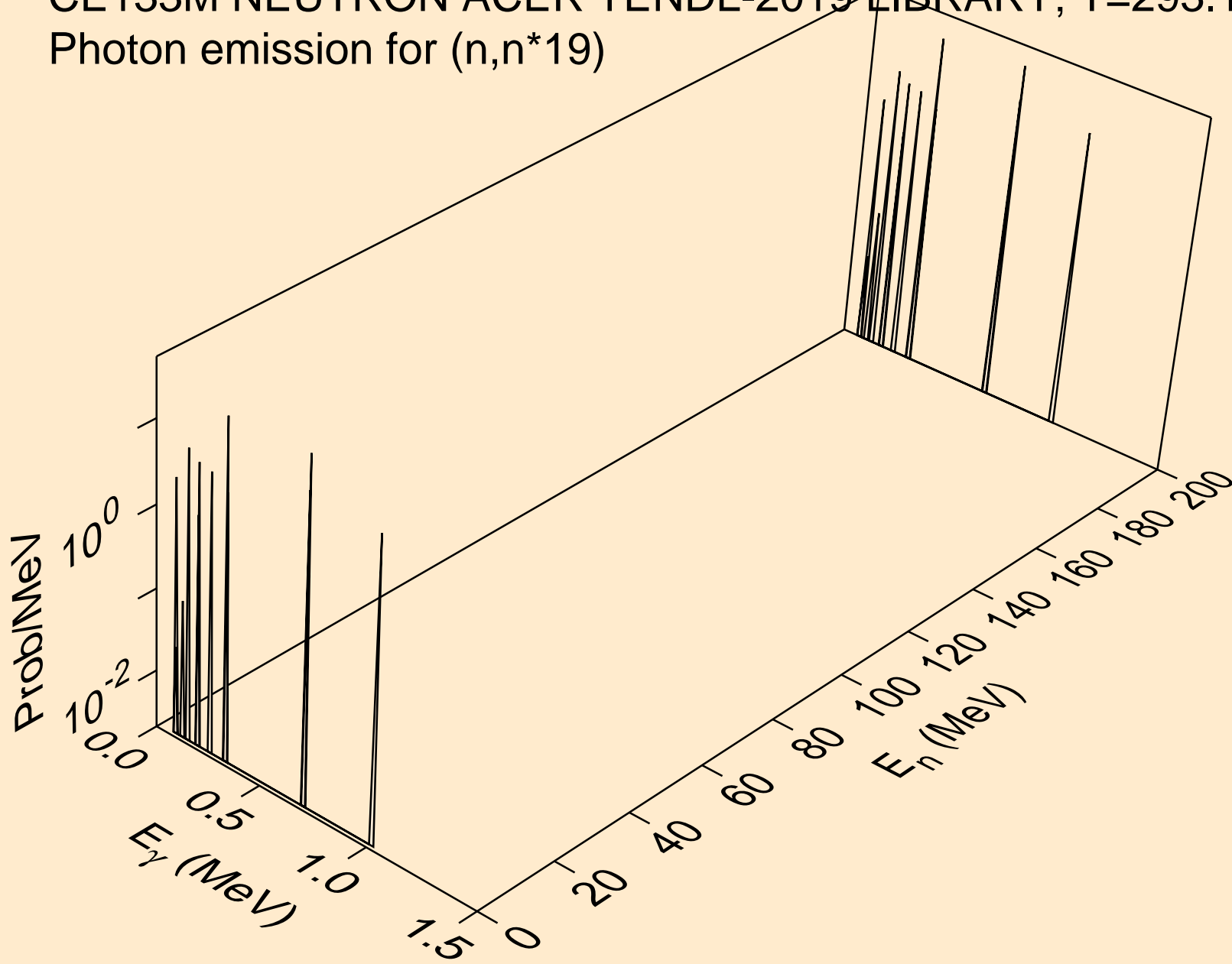

CE133M NEUTRON ACER TENDL-2019 LIBRARY; T=293.16K
Photon emission for (n,n*20)

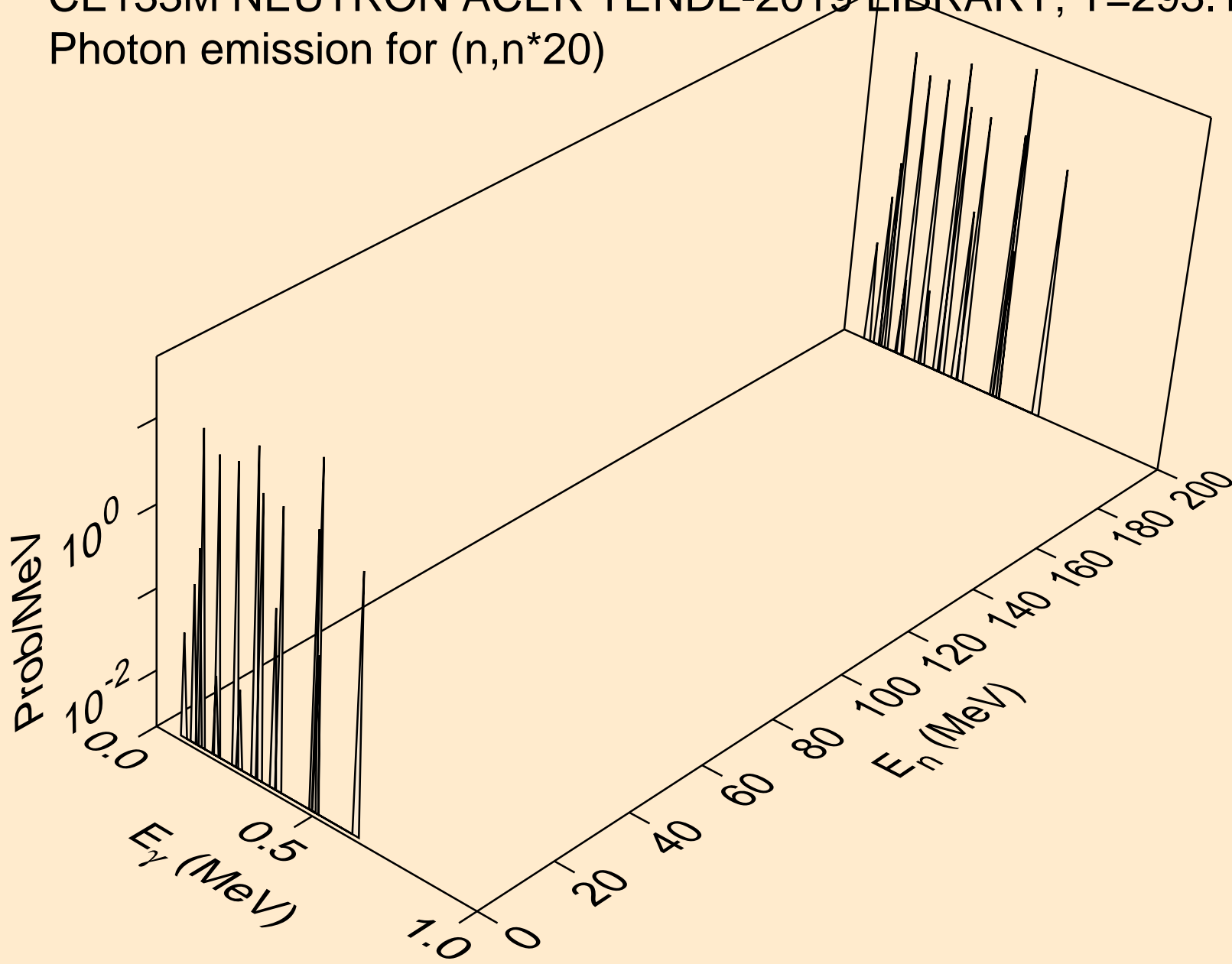

CE133M NEUTRON ACER TENDL-2019 LIBRARY; T=293.16K
Photon emission for (n,n*21)

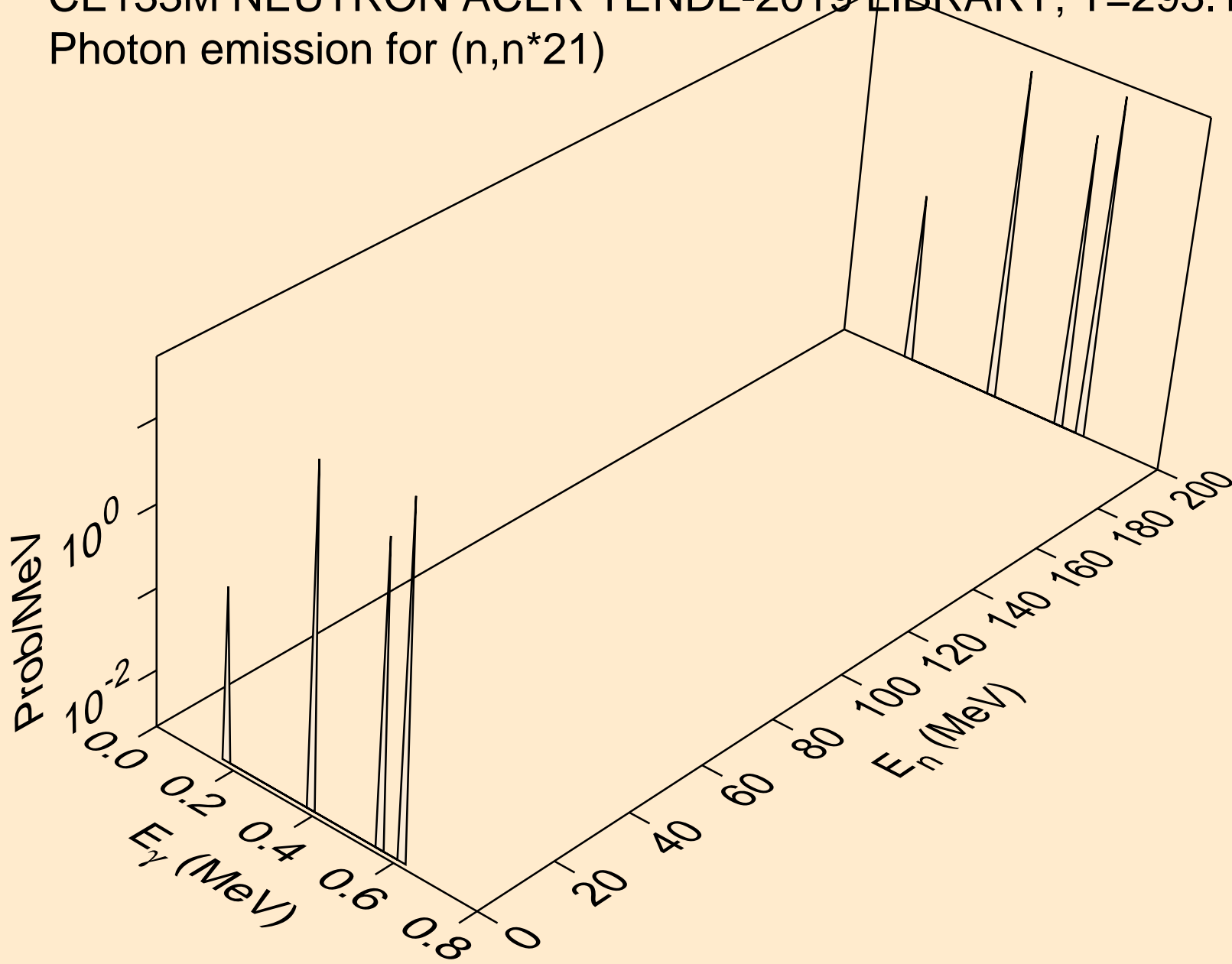

CE133M NEUTRON ACER TENDL-2019 LIBRARY; T=293.16K
Photon emission for (n,n*22)

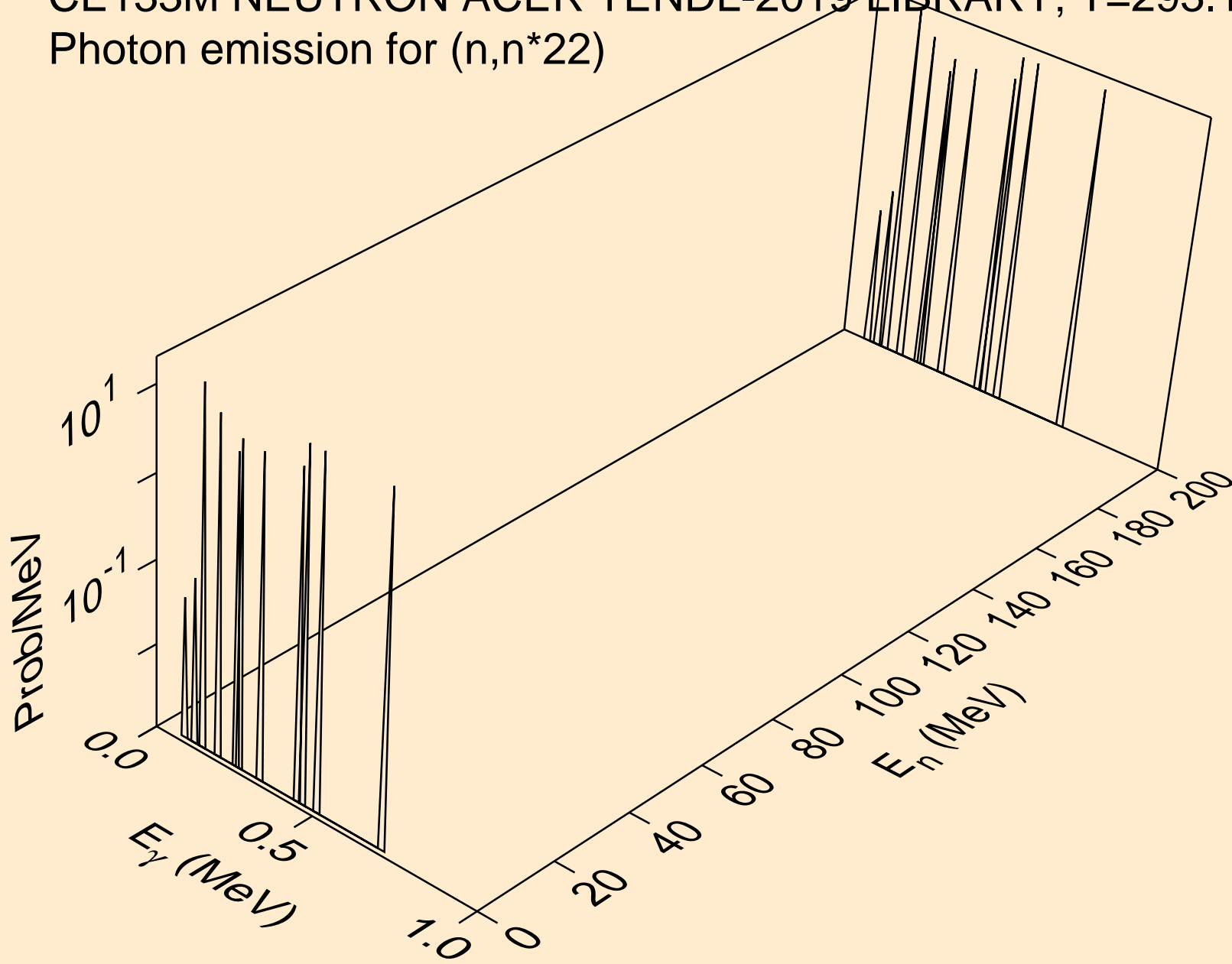

CE133M NEUTRON ACER TENDL-2019 LIBRARY; T=293.16K
Photon emission for (n,n*23)

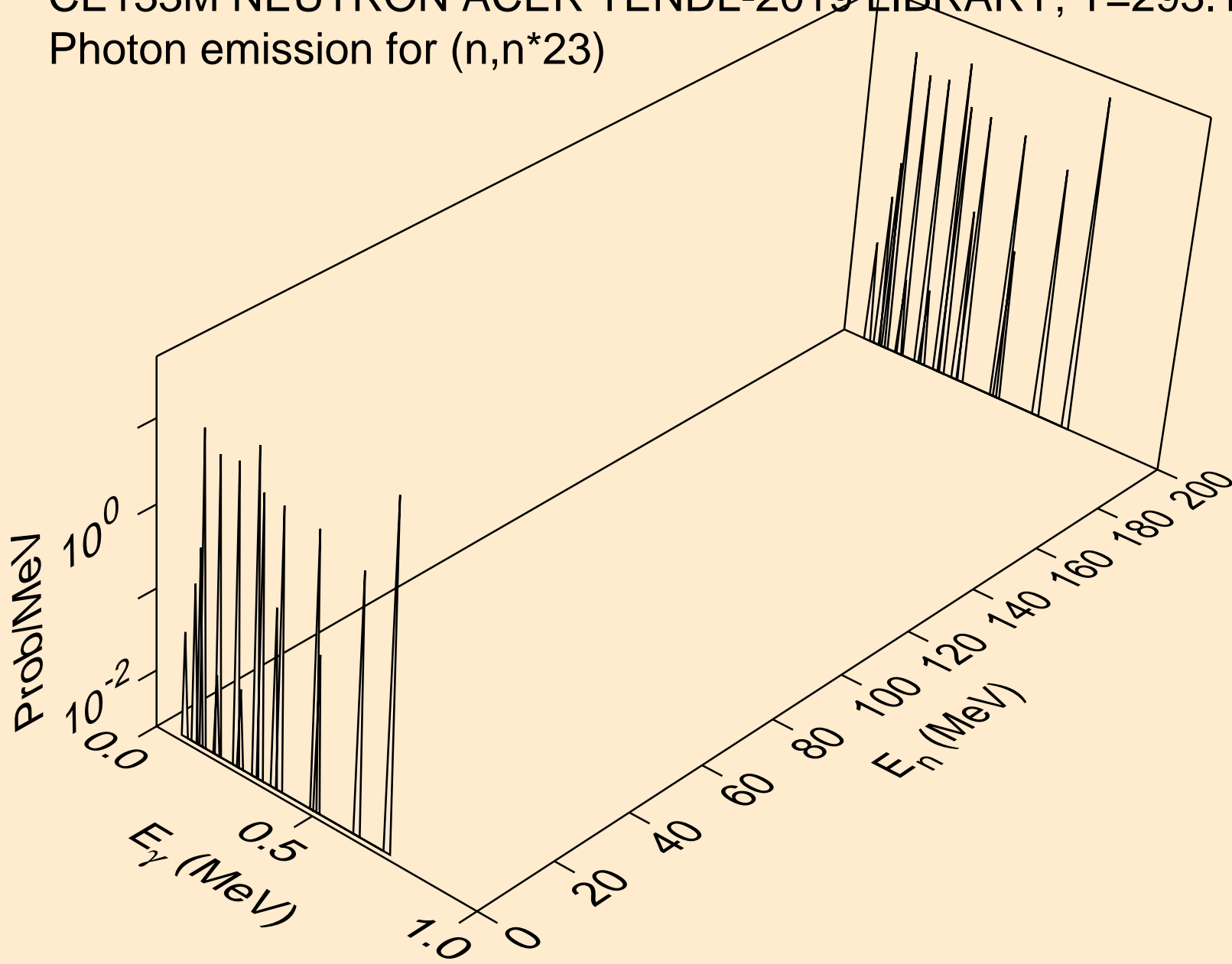

CE133M NEUTRON ACER TENDL-2019 LIBRARY; T=293.16K
Photon emission for (n,n*24)

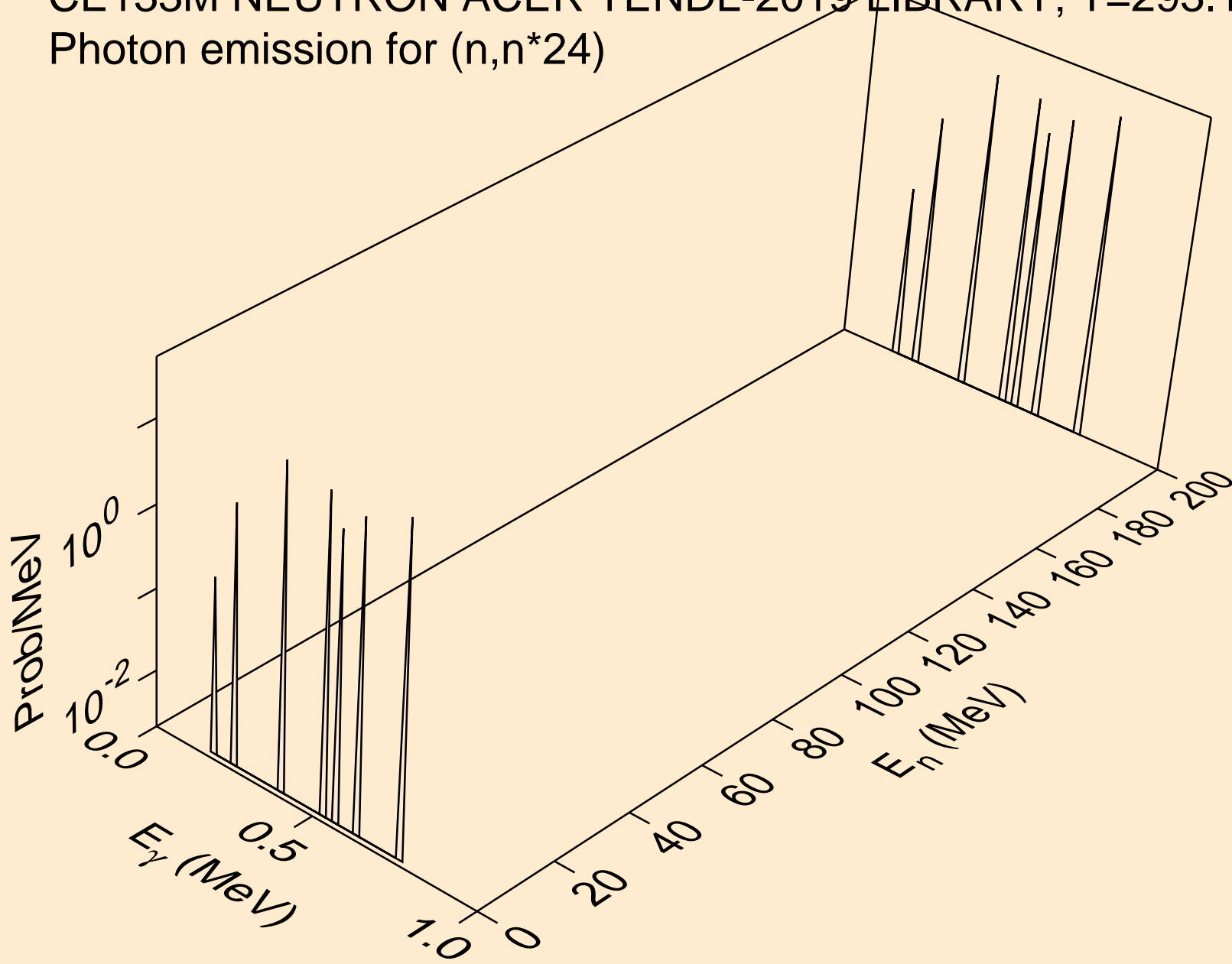

CE133M NEUTRON ACER TENDL-2019 LIBRARY; T=293.16K
Photon emission for (n,n*25)

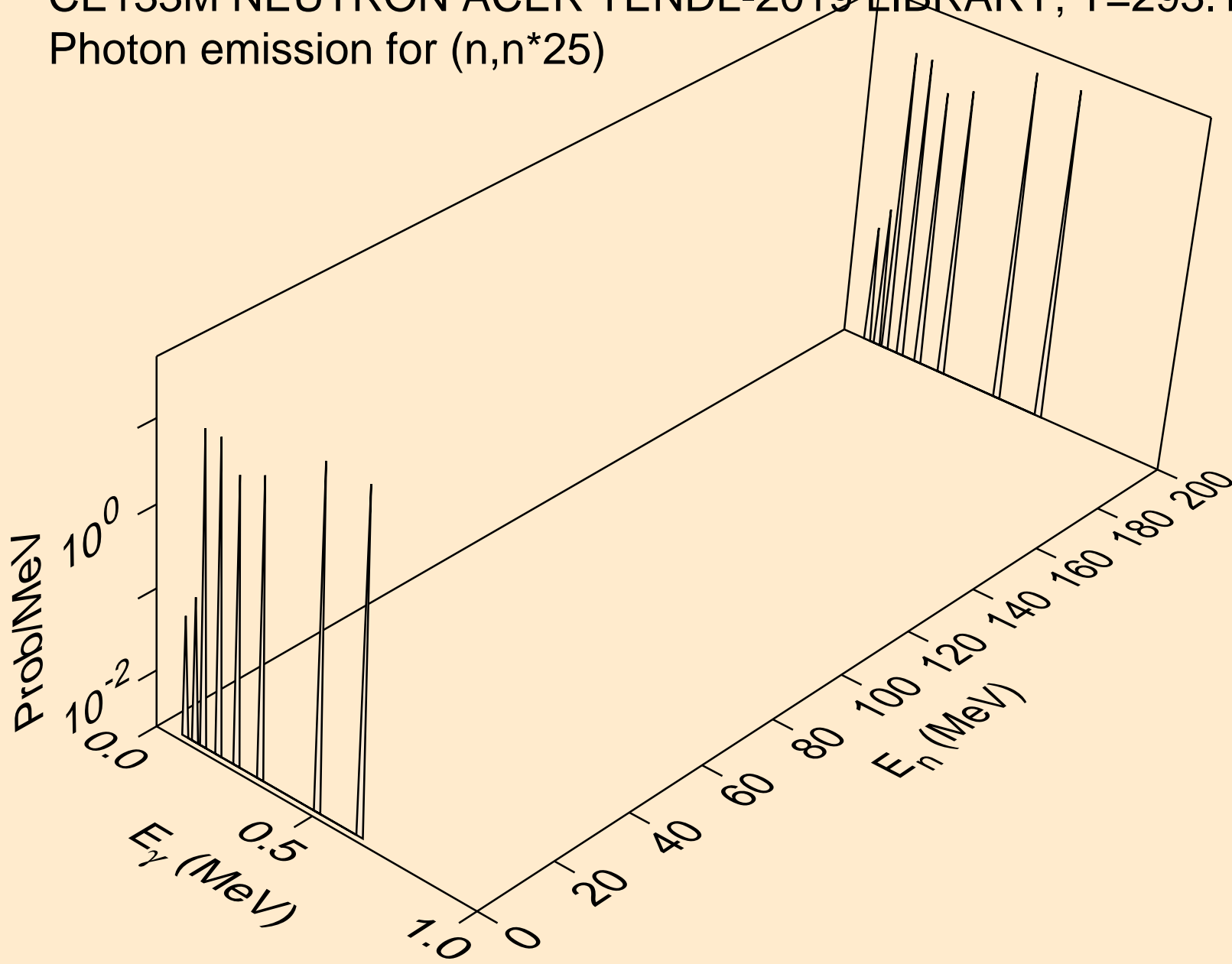

CE133M NEUTRON ACER TENDL-2019 LIBRARY; T=293.16K
Photon emission for (n,n*26)

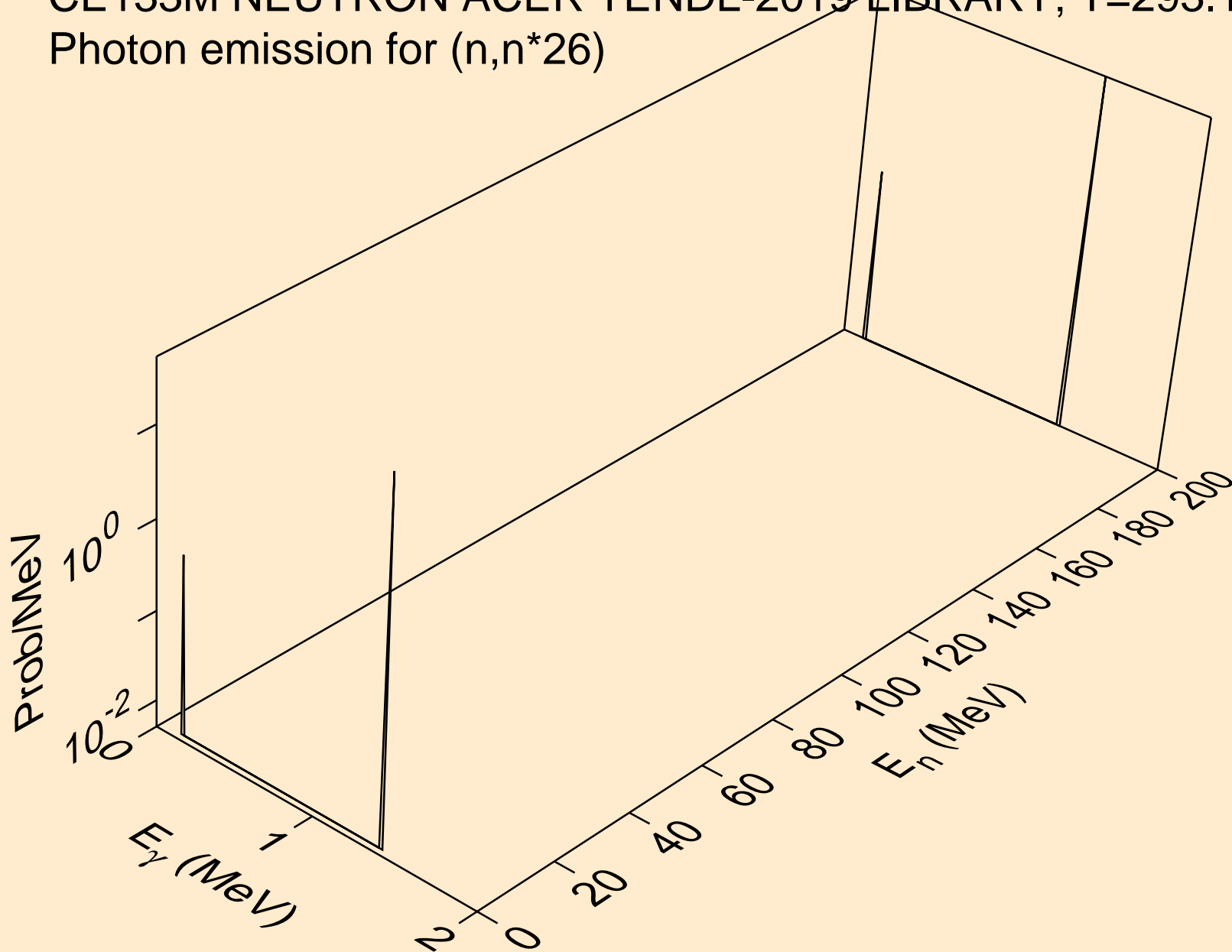

CE133M NEUTRON ACER TENDL-2019 LIBRARY; T=293.16K
Photon emission for (n,n*27)

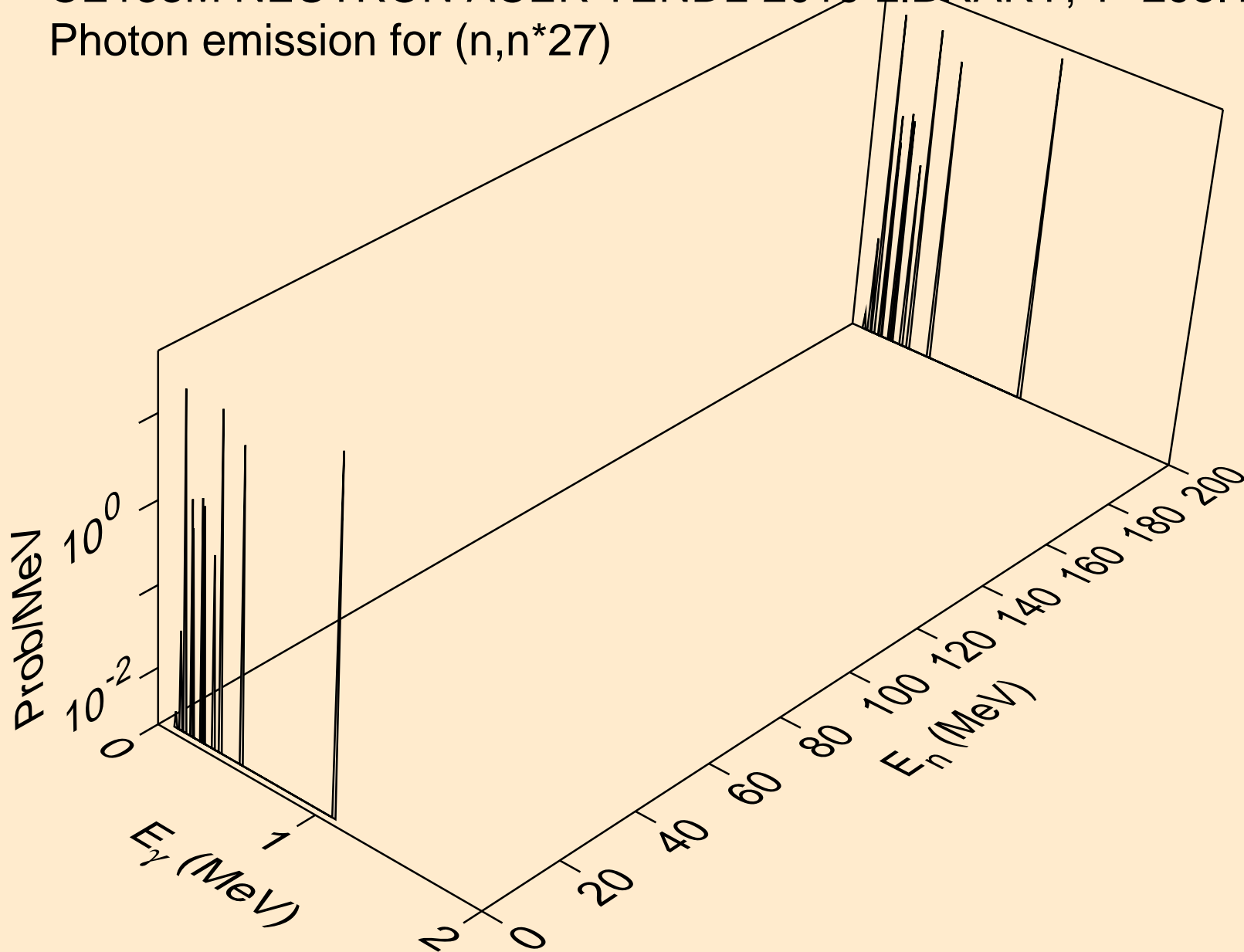

CE133M NEUTRON ACER TENDL-2019 LIBRARY; T=293.16K
Photon emission for (n,n*c)

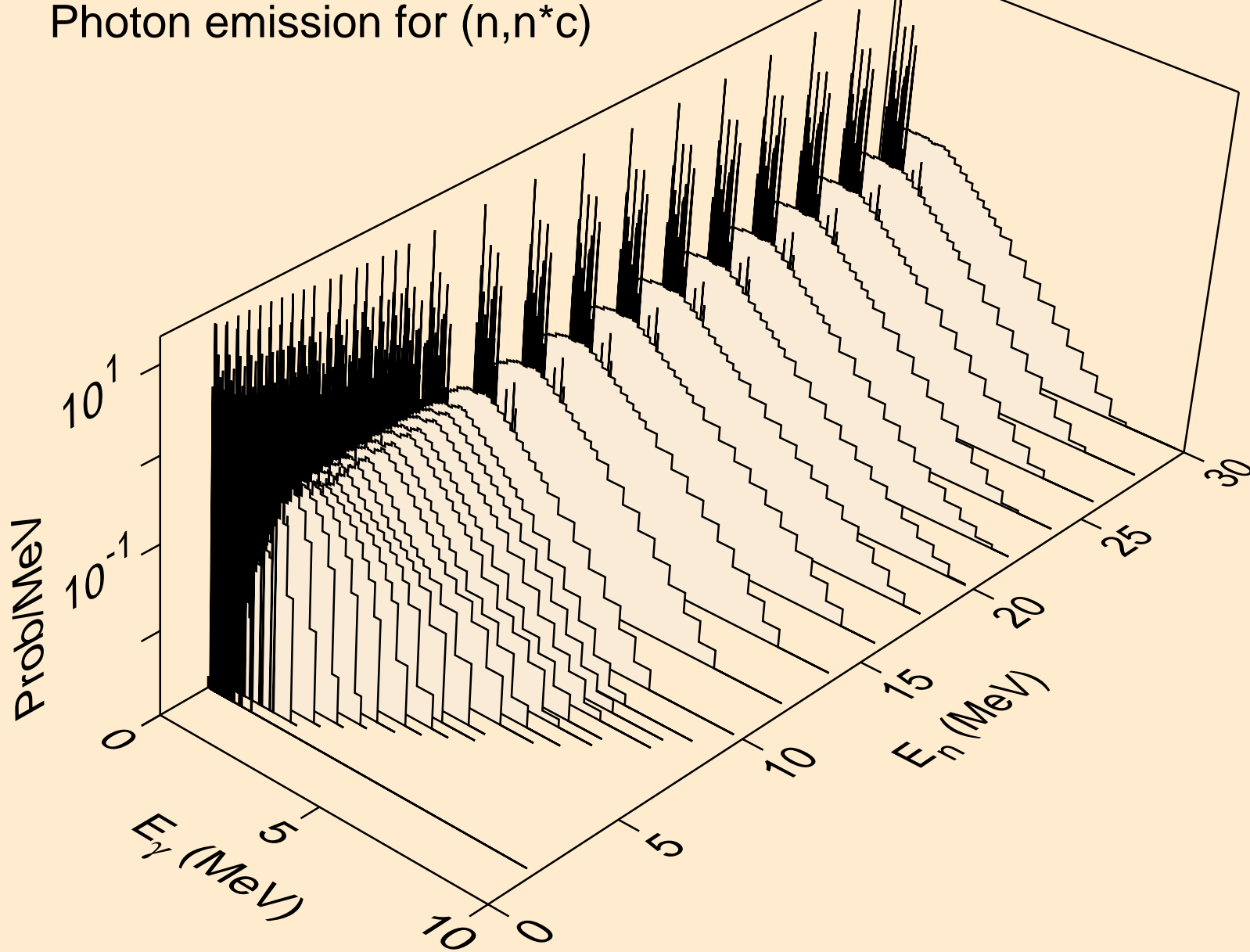

CE133M NEUTRON ACER TENDL-2019 LIBRARY; T=293.16K
Photon emission for (n,gma)

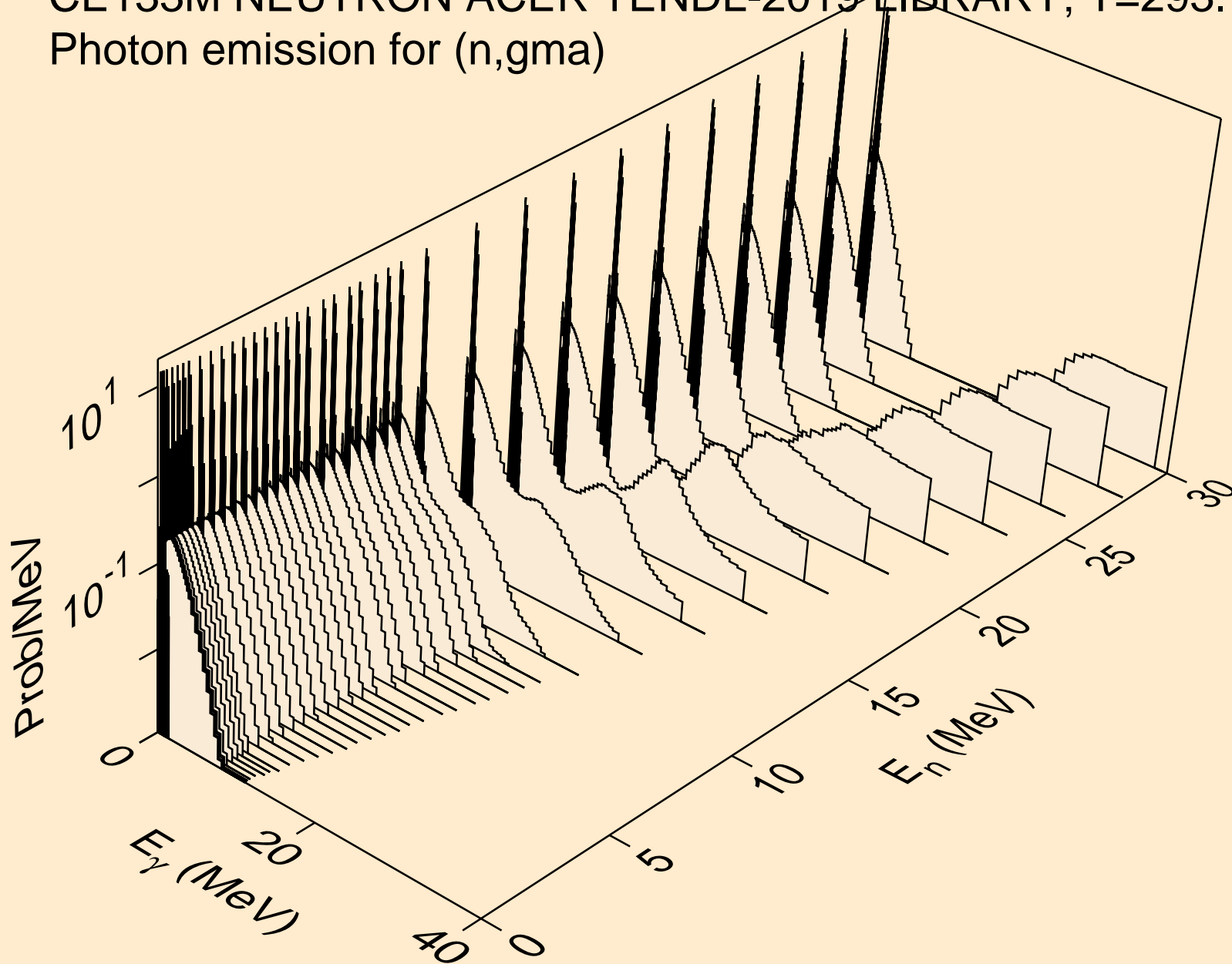

CE133M NEUTRON ACER TENDL-2019 LIBRARY; T=293.16K
Photon emission for (n,p)

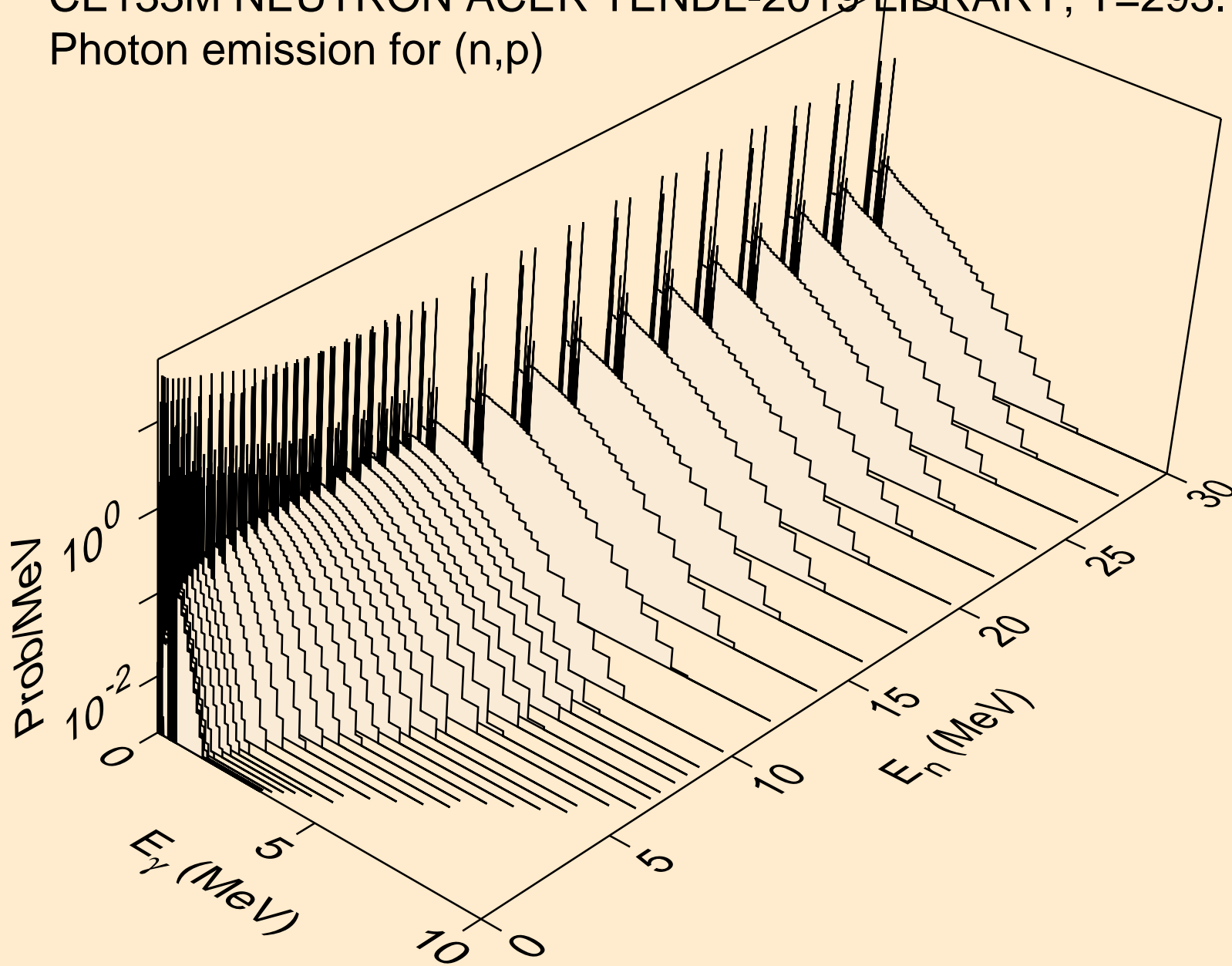

CE133M NEUTRON ACER TENDL-2019 LIBRARY; T=293.16K
Photon emission for (n,d)

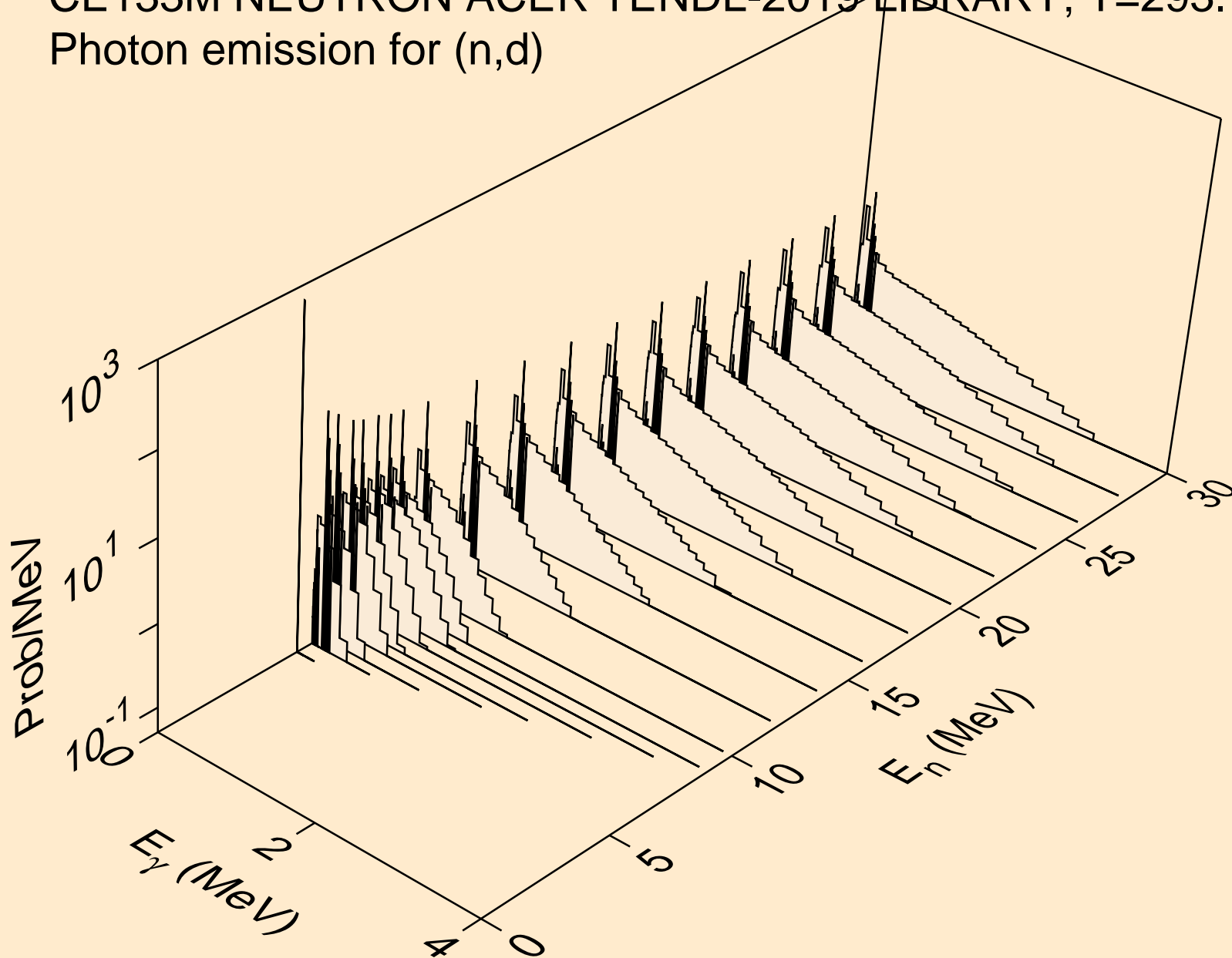

CE133M NEUTRON ACER TENDL-2019 LIBRARY; T=293.16K
Photon emission for (n,t)

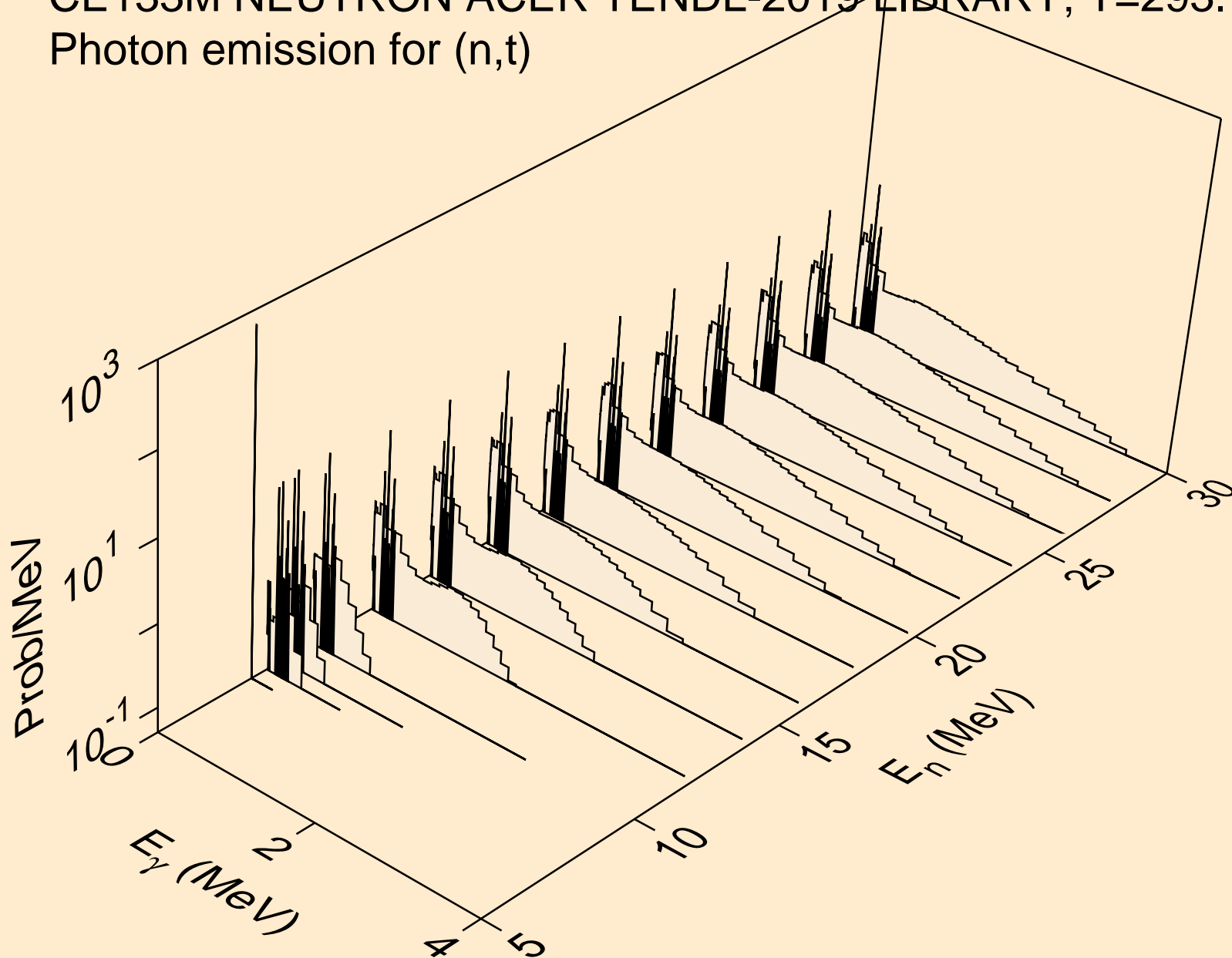

CE133M NEUTRON ACER TENDL-2019 LIBRARY; T=293.16K
Photon emission for (n,he3)

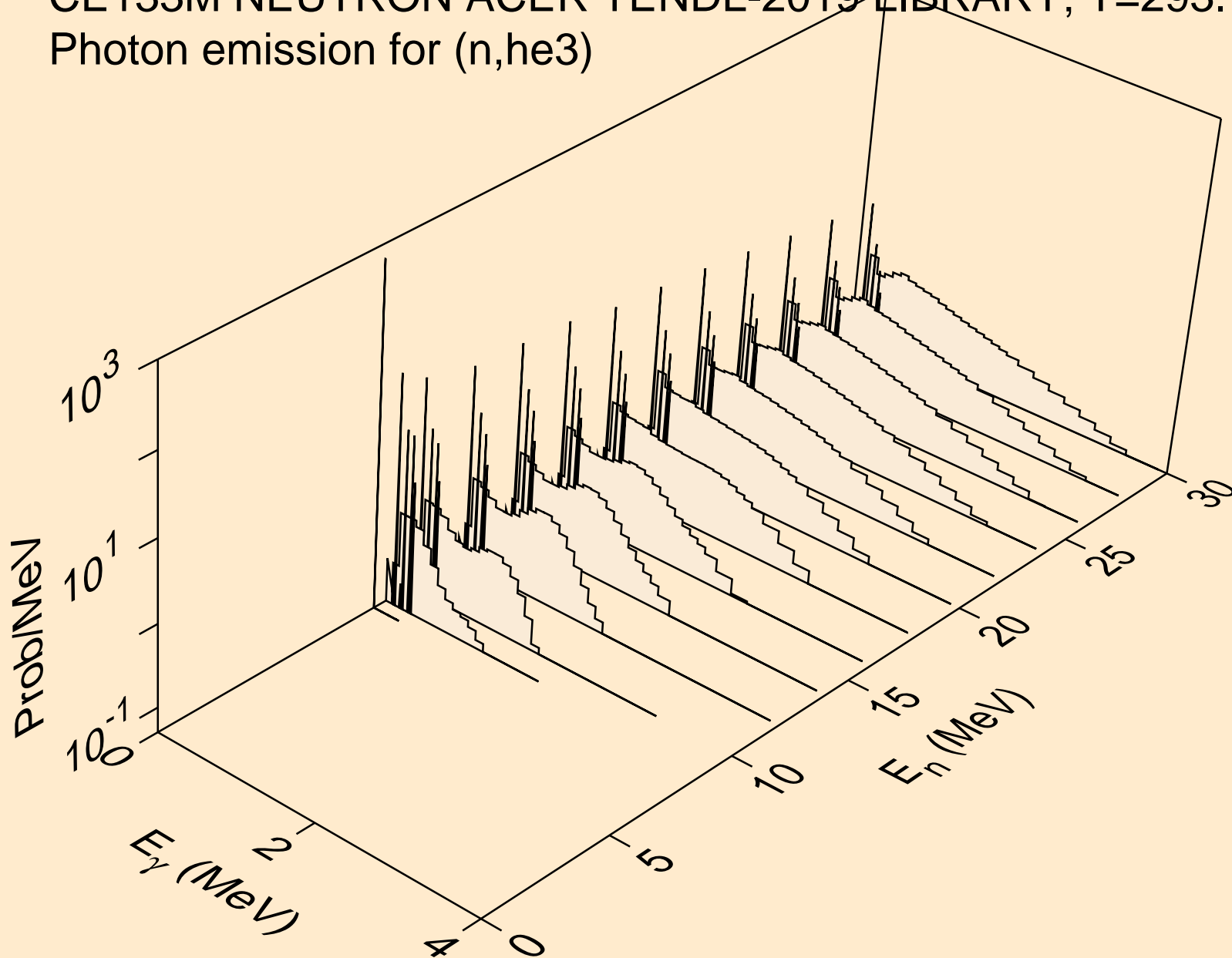

CE133M NEUTRON ACER TENDL-2019 LIBRARY; T=293.16K
Photon emission for (n,a)

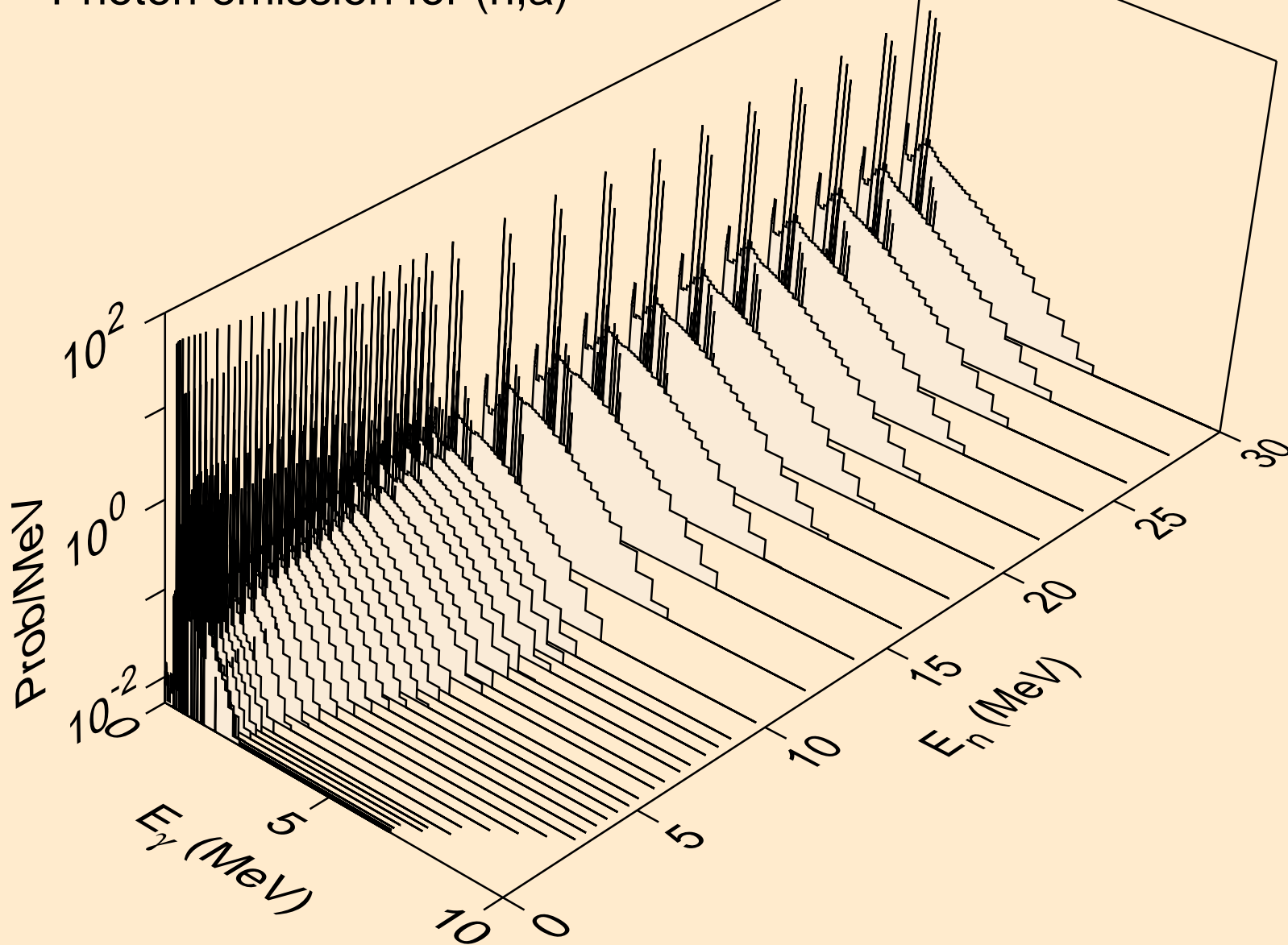

CE133M NEUTRON ACER TENDL-2019 LIBRARY; T=293.16K
Photon emission for (n,2a)

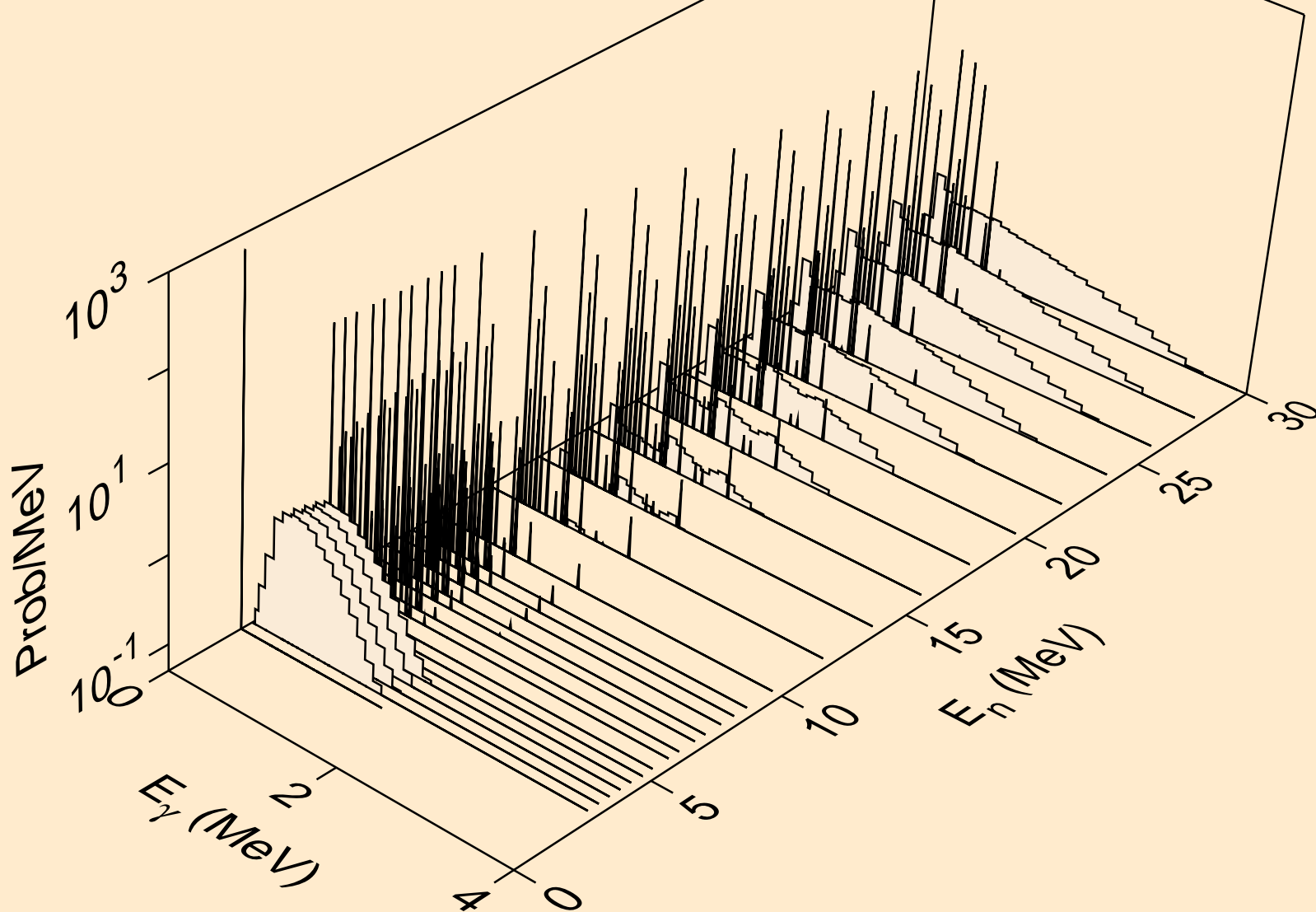

CE133M NEUTRON ACER TENDL-2019 LIBRARY; T=293.16K
Photon emission for (n,2p)

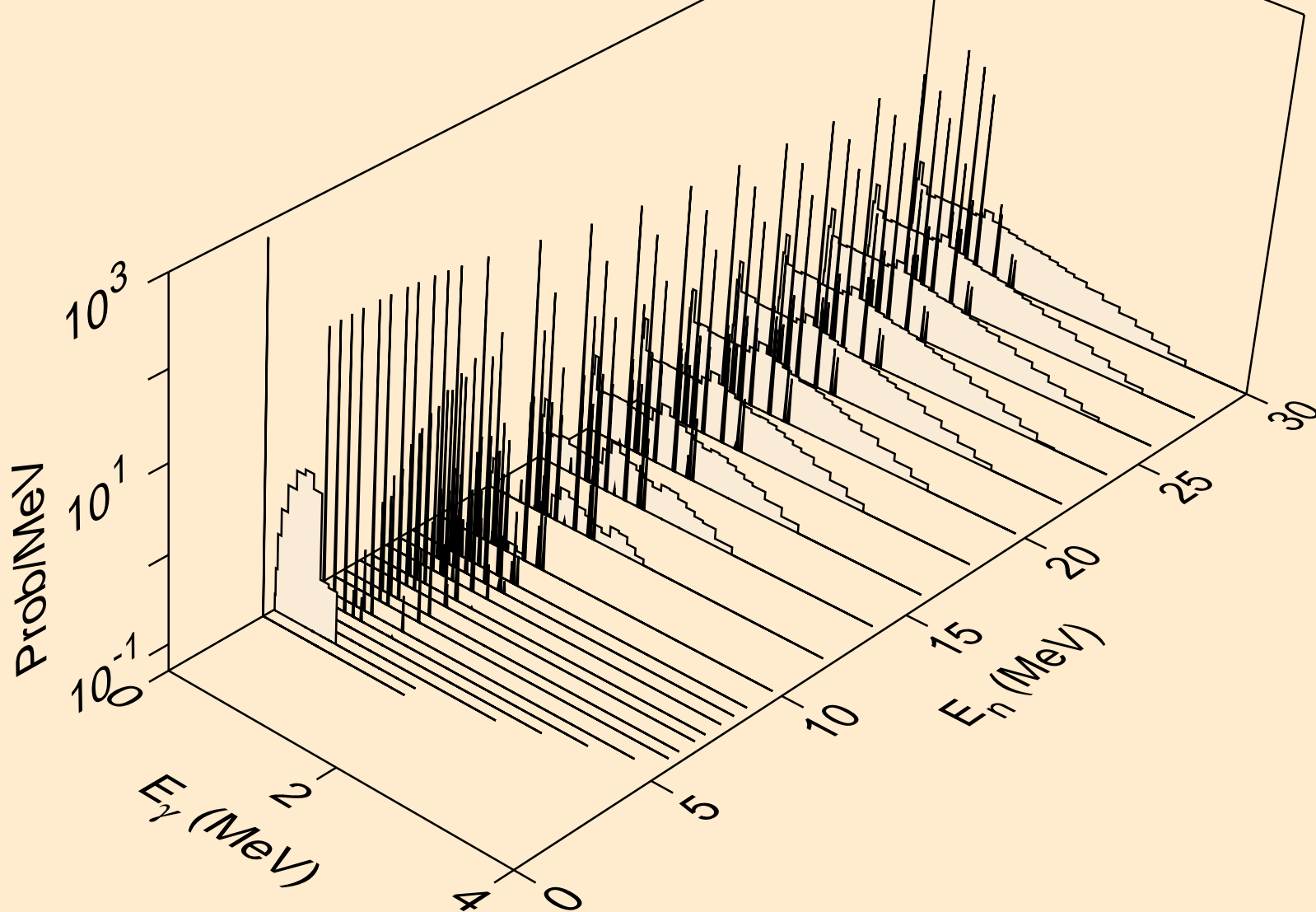

CE133M NEUTRON ACER TENDL-2019 LIBRARY; T=293.16K
Photon emission for (n,p α)

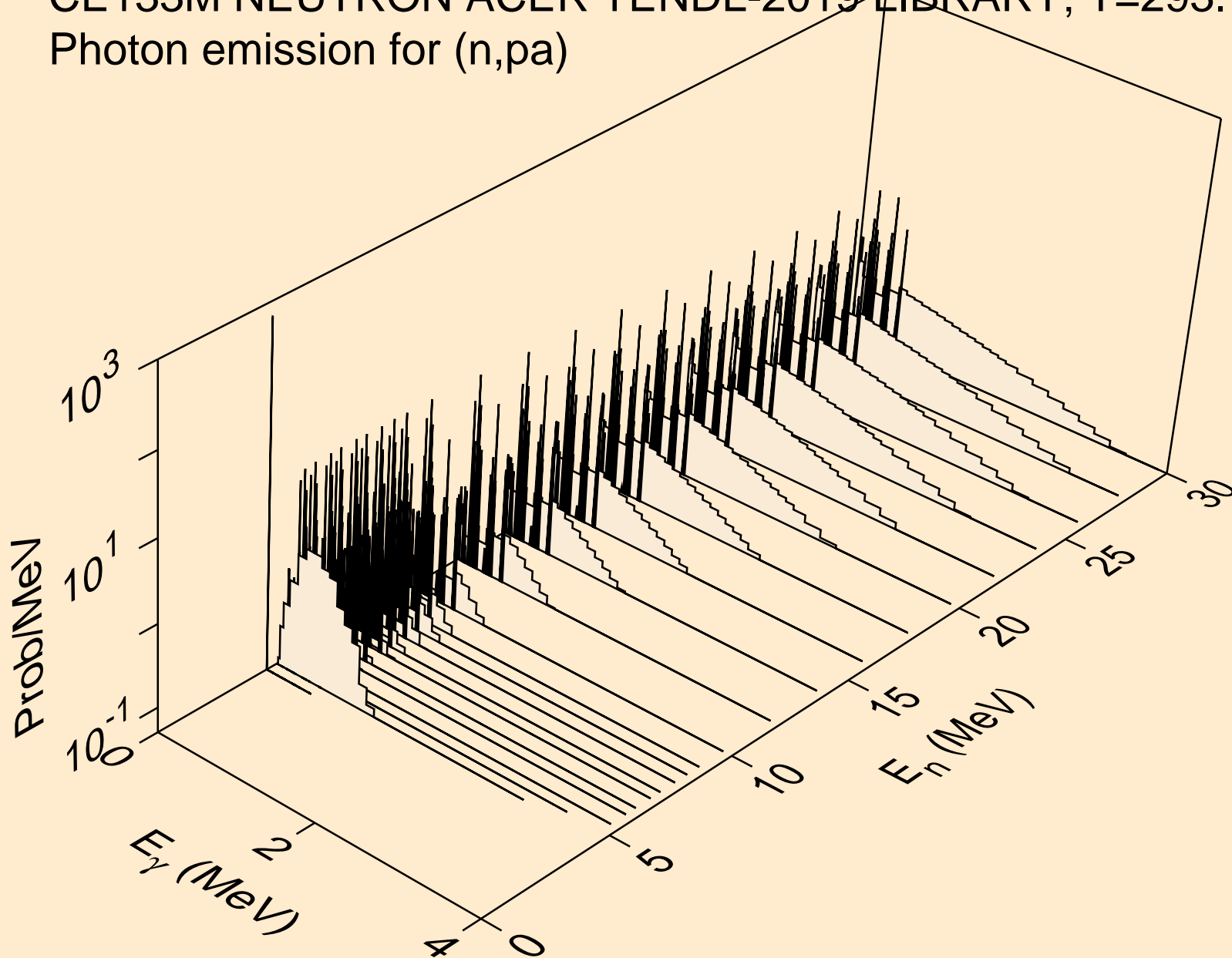

CE133M NEUTRON ACER TENDL-2019 LIBRARY; T=293.16K
Photon emission for (n,pd)

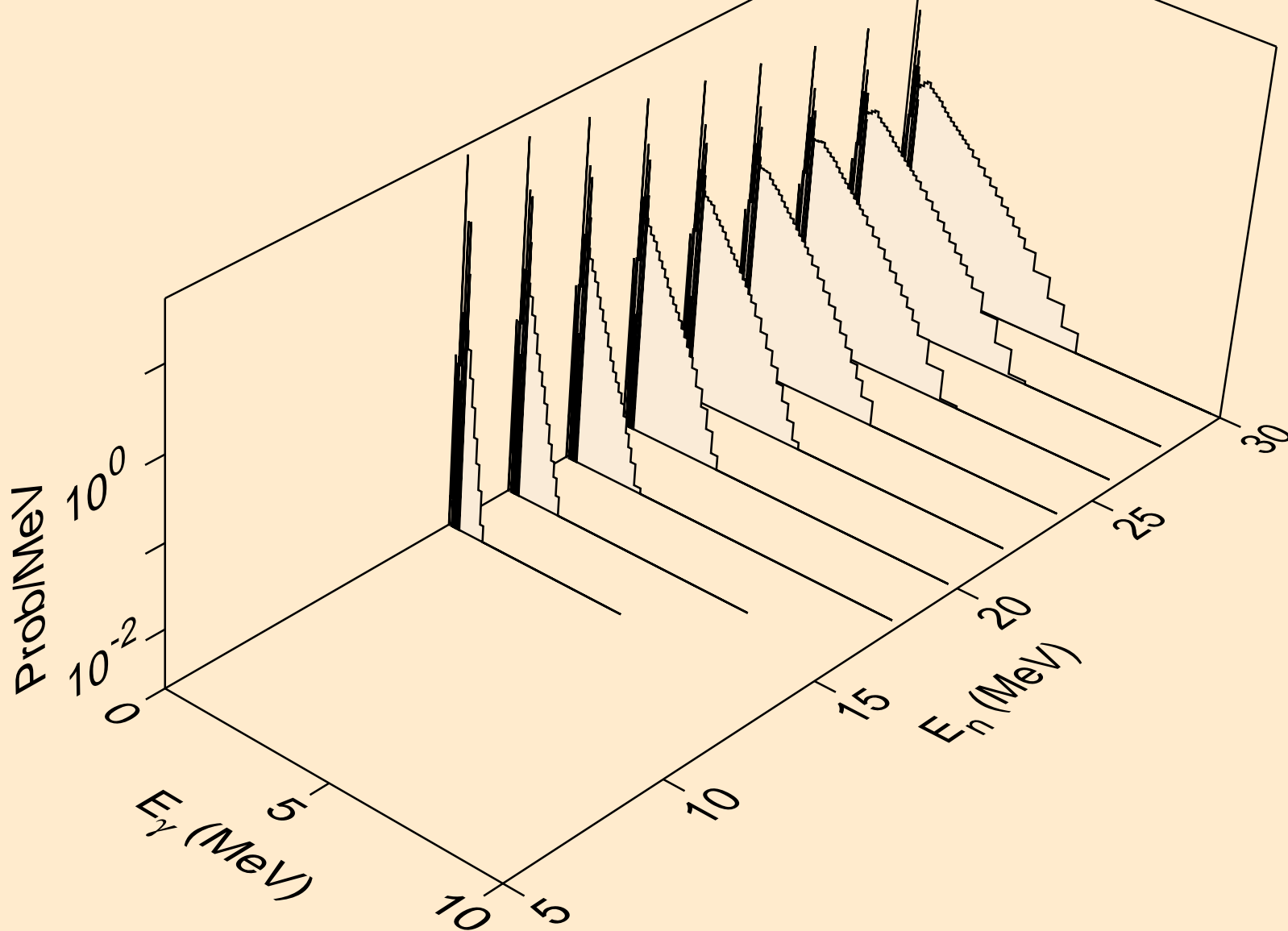

CE133M NEUTRON ACER TENDL-2019 LIBRARY; T=293.16K
Photon emission for (n,pt)

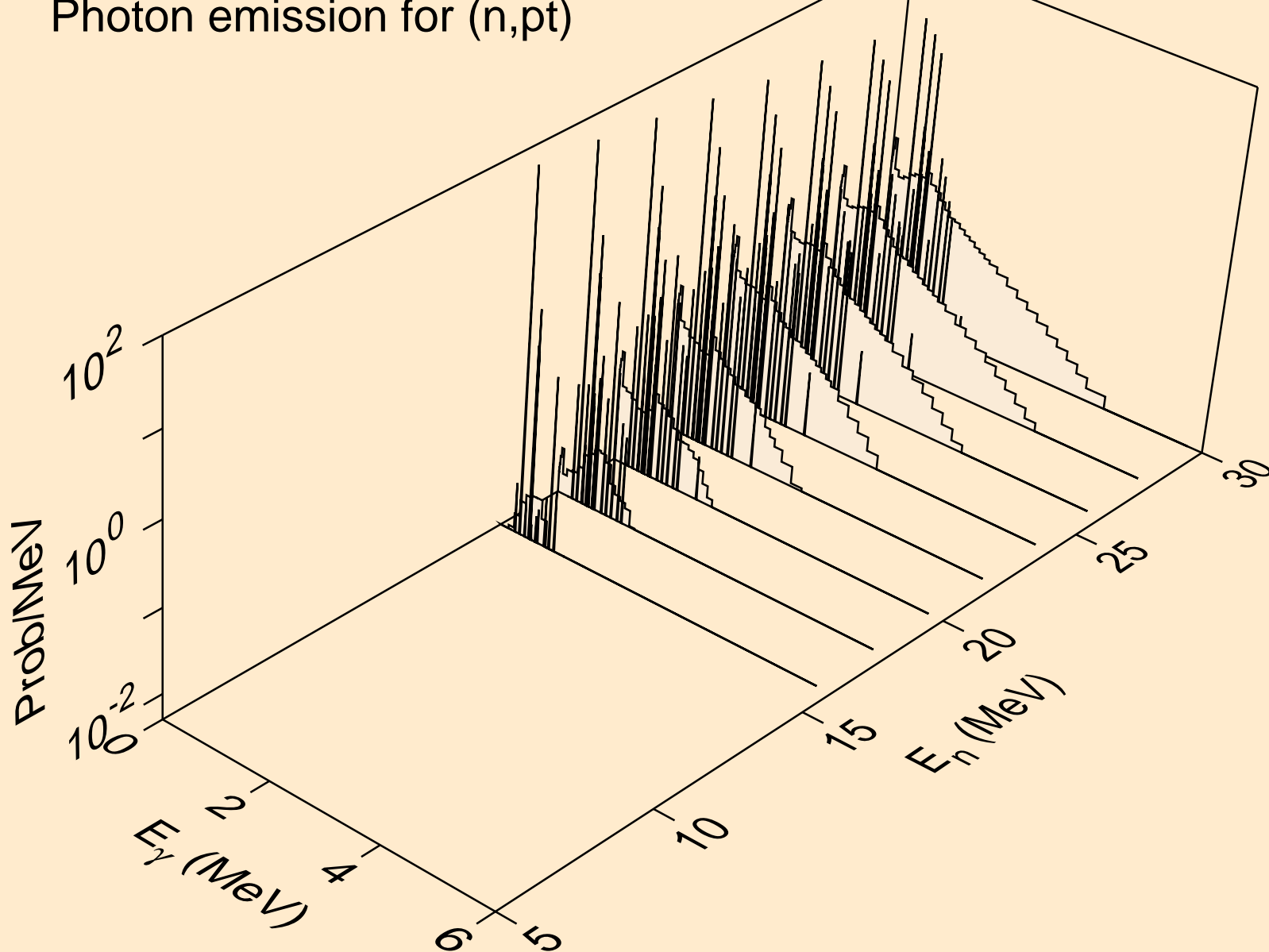

CE133M NEUTRON ACER TENDL-2019 LIBRARY; T=293.16K
Photon emission for (n,da)

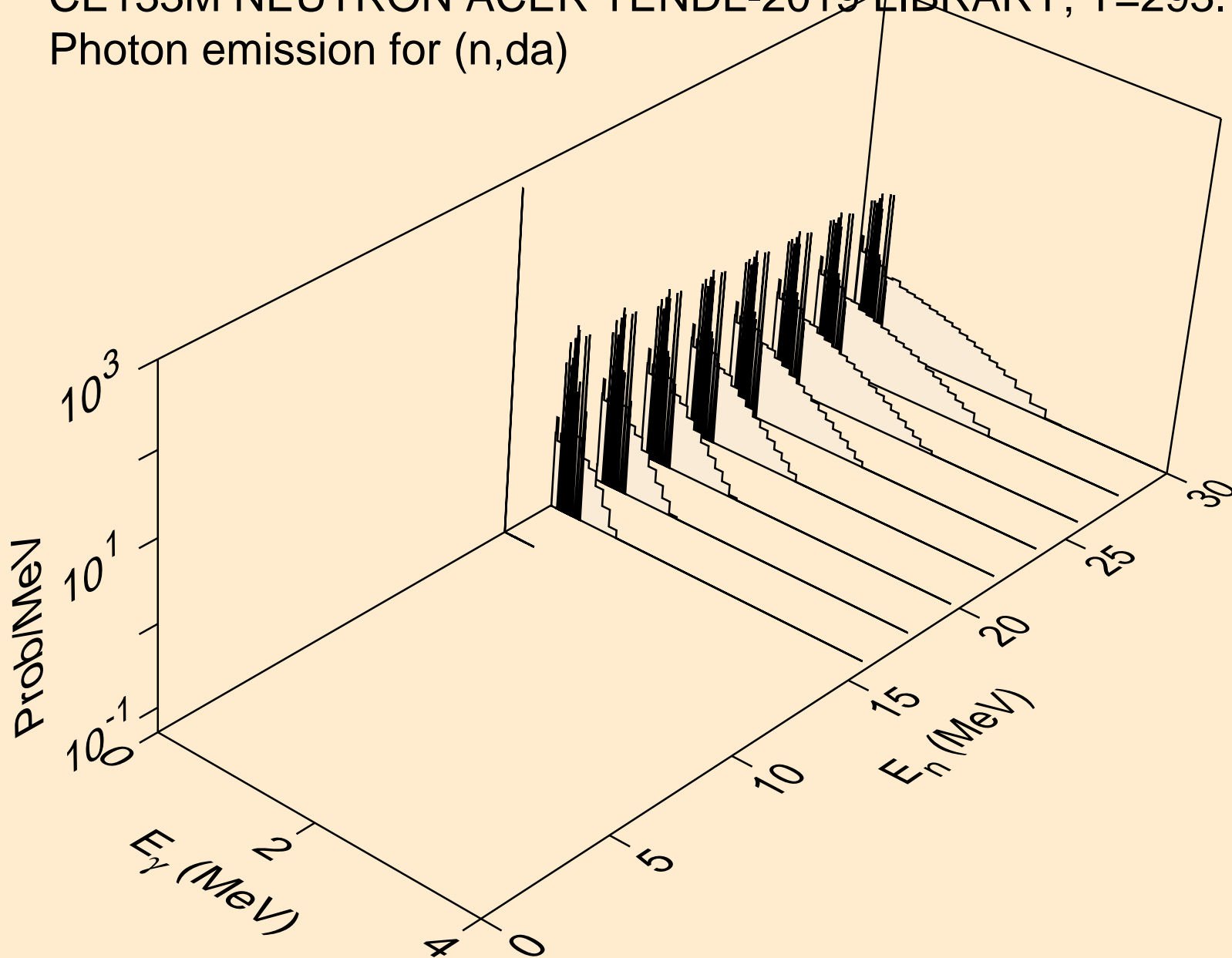

CE133M NEUTRON ACER TENDL-2019 LIBRARY; T=293.16K
thermal capture photon spectrum

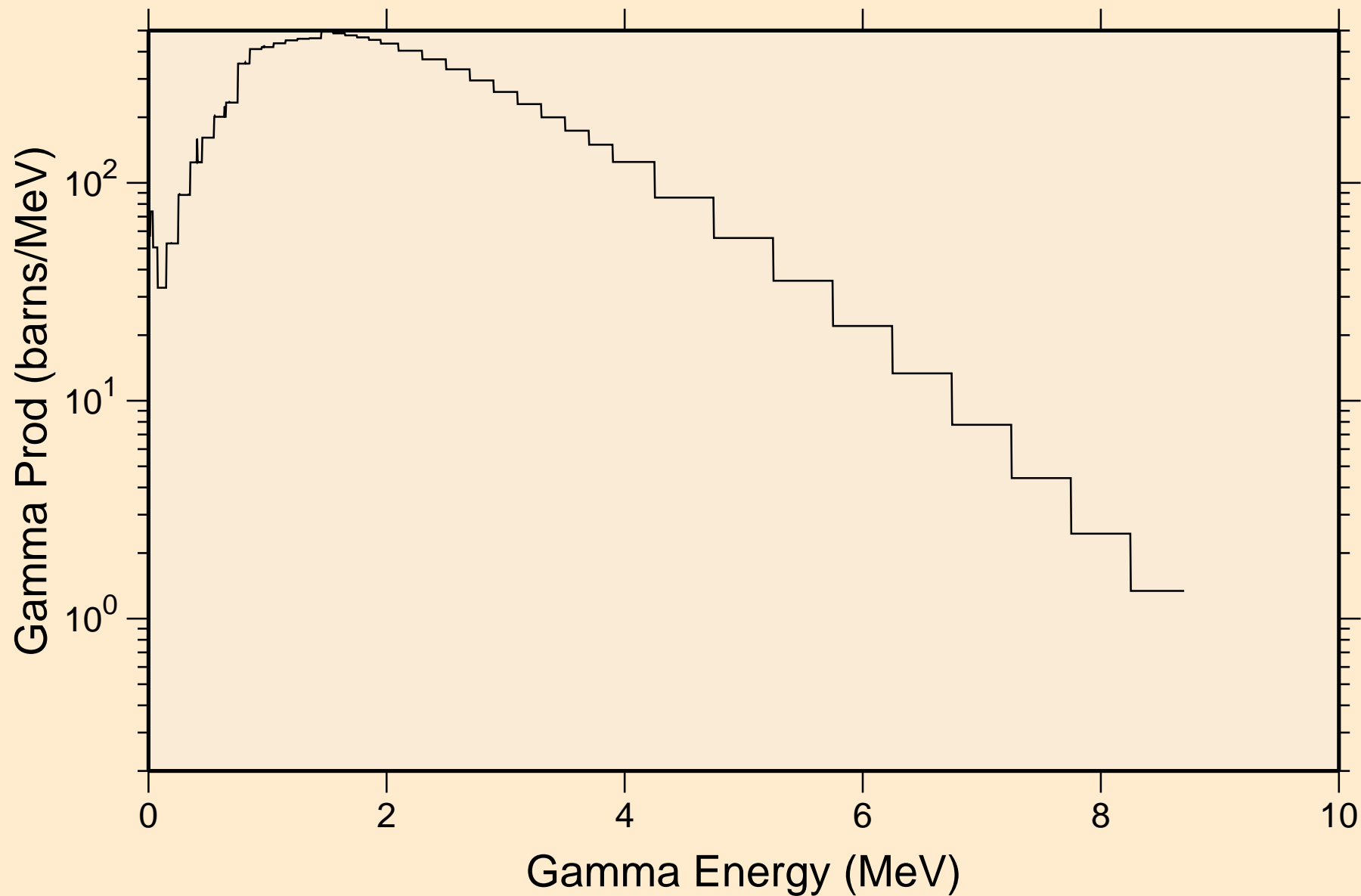

CE133M NEUTRON ACER TENDL-2019 LIBRARY; T=293.16K
14 MeV photon spectrum

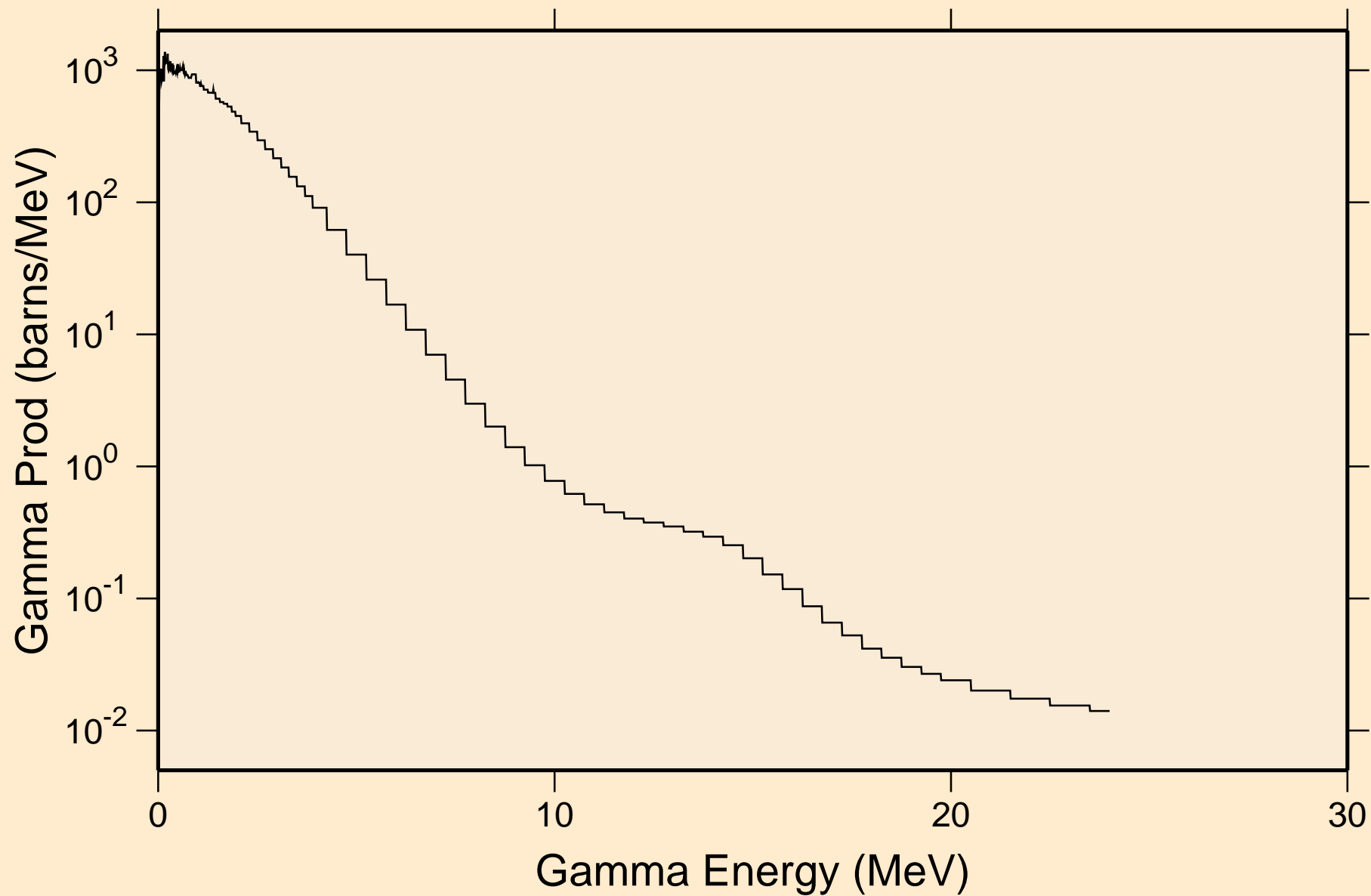

CE133M NEUTRON ACER TENDL-2019 LIBRARY; T=293.16K
Particle heating contributions

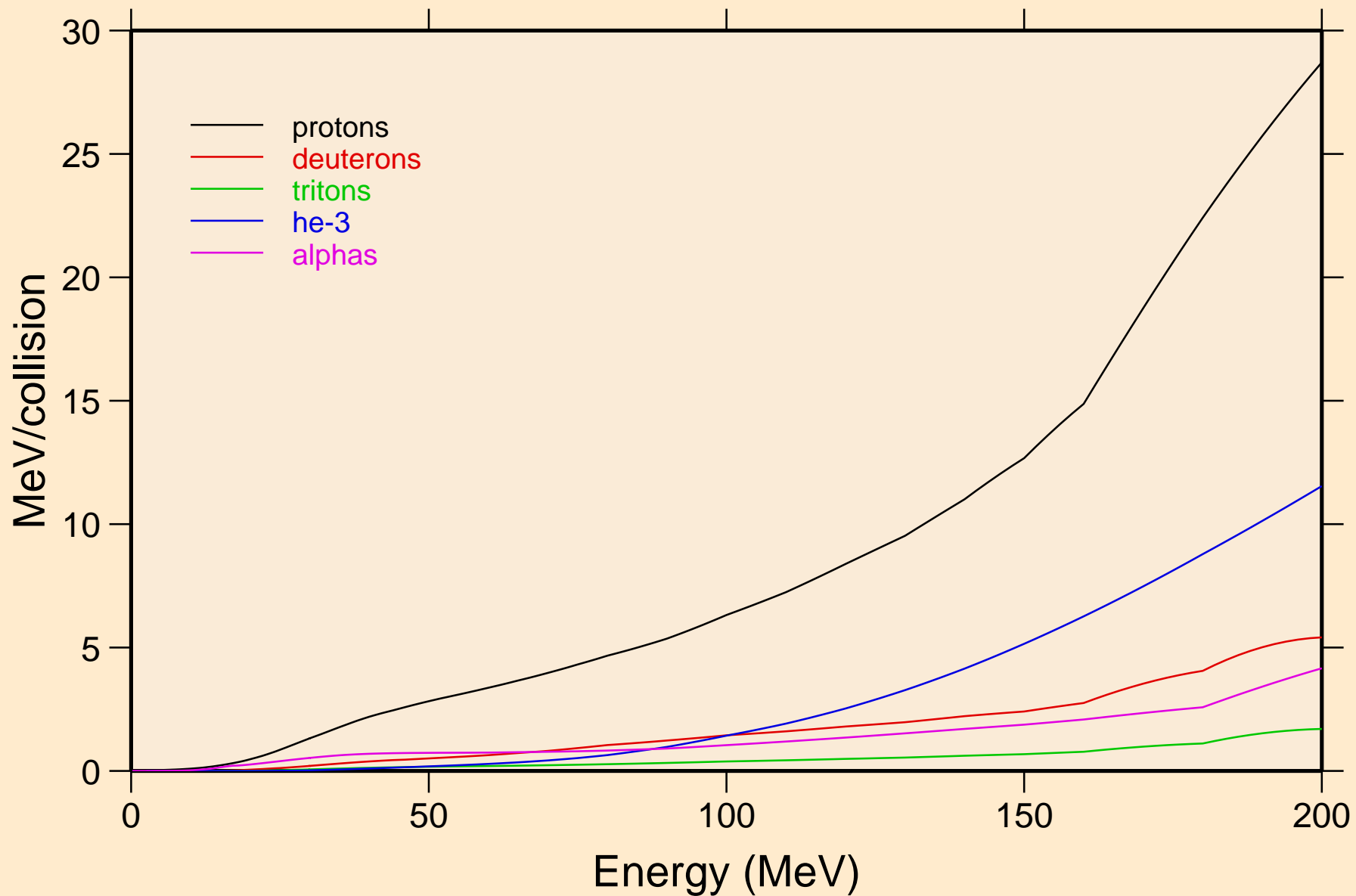

CE133M NEUTRON ACER TENDL-2019 LIBRARY; T=293.16K
Recoil Heating

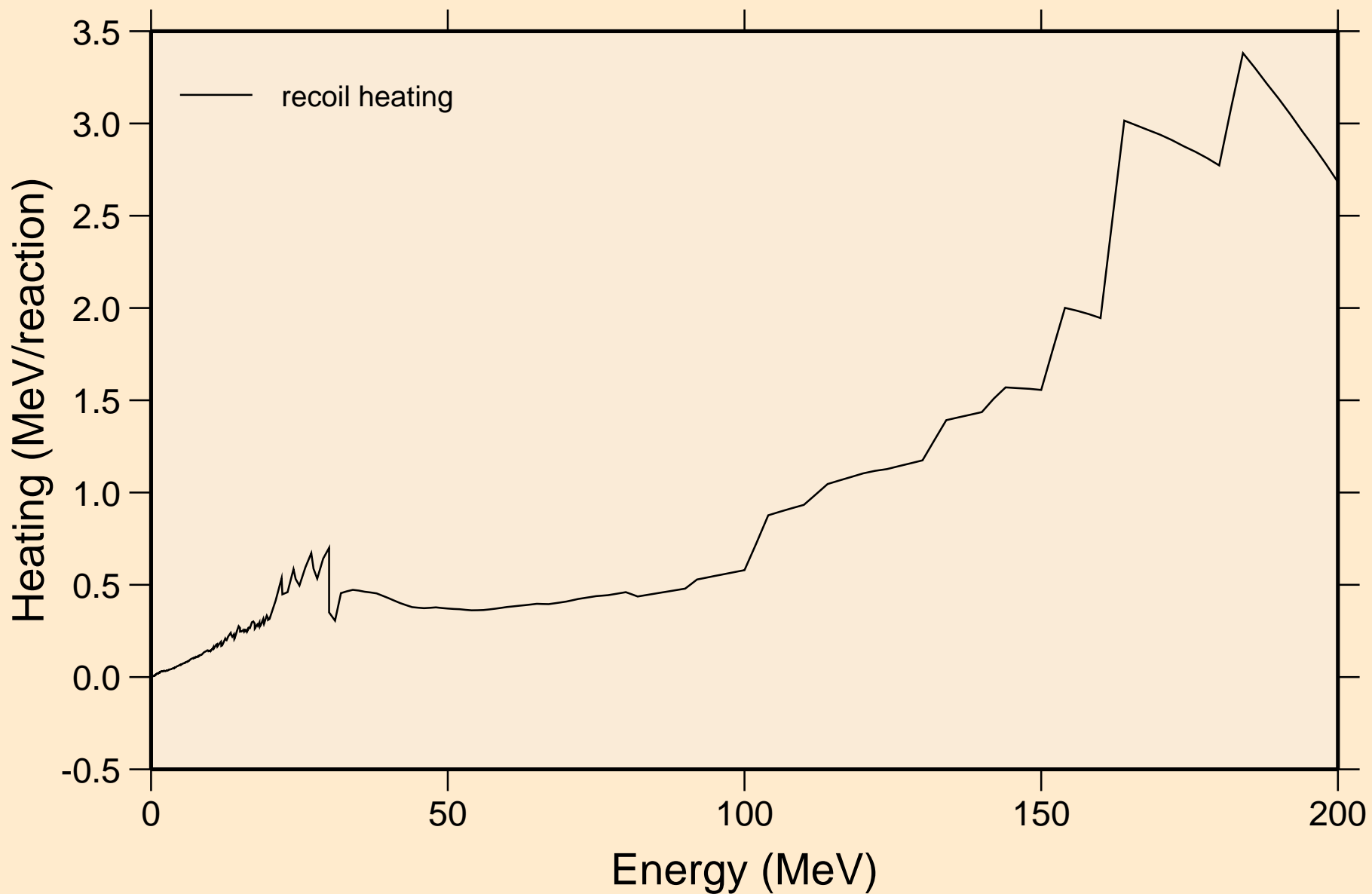

CE133M NEUTRON ACER TENDL-2019 LIBRARY; T=293.16K
Particle production cross sections

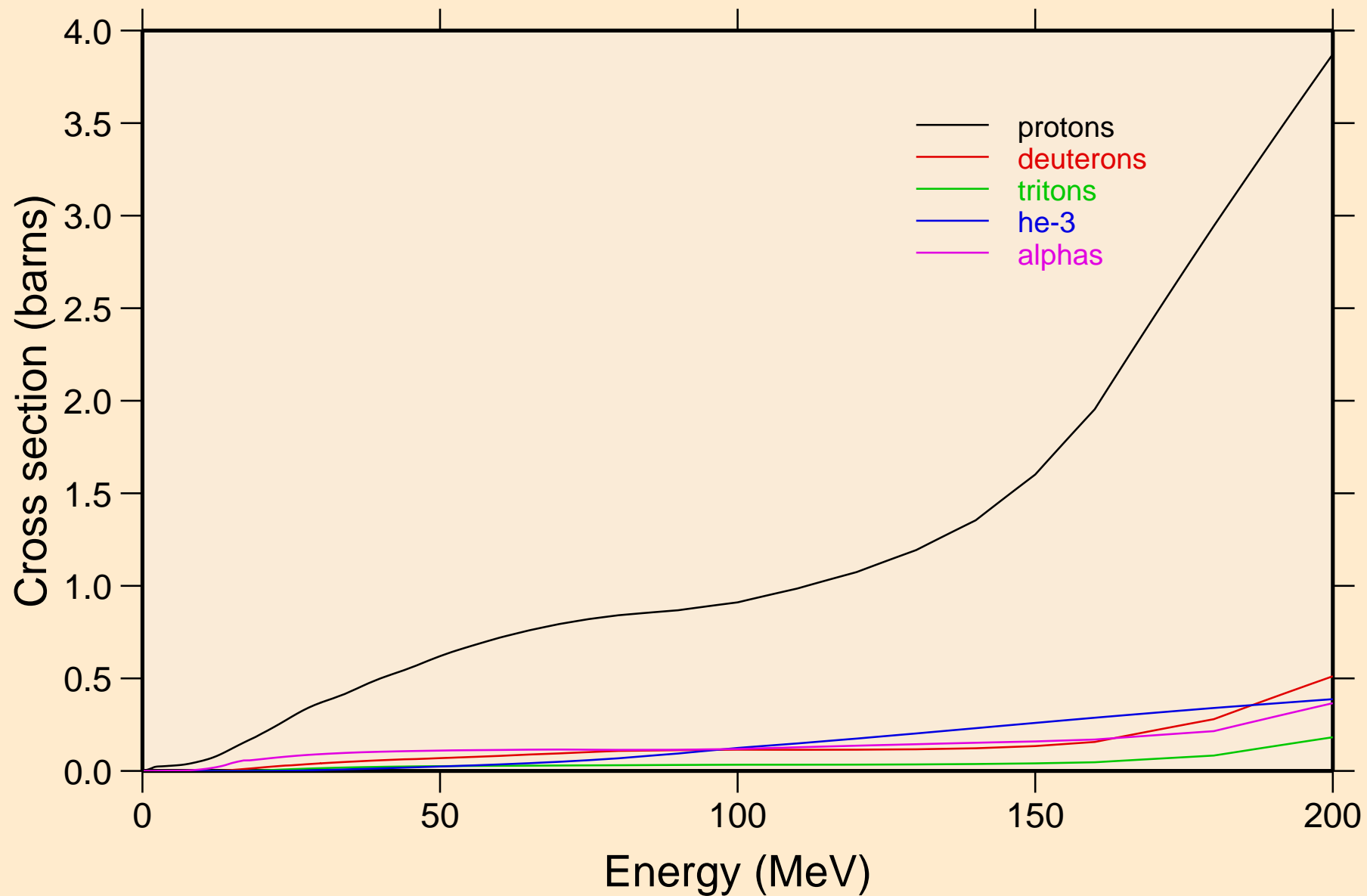

CE133M NEUTRON ACER TENDL-2019 LIBRARY; T=293.16K
protons from (n,x)

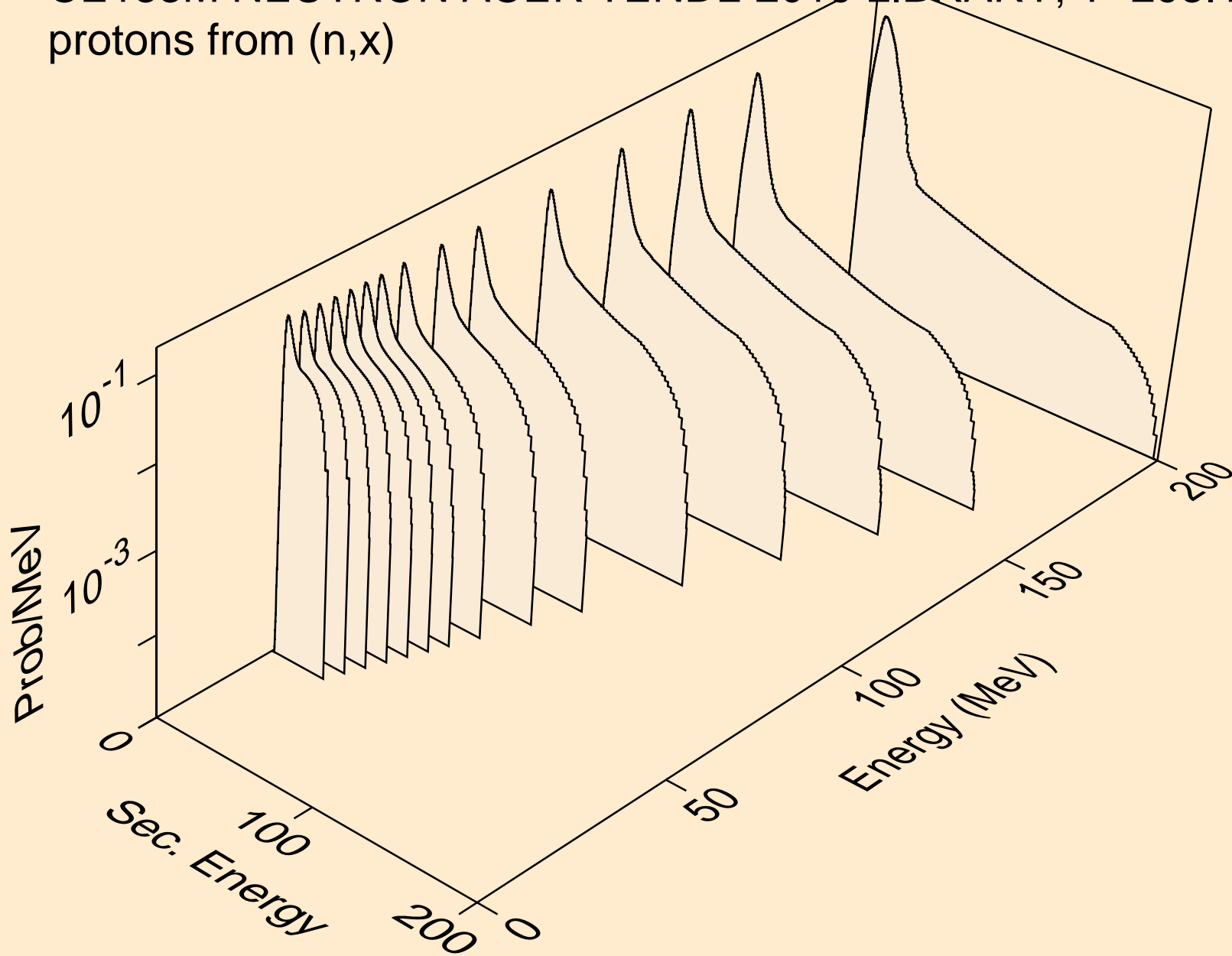

CE133M NEUTRON ACER TENDL-2019 LIBRARY; T=293.16K
protons from (n,n*)p

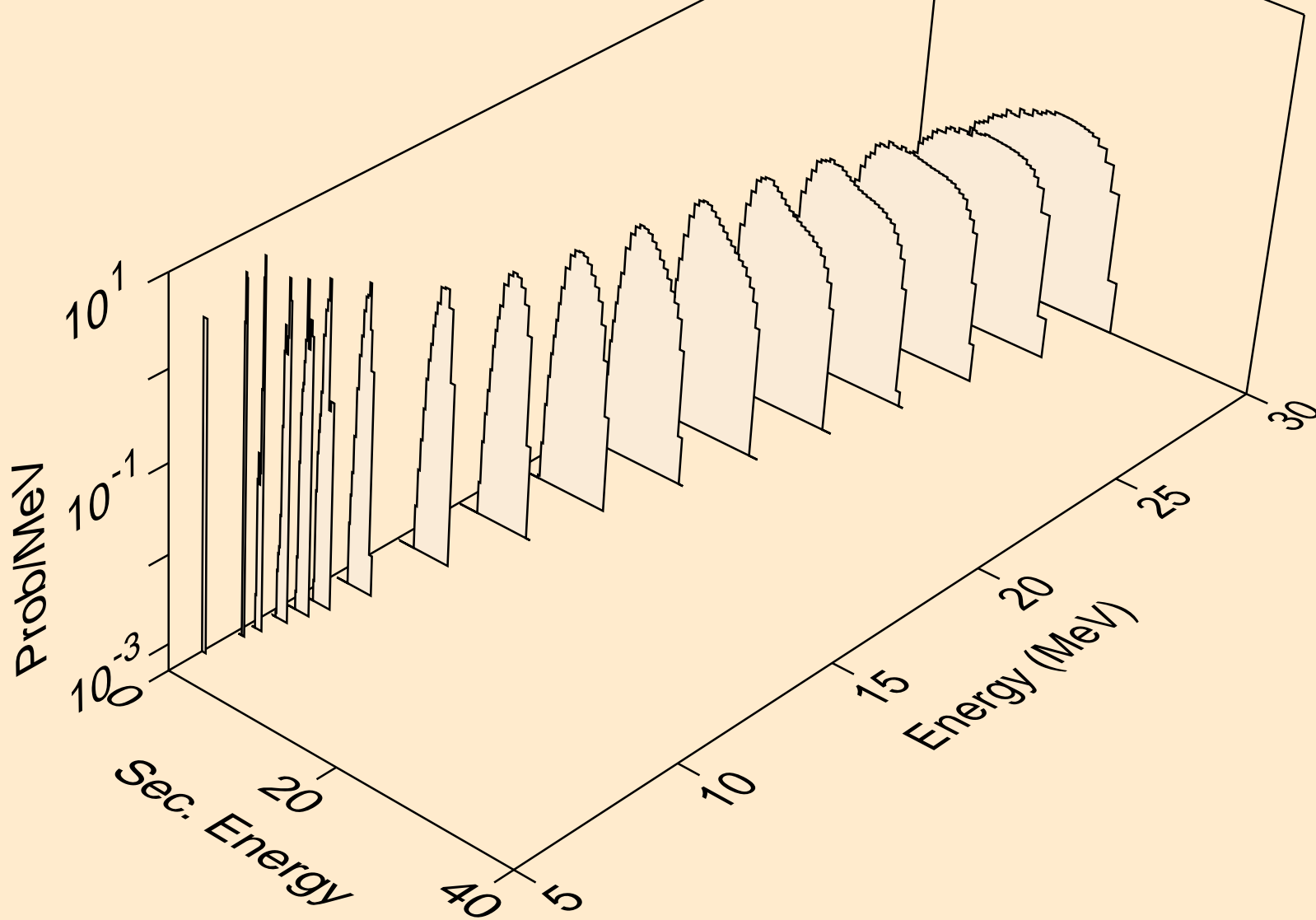

CE133M NEUTRON ACER TENDL-2019 LIBRARY; T=293.16K
protons from (n,2np)

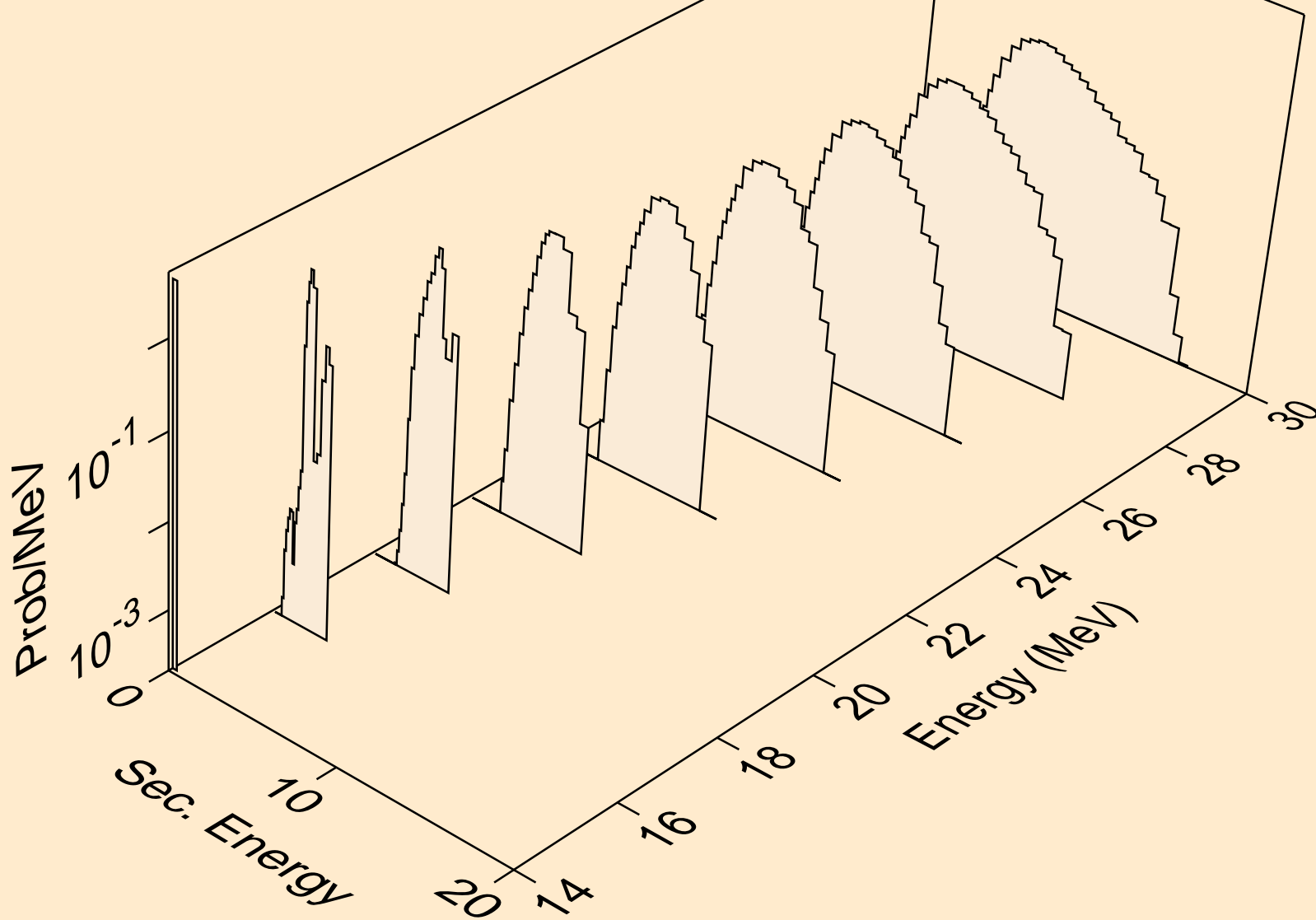

CE133M NEUTRON ACER TENDL-2019 LIBRARY; T=293.16K
protons from (n,3np)

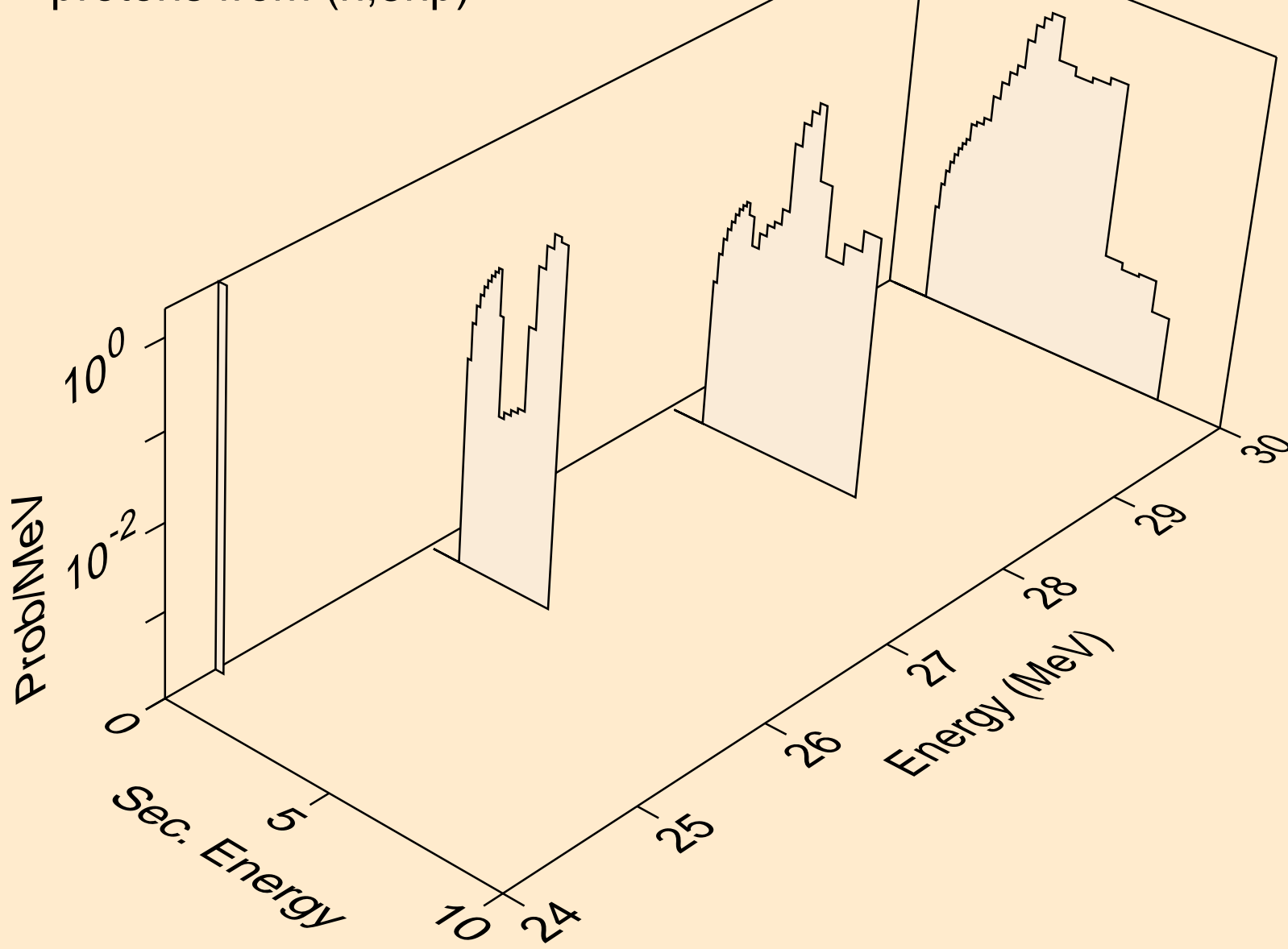

CE133M NEUTRON ACER TENDL-2019 LIBRARY; T=293.16K
protons from (n,2np)

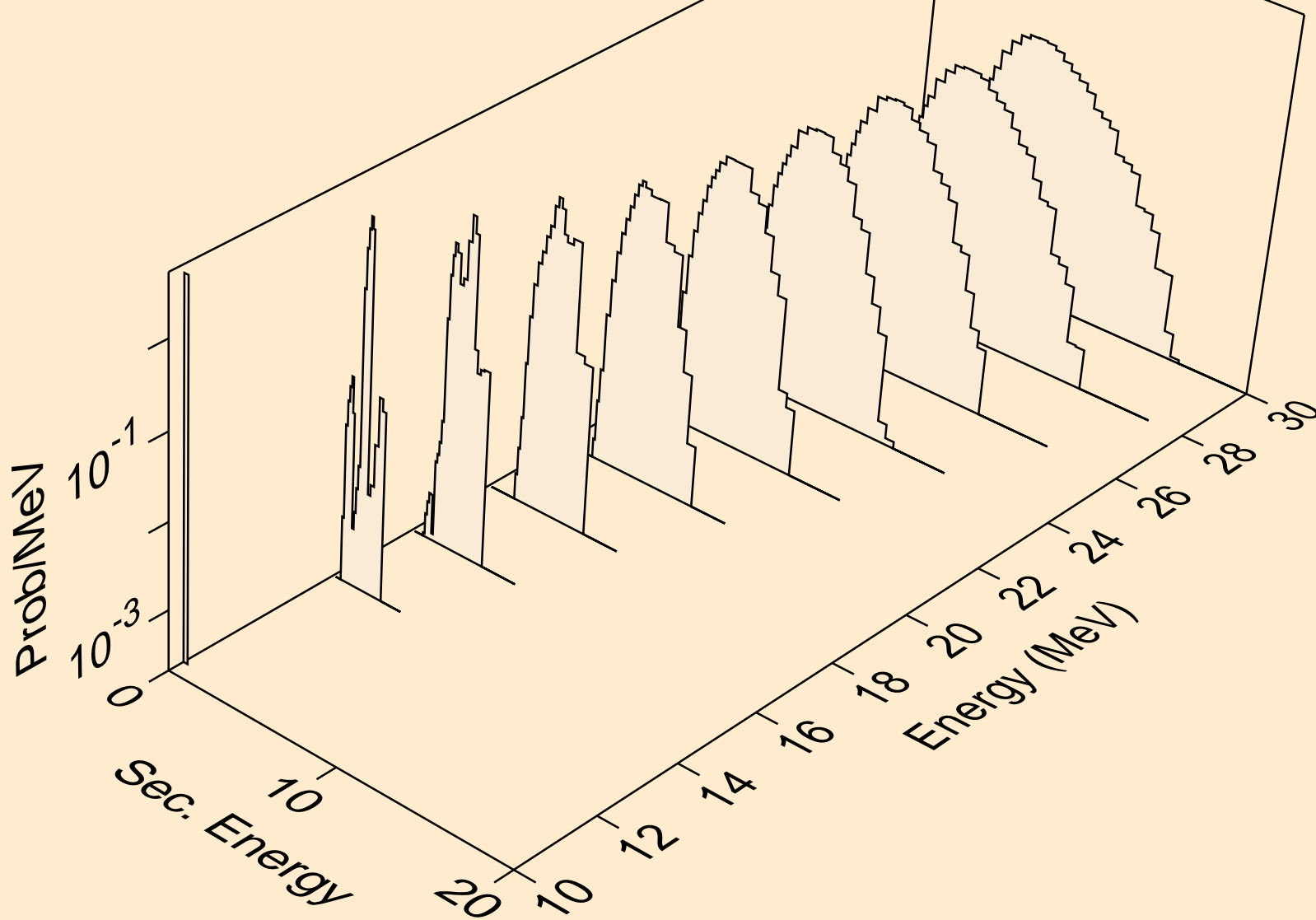

CE133M NEUTRON ACER TENDL-2019 LIBRARY; T=293.16K
protons from (n,npa)

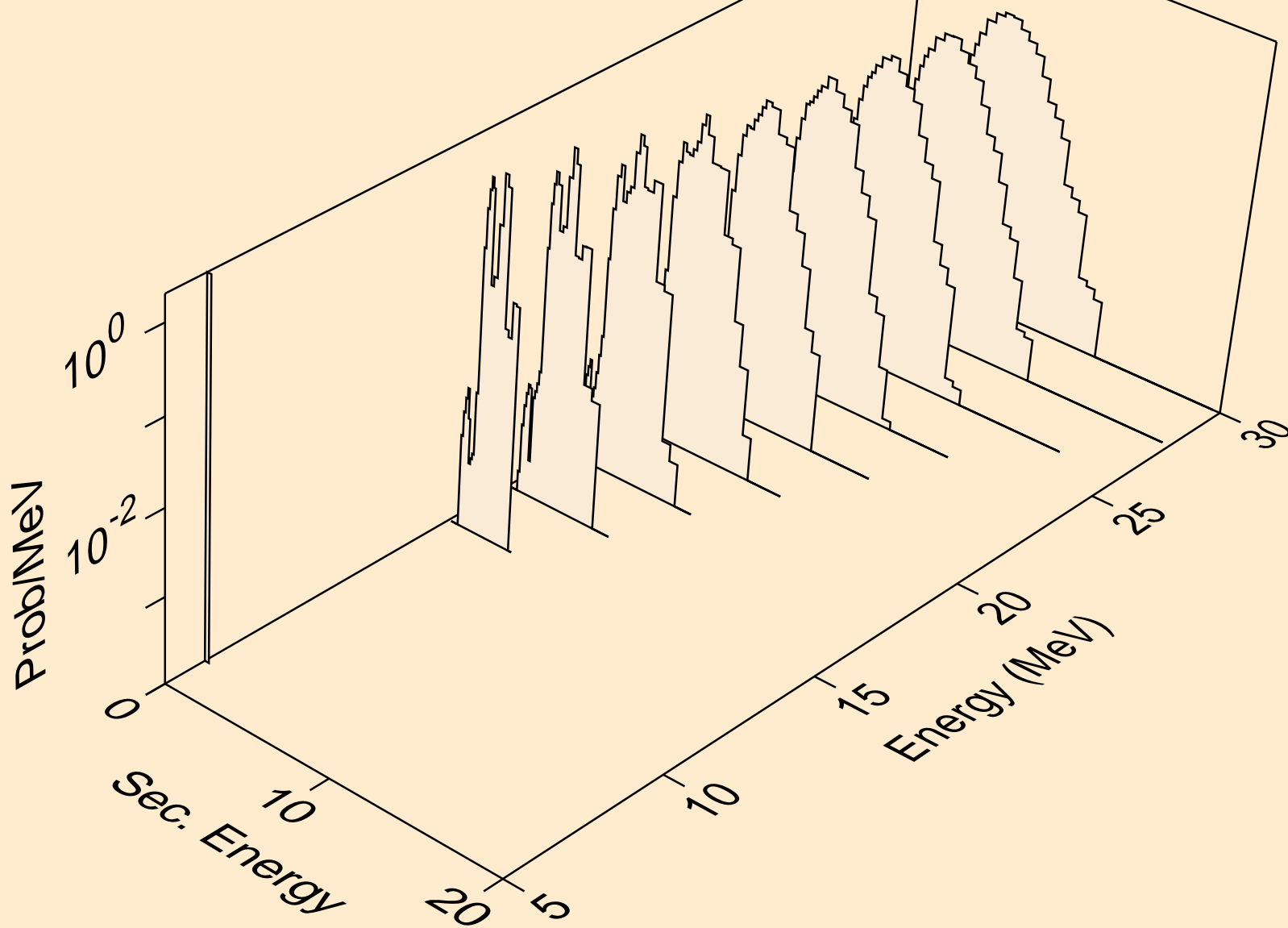

CE133M NEUTRON ACER TENDL-2019 LIBRARY; T=293.16K
protons from (n,p)

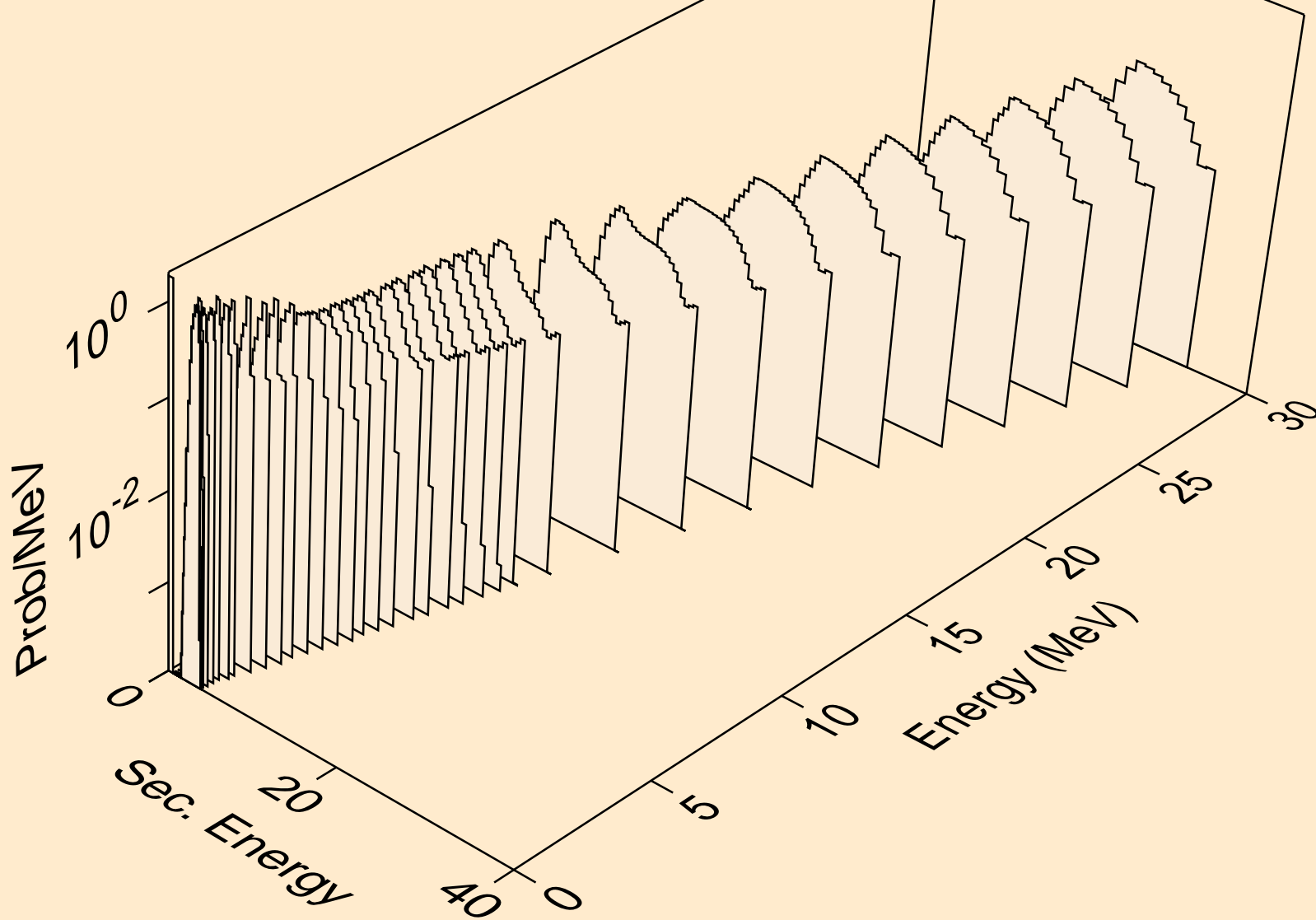

CE133M NEUTRON ACER TENDL-2019 LIBRARY; T=293.16K
protons from (n,2p)

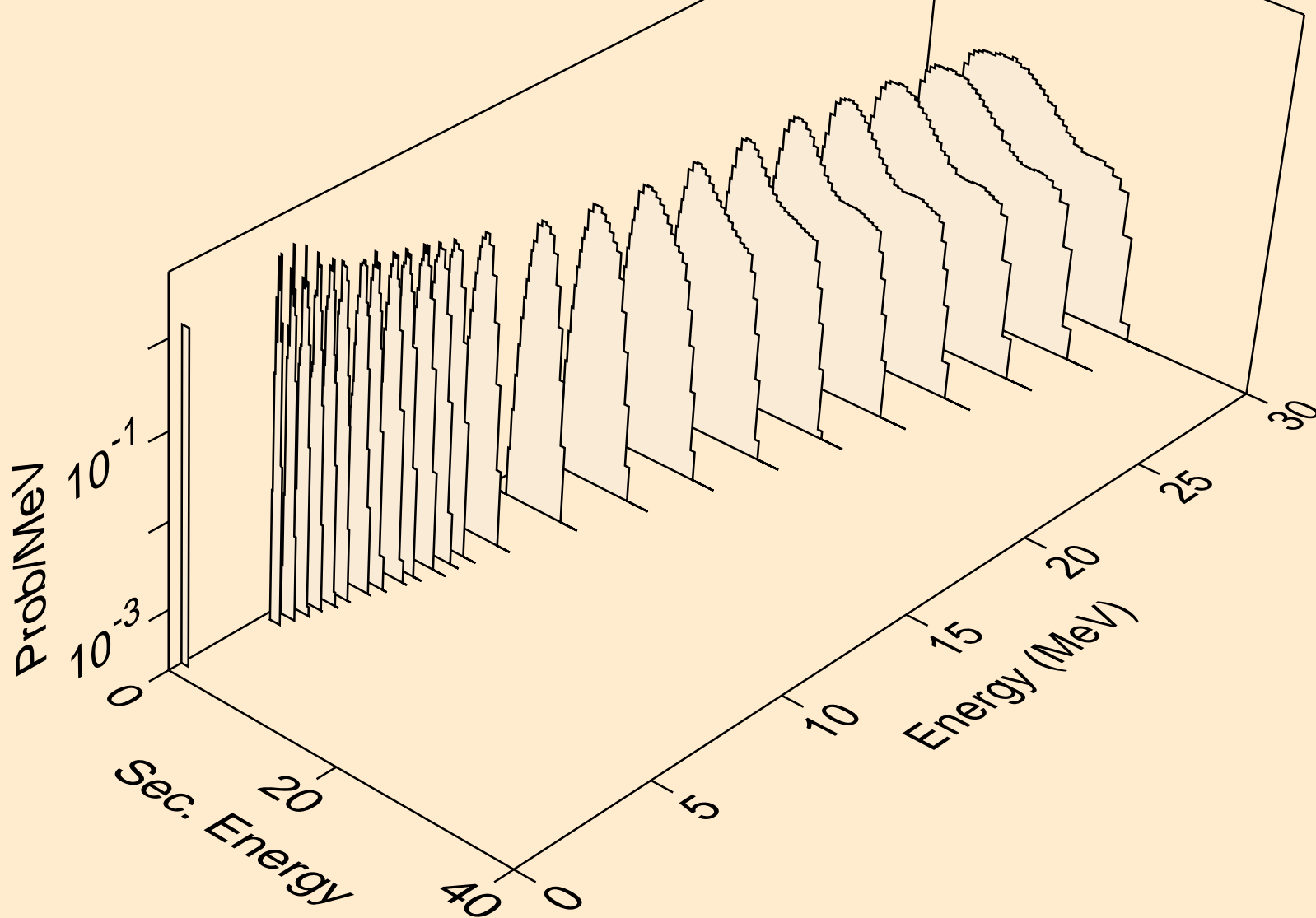

CE133M NEUTRON ACER TENDL-2019 LIBRARY; T=293.16K
protons from (n,p)

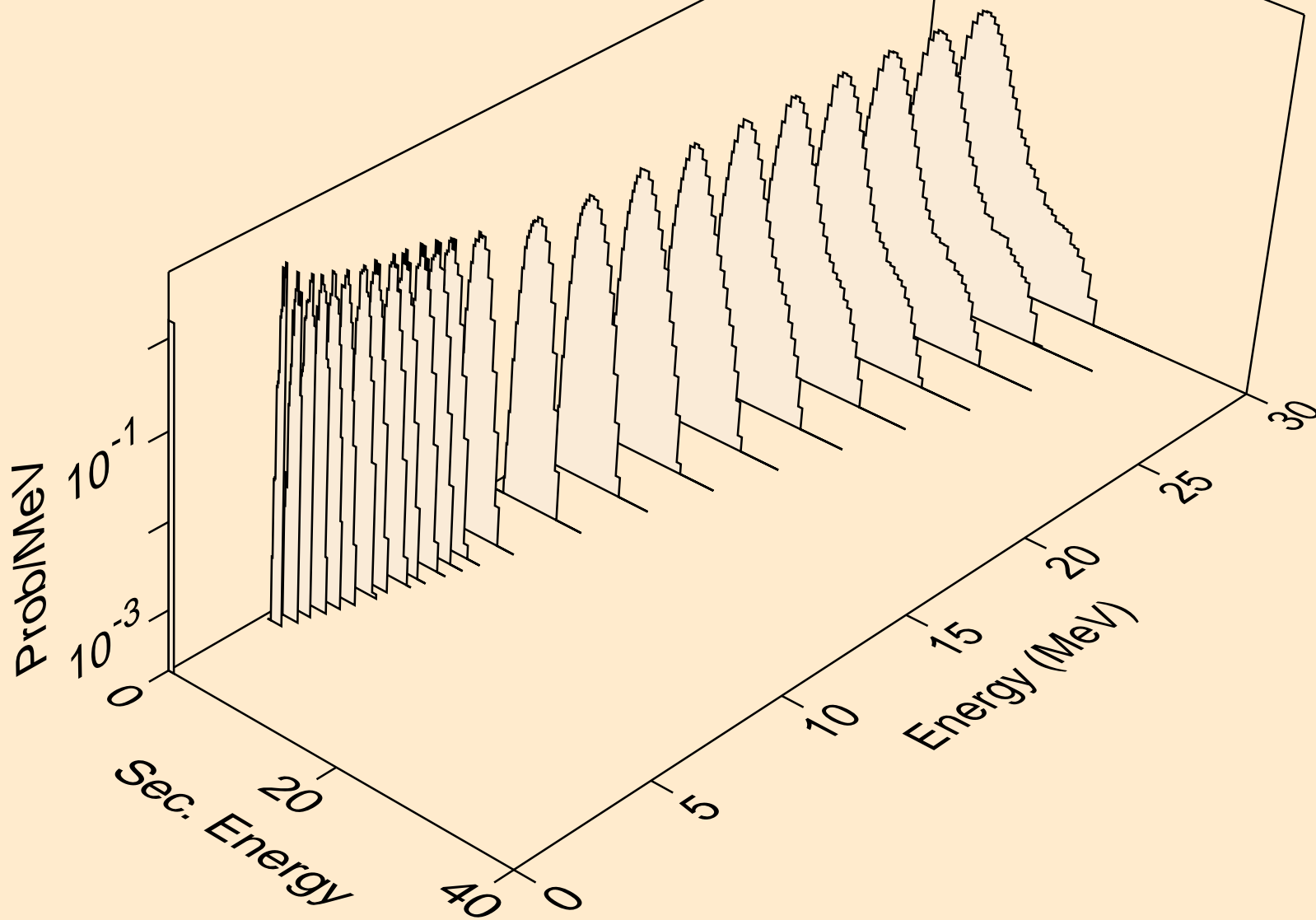

CE133M NEUTRON ACER TENDL-2019 LIBRARY; T=293.16K
protons from (n,pd)

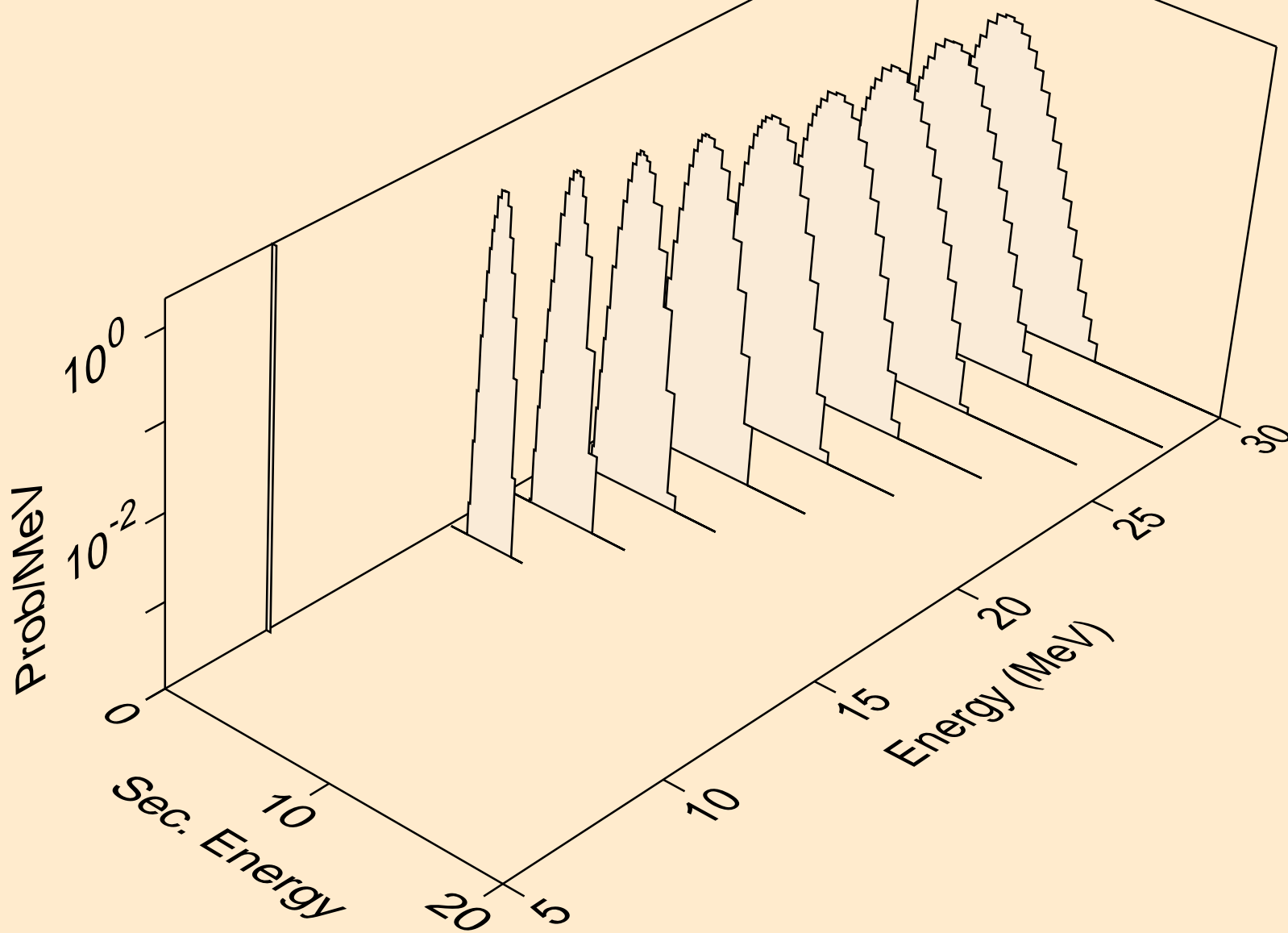

CE133M NEUTRON ACER TENDL-2019 LIBRARY; T=293.16K
protons from (n,pt)

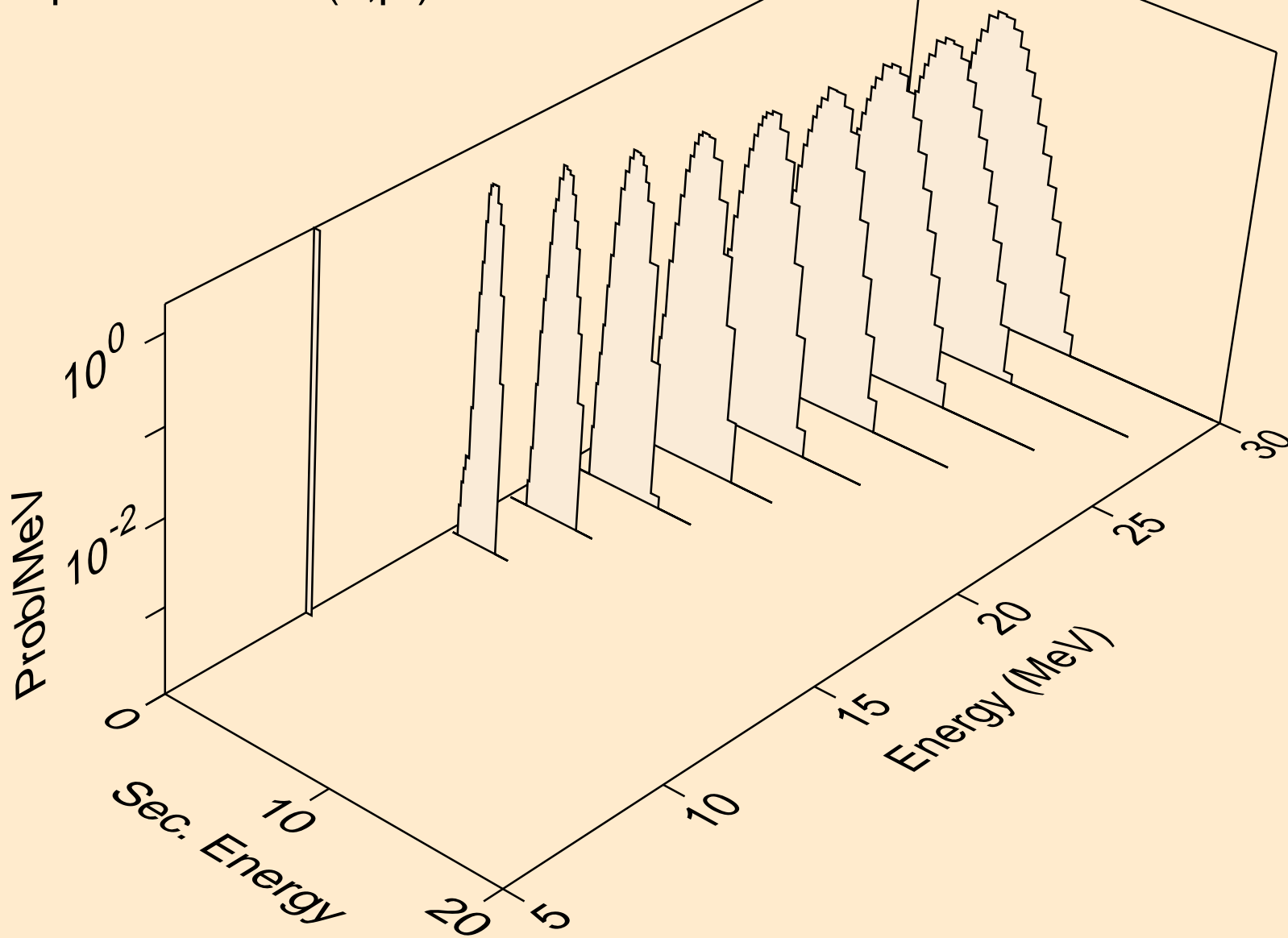

CE133M NEUTRON ACER TENDL-2019 LIBRARY; T=293.16K
deuterons from (n,x)

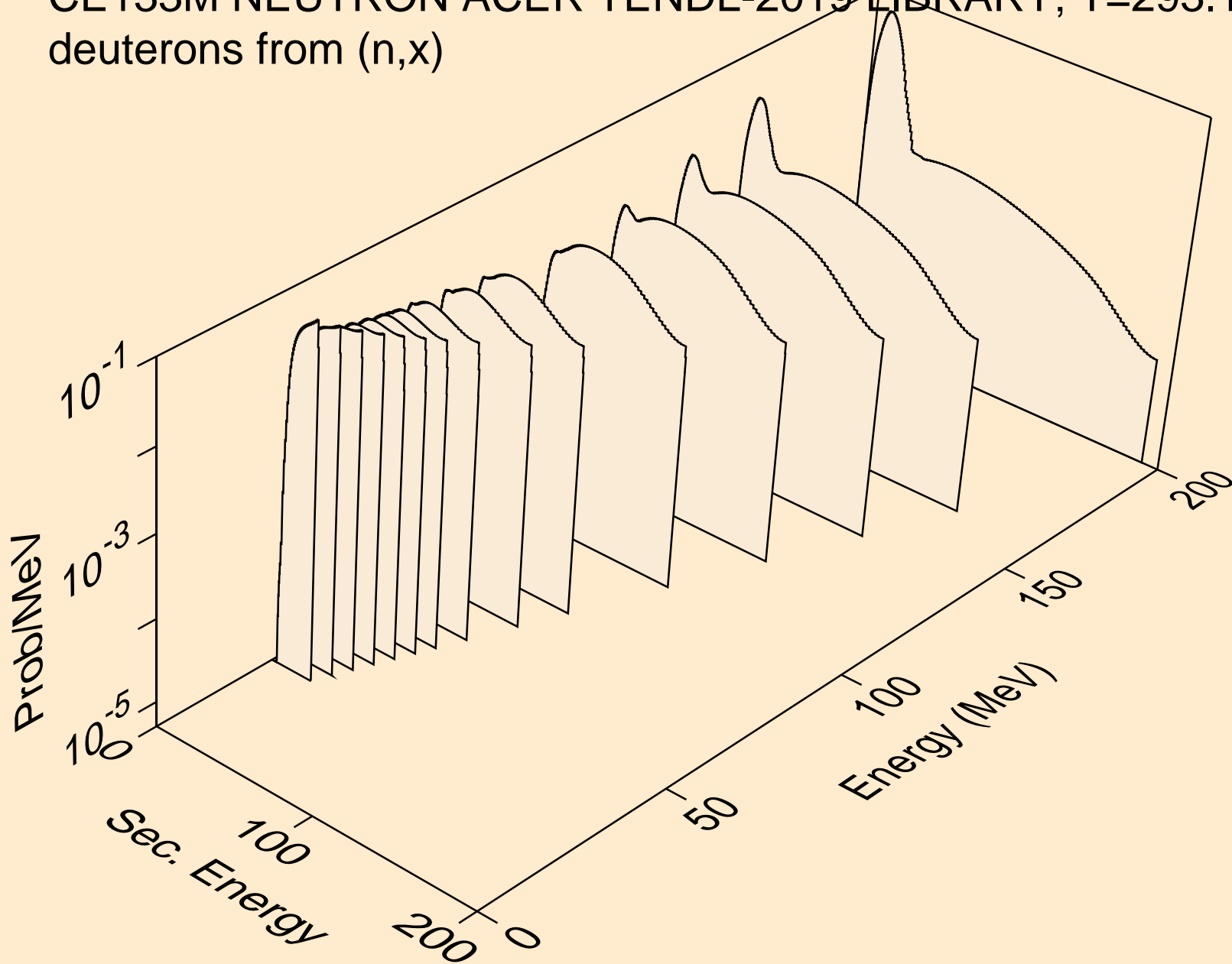

CE133M NEUTRON ACER TENDL-2019 LIBRARY; T=293.16K
deuterons from (n,2nd)

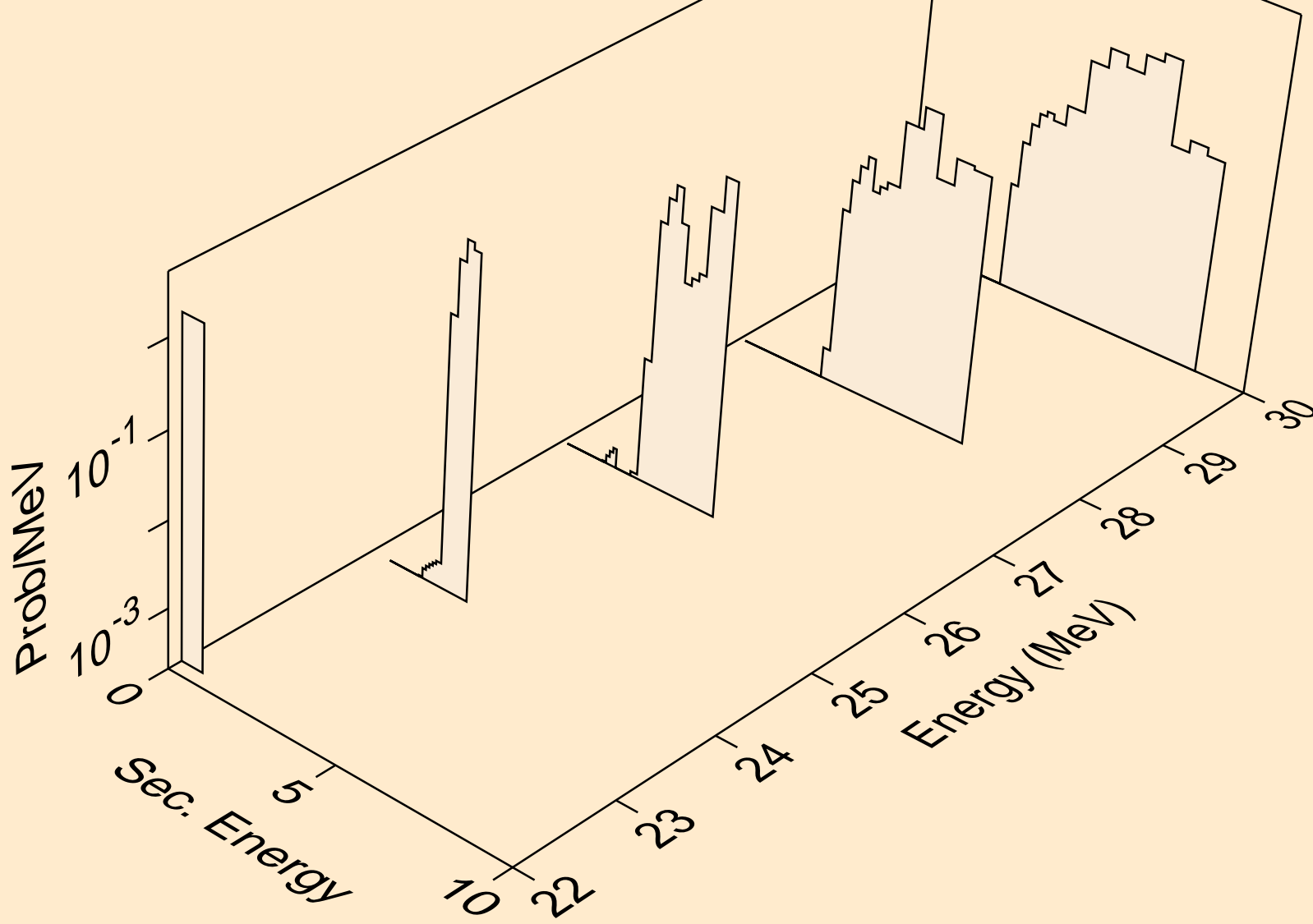

CE133M NEUTRON ACER TENDL-2019 LIBRARY; T=293.16K
deuterons from (n,n*)d

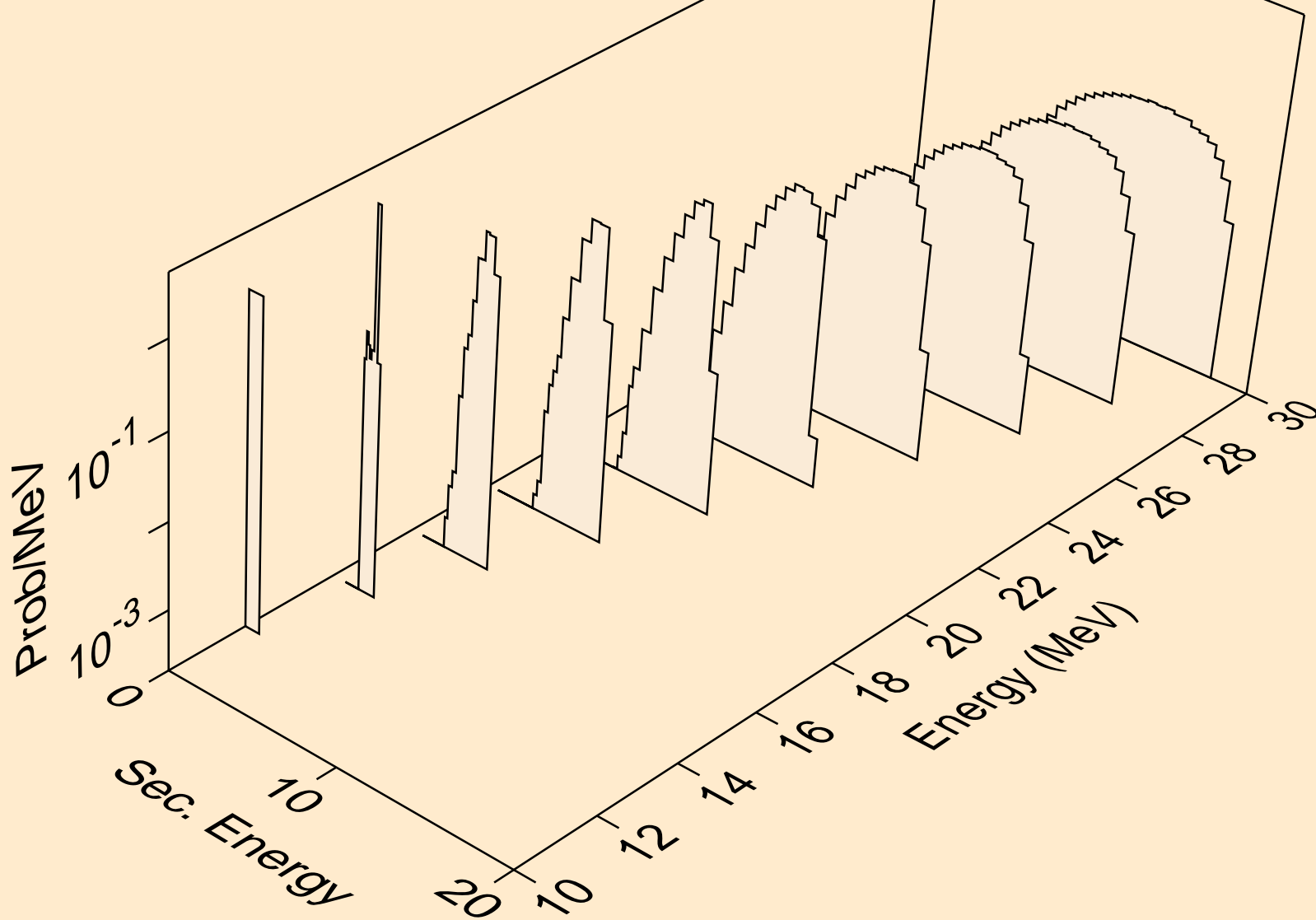

CE133M NEUTRON ACER TENDL-2019 LIBRARY; T=293.16K
deuterons from (n,d)

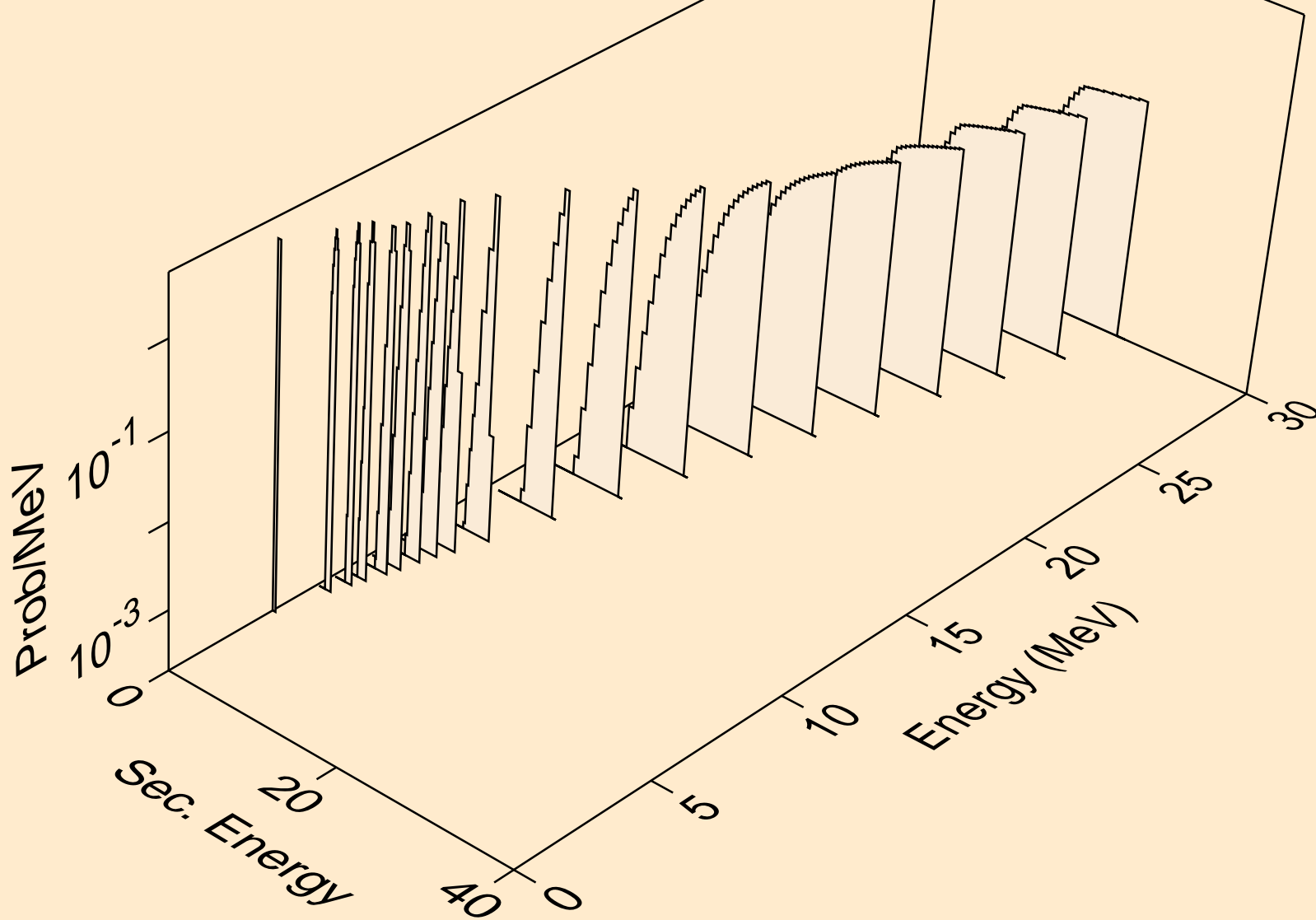

CE133M NEUTRON ACER TENDL-2019 LIBRARY; T=293.16K
deuterons from (n,pd)

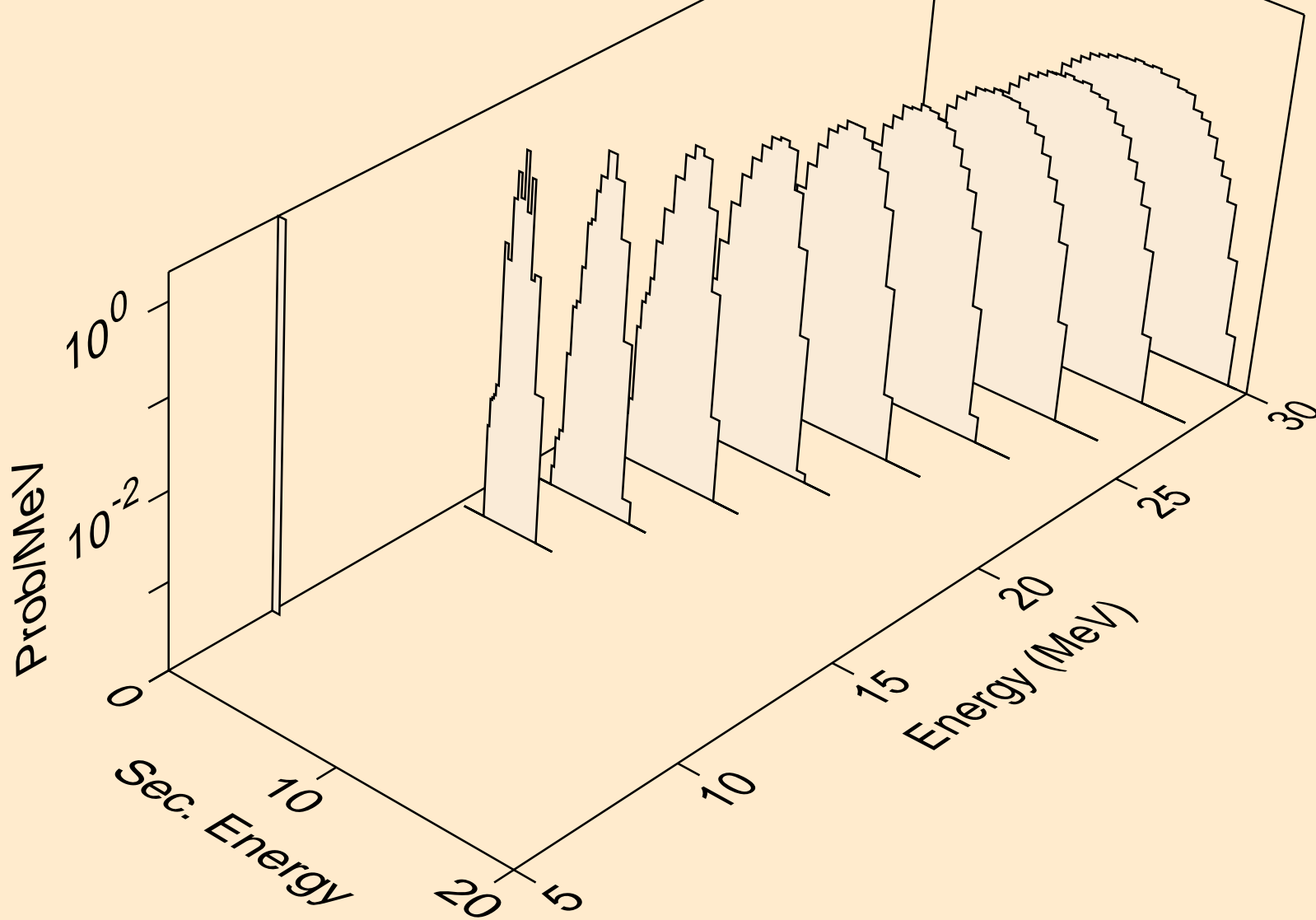

CE133M NEUTRON ACER TENDL-2019 LIBRARY; T=293.16K
deuterons from (n,da)

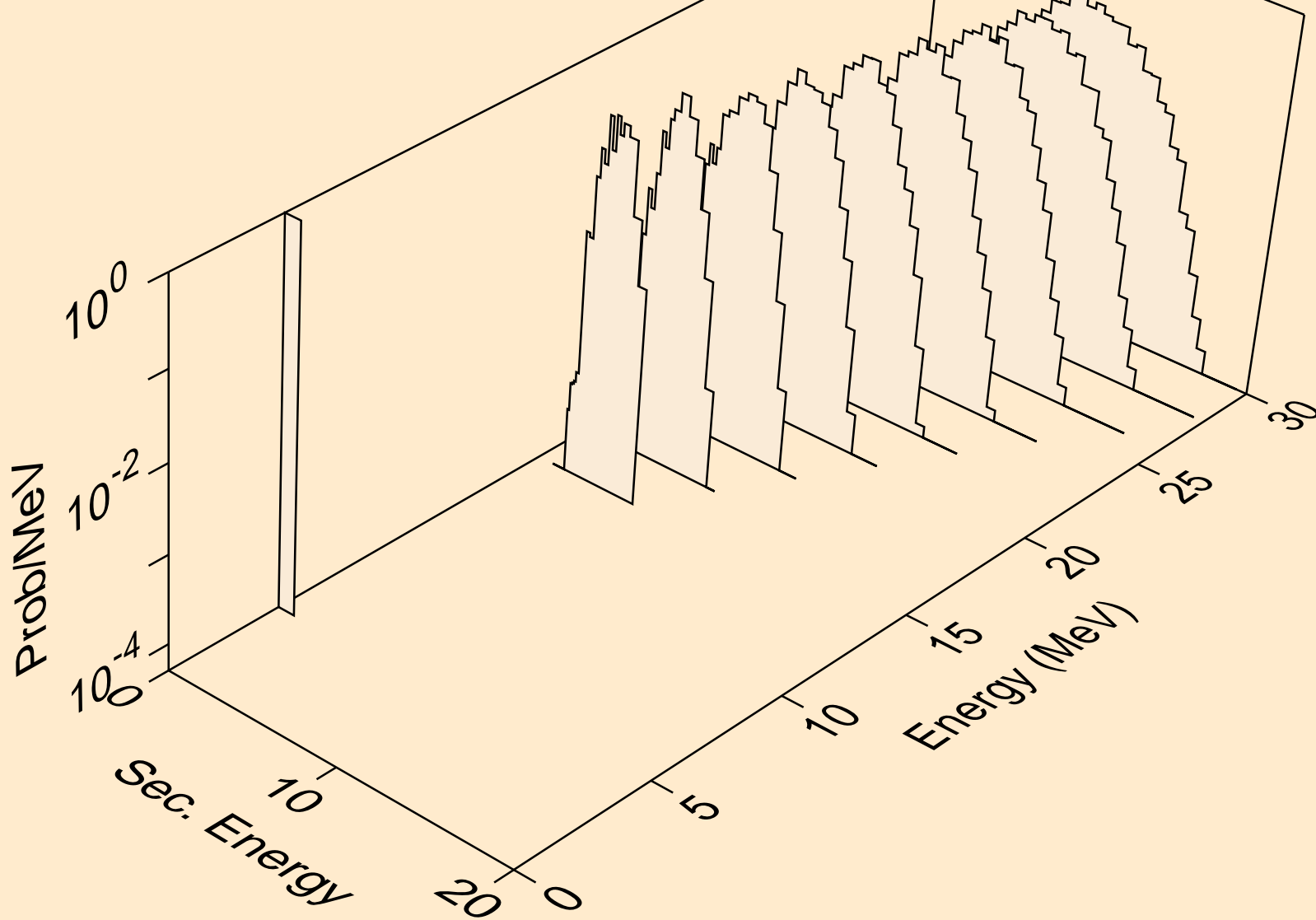

CE133M NEUTRON ACER TENDL-2019 LIBRARY; T=293.16K
tritons from (n,x)

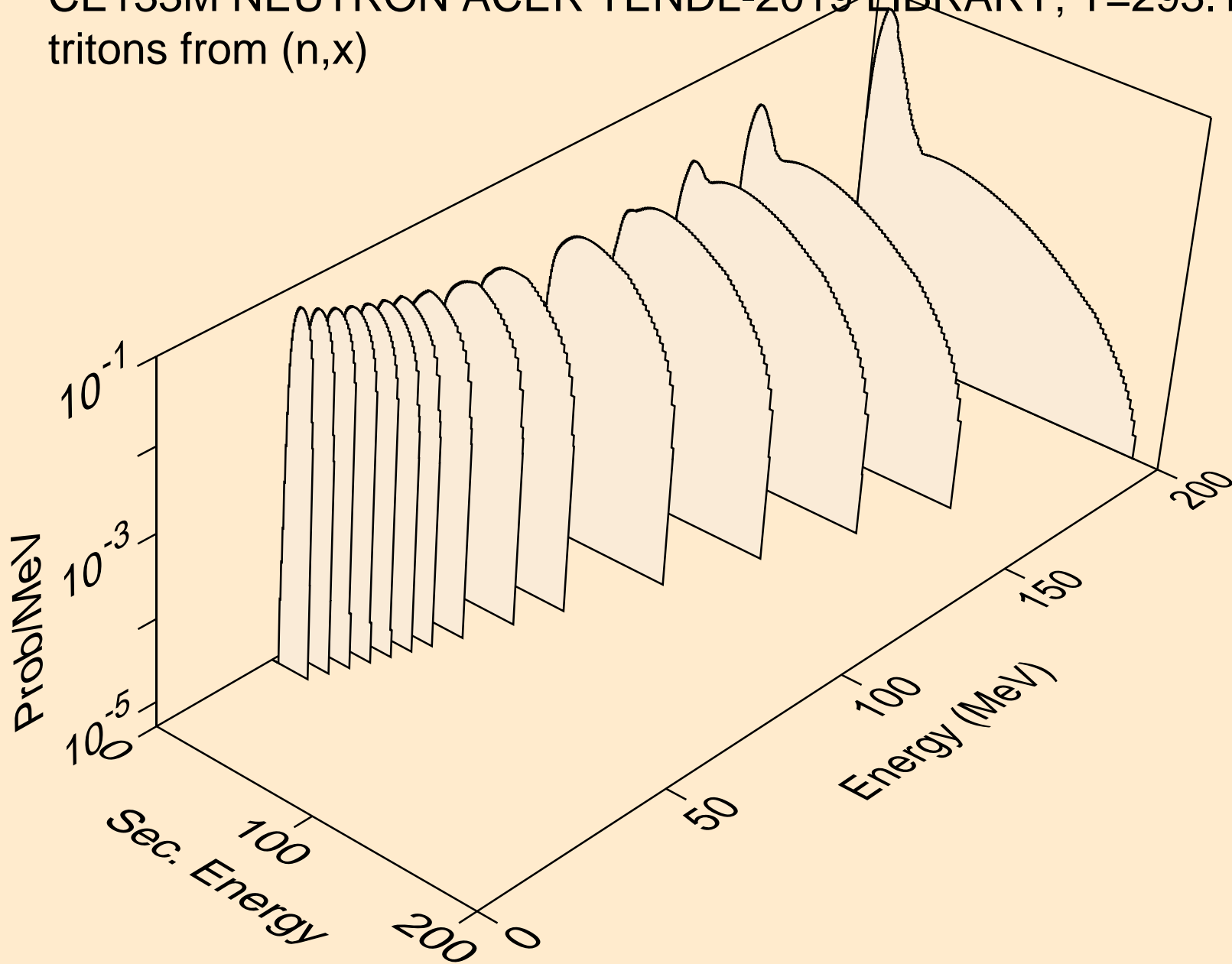

CE133M NEUTRON ACER TENDL-2019 LIBRARY; T=293.16K
tritons from (n,n*)t

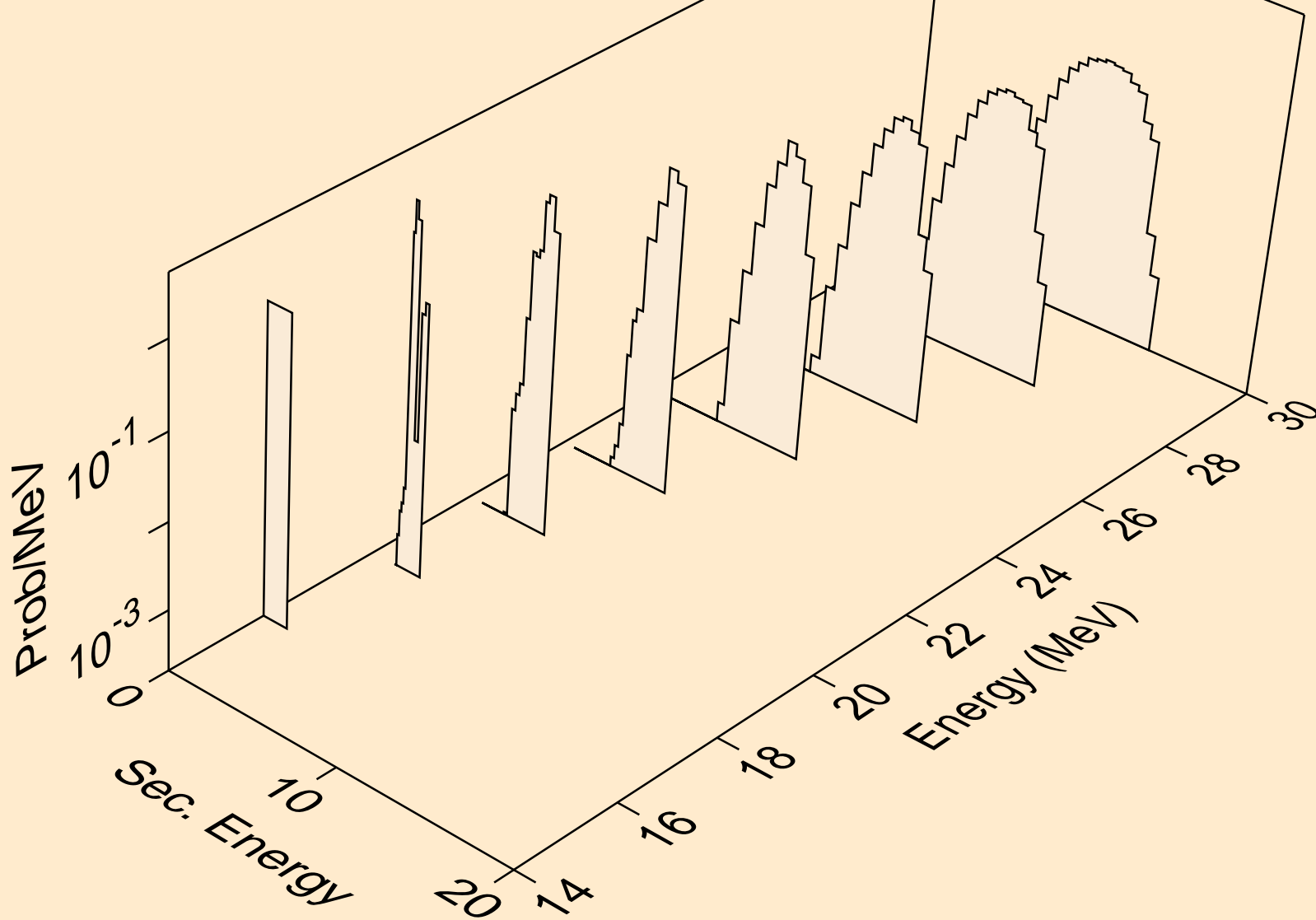

CE133M NEUTRON ACER TENDL-2019 LIBRARY; T=293.16K
tritons from (n,t)

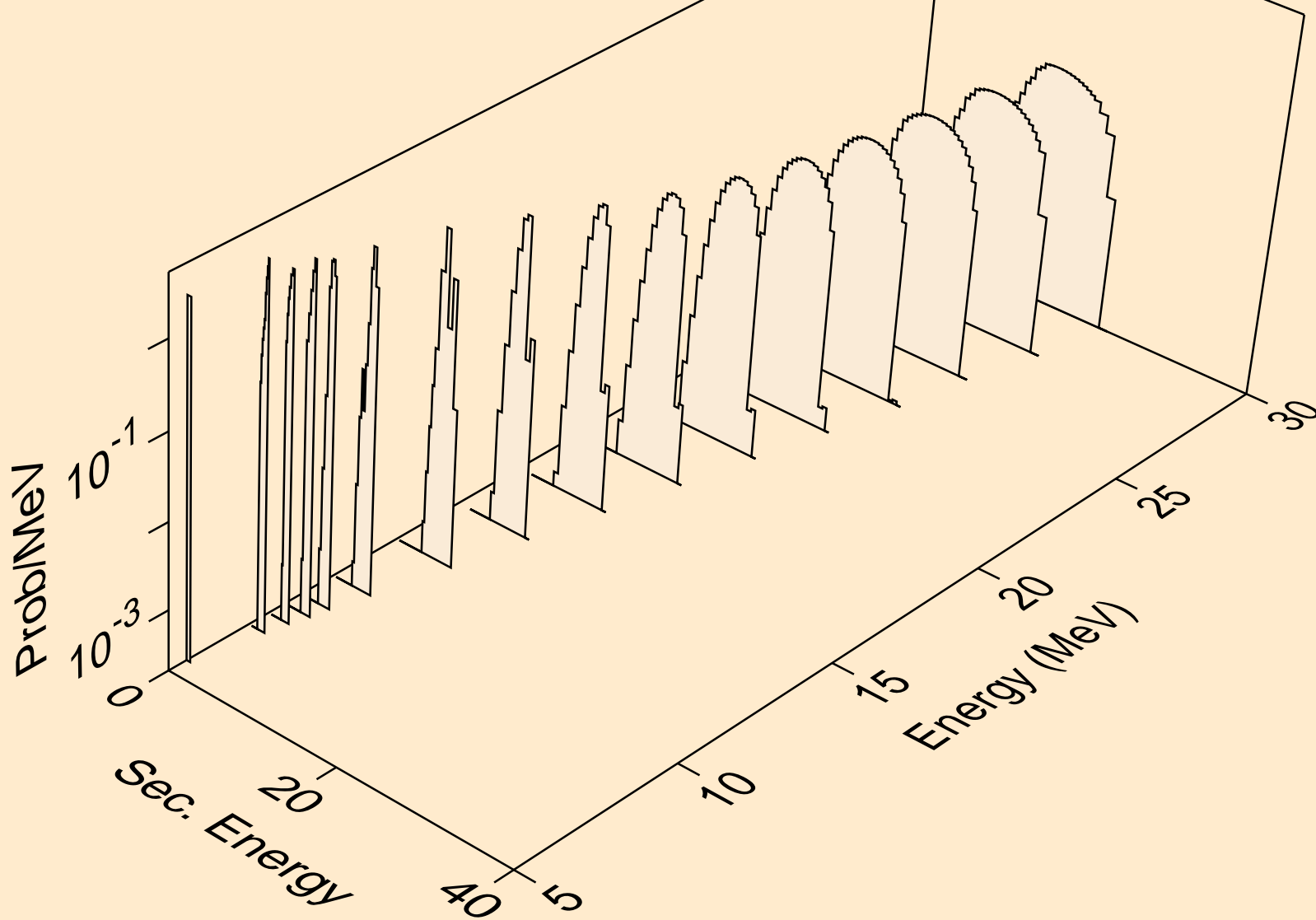

CE133M NEUTRON ACER TENDL-2019 LIBRARY; T=293.16K
tritons from (n,pt)

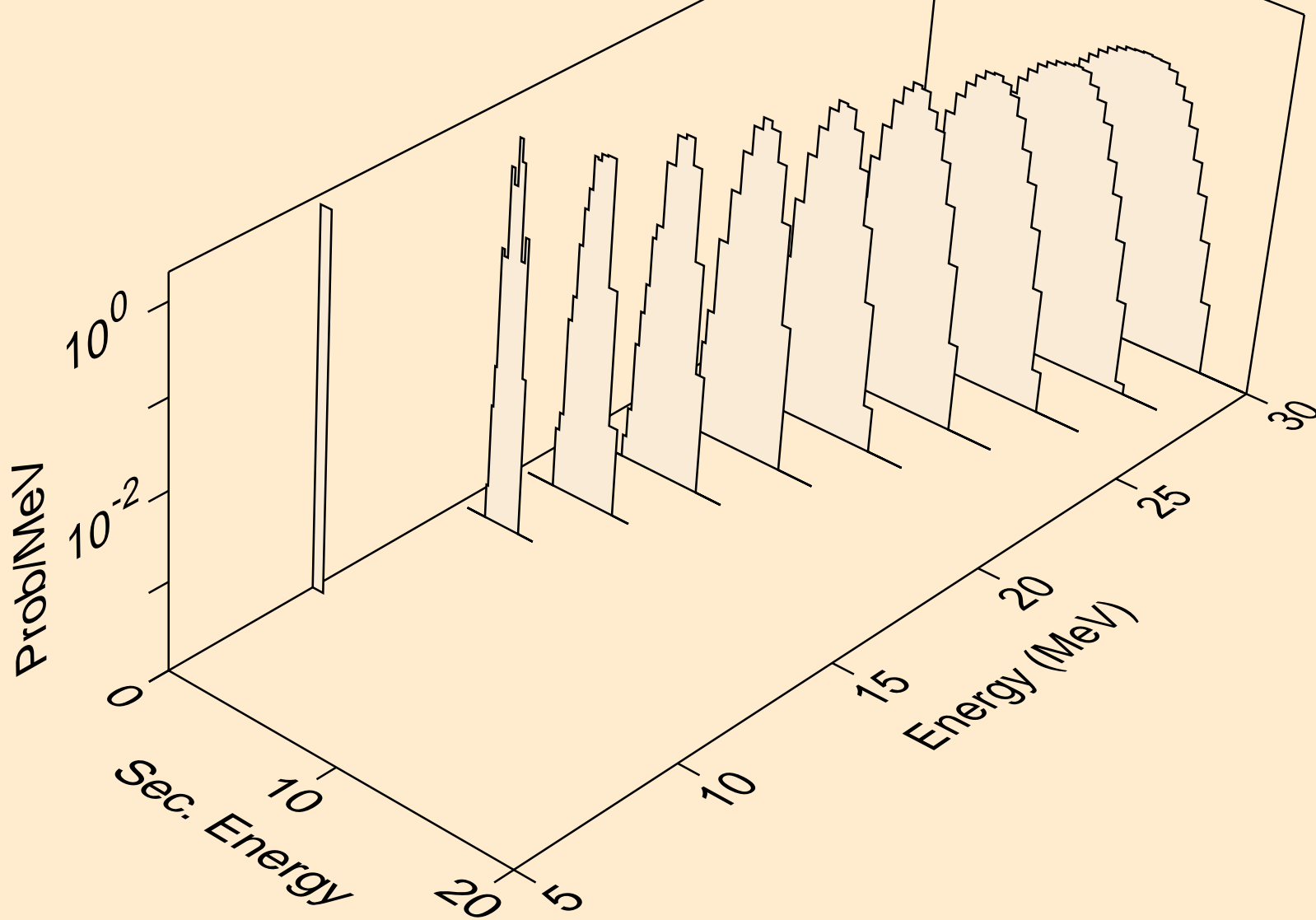

CE133M NEUTRON ACER TENDL-2019 LIBRARY; T=293.16K
he3s from (n,x)

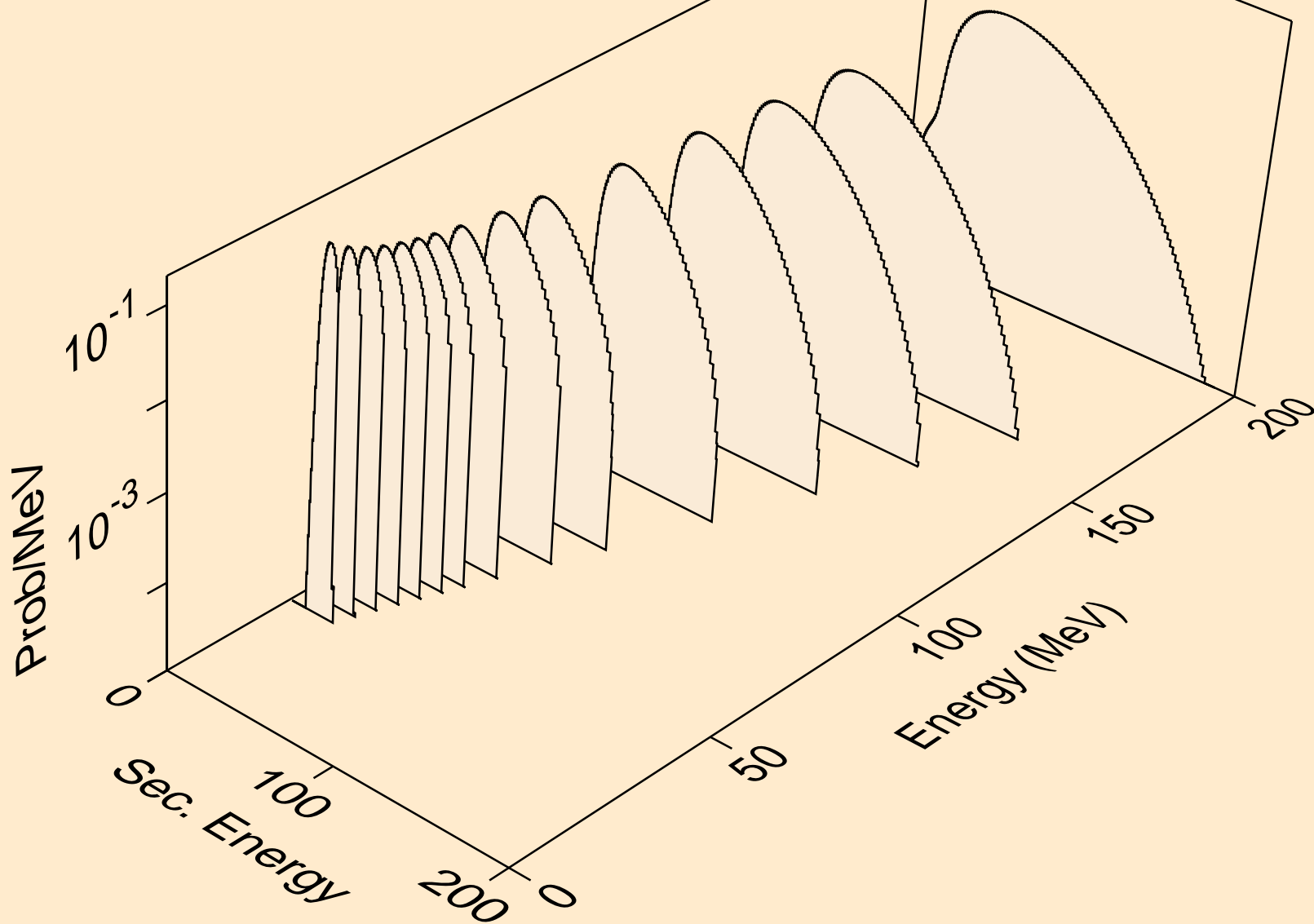

CE133M NEUTRON ACER TENDL-2019 LIBRARY; T=293.16K
he3s from (n,n*)he3

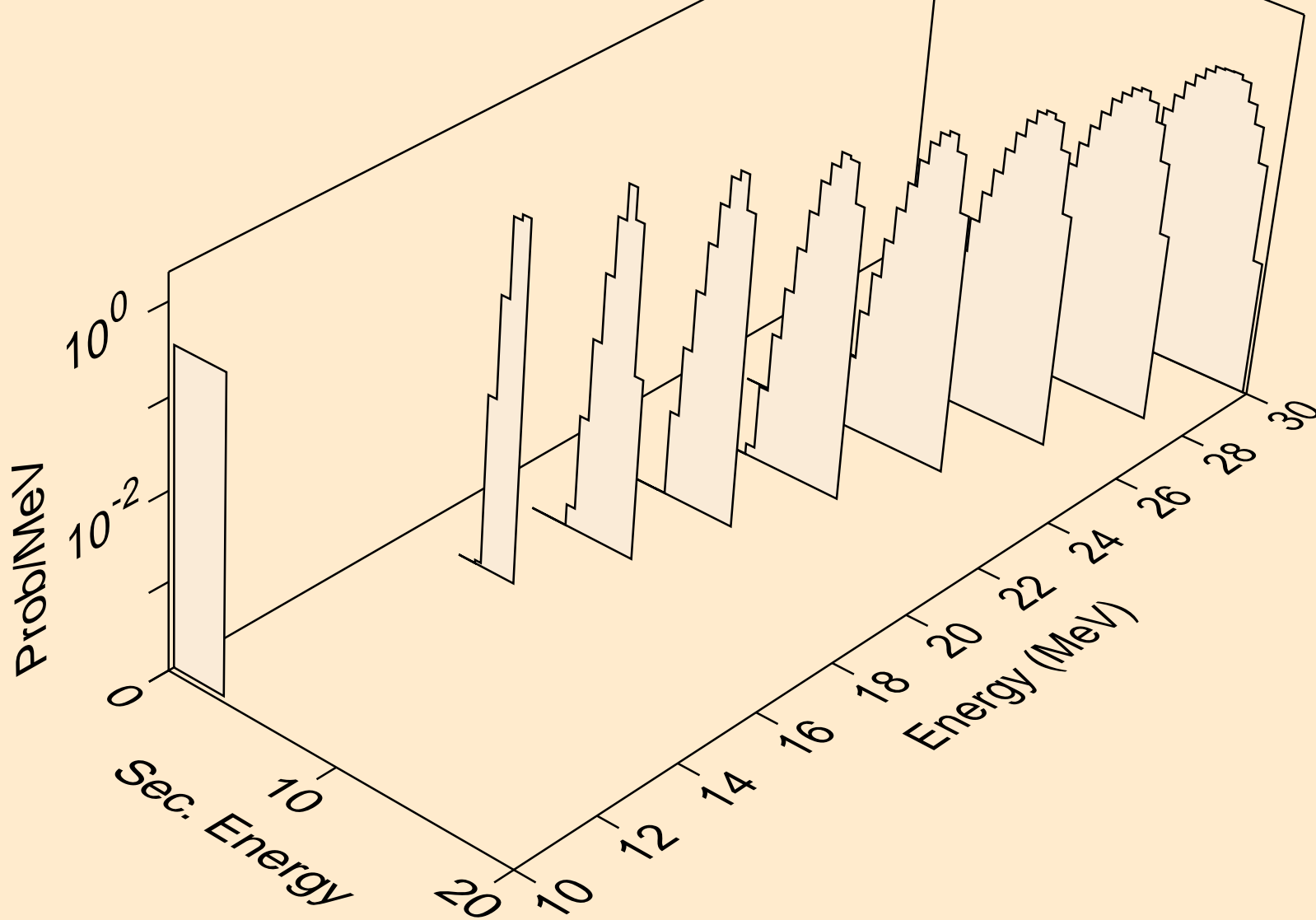

CE133M NEUTRON ACER TENDL-2019 LIBRARY; T=293.16K
he3s from (n,he3)

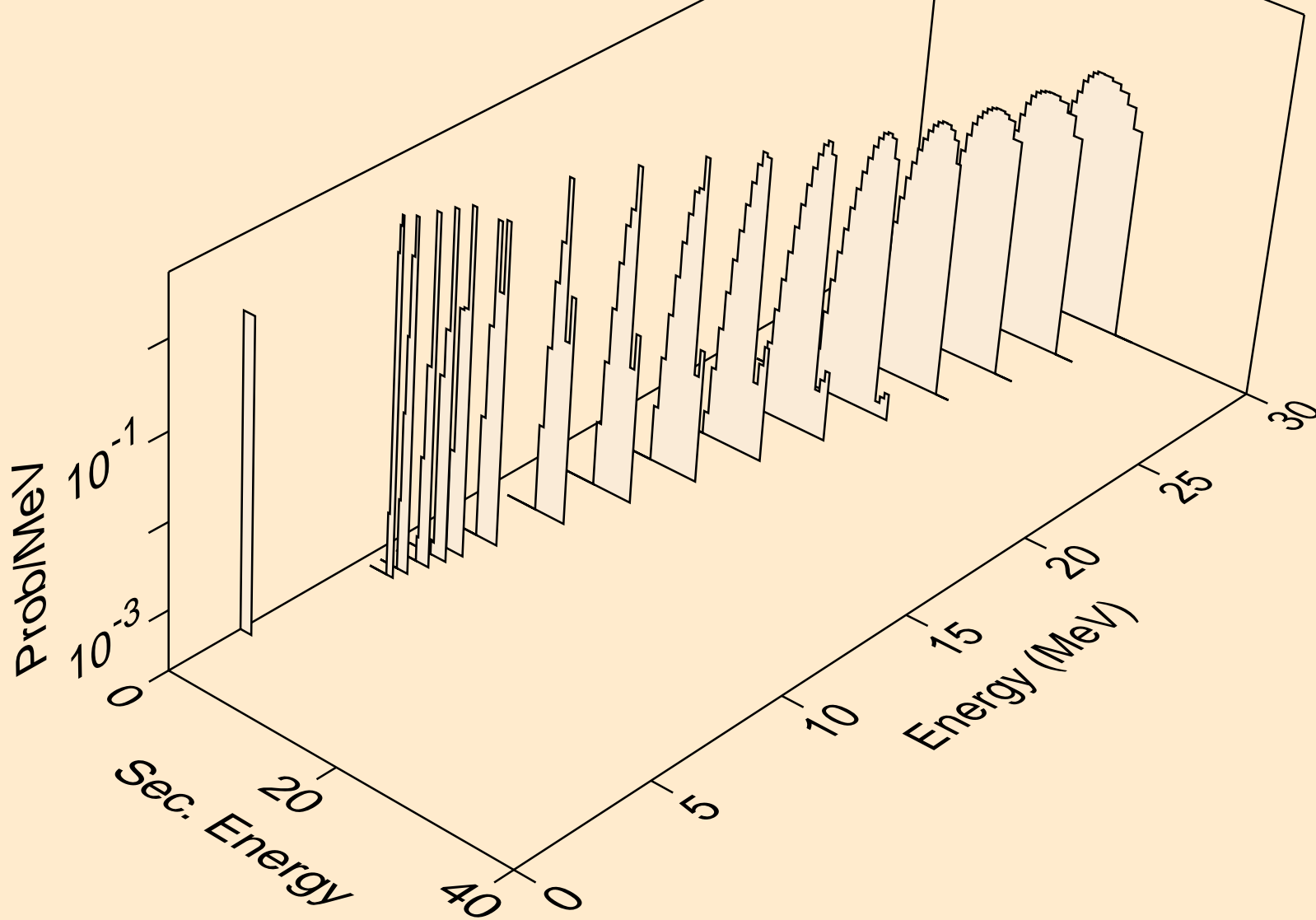

CE133M NEUTRON ACER TENDL-2019 LIBRARY; T=293.16K
alphas from (n,x)

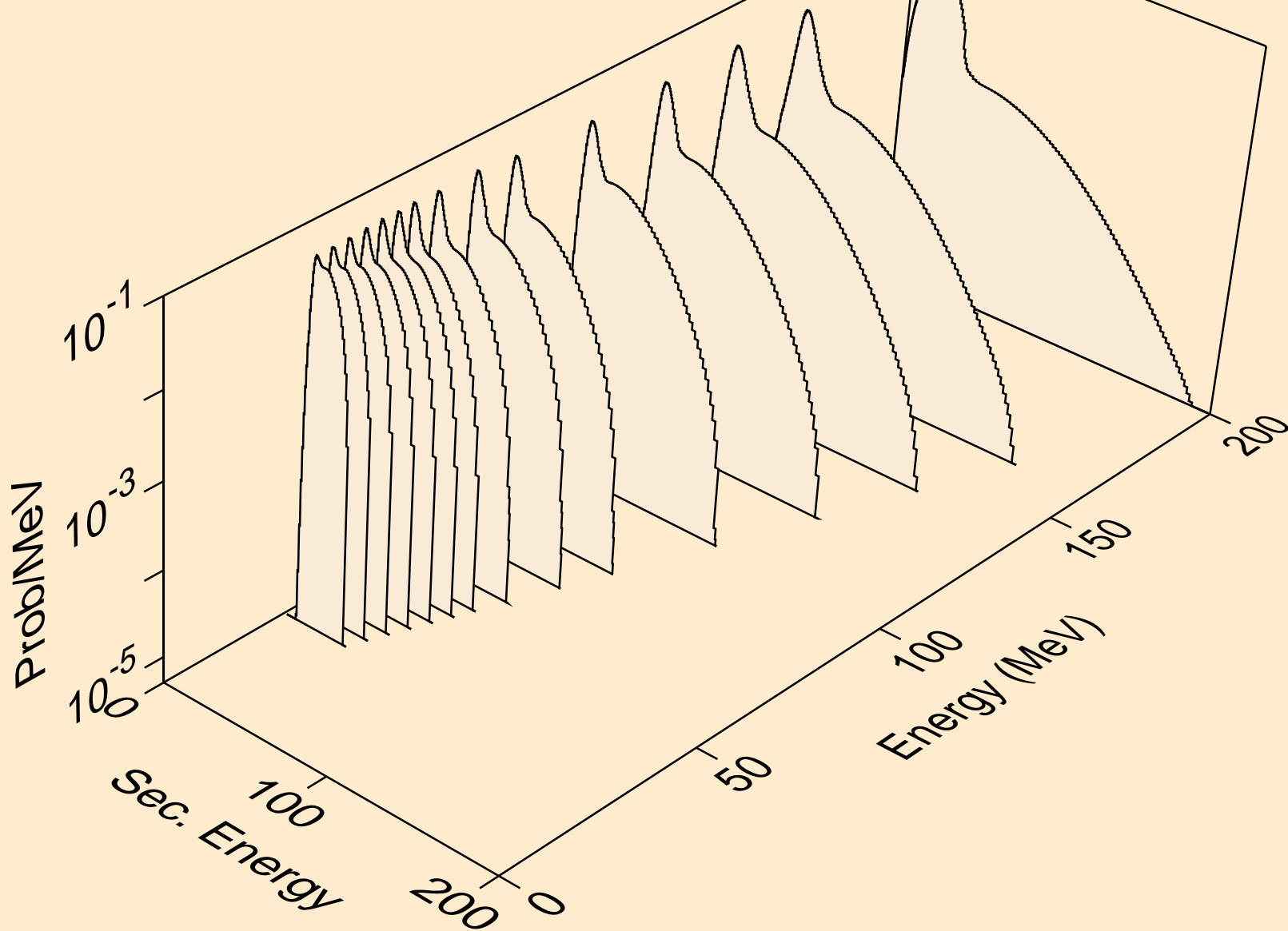

CE133M NEUTRON ACER TENDL-2019 LIBRARY; T=293.16K
alphas from (n,n*)a

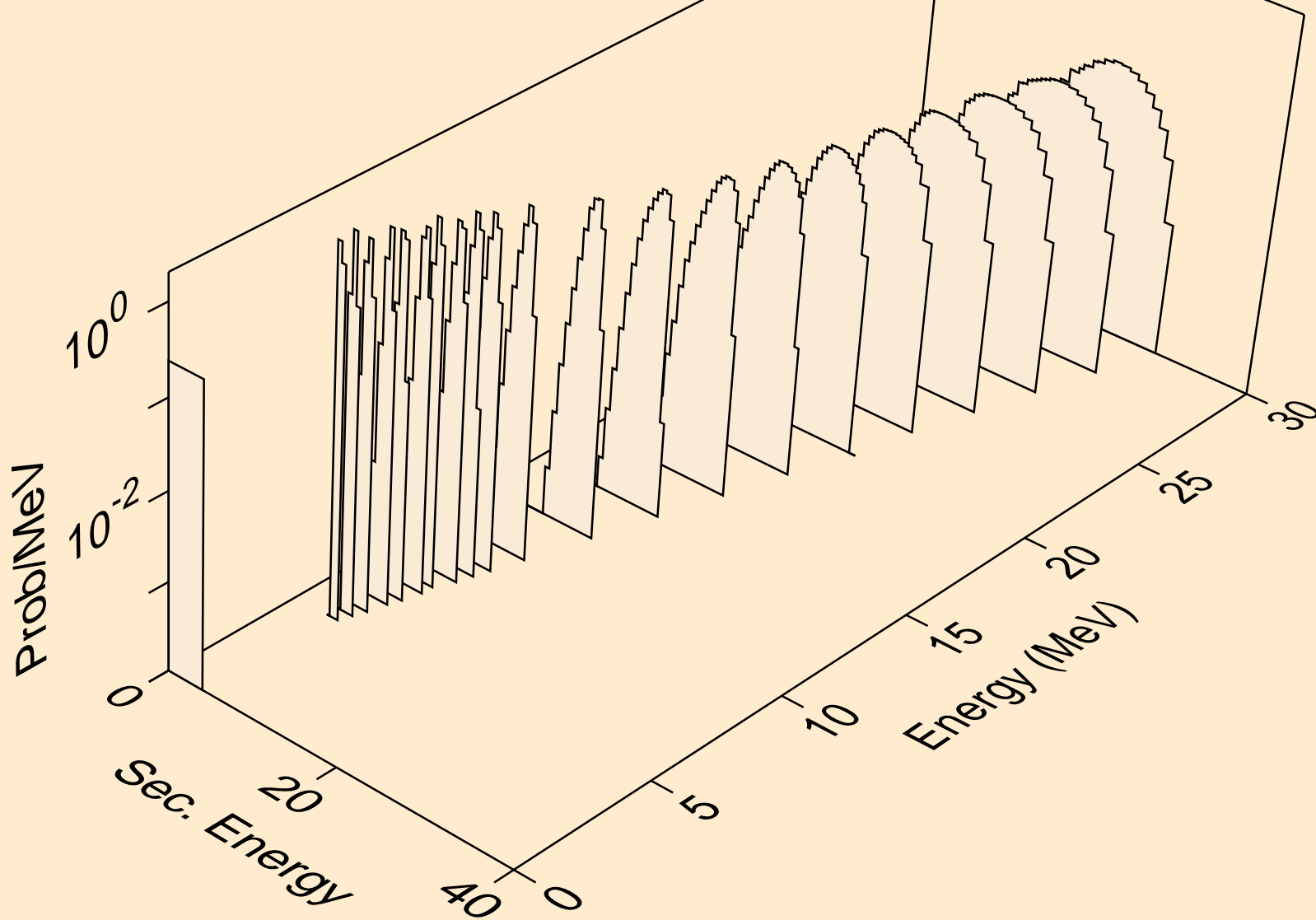

CE133M NEUTRON ACER TENDL-2019 LIBRARY; T=293.16K
alphas from (n,2n)a

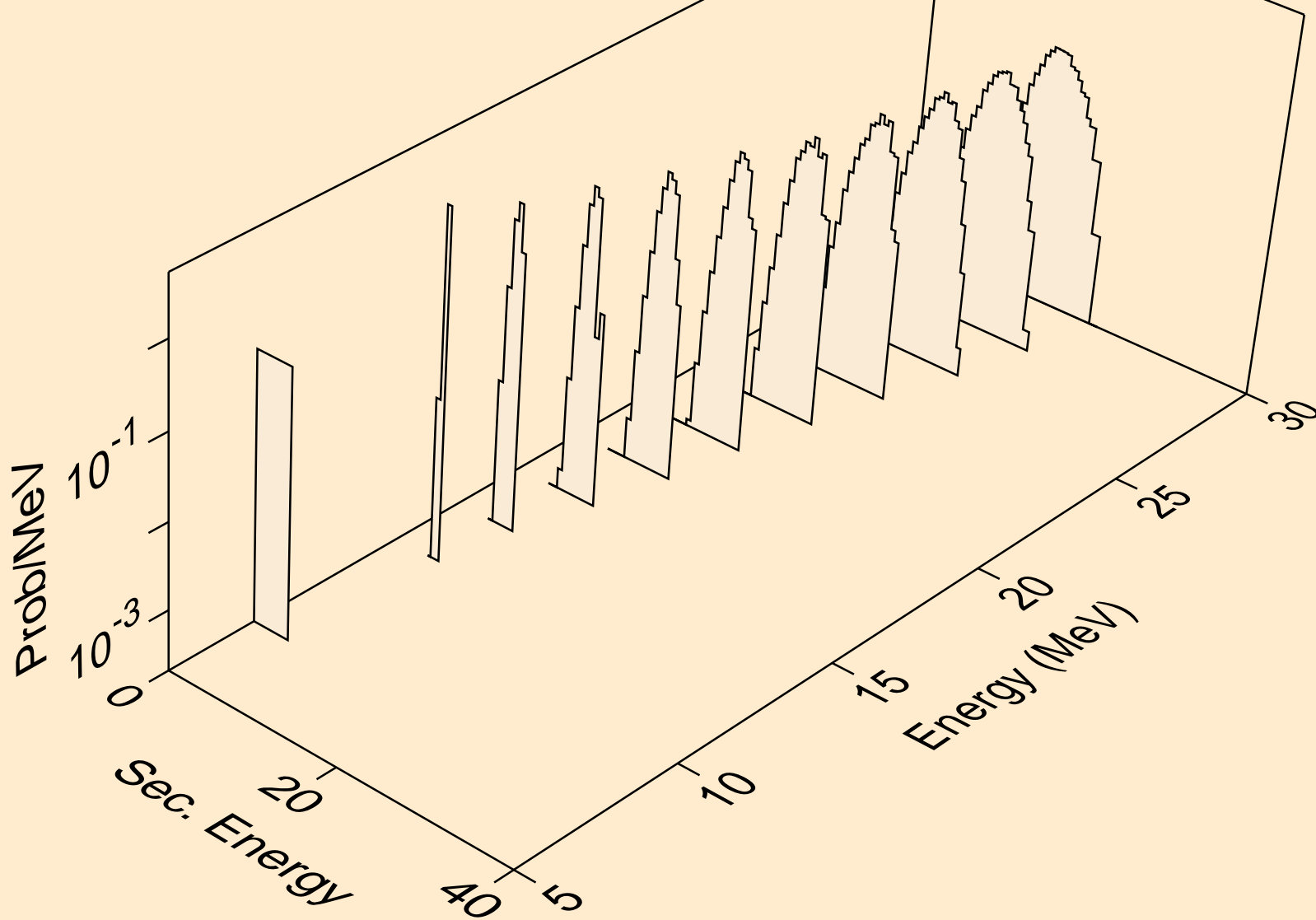

CE133M NEUTRON ACER TENDL-2019 LIBRARY; T=293.16K
alphas from (n,3n)a

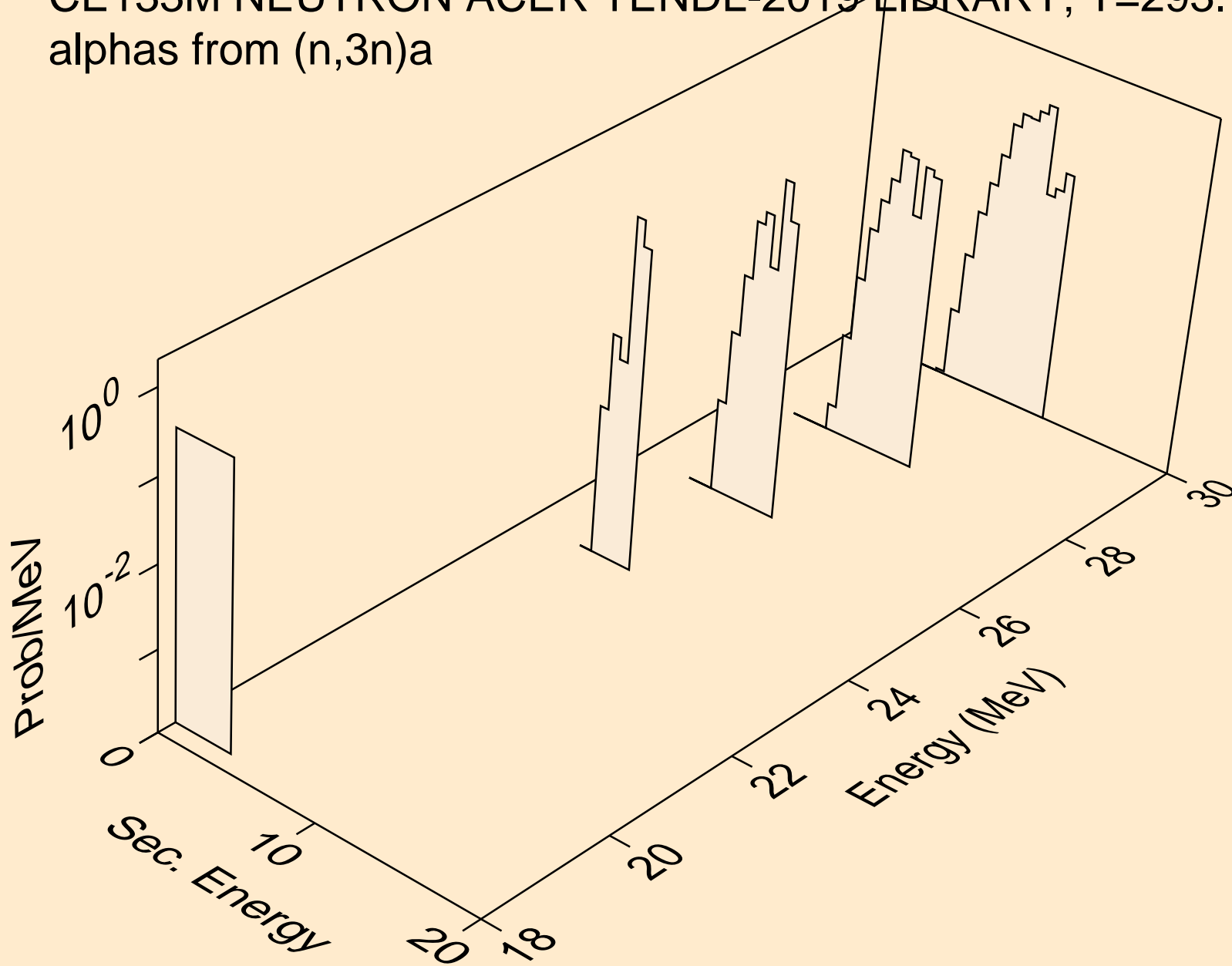

CE133M NEUTRON ACER TENDL-2019 LIBRARY; T=293.16K
alphas from (n,n*)2a

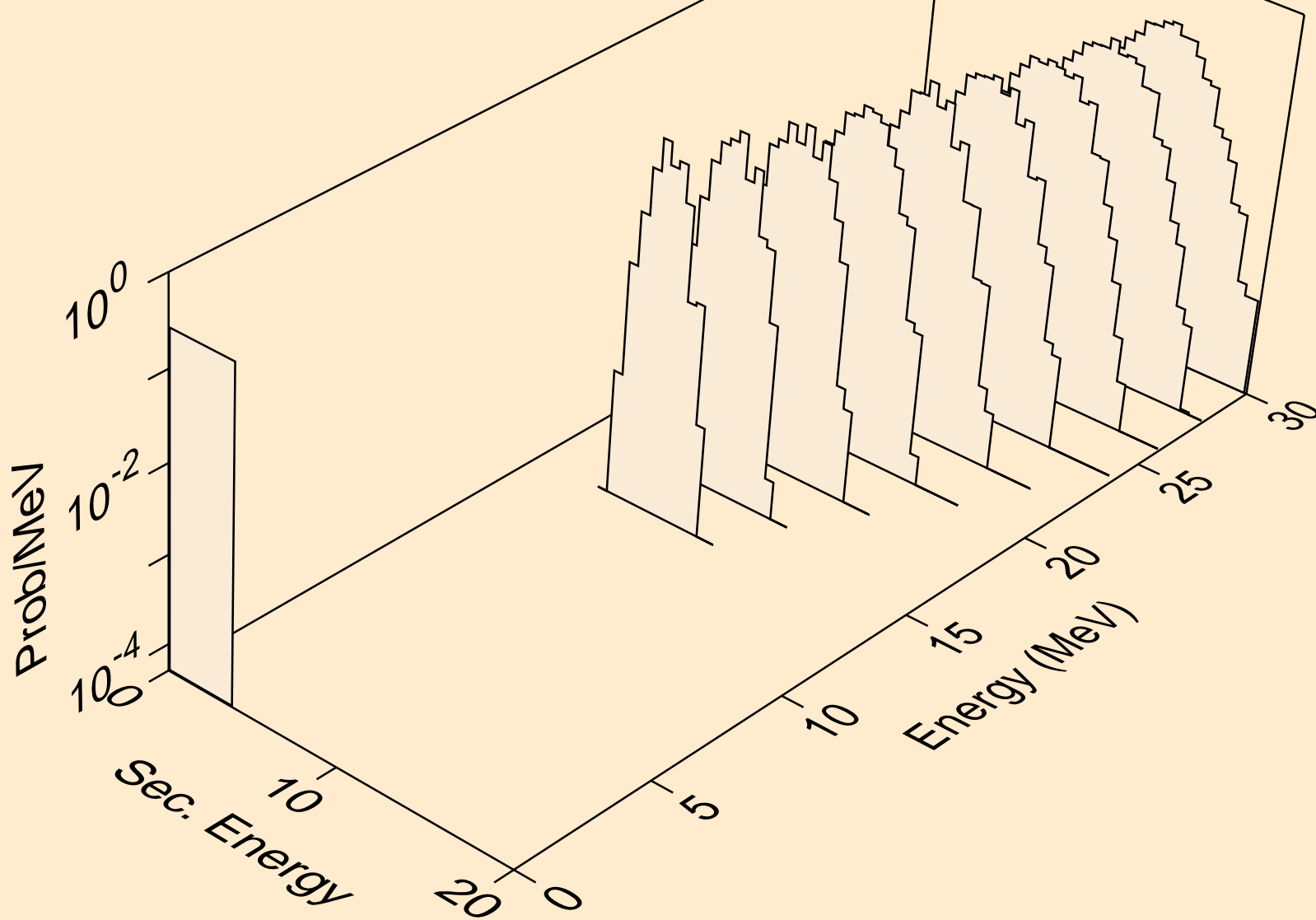

CE133M NEUTRON ACER TENDL-2019 LIBRARY; T=293.16K
alphas from (n,2n)2a

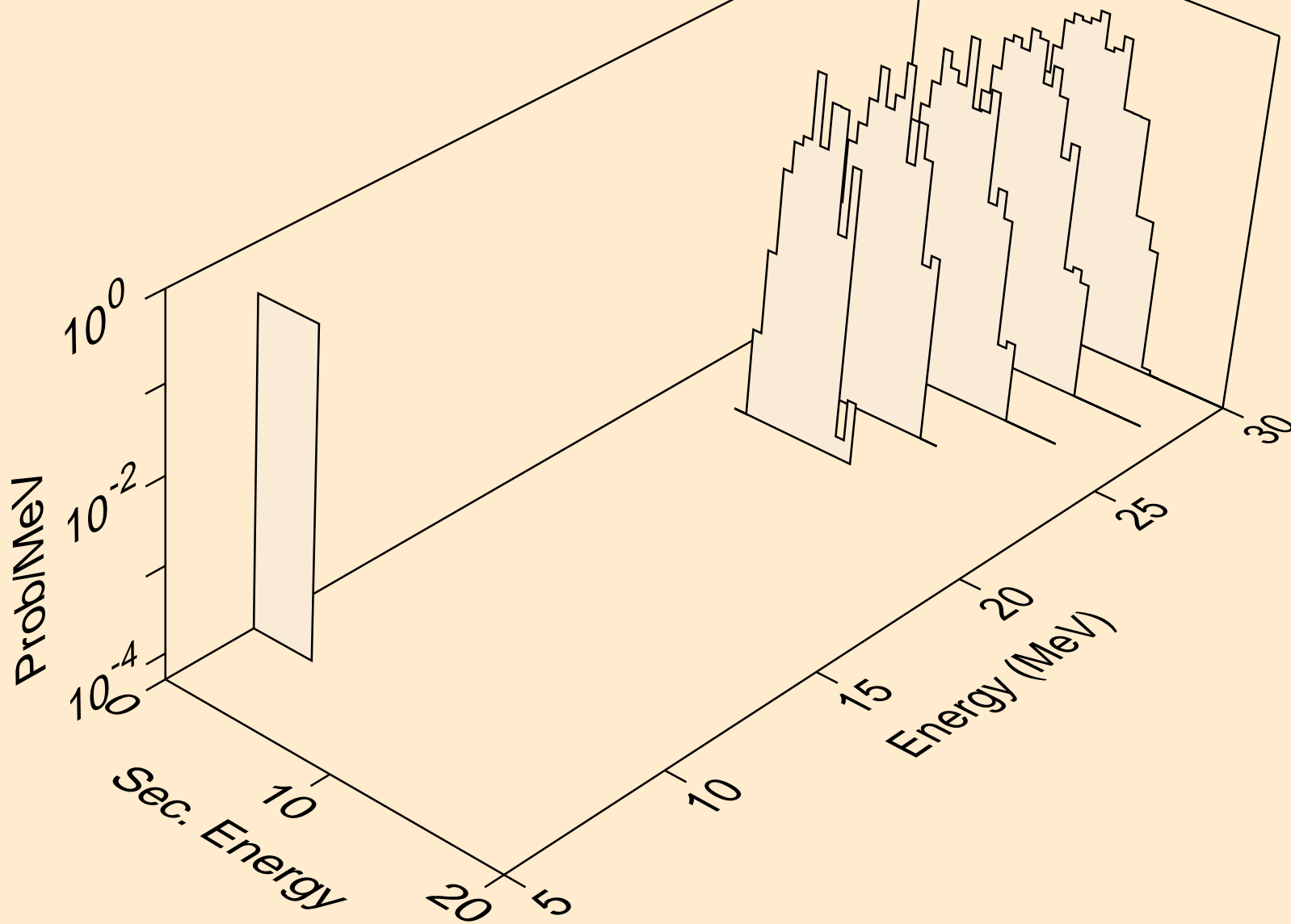

CE133M NEUTRON ACER TENDL-2019 LIBRARY; T=293.16K
alphas from (n,npa)

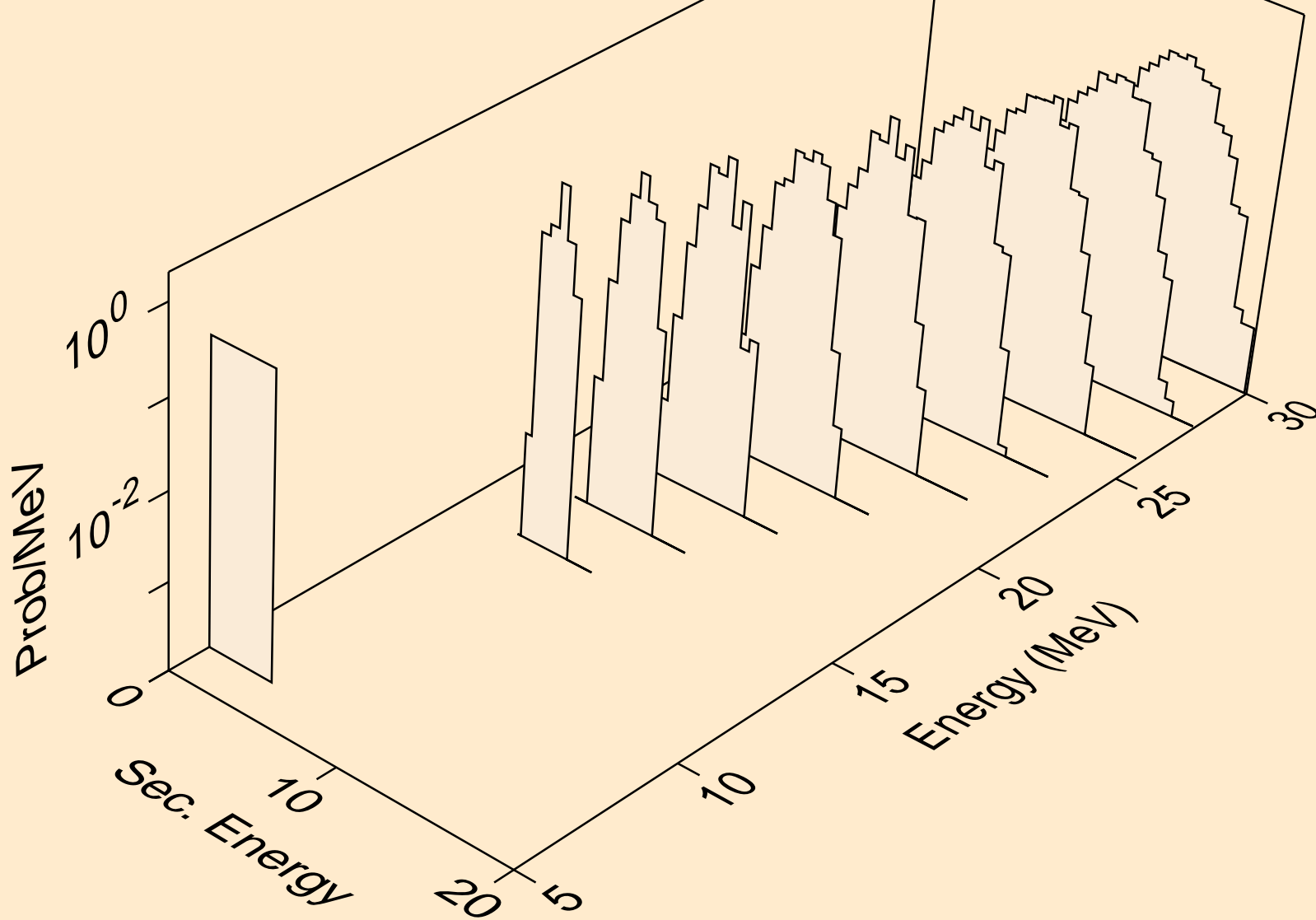

CE133M NEUTRON ACER TENDL-2019 LIBRARY; T=293.16K
alphas from (n,a)

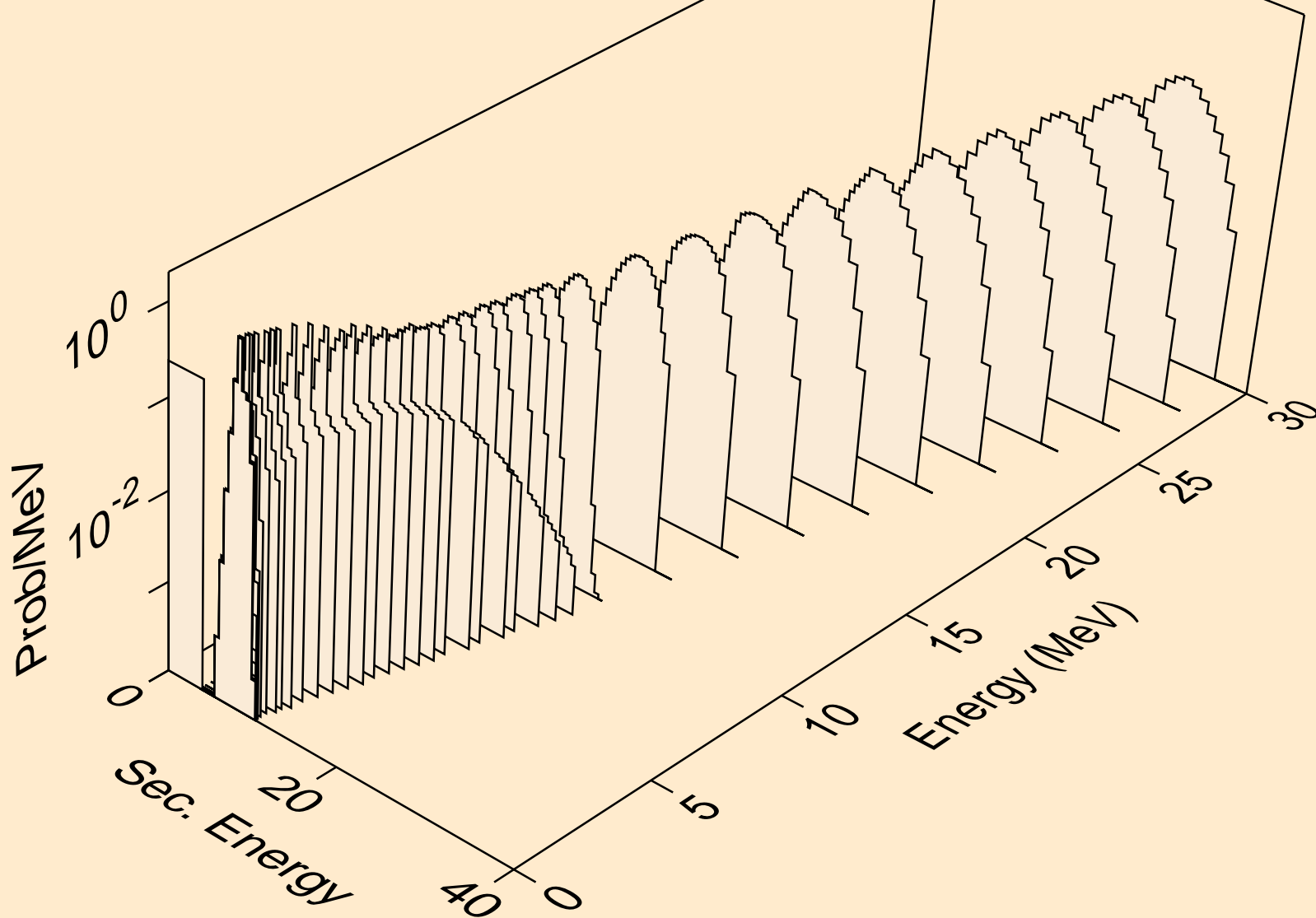

CE133M NEUTRON ACER TENDL-2019 LIBRARY; T=293.16K
alphas from (n,2a)

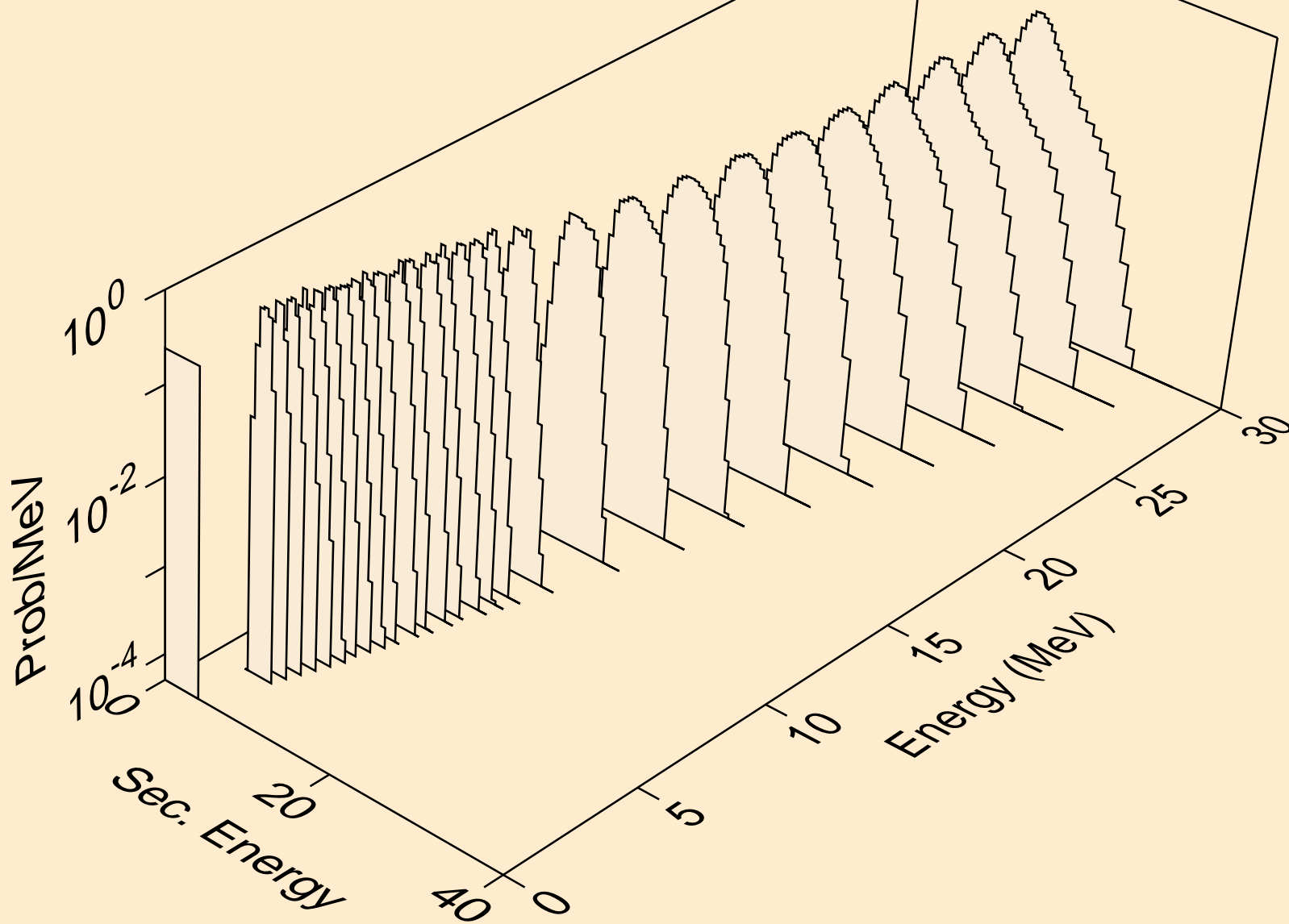

CE133M NEUTRON ACER TENDL-2019 LIBRARY; T=293.16K
alphas from (n,pa)

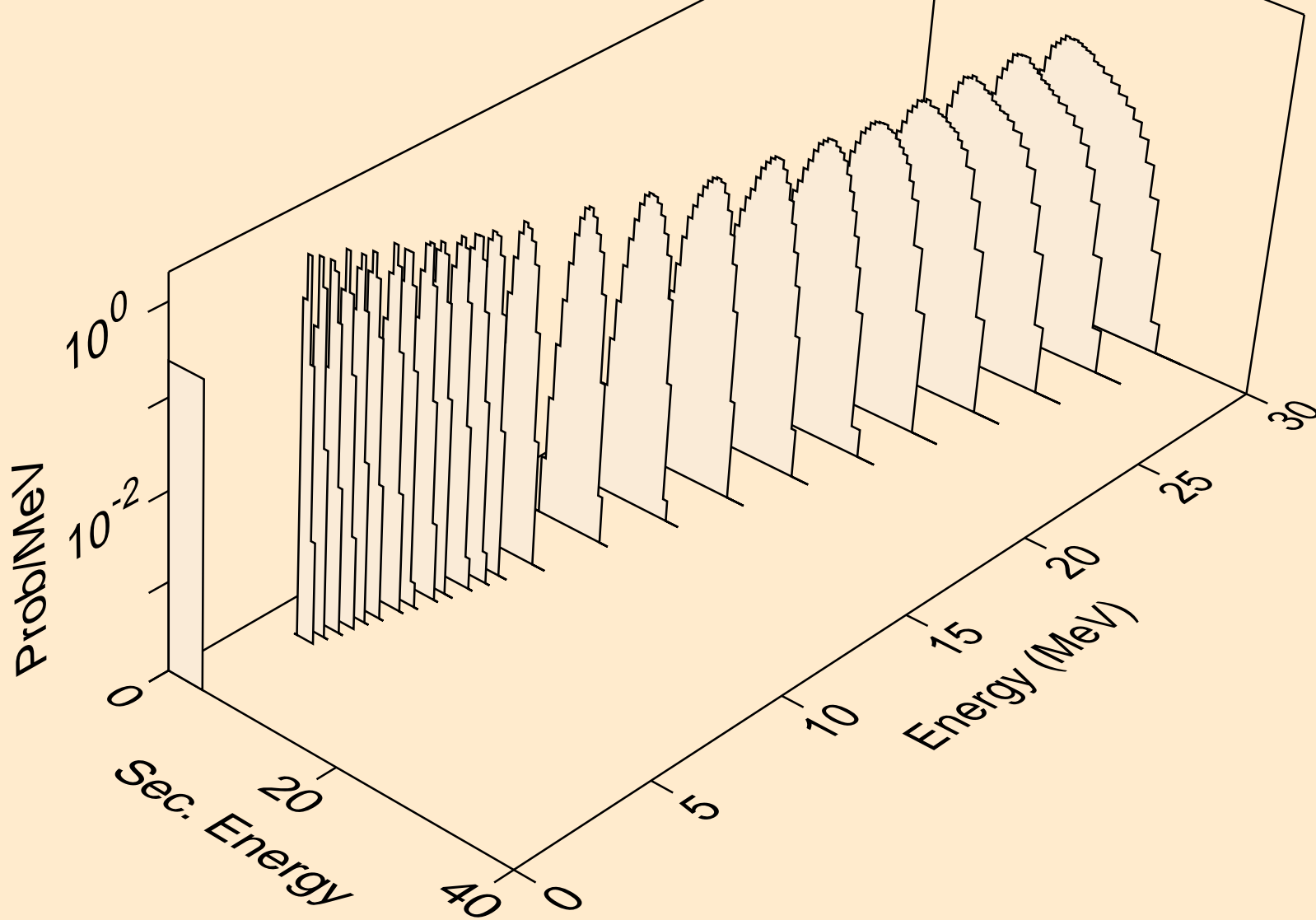

CE133M NEUTRON ACER TENDL-2019 LIBRARY; T=293.16K
alphas from (n,da)

