

CE137M NEUTRON ACER TENDL-2019 LIBRARY; T=293.16K
Principal cross sections

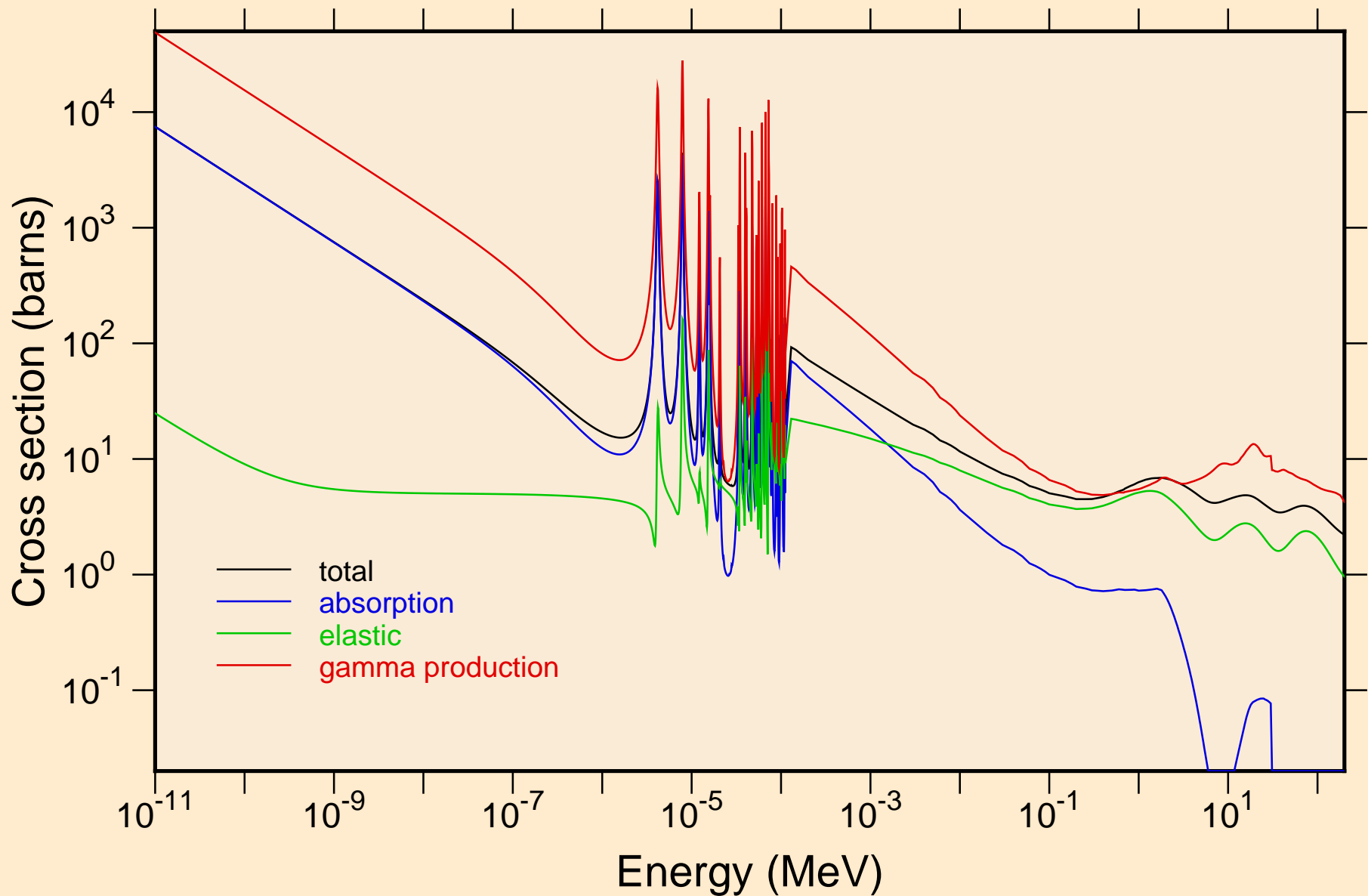

CE137M NEUTRON ACER TENDL-2019 LIBRARY; T=293.16K
resonance total cross section

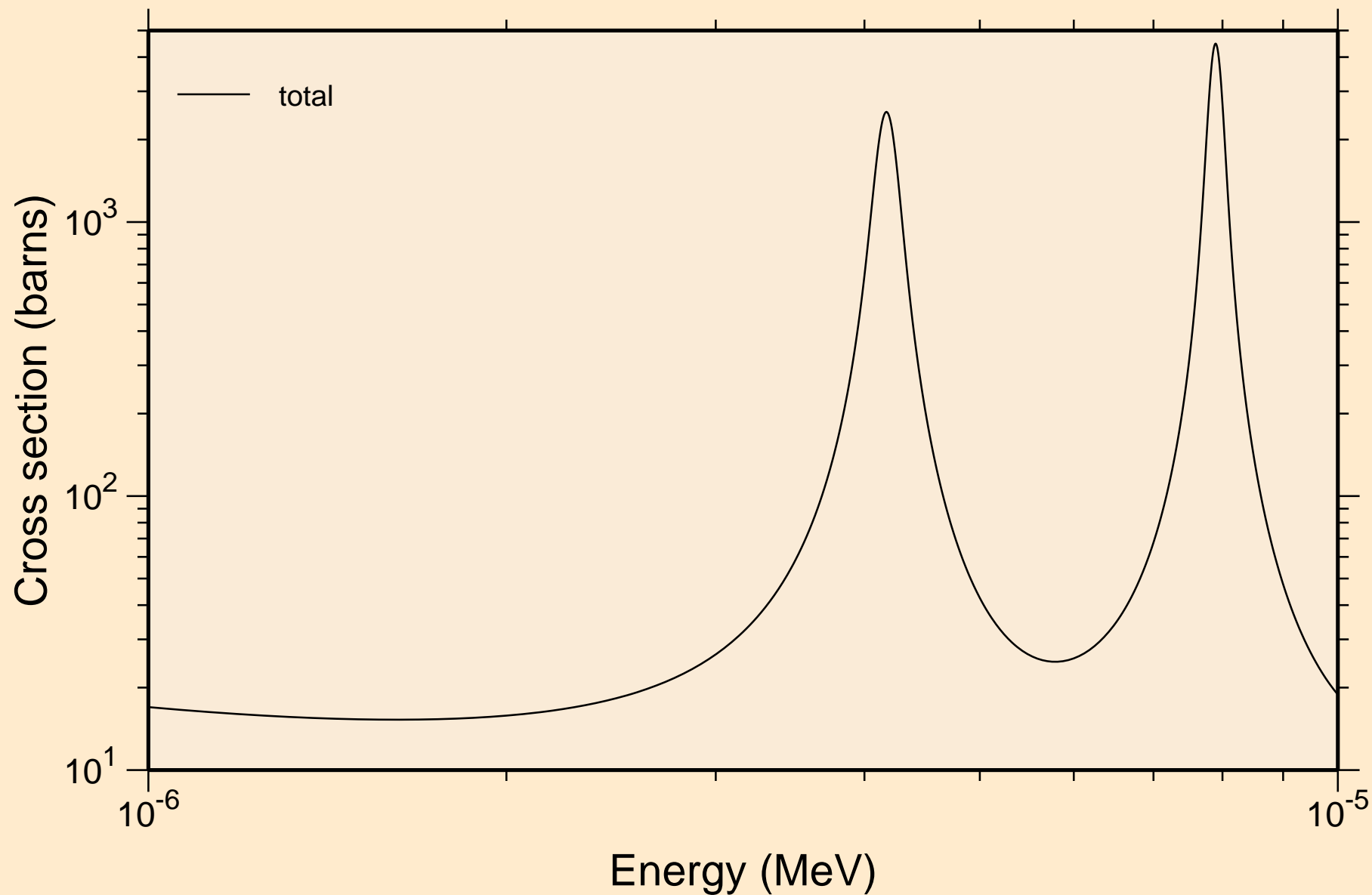

CE137M NEUTRON ACER TENDL-2019 LIBRARY; T=293.16K
resonance total cross section

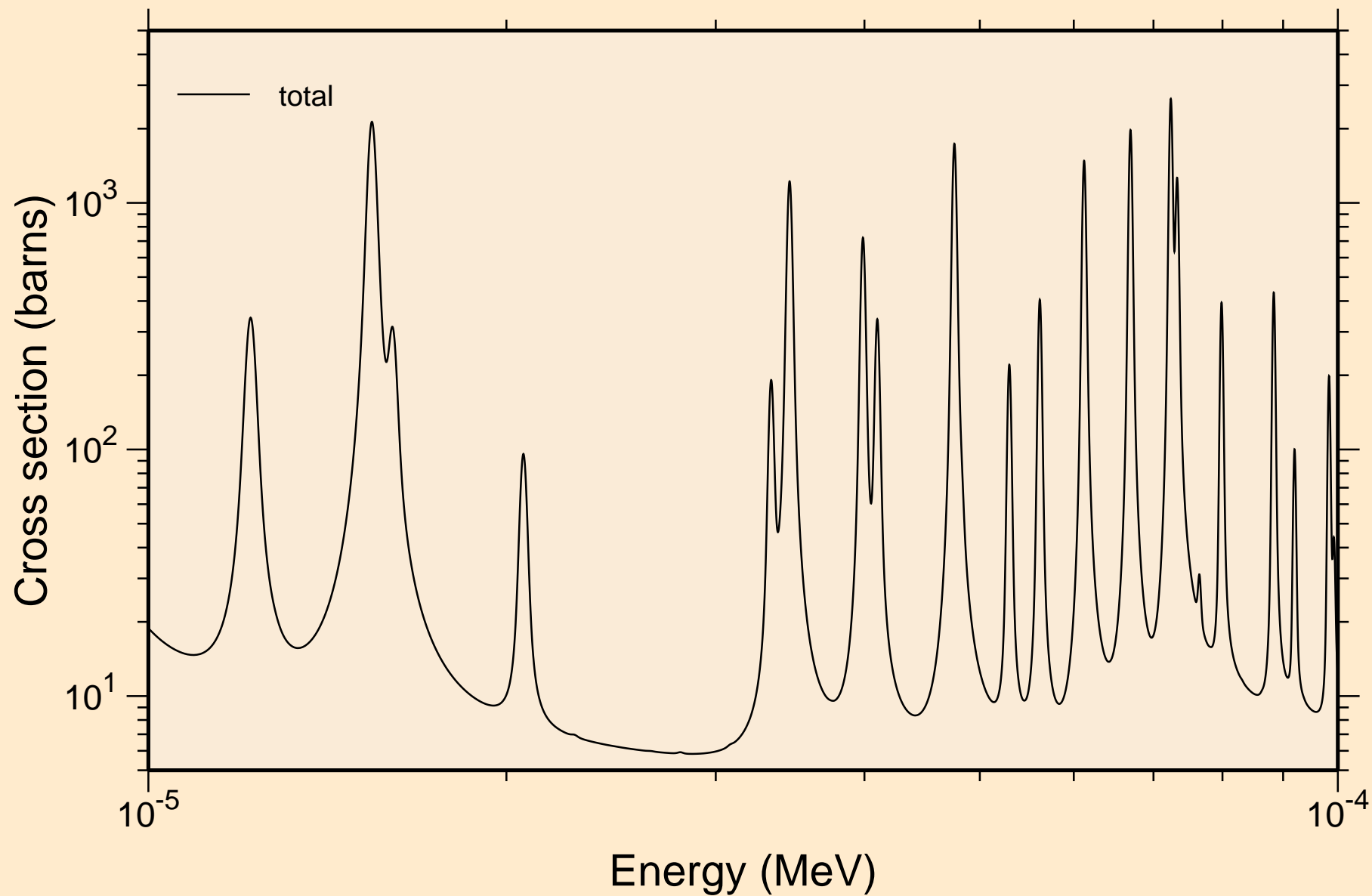

CE137M NEUTRON ACER TENDL-2019 LIBRARY; T=293.16K
resonance total cross section

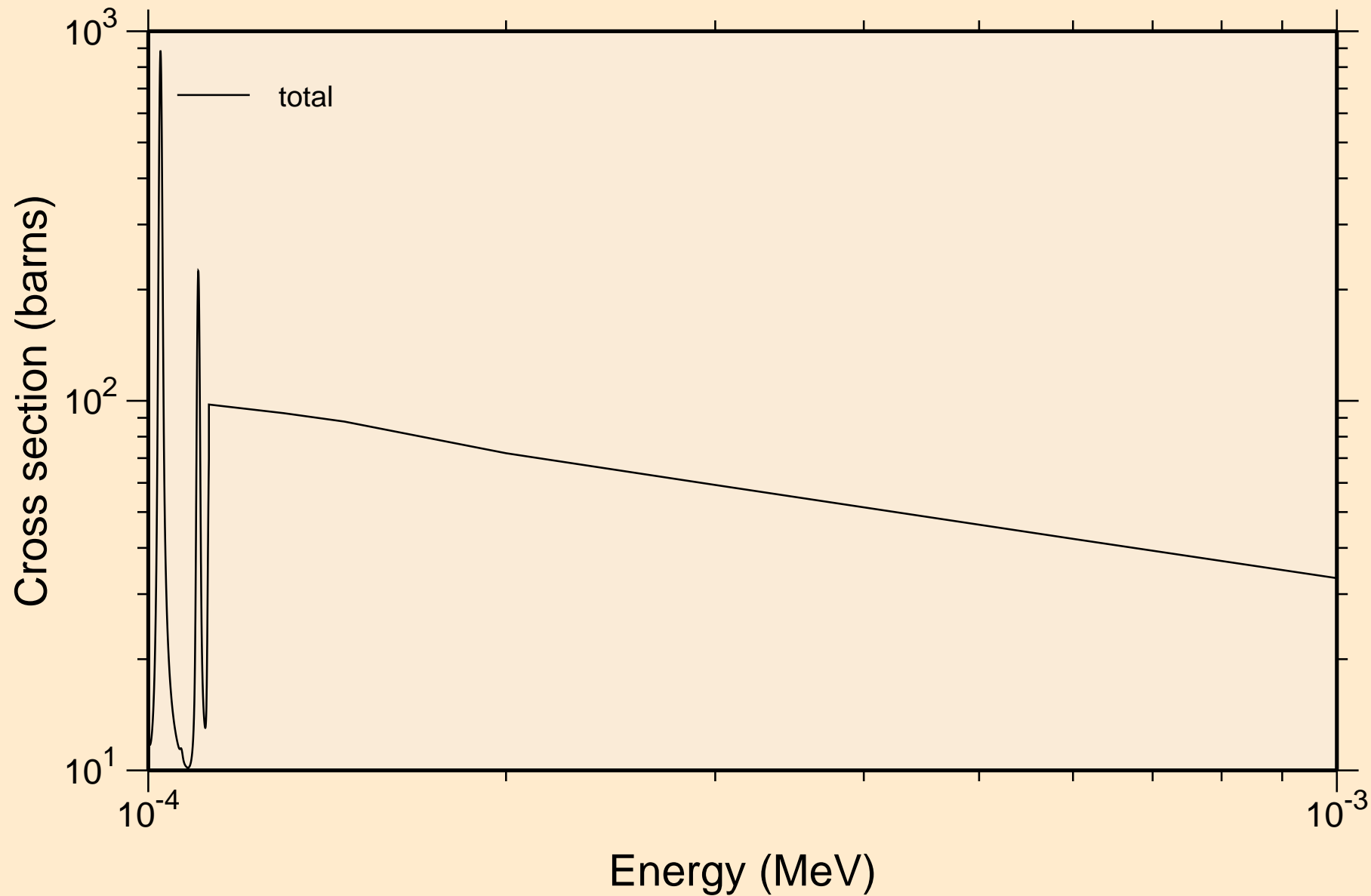

C¹³⁷M NEUTRON ACER TENDL-2019 LIBRARY; T=293.16K
resonance total cross section

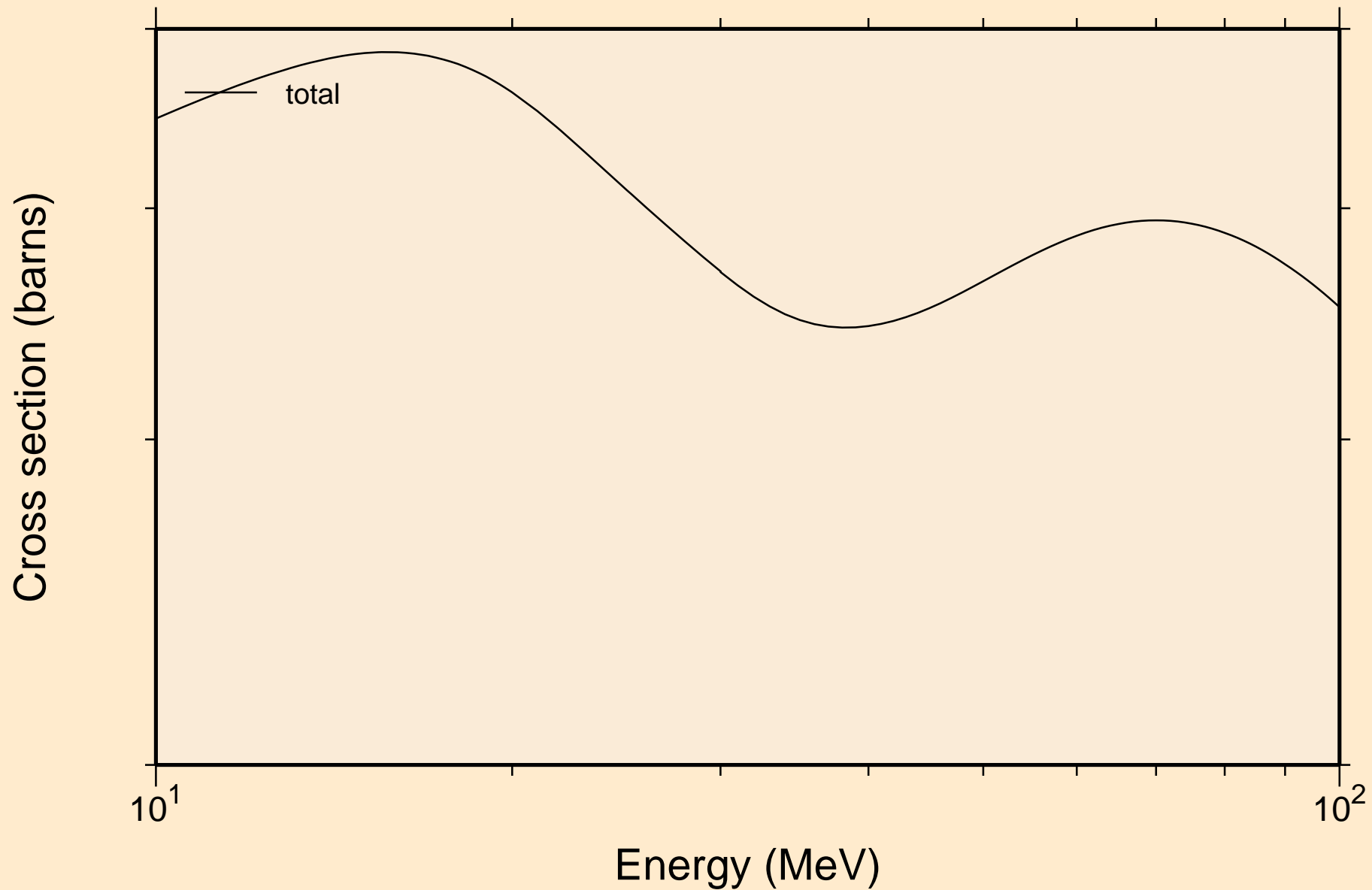

CE137M NEUTRON ACER TENDL-2019 LIBRARY; T=293.16K
resonance absorption cross sections

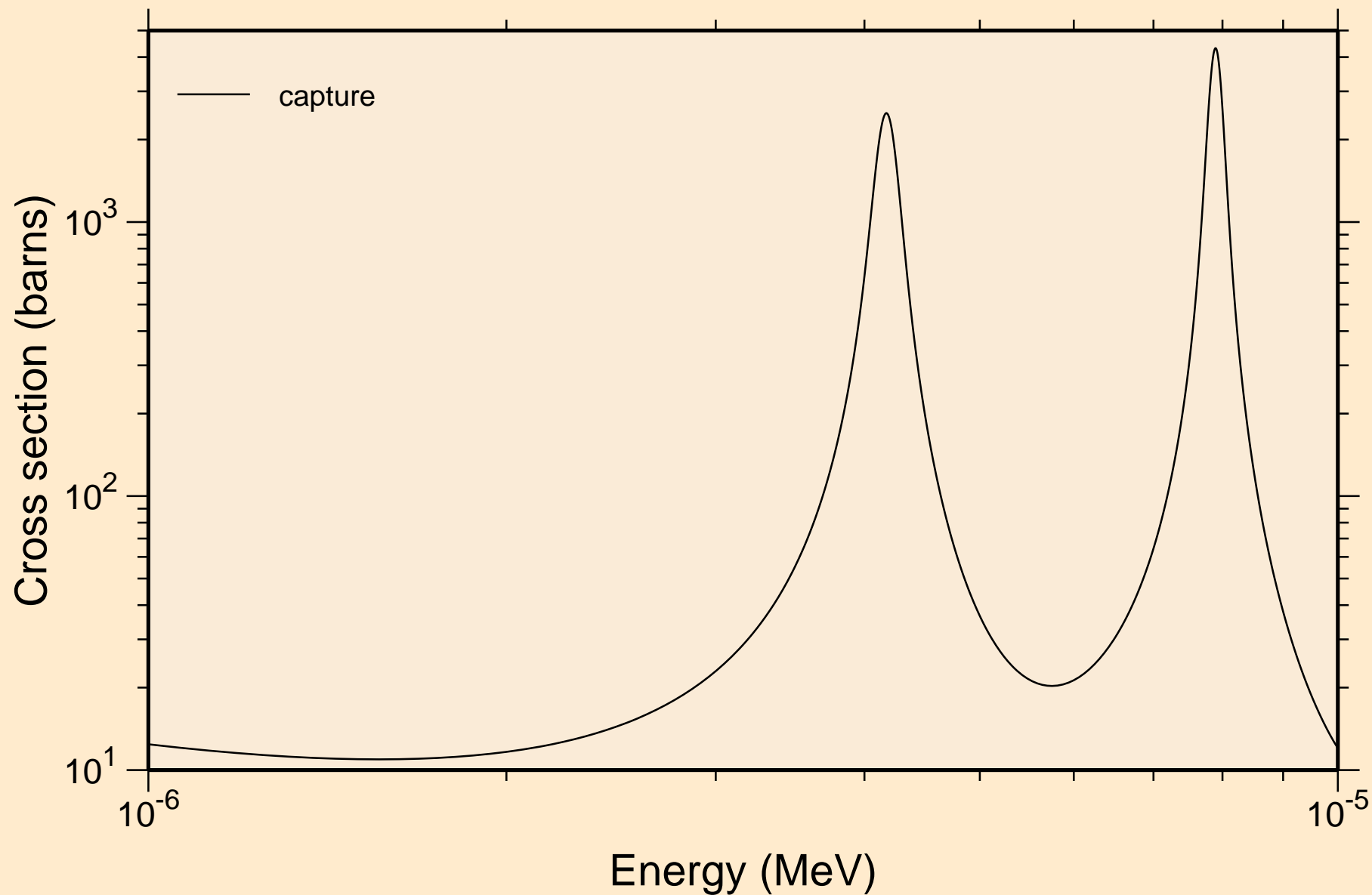

CE137M NEUTRON ACER TENDL-2019 LIBRARY; T=293.16K
resonance absorption cross sections

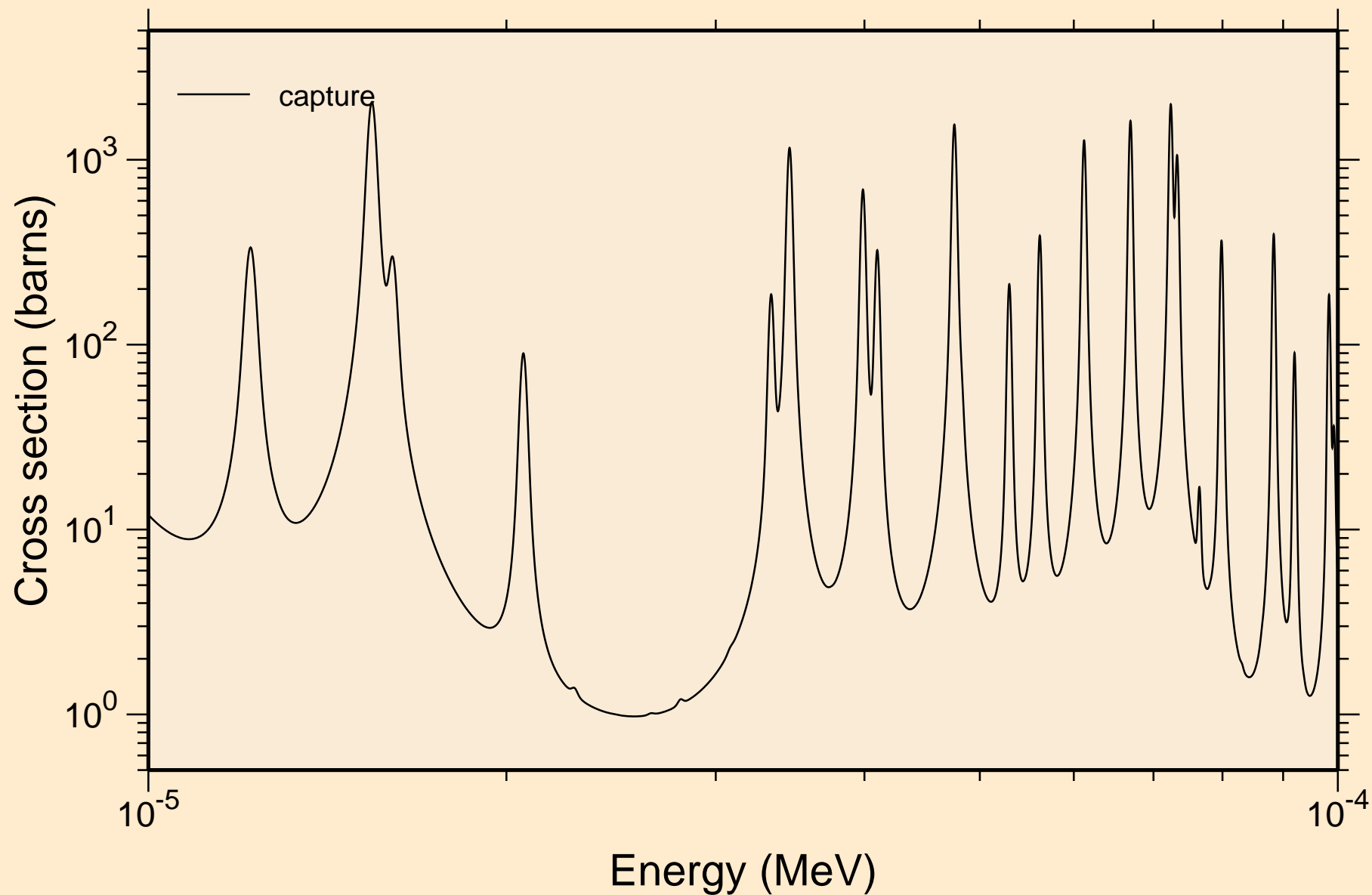

CE137M NEUTRON ACER TENDL-2019 LIBRARY; T=293.16K
resonance absorption cross sections

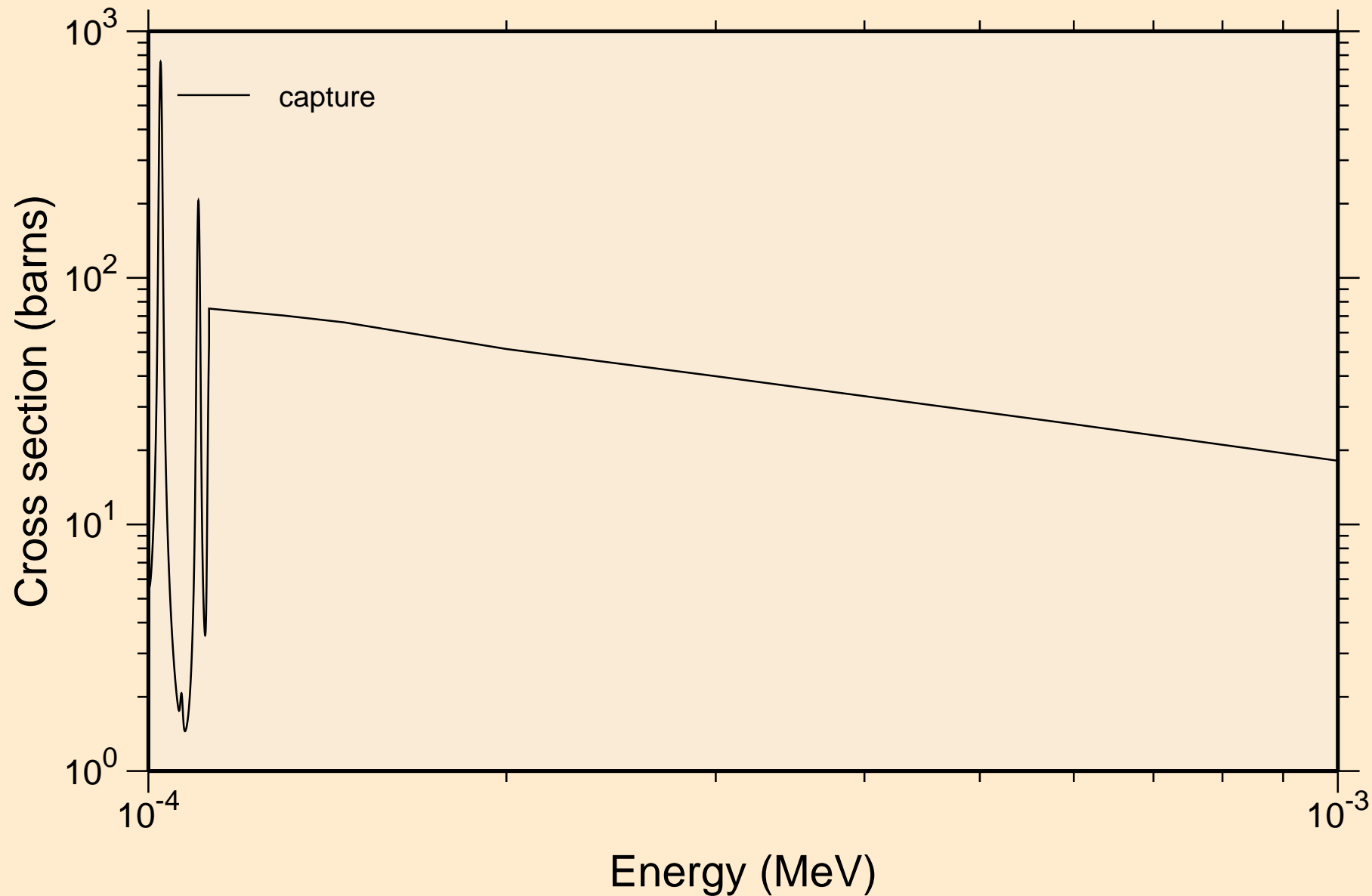

CE137M NEUTRON ACER TENDL-2019 LIBRARY; T=293.16K
resonance absorption cross sections

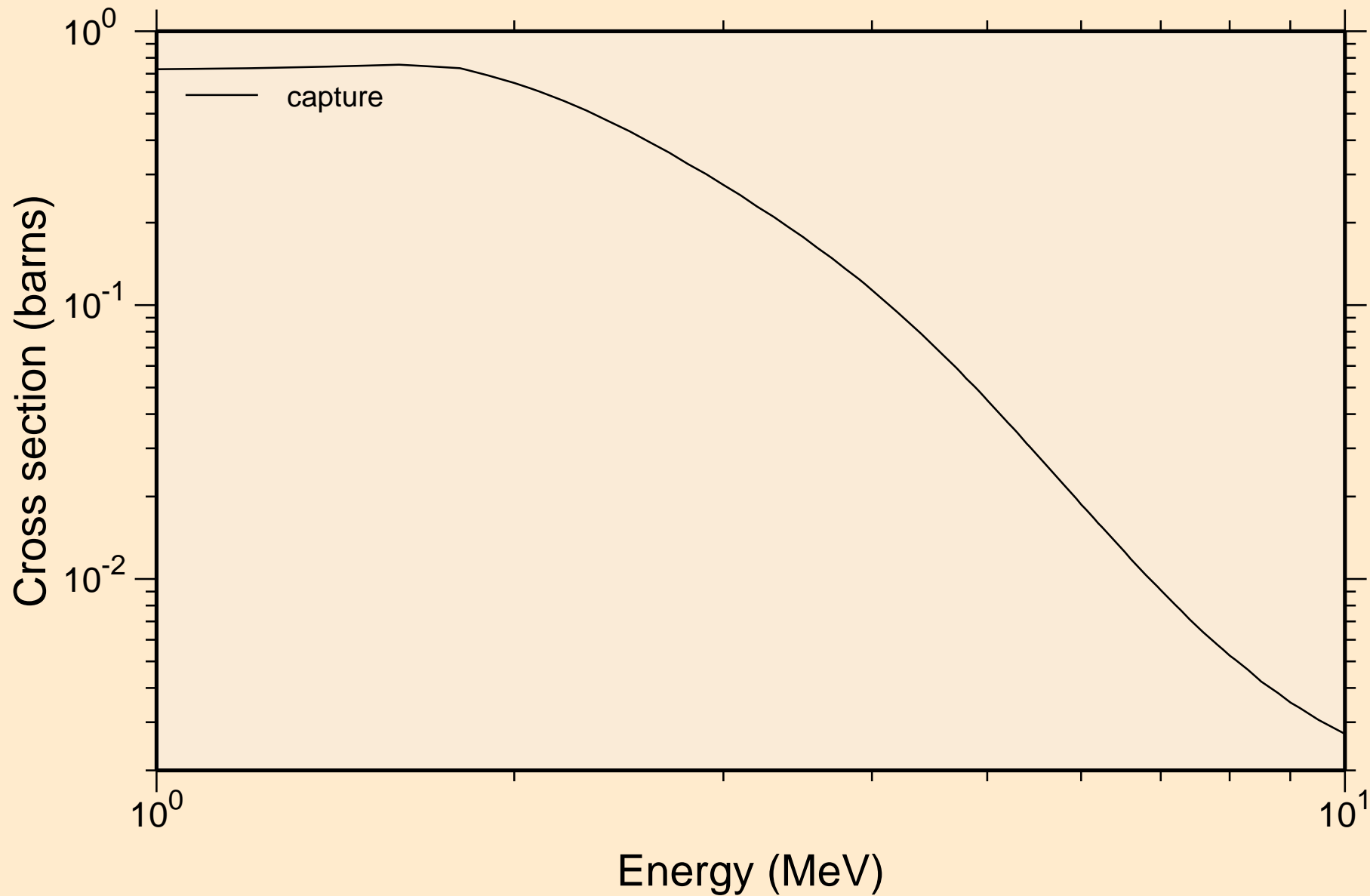

CE137M NEUTRON ACER TENDL-2019 LIBRARY; T=293.16K Heating

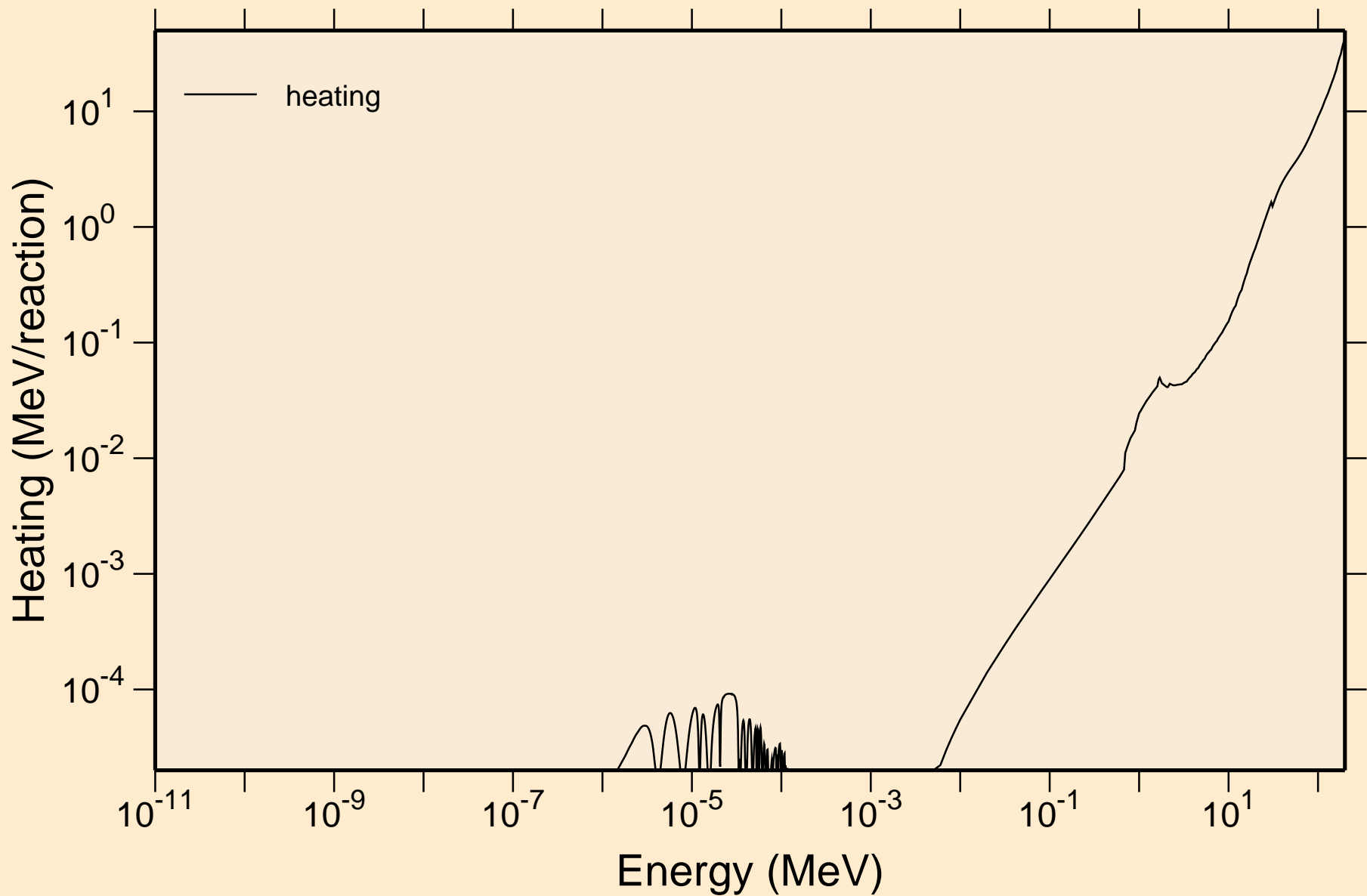

CE137M NEUTRON ACER TENDL-2019 LIBRARY; T=293.16K
Damage

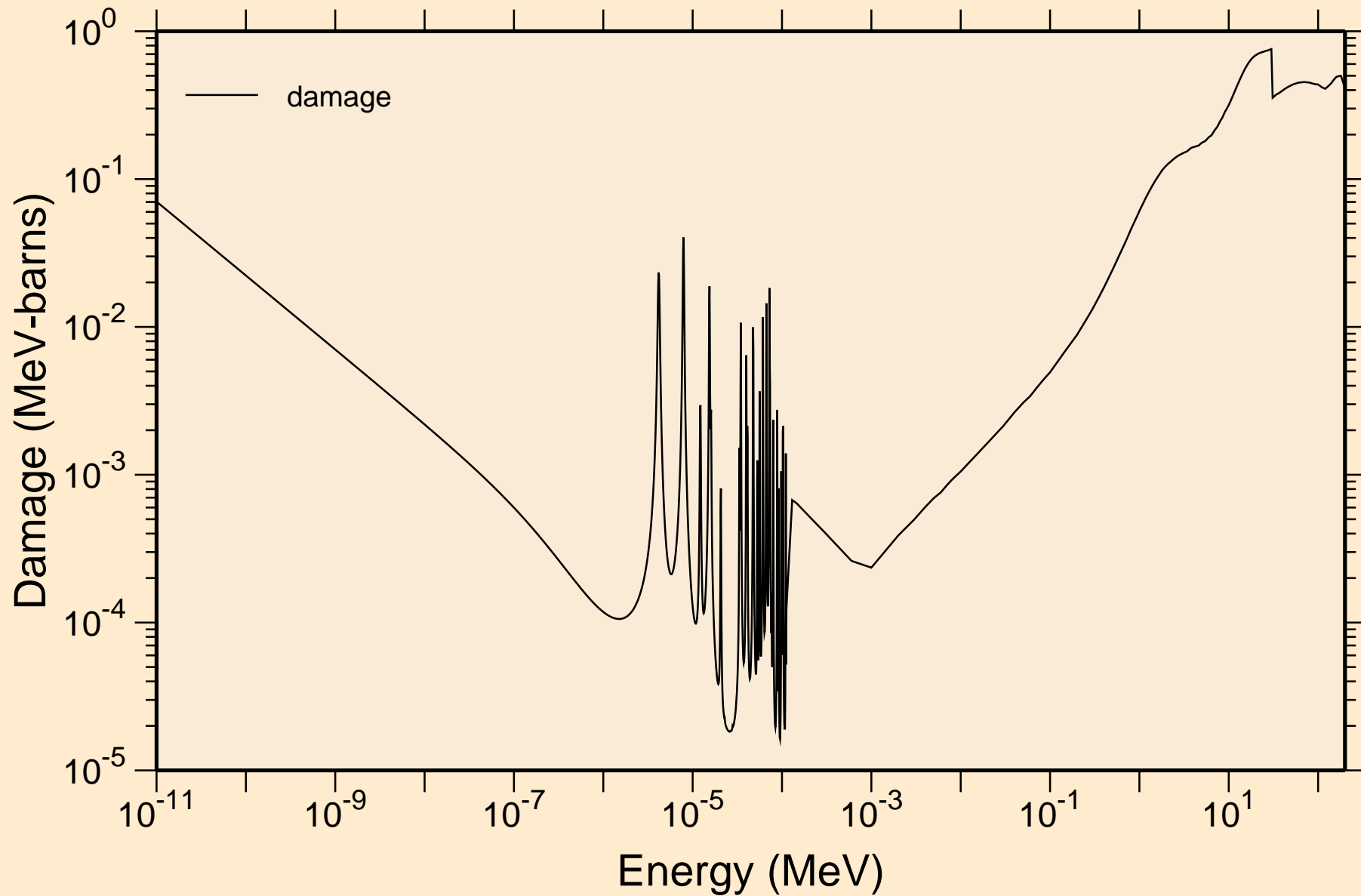

CE137M NEUTRON ACER TENDL-2019 LIBRARY; T=293.16K

Non-threshold reactions

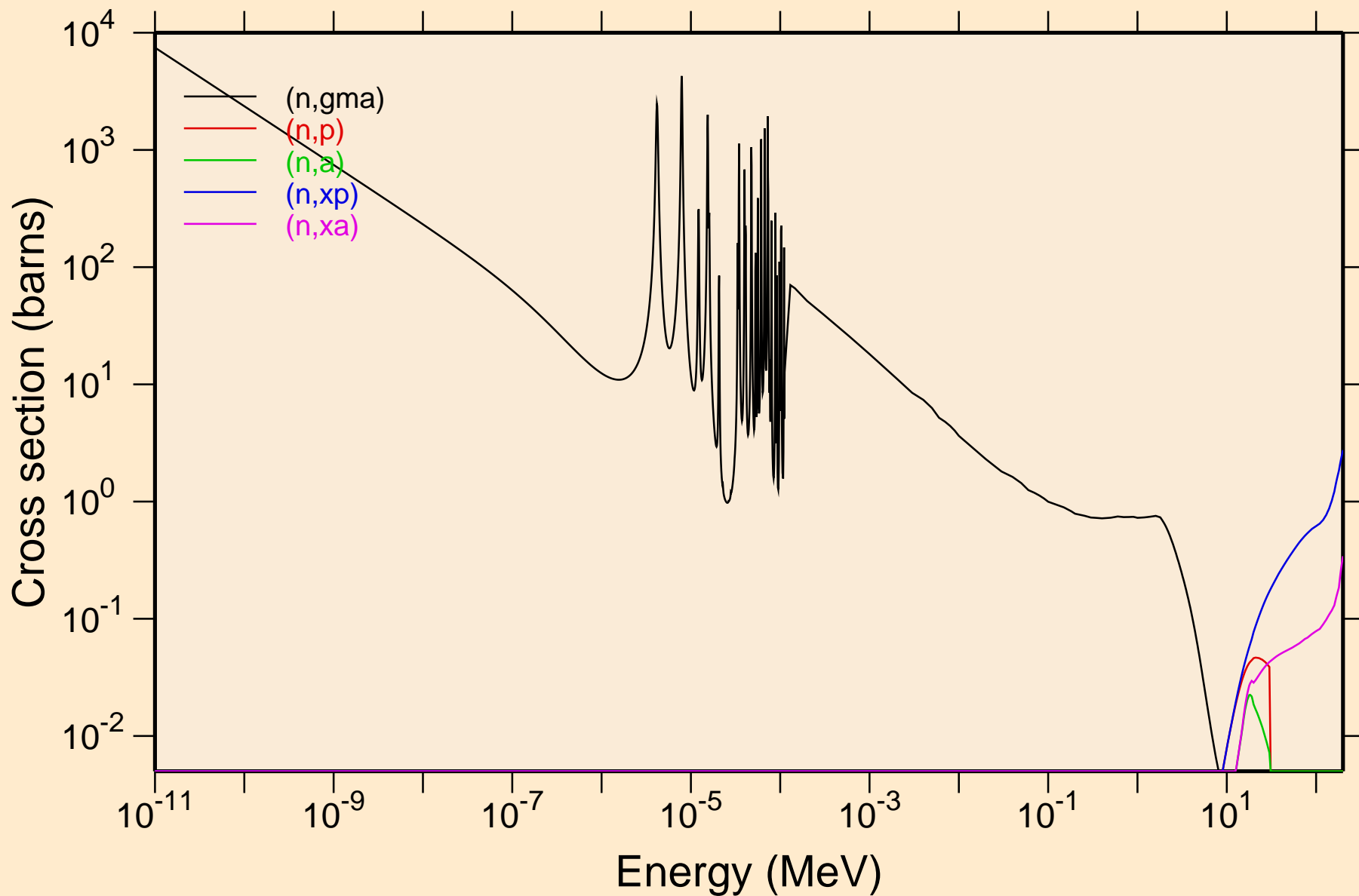

CE137M NEUTRON ACER TENDL-2019 LIBRARY; T=293.16K
Principal cross sections

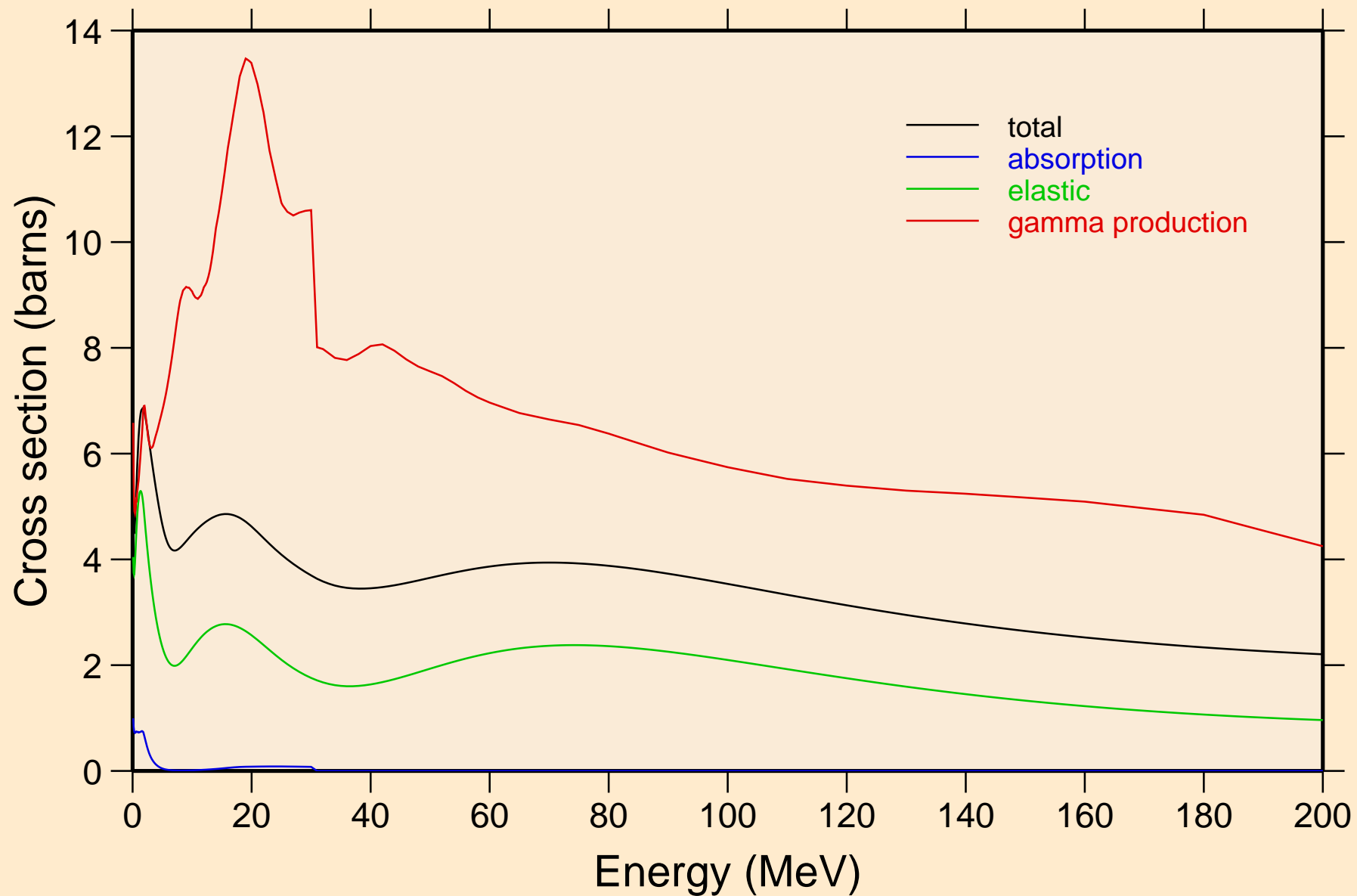

CE137M NEUTRON ACER TENDL-2019 LIBRARY; T=293.16K
Heating

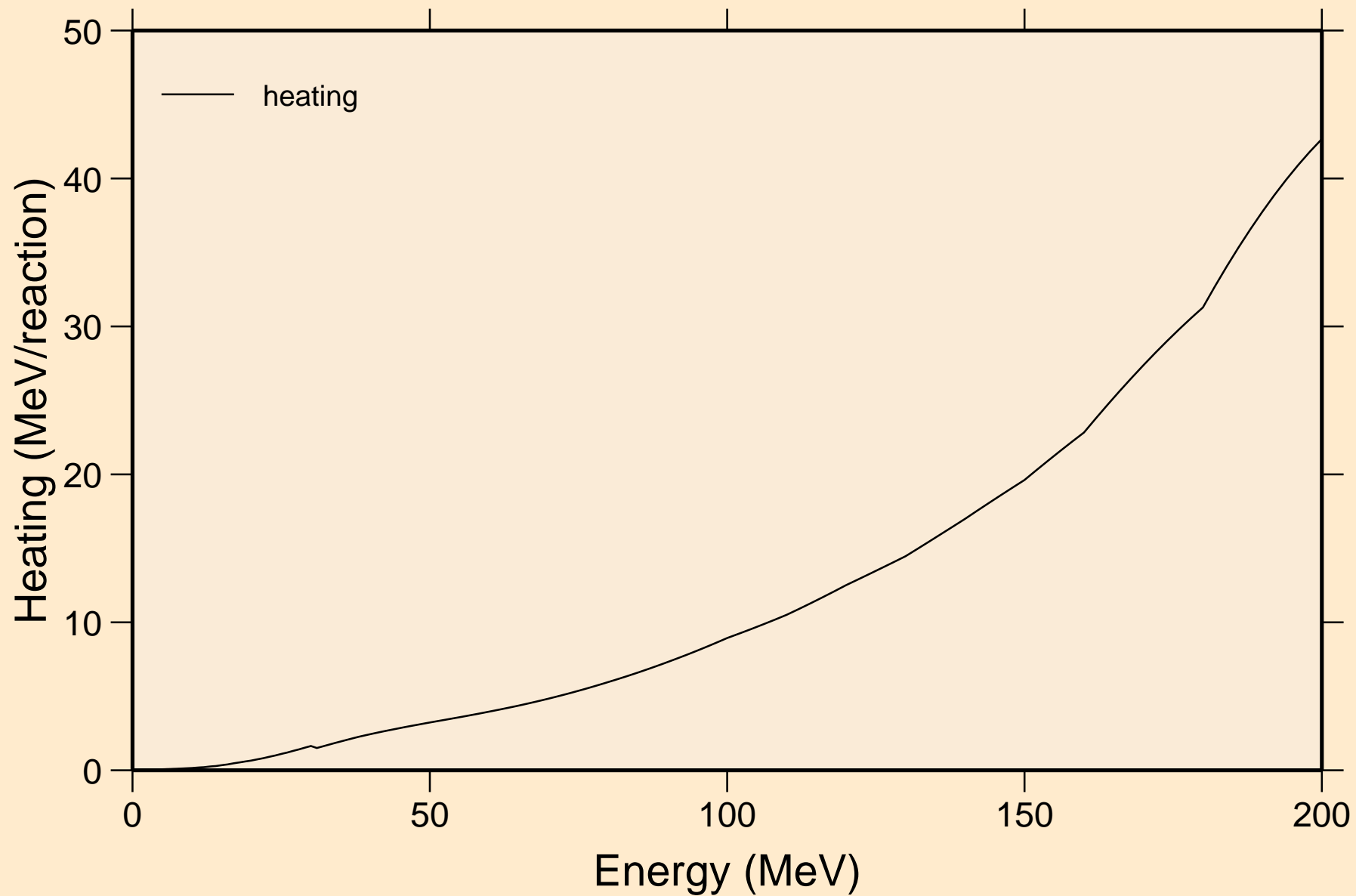

CE137M NEUTRON ACER TENDL-2019 LIBRARY; T=293.16K
Damage

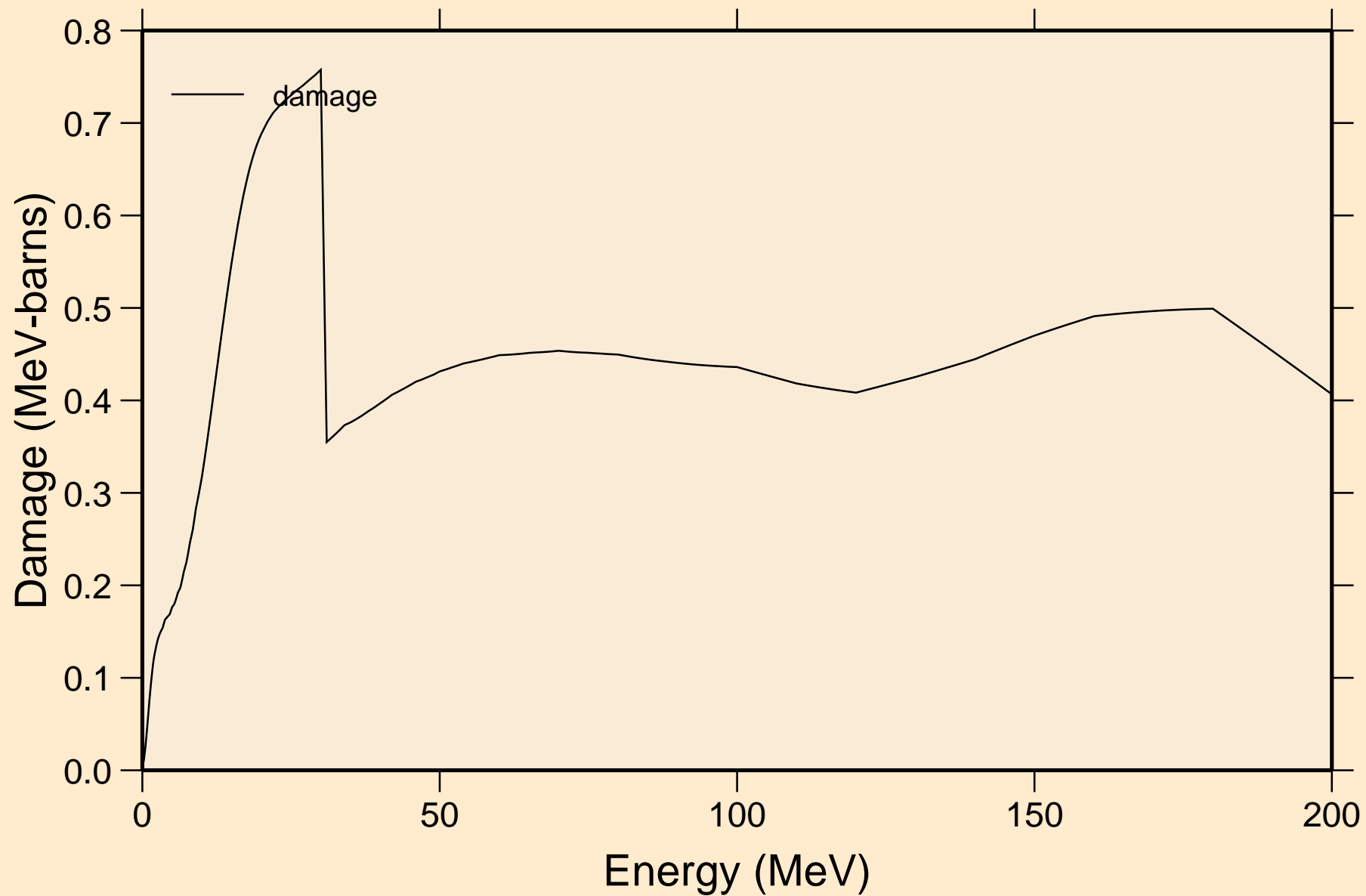

CE137M NEUTRON ACER TENDL-2019 LIBRARY; T=293.16K
Non-threshold reactions

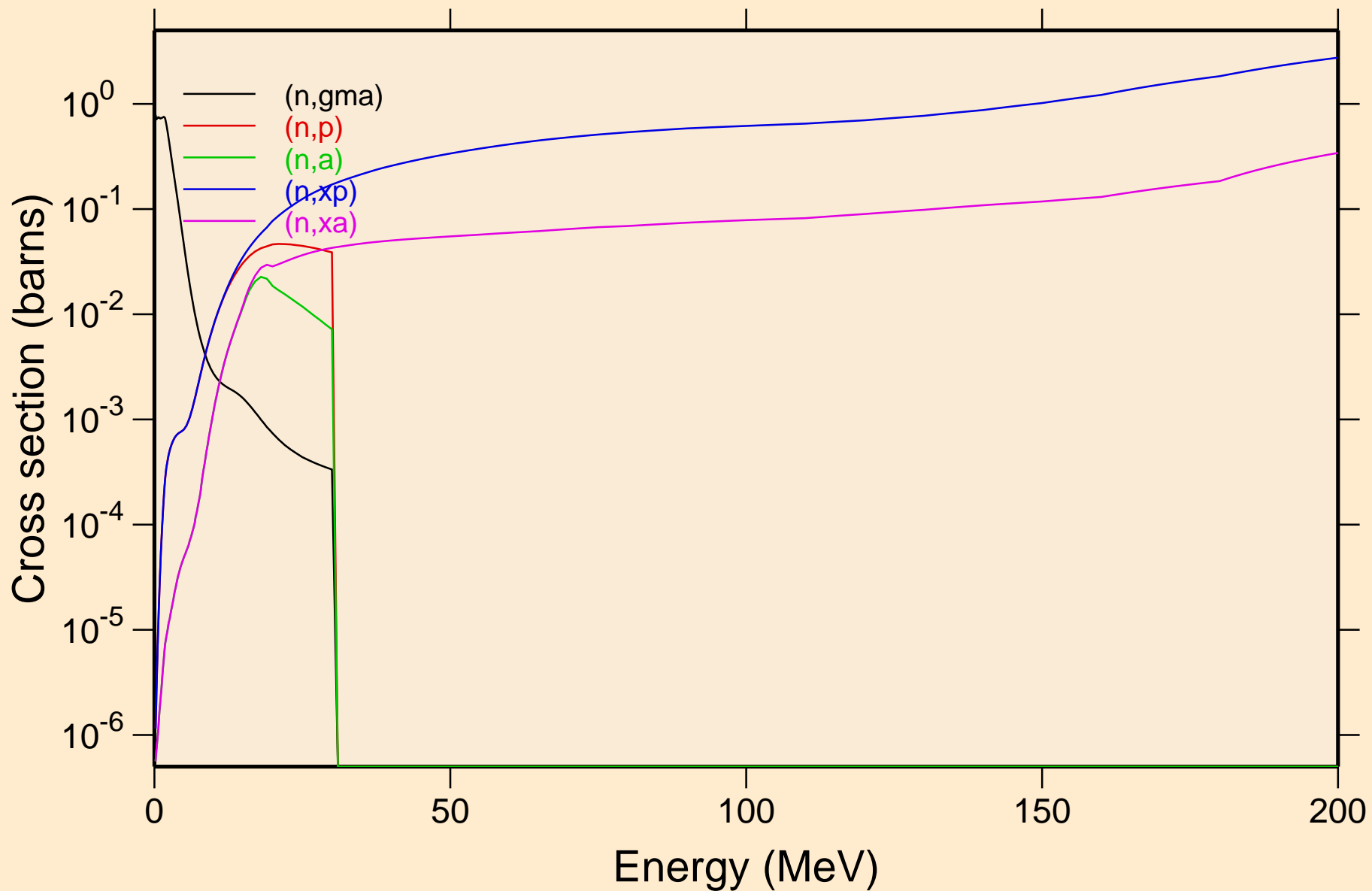

CE137M NEUTRON ACER TENDL-2019 LIBRARY; T=293.16K
Inelastic levels

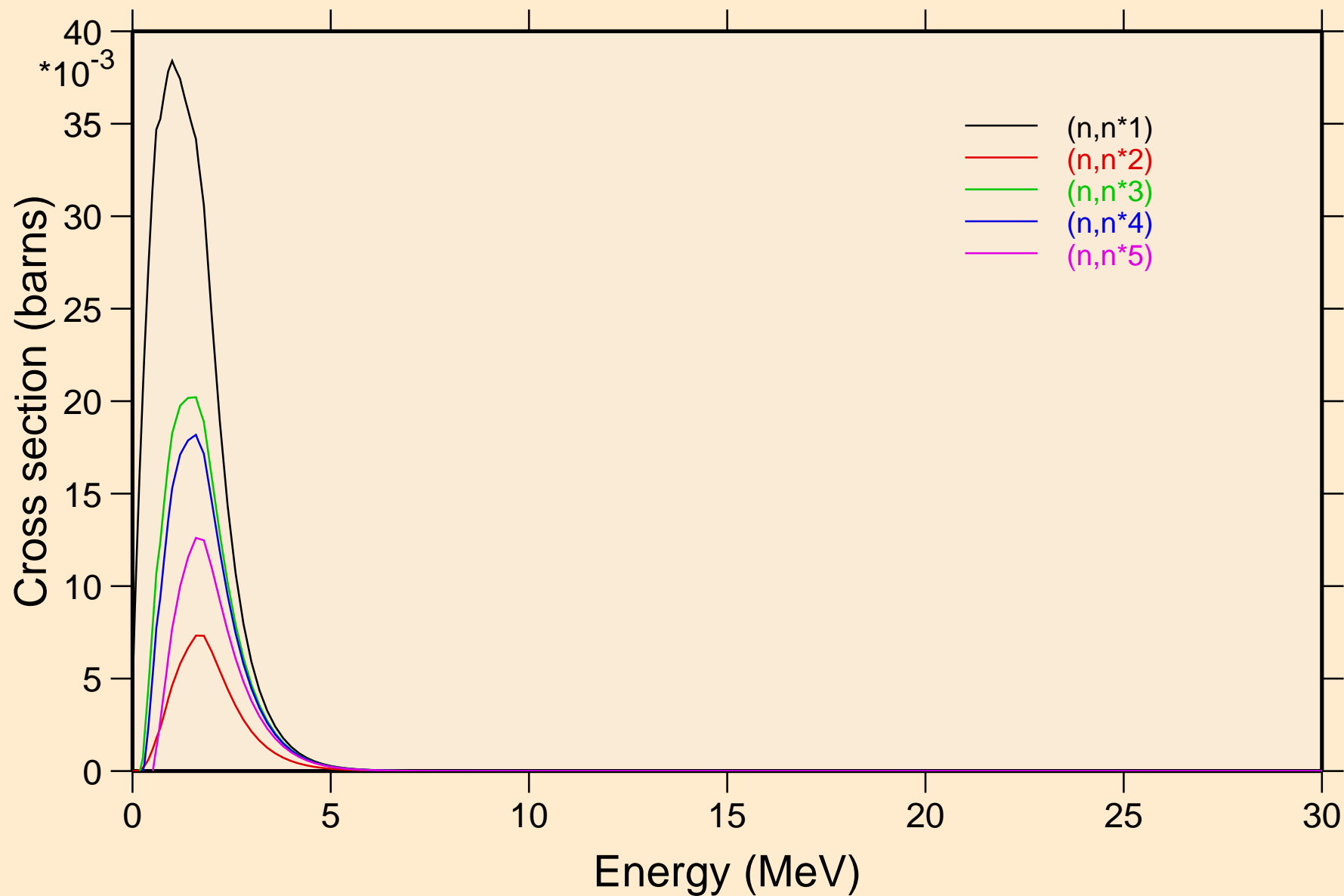

CE137M NEUTRON ACER TENDL-2019 LIBRARY; T=293.16K
Inelastic levels

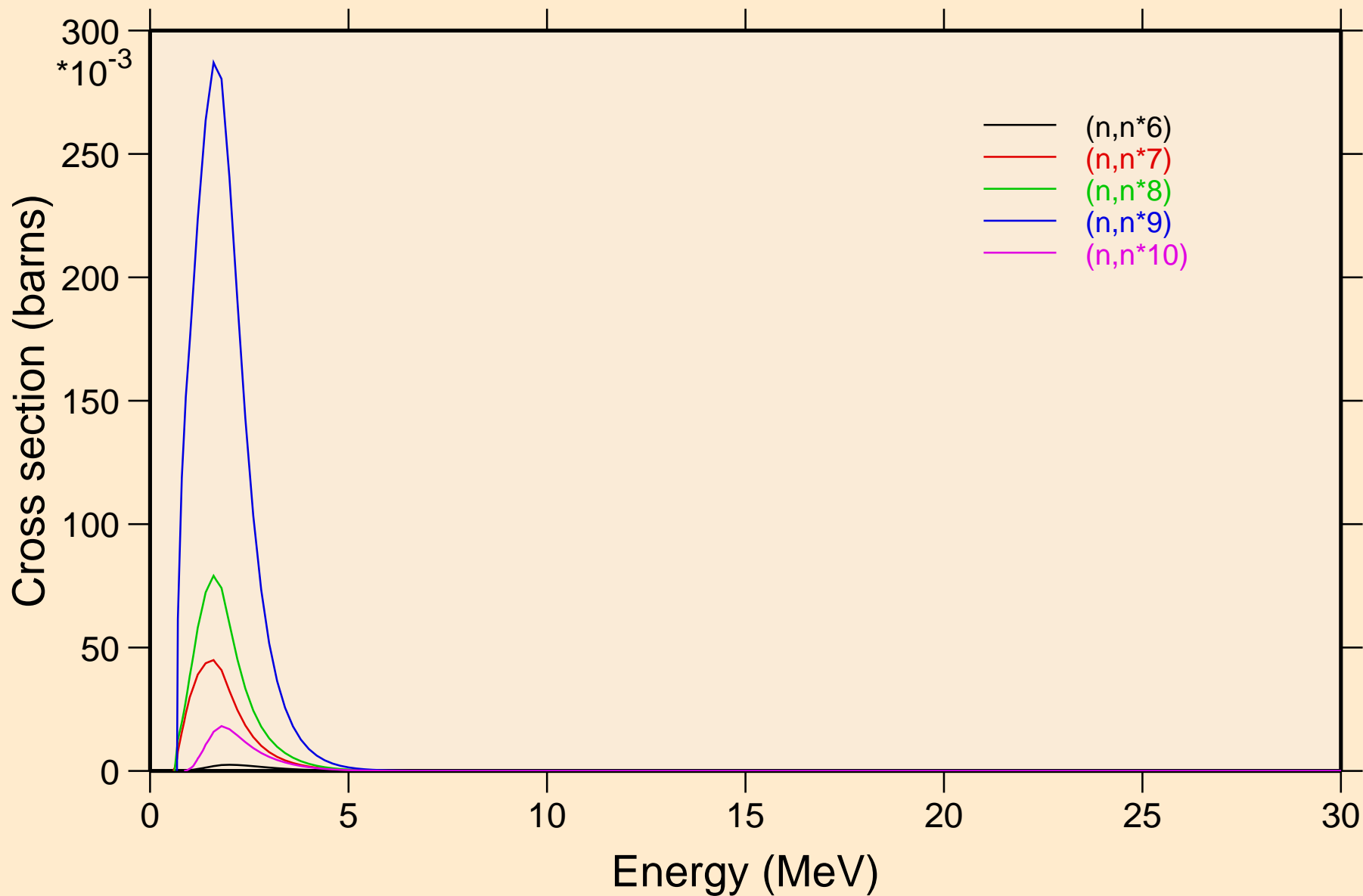

CE137M NEUTRON ACER TENDL-2019 LIBRARY; T=293.16K
Inelastic levels

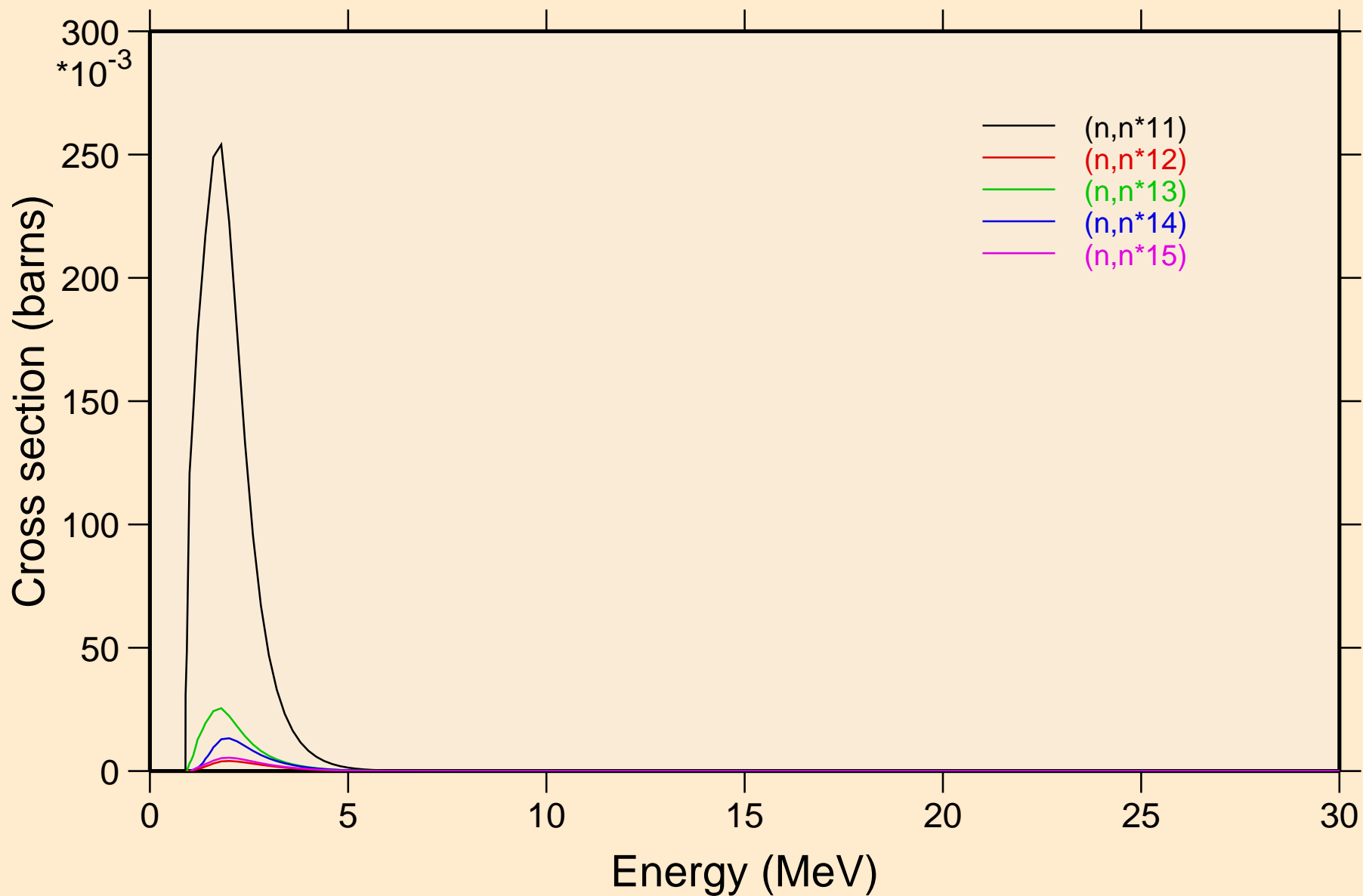

CE137M NEUTRON ACER TENDL-2019 LIBRARY; T=293.16K
Inelastic levels

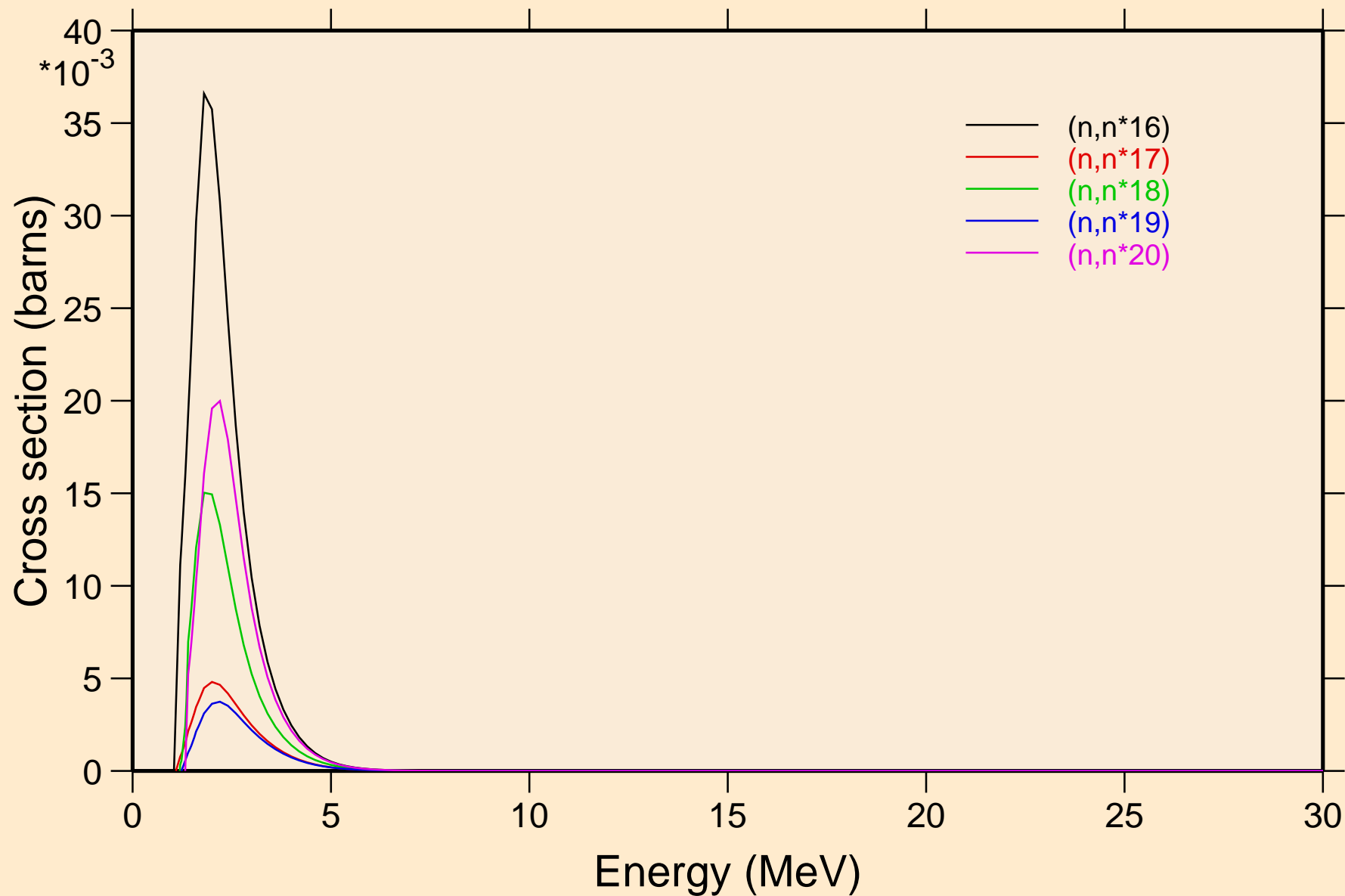

CE137M NEUTRON ACER TENDL-2019 LIBRARY; T=293.16K
Threshold reactions

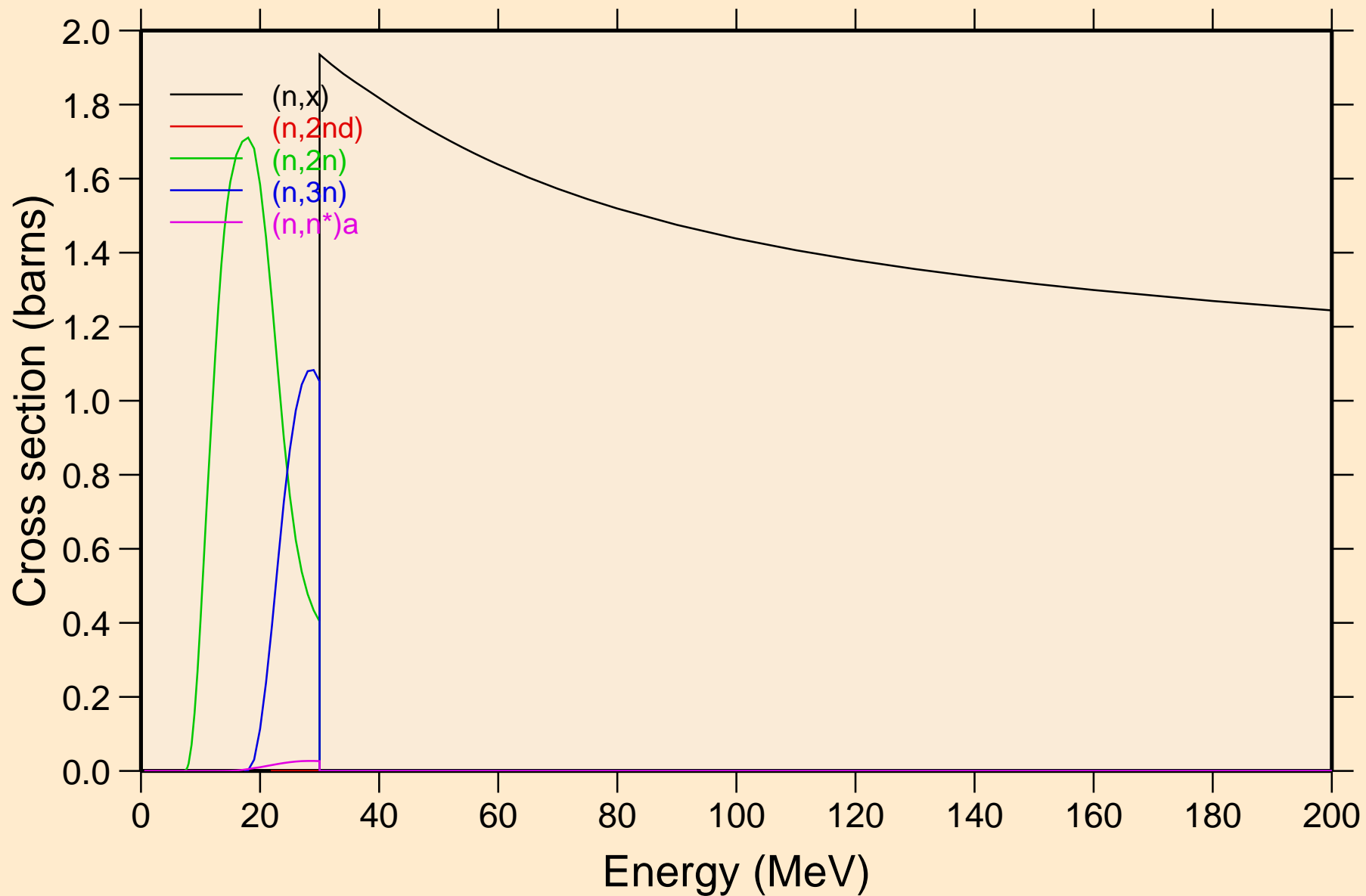

CE137M NEUTRON ACER TENDL-2019 LIBRARY; T=293.16K
Threshold reactions

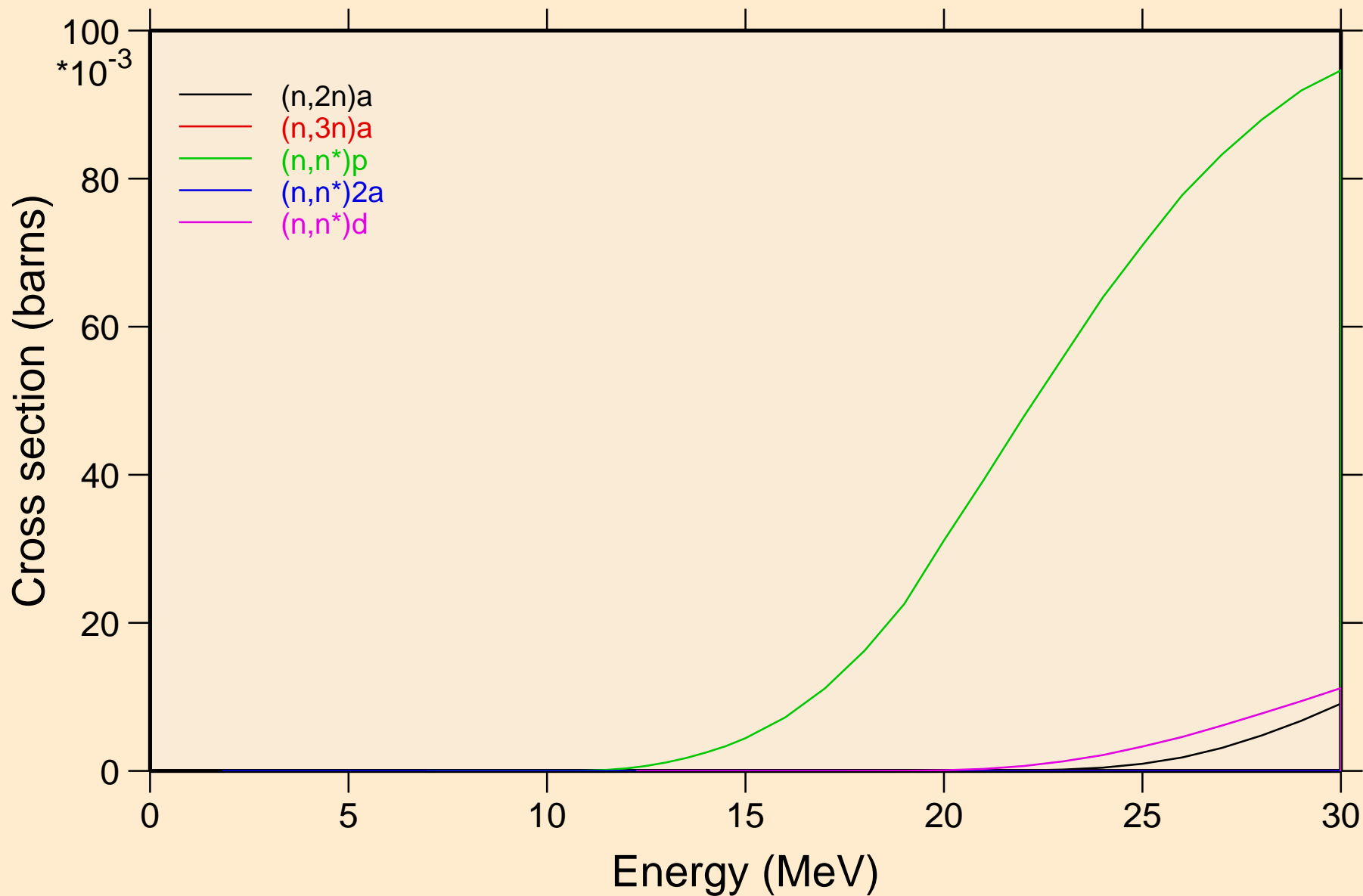

CE137M NEUTRON ACER TENDL-2019 LIBRARY; T=293.16K

Threshold reactions

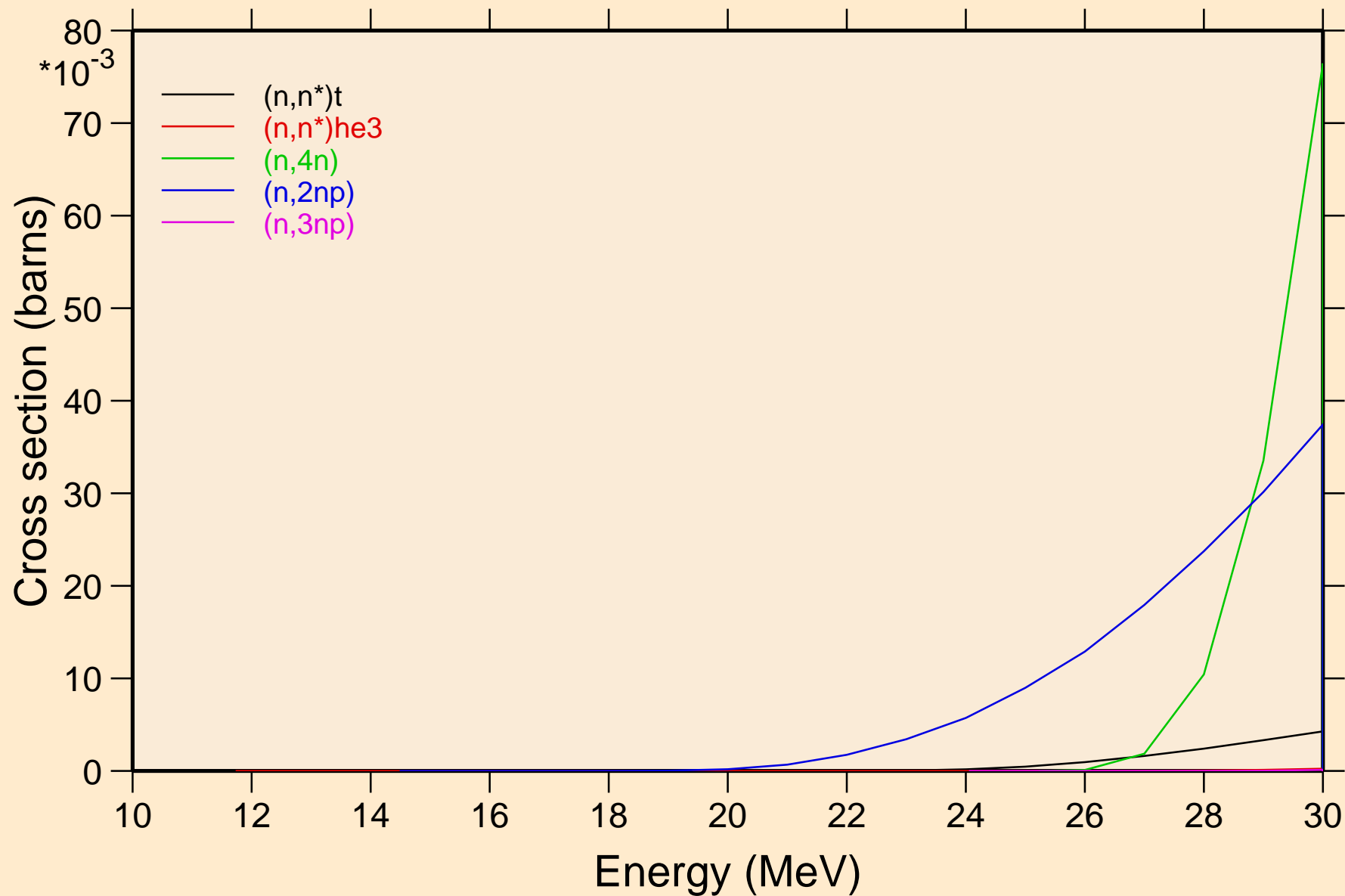

CE137M NEUTRON ACER TENDL-2019 LIBRARY; T=293.16K
Threshold reactions

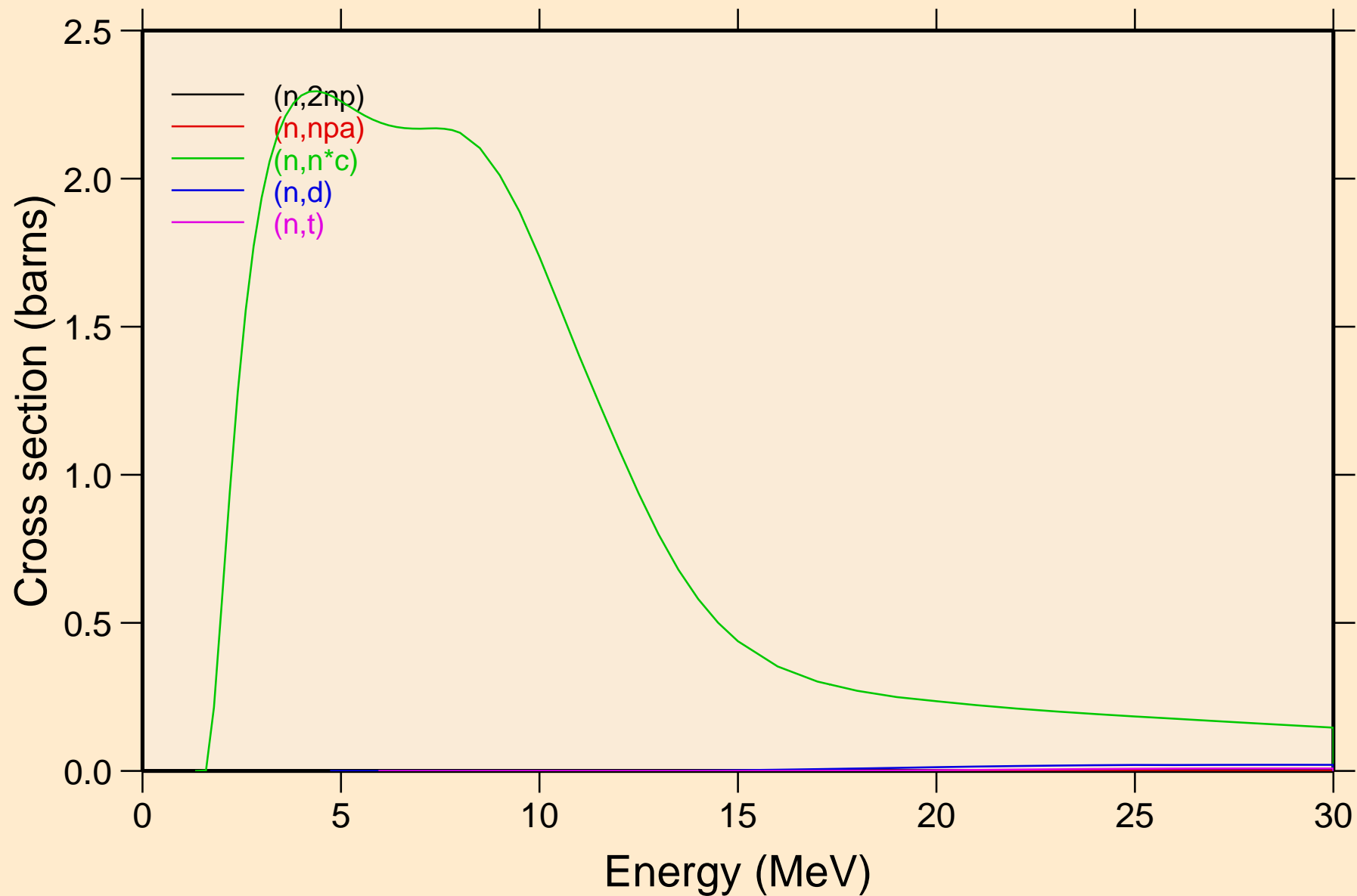

CE137M NEUTRON ACER TENDL-2019 LIBRARY; T=293.16K

Threshold reactions

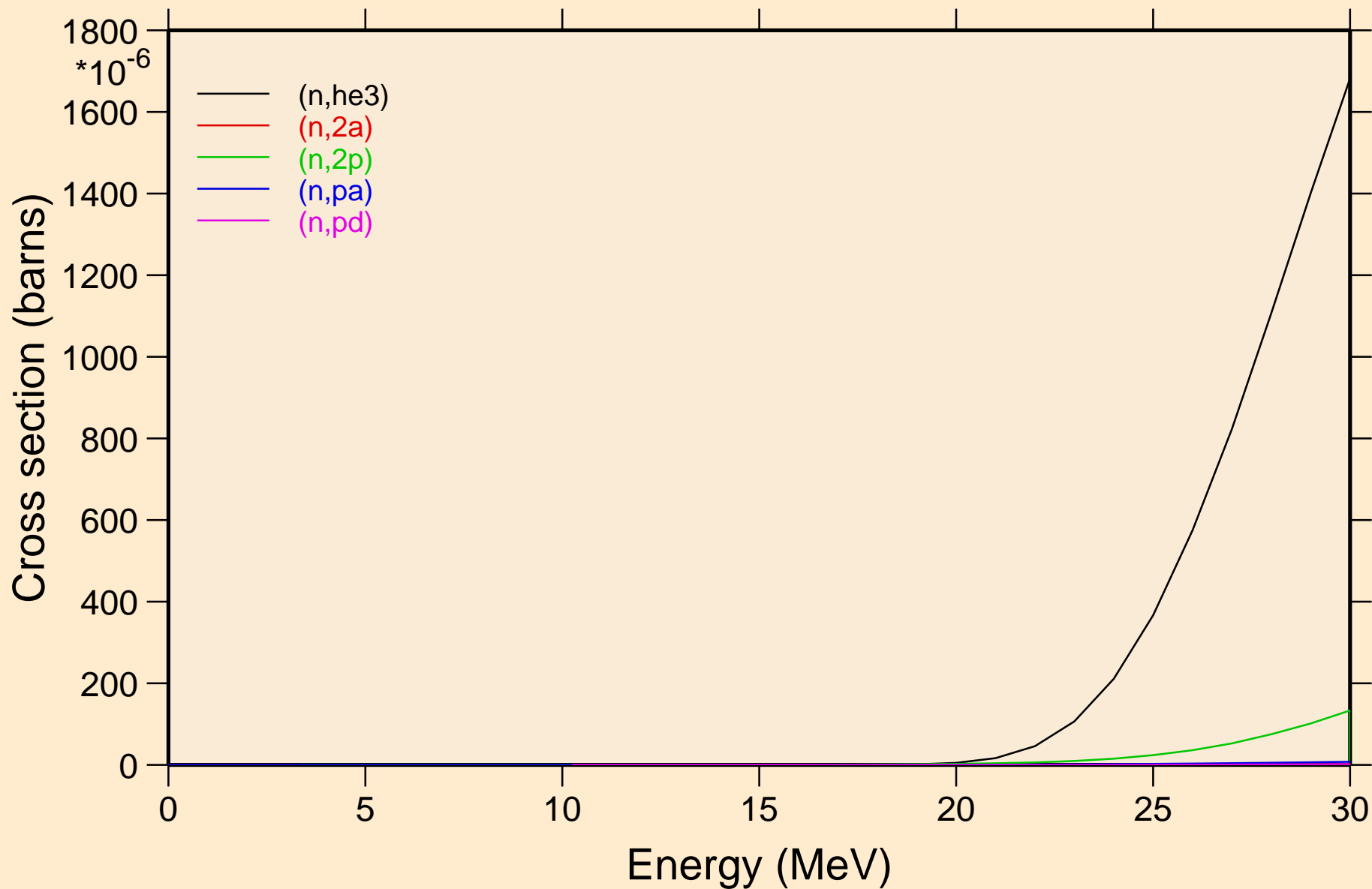

CE137M NEUTRON ACER TENDL-2019 LIBRARY; T=293.16K
Threshold reactions

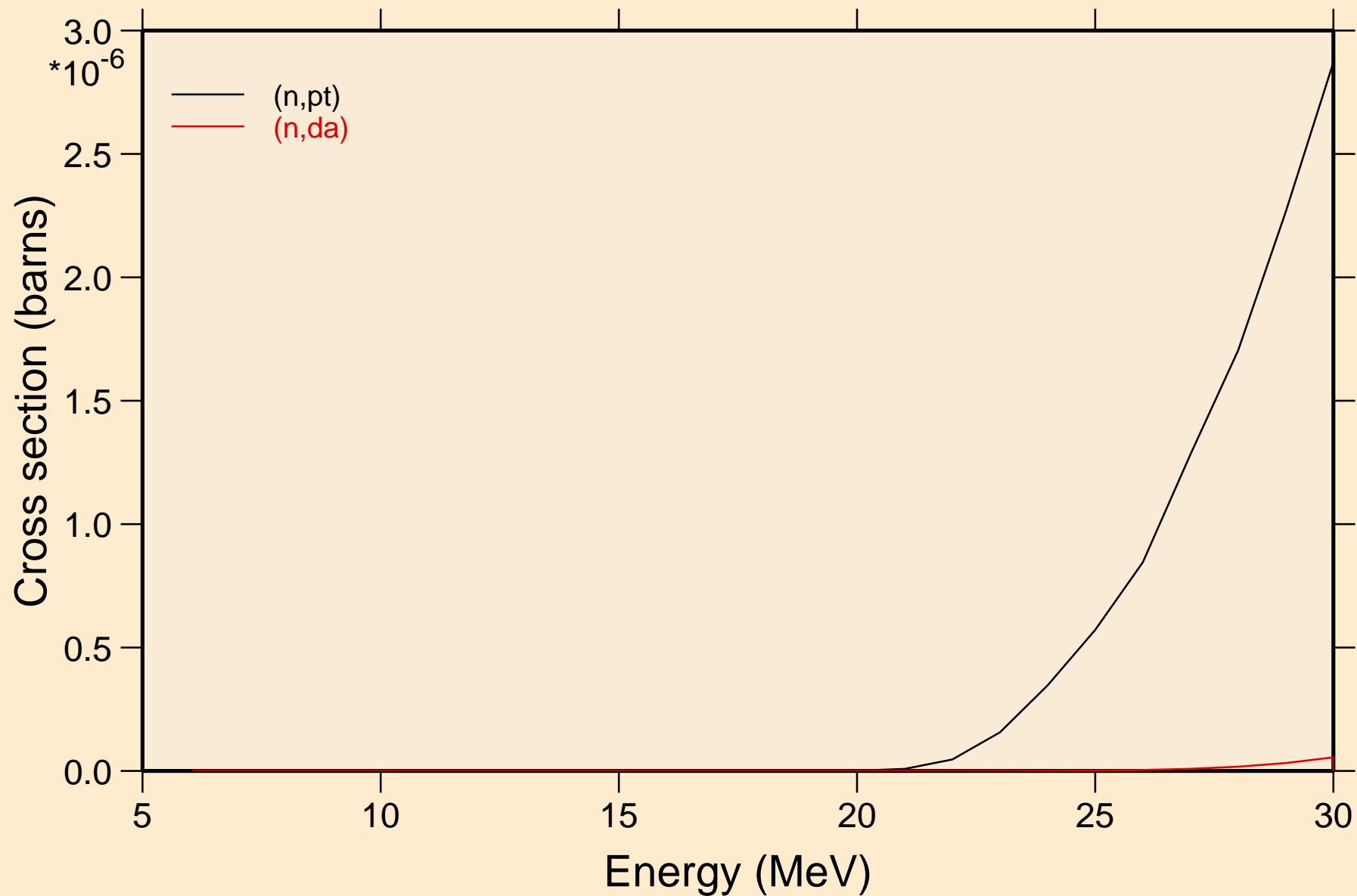

CE137M NEUTRON ACER TENDL-2019 LIBRARY; T=293.16K
Threshold reactions

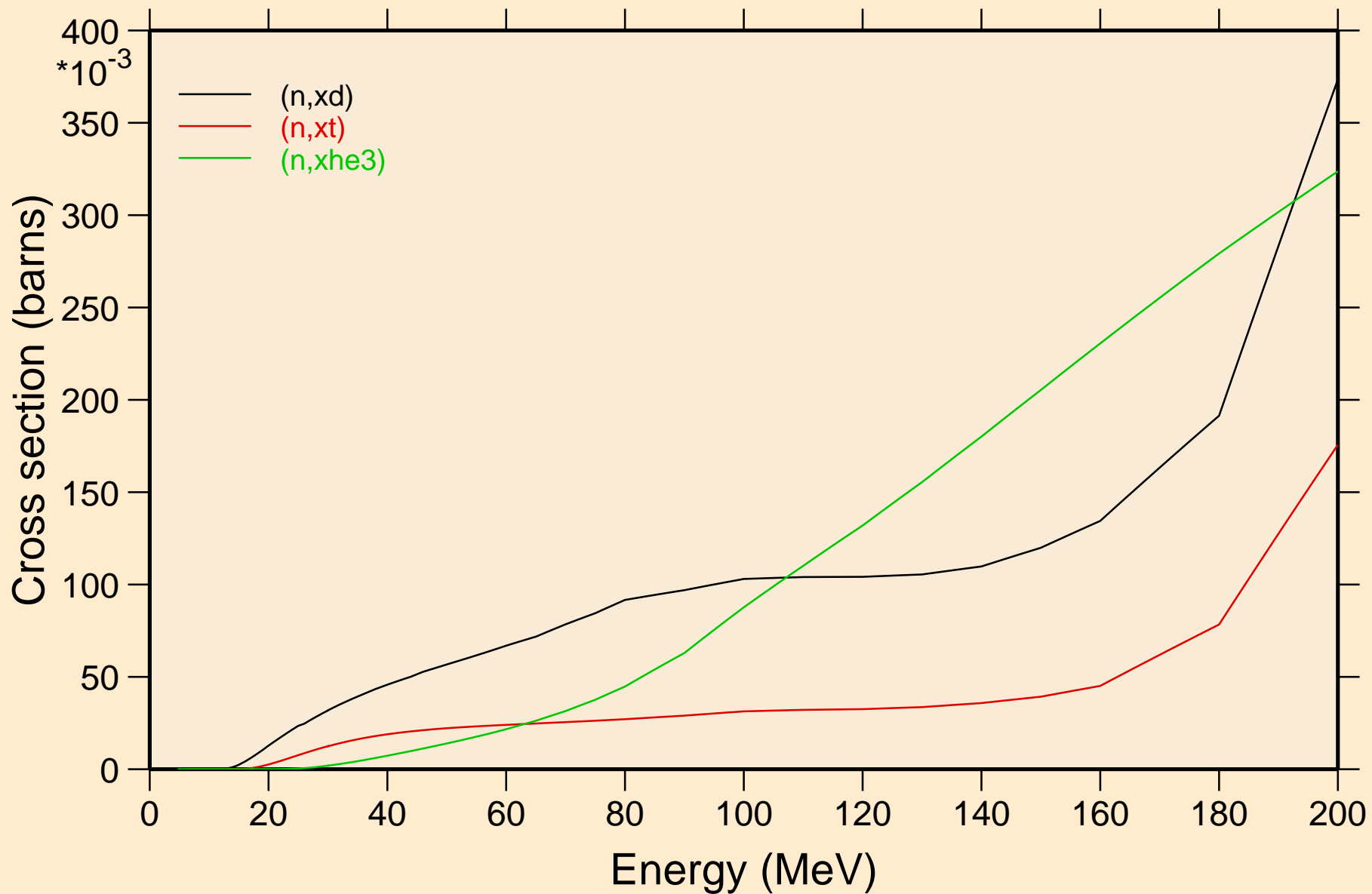

CE137M NEUTRON ACER TENDL-2019 LIBRARY; T=293.16K
angular distribution for elastic

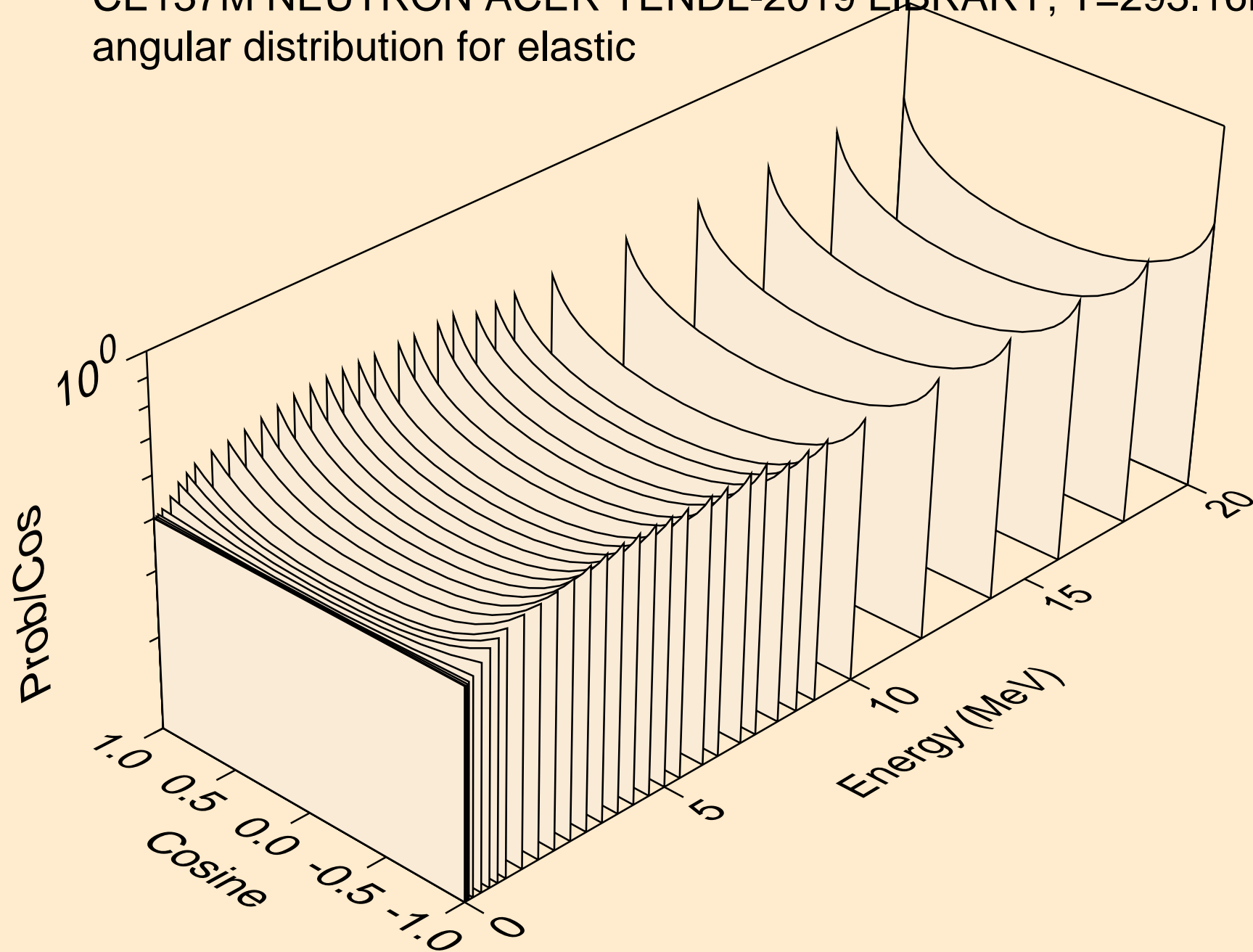

CE137M NEUTRON ACER TENDL-2019 LIBRARY; T=293.16K
angular distribution for elastic

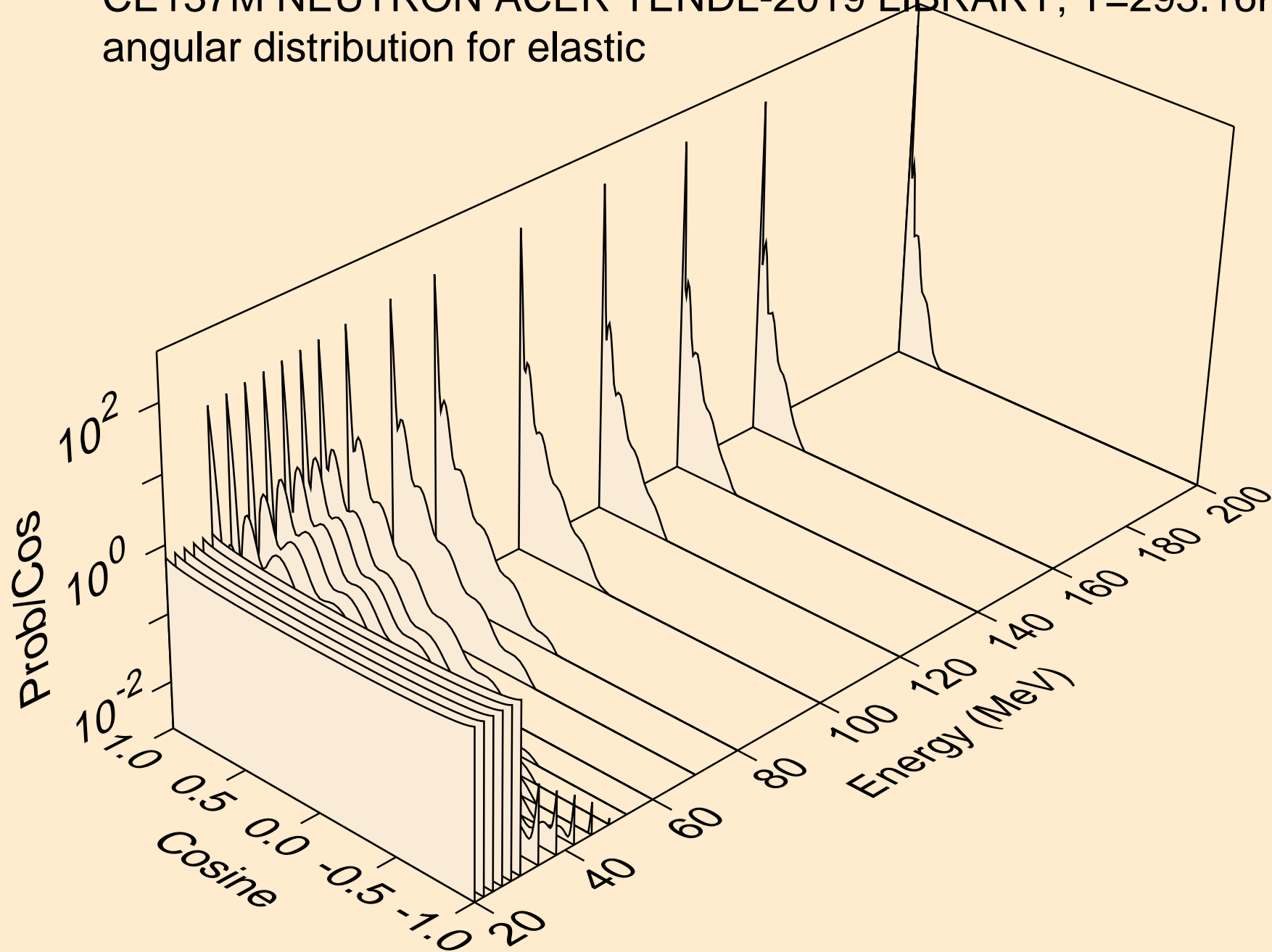

CE137M NEUTRON ACER TENDL-2019 LIBRARY; T=293.16K
angular distribution for (n,n*1)

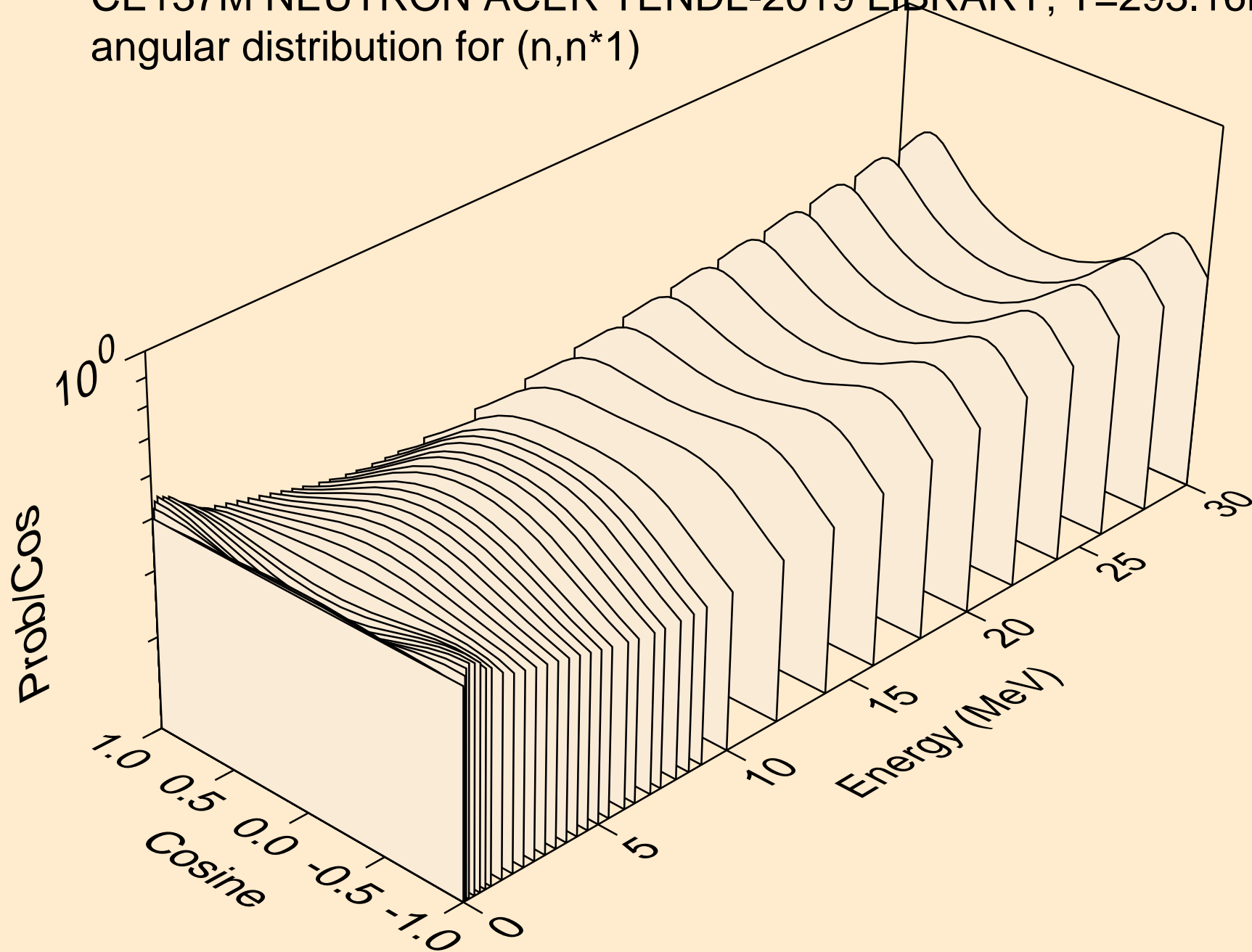

CE137M NEUTRON ACER TENDL-2019 LIBRARY; T=293.16K
angular distribution for (n,n*2)

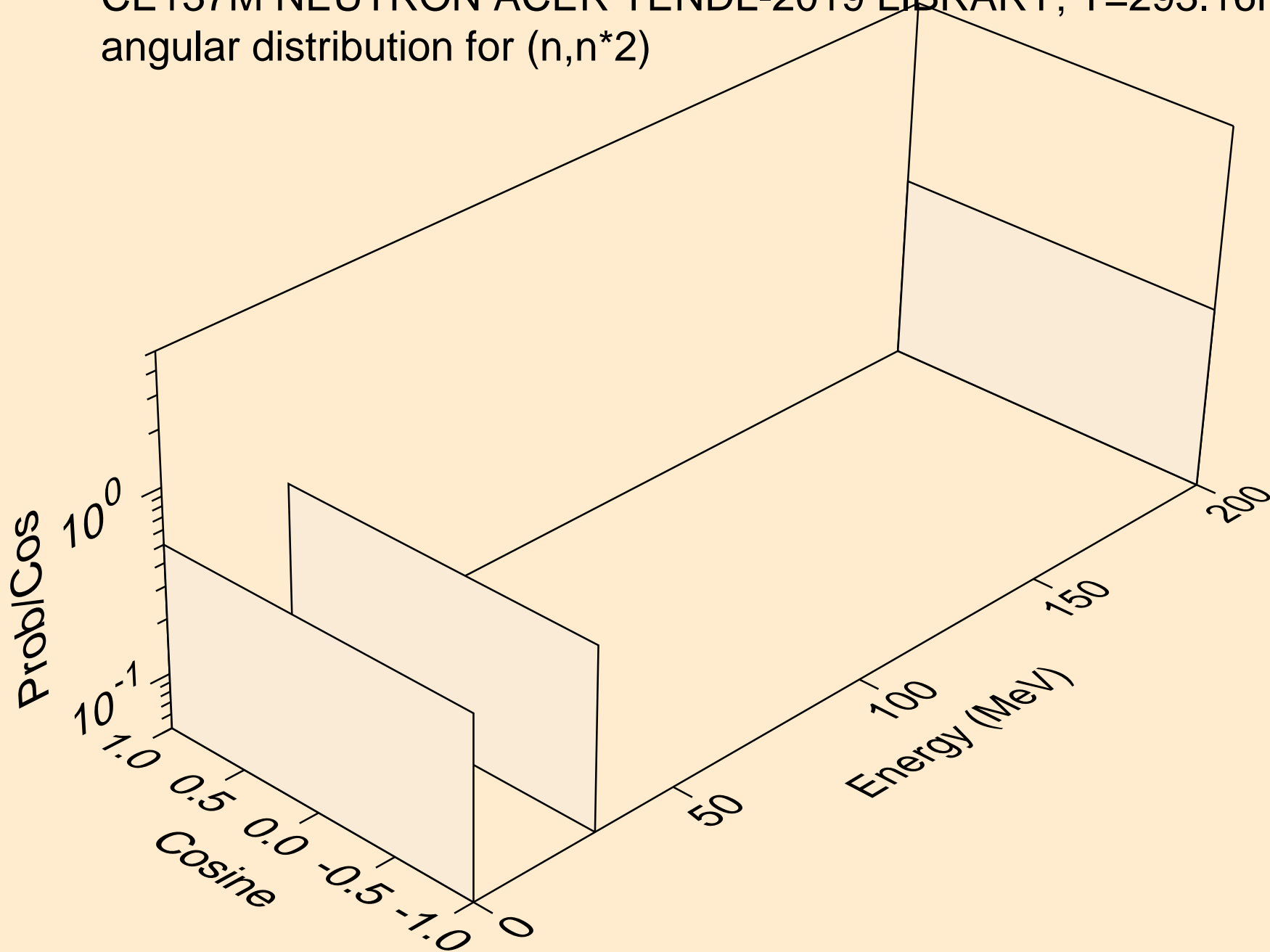

CE137M NEUTRON ACER TENDL-2019 LIBRARY; T=293.16K
angular distribution for (n,n*3)

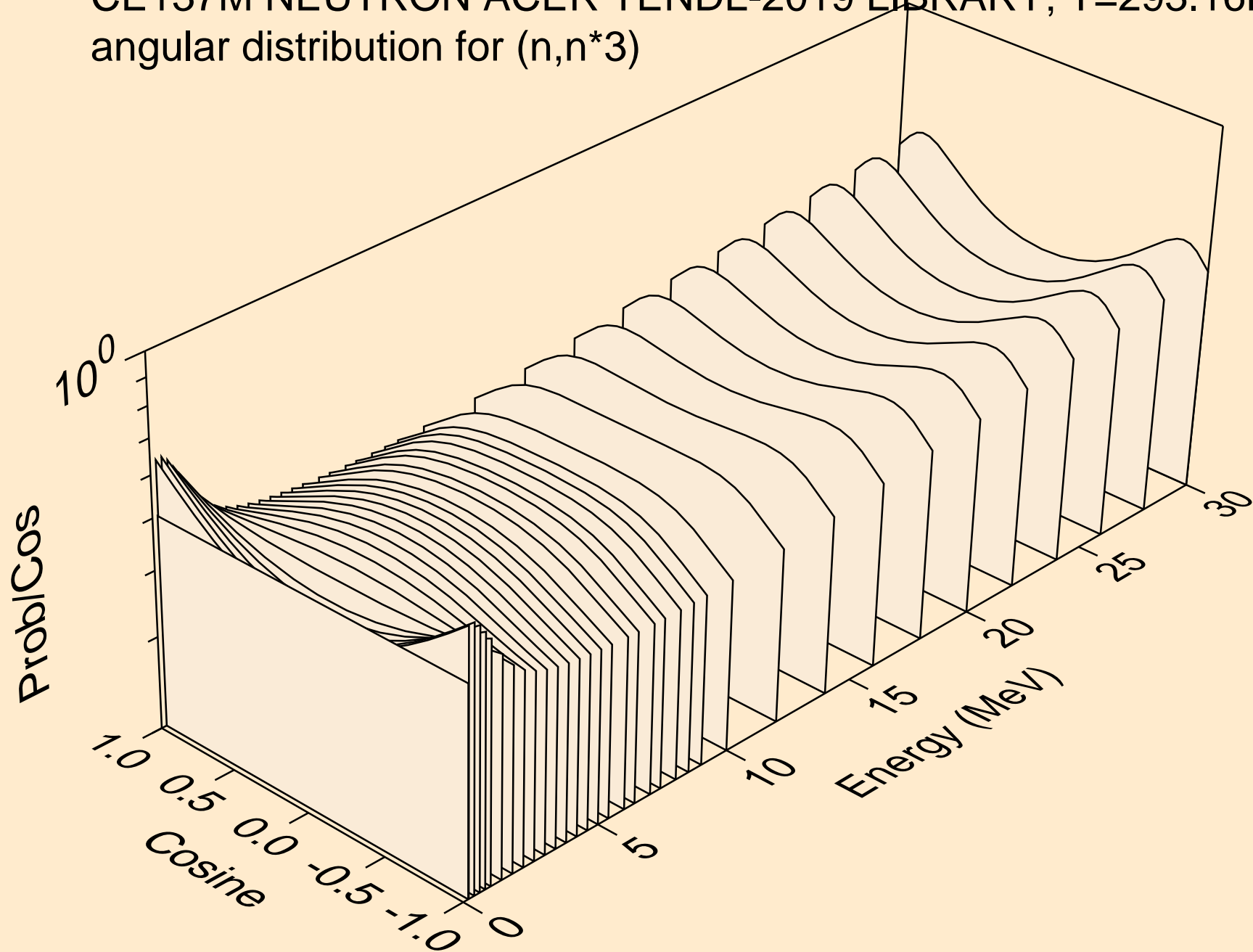

CE137M NEUTRON ACER TENDL-2019 LIBRARY; T=293.16K
angular distribution for (n,n*4)

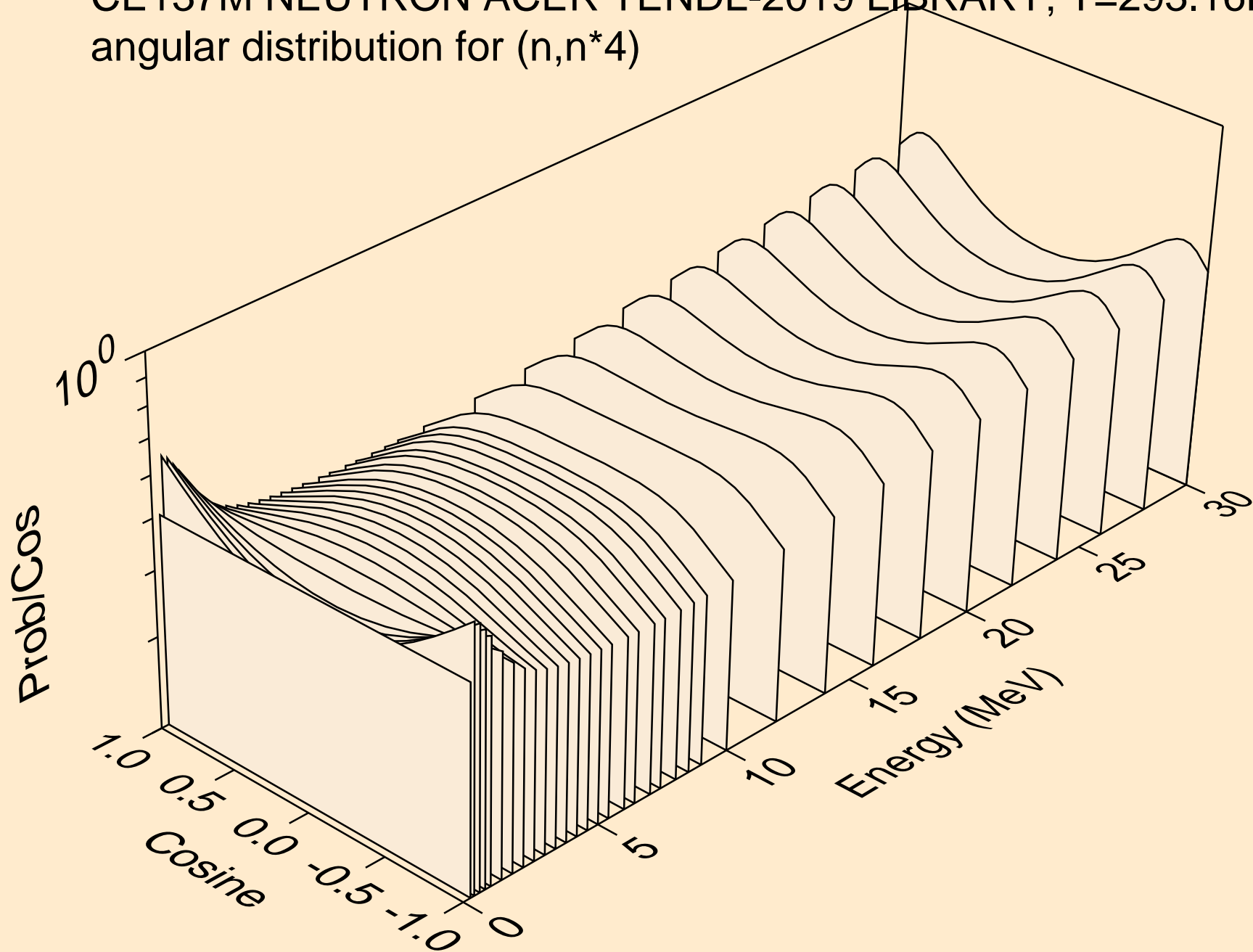

CE137M NEUTRON ACER TENDL-2019 LIBRARY; T=293.16K
angular distribution for (n,n*5)

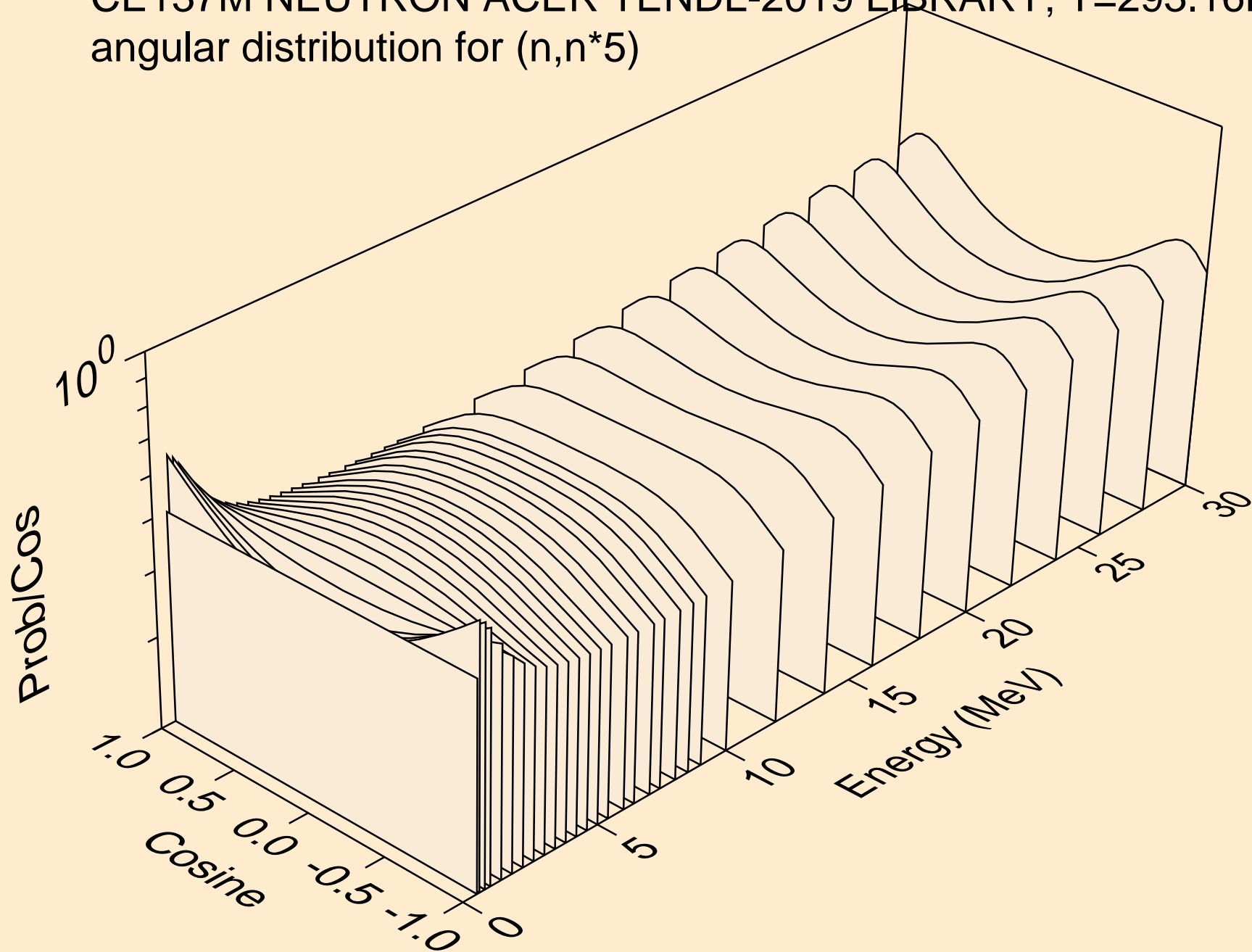

CE137M NEUTRON ACER TENDL-2019 LIBRARY; T=293.16K
angular distribution for (n,n*6)

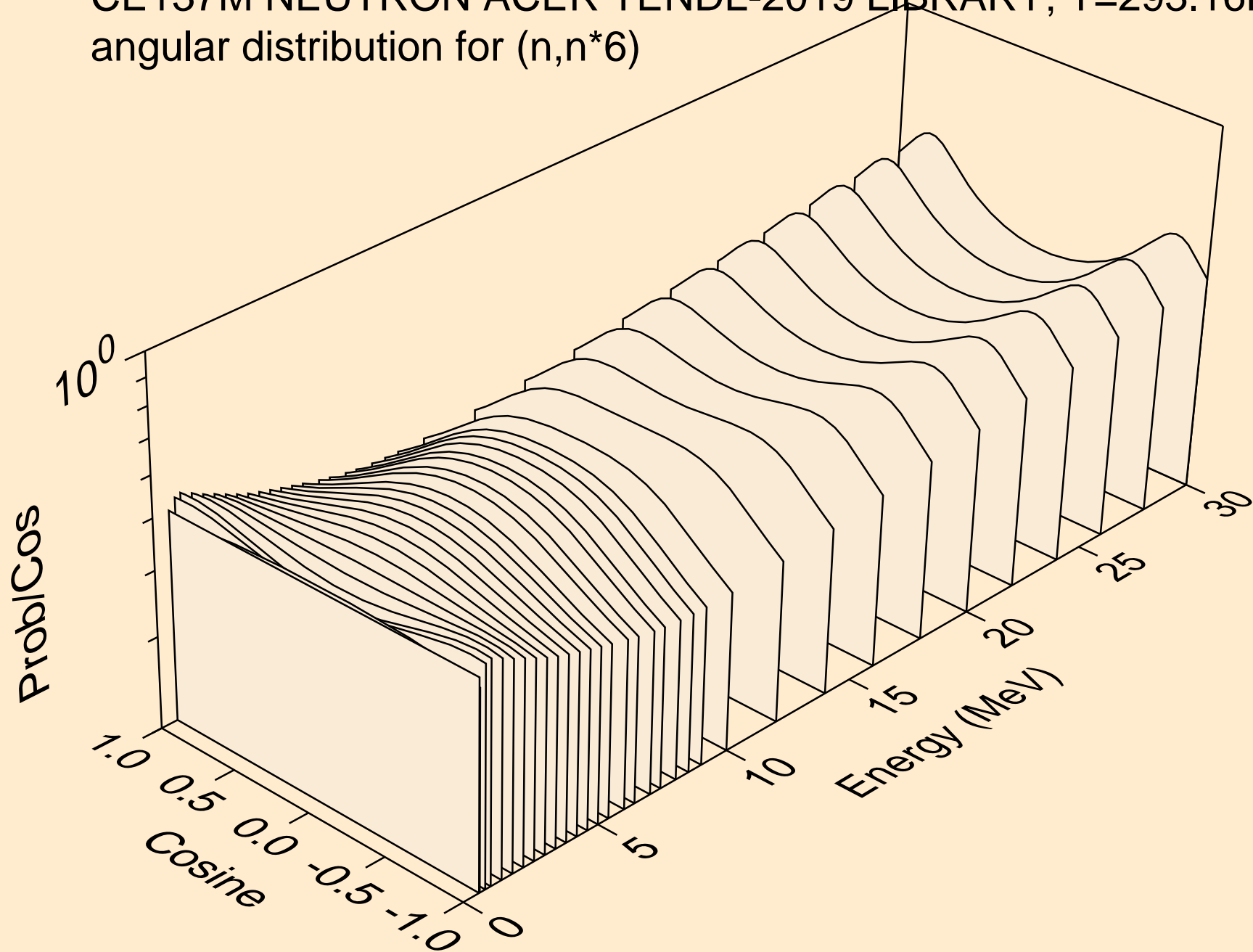

CE137M NEUTRON ACER TENDL-2019 LIBRARY; T=293.16K
angular distribution for (n,n*7)

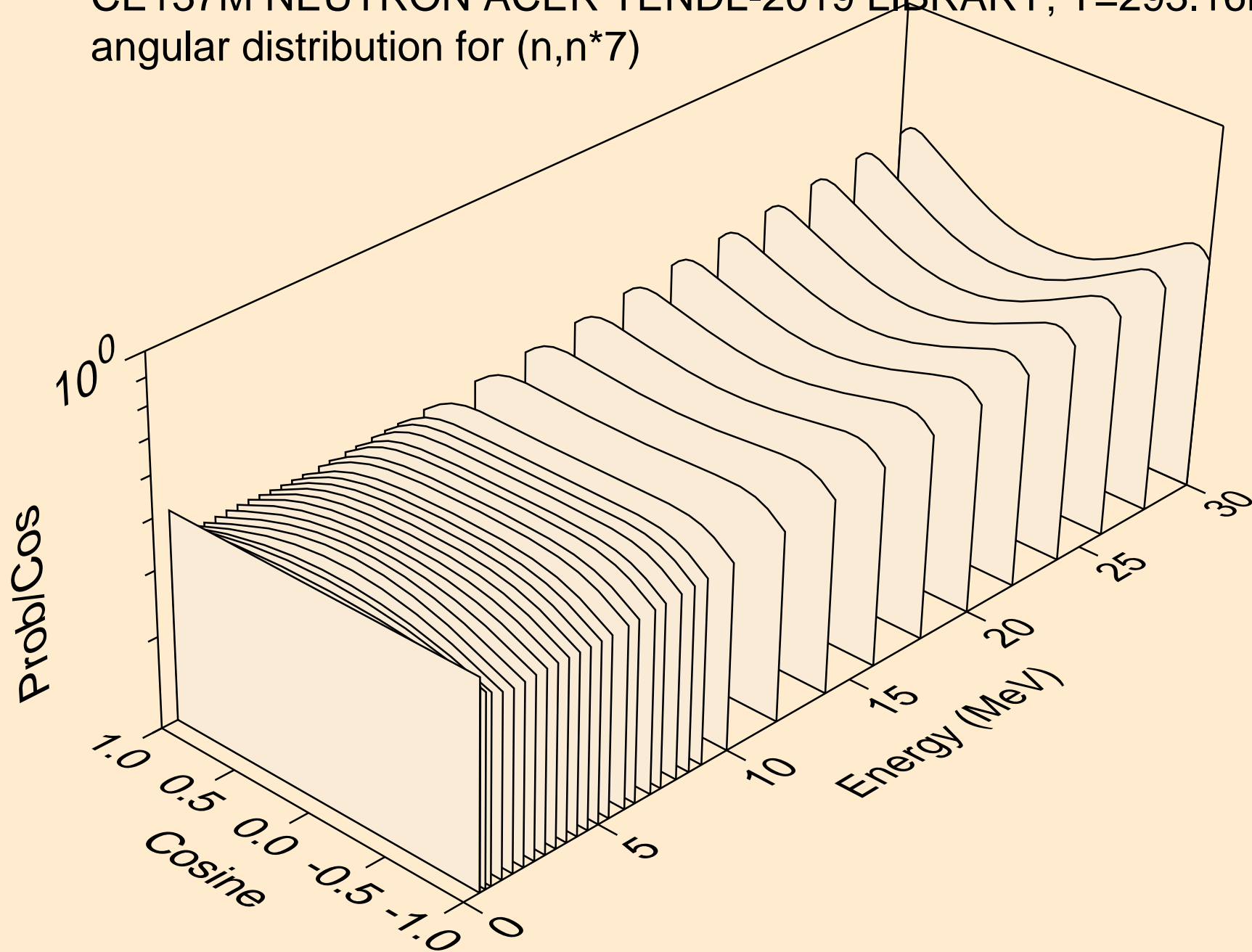

CE137M NEUTRON ACER TENDL-2019 LIBRARY; T=293.16K
angular distribution for (n,n*8)

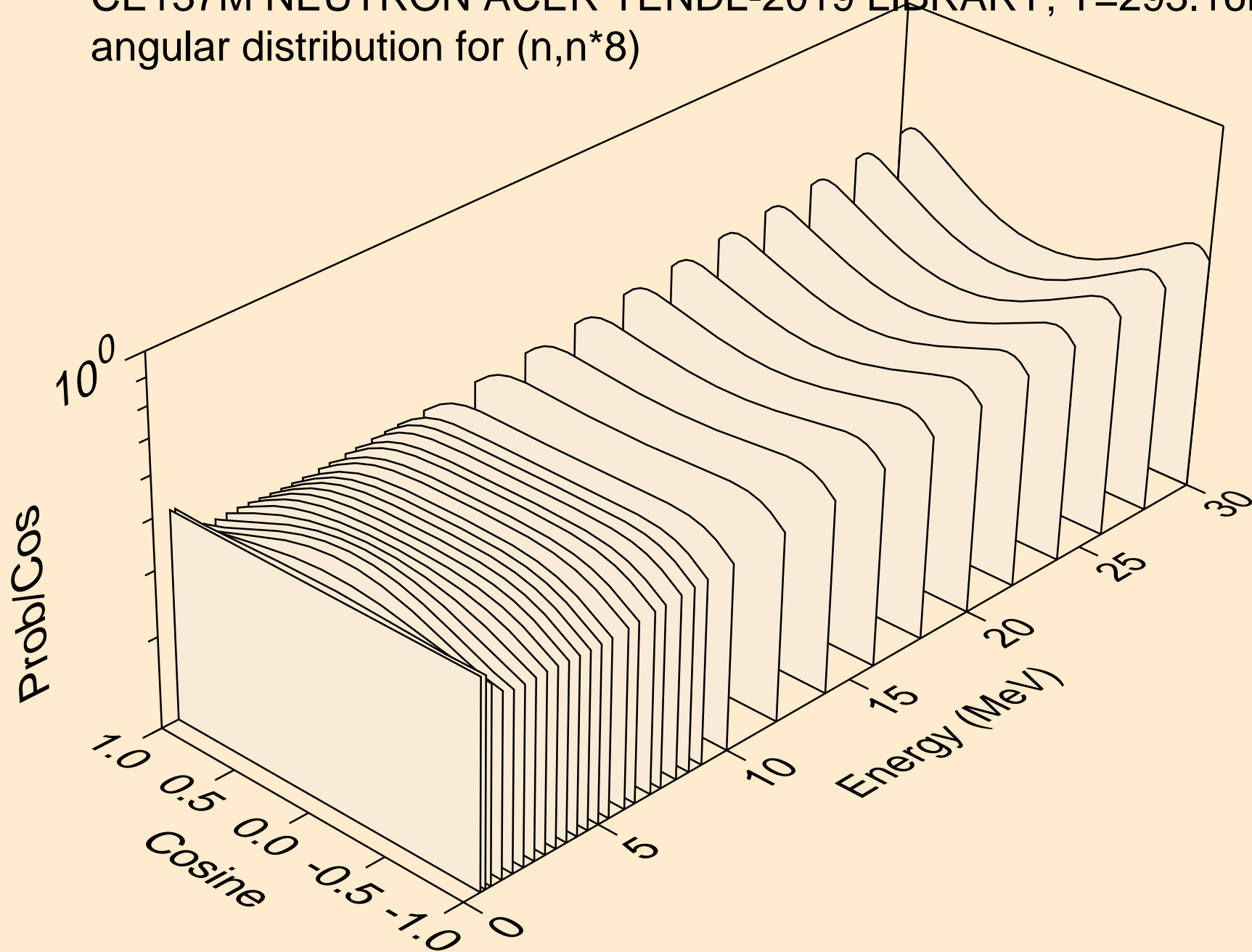

CE137M NEUTRON ACER TENDL-2019 LIBRARY; T=293.16K
angular distribution for (n,n*9)

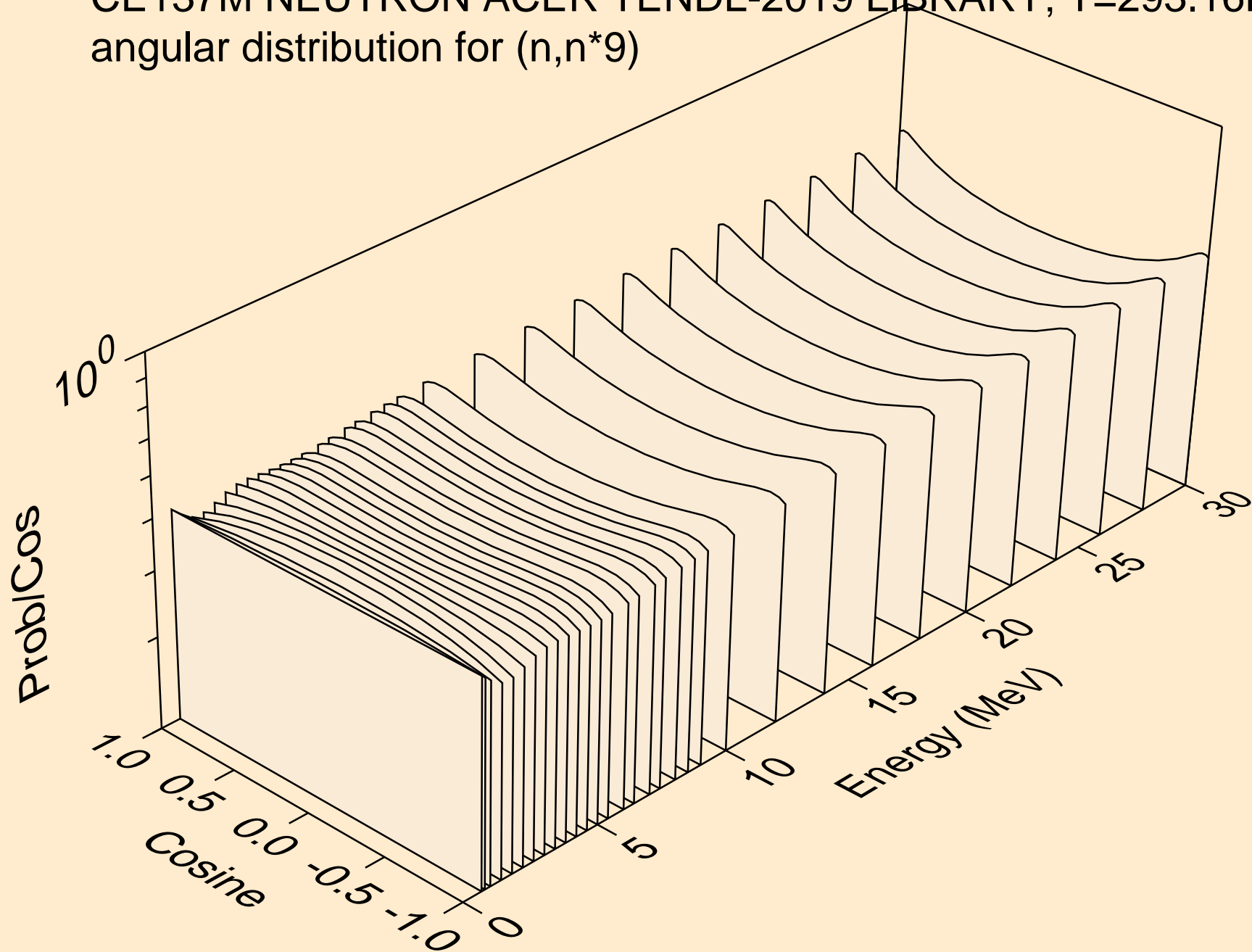

CE137M NEUTRON ACER TENDL-2019 LIBRARY; T=293.16K
angular distribution for (n,n*10)

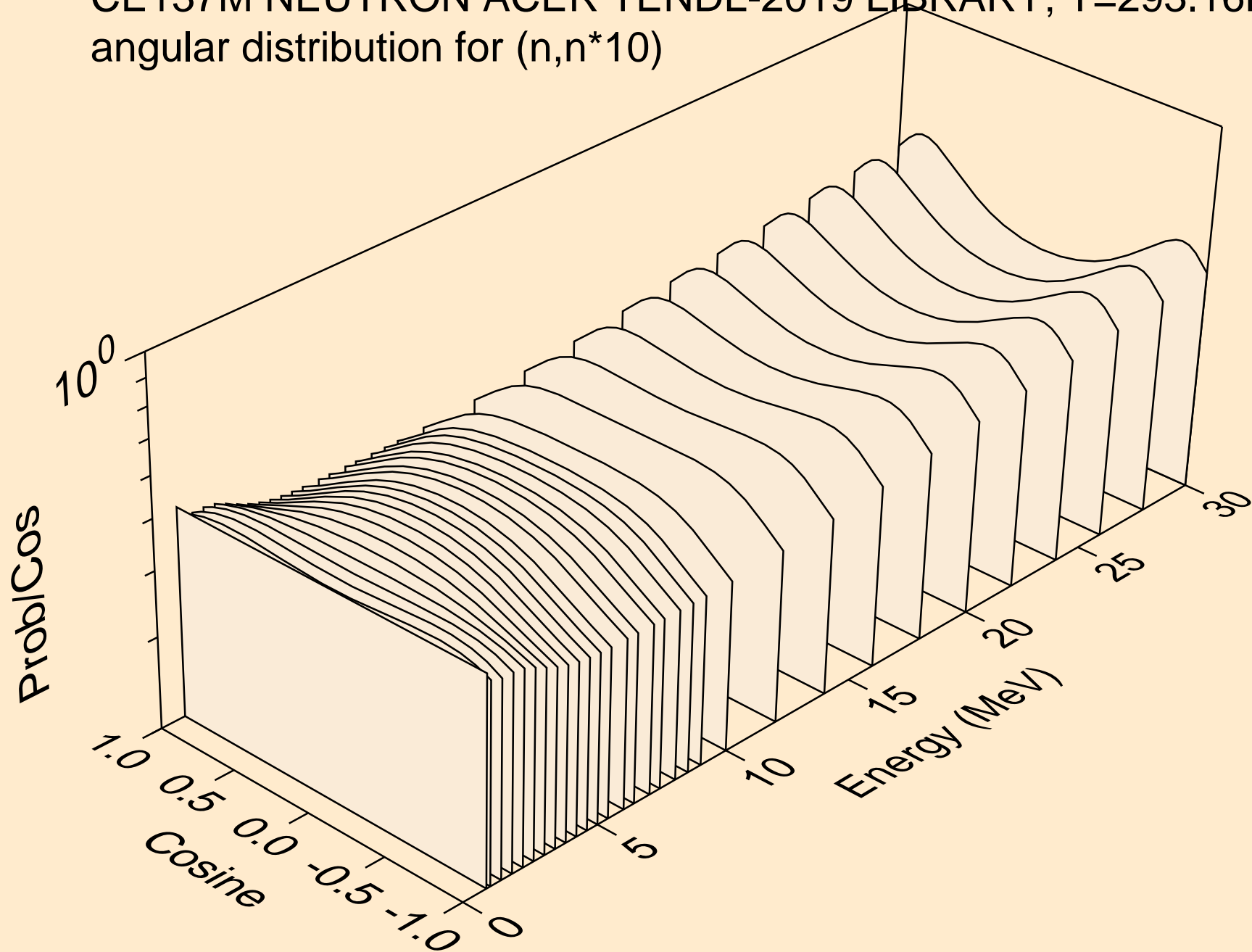

CE137M NEUTRON ACER TENDL-2019 LIBRARY; T=293.16K
angular distribution for (n,n*11)

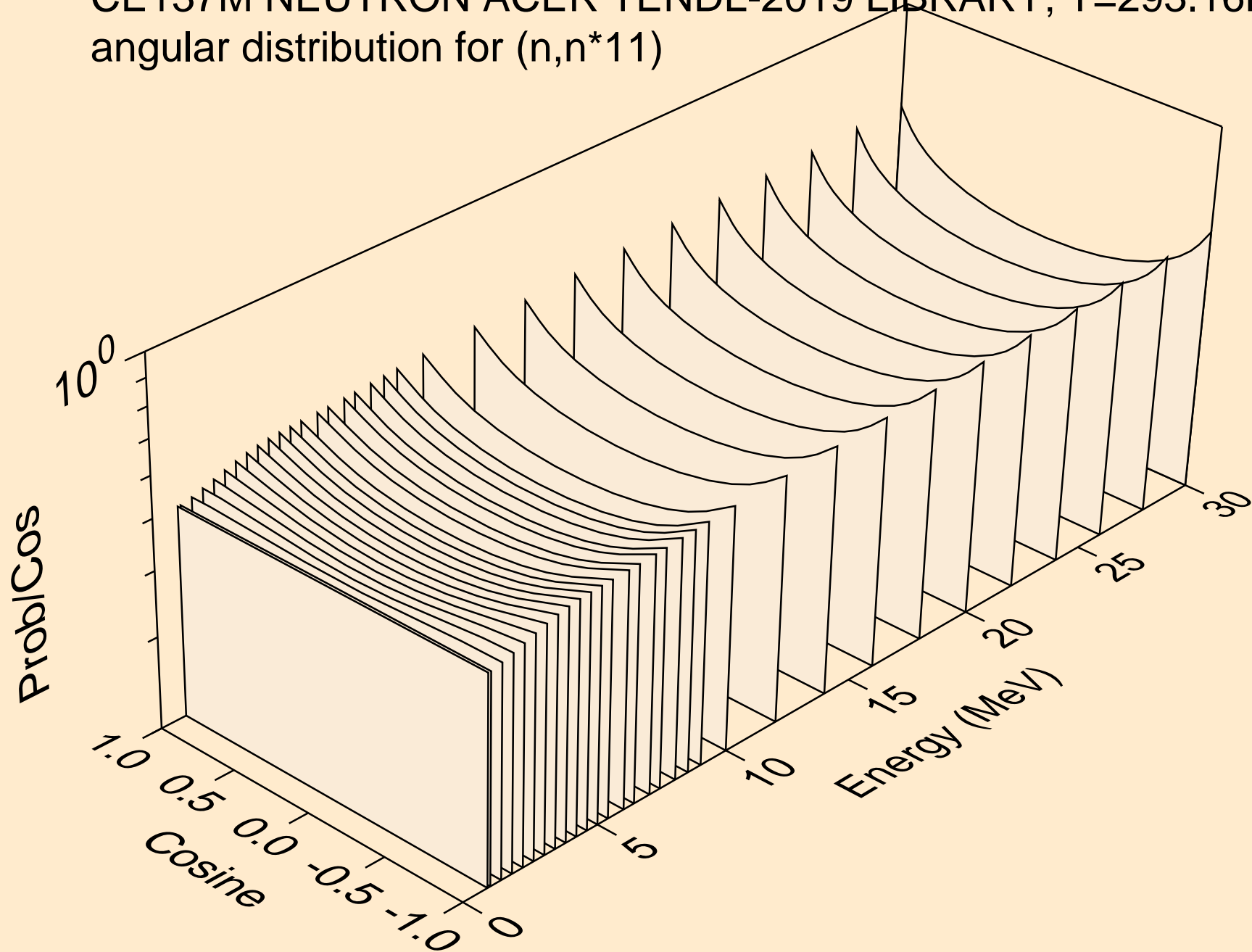

CE137M NEUTRON ACER TENDL-2019 LIBRARY; T=293.16K
angular distribution for (n,n*12)

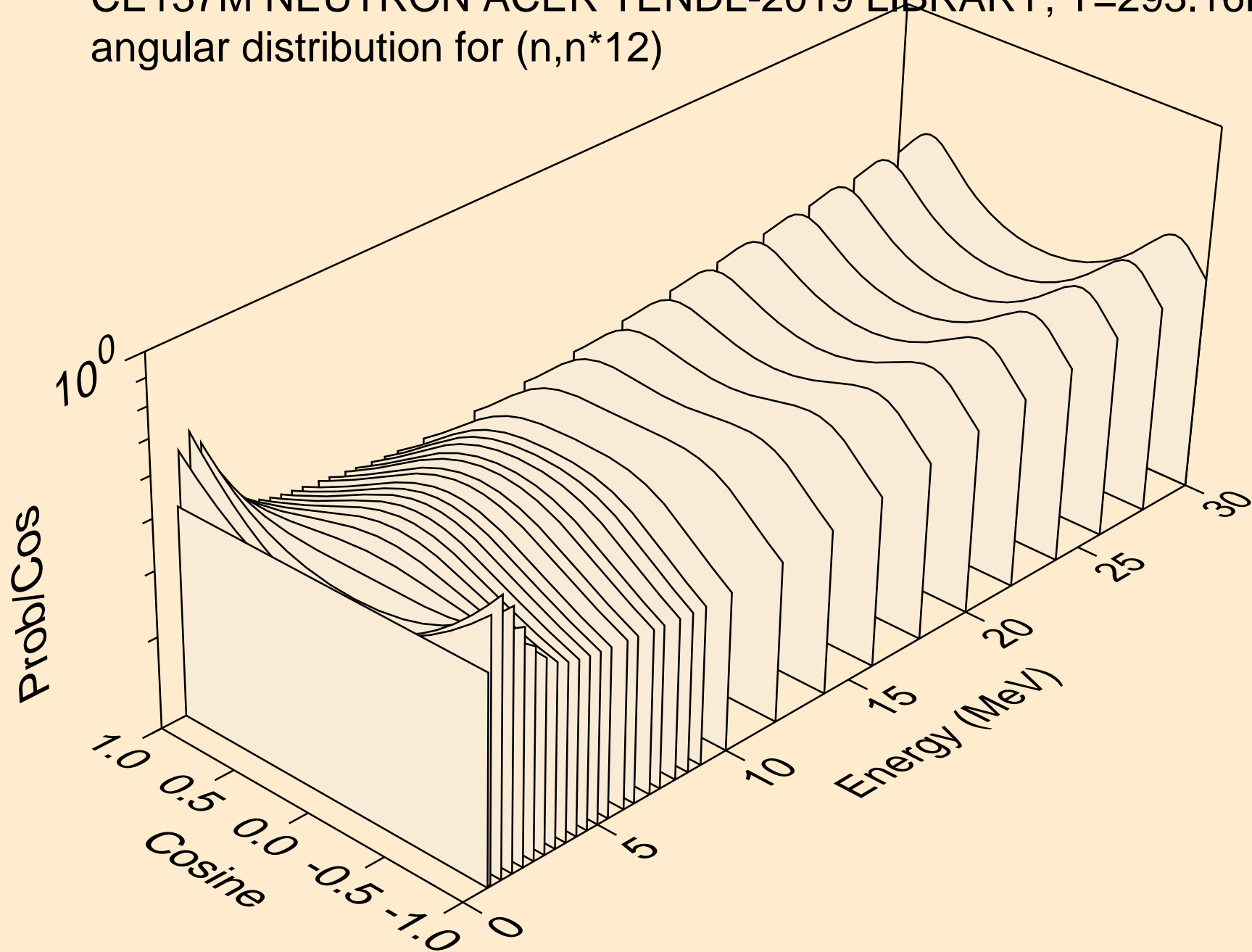

CE137M NEUTRON ACER TENDL-2019 LIBRARY; T=293.16K
angular distribution for (n,n*13)

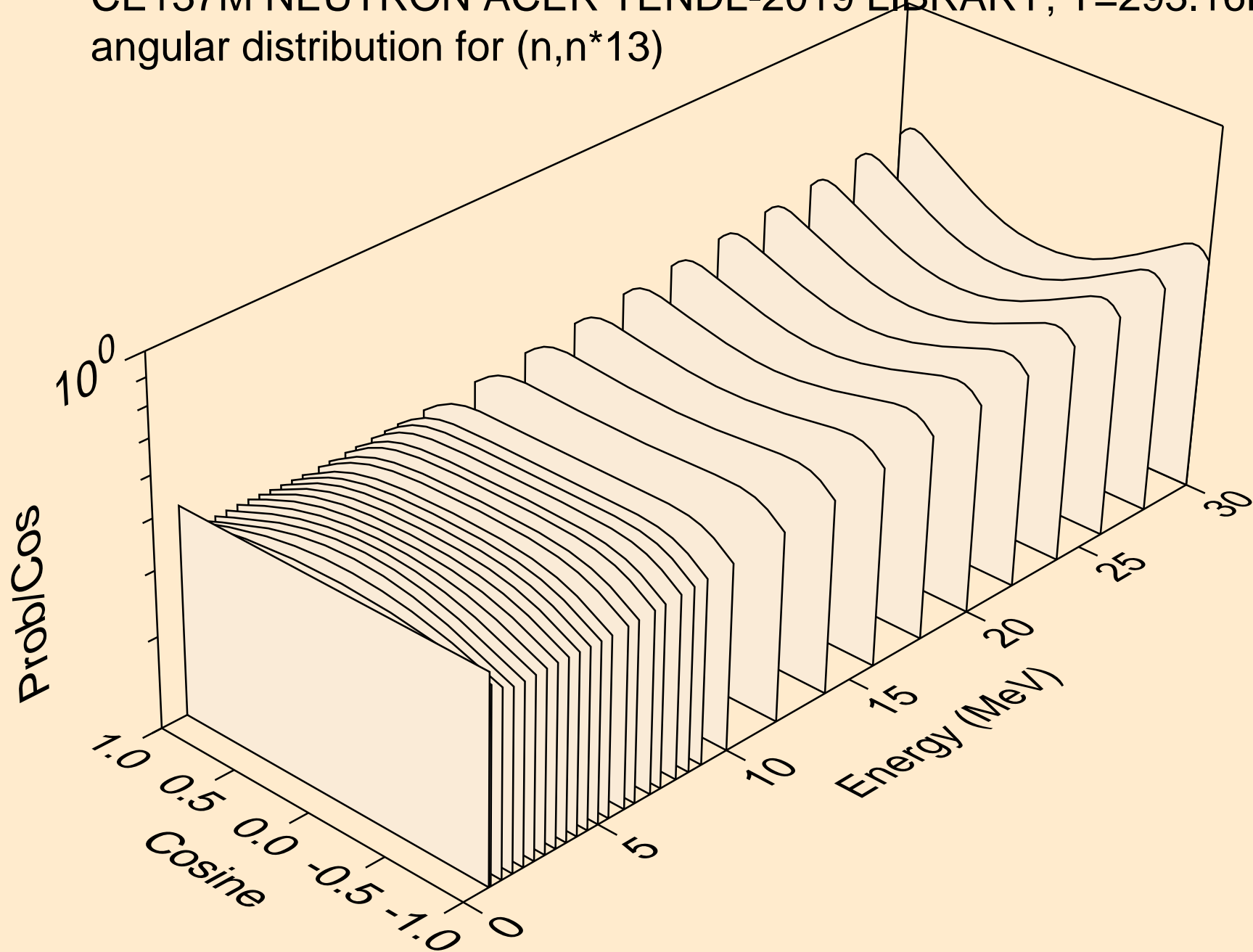

CE137M NEUTRON ACER TENDL-2019 LIBRARY; T=293.16K
angular distribution for (n,n*14)

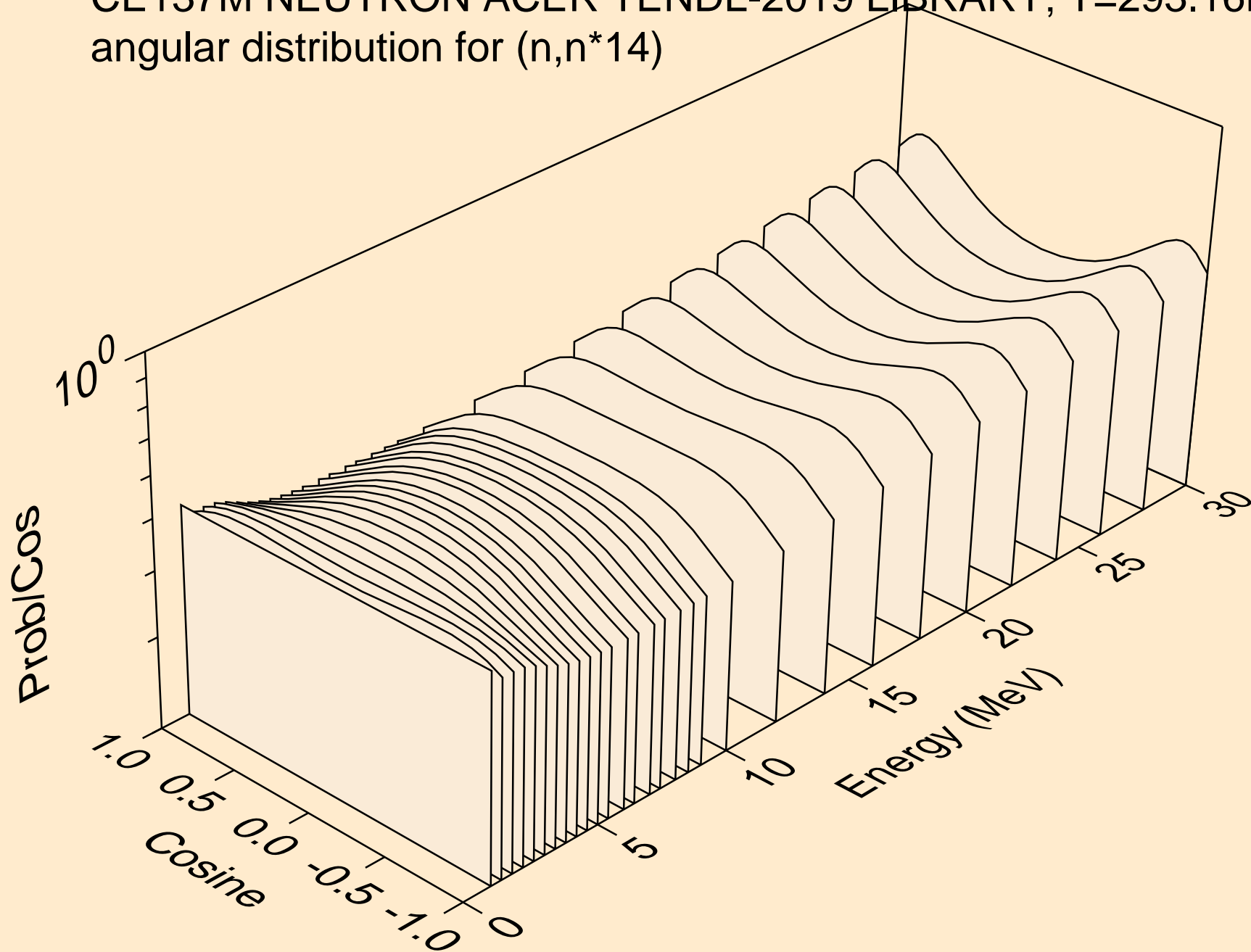

CE137M NEUTRON ACER TENDL-2019 LIBRARY; T=293.16K
angular distribution for (n,n*15)

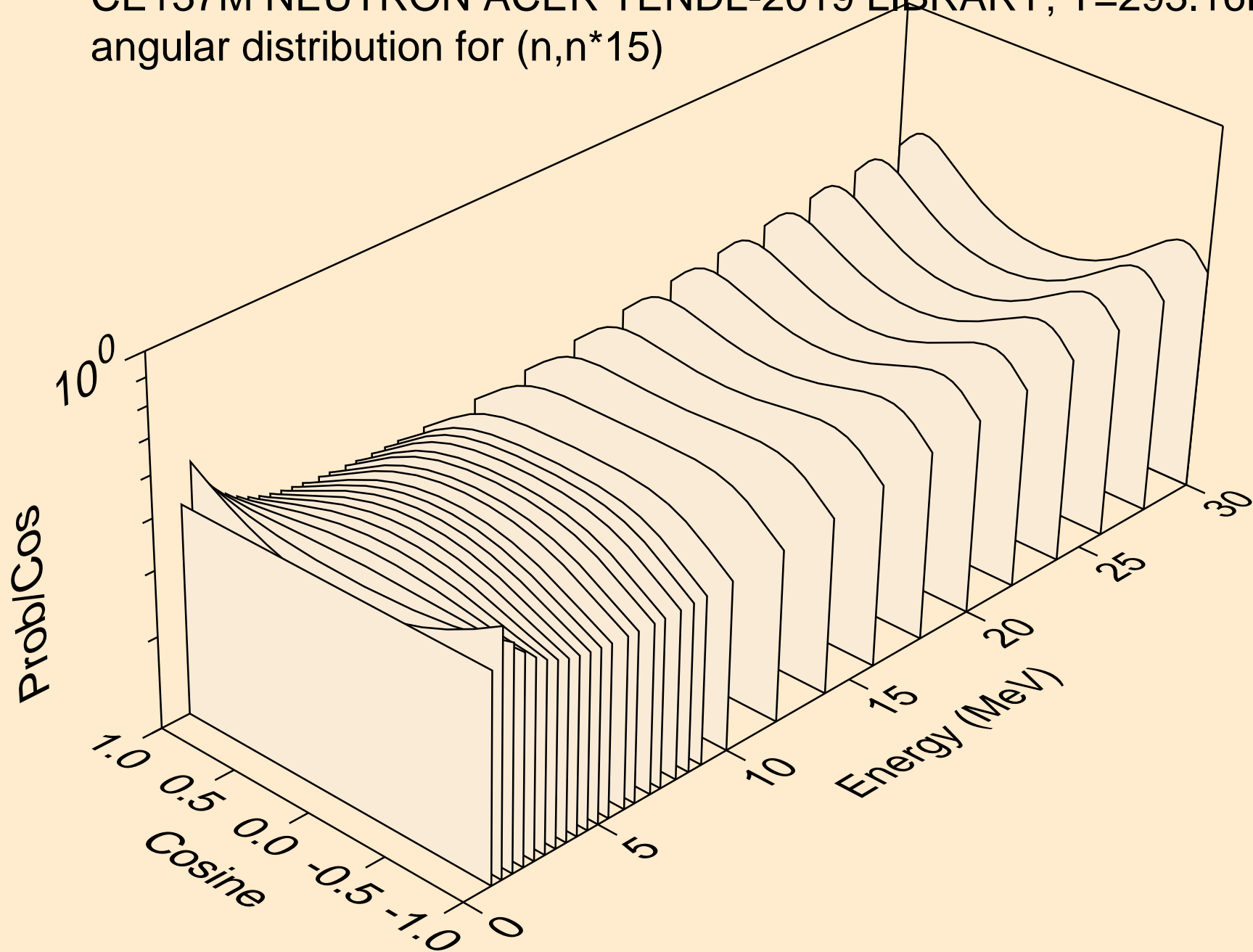

CE137M NEUTRON ACER TENDL-2019 LIBRARY; T=293.16K
angular distribution for (n,n*16)

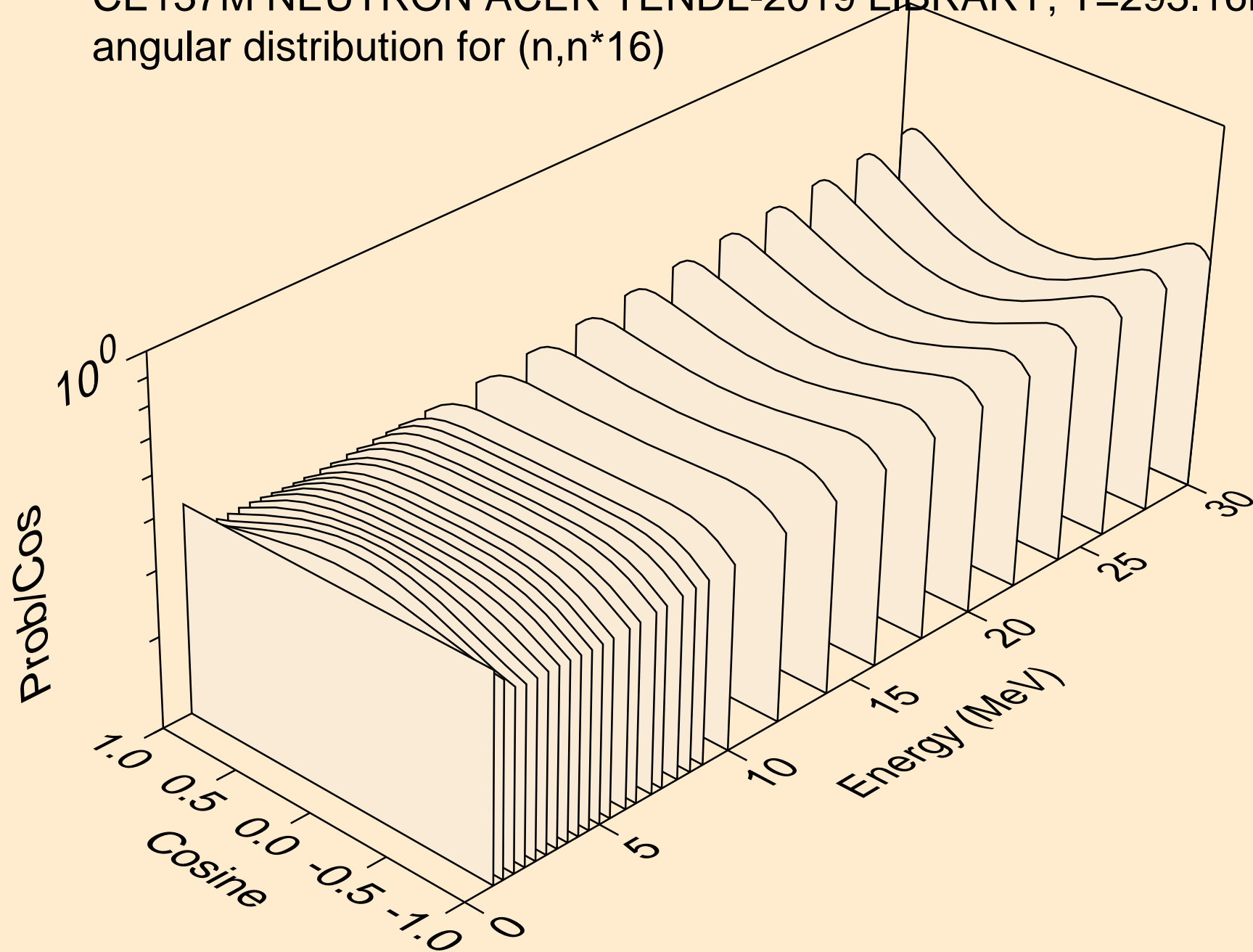

CE137M NEUTRON ACER TENDL-2019 LIBRARY; T=293.16K
angular distribution for (n,n*17)

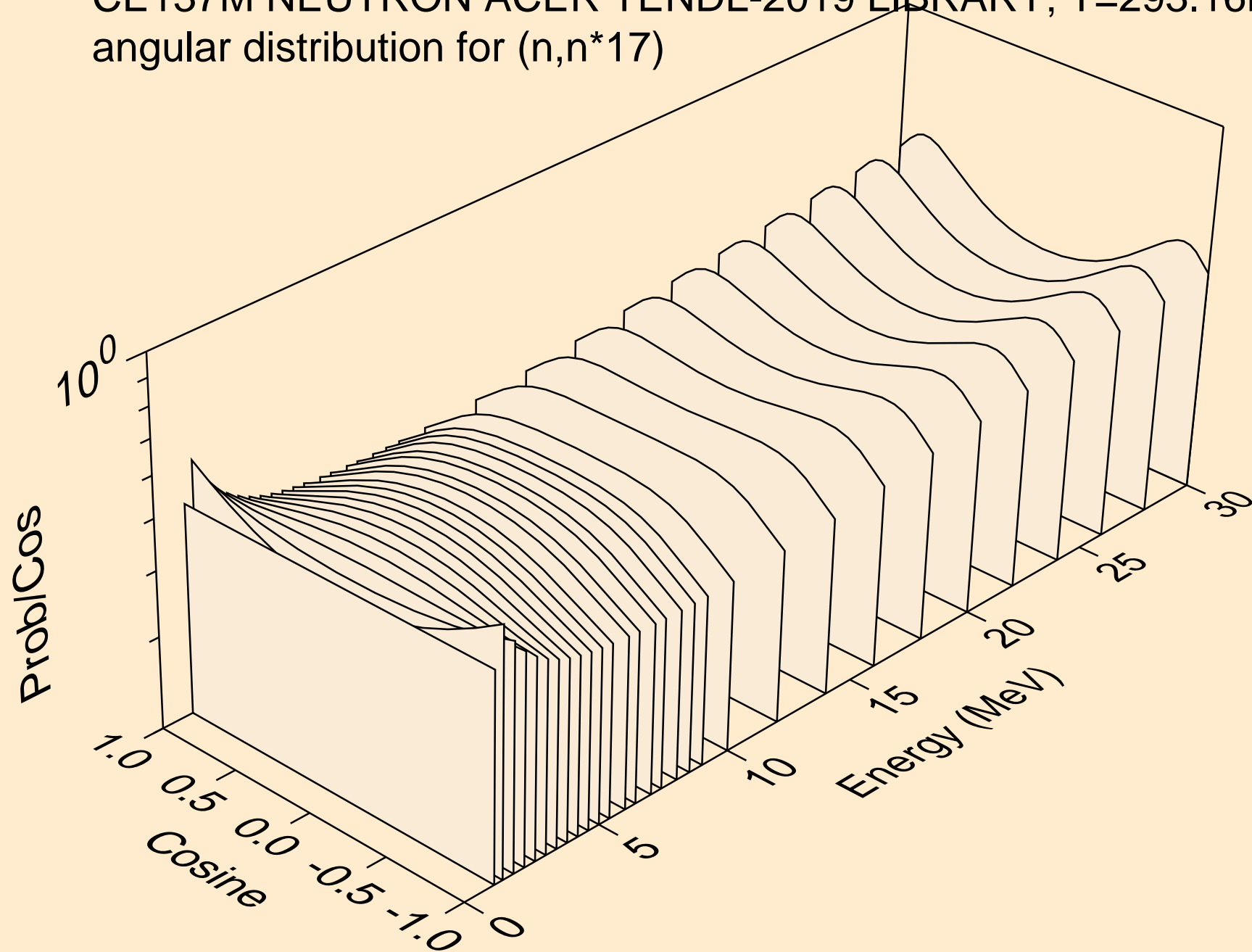

CE137M NEUTRON ACER TENDL-2019 LIBRARY; T=293.16K
angular distribution for (n,n*18)

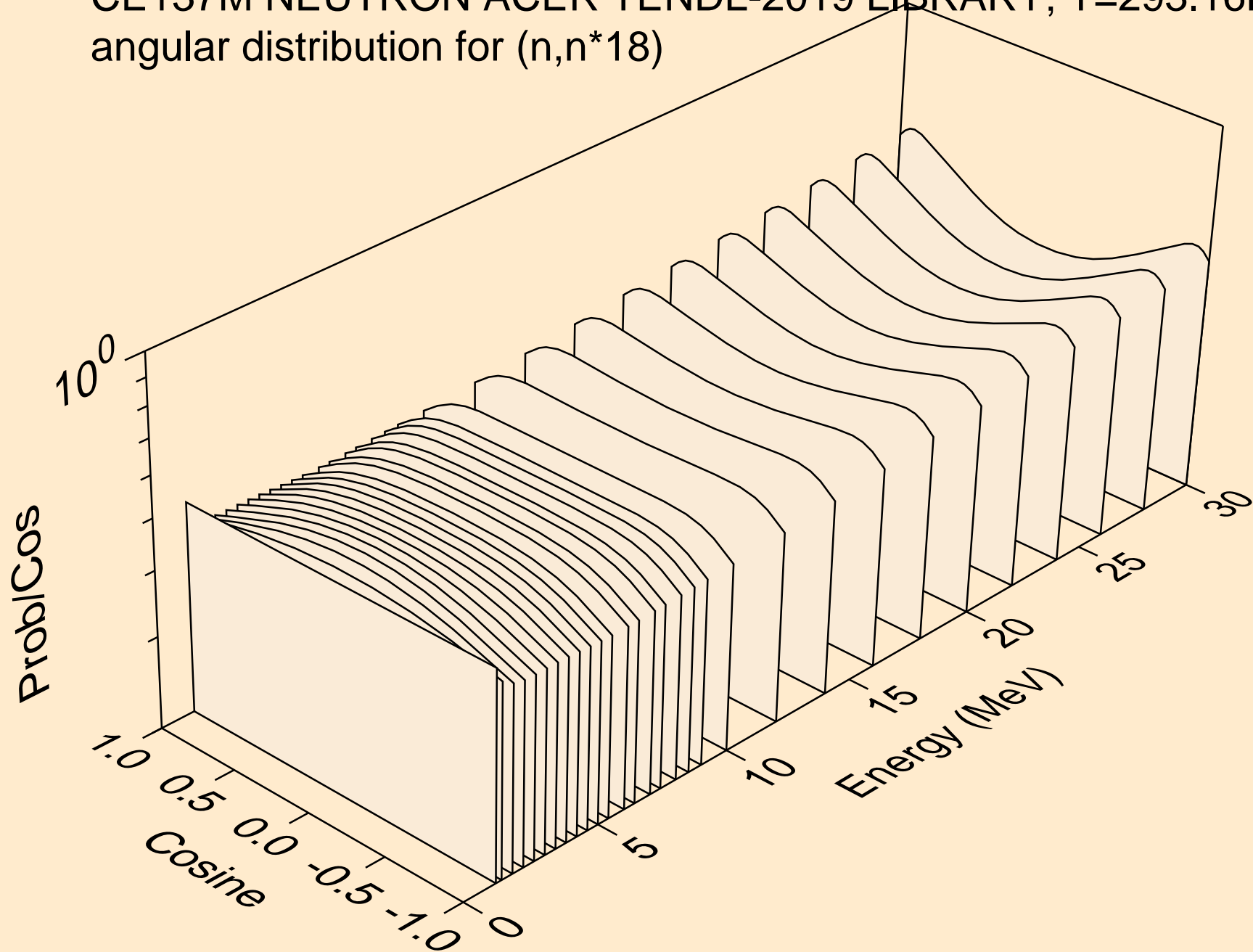

CE137M NEUTRON ACER TENDL-2019 LIBRARY; T=293.16K
angular distribution for (n,n*19)

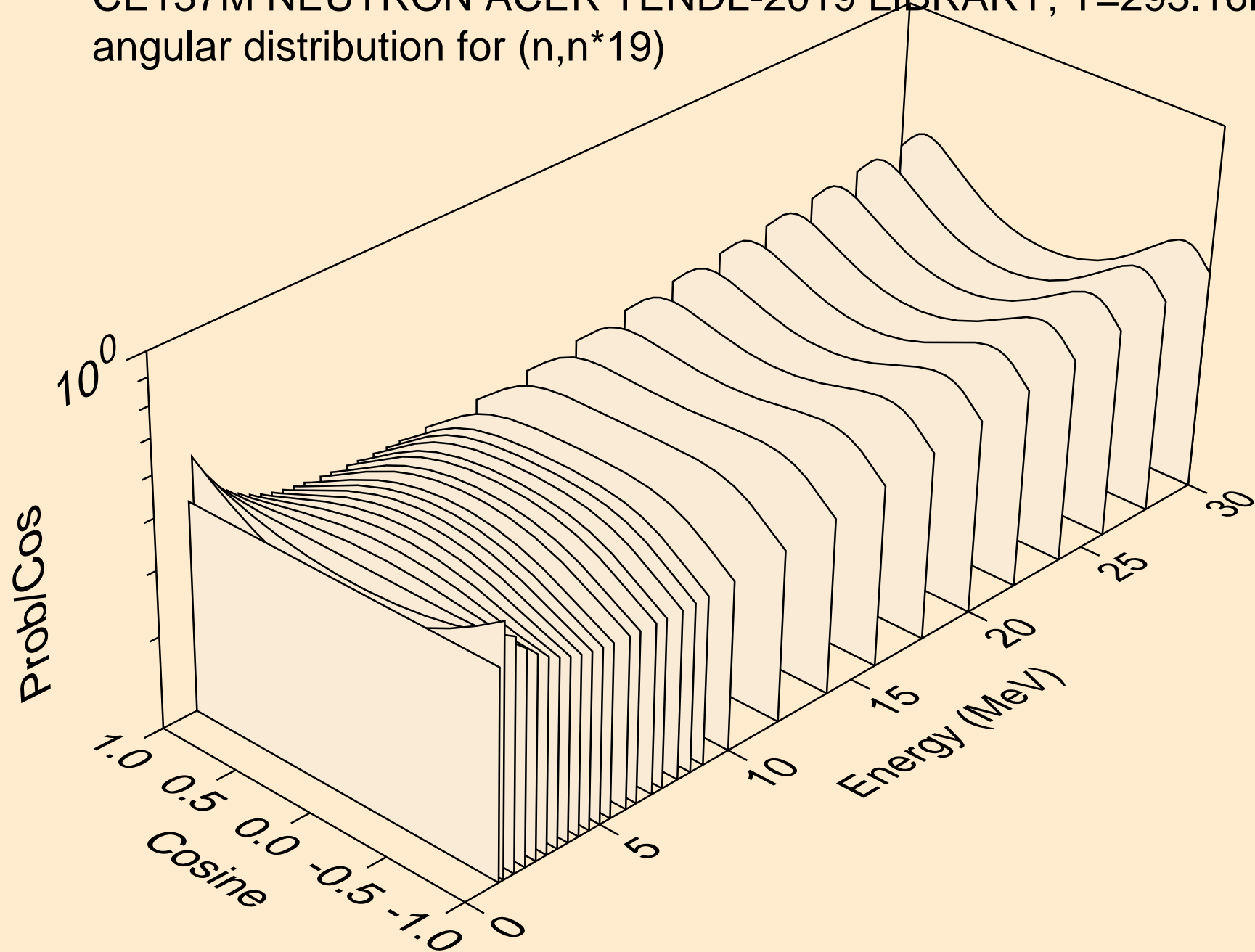

CE137M NEUTRON ACER TENDL-2019 LIBRARY; T=293.16K
angular distribution for (n,n*20)

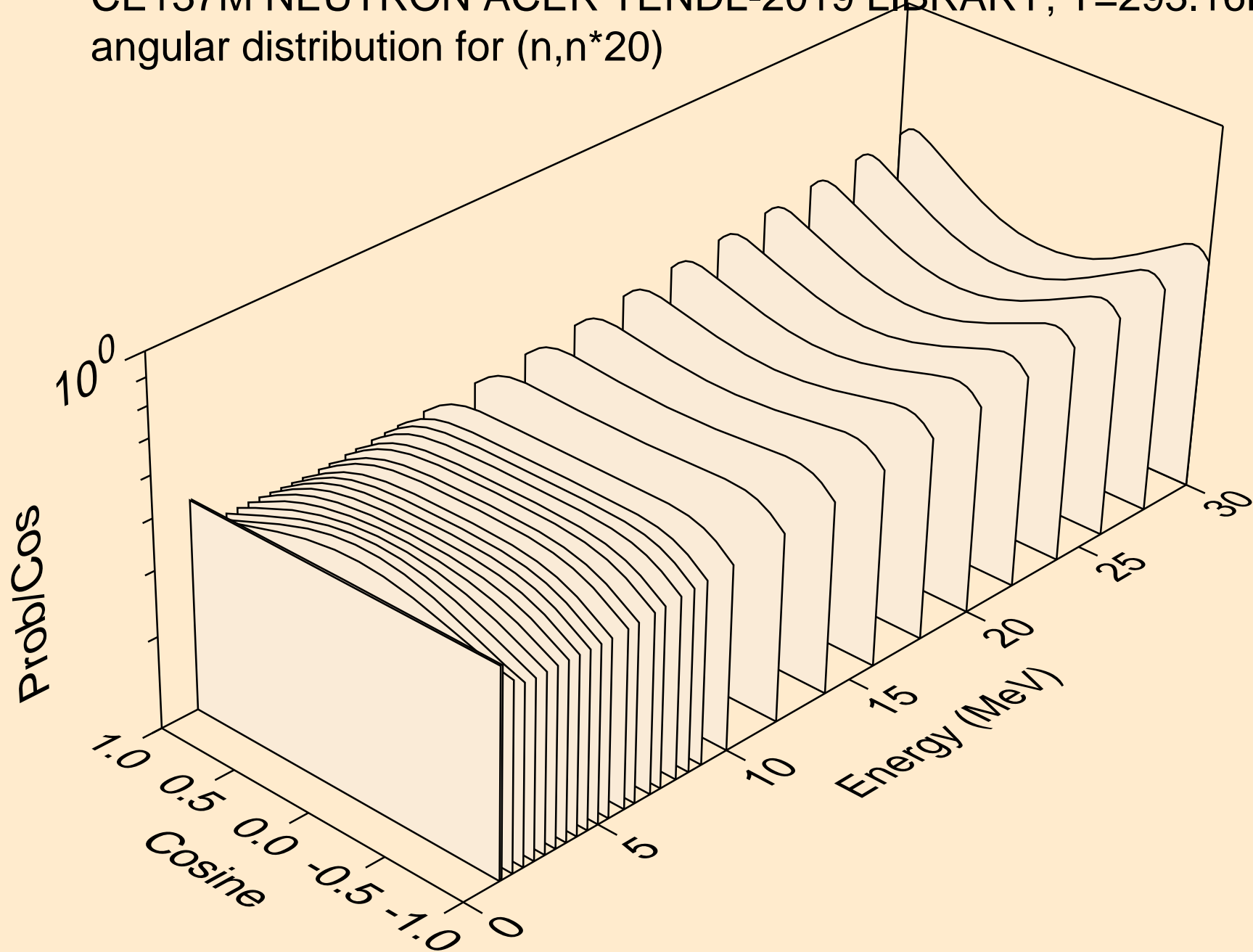

CE137M NEUTRON ACER TENDL-2019 LIBRARY; T=293.16K
Neutron emission for (n,x)

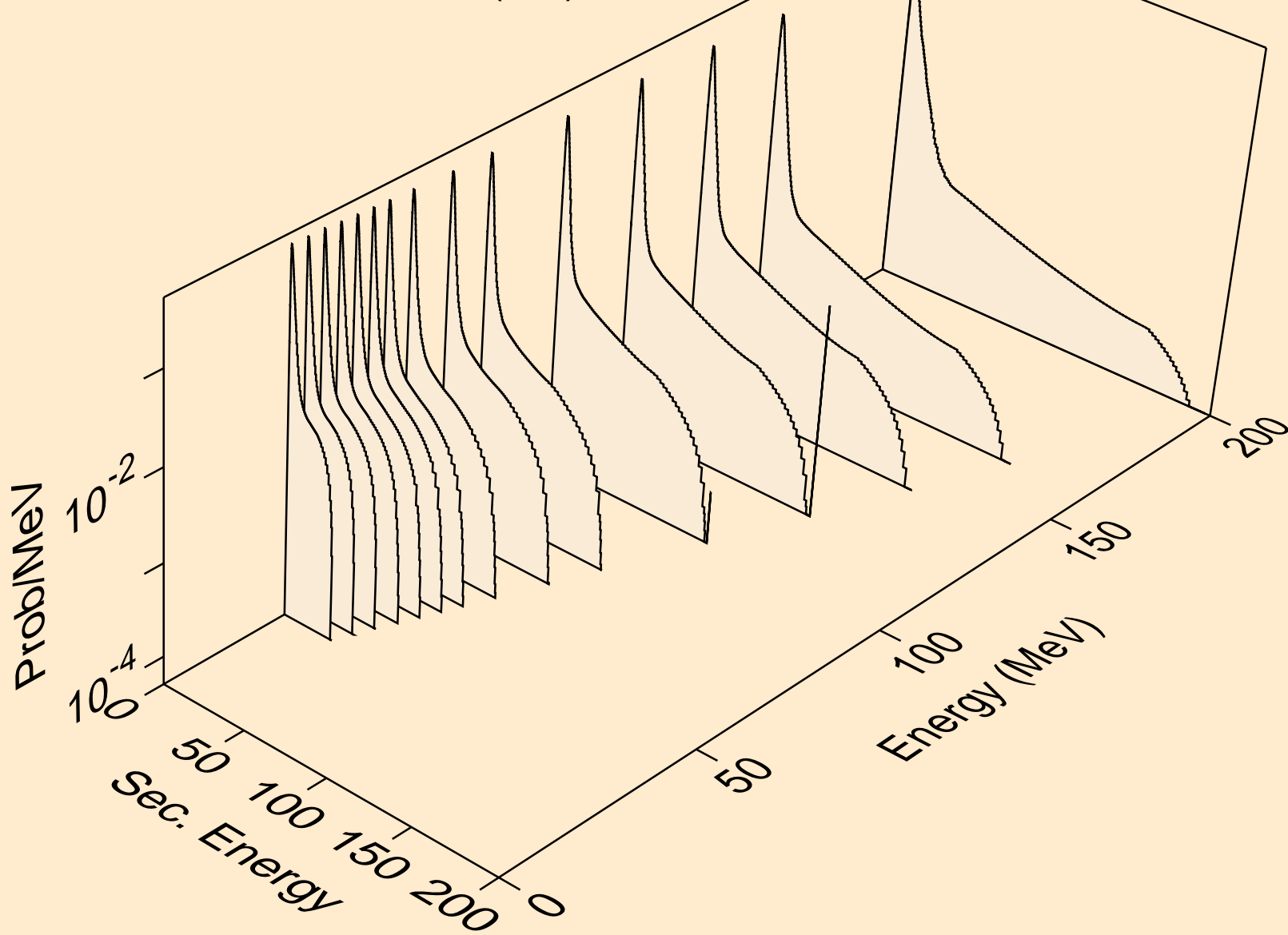

CE137M NEUTRON ACER TENDL-2019 LIBRARY; T=293.16K
Neutron emission for (n,2nd)

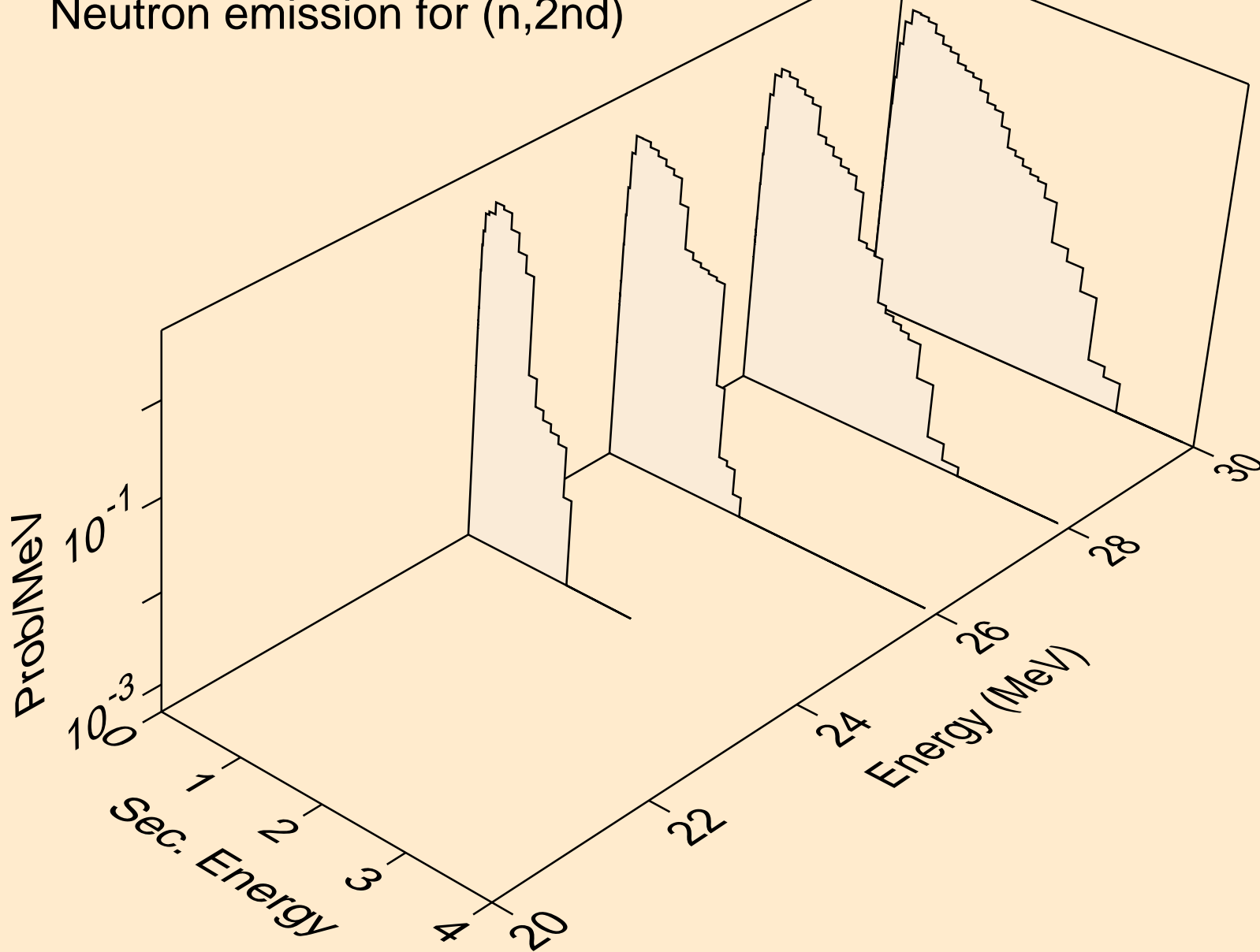

CE137M NEUTRON ACER TENDL-2019 LIBRARY; T=293.16K
Neutron emission for (n,2n)

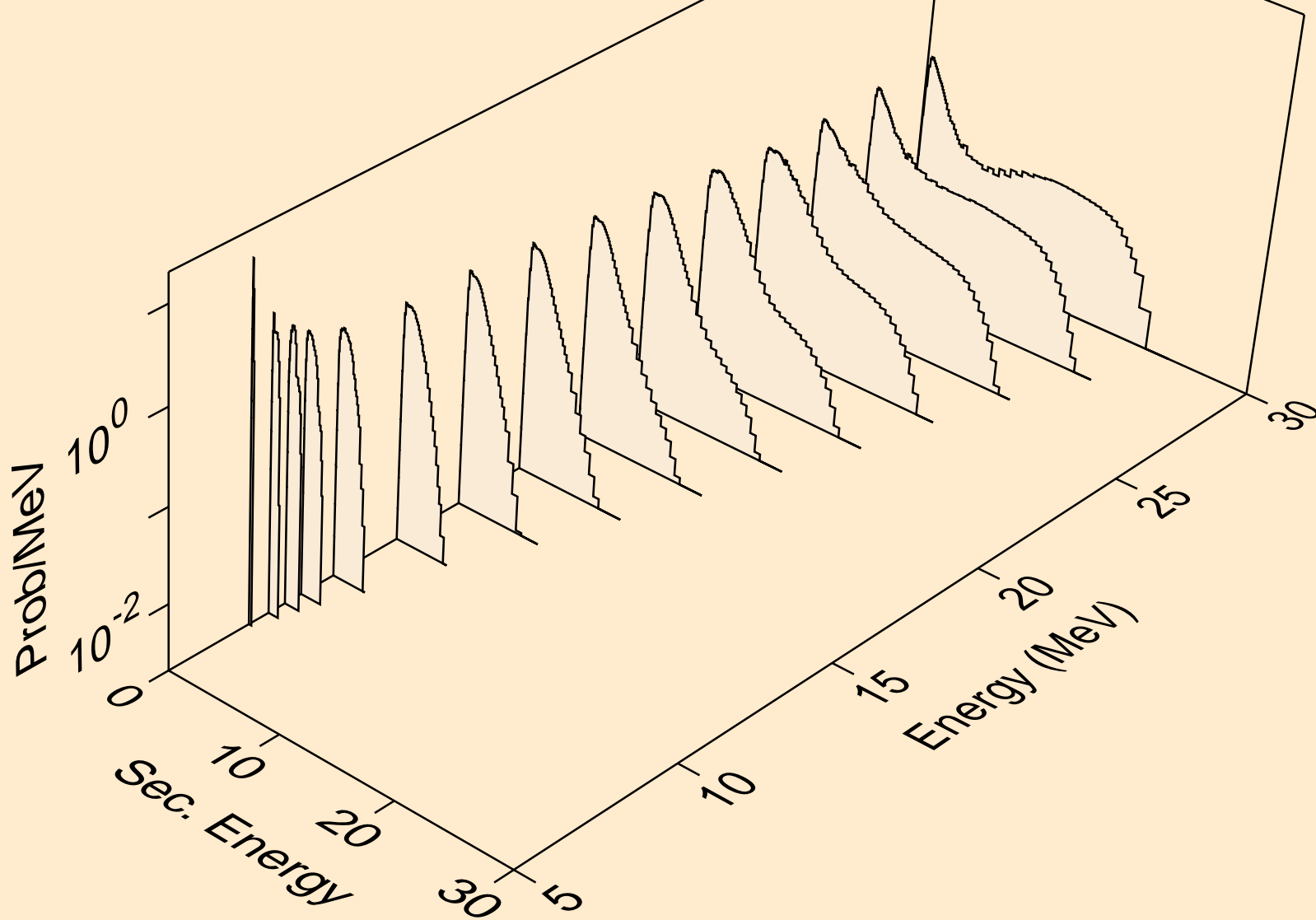

CE137M NEUTRON ACER TENDL-2019 LIBRARY; T=293.16K
Neutron emission for (n,3n)

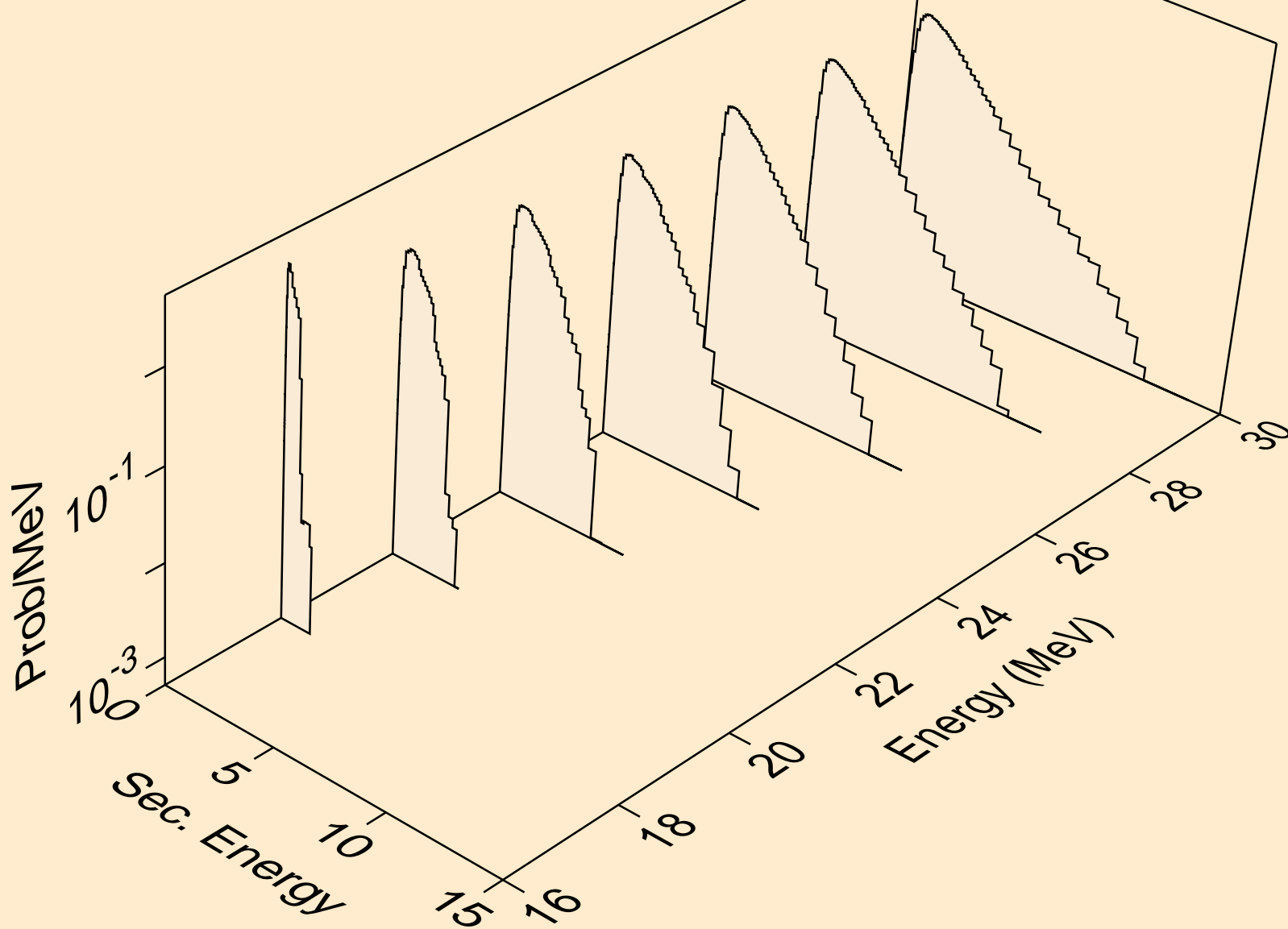

CE137M NEUTRON ACER TENDL-2019 LIBRARY; T=293.16K
Neutron emission for (n,n*)a

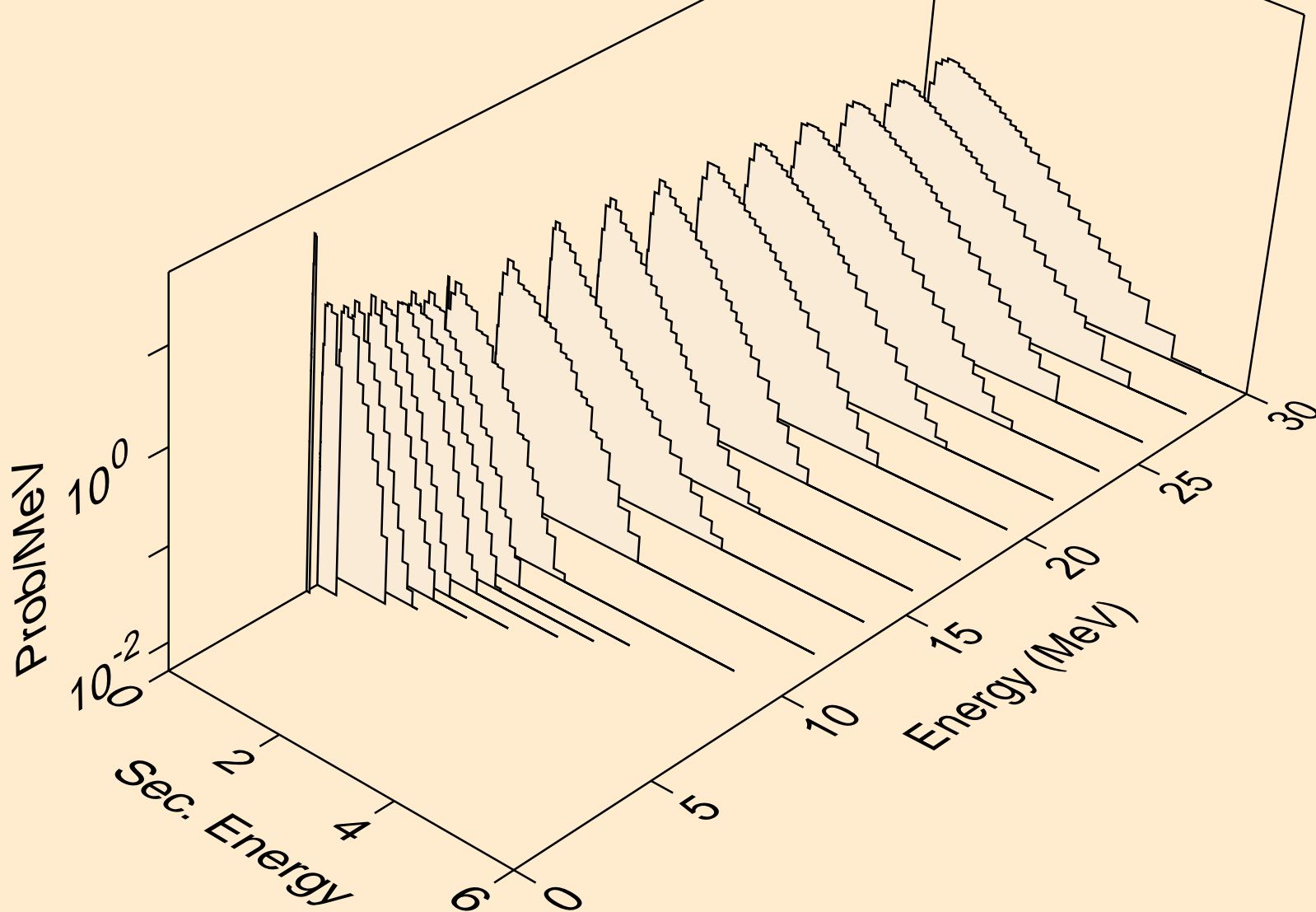

CE137M NEUTRON ACER TENDL-2019 LIBRARY; T=293.16K
Neutron emission for (n,2n)a

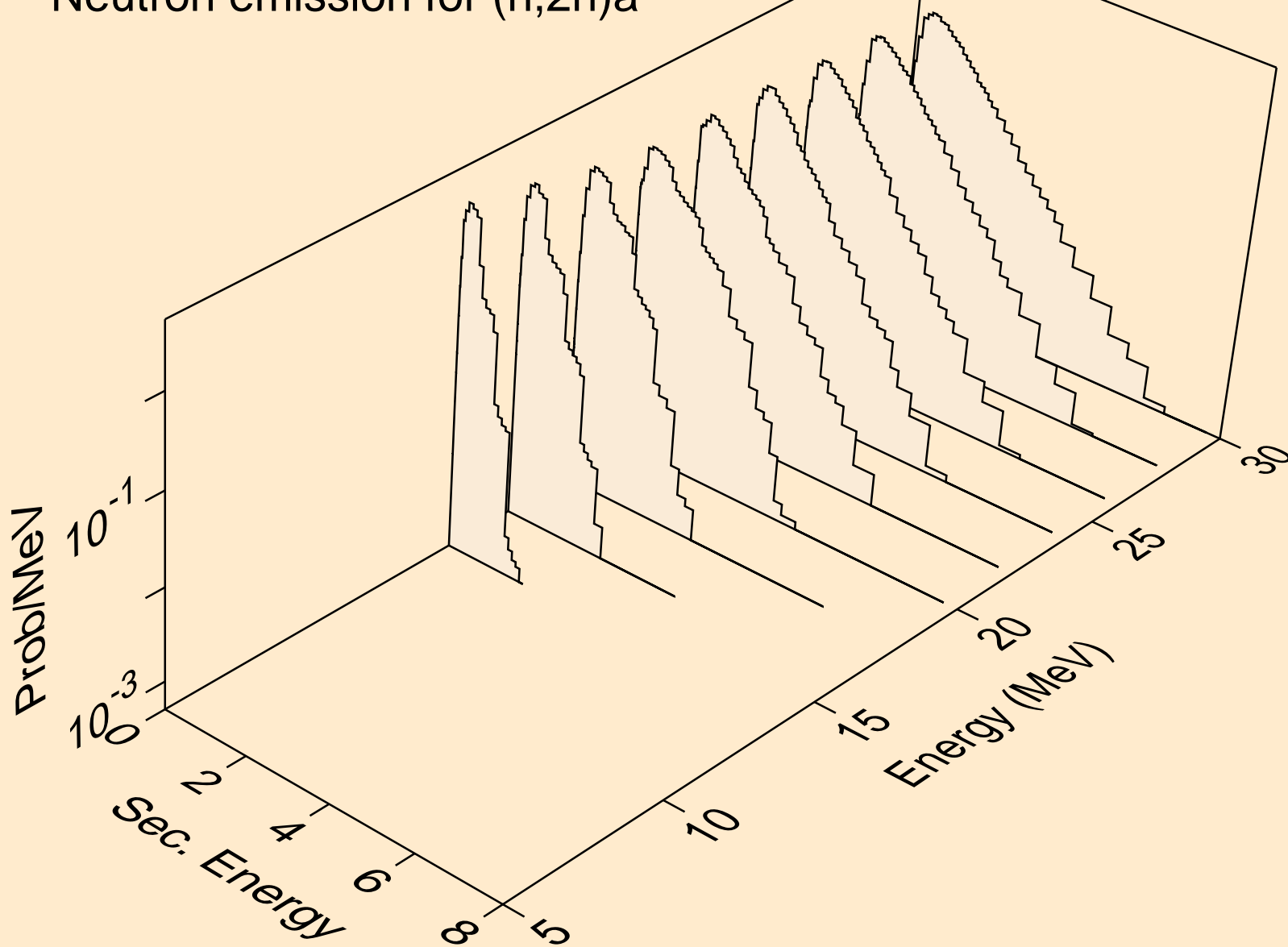

CE137M NEUTRON ACER TENDL-2019 LIBRARY; T=293.16K
Neutron emission for (n,3n)a

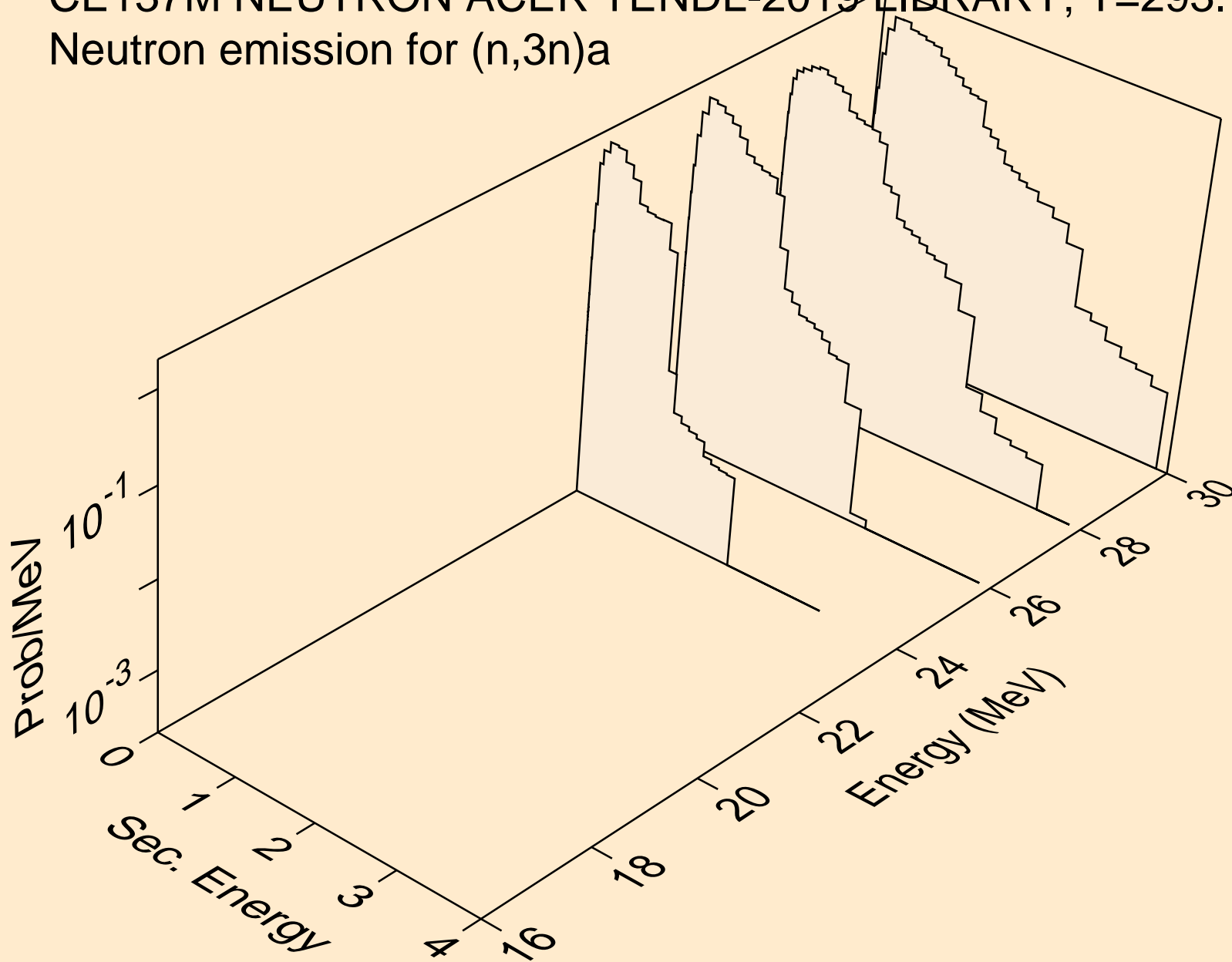

CE137M NEUTRON ACER TENDL-2019 LIBRARY; T=293.16K
Neutron emission for (n,n*)p

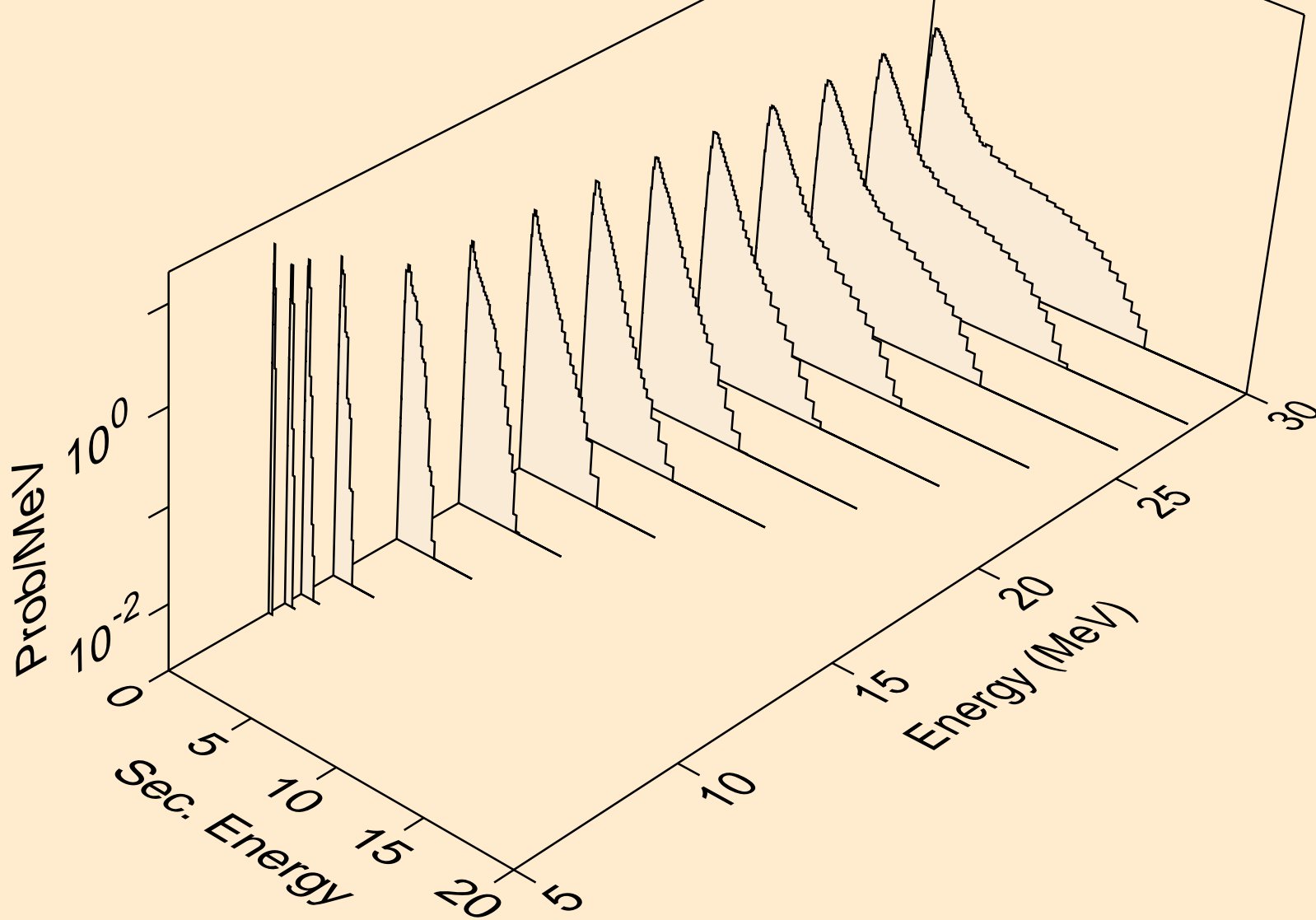

CE137M NEUTRON ACER TENDL-2019 LIBRARY; T=293.16K
Neutron emission for (n,n*)2a

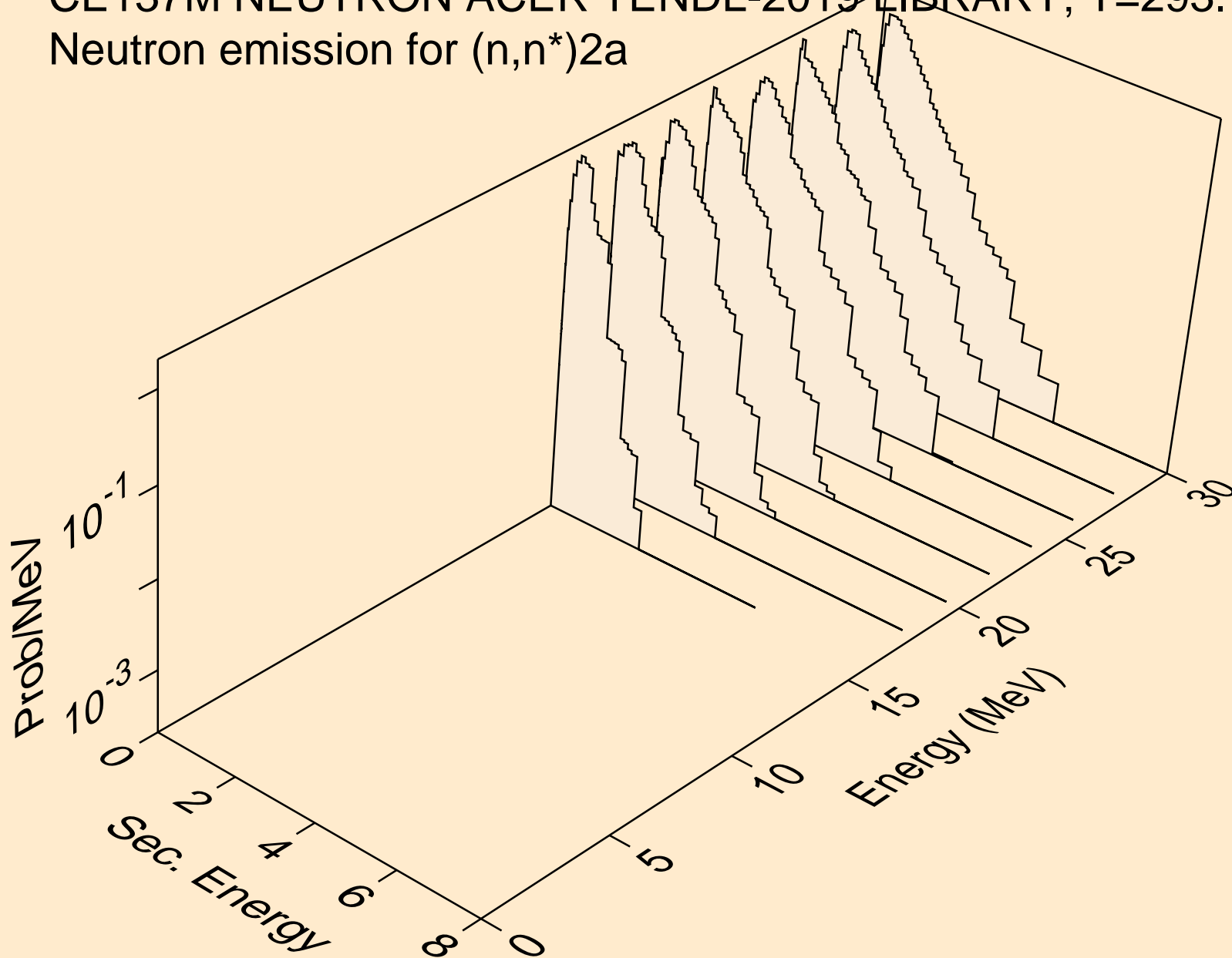

CE137M NEUTRON ACER TENDL-2019 LIBRARY; T=293.16K
Neutron emission for (n,n*)d

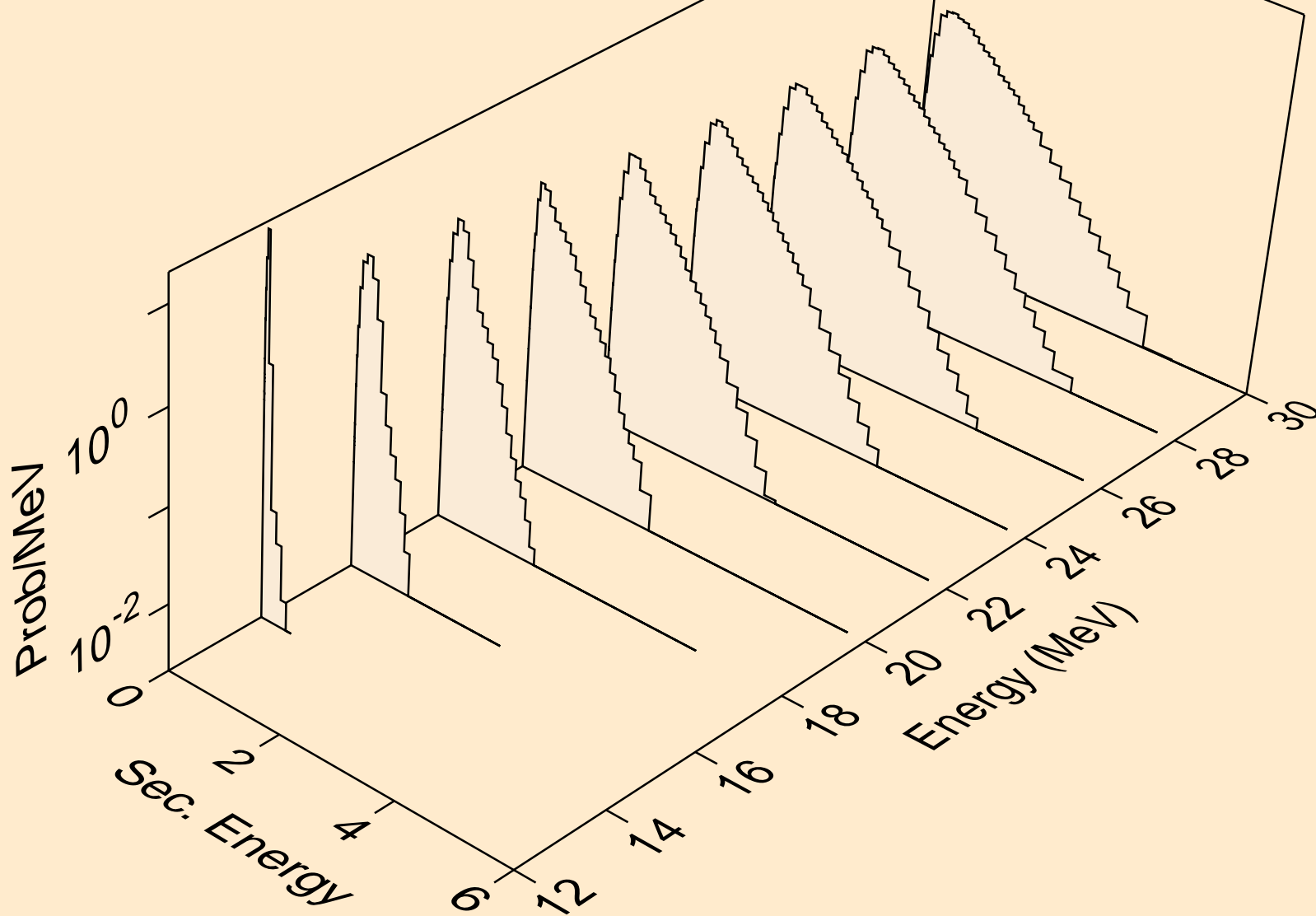

CE137M NEUTRON ACER TENDL-2019 LIBRARY; T=293.16K
Neutron emission for (n,n*)t

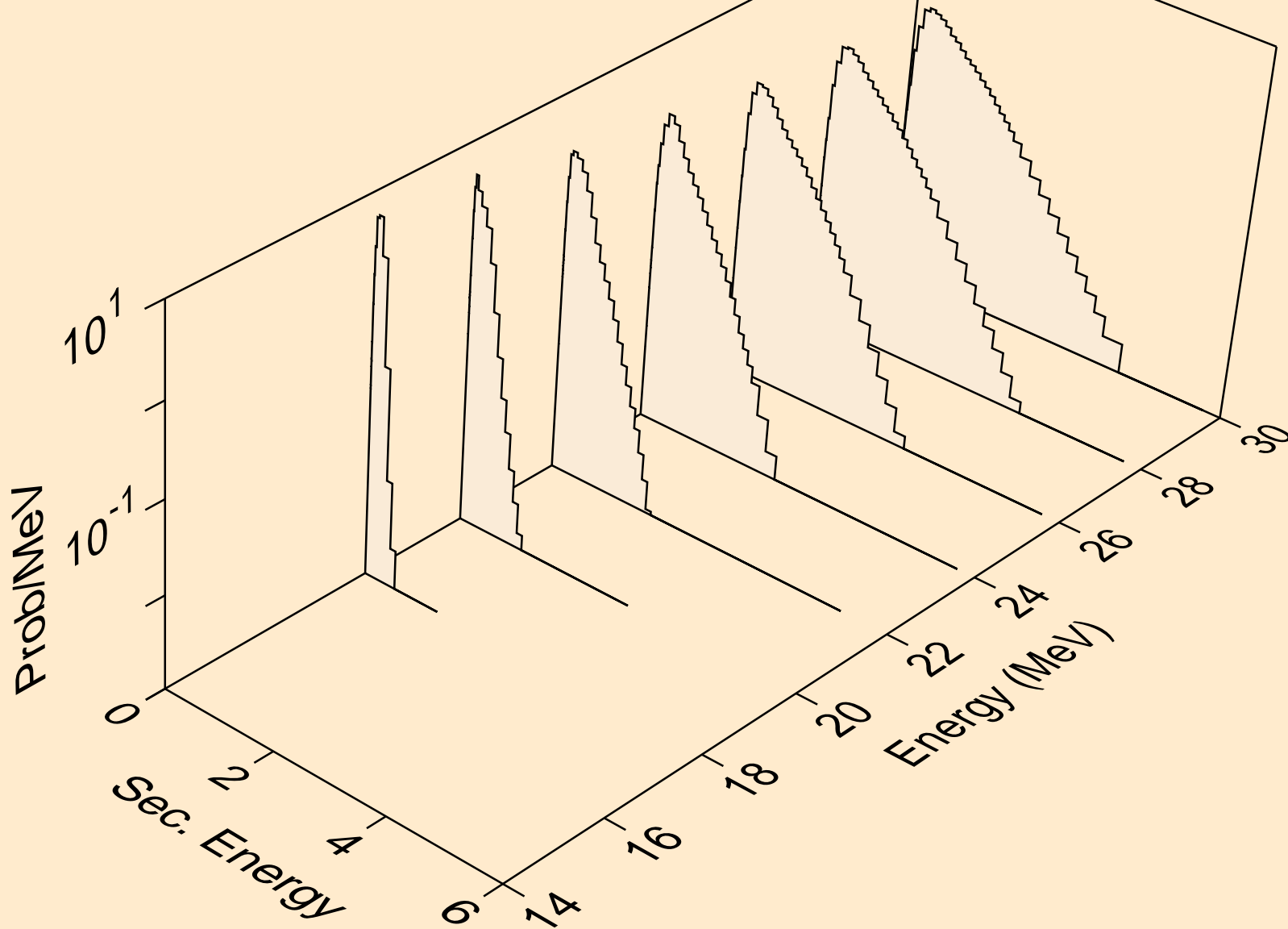

CE137M NEUTRON ACER TENDL-2019 LIBRARY; T=293.16K
Neutron emission for (n,n*)he3

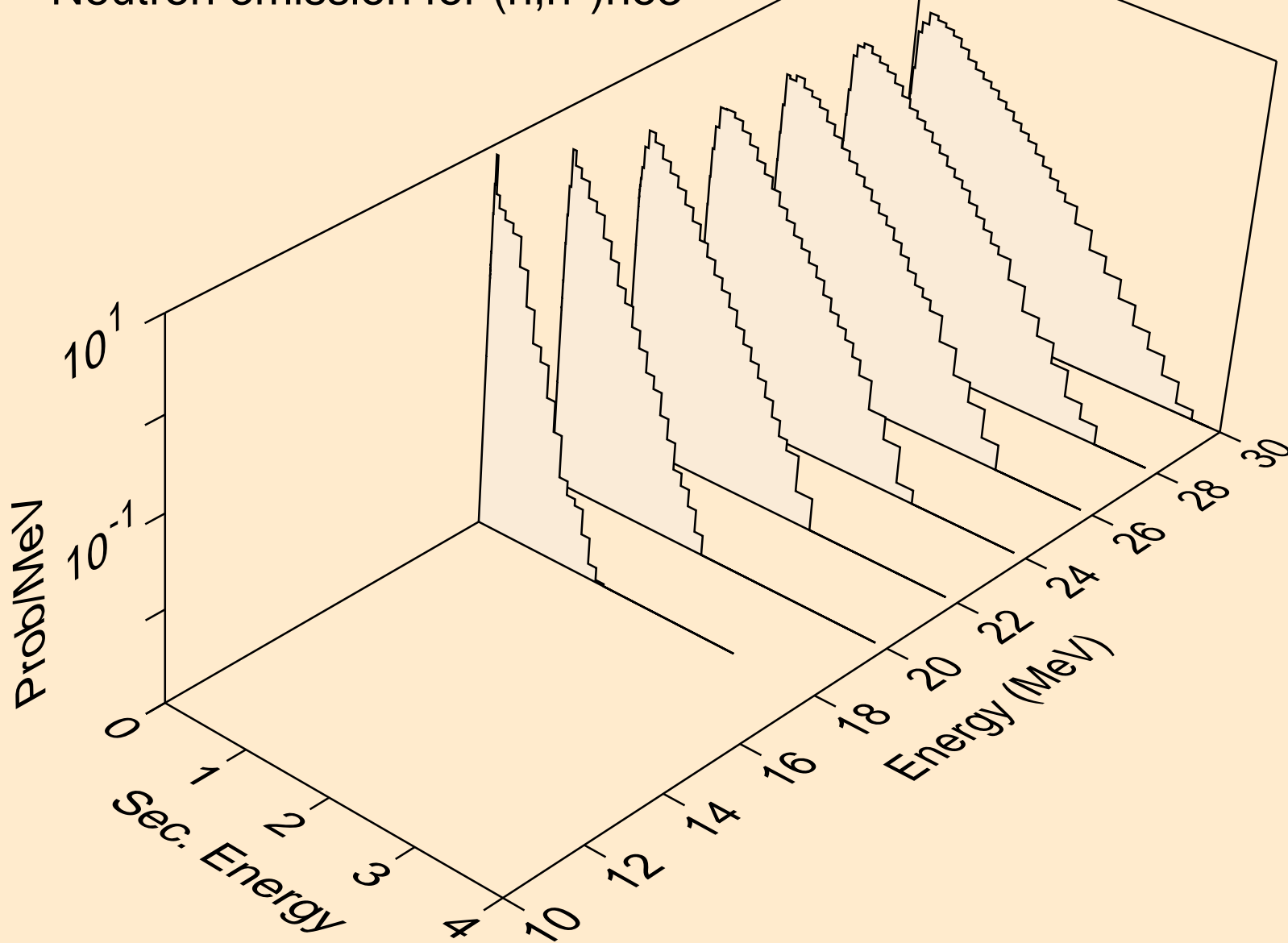

CE137M NEUTRON ACER TENDL-2019 LIBRARY; T=293.16K
Neutron emission for (n,4n)

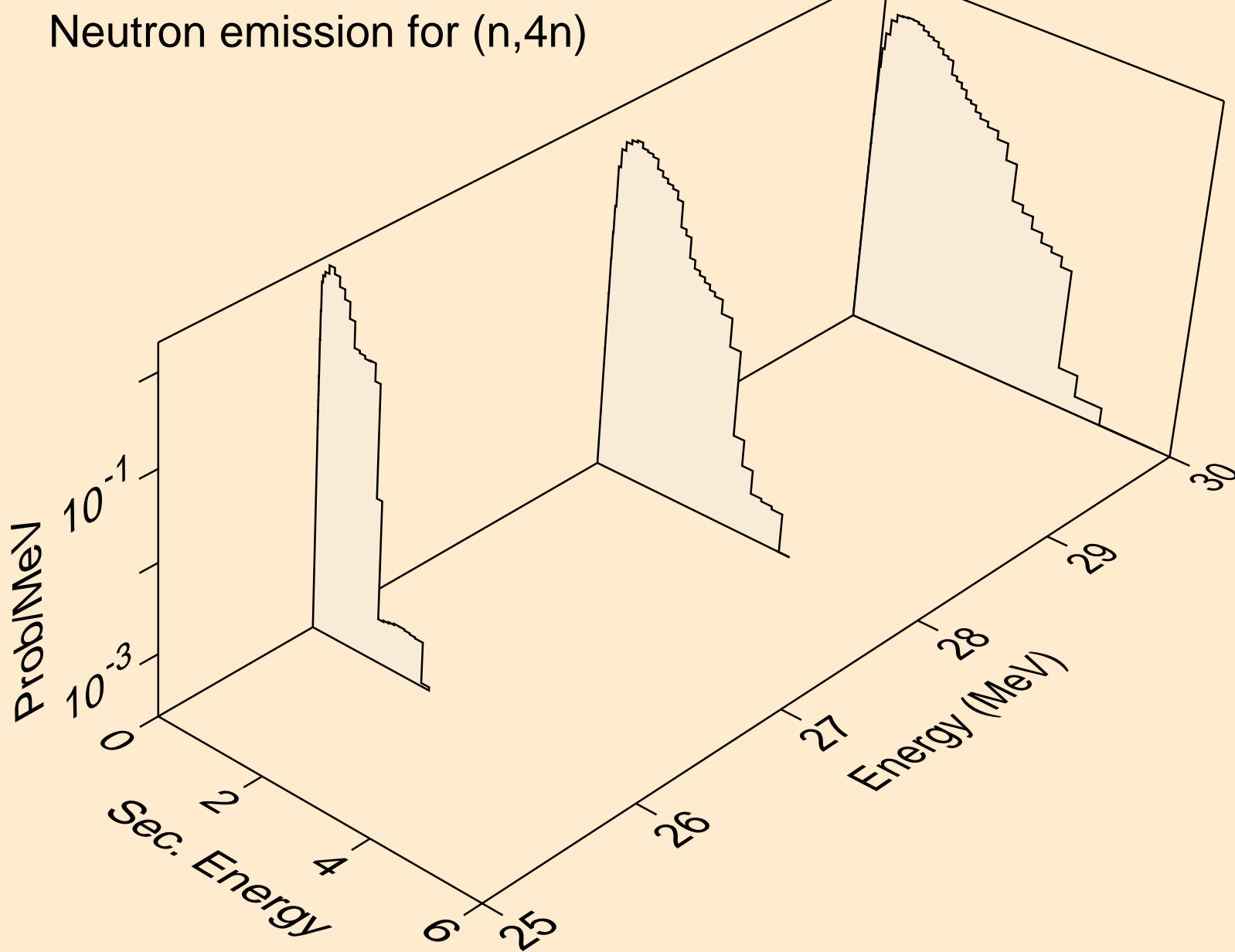

CE137M NEUTRON ACER TENDL-2019 LIBRARY; T=293.16K
Neutron emission for (n,2np)

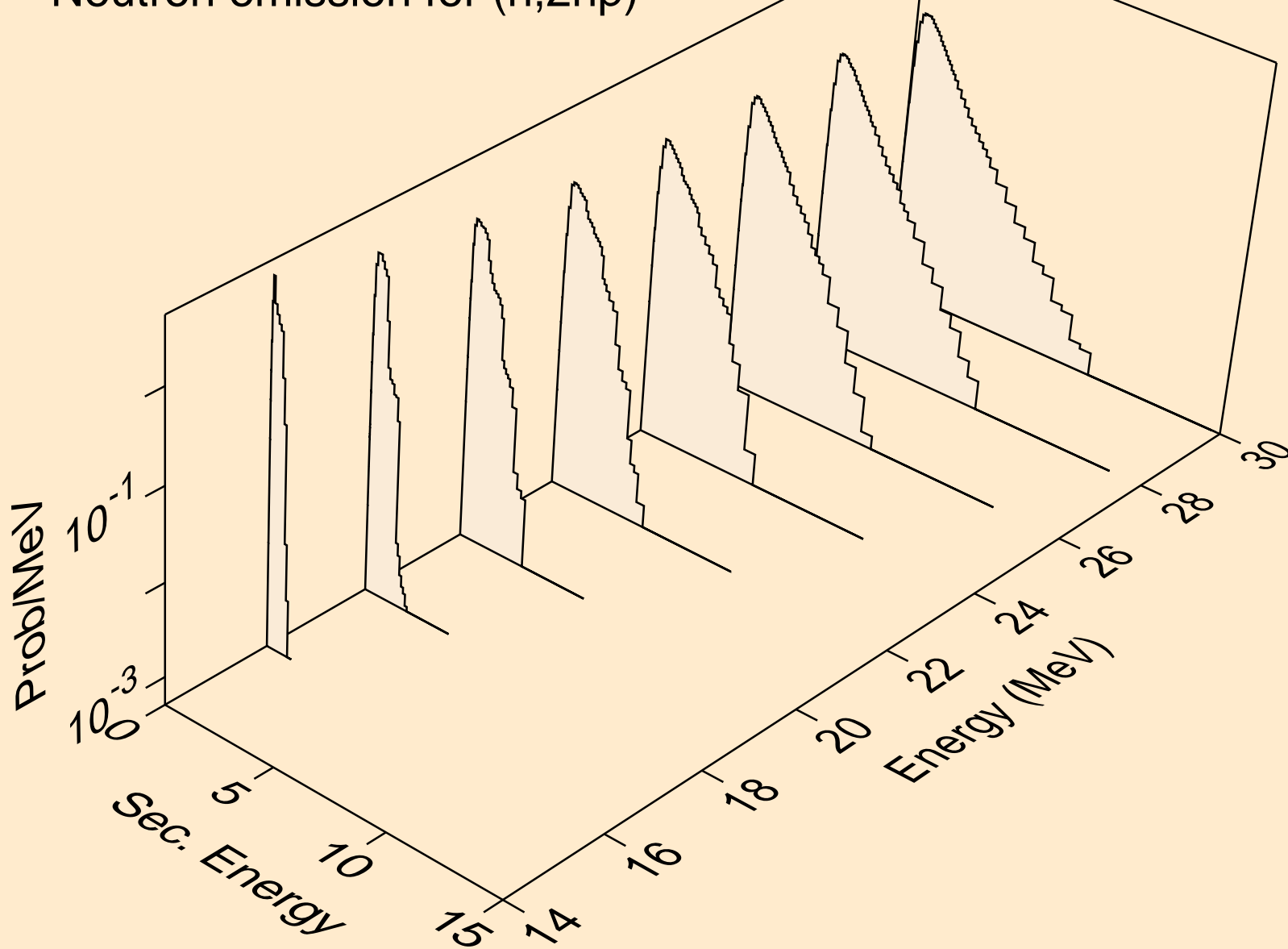

CE137M NEUTRON ACER TENDL-2019 LIBRARY; T=293.16K
Neutron emission for (n,3np)

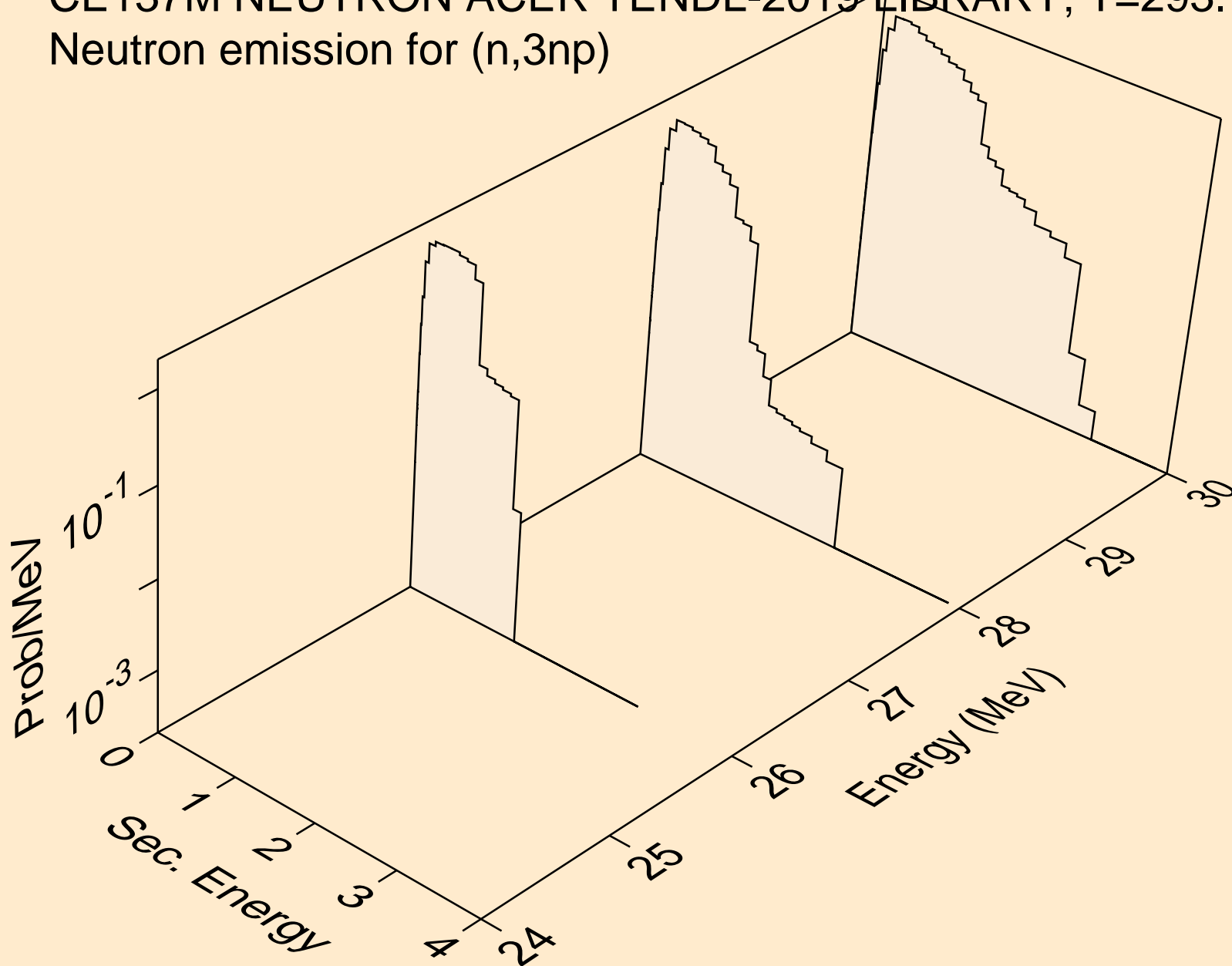

CE137M NEUTRON ACER TENDL-2019 LIBRARY; T=293.16K
Neutron emission for (n,2np)

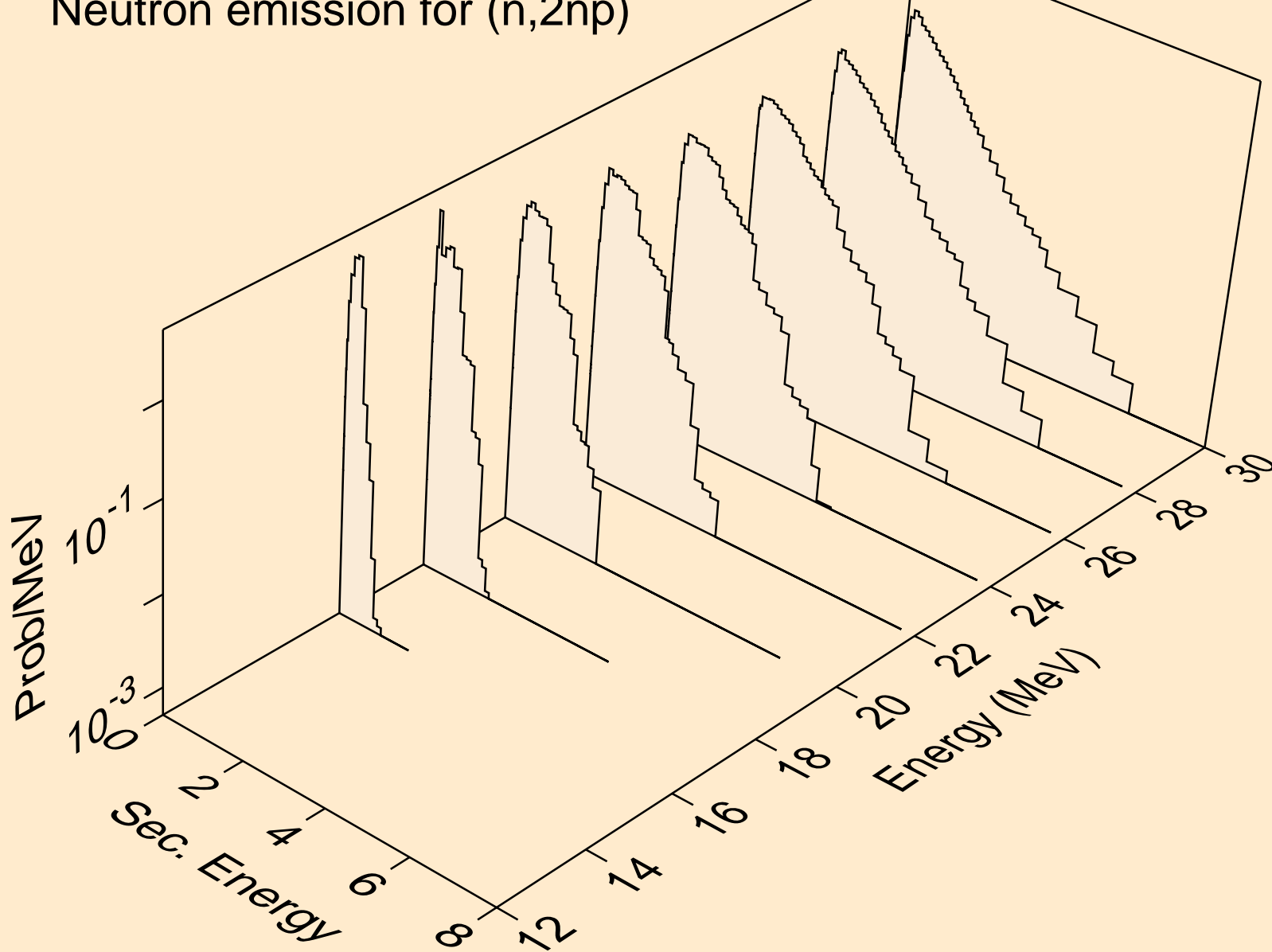

CE137M NEUTRON ACER TENDL-2019 LIBRARY; T=293.16K
Neutron emission for (n,npa)

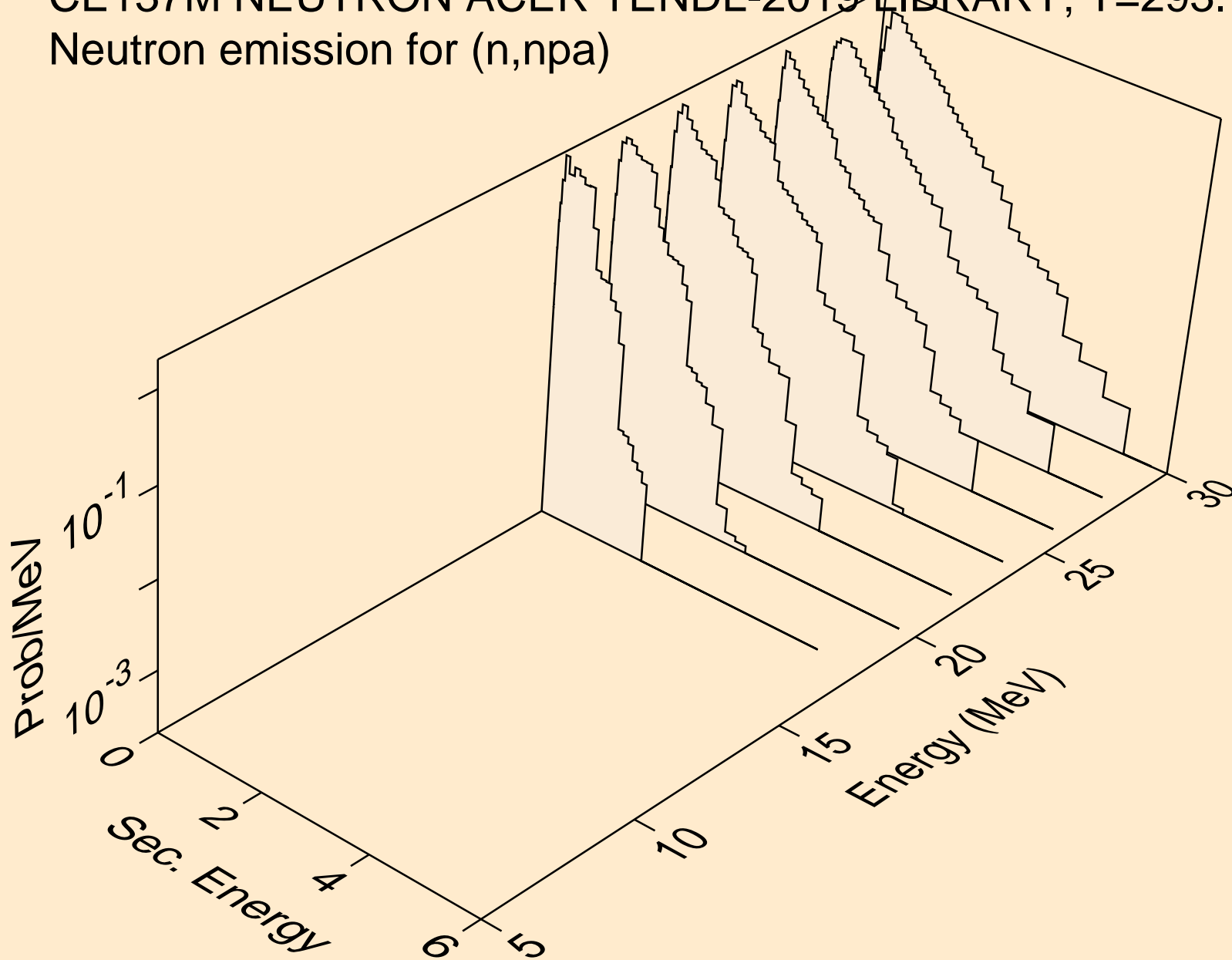

CE137M NEUTRON ACER TENDL-2019 LIBRARY; T=293.16K
Neutron emission for (n,n*c)

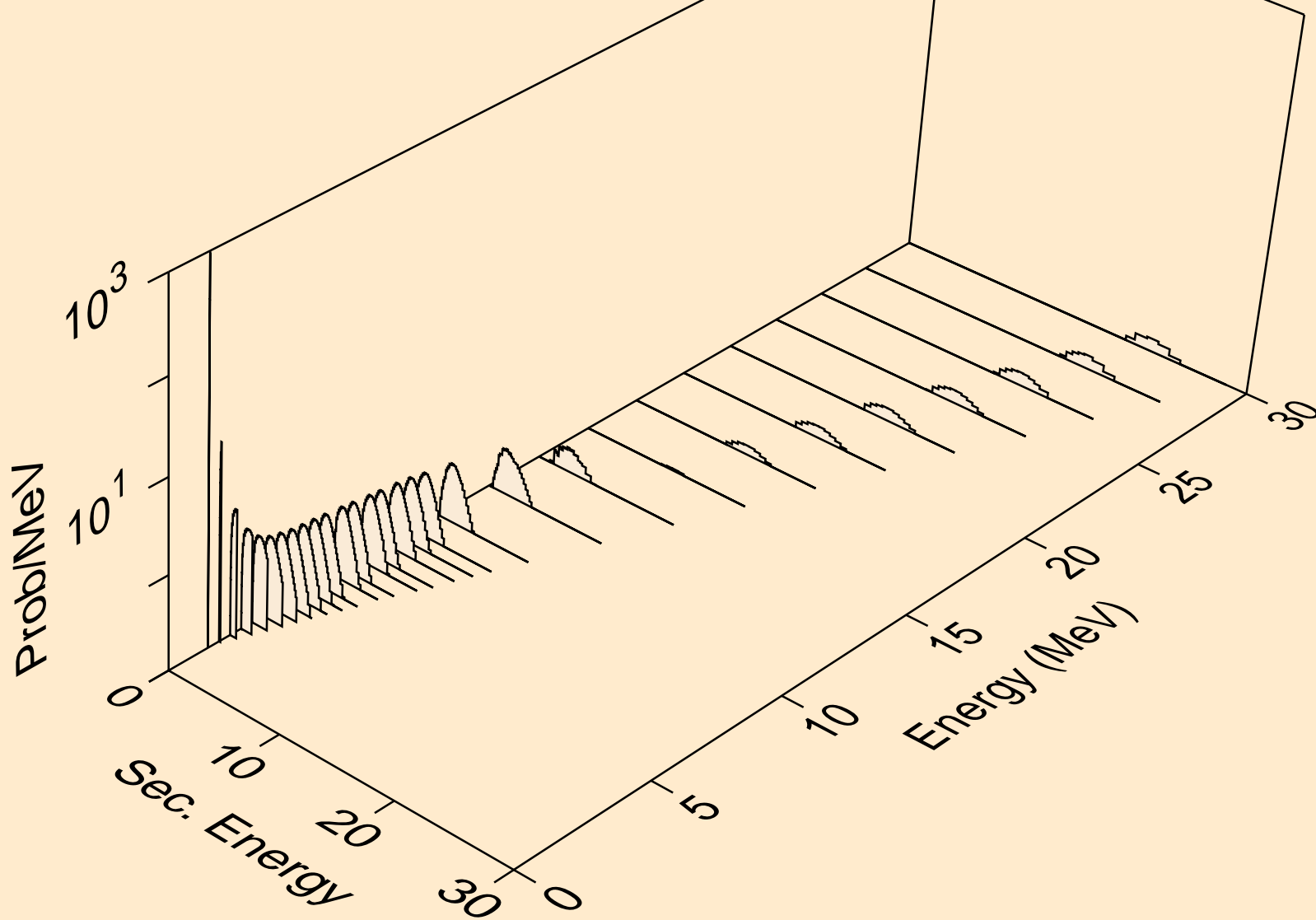

CE137M NEUTRON ACER TENDL-2019 LIBRARY; T=293.16K
Photon emission for (n,x)

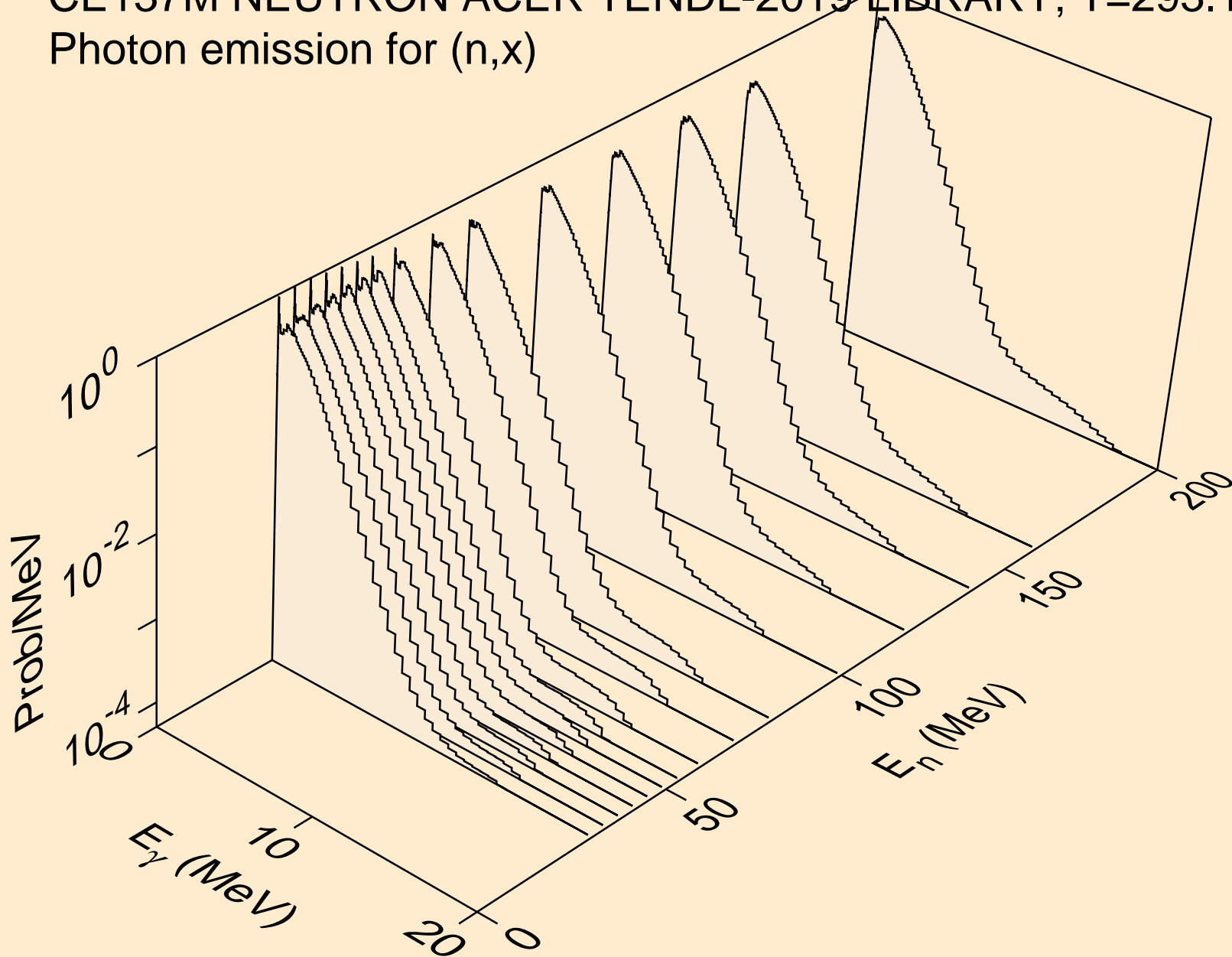

CE137M NEUTRON ACER TENDL-2019 LIBRARY; T=293.16K
Photon emission for (n,2nd)

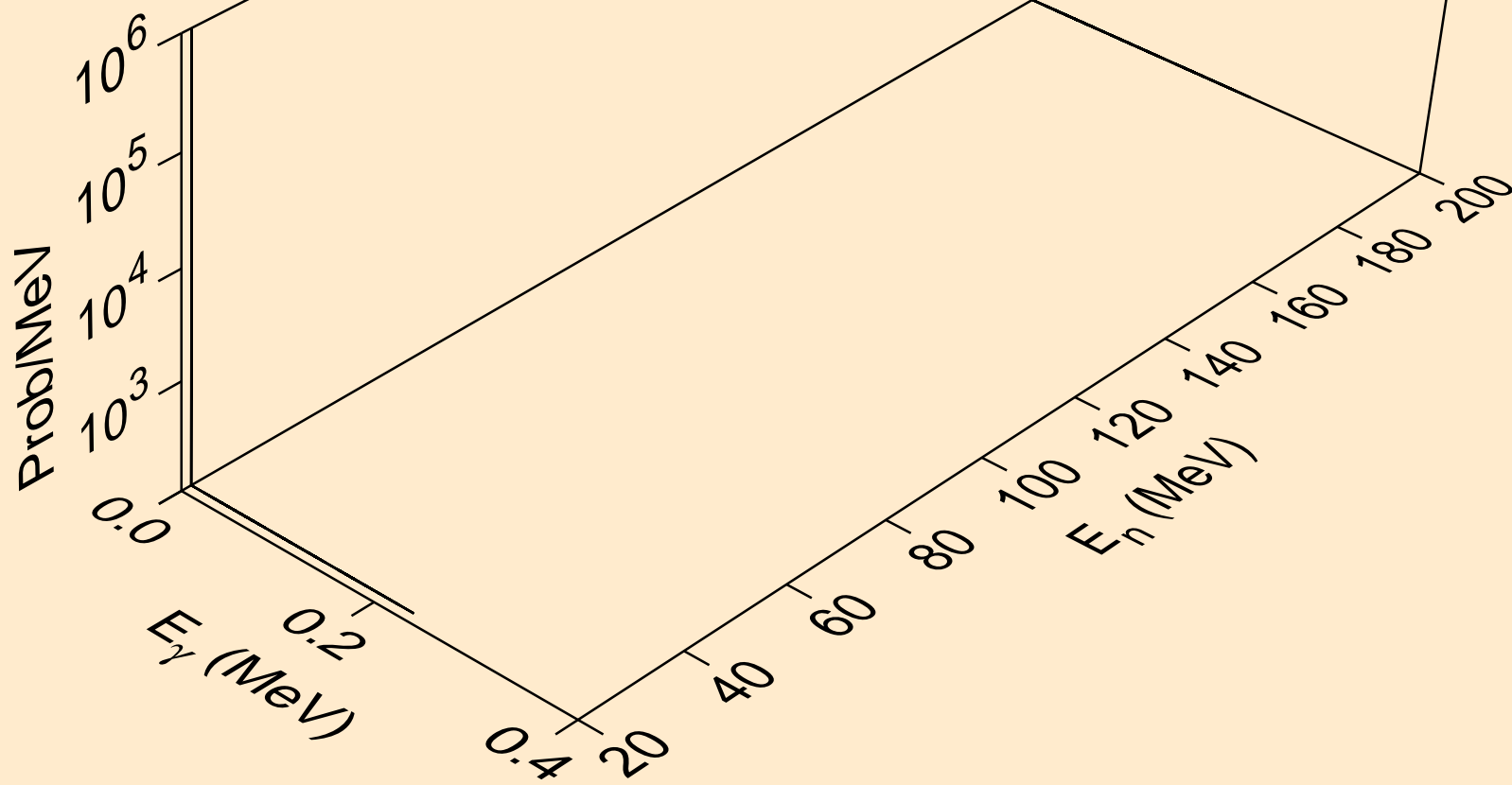

CE137M NEUTRON ACER TENDL-2019 LIBRARY; T=293.16K
Photon emission for (n,2n)

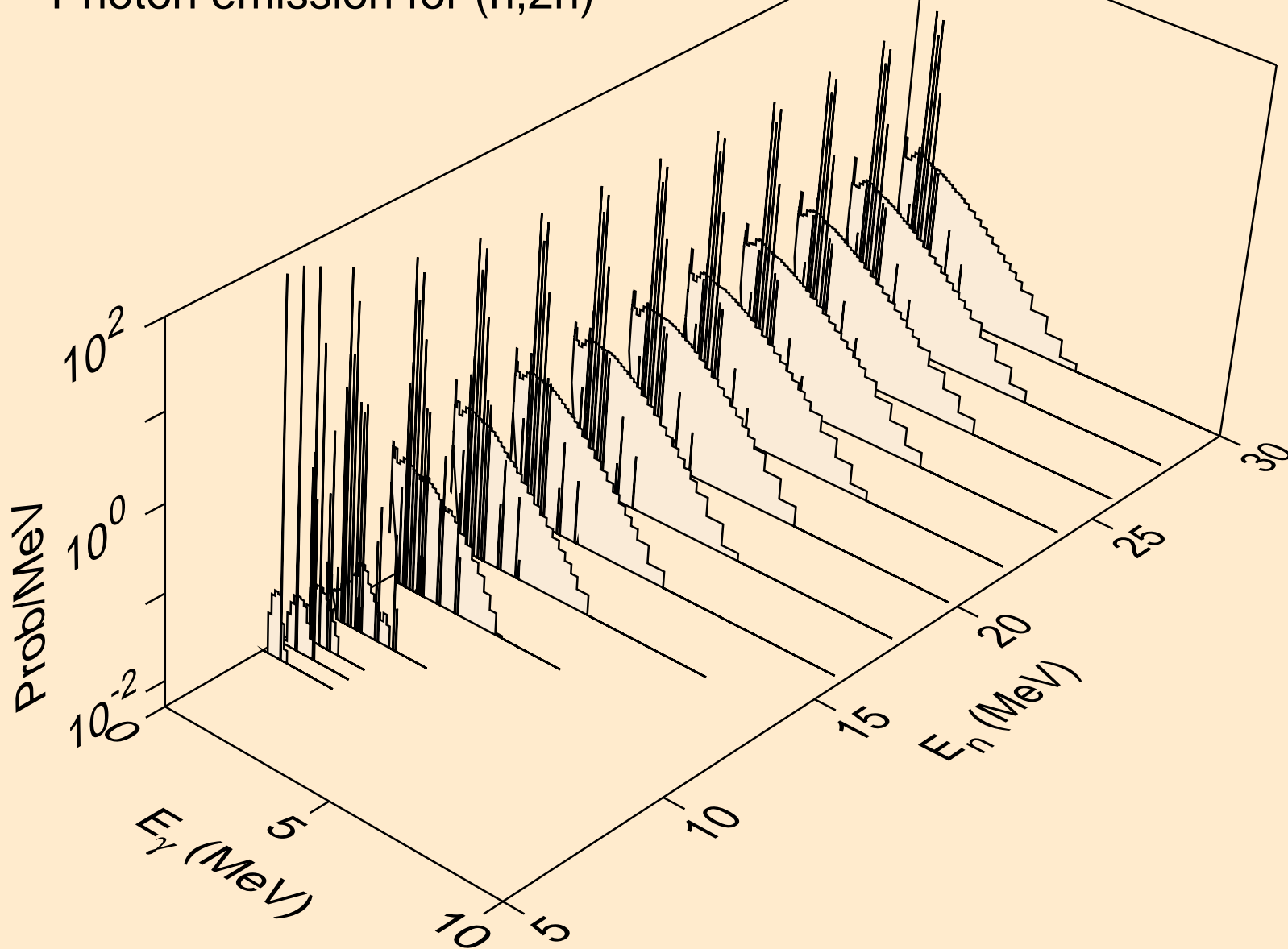

CE137M NEUTRON ACER TENDL-2019 LIBRARY; T=293.16K
Photon emission for (n,3n)

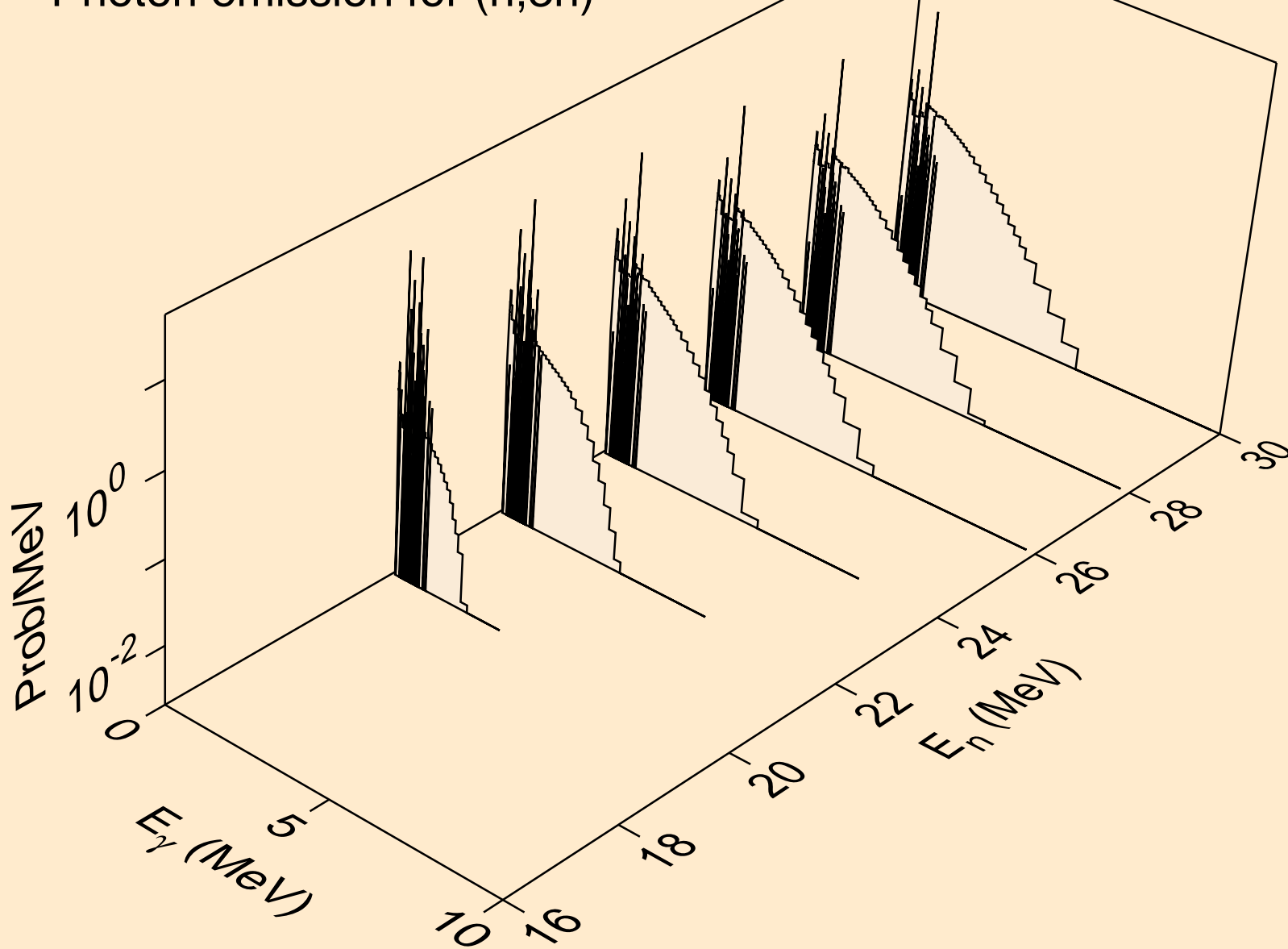

CE137M NEUTRON ACER TENDL-2019 LIBRARY; T=293.16K
Photon emission for (n,n*)a

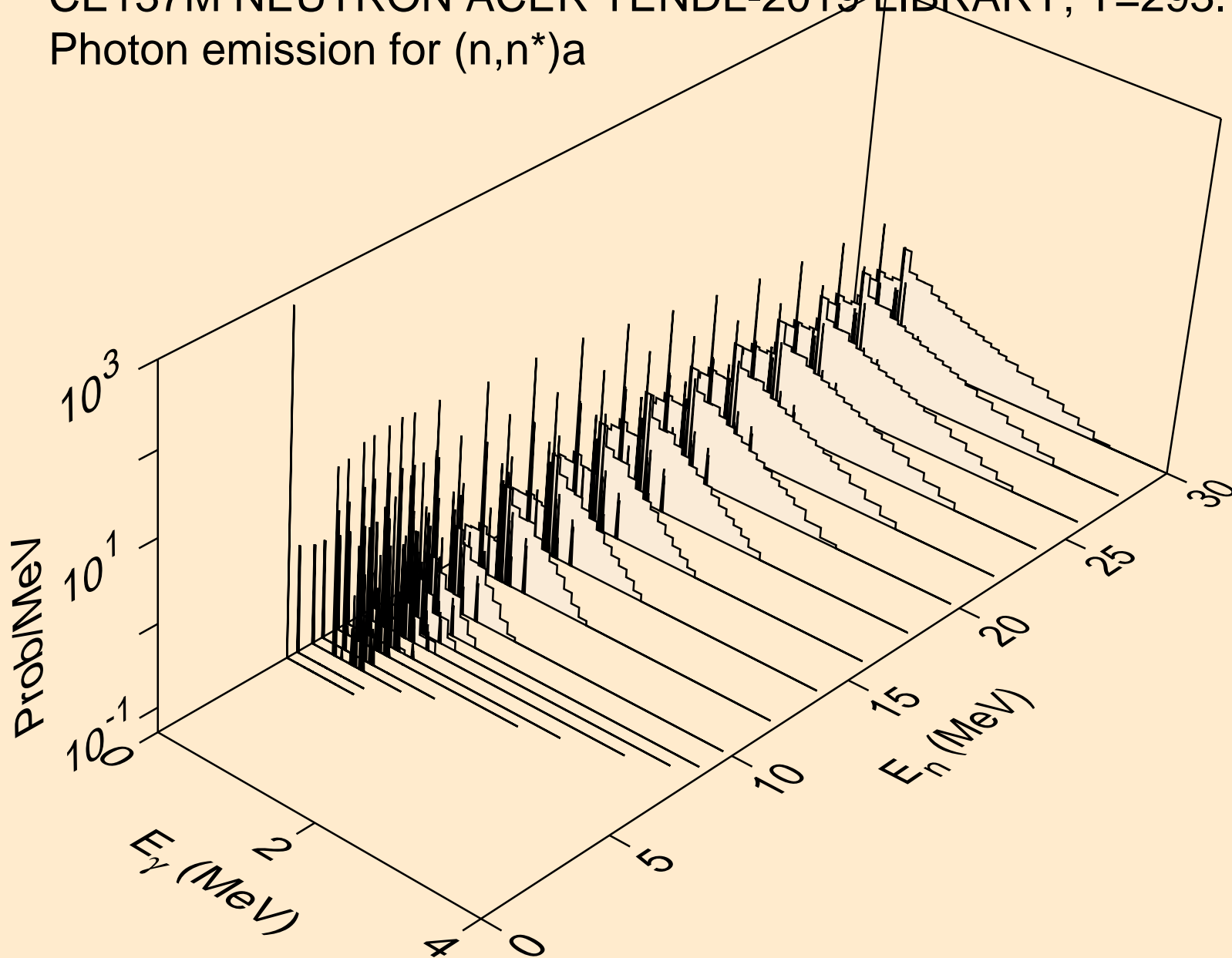

CE137M NEUTRON ACER TENDL-2019 LIBRARY; T=293.16K
Photon emission for (n,2n)a

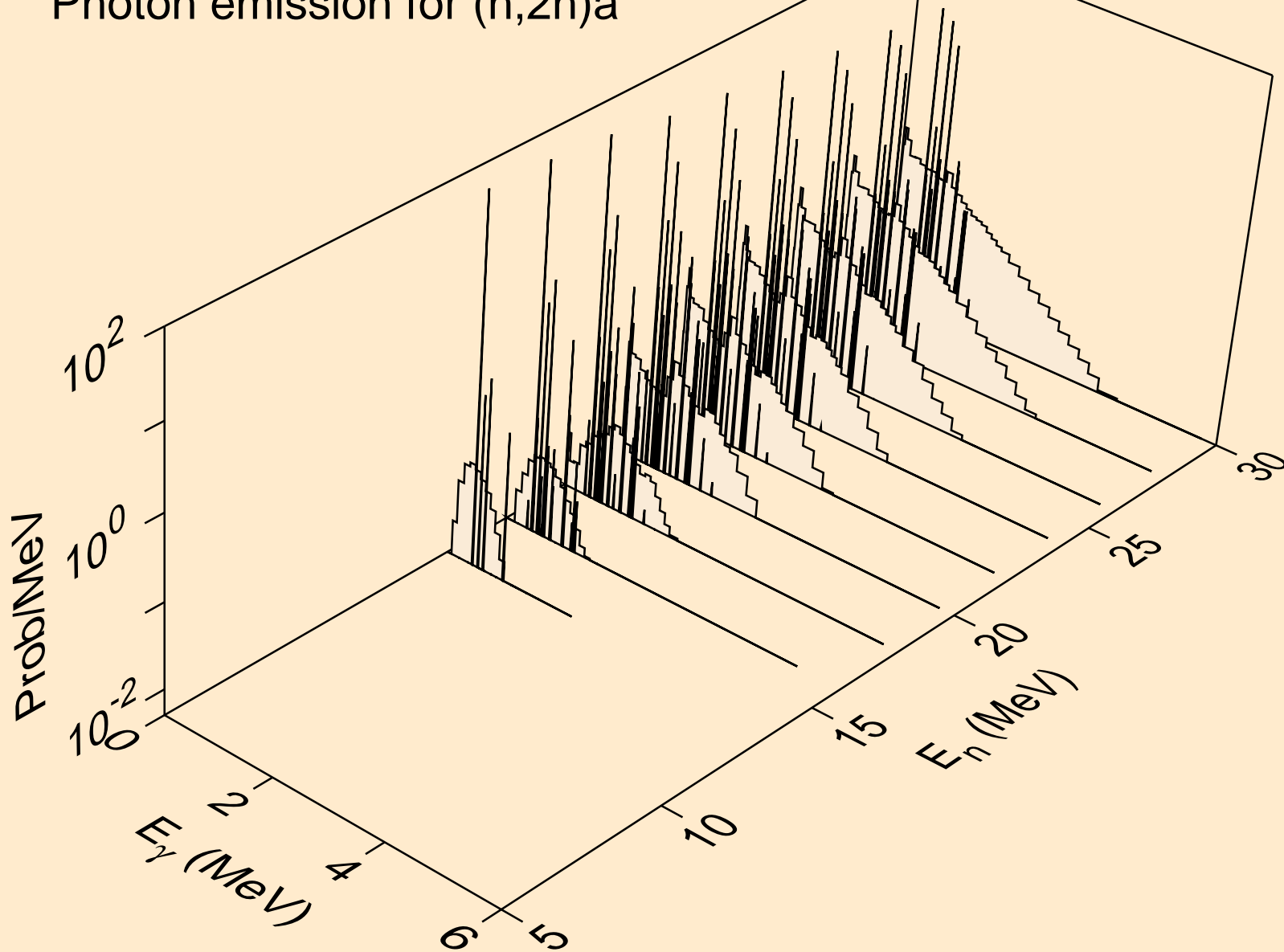

CE137M NEUTRON ACER TENDL-2019 LIBRARY; T=293.16K
Photon emission for (n,3n)a

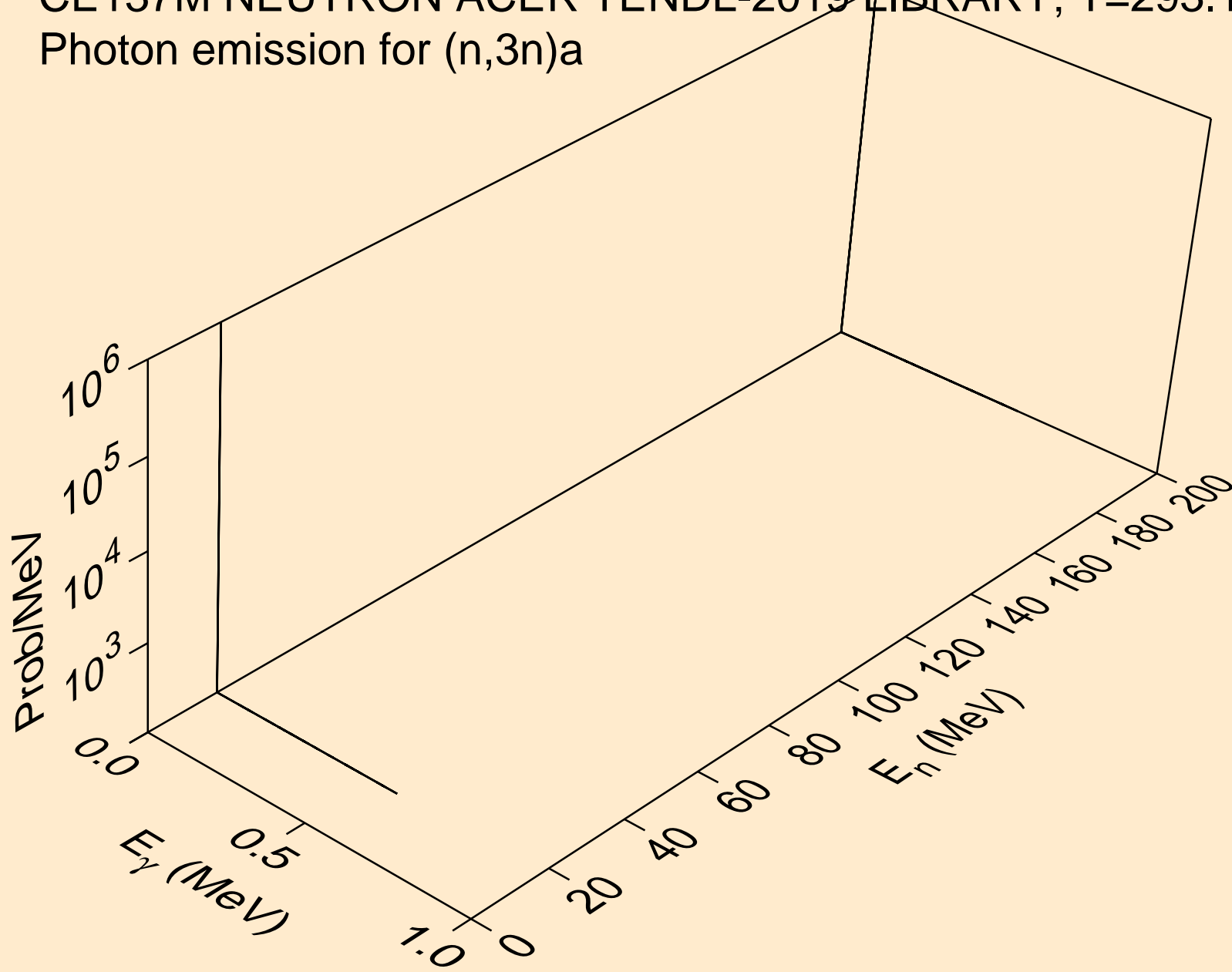

CE137M NEUTRON ACER TENDL-2019 LIBRARY; T=293.16K
Photon emission for (n,n*)p

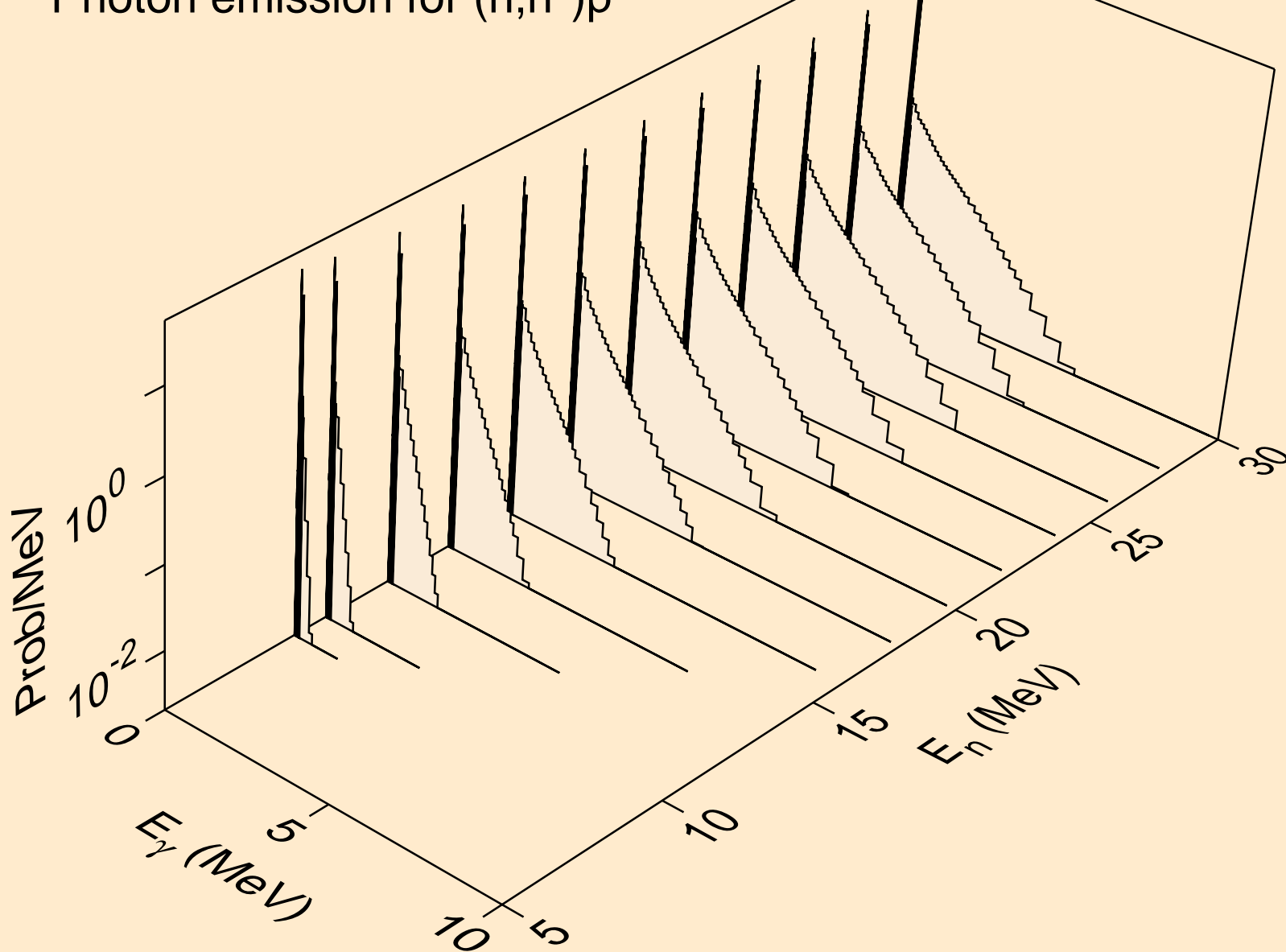

CE137M NEUTRON ACER TENDL-2019 LIBRARY; T=293.16K
Photon emission for (n,n*)2a

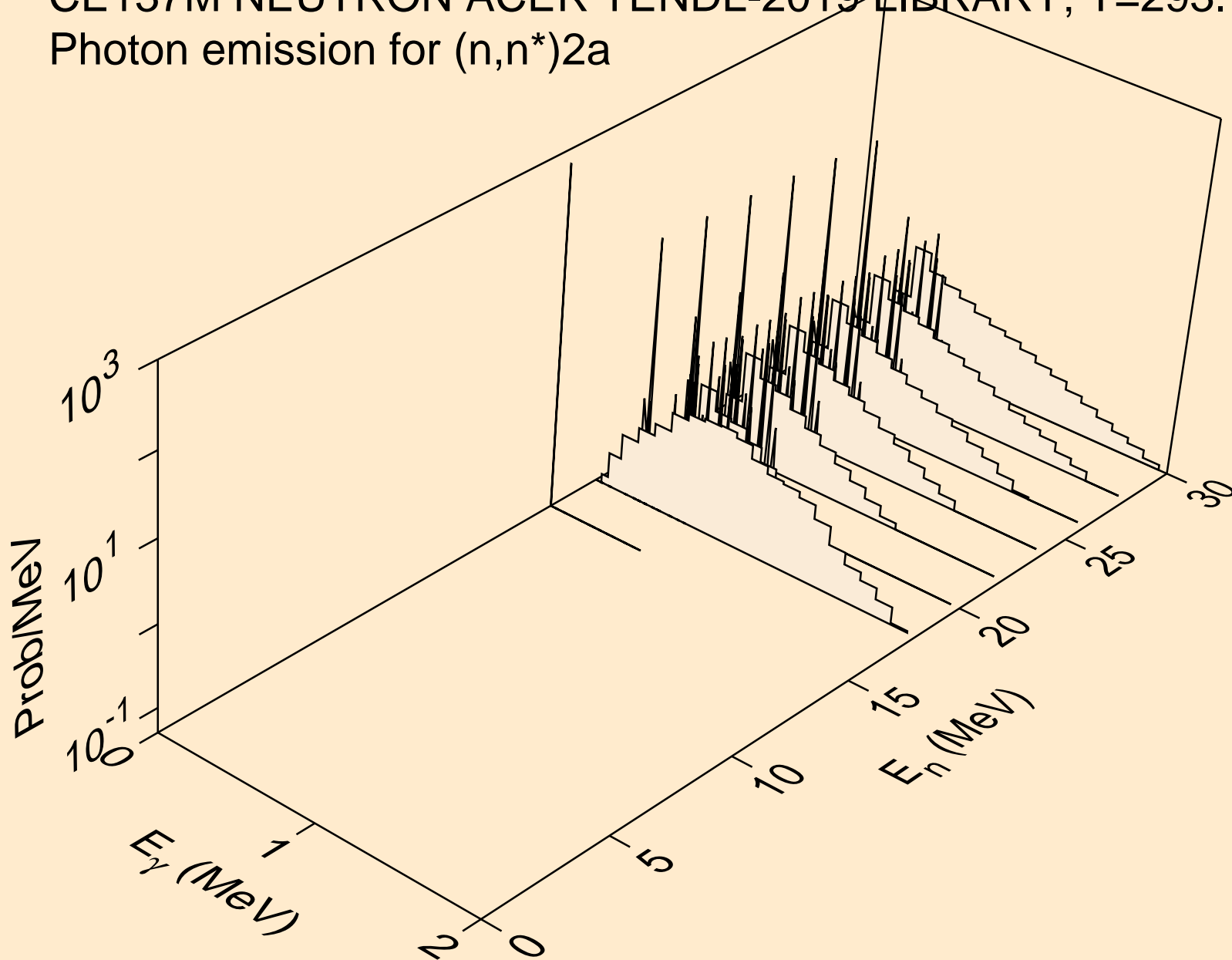

CE137M NEUTRON ACER TENDL-2019 LIBRARY; T=293.16K
Photon emission for (n,n*)d

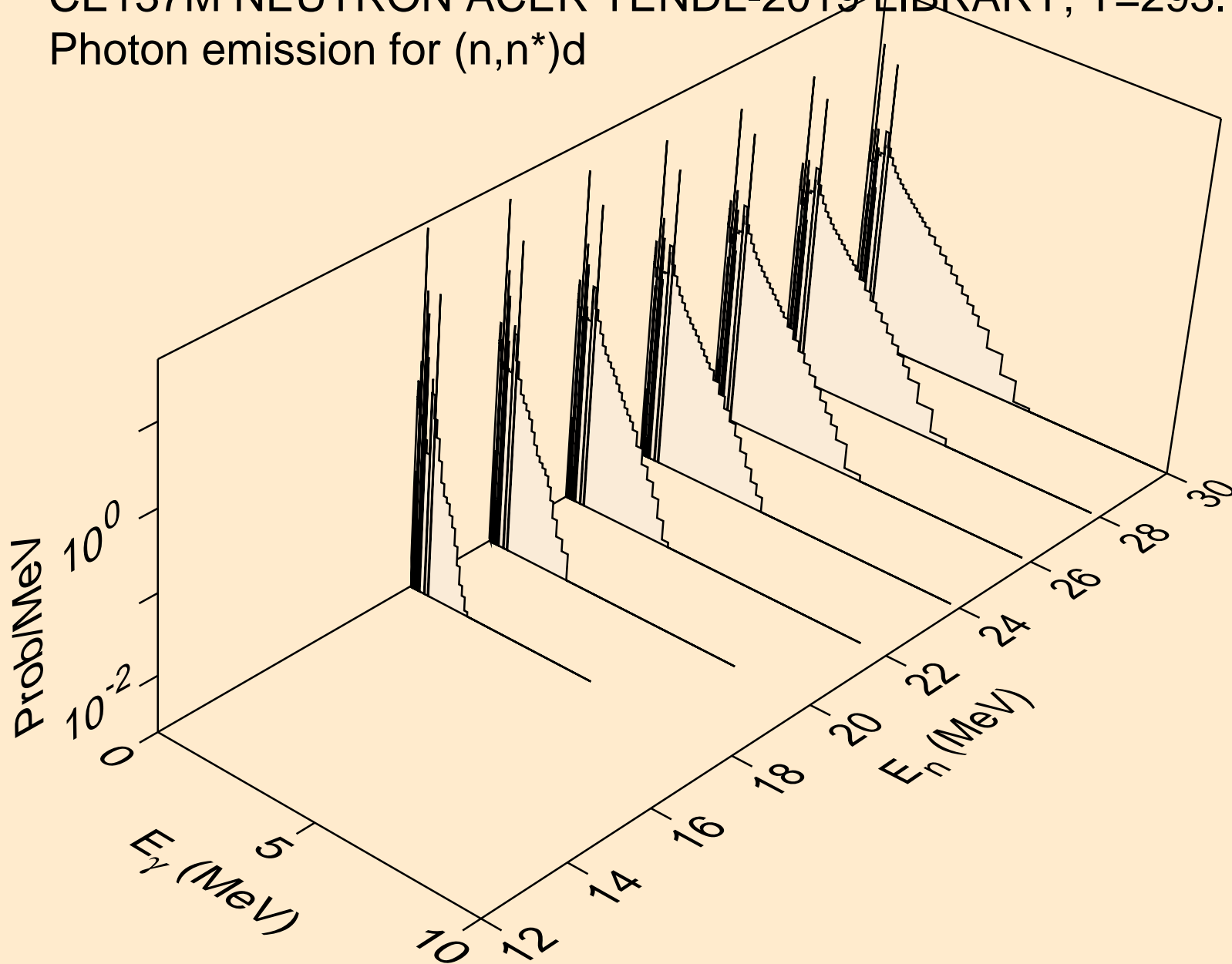

CE137M NEUTRON ACER TENDL-2019 LIBRARY; T=293.16K
Photon emission for (n,n*)t

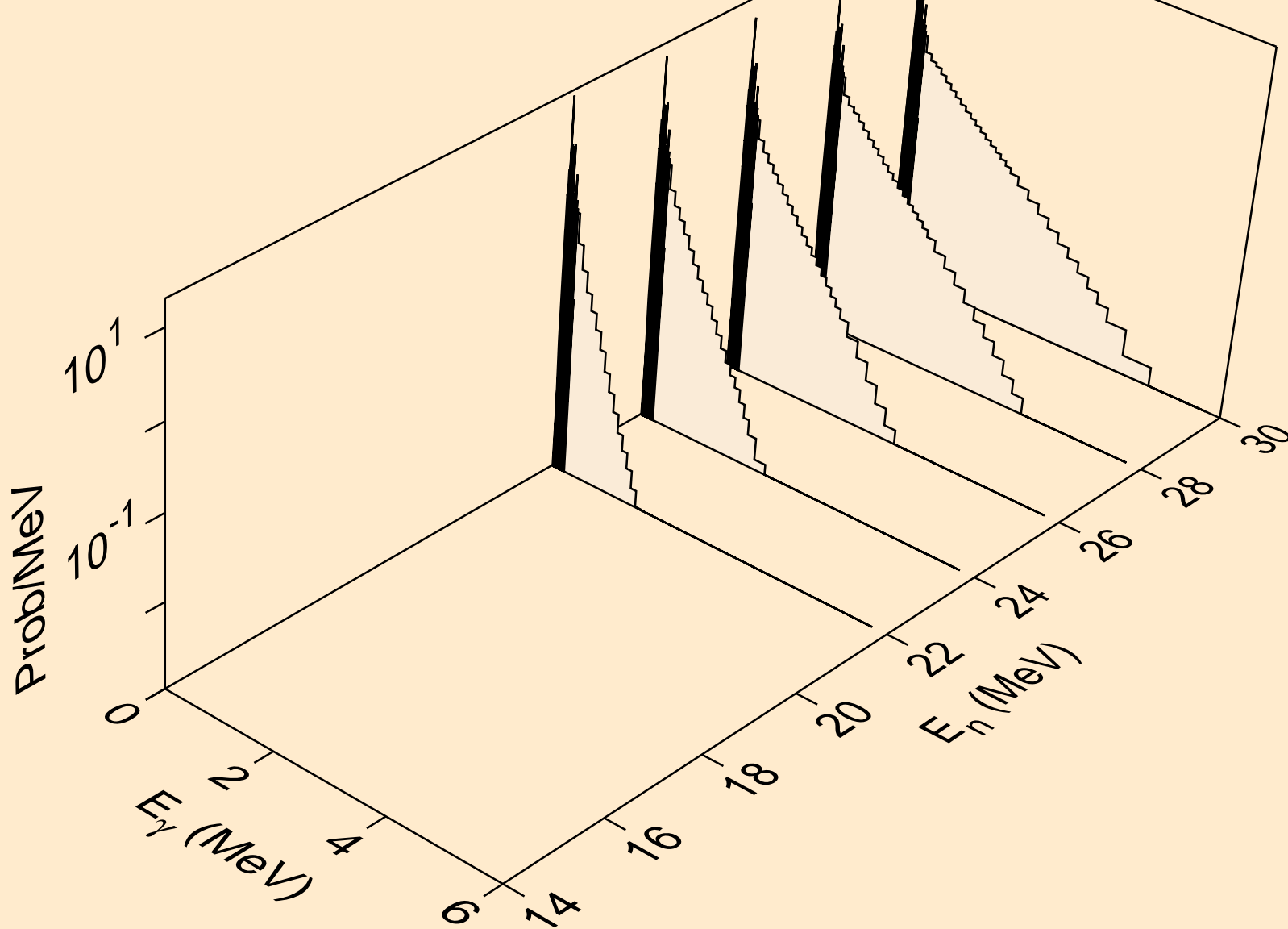

CE137M NEUTRON ACER TENDL-2019 LIBRARY; T=293.16K
Photon emission for (n,n*)he3

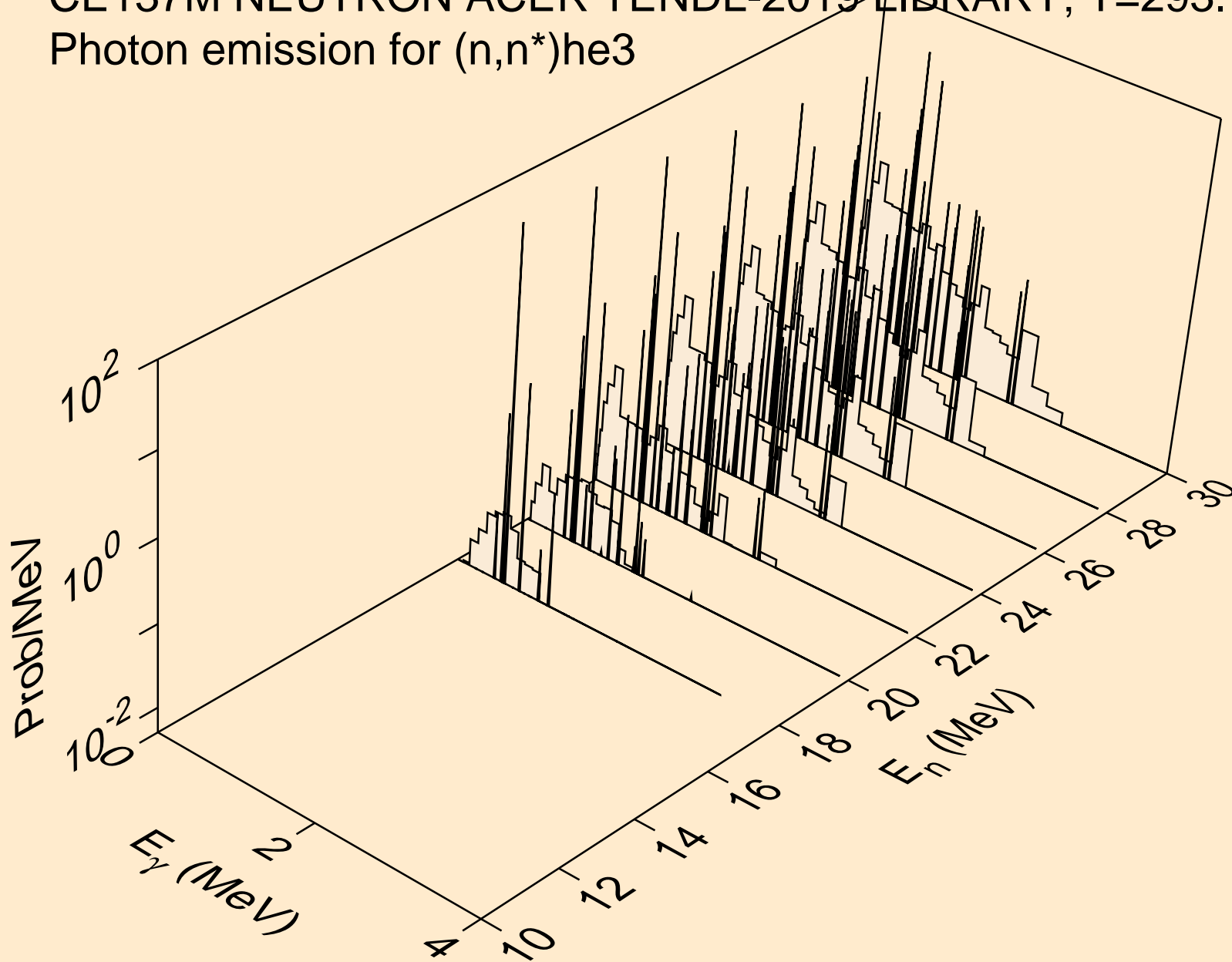

CE137M NEUTRON ACER TENDL-2019 LIBRARY; T=293.16K
Photon emission for (n,4n)

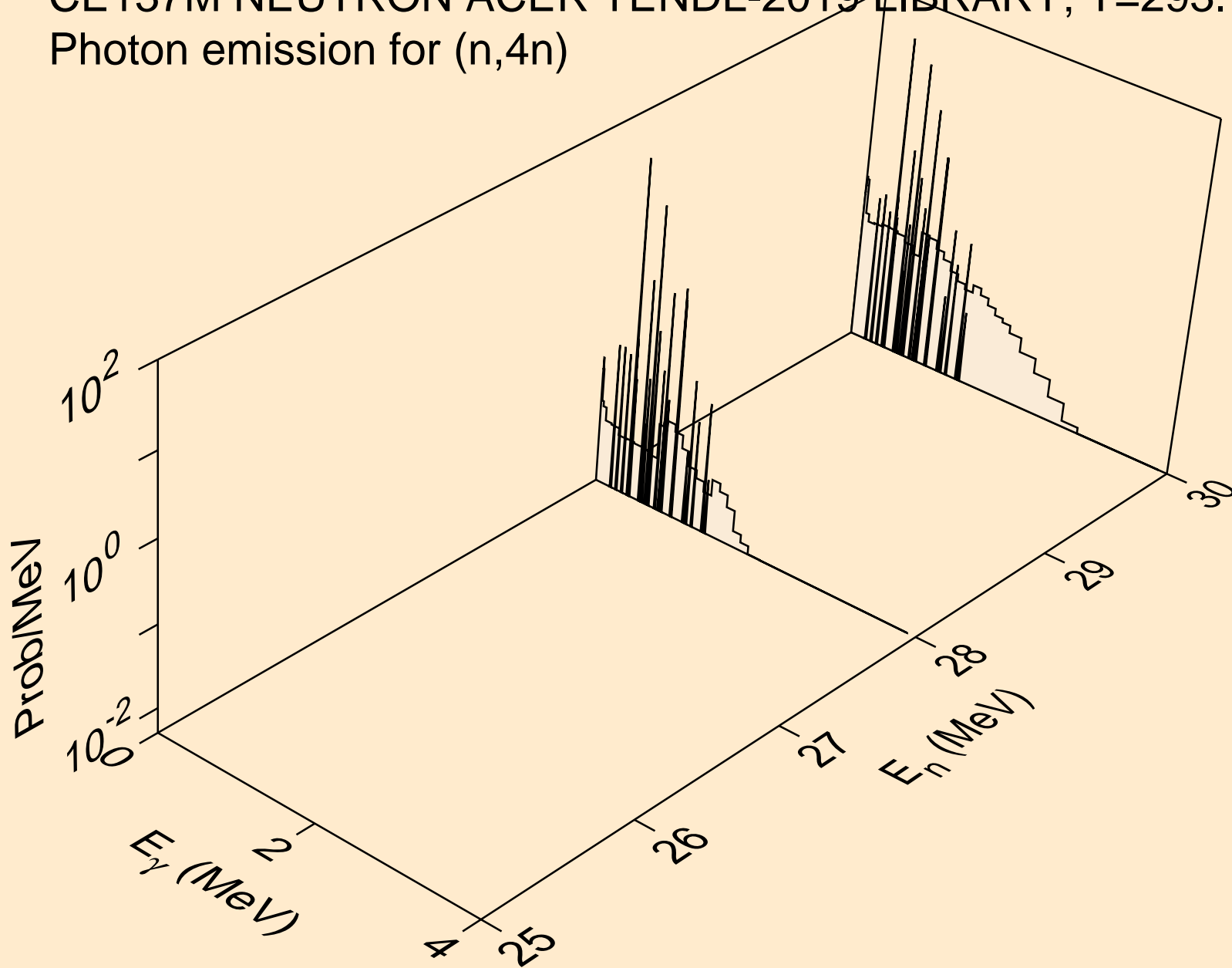

CE137M NEUTRON ACER TENDL-2019 LIBRARY; T=293.16K
Photon emission for (n,2np)

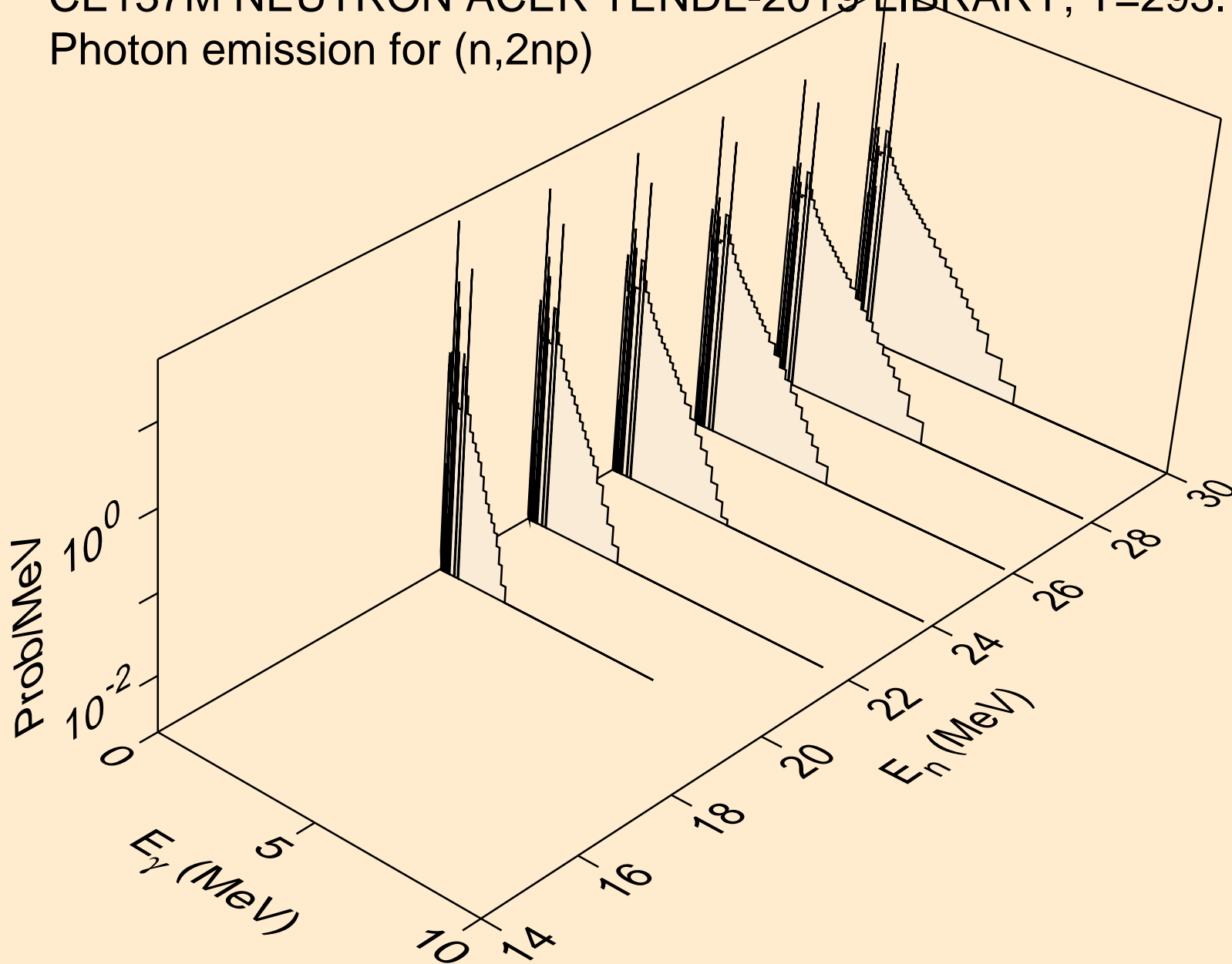

CE137M NEUTRON ACER TENDL-2019 LIBRARY; T=293.16K
Photon emission for (n,3np)

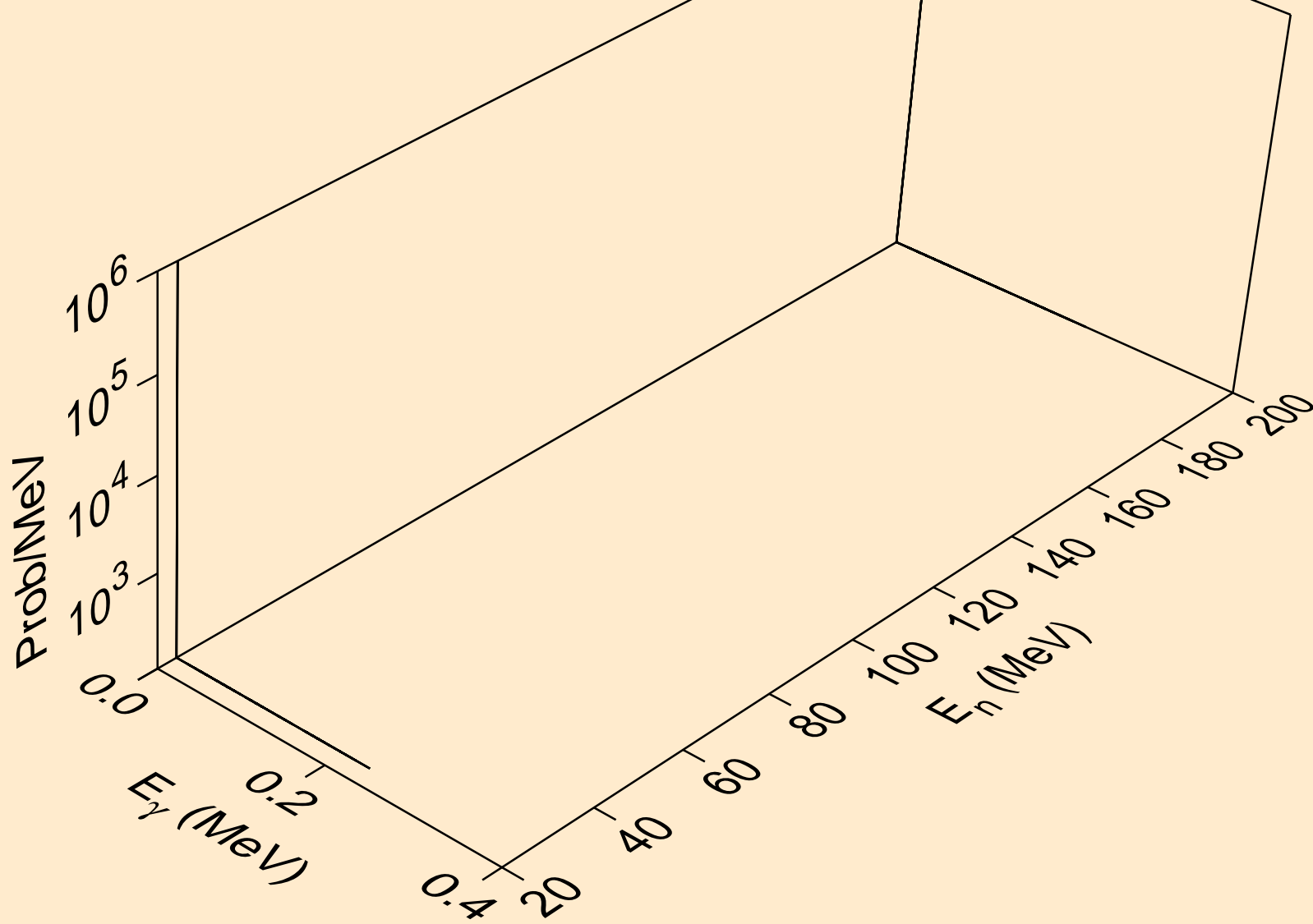

CE137M NEUTRON ACER TENDL-2019 LIBRARY; T=293.16K
Photon emission for (n,2np)

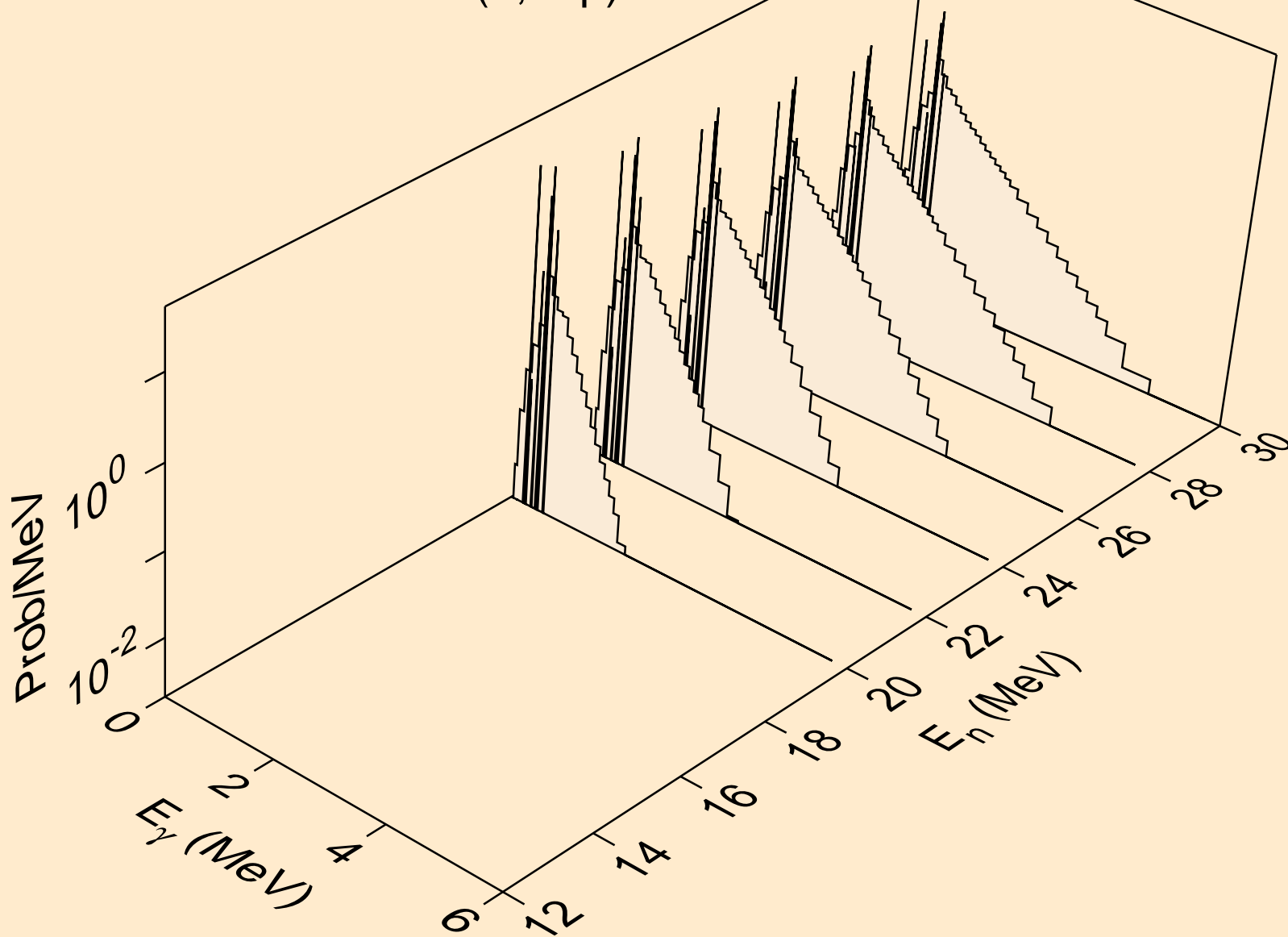

CE137M NEUTRON ACER TENDL-2019 LIBRARY; T=293.16K
Photon emission for (n,npa)

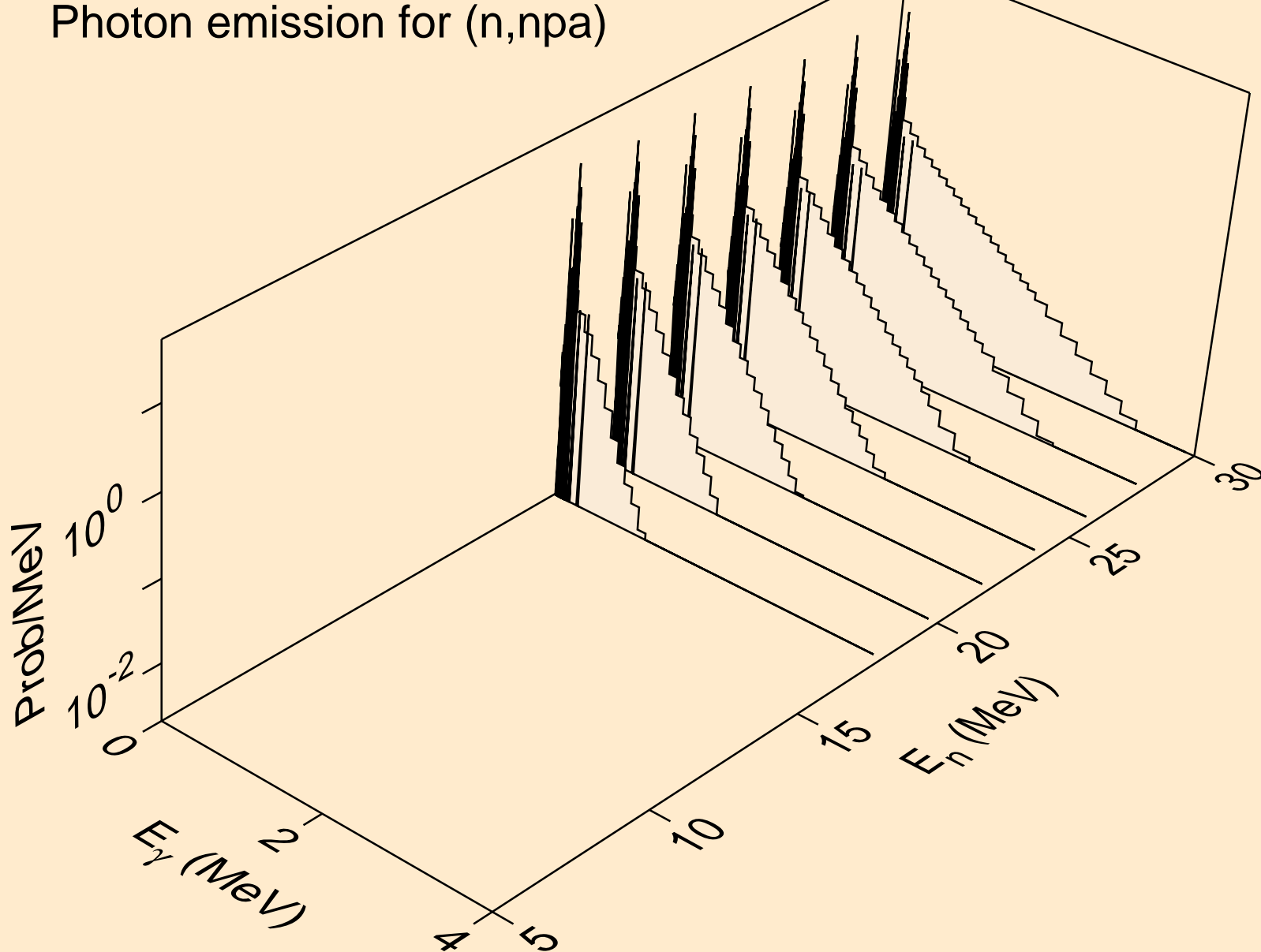

CE137M NEUTRON ACER TENDL-2019 LIBRARY; T=293.16K
Photon emission for (n,n*1)

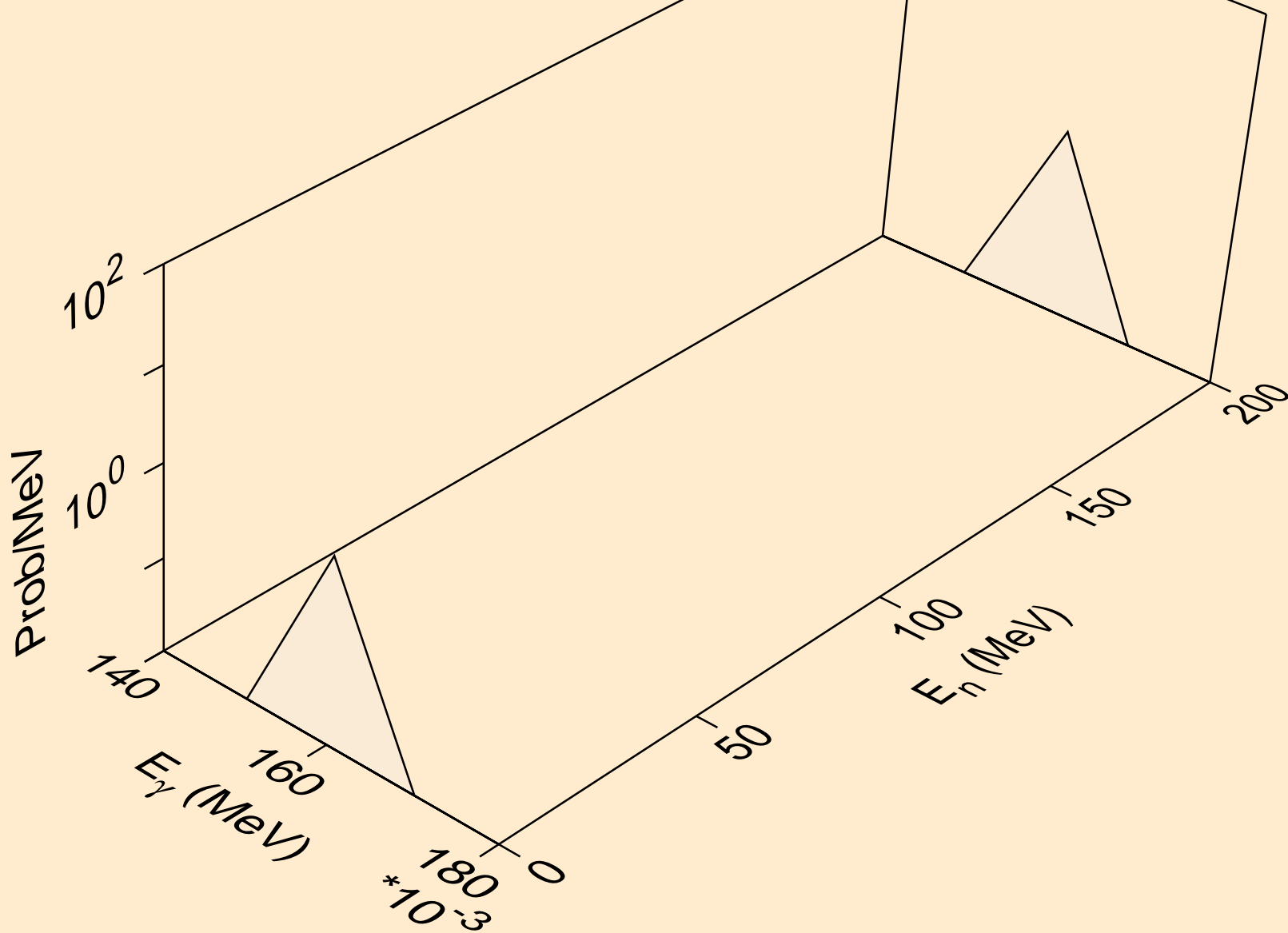

CE137M NEUTRON ACER TENDL-2019 LIBRARY; T=293.16K
Photon emission for (n,n*3)

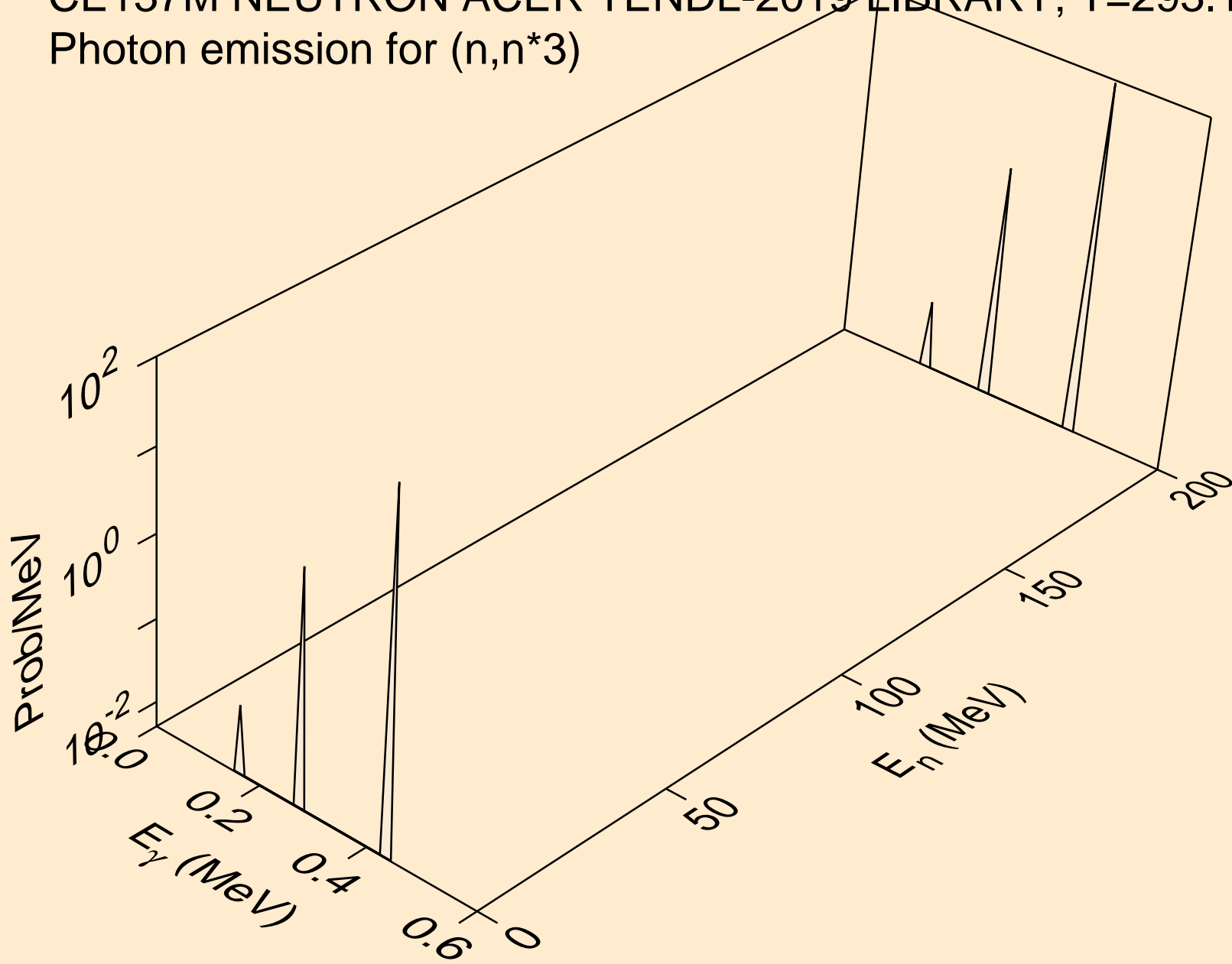

CE137M NEUTRON ACER TENDL-2019 LIBRARY; T=293.16K
Photon emission for (n,n*4)

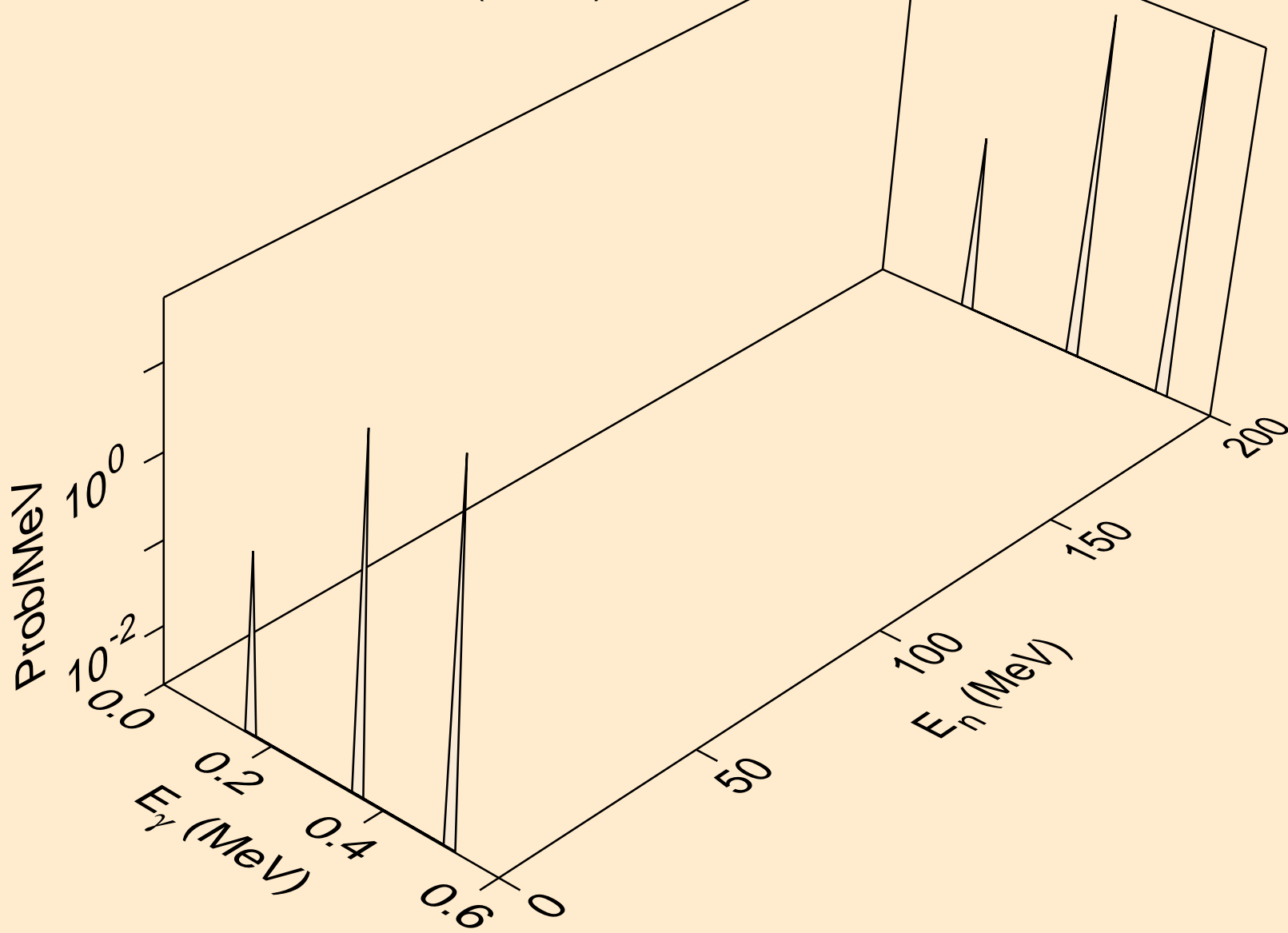

CE137M NEUTRON ACER TENDL-2019 LIBRARY; T=293.16K
Photon emission for (n,n*5)

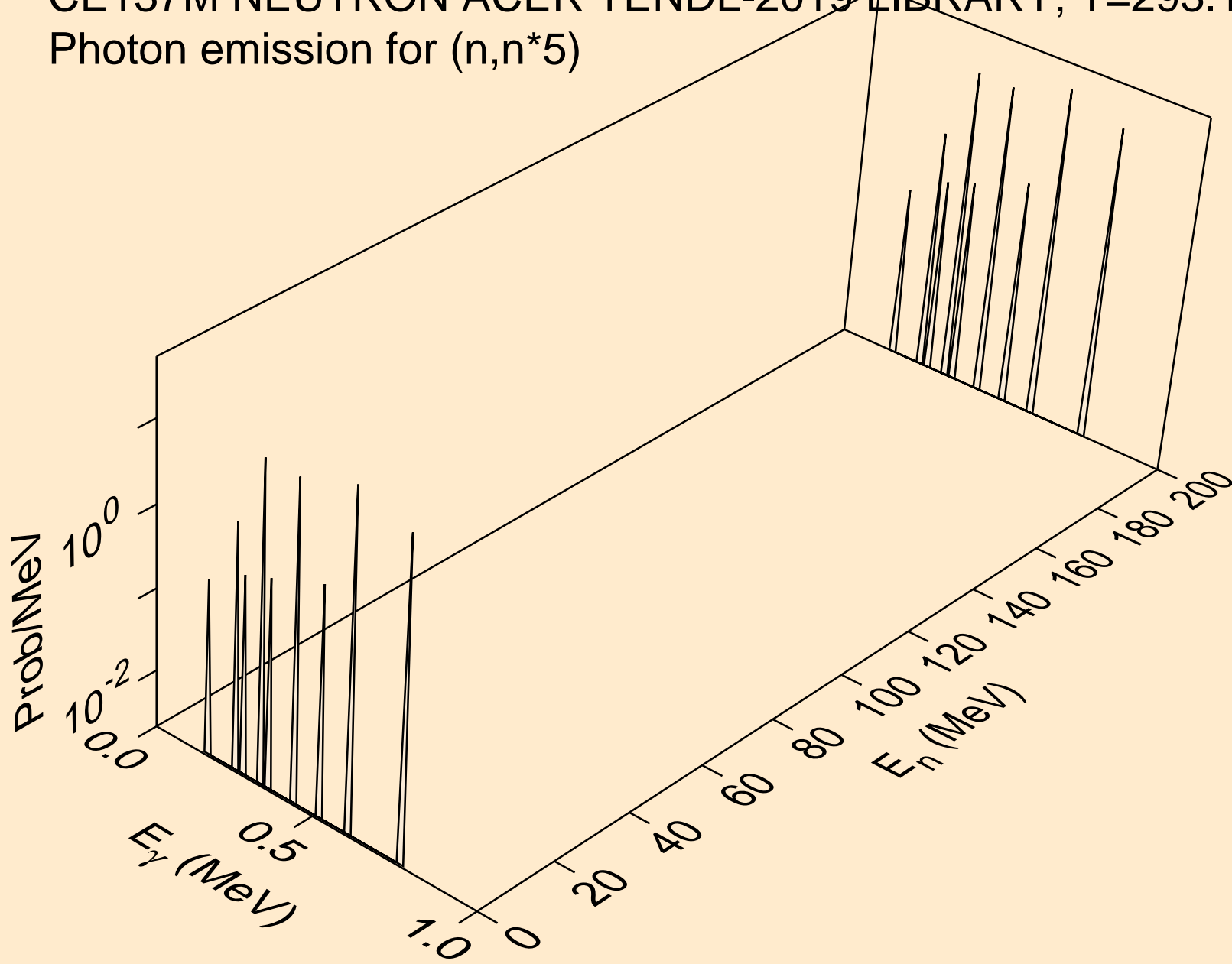

CE137M NEUTRON ACER TENDL-2019 LIBRARY; T=293.16K
Photon emission for (n,n*6)

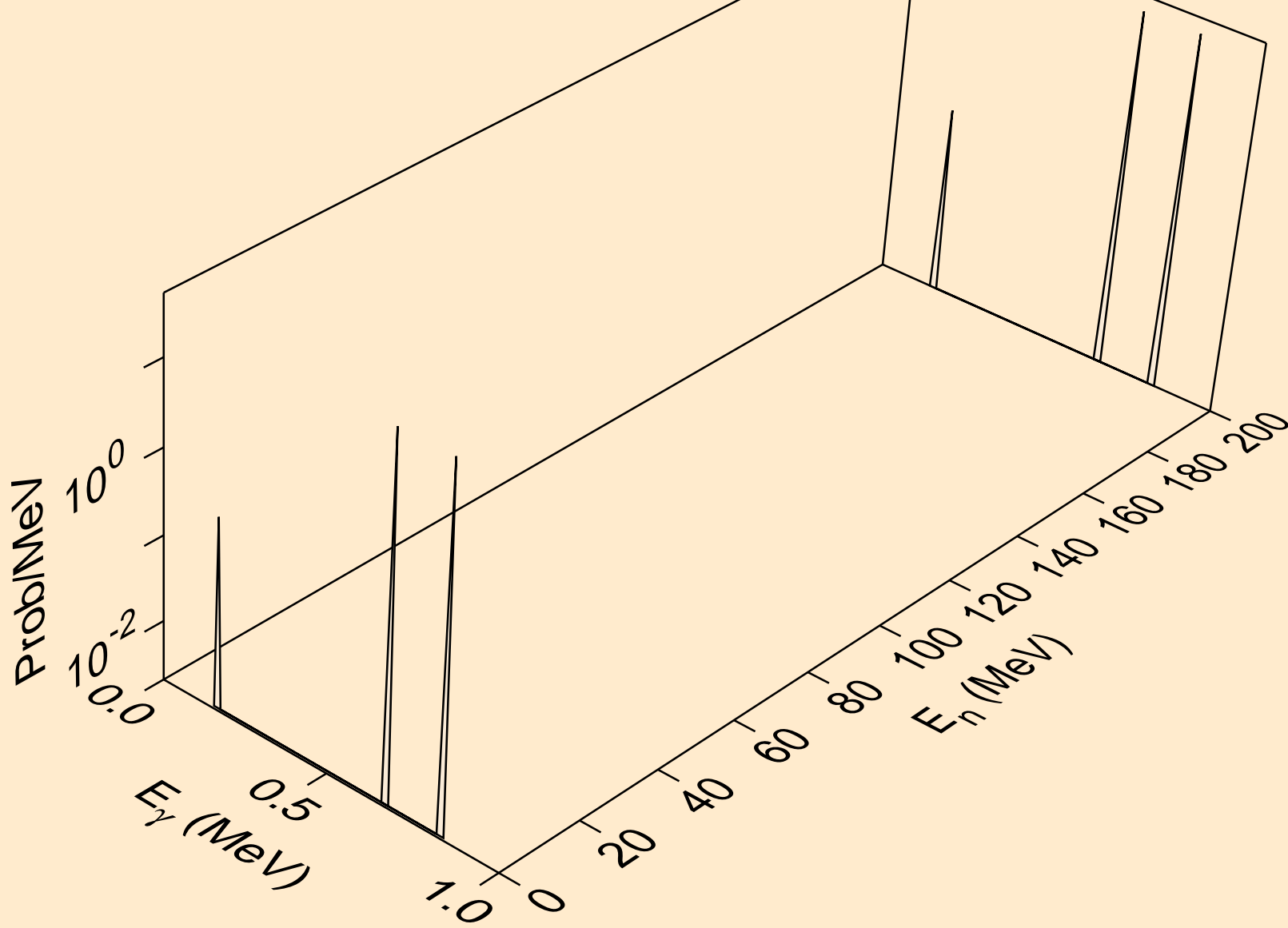

CE137M NEUTRON ACER TENDL-2019 LIBRARY; T=293.16K
Photon emission for (n,n*7)

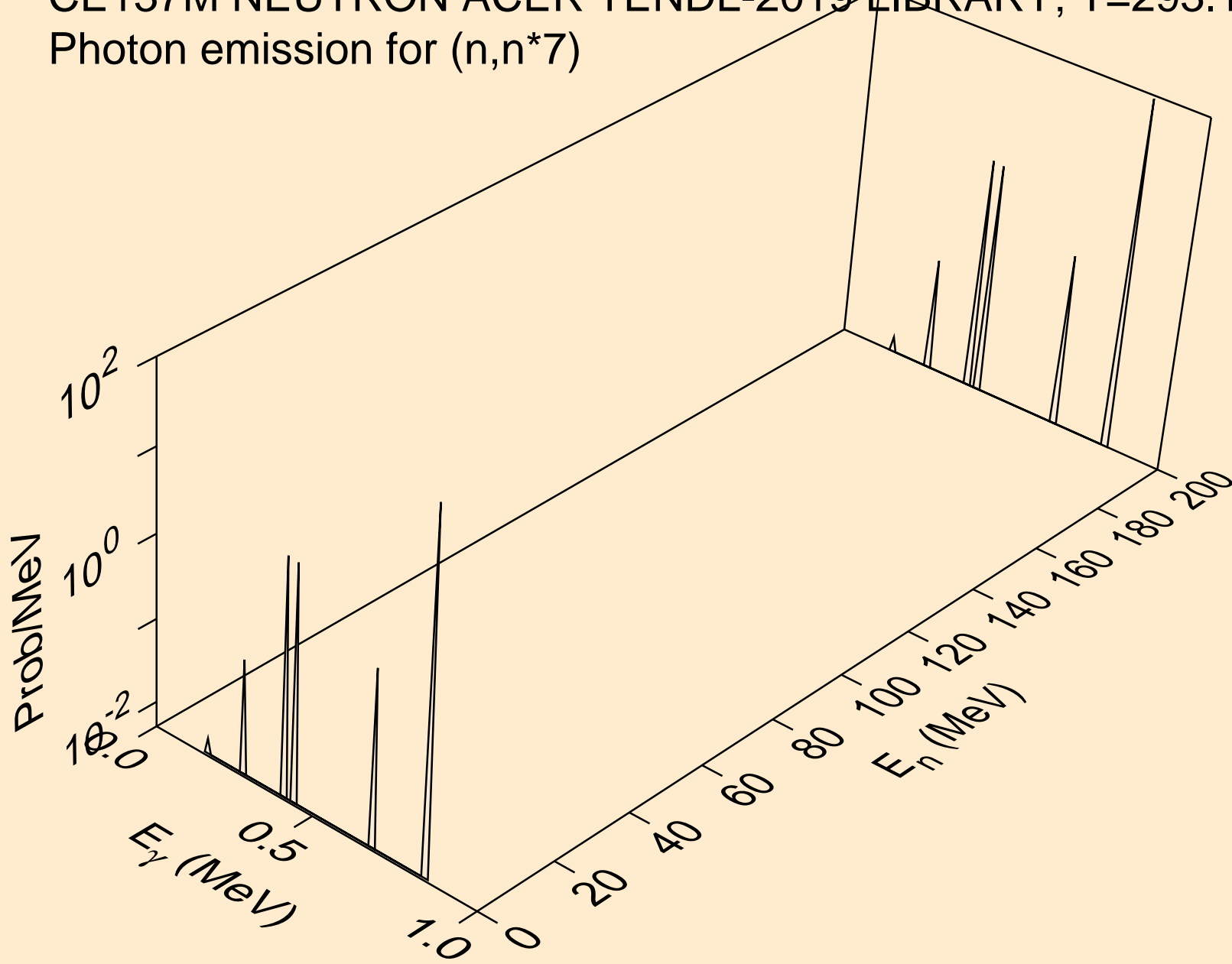

CE137M NEUTRON ACER TENDL-2019 LIBRARY; T=293.16K
Photon emission for (n,n*8)

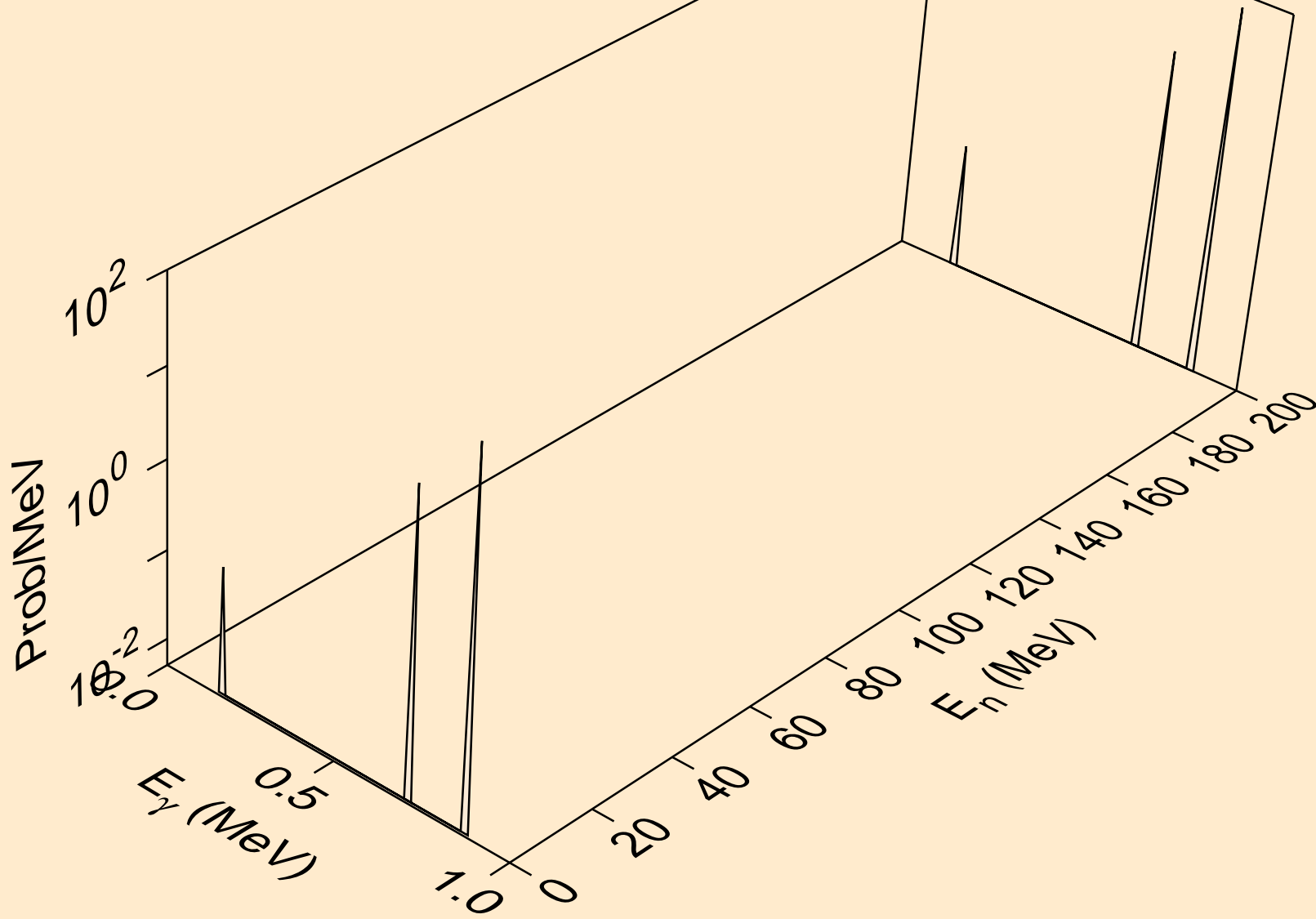

CE137M NEUTRON ACER TENDL-2019 LIBRARY; T=293.16K
Photon emission for (n,n*9)

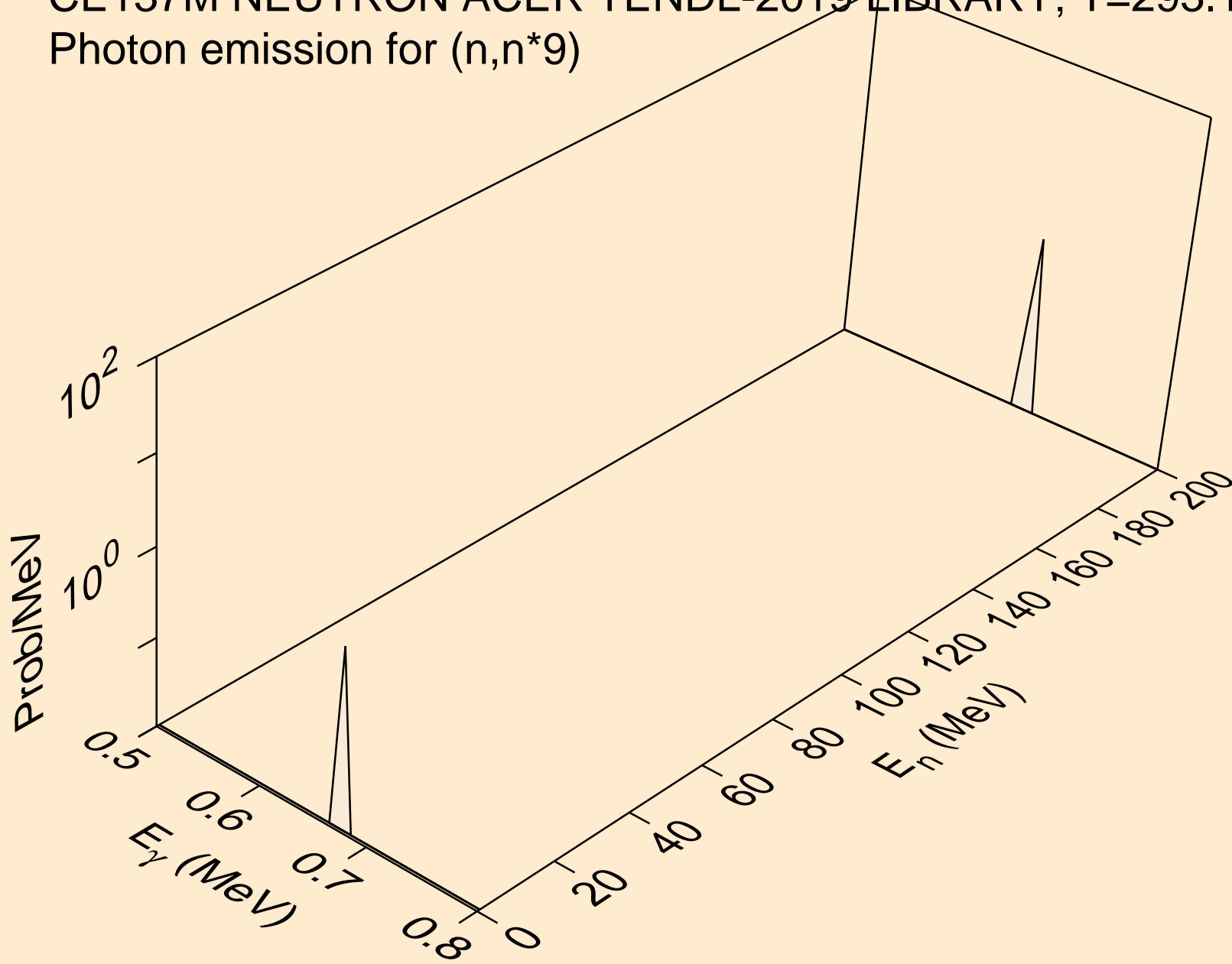

CE137M NEUTRON ACER TENDL-2019 LIBRARY; T=293.16K
Photon emission for (n,n*10)

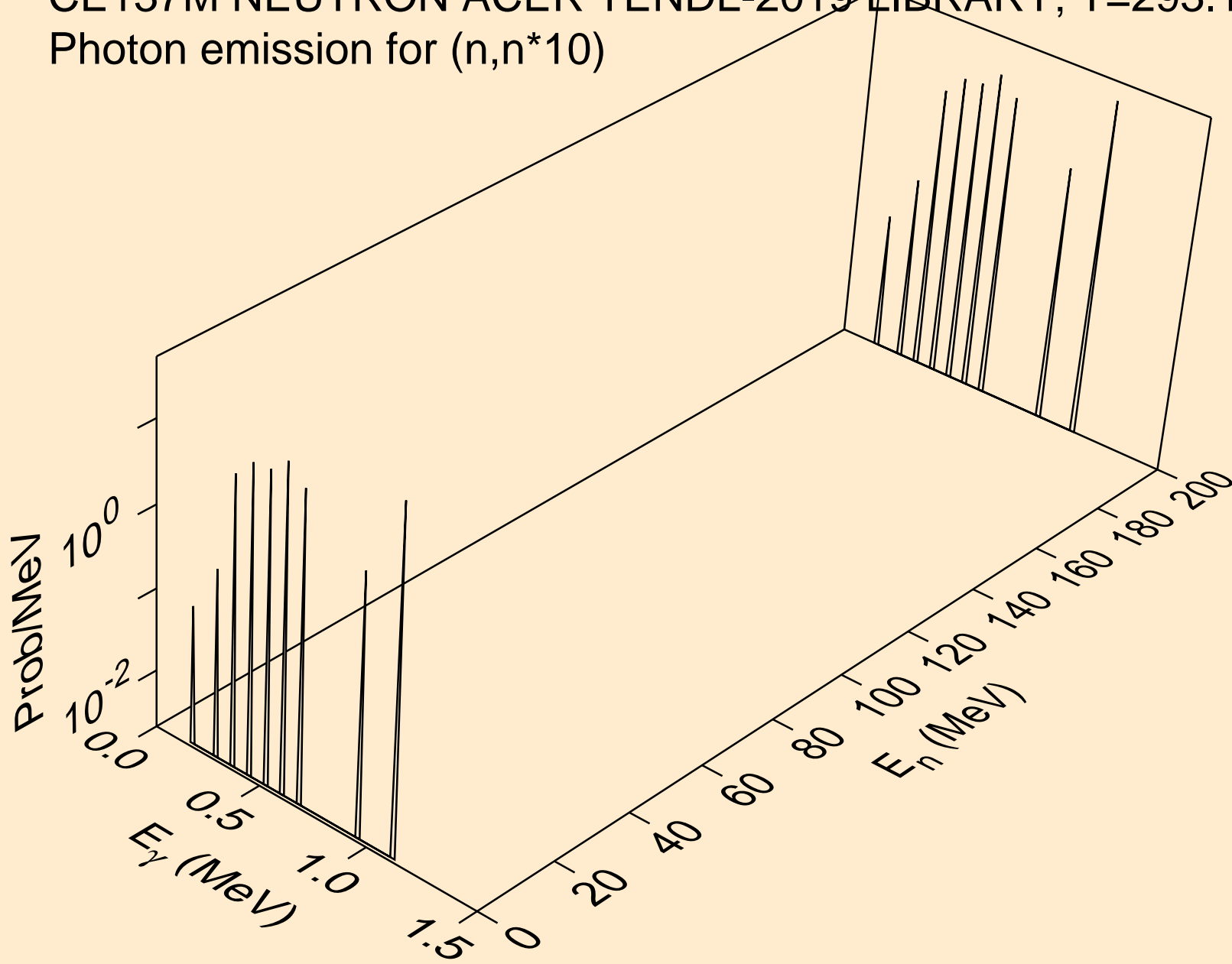

CE137M NEUTRON ACER TENDL-2019 LIBRARY; T=293.16K
Photon emission for (n,n*11)

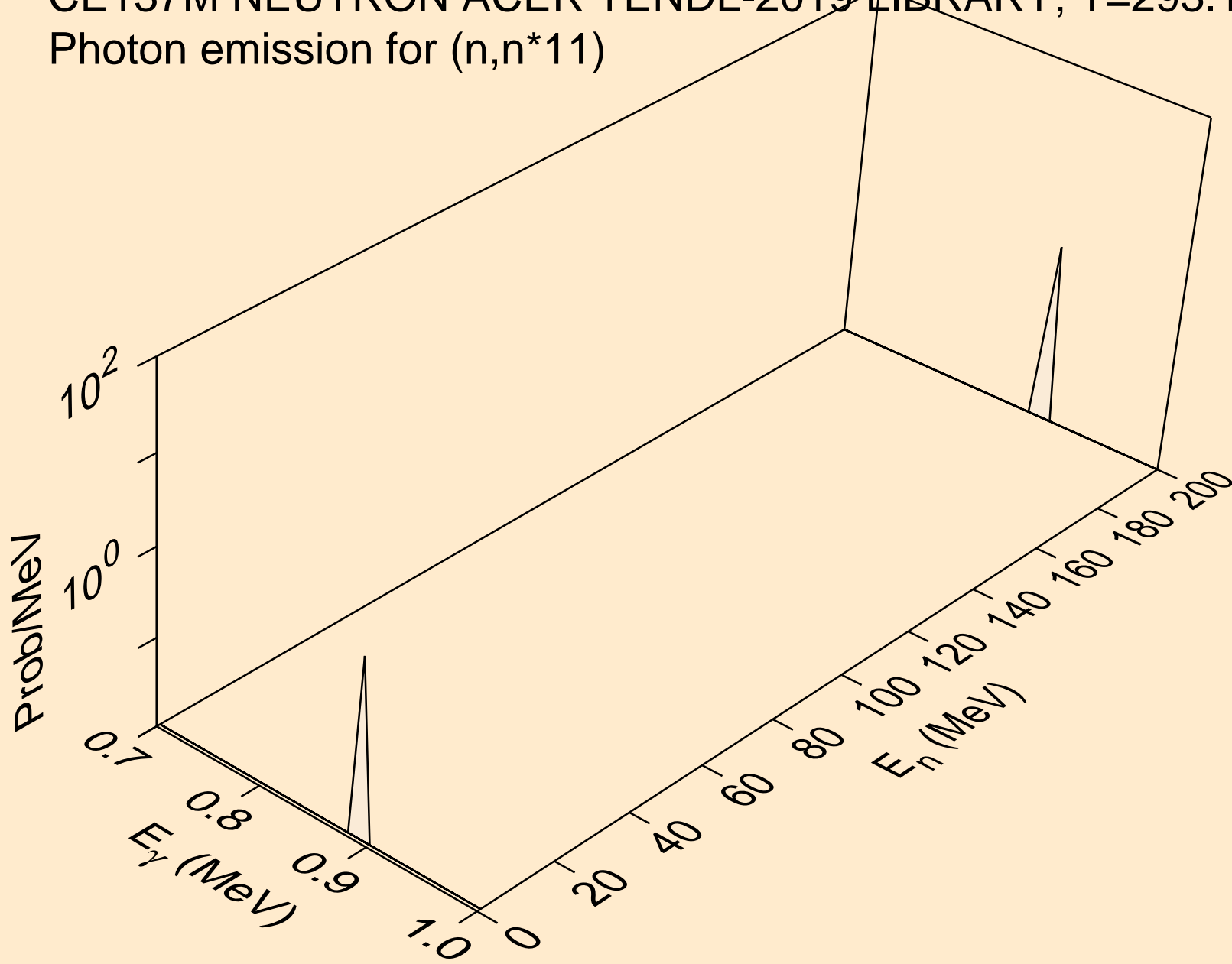

CE137M NEUTRON ACER TENDL-2019 LIBRARY; T=293.16K
Photon emission for (n,n*12)

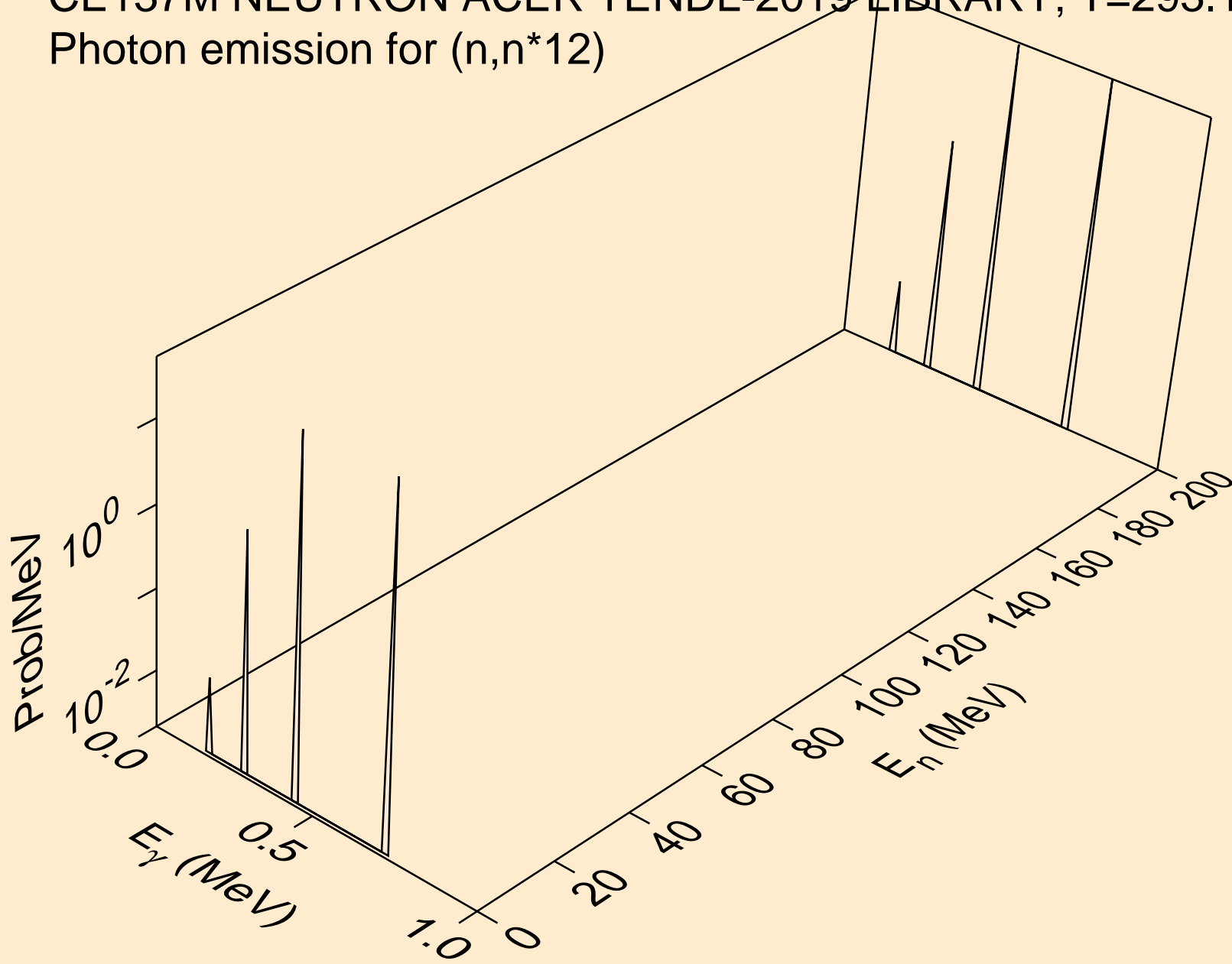

CE137M NEUTRON ACER TENDL-2019 LIBRARY; T=293.16K
Photon emission for (n,n*13)

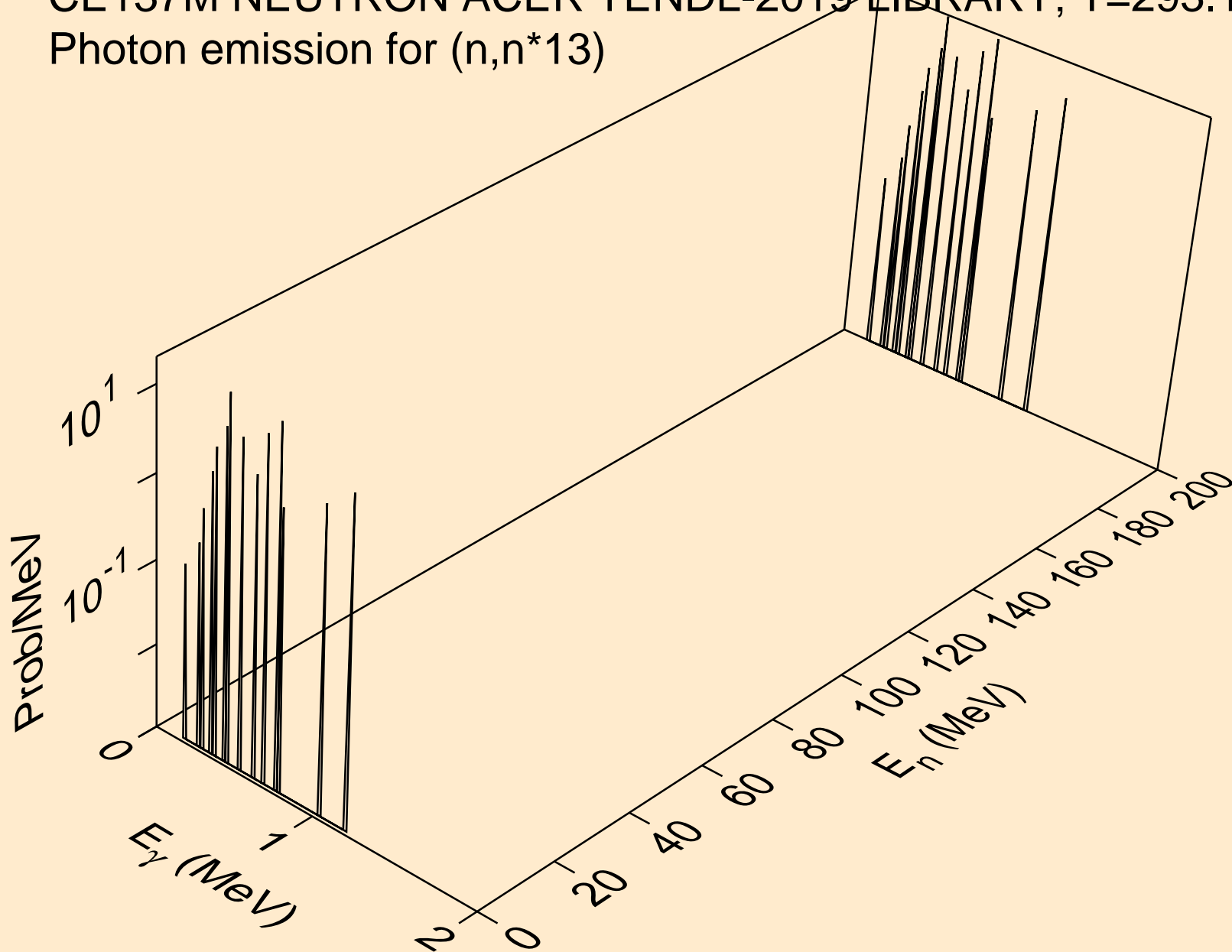

CE137M NEUTRON ACER TENDL-2019 LIBRARY; T=293.16K
Photon emission for (n,n*14)

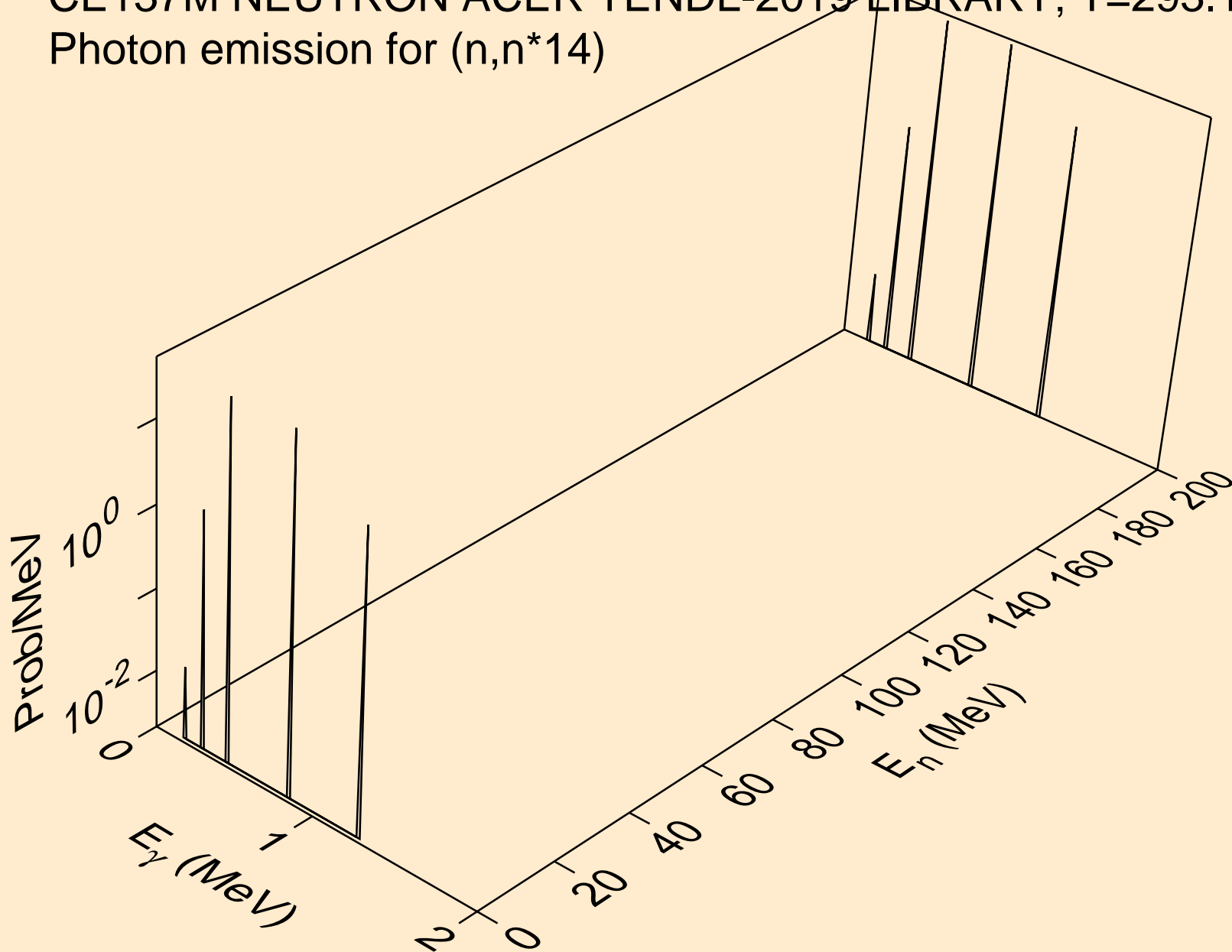

CE137M NEUTRON ACER TENDL-2019 LIBRARY; T=293.16K
Photon emission for (n,n*15)

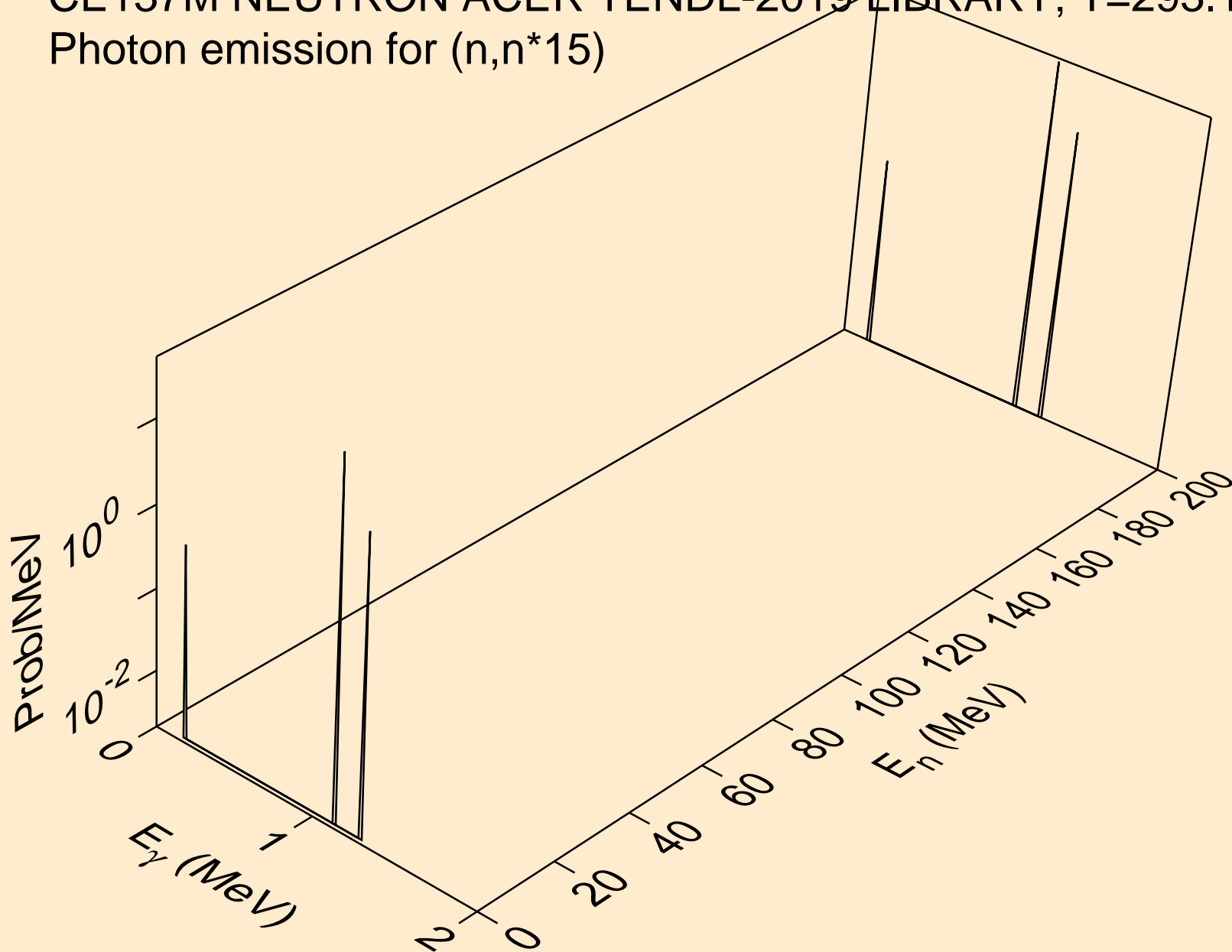

CE137M NEUTRON ACER TENDL-2019 LIBRARY; T=293.16K
Photon emission for (n,n*16)

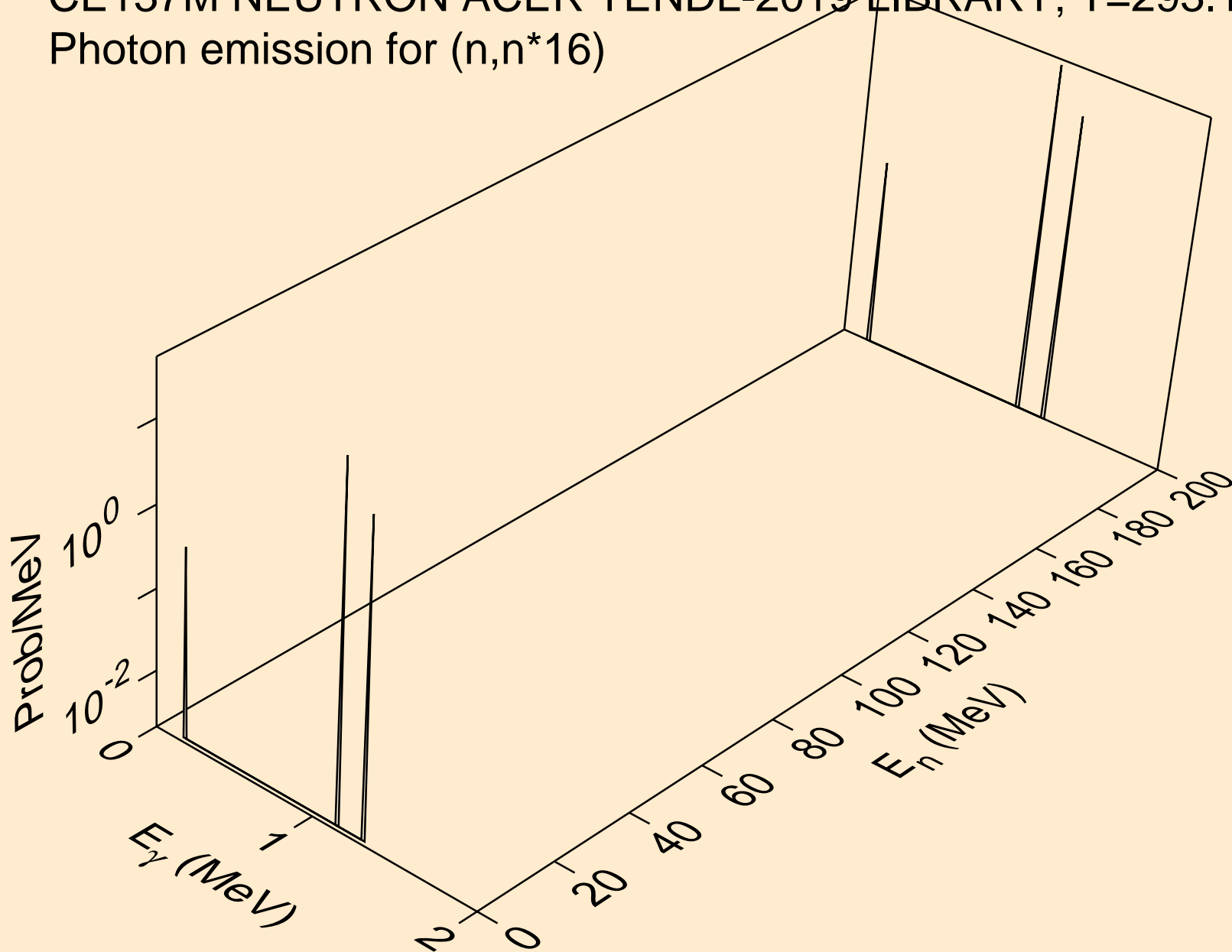

CE137M NEUTRON ACER TENDL-2019 LIBRARY; T=293.16K
Photon emission for (n,n*17)

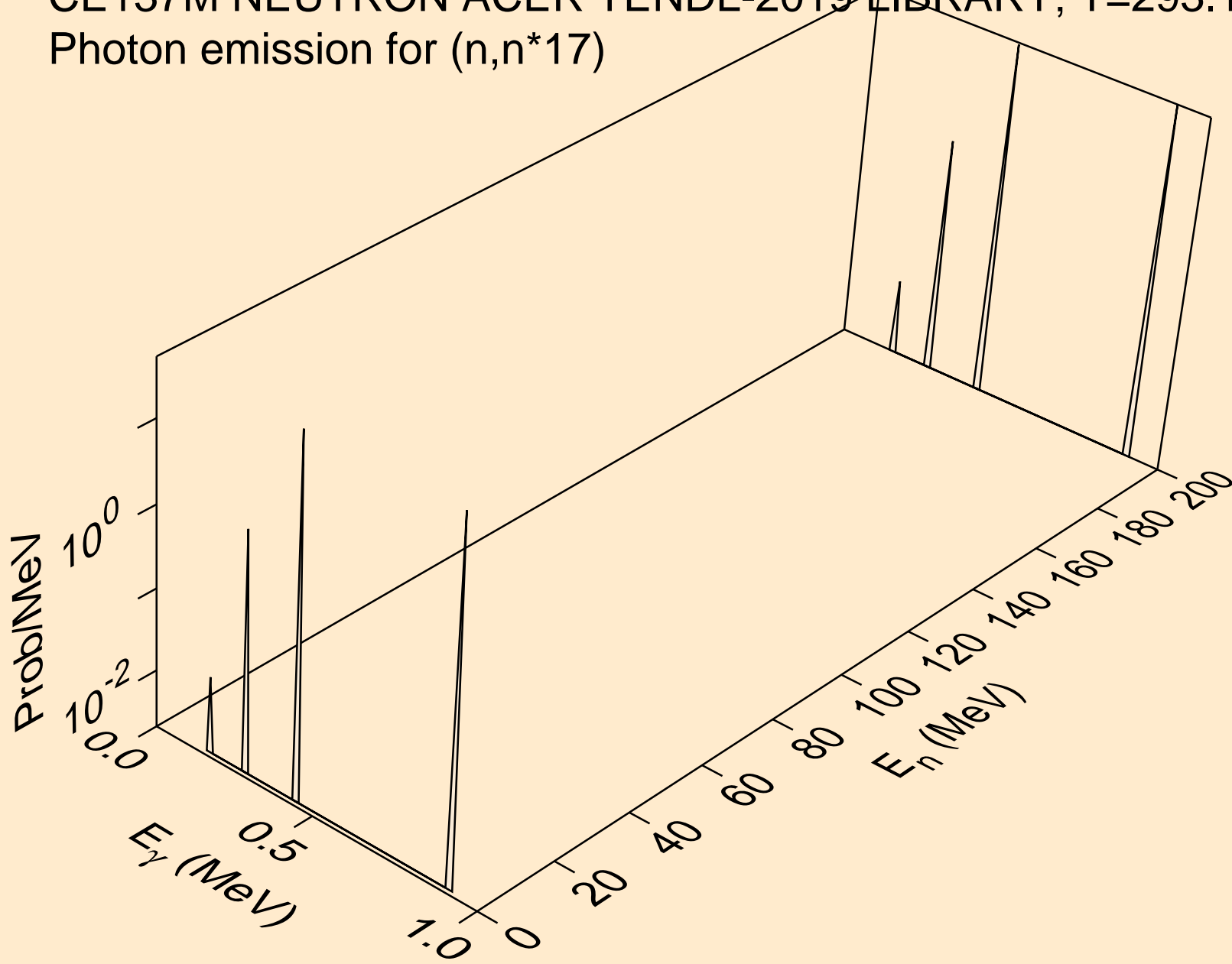

CE137M NEUTRON ACER TENDL-2019 LIBRARY; T=293.16K
Photon emission for (n,n*18)

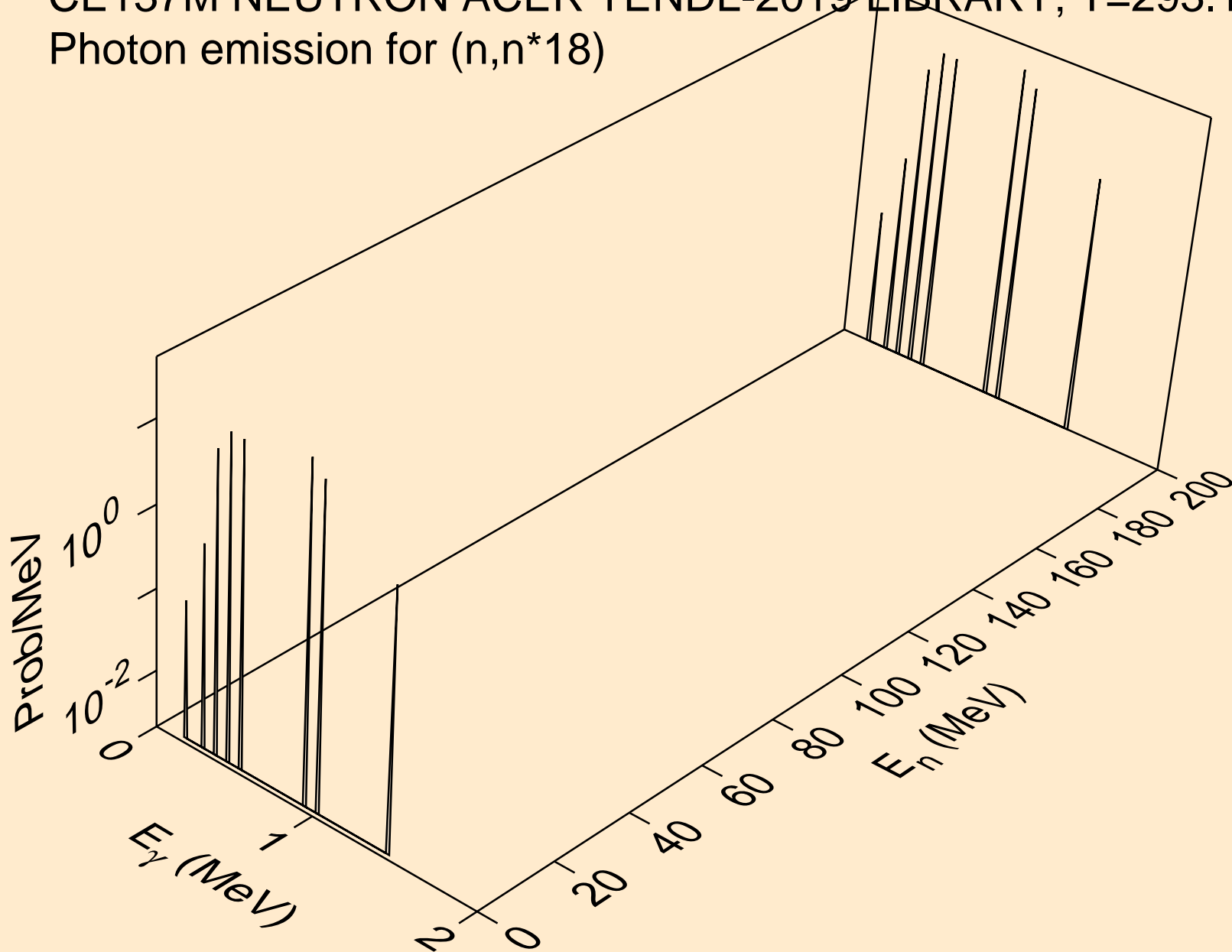

CE137M NEUTRON ACER TENDL-2019 LIBRARY; T=293.16K
Photon emission for (n,n*19)

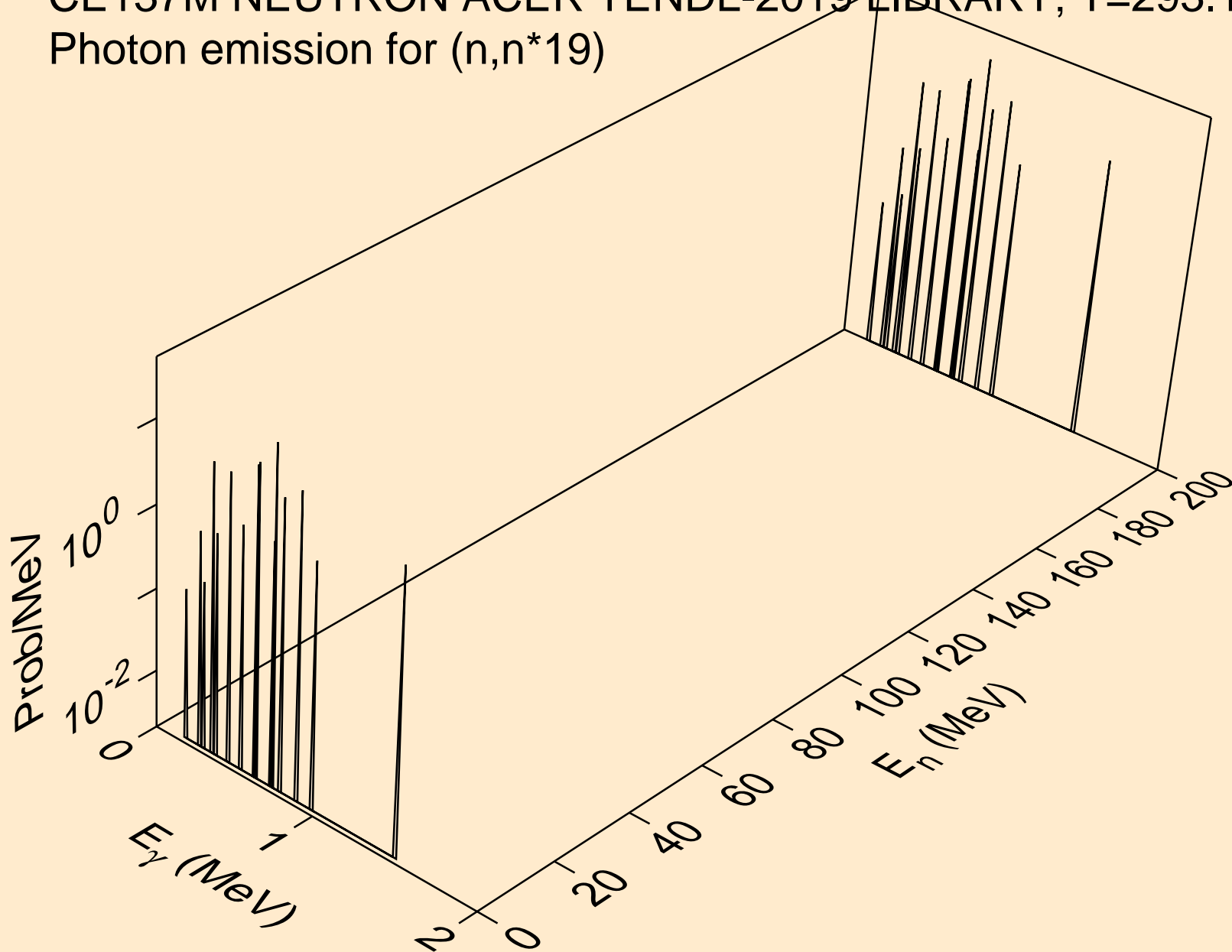

CE137M NEUTRON ACER TENDL-2019 LIBRARY; T=293.16K
Photon emission for (n,n*20)

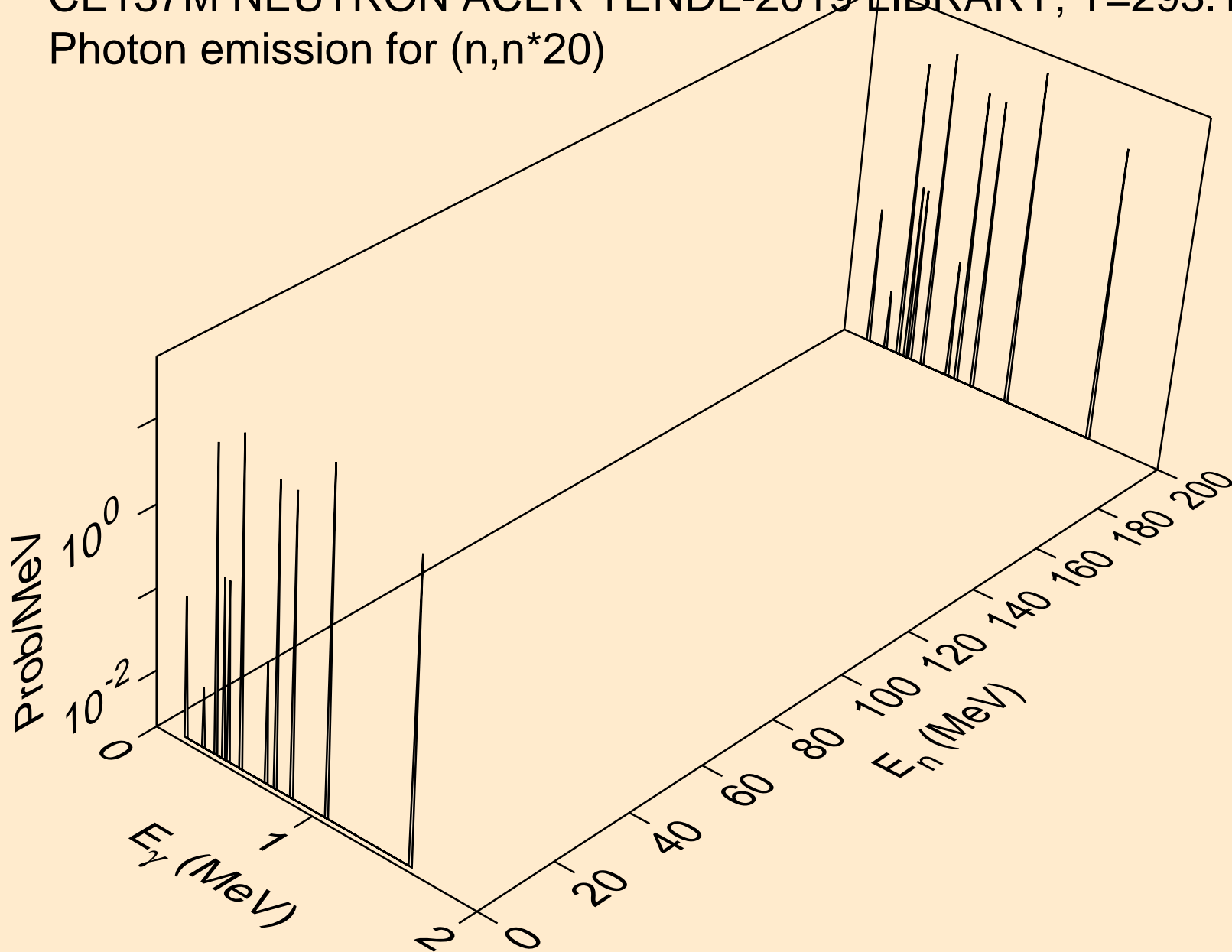

CE137M NEUTRON ACER TENDL-2019 LIBRARY; T=293.16K
Photon emission for (n,n*c)

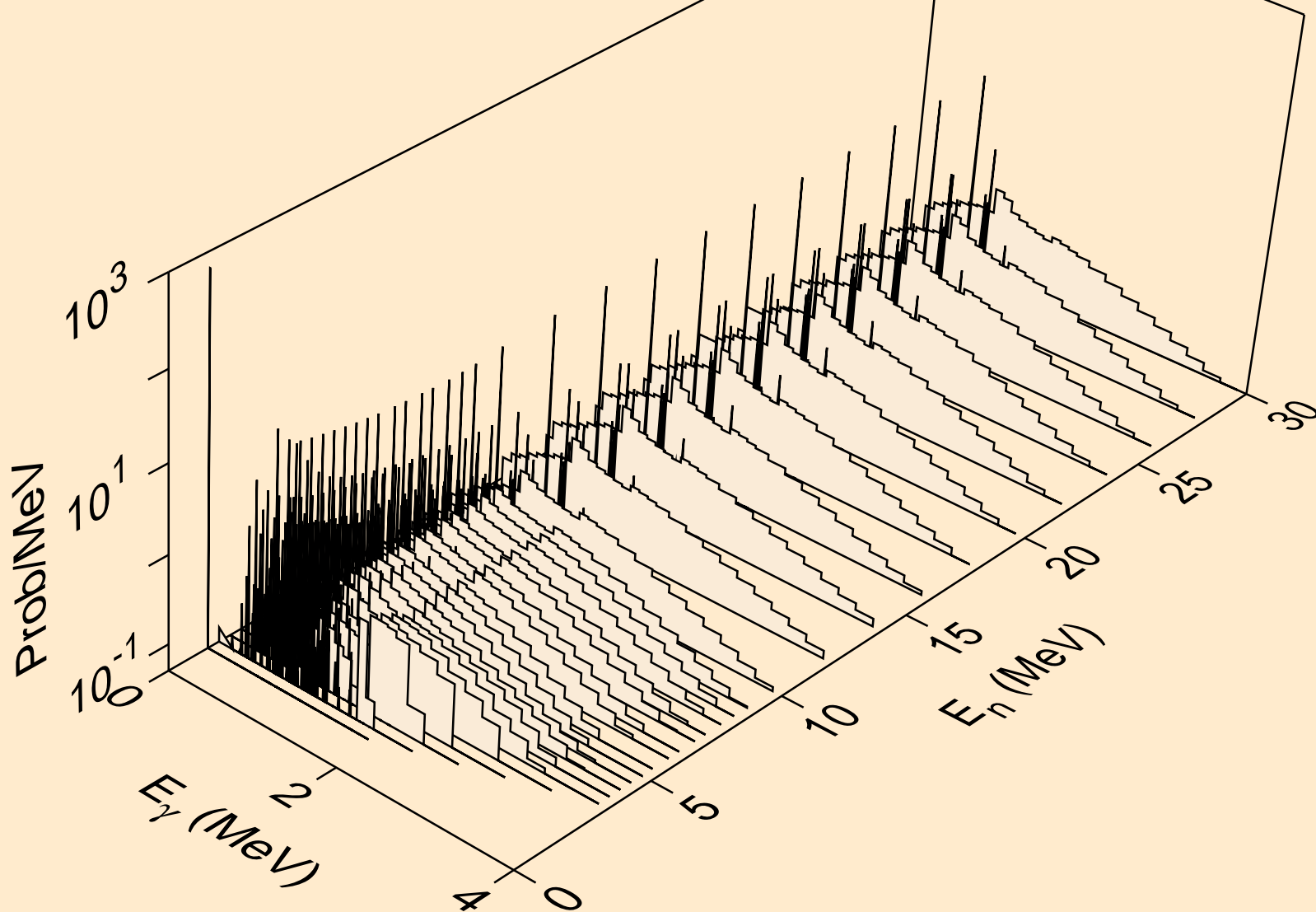

CE137M NEUTRON ACER TENDL-2019 LIBRARY; T=293.16K
Photon emission for (n,gma)

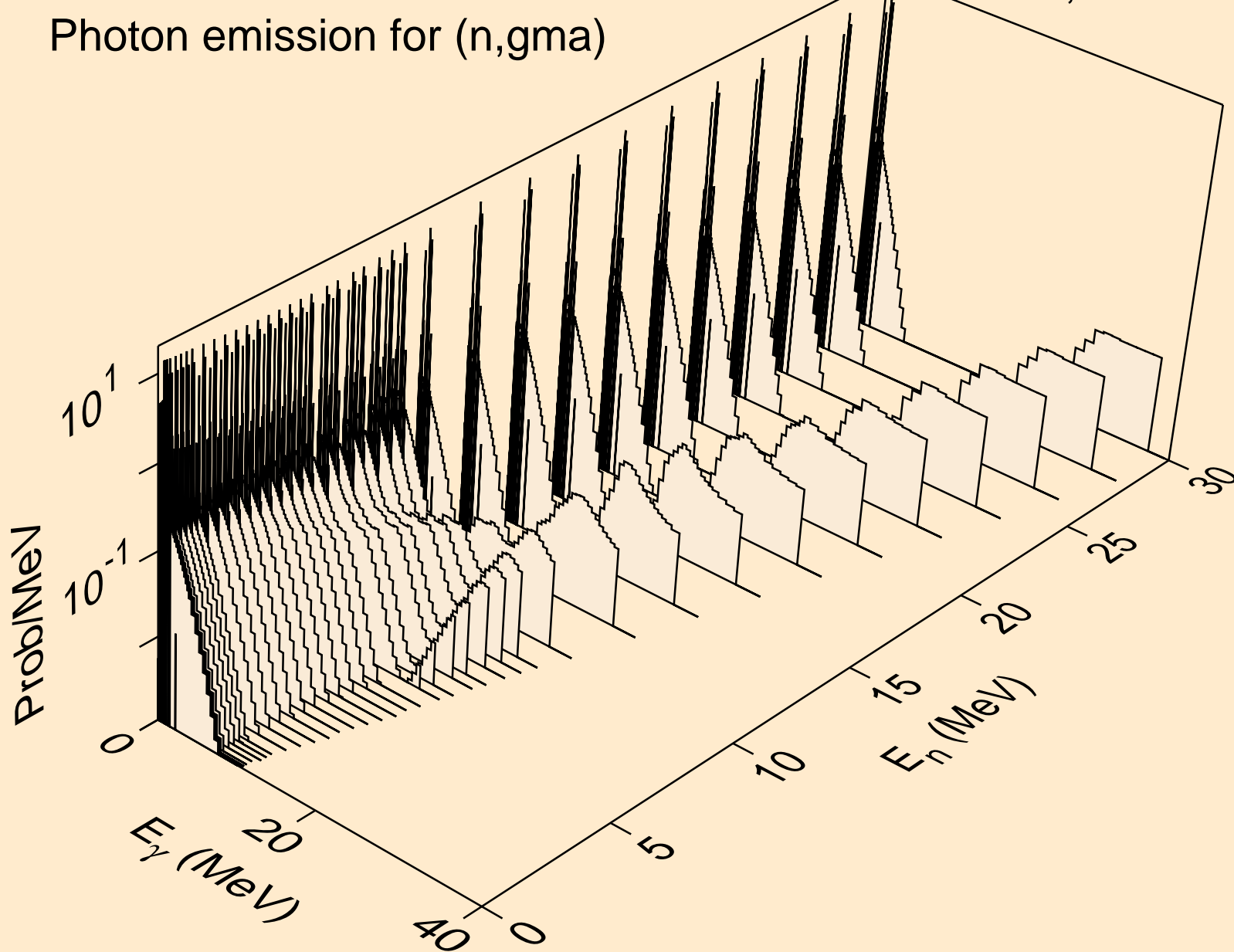

CE137M NEUTRON ACER TENDL-2019 LIBRARY; T=293.16K
Photon emission for (n,p)

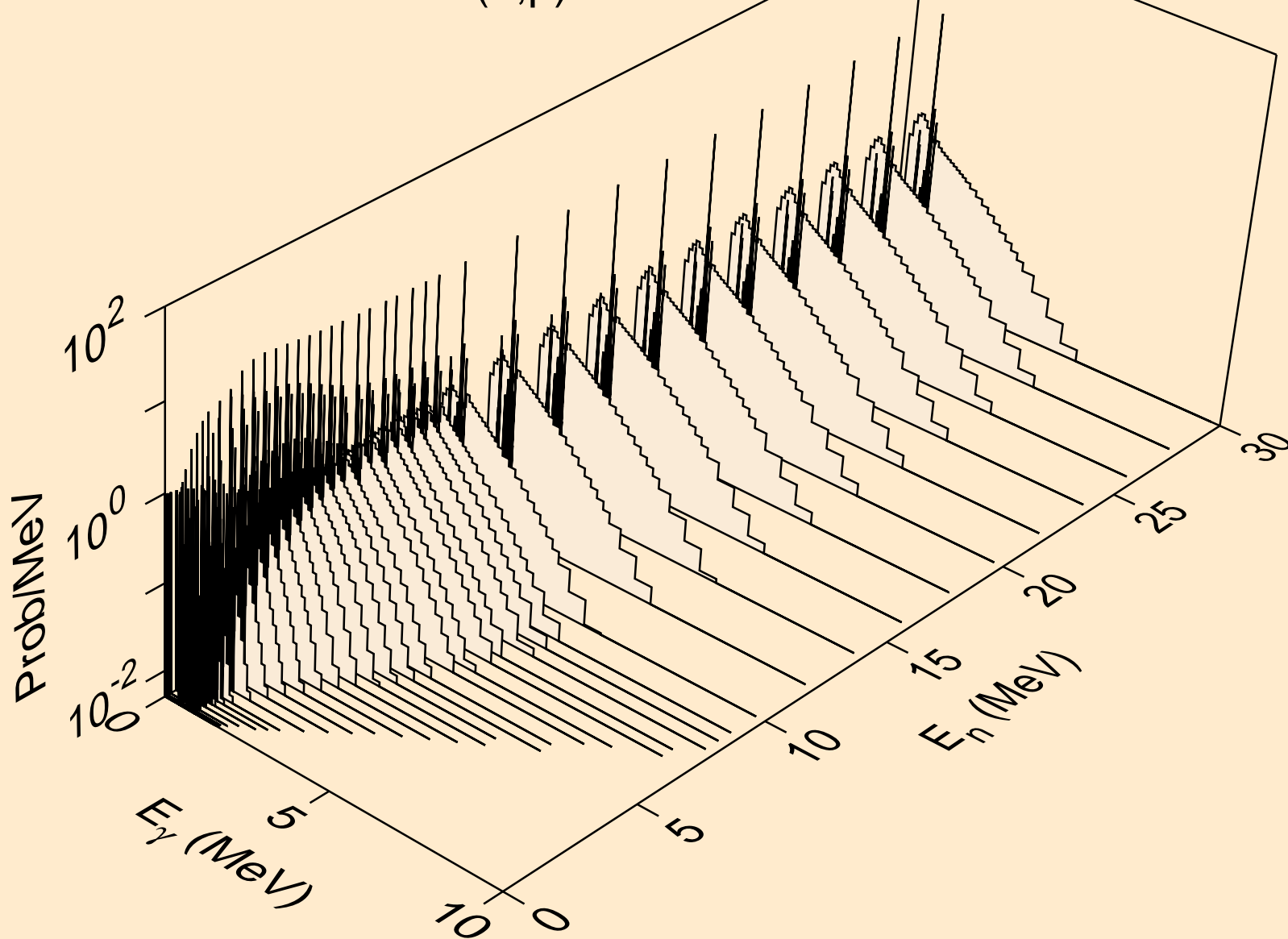

CE137M NEUTRON ACER TENDL-2019 LIBRARY; T=293.16K
Photon emission for (n,d)

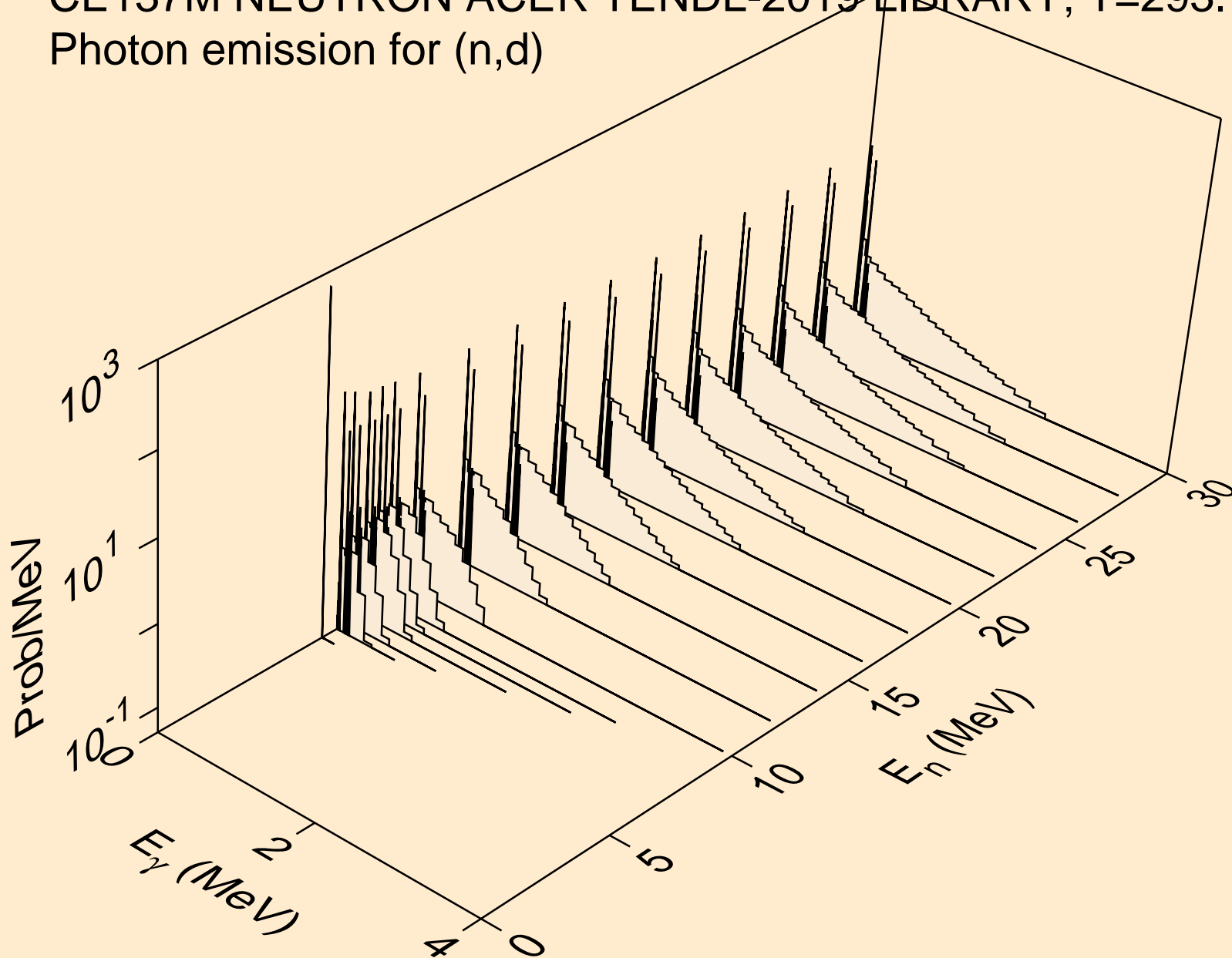

CE137M NEUTRON ACER TENDL-2019 LIBRARY; T=293.16K
Photon emission for (n,t)

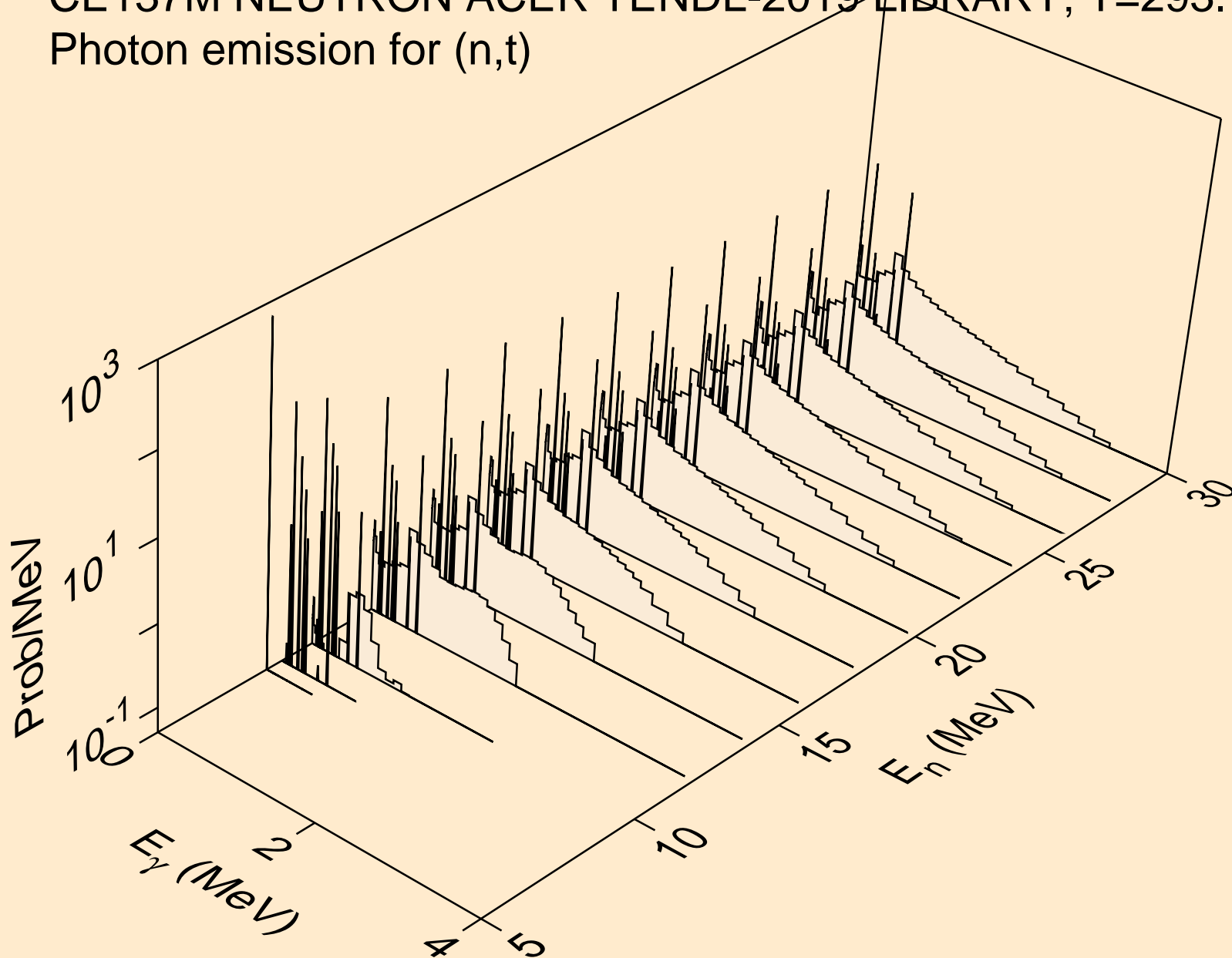

CE137M NEUTRON ACER TENDL-2019 LIBRARY; T=293.16K
Photon emission for (n,he3)

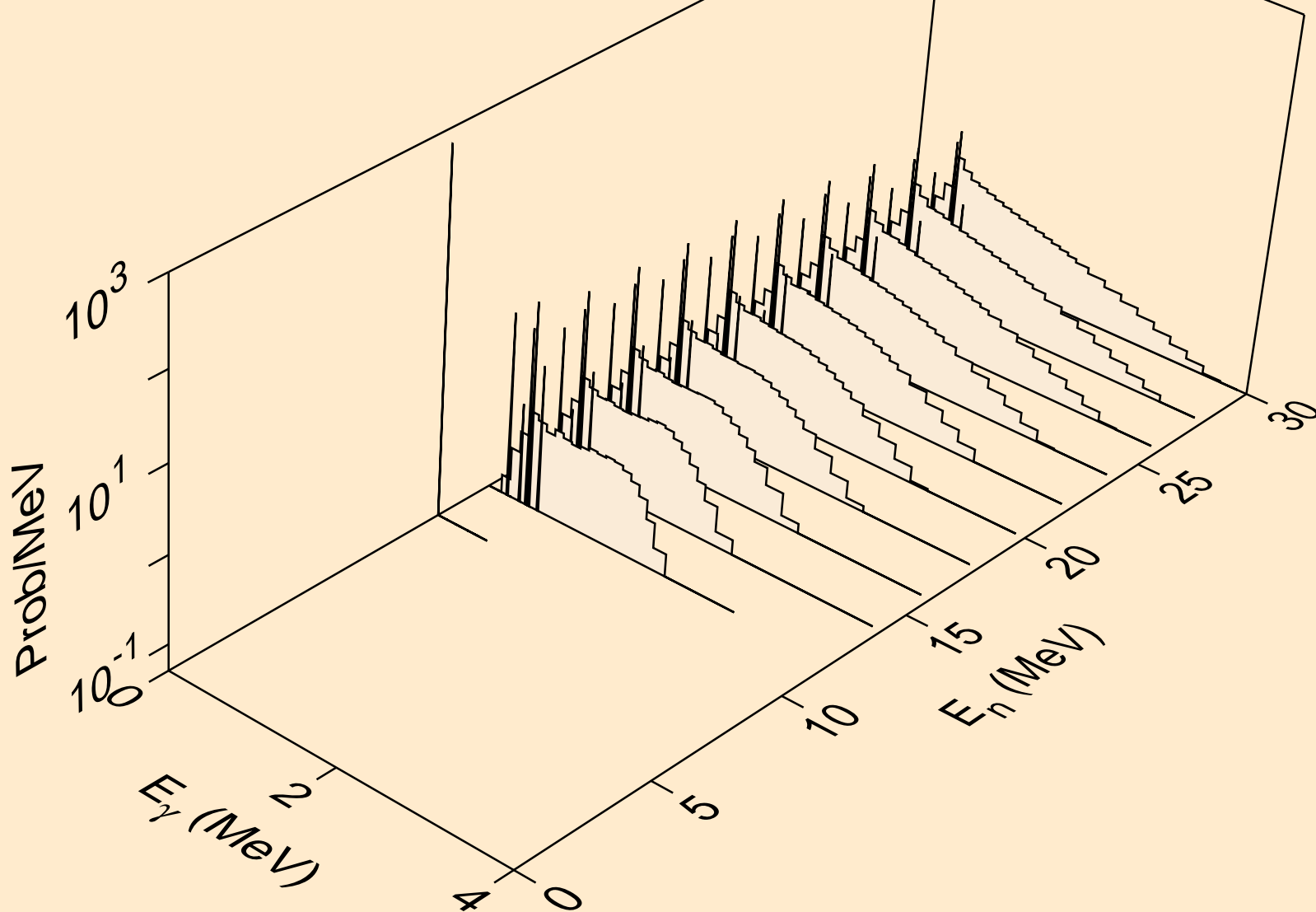

CE137M NEUTRON ACER TENDL-2019 LIBRARY; T=293.16K
Photon emission for (n,a)

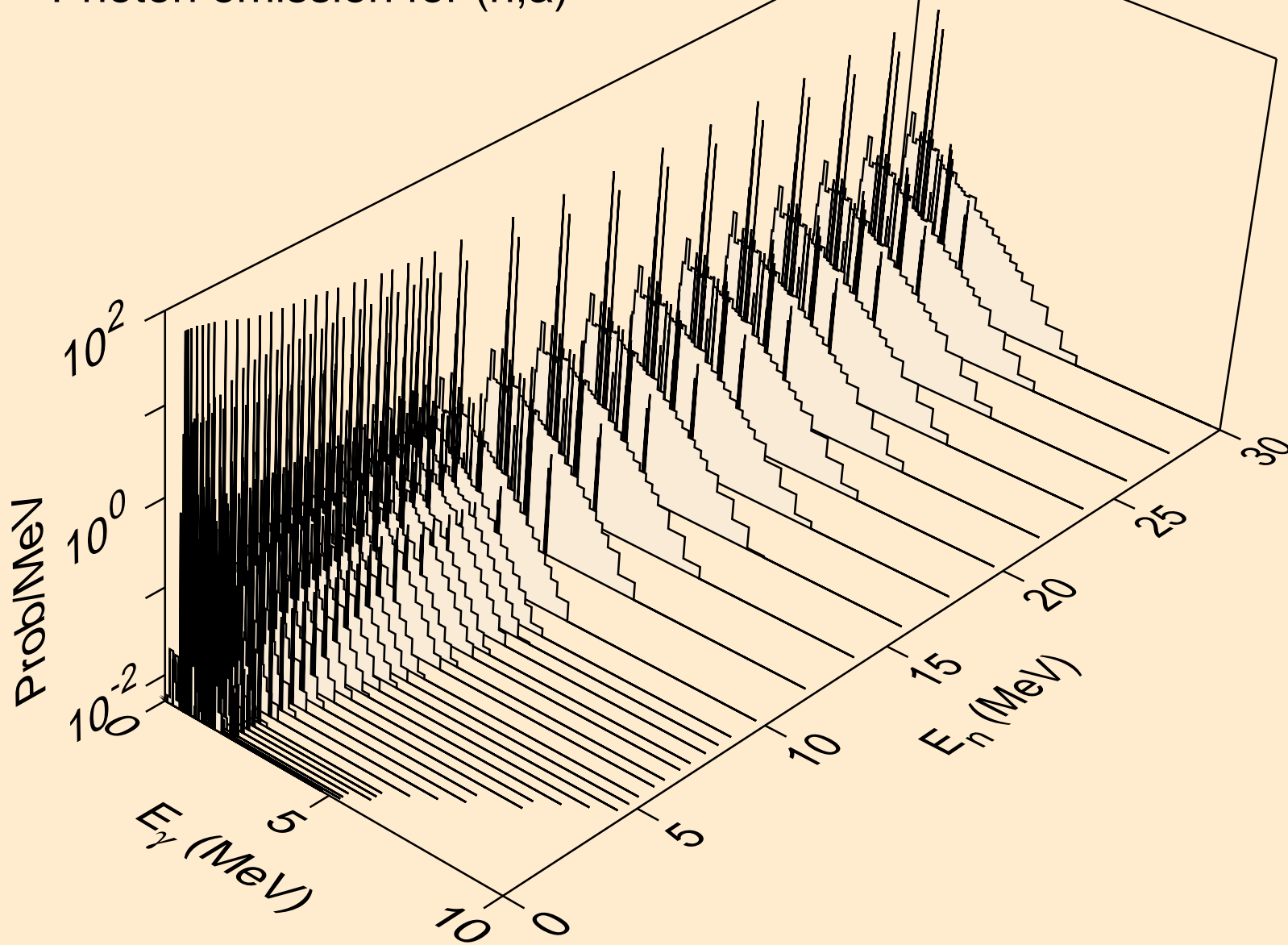

CE137M NEUTRON ACER TENDL-2019 LIBRARY; T=293.16K
Photon emission for (n,2a)

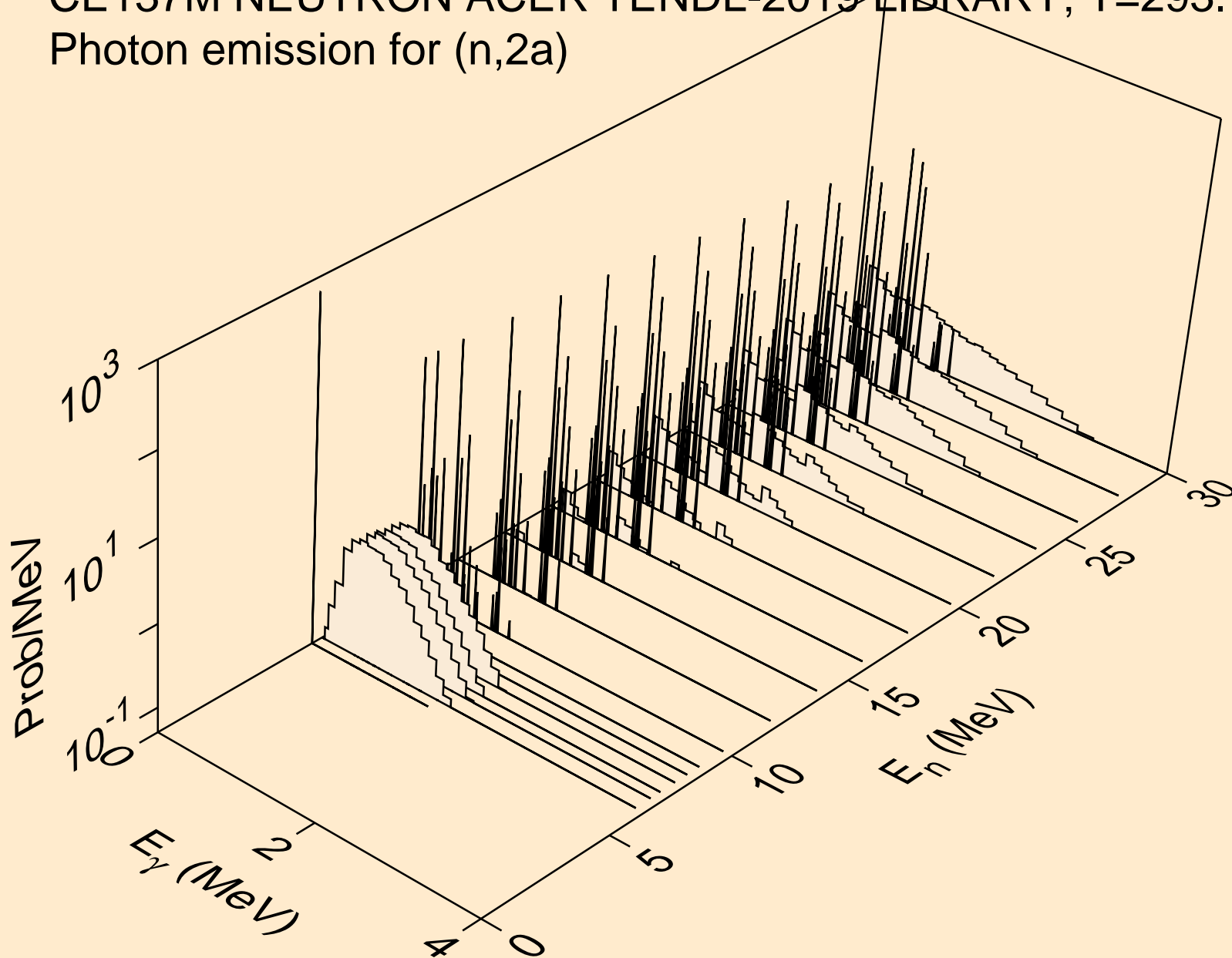

CE137M NEUTRON ACER TENDL-2019 LIBRARY; T=293.16K
Photon emission for (n,2p)

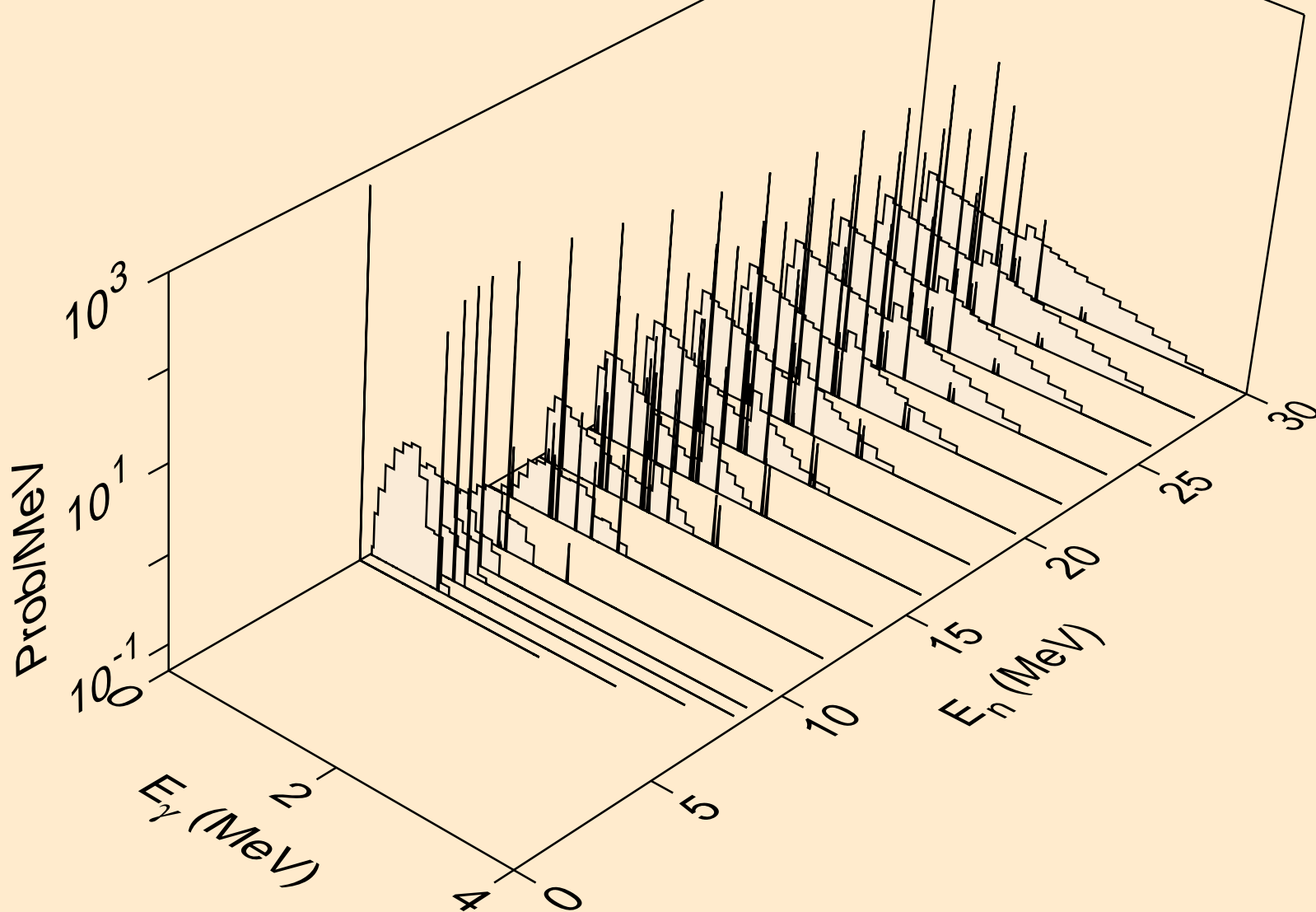

CE137M NEUTRON ACER TENDL-2019 LIBRARY; T=293.16K
Photon emission for (n,p α)

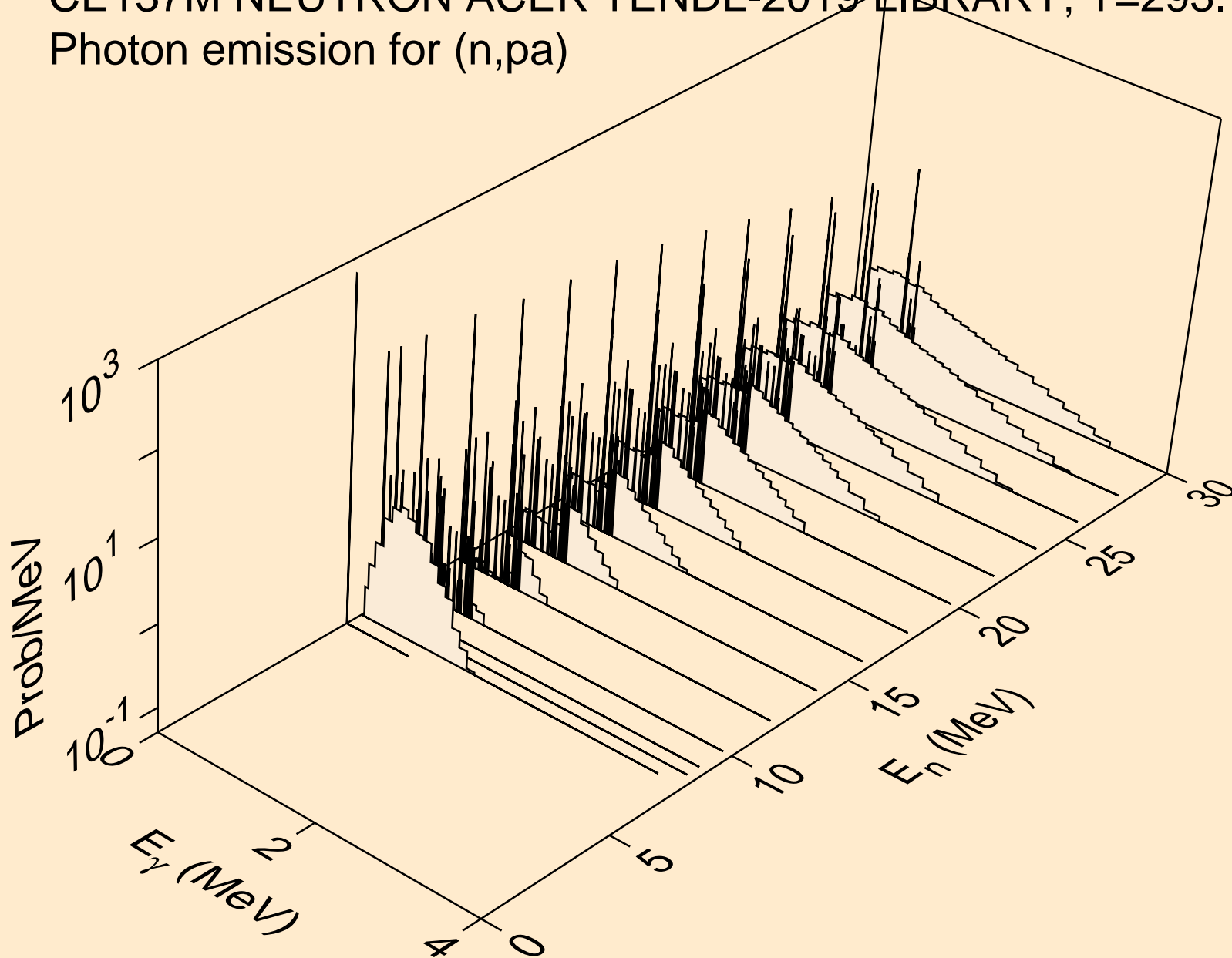

CE137M NEUTRON ACER TENDL-2019 LIBRARY; T=293.16K
Photon emission for (n,pd)

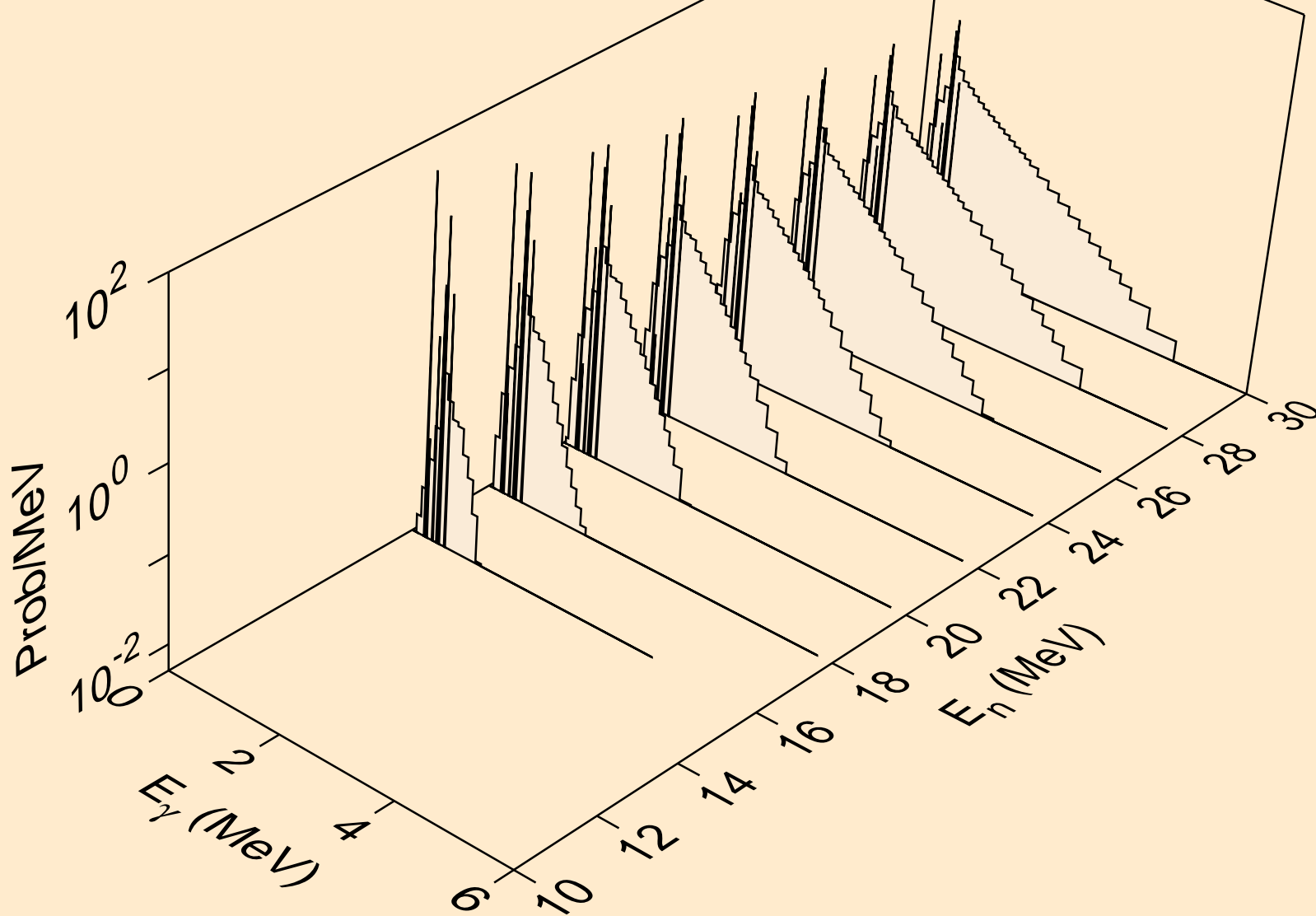

CE137M NEUTRON ACER TENDL-2019 LIBRARY; T=293.16K
Photon emission for (n,pt)

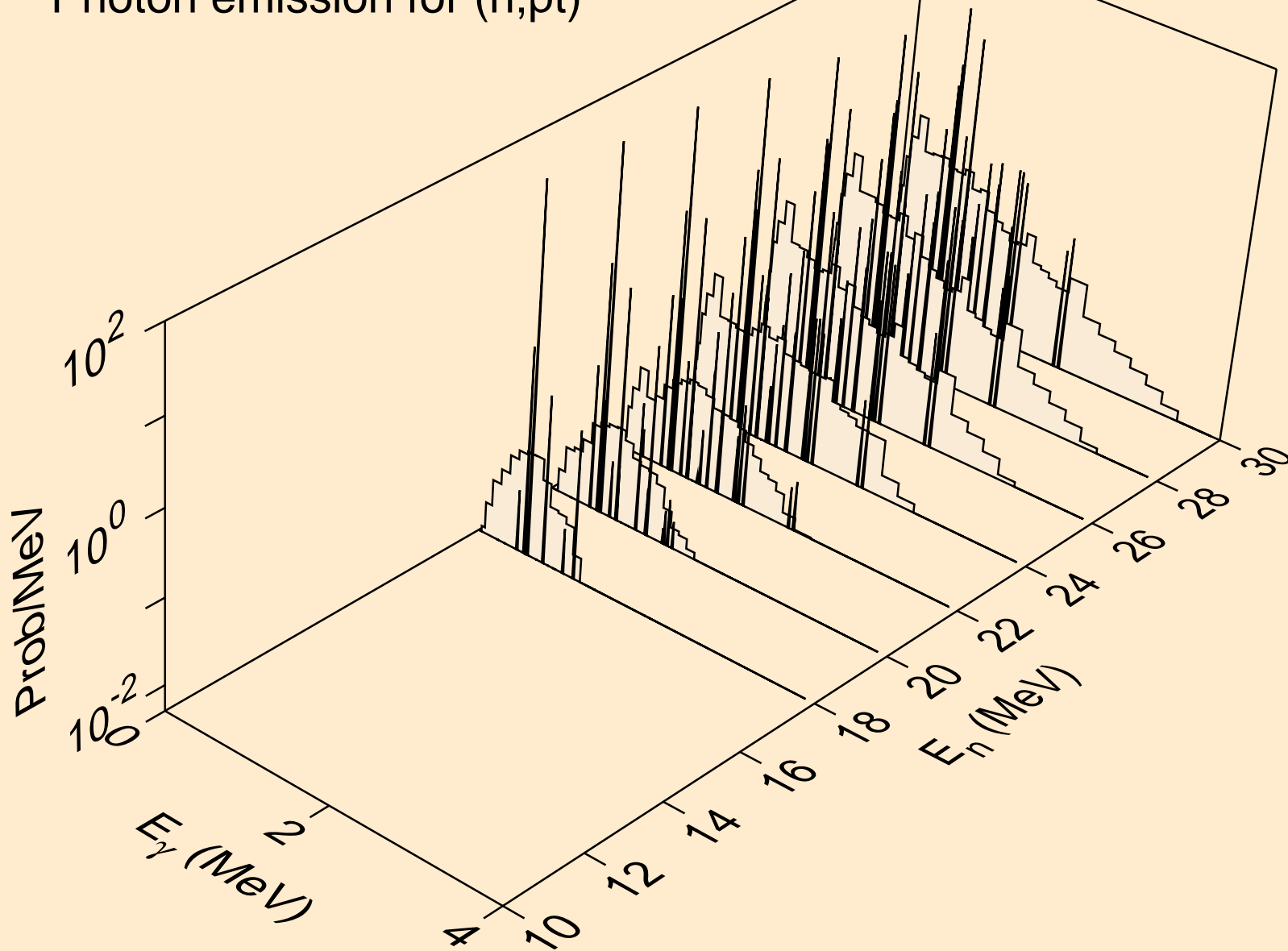

CE137M NEUTRON ACER TENDL-2019 LIBRARY; T=293.16K
Photon emission for (n,da)

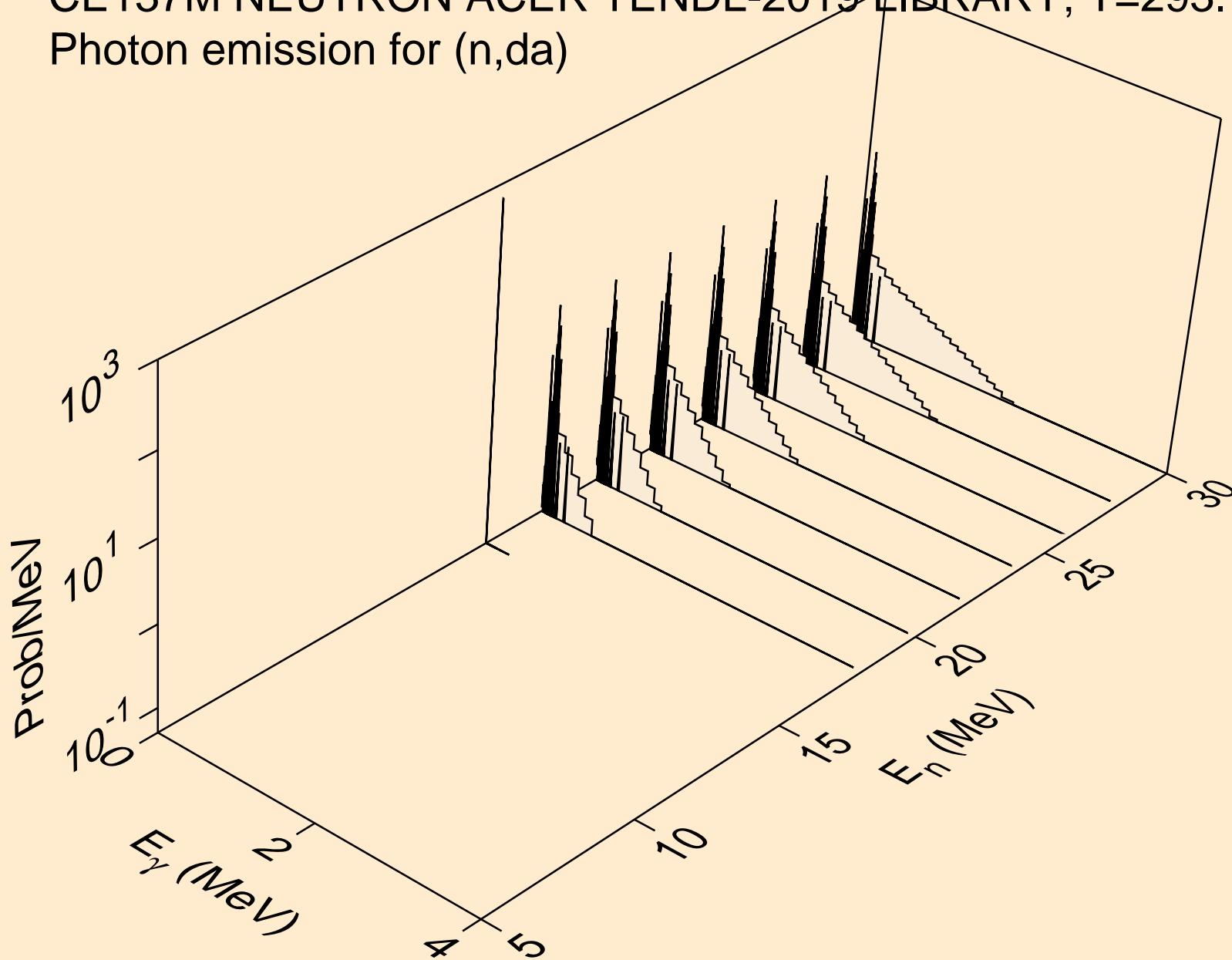

CE137M NEUTRON ACER TENDL-2019 LIBRARY; T=293.16K
thermal capture photon spectrum

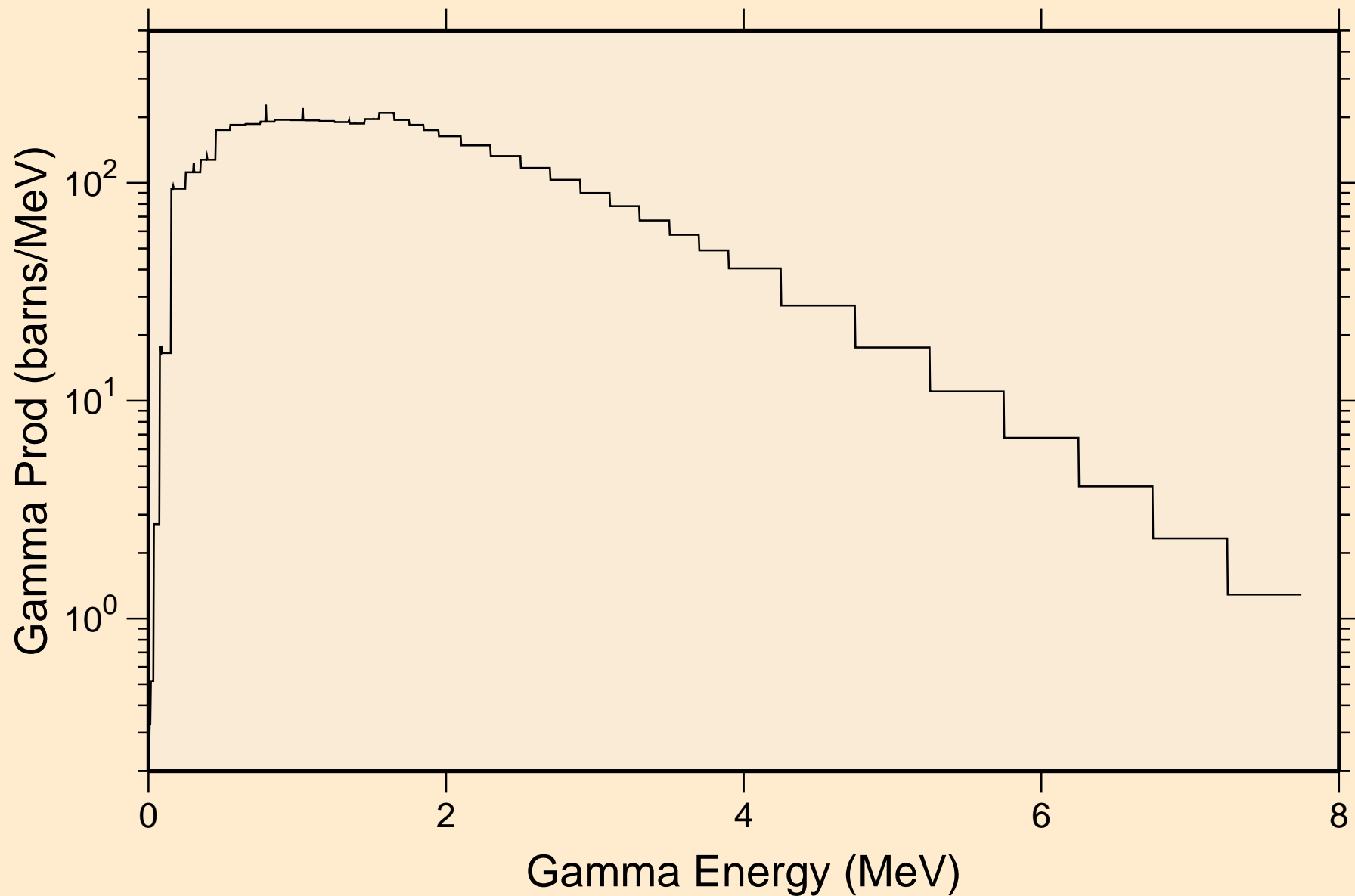

CE137M NEUTRON ACER TENDL-2019 LIBRARY; T=293.16K
14 MeV photon spectrum

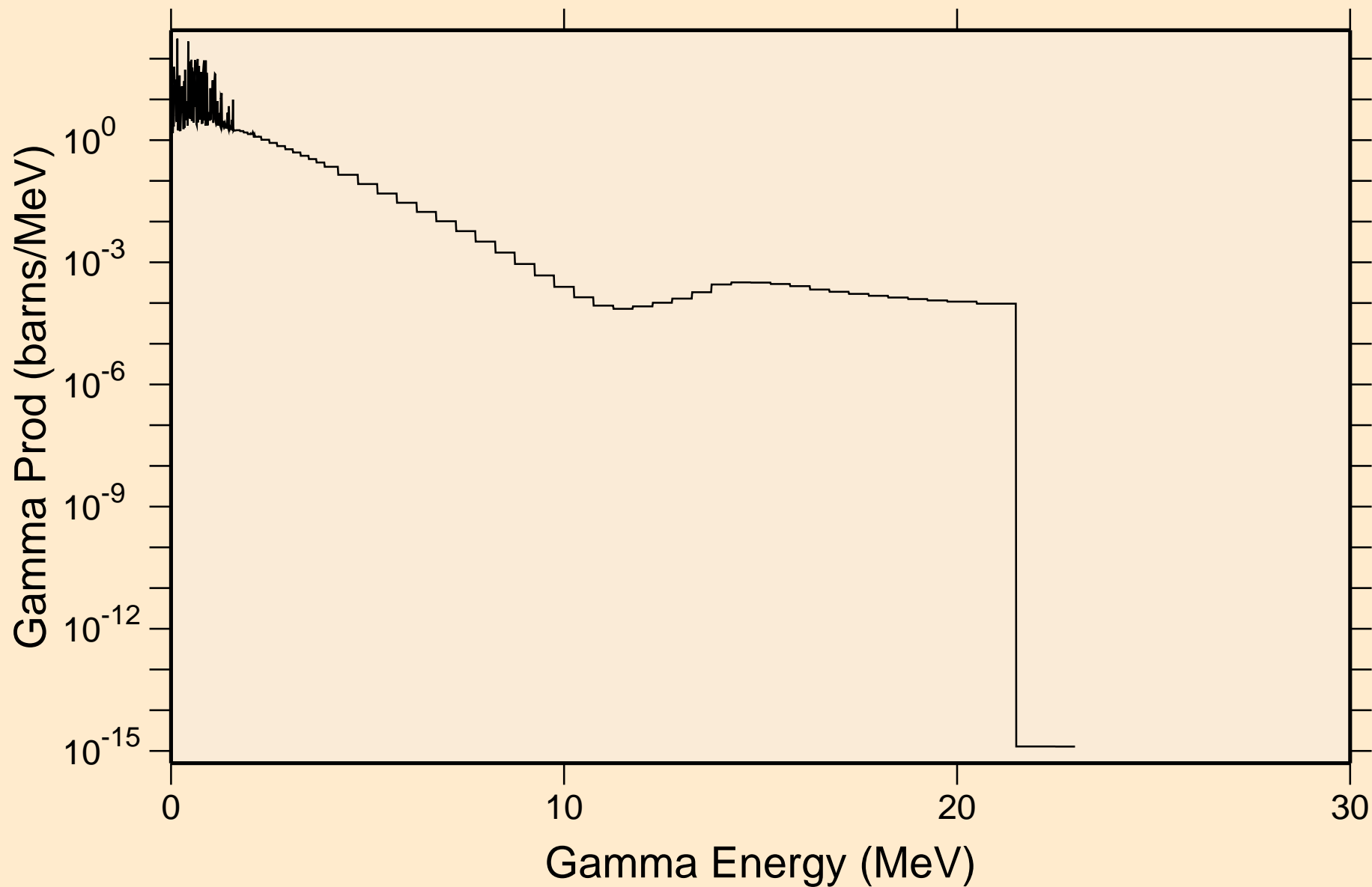

CE137M NEUTRON ACER TENDL-2019 LIBRARY; T=293.16K

Particle heating contributions

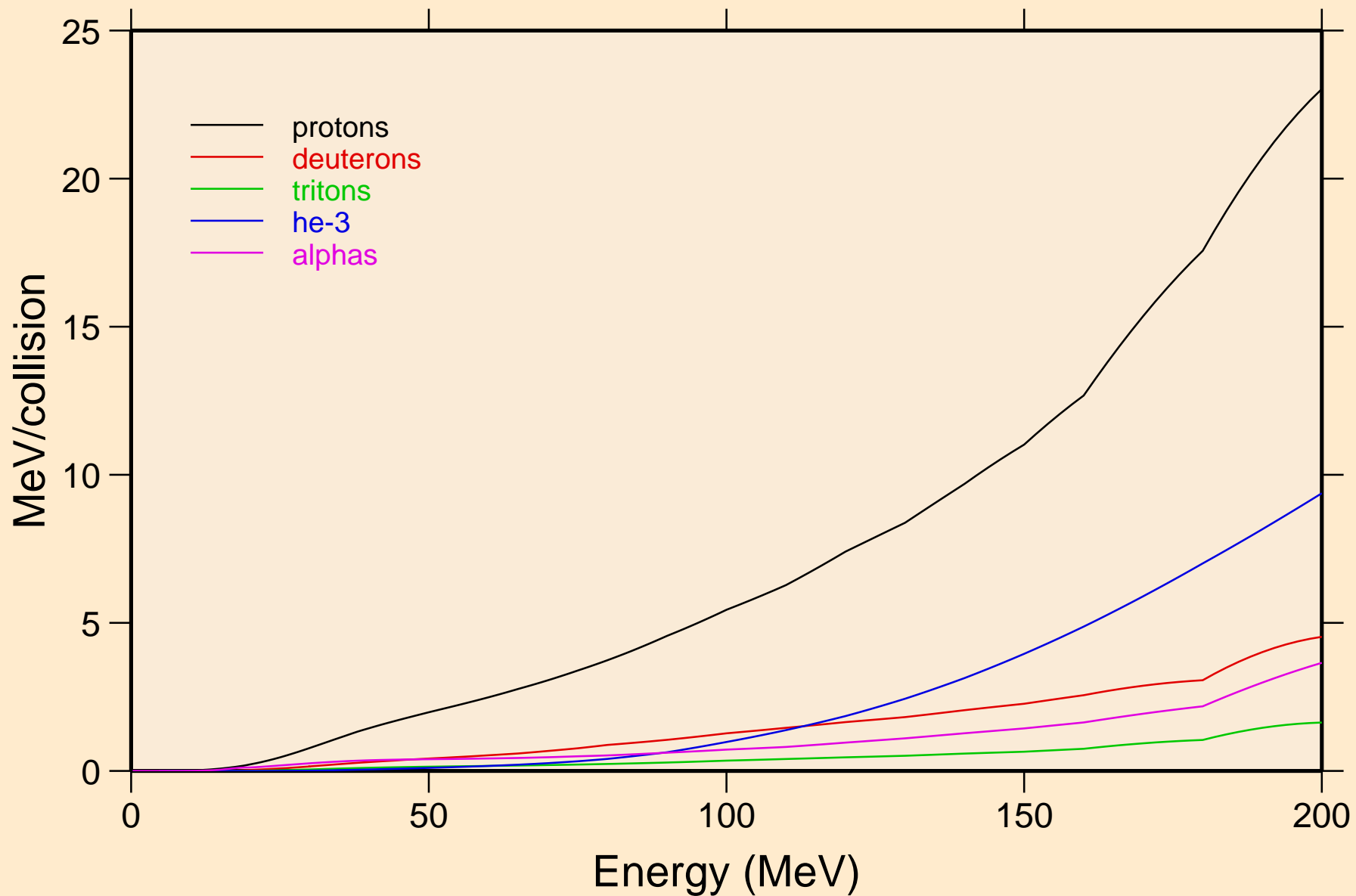

CE137M NEUTRON ACER TENDL-2019 LIBRARY; T=293.16K
Recoil Heating

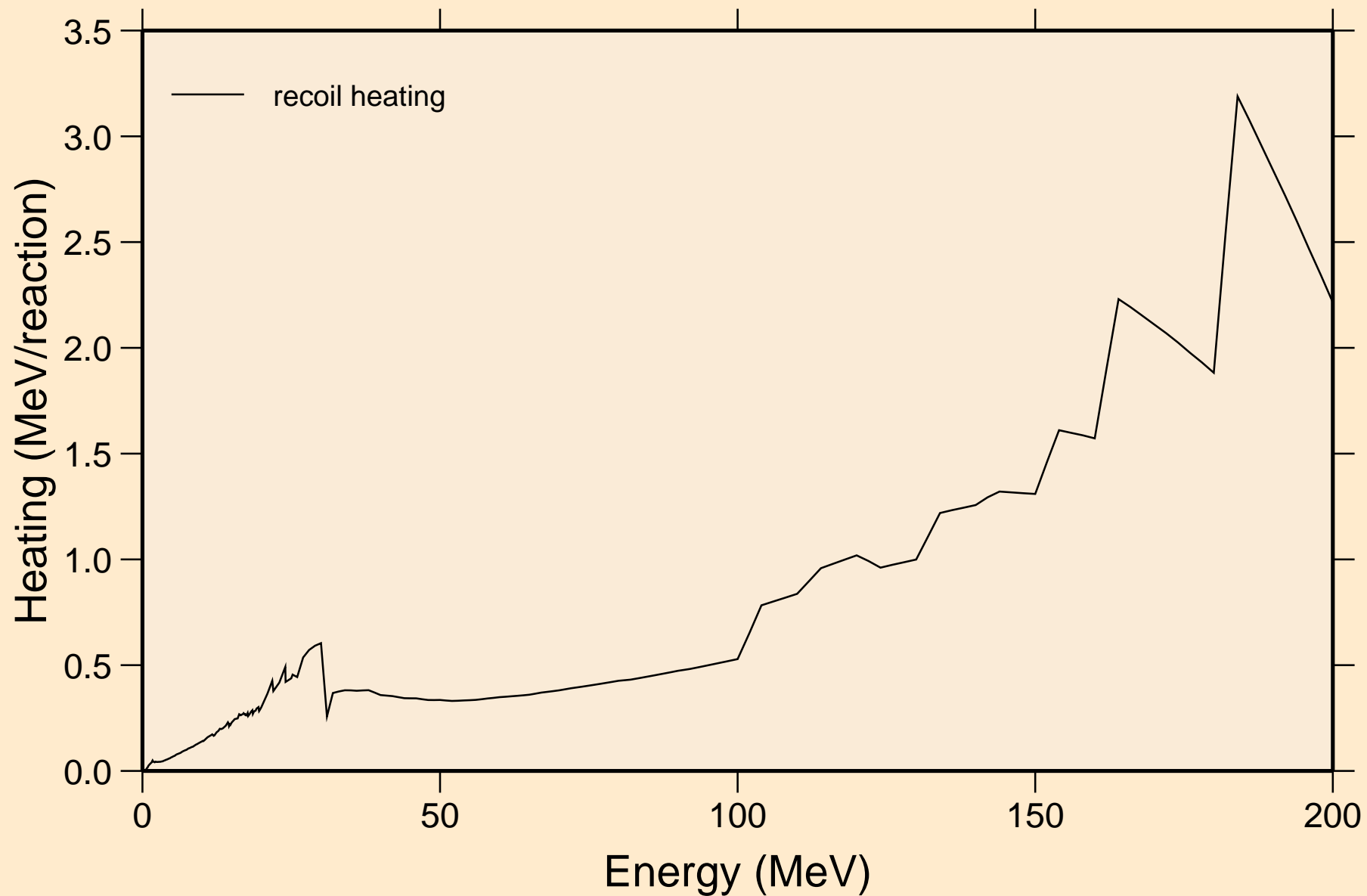

CE137M NEUTRON ACER TENDL-2019 LIBRARY; T=293.16K
Particle production cross sections

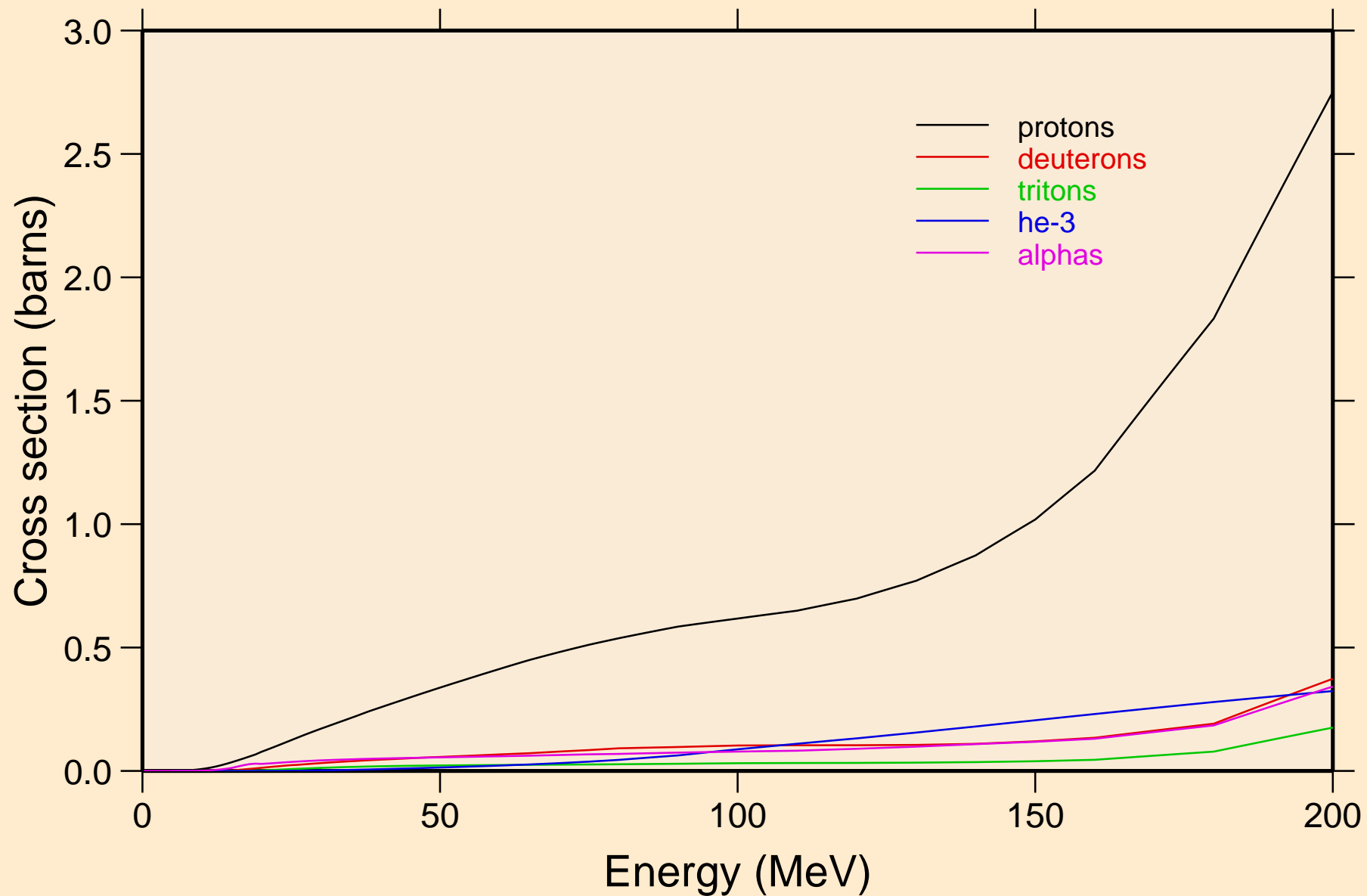

CE137M NEUTRON ACER TENDL-2019 LIBRARY; T=293.16K
protons from (n,x)

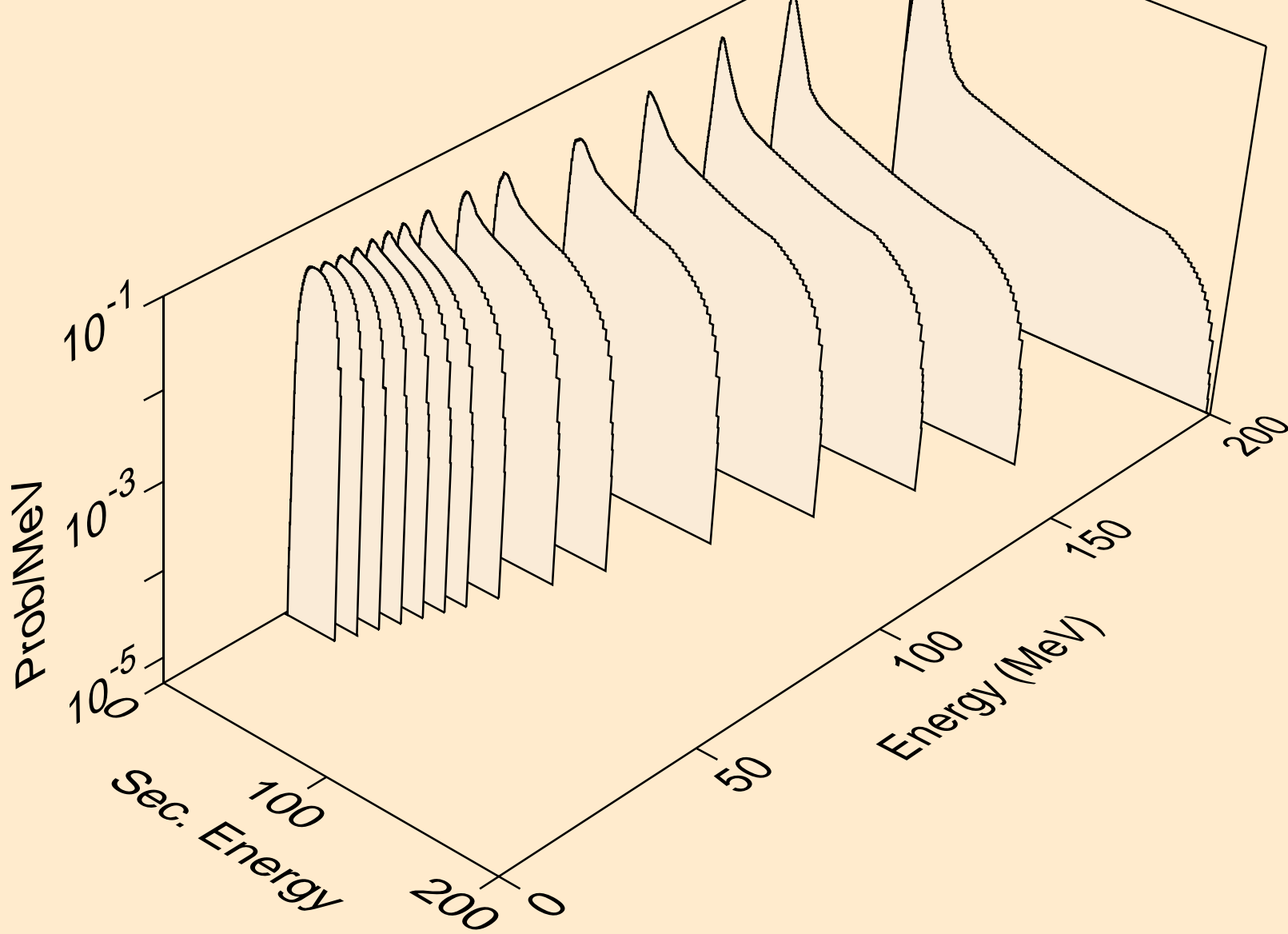

CE137M NEUTRON ACER TENDL-2019 LIBRARY; T=293.16K
protons from (n,n*)p

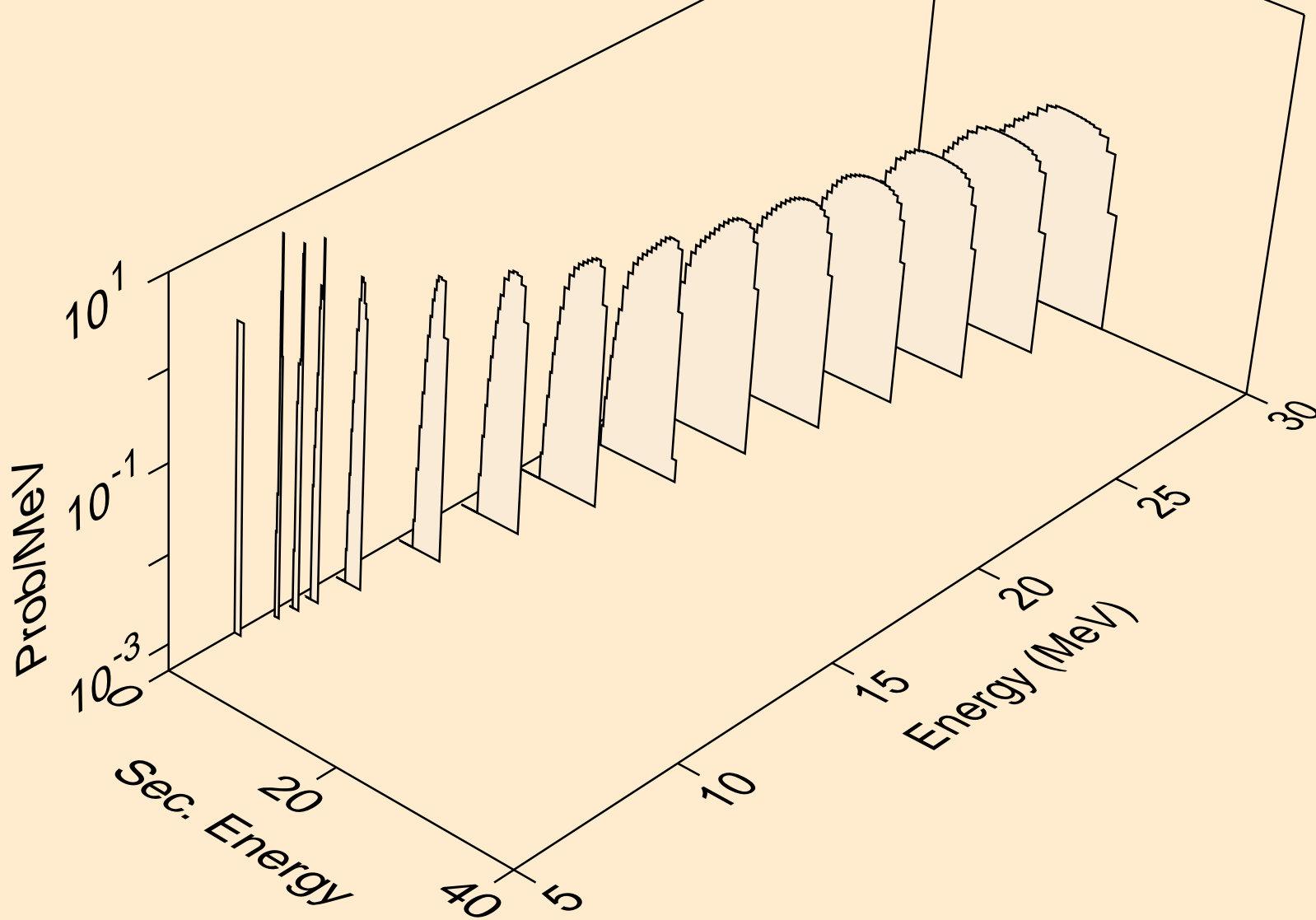

CE137M NEUTRON ACER TENDL-2019 LIBRARY; T=293.16K
protons from (n,2np)

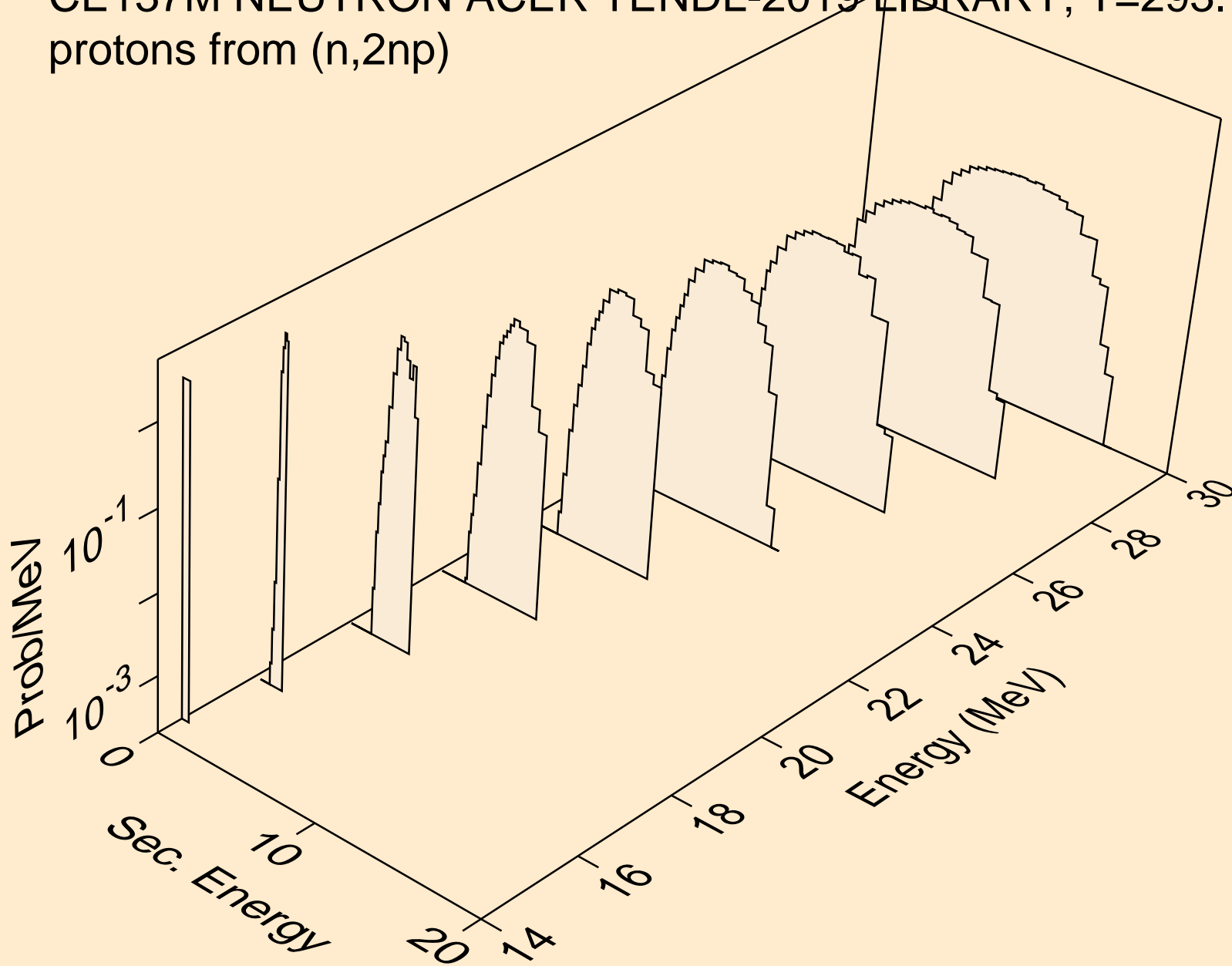

CE137M NEUTRON ACER TENDL-2019 LIBRARY; T=293.16K
protons from (n,3np)

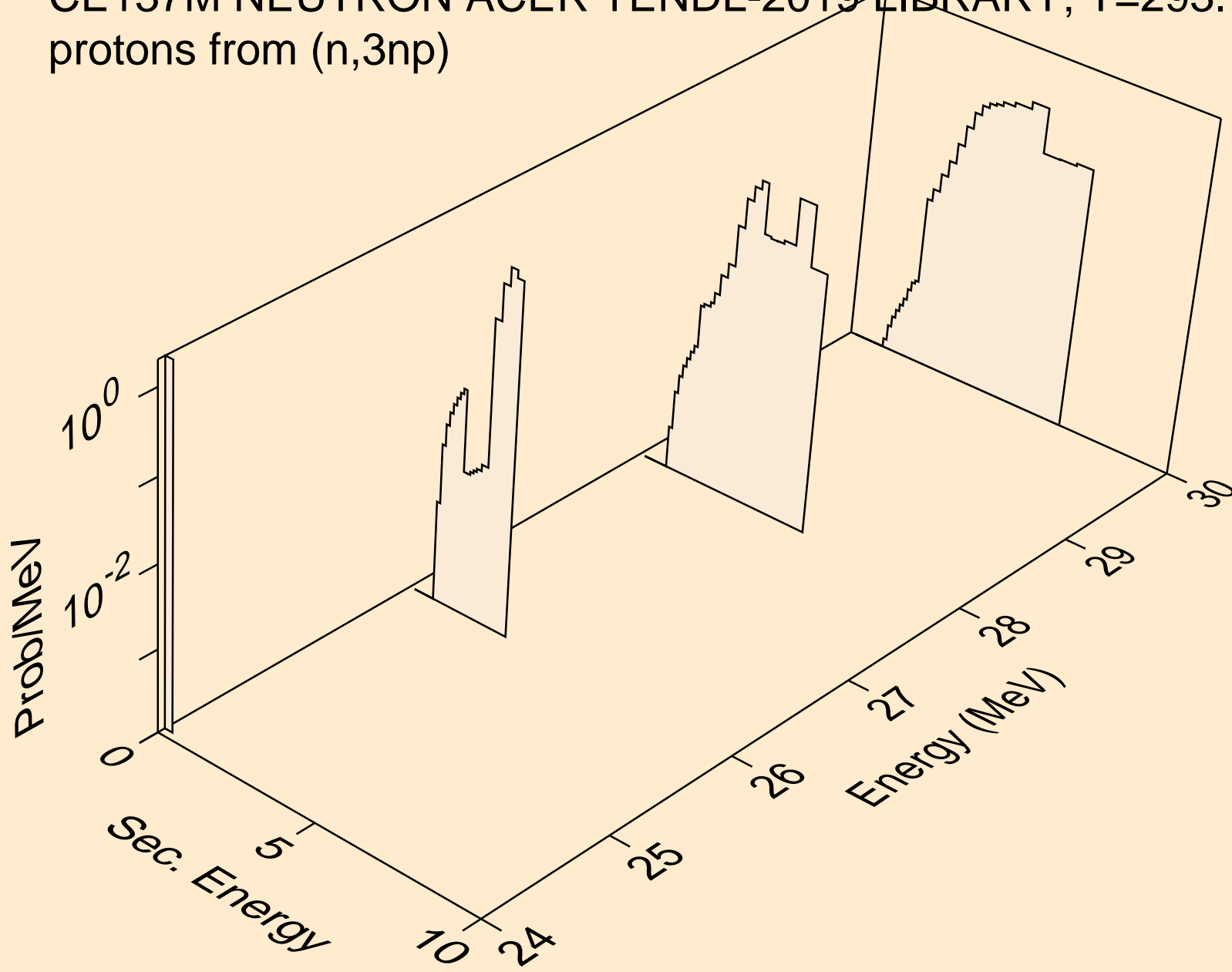

CE137M NEUTRON ACER TENDL-2019 LIBRARY; T=293.16K
protons from (n,2np)

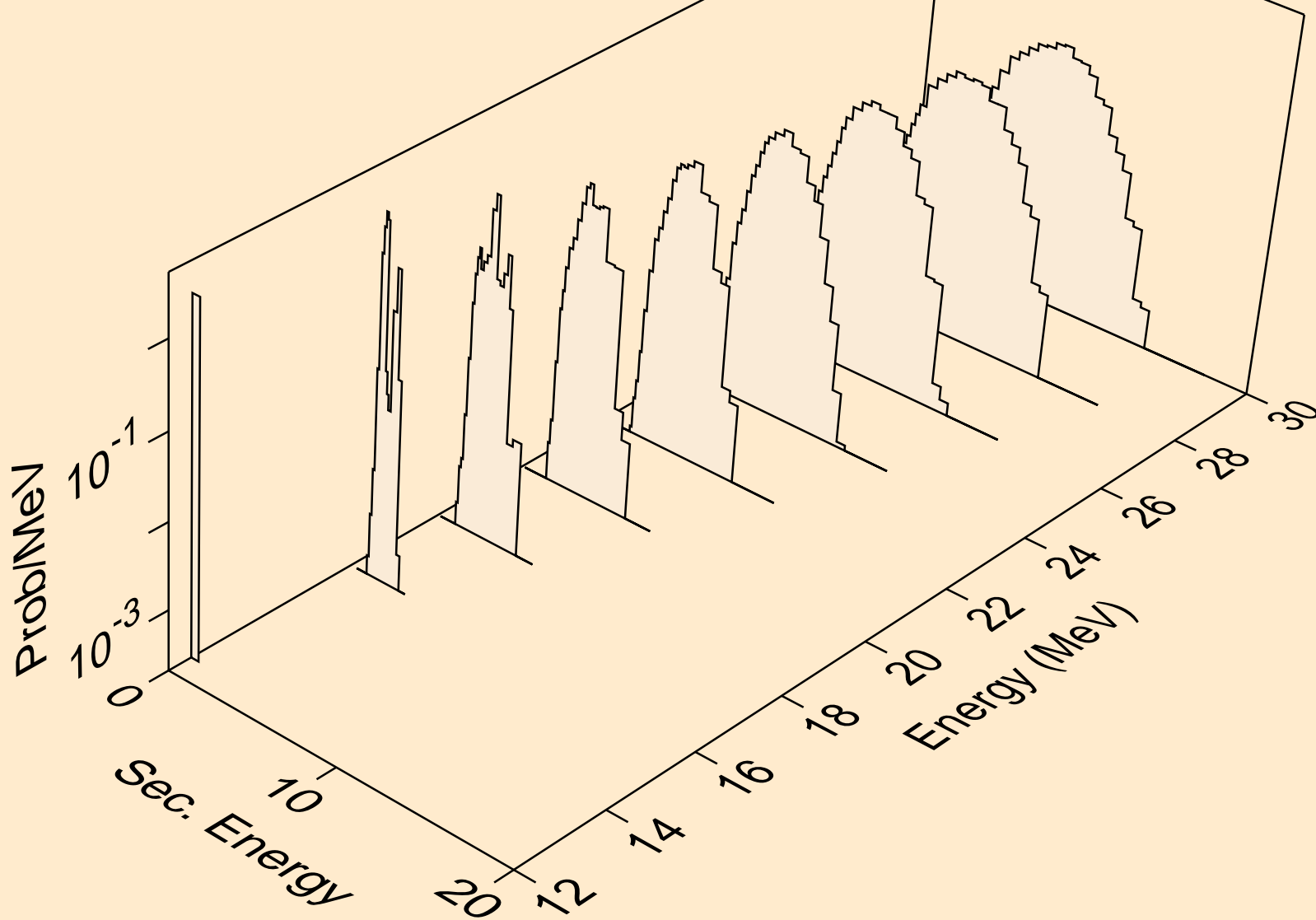

CE137M NEUTRON ACER TENDL-2019 LIBRARY; T=293.16K
protons from (n,npa)

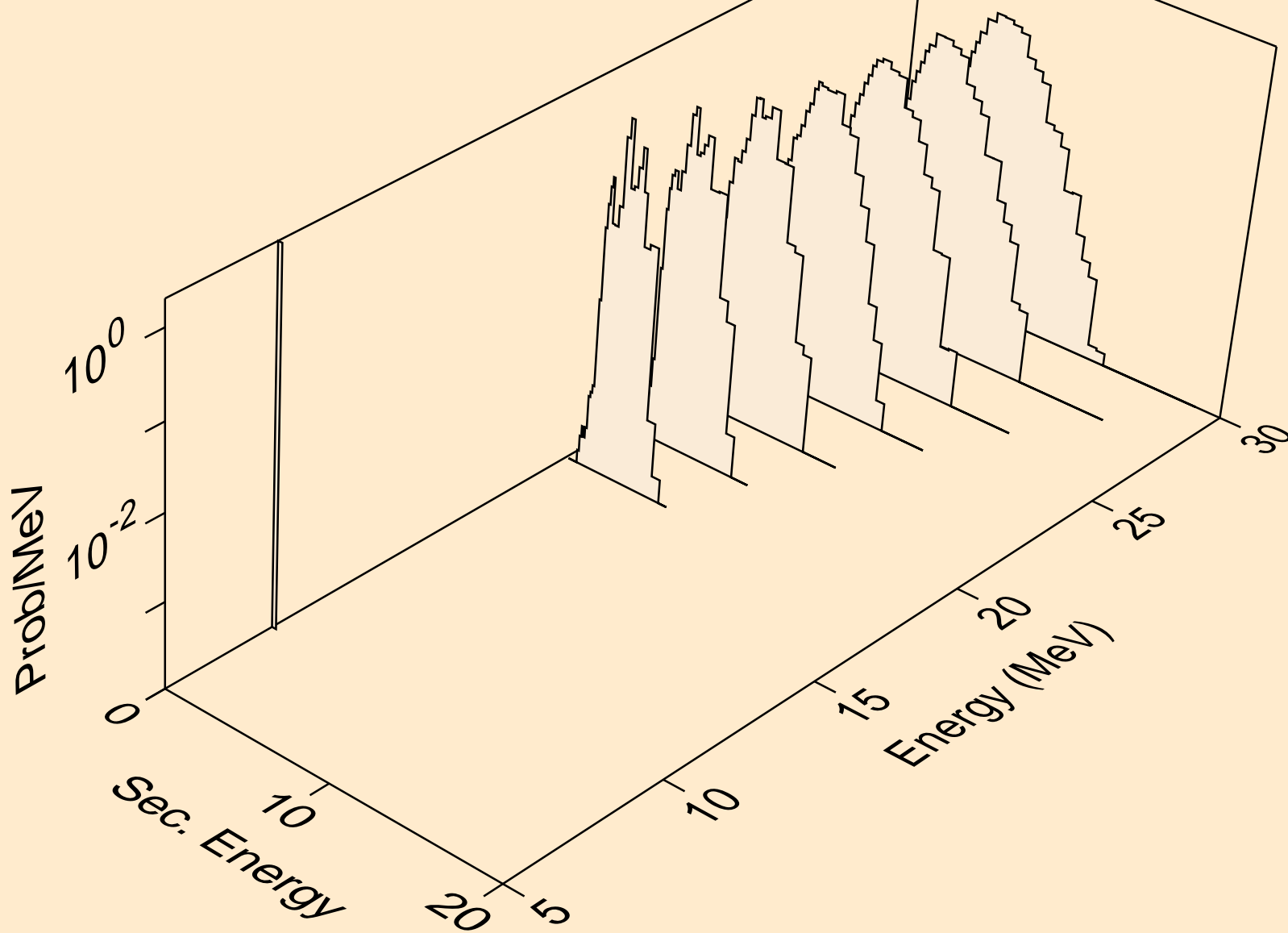

CE137M NEUTRON ACER TENDL-2019 LIBRARY; T=293.16K
protons from (n,p)

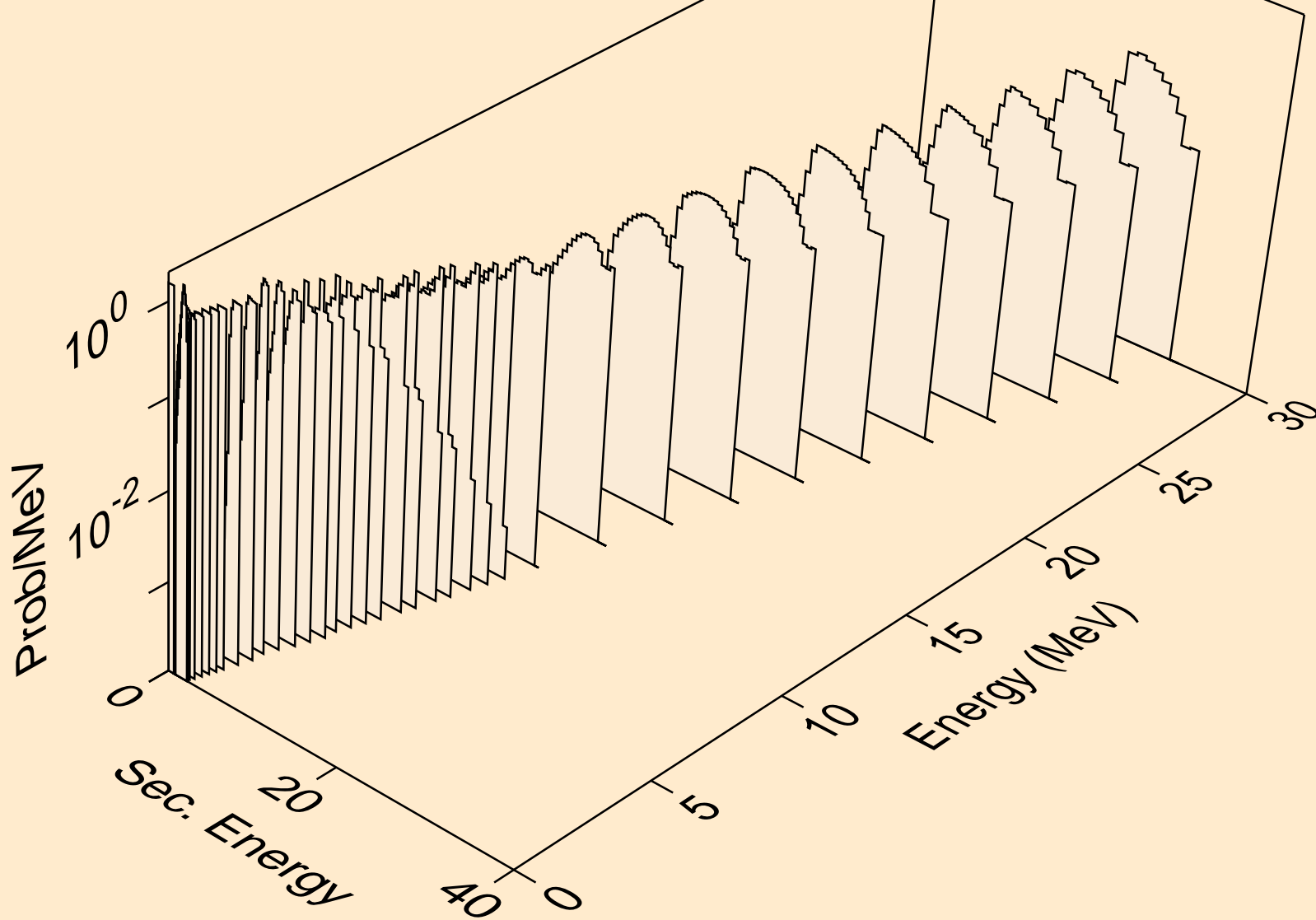

CE137M NEUTRON ACER TENDL-2019 LIBRARY; T=293.16K
protons from (n,2p)

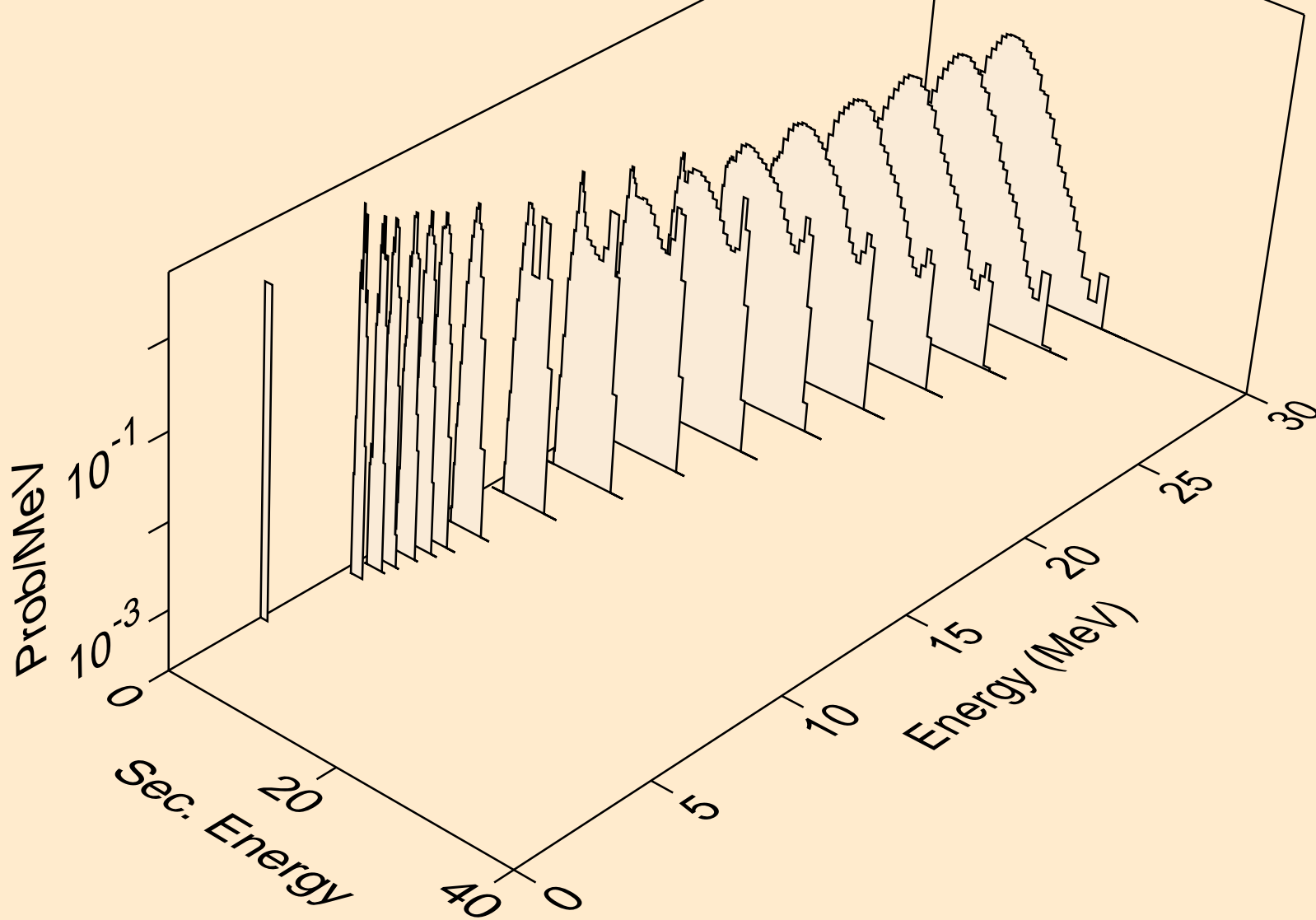

CE137M NEUTRON ACER TENDL-2019 LIBRARY; T=293.16K
protons from (n,p)

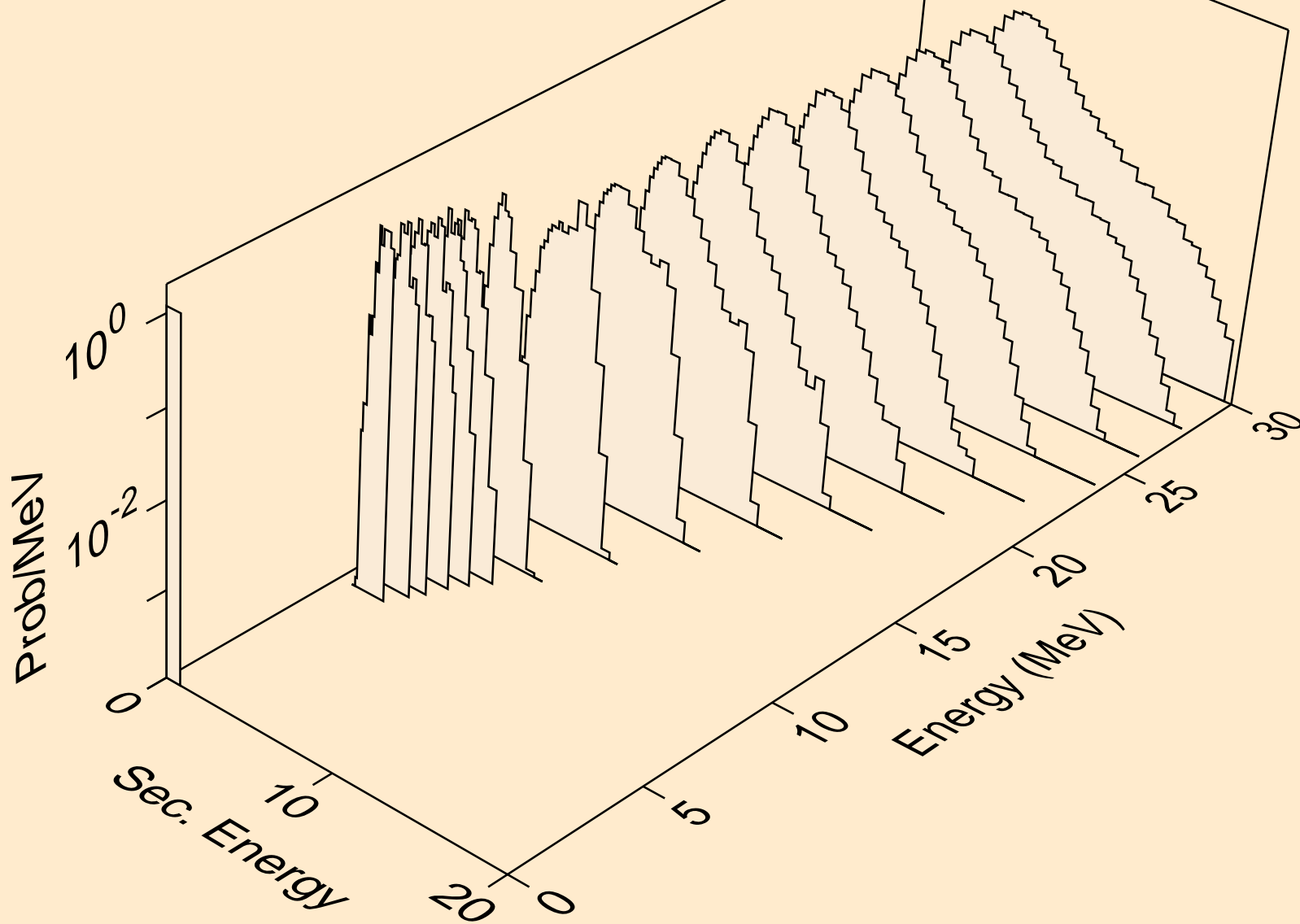

CE137M NEUTRON ACER TENDL-2019 LIBRARY; T=293.16K
protons from (n,pd)

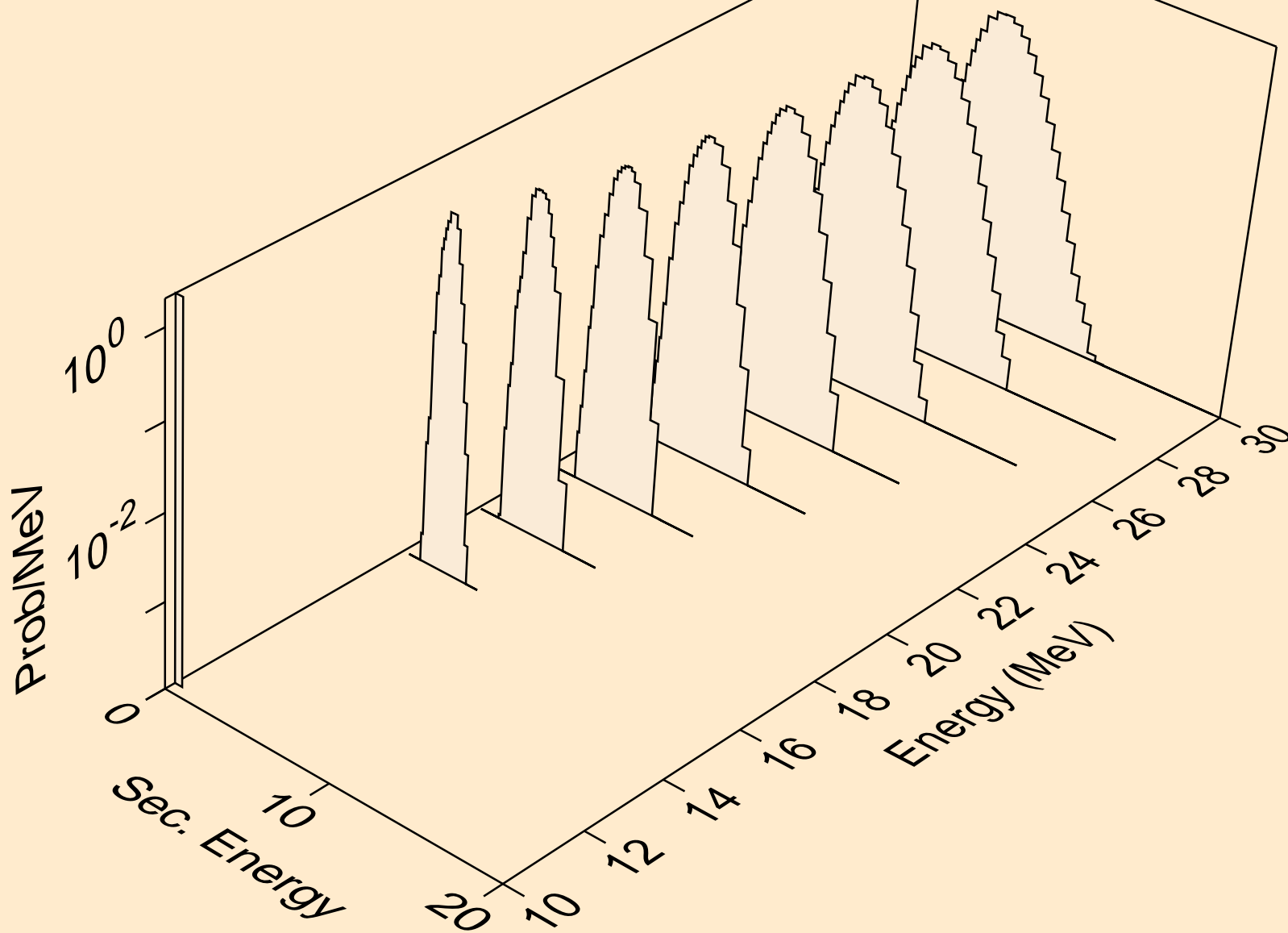

CE137M NEUTRON ACER TENDL-2019 LIBRARY; T=293.16K
protons from (n,pt)

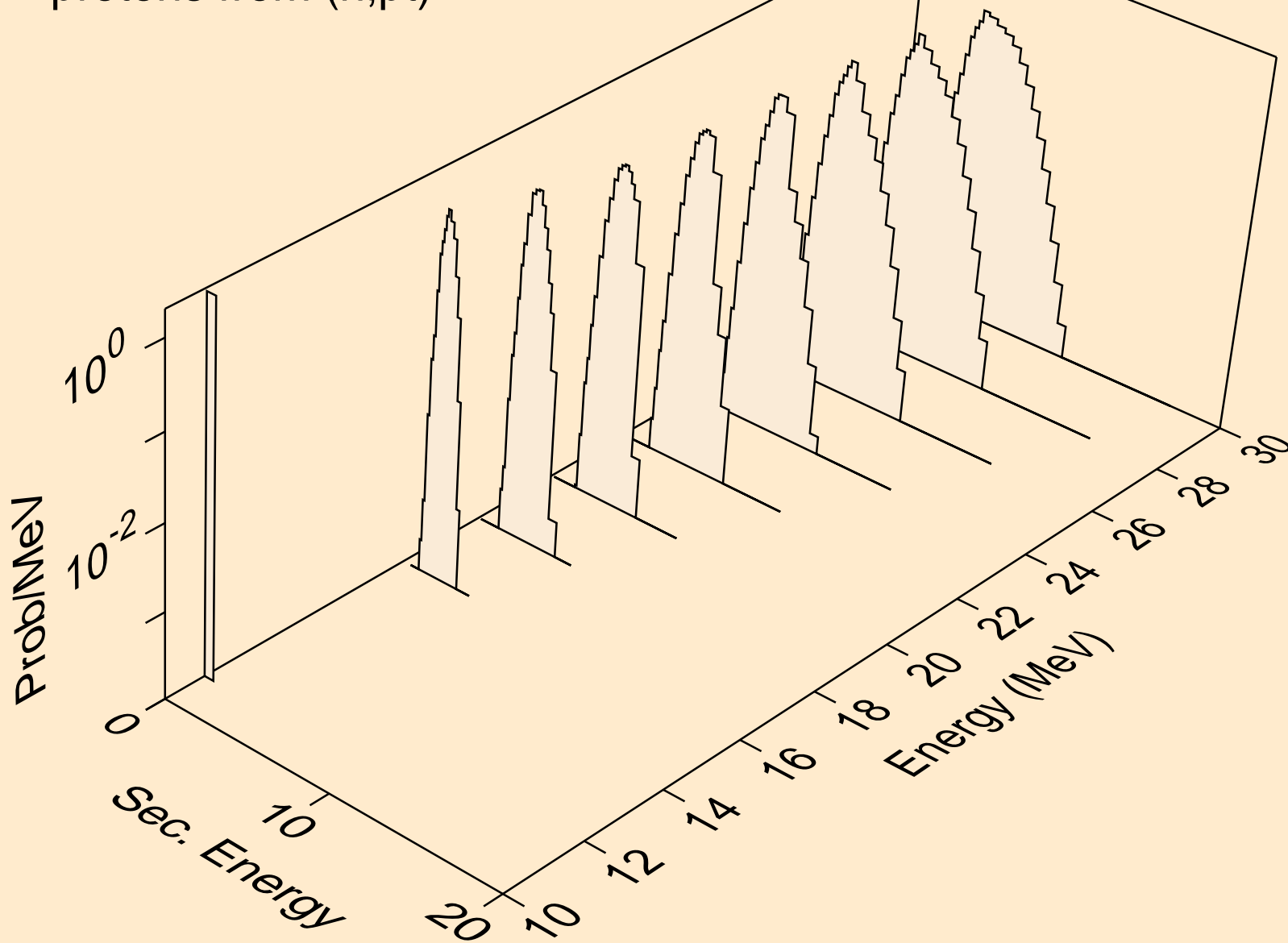

CE137M NEUTRON ACER TENDL-2019 LIBRARY; T=293.16K
deuterons from (n,x)

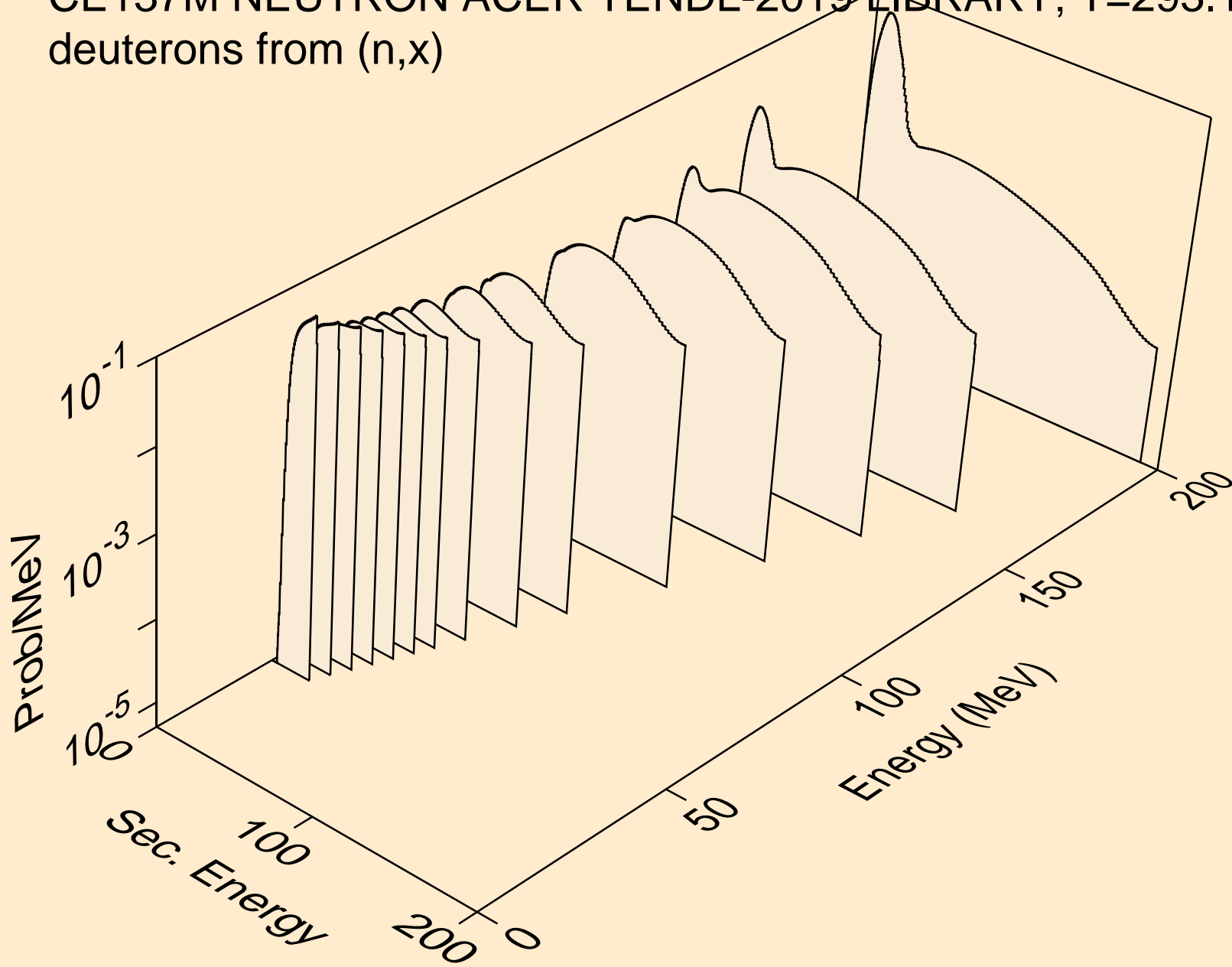

CE137M NEUTRON ACER TENDL-2019 LIBRARY; T=293.16K
deuterons from (n,2nd)

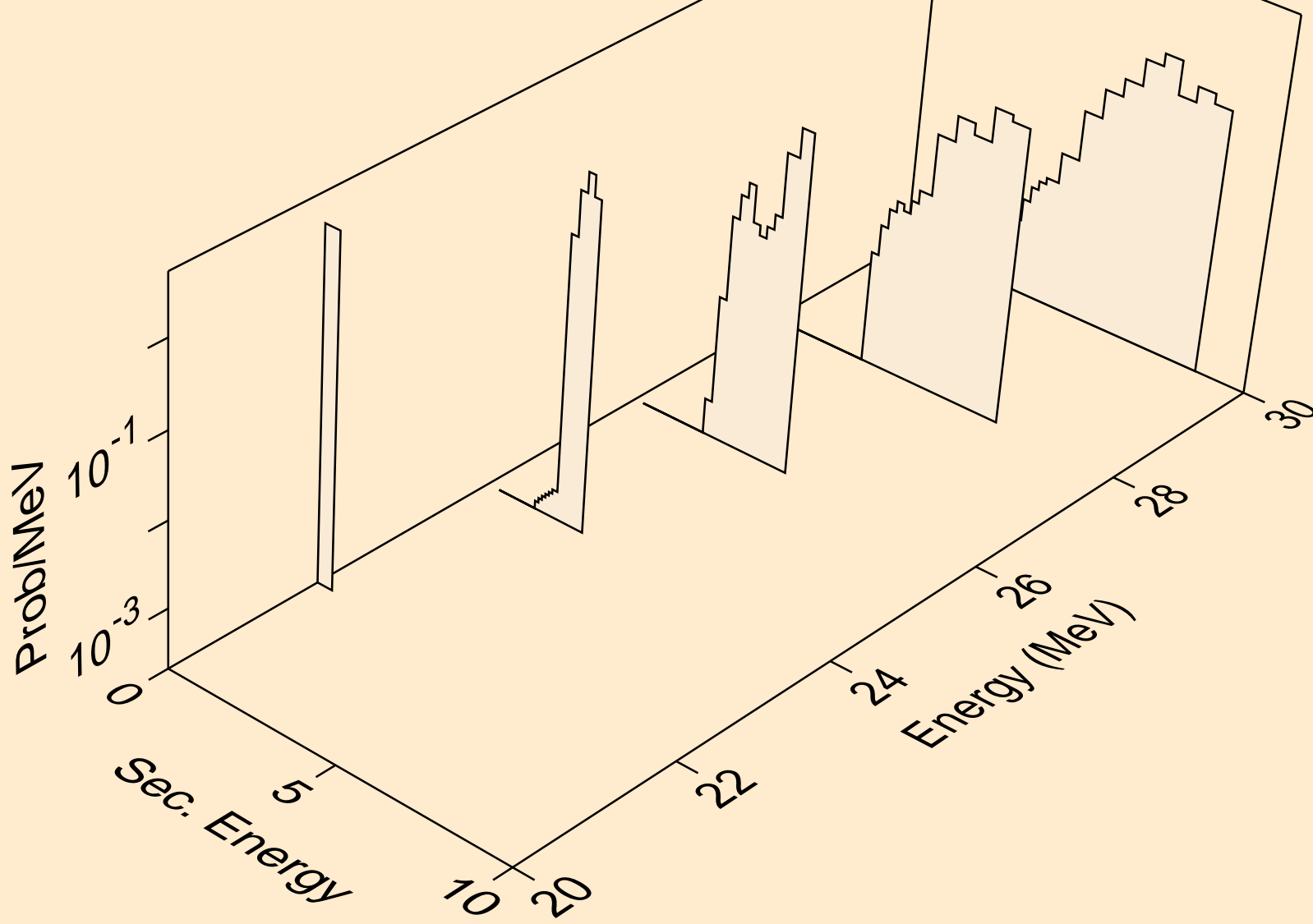

CE137M NEUTRON ACER TENDL-2019 LIBRARY; T=293.16K
deuterons from (n,n*)d

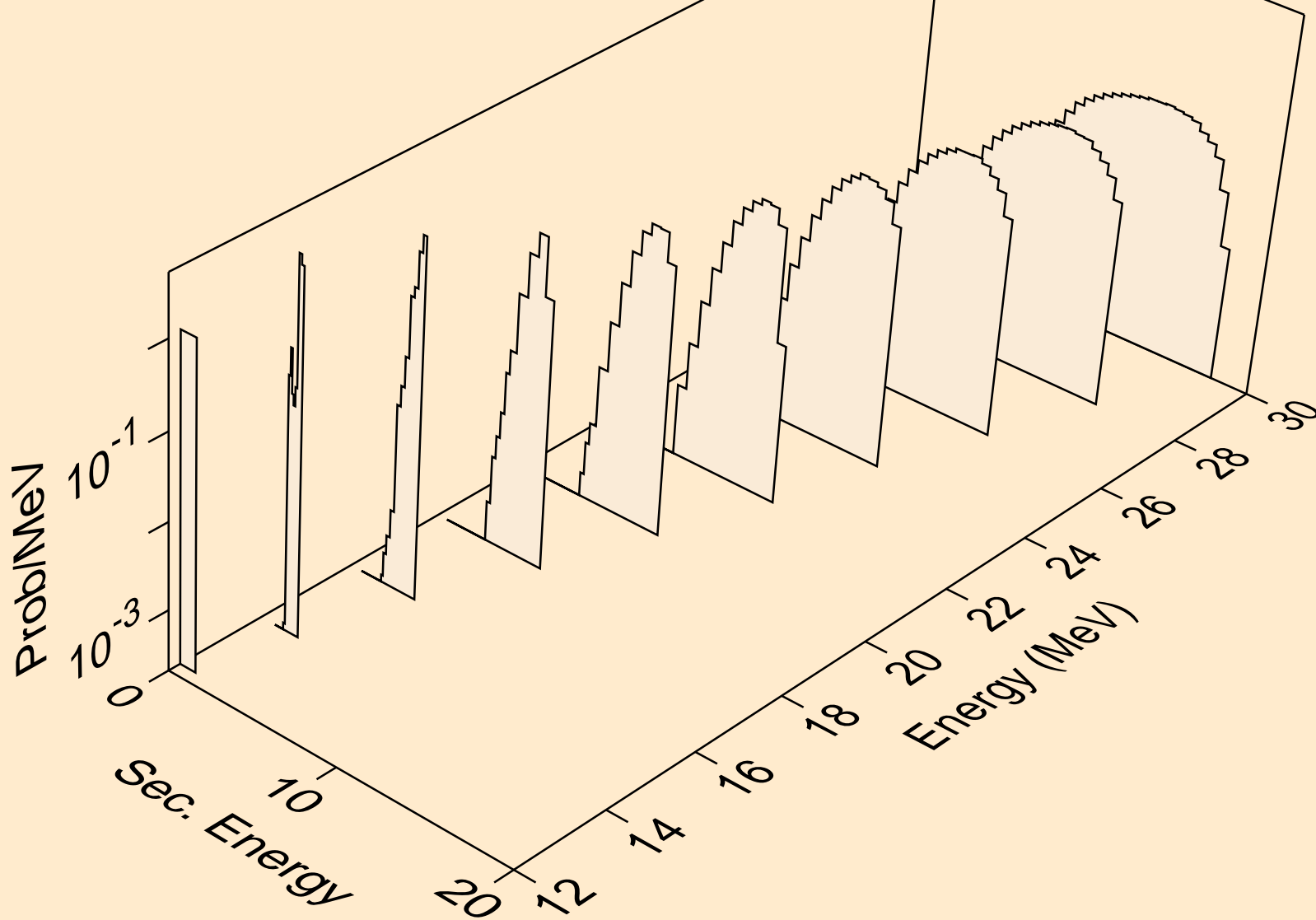

CE137M NEUTRON ACER TENDL-2019 LIBRARY; T=293.16K
deuterons from (n,d)

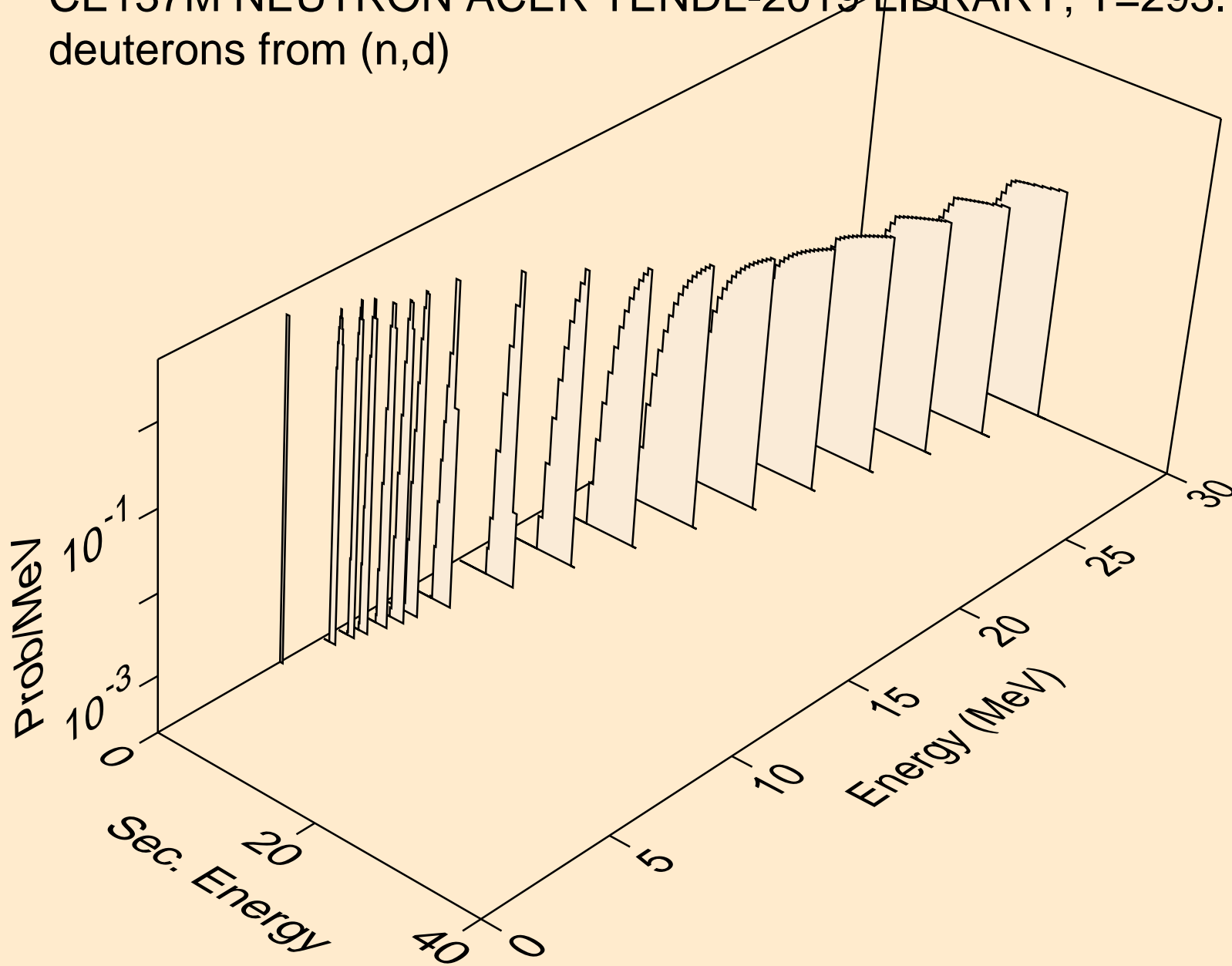

CE137M NEUTRON ACER TENDL-2019 LIBRARY; T=293.16K
deuterons from (n,pd)

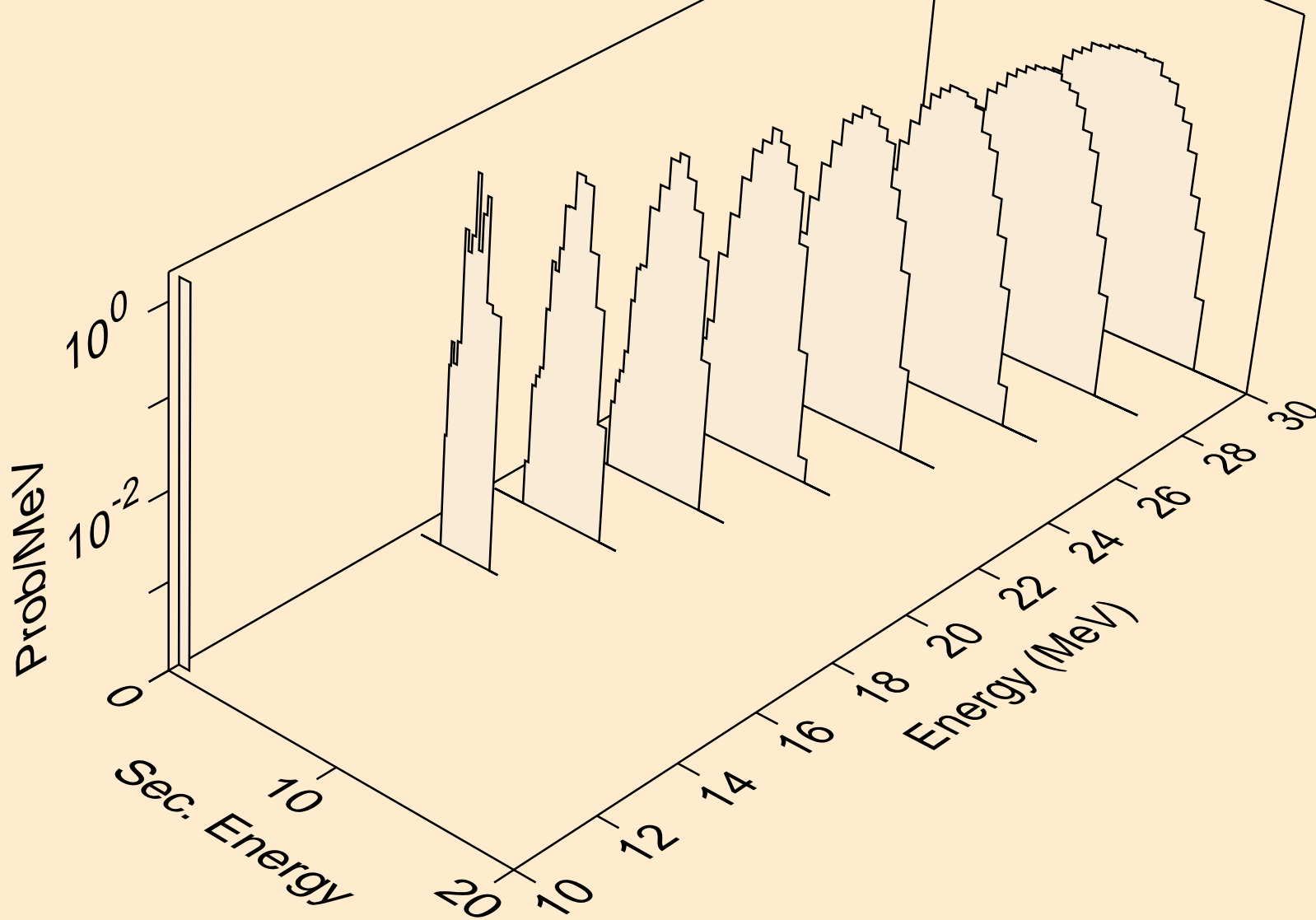

CE137M NEUTRON ACER TENDL-2019 LIBRARY; T=293.16K
deuterons from (n,da)

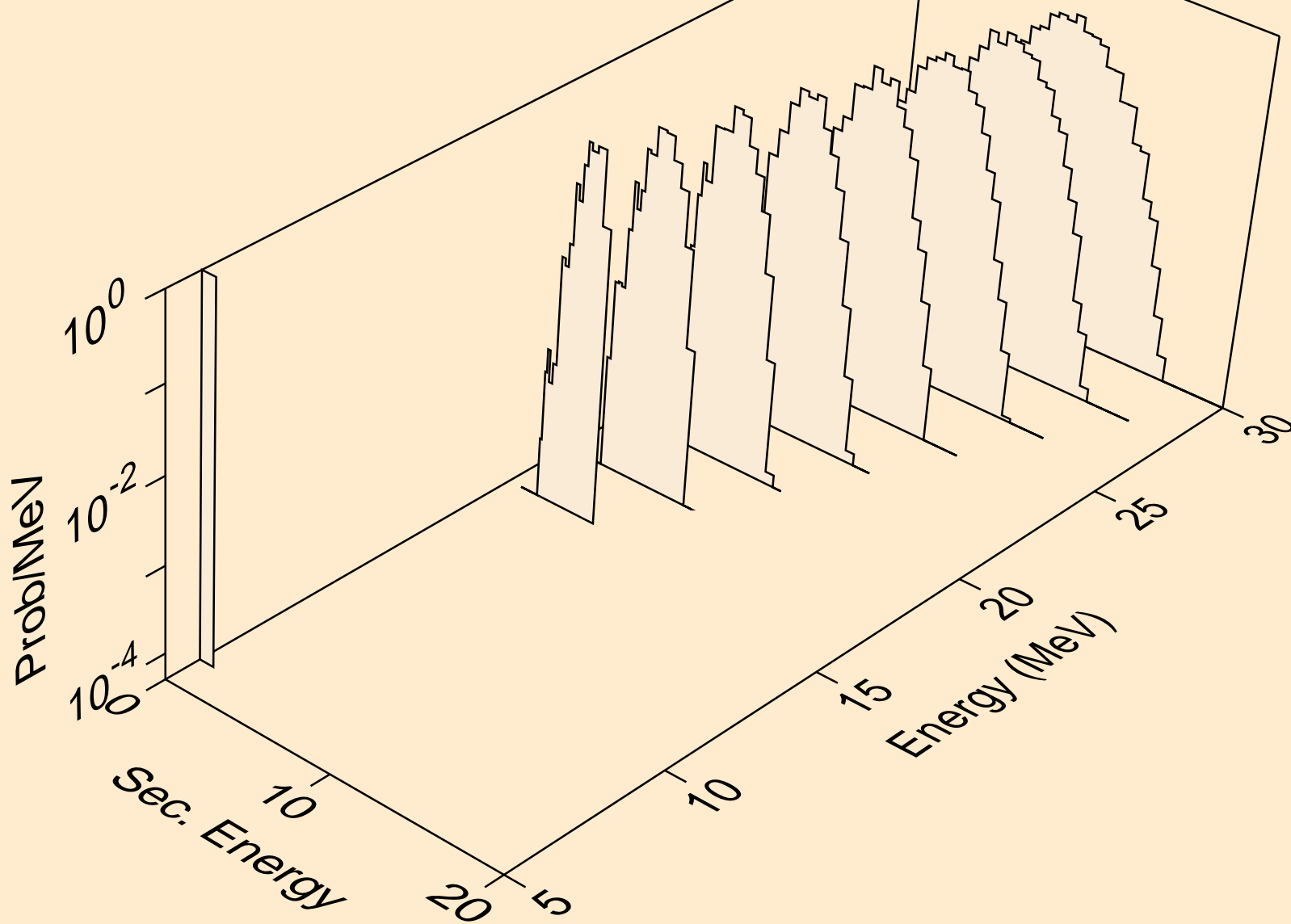

CE137M NEUTRON ACER TENDL-2019 LIBRARY; T=293.16K
tritons from (n,x)

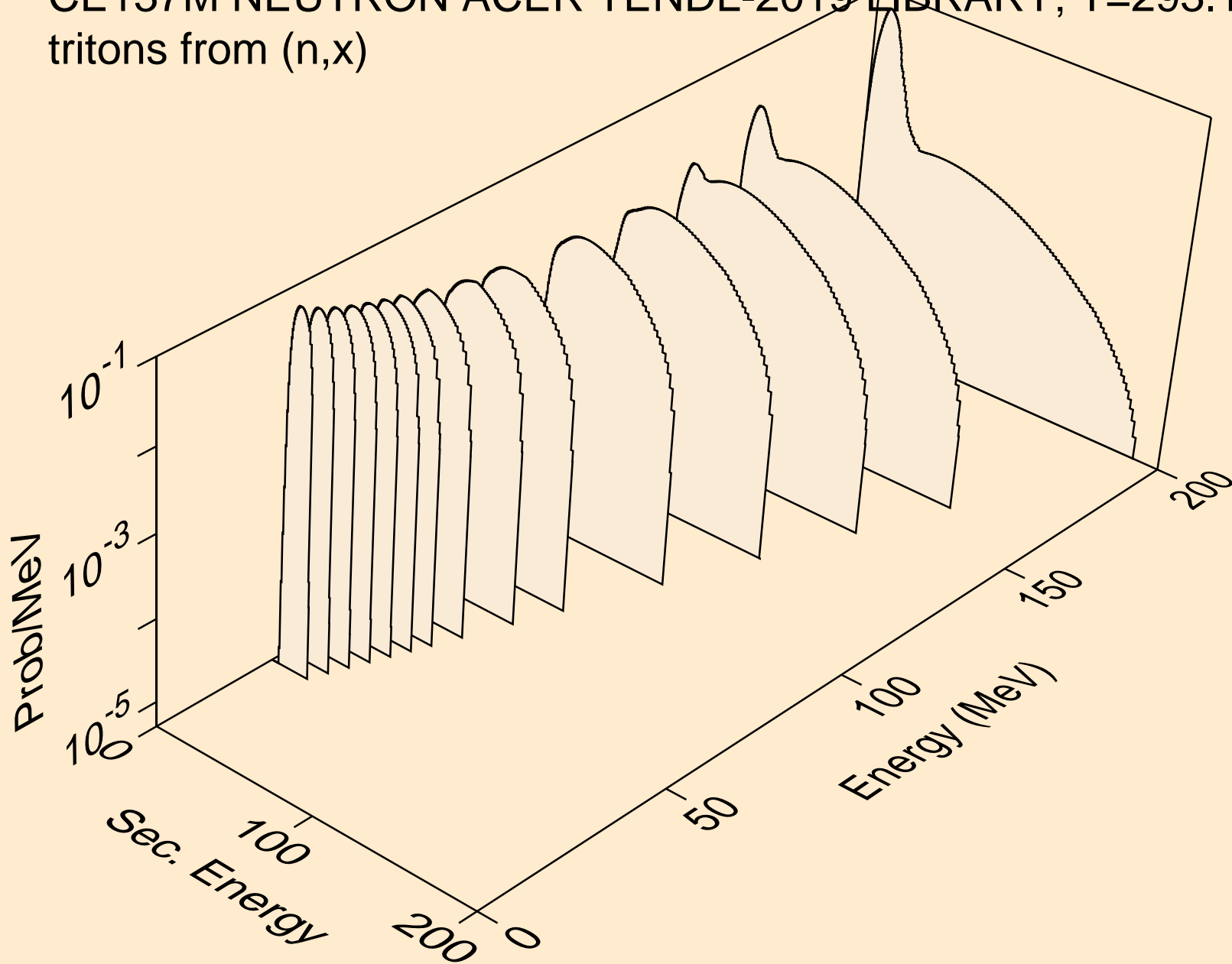

CE137M NEUTRON ACER TENDL-2019 LIBRARY; T=293.16K
tritons from (n,n*)t

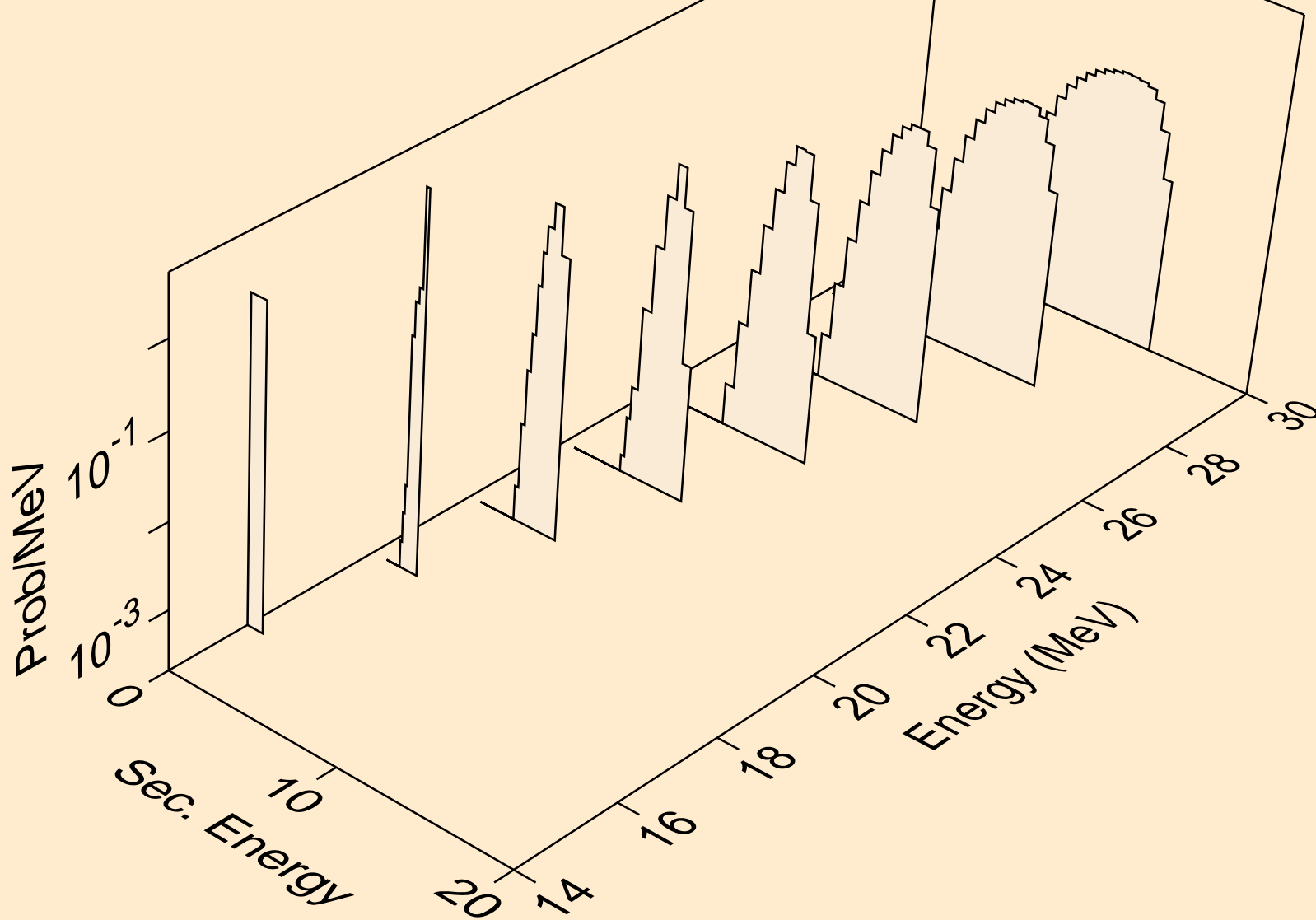

CE137M NEUTRON ACER TENDL-2019 LIBRARY; T=293.16K
tritons from (n,t)

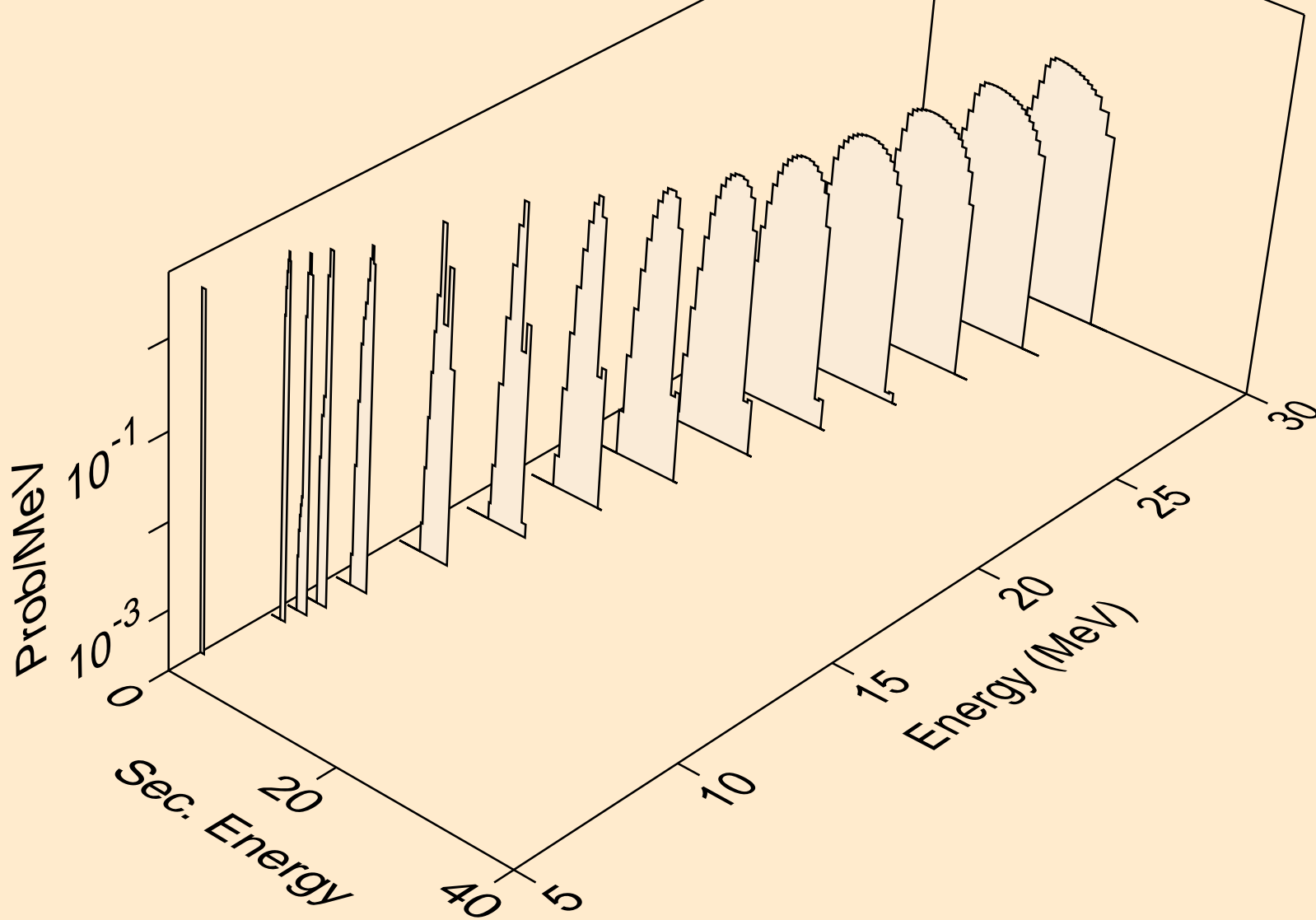

CE137M NEUTRON ACER TENDL-2019 LIBRARY; T=293.16K
tritons from (n,pt)

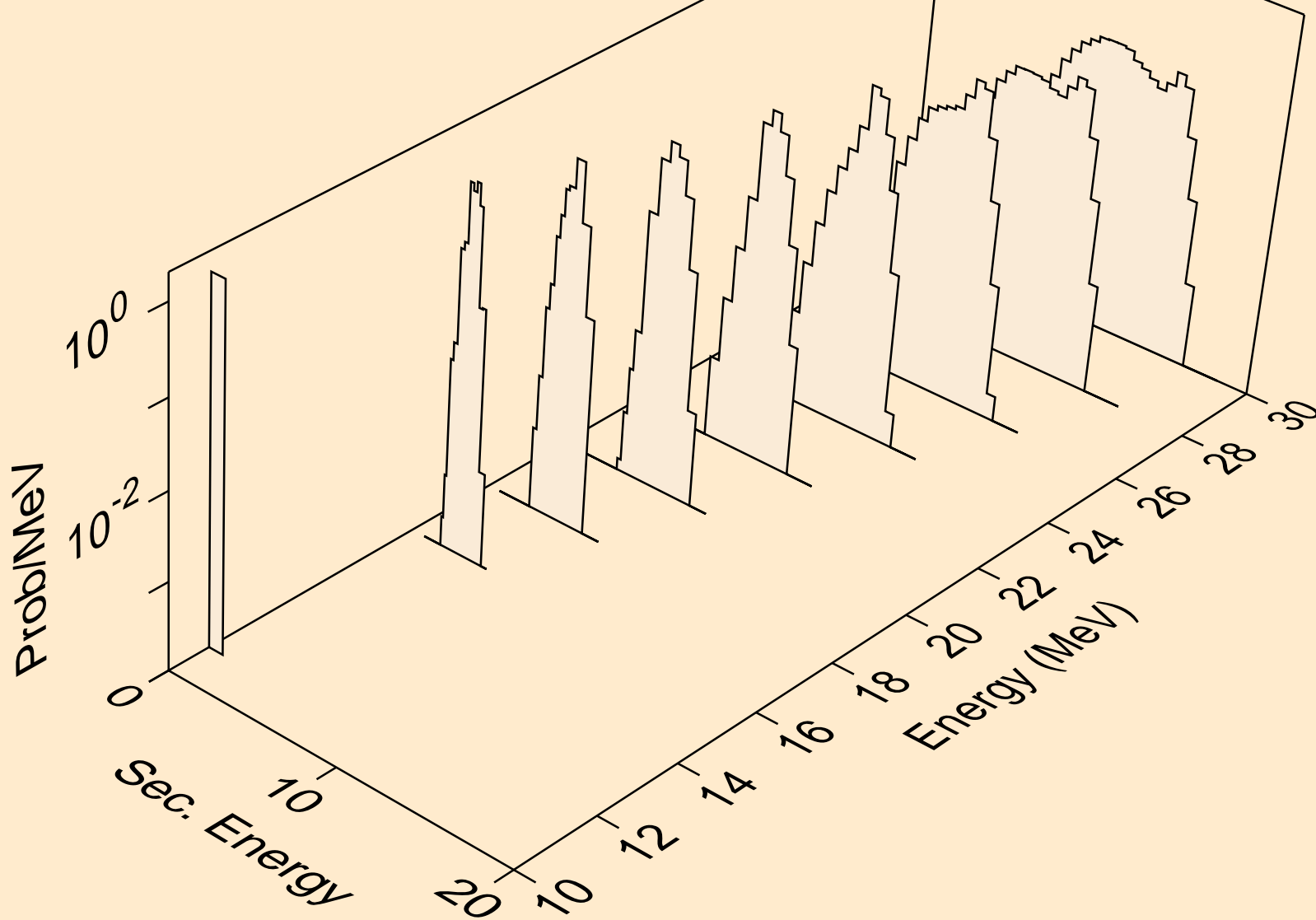

CE137M NEUTRON ACER TENDL-2019 LIBRARY; T=293.16K
he3s from (n,x)

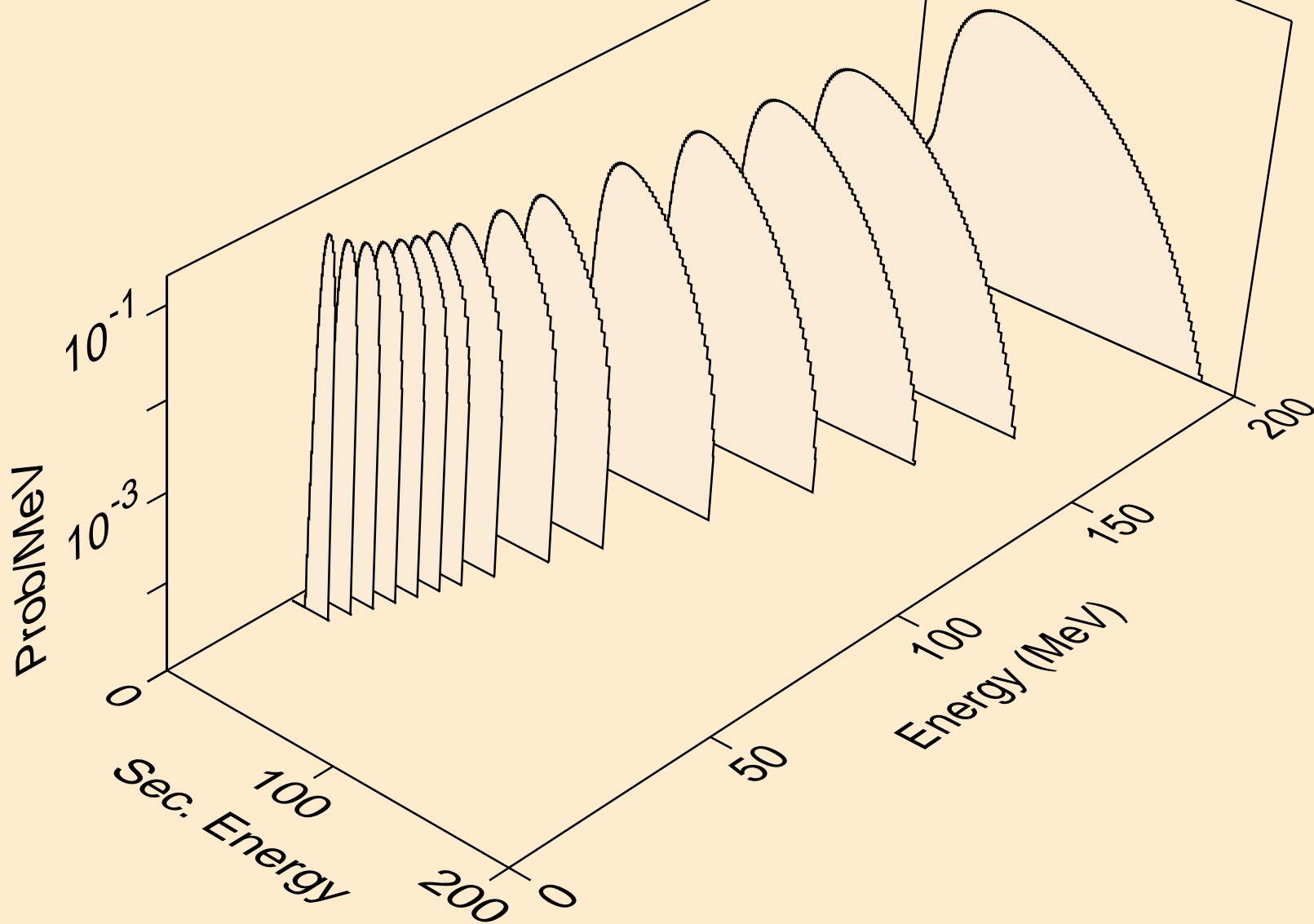

CE137M NEUTRON ACER TENDL-2019 LIBRARY; T=293.16K
he3s from (n,n*)he3

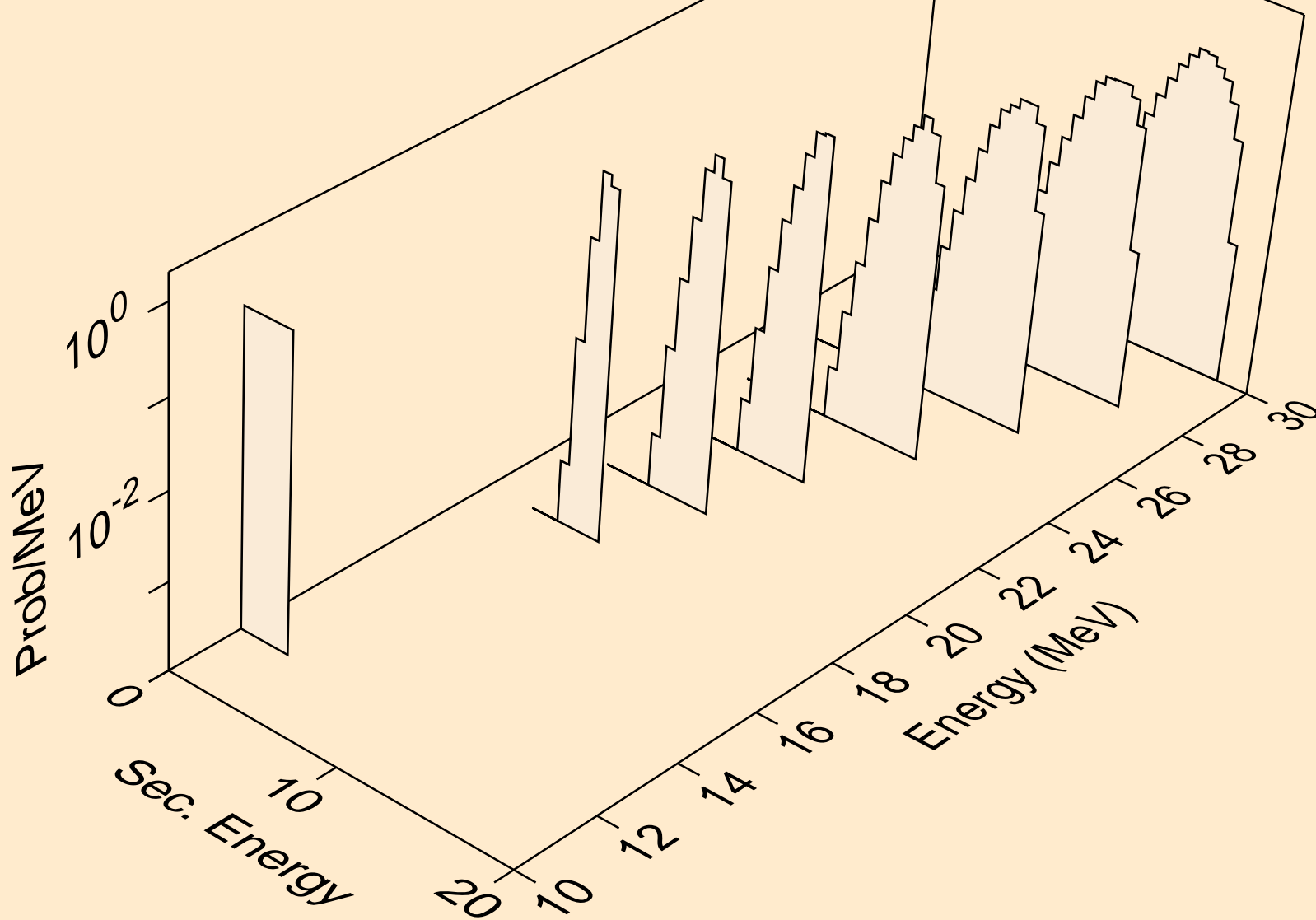

CE137M NEUTRON ACER TENDL-2019 LIBRARY; T=293.16K
he3s from (n,he3)

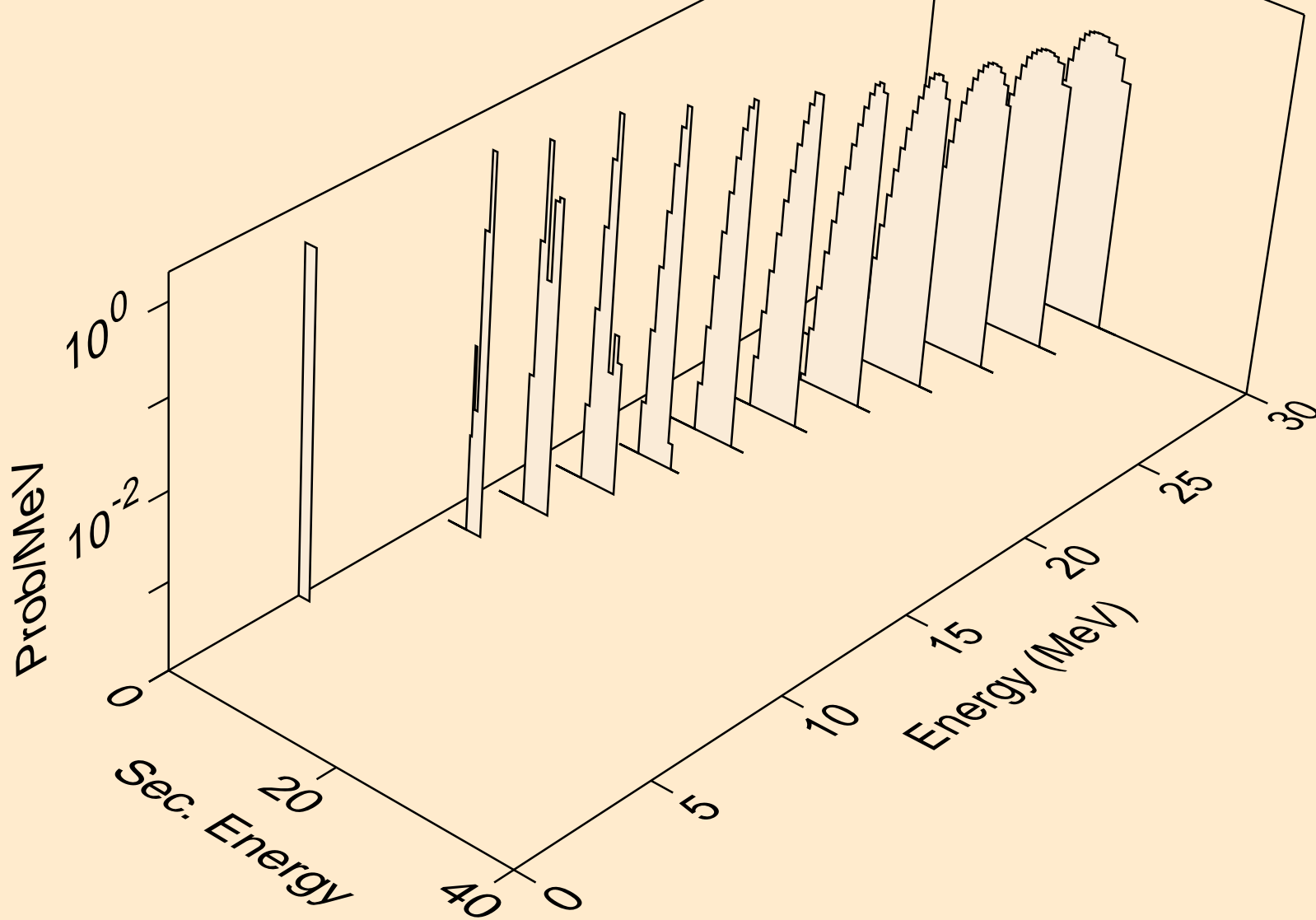

CE137M NEUTRON ACER TENDL-2019 LIBRARY; T=293.16K
alphas from (n,x)

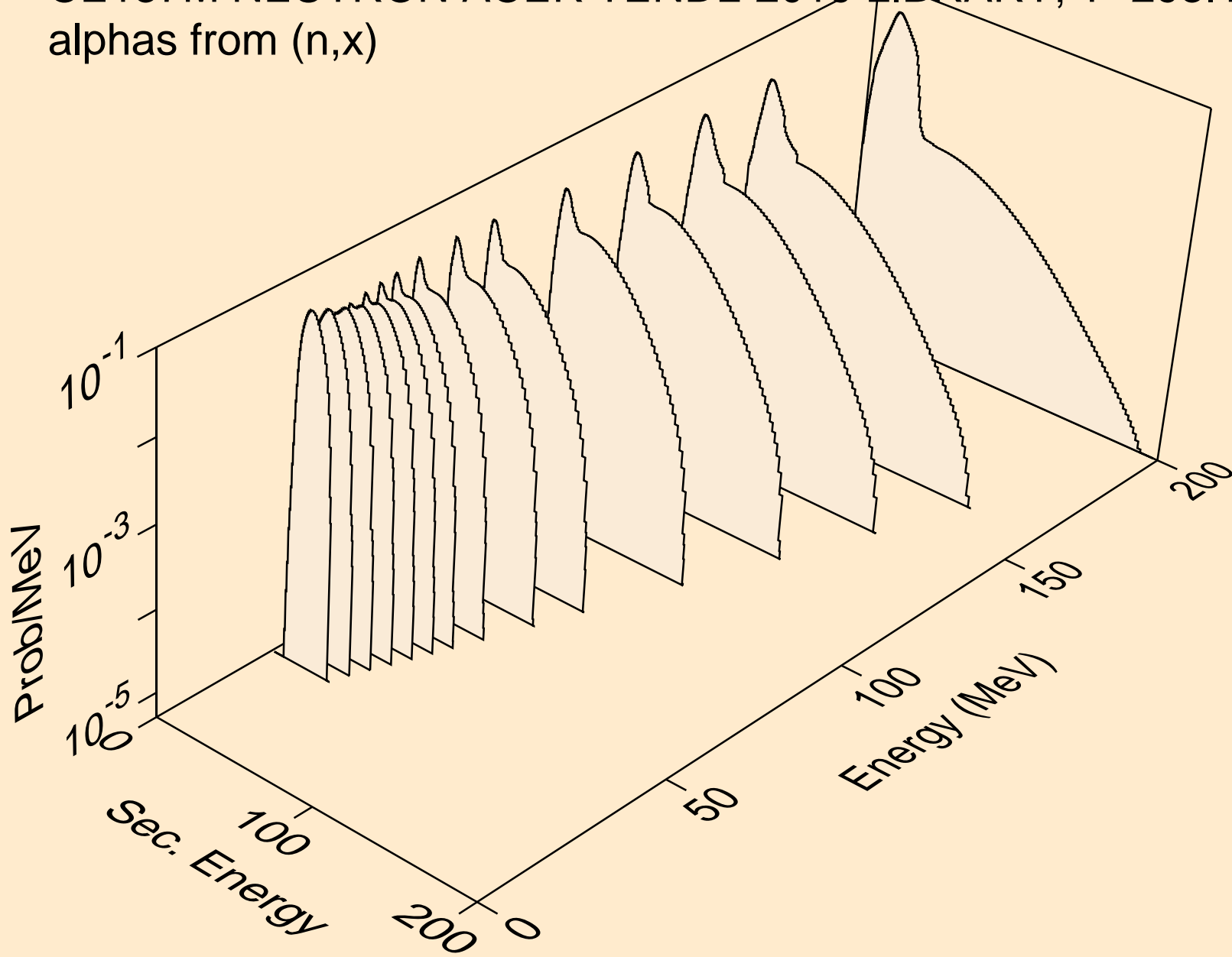

CE137M NEUTRON ACER TENDL-2019 LIBRARY; T=293.16K
alphas from (n,n*)a

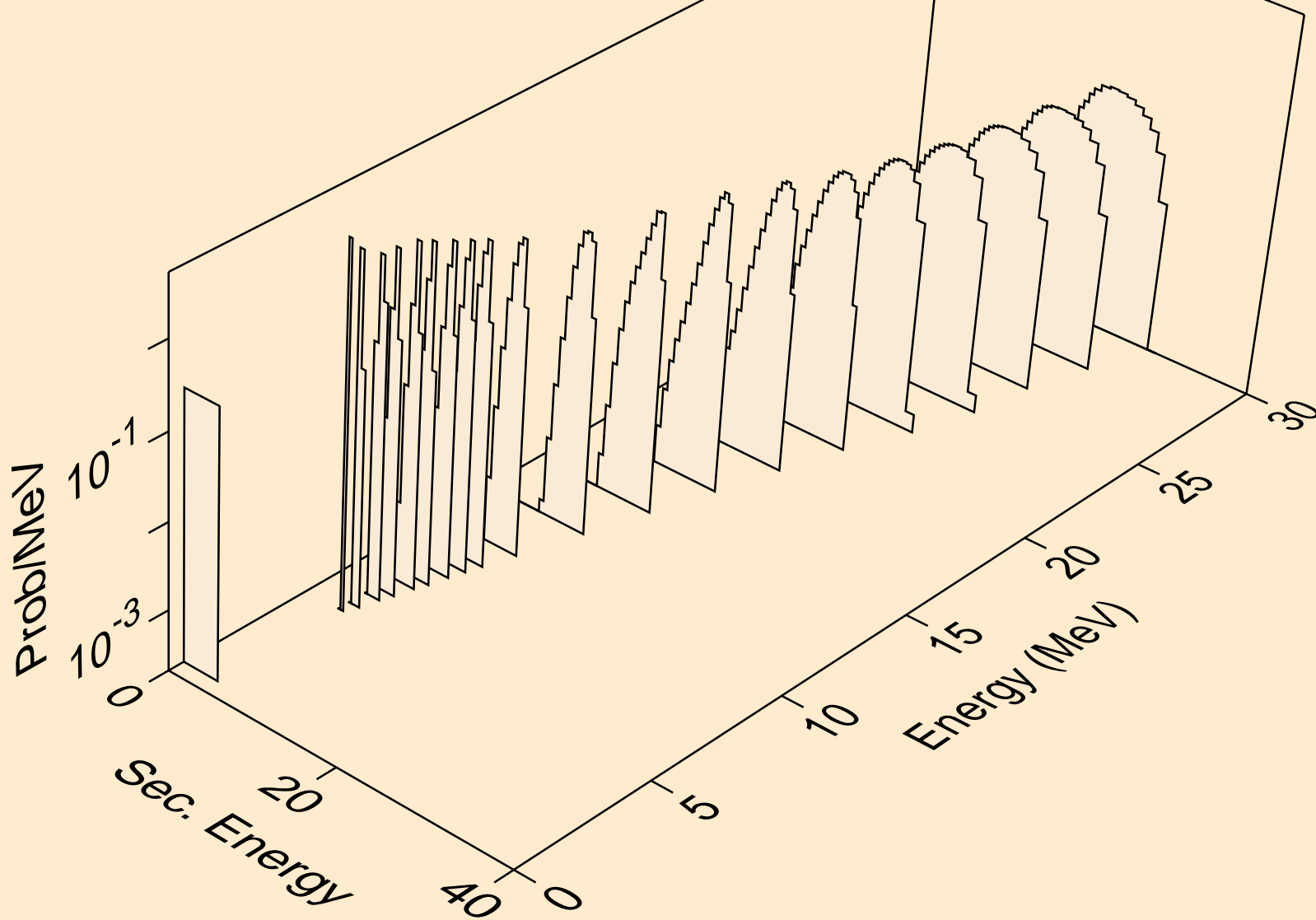

CE137M NEUTRON ACER TENDL-2019 LIBRARY; T=293.16K
alphas from (n,2n)a

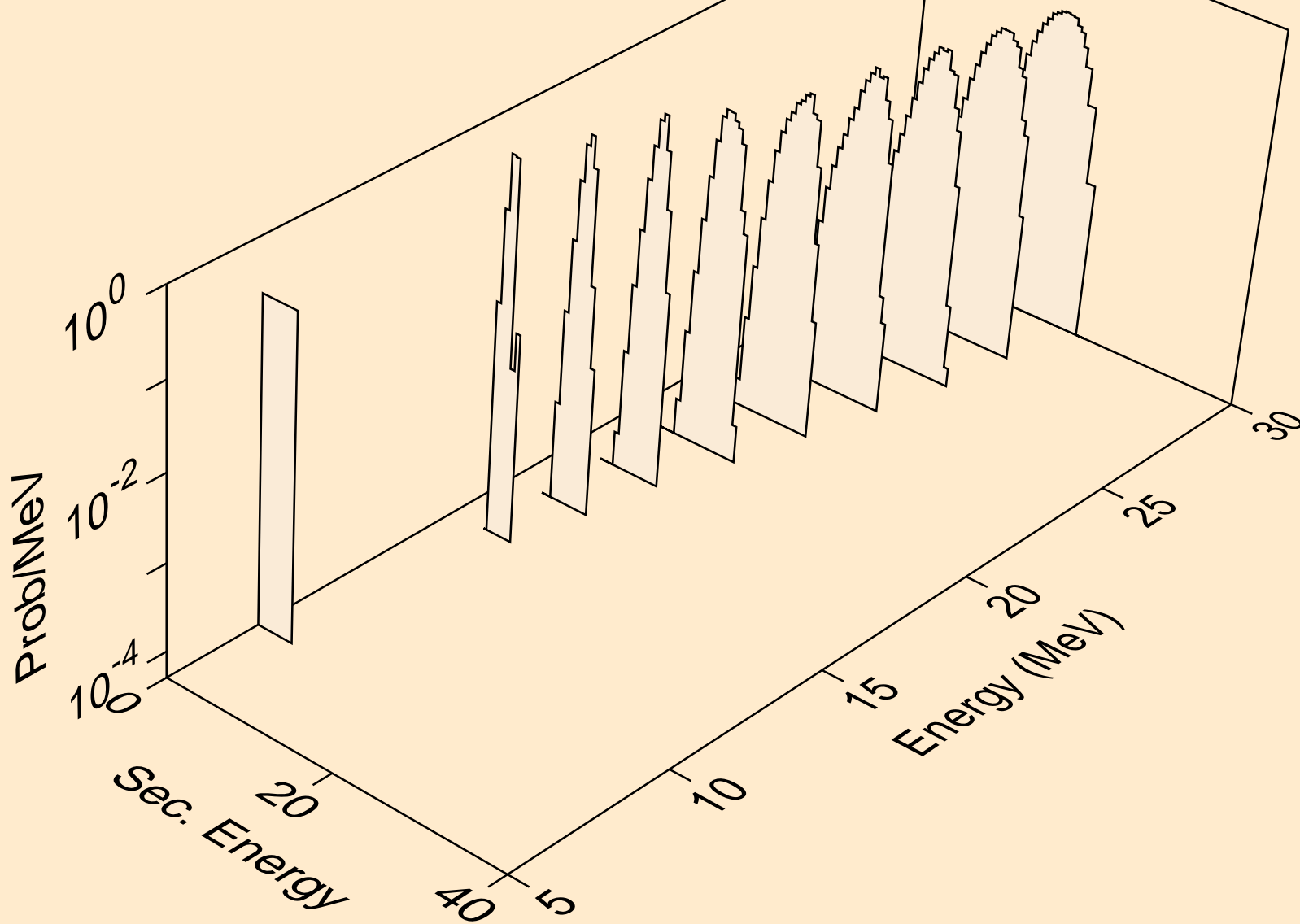

CE137M NEUTRON ACER TENDL-2019 LIBRARY; T=293.16K
alphas from (n,3n)a

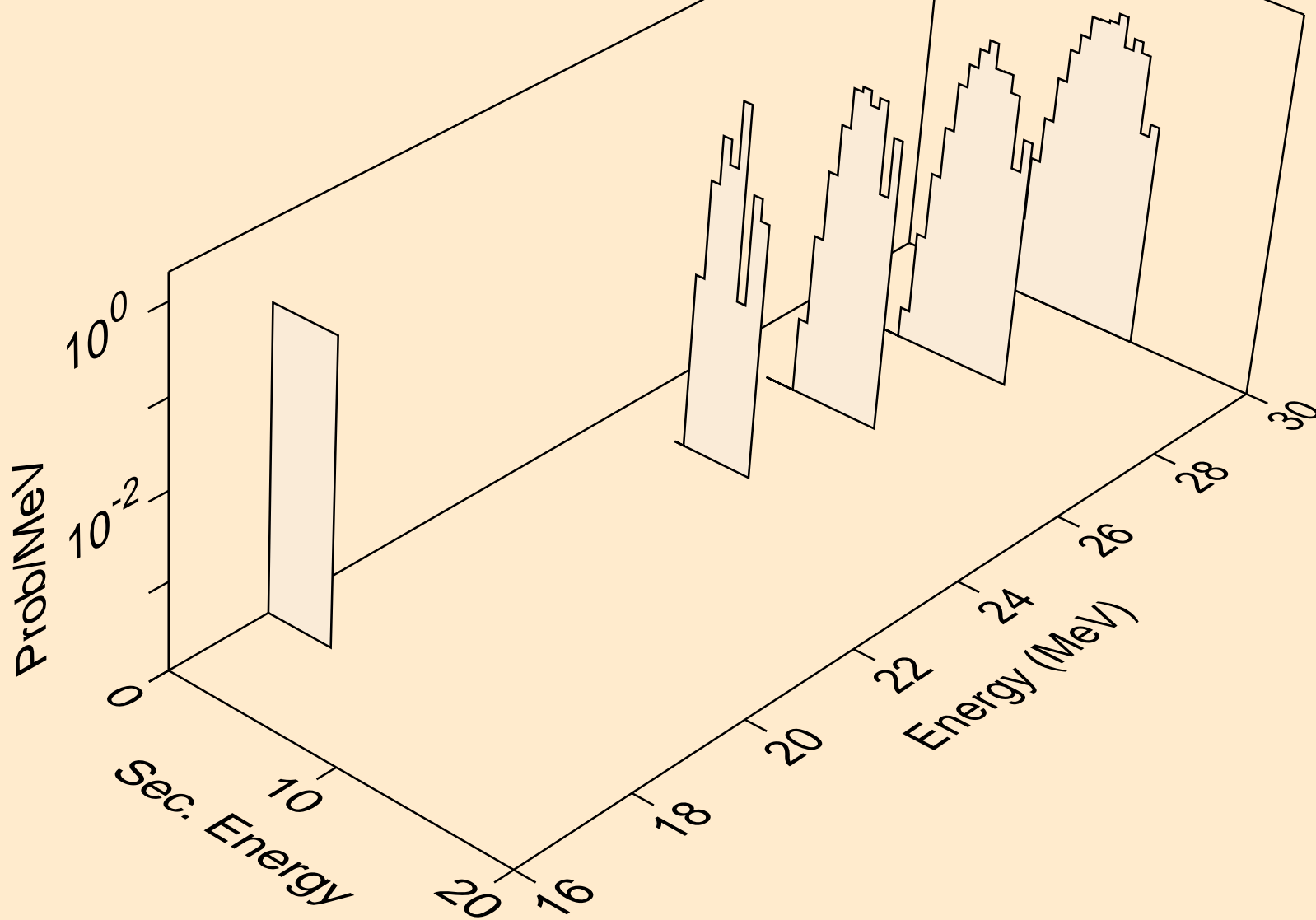

CE137M NEUTRON ACER TENDL-2019 LIBRARY; T=293.16K
alphas from (n,n*)2a

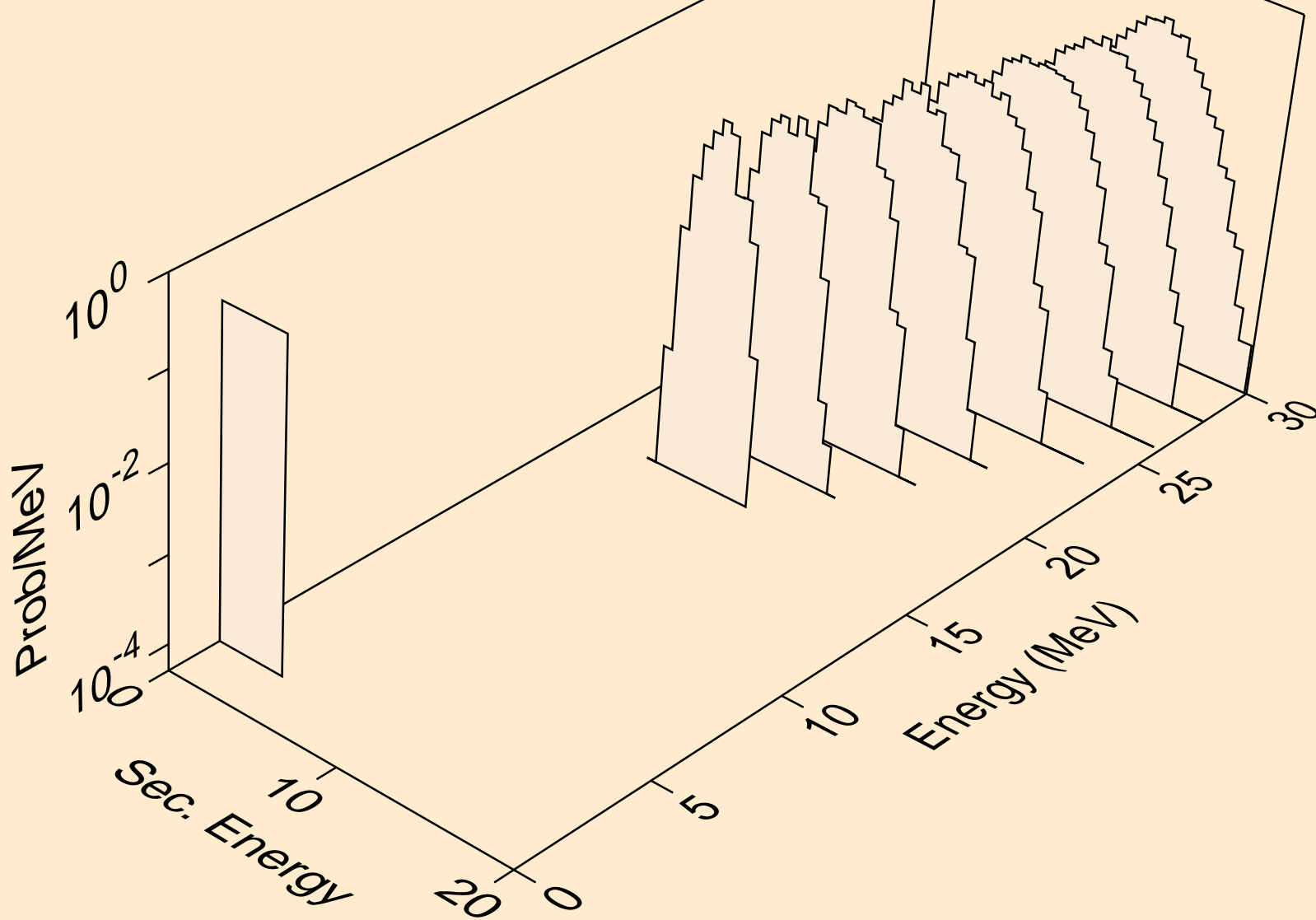

CE137M NEUTRON ACER TENDL-2019 LIBRARY; T=293.16K
alphas from (n,npa)

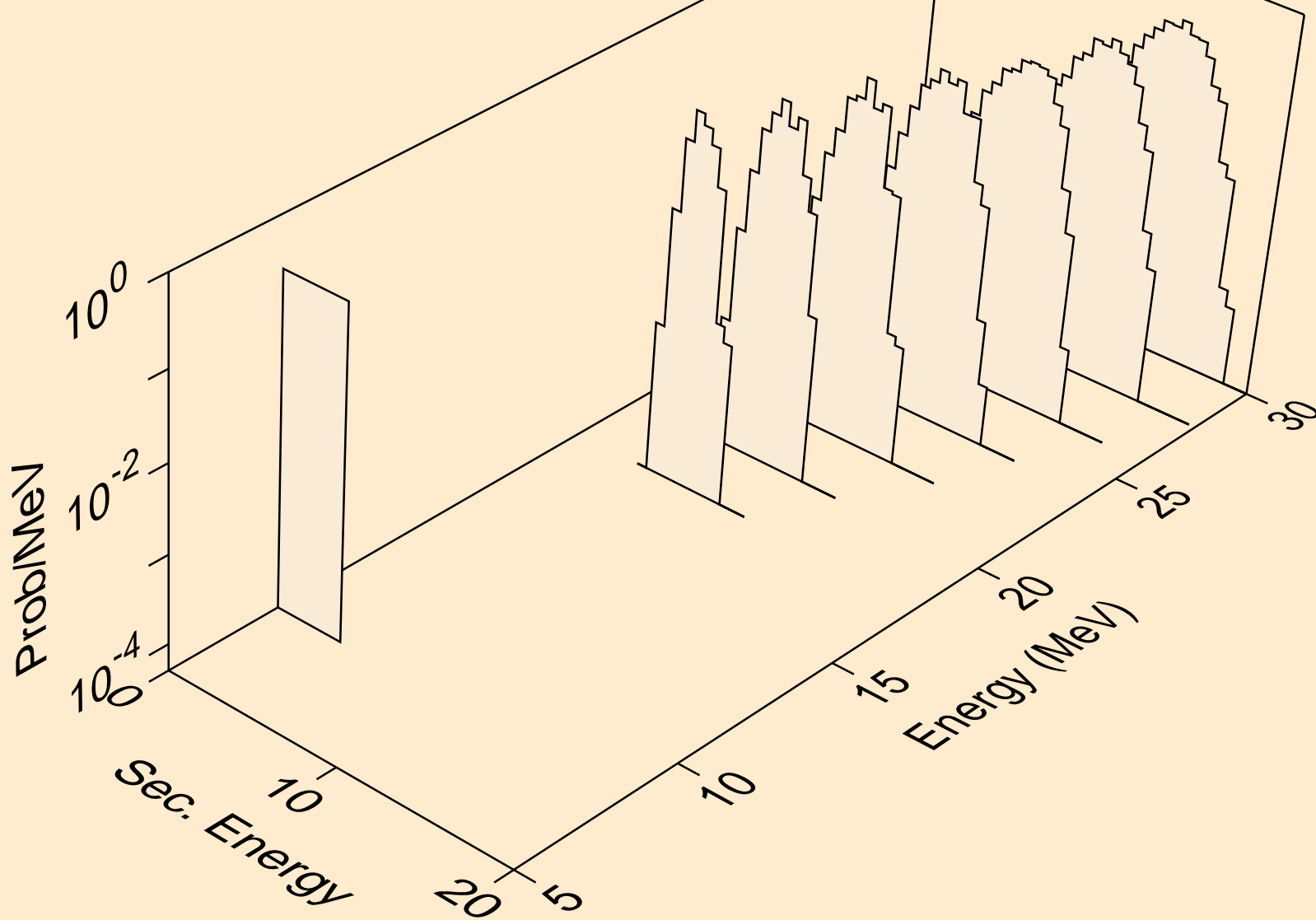

CE137M NEUTRON ACER TENDL-2019 LIBRARY; T=293.16K
alphas from (n,a)

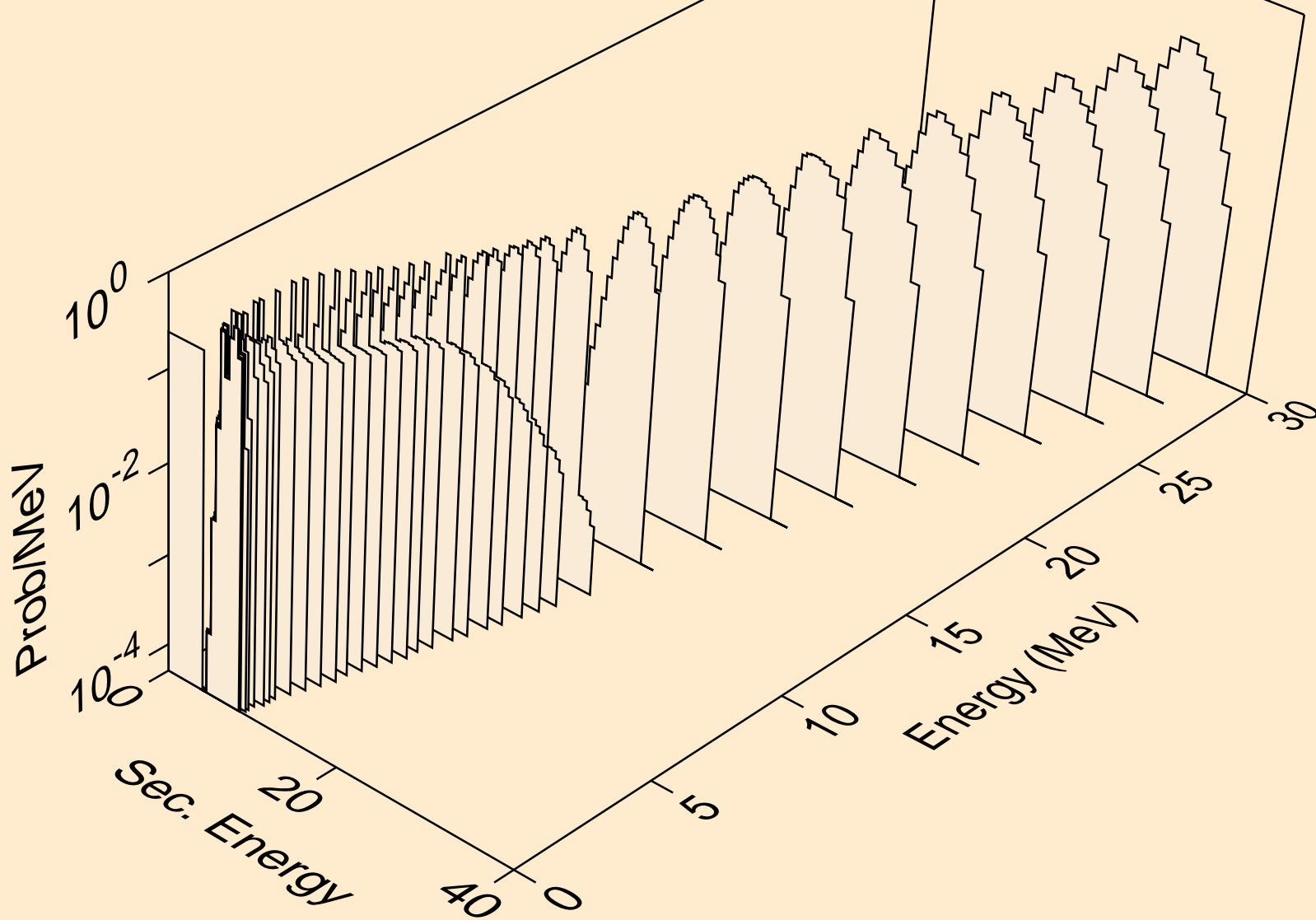

CE137M NEUTRON ACER TENDL-2019 LIBRARY; T=293.16K
alphas from (n,2a)

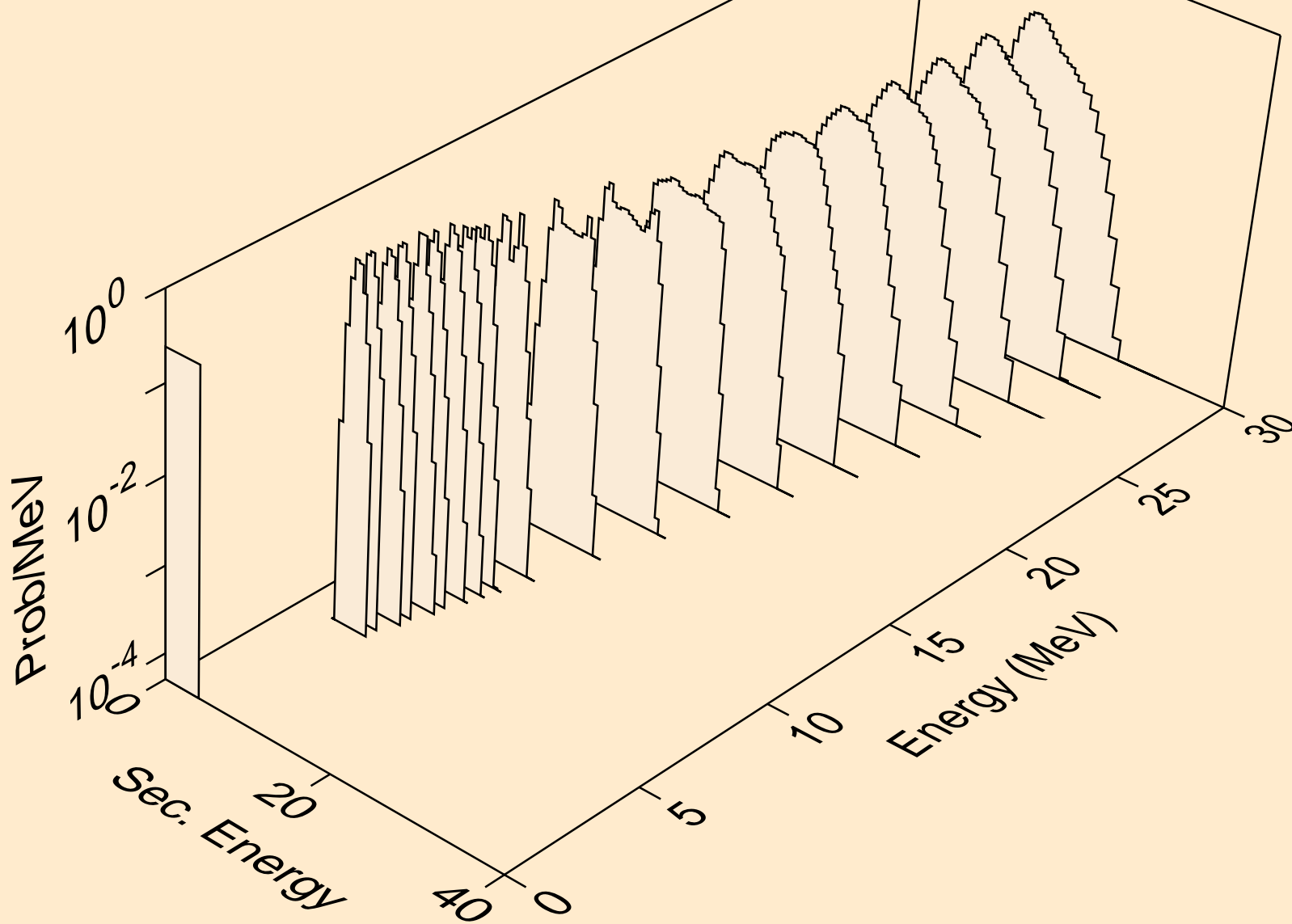

CE137M NEUTRON ACER TENDL-2019 LIBRARY; T=293.16K
alphas from (n,pa)

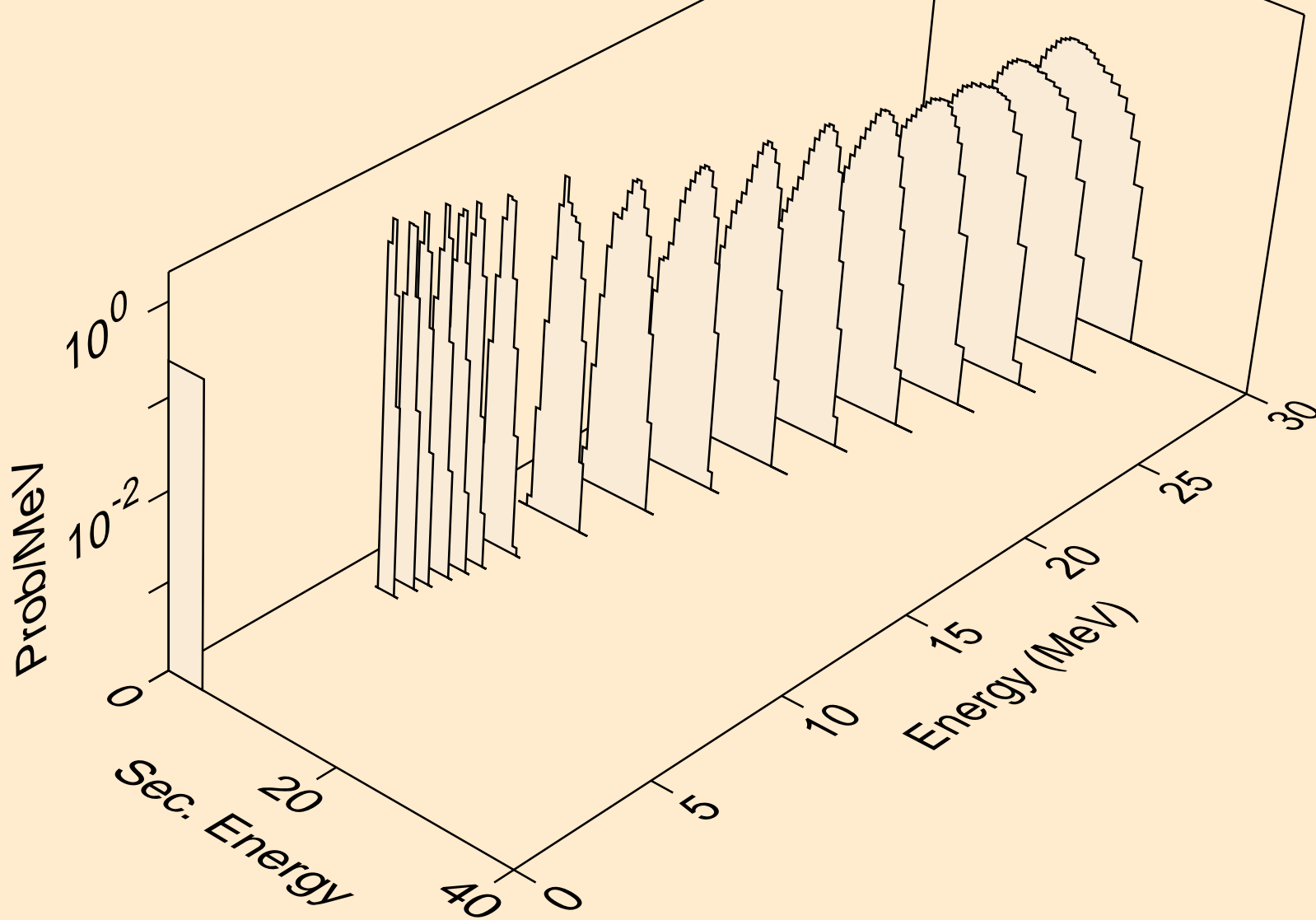

CE137M NEUTRON ACER TENDL-2019 LIBRARY; T=293.16K
alphas from (n,da)

