

CF241 NEUTRON ACER TENDL-2019 LIBRARY; T=293.16K  
Principal cross sections

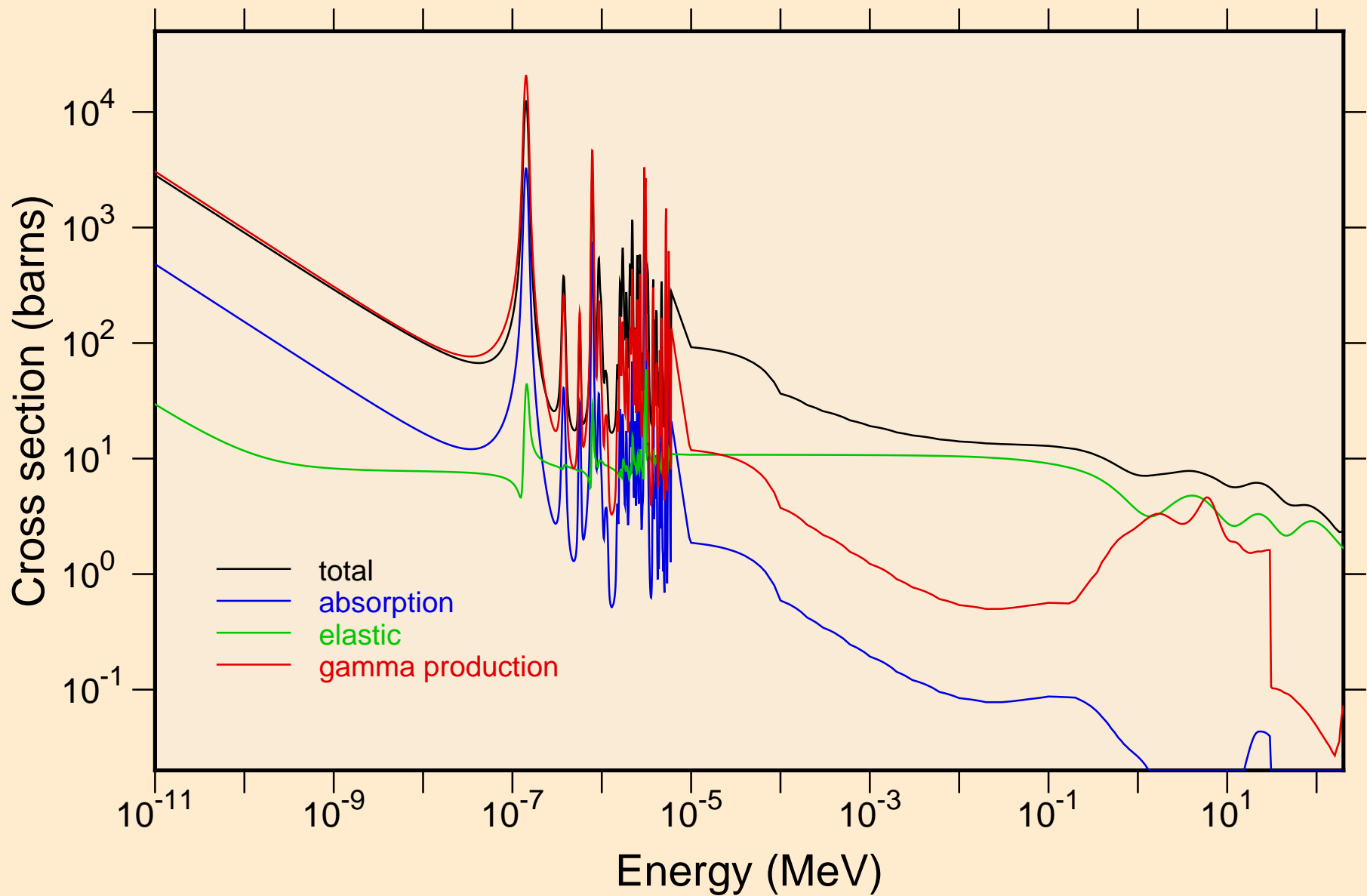

CF241 NEUTRON ACER TENDL-2019 LIBRARY; T=293.16K  
resonance total cross section

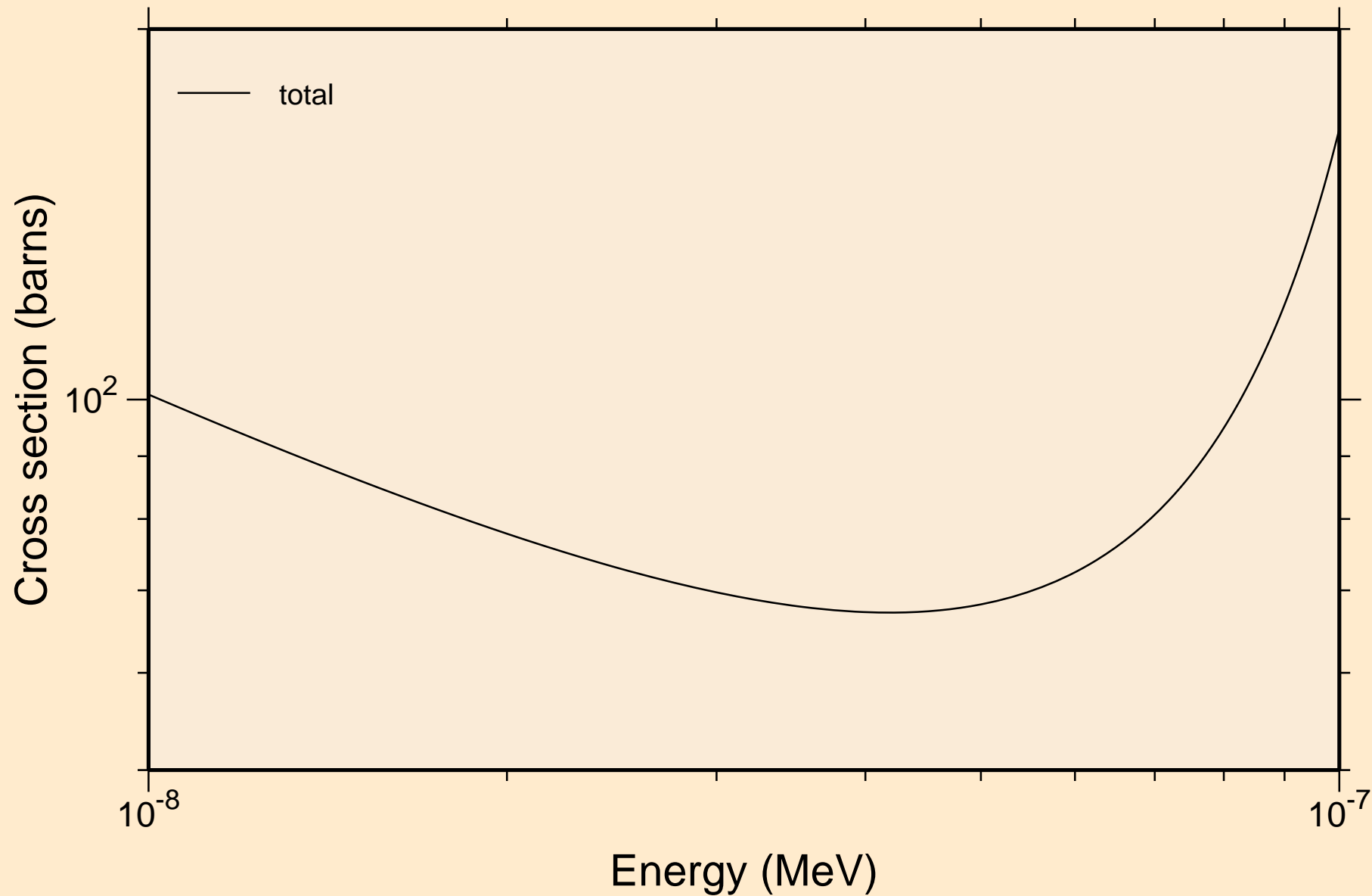

CF241 NEUTRON ACER TENDL-2019 LIBRARY; T=293.16K  
resonance total cross section

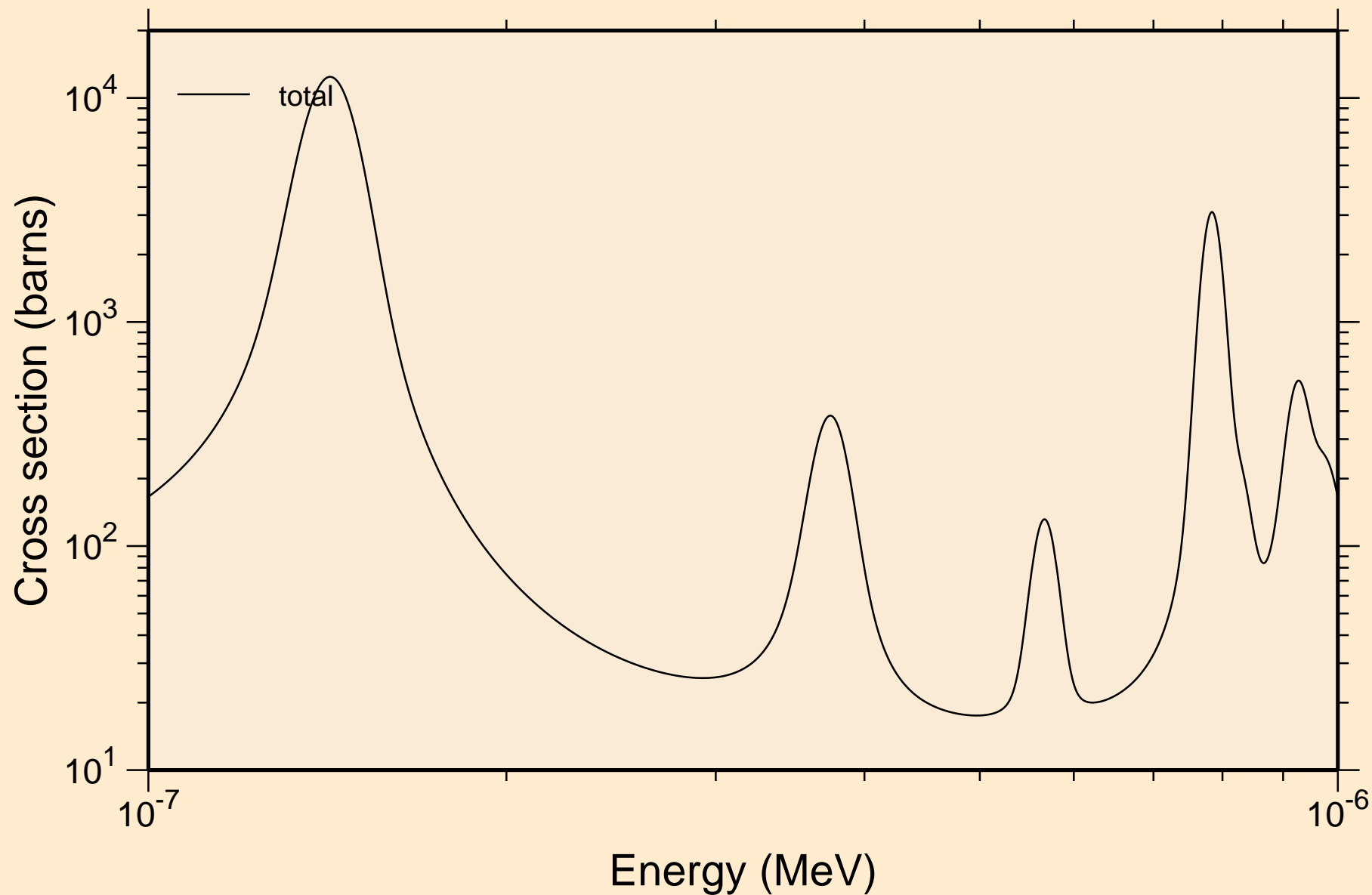

CF241 NEUTRON ACER TENDL-2019 LIBRARY; T=293.16K  
resonance total cross section

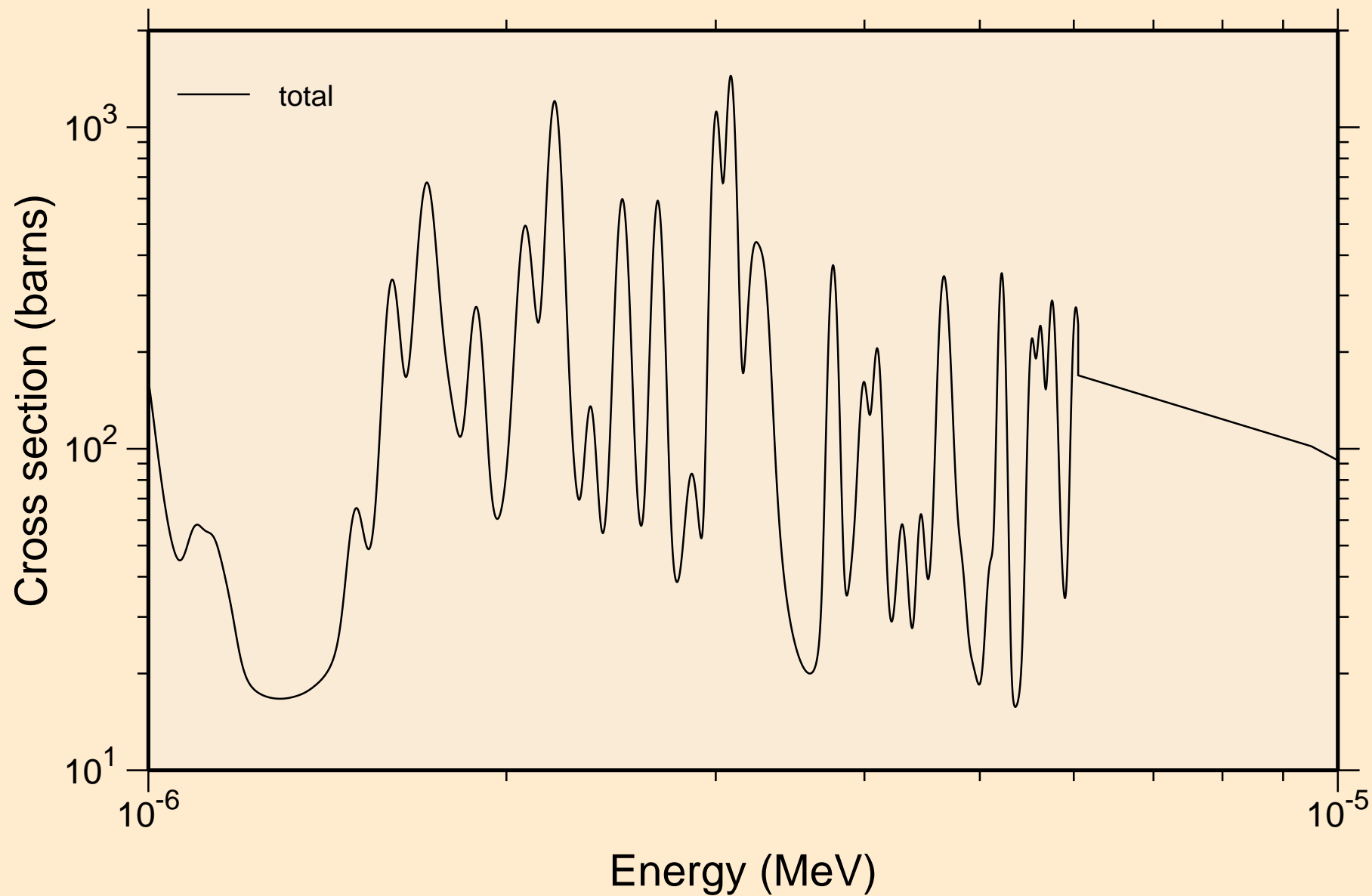

CF241 NEUTRON ACER TENDL-2019 LIBRARY; T=293.16K  
resonance total cross section

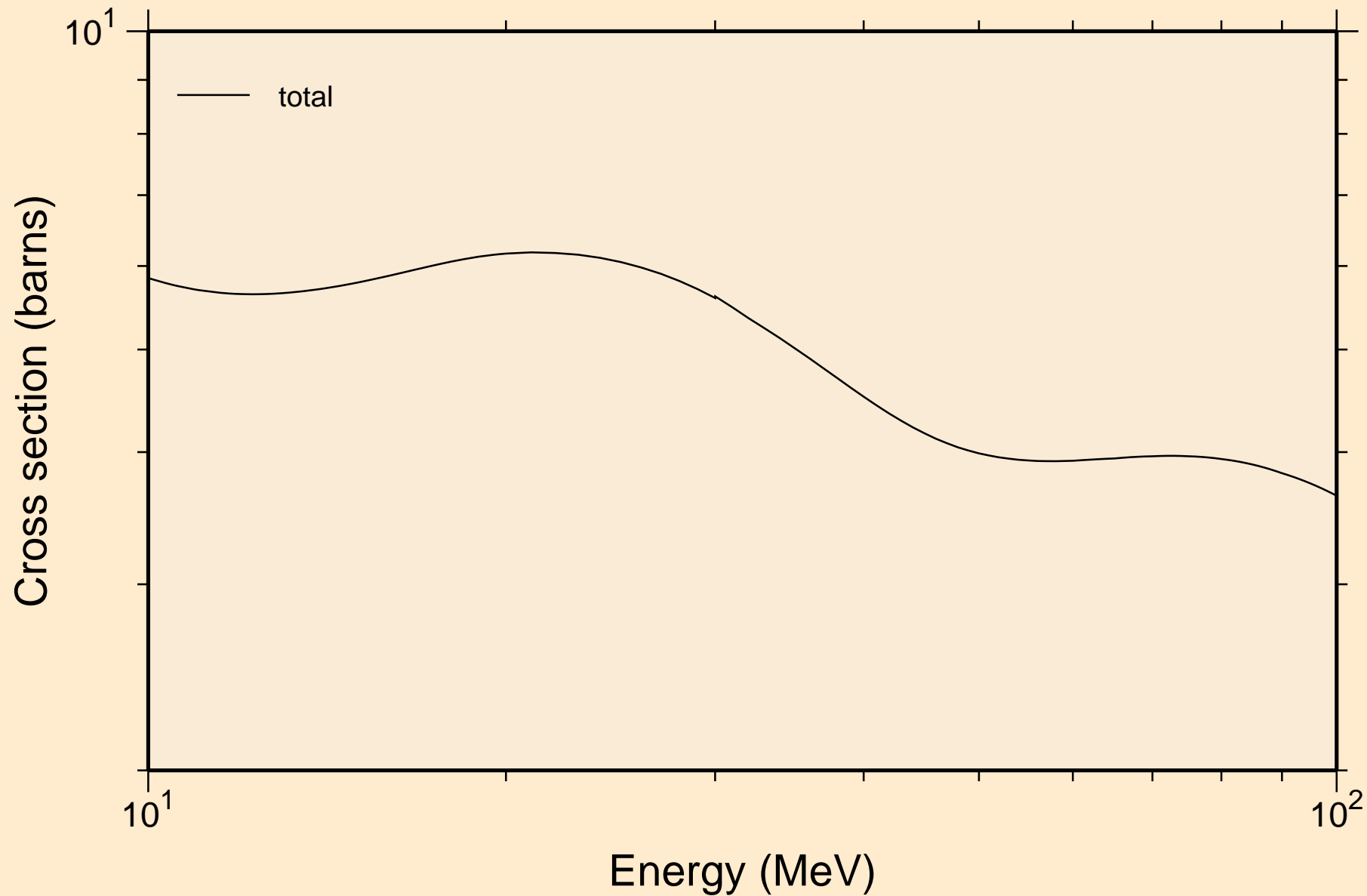

CF241 NEUTRON ACER TENDL-2019 LIBRARY; T=293.16K  
resonance absorption cross sections

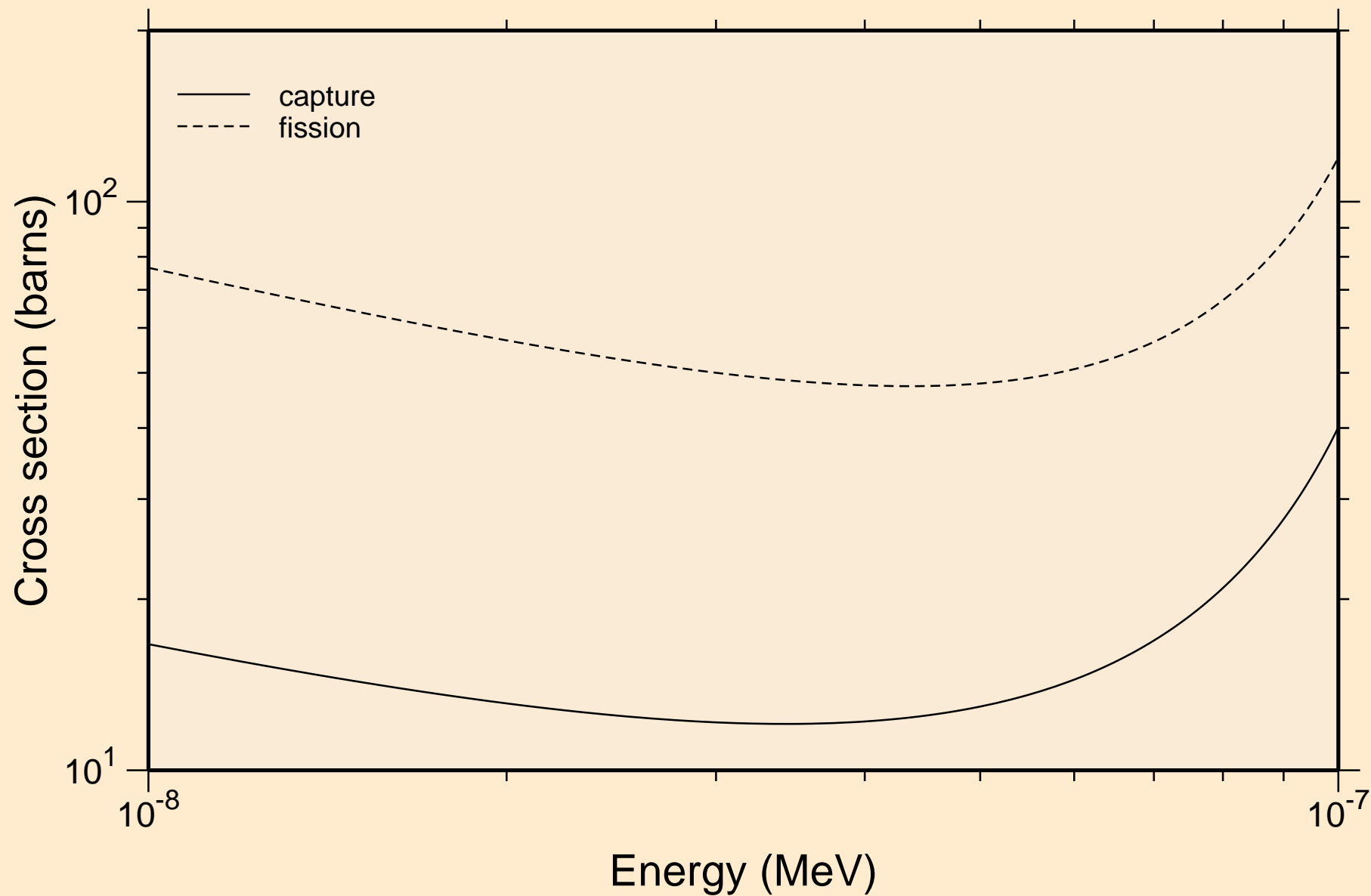

CF241 NEUTRON ACER TENDL-2019 LIBRARY; T=293.16K  
resonance absorption cross sections

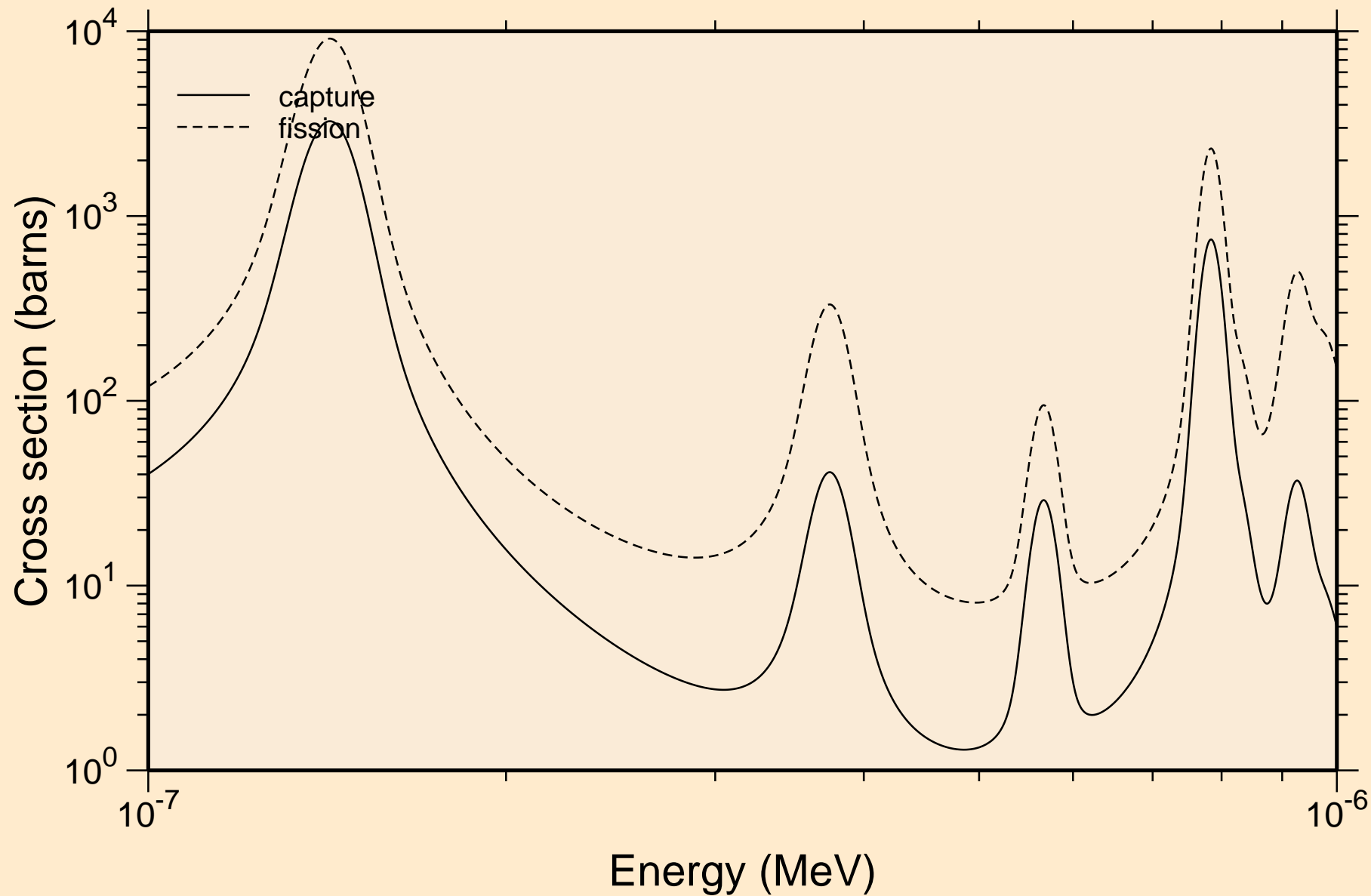

CF241 NEUTRON ACER TENDL-2019 LIBRARY; T=293.16K  
resonance absorption cross sections

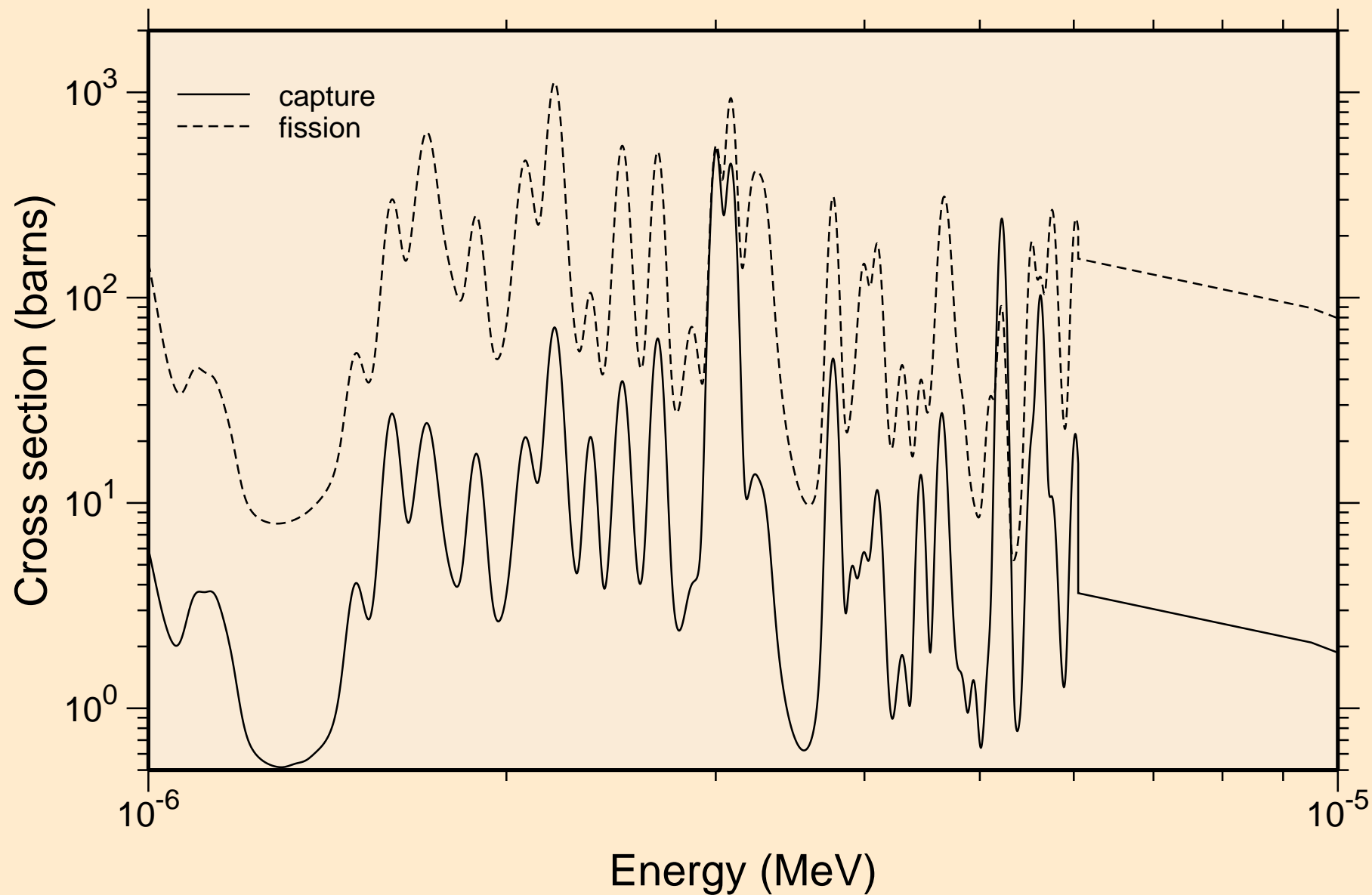



CF241 NEUTRON ACER TENDL-2019 LIBRARY; T=293.16K  
resonance absorption cross sections

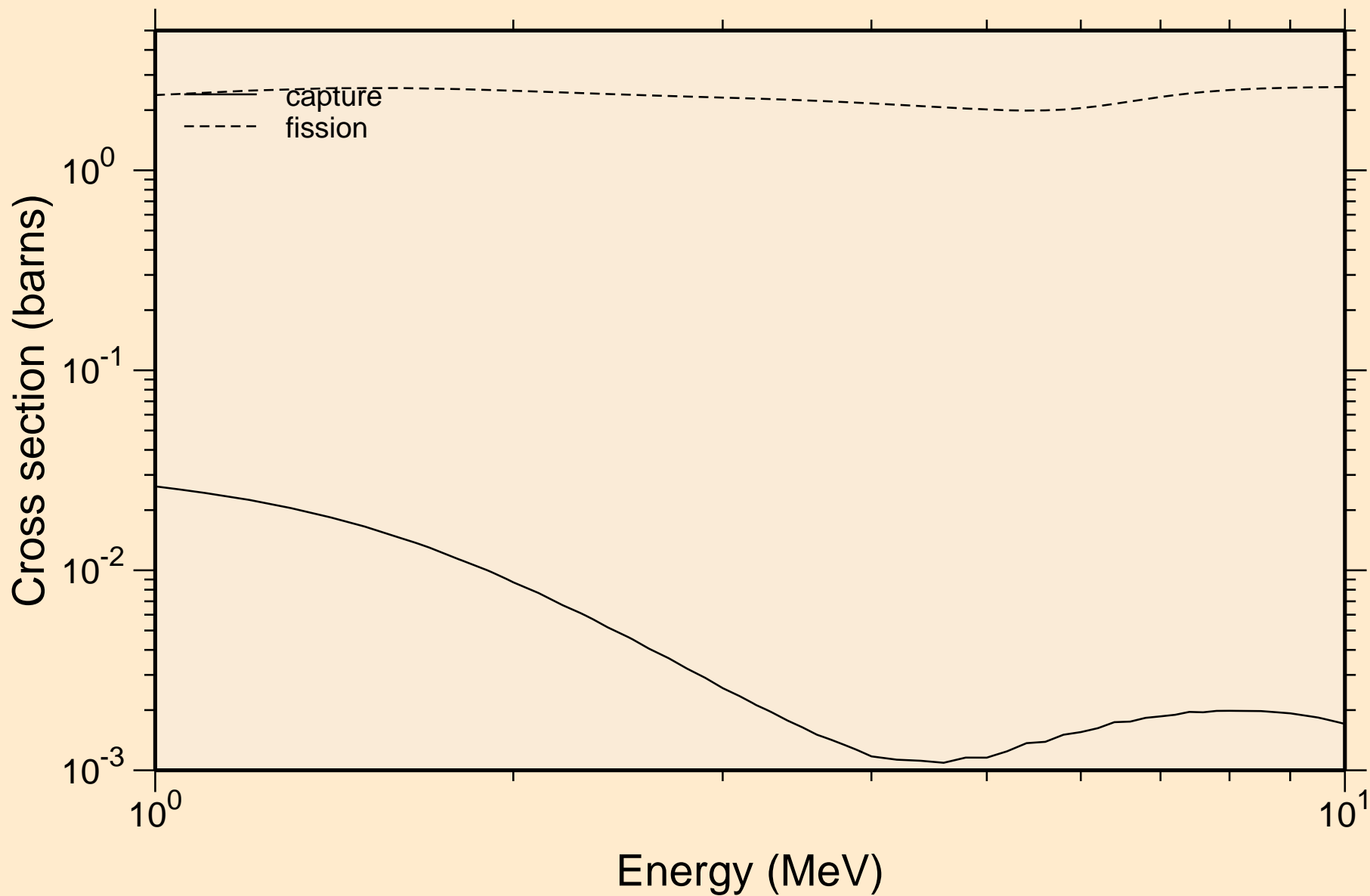

CF241 NEUTRON ACER TENDL-2019 LIBRARY; T=293.16K  
Heating

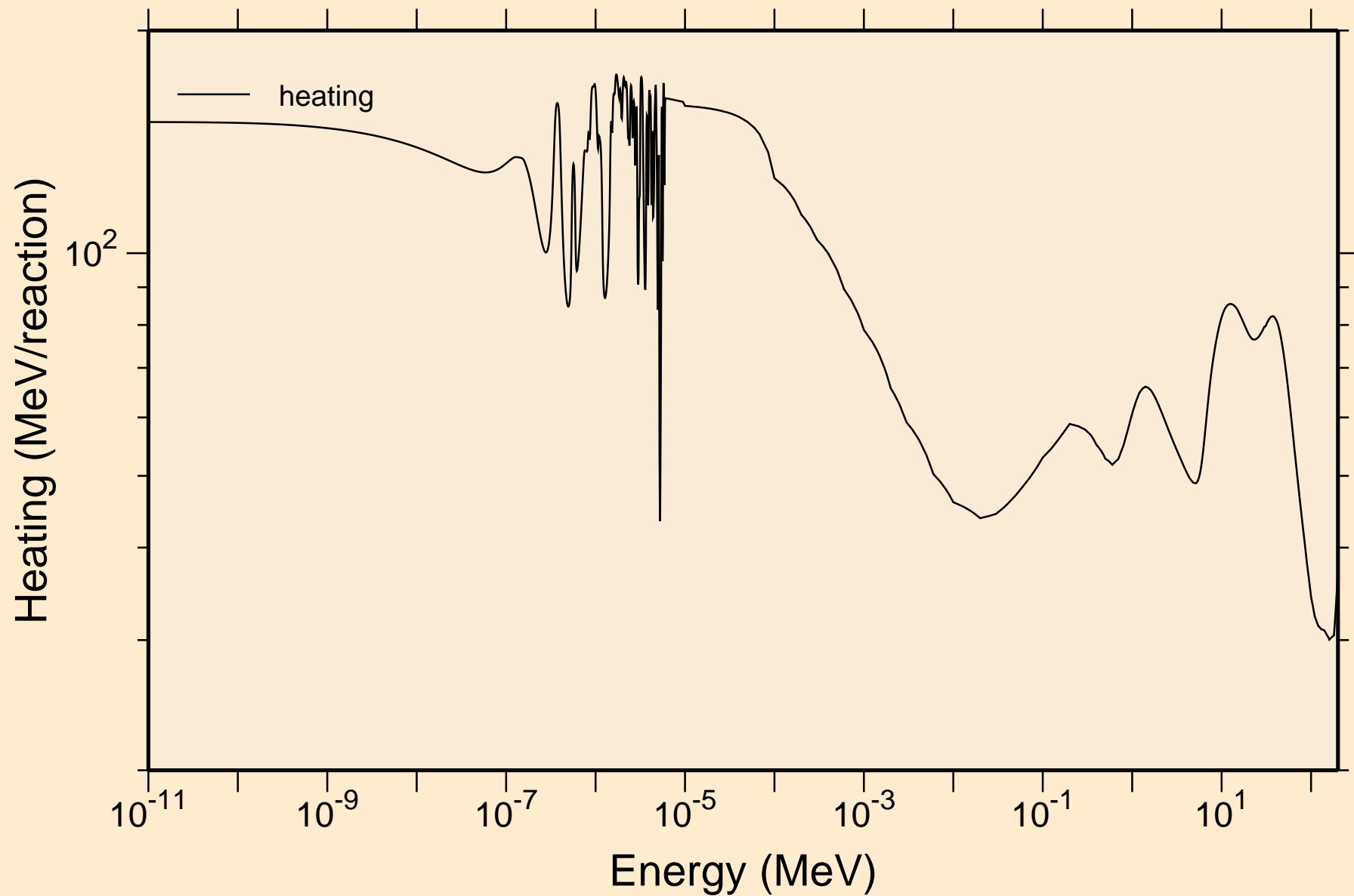

CF241 NEUTRON ACER TENDL-2019 LIBRARY; T=293.16K  
Damage

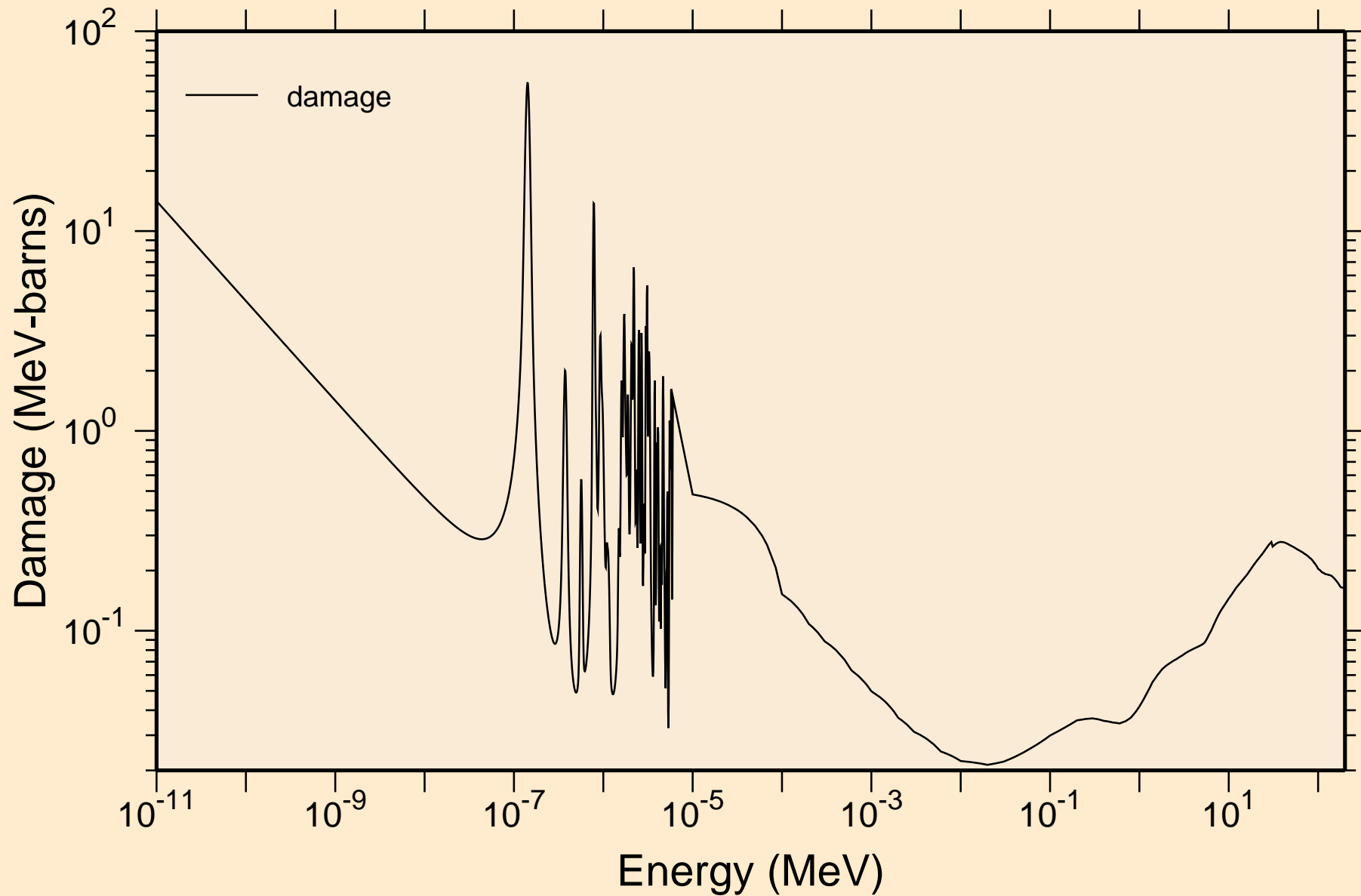

# CF241 NEUTRON ACER TENDL-2019 LIBRARY; T=293.16K

## Non-threshold reactions

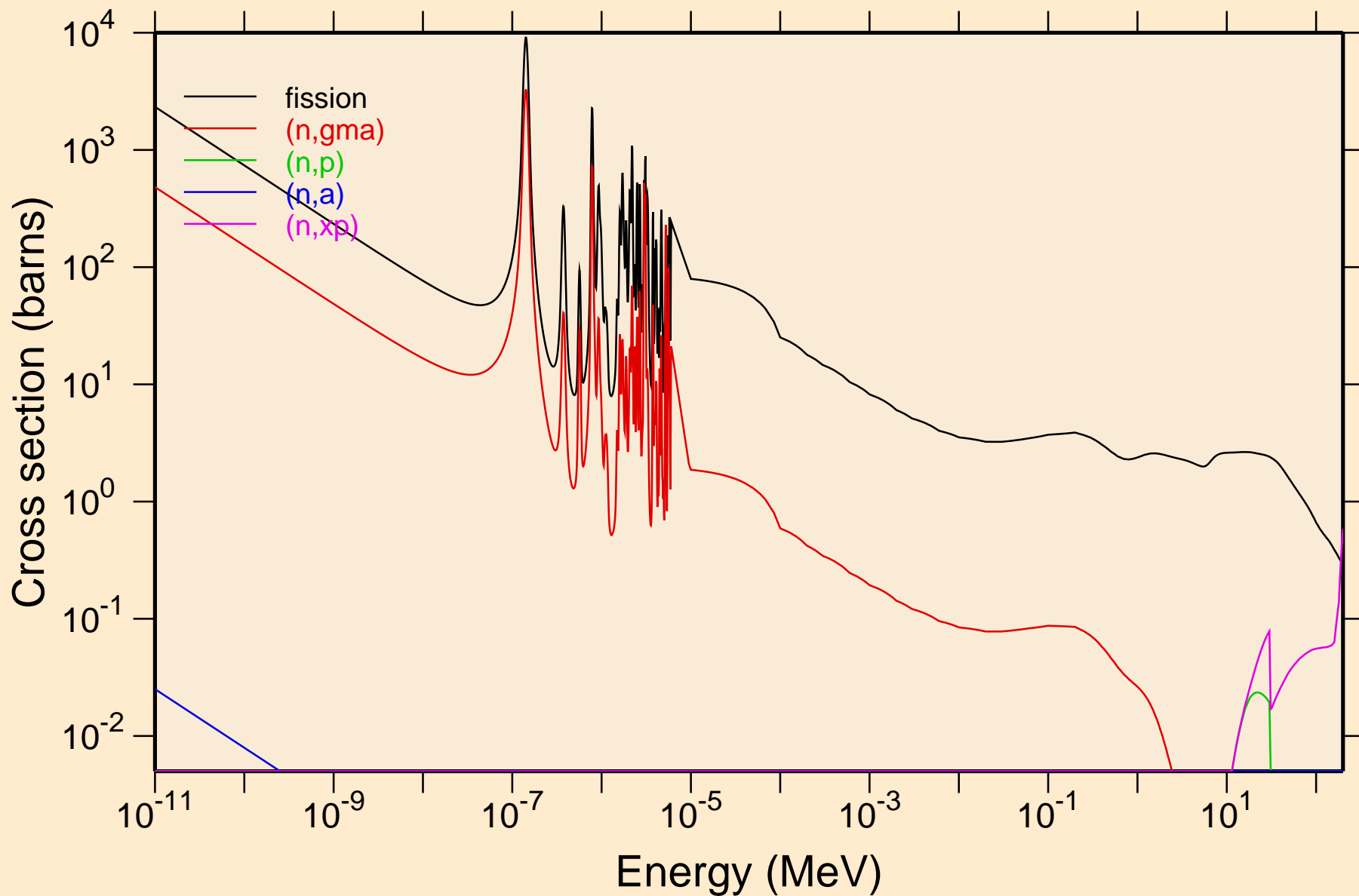

CF241 NEUTRON ACER TENDL-2019 LIBRARY; T=293.16K  
Non-threshold reactions

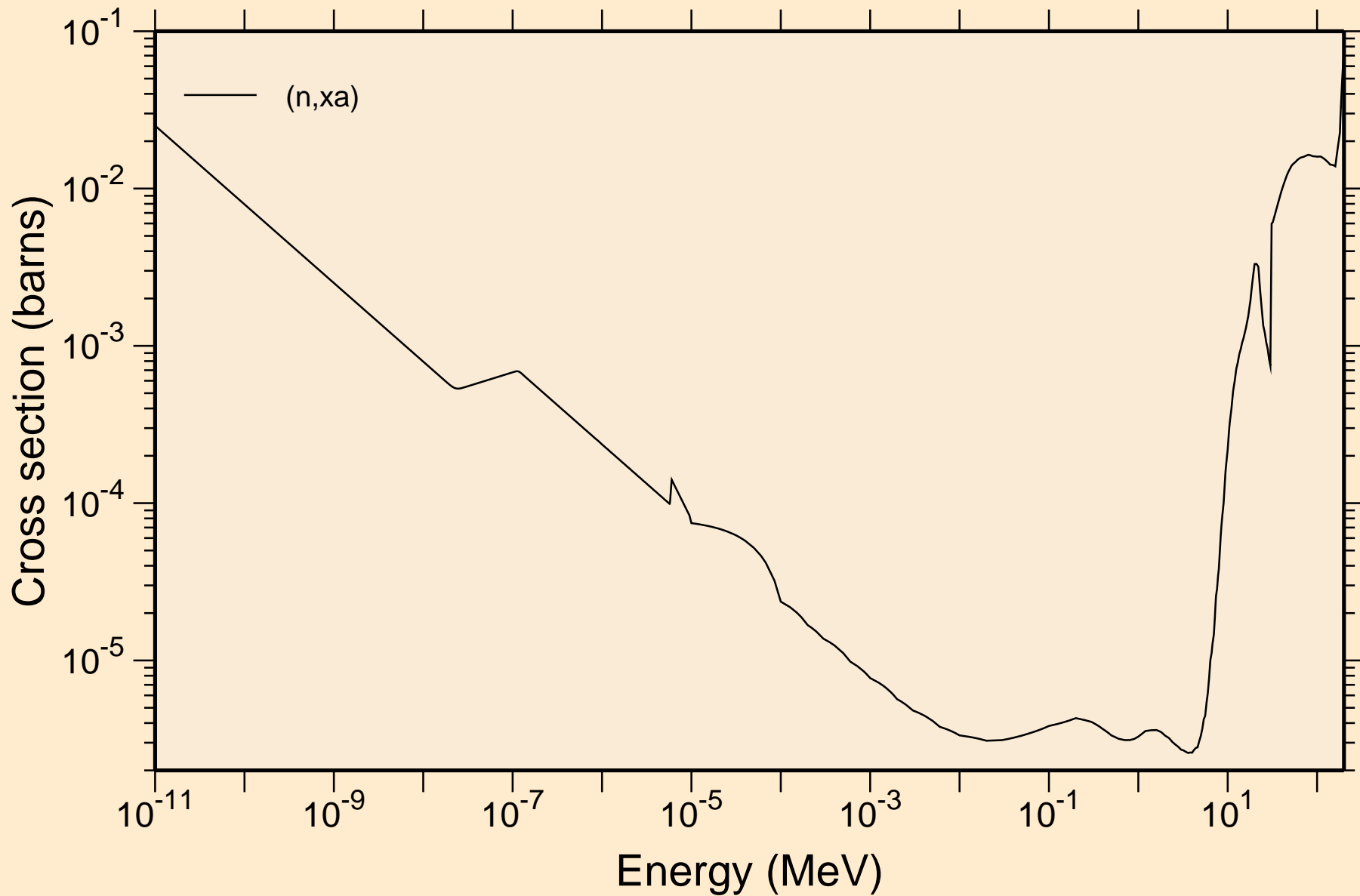

CF241 NEUTRON ACER TENDL-2019 LIBRARY; T=293.16K  
Principal cross sections

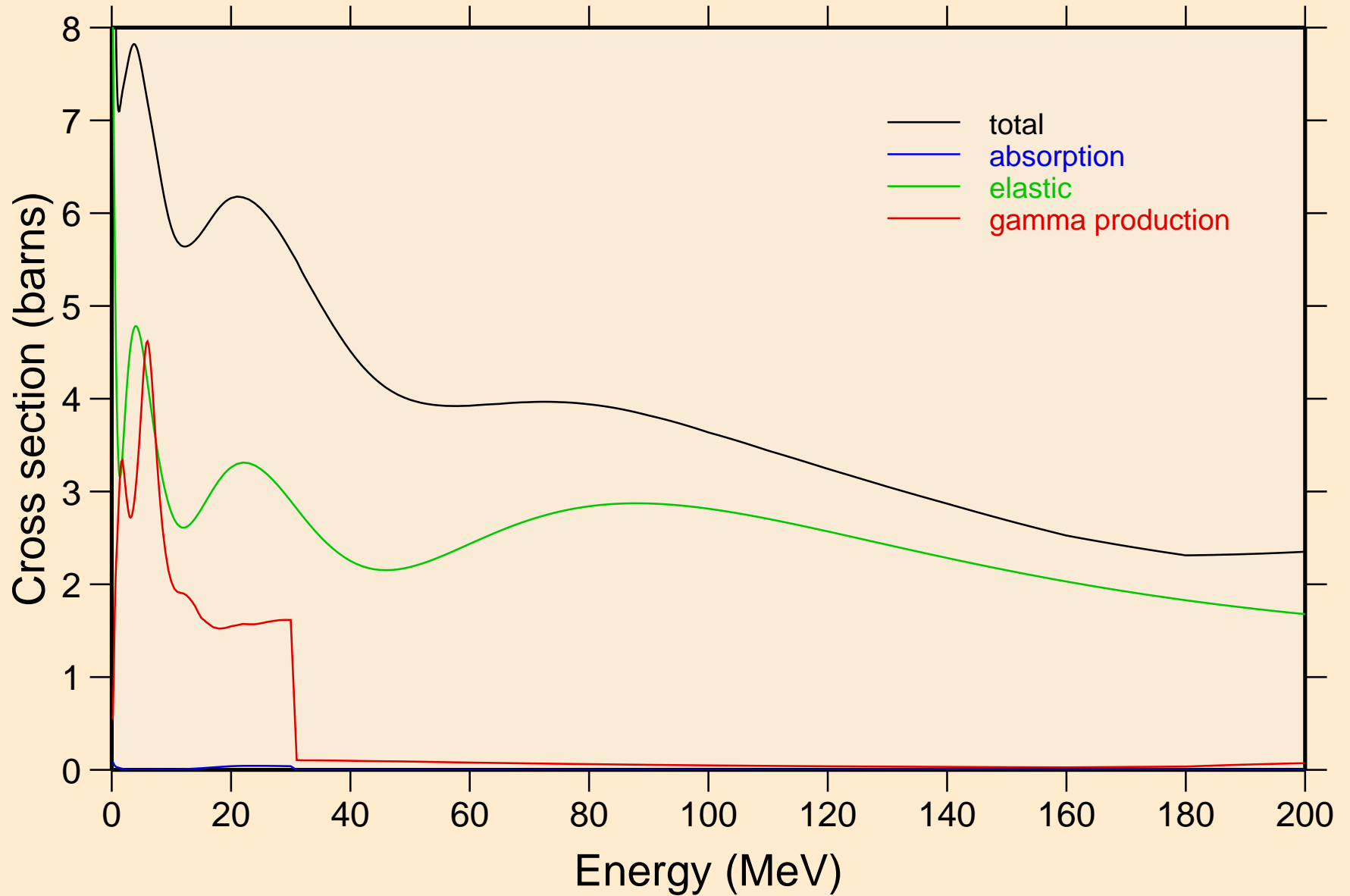

CF241 NEUTRON ACER TENDL-2019 LIBRARY; T=293.16K  
Heating

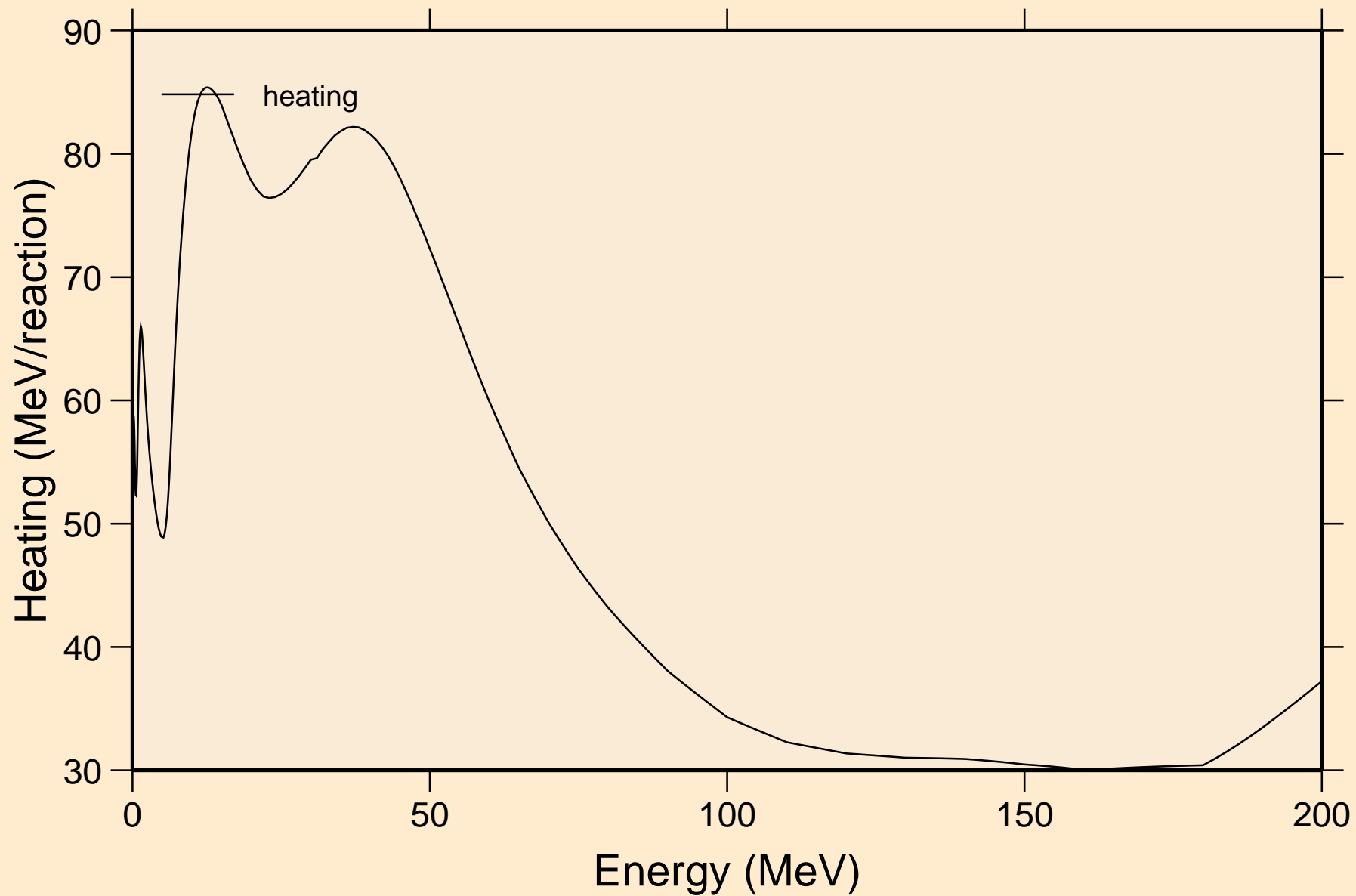

CF241 NEUTRON ACER TENDL-2019 LIBRARY; T=293.16K  
Damage

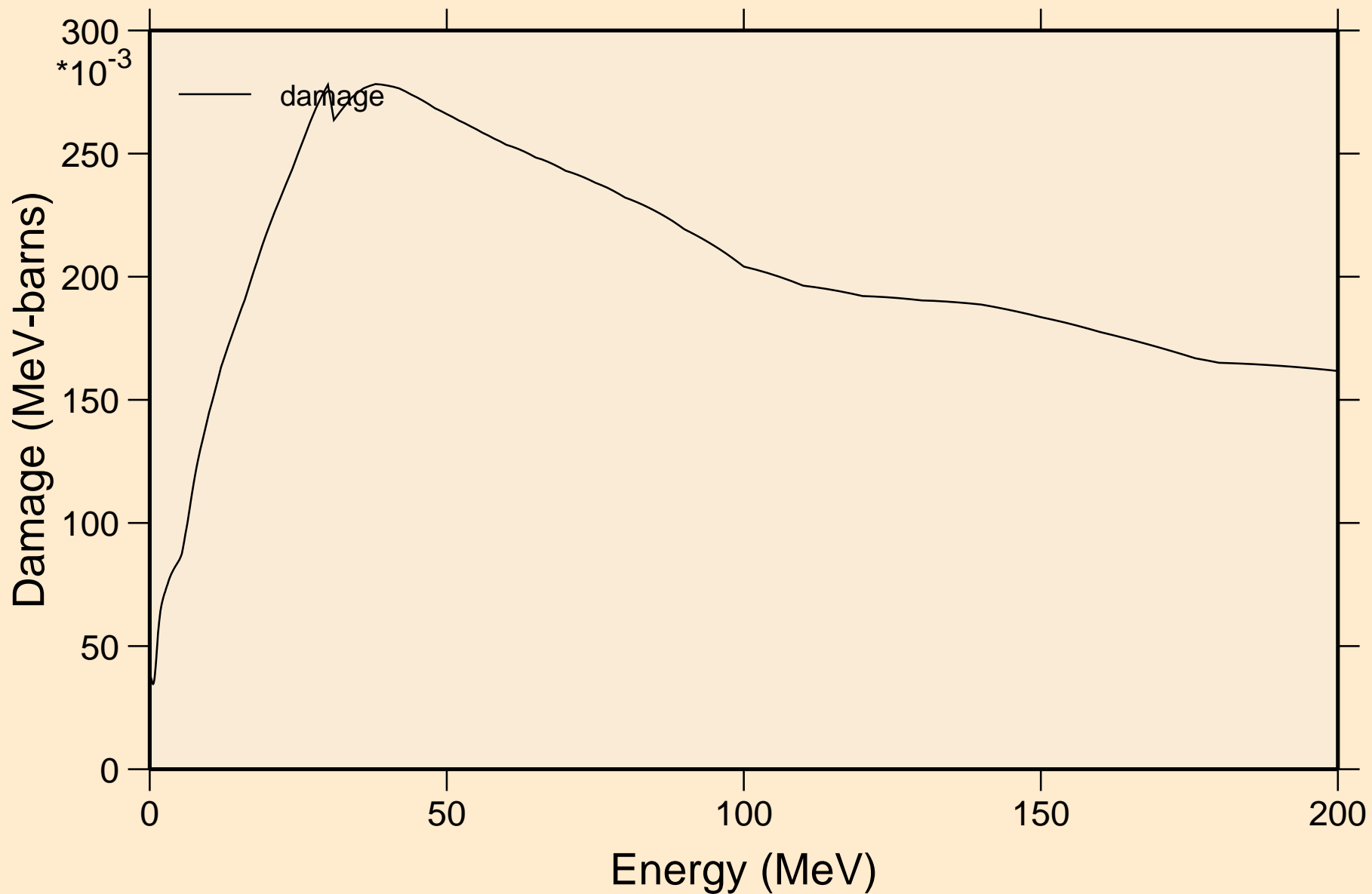



# CF241 NEUTRON ACER TENDL-2019 LIBRARY; T=293.16K

## Non-threshold reactions

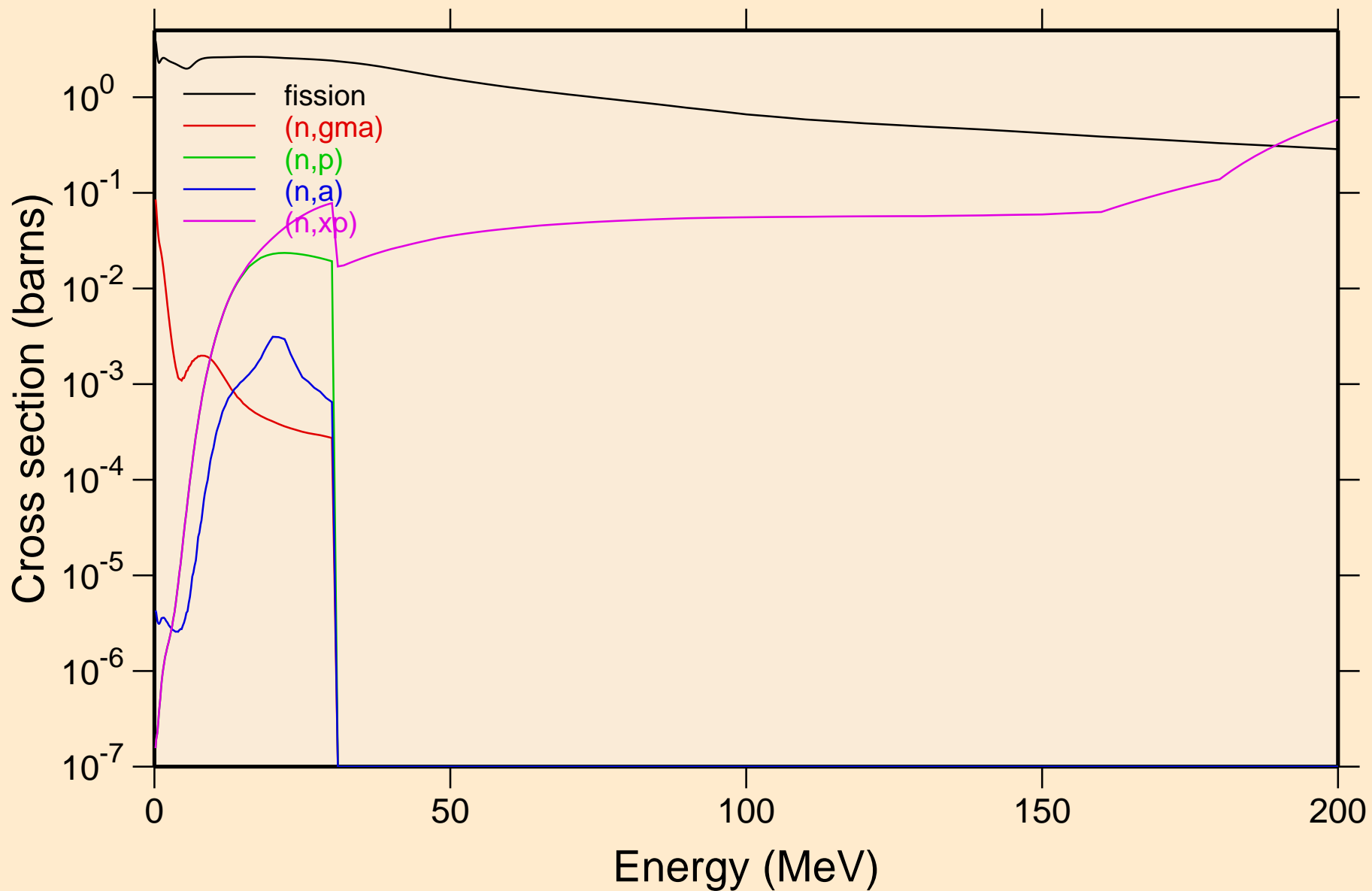

CF241 NEUTRON ACER TENDL-2019 LIBRARY; T=293.16K  
Non-threshold reactions

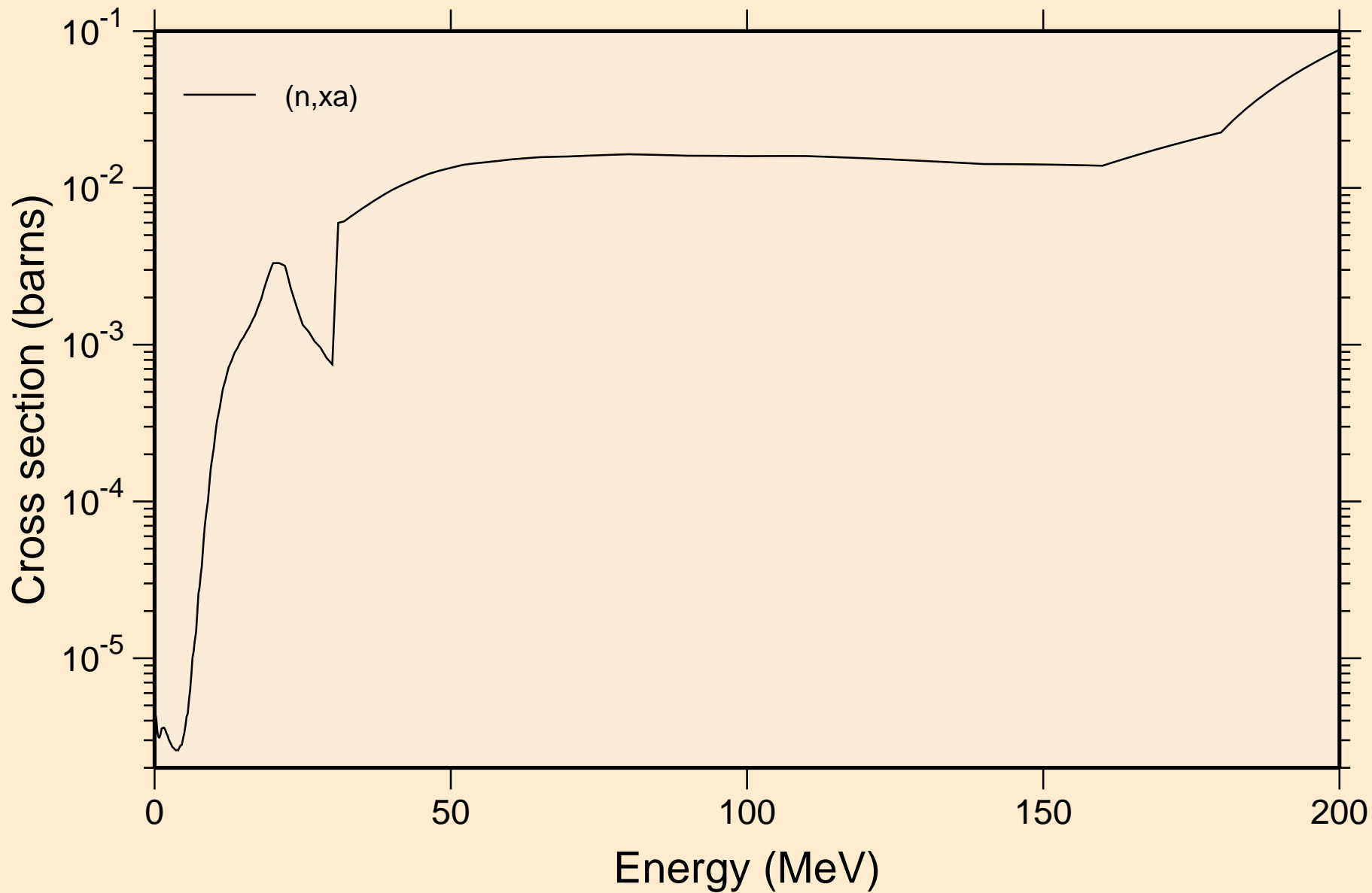

CF241 NEUTRON ACER TENDL-2019 LIBRARY; T=293.16K  
Inelastic levels

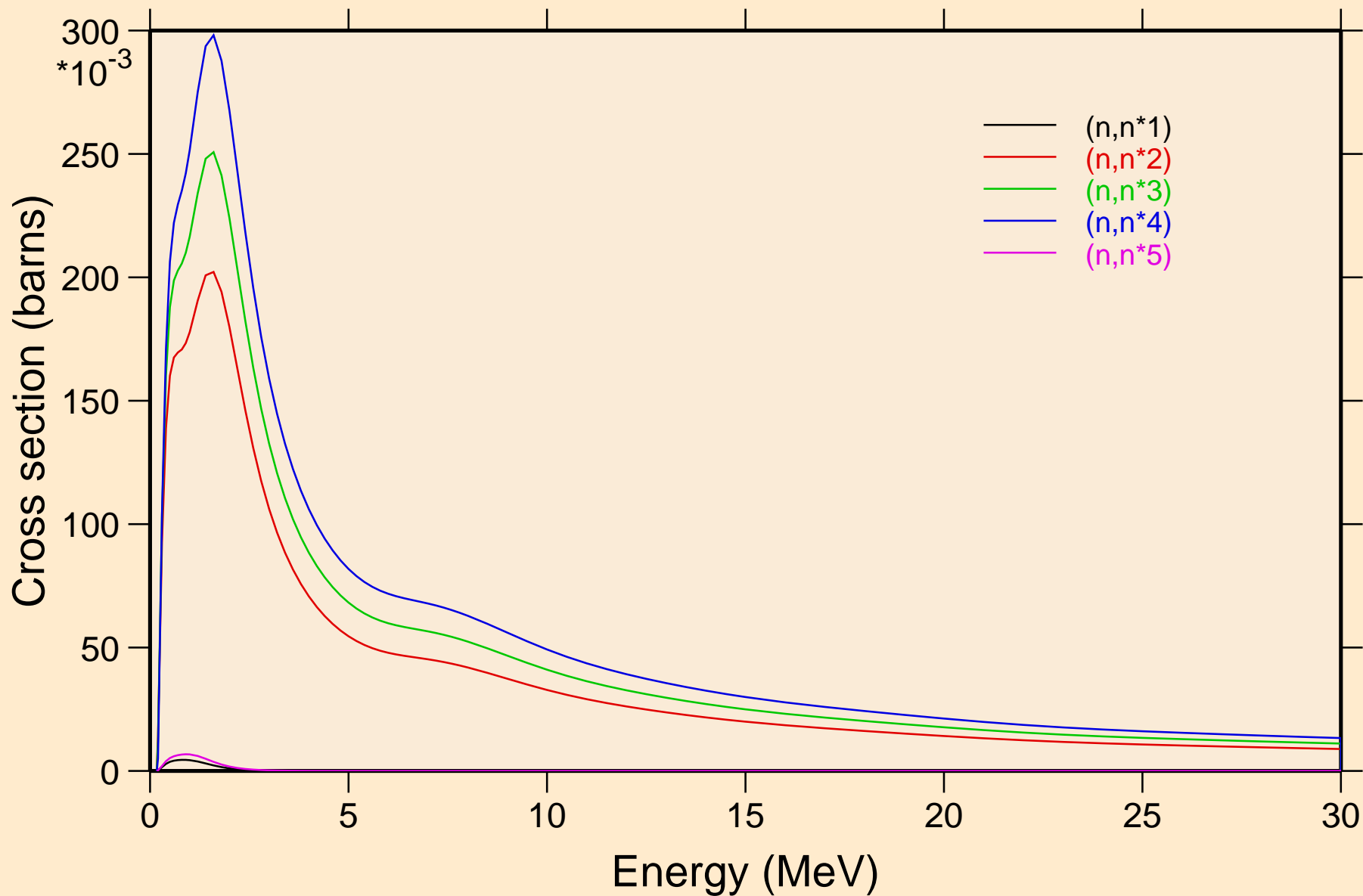

CF241 NEUTRON ACER TENDL-2019 LIBRARY; T=293.16K  
Inelastic levels

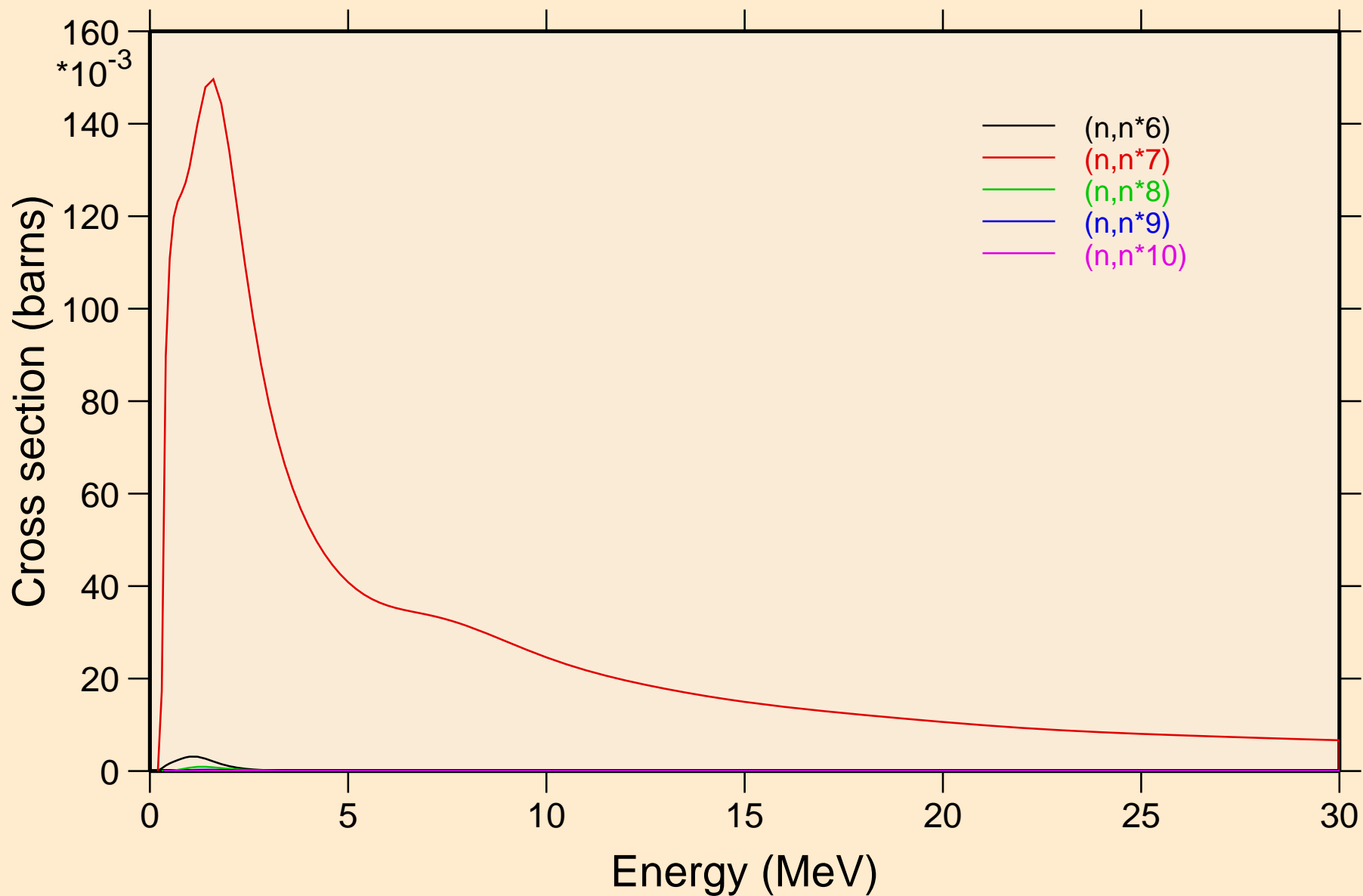

CF241 NEUTRON ACER TENDL-2019 LIBRARY; T=293.16K  
Inelastic levels

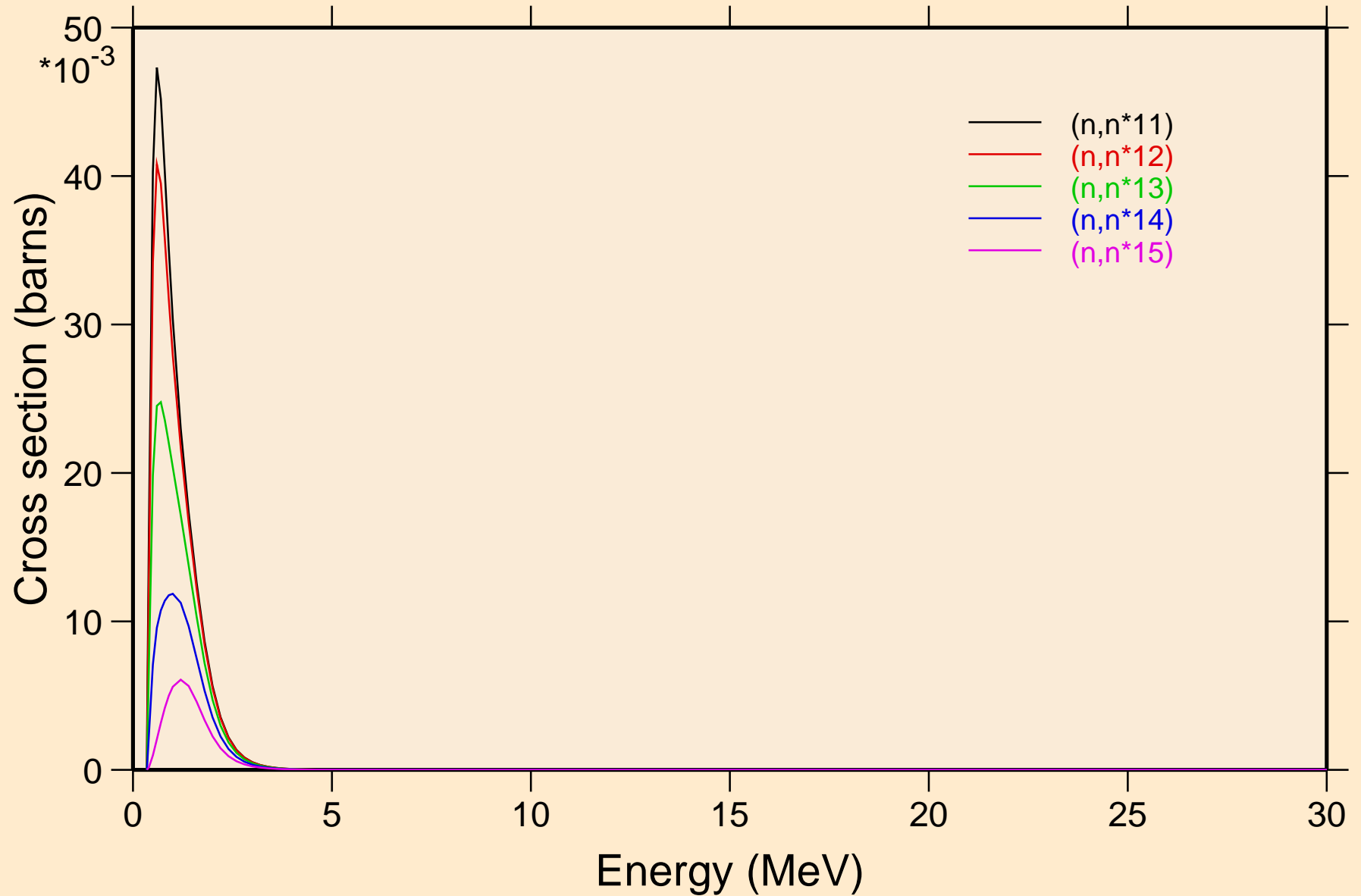

CF241 NEUTRON ACER TENDL-2019 LIBRARY; T=293.16K  
Inelastic levels

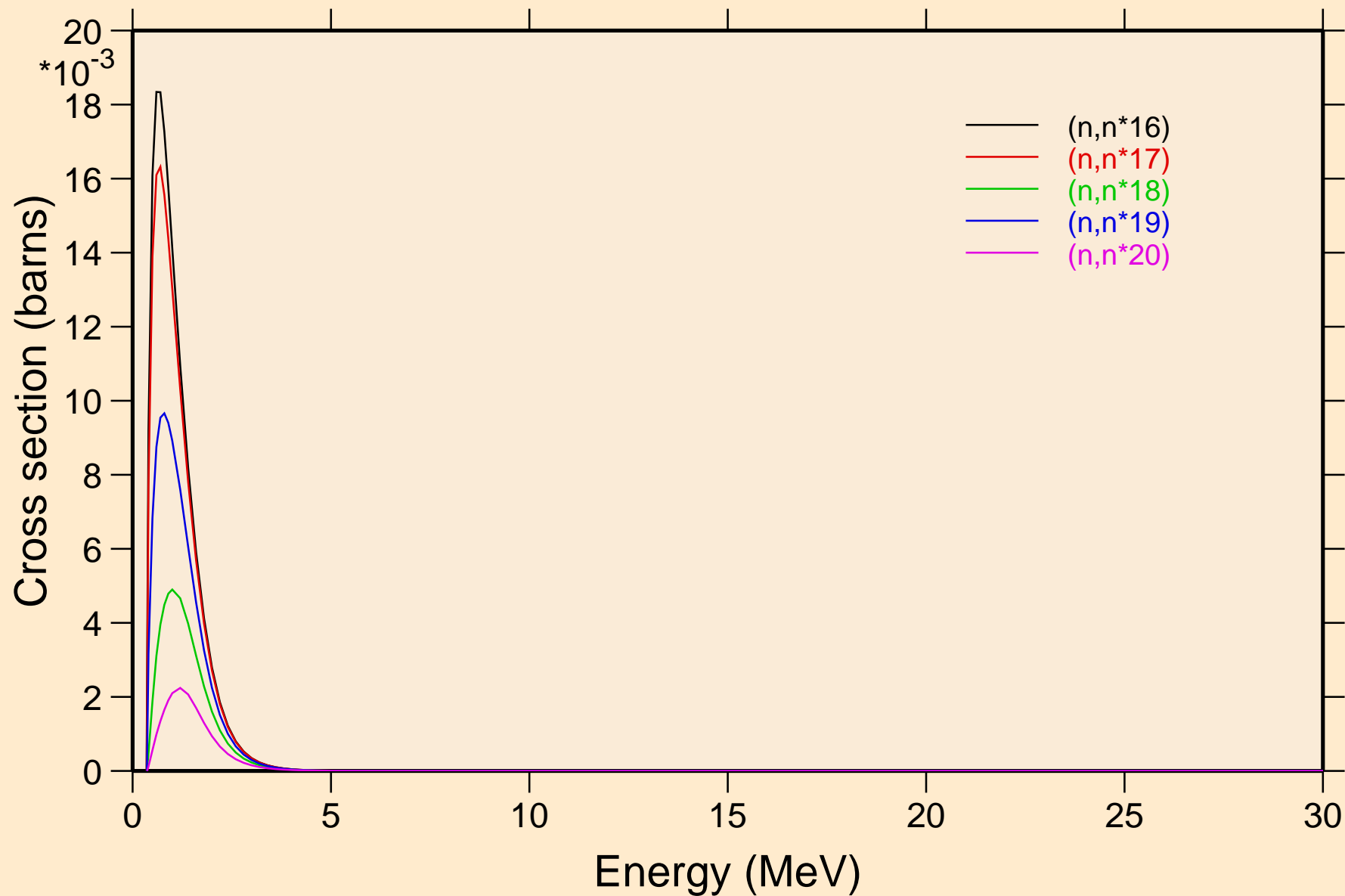

CF241 NEUTRON ACER TENDL-2019 LIBRARY; T=293.16K  
Inelastic levels

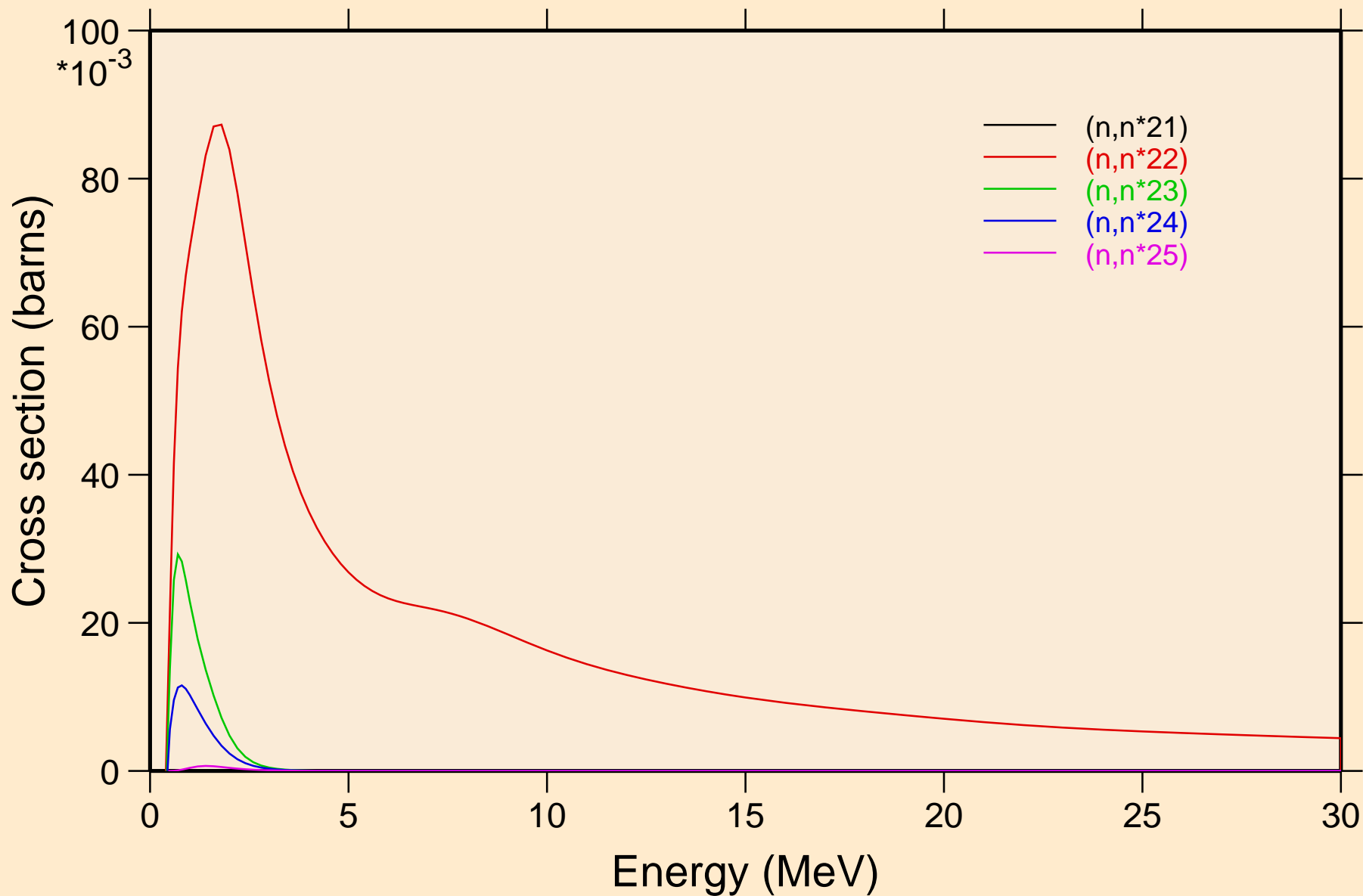

CF241 NEUTRON ACER TENDL-2019 LIBRARY; T=293.16K  
Inelastic levels

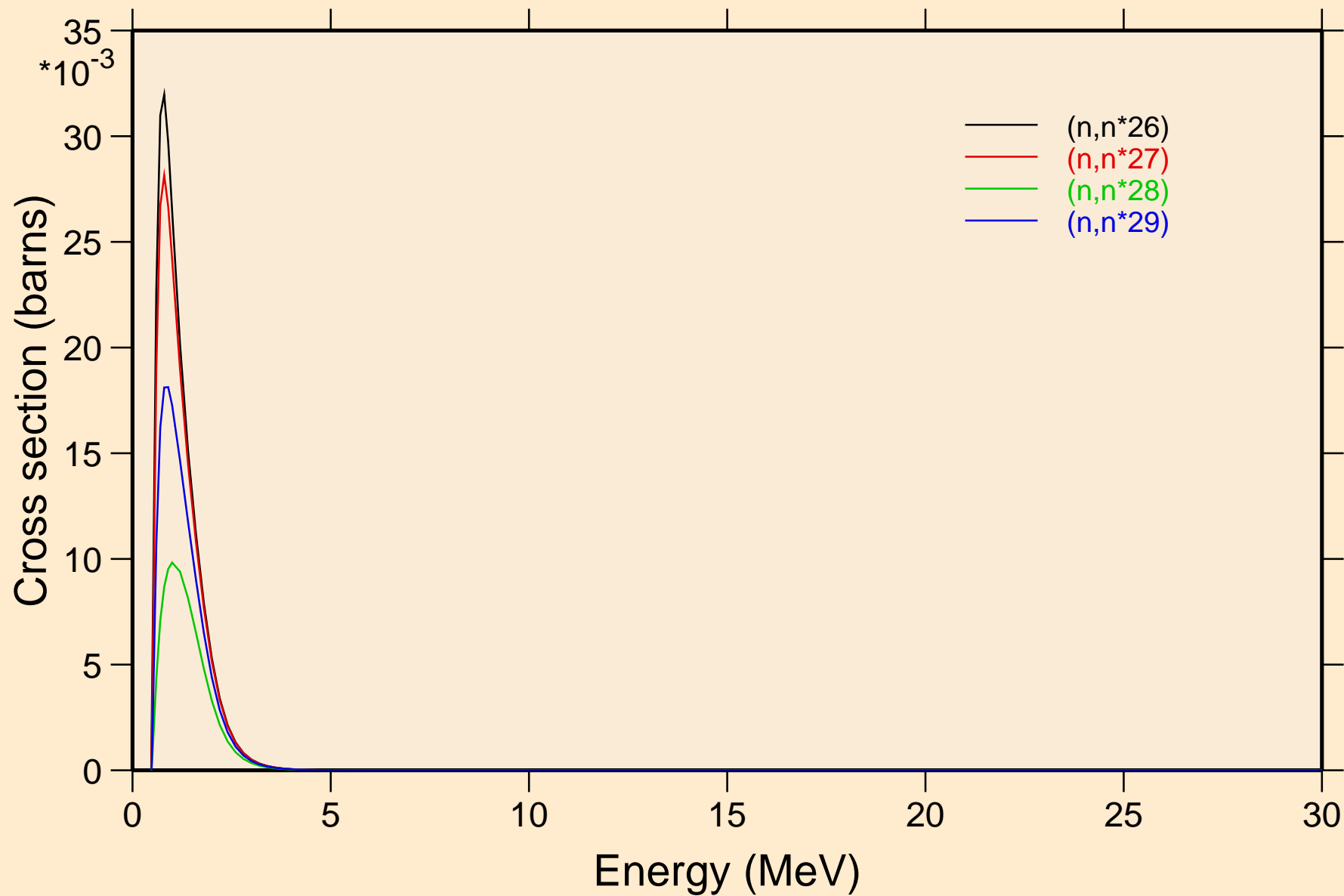



# CF241 NEUTRON ACER TENDL-2019 LIBRARY; T=293.16K

## Threshold reactions

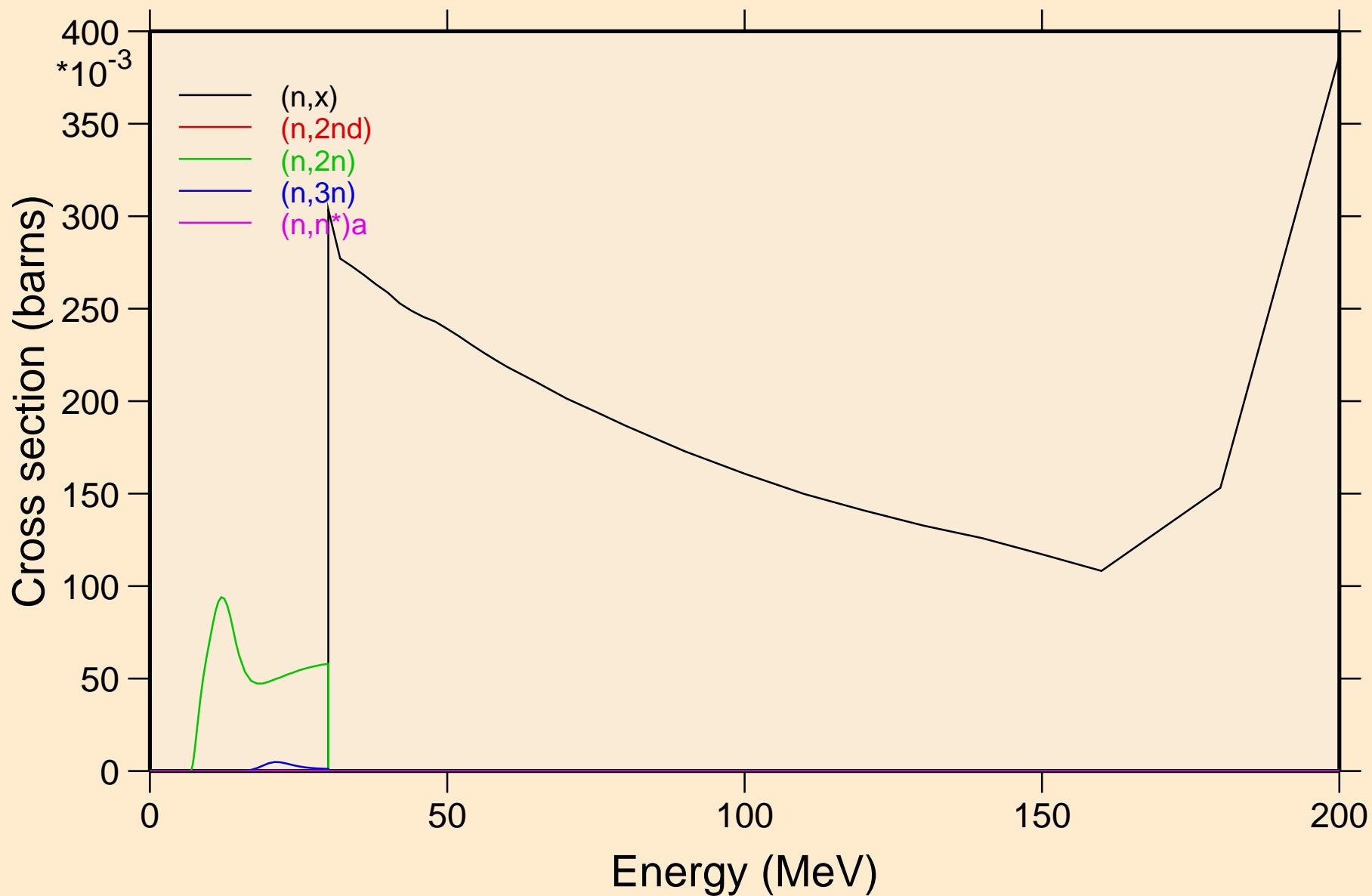

CF241 NEUTRON ACER TENDL-2019 LIBRARY; T=293.16K  
Threshold reactions

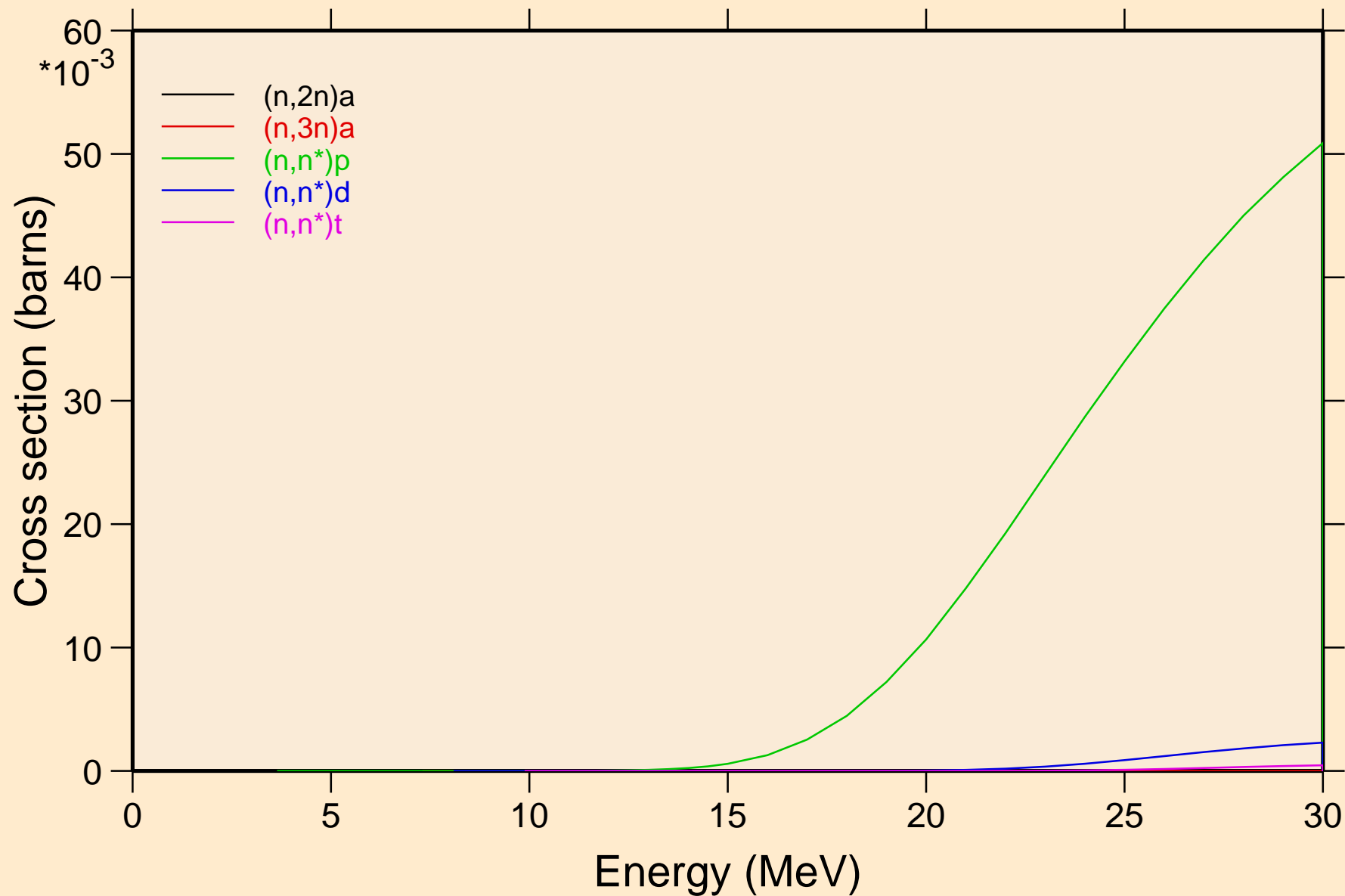

CF241 NEUTRON ACER TENDL-2019 LIBRARY; T=293.16K  
Threshold reactions

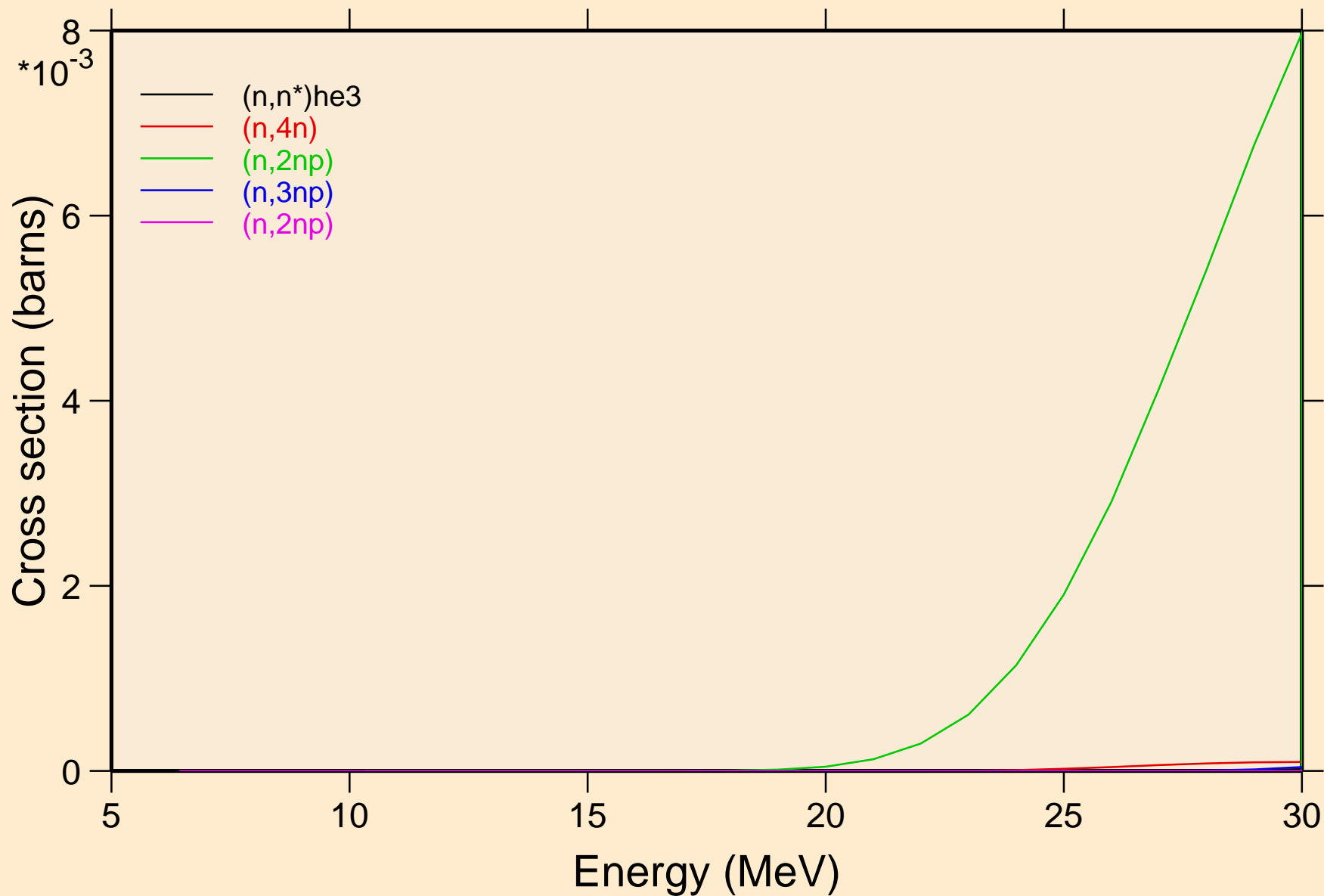

CF241 NEUTRON ACER TENDL-2019 LIBRARY; T=293.16K  
Threshold reactions

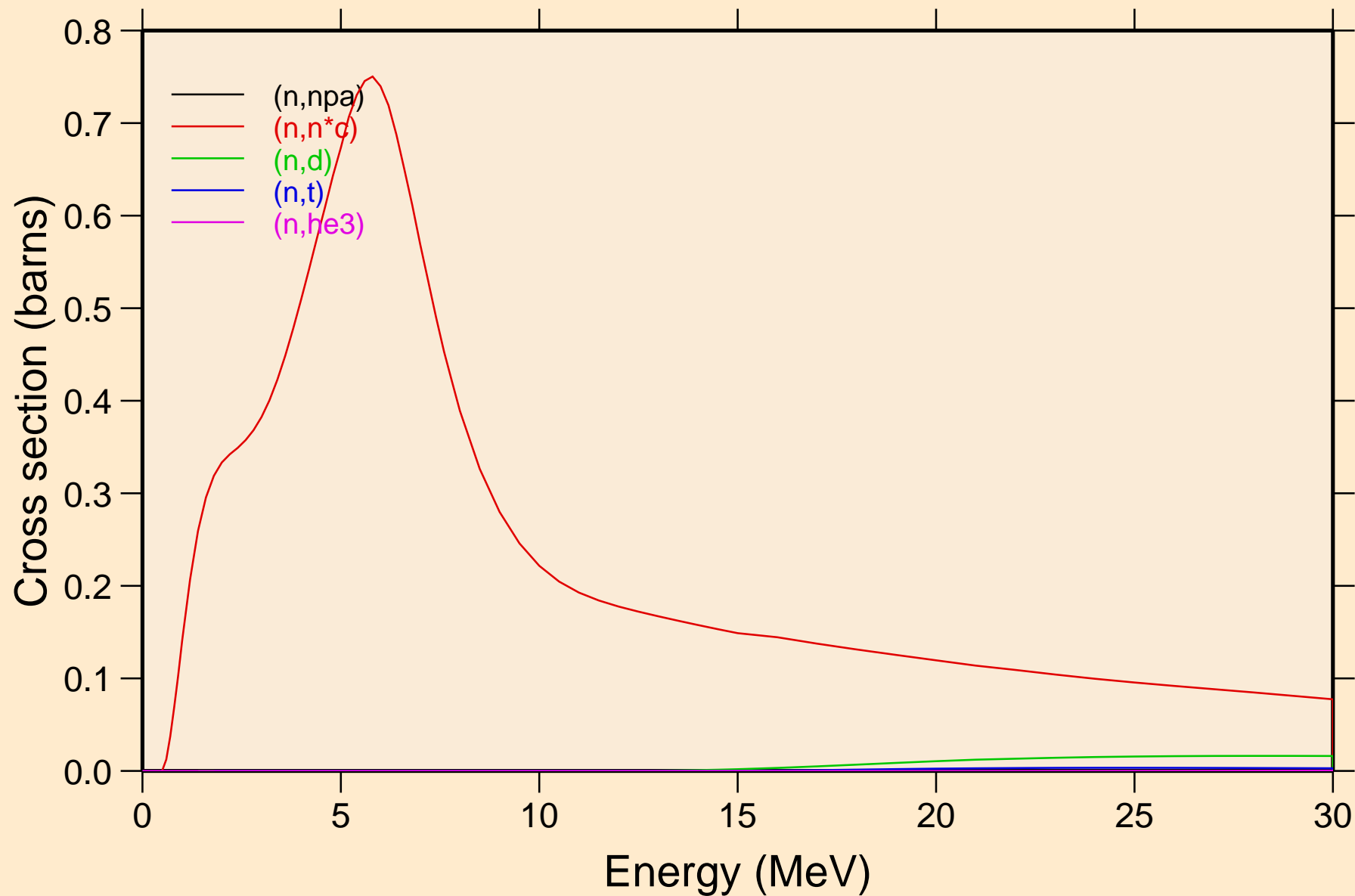

CF241 NEUTRON ACER TENDL-2019 LIBRARY; T=293.16K  
Threshold reactions

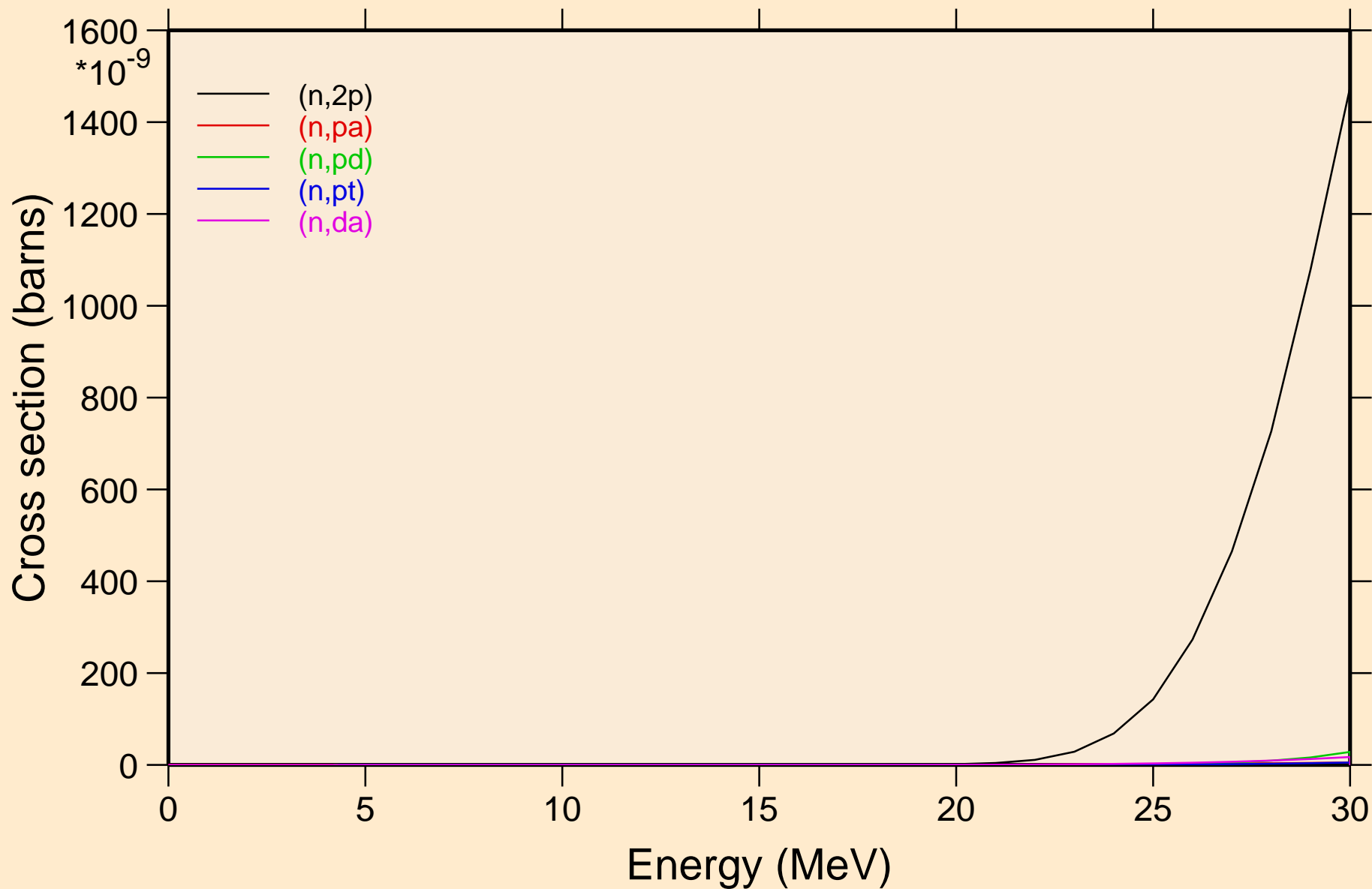

CF241 NEUTRON ACER TENDL-2019 LIBRARY; T=293.16K  
Threshold reactions

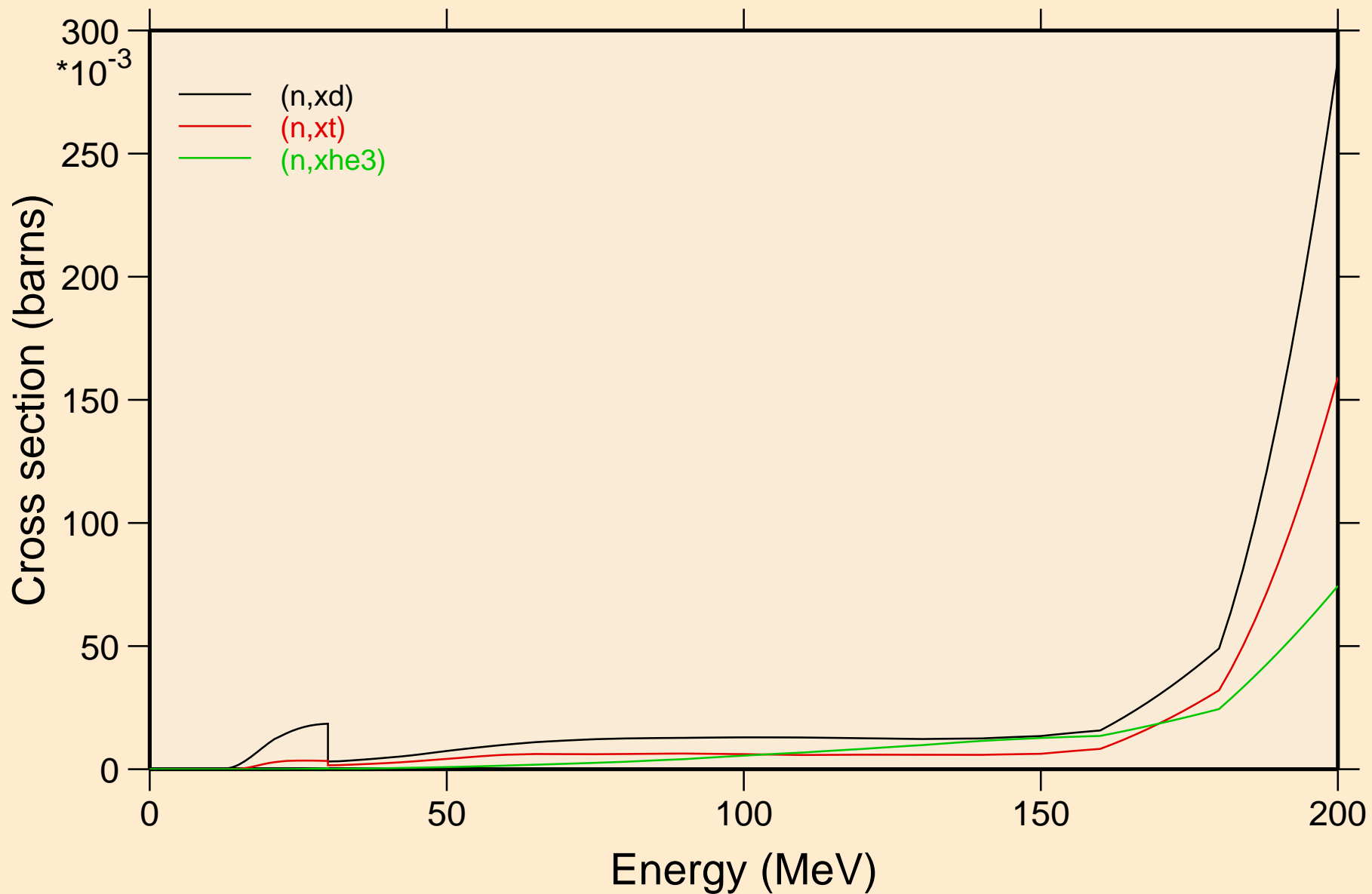

CF241 NEUTRON ACER TENDL-2019 LIBRARY; T=293.16K  
angular distribution for elastic

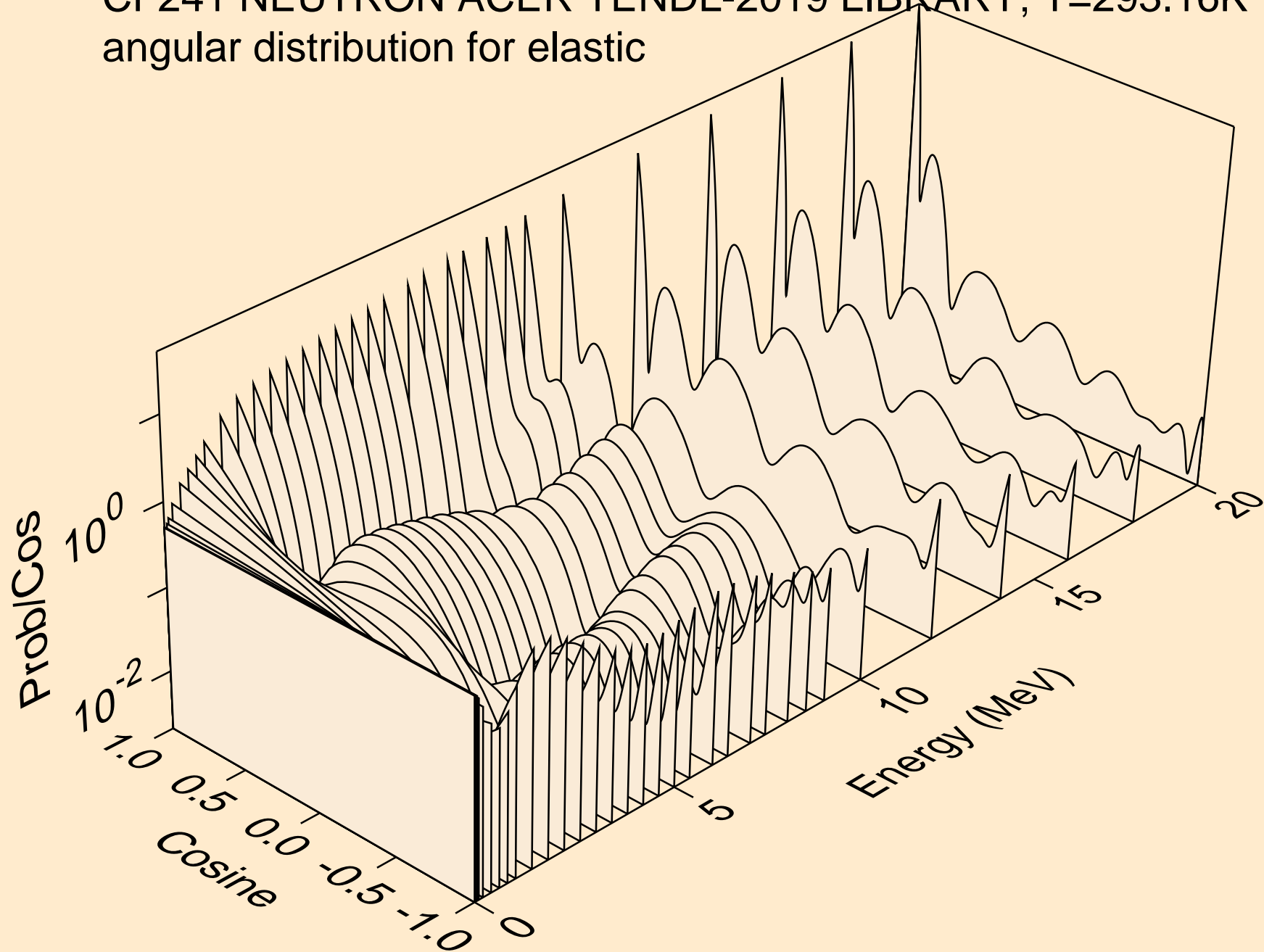

CF241 NEUTRON ACER TENDL-2019 LIBRARY; T=293.16K  
angular distribution for elastic

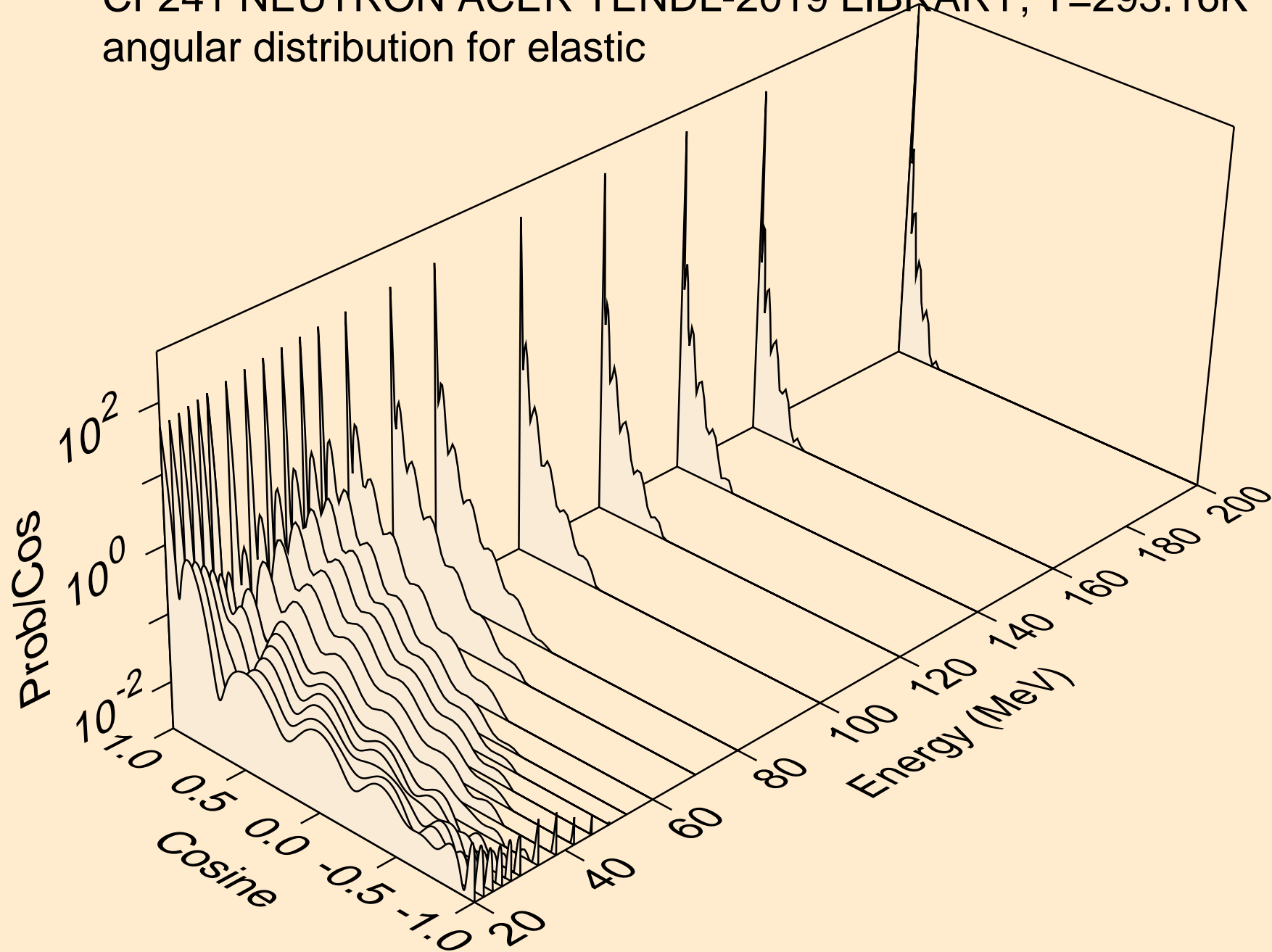



CF241 NEUTRON ACER TENDL-2019 LIBRARY; T=293.16K  
angular distribution for (n,n\*1)

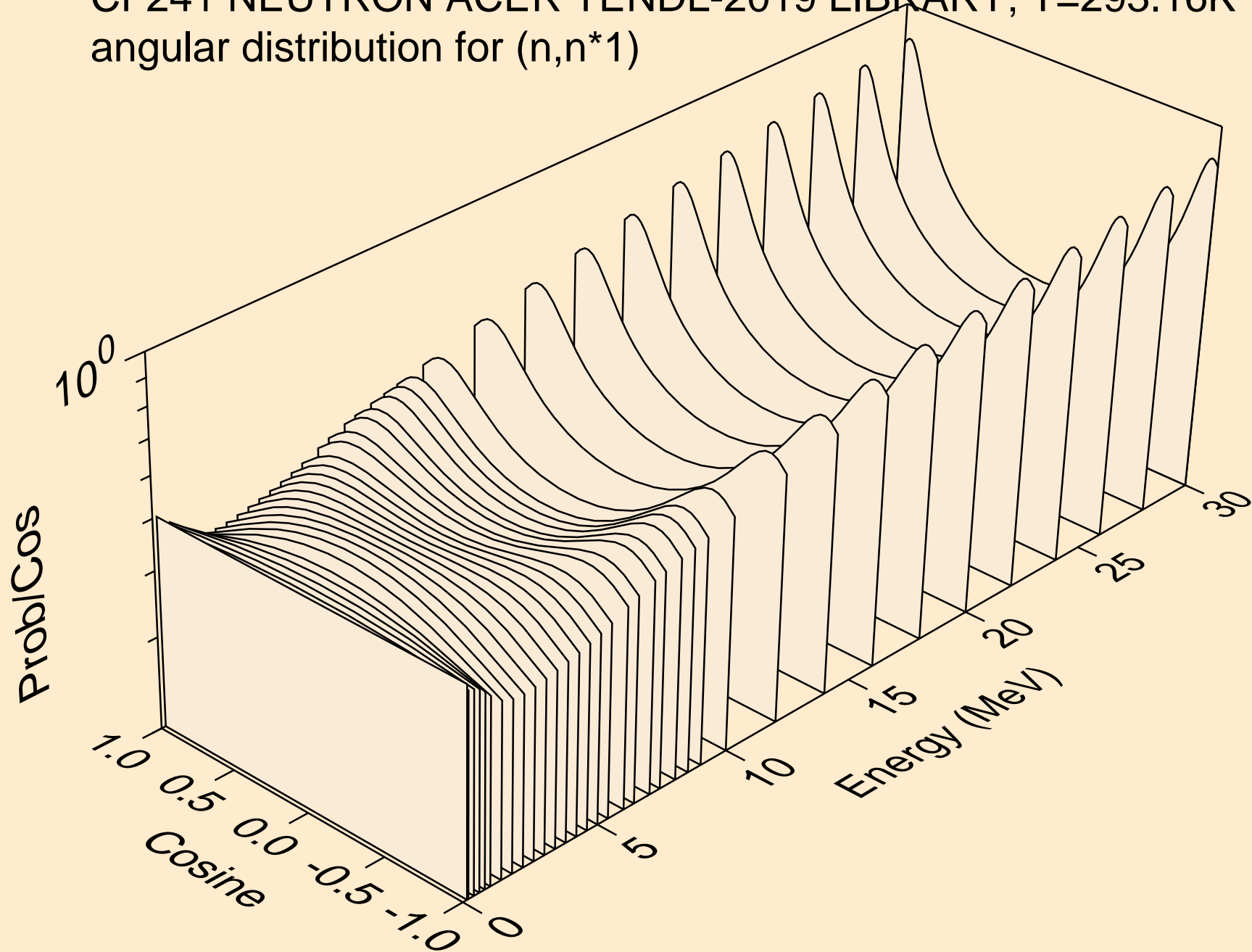

CF241 NEUTRON ACER TENDL-2019 LIBRARY; T=293.16K  
angular distribution for (n,n\*2)

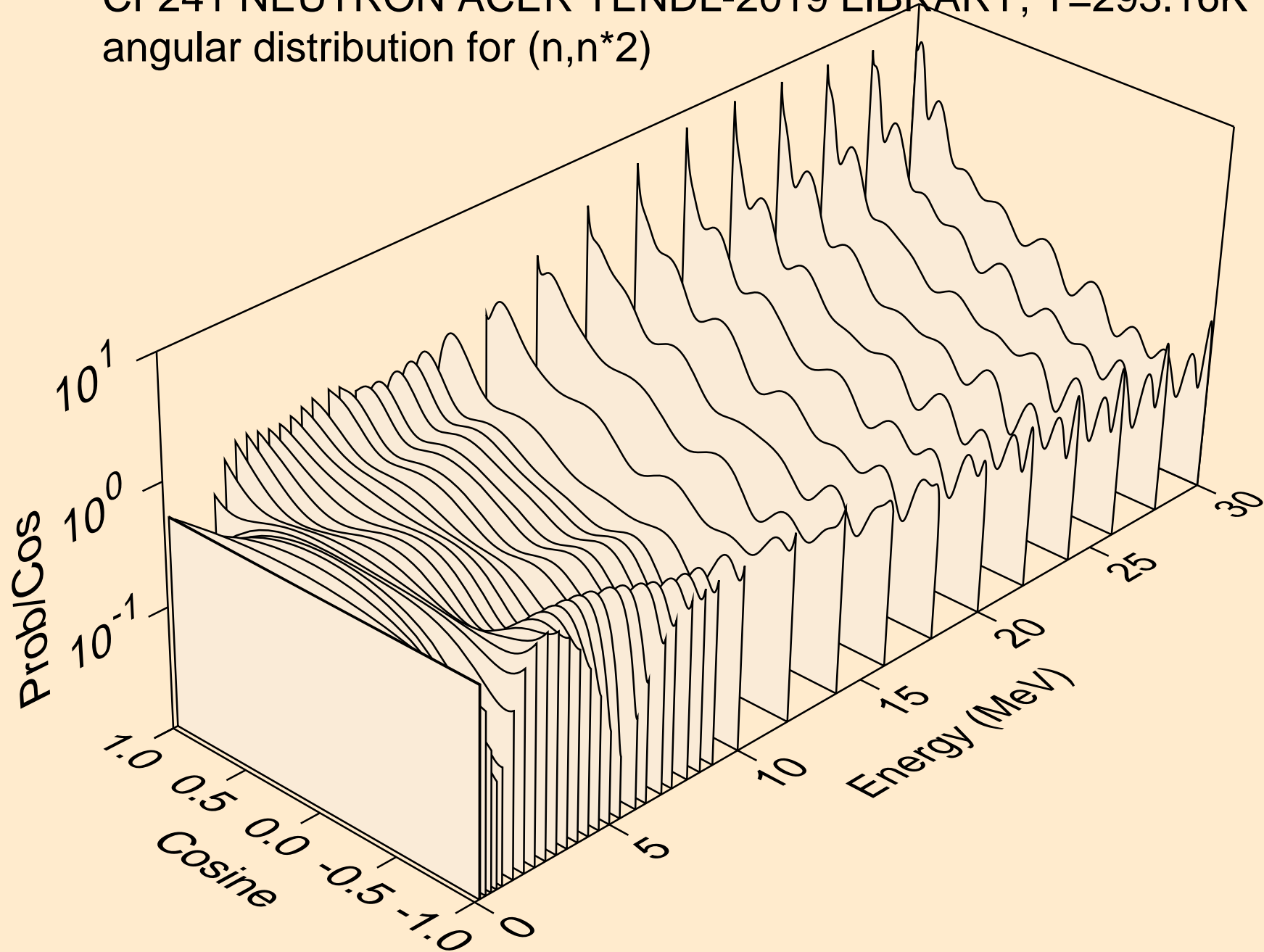

CF241 NEUTRON ACER TENDL-2019 LIBRARY; T=293.16K  
angular distribution for (n,n\*3)

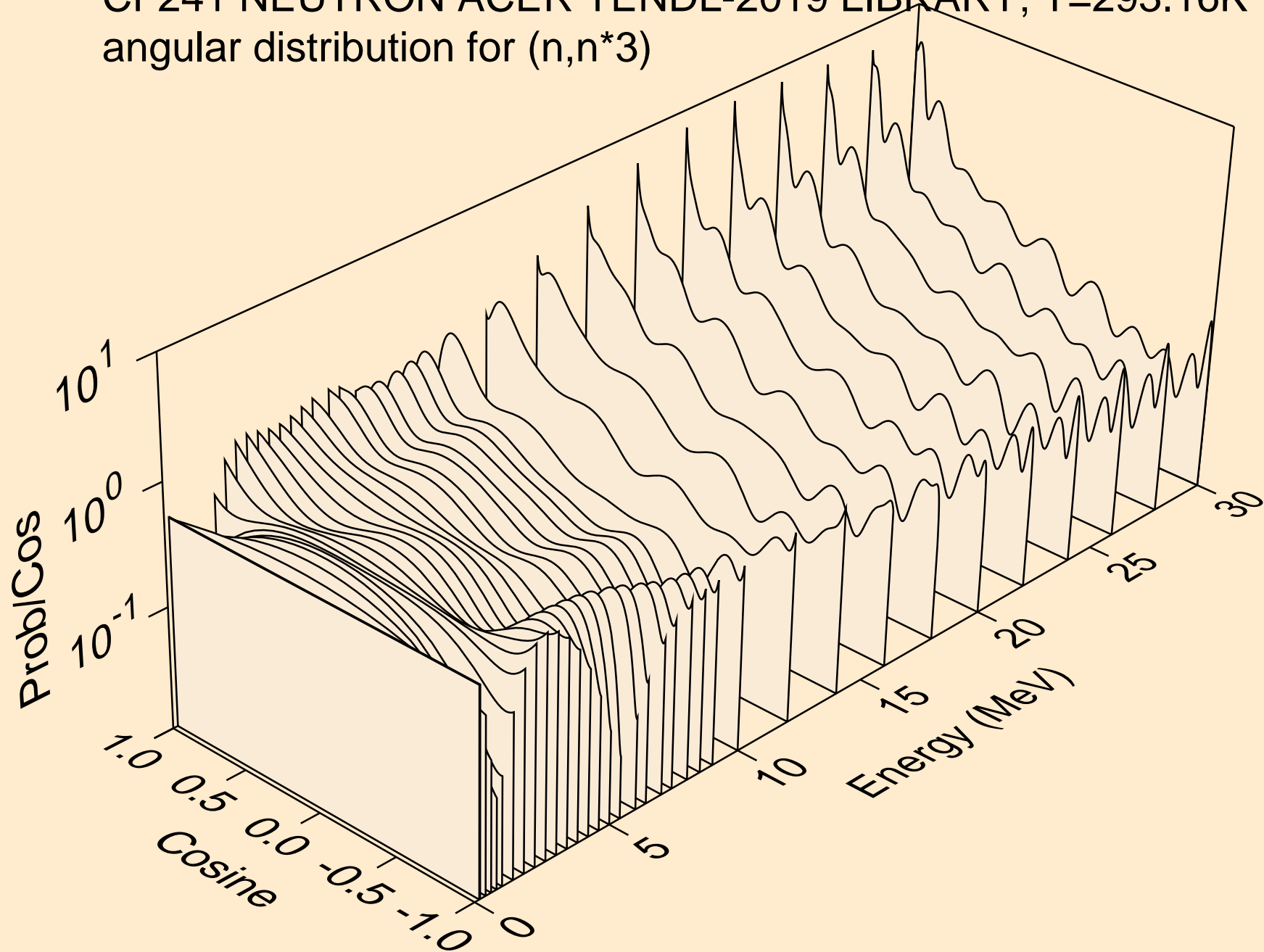

CF241 NEUTRON ACER TENDL-2019 LIBRARY; T=293.16K  
angular distribution for (n,n\*4)

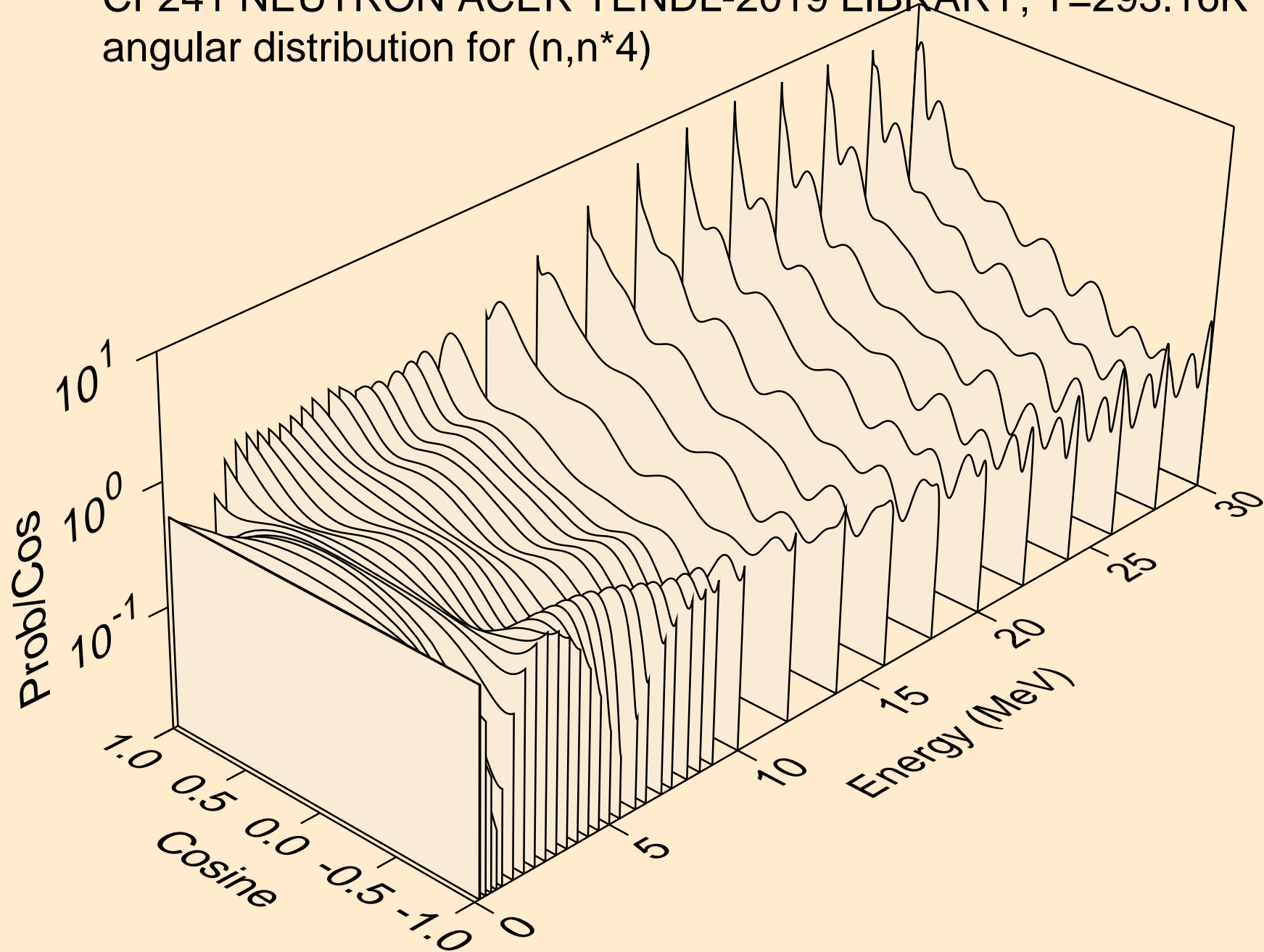

CF241 NEUTRON ACER TENDL-2019 LIBRARY; T=293.16K  
angular distribution for (n,n\*5)

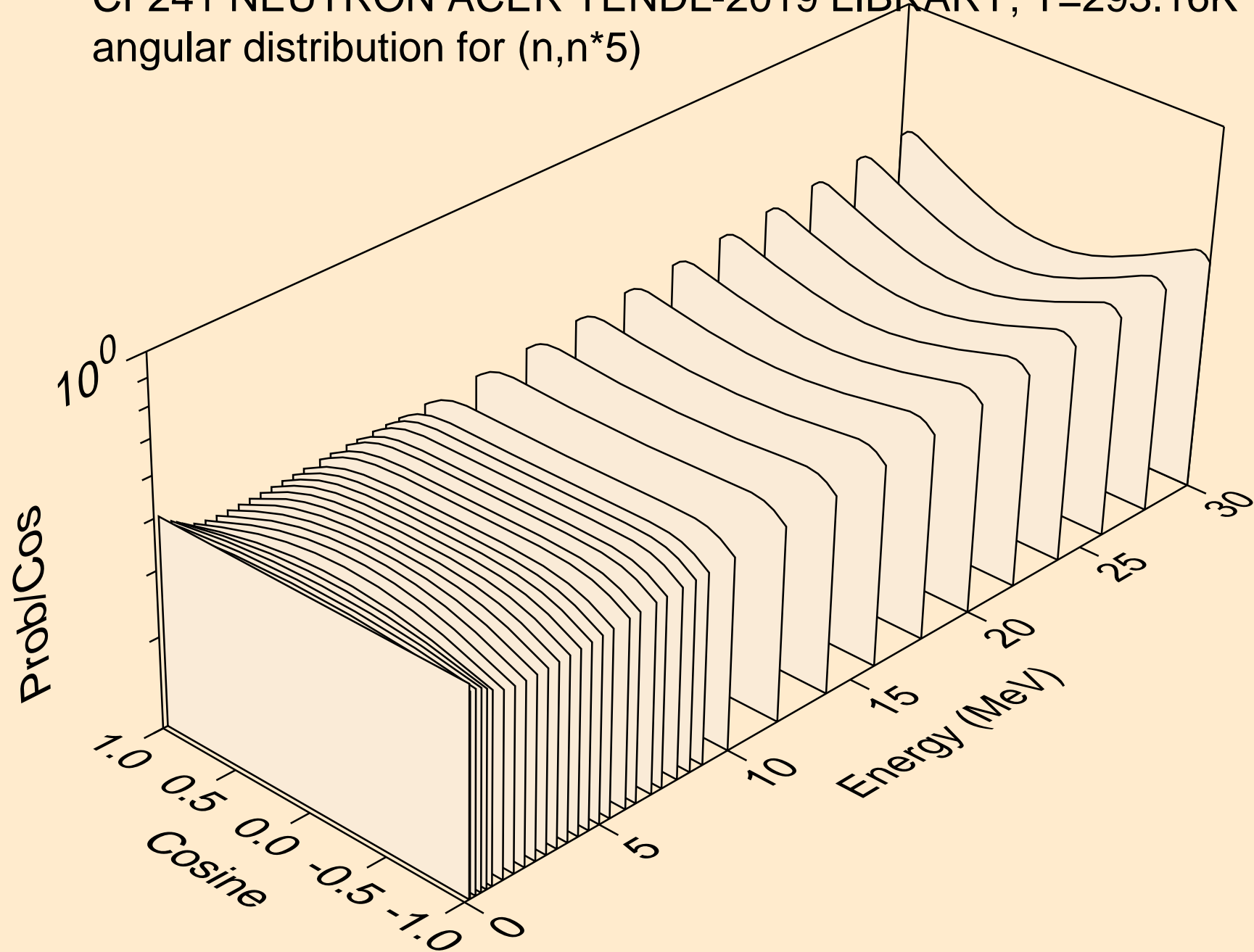

CF241 NEUTRON ACER TENDL-2019 LIBRARY; T=293.16K  
angular distribution for (n,n\*6)

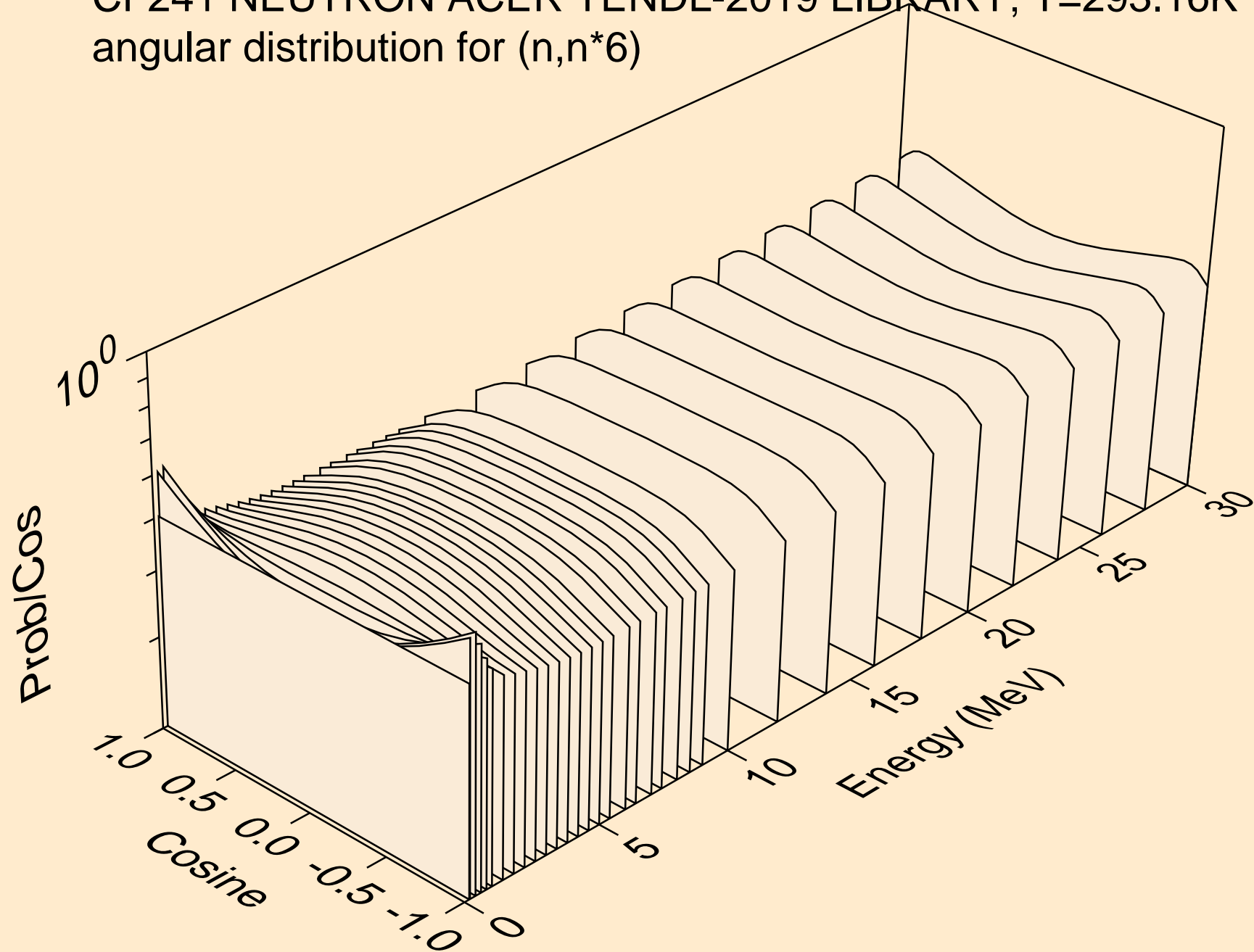

CF241 NEUTRON ACER TENDL-2019 LIBRARY; T=293.16K  
angular distribution for (n,n\*7)

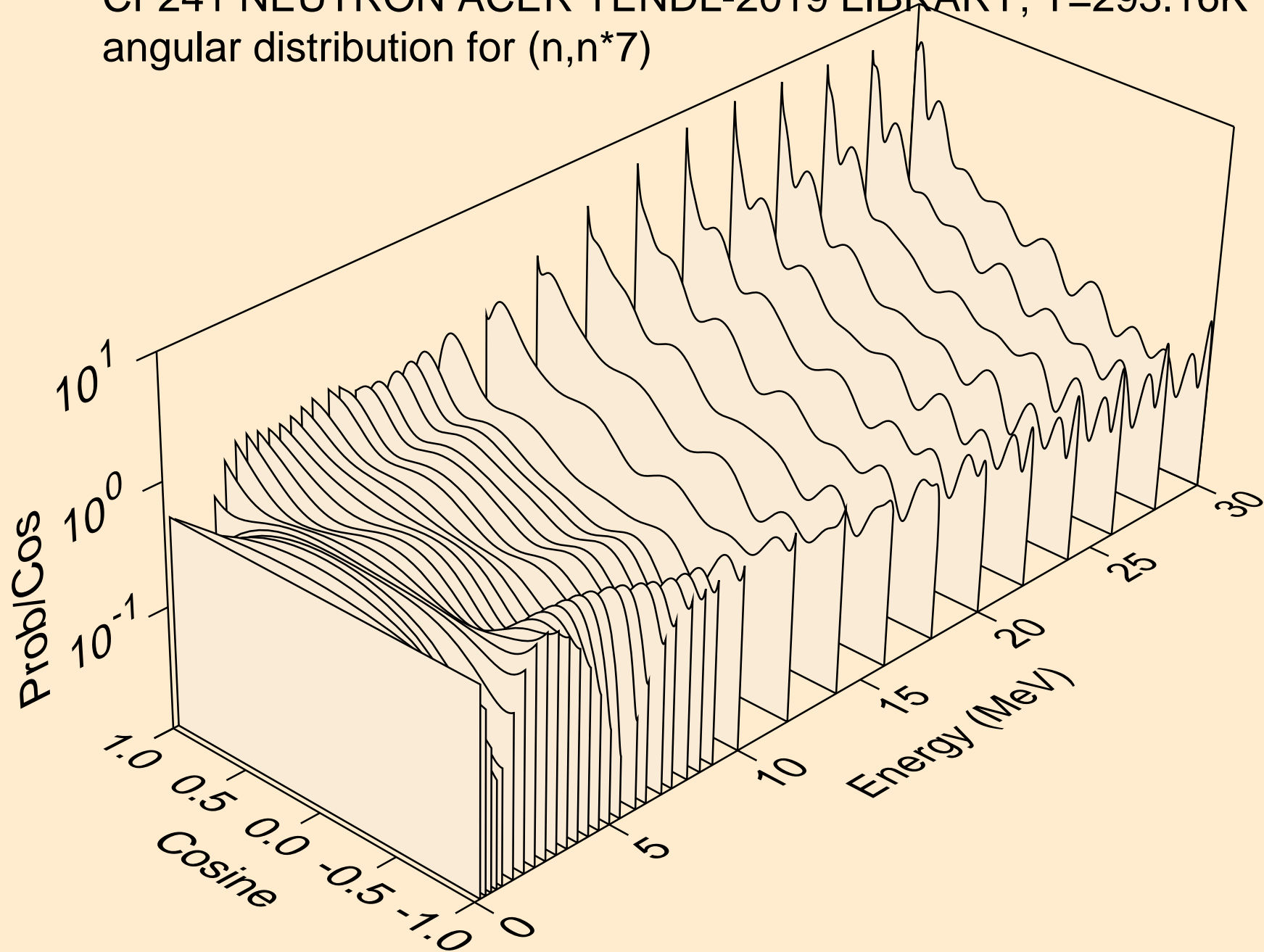

CF241 NEUTRON ACER TENDL-2019 LIBRARY; T=293.16K  
angular distribution for (n,n\*8)

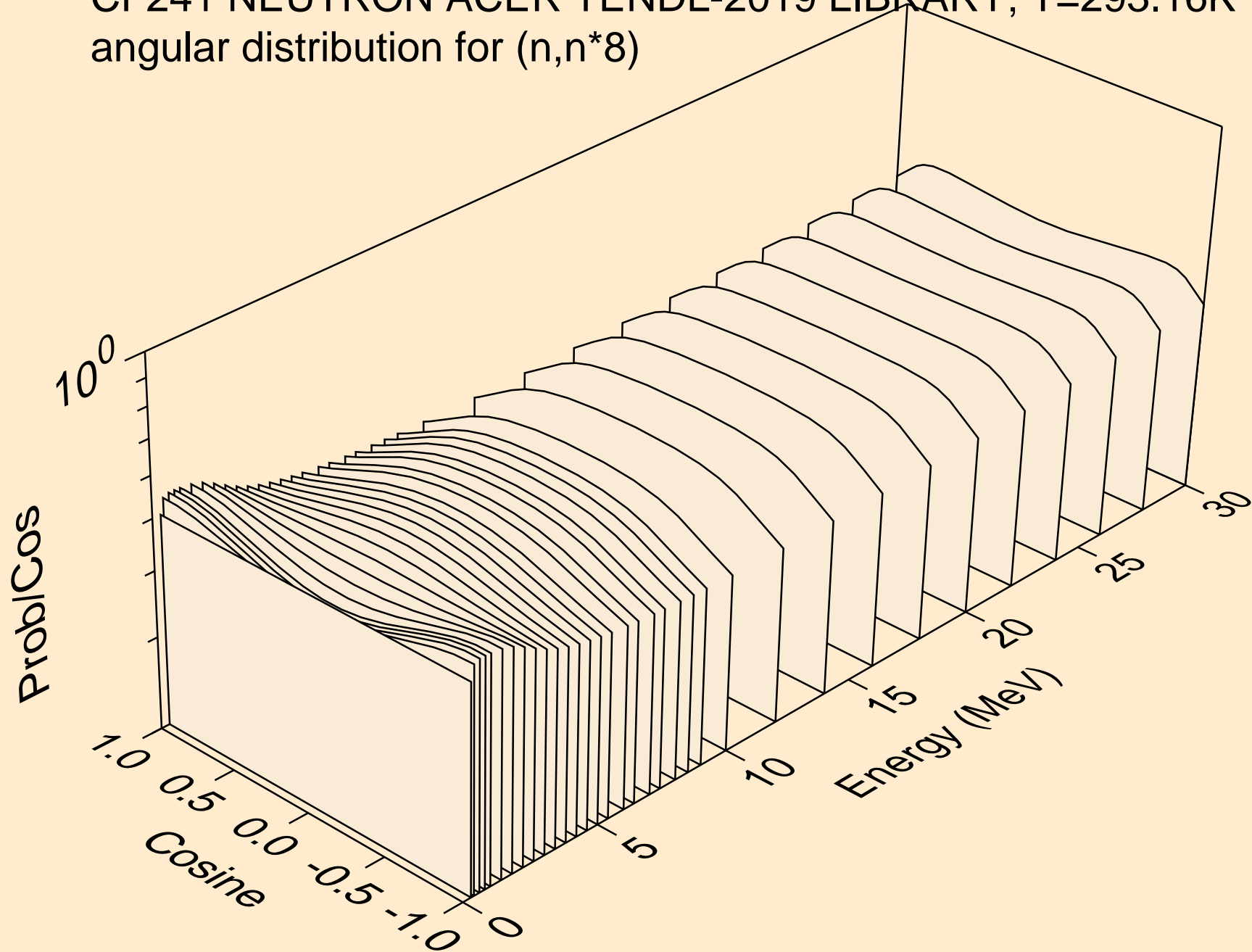



CF241 NEUTRON ACER TENDL-2019 LIBRARY; T=293.16K  
angular distribution for (n,n\*9)

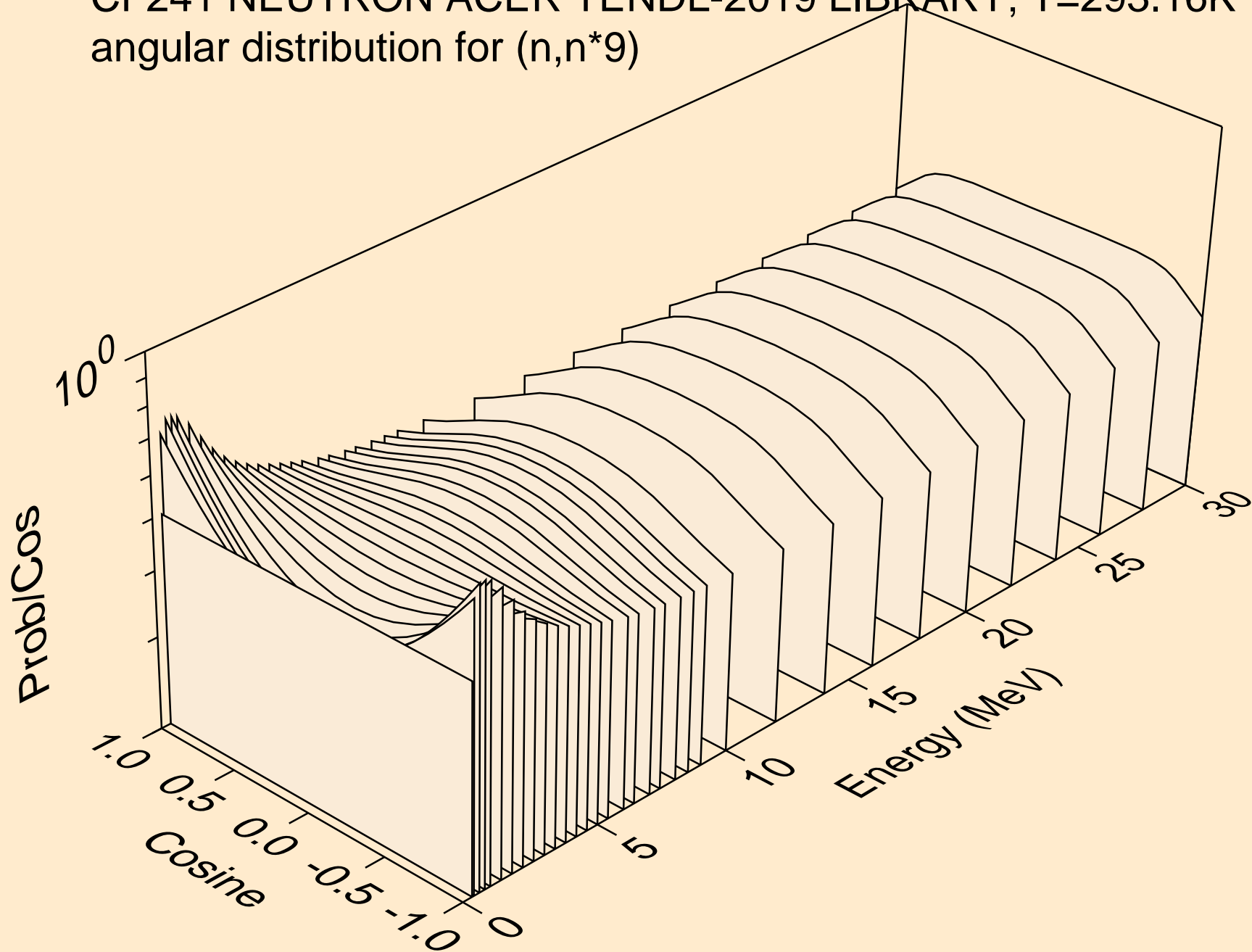

CF241 NEUTRON ACER TENDL-2019 LIBRARY; T=293.16K  
angular distribution for (n,n\*10)

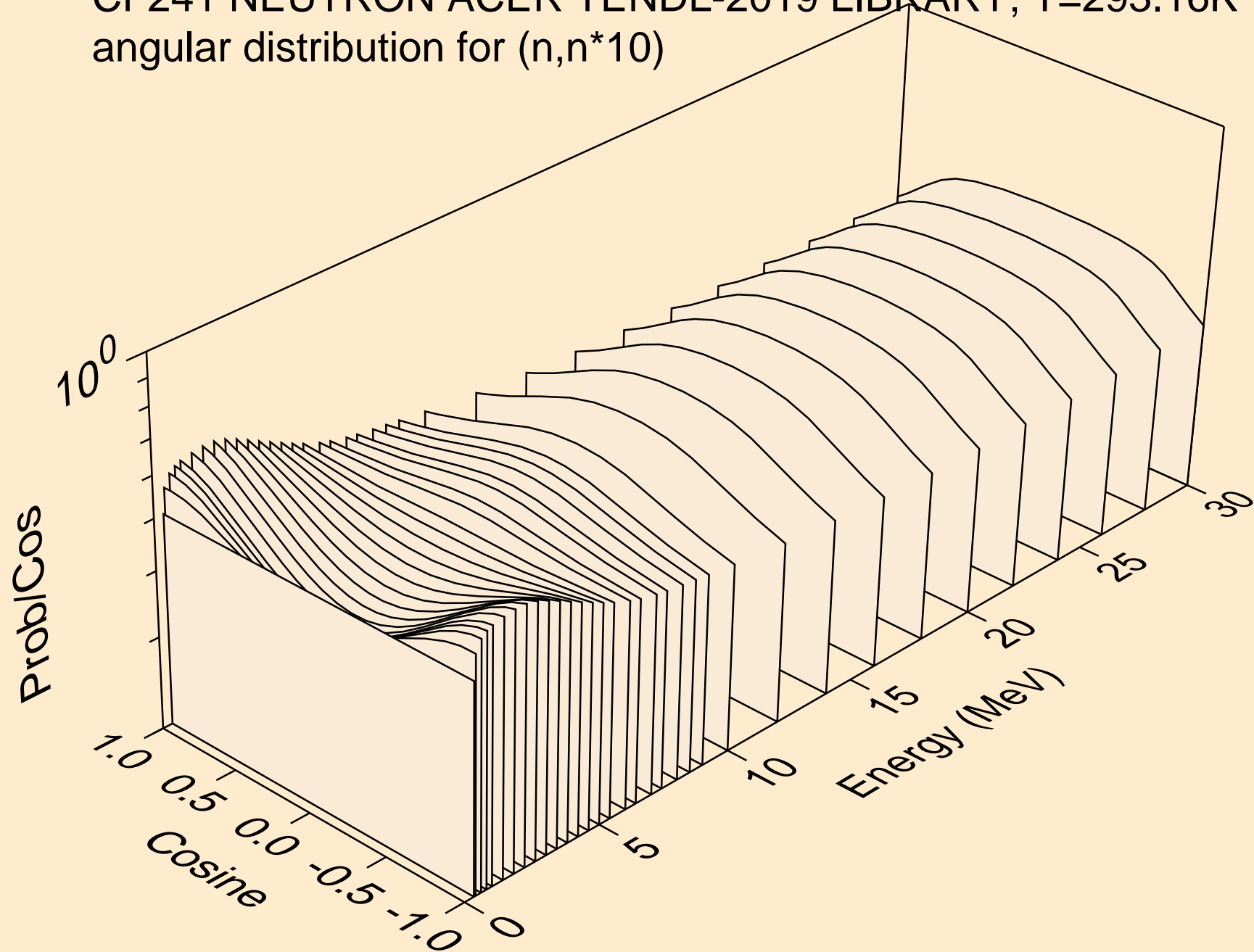

CF241 NEUTRON ACER TENDL-2019 LIBRARY; T=293.16K  
angular distribution for (n,n\*11)

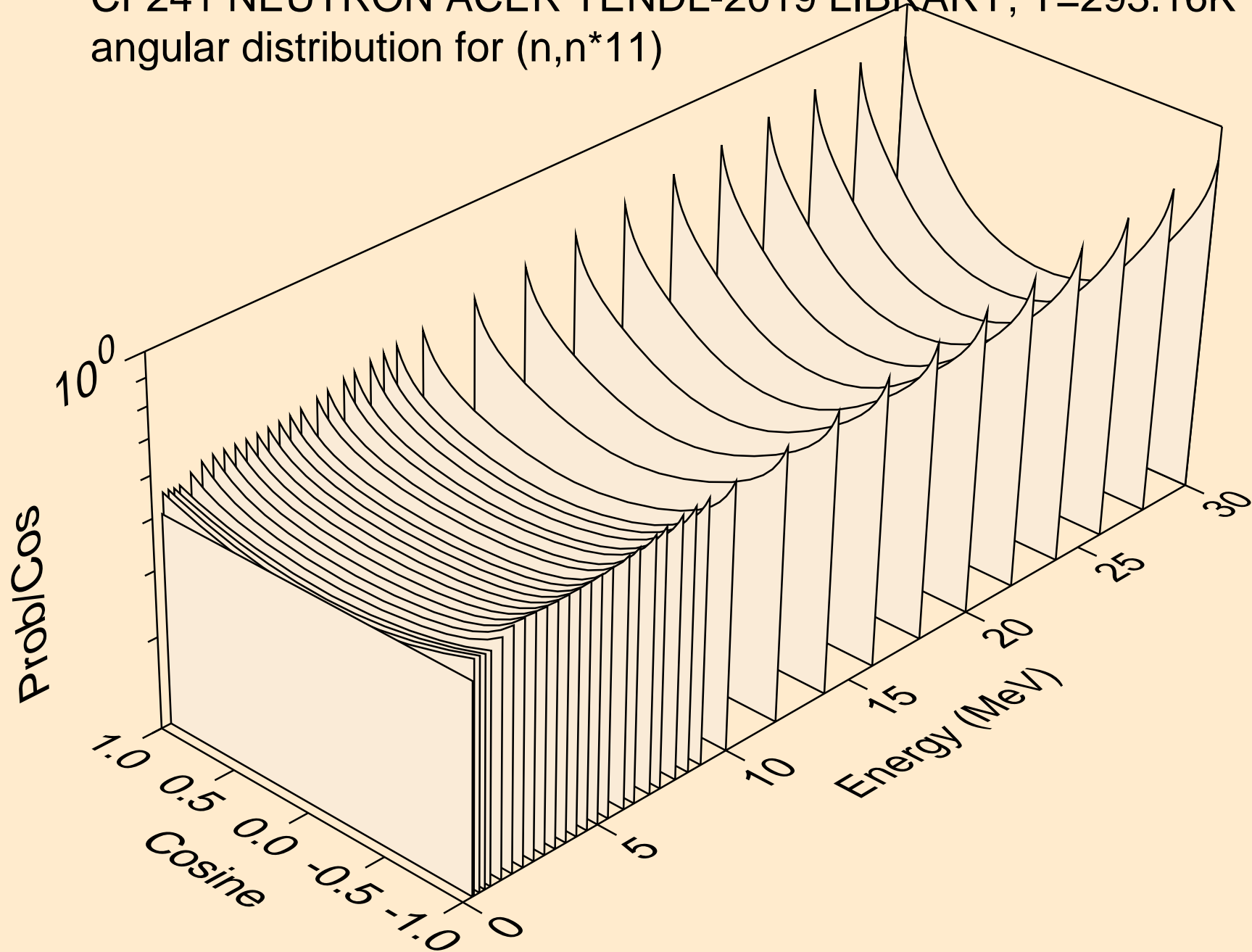

CF241 NEUTRON ACER TENDL-2019 LIBRARY; T=293.16K  
angular distribution for (n,n\*12)

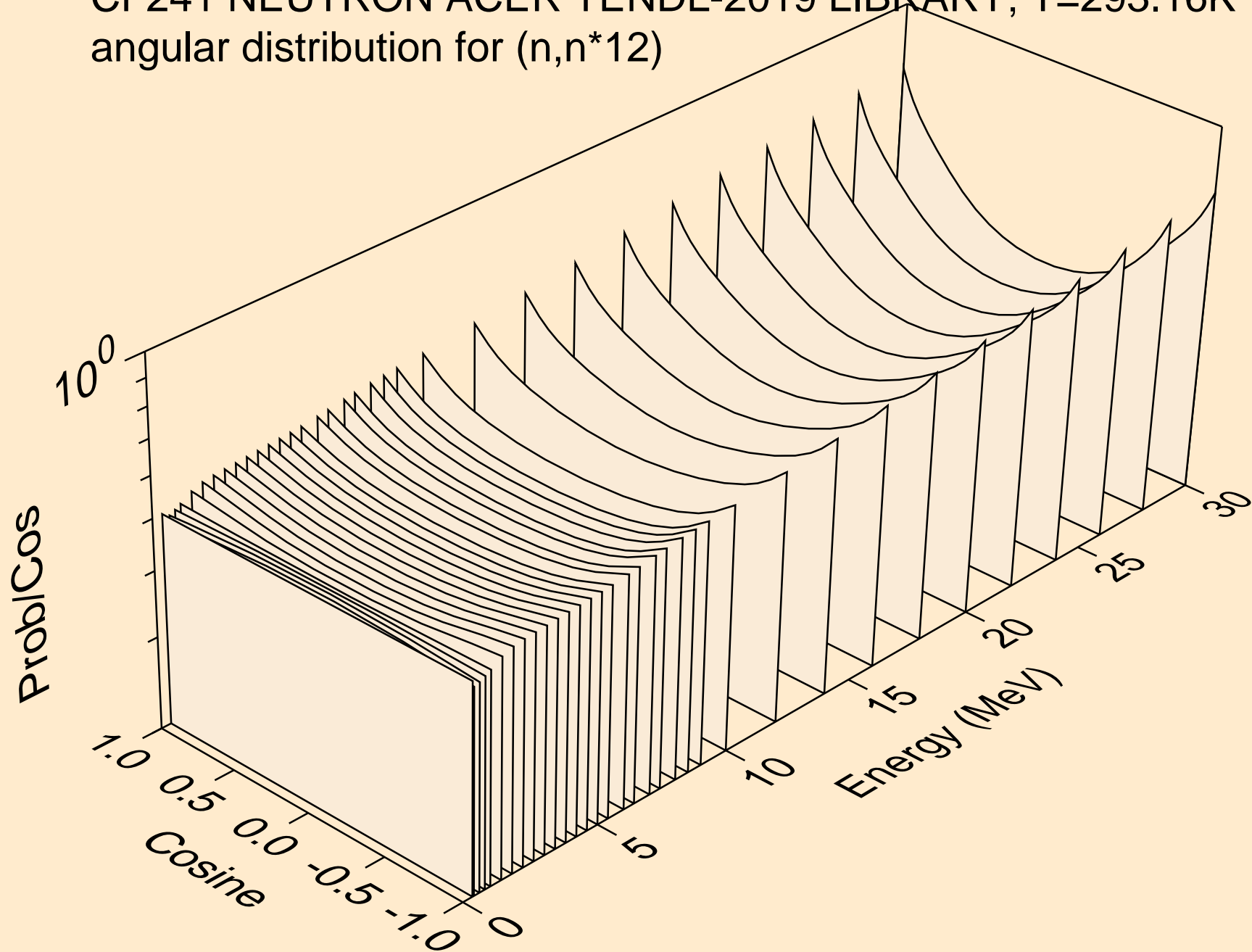

CF241 NEUTRON ACER TENDL-2019 LIBRARY; T=293.16K  
angular distribution for (n,n\*13)

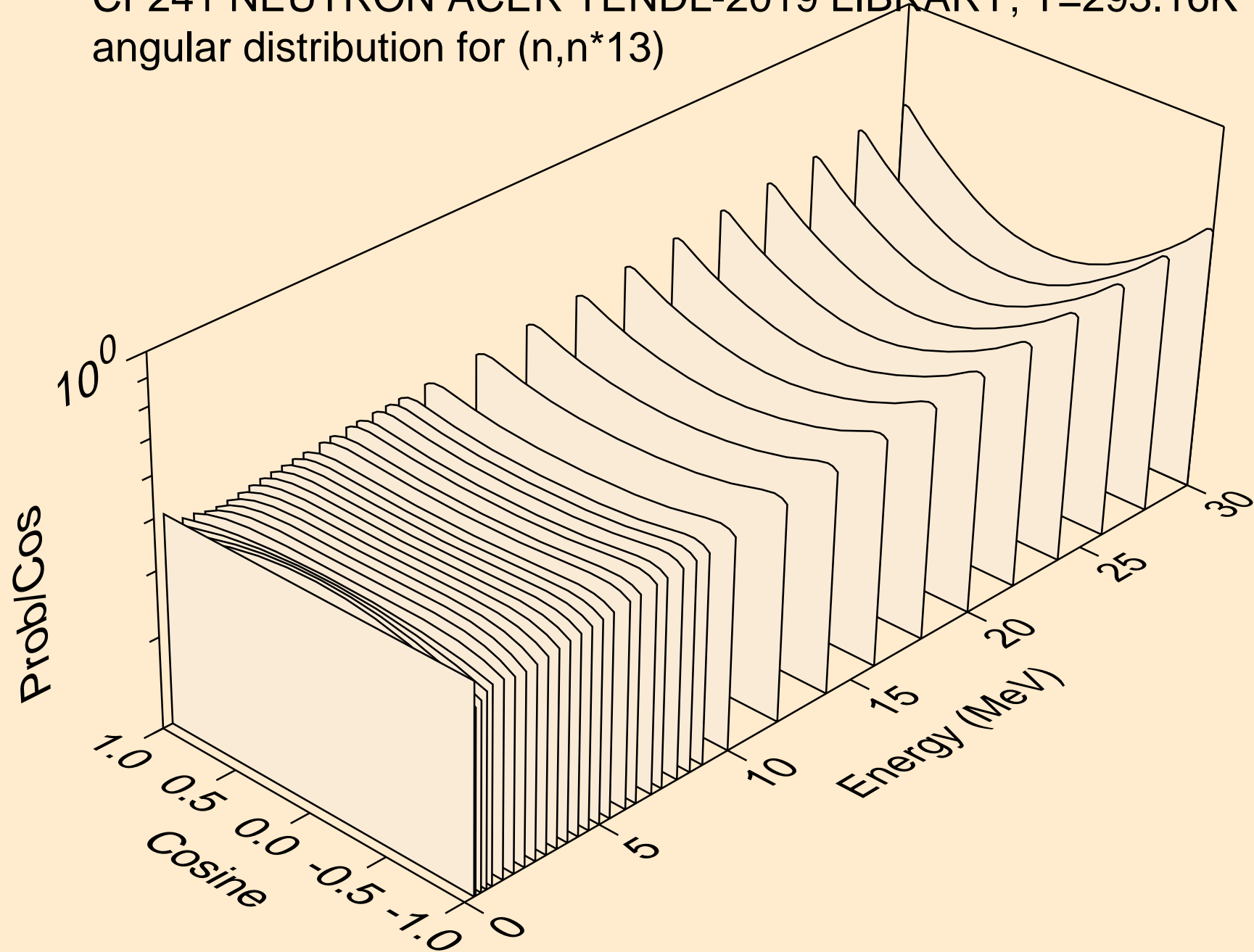

CF241 NEUTRON ACER TENDL-2019 LIBRARY; T=293.16K  
angular distribution for (n,n\*14)

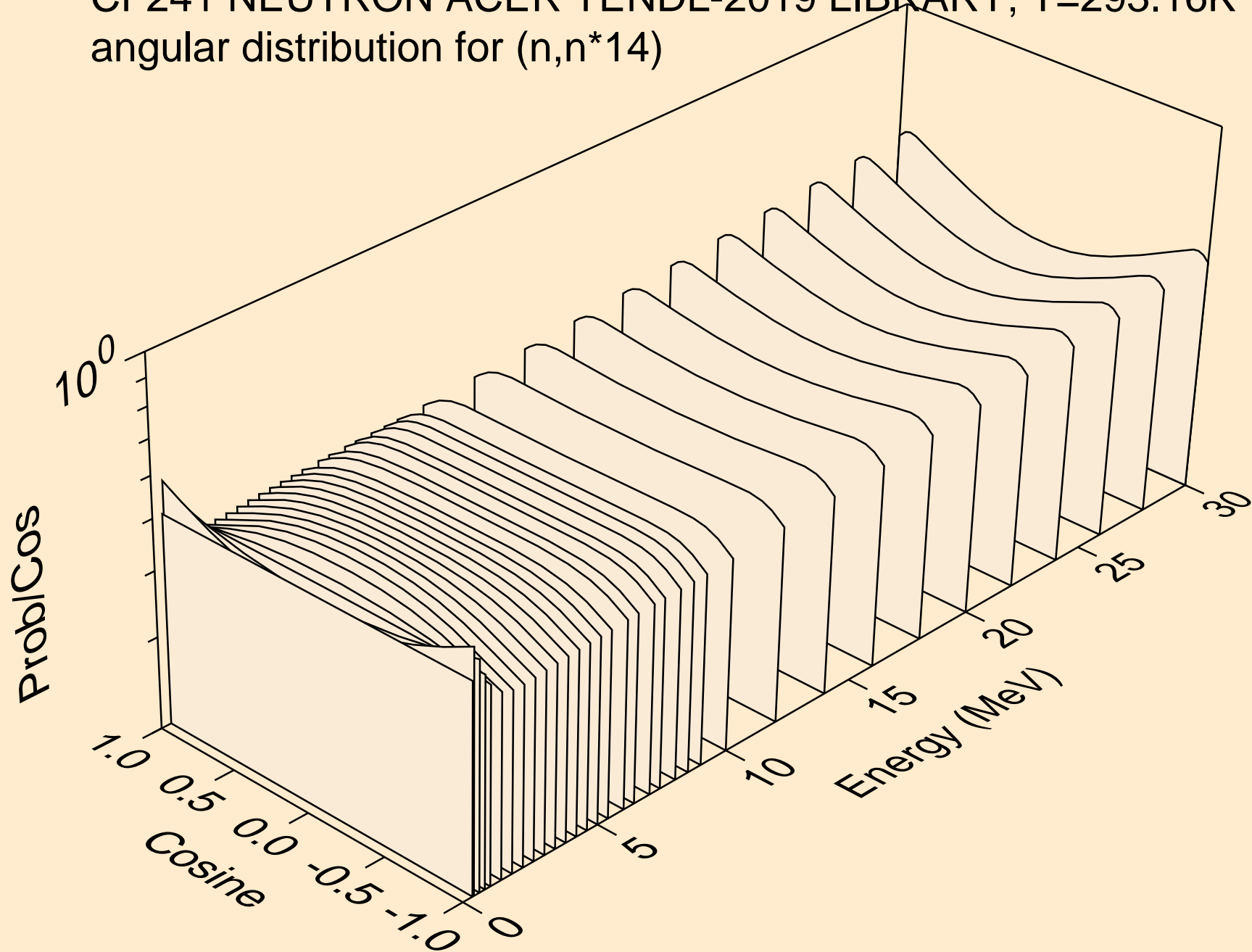

CF241 NEUTRON ACER TENDL-2019 LIBRARY; T=293.16K  
angular distribution for (n,n\*15)

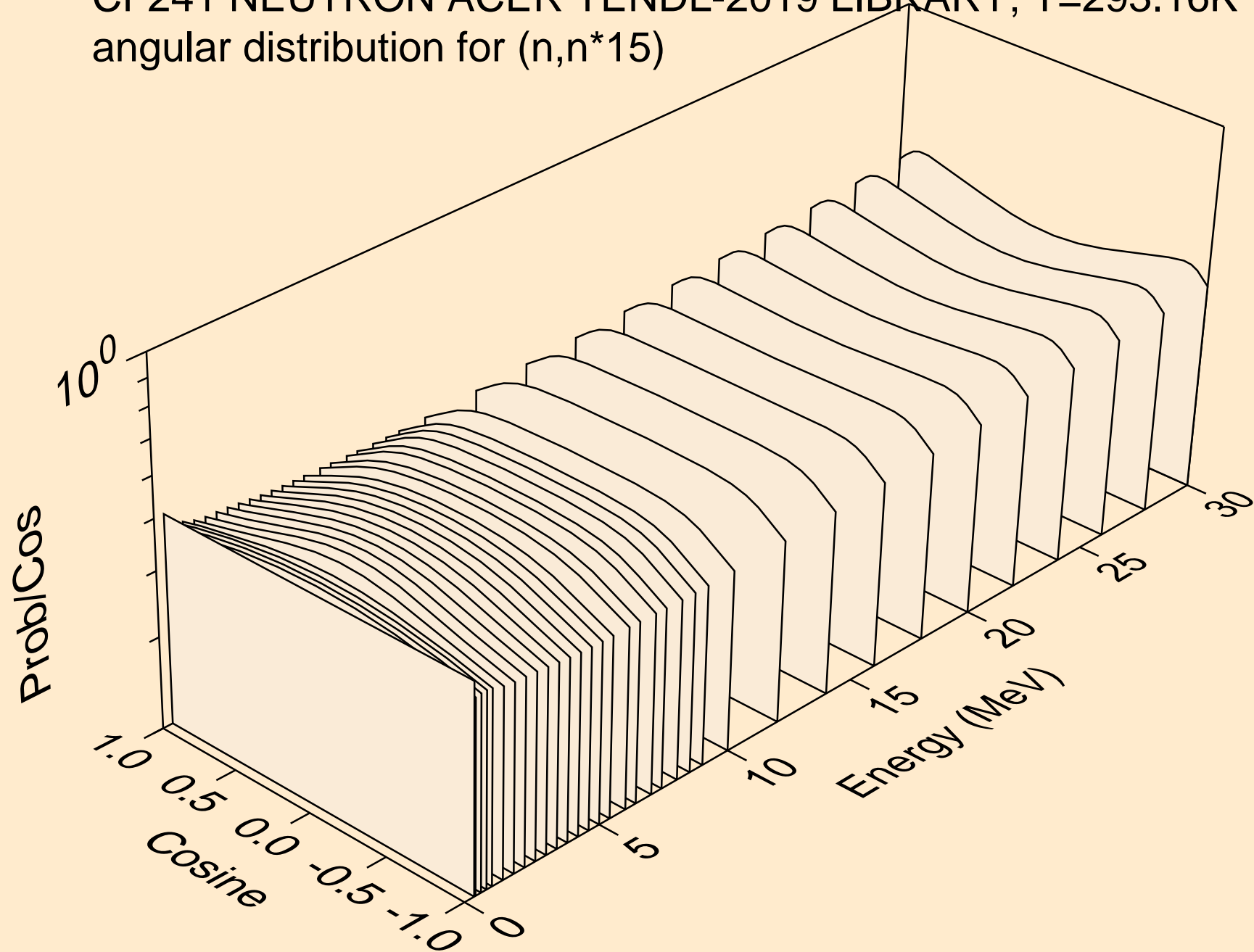

CF241 NEUTRON ACER TENDL-2019 LIBRARY; T=293.16K  
angular distribution for (n,n\*16)

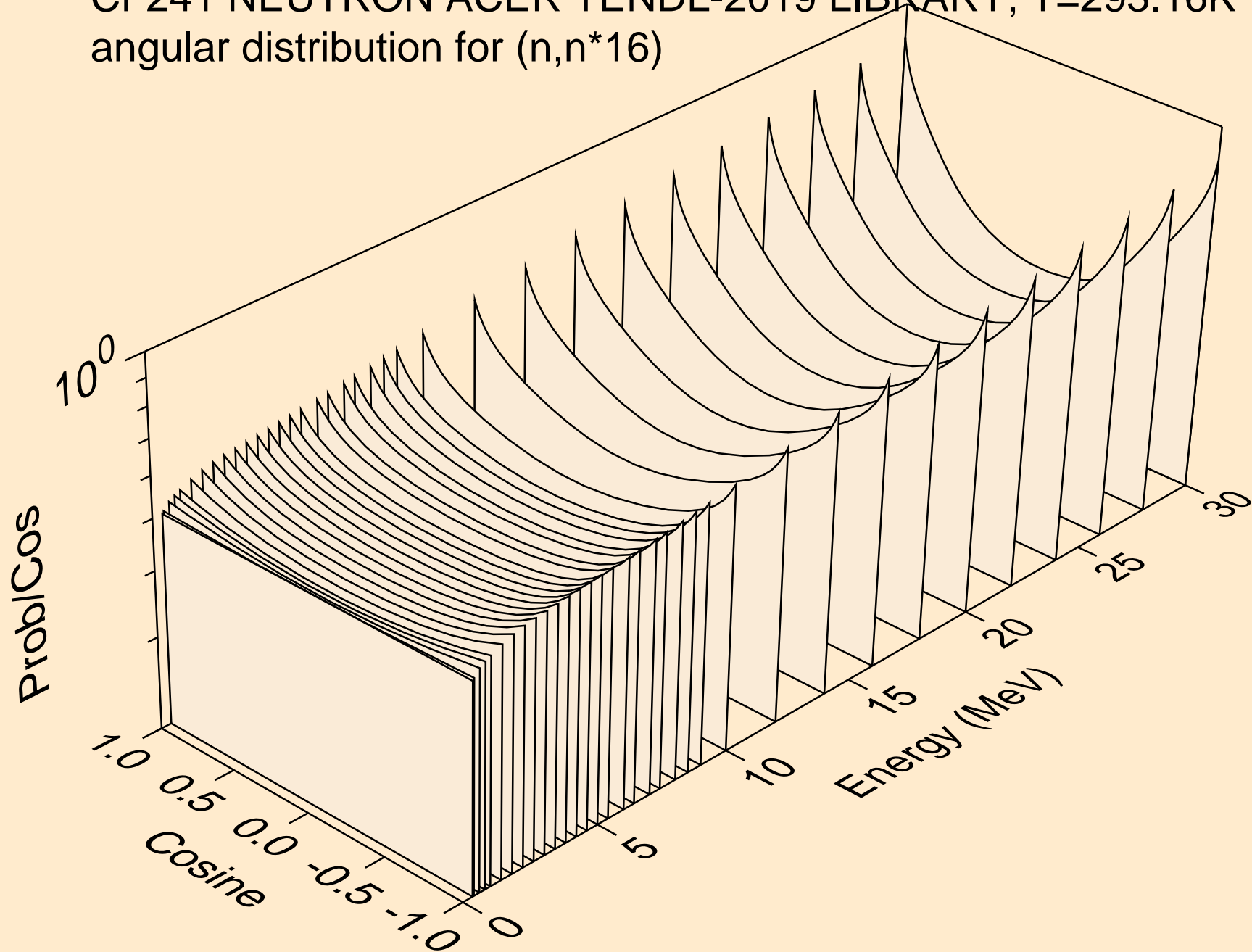



CF241 NEUTRON ACER TENDL-2019 LIBRARY; T=293.16K  
angular distribution for (n,n\*17)

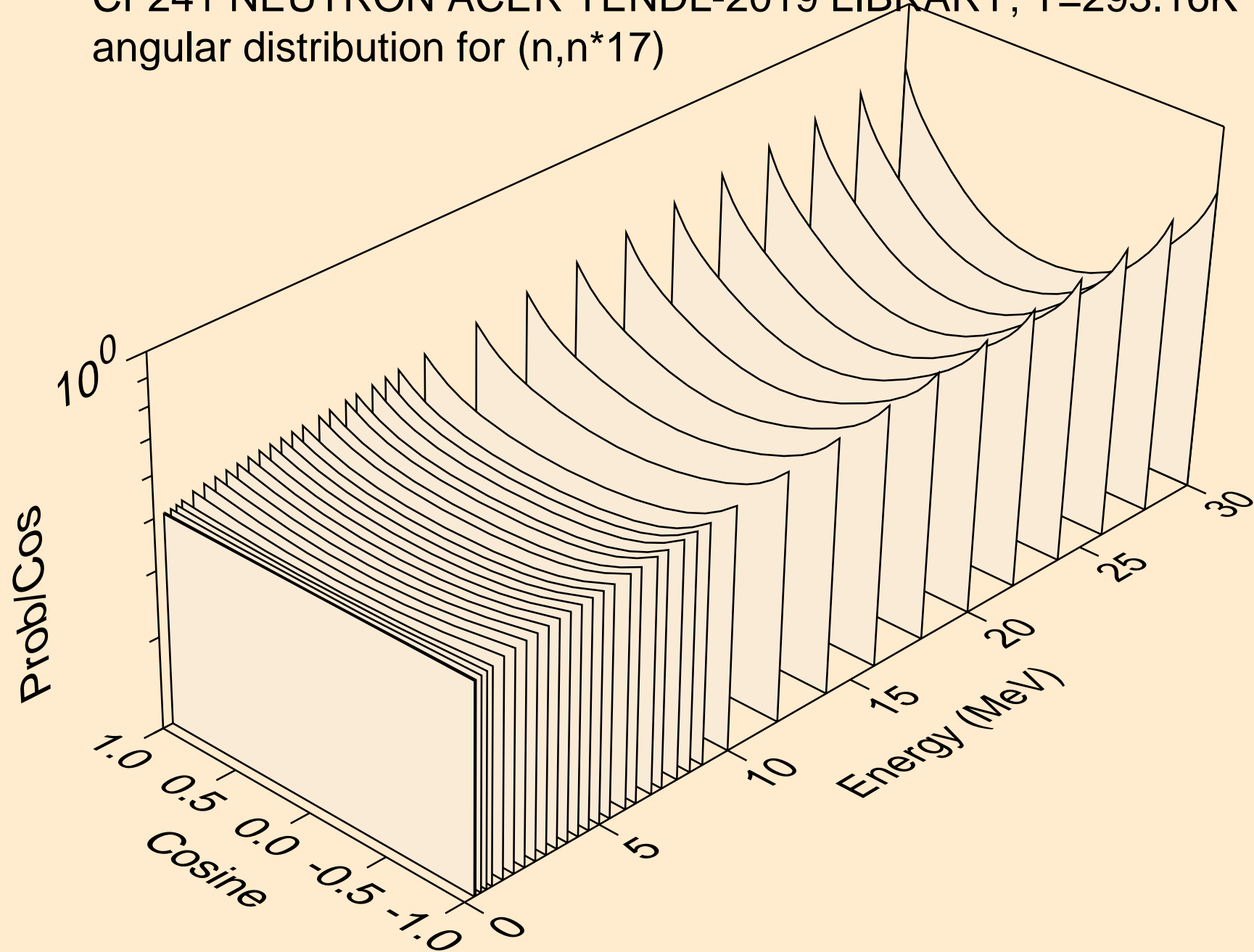

CF241 NEUTRON ACER TENDL-2019 LIBRARY; T=293.16K  
angular distribution for (n,n\*18)

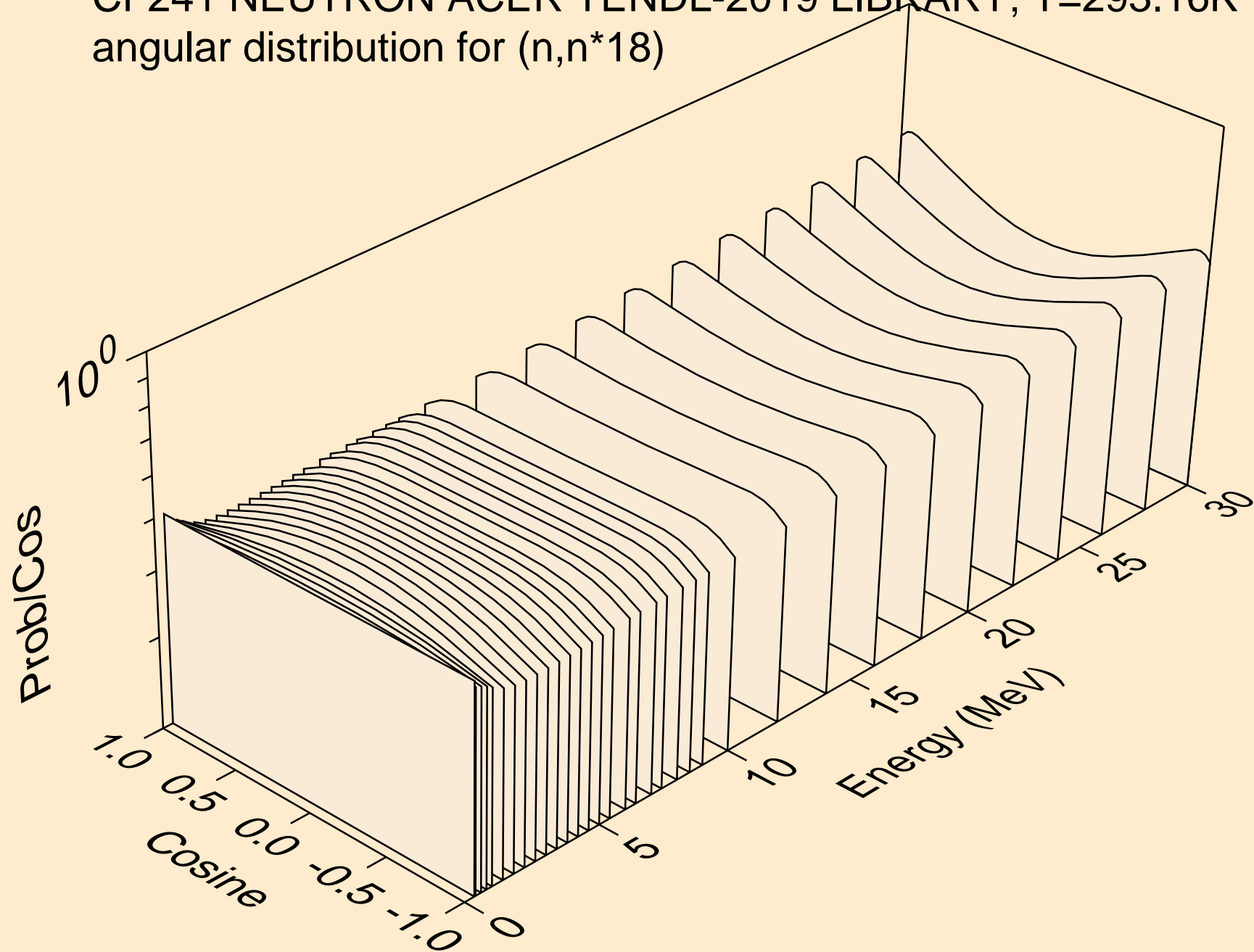

CF241 NEUTRON ACER TENDL-2019 LIBRARY; T=293.16K  
angular distribution for (n,n\*19)

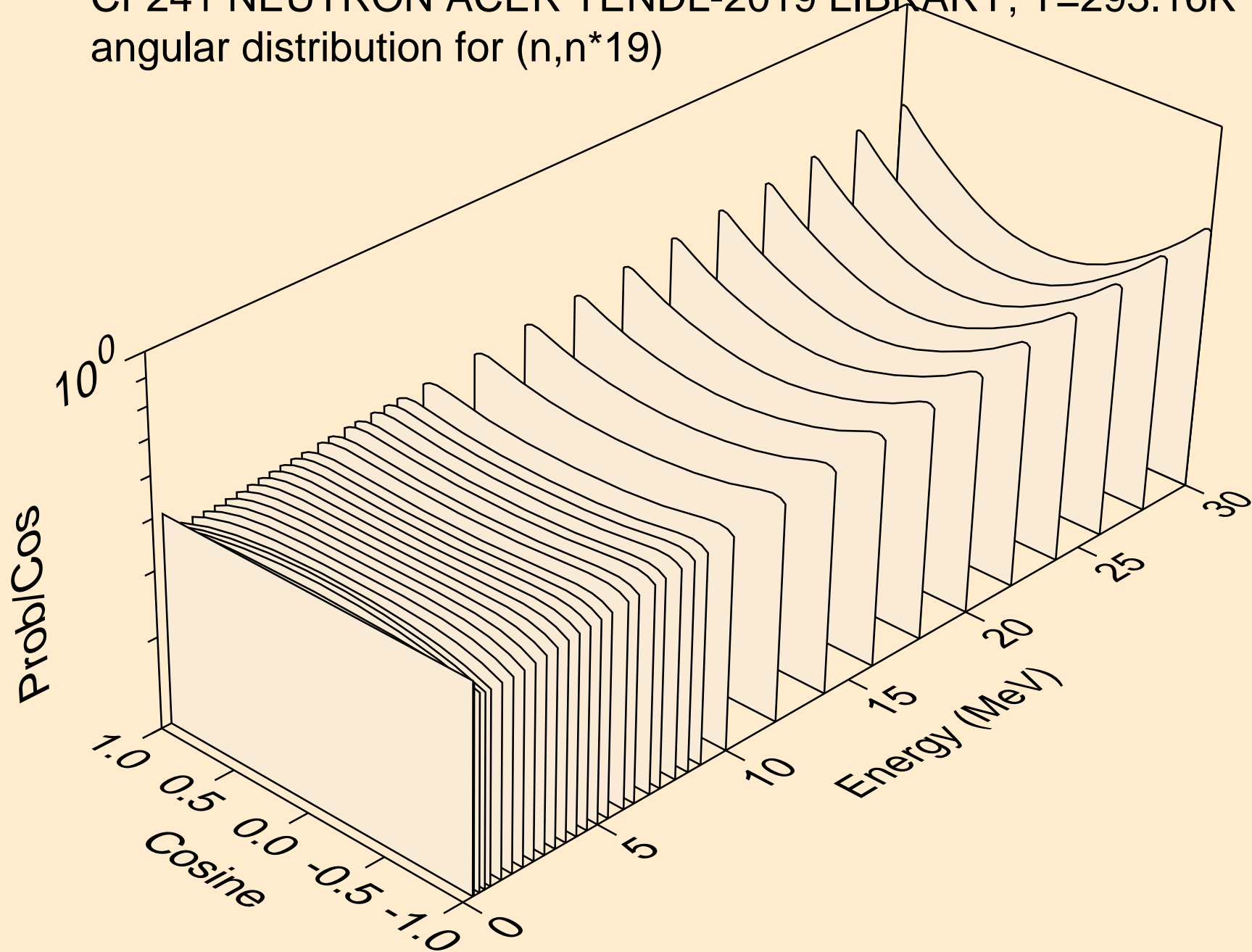

CF241 NEUTRON ACER TENDL-2019 LIBRARY; T=293.16K  
angular distribution for (n,n\*20)

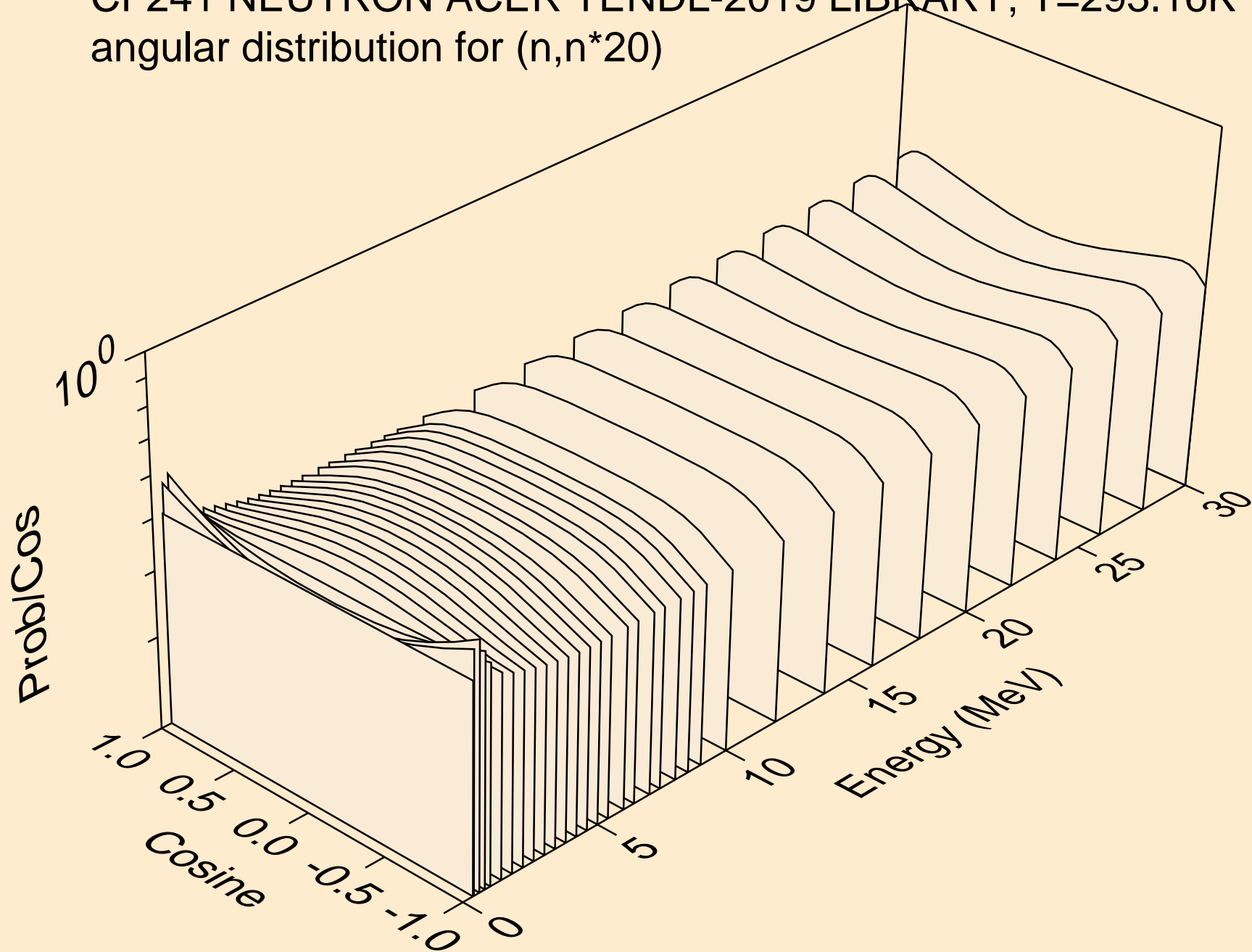

CF241 NEUTRON ACER TENDL-2019 LIBRARY; T=293.16K  
angular distribution for (n,n\*21)

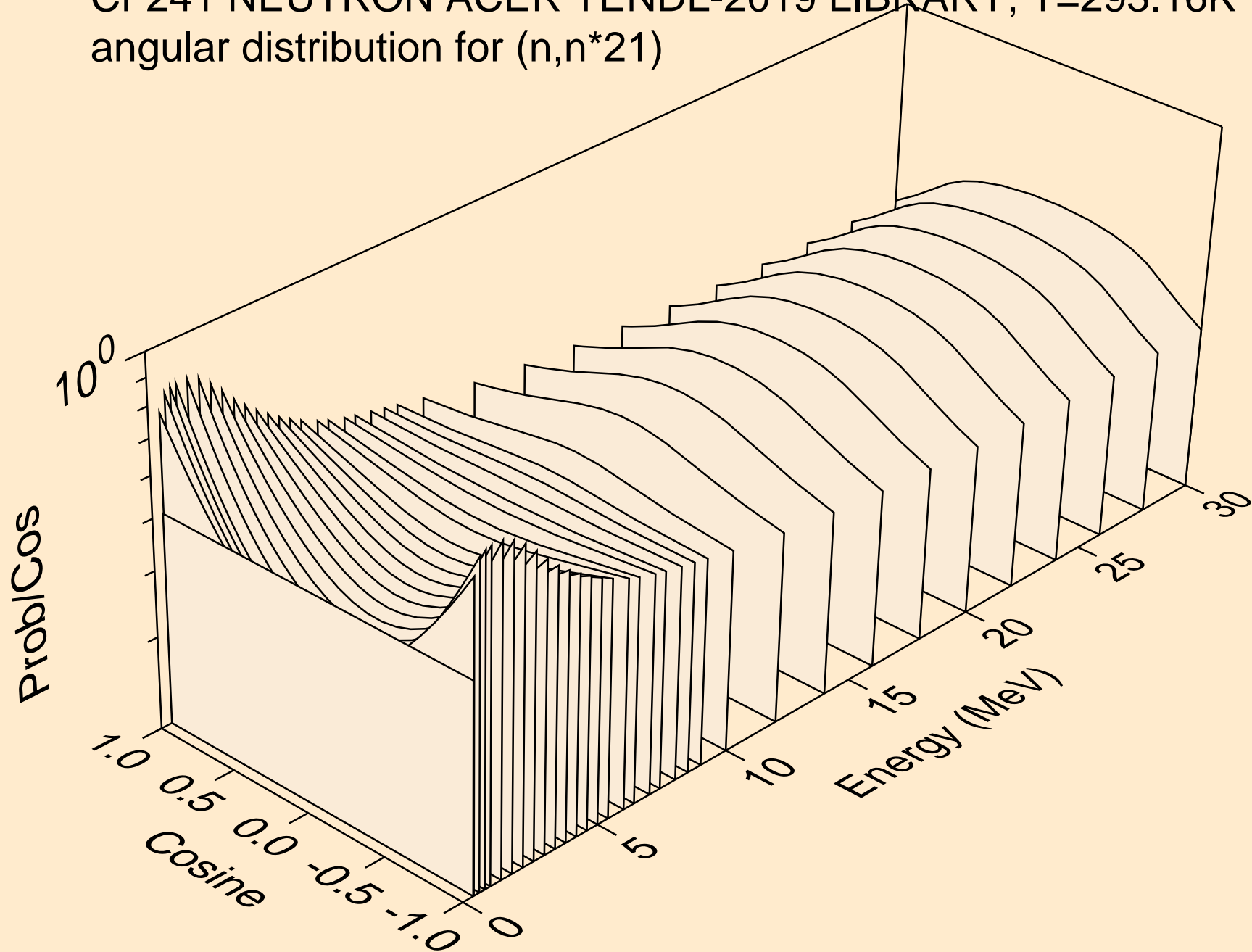

CF241 NEUTRON ACER TENDL-2019 LIBRARY; T=293.16K  
angular distribution for (n,n\*22)

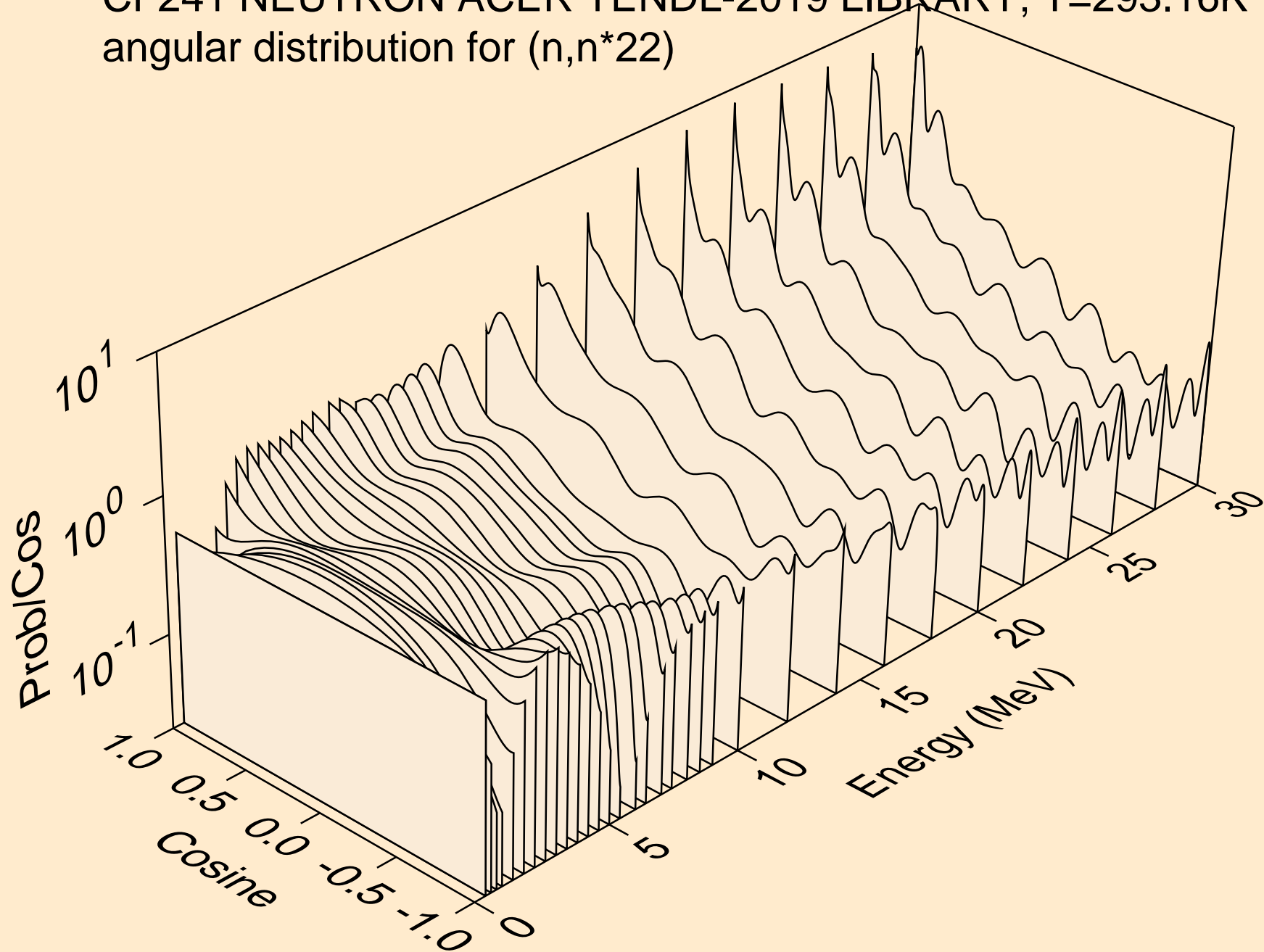

CF241 NEUTRON ACER TENDL-2019 LIBRARY; T=293.16K  
angular distribution for (n,n\*23)

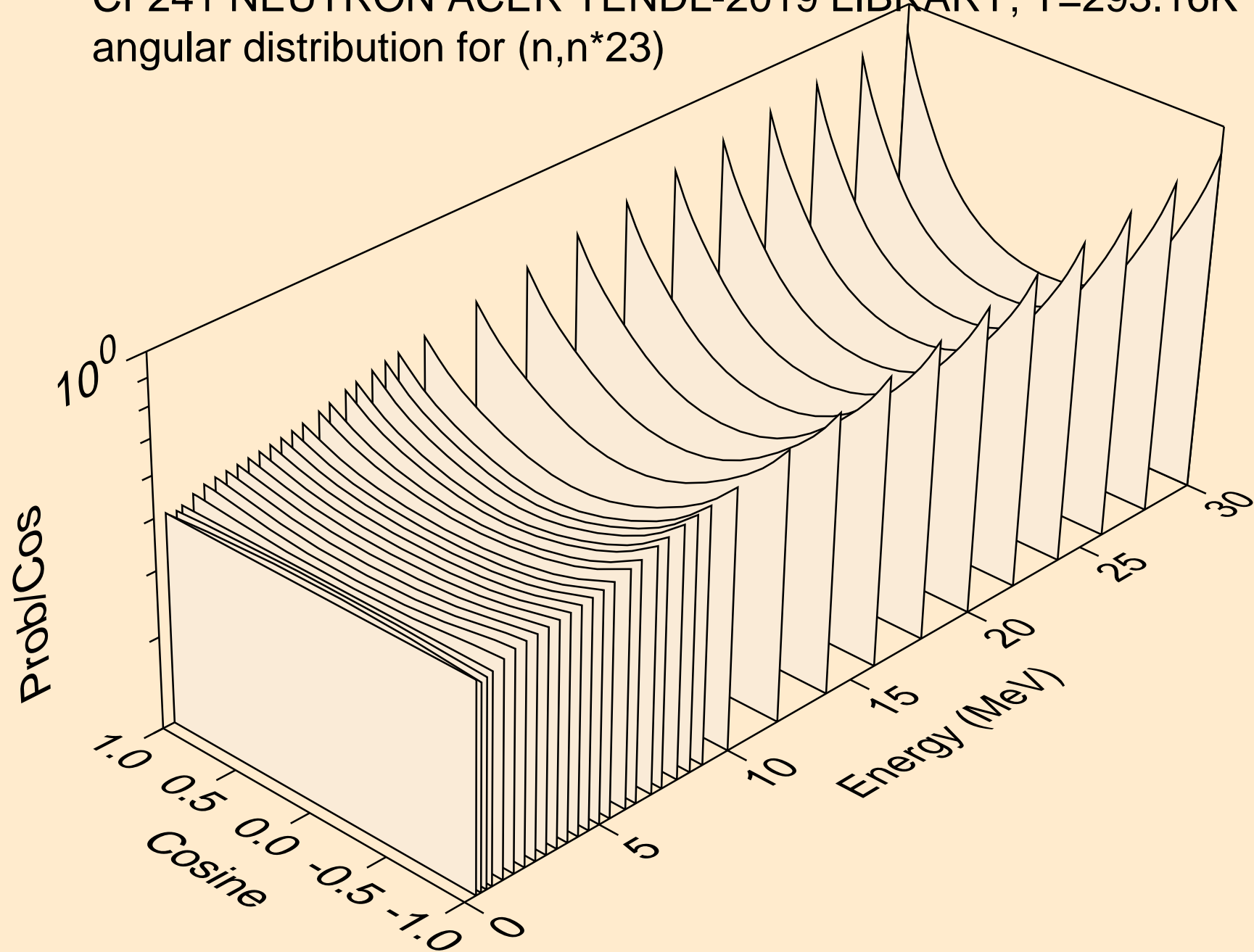

CF241 NEUTRON ACER TENDL-2019 LIBRARY; T=293.16K  
angular distribution for (n,n\*24)

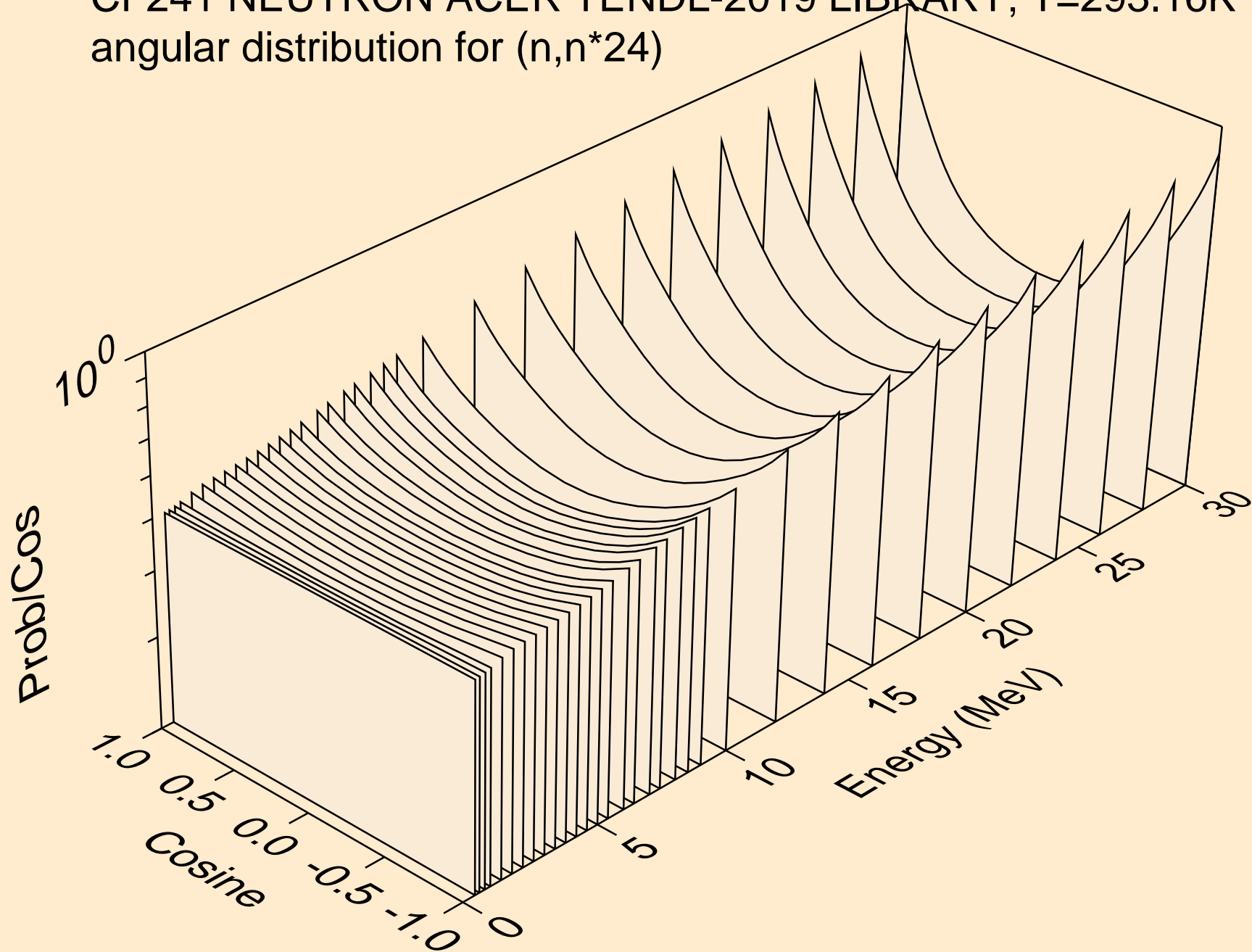



CF241 NEUTRON ACER TENDL-2019 LIBRARY; T=293.16K  
angular distribution for (n,n\*25)

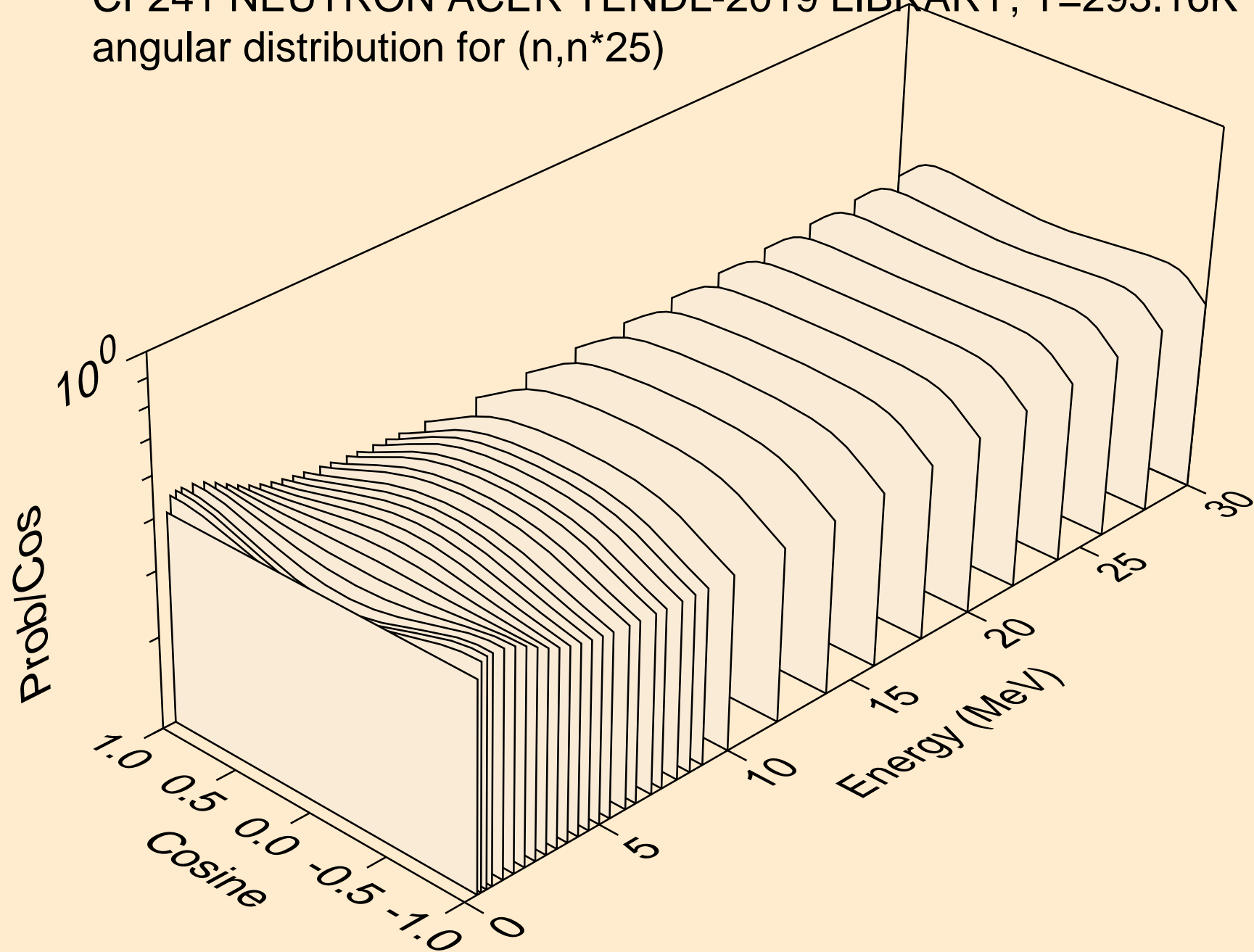

CF241 NEUTRON ACER TENDL-2019 LIBRARY; T=293.16K  
angular distribution for (n,n\*26)

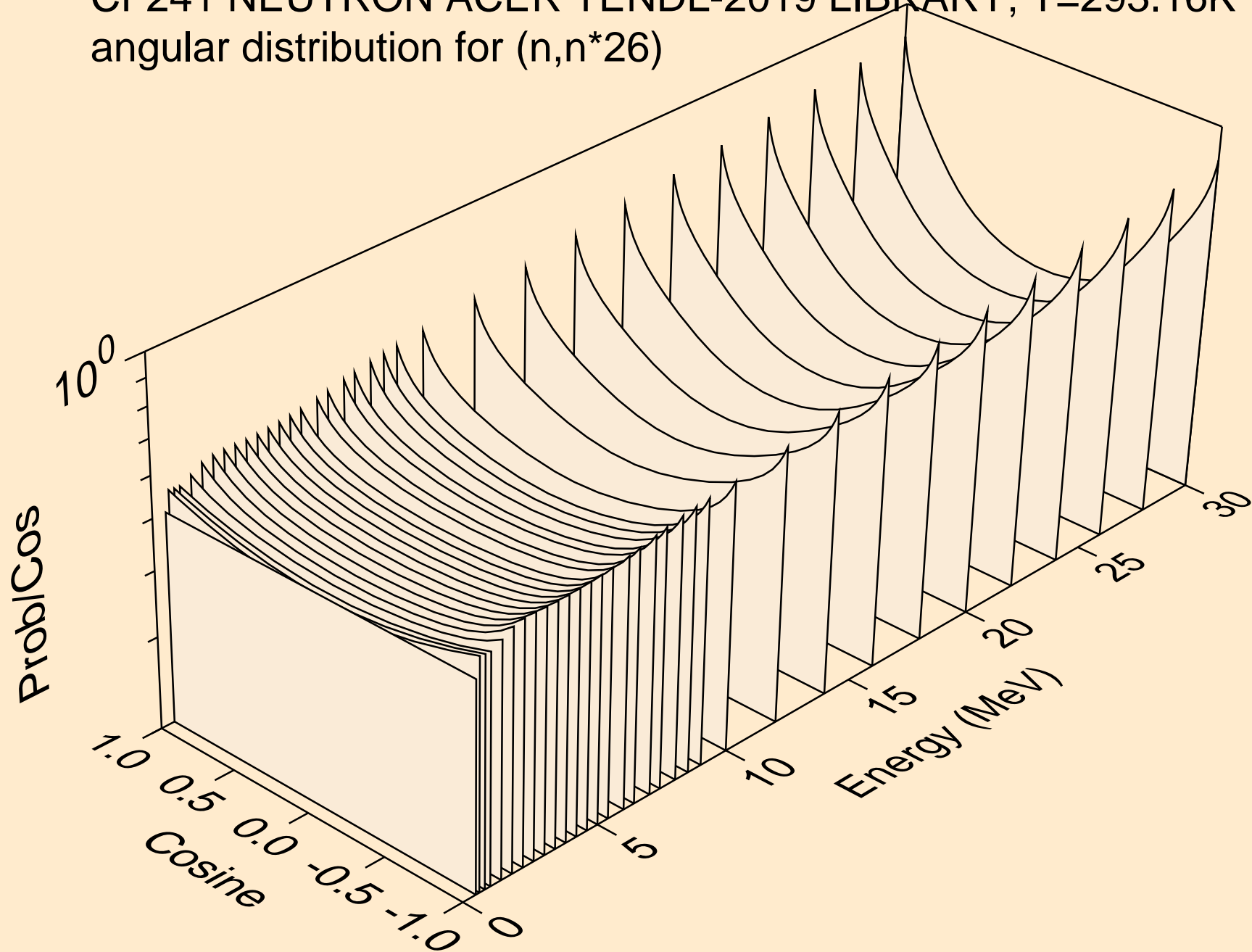

CF241 NEUTRON ACER TENDL-2019 LIBRARY; T=293.16K  
angular distribution for (n,n\*27)

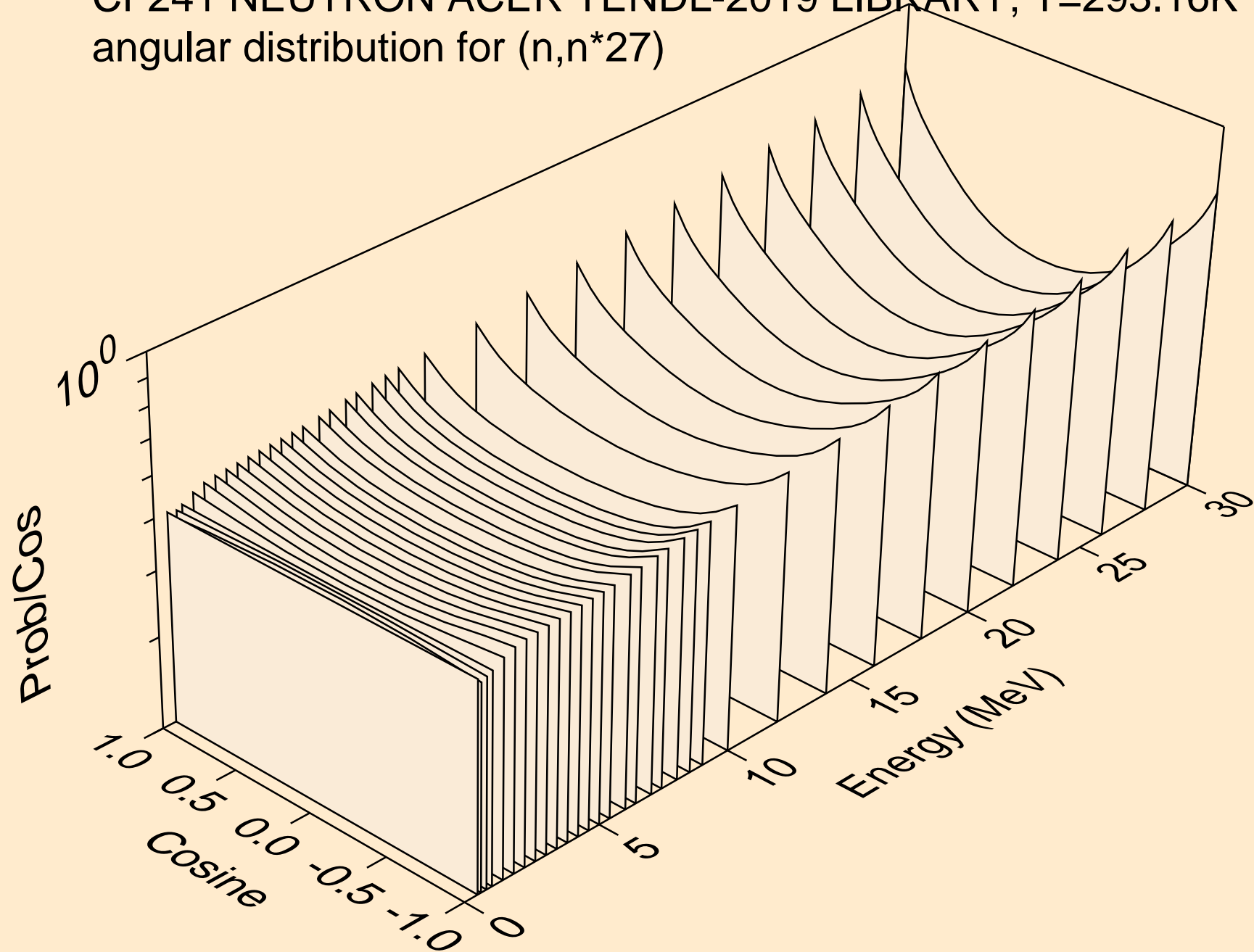

CF241 NEUTRON ACER TENDL-2019 LIBRARY; T=293.16K  
angular distribution for (n,n\*28)

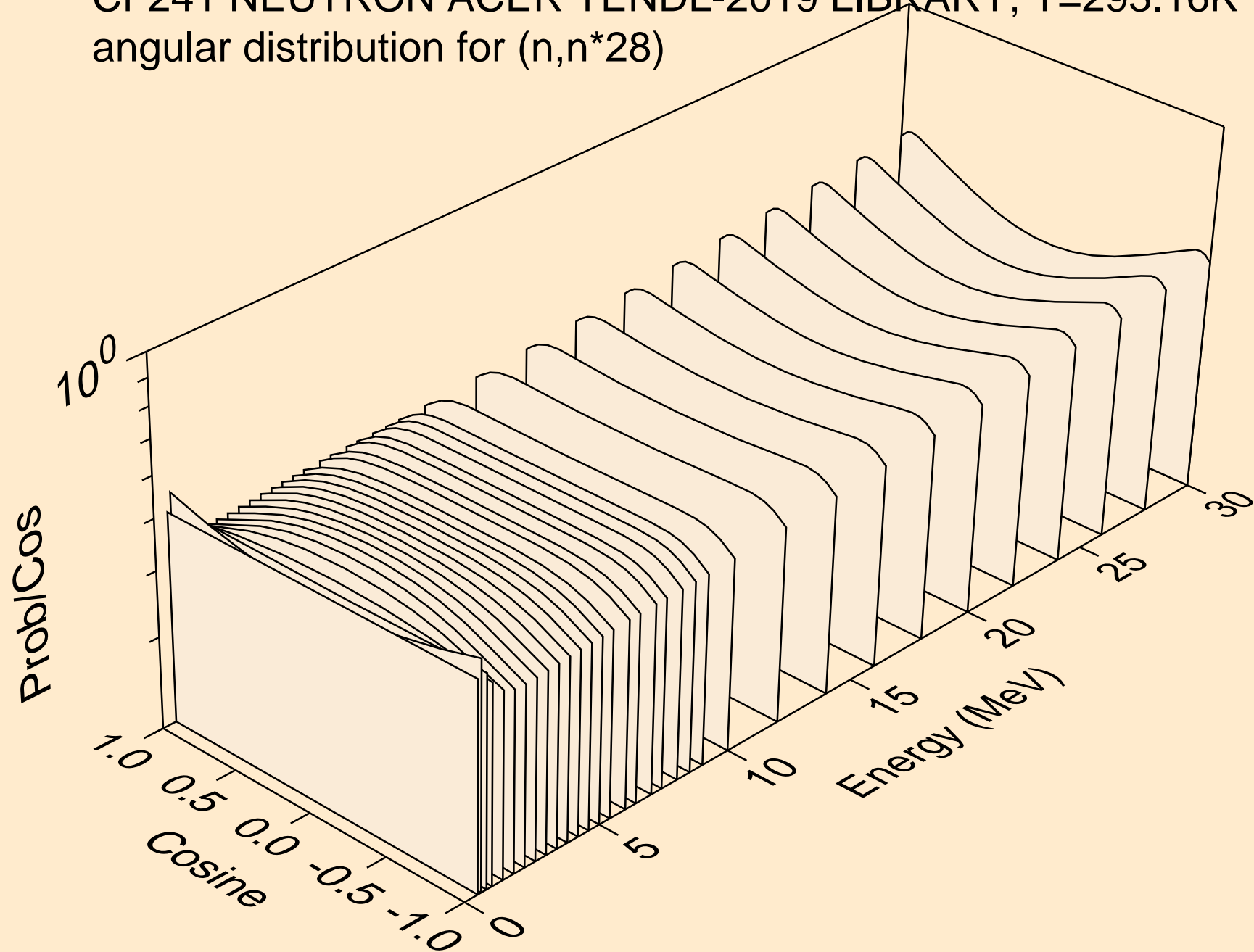

CF241 NEUTRON ACER TENDL-2019 LIBRARY; T=293.16K  
angular distribution for (n,n\*29)

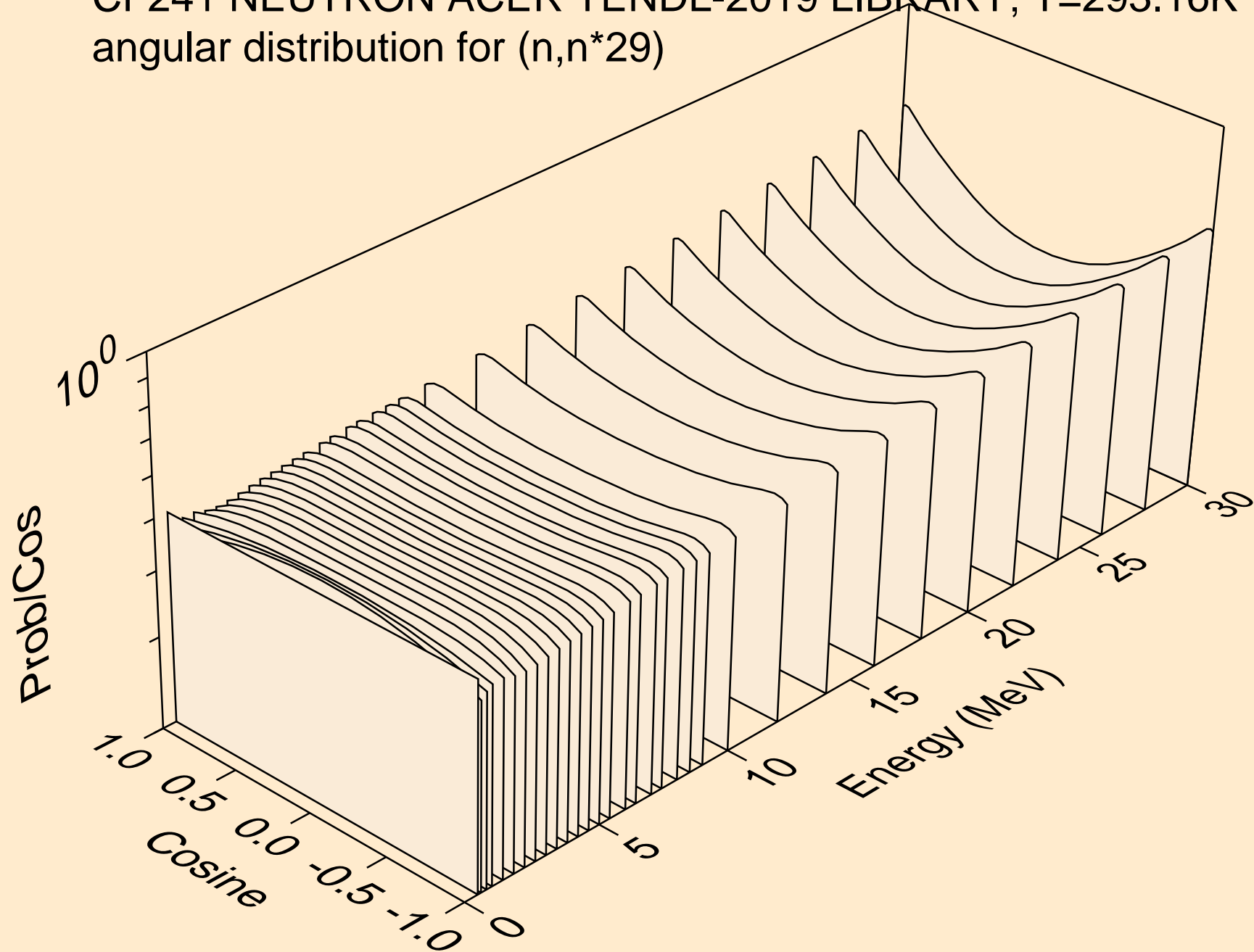

CF241 NEUTRON ACER TENDL-2019 LIBRARY; T=293.16K  
Total fission nubar

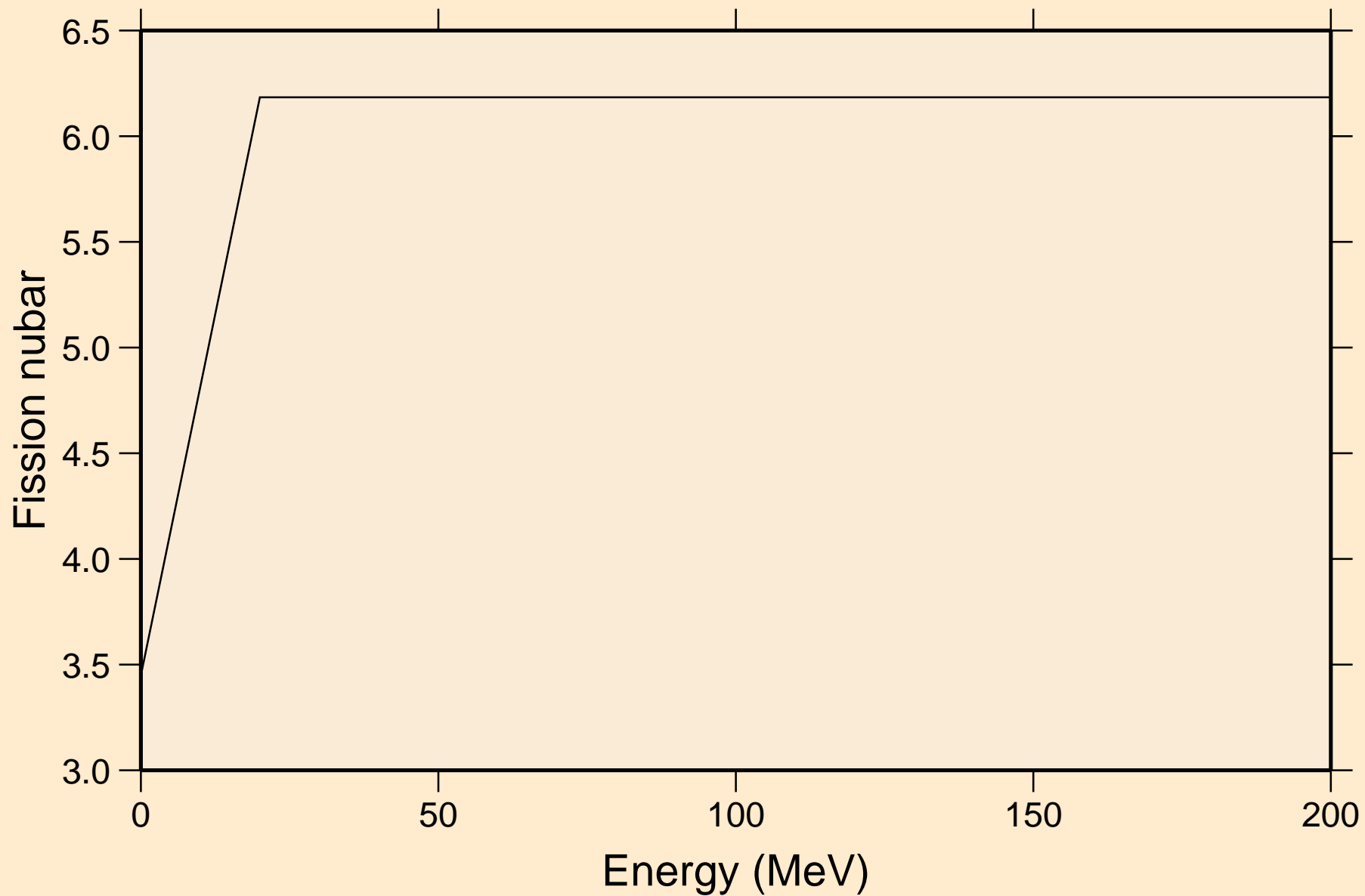

CF241 NEUTRON ACER TENDL-2019 LIBRARY; T=293.16K  
Neutron emission for (n,x)

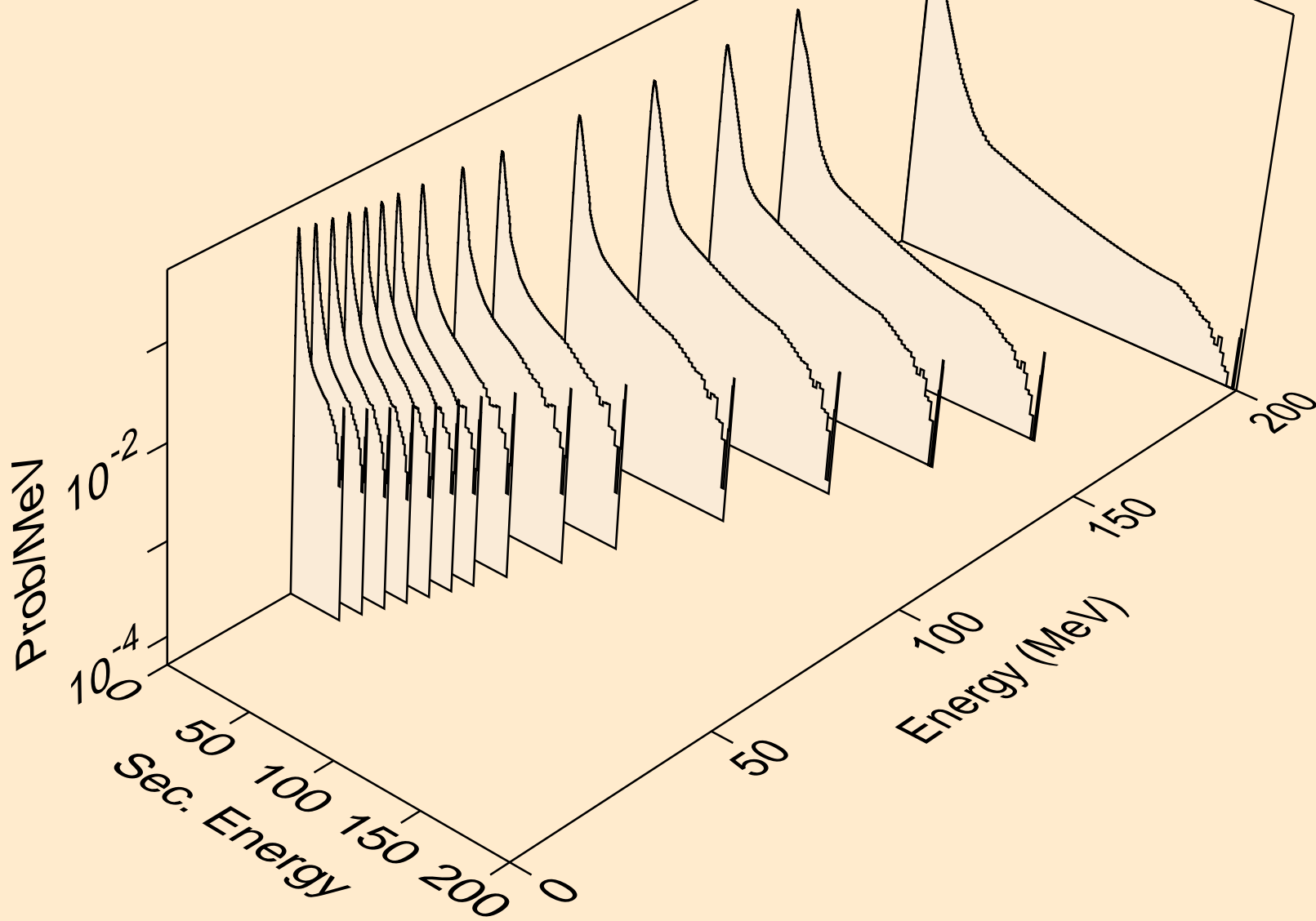

CF241 NEUTRON ACER TENDL-2019 LIBRARY; T=293.16K  
Neutron emission for (n,2nd)

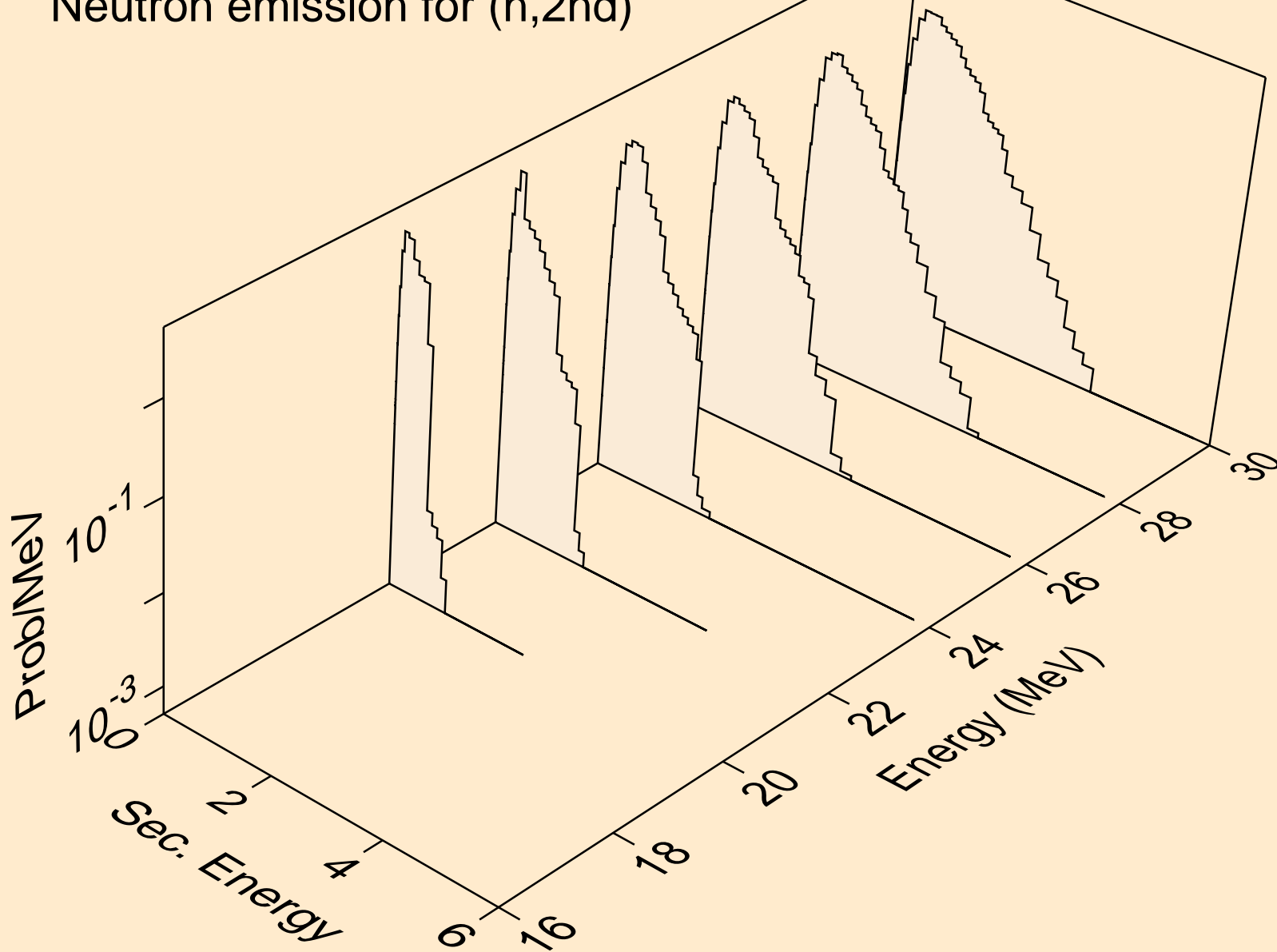



CF241 NEUTRON ACER TENDL-2019 LIBRARY; T=293.16K  
Neutron emission for (n,2n)

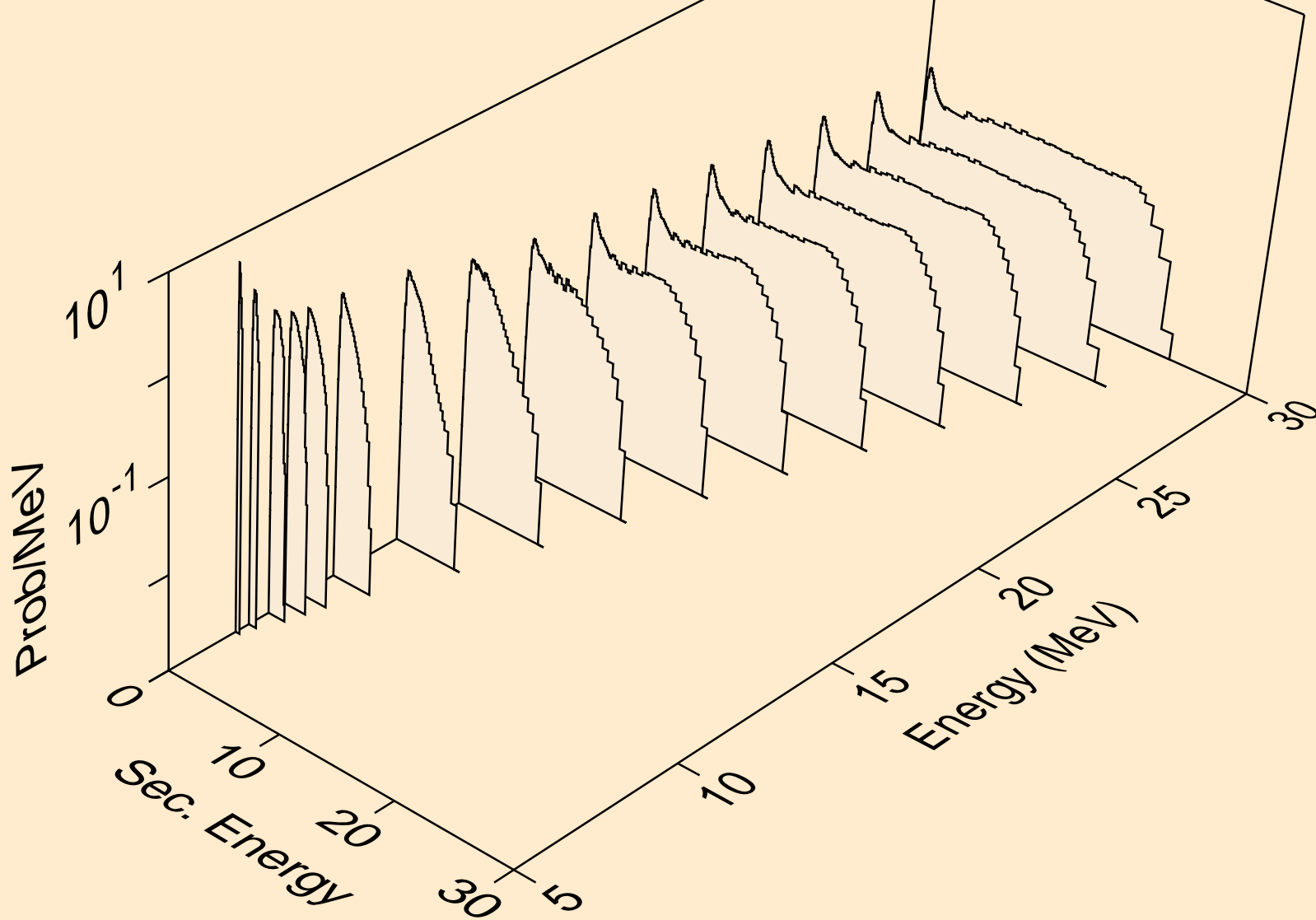

CF241 NEUTRON ACER TENDL-2019 LIBRARY; T=293.16K  
Neutron emission for (n,3n)

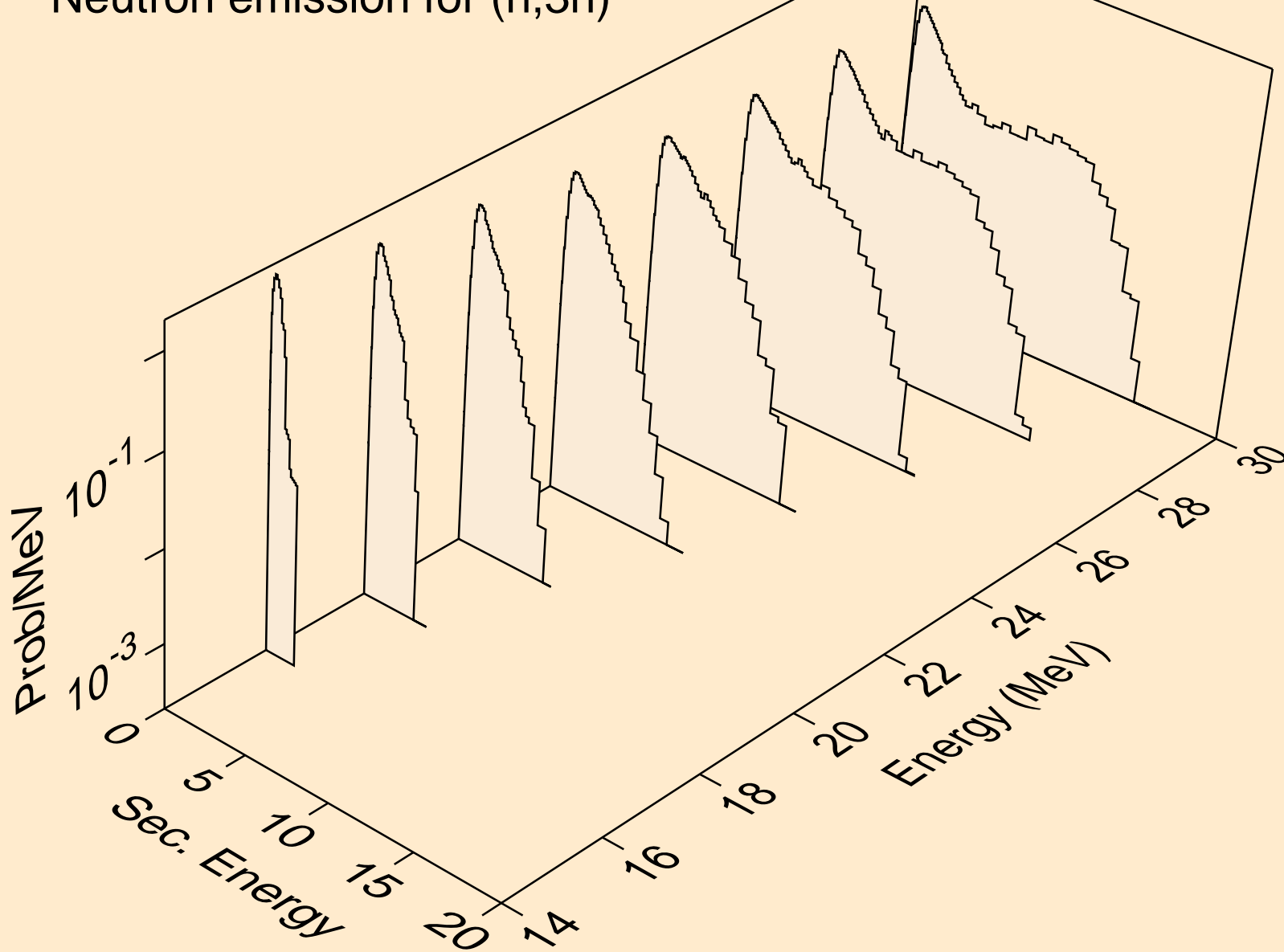

CF241 NEUTRON ACER TENDL-2019 LIBRARY; T=293.16K  
Neutron emission for fission

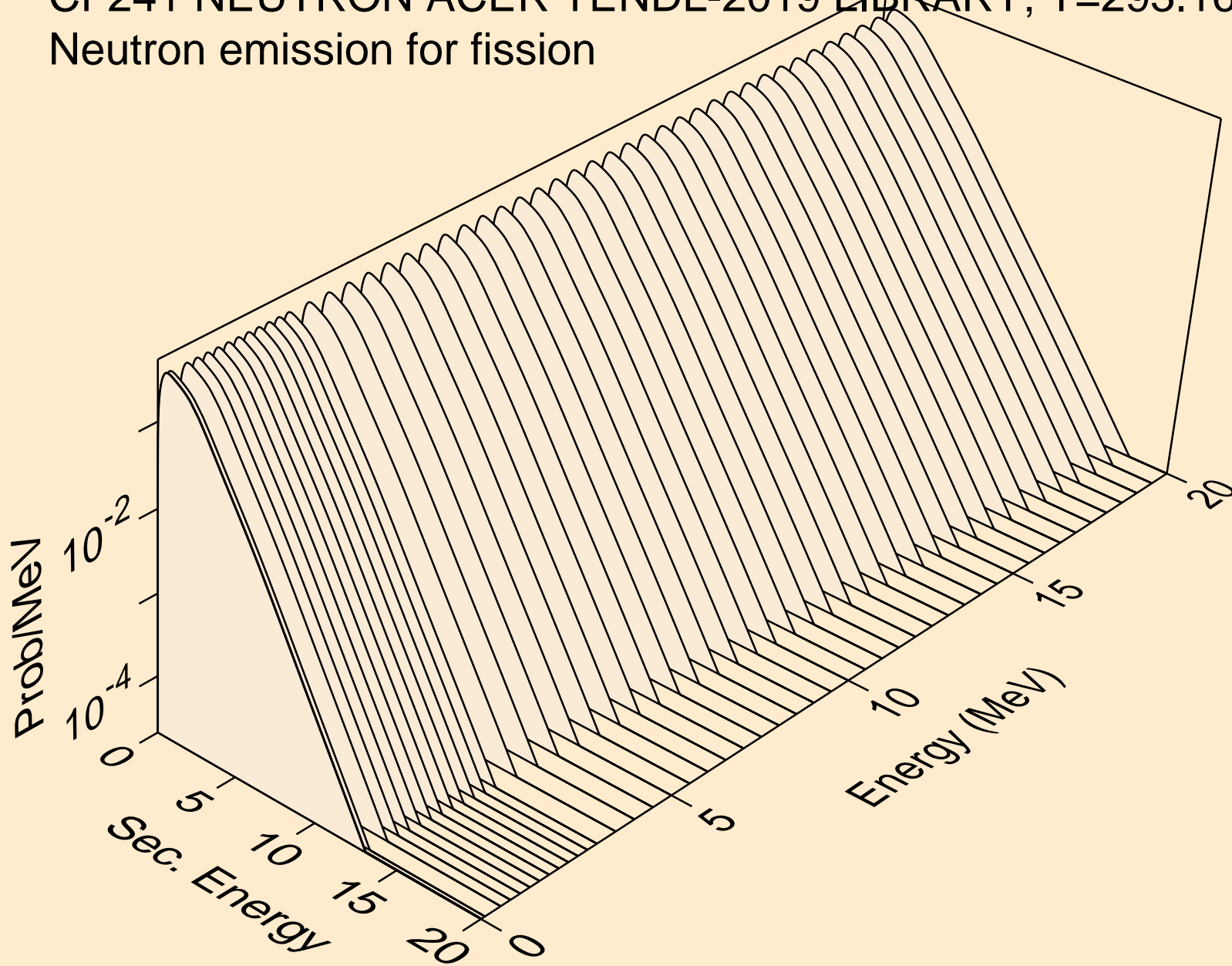

CF241 NEUTRON ACER TENDL-2019 LIBRARY; T=293.16K  
Neutron emission for (n,n\*)a

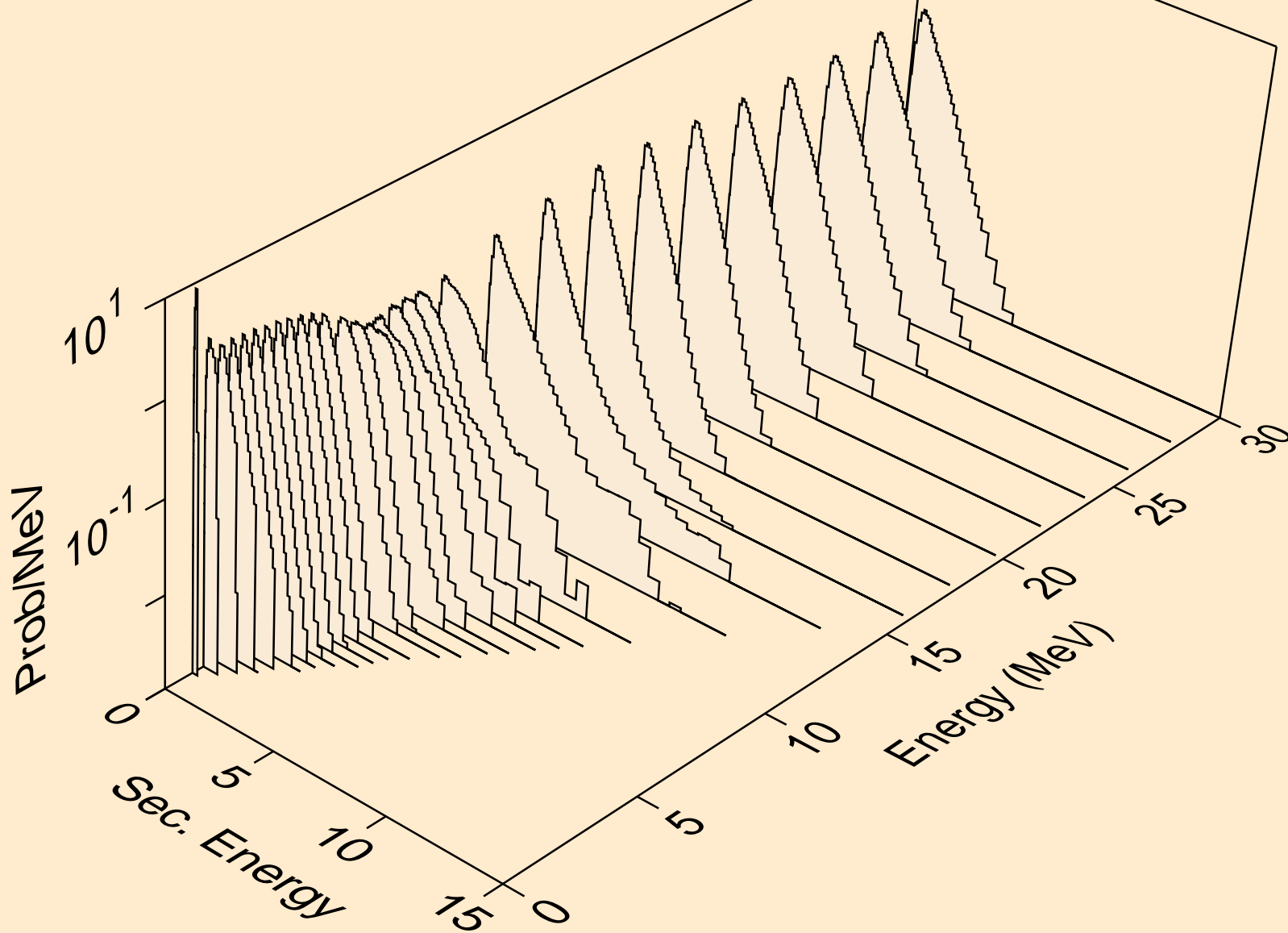

CF241 NEUTRON ACER TENDL-2019 LIBRARY; T=293.16K  
Neutron emission for (n,2n)a

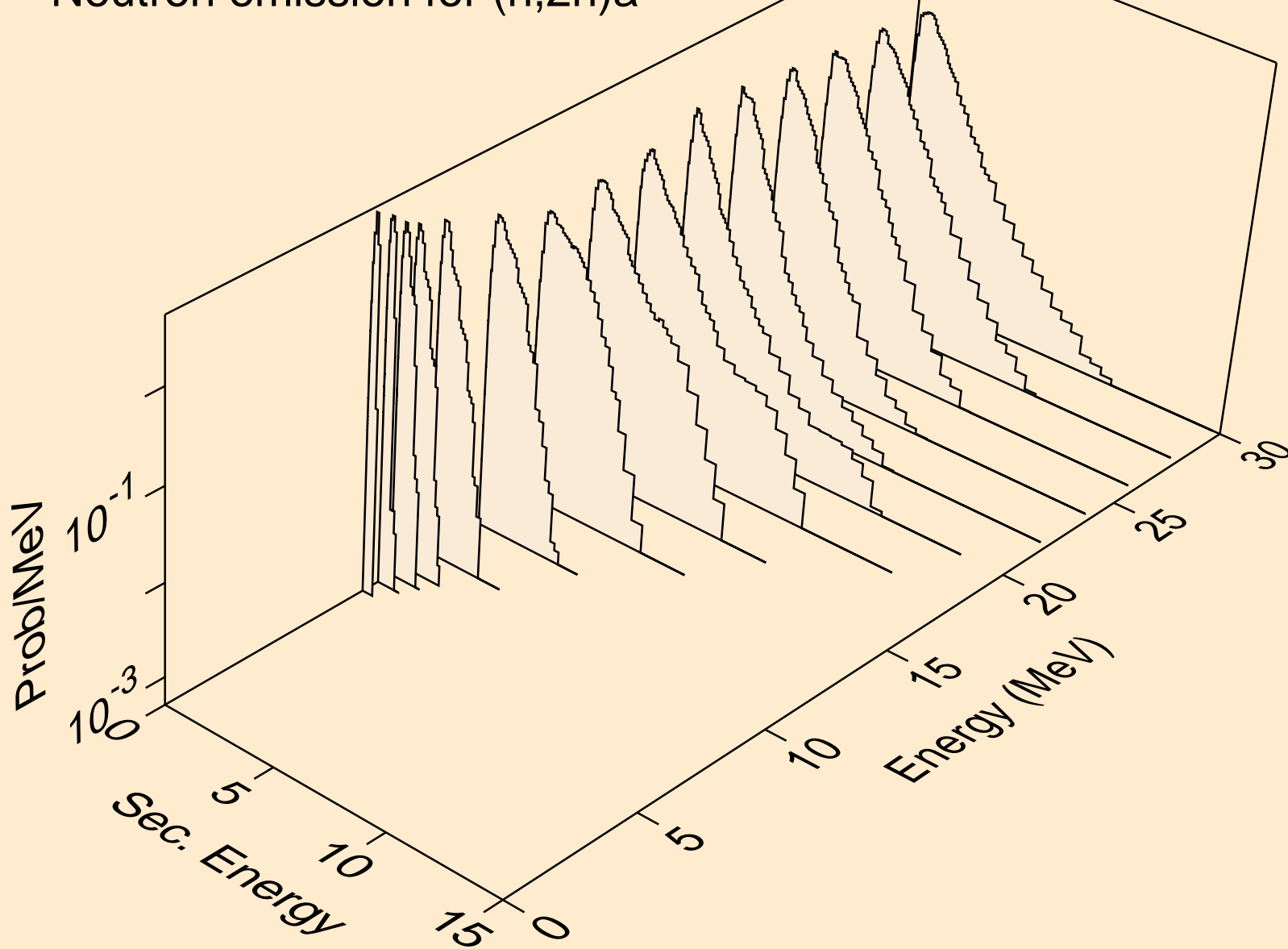

CF241 NEUTRON ACER TENDL-2019 LIBRARY; T=293.16K  
Neutron emission for (n,3n)a

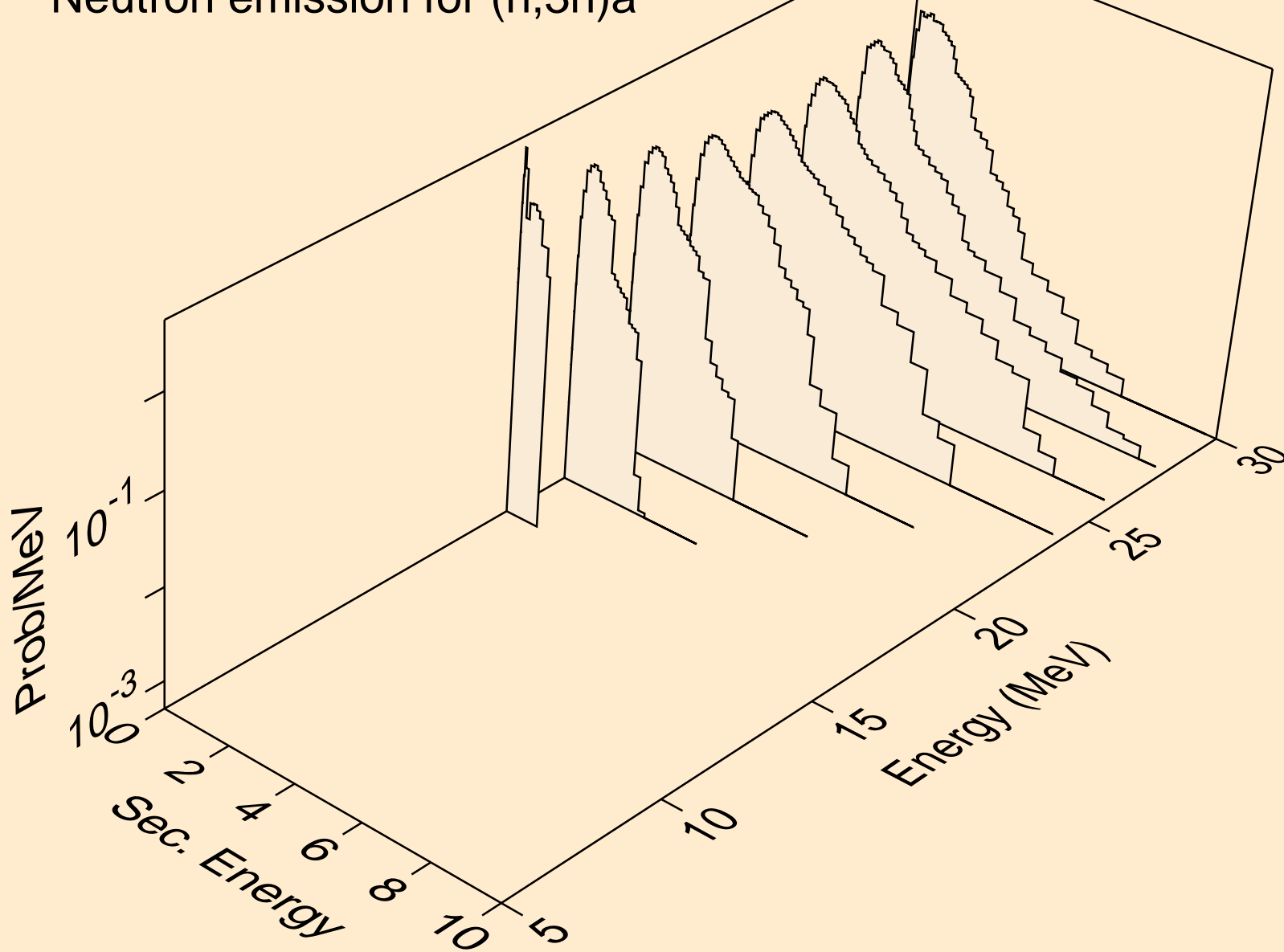

CF241 NEUTRON ACER TENDL-2019 LIBRARY; T=293.16K  
Neutron emission for (n,n\*)p

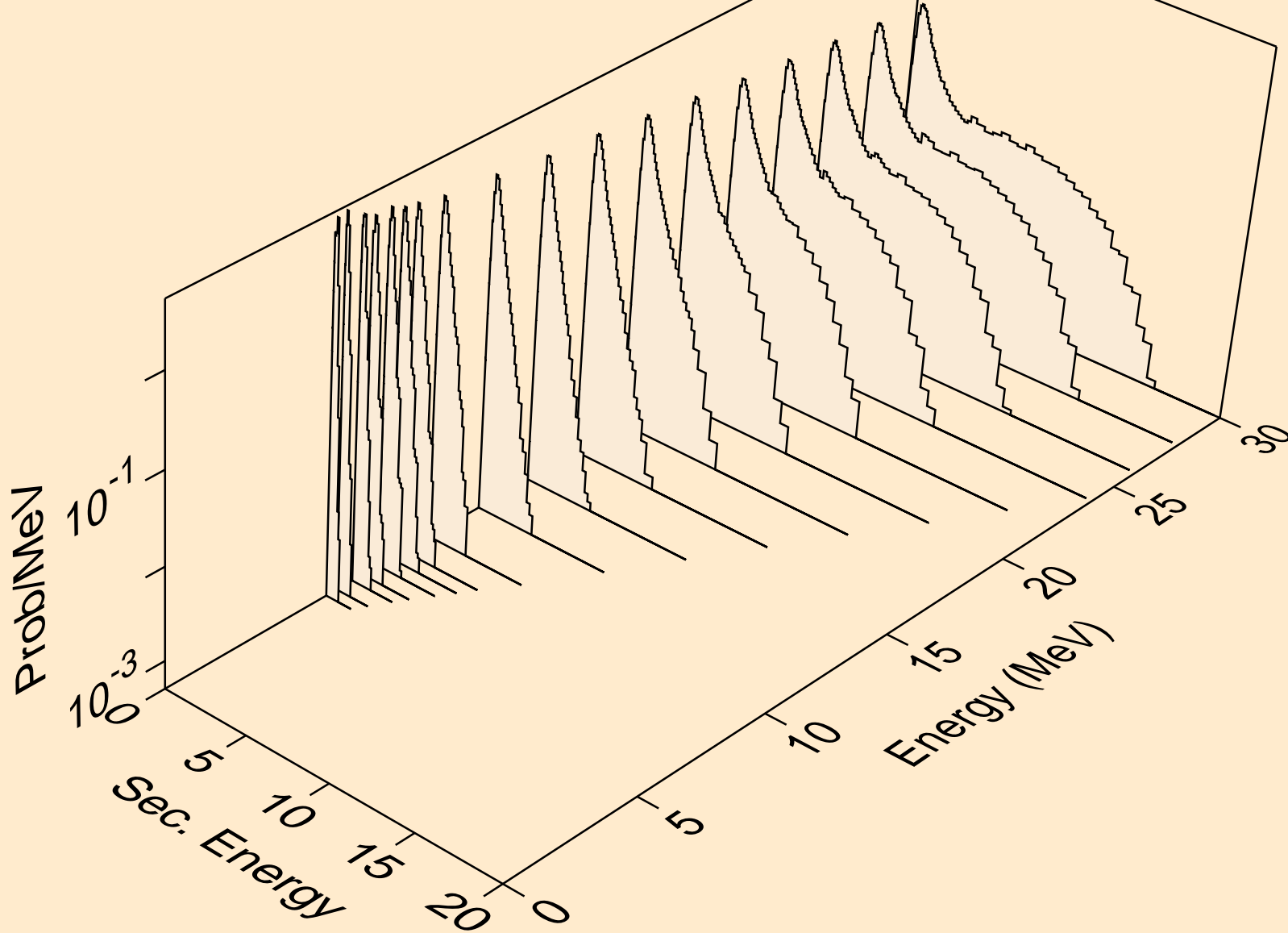

CF241 NEUTRON ACER TENDL-2019 LIBRARY; T=293.16K  
Neutron emission for (n,n\*)d

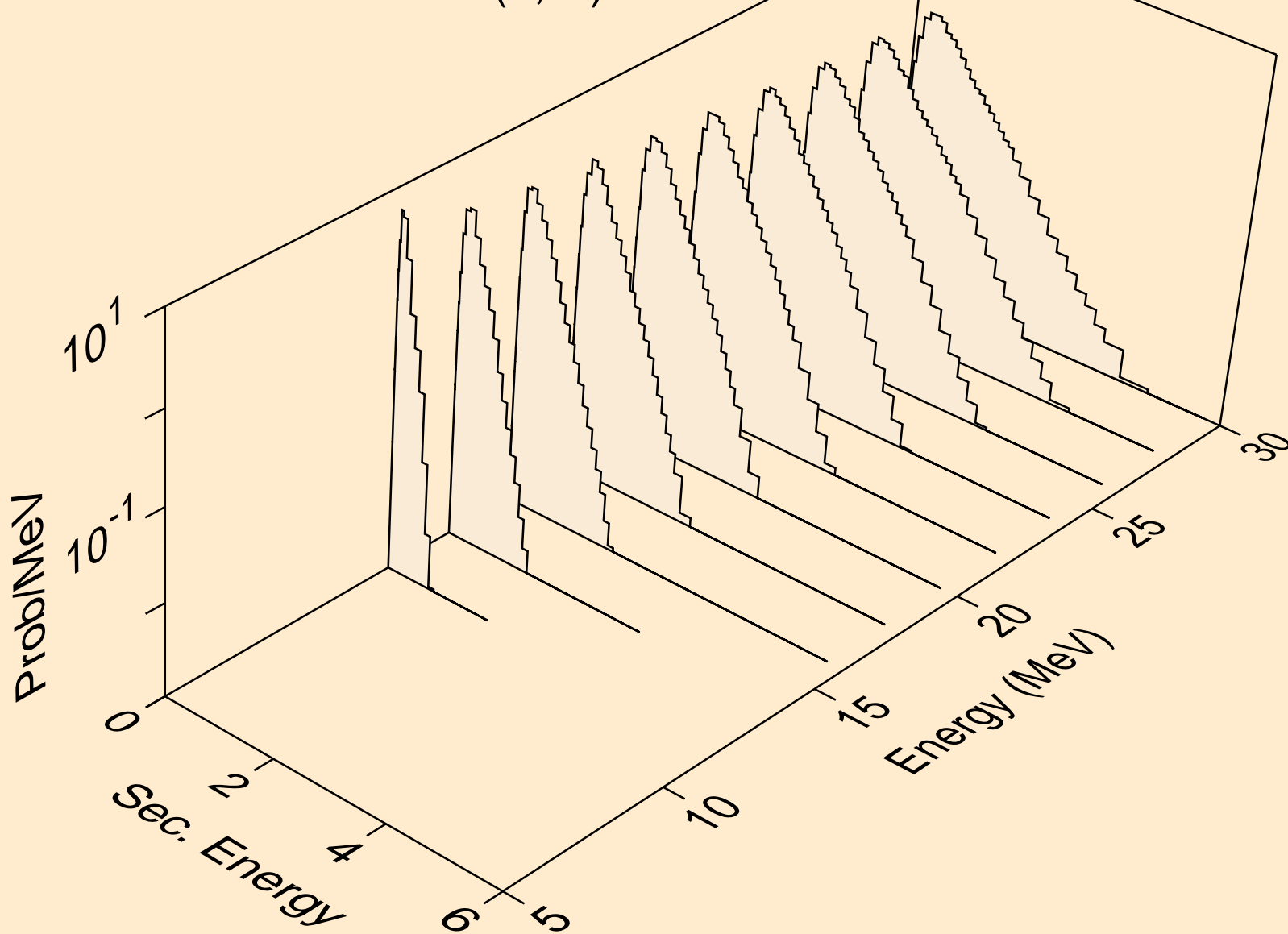



CF241 NEUTRON ACER TENDL-2019 LIBRARY; T=293.16K  
Neutron emission for (n,n\*)t

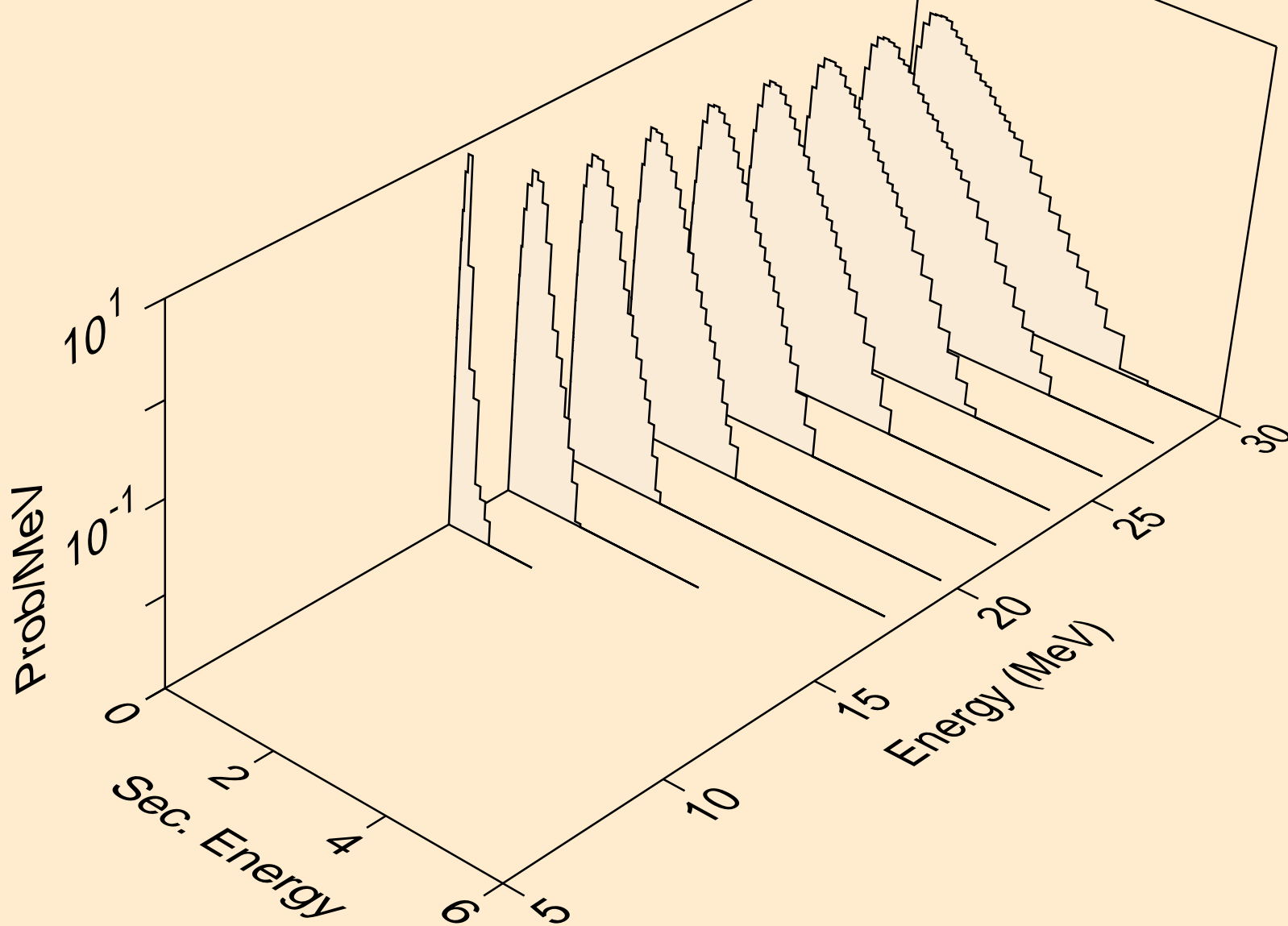

CF241 NEUTRON ACER TENDL-2019 LIBRARY; T=293.16K  
Neutron emission for (n,n\*)he3

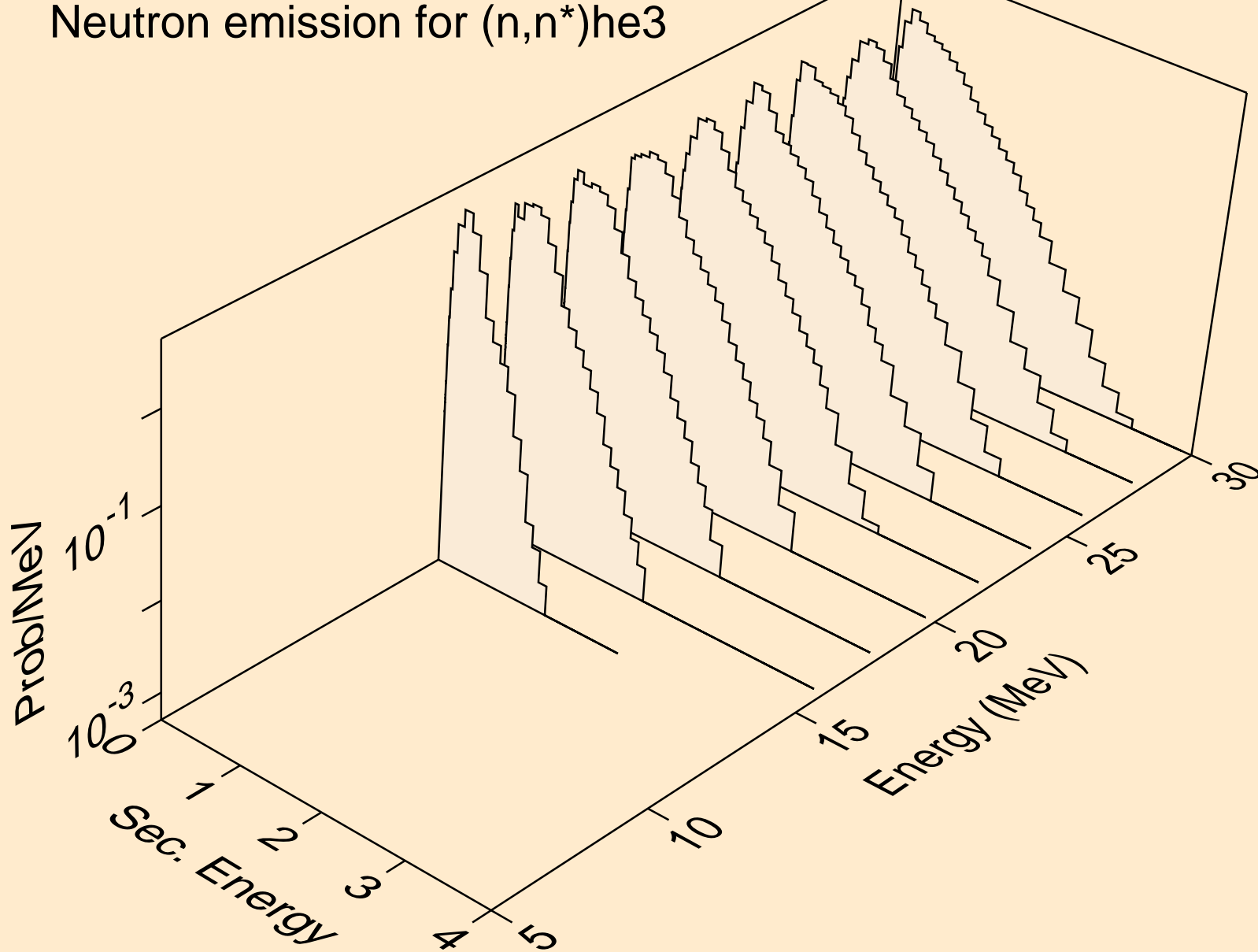

CF241 NEUTRON ACER TENDL-2019 LIBRARY; T=293.16K  
Neutron emission for (n,4n)

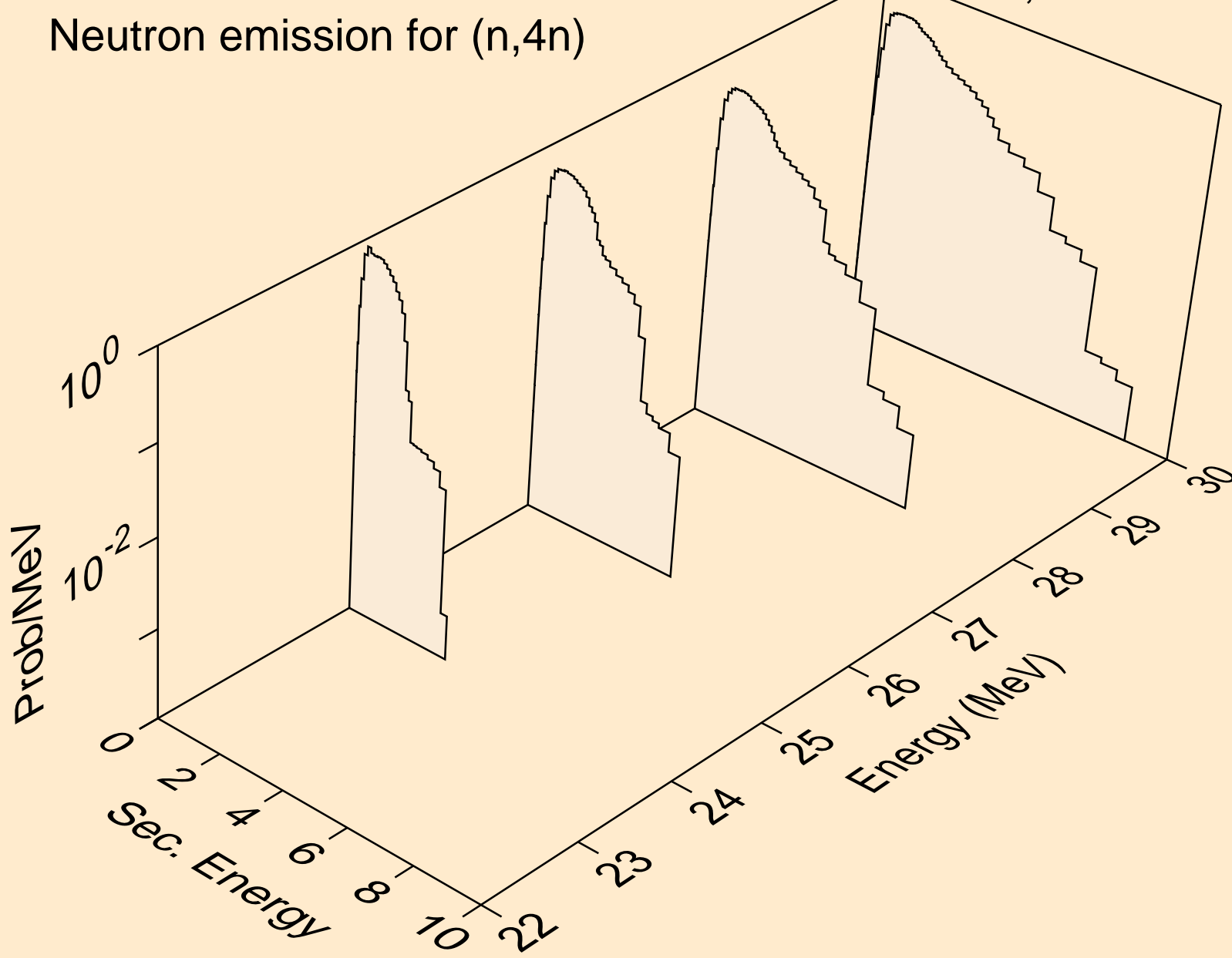

CF241 NEUTRON ACER TENDL-2019 LIBRARY; T=293.16K  
Neutron emission for (n,2np)

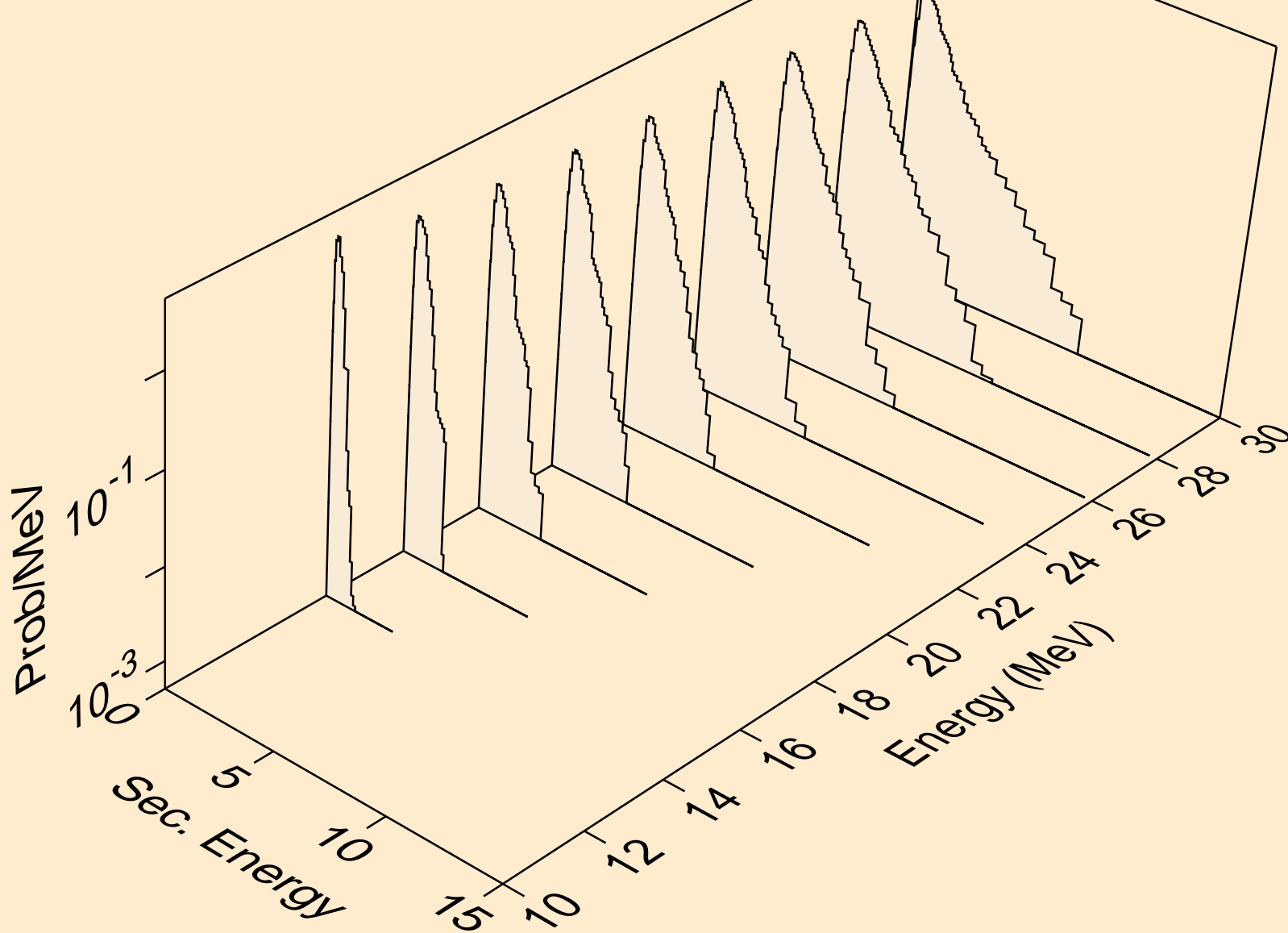

CF241 NEUTRON ACER TENDL-2019 LIBRARY; T=293.16K  
Neutron emission for (n,3np)

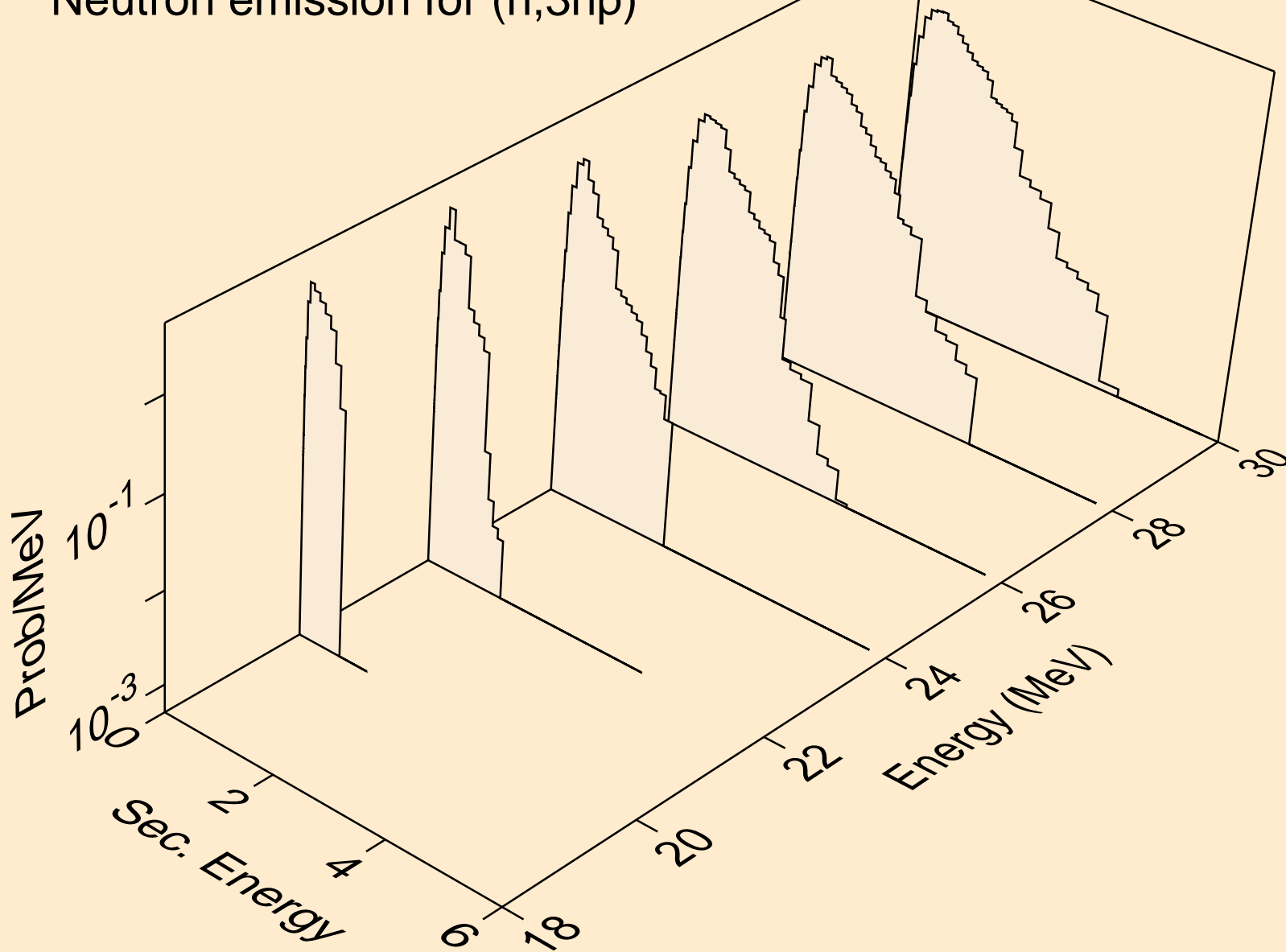

CF241 NEUTRON ACER TENDL-2019 LIBRARY; T=293.16K  
Neutron emission for (n,2np)

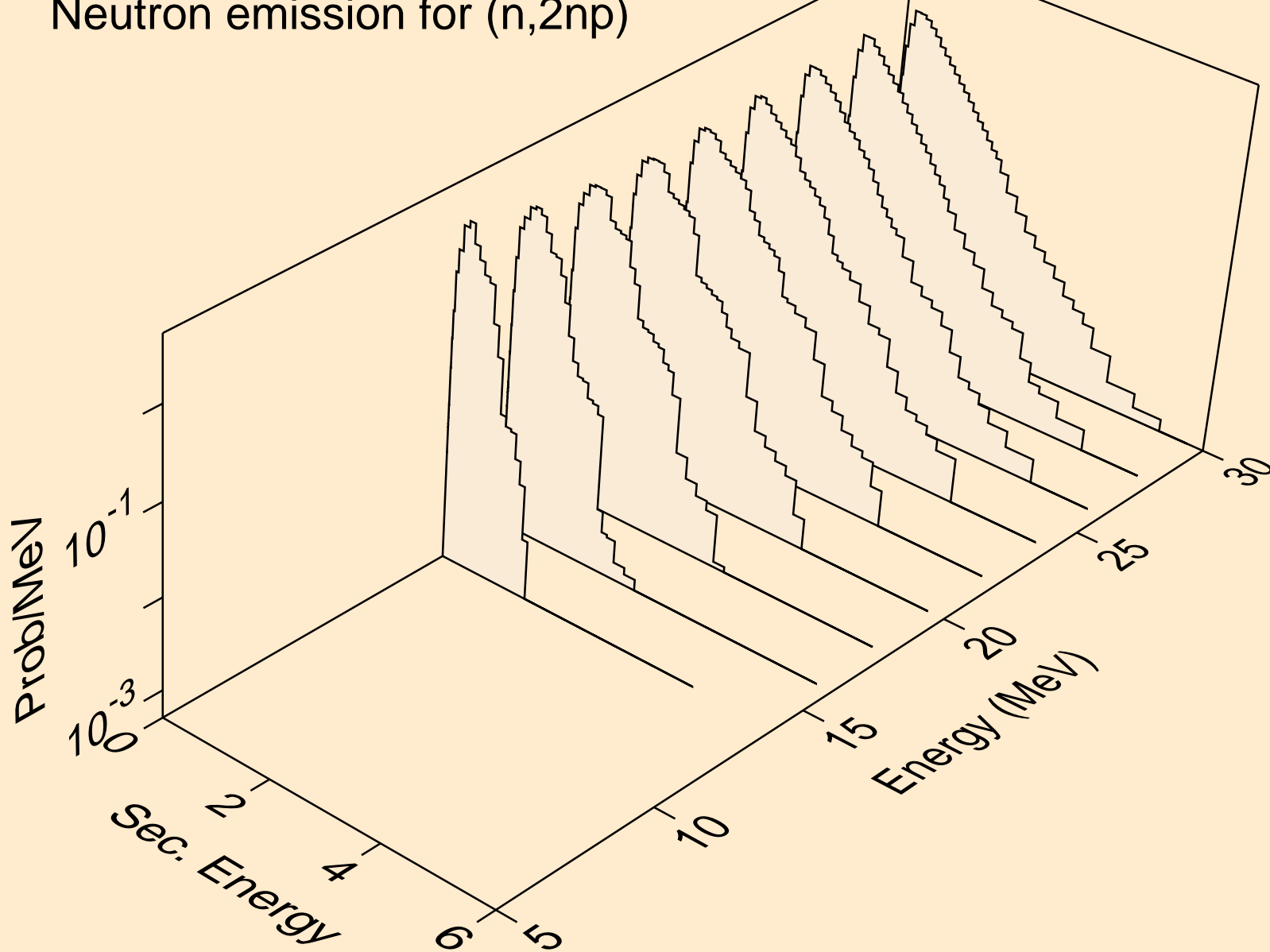

CF241 NEUTRON ACER TENDL-2019 LIBRARY; T=293.16K  
Neutron emission for (n,npa)

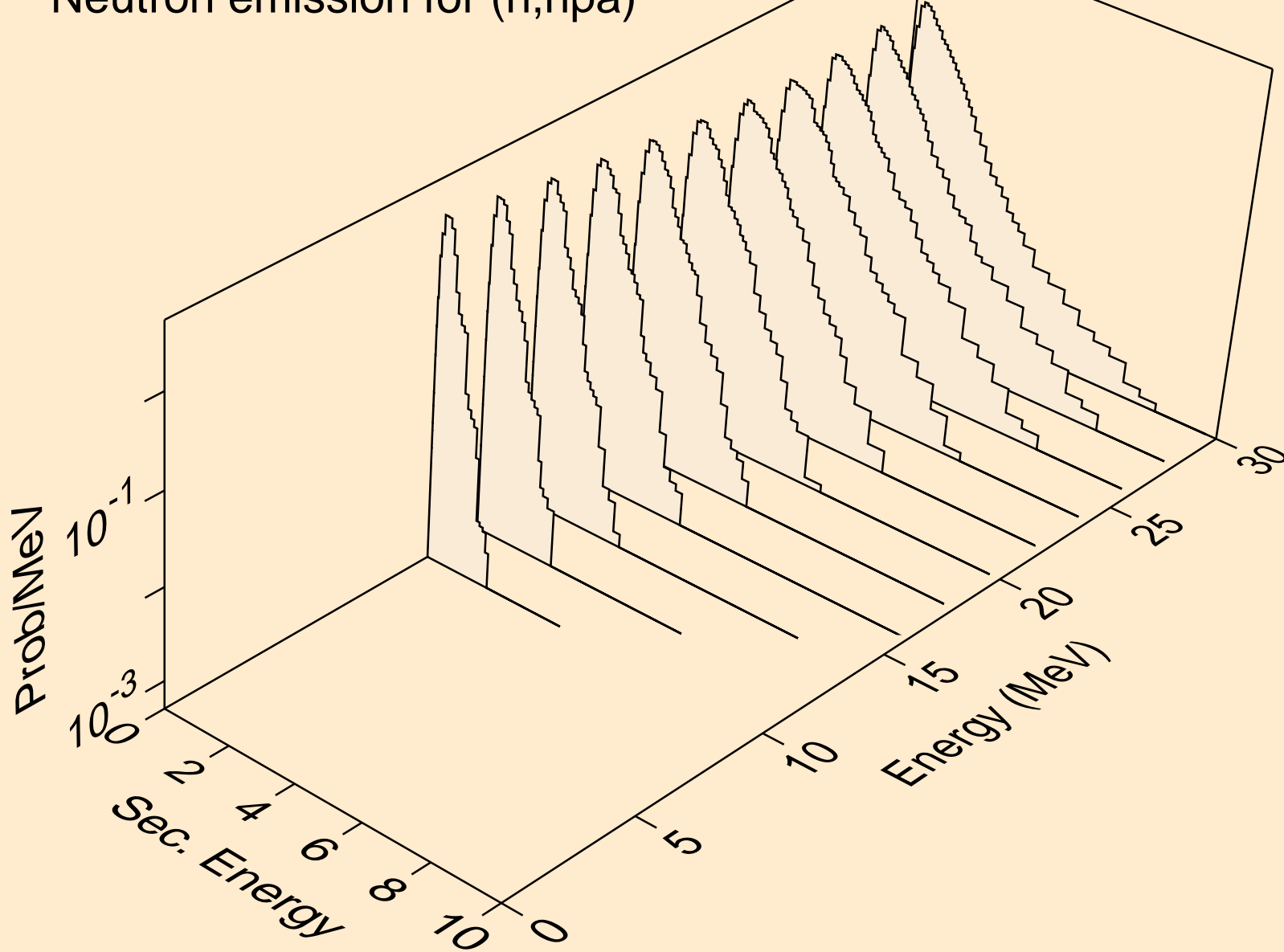

CF241 NEUTRON ACER TENDL-2019 LIBRARY; T=293.16K  
Neutron emission for (n,n\*c)

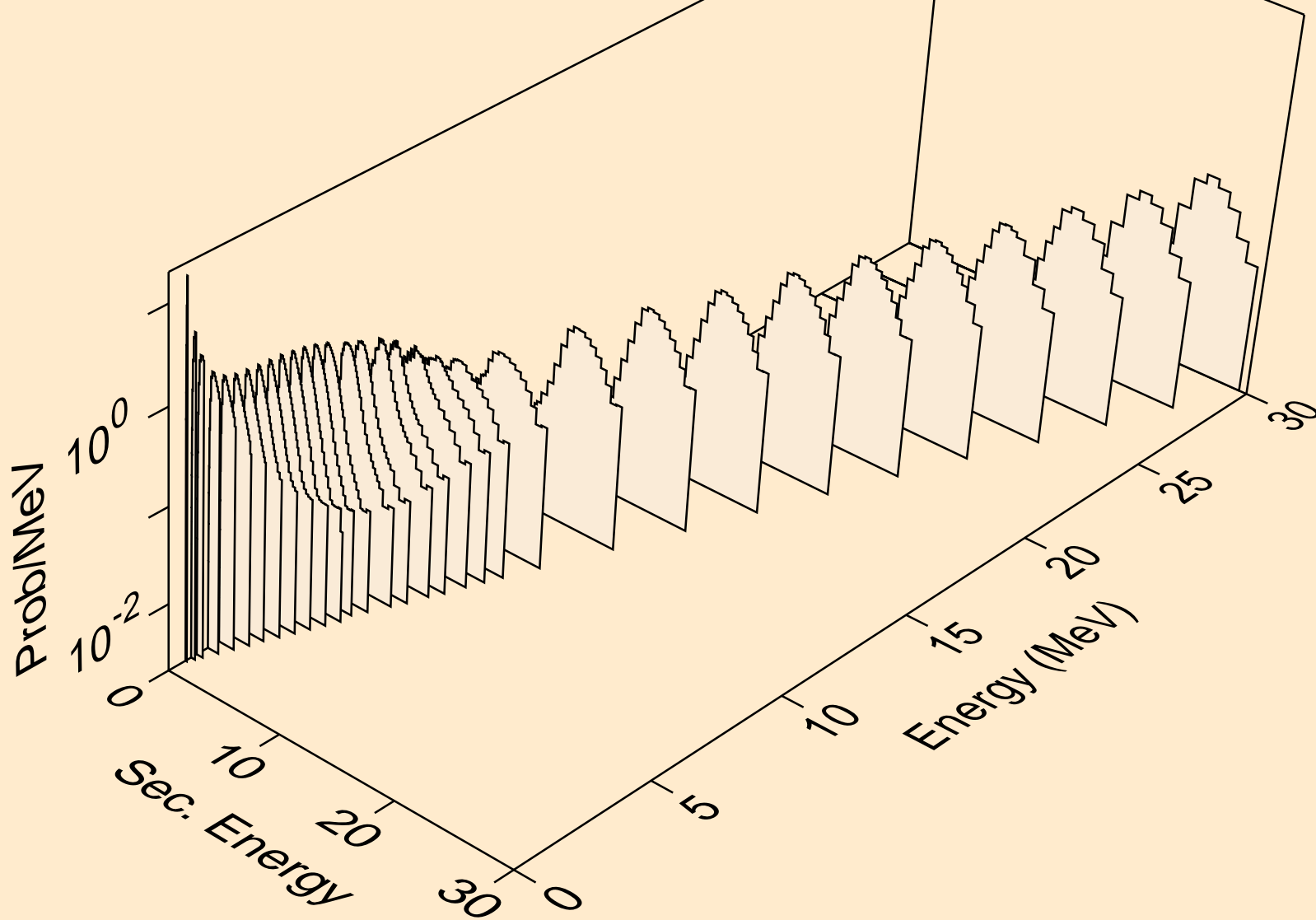



CF241 NEUTRON ACER TENDL-2019 LIBRARY; T=293.16K  
Delayed nubar

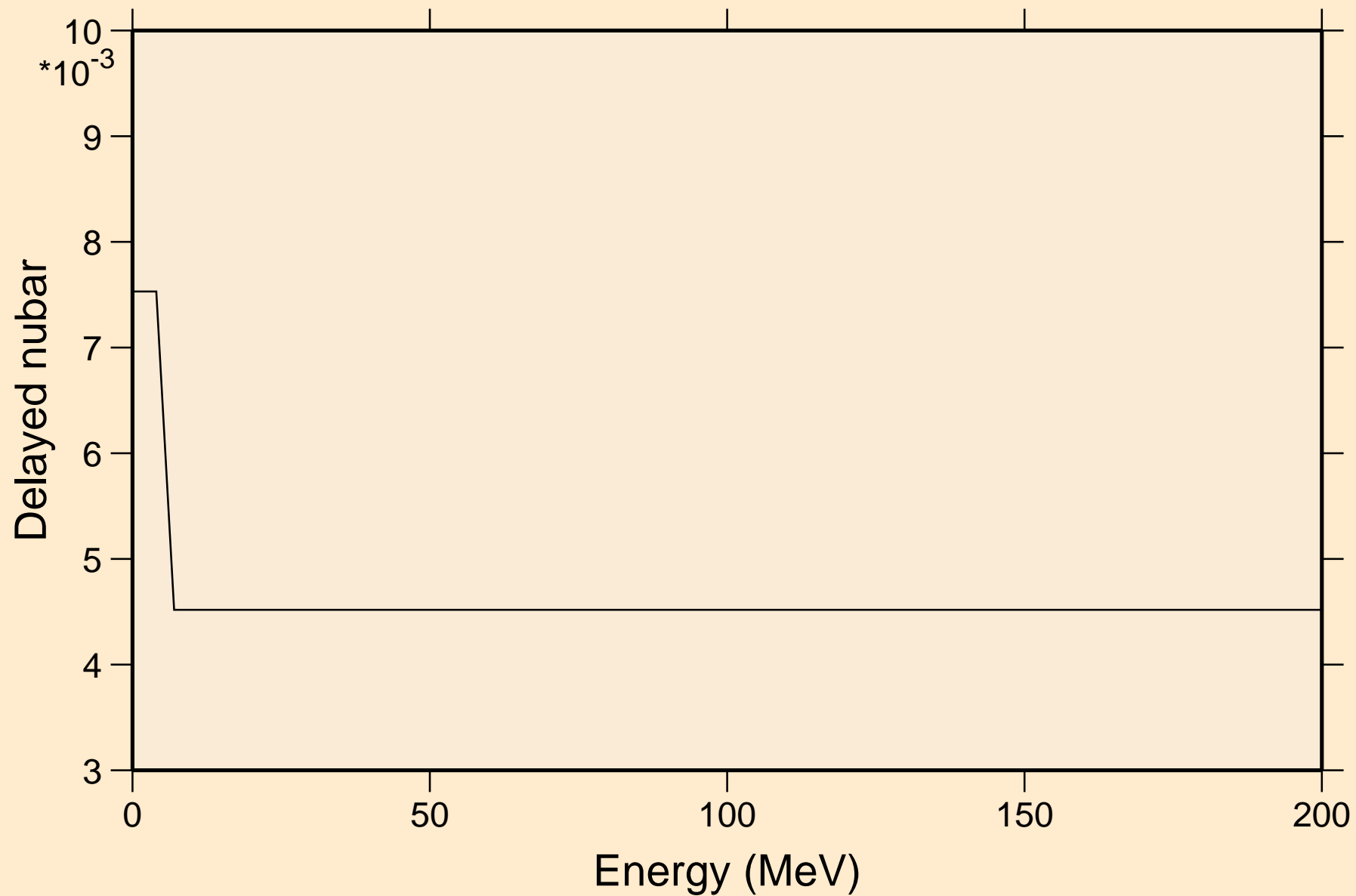

# CF241 NEUTRON ACER TENDL-2019 LIBRARY; T=293.16K

## Delayed neutron spectra

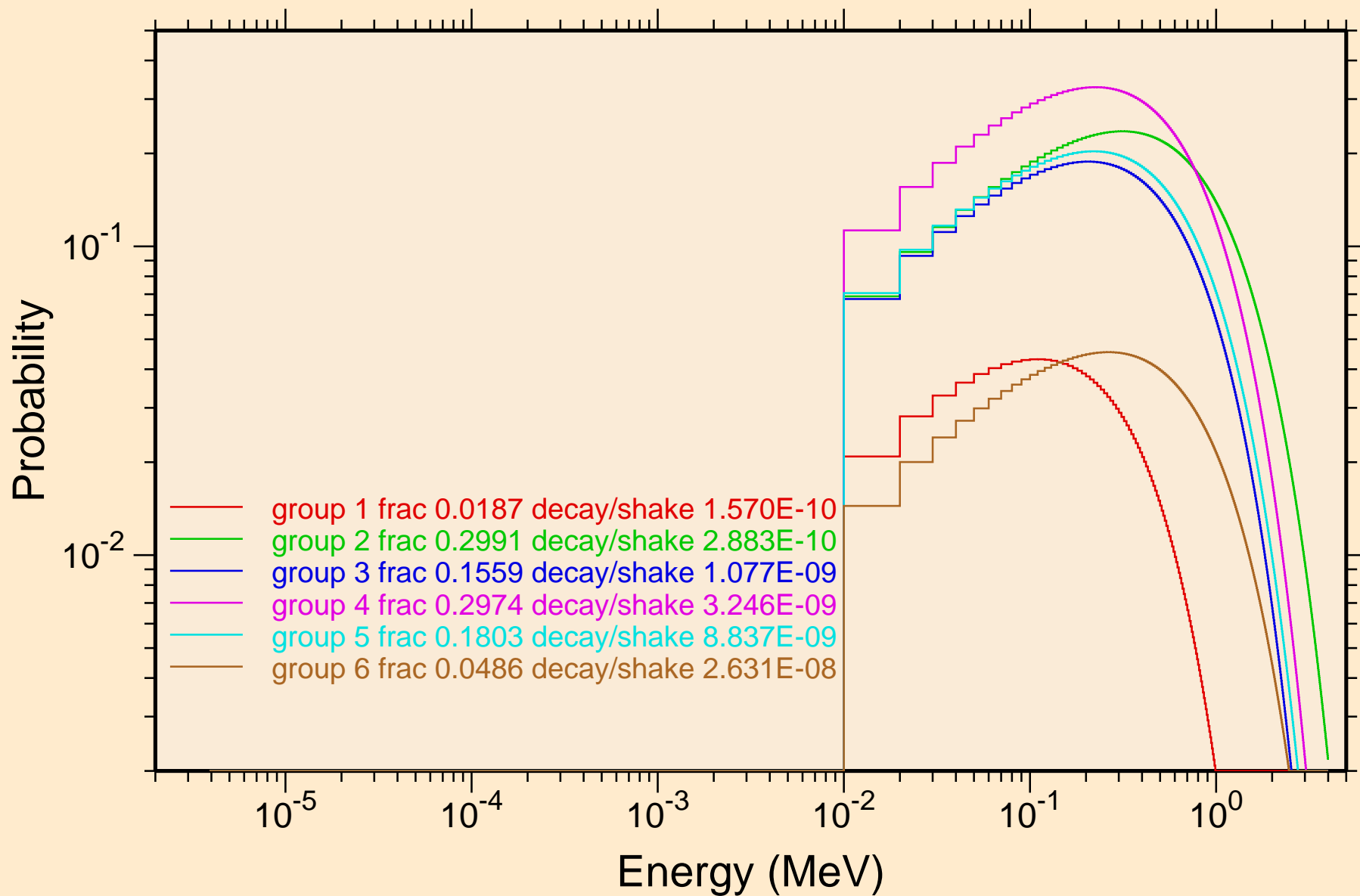

CF241 NEUTRON ACER TENDL-2019 LIBRARY; T=293.16K  
Photon emission for (n,x)

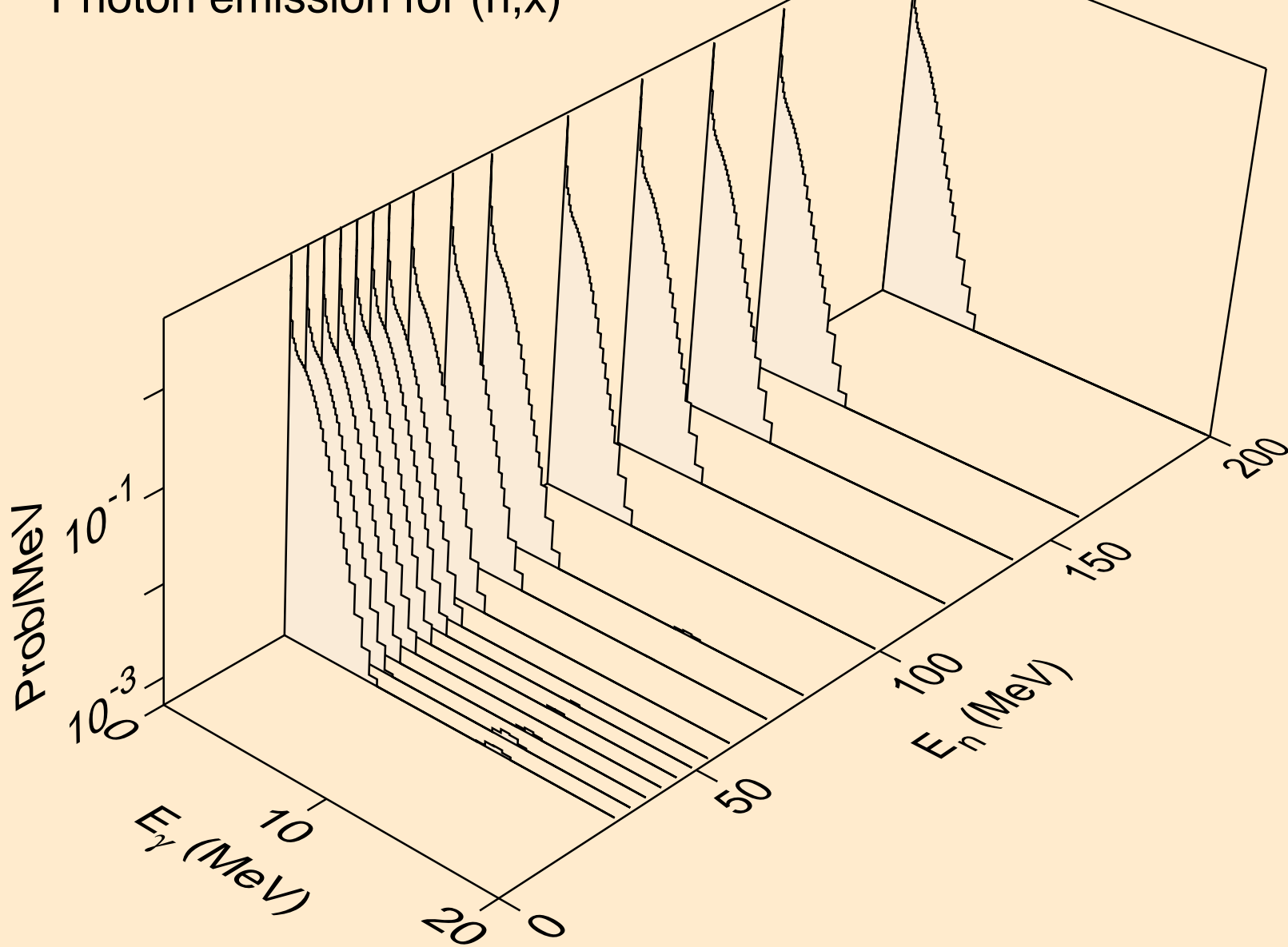

CF241 NEUTRON ACER TENDL-2019 LIBRARY; T=293.16K  
Photon emission for (n,2nd)

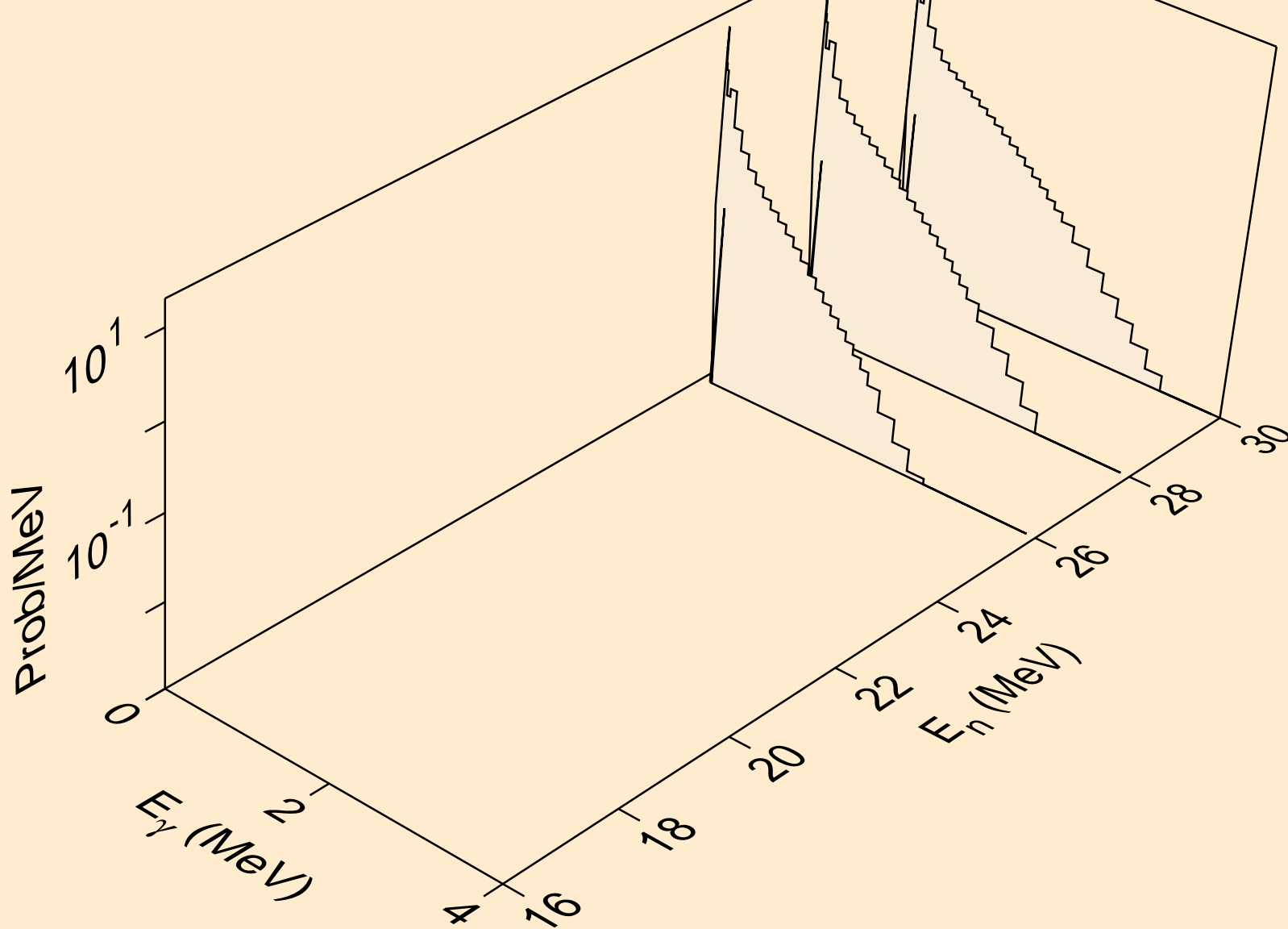

CF241 NEUTRON ACER TENDL-2019 LIBRARY; T=293.16K  
Photon emission for (n,2n)

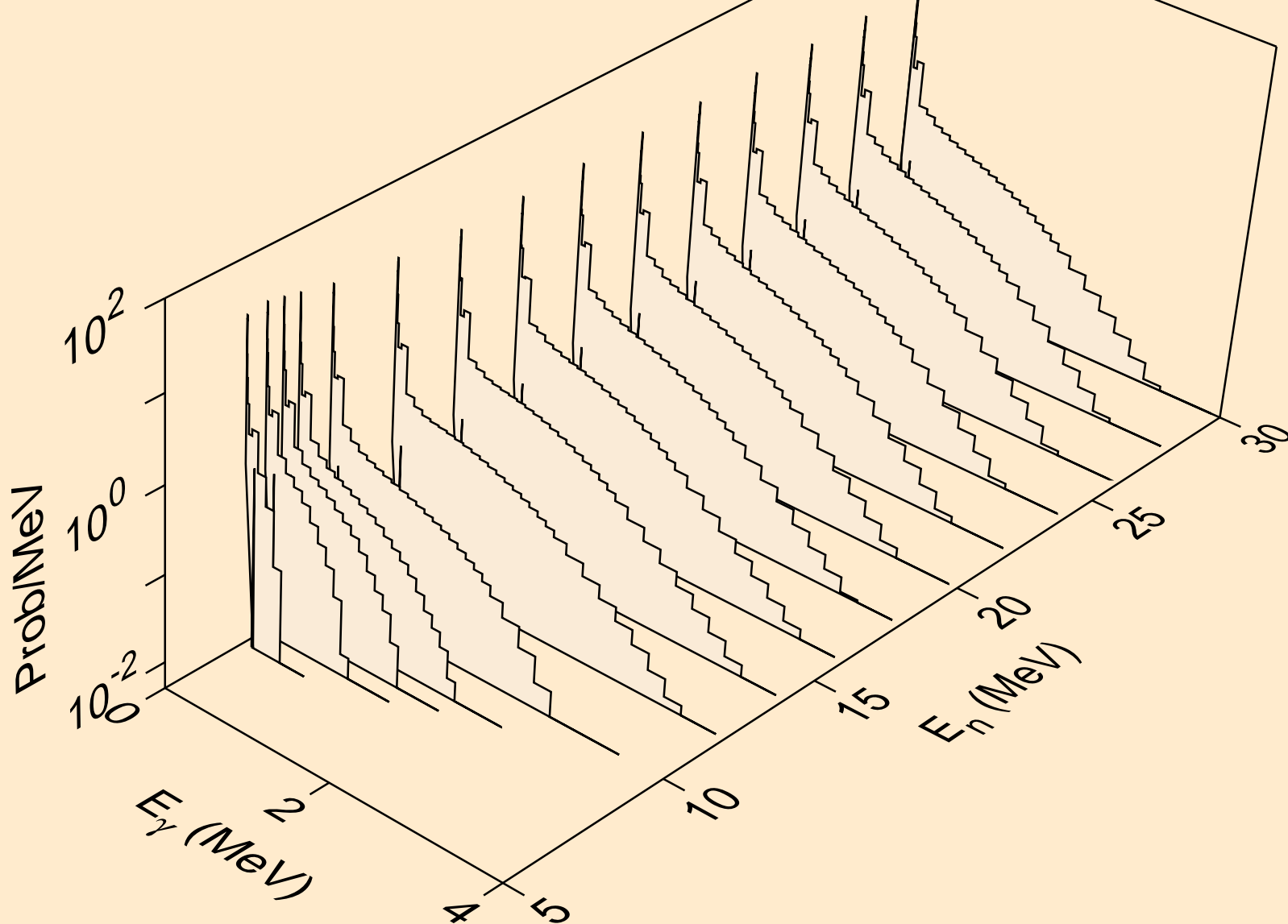

CF241 NEUTRON ACER TENDL-2019 LIBRARY; T=293.16K  
Photon emission for (n,3n)

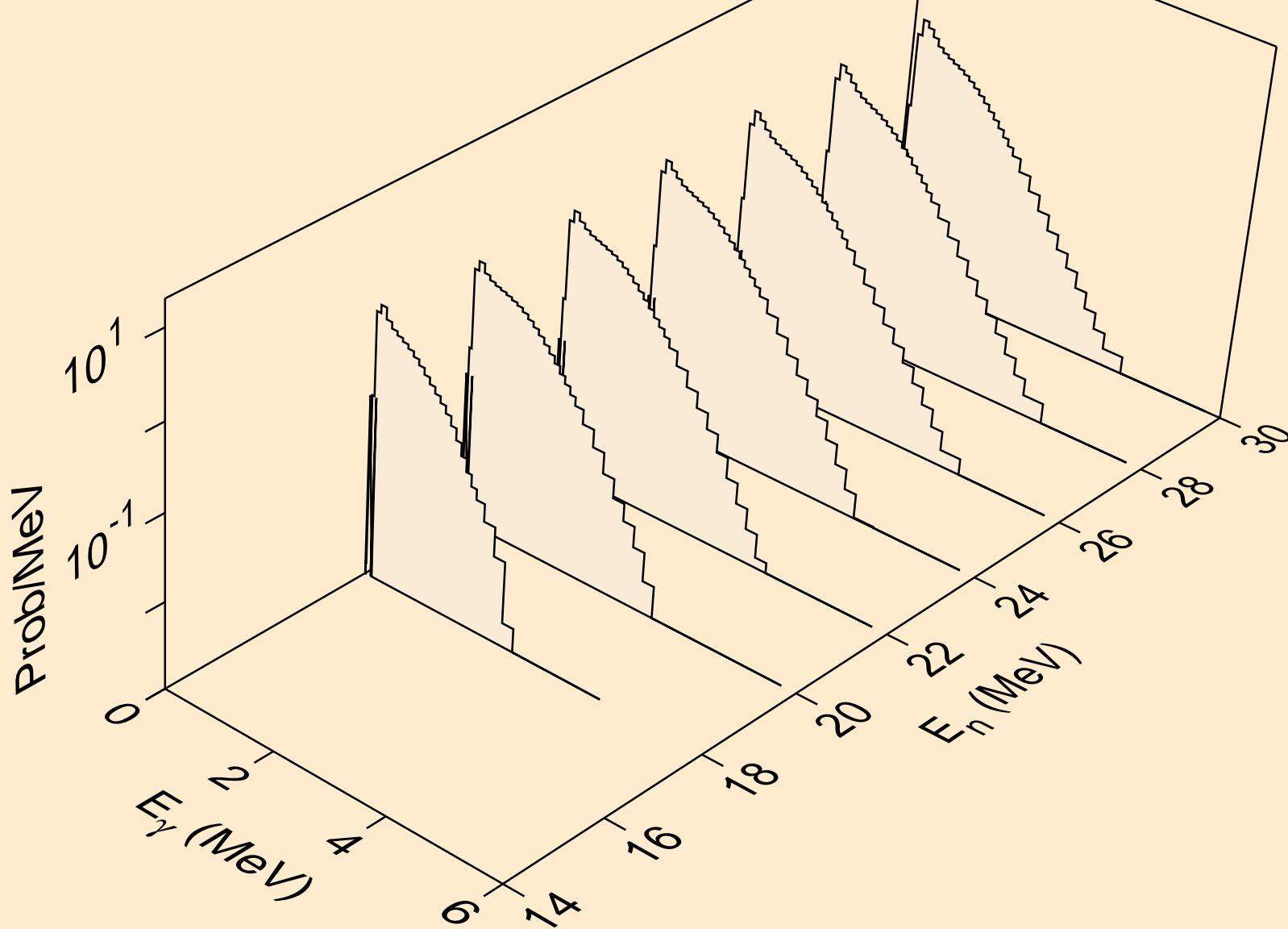

CF241 NEUTRON ACER TENDL-2019 LIBRARY; T=293.16K  
Photon emission for (n,n\*)a

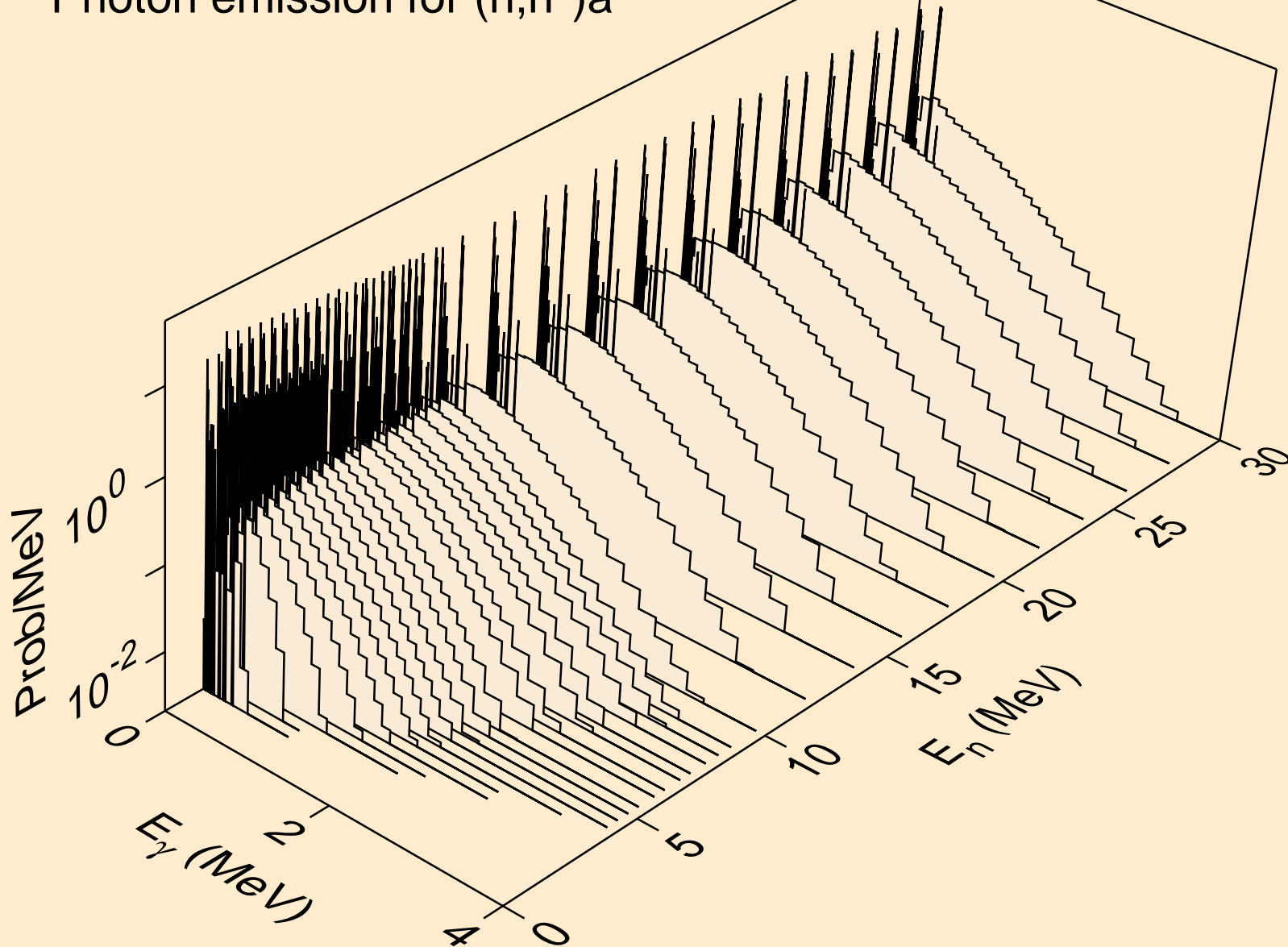

CF241 NEUTRON ACER TENDL-2019 LIBRARY; T=293.16K  
Photon emission for (n,2n)a

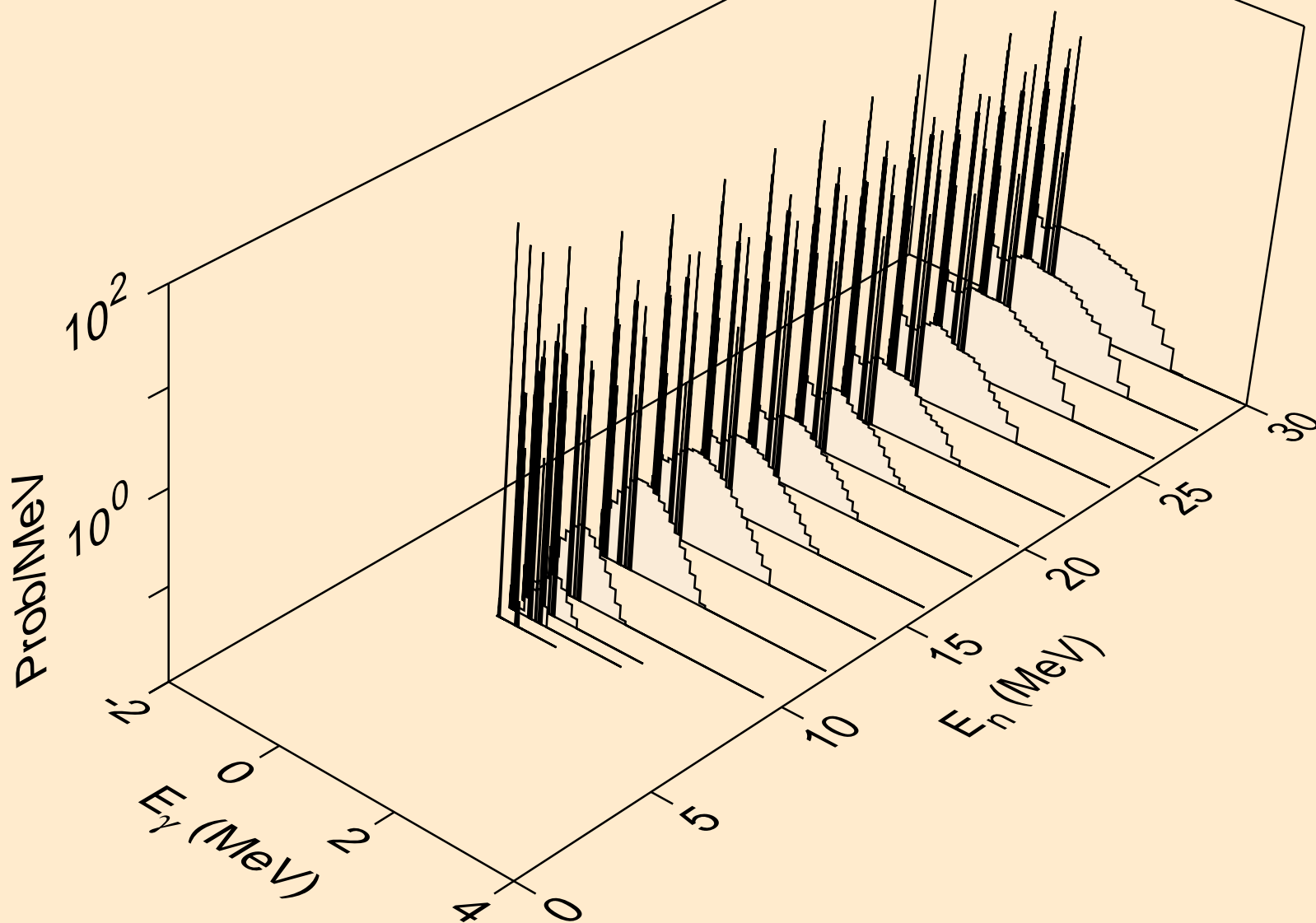



CF241 NEUTRON ACER TENDL-2019 LIBRARY; T=293.16K  
Photon emission for (n,3n)a

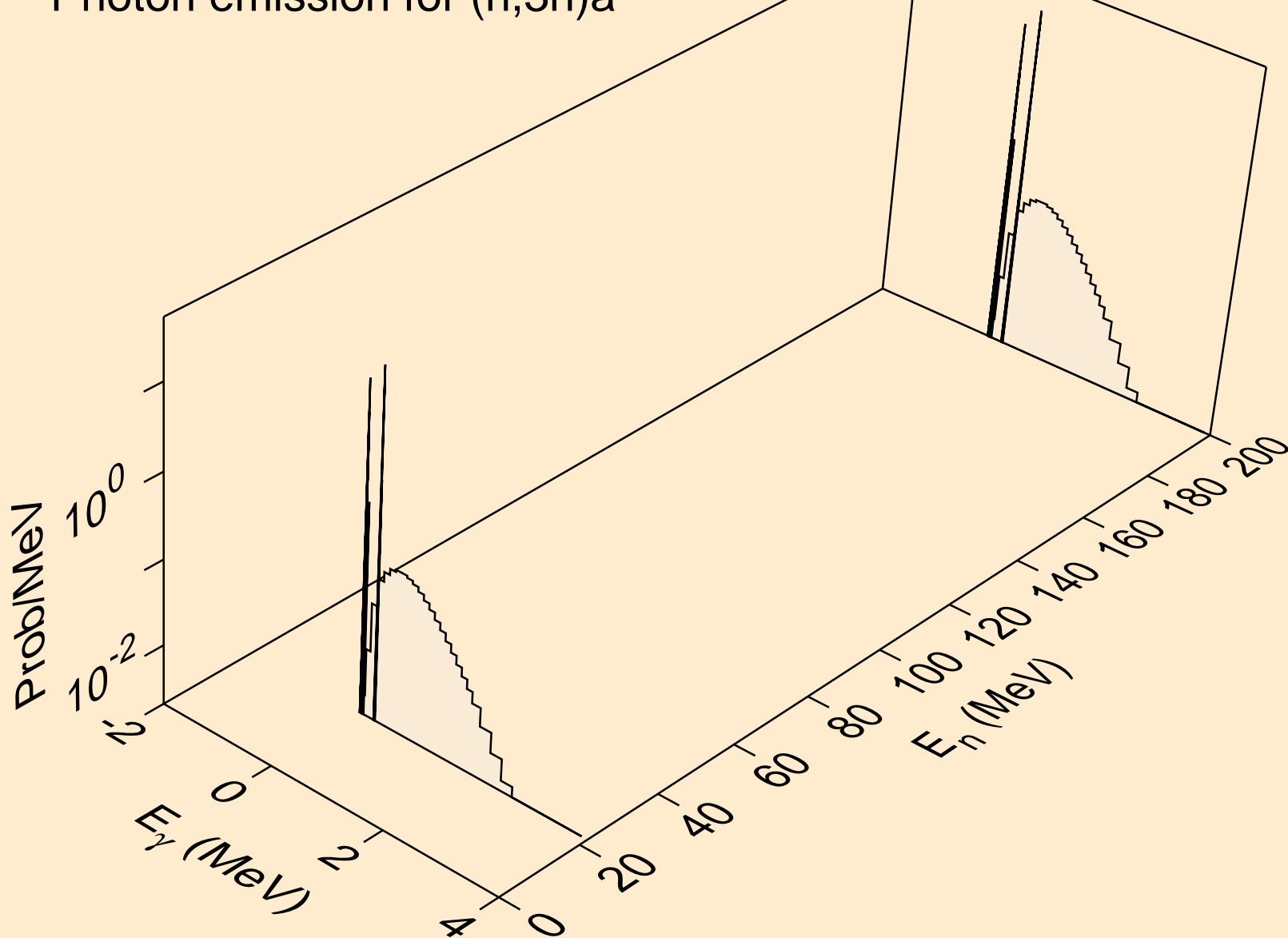

CF241 NEUTRON ACER TENDL-2019 LIBRARY; T=293.16K  
Photon emission for (n,n\*)p

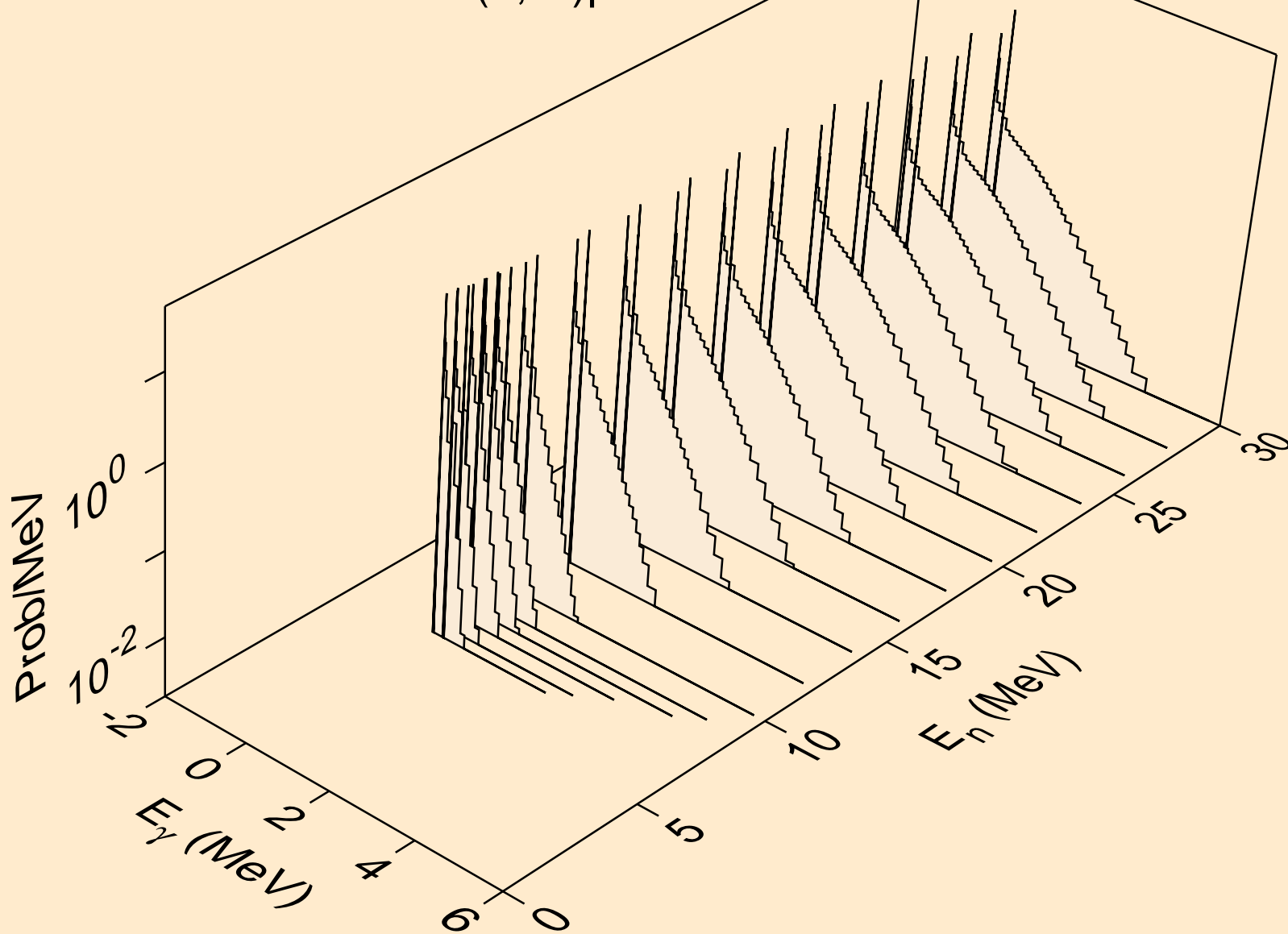

CF241 NEUTRON ACER TENDL-2019 LIBRARY; T=293.16K  
Photon emission for (n,n\*)d

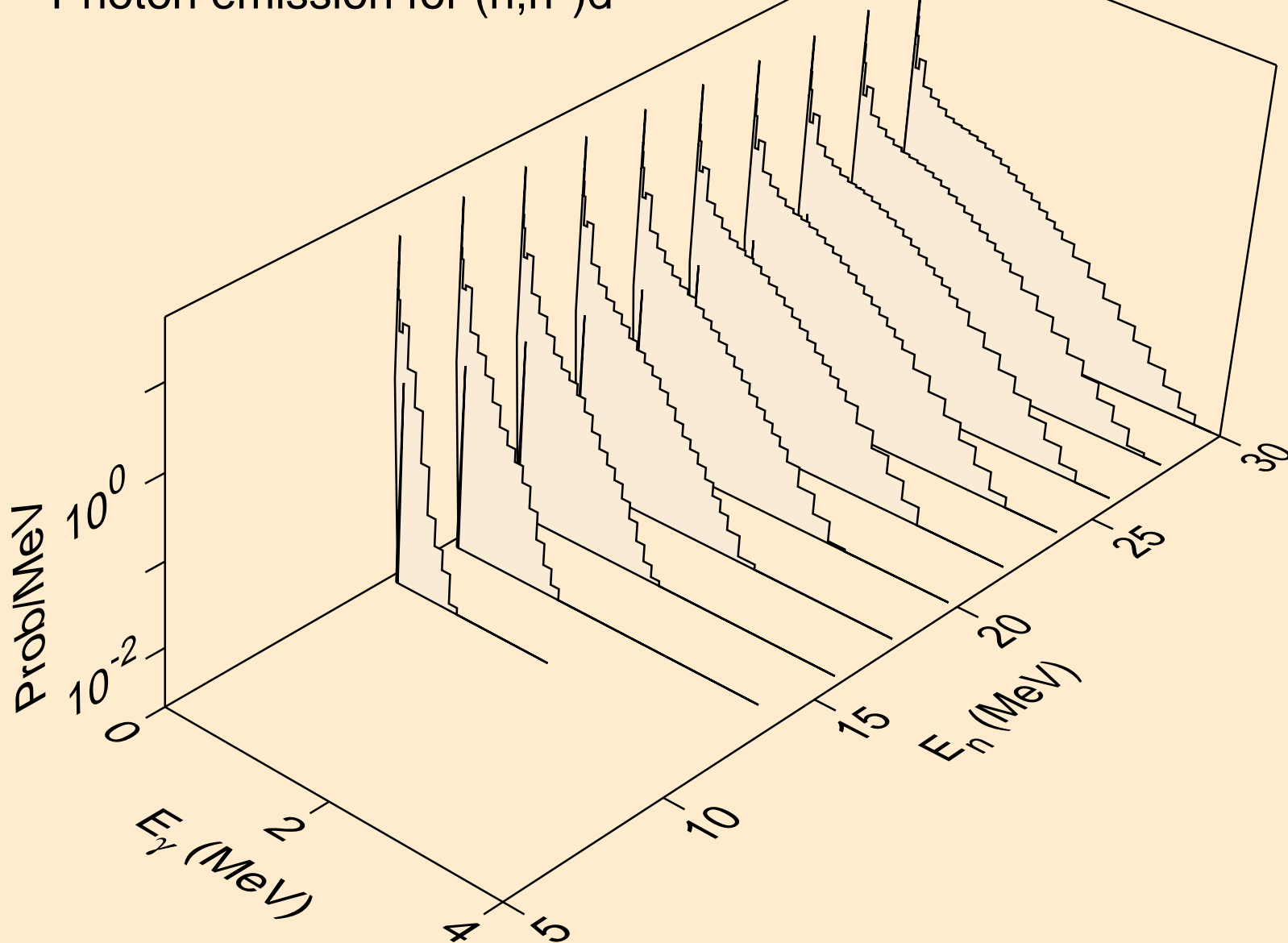

CF241 NEUTRON ACER TENDL-2019 LIBRARY; T=293.16K  
Photon emission for (n,n\*)t

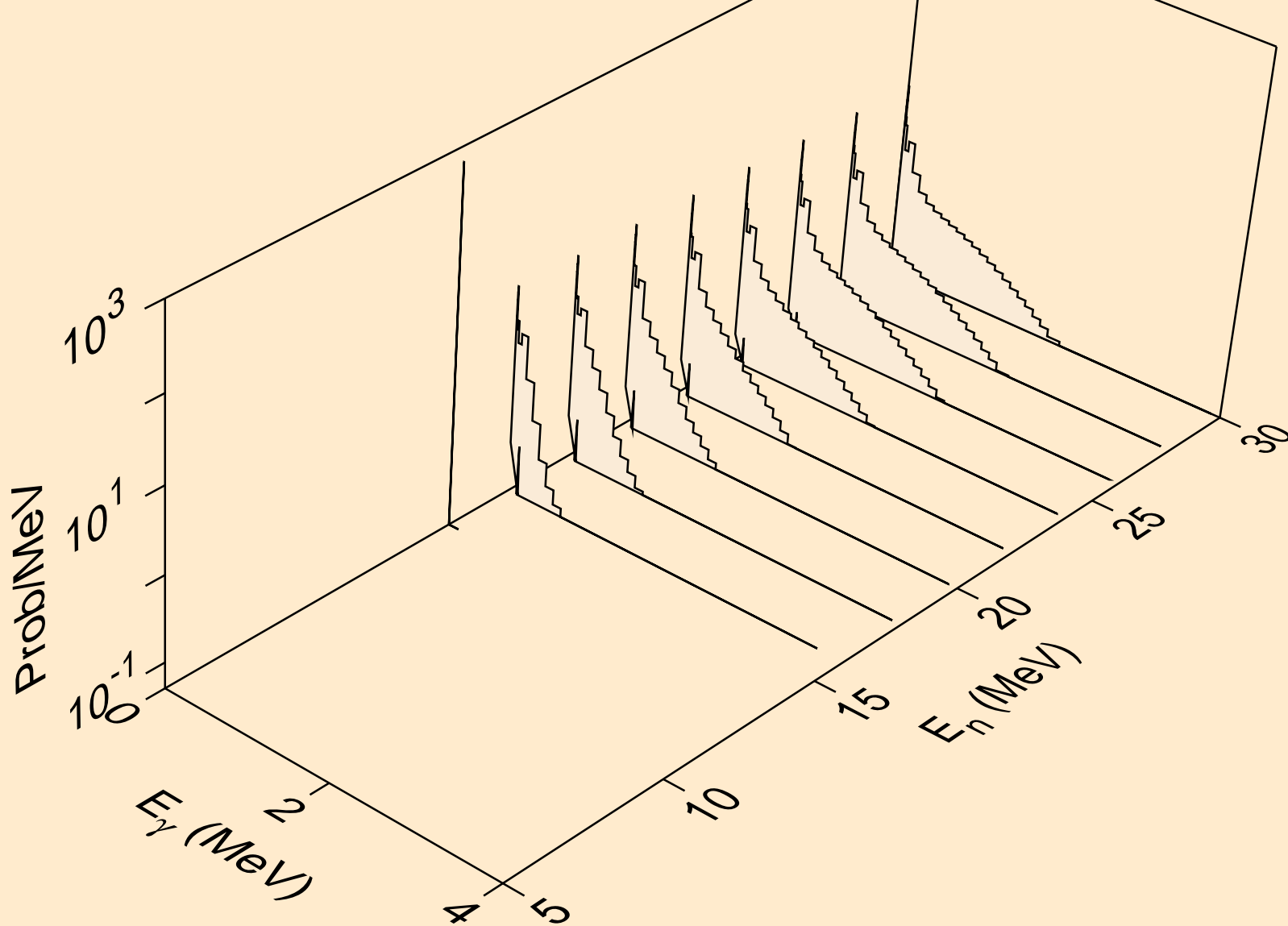

CF241 NEUTRON ACER TENDL-2019 LIBRARY; T=293.16K  
Photon emission for (n,n\*)he3

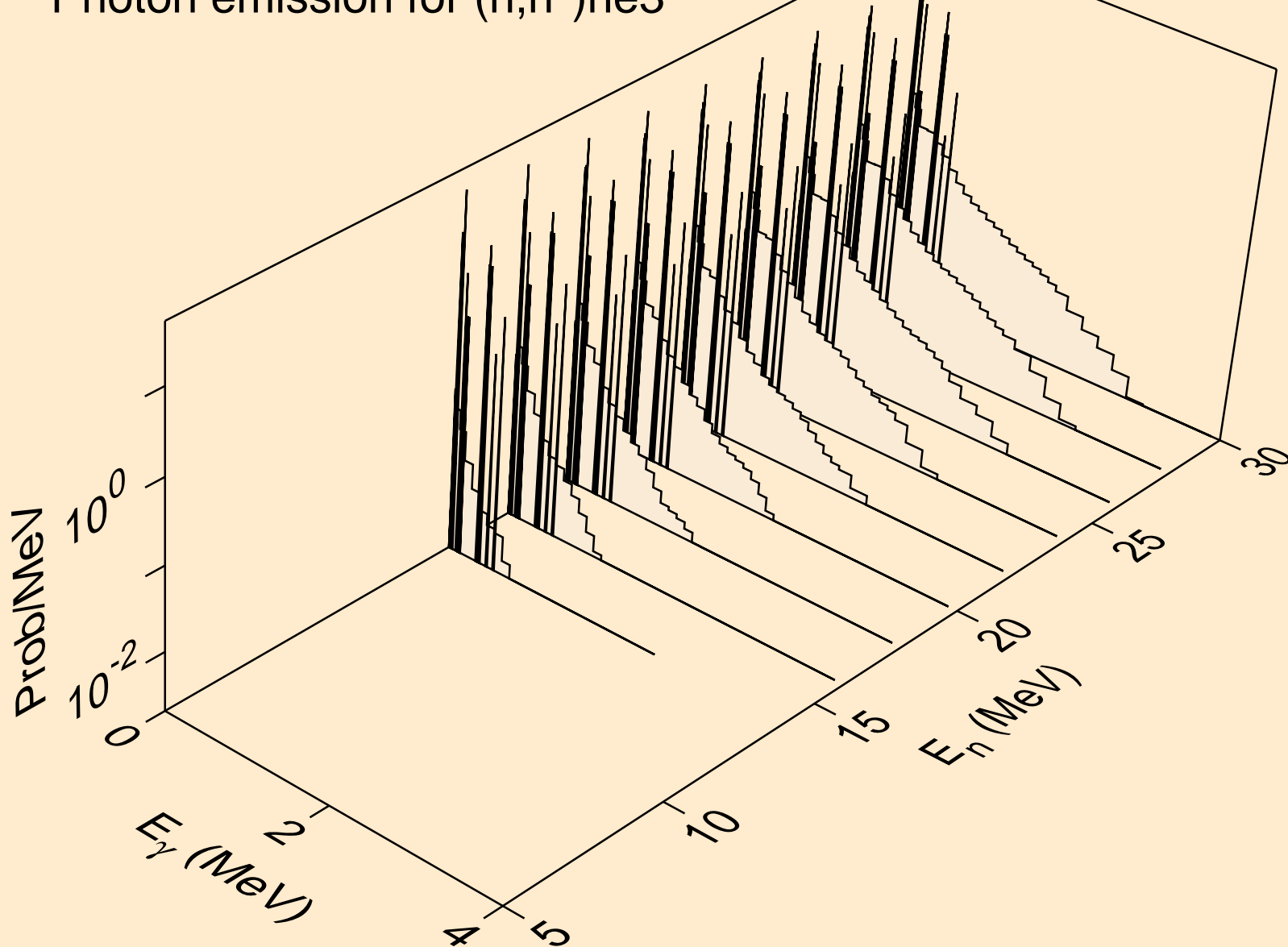

CF241 NEUTRON ACER TENDL-2019 LIBRARY; T=293.16K  
Photon emission for (n,4n)

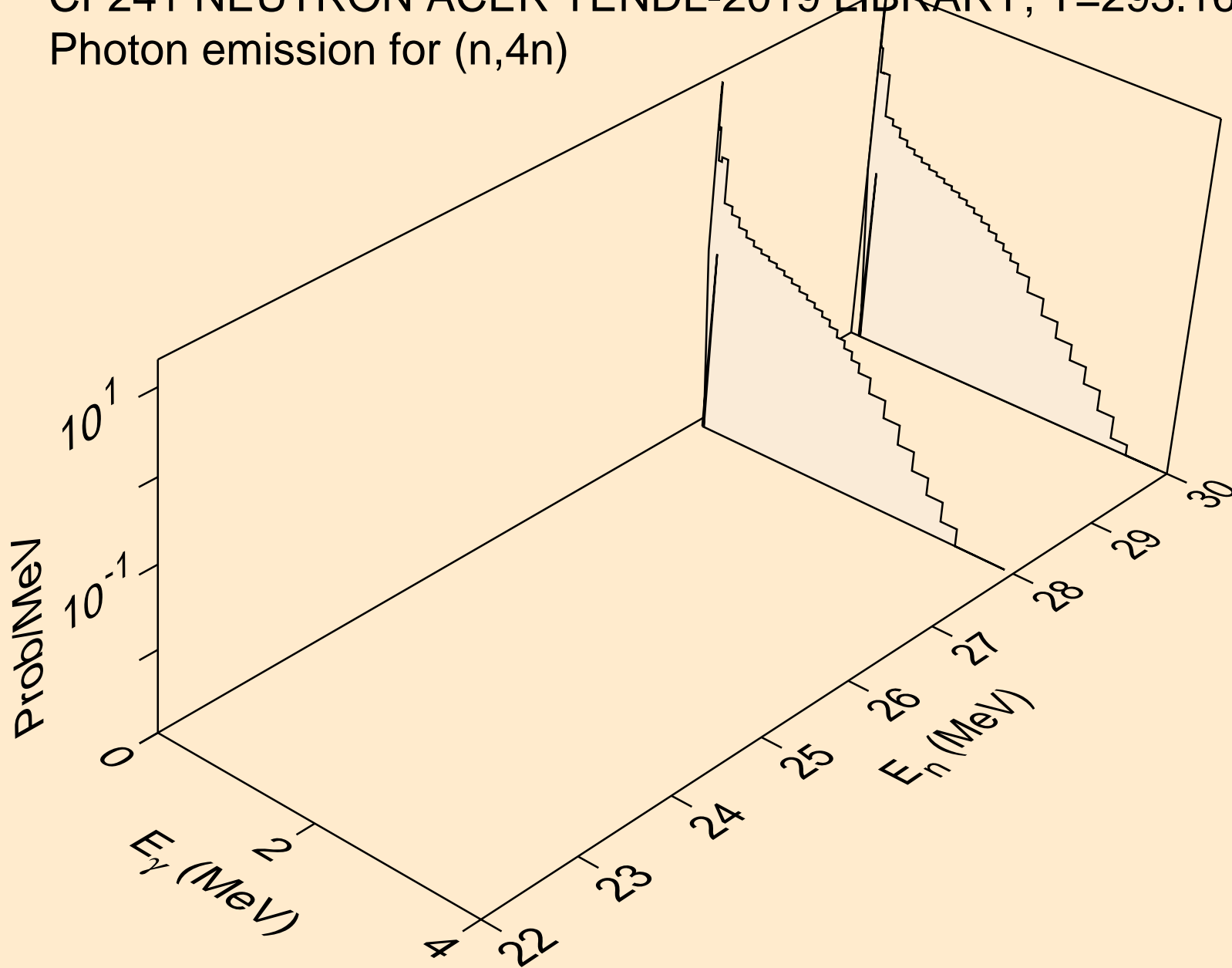

CF241 NEUTRON ACER TENDL-2019 LIBRARY; T=293.16K  
Photon emission for (n,2np)

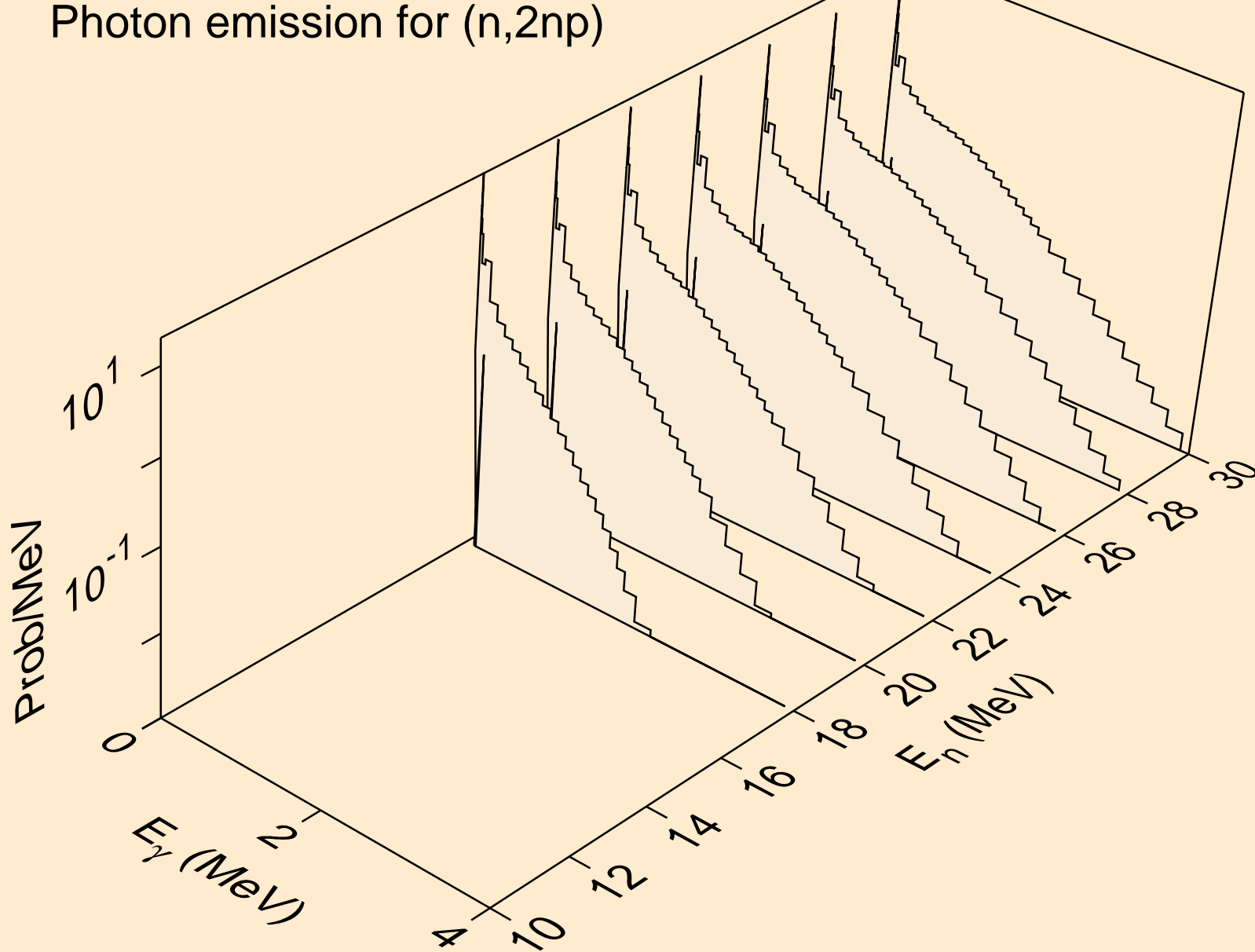

CF241 NEUTRON ACER TENDL-2019 LIBRARY; T=293.16K  
Photon emission for (n,3np)

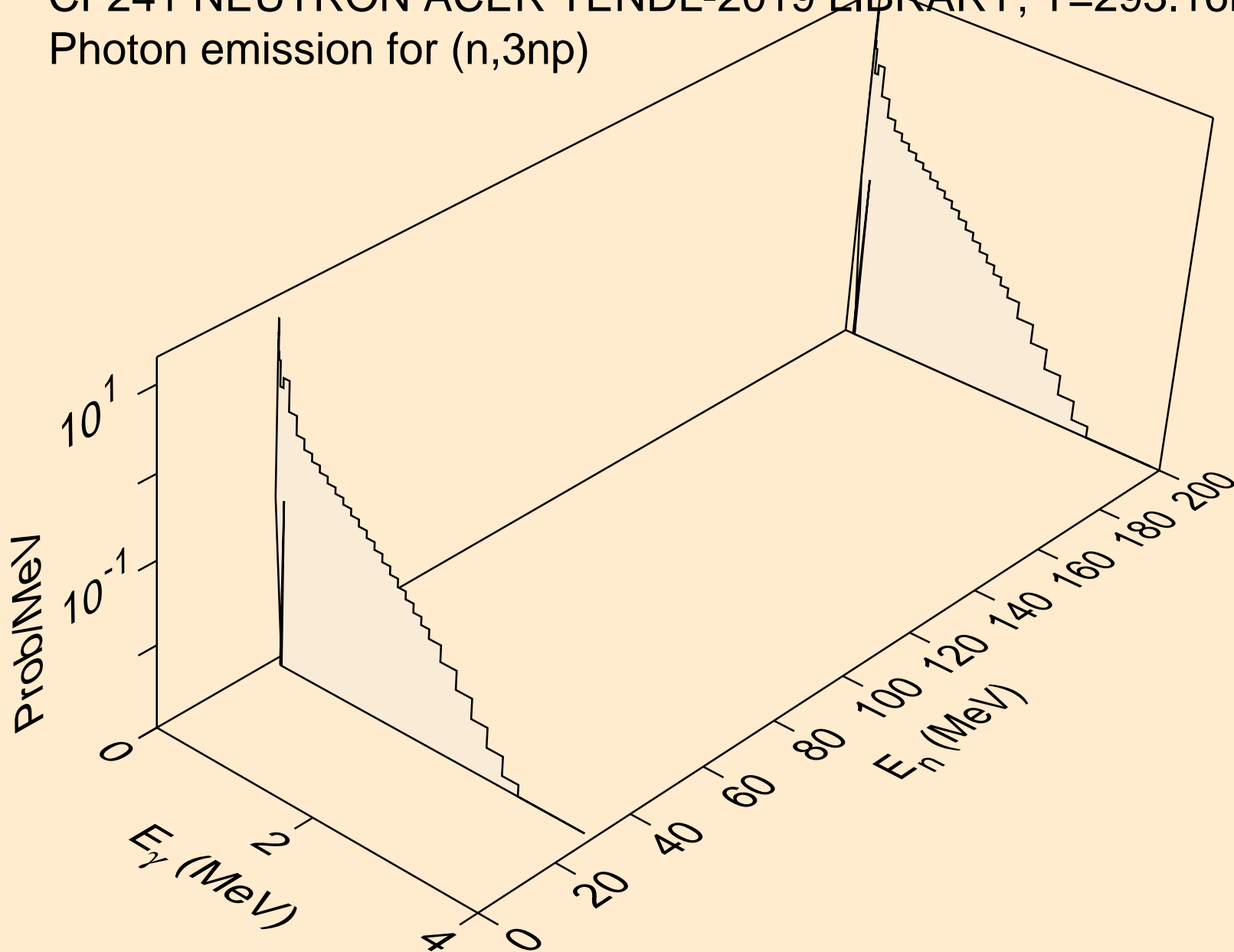



CF241 NEUTRON ACER TENDL-2019 LIBRARY; T=293.16K  
Photon emission for (n,2np)

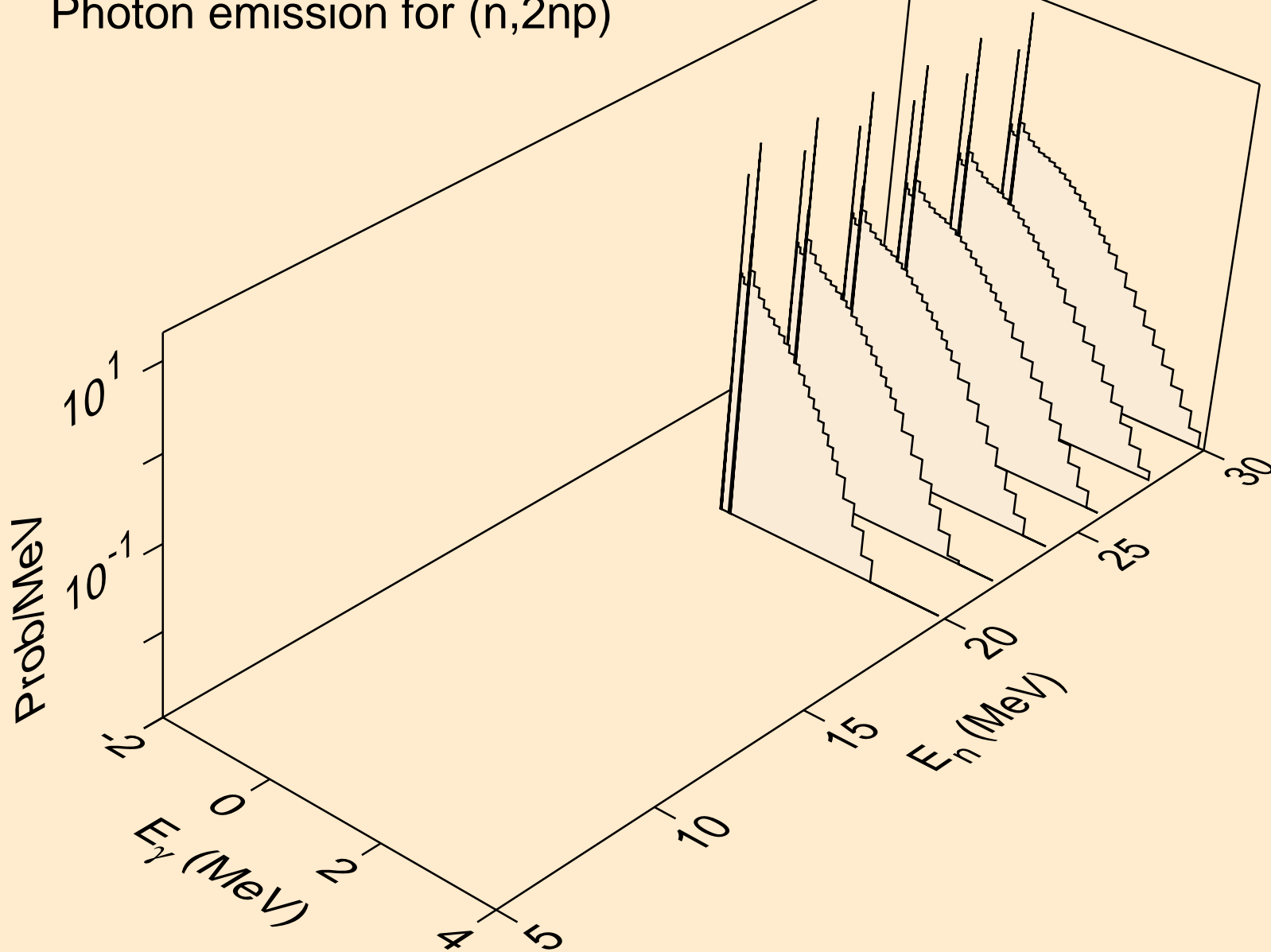

CF241 NEUTRON ACER TENDL-2019 LIBRARY; T=293.16K  
Photon emission for (n,npa)

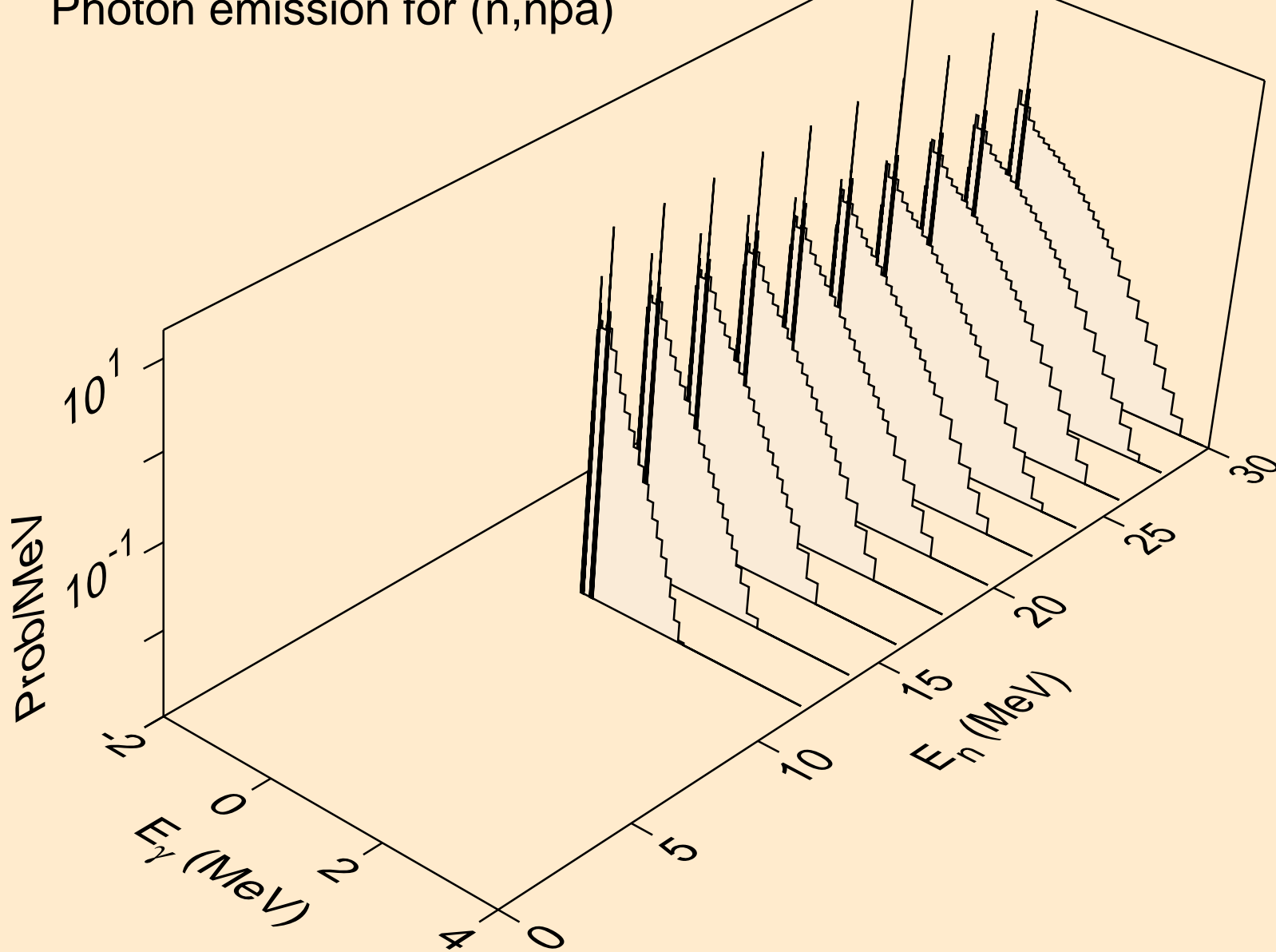

CF241 NEUTRON ACER TENDL-2019 LIBRARY; T=293.16K  
Photon emission for (n,n\*c)

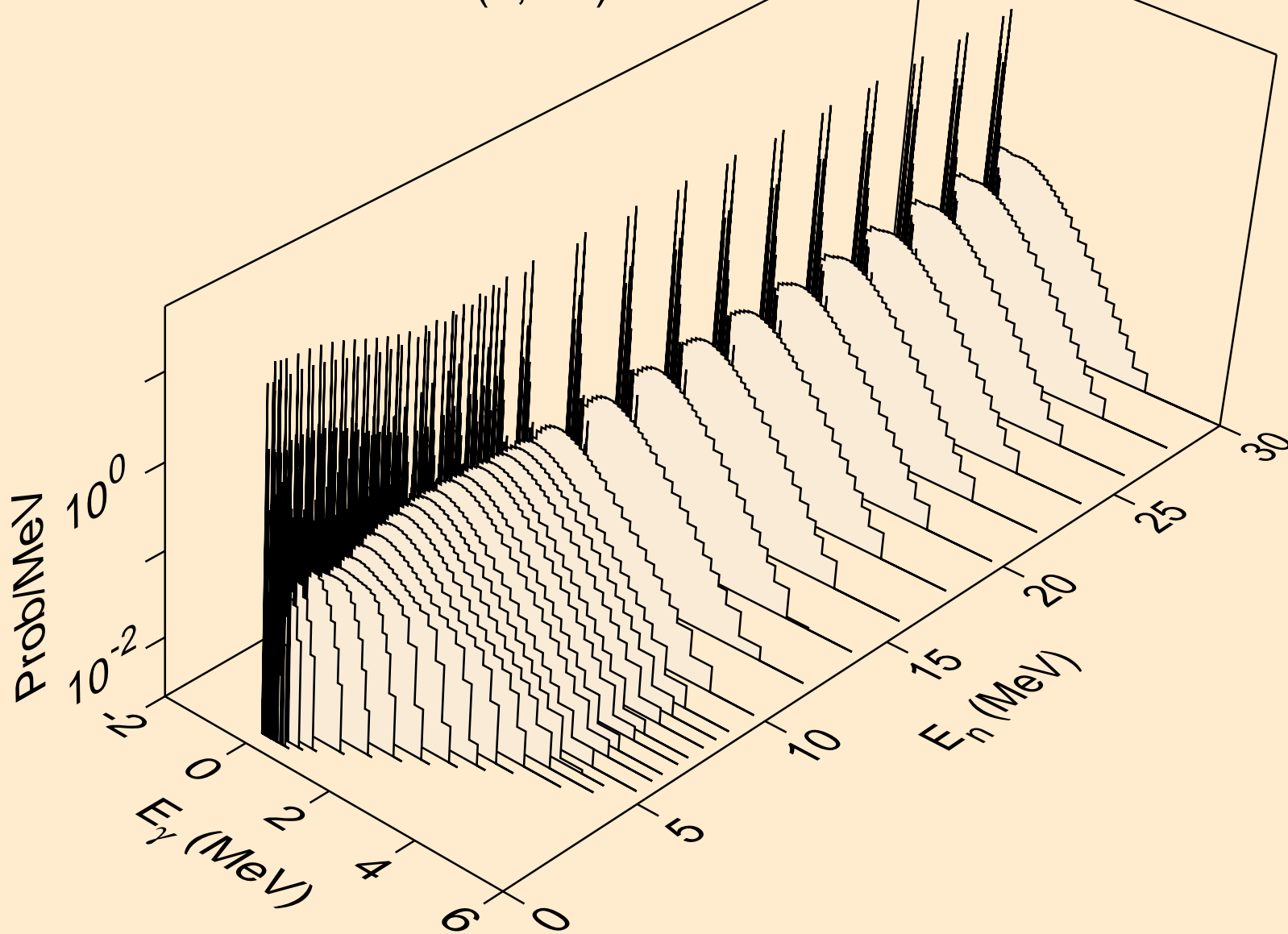

CF241 NEUTRON ACER TENDL-2019 LIBRARY; T=293.16K  
Photon emission for (n,gma)

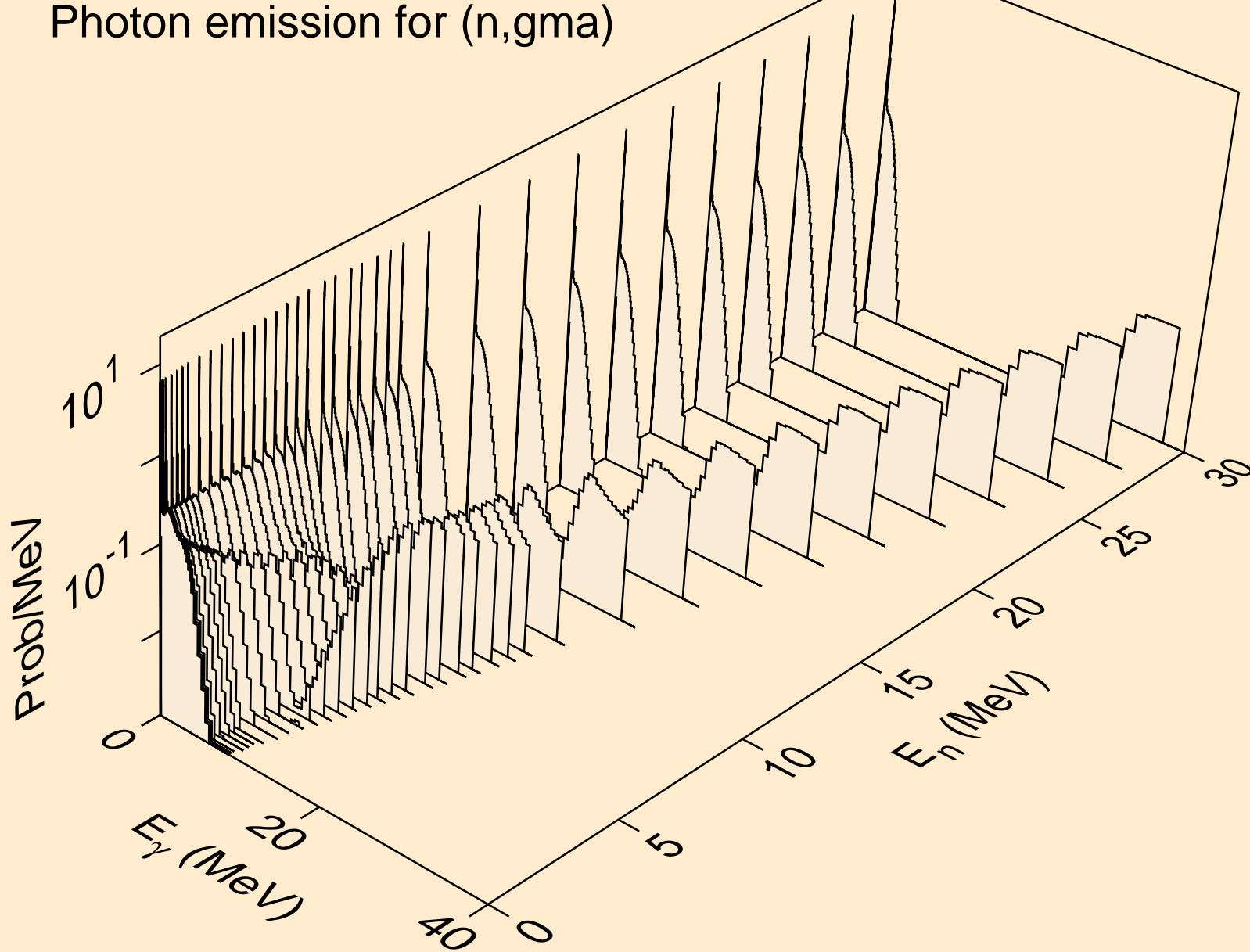

CF241 NEUTRON ACER TENDL-2019 LIBRARY; T=293.16K  
Photon emission for (n,p)

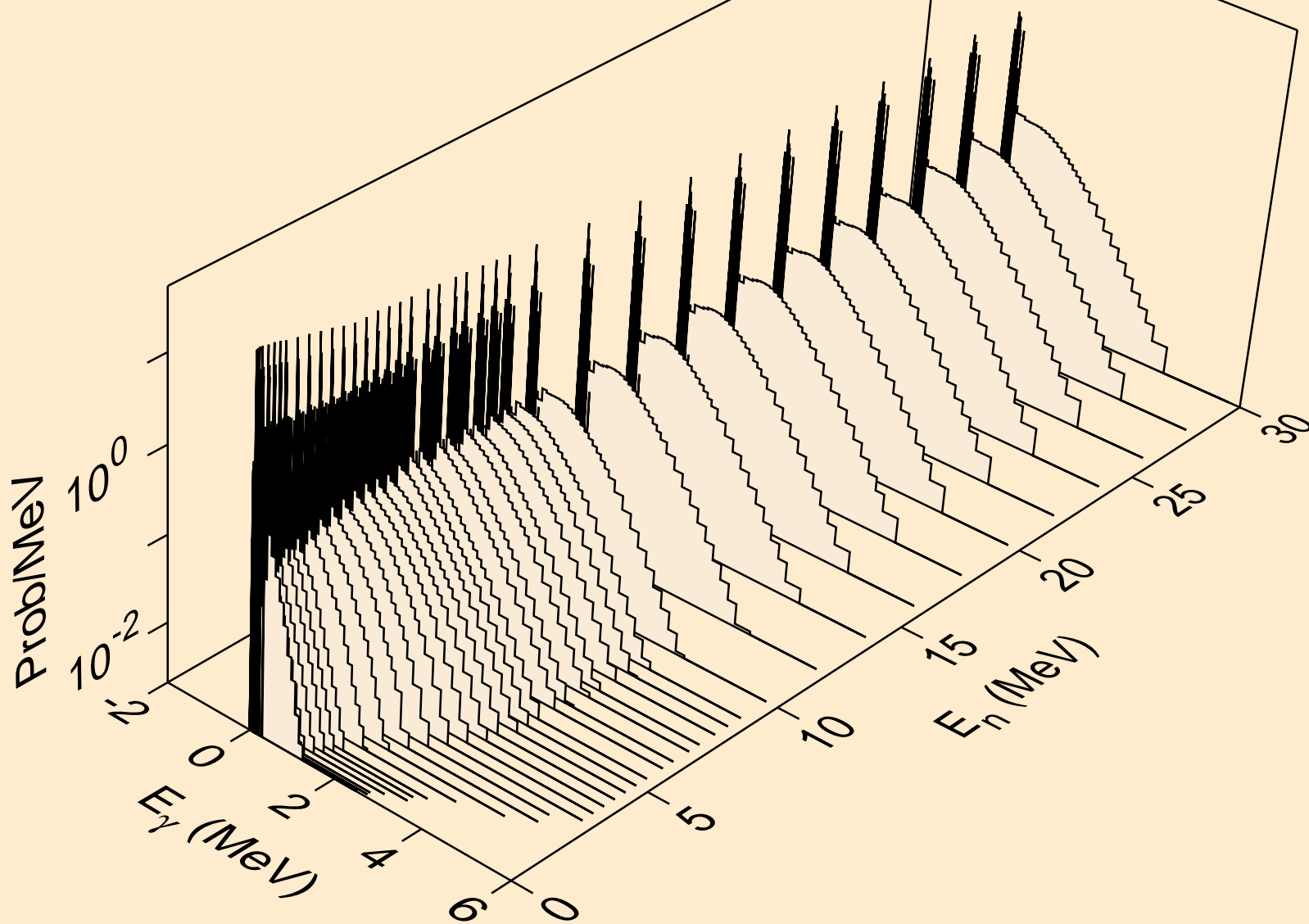

CF241 NEUTRON ACER TENDL-2019 LIBRARY; T=293.16K  
Photon emission for (n,d)

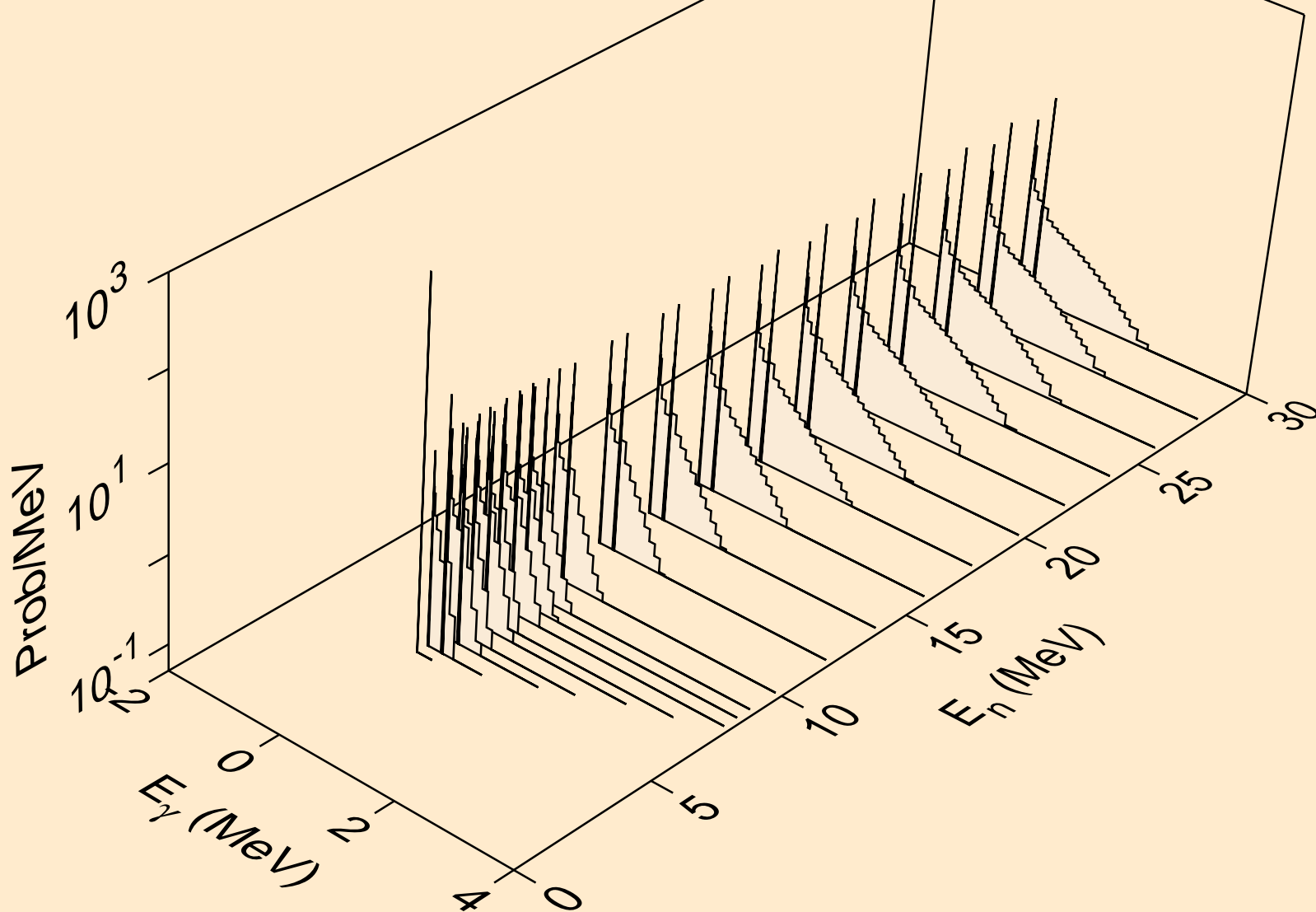

CF241 NEUTRON ACER TENDL-2019 LIBRARY; T=293.16K  
Photon emission for (n,t)

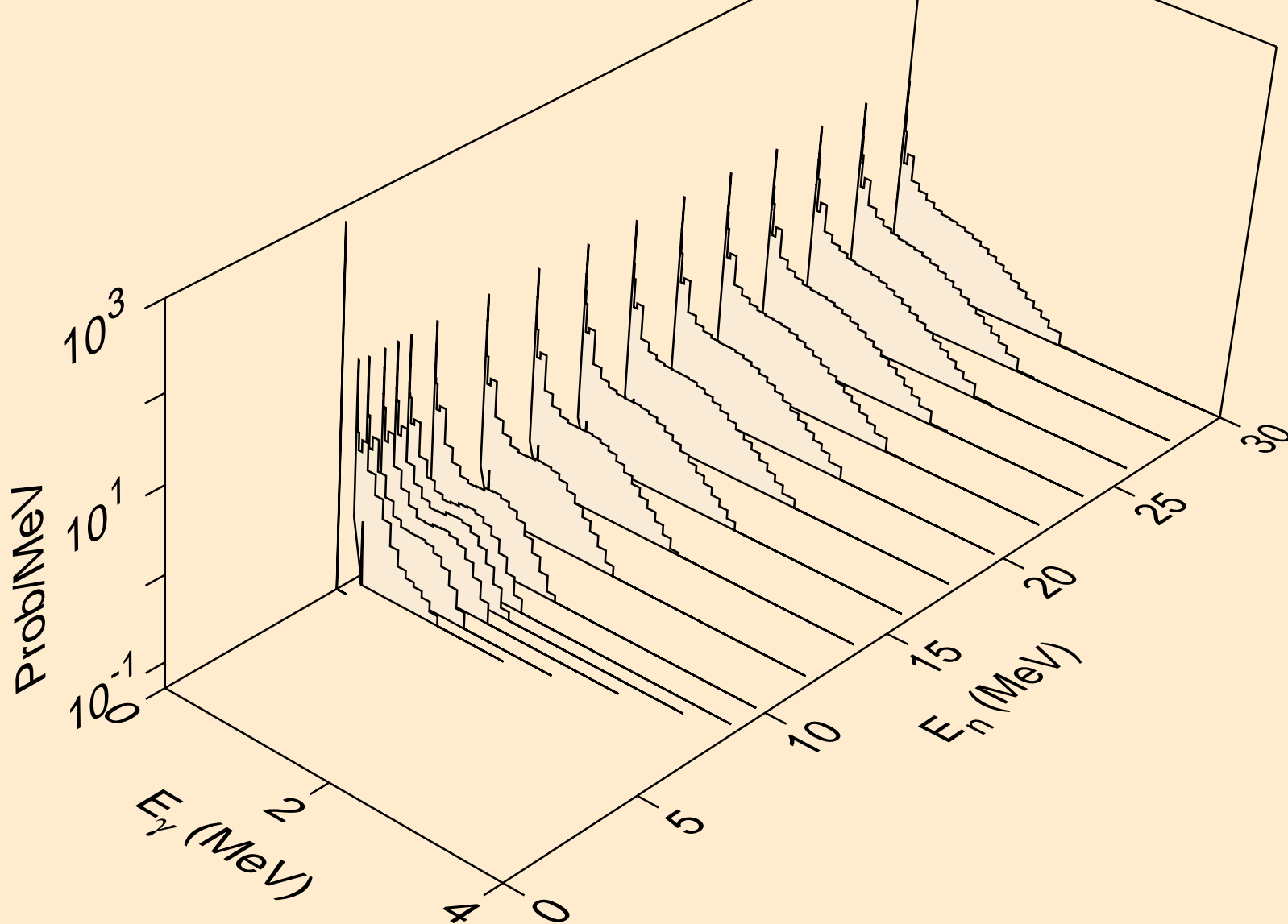

CF241 NEUTRON ACER TENDL-2019 LIBRARY; T=293.16K  
Photon emission for (n,he3)

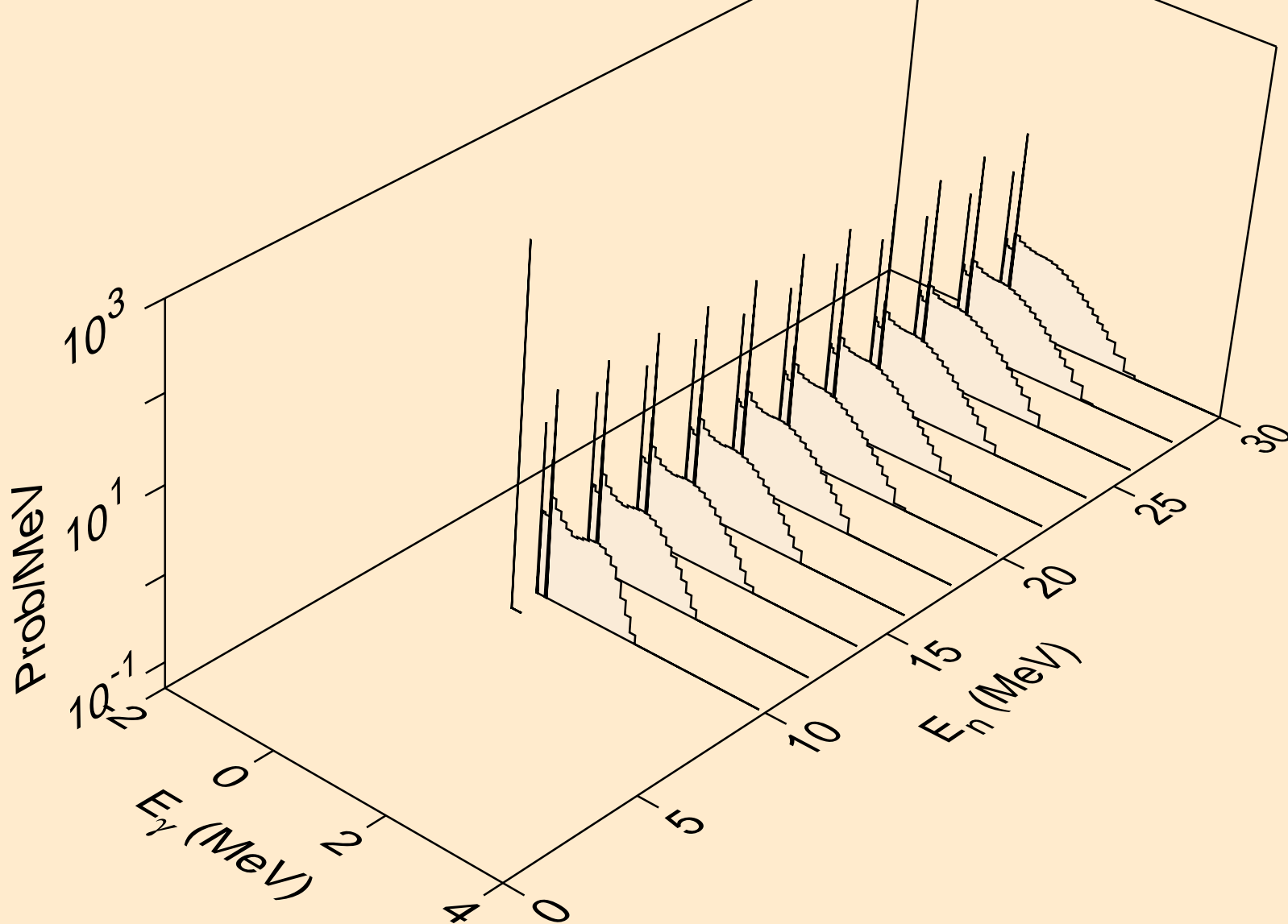



CF241 NEUTRON ACER TENDL-2019 LIBRARY; T=293.16K  
Photon emission for (n,a)

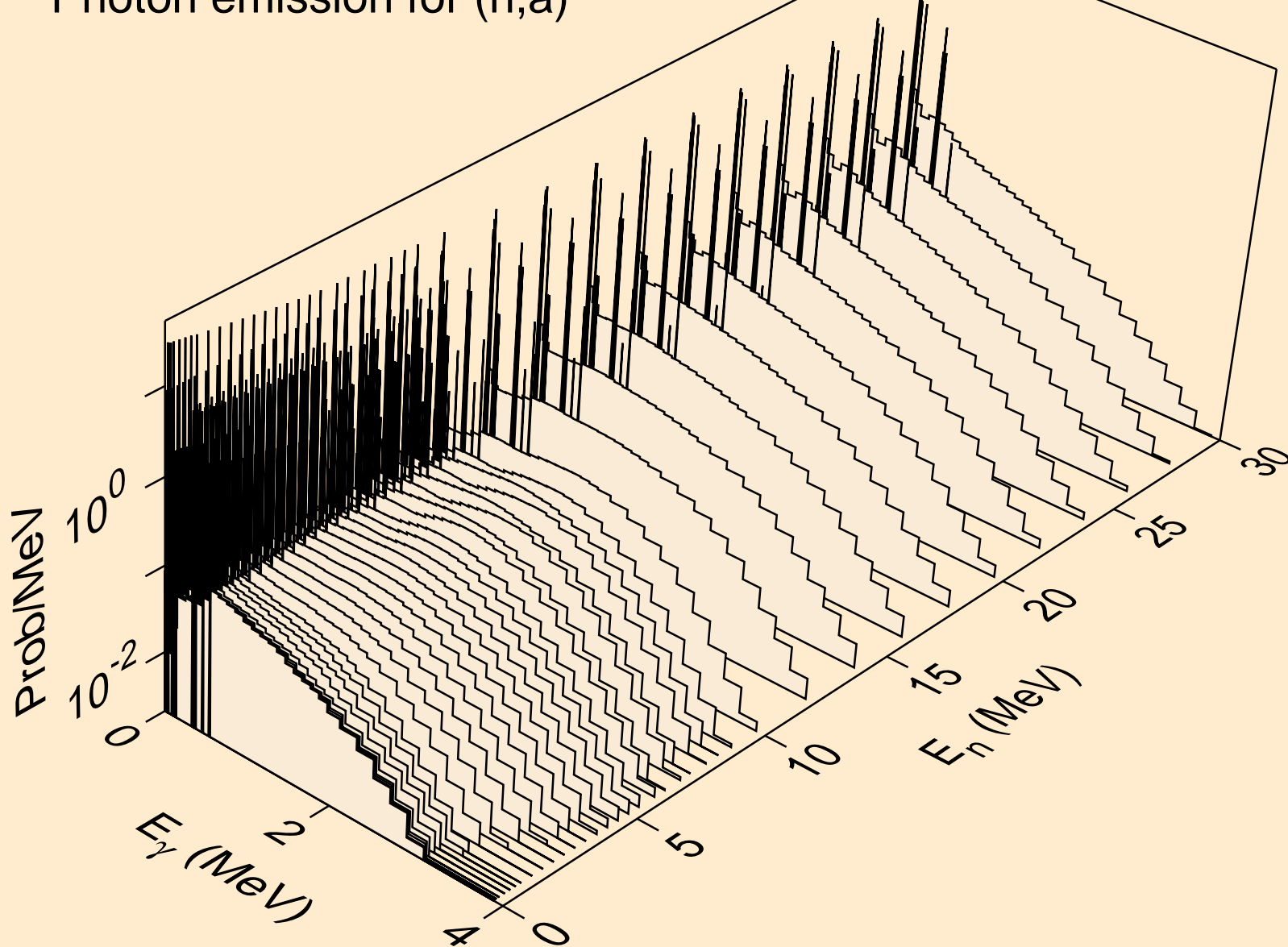

CF241 NEUTRON ACER TENDL-2019 LIBRARY; T=293.16K  
Photon emission for (n,2p)

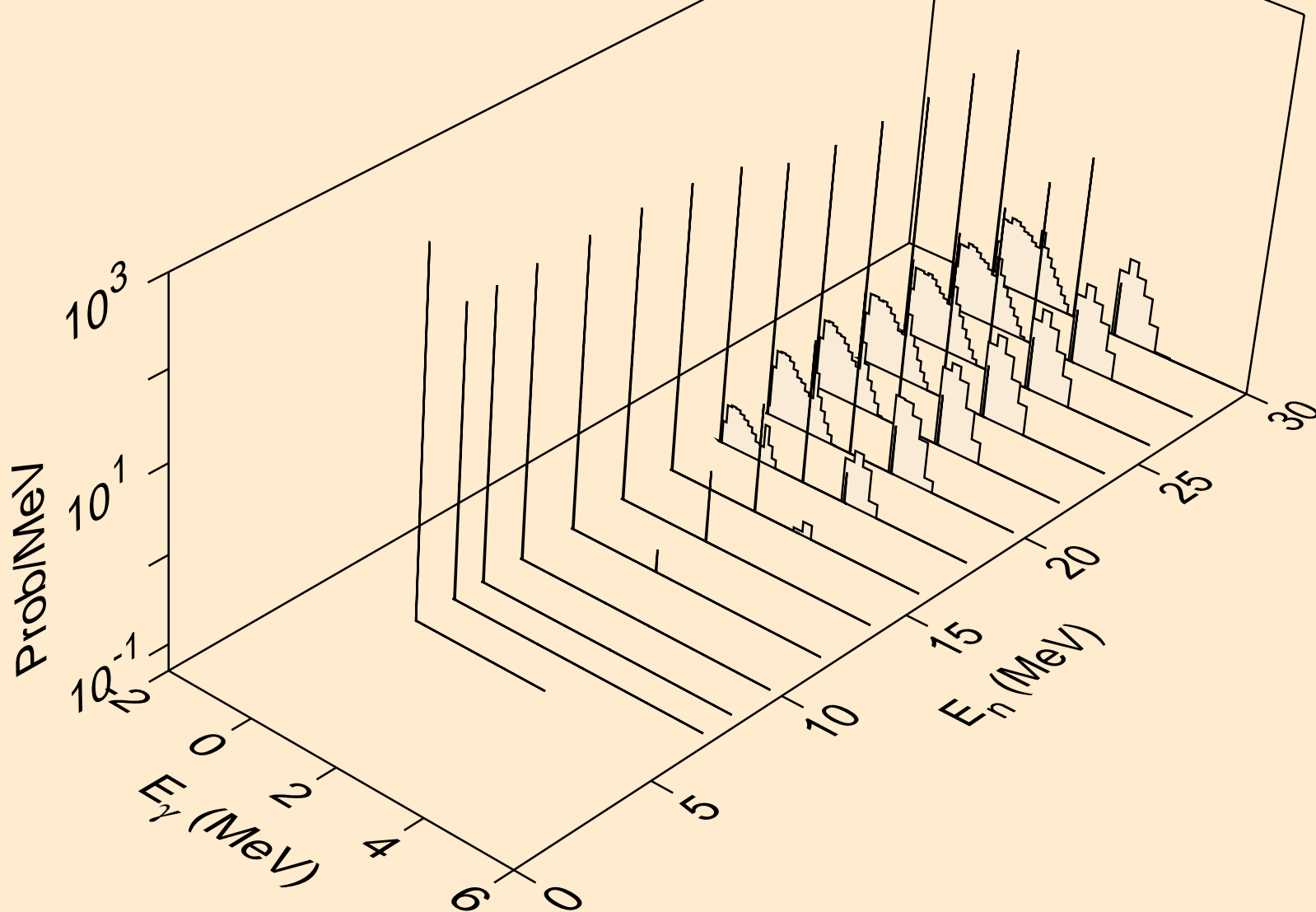

CF241 NEUTRON ACER TENDL-2019 LIBRARY; T=293.16K  
Photon emission for (n,p)

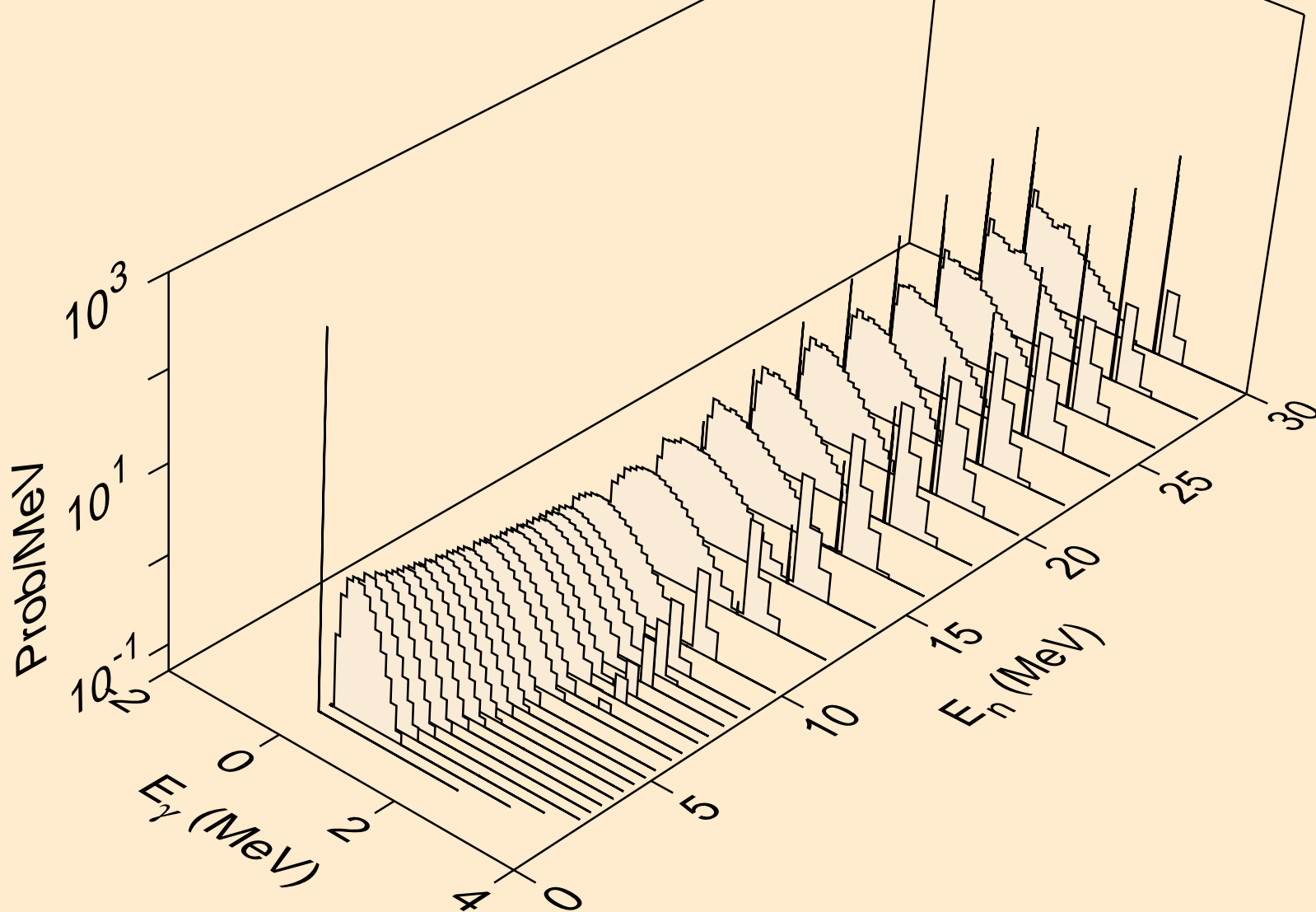

CF241 NEUTRON ACER TENDL-2019 LIBRARY; T=293.16K  
Photon emission for (n,pd)

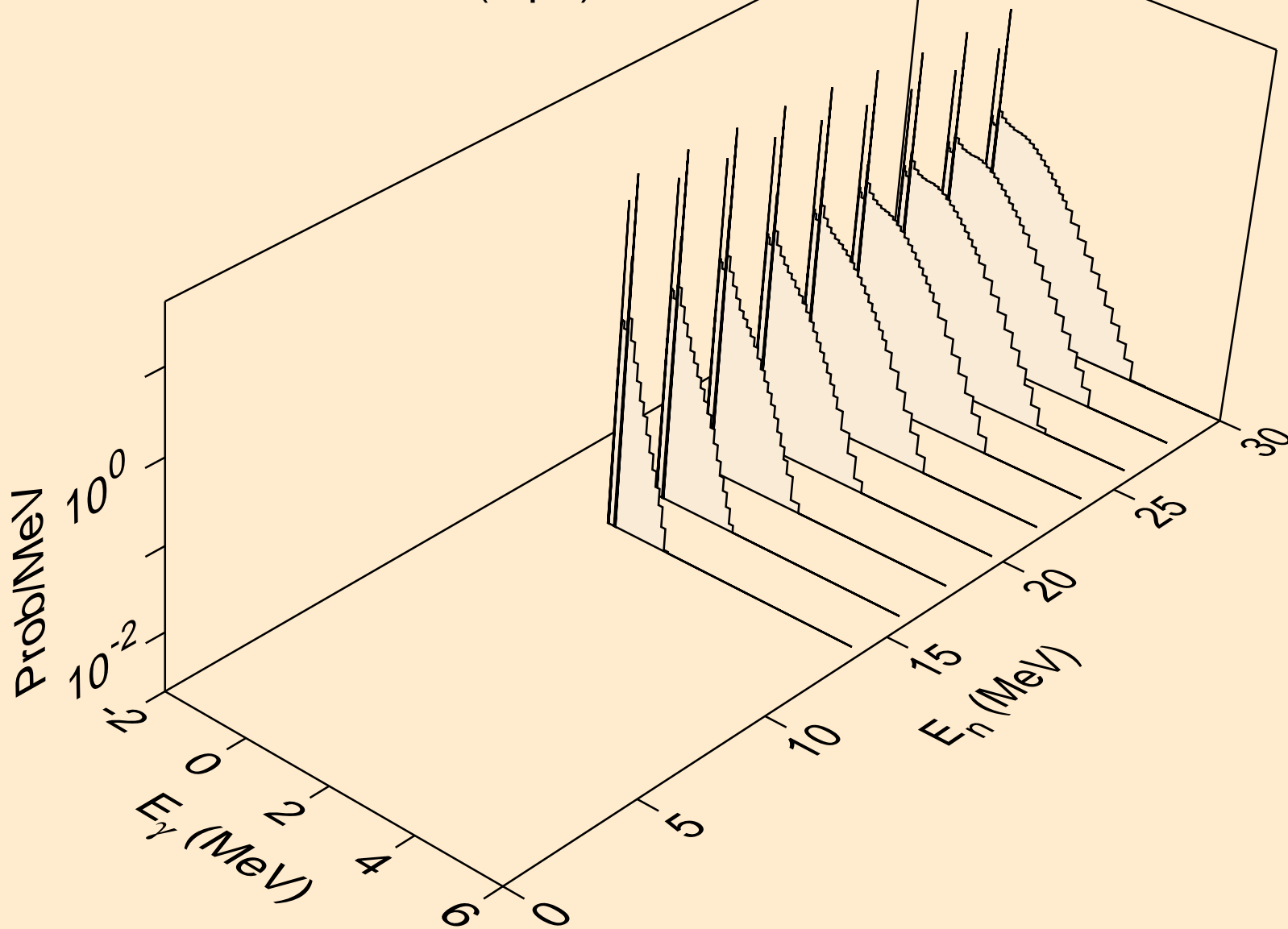

CF241 NEUTRON ACER TENDL-2019 LIBRARY; T=293.16K  
Photon emission for (n,pt)

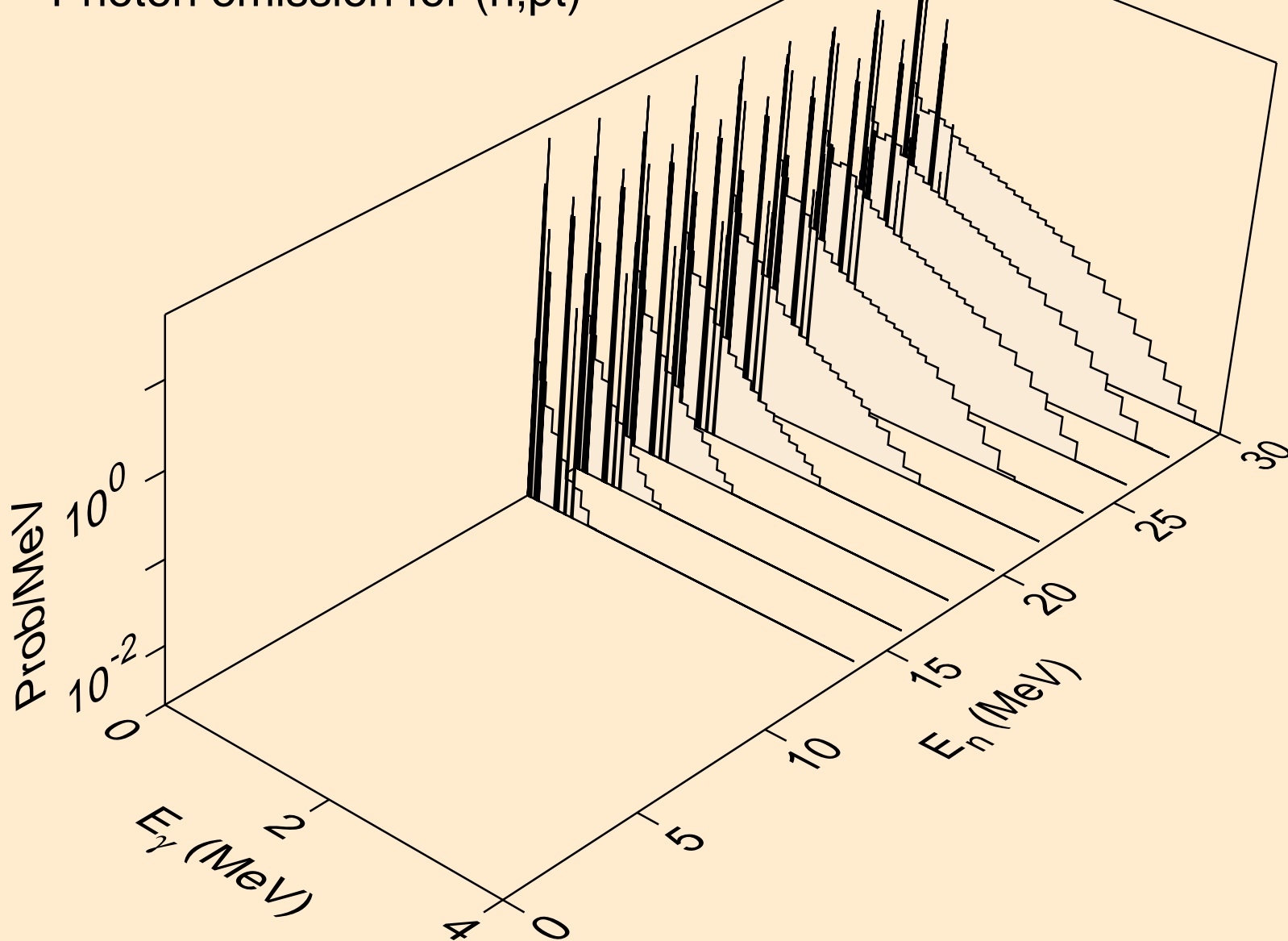

CF241 NEUTRON ACER TENDL-2019 LIBRARY; T=293.16K  
Photon emission for (n,da)

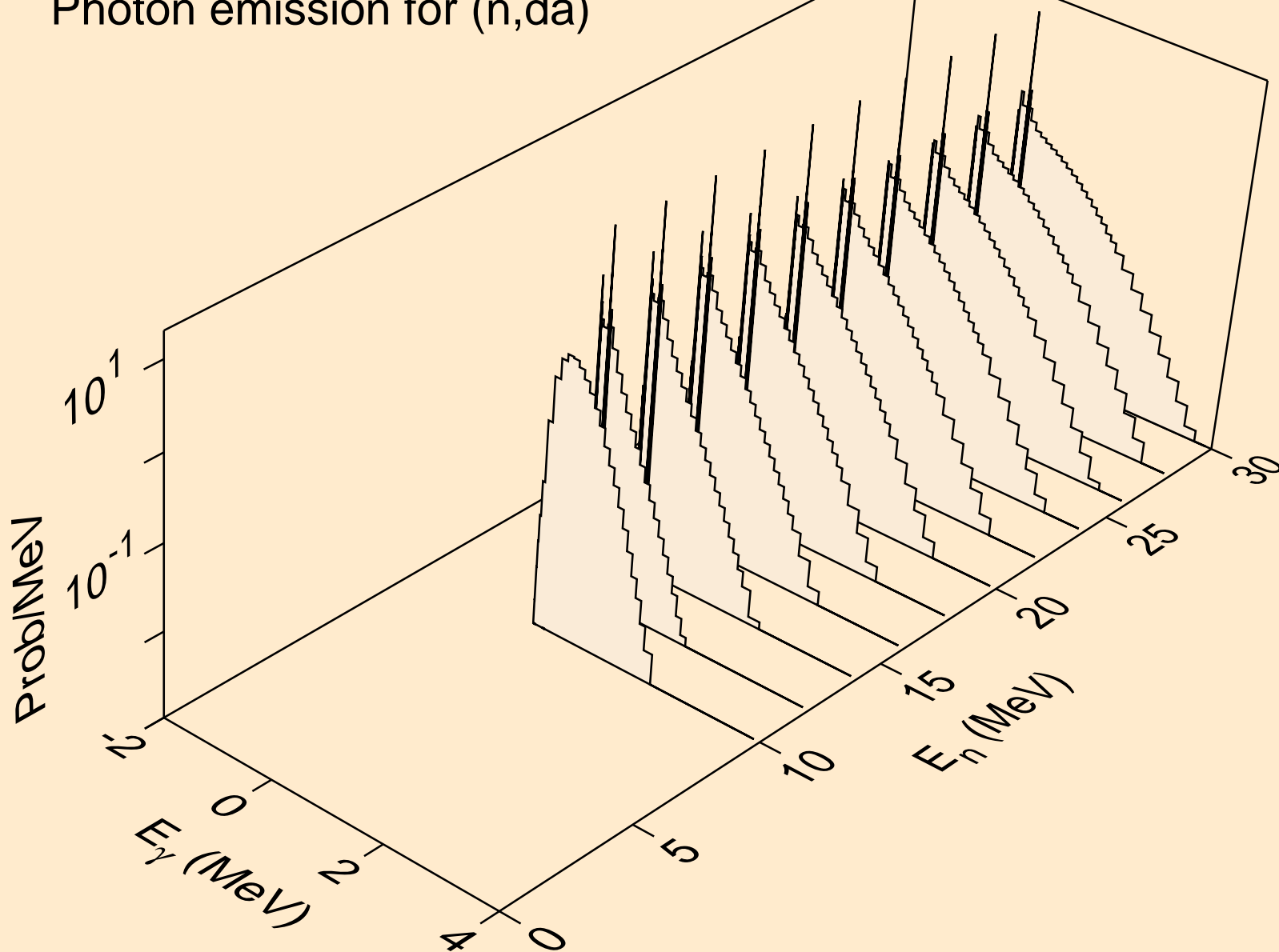

CF241 NEUTRON ACER TENDL-2019 LIBRARY; T=293.16K  
thermal capture photon spectrum

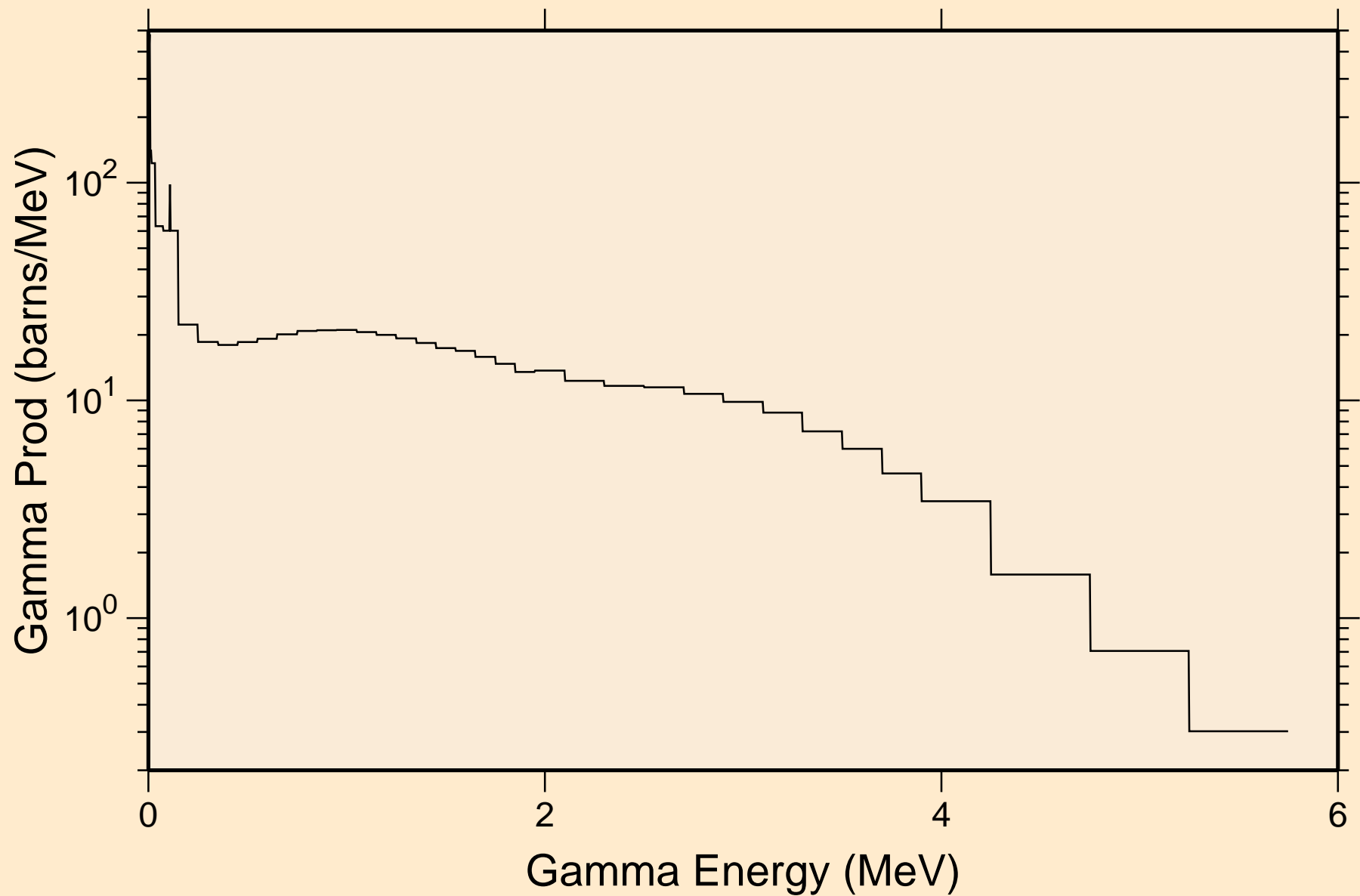

CF241 NEUTRON ACER TENDL-2019 LIBRARY; T=293.16K  
14 MeV photon spectrum

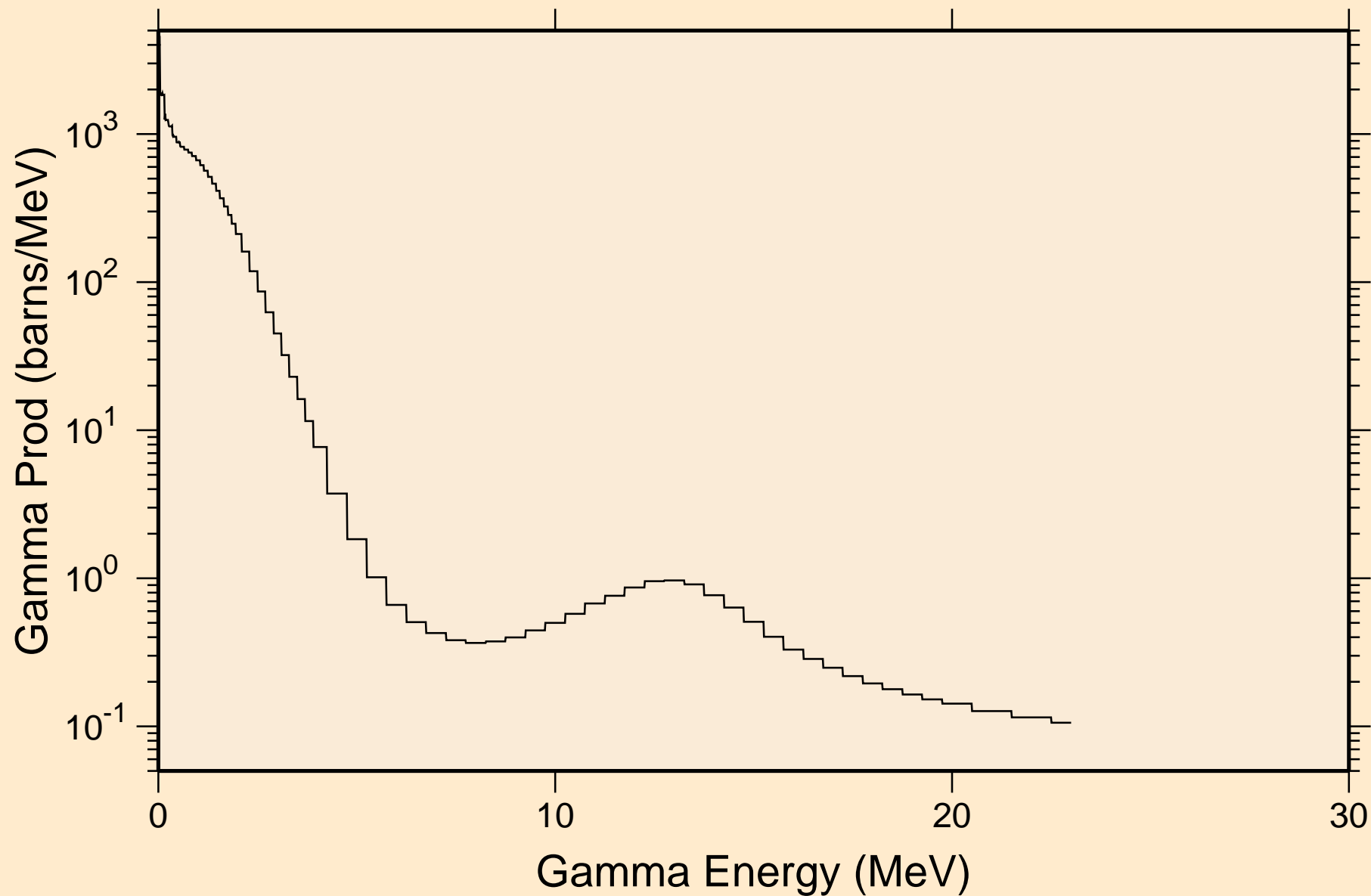



# CF241 NEUTRON ACER TENDL-2019 LIBRARY; T=293.16K

## Particle heating contributions

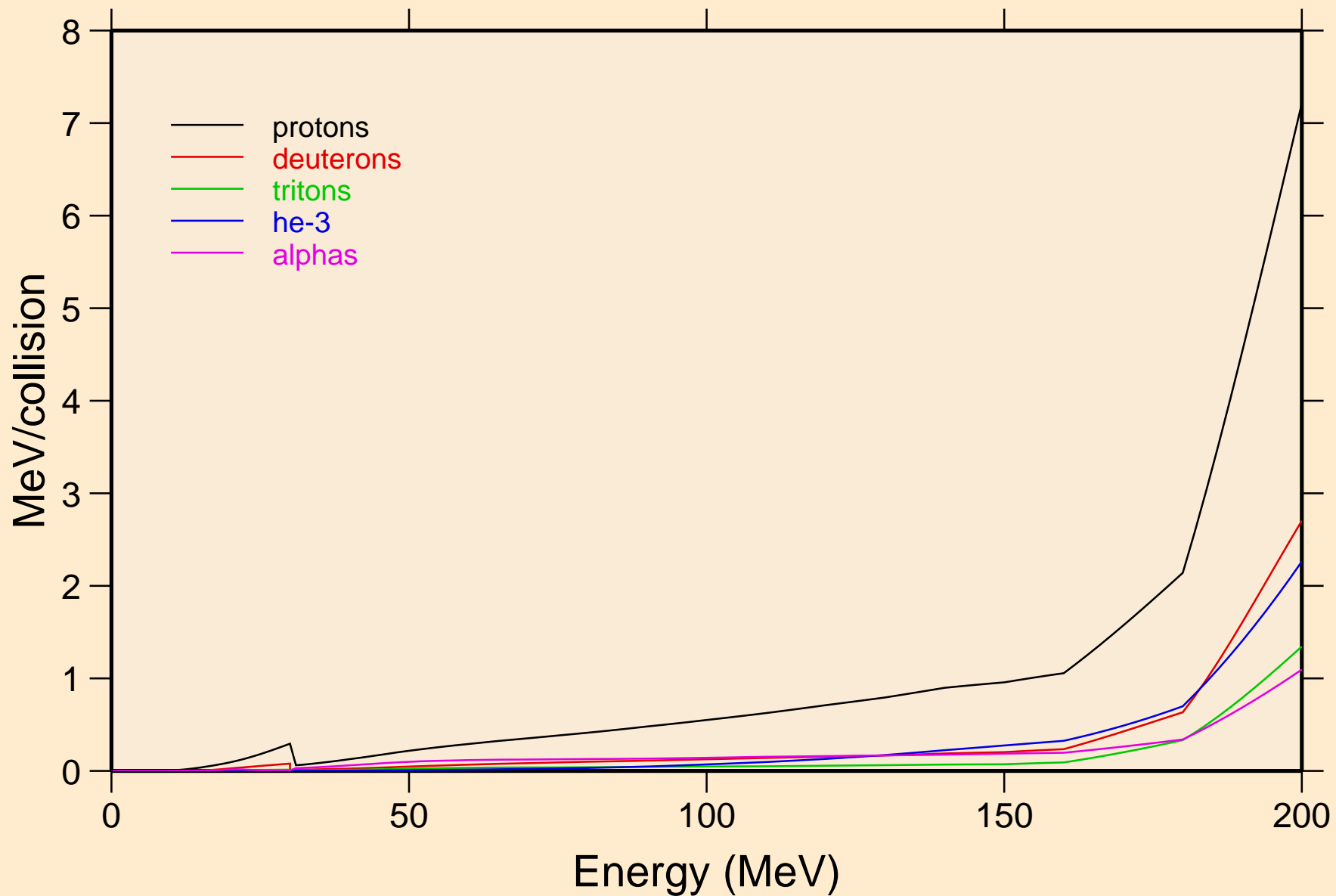

CF241 NEUTRON ACER TENDL-2019 LIBRARY; T=293.16K  
Recoil Heating

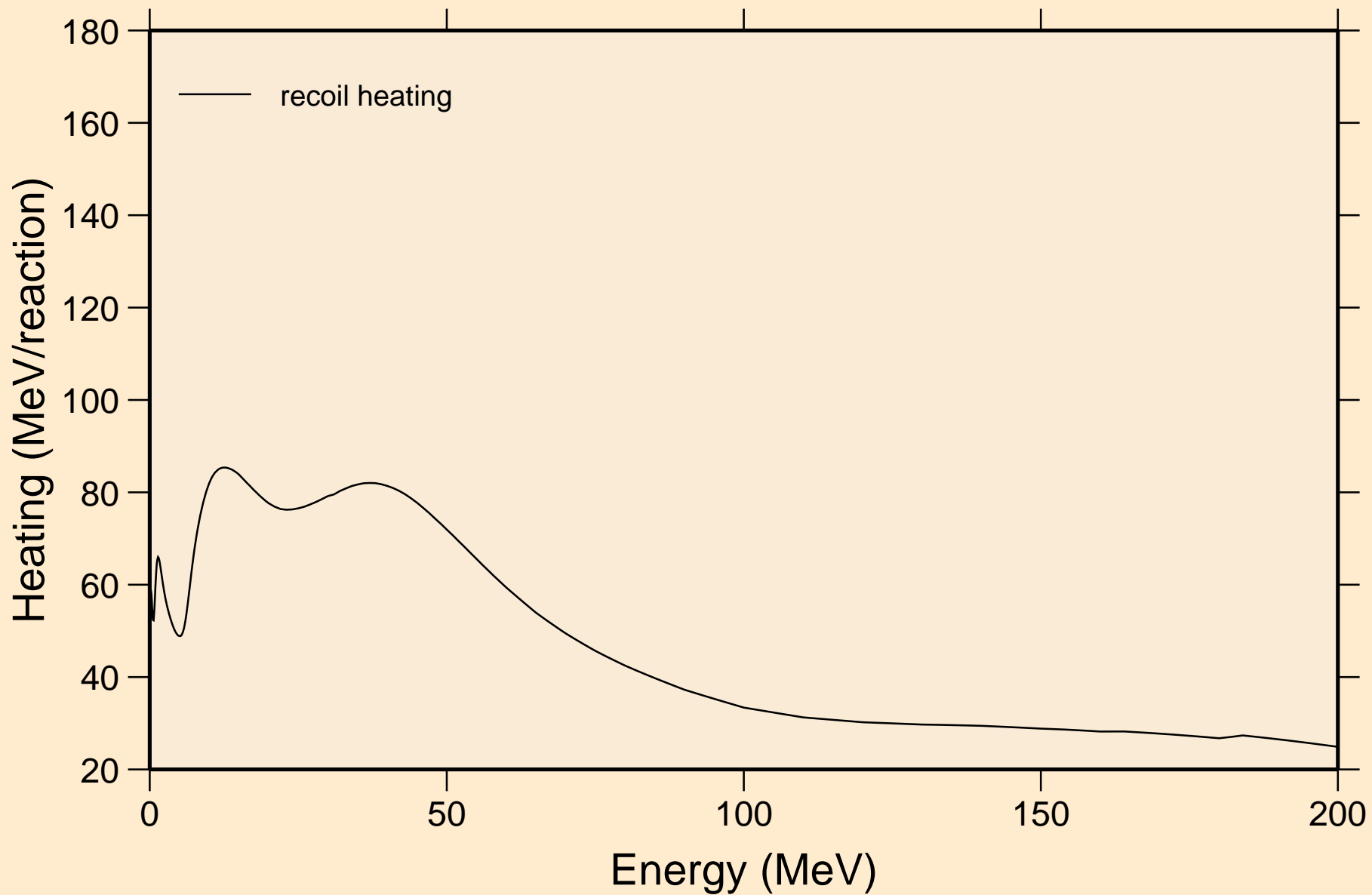

CF241 NEUTRON ACER TENDL-2019 LIBRARY; T=293.16K  
Particle production cross sections

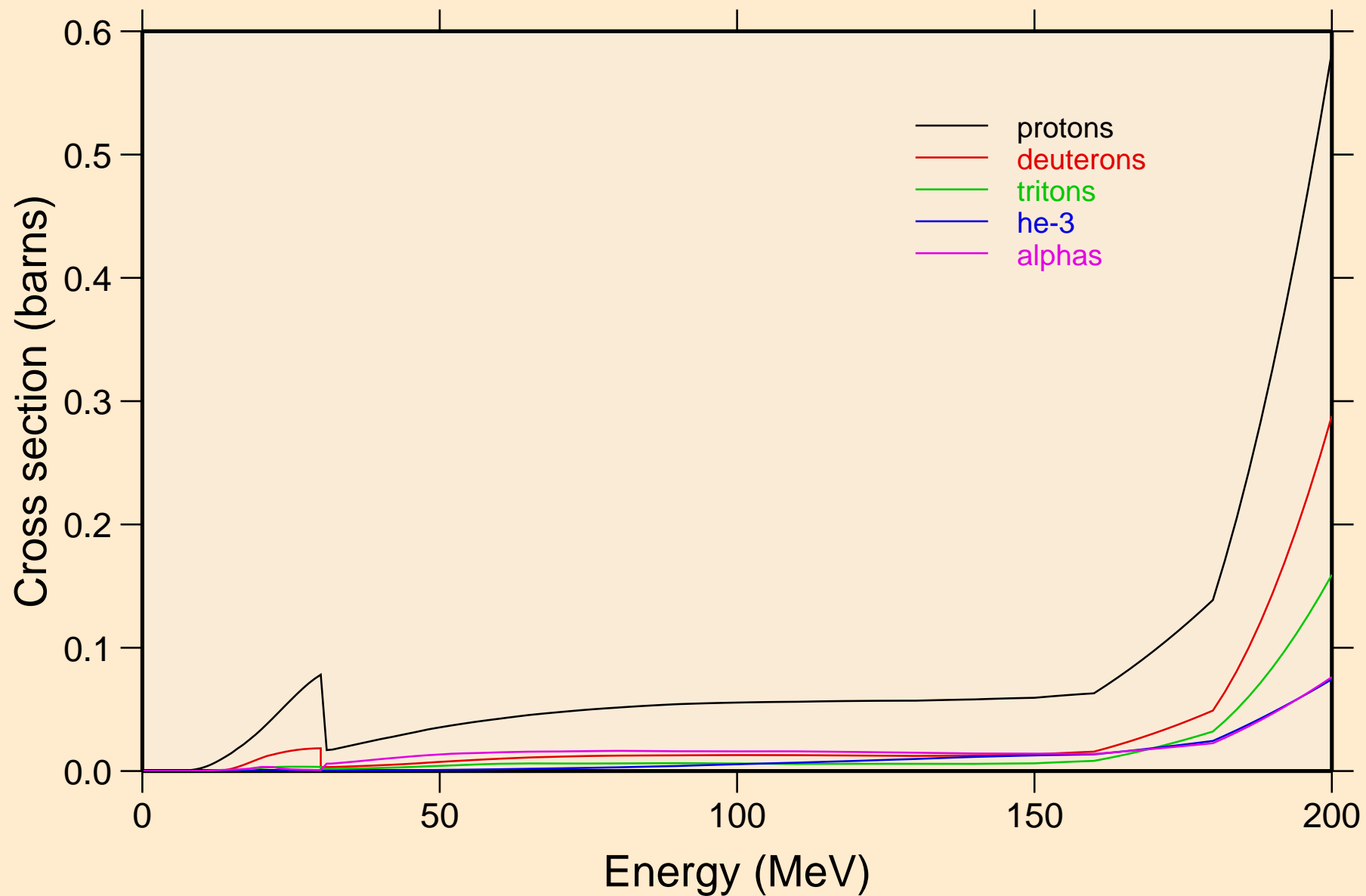

CF241 NEUTRON ACER TENDL-2019 LIBRARY; T=293.16K  
protons from (n,x)

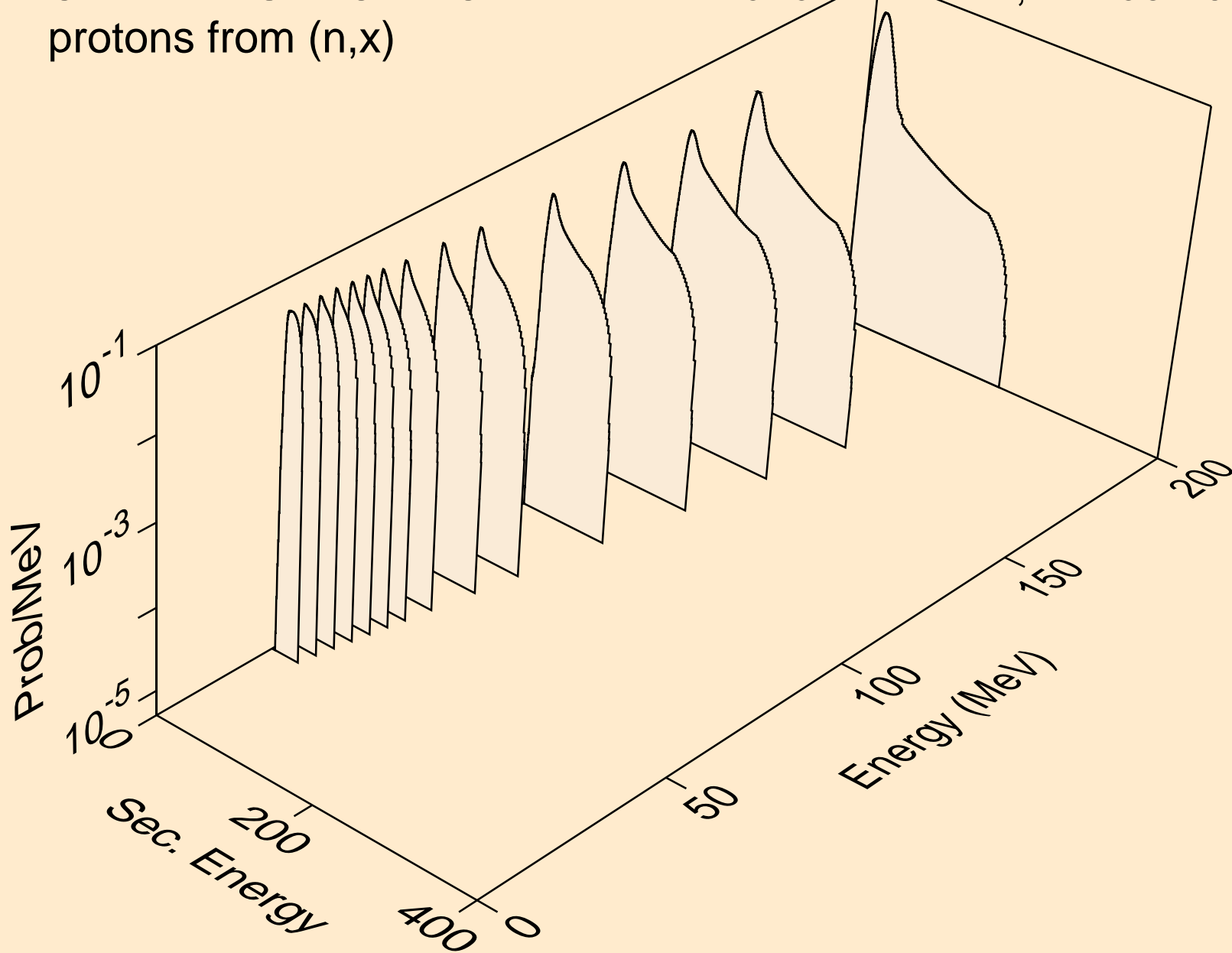

CF241 NEUTRON ACER TENDL-2019 LIBRARY; T=293.16K  
protons from (n,n\*)p

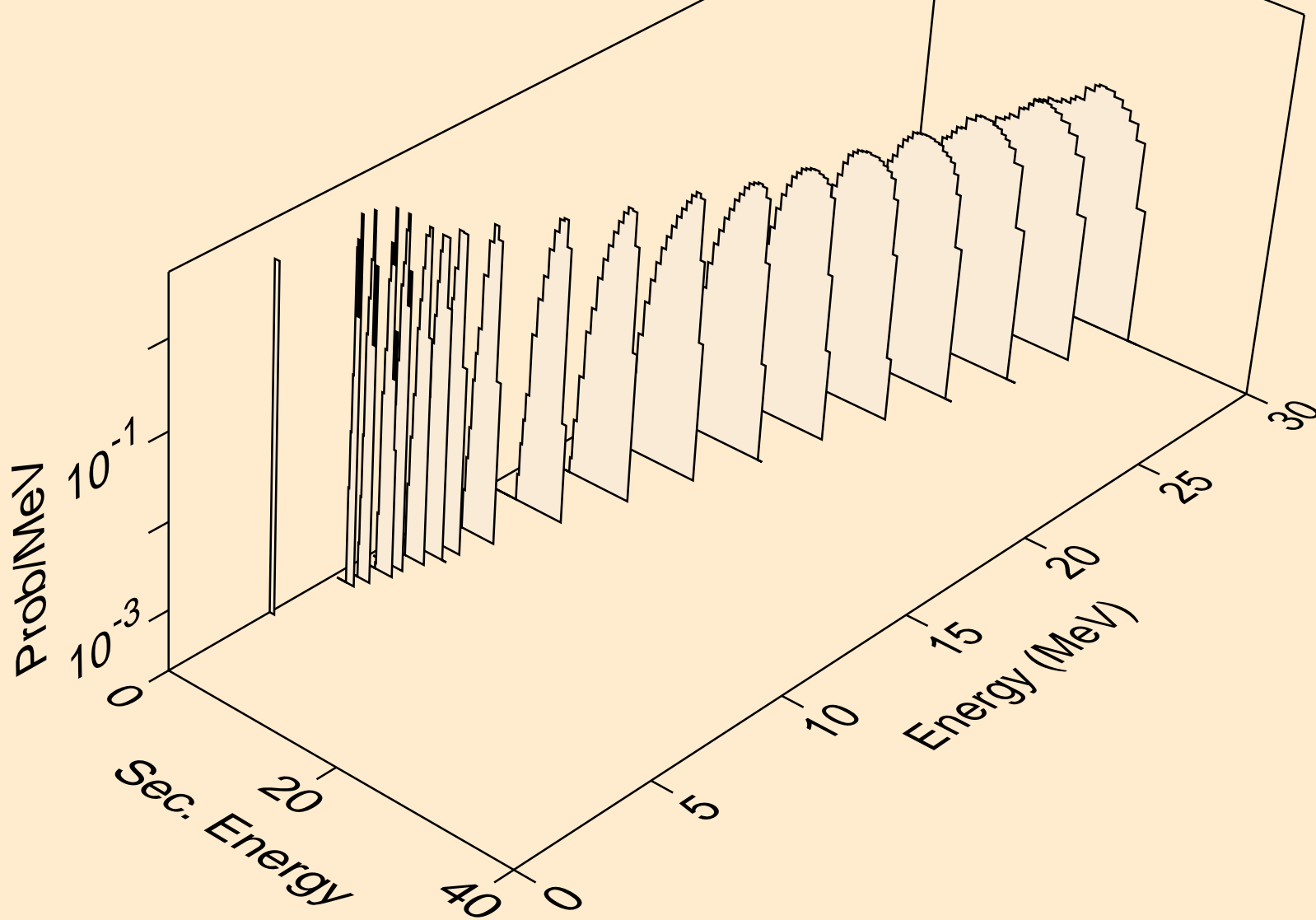

CF241 NEUTRON ACER TENDL-2019 LIBRARY; T=293.16K  
protons from (n,2np)

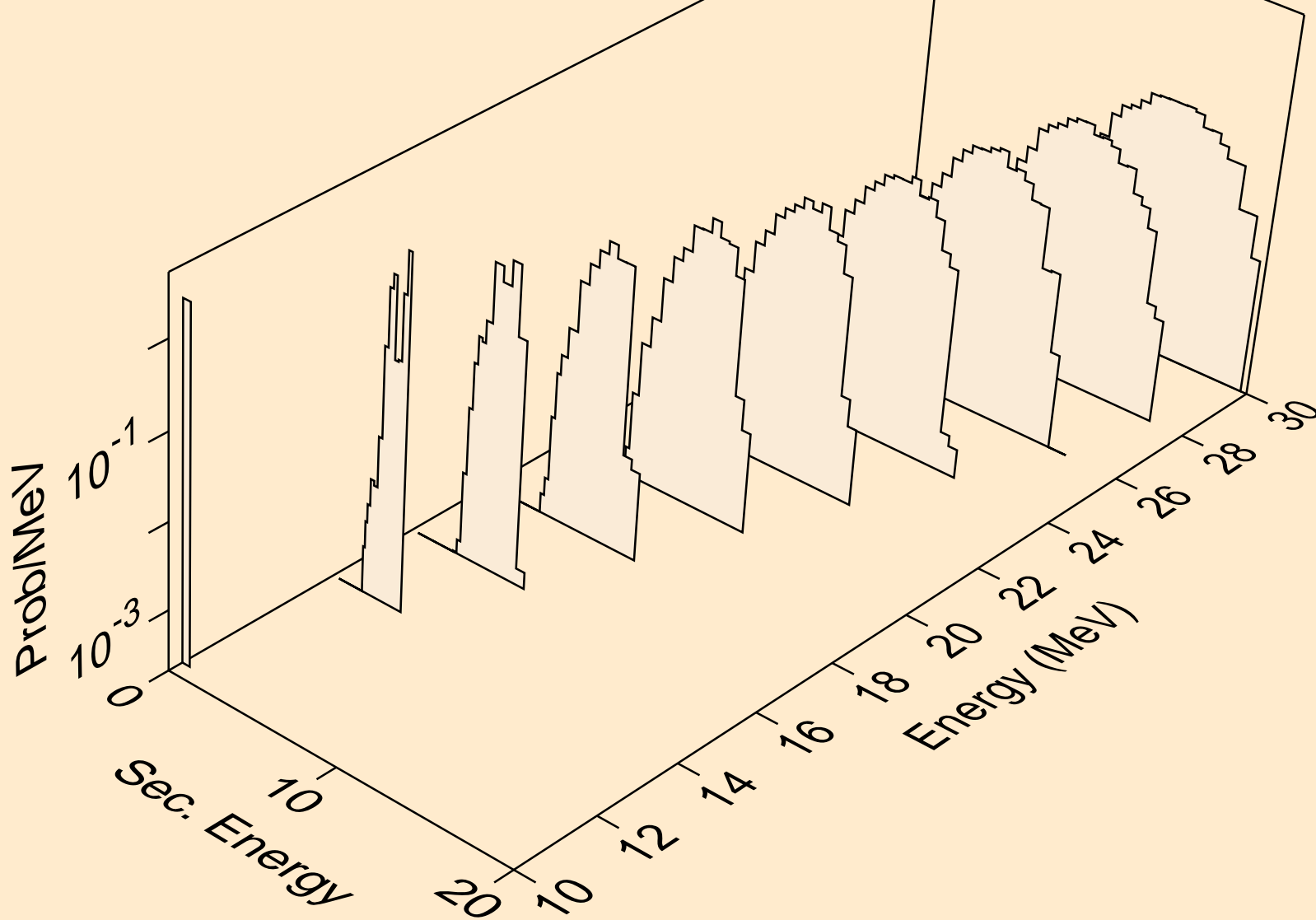

CF241 NEUTRON ACER TENDL-2019 LIBRARY; T=293.16K  
protons from (n,3np)

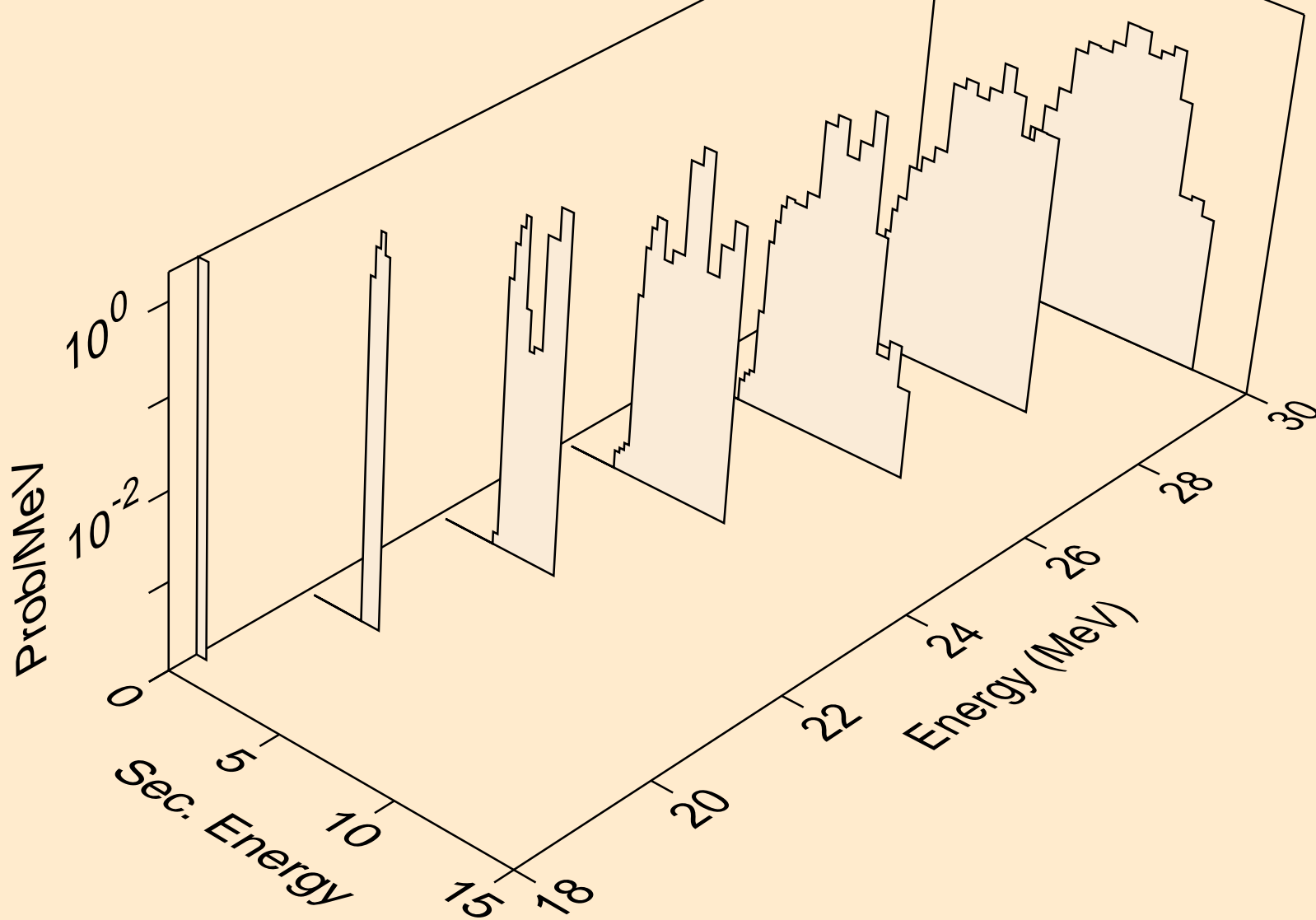

CF241 NEUTRON ACER TENDL-2019 LIBRARY; T=293.16K  
protons from (n,2np)

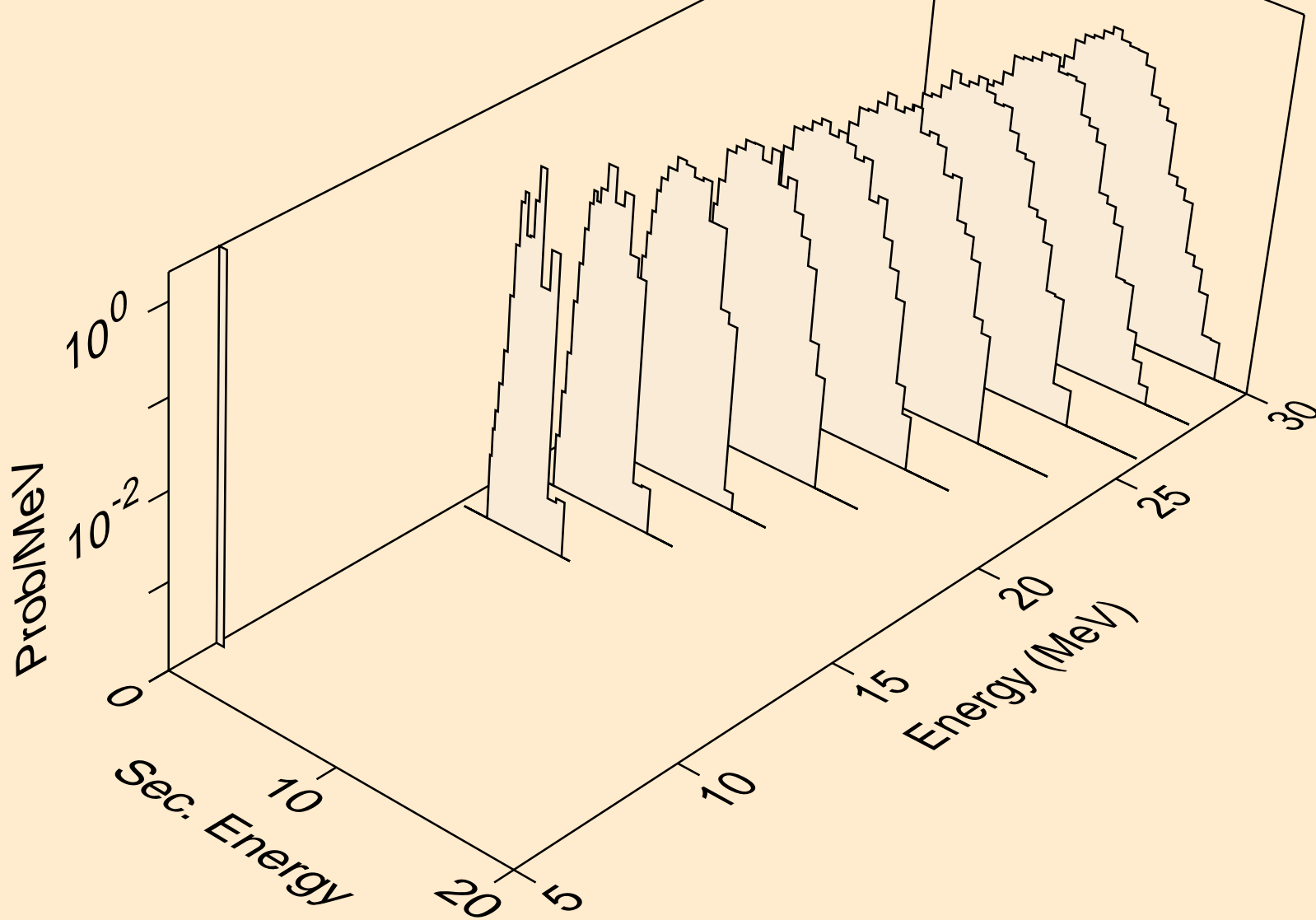



CF241 NEUTRON ACER TENDL-2019 LIBRARY; T=293.16K  
protons from (n,npa)

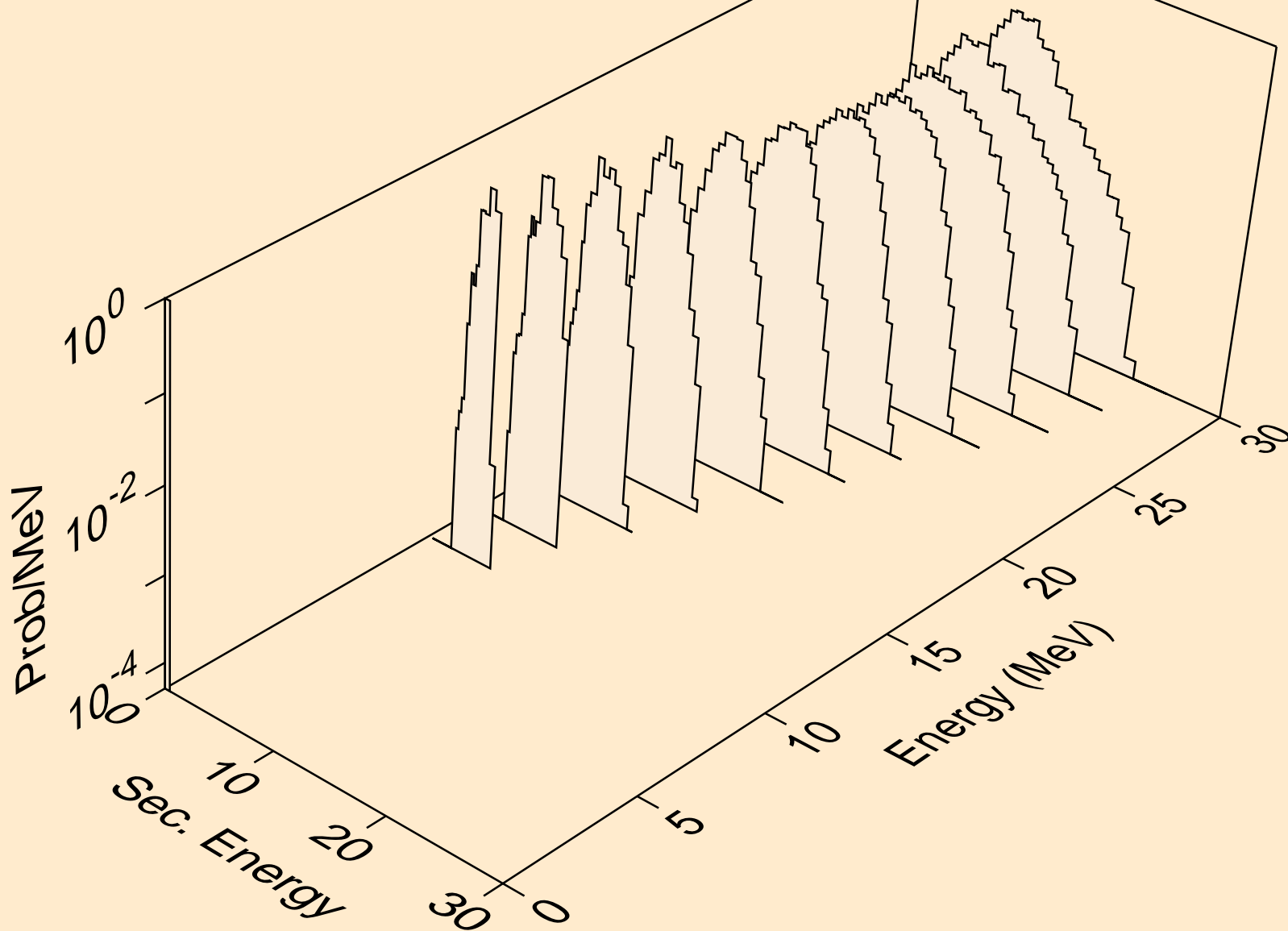

CF241 NEUTRON ACER TENDL-2019 LIBRARY; T=293.16K  
protons from (n,p)

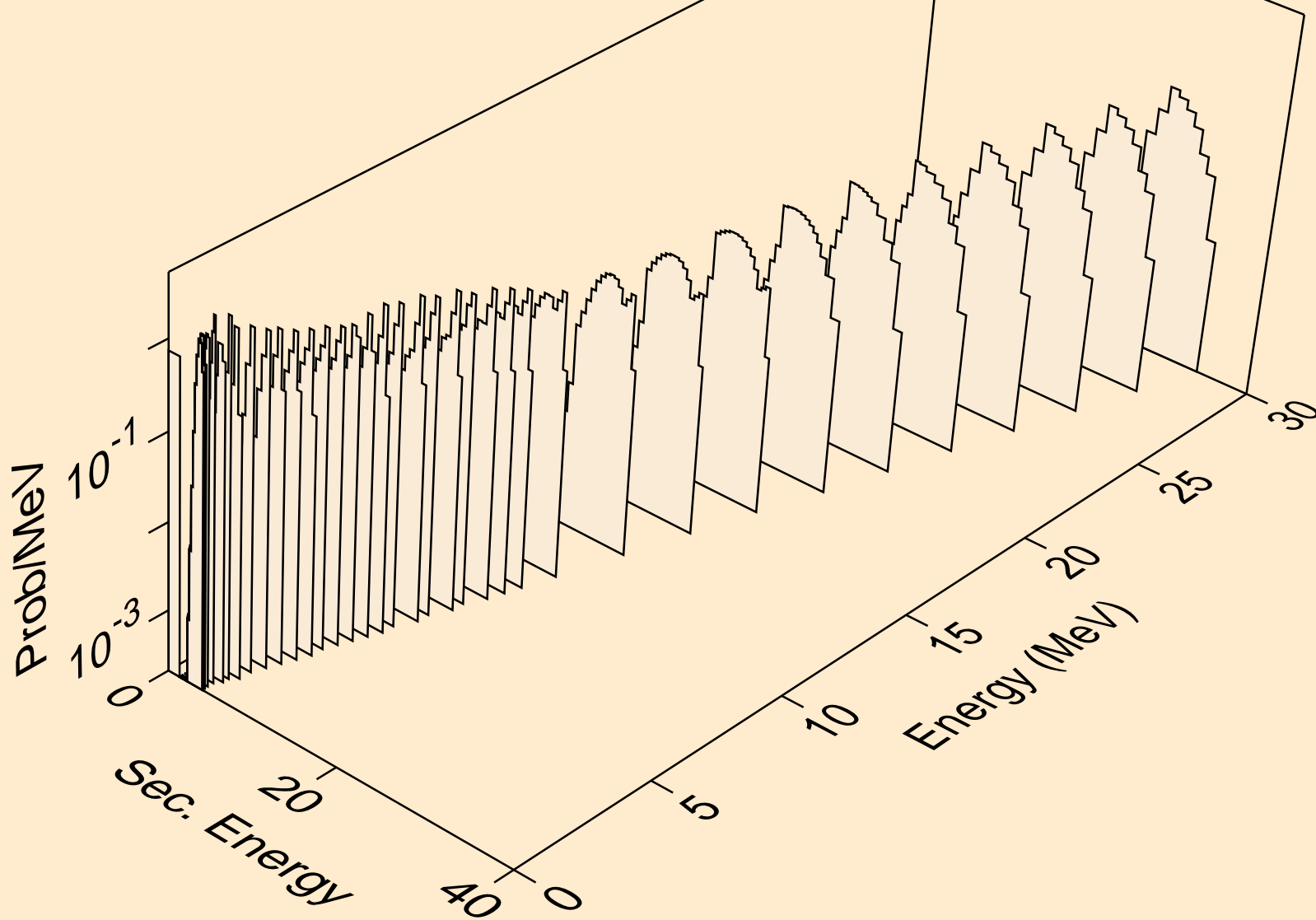

CF241 NEUTRON ACER TENDL-2019 LIBRARY; T=293.16K  
protons from (n,2p)

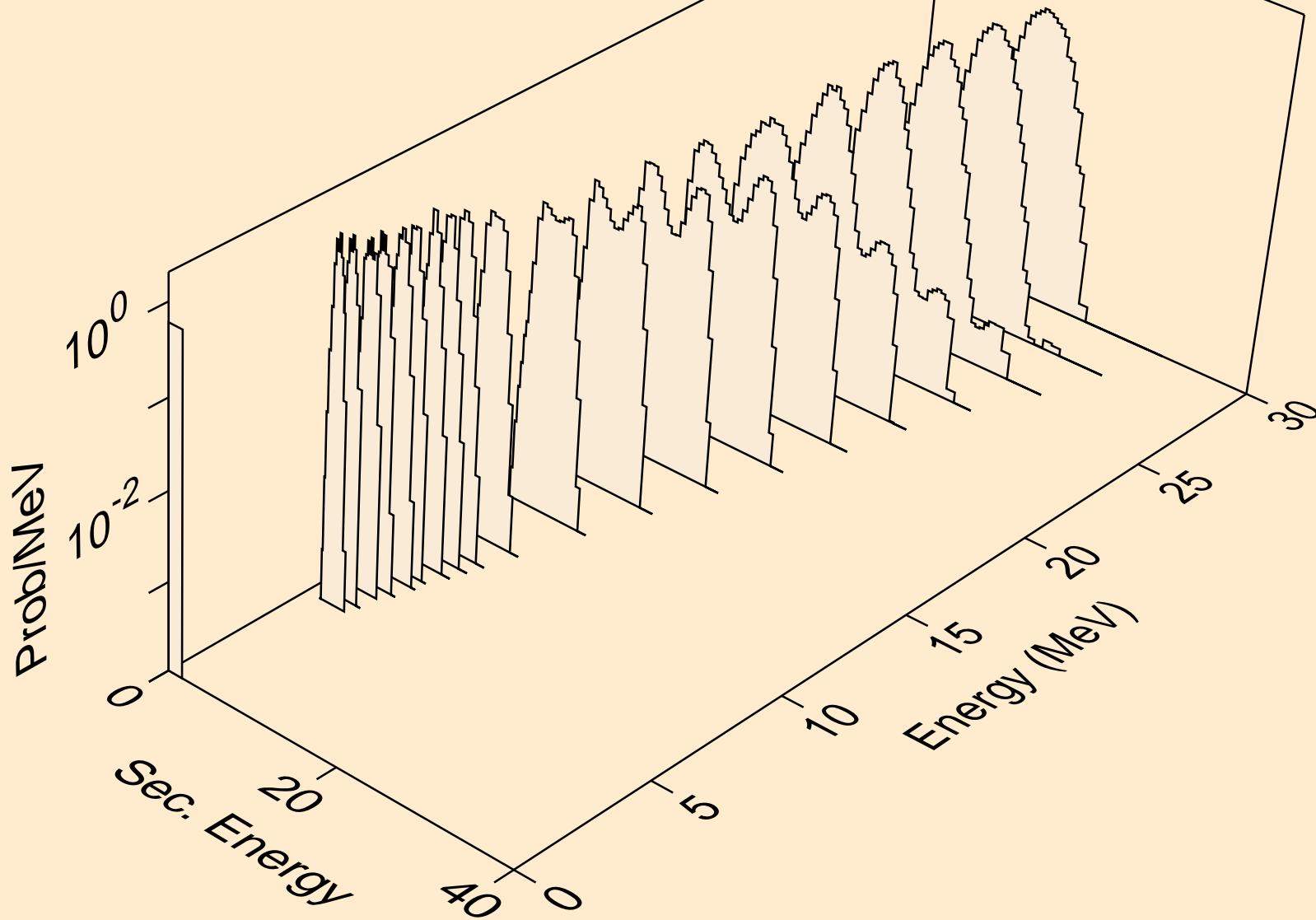

CF241 NEUTRON ACER TENDL-2019 LIBRARY; T=293.16K  
protons from (n,p)

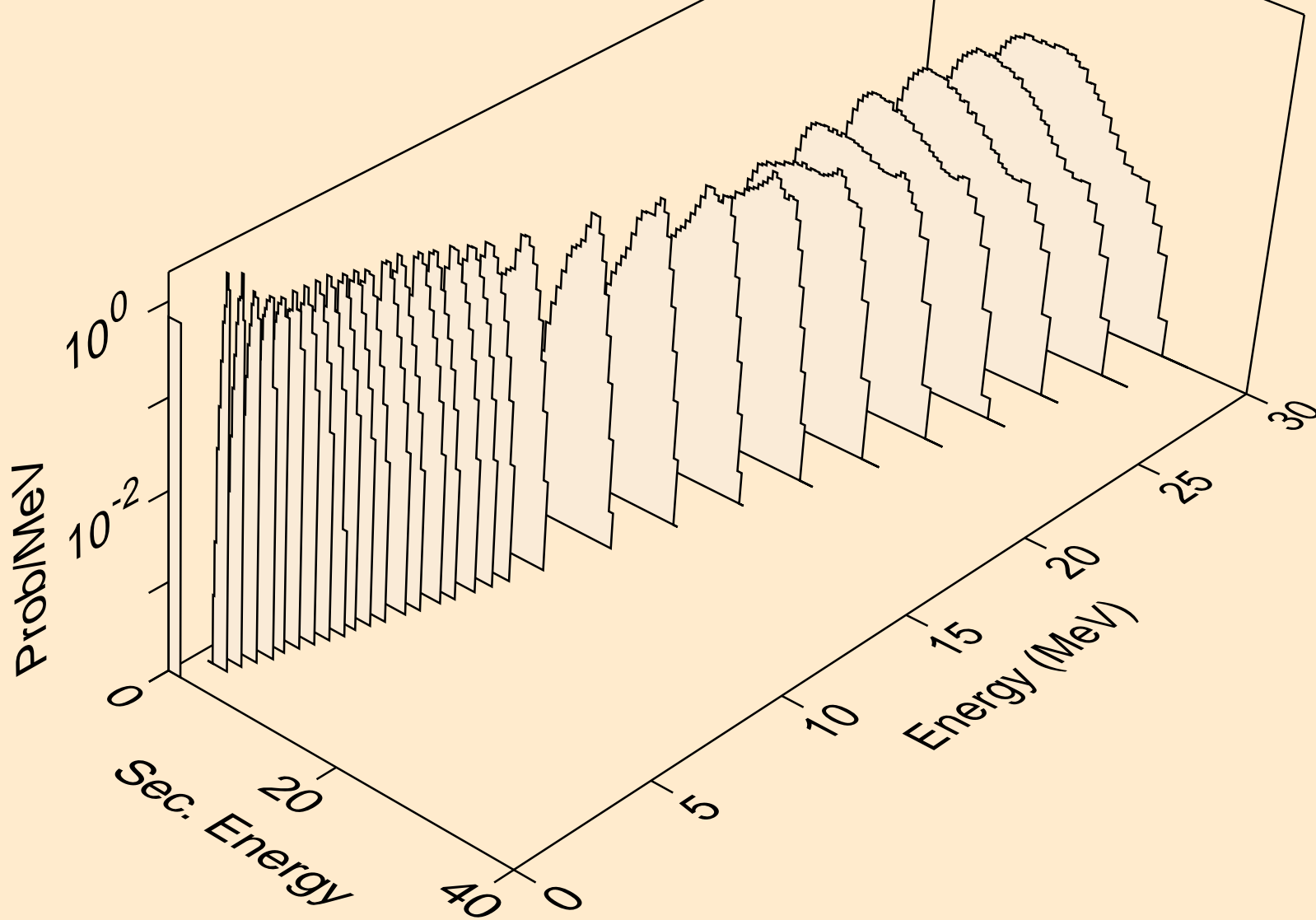

CF241 NEUTRON ACER TENDL-2019 LIBRARY; T=293.16K  
protons from (n,pd)

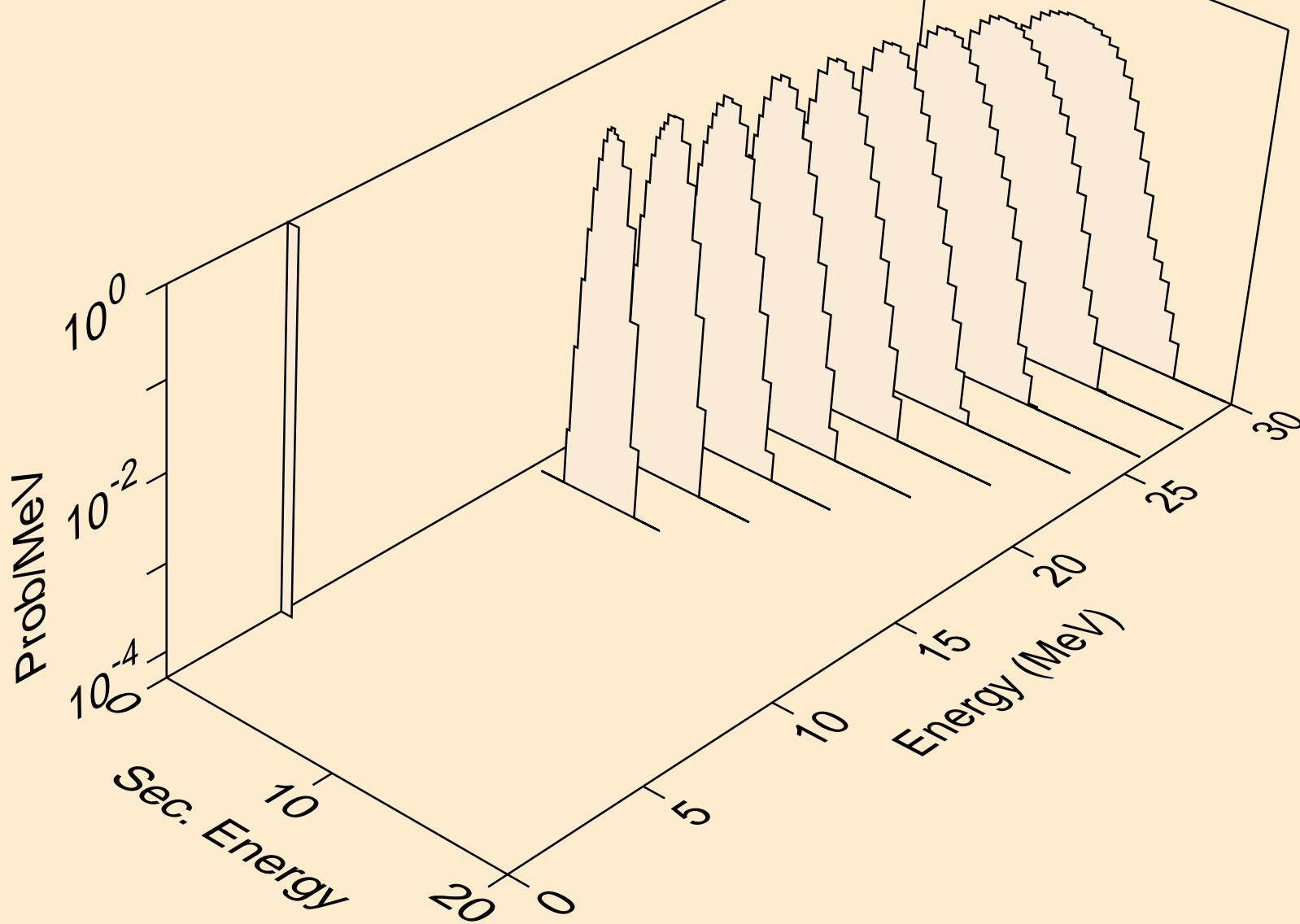

CF241 NEUTRON ACER TENDL-2019 LIBRARY; T=293.16K  
protons from (n,pt)

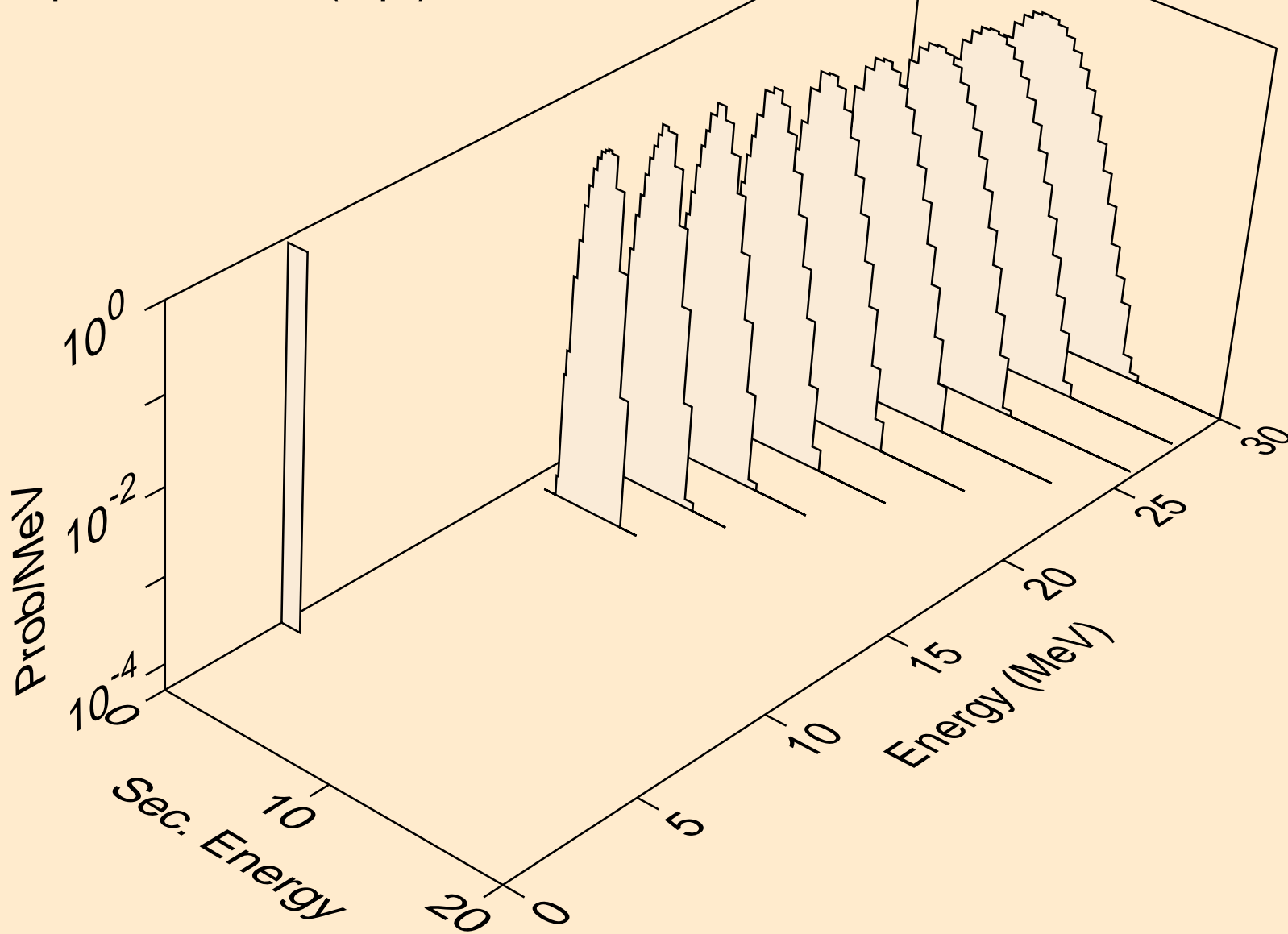

CF241 NEUTRON ACER TENDL-2019 LIBRARY; T=293.16K  
deuterons from (n,x)

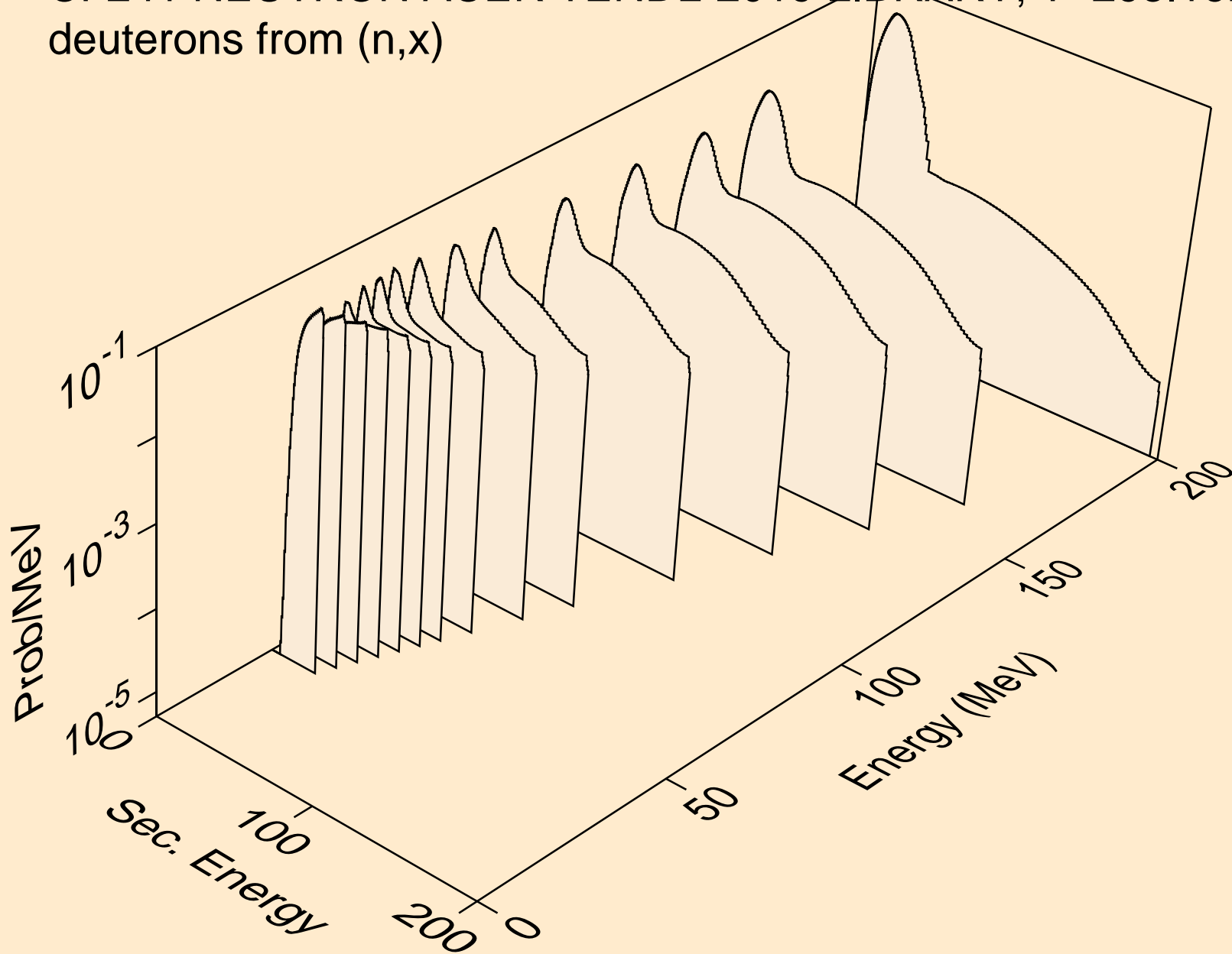

CF241 NEUTRON ACER TENDL-2019 LIBRARY; T=293.16K  
deuterons from (n,2nd)

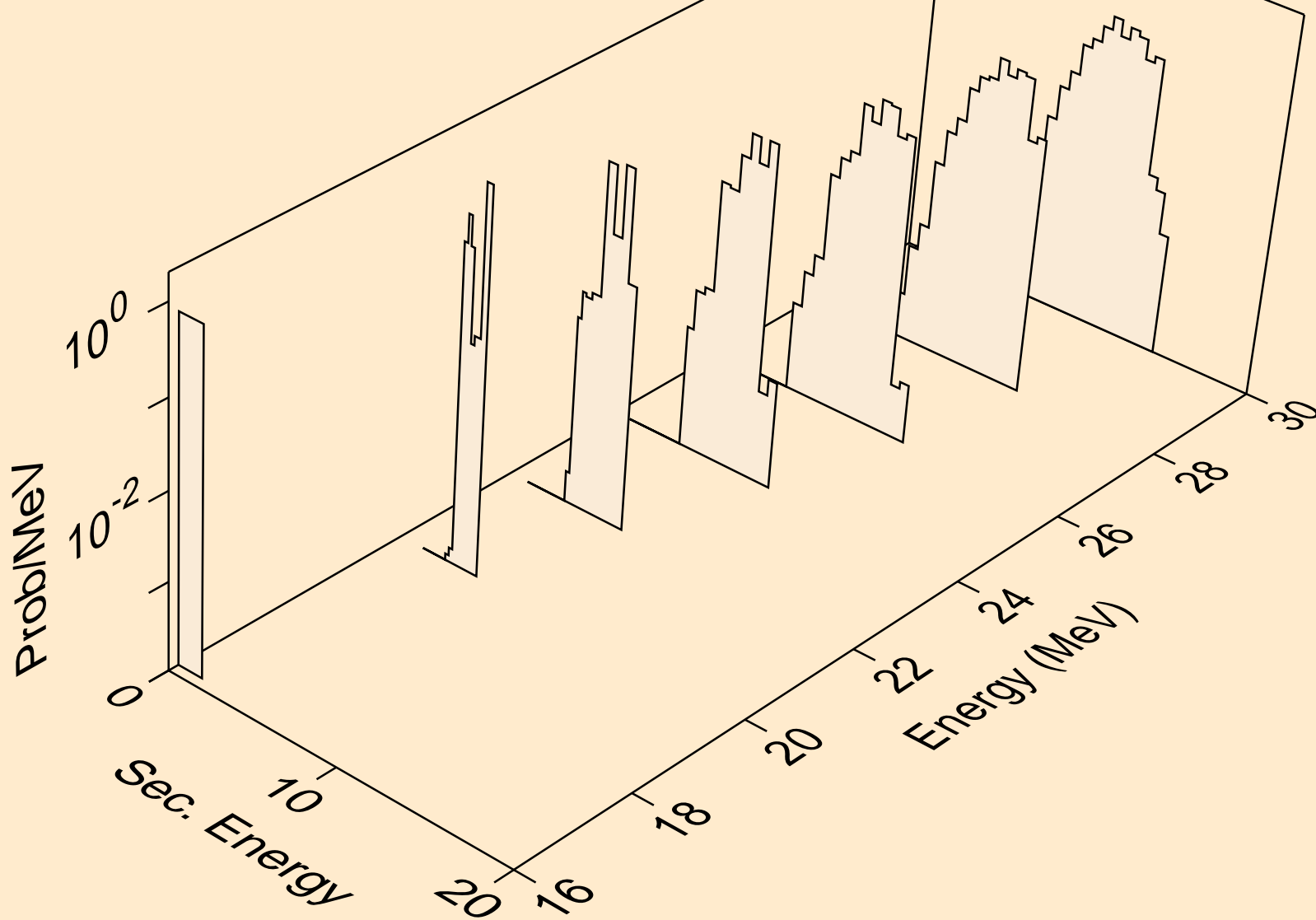



CF241 NEUTRON ACER TENDL-2019 LIBRARY; T=293.16K  
deuterons from (n,n\*)d

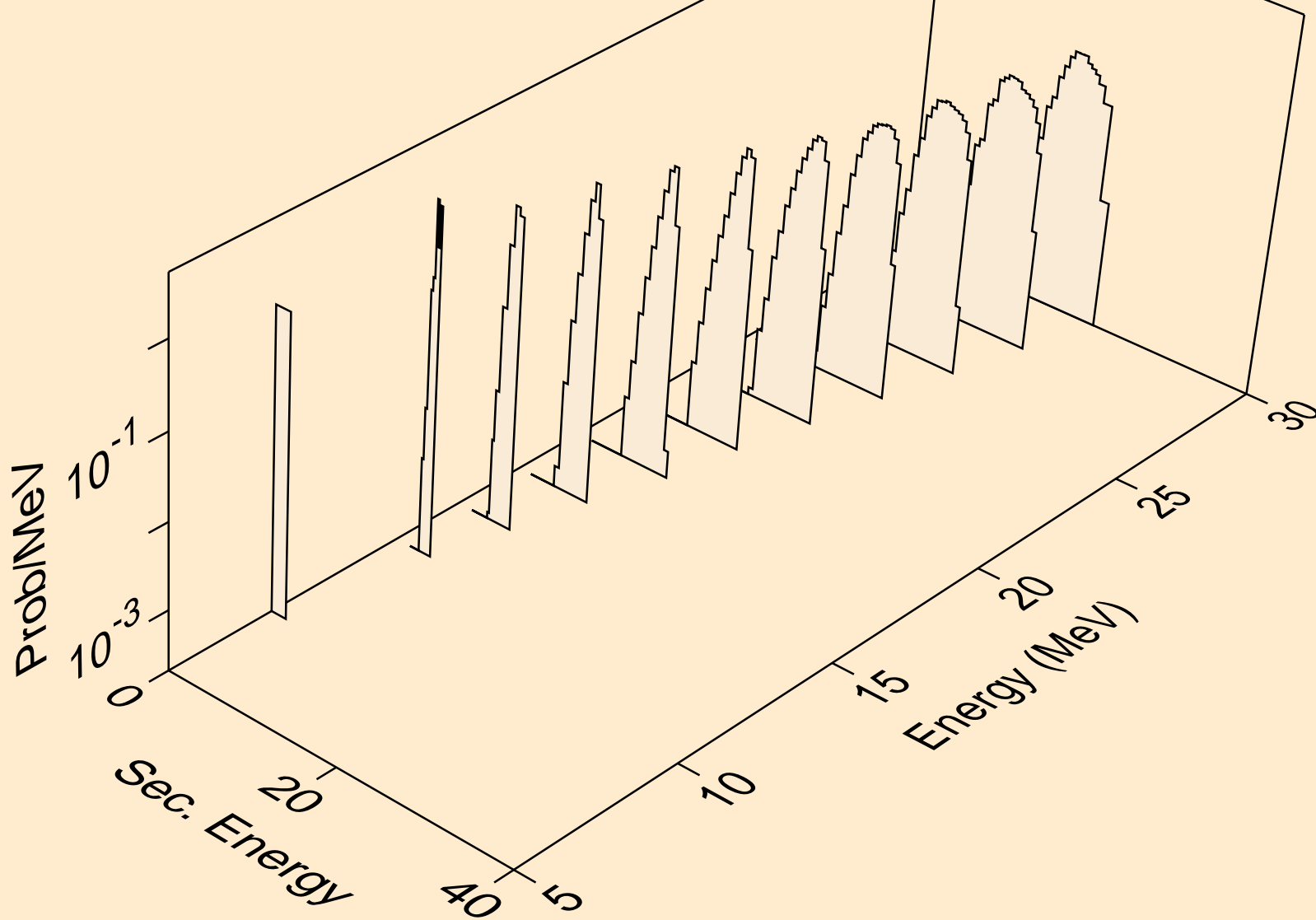

CF241 NEUTRON ACER TENDL-2019 LIBRARY; T=293.16K  
deuterons from (n,d)

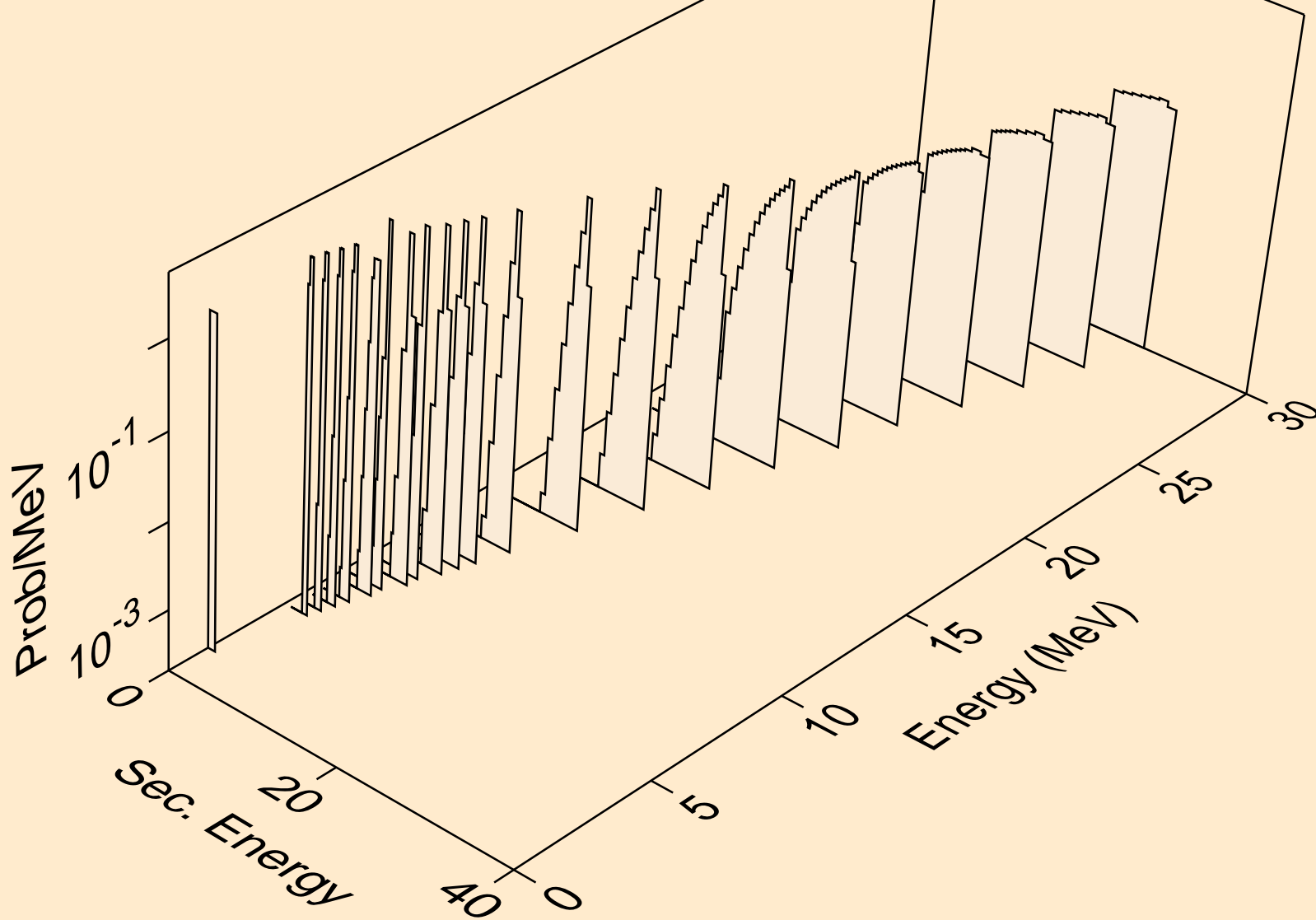

CF241 NEUTRON ACER TENDL-2019 LIBRARY; T=293.16K  
deuterons from (n,pd)

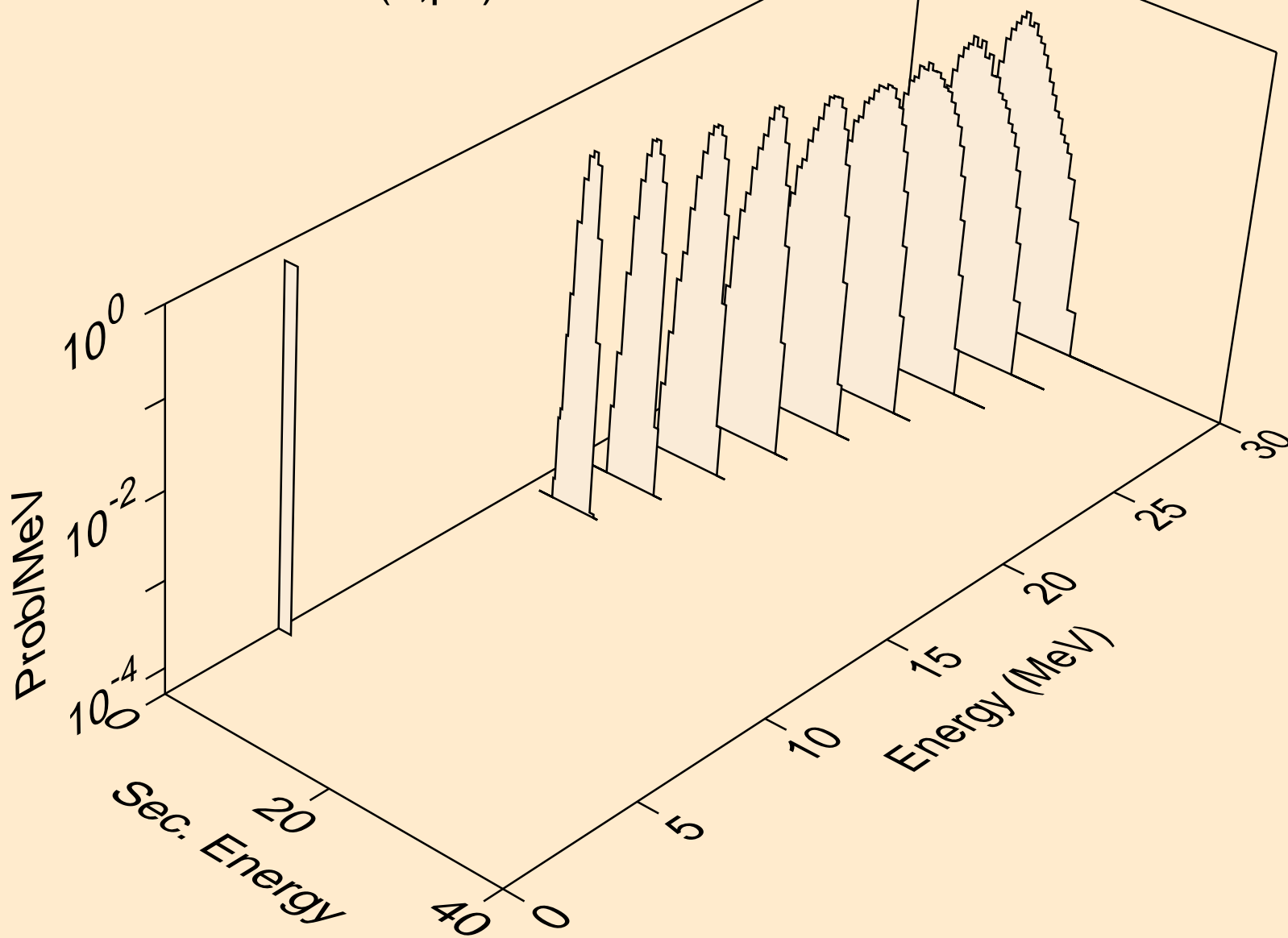

CF241 NEUTRON ACER TENDL-2019 LIBRARY; T=293.16K  
deuterons from (n,da)

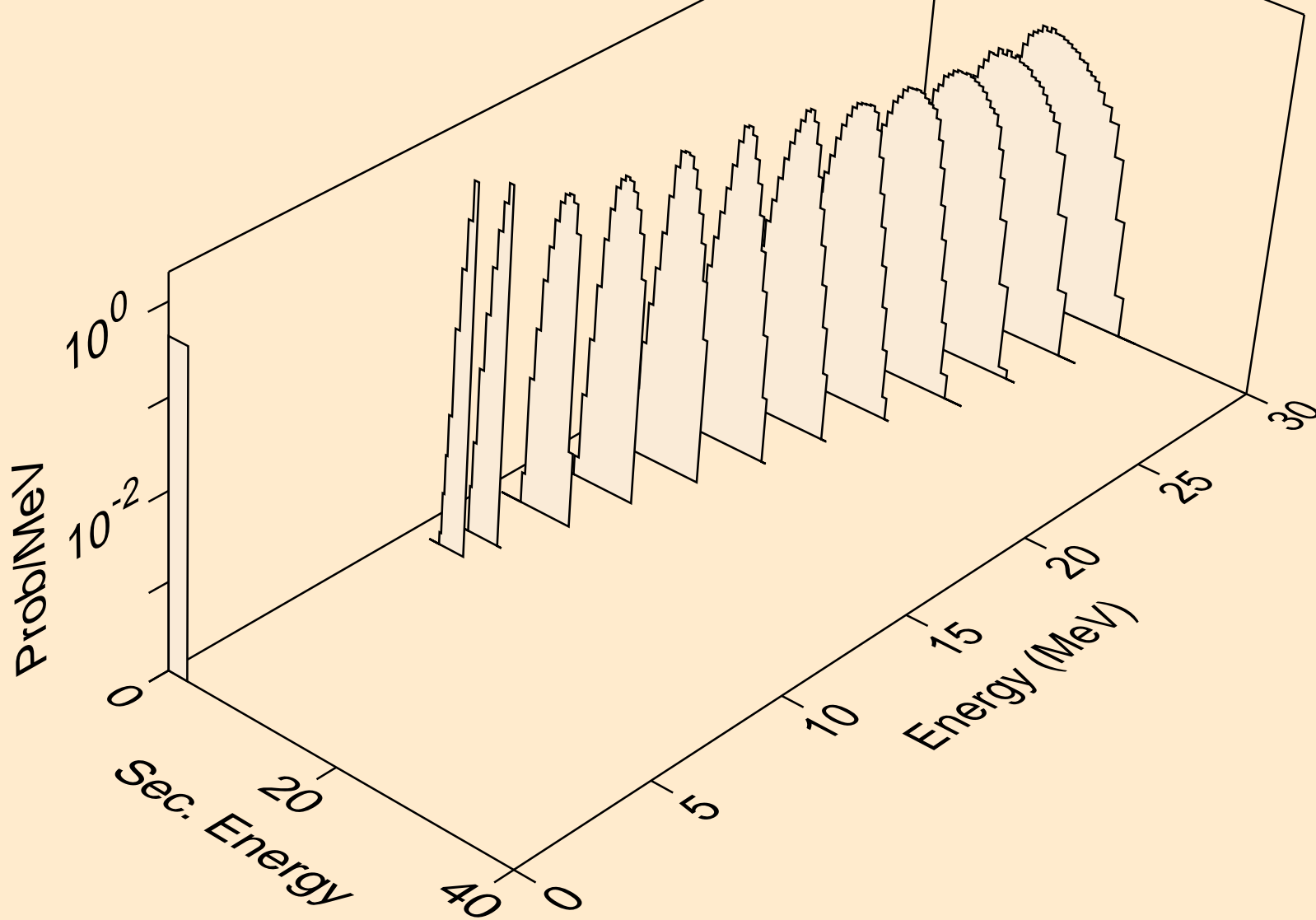

CF241 NEUTRON ACER TENDL-2019 LIBRARY; T=293.16K  
tritons from (n,x)

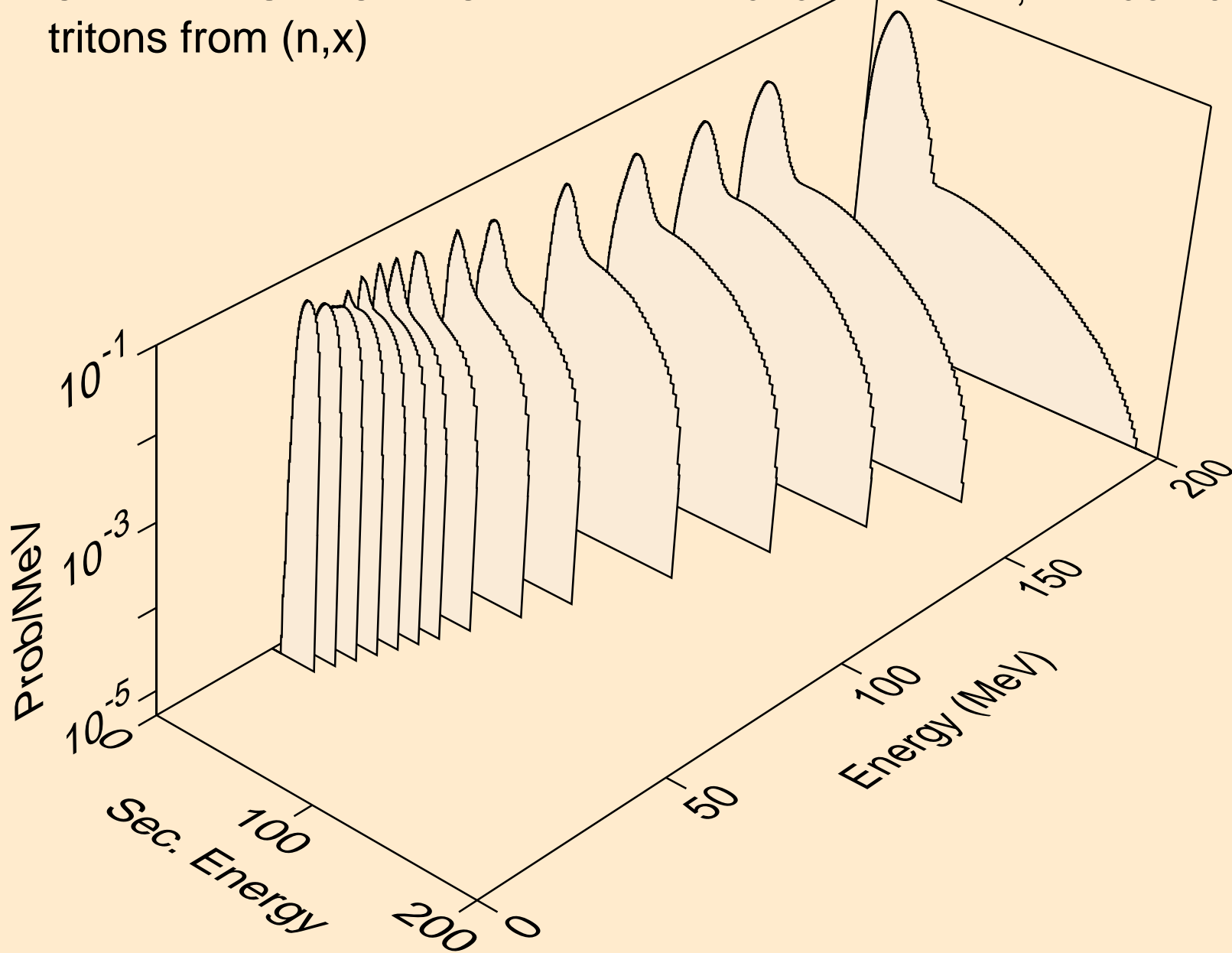

CF241 NEUTRON ACER TENDL-2019 LIBRARY; T=293.16K  
tritons from (n,n\*)t

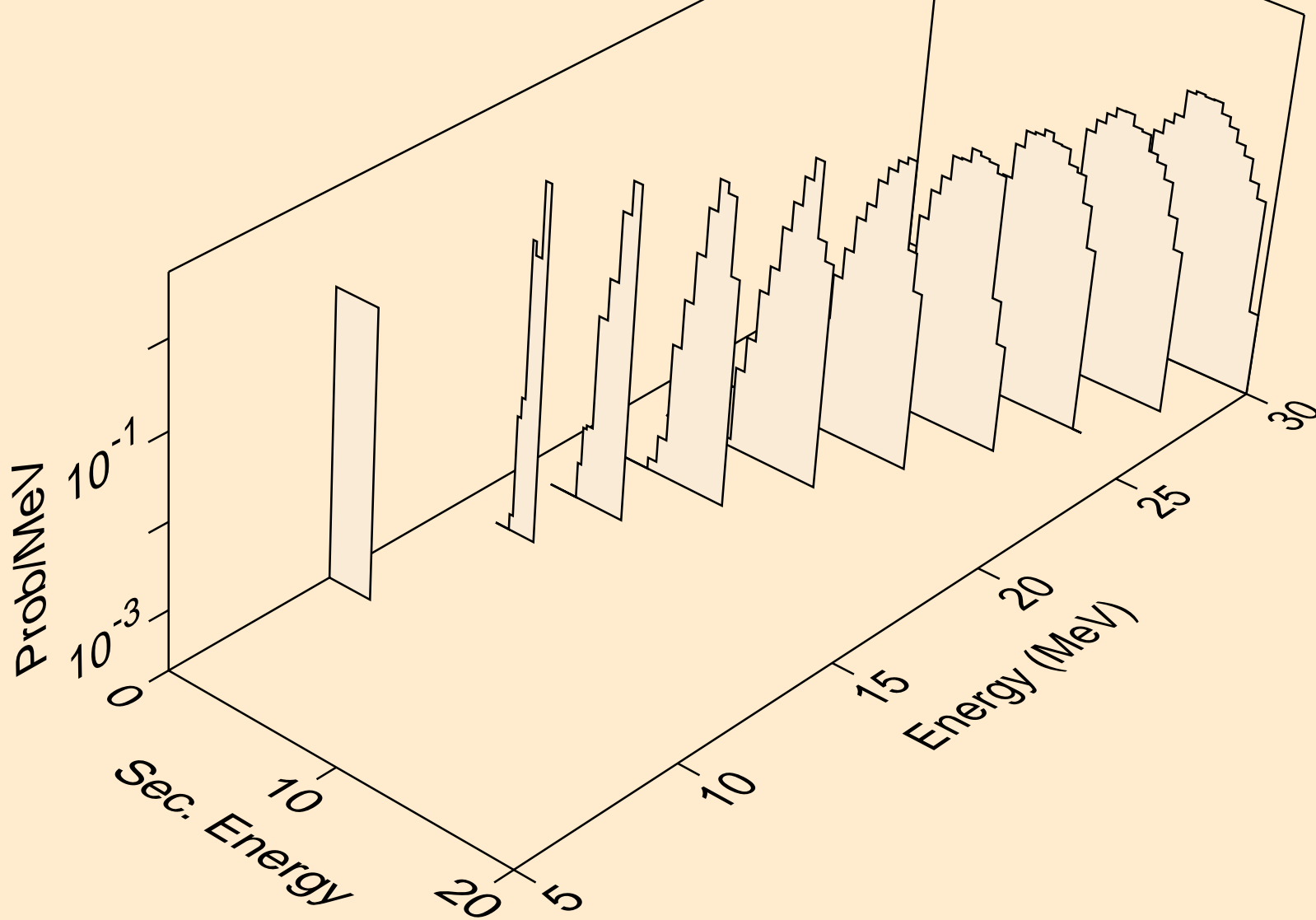

CF241 NEUTRON ACER TENDL-2019 LIBRARY; T=293.16K  
tritons from (n,t)

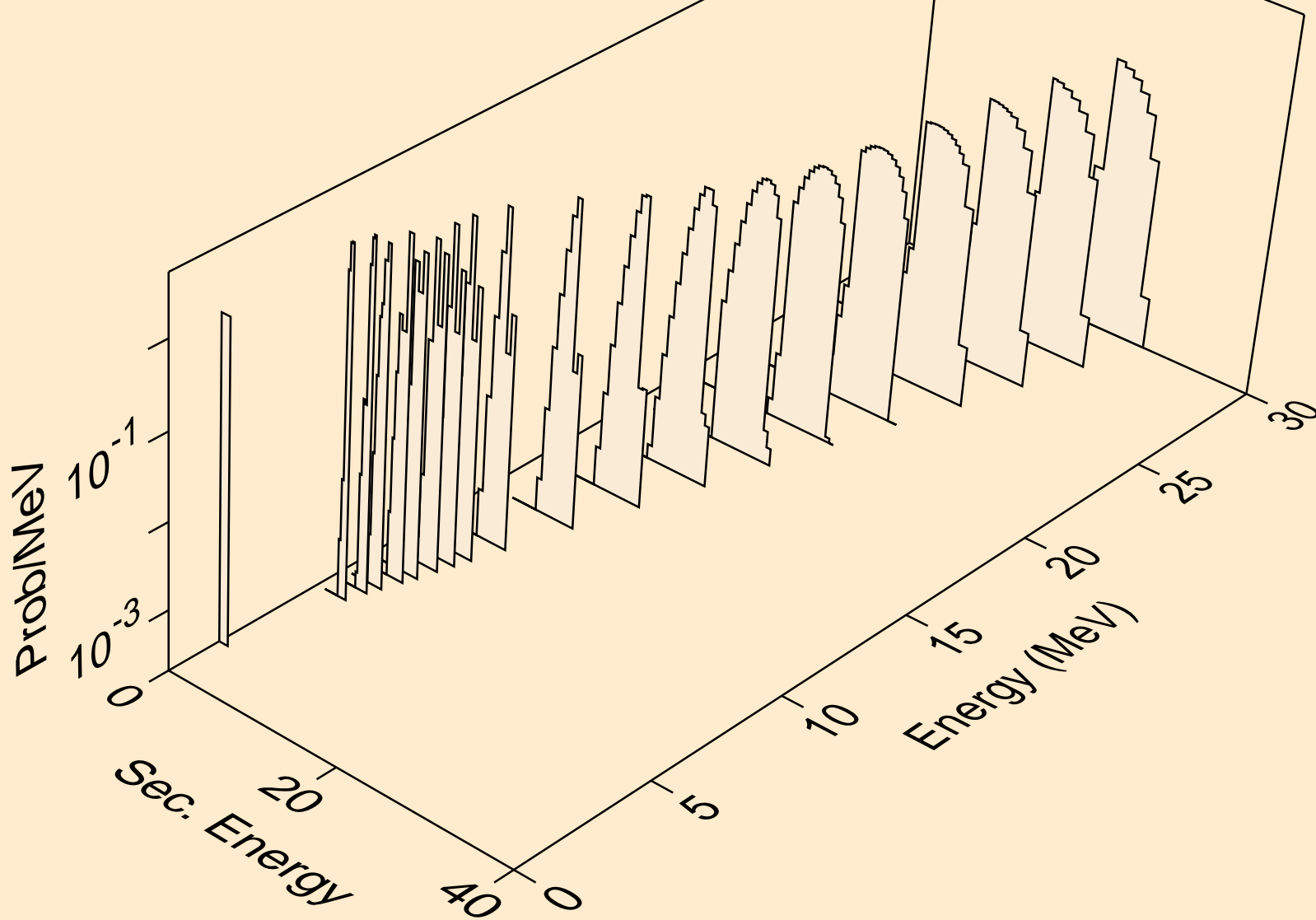

CF241 NEUTRON ACER TENDL-2019 LIBRARY; T=293.16K  
tritons from (n,pt)

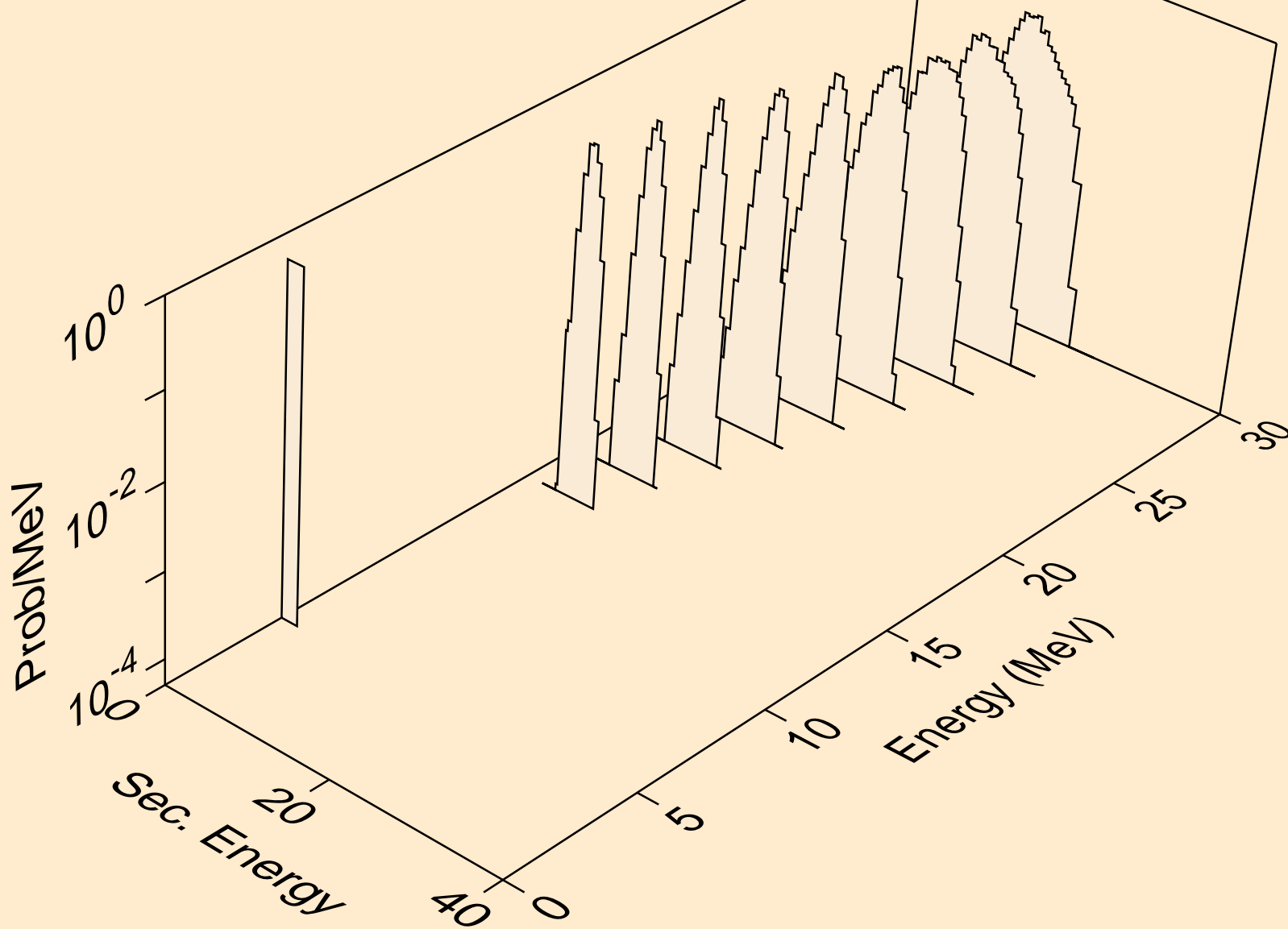



CF241 NEUTRON ACER TENDL-2019 LIBRARY; T=293.16K  
he3s from (n,x)

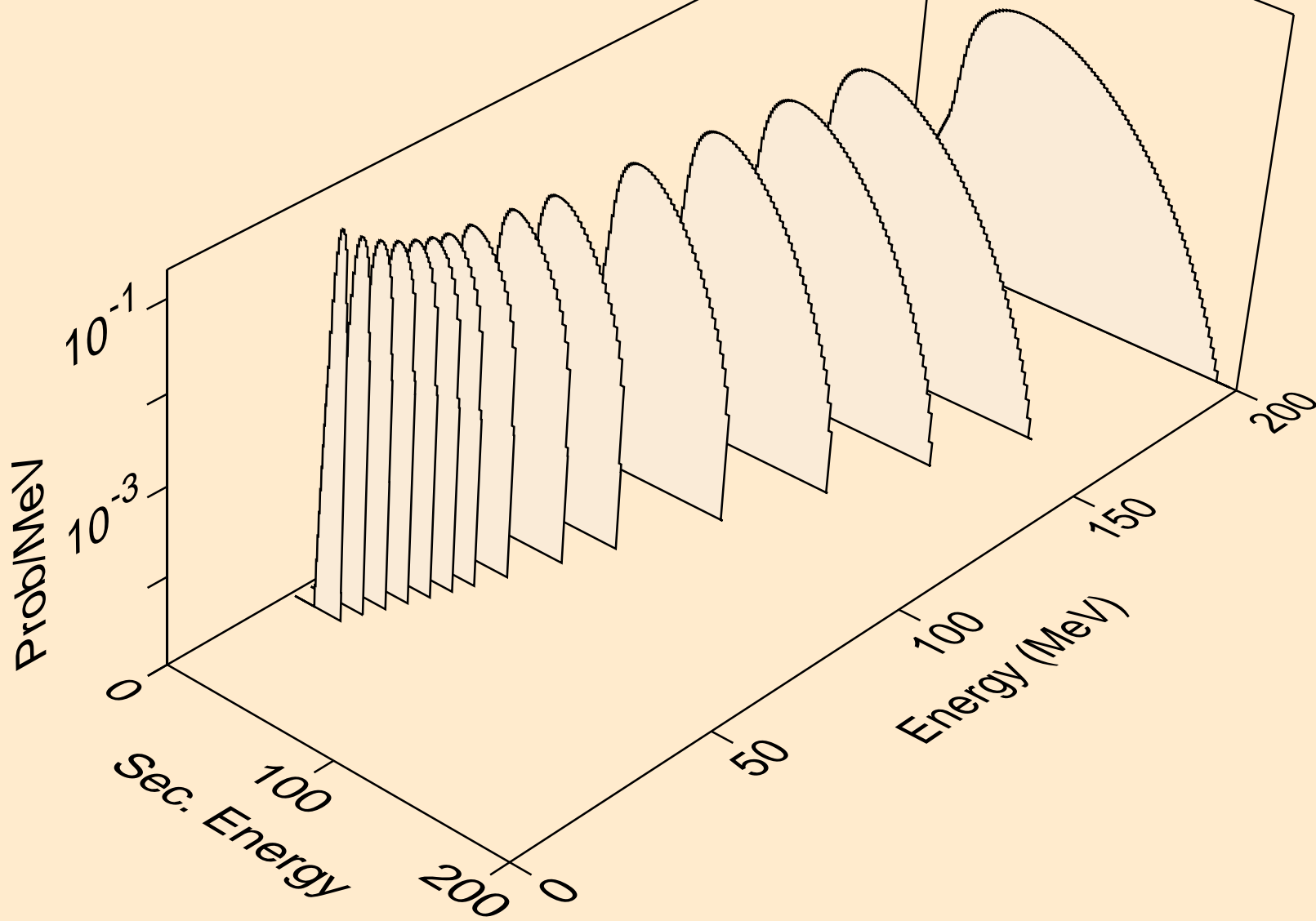

CF241 NEUTRON ACER TENDL-2019 LIBRARY; T=293.16K  
he3s from (n,n\*)he3

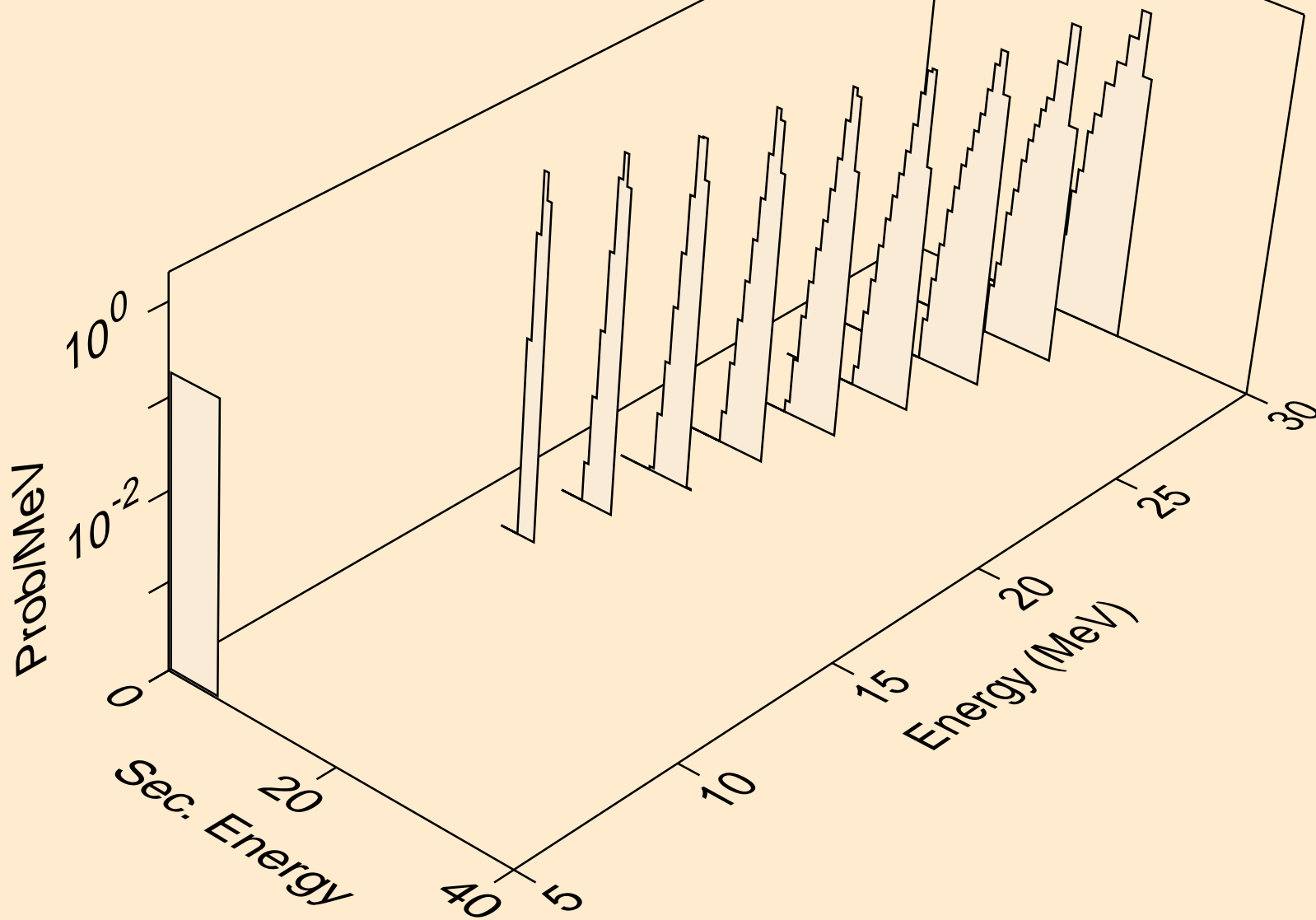

CF241 NEUTRON ACER TENDL-2019 LIBRARY; T=293.16K  
he3s from (n,he3)

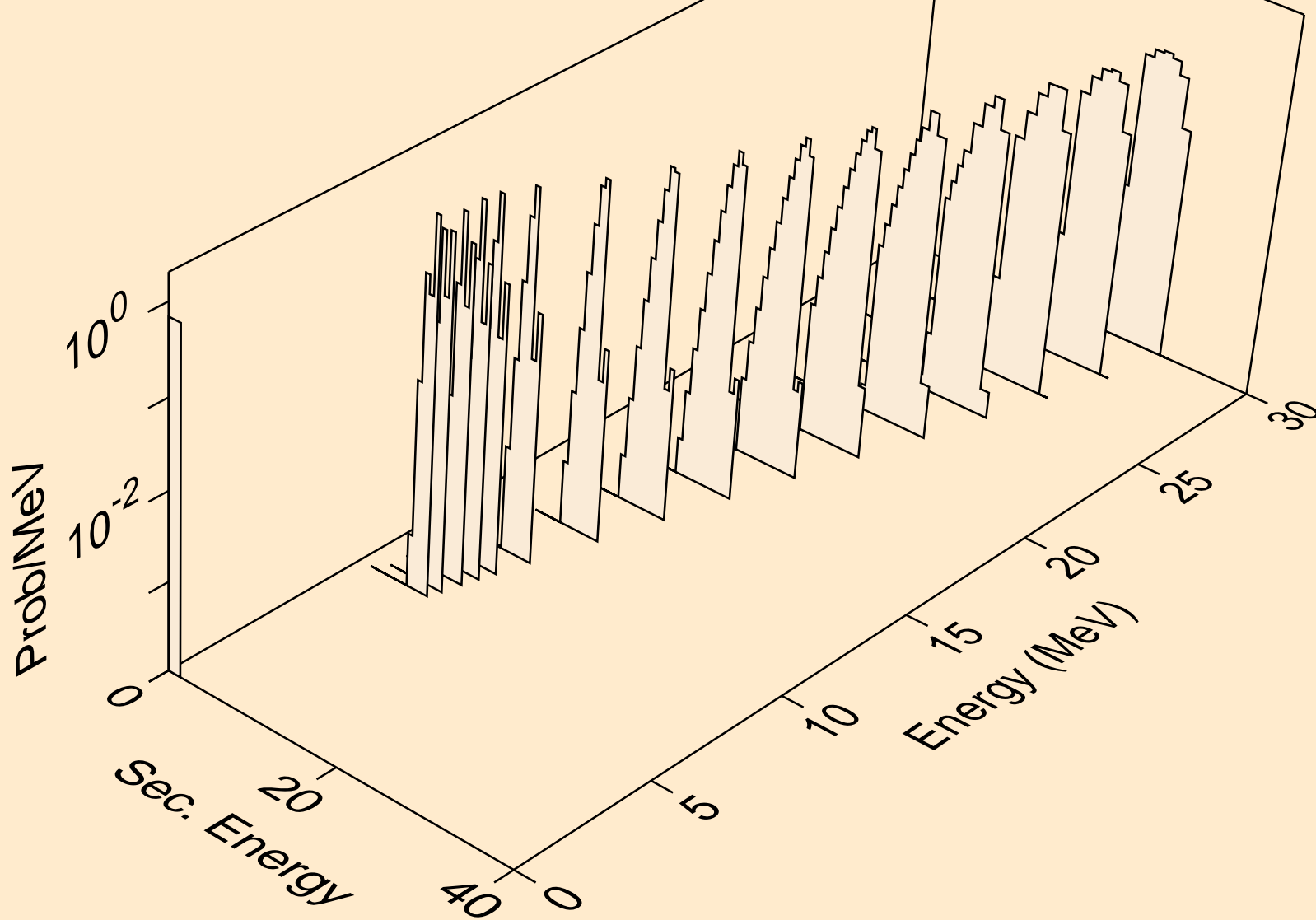

CF241 NEUTRON ACER TENDL-2019 LIBRARY; T=293.16K  
alphas from (n,x)

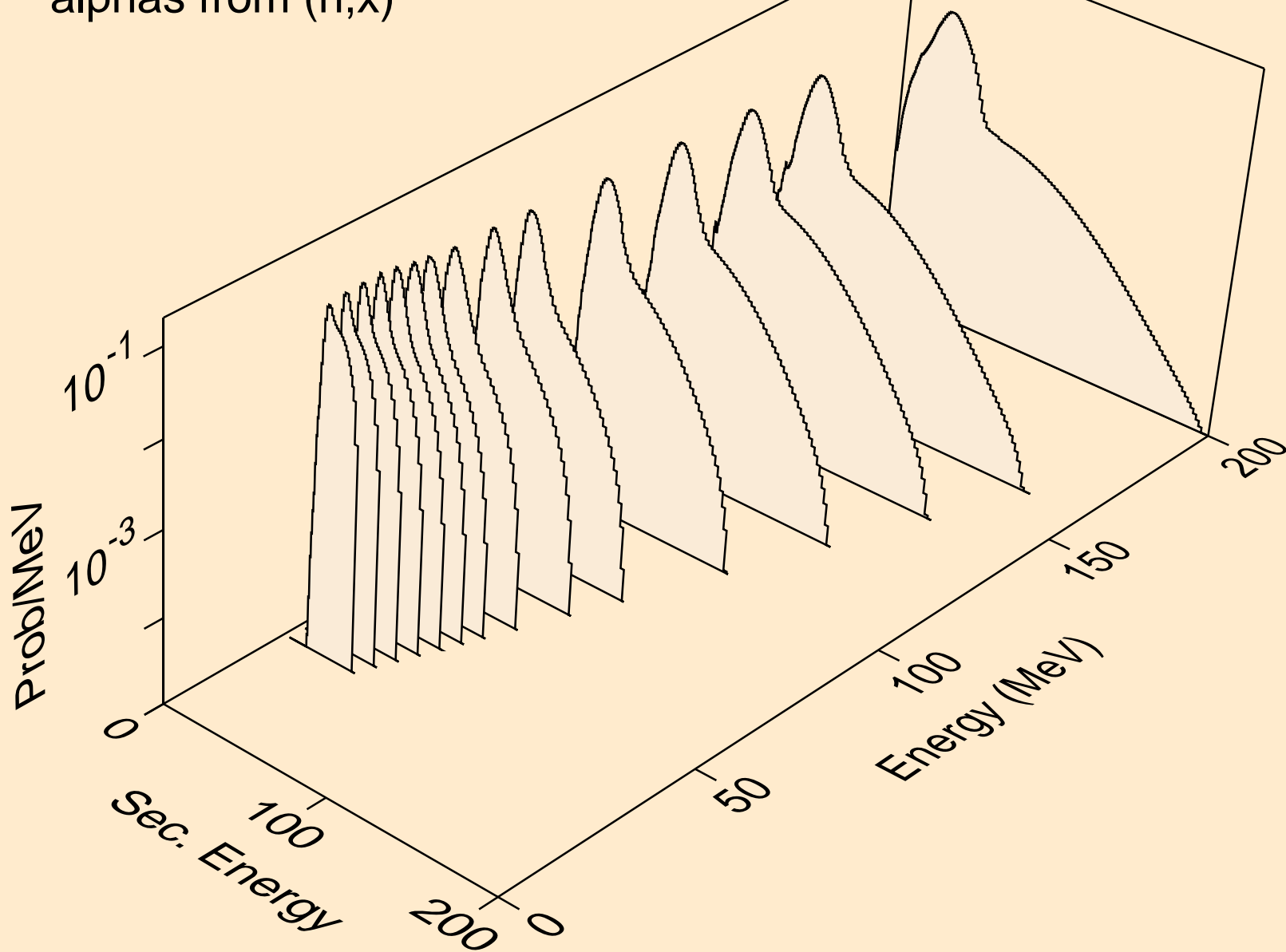

CF241 NEUTRON ACER TENDL-2019 LIBRARY; T=293.16K  
alphas from (n,n\*)a

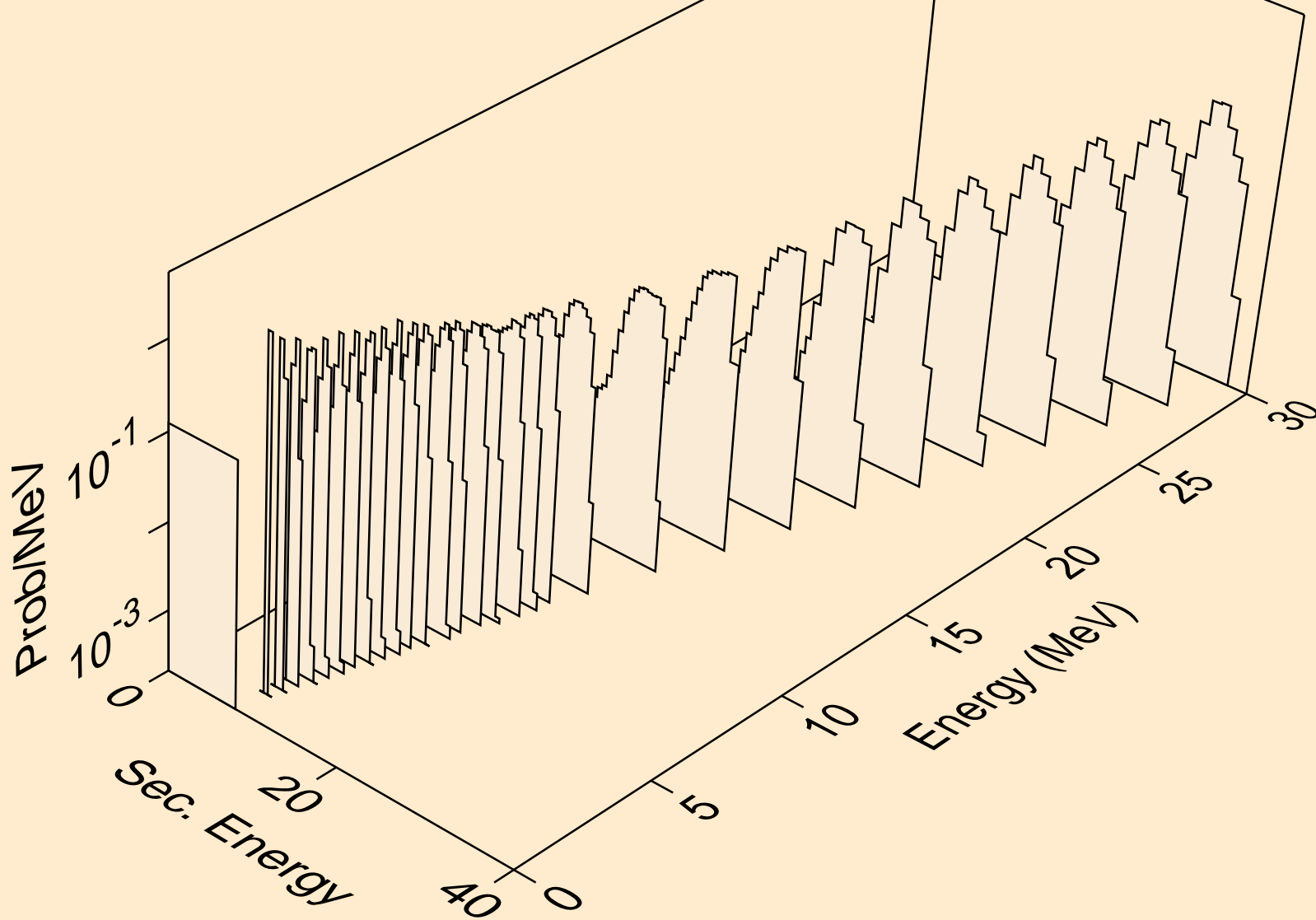

CF241 NEUTRON ACER TENDL-2019 LIBRARY; T=293.16K  
alphas from (n,2n)a

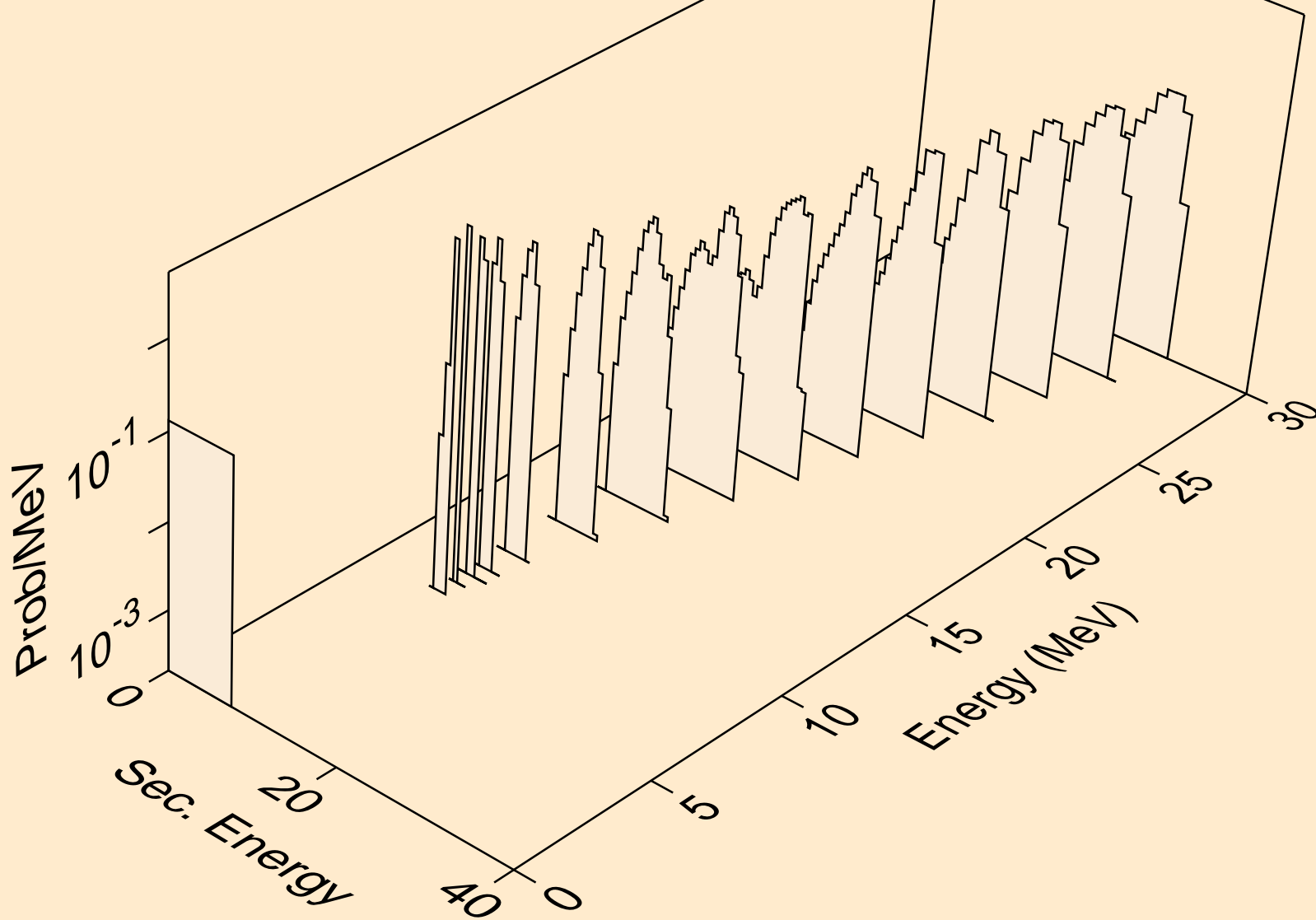

CF241 NEUTRON ACER TENDL-2019 LIBRARY; T=293.16K  
alphas from (n,3n)a

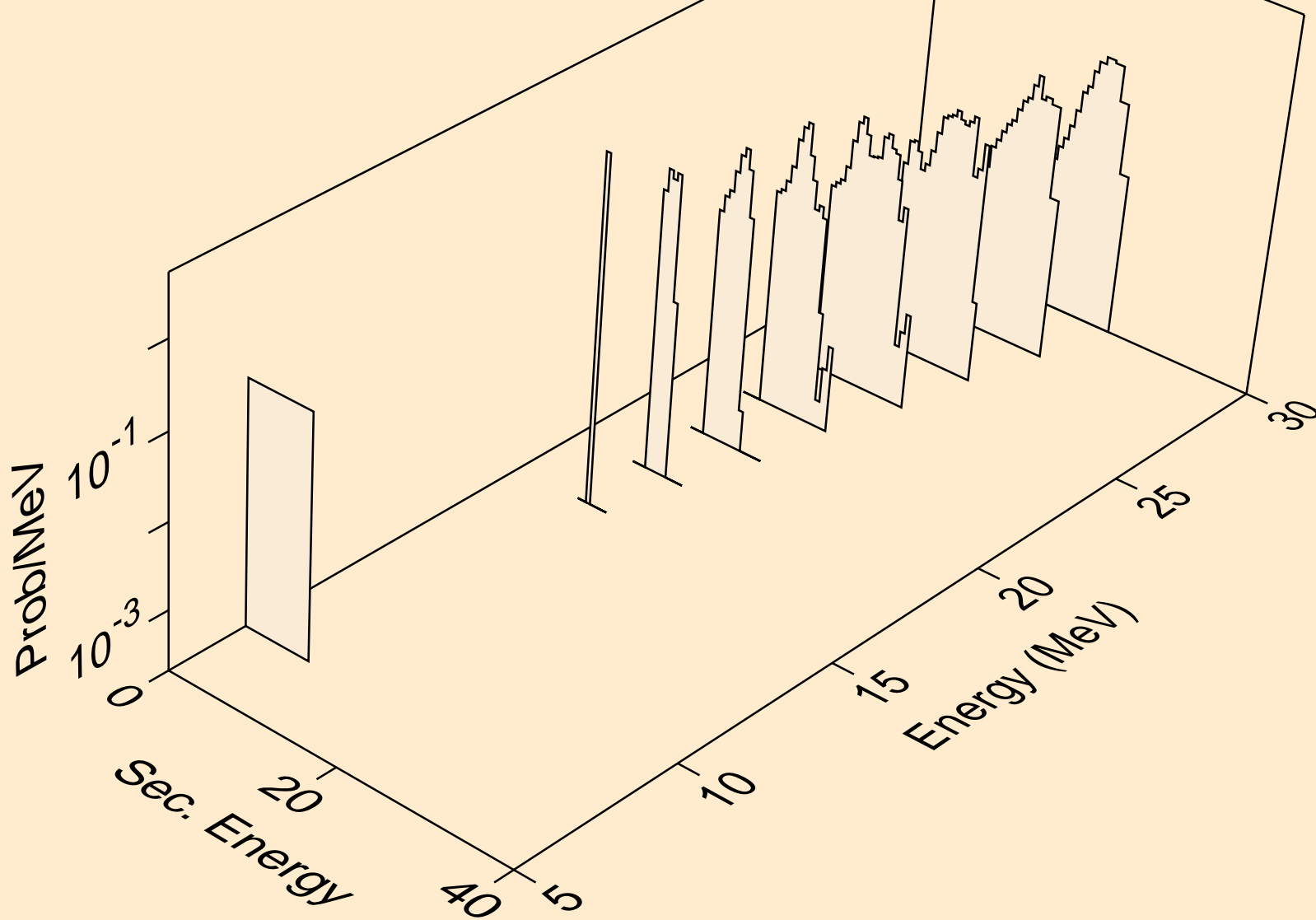

CF241 NEUTRON ACER TENDL-2019 LIBRARY; T=293.16K  
alphas from (n,npa)

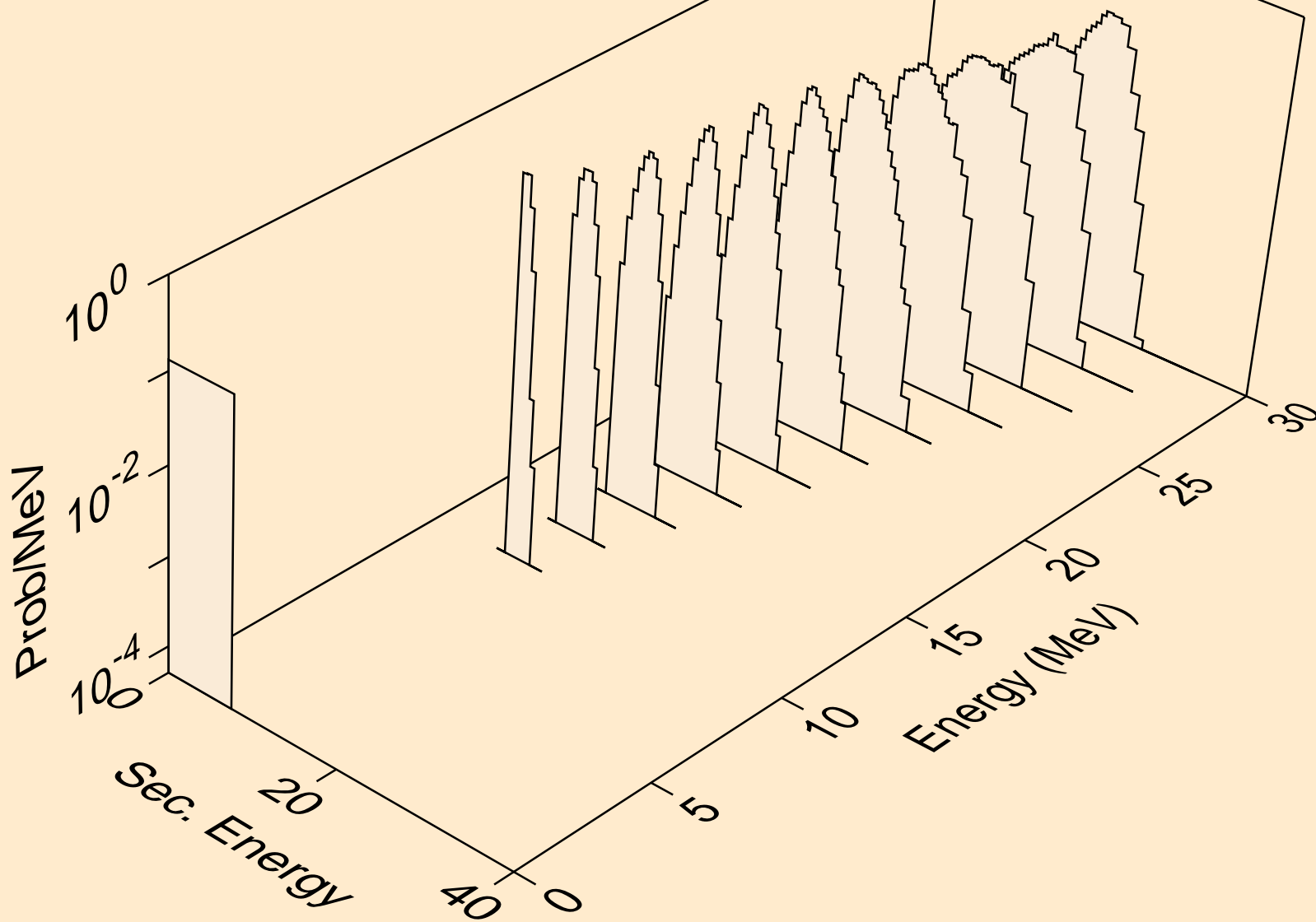



CF241 NEUTRON ACER TENDL-2019 LIBRARY; T=293.16K  
alphas from (n,a)

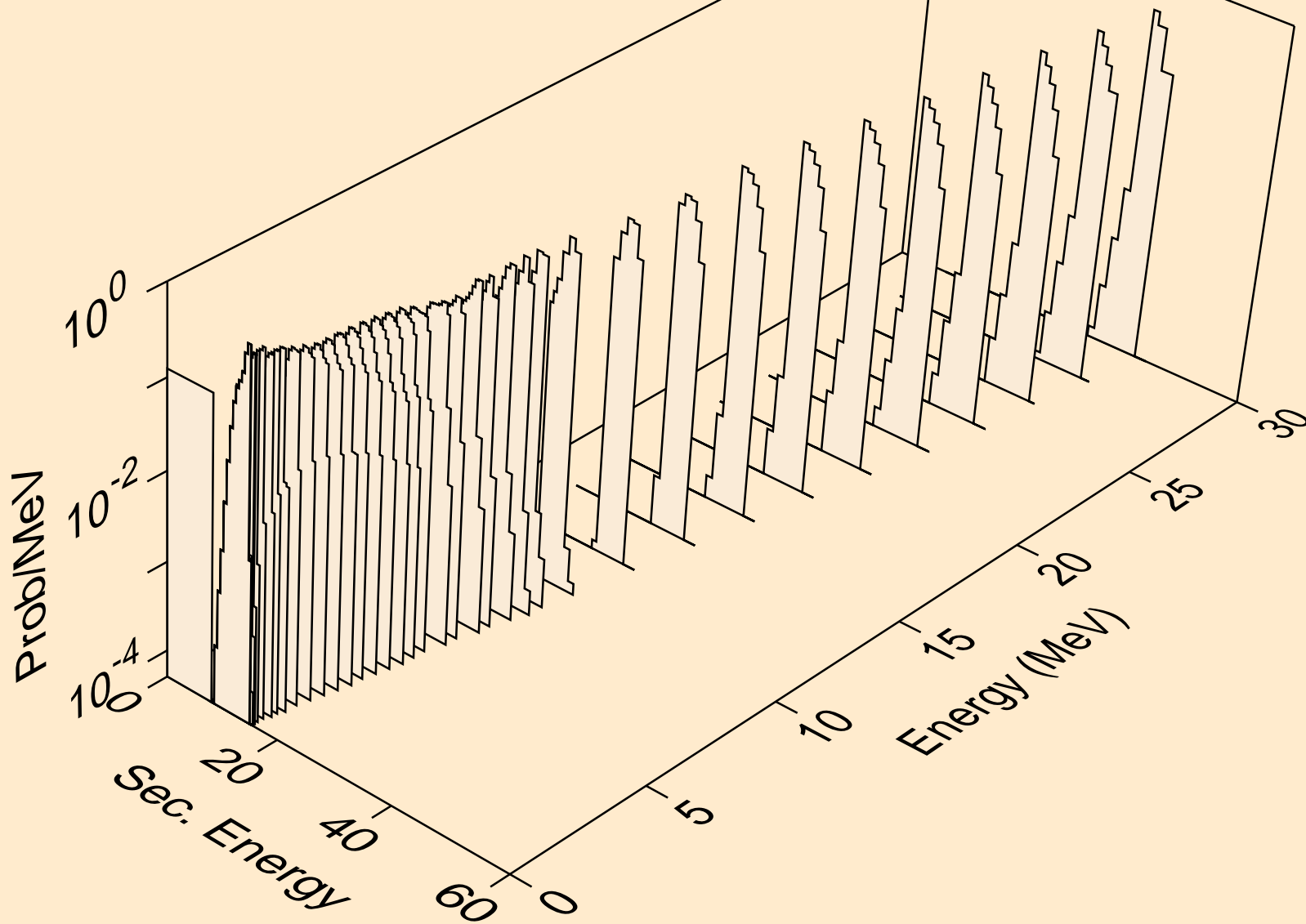

CF241 NEUTRON ACER TENDL-2019 LIBRARY; T=293.16K  
alphas from (n,pa)

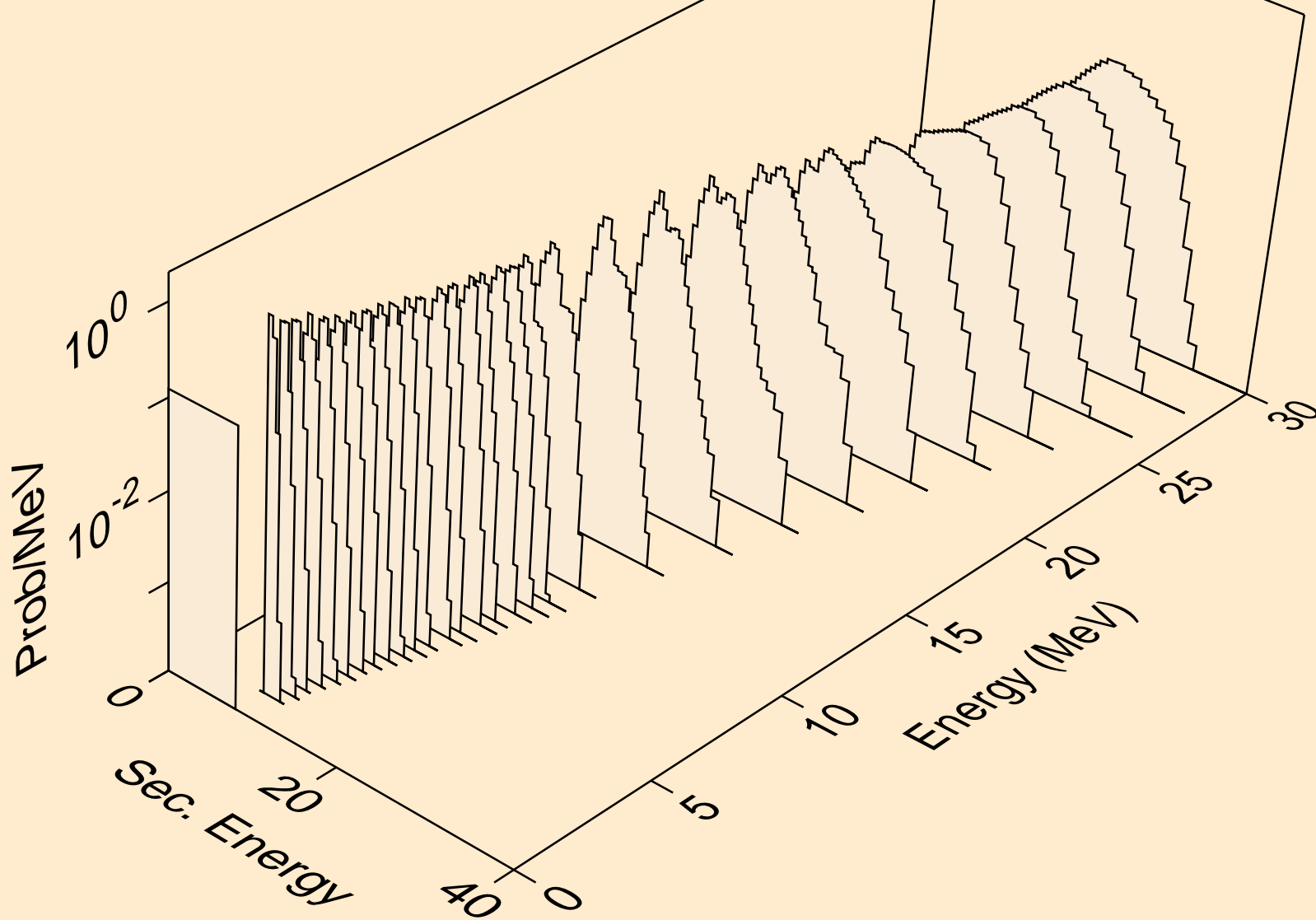

CF241 NEUTRON ACER TENDL-2019 LIBRARY; T=293.16K  
alphas from (n,da)

