

CF255 NEUTRON ACER TENDL-2019 LIBRARY; T=293.16K

Principal cross sections

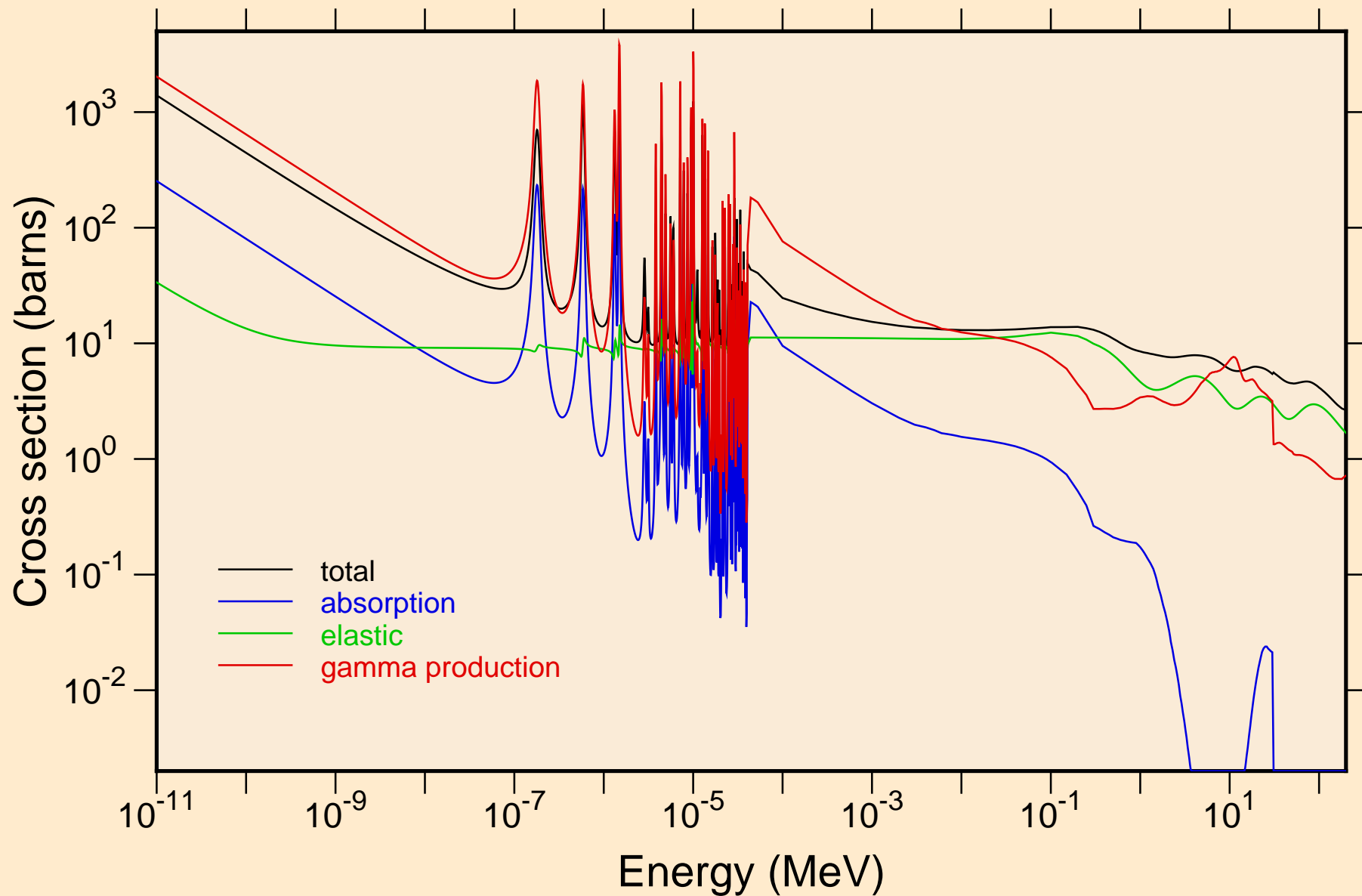

CF255 NEUTRON ACER TENDL-2019 LIBRARY; T=293.16K
resonance total cross section

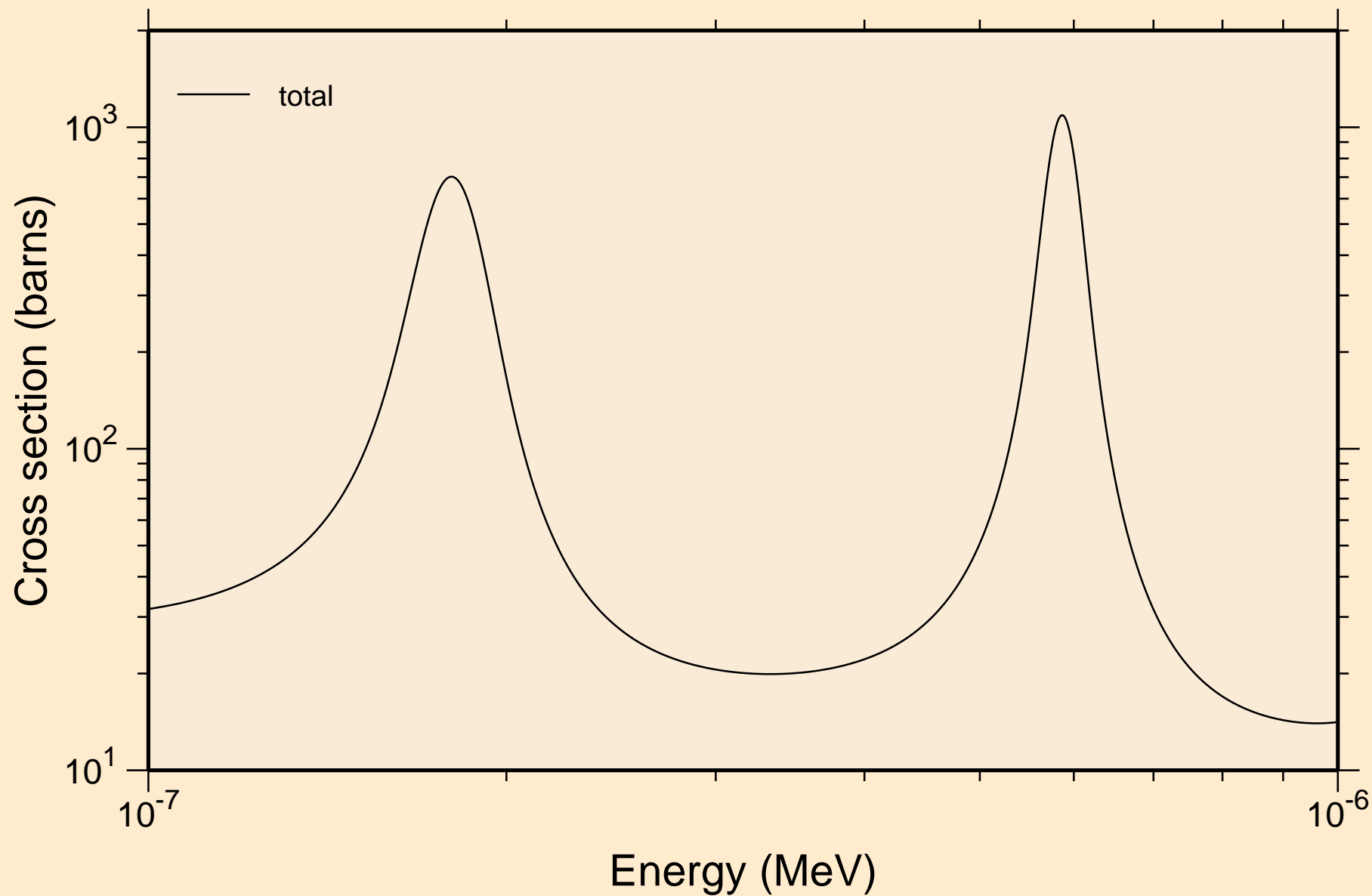

CF255 NEUTRON ACER TENDL-2019 LIBRARY; T=293.16K
resonance total cross section

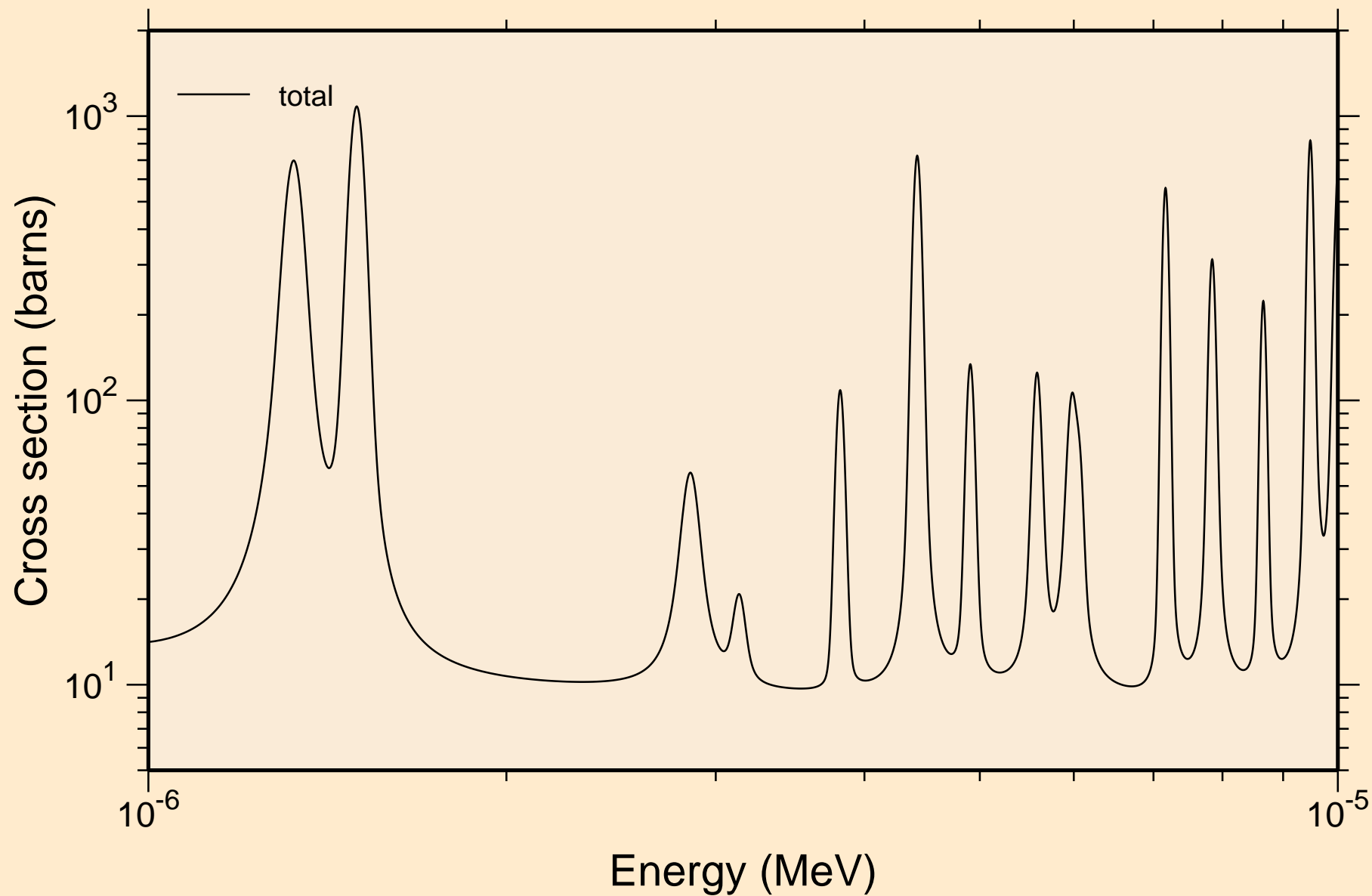

CF255 NEUTRON ACER TENDL-2019 LIBRARY; T=293.16K
resonance total cross section

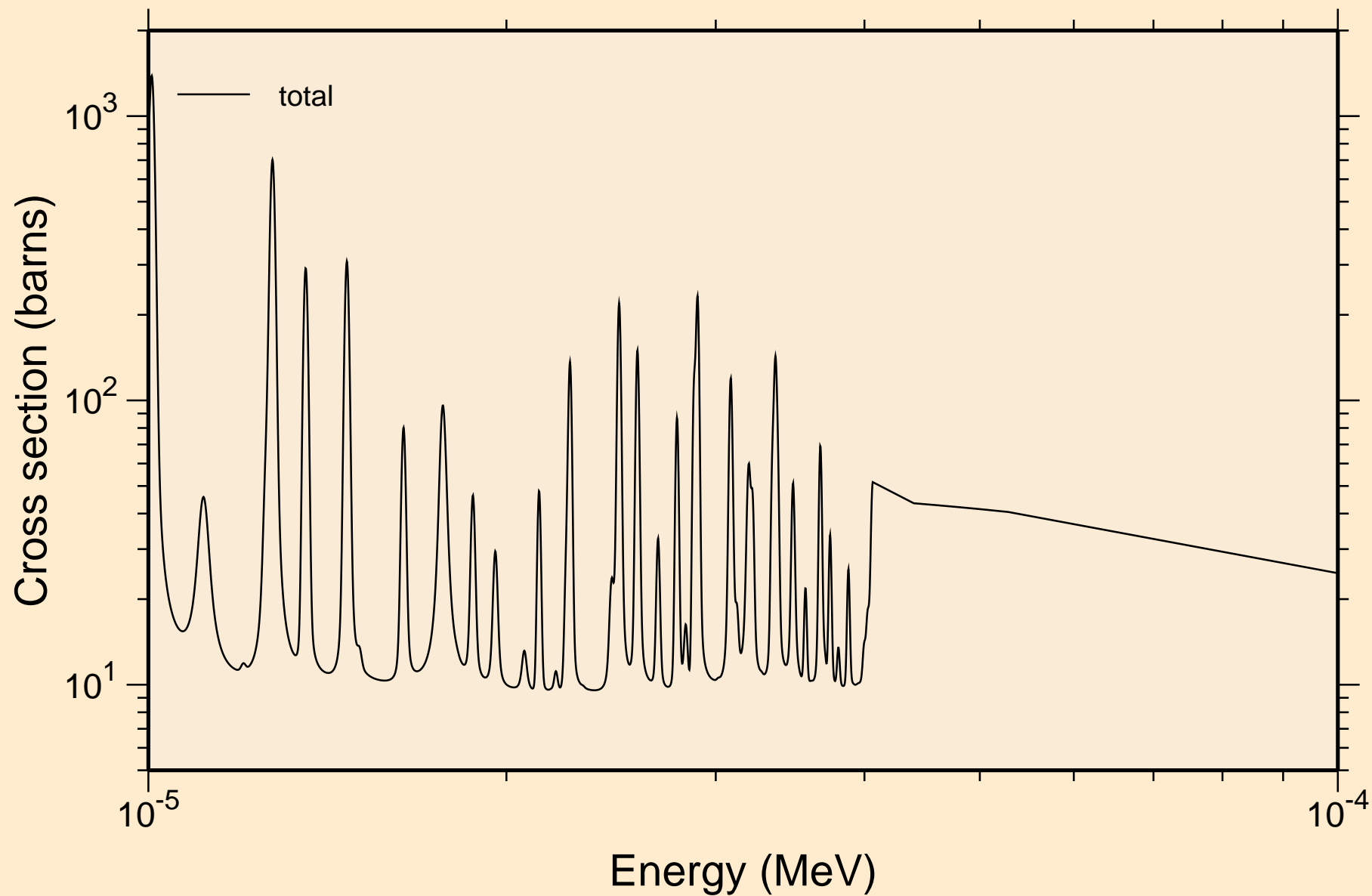

CF255 NEUTRON ACER TENDL-2019 LIBRARY; T=293.16K
resonance total cross section

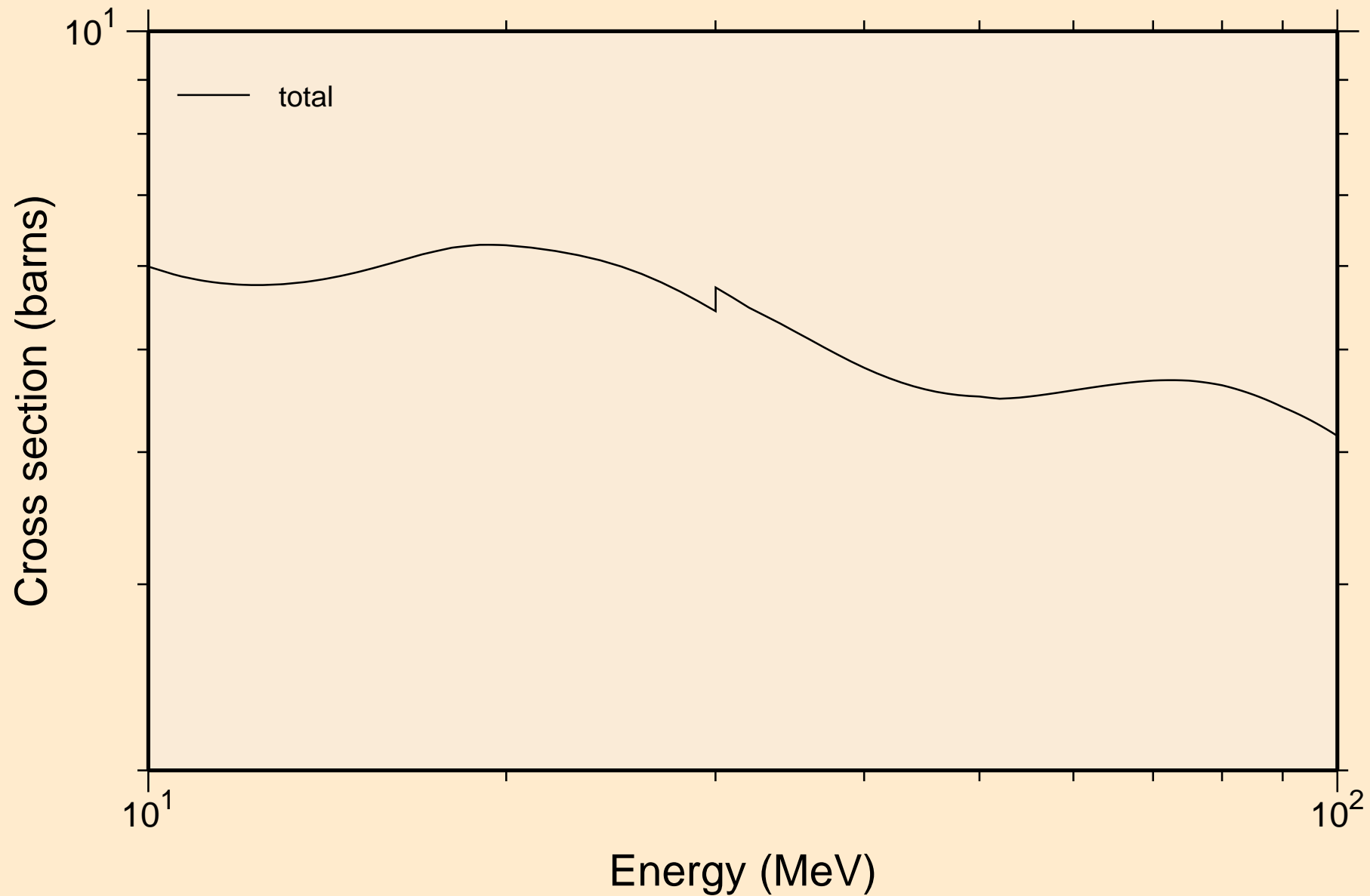

CF255 NEUTRON ACER TENDL-2019 LIBRARY; T=293.16K
resonance absorption cross sections

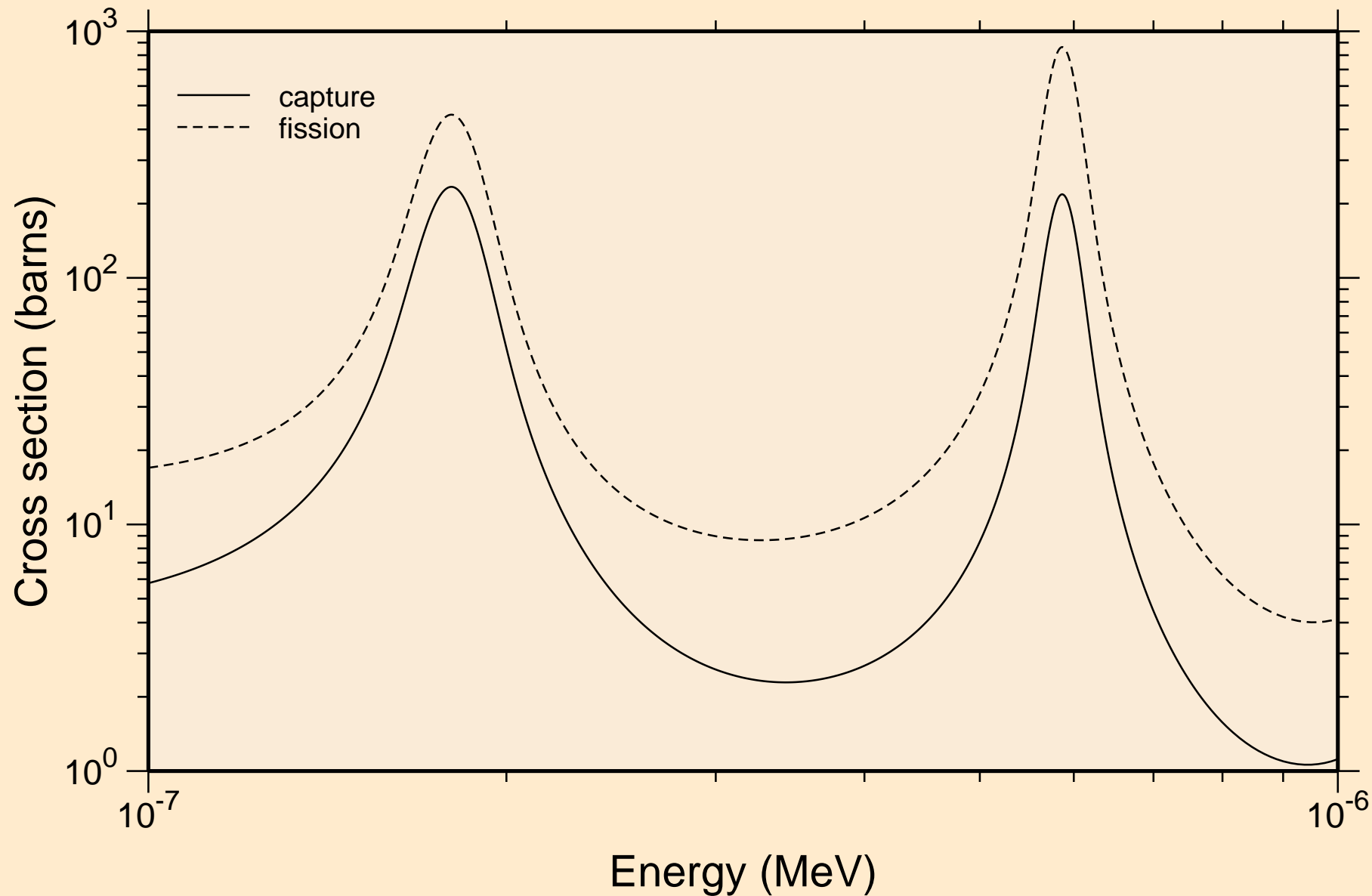

CF255 NEUTRON ACER TENDL-2019 LIBRARY; T=293.16K
resonance absorption cross sections

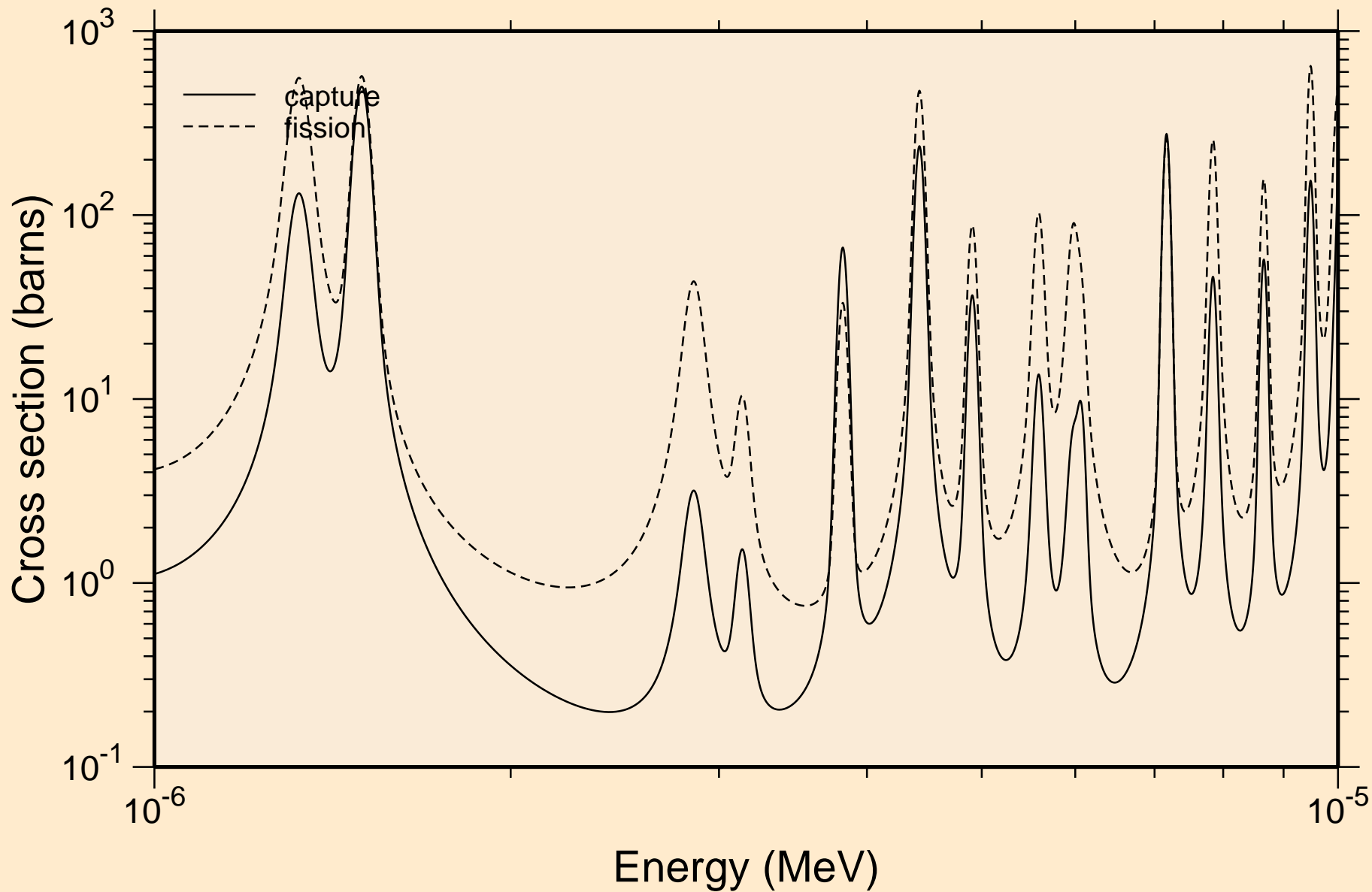

CF255 NEUTRON ACER TENDL-2019 LIBRARY; T=293.16K
resonance absorption cross sections

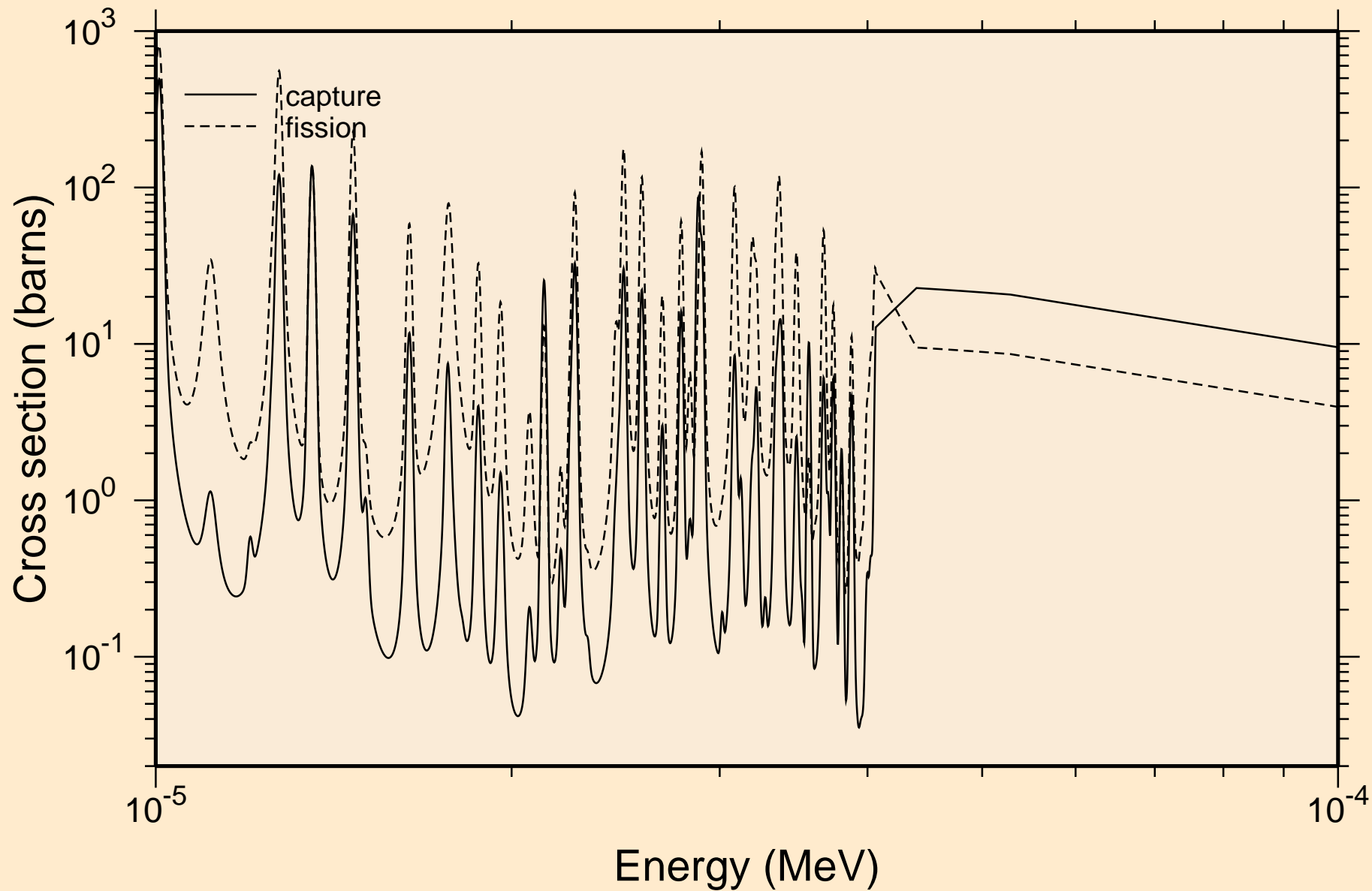

CF255 NEUTRON ACER TENDL-2019 LIBRARY; T=293.16K
resonance absorption cross sections

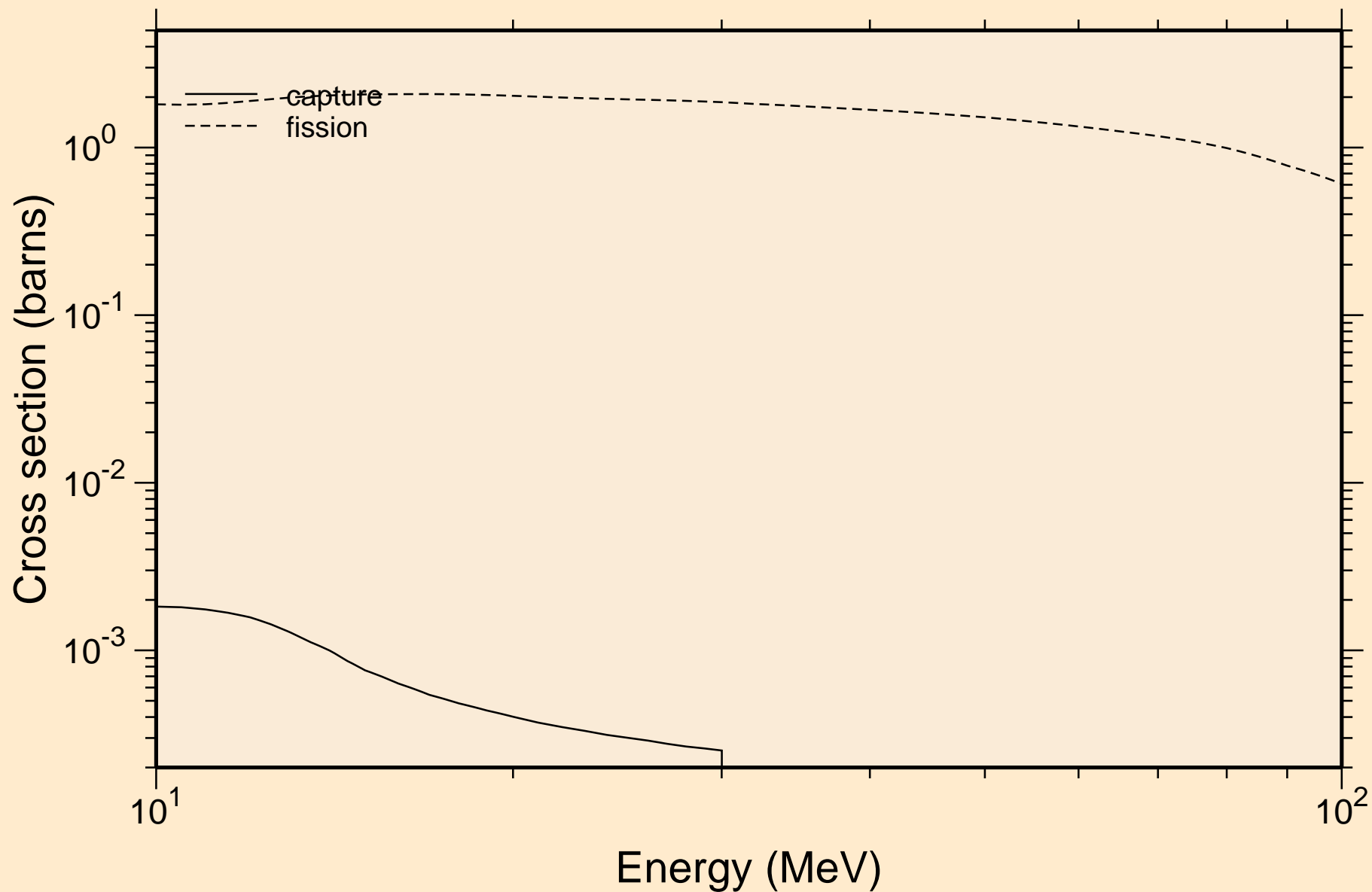

CF255 NEUTRON ACER TENDL-2019 LIBRARY; T=293.16K
Heating

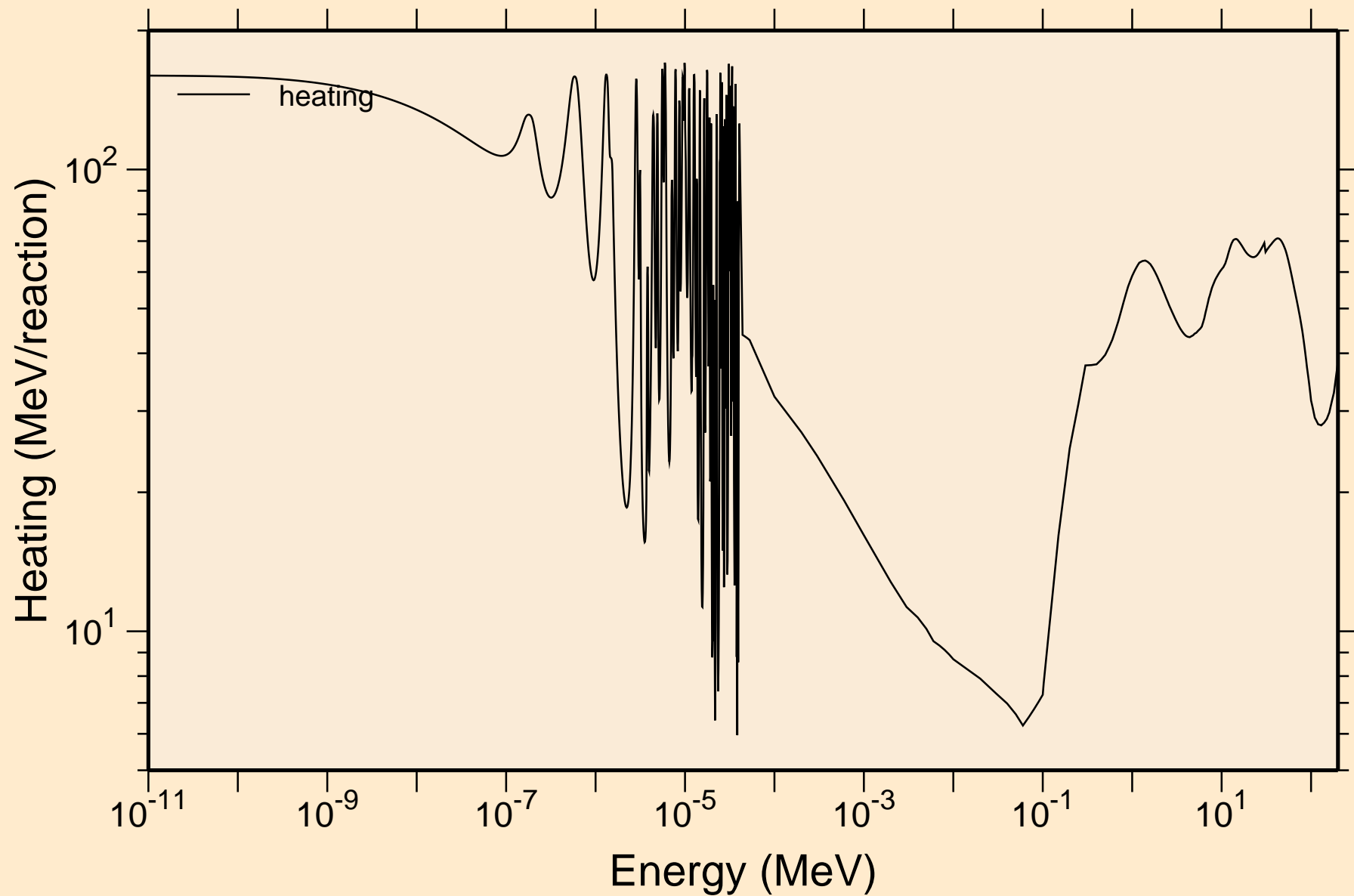

CF255 NEUTRON ACER TENDL-2019 LIBRARY; T=293.16K
Damage

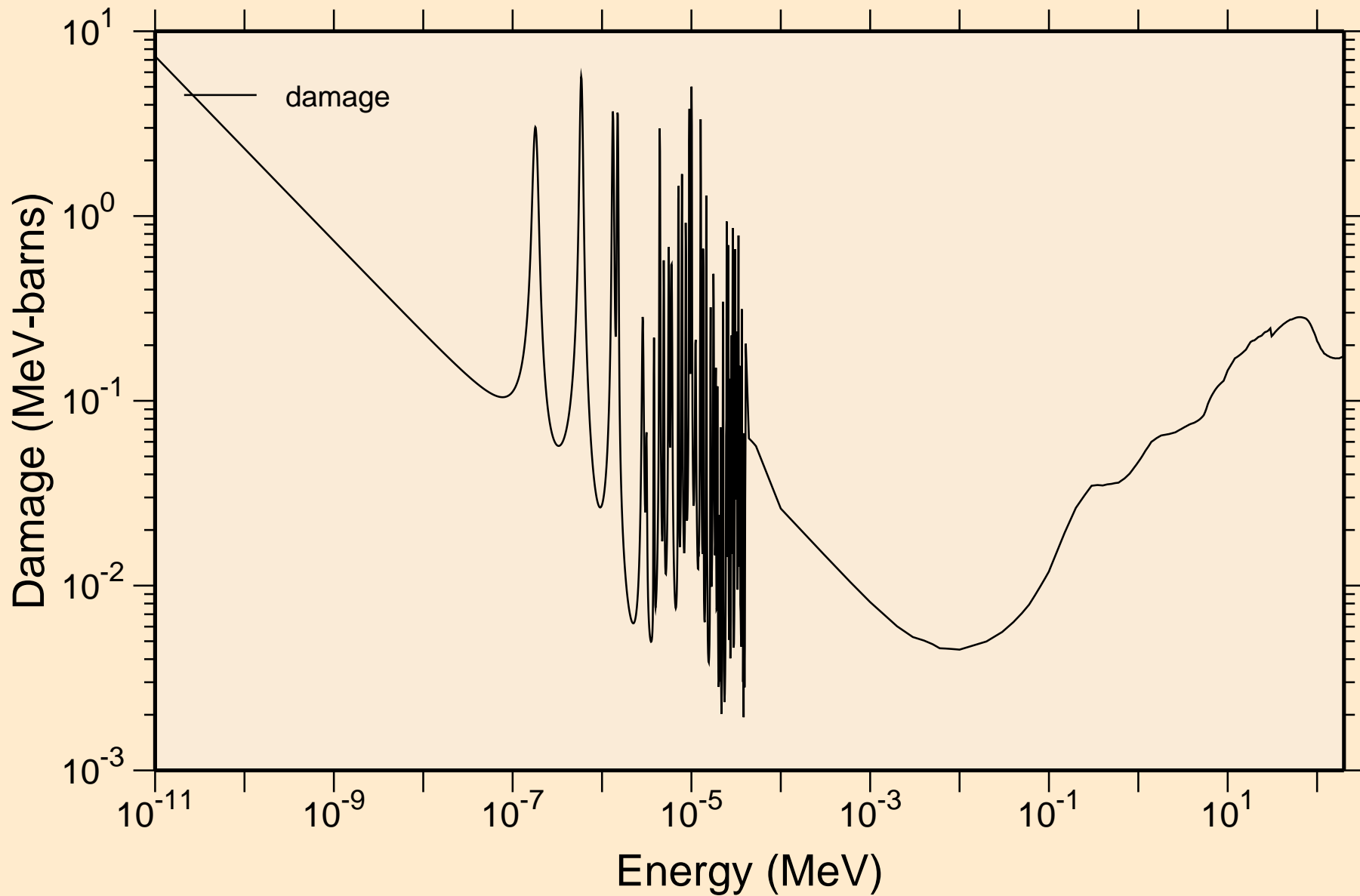

CF255 NEUTRON ACER TENDL-2019 LIBRARY; T=293.16K

Non-threshold reactions

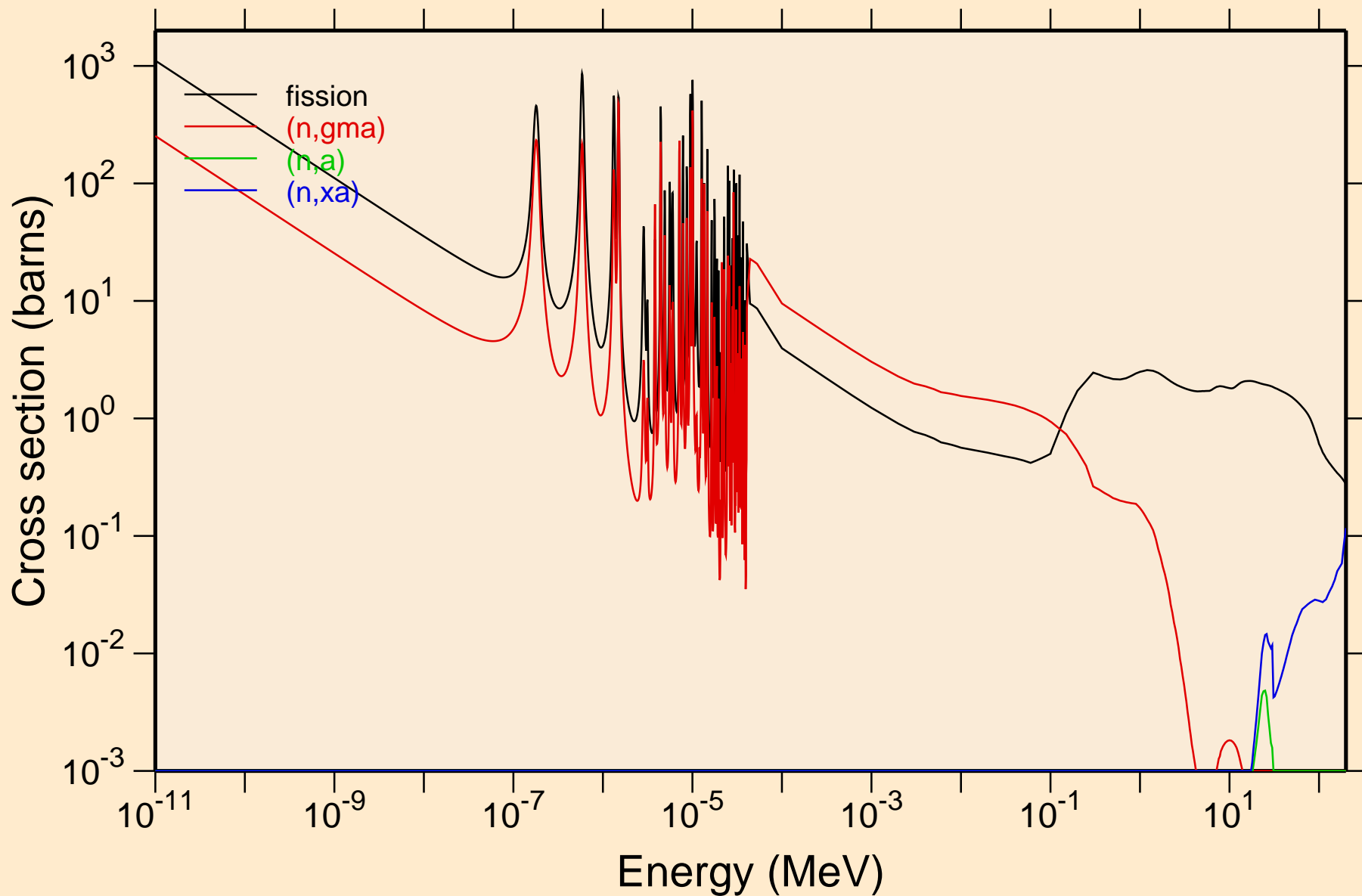

CF255 NEUTRON ACER TENDL-2019 LIBRARY; T=293.16K

Principal cross sections

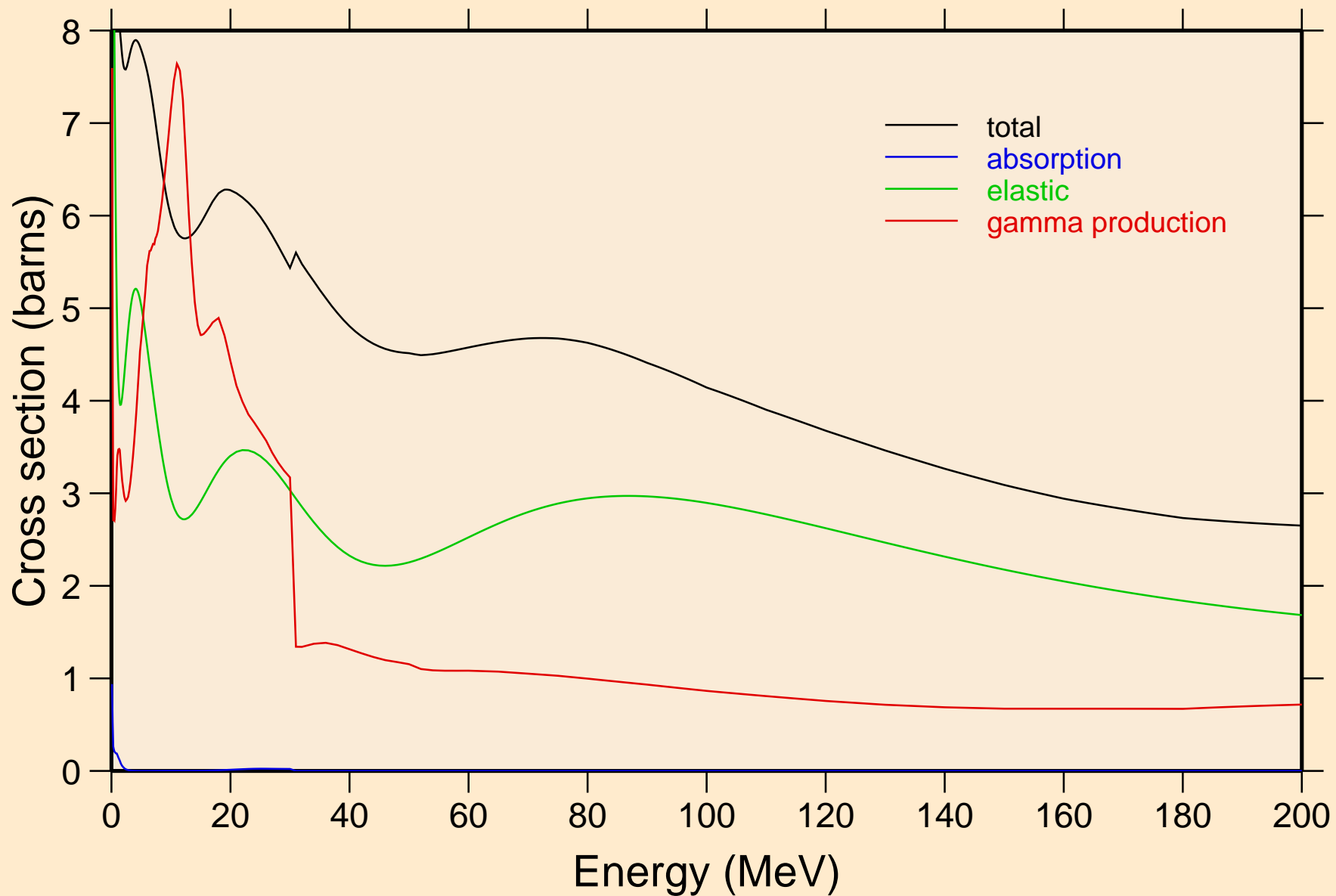

CF255 NEUTRON ACER TENDL-2019 LIBRARY; T=293.16K
Heating

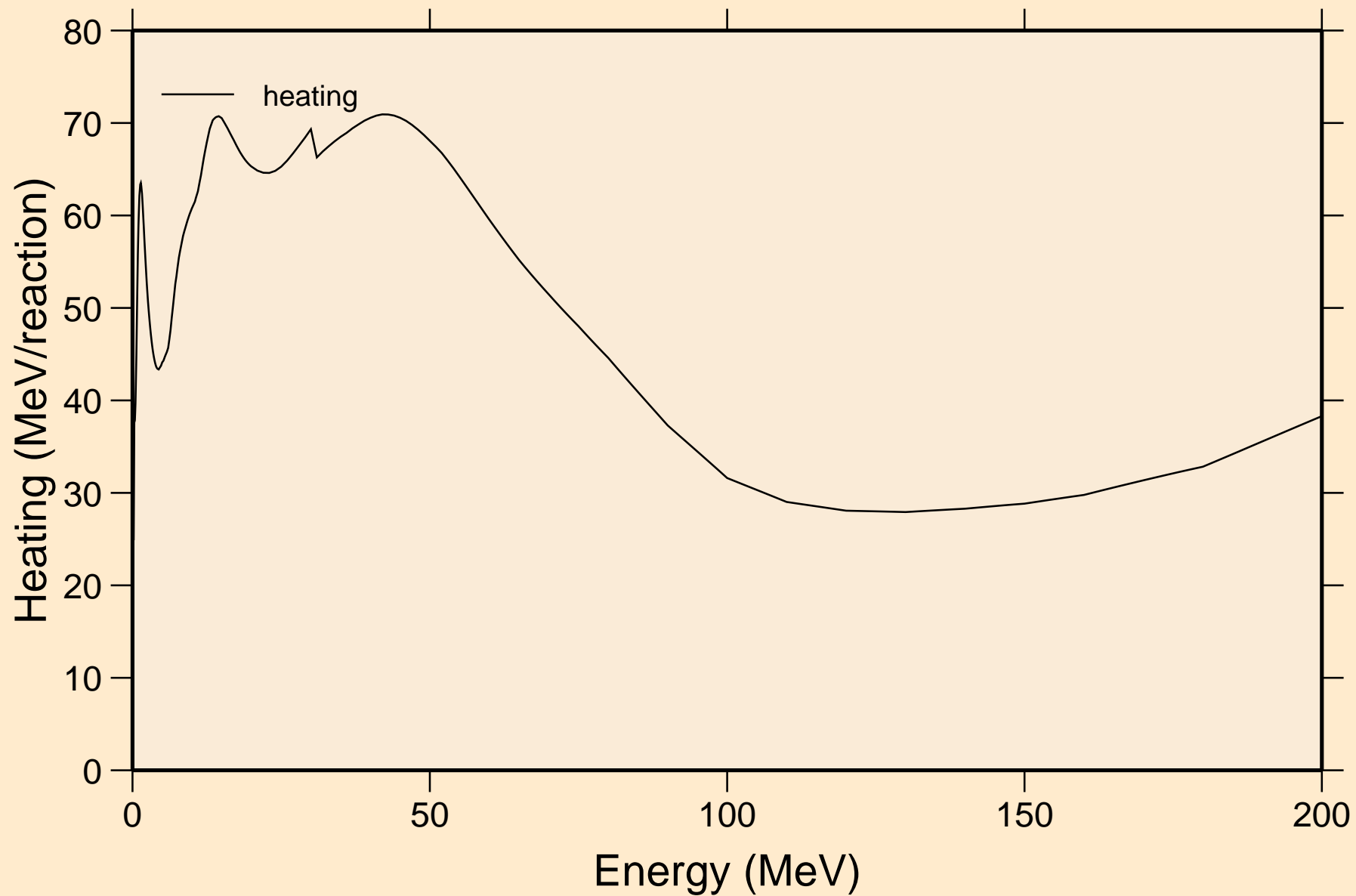

CF255 NEUTRON ACER TENDL-2019 LIBRARY; T=293.16K
Damage

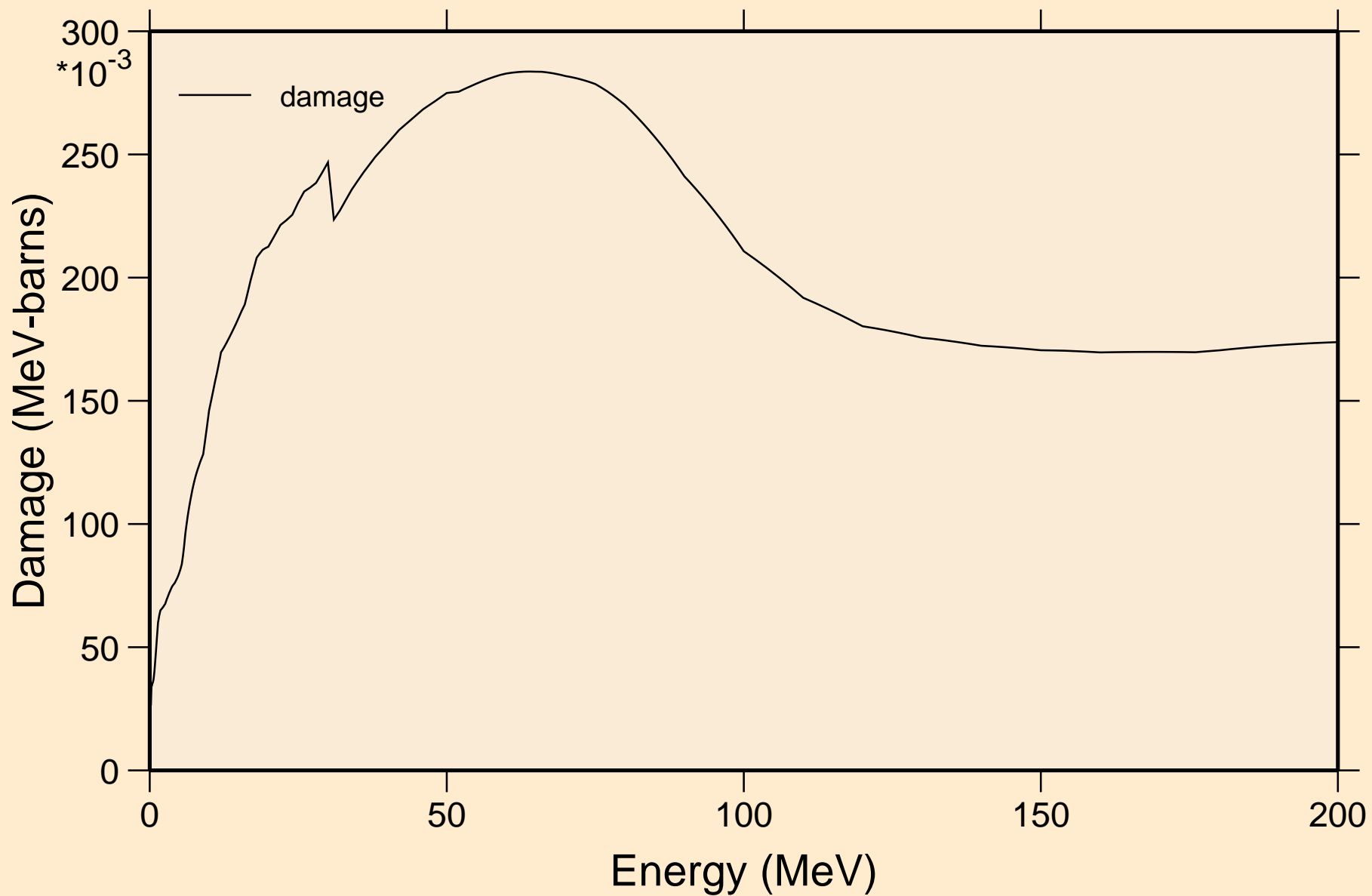

CF255 NEUTRON ACER TENDL-2019 LIBRARY; T=293.16K
Non-threshold reactions

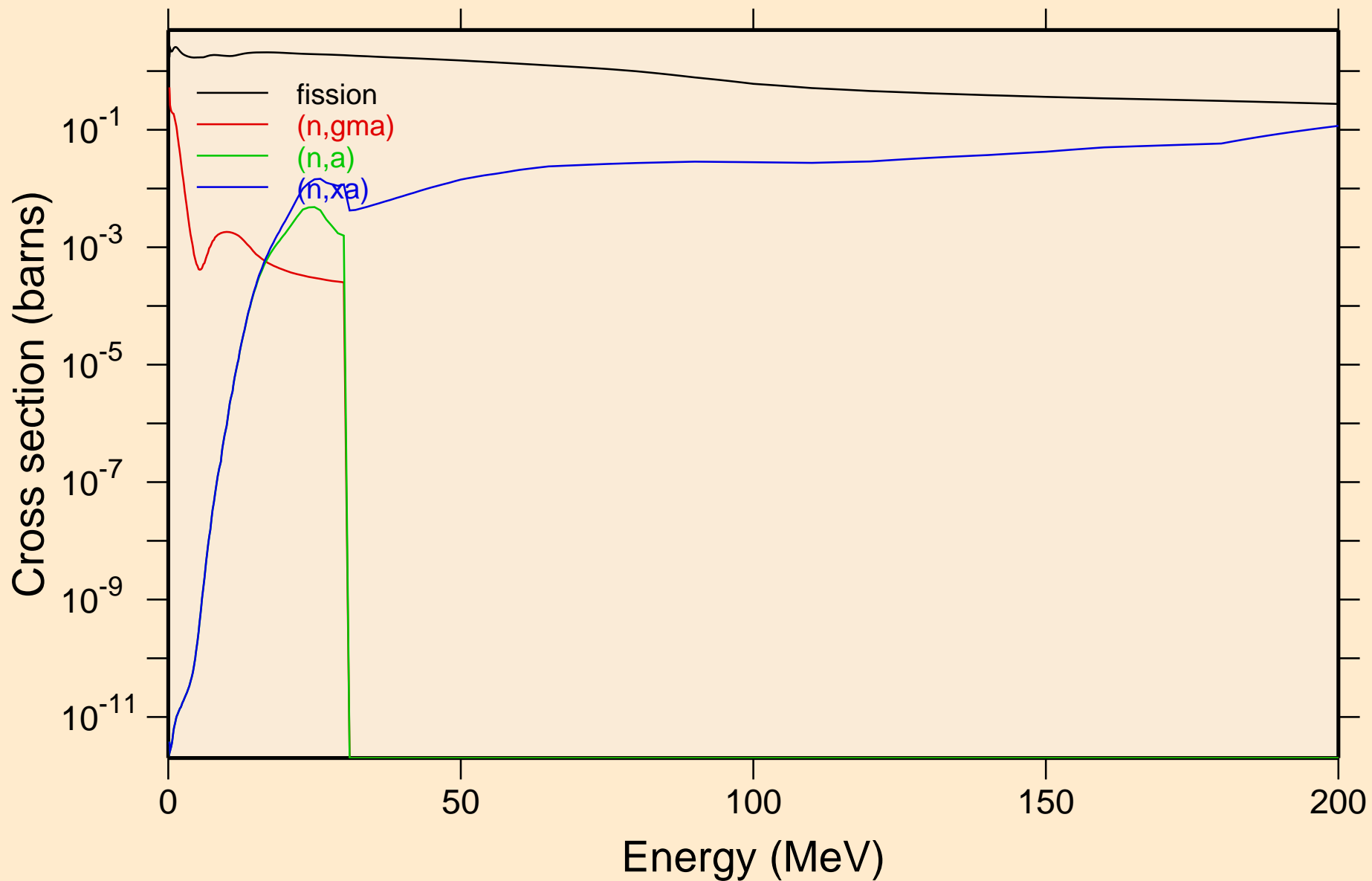

CF255 NEUTRON ACER TENDL-2019 LIBRARY; T=293.16K
Inelastic levels

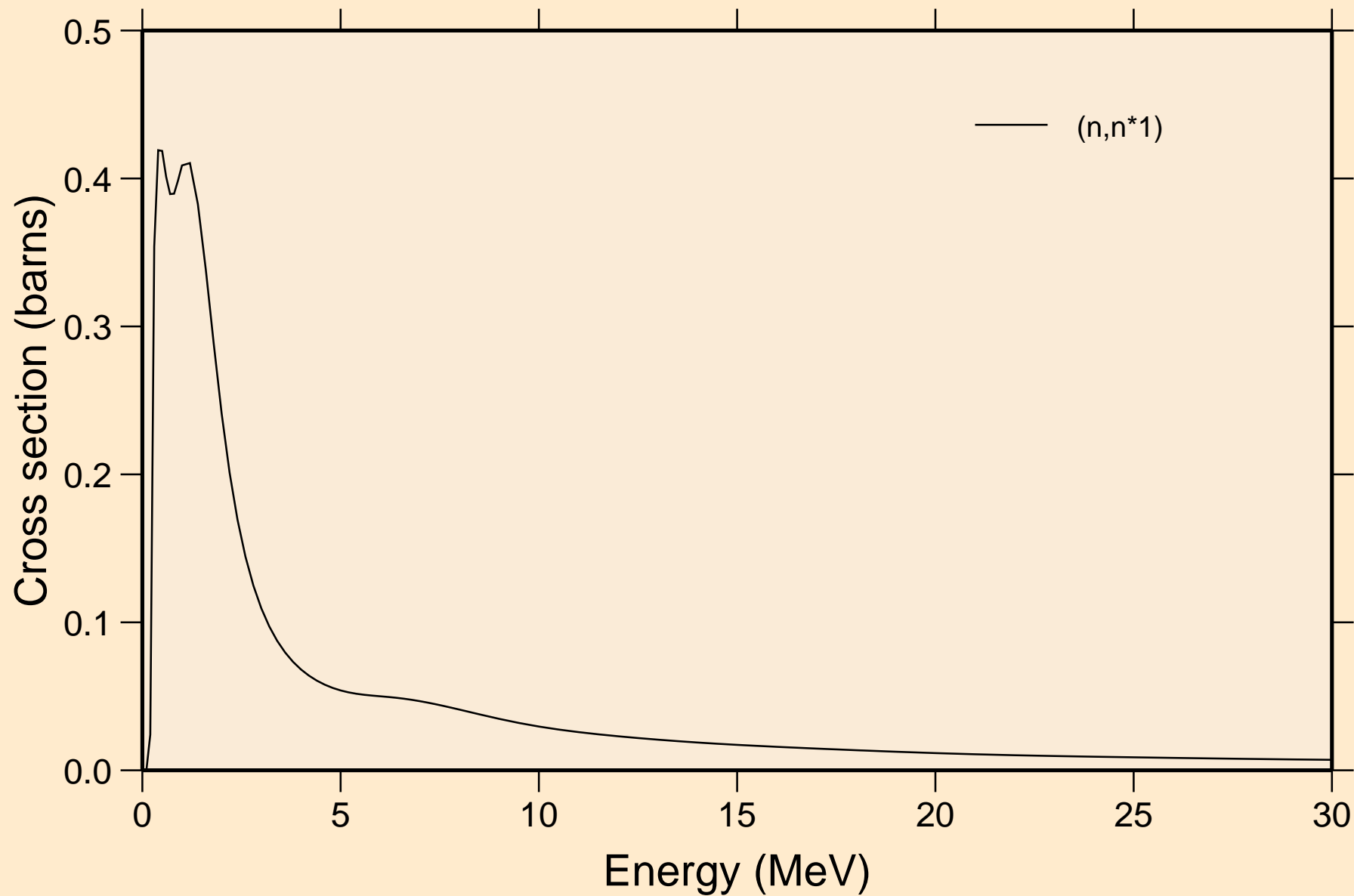

CF255 NEUTRON ACER TENDL-2019 LIBRARY; T=293.16K

Threshold reactions

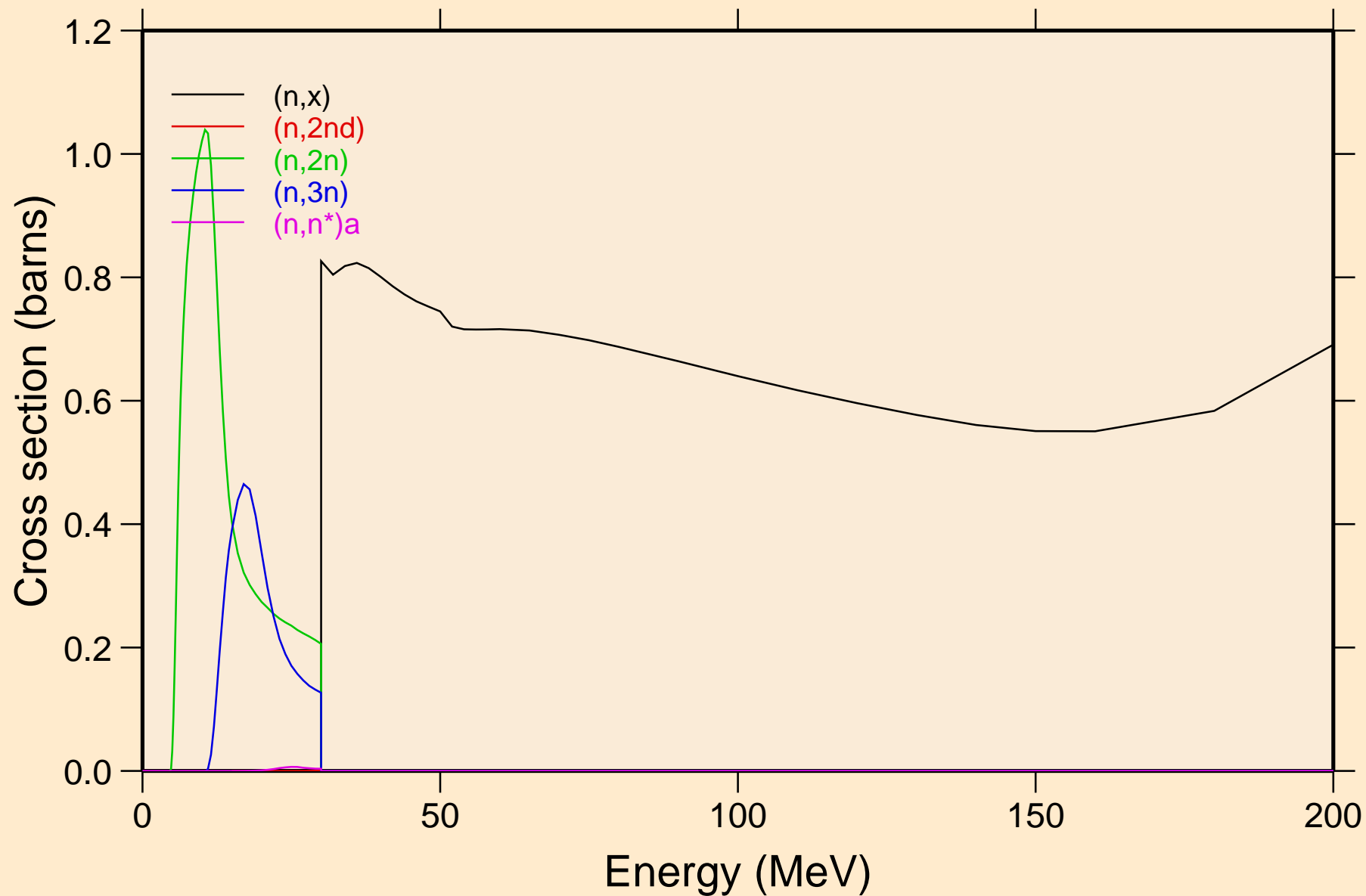

CF255 NEUTRON ACER TENDL-2019 LIBRARY; T=293.16K

Threshold reactions

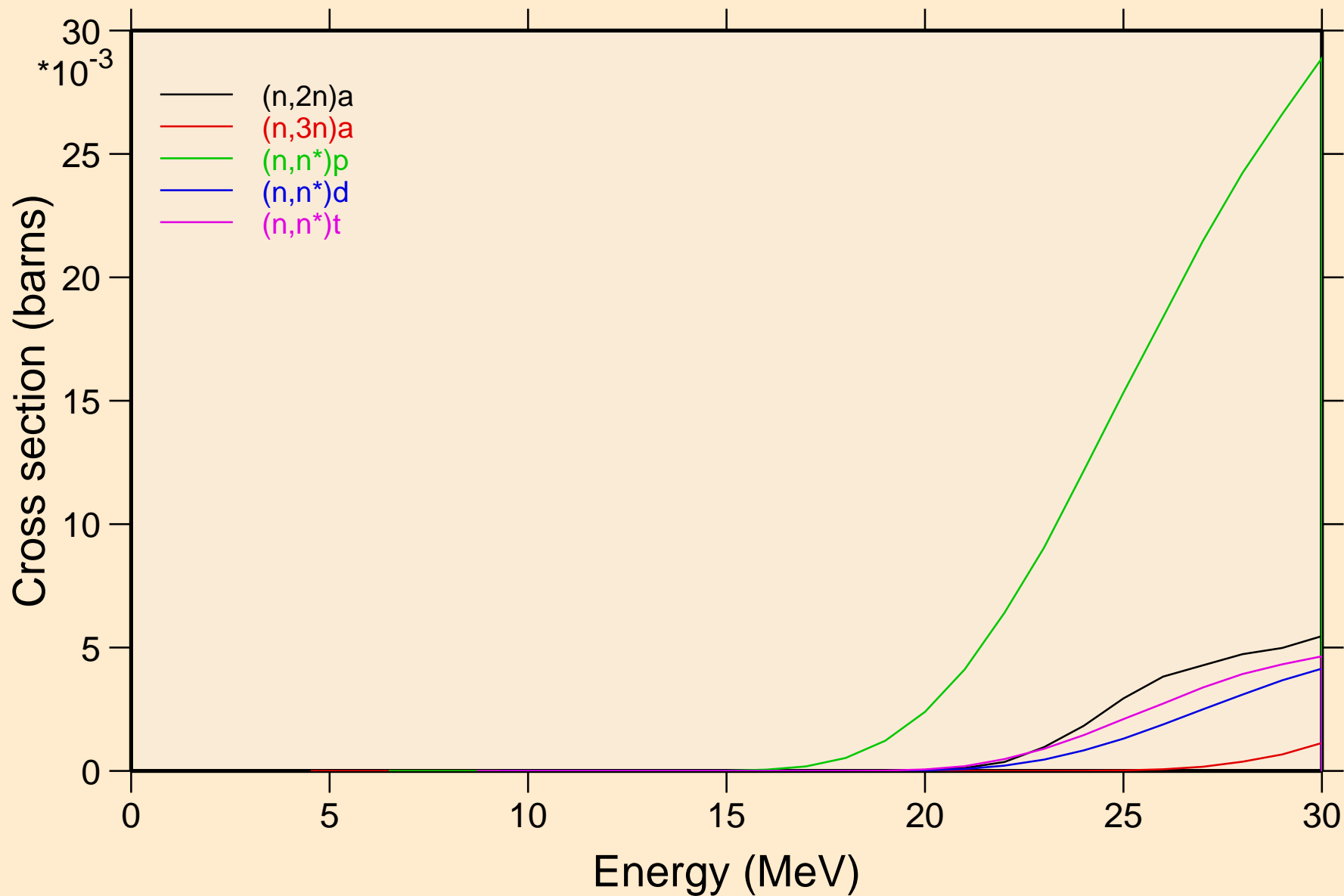

CF255 NEUTRON ACER TENDL-2019 LIBRARY; T=293.16K
Threshold reactions

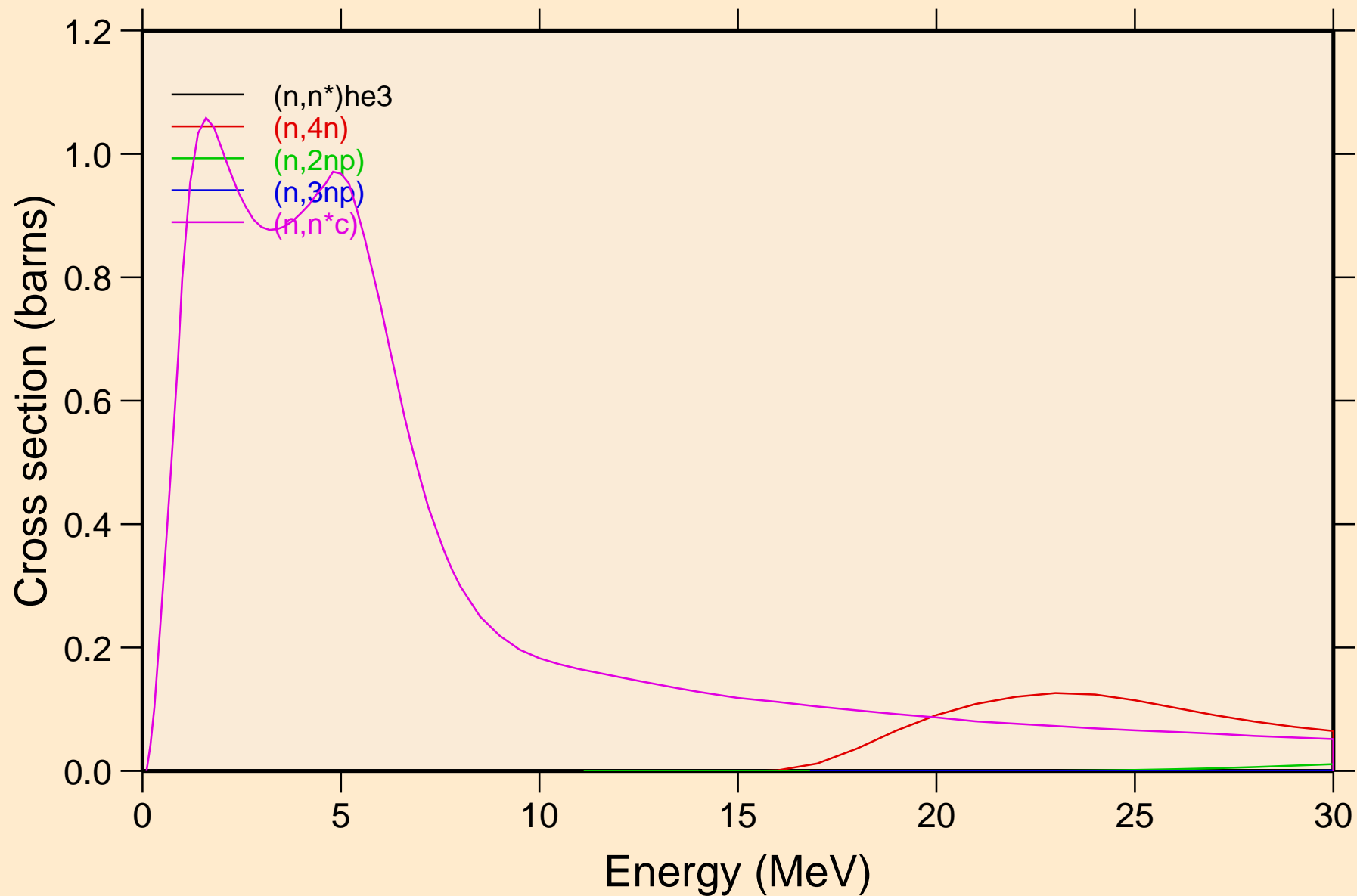

CF255 NEUTRON ACER TENDL-2019 LIBRARY; T=293.16K
Threshold reactions

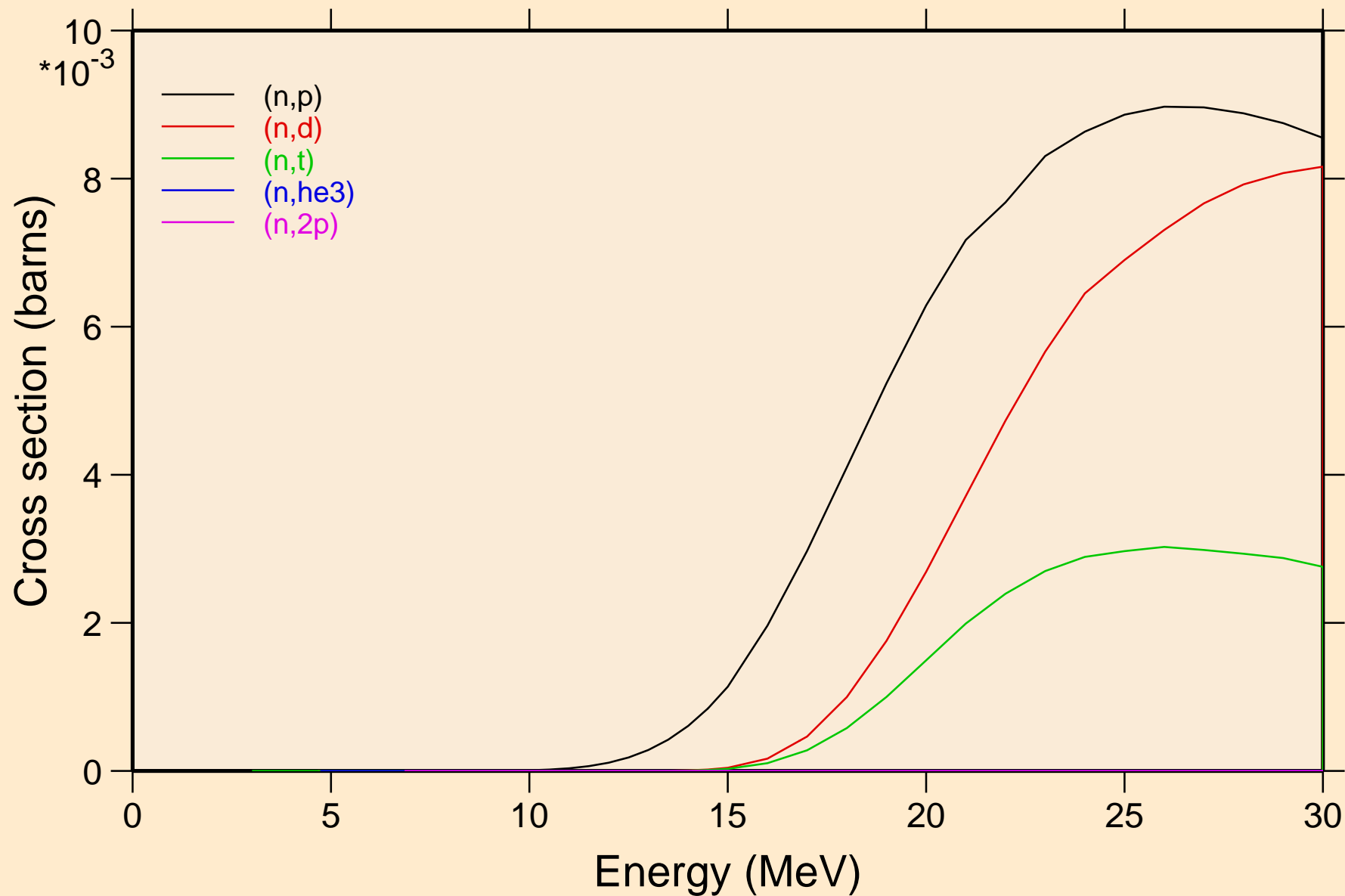

CF255 NEUTRON ACER TENDL-2019 LIBRARY; T=293.16K
Threshold reactions

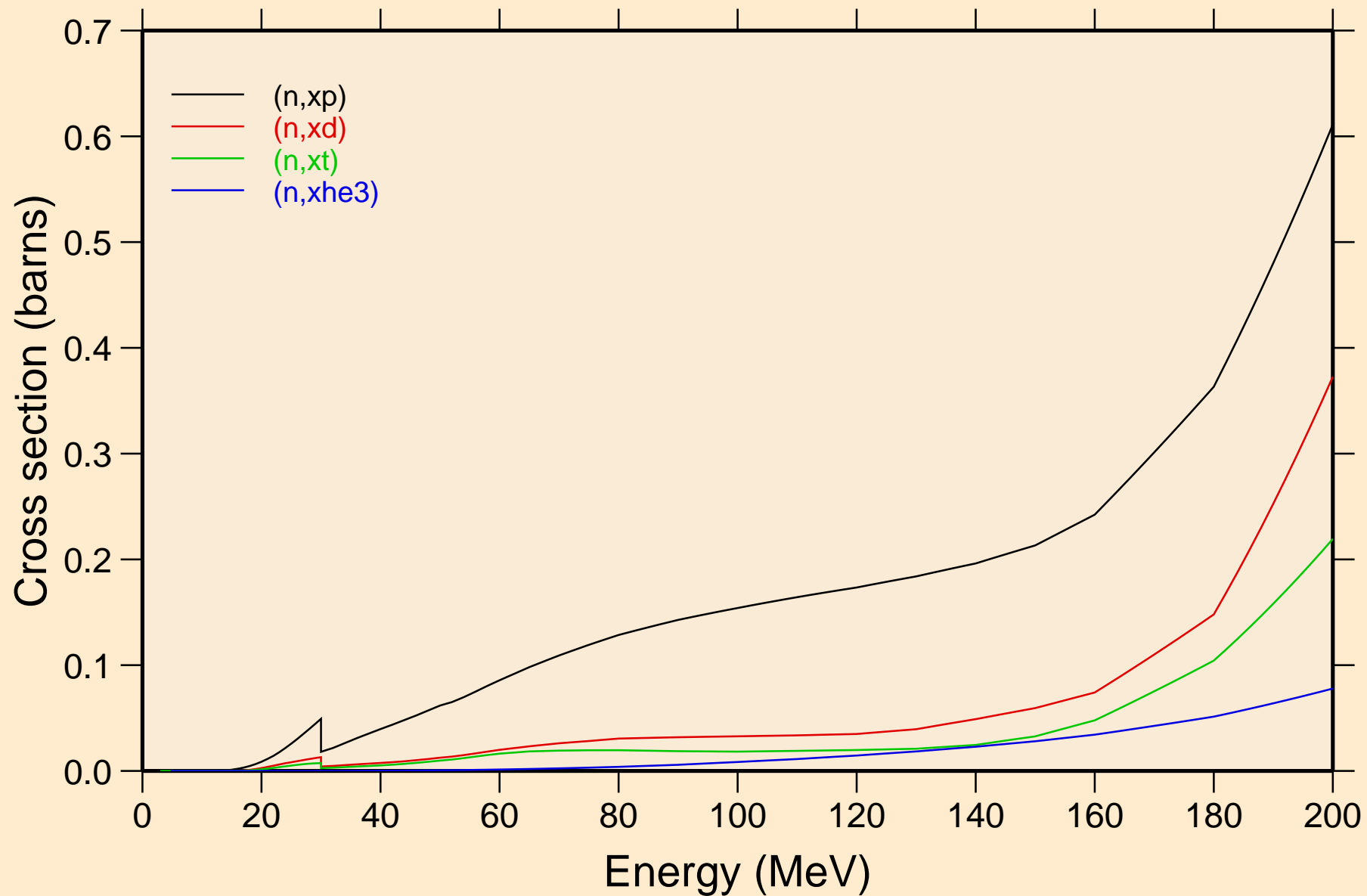

CF255 NEUTRON ACER TENDL-2019 LIBRARY; T=293.16K
angular distribution for elastic

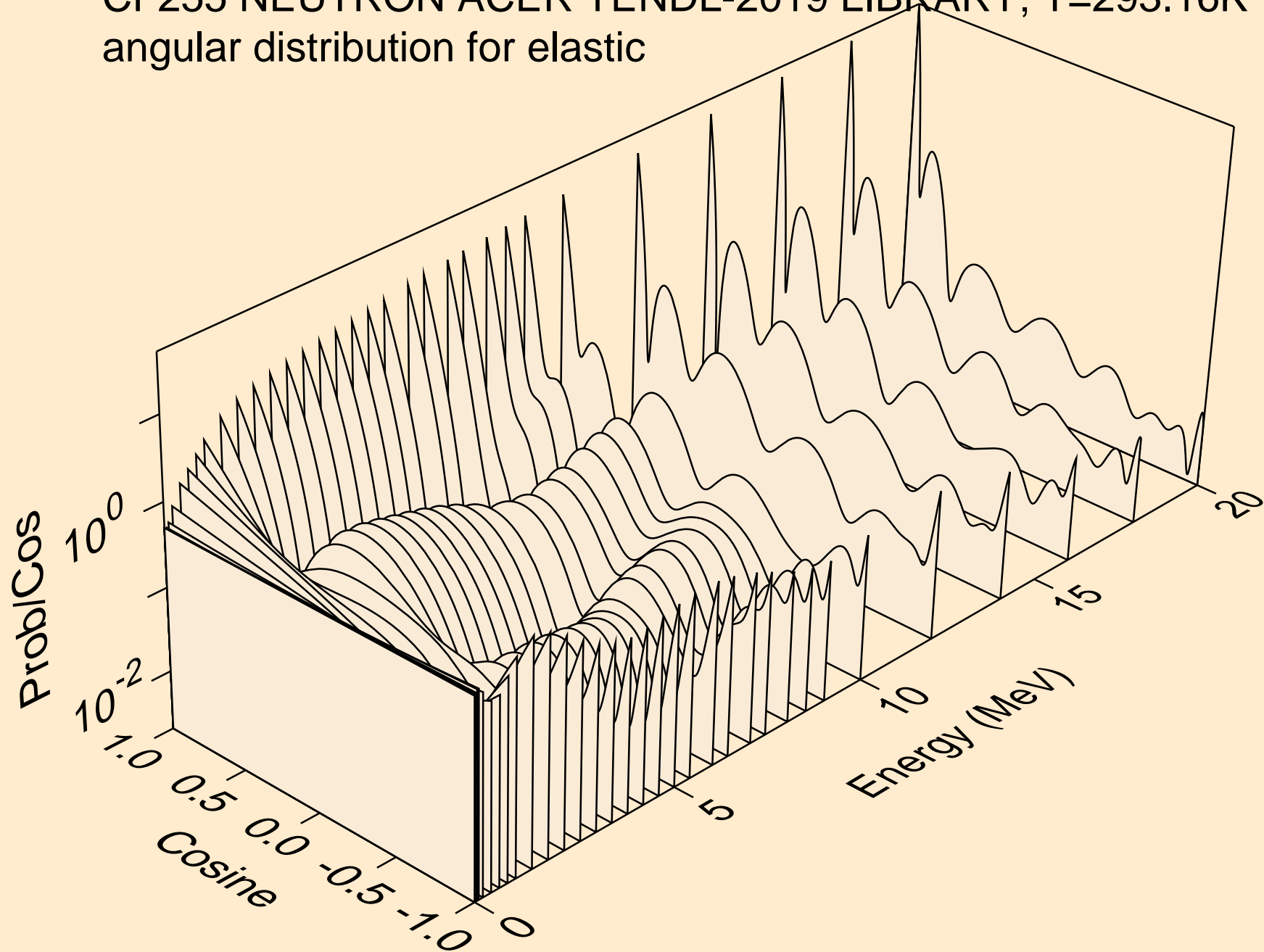

CF255 NEUTRON ACER TENDL-2019 LIBRARY; T=293.16K
angular distribution for elastic

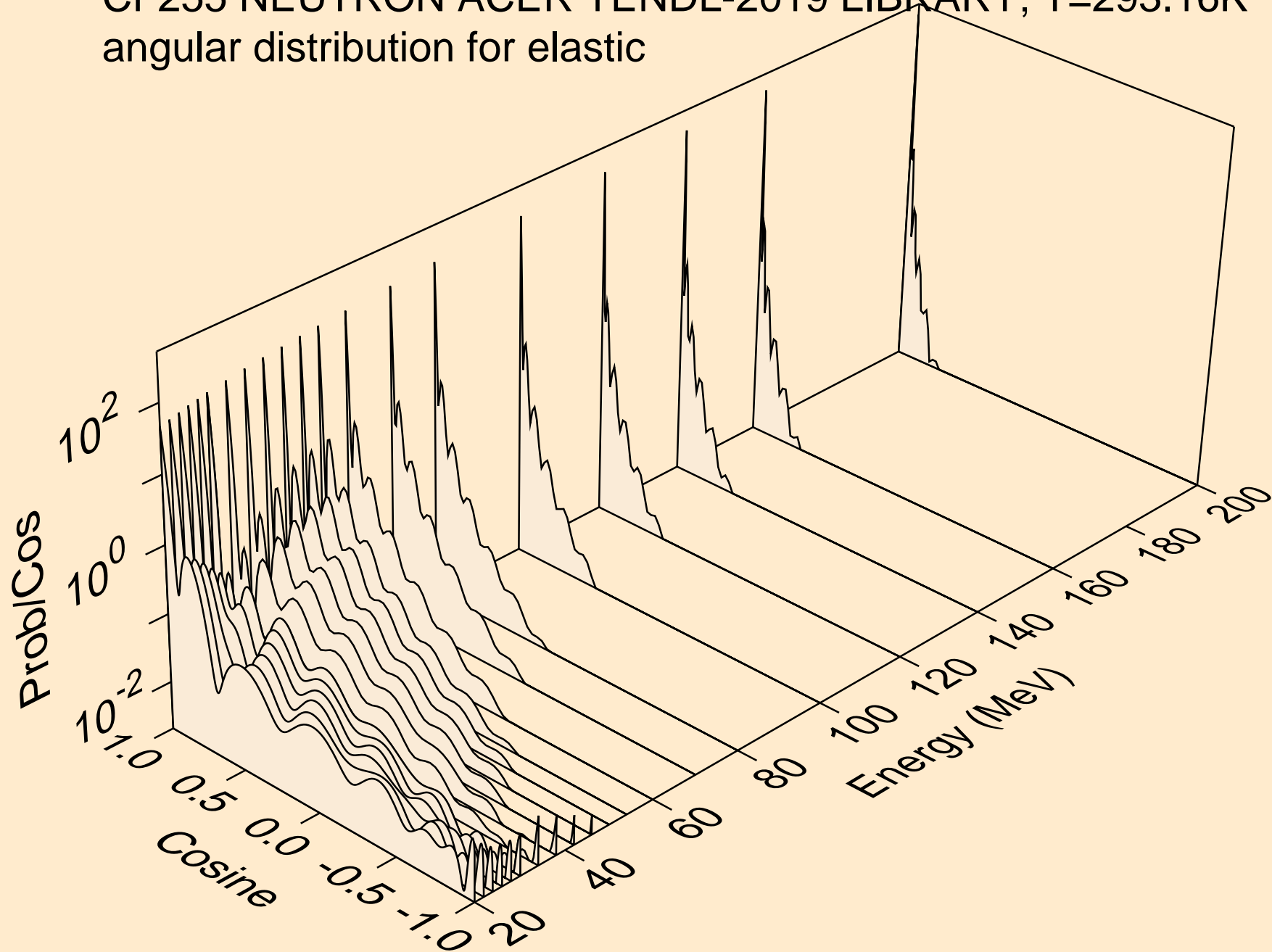

CF255 NEUTRON ACER TENDL-2019 LIBRARY; T=293.16K
angular distribution for (n,n*1)

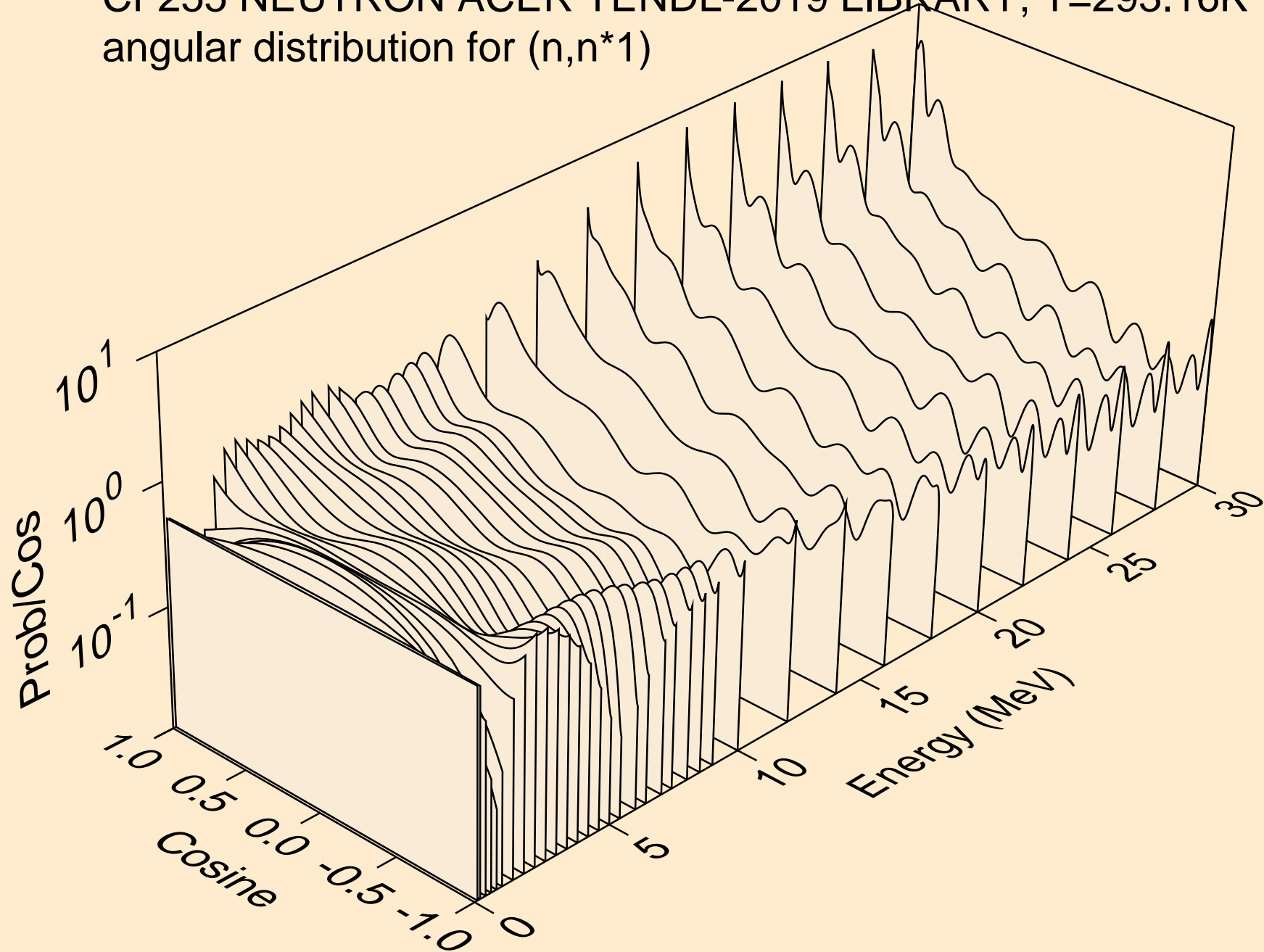

CF255 NEUTRON ACER TENDL-2019 LIBRARY; T=293.16K
Total fission nuabar

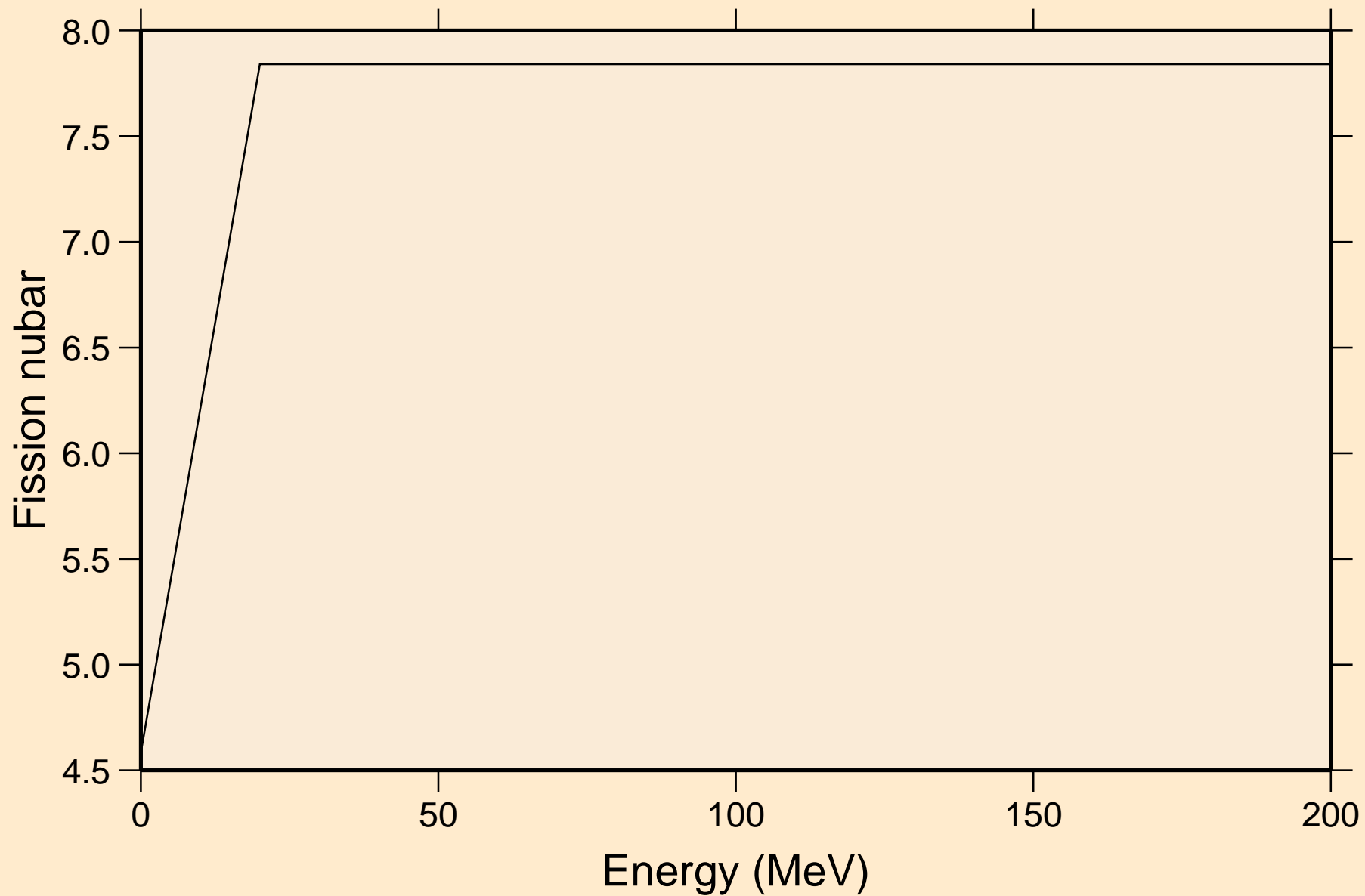

CF255 NEUTRON ACER TENDL-2019 LIBRARY; T=293.16K
Neutron emission for (n,x)

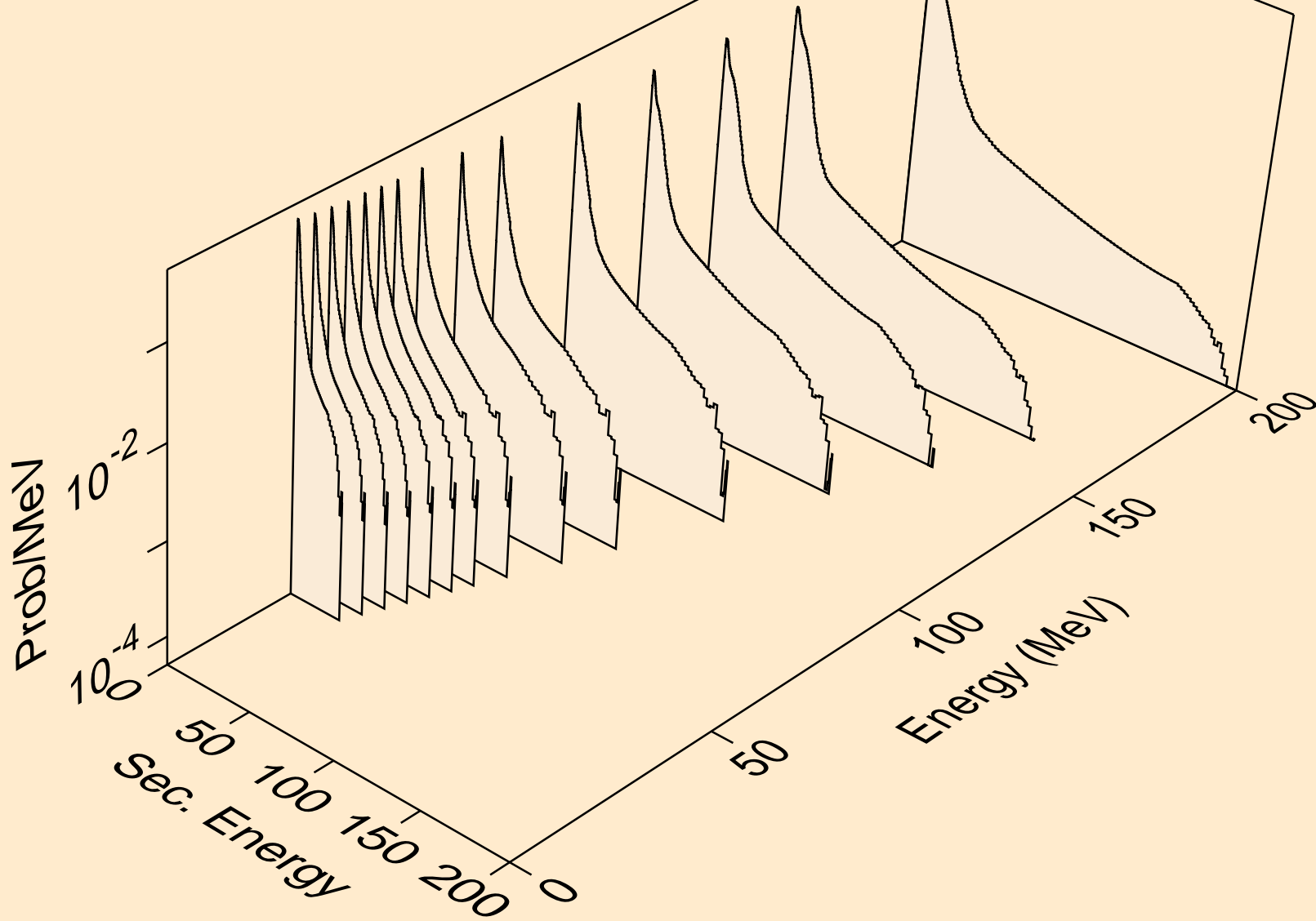

CF255 NEUTRON ACER TENDL-2019 LIBRARY; T=293.16K
Neutron emission for (n,2nd)

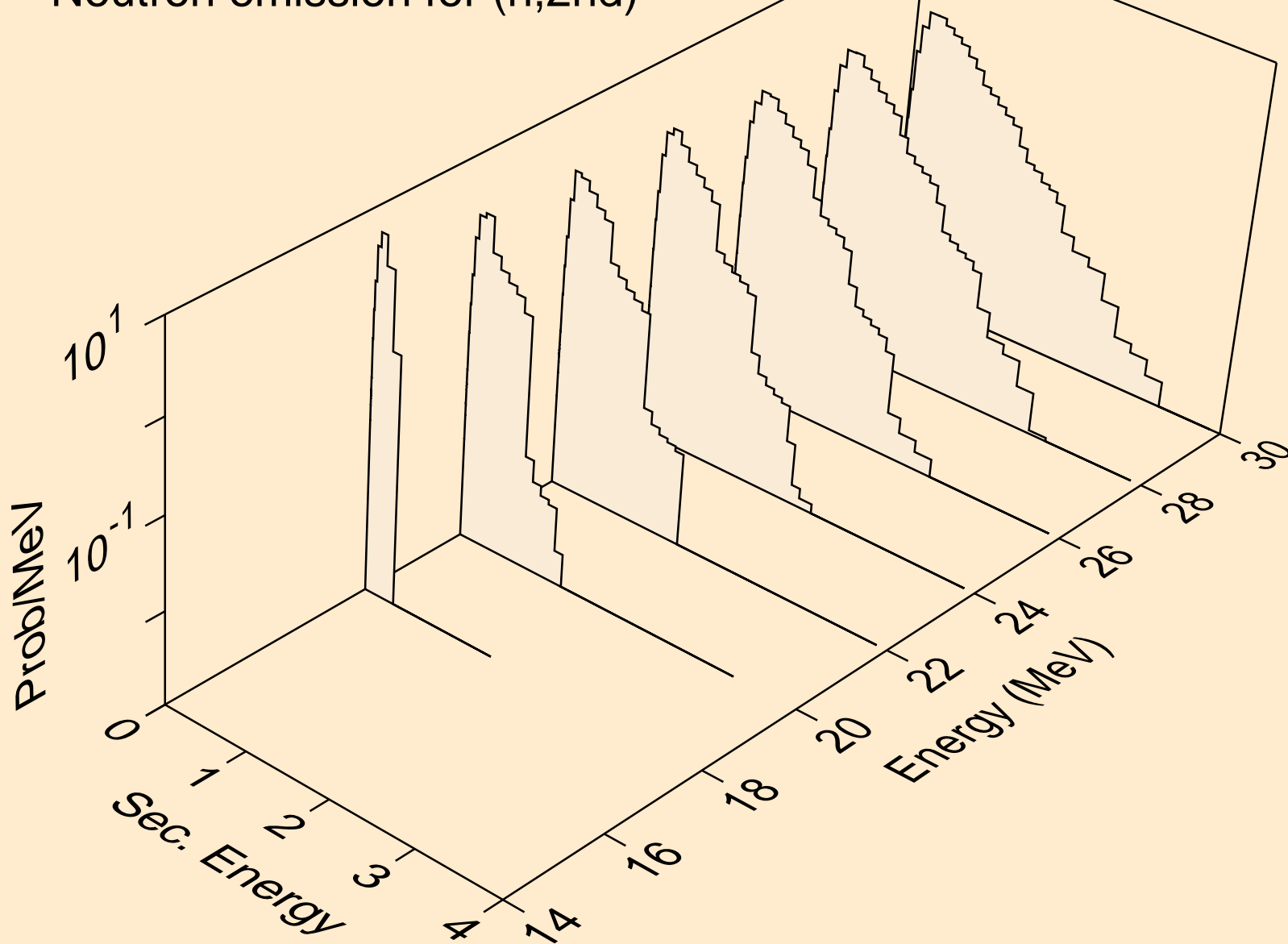

CF255 NEUTRON ACER TENDL-2019 LIBRARY; T=293.16K
Neutron emission for (n,2n)

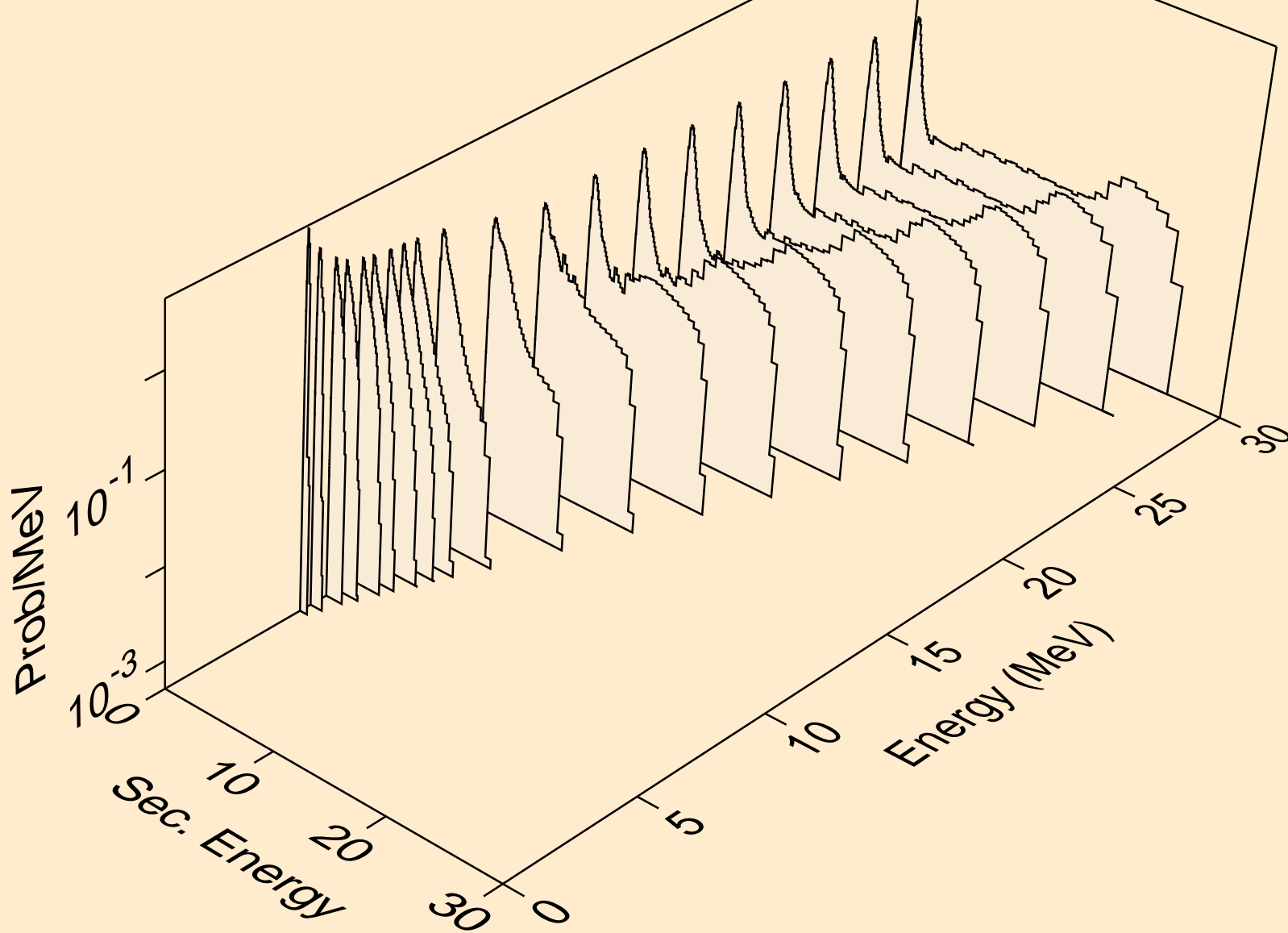

CF255 NEUTRON ACER TENDL-2019 LIBRARY; T=293.16K
Neutron emission for (n,3n)

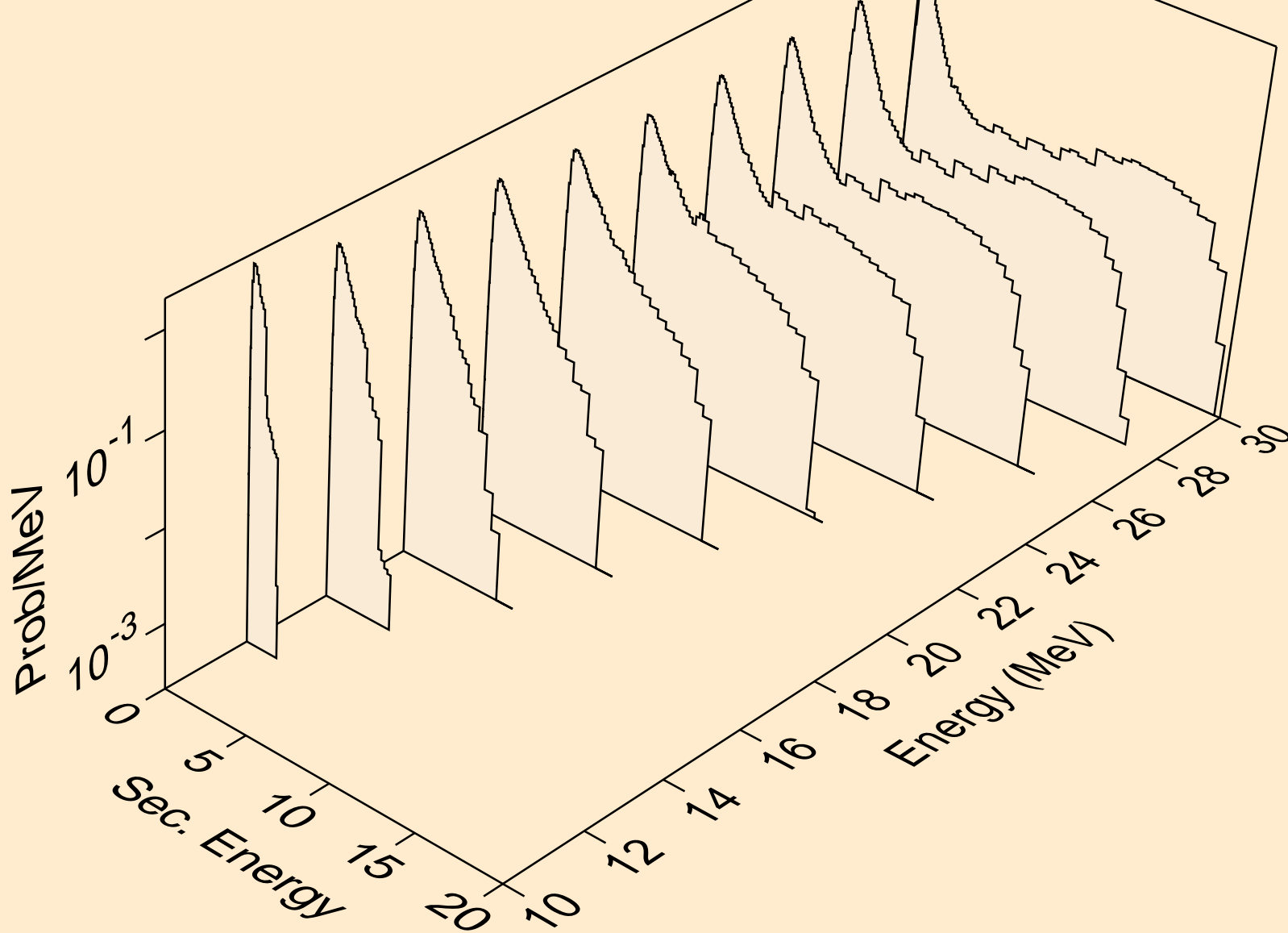

CF255 NEUTRON ACER TENDL-2019 LIBRARY; T=293.16K
Neutron emission for fission

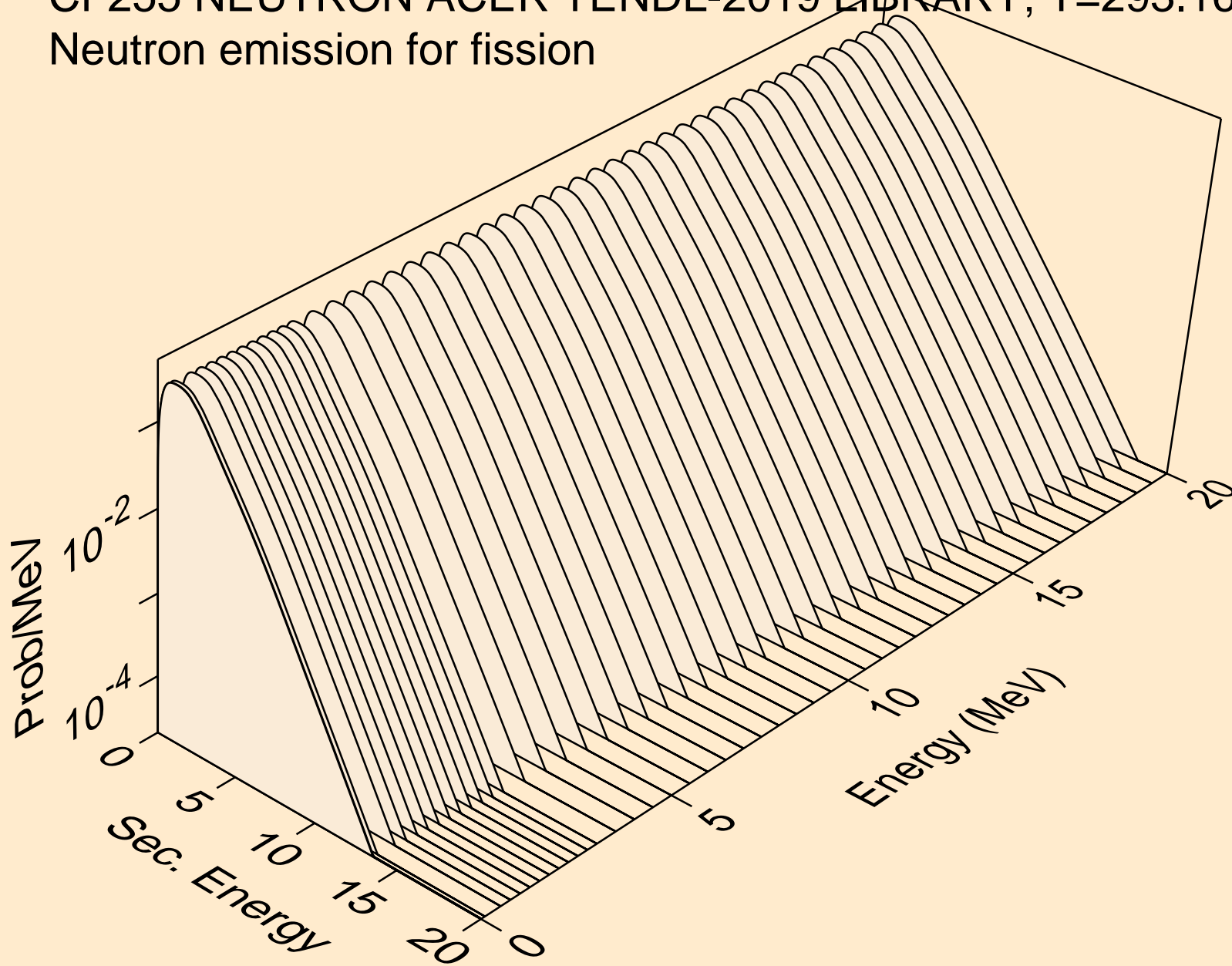

CF255 NEUTRON ACER TENDL-2019 LIBRARY; T=293.16K
Neutron emission for (n,n*)a

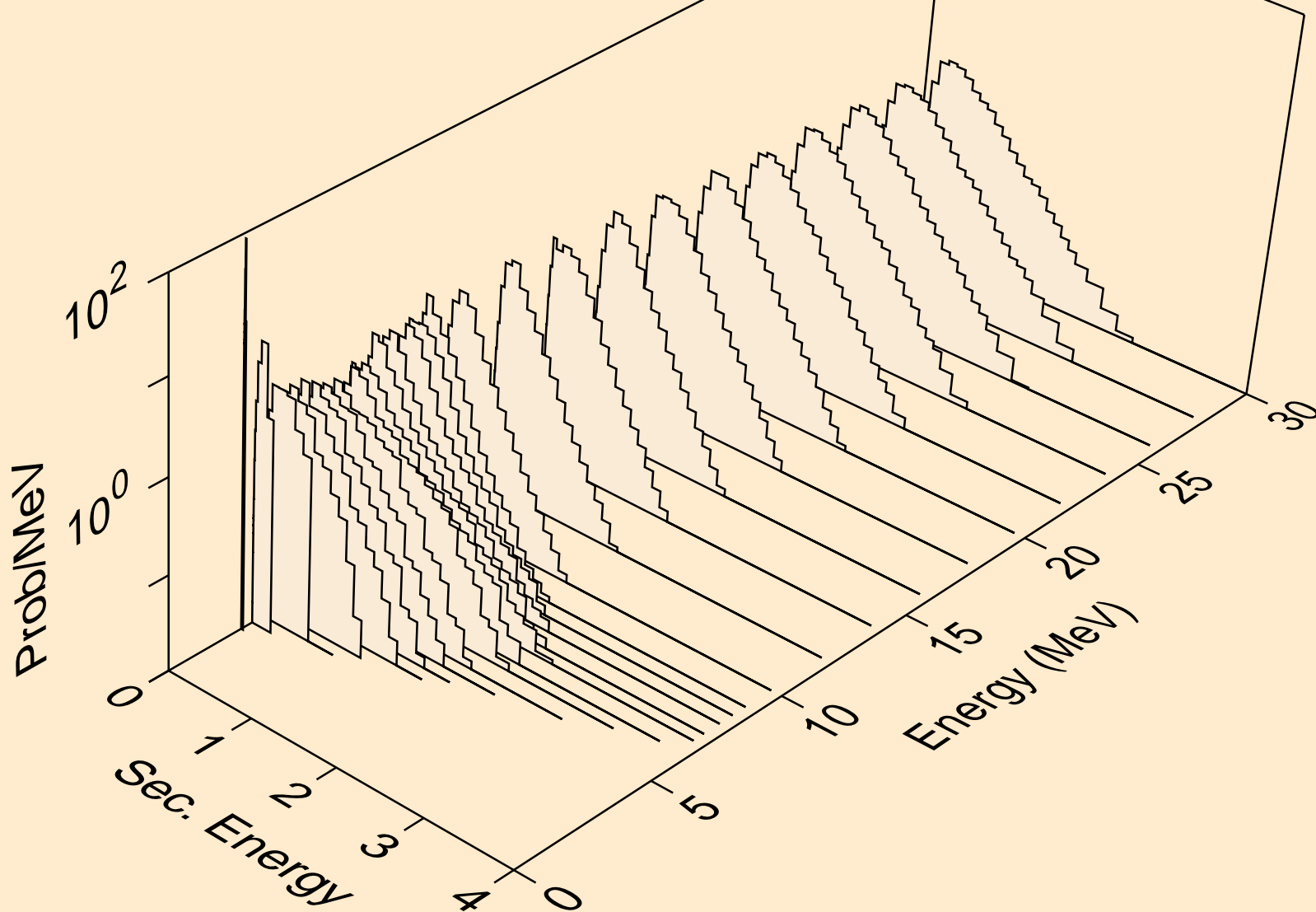

CF255 NEUTRON ACER TENDL-2019 LIBRARY; T=293.16K
Neutron emission for (n,2n)a

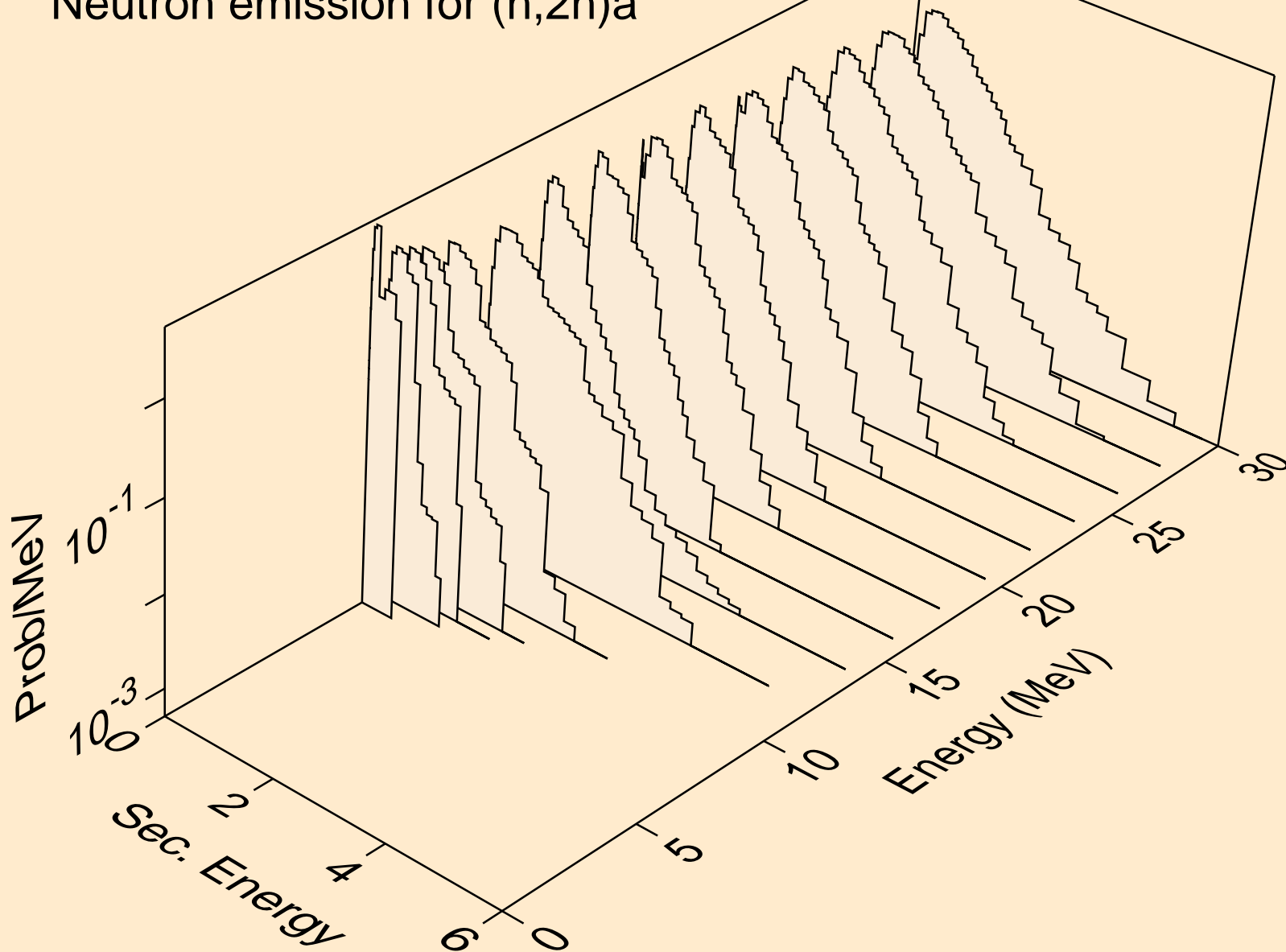

CF255 NEUTRON ACER TENDL-2019 LIBRARY; T=293.16K
Neutron emission for (n,3n)a

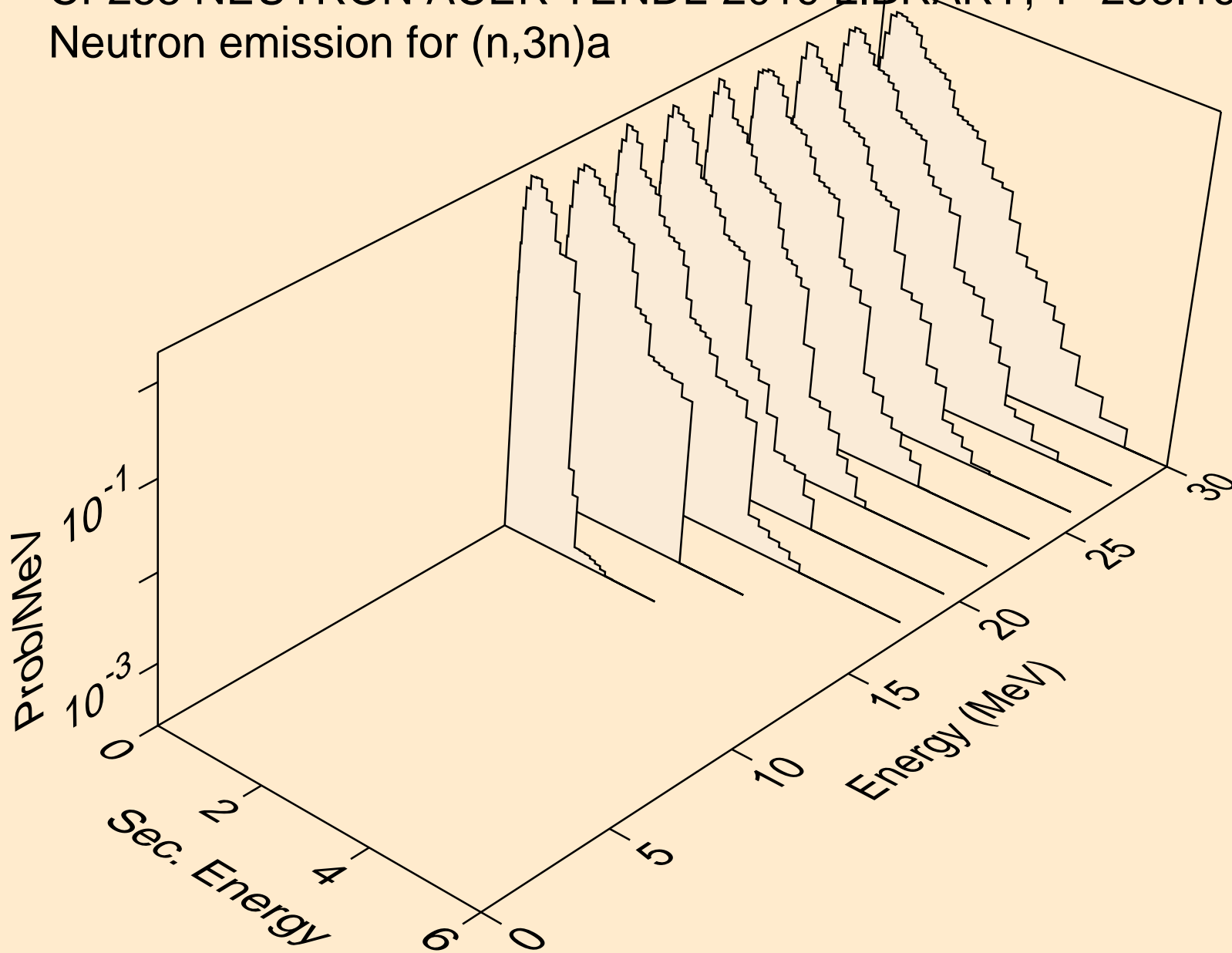

CF255 NEUTRON ACER TENDL-2019 LIBRARY; T=293.16K
Neutron emission for (n,n*)p

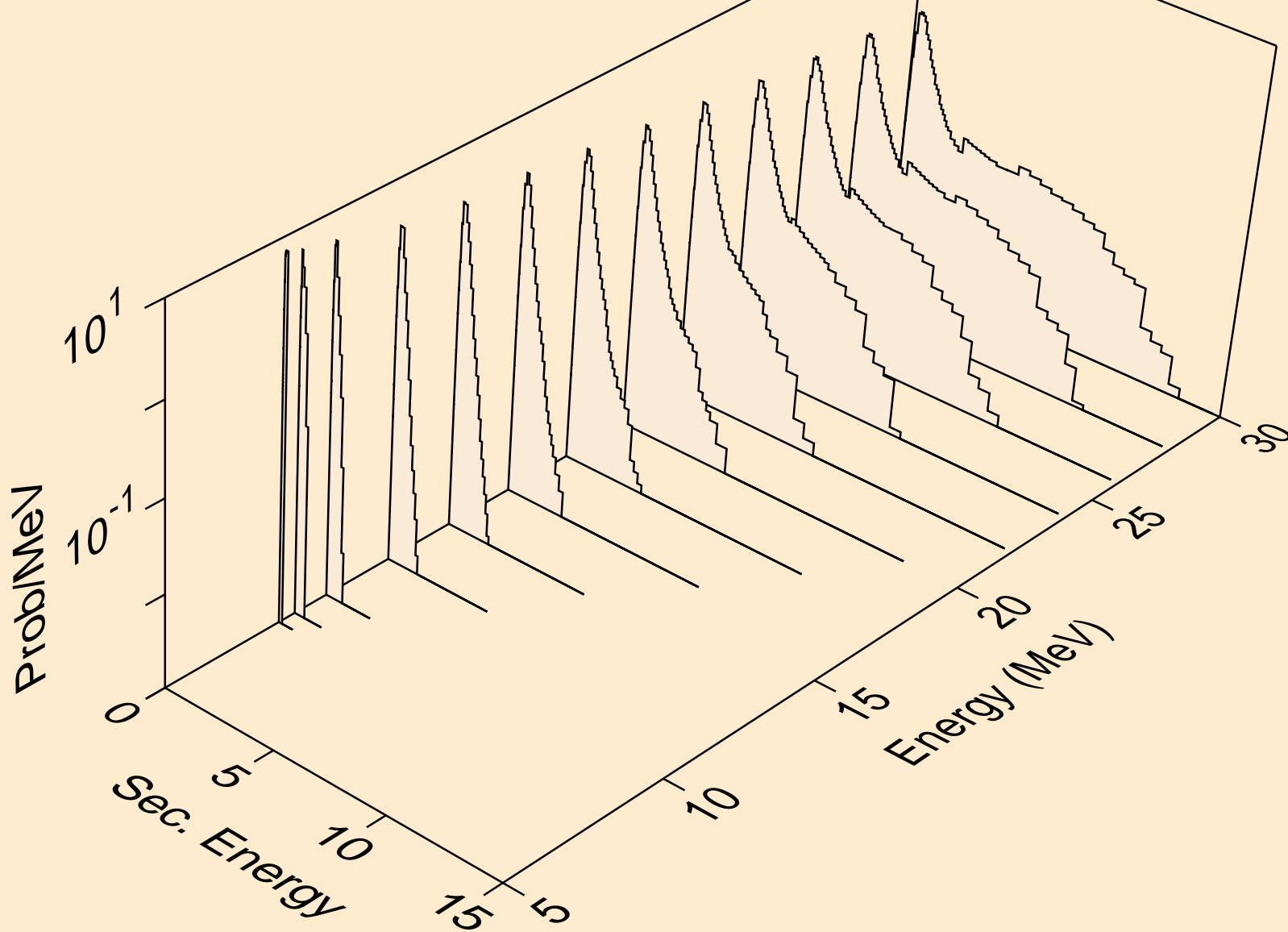

CF255 NEUTRON ACER TENDL-2019 LIBRARY; T=293.16K
Neutron emission for (n,n*)d

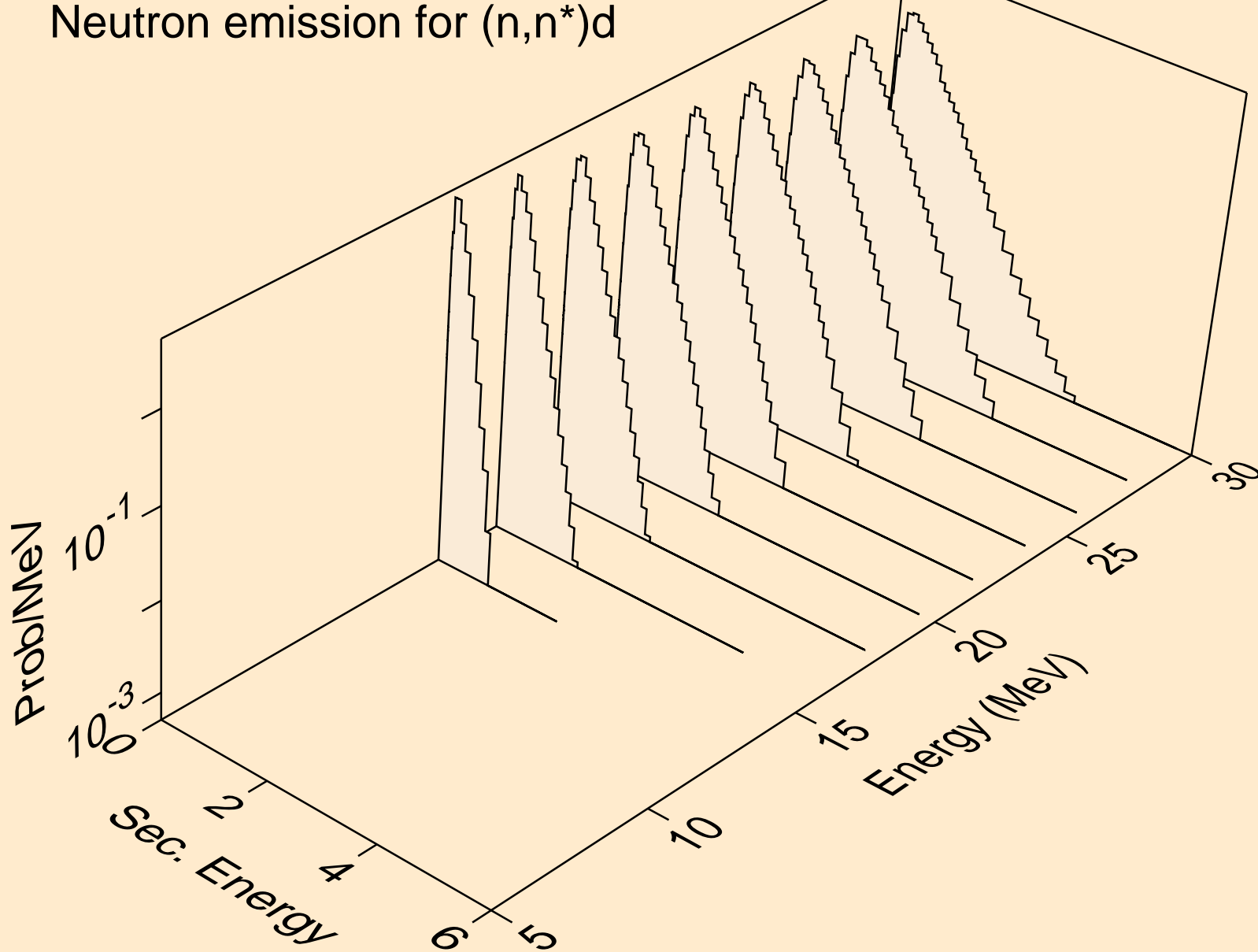

CF255 NEUTRON ACER TENDL-2019 LIBRARY; T=293.16K
Neutron emission for (n,n*)t

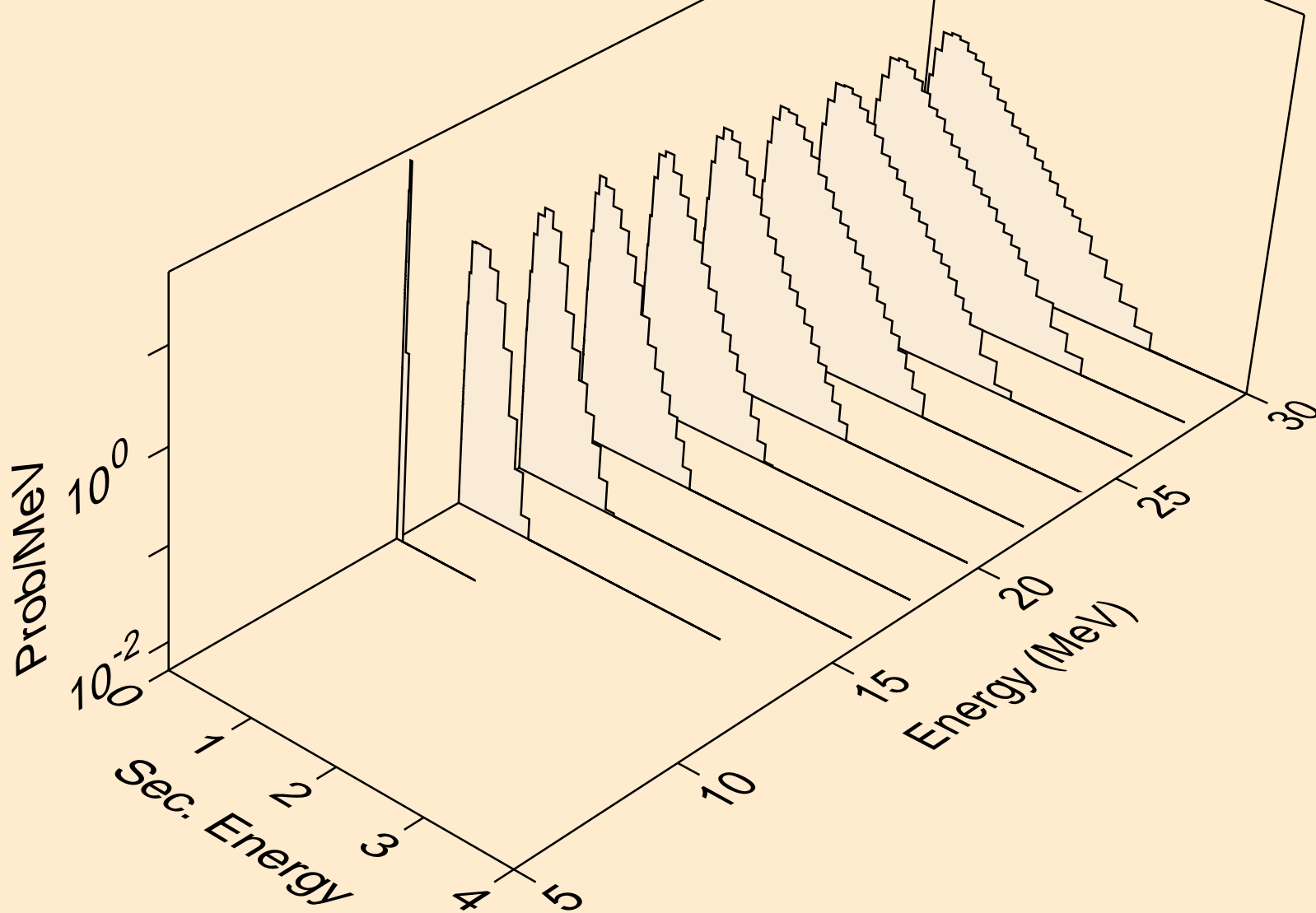

CF255 NEUTRON ACER TENDL-2019 LIBRARY; T=293.16K
Neutron emission for (n,n*)he3

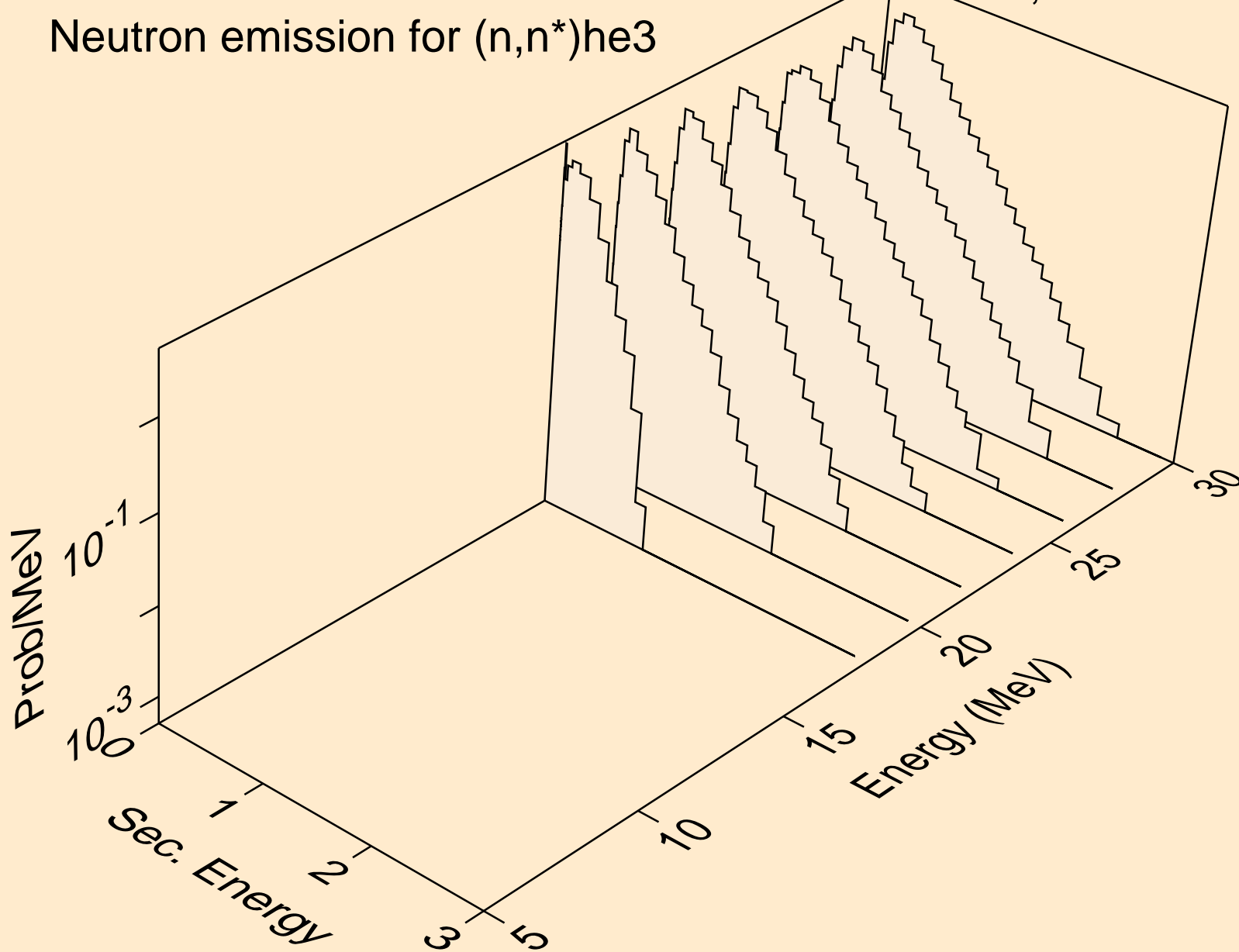

CF255 NEUTRON ACER TENDL-2019 LIBRARY; T=293.16K
Neutron emission for (n,4n)

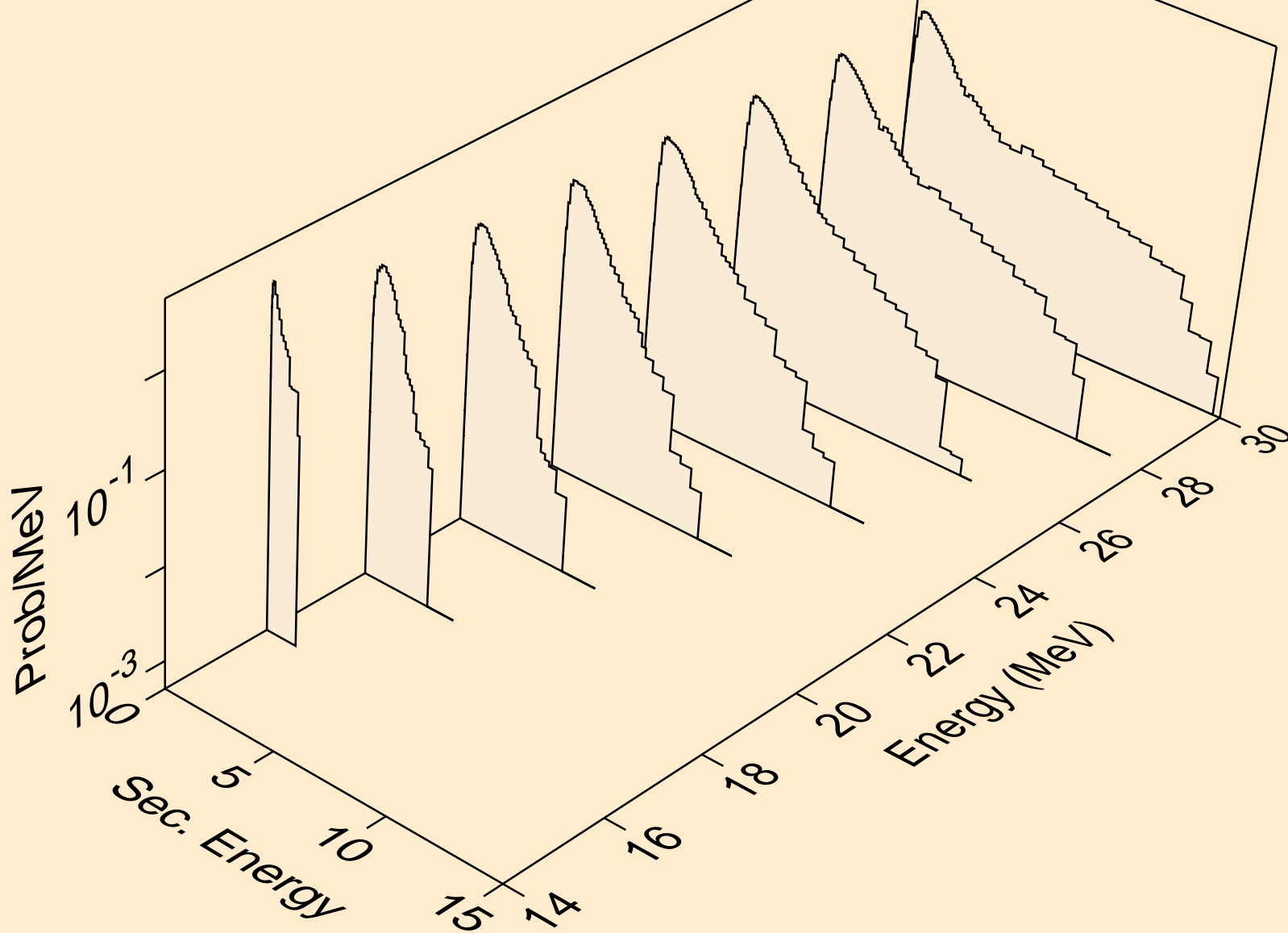

CF255 NEUTRON ACER TENDL-2019 LIBRARY; T=293.16K
Neutron emission for (n,2np)

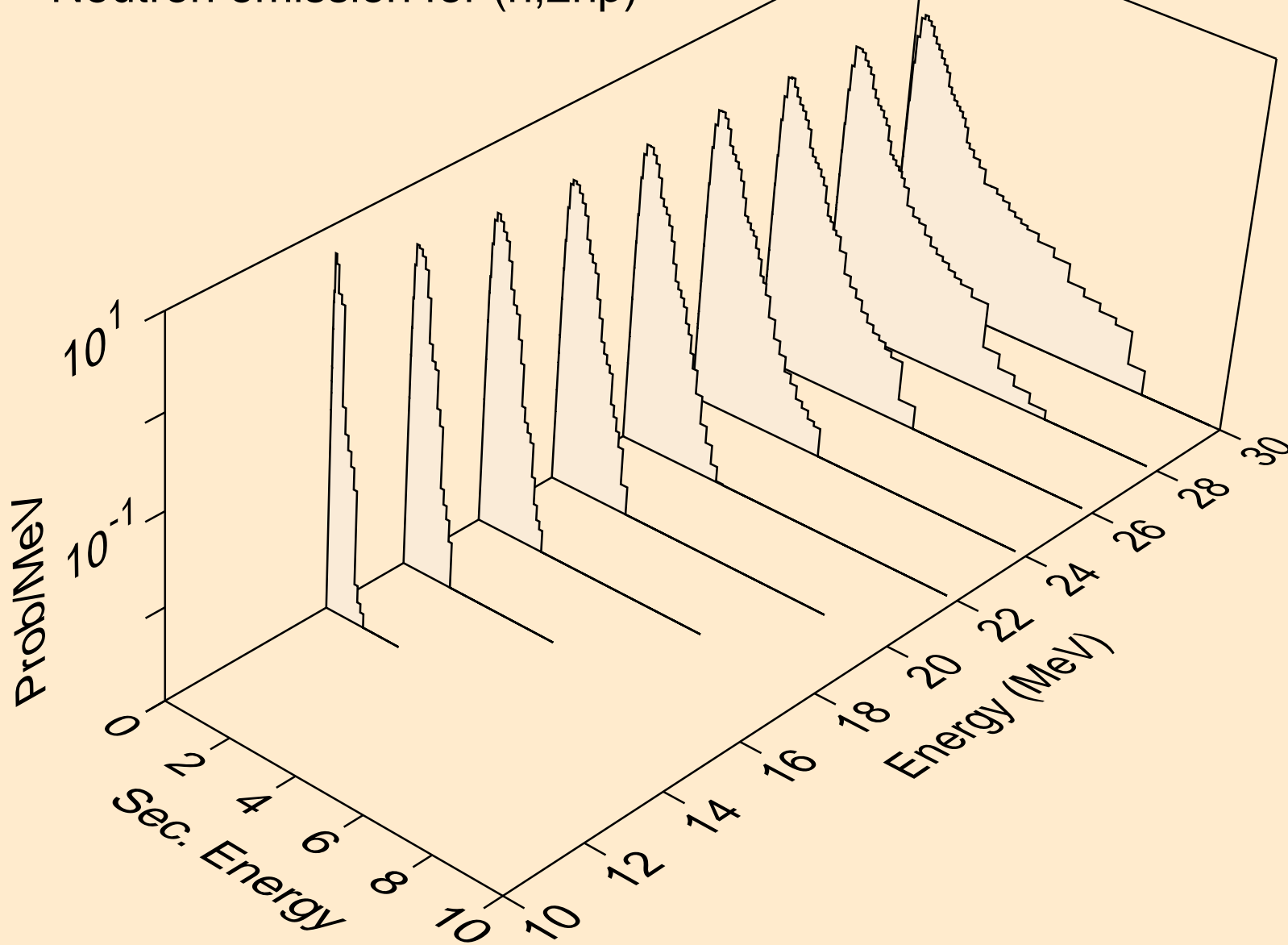

CF255 NEUTRON ACER TENDL-2019 LIBRARY; T=293.16K
Neutron emission for (n,3np)

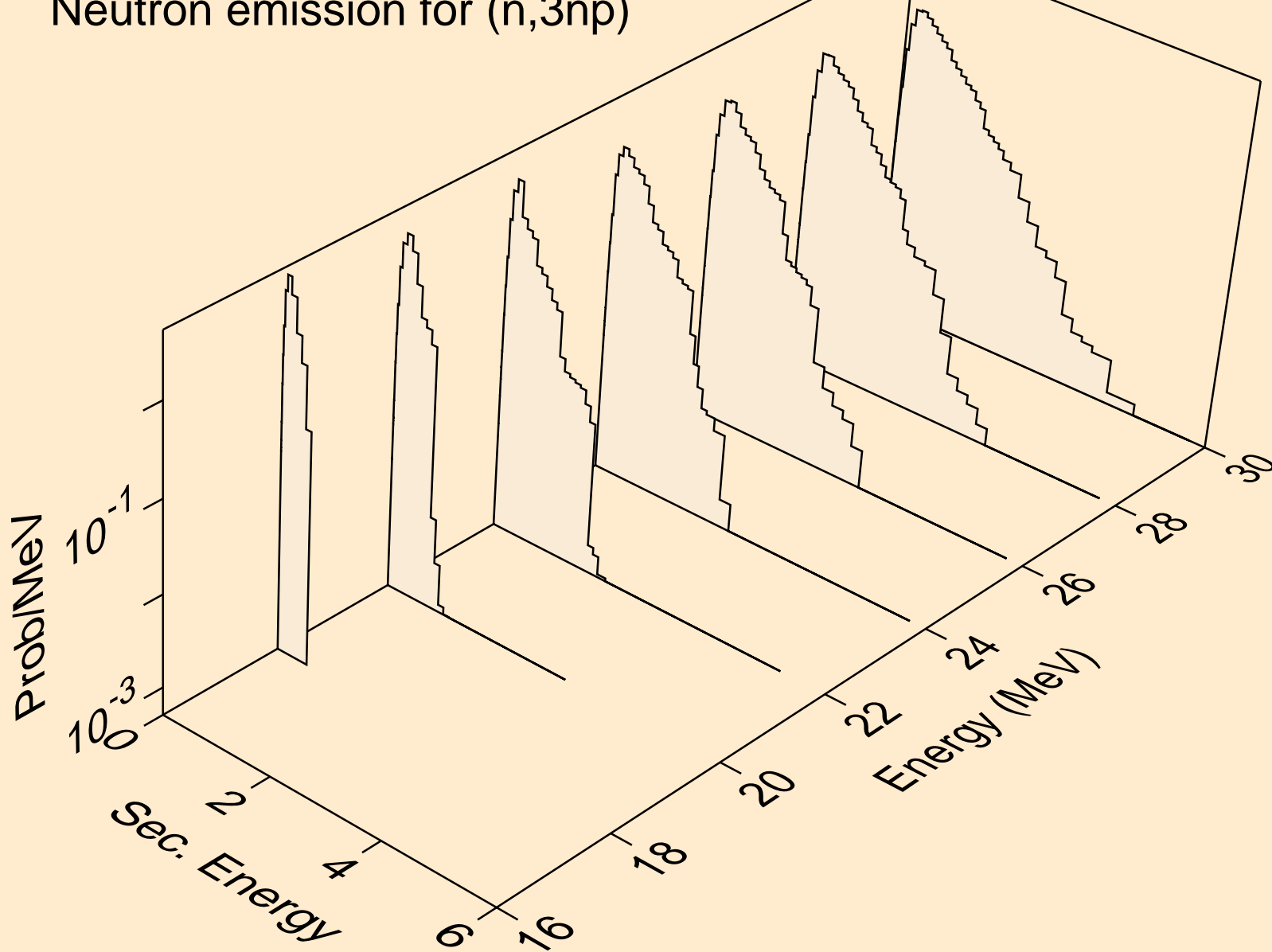

CF255 NEUTRON ACER TENDL-2019 LIBRARY; T=293.16K
Neutron emission for (n,n*c)

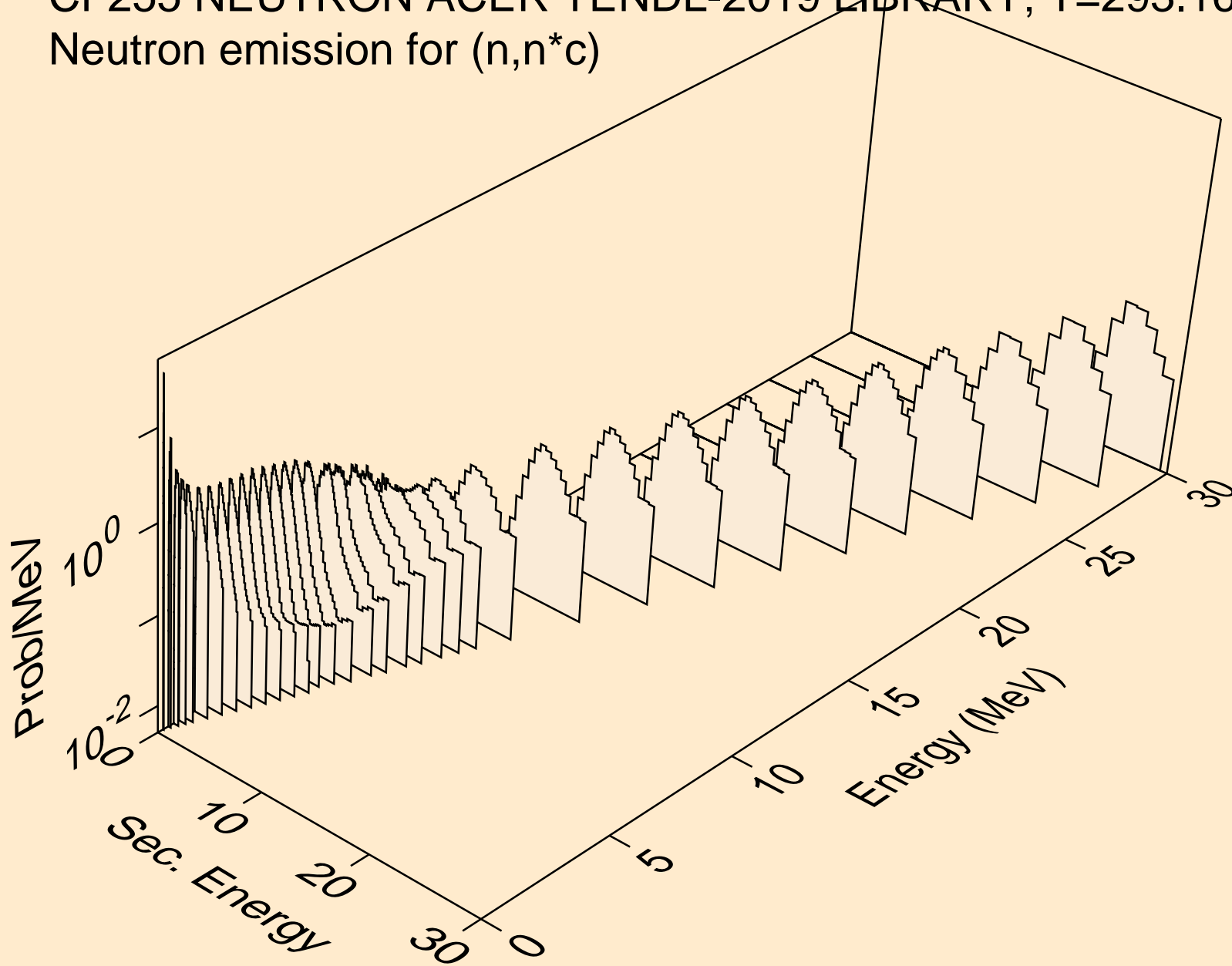

CF255 NEUTRON ACER TENDL-2019 LIBRARY; T=293.16K
Delayed nubar

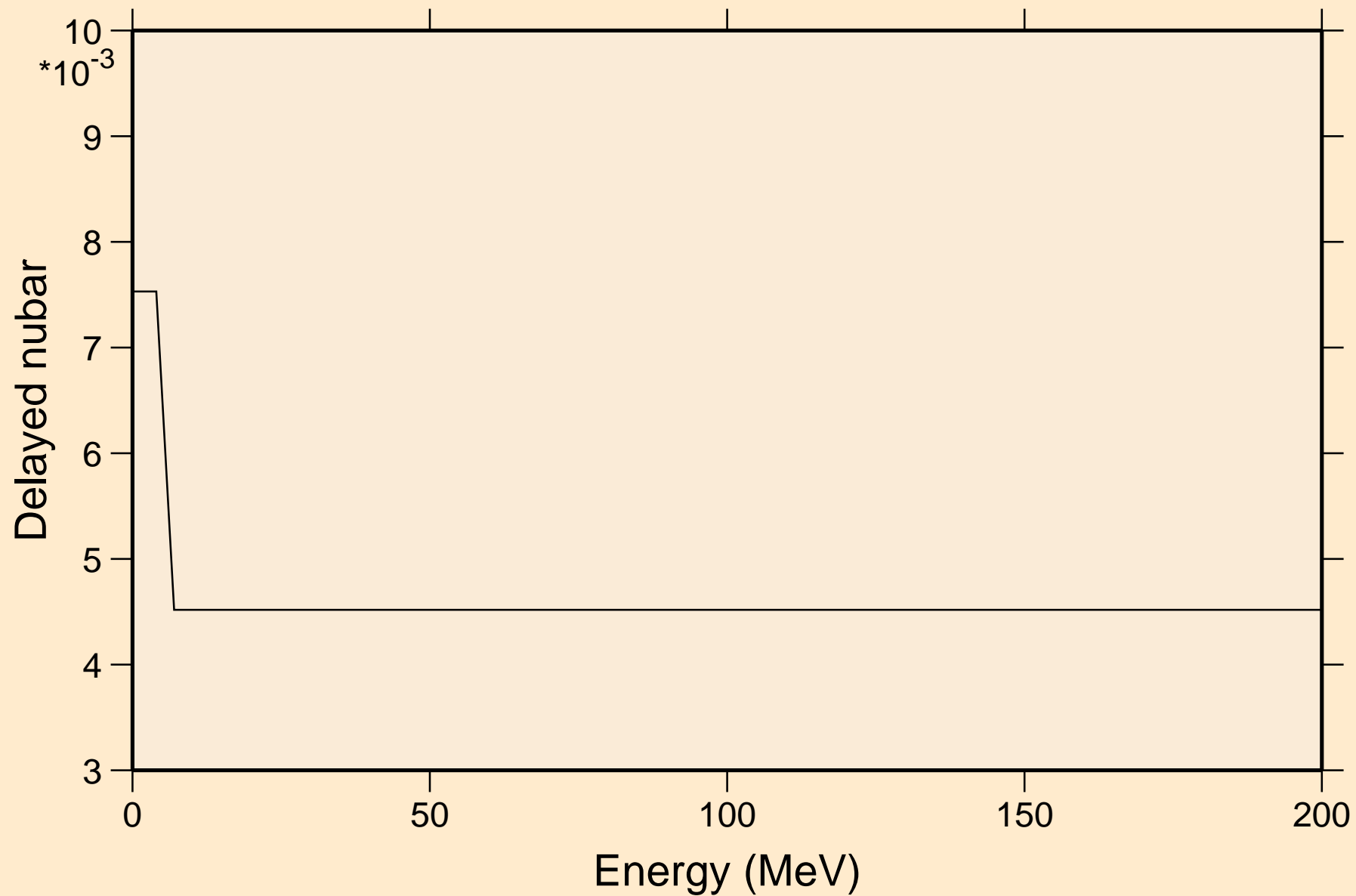

CF255 NEUTRON ACER TENDL-2019 LIBRARY; T=293.16K

Delayed neutron spectra

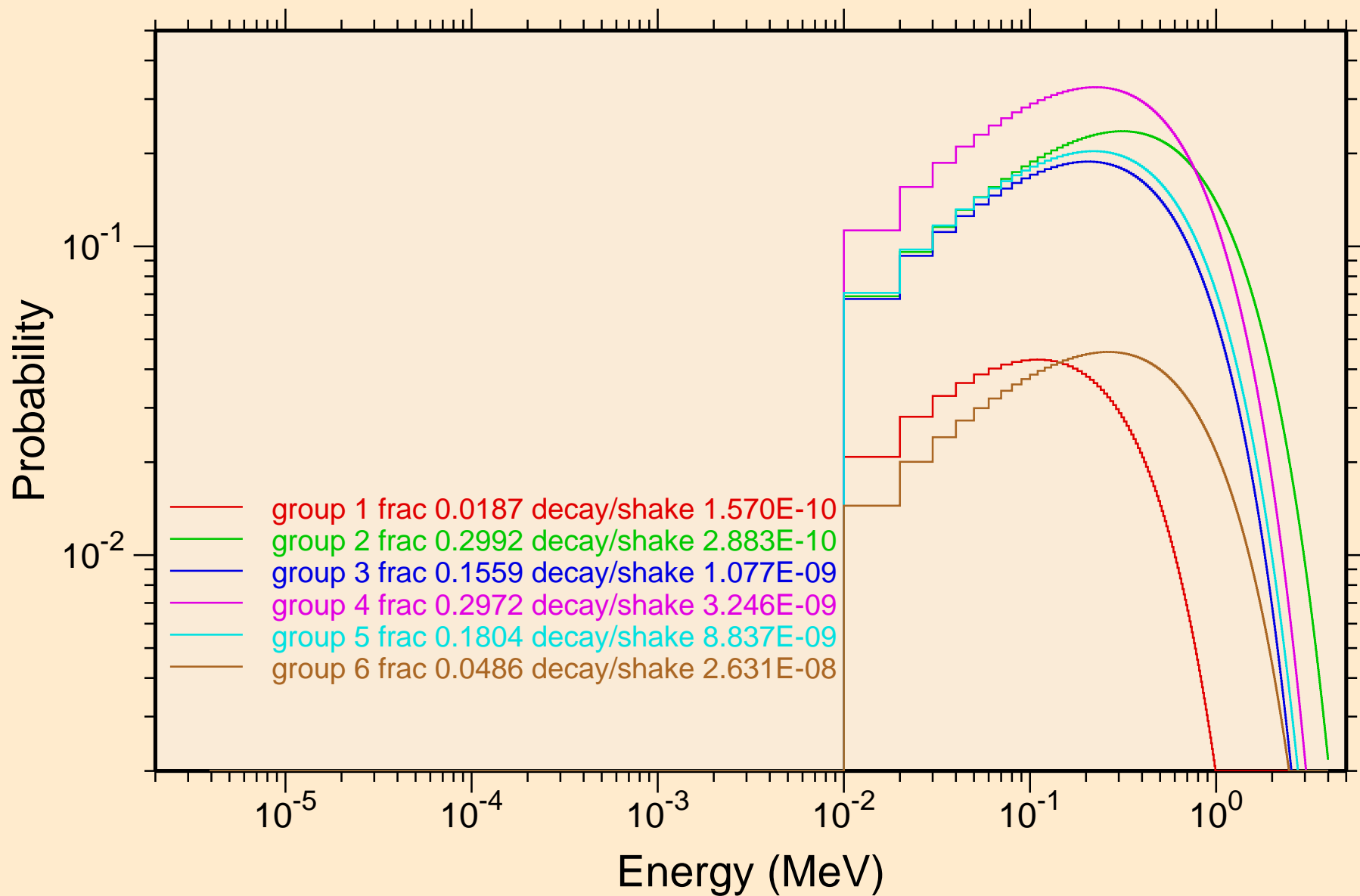

CF255 NEUTRON ACER TENDL-2019 LIBRARY; T=293.16K
Photon emission for (n,x)

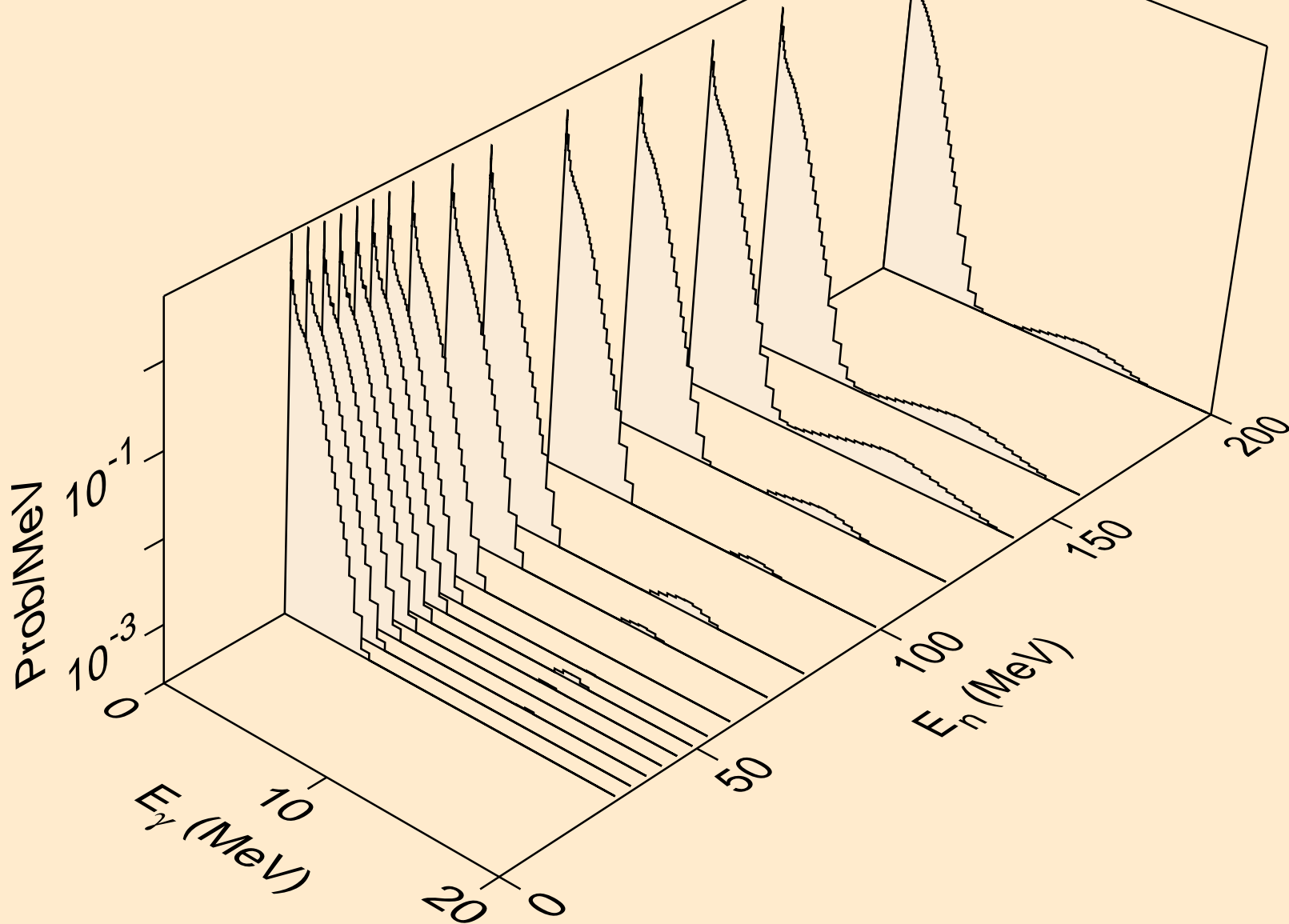

CF255 NEUTRON ACER TENDL-2019 LIBRARY; T=293.16K
Photon emission for (n,2nd)

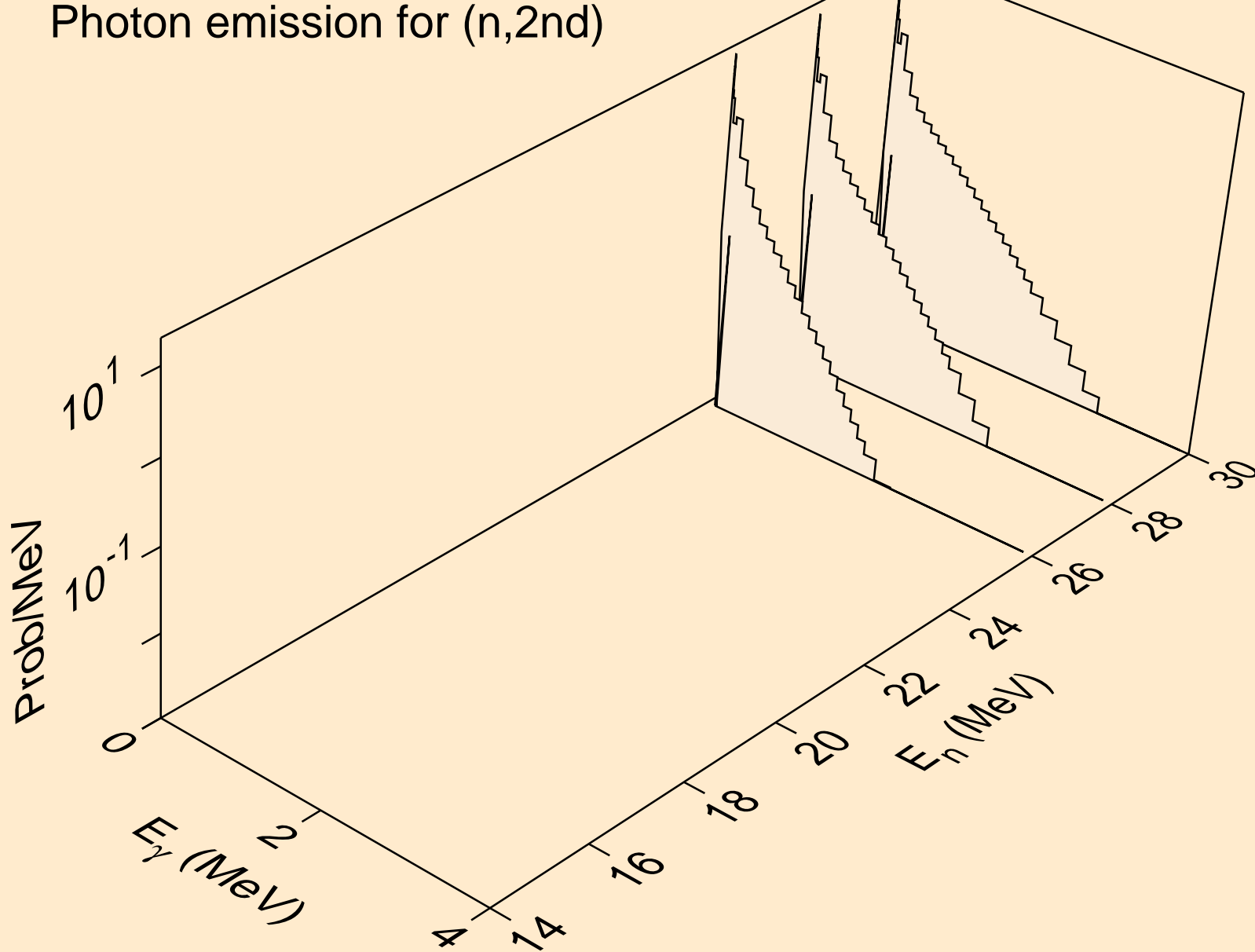

CF255 NEUTRON ACER TENDL-2019 LIBRARY; T=293.16K
Photon emission for (n,2n)

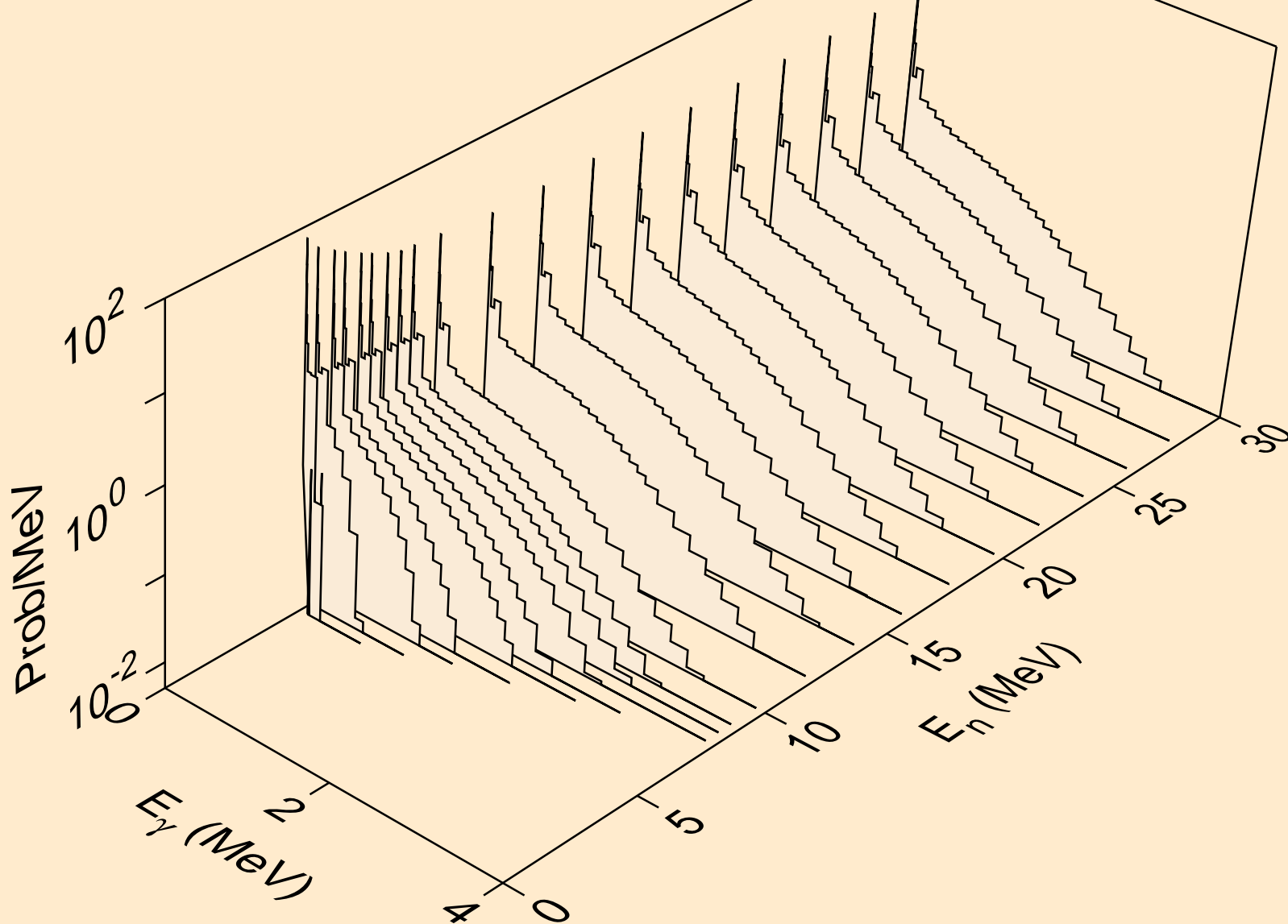

CF255 NEUTRON ACER TENDL-2019 LIBRARY; T=293.16K
Photon emission for (n,3n)

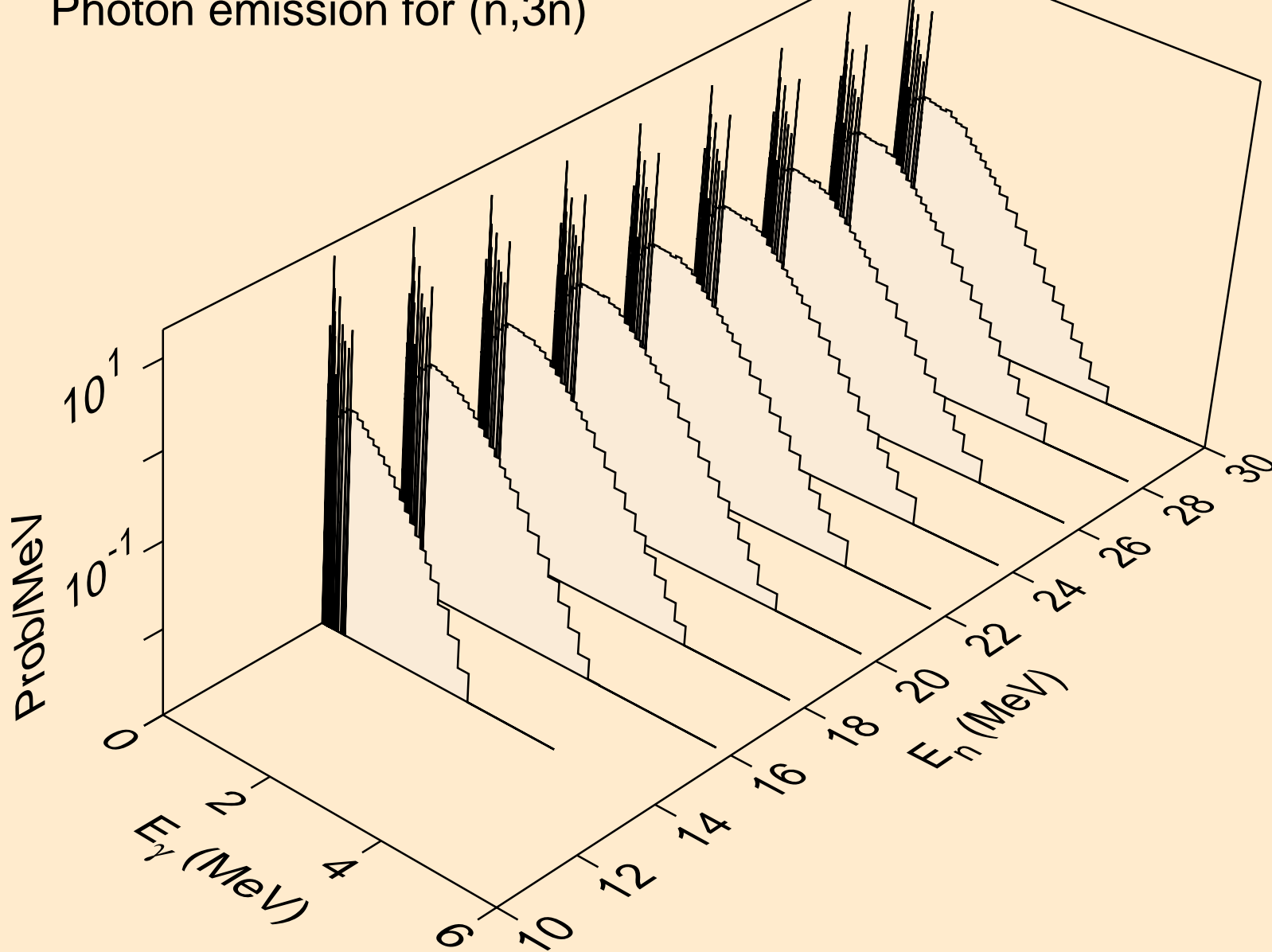

CF255 NEUTRON ACER TENDL-2019 LIBRARY; T=293.16K
Photon emission for (n,n*)a

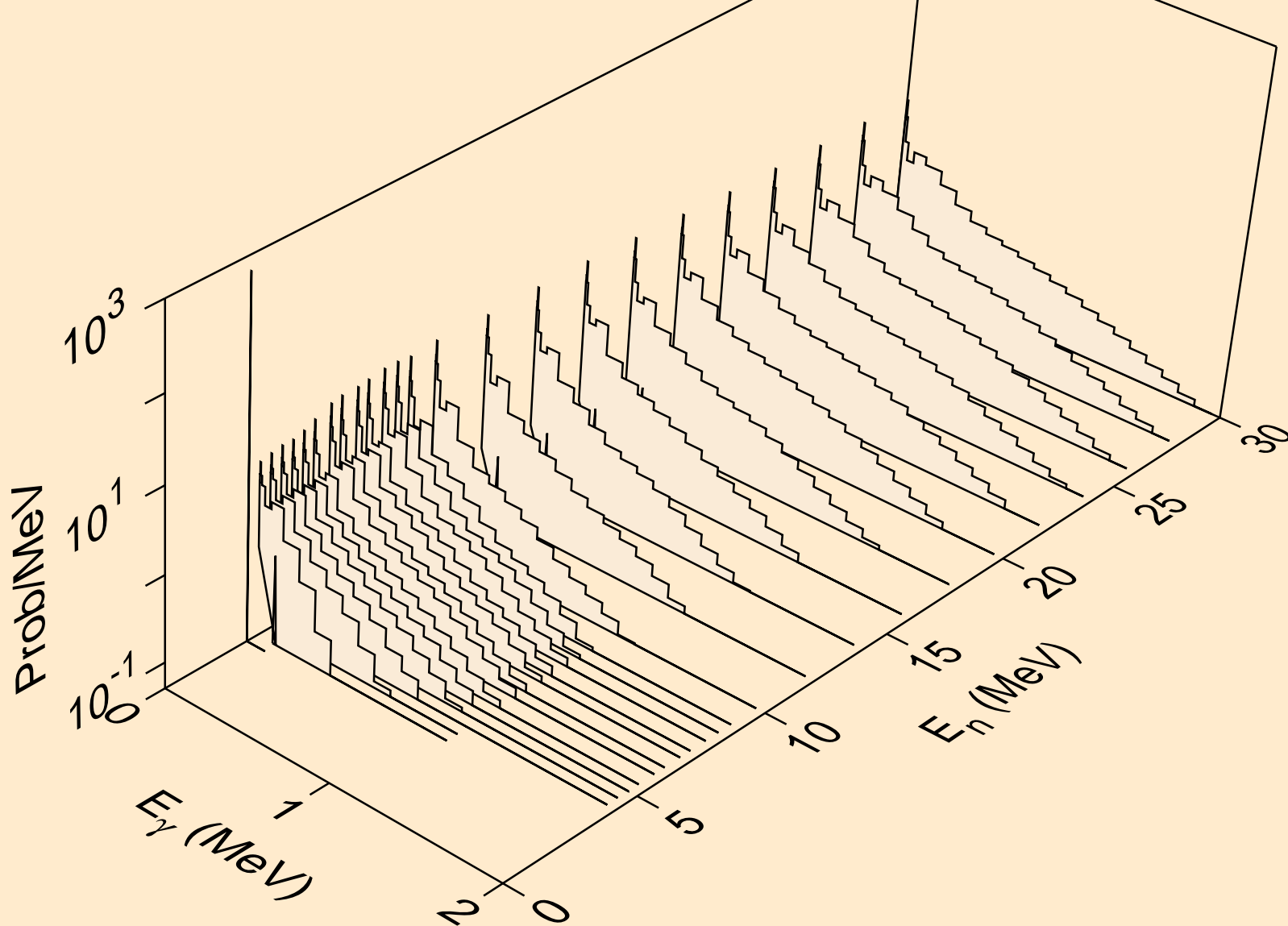

CF255 NEUTRON ACER TENDL-2019 LIBRARY; T=293.16K
Photon emission for (n,2n)_a

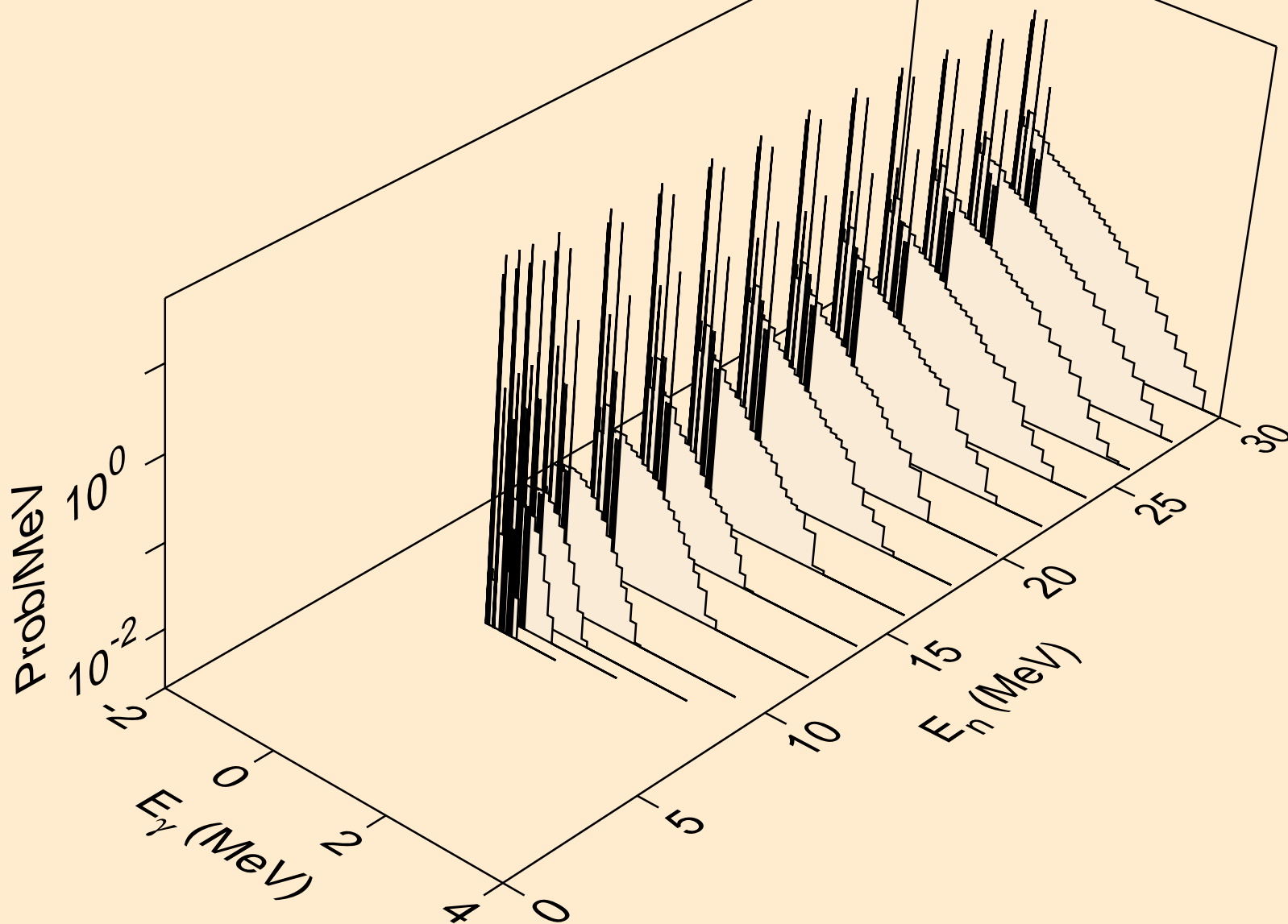

CF255 NEUTRON ACER TENDL-2019 LIBRARY; T=293.16K
Photon emission for (n,3n)a

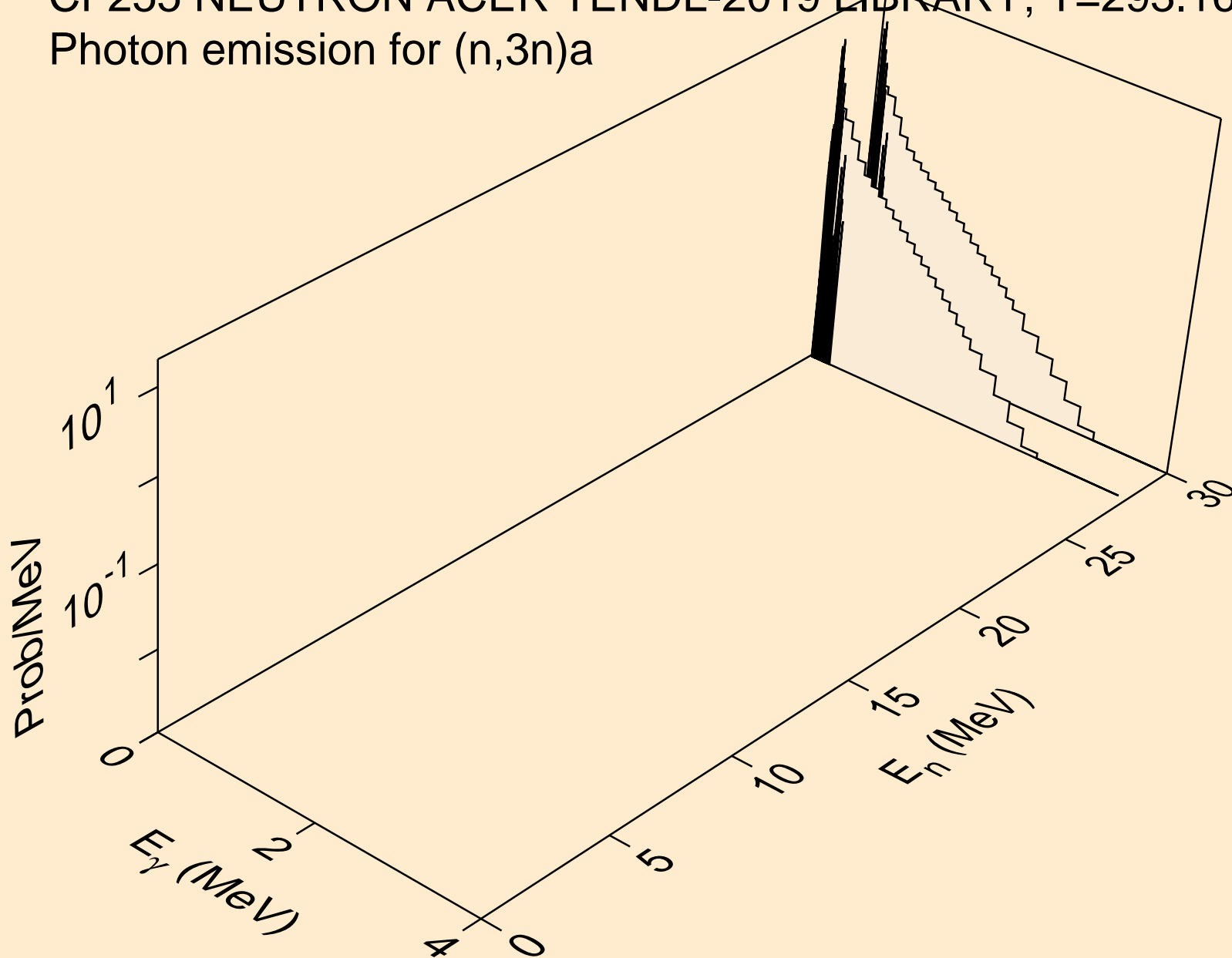

CF255 NEUTRON ACER TENDL-2019 LIBRARY; T=293.16K
Photon emission for (n,n*)p

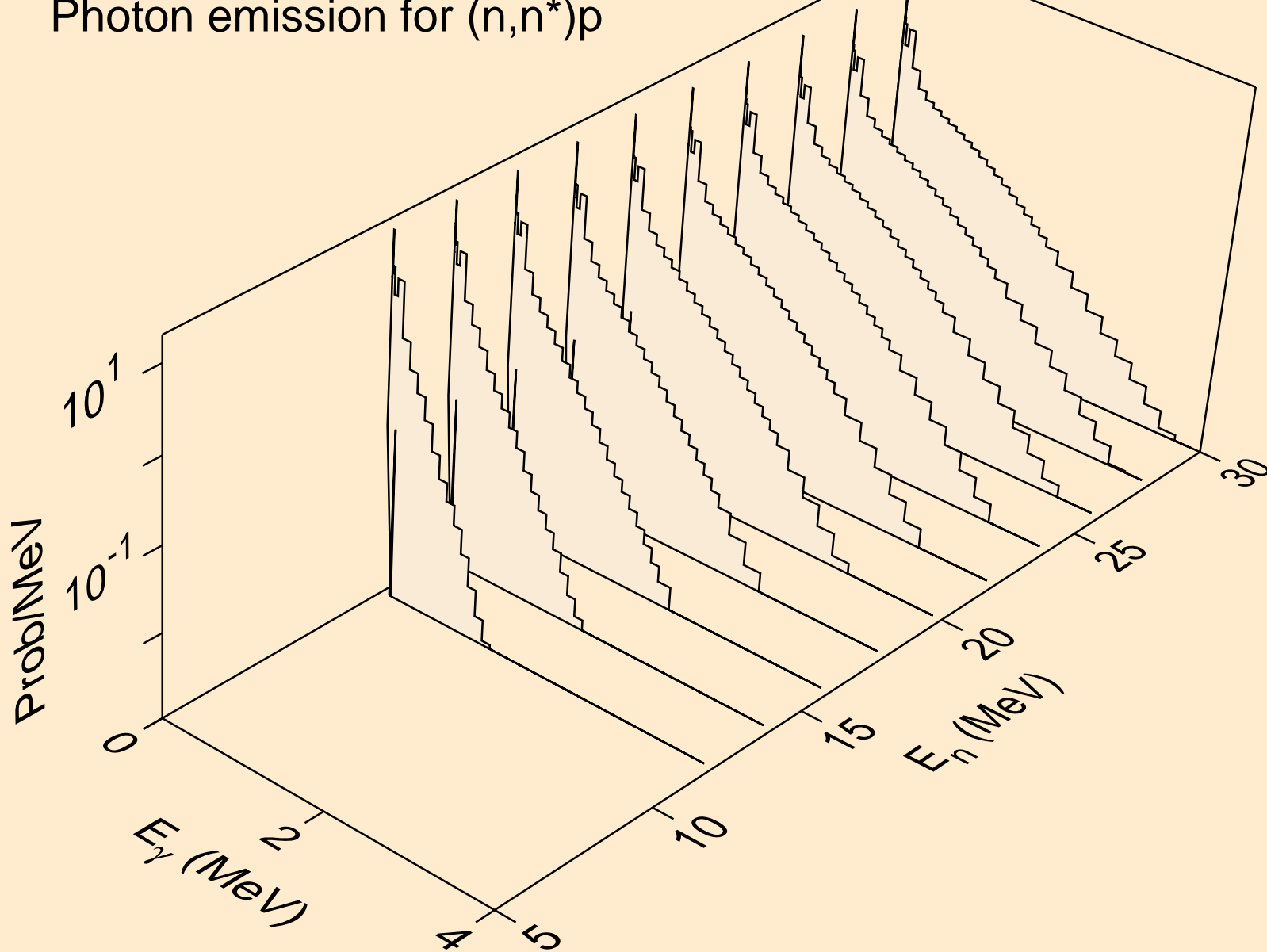

CF255 NEUTRON ACER TENDL-2019 LIBRARY; T=293.16K
Photon emission for (n,n*)d

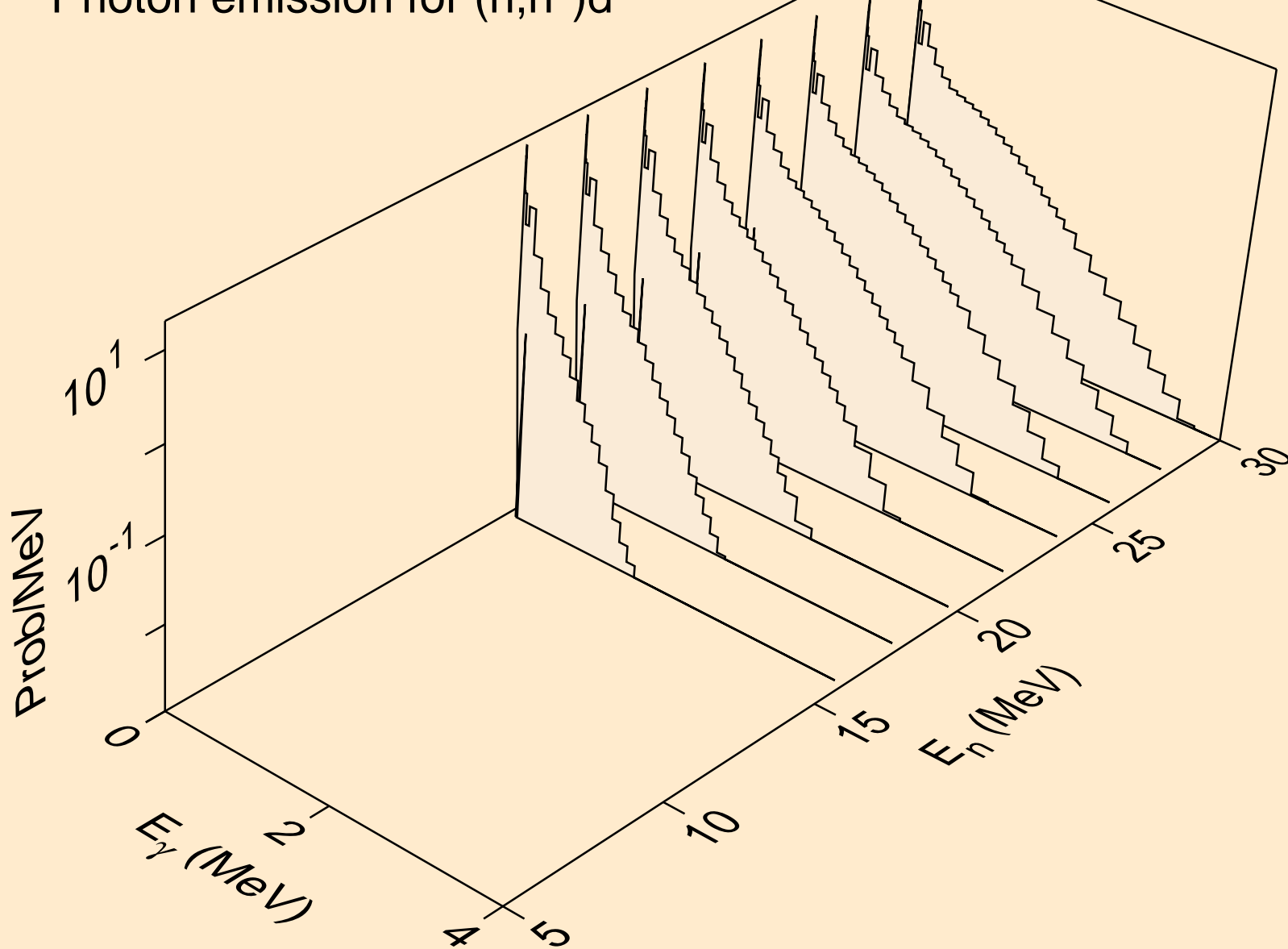

CF255 NEUTRON ACER TENDL-2019 LIBRARY; T=293.16K
Photon emission for (n,n*)t

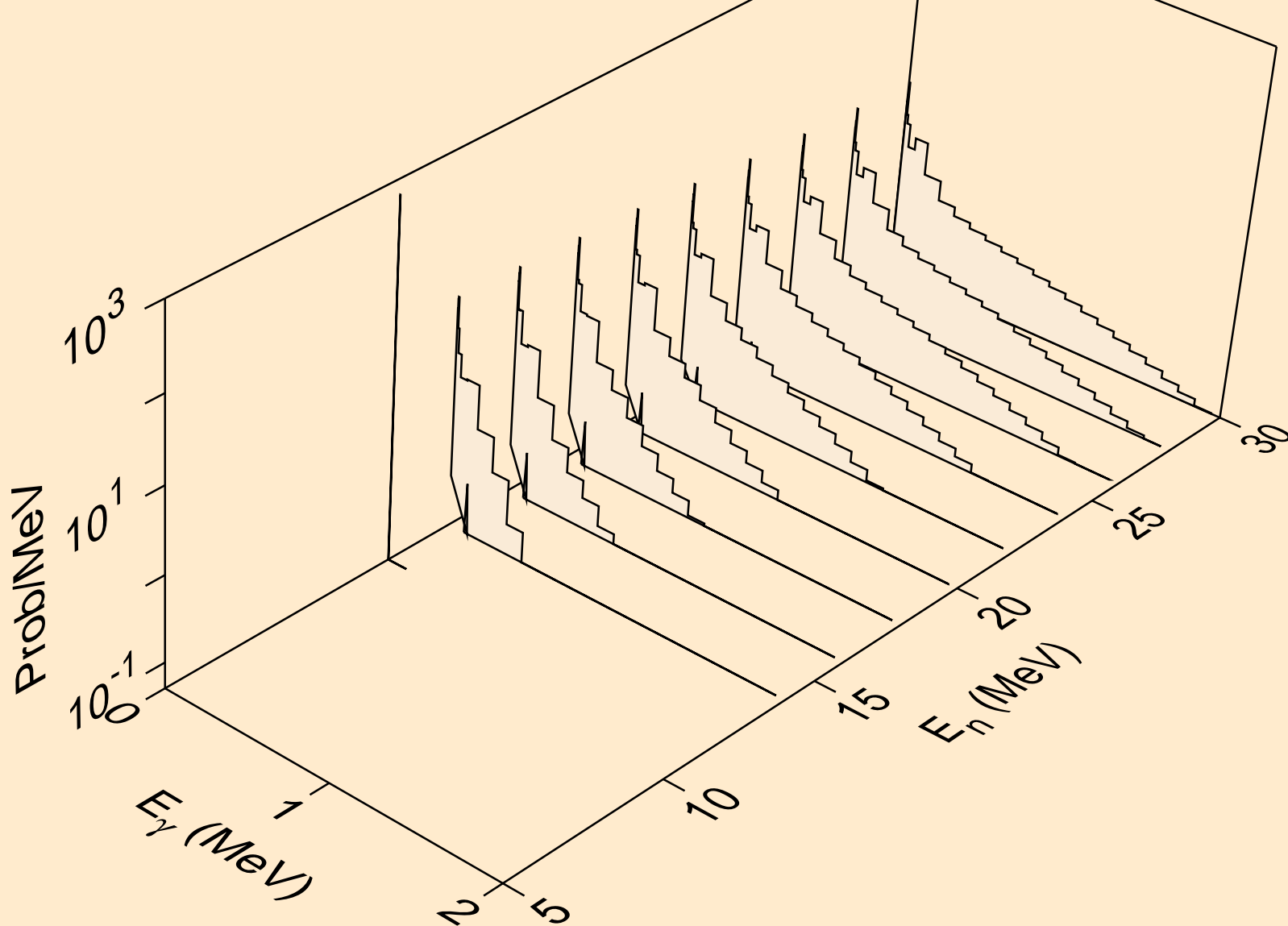

CF255 NEUTRON ACER TENDL-2019 LIBRARY; T=293.16K
Photon emission for (n,n*)he3

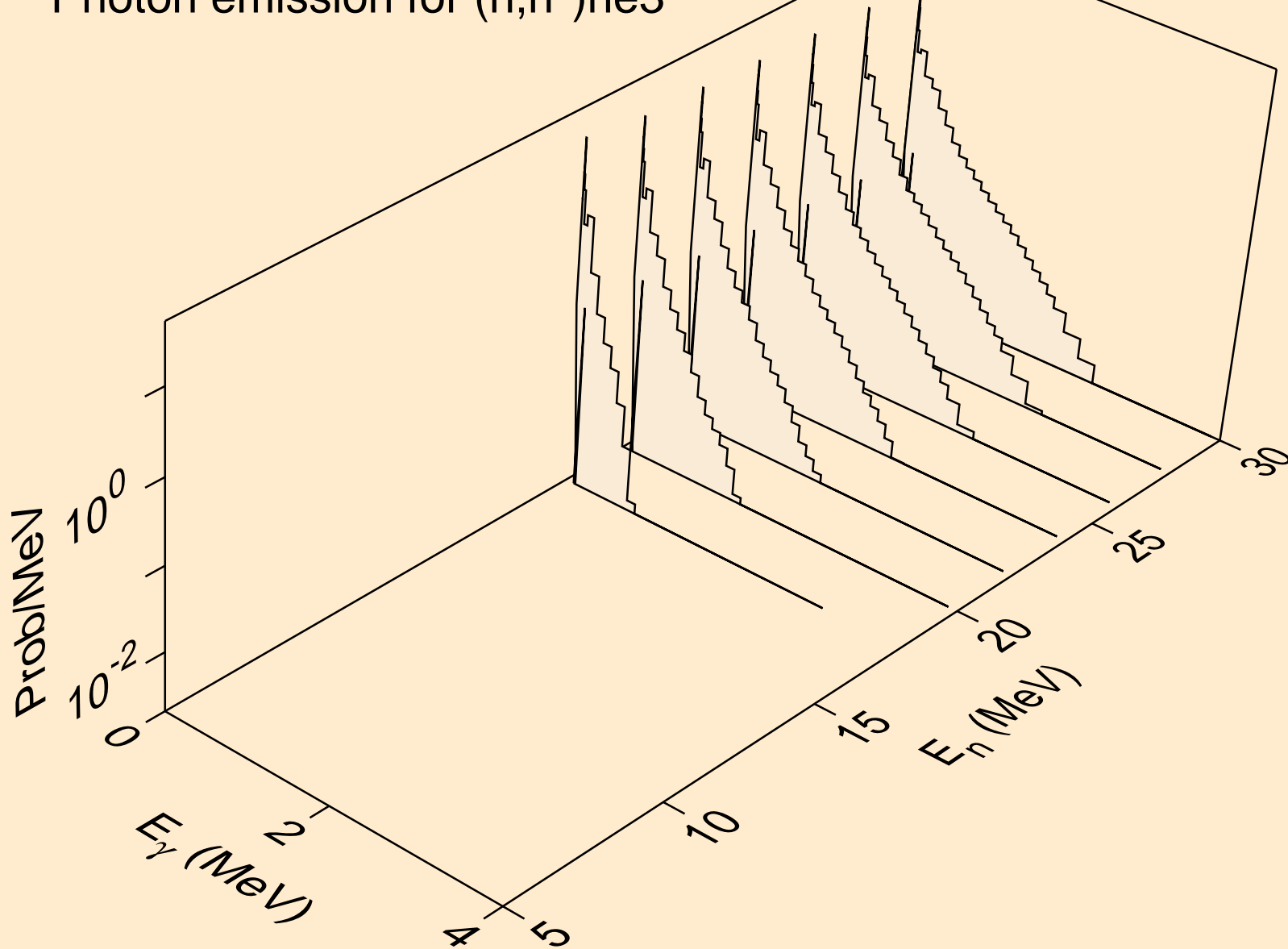

CF255 NEUTRON ACER TENDL-2019 LIBRARY; T=293.16K
Photon emission for (n,4n)

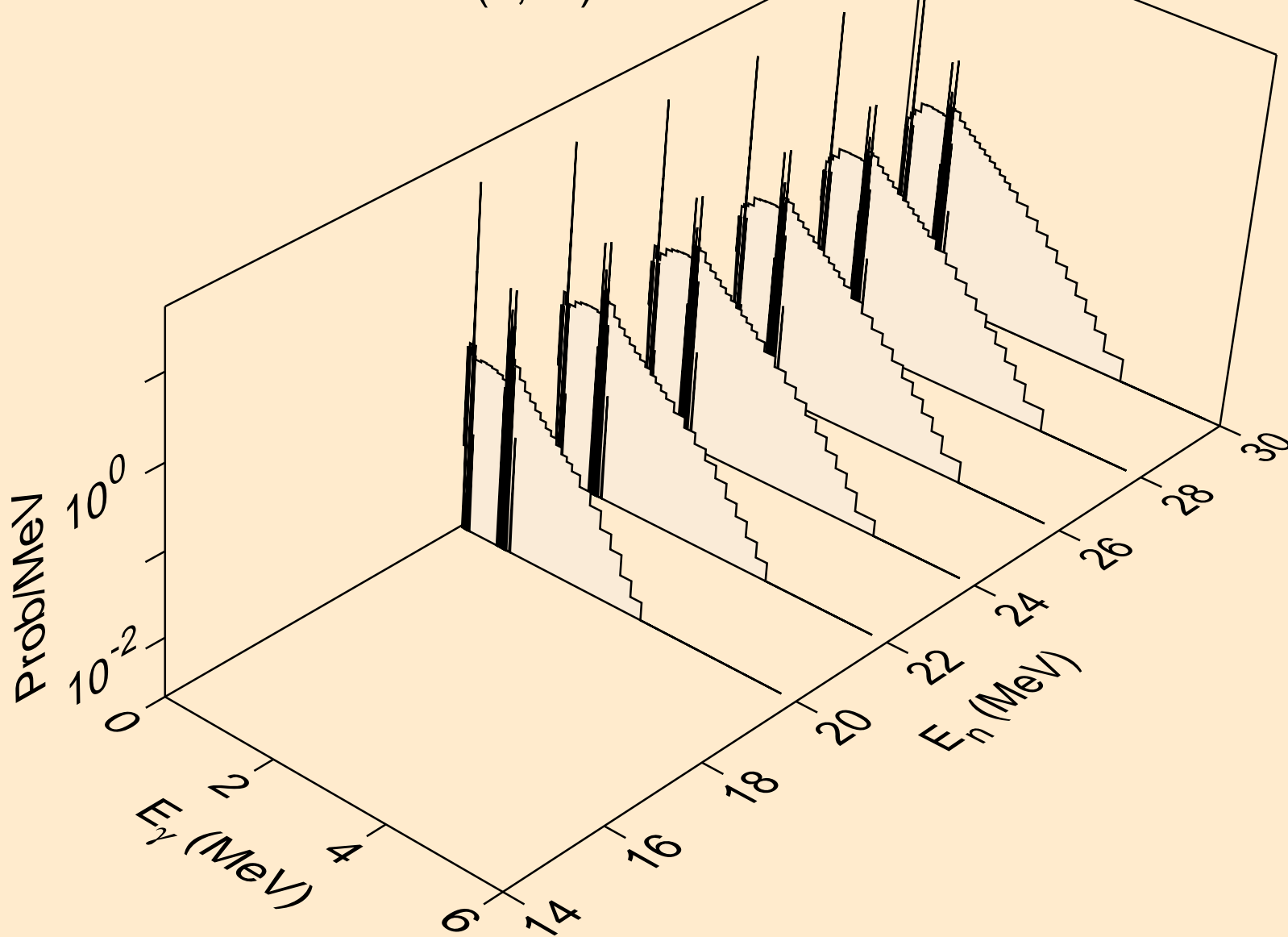

CF255 NEUTRON ACER TENDL-2019 LIBRARY; T=293.16K
Photon emission for (n,2np)

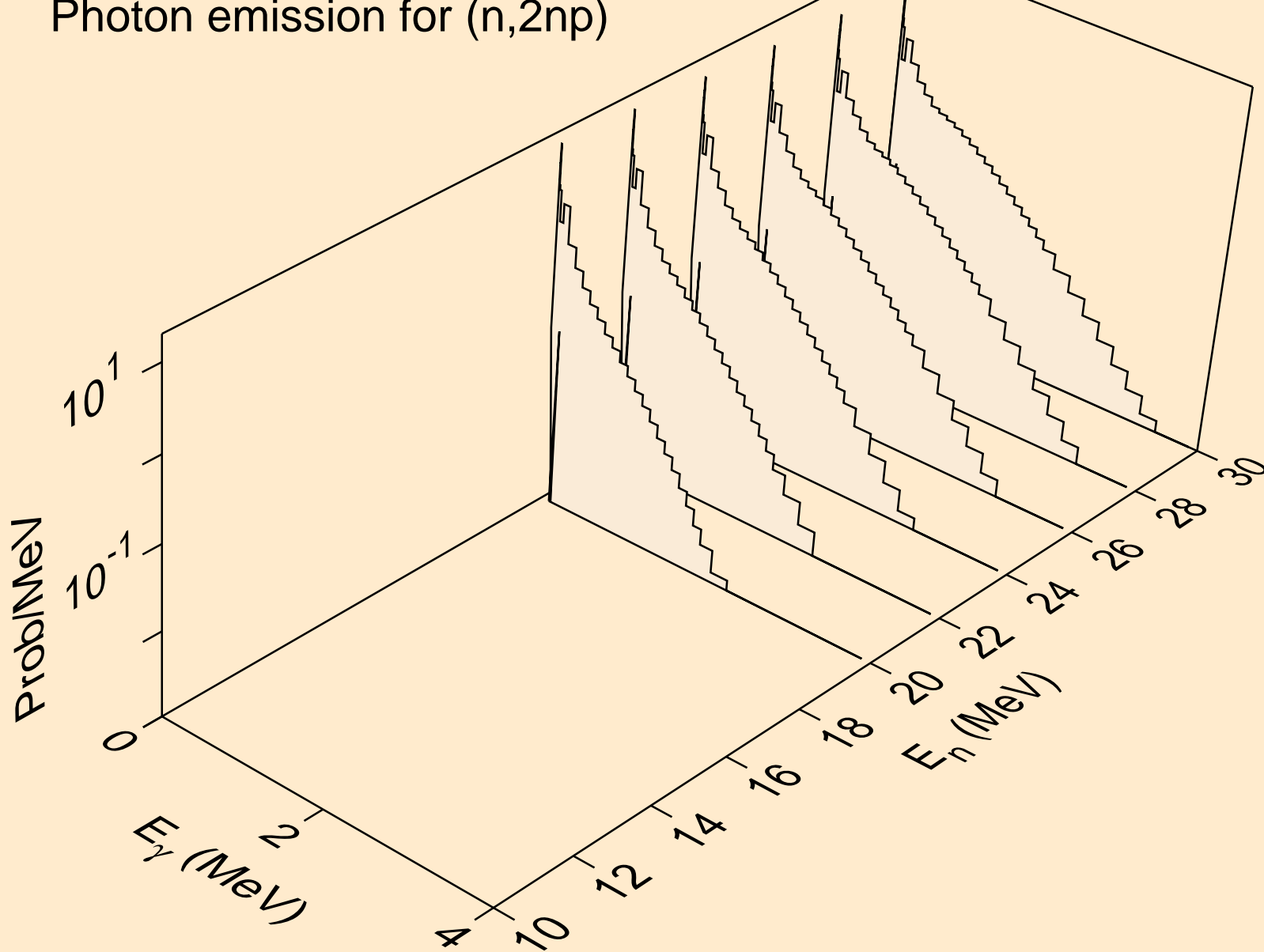

CF255 NEUTRON ACER TENDL-2019 LIBRARY; T=293.16K
Photon emission for (n,3np)

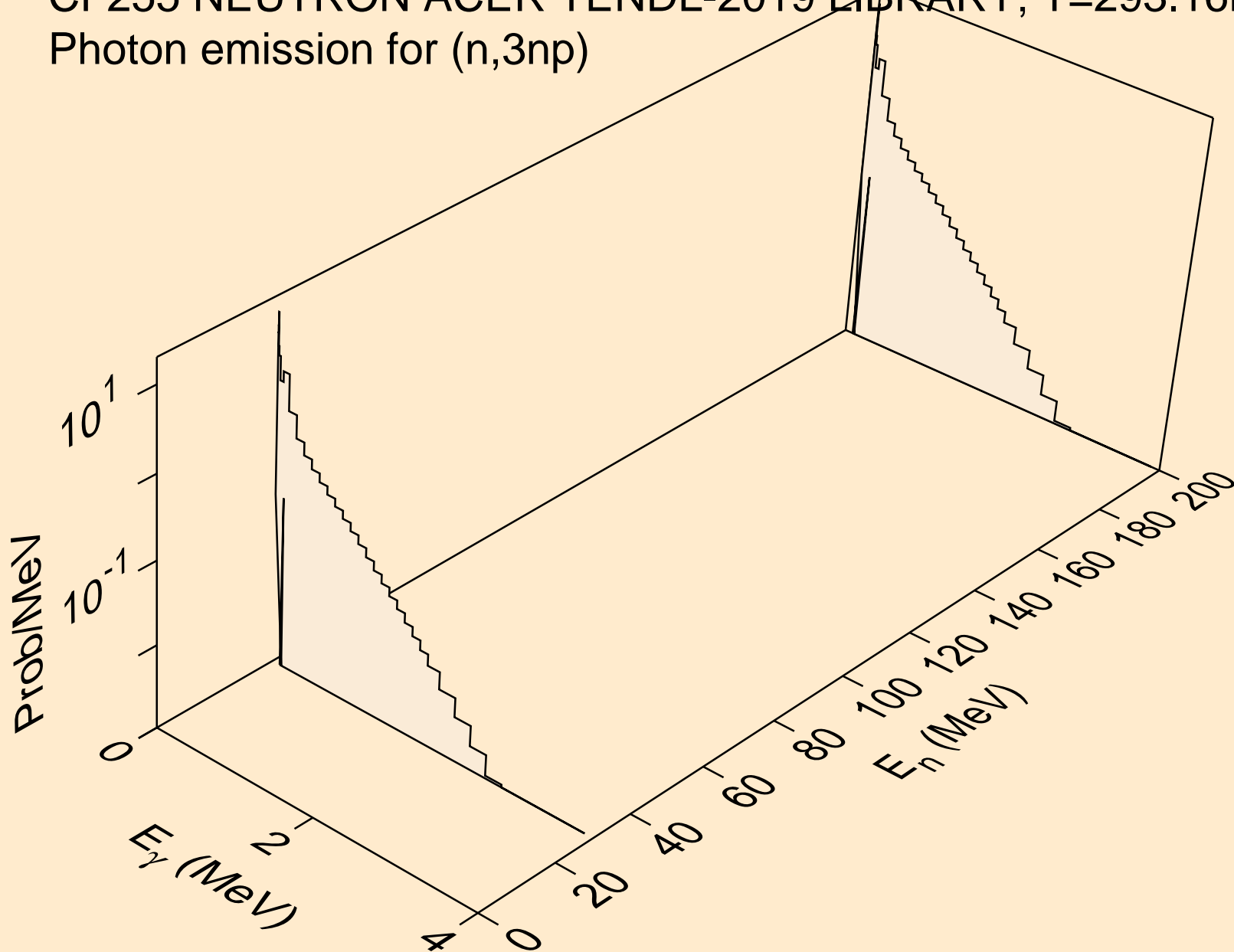

CF255 NEUTRON ACER TENDL-2019 LIBRARY; T=293.16K
Photon emission for (n,n*c)

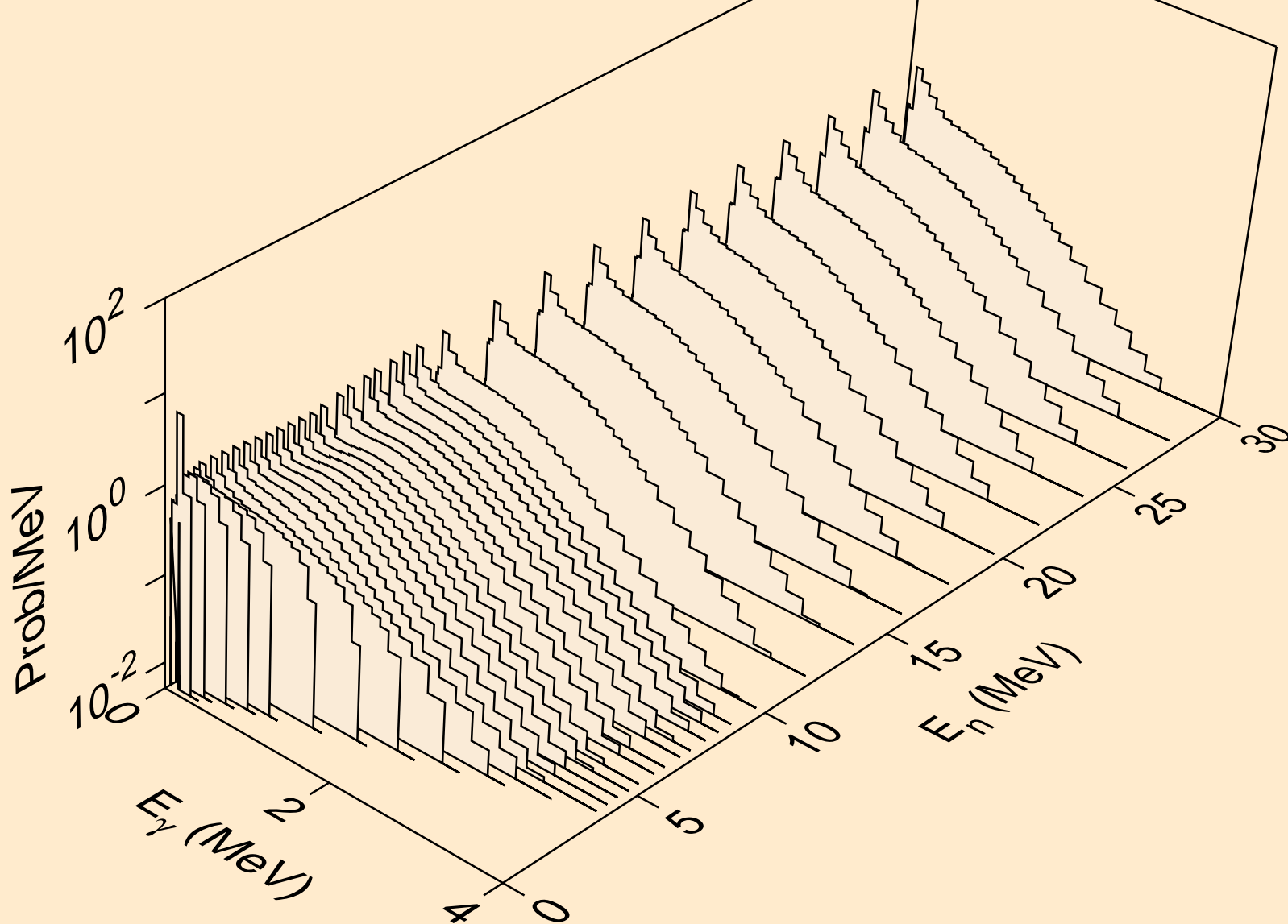

CF255 NEUTRON ACER TENDL-2019 LIBRARY; T=293.16K
Photon emission for (n,gma)

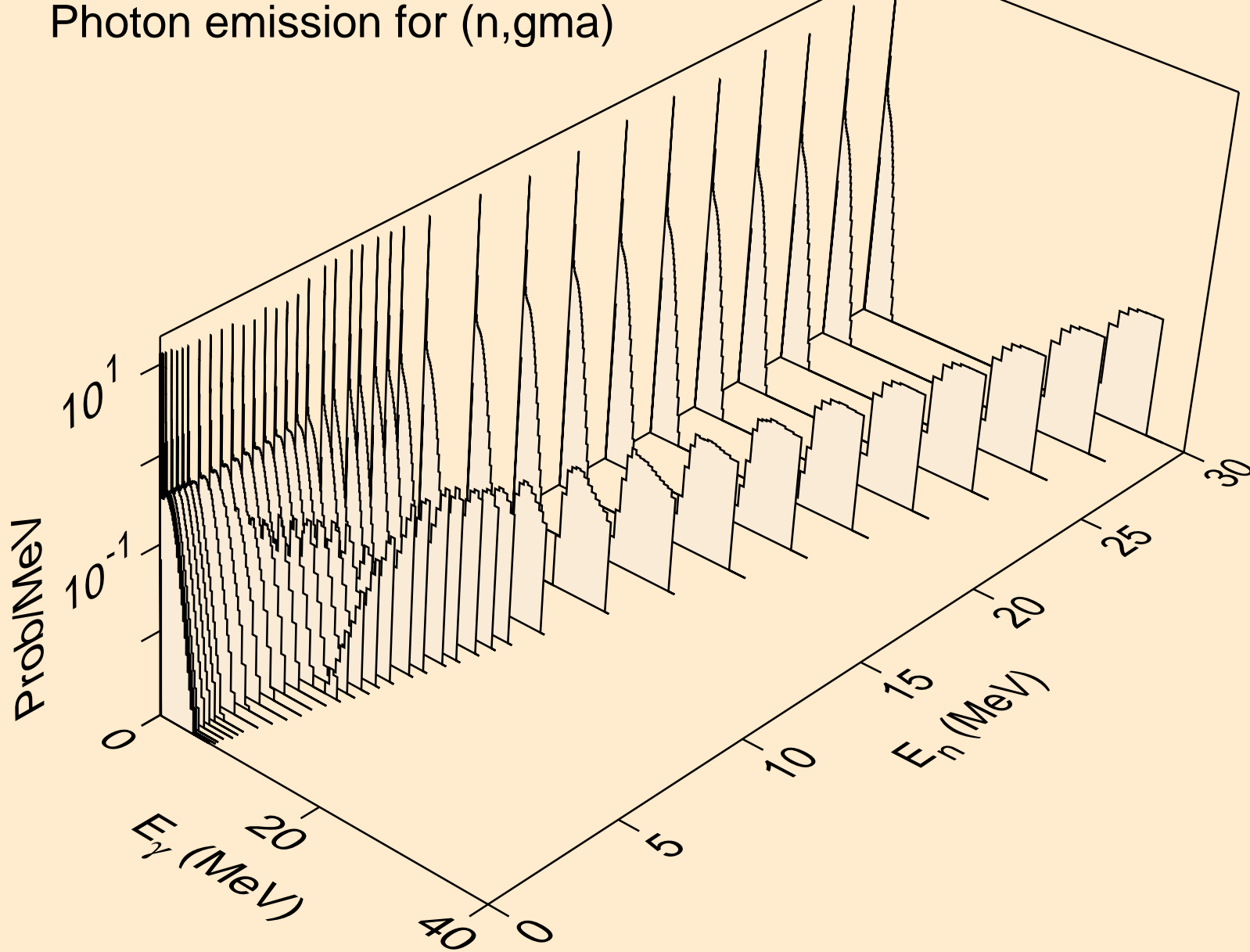

CF255 NEUTRON ACER TENDL-2019 LIBRARY; T=293.16K
Photon emission for (n,p)

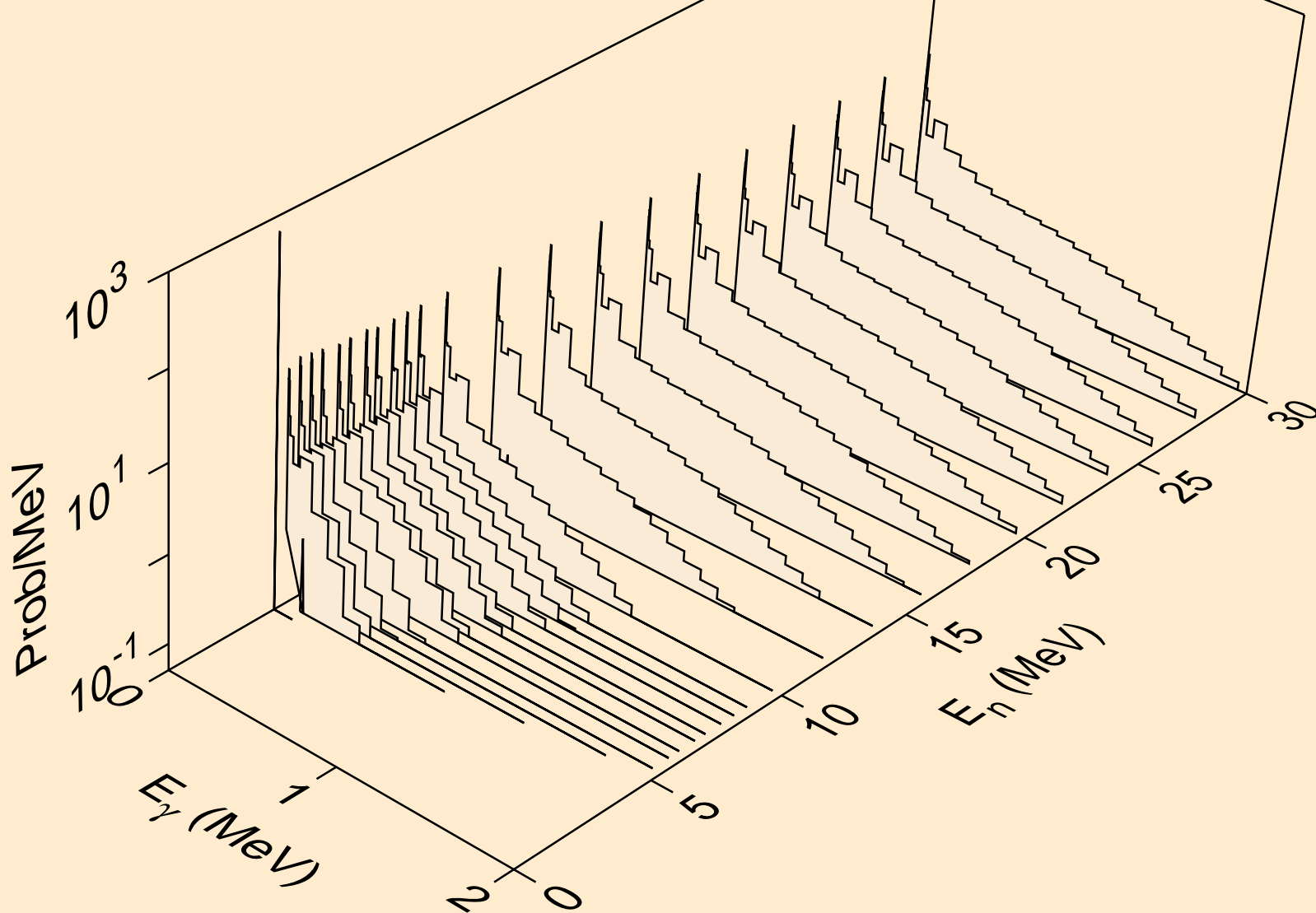

CF255 NEUTRON ACER TENDL-2019 LIBRARY; T=293.16K
Photon emission for (n,d)

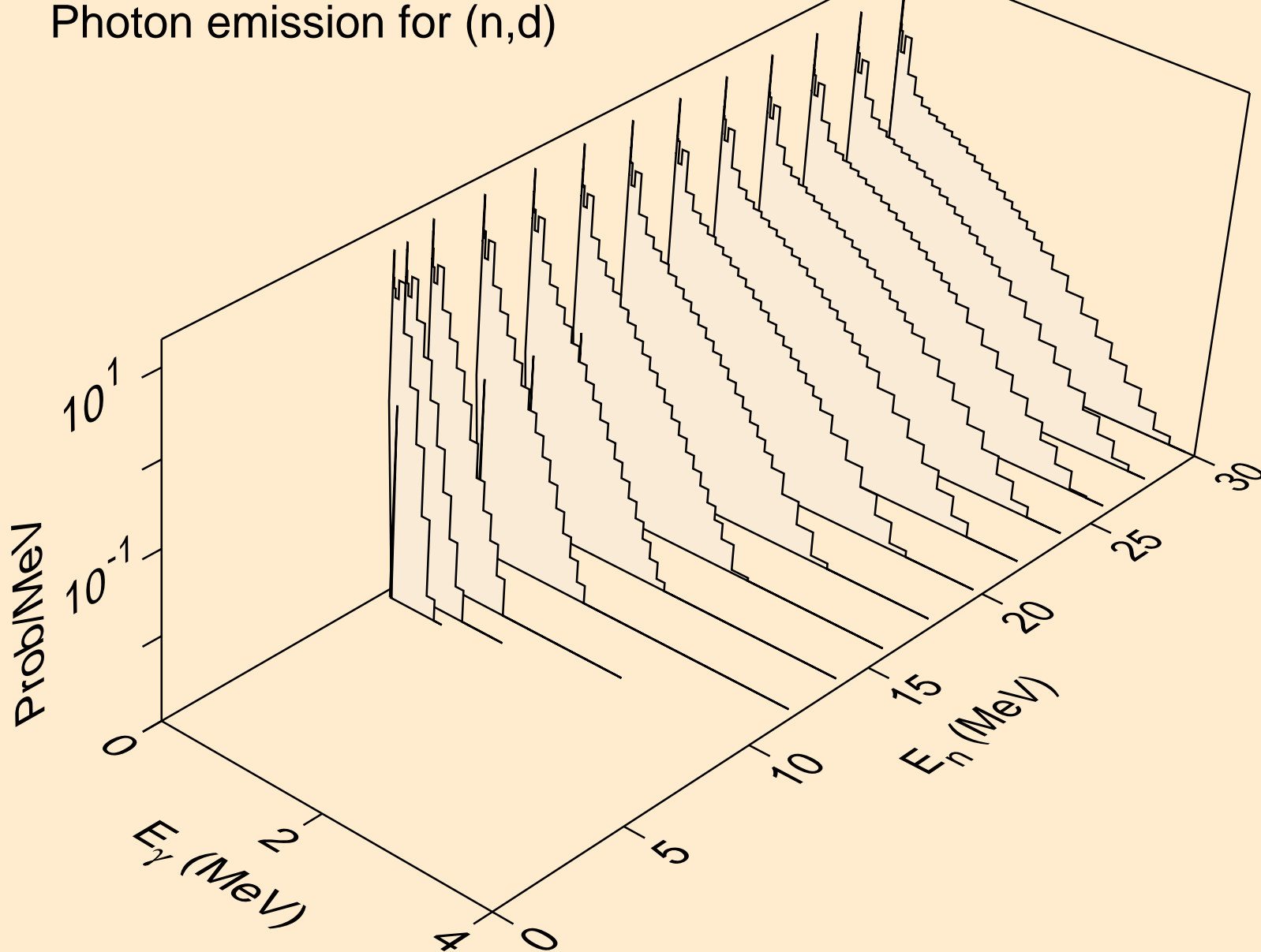

CF255 NEUTRON ACER TENDL-2019 LIBRARY; T=293.16K
Photon emission for (n,t)

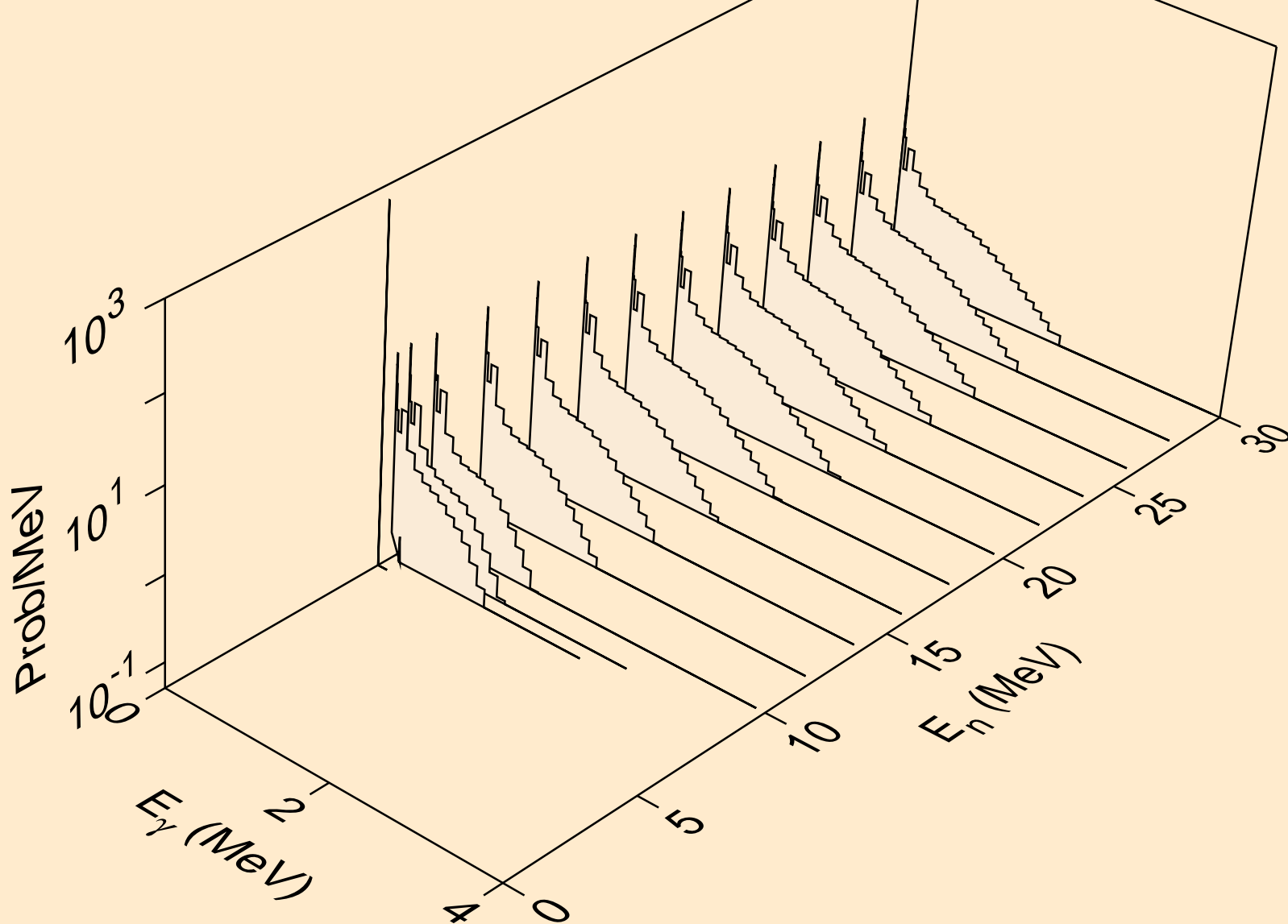

CF255 NEUTRON ACER TENDL-2019 LIBRARY; T=293.16K
Photon emission for (n,he3)

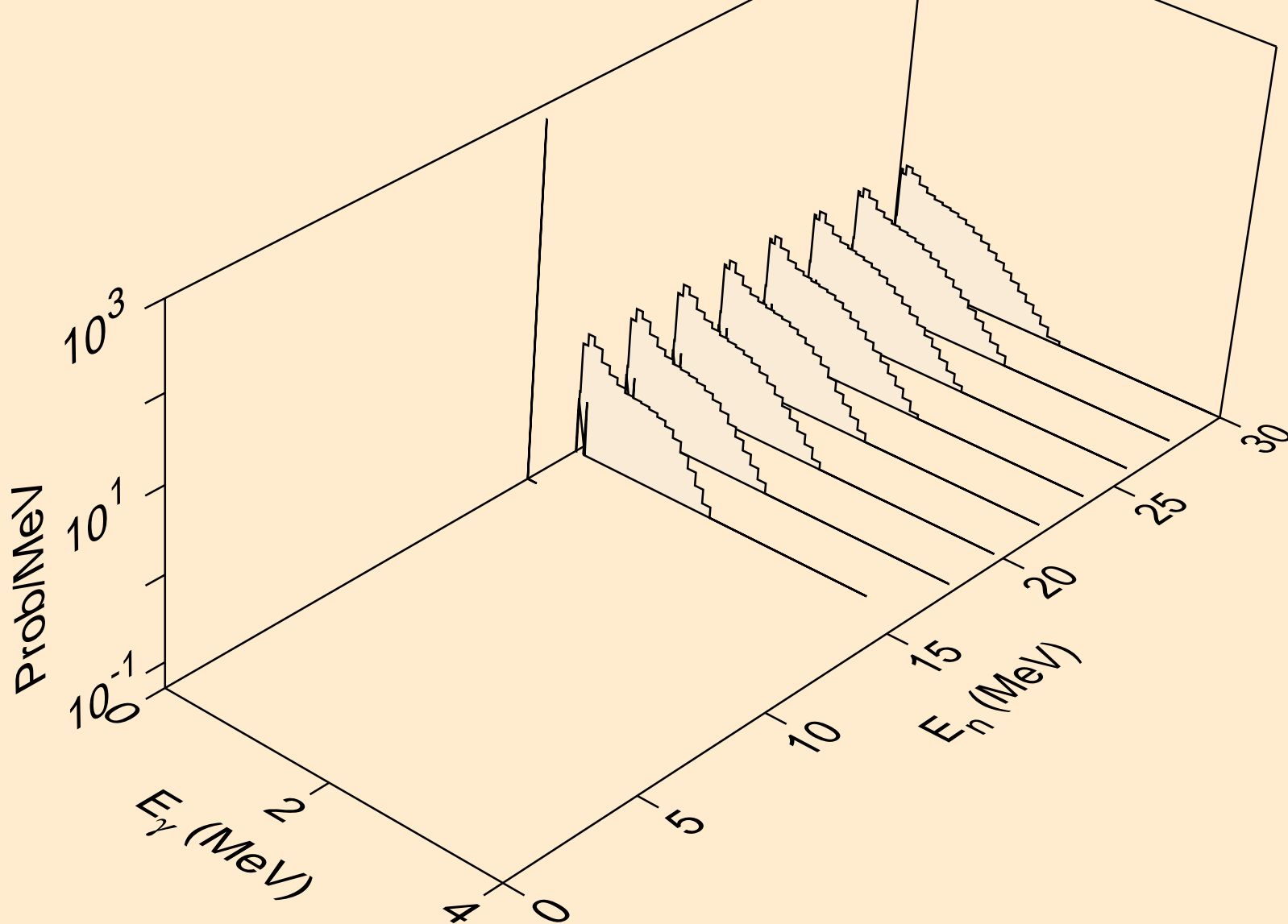

CF255 NEUTRON ACER TENDL-2019 LIBRARY; T=293.16K
Photon emission for (n,a)

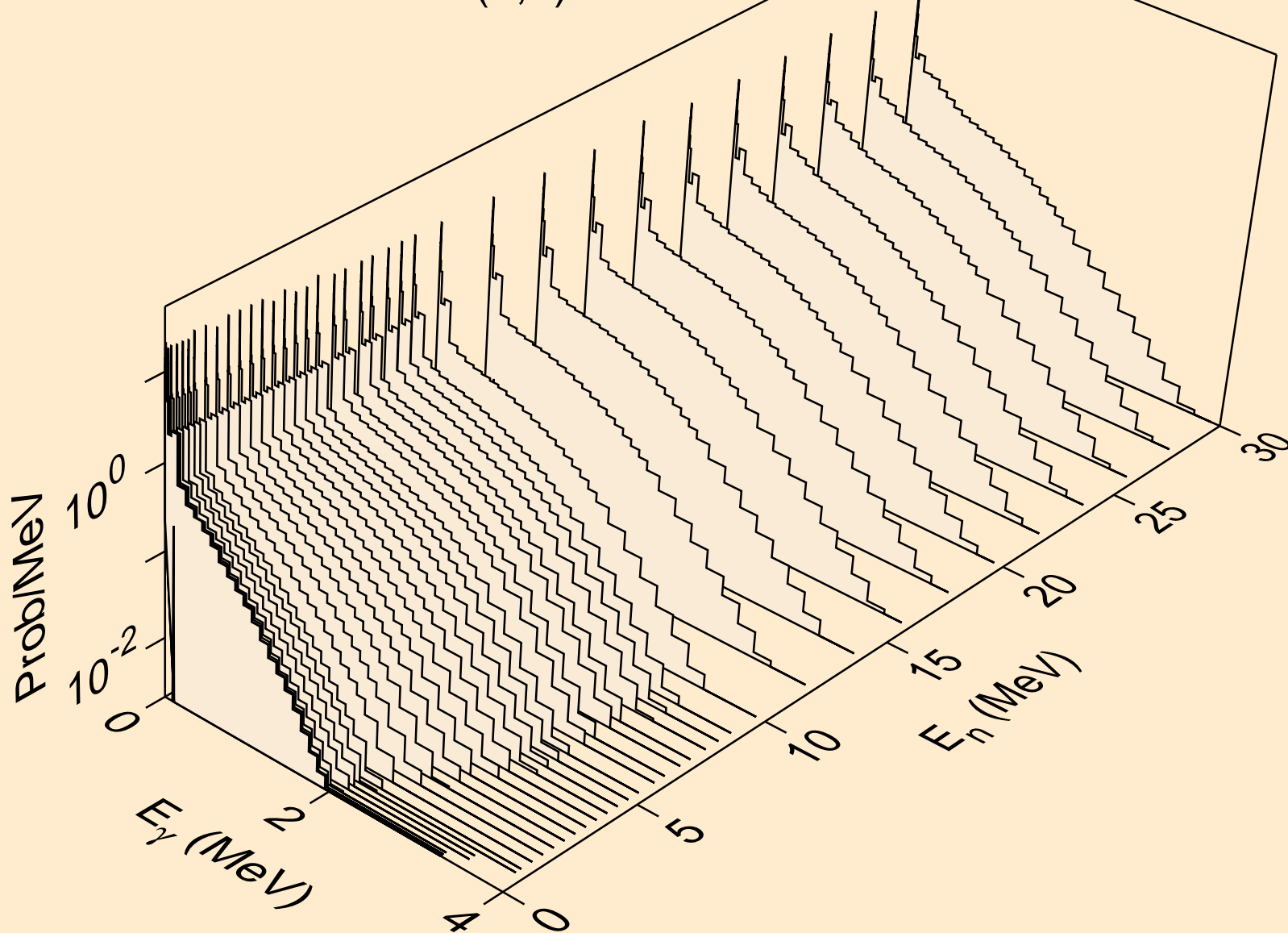

CF255 NEUTRON ACER TENDL-2019 LIBRARY; T=293.16K
Photon emission for (n,2p)

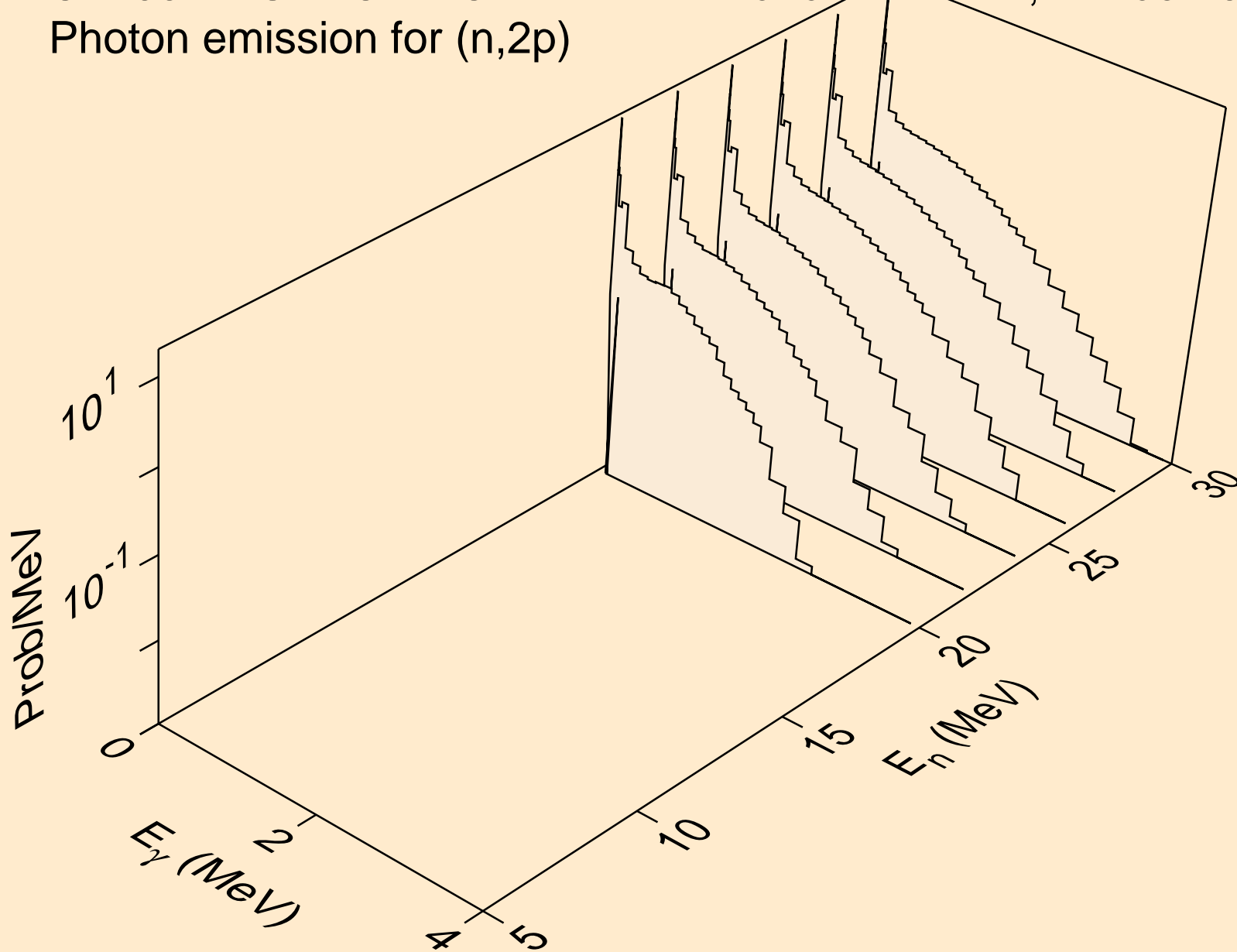

CF255 NEUTRON ACER TENDL-2019 LIBRARY; T=293.16K
thermal capture photon spectrum

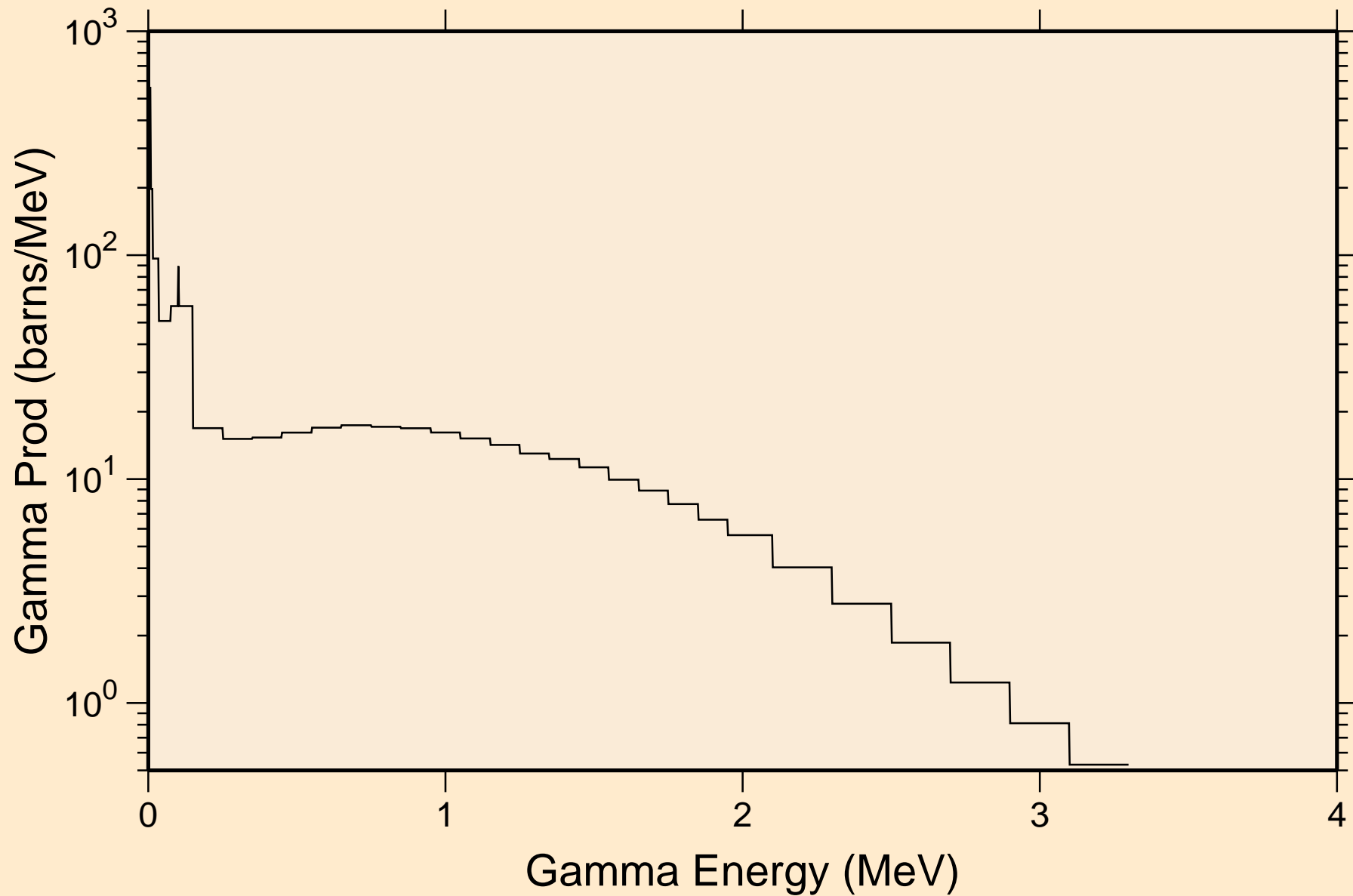

CF255 NEUTRON ACER TENDL-2019 LIBRARY; T=293.16K
14 MeV photon spectrum

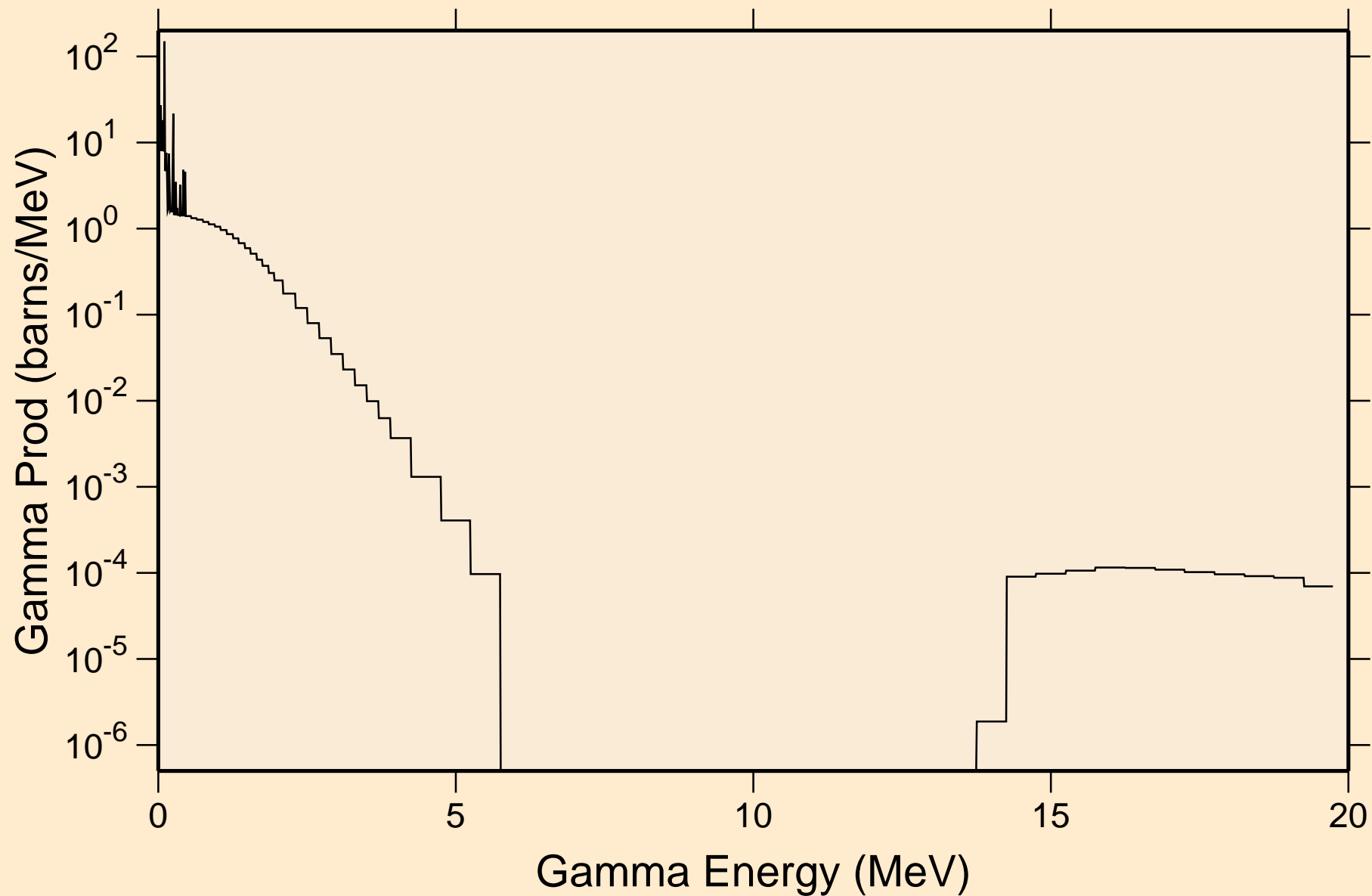

CF255 NEUTRON ACER TENDL-2019 LIBRARY; T=293.16K

Particle heating contributions

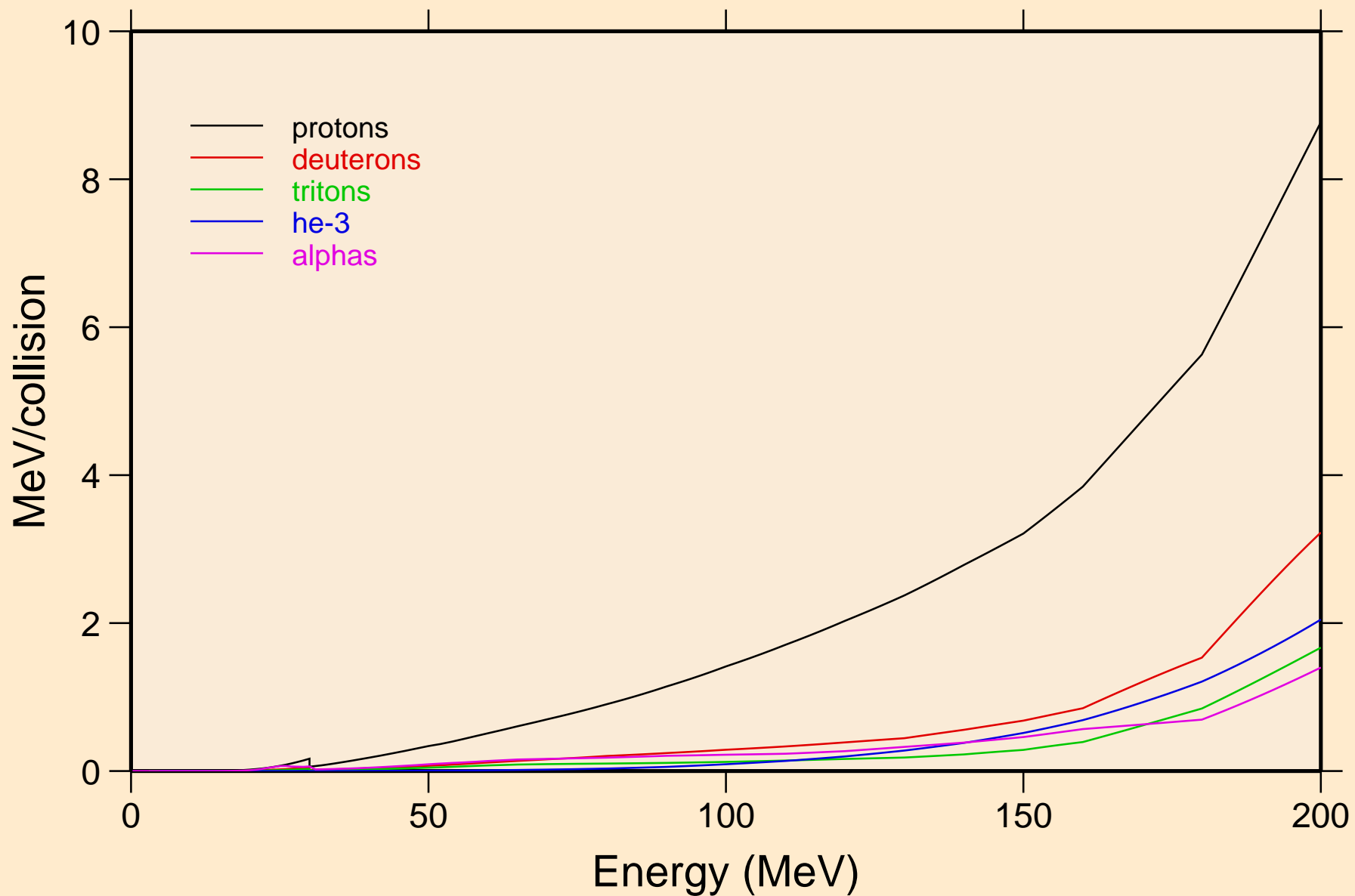

CF255 NEUTRON ACER TENDL-2019 LIBRARY; T=293.16K
Recoil Heating

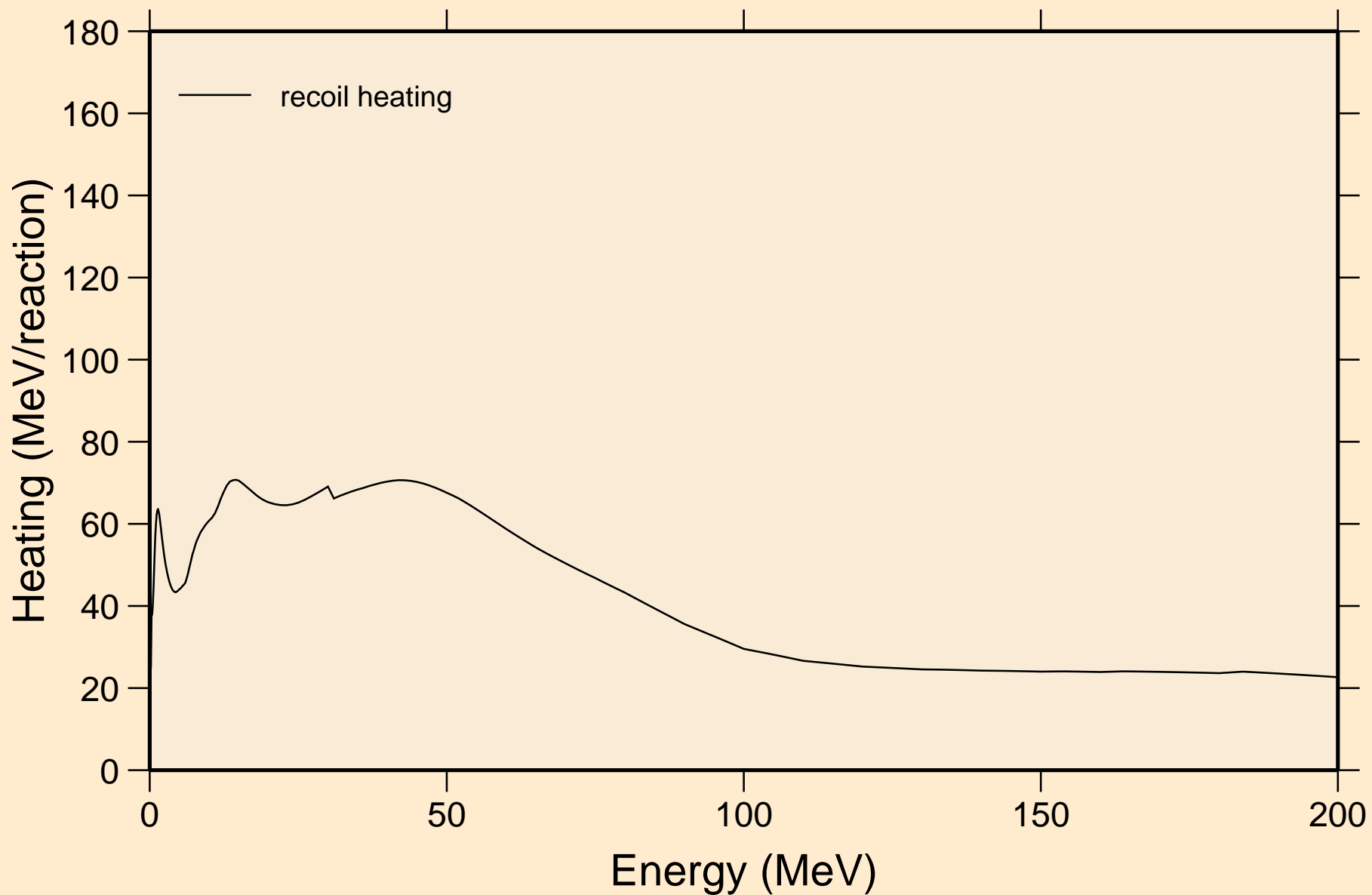

CF255 NEUTRON ACER TENDL-2019 LIBRARY; T=293.16K

Particle production cross sections

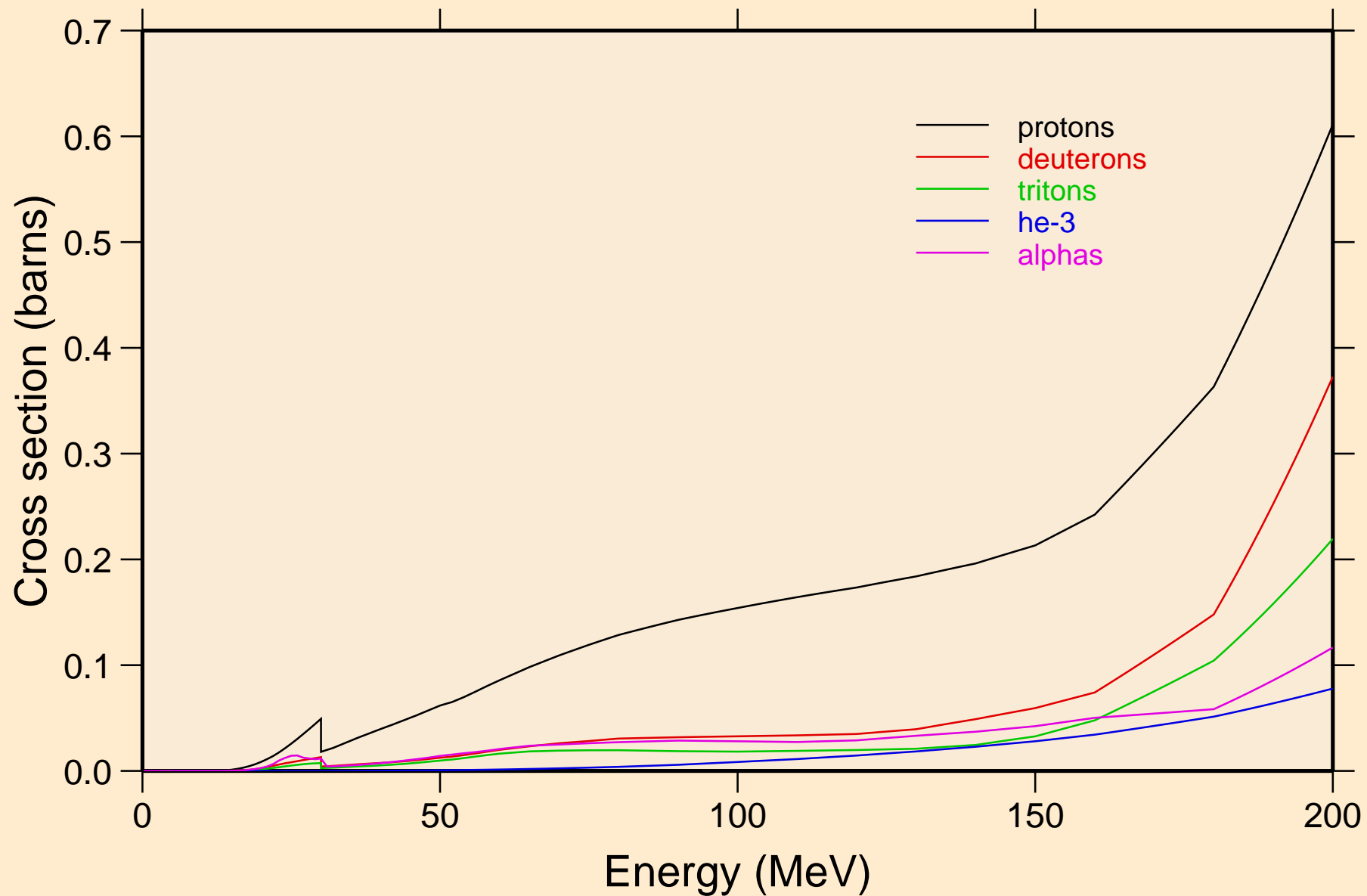

CF255 NEUTRON ACER TENDL-2019 LIBRARY; T=293.16K
protons from (n,x)

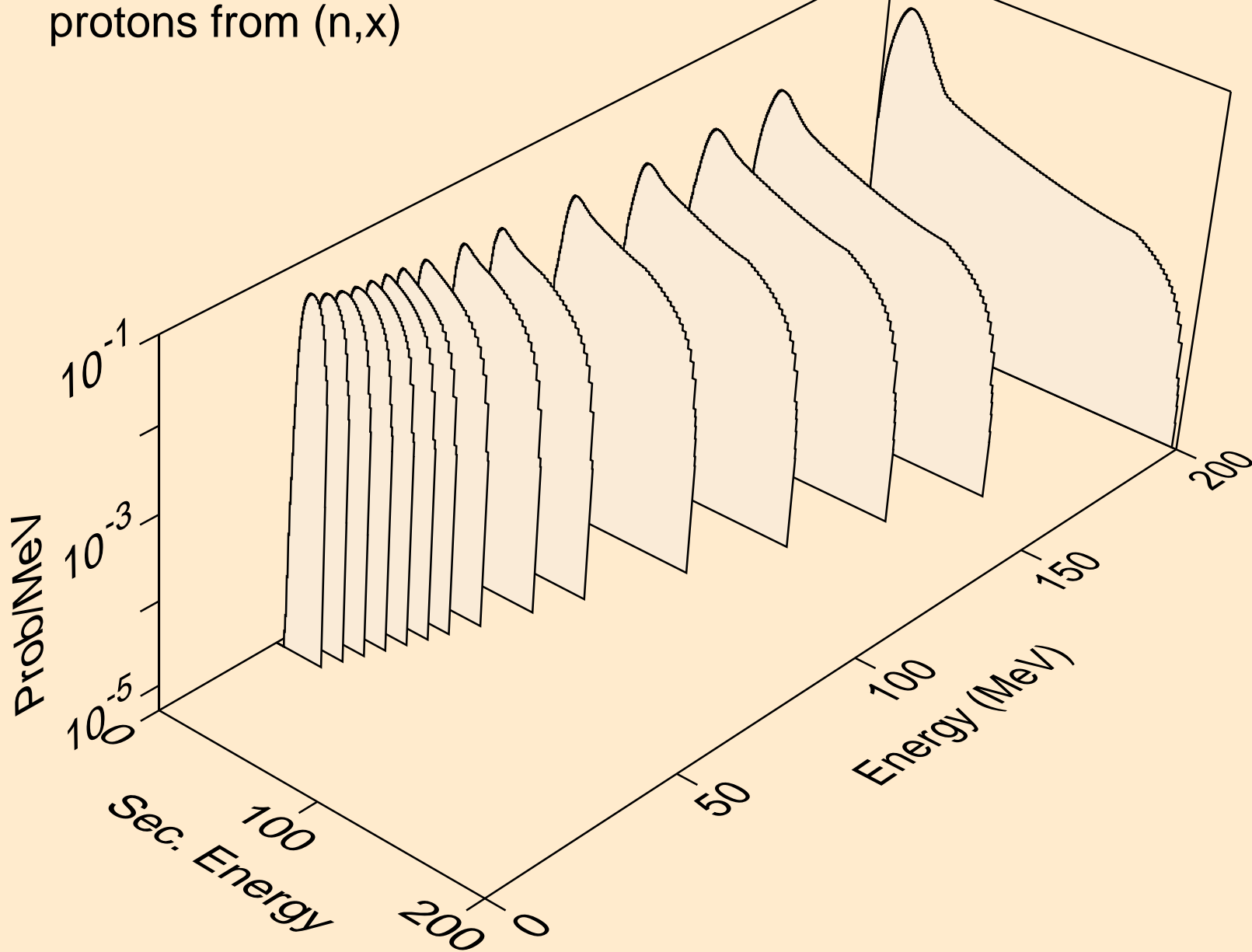

CF255 NEUTRON ACER TENDL-2019 LIBRARY; T=293.16K
protons from (n,n*)p

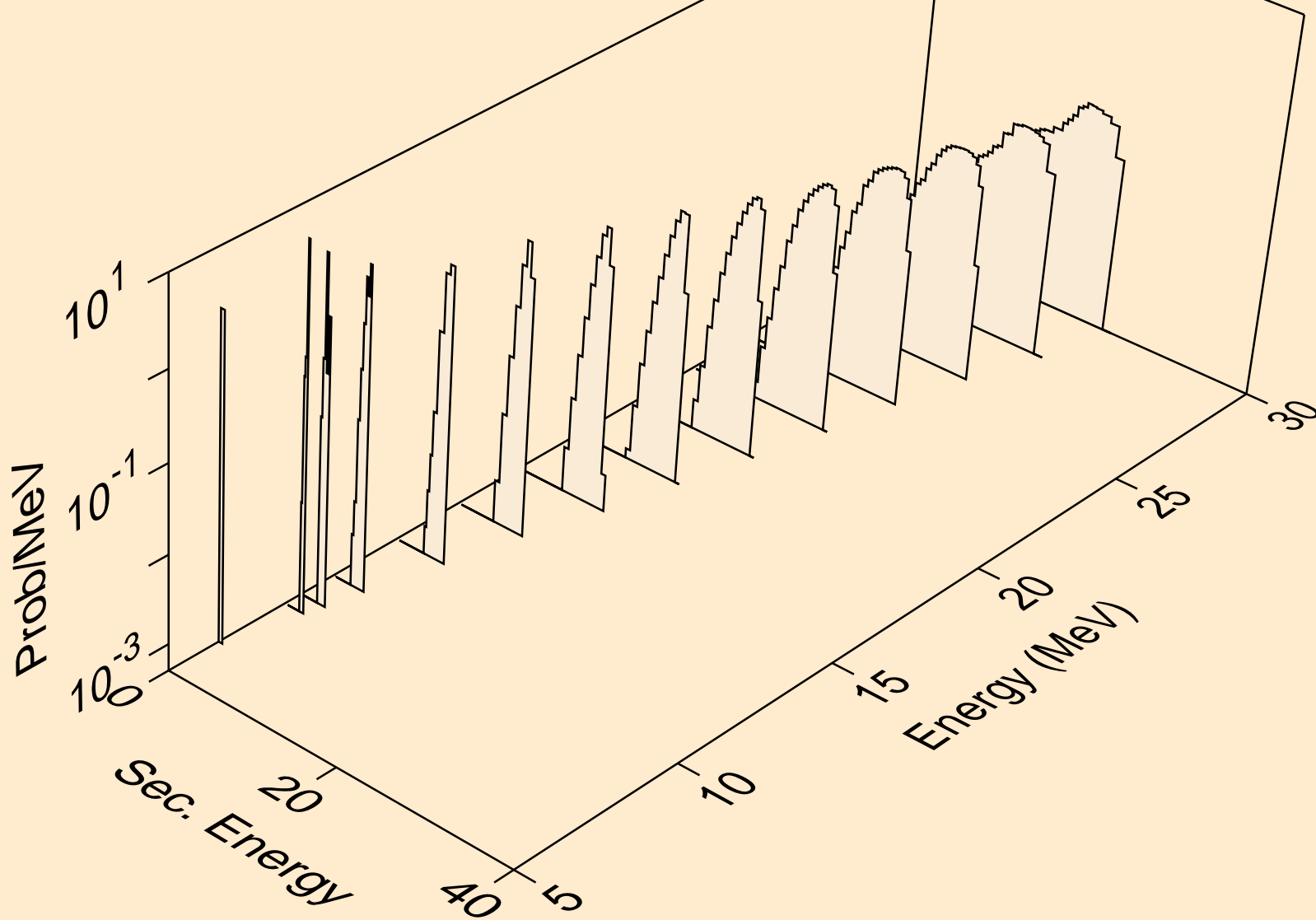

CF255 NEUTRON ACER TENDL-2019 LIBRARY; T=293.16K
protons from (n,2np)

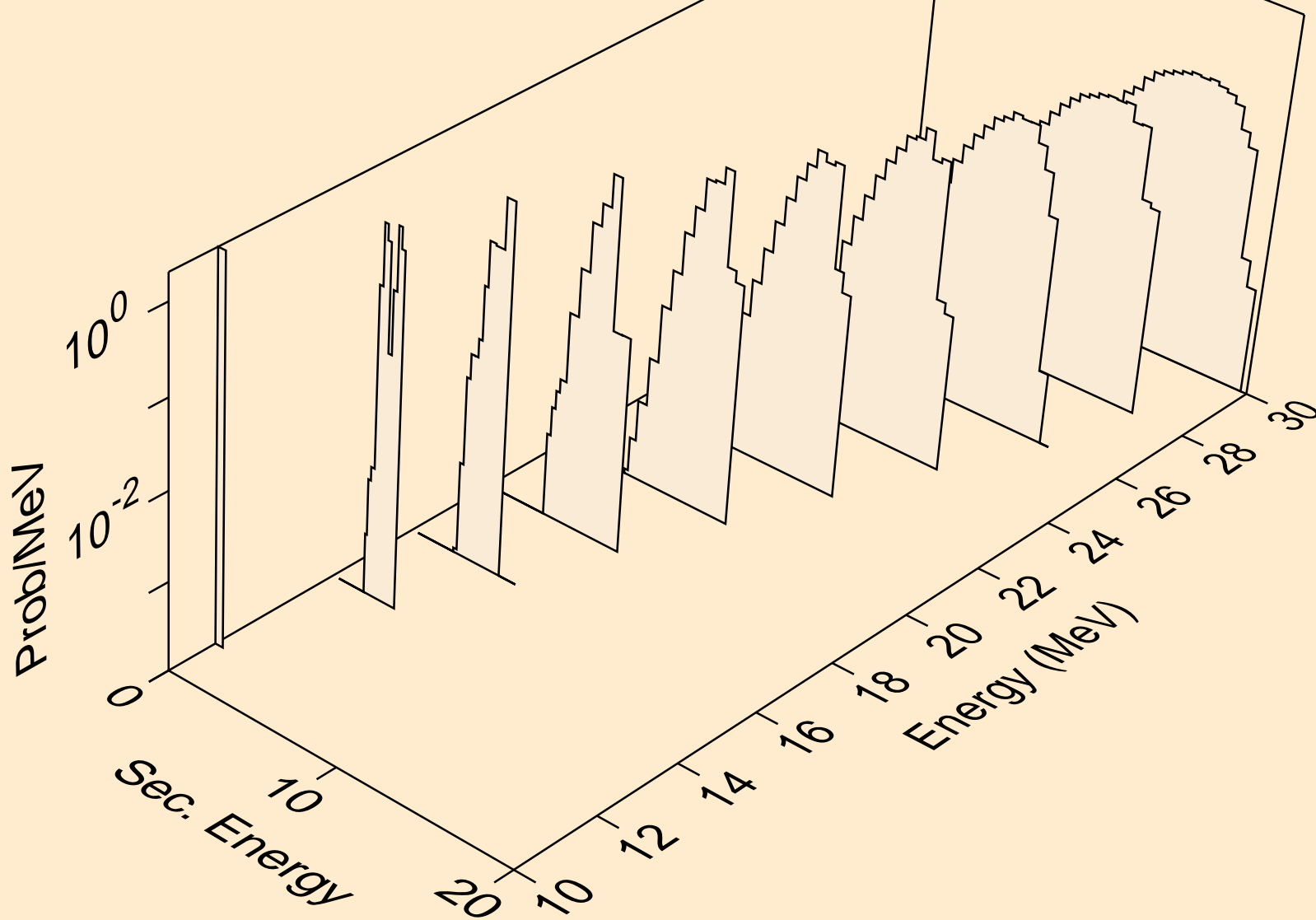

CF255 NEUTRON ACER TENDL-2019 LIBRARY; T=293.16K
protons from (n,3np)

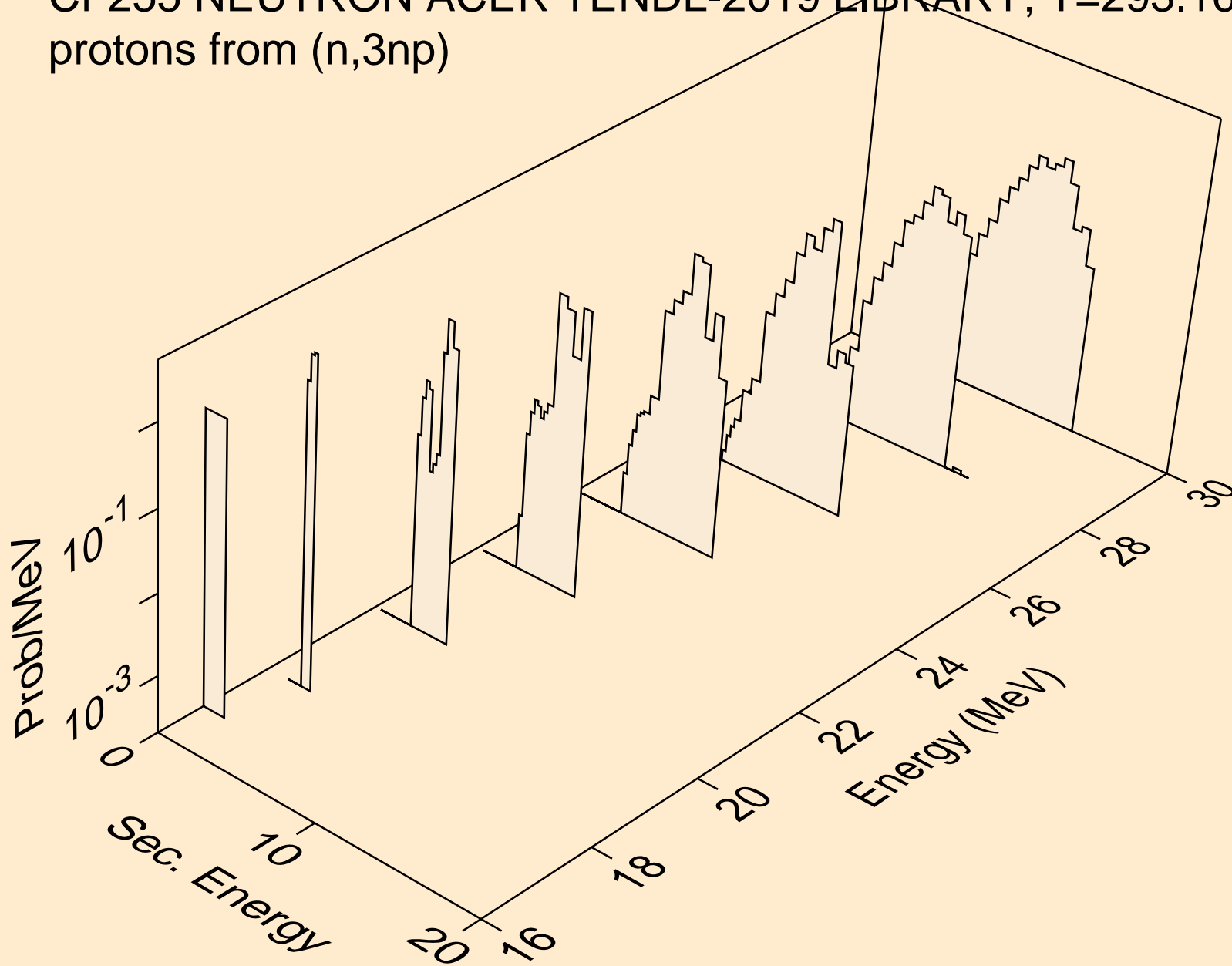

CF255 NEUTRON ACER TENDL-2019 LIBRARY; T=293.16K
protons from (n,p)

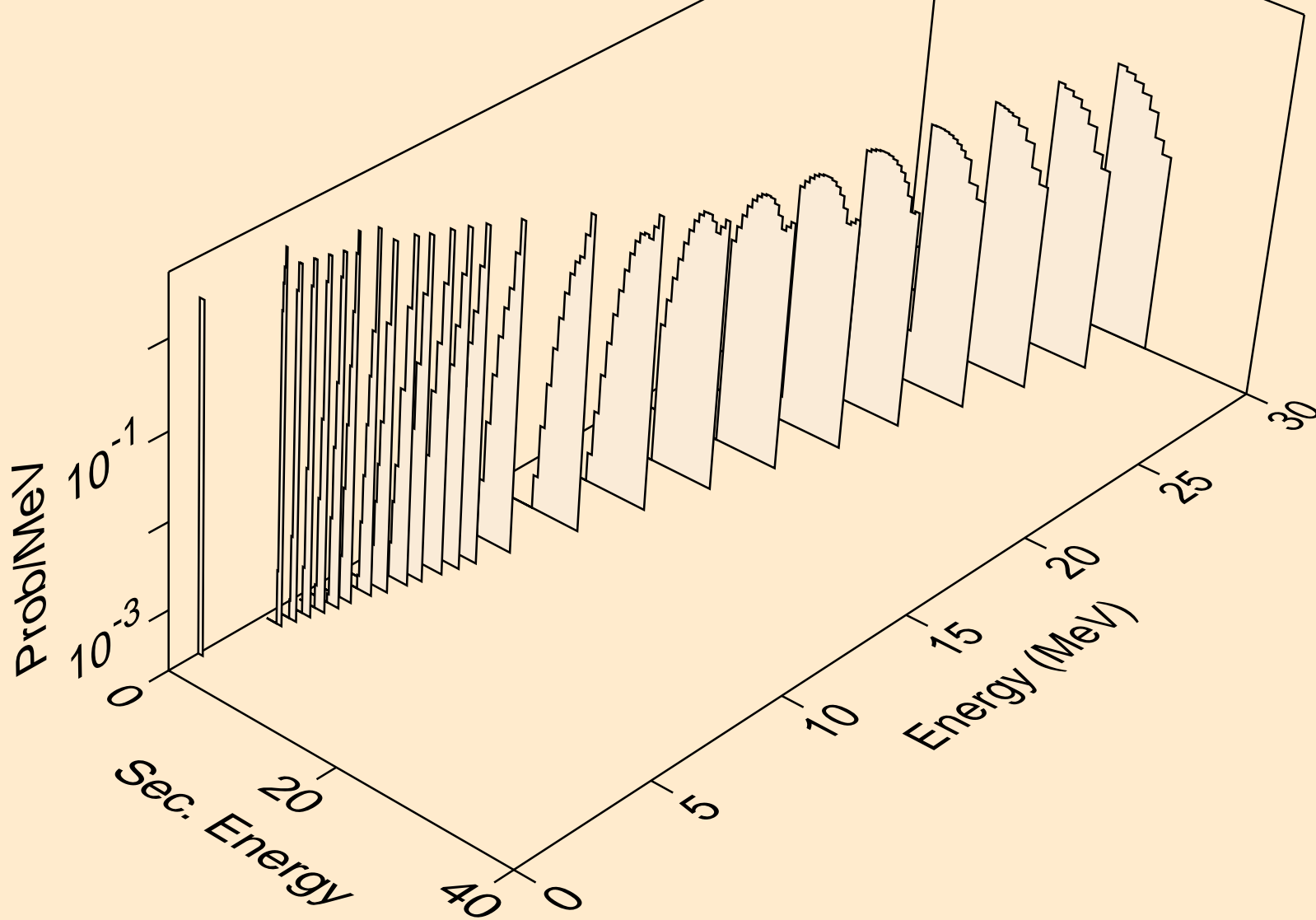

CF255 NEUTRON ACER TENDL-2019 LIBRARY; T=293.16K
protons from (n,2p)

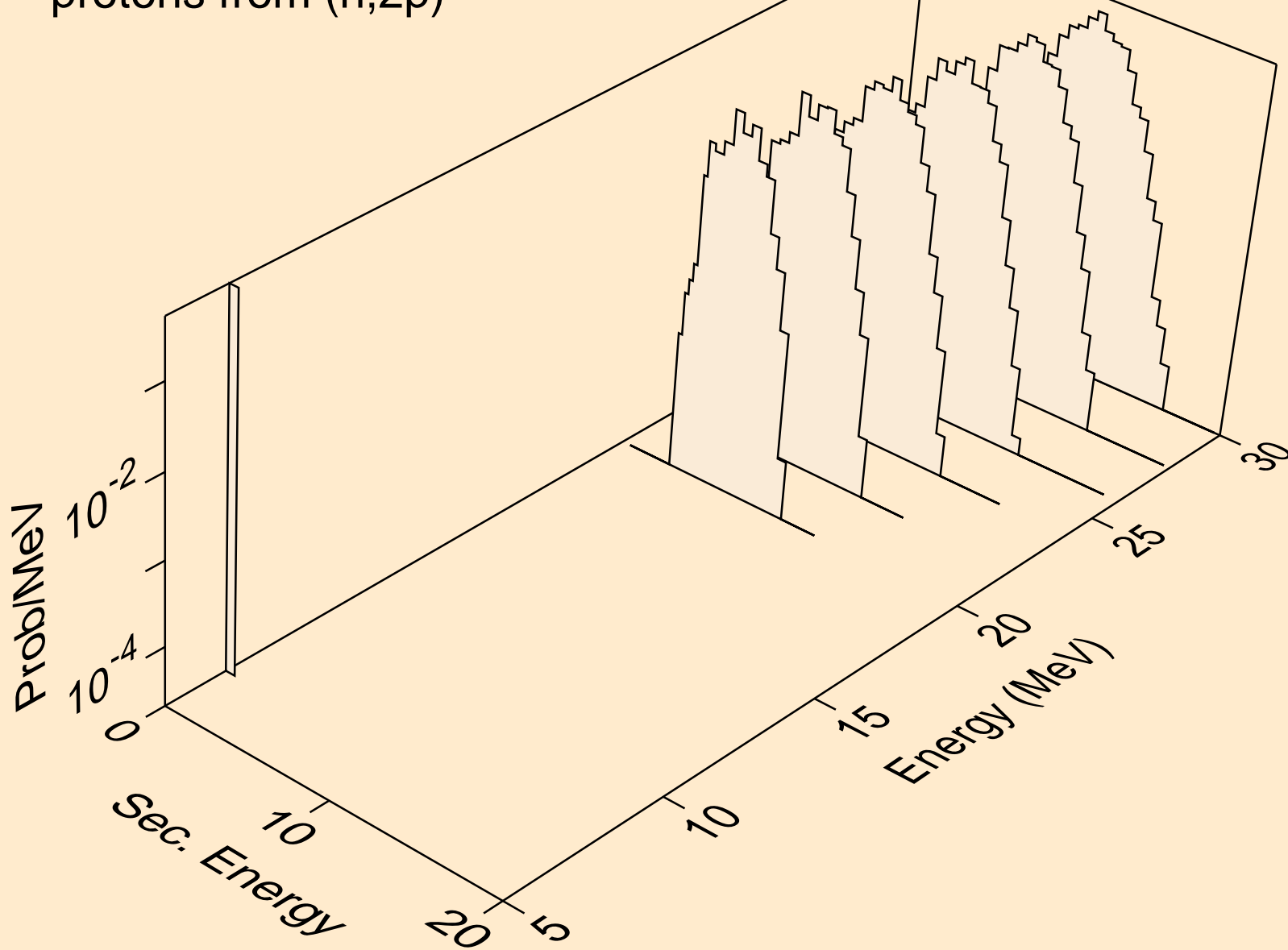

CF255 NEUTRON ACER TENDL-2019 LIBRARY; T=293.16K
deuterons from (n,x)

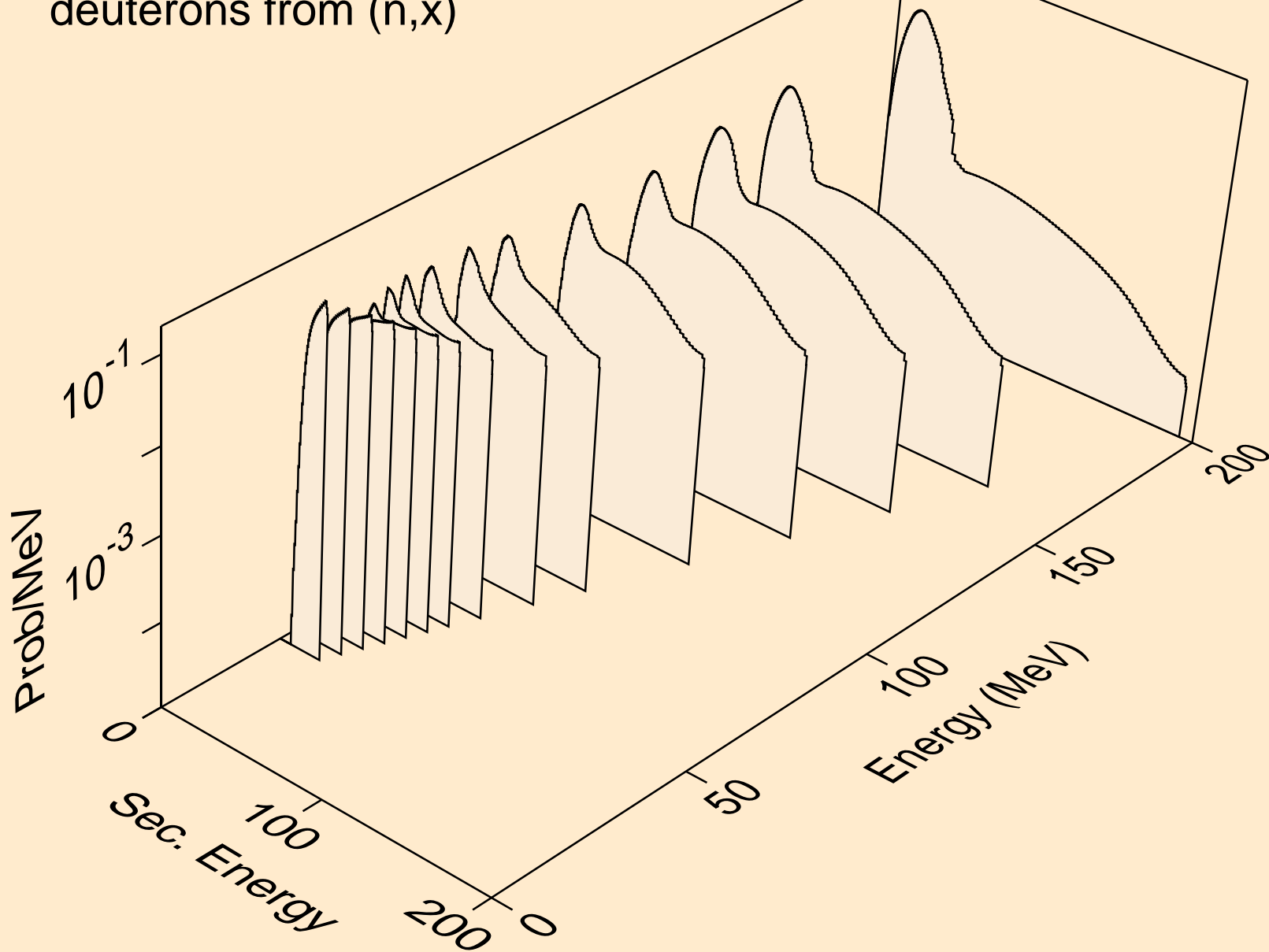

CF255 NEUTRON ACER TENDL-2019 LIBRARY; T=293.16K
deuterons from (n,2nd)

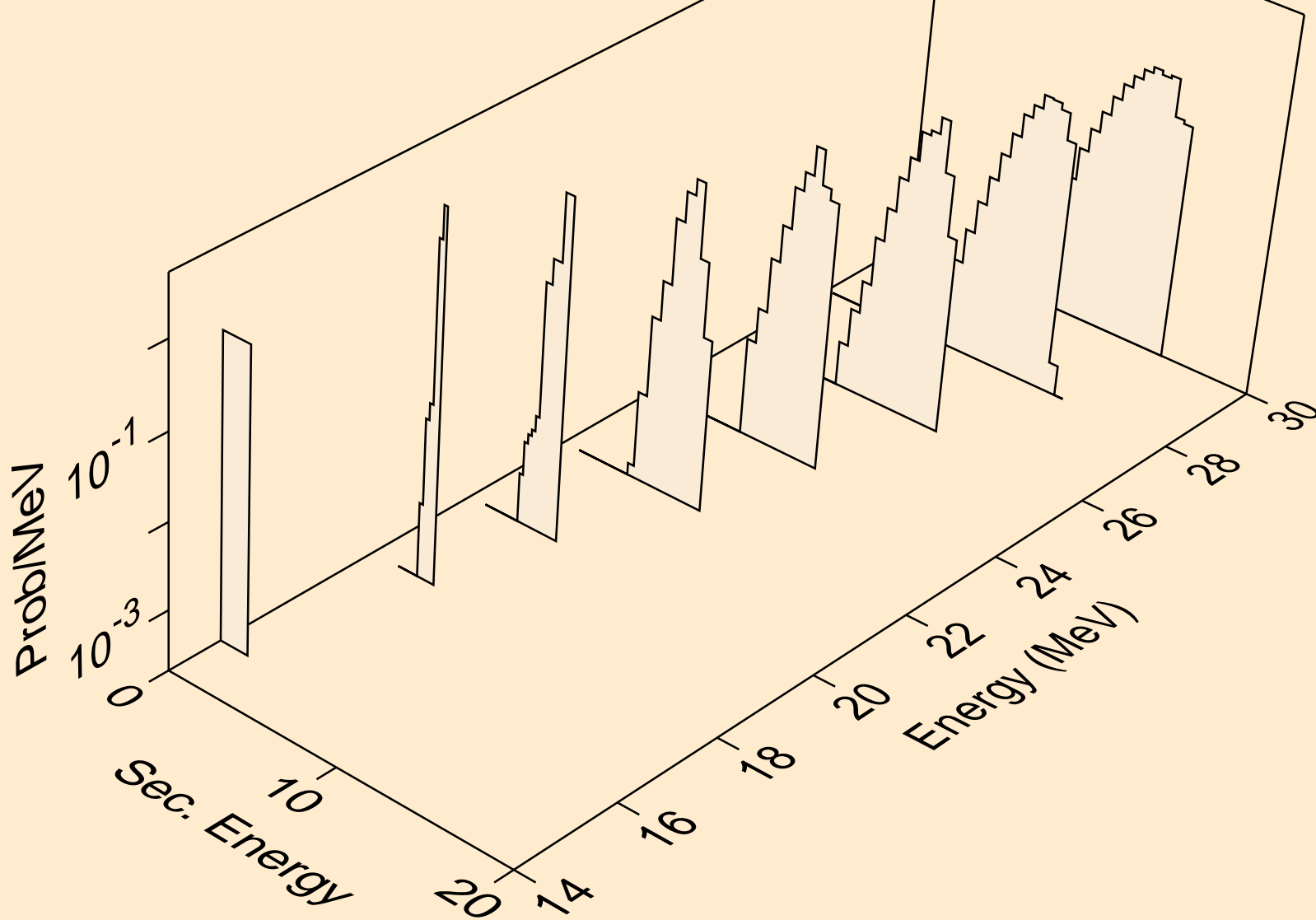

CF255 NEUTRON ACER TENDL-2019 LIBRARY; T=293.16K
deuterons from (n,n*)d

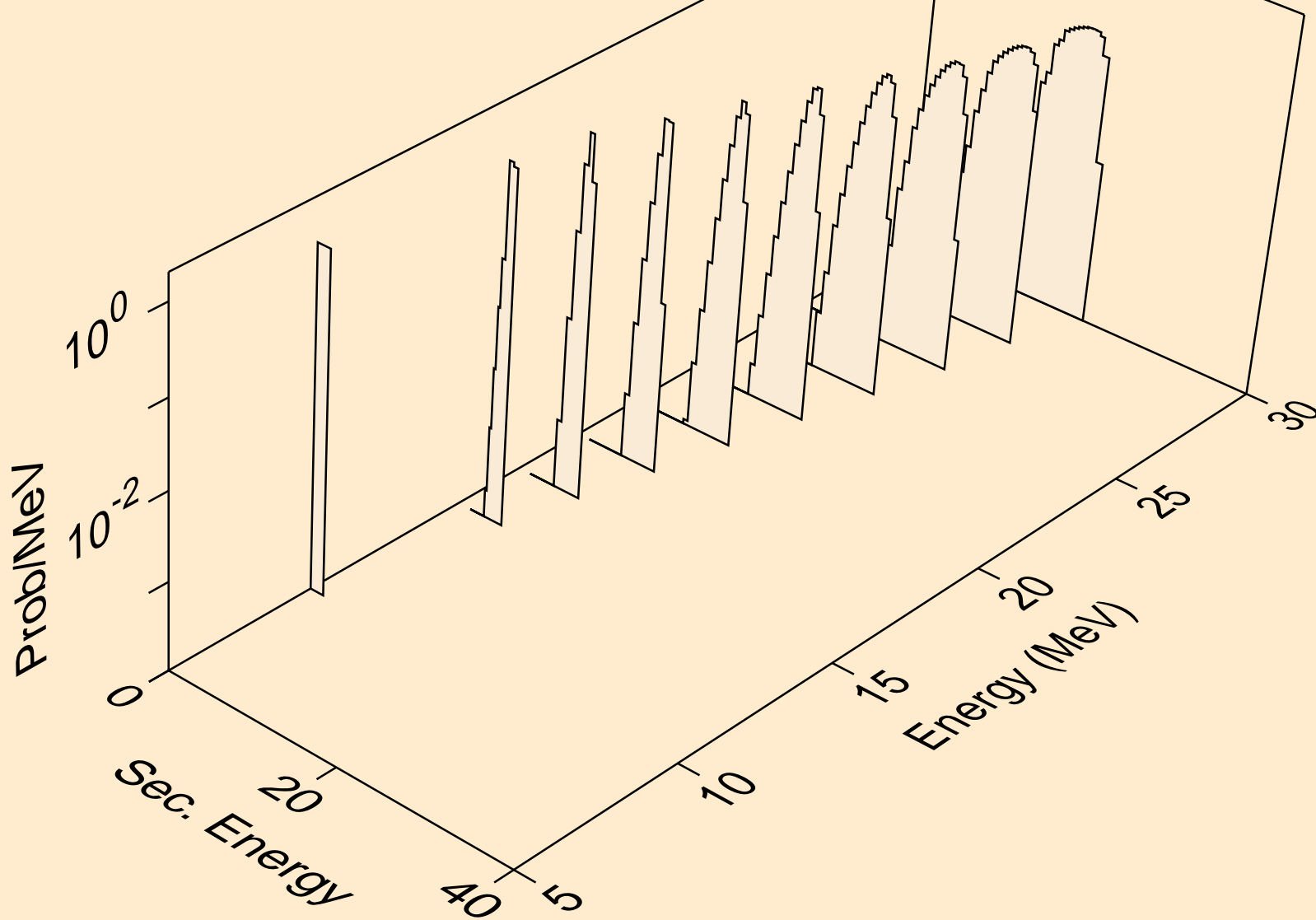

CF255 NEUTRON ACER TENDL-2019 LIBRARY; T=293.16K
deuterons from (n,d)

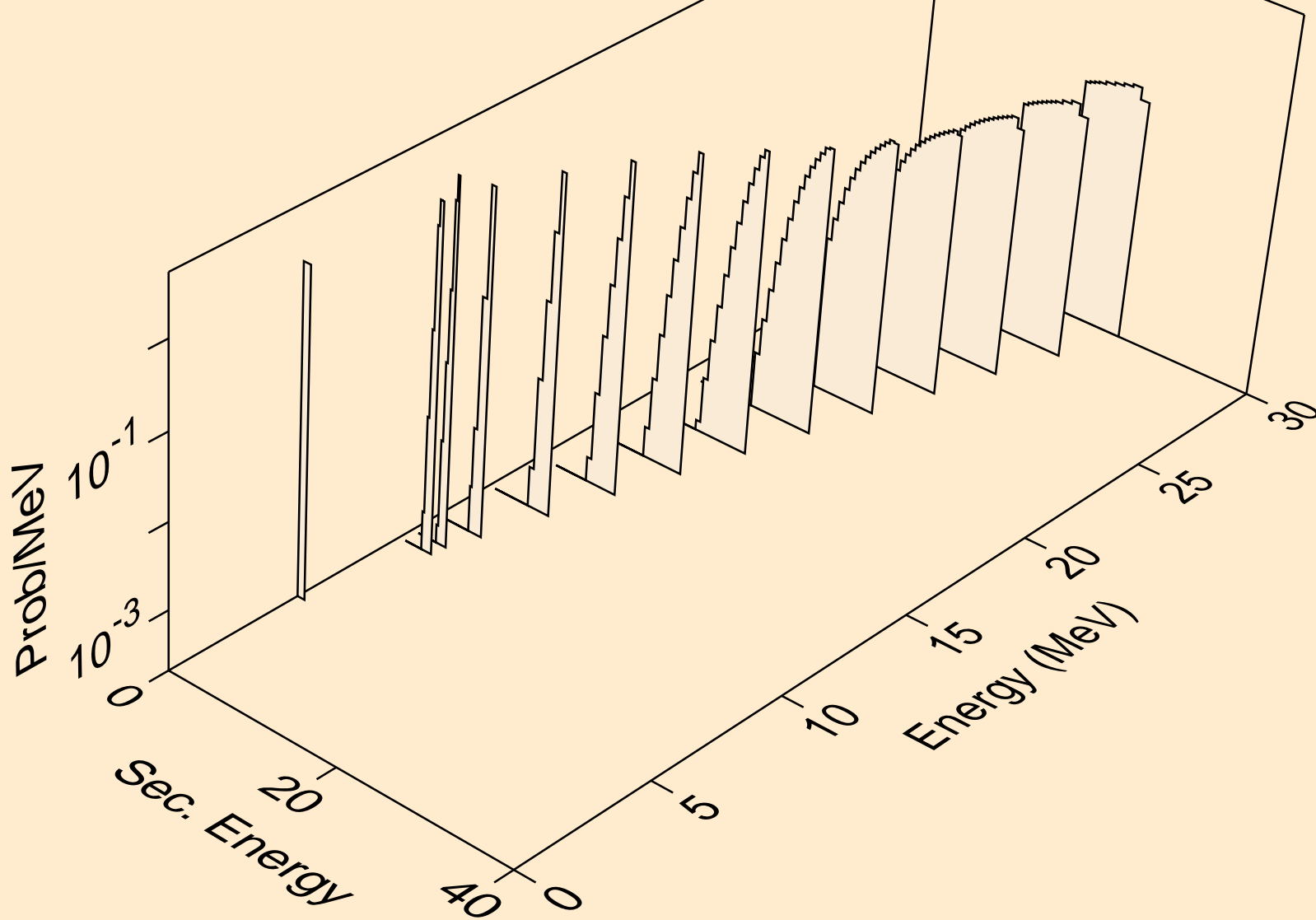

CF255 NEUTRON ACER TENDL-2019 LIBRARY; T=293.16K
tritons from (n,x)

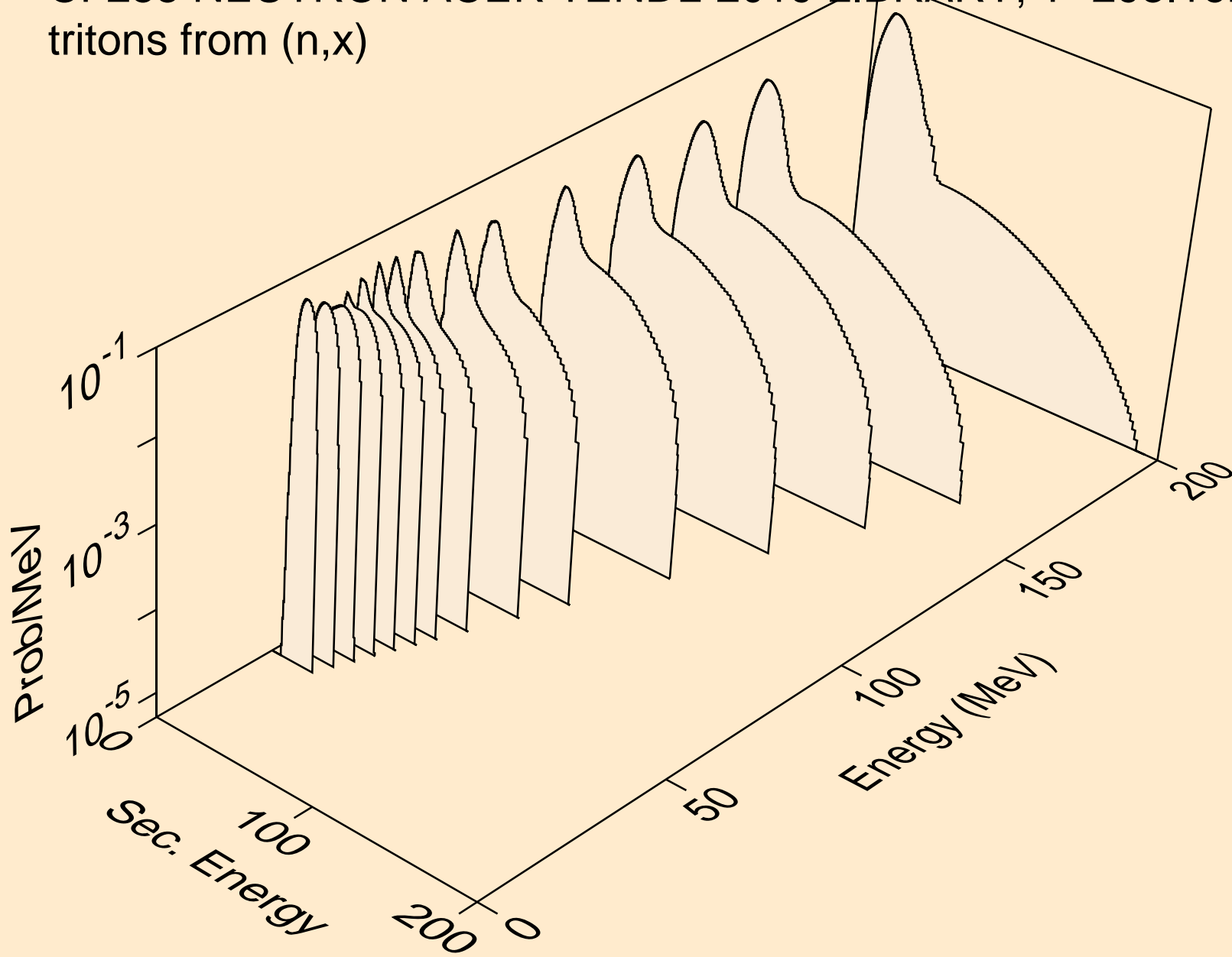

CF255 NEUTRON ACER TENDL-2019 LIBRARY; T=293.16K
tritons from (n,n*)t

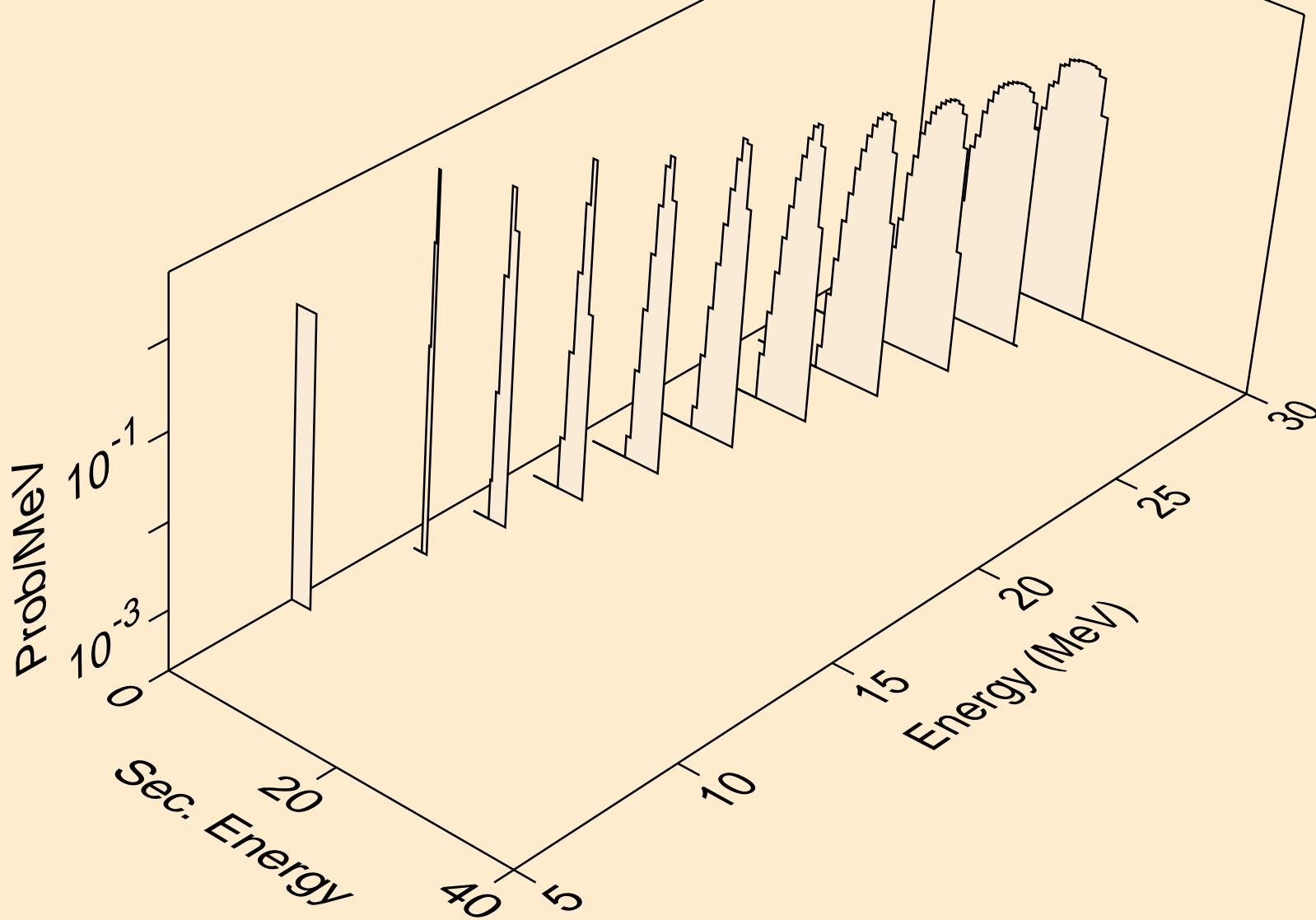

CF255 NEUTRON ACER TENDL-2019 LIBRARY; T=293.16K
tritons from (n,t)

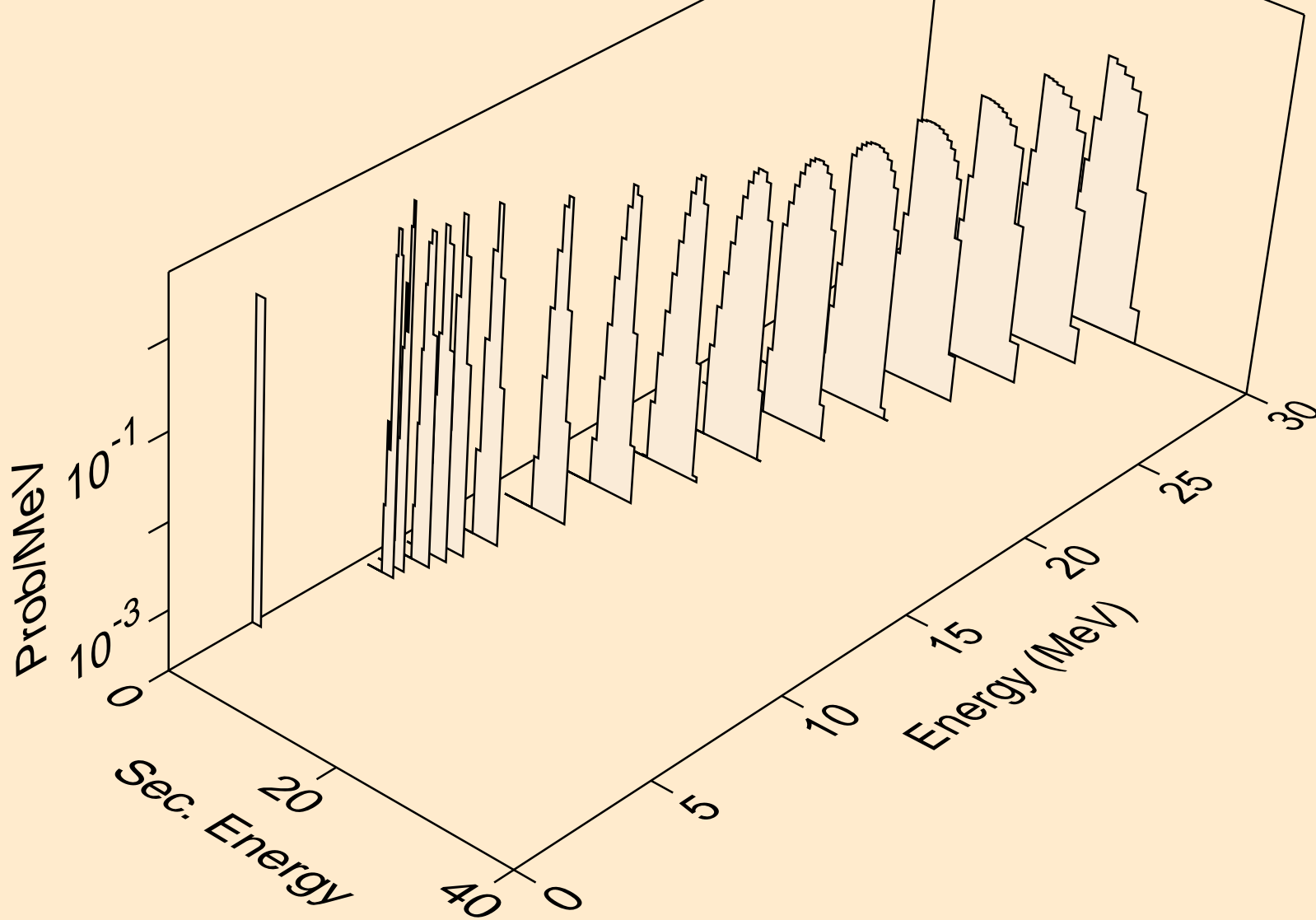

CF255 NEUTRON ACER TENDL-2019 LIBRARY; T=293.16K
he3s from (n,x)

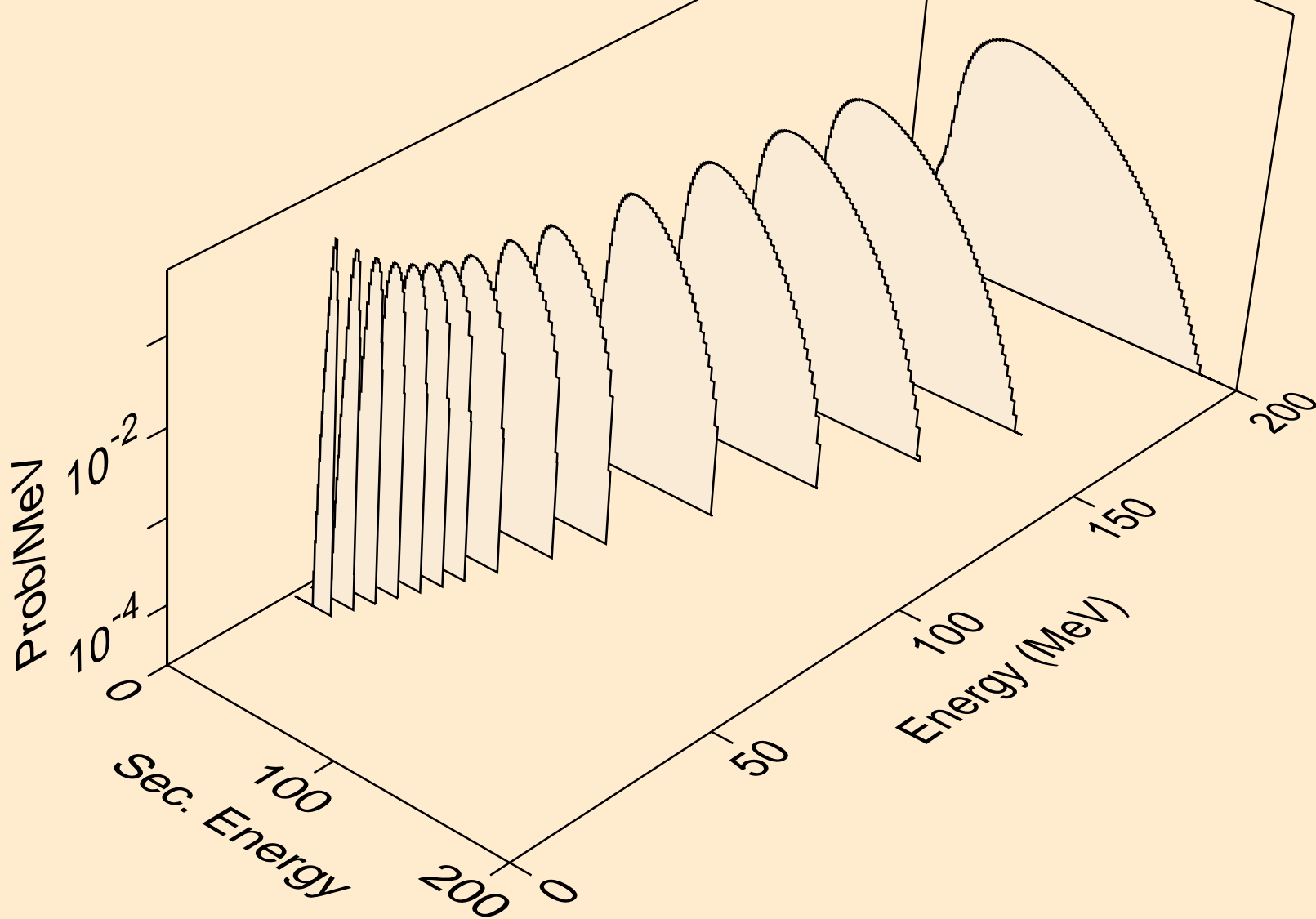

CF255 NEUTRON ACER TENDL-2019 LIBRARY; T=293.16K
he3s from (n,n*)he3

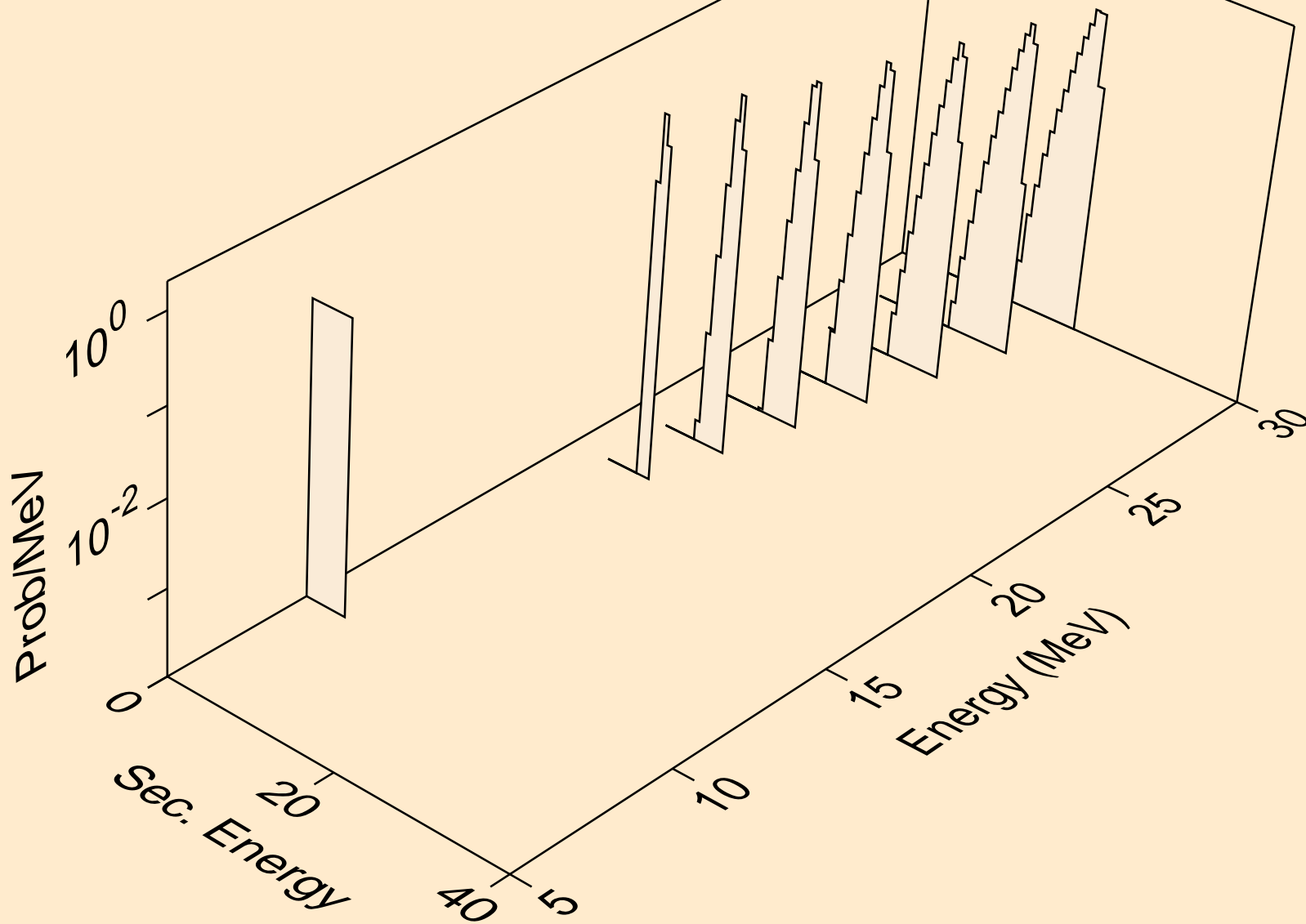

CF255 NEUTRON ACER TENDL-2019 LIBRARY; T=293.16K
he3s from (n,he3)

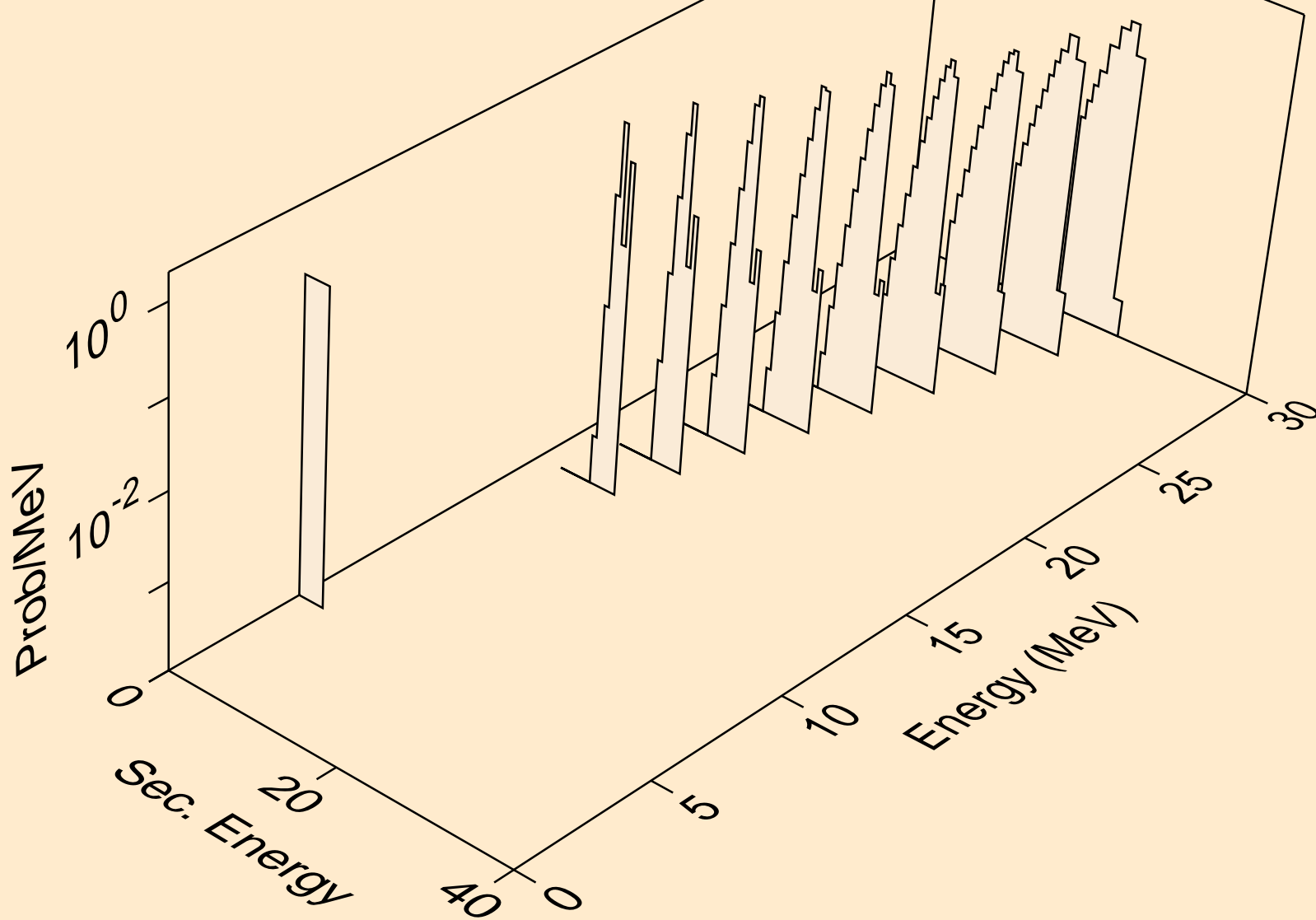

CF255 NEUTRON ACER TENDL-2019 LIBRARY; T=293.16K
alphas from (n,x)

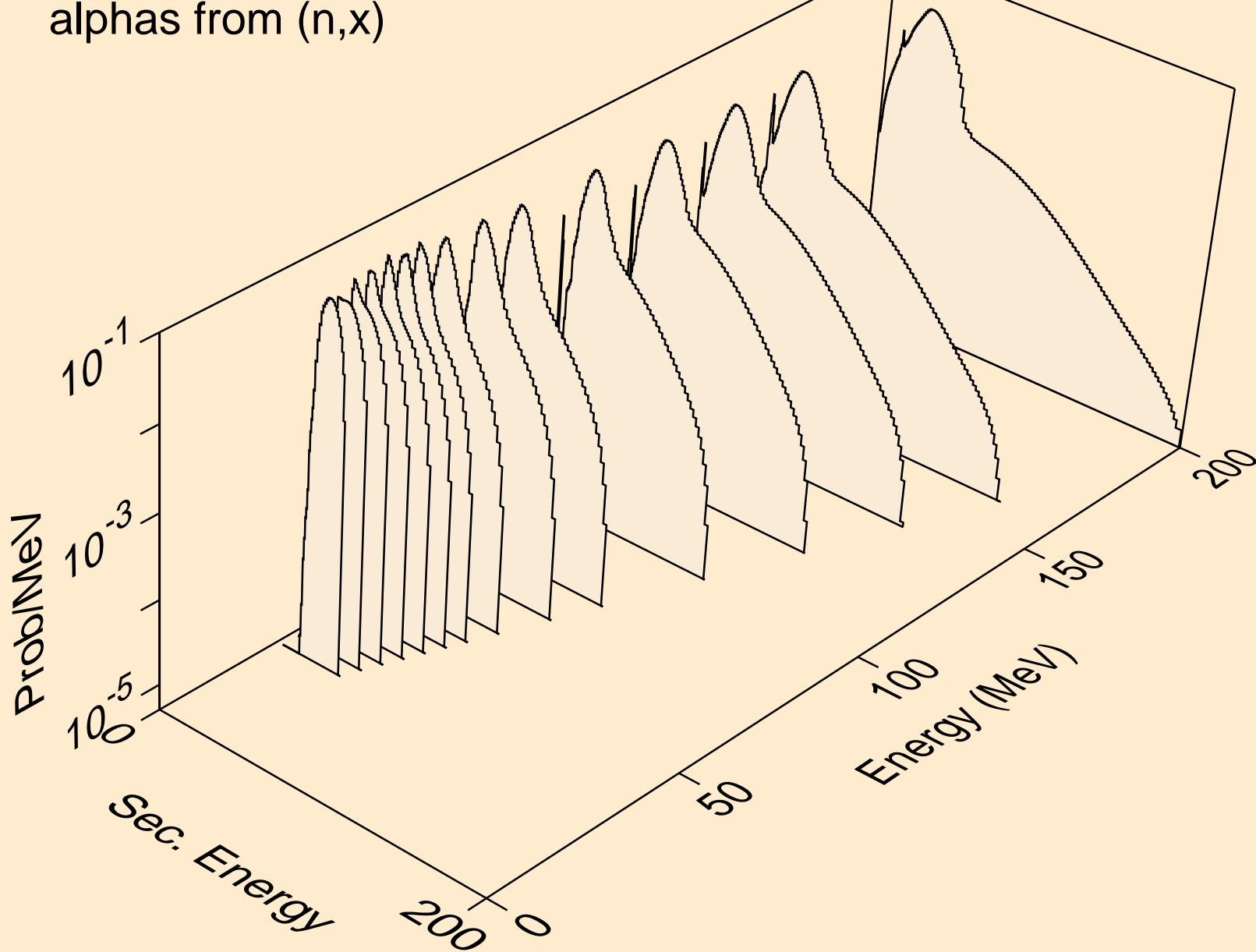

CF255 NEUTRON ACER TENDL-2019 LIBRARY; T=293.16K
alphas from (n,n*)a

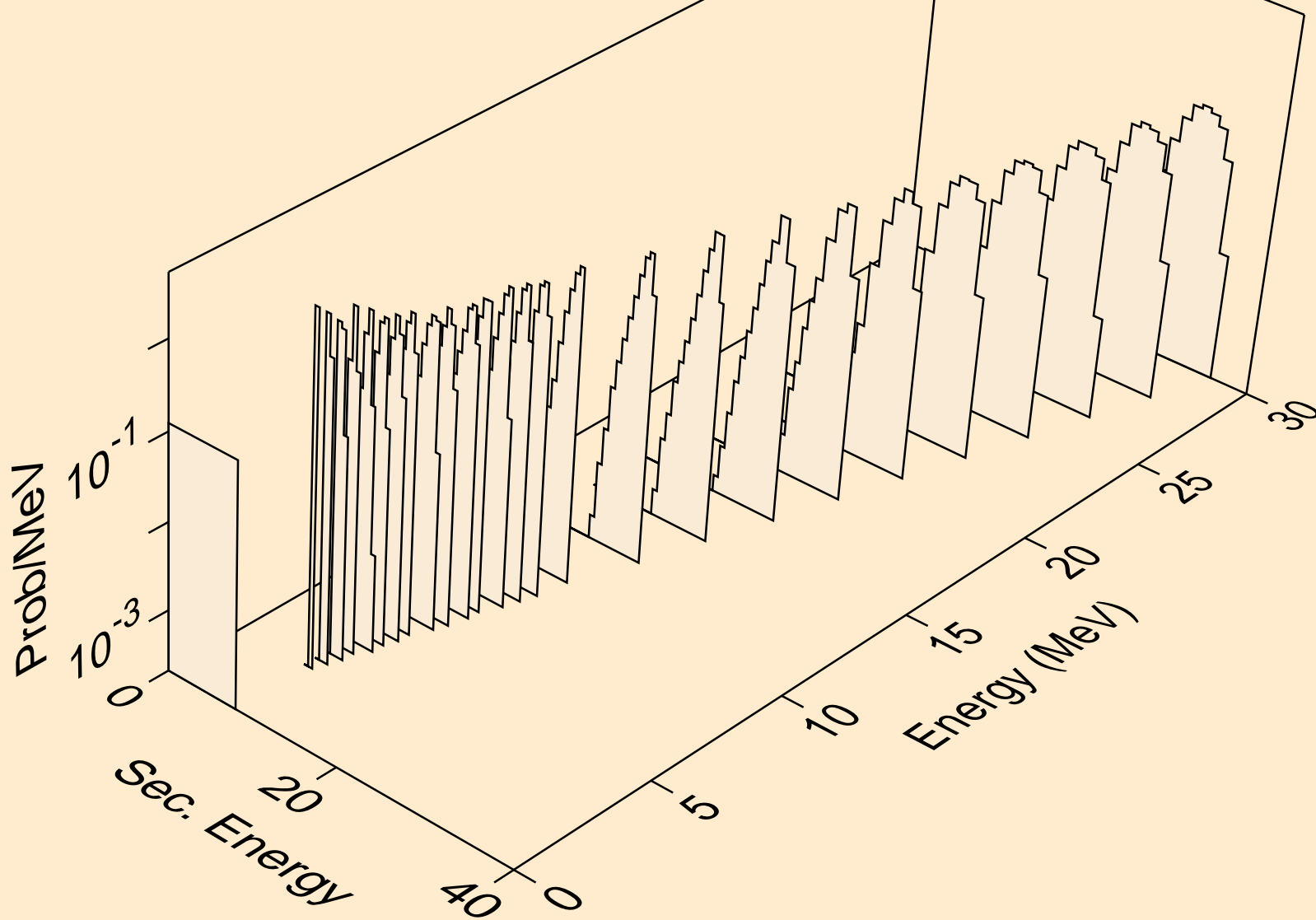

CF255 NEUTRON ACER TENDL-2019 LIBRARY; T=293.16K
alphas from (n,2n)a

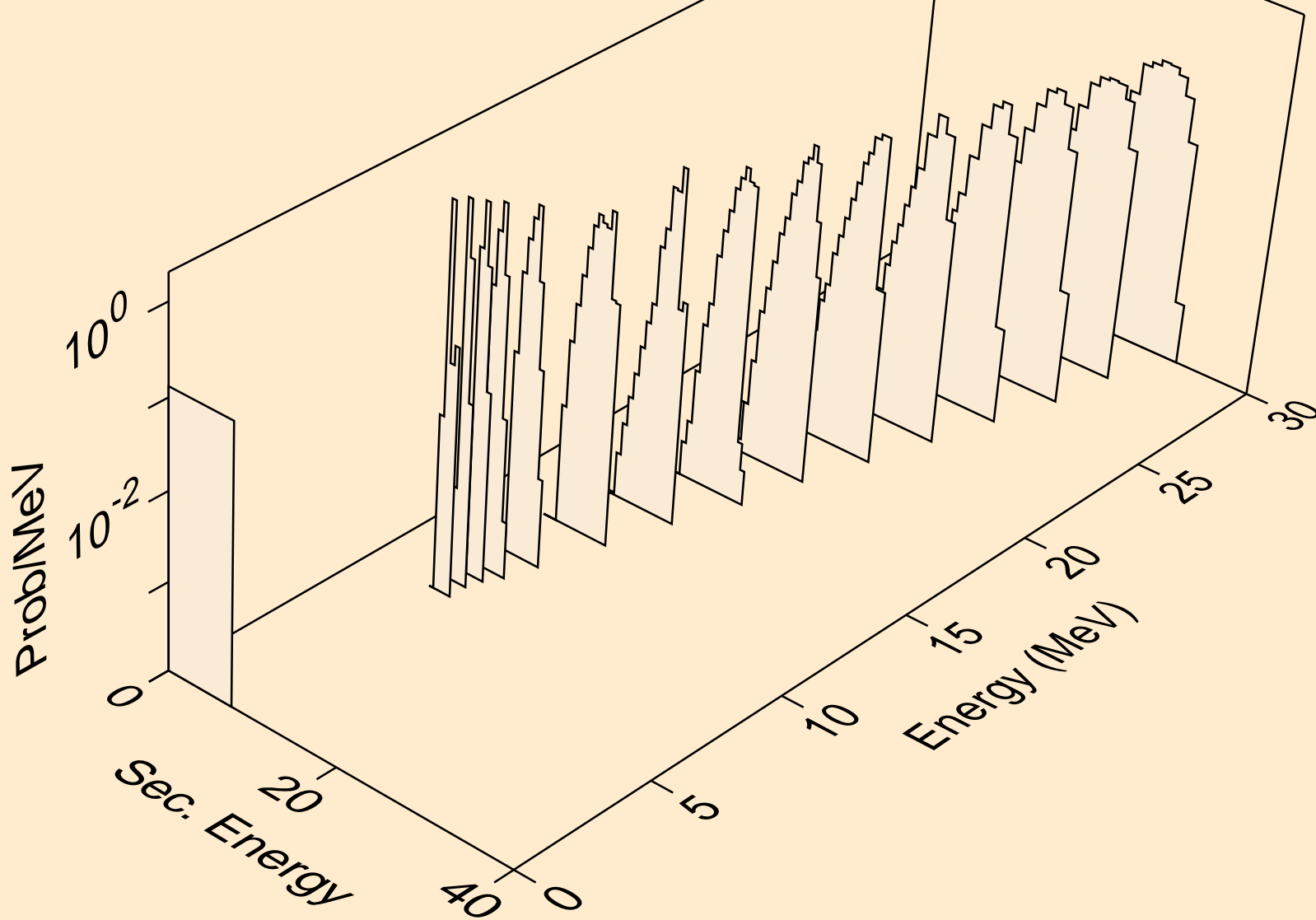

CF255 NEUTRON ACER TENDL-2019 LIBRARY; T=293.16K
alphas from (n,3n)a

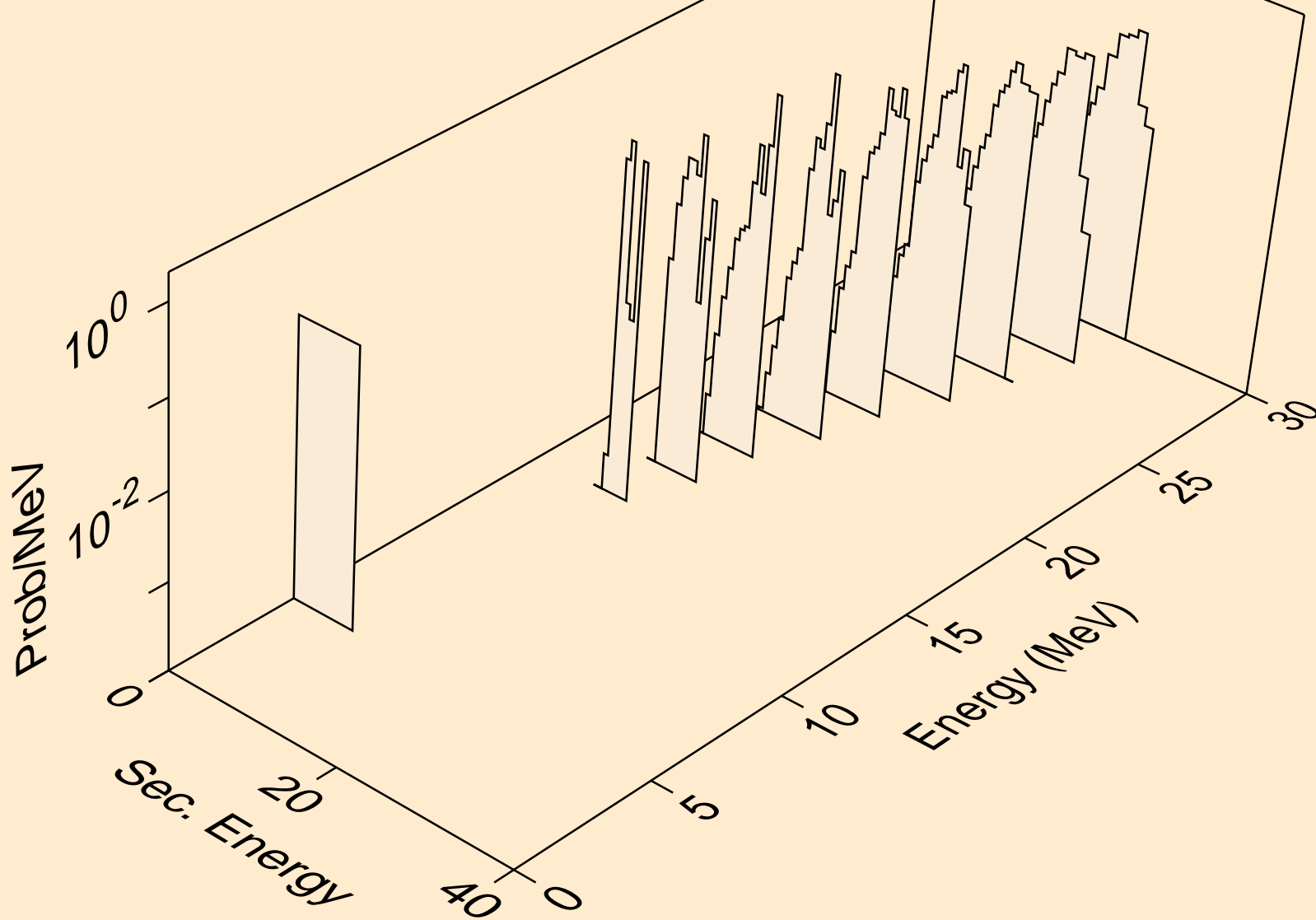

CF255 NEUTRON ACER TENDL-2019 LIBRARY; T=293.16K
alphas from (n,a)

