

CM232 NEUTRON ACER TENDL-2019 LIBRARY; T=293.16K
Principal cross sections

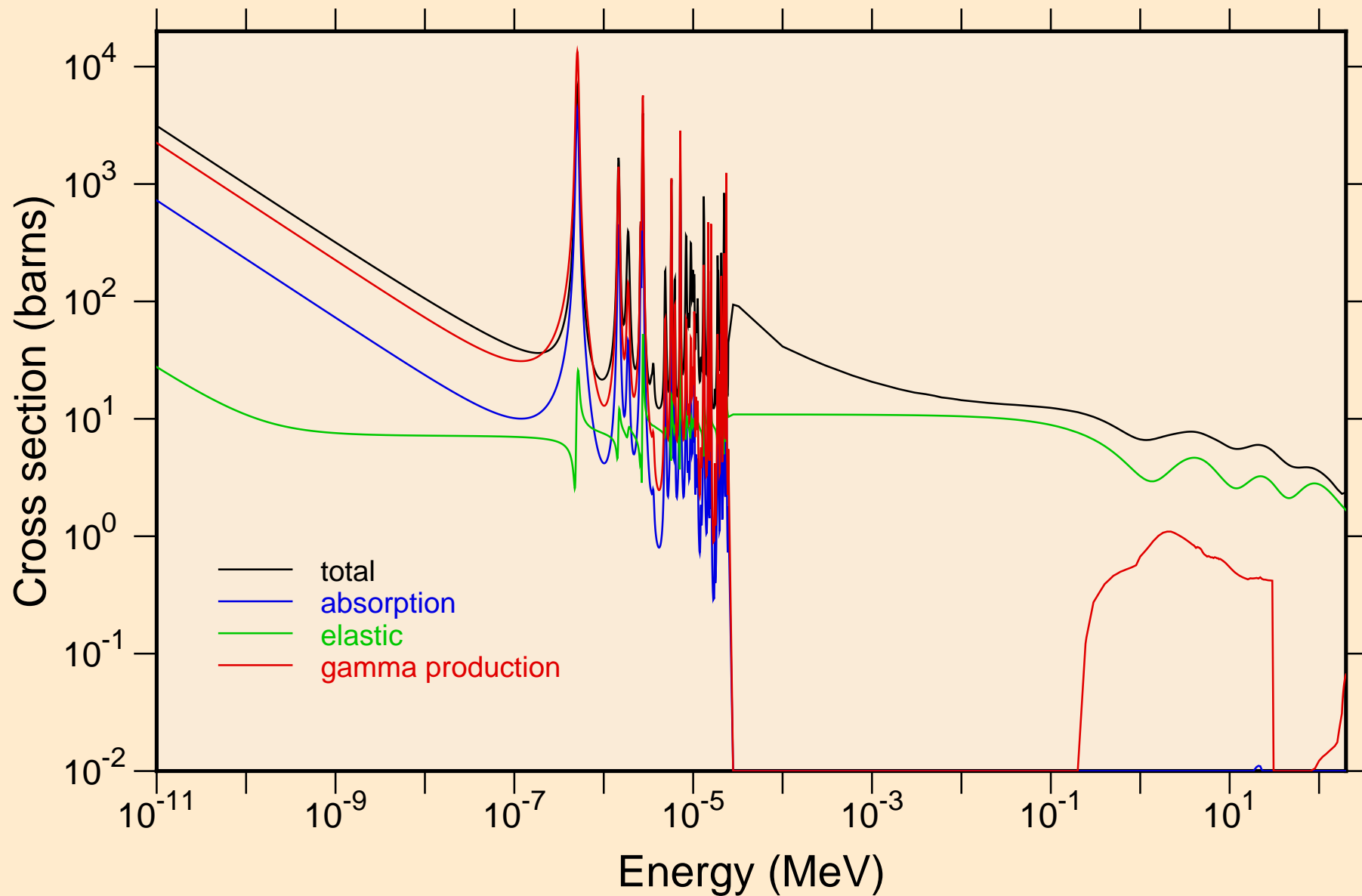

CM232 NEUTRON ACER TENDL-2019 LIBRARY; T=293.16K
resonance total cross section

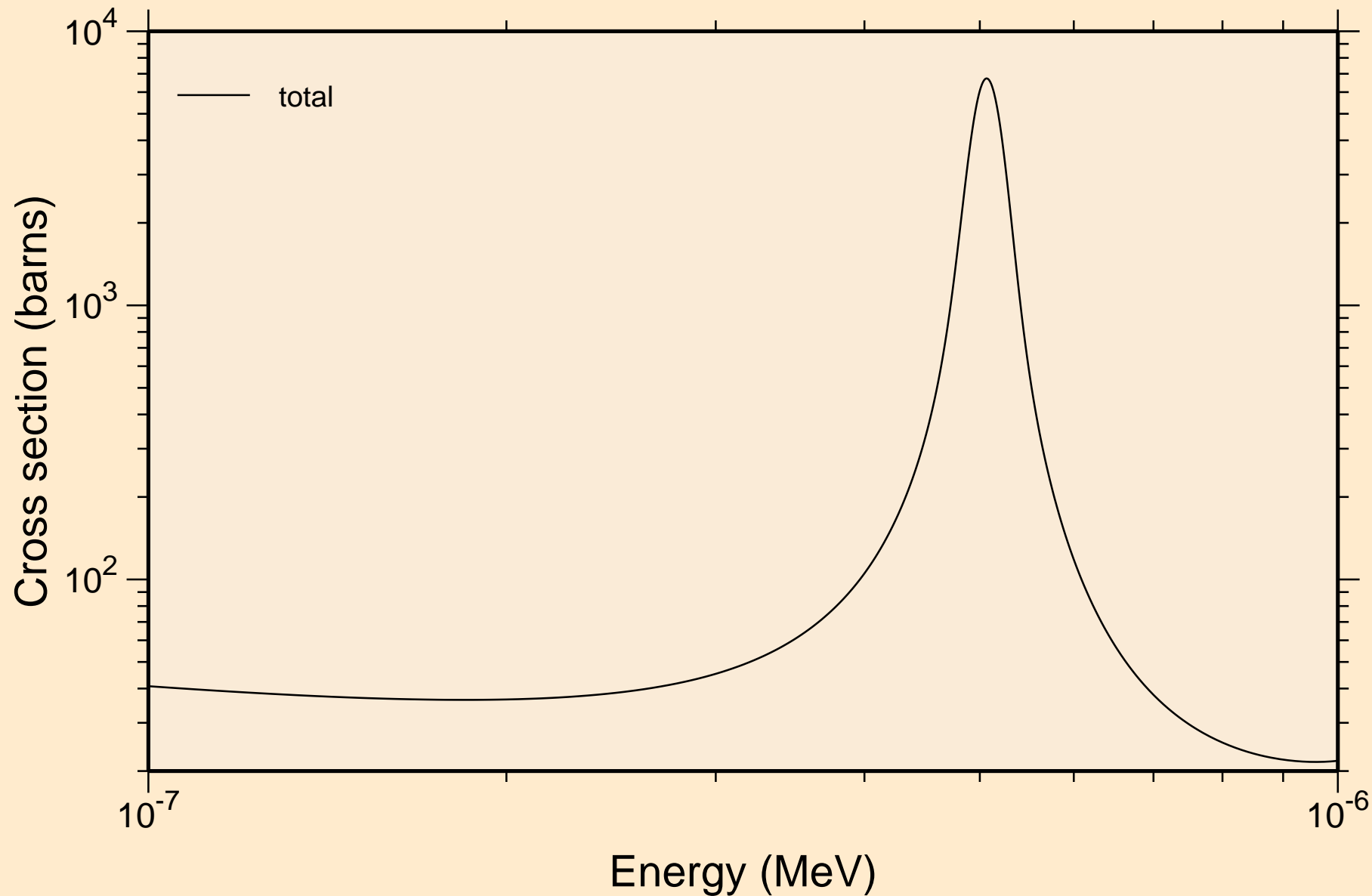

CM232 NEUTRON ACER TENDL-2019 LIBRARY; T=293.16K
resonance total cross section

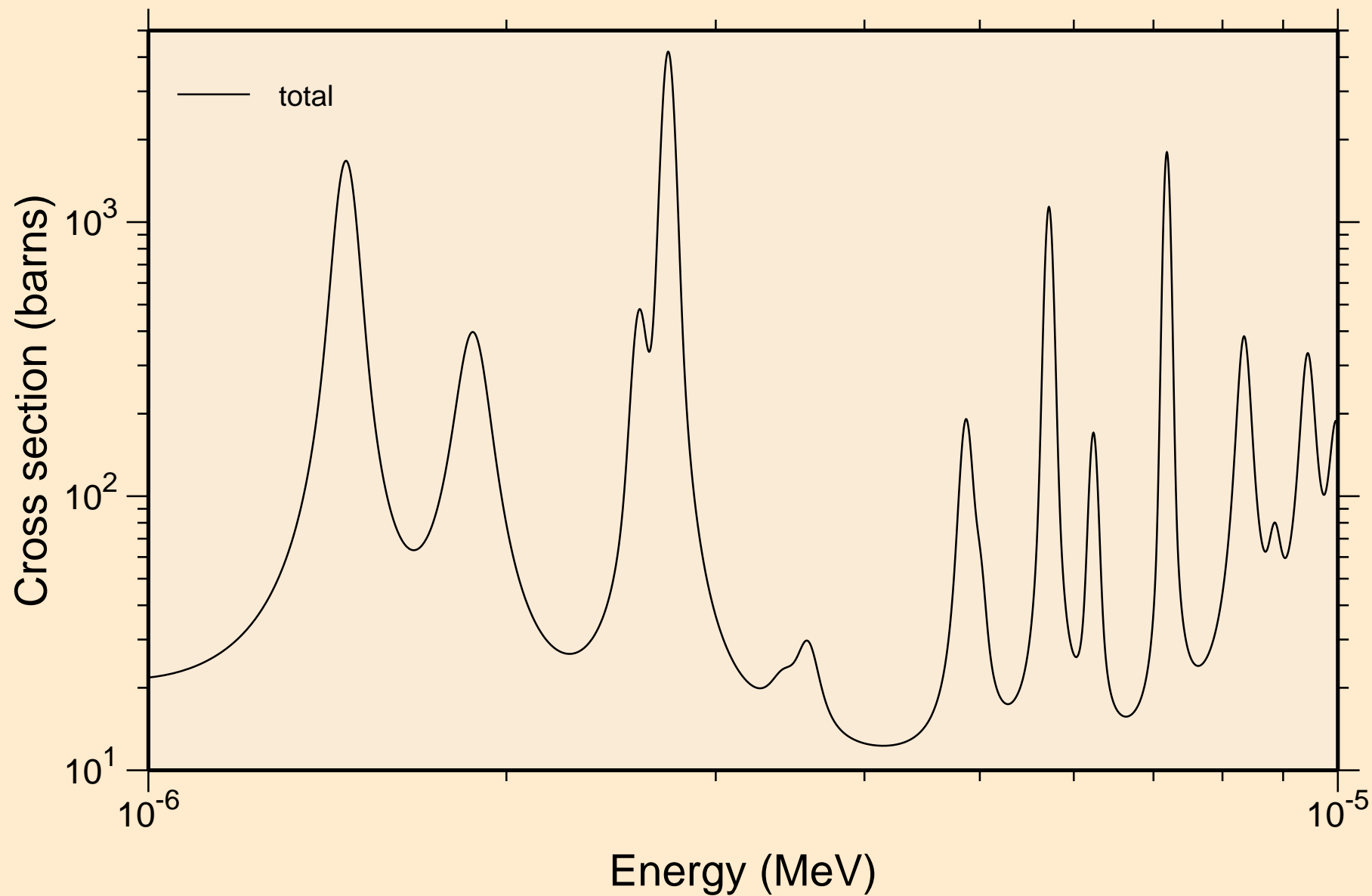

CM232 NEUTRON ACER TENDL-2019 LIBRARY; T=293.16K
resonance total cross section

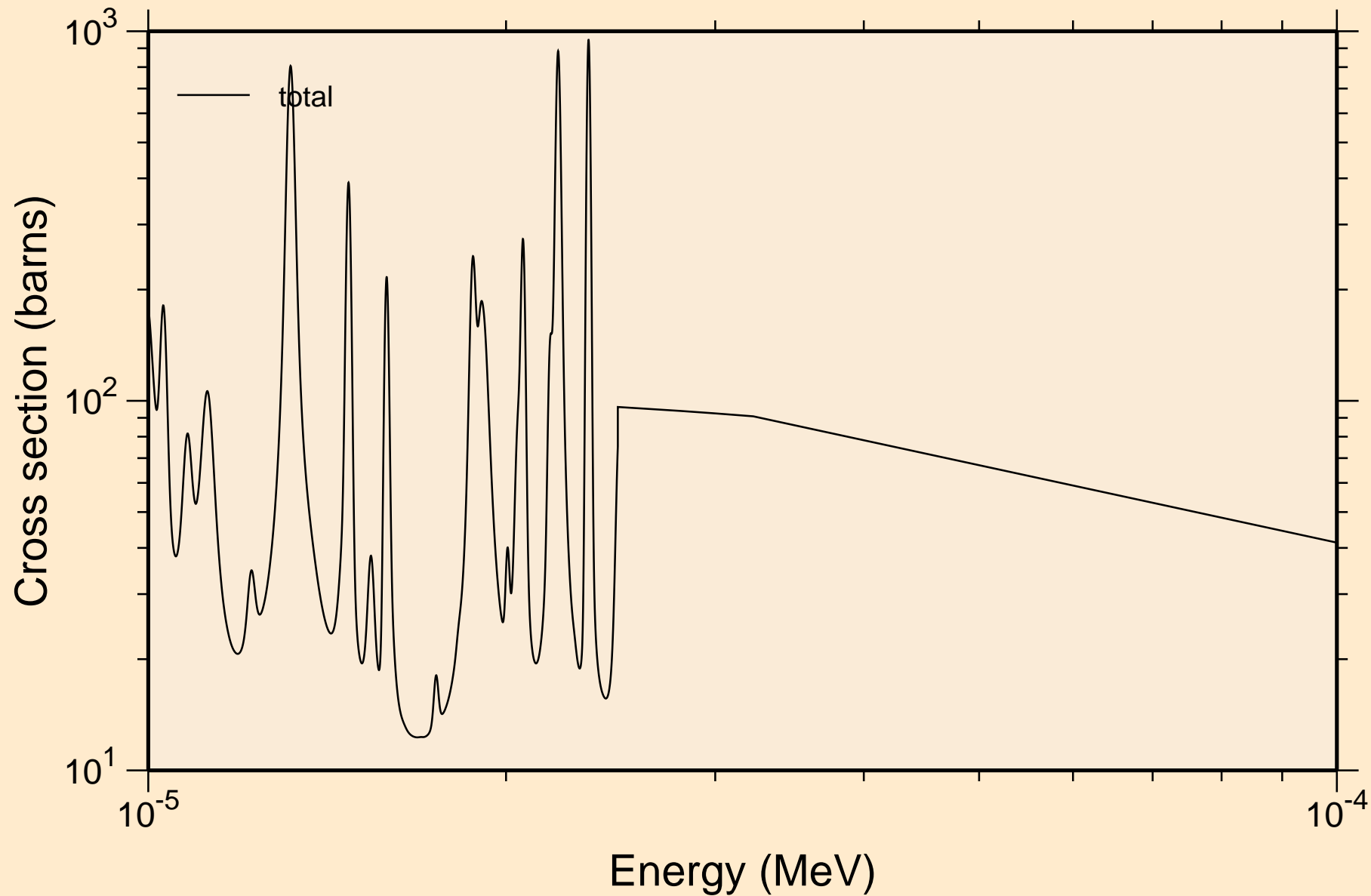

CM232 NEUTRON ACER TENDL-2019 LIBRARY; T=293.16K
resonance total cross section

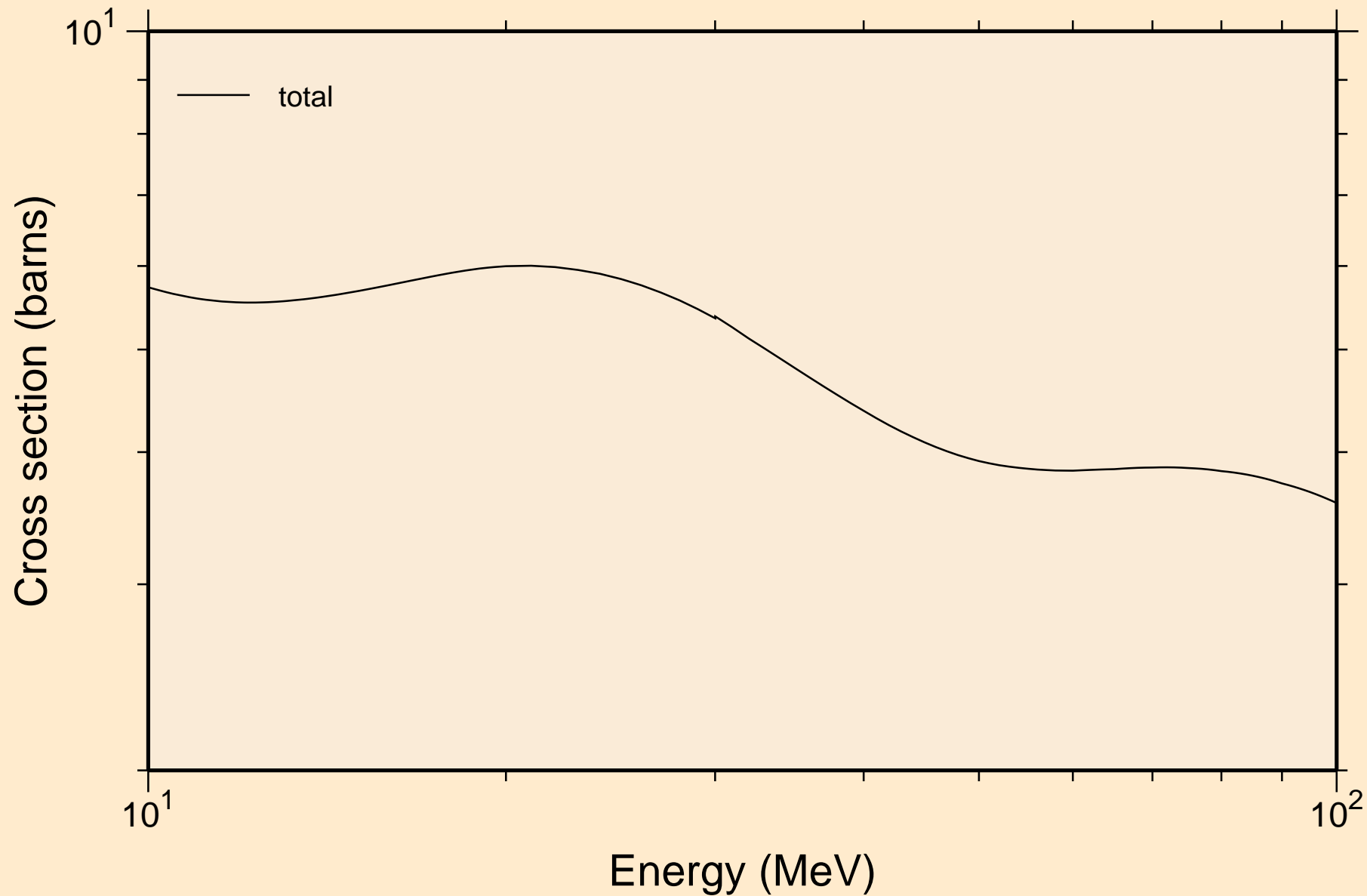

CM232 NEUTRON ACER TENDL-2019 LIBRARY; T=293.16K
resonance absorption cross sections

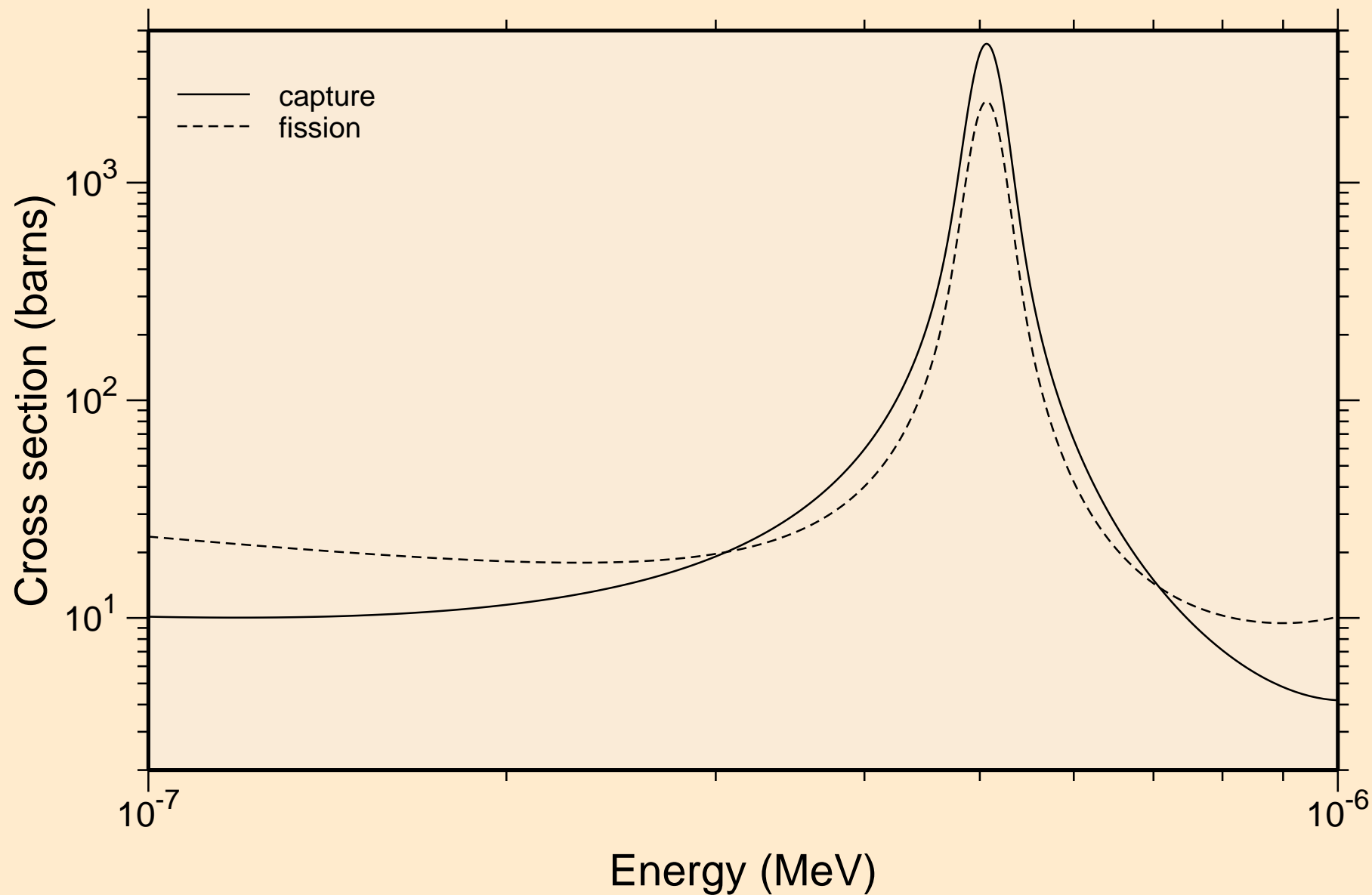

CM232 NEUTRON ACER TENDL-2019 LIBRARY; T=293.16K
resonance absorption cross sections

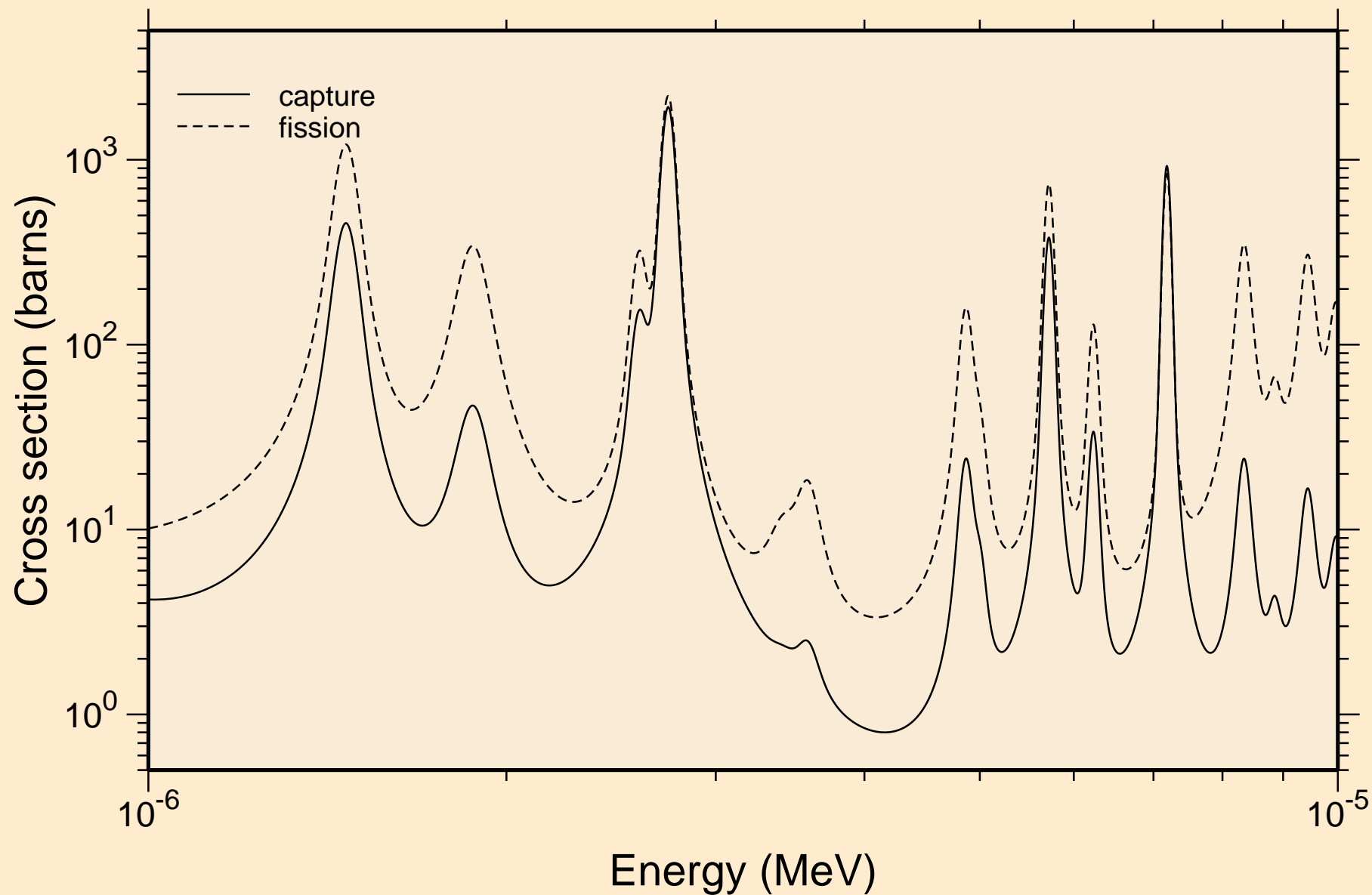

CM232 NEUTRON ACER TENDL-2019 LIBRARY; T=293.16K
resonance absorption cross sections

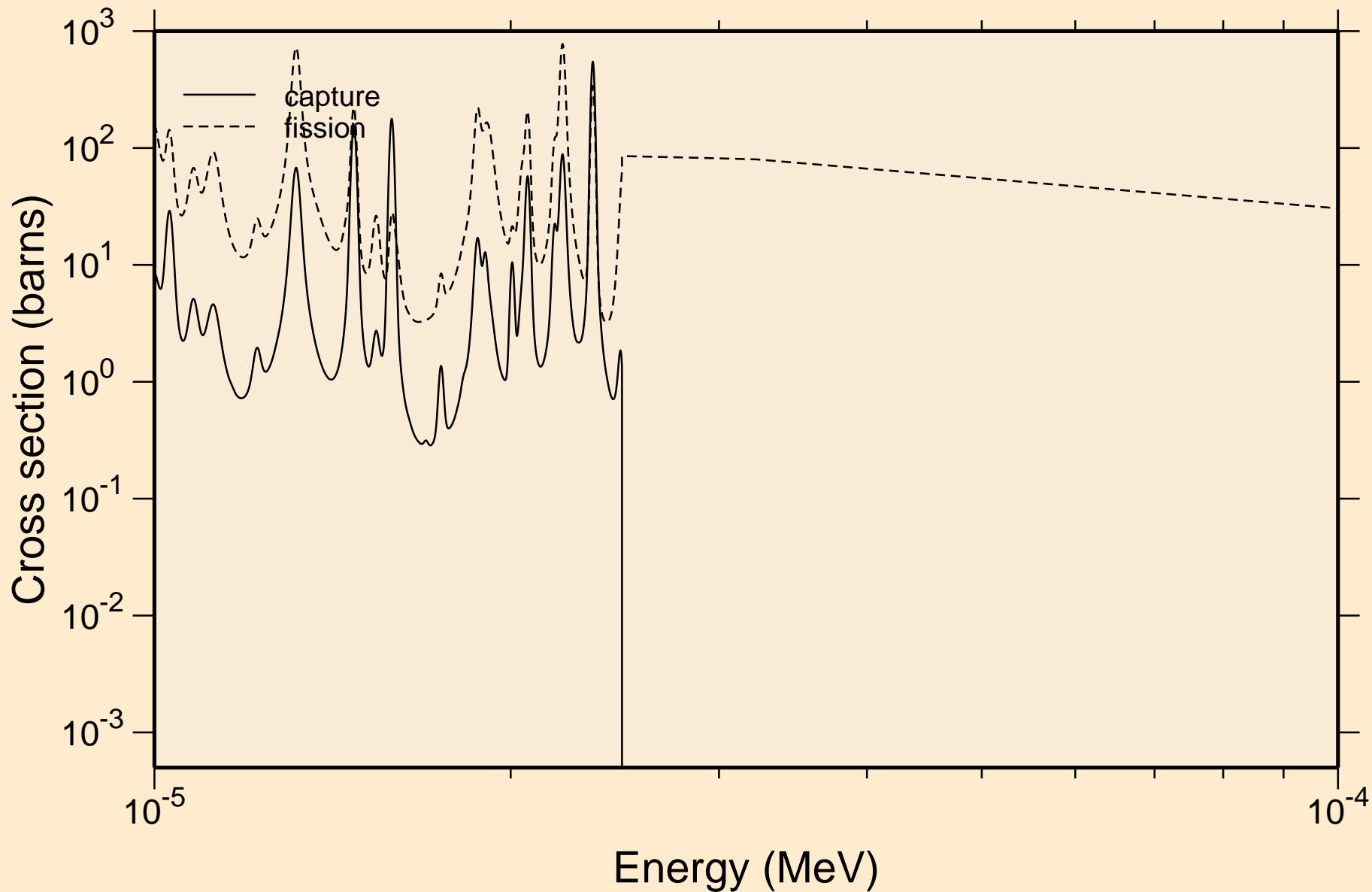

CM232 NEUTRON ACER TENDL-2019 LIBRARY; T=293.16K
resonance absorption cross sections

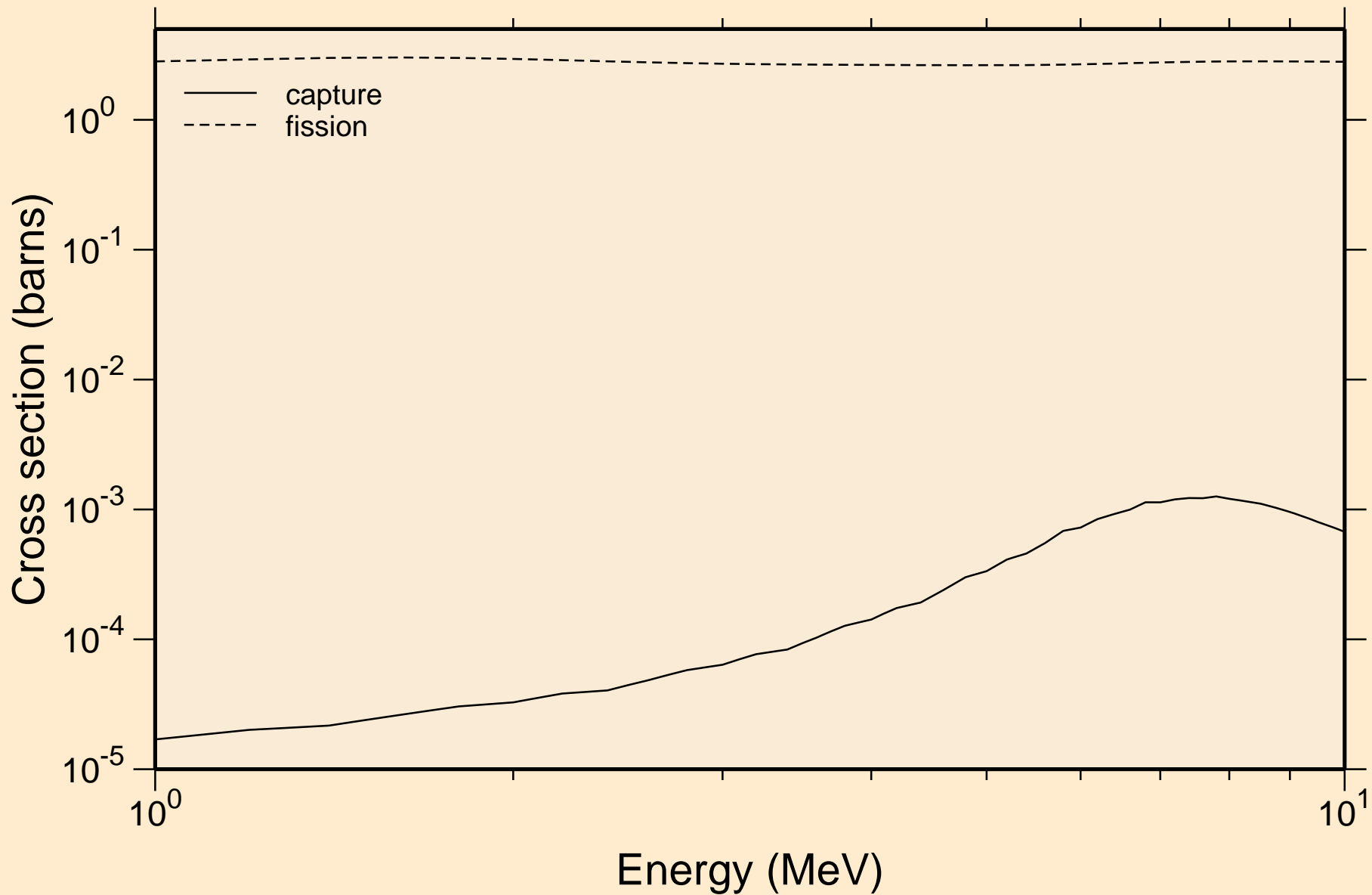

CM232 NEUTRON ACER TENDL-2019 LIBRARY; T=293.16K
Heating

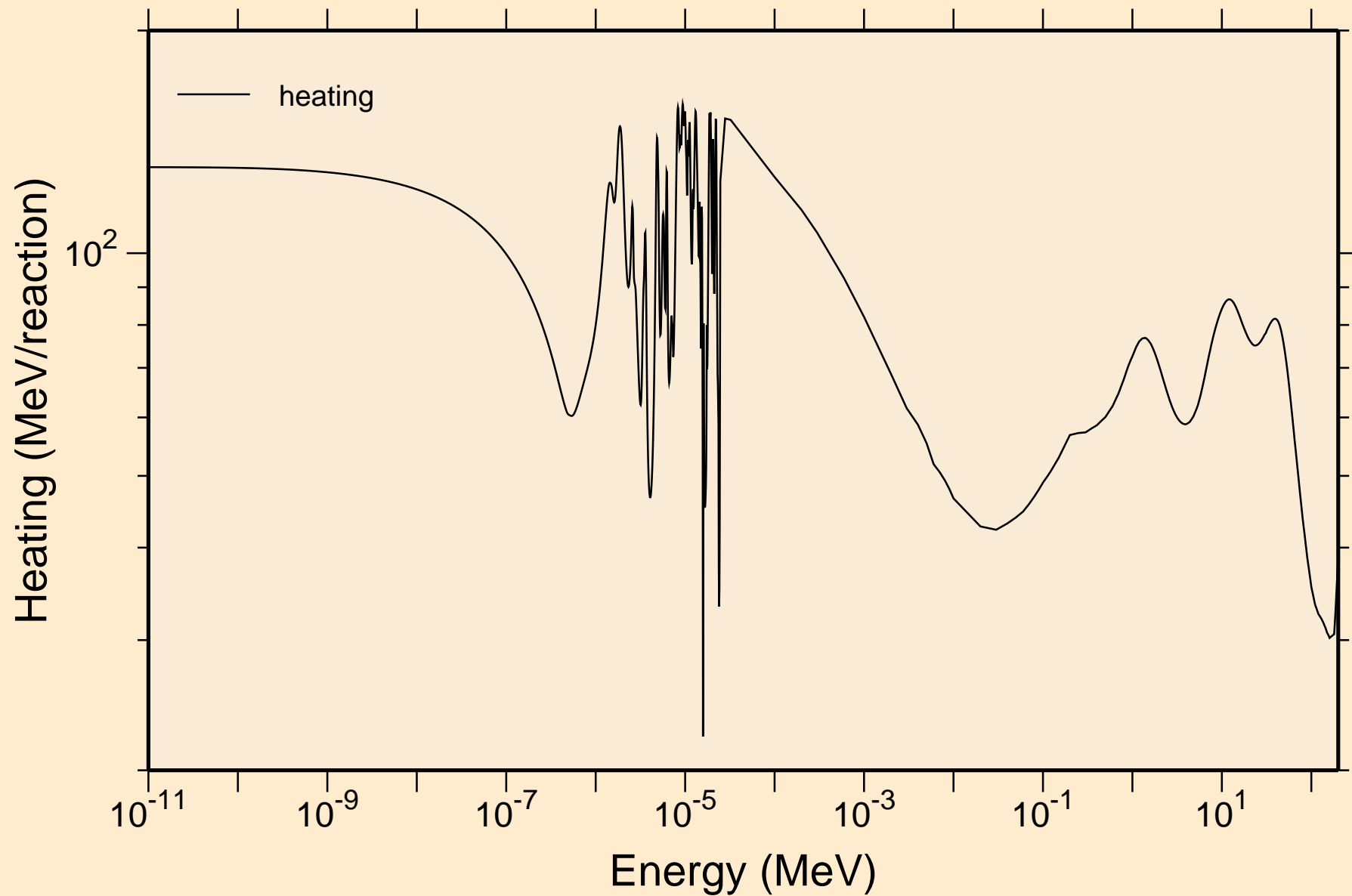

CM232 NEUTRON ACER TENDL-2019 LIBRARY; T=293.16K
Damage

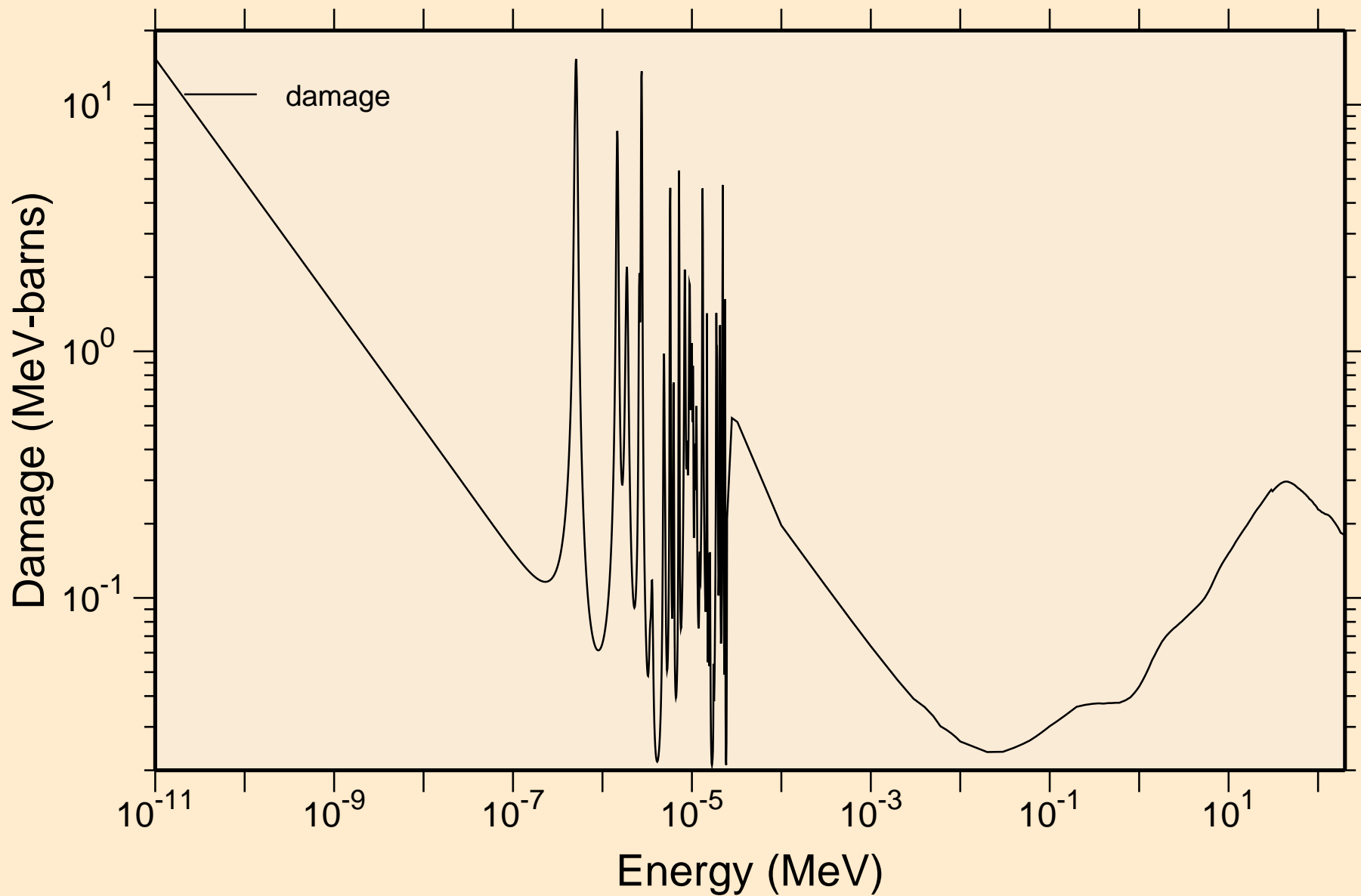

CM232 NEUTRON ACER TENDL-2019 LIBRARY; T=293.16K

Non-threshold reactions

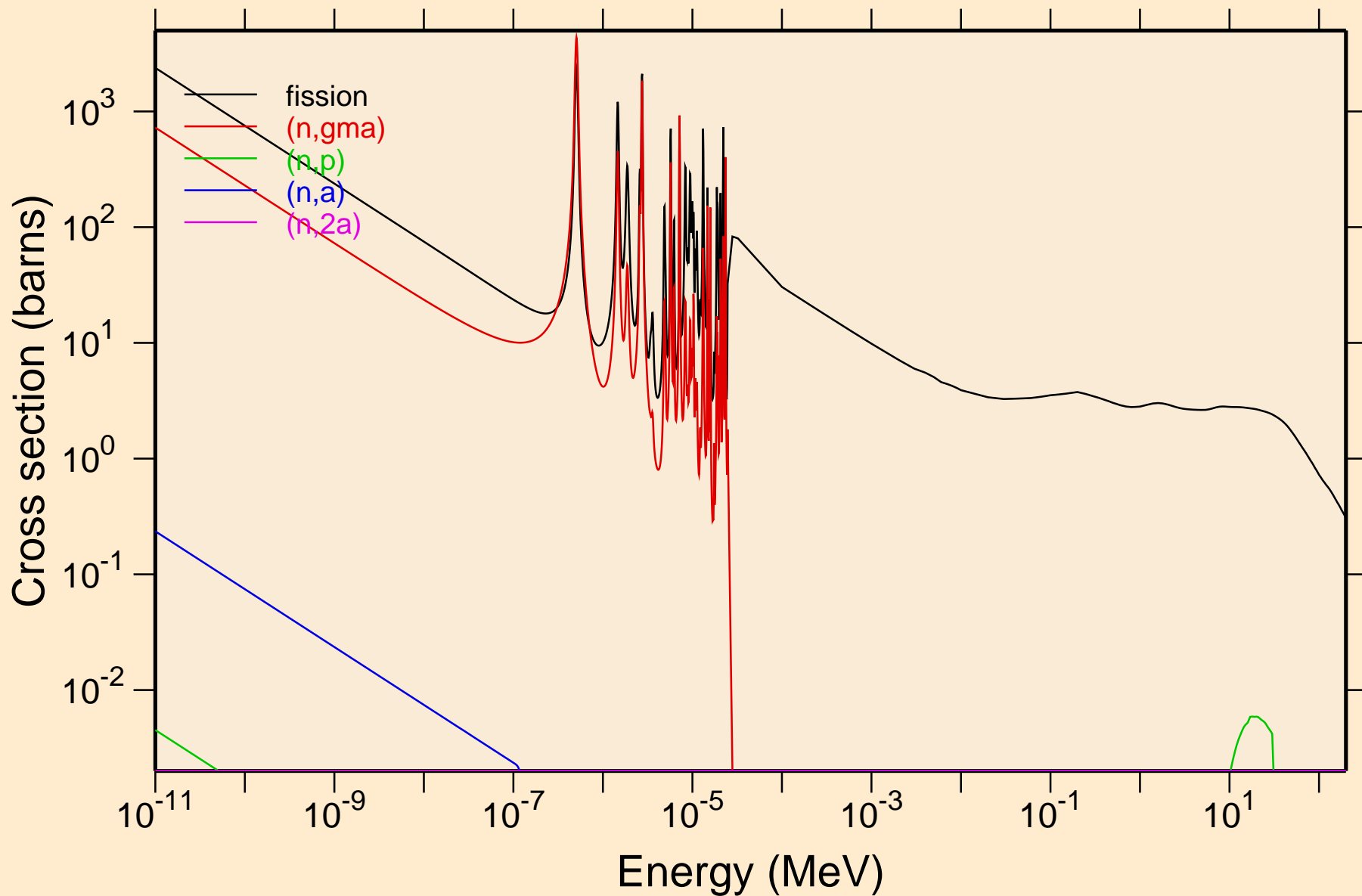

CM232 NEUTRON ACER TENDL-2019 LIBRARY; T=293.16K
Non-threshold reactions

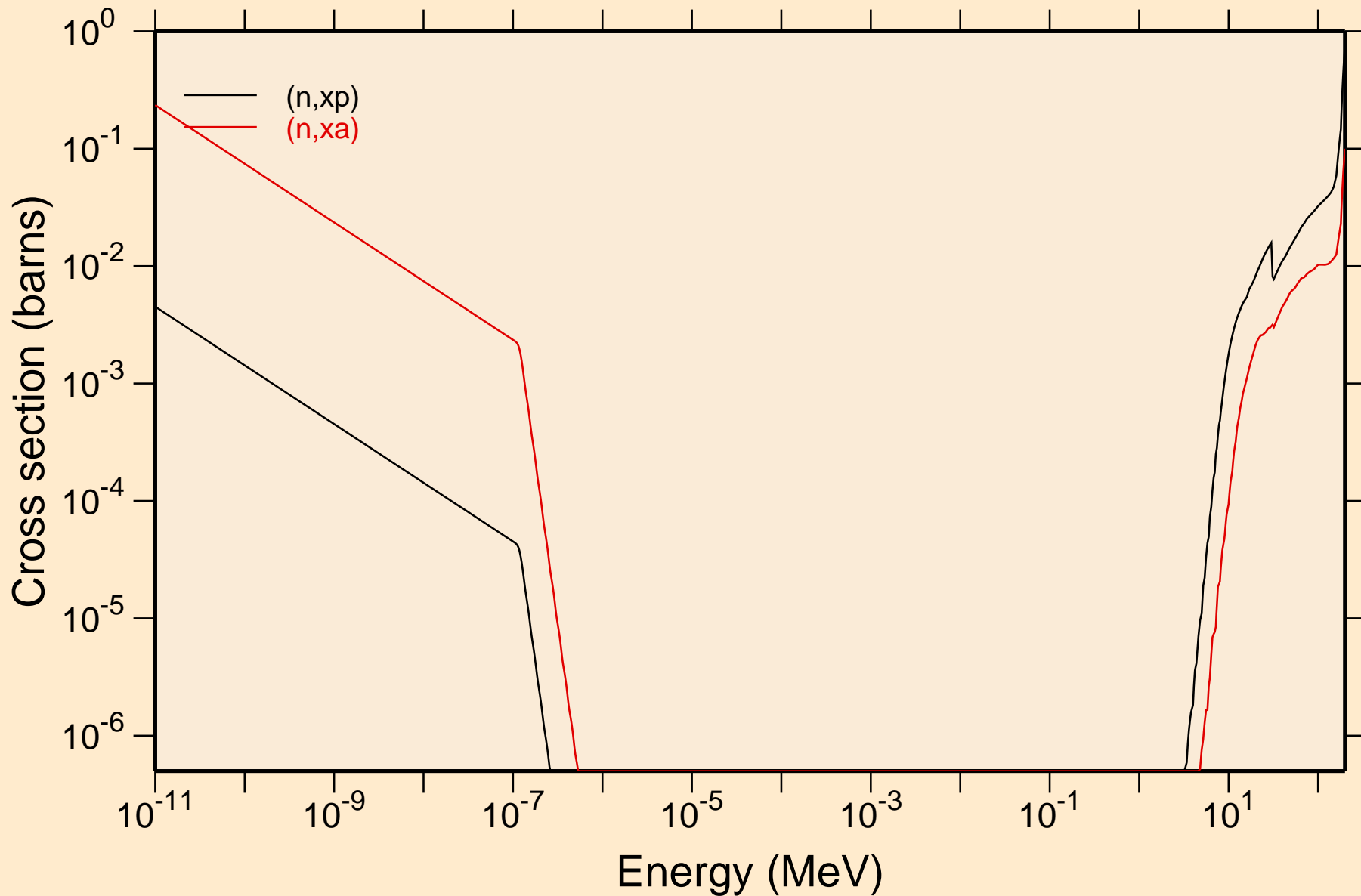

CM232 NEUTRON ACER TENDL-2019 LIBRARY; T=293.16K

Principal cross sections

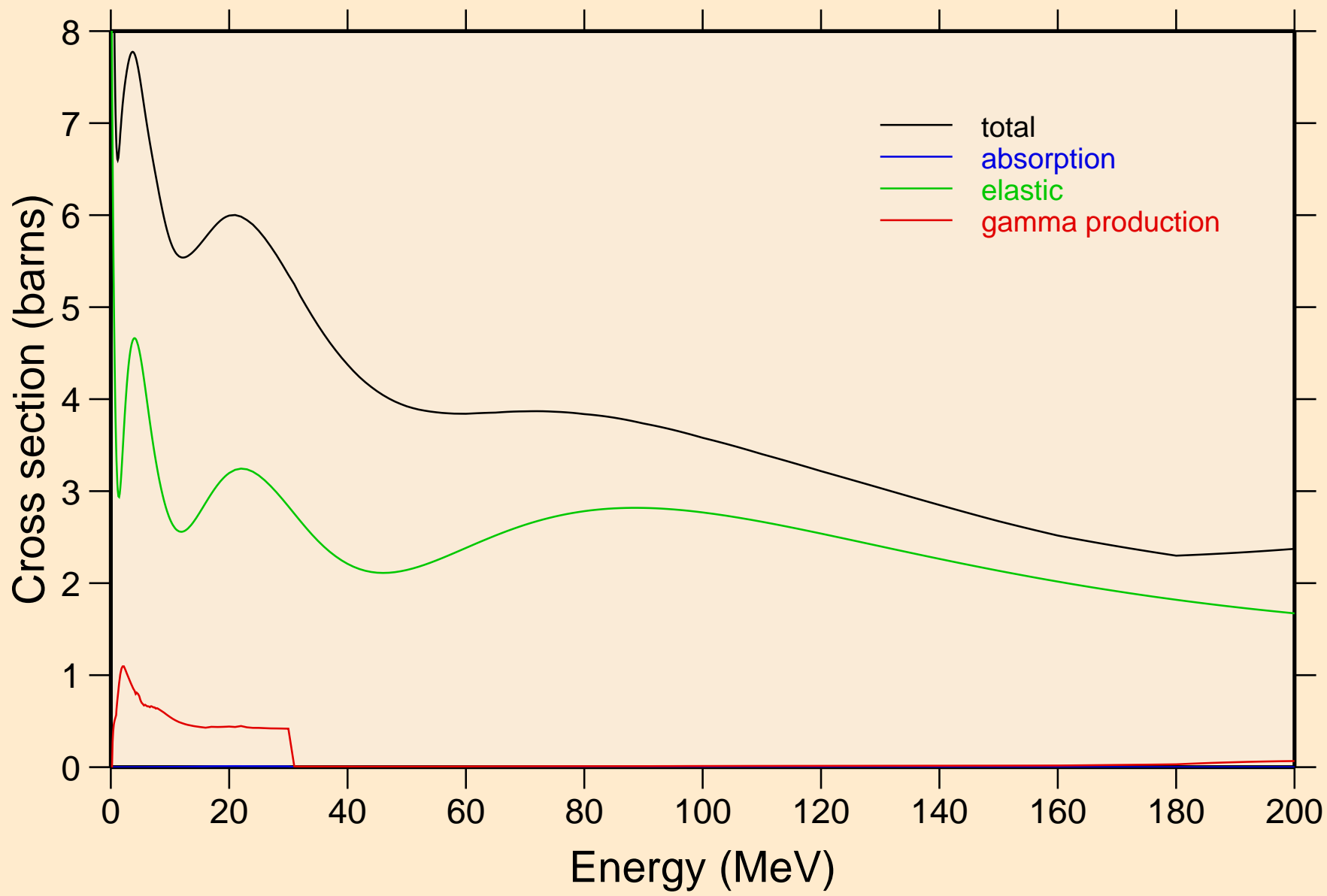

CM232 NEUTRON ACER TENDL-2019 LIBRARY; T=293.16K
Heating

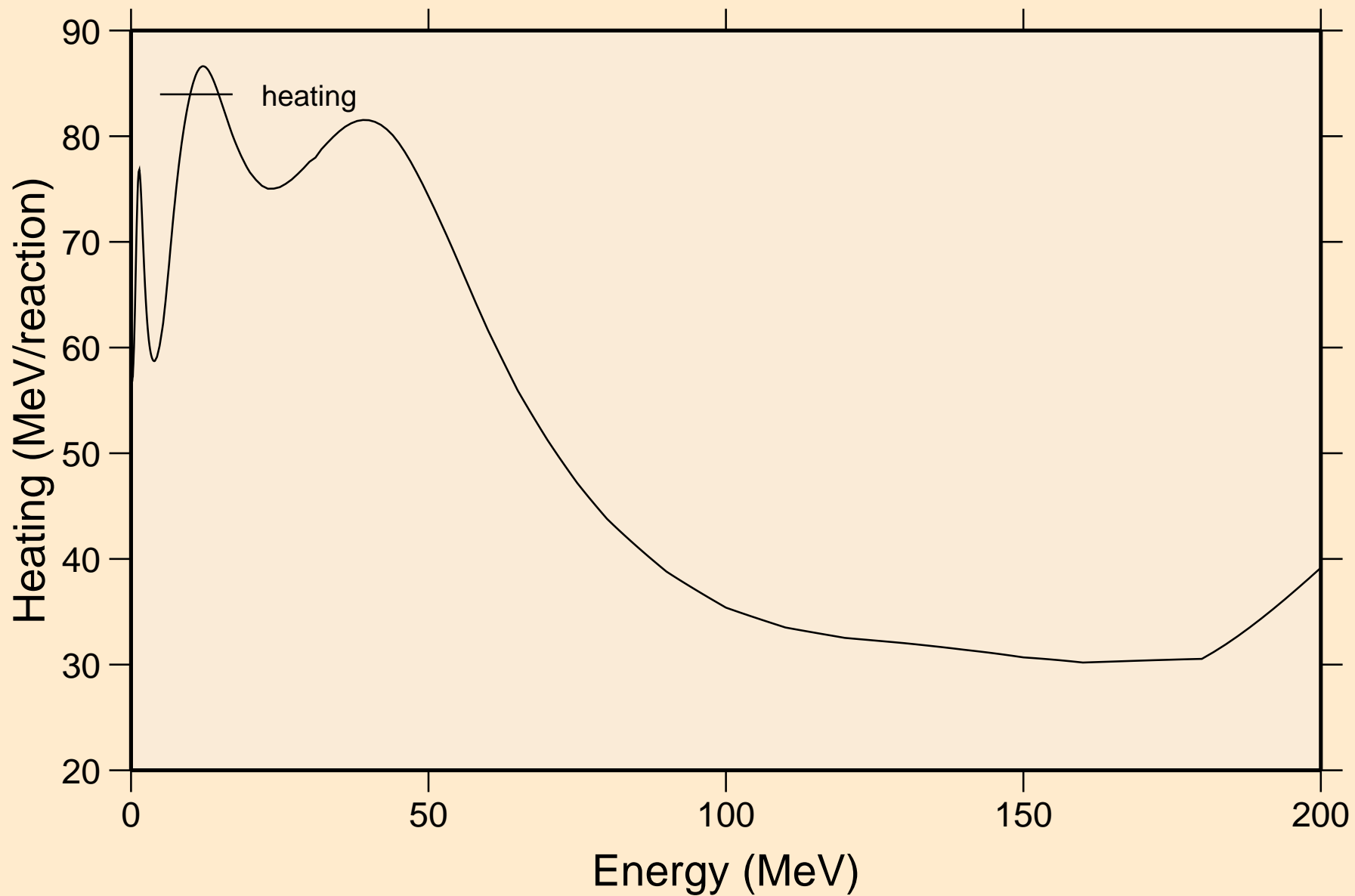

CM232 NEUTRON ACER TENDL-2019 LIBRARY; T=293.16K
Damage

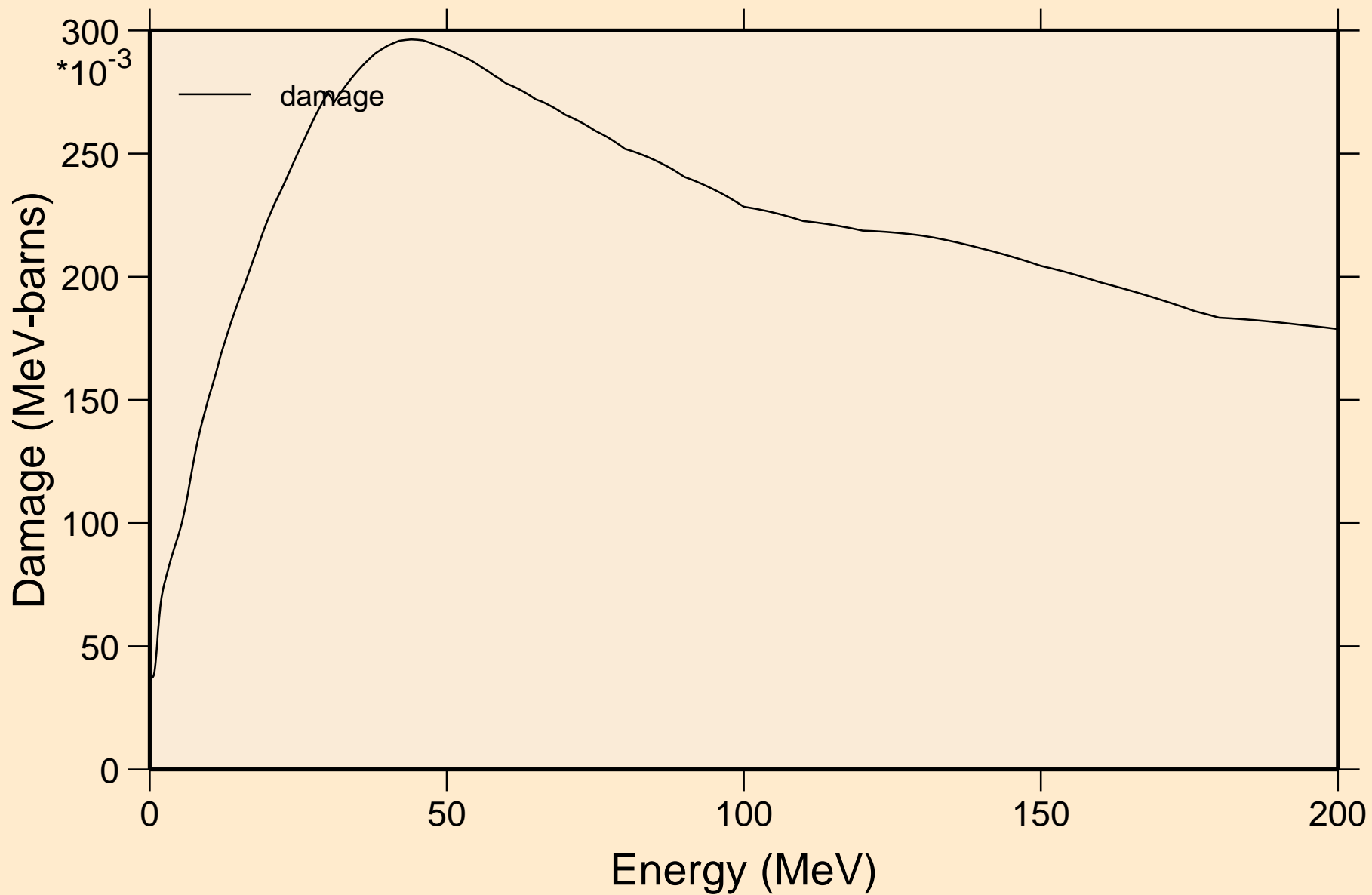

CM232 NEUTRON ACER TENDL-2019 LIBRARY; T=293.16K
Non-threshold reactions

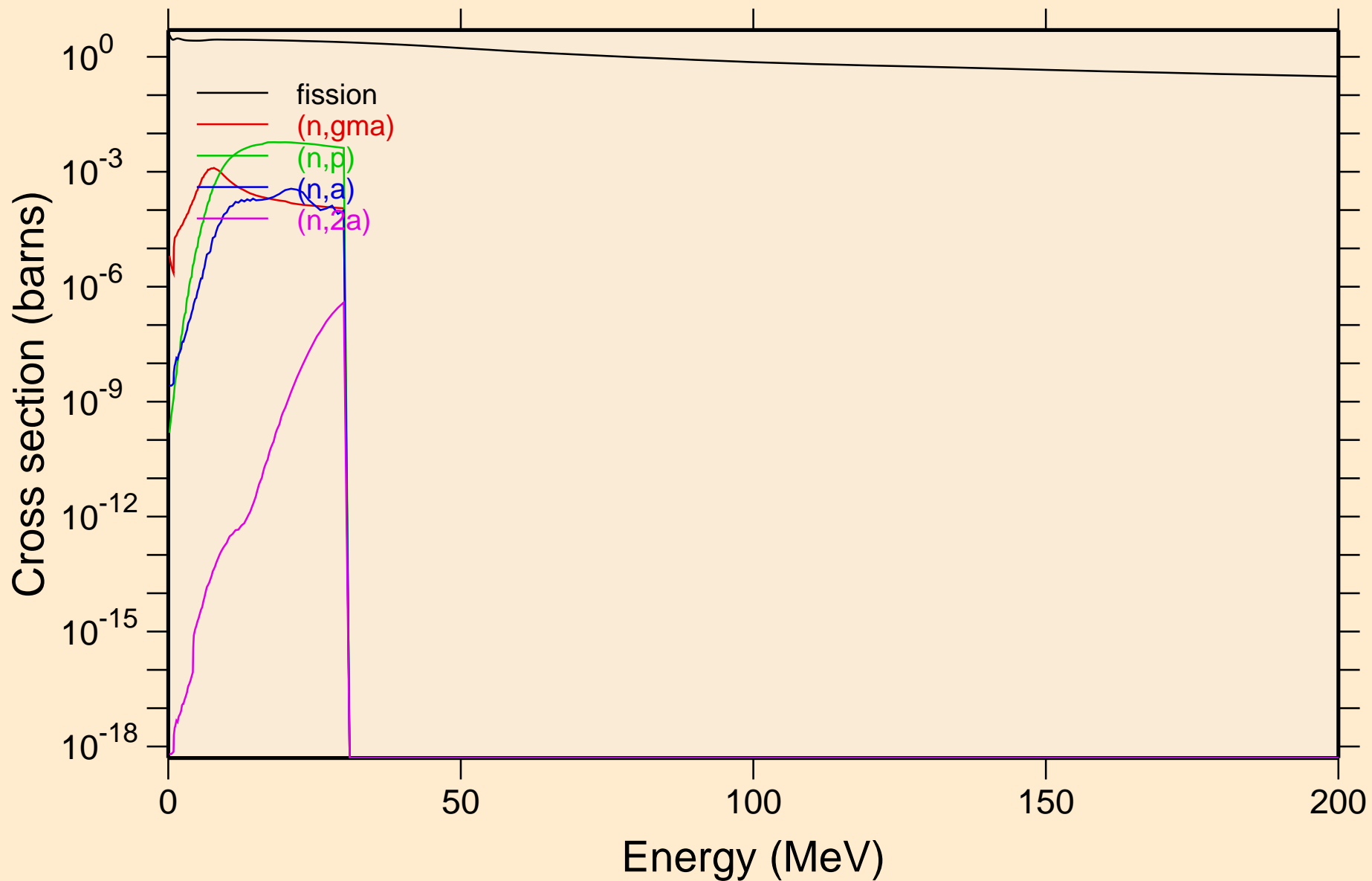

CM232 NEUTRON ACER TENDL-2019 LIBRARY; T=293.16K
Non-threshold reactions

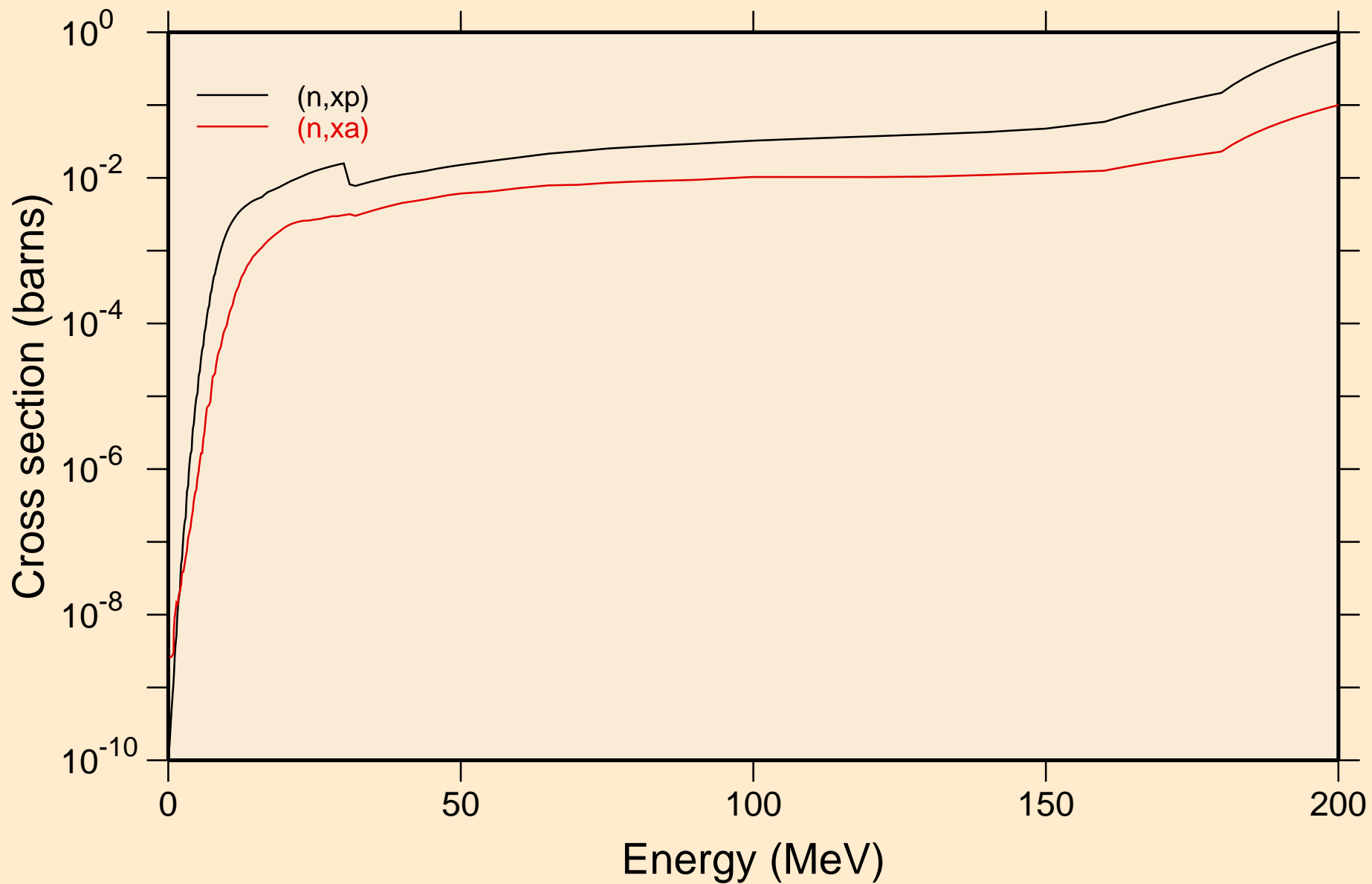

CM232 NEUTRON ACER TENDL-2019 LIBRARY; T=293.16K
Inelastic levels

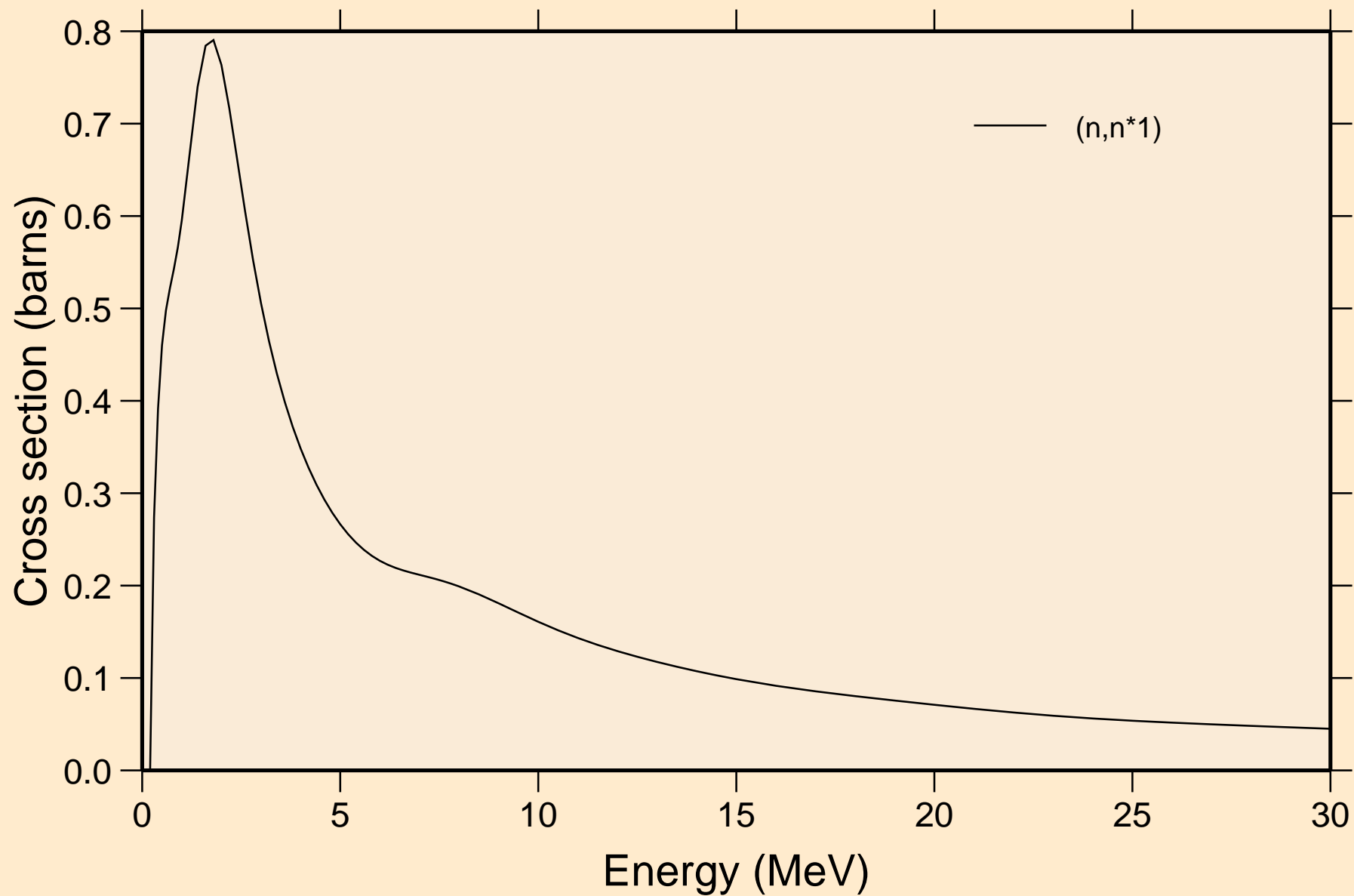

CM232 NEUTRON ACER TENDL-2019 LIBRARY; T=293.16K

Threshold reactions

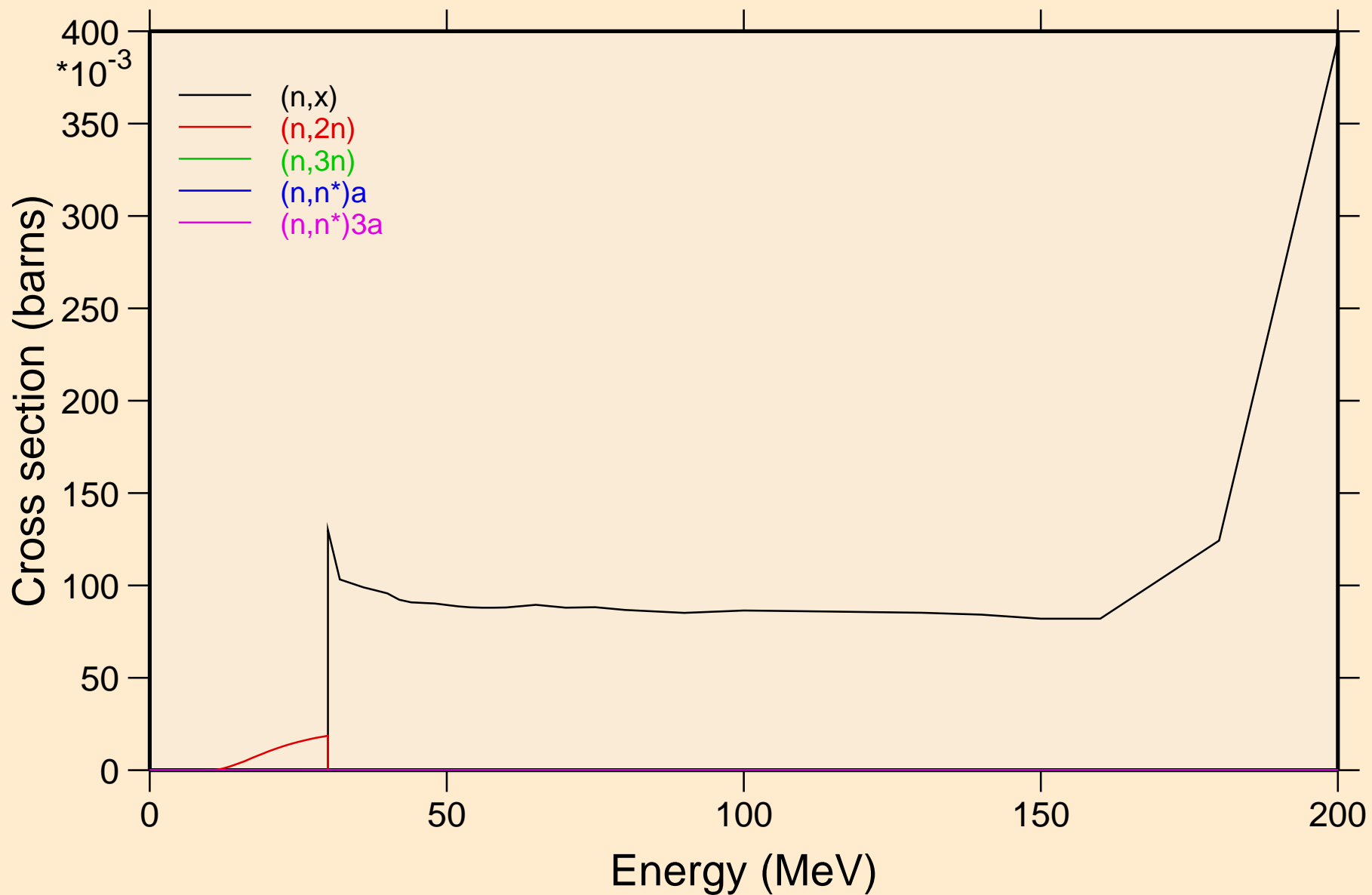

CM232 NEUTRON ACER TENDL-2019 LIBRARY; T=293.16K
Threshold reactions

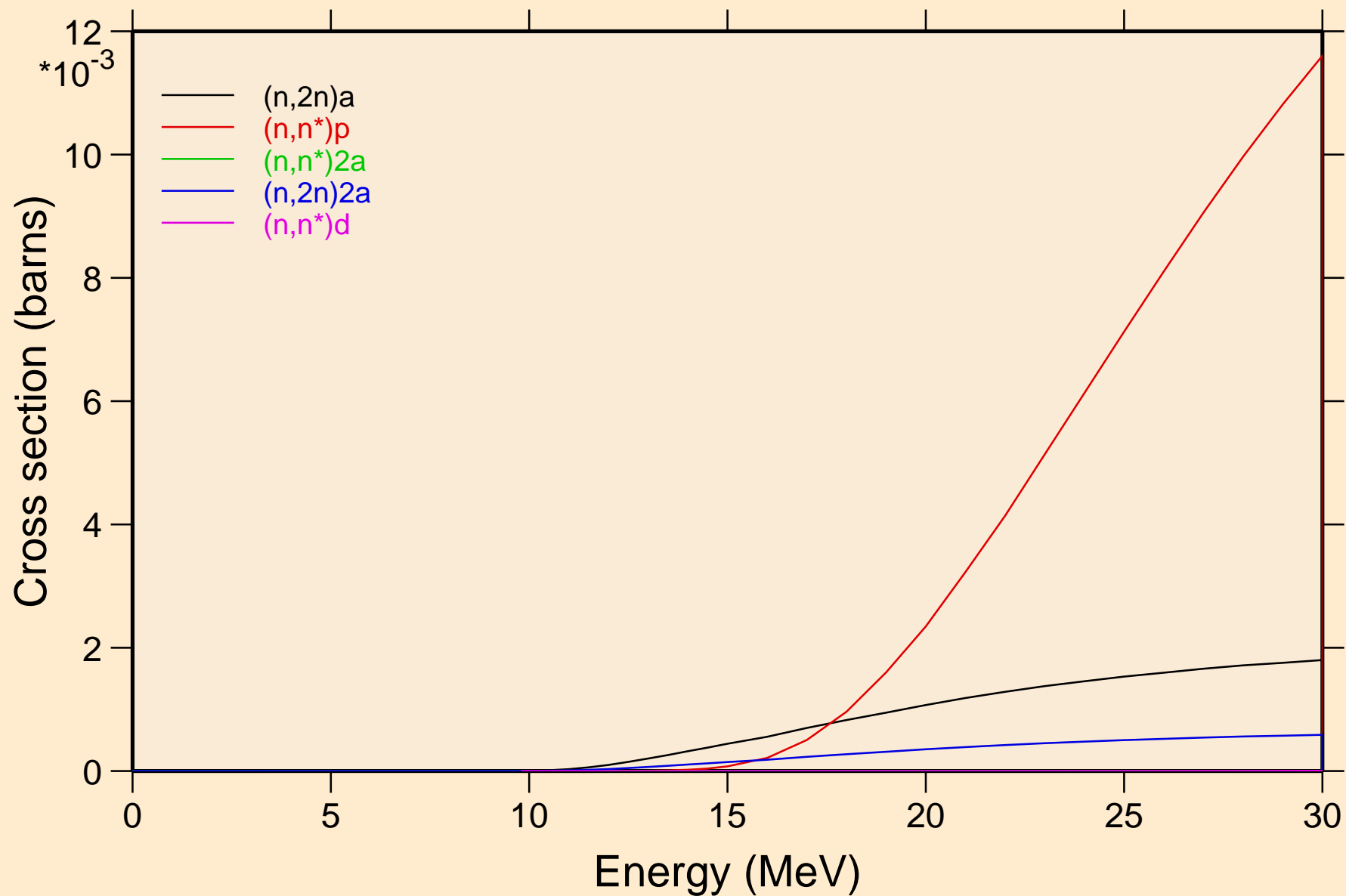

CM232 NEUTRON ACER TENDL-2019 LIBRARY; T=293.16K
Threshold reactions

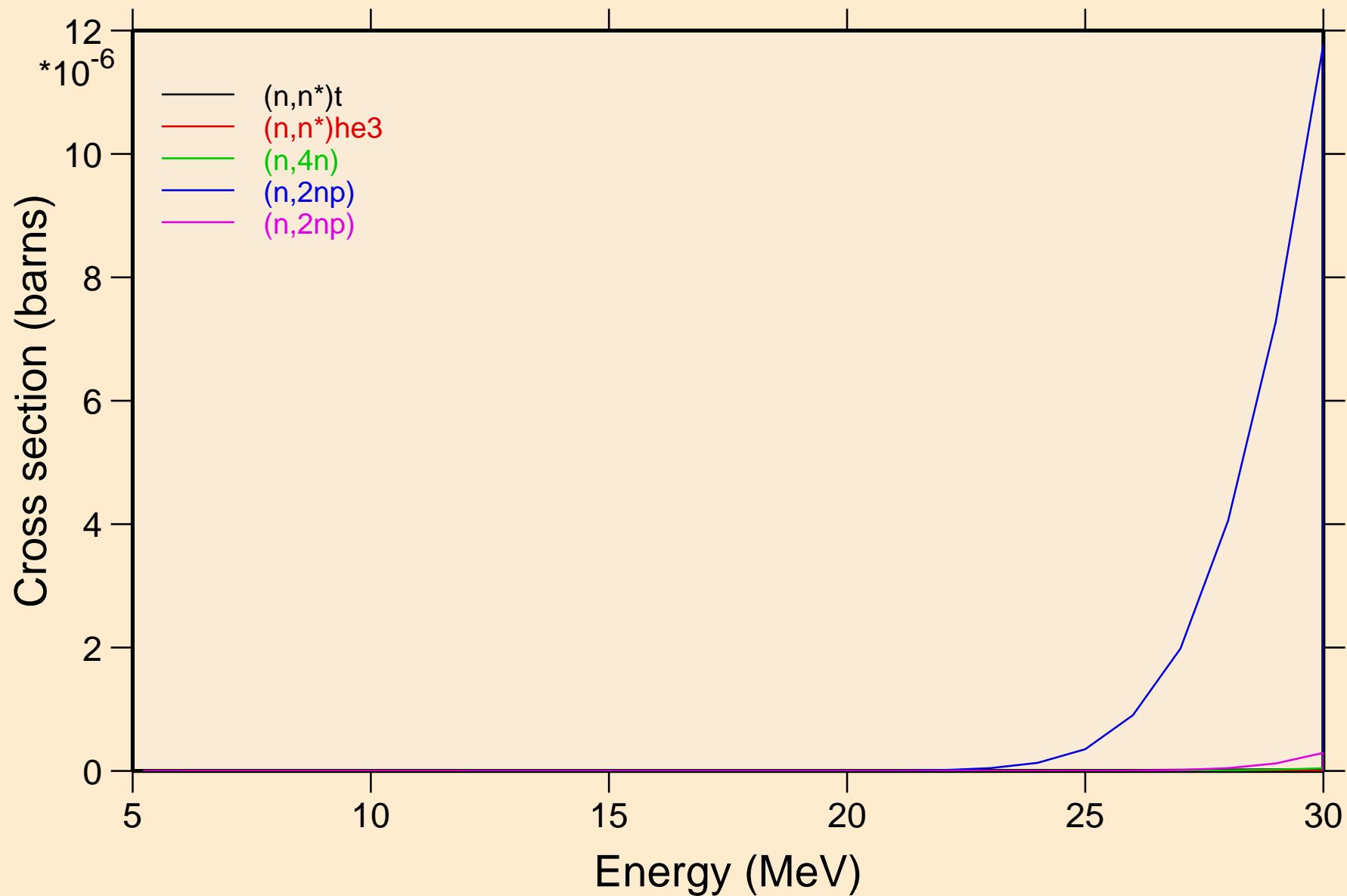

CM232 NEUTRON ACER TENDL-2019 LIBRARY; T=293.16K
Threshold reactions

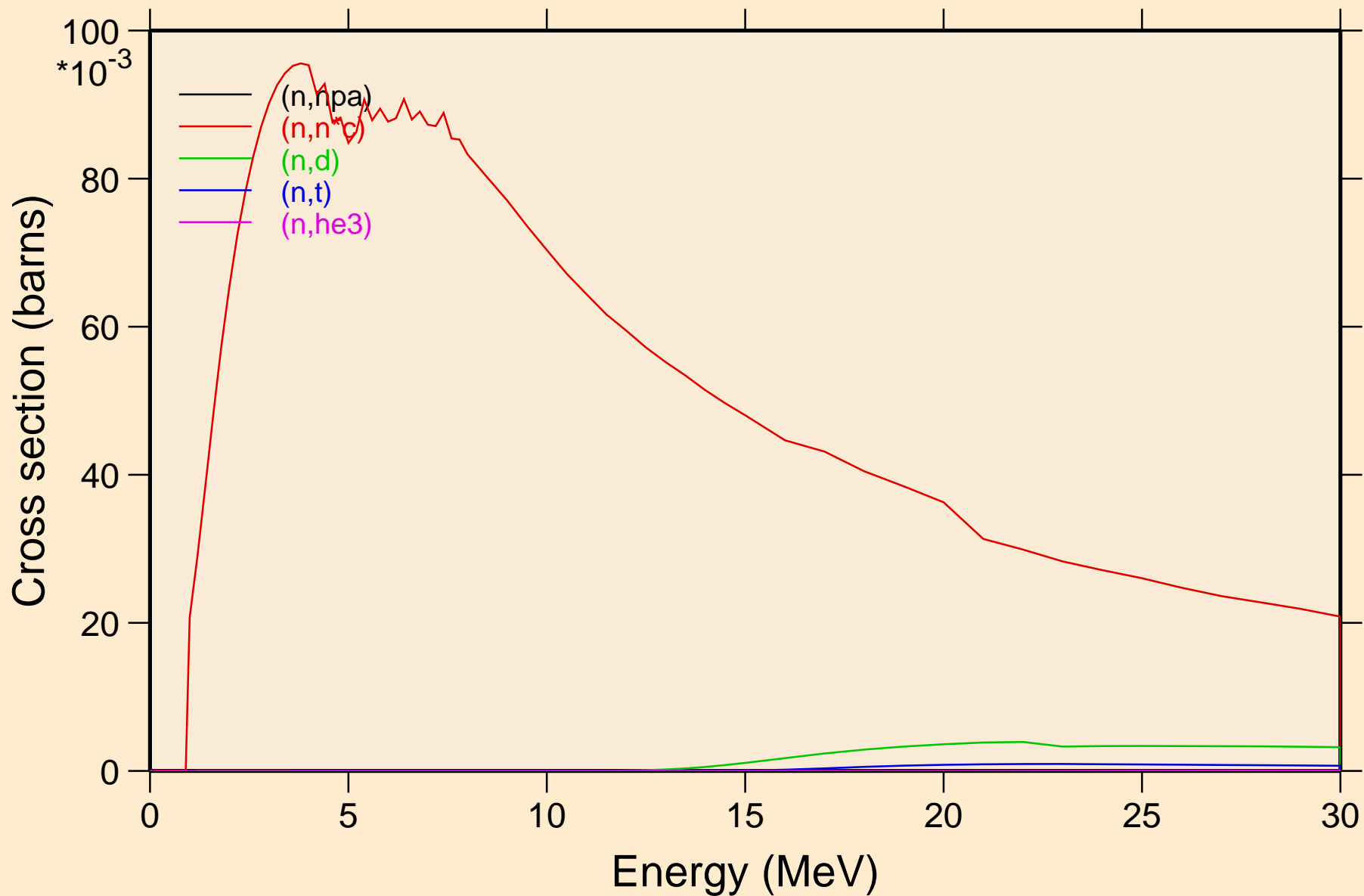

CM232 NEUTRON ACER TENDL-2019 LIBRARY; T=293.16K
Threshold reactions

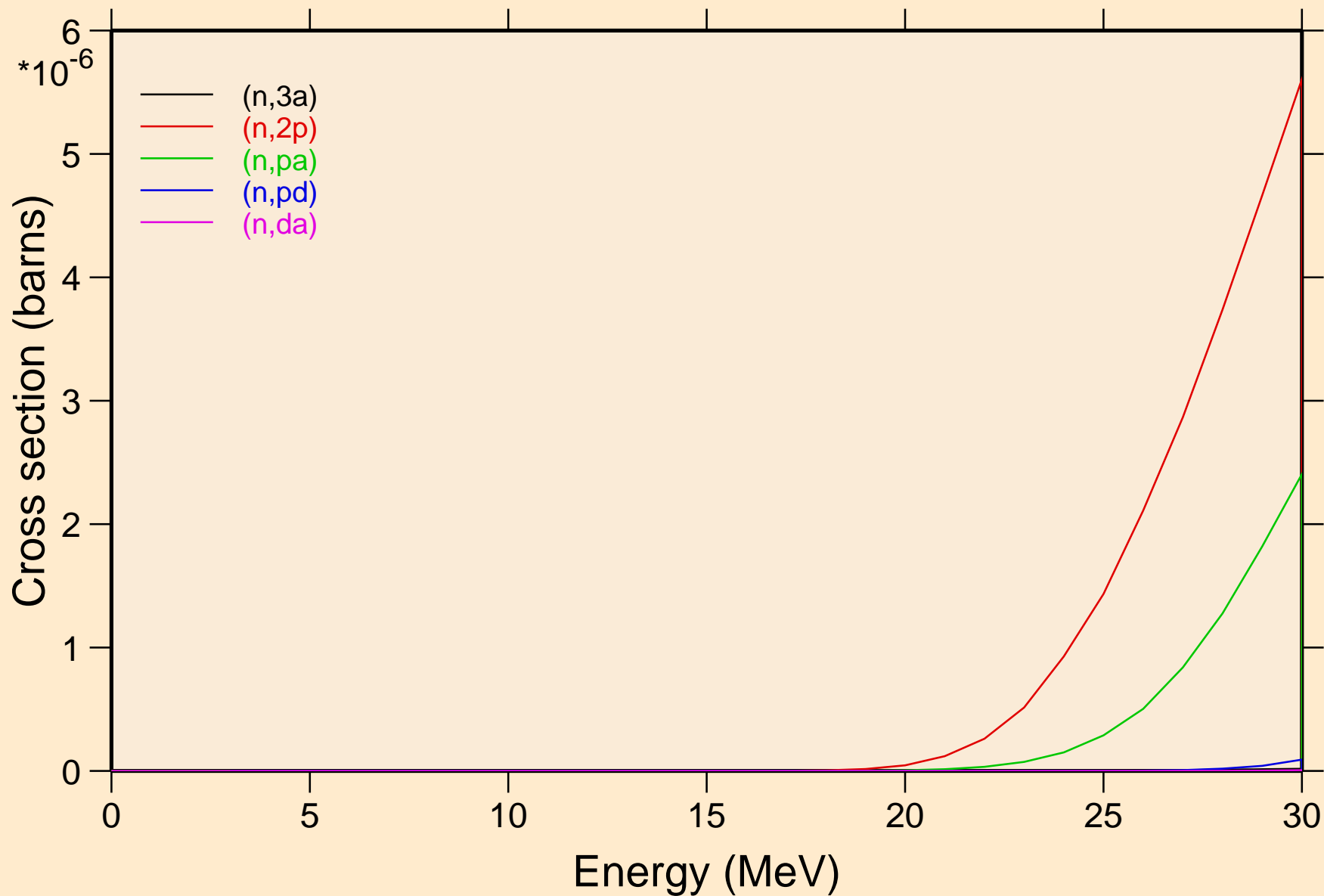

CM232 NEUTRON ACER TENDL-2019 LIBRARY; T=293.16K
Threshold reactions

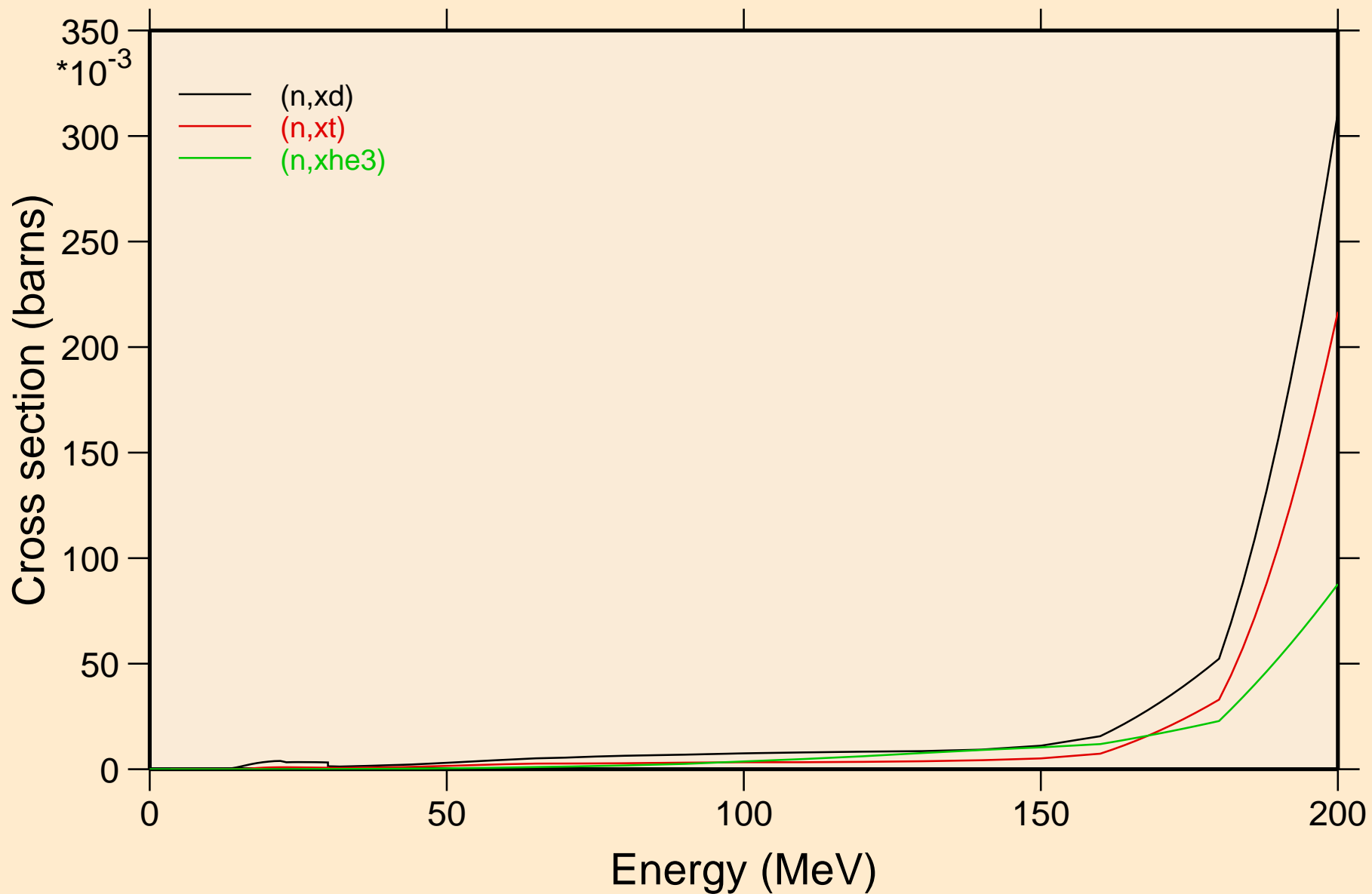

CM232 NEUTRON ACER TENDL-2019 LIBRARY; T=293.16K
angular distribution for elastic

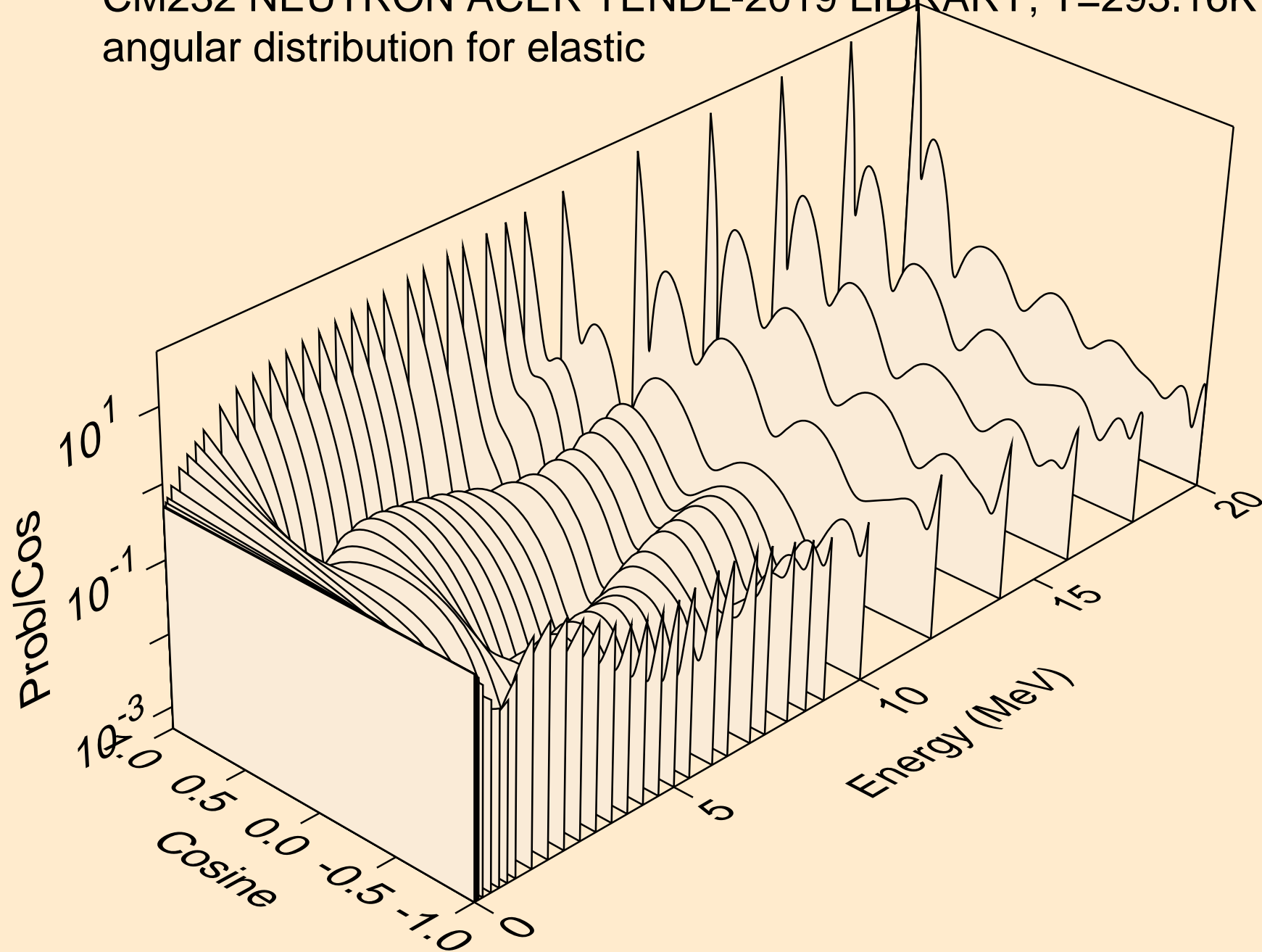

CM232 NEUTRON ACER TENDL-2019 LIBRARY; T=293.16K
angular distribution for elastic

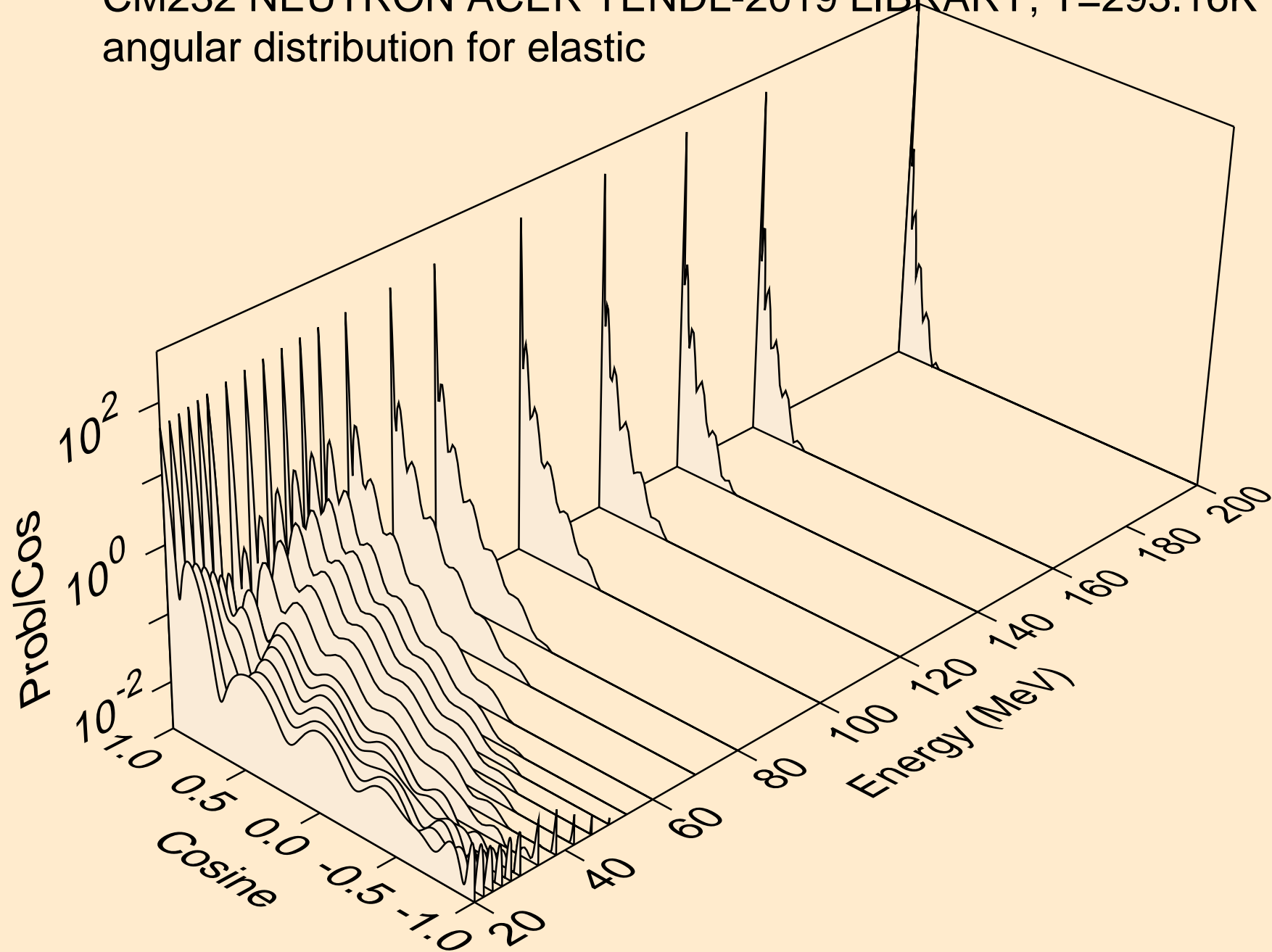

CM232 NEUTRON ACER TENDL-2019 LIBRARY; T=293.16K
angular distribution for (n,n*1)

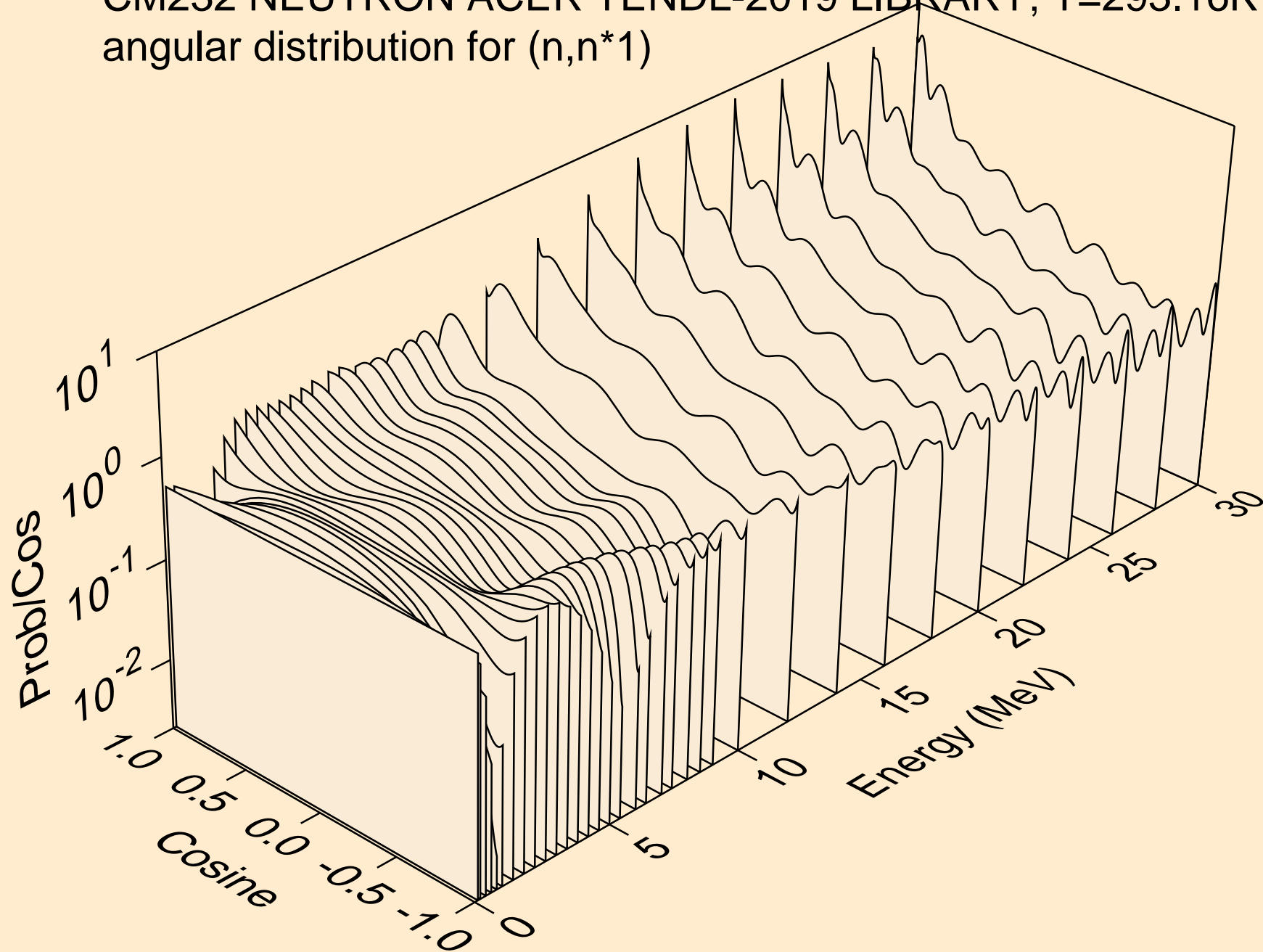

CM232 NEUTRON ACER TENDL-2019 LIBRARY; T=293.16K
Total fission nubar

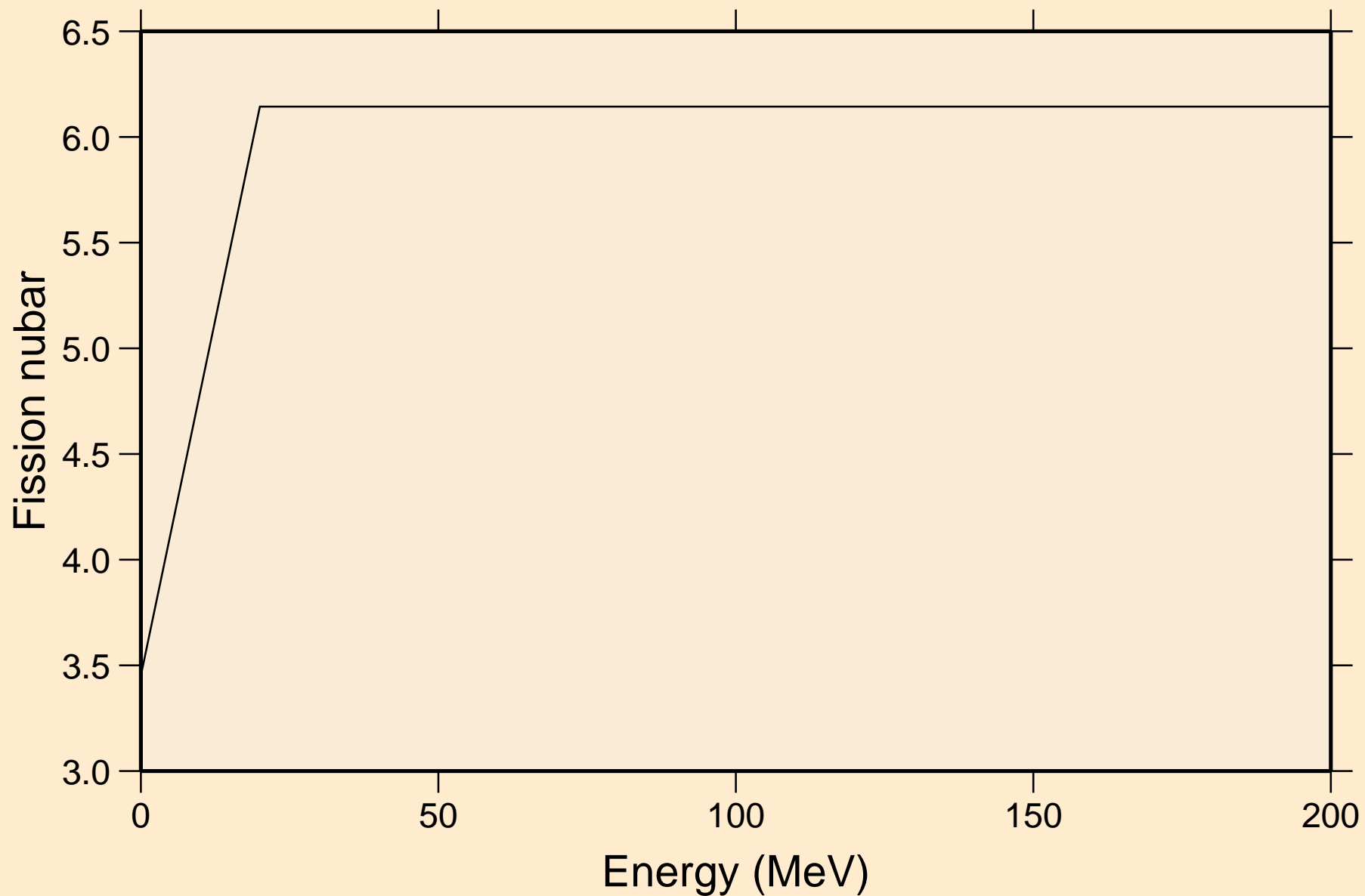

CM232 NEUTRON ACER TENDL-2019 LIBRARY; T=293.16K
Neutron emission for (n,x)

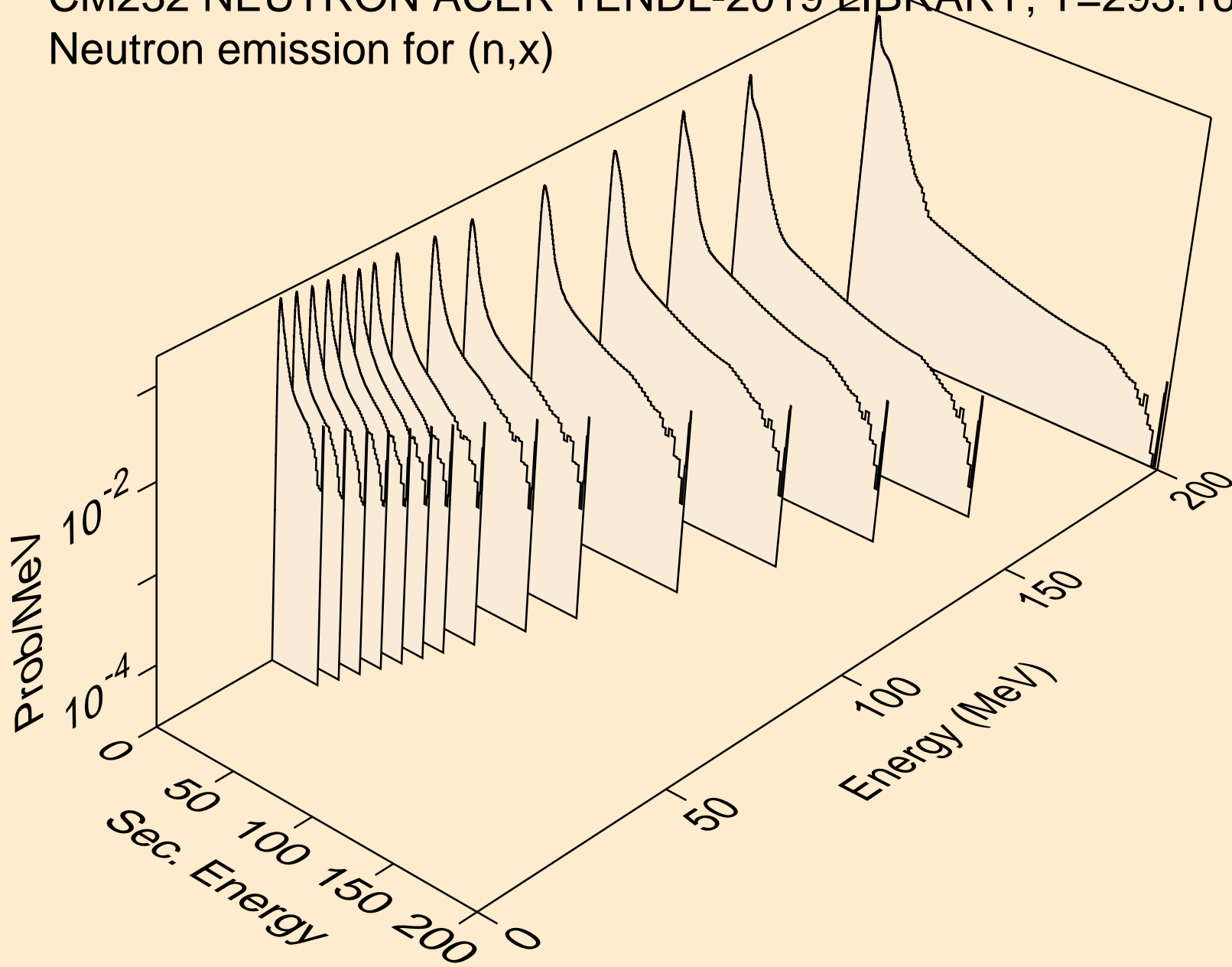

CM232 NEUTRON ACER TENDL-2019 LIBRARY; T=293.16K
Neutron emission for (n,2n)

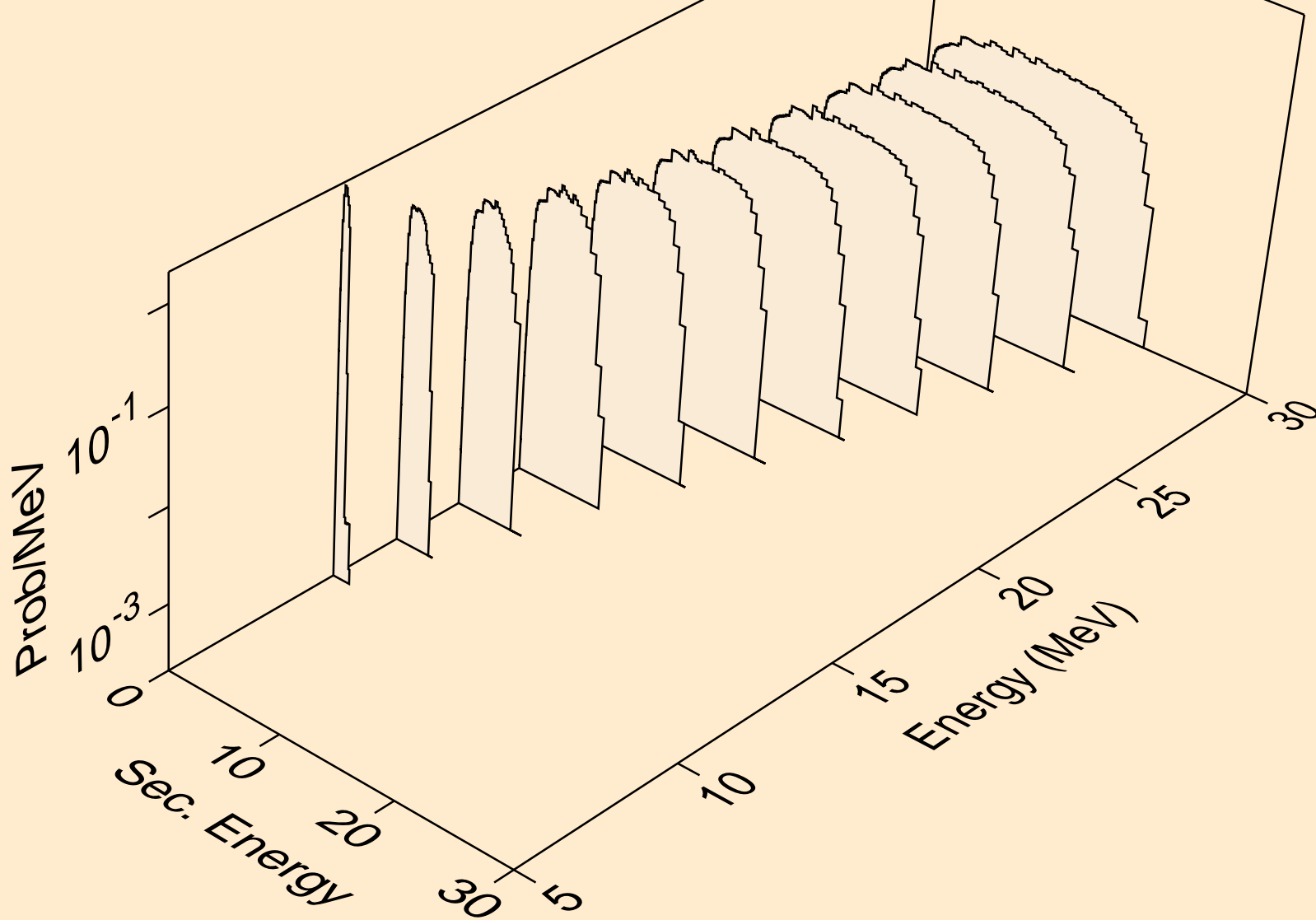

CM232 NEUTRON ACER TENDL-2019 LIBRARY; T=293.16K
Neutron emission for (n,3n)

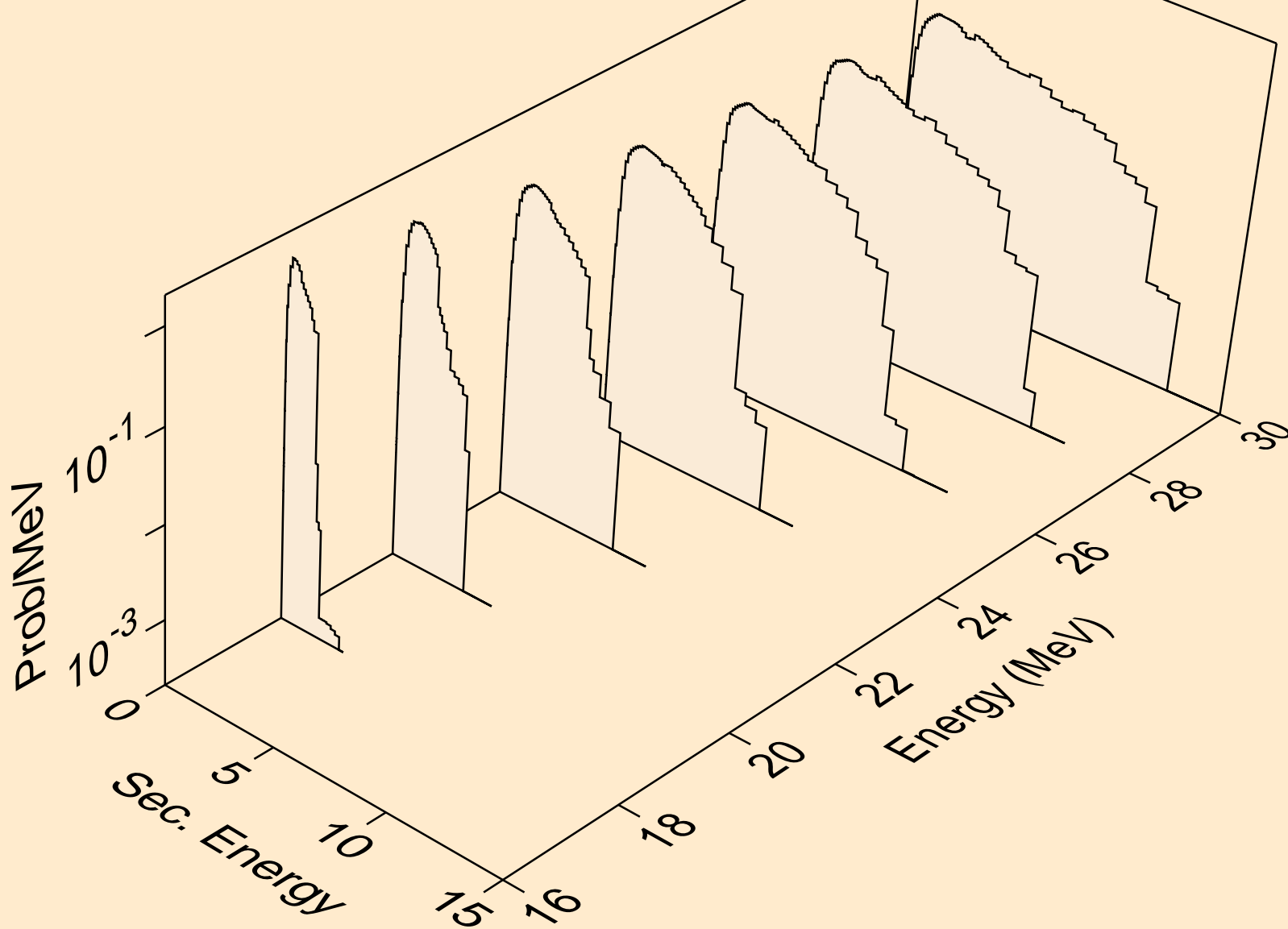

CM232 NEUTRON ACER TENDL-2019 LIBRARY; T=293.16K
Neutron emission for fission

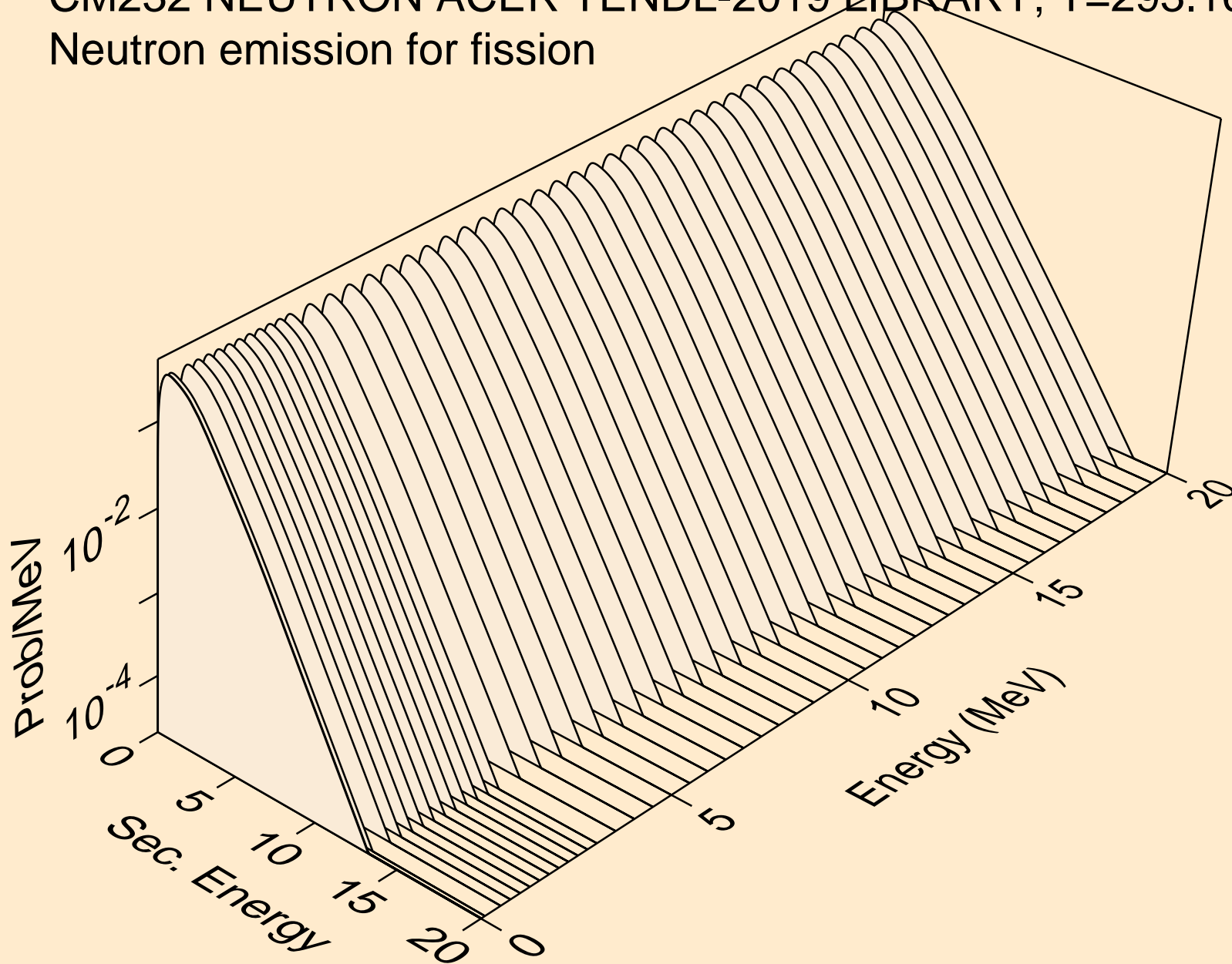

CM232 NEUTRON ACER TENDL-2019 LIBRARY; T=293.16K
Neutron emission for (n,n*)a

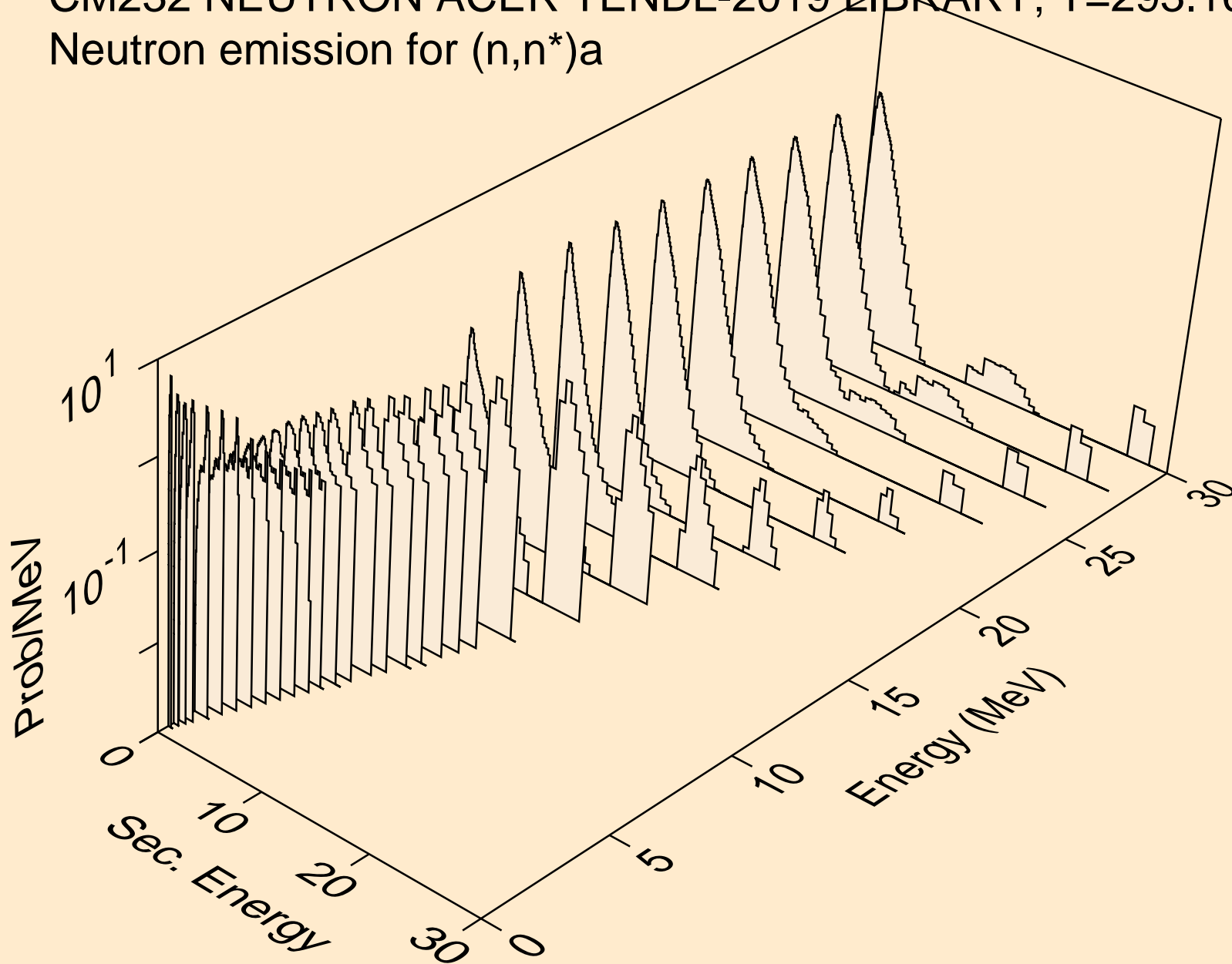

CM232 NEUTRON ACER TENDL-2019 LIBRARY; T=293.16K
Neutron emission for (n,n*)3a

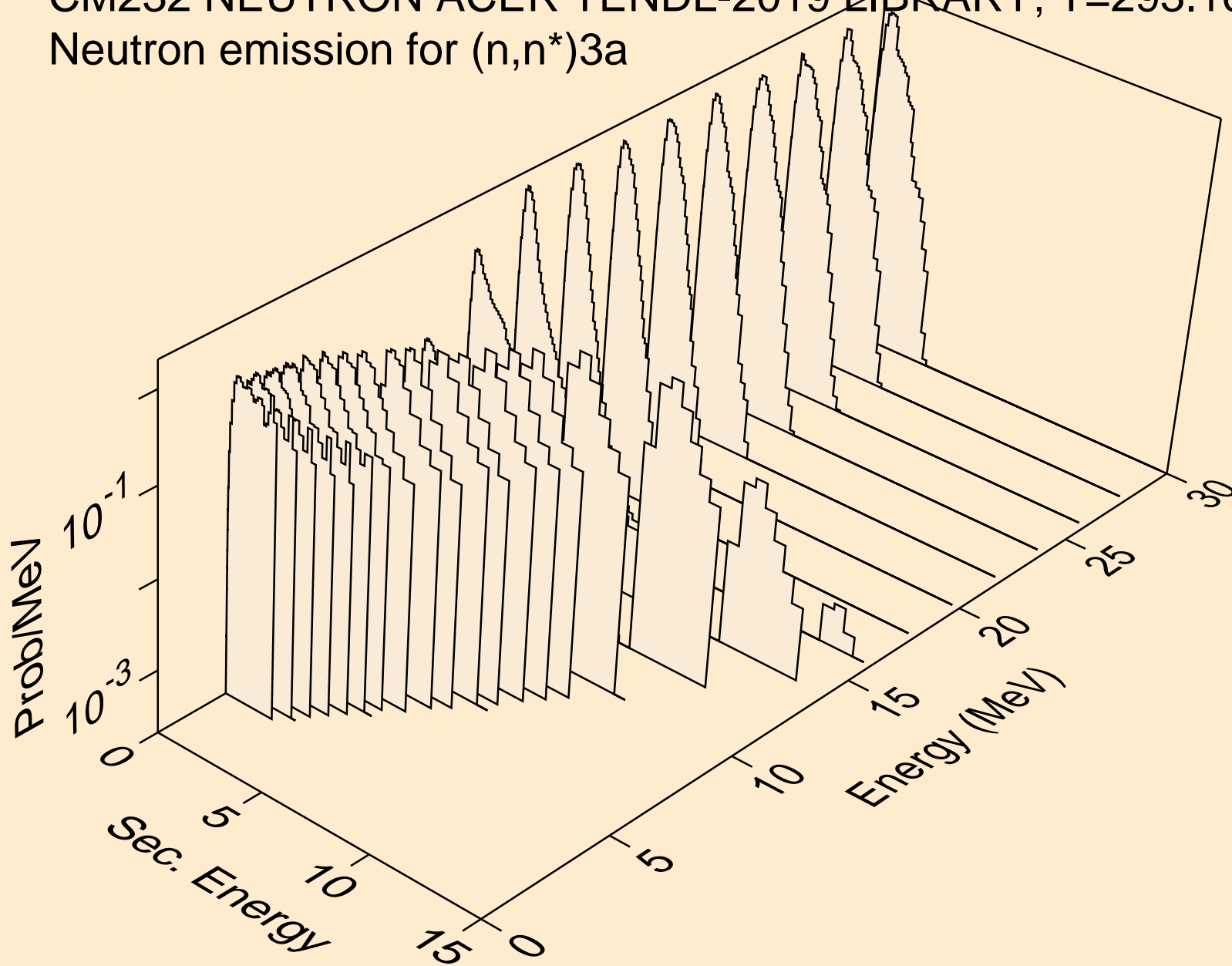

CM232 NEUTRON ACER TENDL-2019 LIBRARY; T=293.16K
Neutron emission for (n,2n)a

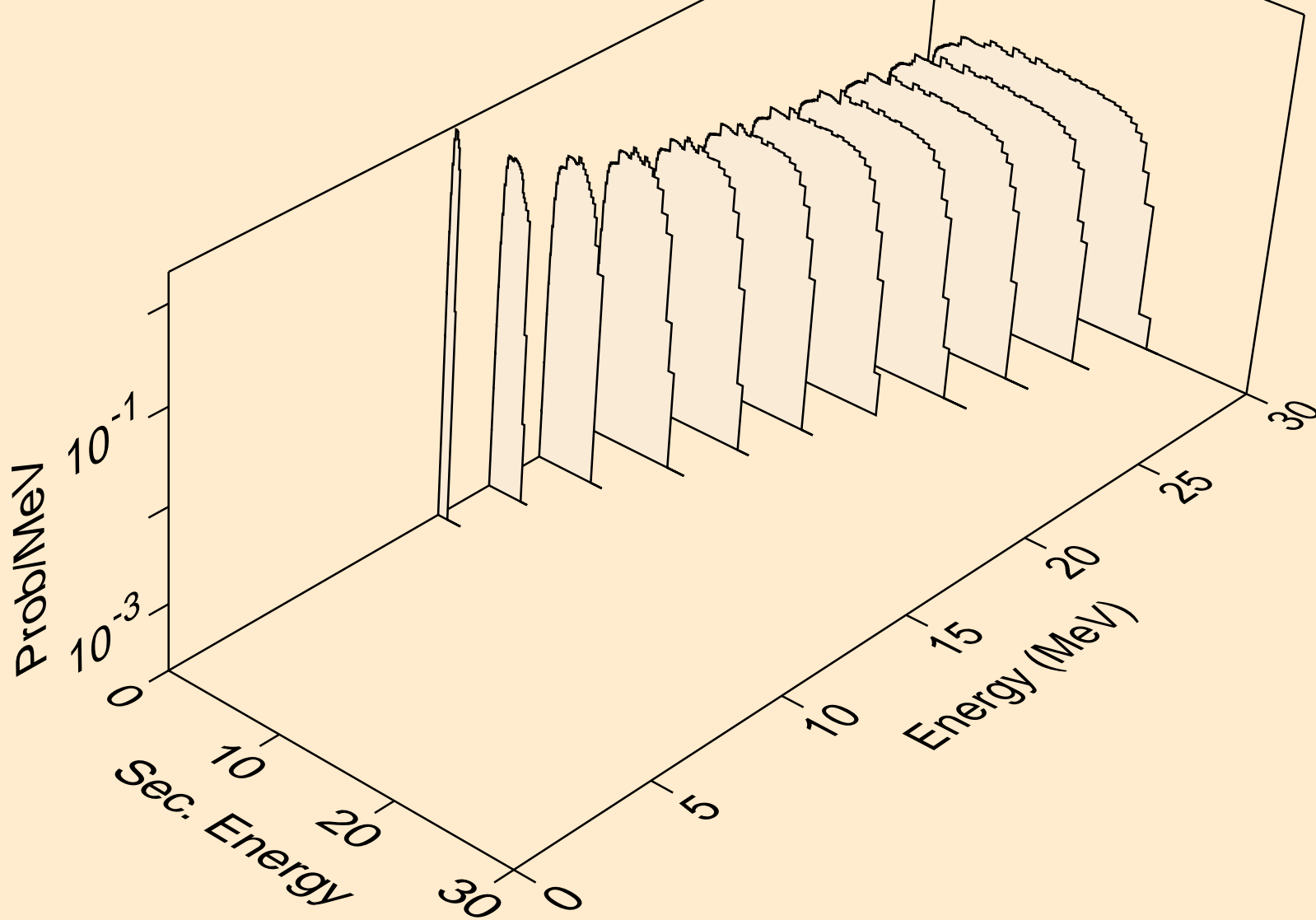

CM232 NEUTRON ACER TENDL-2019 LIBRARY; T=293.16K
Neutron emission for (n,n*)p

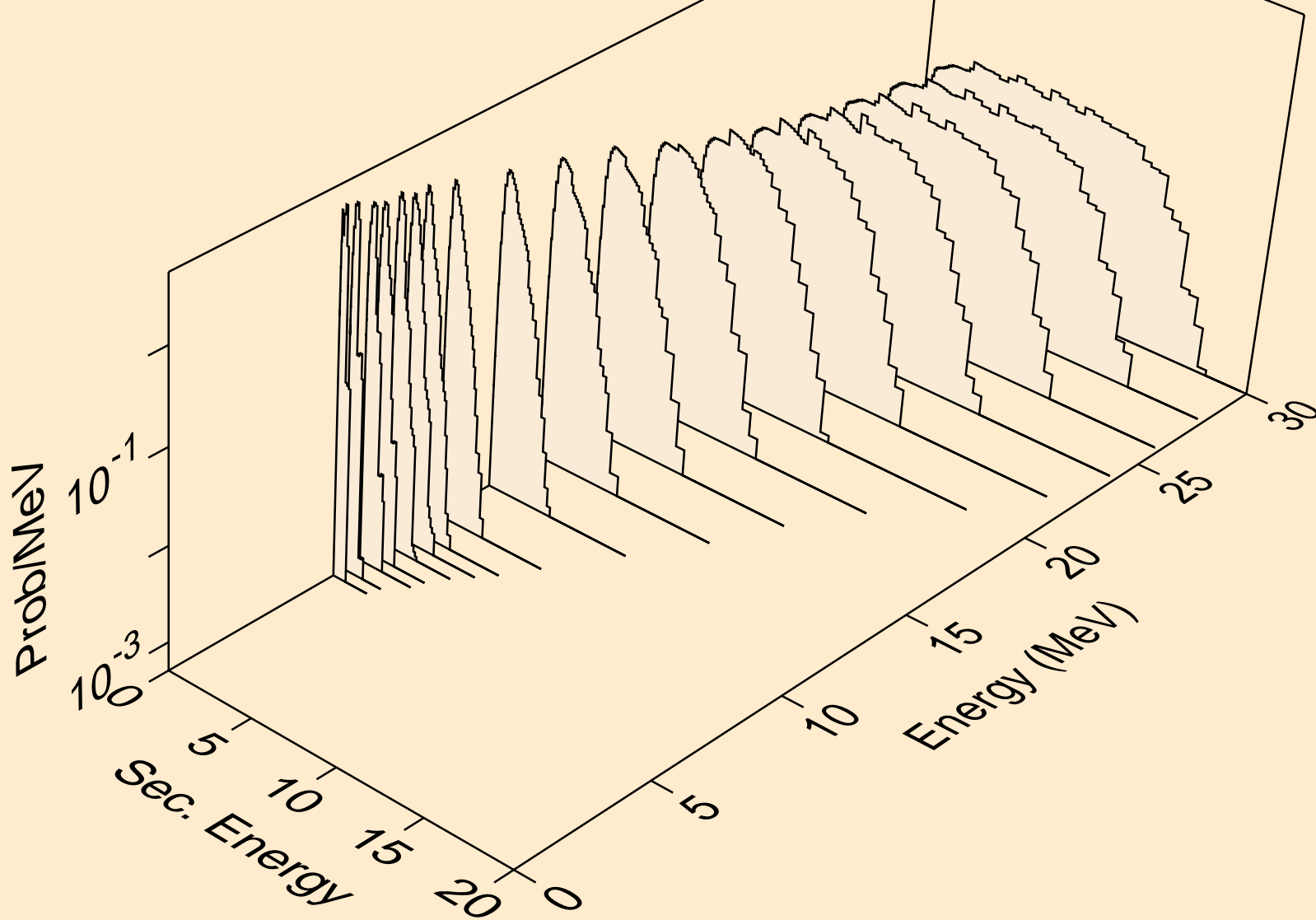

CM232 NEUTRON ACER TENDL-2019 LIBRARY; T=293.16K
Neutron emission for (n,n*)2a

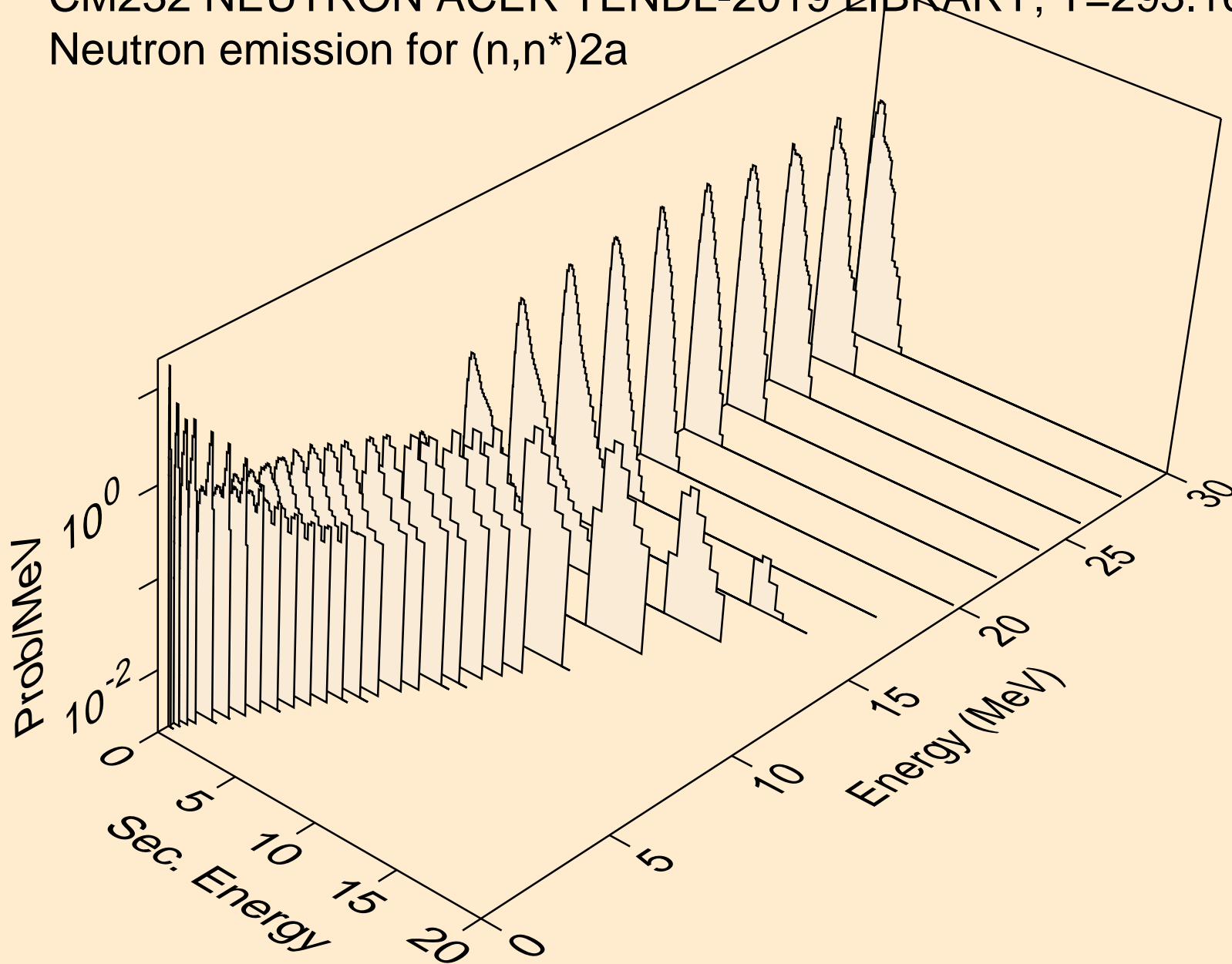

CM232 NEUTRON ACER TENDL-2019 LIBRARY; T=293.16K
Neutron emission for (n,2n)2a

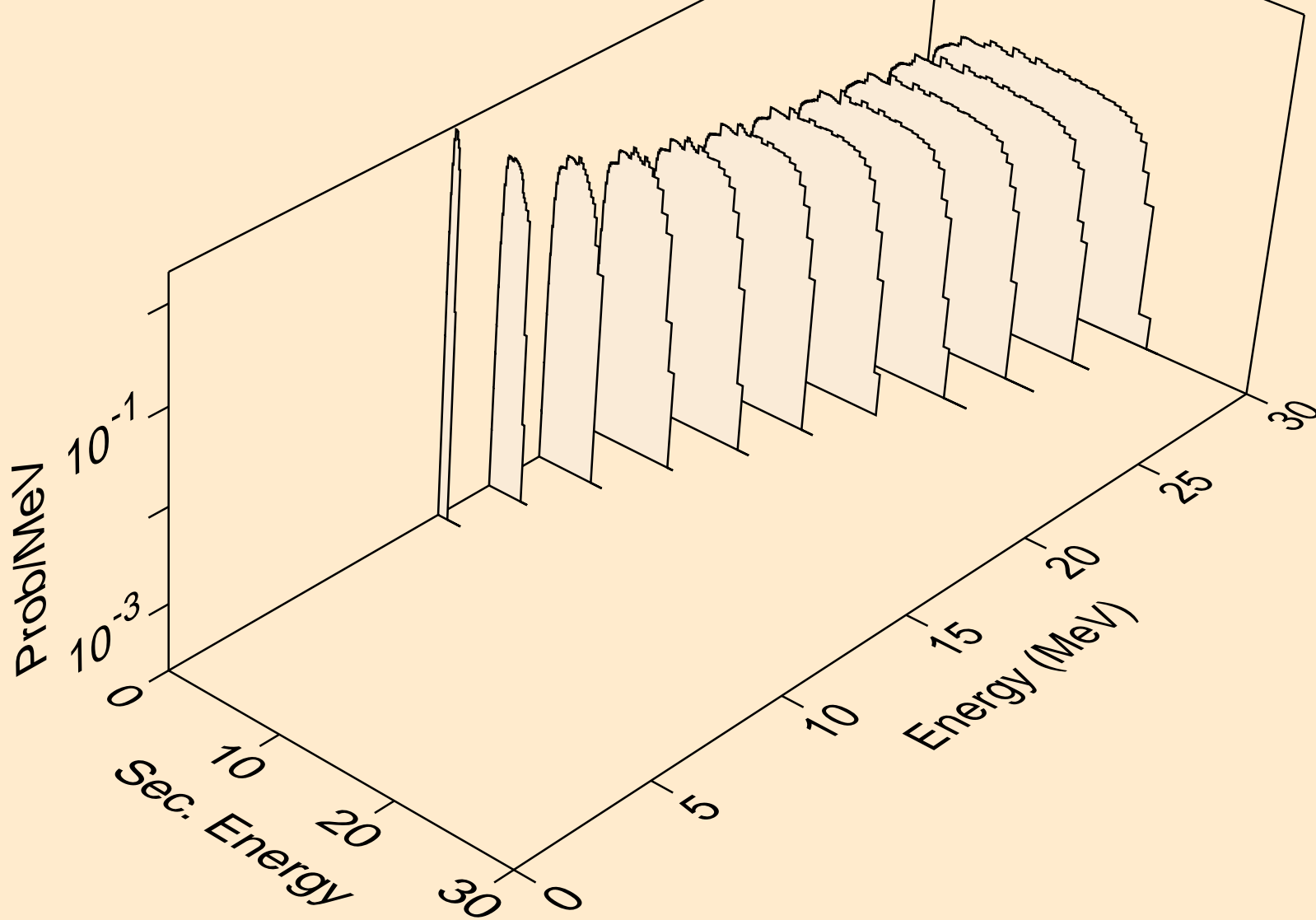

CM232 NEUTRON ACER TENDL-2019 LIBRARY; T=293.16K
Neutron emission for (n,n*)d

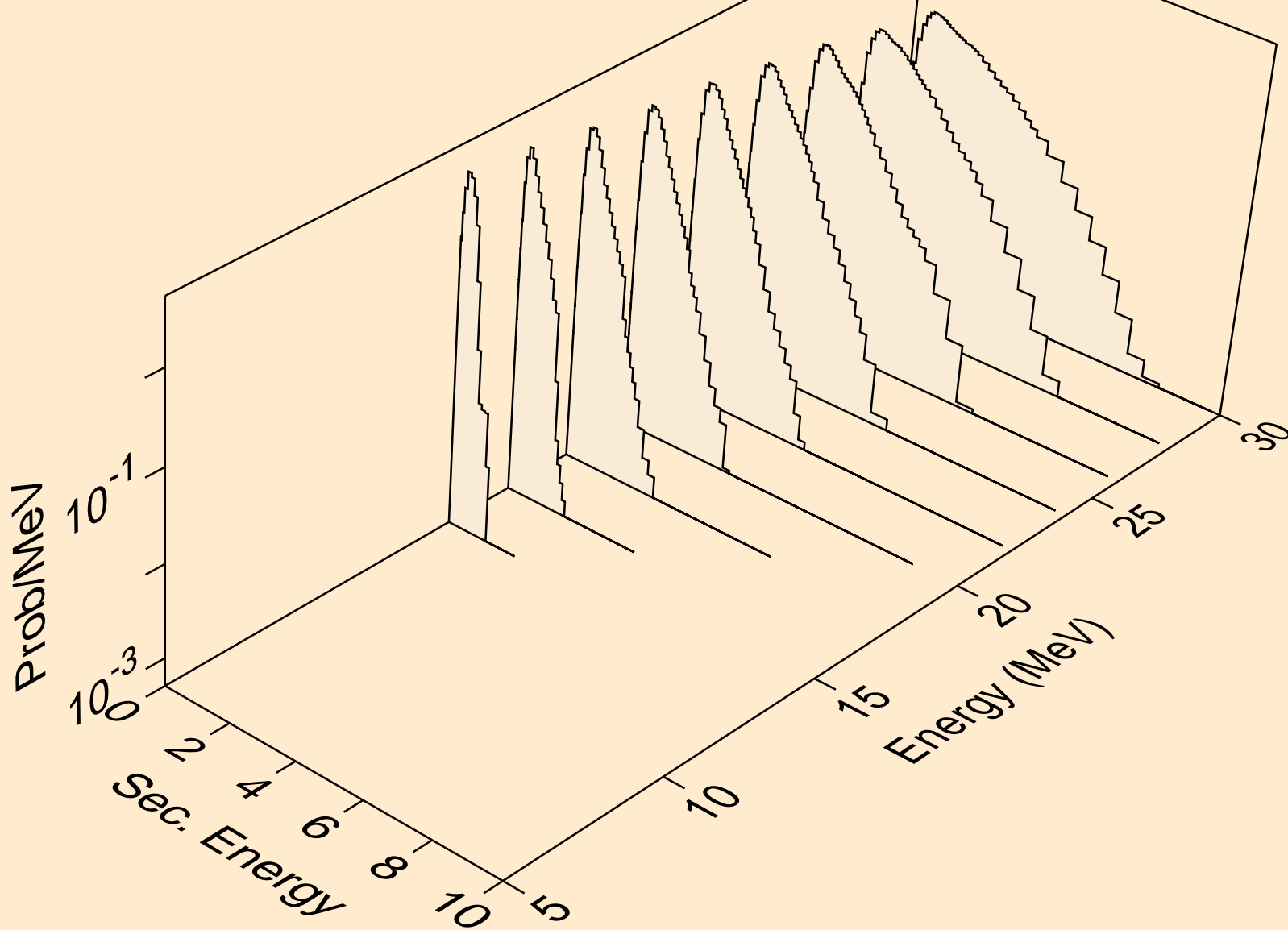

CM232 NEUTRON ACER TENDL-2019 LIBRARY; T=293.16K
Neutron emission for (n,n*)t

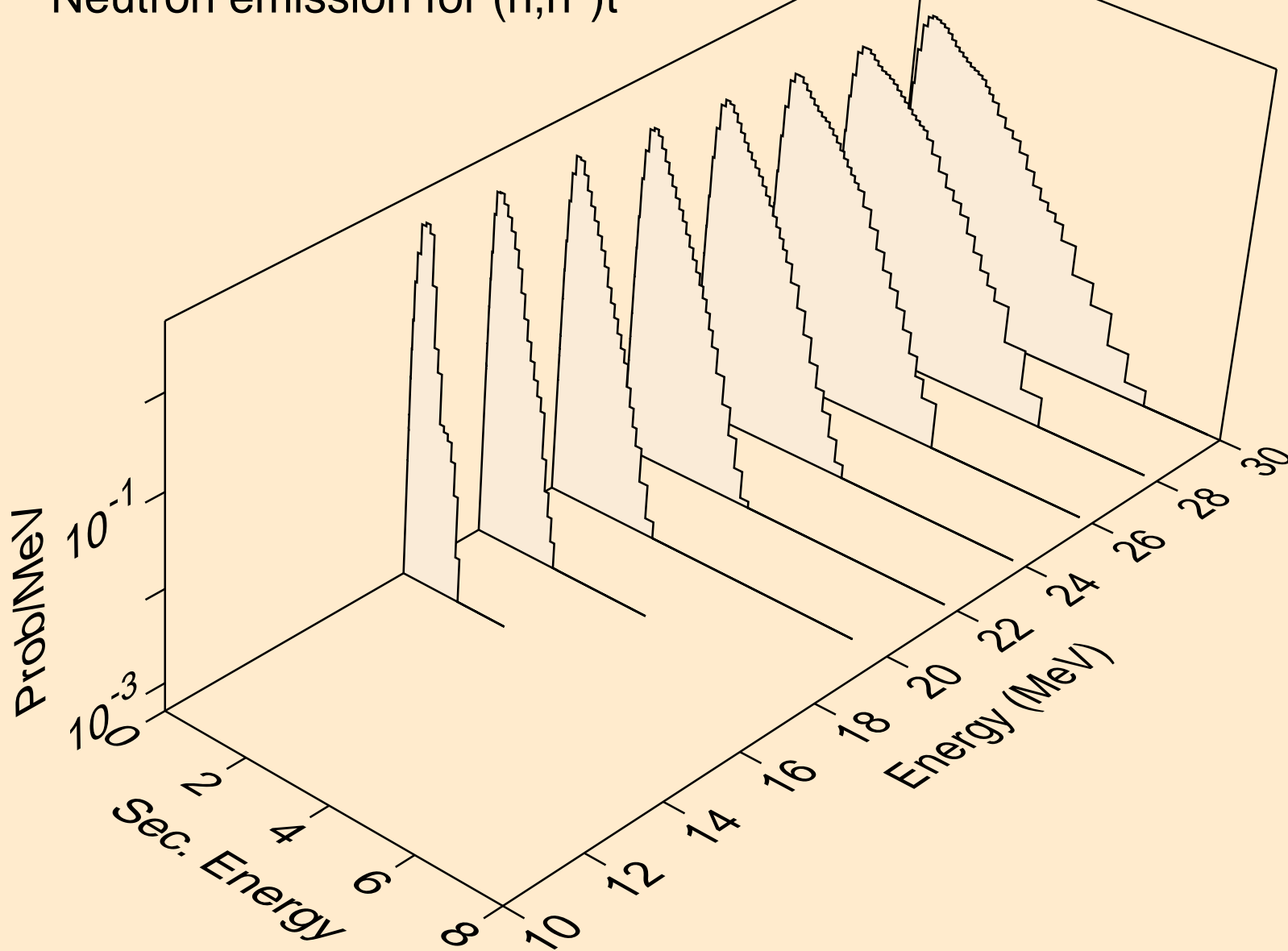

CM232 NEUTRON ACER TENDL-2019 LIBRARY; T=293.16K
Neutron emission for (n,n*)he3

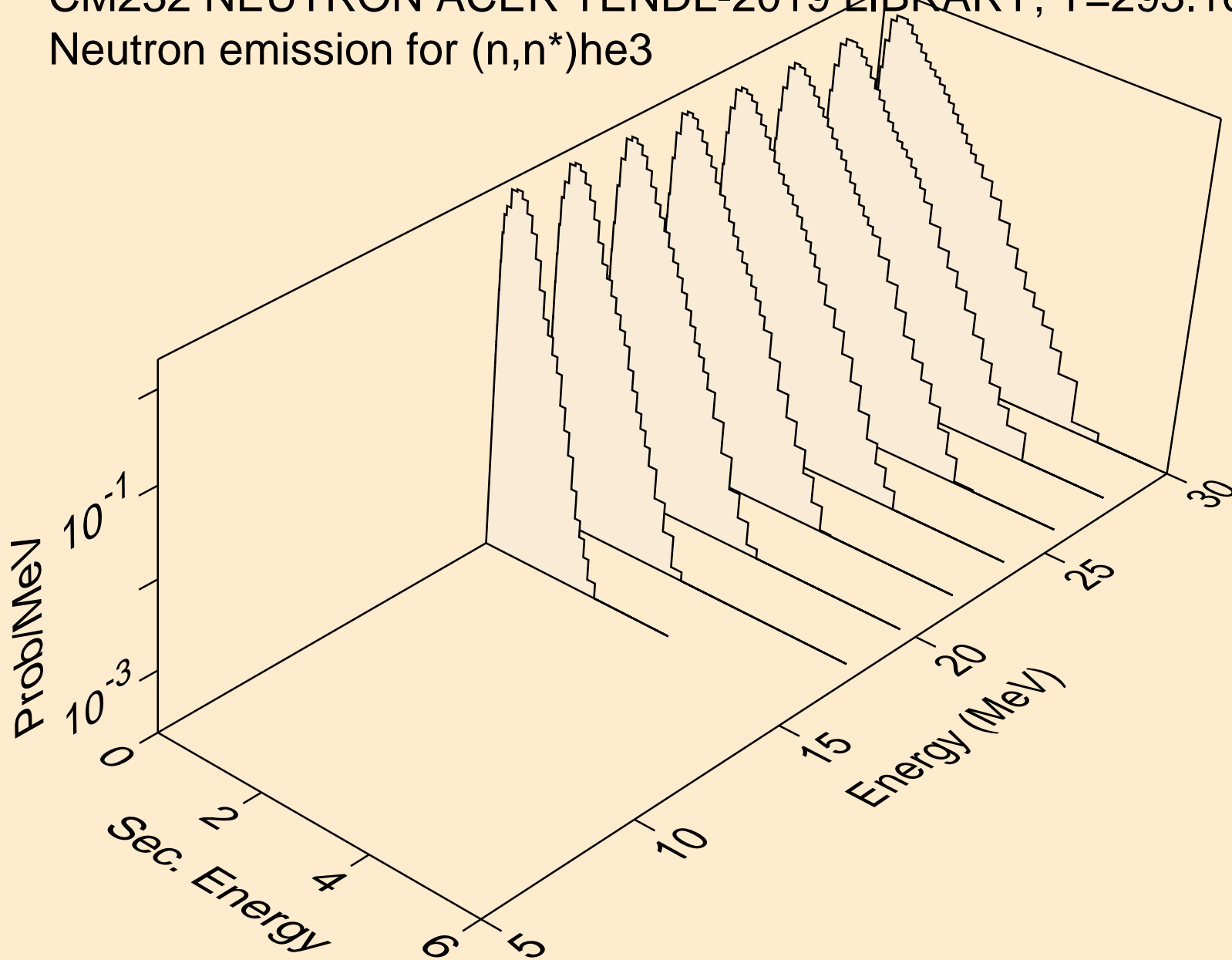

CM232 NEUTRON ACER TENDL-2019 LIBRARY; T=293.16K
Neutron emission for (n,4n)

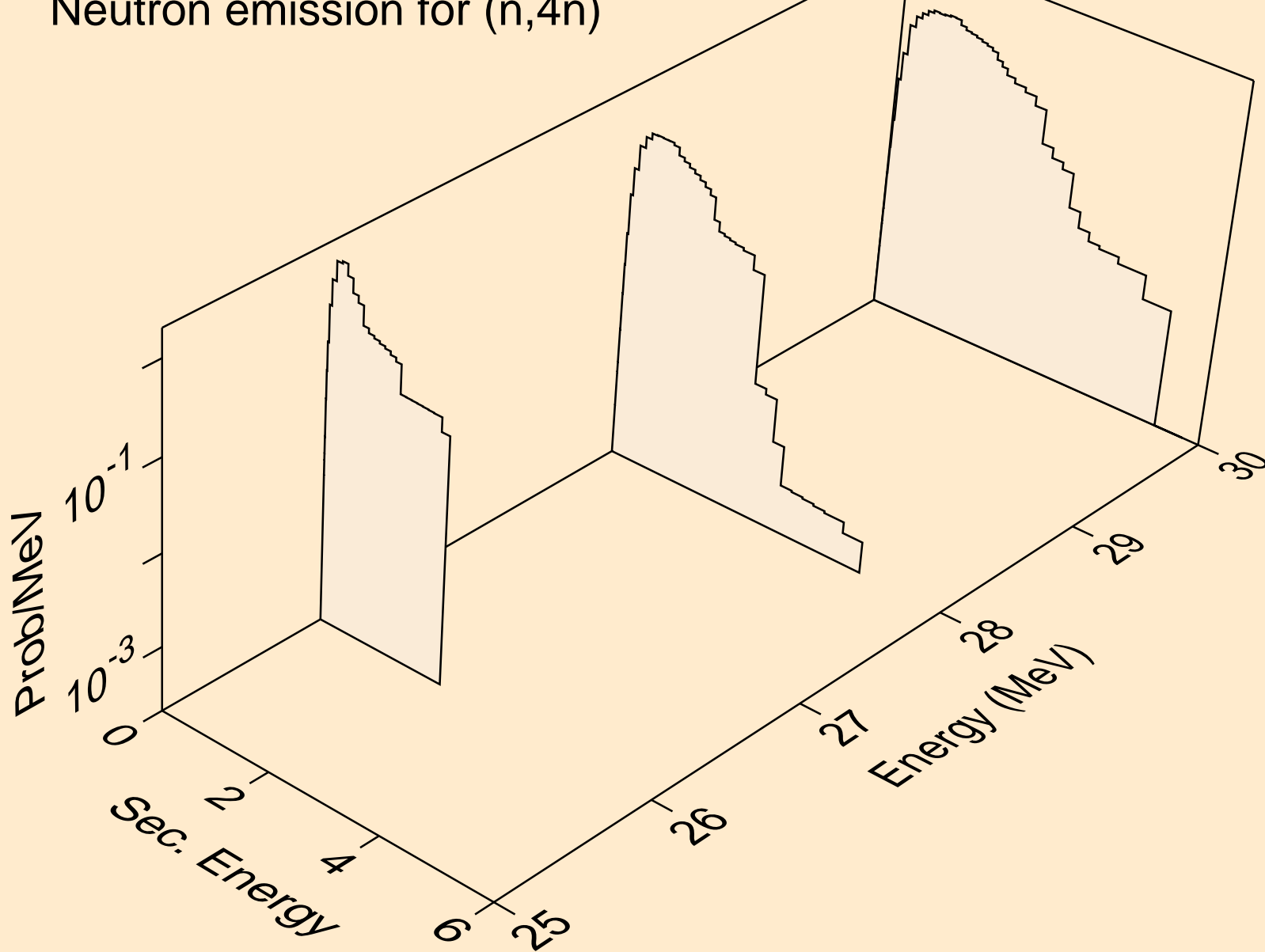

CM232 NEUTRON ACER TENDL-2019 LIBRARY; T=293.16K
Neutron emission for (n,2np)

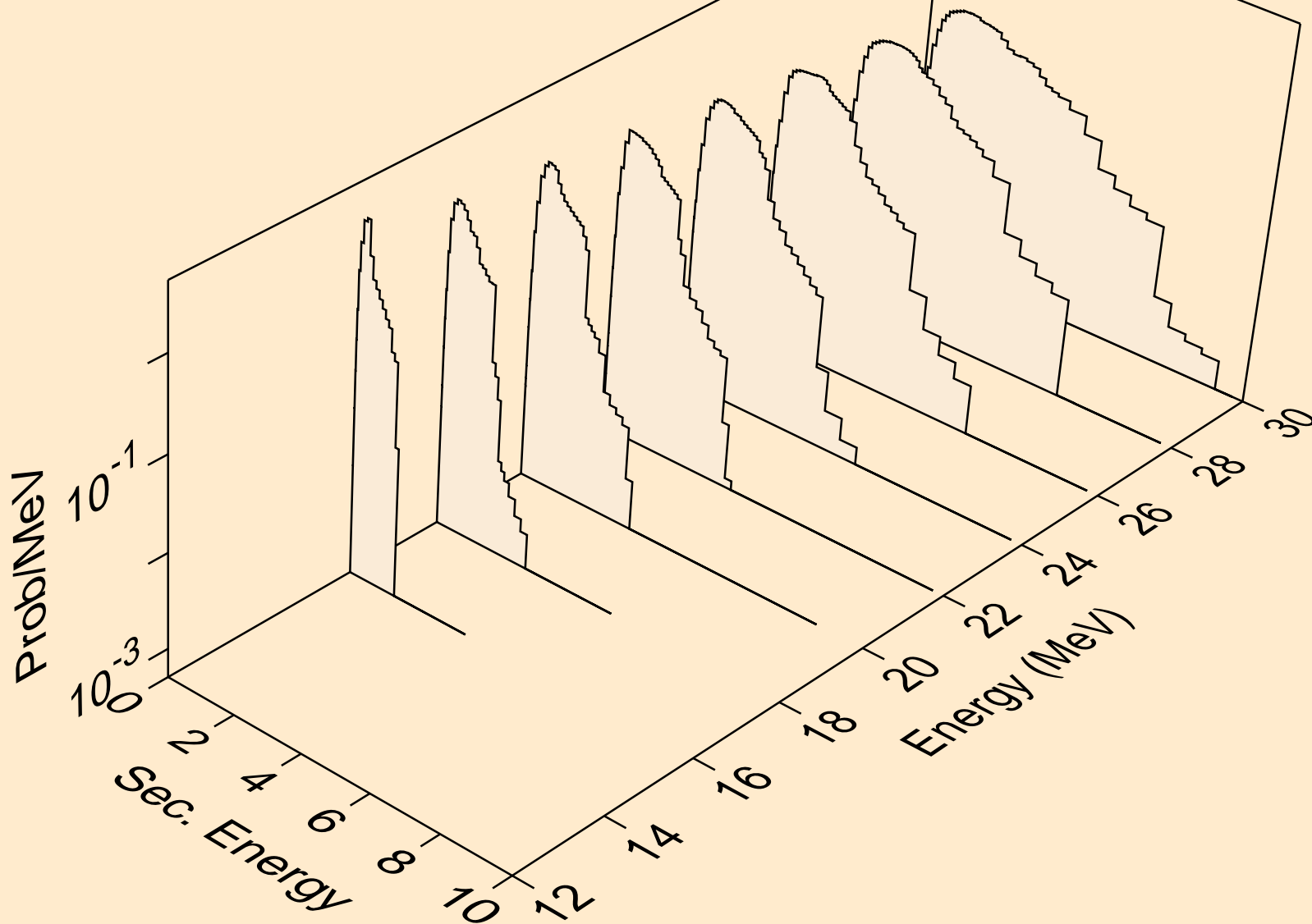

CM232 NEUTRON ACER TENDL-2019 LIBRARY; T=293.16K
Neutron emission for (n,2np)

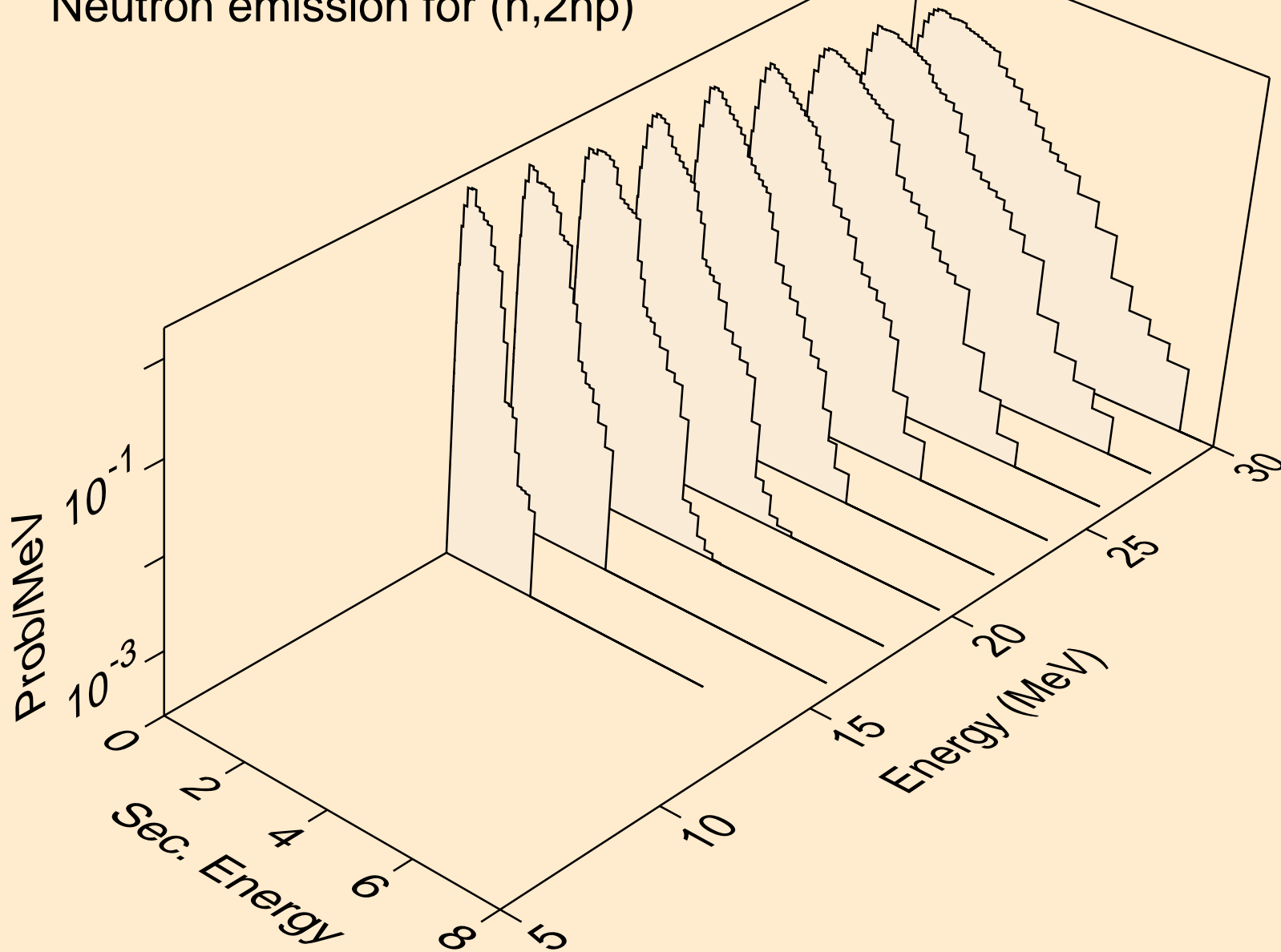

CM232 NEUTRON ACER TENDL-2019 LIBRARY; T=293.16K
Neutron emission for (n,npa)

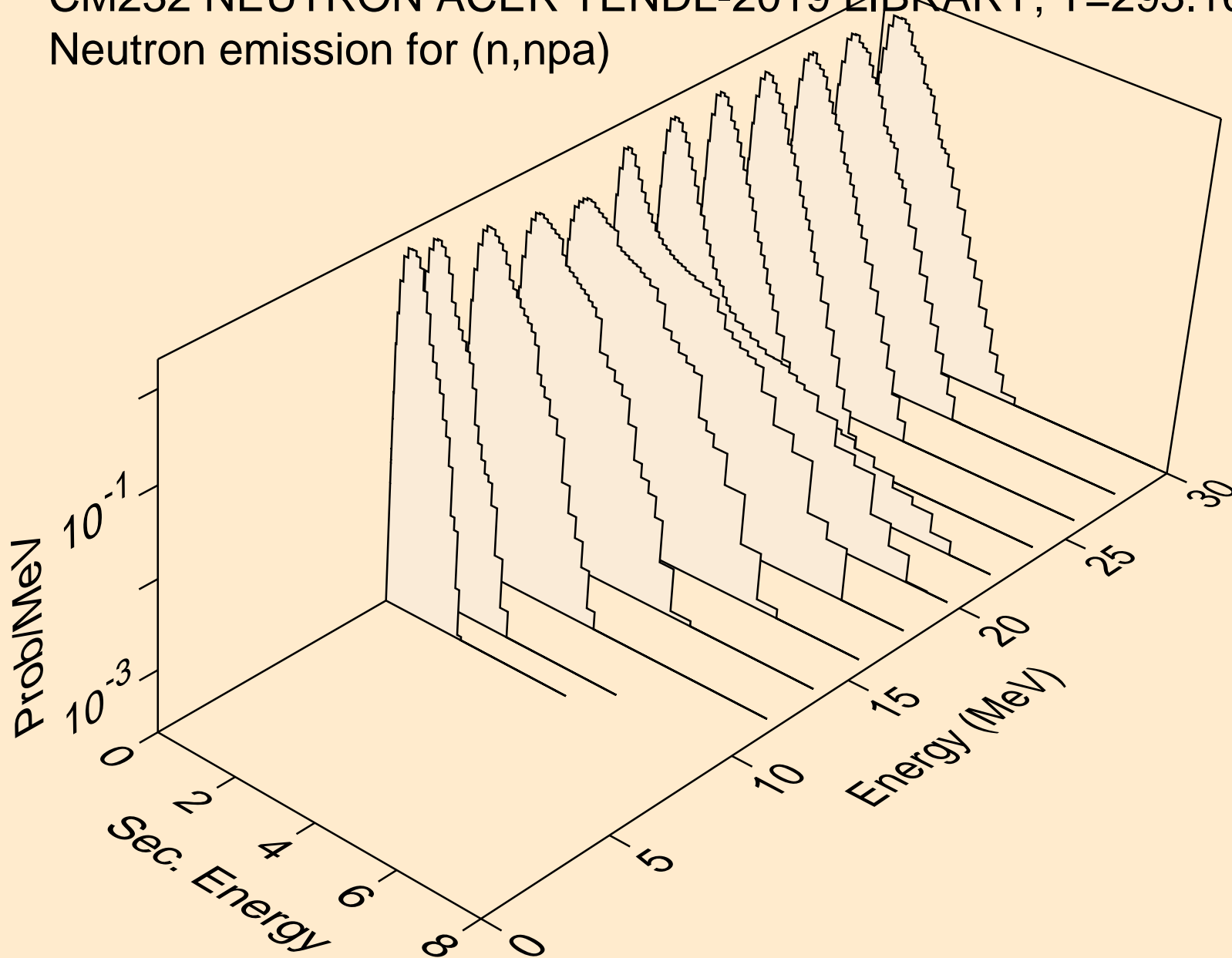

CM232 NEUTRON ACER TENDL-2019 LIBRARY; T=293.16K
Neutron emission for (n,n*c)

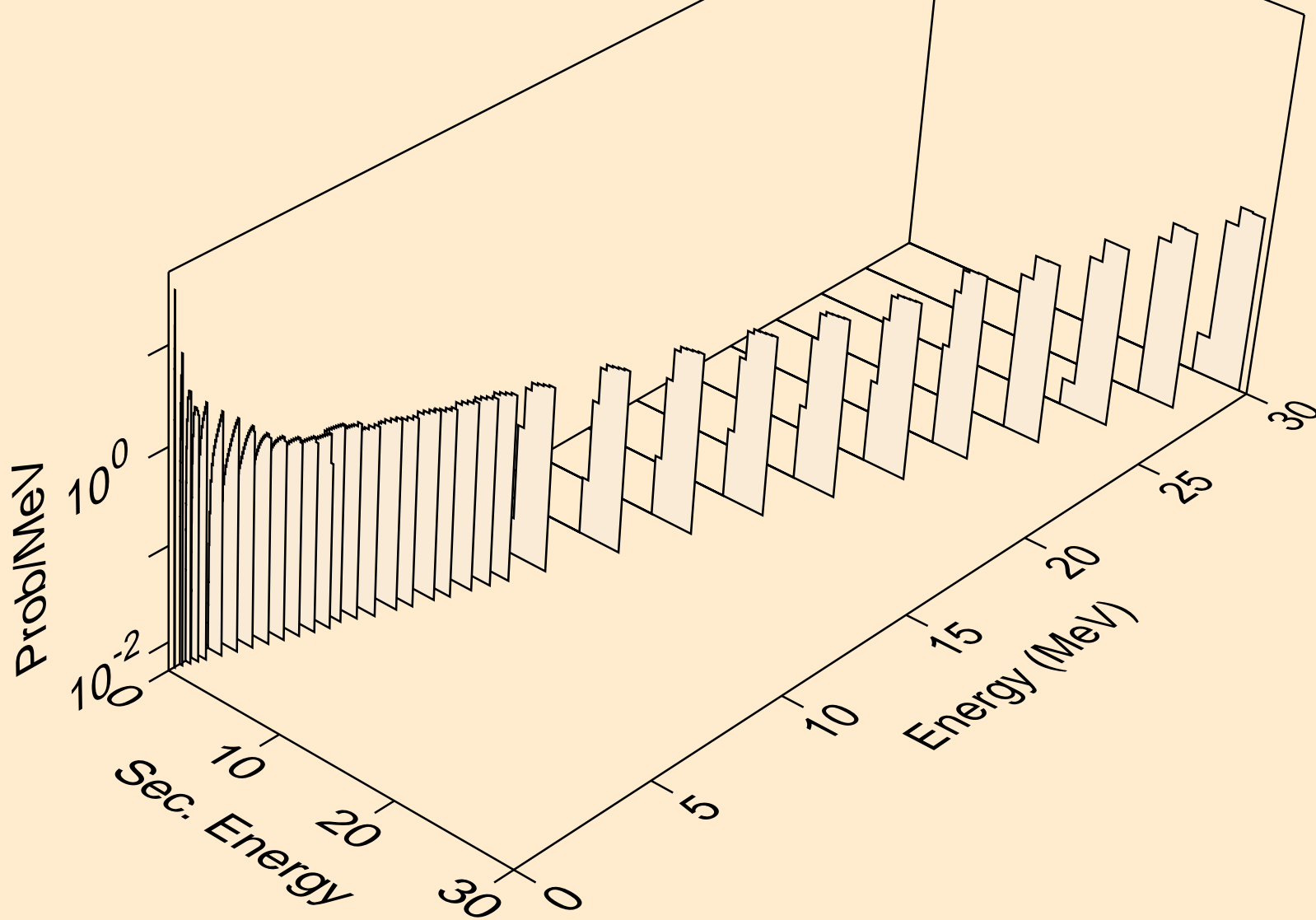

CM232 NEUTRON ACER TENDL-2019 LIBRARY; T=293.16K

Delayed nubar

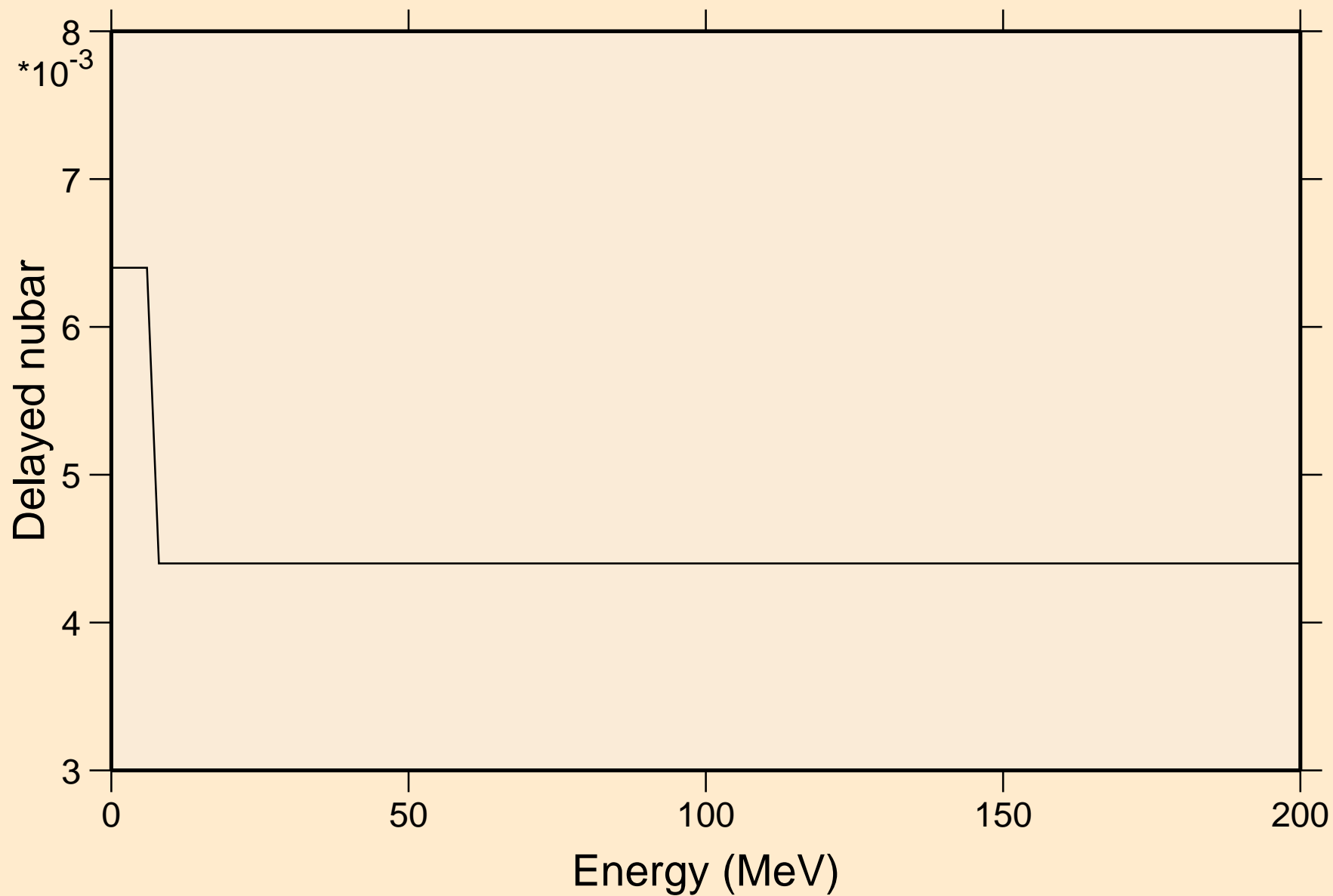

CM232 NEUTRON ACER TENDL-2019 LIBRARY; T=293.16K

Delayed neutron spectra

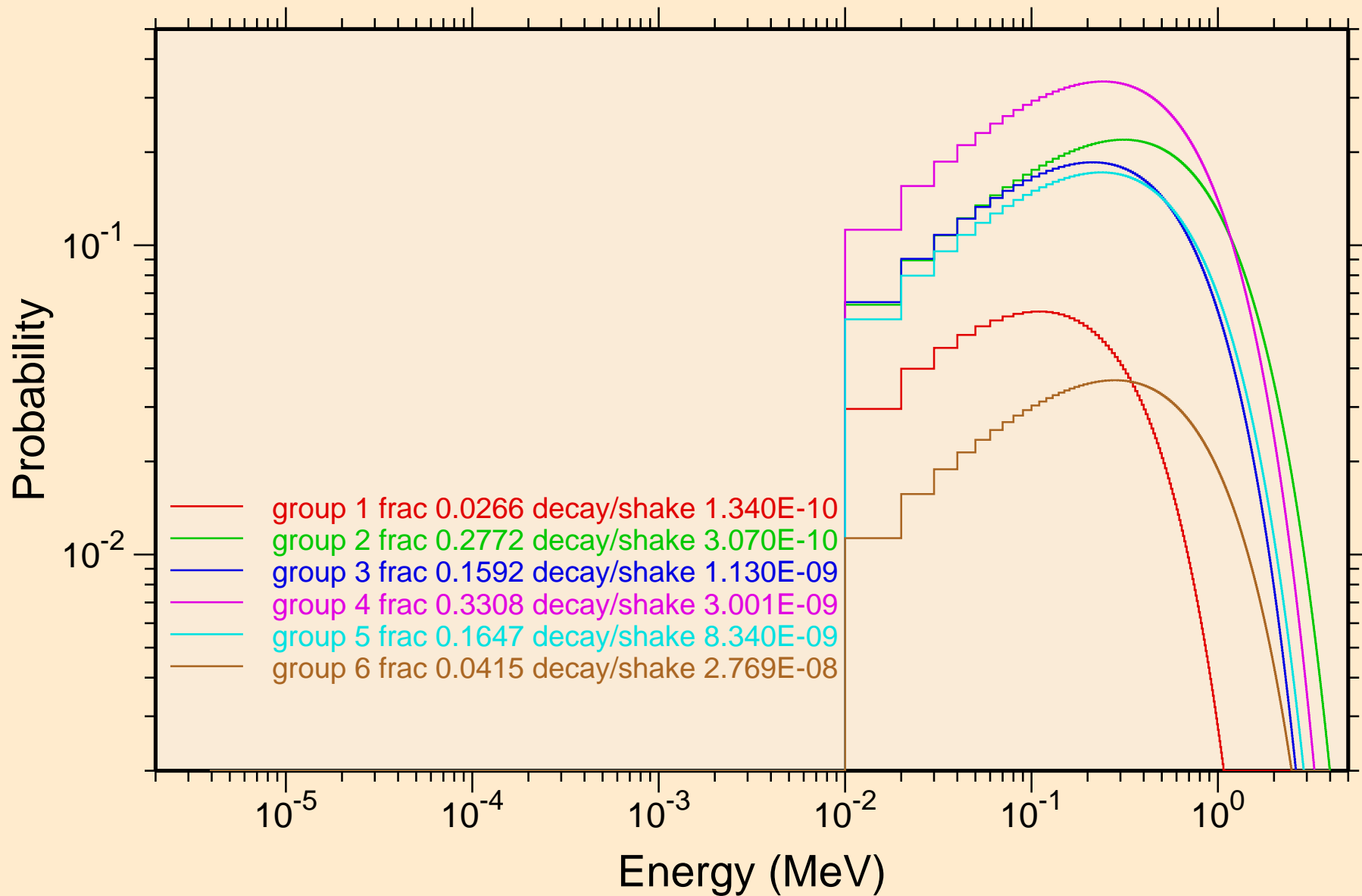

CM232 NEUTRON ACER TENDL-2019 LIBRARY; T=293.16K
Photon emission for (n,x)

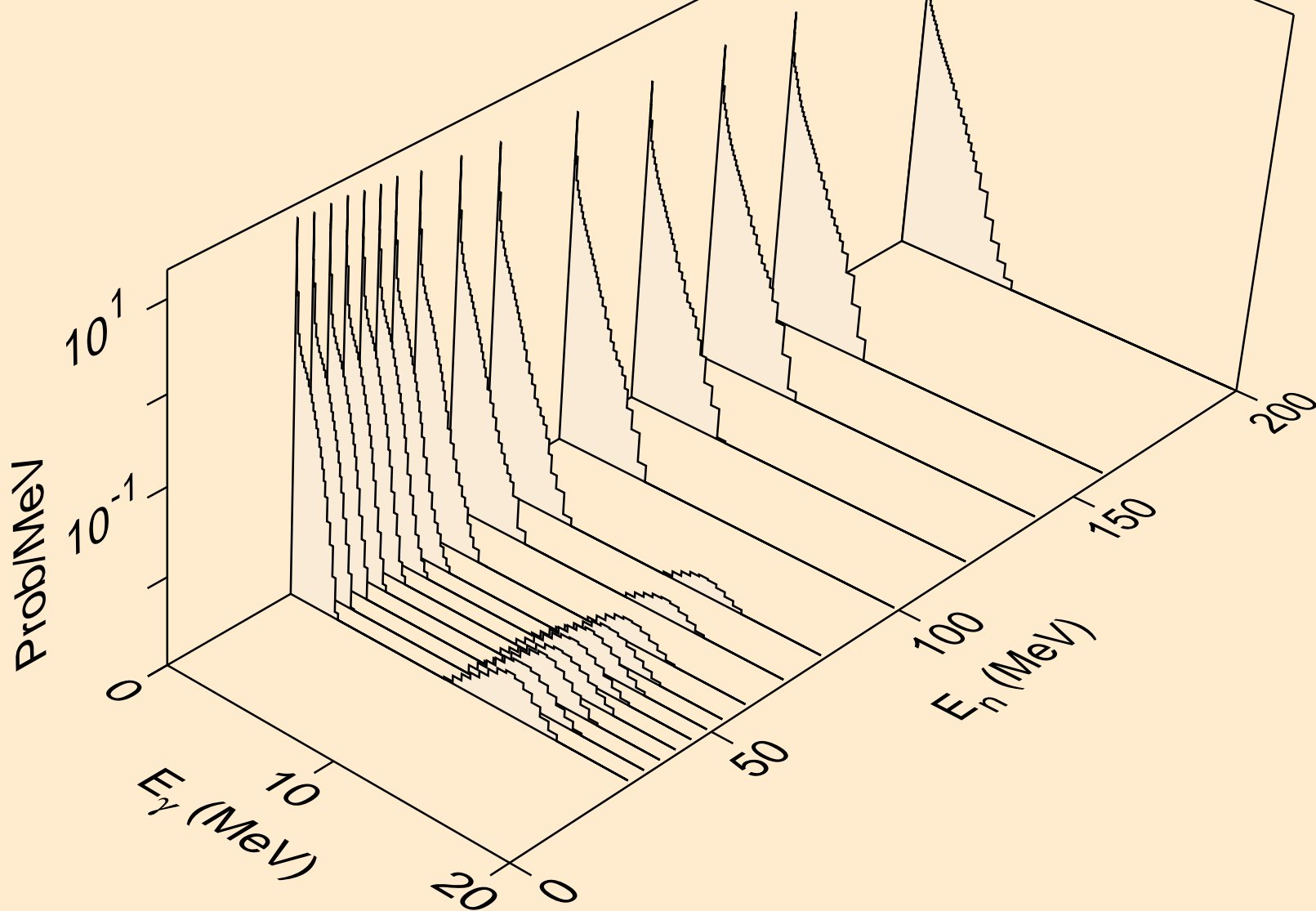

CM232 NEUTRON ACER TENDL-2019 LIBRARY; T=293.16K
Photon emission for (n,2n)

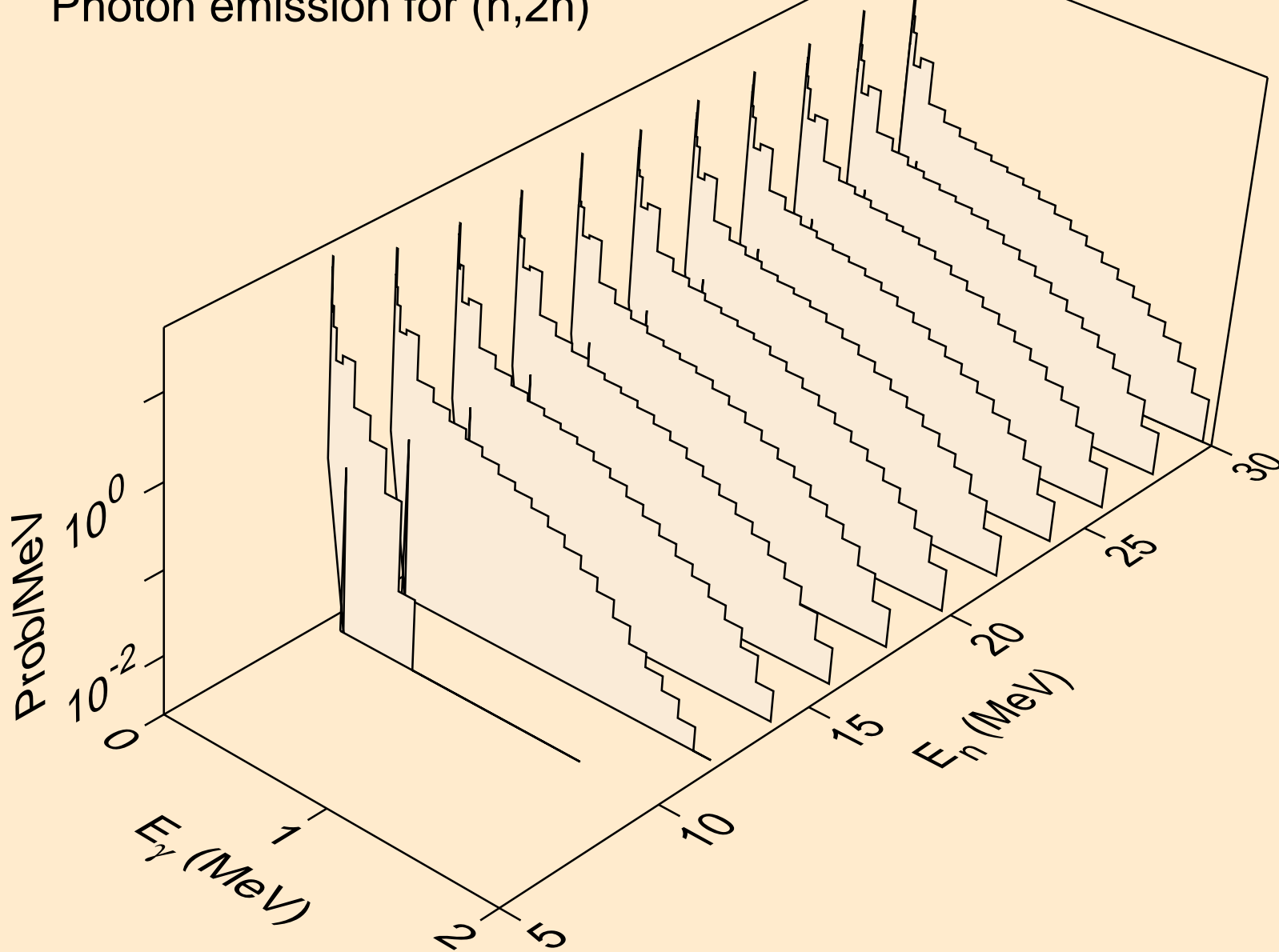

CM232 NEUTRON ACER TENDL-2019 LIBRARY; T=293.16K
Photon emission for (n,3n)

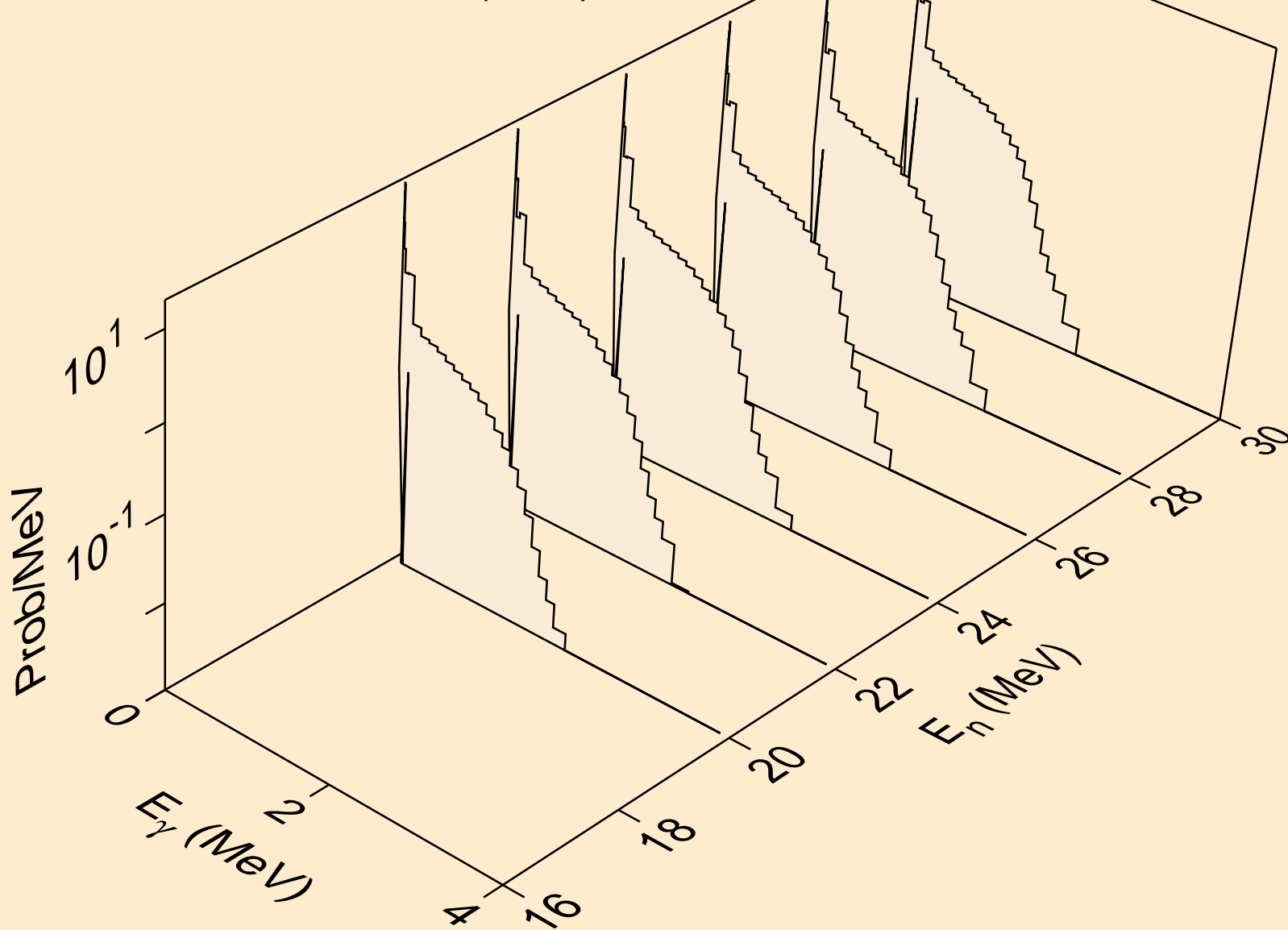

CM232 NEUTRON ACER TENDL-2019 LIBRARY; T=293.16K
Photon emission for (n,n*)a

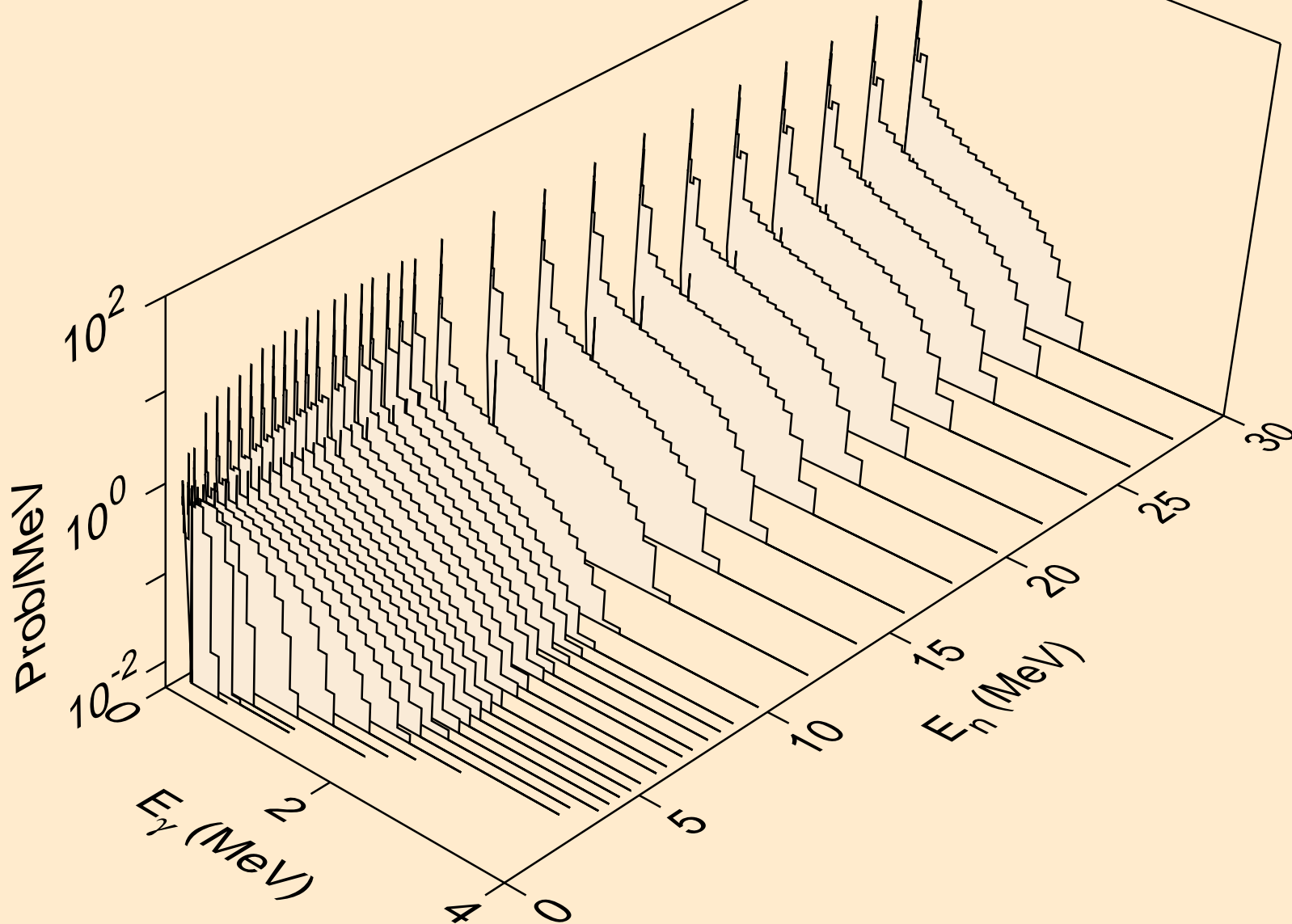

CM232 NEUTRON ACER TENDL-2019 LIBRARY; T=293.16K
Photon emission for (n,n*)3a

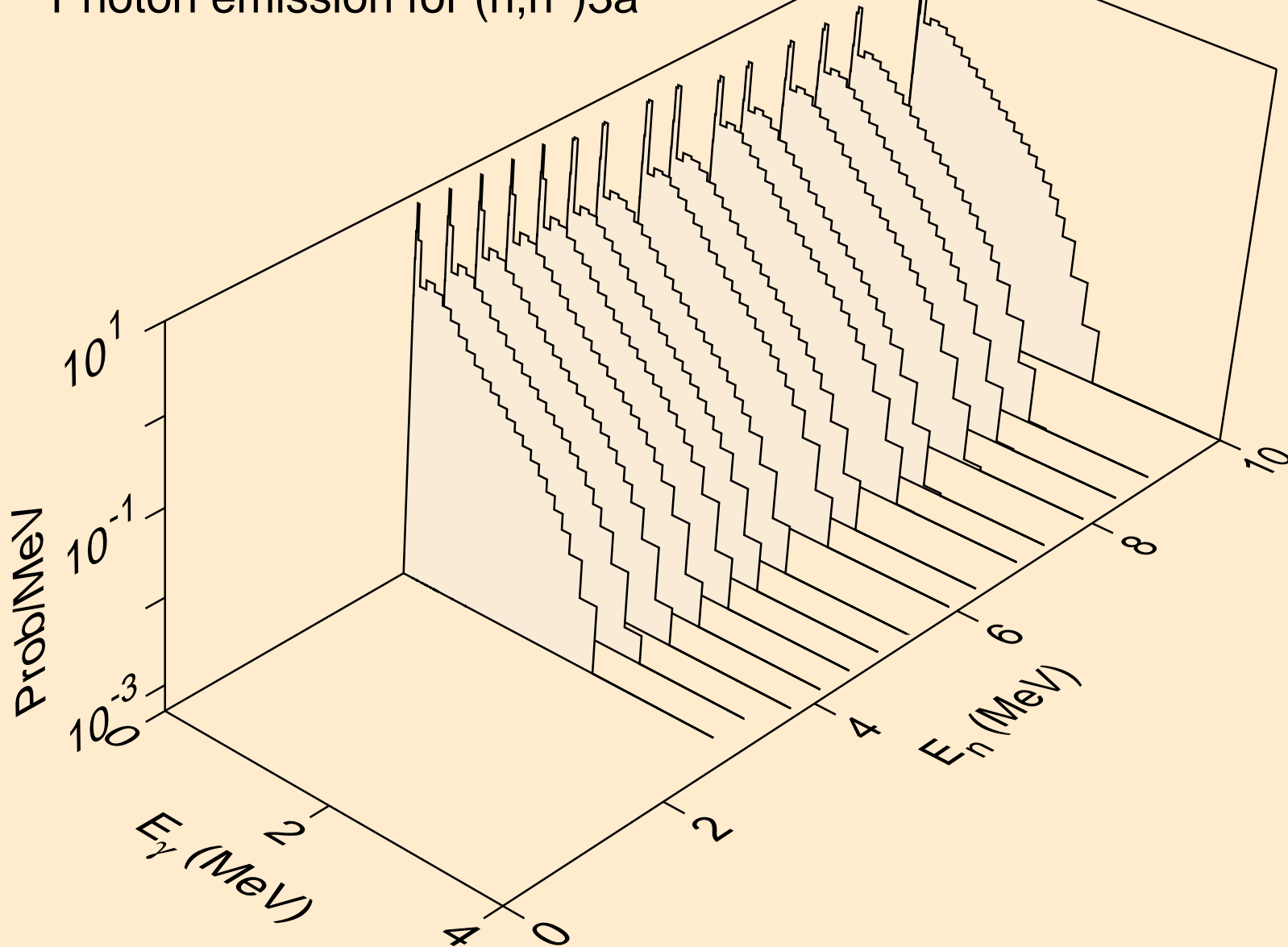

CM232 NEUTRON ACER TENDL-2019 LIBRARY; T=293.16K
Photon emission for (n,2n)a

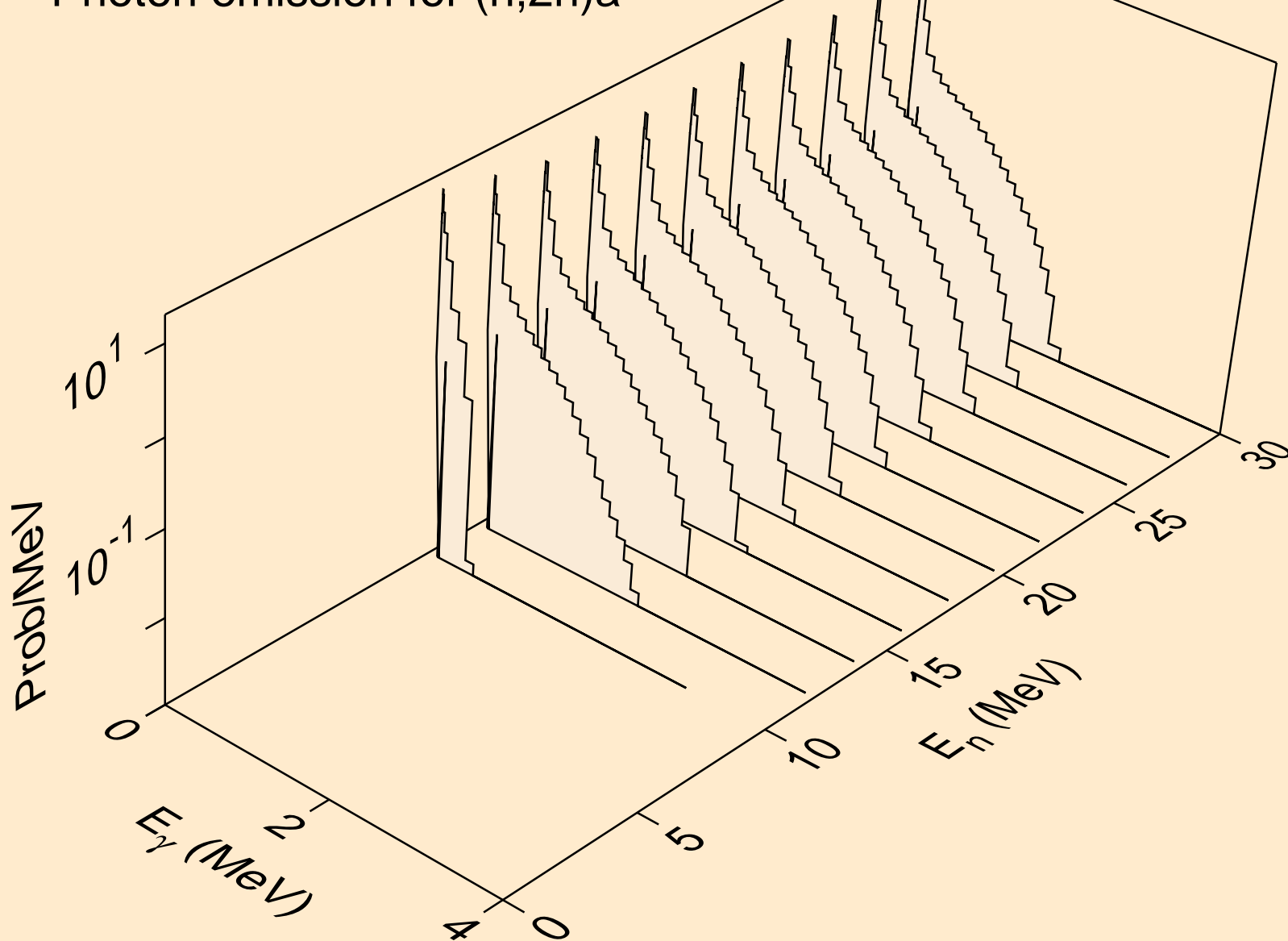

CM232 NEUTRON ACER TENDL-2019 LIBRARY; T=293.16K
Photon emission for (n,n*)p

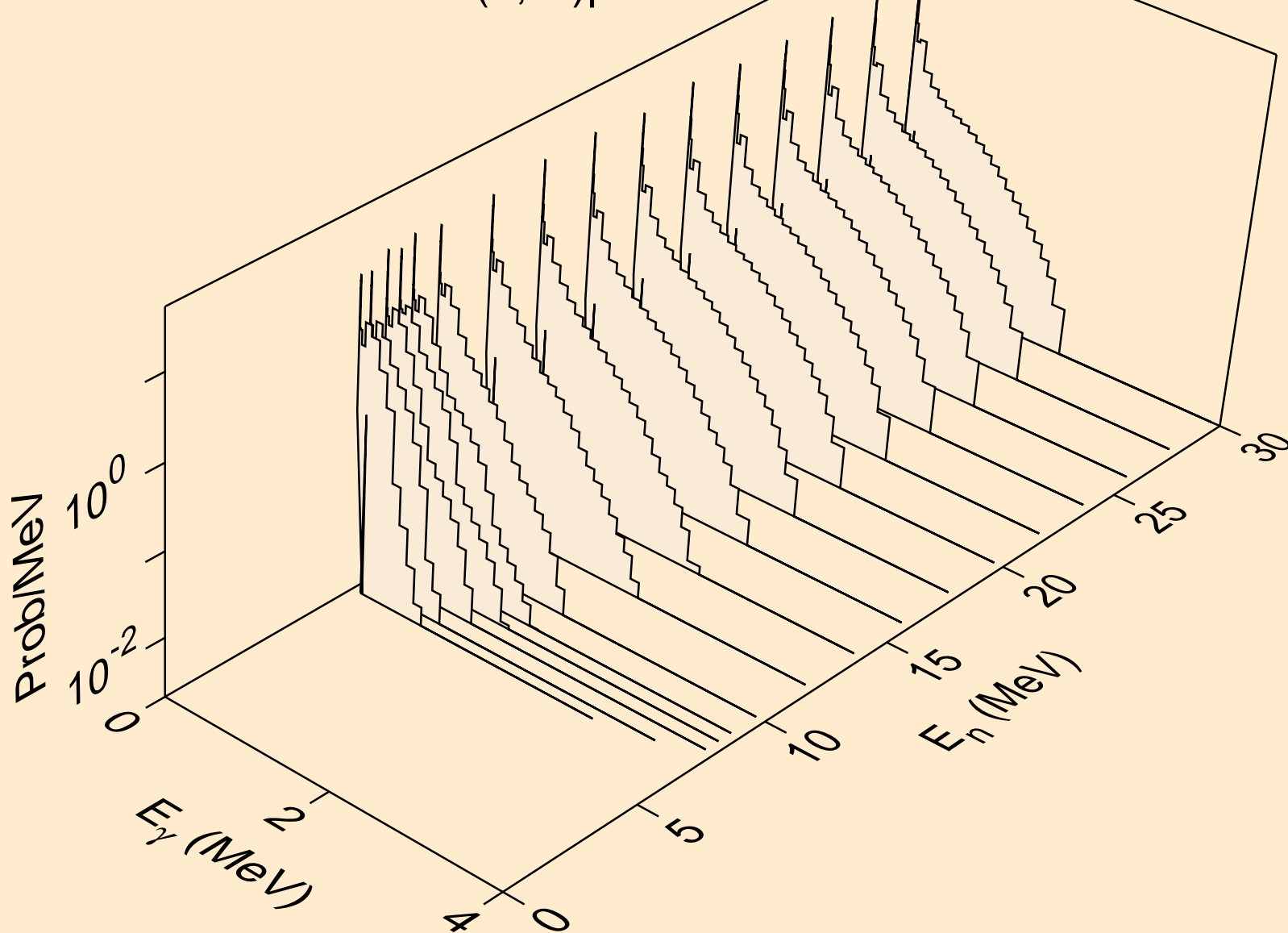

CM232 NEUTRON ACER TENDL-2019 LIBRARY; T=293.16K
Photon emission for (n,n*)2a

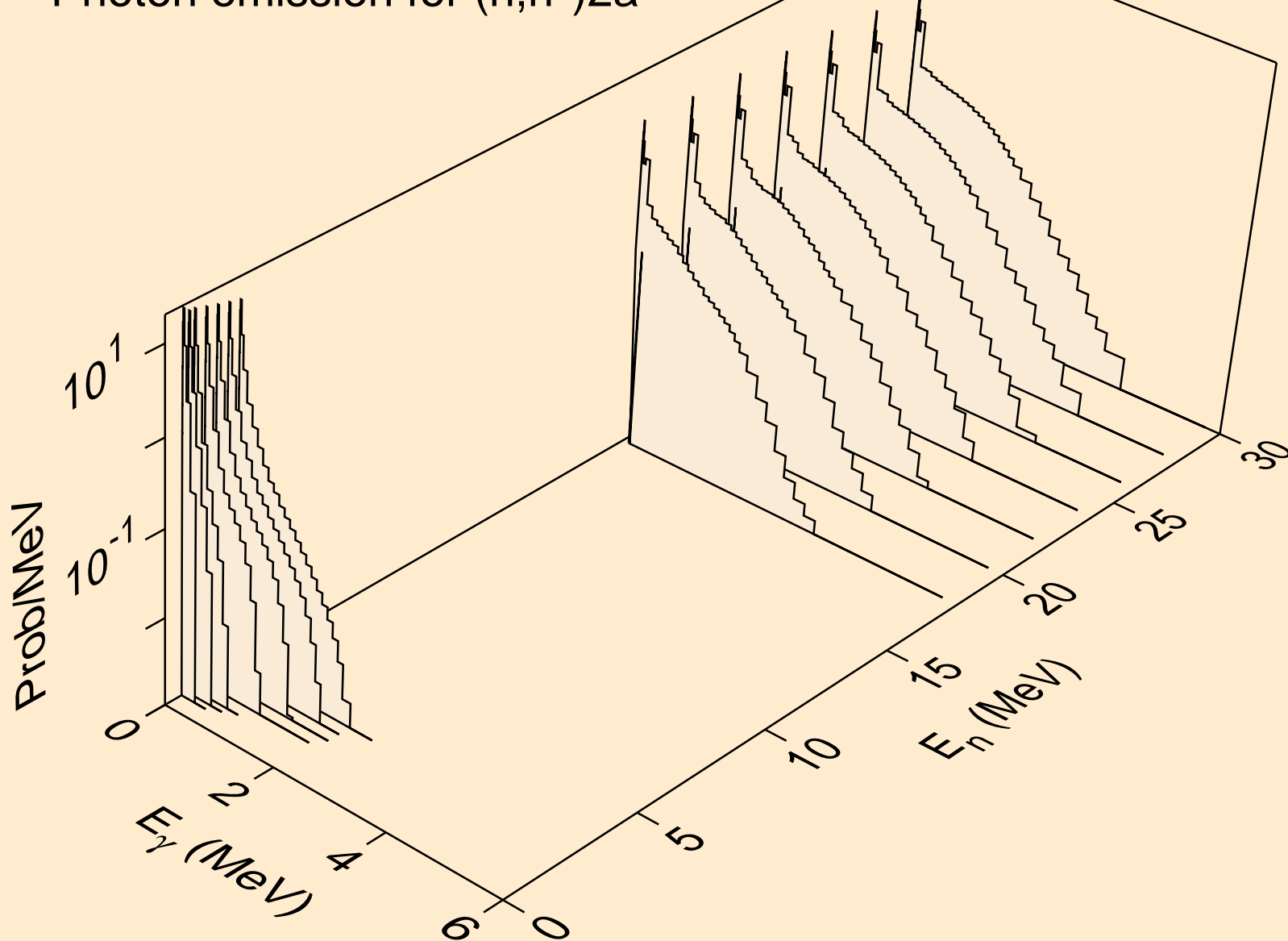

CM232 NEUTRON ACER TENDL-2019 LIBRARY; T=293.16K
Photon emission for (n,2n)2a

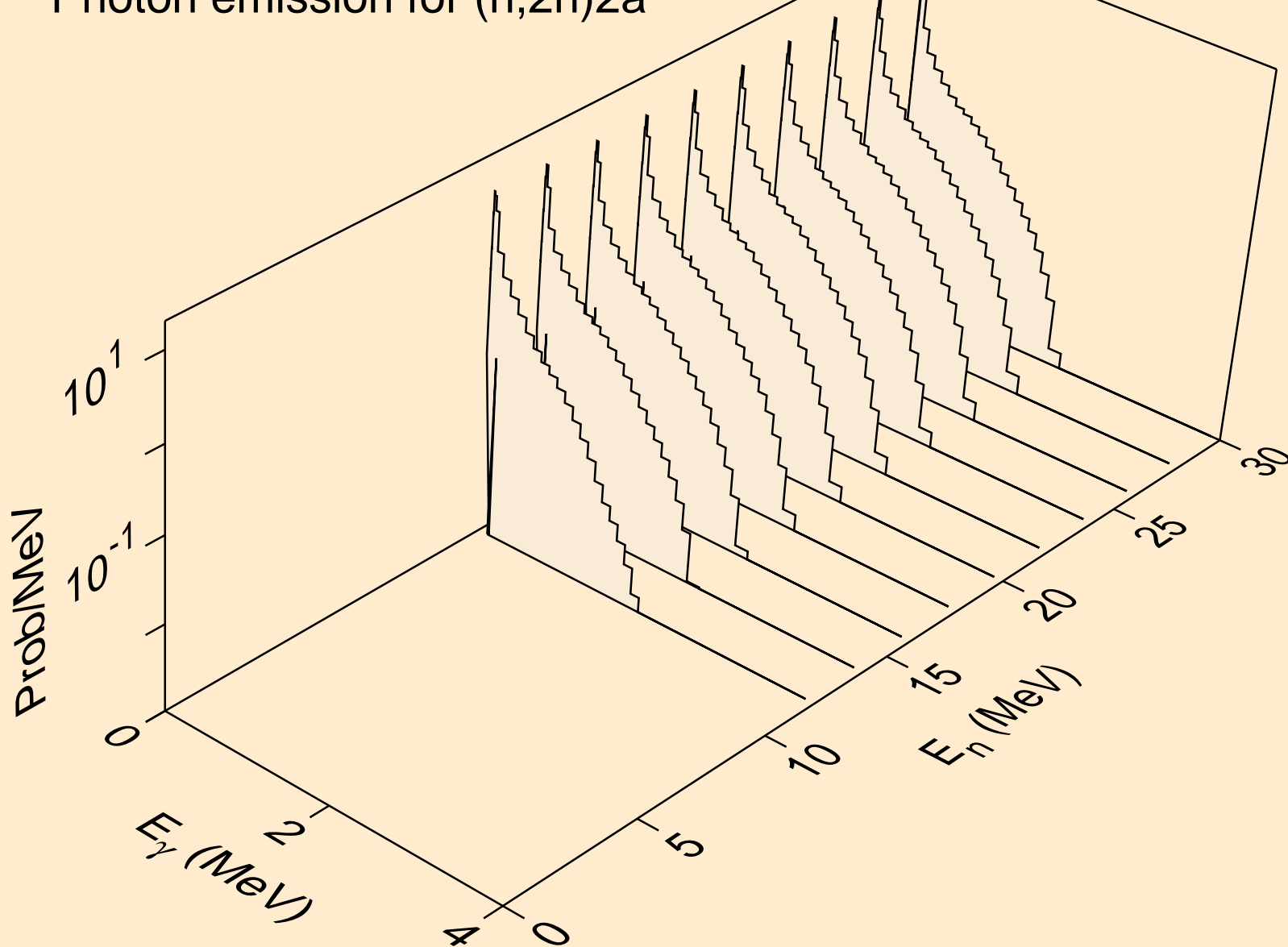

CM232 NEUTRON ACER TENDL-2019 LIBRARY; T=293.16K
Photon emission for (n,n*)d

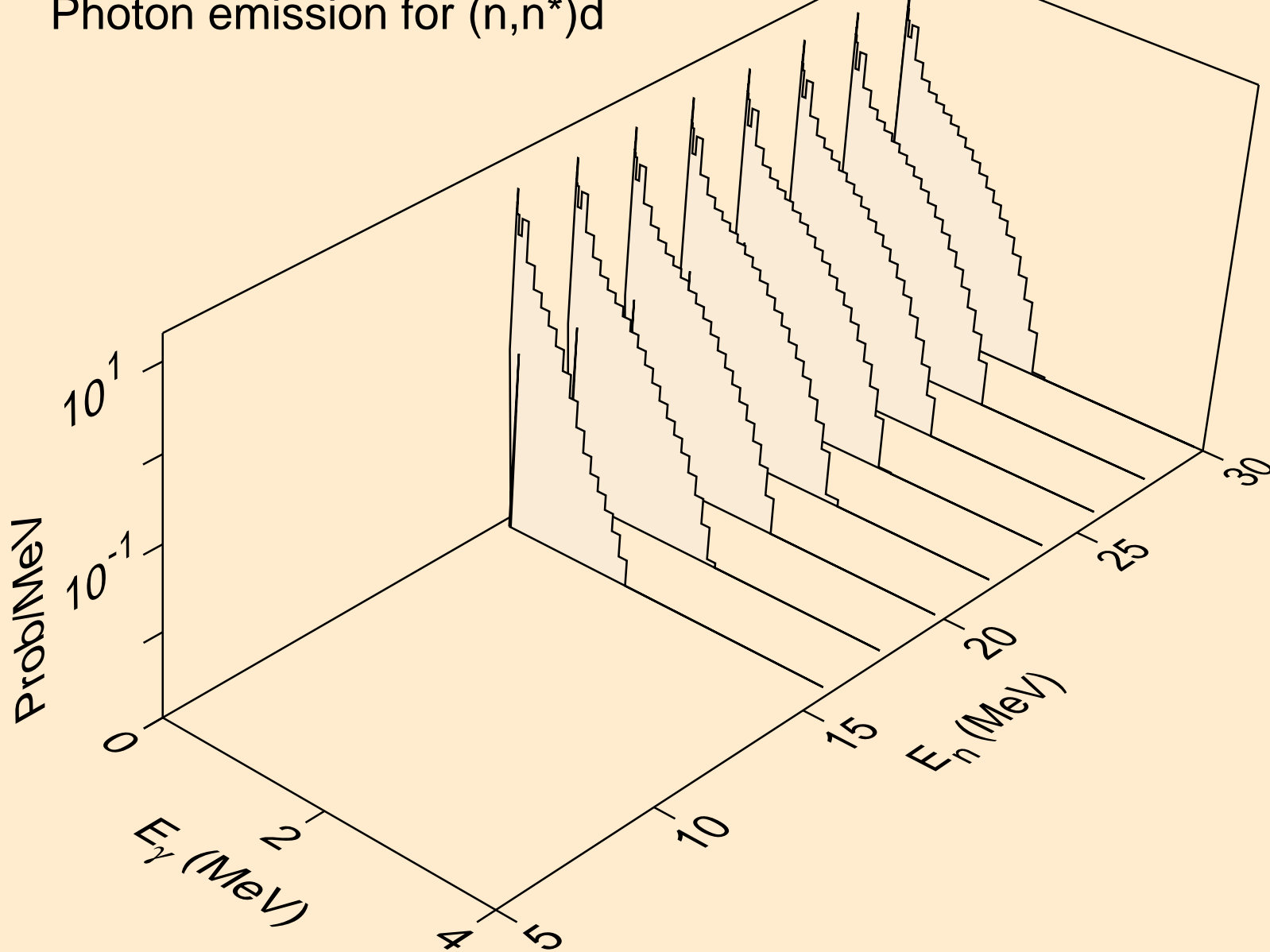

CM232 NEUTRON ACER TENDL-2019 LIBRARY; T=293.16K
Photon emission for (n,n*)t

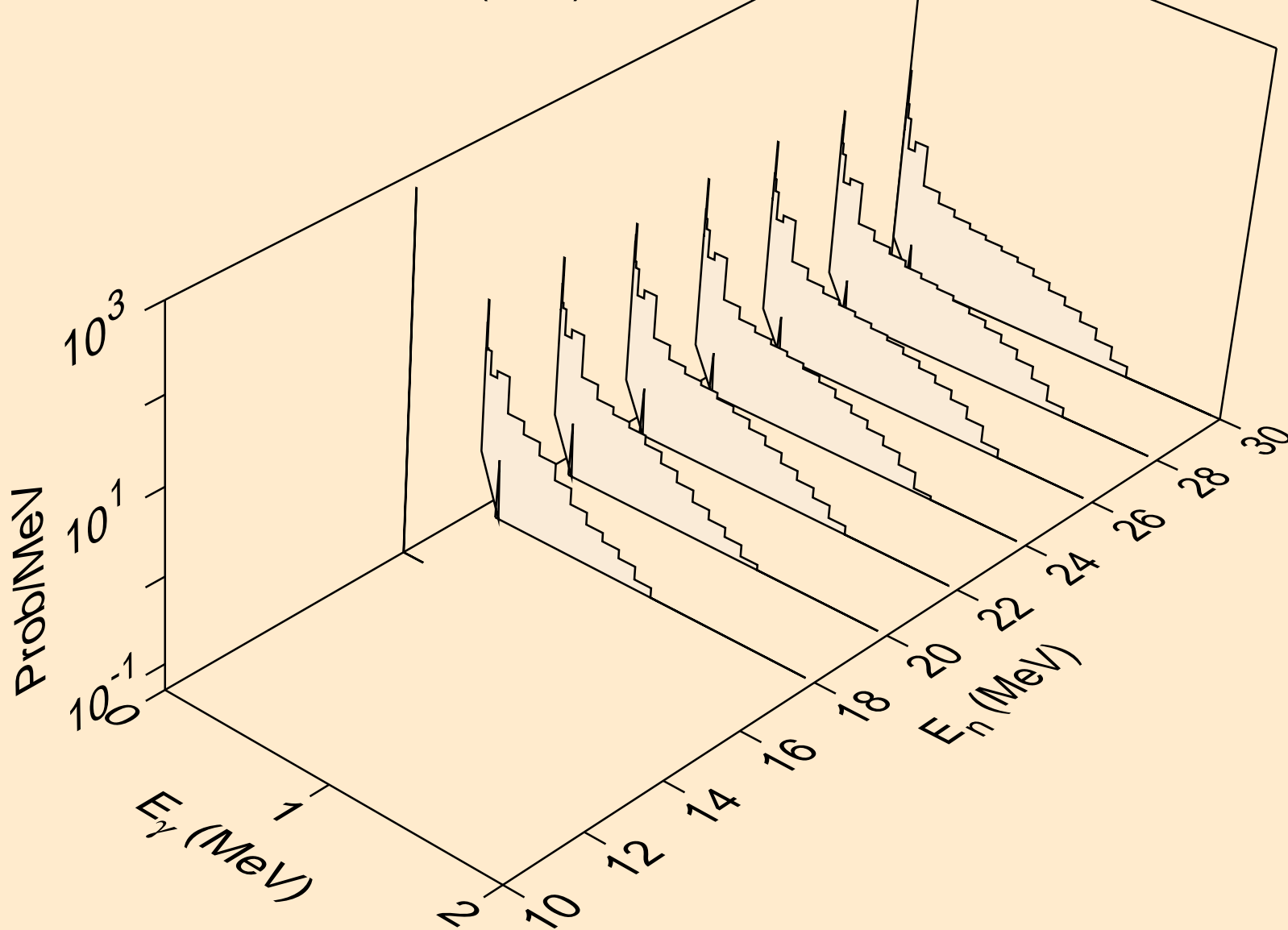

CM232 NEUTRON ACER TENDL-2019 LIBRARY; T=293.16K
Photon emission for (n,n*)he3

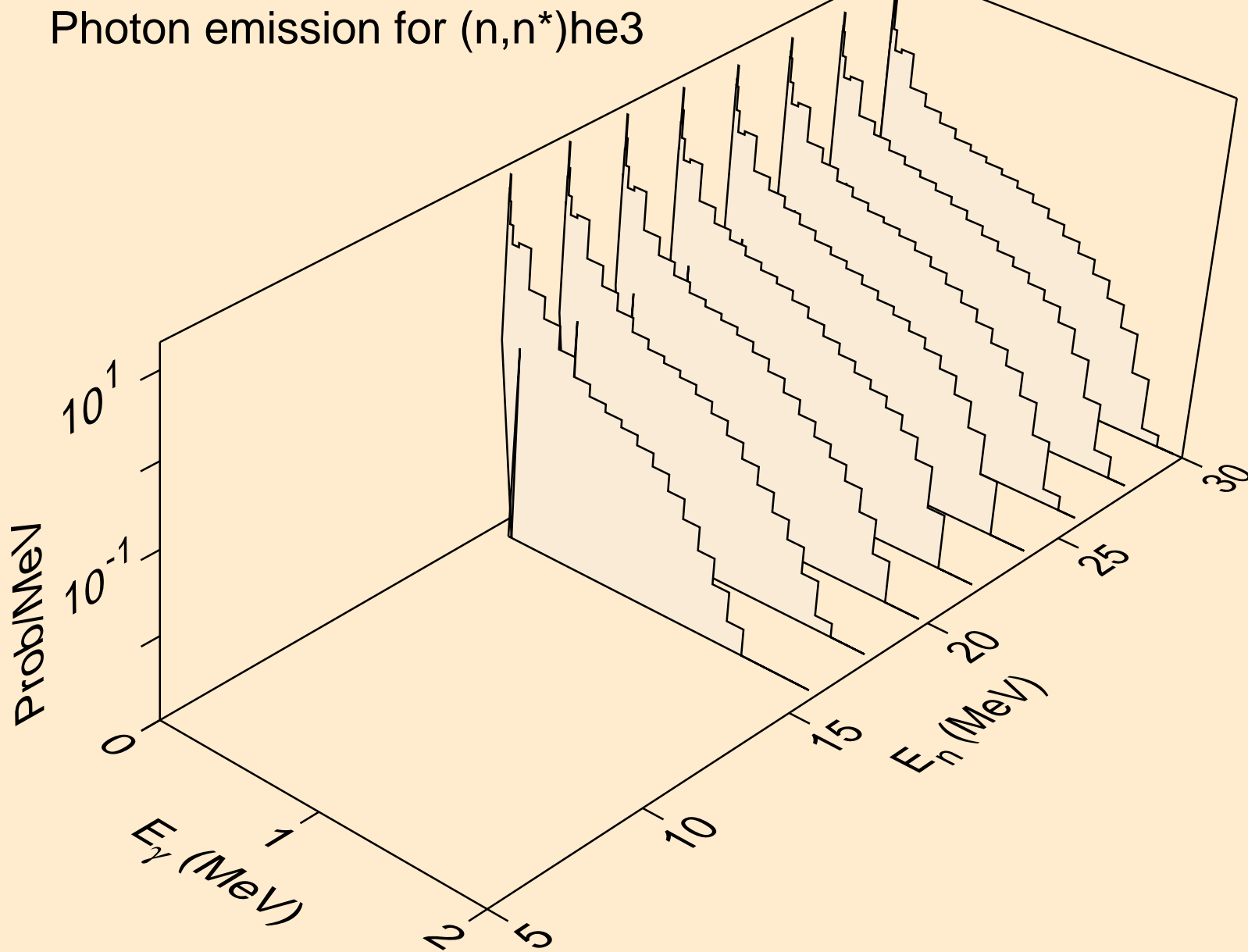

CM232 NEUTRON ACER TENDL-2019 LIBRARY; T=293.16K
Photon emission for (n,4n)

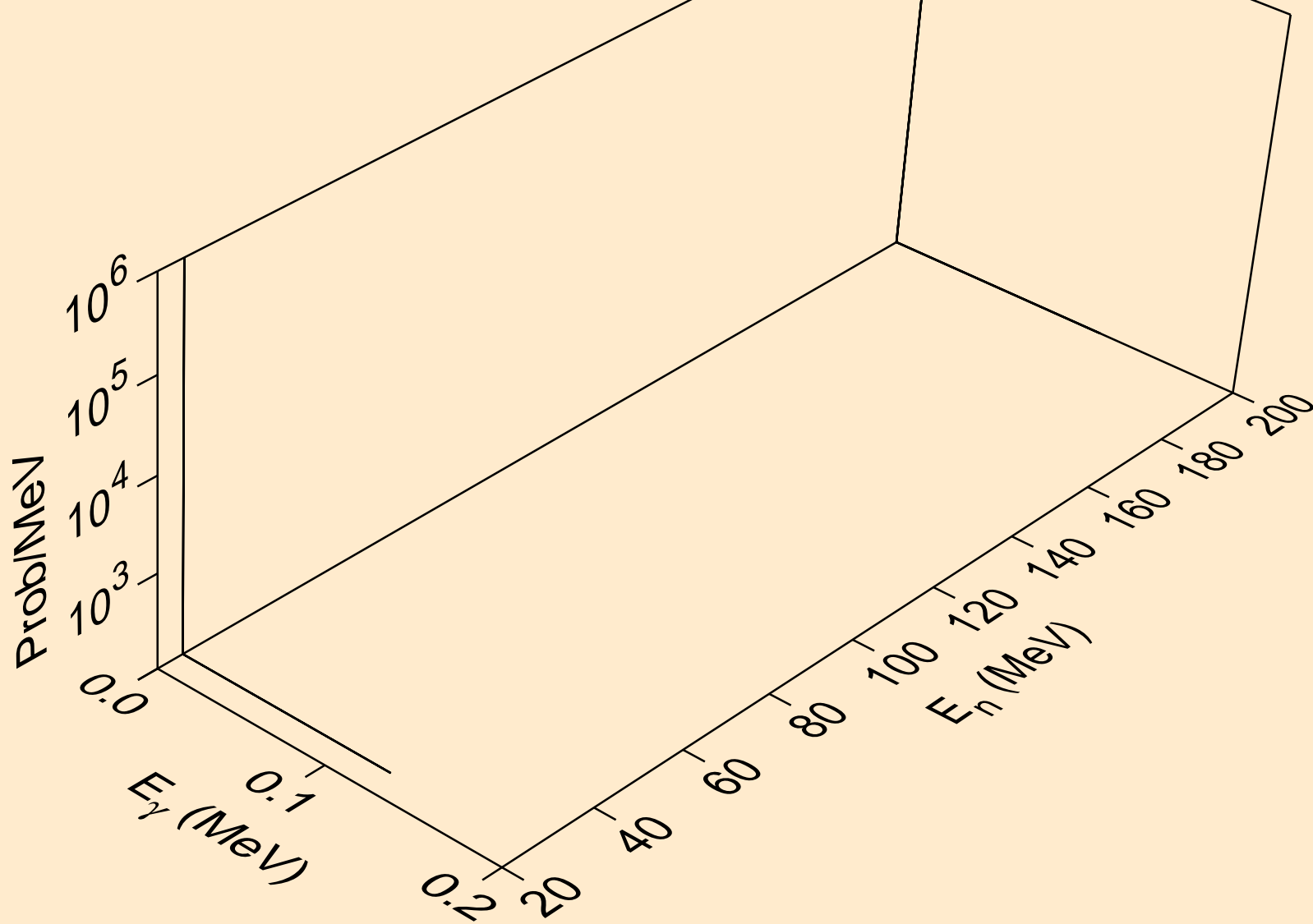

CM232 NEUTRON ACER TENDL-2019 LIBRARY; T=293.16K
Photon emission for (n,2np)

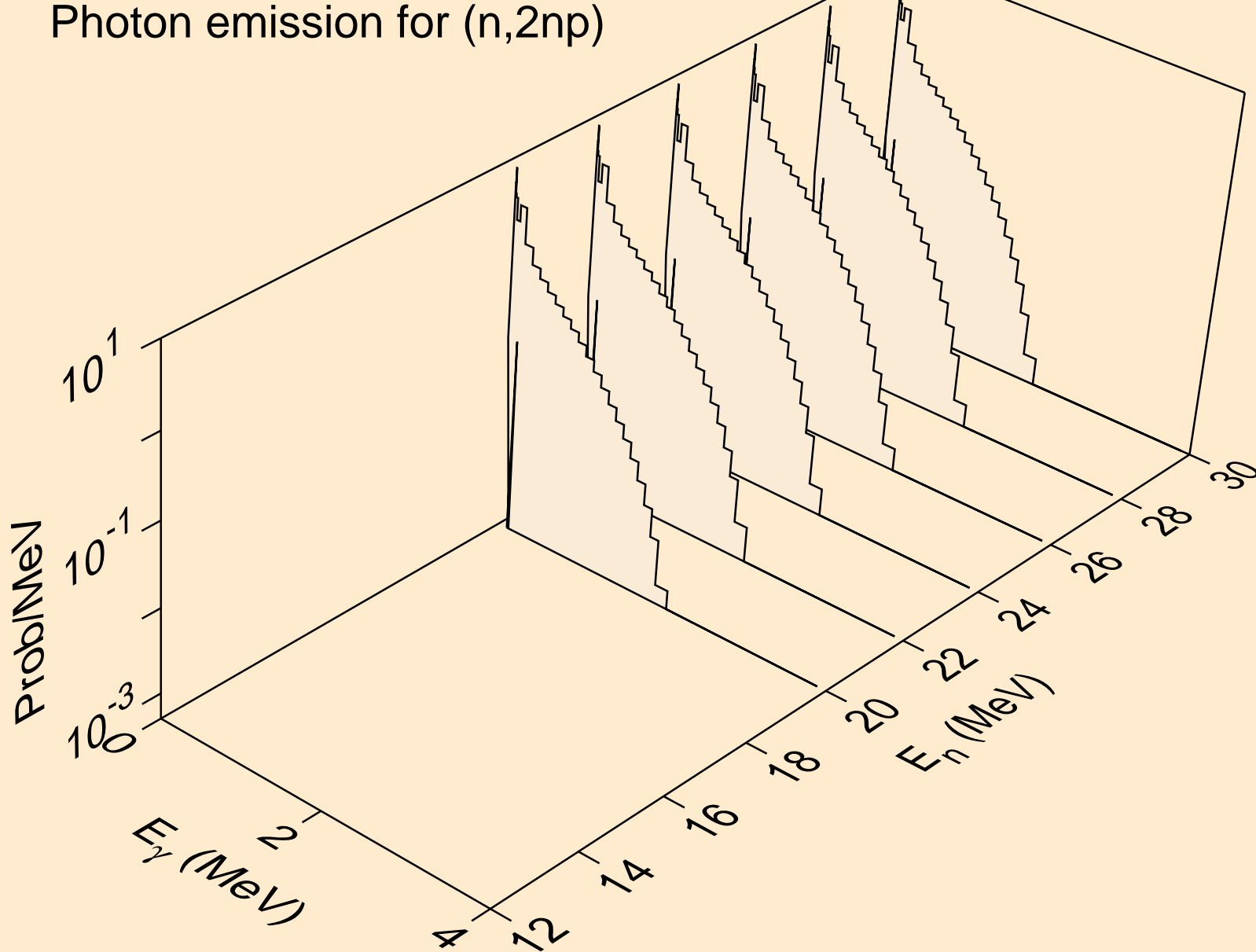

CM232 NEUTRON ACER TENDL-2019 LIBRARY; T=293.16K
Photon emission for (n,2np)

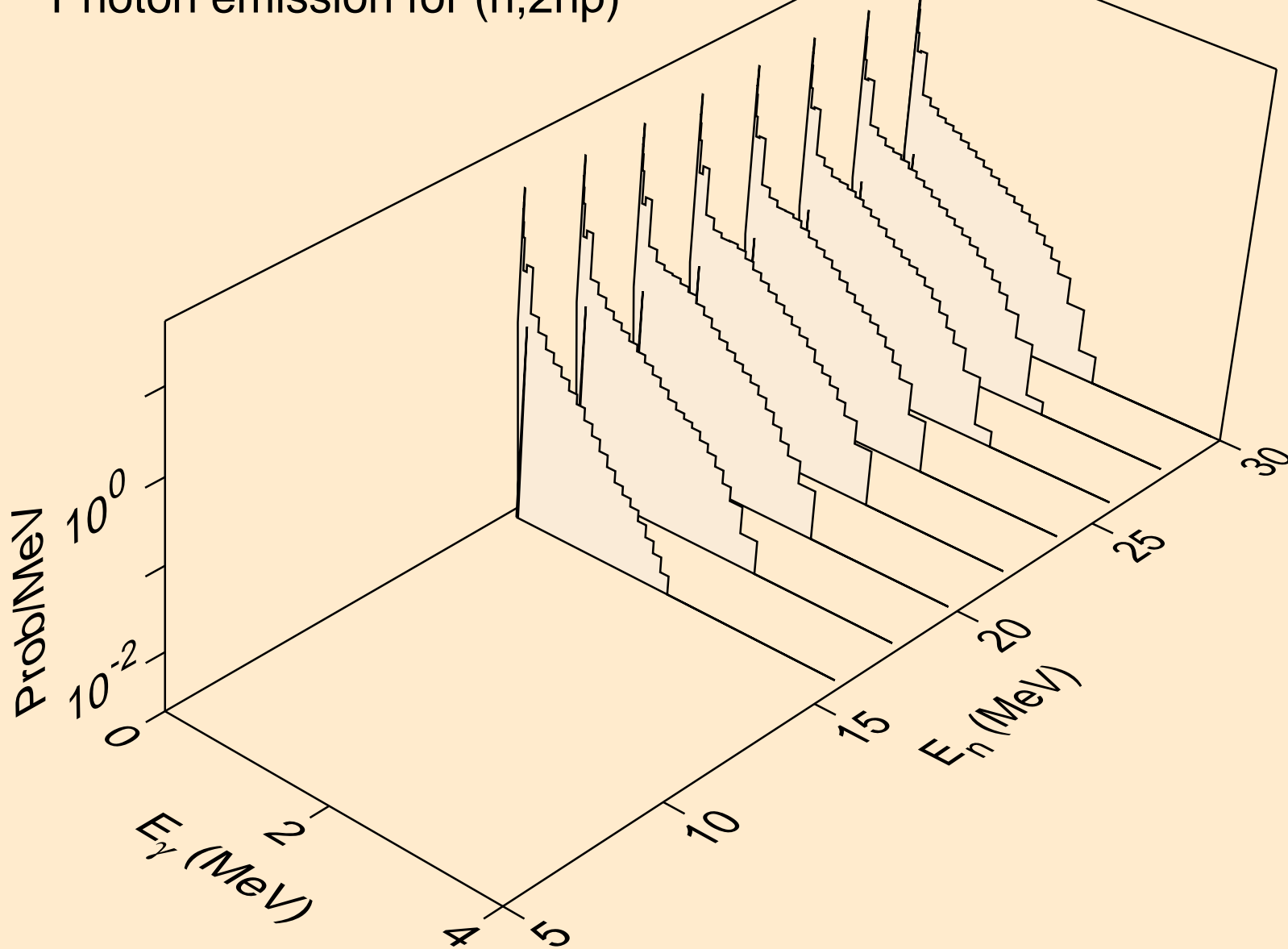

CM232 NEUTRON ACER TENDL-2019 LIBRARY; T=293.16K
Photon emission for (n,npa)

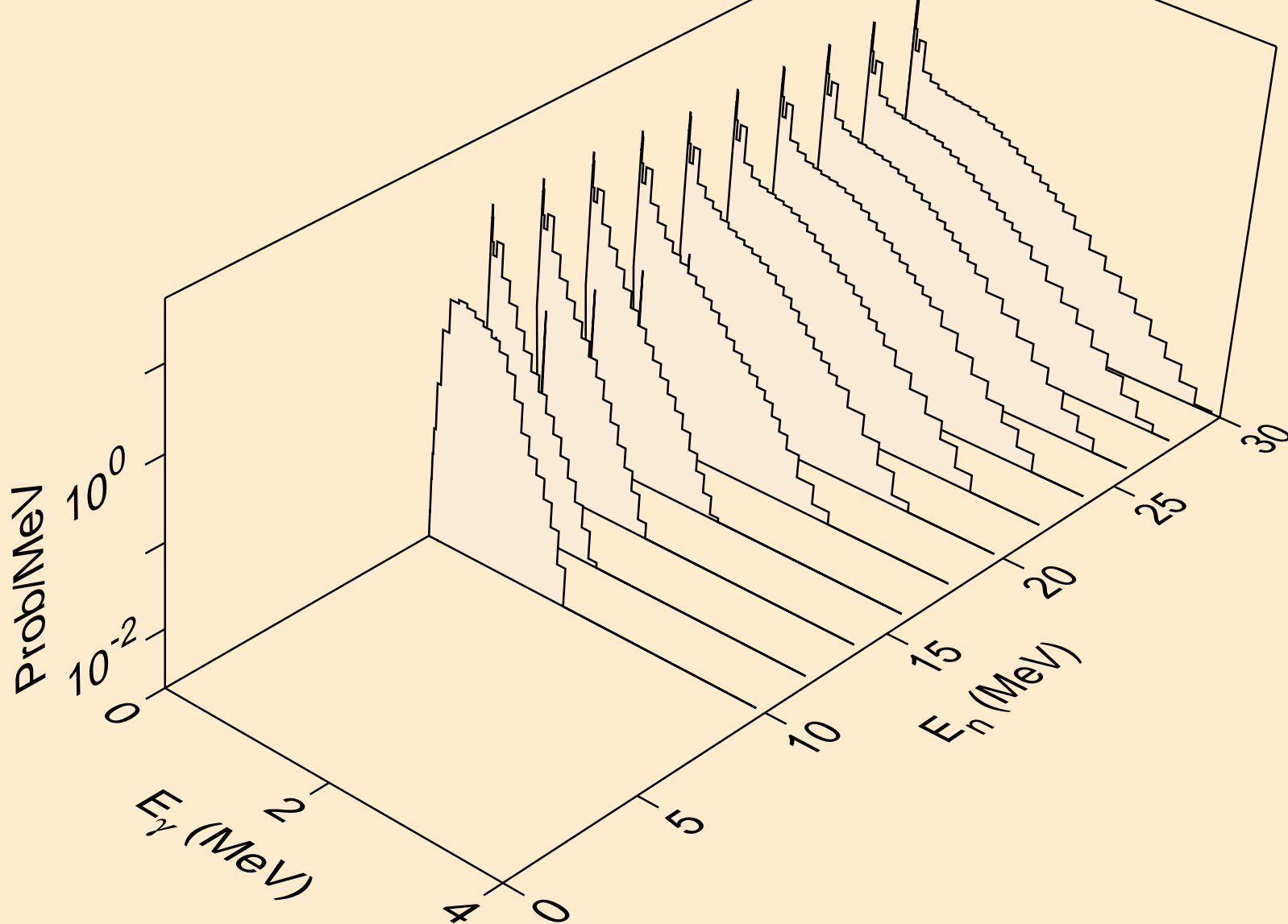

CM232 NEUTRON ACER TENDL-2019 LIBRARY; T=293.16K
Photon emission for (n,n*c)

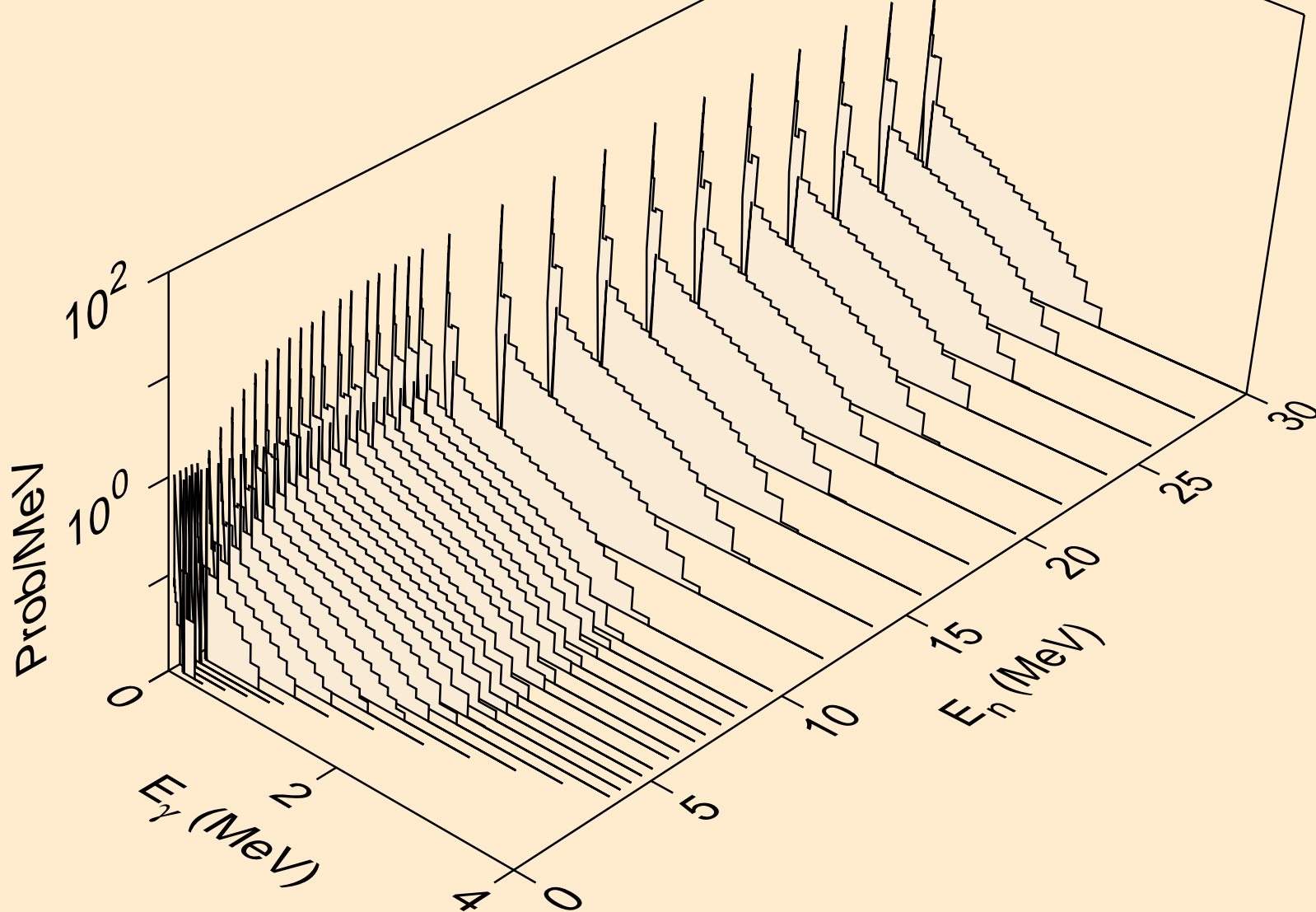

CM232 NEUTRON ACER TENDL-2019 LIBRARY; T=293.16K
Photon emission for (n,gma)

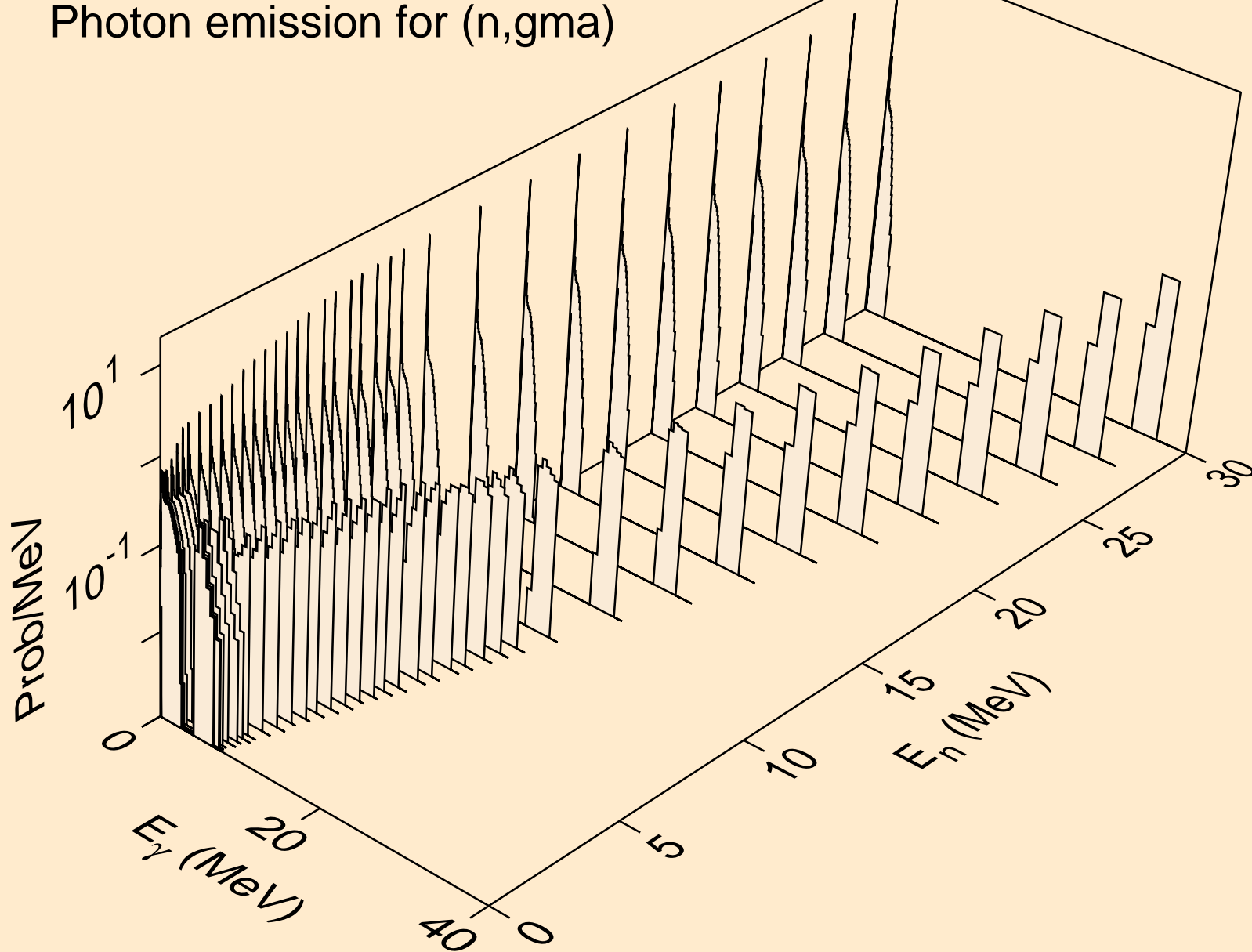

CM232 NEUTRON ACER TENDL-2019 LIBRARY; T=293.16K
Photon emission for (n,p)

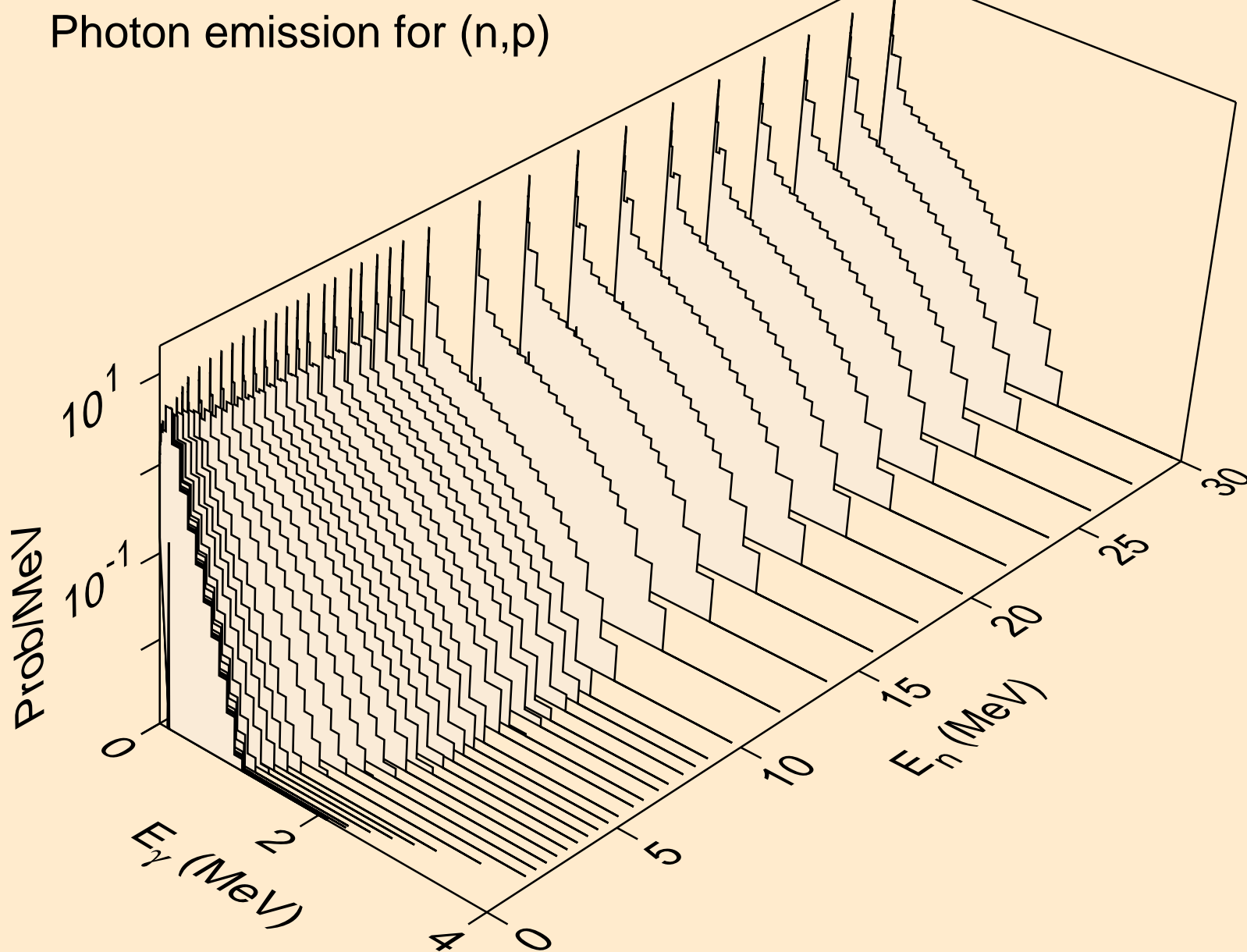

CM232 NEUTRON ACER TENDL-2019 LIBRARY; T=293.16K
Photon emission for (n,d)

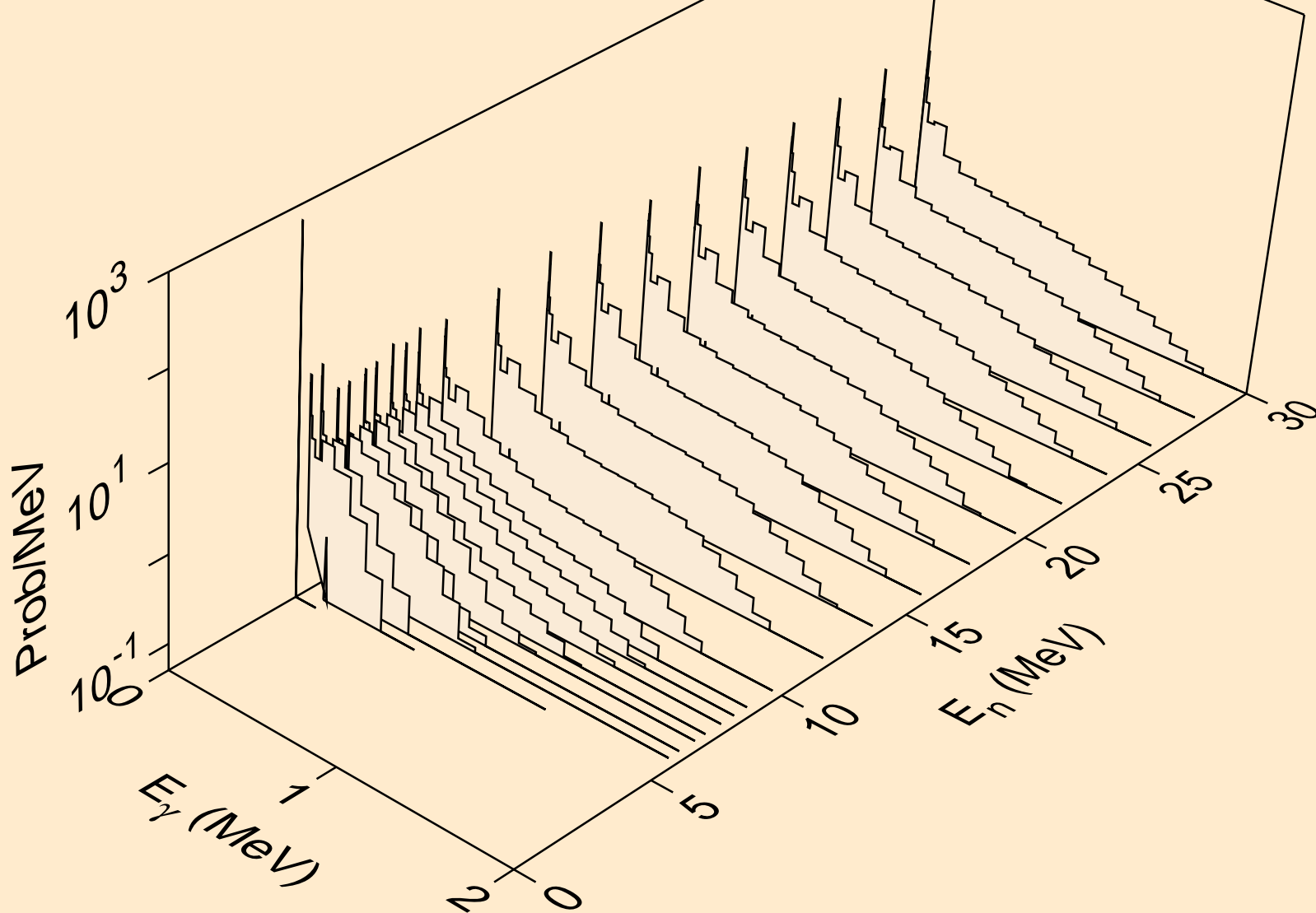

CM232 NEUTRON ACER TENDL-2019 LIBRARY; T=293.16K
Photon emission for (n,t)

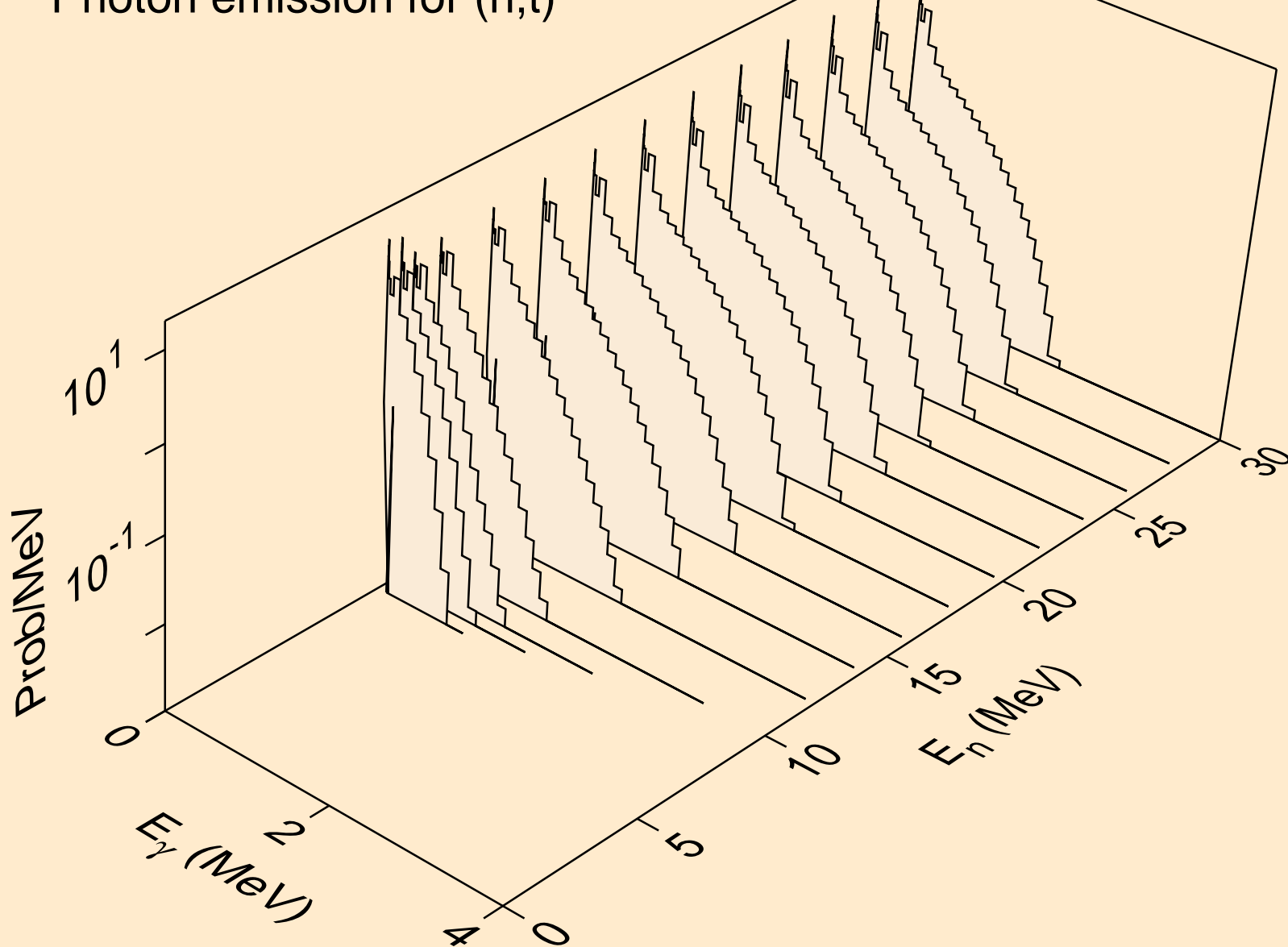

CM232 NEUTRON ACER TENDL-2019 LIBRARY; T=293.16K
Photon emission for (n,he3)

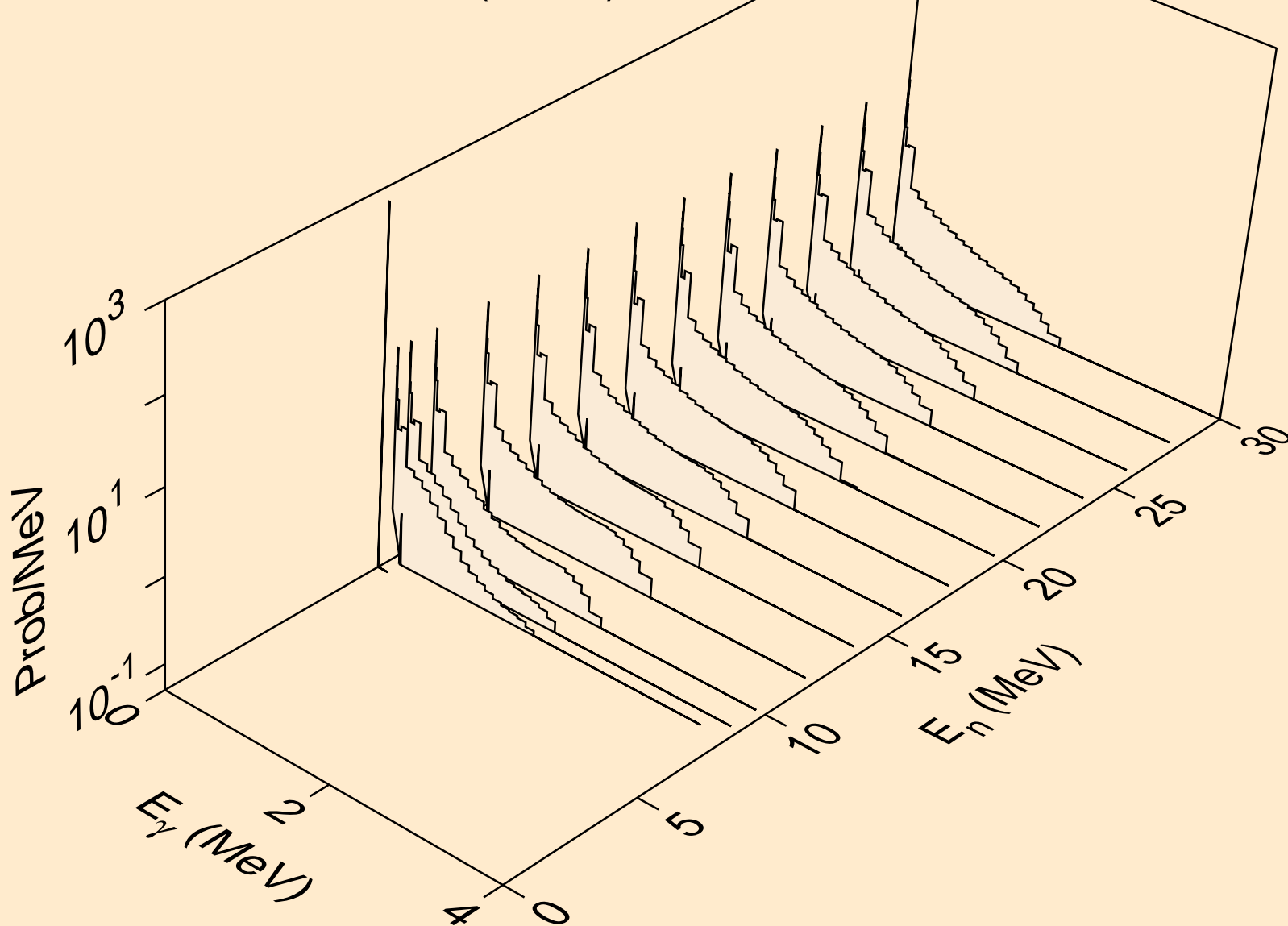

CM232 NEUTRON ACER TENDL-2019 LIBRARY; T=293.16K
Photon emission for (n,a)

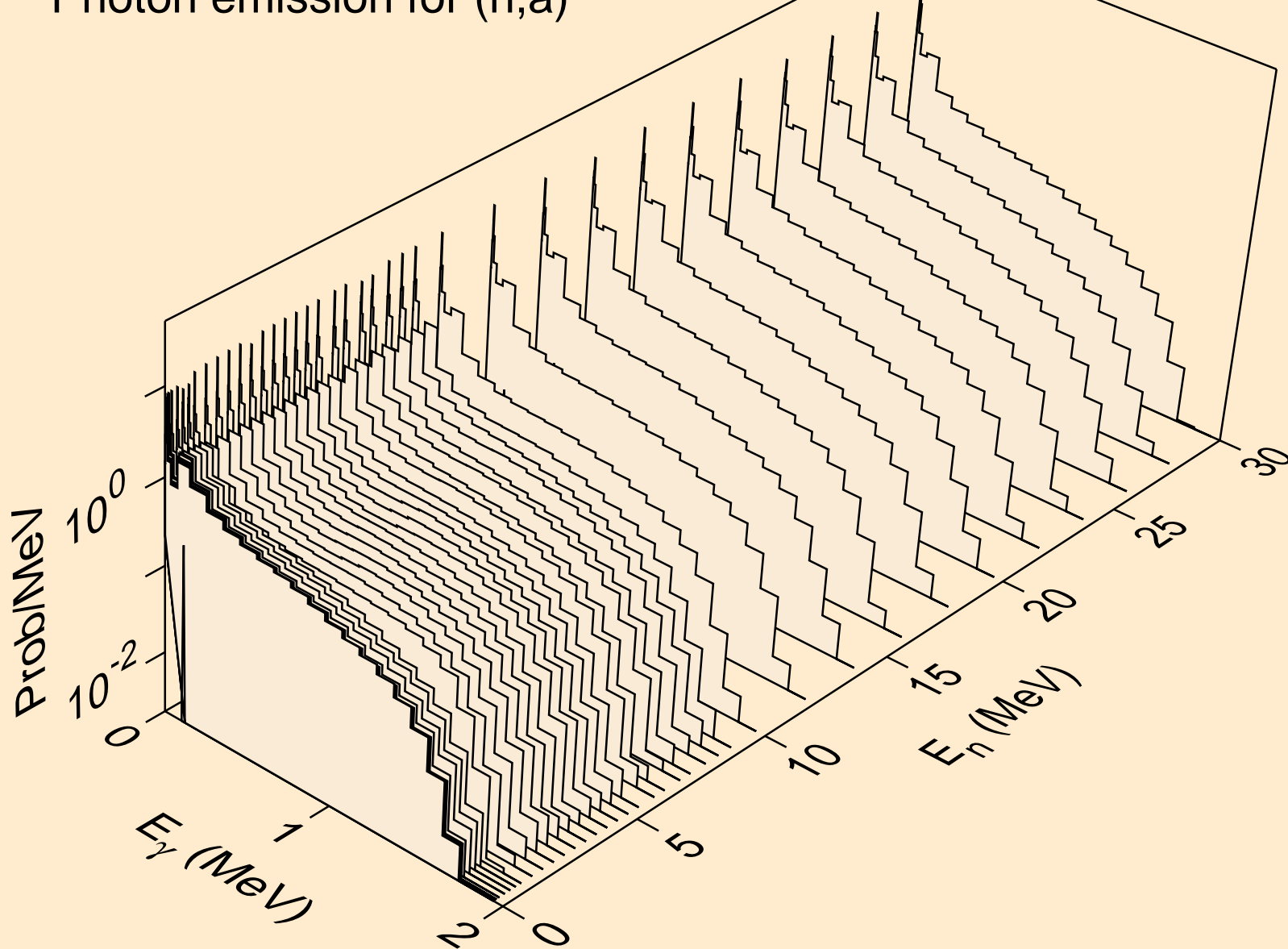

CM232 NEUTRON ACER TENDL-2019 LIBRARY; T=293.16K
Photon emission for (n,2a)

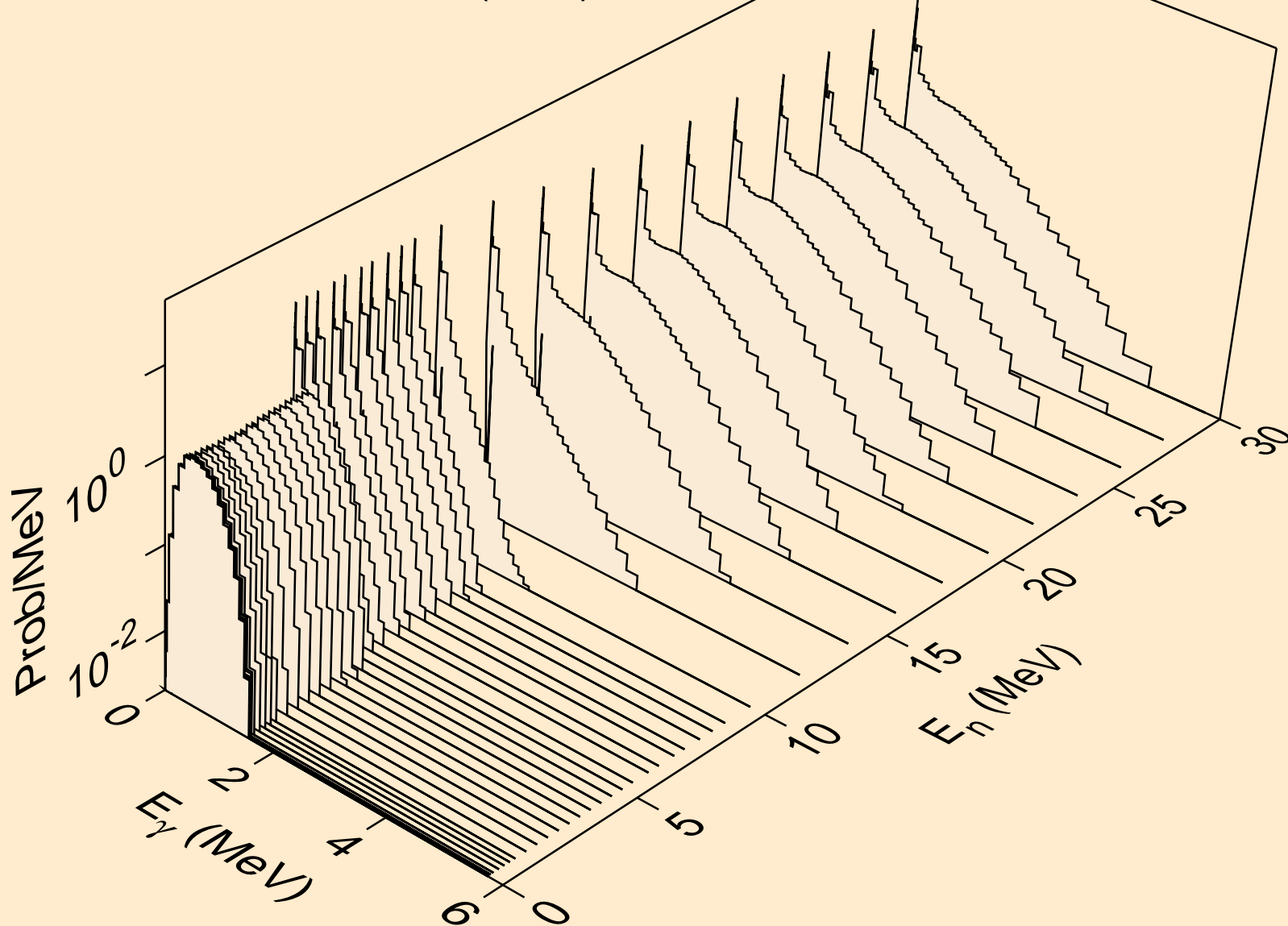

CM232 NEUTRON ACER TENDL-2019 LIBRARY; T=293.16K
Photon emission for (n,2p)

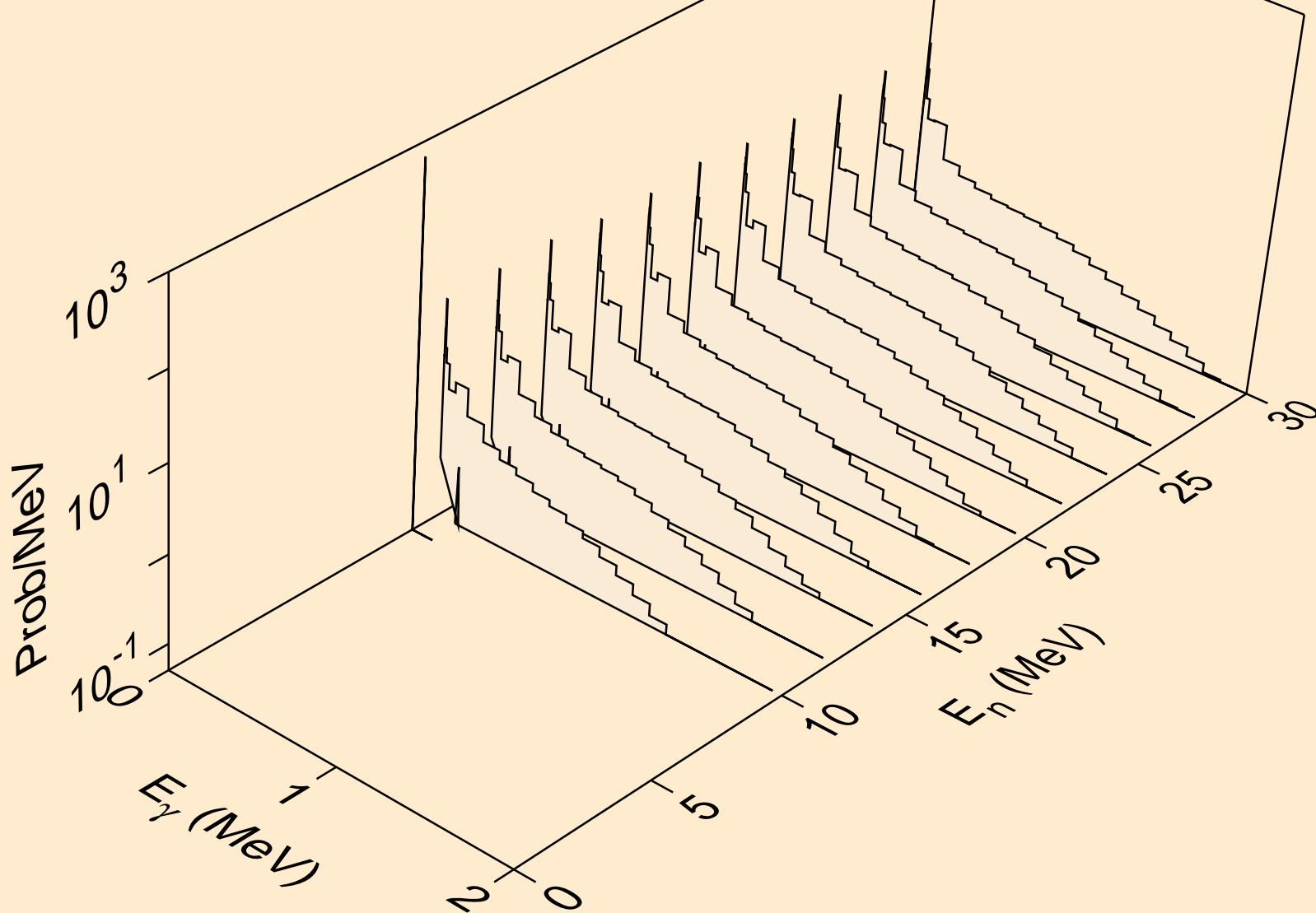

CM232 NEUTRON ACER TENDL-2019 LIBRARY; T=293.16K
Photon emission for (n,p α)

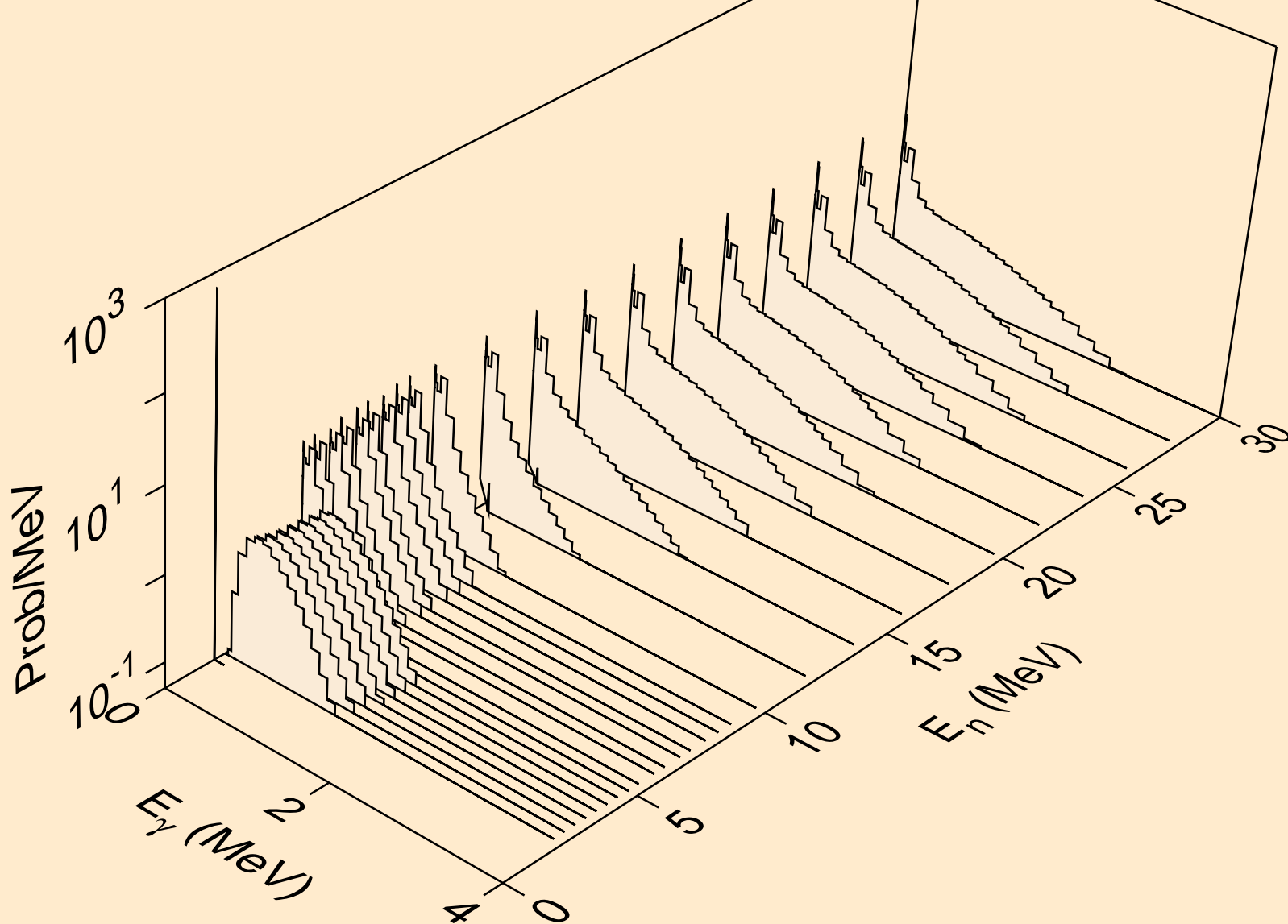

CM232 NEUTRON ACER TENDL-2019 LIBRARY; T=293.16K
Photon emission for (n,pd)

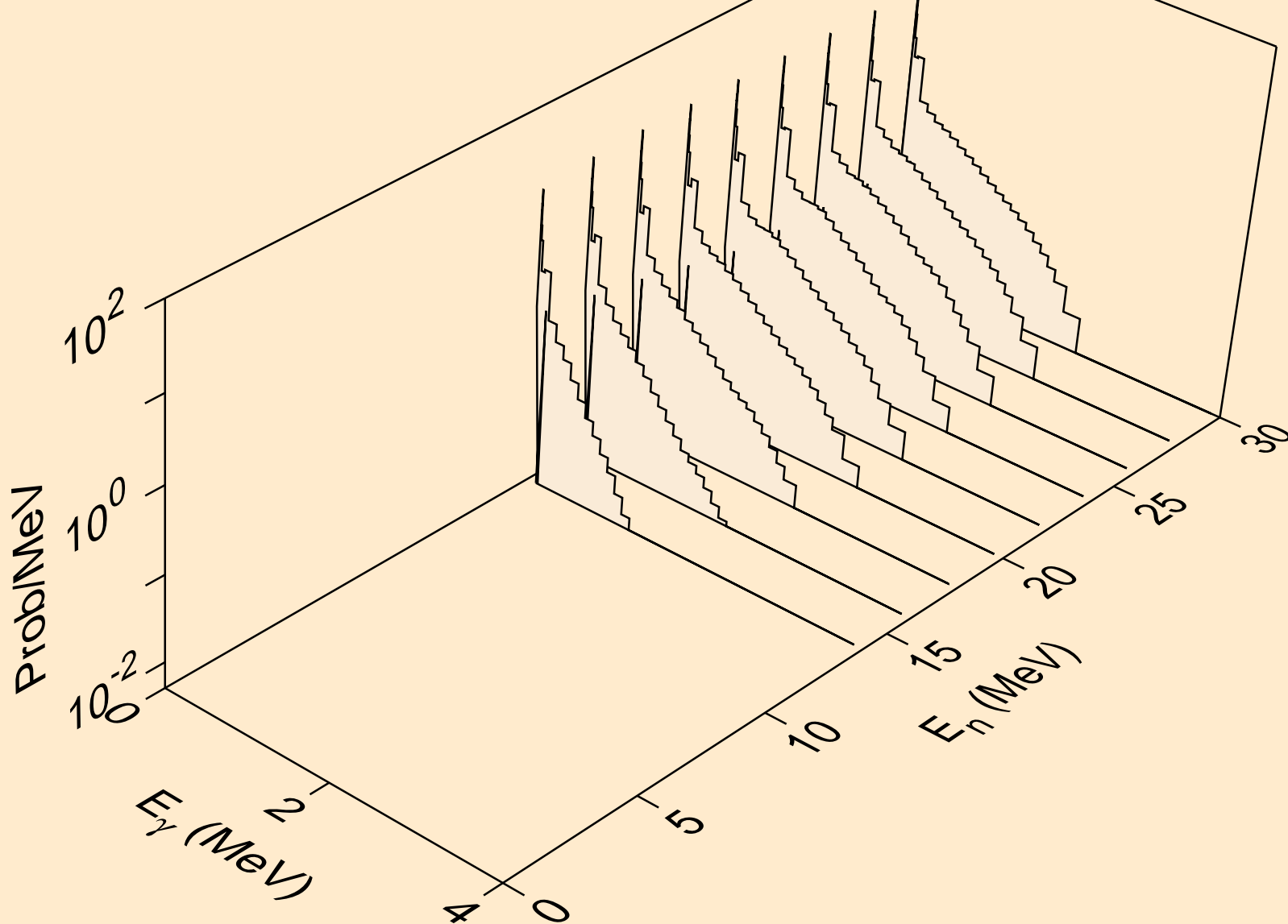

CM232 NEUTRON ACER TENDL-2019 LIBRARY; T=293.16K
Photon emission for (n,da)

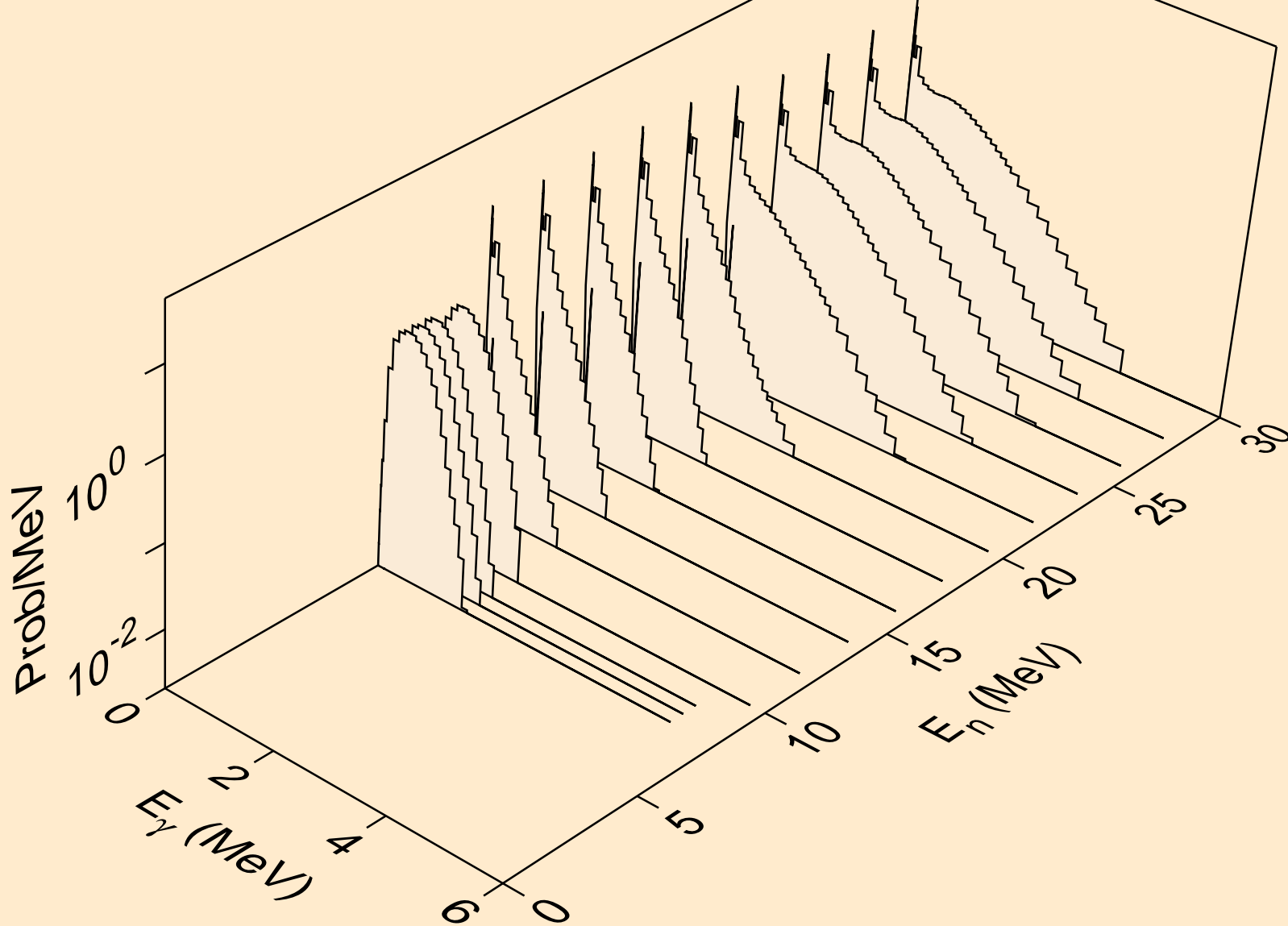

CM232 NEUTRON ACER TENDL-2019 LIBRARY; T=293.16K
thermal capture photon spectrum

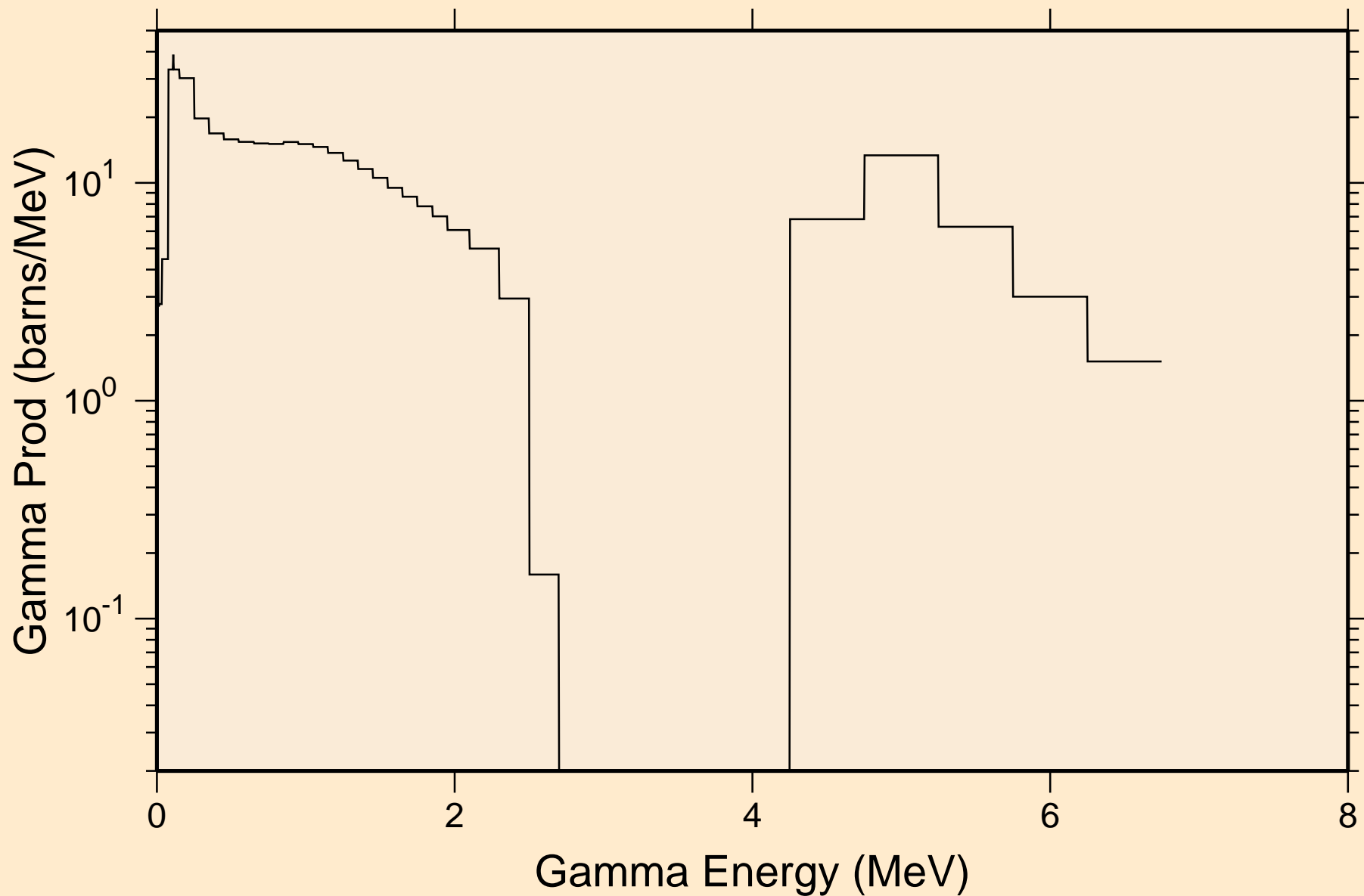

CM232 NEUTRON ACER TENDL-2019 LIBRARY; T=293.16K
14 MeV photon spectrum

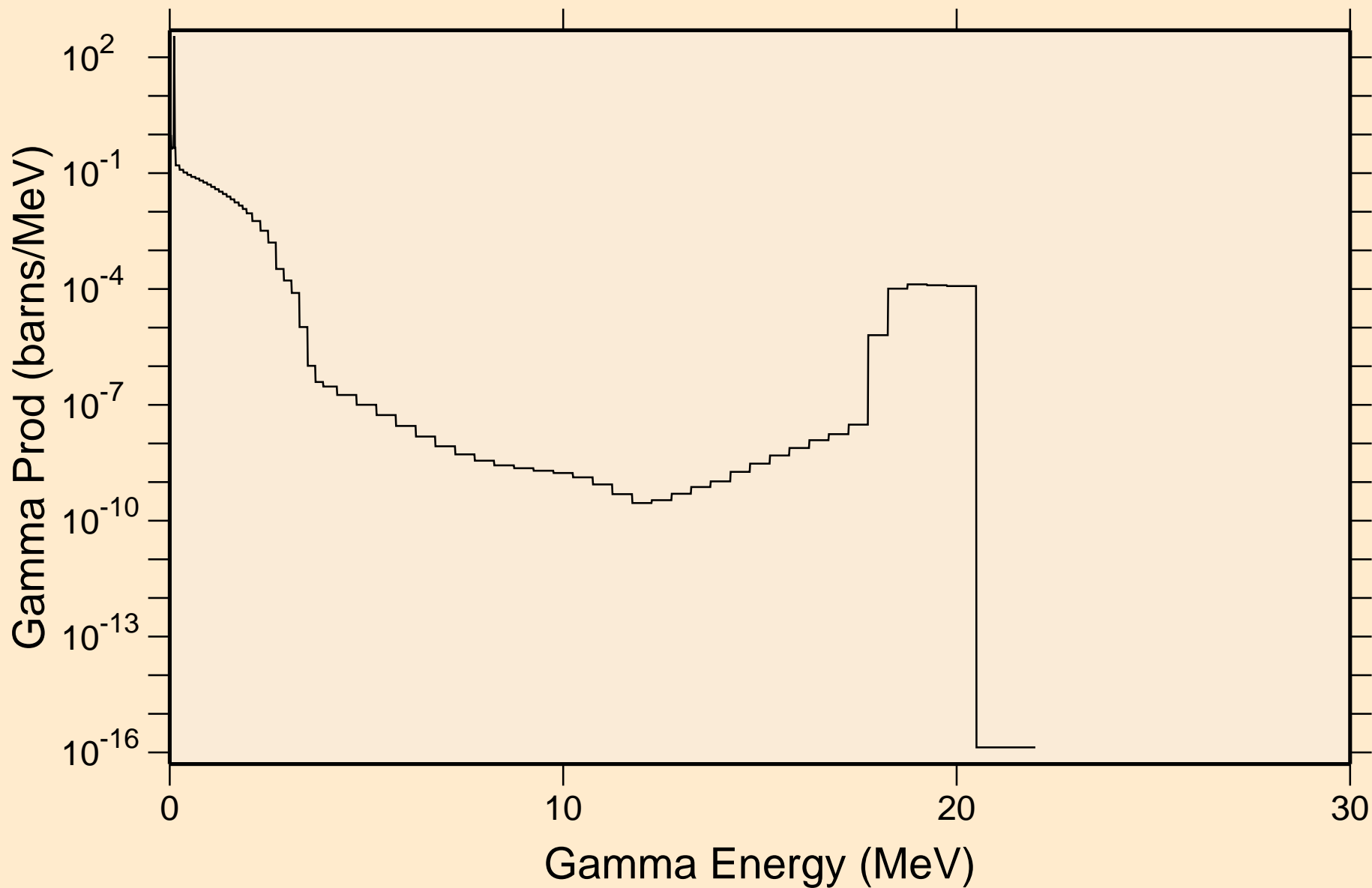

CM232 NEUTRON ACER TENDL-2019 LIBRARY; T=293.16K

Particle heating contributions

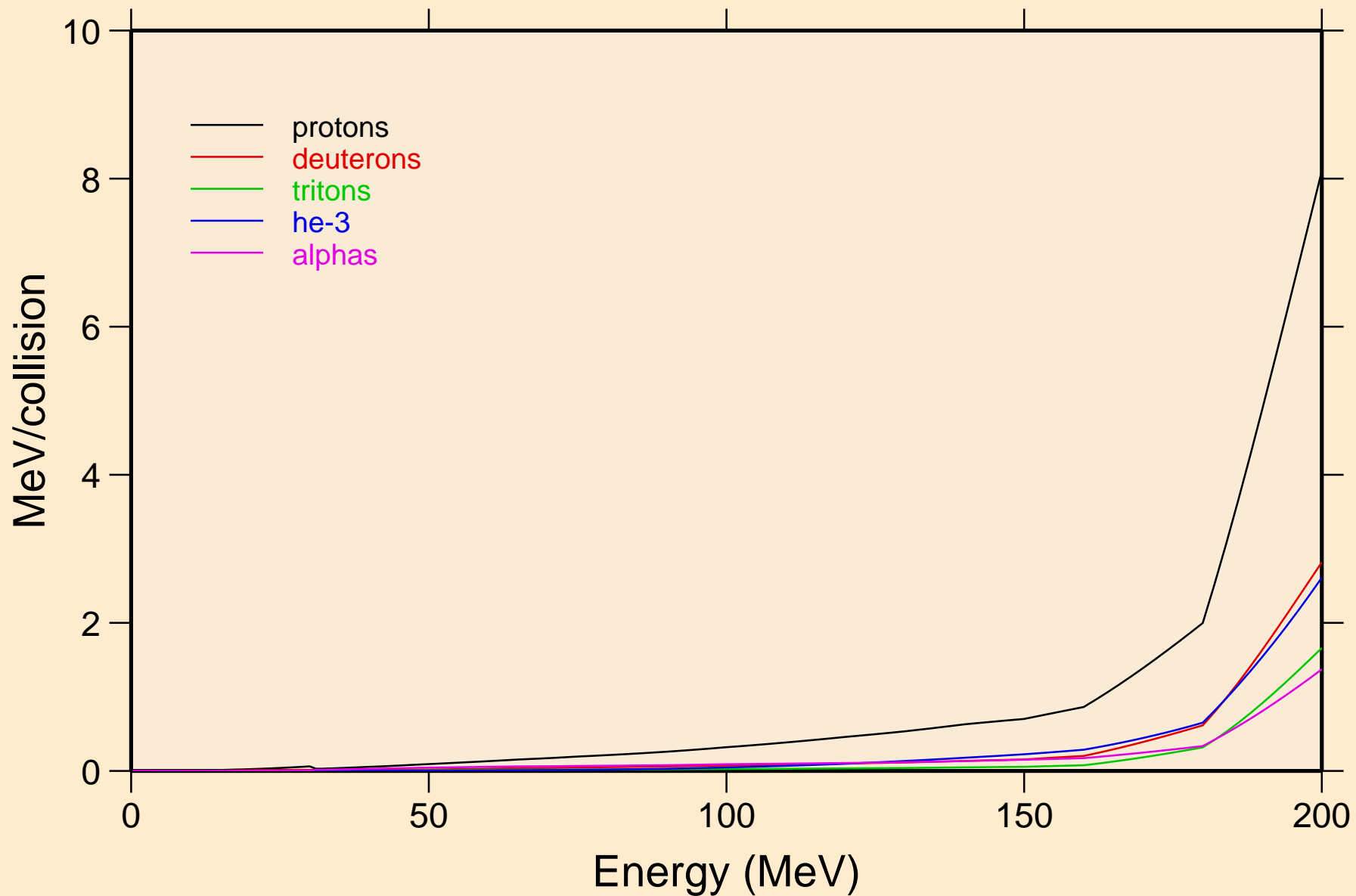

CM232 NEUTRON ACER TENDL-2019 LIBRARY; T=293.16K
Recoil Heating

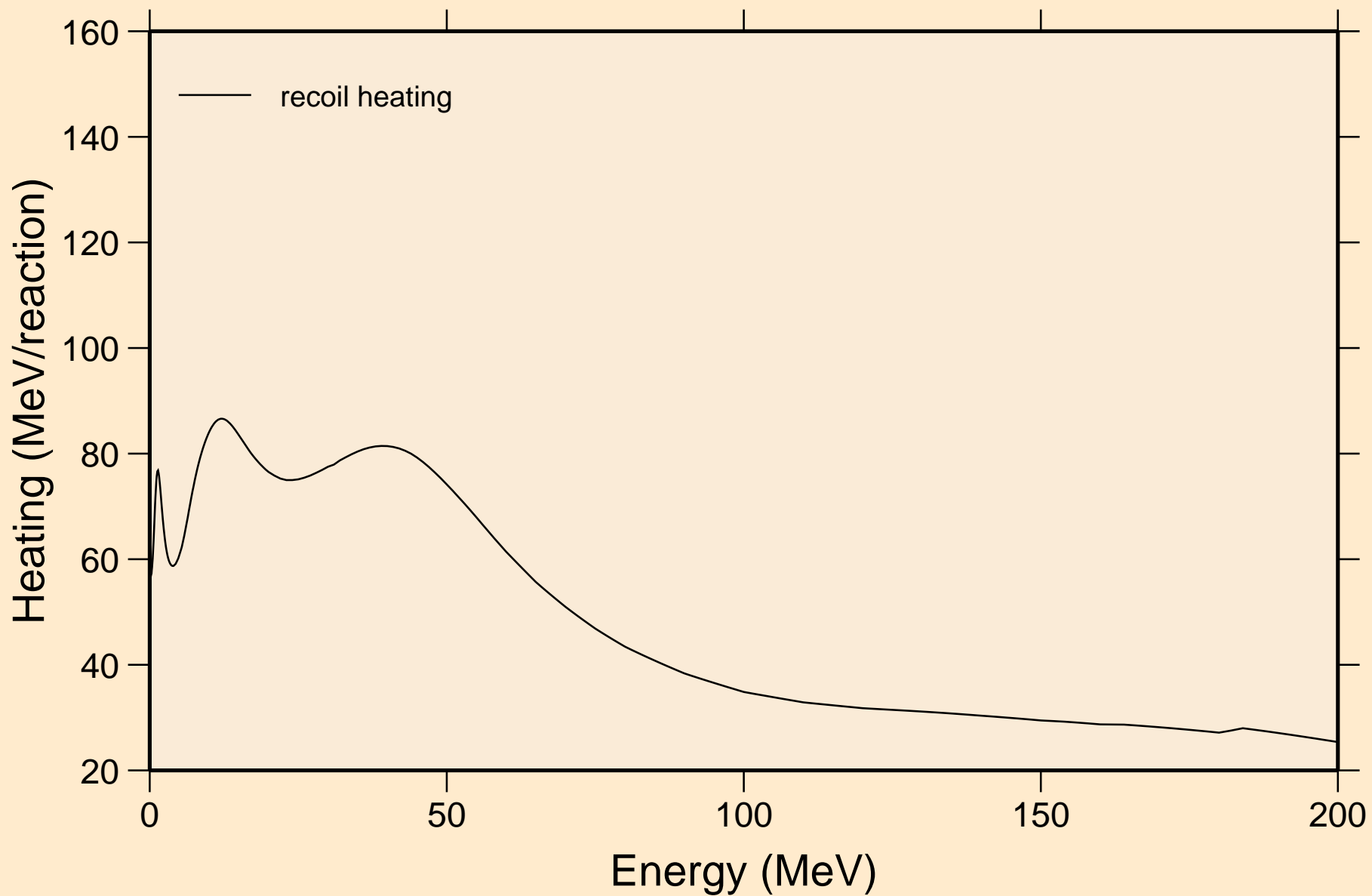

CM232 NEUTRON ACER TENDL-2019 LIBRARY; T=293.16K
Particle production cross sections

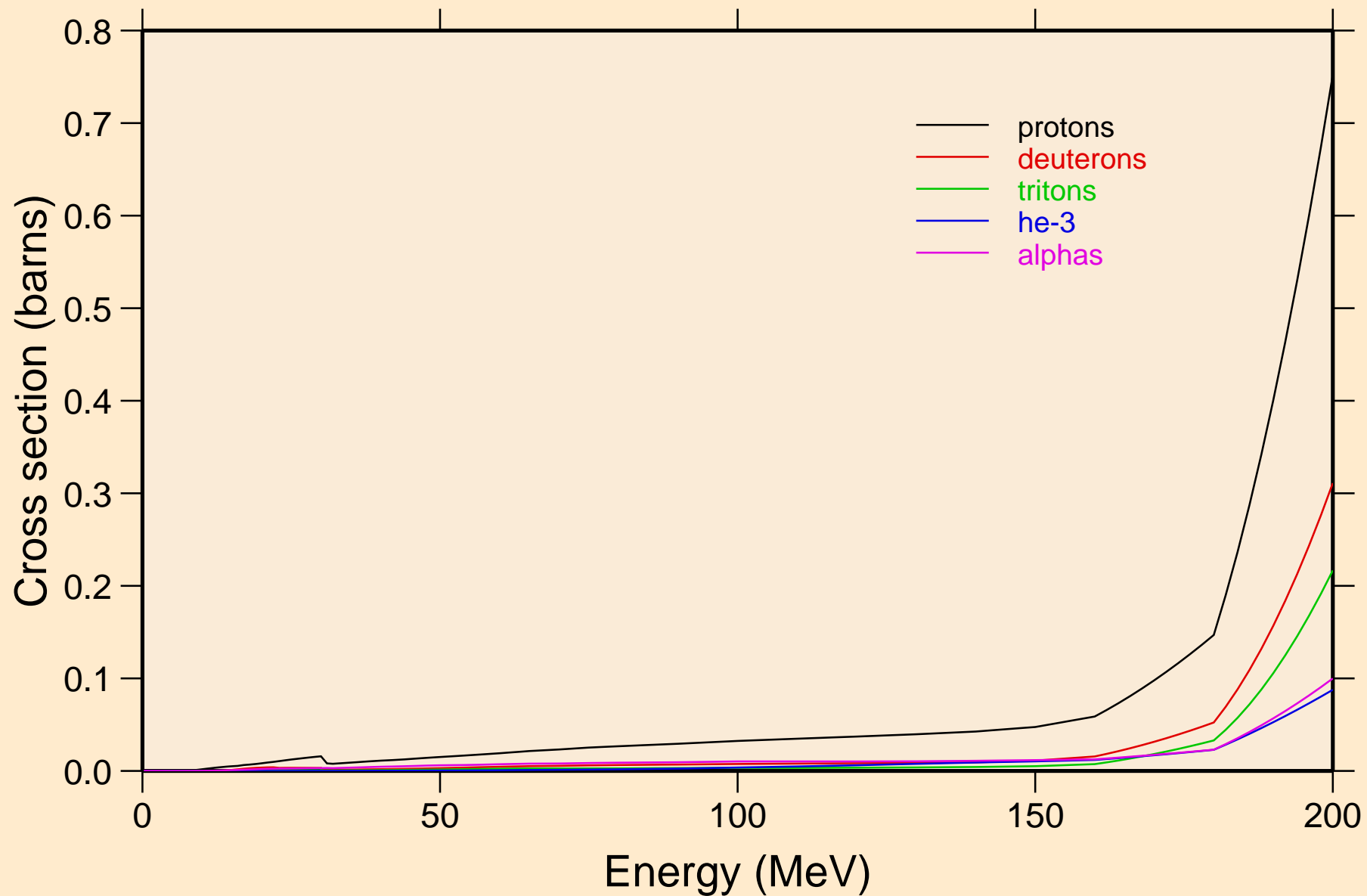

CM232 NEUTRON ACER TENDL-2019 LIBRARY; T=293.16K
protons from (n,x)

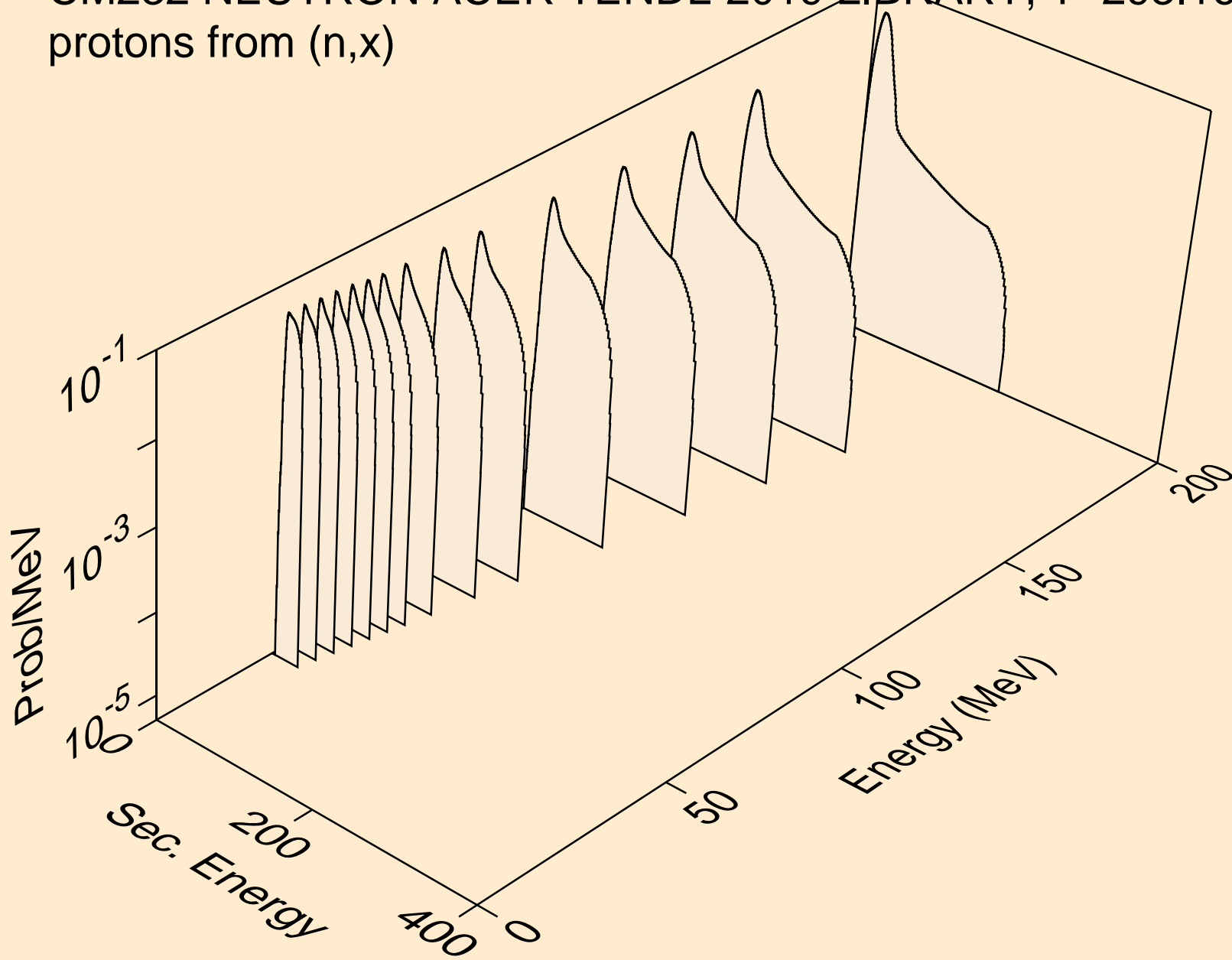

CM232 NEUTRON ACER TENDL-2019 LIBRARY; T=293.16K
protons from (n,n*)p

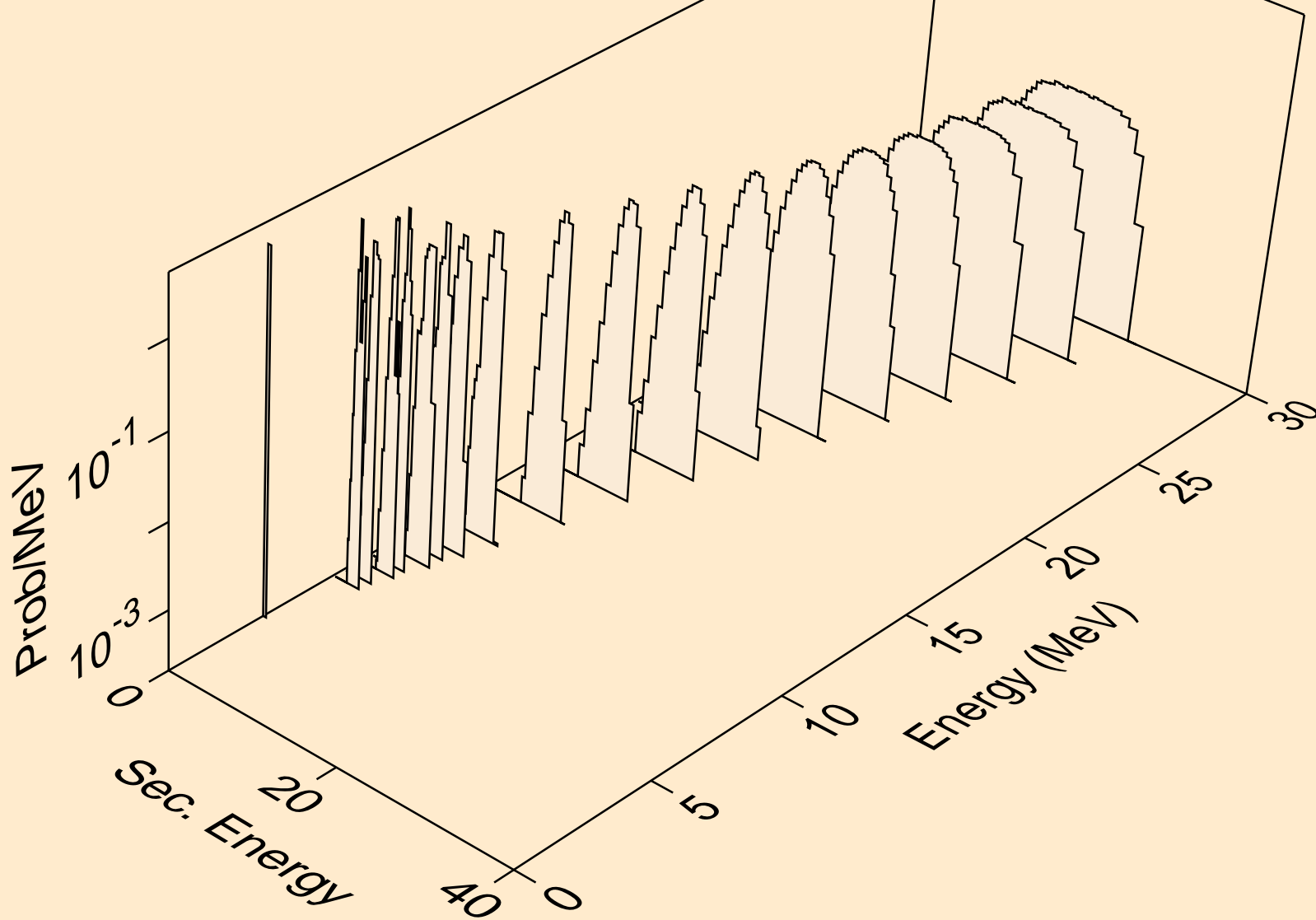

CM232 NEUTRON ACER TENDL-2019 LIBRARY; T=293.16K
protons from (n,2np)

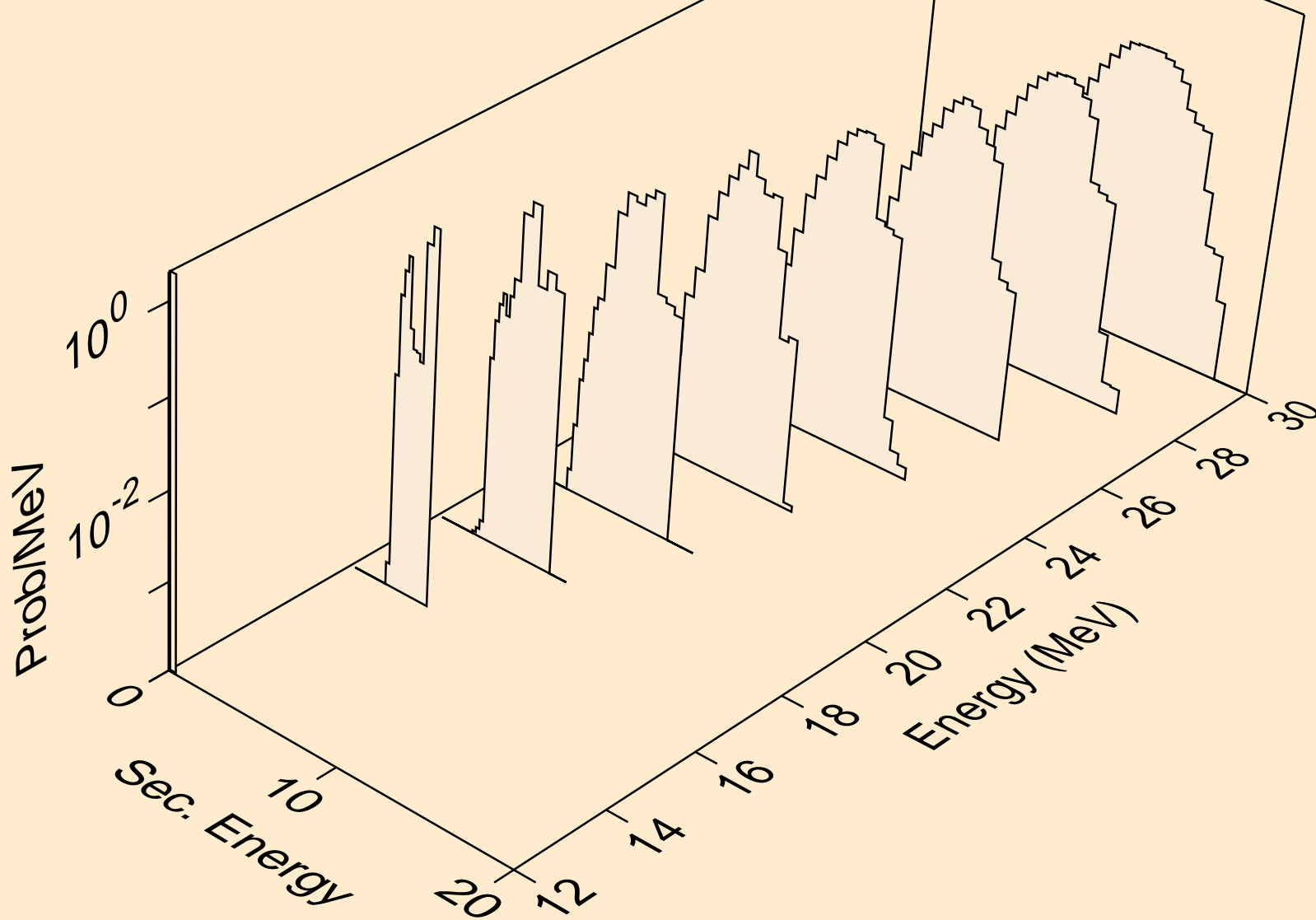

CM232 NEUTRON ACER TENDL-2019 LIBRARY; T=293.16K
protons from (n,2np)

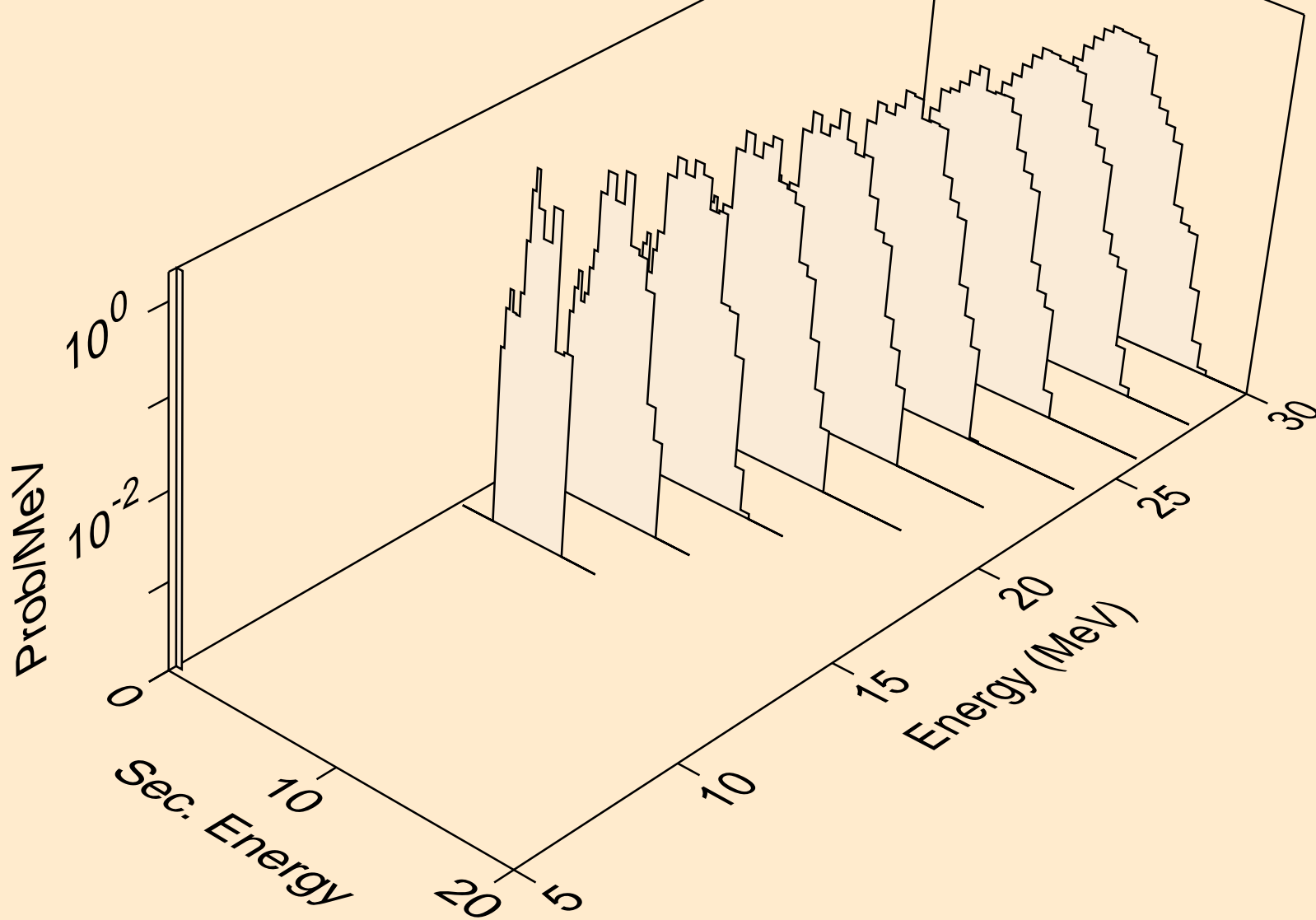

CM232 NEUTRON ACER TENDL-2019 LIBRARY; T=293.16K
protons from (n,npa)

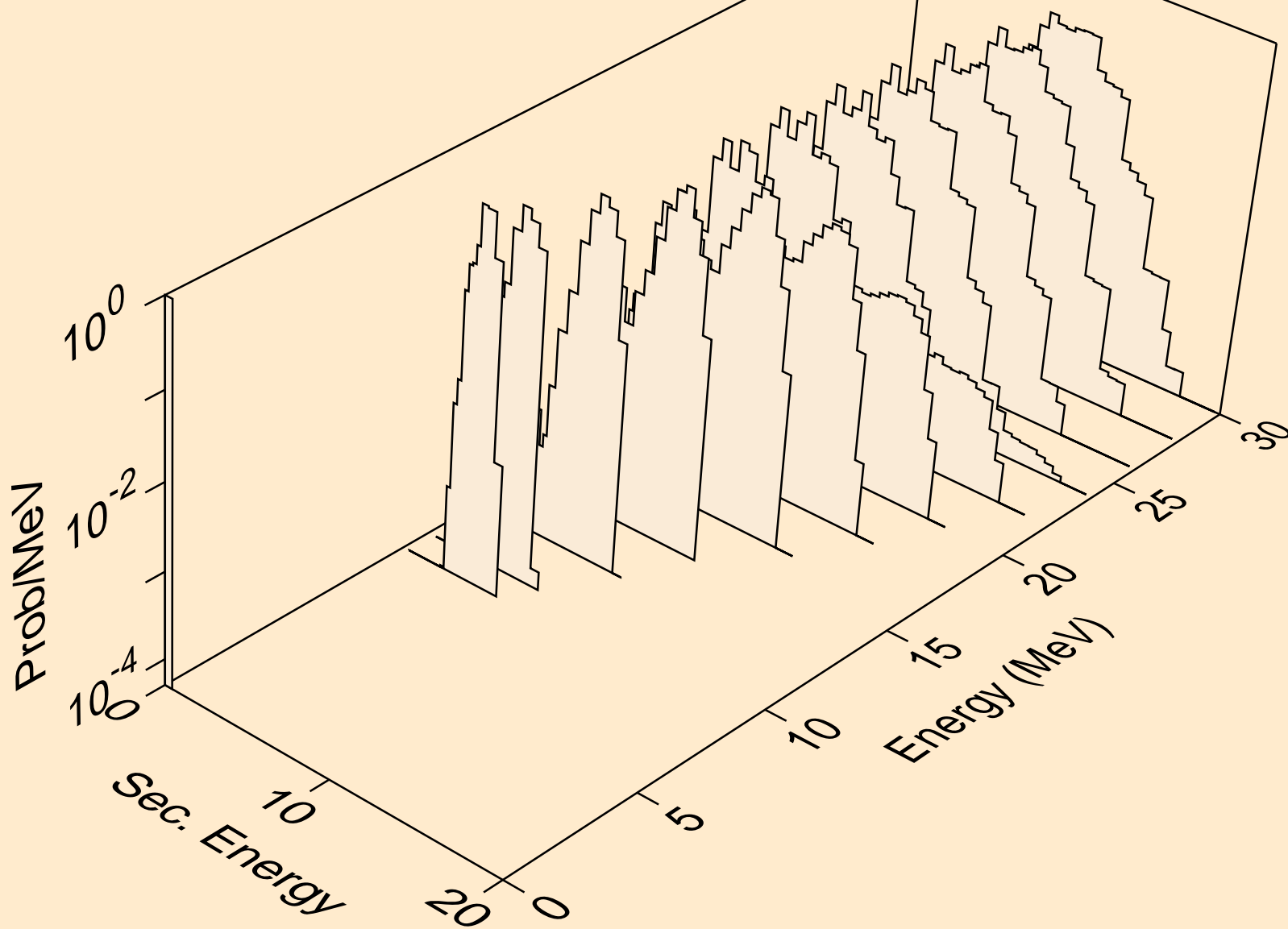

CM232 NEUTRON ACER TENDL-2019 LIBRARY; T=293.16K
protons from (n,p)

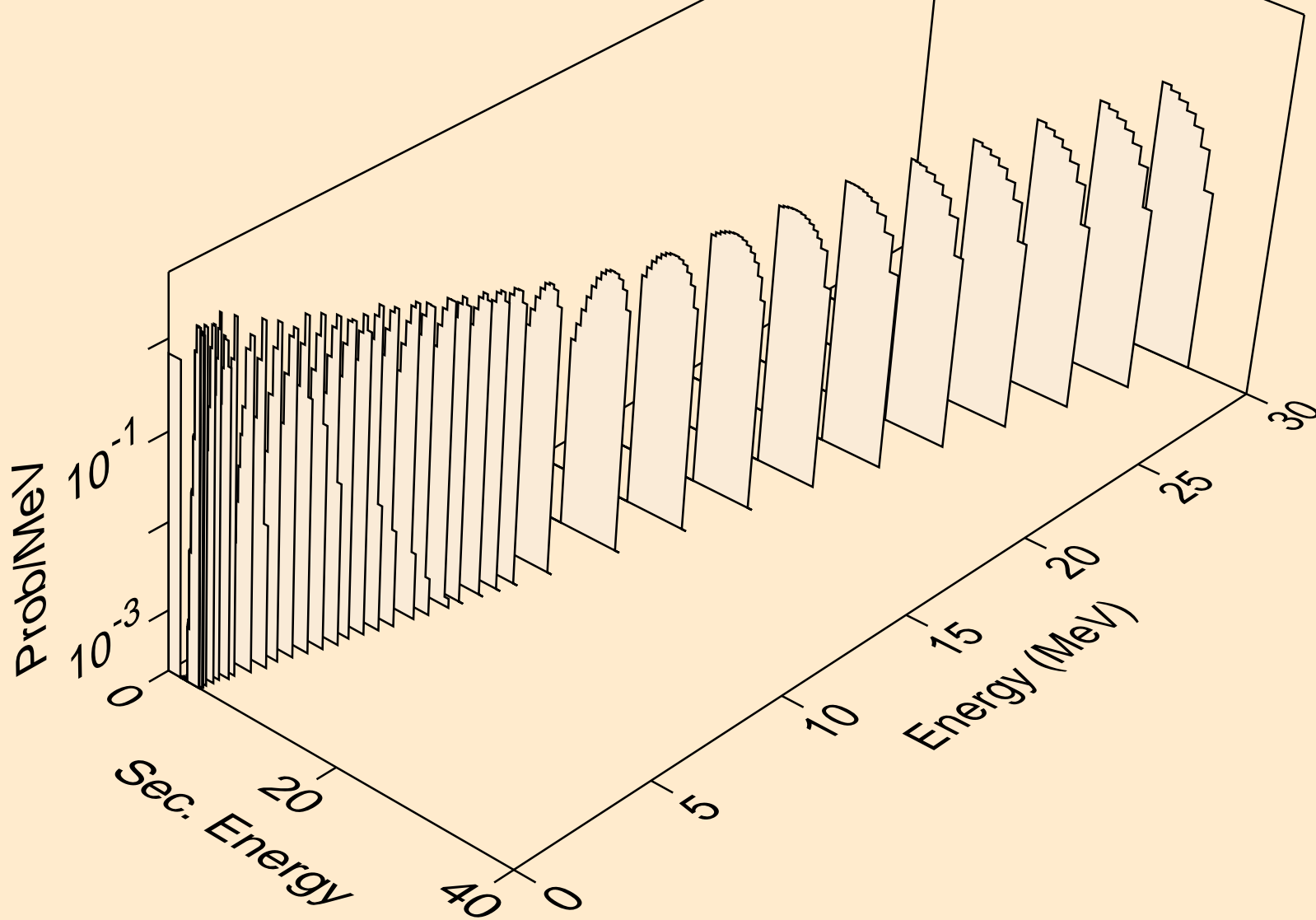

CM232 NEUTRON ACER TENDL-2019 LIBRARY; T=293.16K
protons from (n,2p)

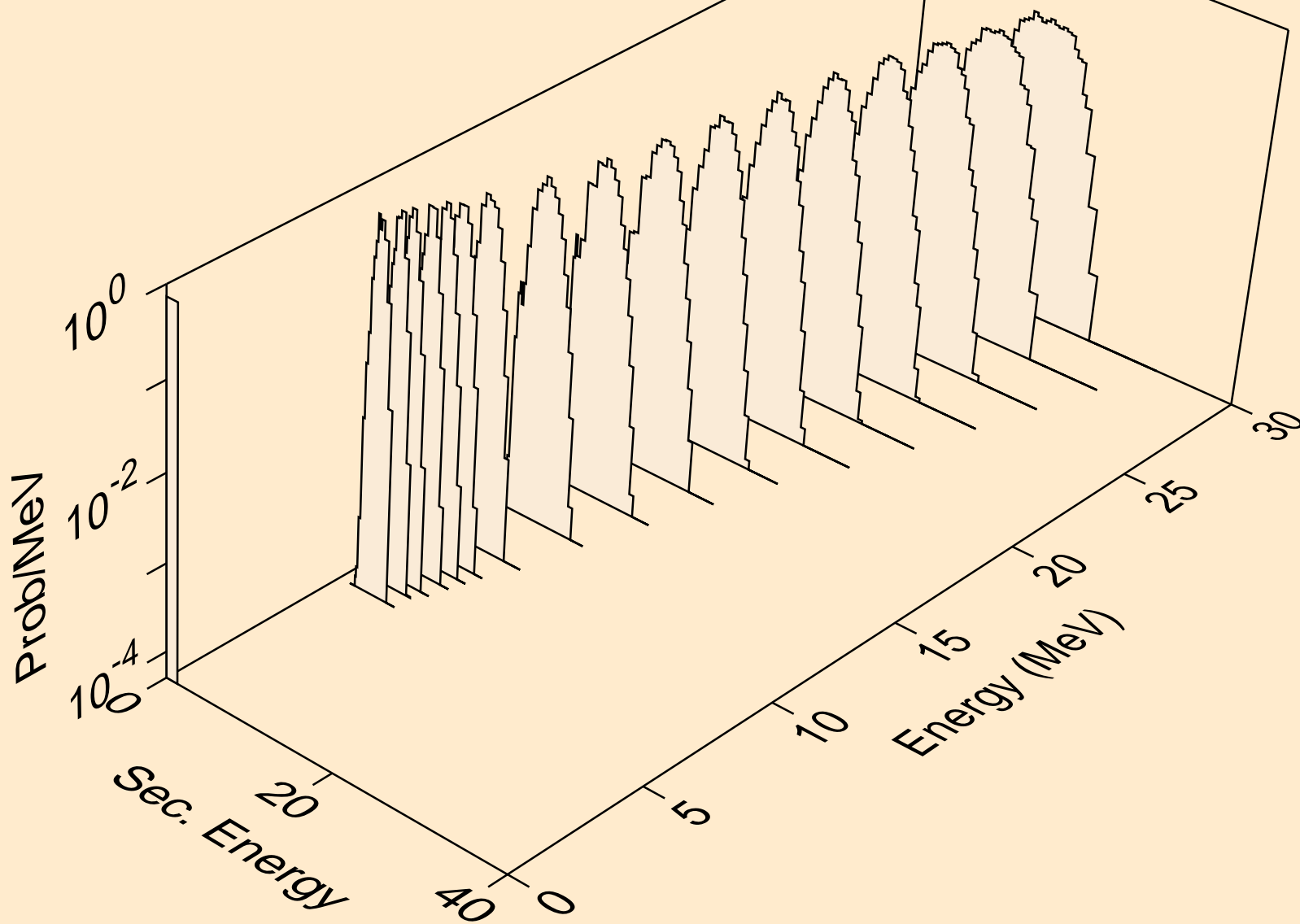

CM232 NEUTRON ACER TENDL-2019 LIBRARY; T=293.16K
protons from (n,p)

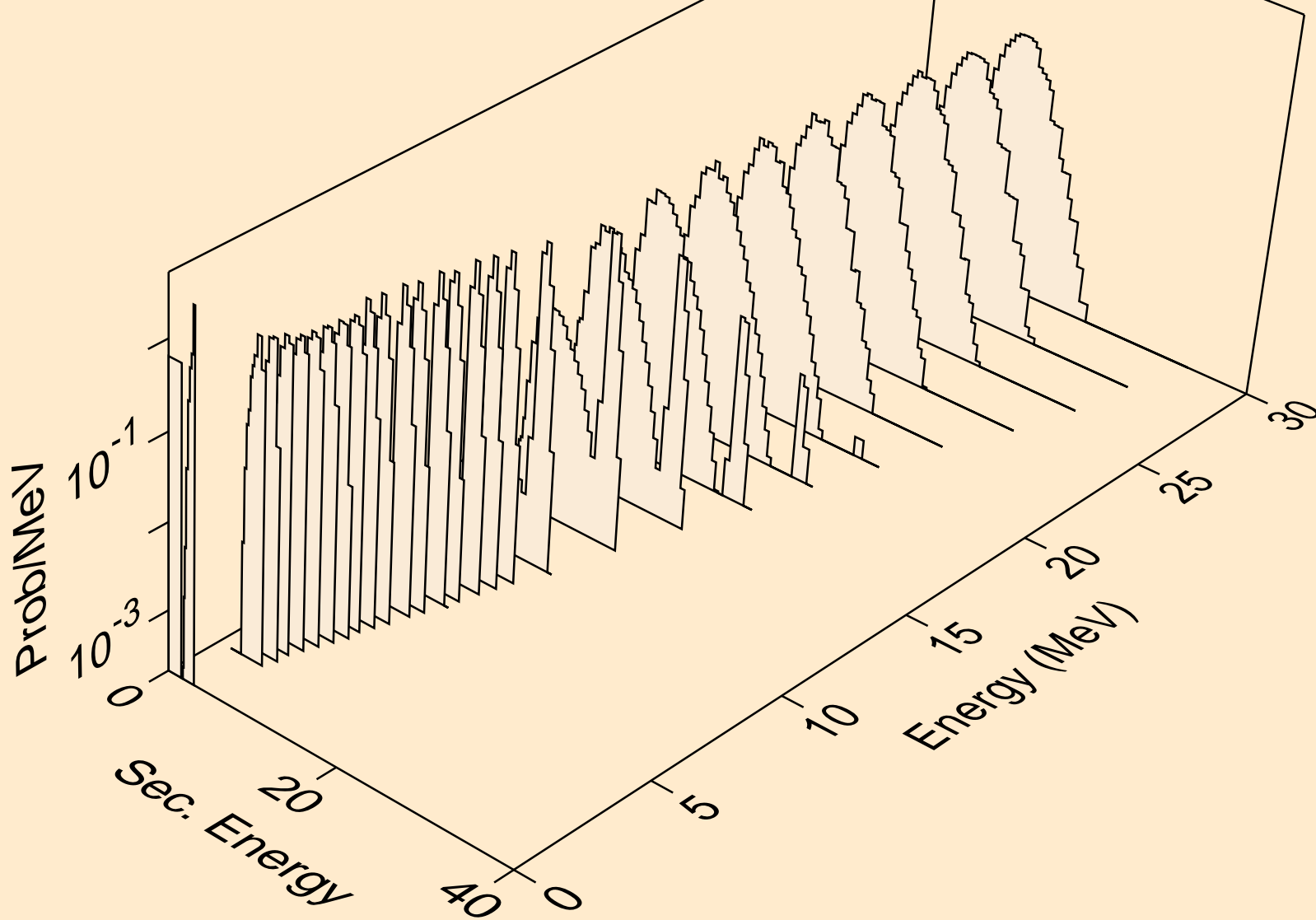

CM232 NEUTRON ACER TENDL-2019 LIBRARY; T=293.16K
protons from (n,pd)

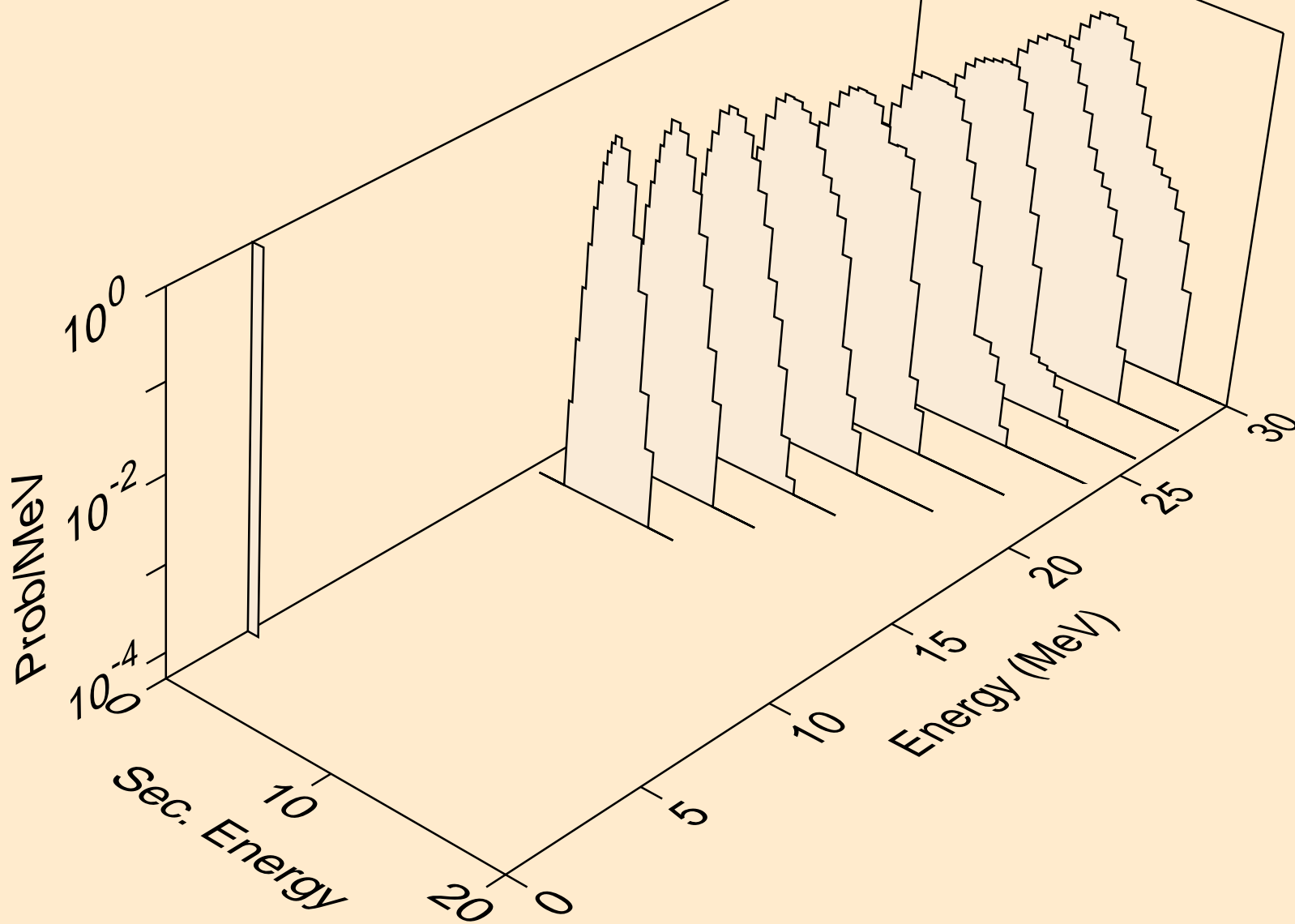

CM232 NEUTRON ACER TENDL-2019 LIBRARY; T=293.16K
deuterons from (n,x)

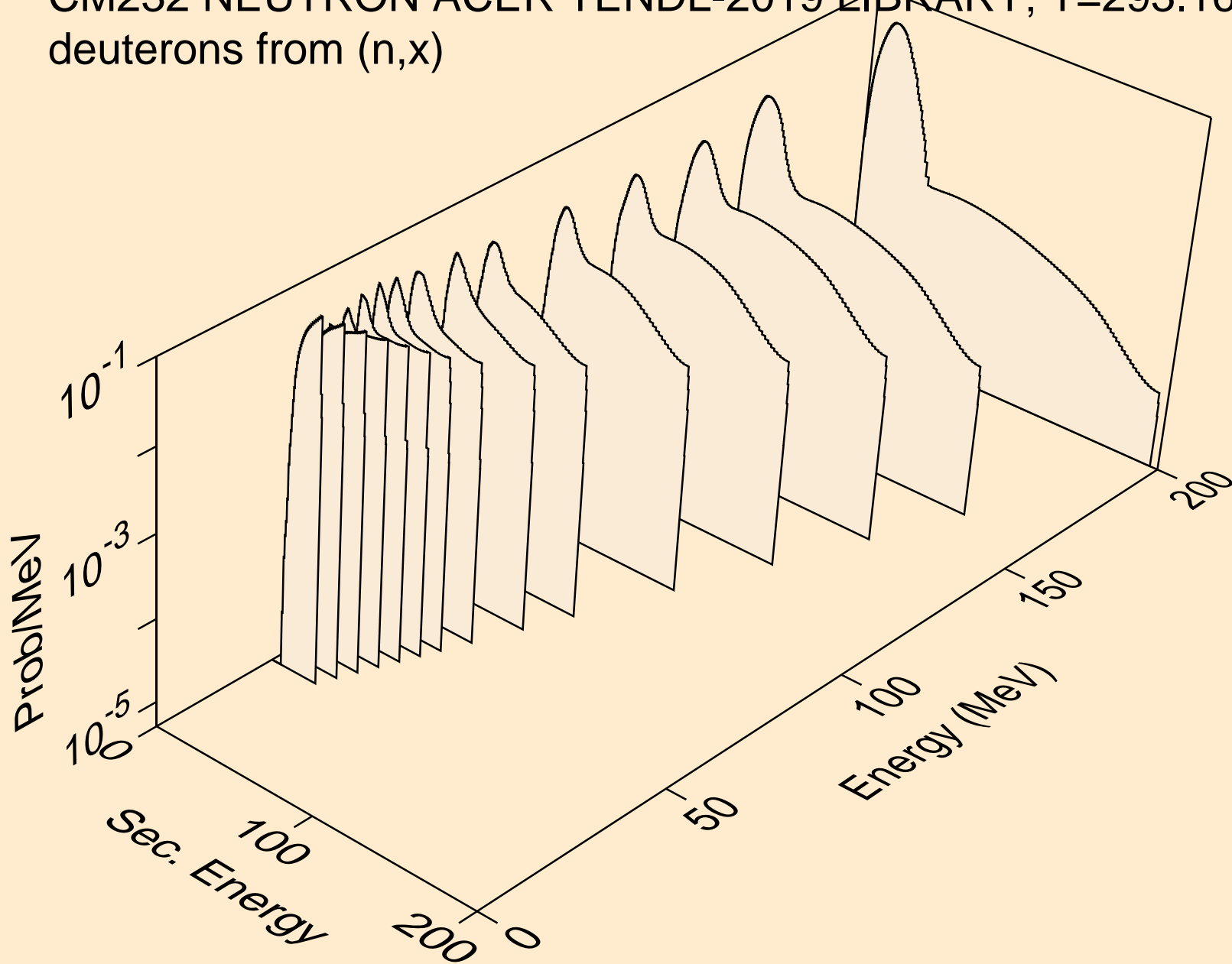

CM232 NEUTRON ACER TENDL-2019 LIBRARY; T=293.16K
deuterons from (n,n*)d

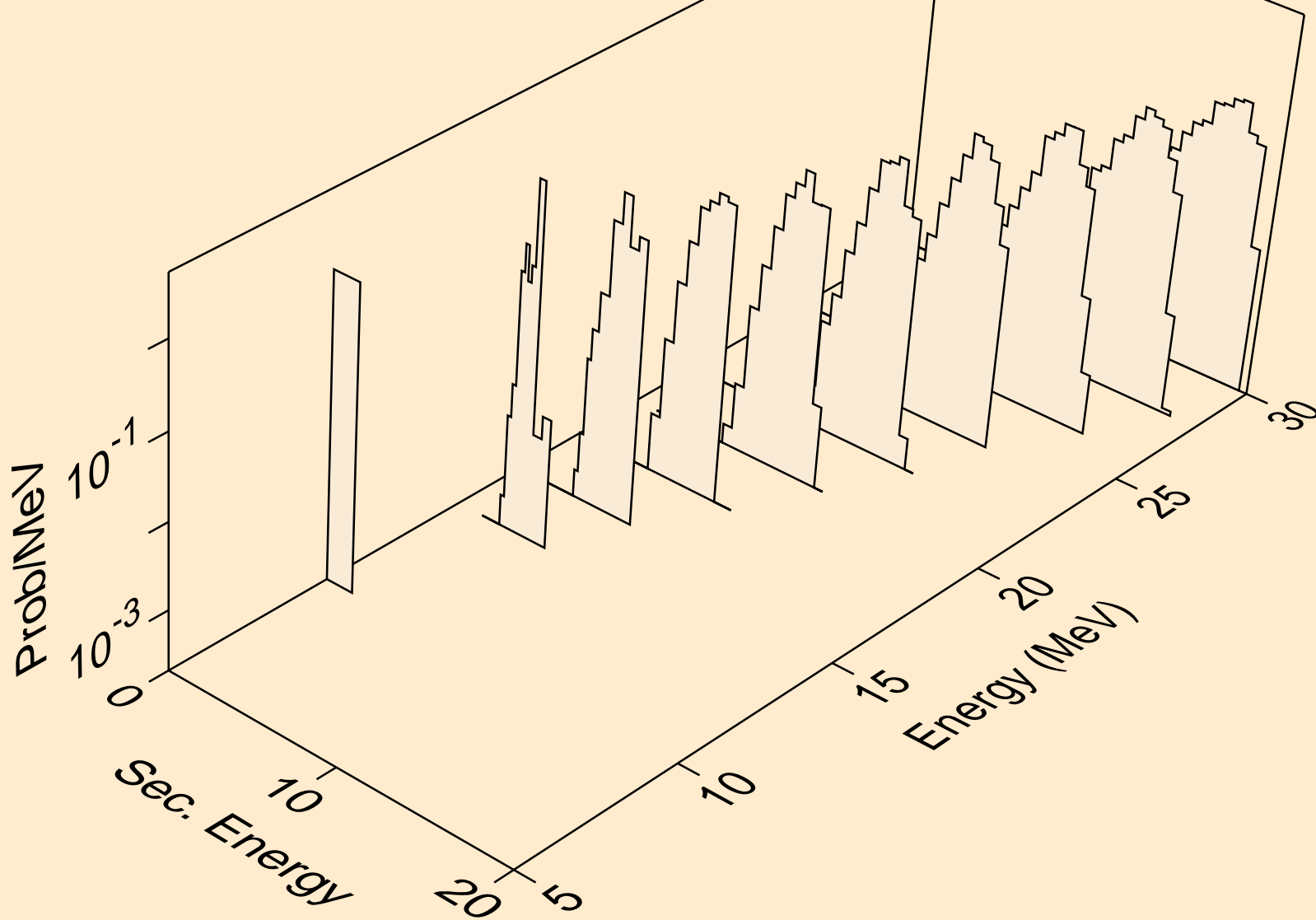

CM232 NEUTRON ACER TENDL-2019 LIBRARY; T=293.16K
deuterons from (n,d)

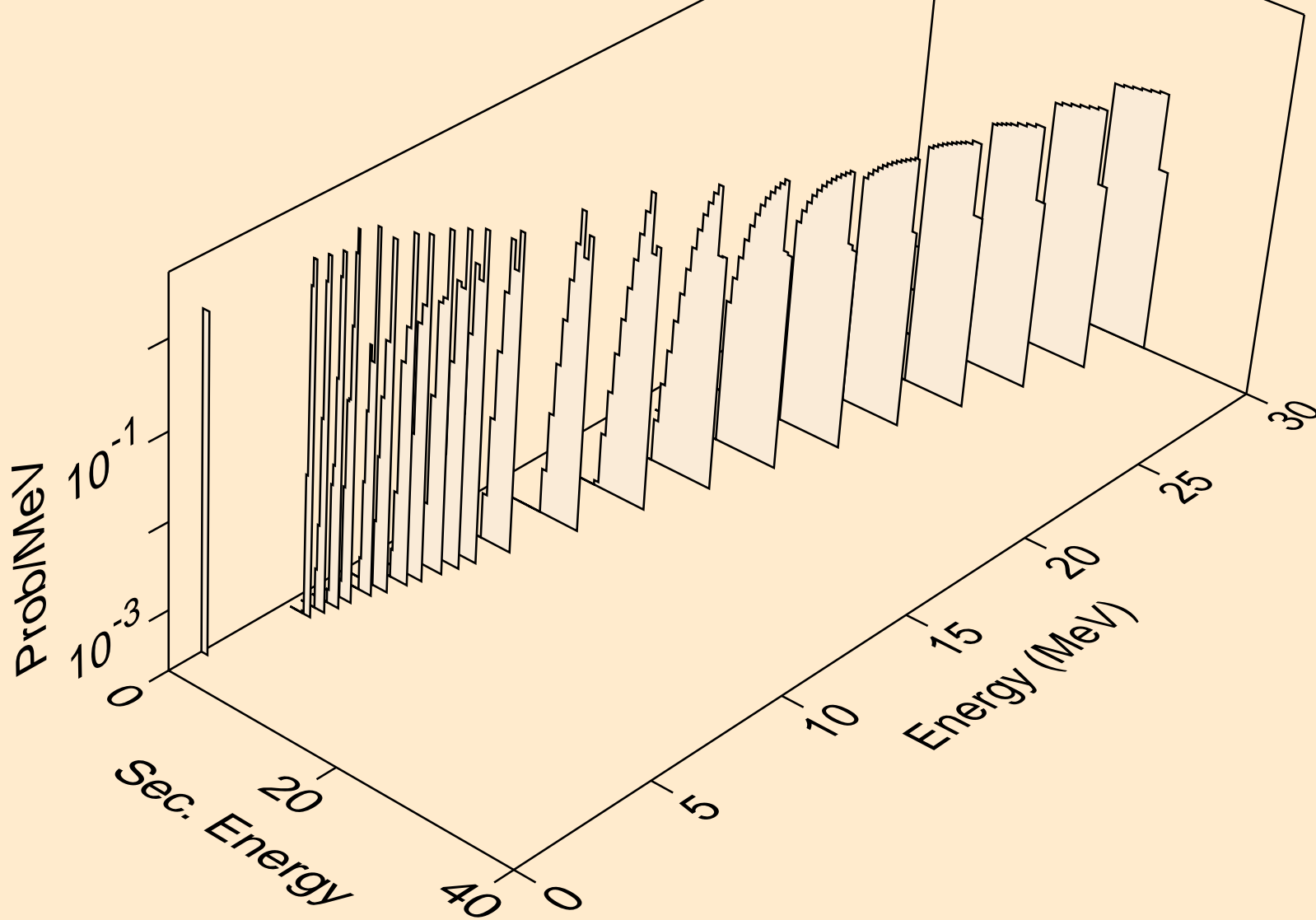

CM232 NEUTRON ACER TENDL-2019 LIBRARY; T=293.16K
deuterons from (n,pd)

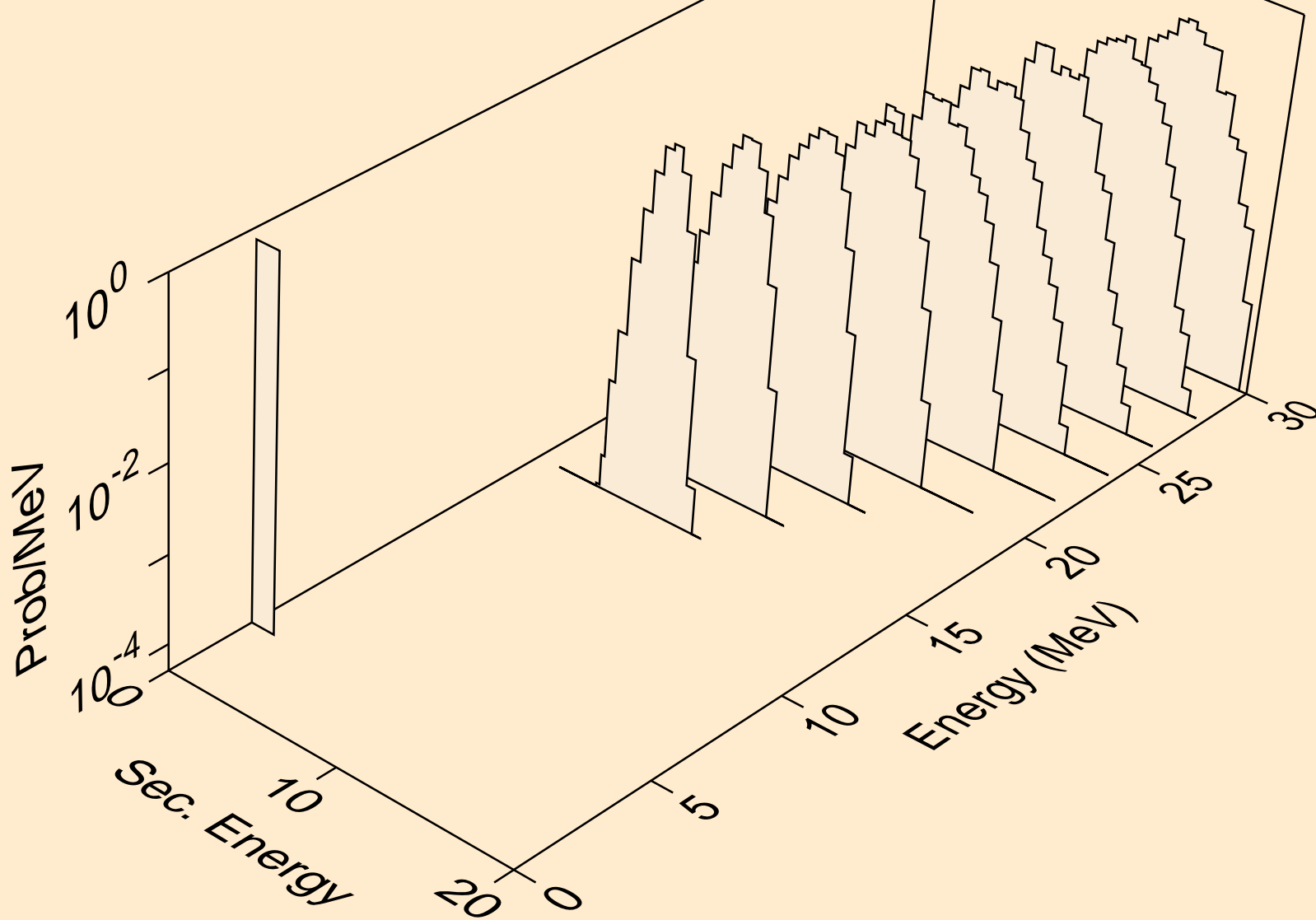

CM232 NEUTRON ACER TENDL-2019 LIBRARY; T=293.16K
deuterons from (n,da)

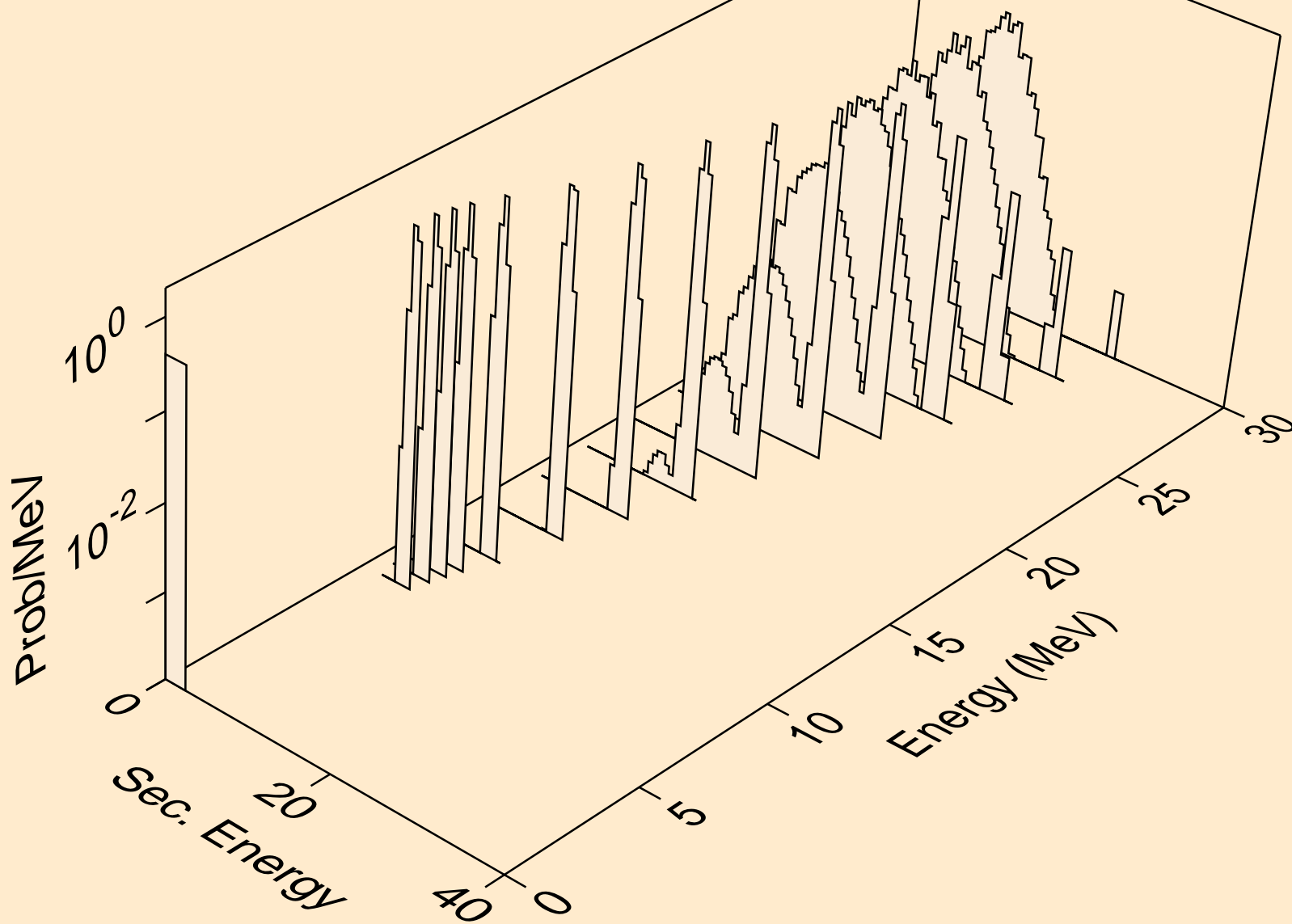

CM232 NEUTRON ACER TENDL-2019 LIBRARY; T=293.16K
tritons from (n,x)

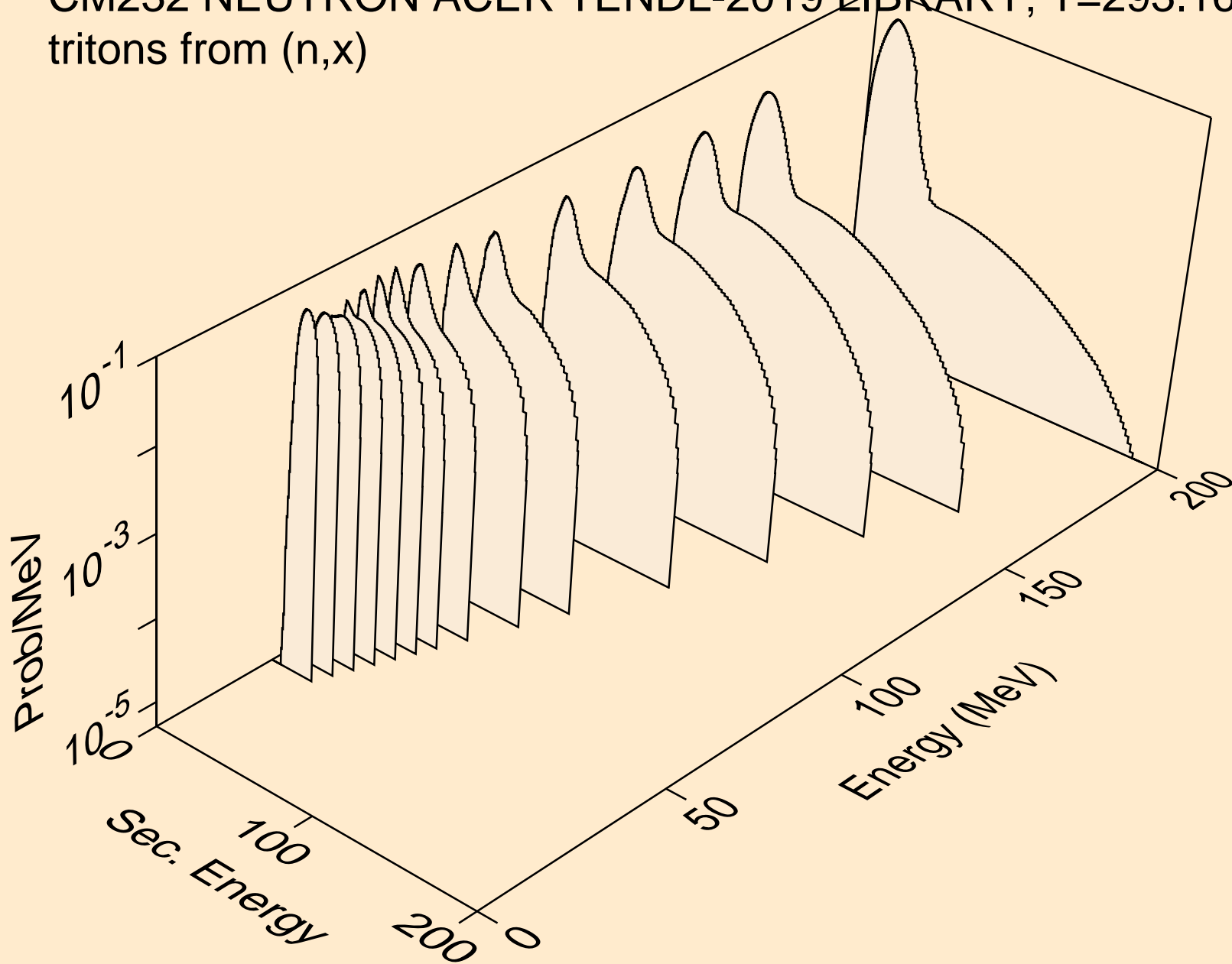

CM232 NEUTRON ACER TENDL-2019 LIBRARY; T=293.16K
tritons from (n,n*)t

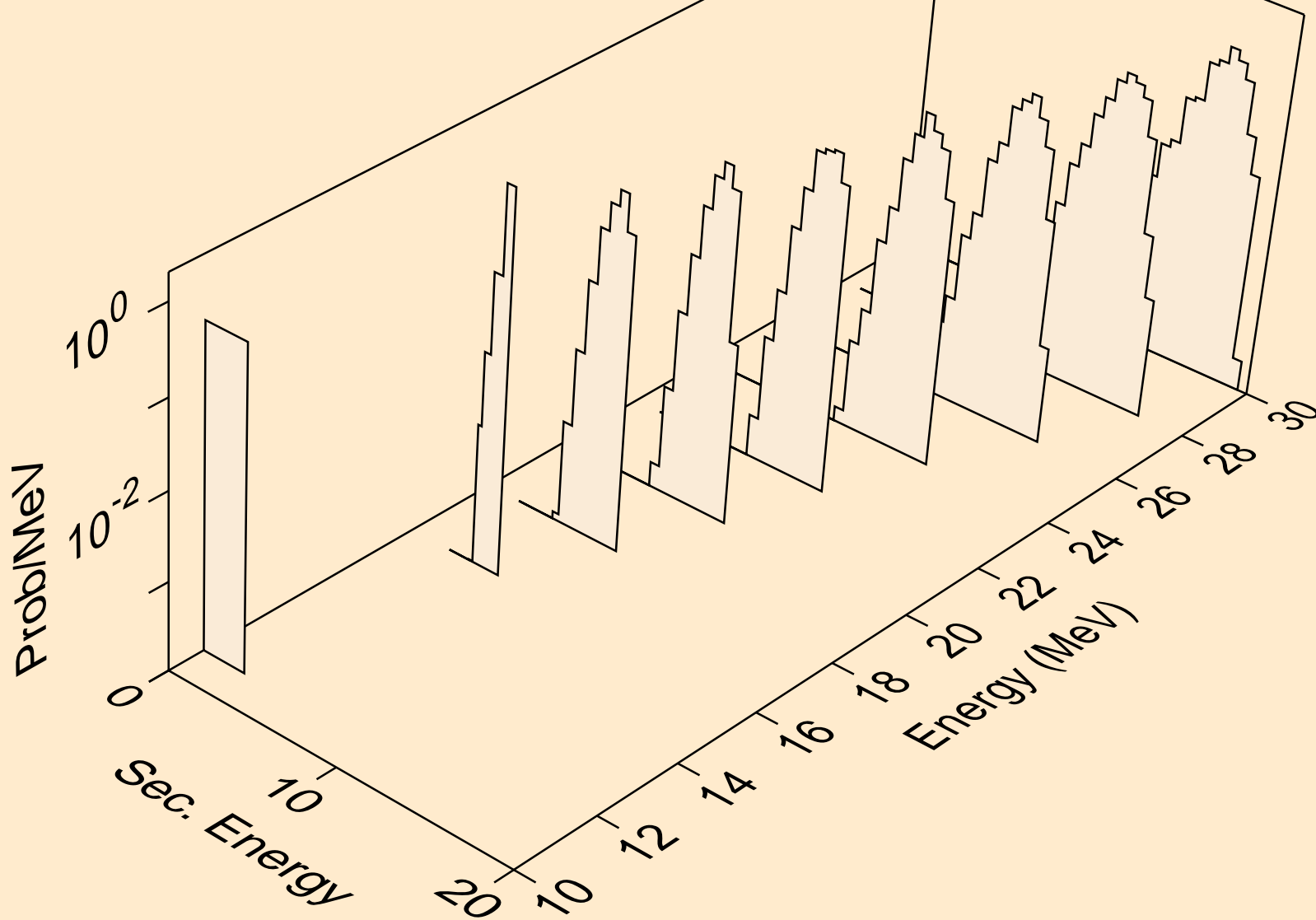

CM232 NEUTRON ACER TENDL-2019 LIBRARY; T=293.16K
tritons from (n,t)

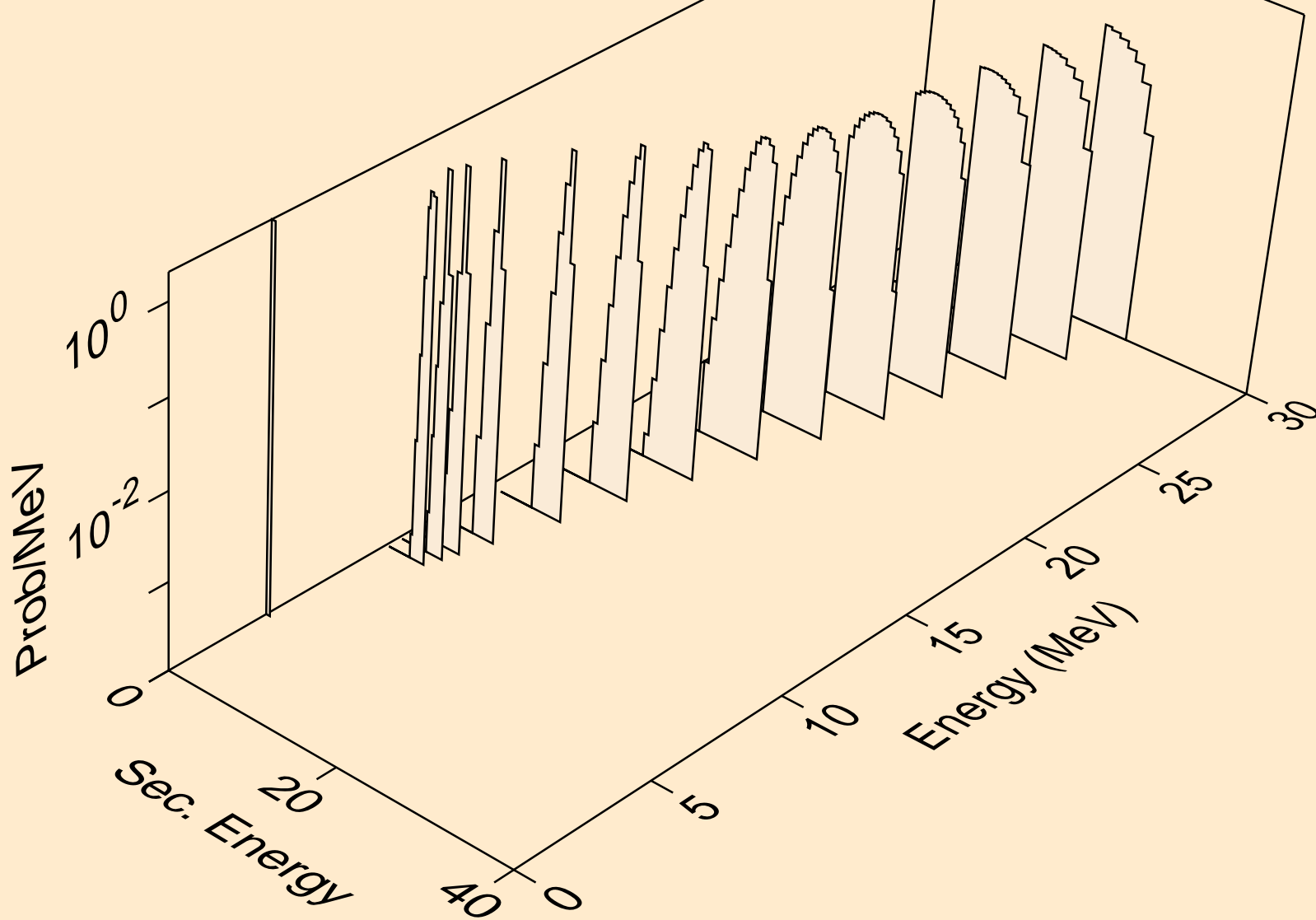

CM232 NEUTRON ACER TENDL-2019 LIBRARY; T=293.16K
he3s from (n,x)

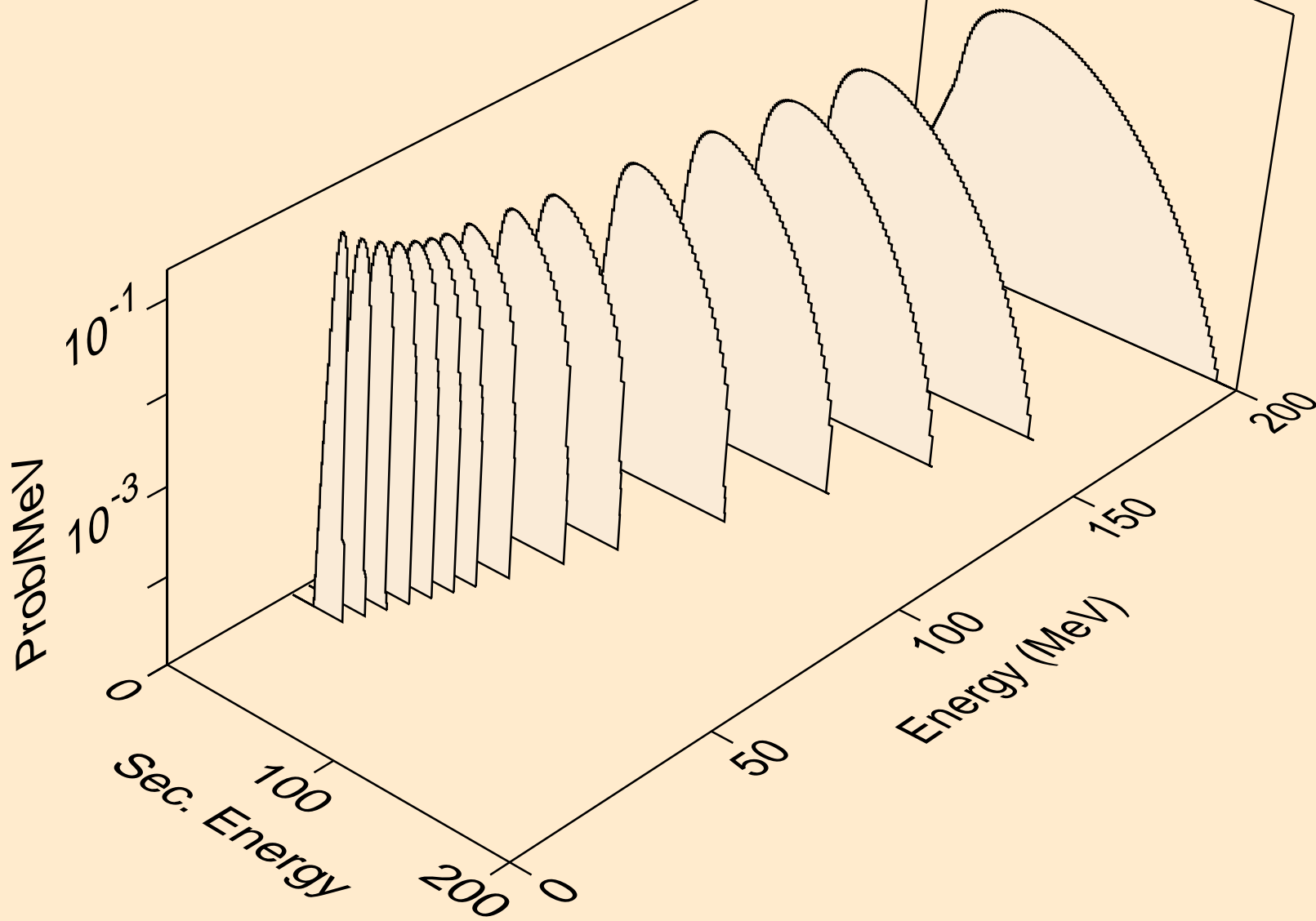

CM232 NEUTRON ACER TENDL-2019 LIBRARY; T=293.16K
he3s from (n,n*)he3

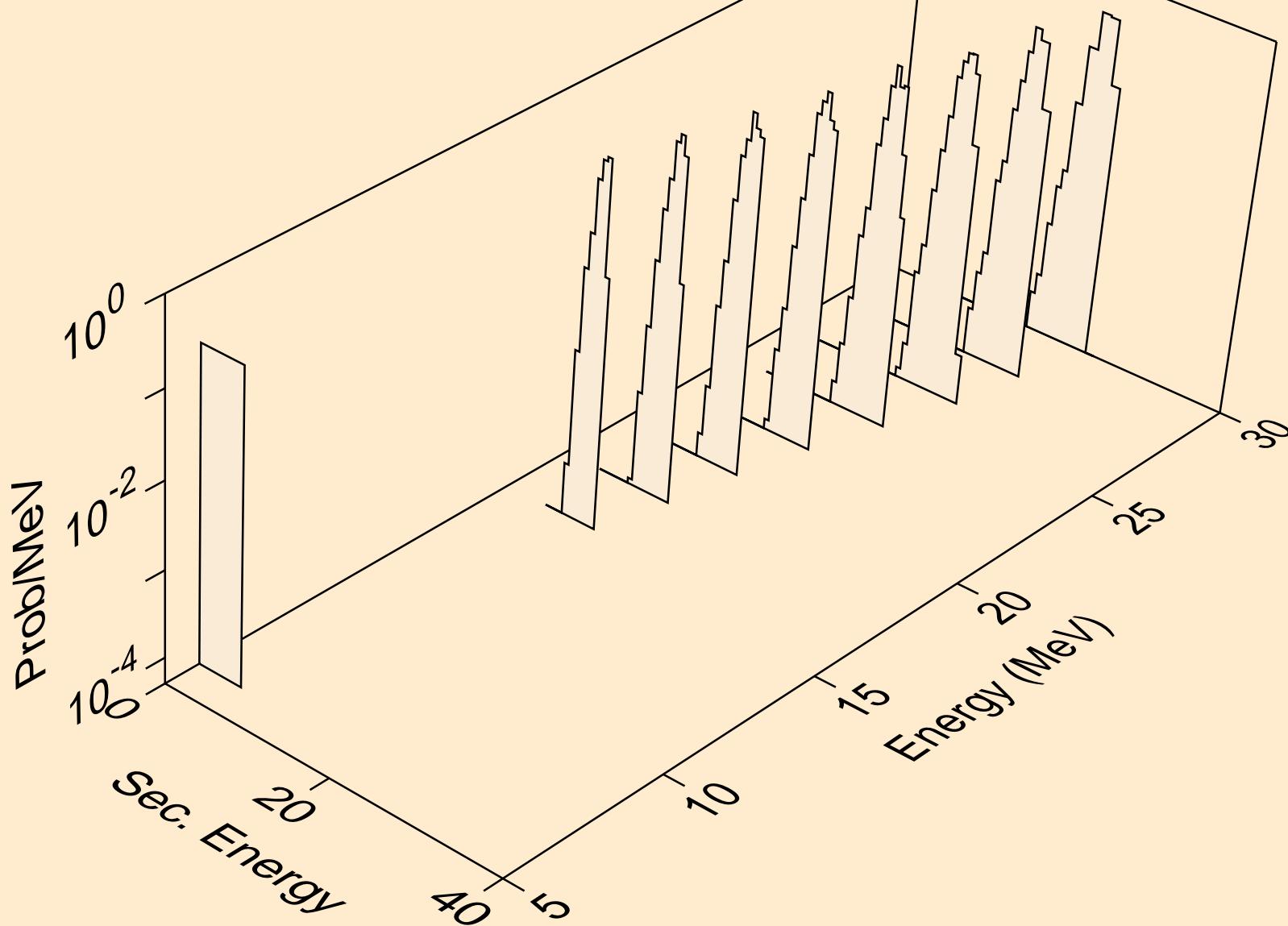

CM232 NEUTRON ACER TENDL-2019 LIBRARY; T=293.16K
he3s from (n,he3)

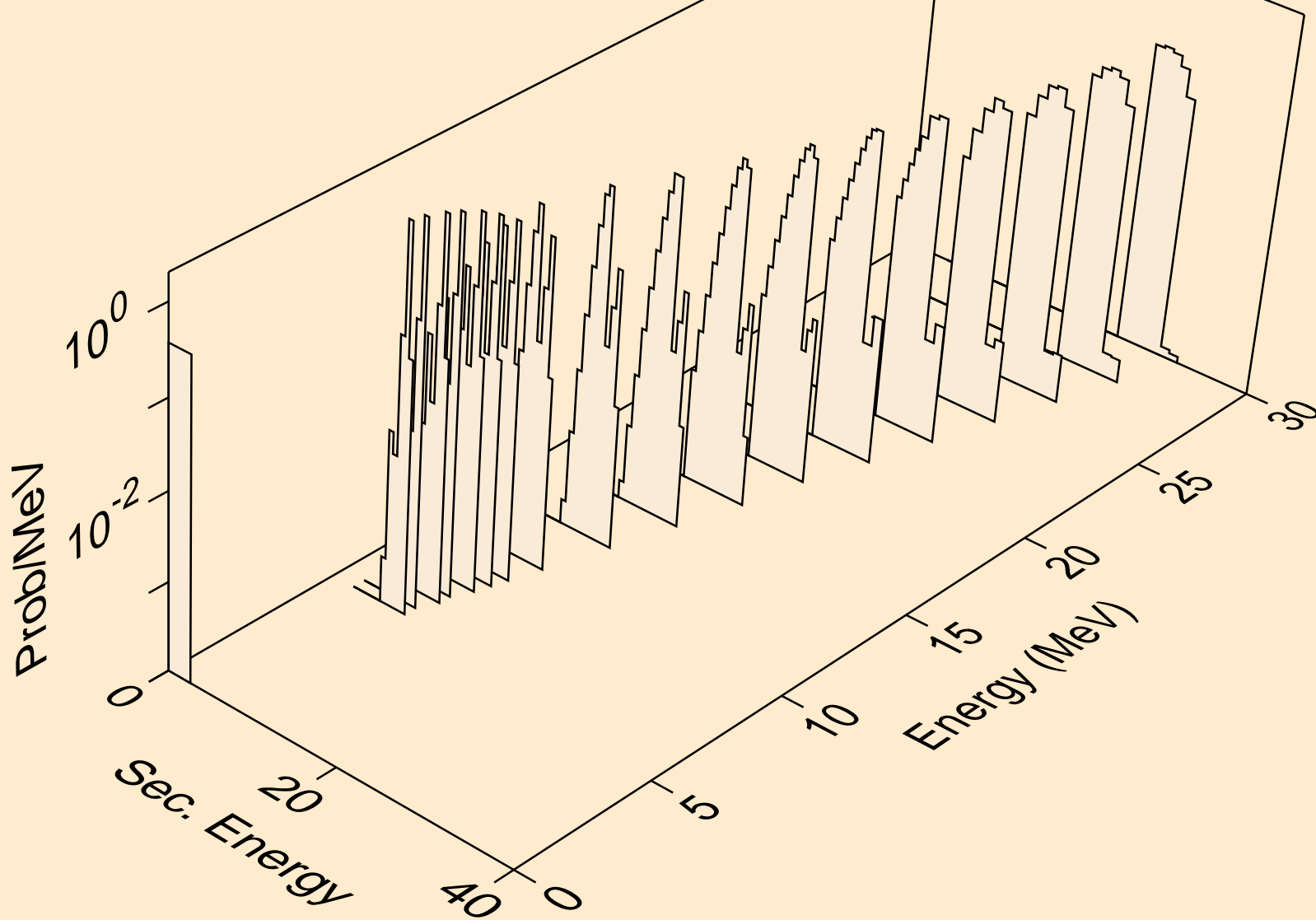

CM232 NEUTRON ACER TENDL-2019 LIBRARY; T=293.16K
alphas from (n,x)

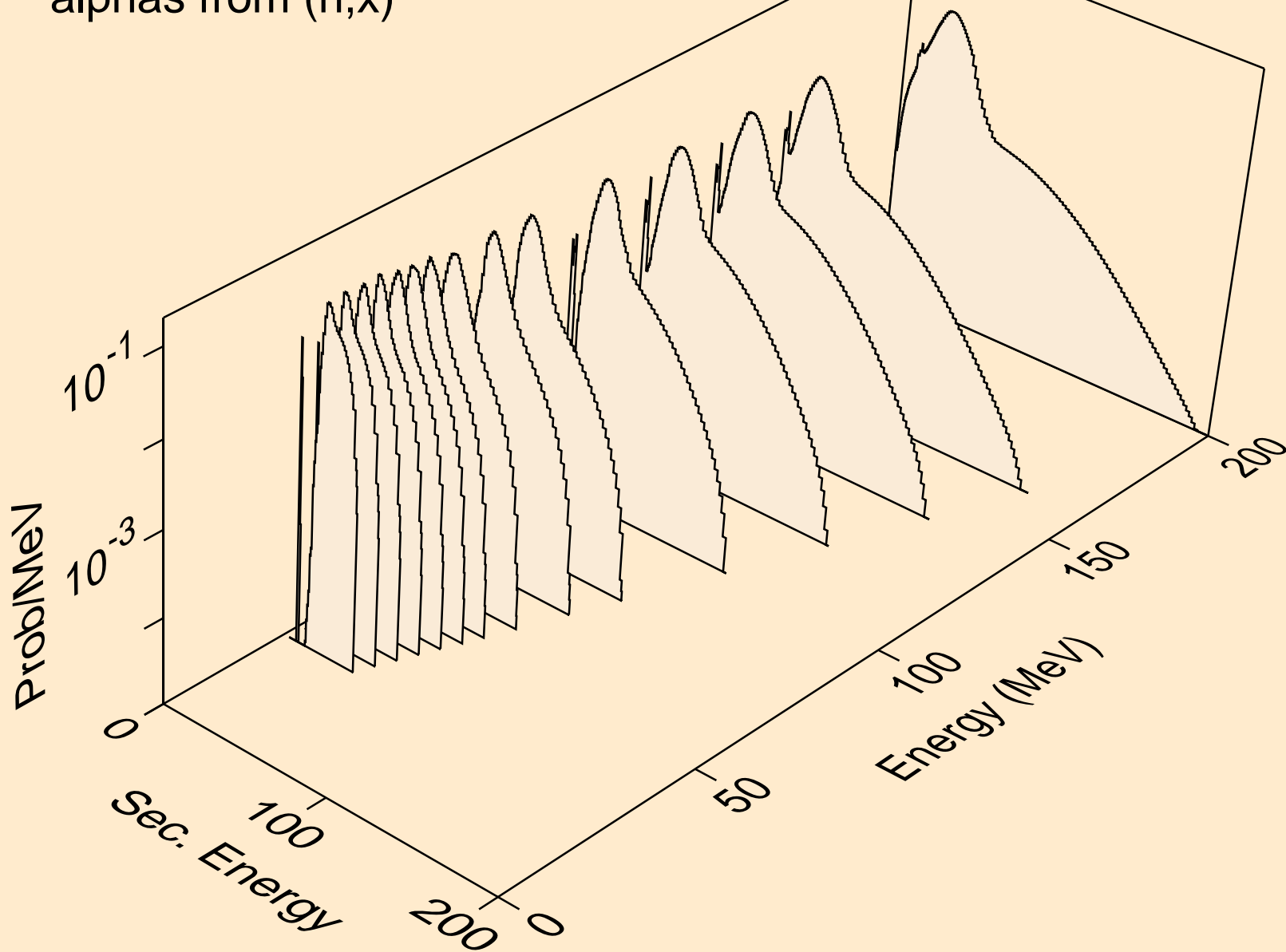

CM232 NEUTRON ACER TENDL-2019 LIBRARY; T=293.16K
alphas from (n,n*)a

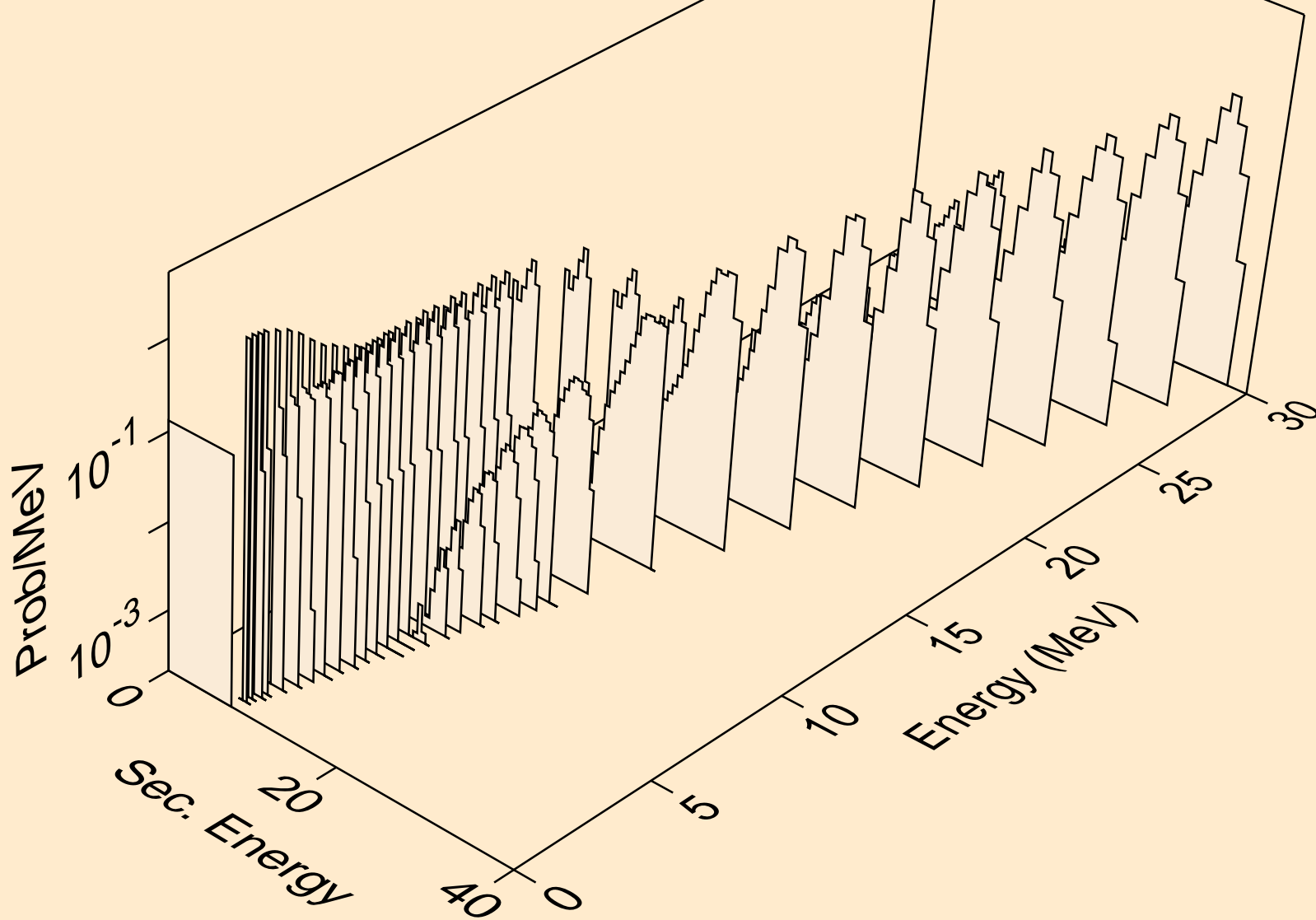

CM232 NEUTRON ACER TENDL-2019 LIBRARY; T=293.16K
alphas from (n,n*)3a

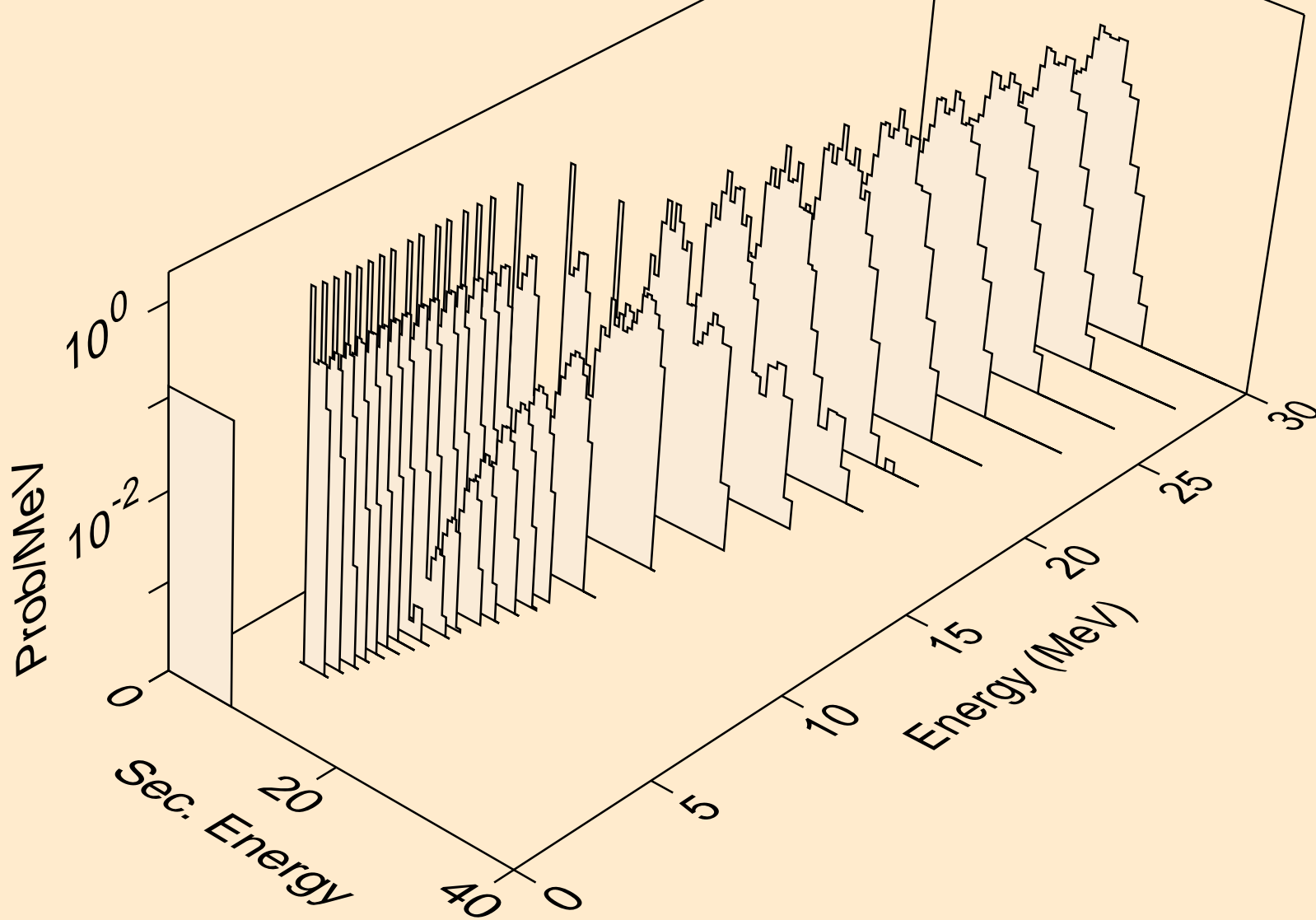

CM232 NEUTRON ACER TENDL-2019 LIBRARY; T=293.16K
alphas from (n,2n)a

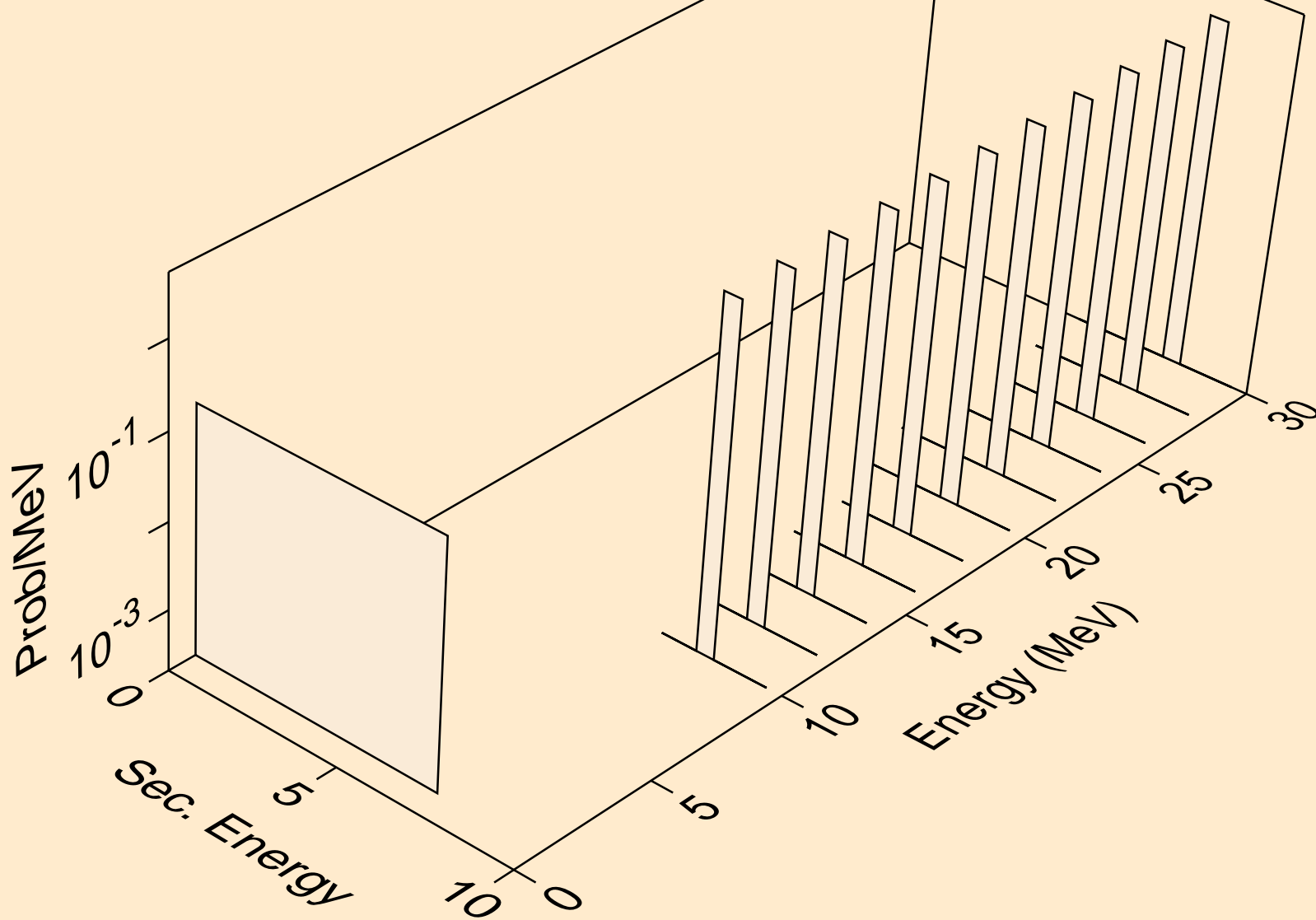

CM232 NEUTRON ACER TENDL-2019 LIBRARY; T=293.16K
alphas from (n,n*)2a

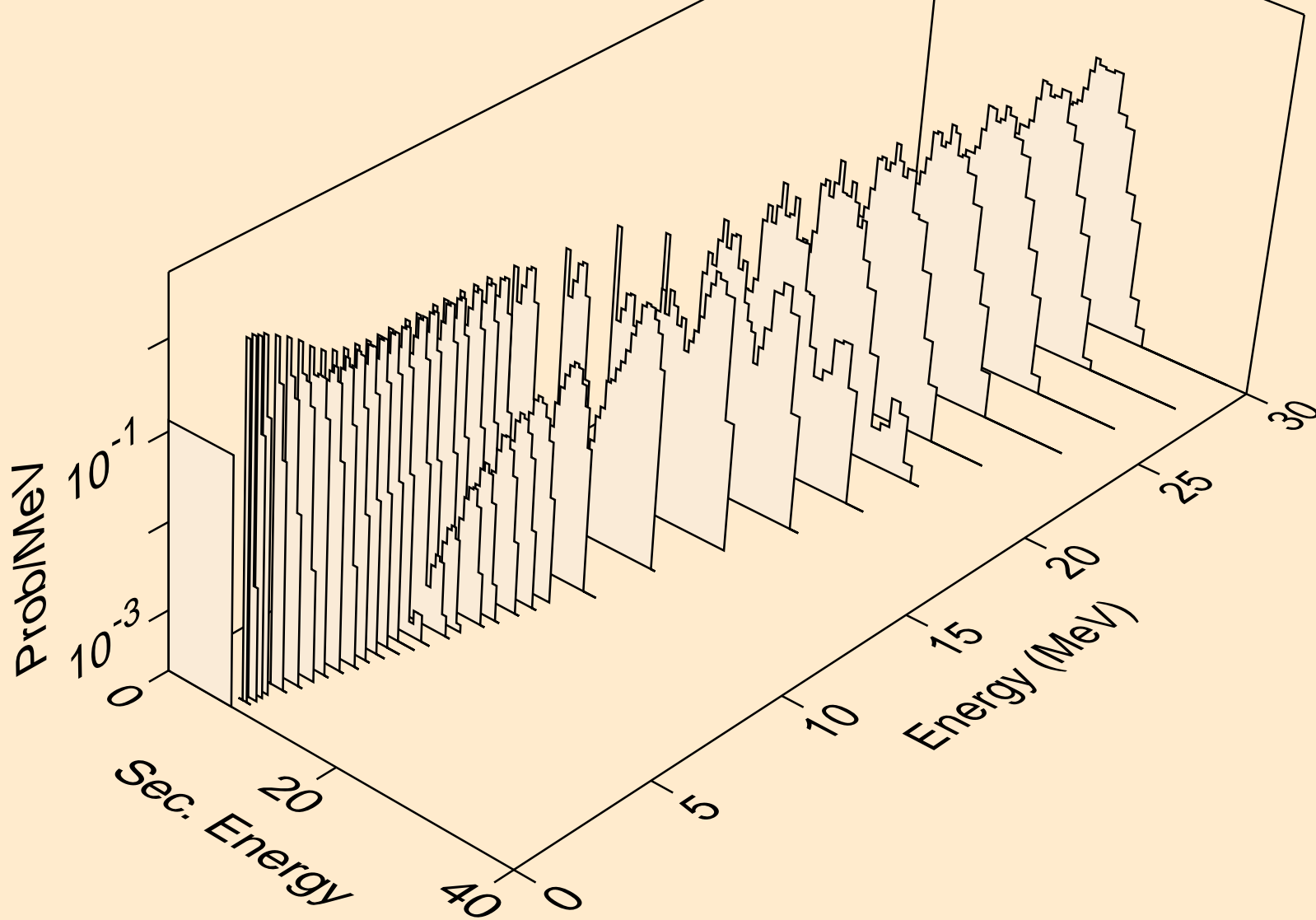

CM232 NEUTRON ACER TENDL-2019 LIBRARY; T=293.16K
alphas from (n,2n)2a

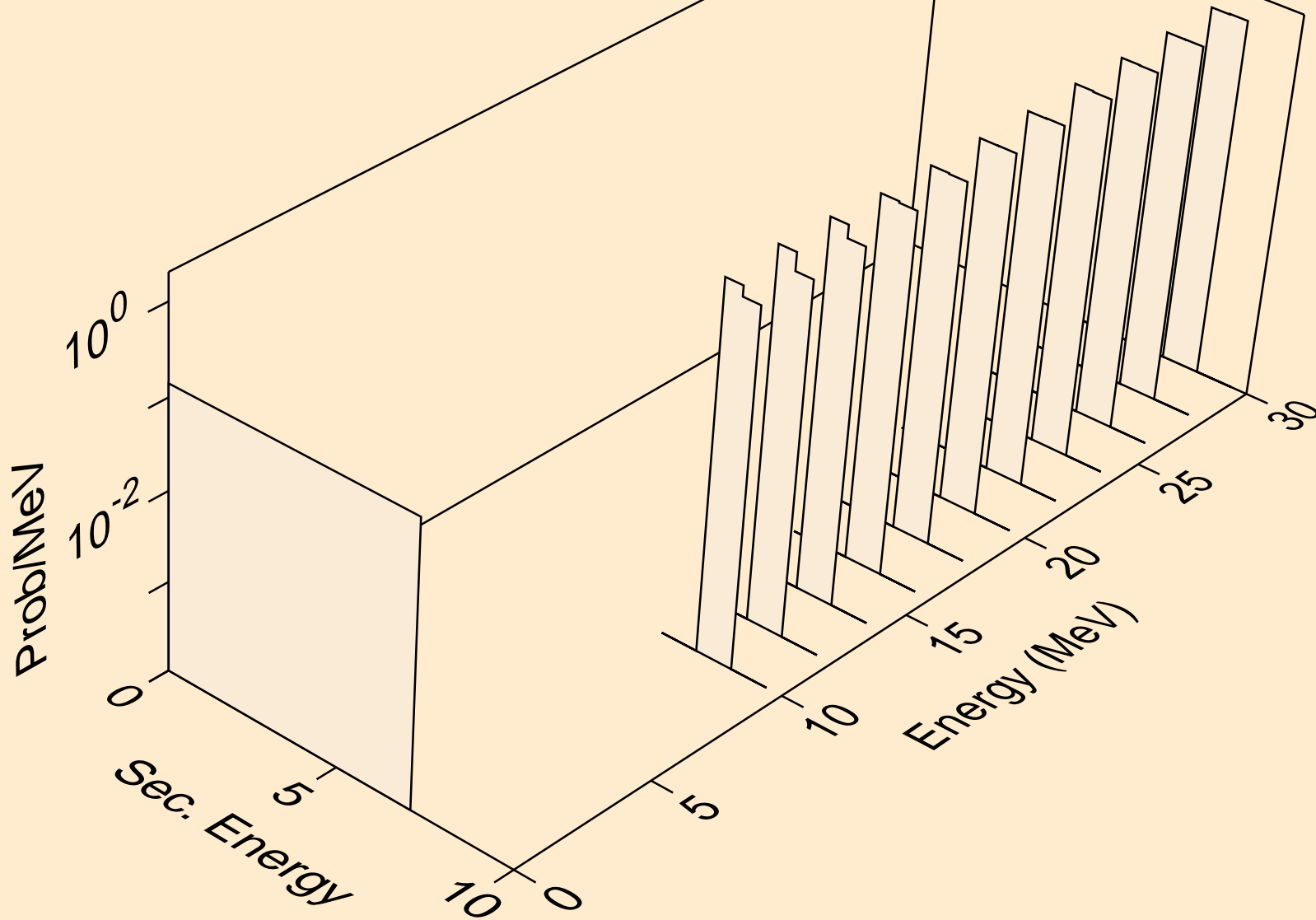

CM232 NEUTRON ACER TENDL-2019 LIBRARY; T=293.16K
alphas from (n,npa)

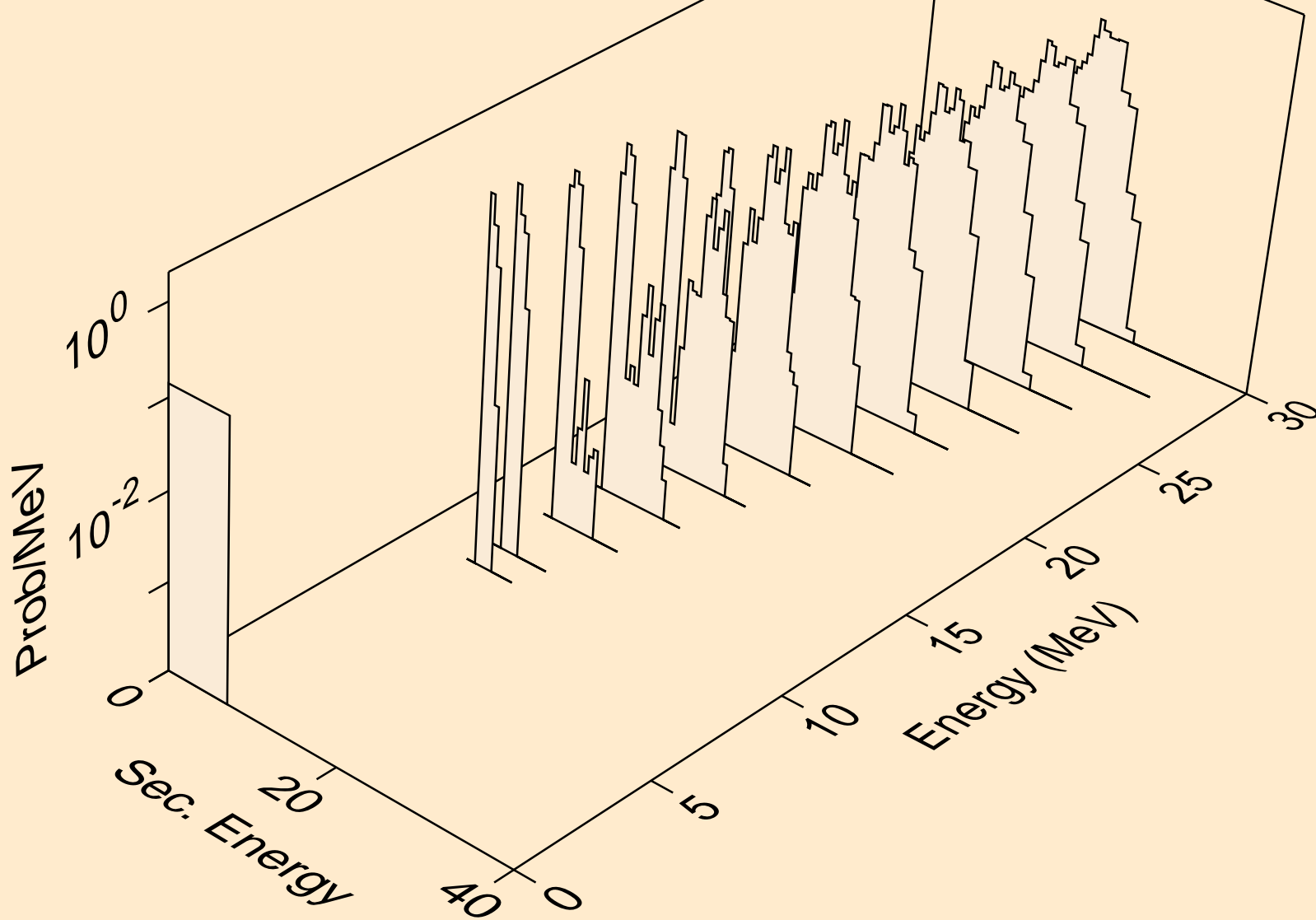

CM232 NEUTRON ACER TENDL-2019 LIBRARY; T=293.16K
alphas from (n,a)

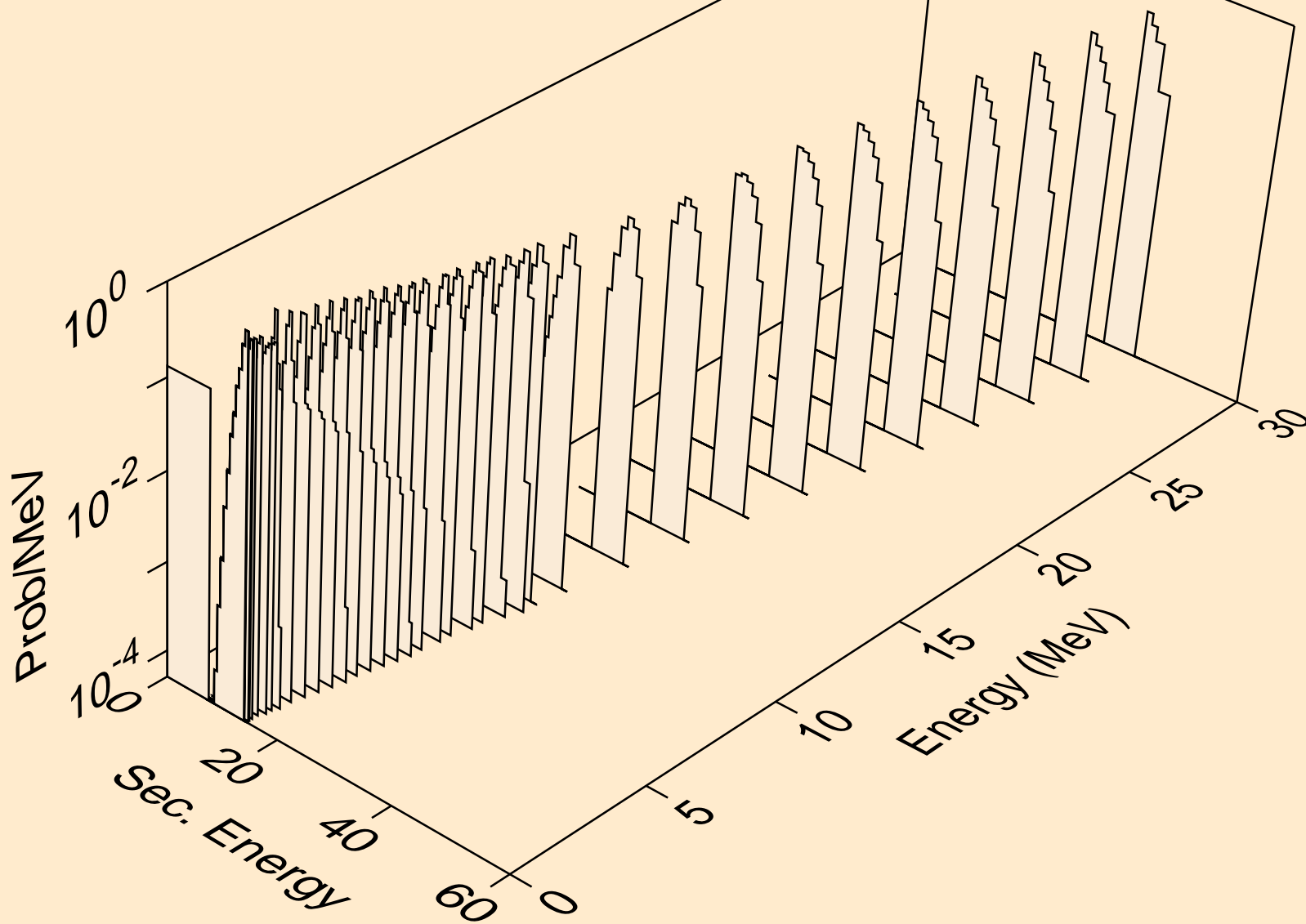

CM232 NEUTRON ACER TENDL-2019 LIBRARY; T=293.16K
alphas from (n,2a)

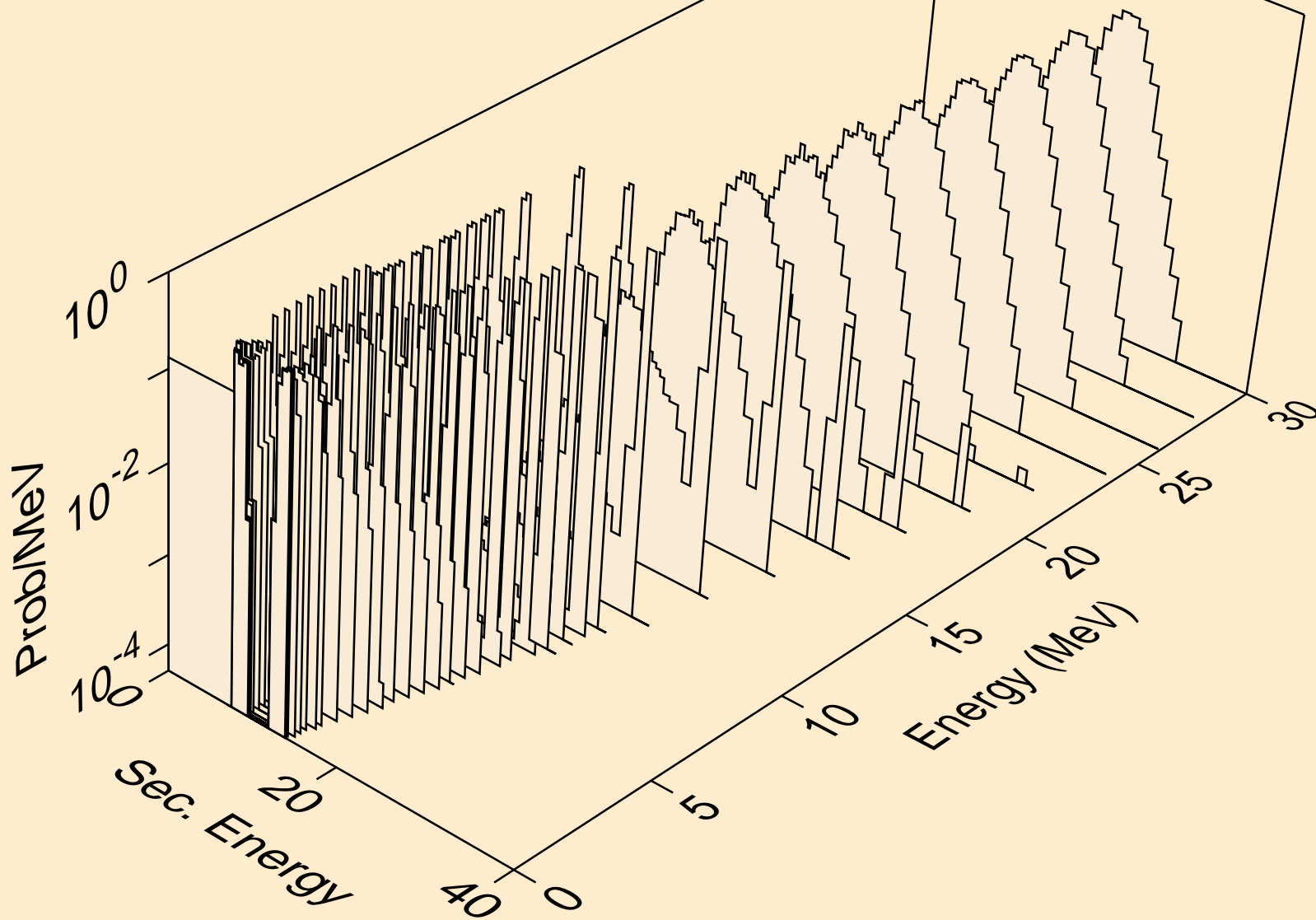

CM232 NEUTRON ACER TENDL-2019 LIBRARY; T=293.16K
alphas from (n,3a)

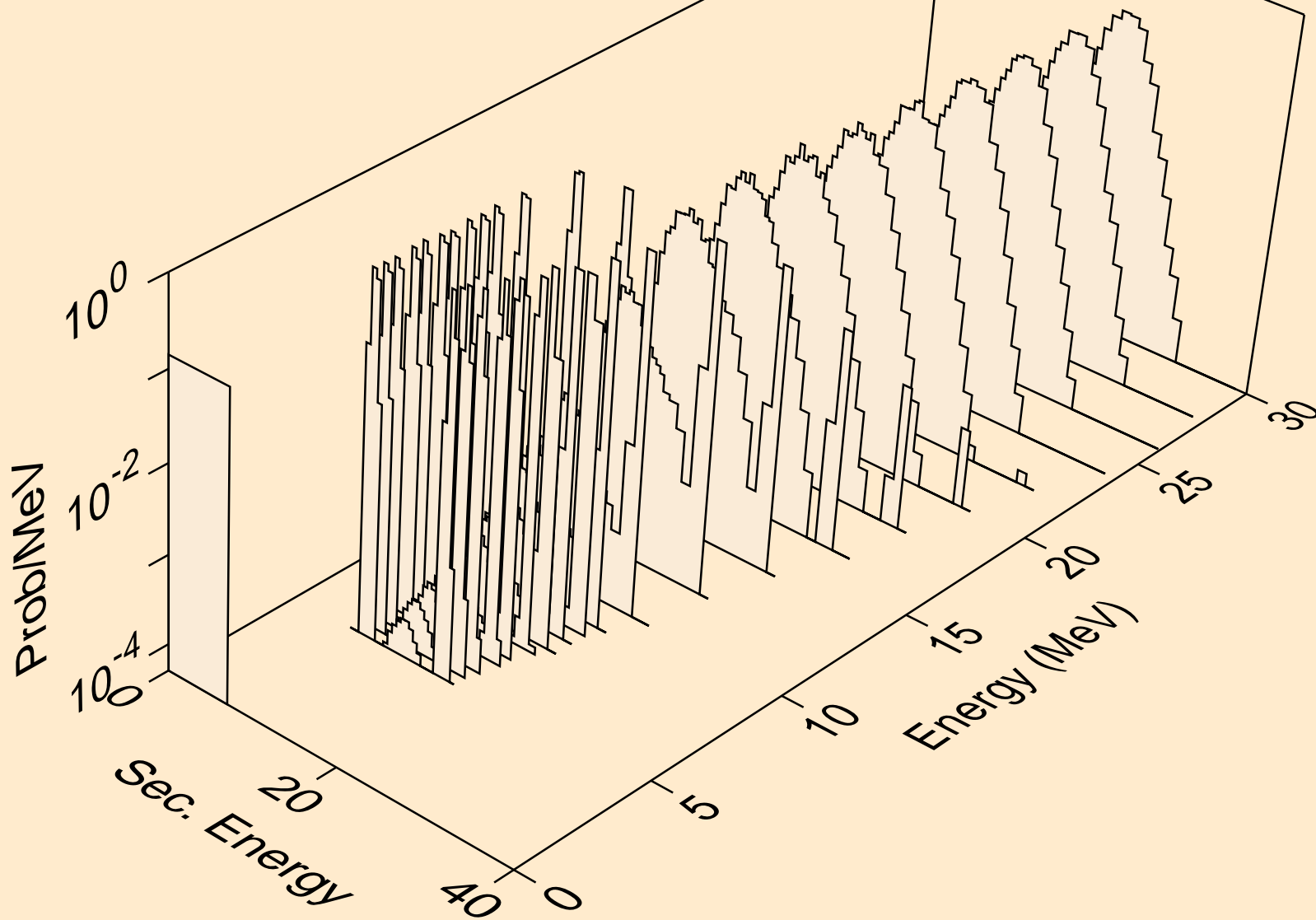

CM232 NEUTRON ACER TENDL-2019 LIBRARY; T=293.16K
alphas from (n,pa)

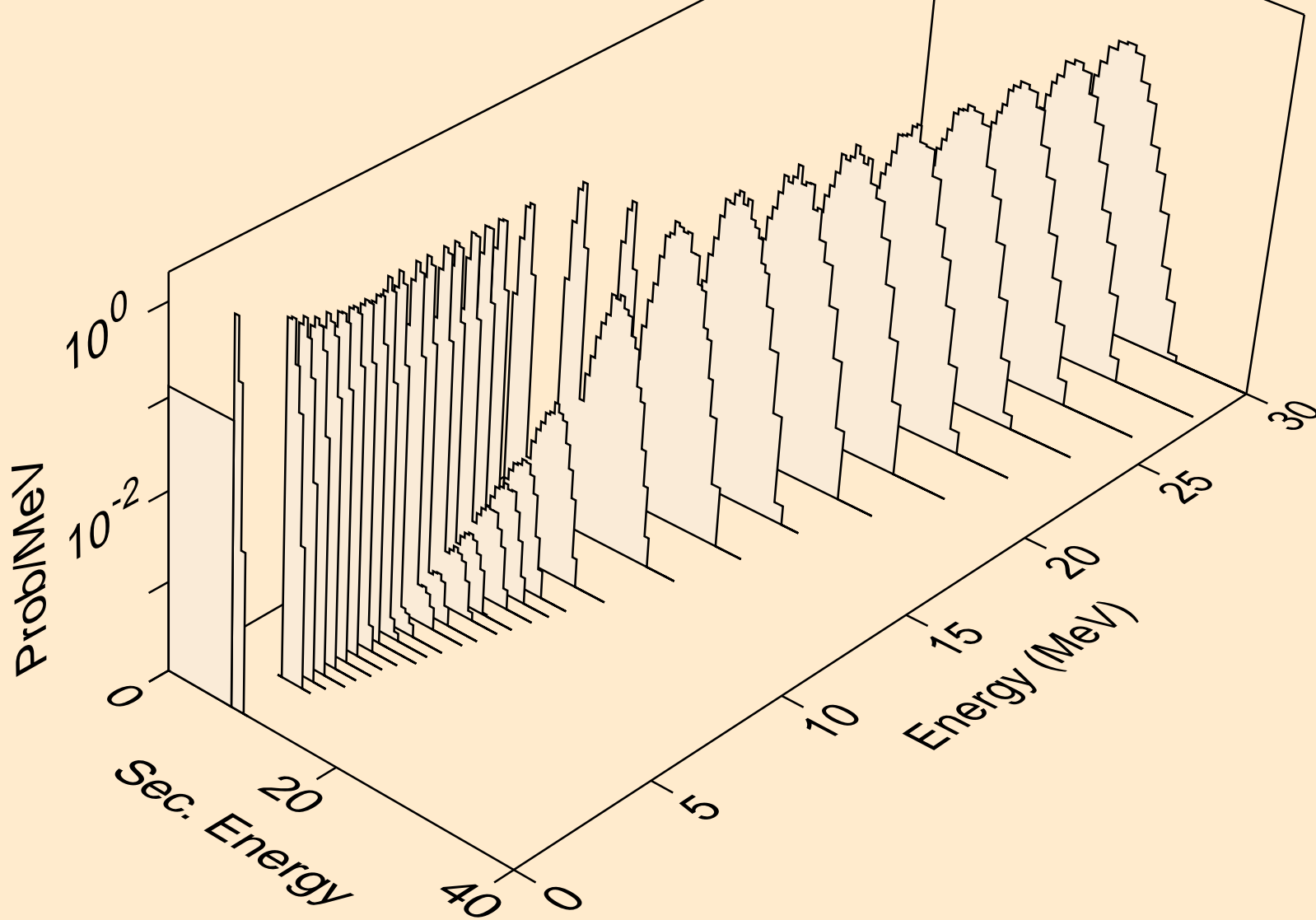

CM232 NEUTRON ACER TENDL-2019 LIBRARY; T=293.16K
alphas from (n,da)

