

CM246 NEUTRON ACER TENDL-2019 LIBRARY; T=293.16K
Principal cross sections

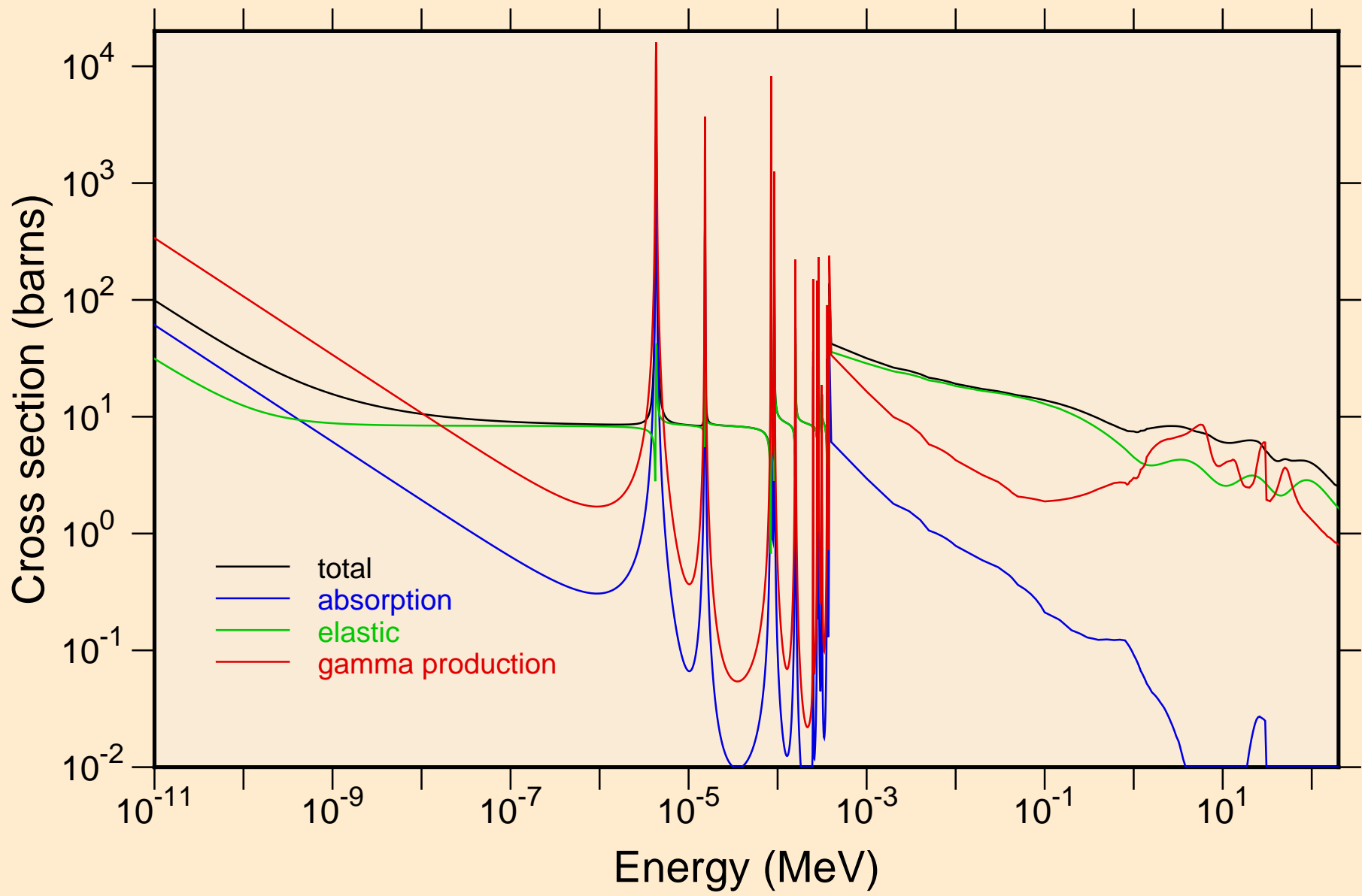

CM246 NEUTRON ACER TENDL-2019 LIBRARY; T=293.16K
resonance total cross section

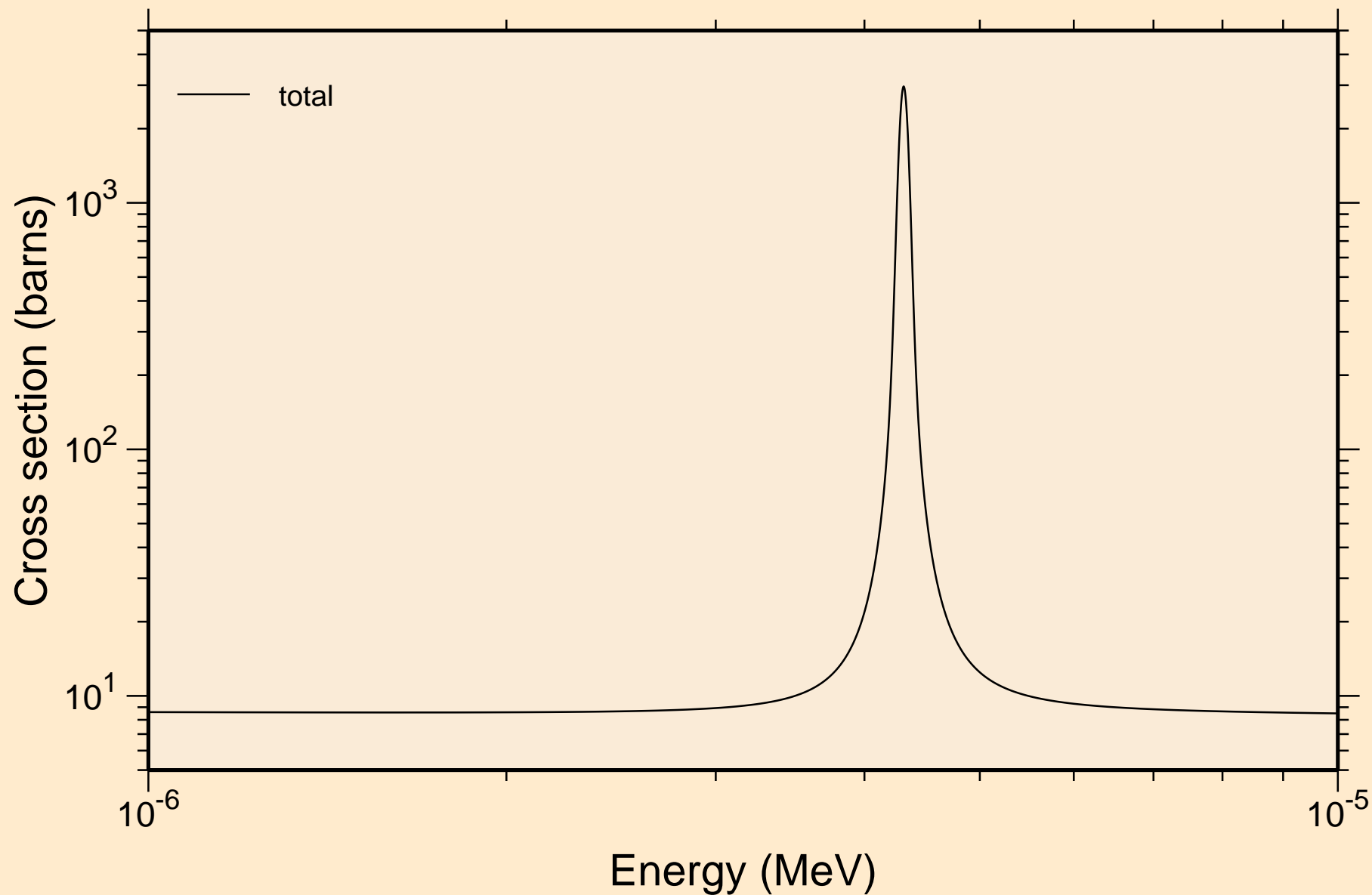

CM246 NEUTRON ACER TENDL-2019 LIBRARY; T=293.16K
resonance total cross section

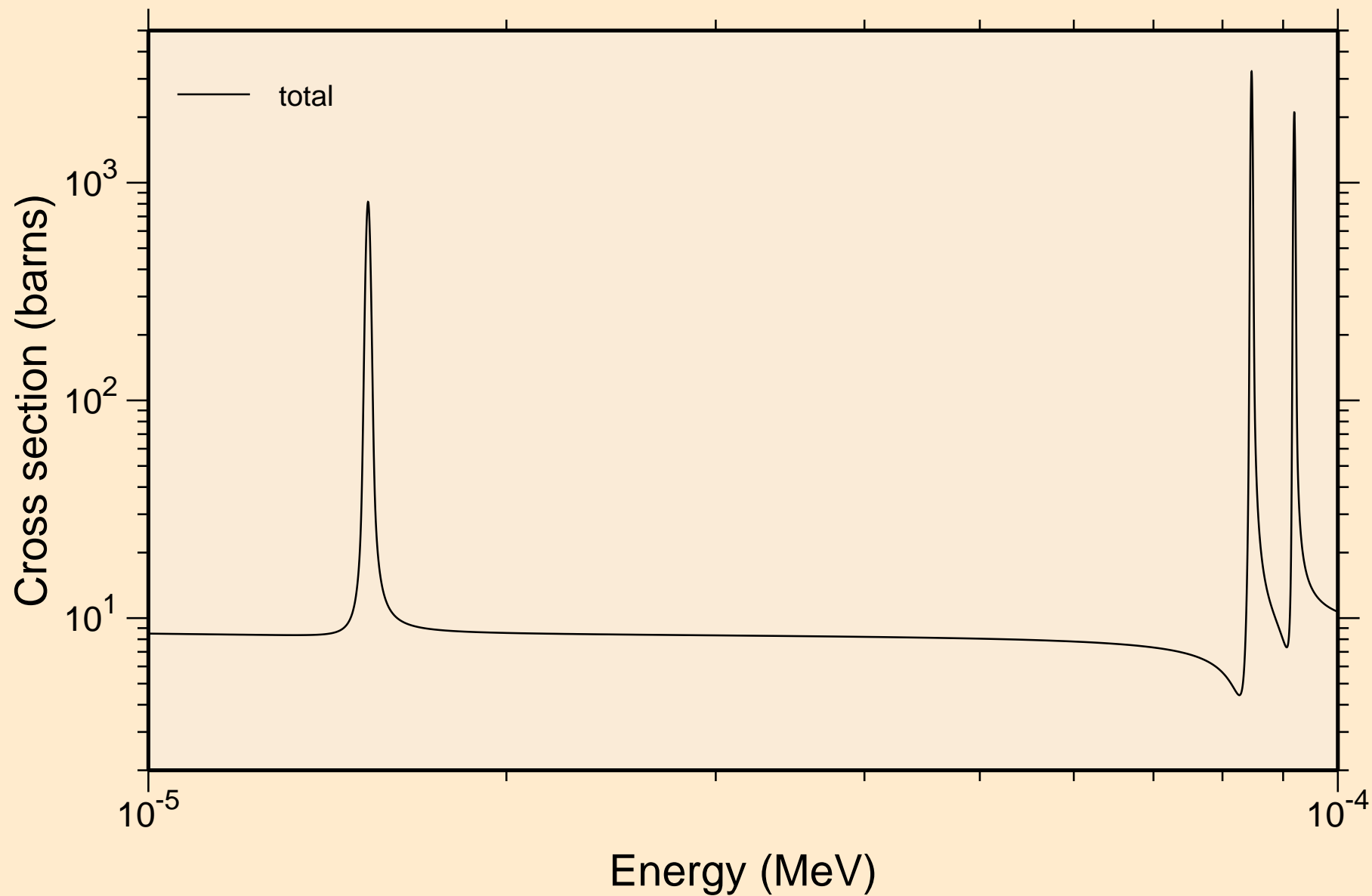

CM246 NEUTRON ACER TENDL-2019 LIBRARY; T=293.16K
resonance total cross section

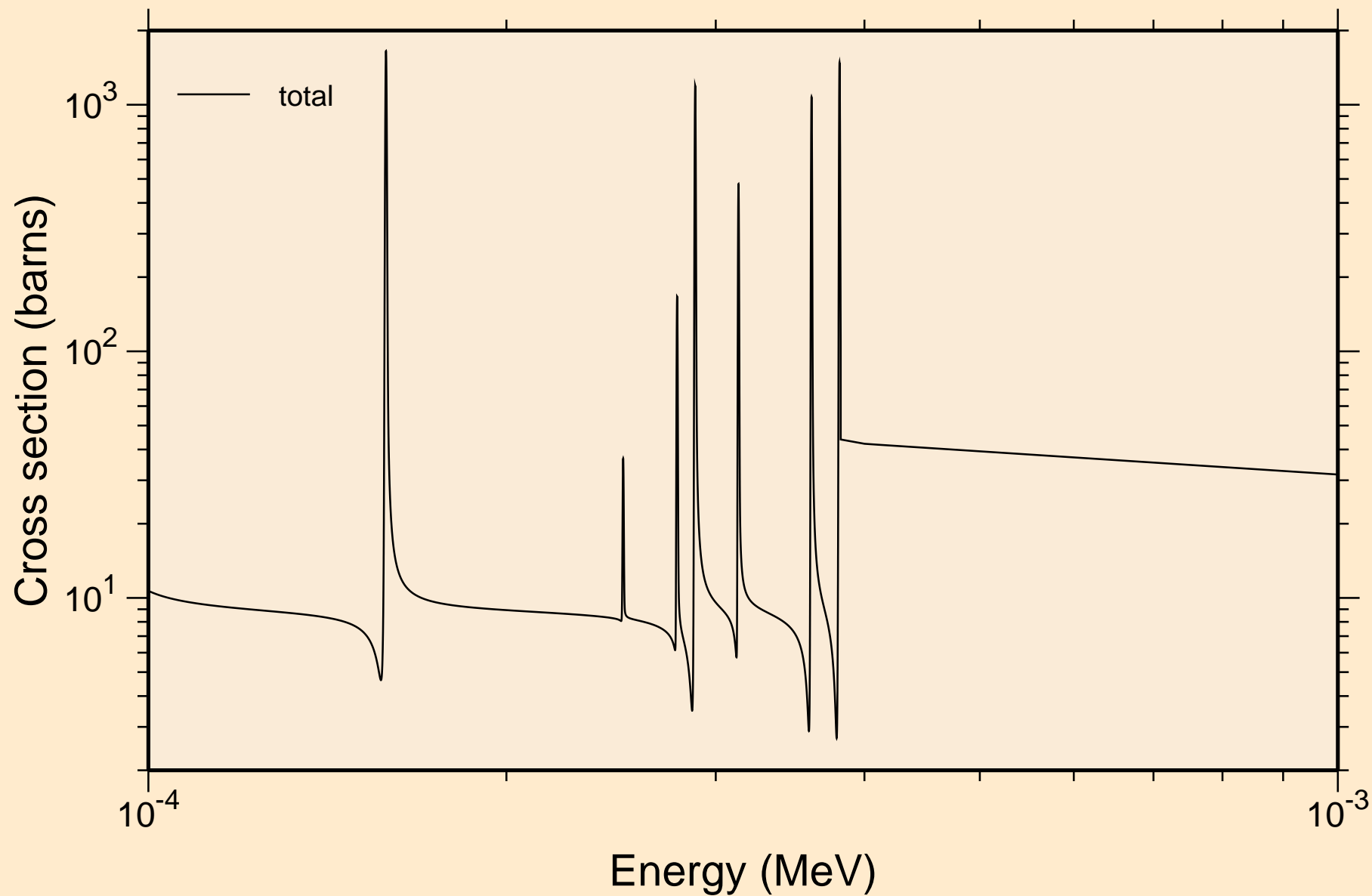

CM246 NEUTRON ACER TENDL-2019 LIBRARY; T=293.16K
resonance total cross section

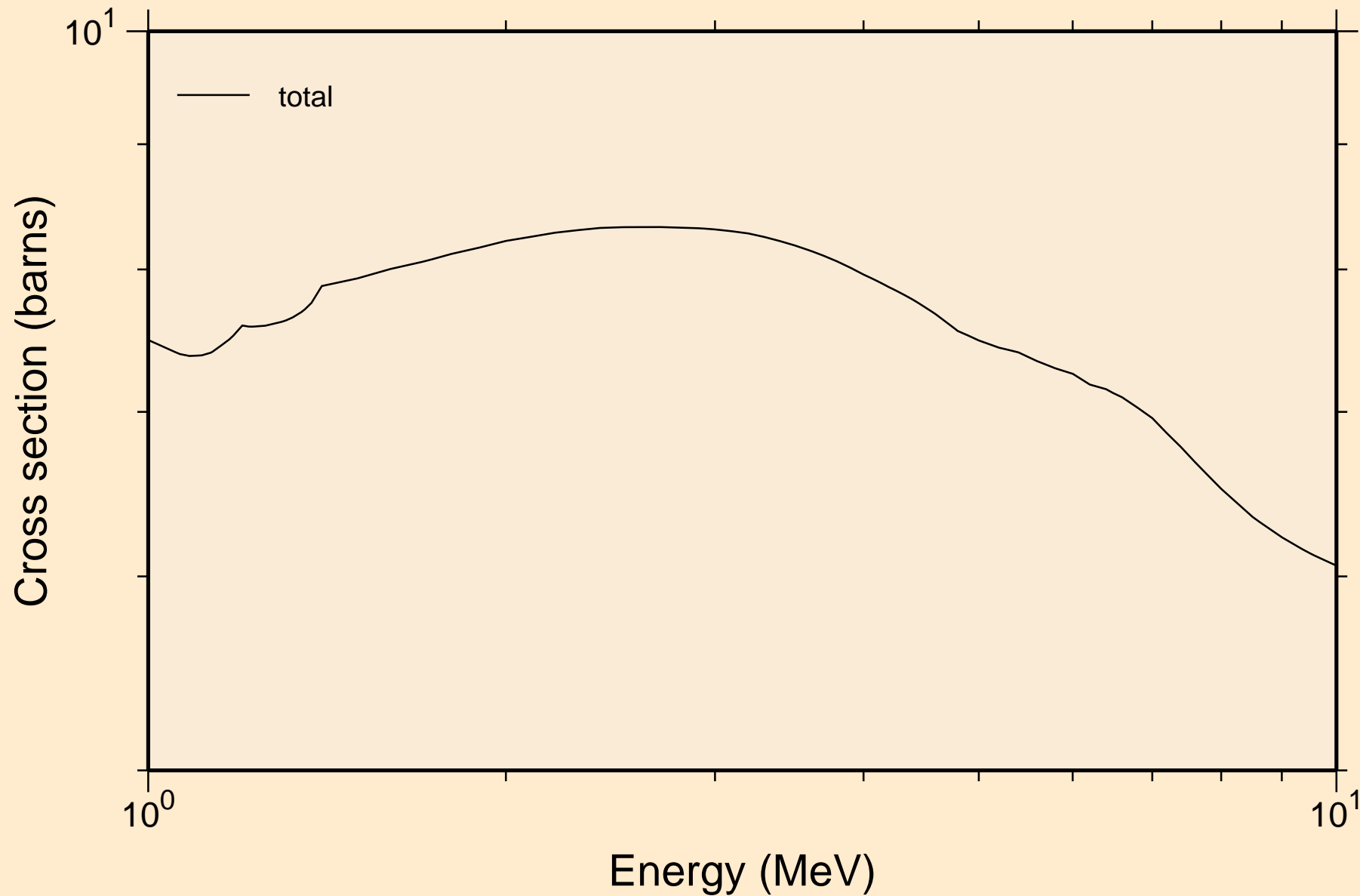

CM246 NEUTRON ACER TENDL-2019 LIBRARY; T=293.16K
resonance absorption cross sections

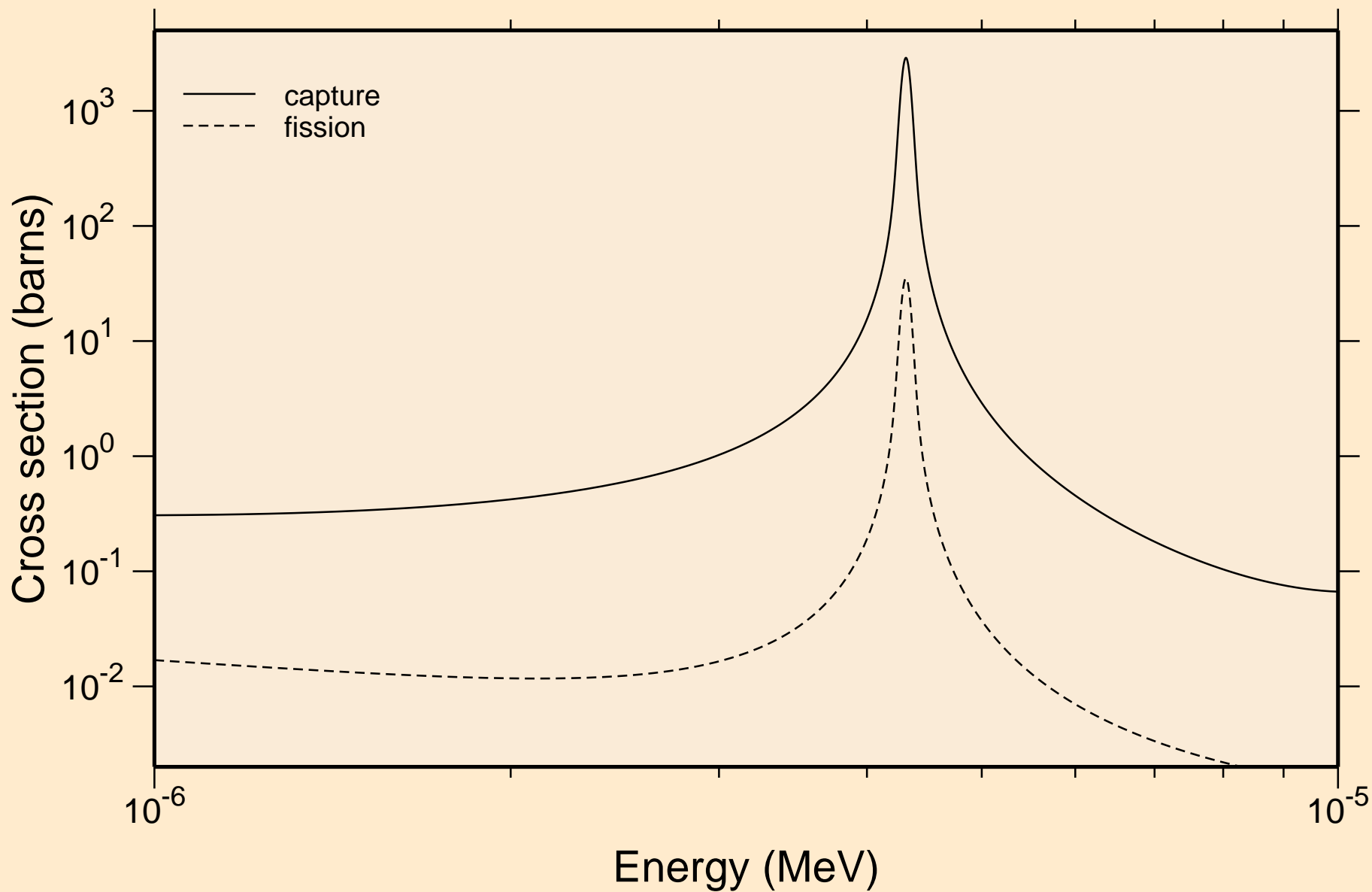

CM246 NEUTRON ACER TENDL-2019 LIBRARY; T=293.16K
resonance absorption cross sections

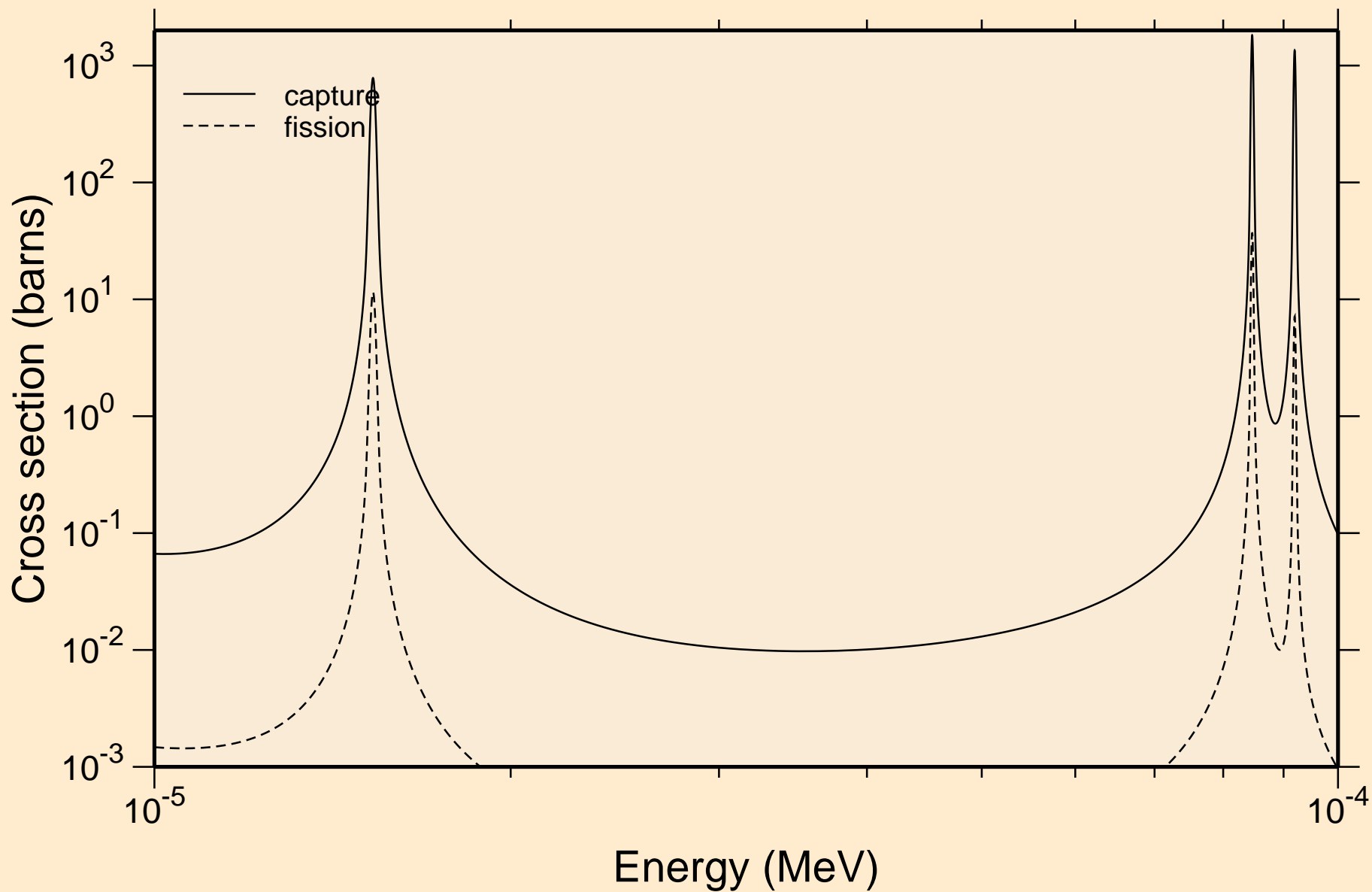

CM246 NEUTRON ACER TENDL-2019 LIBRARY; T=293.16K
resonance absorption cross sections

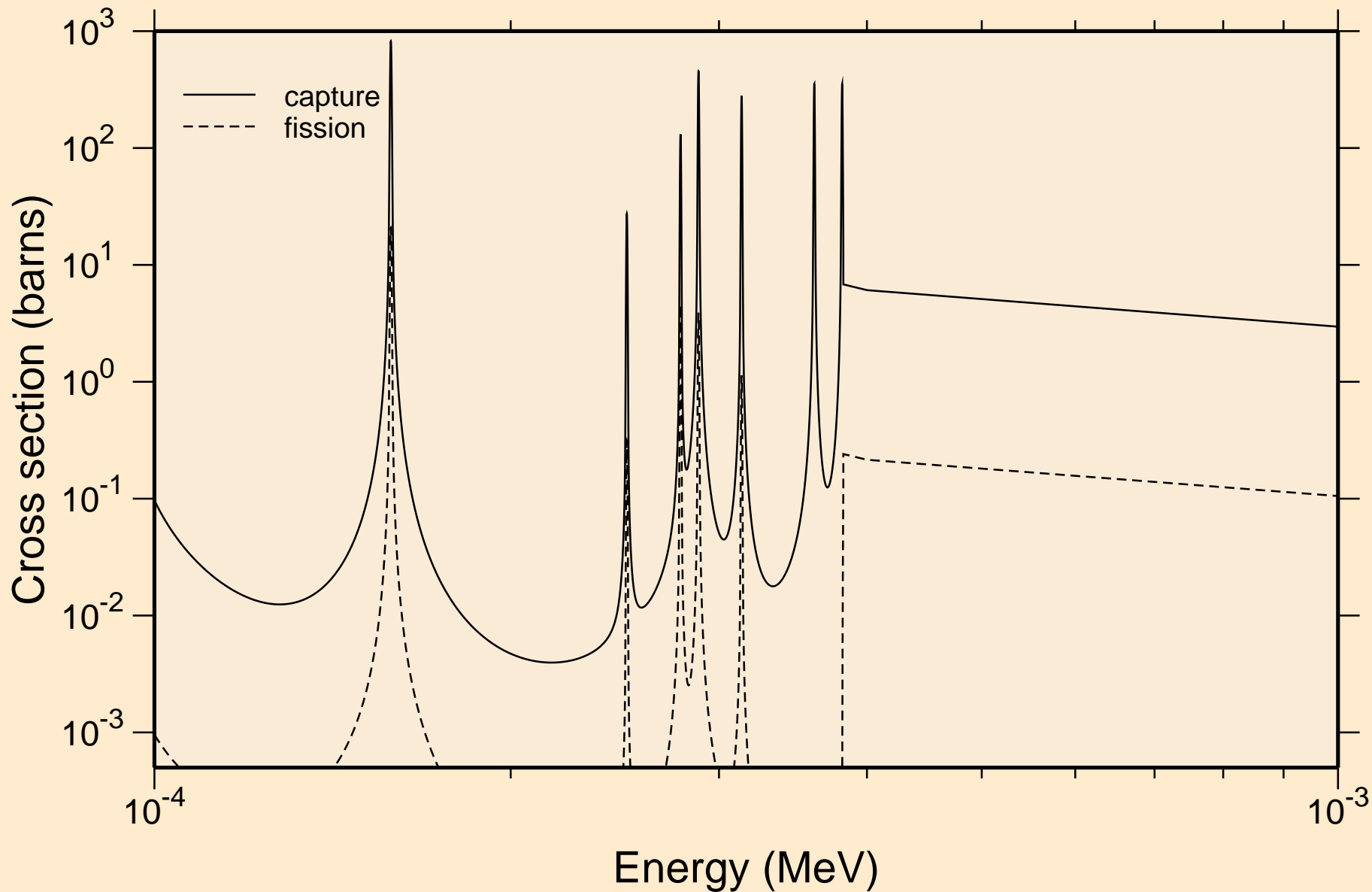

CM246 NEUTRON ACER TENDL-2019 LIBRARY; T=293.16K
resonance absorption cross sections

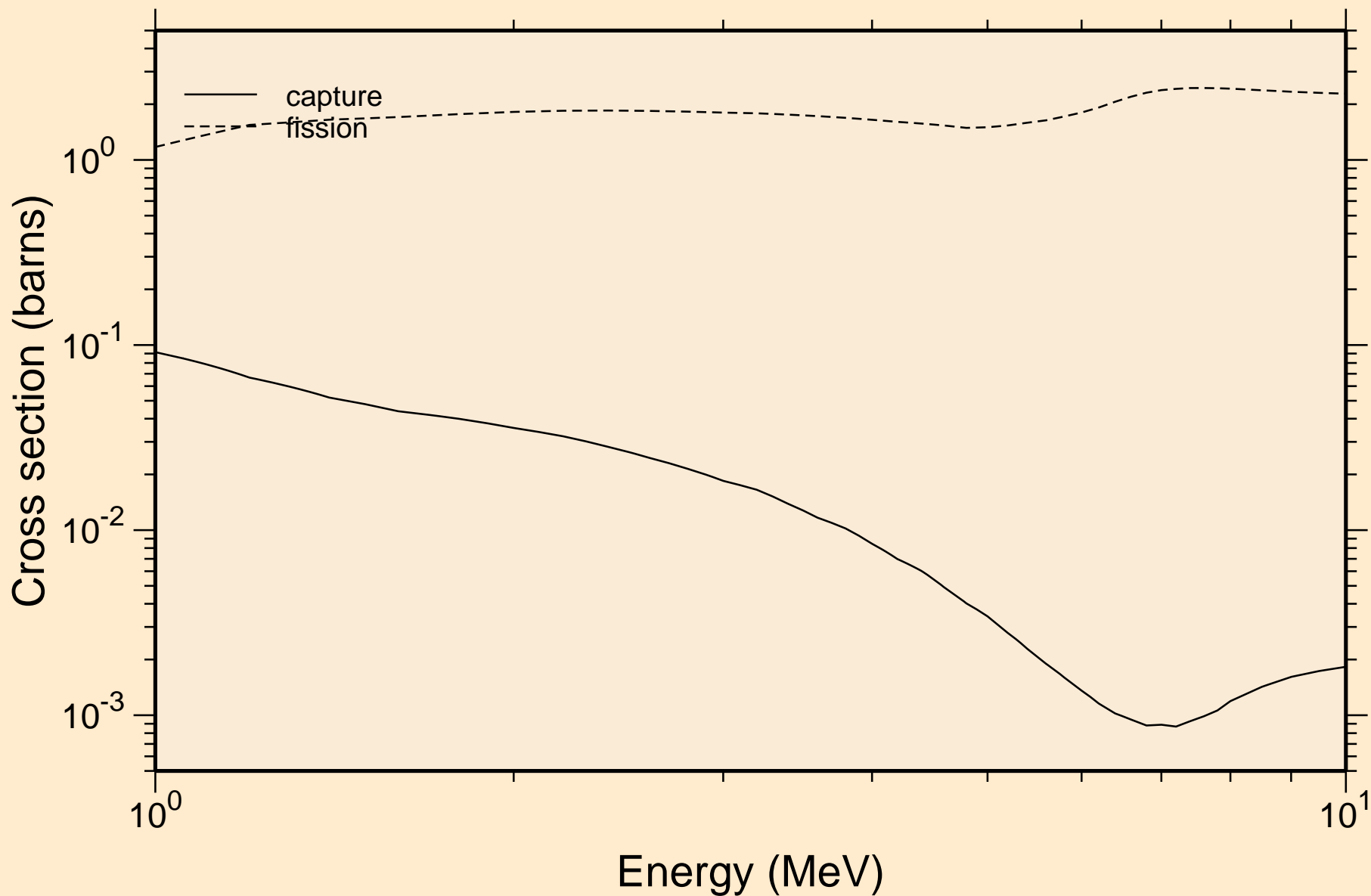

CM246 NEUTRON ACER TENDL-2019 LIBRARY; T=293.16K
Heating

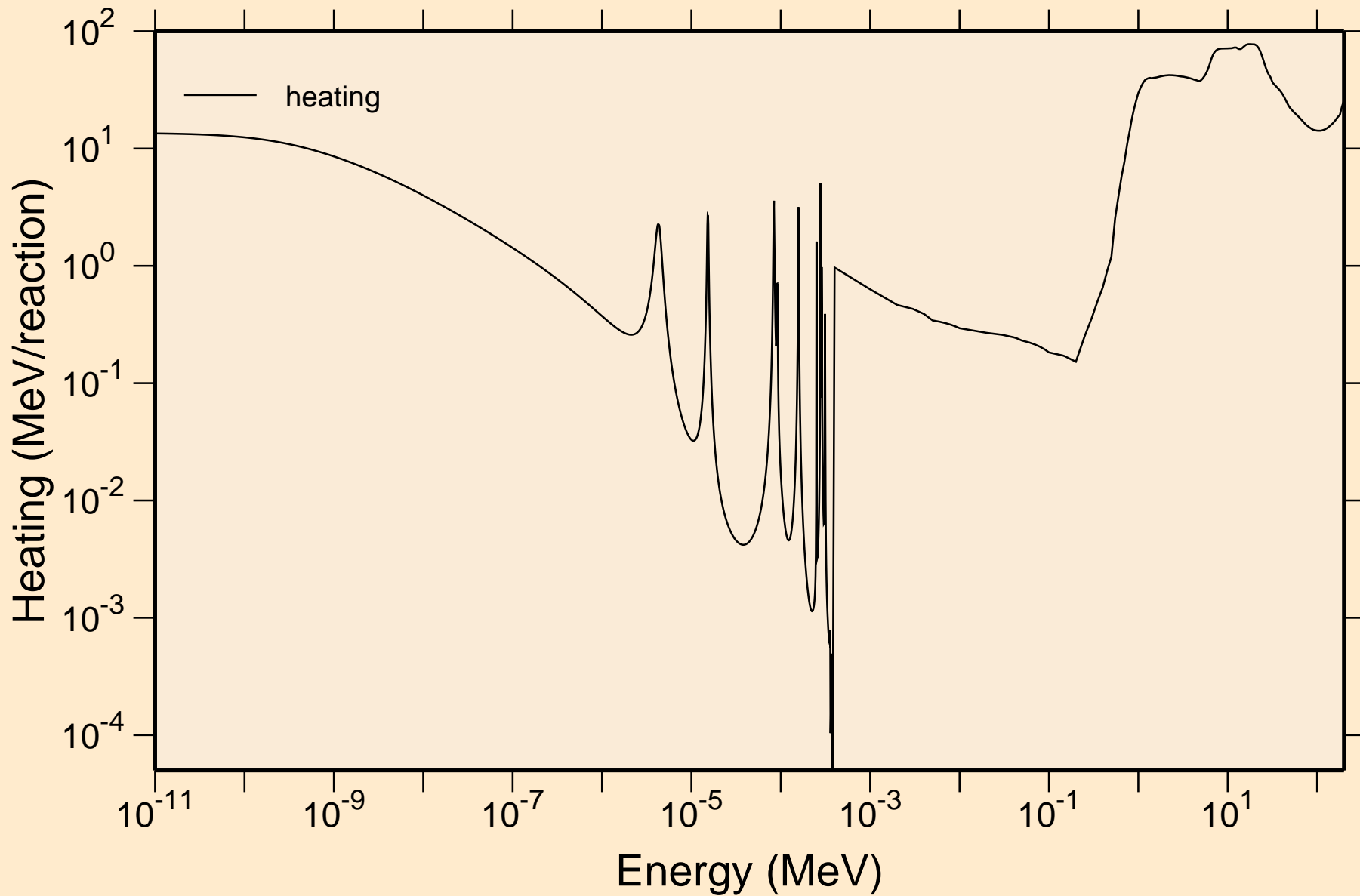

CM246 NEUTRON ACER TENDL-2019 LIBRARY; T=293.16K
Damage

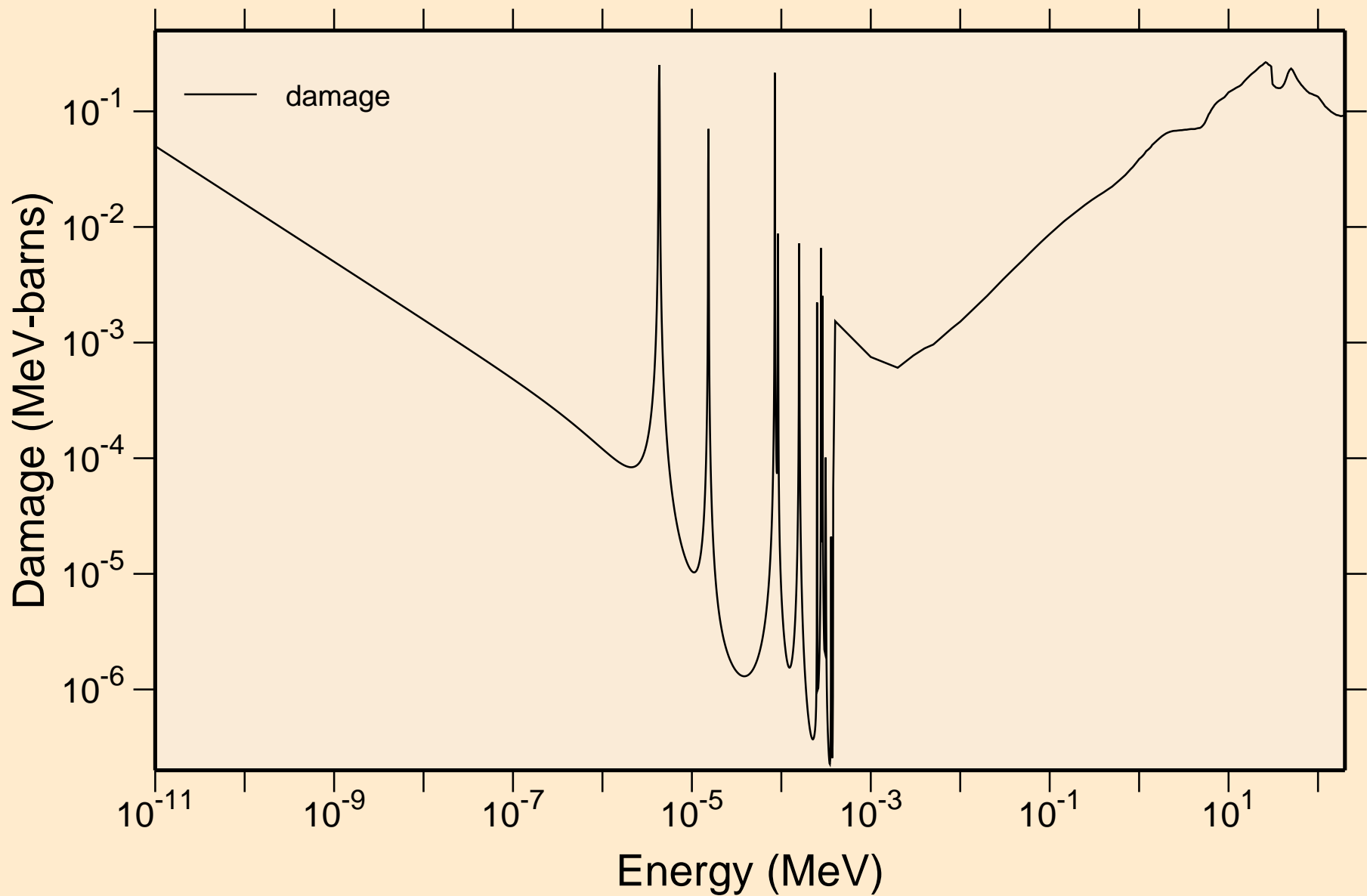

CM246 NEUTRON ACER TENDL-2019 LIBRARY; T=293.16K
Non-threshold reactions

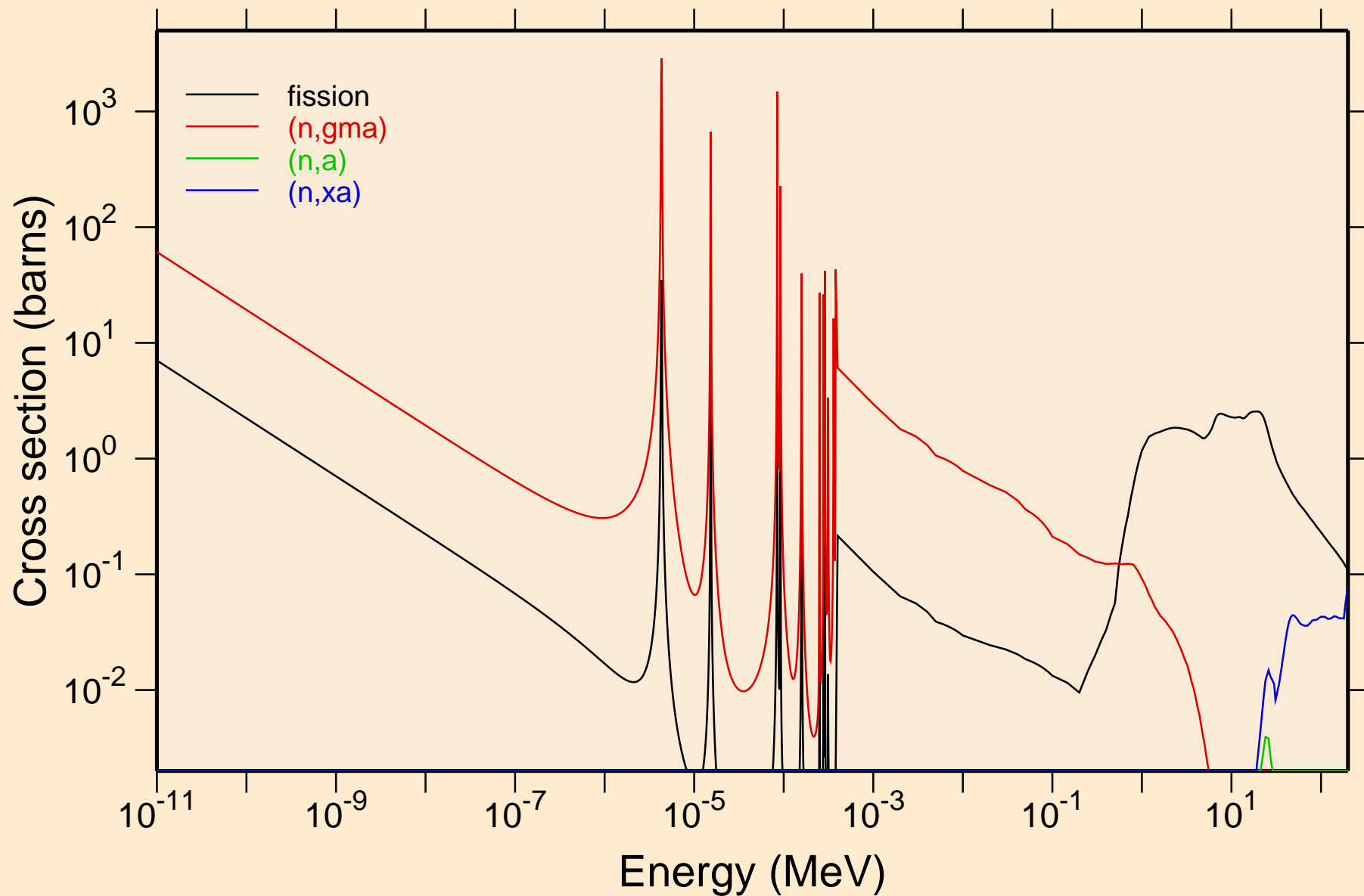

CM246 NEUTRON ACER TENDL-2019 LIBRARY; T=293.16K
Principal cross sections

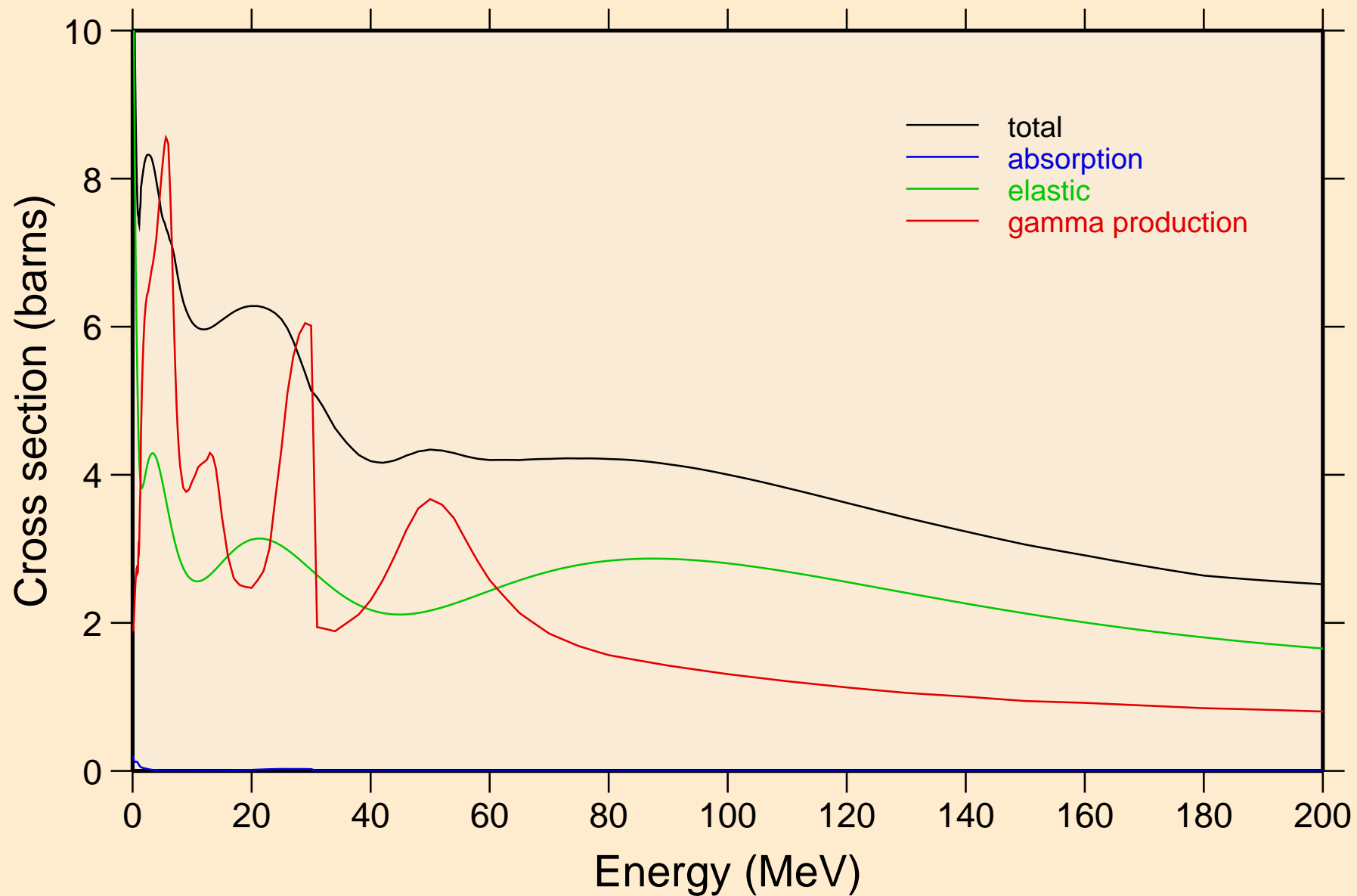

CM246 NEUTRON ACER TENDL-2019 LIBRARY; T=293.16K
Heating

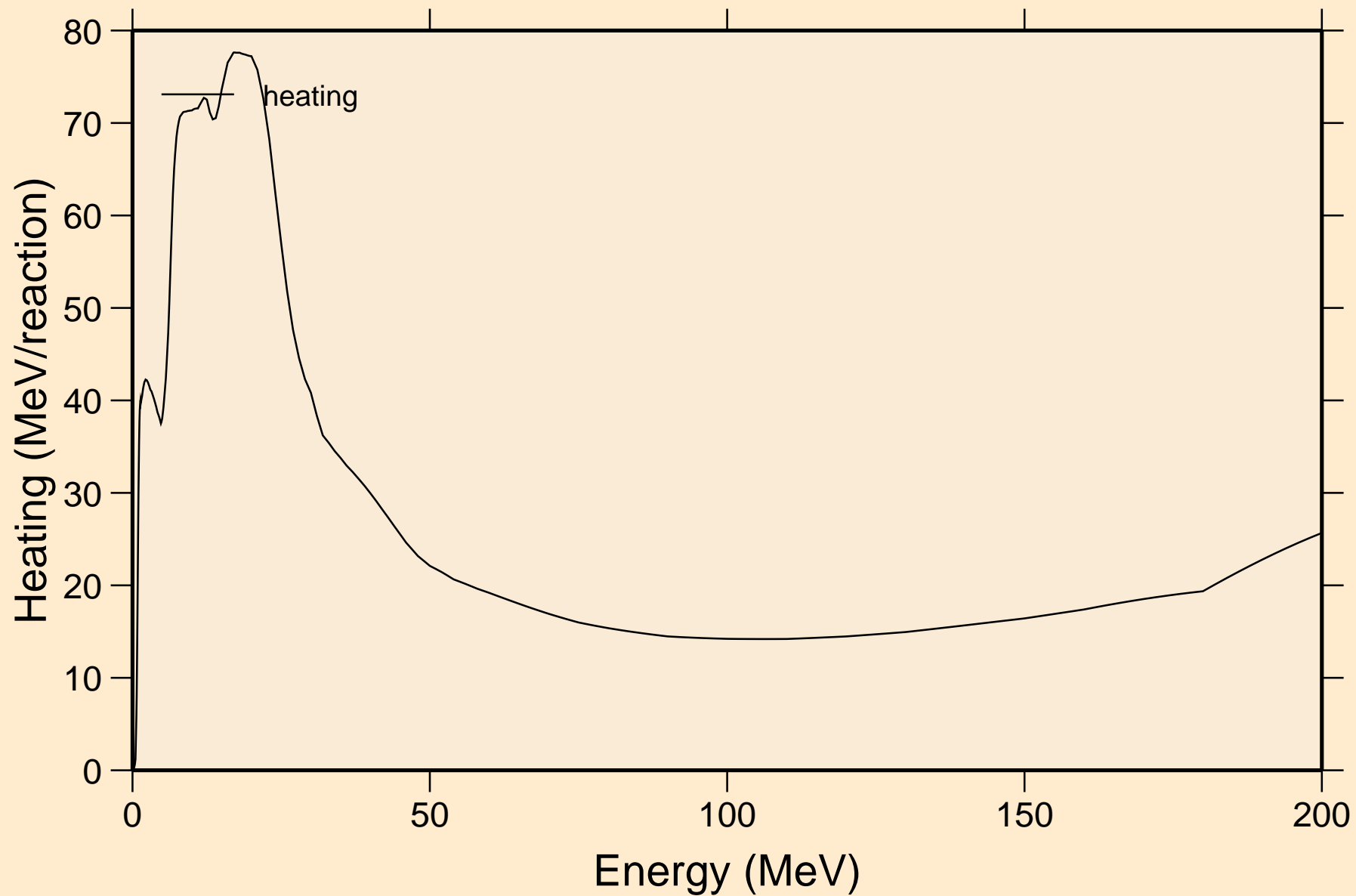

CM246 NEUTRON ACER TENDL-2019 LIBRARY; T=293.16K
Damage

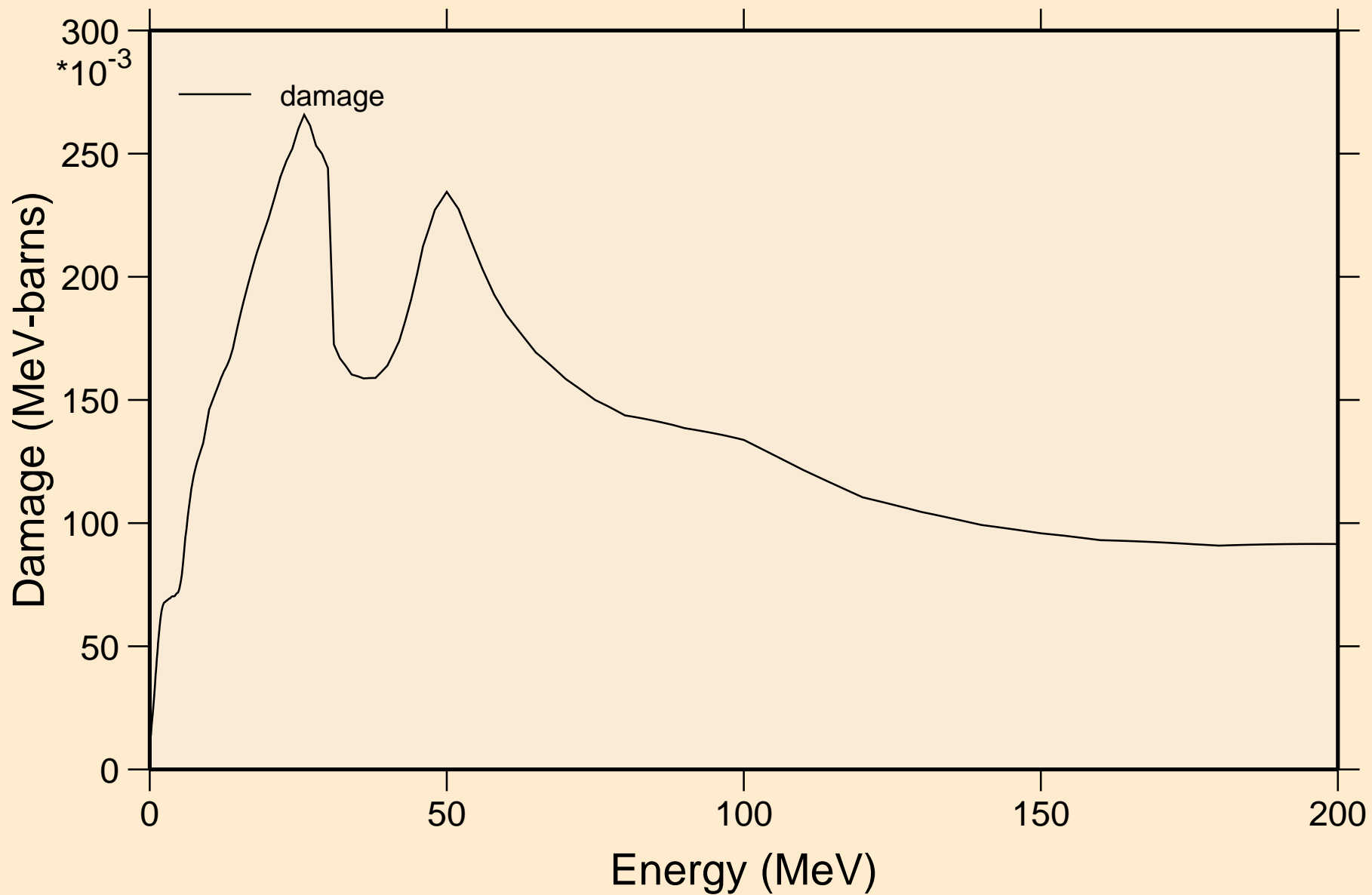

CM246 NEUTRON ACER TENDL-2019 LIBRARY; T=293.16K
Non-threshold reactions

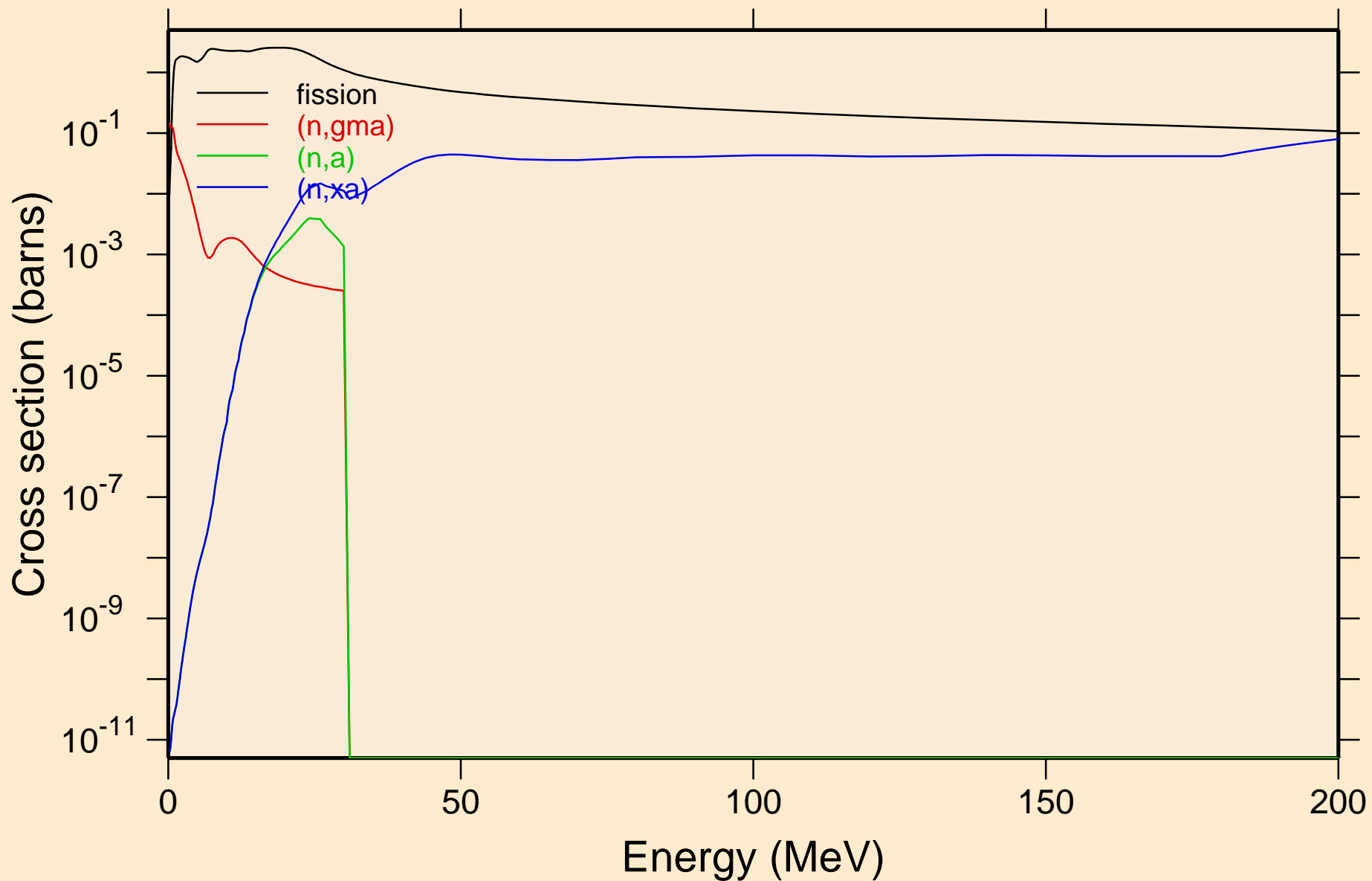

CM246 NEUTRON ACER TENDL-2019 LIBRARY; T=293.16K
Inelastic levels

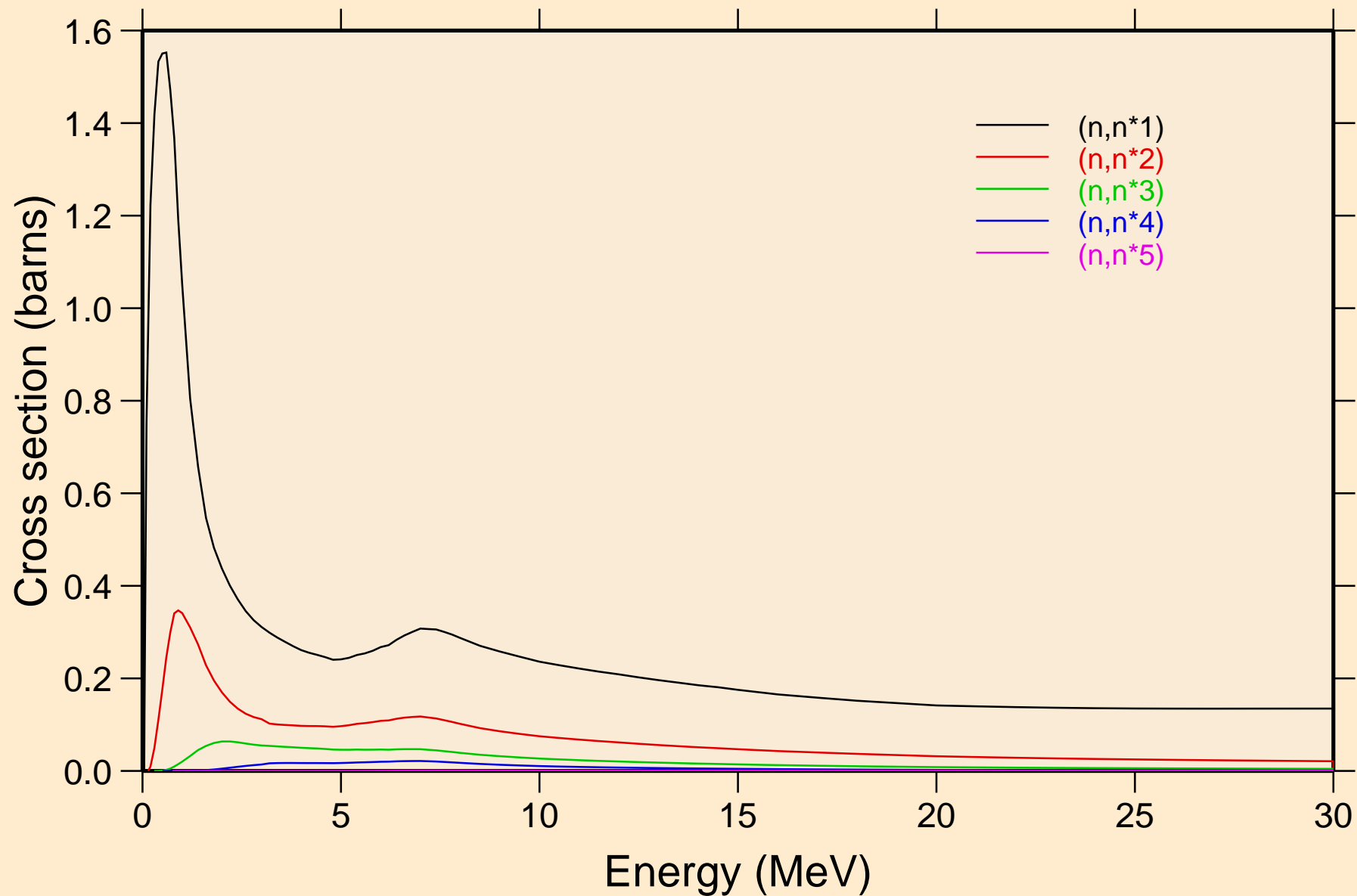

CM246 NEUTRON ACER TENDL-2019 LIBRARY; T=293.16K
Inelastic levels

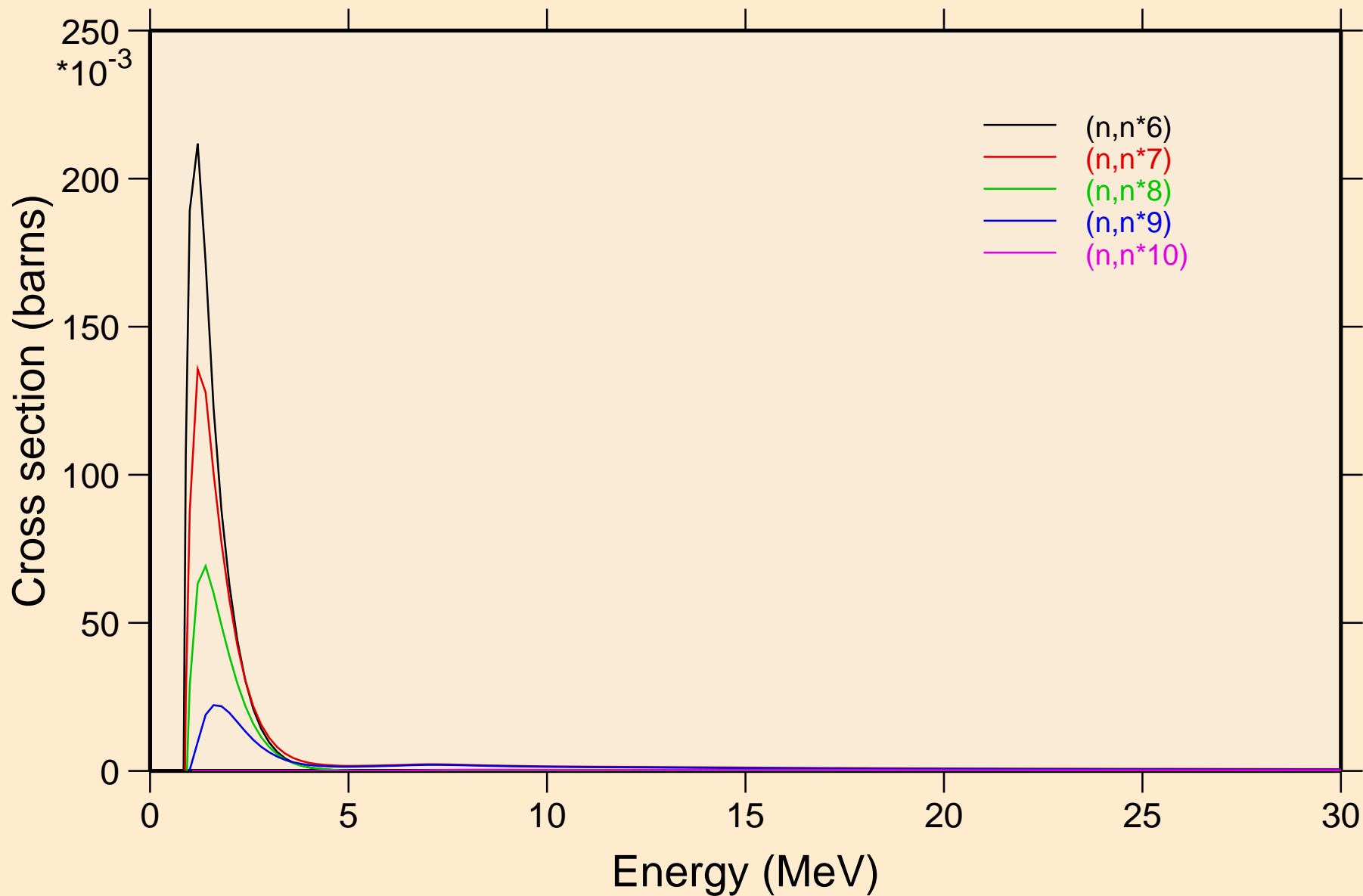

CM246 NEUTRON ACER TENDL-2019 LIBRARY; T=293.16K
Inelastic levels

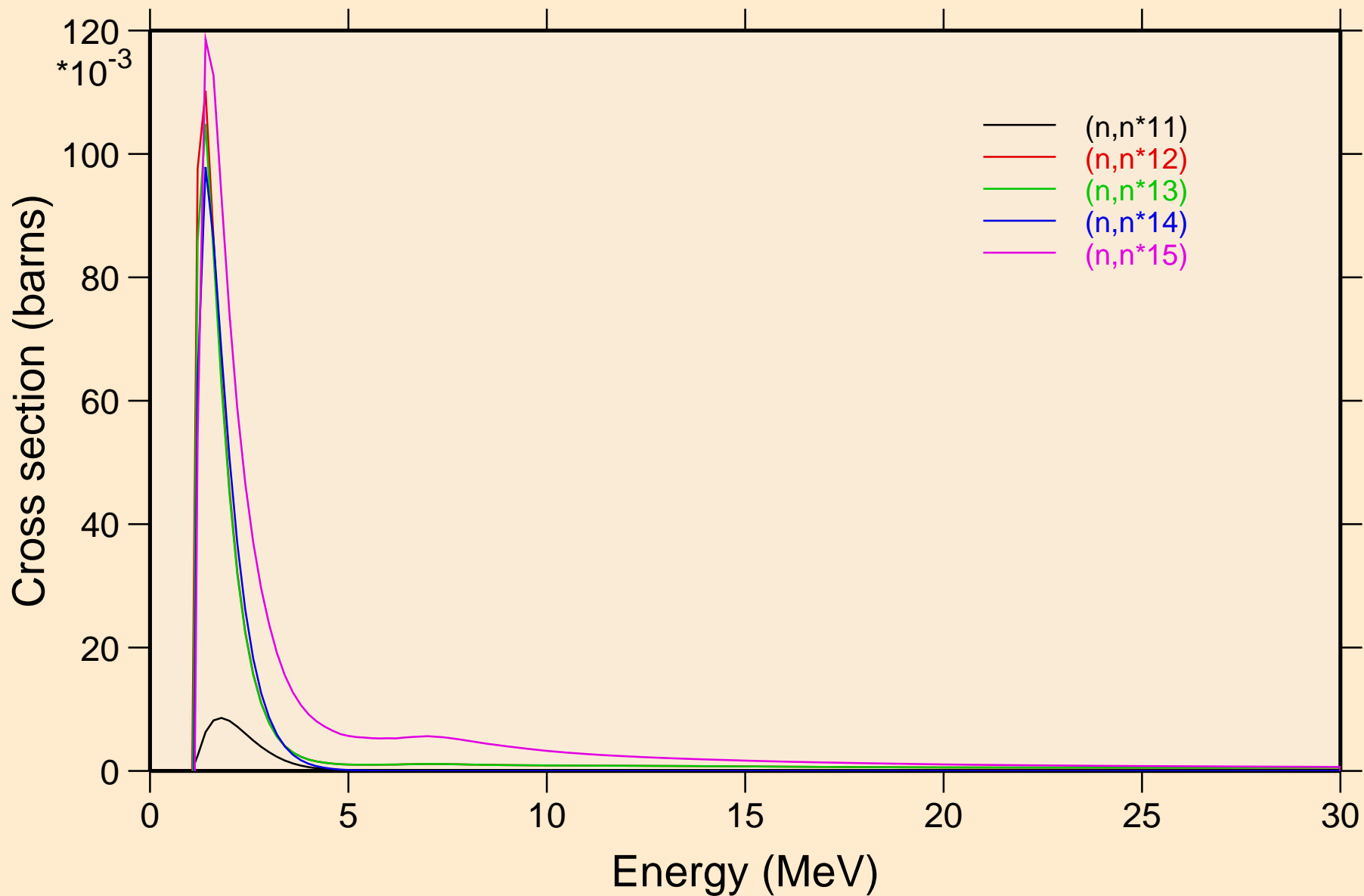

CM246 NEUTRON ACER TENDL-2019 LIBRARY; T=293.16K
Inelastic levels

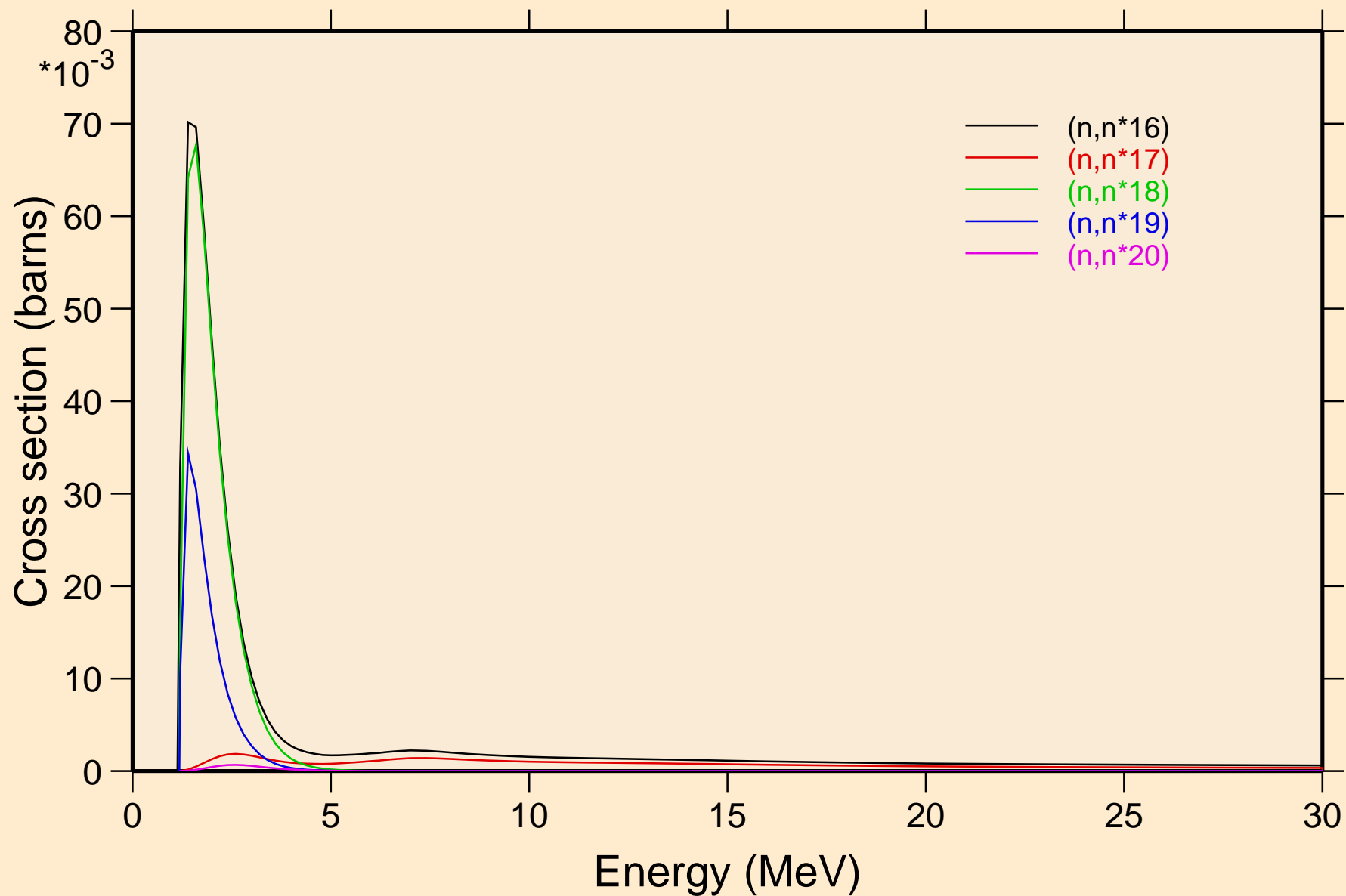

CM246 NEUTRON ACER TENDL-2019 LIBRARY; T=293.16K
Inelastic levels

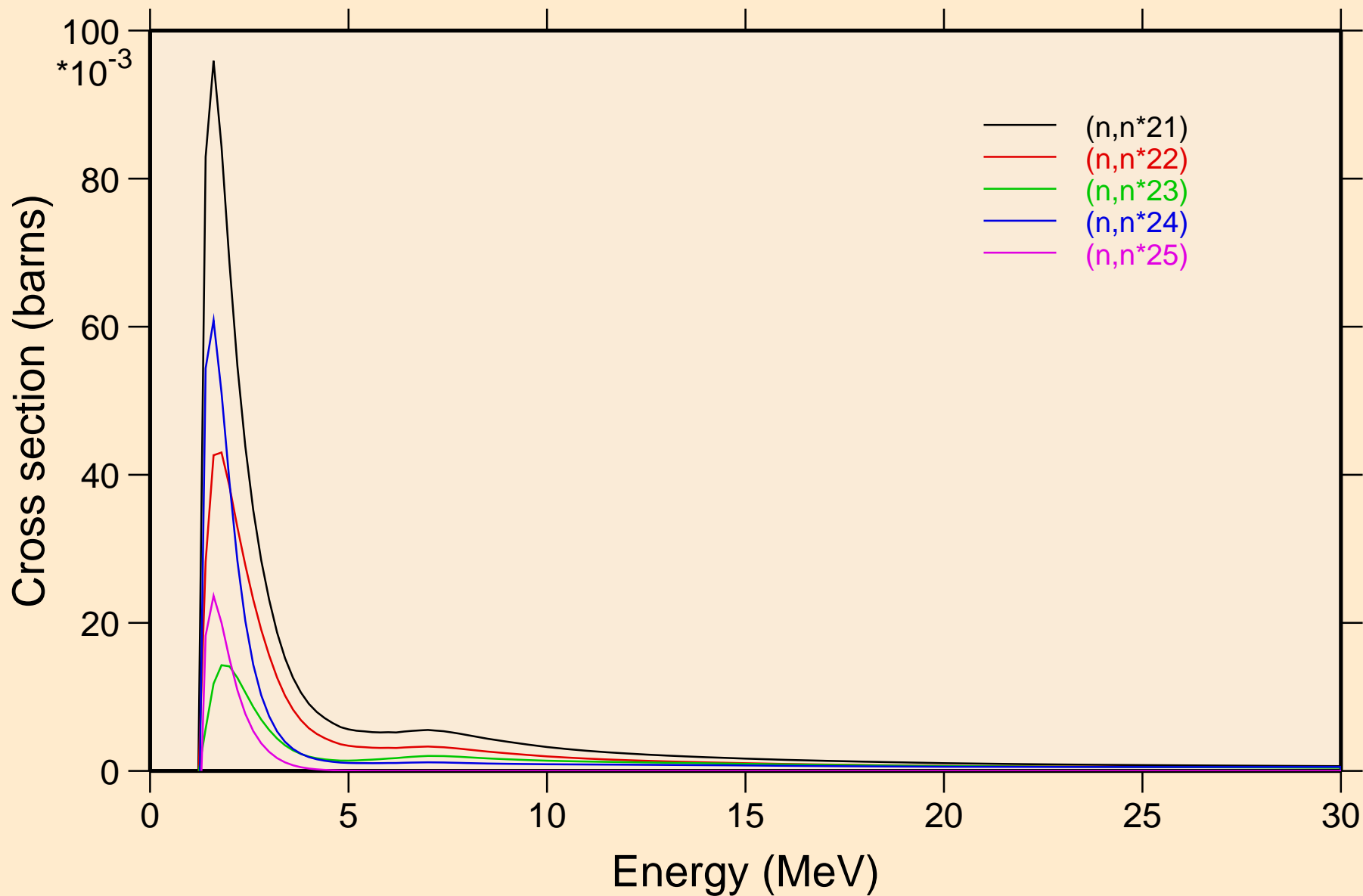

CM246 NEUTRON ACER TENDL-2019 LIBRARY; T=293.16K
Inelastic levels

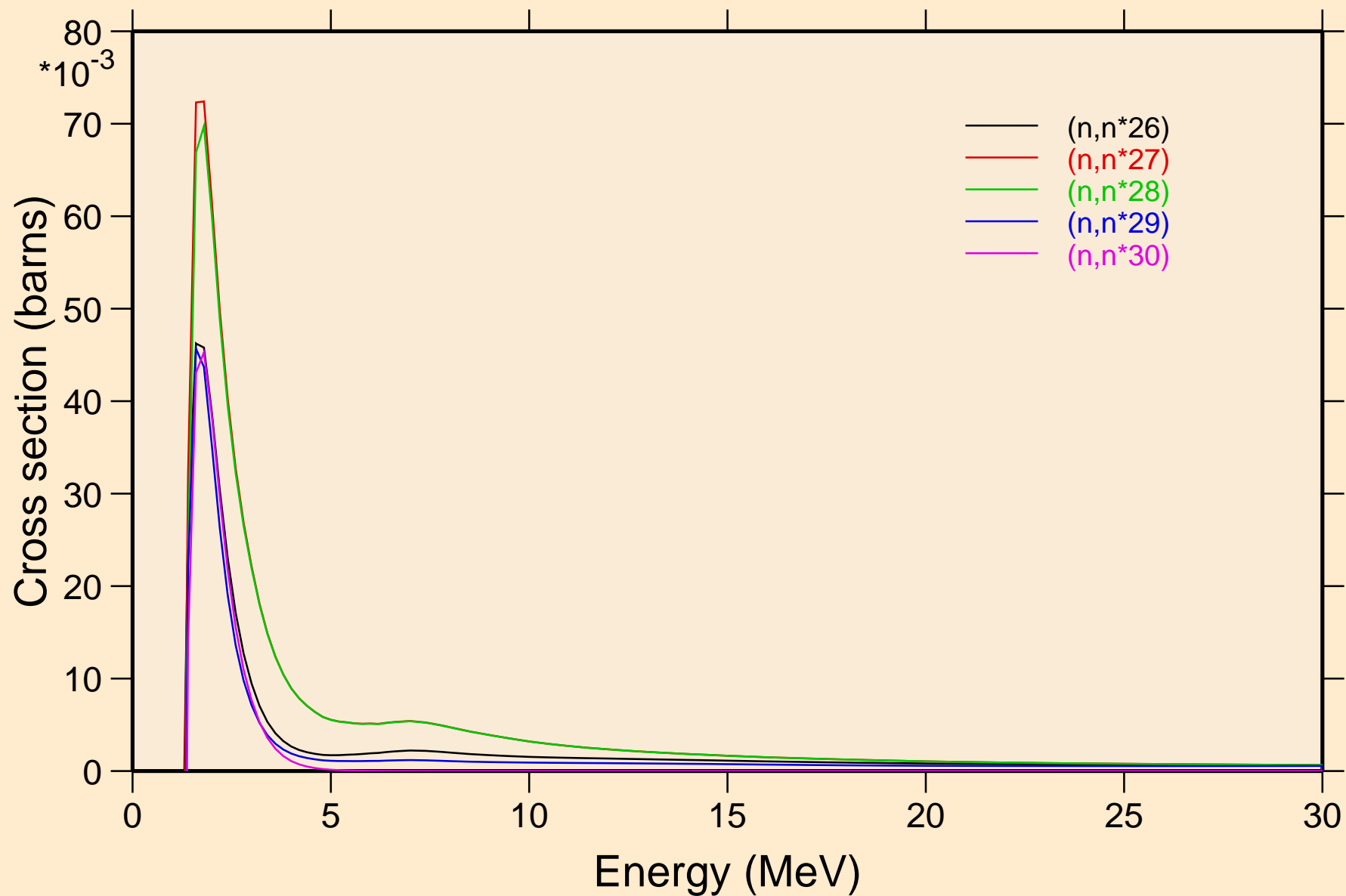

CM246 NEUTRON ACER TENDL-2019 LIBRARY; T=293.16K

Threshold reactions

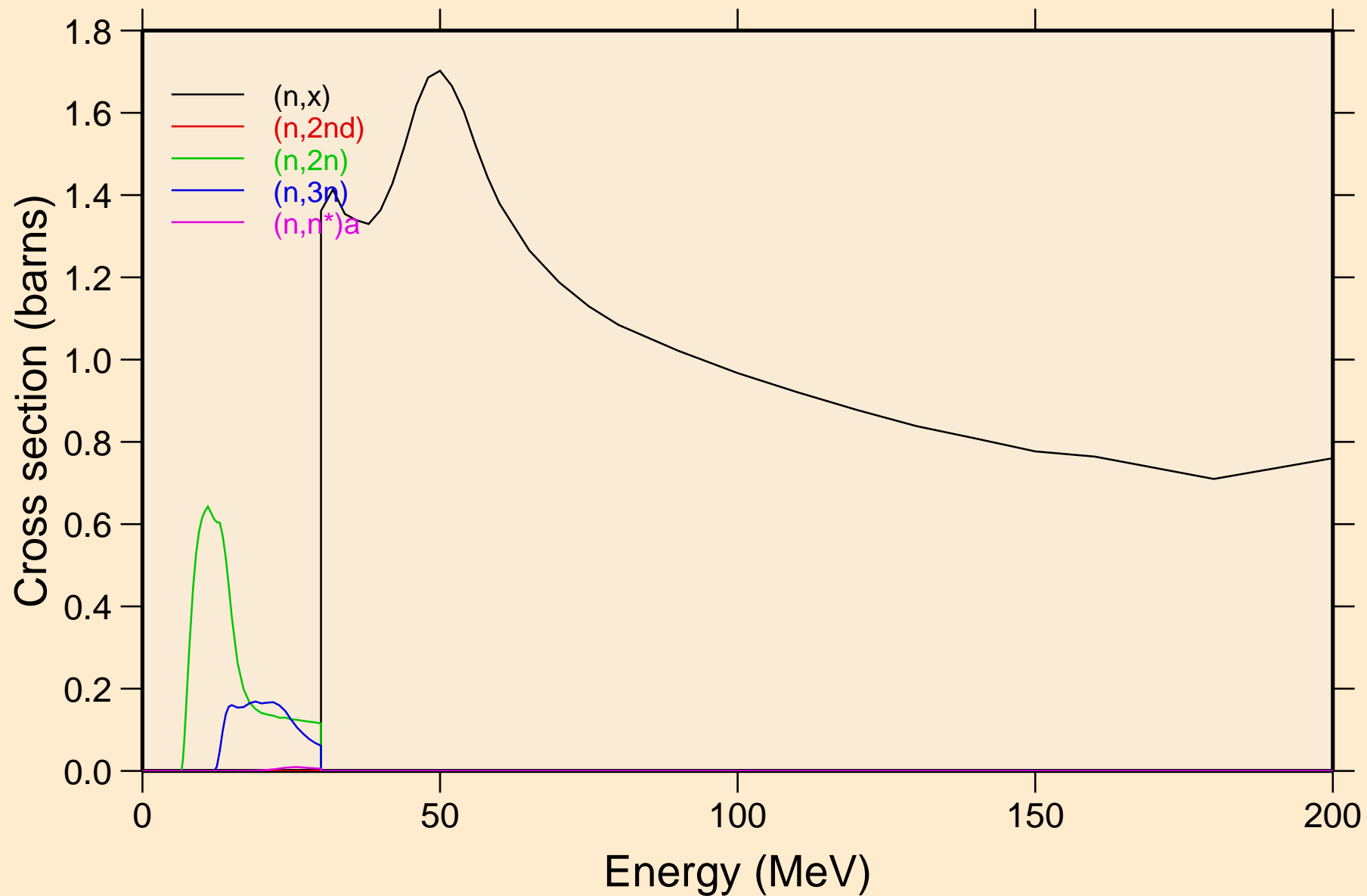

CM246 NEUTRON ACER TENDL-2019 LIBRARY; T=293.16K
Threshold reactions

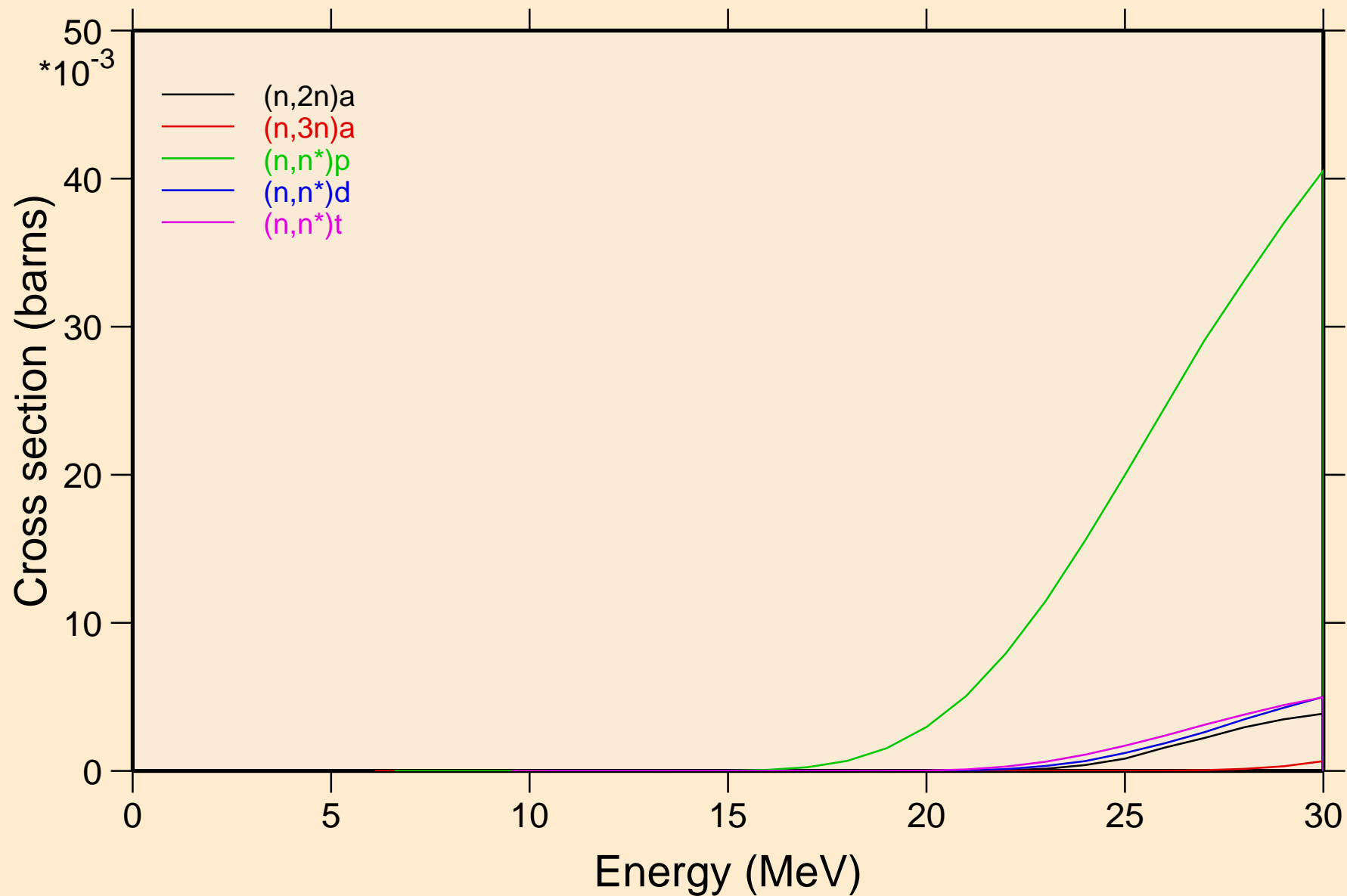

CM246 NEUTRON ACER TENDL-2019 LIBRARY; T=293.16K
Threshold reactions

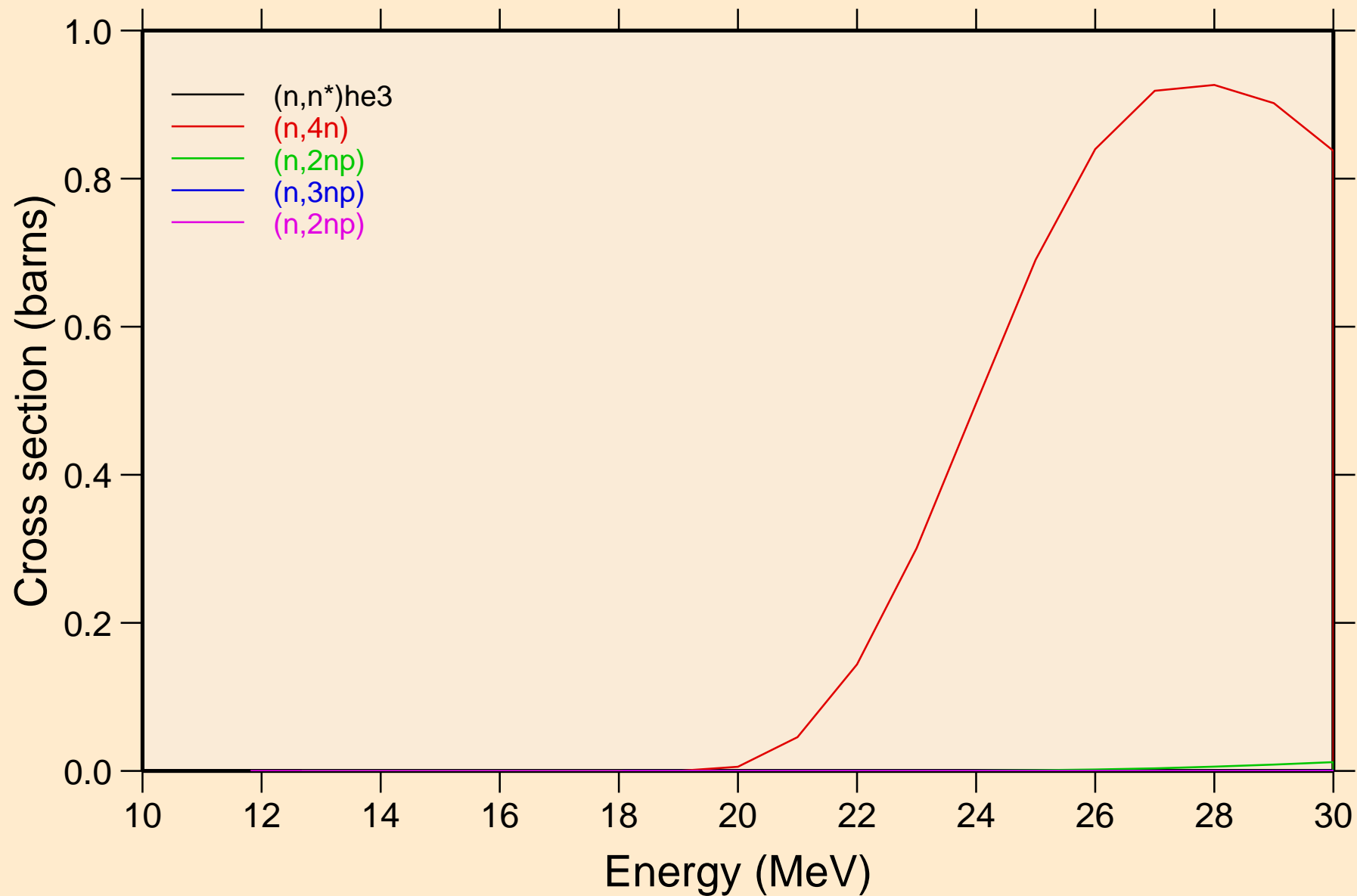

CM246 NEUTRON ACER TENDL-2019 LIBRARY; T=293.16K
Threshold reactions

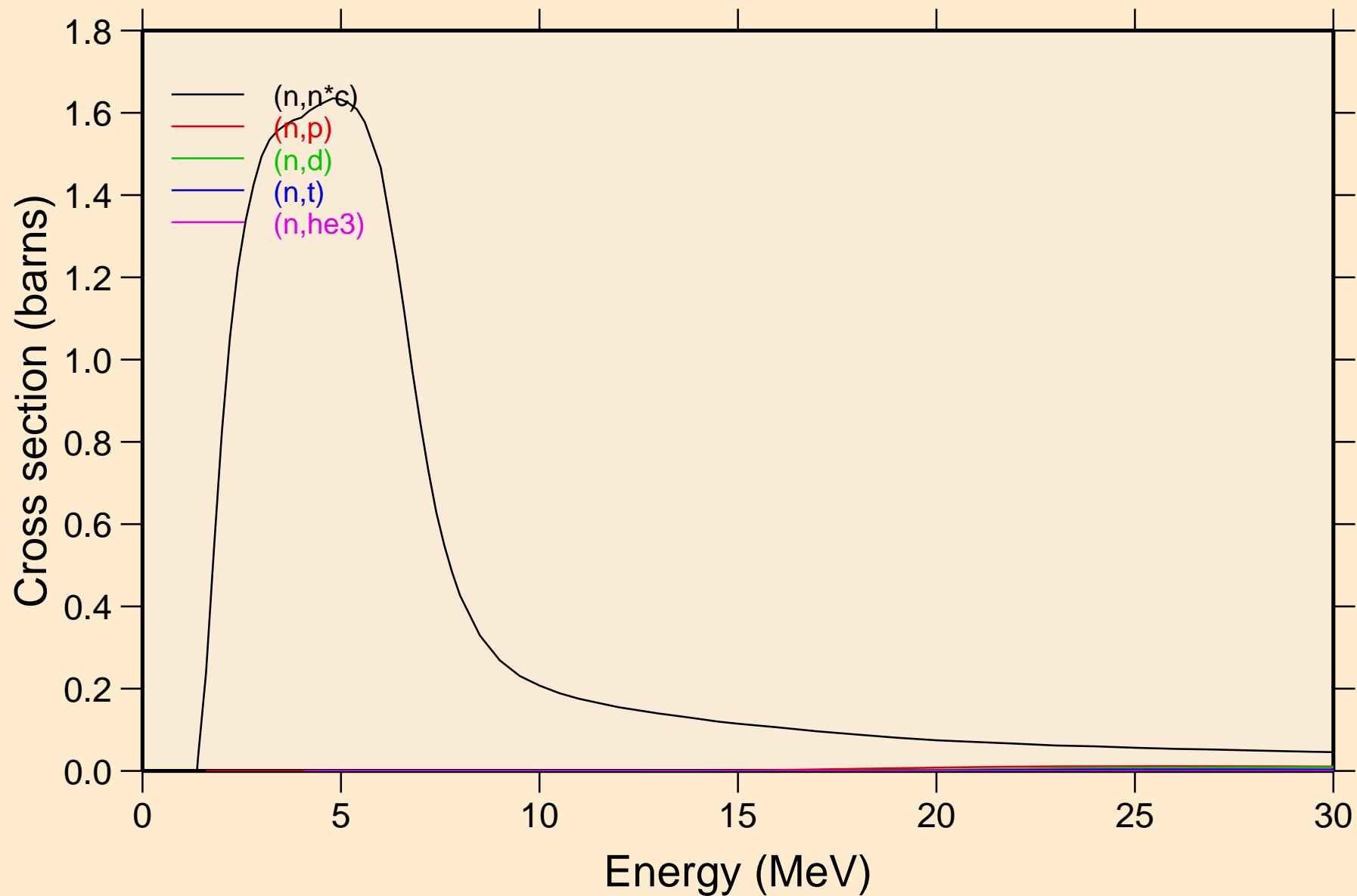

CM246 NEUTRON ACER TENDL-2019 LIBRARY; T=293.16K
Threshold reactions

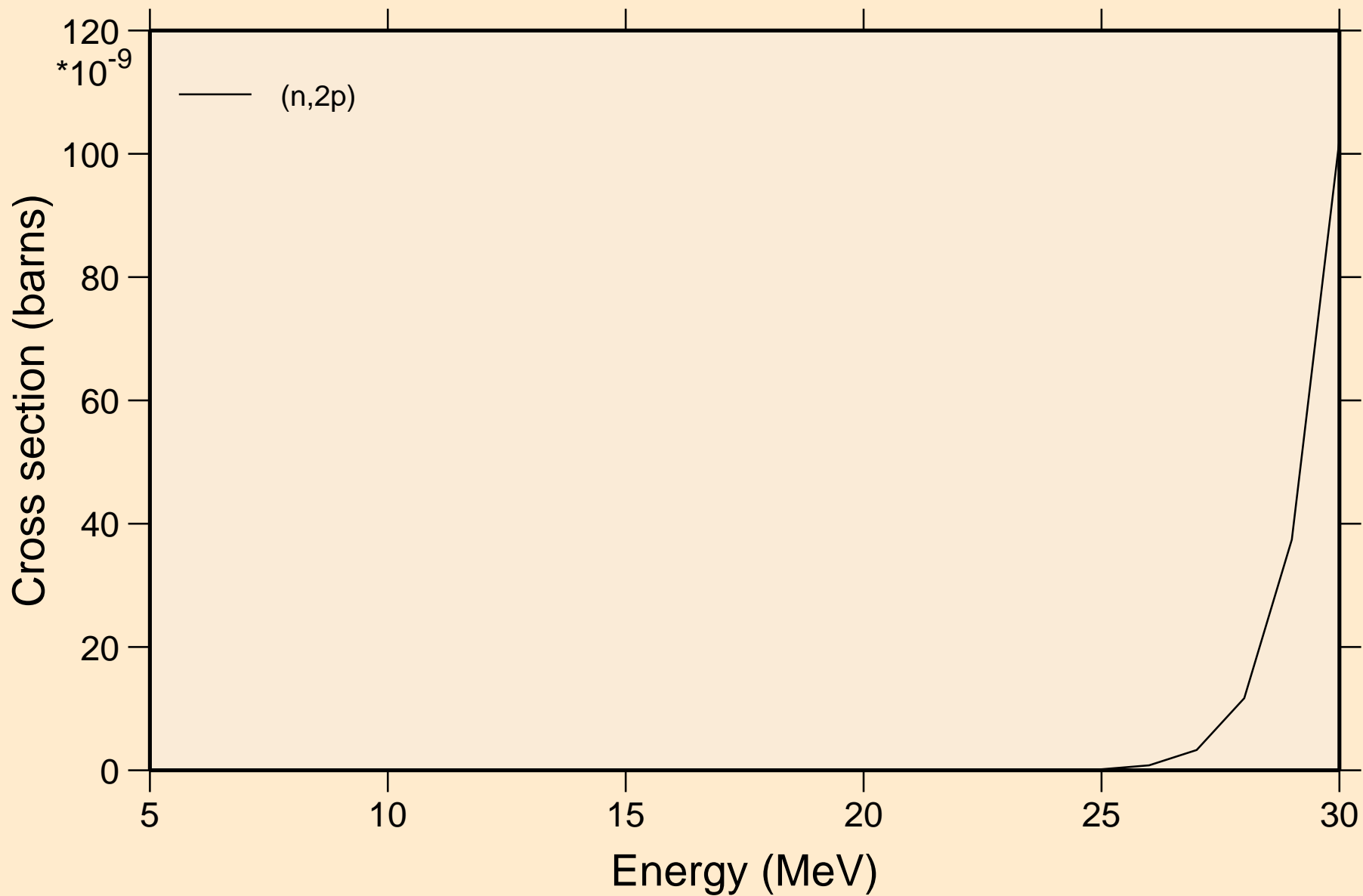

CM246 NEUTRON ACER TENDL-2019 LIBRARY; T=293.16K
Threshold reactions

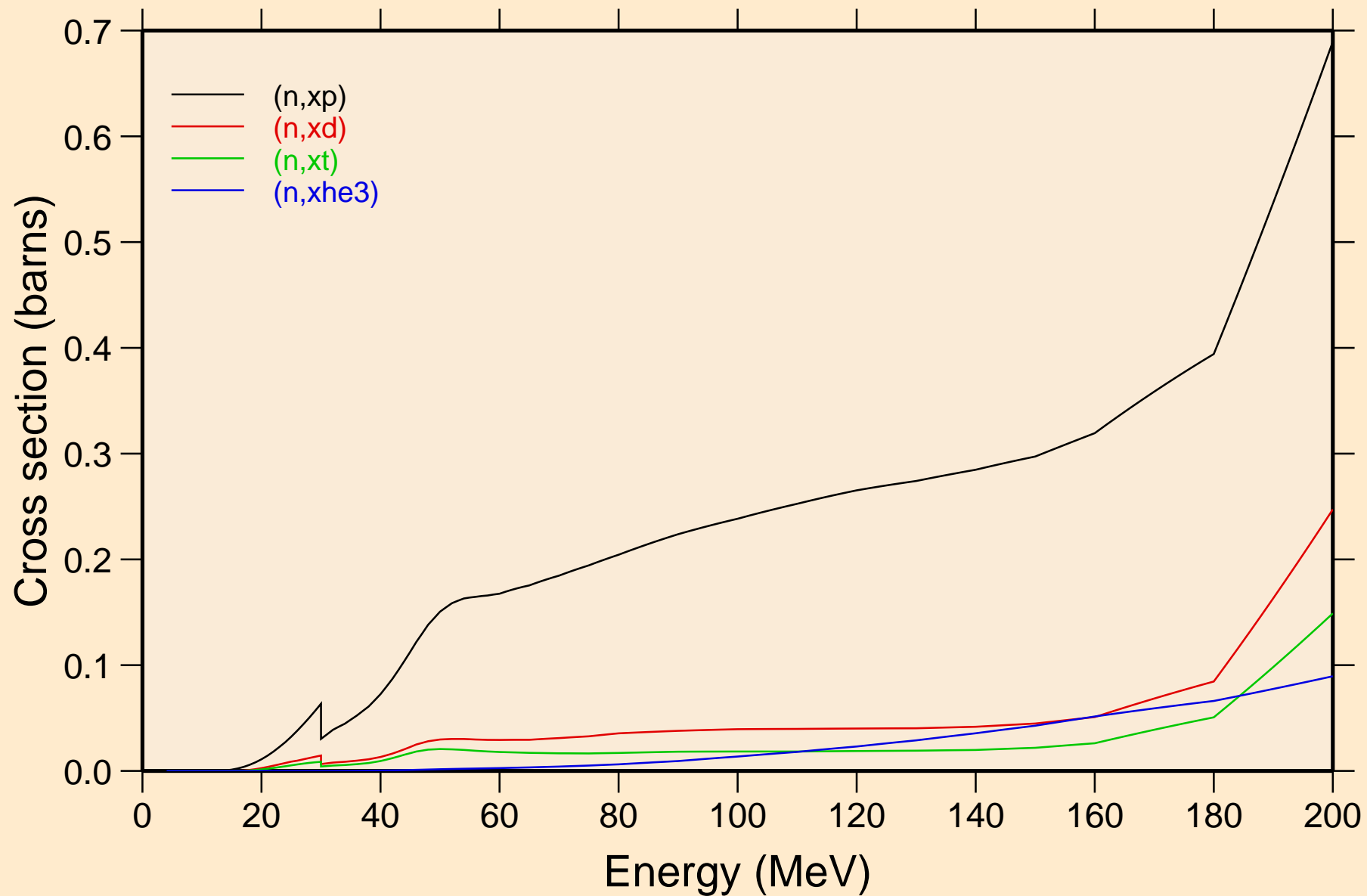

CM246 NEUTRON ACER TENDL-2019 LIBRARY; T=293.16K
angular distribution for elastic

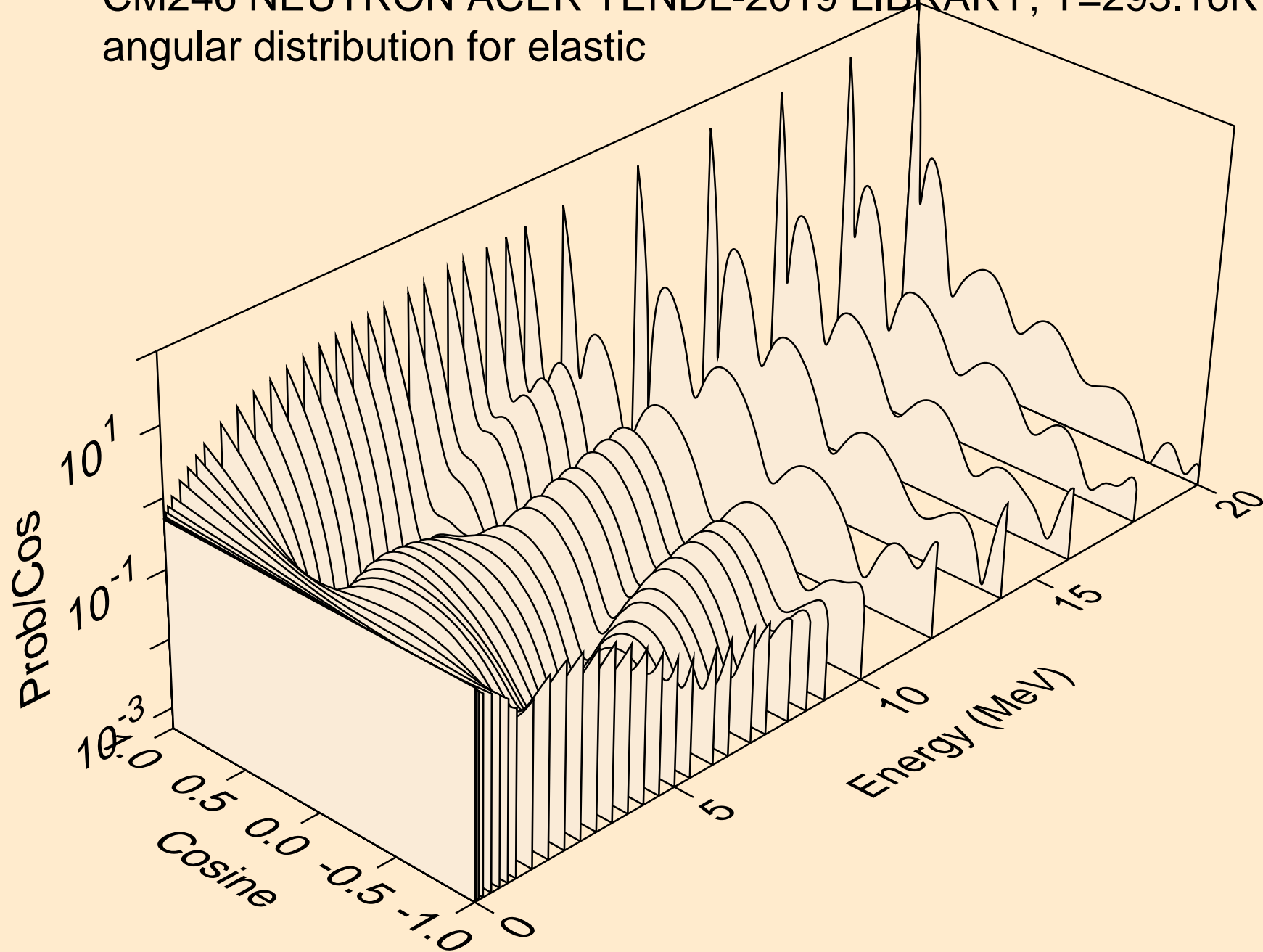

CM246 NEUTRON ACER TENDL-2019 LIBRARY; T=293.16K
angular distribution for elastic

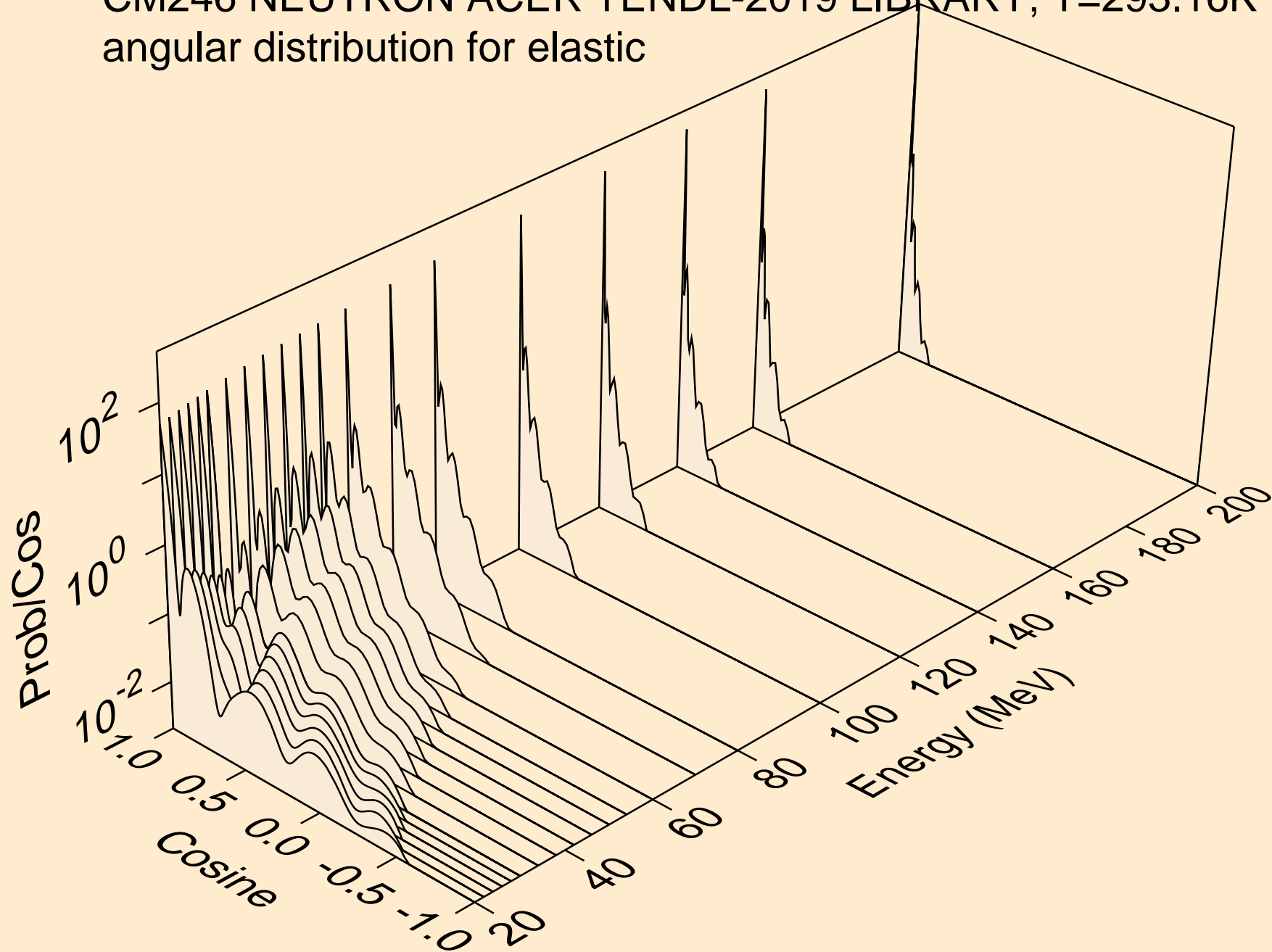

CM246 NEUTRON ACER TENDL-2019 LIBRARY; T=293.16K
angular distribution for (n,n*1)

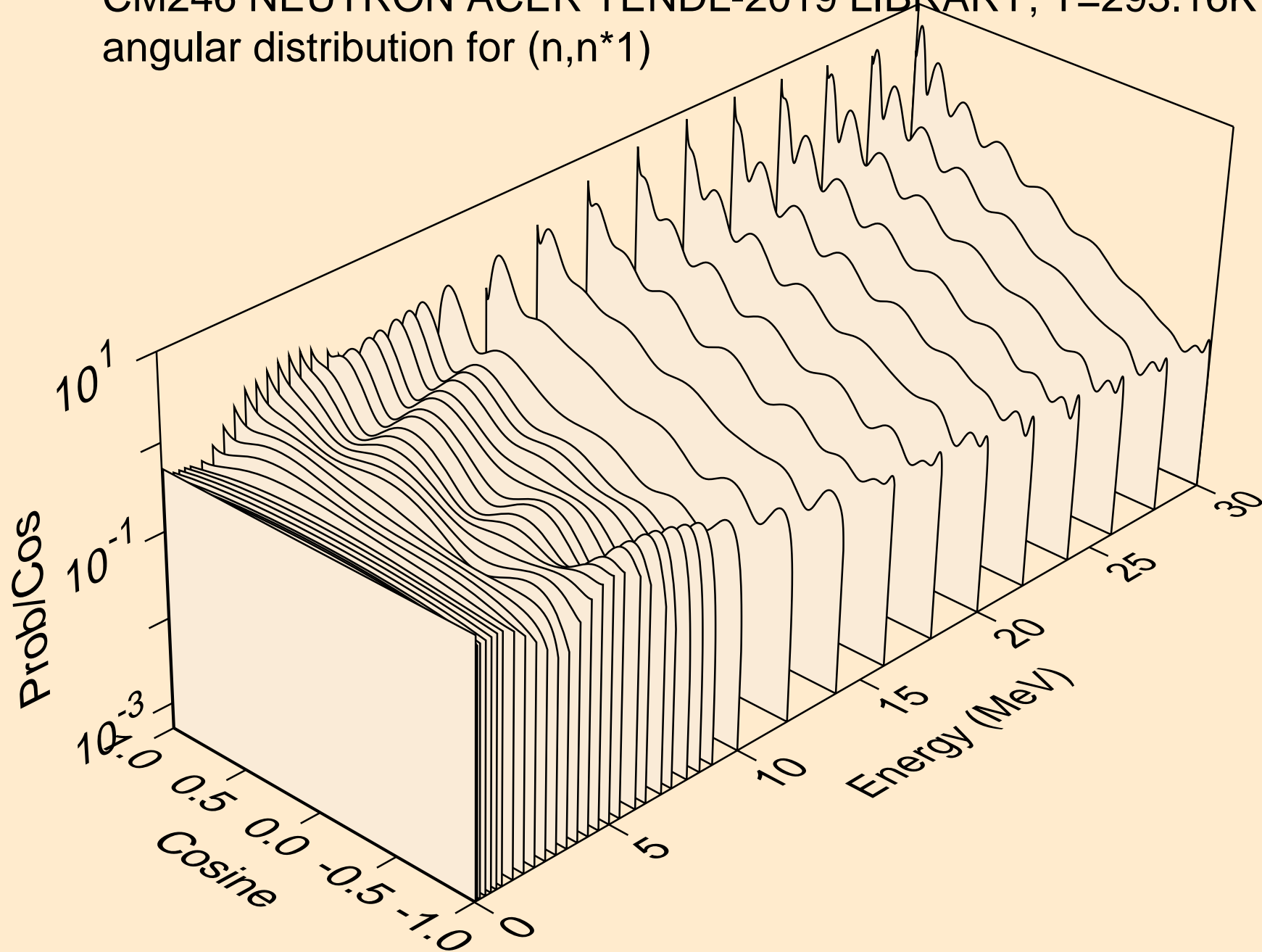

CM246 NEUTRON ACER TENDL-2019 LIBRARY; T=293.16K
angular distribution for (n,n*2)

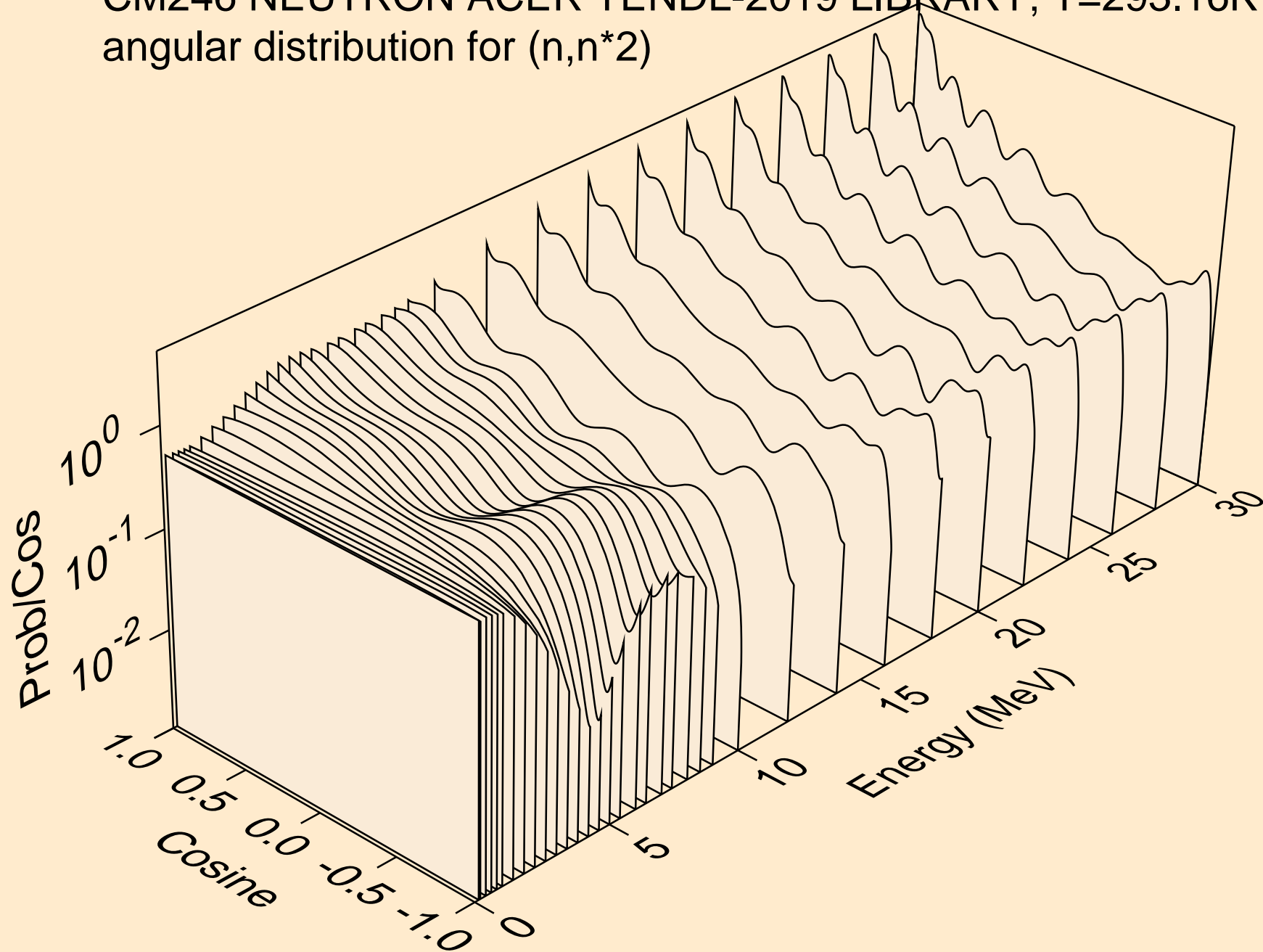

CM246 NEUTRON ACER TENDL-2019 LIBRARY; T=293.16K
angular distribution for (n,n*3)

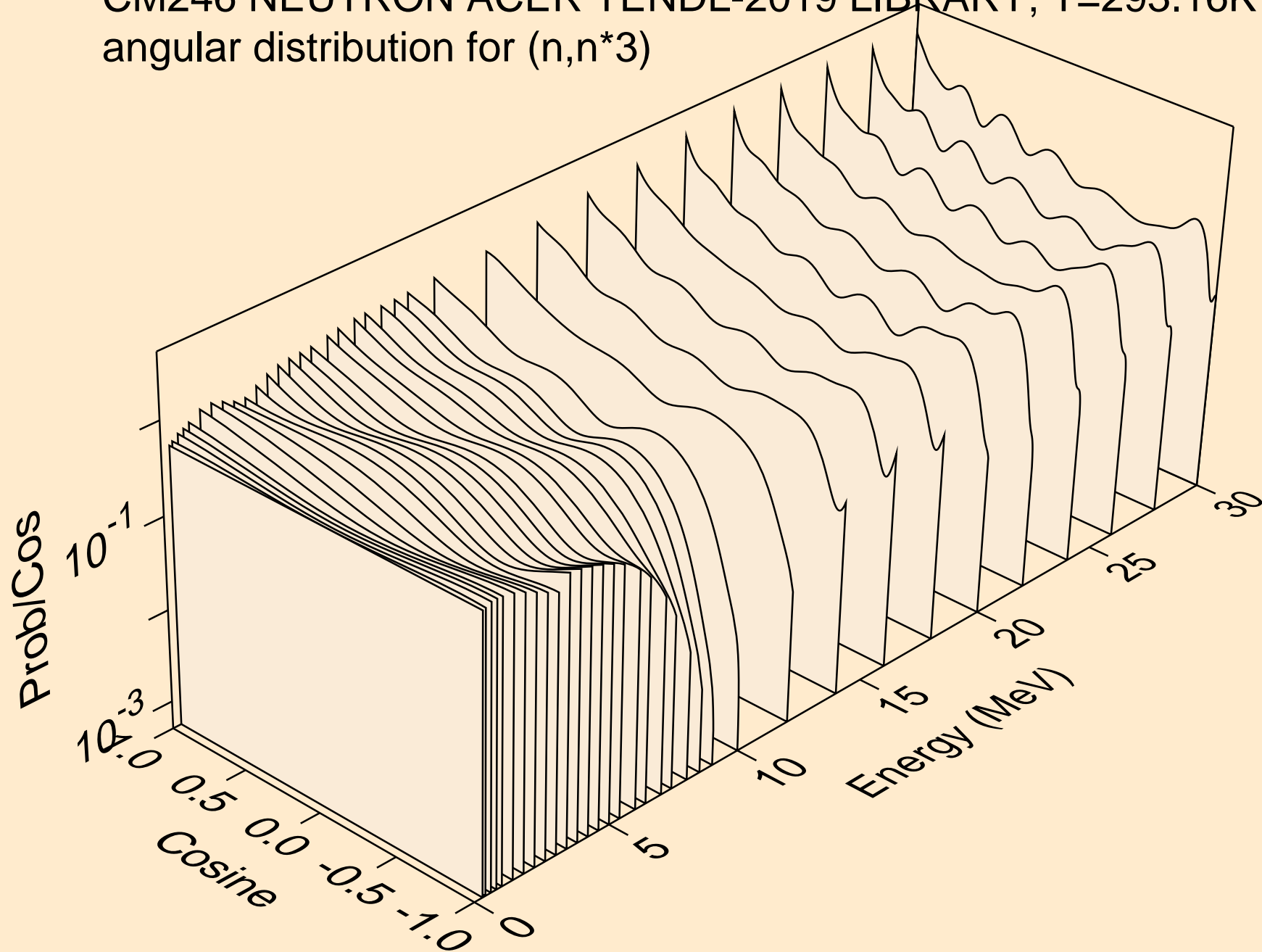

CM246 NEUTRON ACER TENDL-2019 LIBRARY; T=293.16K
angular distribution for (n,n*4)

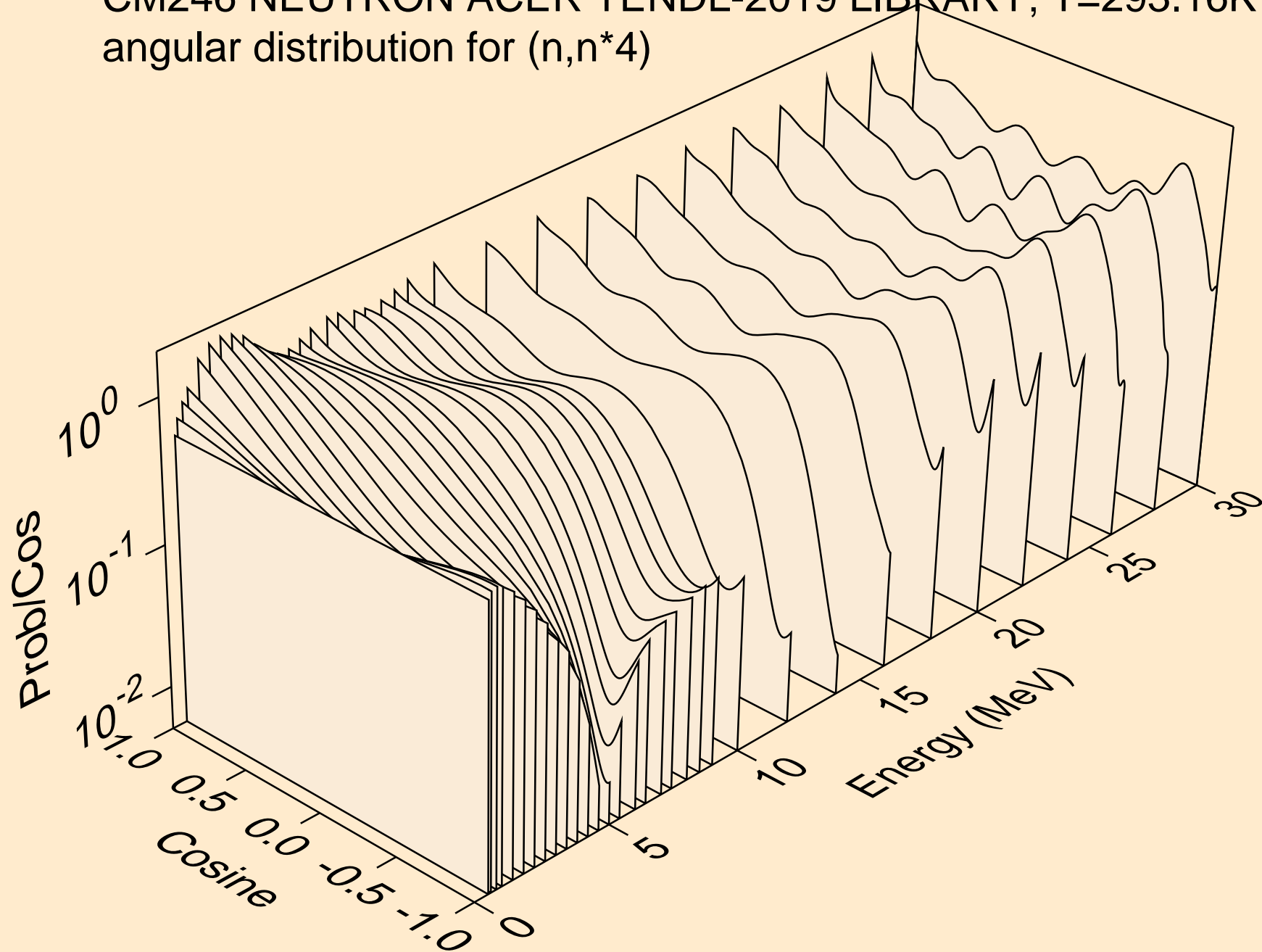

CM246 NEUTRON ACER TENDL-2019 LIBRARY; T=293.16K
angular distribution for (n,n*5)

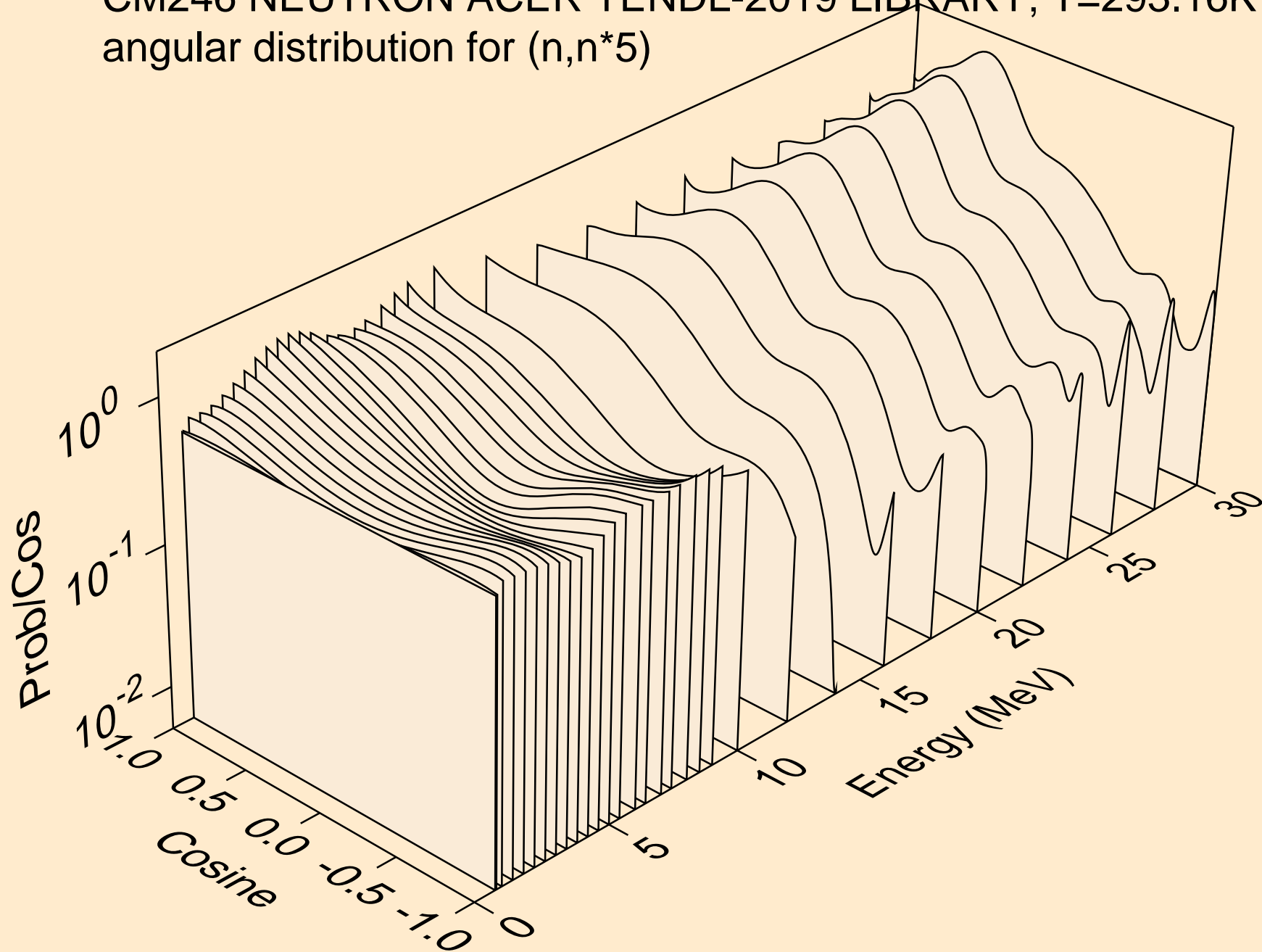

CM246 NEUTRON ACER TENDL-2019 LIBRARY; T=293.16K
angular distribution for (n,n*6)

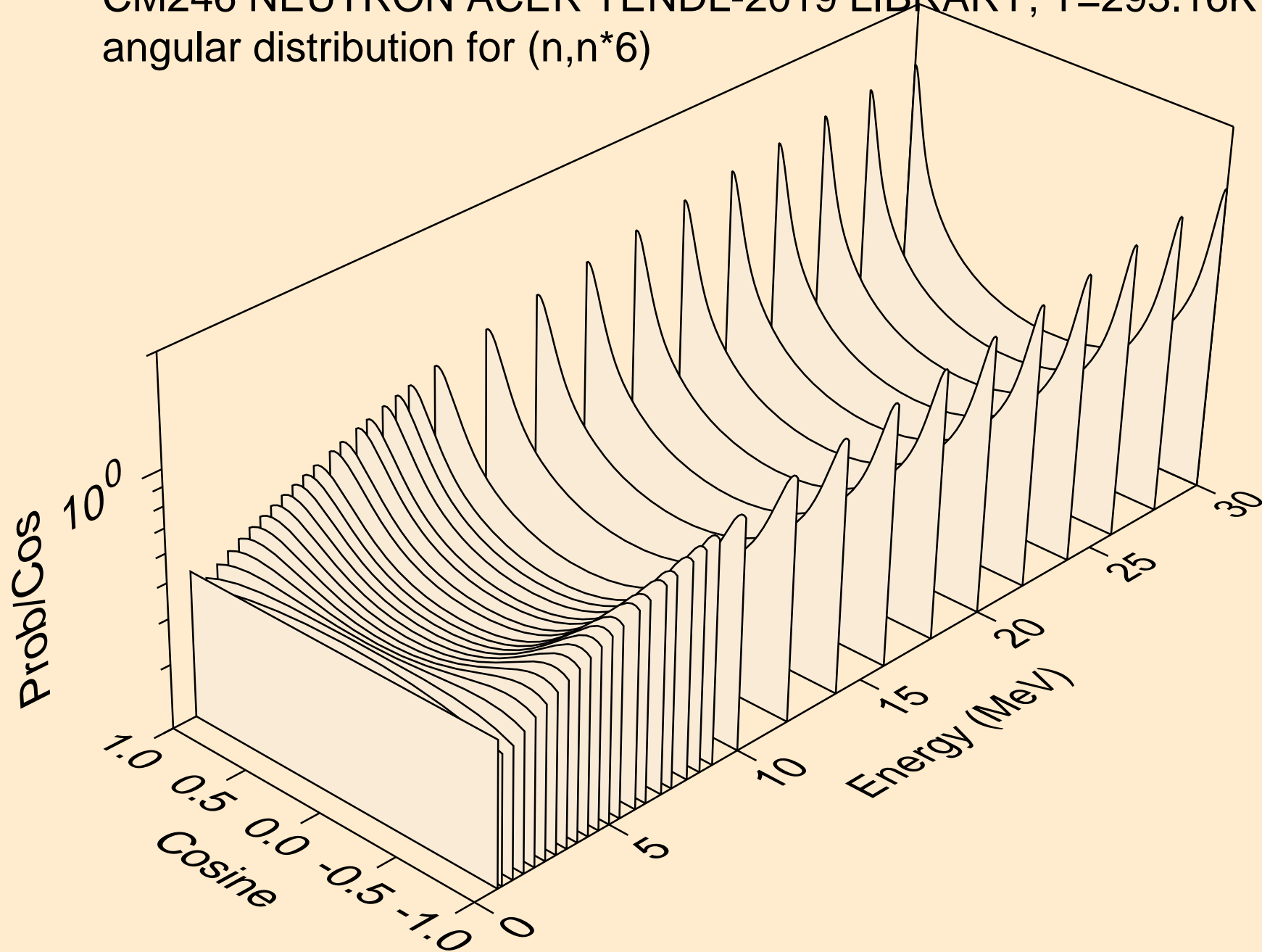

CM246 NEUTRON ACER TENDL-2019 LIBRARY; T=293.16K
angular distribution for (n,n*7)

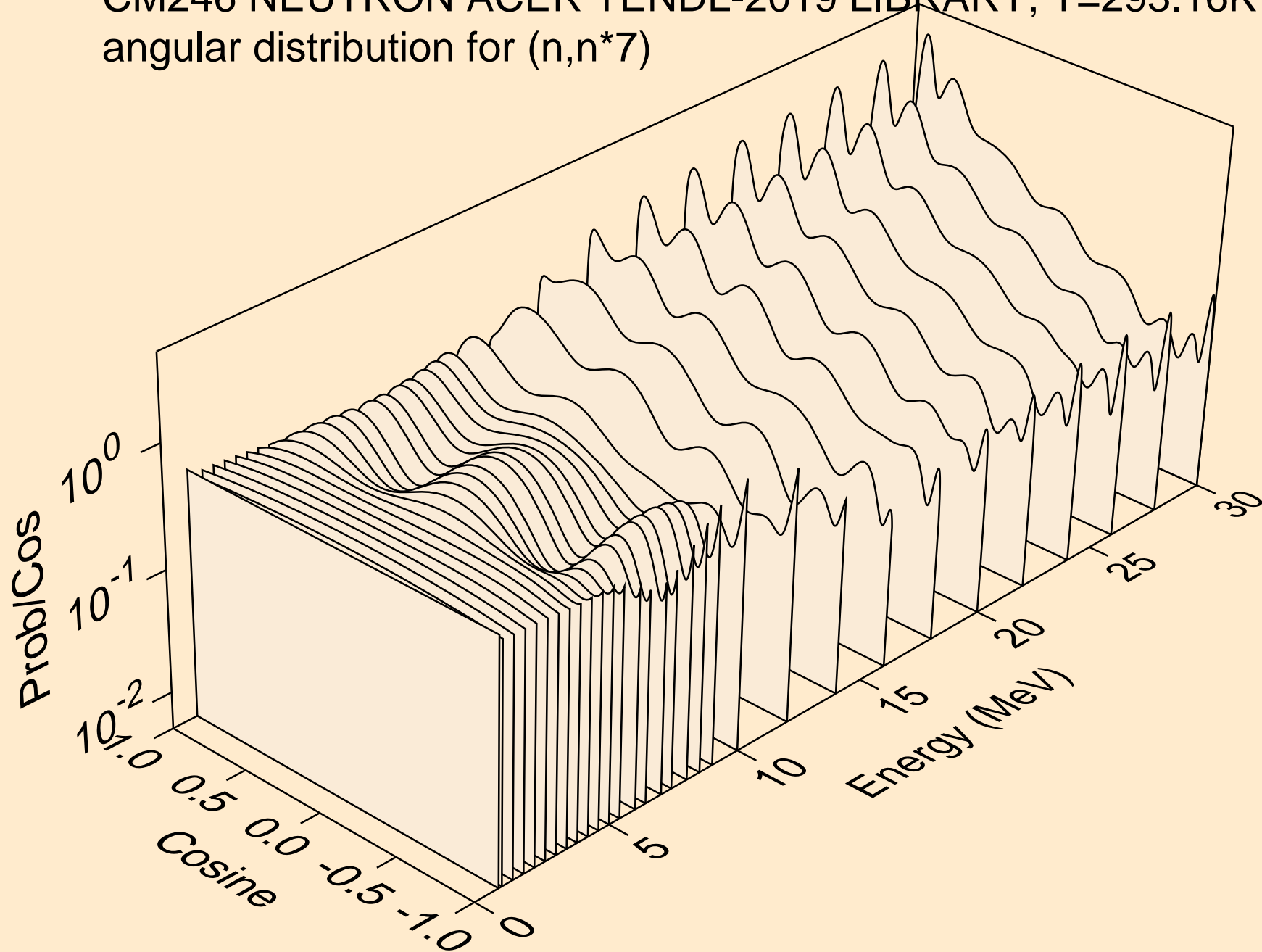

CM246 NEUTRON ACER TENDL-2019 LIBRARY; T=293.16K
angular distribution for (n,n*8)

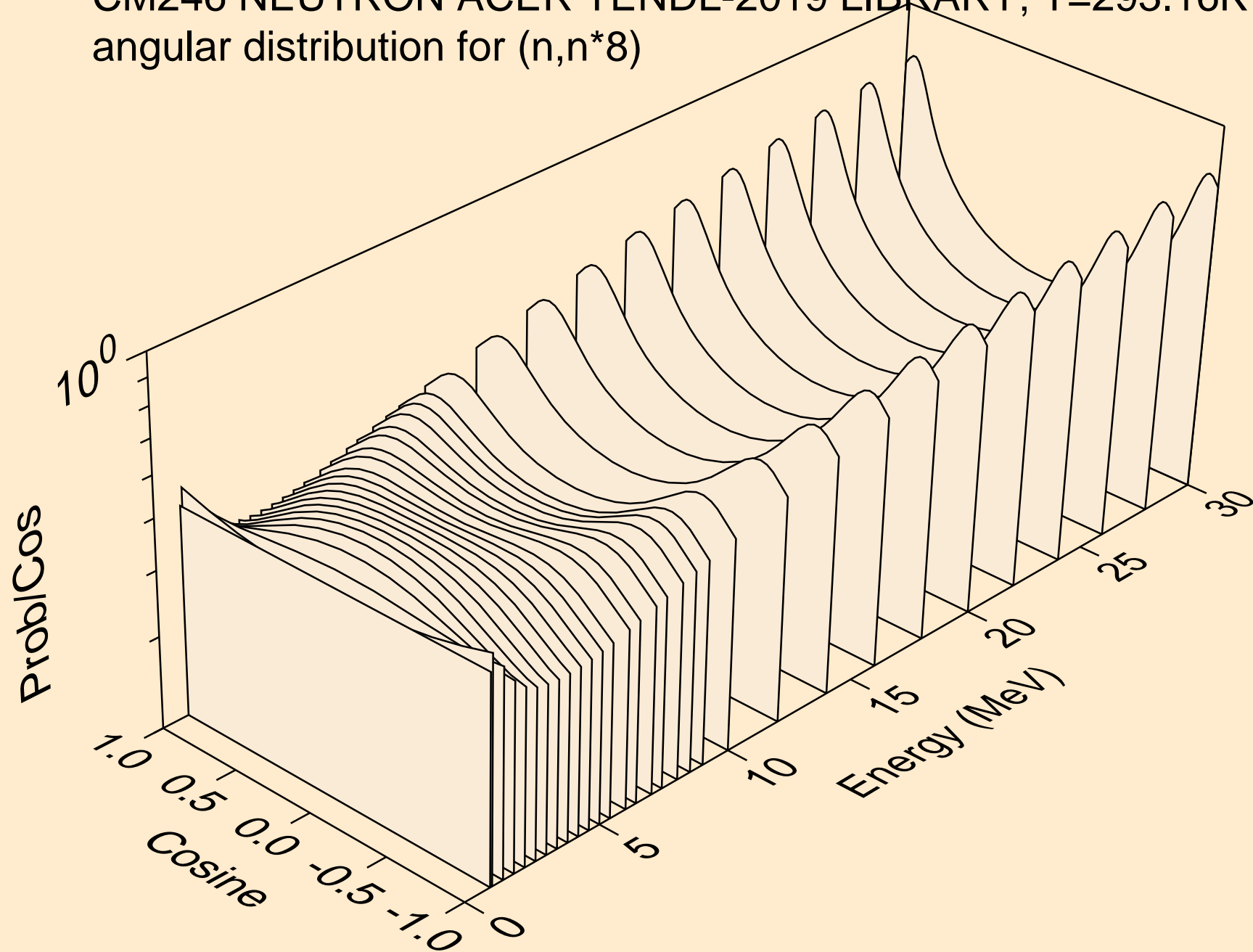

CM246 NEUTRON ACER TENDL-2019 LIBRARY; T=293.16K
angular distribution for (n,n*9)

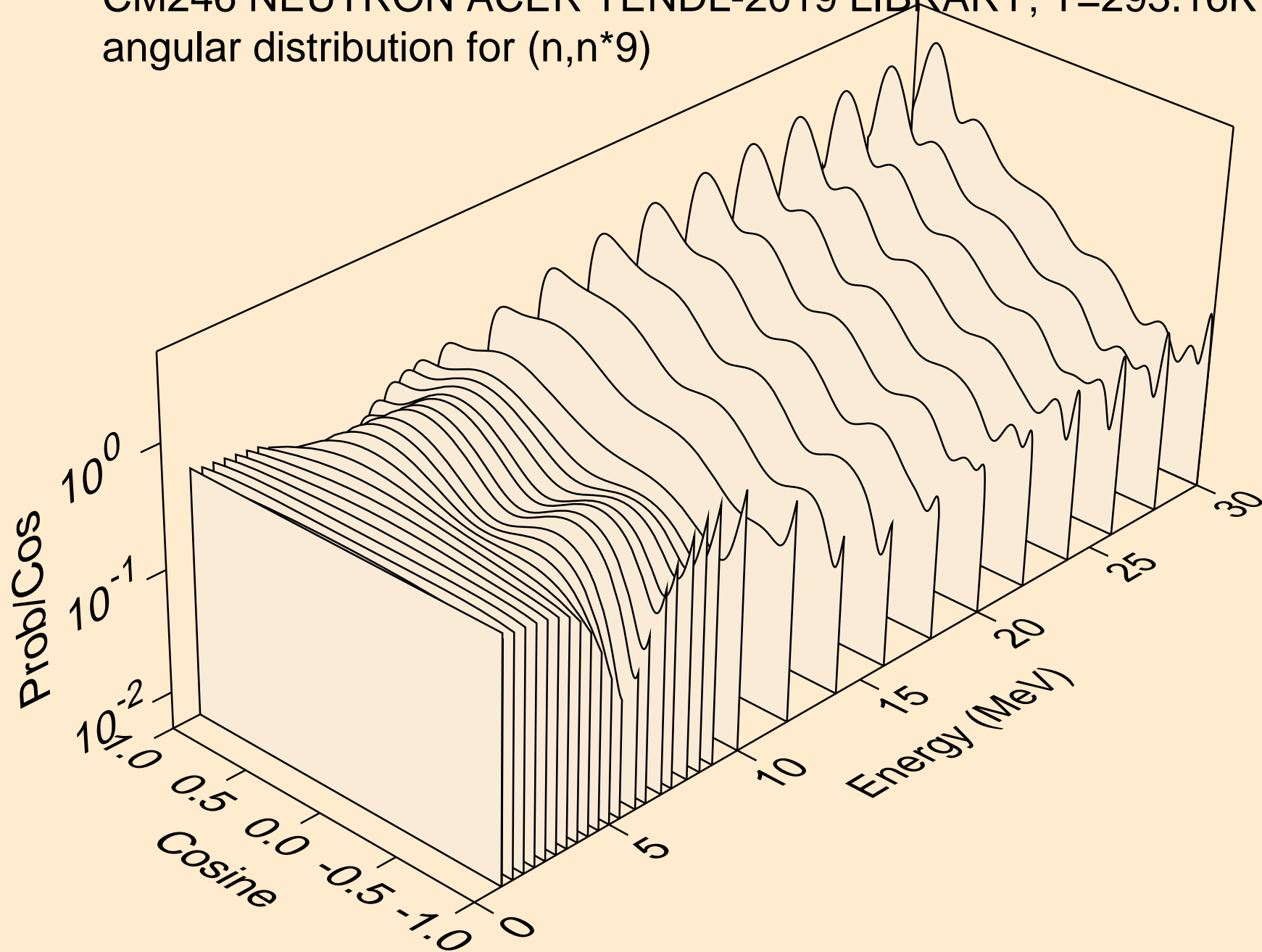

CM246 NEUTRON ACER TENDL-2019 LIBRARY; T=293.16K
angular distribution for (n,n*10)

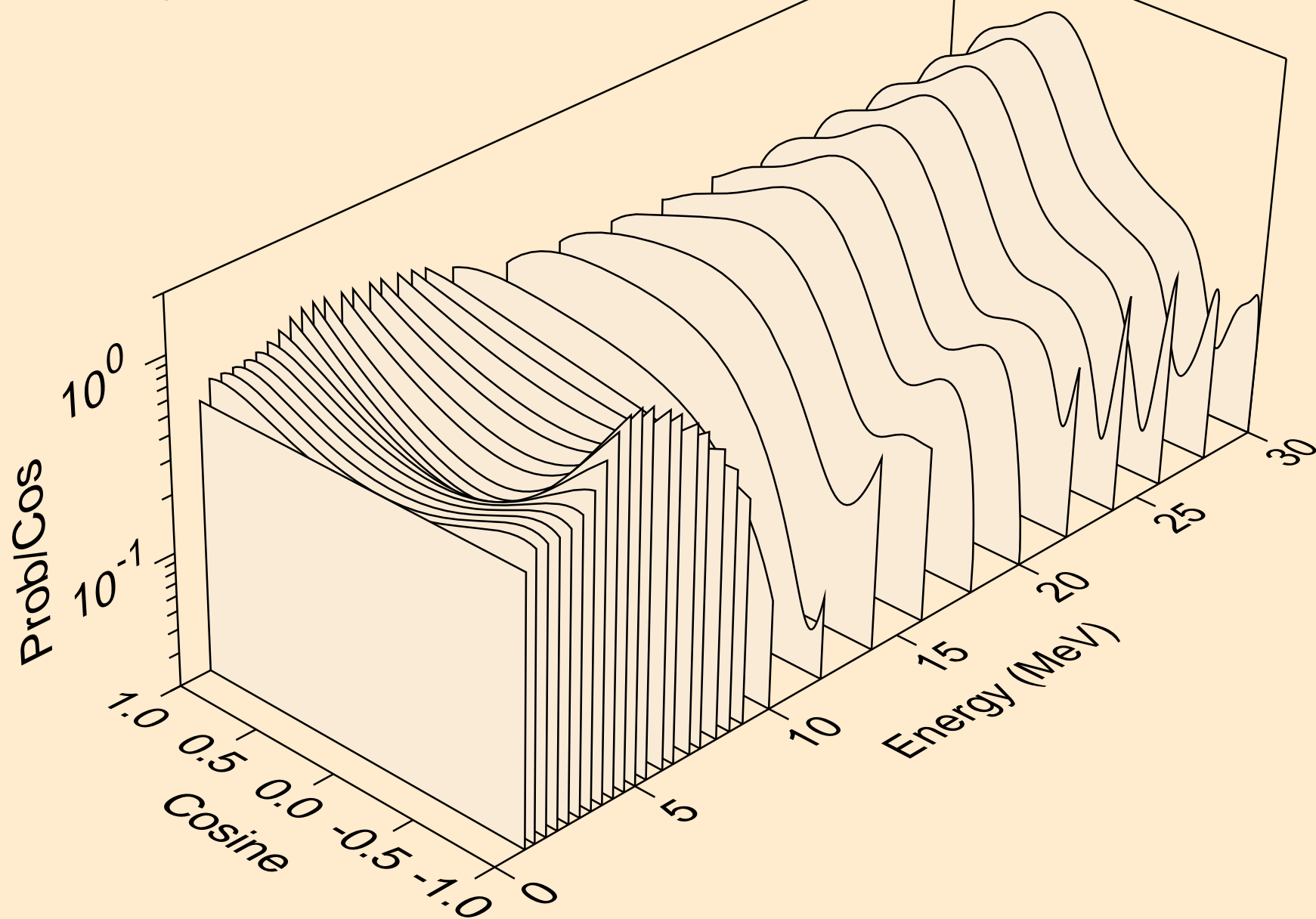

CM246 NEUTRON ACER TENDL-2019 LIBRARY; T=293.16K
angular distribution for (n,n*11)

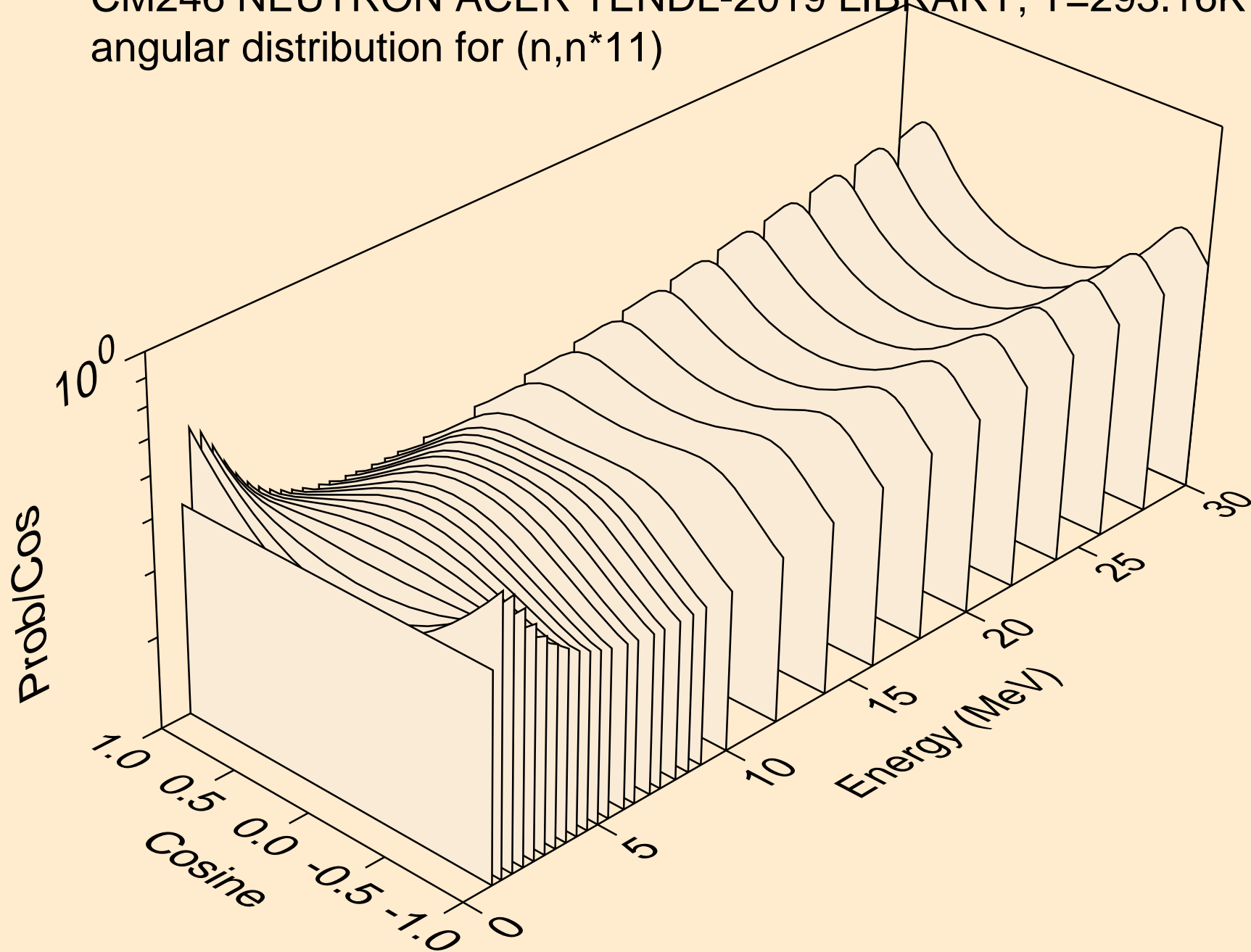

CM246 NEUTRON ACER TENDL-2019 LIBRARY; T=293.16K
angular distribution for (n,n*12)

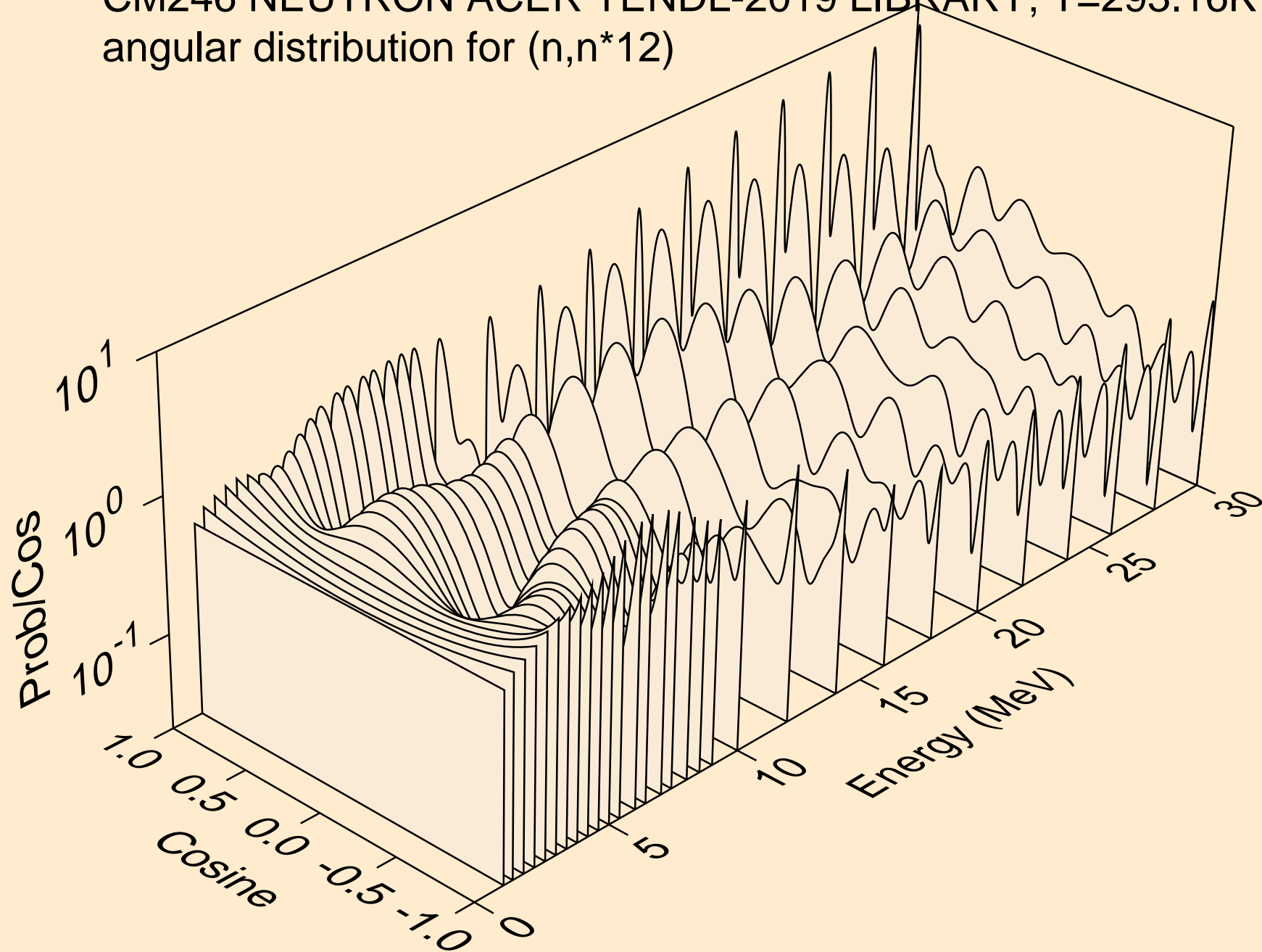

CM246 NEUTRON ACER TENDL-2019 LIBRARY; T=293.16K
angular distribution for (n,n*13)

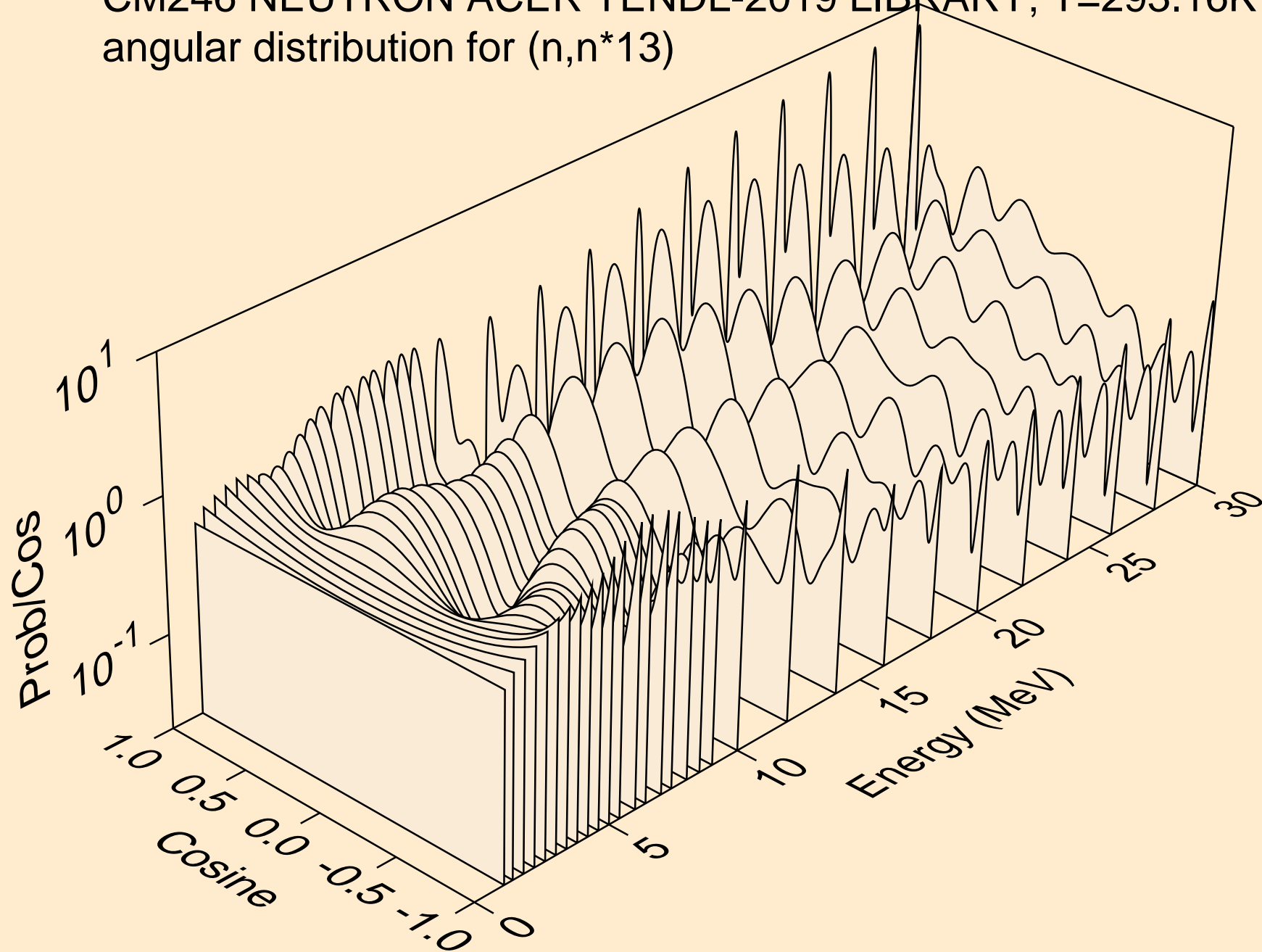

CM246 NEUTRON ACER TENDL-2019 LIBRARY; T=293.16K
angular distribution for (n,n*14)

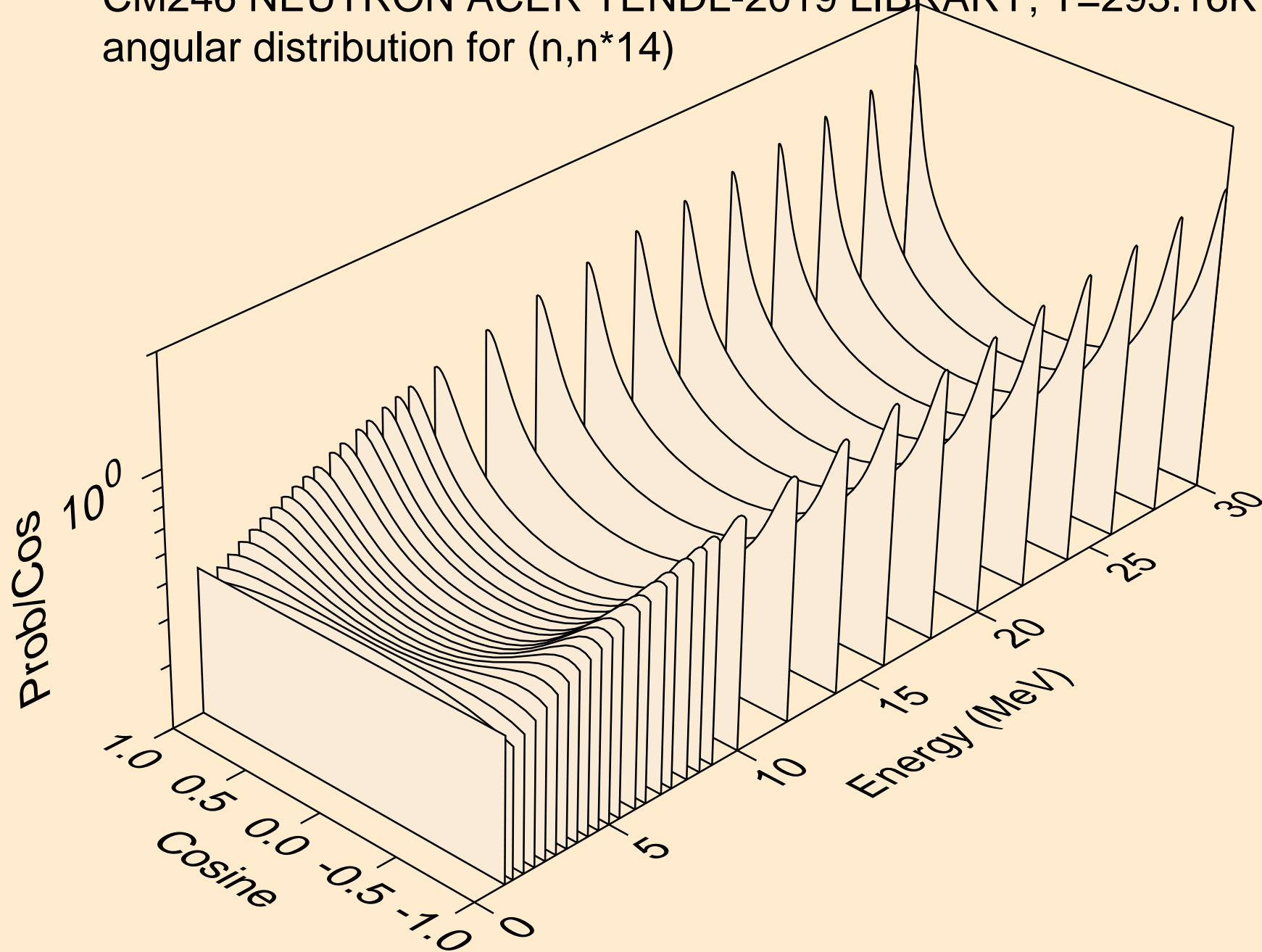

CM246 NEUTRON ACER TENDL-2019 LIBRARY; T=293.16K
angular distribution for (n,n*15)

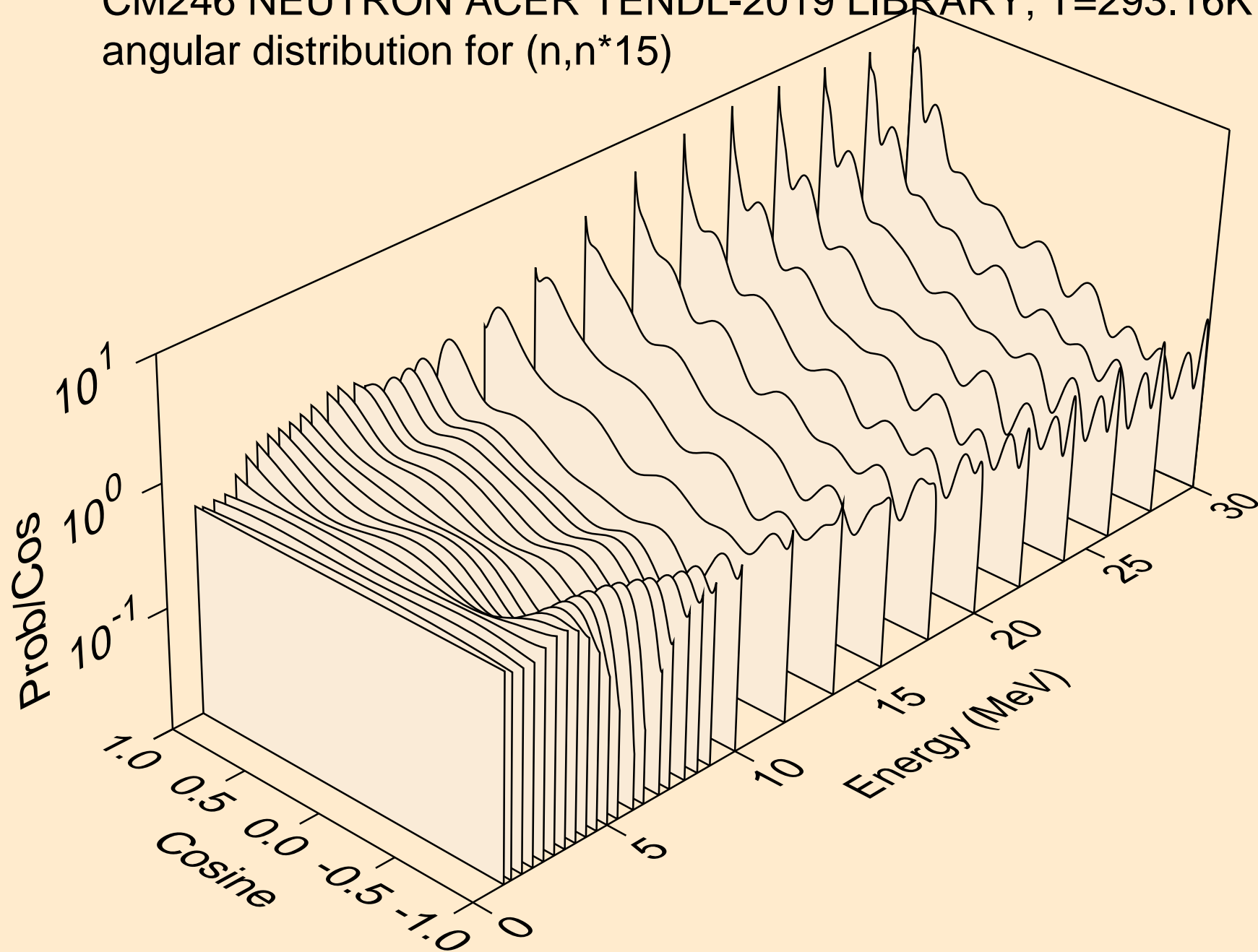

CM246 NEUTRON ACER TENDL-2019 LIBRARY; T=293.16K
angular distribution for (n,n*16)

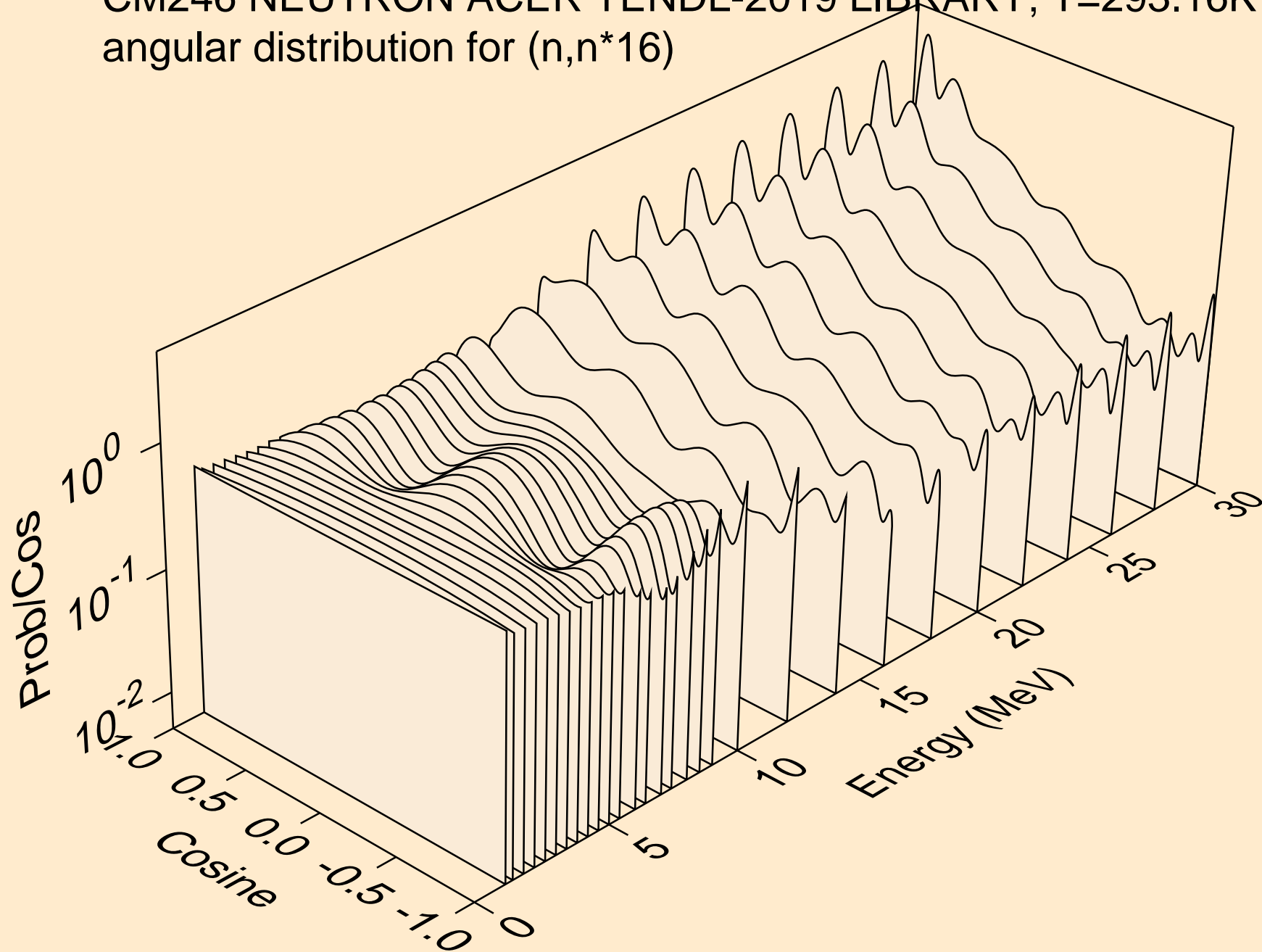

CM246 NEUTRON ACER TENDL-2019 LIBRARY; T=293.16K
angular distribution for (n,n*17)

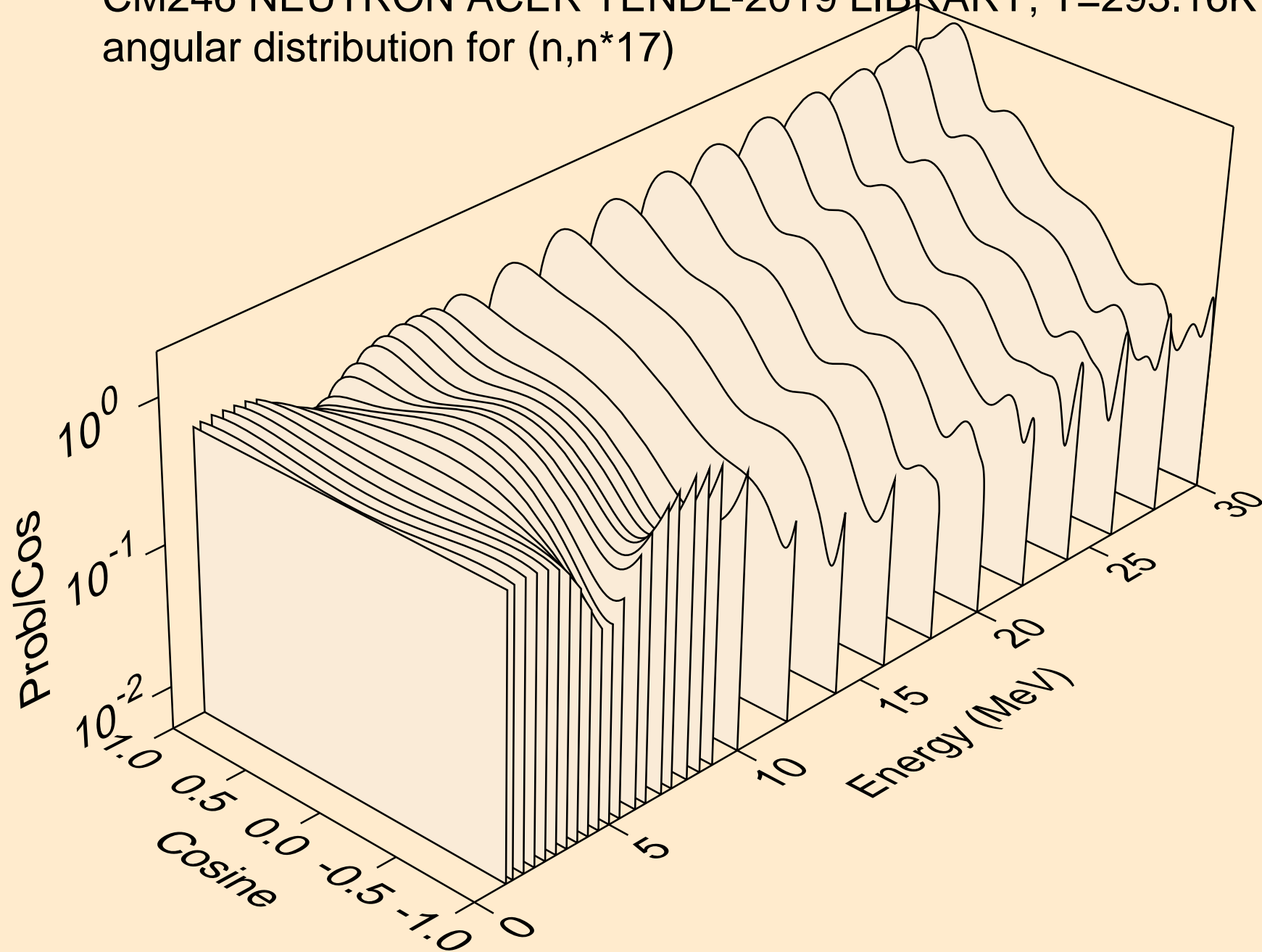

CM246 NEUTRON ACER TENDL-2019 LIBRARY; T=293.16K
angular distribution for (n,n*18)

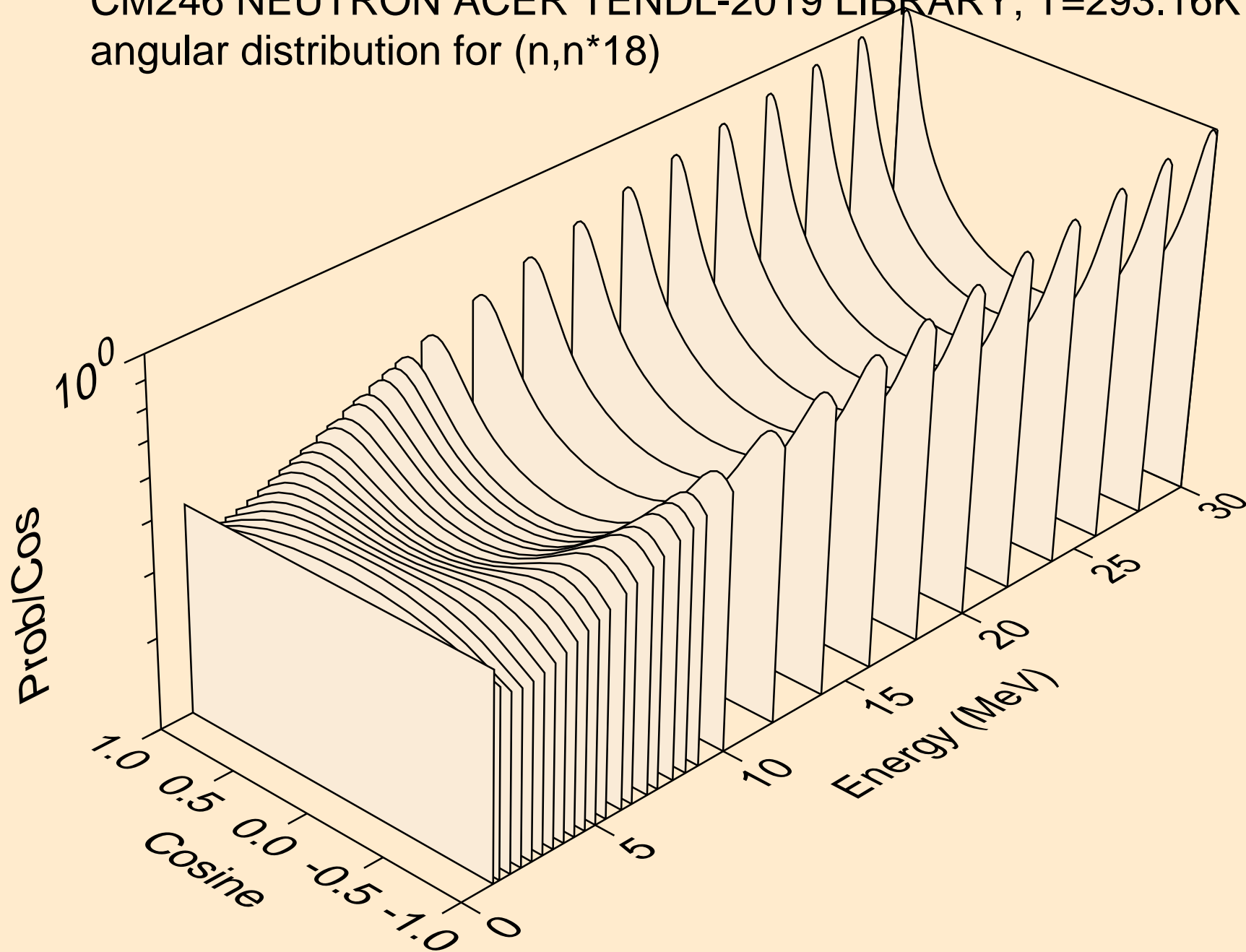

CM246 NEUTRON ACER TENDL-2019 LIBRARY; T=293.16K
angular distribution for (n,n*19)

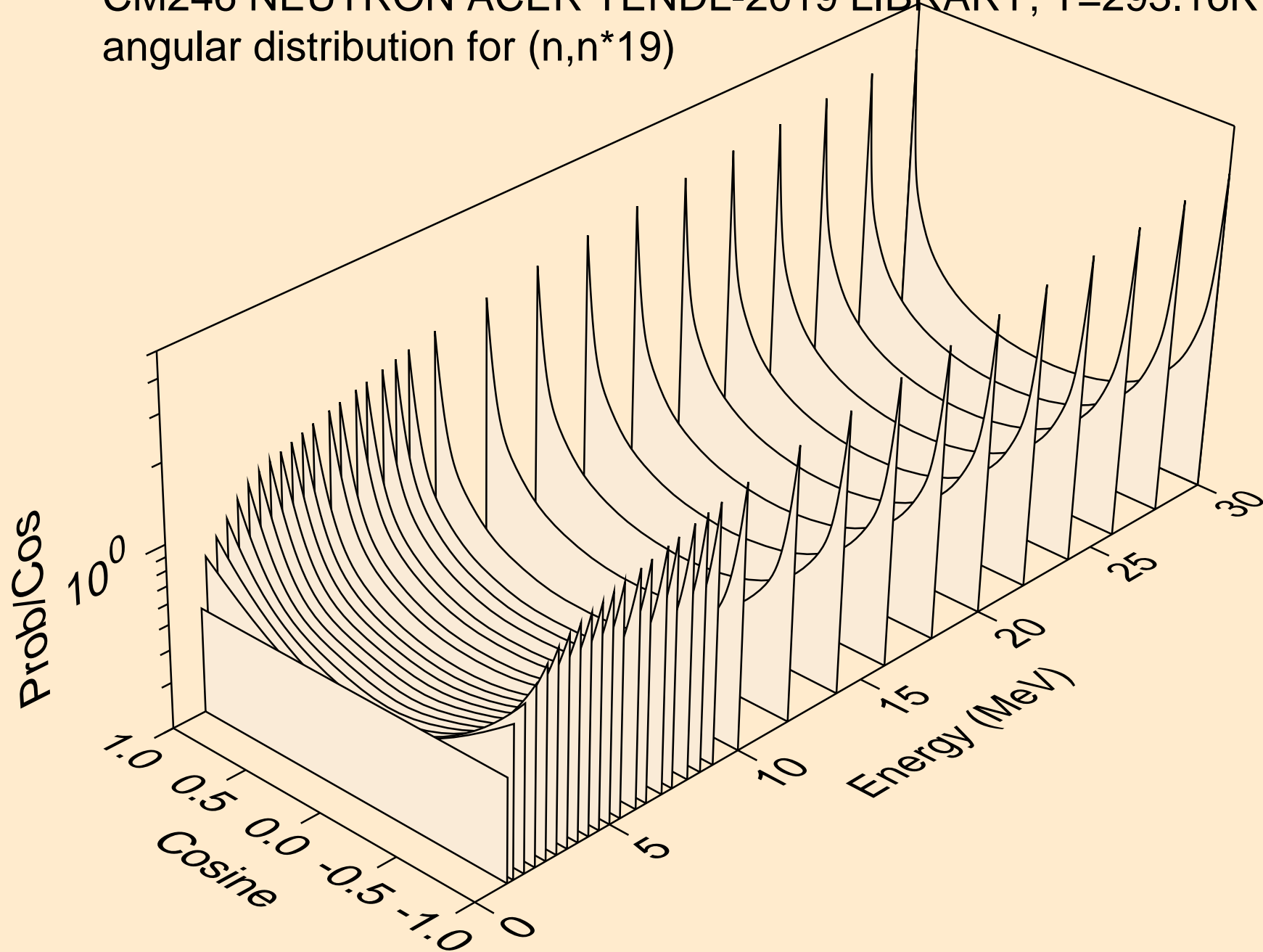

CM246 NEUTRON ACER TENDL-2019 LIBRARY; T=293.16K
angular distribution for (n,n*20)

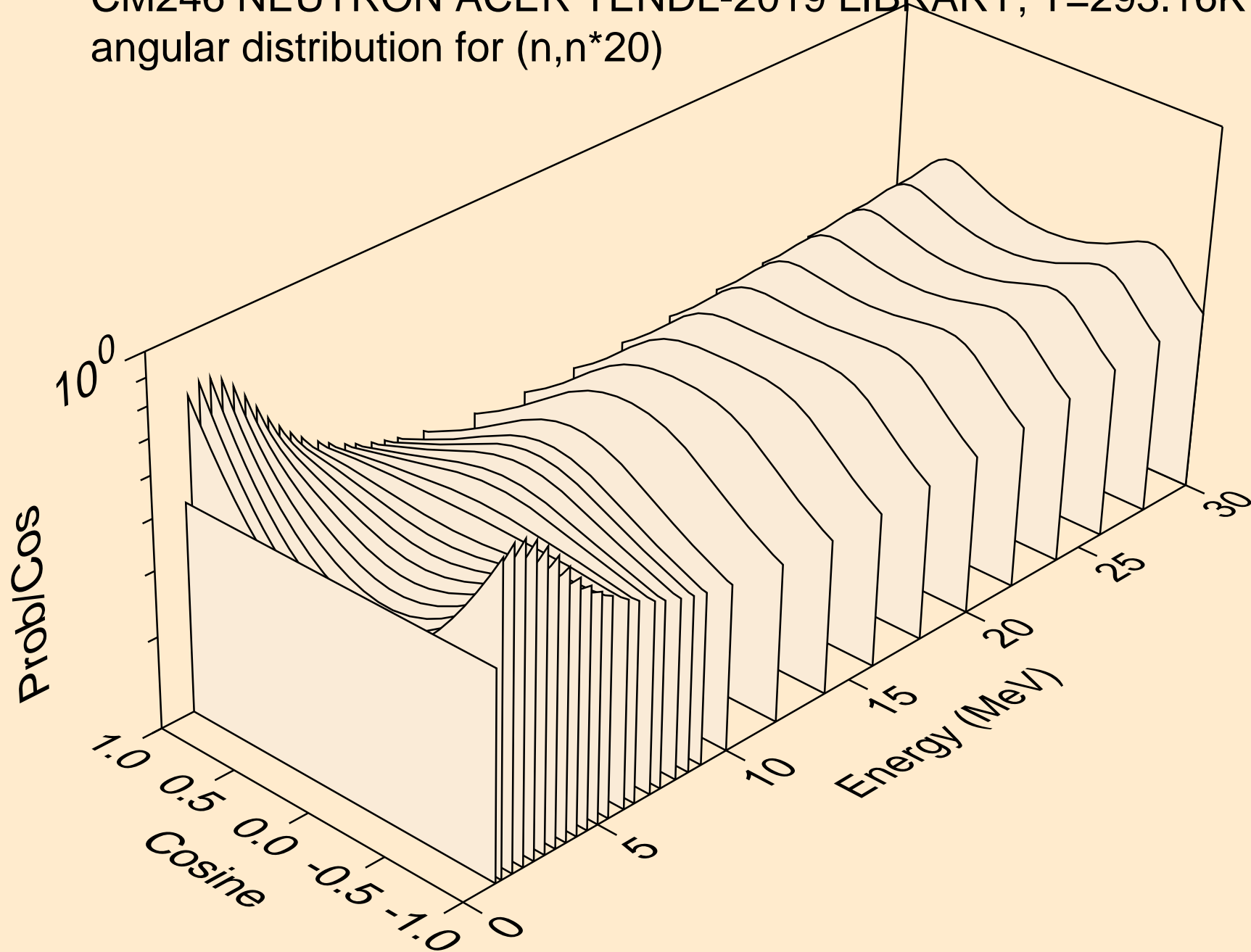

CM246 NEUTRON ACER TENDL-2019 LIBRARY; T=293.16K
angular distribution for (n,n*21)

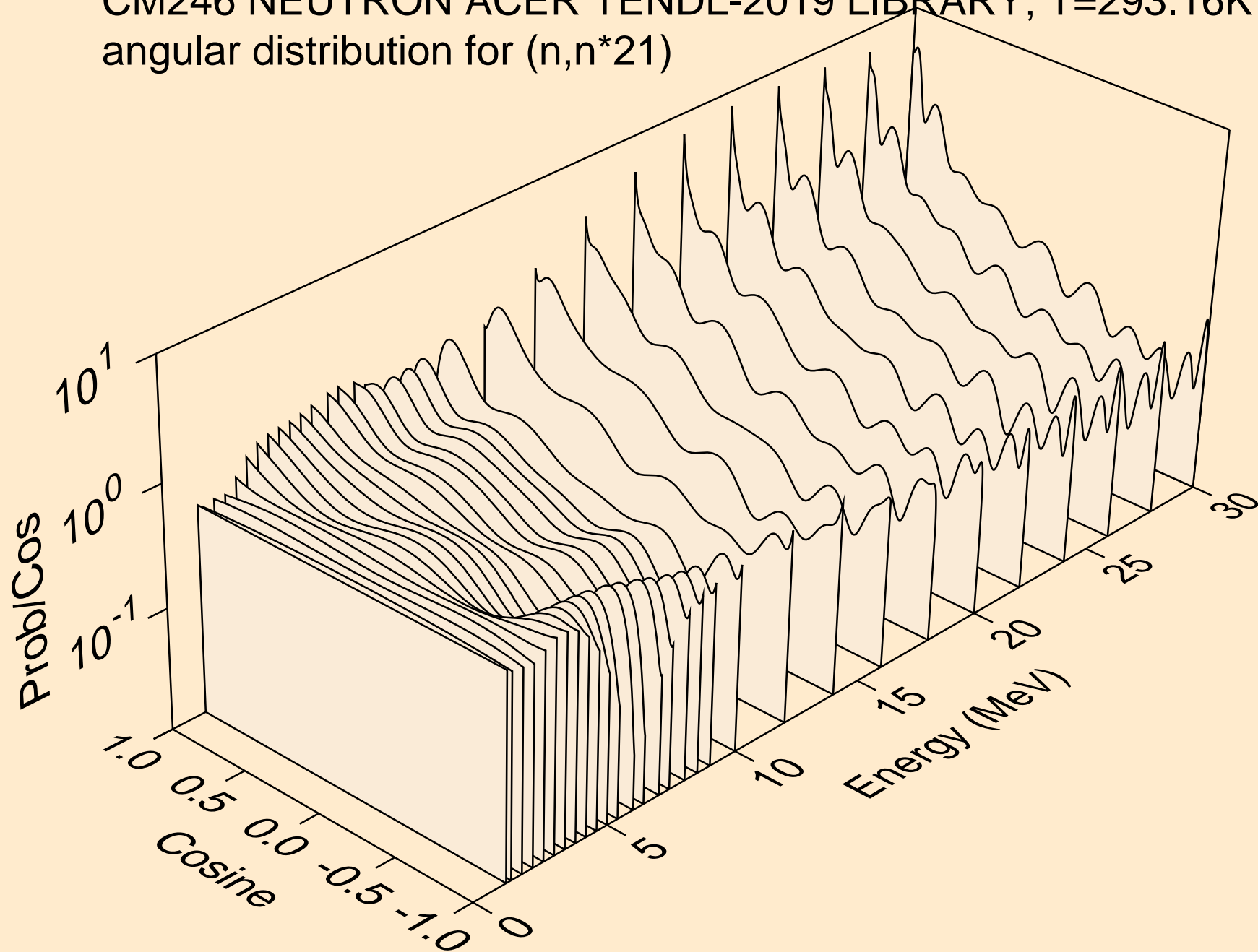

CM246 NEUTRON ACER TENDL-2019 LIBRARY; T=293.16K
angular distribution for (n,n*22)

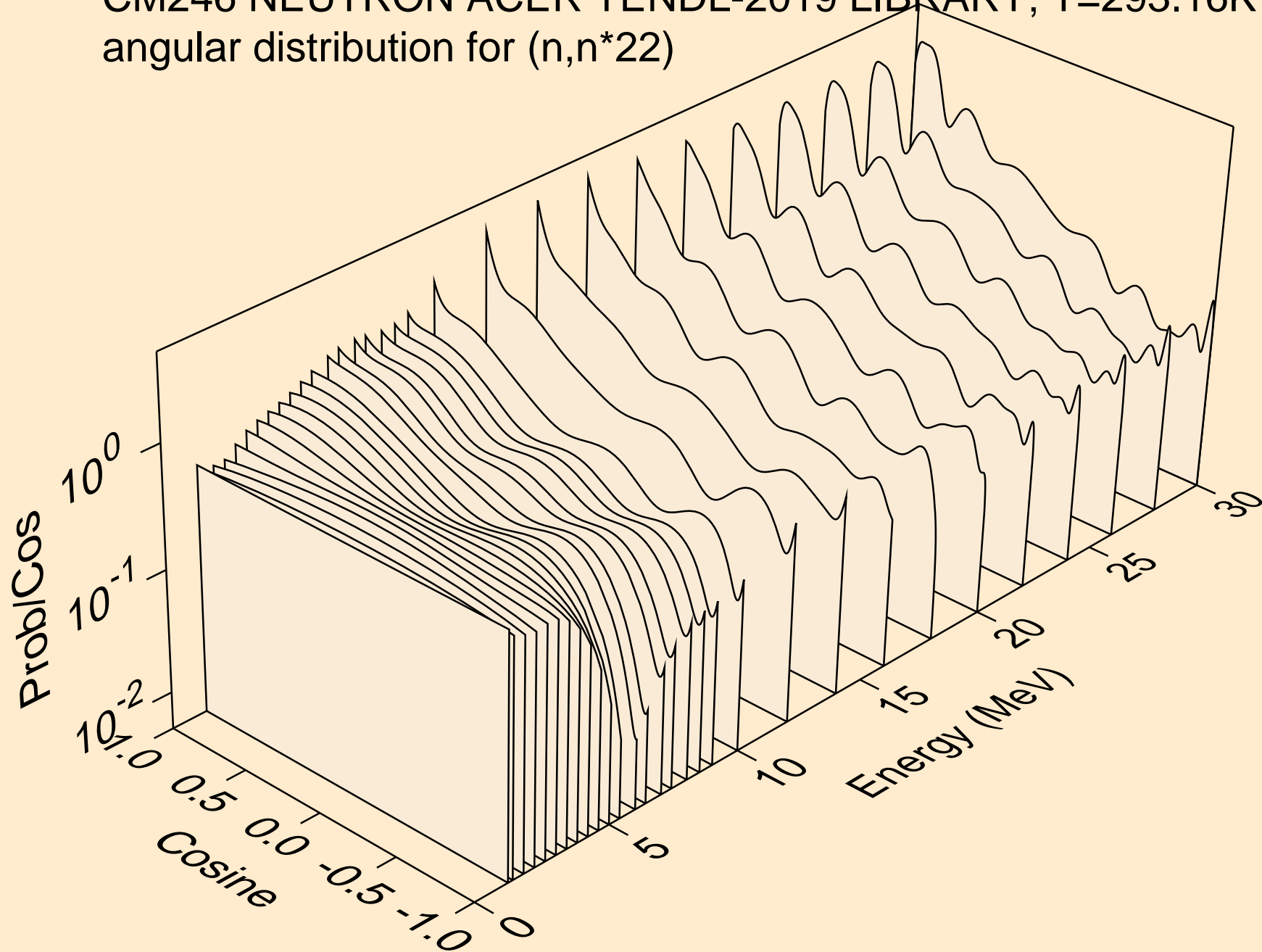

CM246 NEUTRON ACER TENDL-2019 LIBRARY; T=293.16K
angular distribution for (n,n*23)

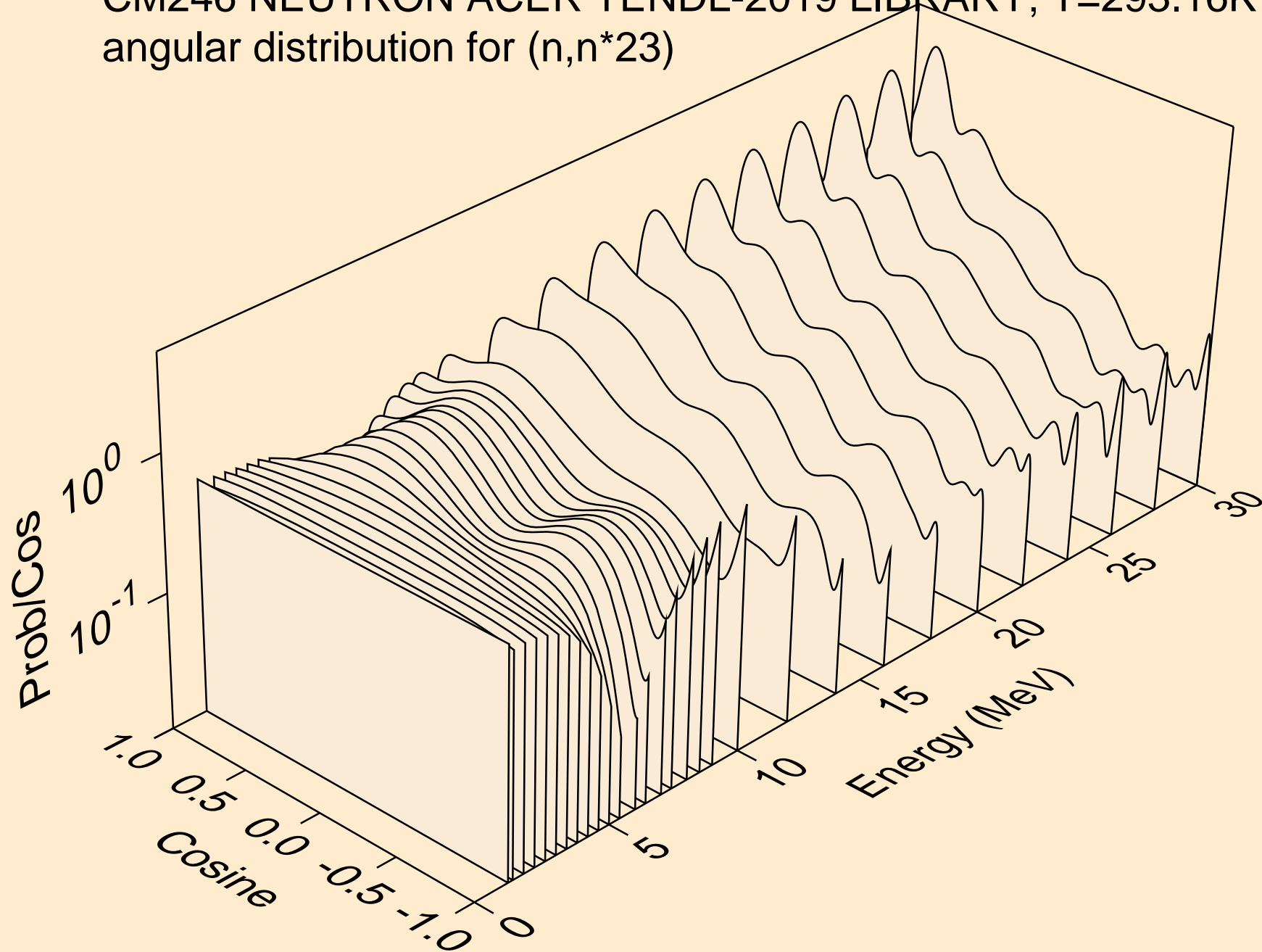

CM246 NEUTRON ACER TENDL-2019 LIBRARY; T=293.16K
angular distribution for (n,n*24)

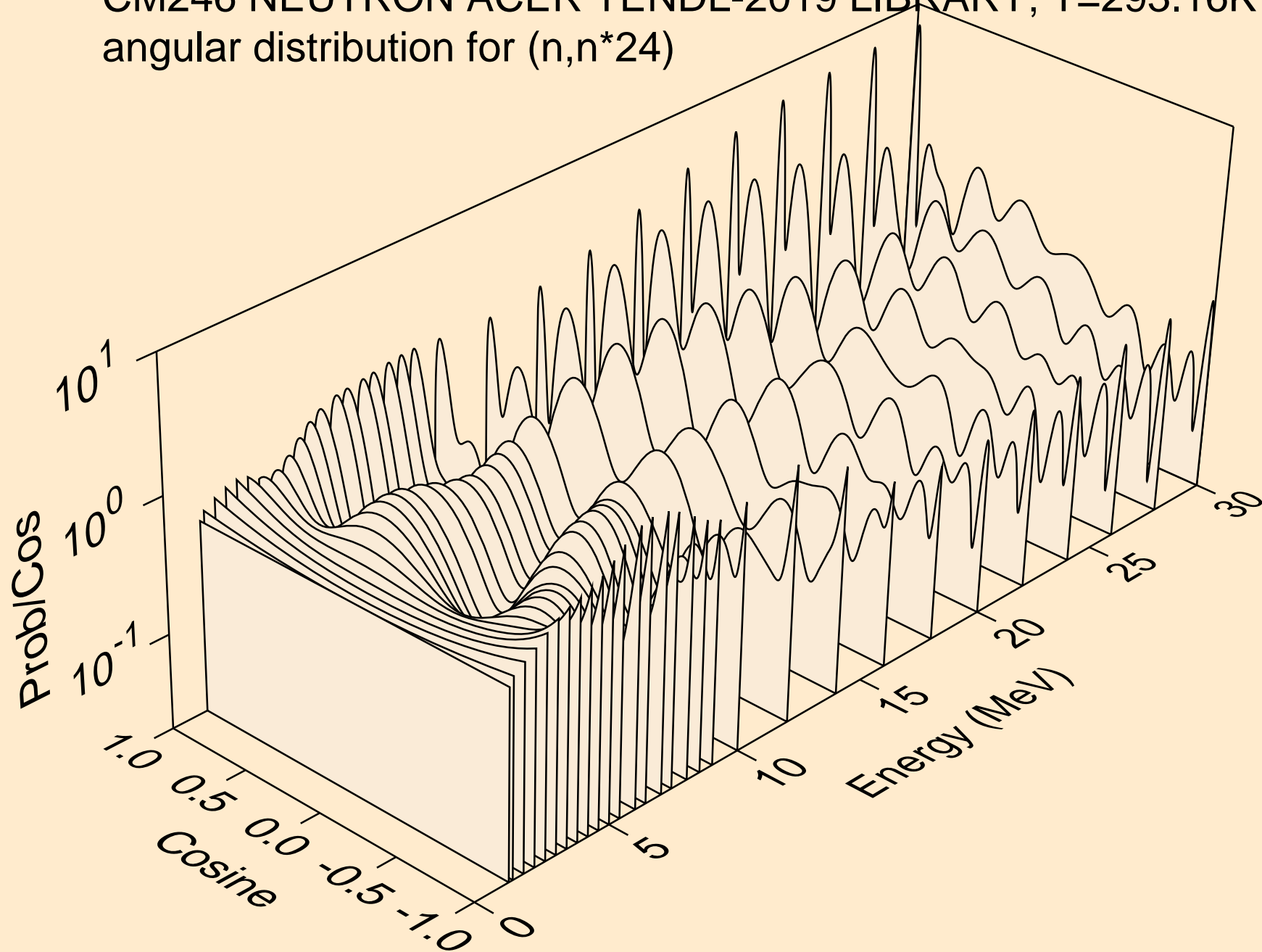

CM246 NEUTRON ACER TENDL-2019 LIBRARY; T=293.16K
angular distribution for (n,n*25)

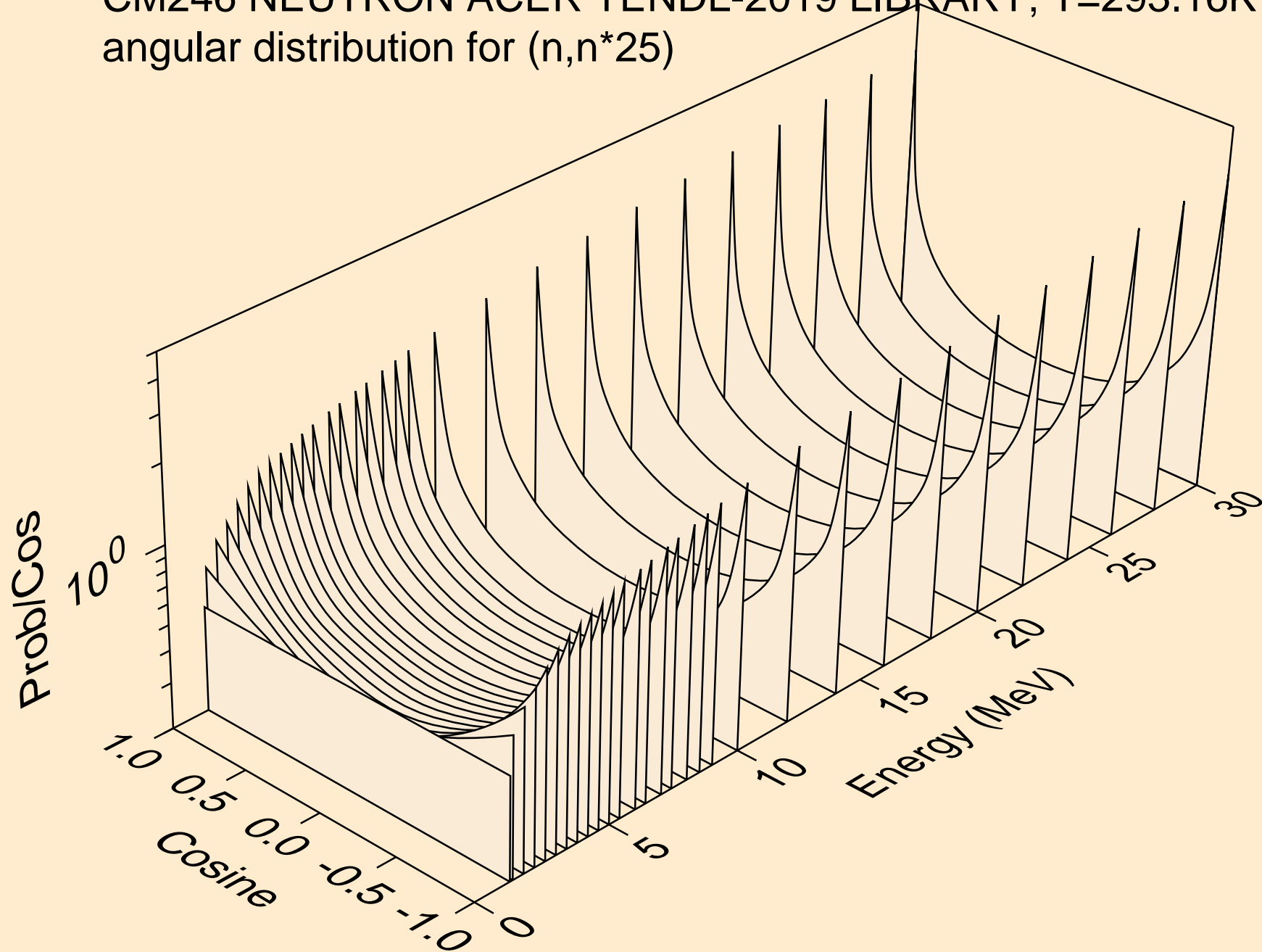

CM246 NEUTRON ACER TENDL-2019 LIBRARY; T=293.16K
angular distribution for (n,n*26)

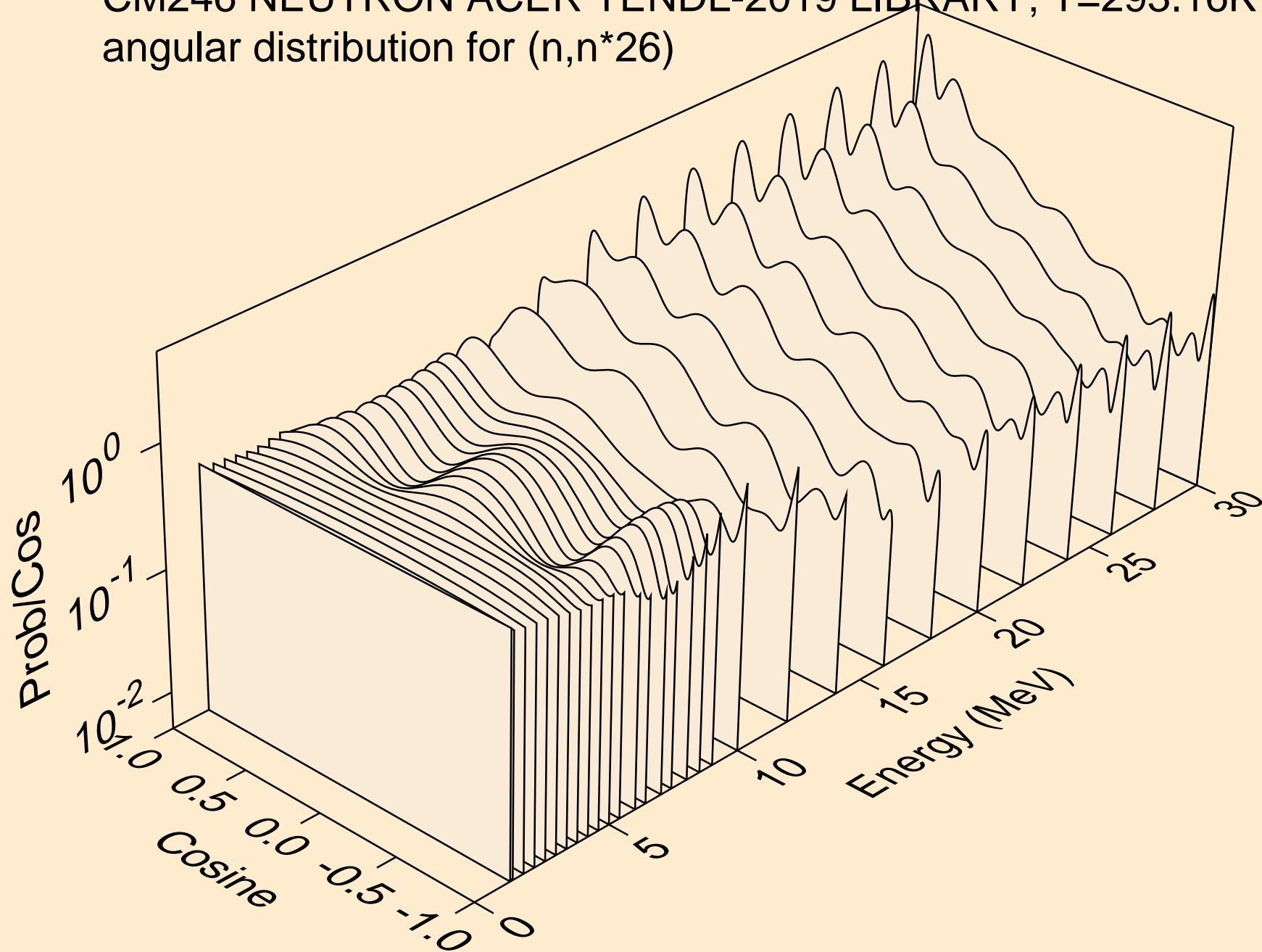

CM246 NEUTRON ACER TENDL-2019 LIBRARY; T=293.16K
angular distribution for (n,n*27)

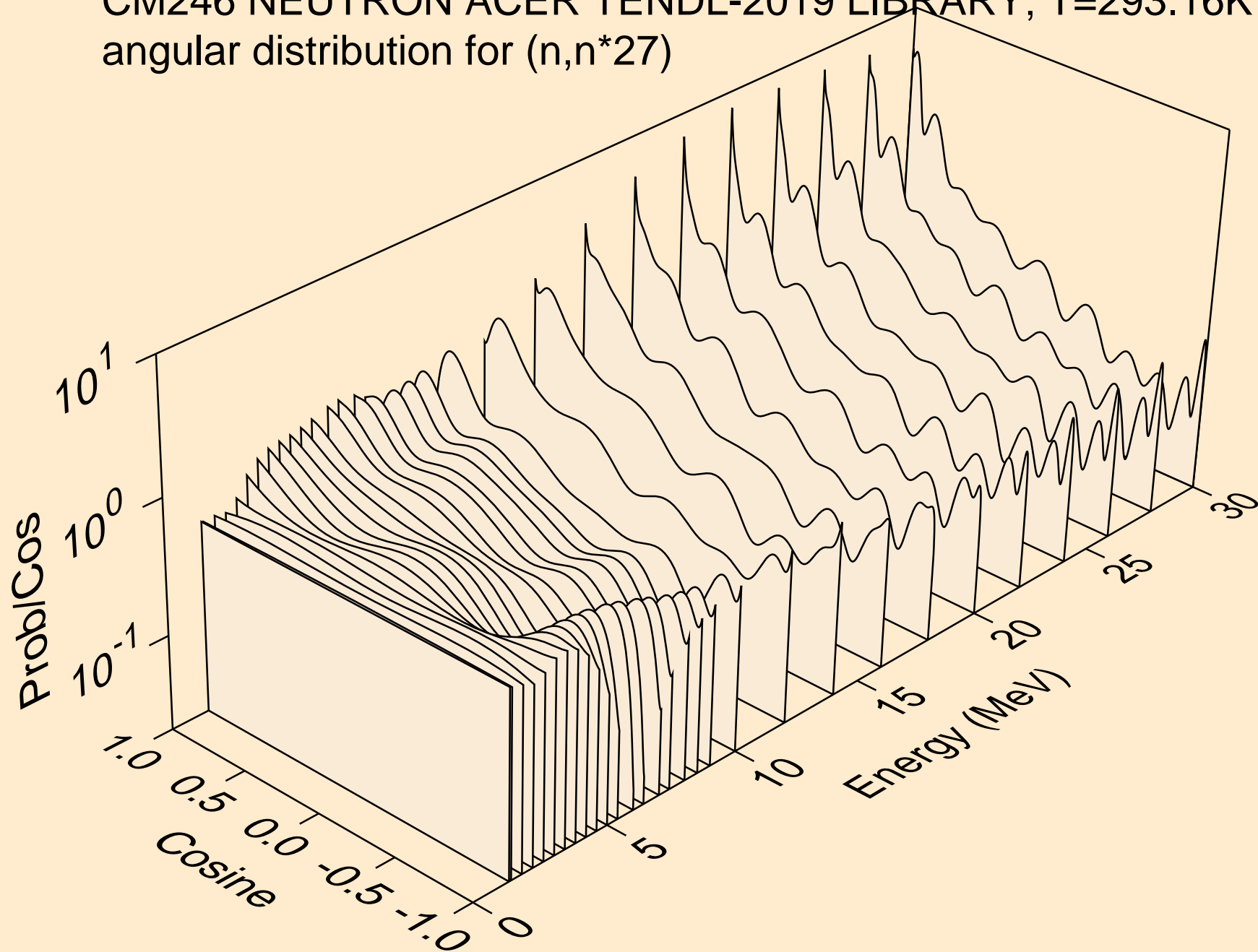

CM246 NEUTRON ACER TENDL-2019 LIBRARY; T=293.16K
angular distribution for (n,n*28)

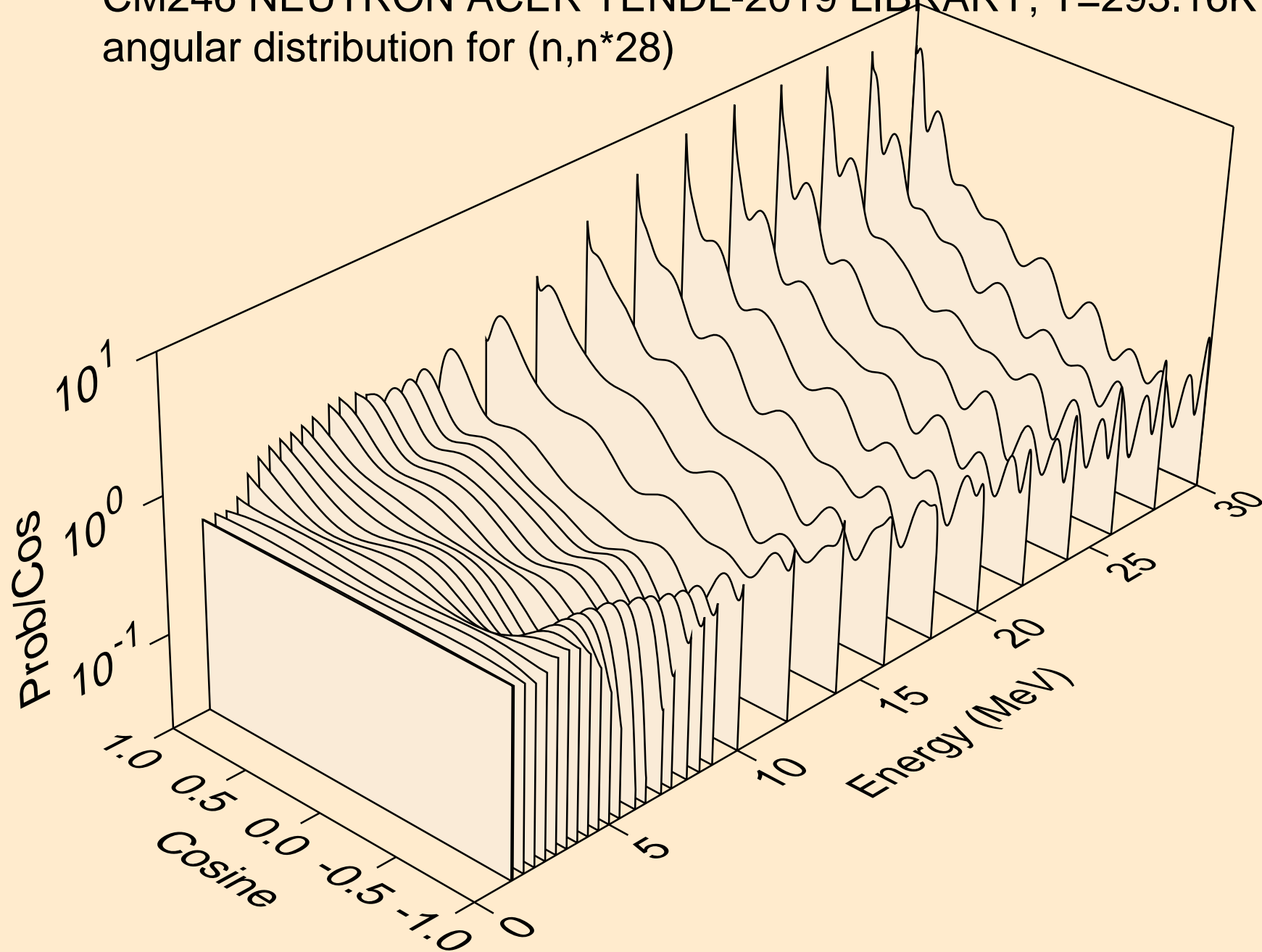

CM246 NEUTRON ACER TENDL-2019 LIBRARY; T=293.16K
angular distribution for (n,n*29)

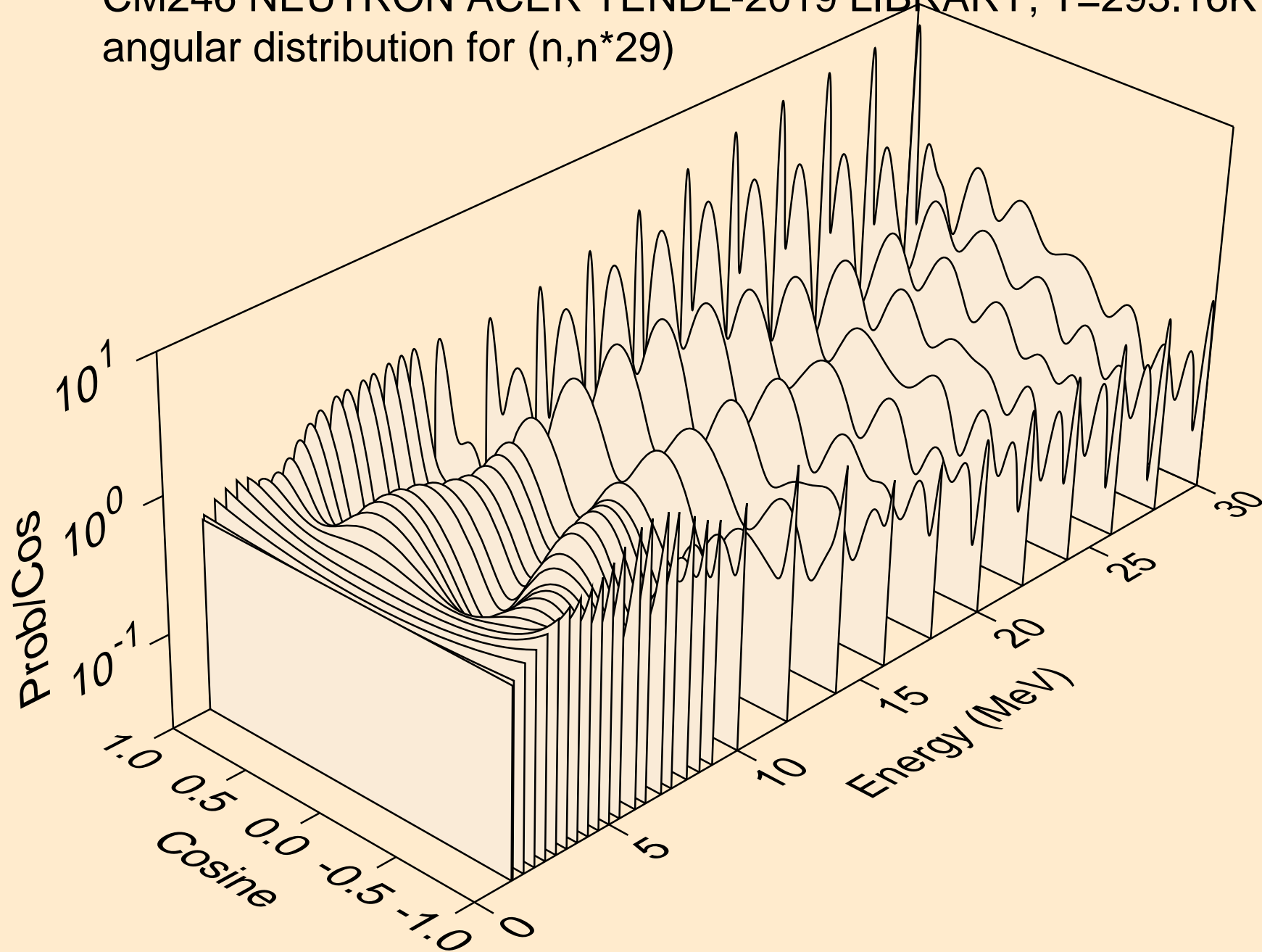

CM246 NEUTRON ACER TENDL-2019 LIBRARY; T=293.16K
angular distribution for (n,n*30)

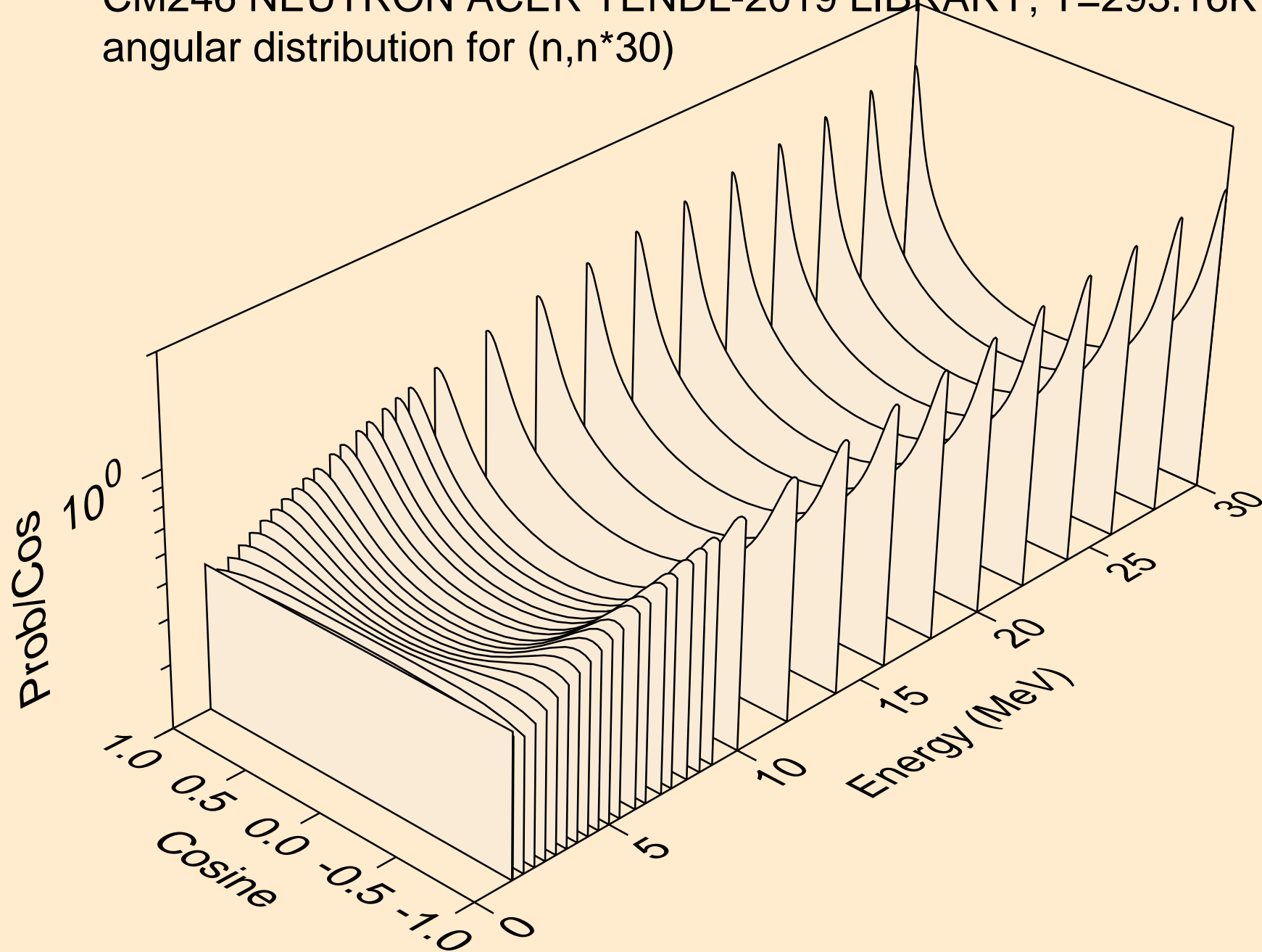

CM246 NEUTRON ACER TENDL-2019 LIBRARY; T=293.16K
Total fission nubar

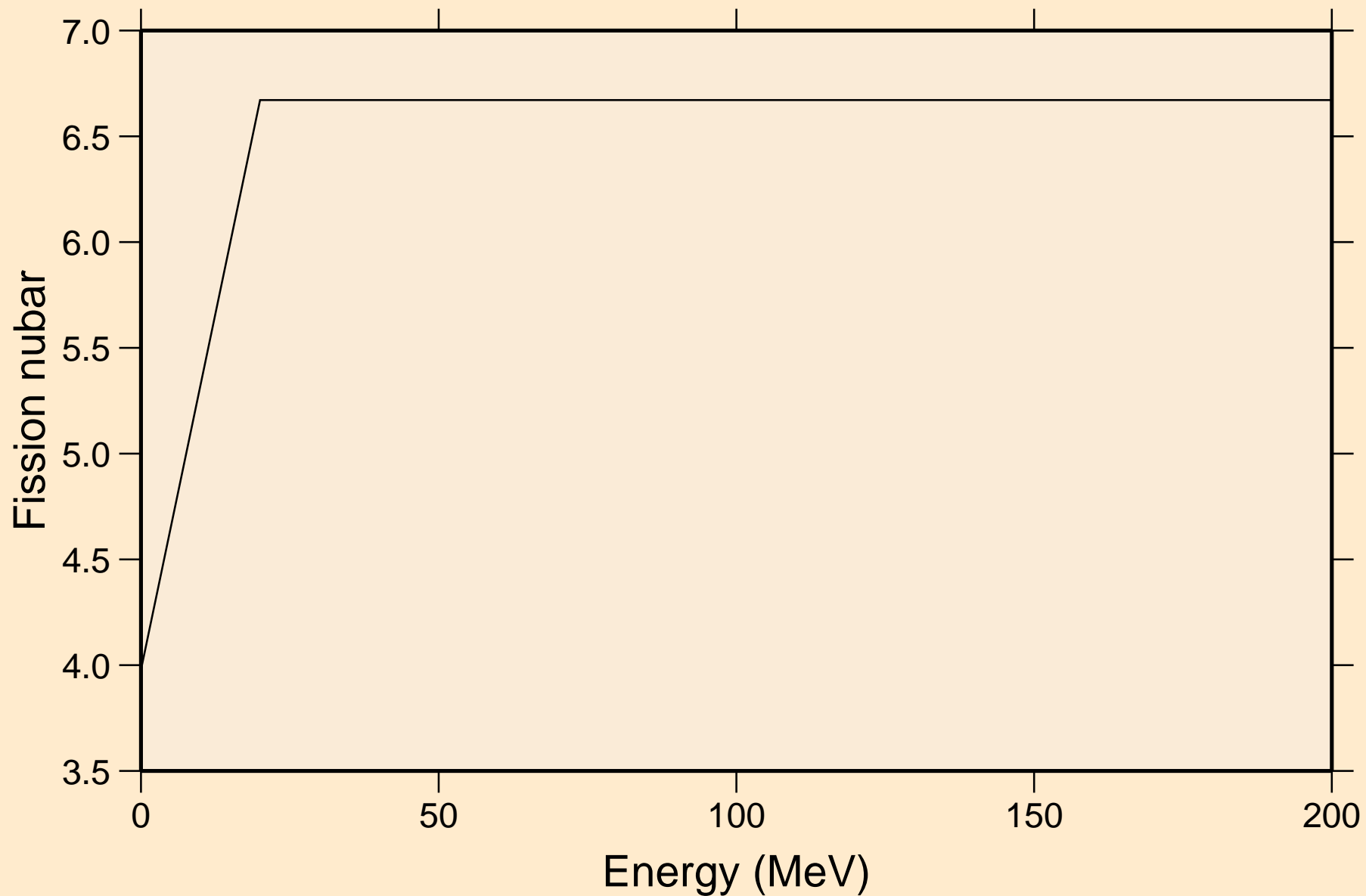

CM246 NEUTRON ACER TENDL-2019 LIBRARY; T=293.16K
Neutron emission for (n,x)

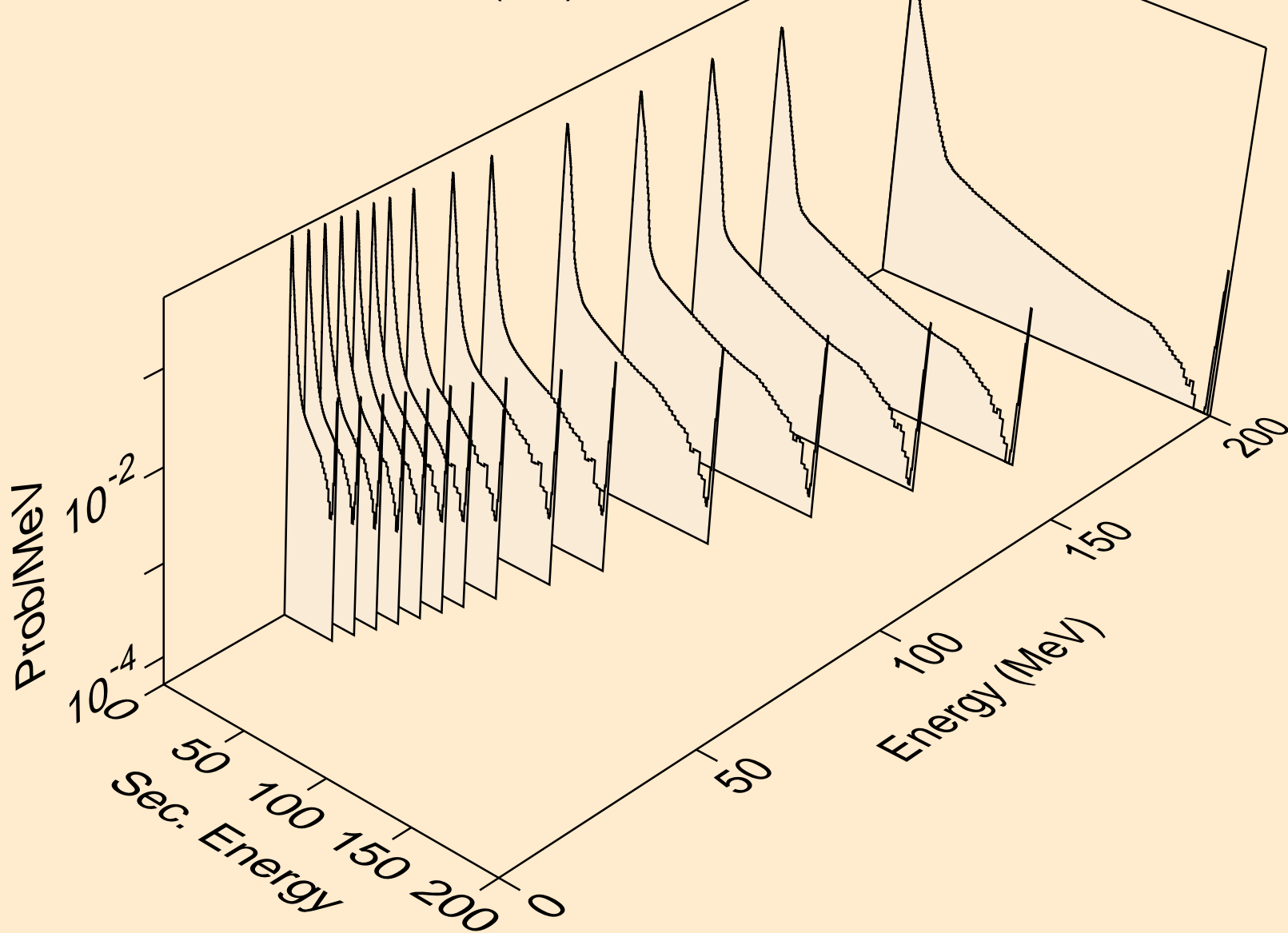

CM246 NEUTRON ACER TENDL-2019 LIBRARY; T=293.16K
Neutron emission for (n,2nd)

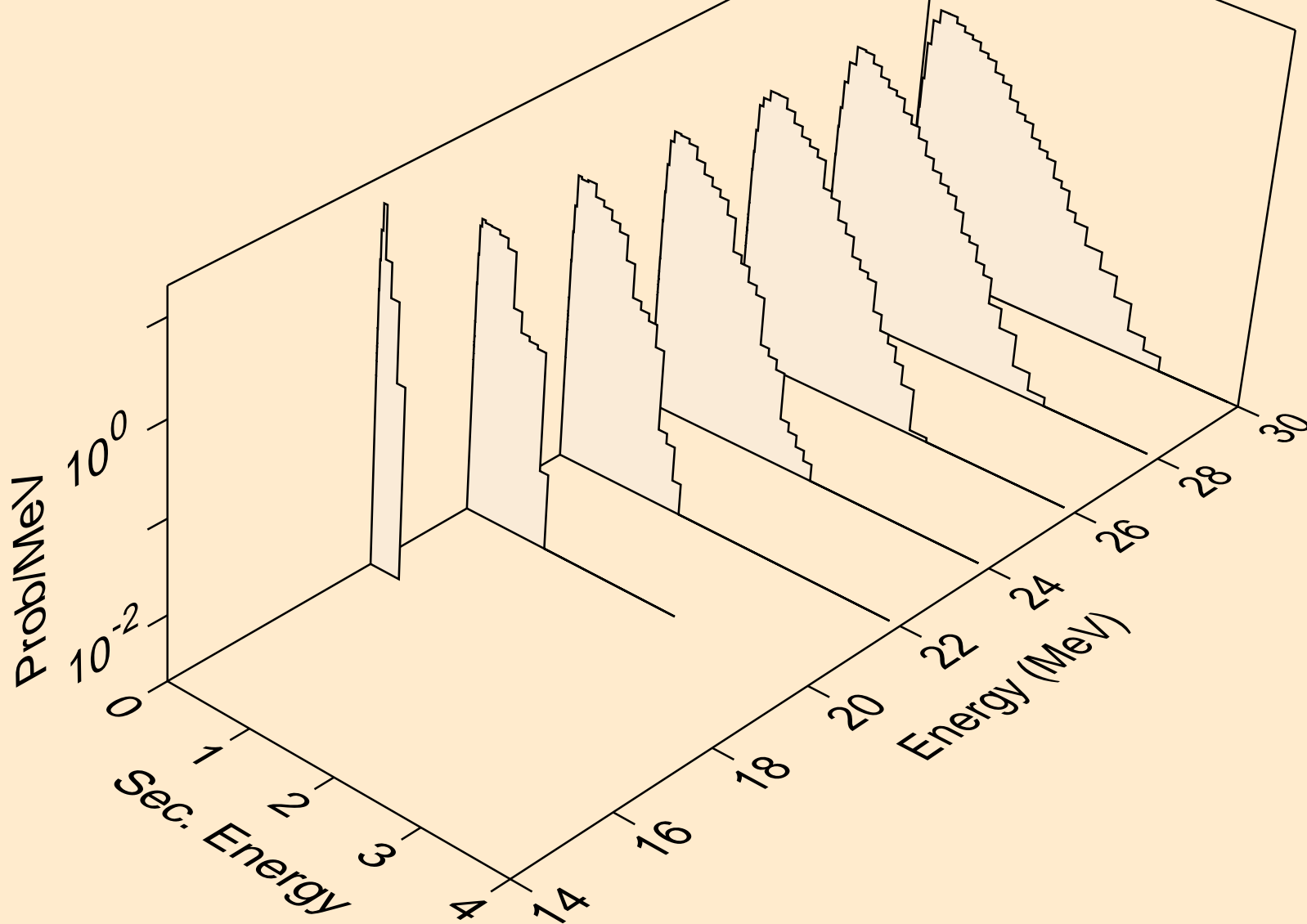

CM246 NEUTRON ACER TENDL-2019 LIBRARY; T=293.16K
Neutron emission for (n,2n)

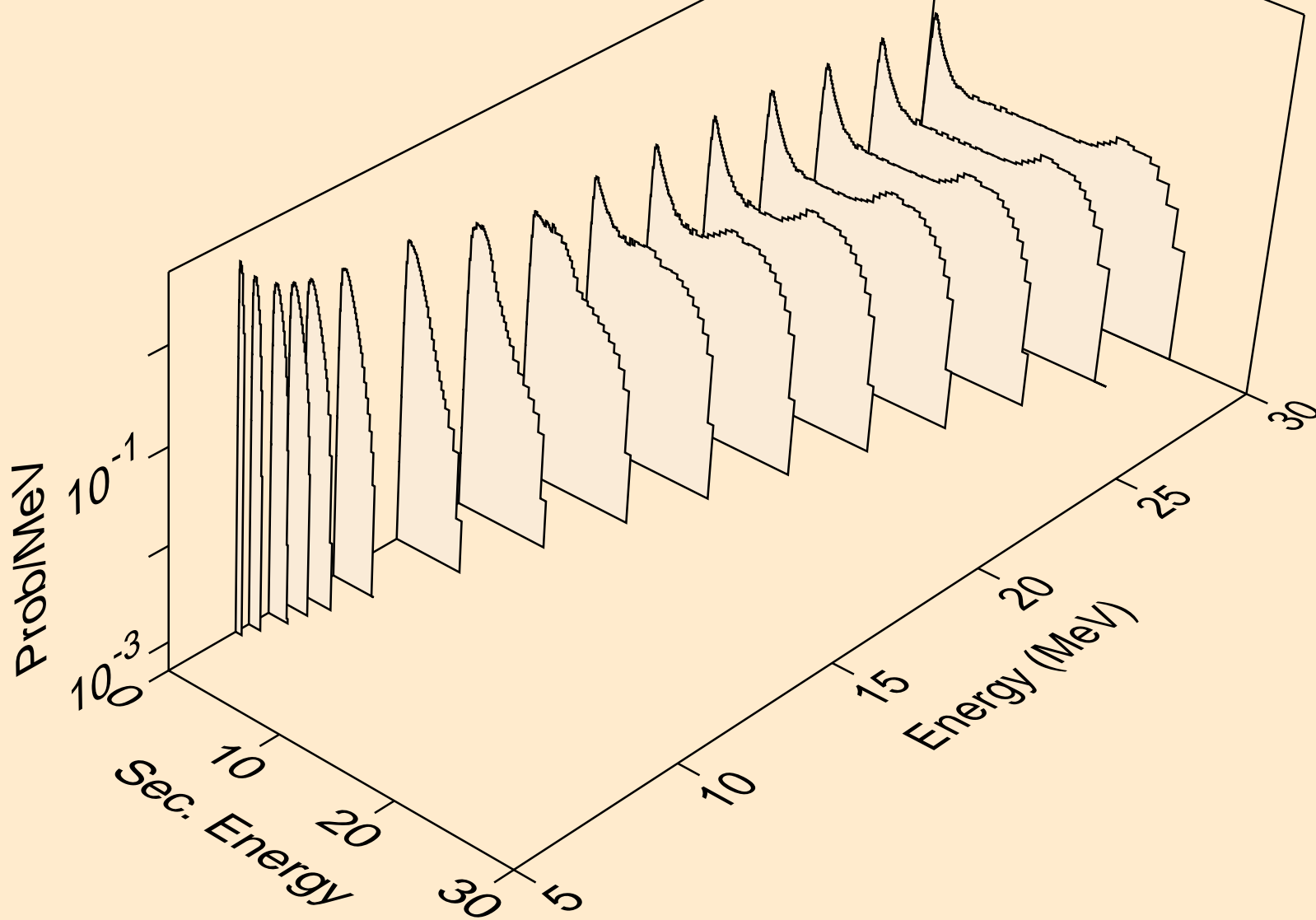

CM246 NEUTRON ACER TENDL-2019 LIBRARY; T=293.16K
Neutron emission for (n,3n)

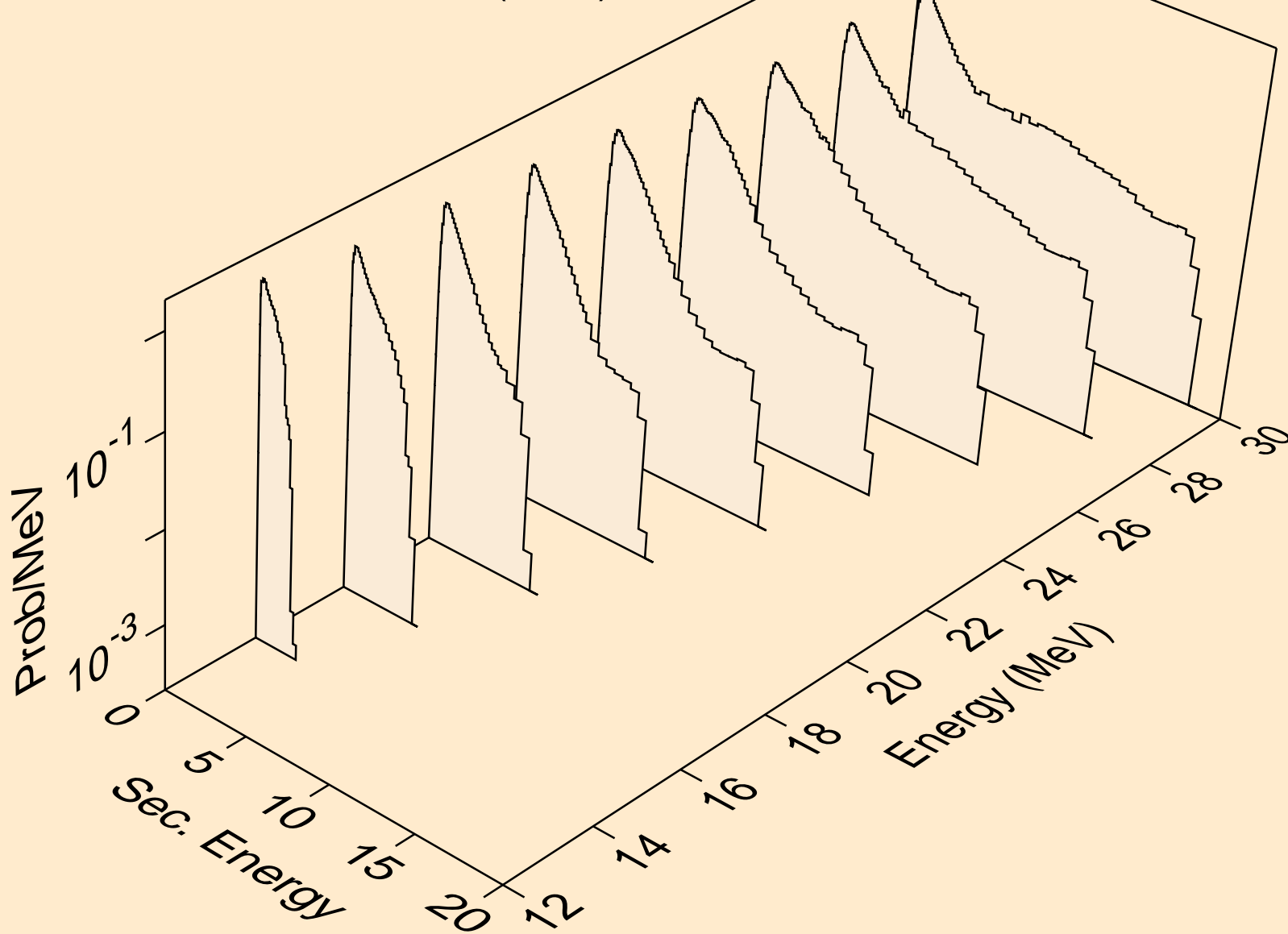

CM246 NEUTRON ACER TENDL-2019 LIBRARY; T=293.16K
Neutron emission for fission

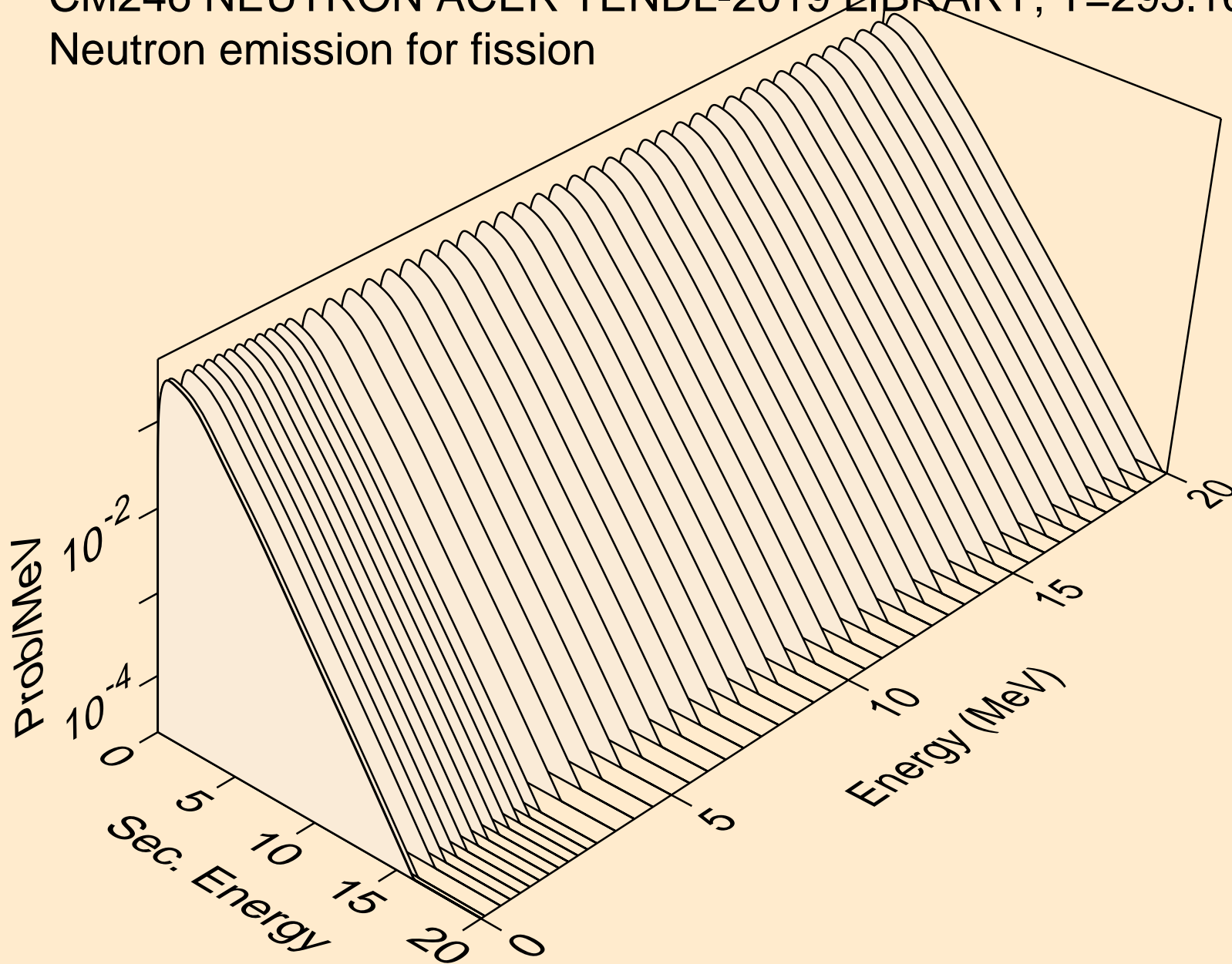

CM246 NEUTRON ACER TENDL-2019 LIBRARY; T=293.16K
Neutron emission for (n,n*)a

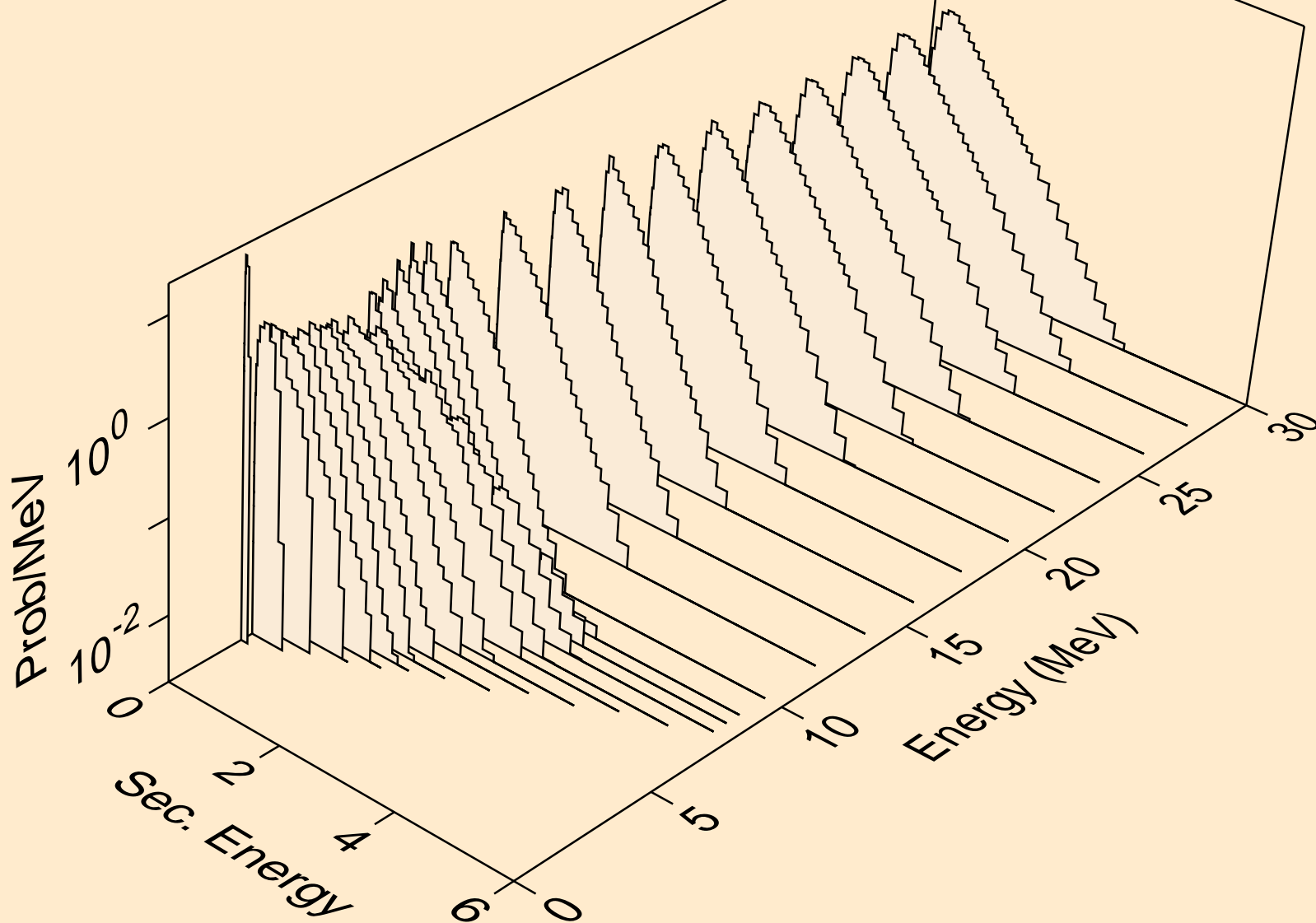

CM246 NEUTRON ACER TENDL-2019 LIBRARY; T=293.16K
Neutron emission for (n,2n)a

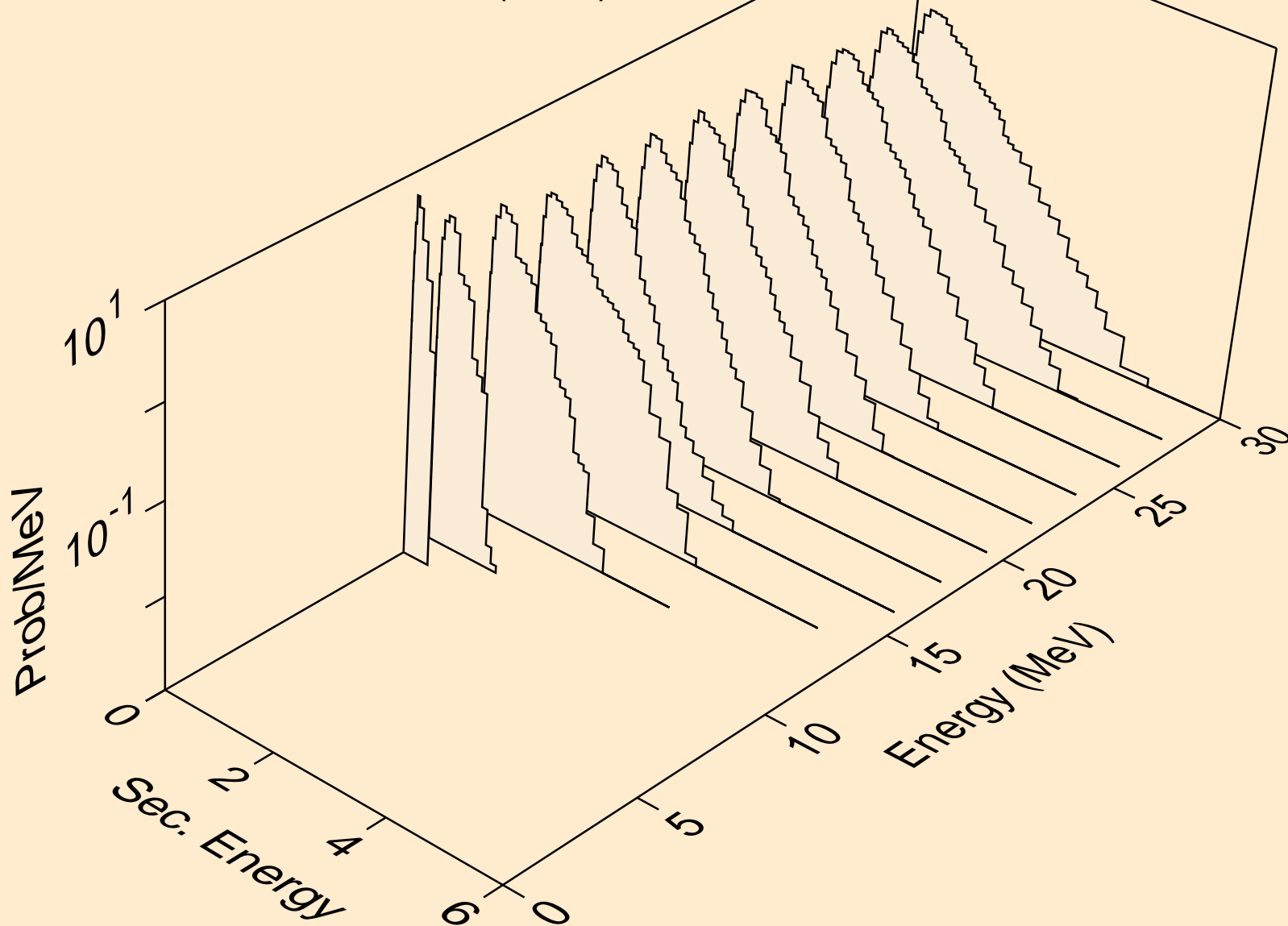

CM246 NEUTRON ACER TENDL-2019 LIBRARY; T=293.16K
Neutron emission for (n,3n)a

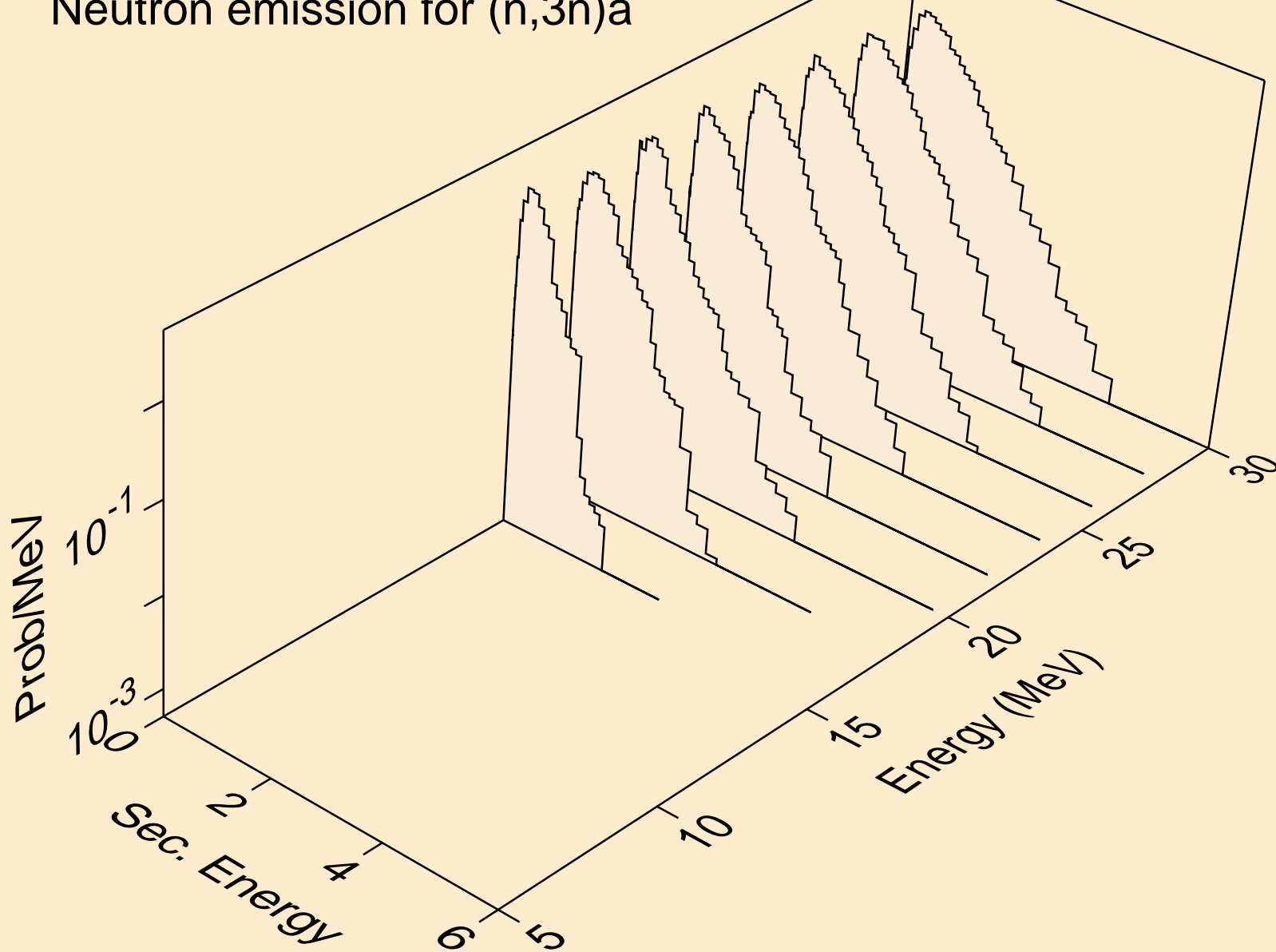

CM246 NEUTRON ACER TENDL-2019 LIBRARY; T=293.16K
Neutron emission for (n,n*)p

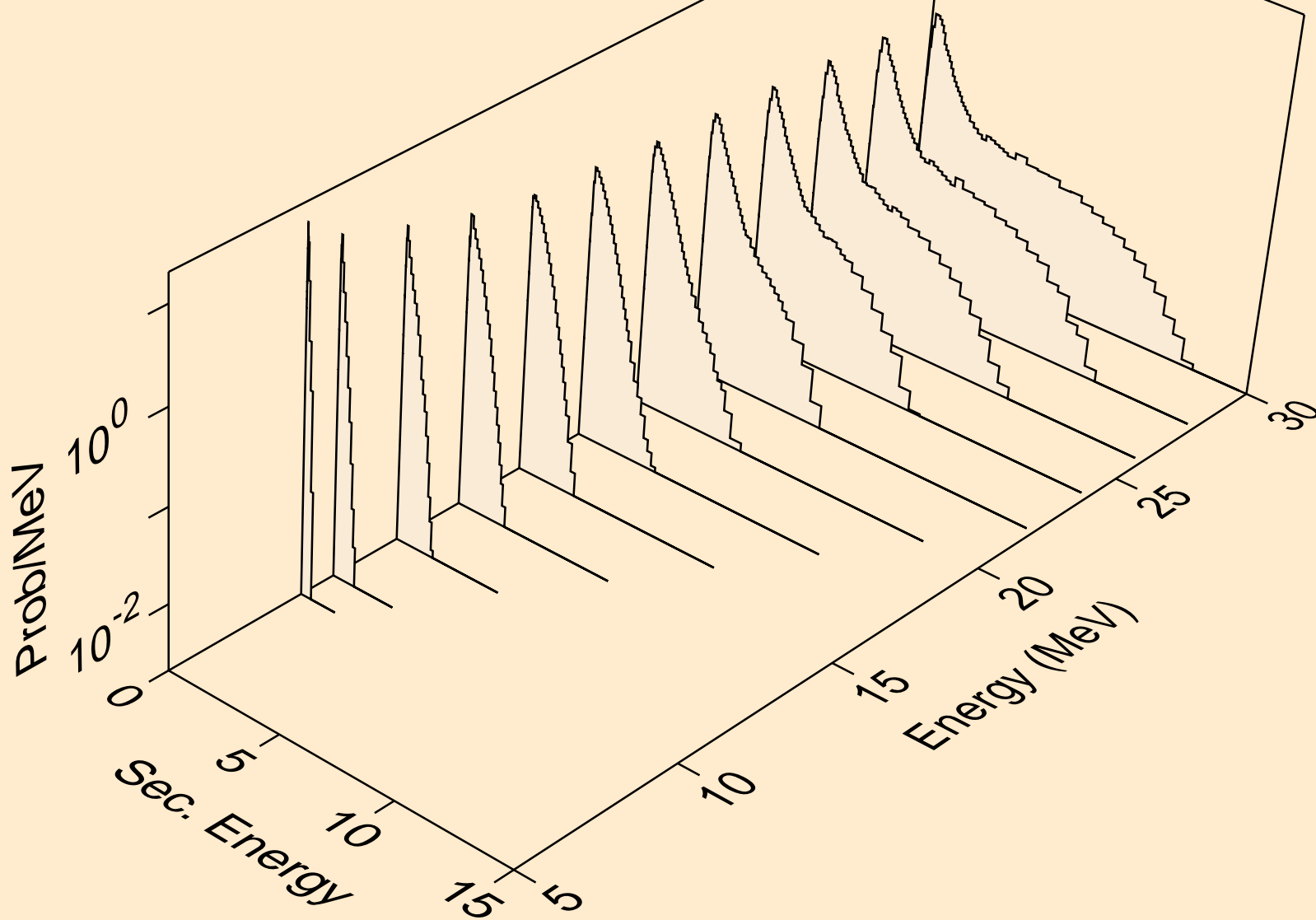

CM246 NEUTRON ACER TENDL-2019 LIBRARY; T=293.16K
Neutron emission for (n,n*)d

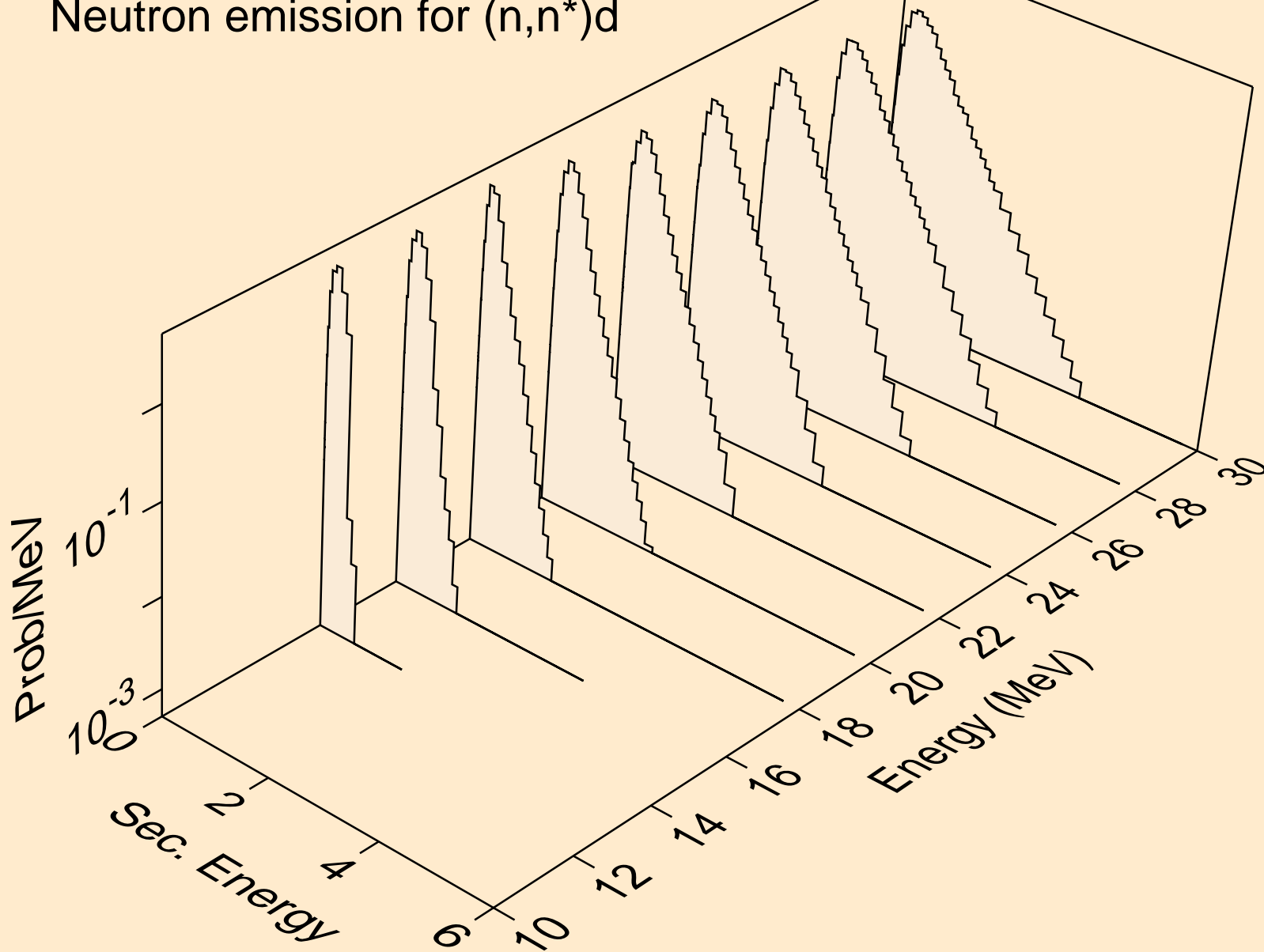

CM246 NEUTRON ACER TENDL-2019 LIBRARY; T=293.16K
Neutron emission for (n,n*)t

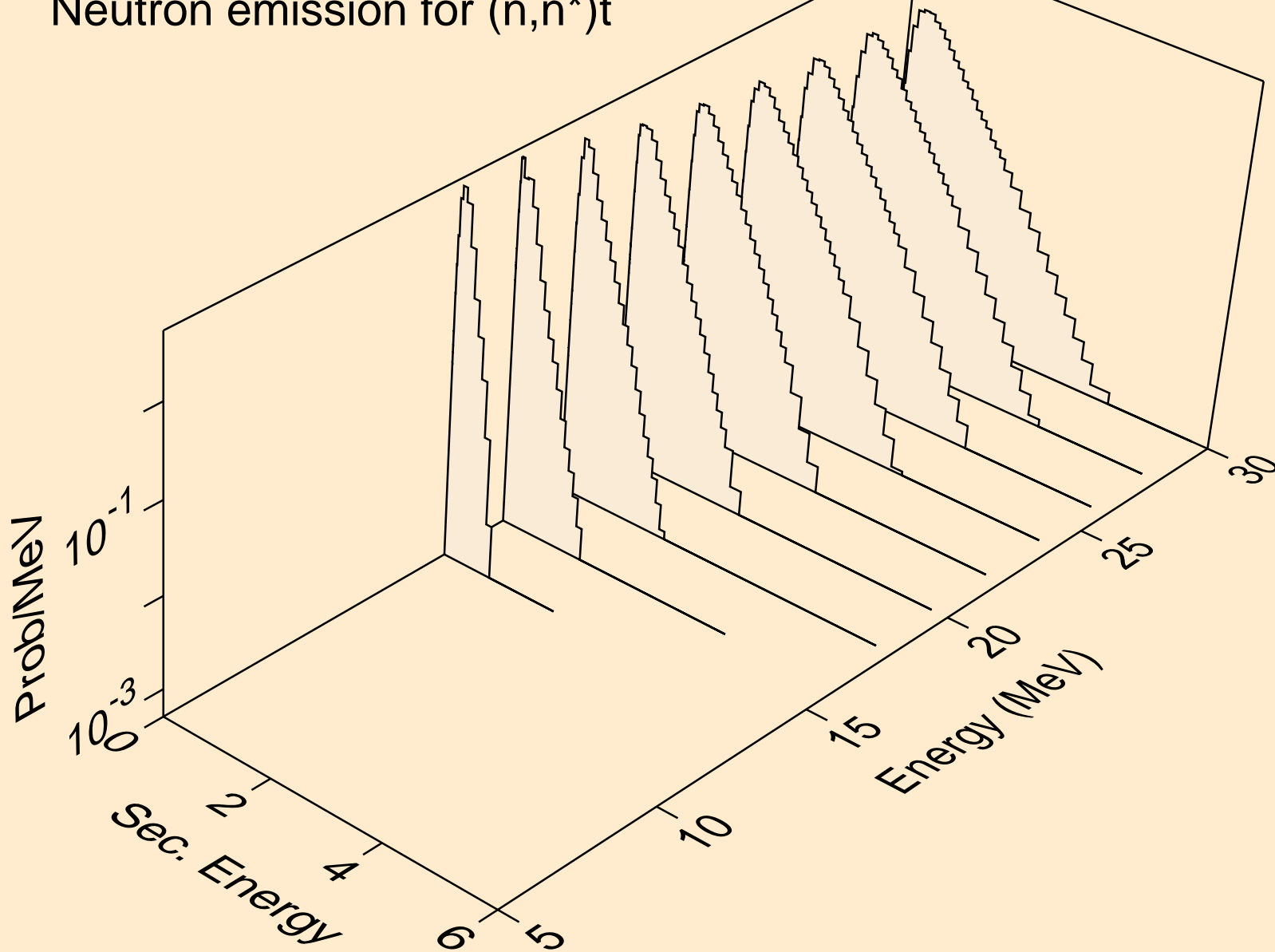

CM246 NEUTRON ACER TENDL-2019 LIBRARY; T=293.16K
Neutron emission for (n,n*)he3

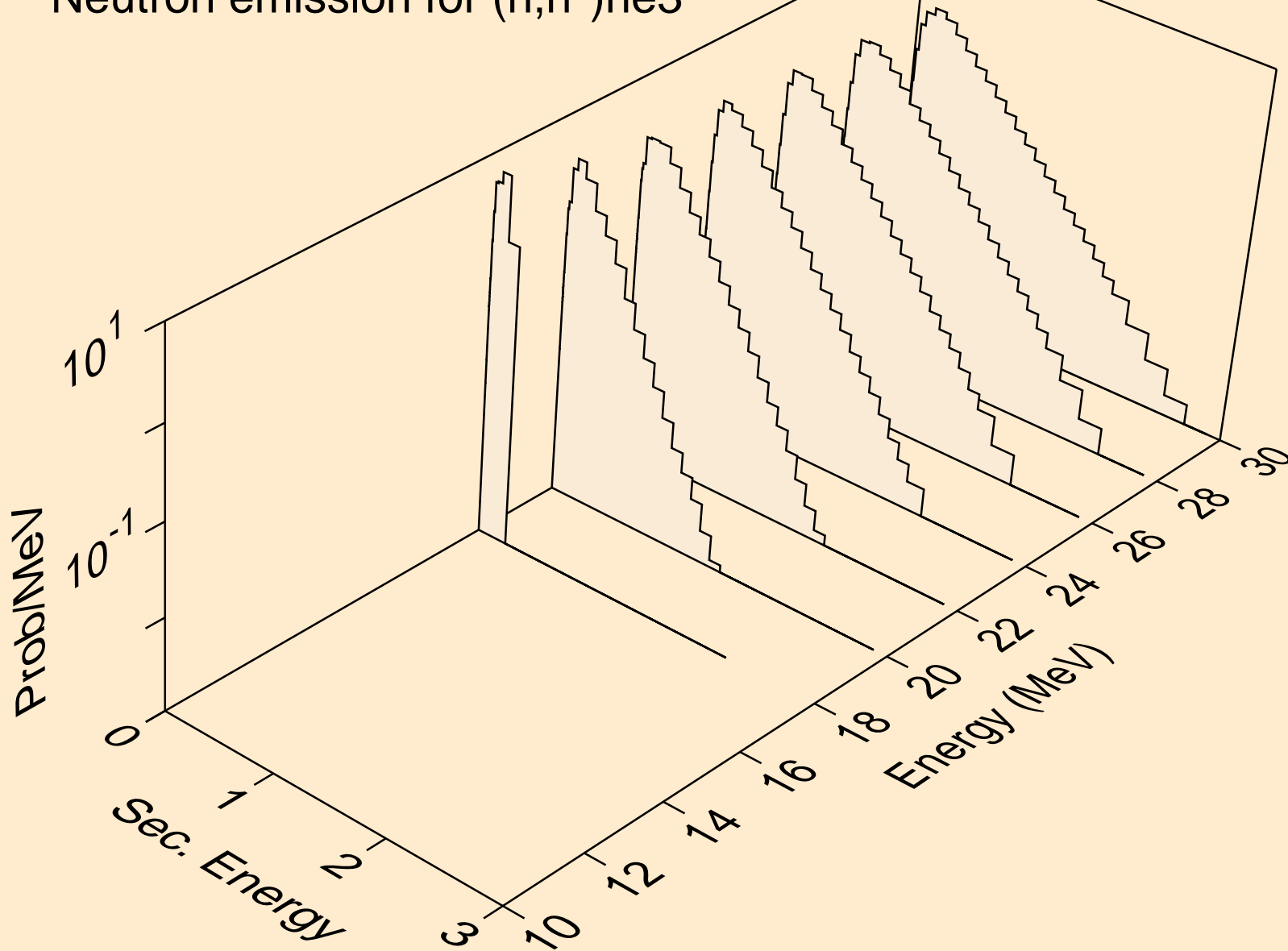

CM246 NEUTRON ACER TENDL-2019 LIBRARY; T=293.16K
Neutron emission for (n,4n)

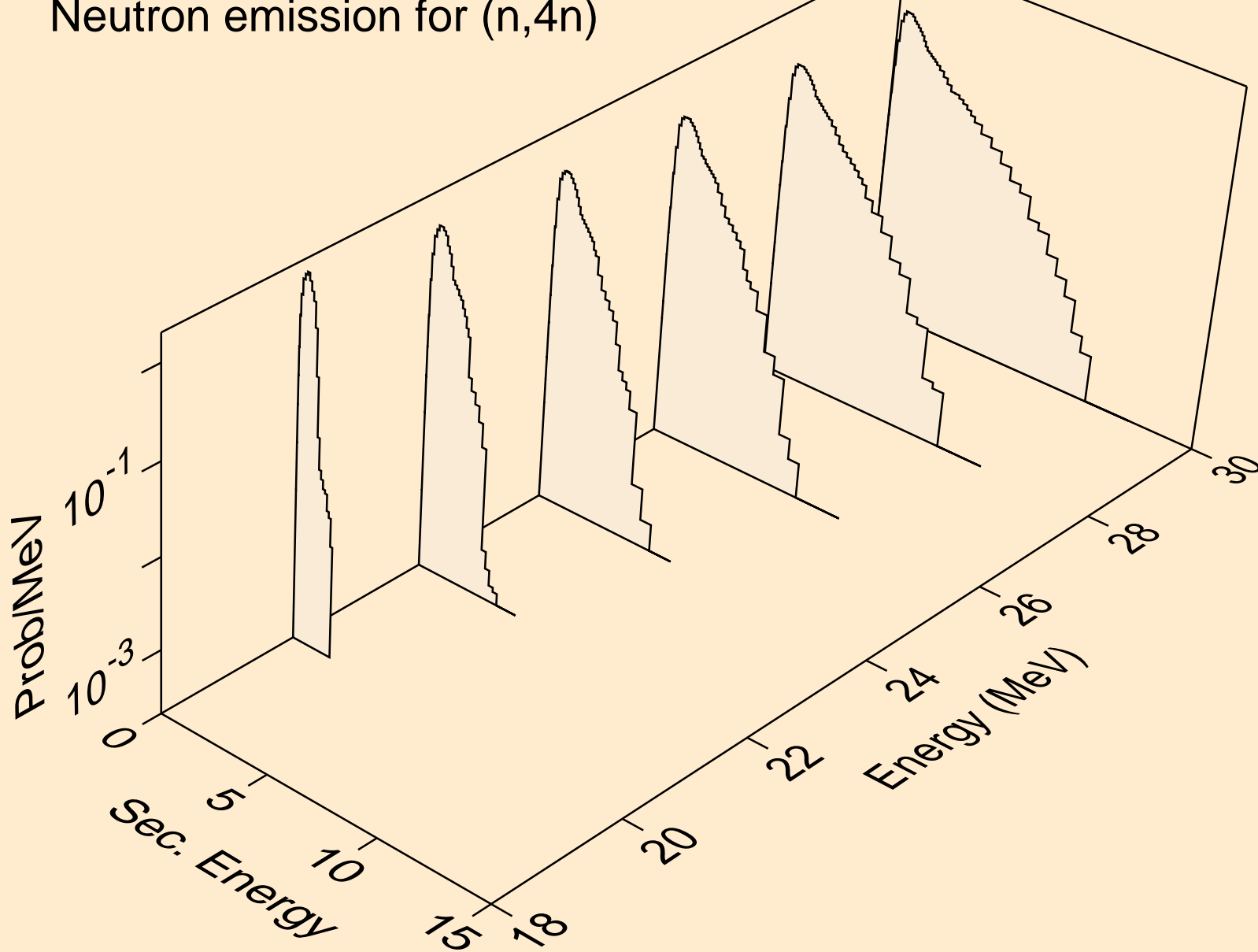

CM246 NEUTRON ACER TENDL-2019 LIBRARY; T=293.16K
Neutron emission for (n,2np)

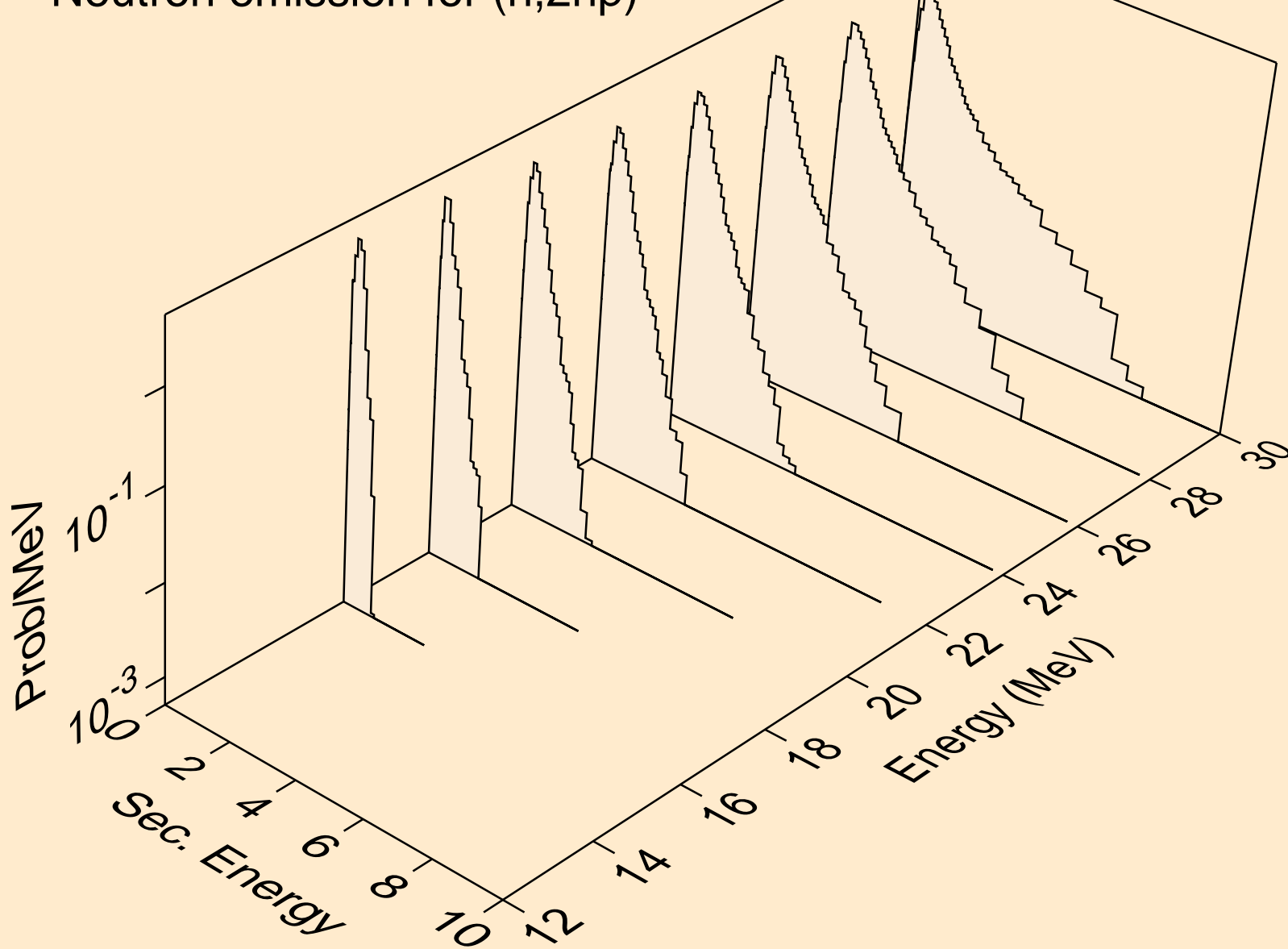

CM246 NEUTRON ACER TENDL-2019 LIBRARY; T=293.16K
Neutron emission for (n,3np)

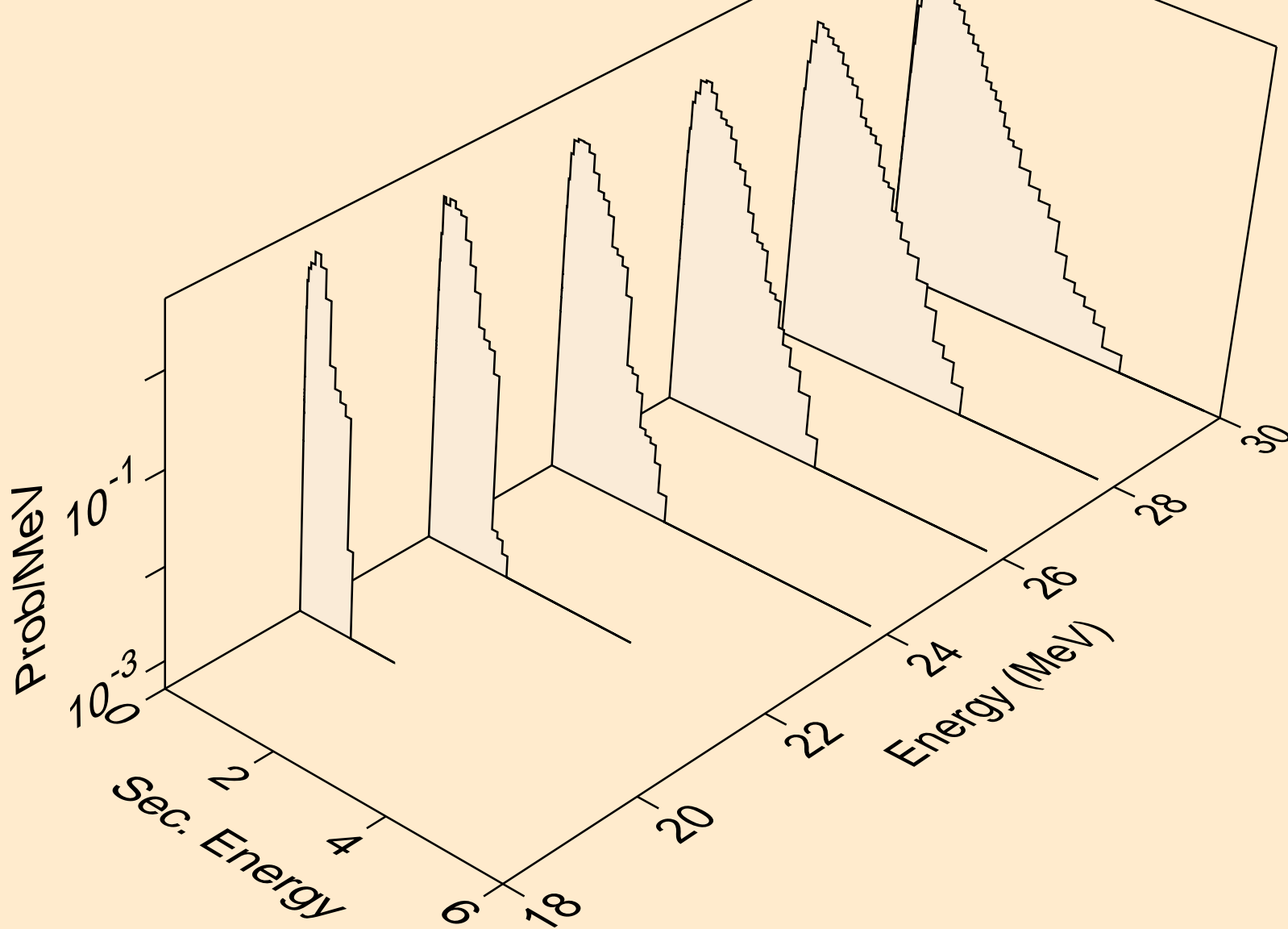

CM246 NEUTRON ACER TENDL-2019 LIBRARY; T=293.16K
Neutron emission for (n,2np)

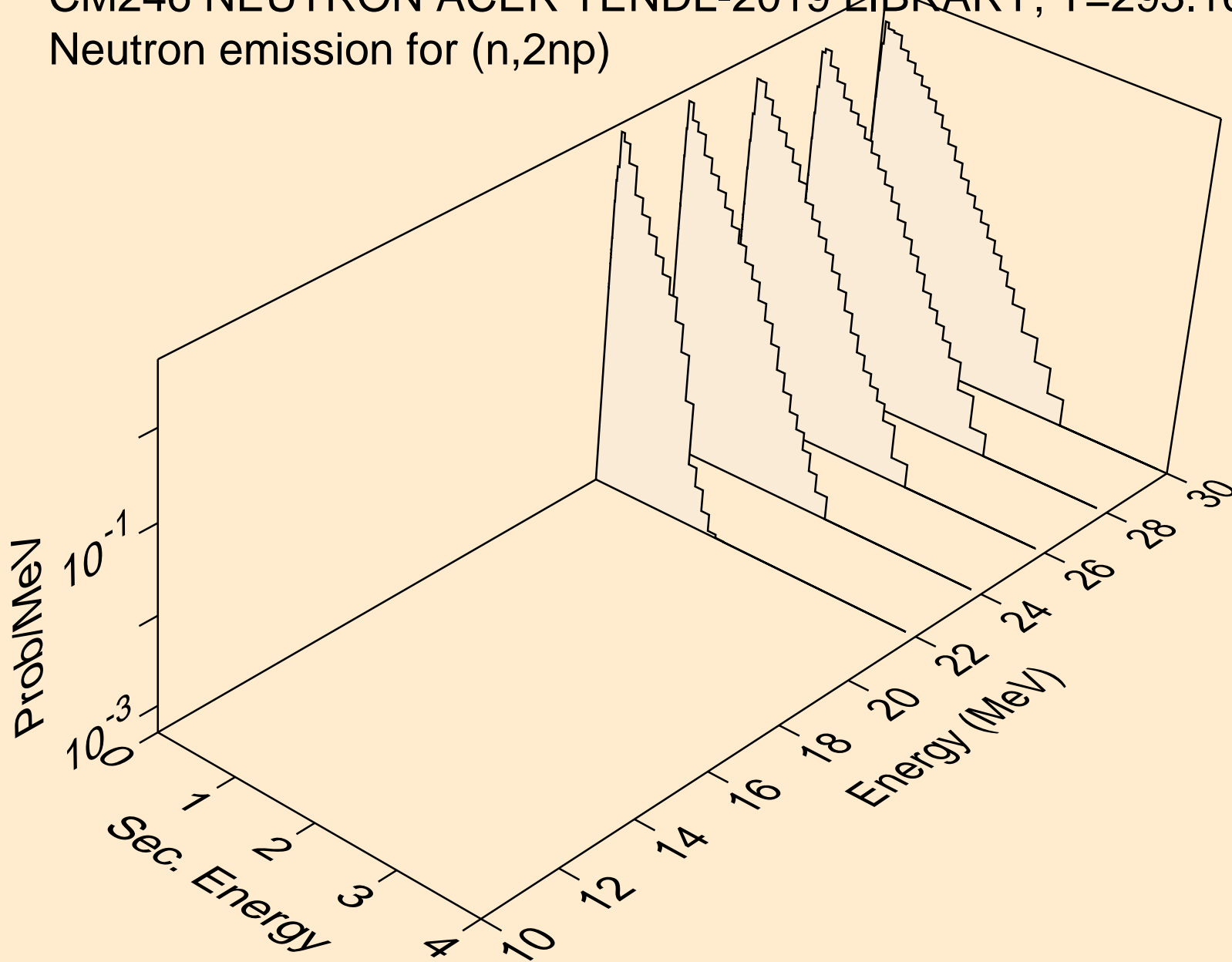

CM246 NEUTRON ACER TENDL-2019 LIBRARY; T=293.16K
Neutron emission for (n,n*c)

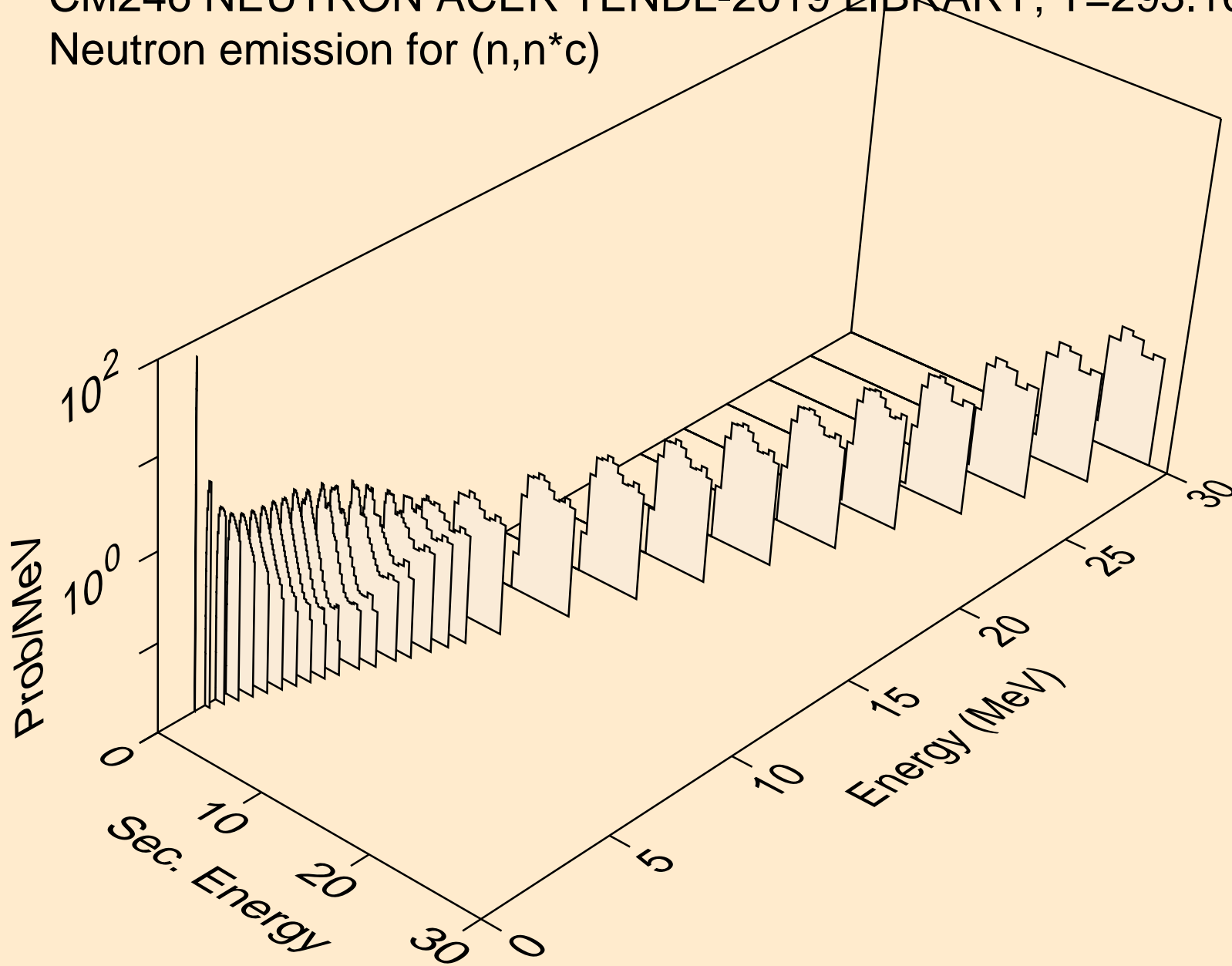

CM246 NEUTRON ACER TENDL-2019 LIBRARY; T=293.16K

Delayed nubar

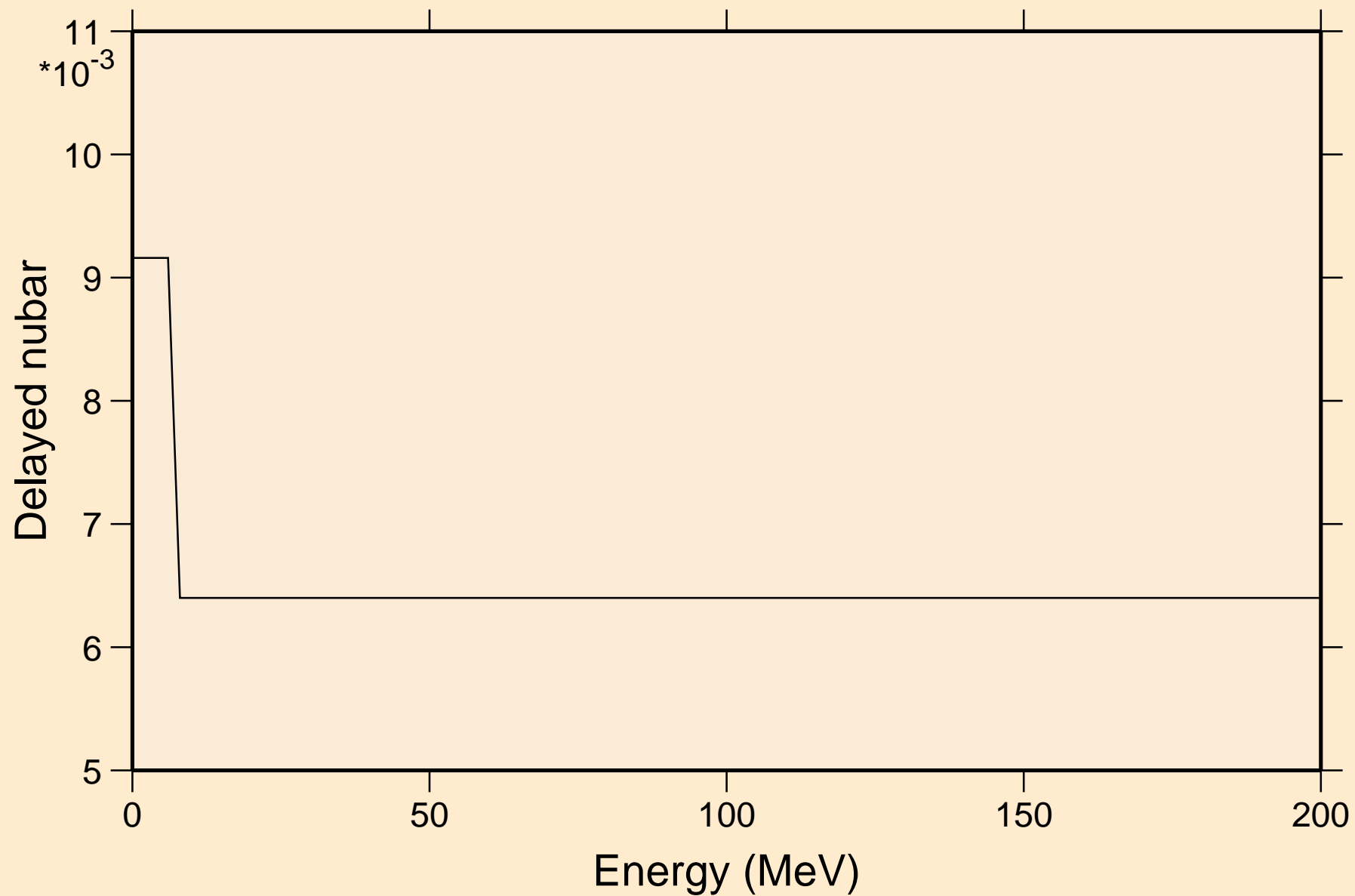

CM246 NEUTRON ACER TENDL-2019 LIBRARY; T=293.16K

Delayed neutron spectra

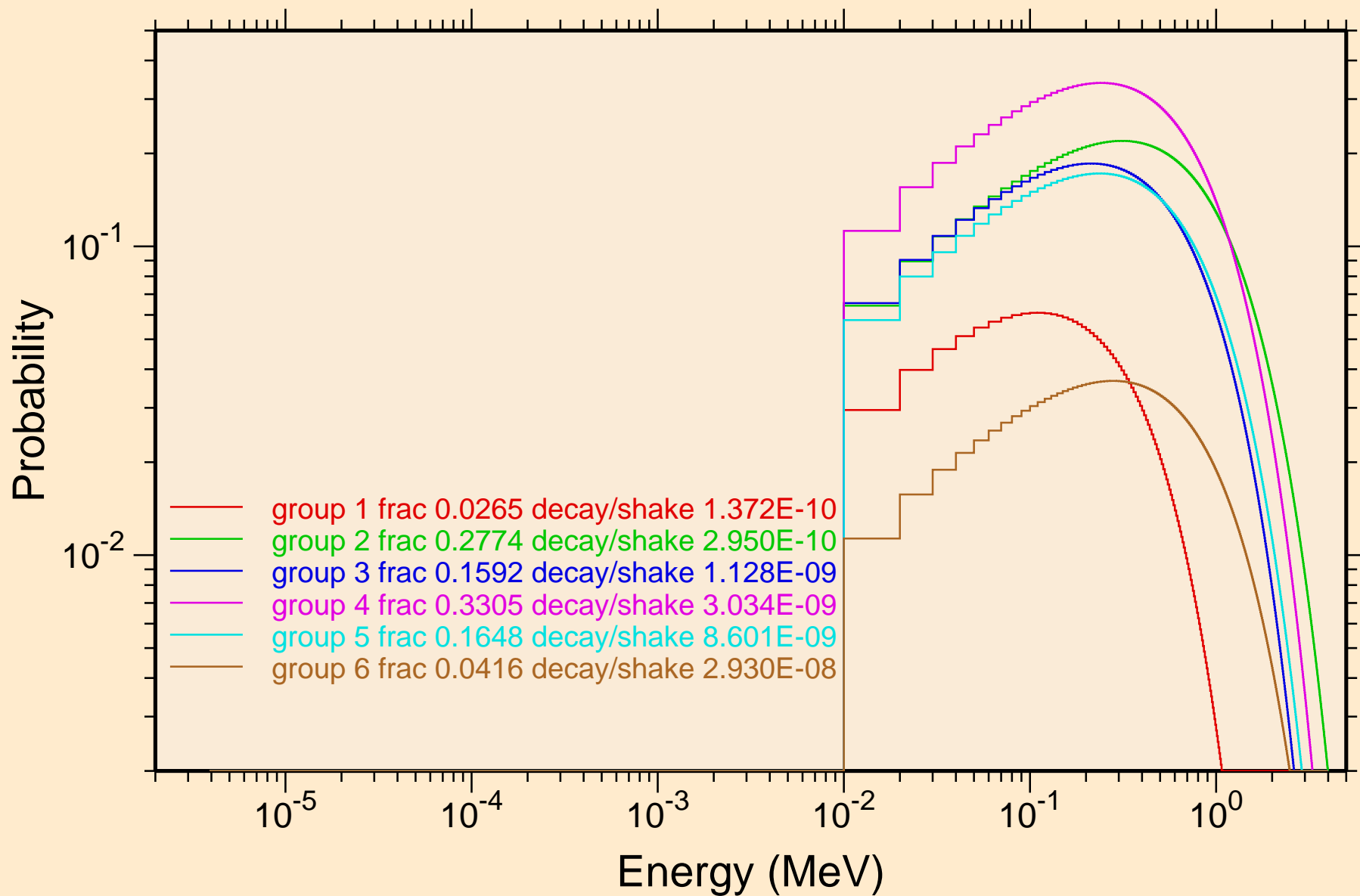

CM246 NEUTRON ACER TENDL-2019 LIBRARY; T=293.16K
Photon emission for (n,x)

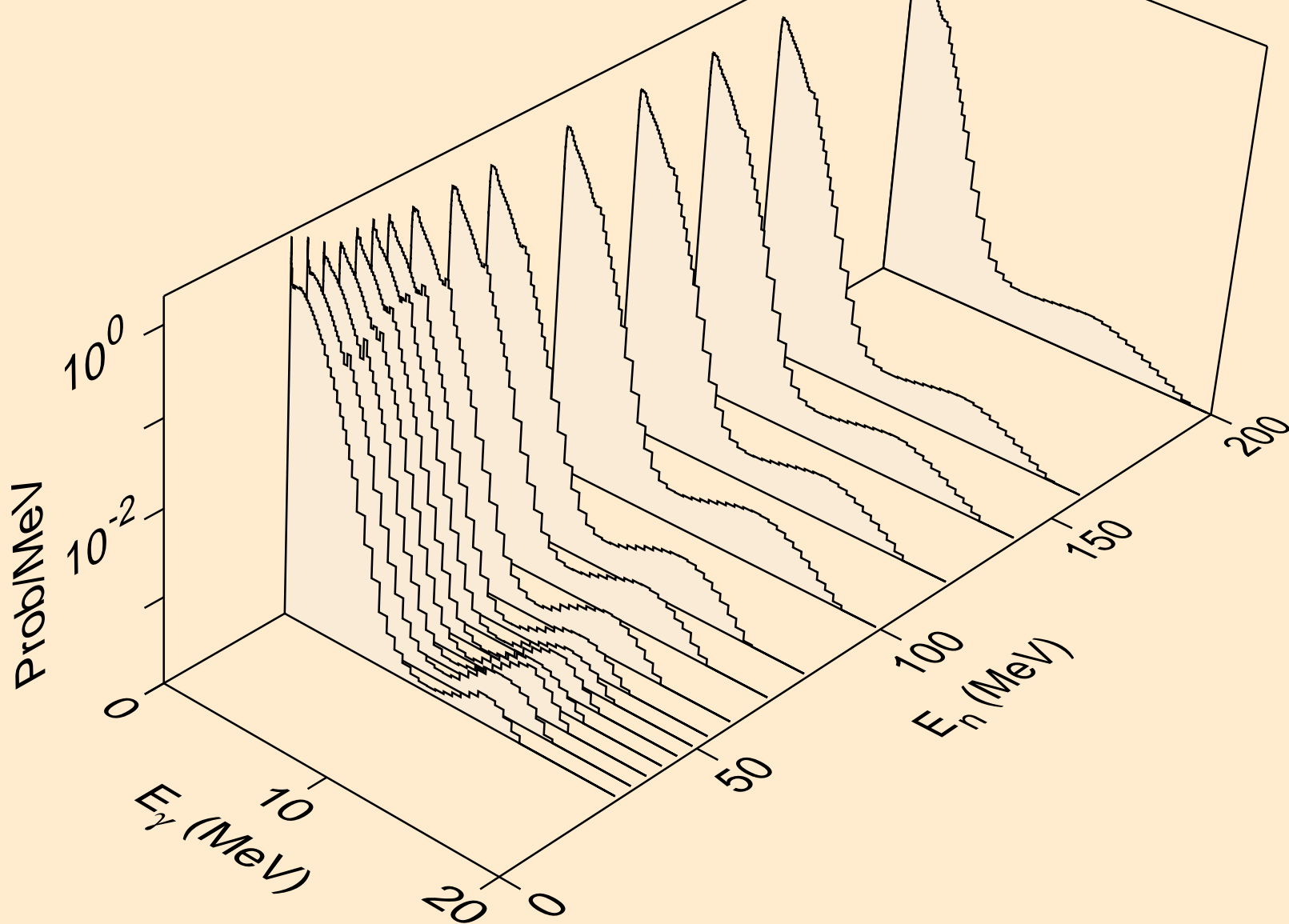

CM246 NEUTRON ACER TENDL-2019 LIBRARY; T=293.16K
Photon emission for (n,2nd)

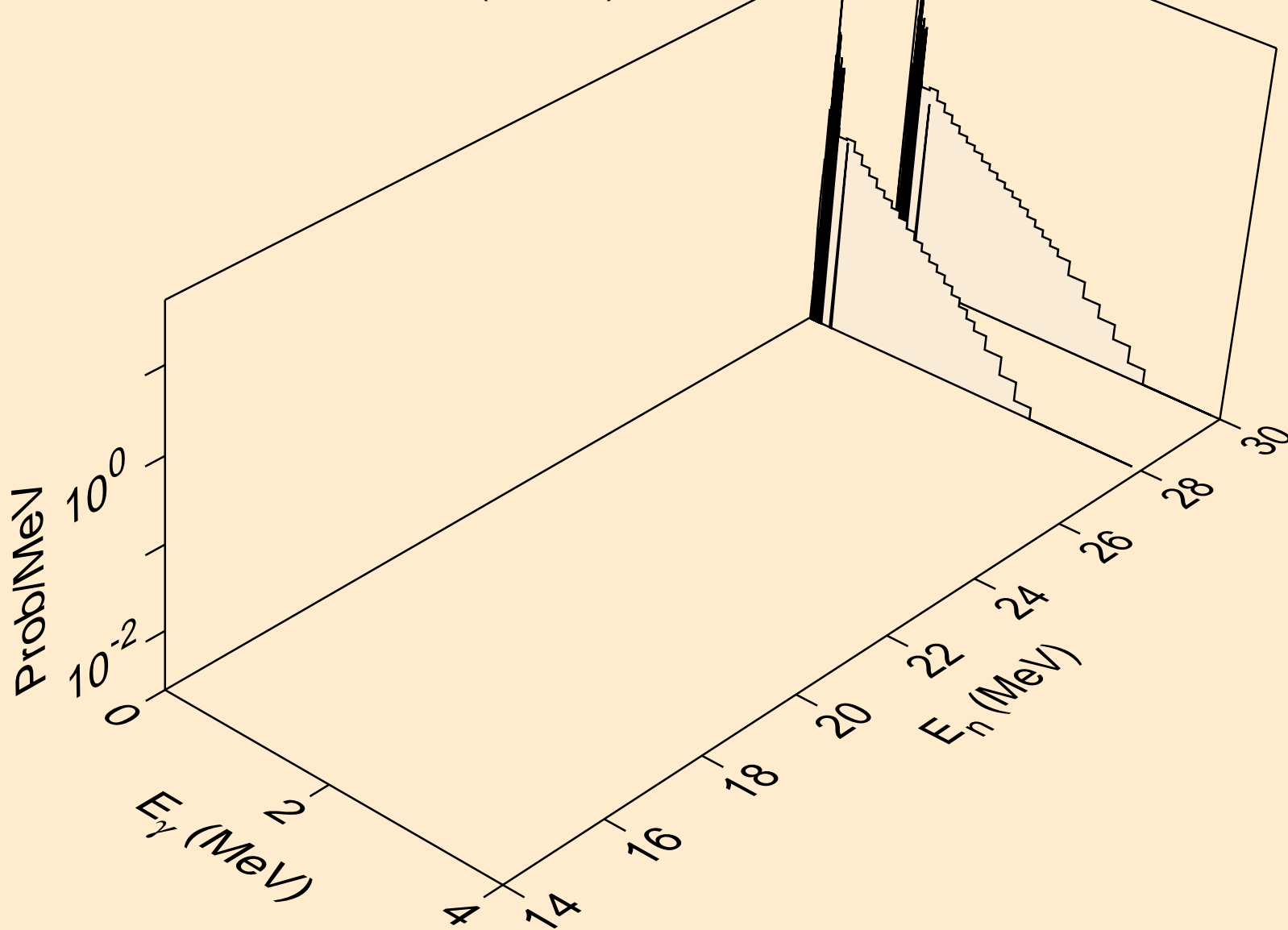

CM246 NEUTRON ACER TENDL-2019 LIBRARY; T=293.16K
Photon emission for (n,2n)

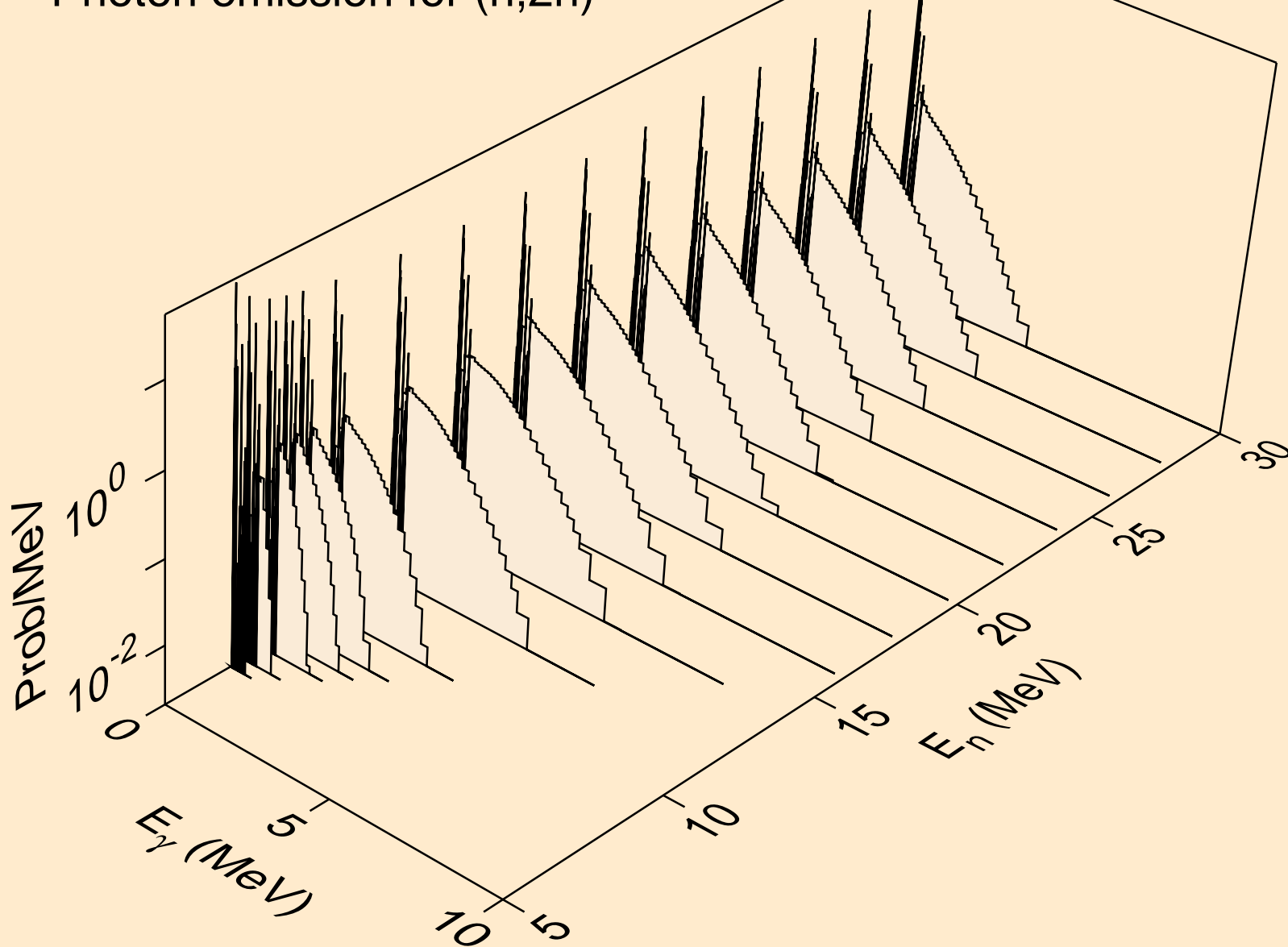

CM246 NEUTRON ACER TENDL-2019 LIBRARY; T=293.16K
Photon emission for (n,3n)

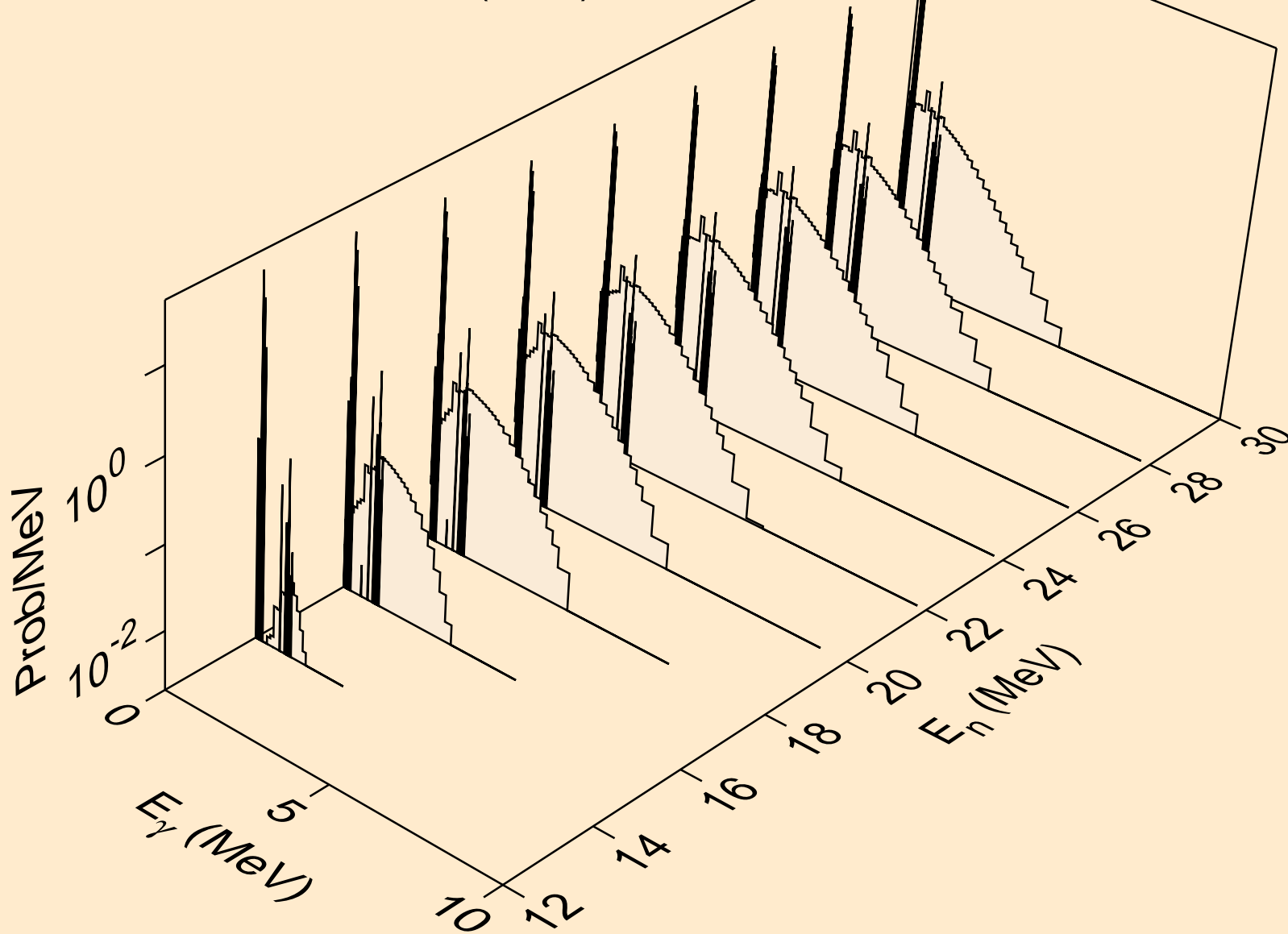

CM246 NEUTRON ACER TENDL-2019 LIBRARY; T=293.16K
Photon emission for (n,n*)a

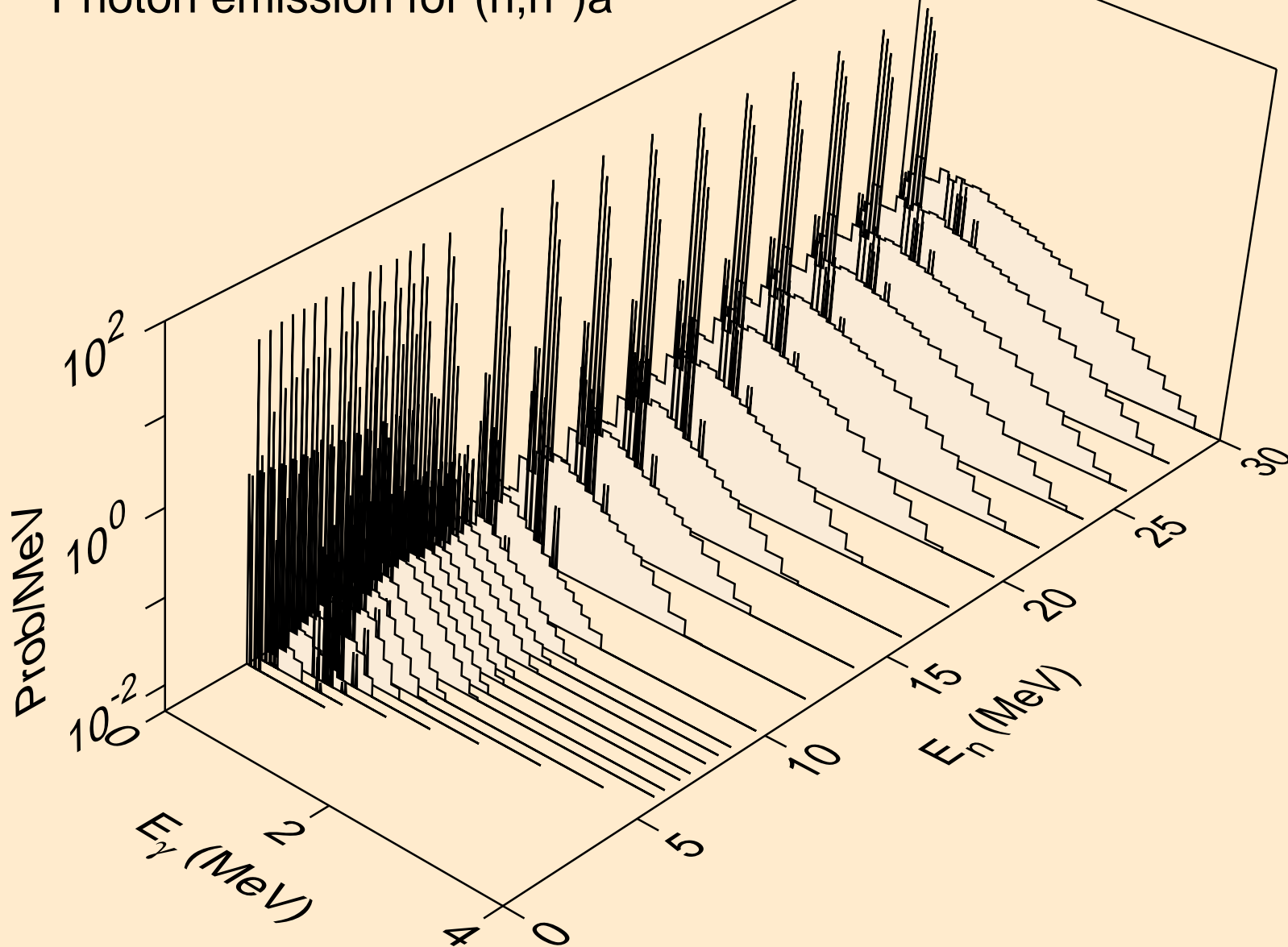

CM246 NEUTRON ACER TENDL-2019 LIBRARY; T=293.16K
Photon emission for (n,2n)a

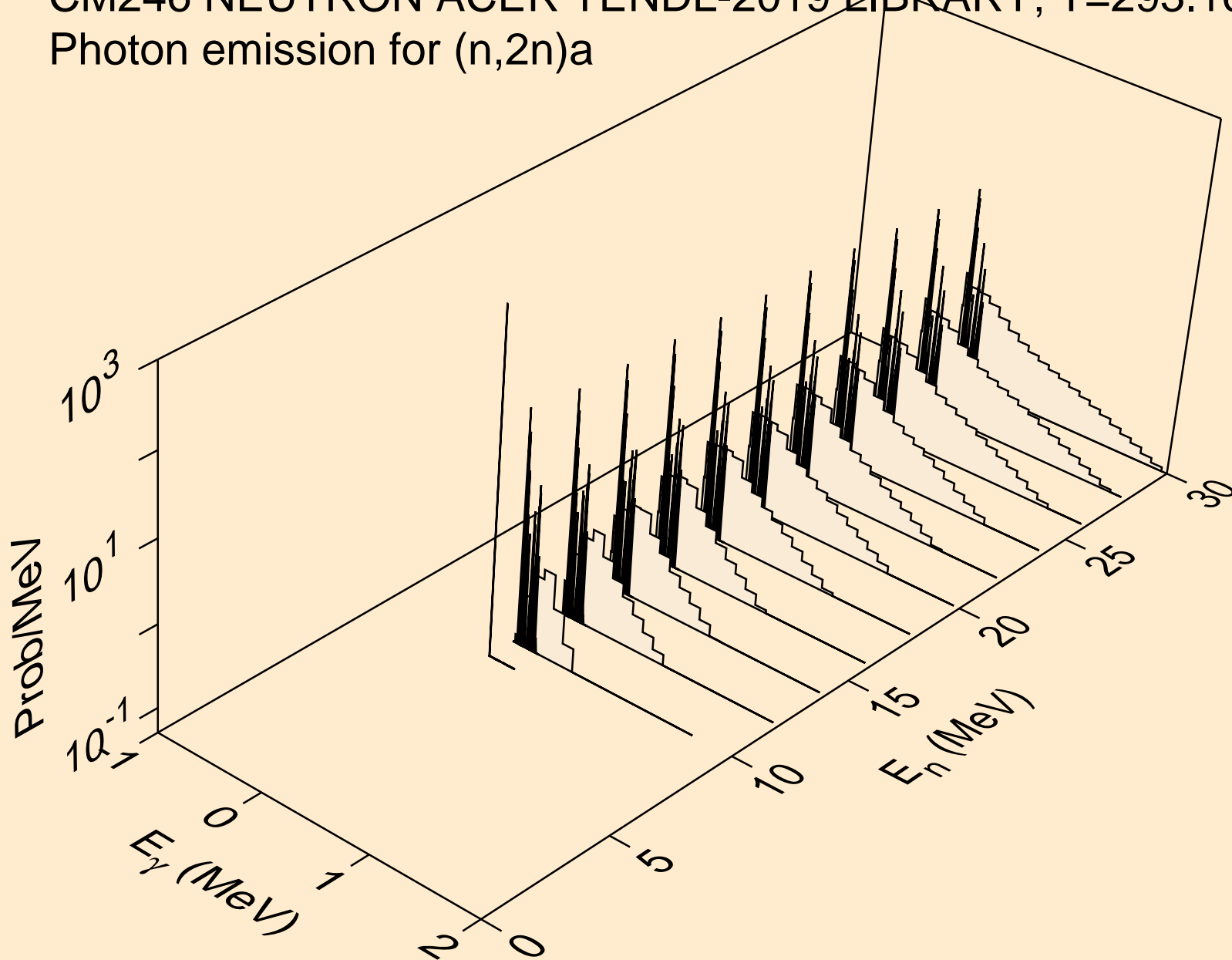

CM246 NEUTRON ACER TENDL-2019 LIBRARY; T=293.16K
Photon emission for (n,3n)a

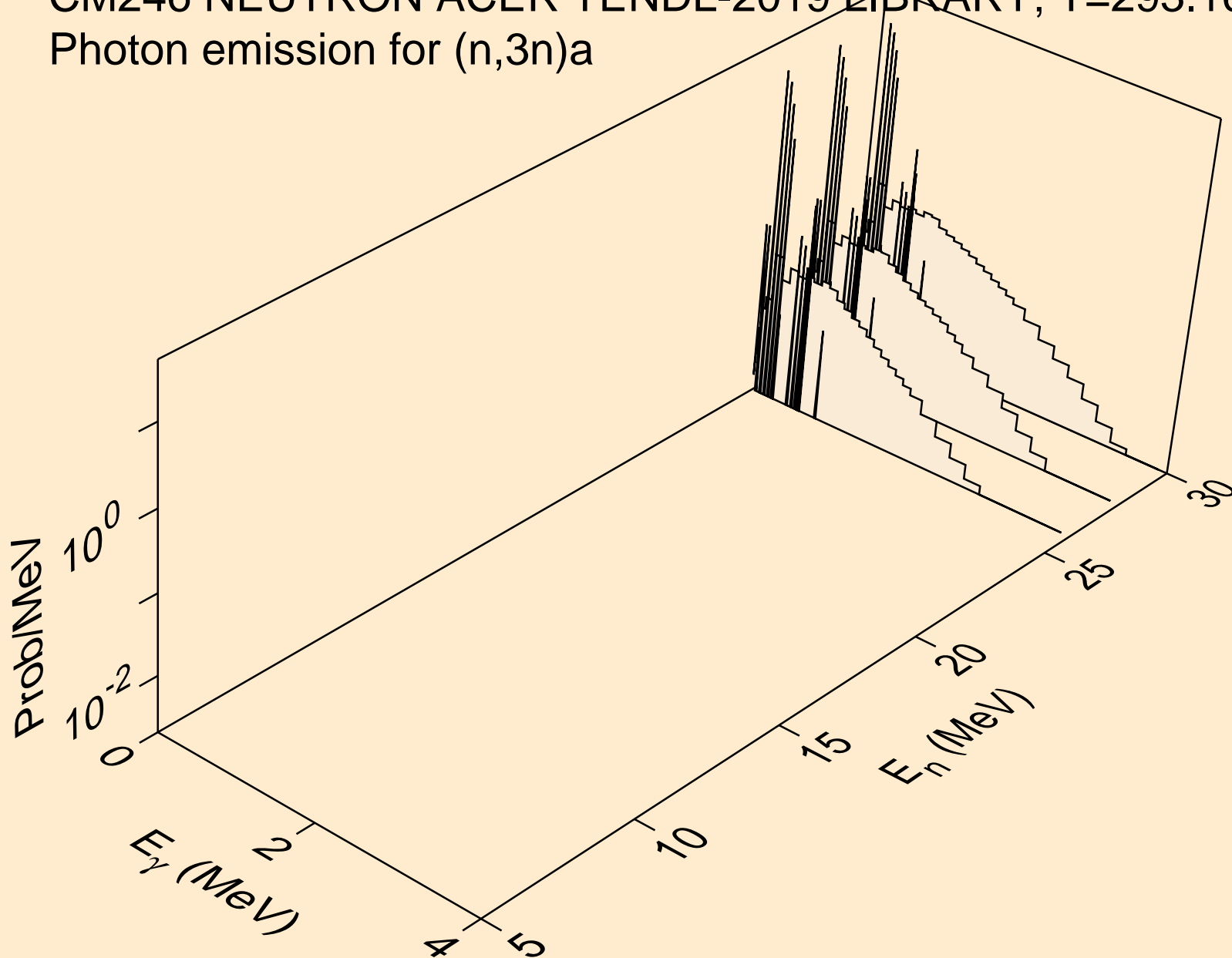

CM246 NEUTRON ACER TENDL-2019 LIBRARY; T=293.16K
Photon emission for (n,n*)p

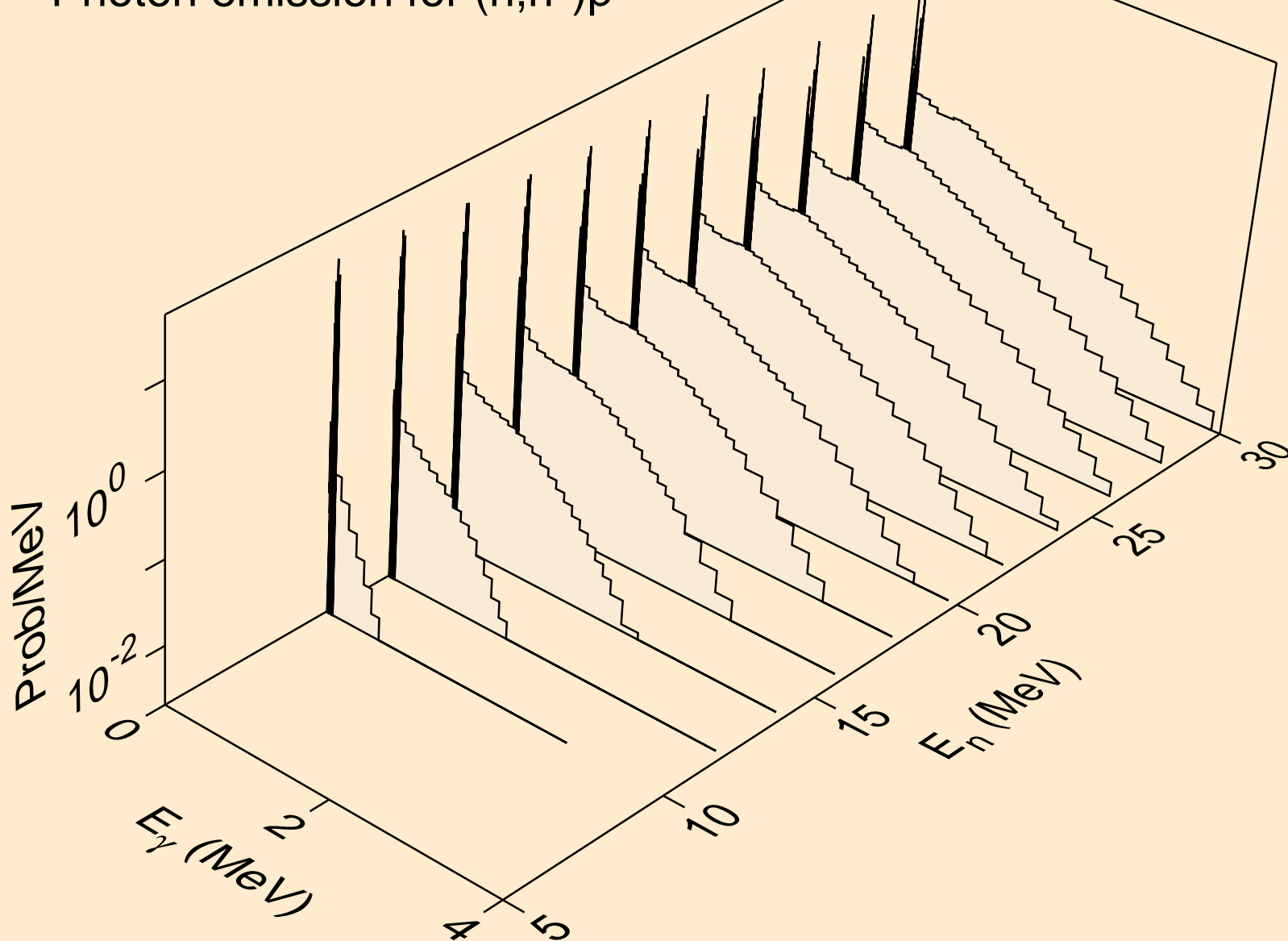

CM246 NEUTRON ACER TENDL-2019 LIBRARY; T=293.16K
Photon emission for (n,n*)d

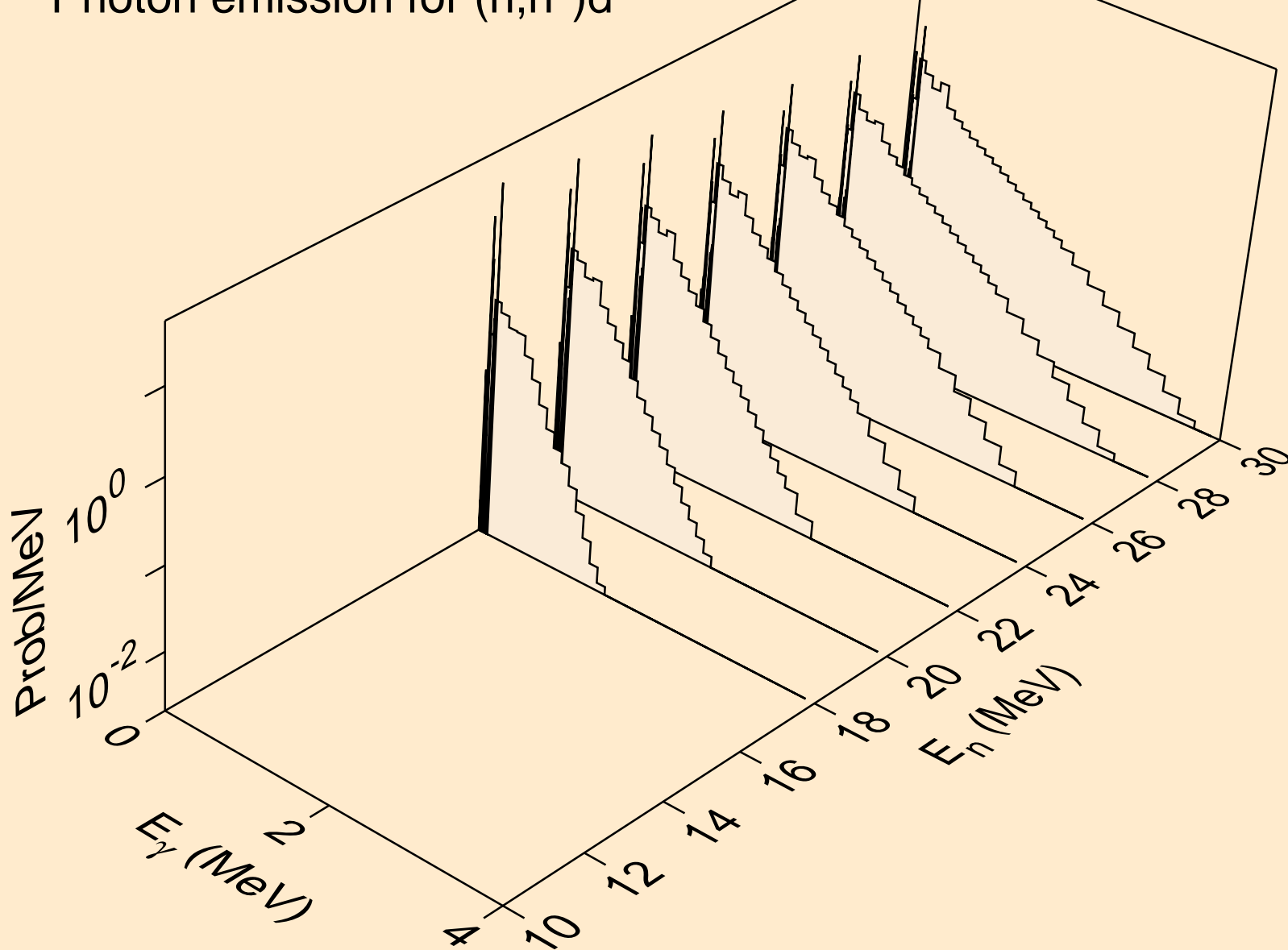

CM246 NEUTRON ACER TENDL-2019 LIBRARY; T=293.16K
Photon emission for (n,n*)t

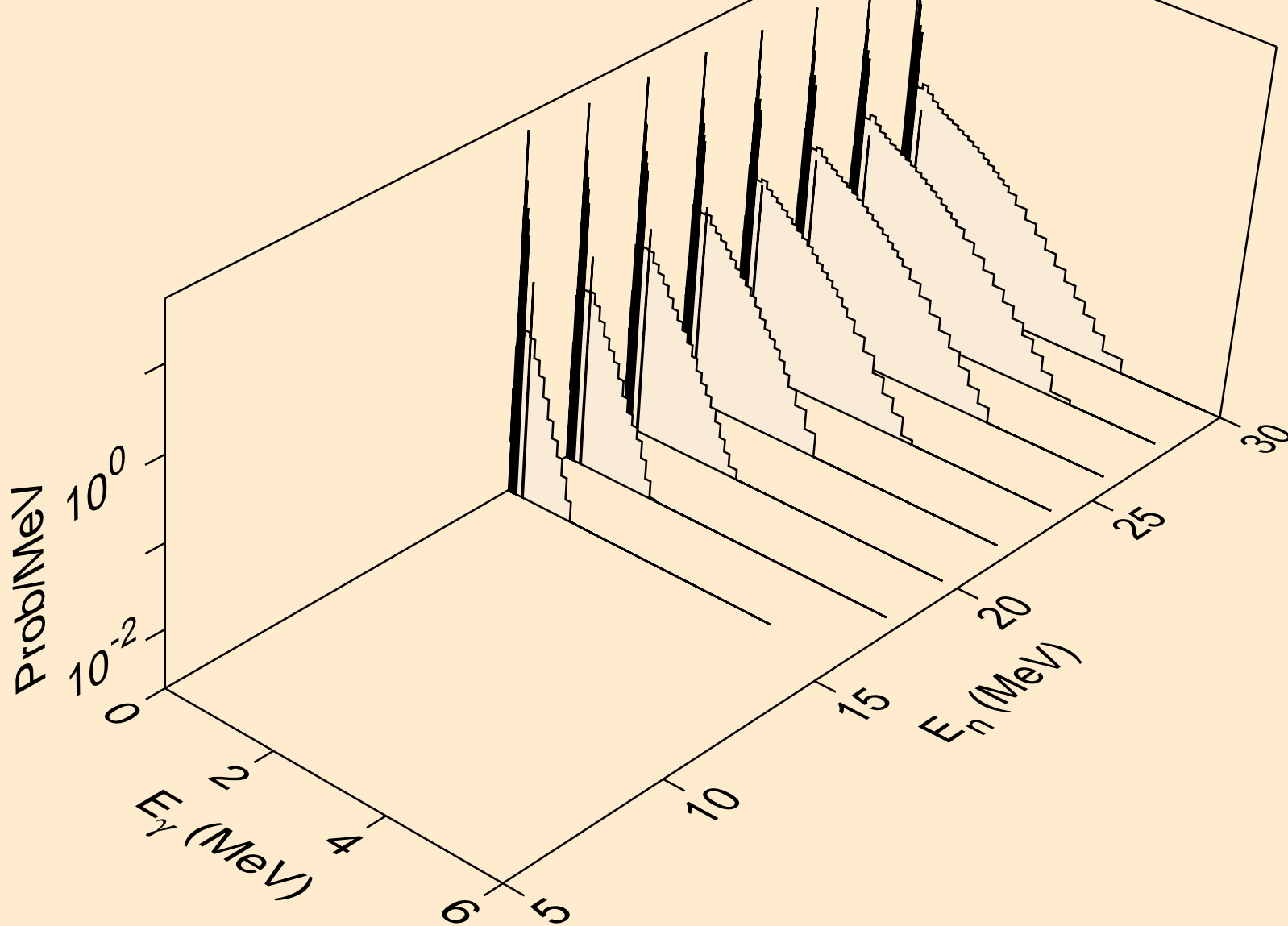

CM246 NEUTRON ACER TENDL-2019 LIBRARY; T=293.16K
Photon emission for (n,n*)he3

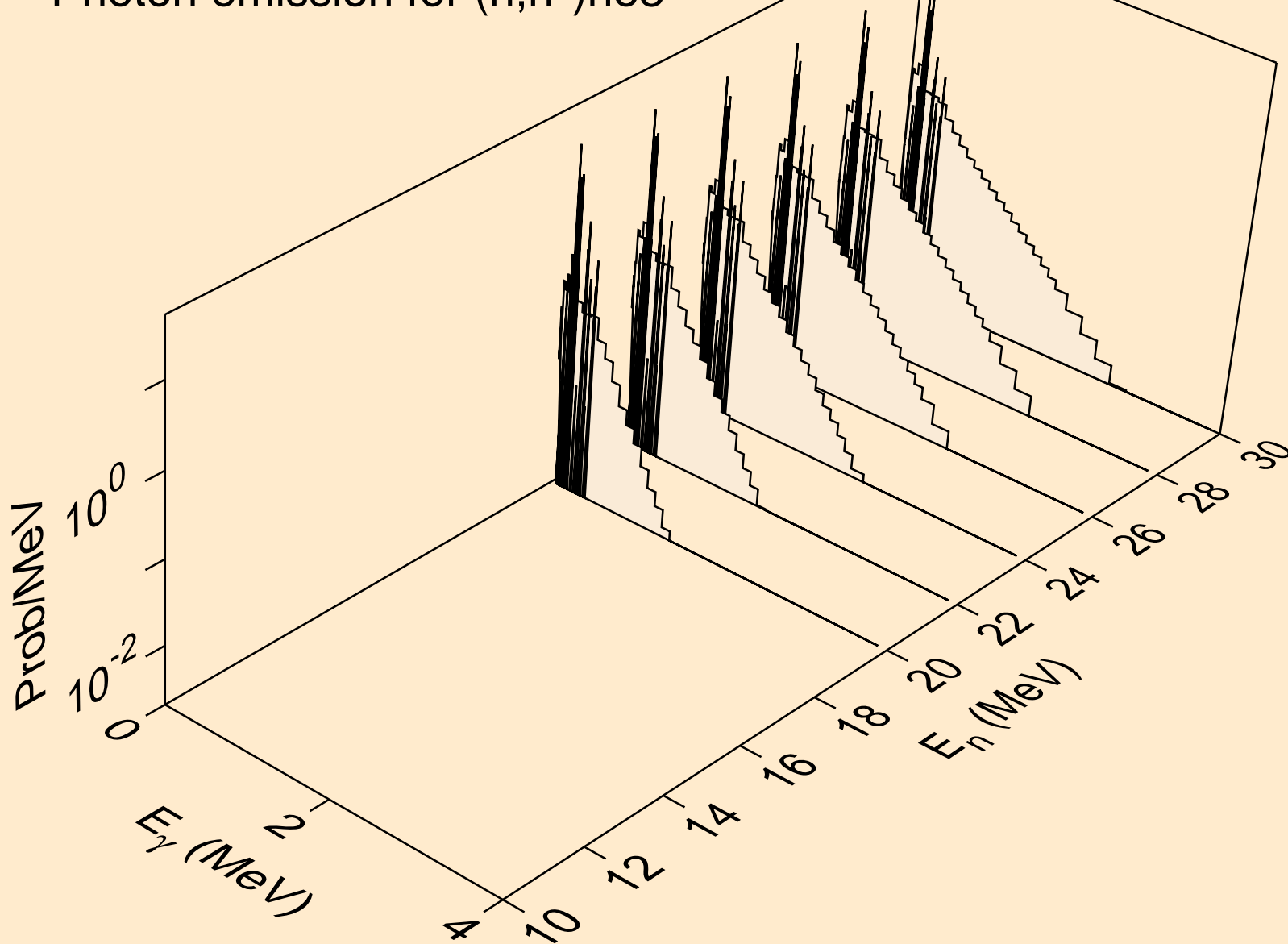

CM246 NEUTRON ACER TENDL-2019 LIBRARY; T=293.16K
Photon emission for (n,4n)

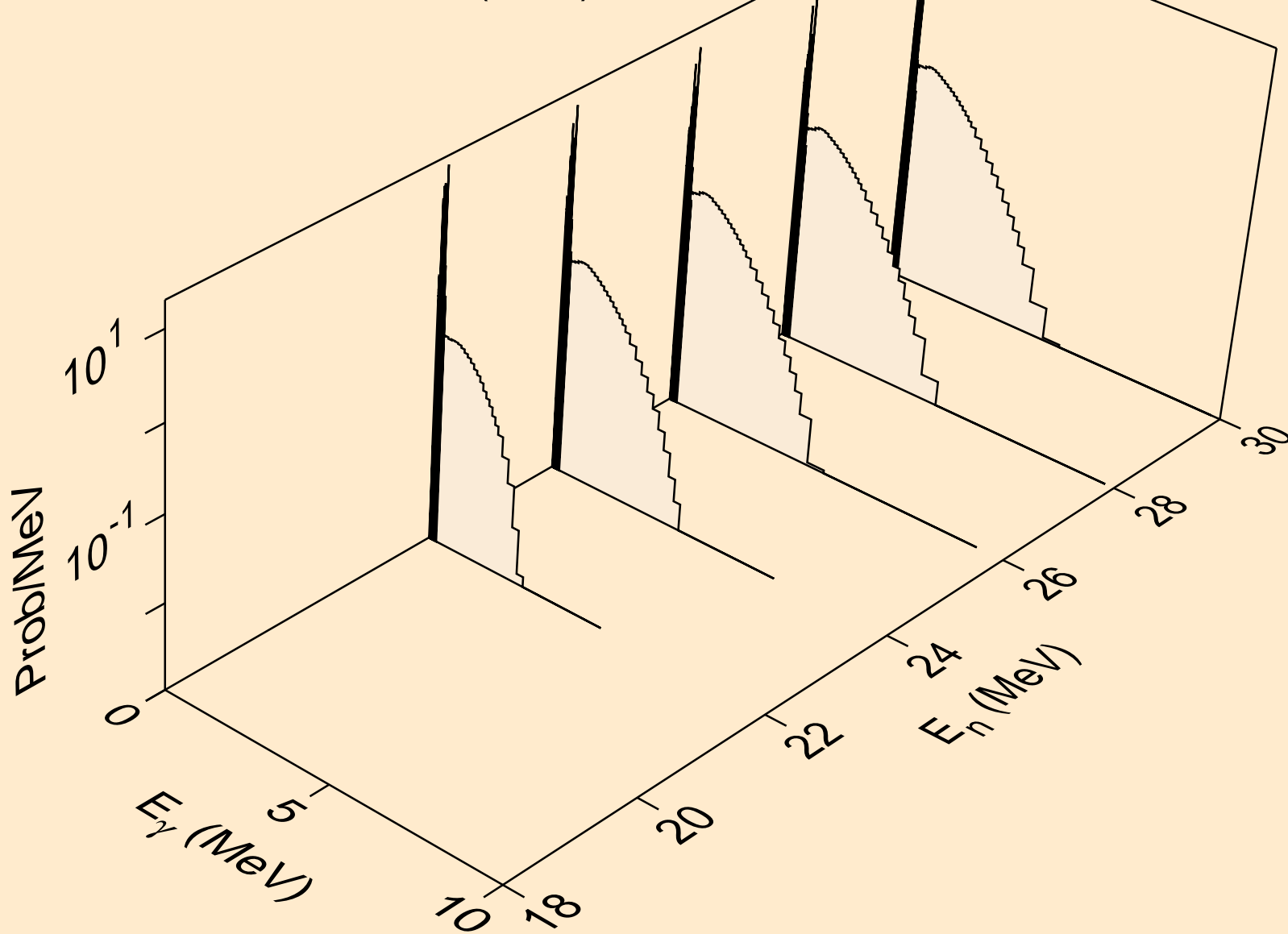

CM246 NEUTRON ACER TENDL-2019 LIBRARY; T=293.16K
Photon emission for (n,2np)

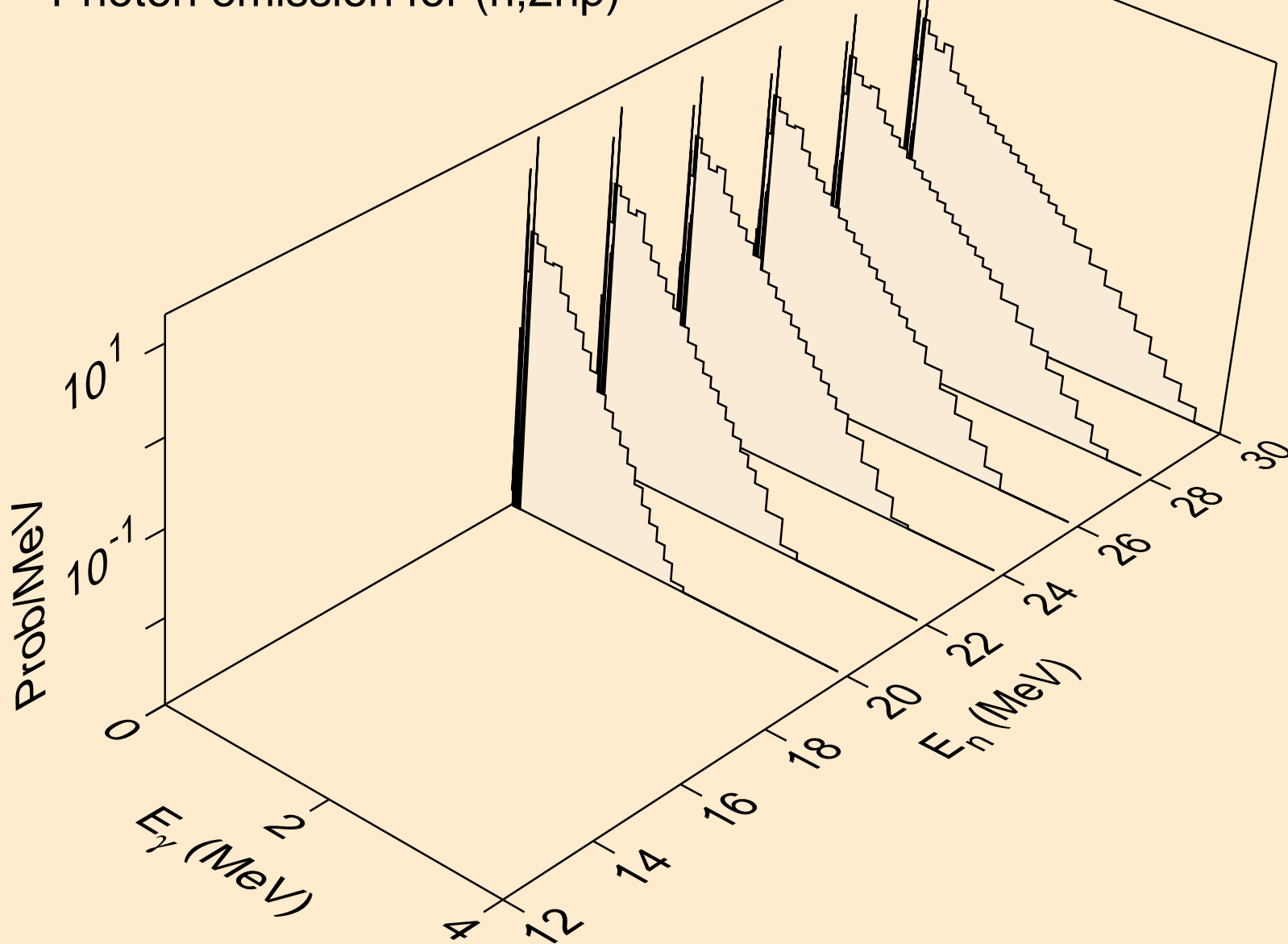

CM246 NEUTRON ACER TENDL-2019 LIBRARY; T=293.16K
Photon emission for (n,3np)

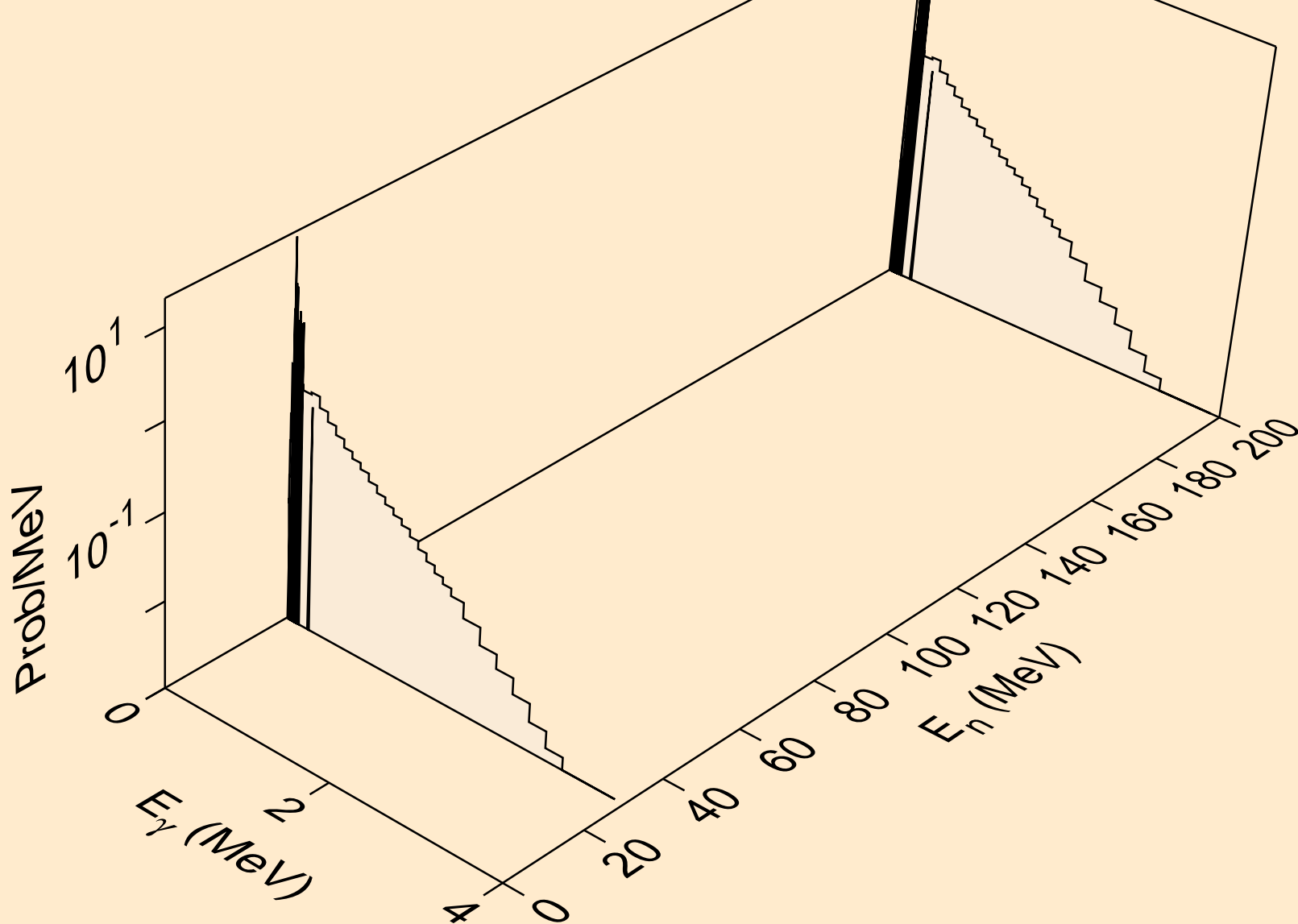

CM246 NEUTRON ACER TENDL-2019 LIBRARY; T=293.16K
Photon emission for (n,2np)

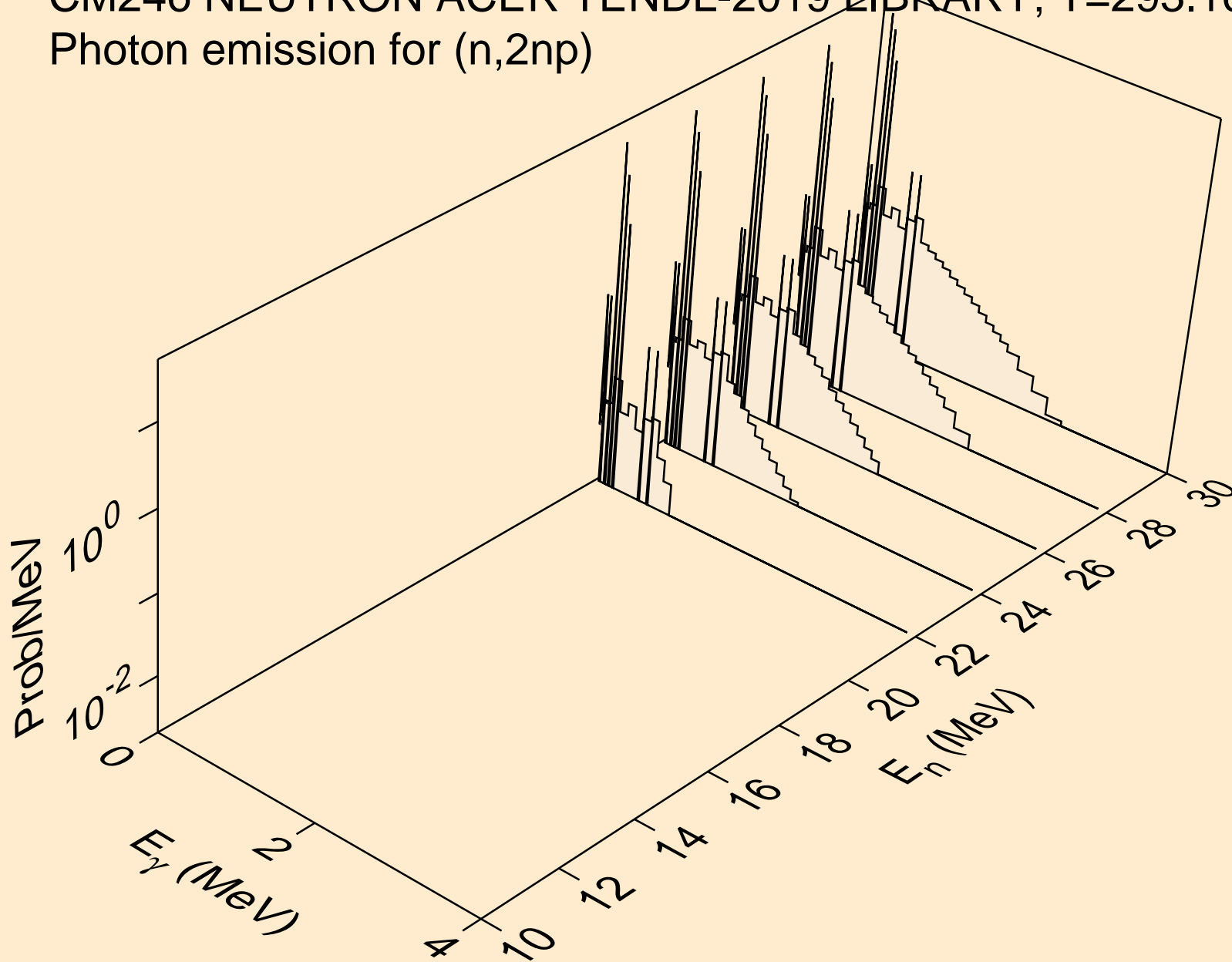

CM246 NEUTRON ACER TENDL-2019 LIBRARY; T=293.16K
Photon emission for (n,n*c)

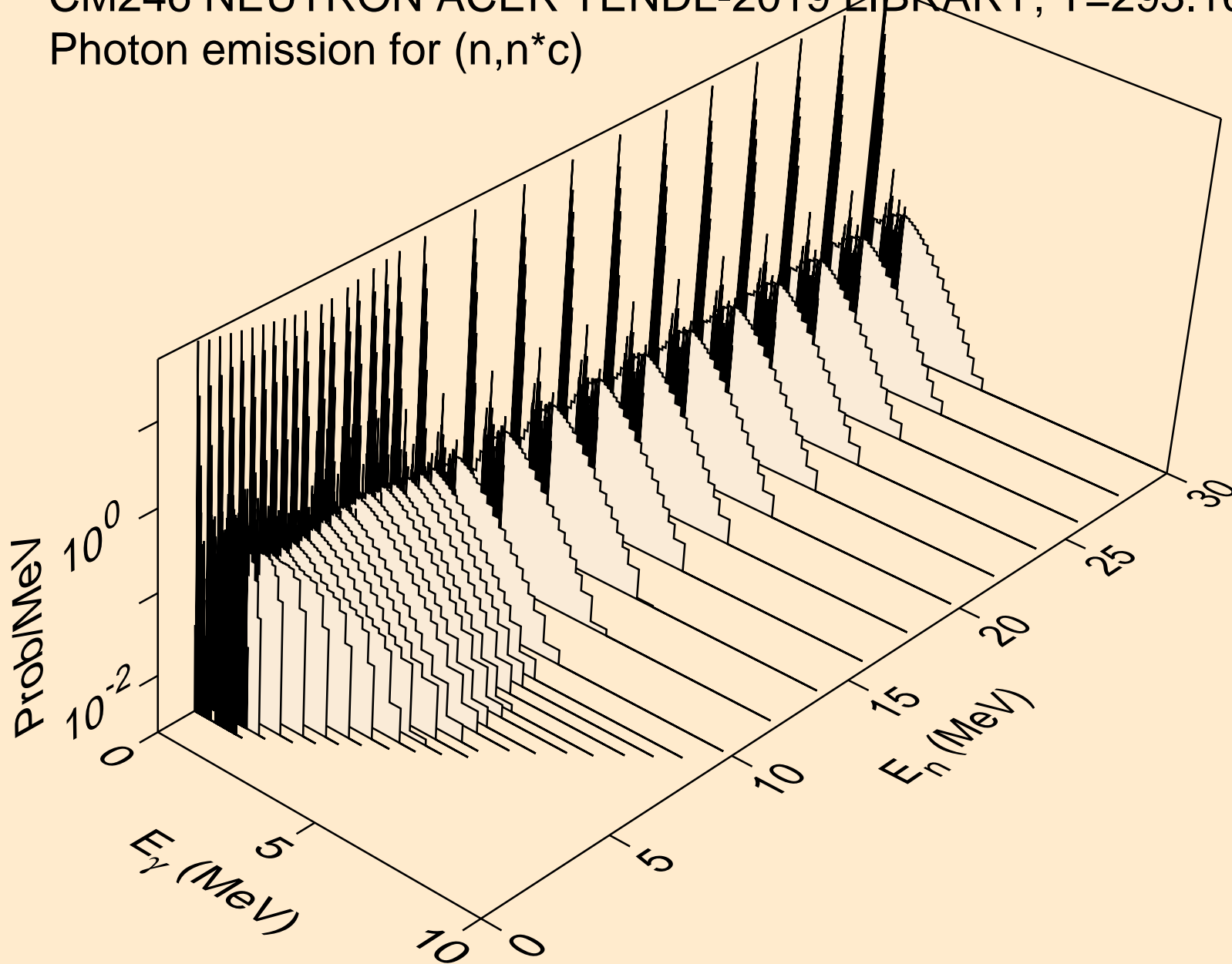

CM246 NEUTRON ACER TENDL-2019 LIBRARY; T=293.16K
Photon emission for (n,gma)

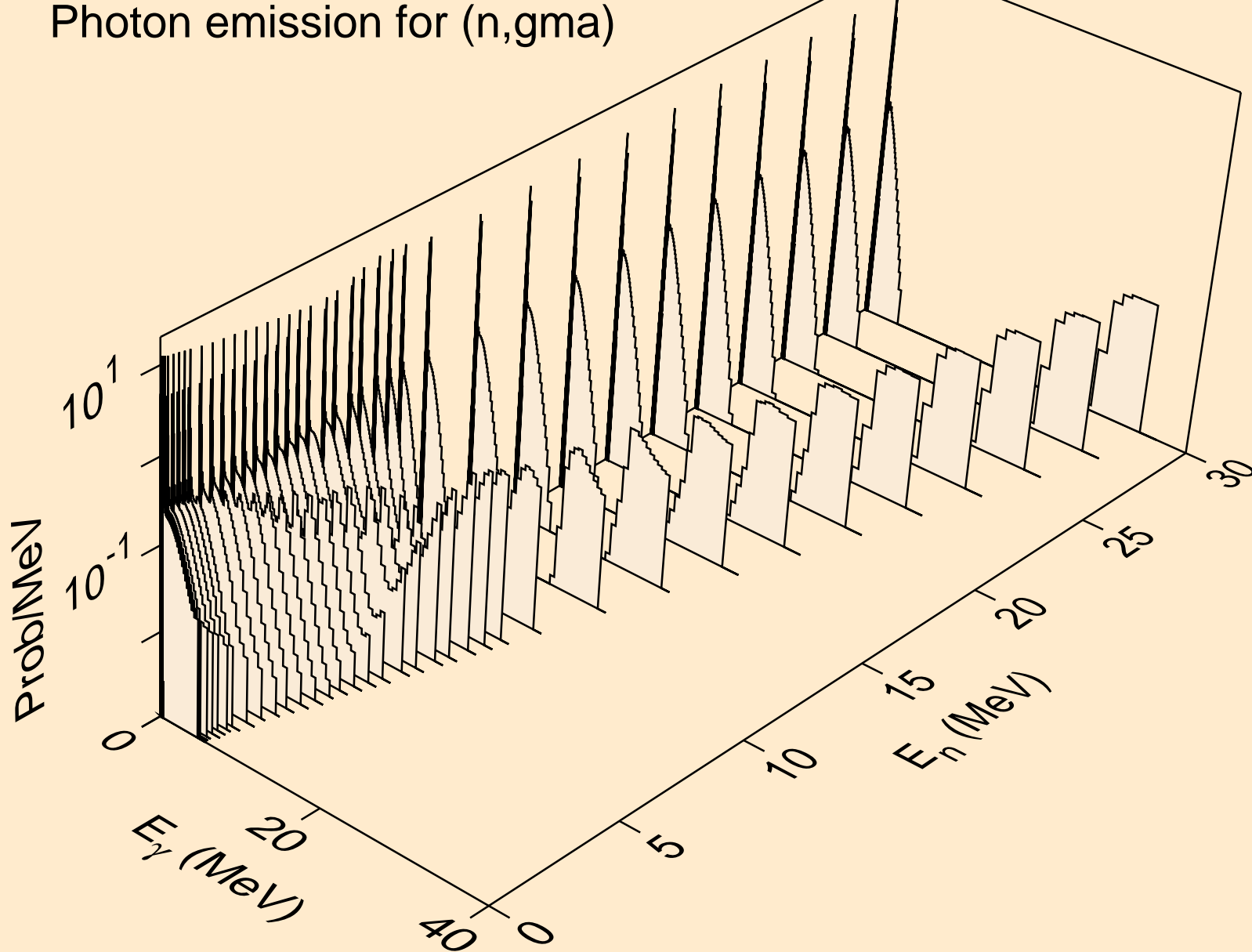

CM246 NEUTRON ACER TENDL-2019 LIBRARY; T=293.16K
Photon emission for (n,p)

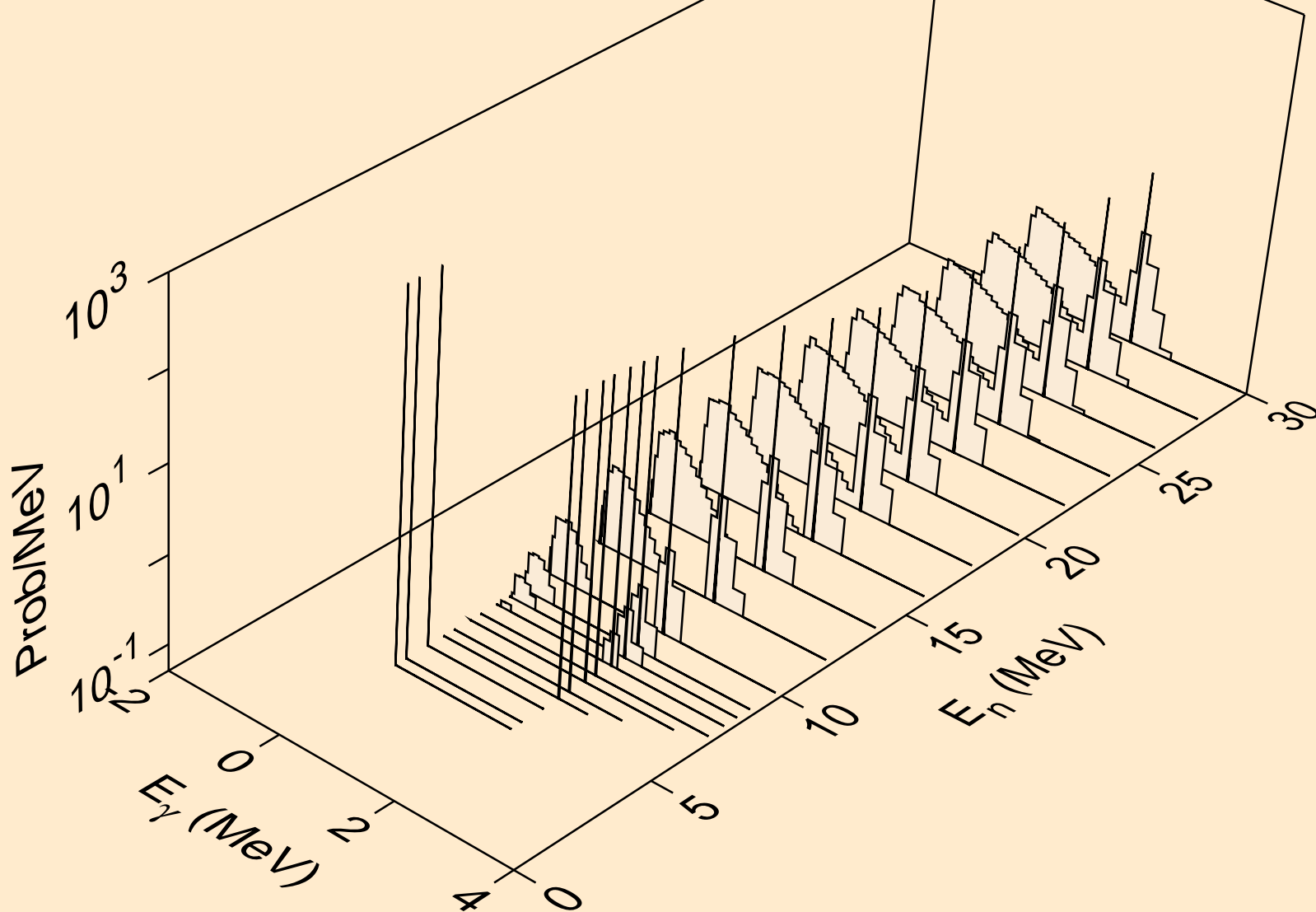

CM246 NEUTRON ACER TENDL-2019 LIBRARY; T=293.16K
Photon emission for (n,d)

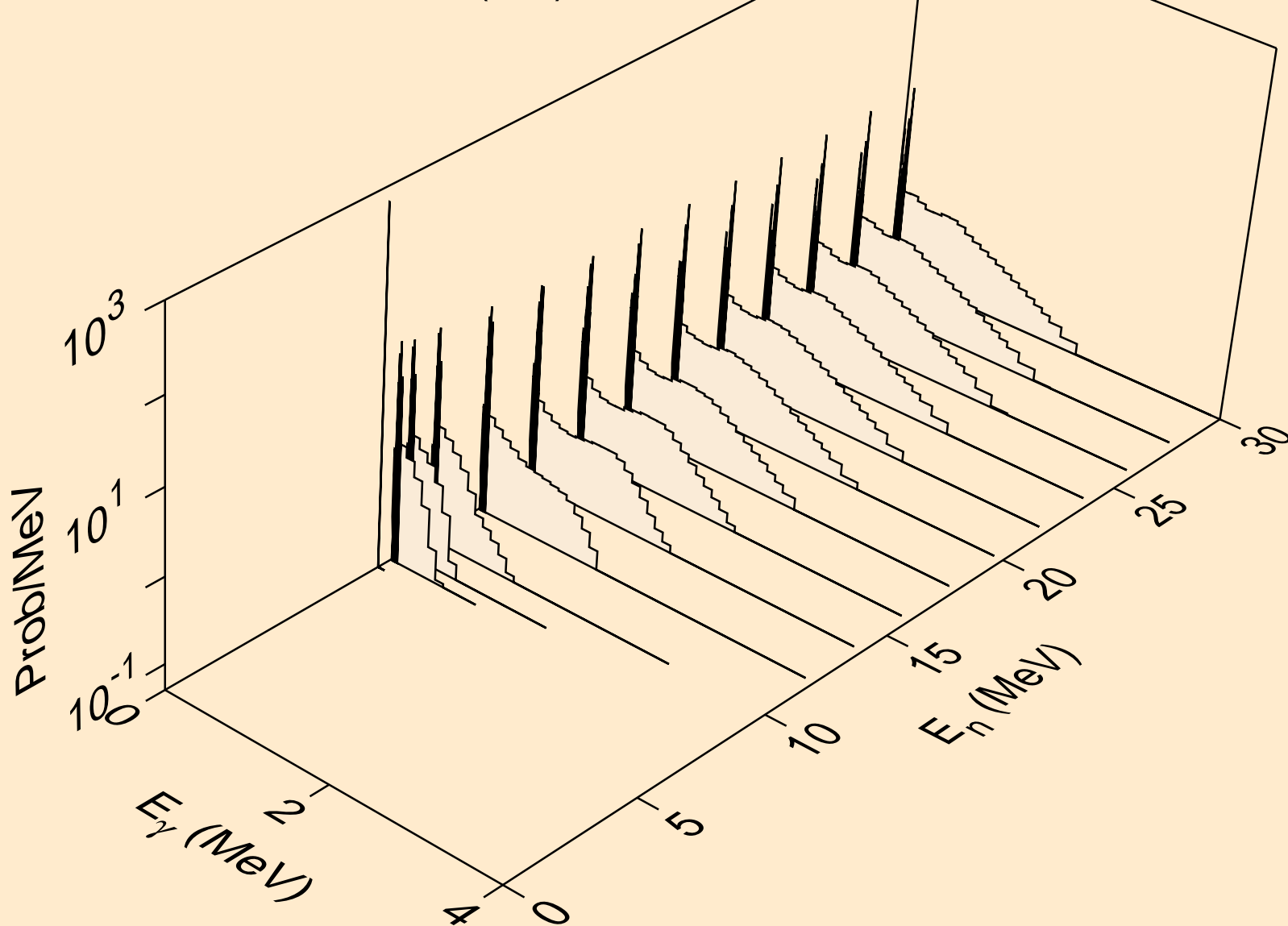

CM246 NEUTRON ACER TENDL-2019 LIBRARY; T=293.16K
Photon emission for (n,t)

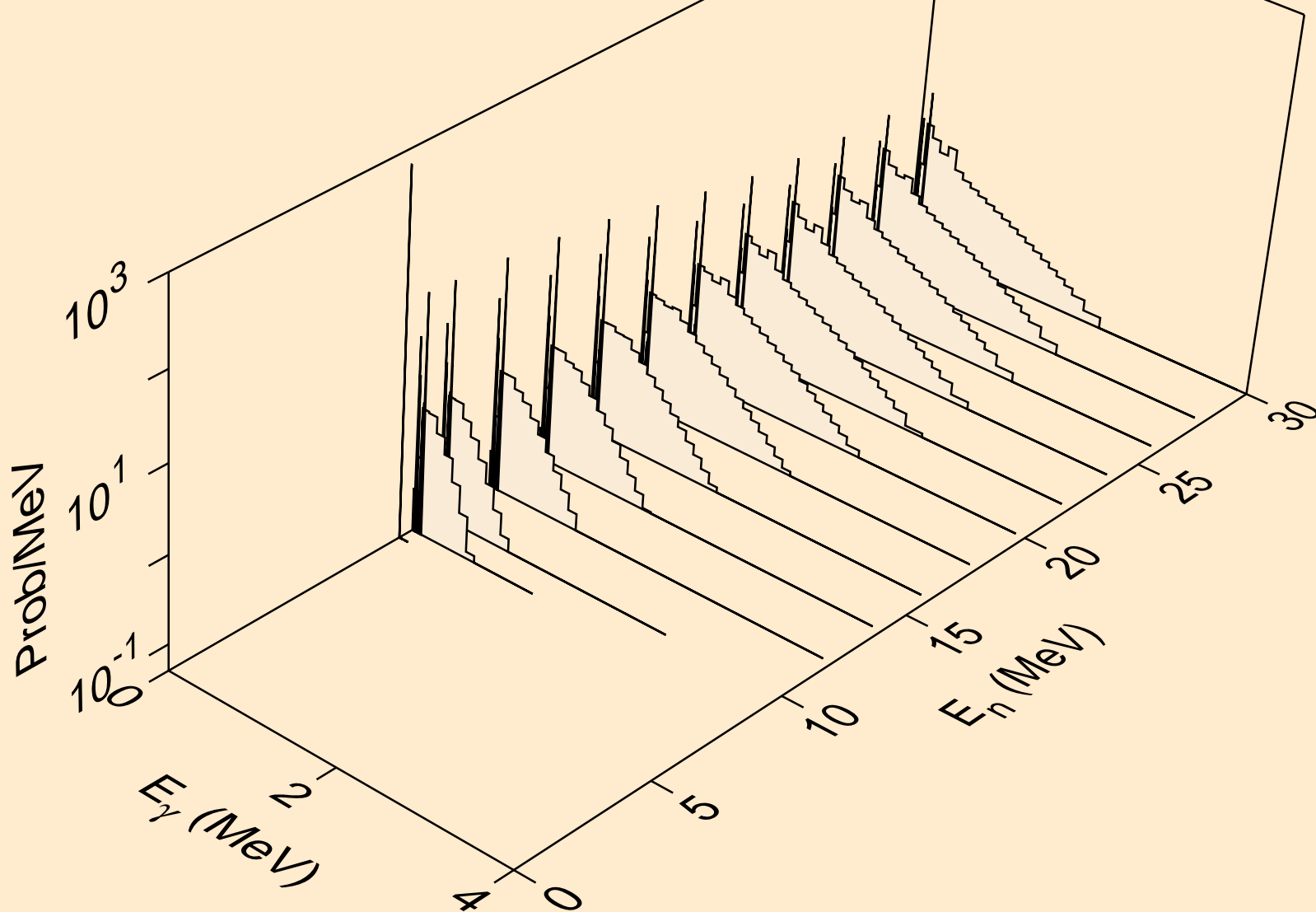

CM246 NEUTRON ACER TENDL-2019 LIBRARY; T=293.16K
Photon emission for (n,he3)

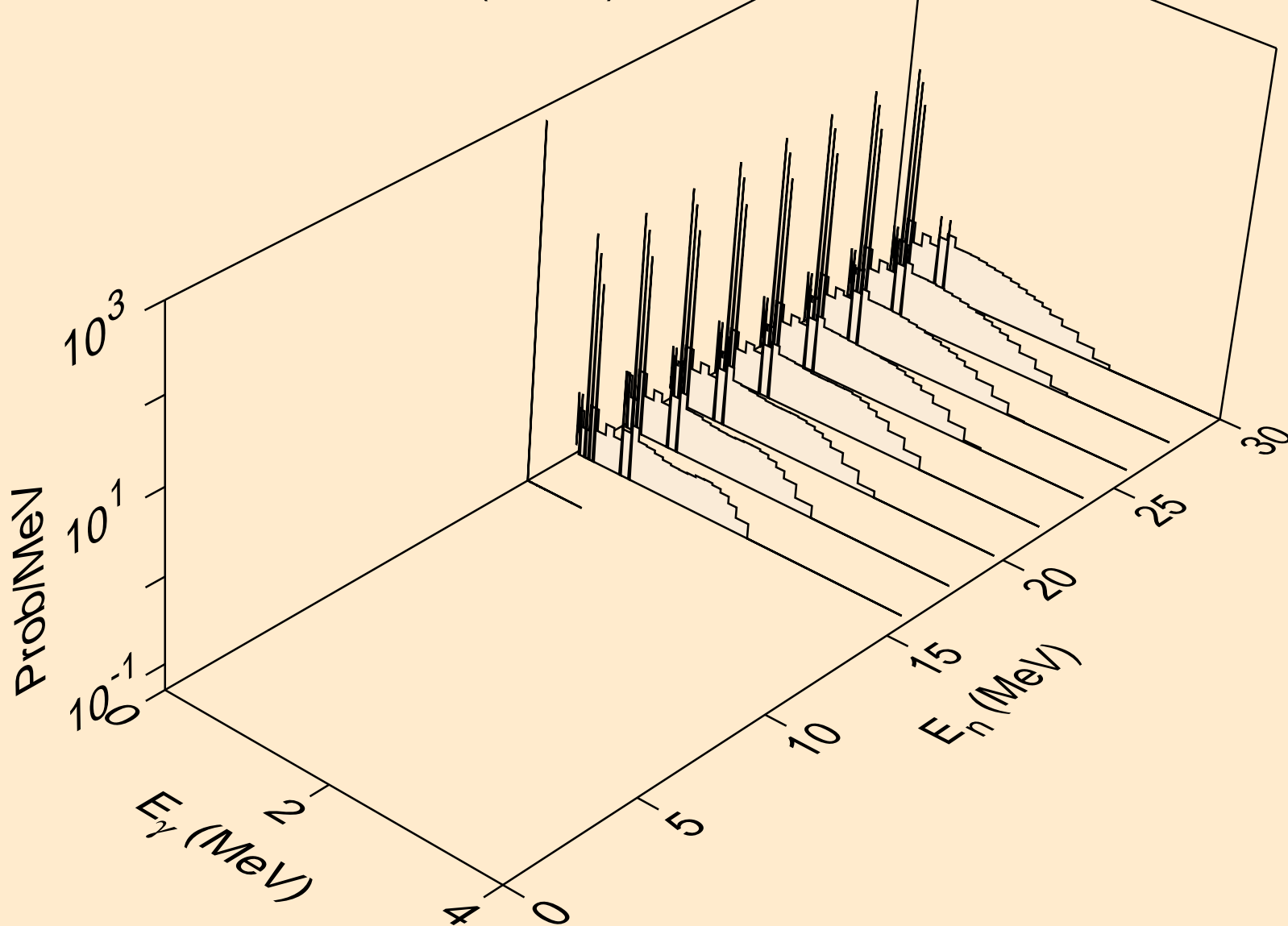

CM246 NEUTRON ACER TENDL-2019 LIBRARY; T=293.16K
Photon emission for (n,a)

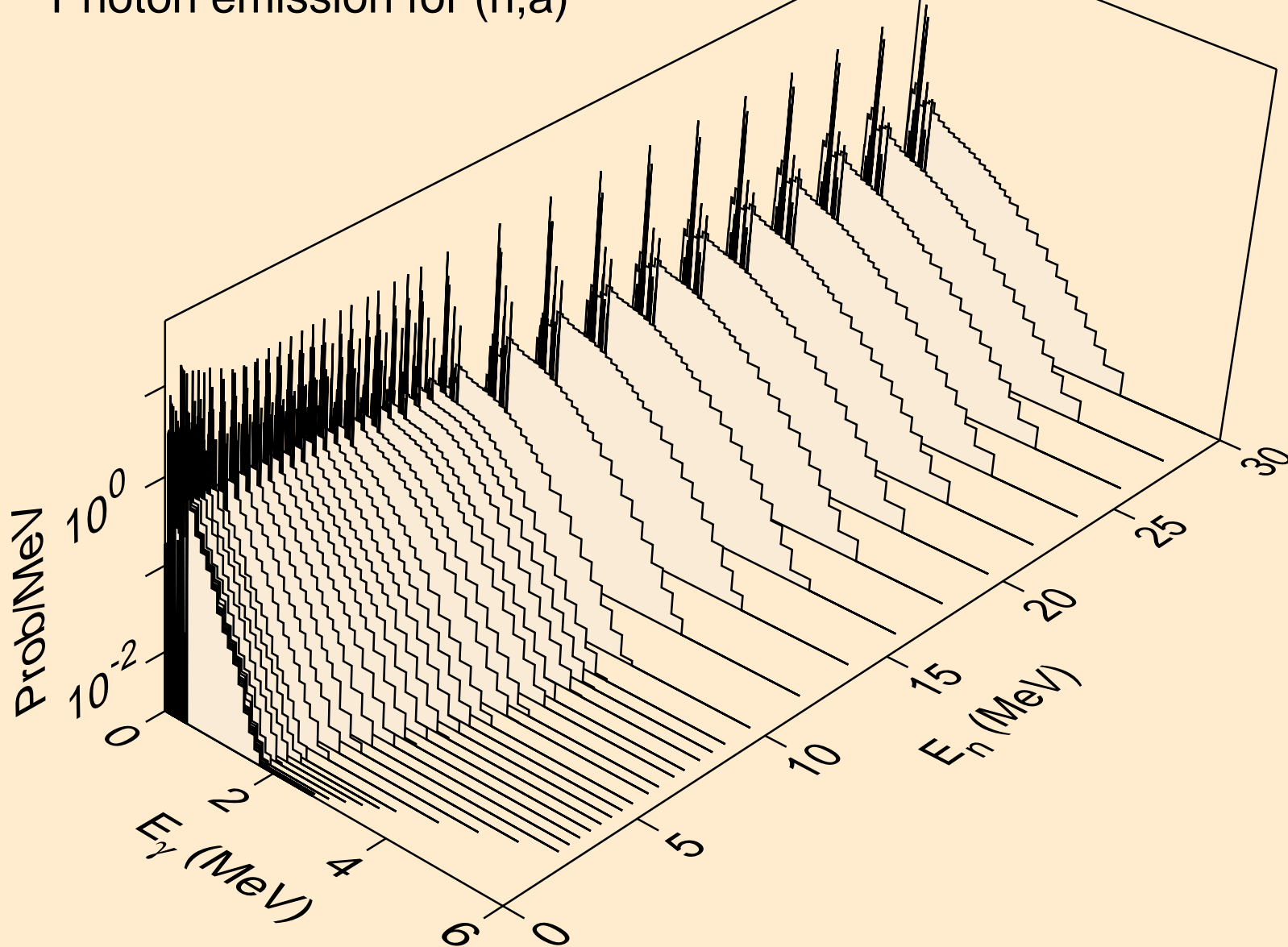

CM246 NEUTRON ACER TENDL-2019 LIBRARY; T=293.16K
Photon emission for (n,2p)

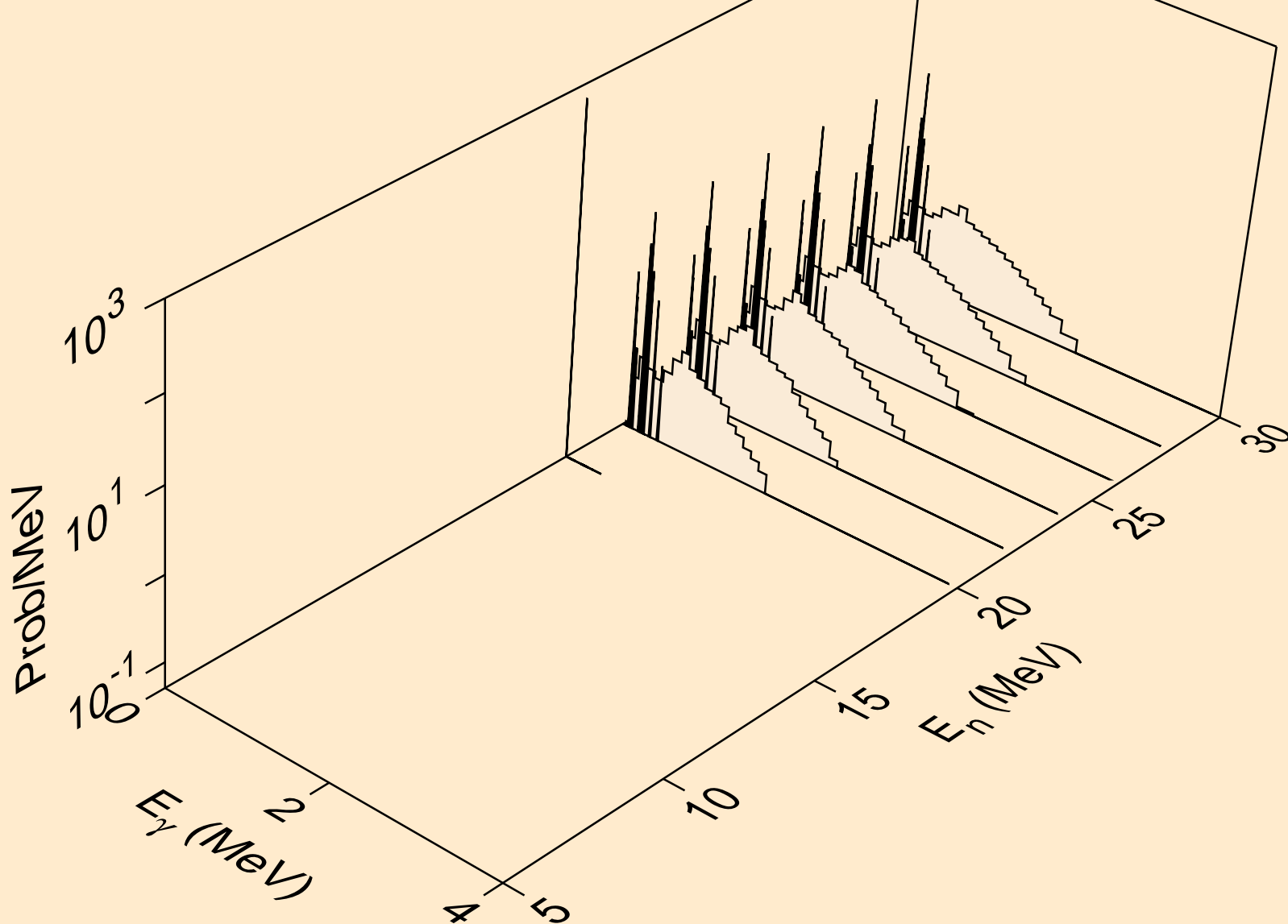

CM246 NEUTRON ACER TENDL-2019 LIBRARY; T=293.16K
thermal capture photon spectrum

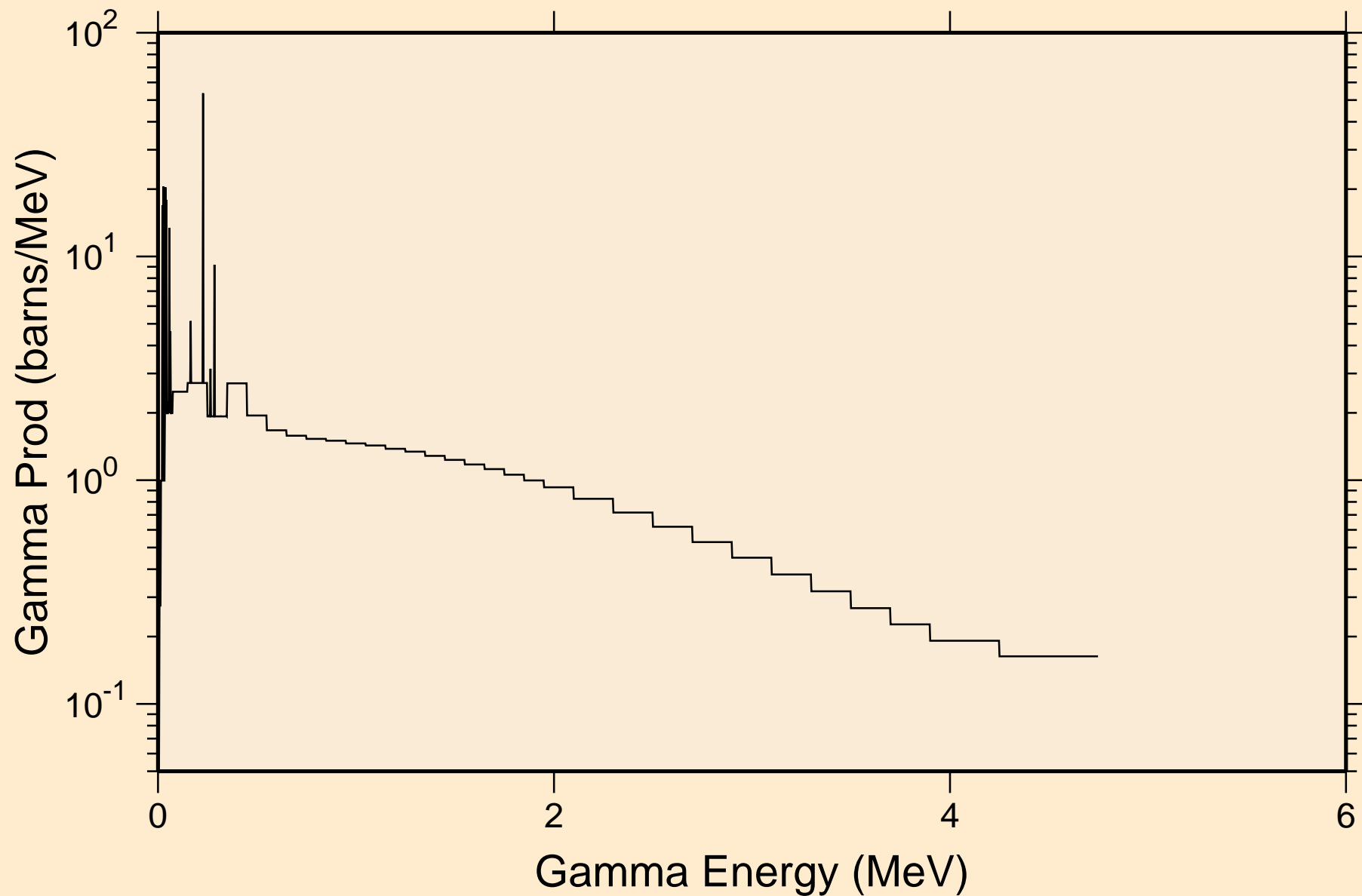

CM246 NEUTRON ACER TENDL-2019 LIBRARY; T=293.16K
14 MeV photon spectrum

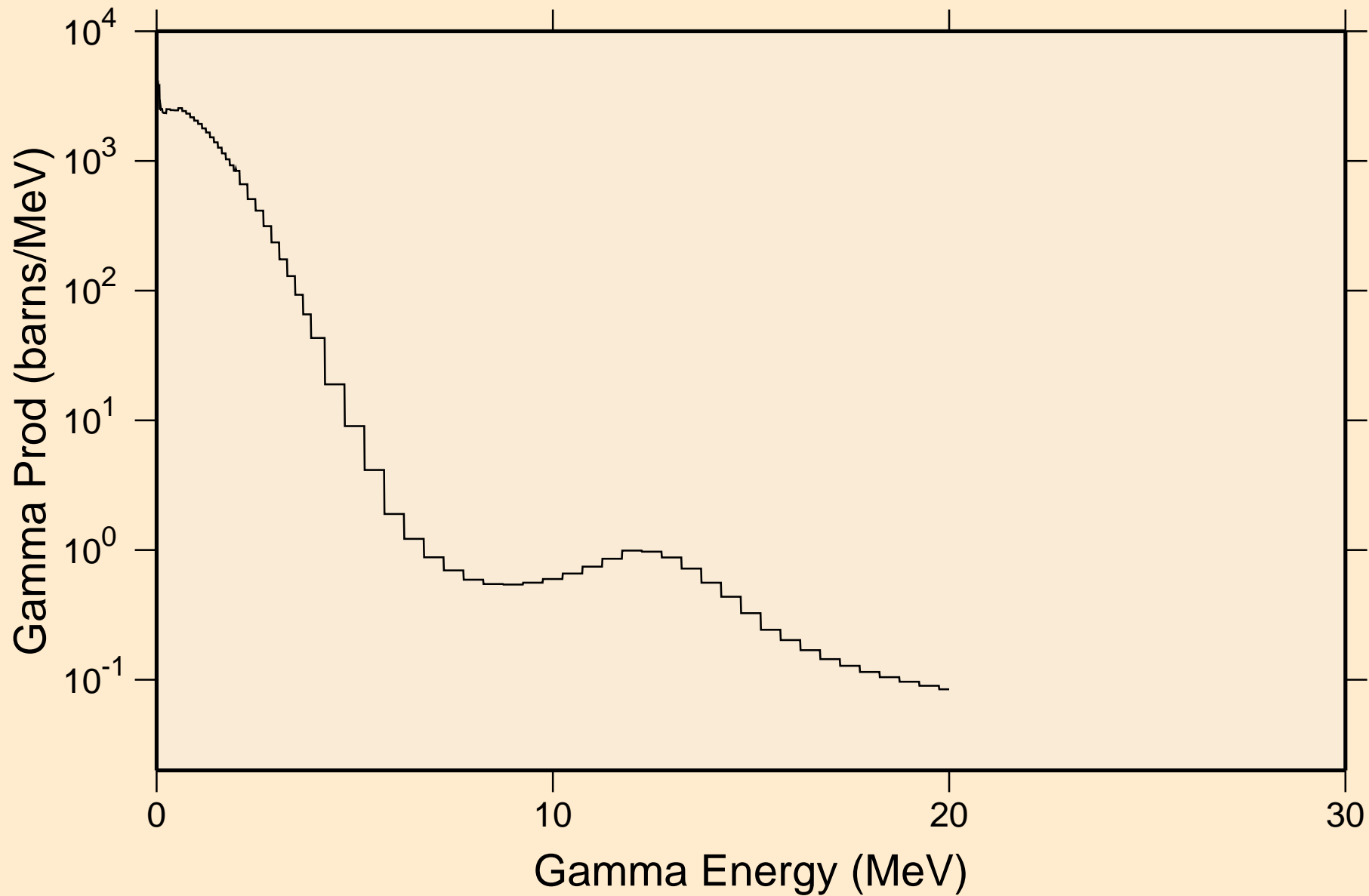

CM246 NEUTRON ACER TENDL-2019 LIBRARY; T=293.16K
Particle heating contributions

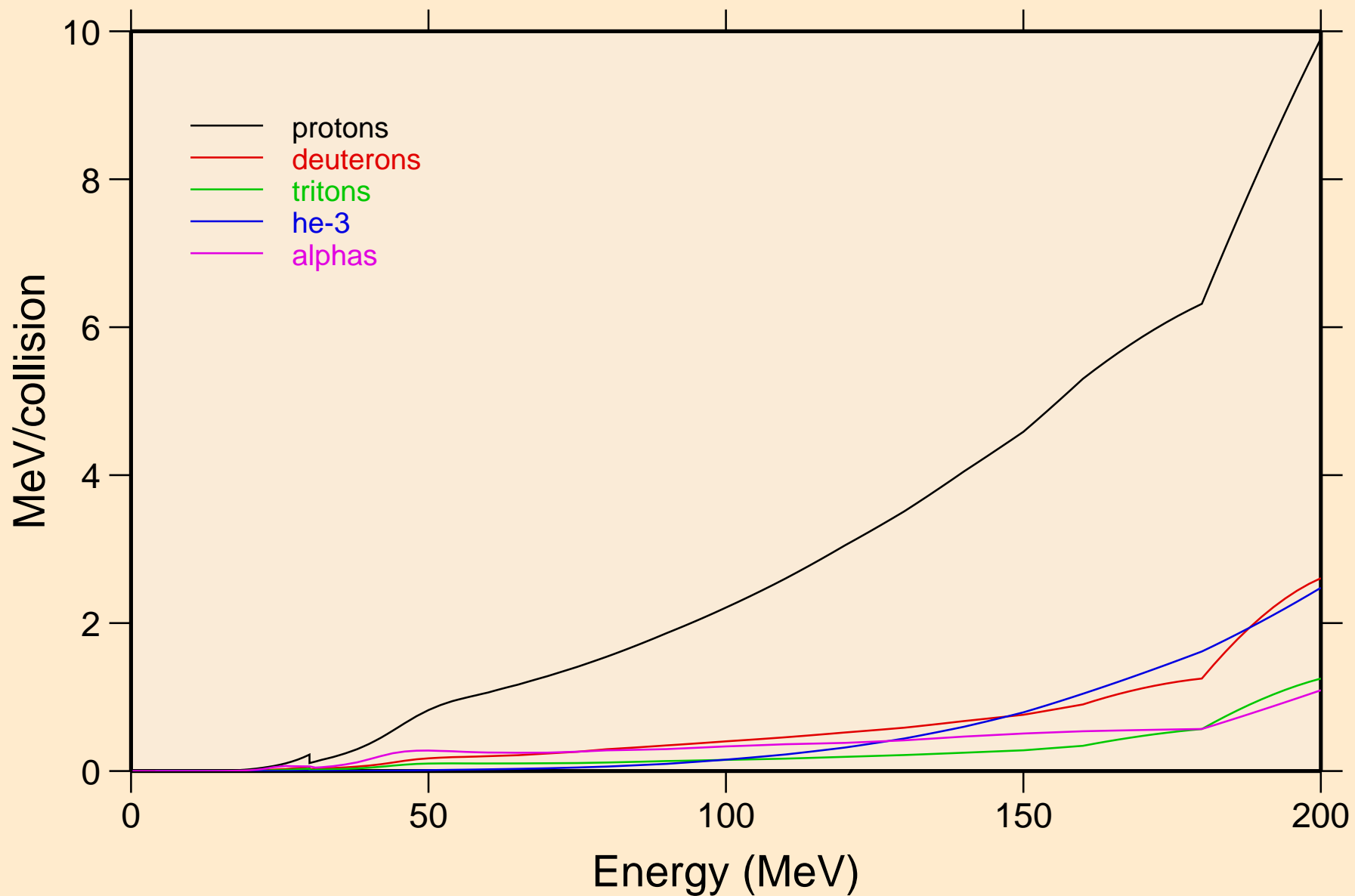

CM246 NEUTRON ACER TENDL-2019 LIBRARY; T=293.16K
Recoil Heating

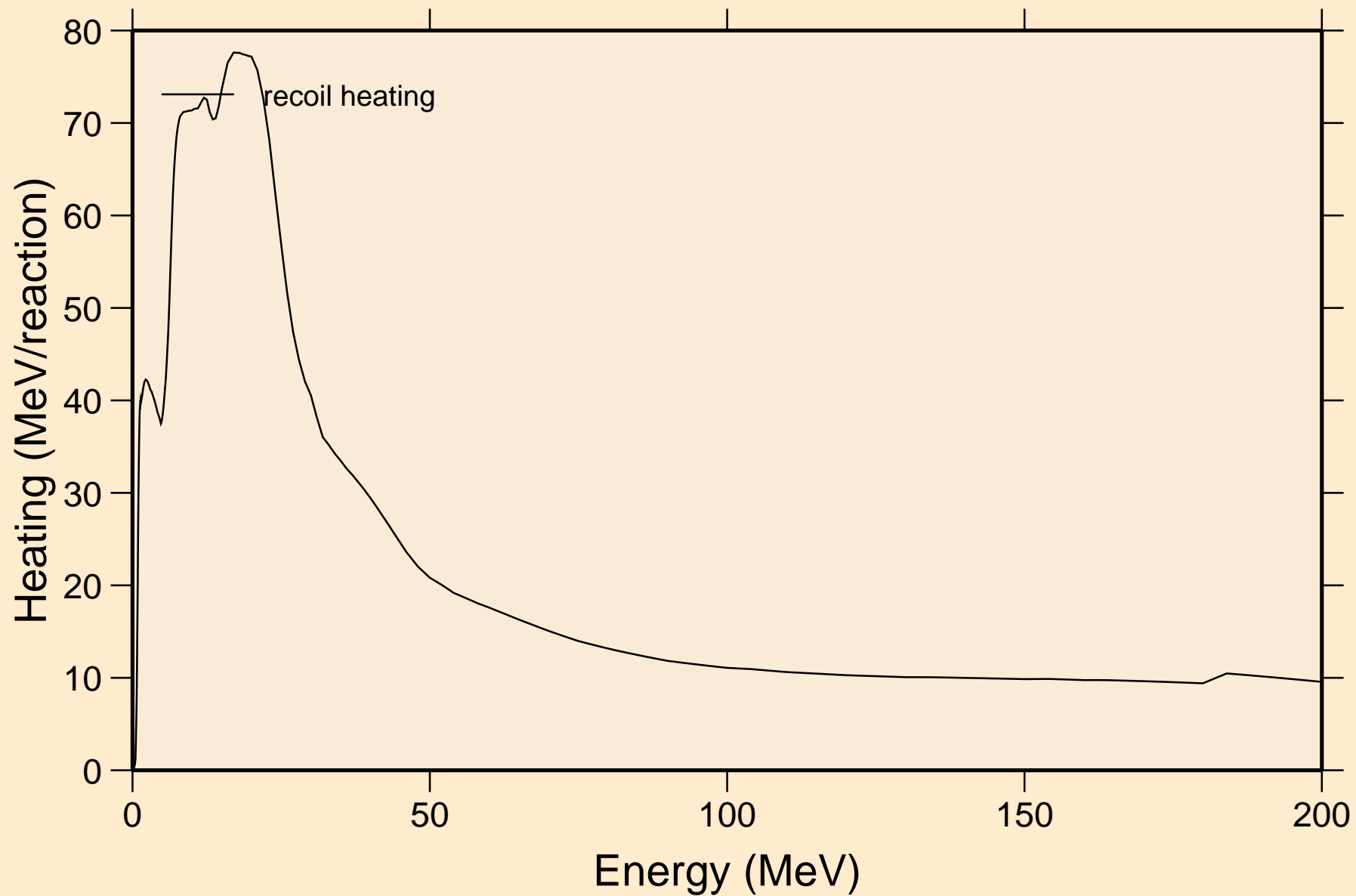

CM246 NEUTRON ACER TENDL-2019 LIBRARY; T=293.16K
Particle production cross sections

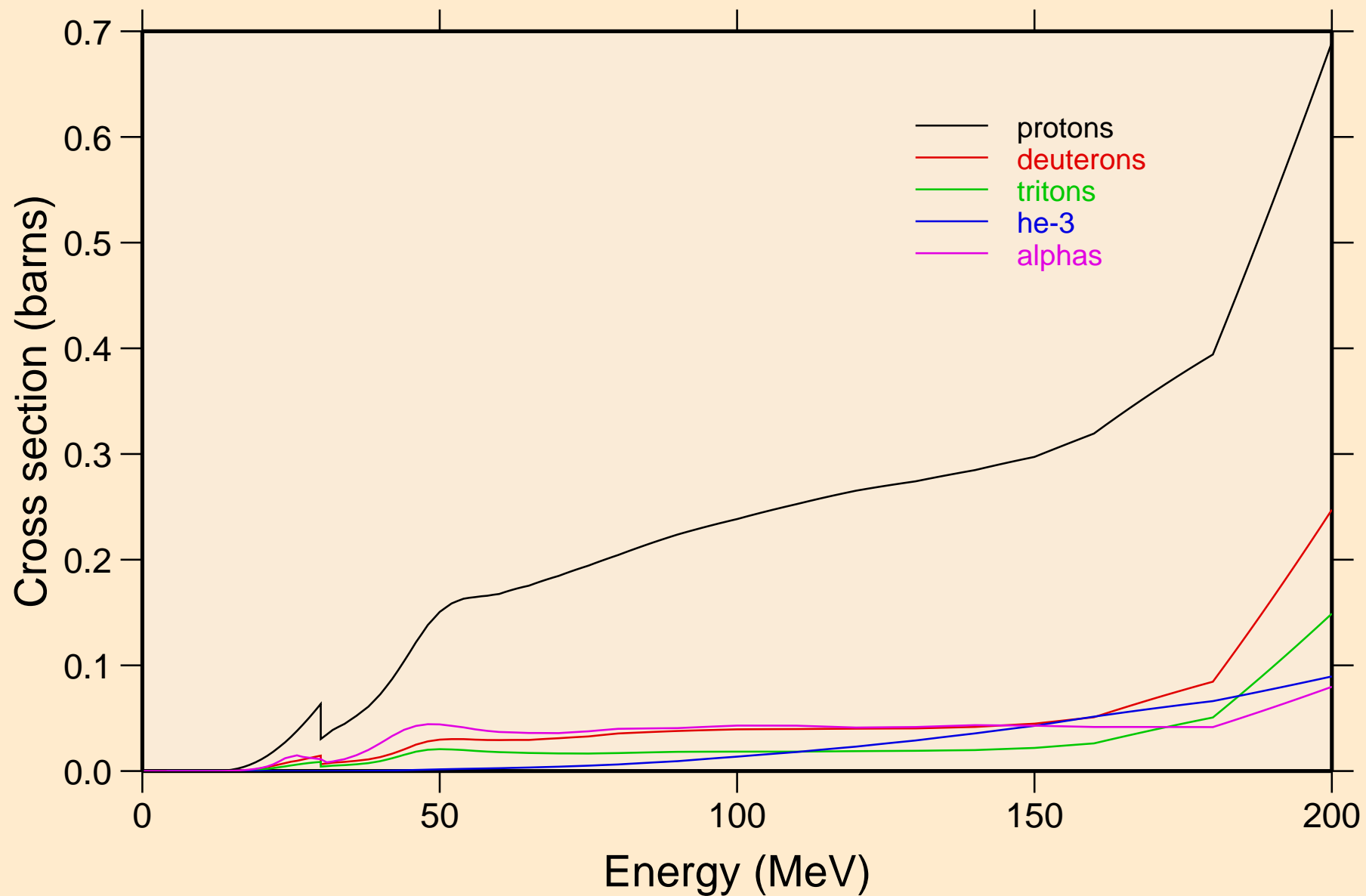

CM246 NEUTRON ACER TENDL-2019 LIBRARY; T=293.16K
protons from (n,x)

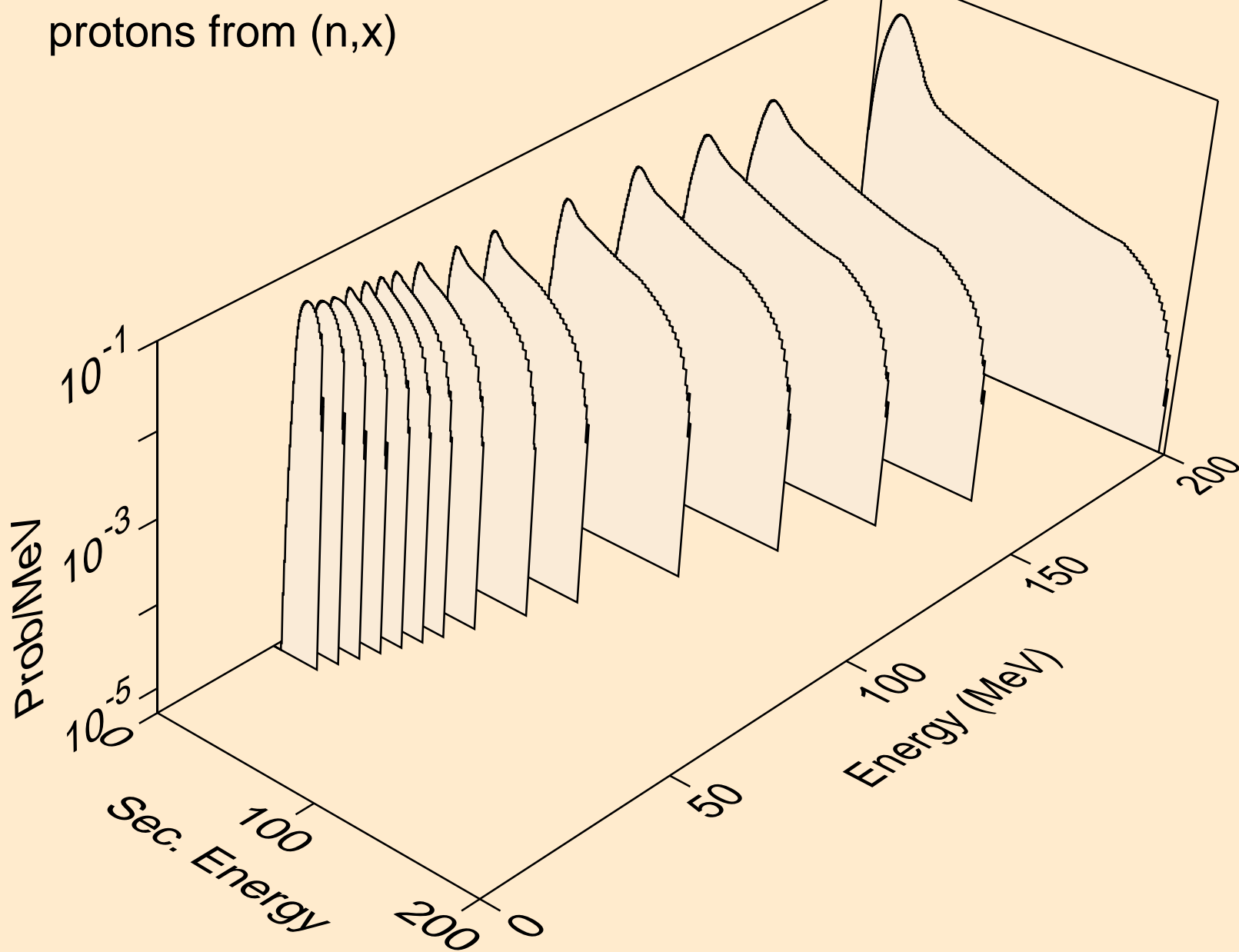

CM246 NEUTRON ACER TENDL-2019 LIBRARY; T=293.16K
protons from (n,n*)p

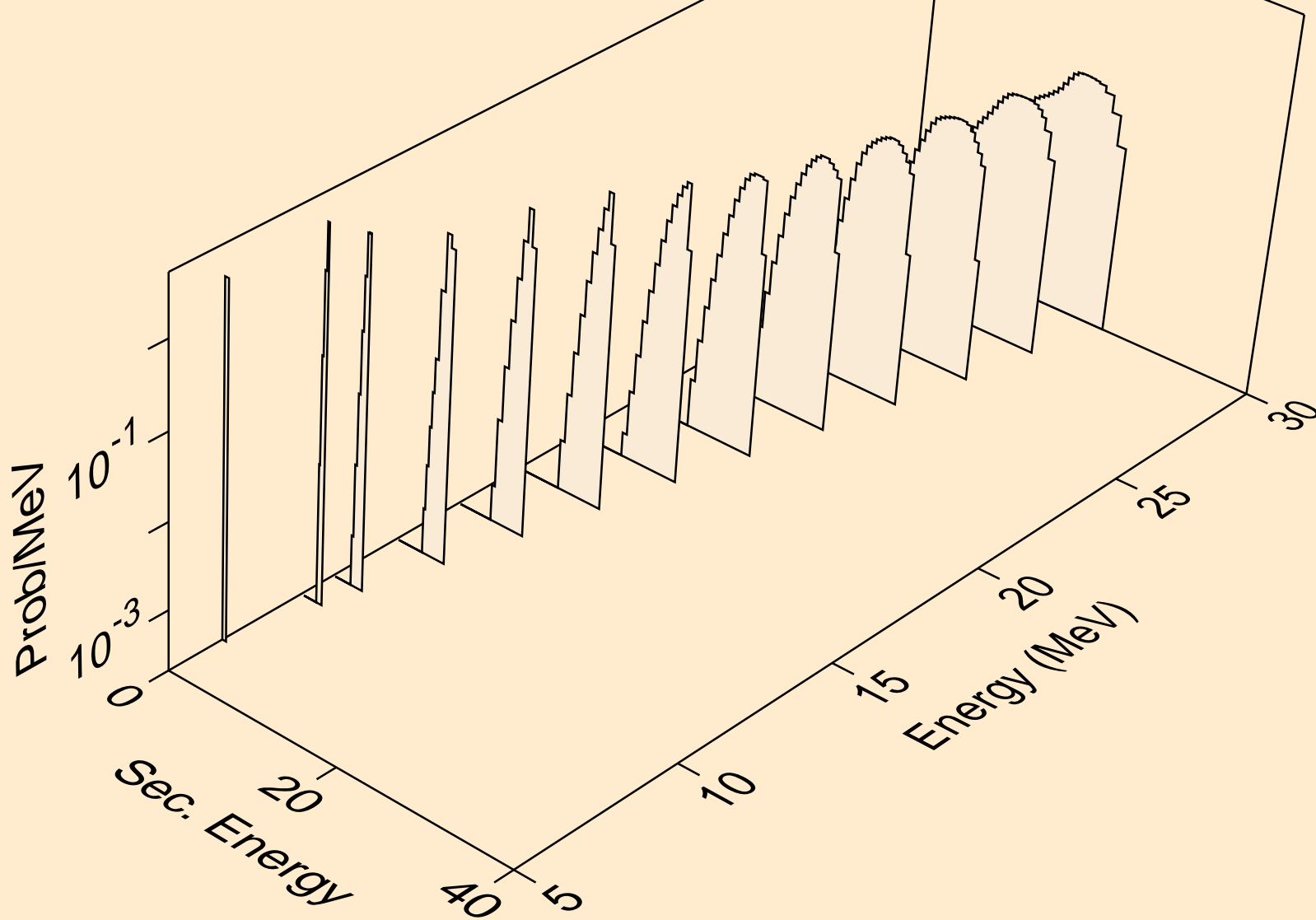

CM246 NEUTRON ACER TENDL-2019 LIBRARY; T=293.16K
protons from (n,2np)

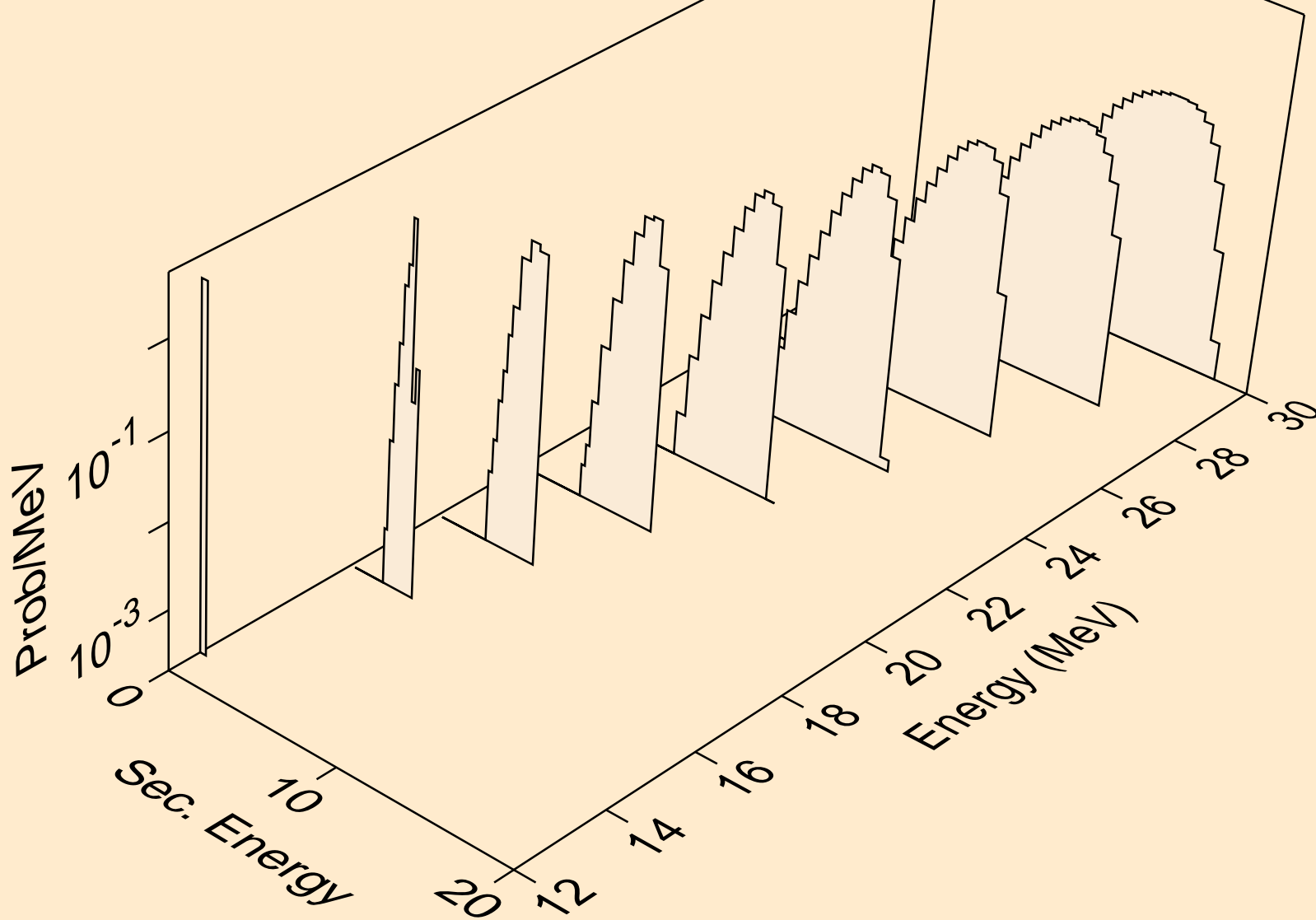

CM246 NEUTRON ACER TENDL-2019 LIBRARY; T=293.16K
protons from (n,3np)

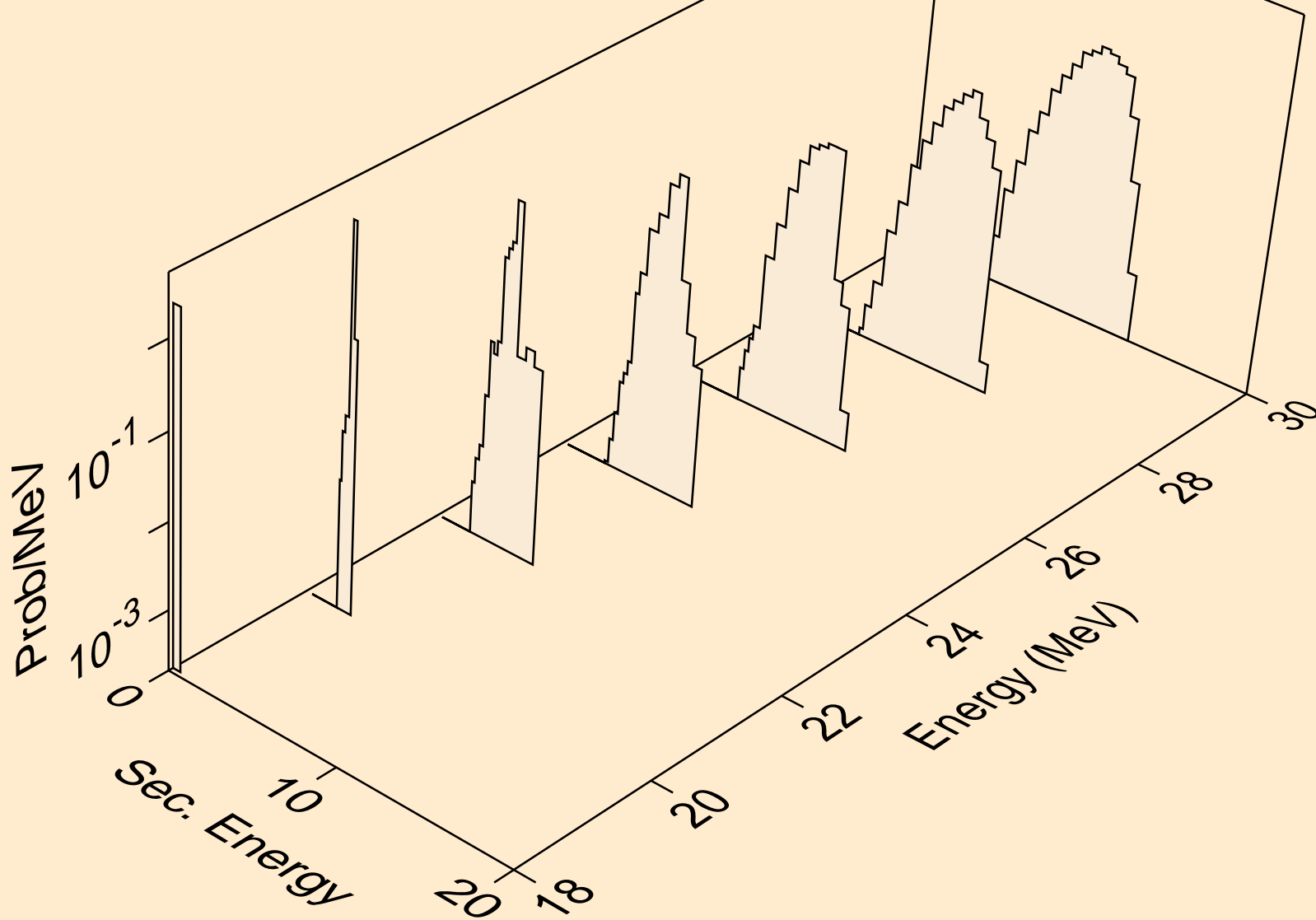

CM246 NEUTRON ACER TENDL-2019 LIBRARY; T=293.16K
protons from (n,2np)

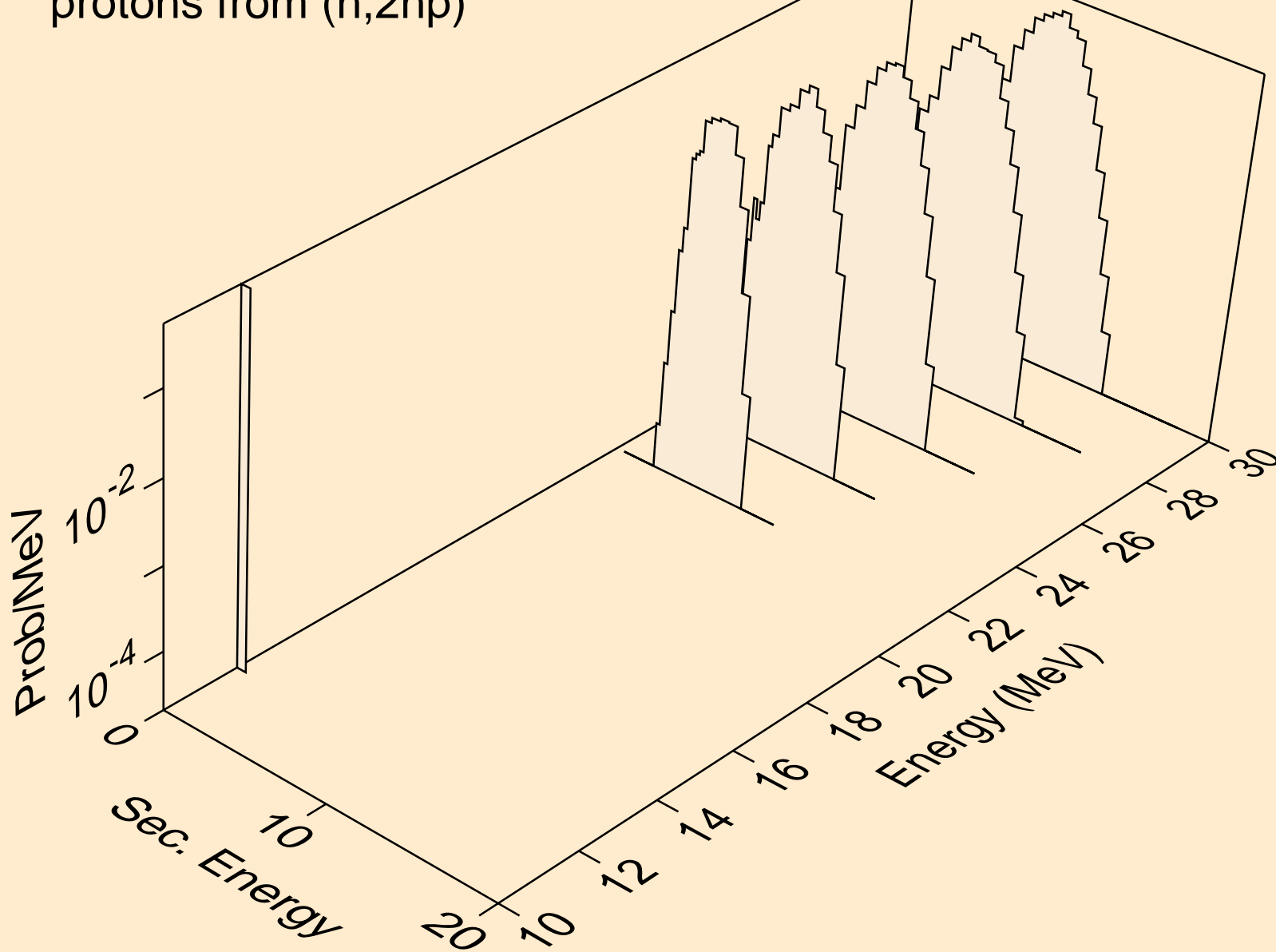

CM246 NEUTRON ACER TENDL-2019 LIBRARY; T=293.16K
protons from (n,p)

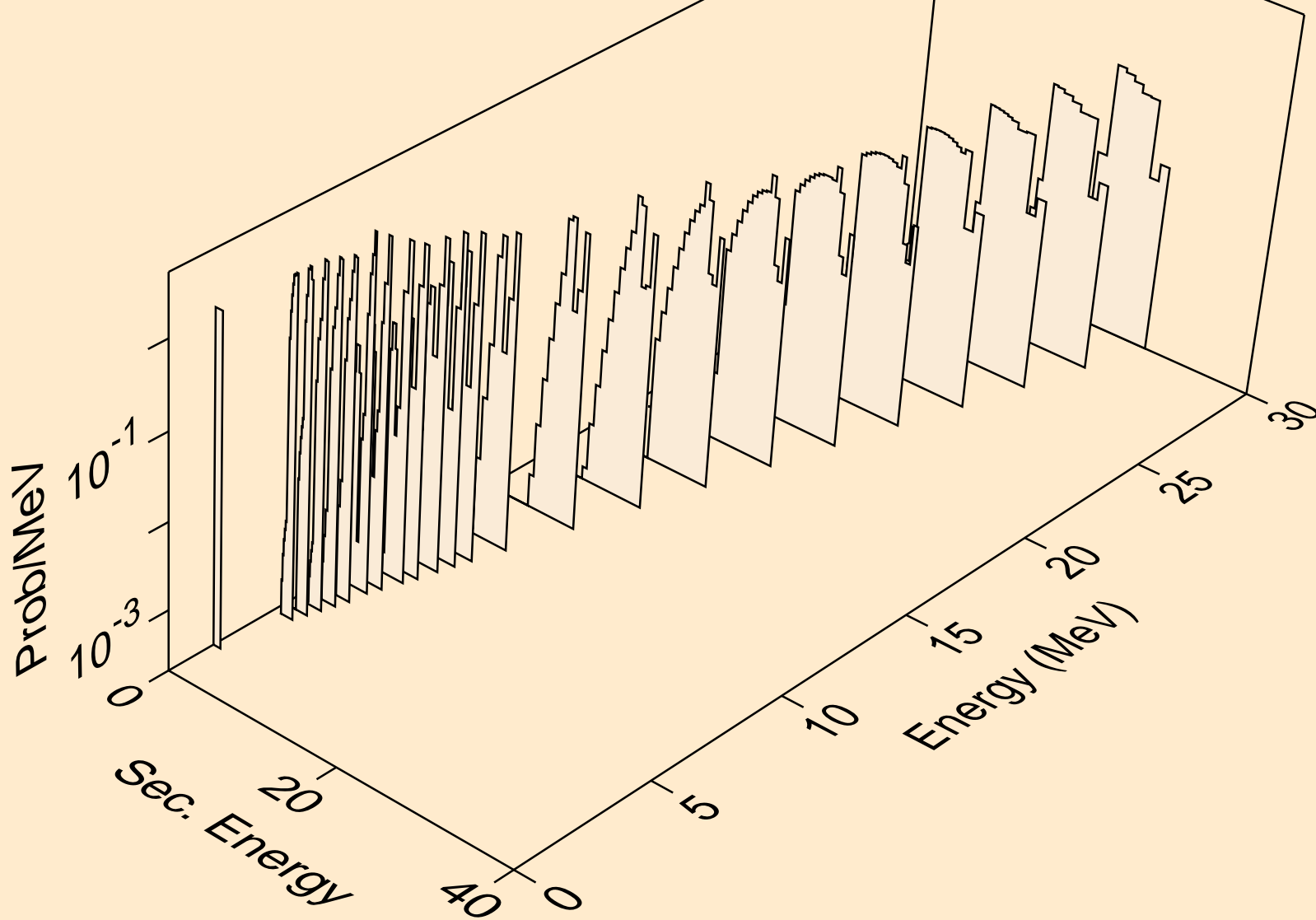

CM246 NEUTRON ACER TENDL-2019 LIBRARY; T=293.16K
protons from (n,2p)

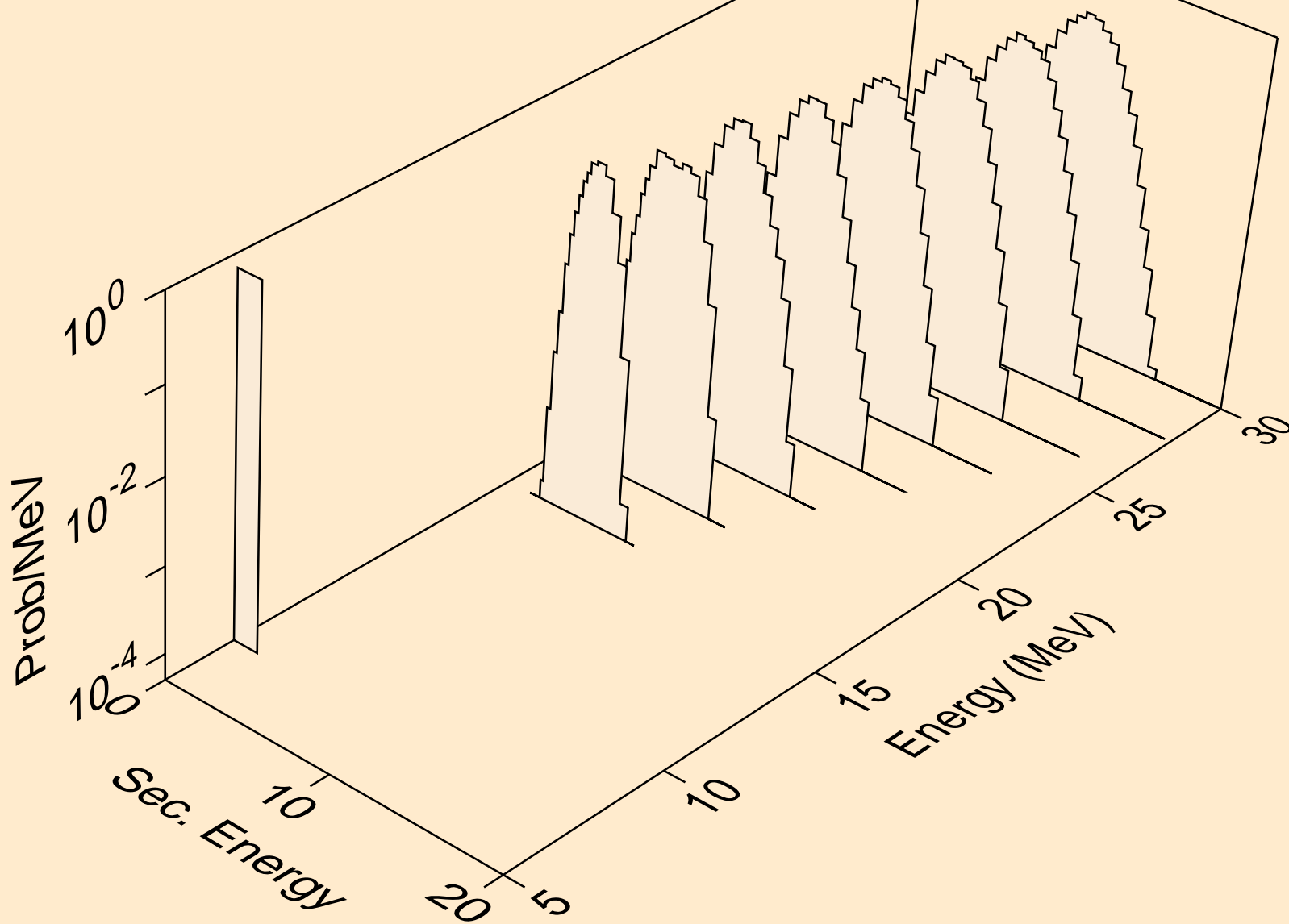

CM246 NEUTRON ACER TENDL-2019 LIBRARY; T=293.16K
deuterons from (n,x)

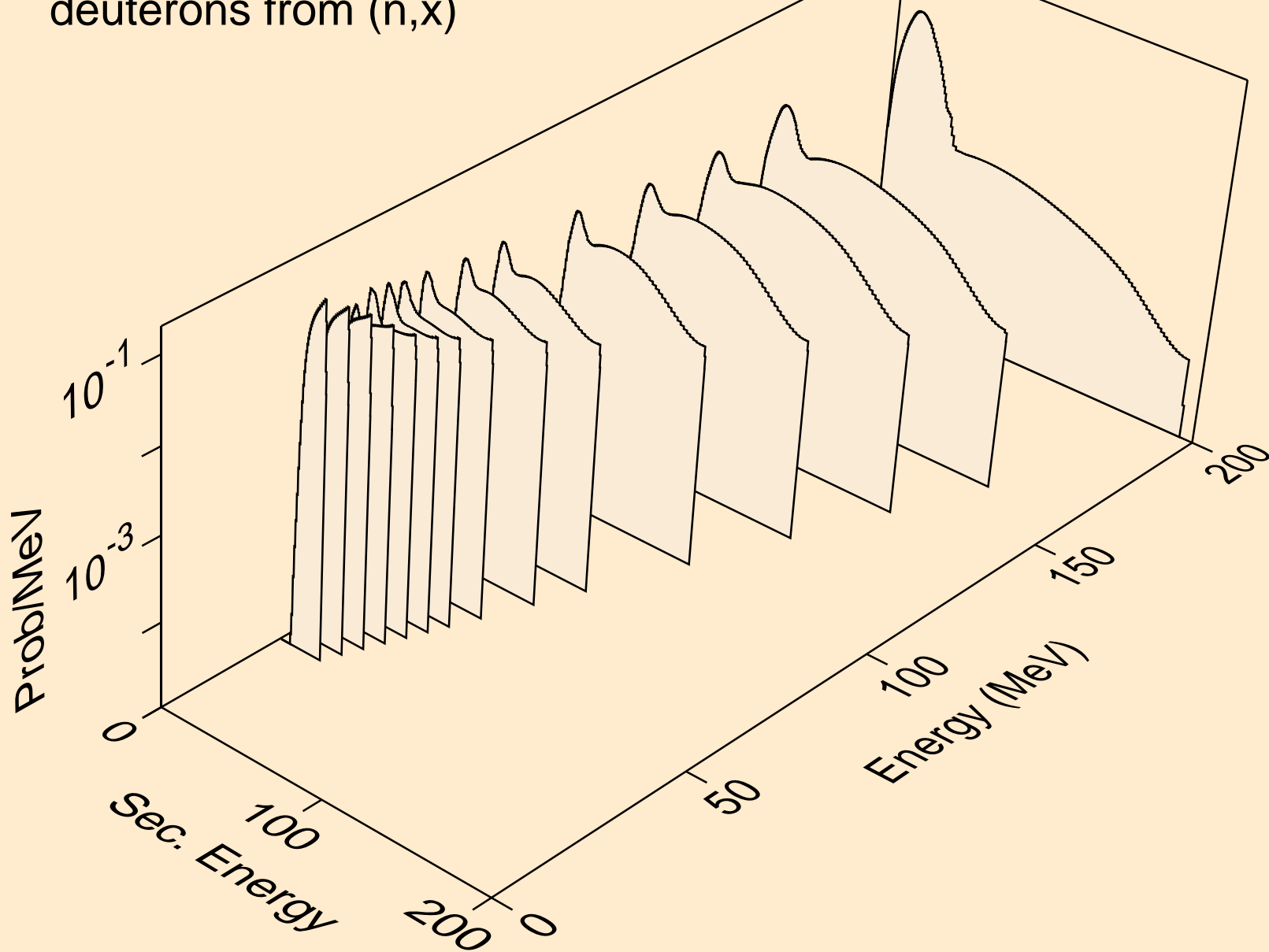

CM246 NEUTRON ACER TENDL-2019 LIBRARY; T=293.16K
deuterons from (n,2nd)

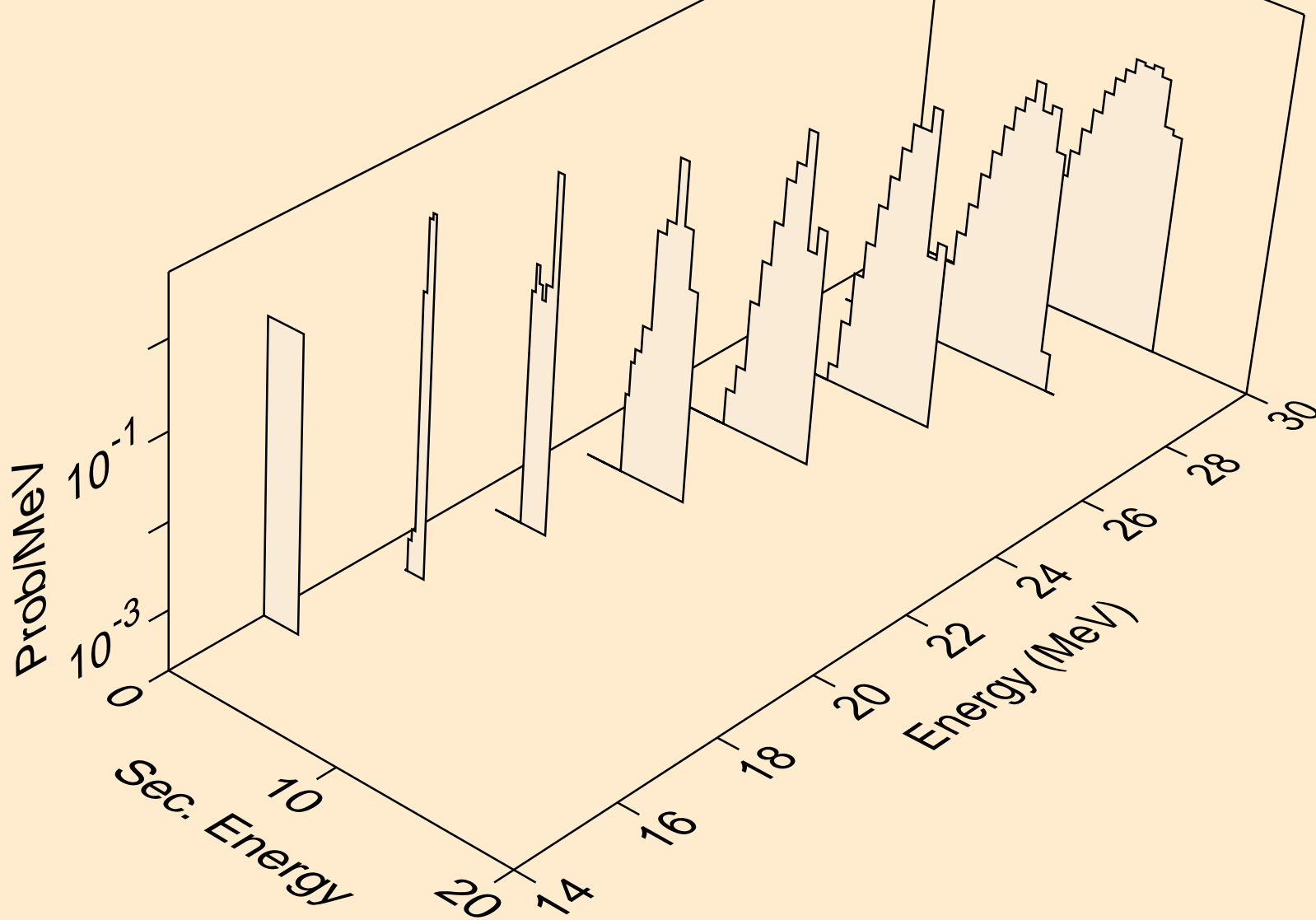

CM246 NEUTRON ACER TENDL-2019 LIBRARY; T=293.16K
deuterons from (n,n*)d

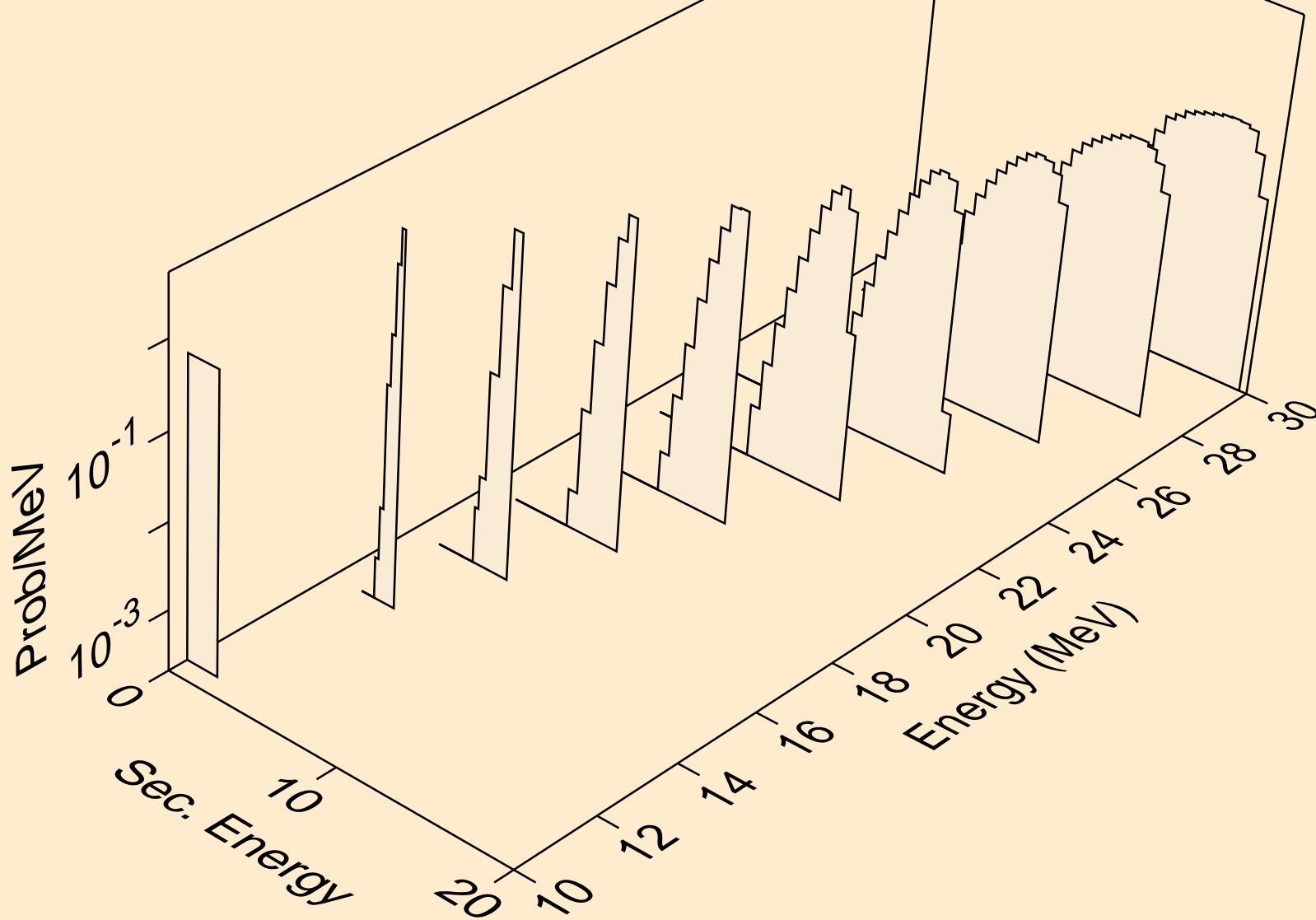

CM246 NEUTRON ACER TENDL-2019 LIBRARY; T=293.16K
deuterons from (n,d)

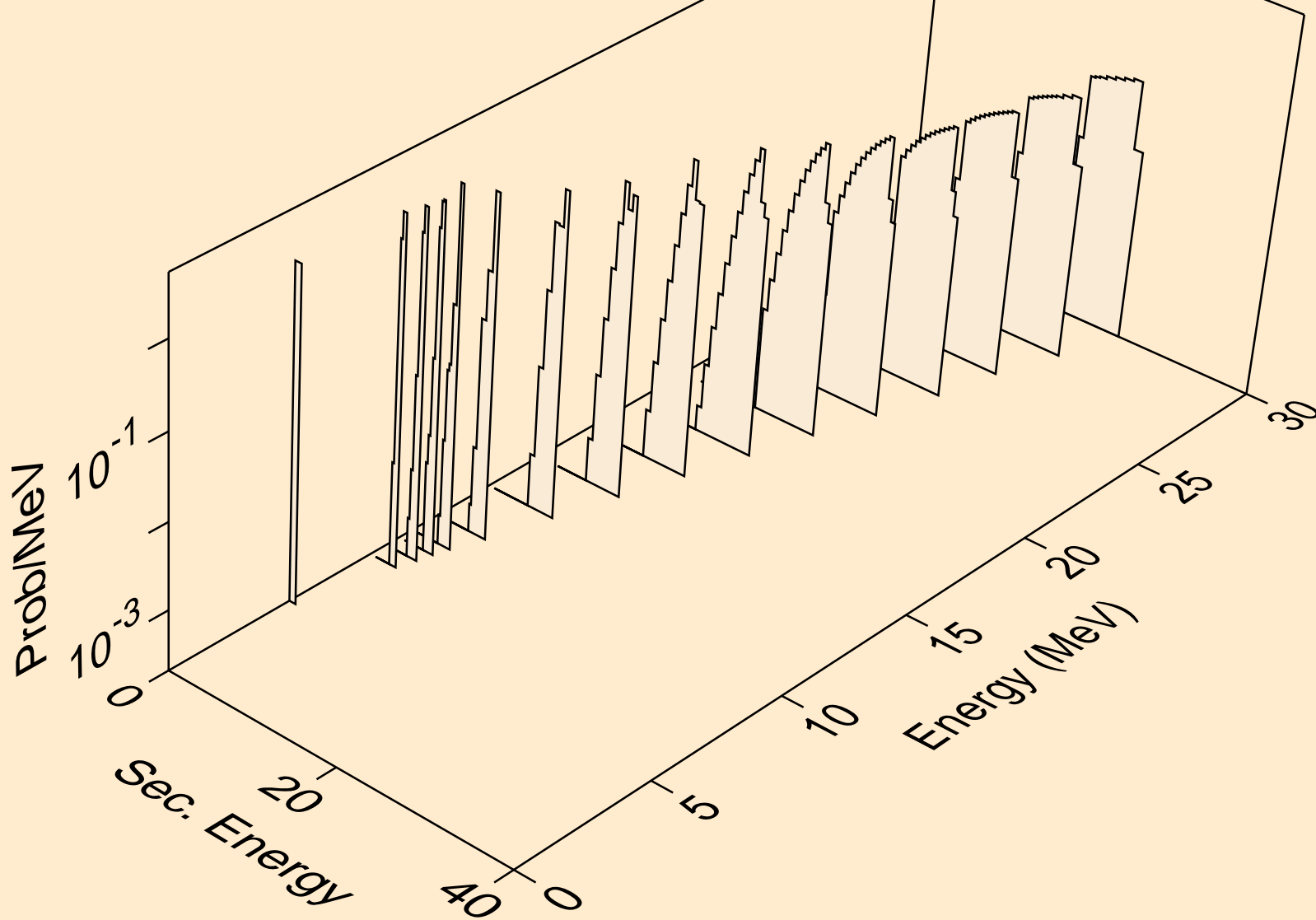

CM246 NEUTRON ACER TENDL-2019 LIBRARY; T=293.16K
tritons from (n,x)

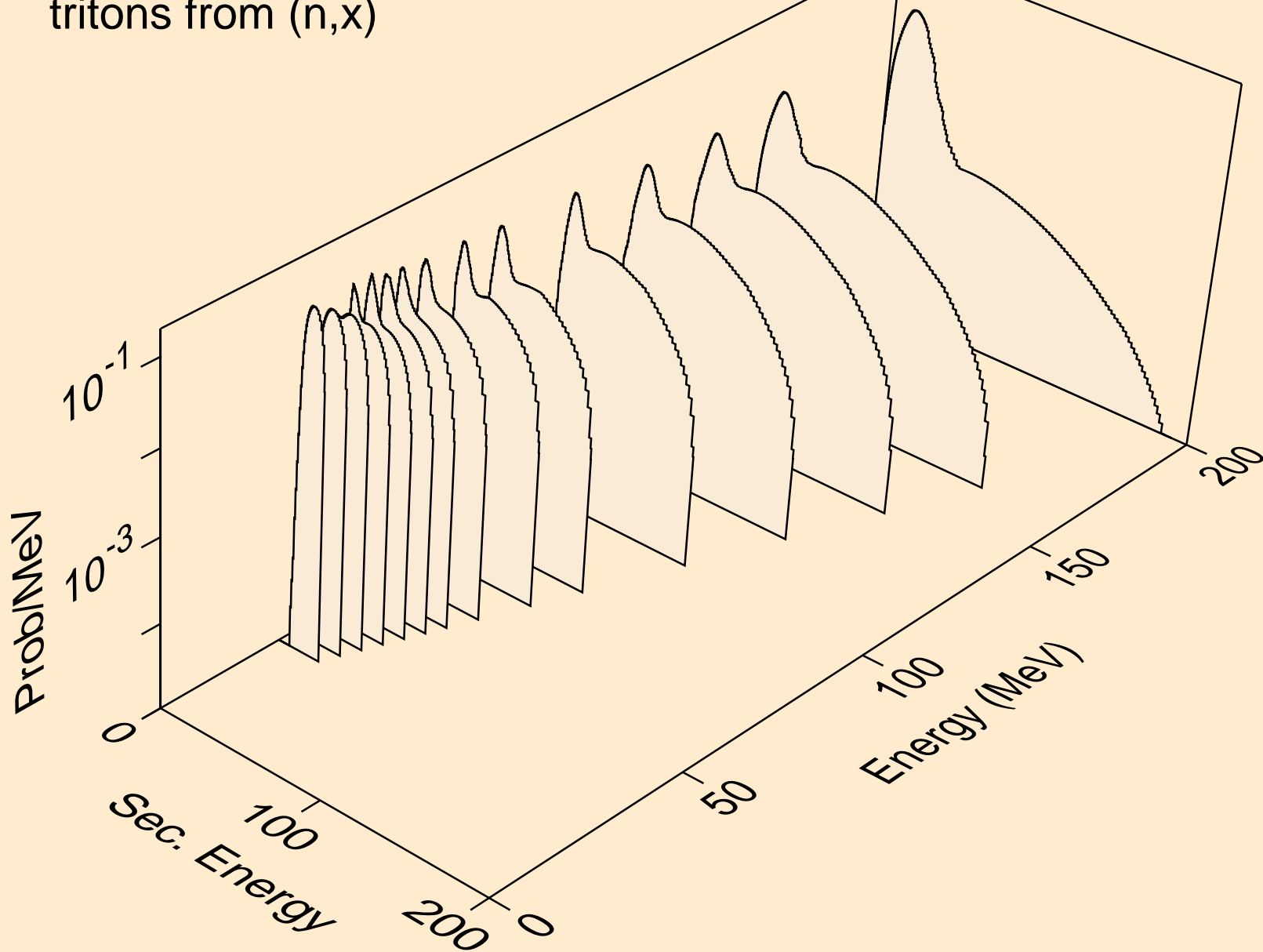

CM246 NEUTRON ACER TENDL-2019 LIBRARY; T=293.16K
tritons from (n,n*)t

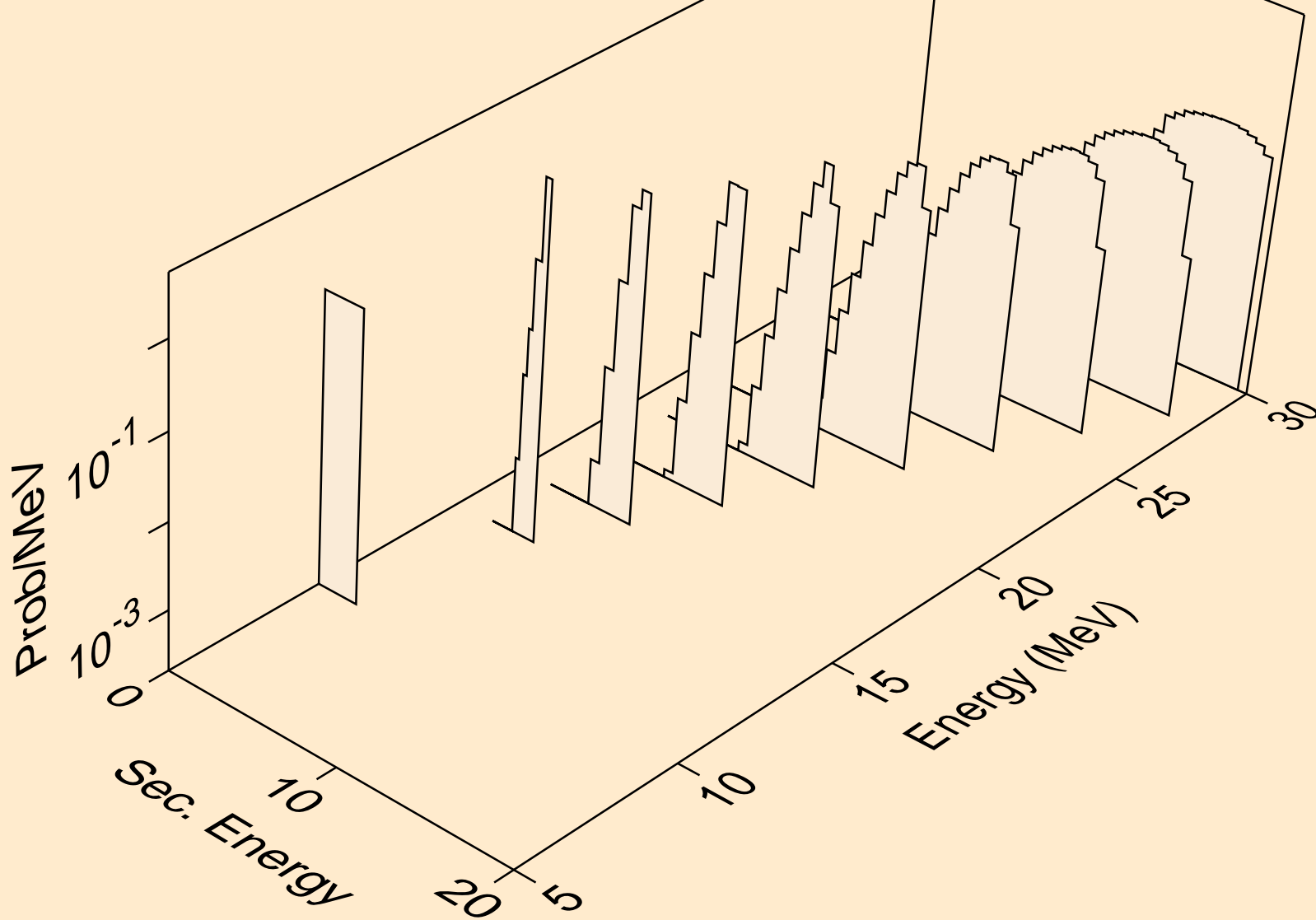

CM246 NEUTRON ACER TENDL-2019 LIBRARY; T=293.16K
tritons from (n,t)

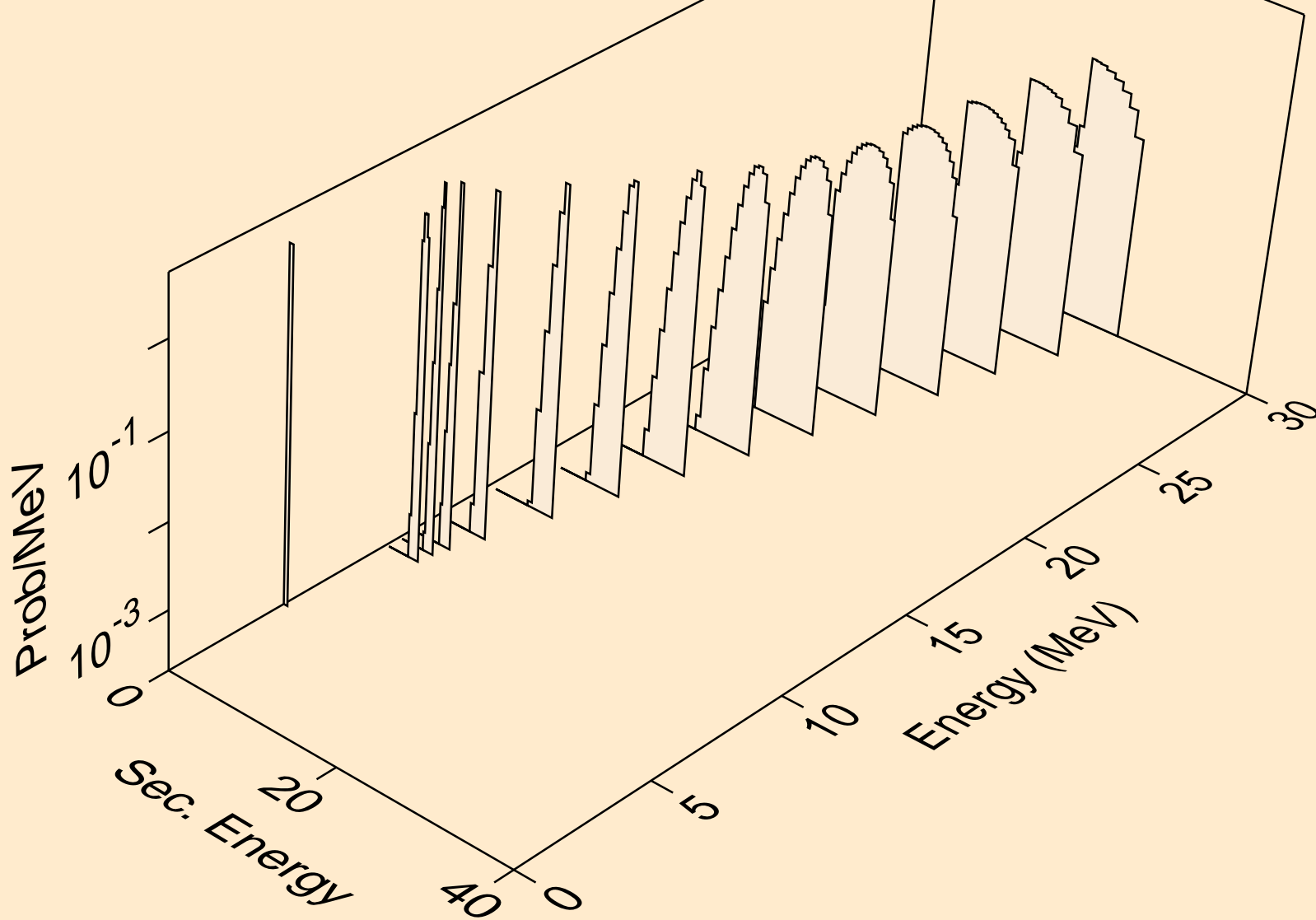

CM246 NEUTRON ACER TENDL-2019 LIBRARY; T=293.16K
he3s from (n,x)

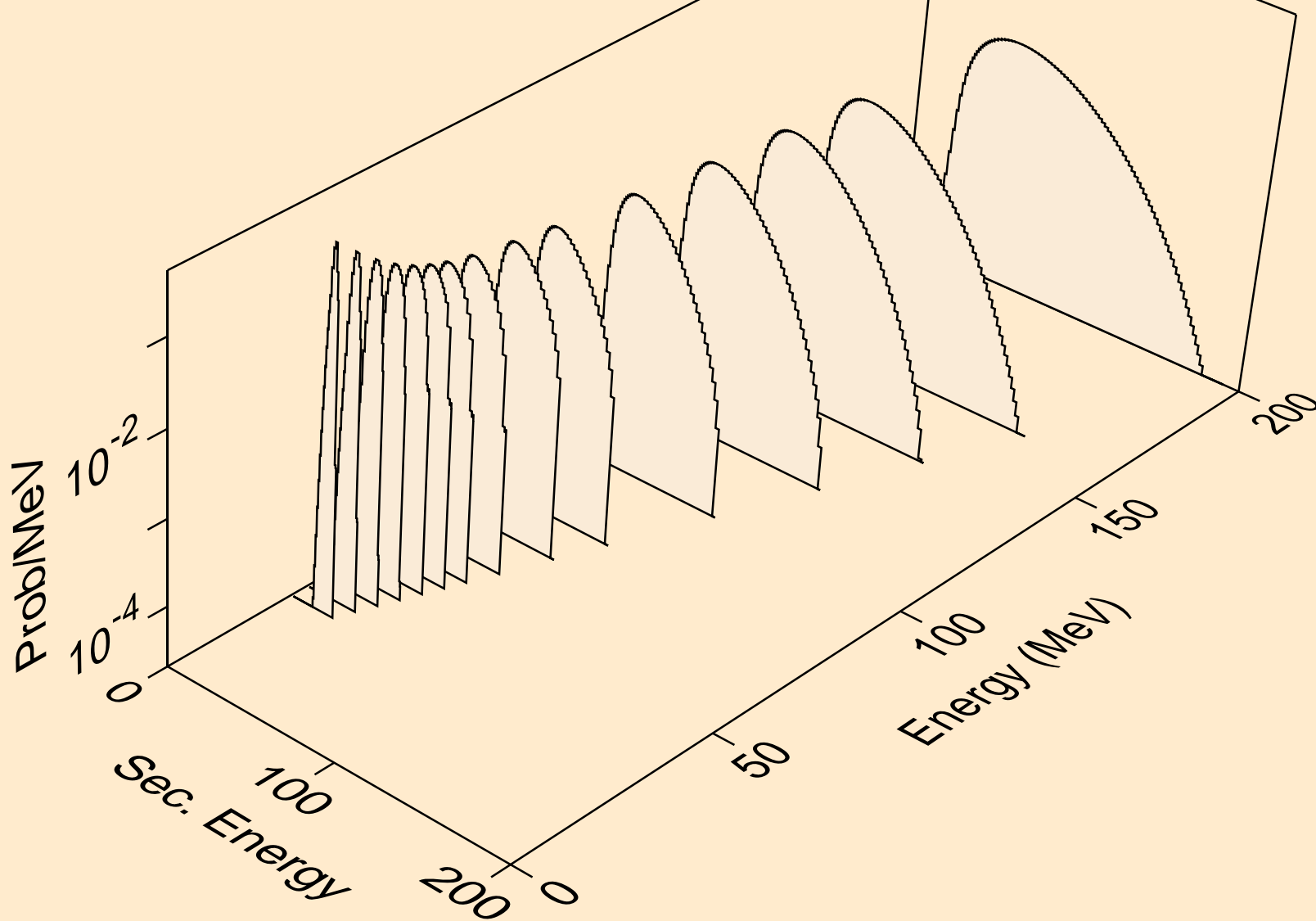

CM246 NEUTRON ACER TENDL-2019 LIBRARY; T=293.16K
he3s from (n,n*)he3

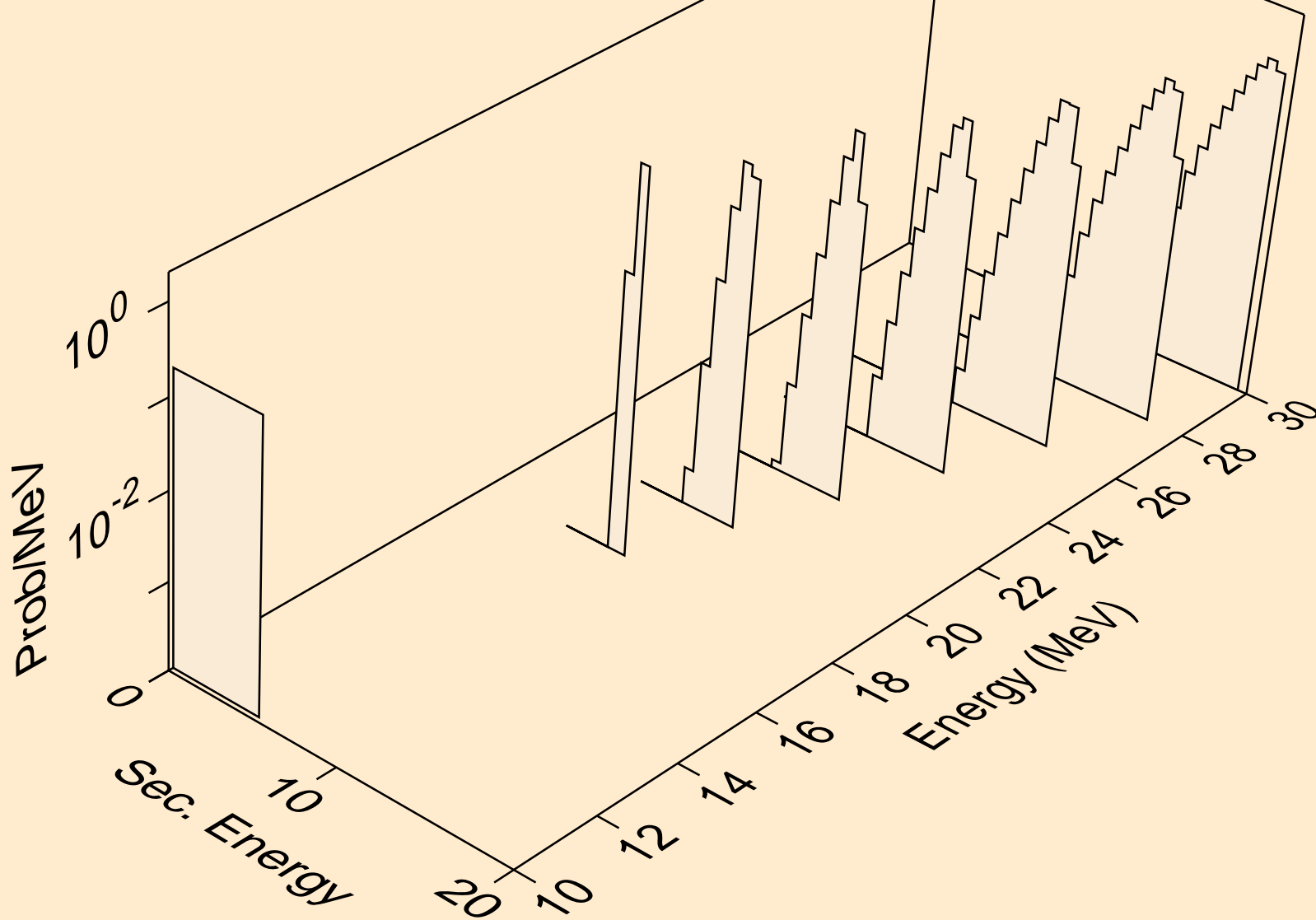

CM246 NEUTRON ACER TENDL-2019 LIBRARY; T=293.16K
he3s from (n,he3)

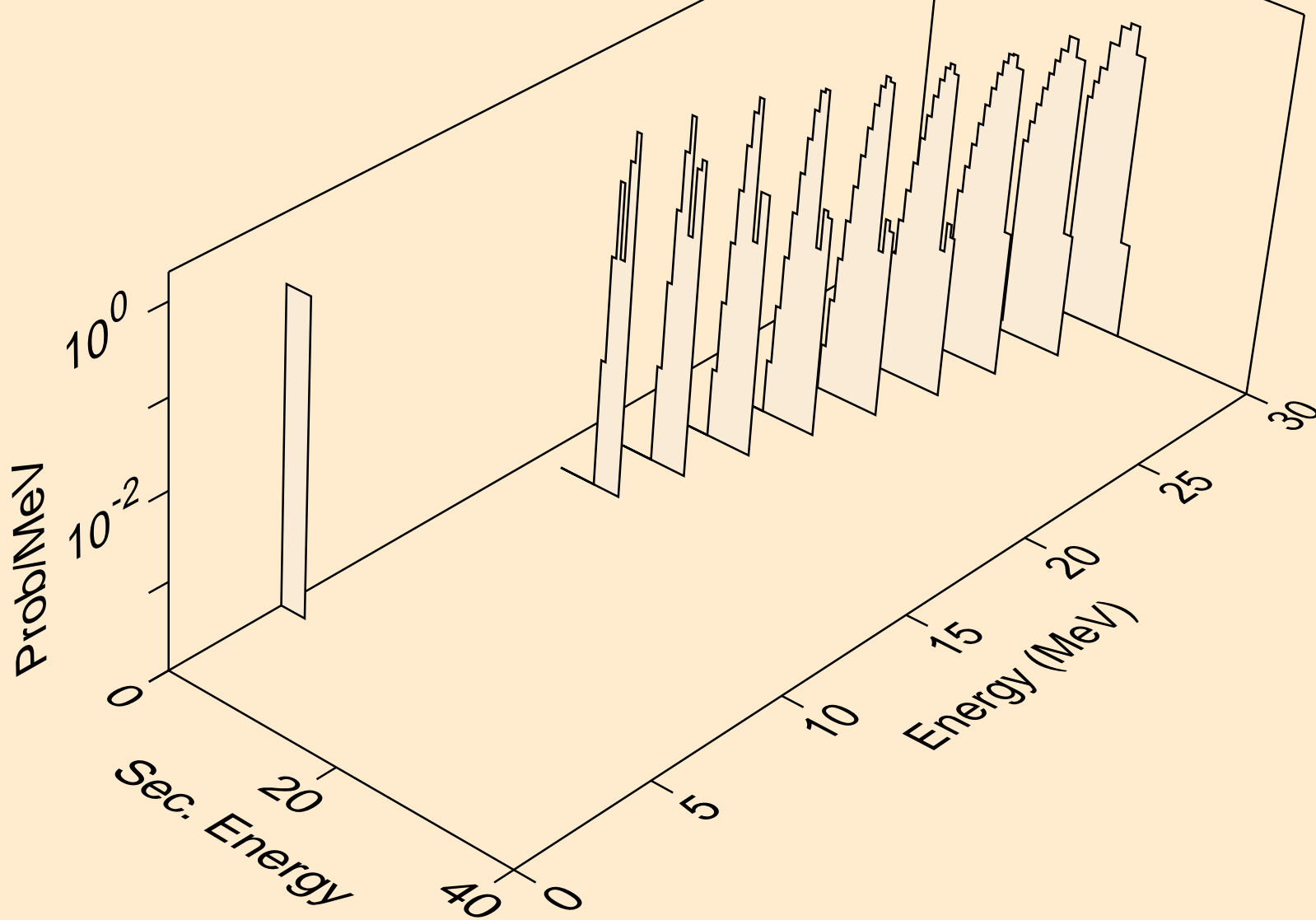

CM246 NEUTRON ACER TENDL-2019 LIBRARY; T=293.16K
alphas from (n,x)

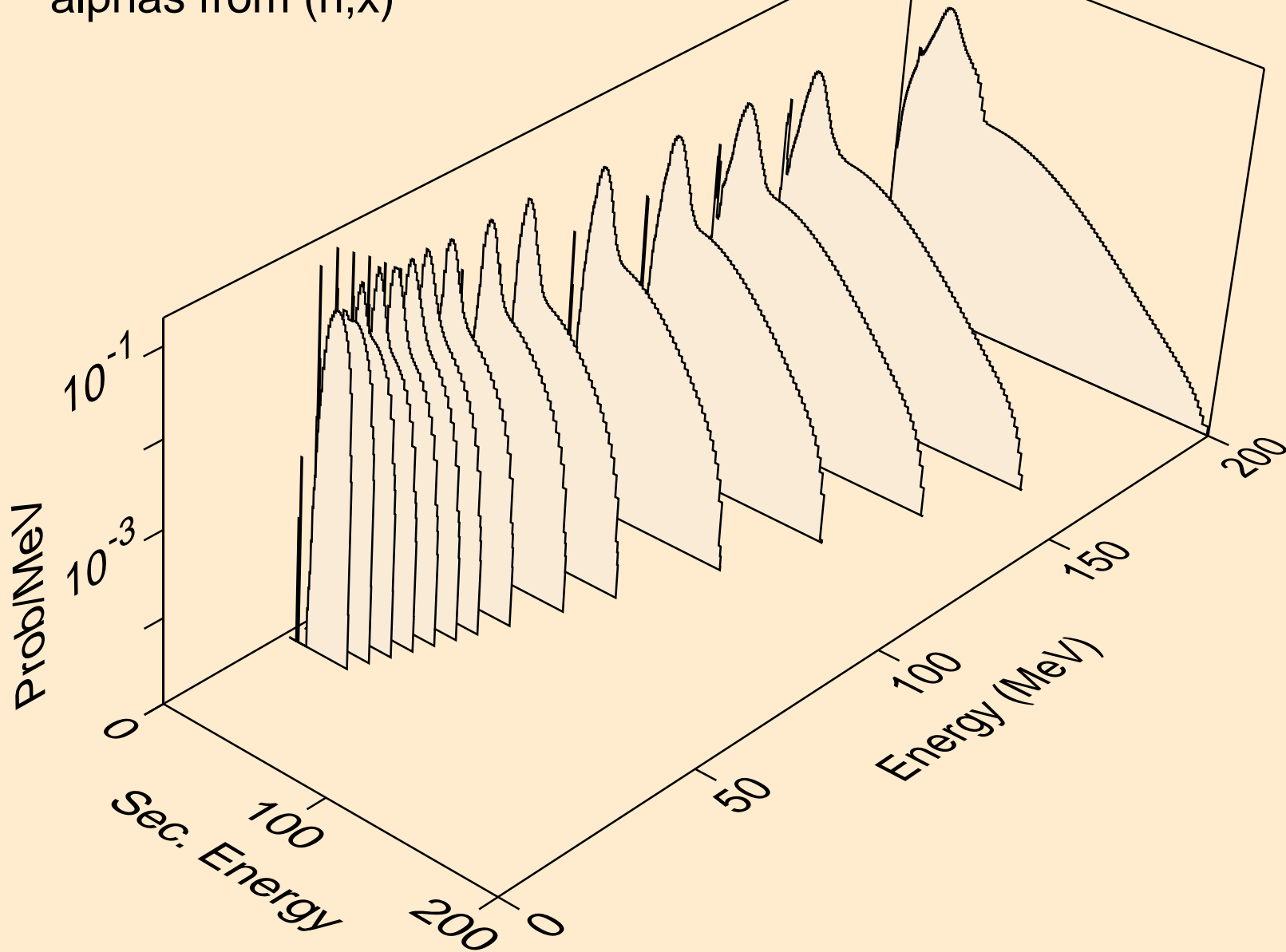

CM246 NEUTRON ACER TENDL-2019 LIBRARY; T=293.16K
alphas from (n,n*)a

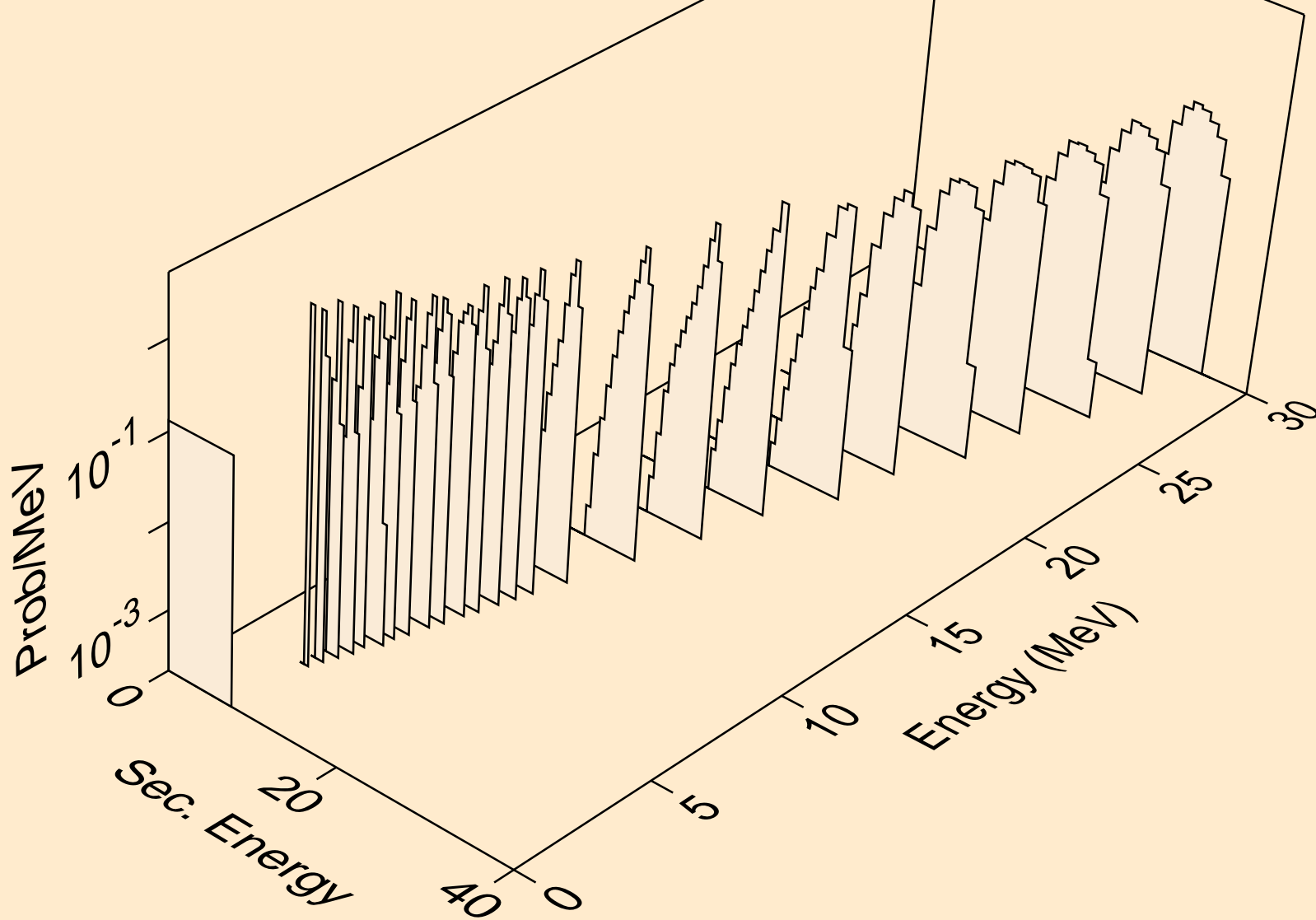

CM246 NEUTRON ACER TENDL-2019 LIBRARY; T=293.16K
alphas from (n,2n)a

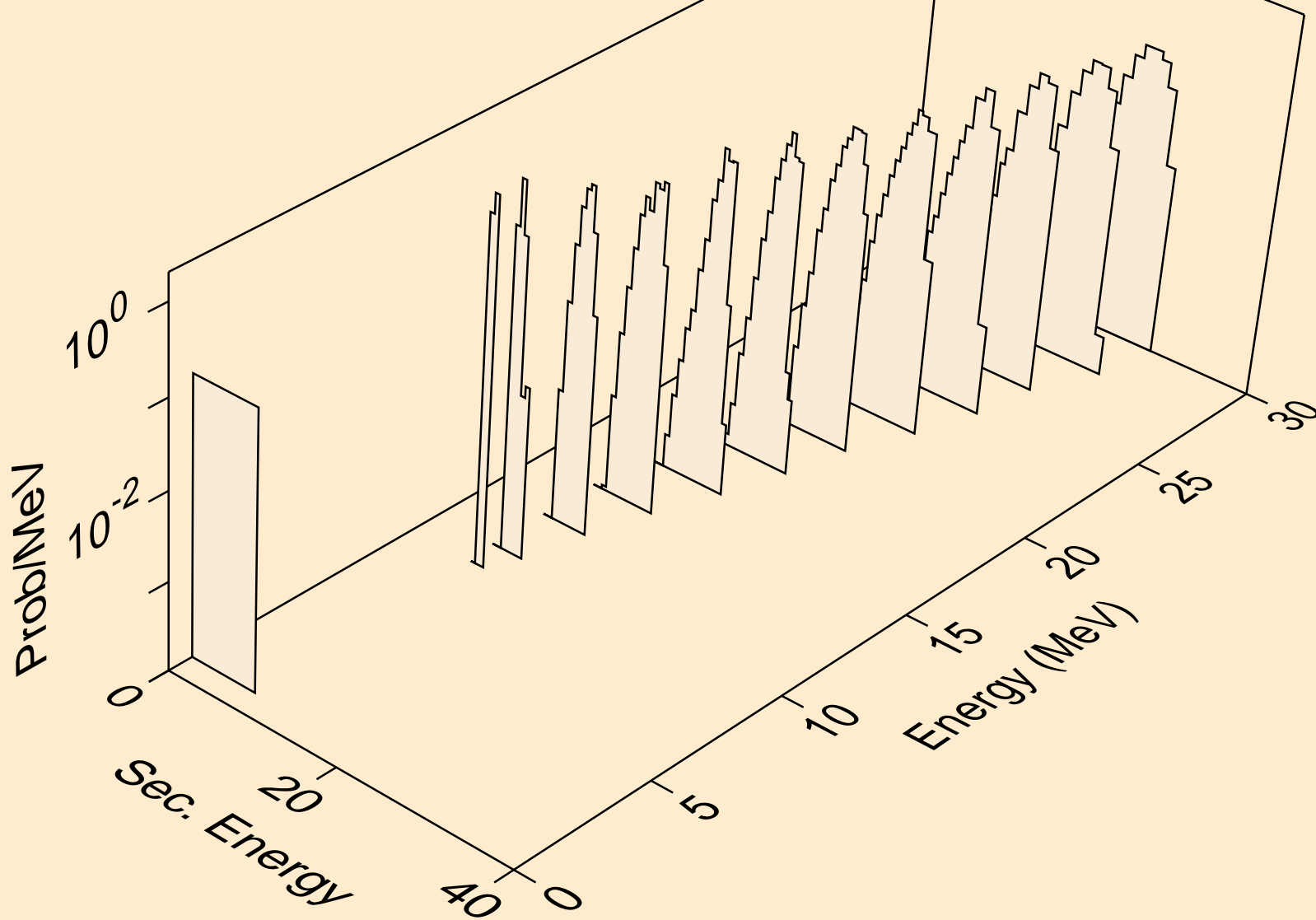

CM246 NEUTRON ACER TENDL-2019 LIBRARY; T=293.16K
alphas from (n,3n)a

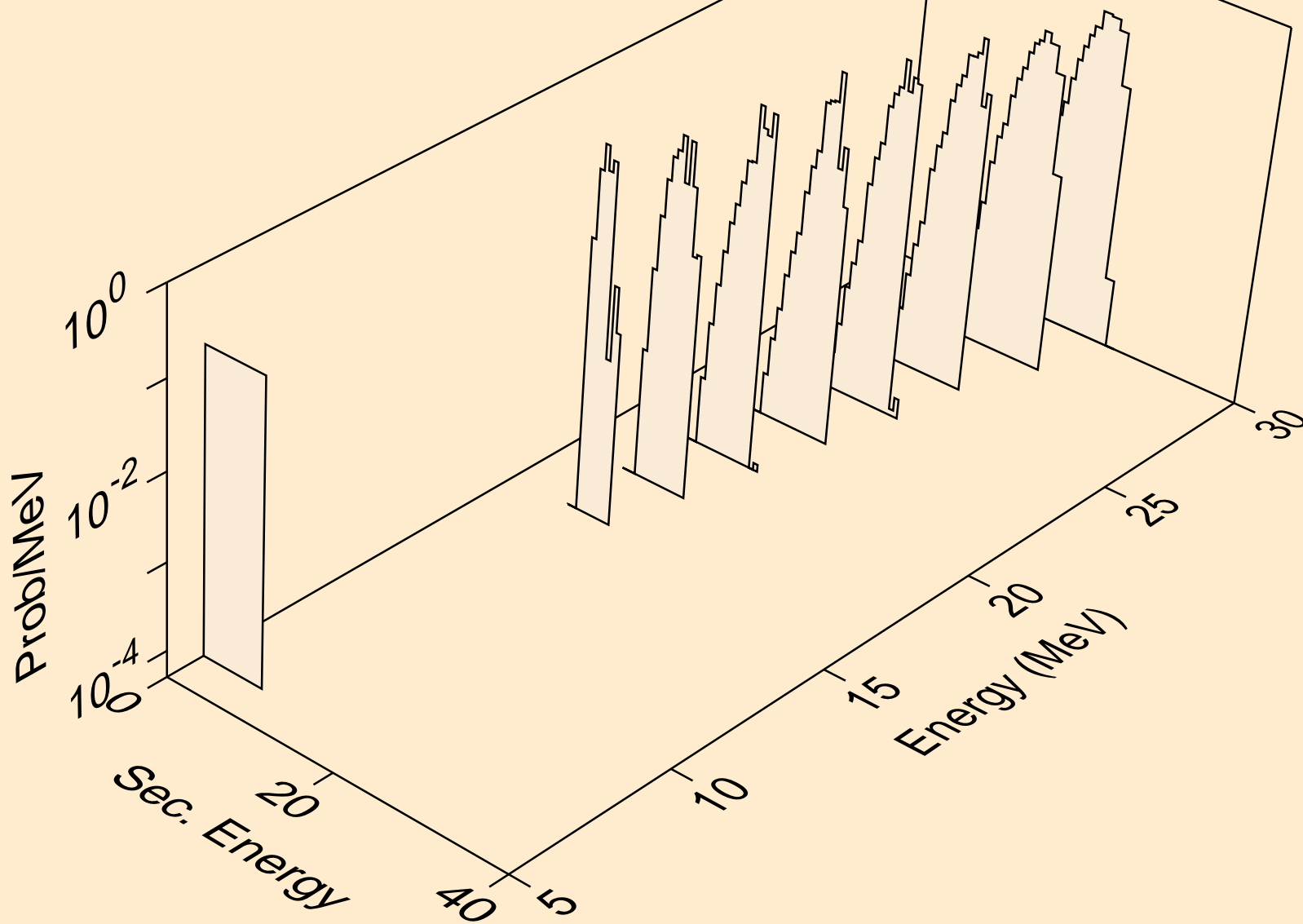

CM246 NEUTRON ACER TENDL-2019 LIBRARY; T=293.16K
alphas from (n,a)

