

DY155 NEUTRON ACER TENDL-2019 LIBRARY; T=293.16K
Principal cross sections

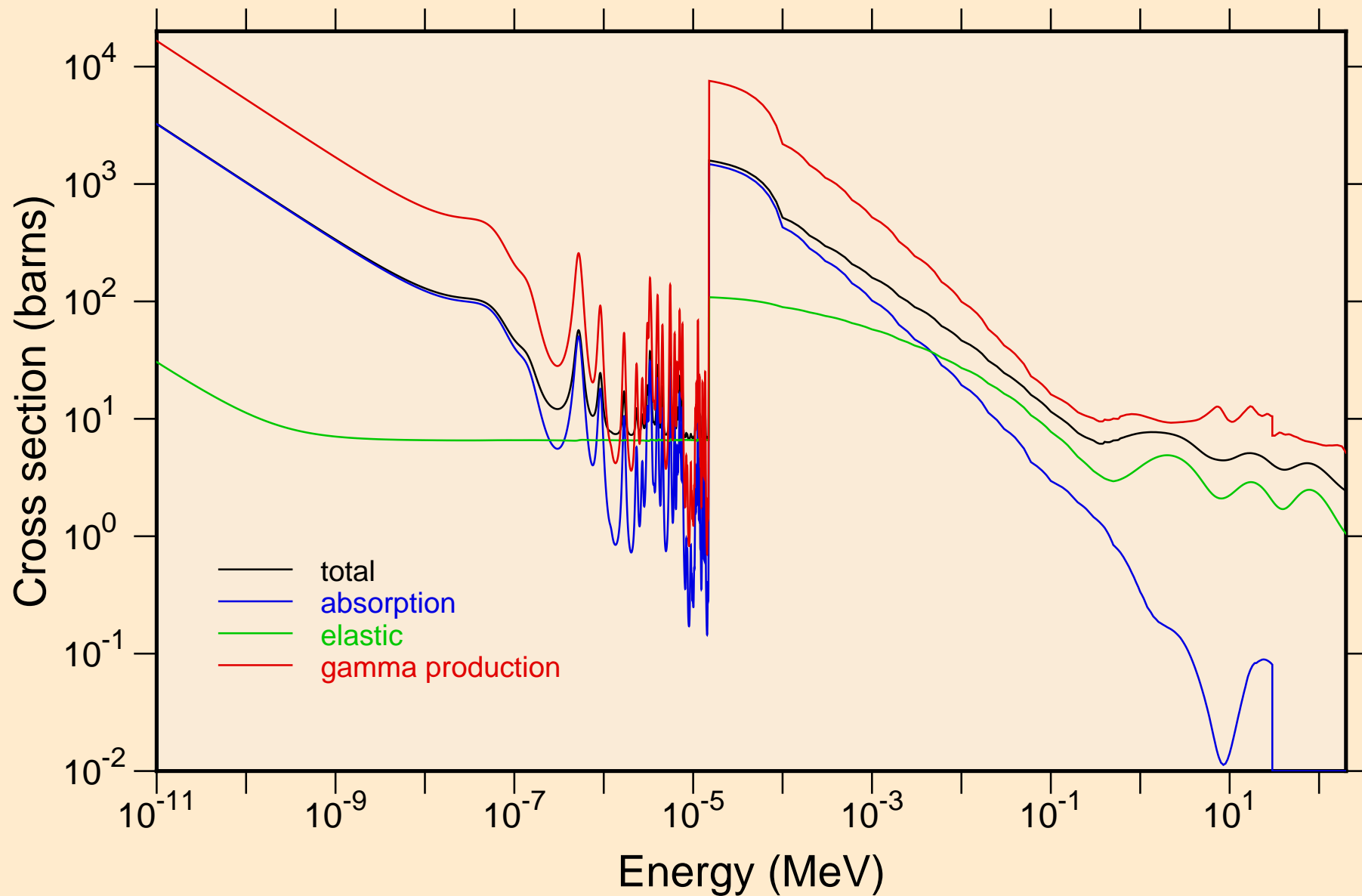

DY155 NEUTRON ACER TENDL-2019 LIBRARY; T=293.16K
resonance total cross section

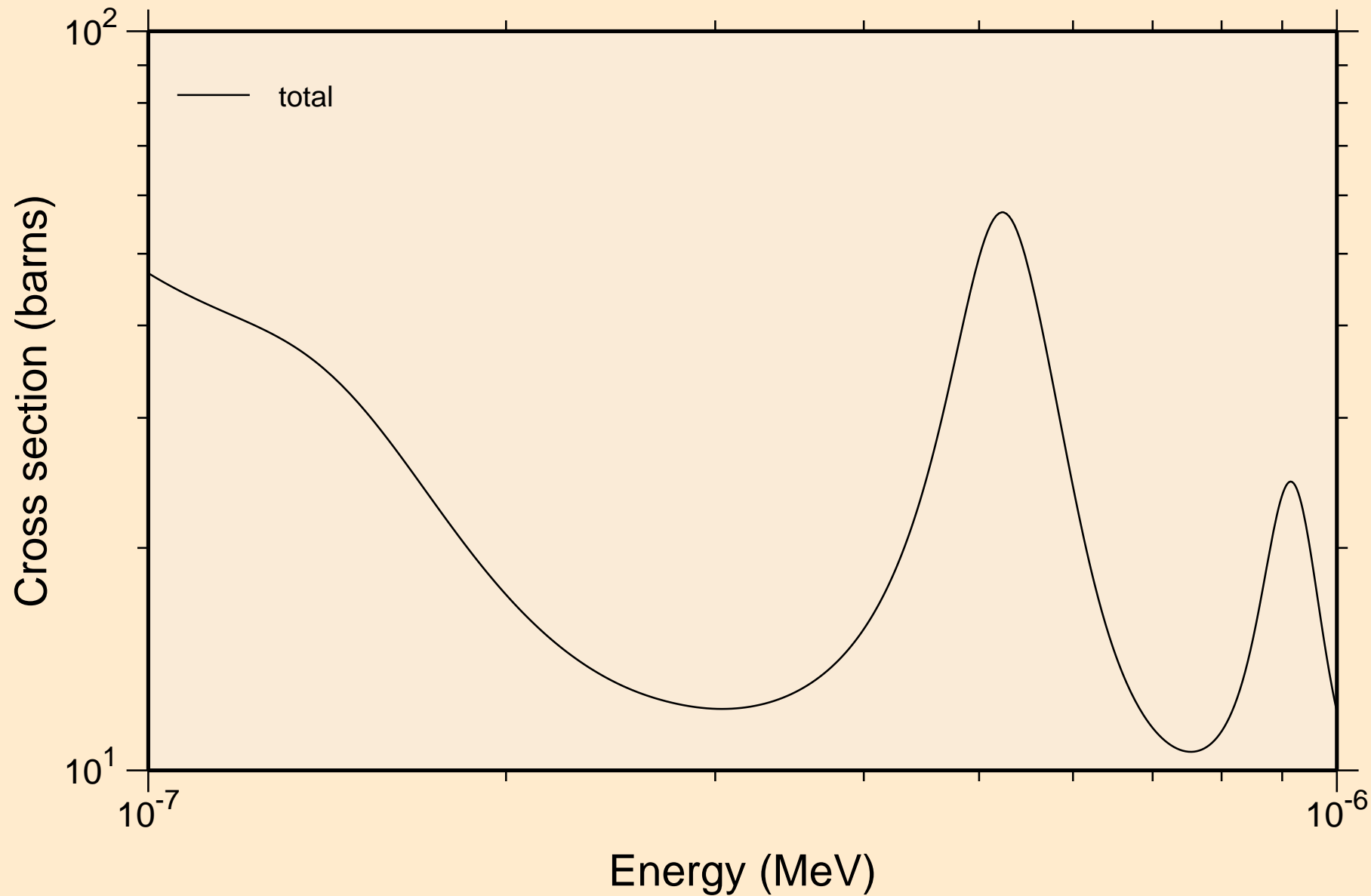

DY155 NEUTRON ACER TENDL-2019 LIBRARY; T=293.16K
resonance total cross section

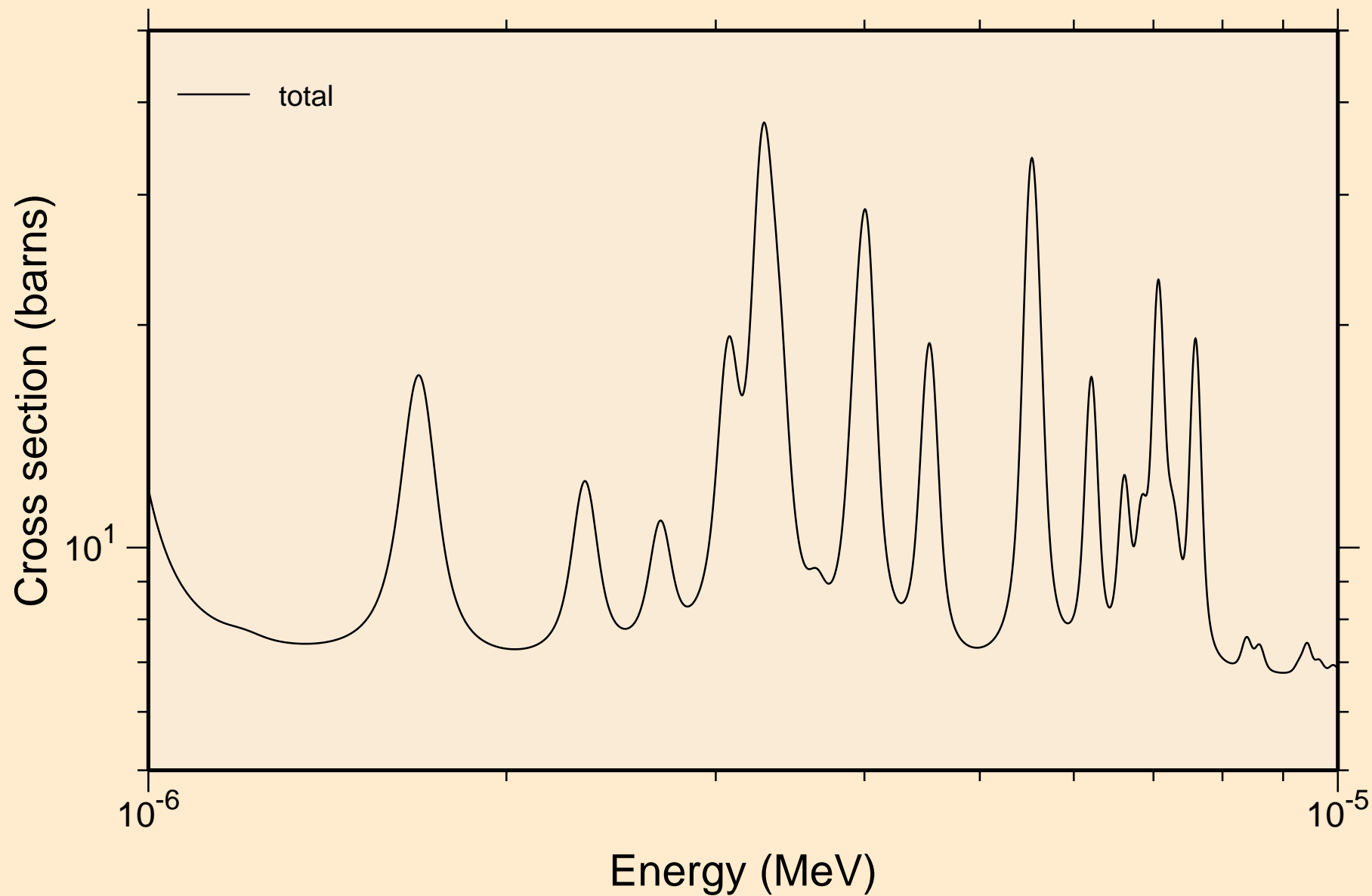

DY155 NEUTRON ACER TENDL-2019 LIBRARY; T=293.16K
resonance total cross section

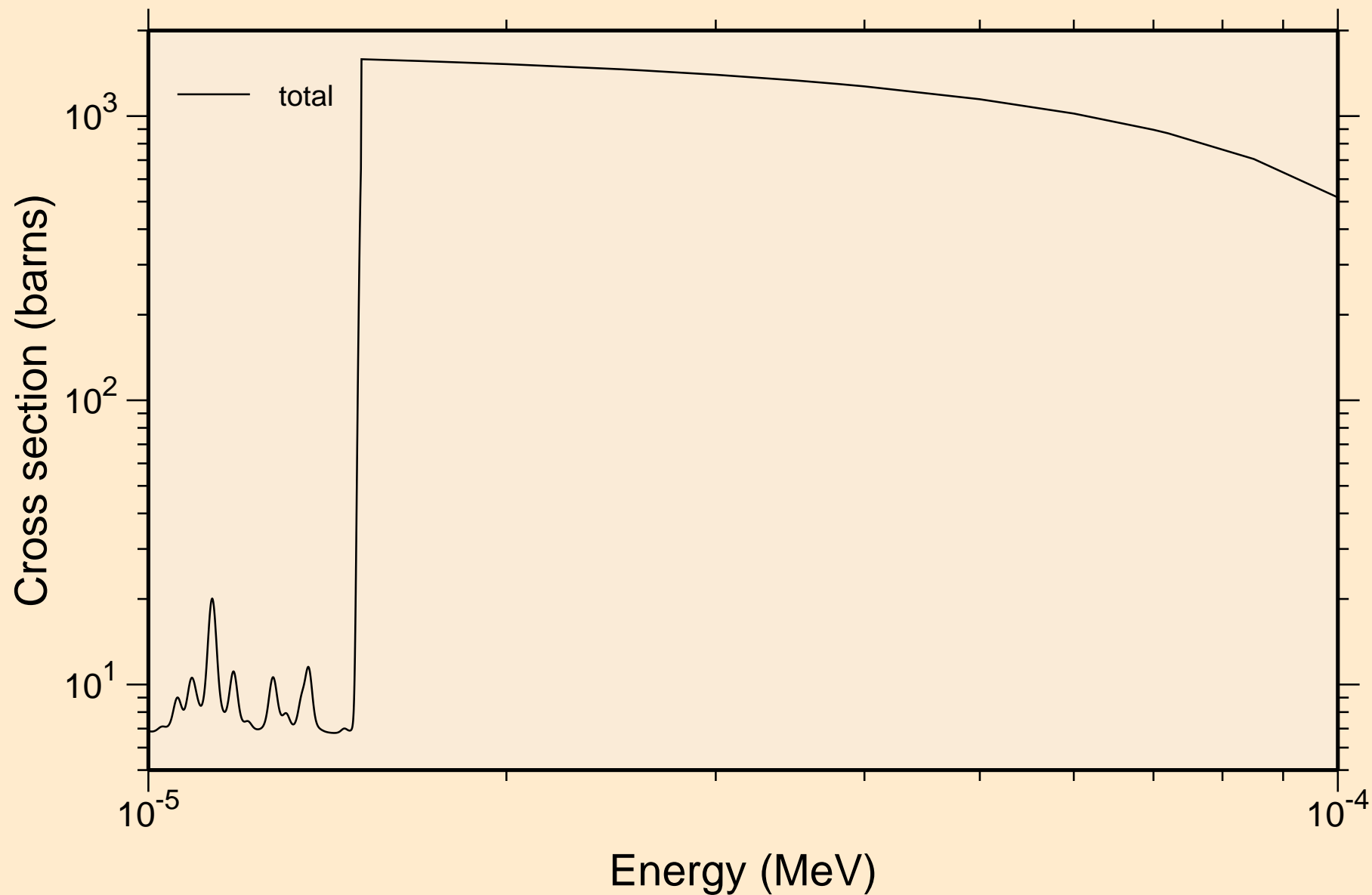

DY155 NEUTRON ACER TENDL-2019 LIBRARY; T=293.16K
resonance total cross section

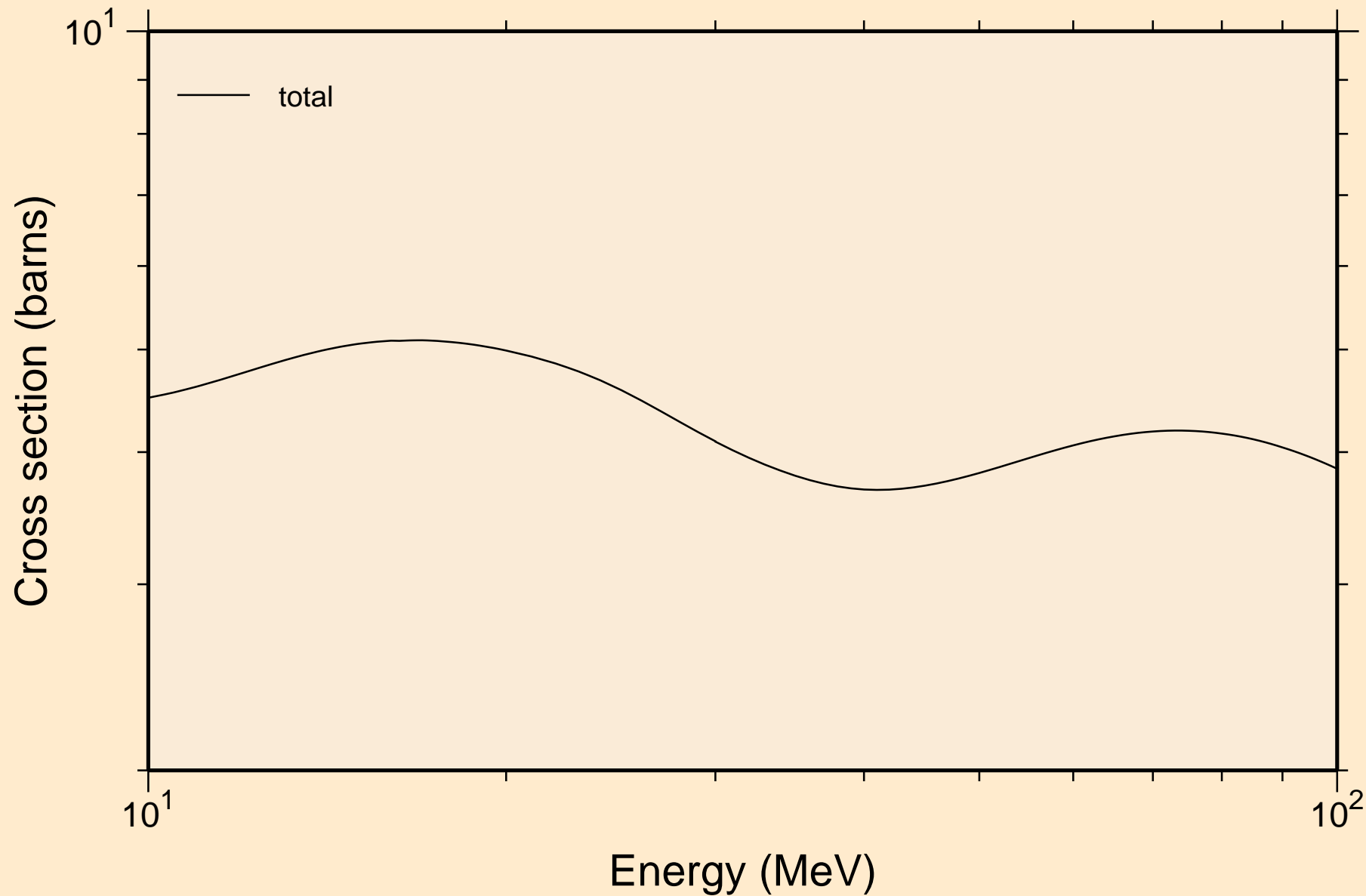

DY155 NEUTRON ACER TENDL-2019 LIBRARY; T=293.16K
resonance absorption cross sections

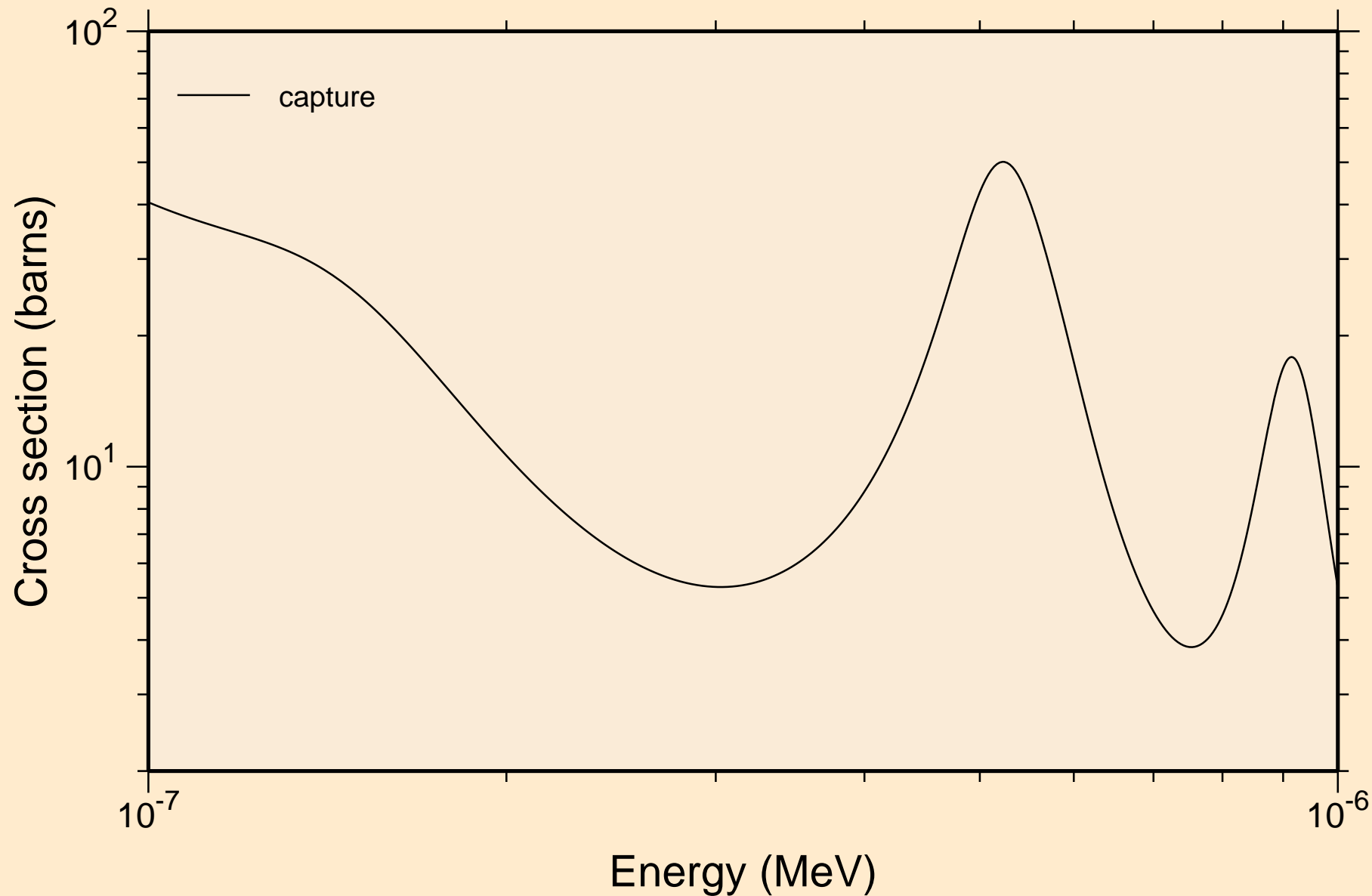

DY155 NEUTRON ACER TENDL-2019 LIBRARY; T=293.16K
resonance absorption cross sections

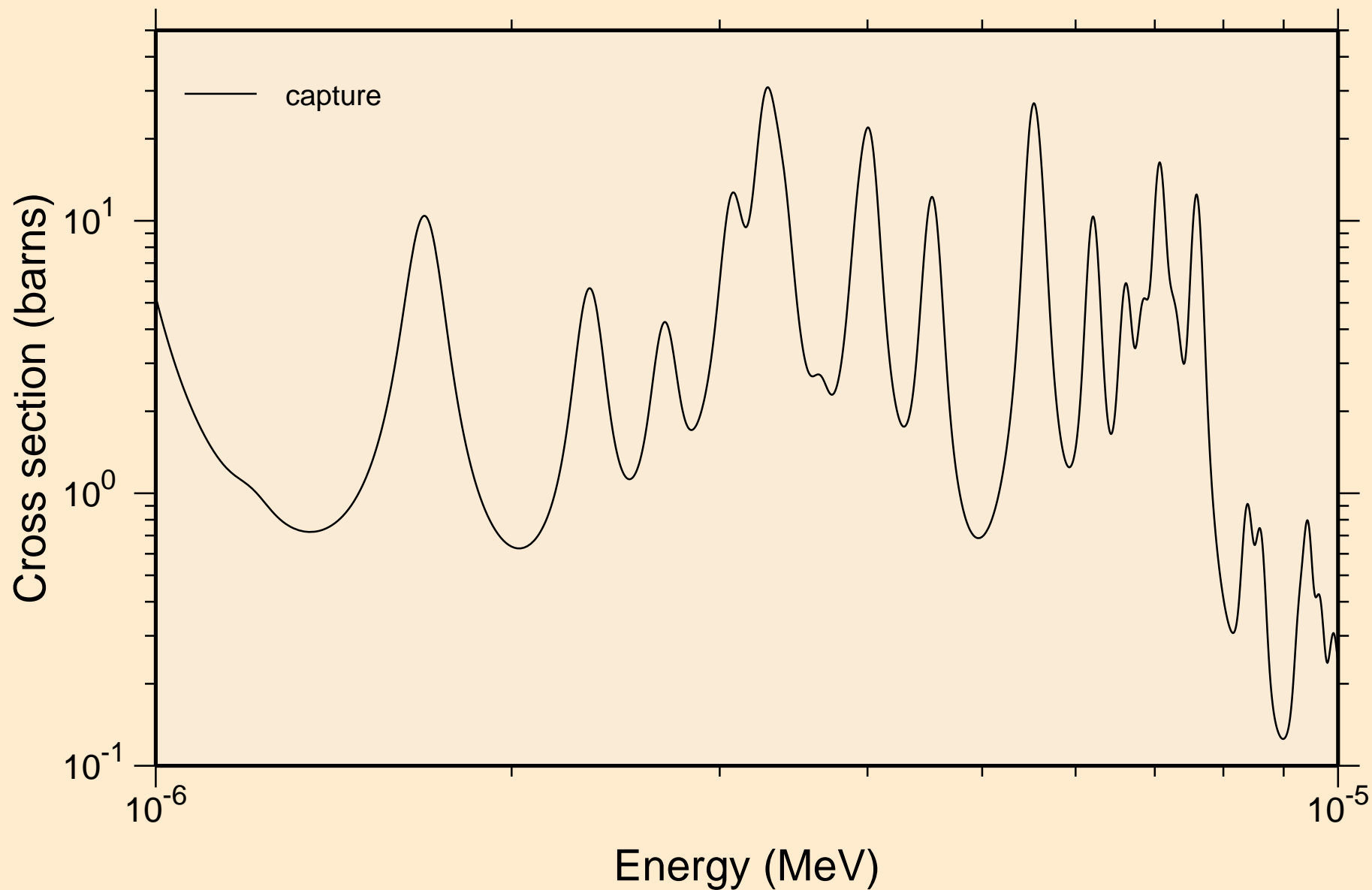

DY155 NEUTRON ACER TENDL-2019 LIBRARY; T=293.16K
resonance absorption cross sections

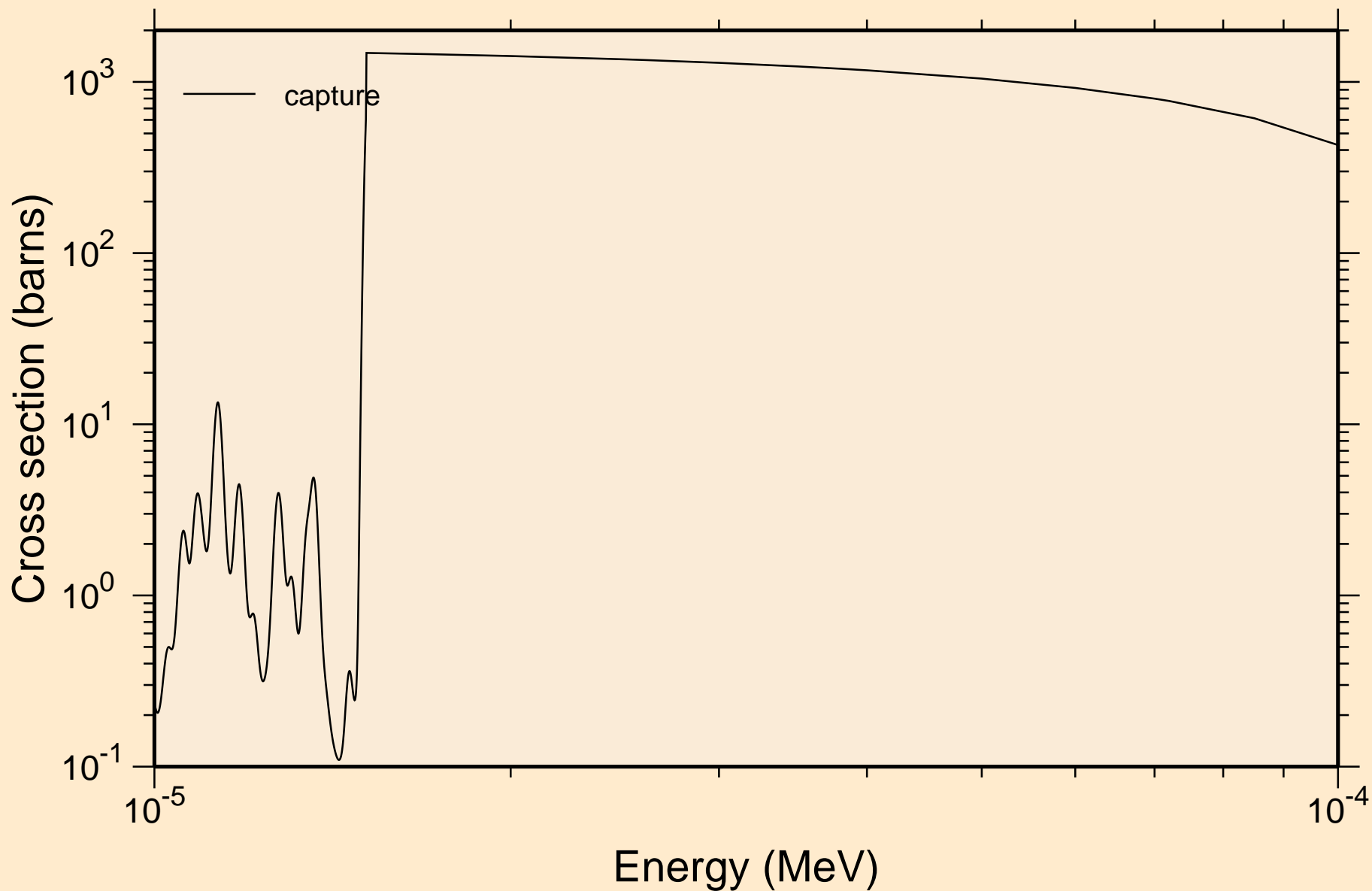

DY155 NEUTRON ACER TENDL-2019 LIBRARY; T=293.16K
resonance absorption cross sections

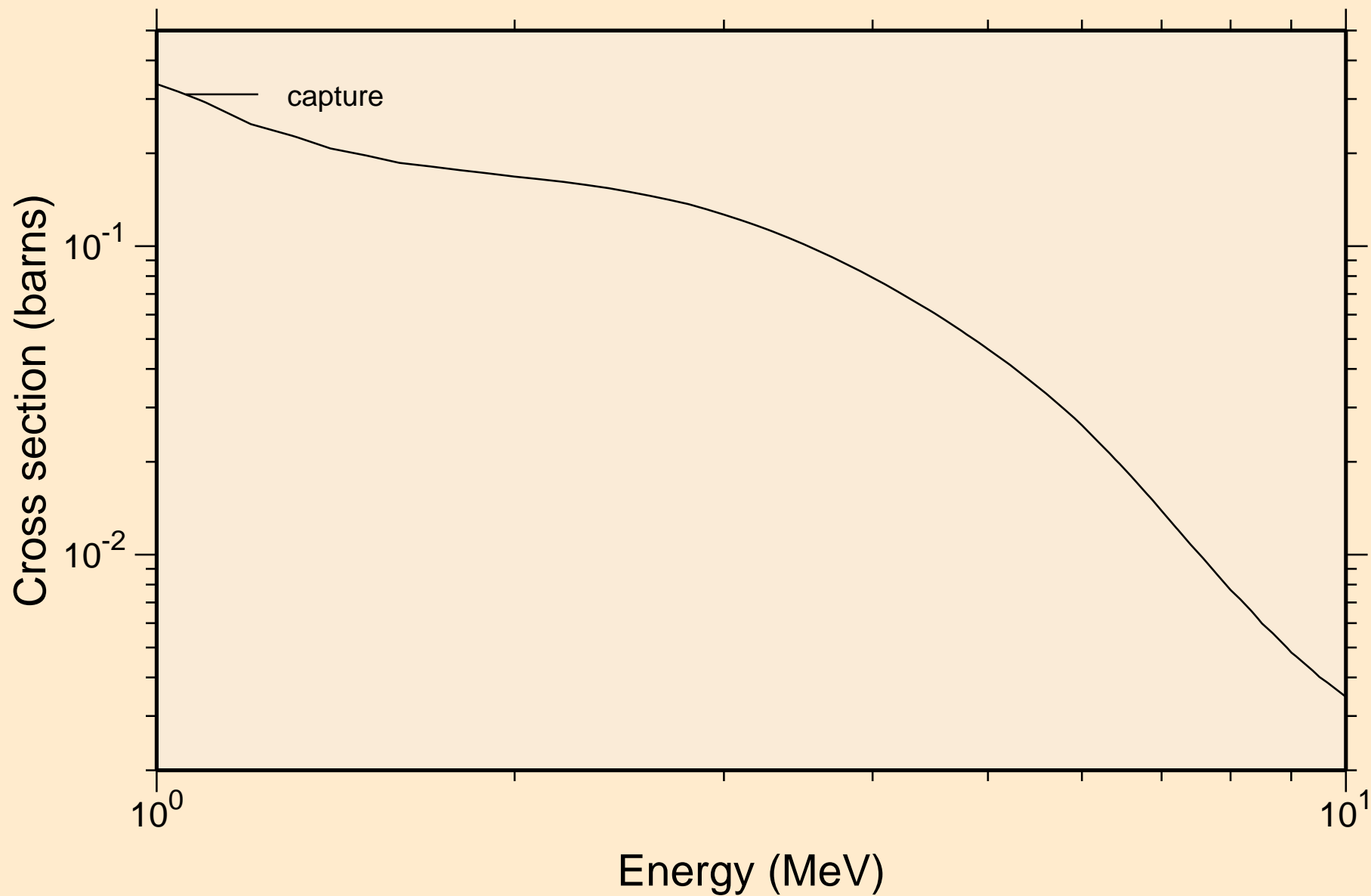

DY155 NEUTRON ACER TENDL-2019 LIBRARY; T=293.16K
Heating

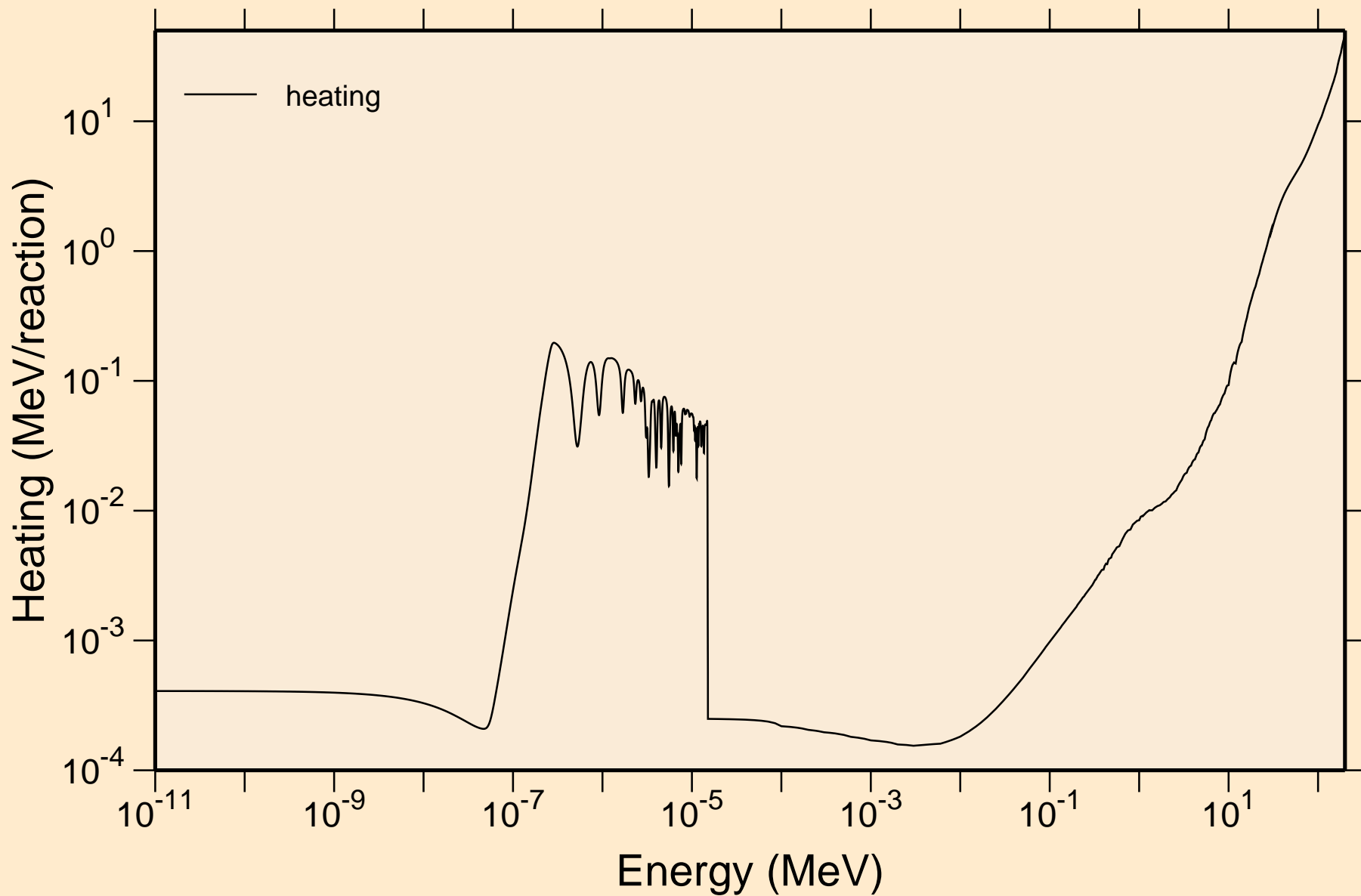

DY155 NEUTRON ACER TENDL-2019 LIBRARY; T=293.16K
Damage

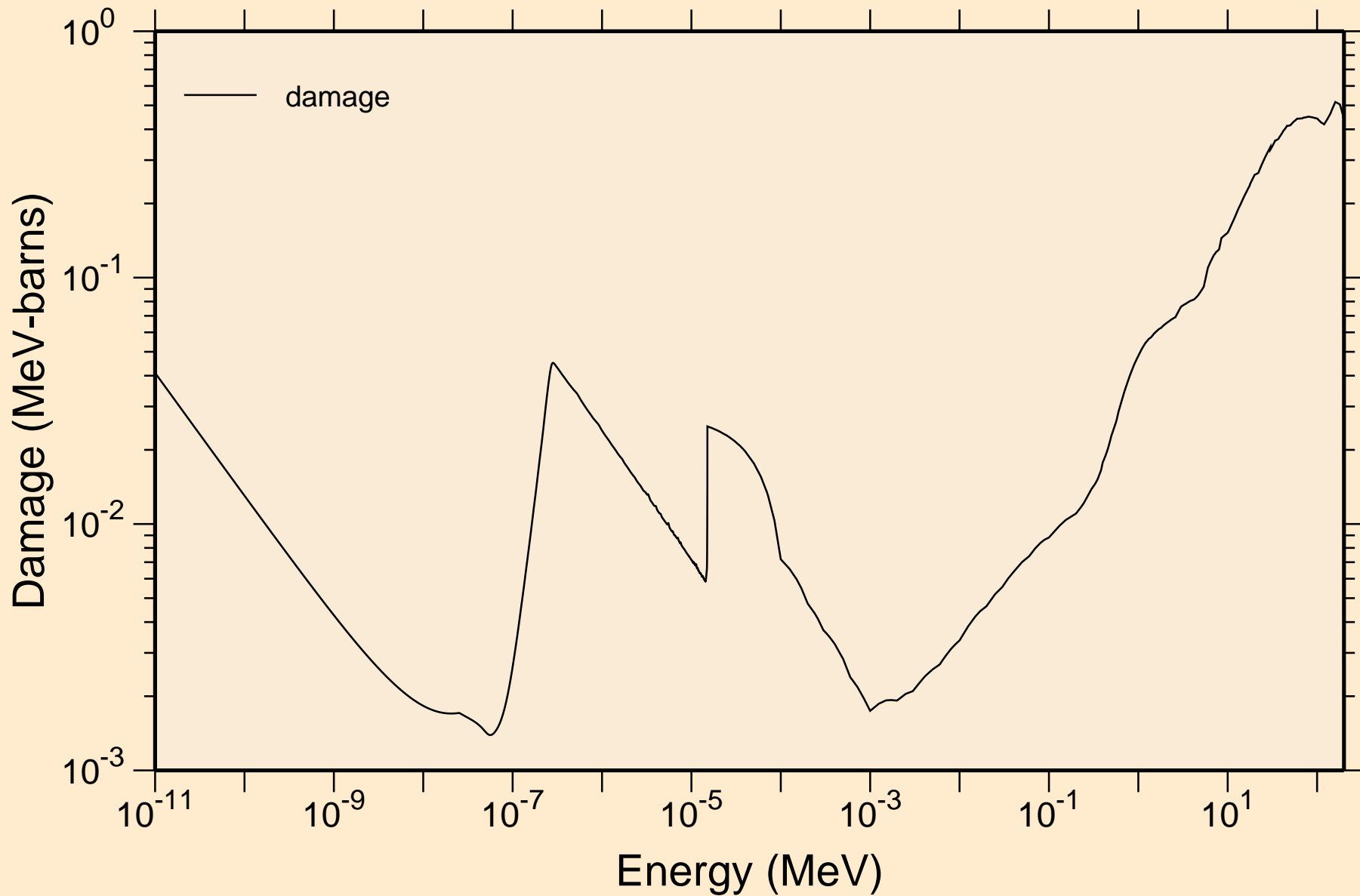

DY155 NEUTRON ACER TENDL-2019 LIBRARY; T=293.16K
Non-threshold reactions

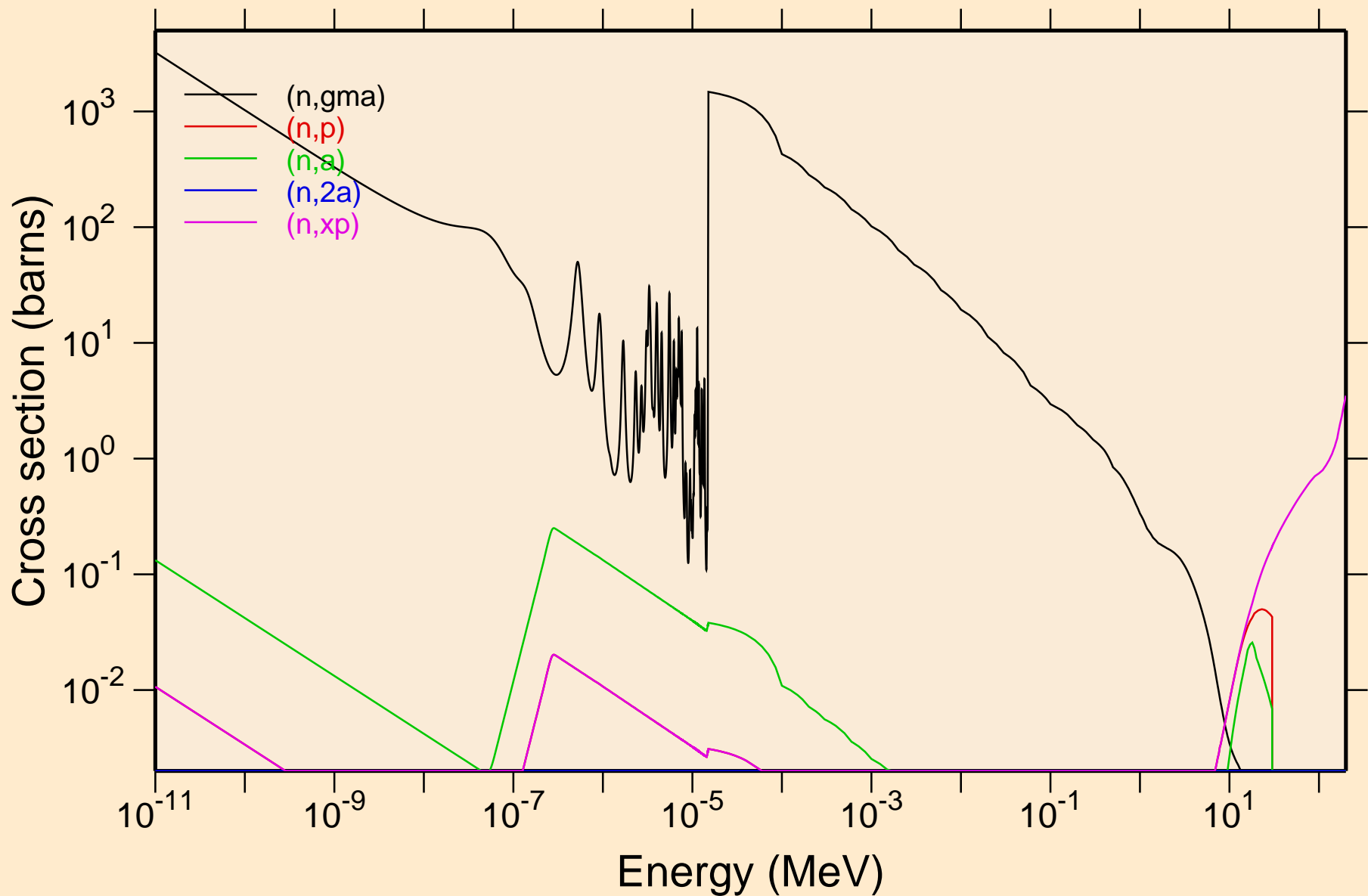

DY155 NEUTRON ACER TENDL-2019 LIBRARY; T=293.16K
Non-threshold reactions

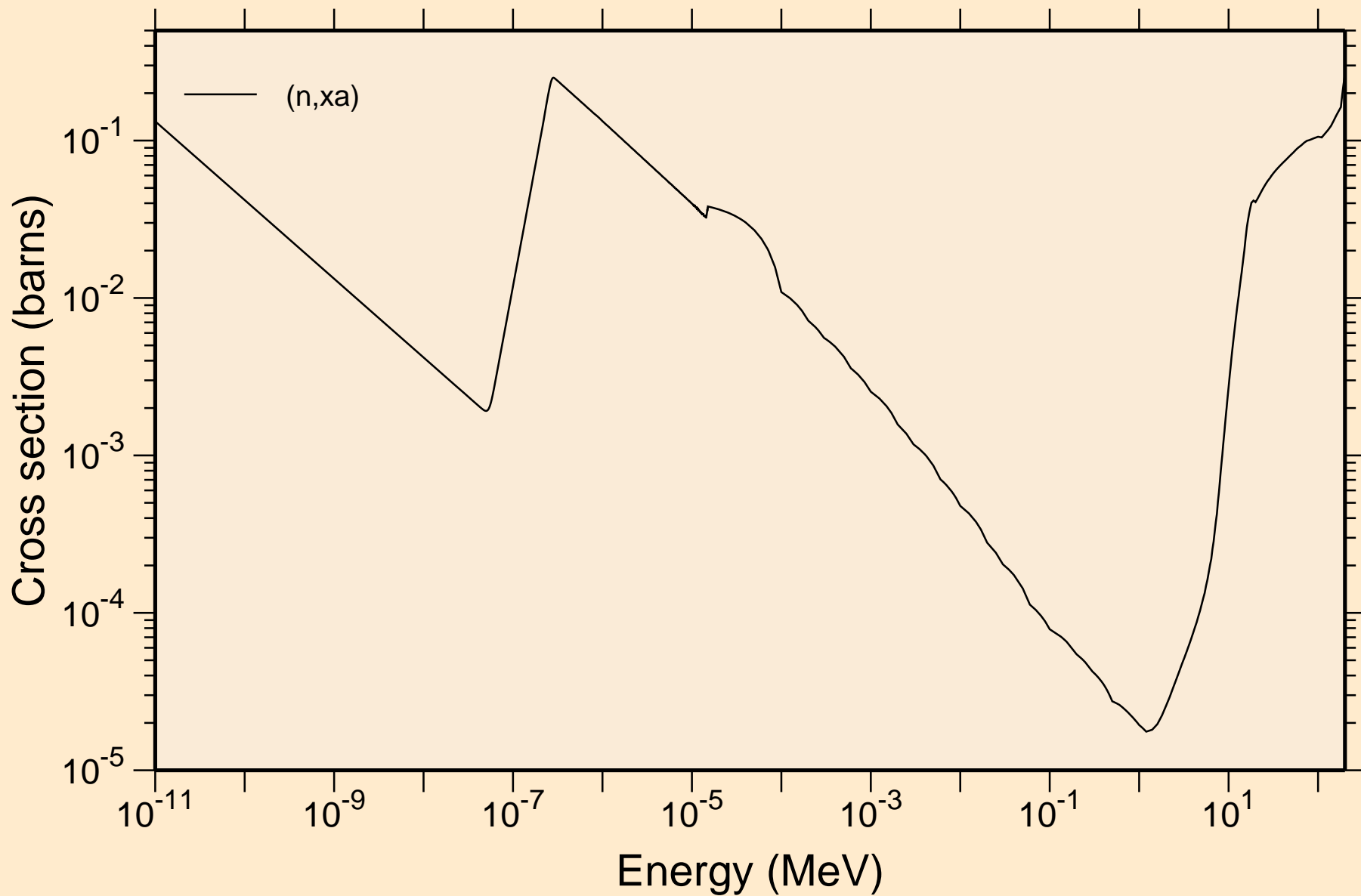

DY155 NEUTRON ACER TENDL-2019 LIBRARY; T=293.16K
Principal cross sections

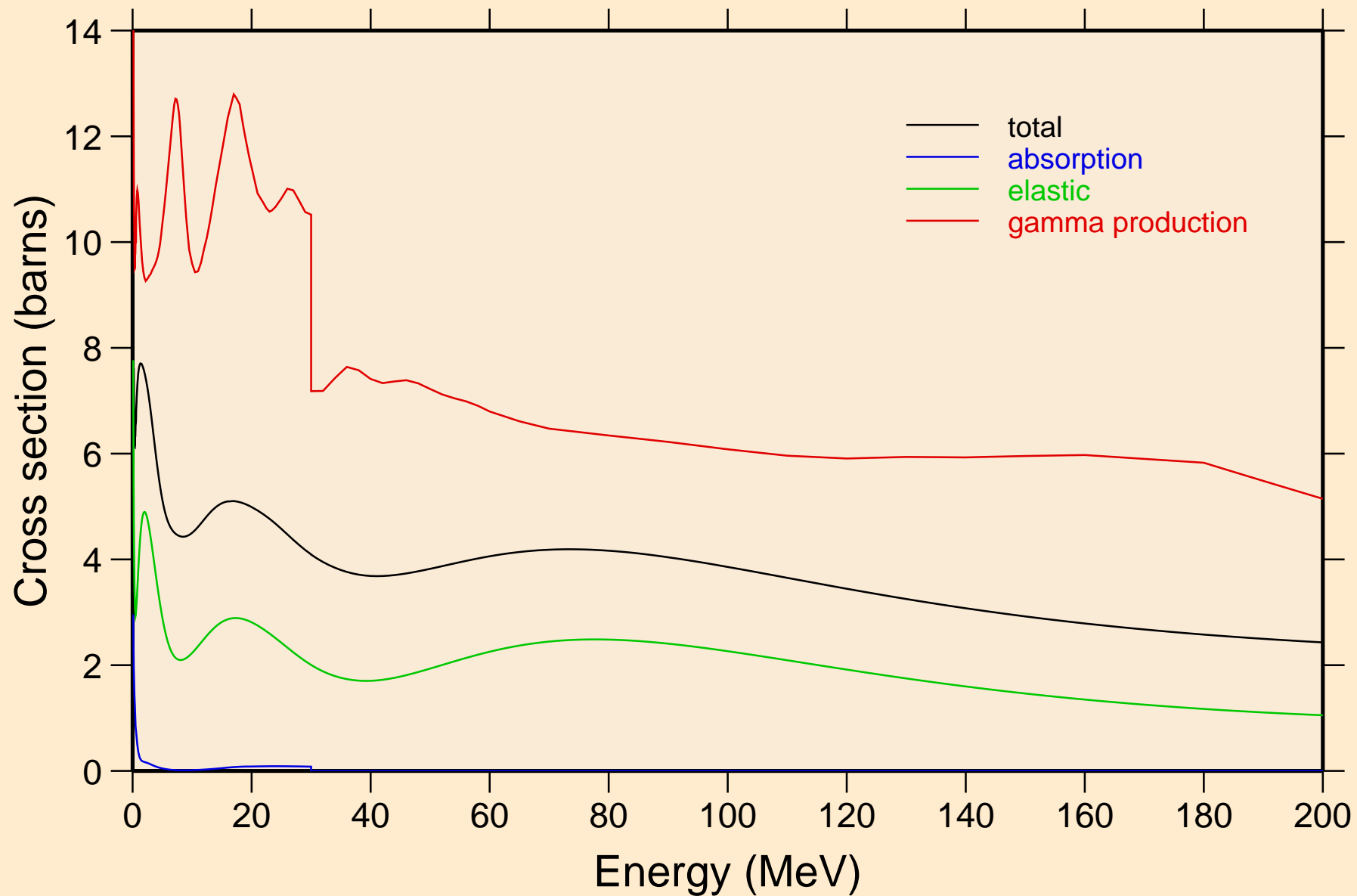

DY155 NEUTRON ACER TENDL-2019 LIBRARY; T=293.16K
Heating

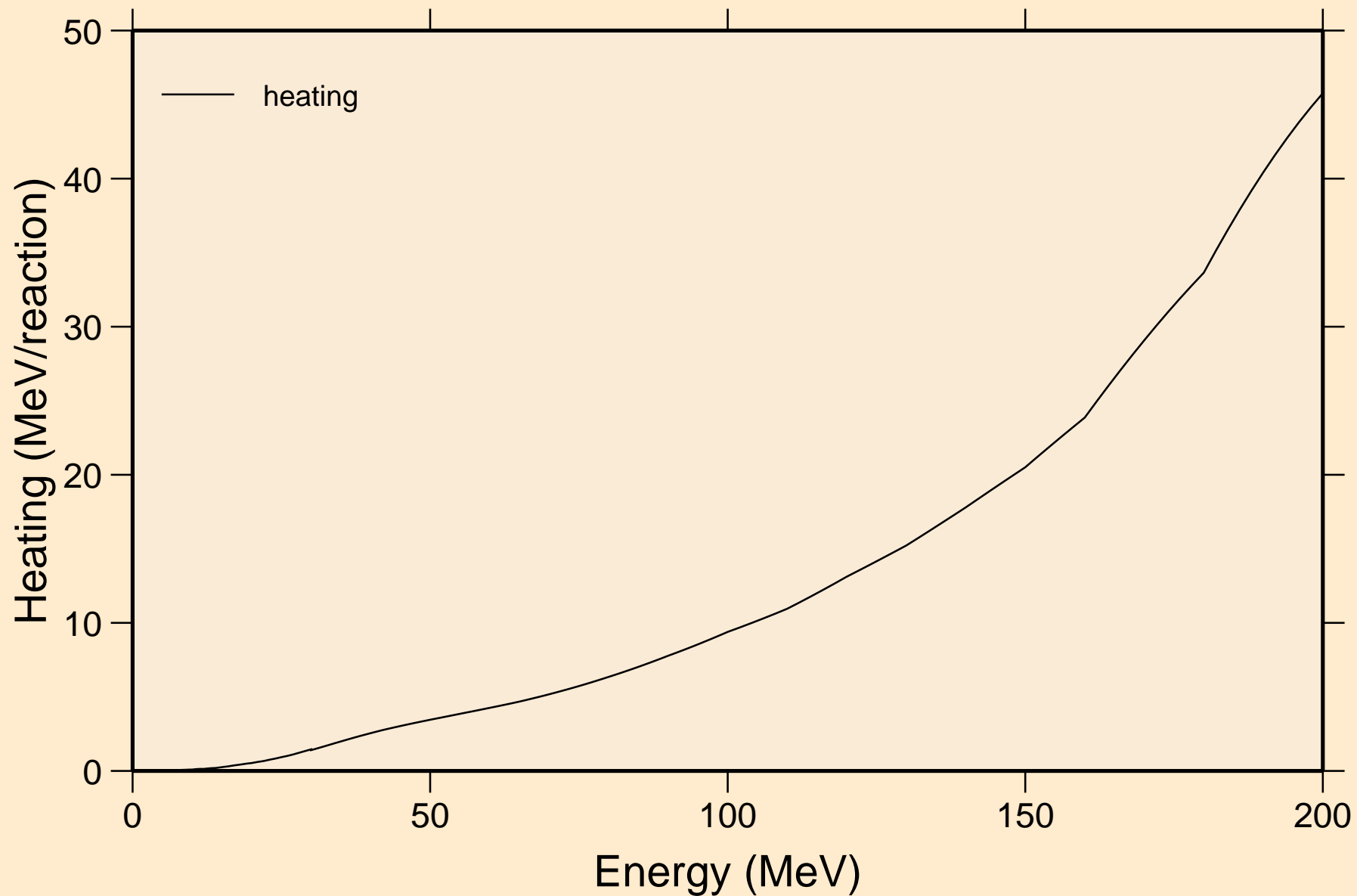

DY155 NEUTRON ACER TENDL-2019 LIBRARY; T=293.16K
Damage

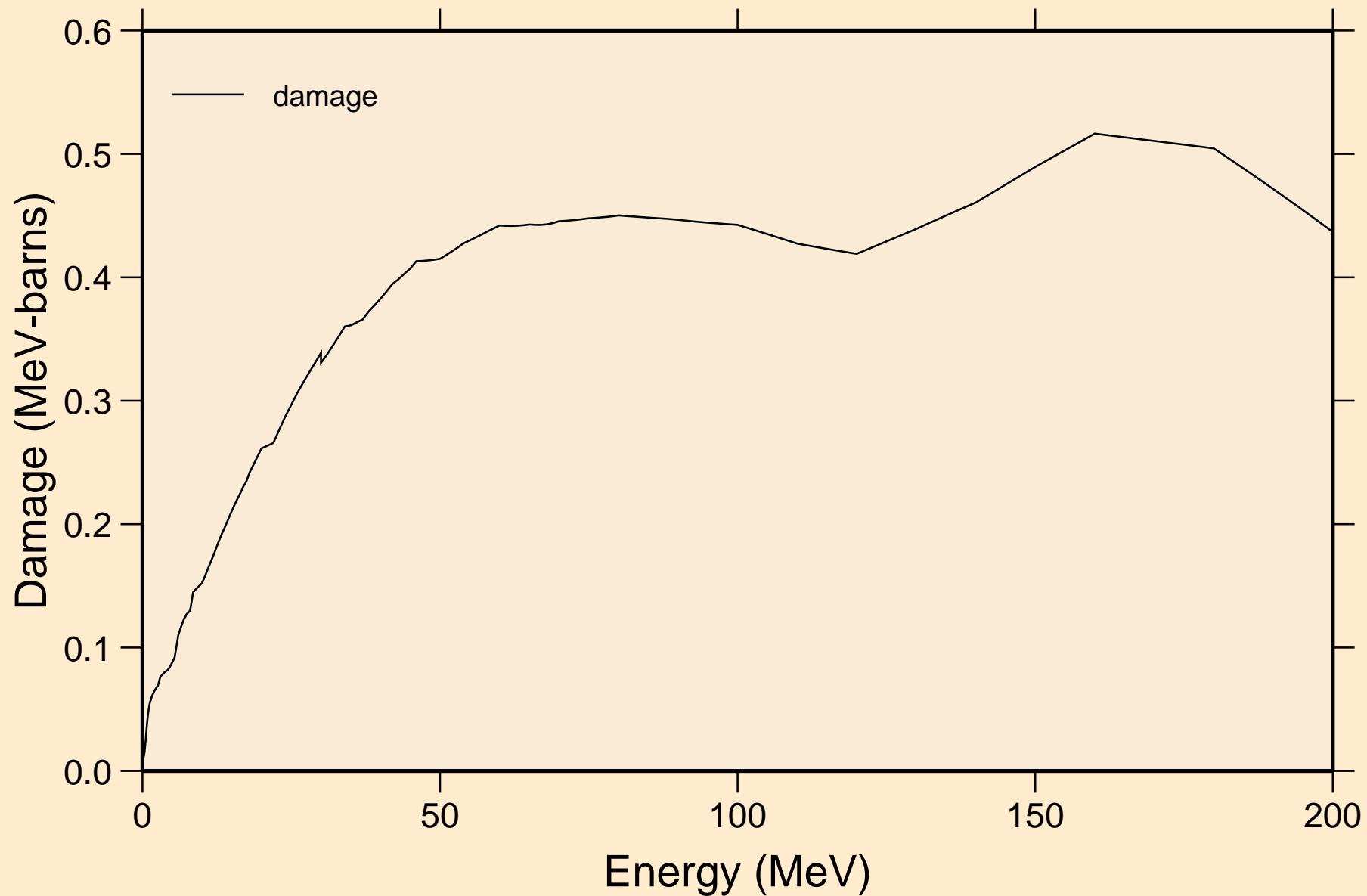

DY155 NEUTRON ACER TENDL-2019 LIBRARY; T=293.16K
Non-threshold reactions

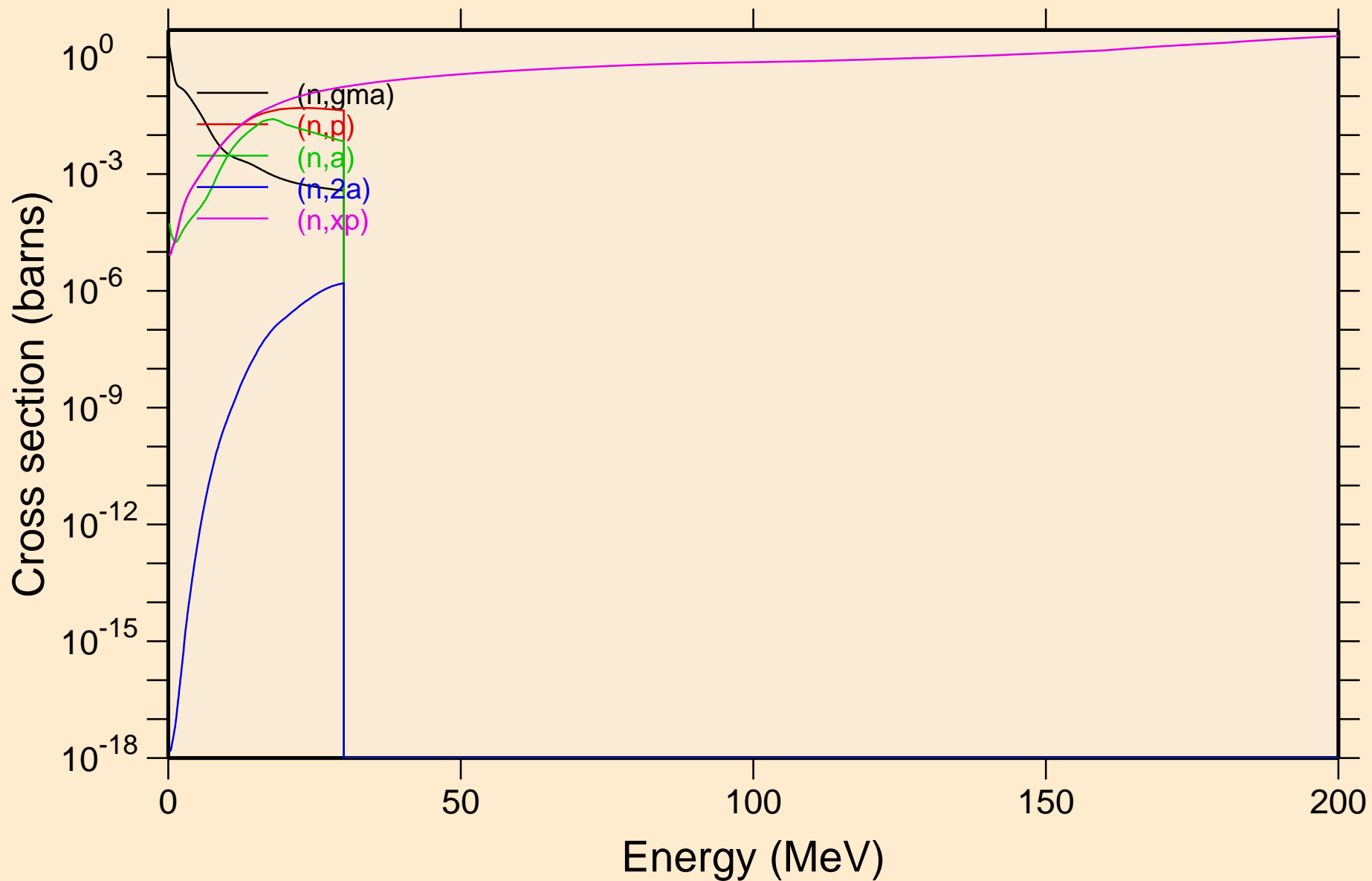

DY155 NEUTRON ACER TENDL-2019 LIBRARY; T=293.16K
Non-threshold reactions

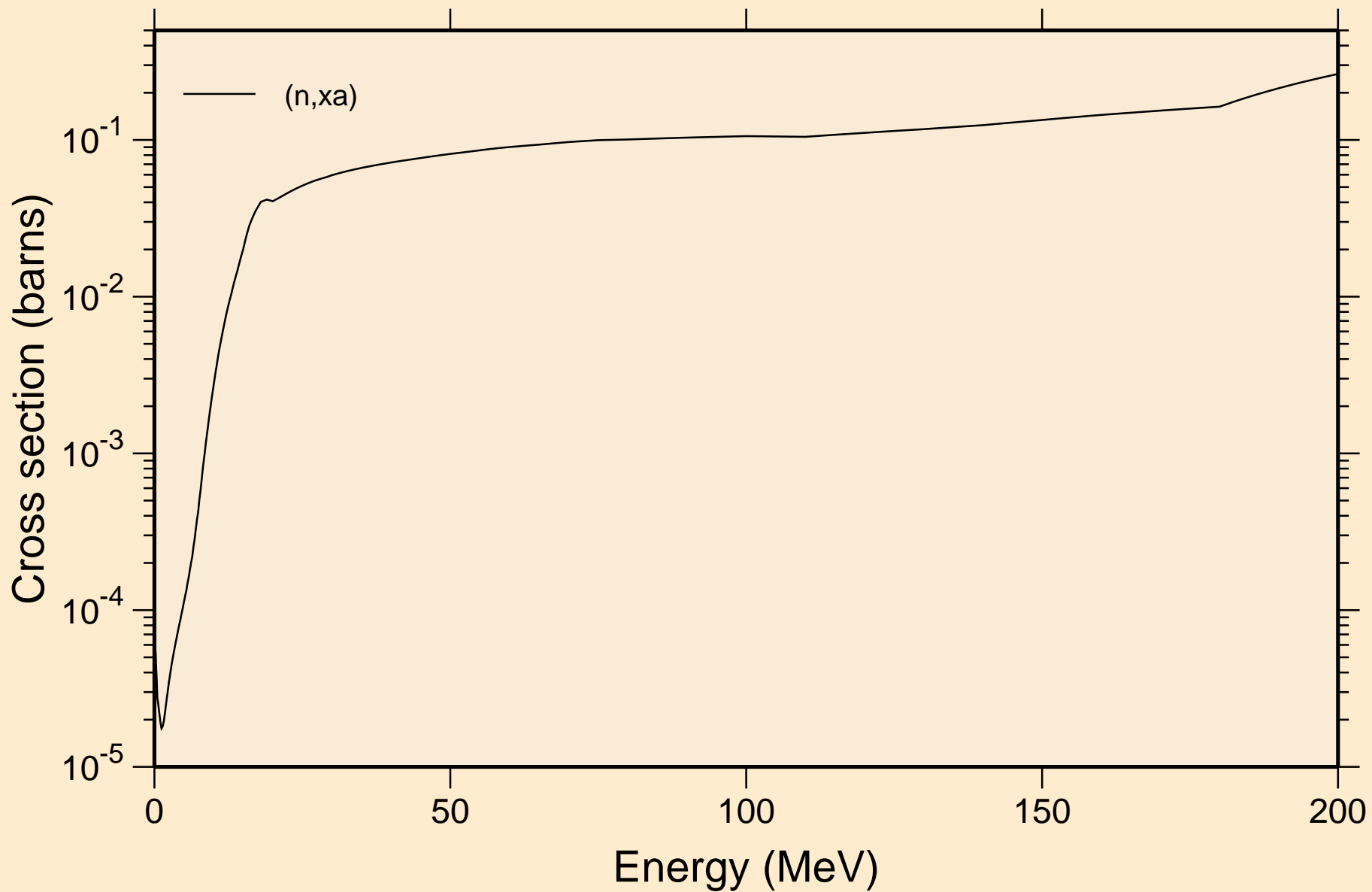

DY155 NEUTRON ACER TENDL-2019 LIBRARY; T=293.16K
Inelastic levels

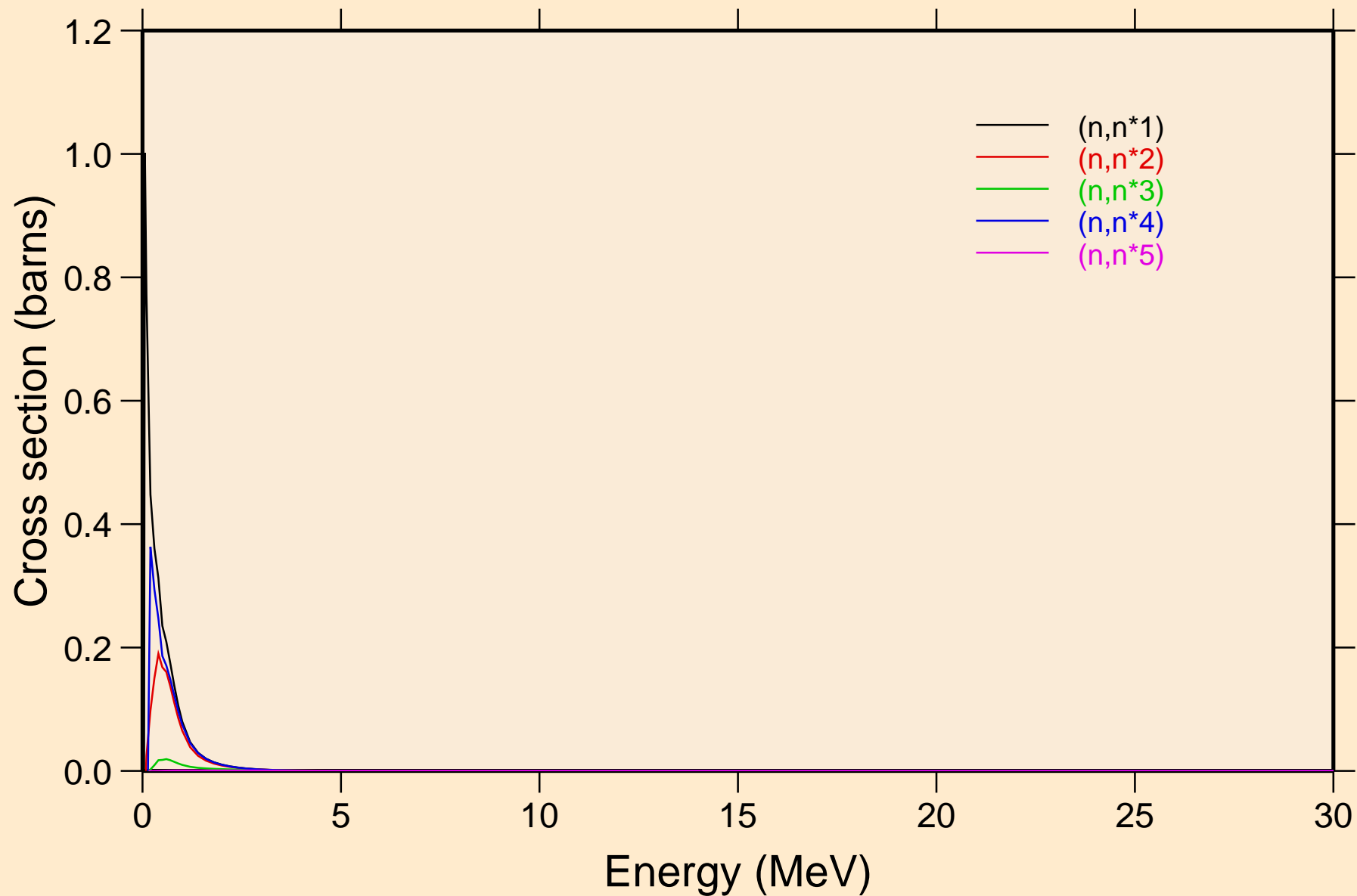

DY155 NEUTRON ACER TENDL-2019 LIBRARY; T=293.16K
Inelastic levels

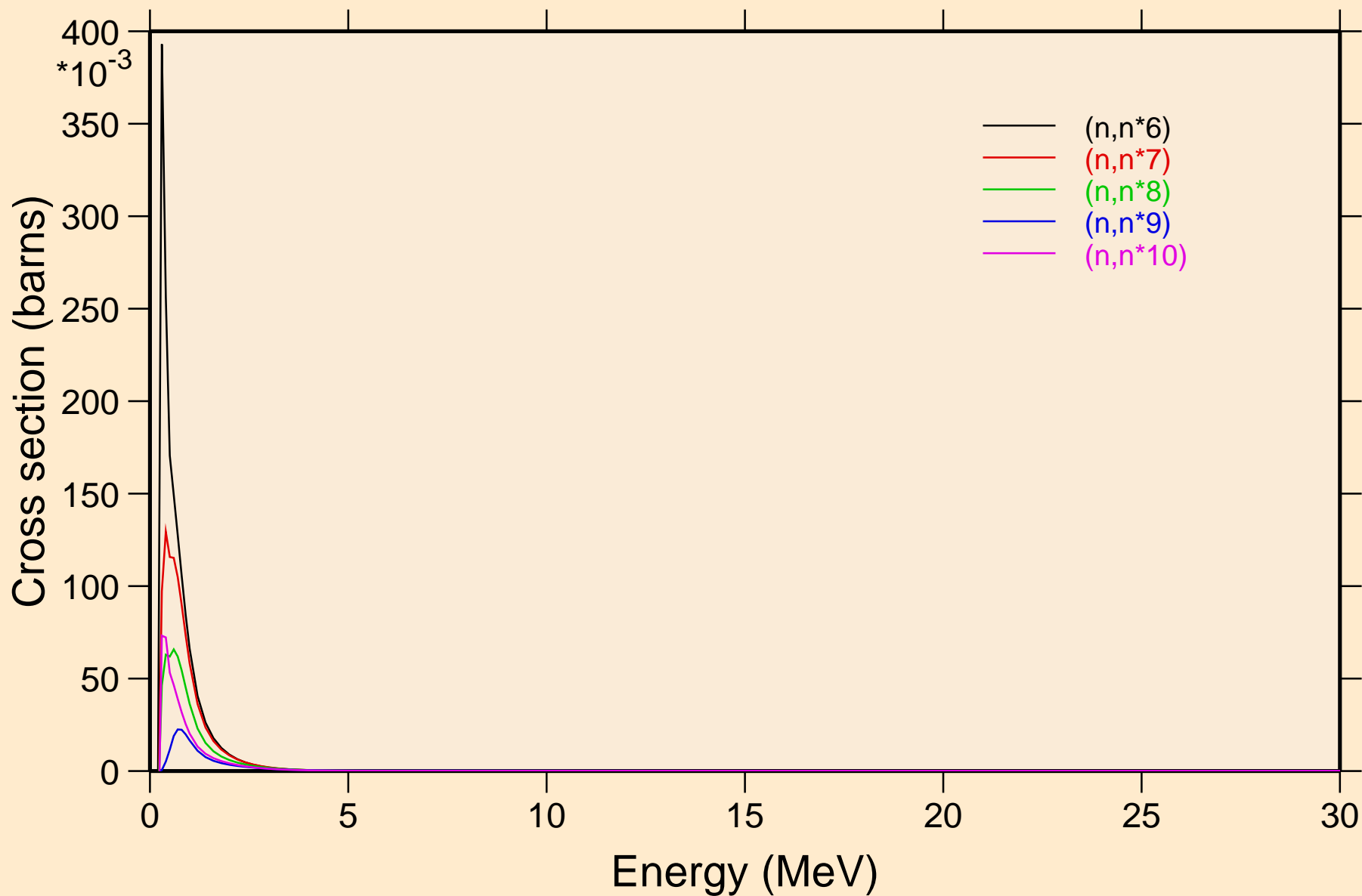

DY155 NEUTRON ACER TENDL-2019 LIBRARY; T=293.16K
Inelastic levels

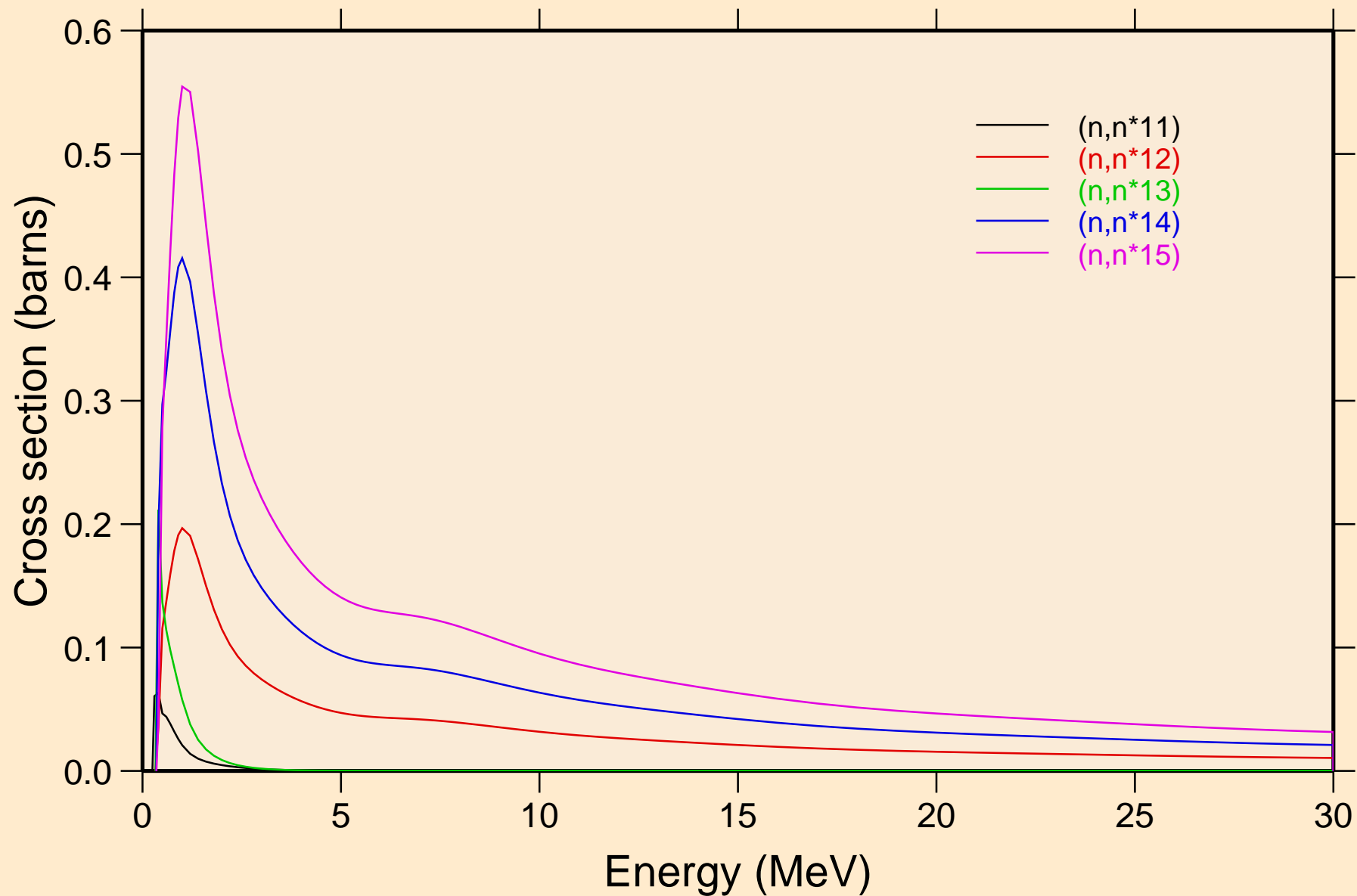

DY155 NEUTRON ACER TENDL-2019 LIBRARY; T=293.16K
Inelastic levels

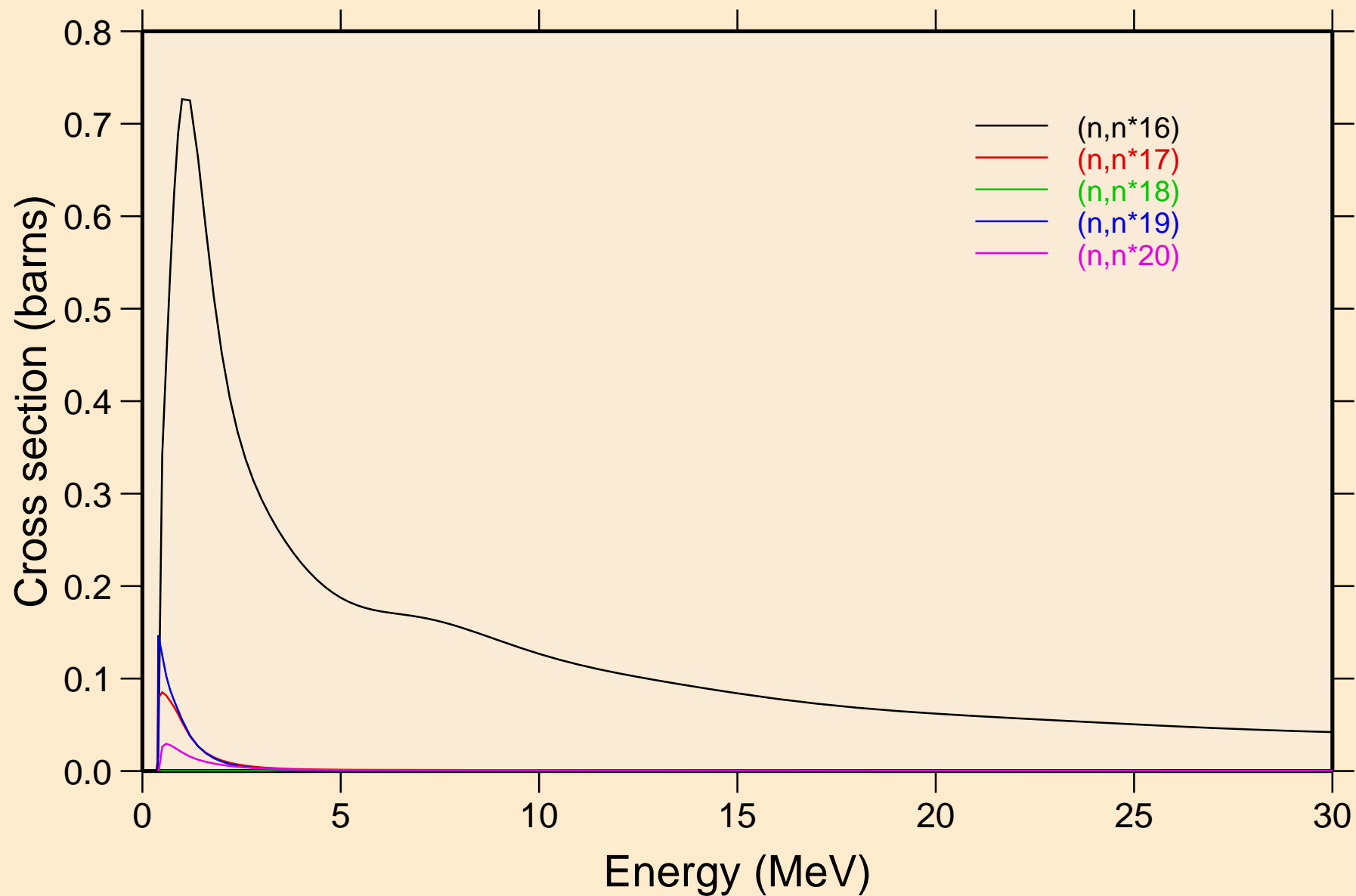

DY155 NEUTRON ACER TENDL-2019 LIBRARY; T=293.16K
Inelastic levels

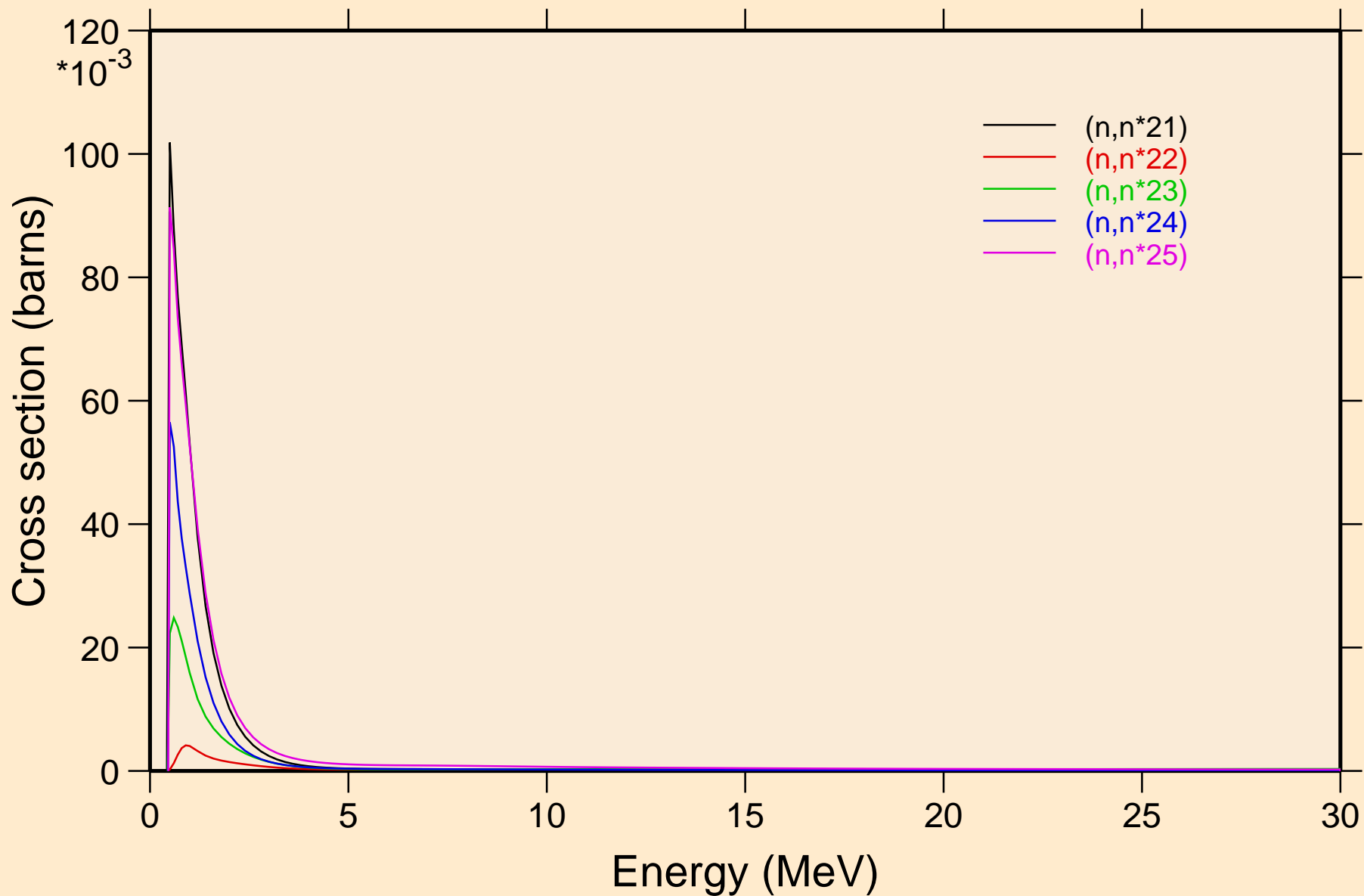

DY155 NEUTRON ACER TENDL-2019 LIBRARY; T=293.16K
Inelastic levels

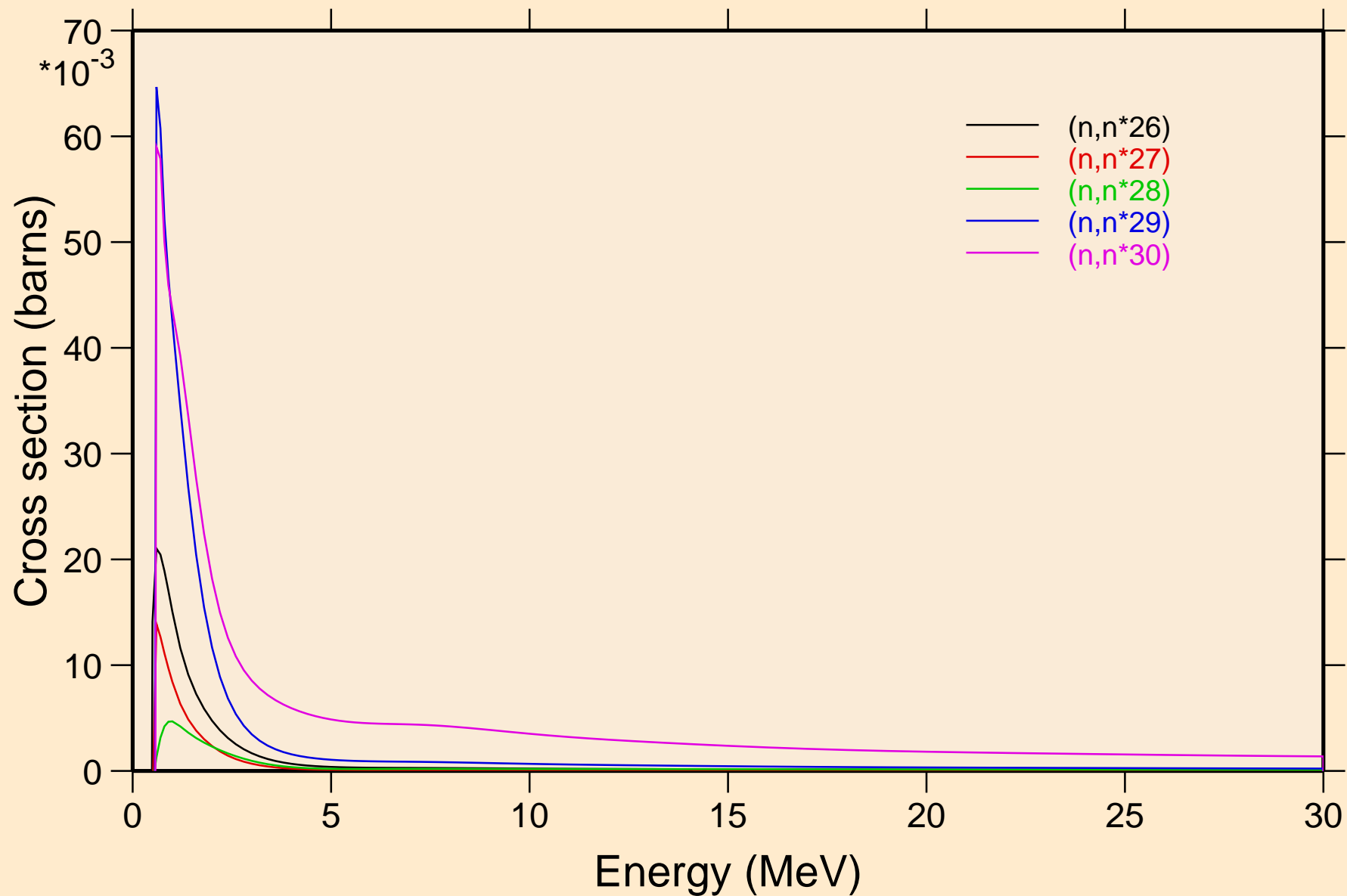

DY155 NEUTRON ACER TENDL-2019 LIBRARY; T=293.16K
Threshold reactions

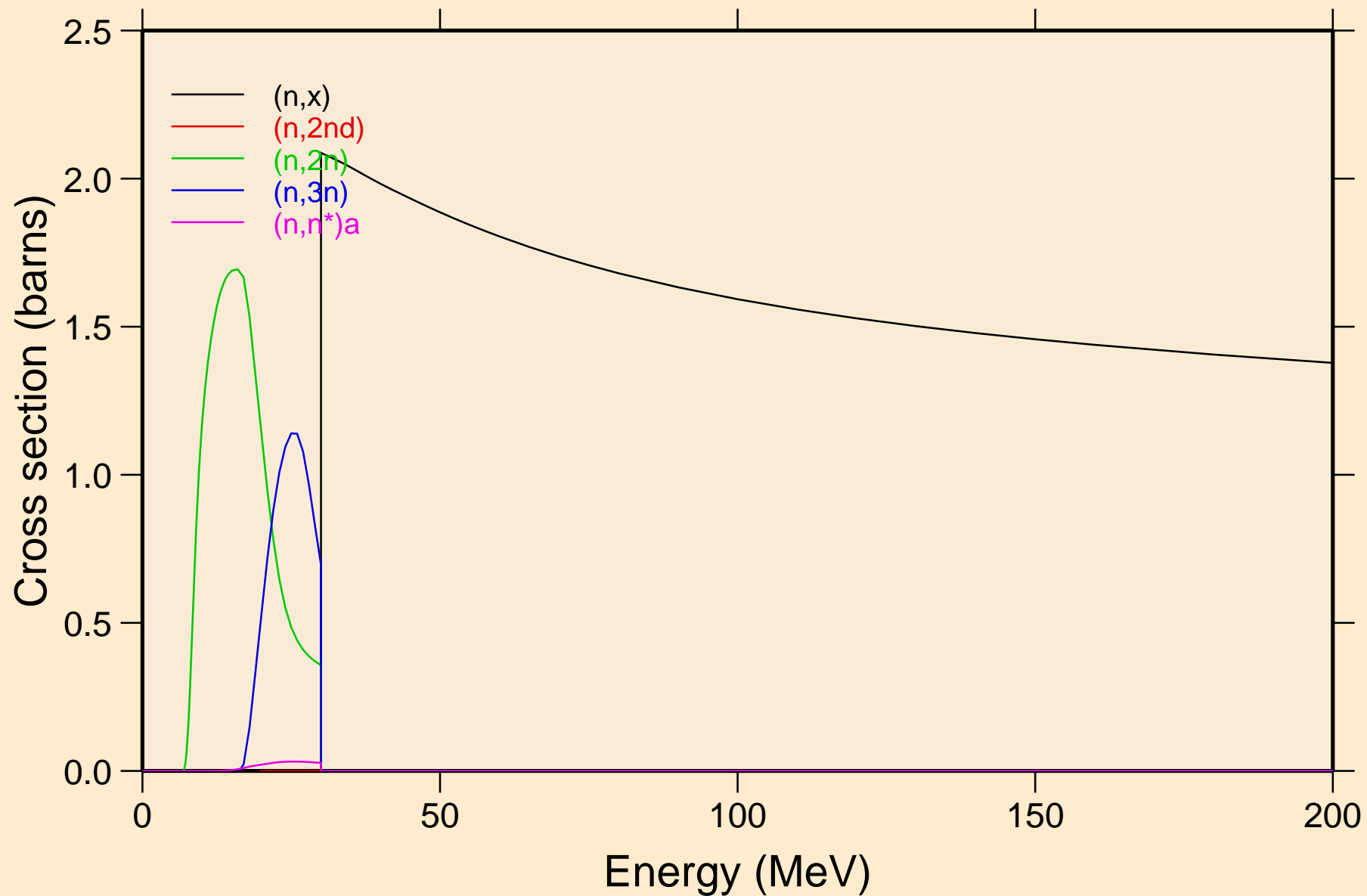

DY155 NEUTRON ACER TENDL-2019 LIBRARY; T=293.16K
Threshold reactions

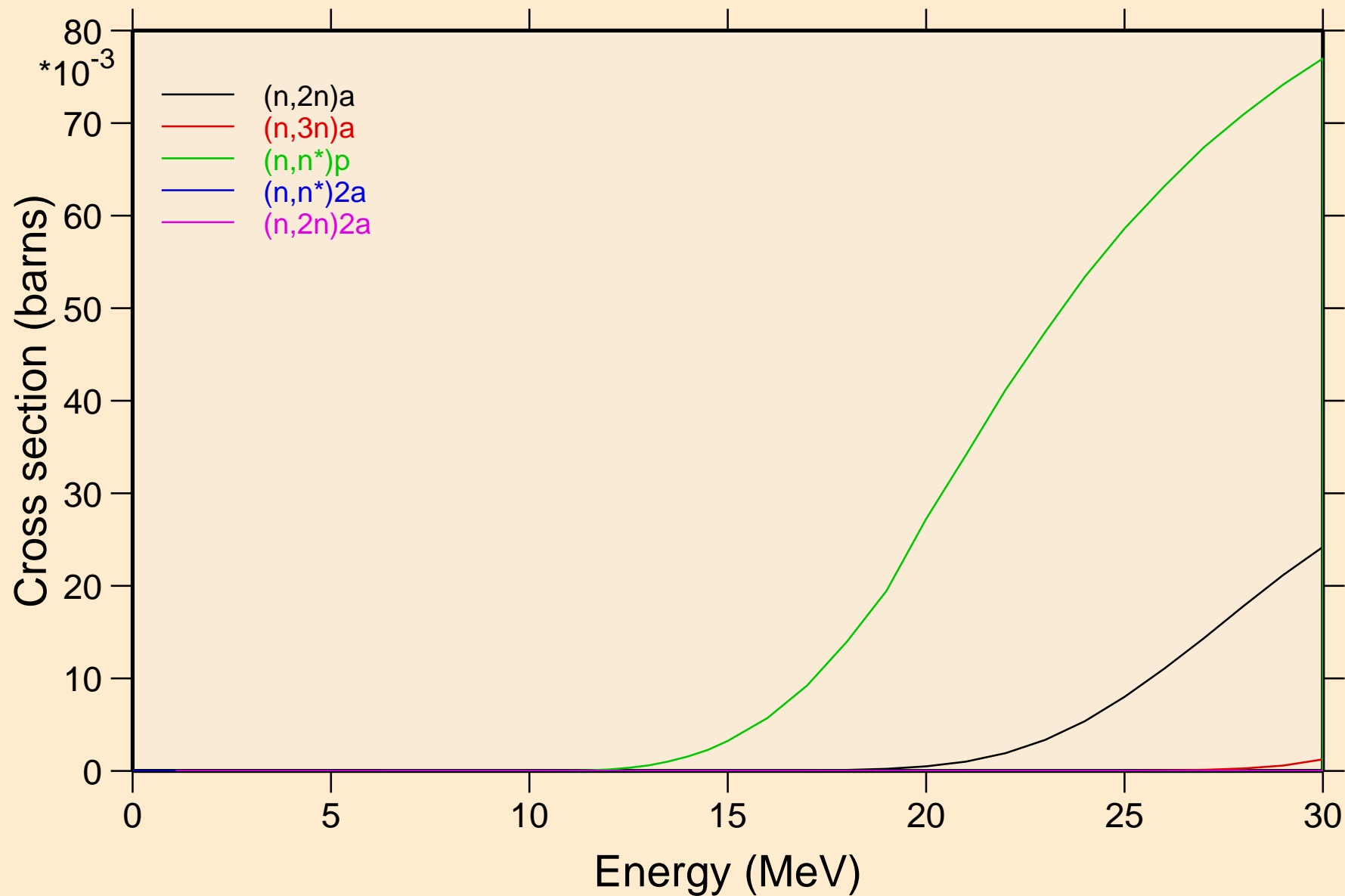

DY155 NEUTRON ACER TENDL-2019 LIBRARY; T=293.16K
Threshold reactions

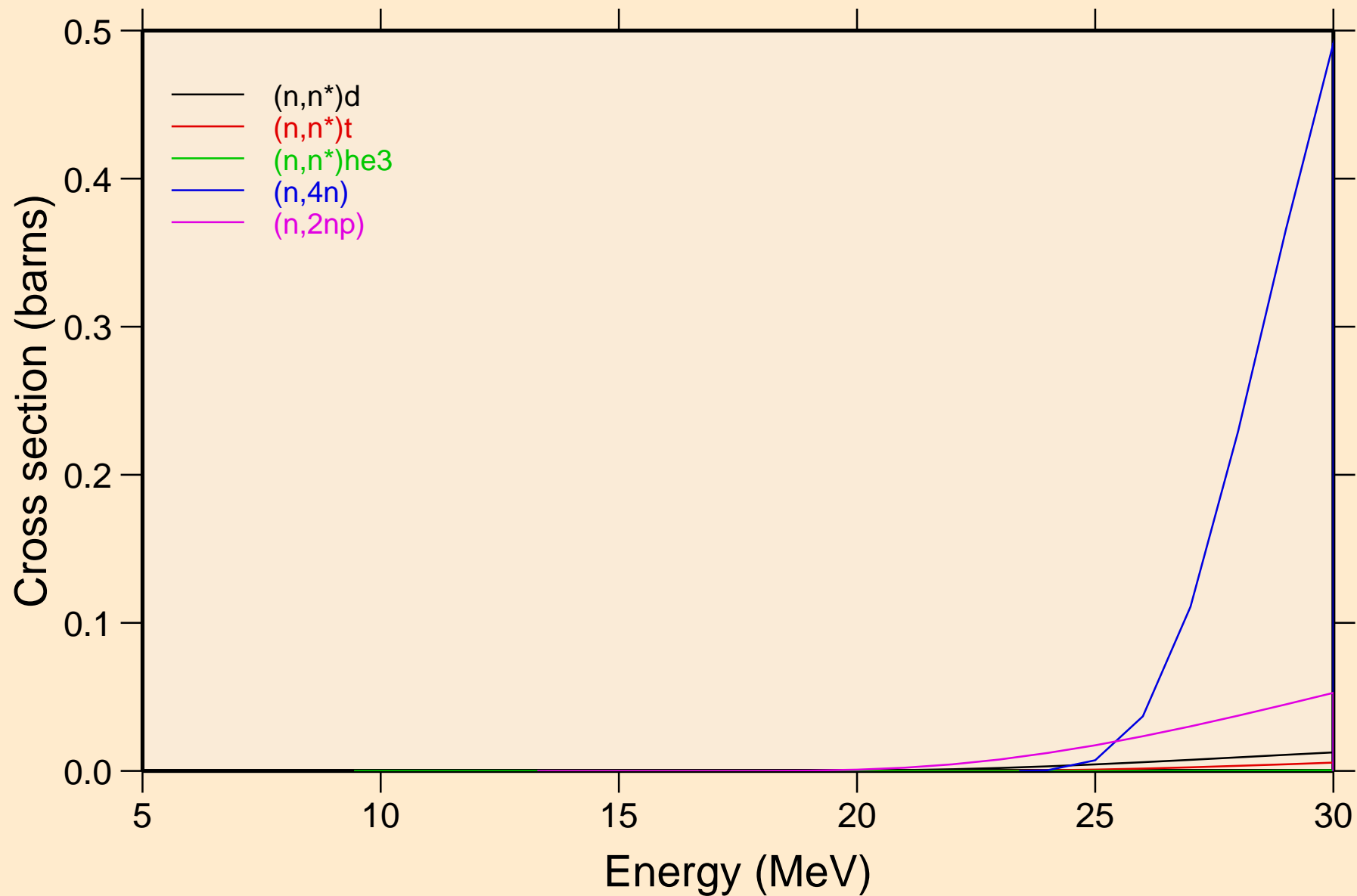

DY155 NEUTRON ACER TENDL-2019 LIBRARY; T=293.16K
Threshold reactions

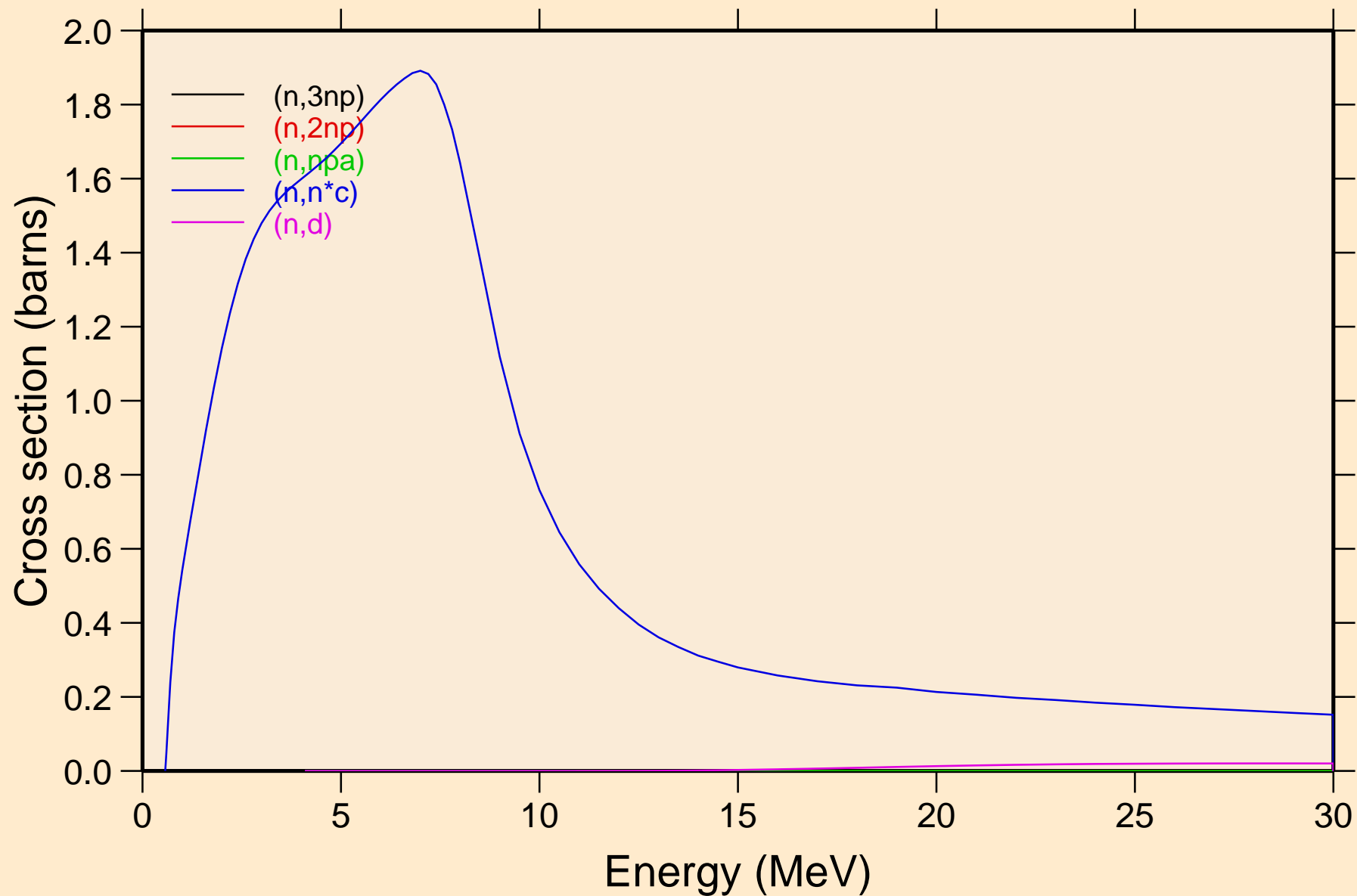

DY155 NEUTRON ACER TENDL-2019 LIBRARY; T=293.16K
Threshold reactions

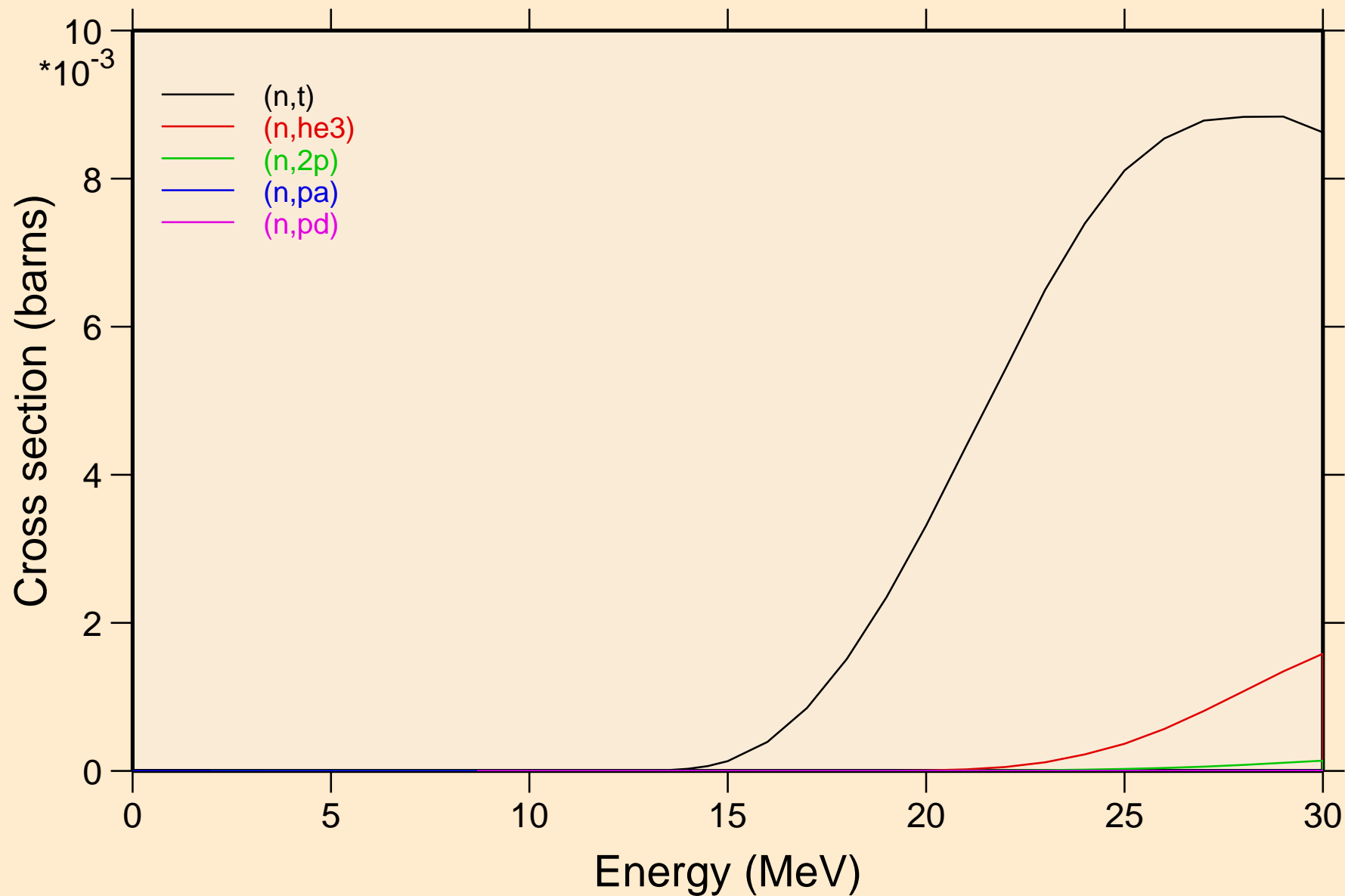

DY155 NEUTRON ACER TENDL-2019 LIBRARY; T=293.16K
Threshold reactions

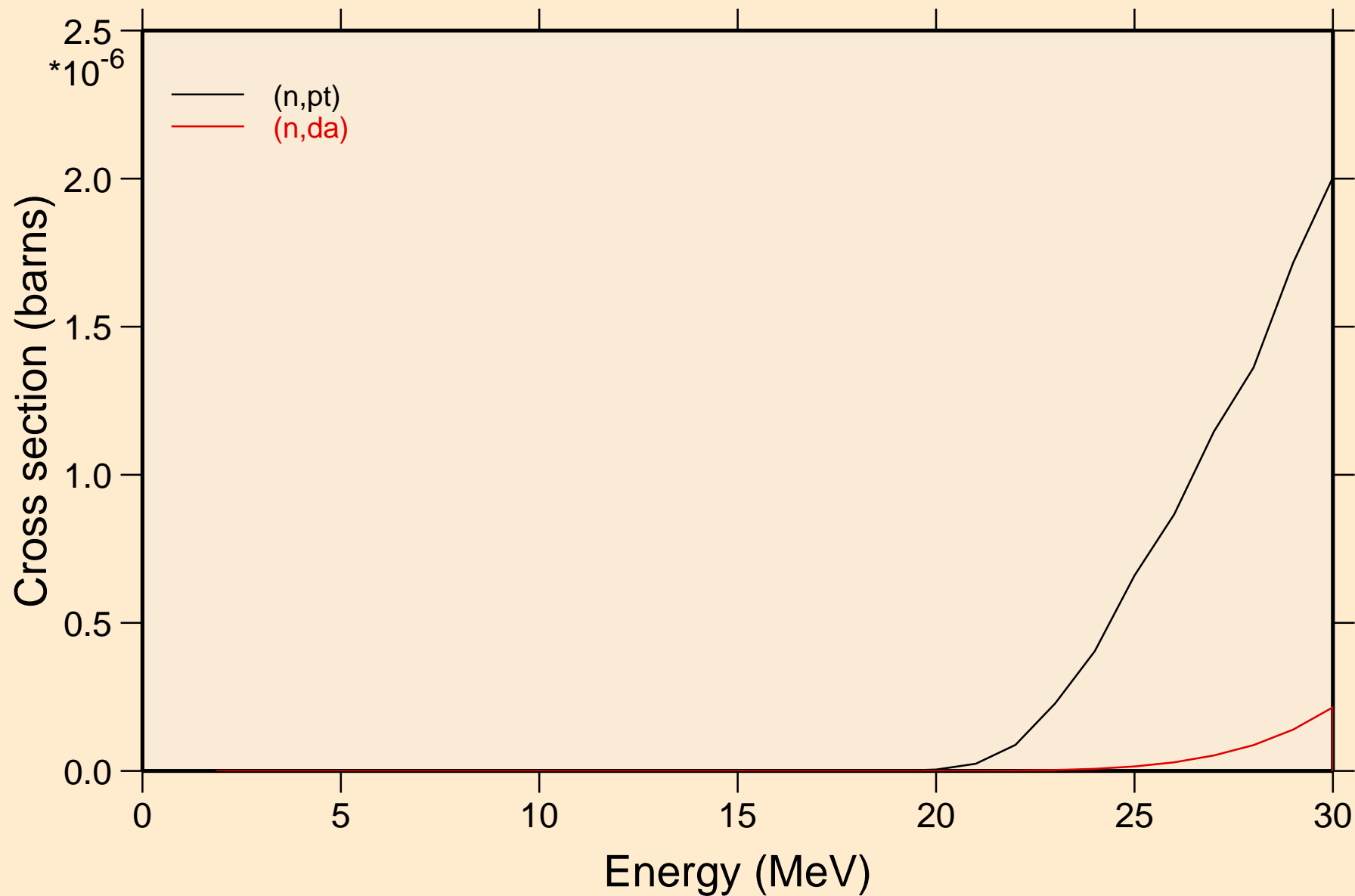

DY155 NEUTRON ACER TENDL-2019 LIBRARY; T=293.16K
Threshold reactions

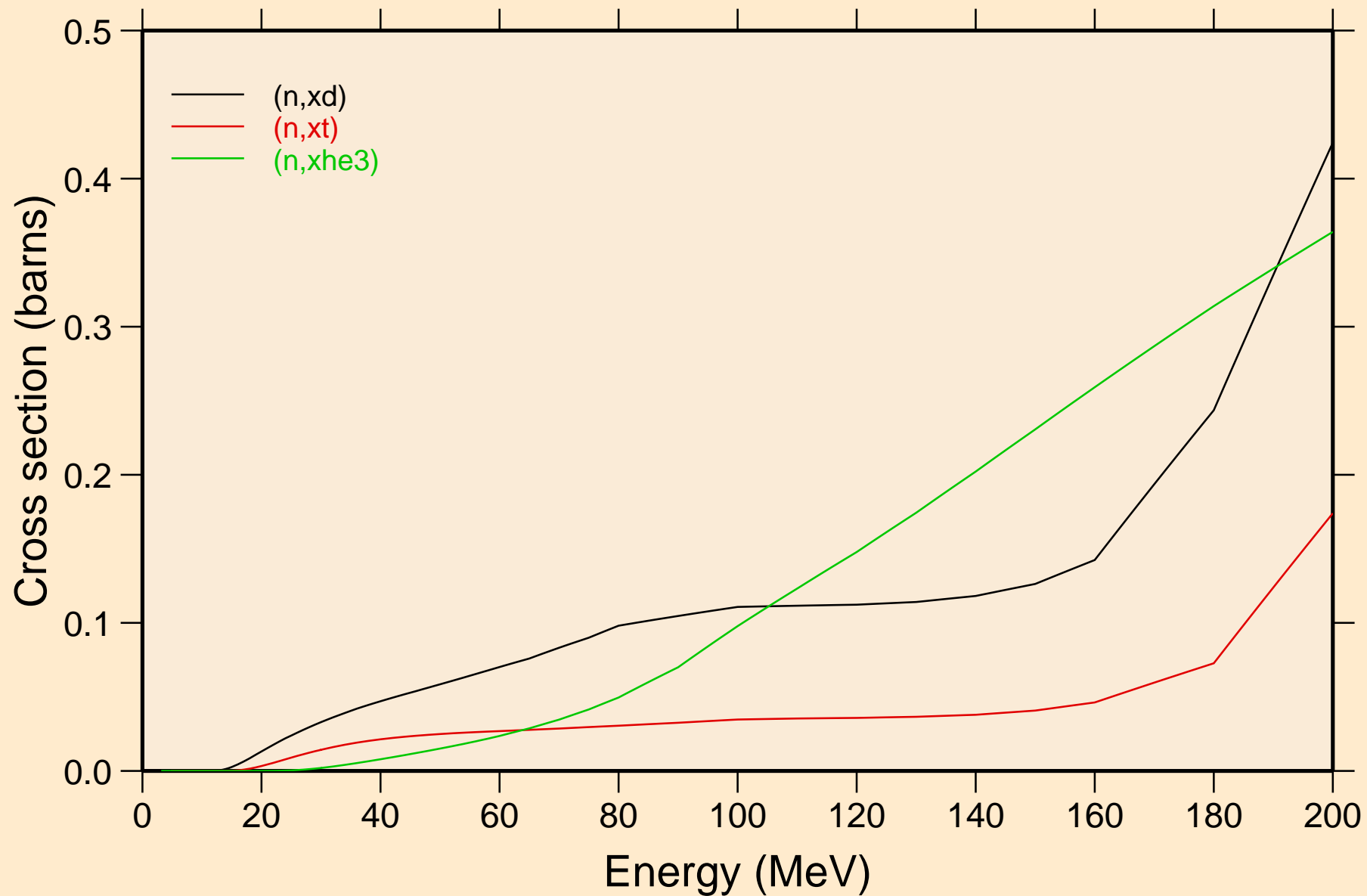

DY155 NEUTRON ACER TENDL-2019 LIBRARY; T=293.16K
angular distribution for elastic

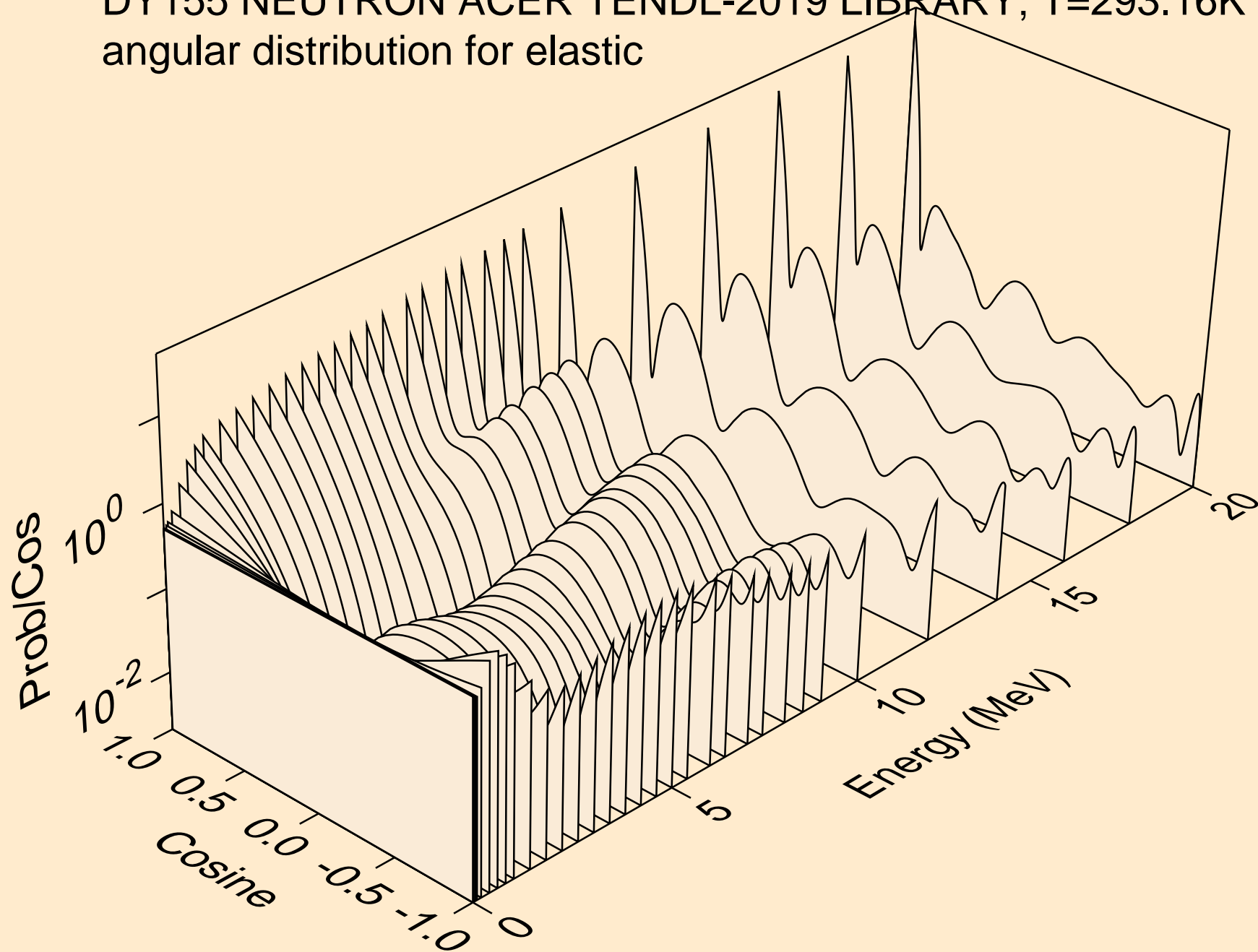

DY155 NEUTRON ACER TENDL-2019 LIBRARY; T=293.16K
angular distribution for elastic

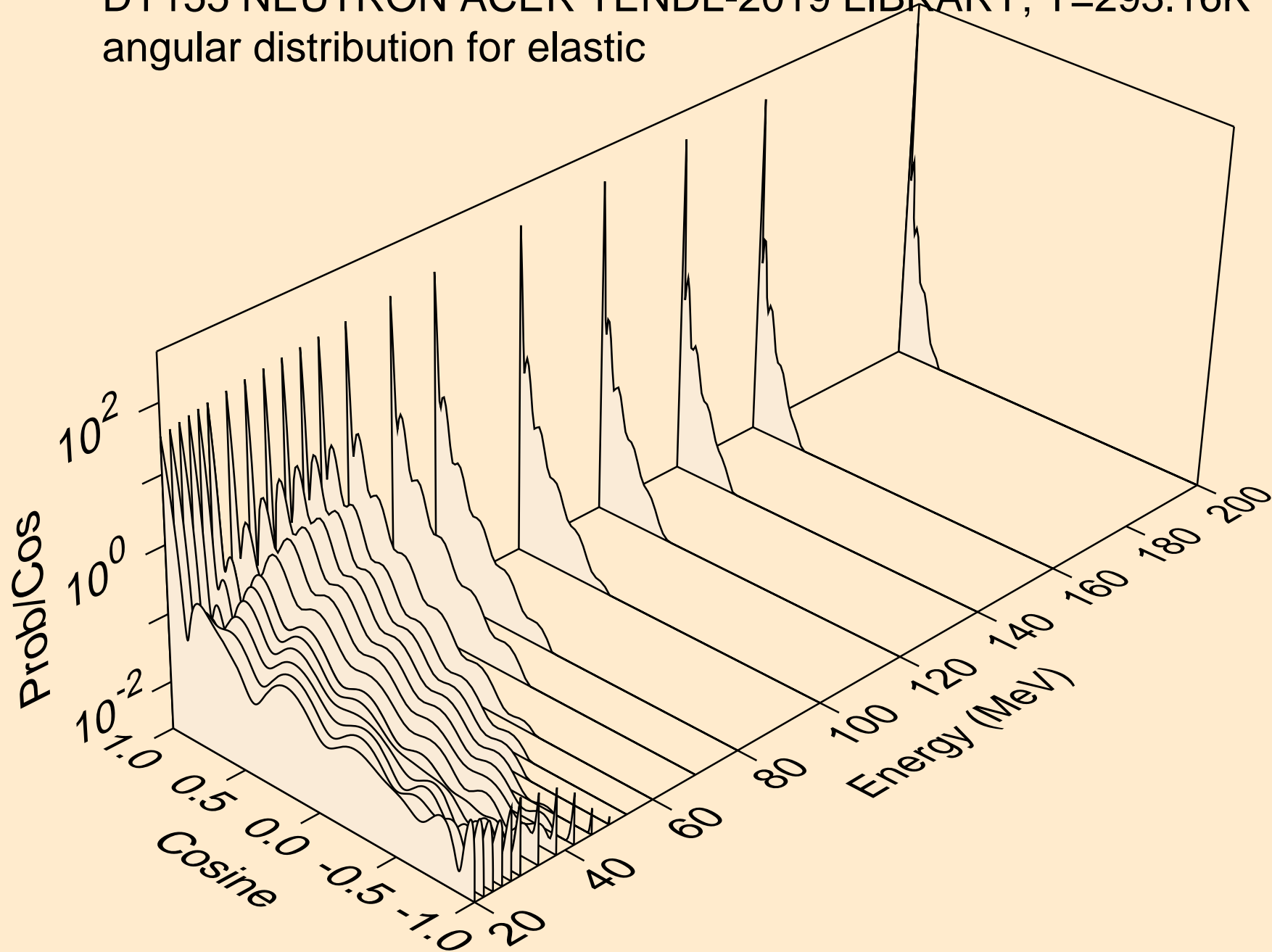

DY155 NEUTRON ACER TENDL-2019 LIBRARY; T=293.16K
angular distribution for (n,n*1)

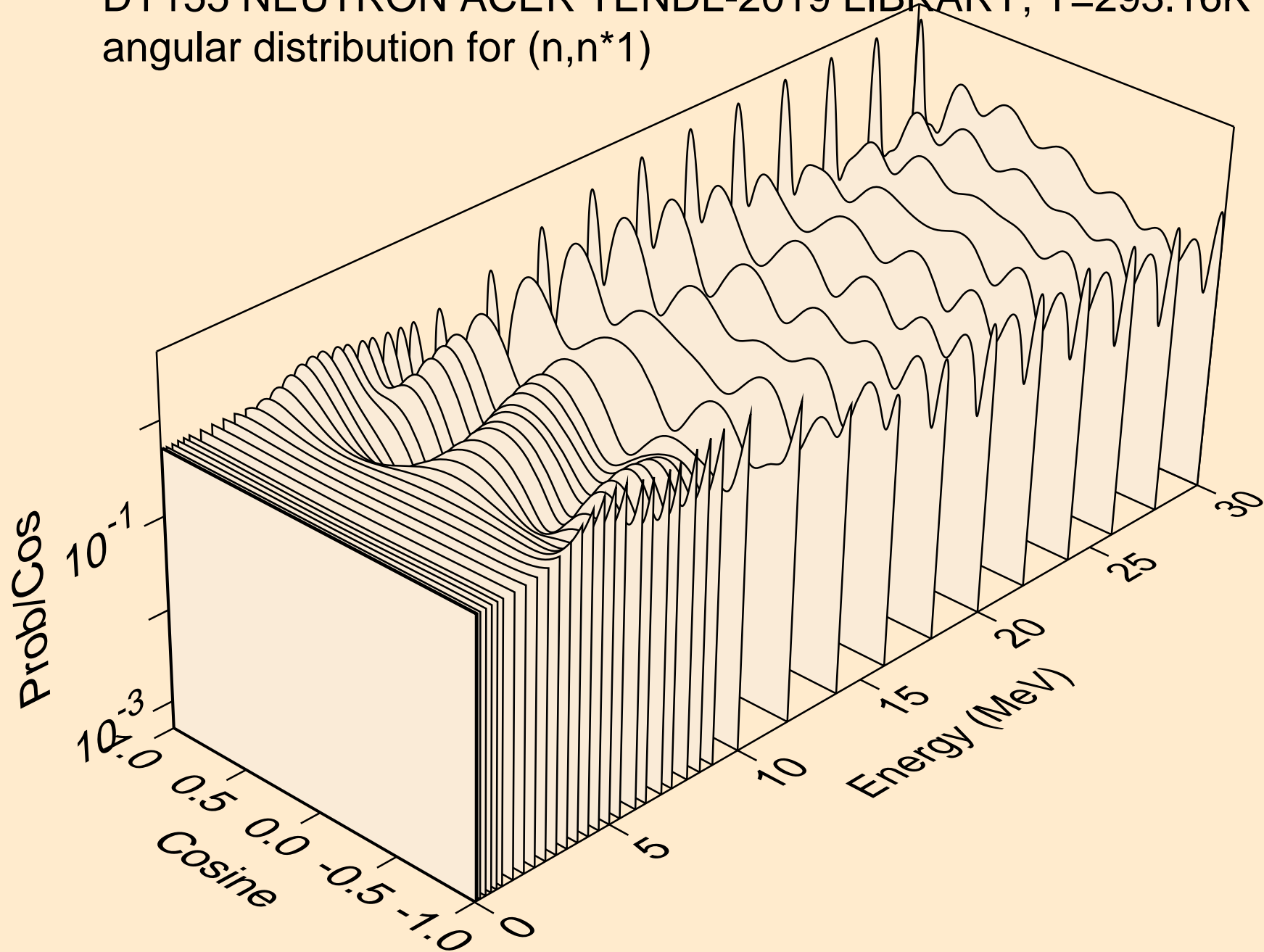

DY155 NEUTRON ACER TENDL-2019 LIBRARY; T=293.16K
angular distribution for (n,n*2)

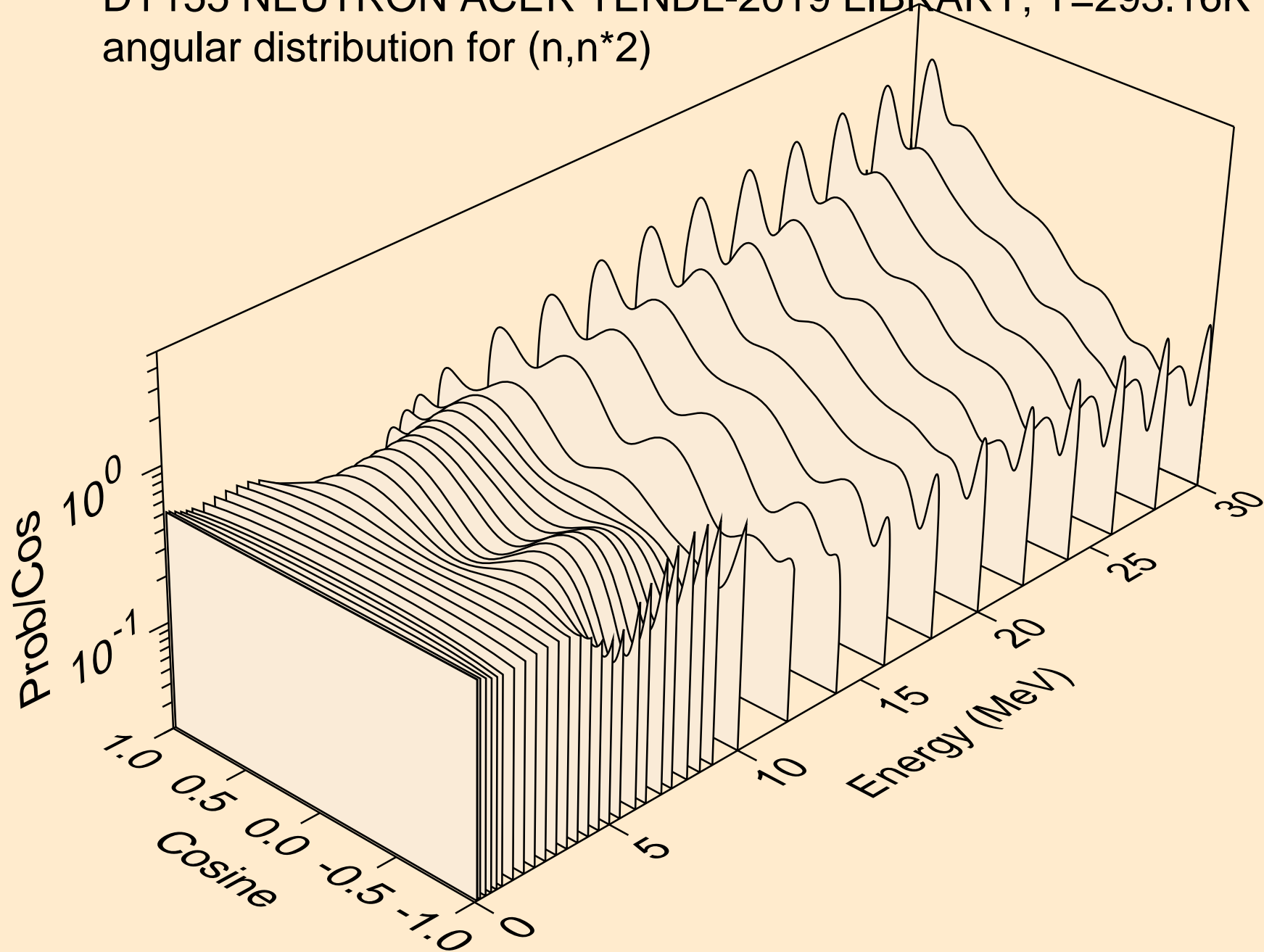

DY155 NEUTRON ACER TENDL-2019 LIBRARY; T=293.16K
angular distribution for (n,n*3)

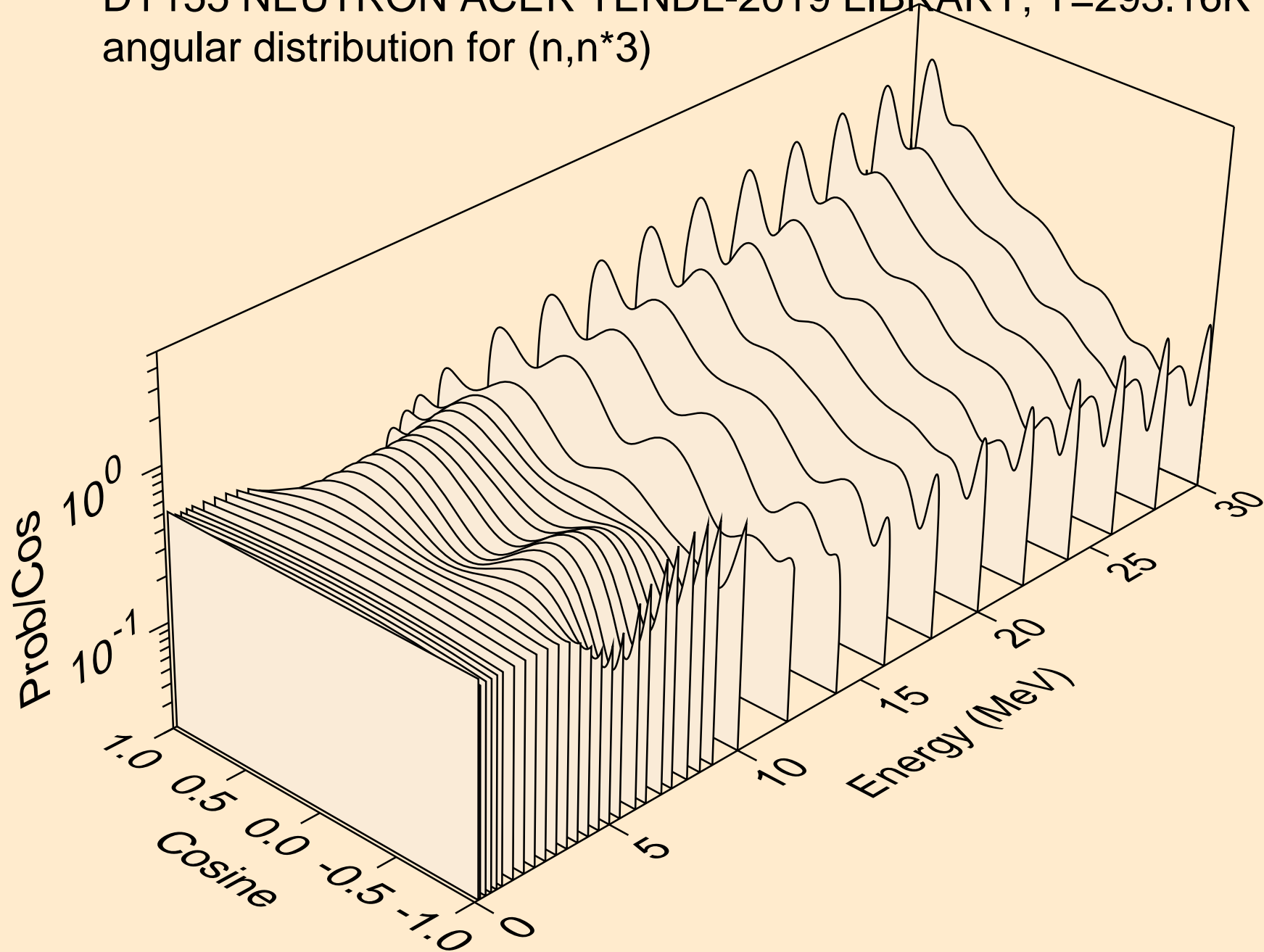

DY155 NEUTRON ACER TENDL-2019 LIBRARY; T=293.16K
angular distribution for (n,n*4)

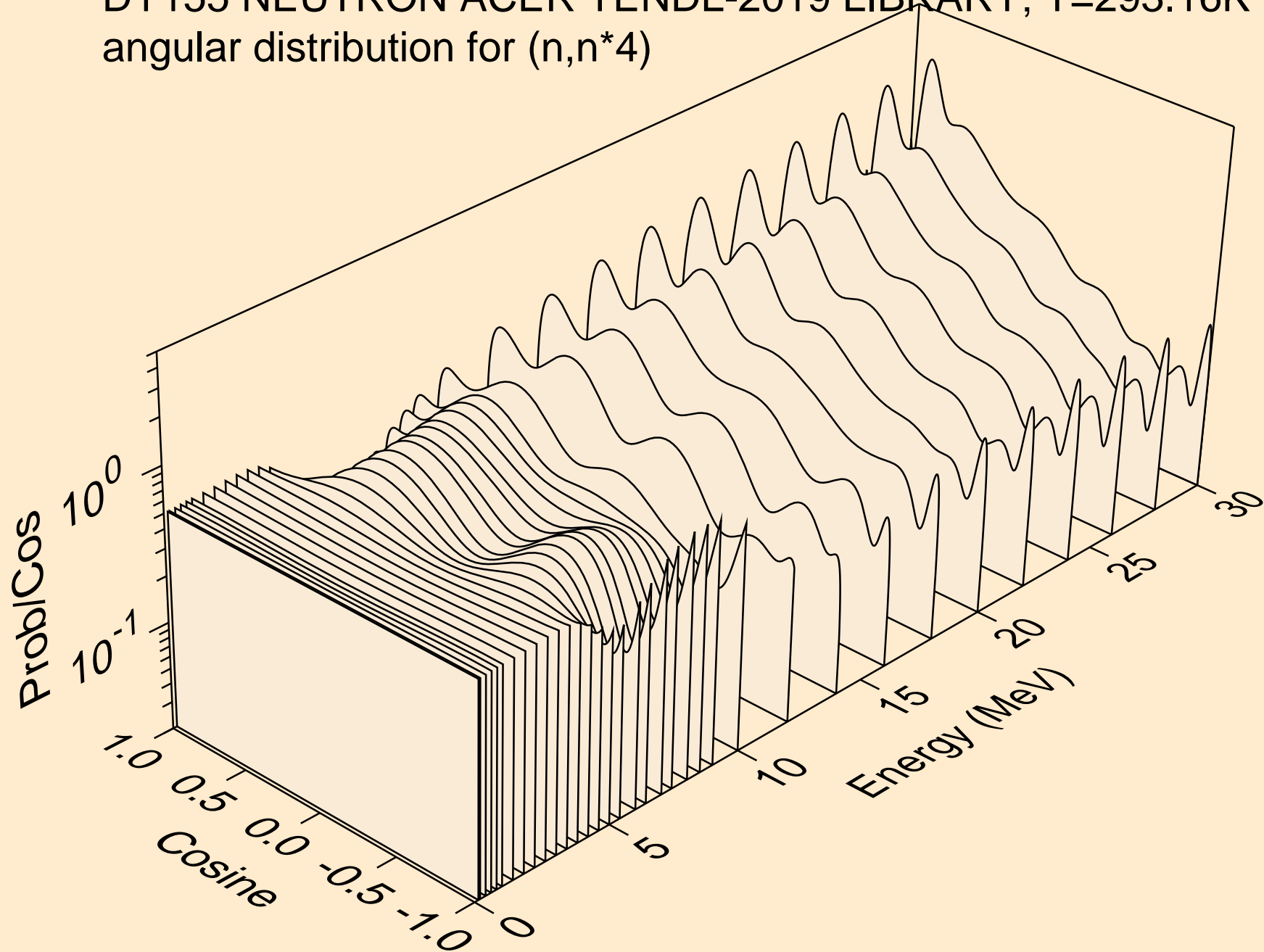

DY155 NEUTRON ACER TENDL-2019 LIBRARY; T=293.16K
angular distribution for (n,n*5)

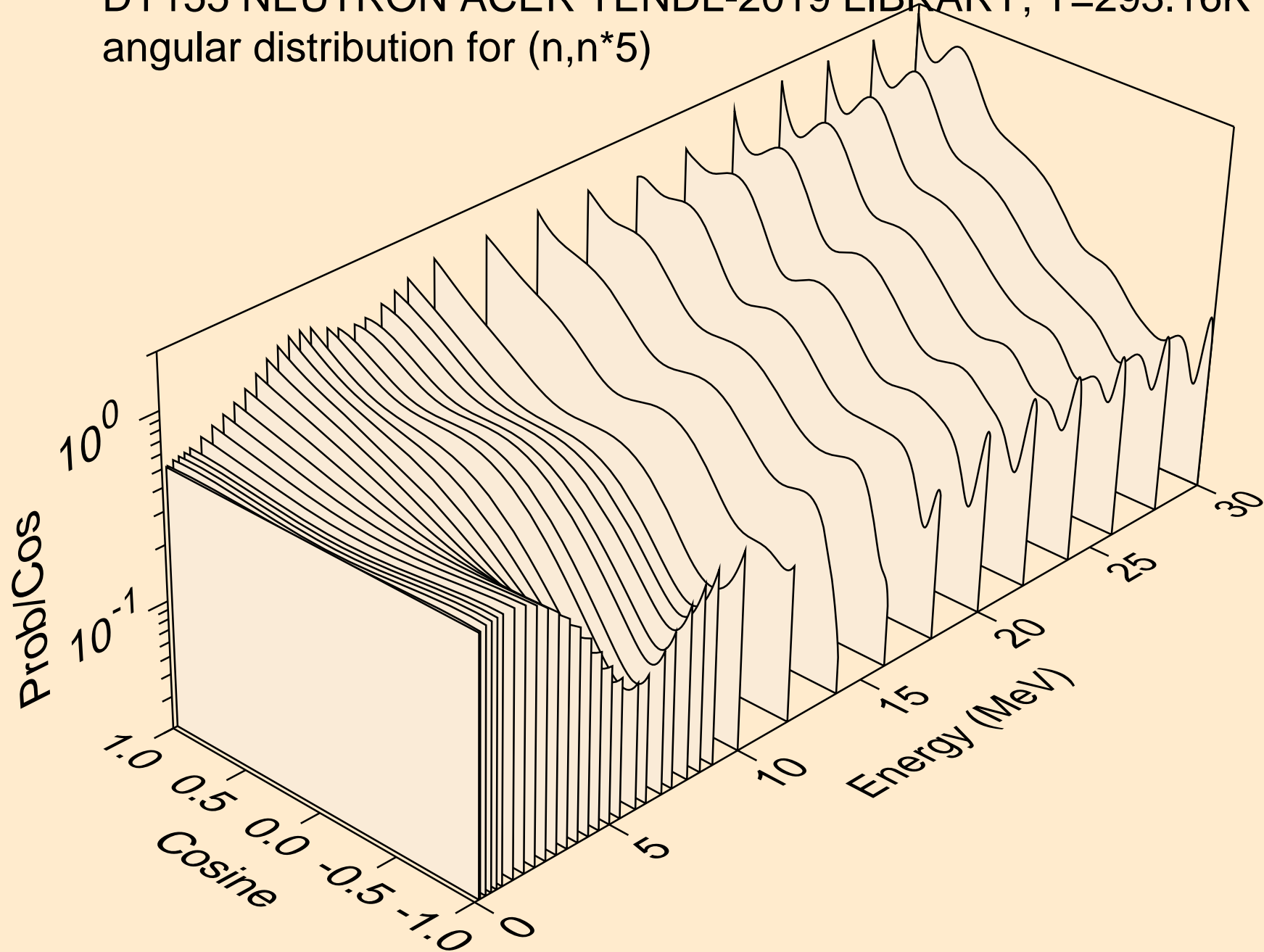

DY155 NEUTRON ACER TENDL-2019 LIBRARY; T=293.16K
angular distribution for (n,n*6)

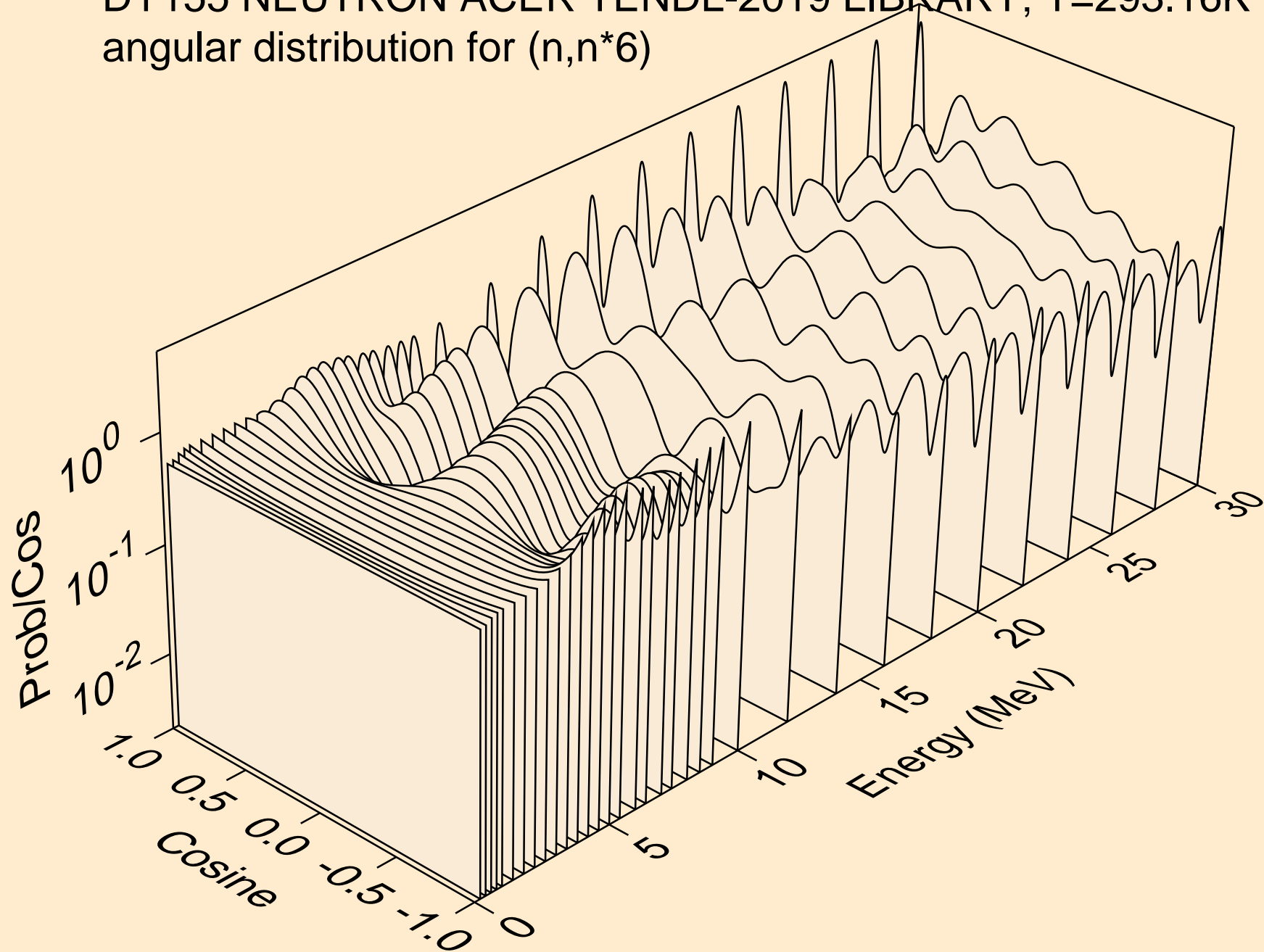

DY155 NEUTRON ACER TENDL-2019 LIBRARY; T=293.16K
angular distribution for (n,n*7)

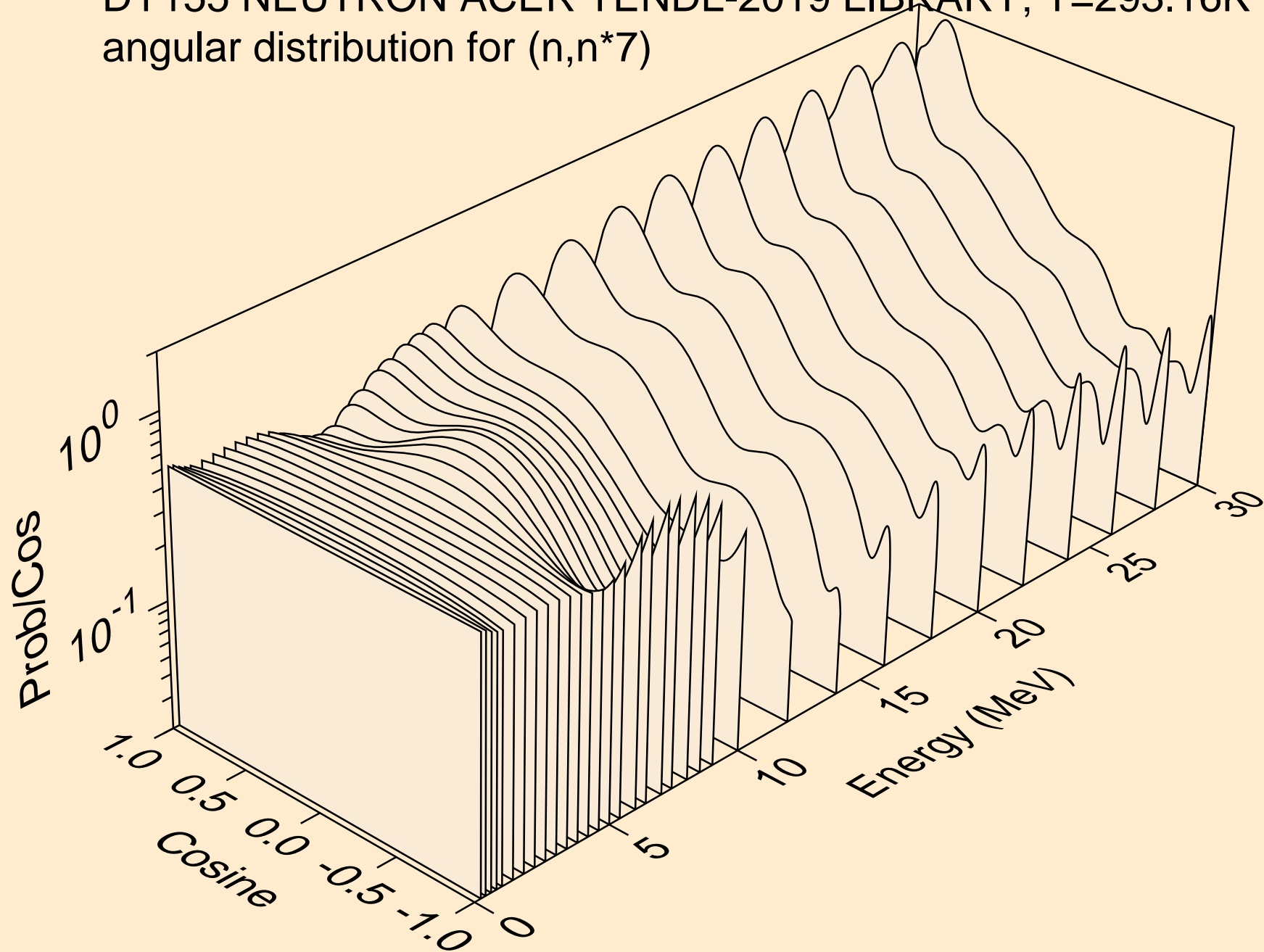

DY155 NEUTRON ACER TENDL-2019 LIBRARY; T=293.16K
angular distribution for (n,n*8)

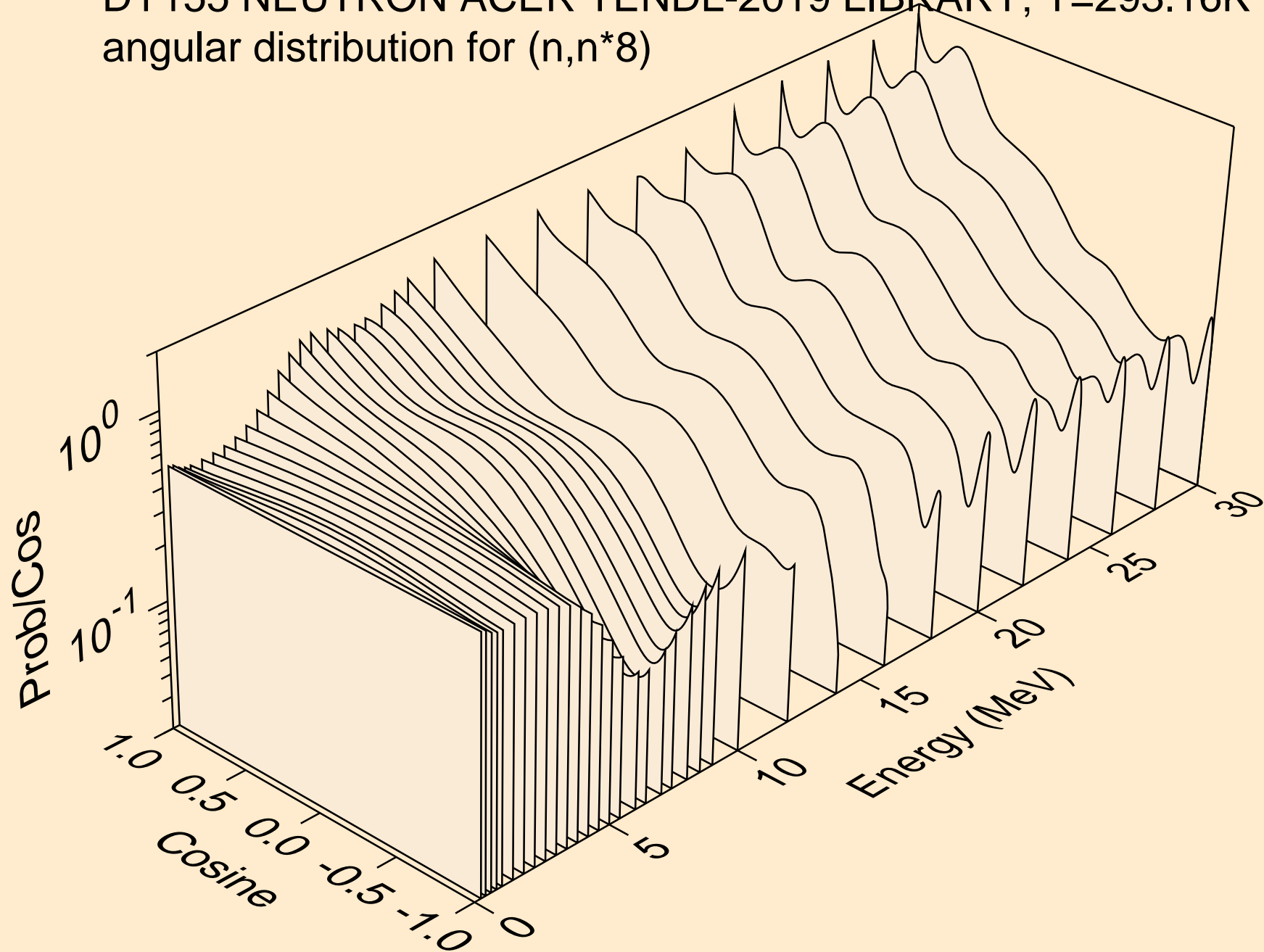

DY155 NEUTRON ACER TENDL-2019 LIBRARY; T=293.16K
angular distribution for (n,n*9)

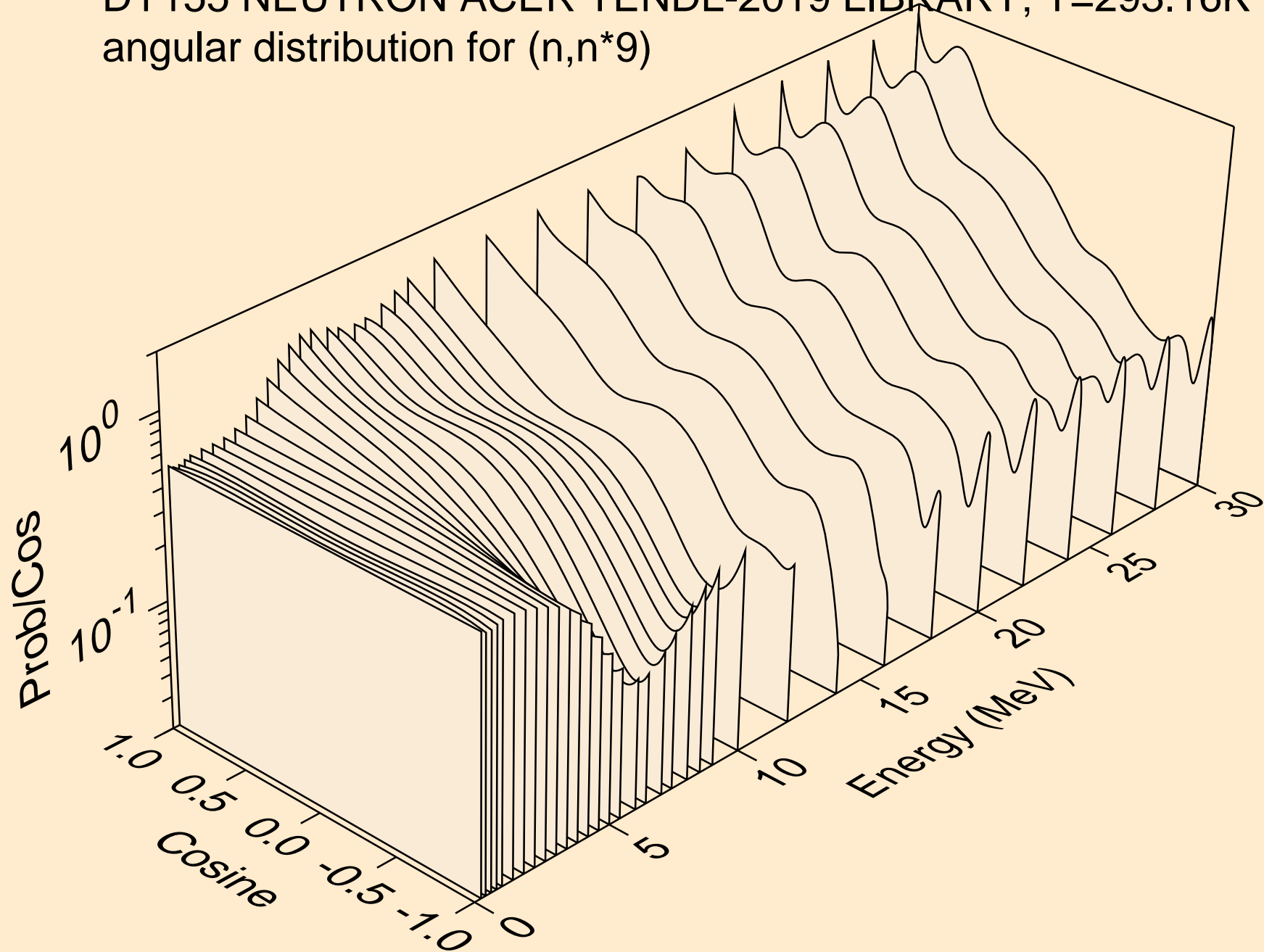

DY155 NEUTRON ACER TENDL-2019 LIBRARY; T=293.16K
angular distribution for (n,n*10)

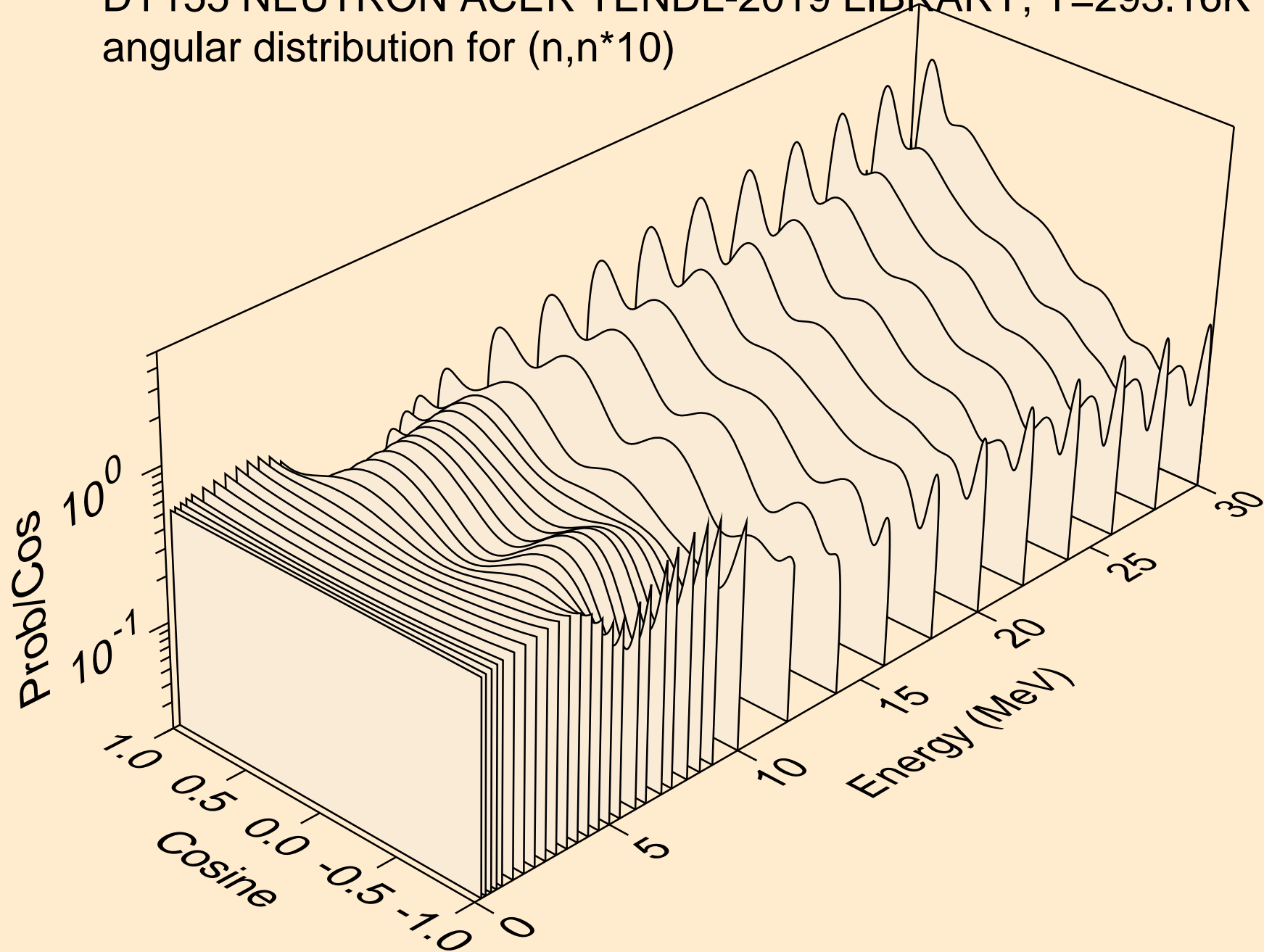

DY155 NEUTRON ACER TENDL-2019 LIBRARY; T=293.16K
angular distribution for (n,n*11)

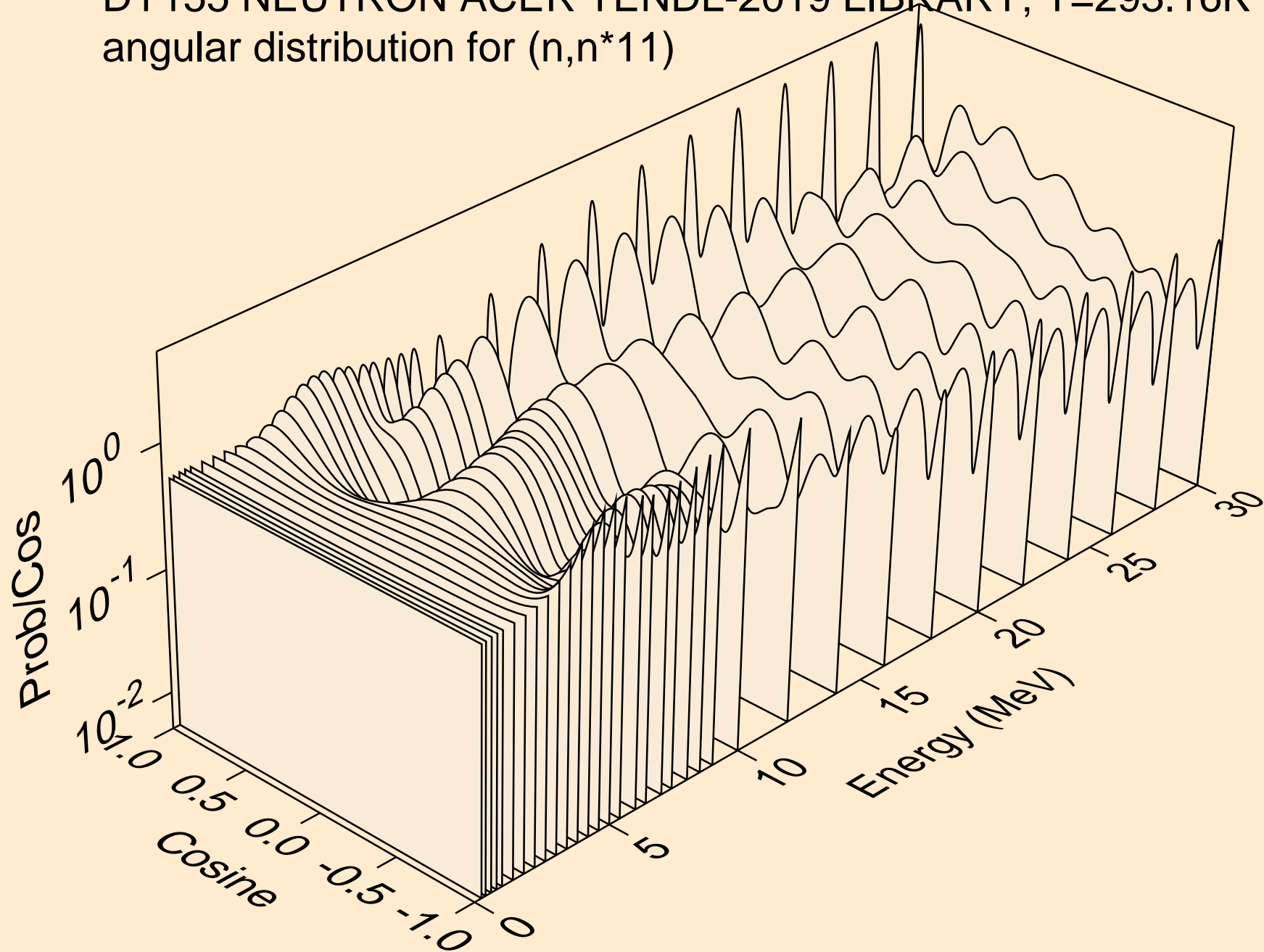

DY155 NEUTRON ACER TENDL-2019 LIBRARY; T=293.16K
angular distribution for (n,n*12)

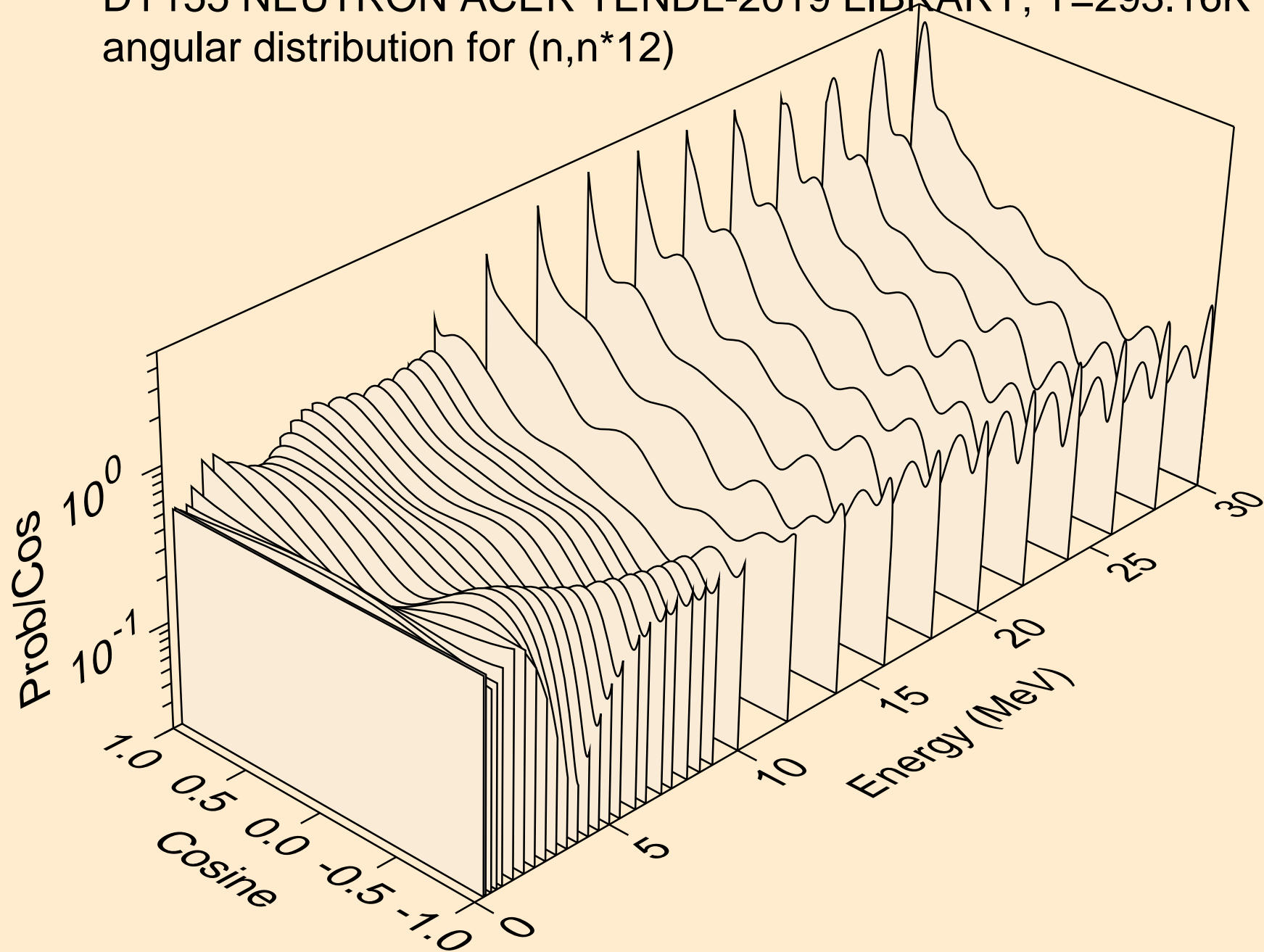

DY155 NEUTRON ACER TENDL-2019 LIBRARY; T=293.16K
angular distribution for (n,n*13)

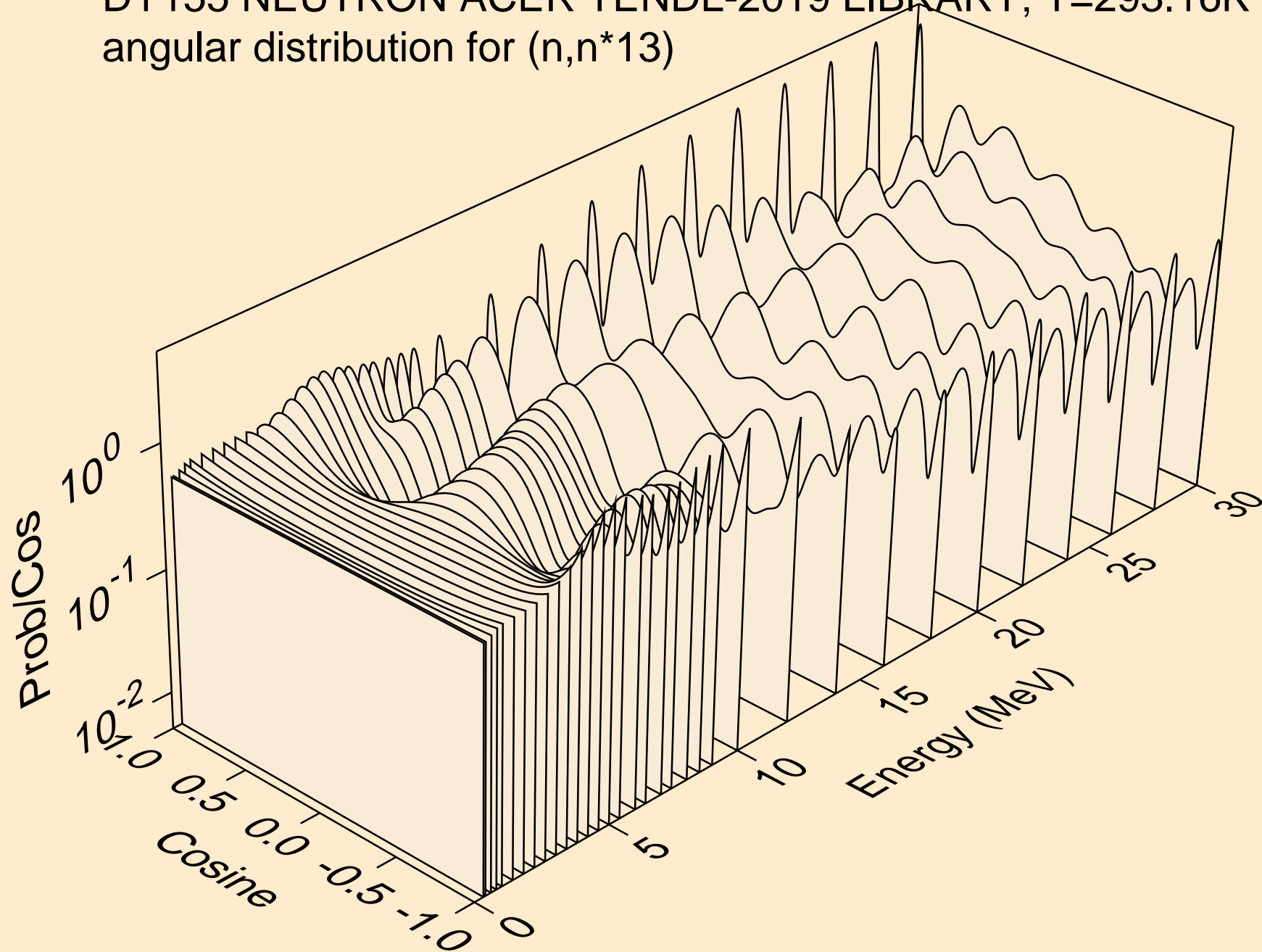

DY155 NEUTRON ACER TENDL-2019 LIBRARY; T=293.16K
angular distribution for (n,n*14)

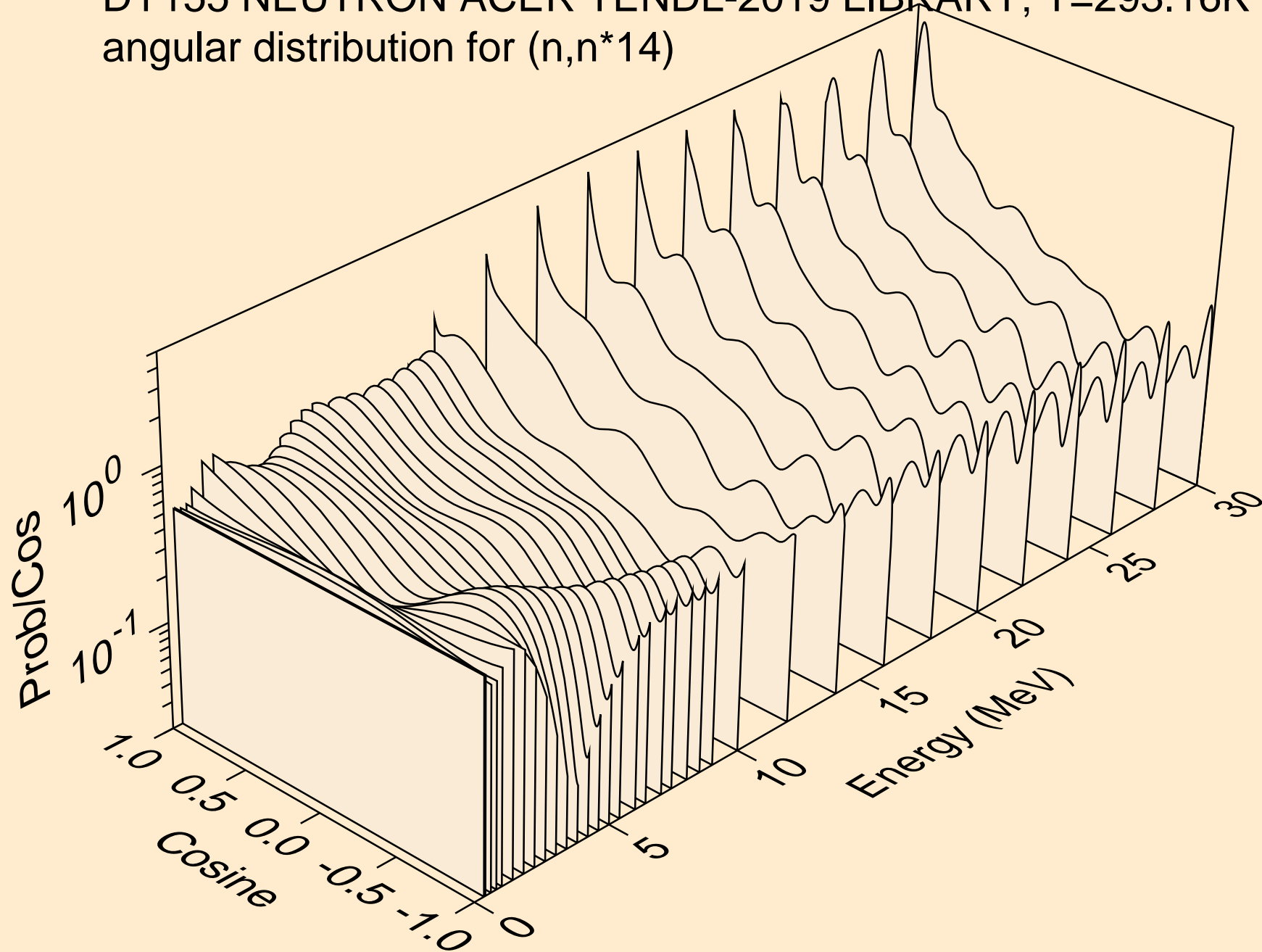

DY155 NEUTRON ACER TENDL-2019 LIBRARY; T=293.16K
angular distribution for (n,n*15)

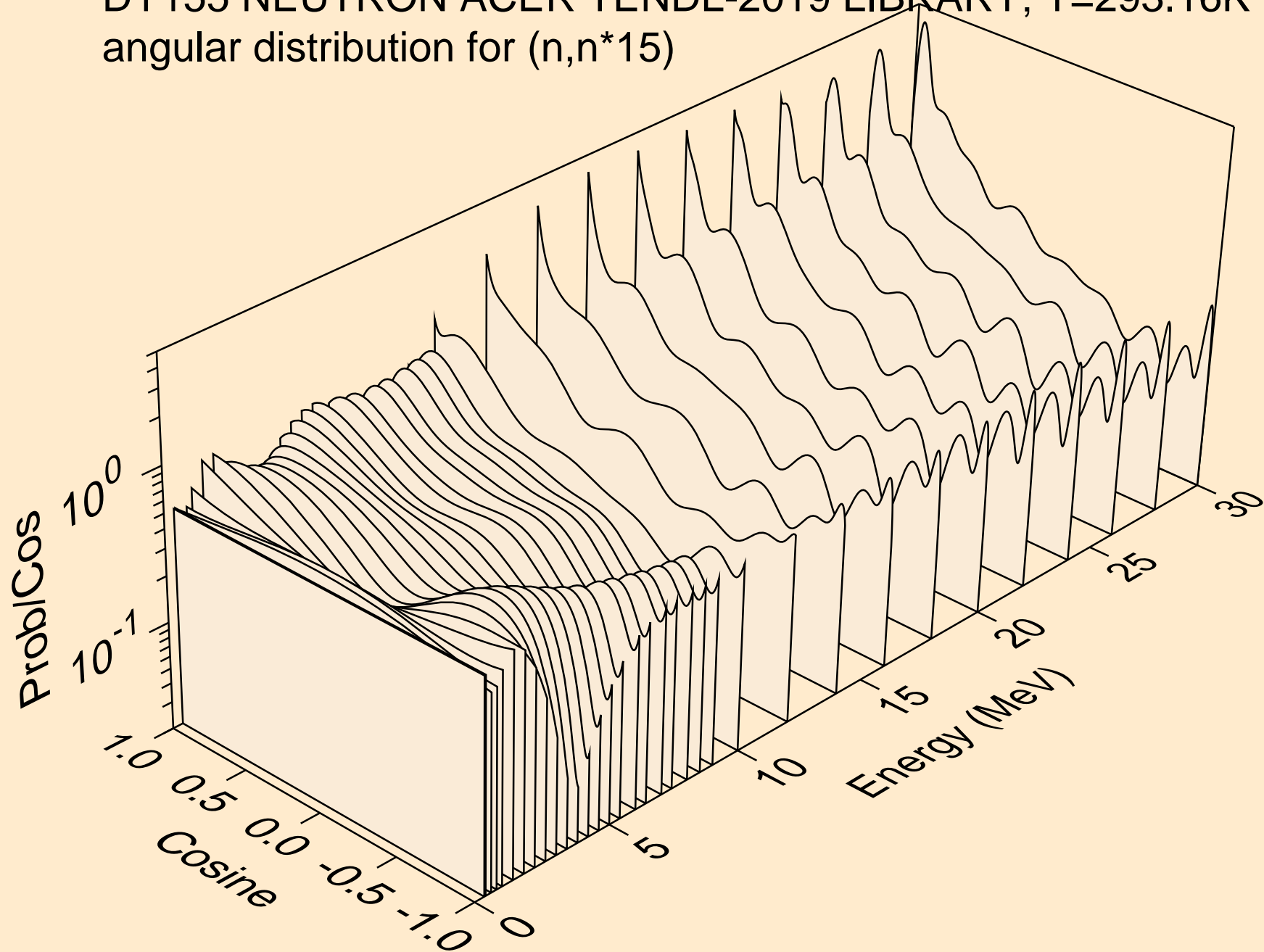

DY155 NEUTRON ACER TENDL-2019 LIBRARY; T=293.16K
angular distribution for (n,n*16)

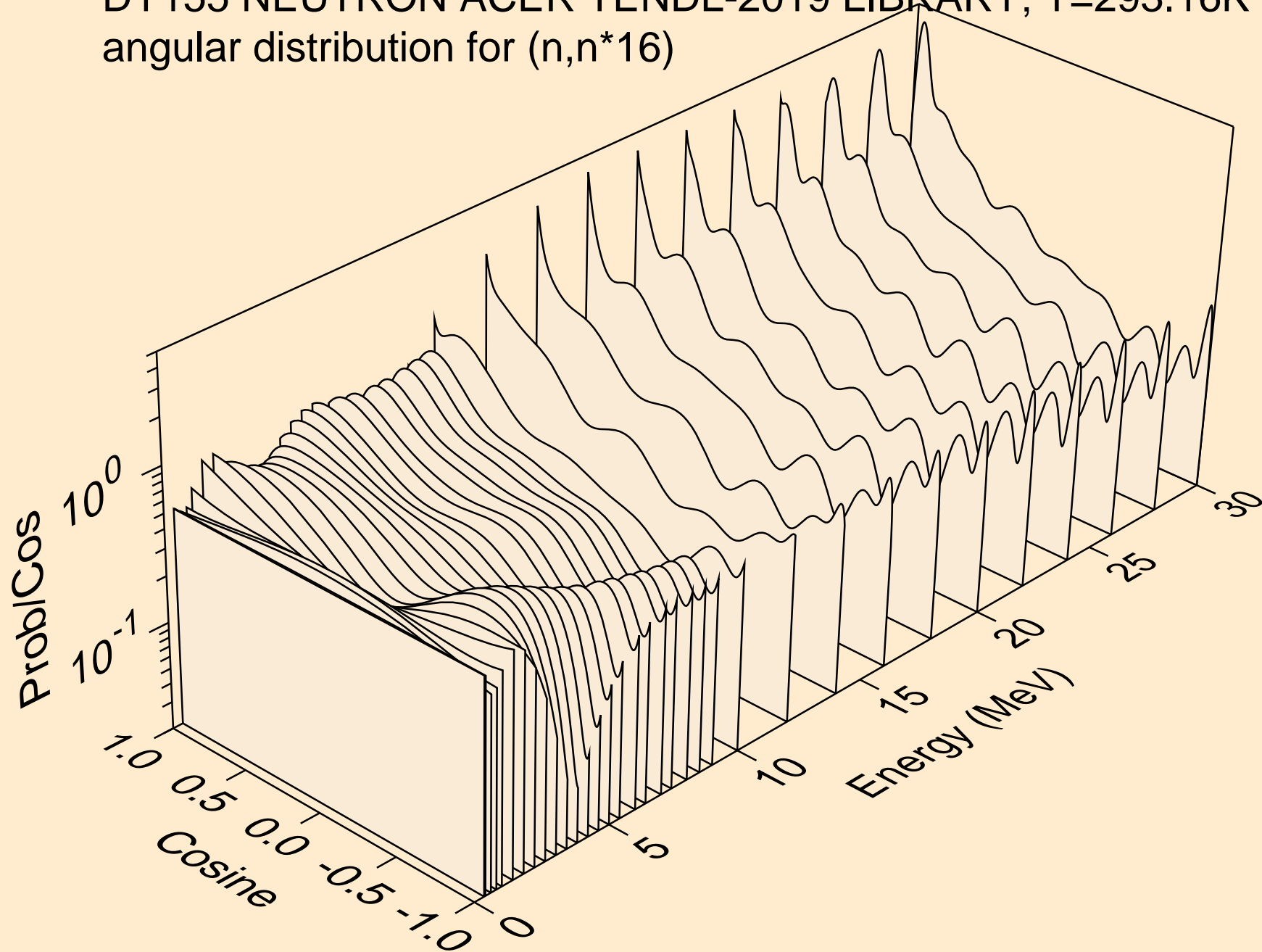

DY155 NEUTRON ACER TENDL-2019 LIBRARY; T=293.16K
angular distribution for (n,n*17)

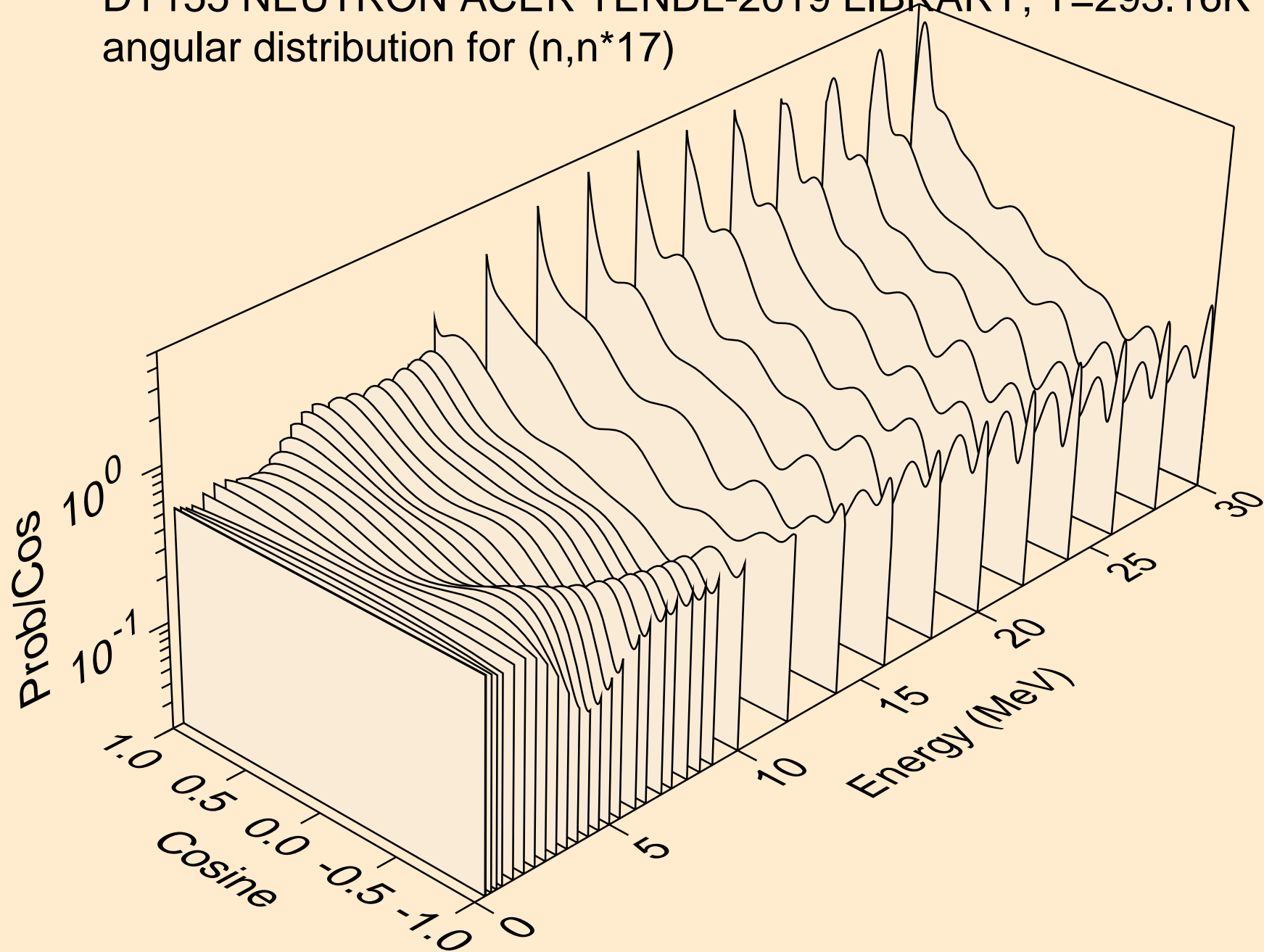

DY155 NEUTRON ACER TENDL-2019 LIBRARY; T=293.16K
angular distribution for (n,n*18)

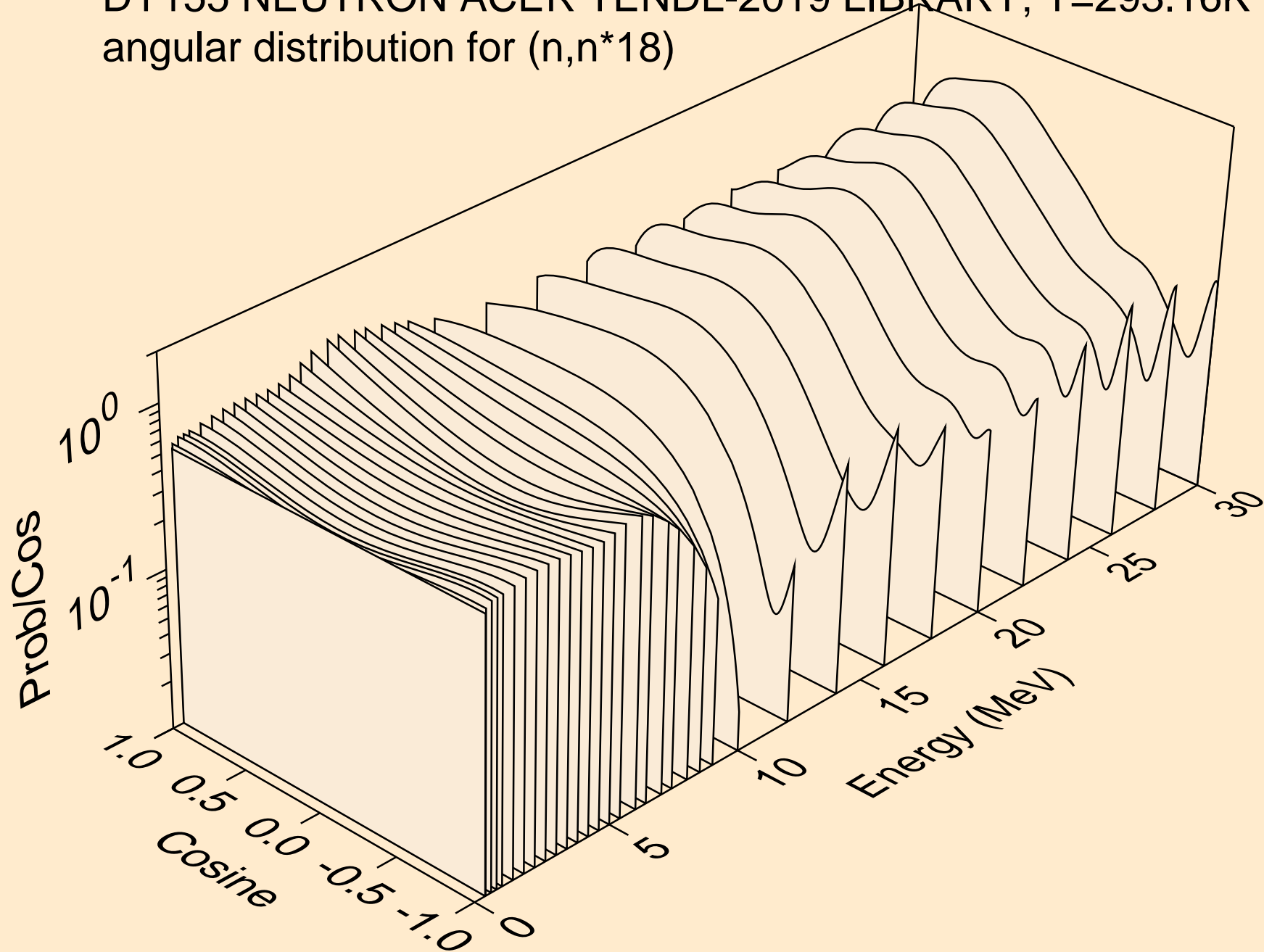

DY155 NEUTRON ACER TENDL-2019 LIBRARY; T=293.16K
angular distribution for (n,n*19)

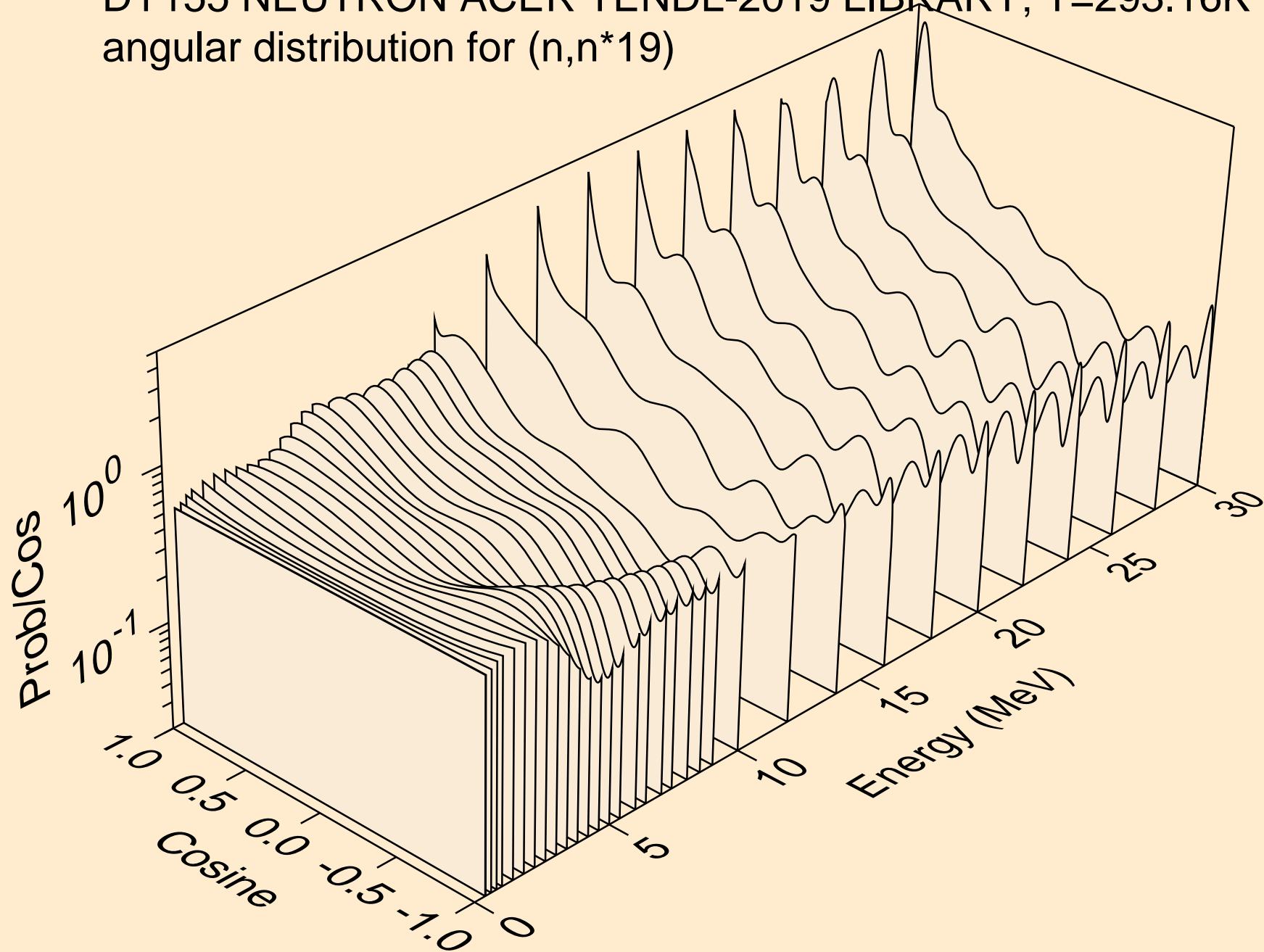

DY155 NEUTRON ACER TENDL-2019 LIBRARY; T=293.16K
angular distribution for (n,n*20)

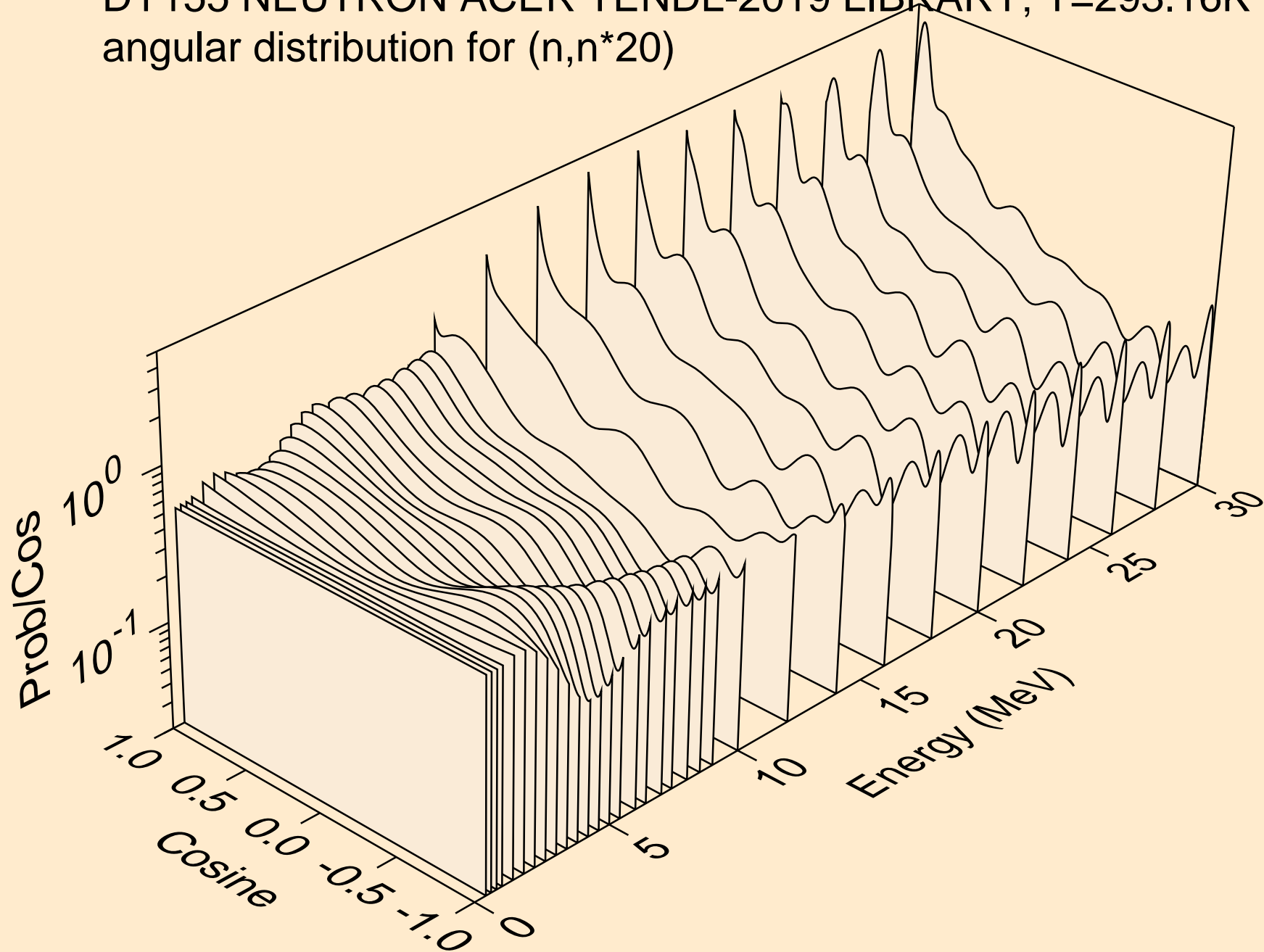

DY155 NEUTRON ACER TENDL-2019 LIBRARY; T=293.16K
angular distribution for (n,n*21)

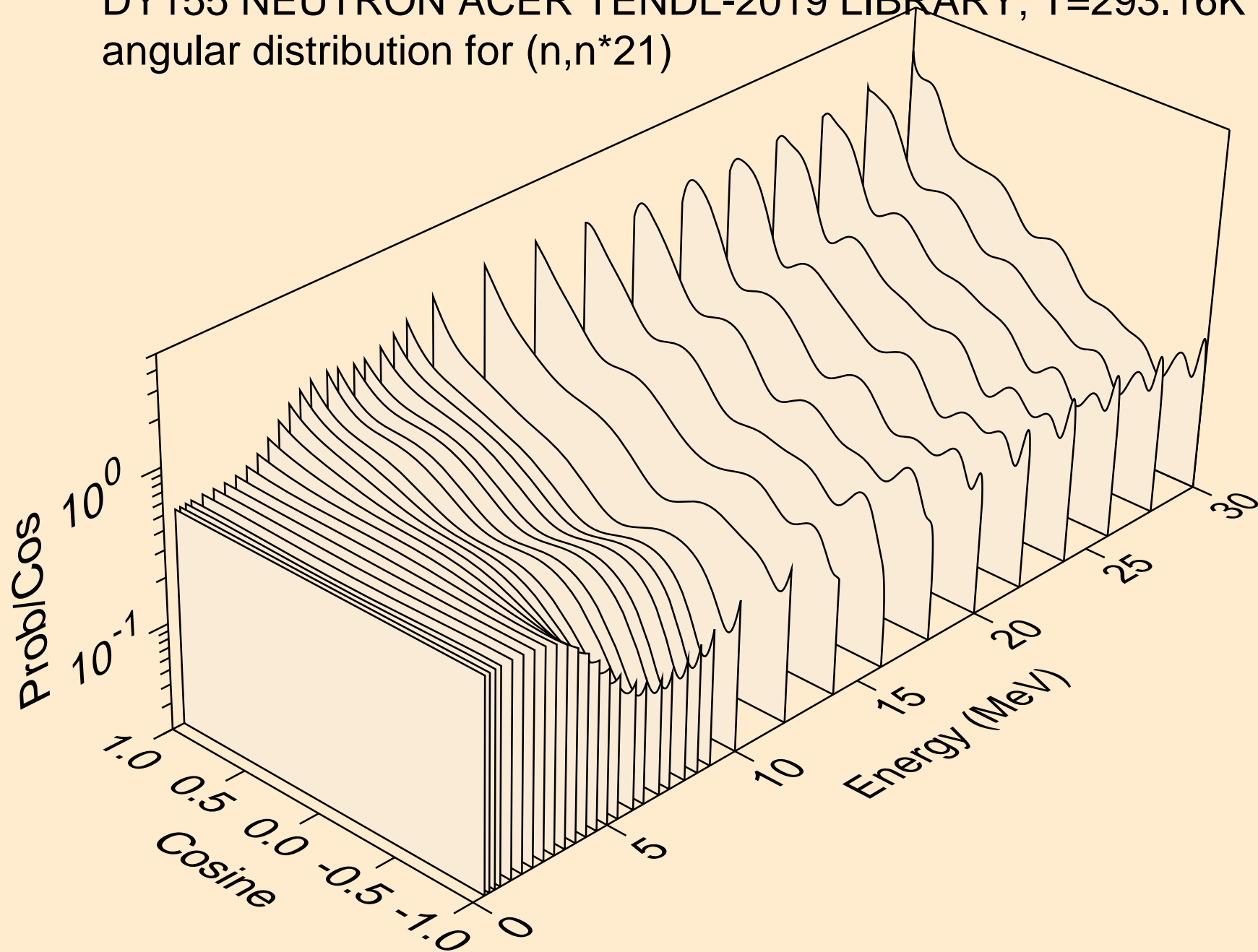

DY155 NEUTRON ACER TENDL-2019 LIBRARY; T=293.16K
angular distribution for (n,n*22)

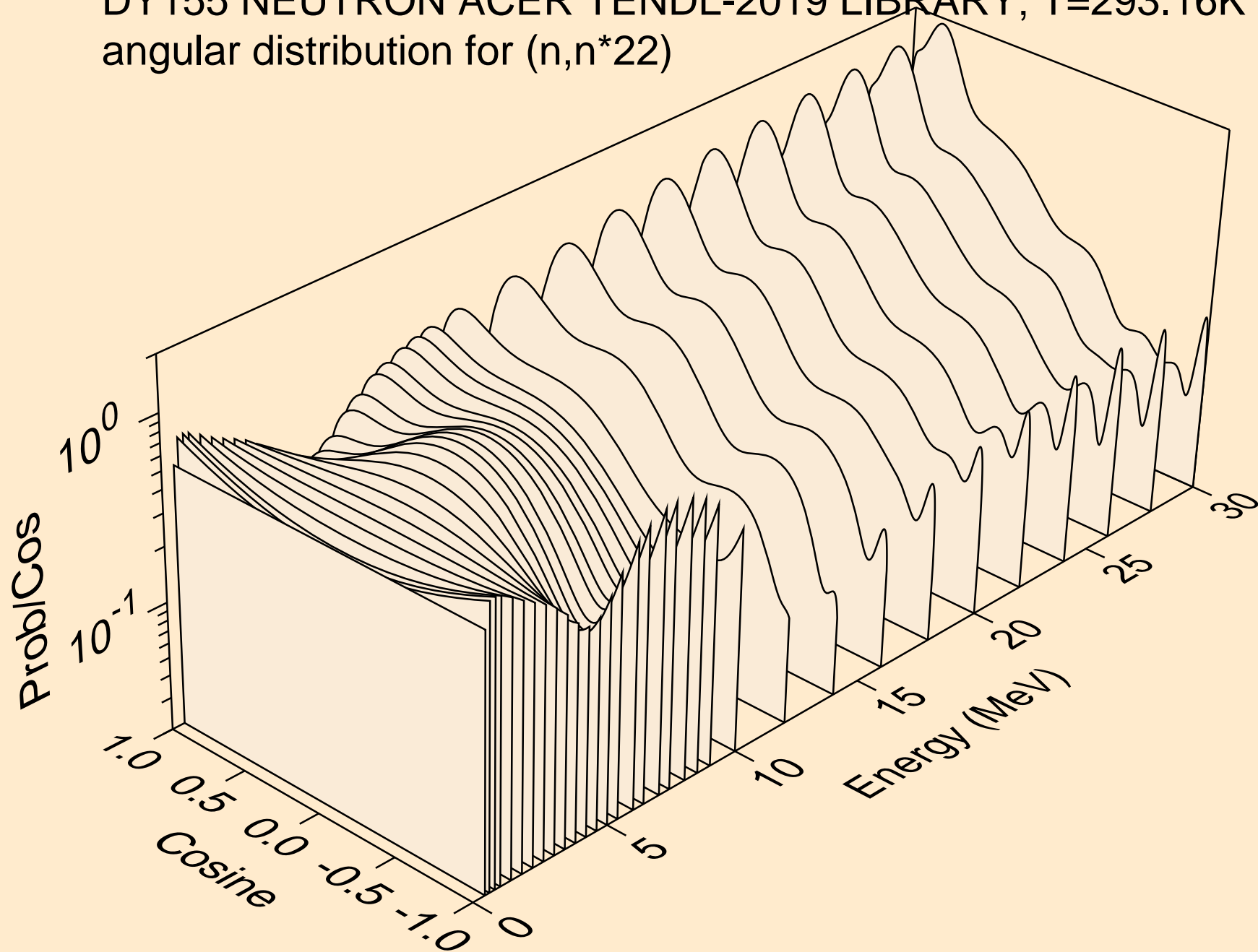

DY155 NEUTRON ACER TENDL-2019 LIBRARY; T=293.16K
angular distribution for (n,n*23)

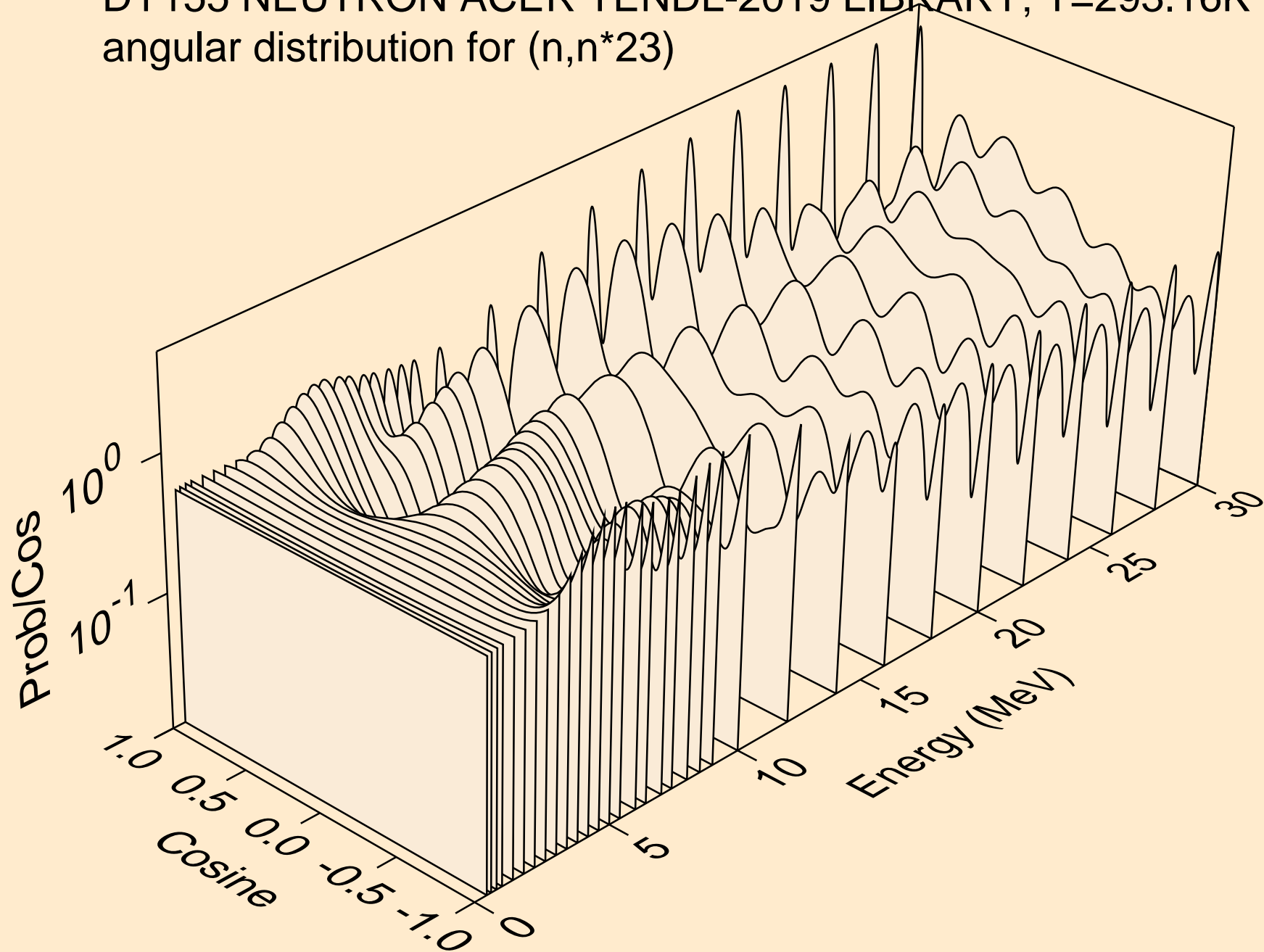

DY155 NEUTRON ACER TENDL-2019 LIBRARY; T=293.16K
angular distribution for (n,n*24)

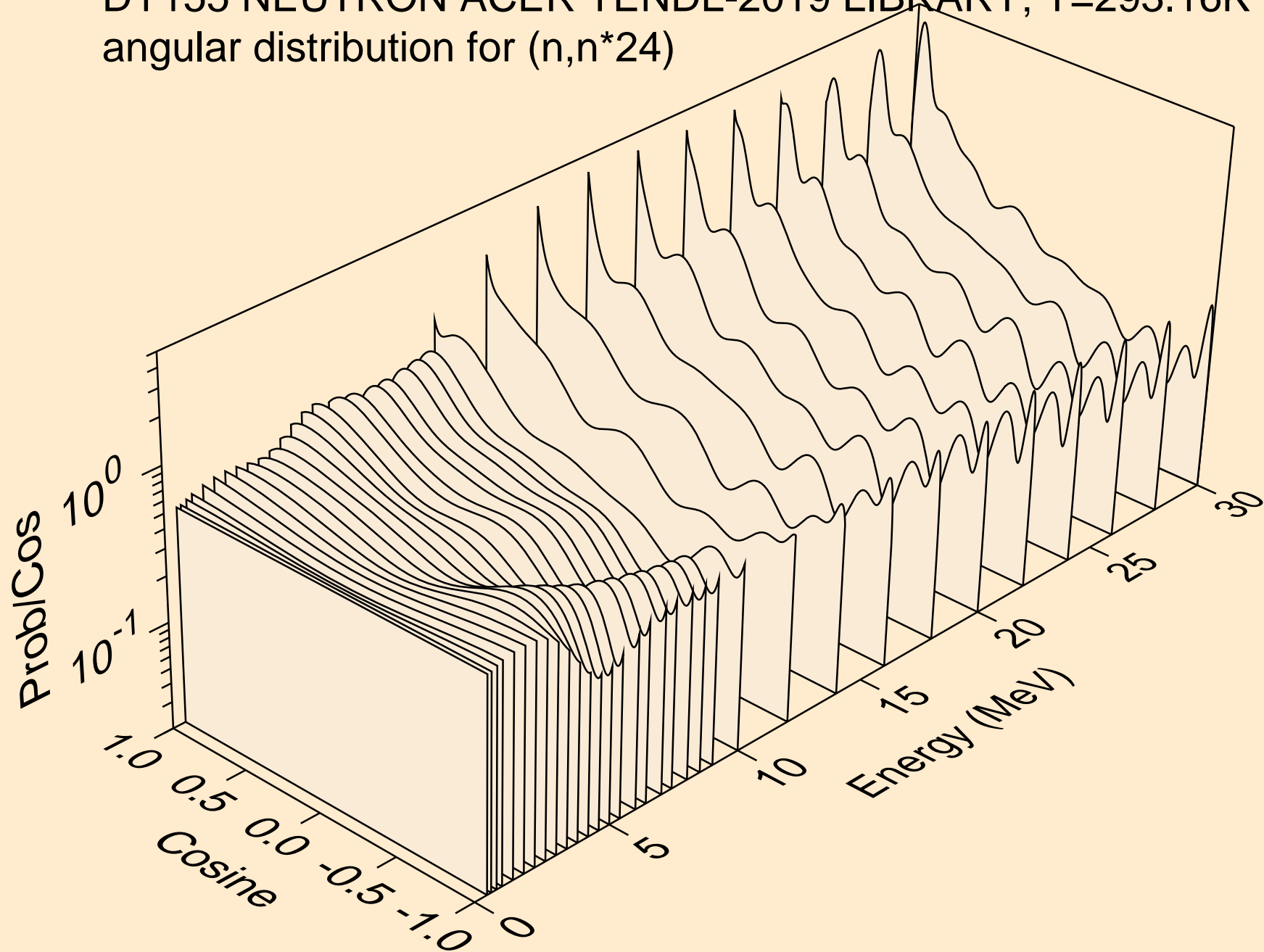

DY155 NEUTRON ACER TENDL-2019 LIBRARY; T=293.16K
angular distribution for (n,n*25)

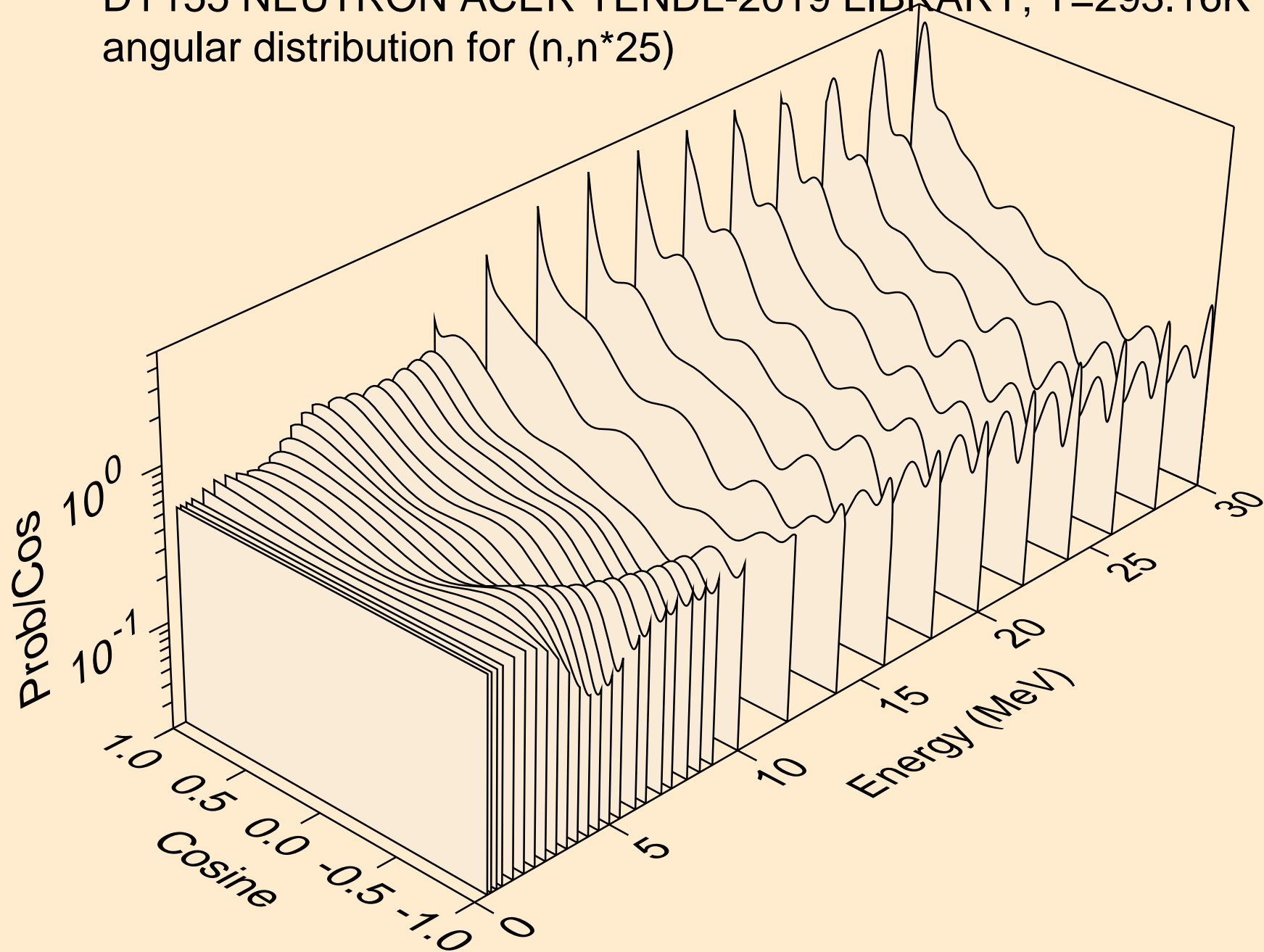

DY155 NEUTRON ACER TENDL-2019 LIBRARY; T=293.16K
angular distribution for (n,n*26)

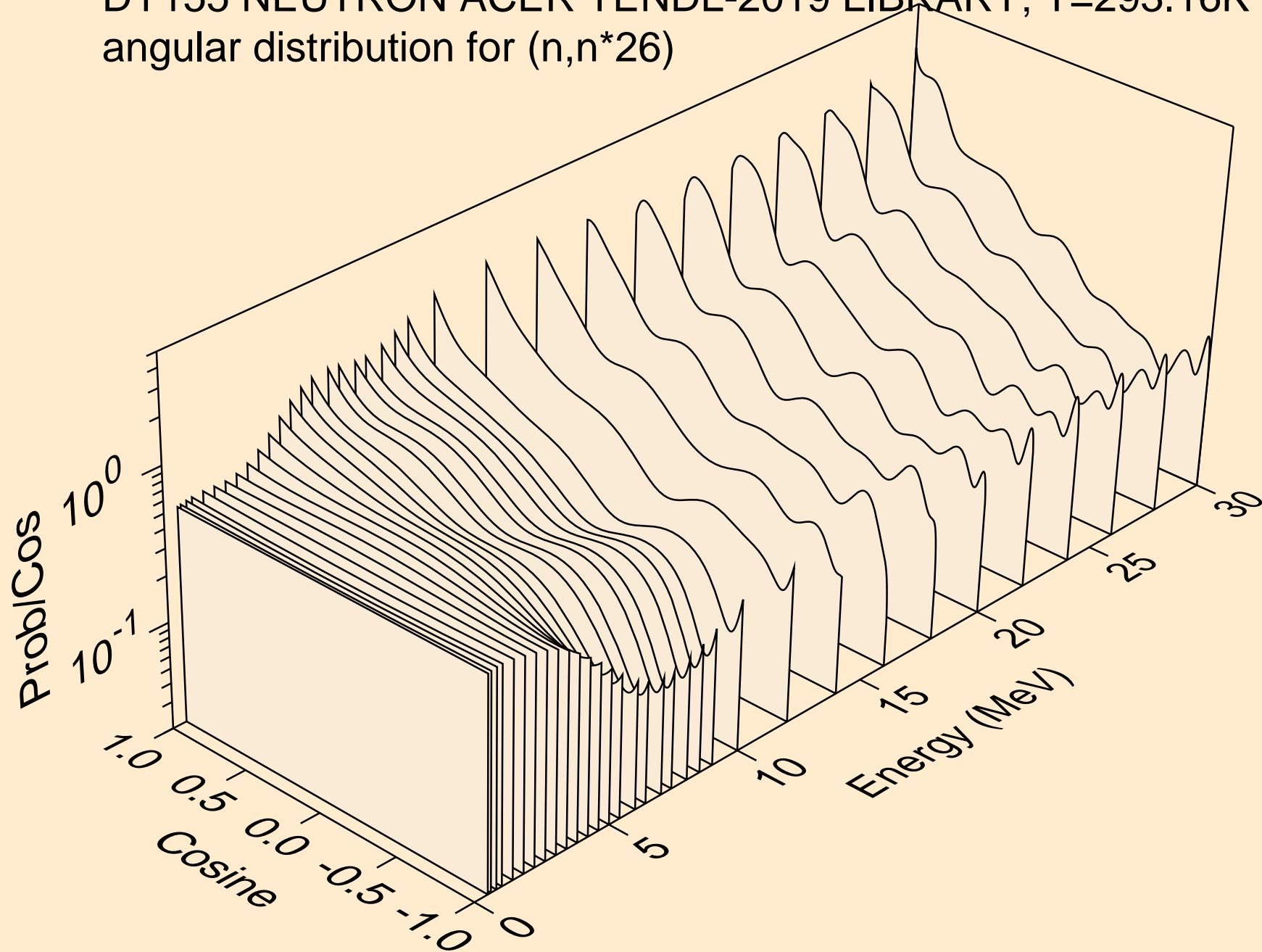

DY155 NEUTRON ACER TENDL-2019 LIBRARY; T=293.16K
angular distribution for (n,n*27)

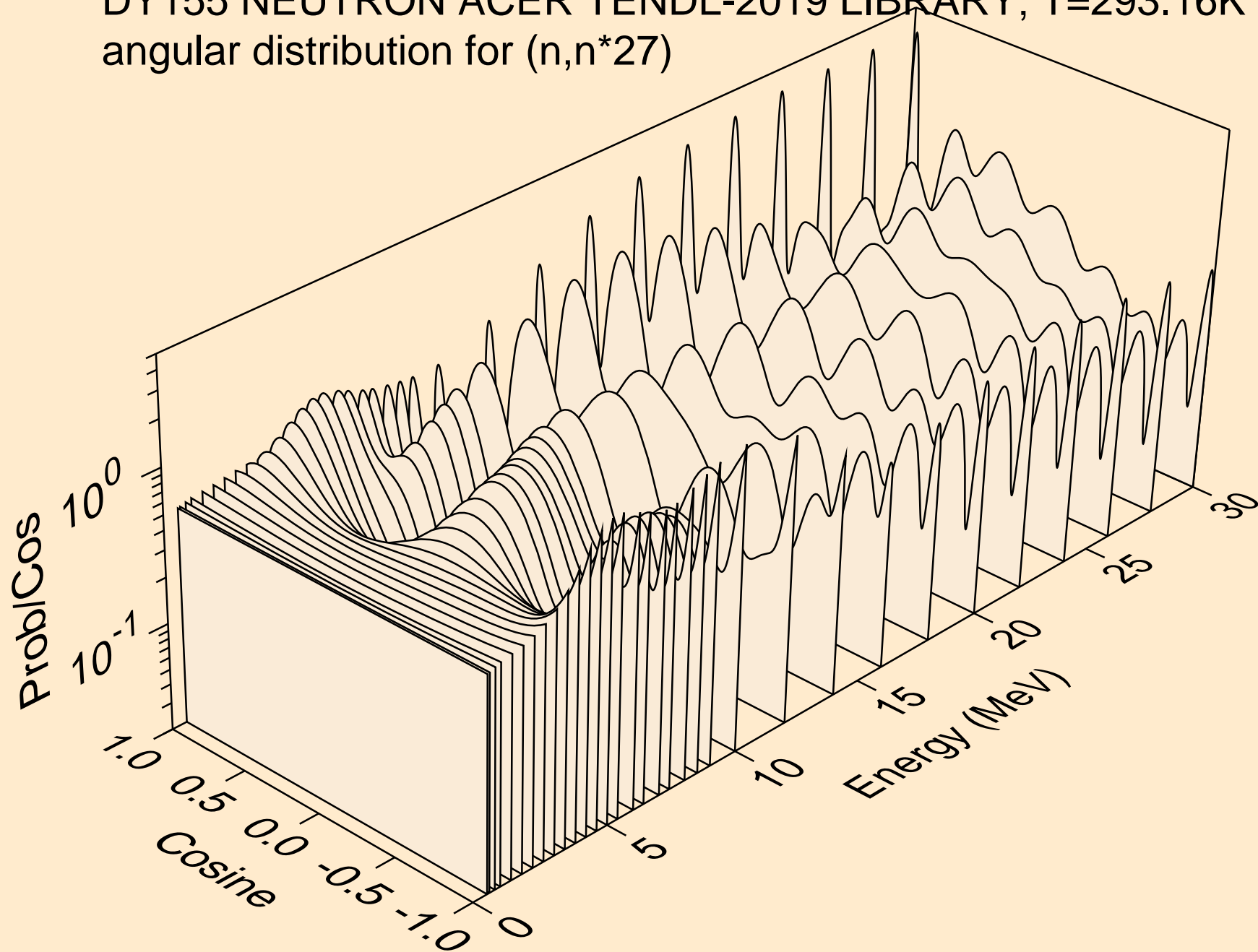

DY155 NEUTRON ACER TENDL-2019 LIBRARY; T=293.16K
angular distribution for (n,n*28)

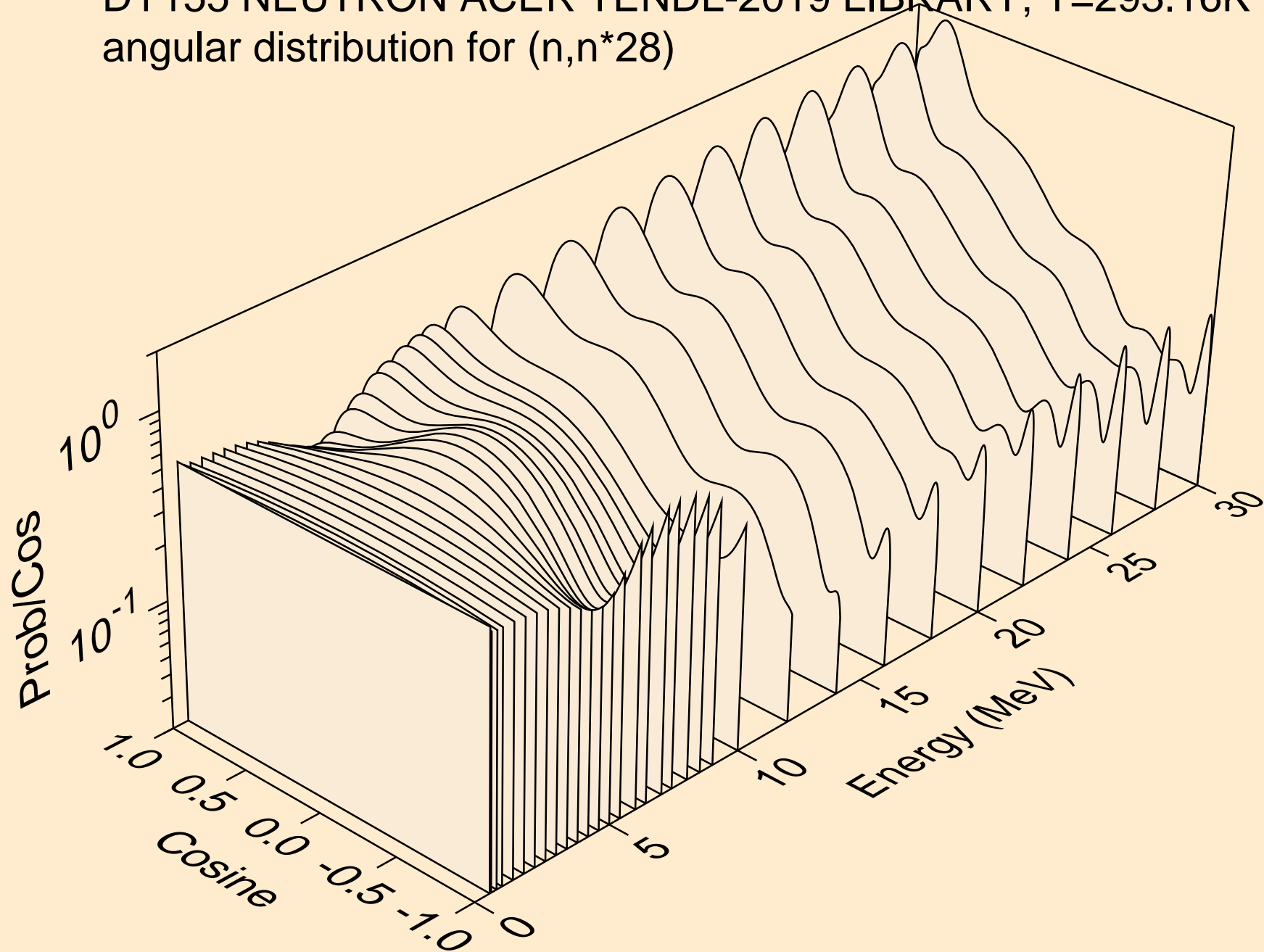

DY155 NEUTRON ACER TENDL-2019 LIBRARY; T=293.16K
angular distribution for (n,n*29)

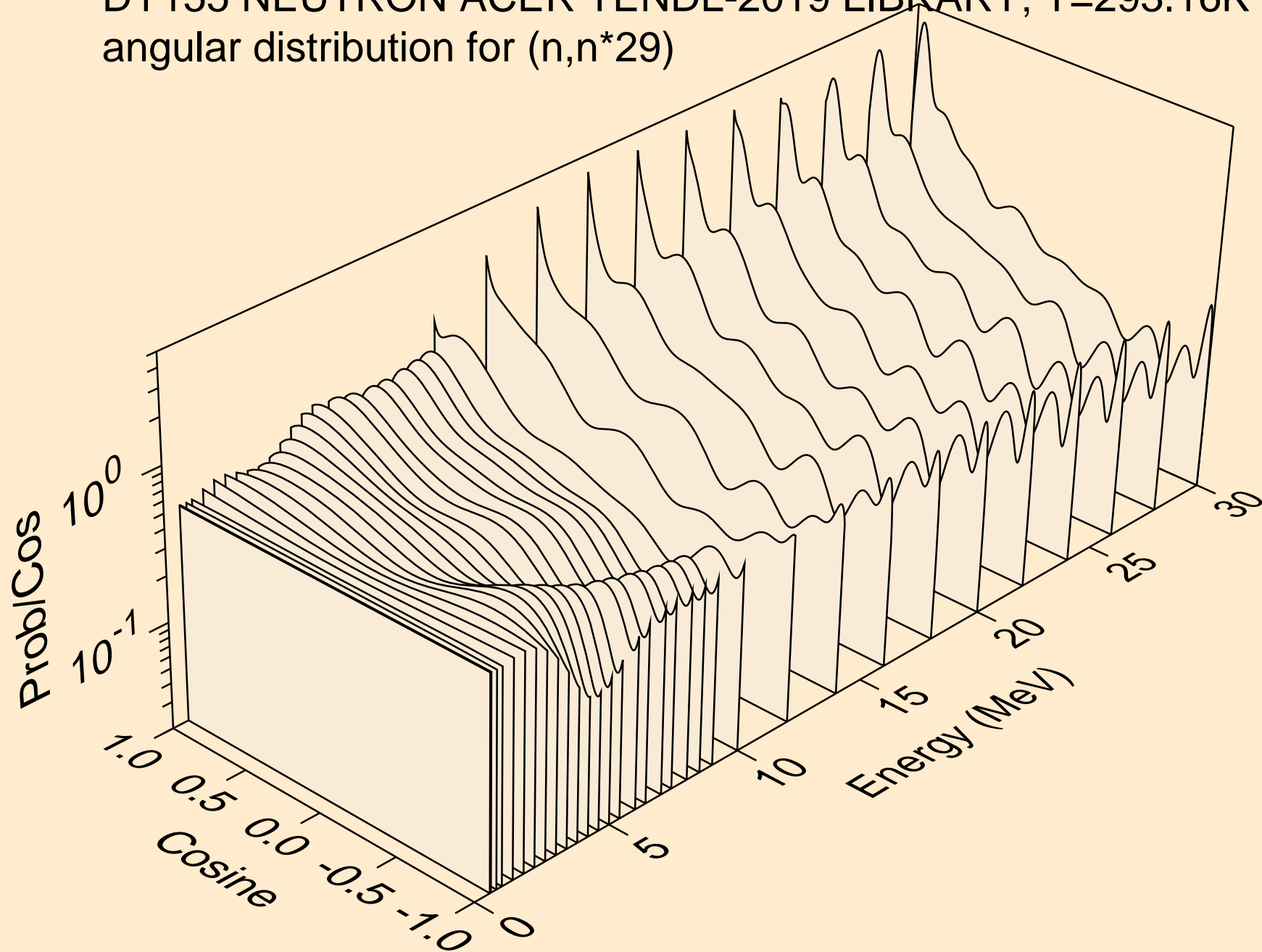

DY155 NEUTRON ACER TENDL-2019 LIBRARY; T=293.16K
angular distribution for (n,n*30)

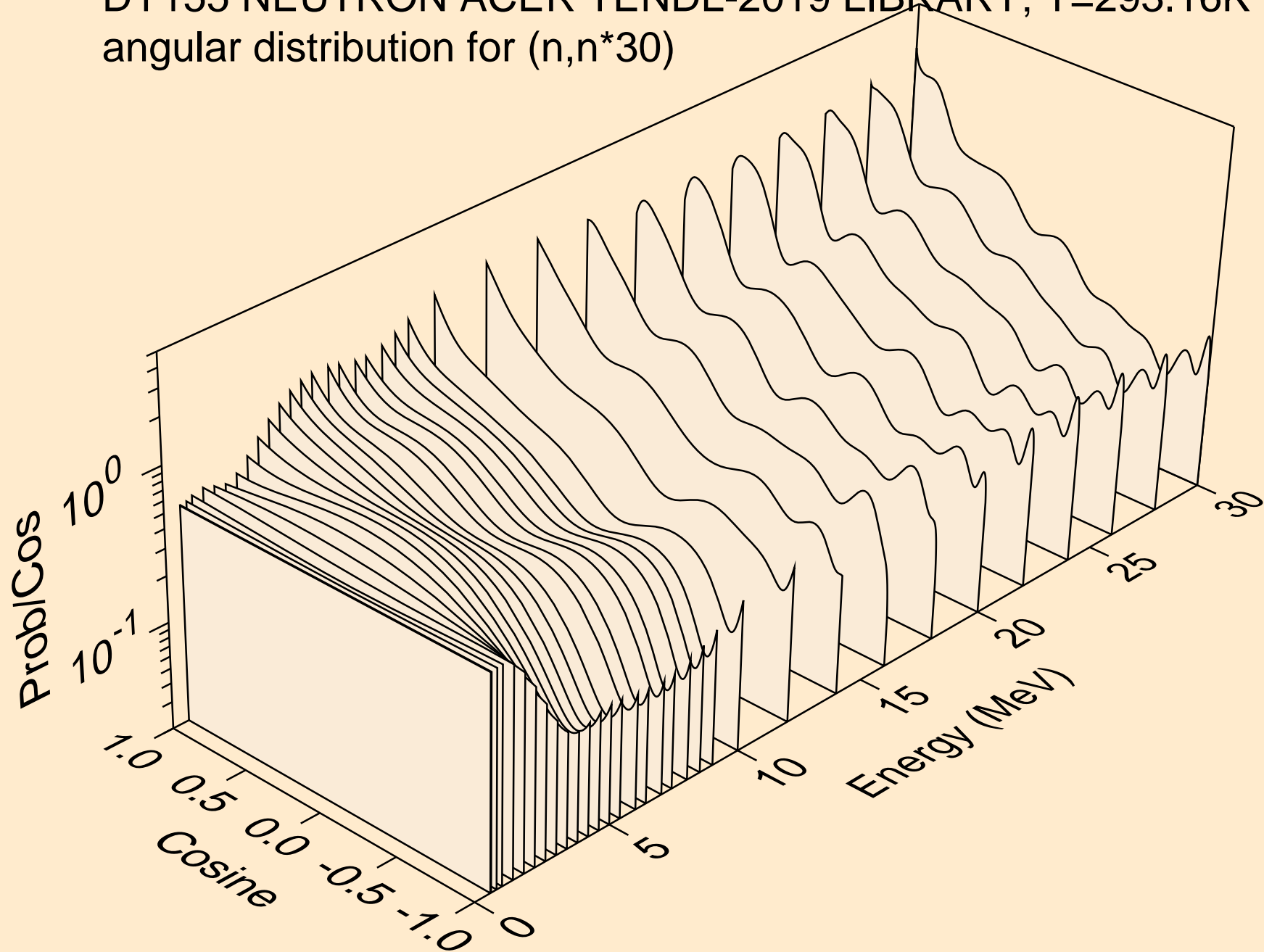

DY155 NEUTRON ACER TENDL-2019 LIBRARY; T=293.16K
Neutron emission for (n,x)

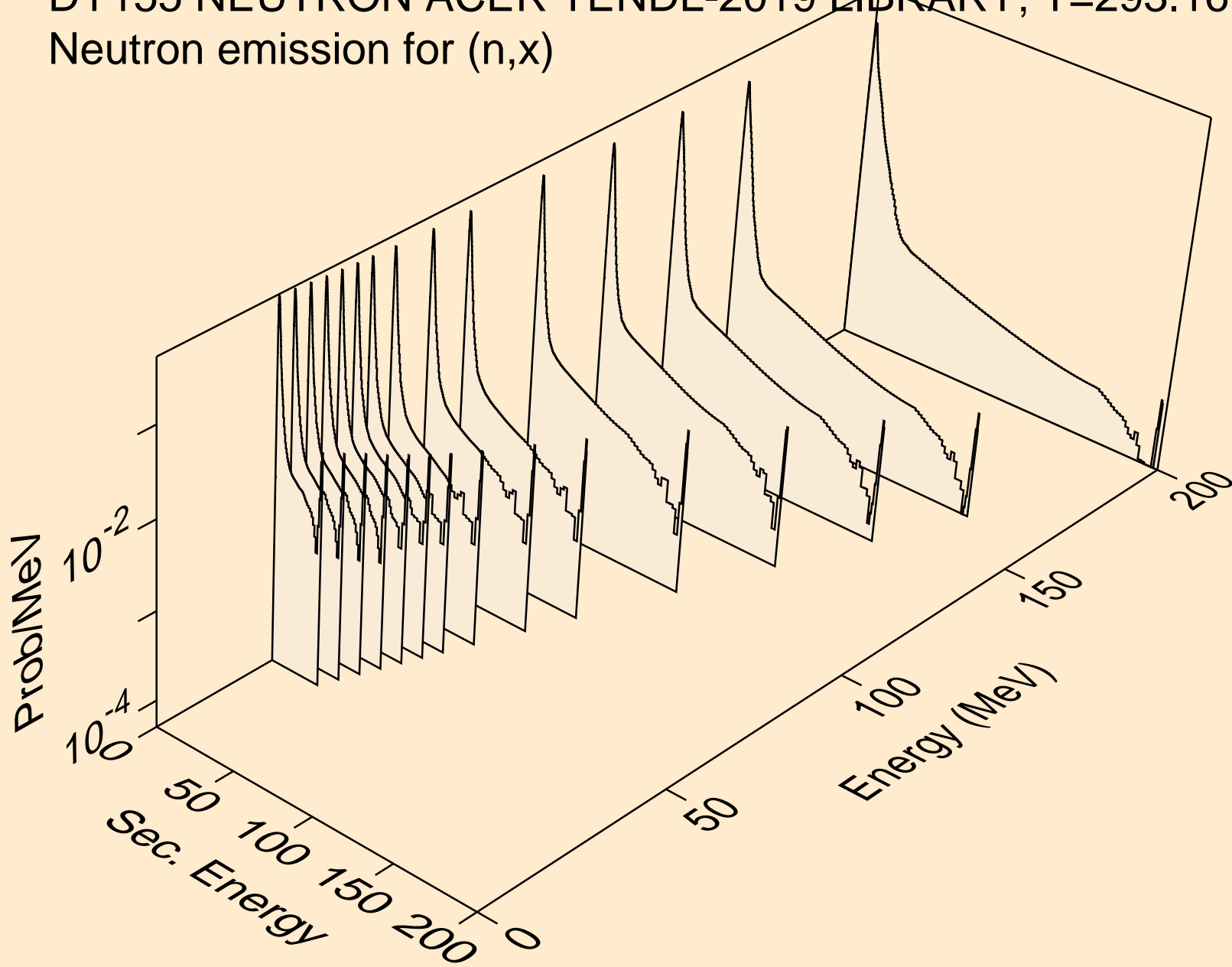

DY155 NEUTRON ACER TENDL-2019 LIBRARY; T=293.16K
Neutron emission for (n,2nd)

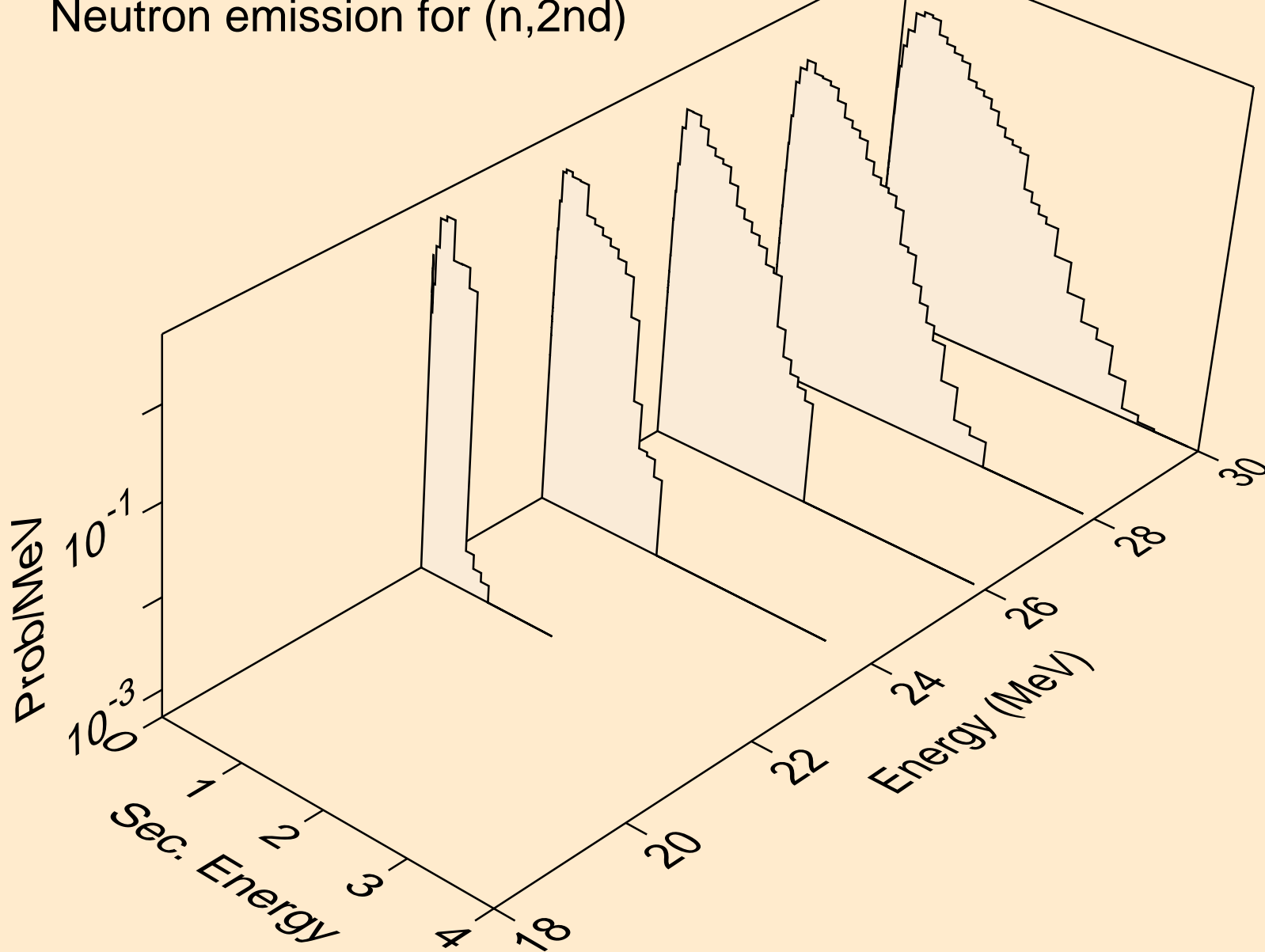

DY155 NEUTRON ACER TENDL-2019 LIBRARY; T=293.16K
Neutron emission for (n,2n)

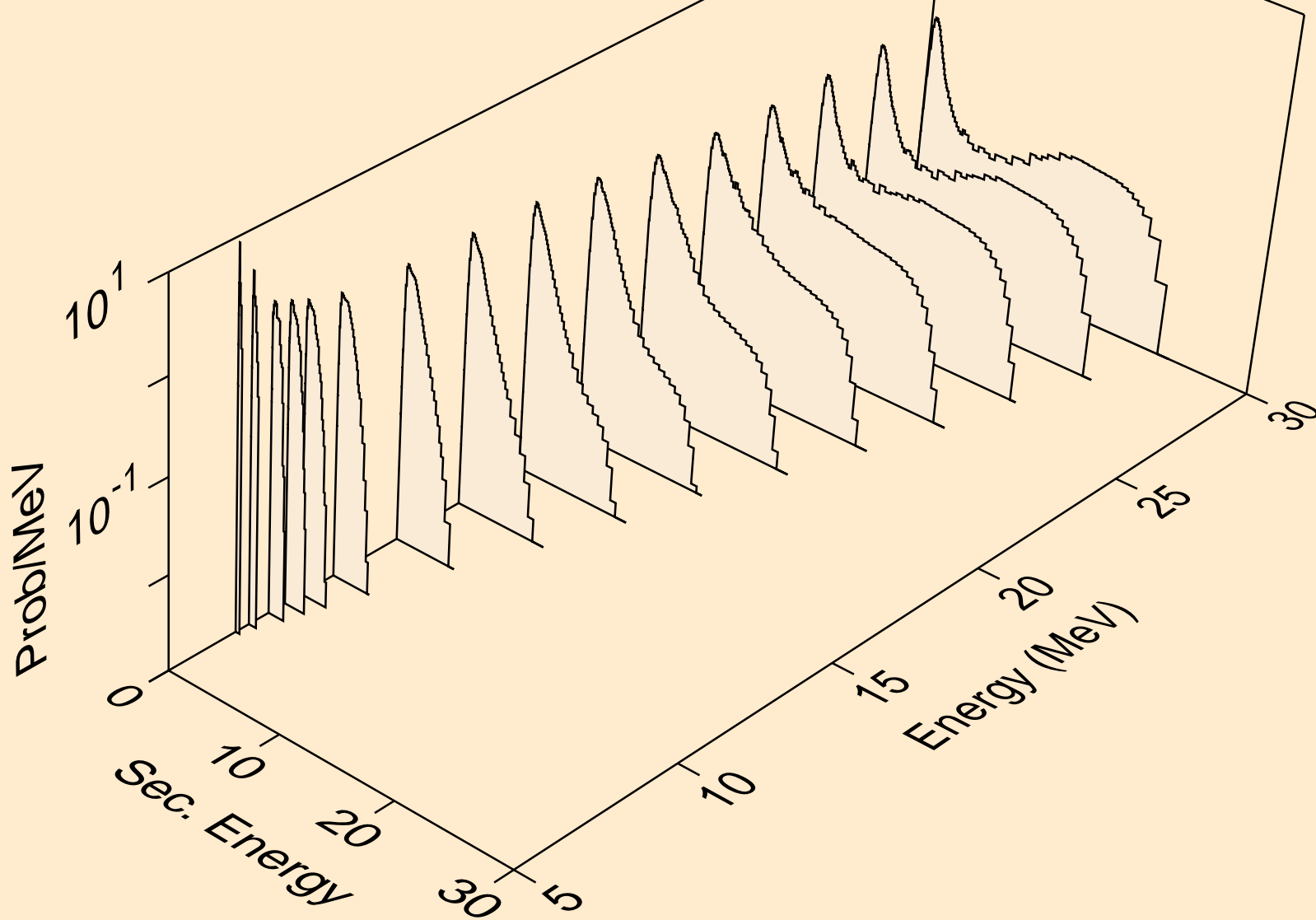

DY155 NEUTRON ACER TENDL-2019 LIBRARY; T=293.16K
Neutron emission for (n,3n)

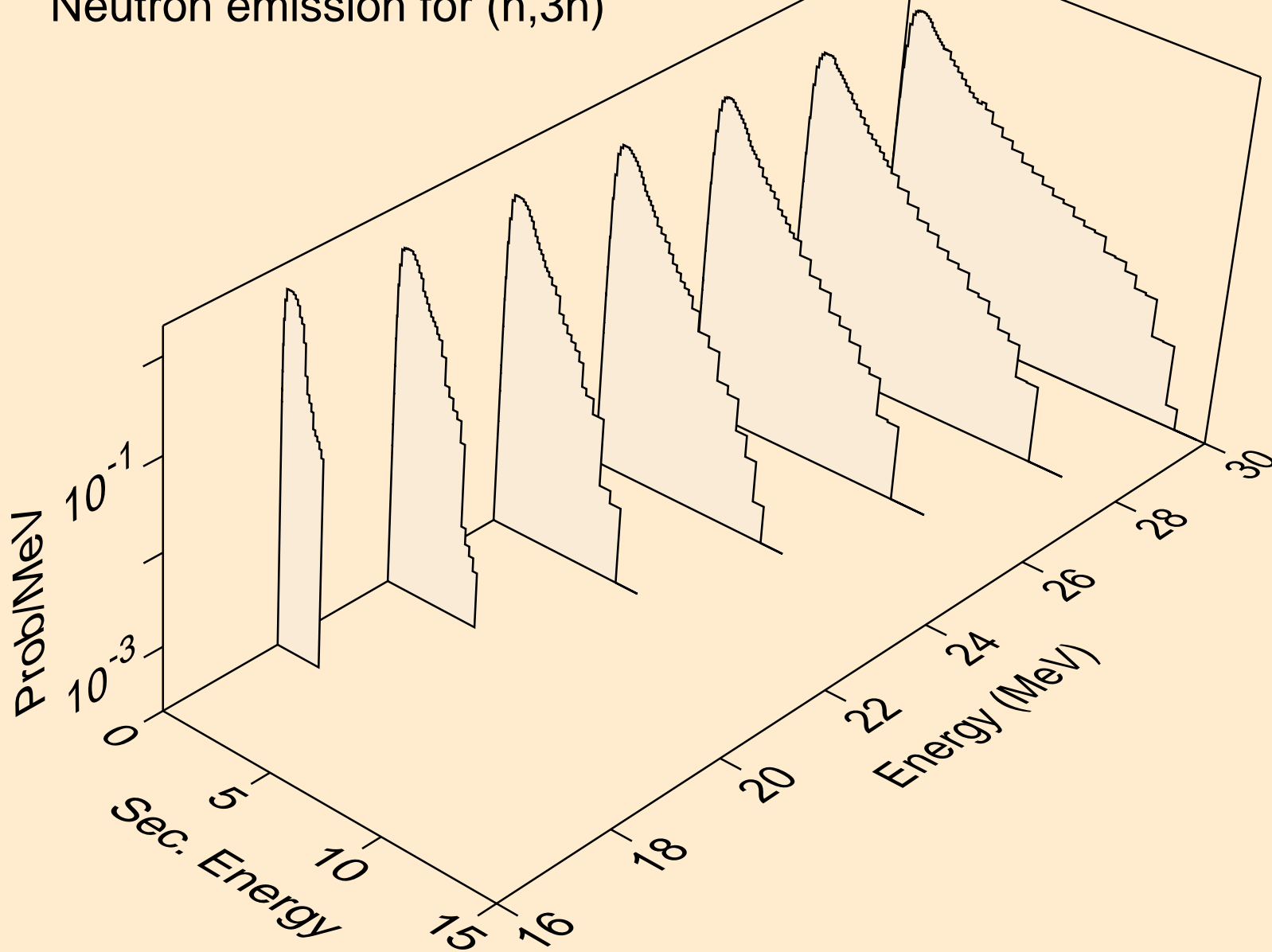

DY155 NEUTRON ACER TENDL-2019 LIBRARY; T=293.16K
Neutron emission for (n,n*)a

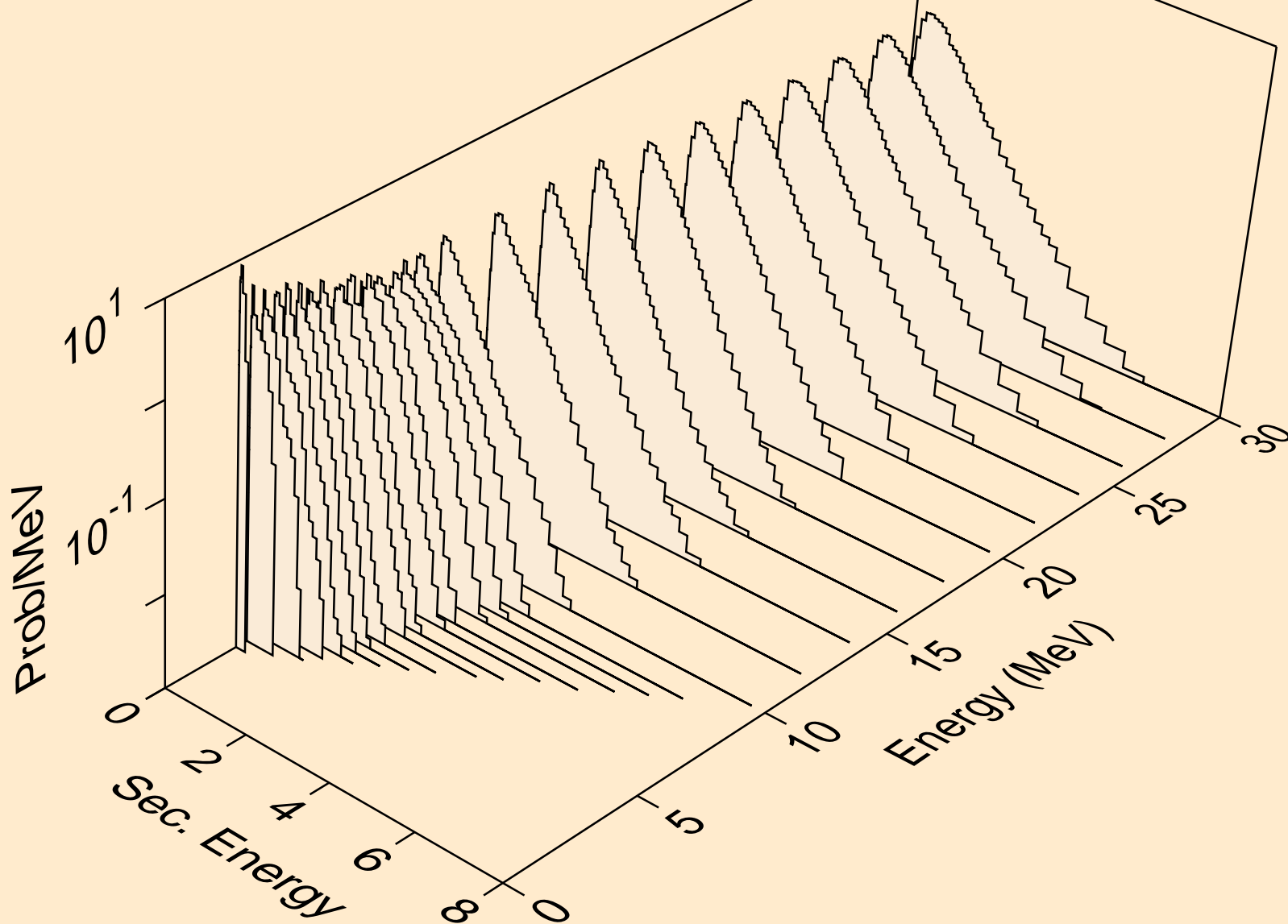

DY155 NEUTRON ACER TENDL-2019 LIBRARY; T=293.16K
Neutron emission for (n,2n)a

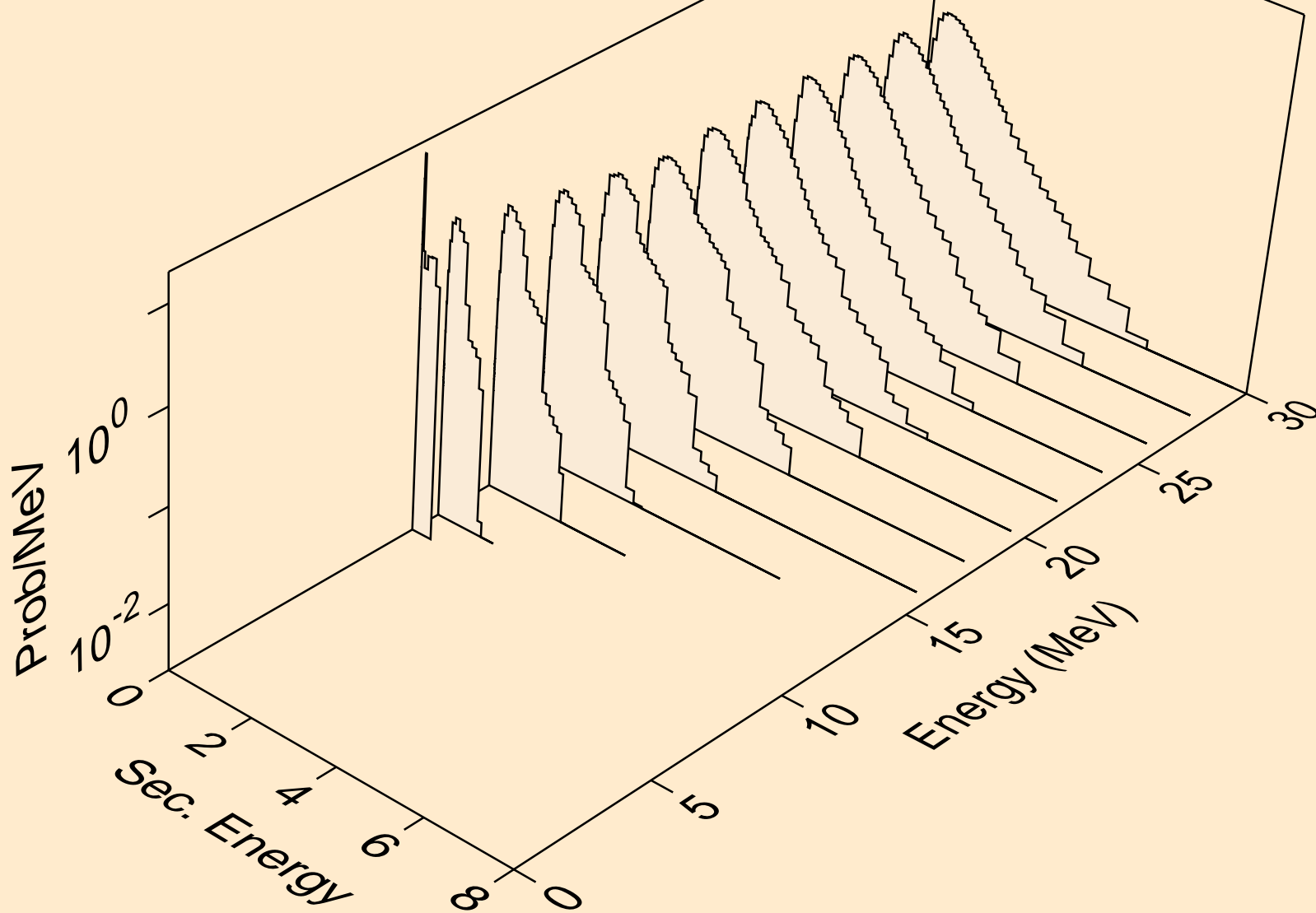

DY155 NEUTRON ACER TENDL-2019 LIBRARY; T=293.16K
Neutron emission for (n,3n)a

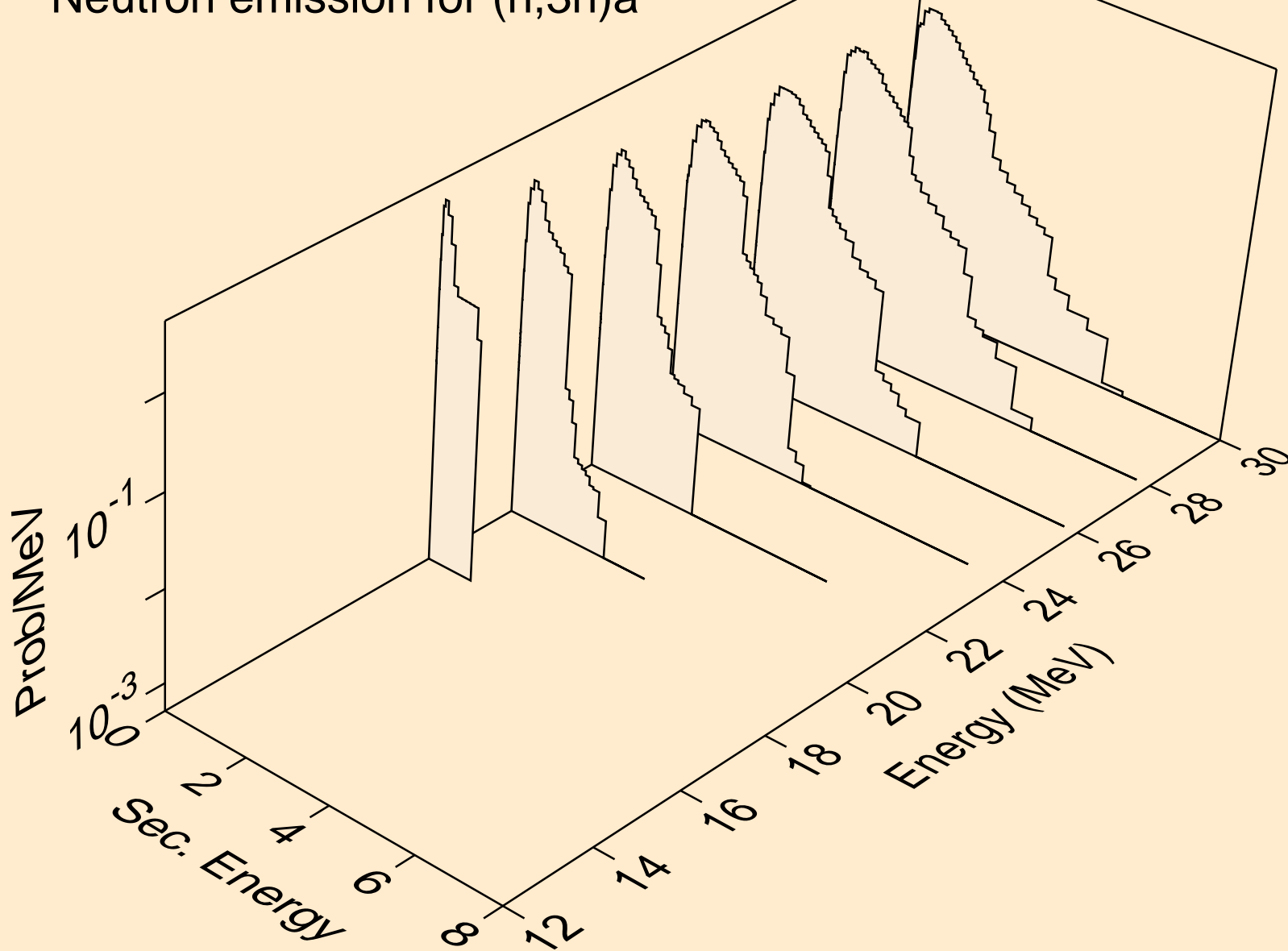

DY155 NEUTRON ACER TENDL-2019 LIBRARY; T=293.16K
Neutron emission for (n,n*)p

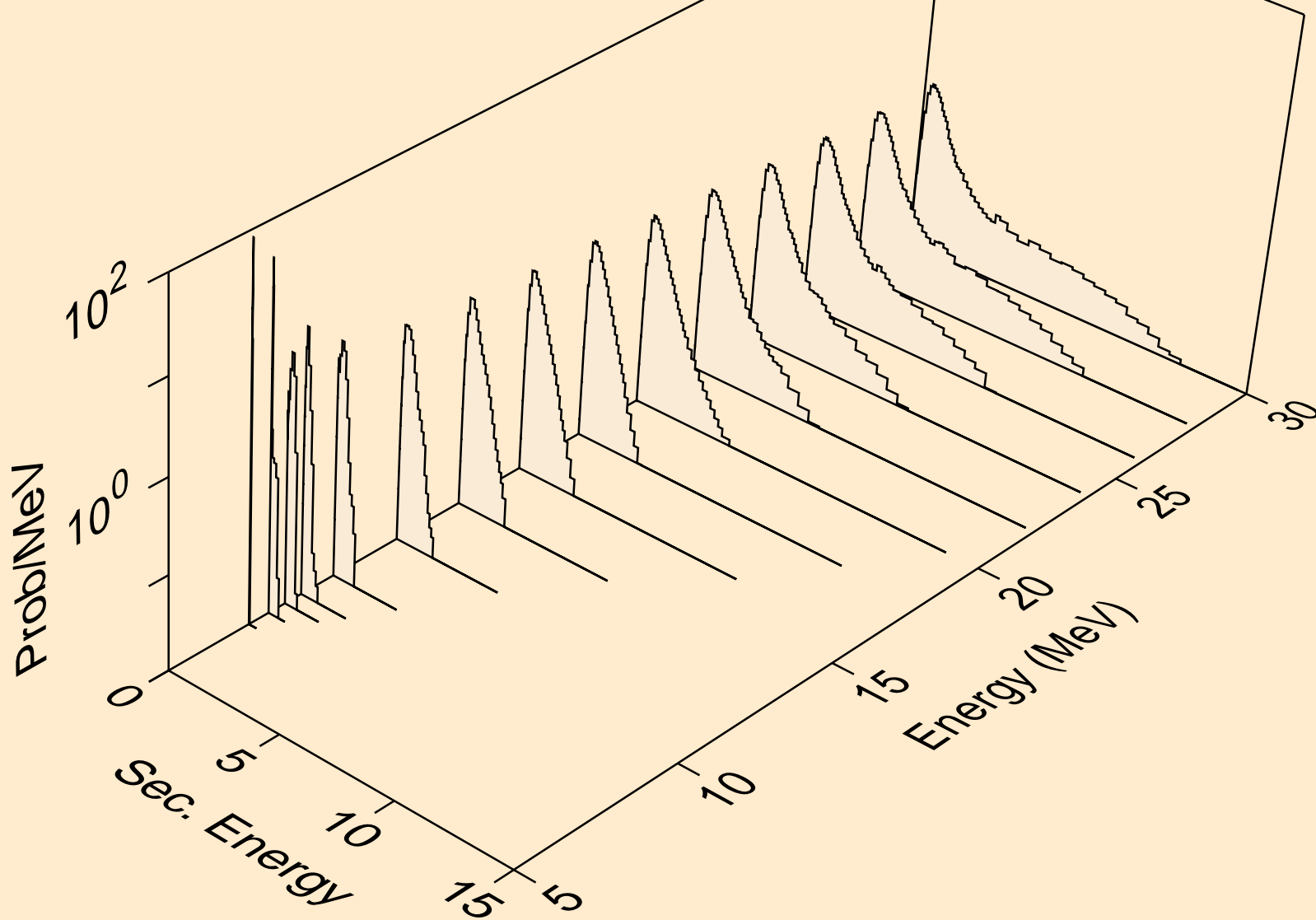

DY155 NEUTRON ACER TENDL-2019 LIBRARY; T=293.16K
Neutron emission for (n,n*)2a

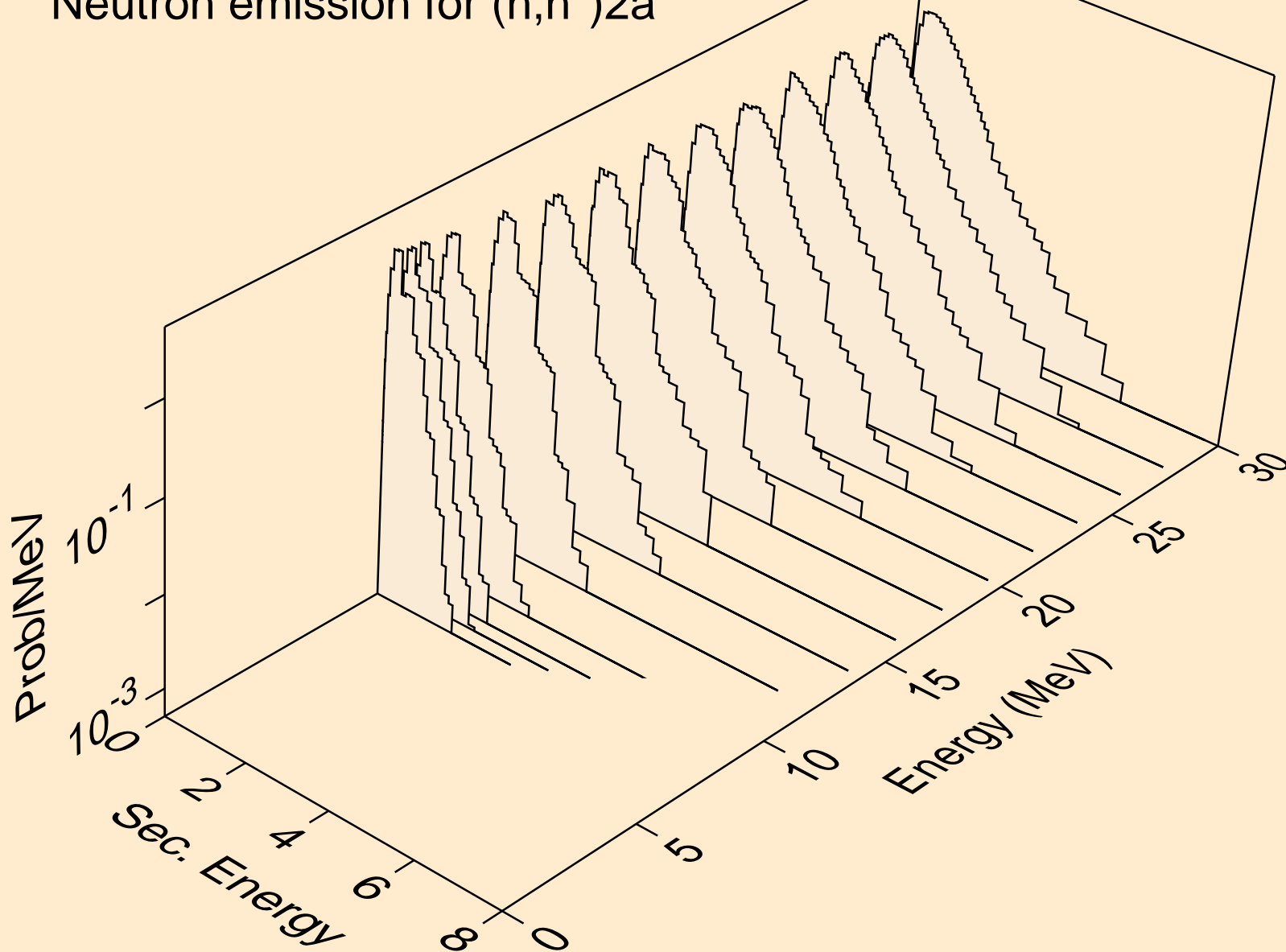

DY155 NEUTRON ACER TENDL-2019 LIBRARY; T=293.16K
Neutron emission for (n,2n)2a

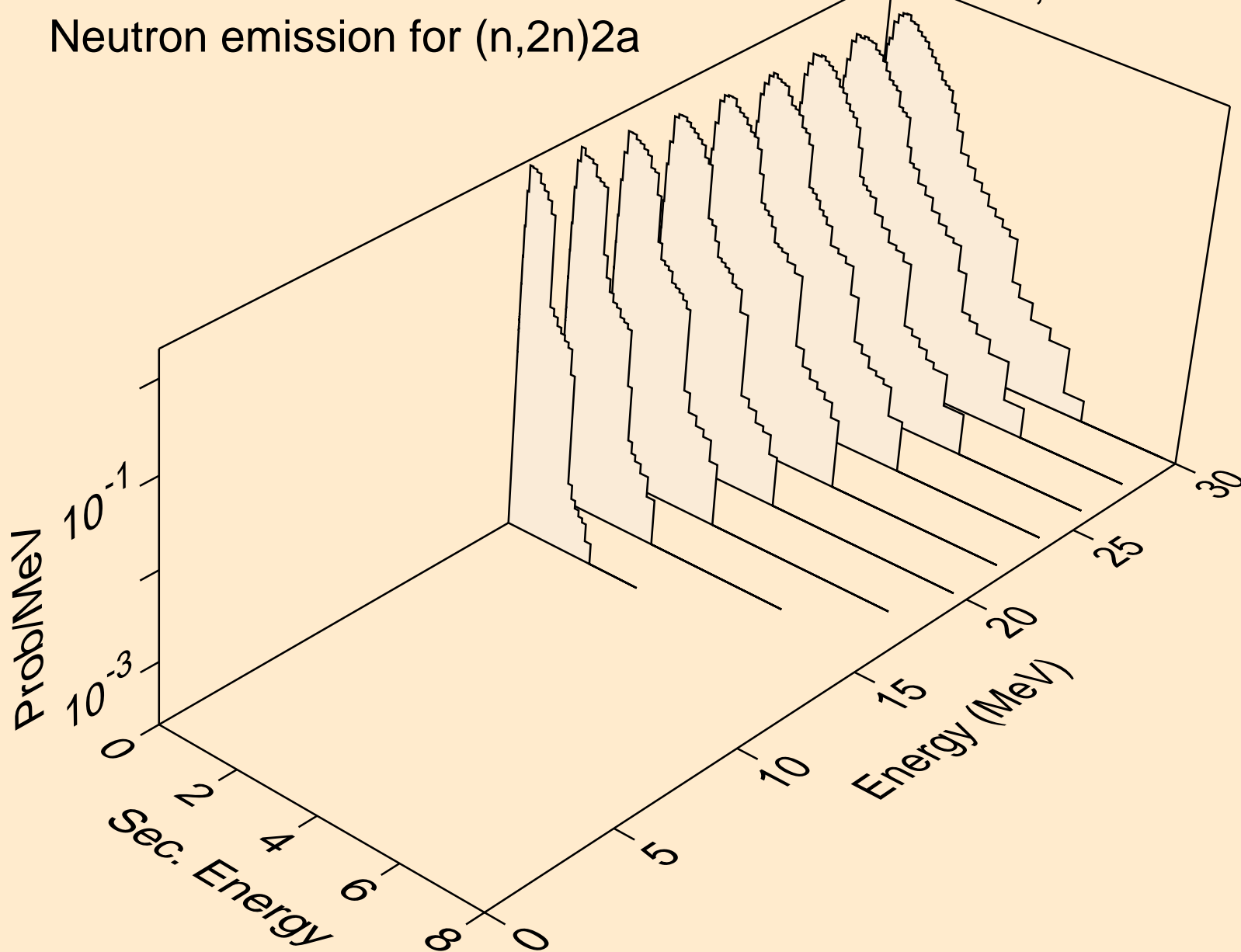

DY155 NEUTRON ACER TENDL-2019 LIBRARY; T=293.16K
Neutron emission for (n,n*)d

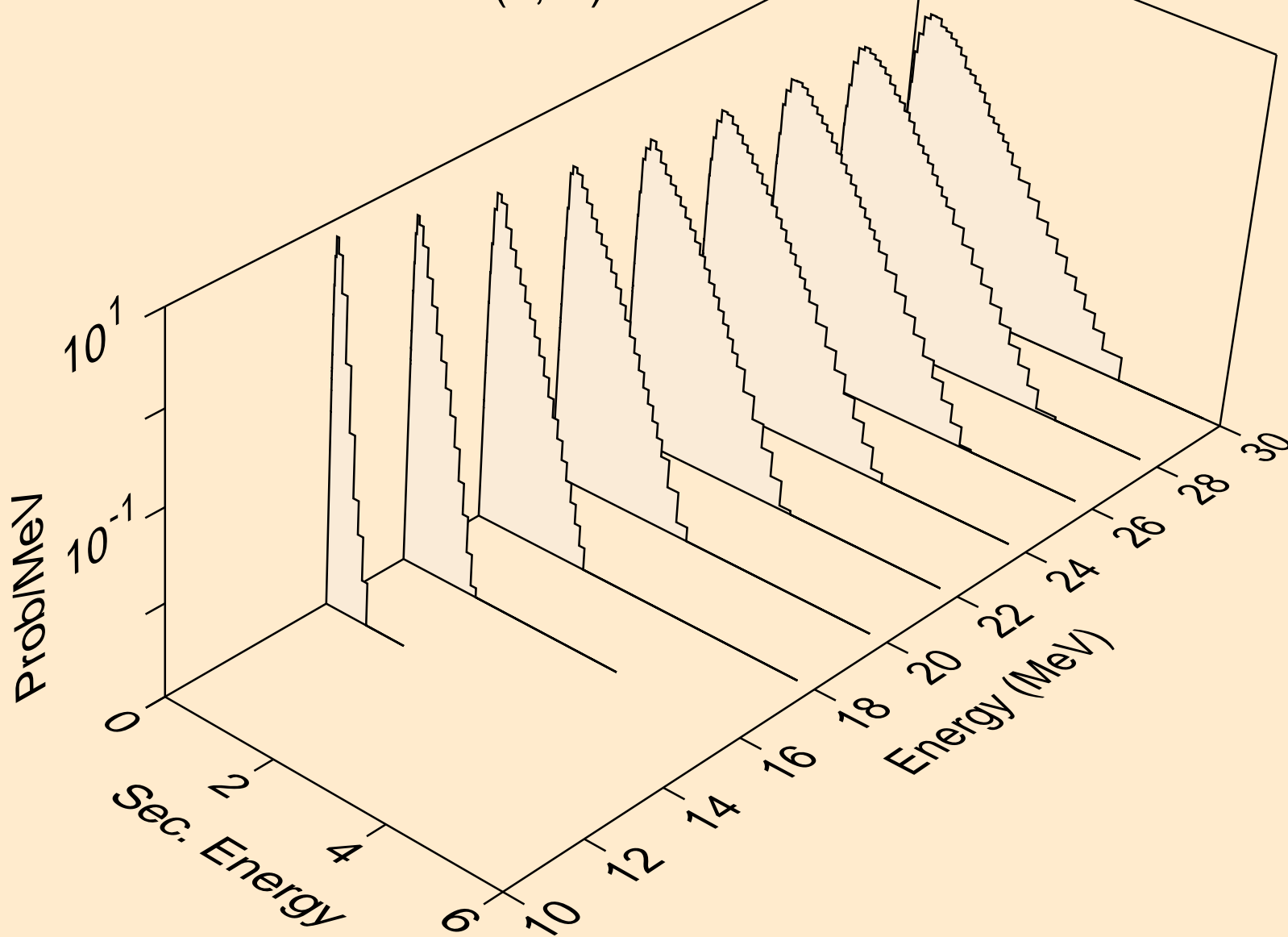

DY155 NEUTRON ACER TENDL-2019 LIBRARY; T=293.16K
Neutron emission for (n,n*)t

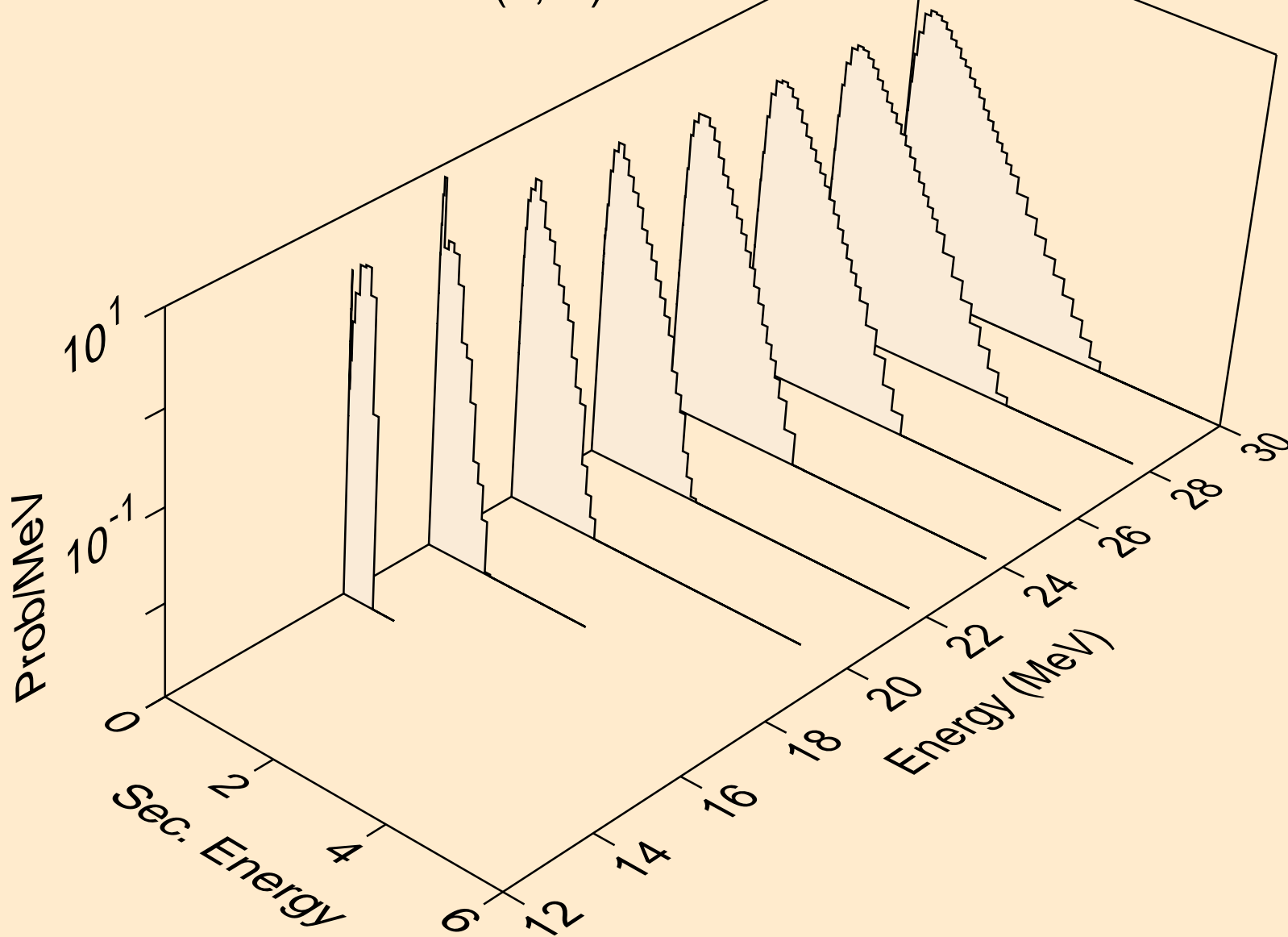

DY155 NEUTRON ACER TENDL-2019 LIBRARY; T=293.16K
Neutron emission for (n,n*)he3

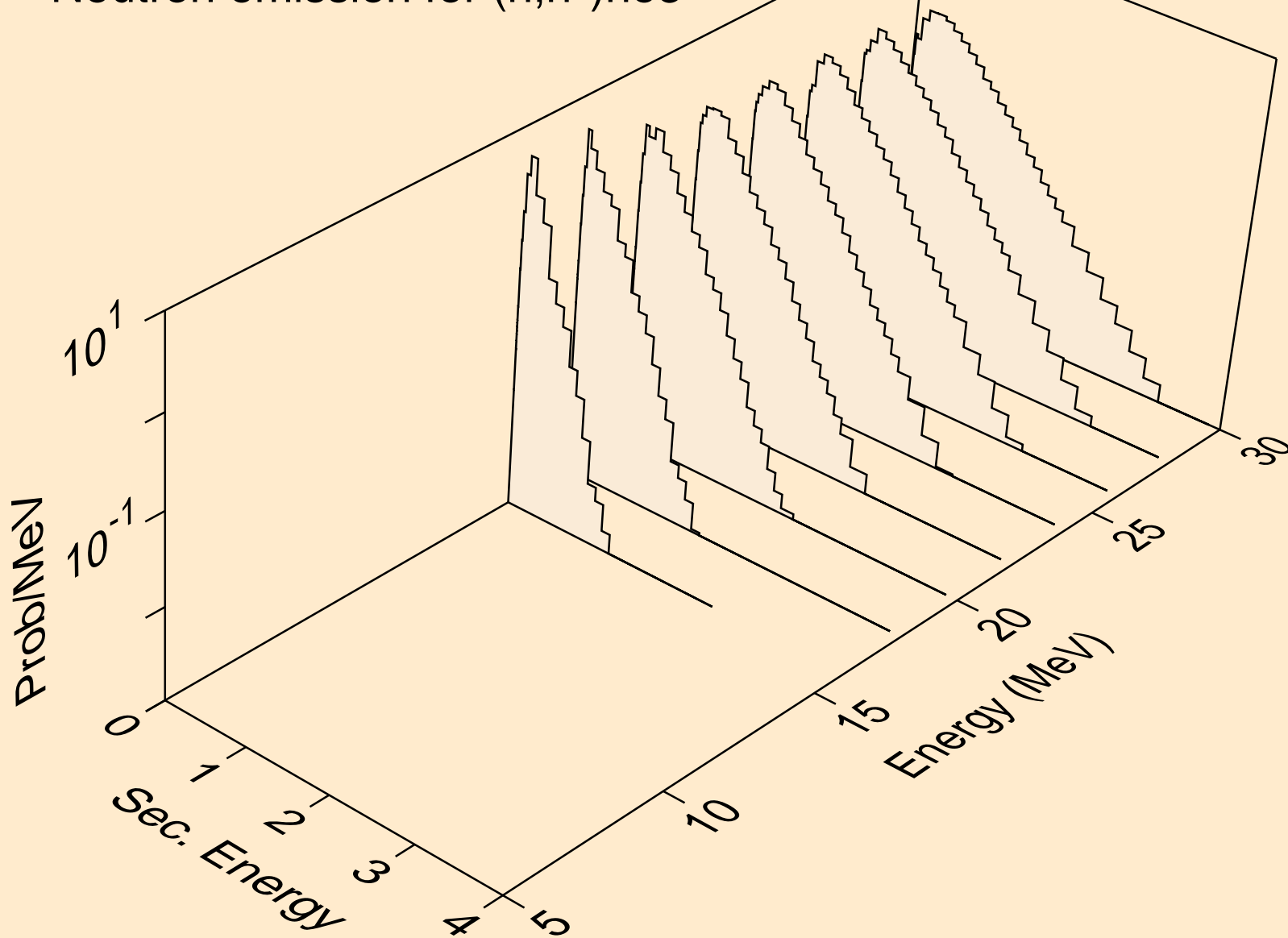

DY155 NEUTRON ACER TENDL-2019 LIBRARY; T=293.16K
Neutron emission for (n,4n)

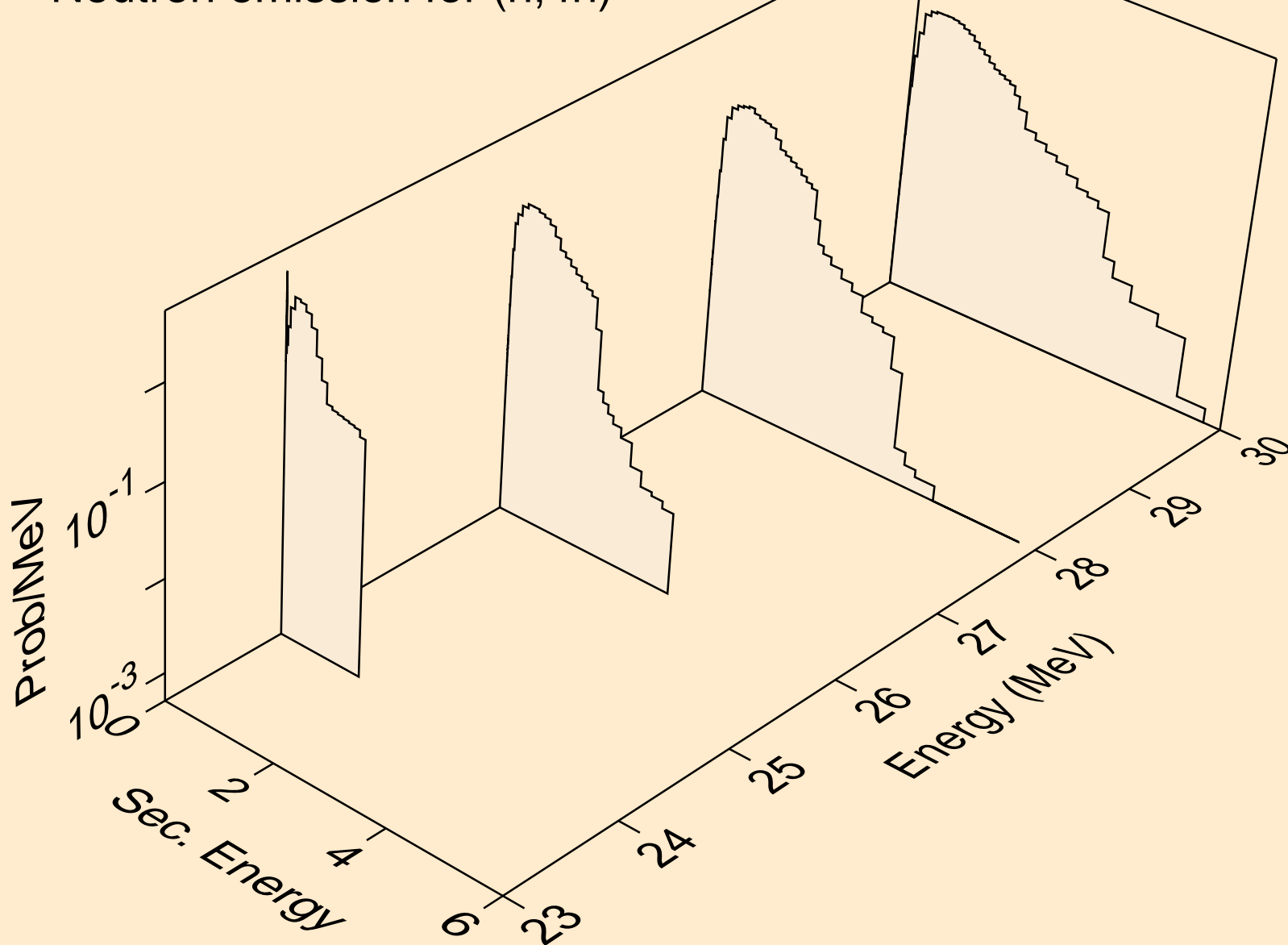

DY155 NEUTRON ACER TENDL-2019 LIBRARY; T=293.16K
Neutron emission for (n,2np)

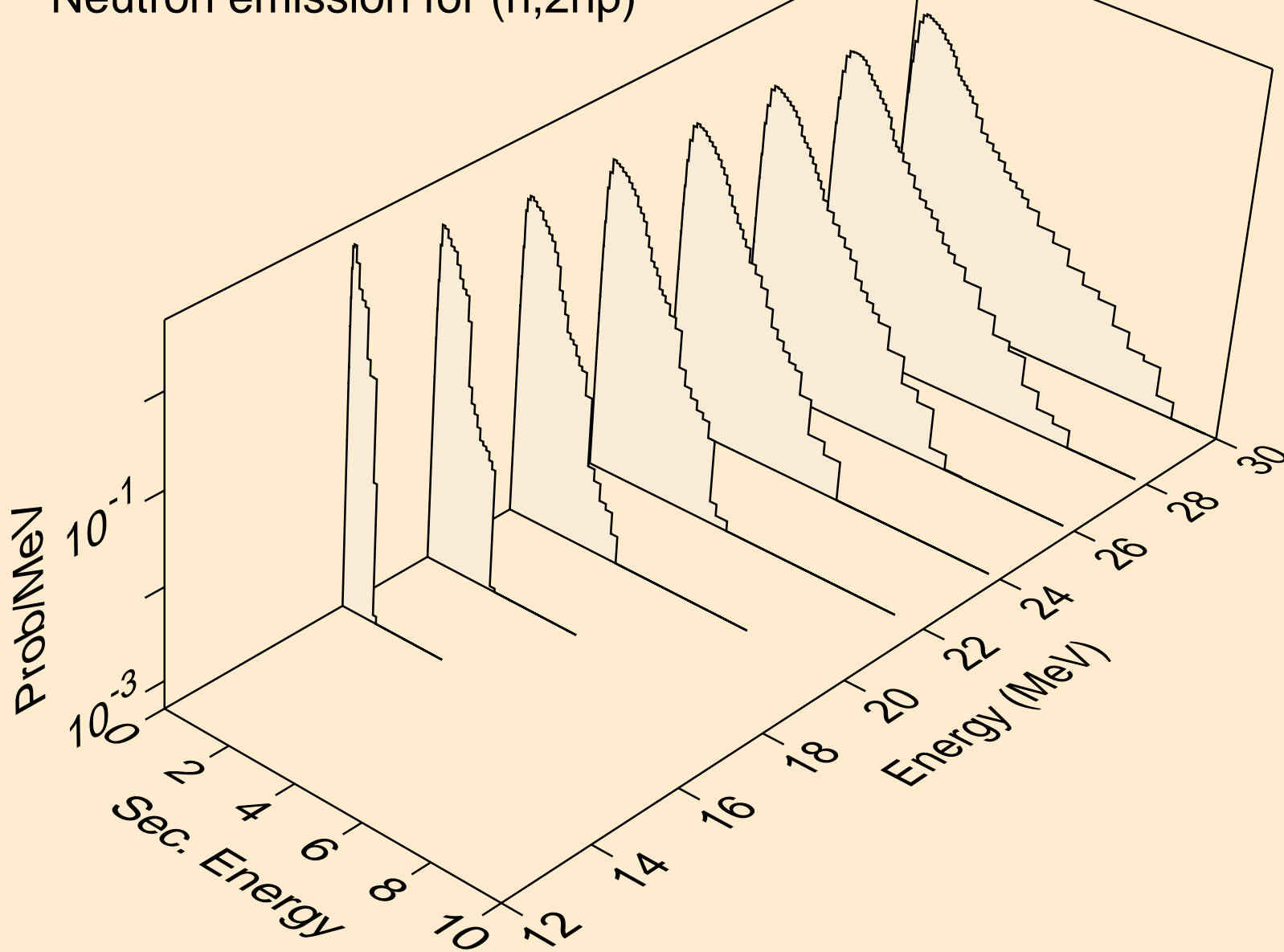

DY155 NEUTRON ACER TENDL-2019 LIBRARY; T=293.16K
Neutron emission for (n,3np)

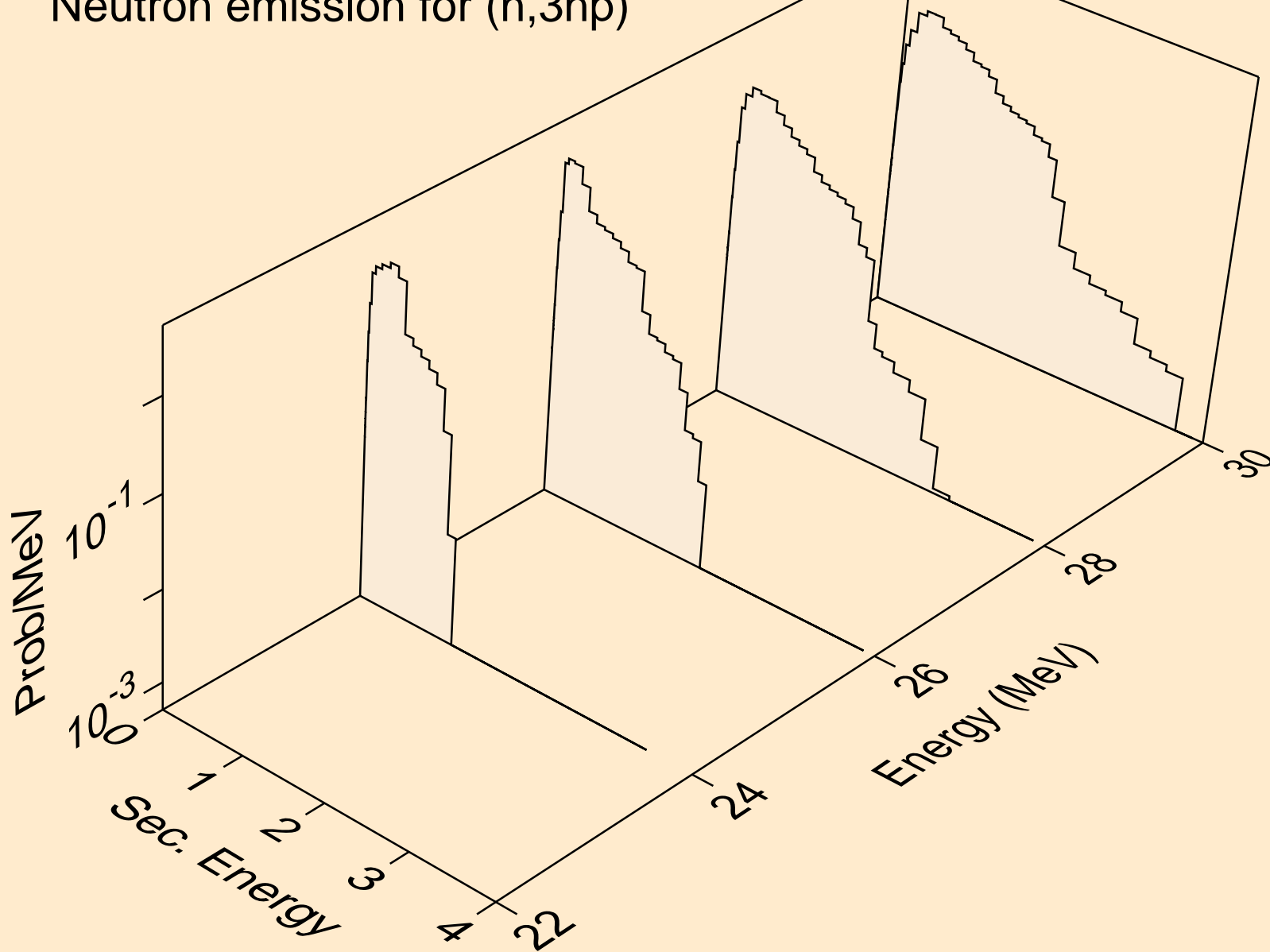

DY155 NEUTRON ACER TENDL-2019 LIBRARY; T=293.16K
Neutron emission for (n,2np)

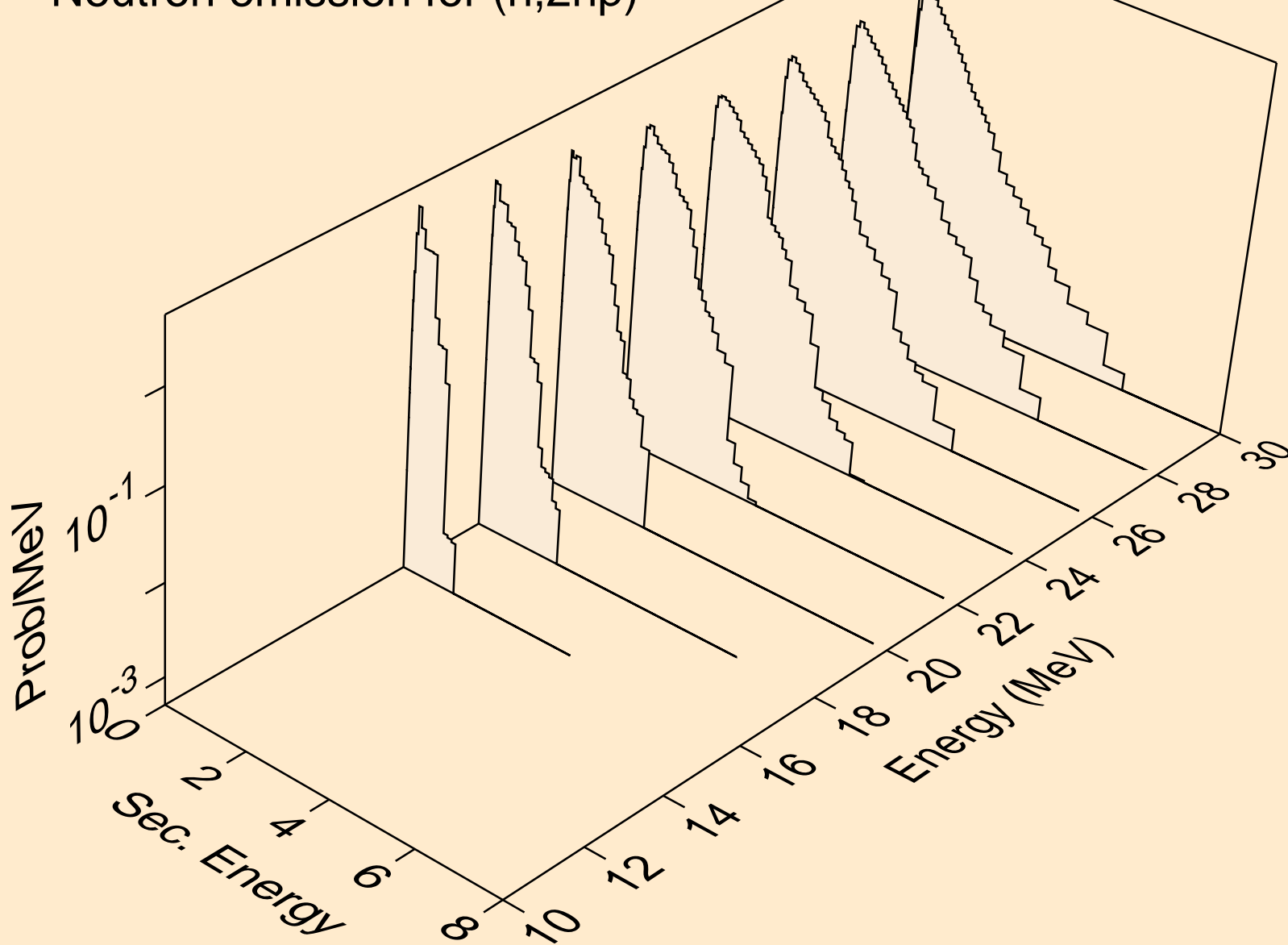

DY155 NEUTRON ACER TENDL-2019 LIBRARY; T=293.16K
Neutron emission for (n,npa)

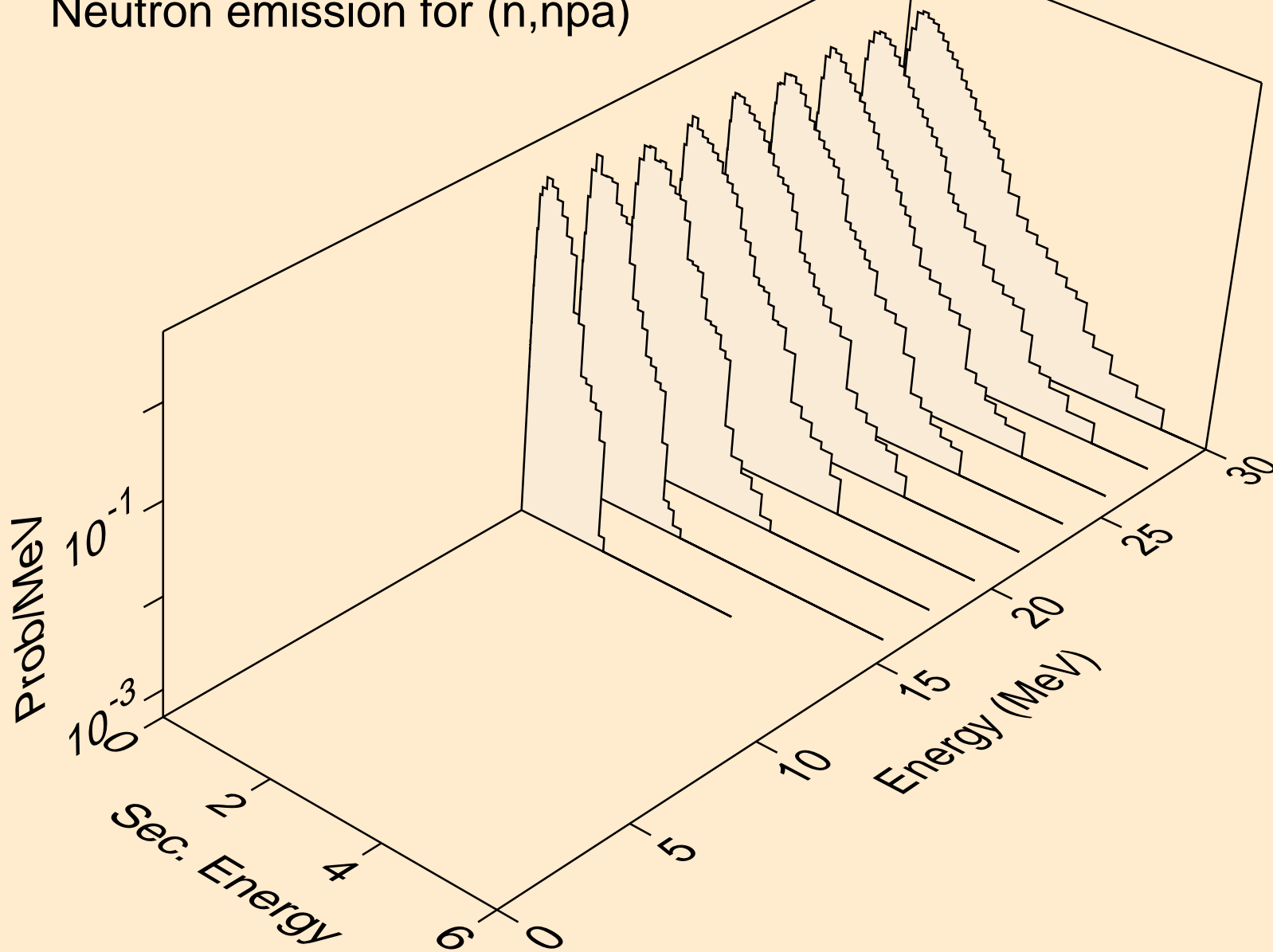

DY155 NEUTRON ACER TENDL-2019 LIBRARY; T=293.16K
Neutron emission for (n,n*c)

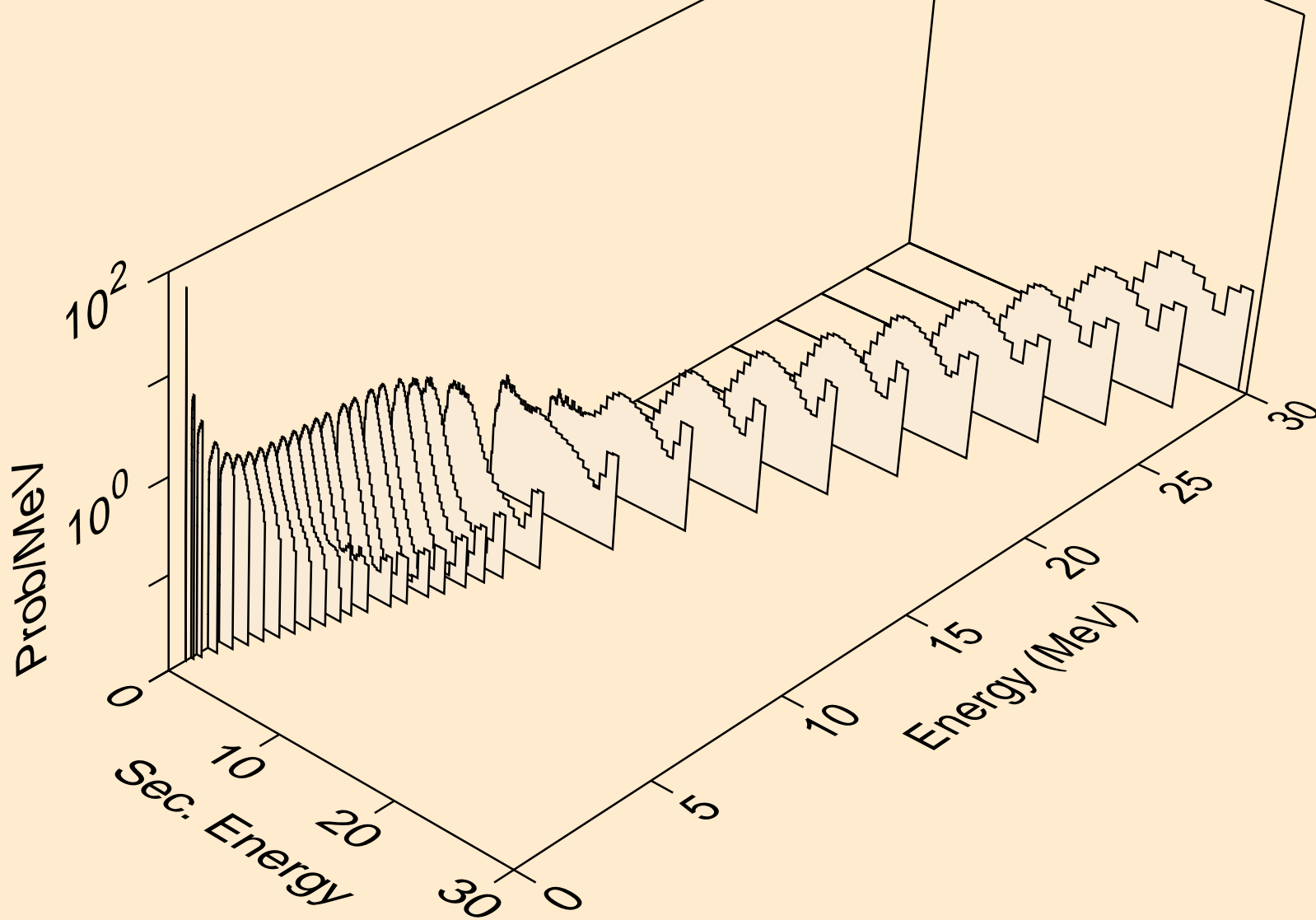

DY155 NEUTRON ACER TENDL-2019 LIBRARY; T=293.16K
Photon emission for (n,x)

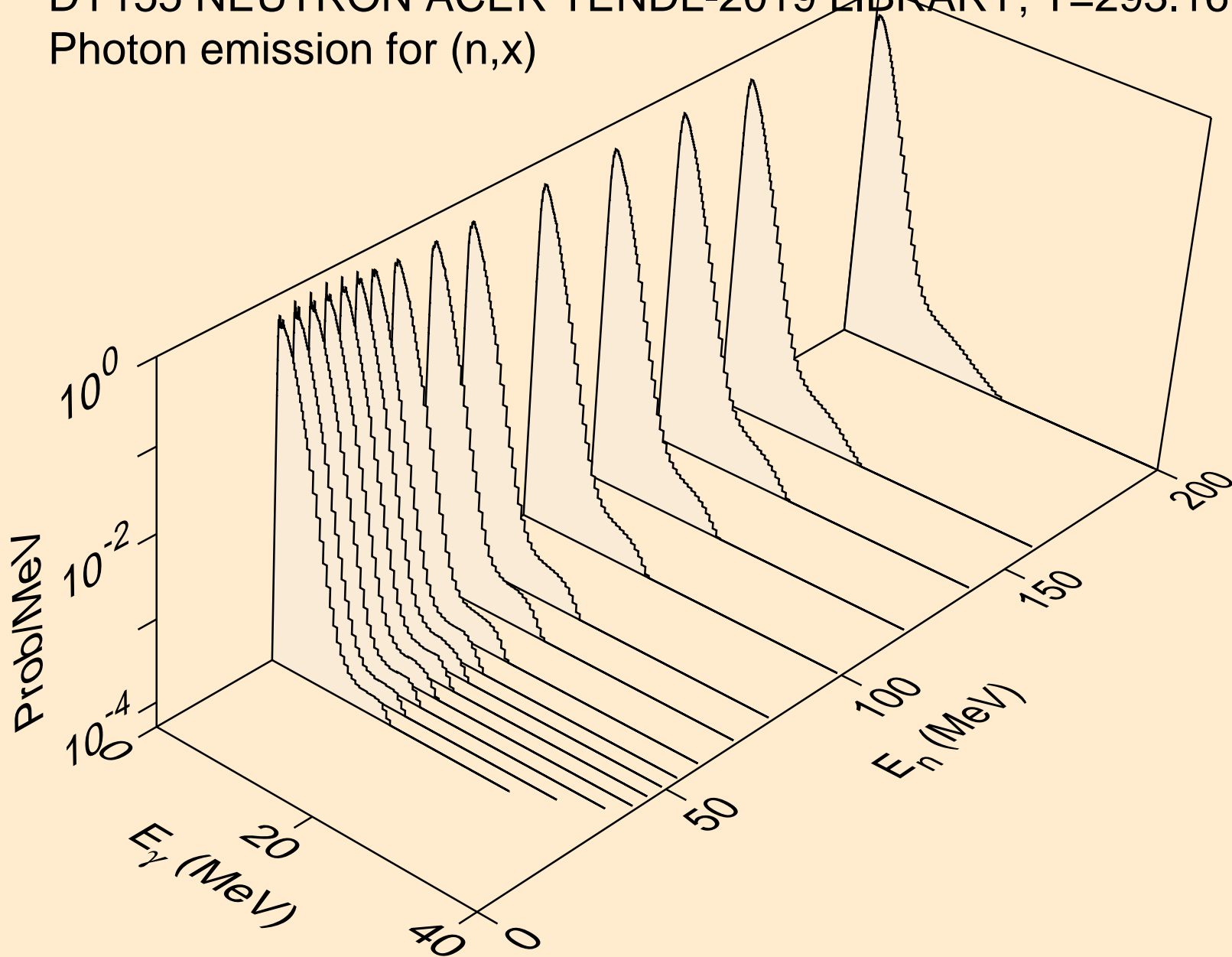

DY155 NEUTRON ACER TENDL-2019 LIBRARY; T=293.16K
Photon emission for (n,2nd)

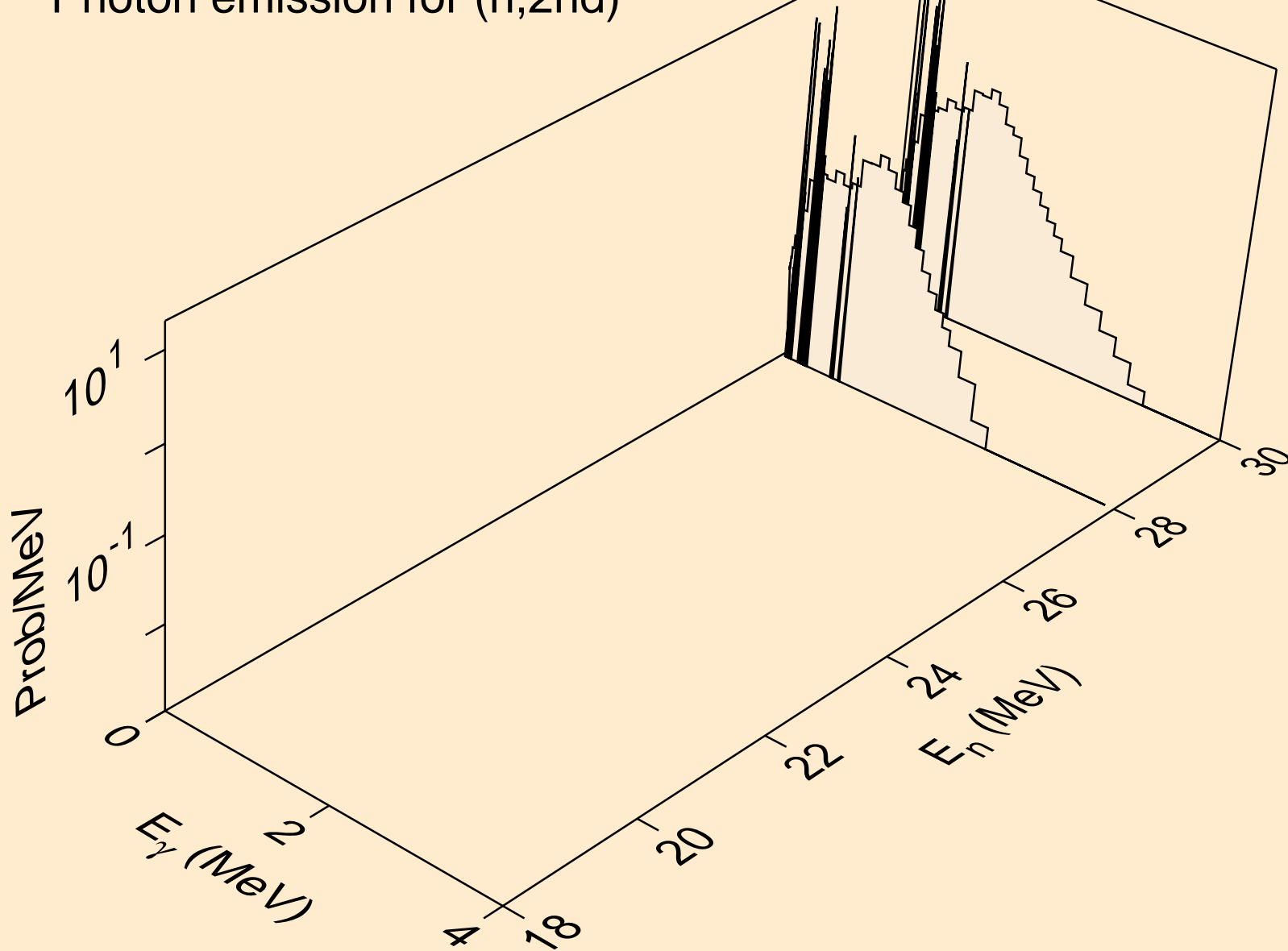

DY155 NEUTRON ACER TENDL-2019 LIBRARY; T=293.16K
Photon emission for (n,2n)

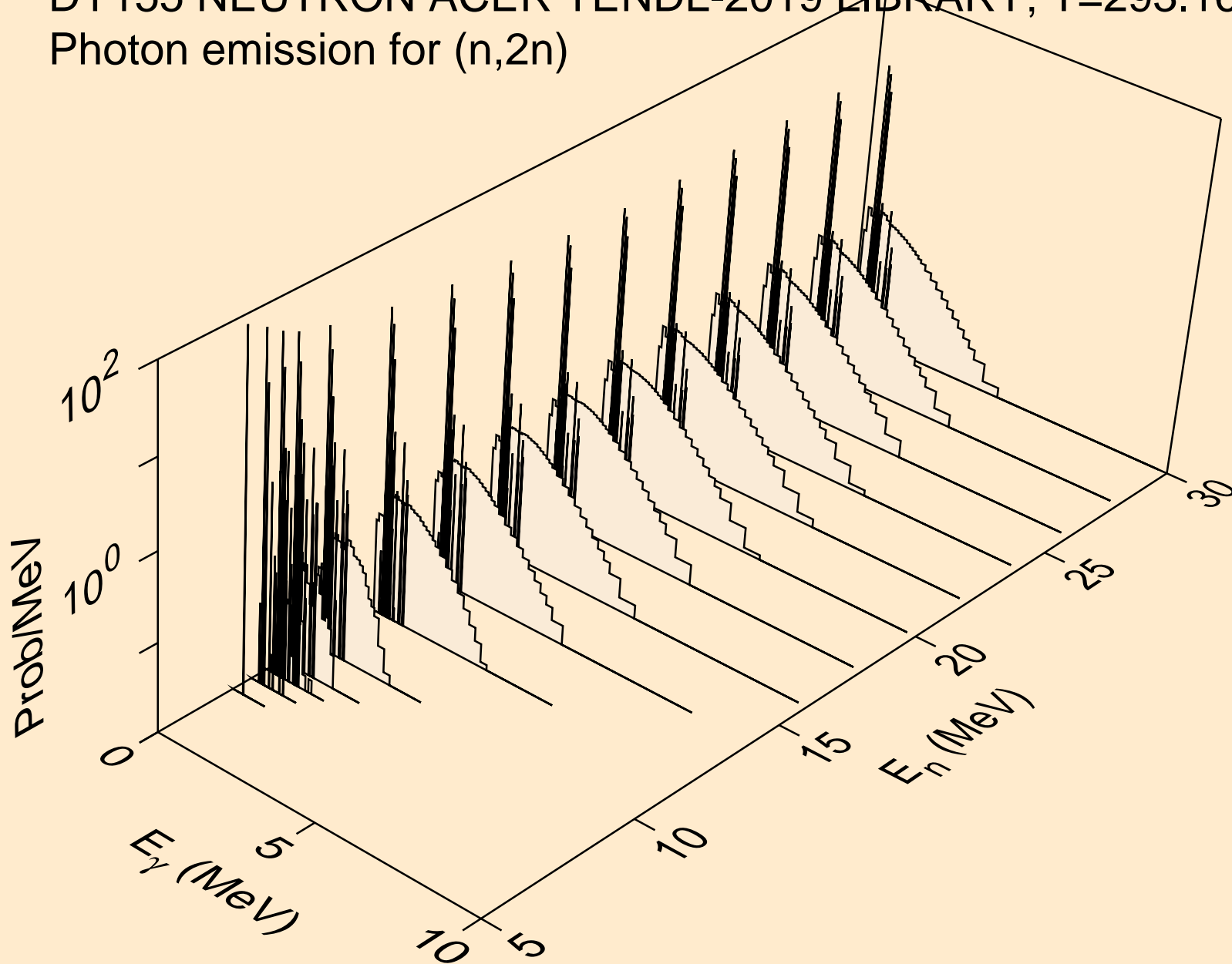

DY155 NEUTRON ACER TENDL-2019 LIBRARY; T=293.16K
Photon emission for (n,3n)

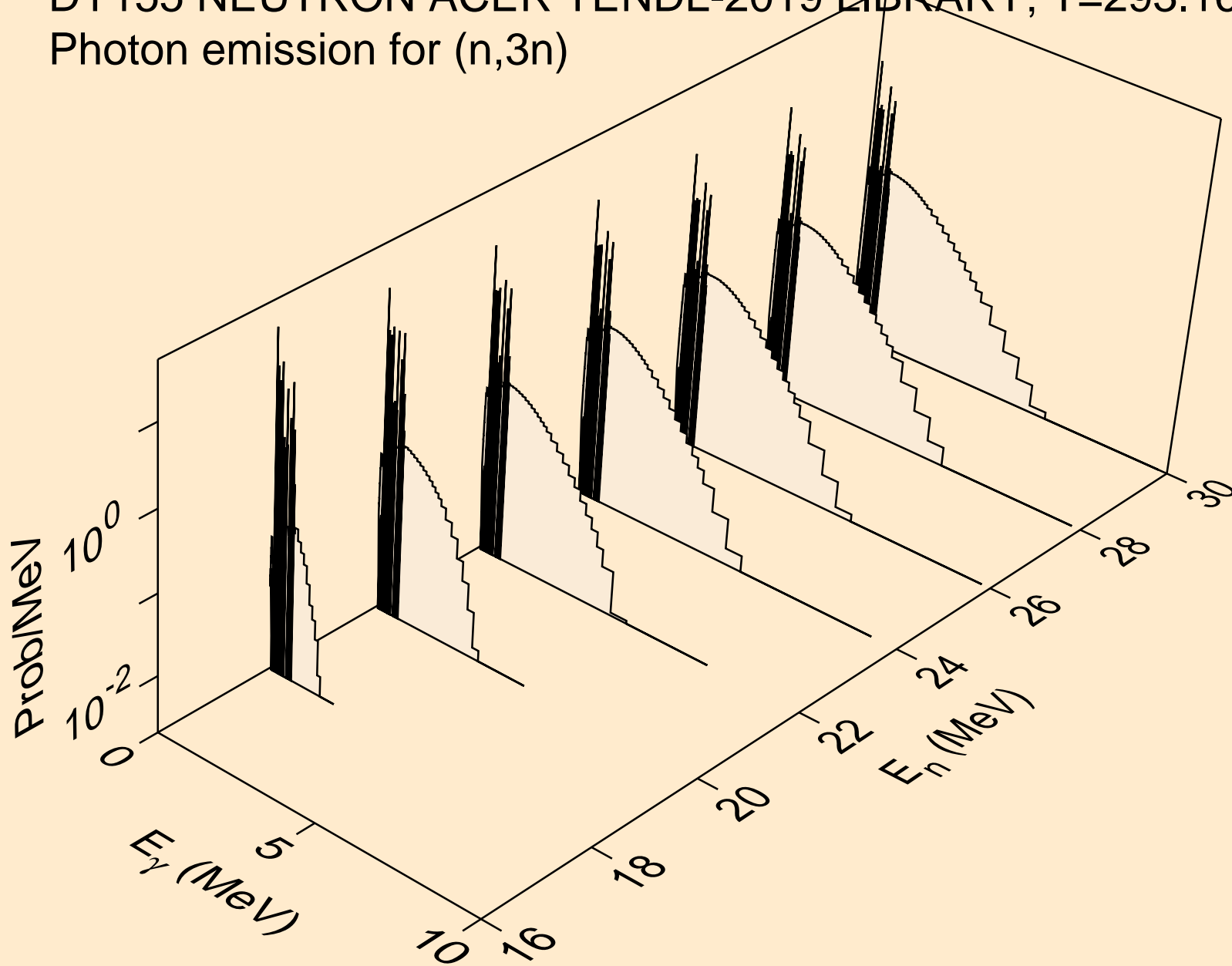

DY155 NEUTRON ACER TENDL-2019 LIBRARY; T=293.16K
Photon emission for (n,n*)a

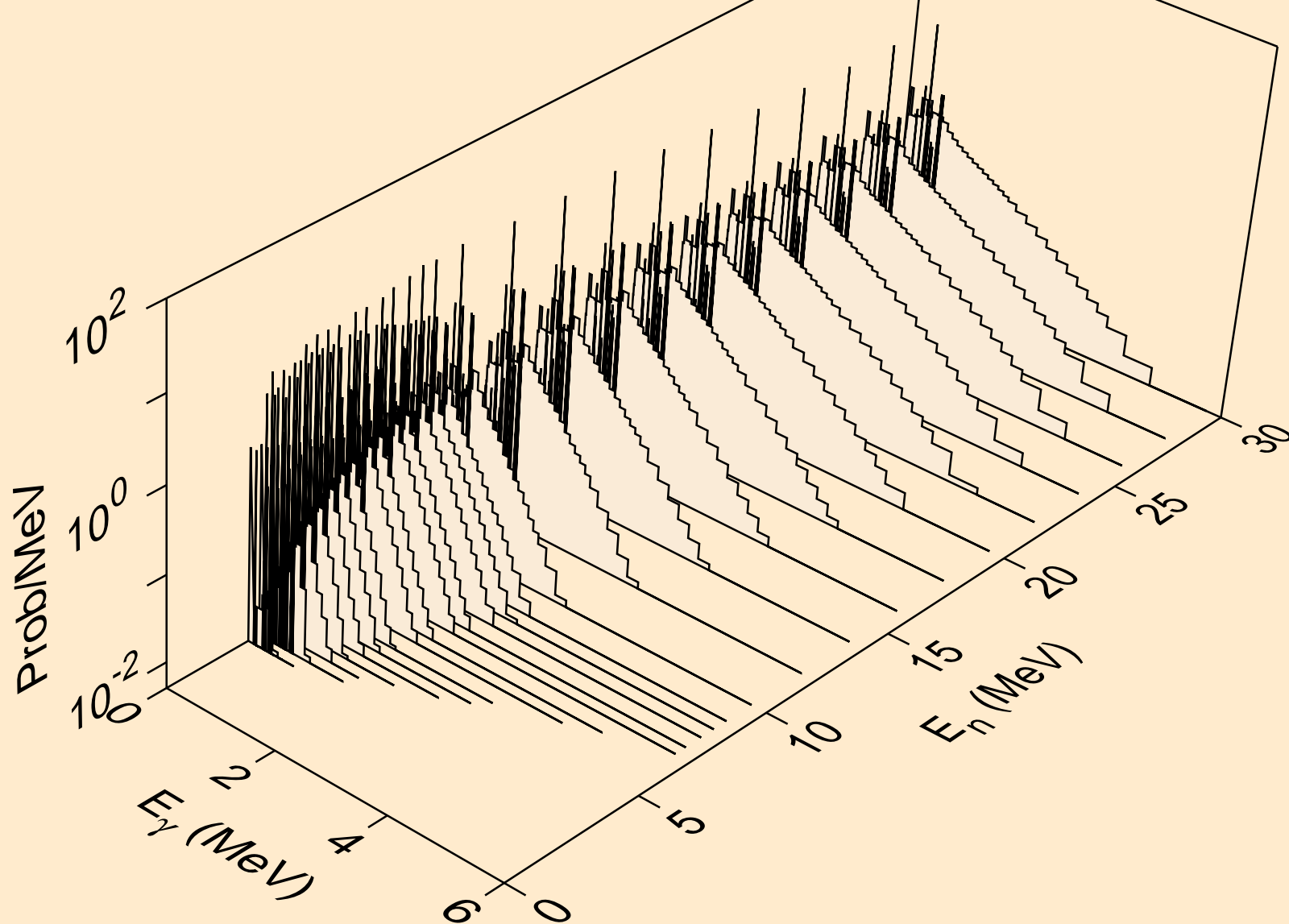

DY155 NEUTRON ACER TENDL-2019 LIBRARY; T=293.16K
Photon emission for (n,2n)a

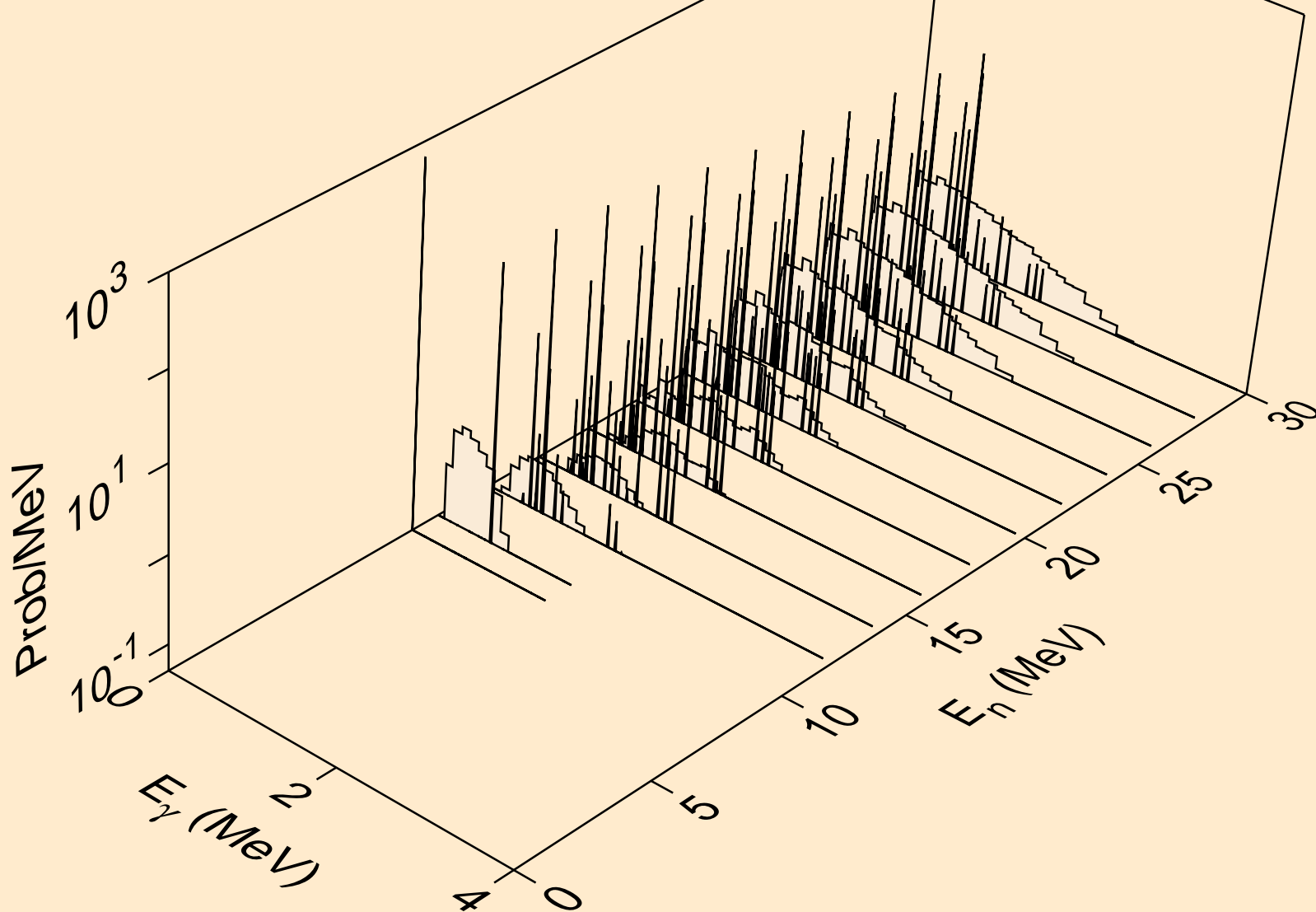

DY155 NEUTRON ACER TENDL-2019 LIBRARY; T=293.16K
Photon emission for (n,3n)a

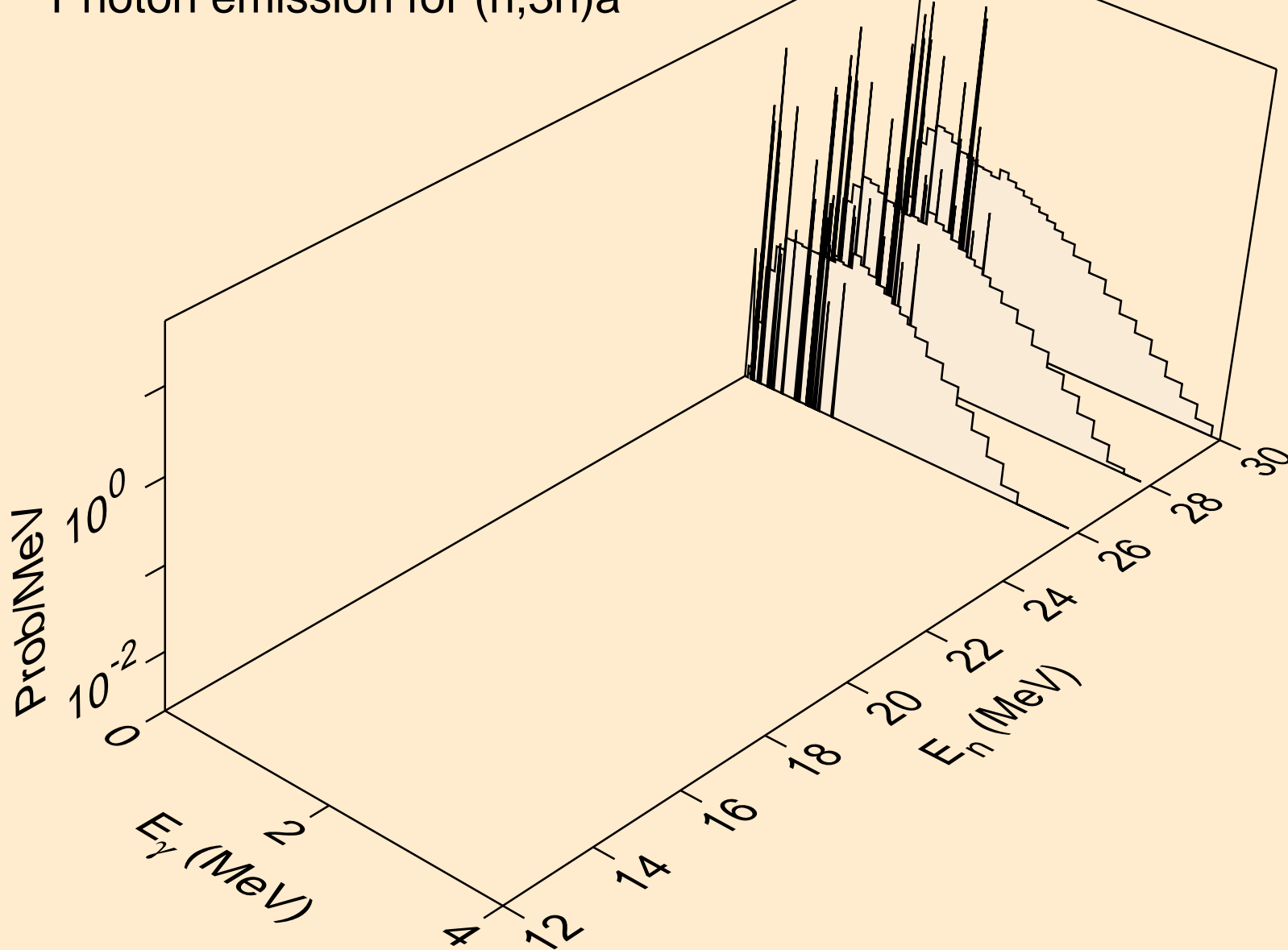

DY155 NEUTRON ACER TENDL-2019 LIBRARY; T=293.16K
Photon emission for (n,n*)p

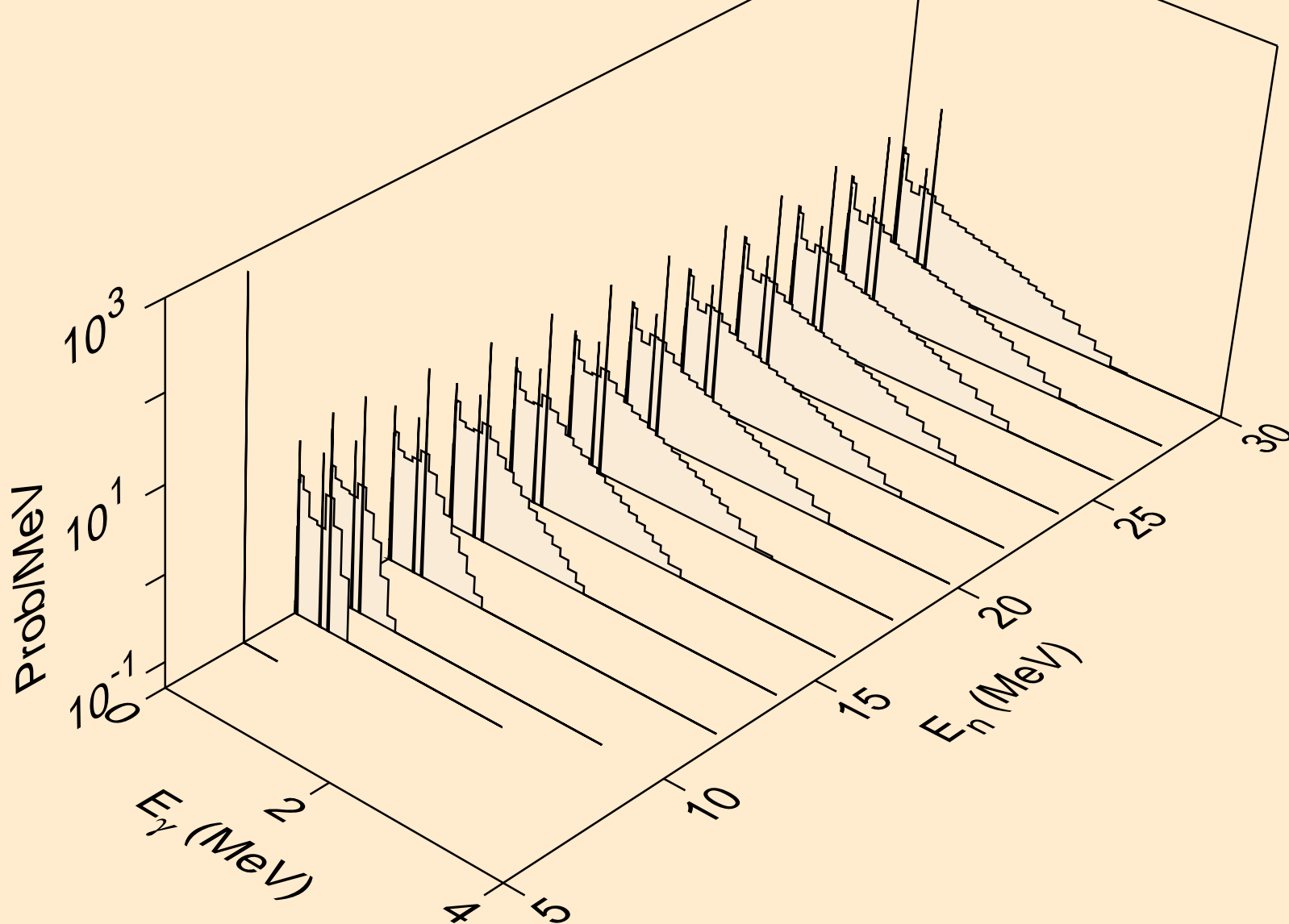

DY155 NEUTRON ACER TENDL-2019 LIBRARY; T=293.16K
Photon emission for (n,n*)2a

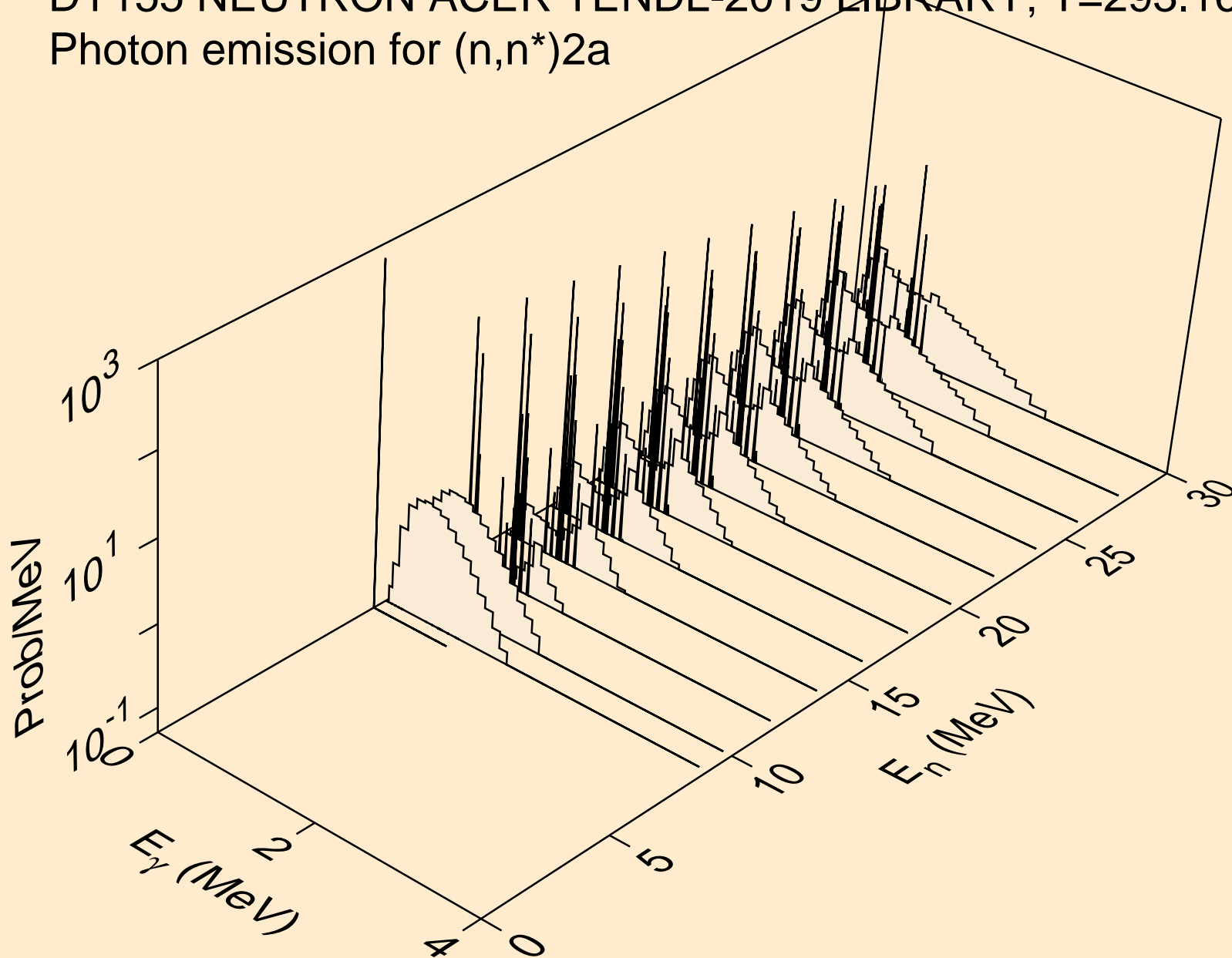

DY155 NEUTRON ACER TENDL-2019 LIBRARY; T=293.16K
Photon emission for (n,2n)2a

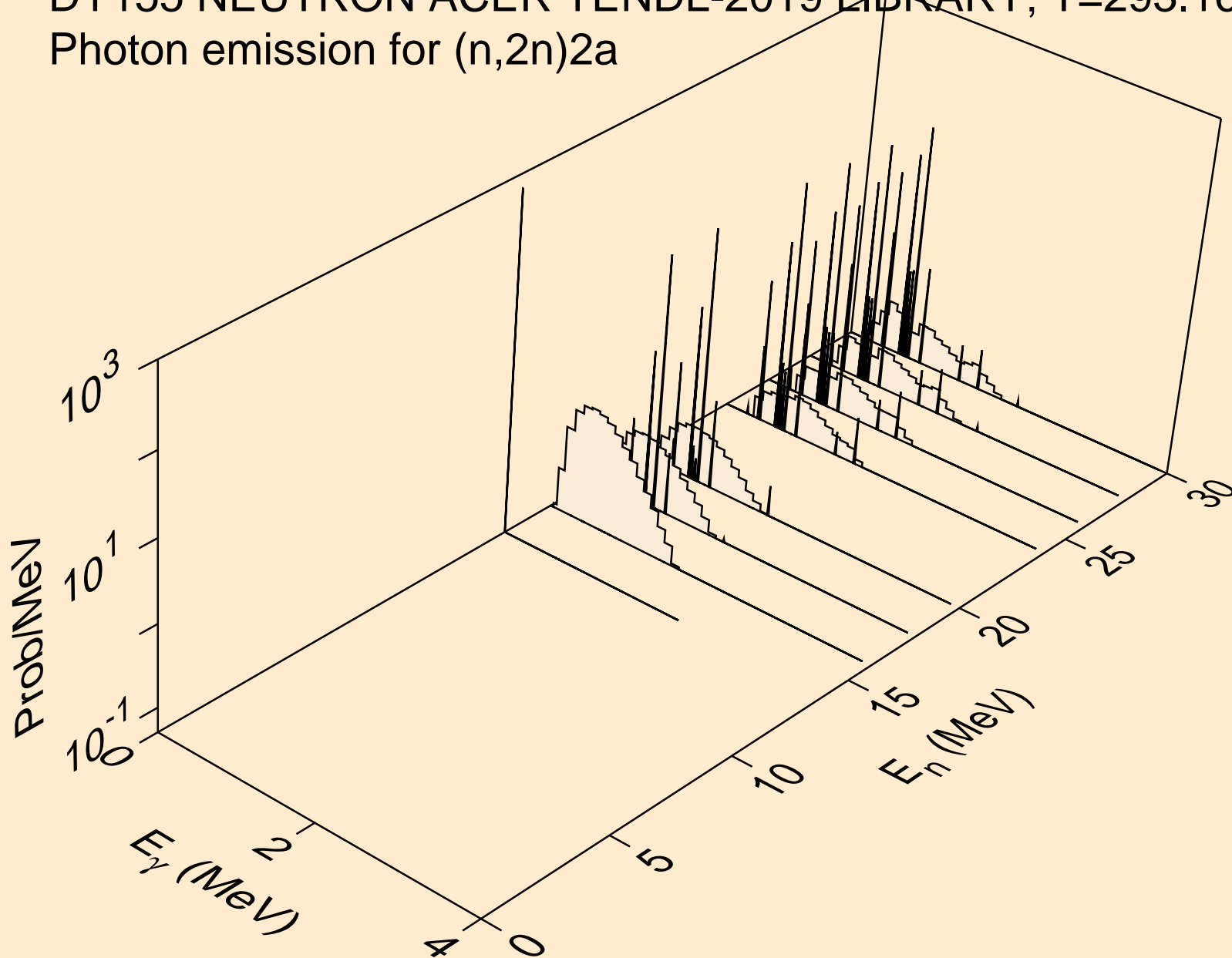

DY155 NEUTRON ACER TENDL-2019 LIBRARY; T=293.16K
Photon emission for (n,n*)d

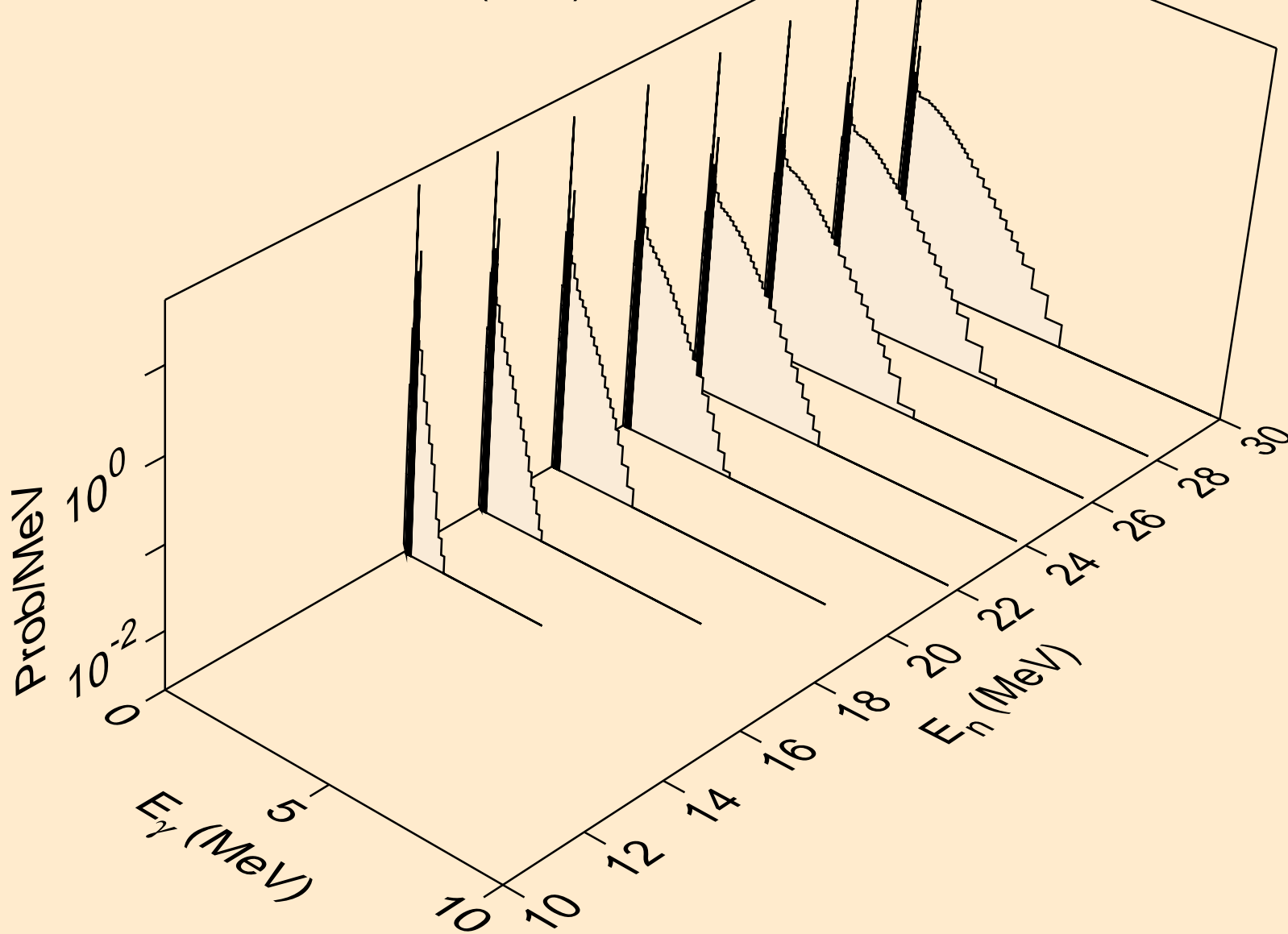

DY155 NEUTRON ACER TENDL-2019 LIBRARY; T=293.16K
Photon emission for (n,n*)t

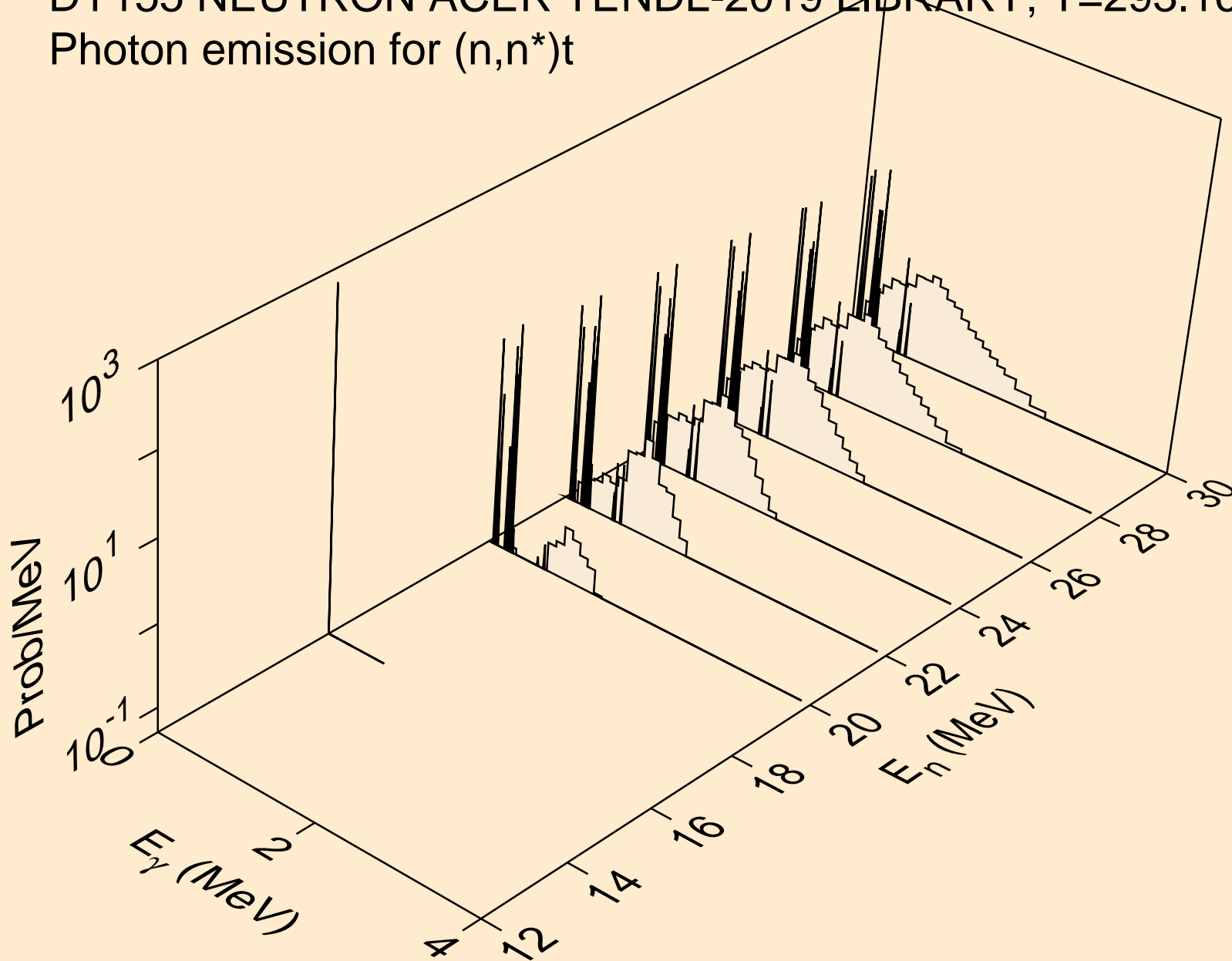

DY155 NEUTRON ACER TENDL-2019 LIBRARY; T=293.16K
Photon emission for (n,n*)he3

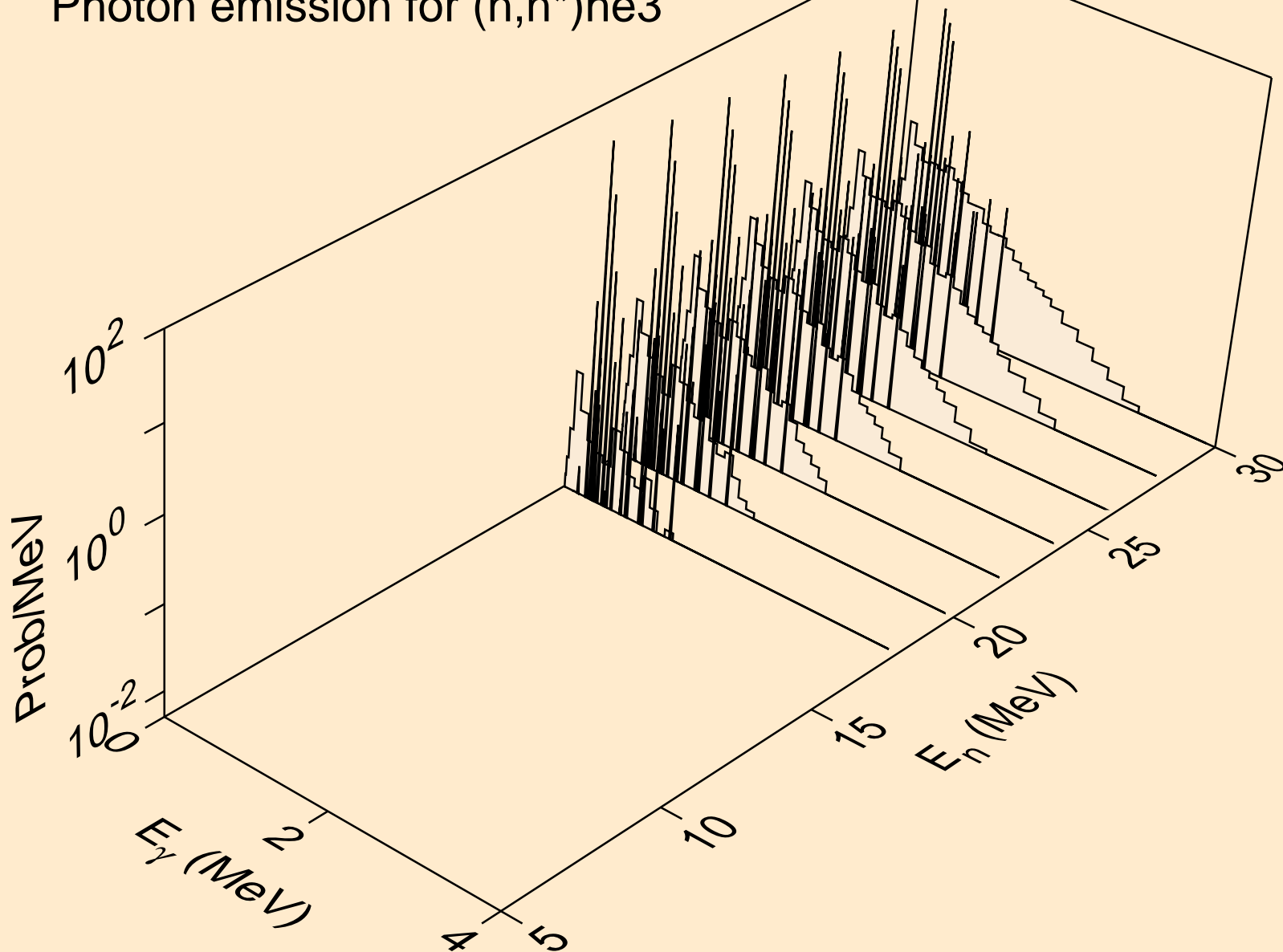

DY155 NEUTRON ACER TENDL-2019 LIBRARY; T=293.16K
Photon emission for (n,4n)

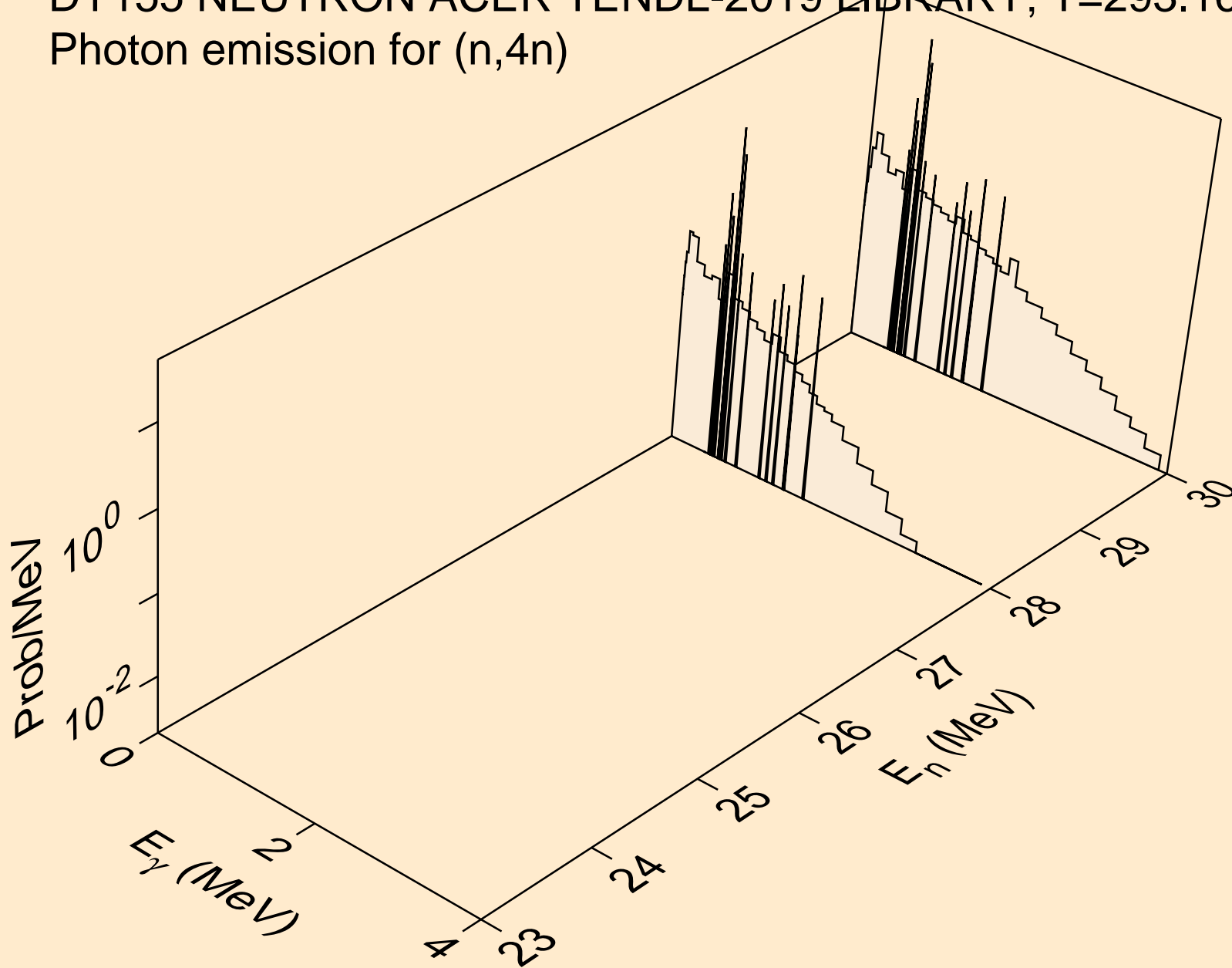

DY155 NEUTRON ACER TENDL-2019 LIBRARY; T=293.16K
Photon emission for (n,2np)

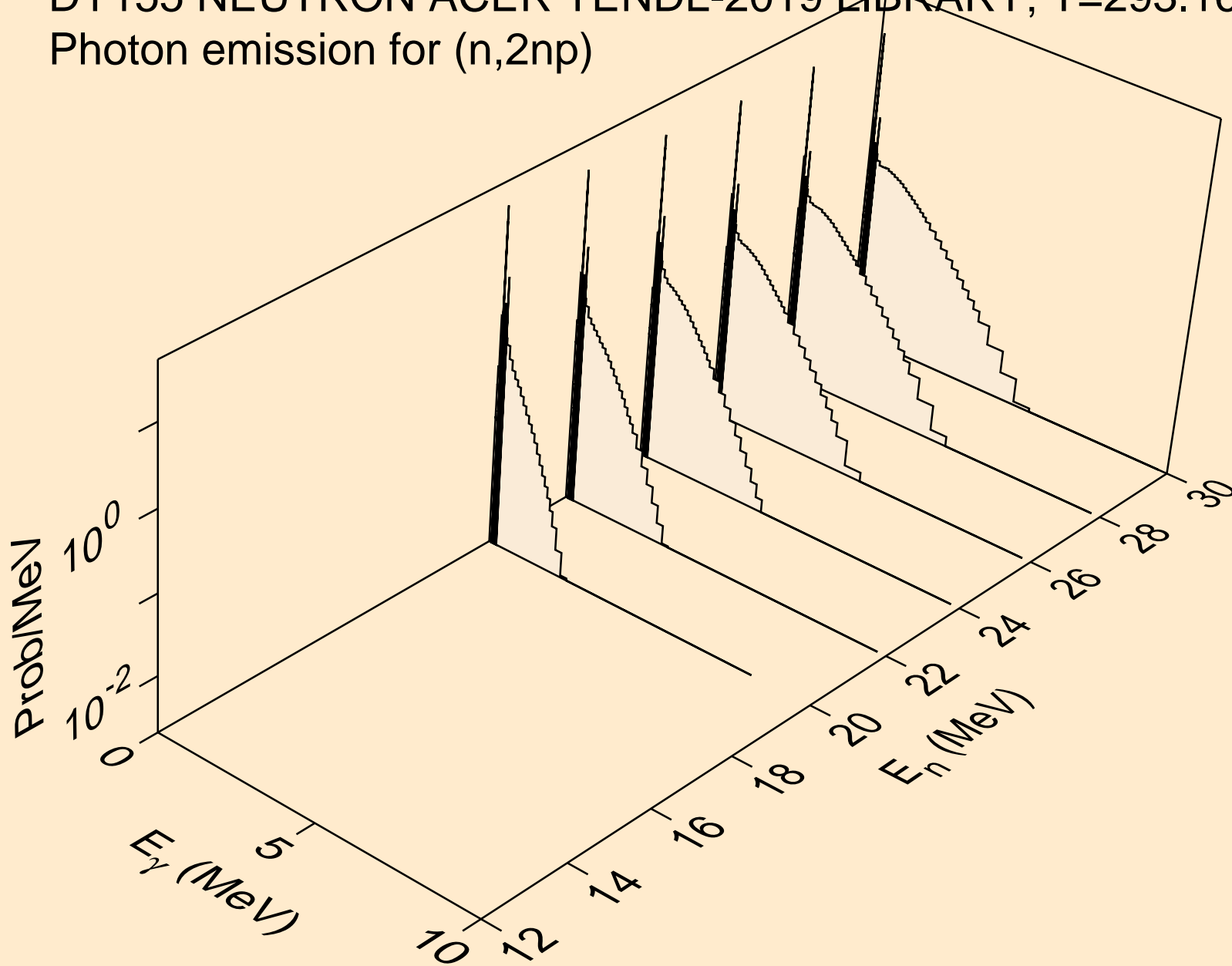

DY155 NEUTRON ACER TENDL-2019 LIBRARY; T=293.16K
Photon emission for (n,3np)

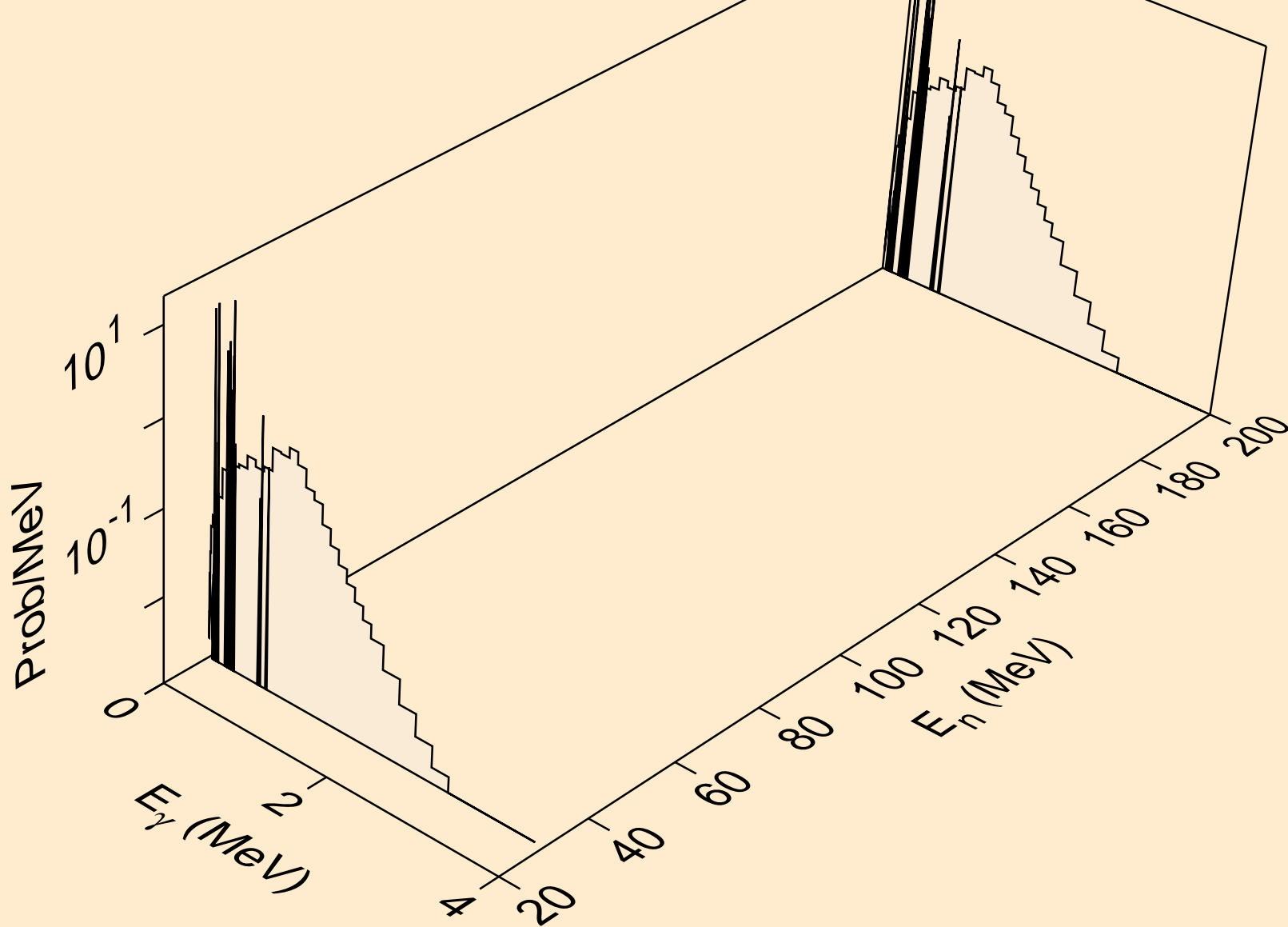

DY155 NEUTRON ACER TENDL-2019 LIBRARY; T=293.16K
Photon emission for (n,2np)

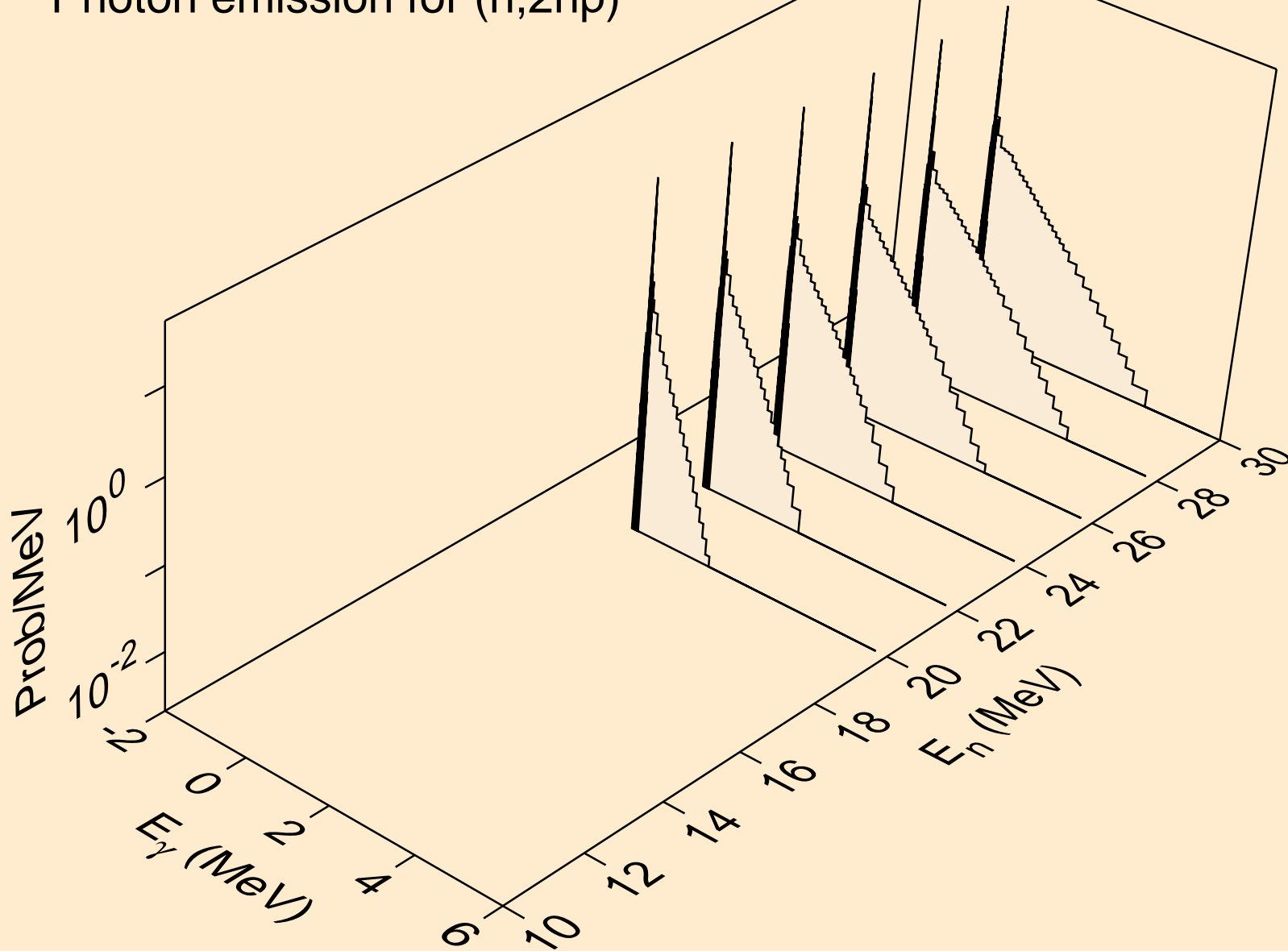

DY155 NEUTRON ACER TENDL-2019 LIBRARY; T=293.16K
Photon emission for (n,npa)

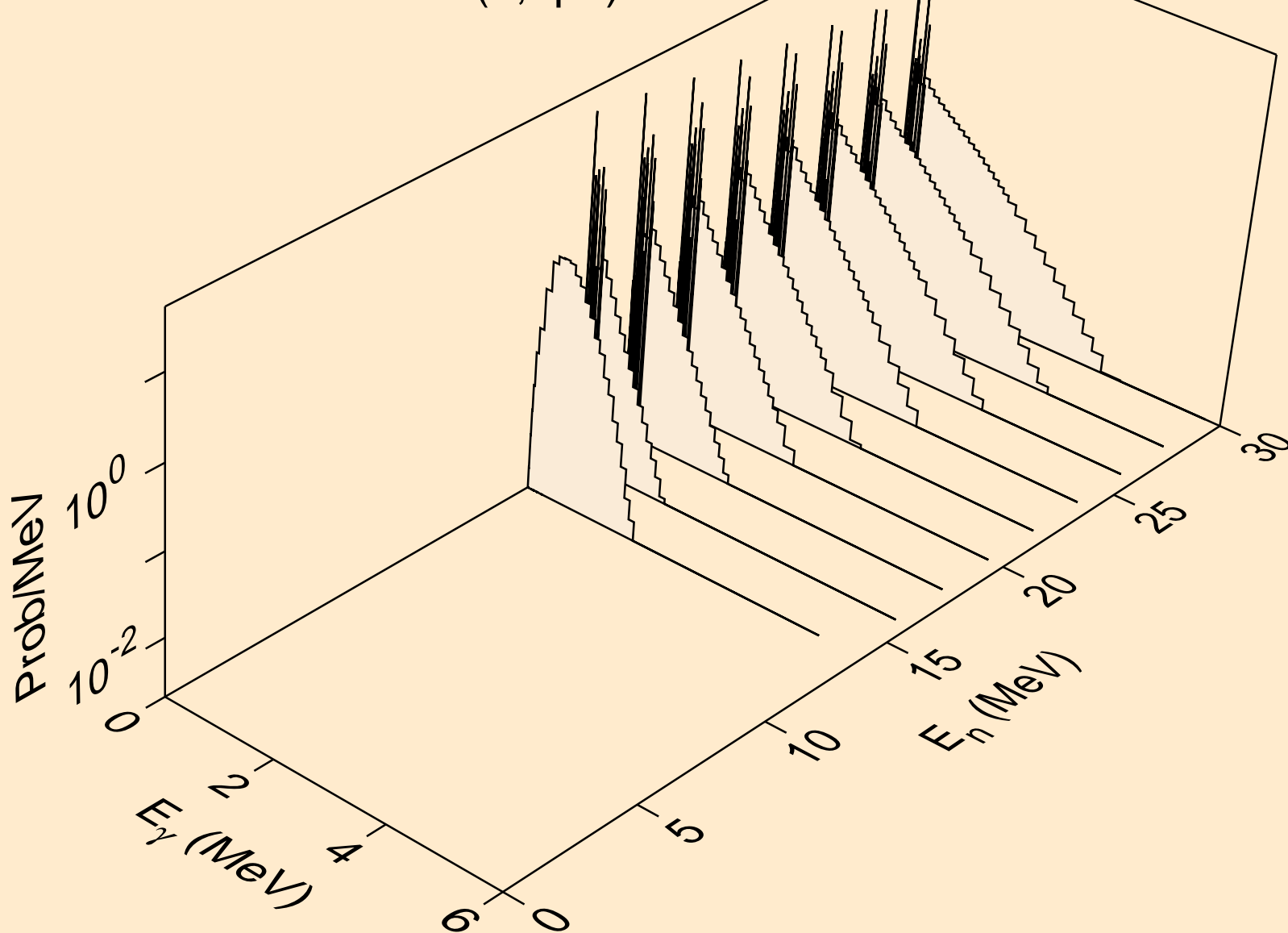

DY155 NEUTRON ACER TENDL-2019 LIBRARY; T=293.16K
Photon emission for (n,n*c)

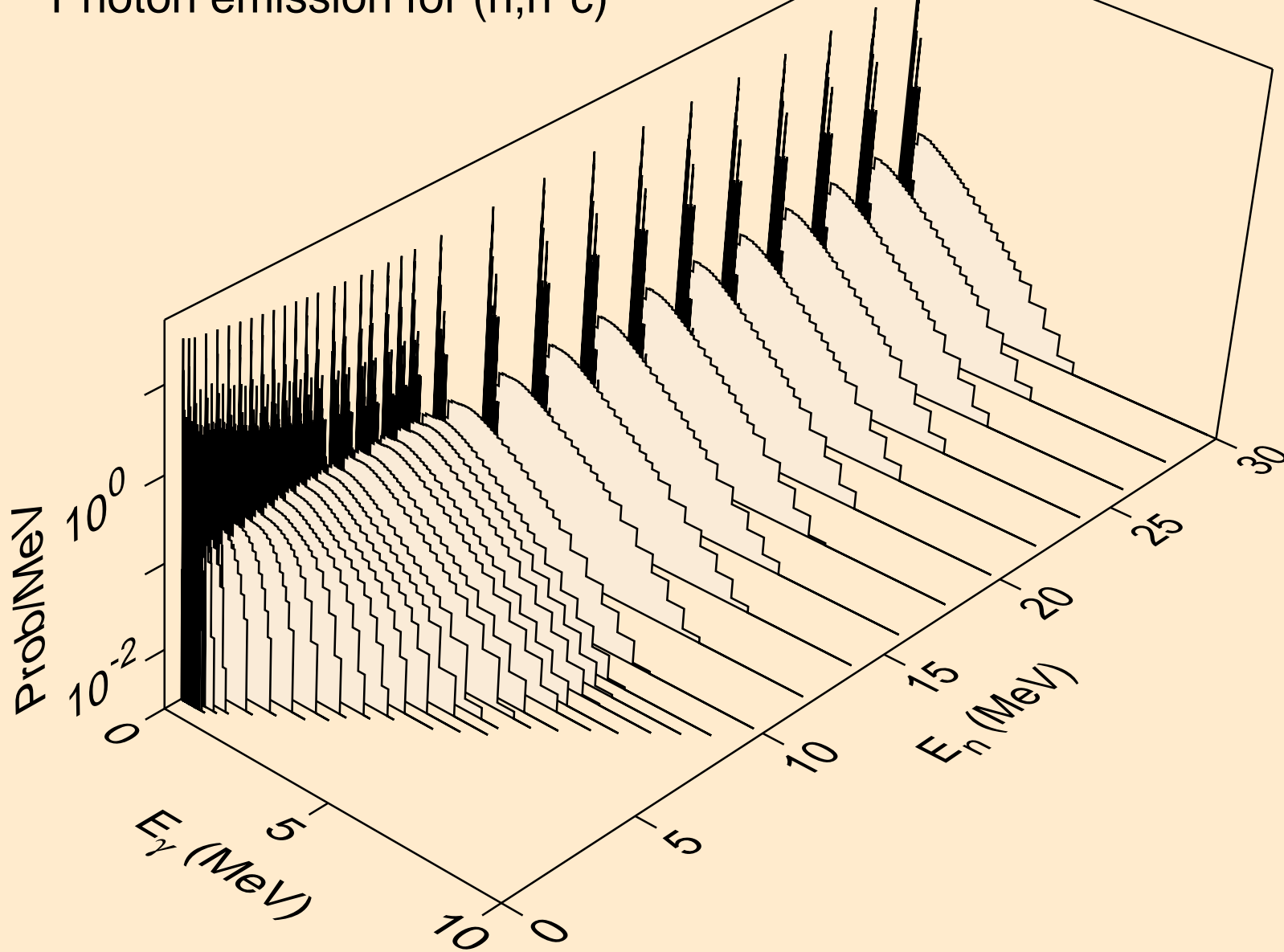

DY155 NEUTRON ACER TENDL-2019 LIBRARY; T=293.16K
Photon emission for (n,gma)

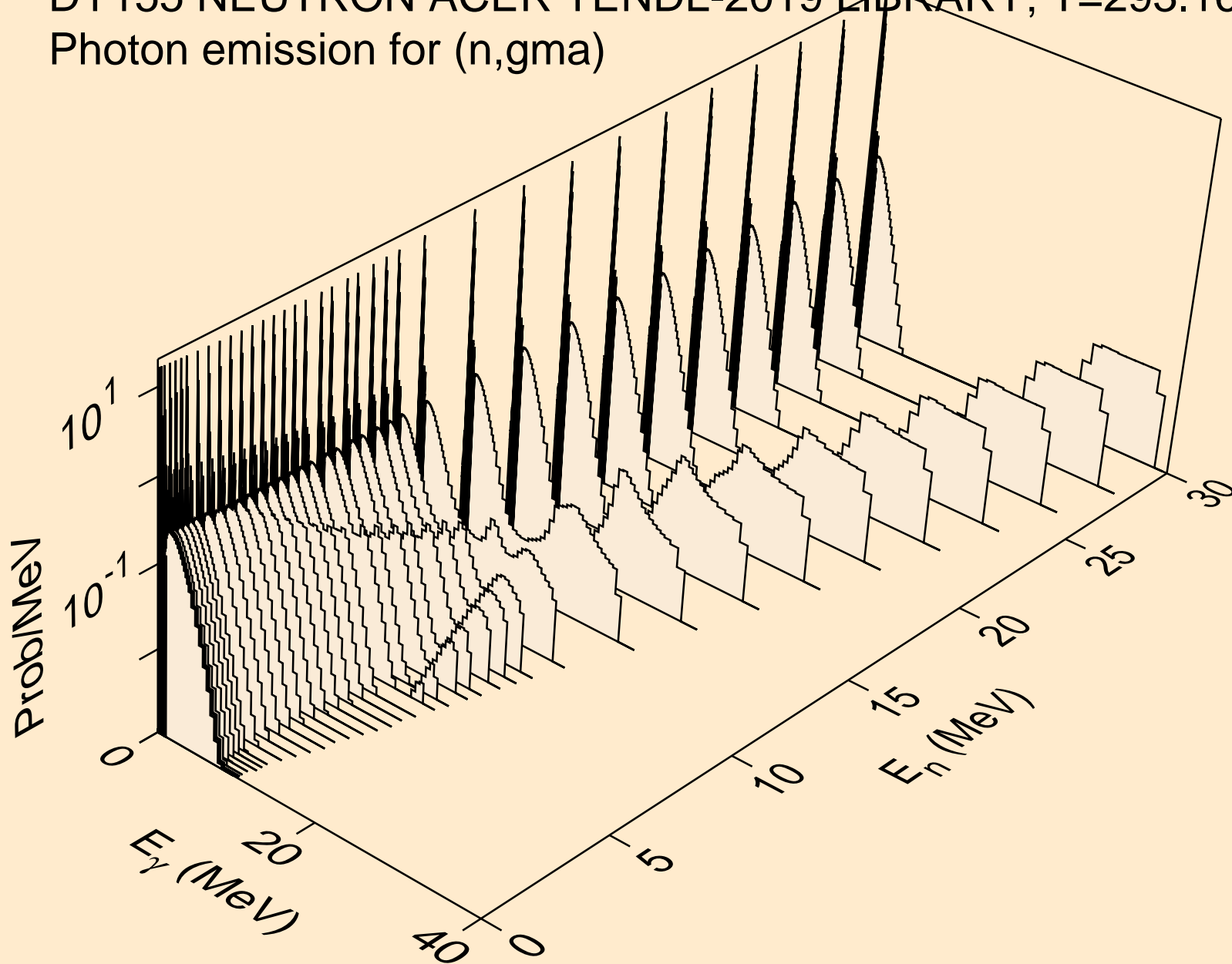

DY155 NEUTRON ACER TENDL-2019 LIBRARY; T=293.16K
Photon emission for (n,p)

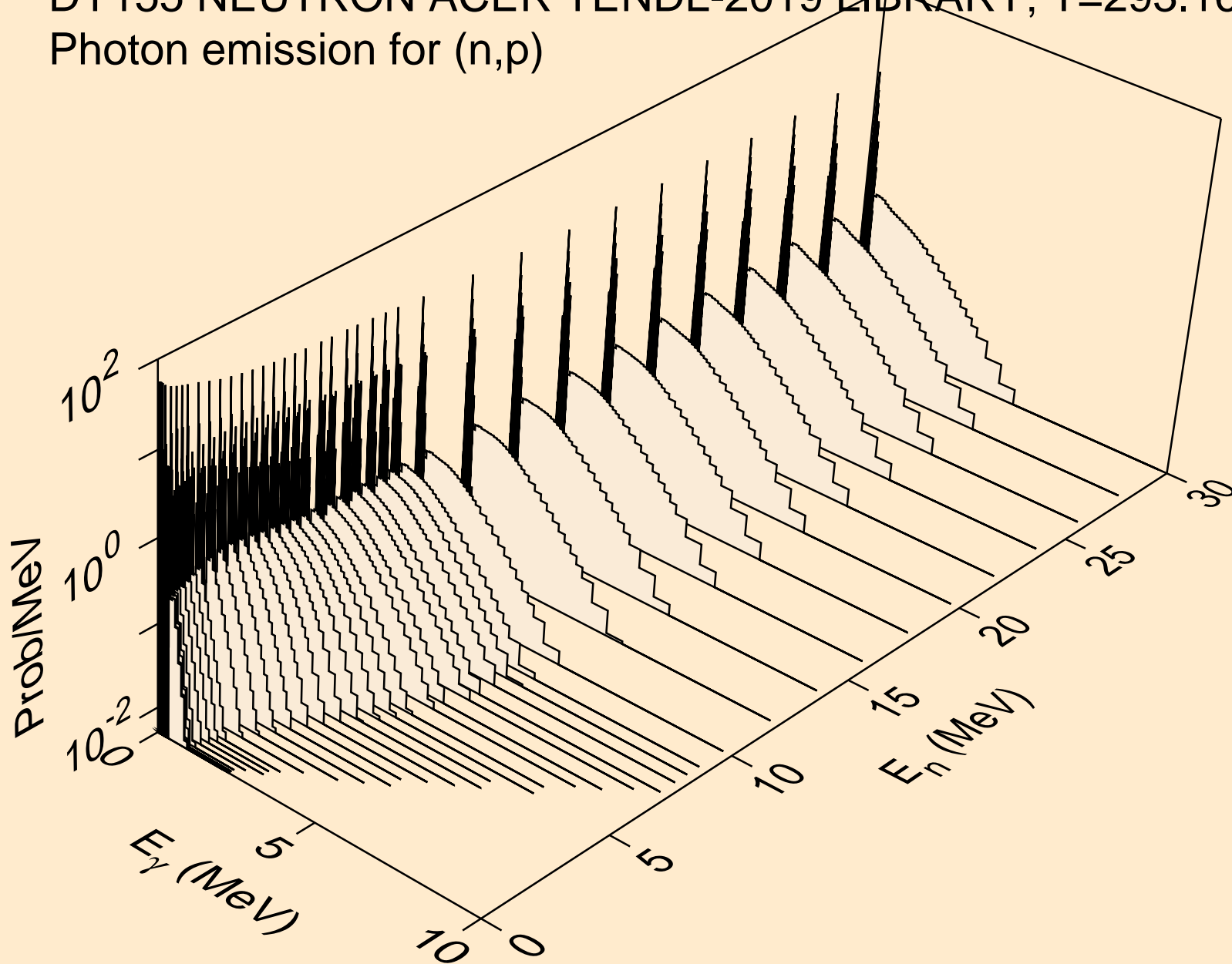

DY155 NEUTRON ACER TENDL-2019 LIBRARY; T=293.16K
Photon emission for (n,d)

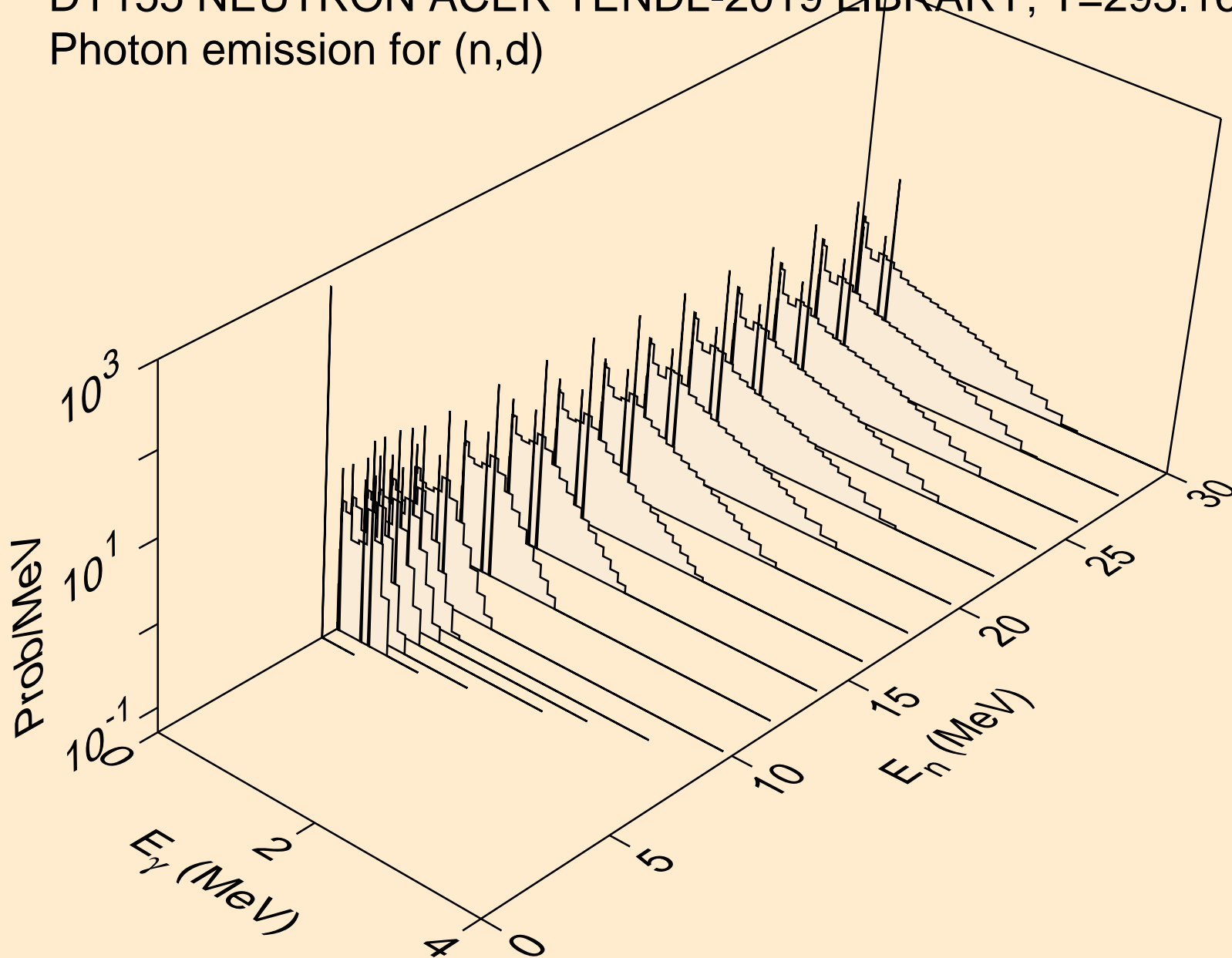

DY155 NEUTRON ACER TENDL-2019 LIBRARY; T=293.16K
Photon emission for (n,t)

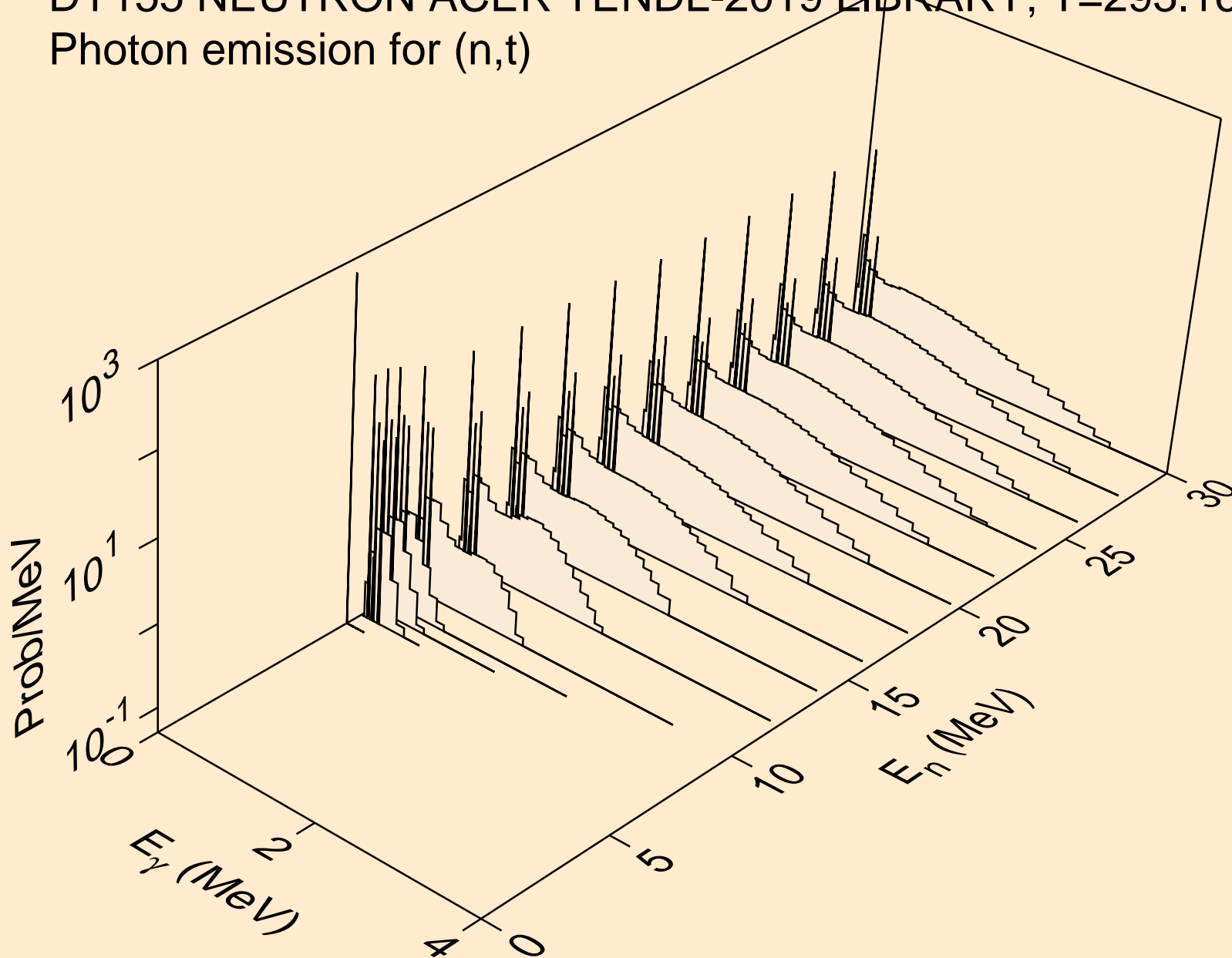

DY155 NEUTRON ACER TENDL-2019 LIBRARY; T=293.16K
Photon emission for (n,he3)

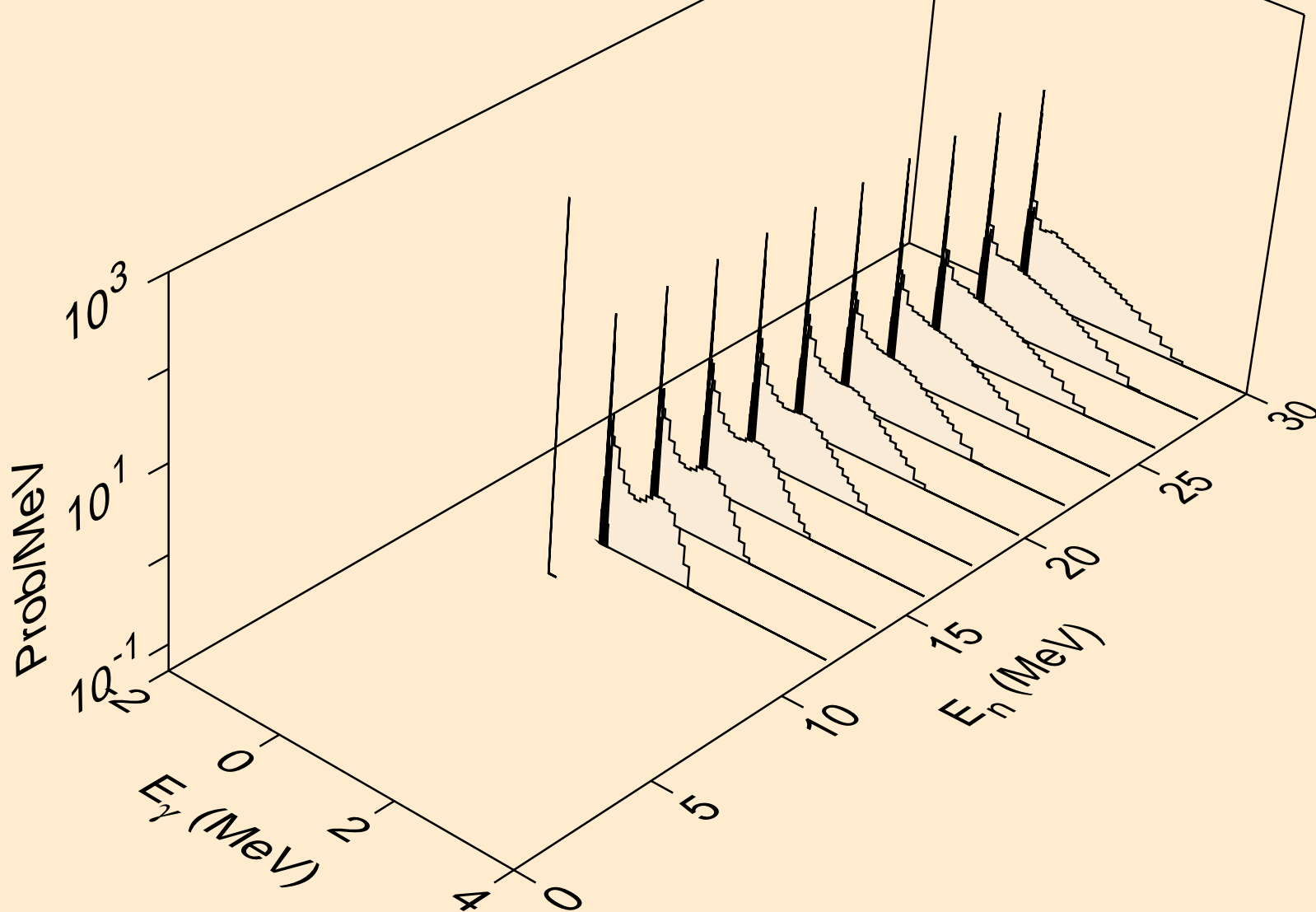

DY155 NEUTRON ACER TENDL-2019 LIBRARY; T=293.16K
Photon emission for (n,a)

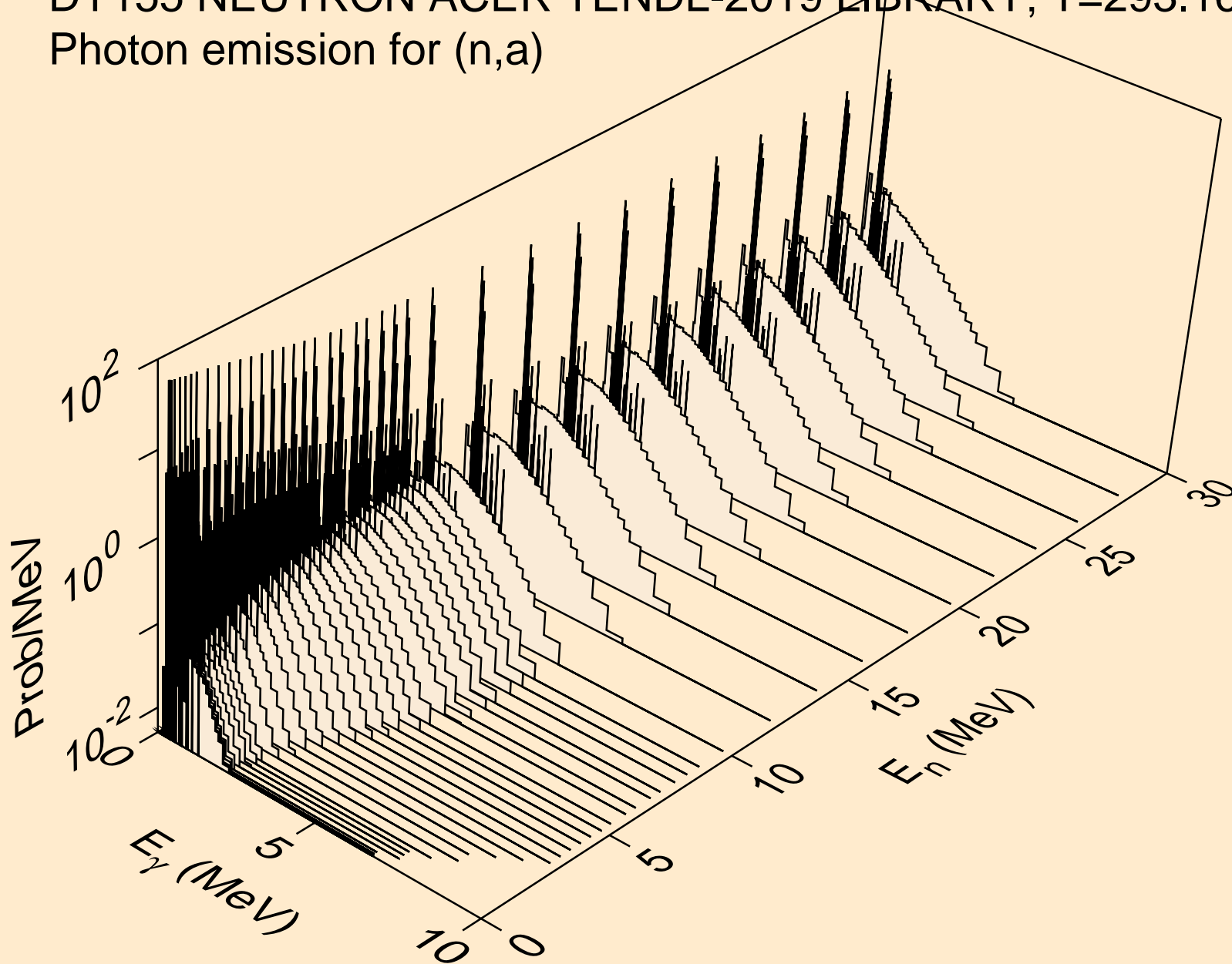

DY155 NEUTRON ACER TENDL-2019 LIBRARY; T=293.16K
Photon emission for (n,2a)

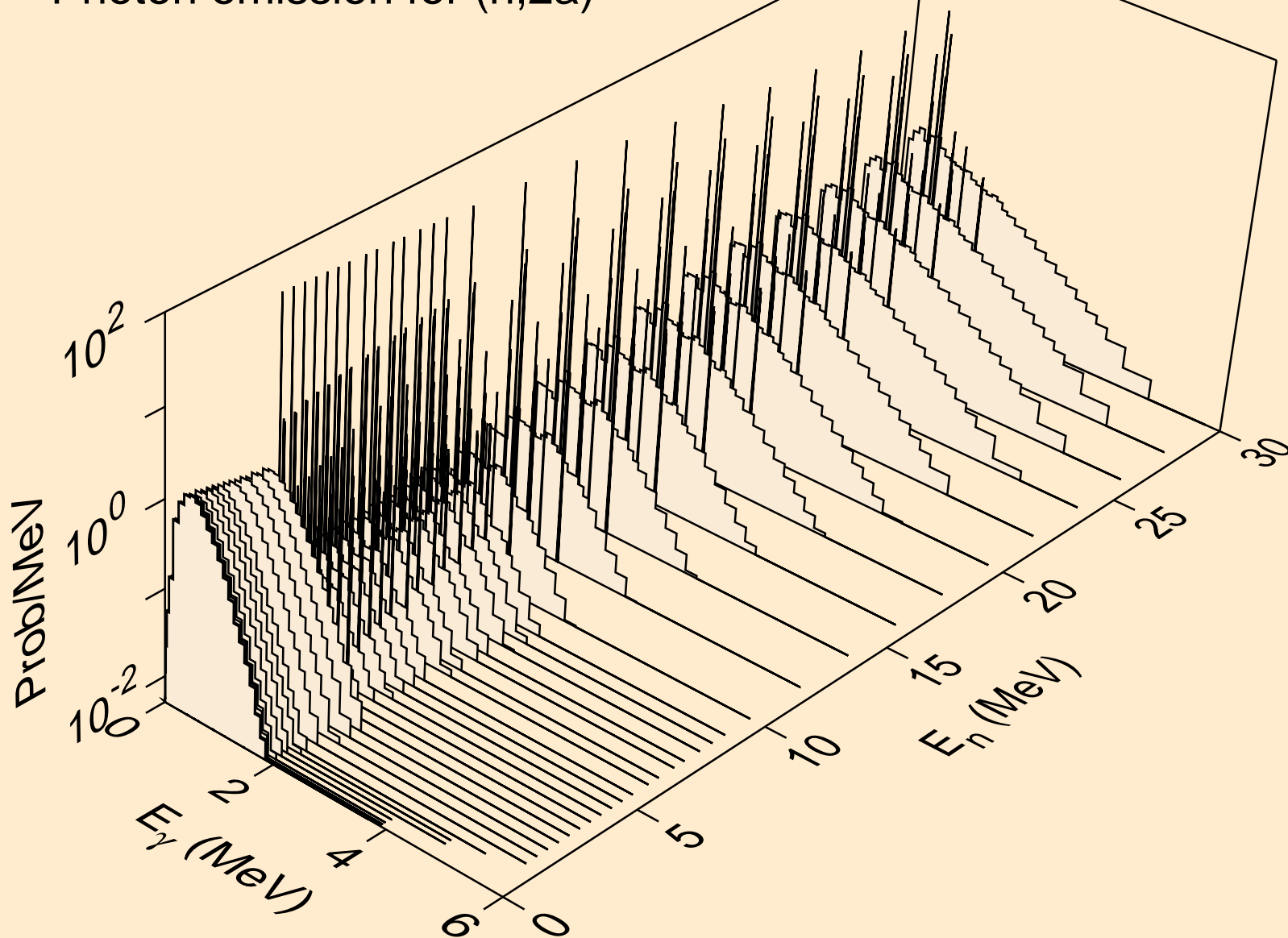

DY155 NEUTRON ACER TENDL-2019 LIBRARY; T=293.16K
Photon emission for (n,2p)

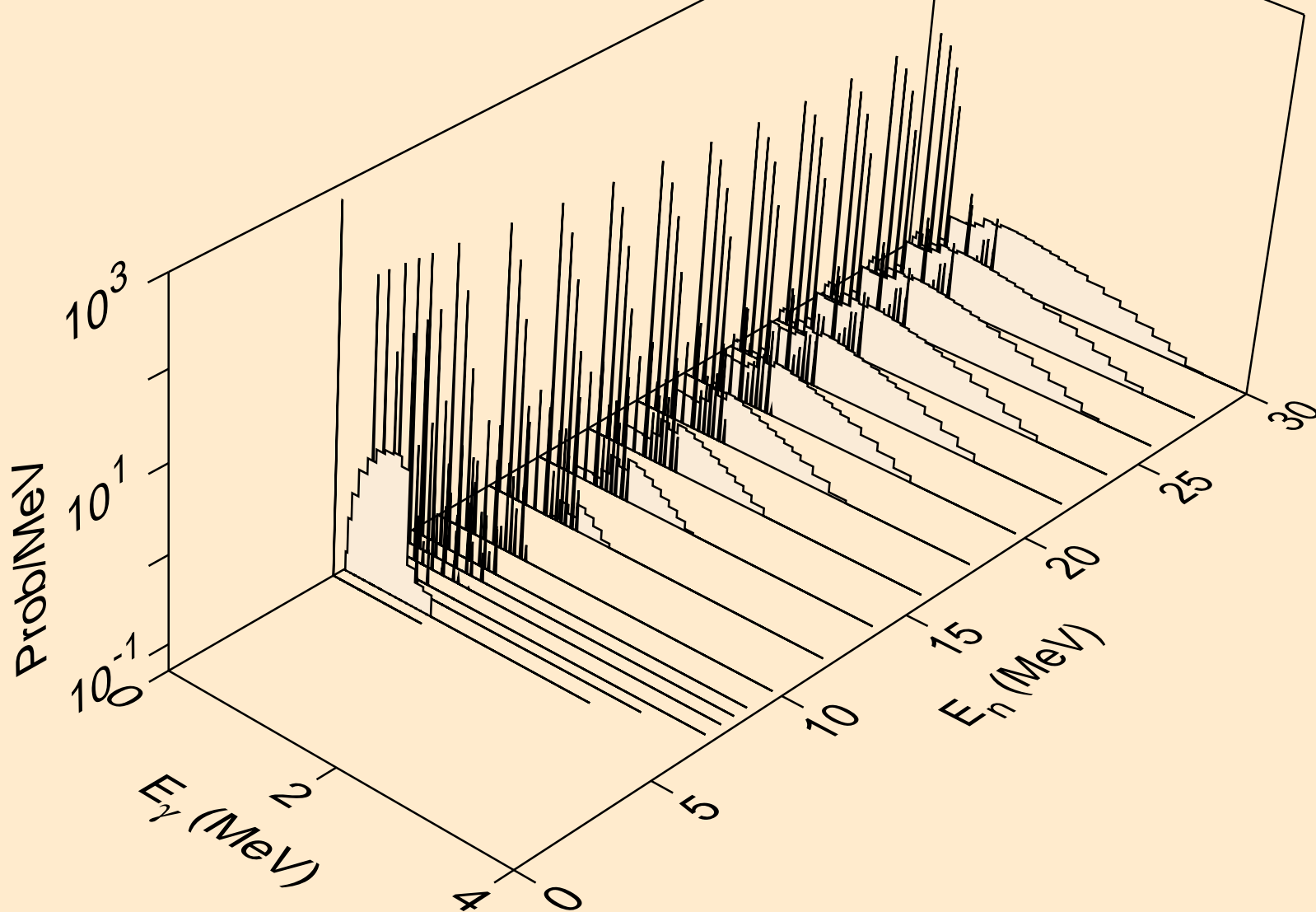

DY155 NEUTRON ACER TENDL-2019 LIBRARY; T=293.16K
Photon emission for (n,p)

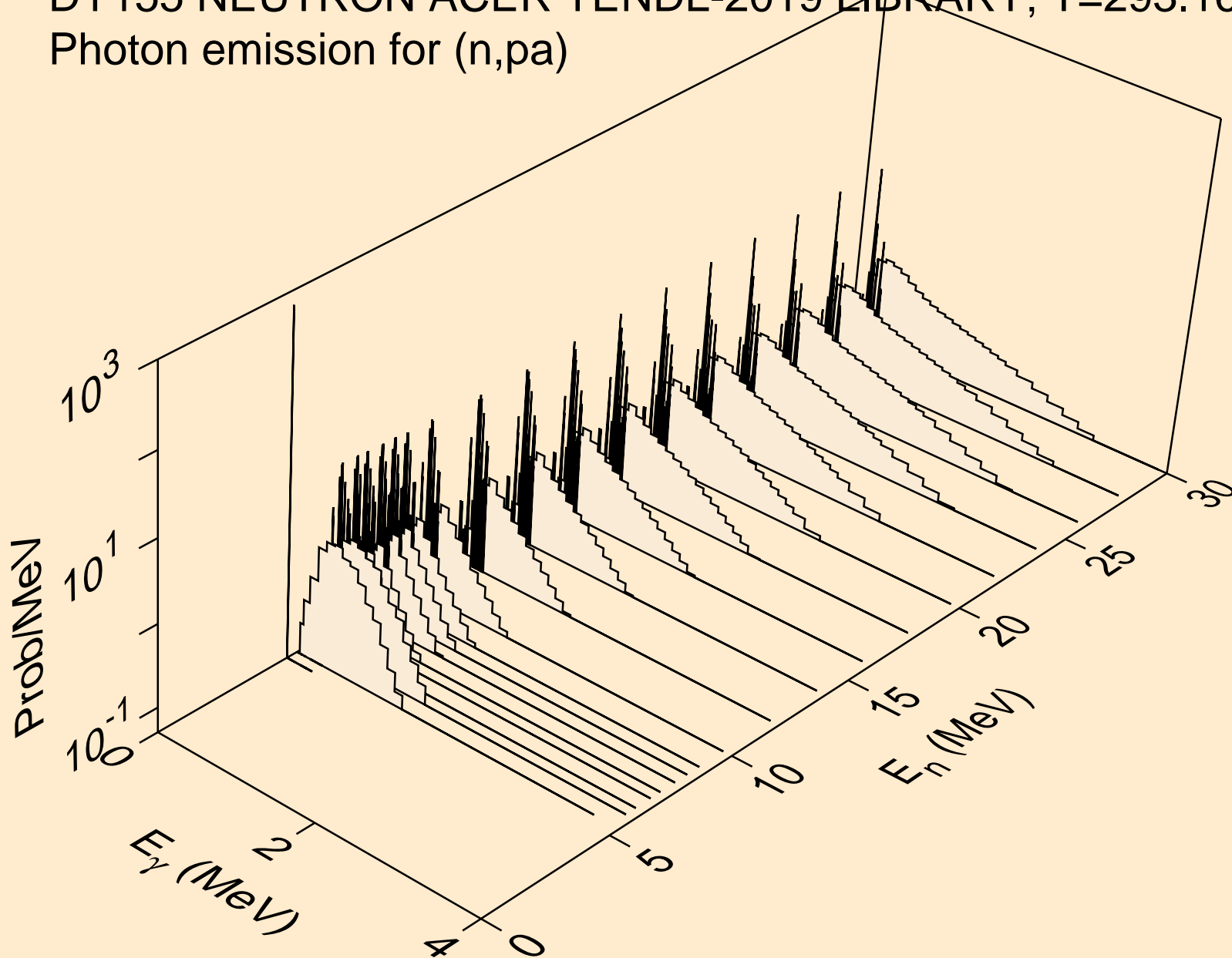

DY155 NEUTRON ACER TENDL-2019 LIBRARY; T=293.16K
Photon emission for (n,pd)

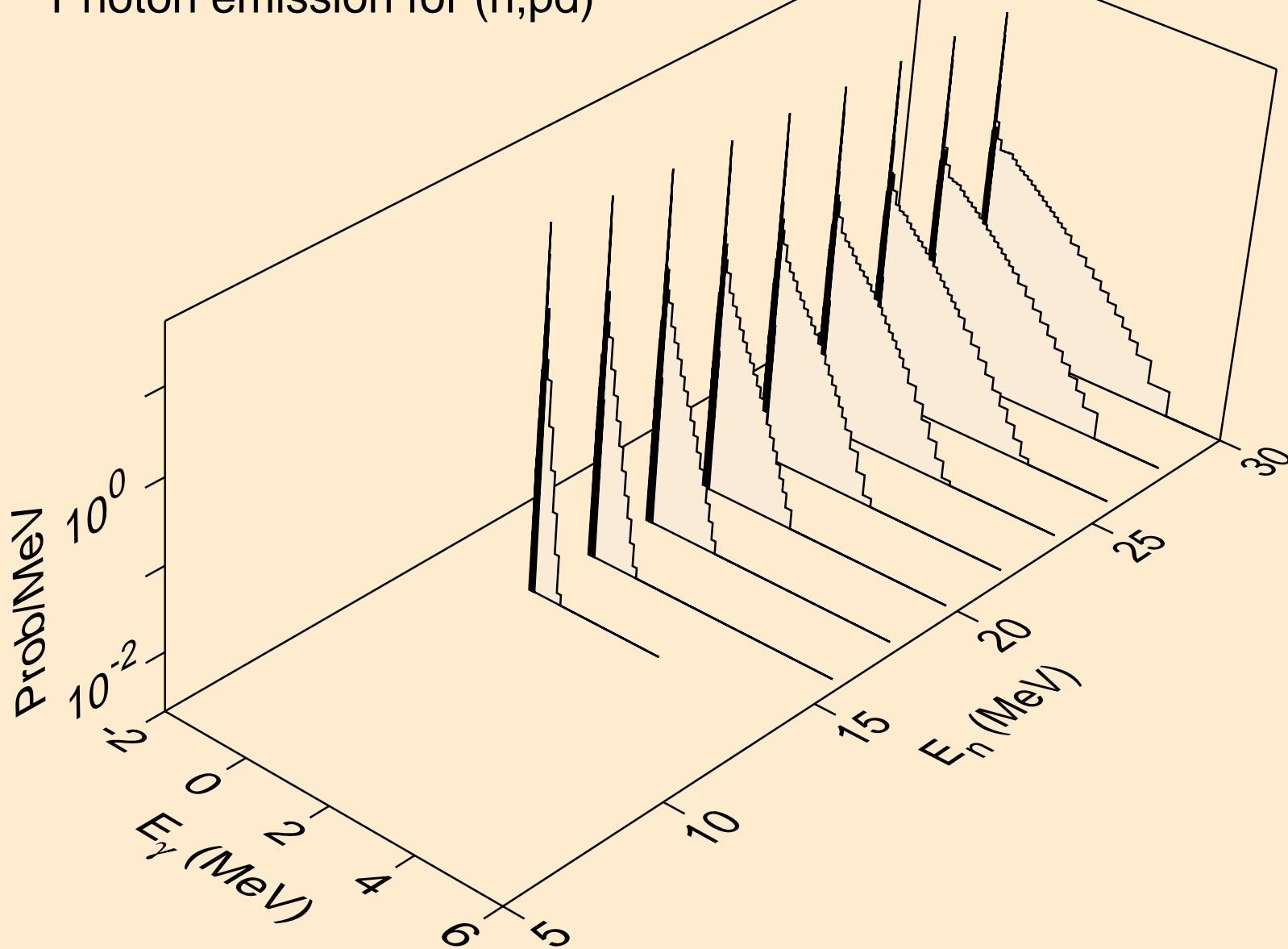

DY155 NEUTRON ACER TENDL-2019 LIBRARY; T=293.16K
Photon emission for (n,pt)

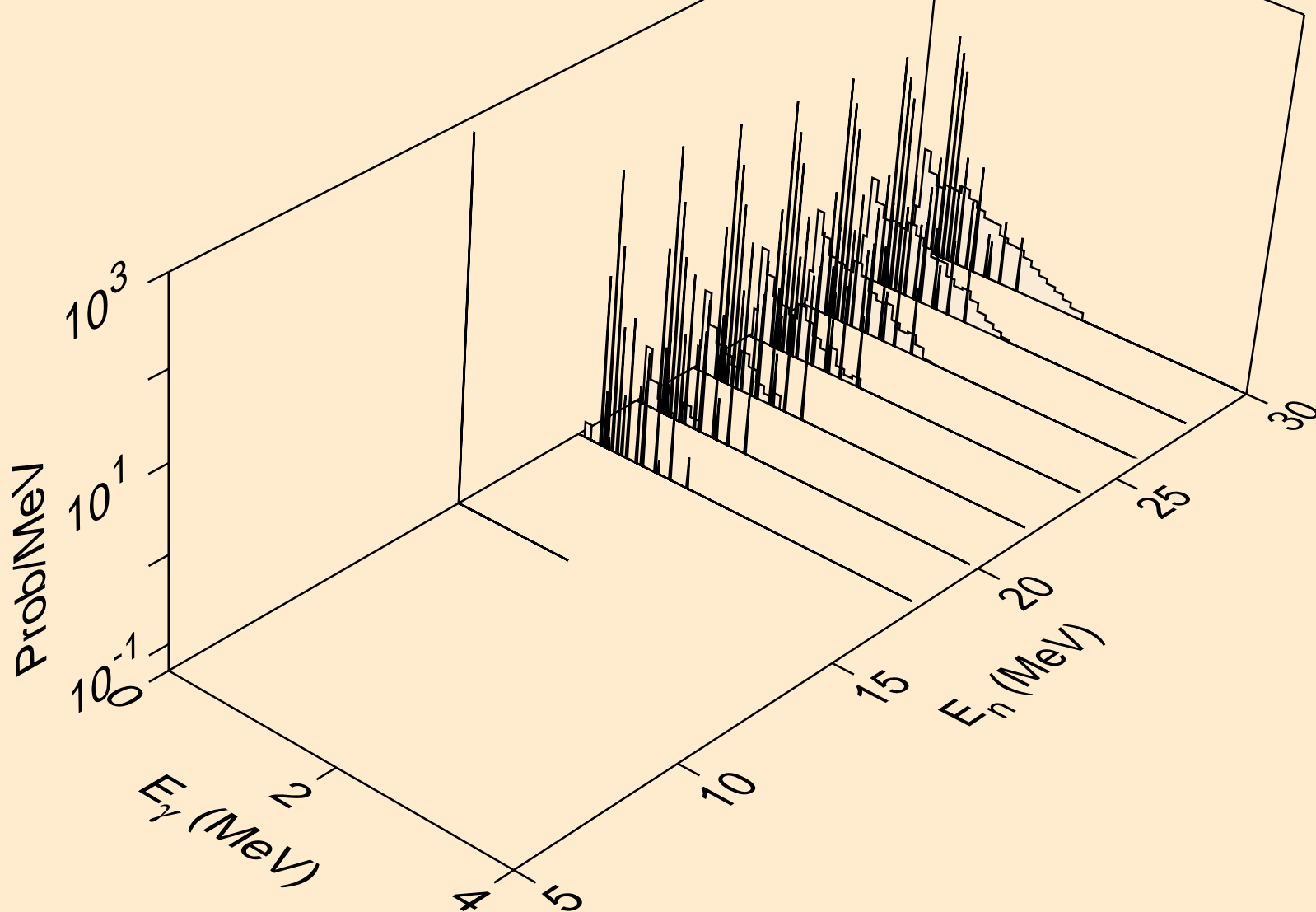

DY155 NEUTRON ACER TENDL-2019 LIBRARY; T=293.16K
Photon emission for (n,da)

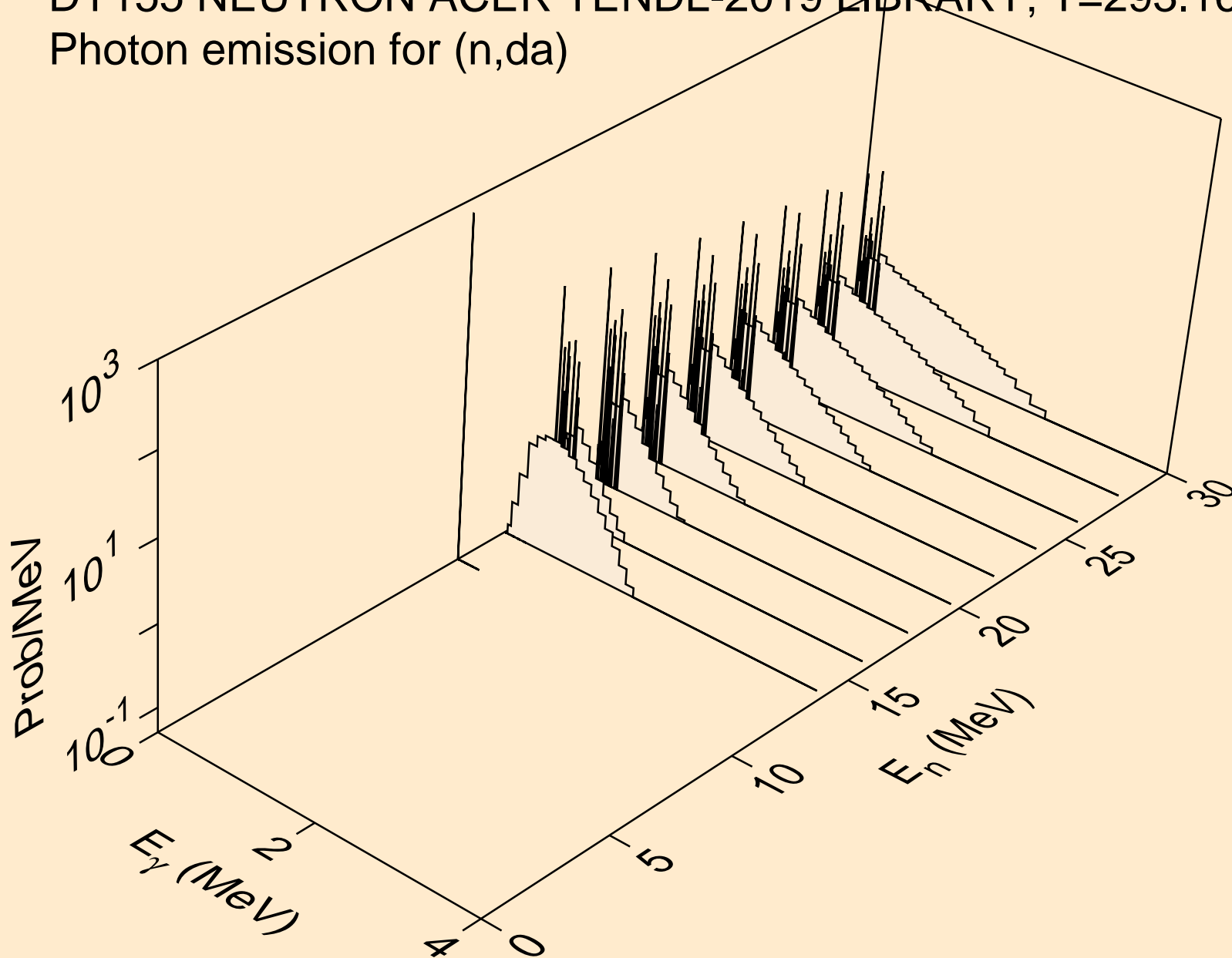

DY155 NEUTRON ACER TENDL-2019 LIBRARY; T=293.16K
thermal capture photon spectrum

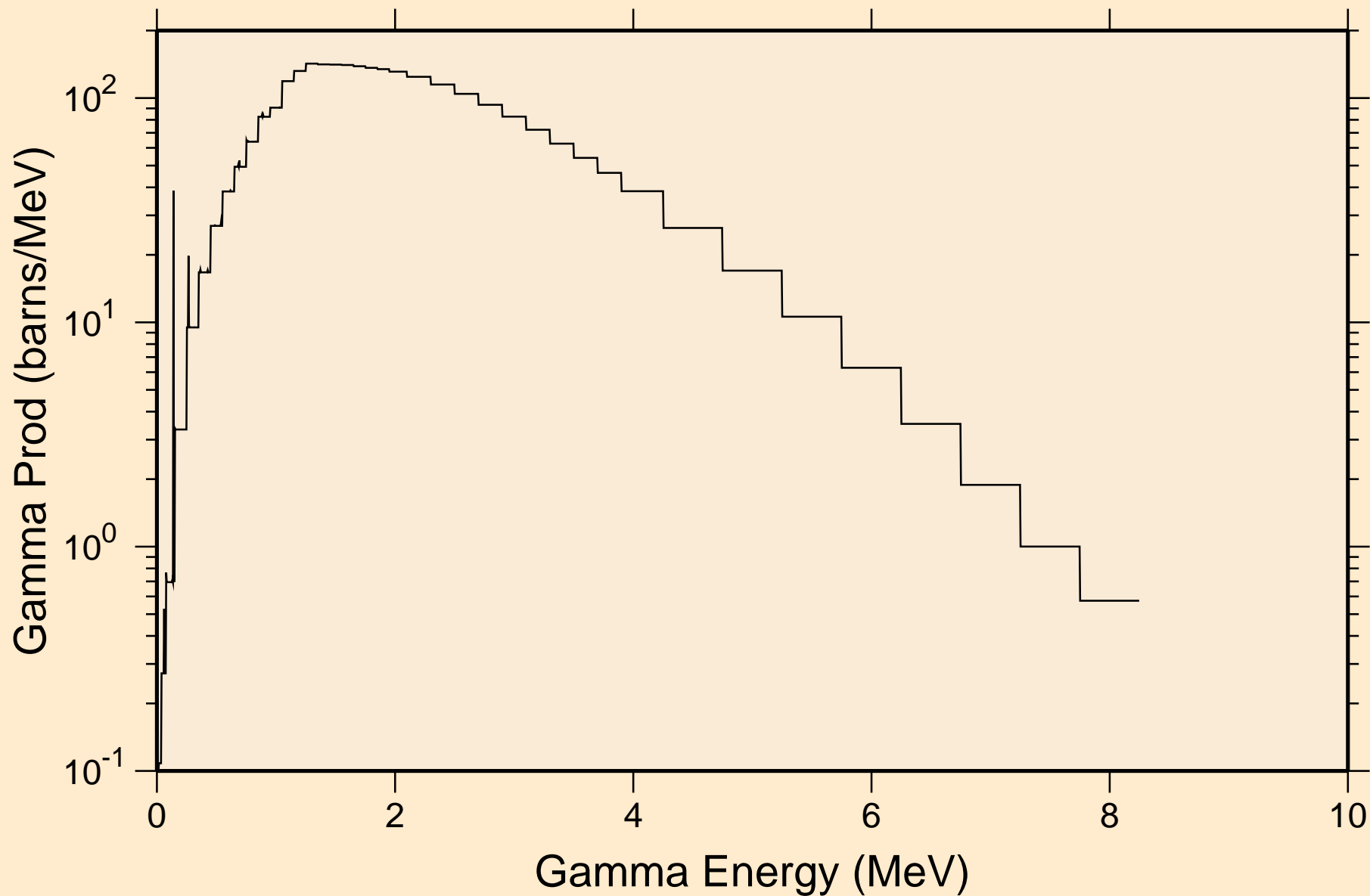

DY155 NEUTRON ACER TENDL-2019 LIBRARY; T=293.16K
14 MeV photon spectrum

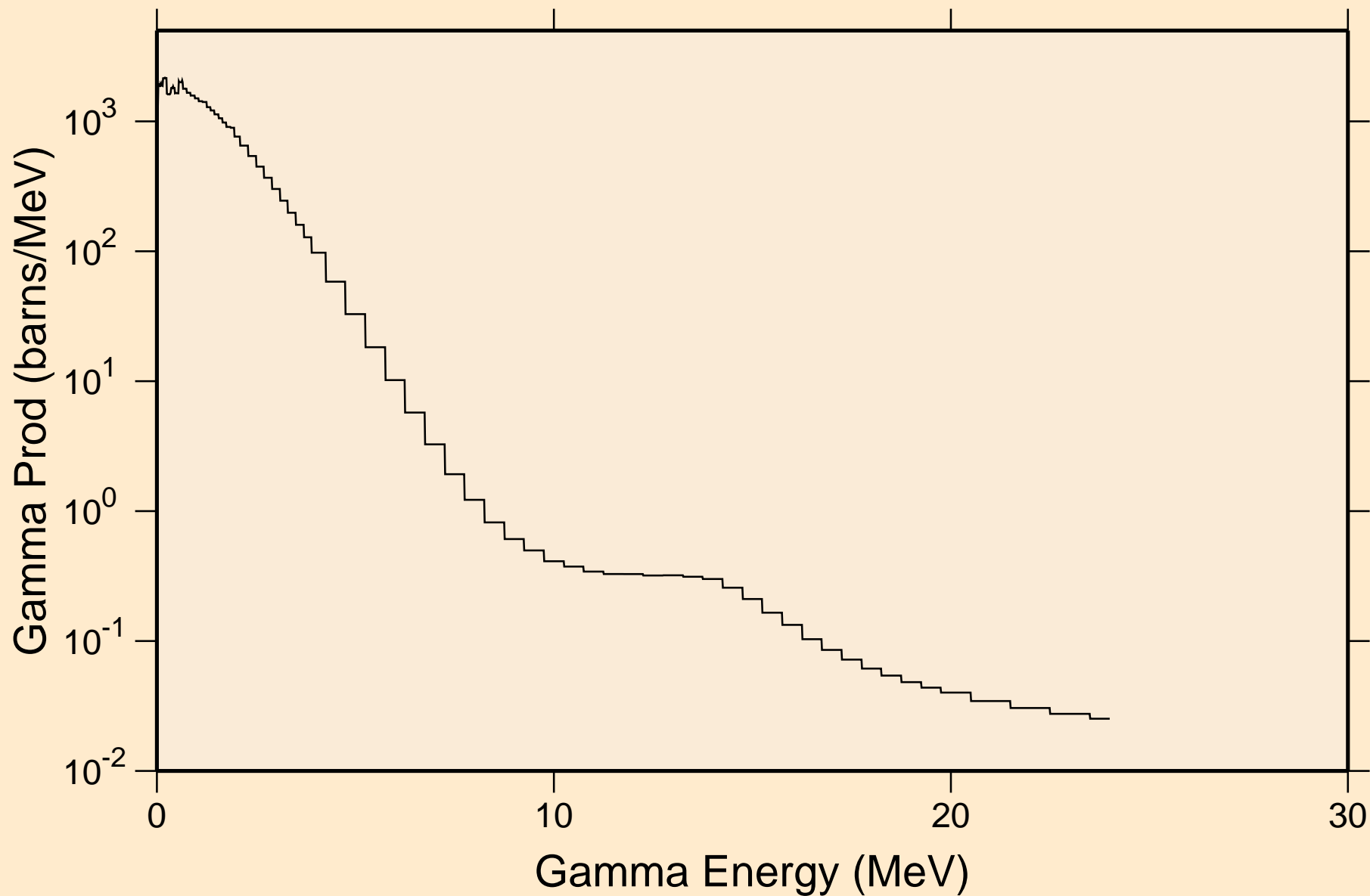

DY155 NEUTRON ACER TENDL-2019 LIBRARY; T=293.16K

Particle heating contributions

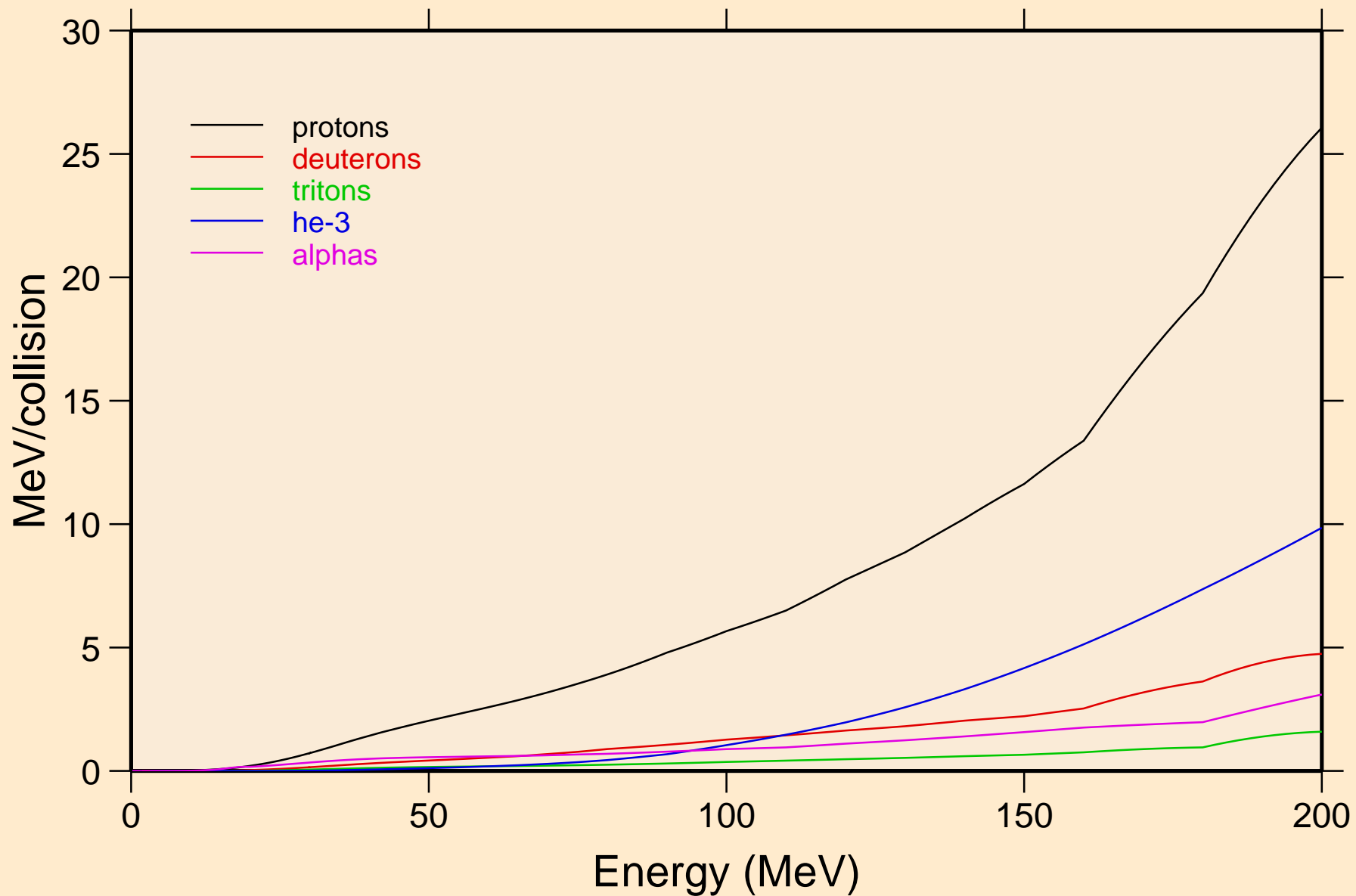

DY155 NEUTRON ACER TENDL-2019 LIBRARY; T=293.16K
Recoil Heating

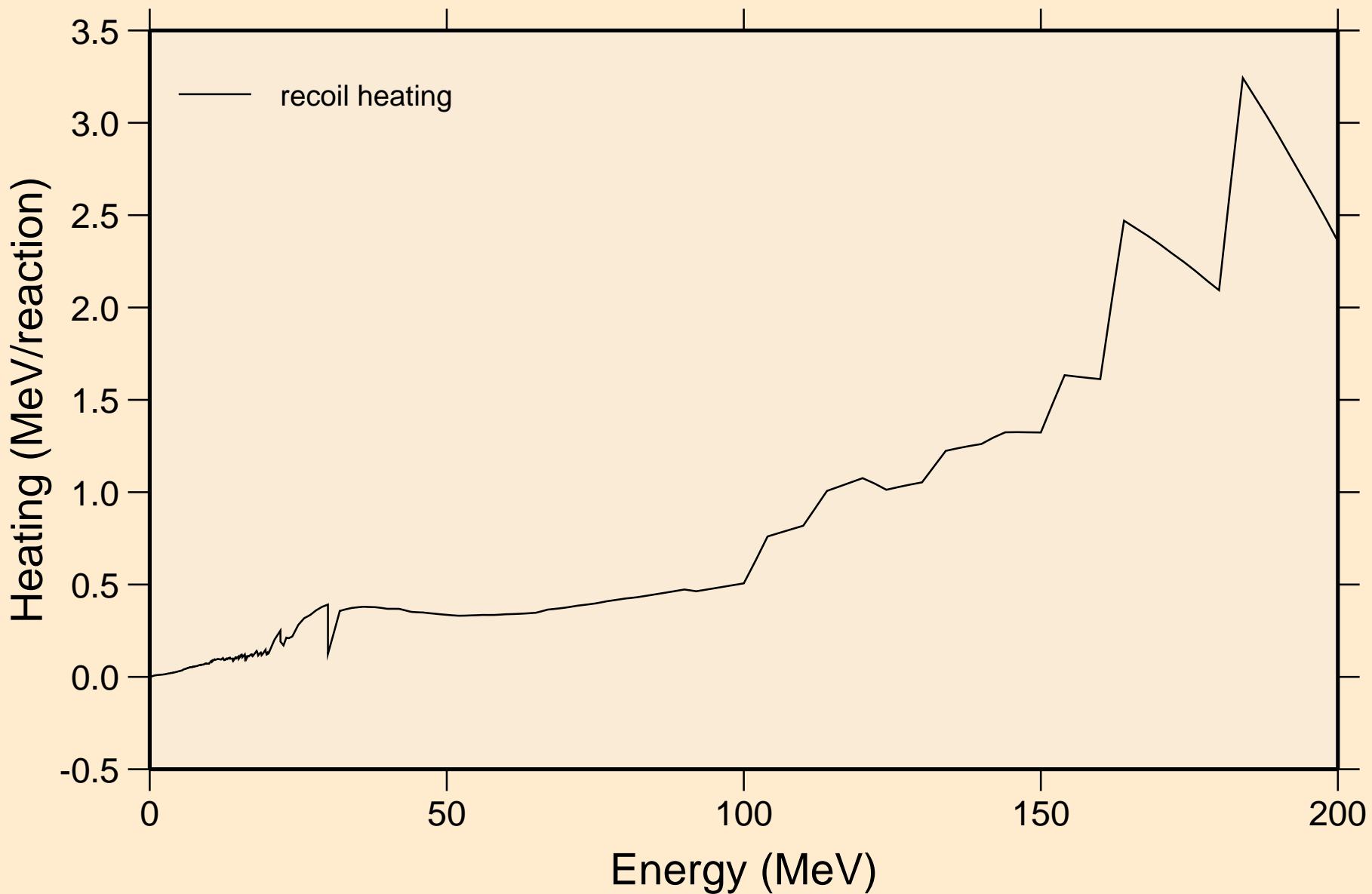

DY155 NEUTRON ACER TENDL-2019 LIBRARY; T=293.16K
Particle production cross sections

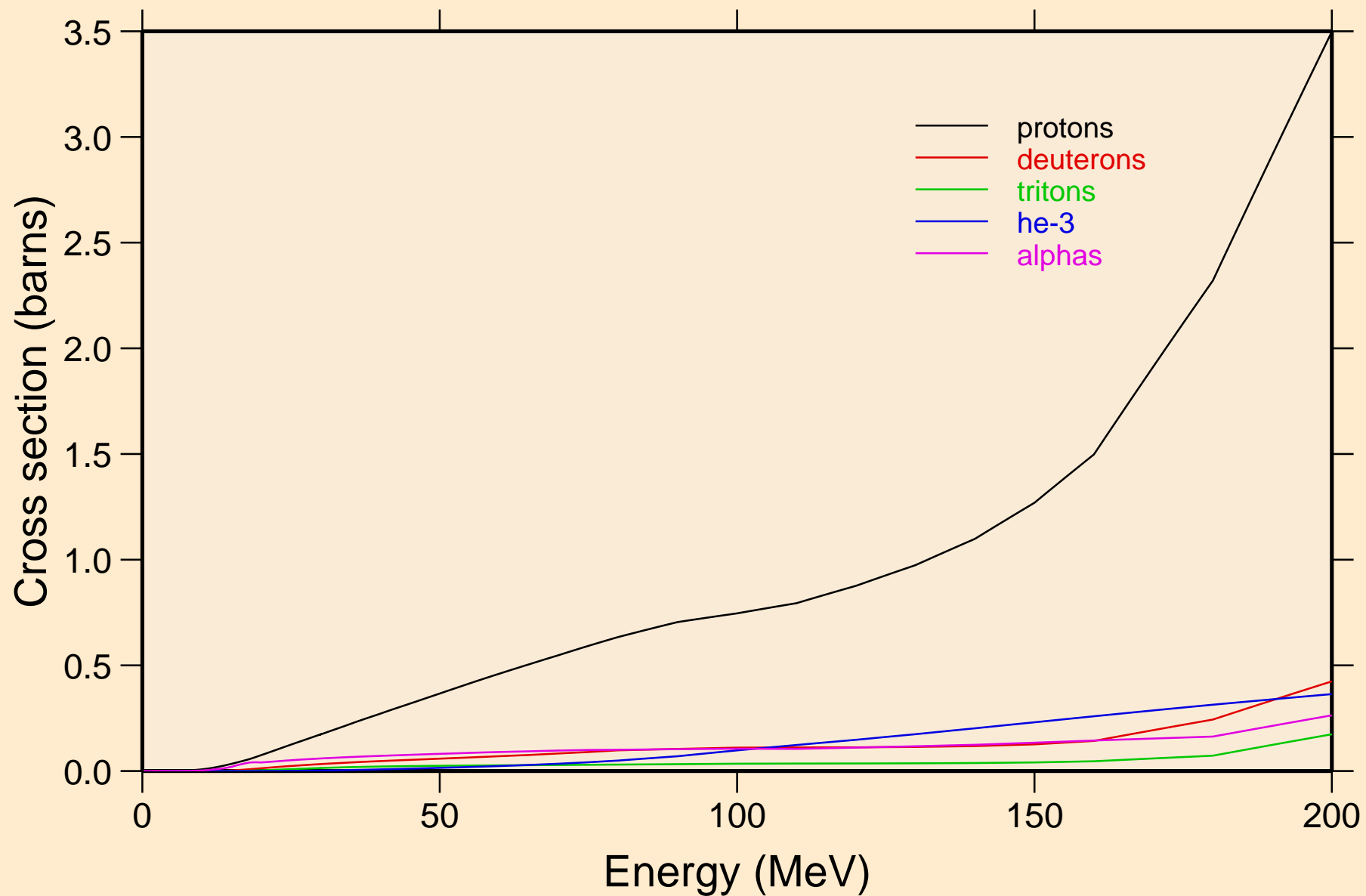

DY155 NEUTRON ACER TENDL-2019 LIBRARY; T=293.16K
protons from (n,x)

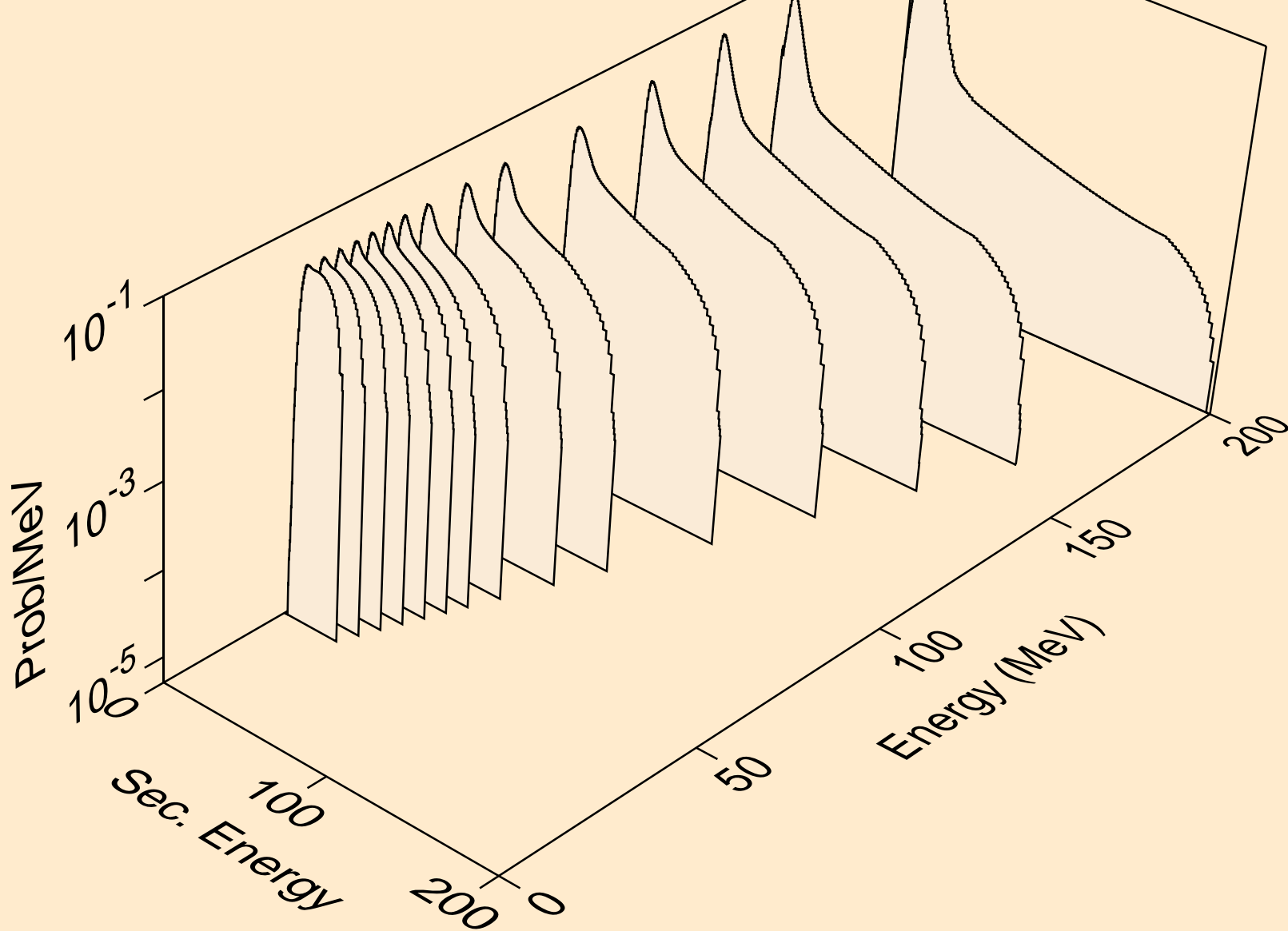

DY155 NEUTRON ACER TENDL-2019 LIBRARY; T=293.16K
protons from (n,n*)p

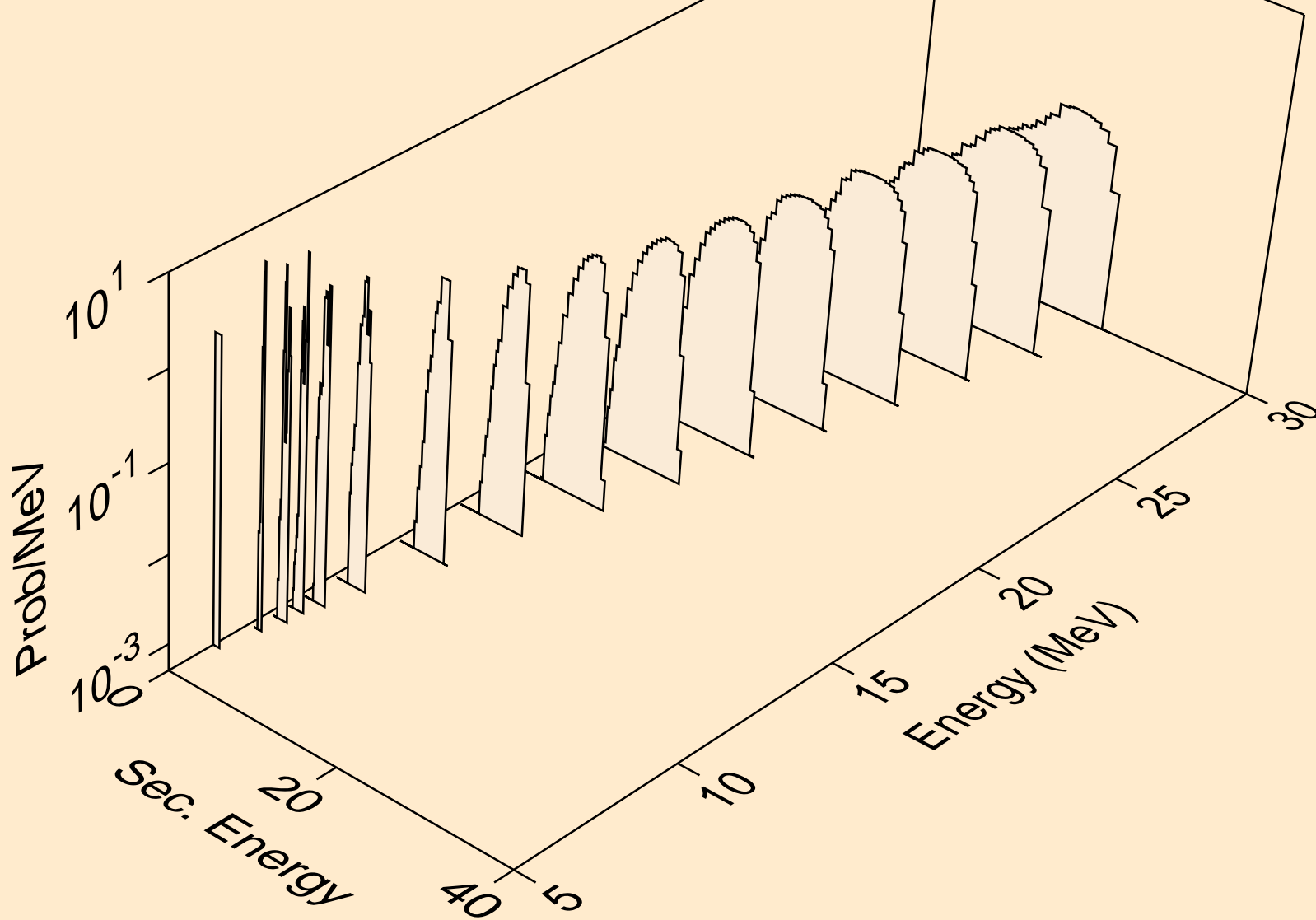

DY155 NEUTRON ACER TENDL-2019 LIBRARY; T=293.16K
protons from (n,2np)

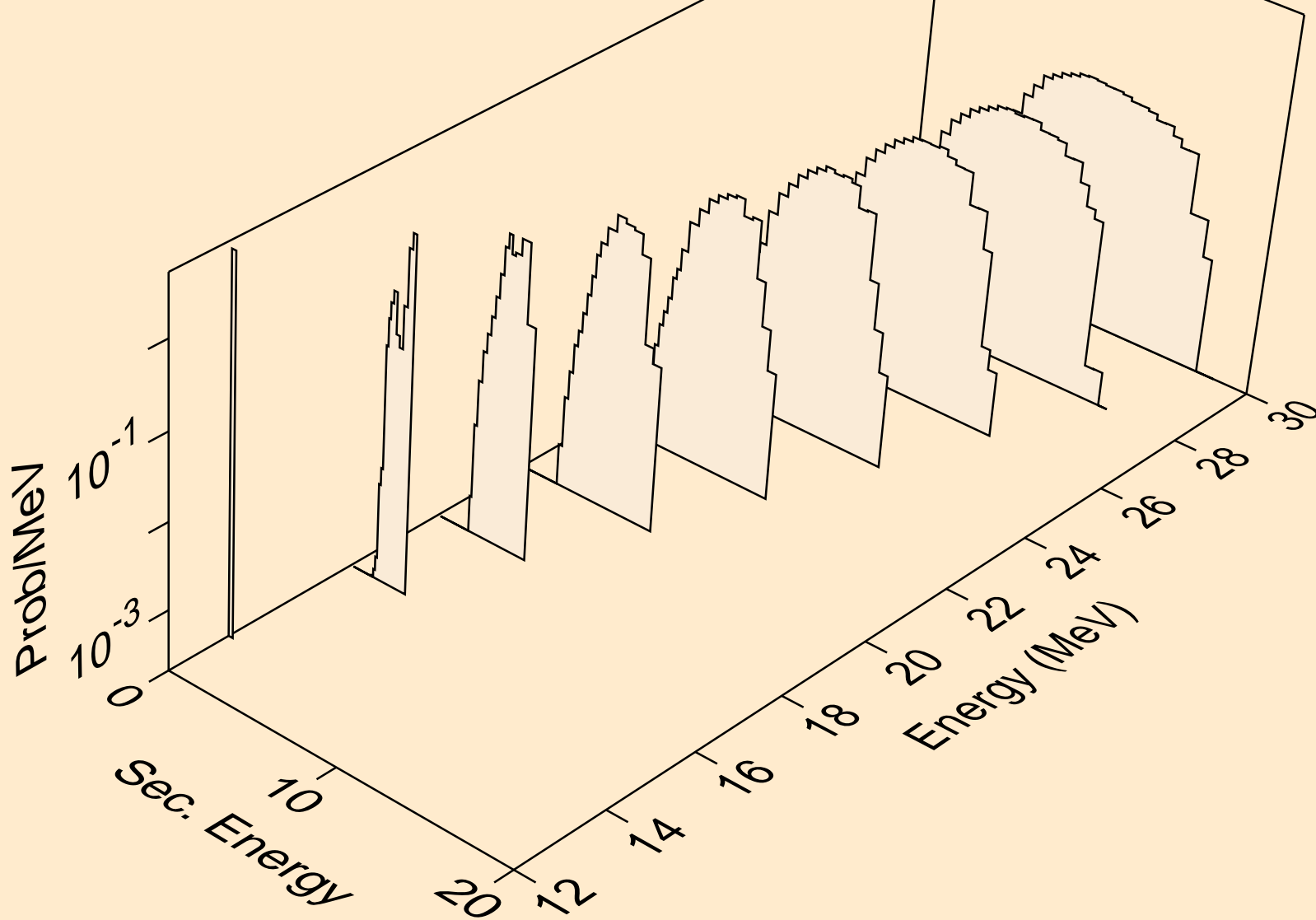

DY155 NEUTRON ACER TENDL-2019 LIBRARY; T=293.16K
protons from (n,3np)

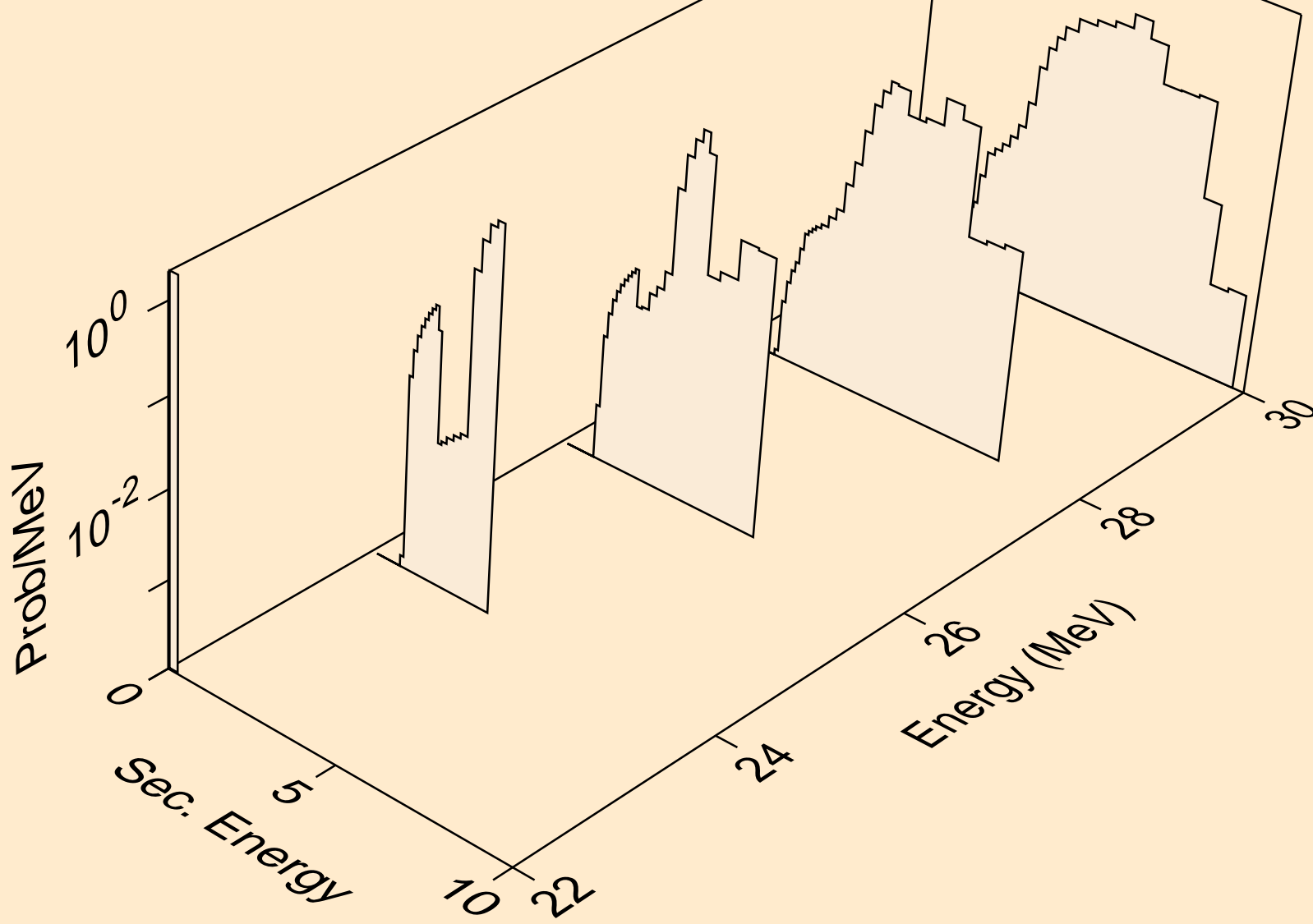

DY155 NEUTRON ACER TENDL-2019 LIBRARY; T=293.16K
protons from (n,2np)

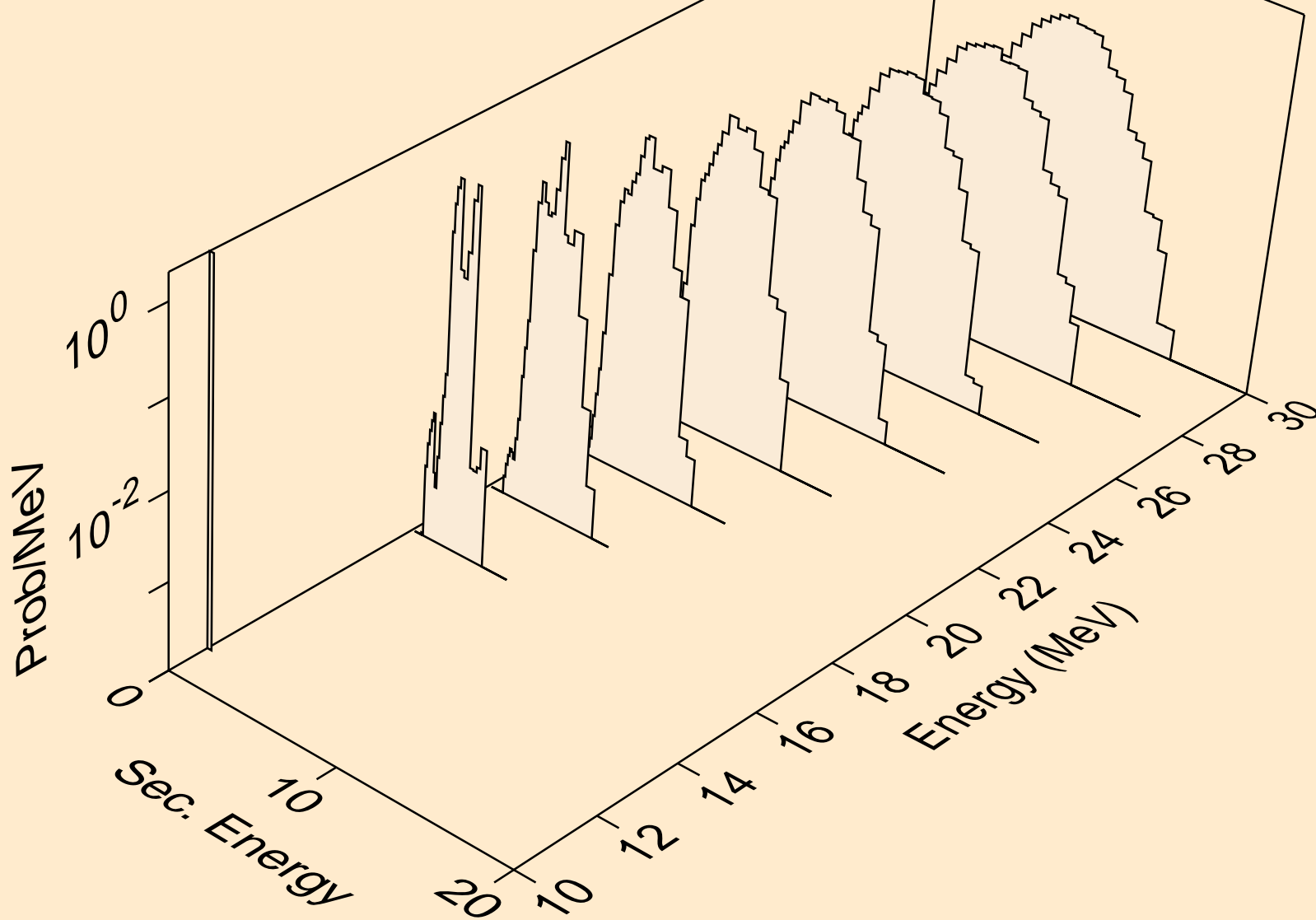

DY155 NEUTRON ACER TENDL-2019 LIBRARY; T=293.16K
protons from (n,npa)

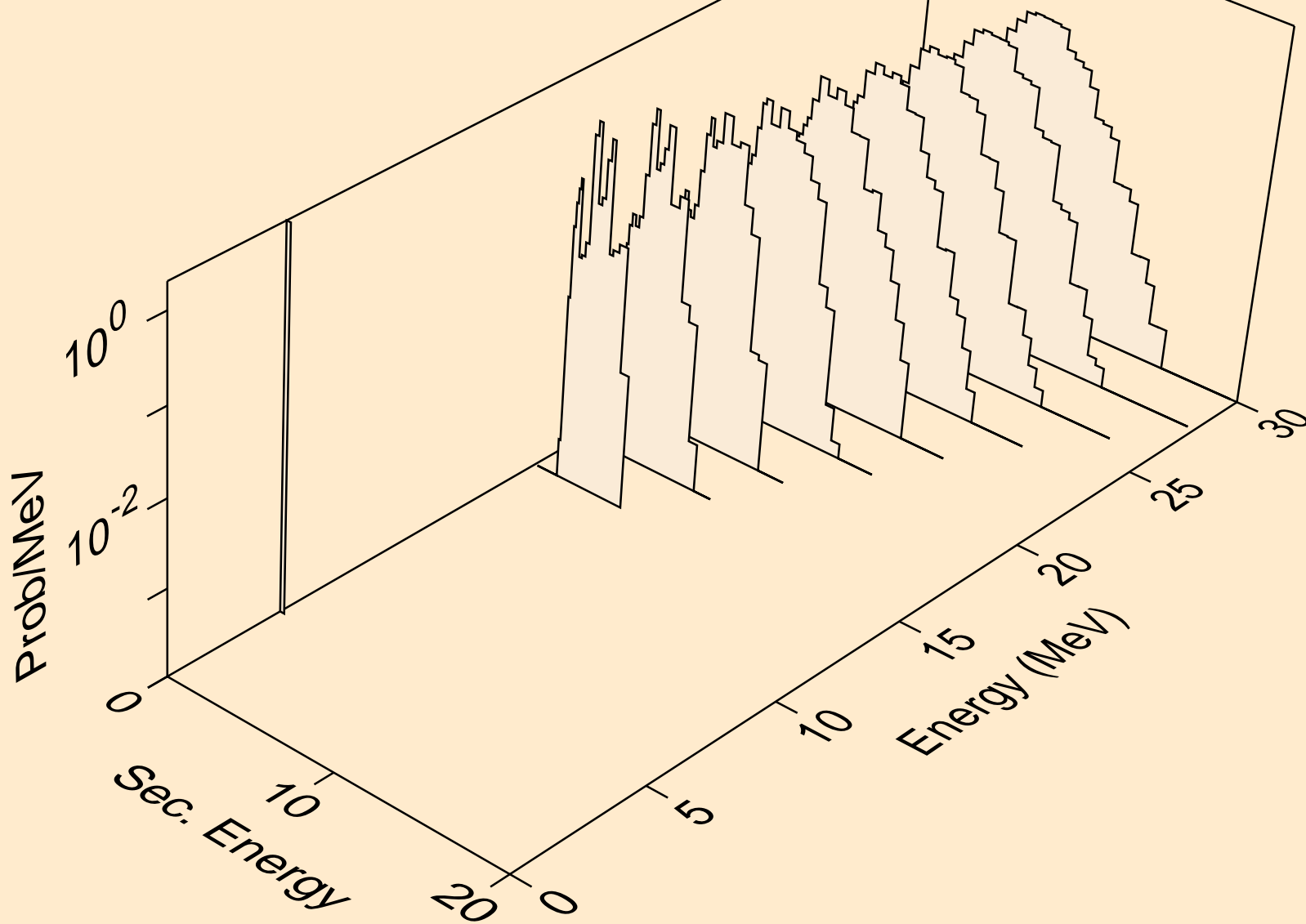

DY155 NEUTRON ACER TENDL-2019 LIBRARY; T=293.16K
protons from (n,p)

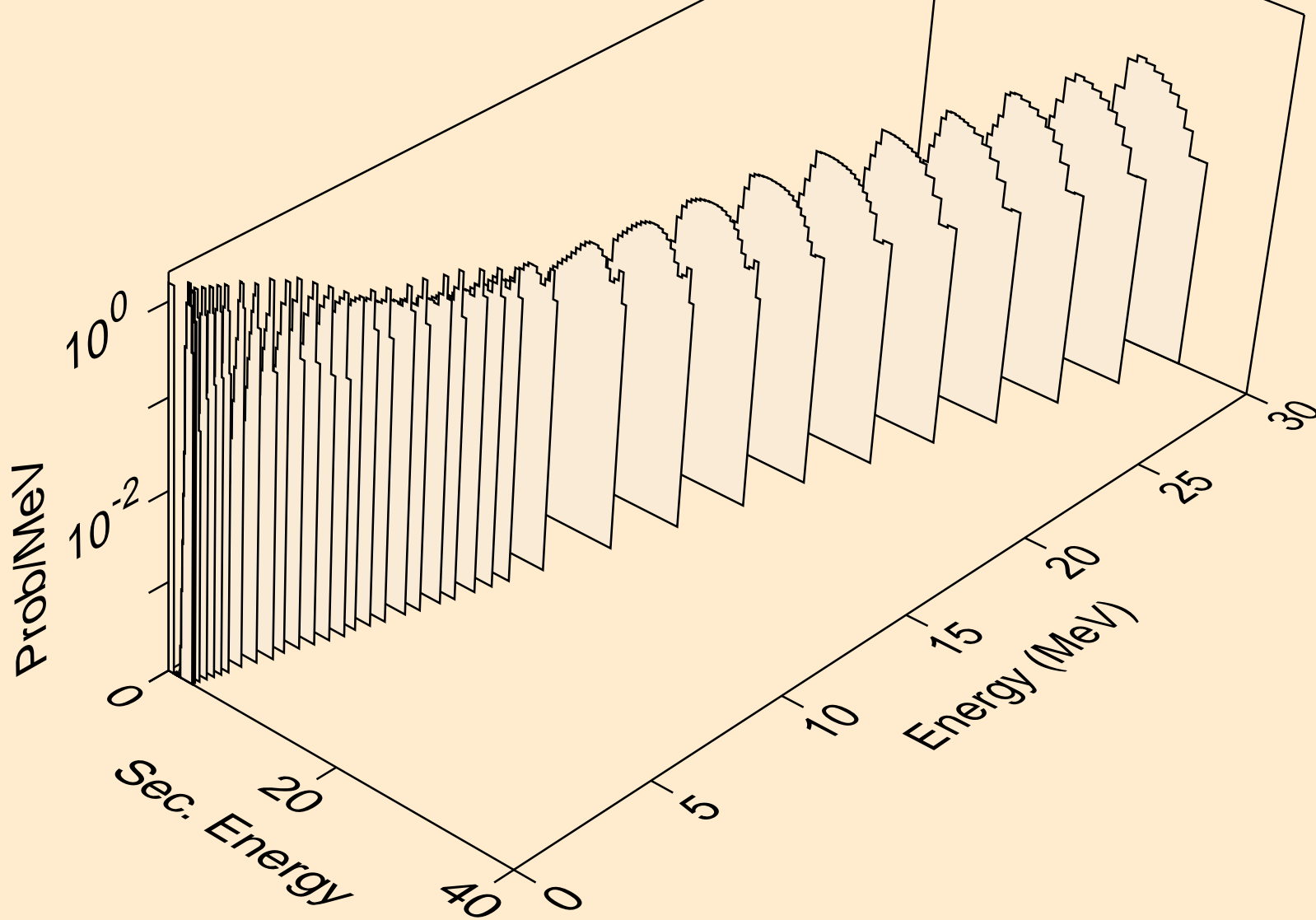

DY155 NEUTRON ACER TENDL-2019 LIBRARY; T=293.16K
protons from (n,2p)

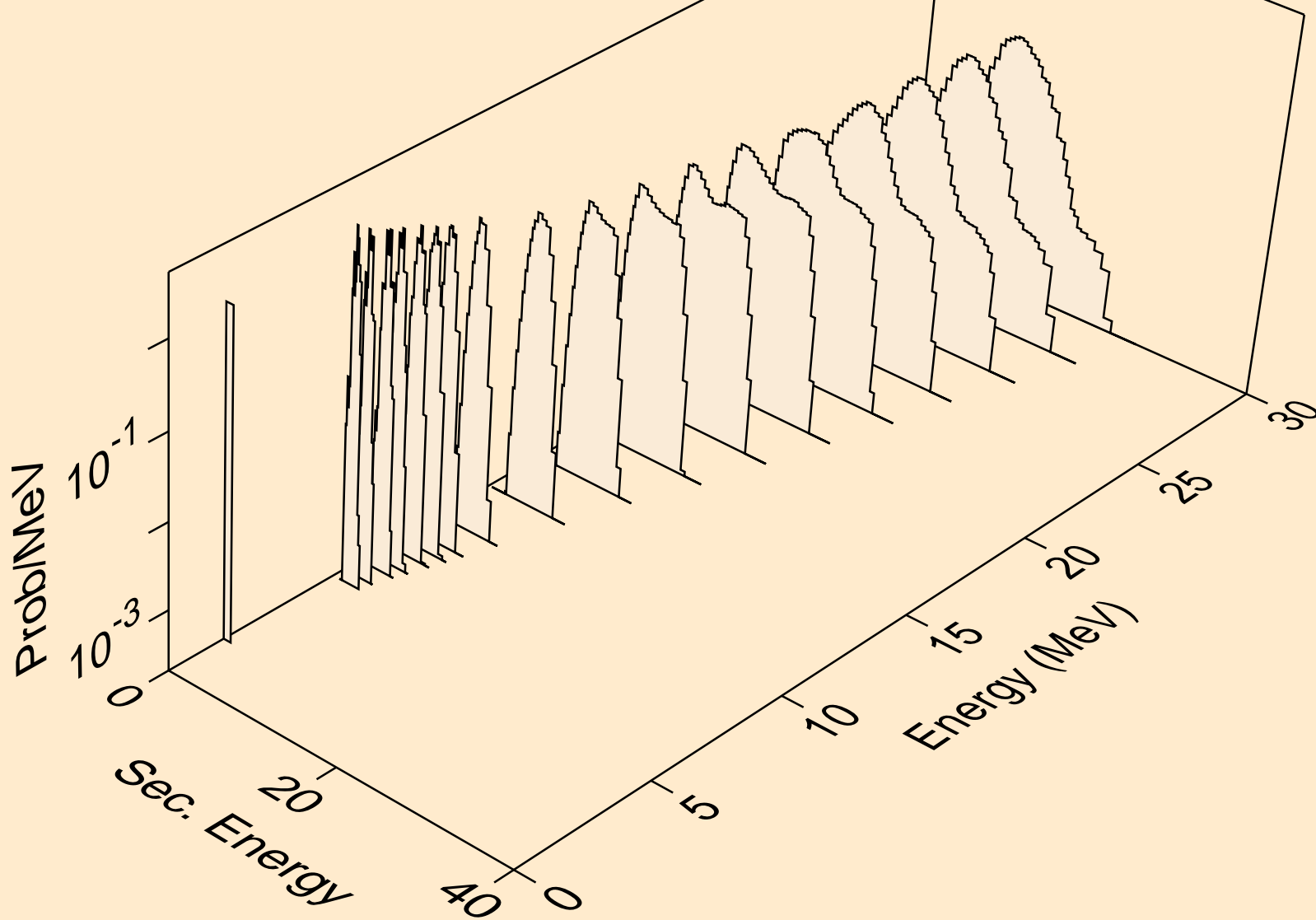

DY155 NEUTRON ACER TENDL-2019 LIBRARY; T=293.16K
protons from (n,p)

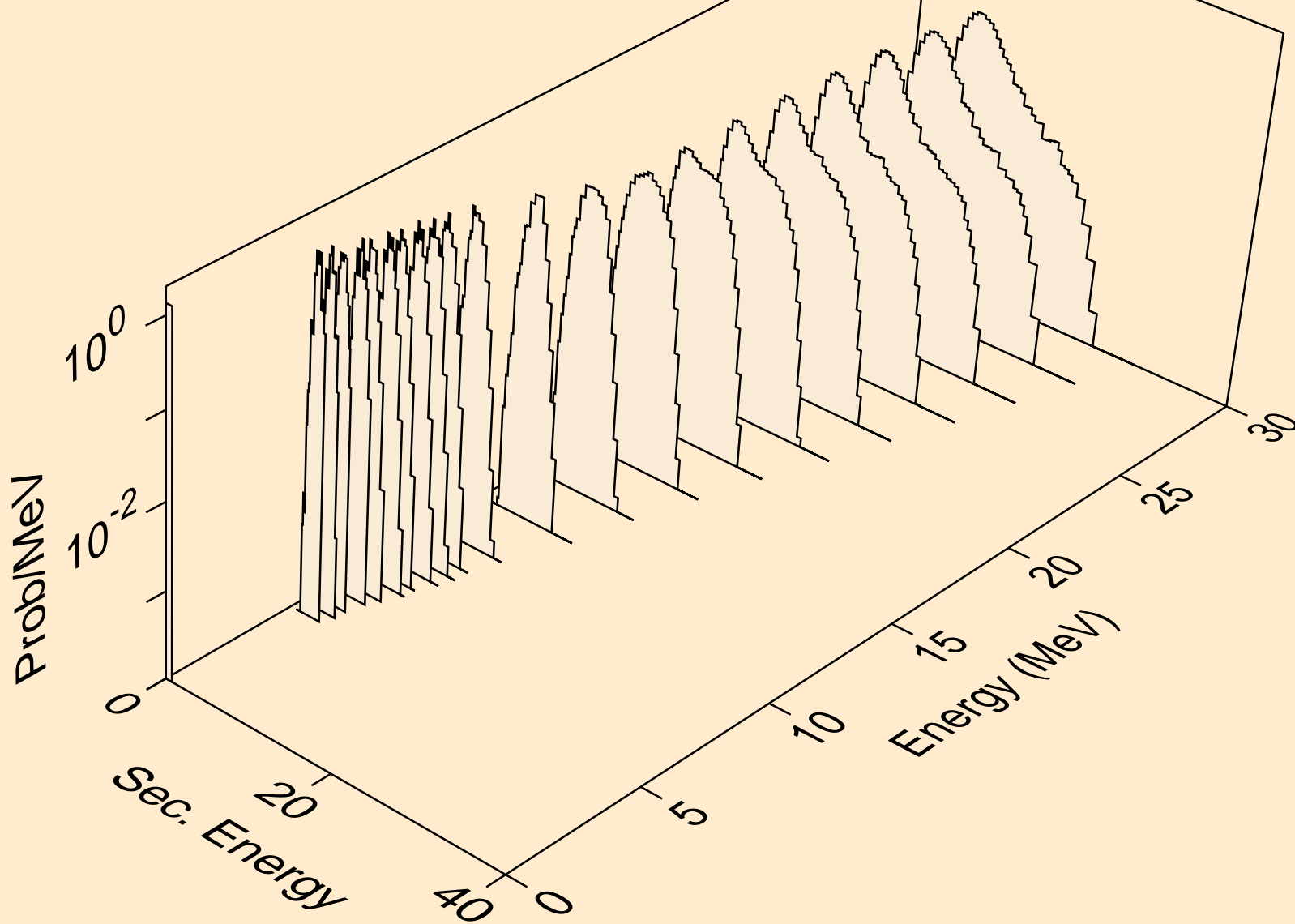

DY155 NEUTRON ACER TENDL-2019 LIBRARY; T=293.16K
protons from (n,pd)

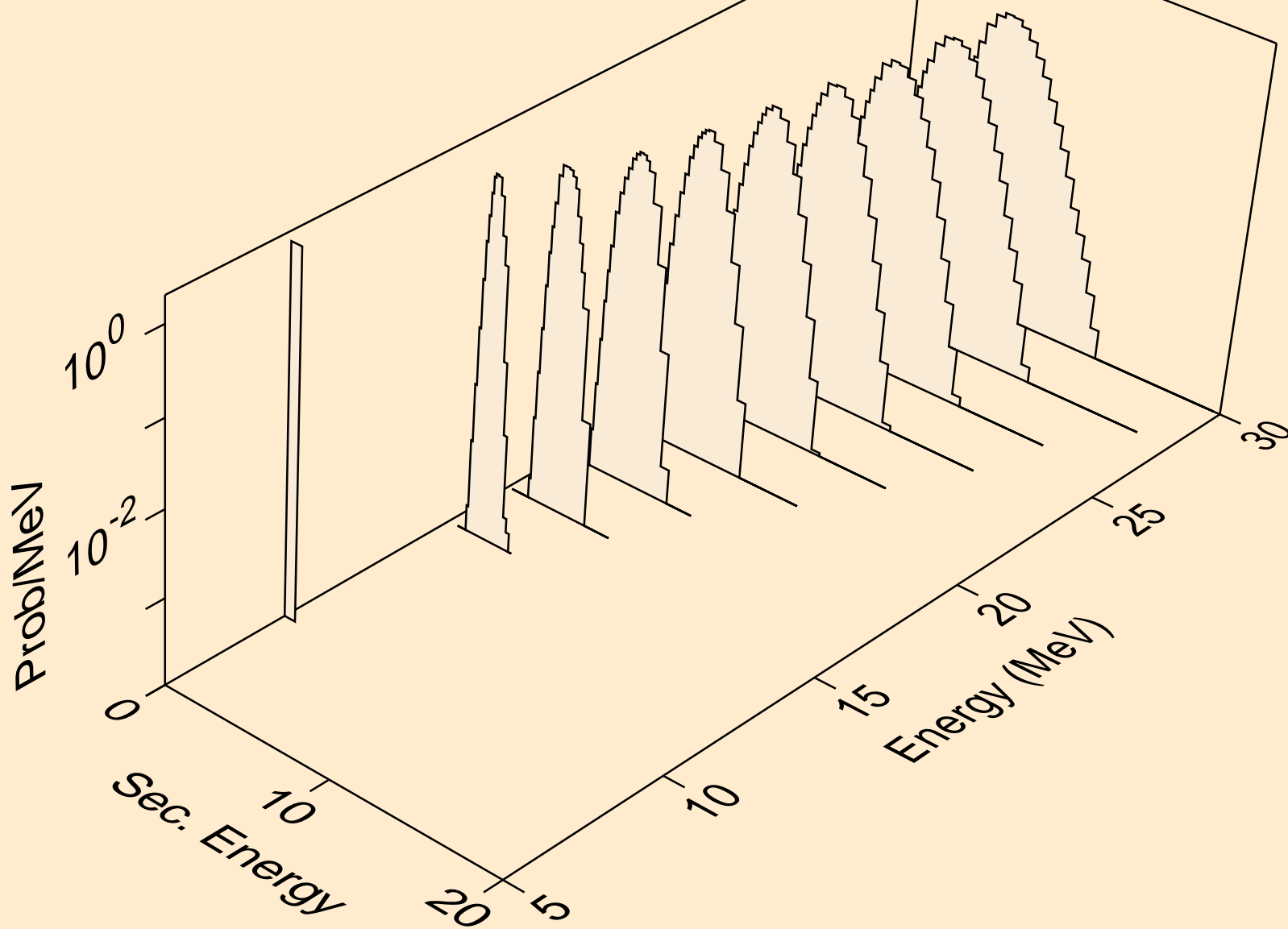

DY155 NEUTRON ACER TENDL-2019 LIBRARY; T=293.16K
protons from (n,pt)

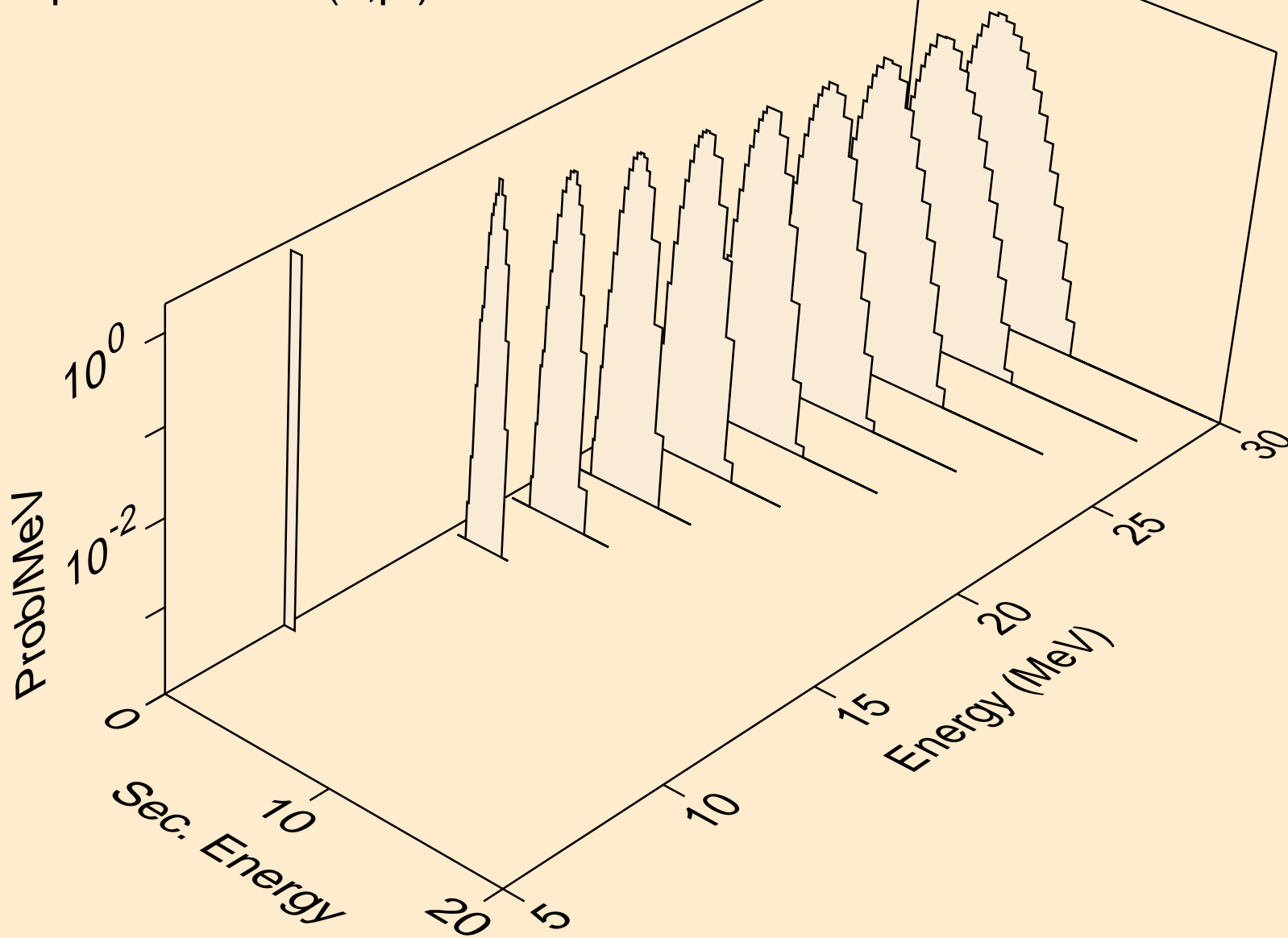

DY155 NEUTRON ACER TENDL-2019 LIBRARY; T=293.16K
deuterons from (n,x)

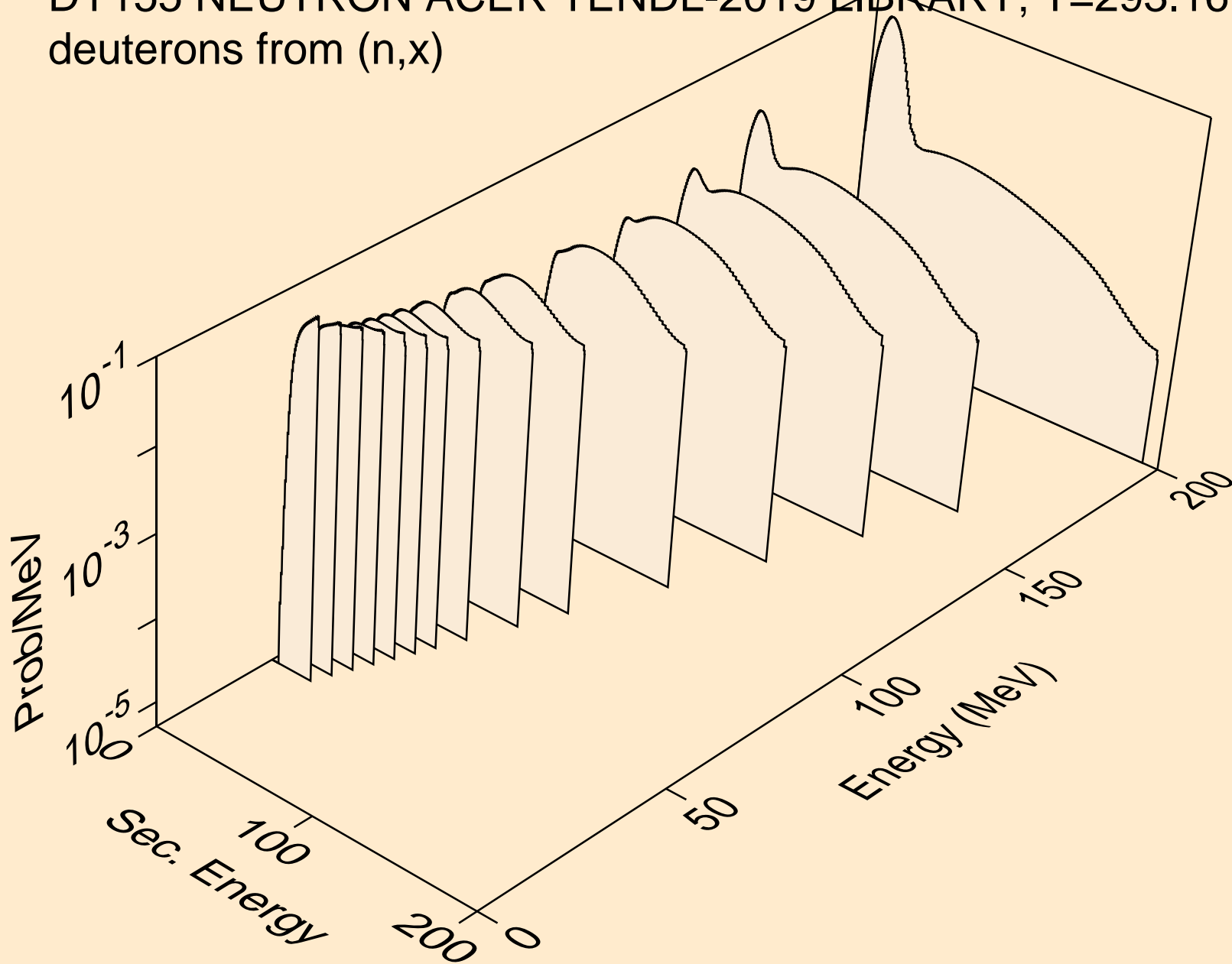

DY155 NEUTRON ACER TENDL-2019 LIBRARY; T=293.16K
deuterons from (n,2nd)

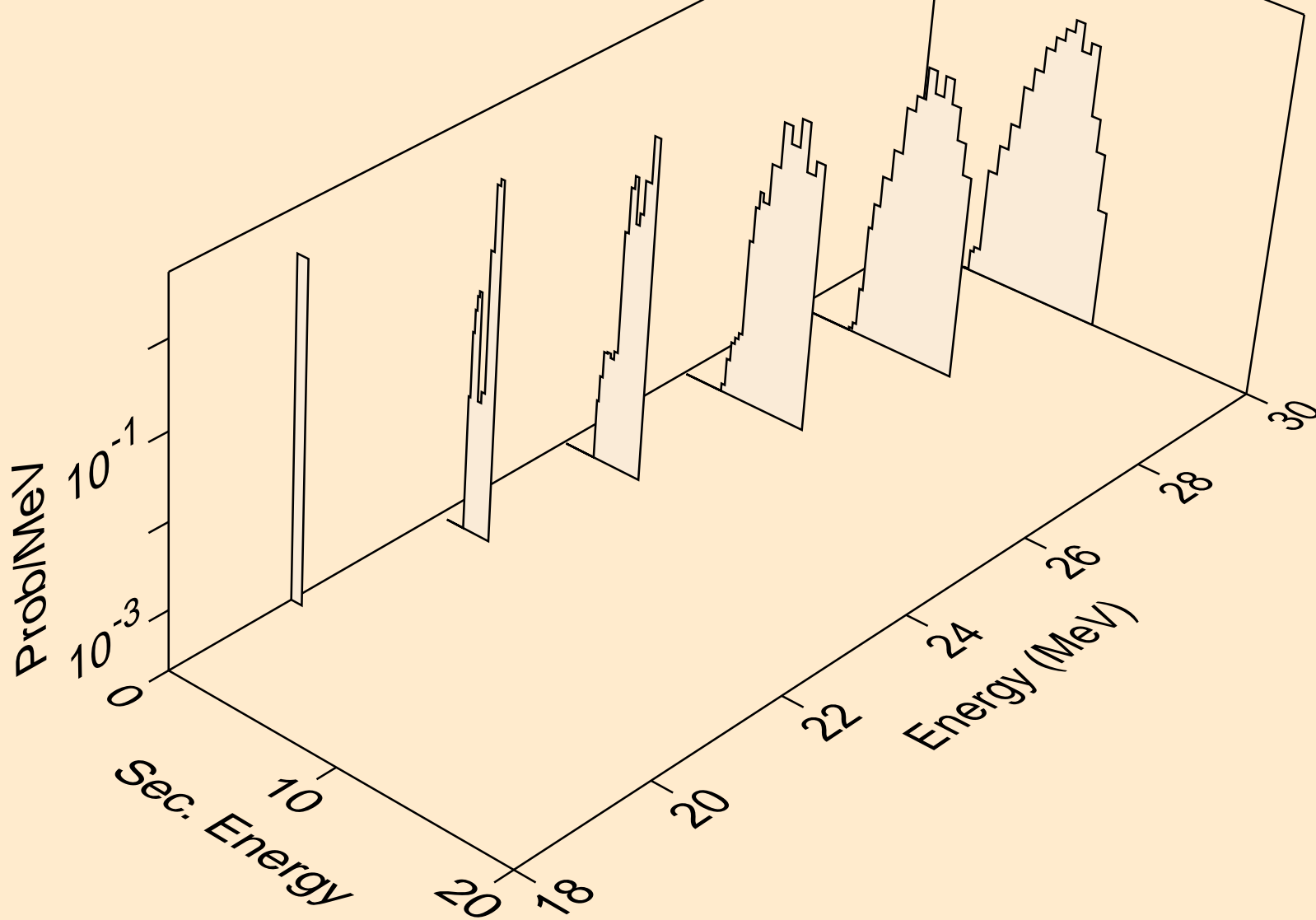

DY155 NEUTRON ACER TENDL-2019 LIBRARY; T=293.16K
deuterons from (n,n*)d

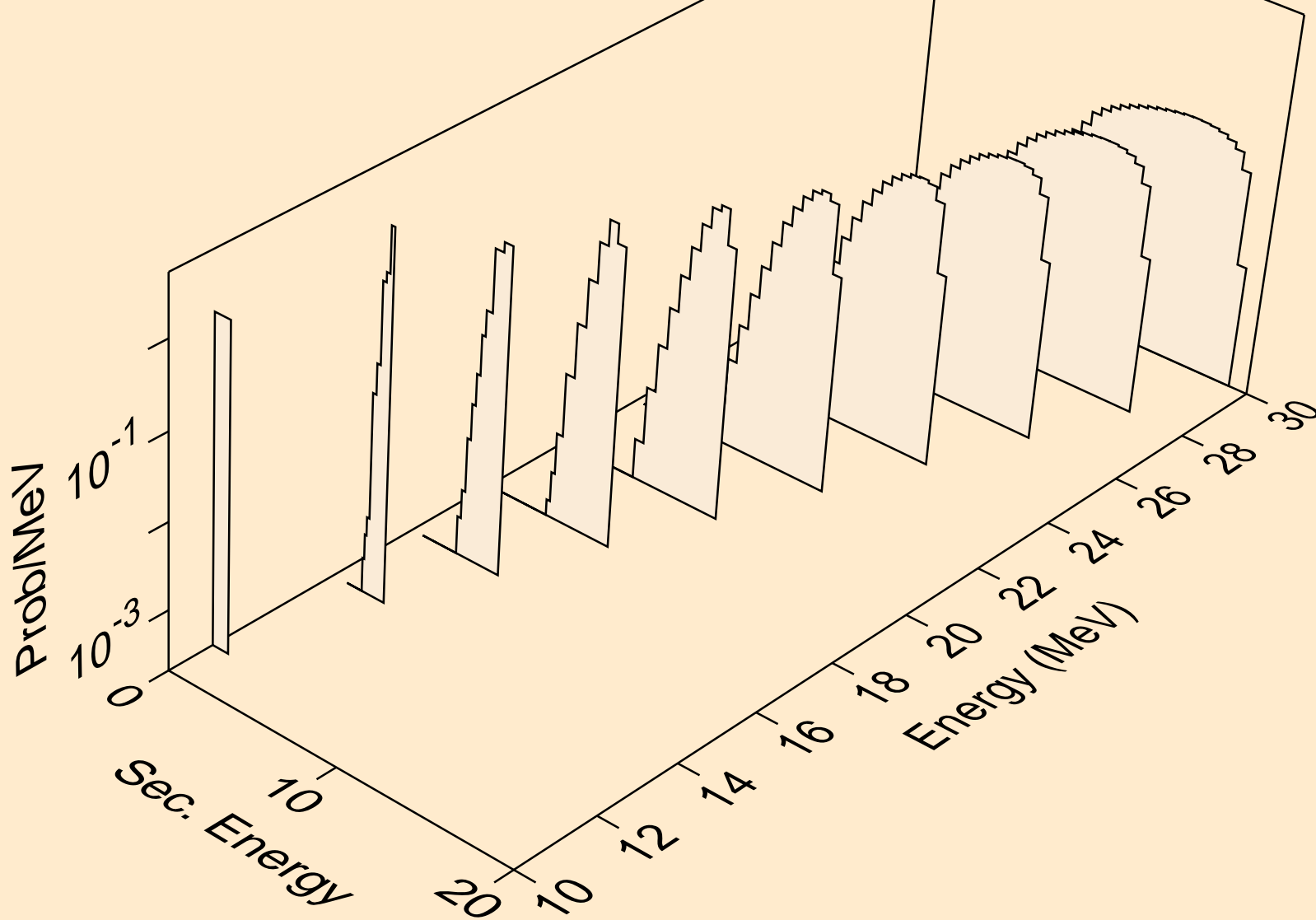

DY155 NEUTRON ACER TENDL-2019 LIBRARY; T=293.16K
deuterons from (n,d)

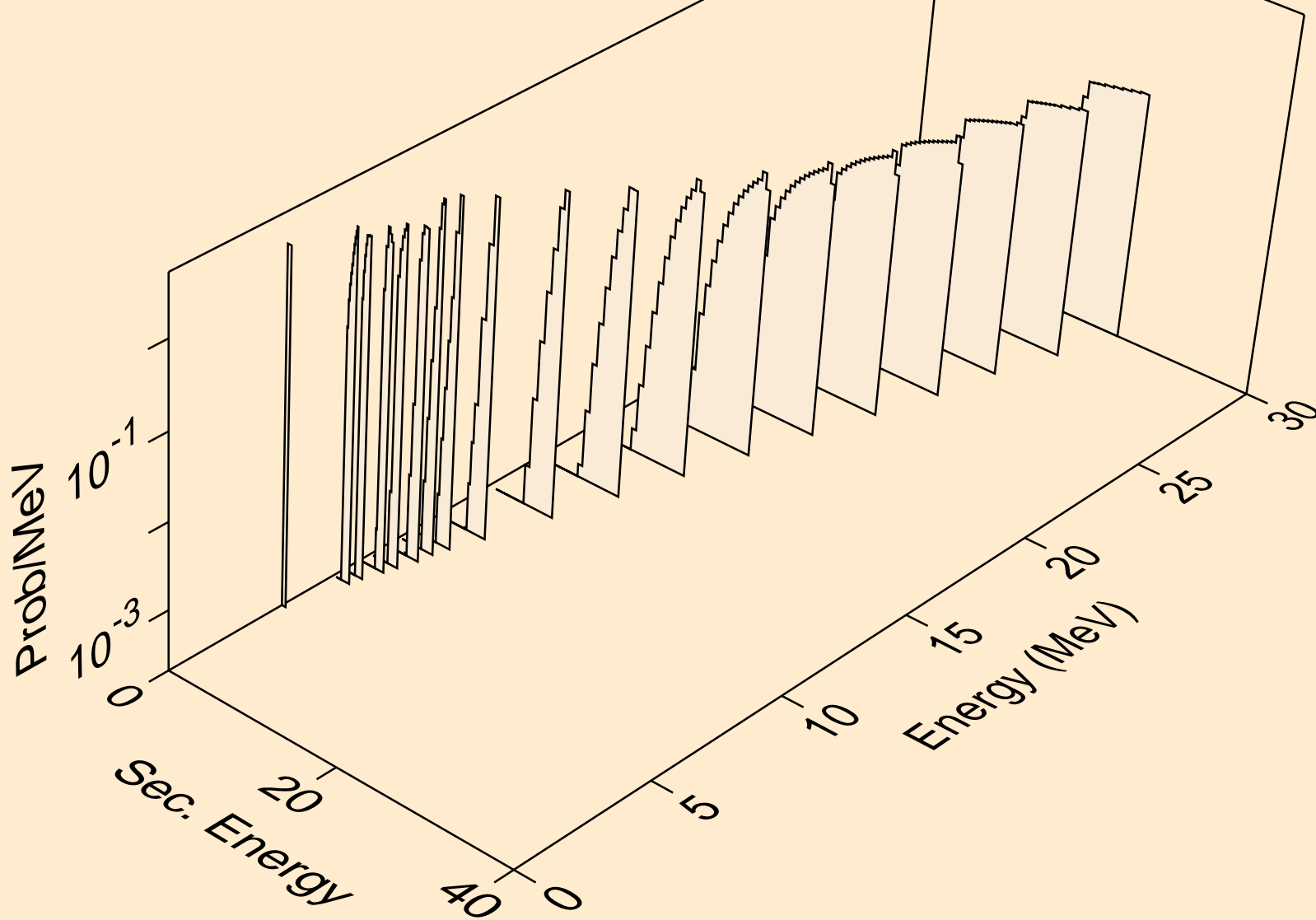

DY155 NEUTRON ACER TENDL-2019 LIBRARY; T=293.16K
deuterons from (n,pd)

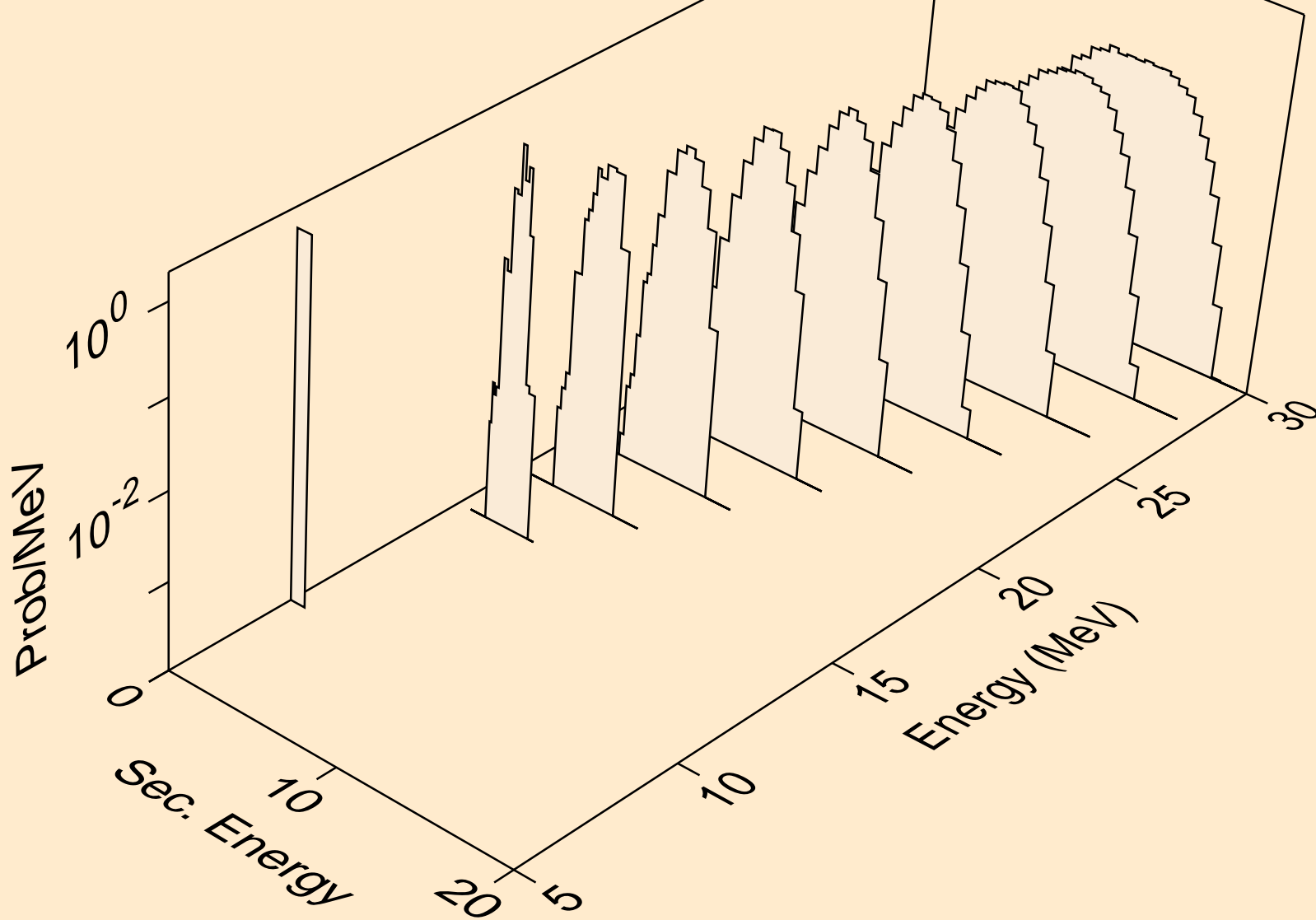

DY155 NEUTRON ACER TENDL-2019 LIBRARY; T=293.16K
deuterons from (n,da)

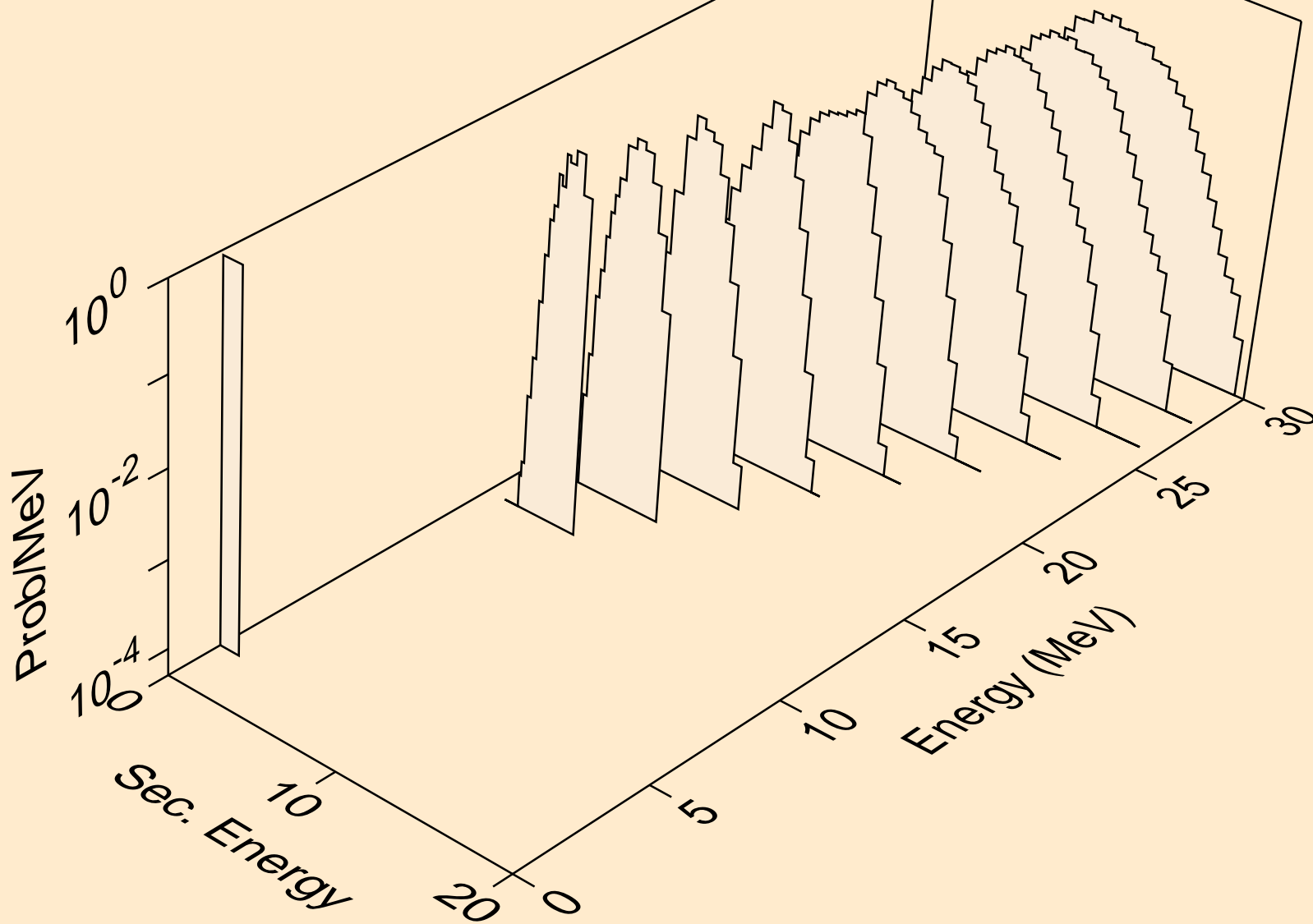

DY155 NEUTRON ACER TENDL-2019 LIBRARY; T=293.16K
tritons from (n,x)

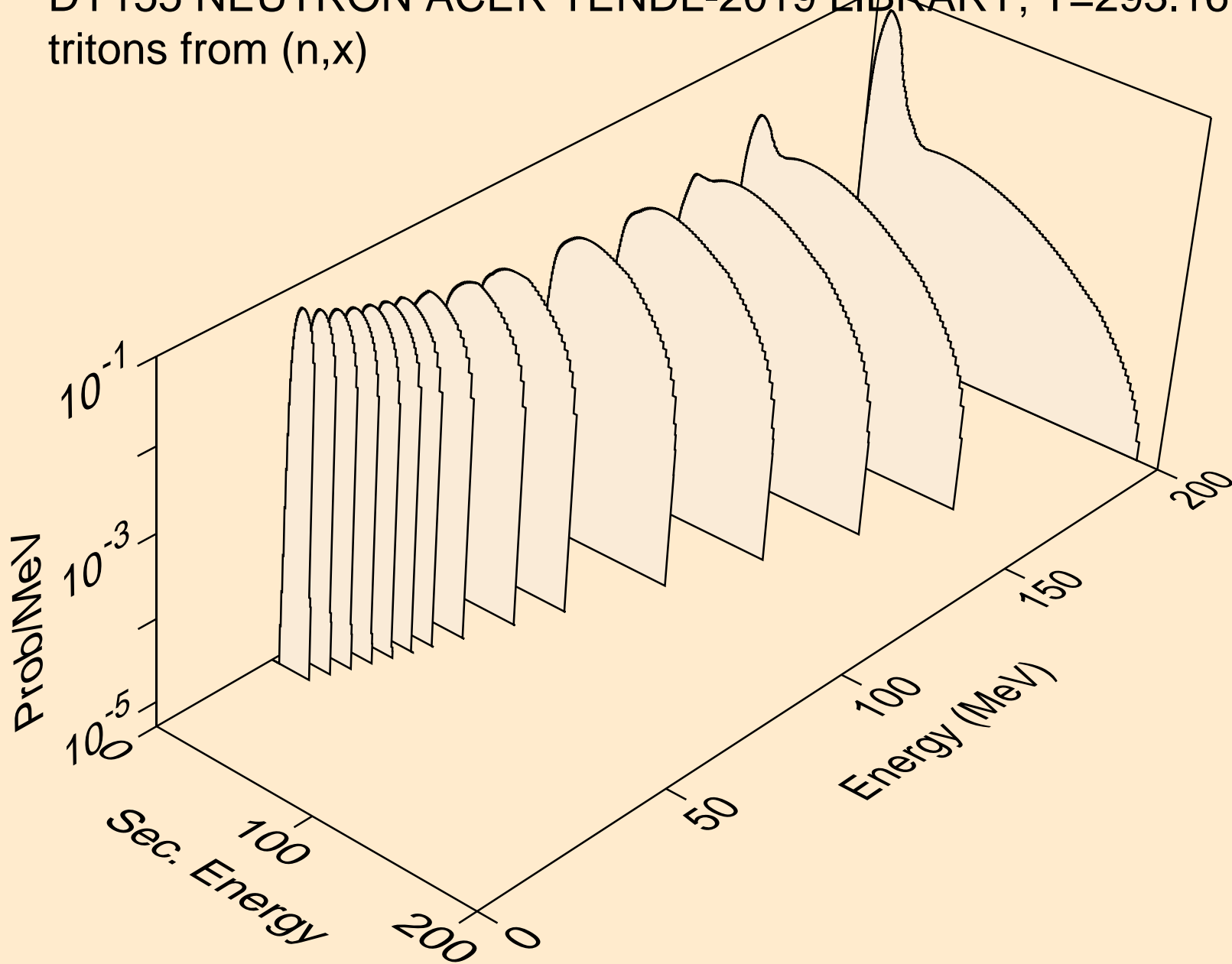

DY155 NEUTRON ACER TENDL-2019 LIBRARY; T=293.16K
tritons from (n,n*)t

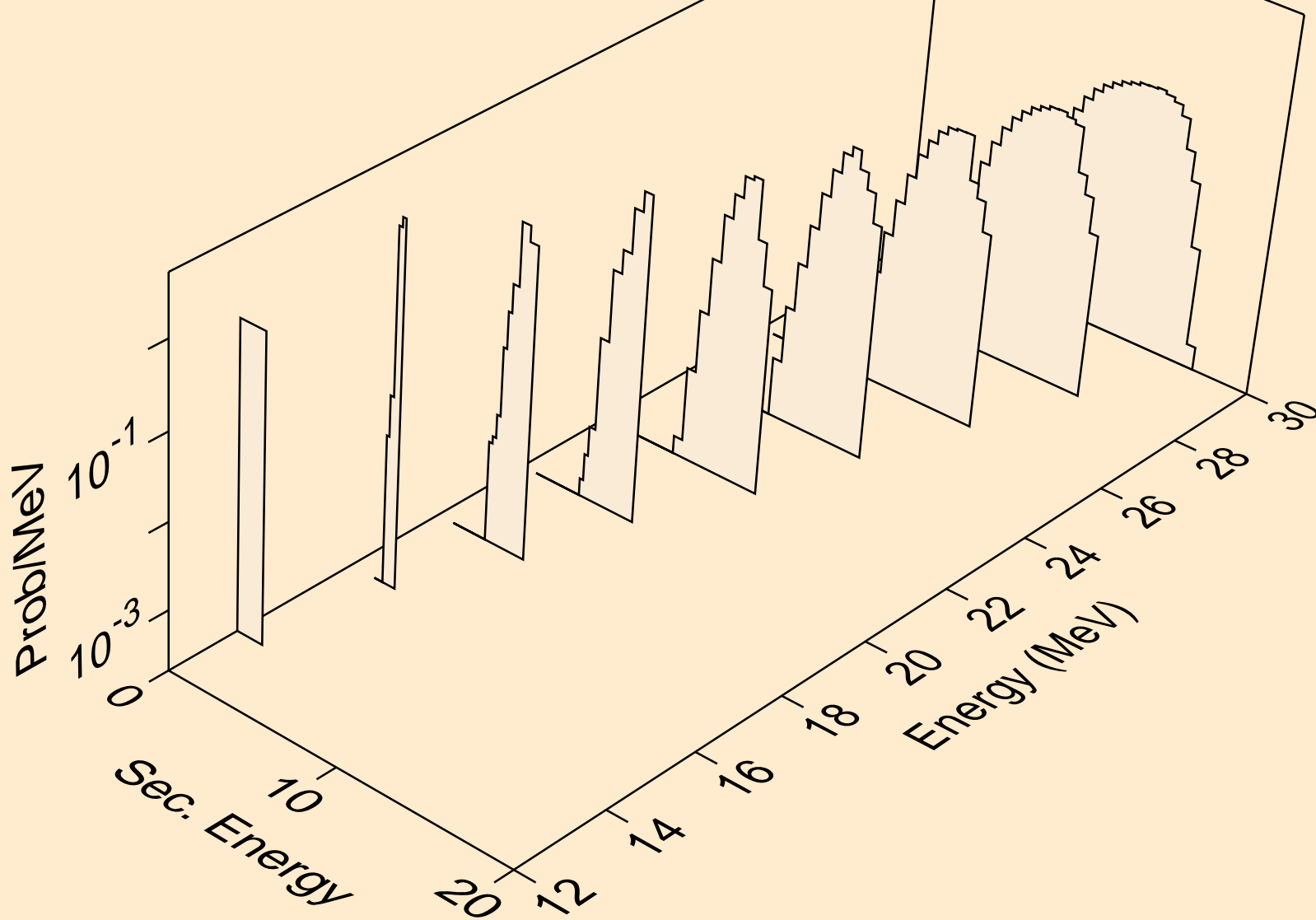

DY155 NEUTRON ACER TENDL-2019 LIBRARY; T=293.16K
tritons from (n,t)

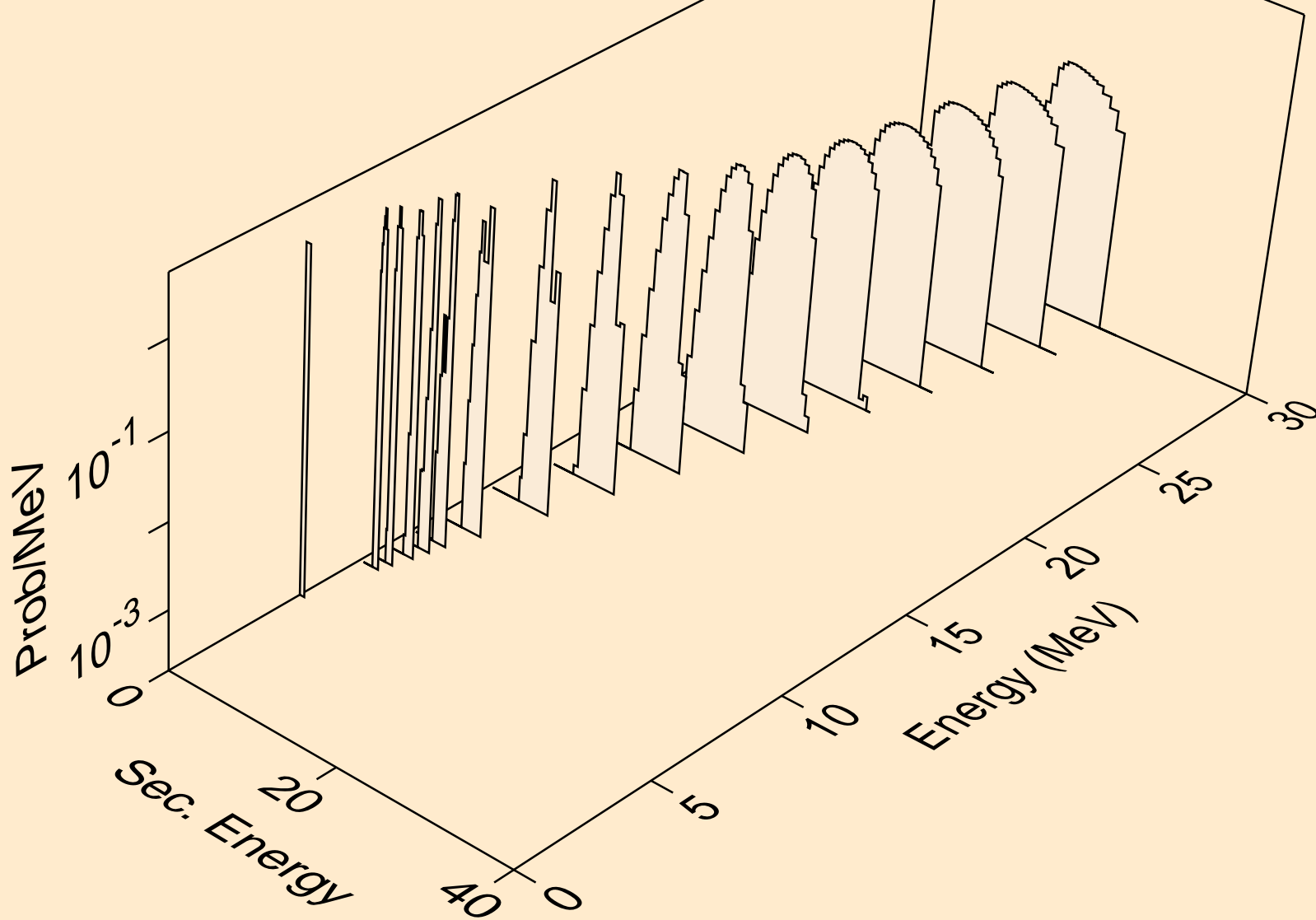

DY155 NEUTRON ACER TENDL-2019 LIBRARY; T=293.16K
tritons from (n,pt)

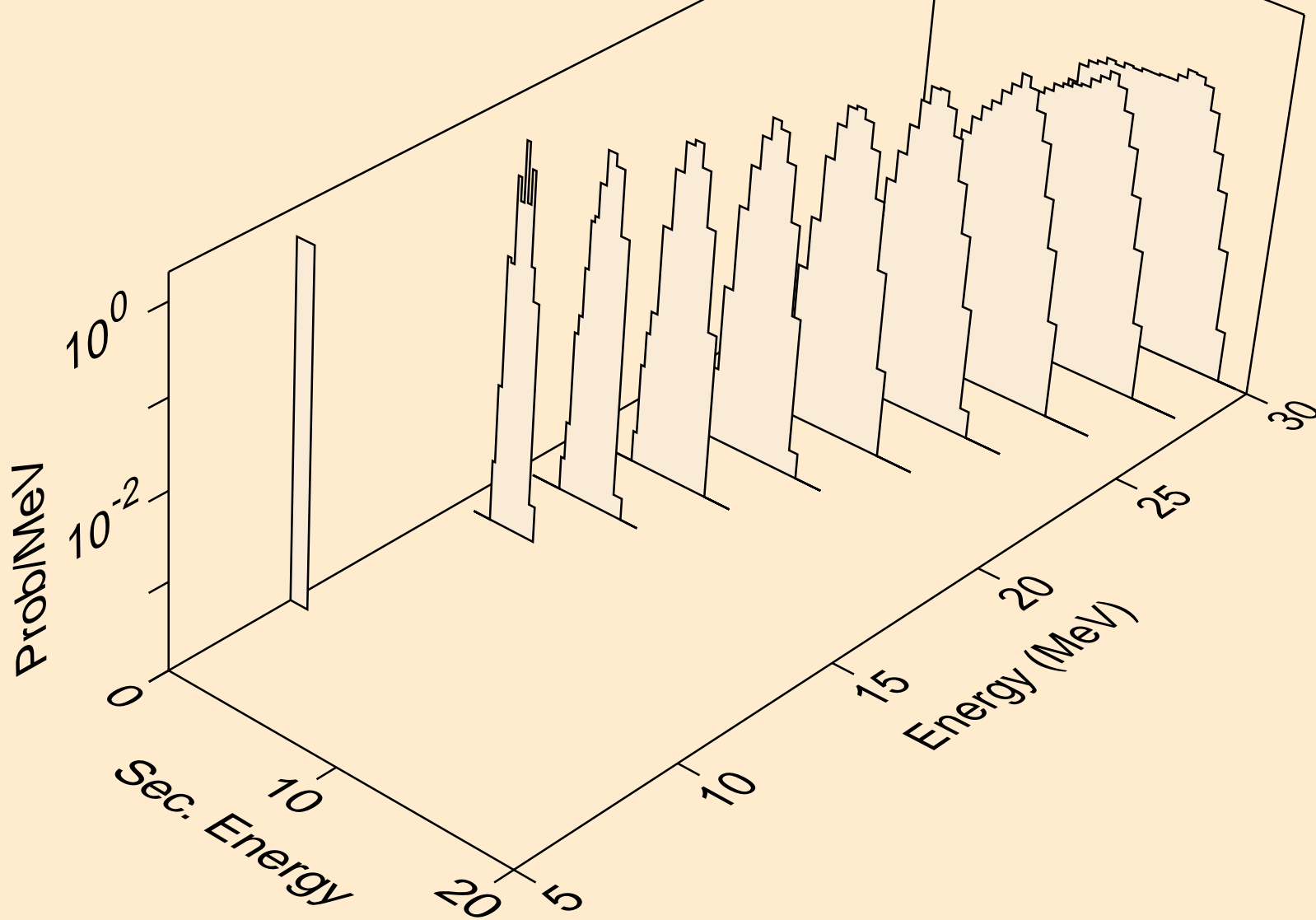

DY155 NEUTRON ACER TENDL-2019 LIBRARY; T=293.16K
he3s from (n,x)

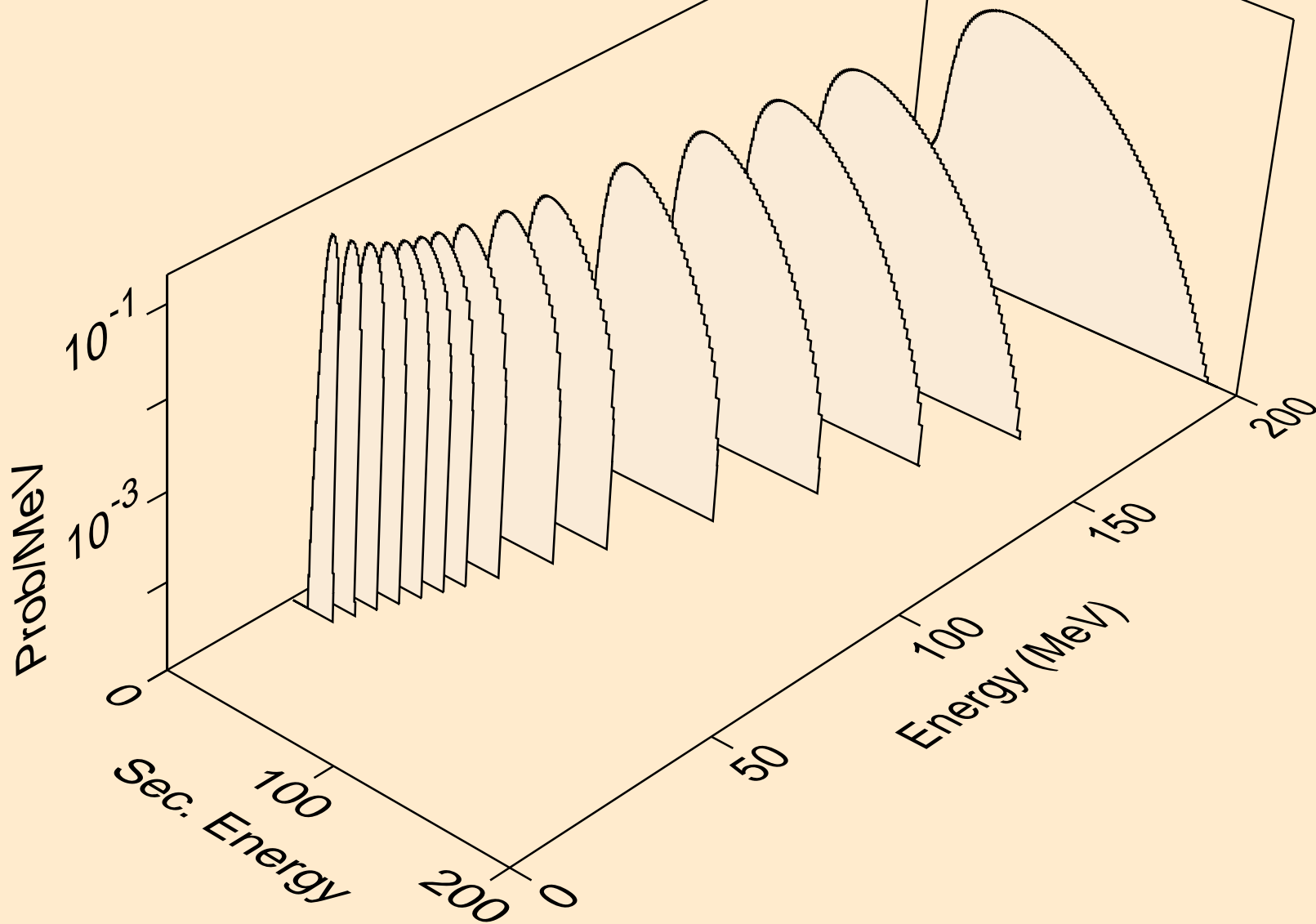

DY155 NEUTRON ACER TENDL-2019 LIBRARY; T=293.16K
he3s from (n,n*)he3

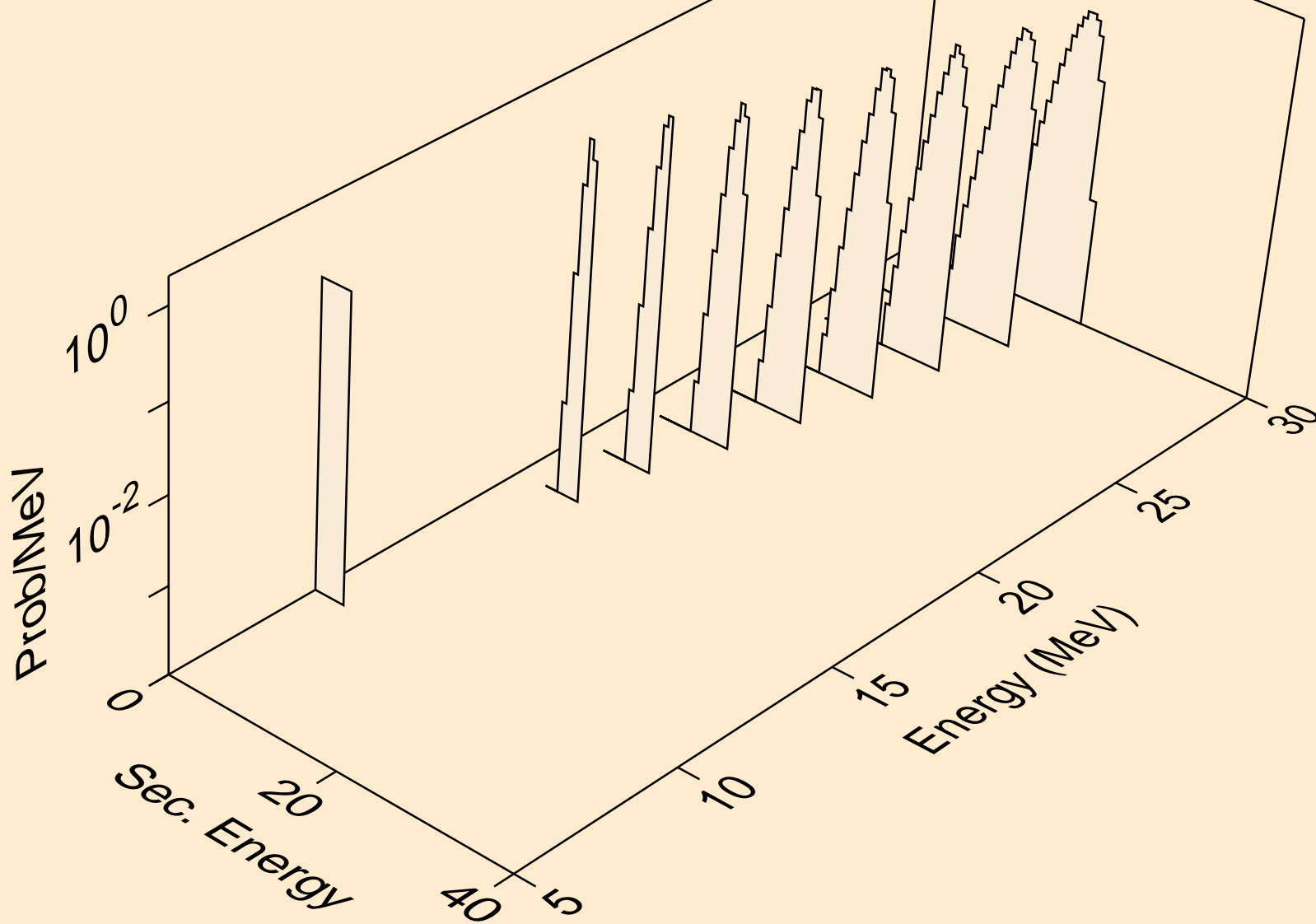

DY155 NEUTRON ACER TENDL-2019 LIBRARY; T=293.16K
he3s from (n,he3)

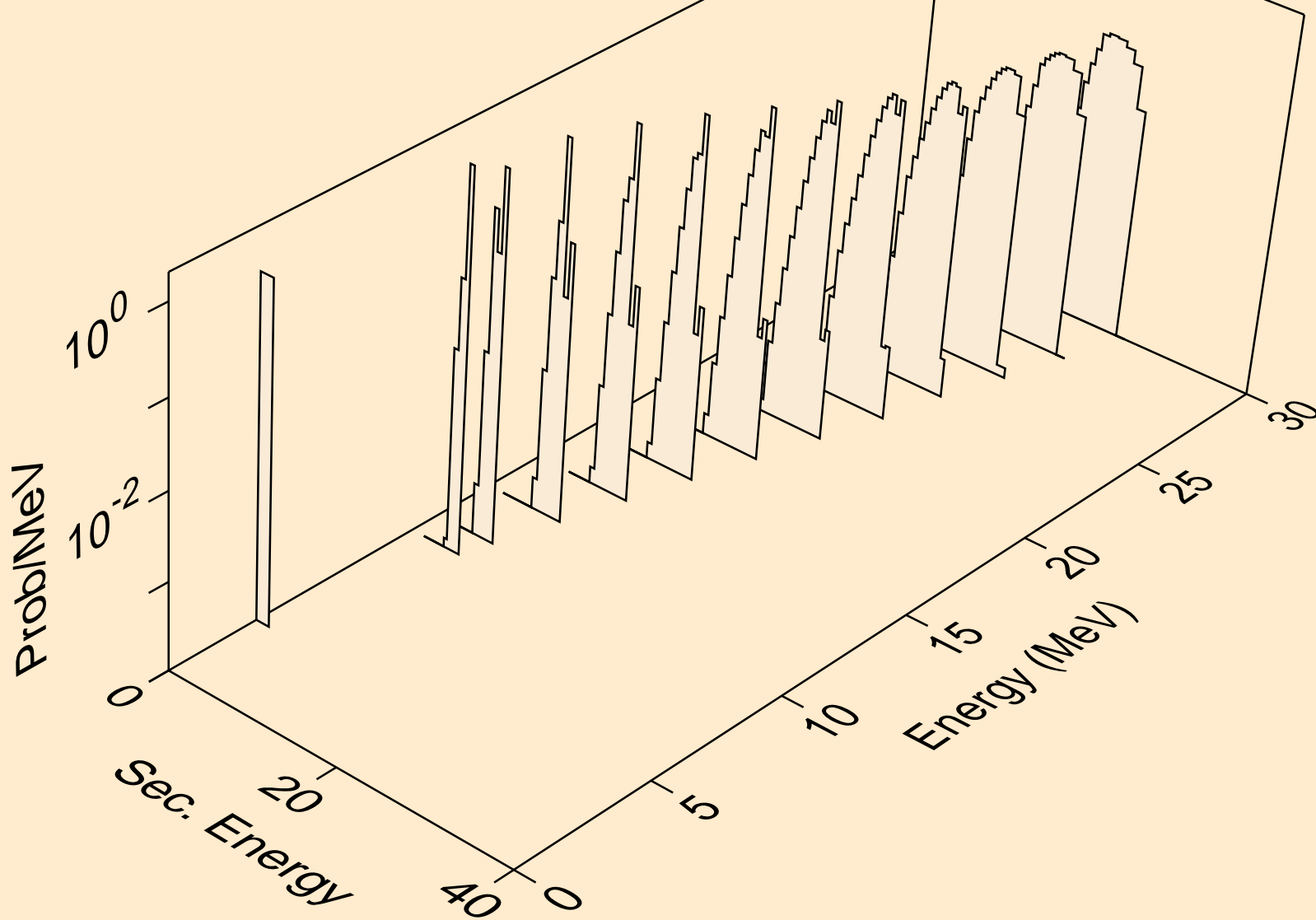

DY155 NEUTRON ACER TENDL-2019 LIBRARY; T=293.16K
alphas from (n,x)

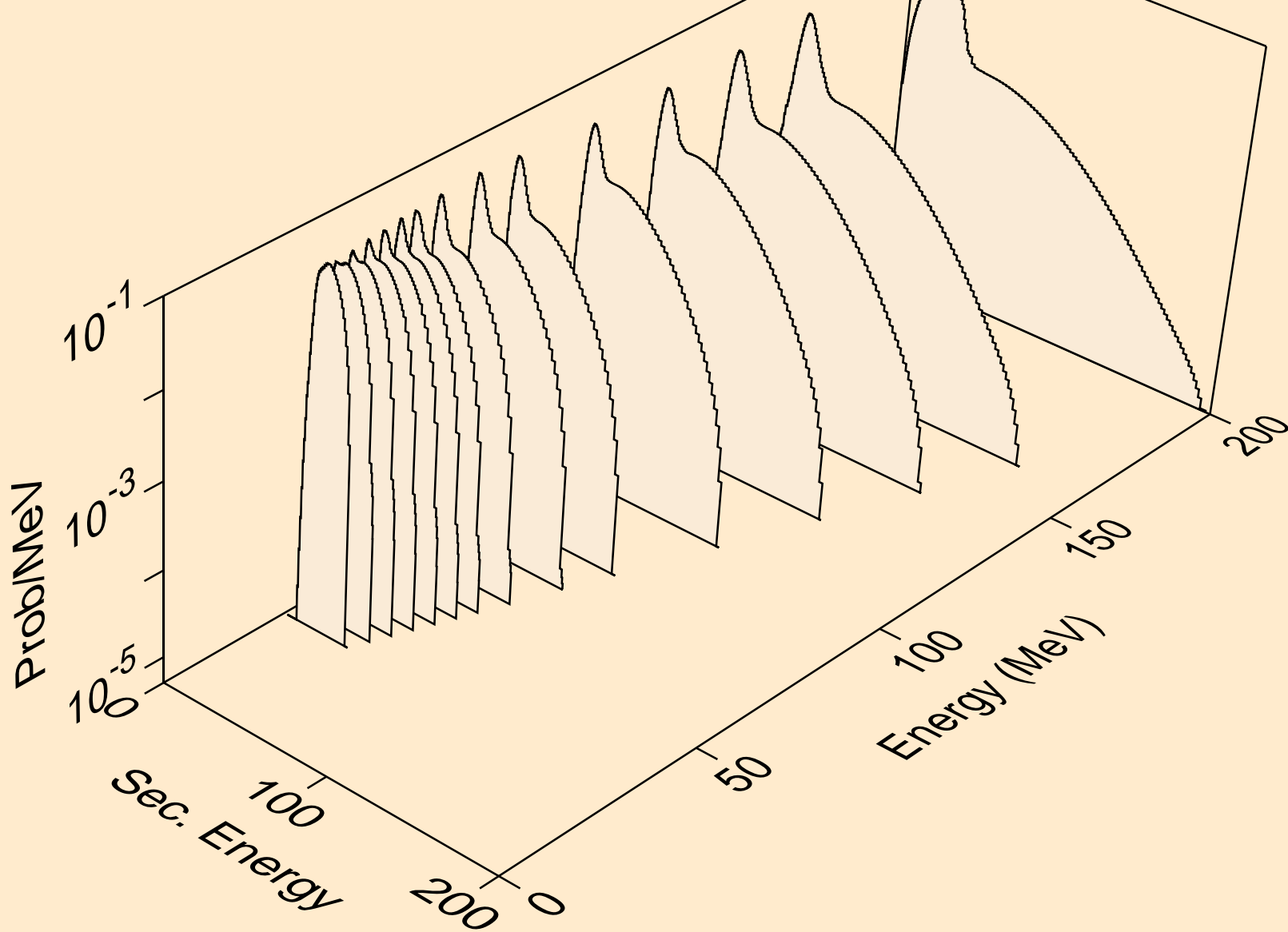

DY155 NEUTRON ACER TENDL-2019 LIBRARY; T=293.16K
alphas from (n,n*)a

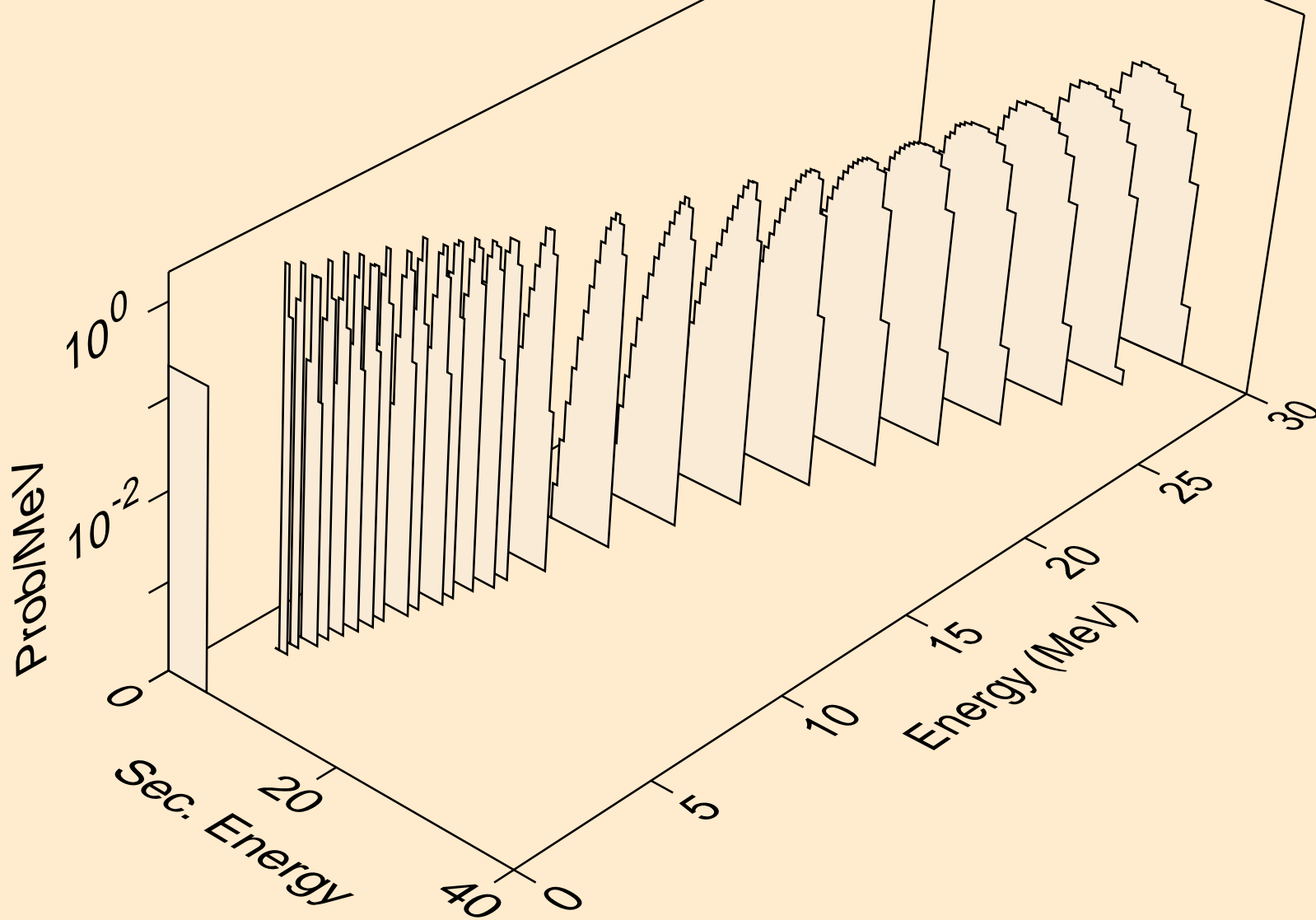

DY155 NEUTRON ACER TENDL-2019 LIBRARY; T=293.16K
alphas from (n,2n)a

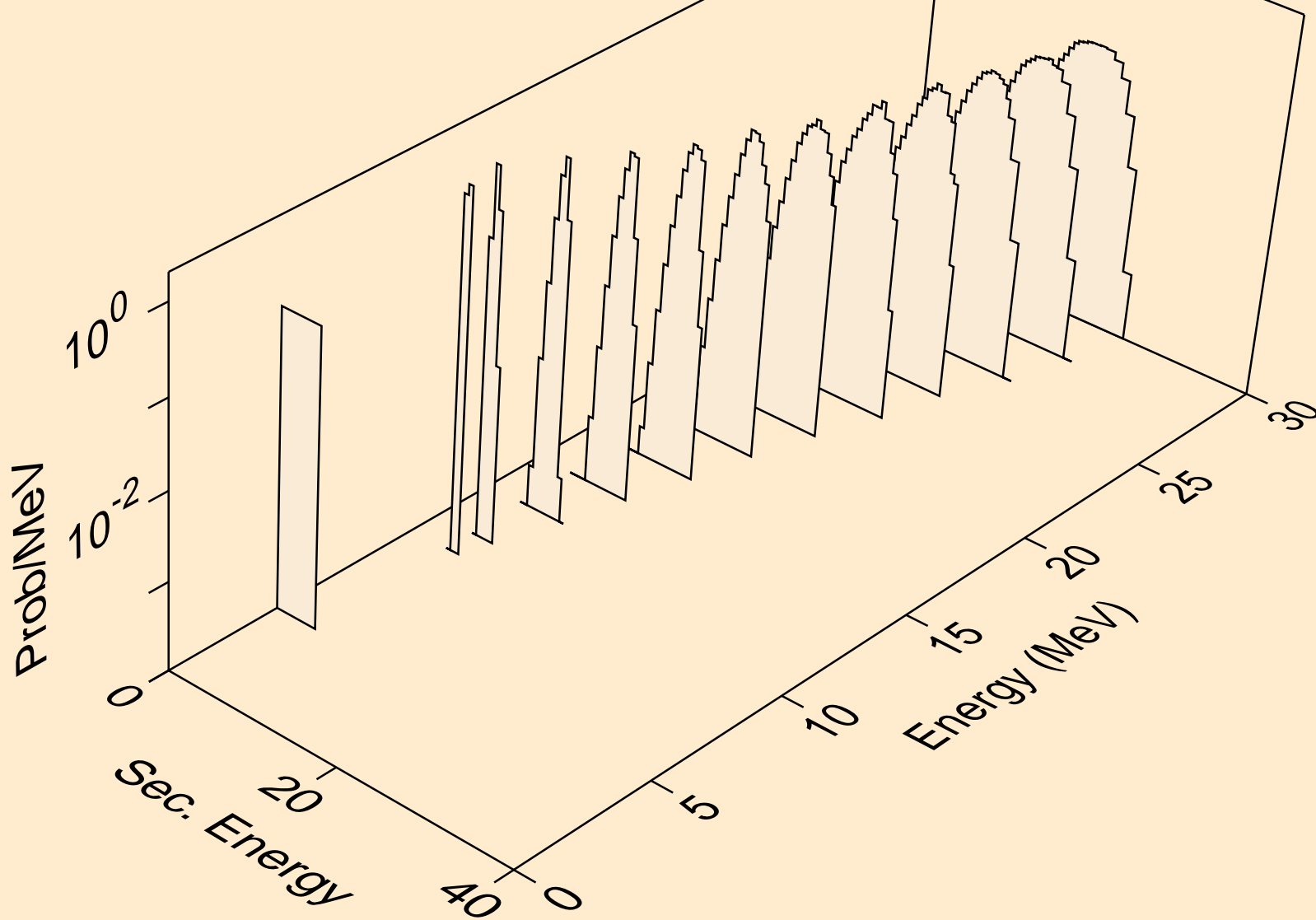

DY155 NEUTRON ACER TENDL-2019 LIBRARY; T=293.16K
alphas from (n,3n)a

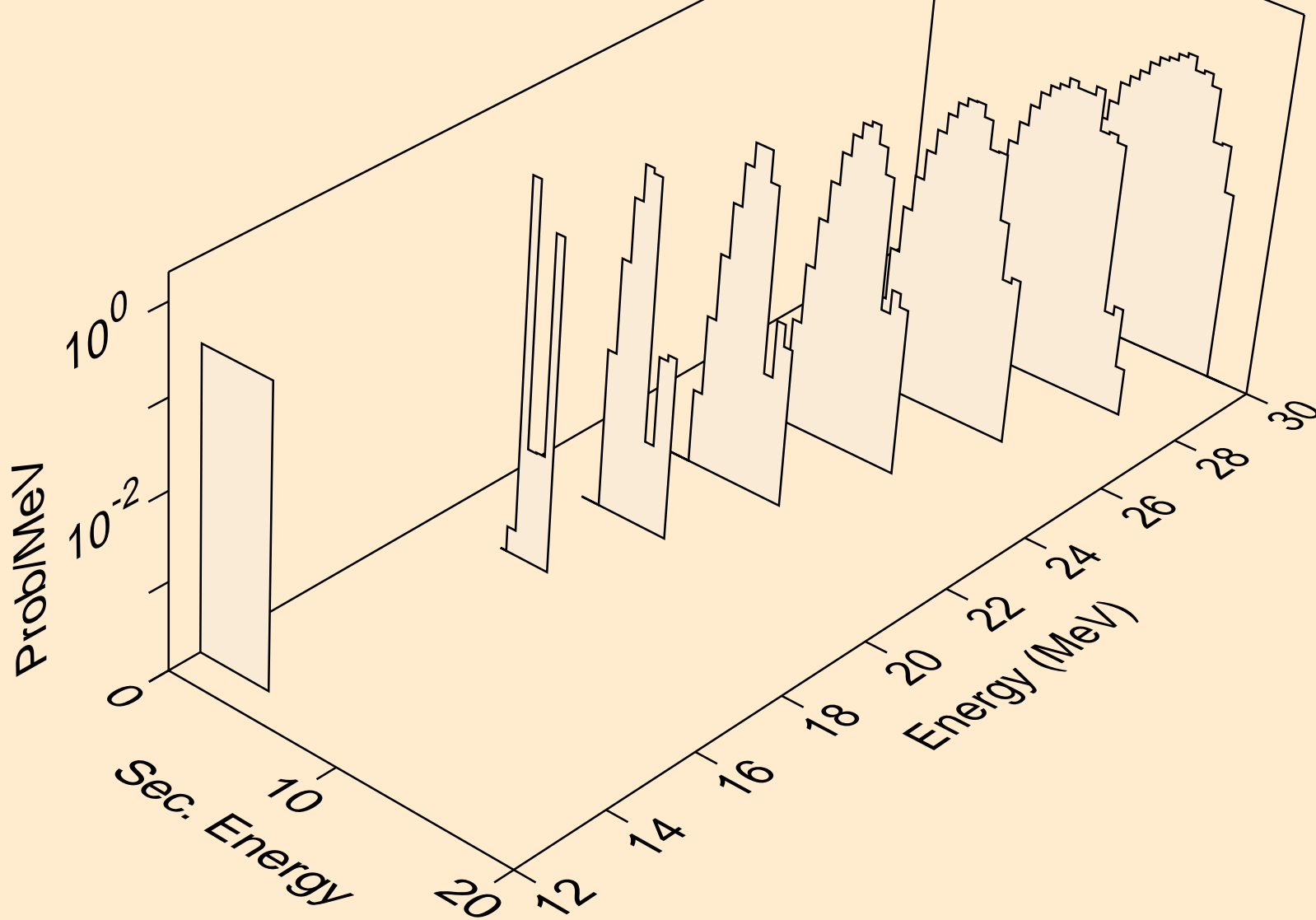

DY155 NEUTRON ACER TENDL-2019 LIBRARY; T=293.16K
alphas from (n,n*)2a

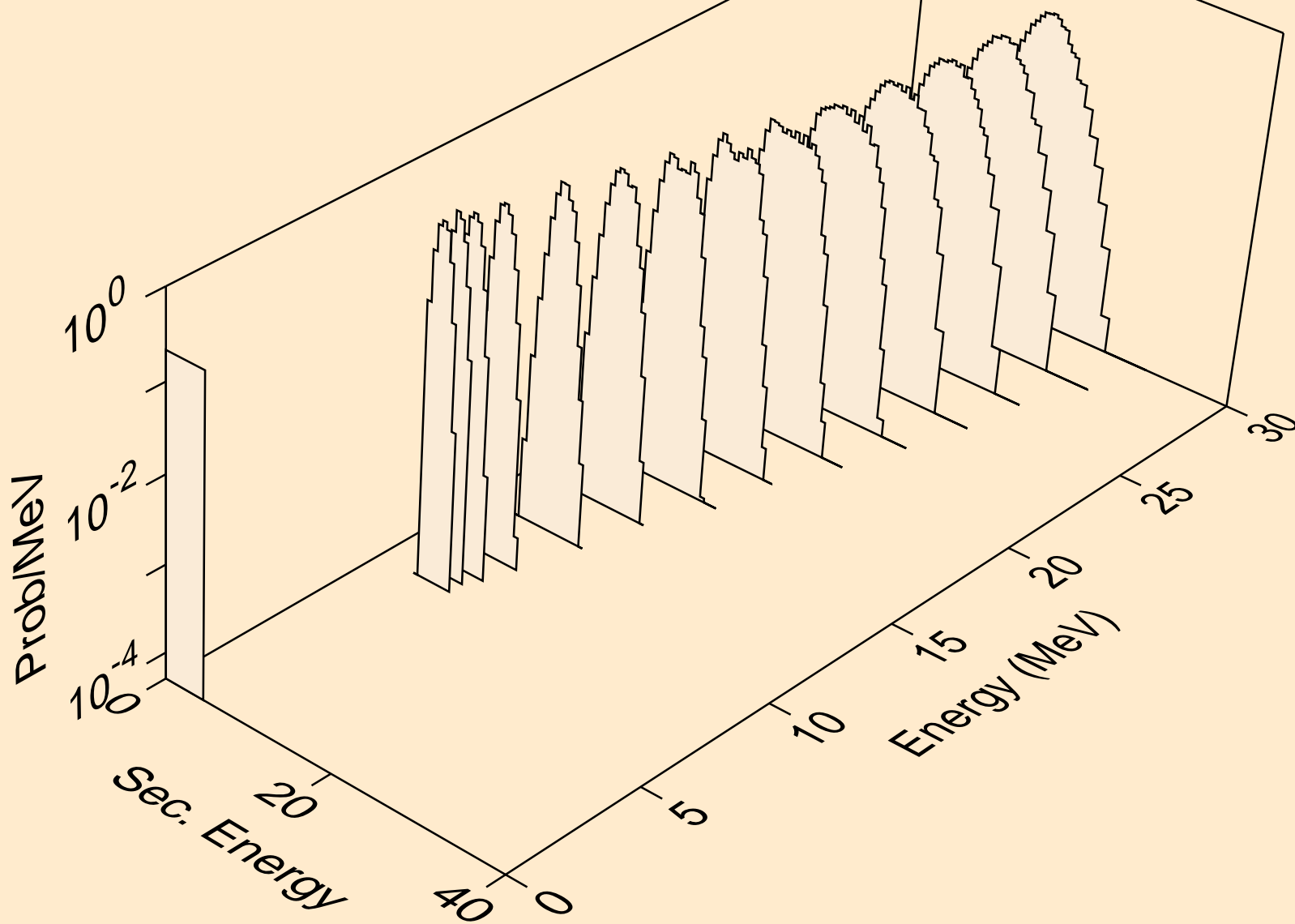

DY155 NEUTRON ACER TENDL-2019 LIBRARY; T=293.16K
alphas from (n,2n)2a

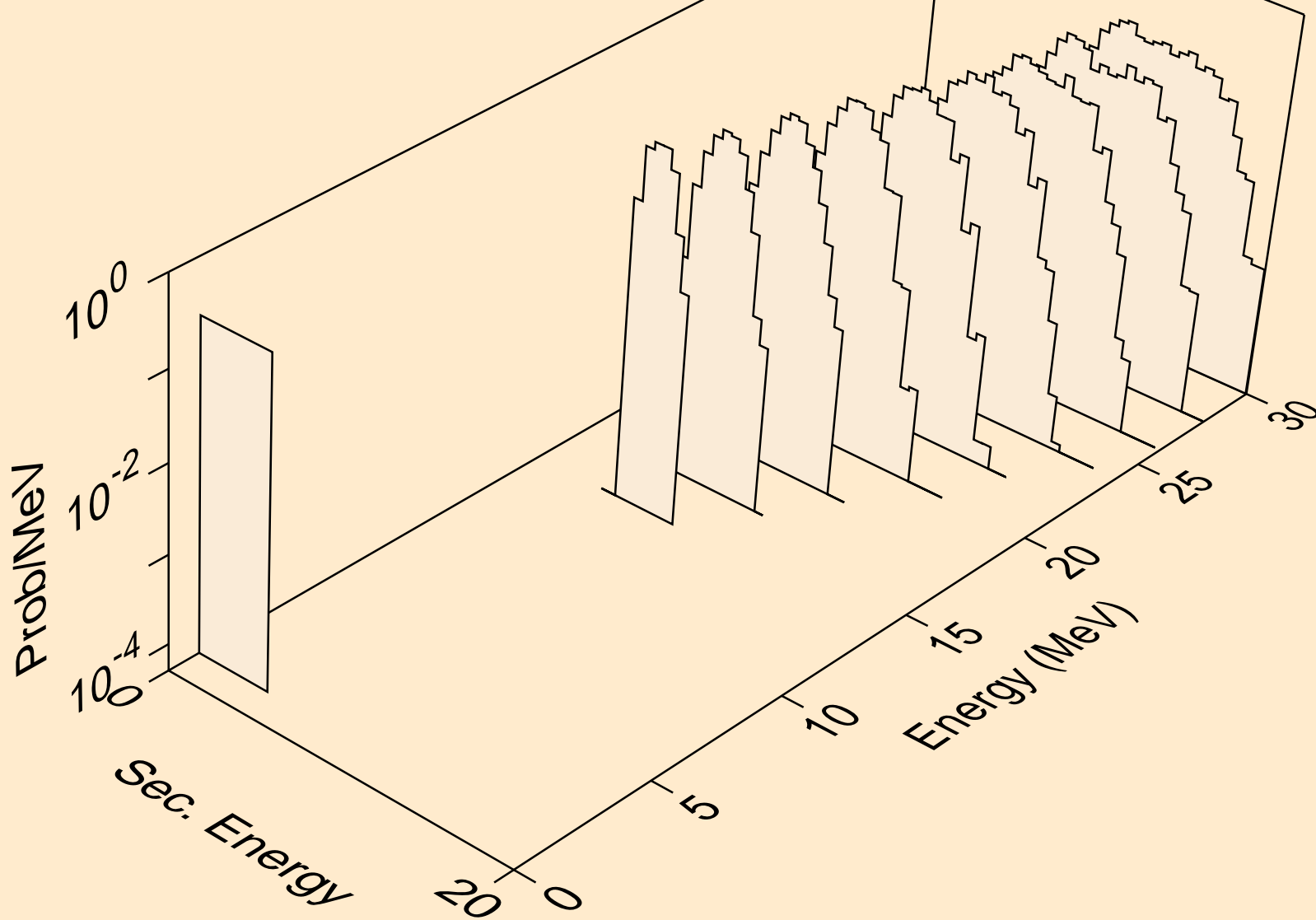

DY155 NEUTRON ACER TENDL-2019 LIBRARY; T=293.16K
alphas from (n,npa)

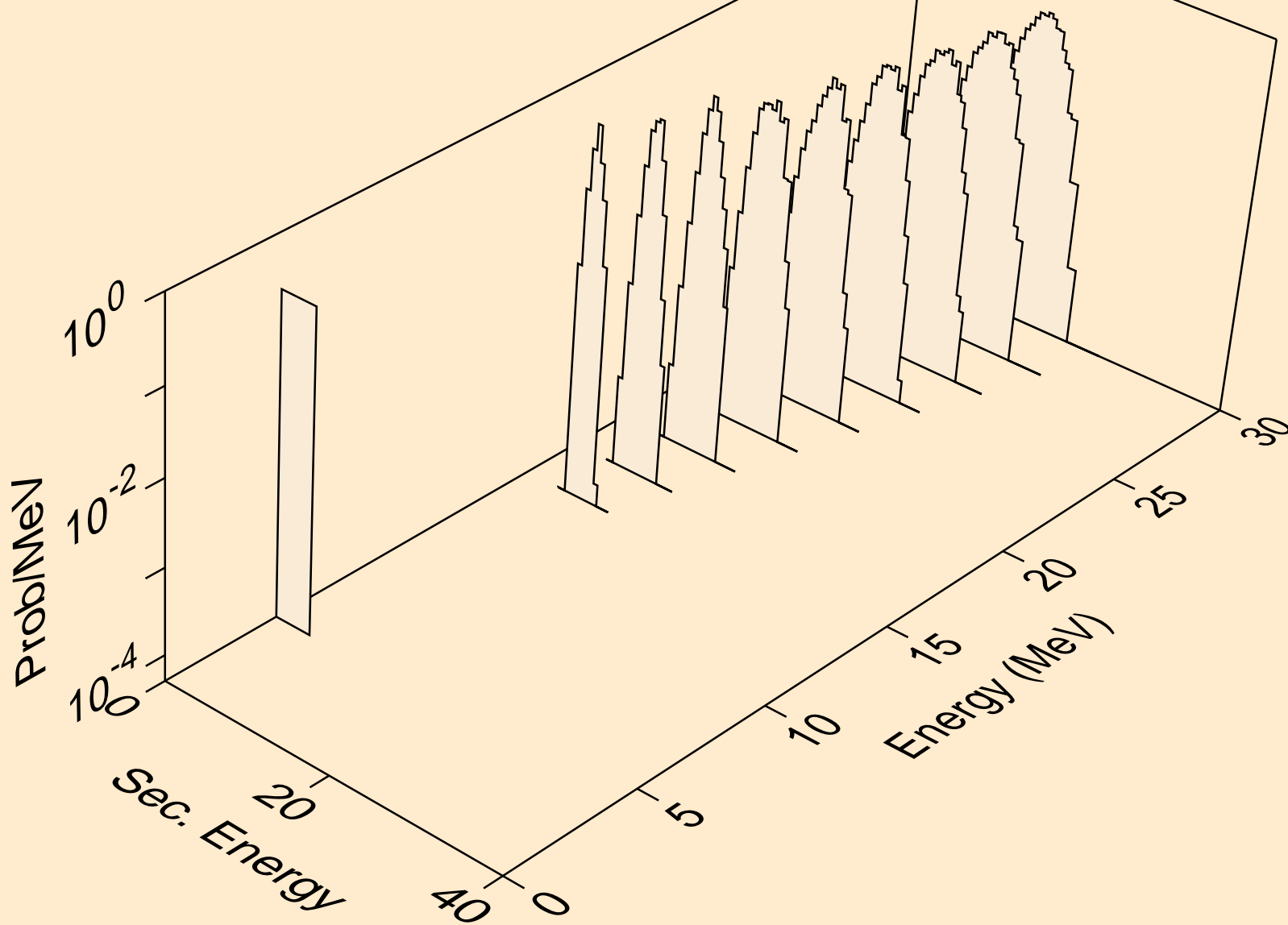

DY155 NEUTRON ACER TENDL-2019 LIBRARY; T=293.16K
alphas from (n,a)

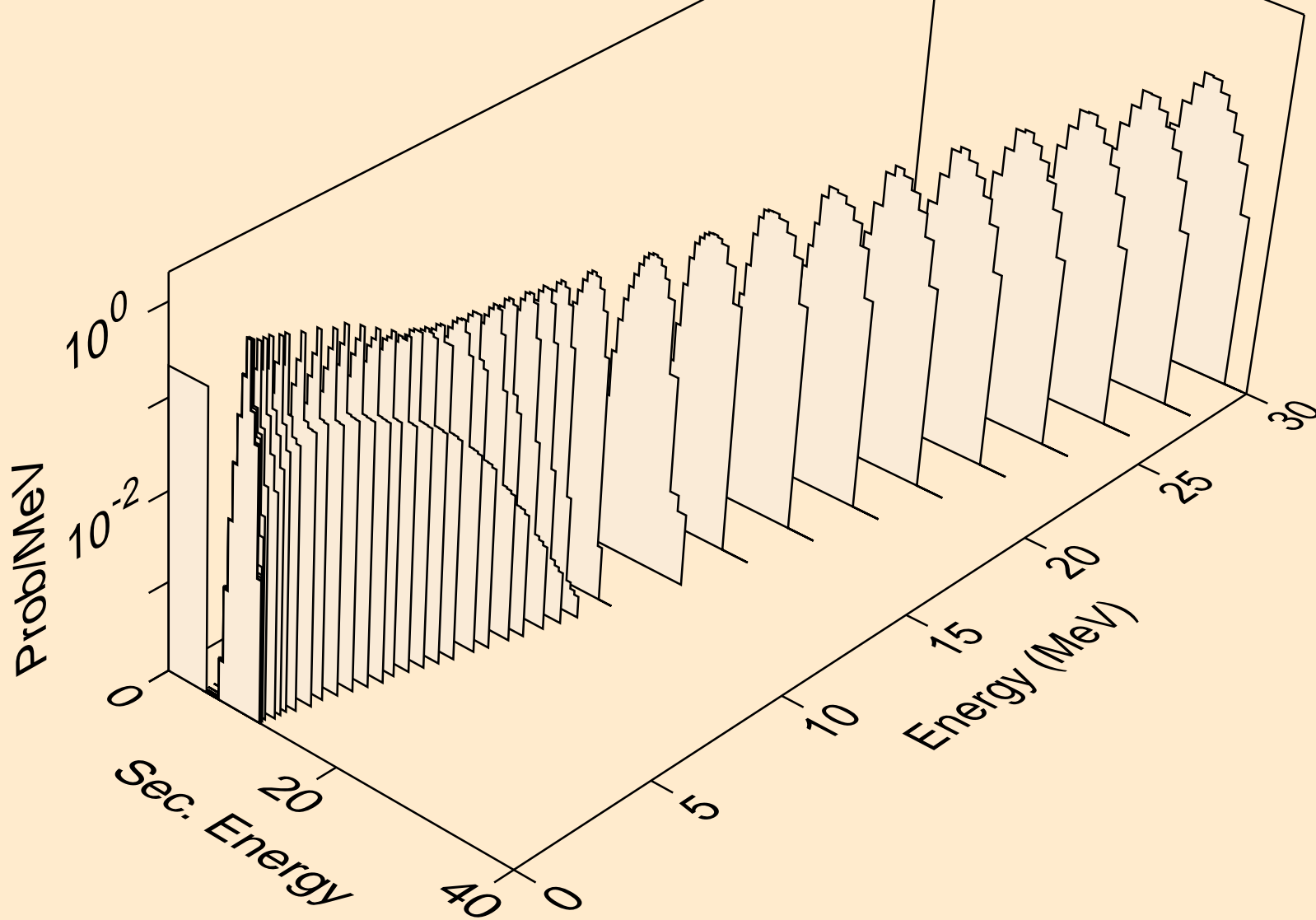

DY155 NEUTRON ACER TENDL-2019 LIBRARY; T=293.16K
alphas from (n,2a)

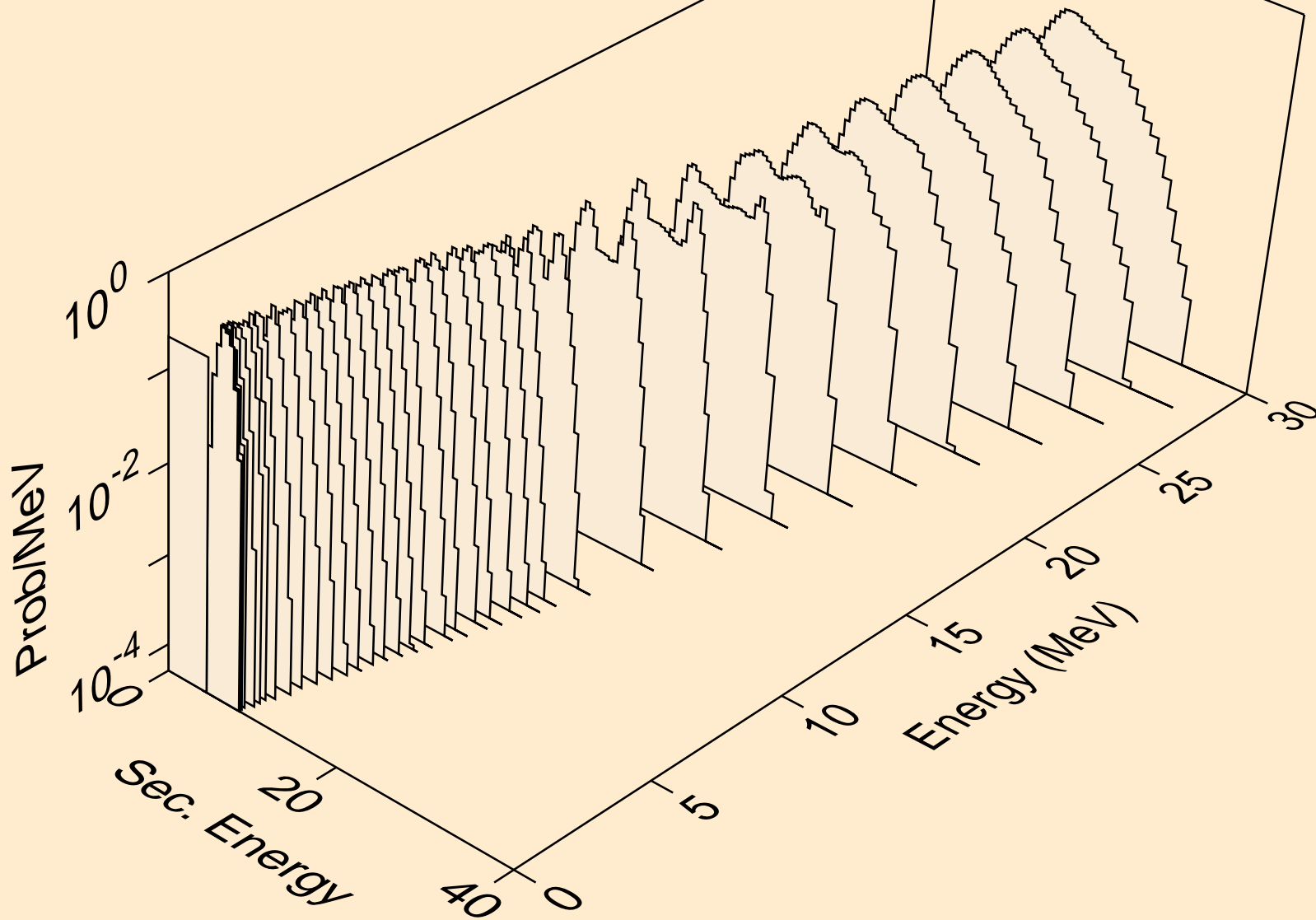

DY155 NEUTRON ACER TENDL-2019 LIBRARY; T=293.16K
alphas from (n,pa)

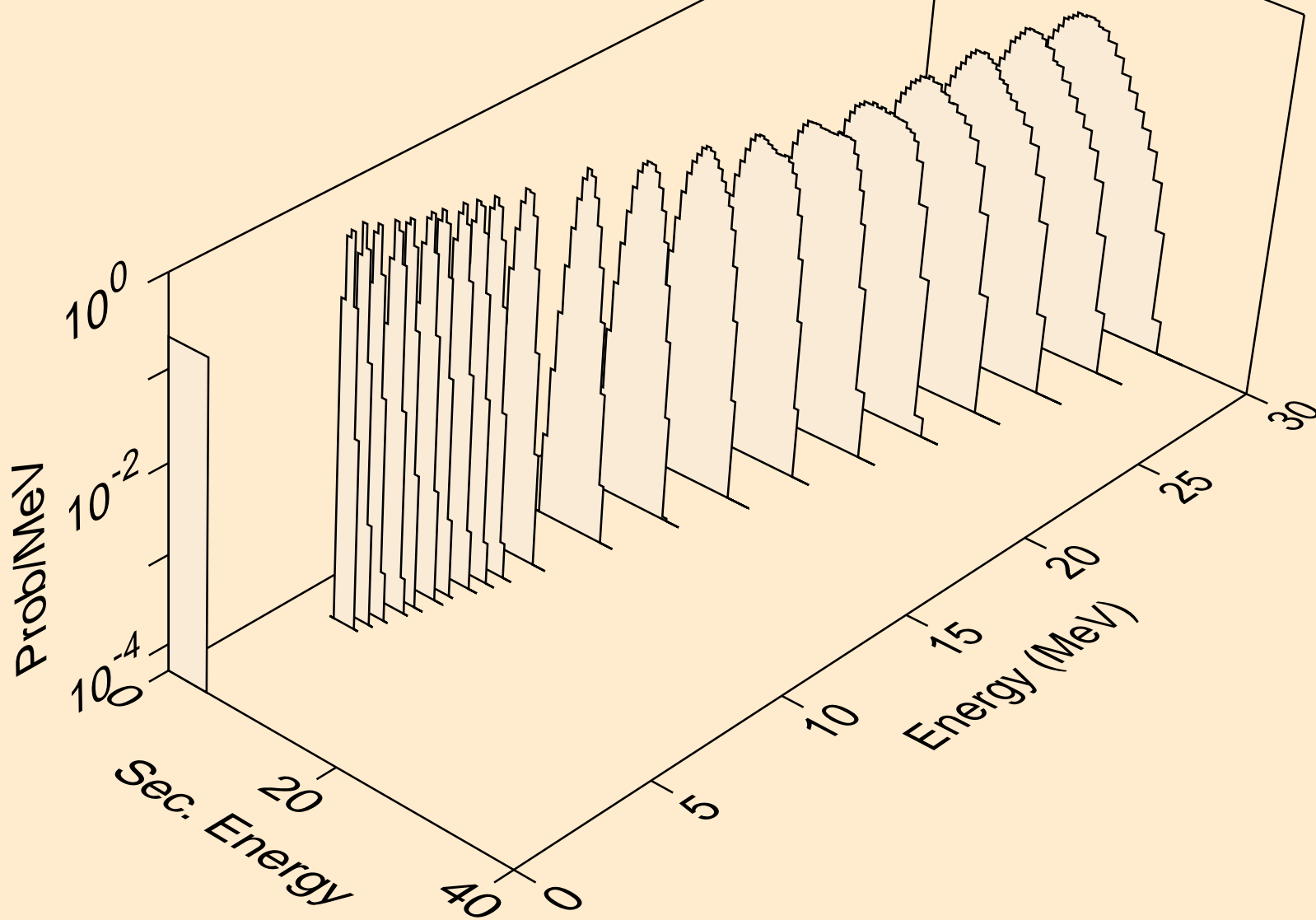

DY155 NEUTRON ACER TENDL-2019 LIBRARY; T=293.16K
alphas from (n,da)

