

DY159 NEUTRON ACER TENDL-2019 LIBRARY; T=293.16K  
Principal cross sections

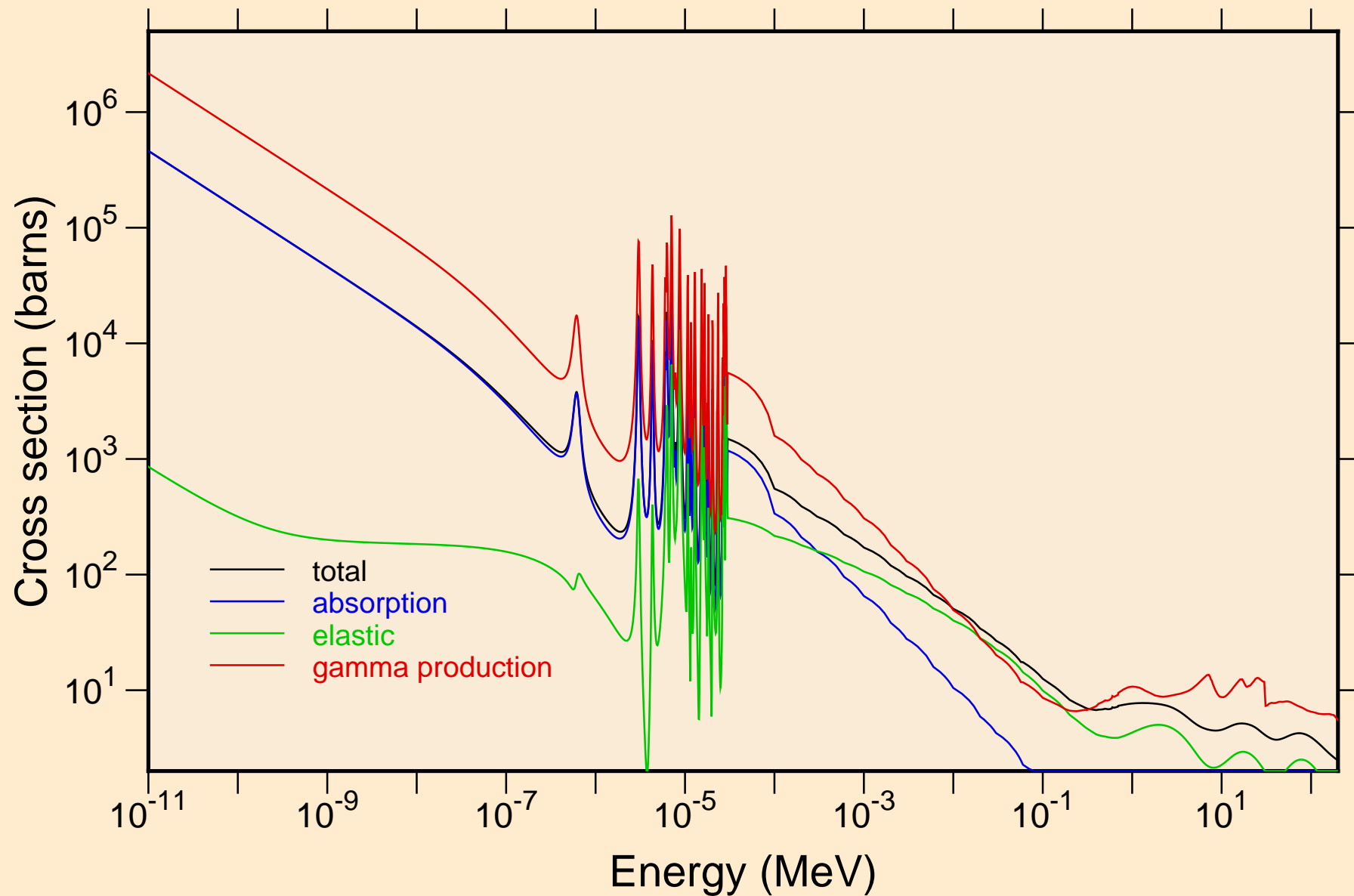

DY159 NEUTRON ACER TENDL-2019 LIBRARY; T=293.16K  
resonance total cross section

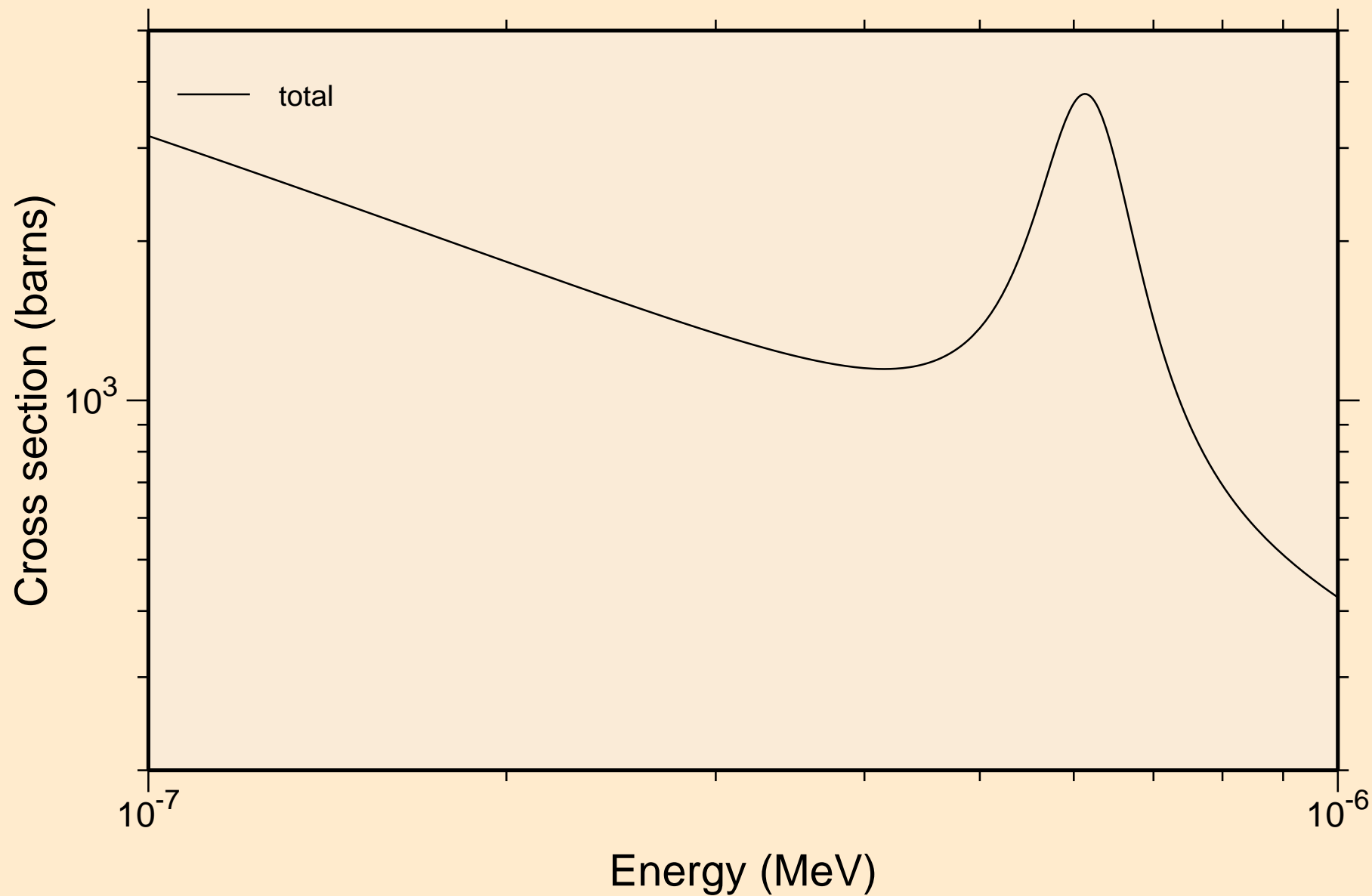

DY159 NEUTRON ACER TENDL-2019 LIBRARY; T=293.16K  
resonance total cross section

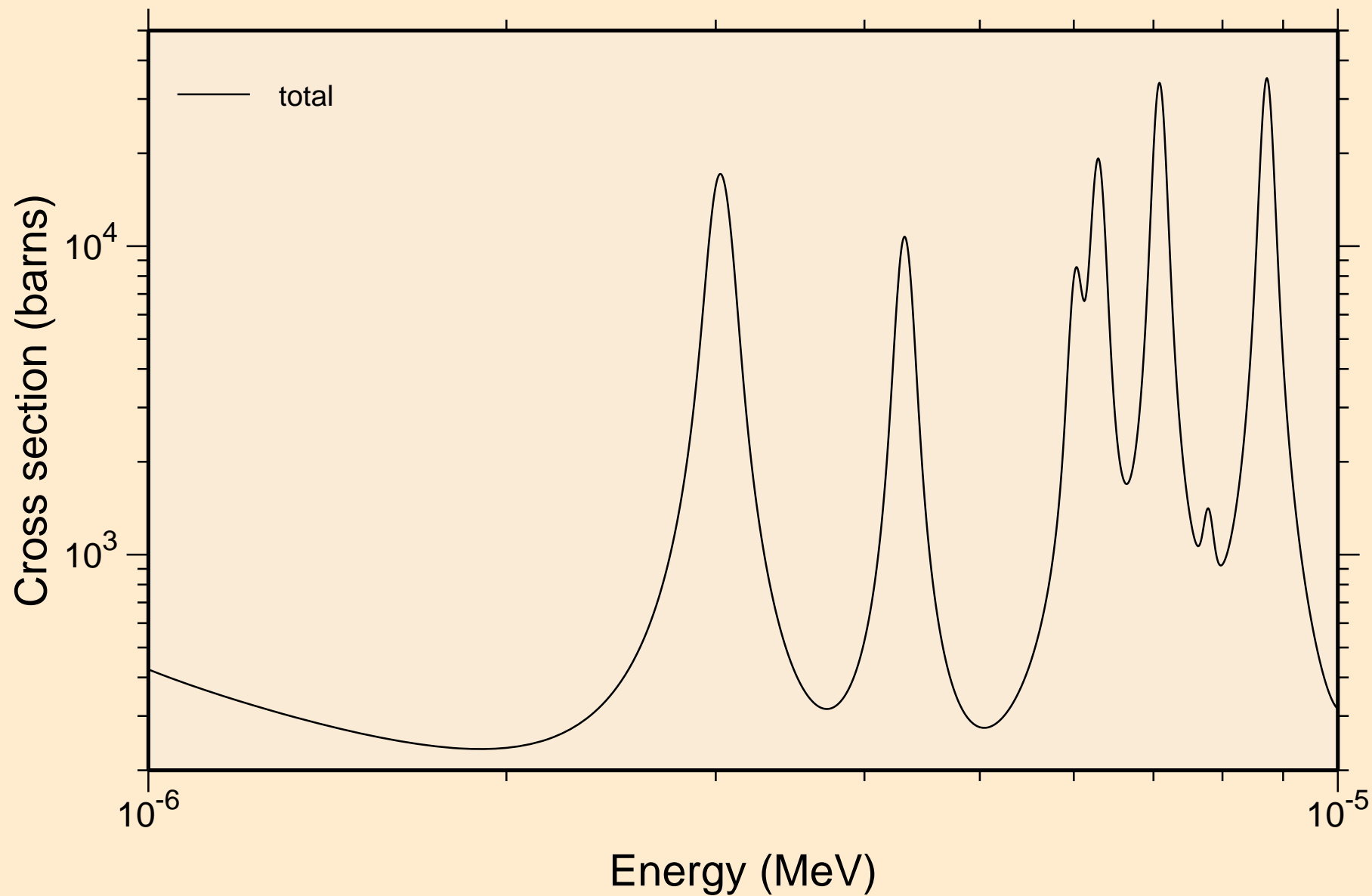

DY159 NEUTRON ACER TENDL-2019 LIBRARY; T=293.16K  
resonance total cross section

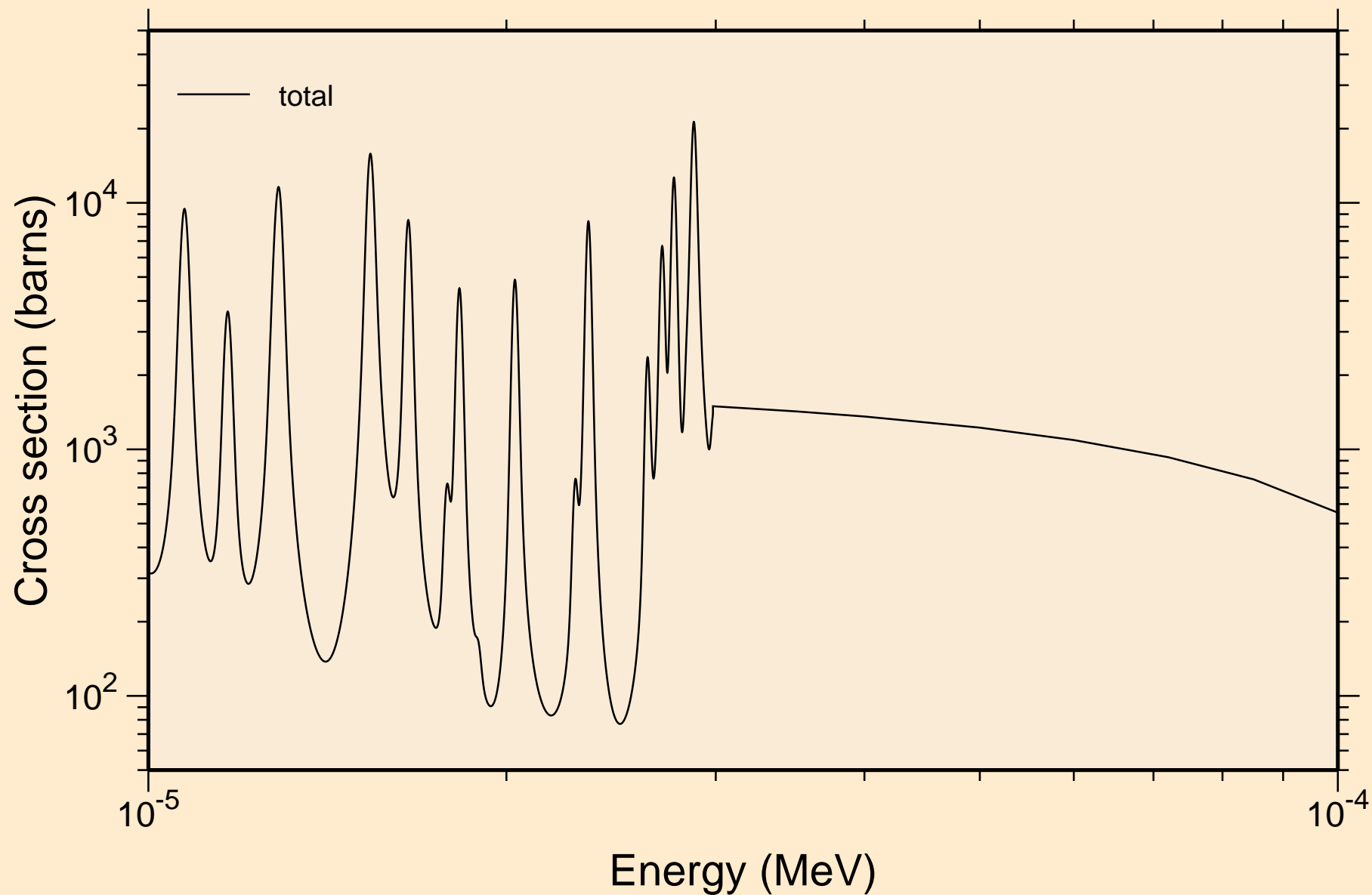

DY159 NEUTRON ACER TENDL-2019 LIBRARY; T=293.16K  
resonance total cross section

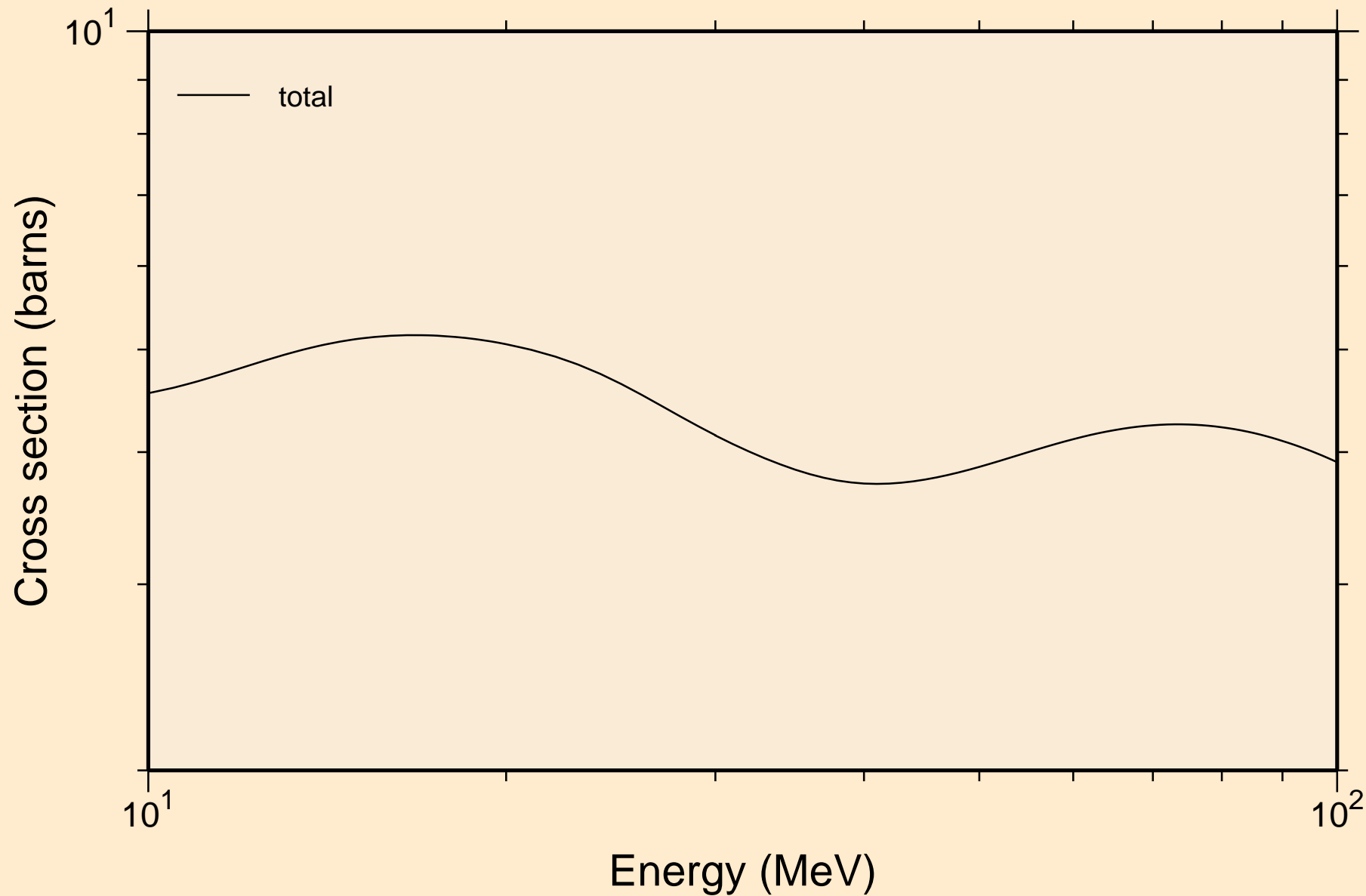

DY159 NEUTRON ACER TENDL-2019 LIBRARY; T=293.16K  
resonance absorption cross sections

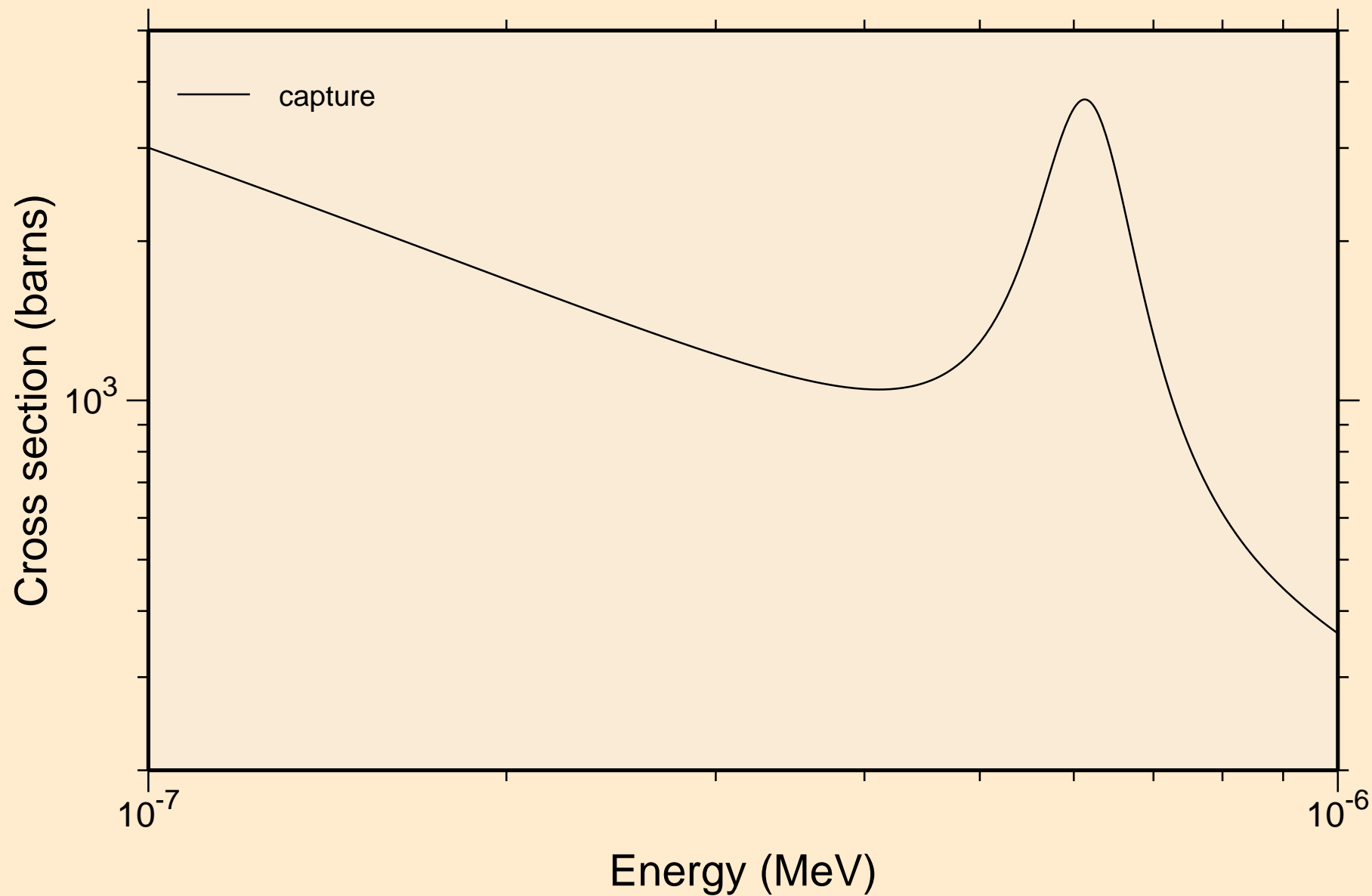

DY159 NEUTRON ACER TENDL-2019 LIBRARY; T=293.16K  
resonance absorption cross sections

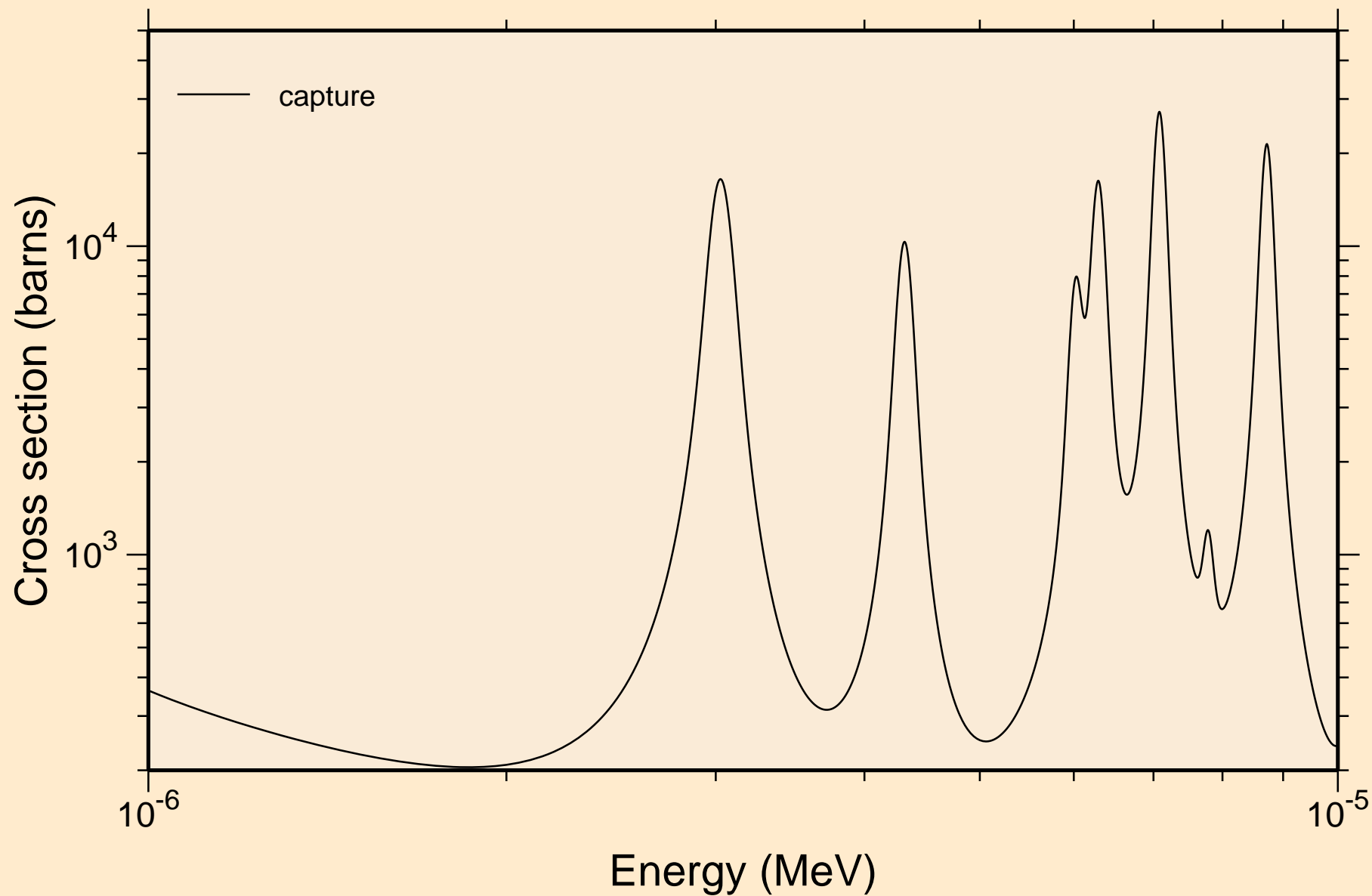

DY159 NEUTRON ACER TENDL-2019 LIBRARY; T=293.16K  
resonance absorption cross sections

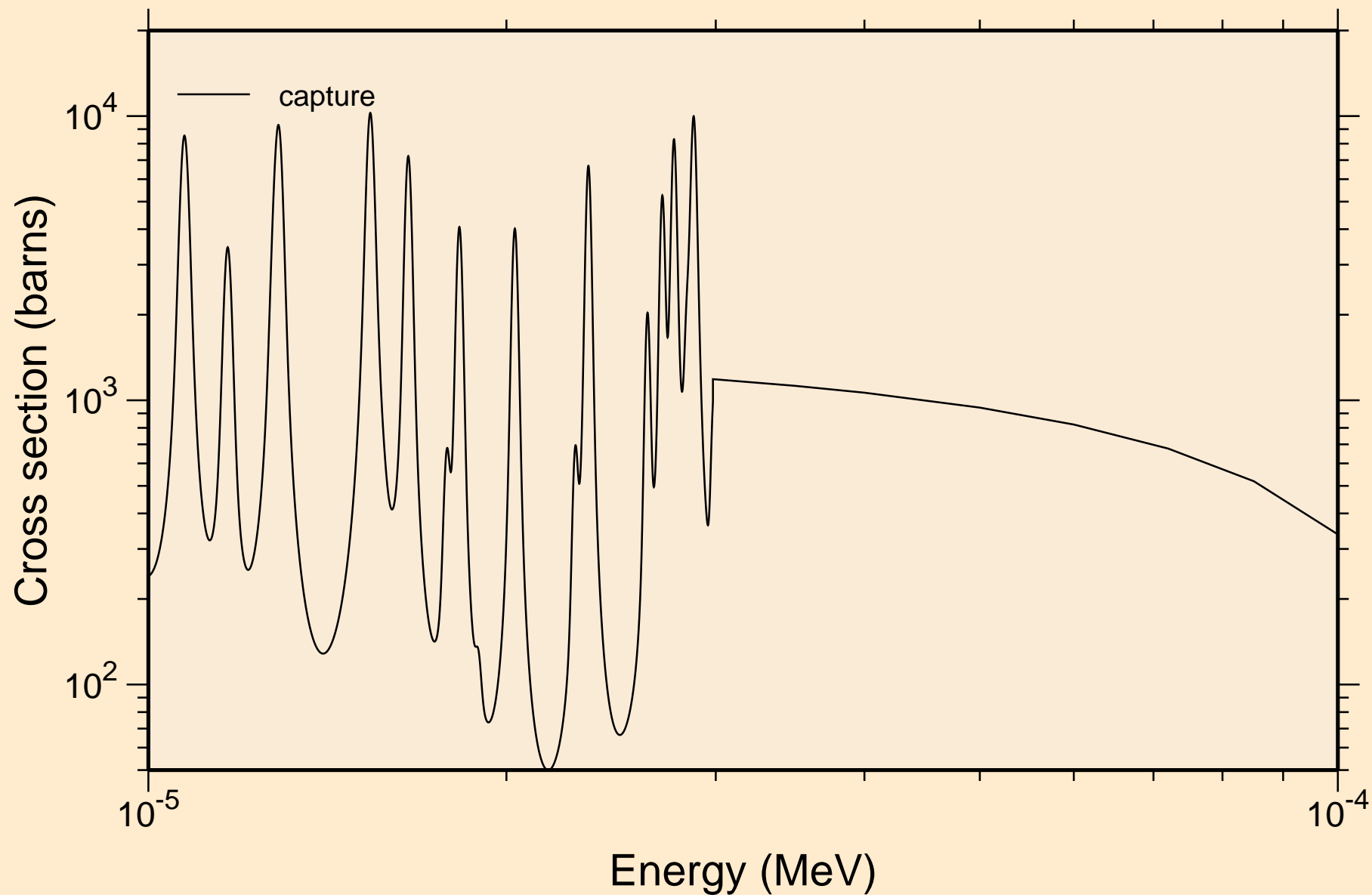



DY159 NEUTRON ACER TENDL-2019 LIBRARY; T=293.16K  
resonance absorption cross sections

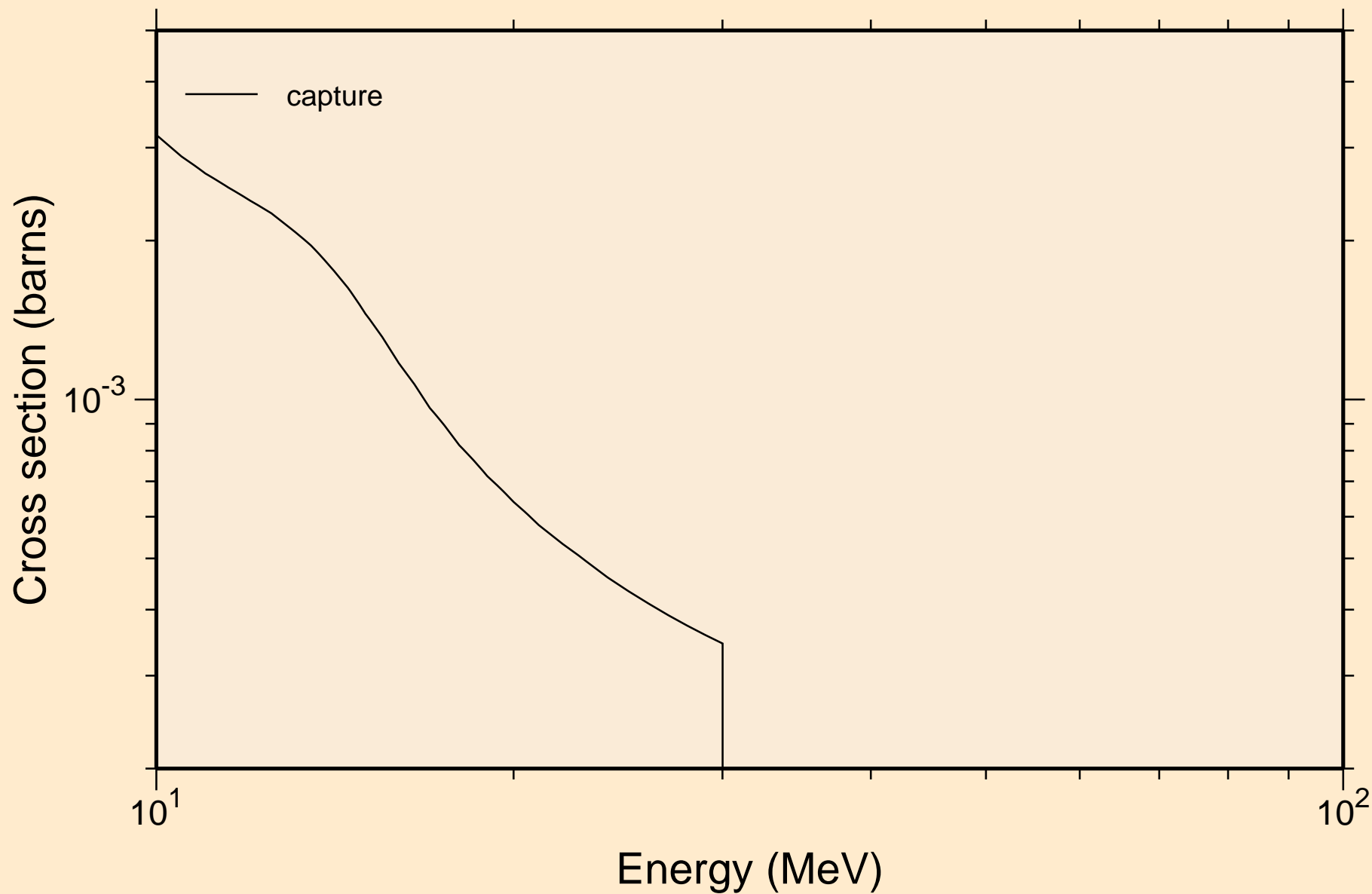

DY159 NEUTRON ACER TENDL-2019 LIBRARY; T=293.16K  
Heating

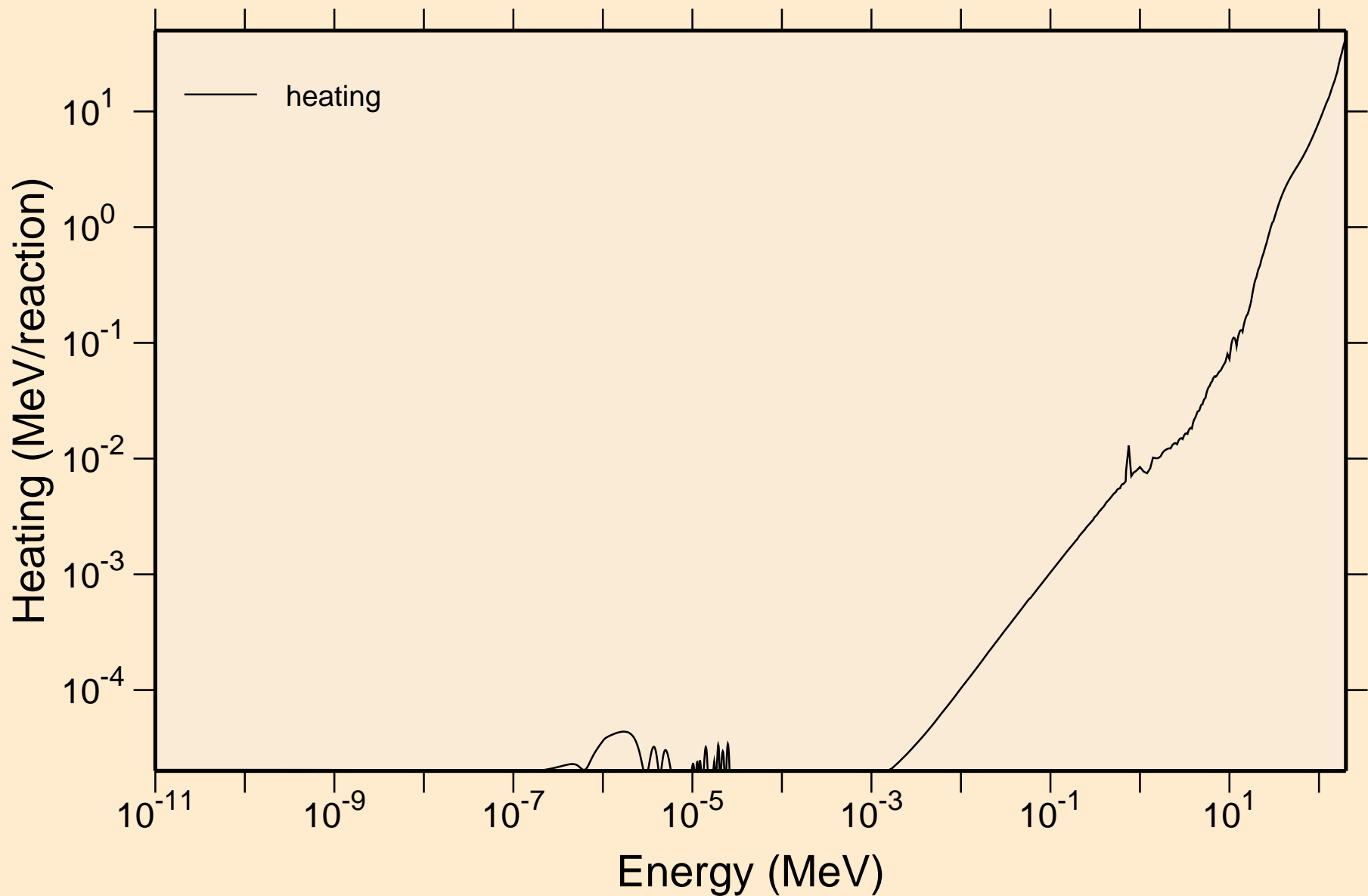

DY159 NEUTRON ACER TENDL-2019 LIBRARY; T=293.16K  
Damage

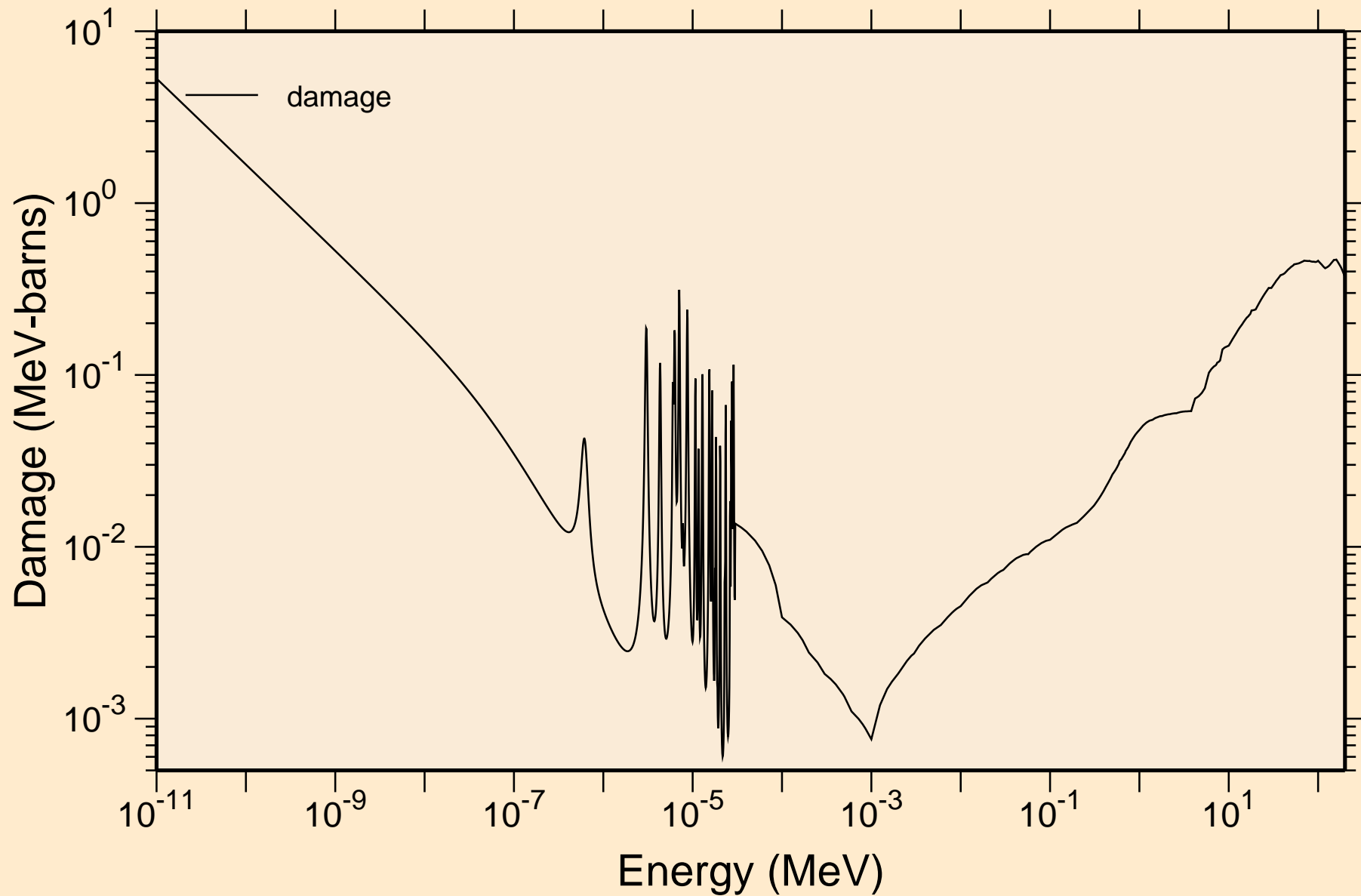

DY159 NEUTRON ACER TENDL-2019 LIBRARY; T=293.16K  
Non-threshold reactions

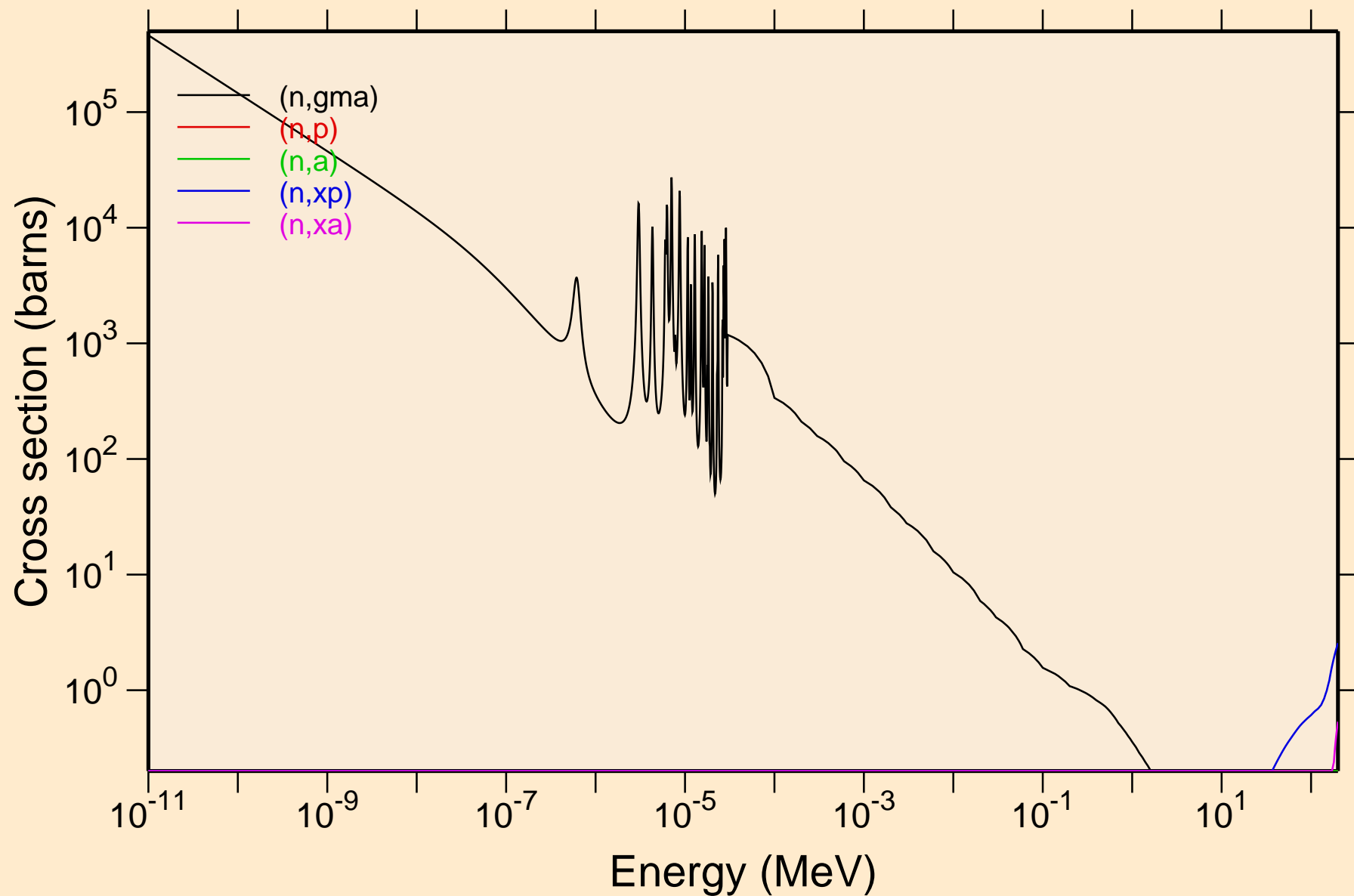

DY159 NEUTRON ACER TENDL-2019 LIBRARY; T=293.16K  
Principal cross sections

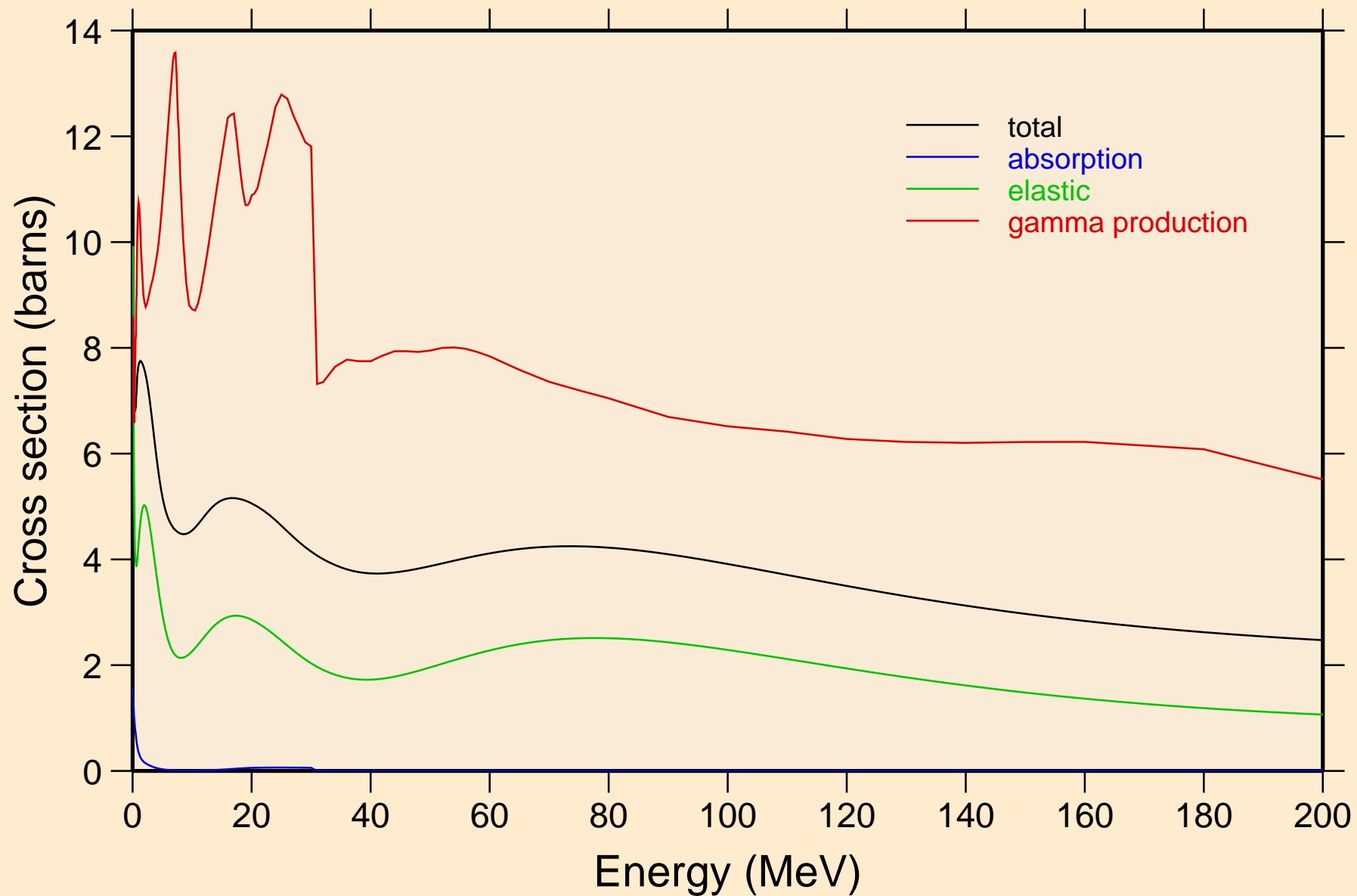

DY159 NEUTRON ACER TENDL-2019 LIBRARY; T=293.16K  
Heating

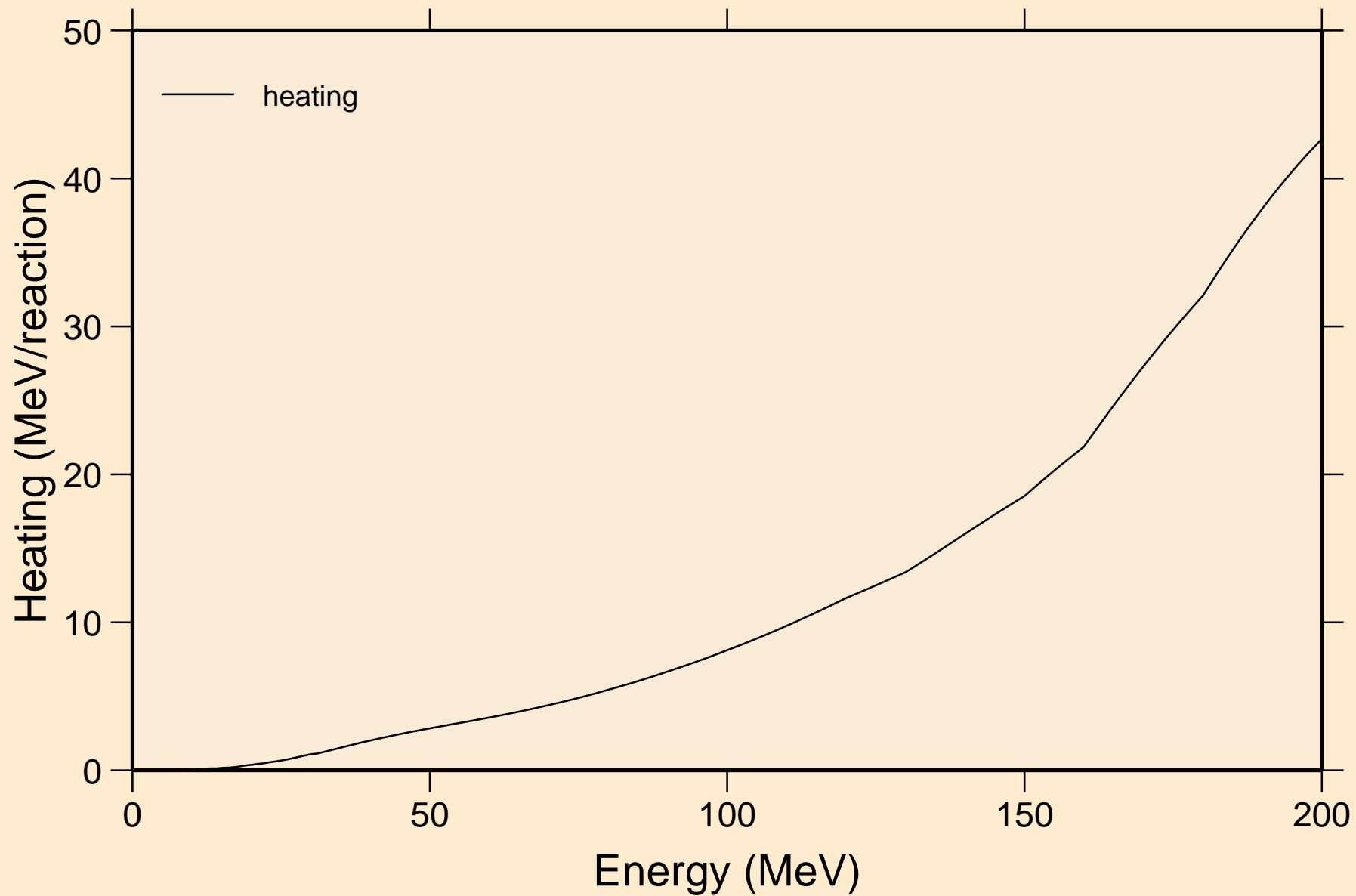

DY159 NEUTRON ACER TENDL-2019 LIBRARY; T=293.16K  
Damage

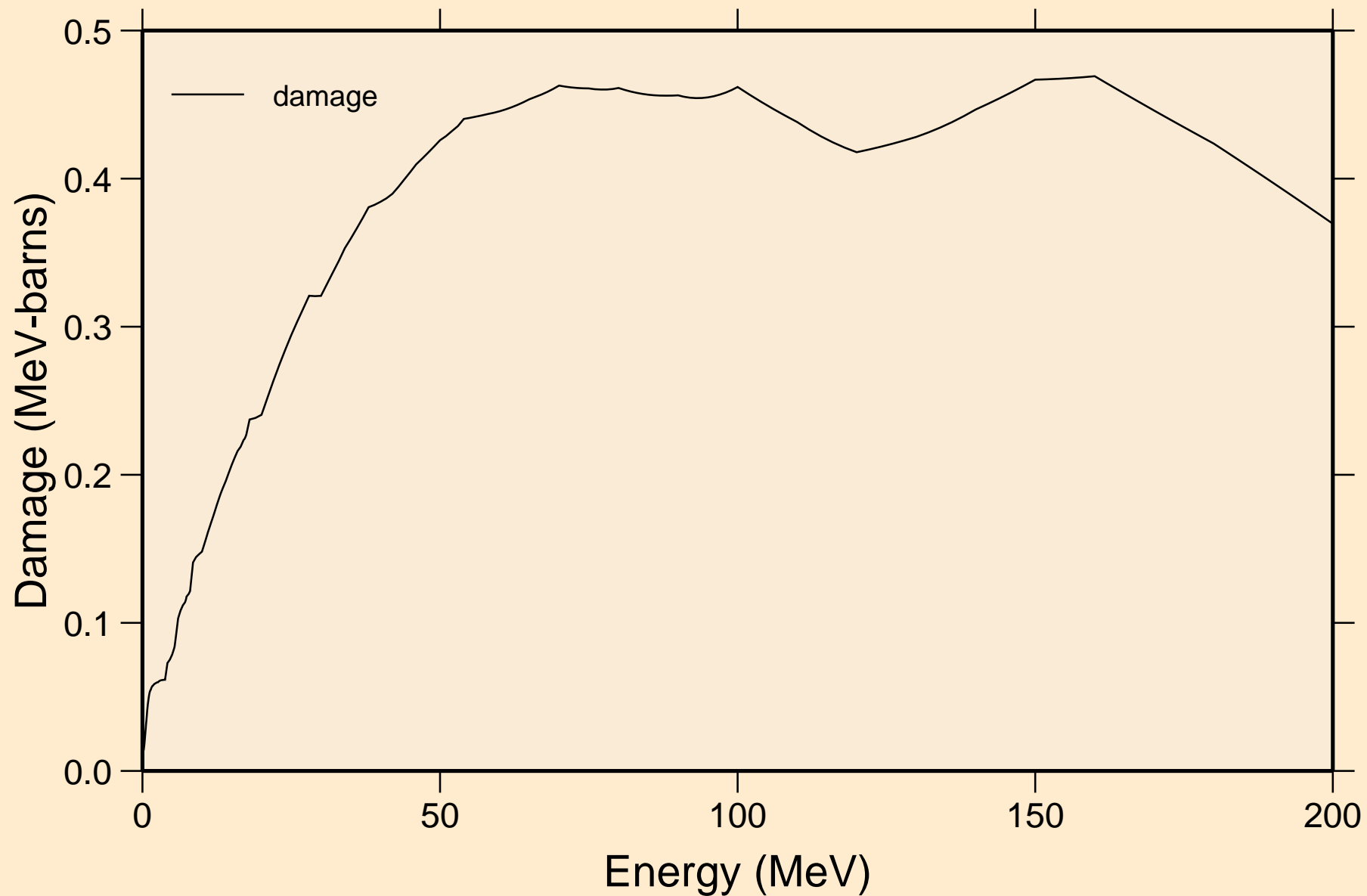

DY159 NEUTRON ACER TENDL-2019 LIBRARY; T=293.16K  
Non-threshold reactions

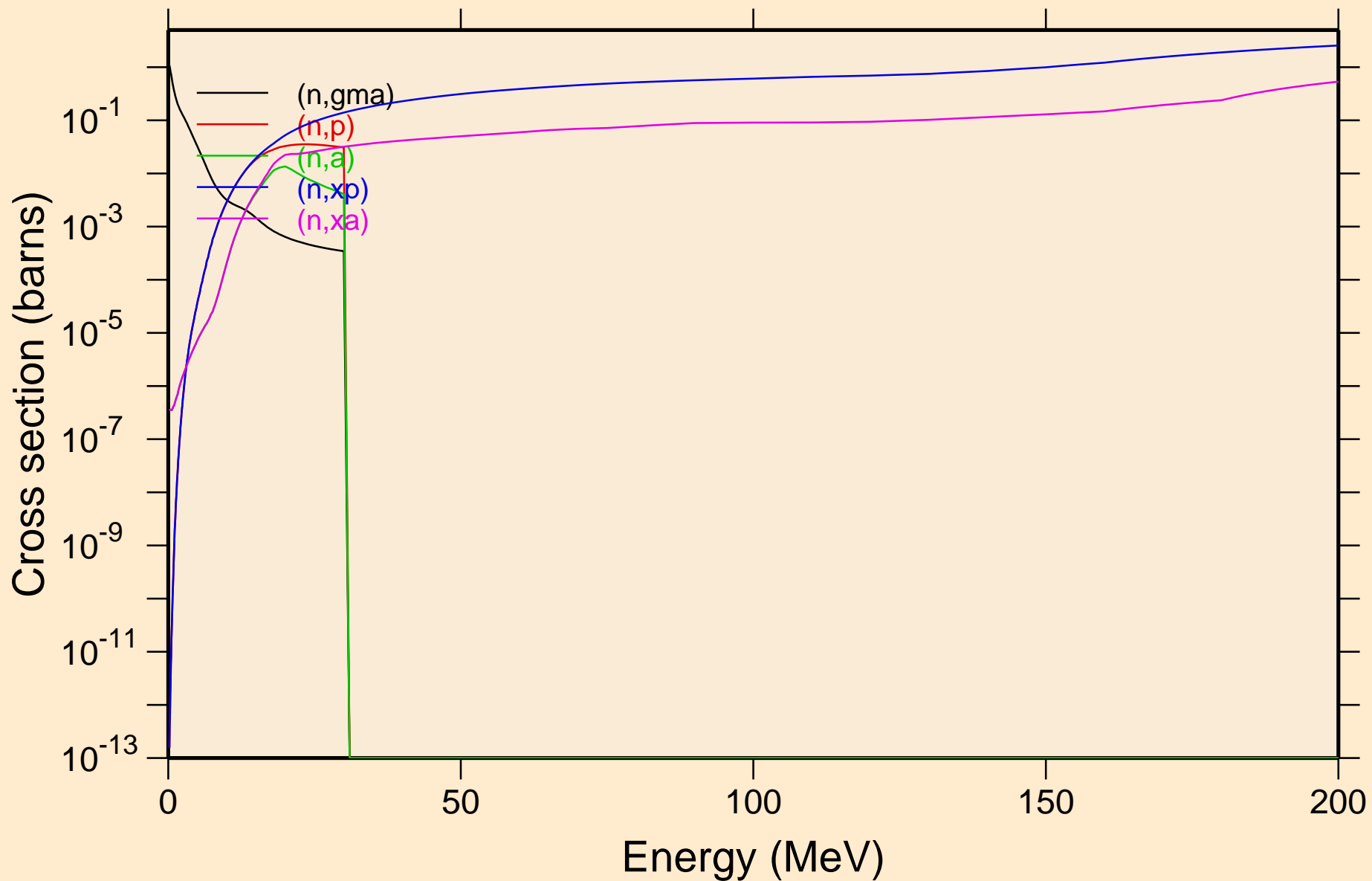



DY159 NEUTRON ACER TENDL-2019 LIBRARY; T=293.16K  
Inelastic levels

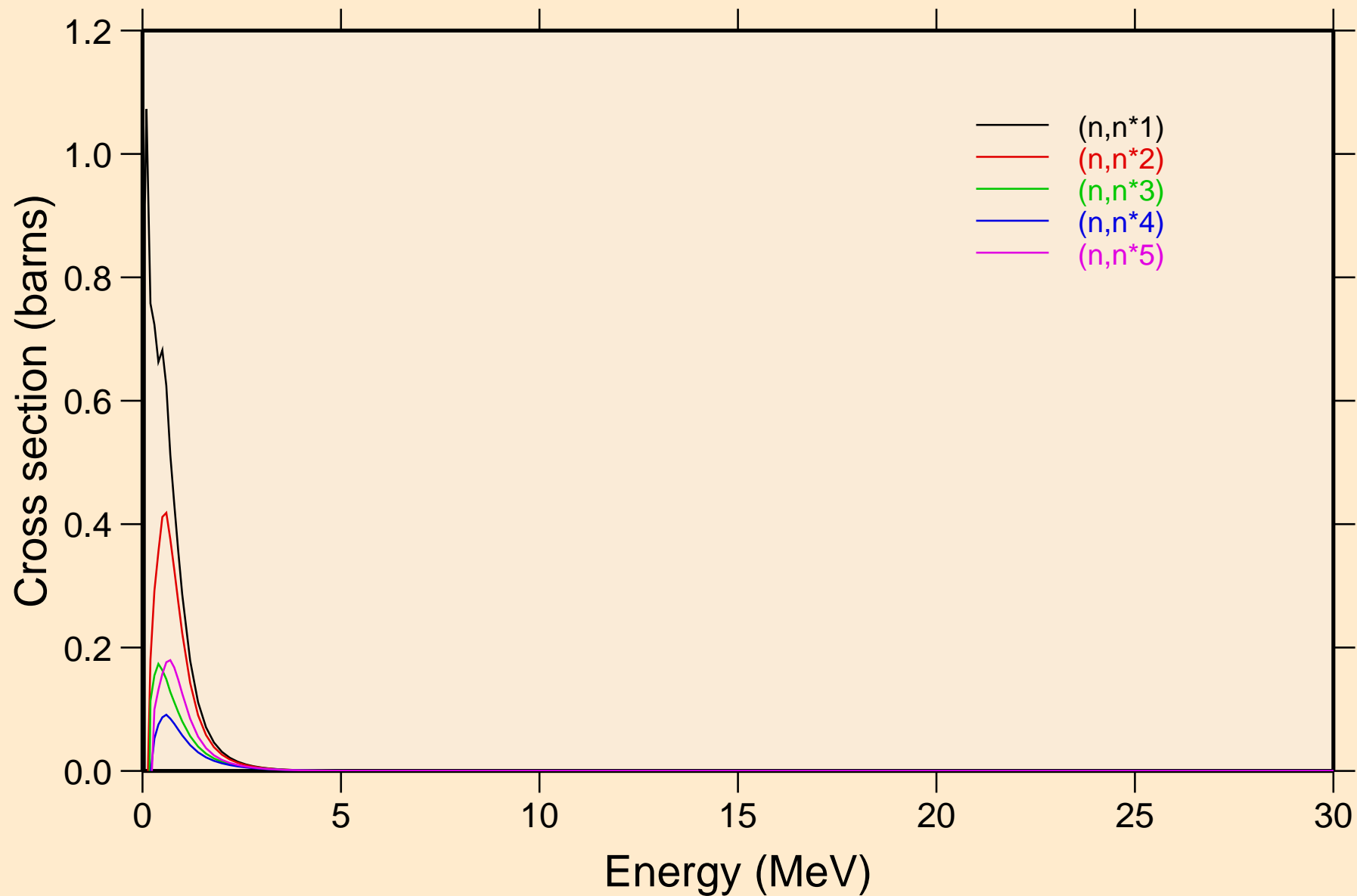

DY159 NEUTRON ACER TENDL-2019 LIBRARY; T=293.16K  
Inelastic levels

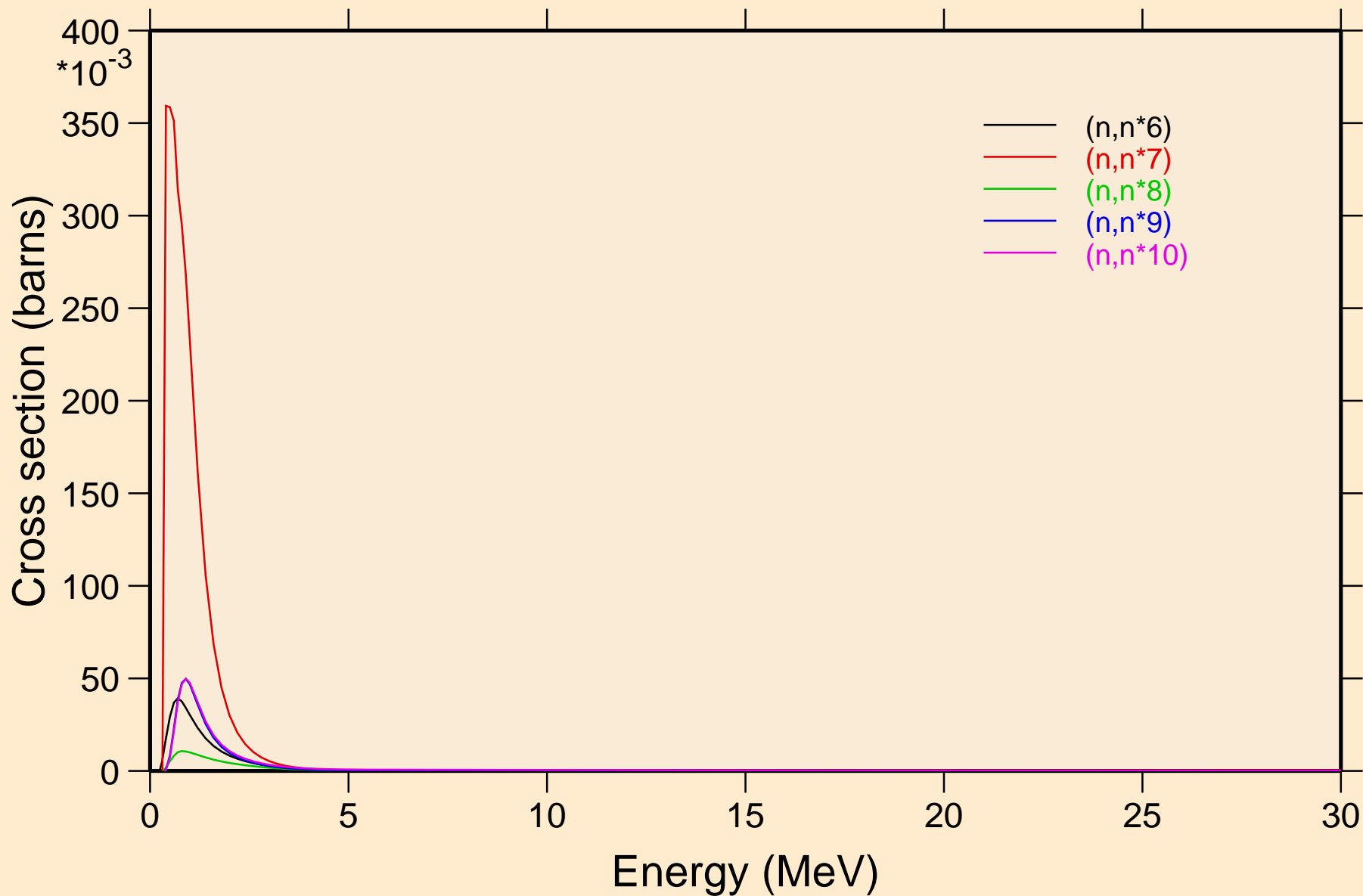

DY159 NEUTRON ACER TENDL-2019 LIBRARY; T=293.16K  
Inelastic levels

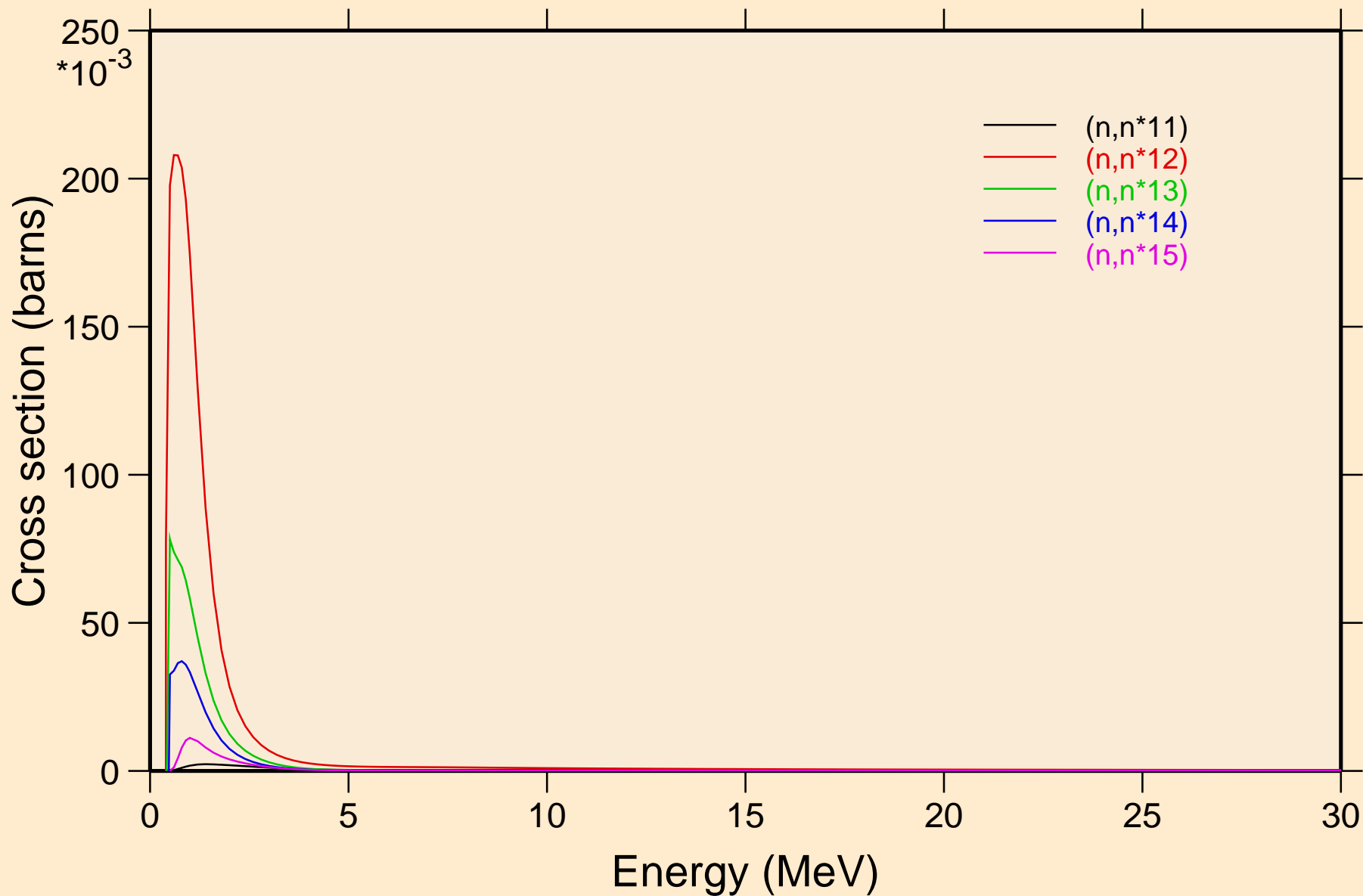

DY159 NEUTRON ACER TENDL-2019 LIBRARY; T=293.16K  
Inelastic levels

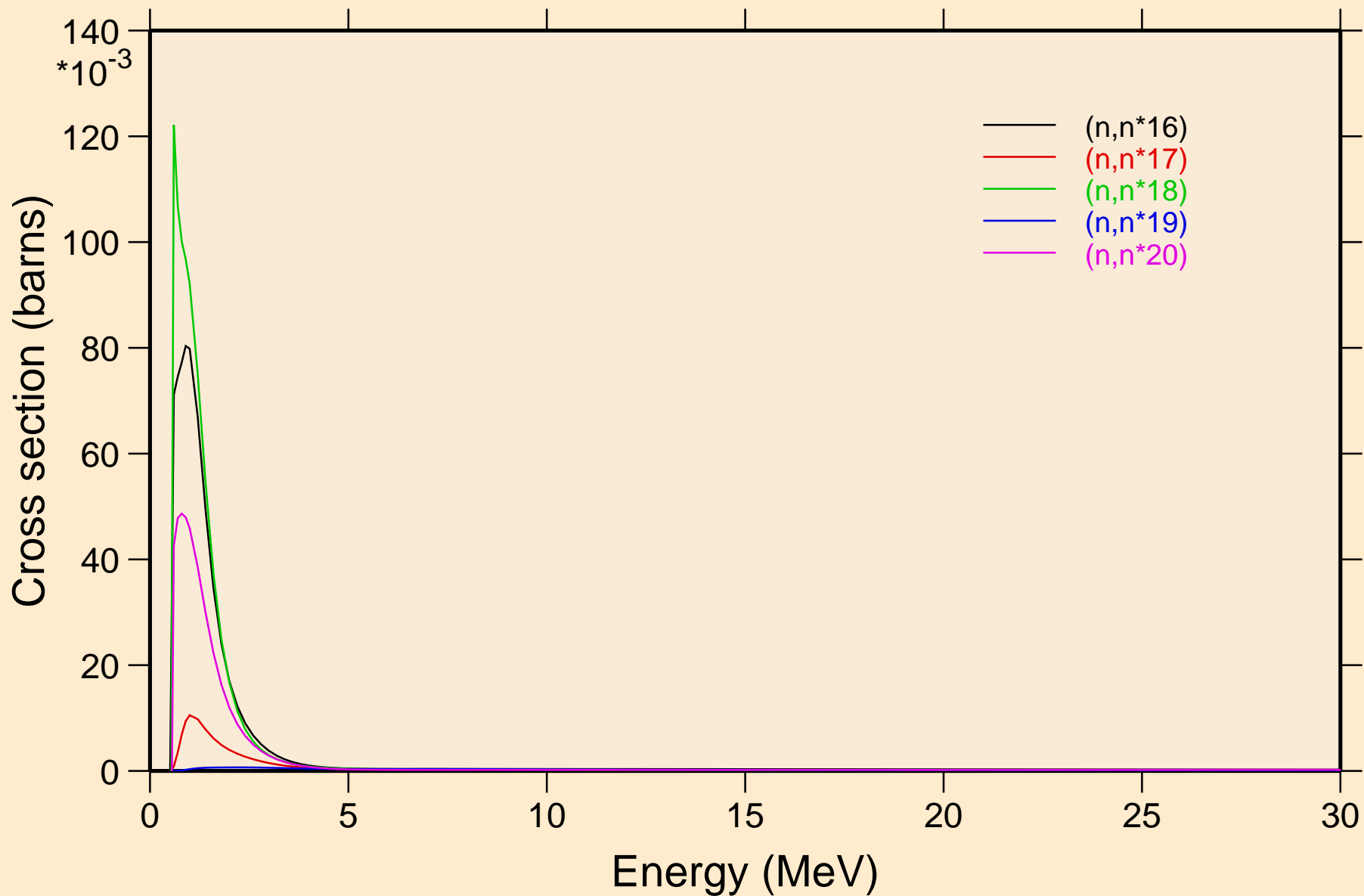

DY159 NEUTRON ACER TENDL-2019 LIBRARY; T=293.16K  
Inelastic levels

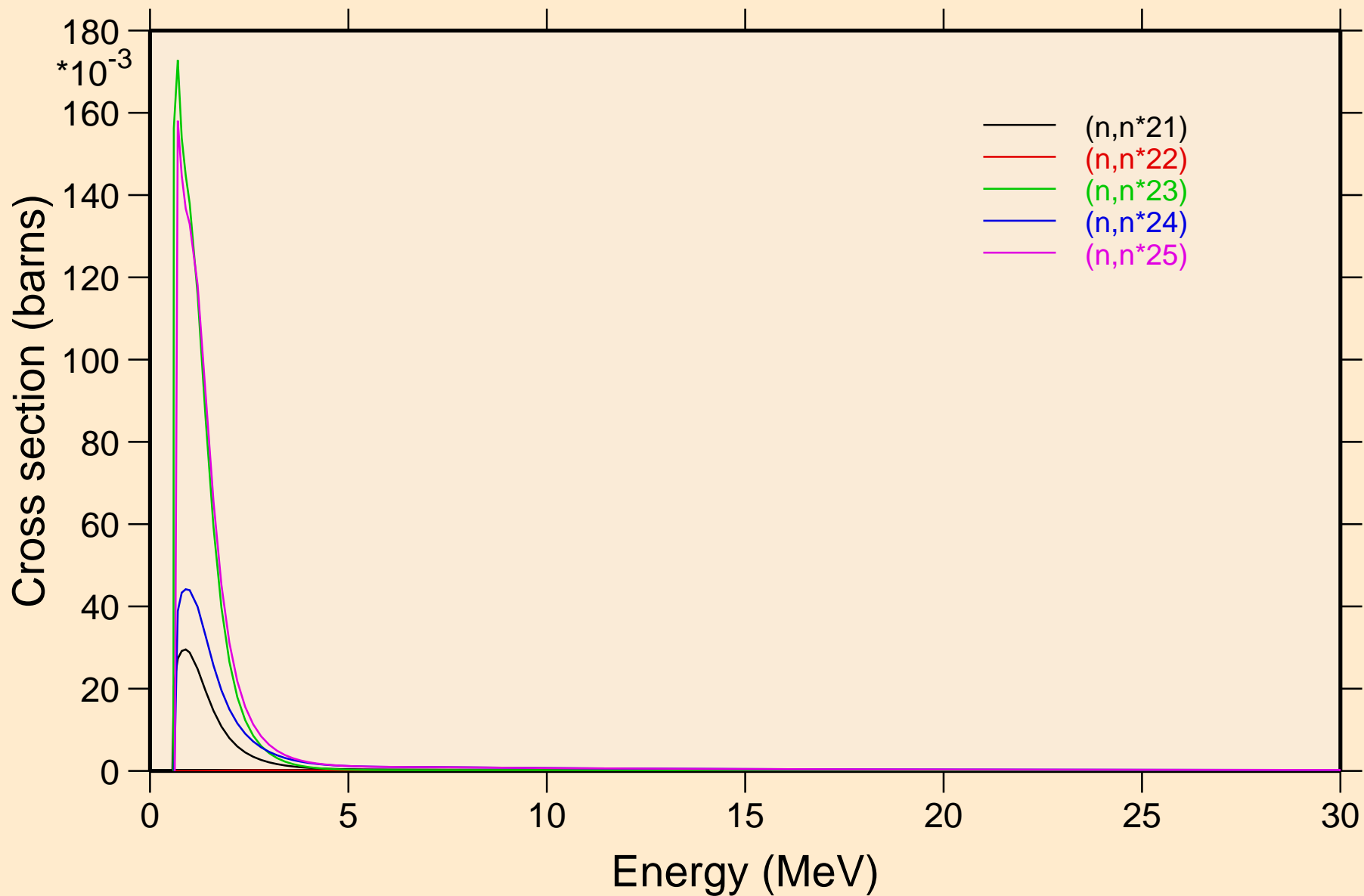

DY159 NEUTRON ACER TENDL-2019 LIBRARY; T=293.16K  
Inelastic levels

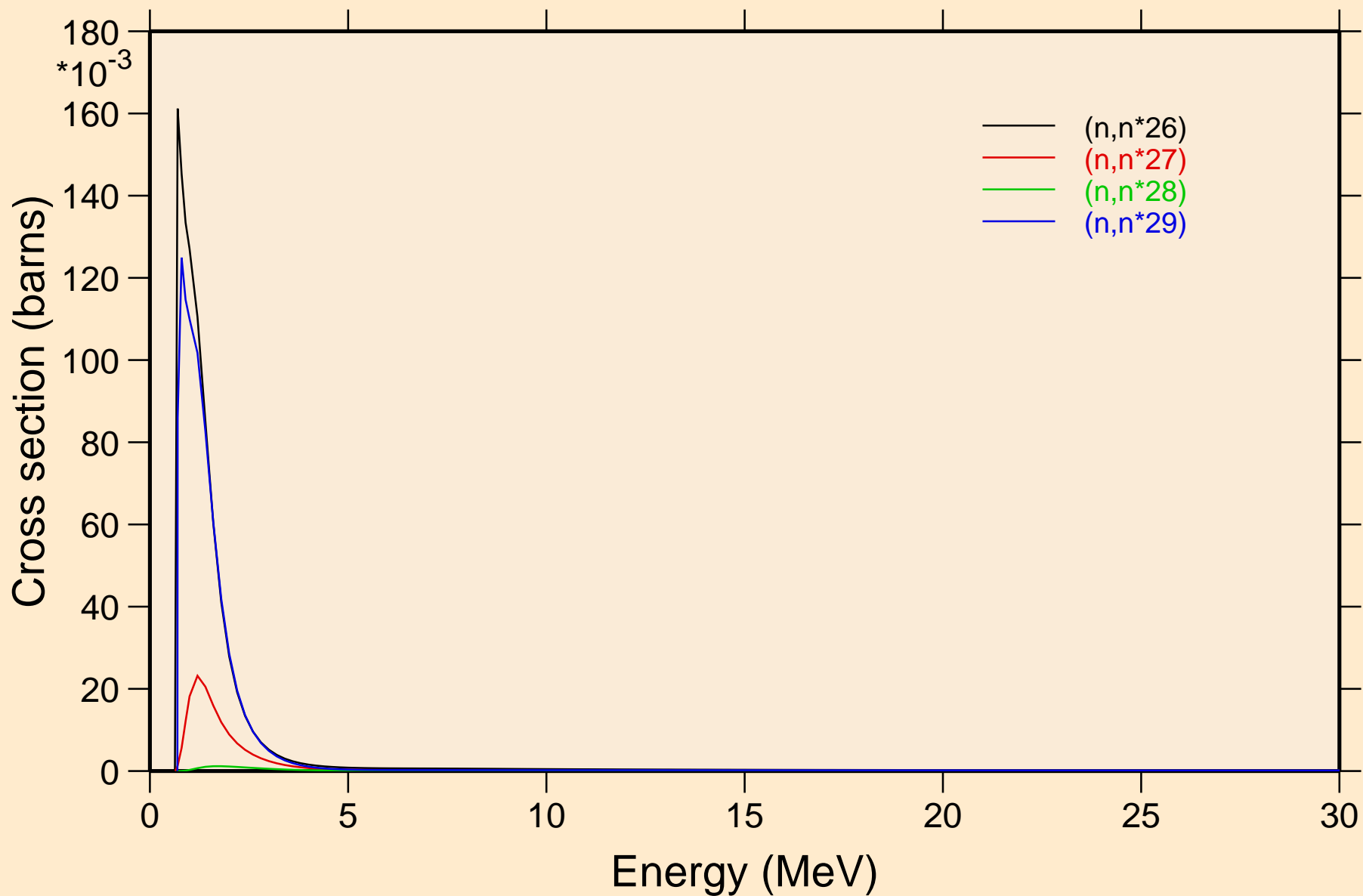

DY159 NEUTRON ACER TENDL-2019 LIBRARY; T=293.16K  
Threshold reactions

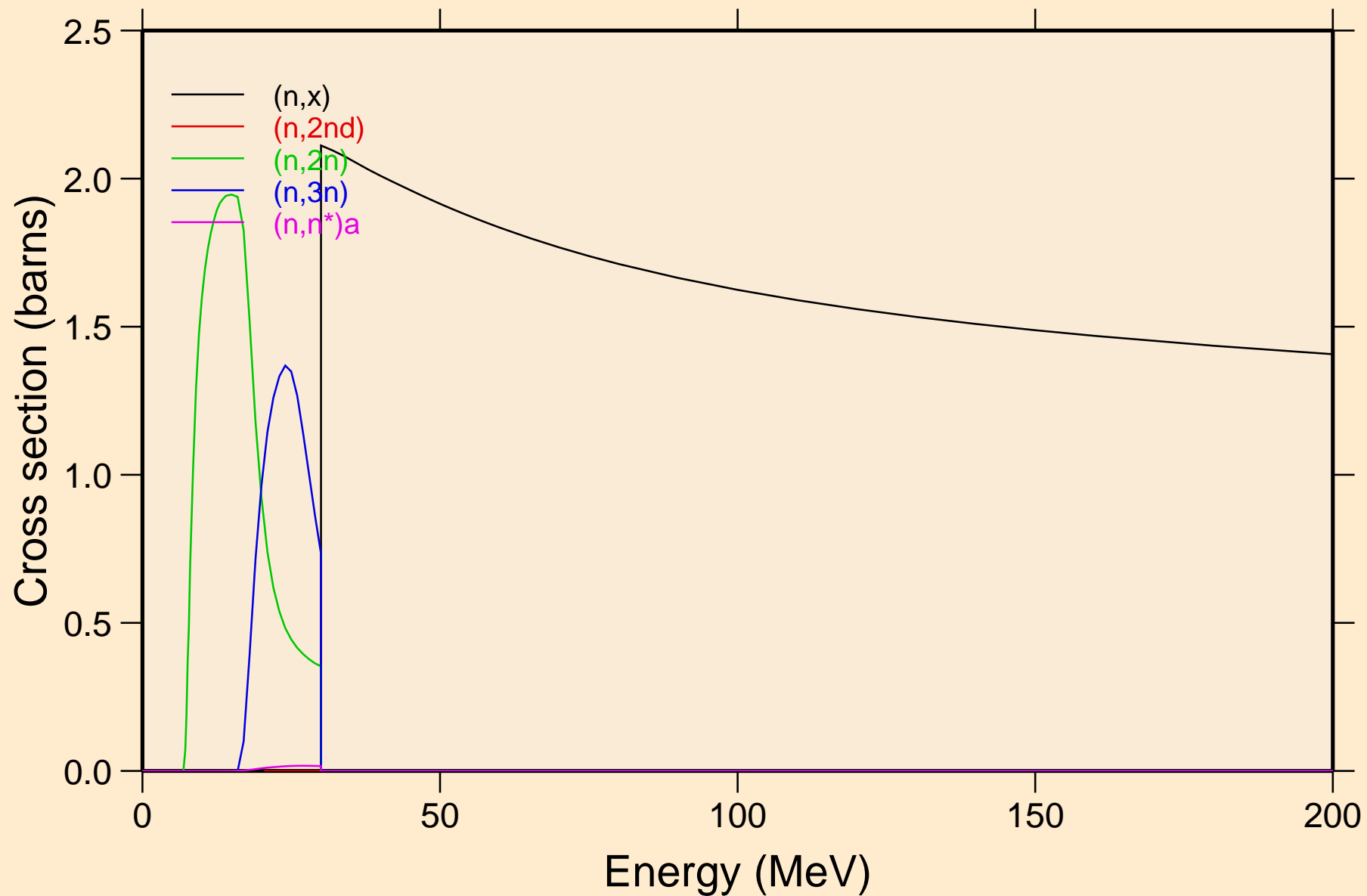

DY159 NEUTRON ACER TENDL-2019 LIBRARY; T=293.16K  
Threshold reactions

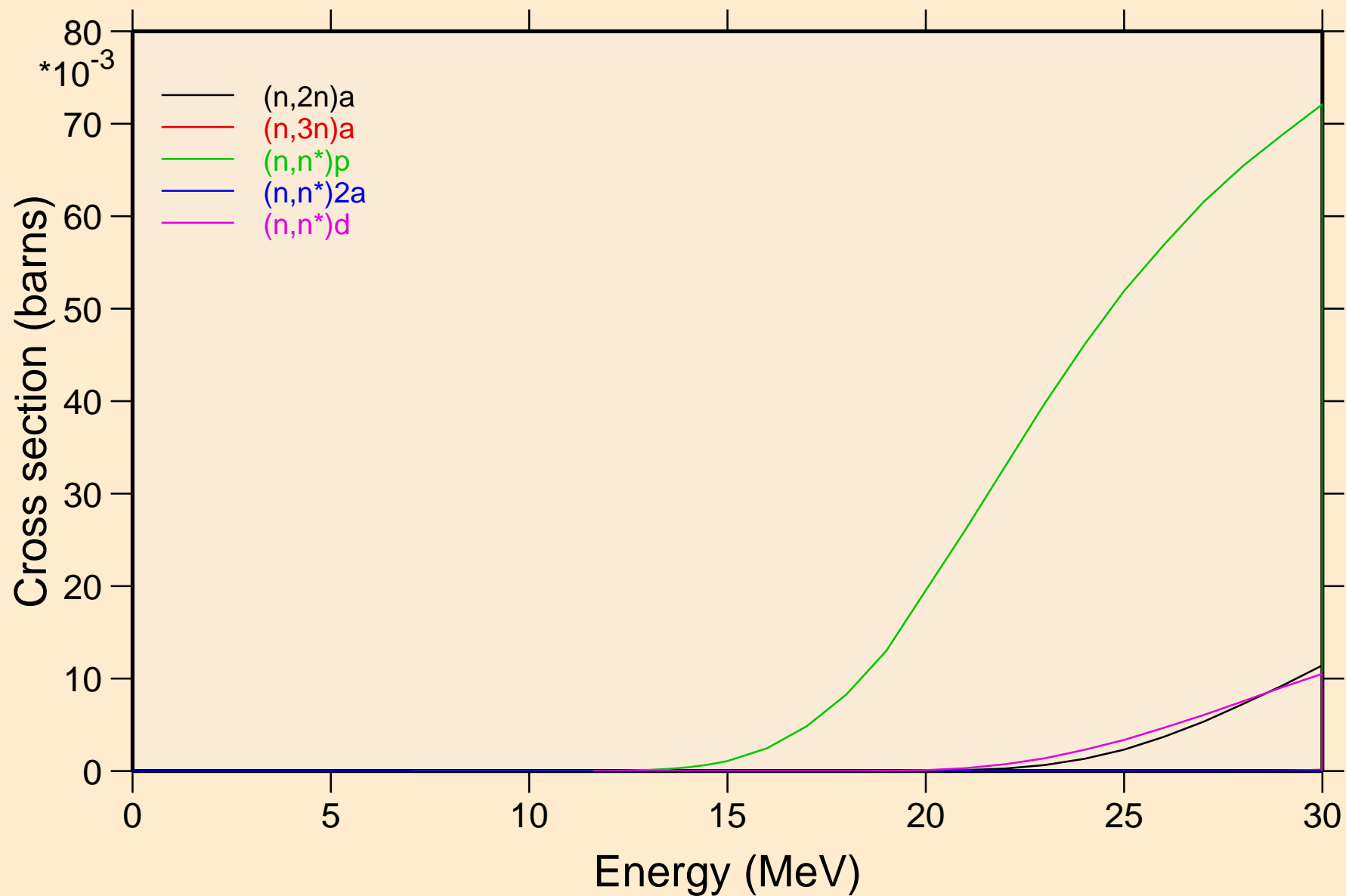



DY159 NEUTRON ACER TENDL-2019 LIBRARY; T=293.16K  
Threshold reactions

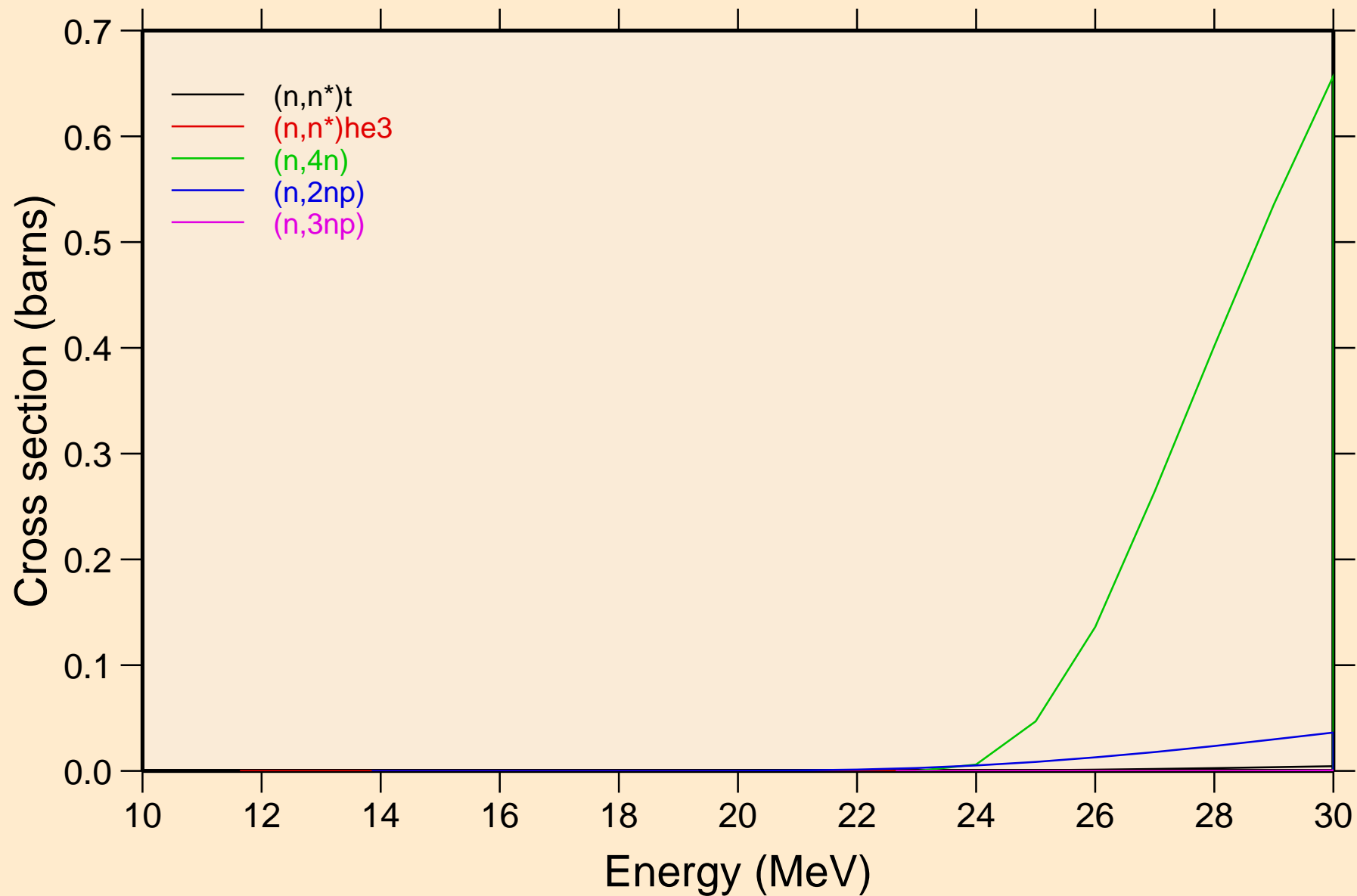

DY159 NEUTRON ACER TENDL-2019 LIBRARY; T=293.16K  
Threshold reactions

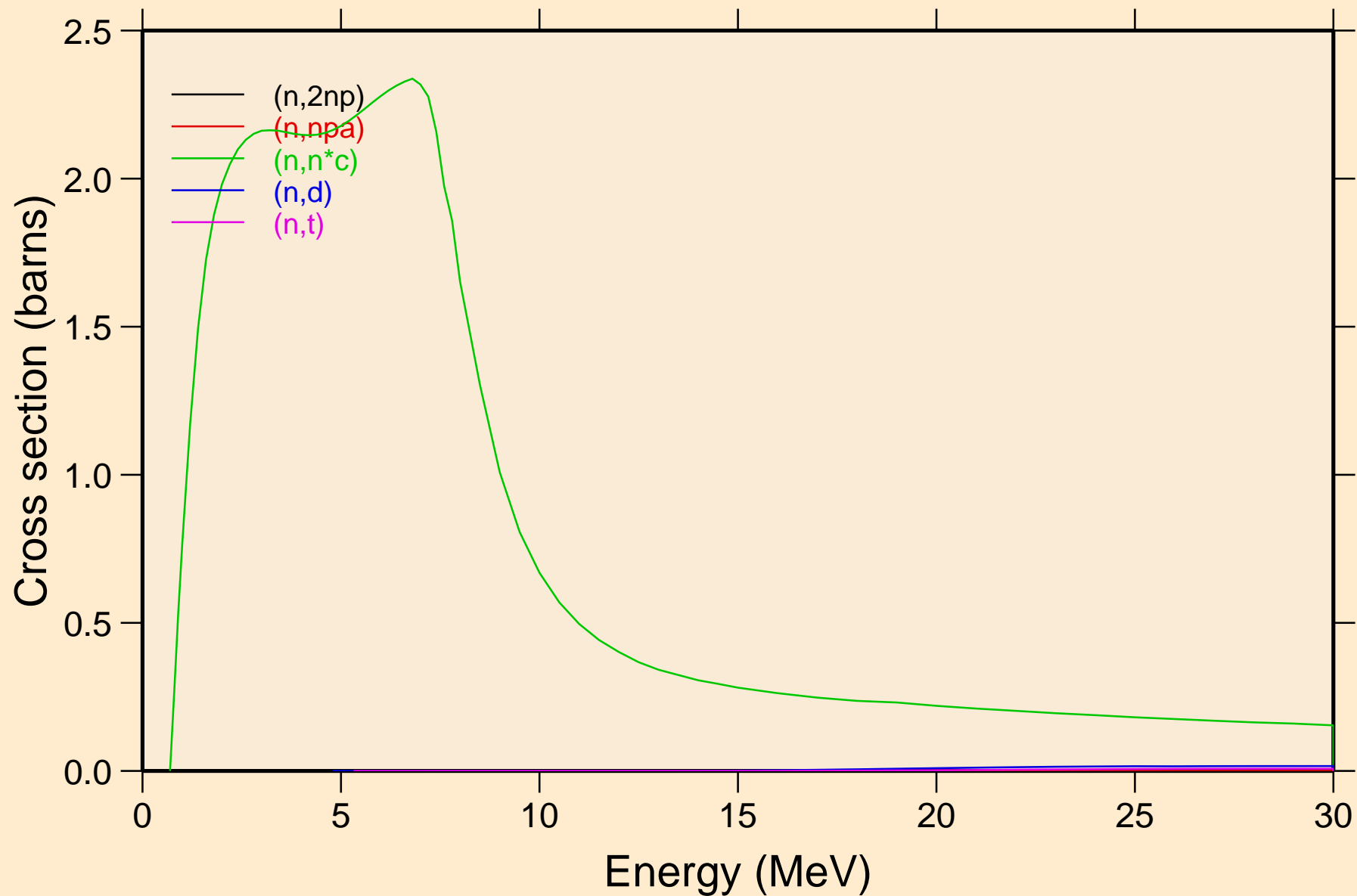

DY159 NEUTRON ACER TENDL-2019 LIBRARY; T=293.16K  
Threshold reactions

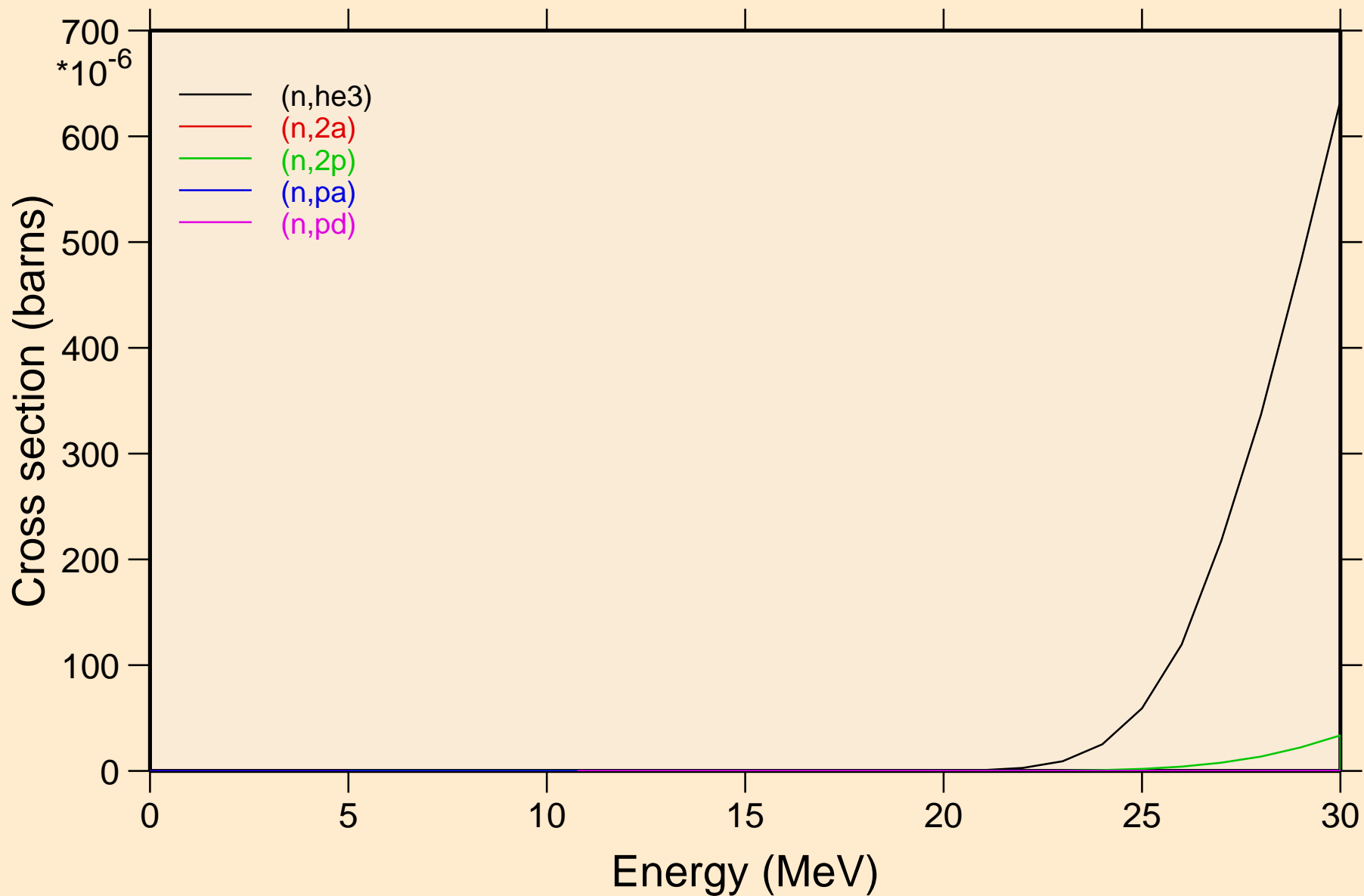

DY159 NEUTRON ACER TENDL-2019 LIBRARY; T=293.16K  
Threshold reactions

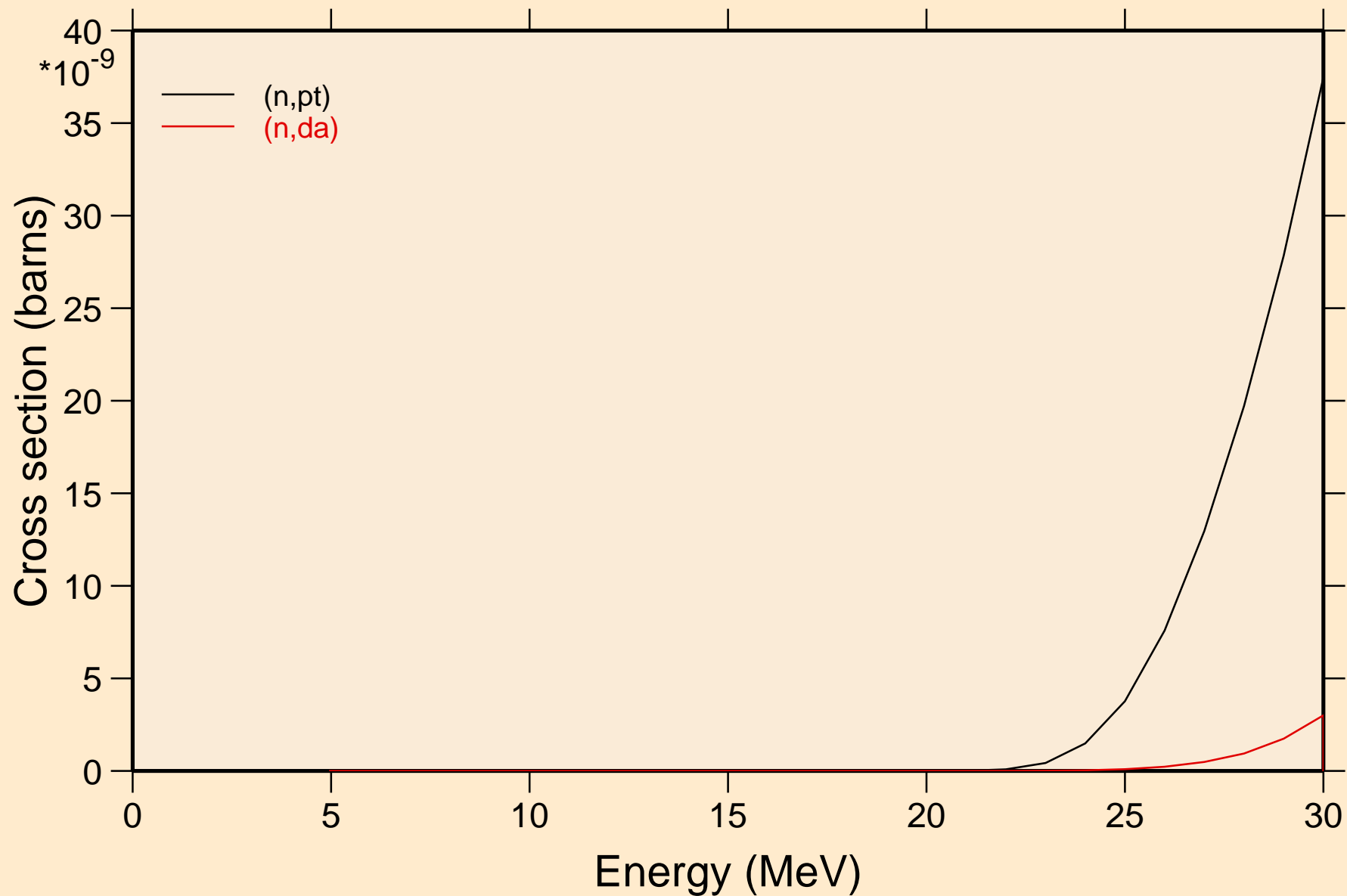

DY159 NEUTRON ACER TENDL-2019 LIBRARY; T=293.16K  
Threshold reactions

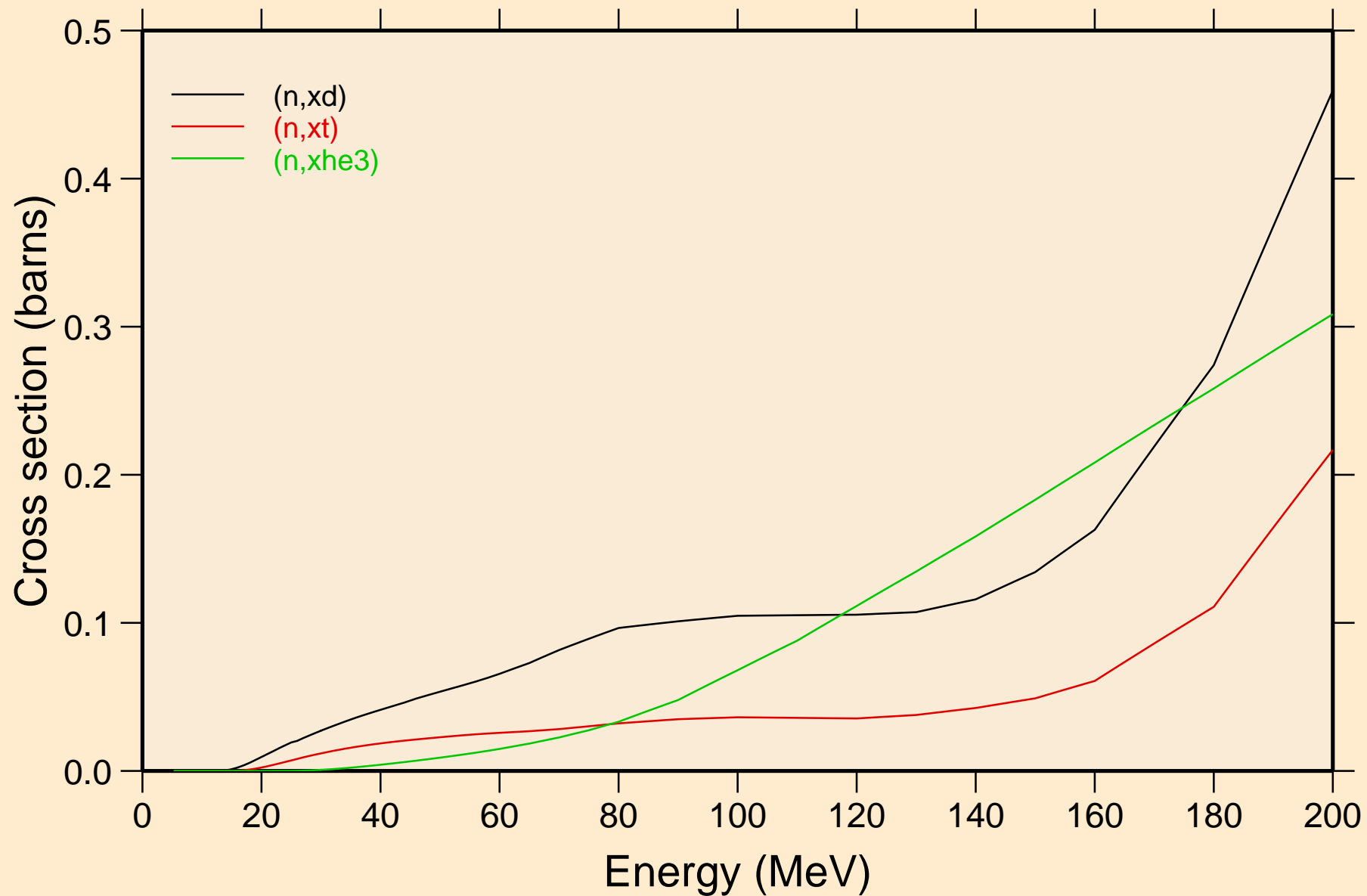

DY159 NEUTRON ACER TENDL-2019 LIBRARY; T=293.16K  
angular distribution for elastic

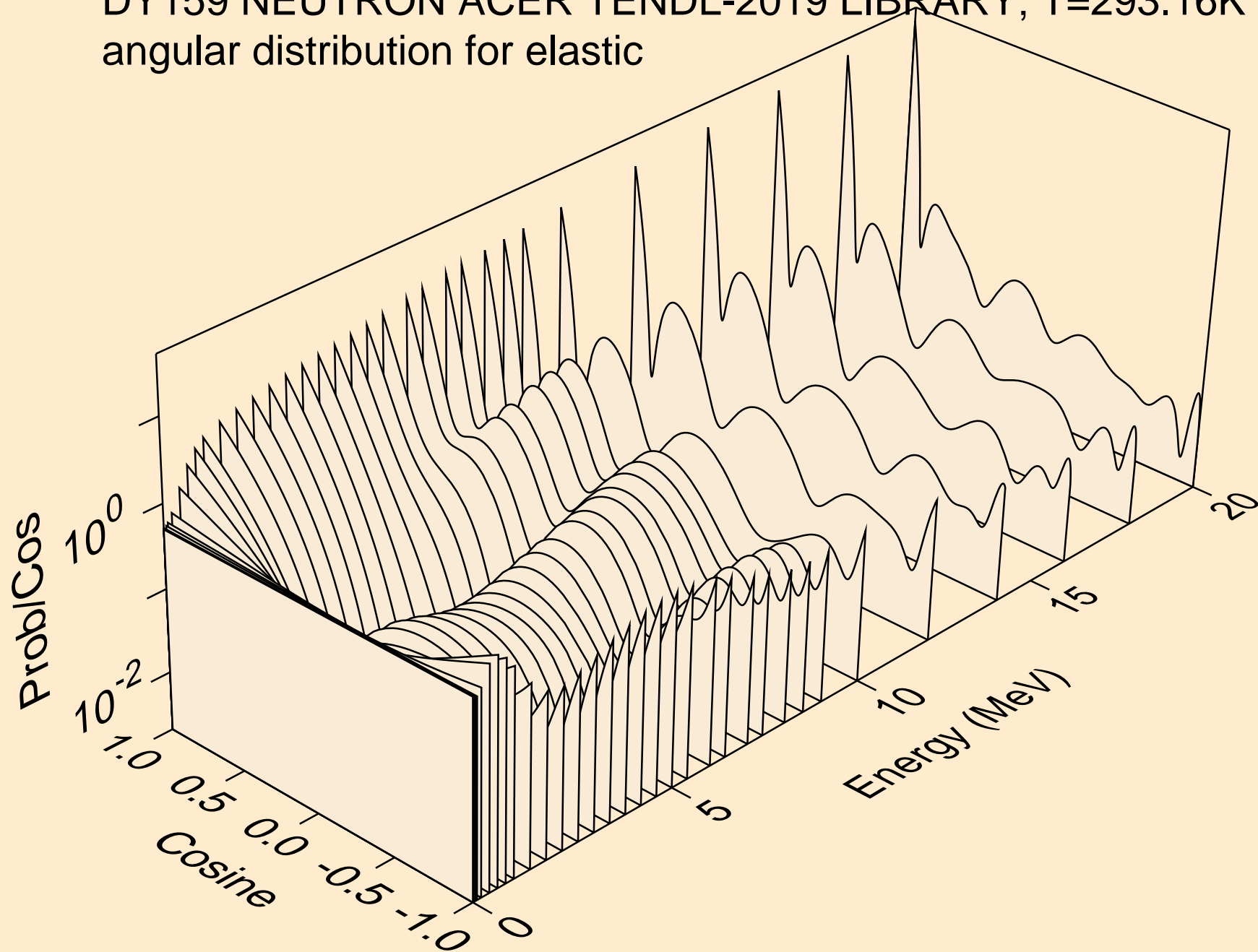

DY159 NEUTRON ACER TENDL-2019 LIBRARY; T=293.16K  
angular distribution for elastic

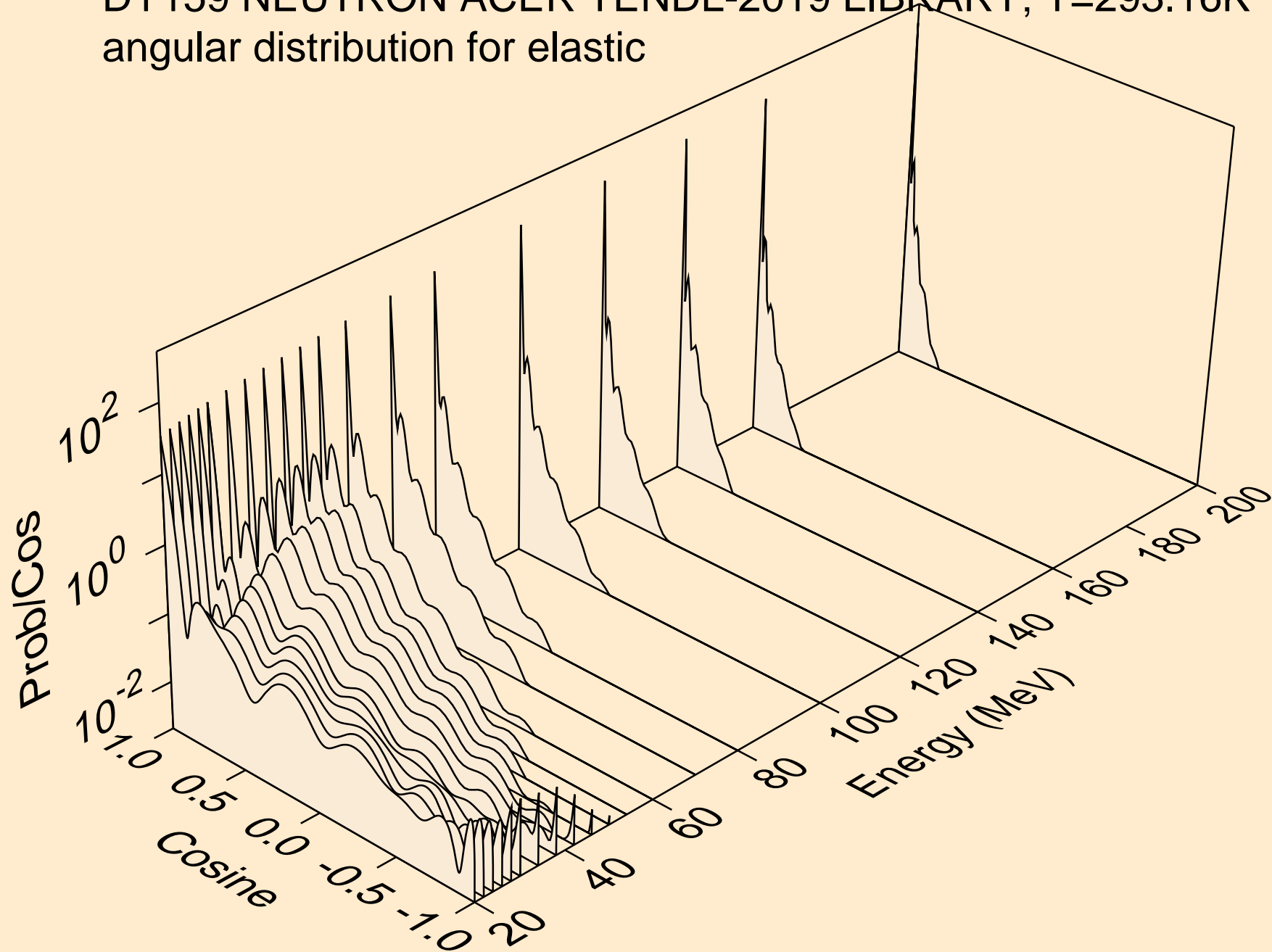

DY159 NEUTRON ACER TENDL-2019 LIBRARY; T=293.16K  
angular distribution for (n,n\*1)

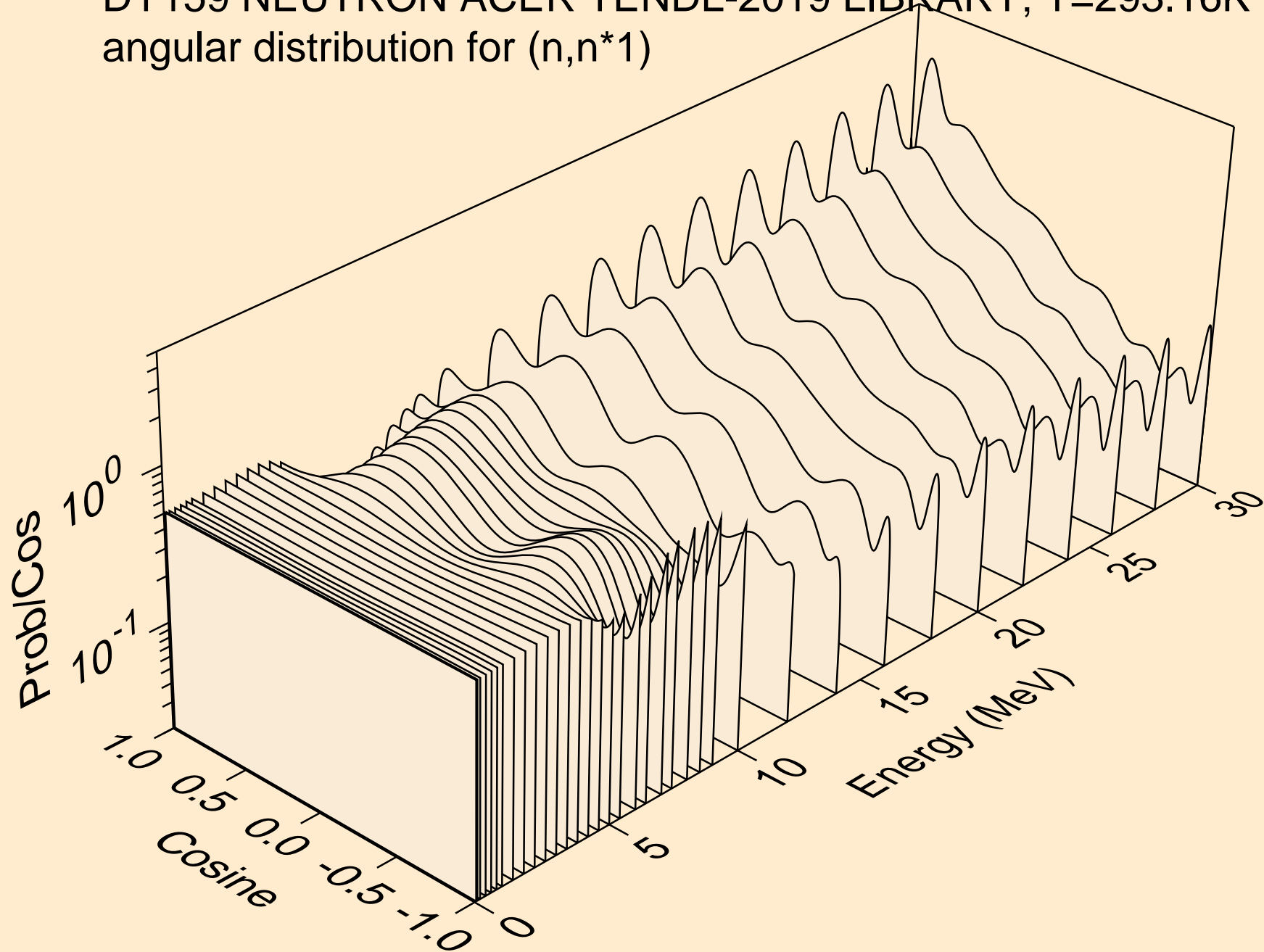



DY159 NEUTRON ACER TENDL-2019 LIBRARY; T=293.16K  
angular distribution for (n,n\*2)

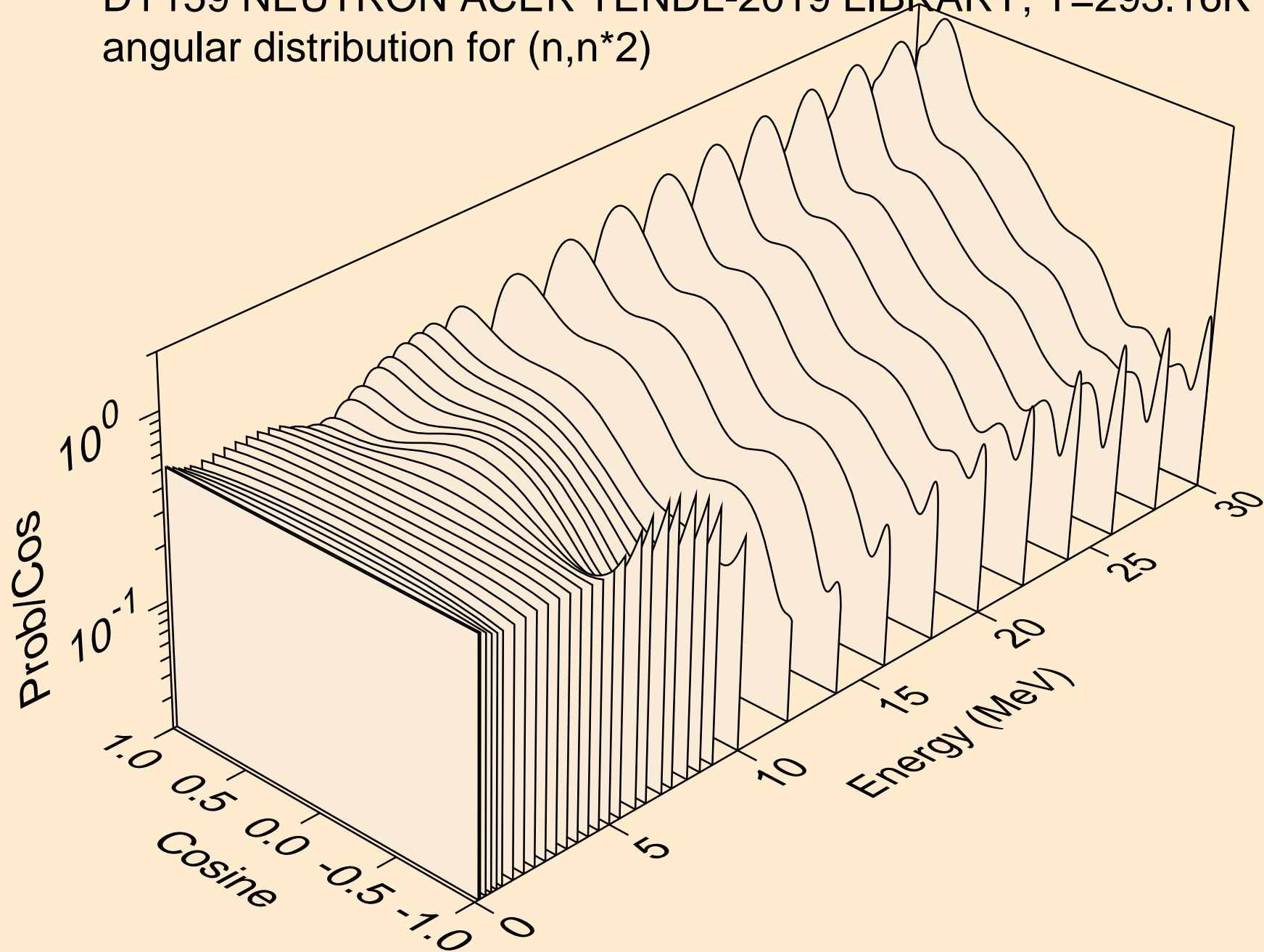

DY159 NEUTRON ACER TENDL-2019 LIBRARY; T=293.16K  
angular distribution for (n,n\*3)

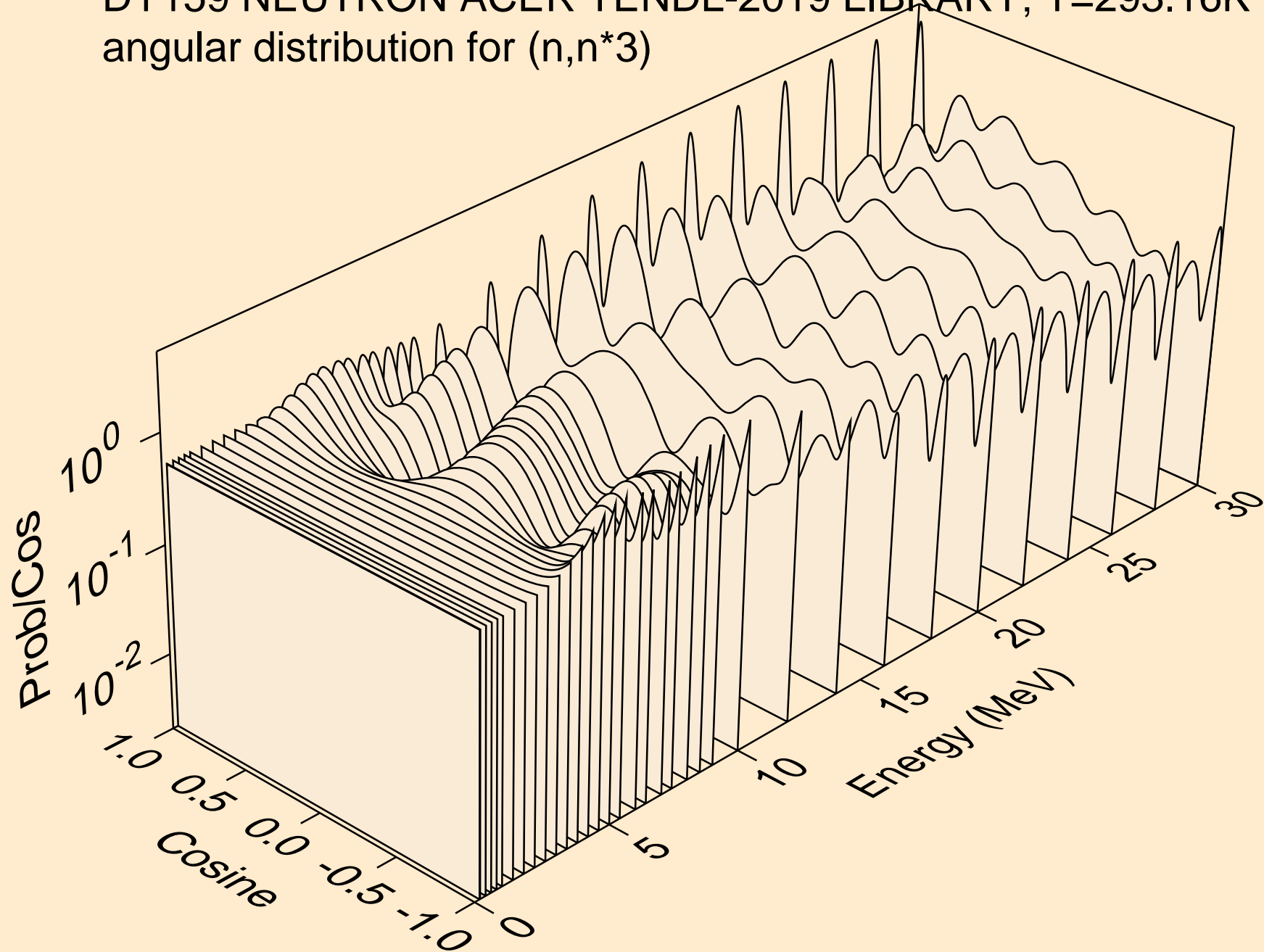

DY159 NEUTRON ACER TENDL-2019 LIBRARY; T=293.16K  
angular distribution for (n,n\*4)

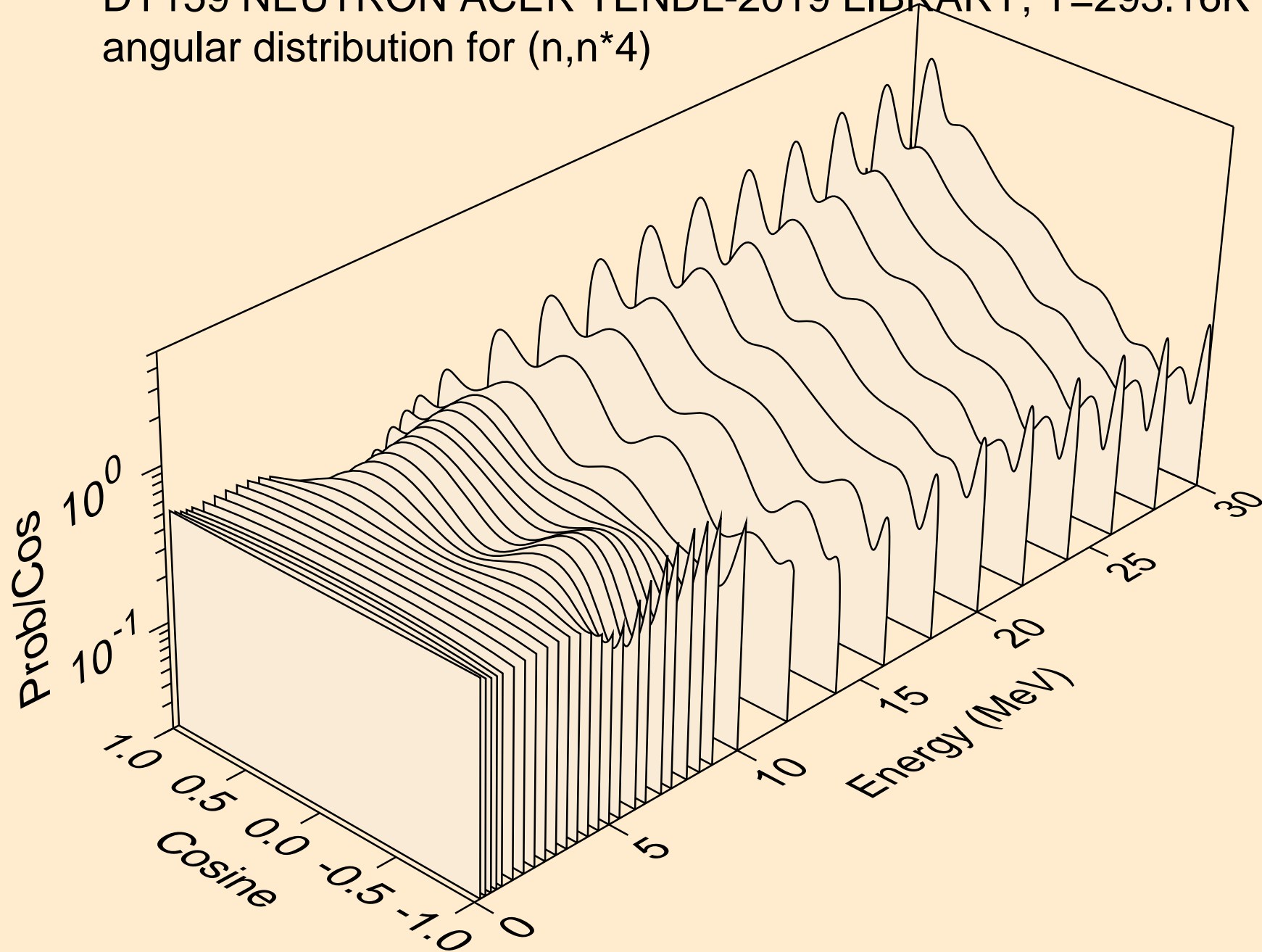

DY159 NEUTRON ACER TENDL-2019 LIBRARY; T=293.16K  
angular distribution for (n,n\*5)

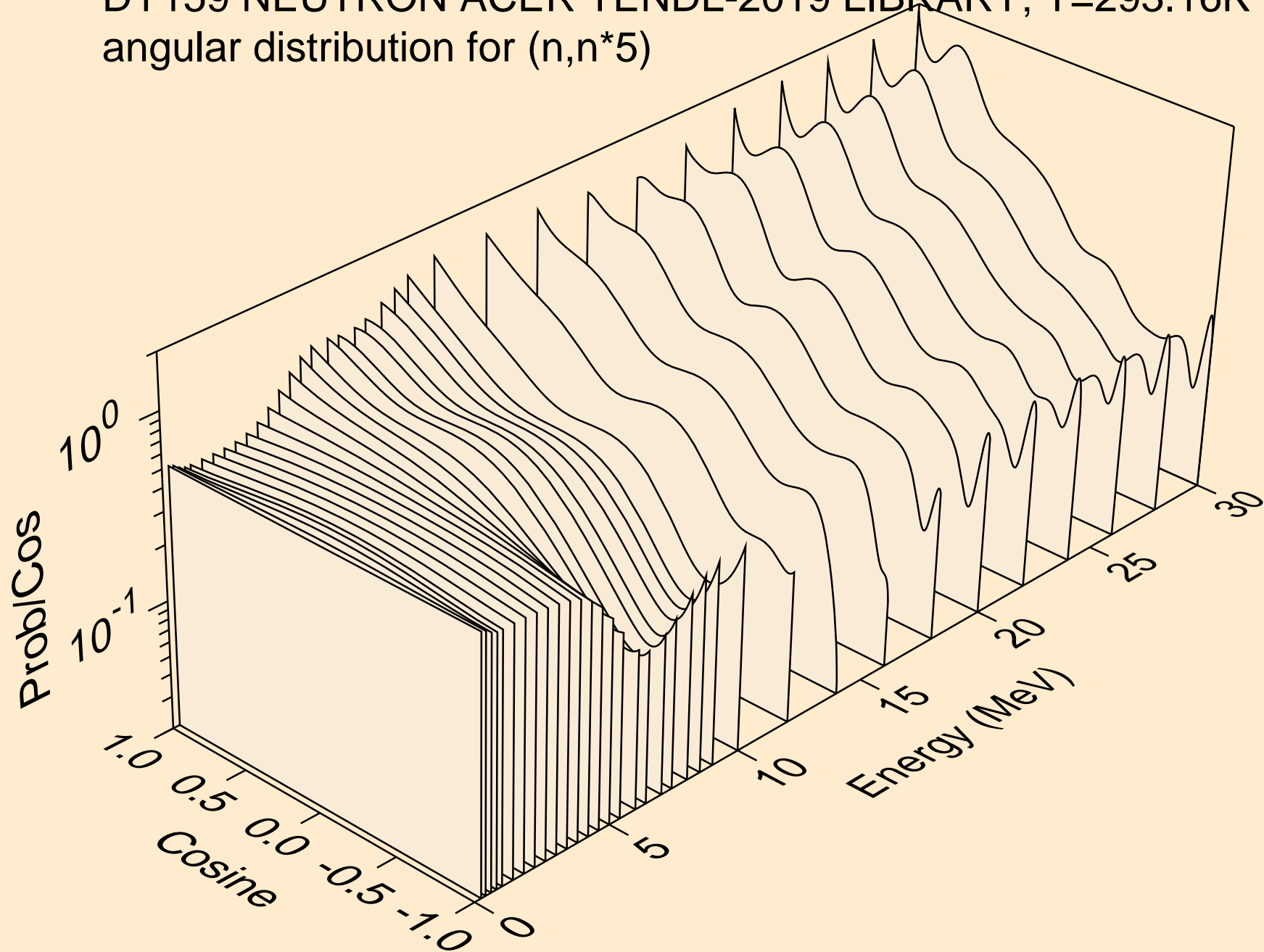

DY159 NEUTRON ACER TENDL-2019 LIBRARY; T=293.16K  
angular distribution for (n,n\*6)

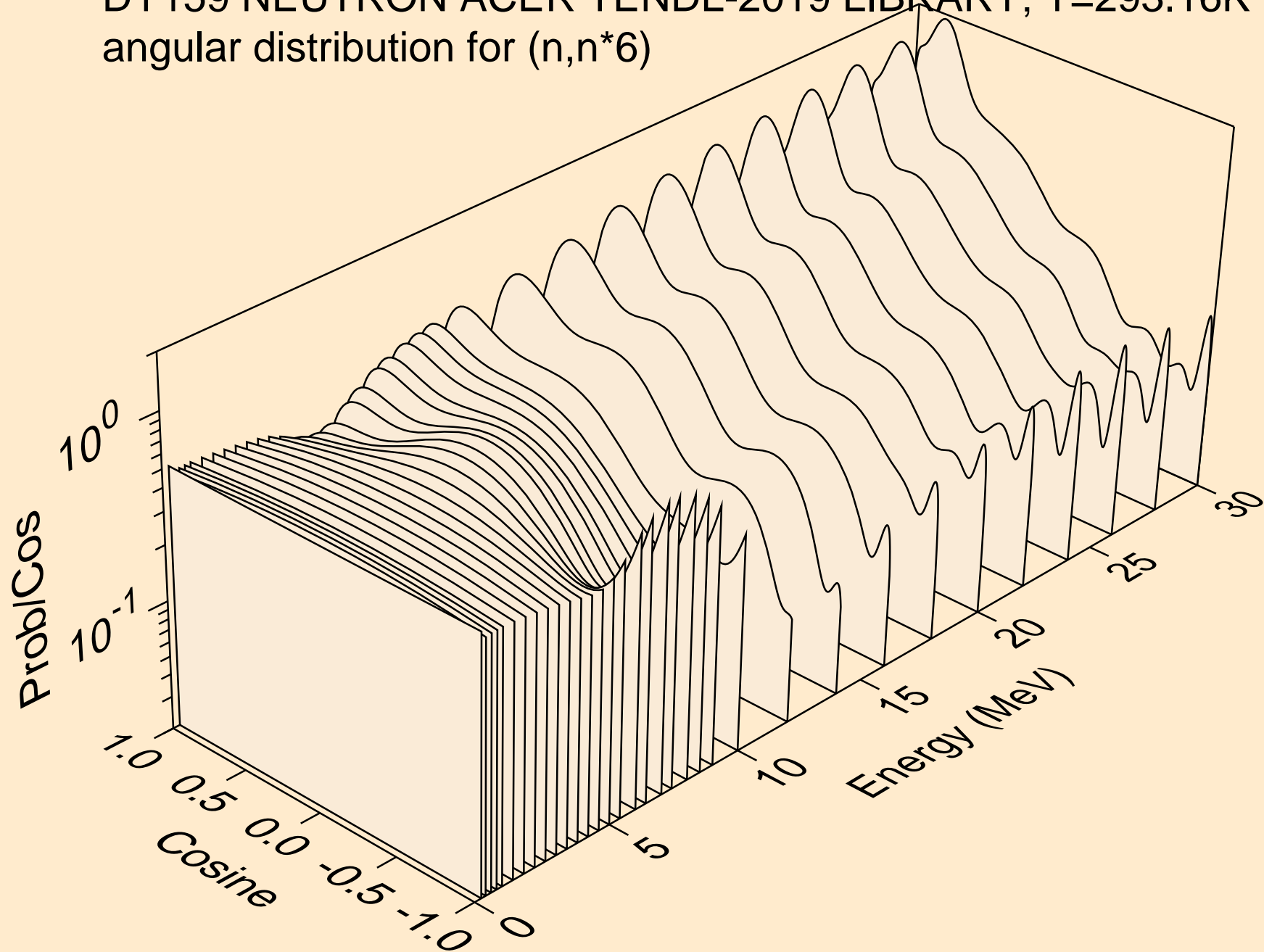

DY159 NEUTRON ACER TENDL-2019 LIBRARY; T=293.16K  
angular distribution for (n,n\*7)

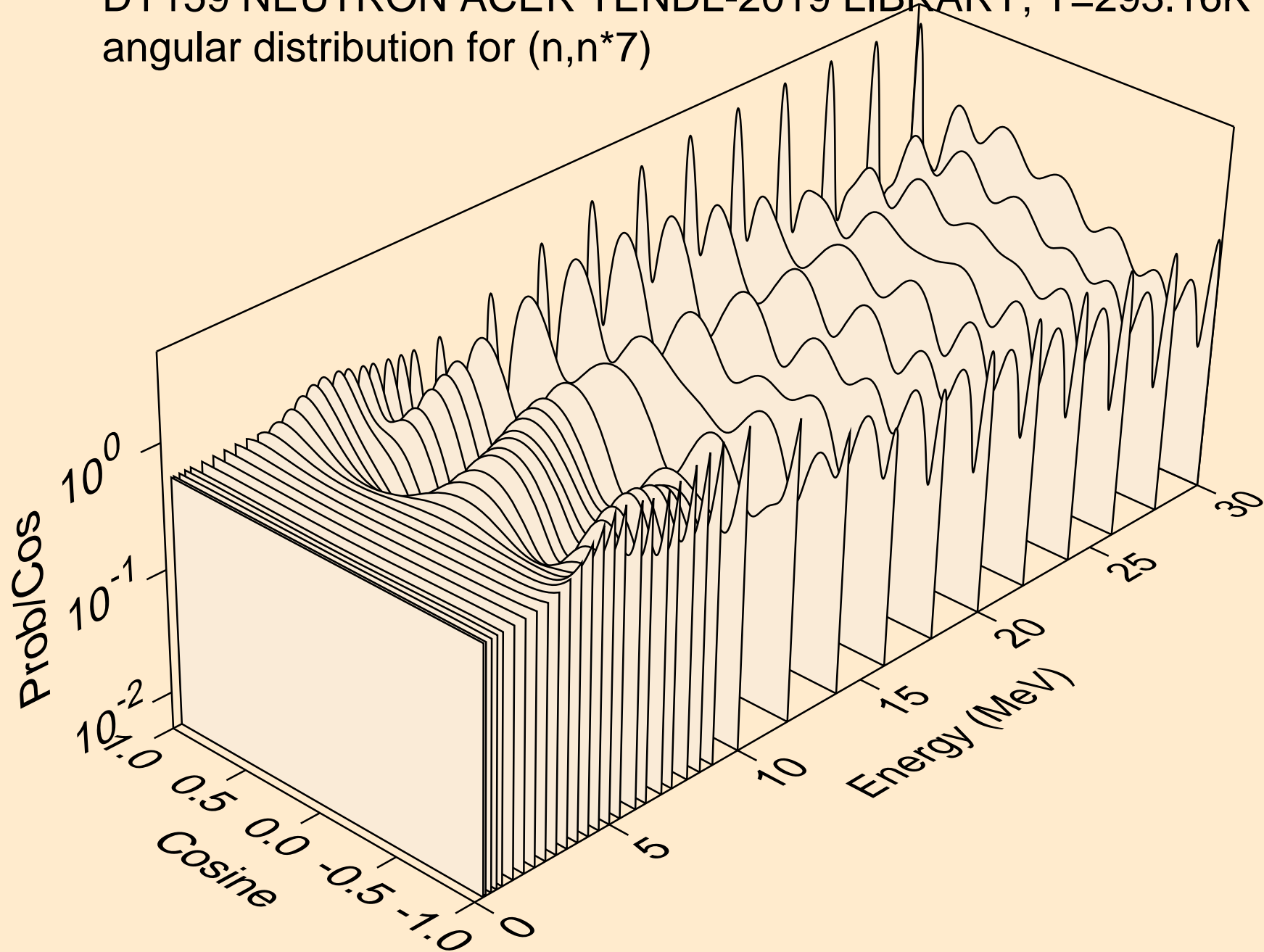

DY159 NEUTRON ACER TENDL-2019 LIBRARY; T=293.16K  
angular distribution for (n,n\*8)

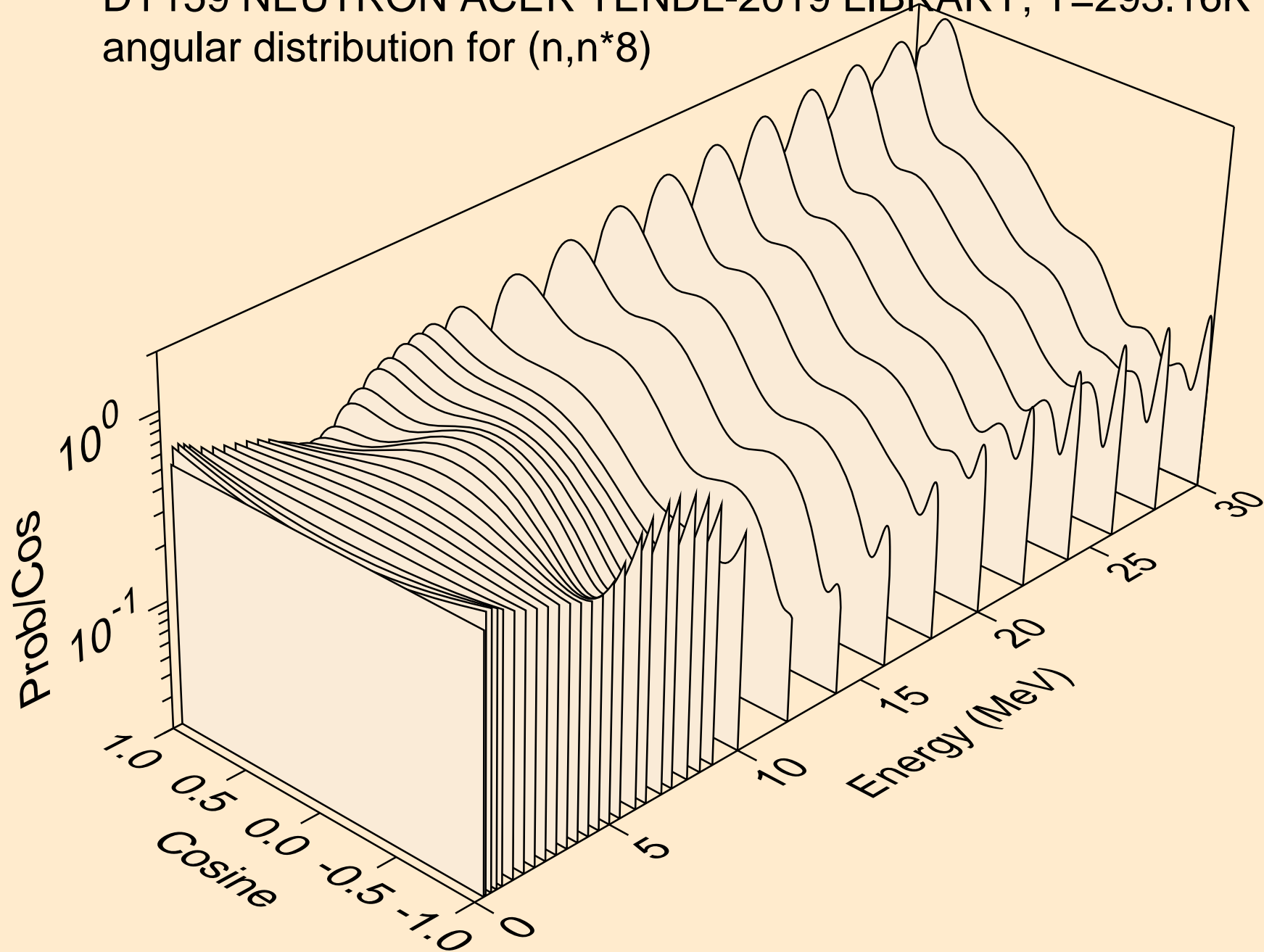

DY159 NEUTRON ACER TENDL-2019 LIBRARY; T=293.16K  
angular distribution for (n,n\*9)

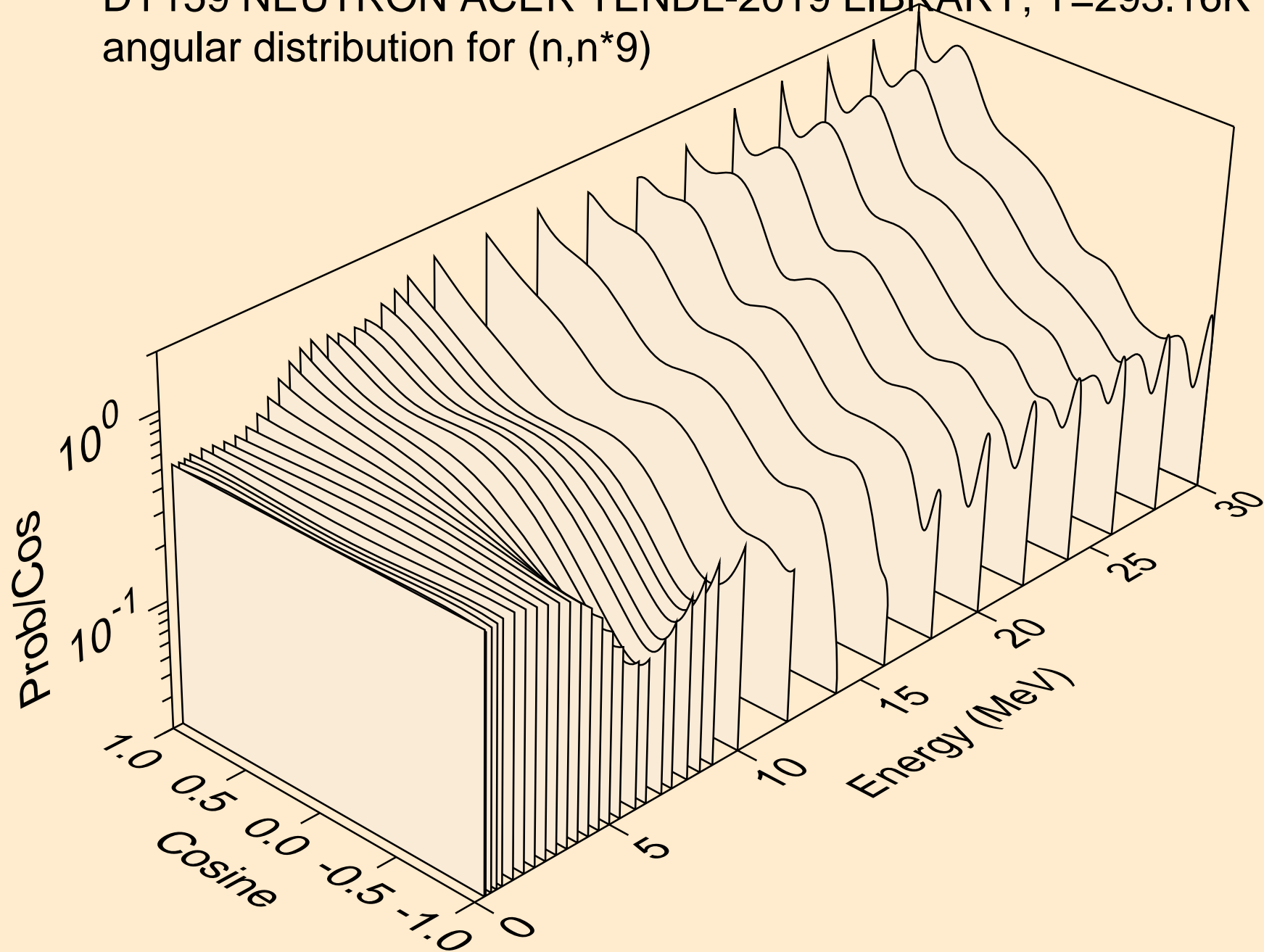



DY159 NEUTRON ACER TENDL-2019 LIBRARY; T=293.16K  
angular distribution for (n,n\*10)

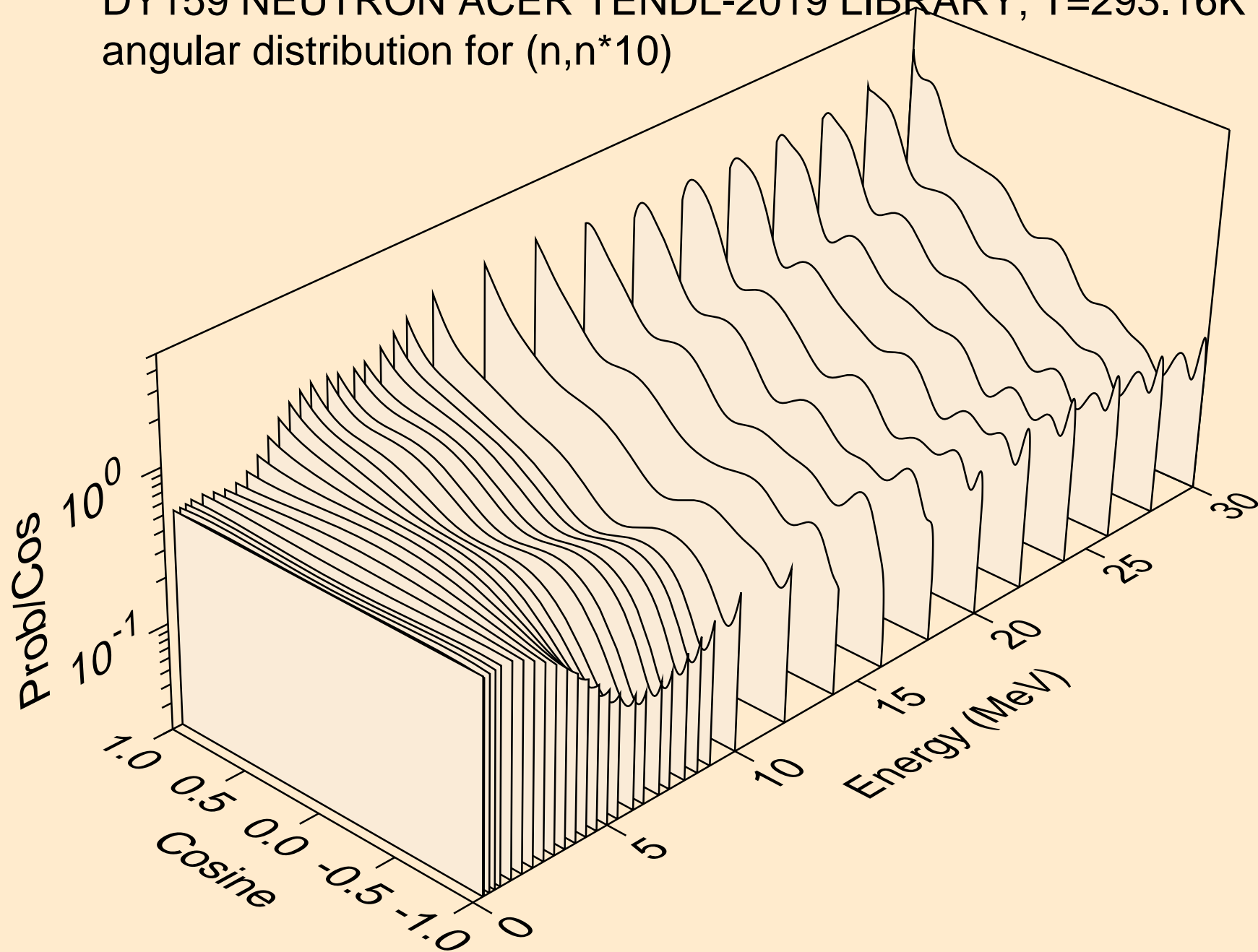

DY159 NEUTRON ACER TENDL-2019 LIBRARY; T=293.16K  
angular distribution for (n,n\*11)

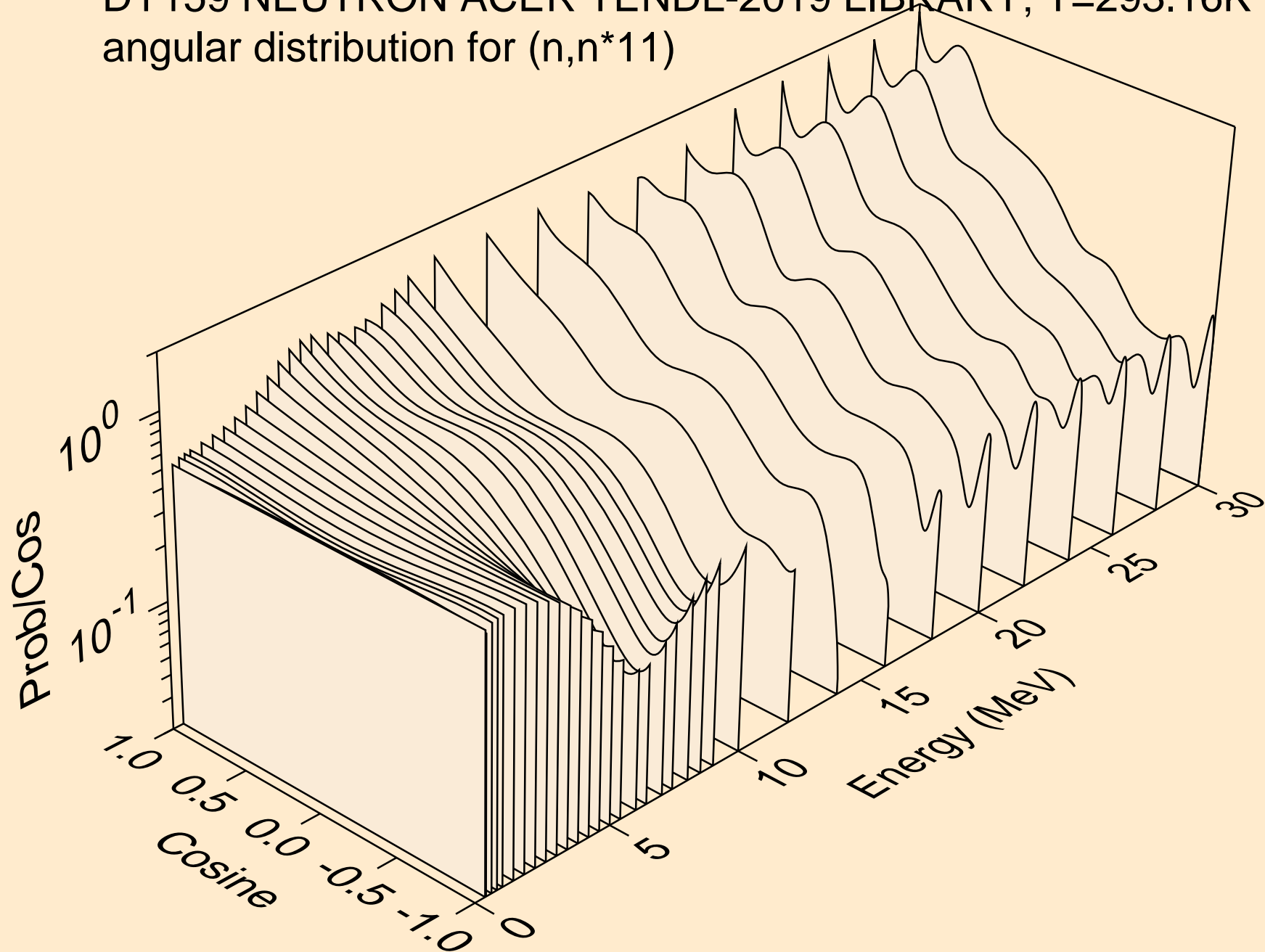

DY159 NEUTRON ACER TENDL-2019 LIBRARY; T=293.16K  
angular distribution for (n,n\*12)

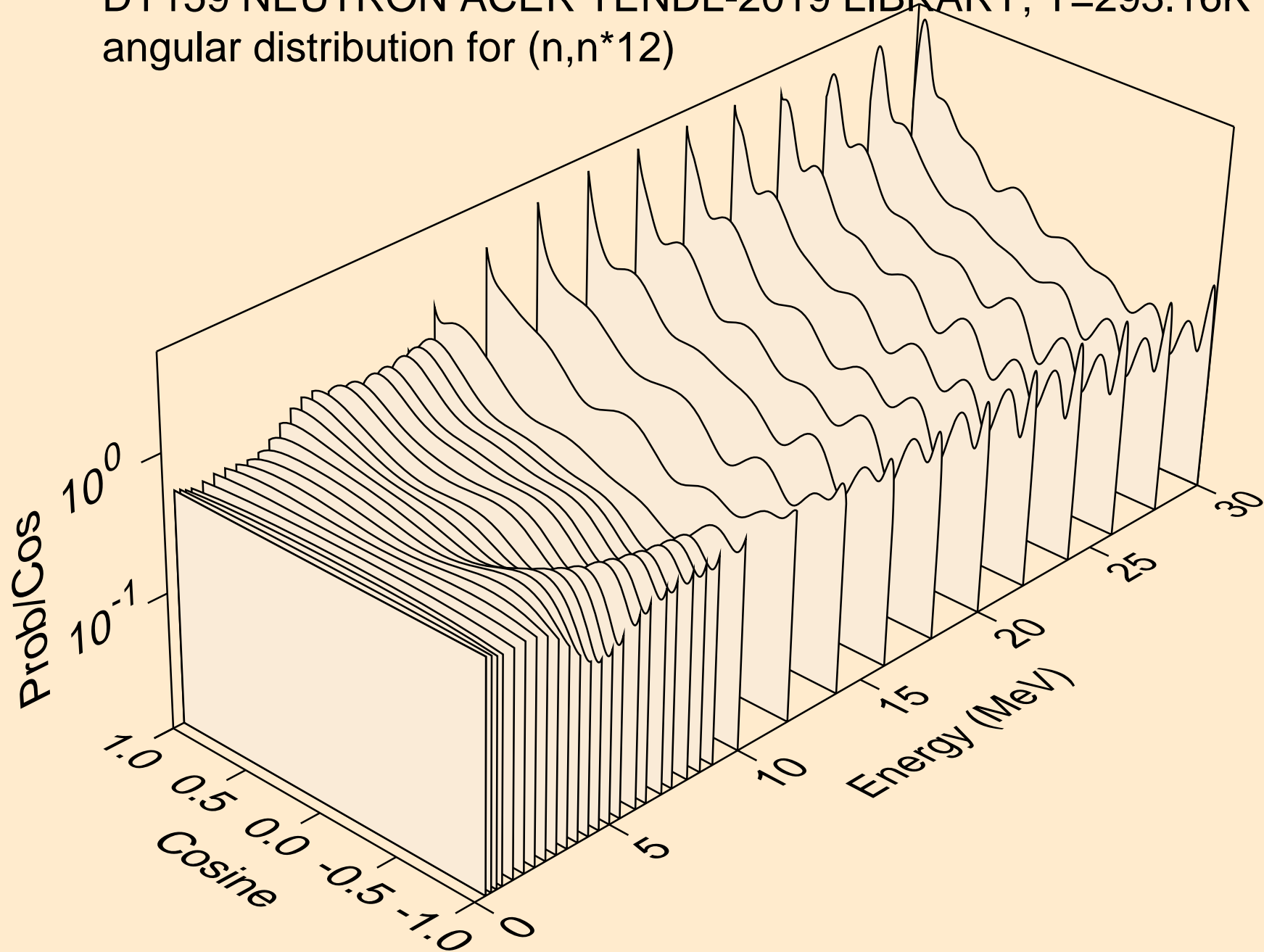

DY159 NEUTRON ACER TENDL-2019 LIBRARY; T=293.16K  
angular distribution for (n,n\*13)

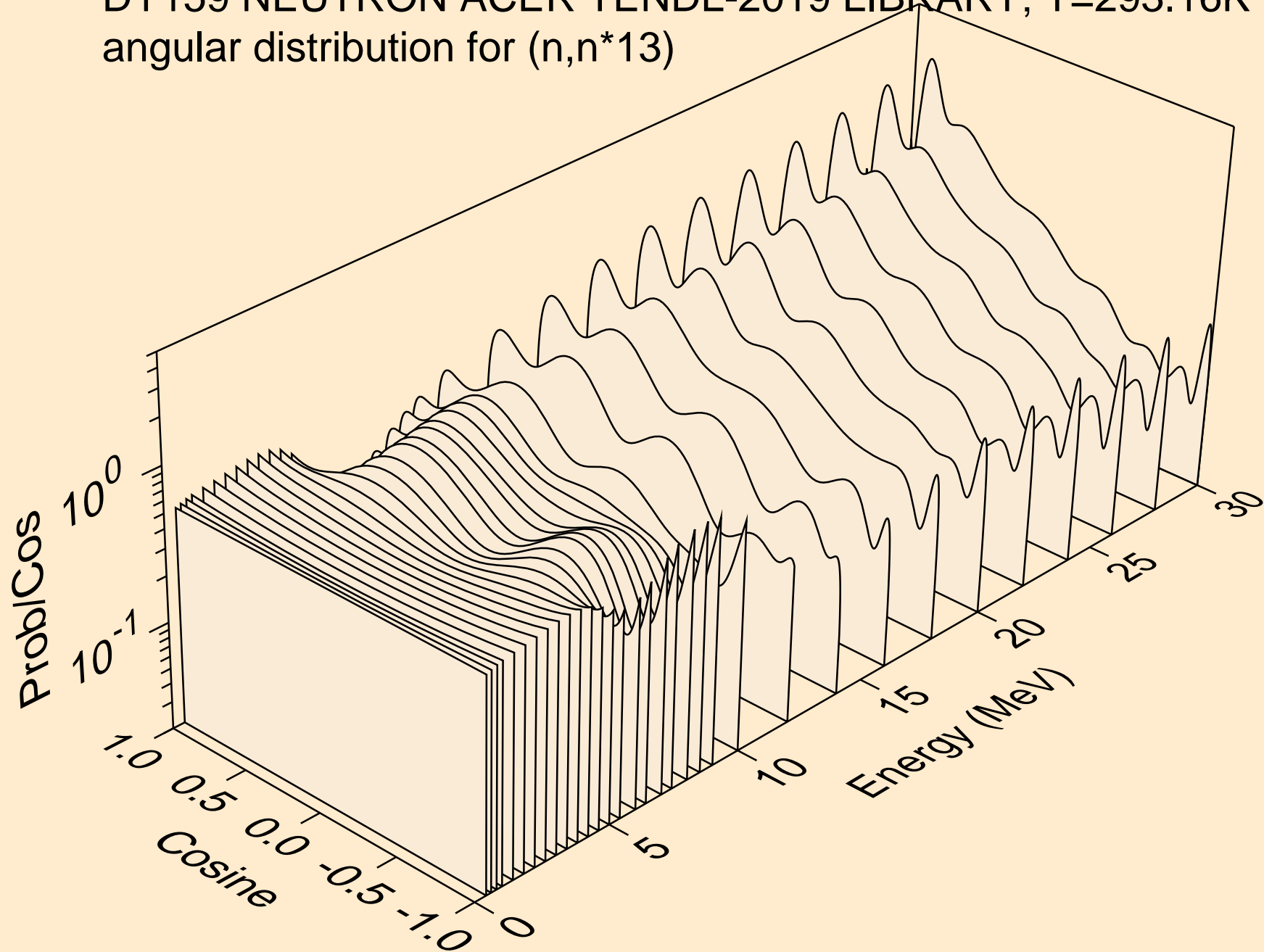

DY159 NEUTRON ACER TENDL-2019 LIBRARY; T=293.16K  
angular distribution for (n,n\*14)

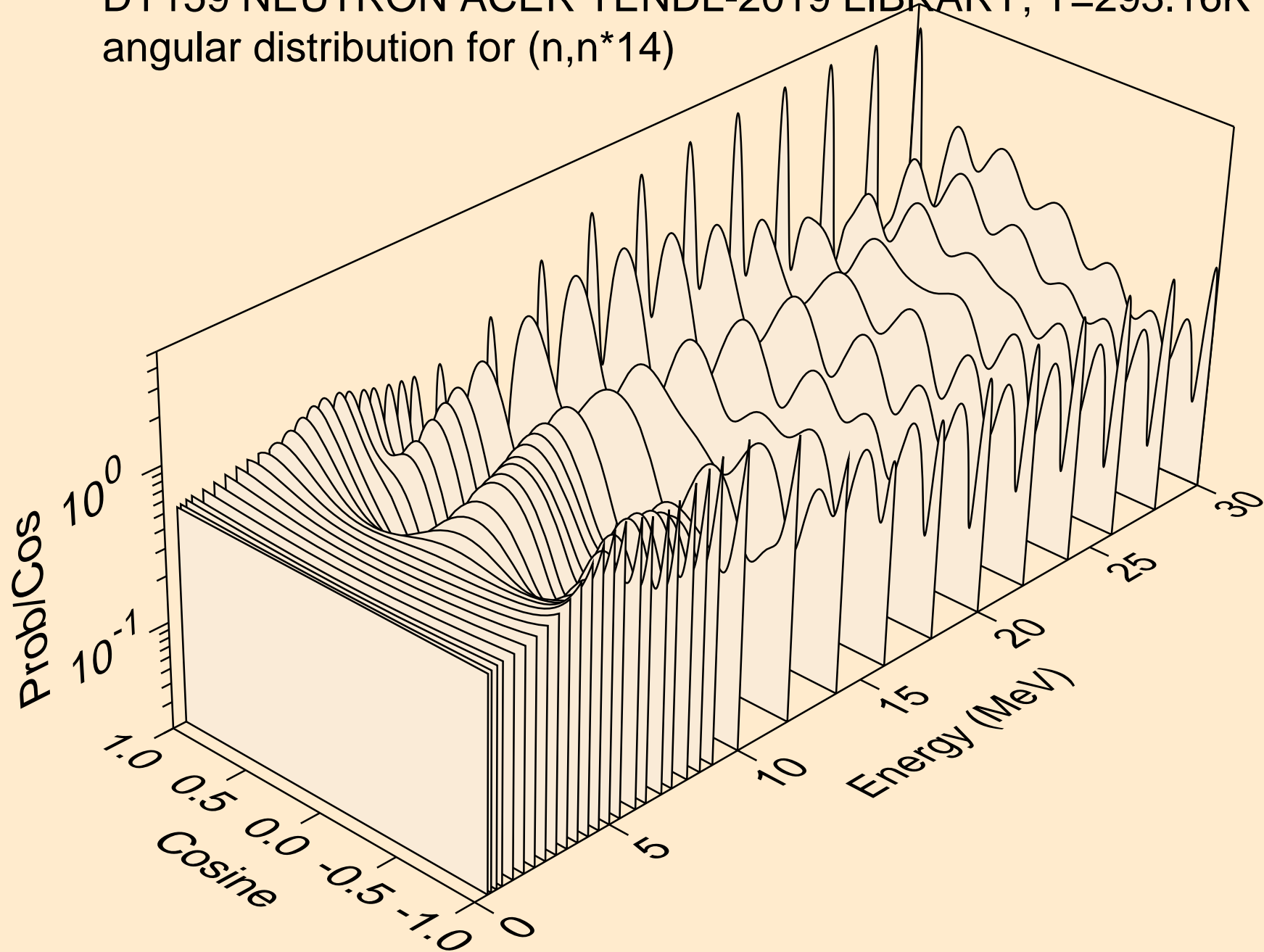

DY159 NEUTRON ACER TENDL-2019 LIBRARY; T=293.16K  
angular distribution for (n,n\*15)

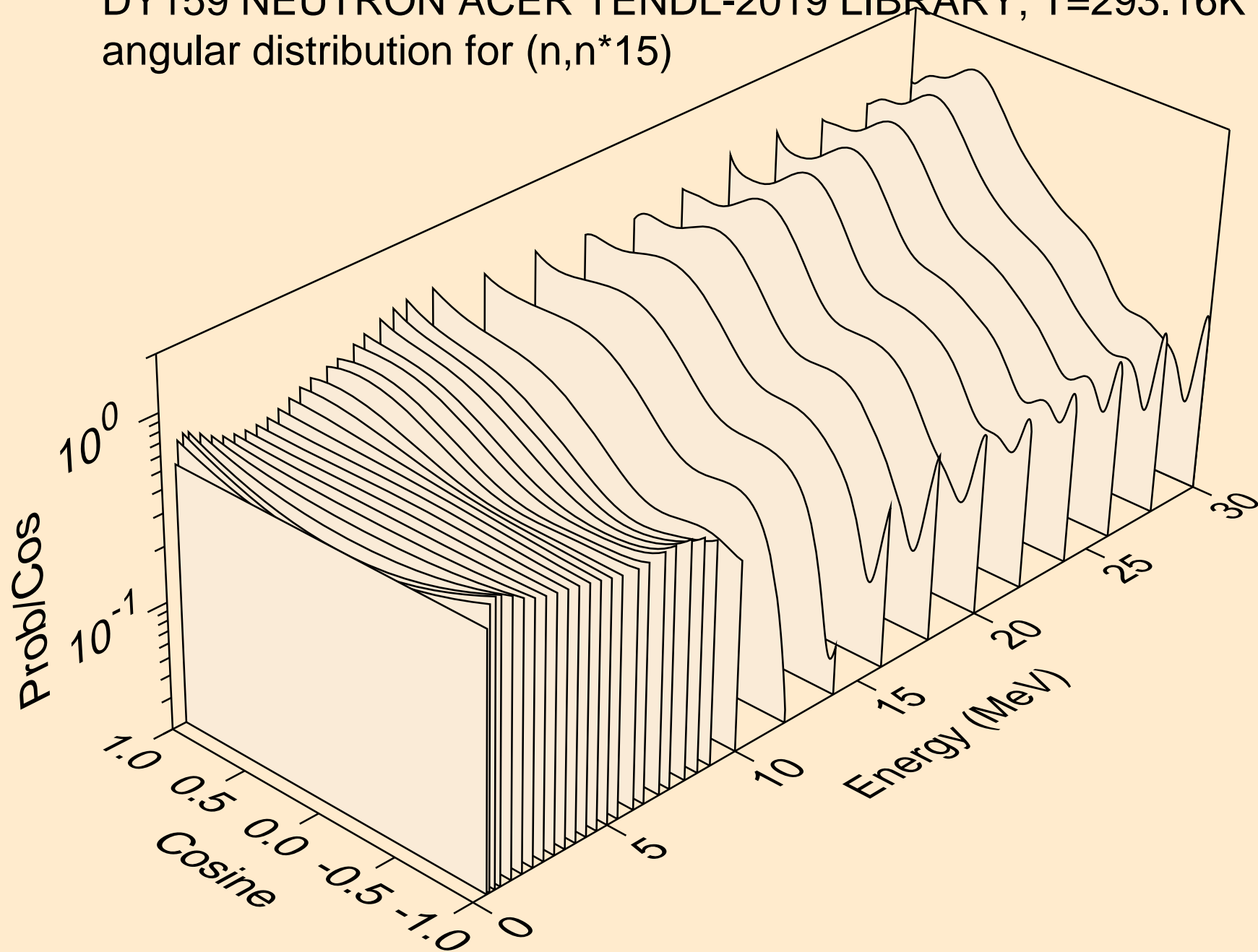

DY159 NEUTRON ACER TENDL-2019 LIBRARY; T=293.16K  
angular distribution for (n,n\*16)

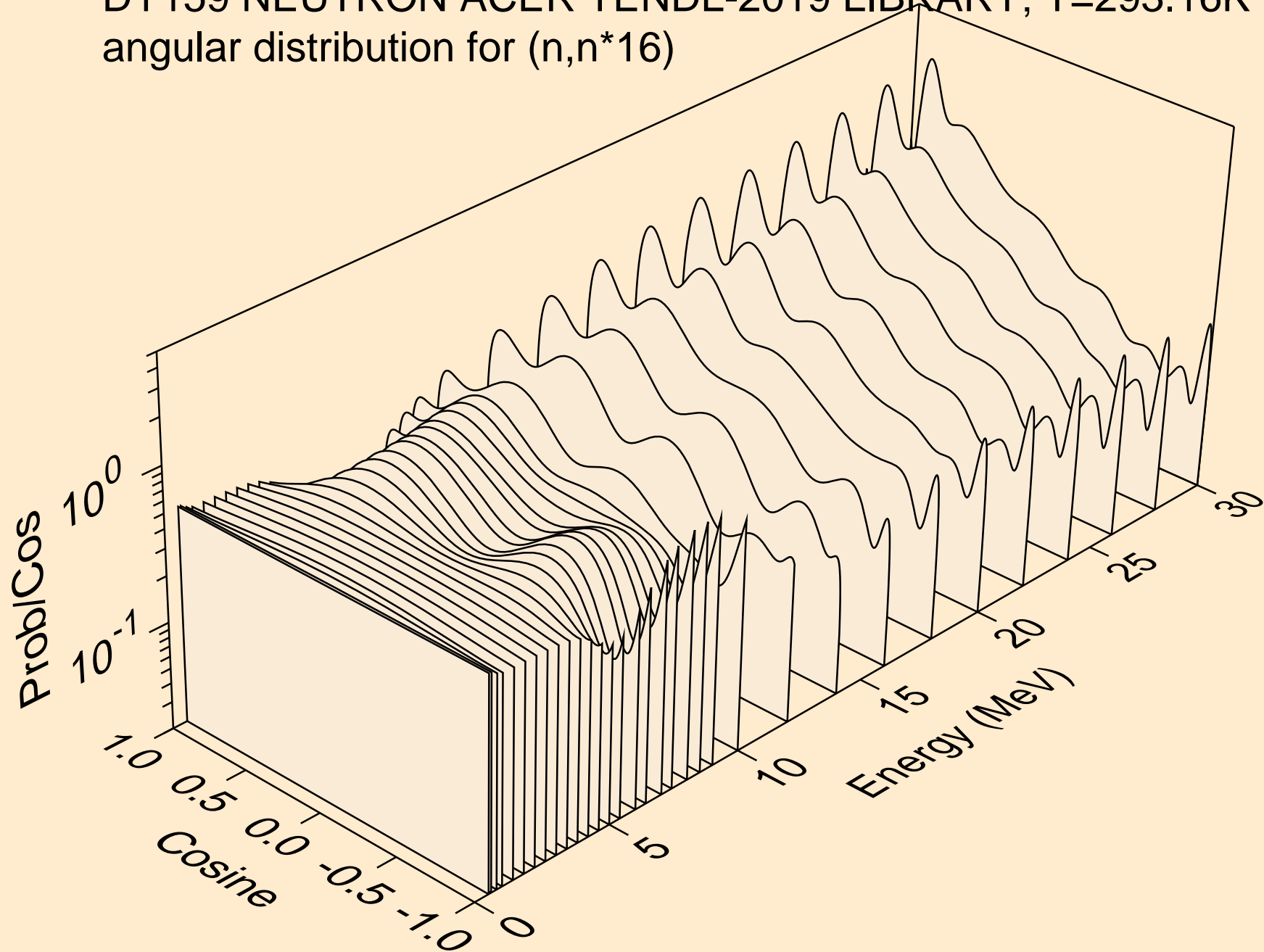

DY159 NEUTRON ACER TENDL-2019 LIBRARY; T=293.16K  
angular distribution for (n,n\*17)

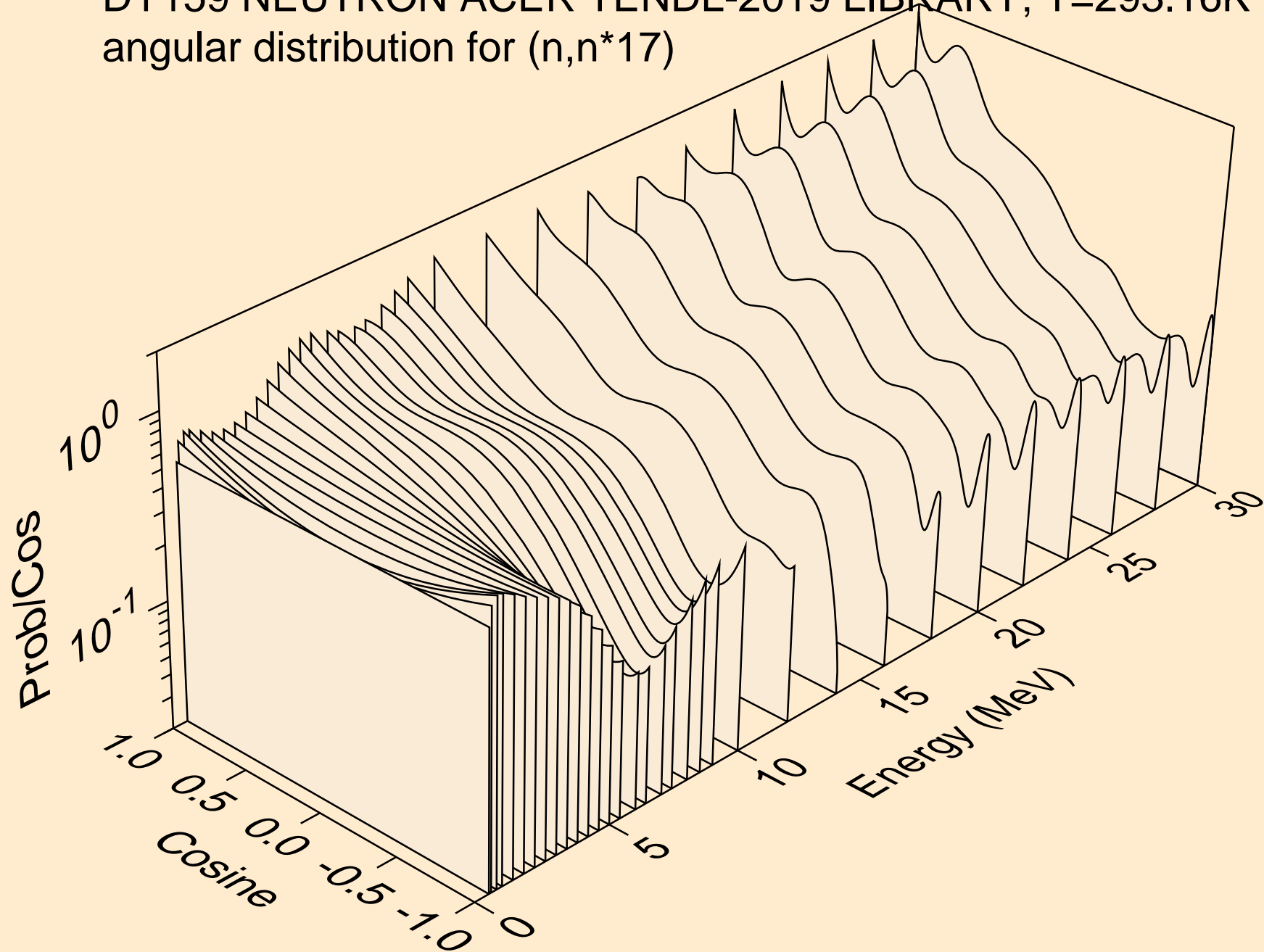



DY159 NEUTRON ACER TENDL-2019 LIBRARY; T=293.16K  
angular distribution for (n,n\*18)

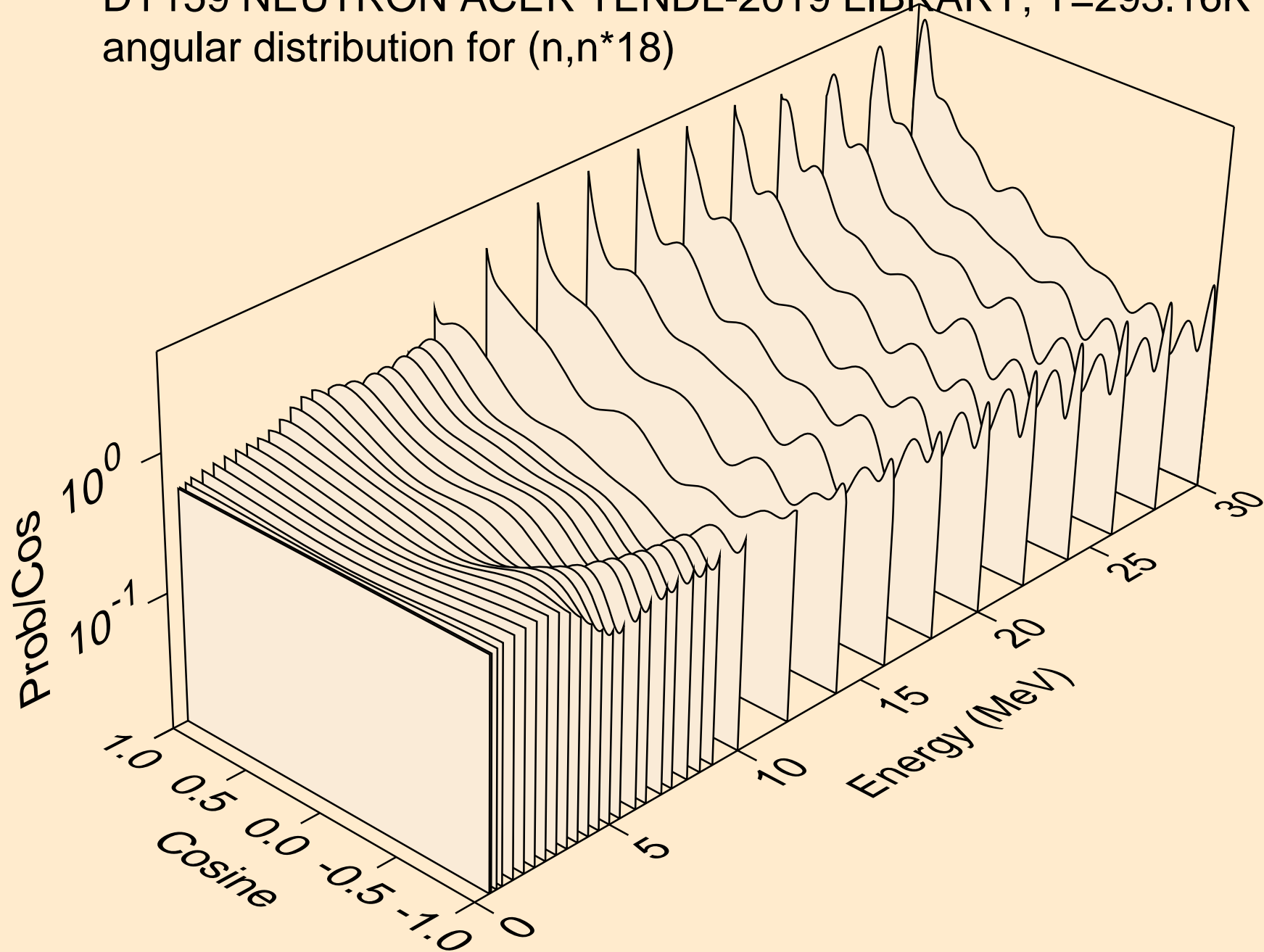

DY159 NEUTRON ACER TENDL-2019 LIBRARY; T=293.16K  
angular distribution for (n,n\*19)

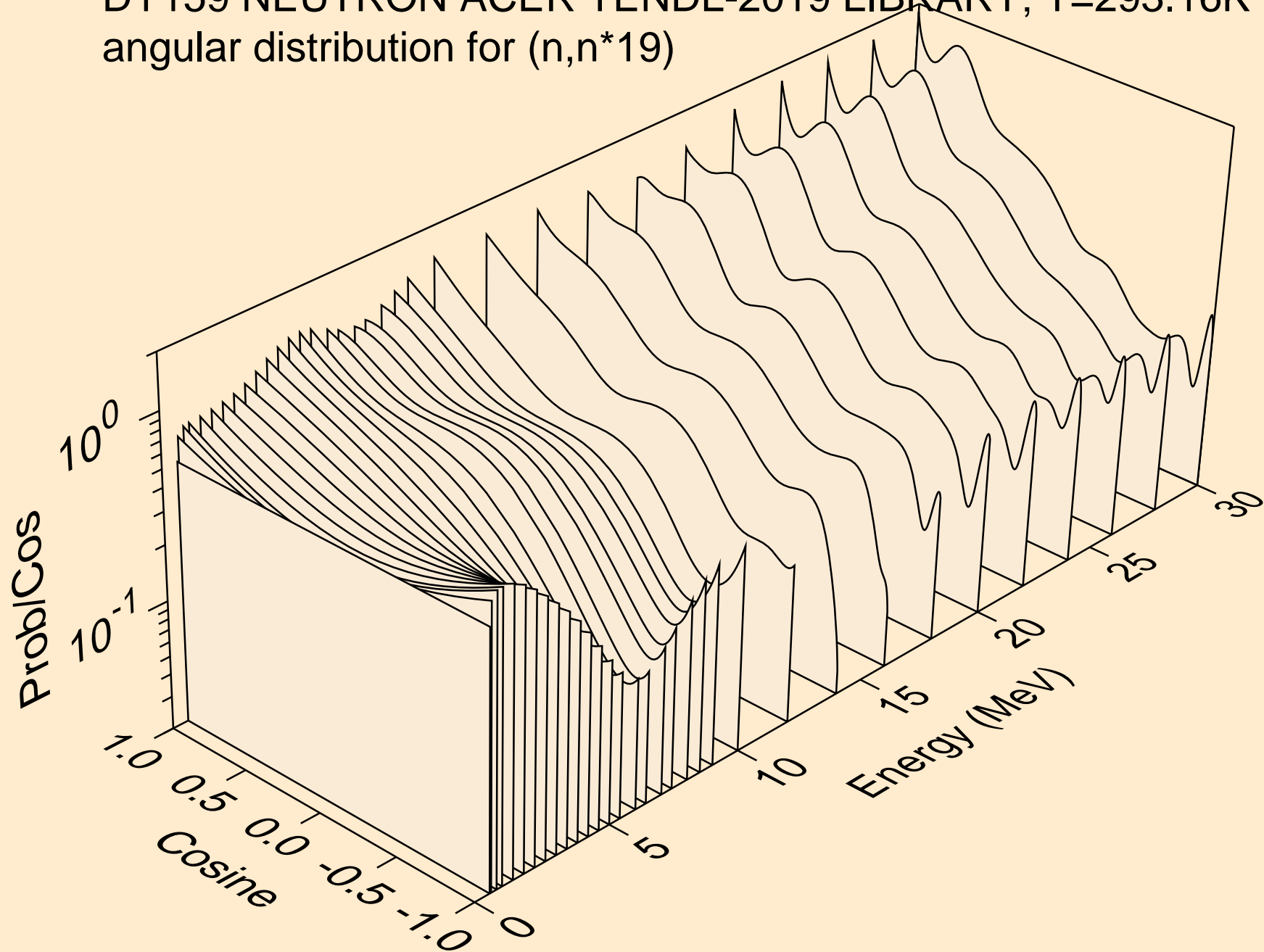

DY159 NEUTRON ACER TENDL-2019 LIBRARY; T=293.16K  
angular distribution for (n,n\*20)

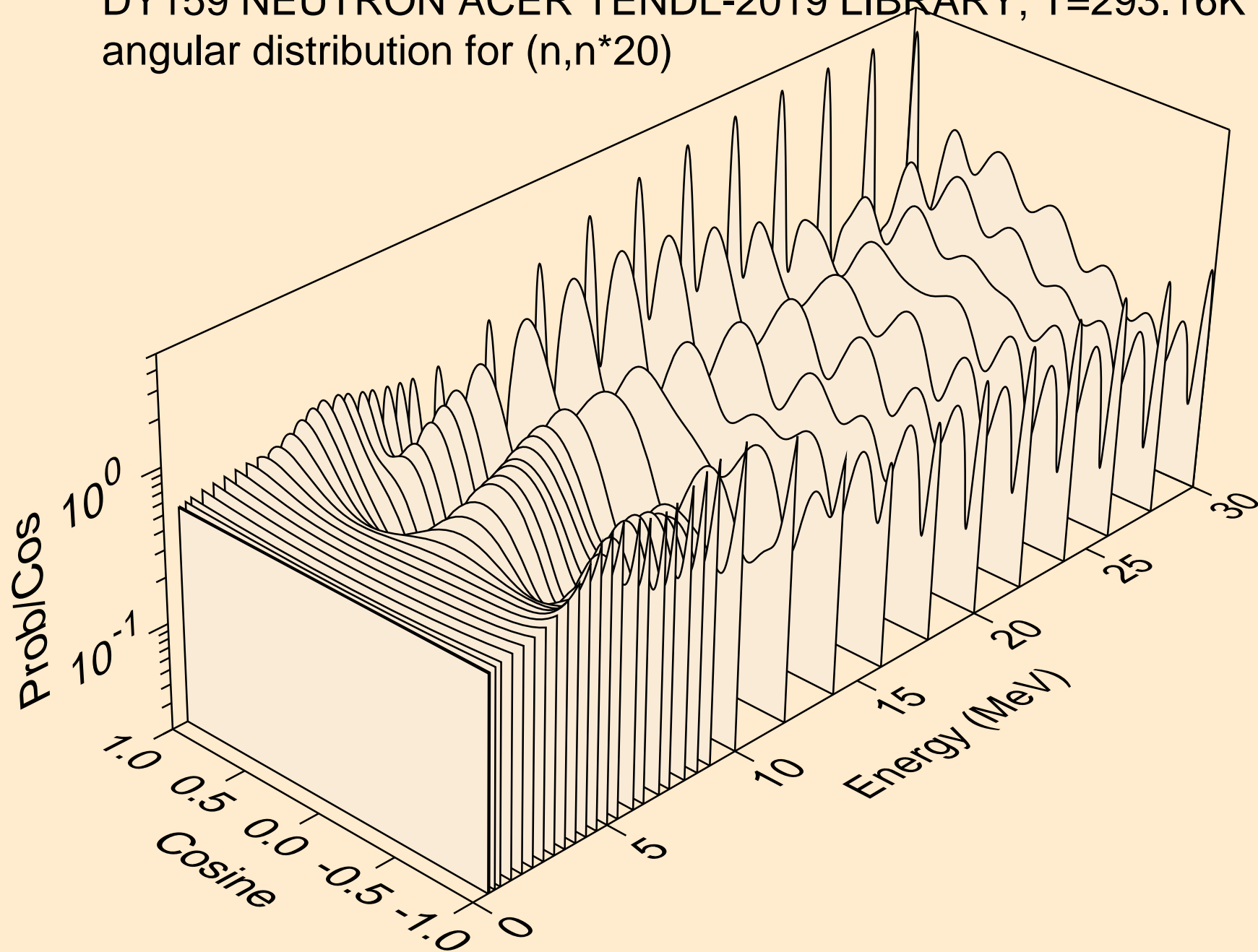

DY159 NEUTRON ACER TENDL-2019 LIBRARY; T=293.16K  
angular distribution for (n,n\*21)

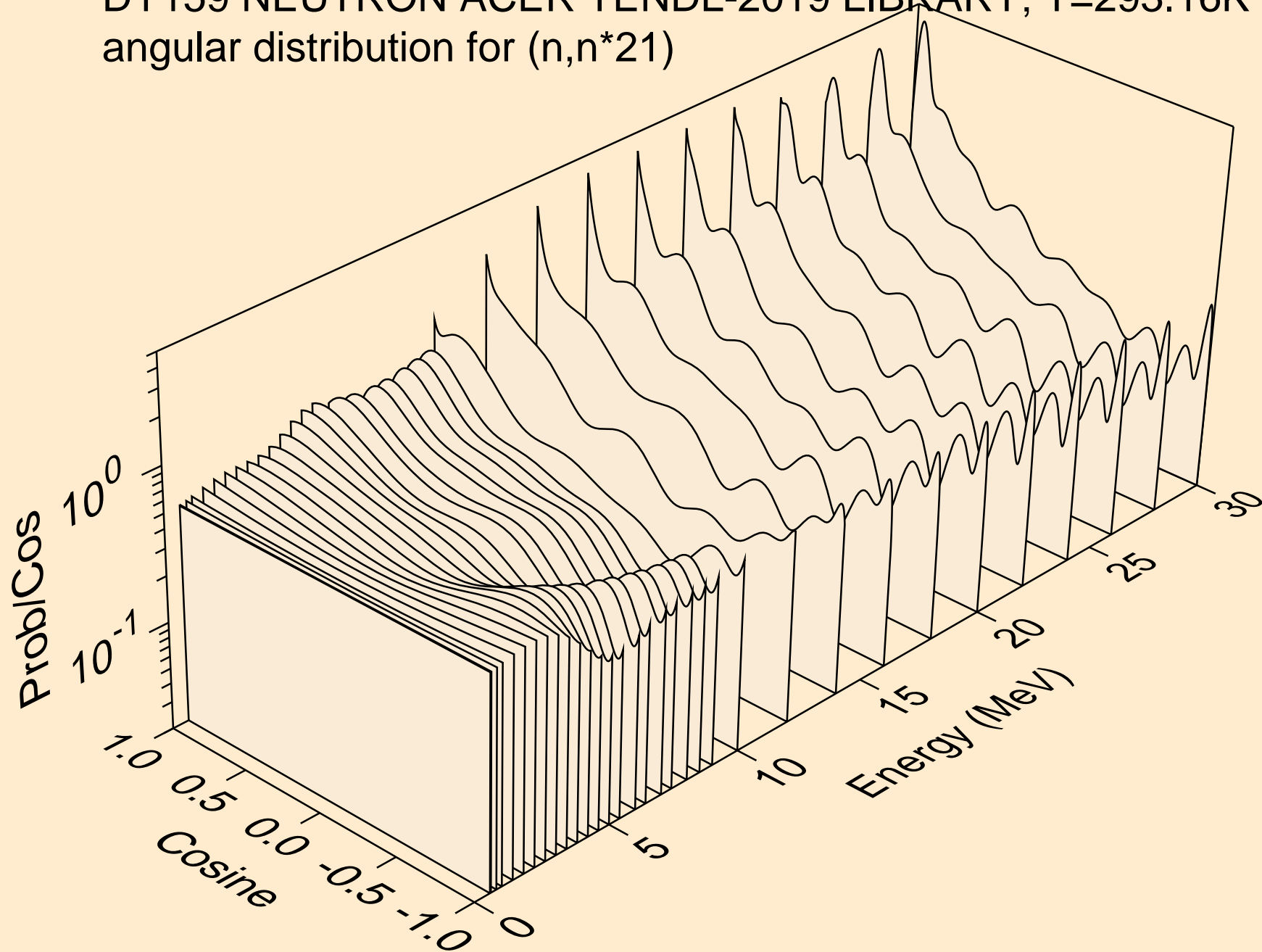

DY159 NEUTRON ACER TENDL-2019 LIBRARY; T=293.16K  
angular distribution for (n,n\*22)

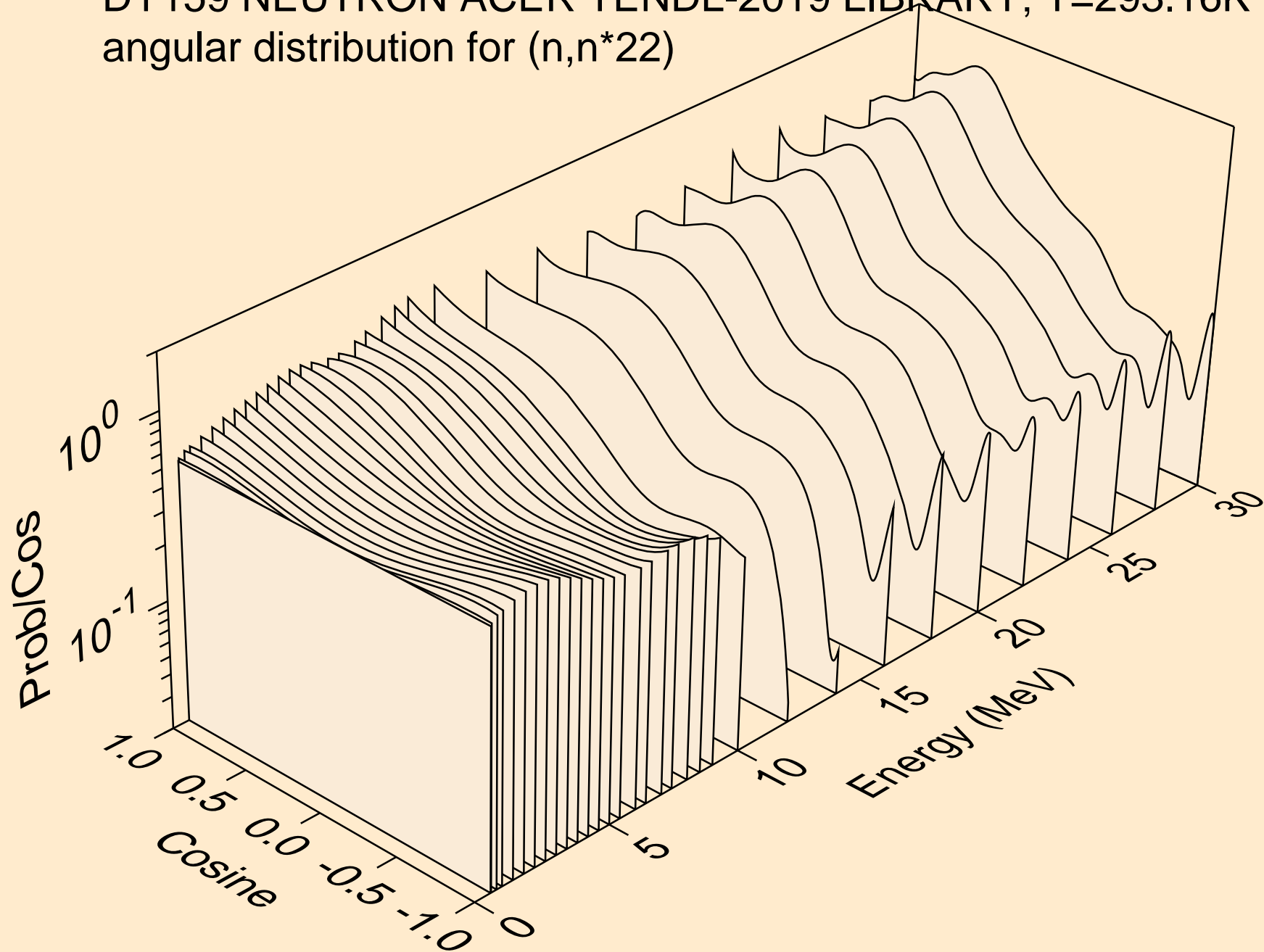

DY159 NEUTRON ACER TENDL-2019 LIBRARY; T=293.16K  
angular distribution for (n,n\*23)

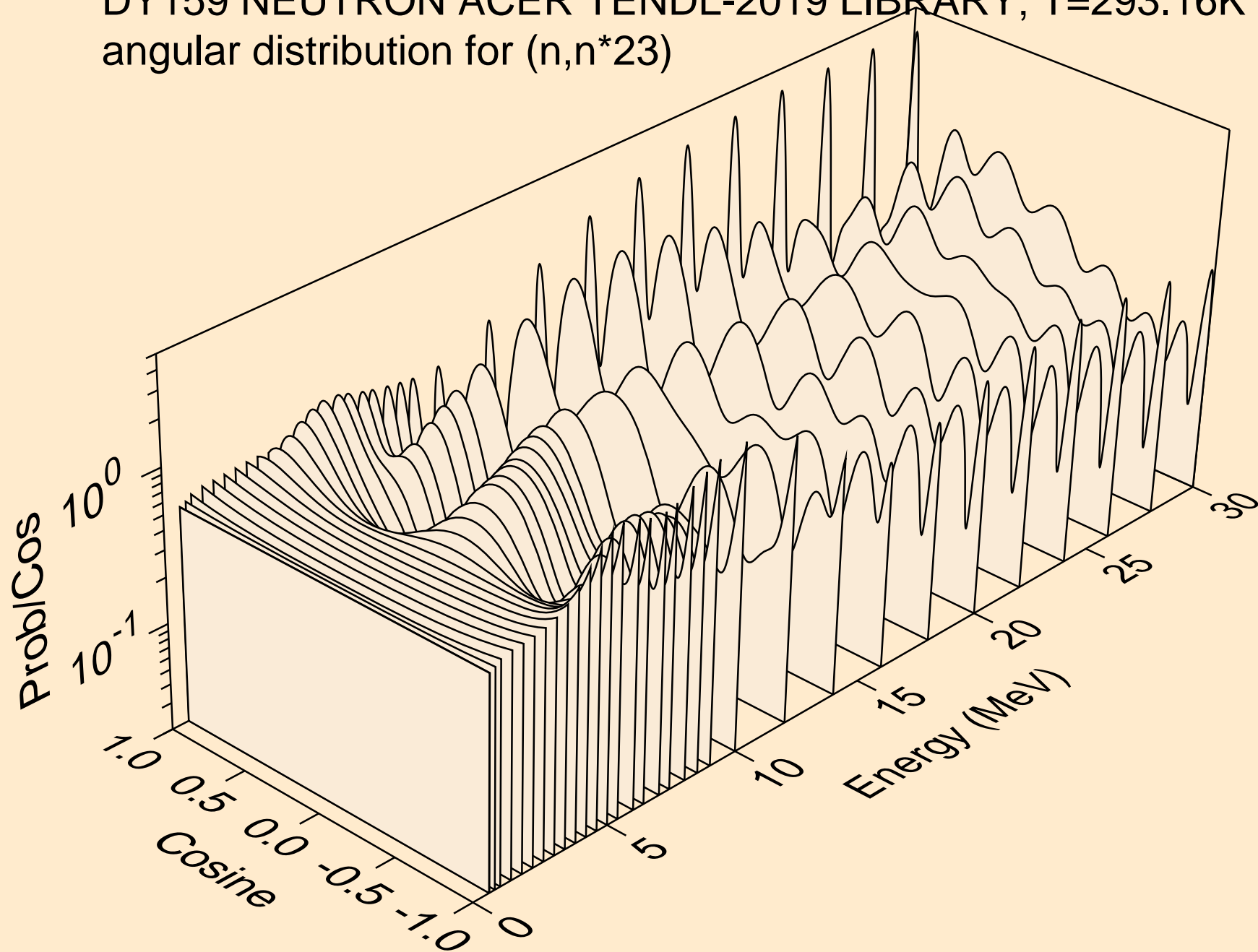

DY159 NEUTRON ACER TENDL-2019 LIBRARY; T=293.16K  
angular distribution for (n,n\*24)

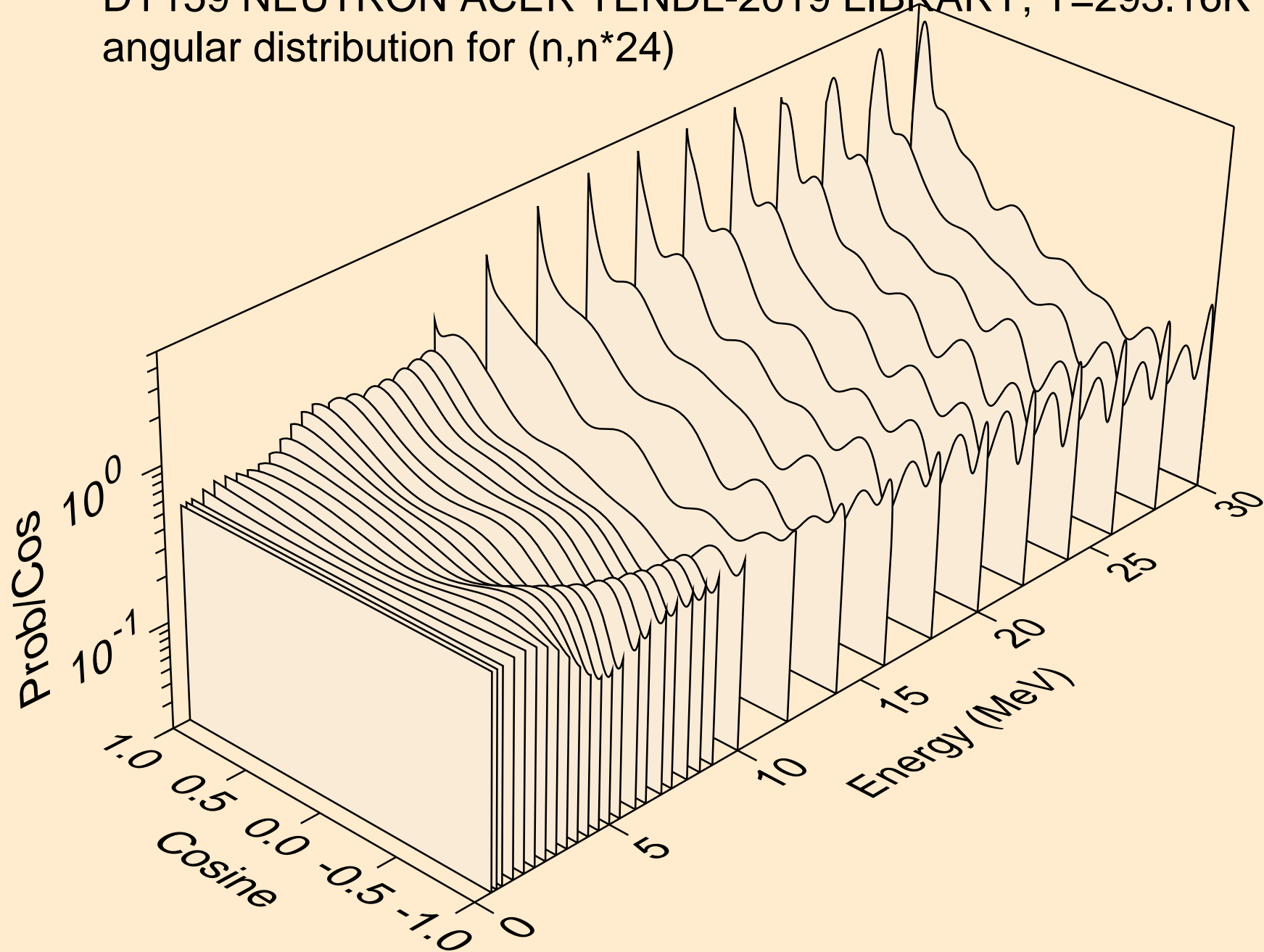

DY159 NEUTRON ACER TENDL-2019 LIBRARY; T=293.16K  
angular distribution for (n,n\*25)

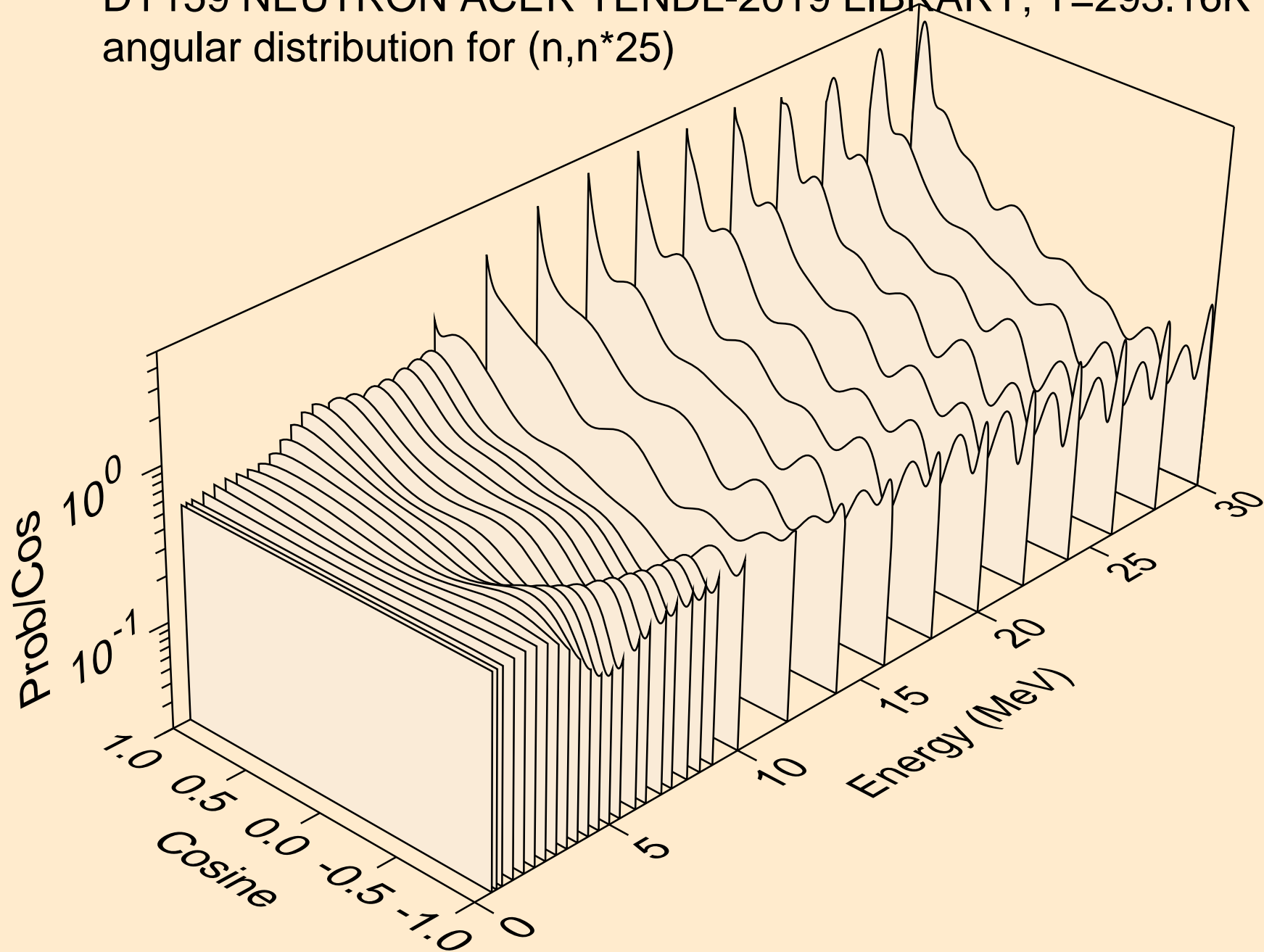



DY159 NEUTRON ACER TENDL-2019 LIBRARY; T=293.16K  
angular distribution for (n,n\*26)

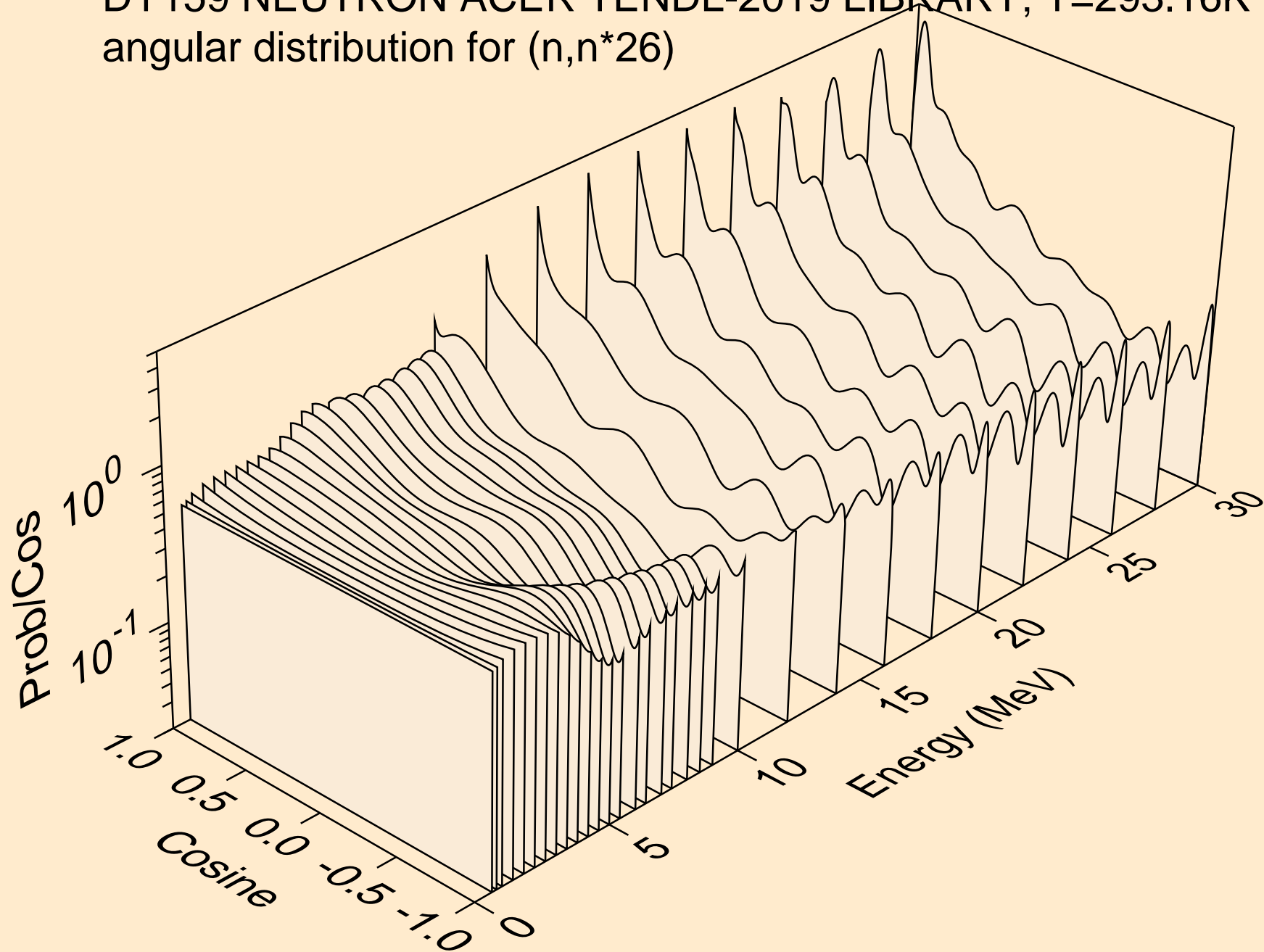

DY159 NEUTRON ACER TENDL-2019 LIBRARY; T=293.16K  
angular distribution for (n,n\*27)

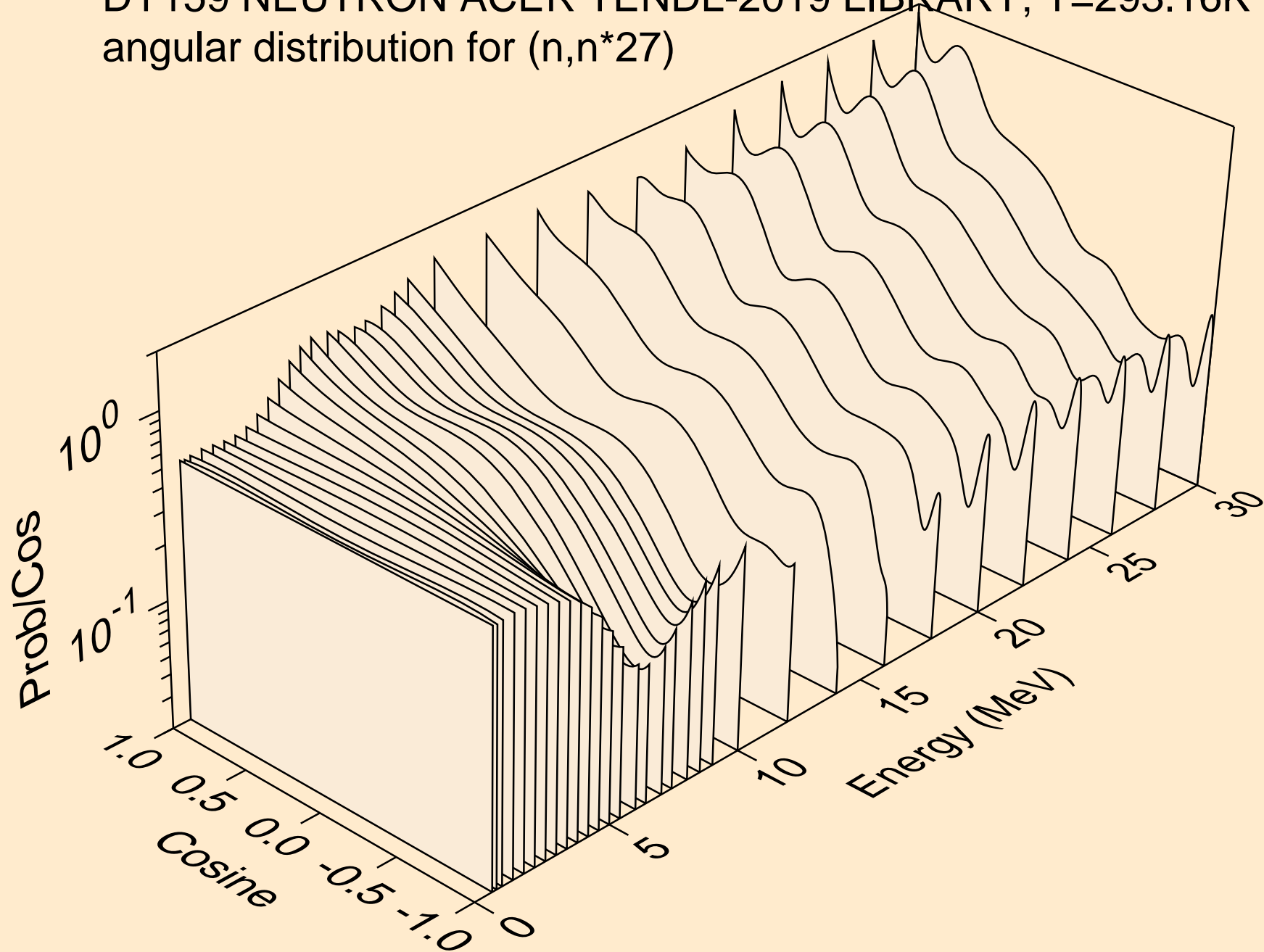

DY159 NEUTRON ACER TENDL-2019 LIBRARY; T=293.16K  
angular distribution for (n,n\*28)

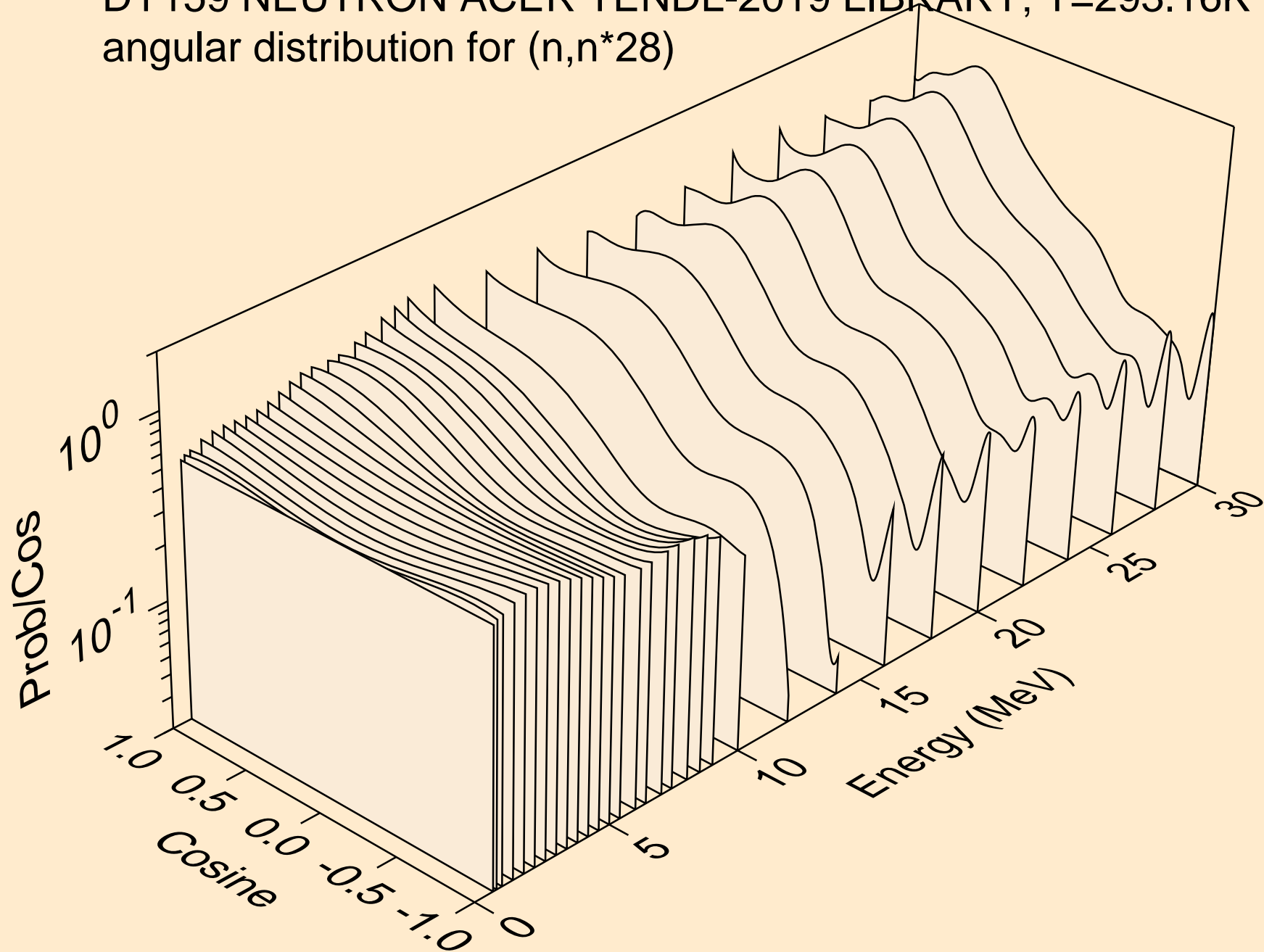

DY159 NEUTRON ACER TENDL-2019 LIBRARY; T=293.16K  
angular distribution for (n,n\*29)

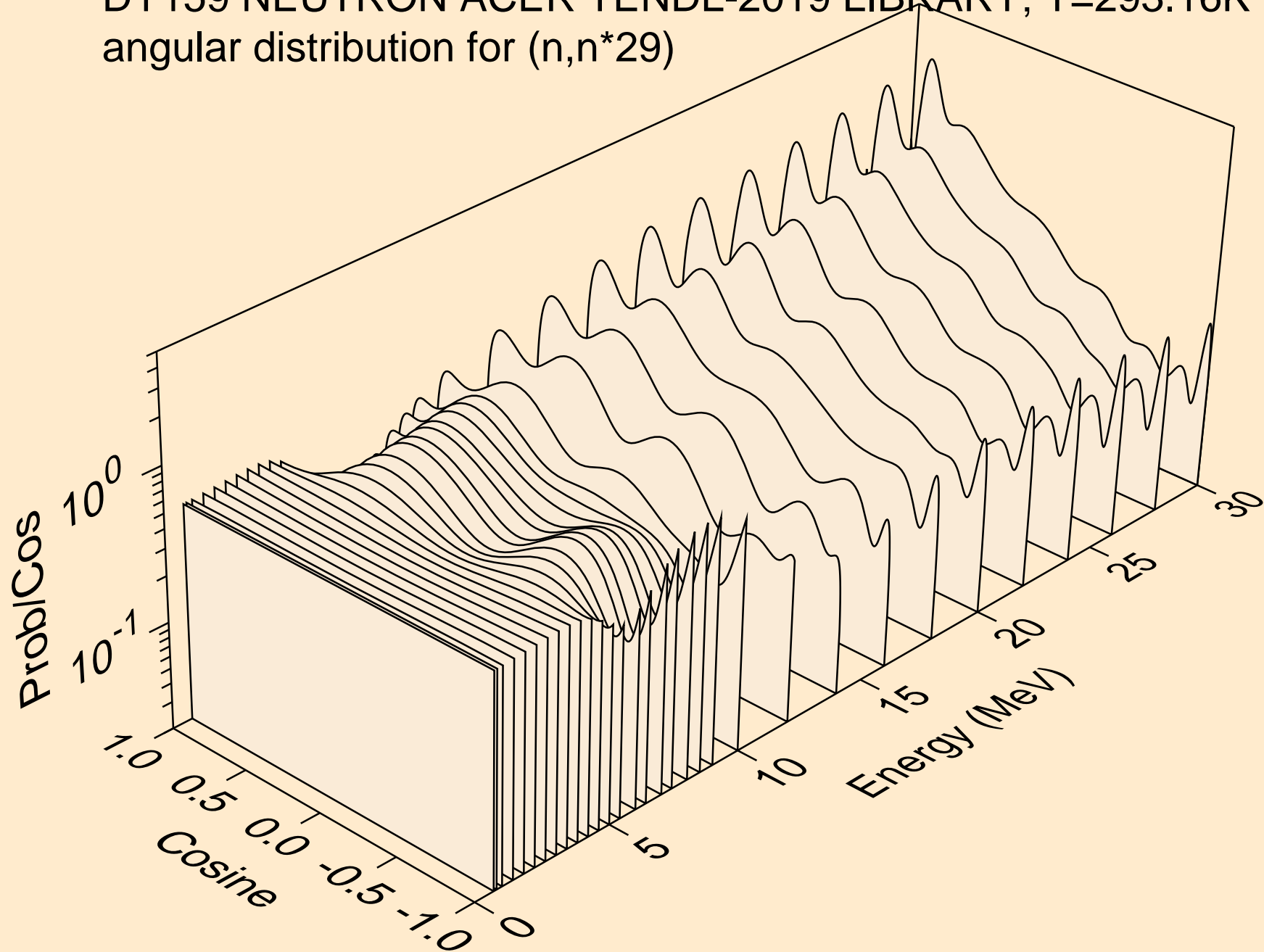

DY159 NEUTRON ACER TENDL-2019 LIBRARY; T=293.16K  
Neutron emission for (n,x)

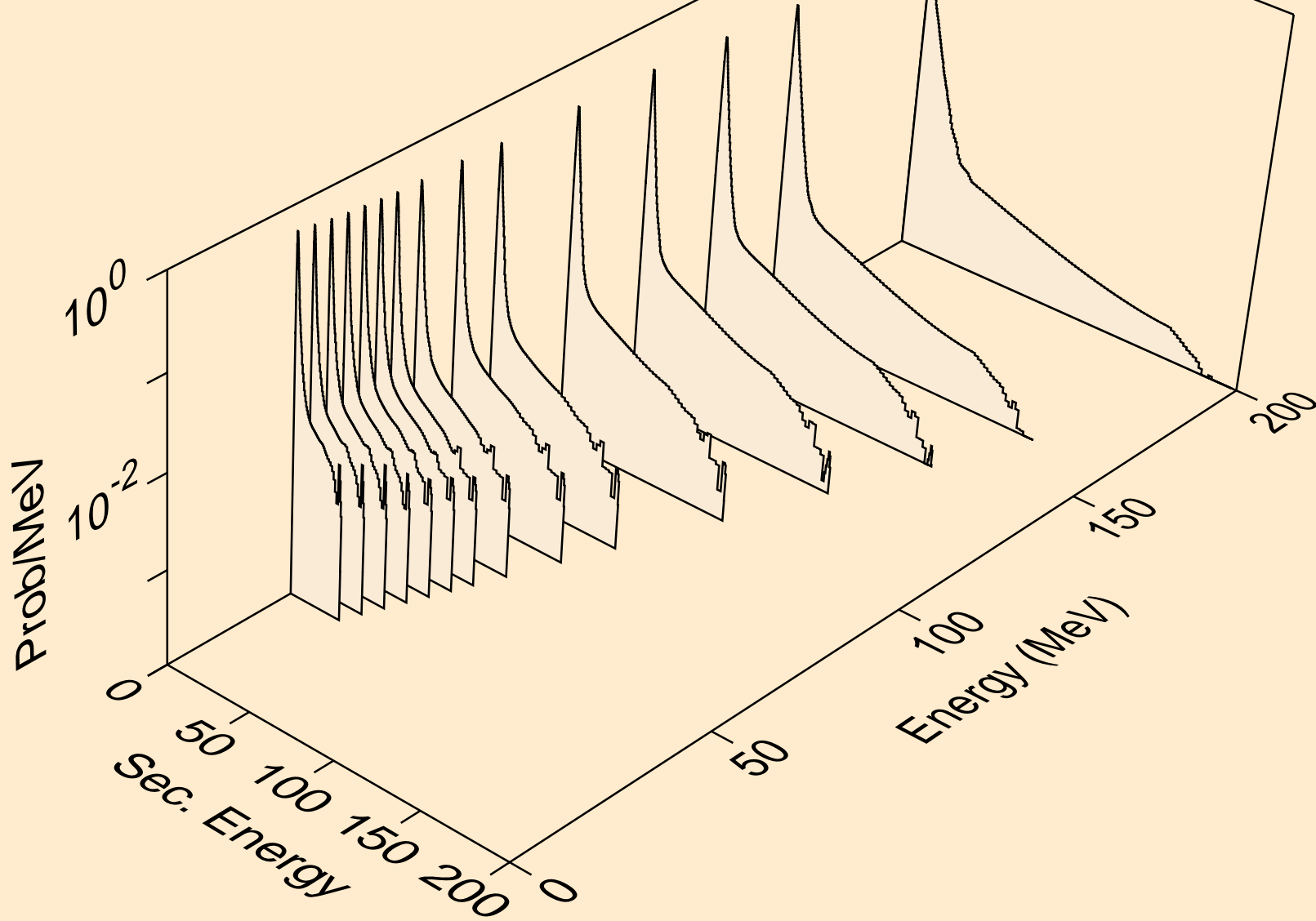

DY159 NEUTRON ACER TENDL-2019 LIBRARY; T=293.16K  
Neutron emission for (n,2nd)

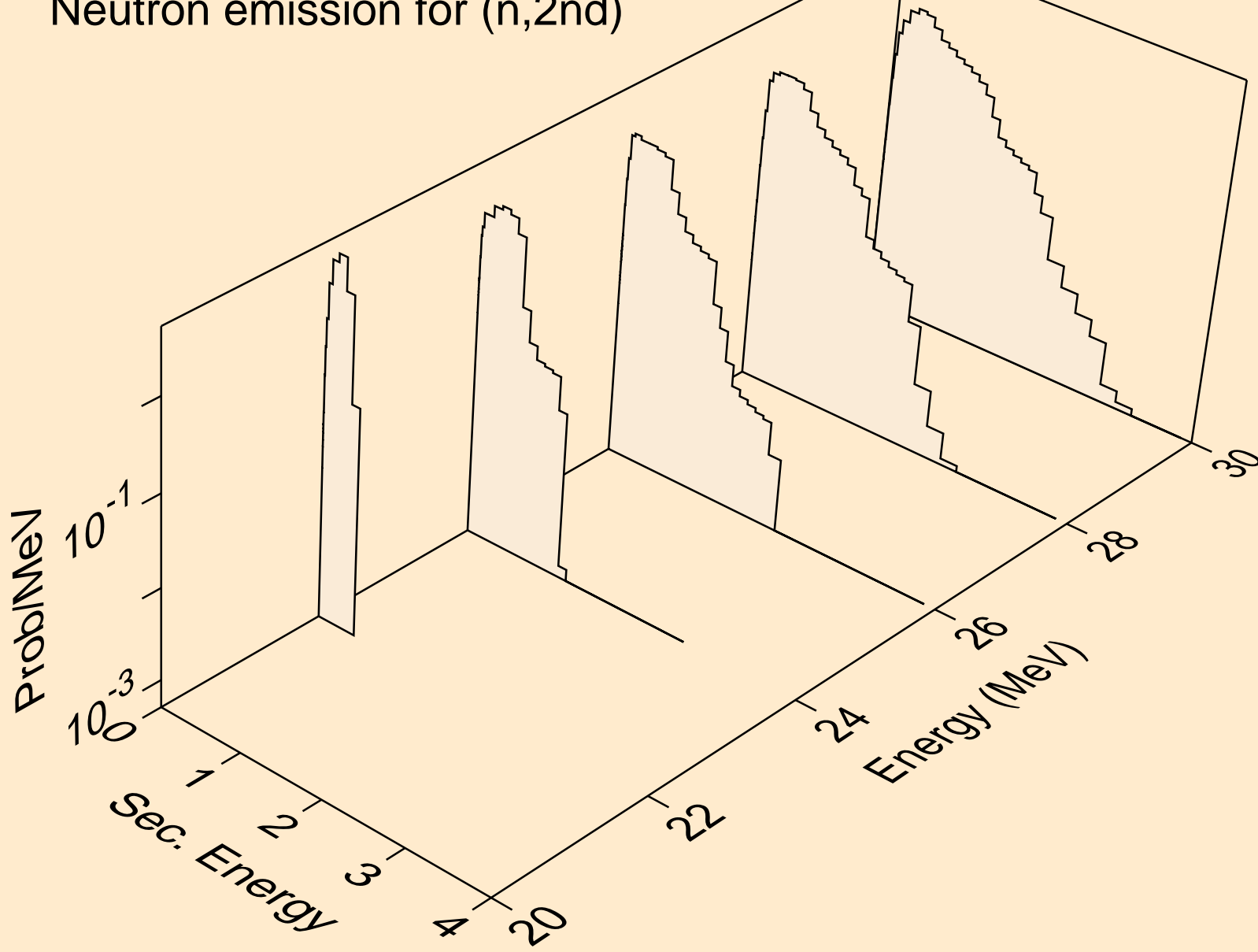

DY159 NEUTRON ACER TENDL-2019 LIBRARY; T=293.16K  
Neutron emission for (n,2n)

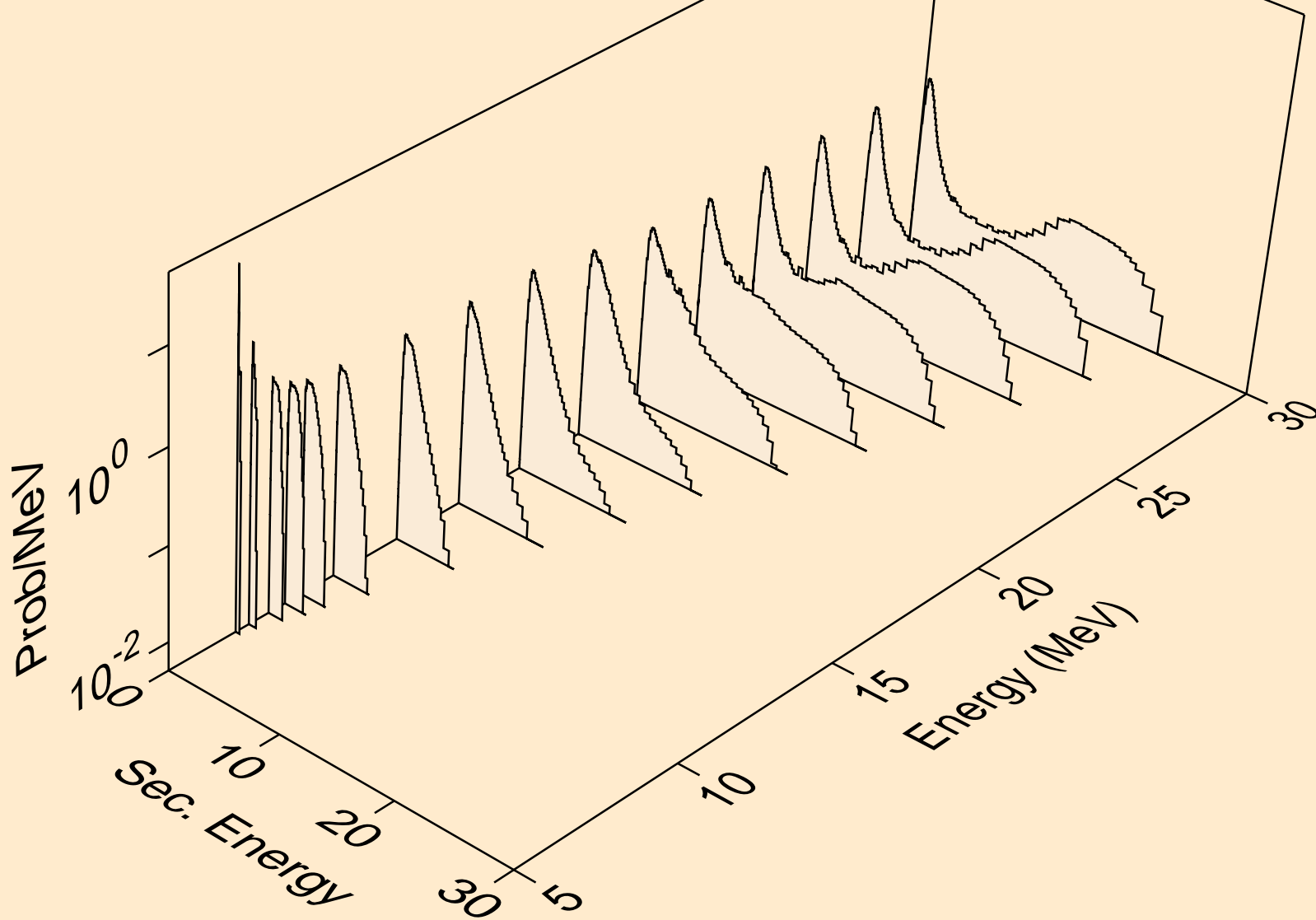

DY159 NEUTRON ACER TENDL-2019 LIBRARY; T=293.16K  
Neutron emission for (n,3n)

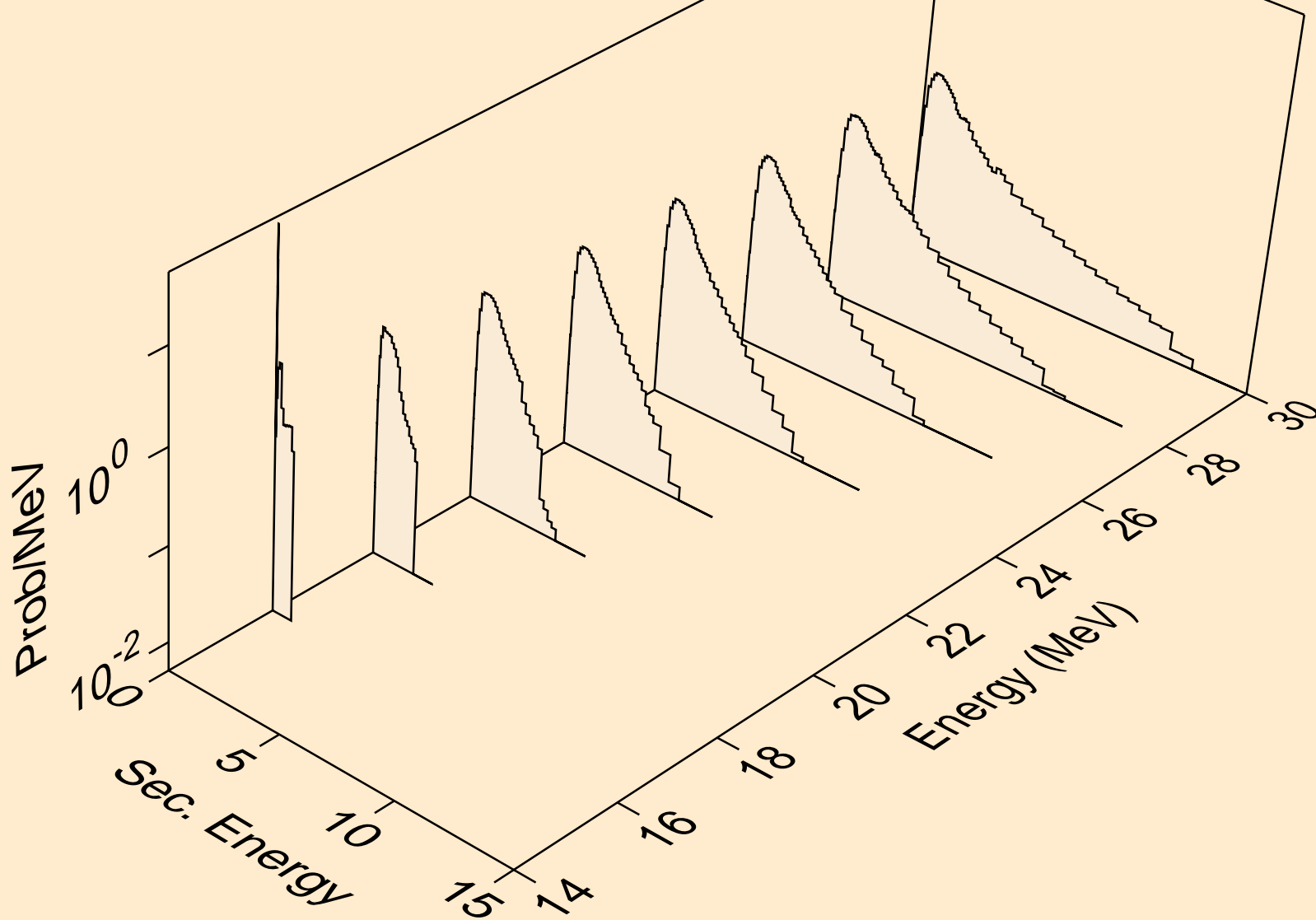



DY159 NEUTRON ACER TENDL-2019 LIBRARY; T=293.16K  
Neutron emission for (n,n\*)a

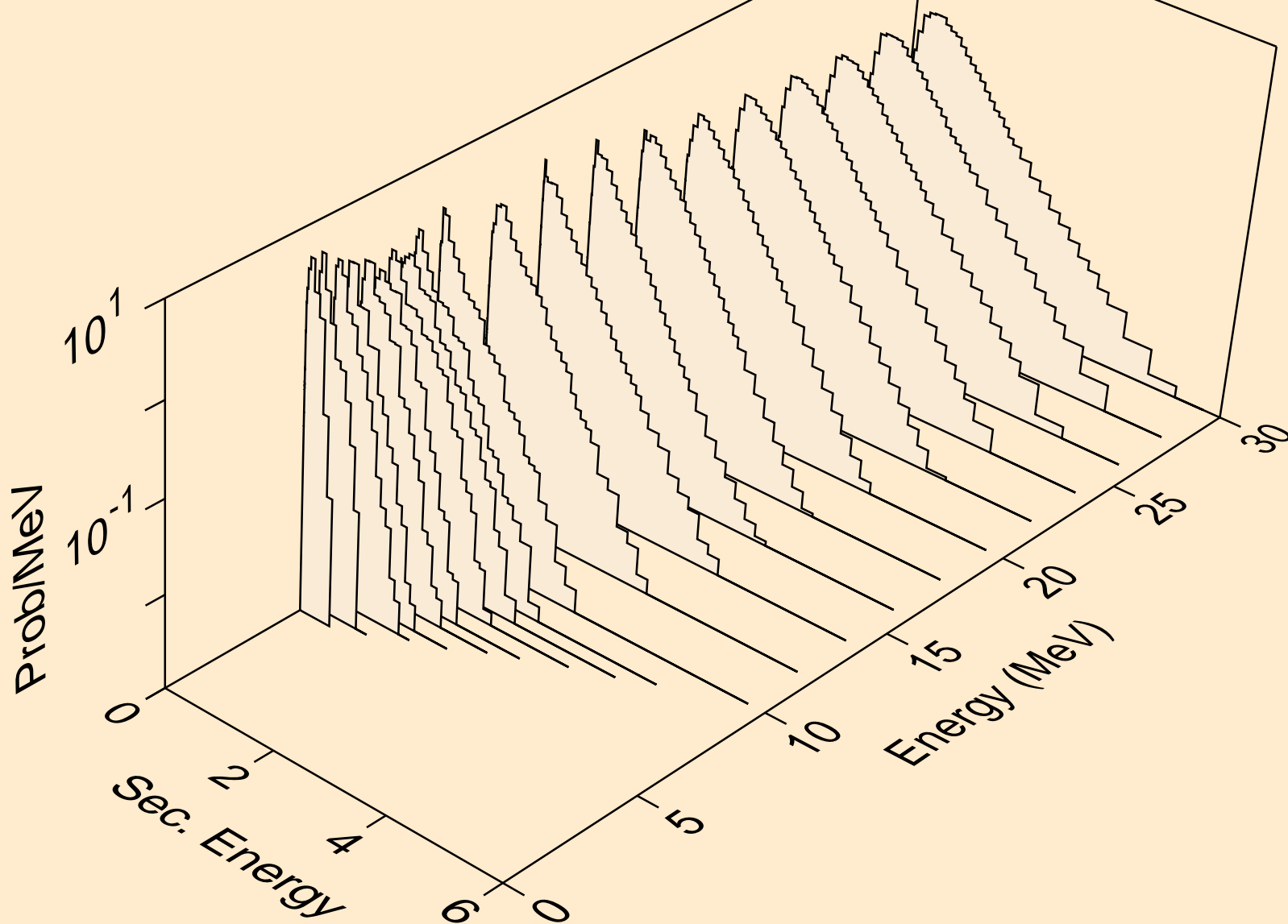

DY159 NEUTRON ACER TENDL-2019 LIBRARY; T=293.16K  
Neutron emission for (n,2n)a

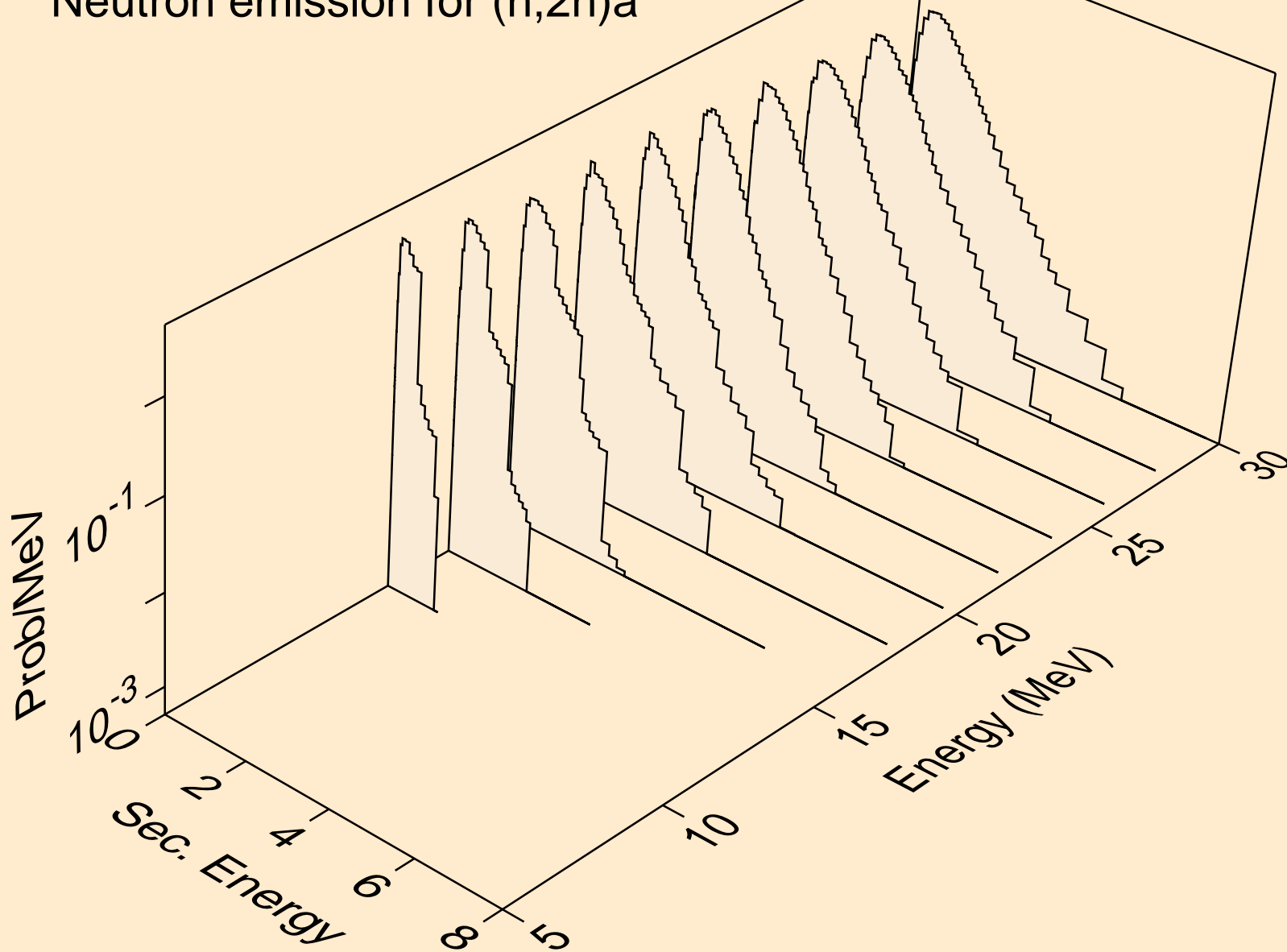

DY159 NEUTRON ACER TENDL-2019 LIBRARY; T=293.16K  
Neutron emission for (n,3n)a

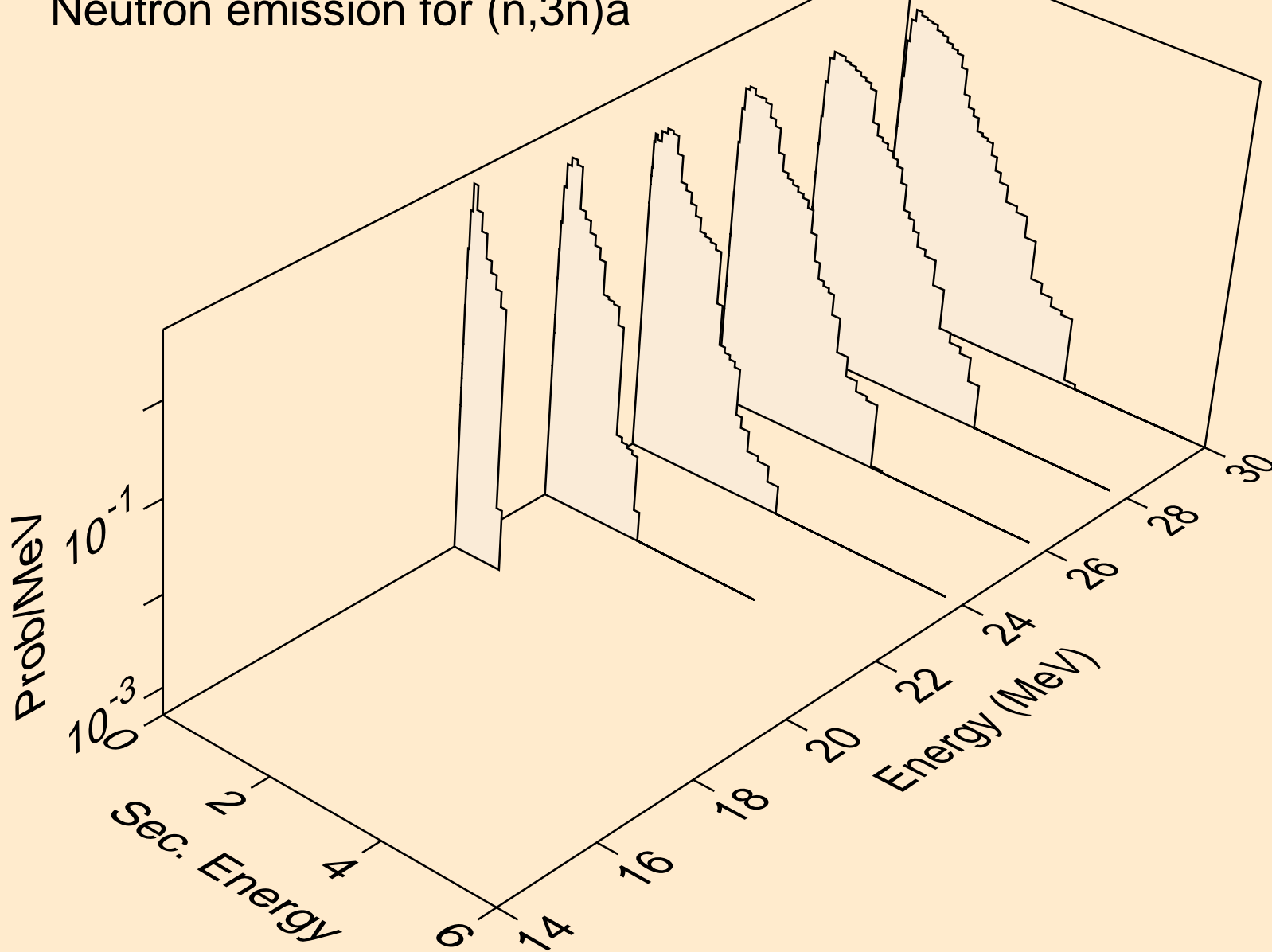

DY159 NEUTRON ACER TENDL-2019 LIBRARY; T=293.16K  
Neutron emission for (n,n\*)p

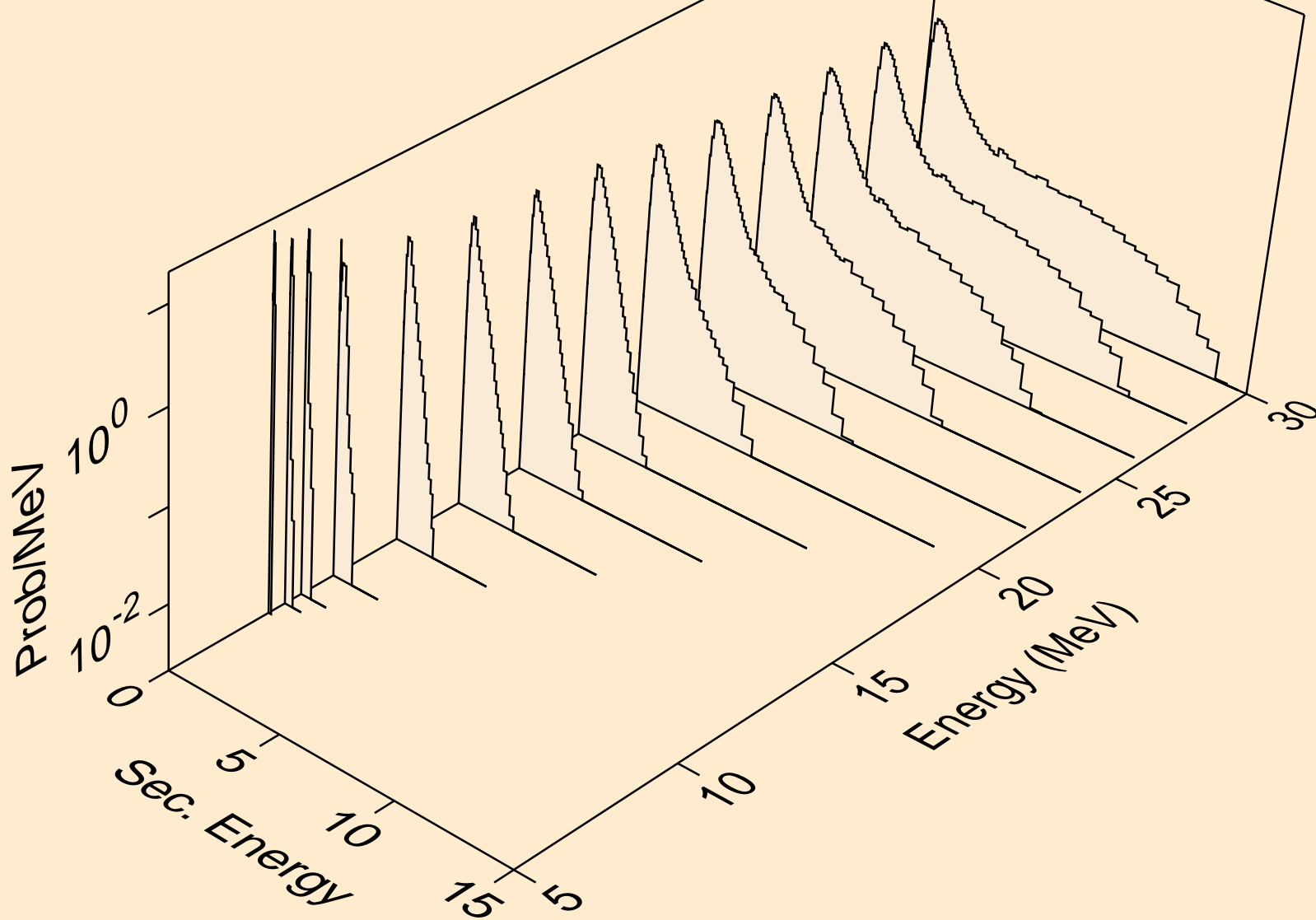

DY159 NEUTRON ACER TENDL-2019 LIBRARY; T=293.16K  
Neutron emission for (n,n\*)2a

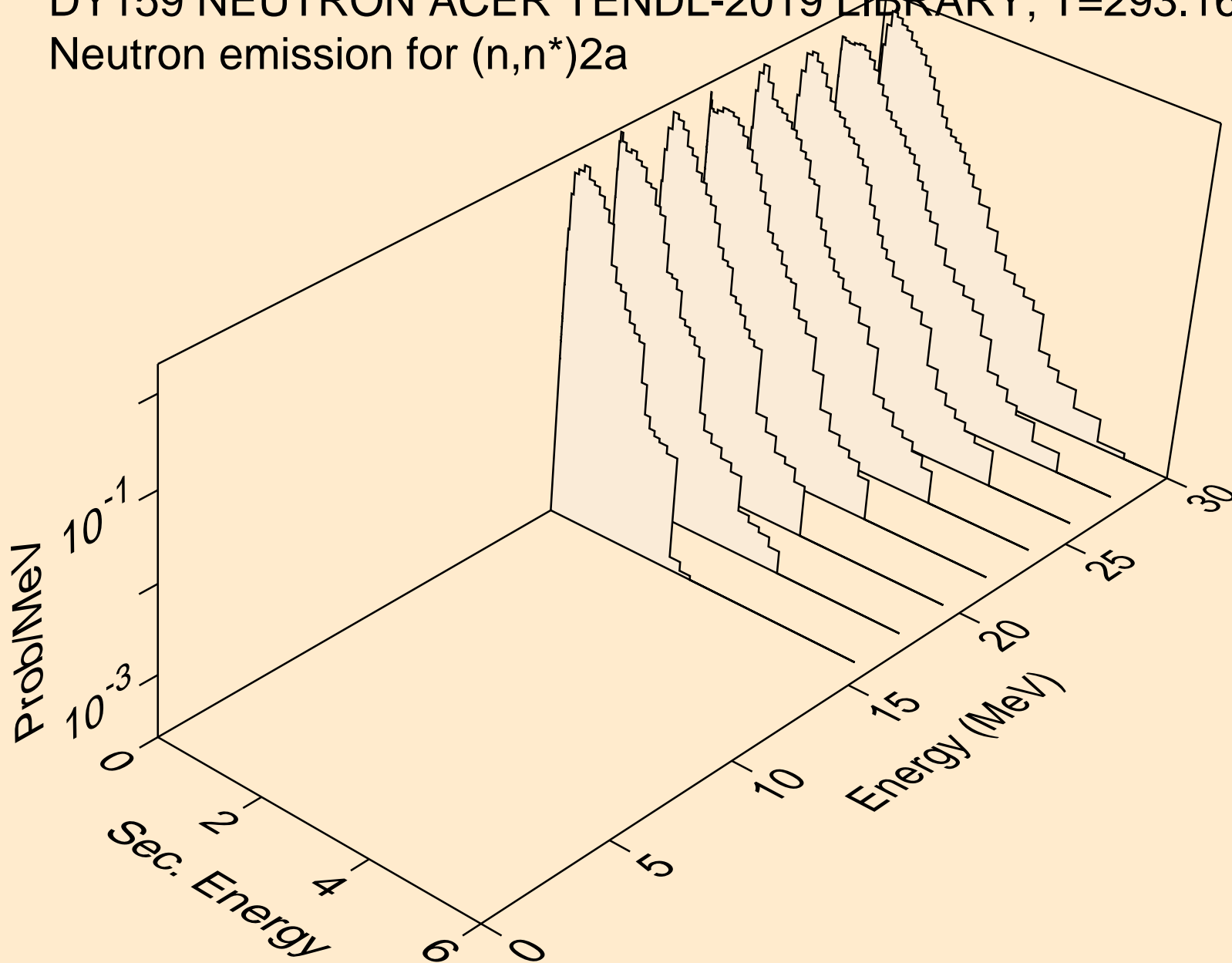

DY159 NEUTRON ACER TENDL-2019 LIBRARY; T=293.16K  
Neutron emission for (n,n\*)d

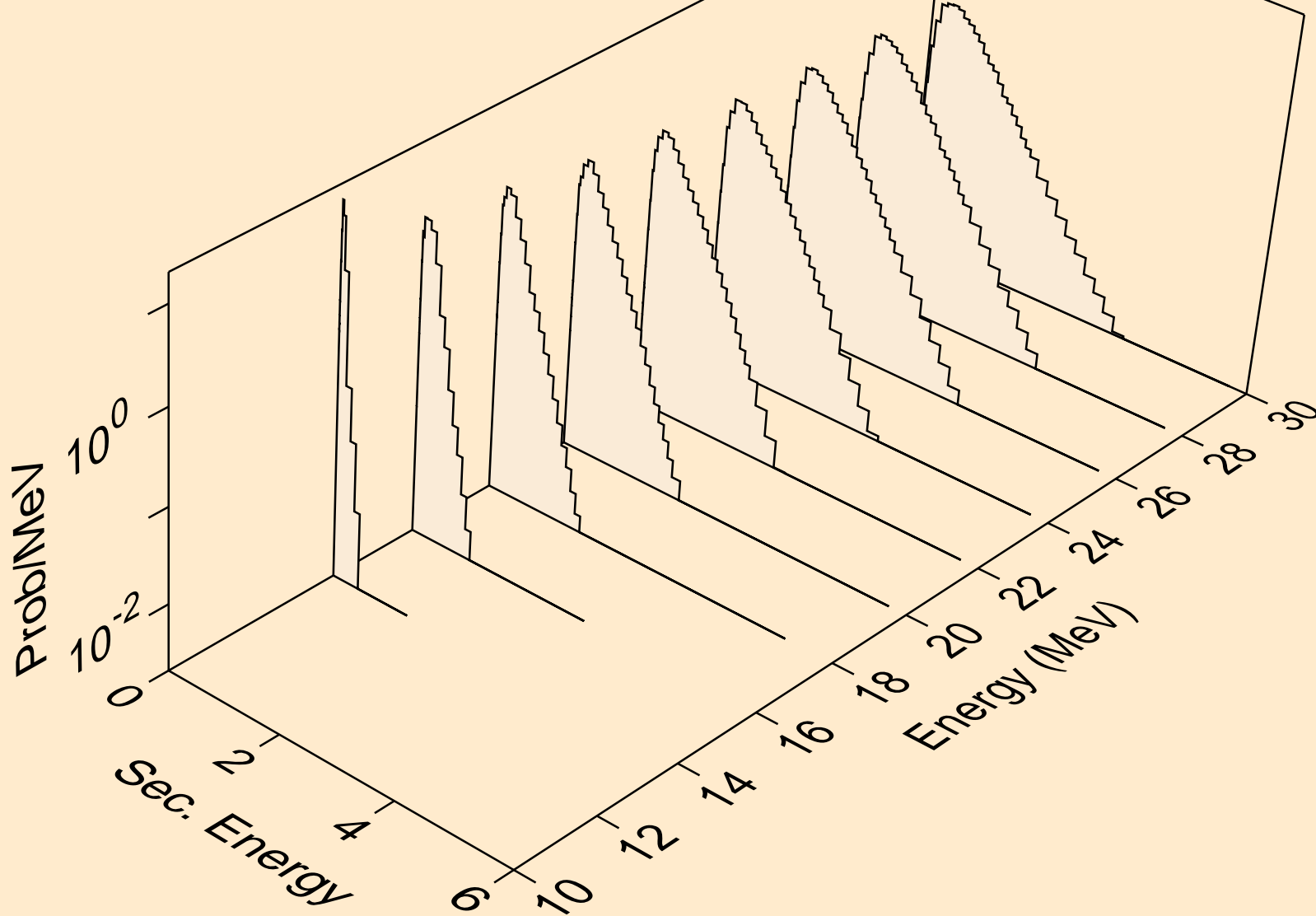

DY159 NEUTRON ACER TENDL-2019 LIBRARY; T=293.16K  
Neutron emission for (n,n\*)t

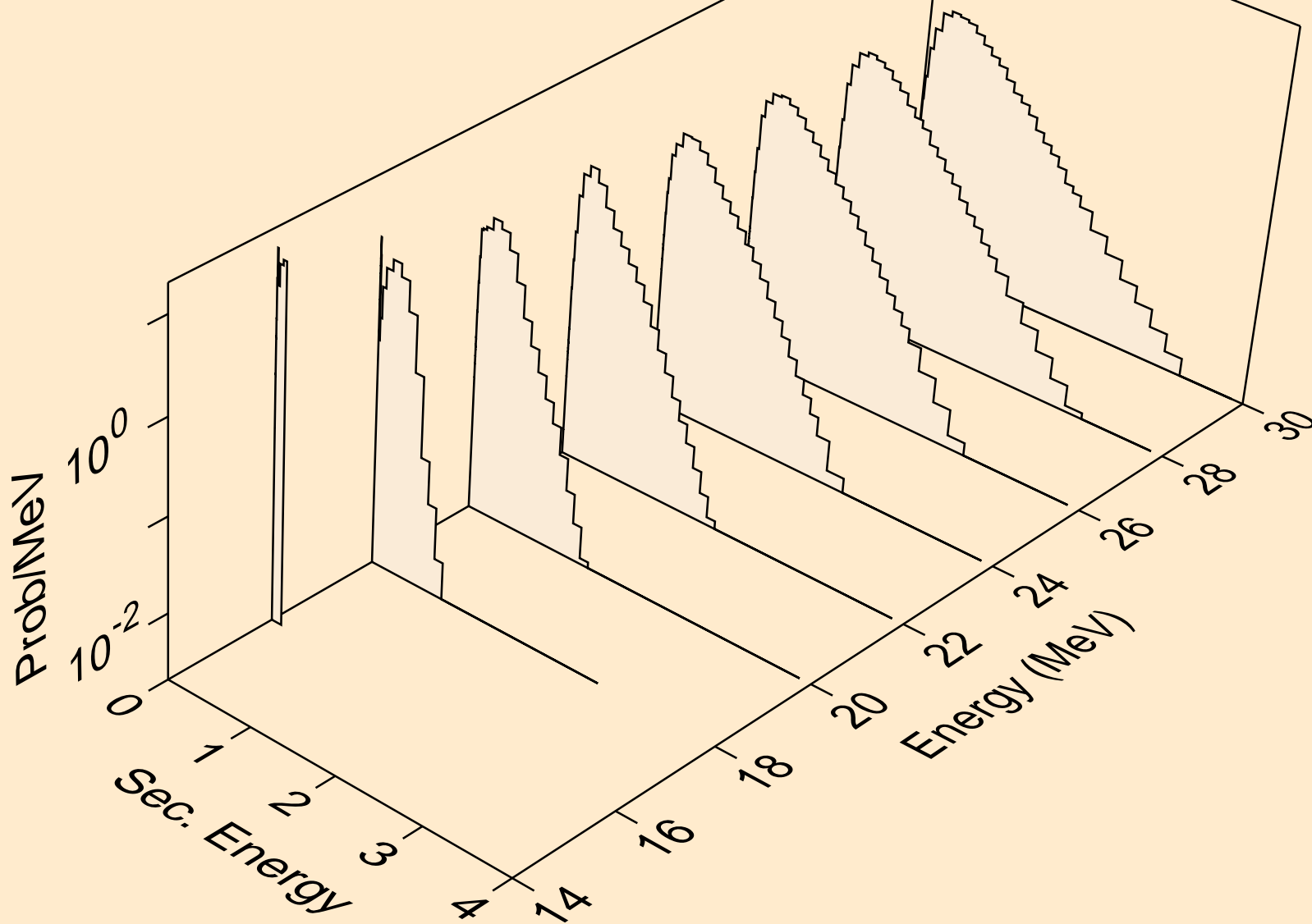

DY159 NEUTRON ACER TENDL-2019 LIBRARY; T=293.16K  
Neutron emission for (n,n\*)he3

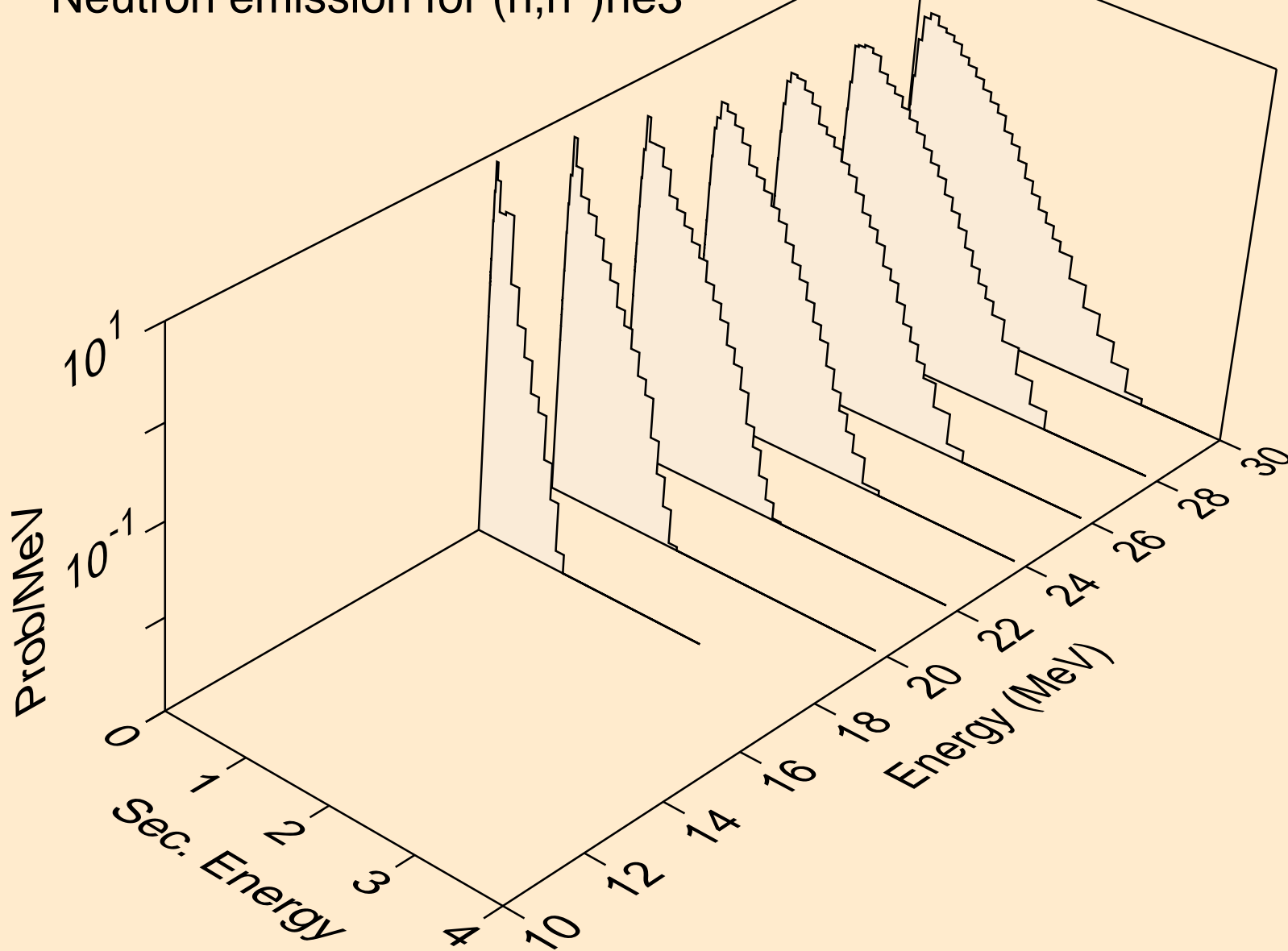



DY159 NEUTRON ACER TENDL-2019 LIBRARY; T=293.16K  
Neutron emission for (n,4n)

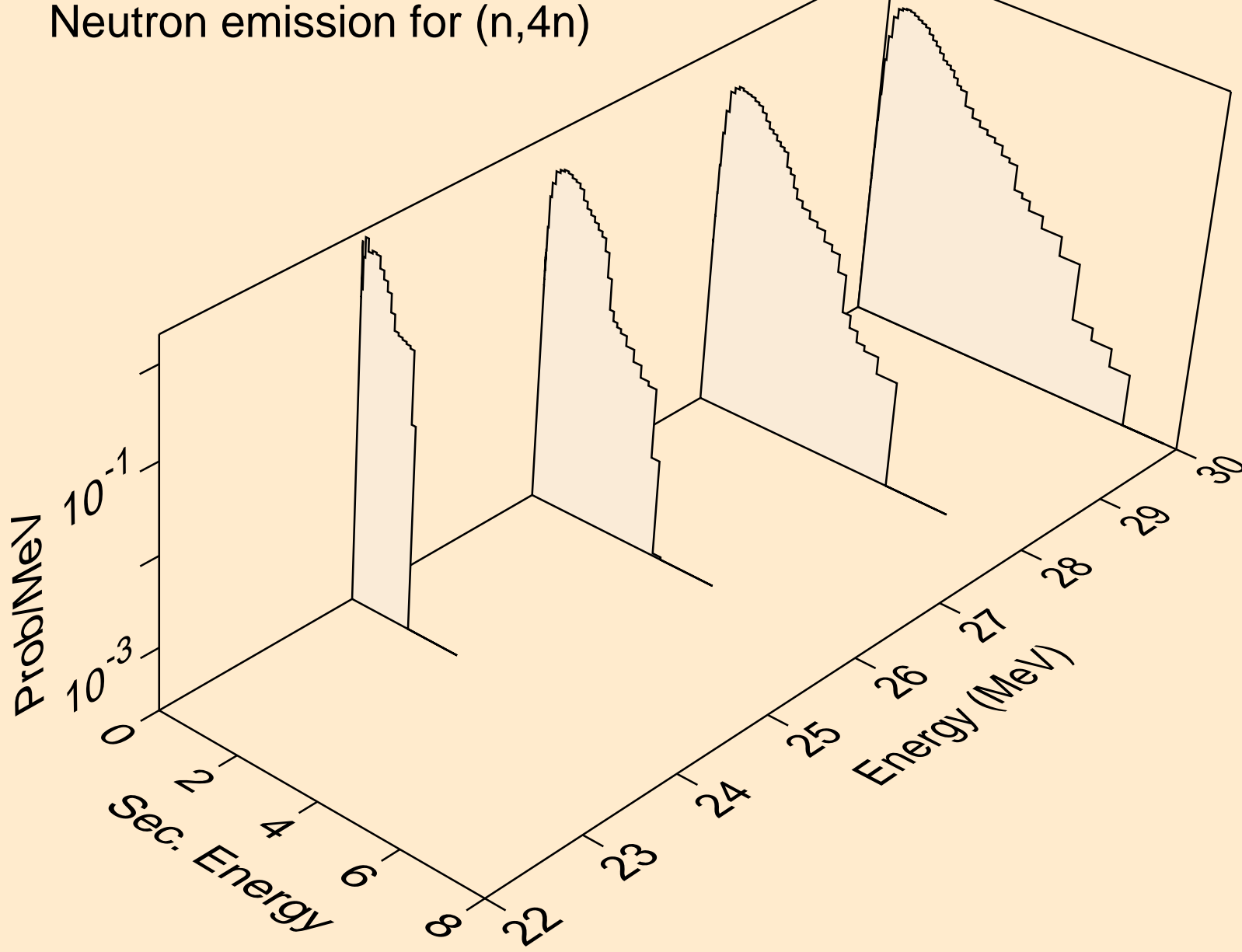

DY159 NEUTRON ACER TENDL-2019 LIBRARY; T=293.16K  
Neutron emission for (n,2np)

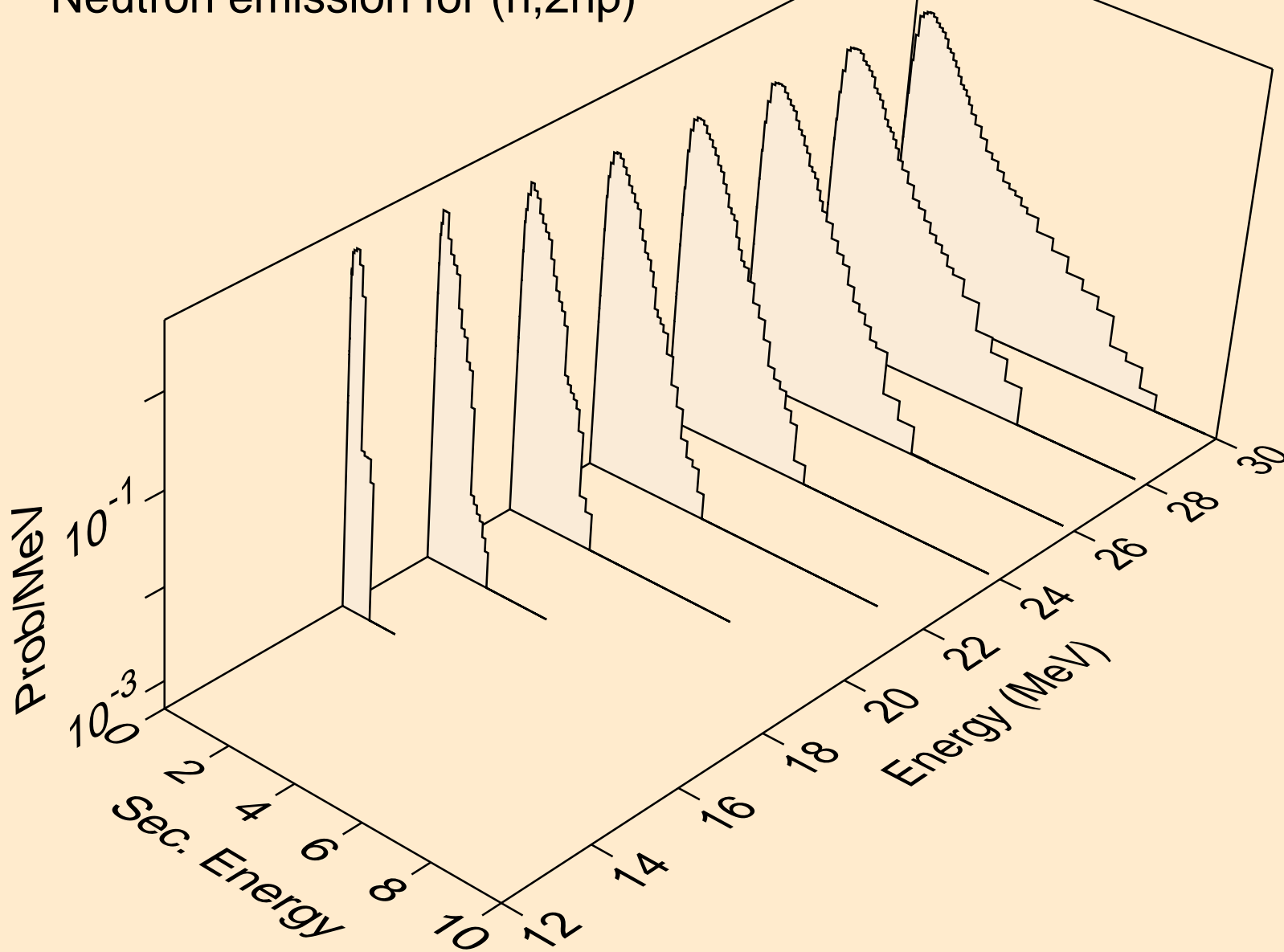

DY159 NEUTRON ACER TENDL-2019 LIBRARY; T=293.16K  
Neutron emission for (n,3np)

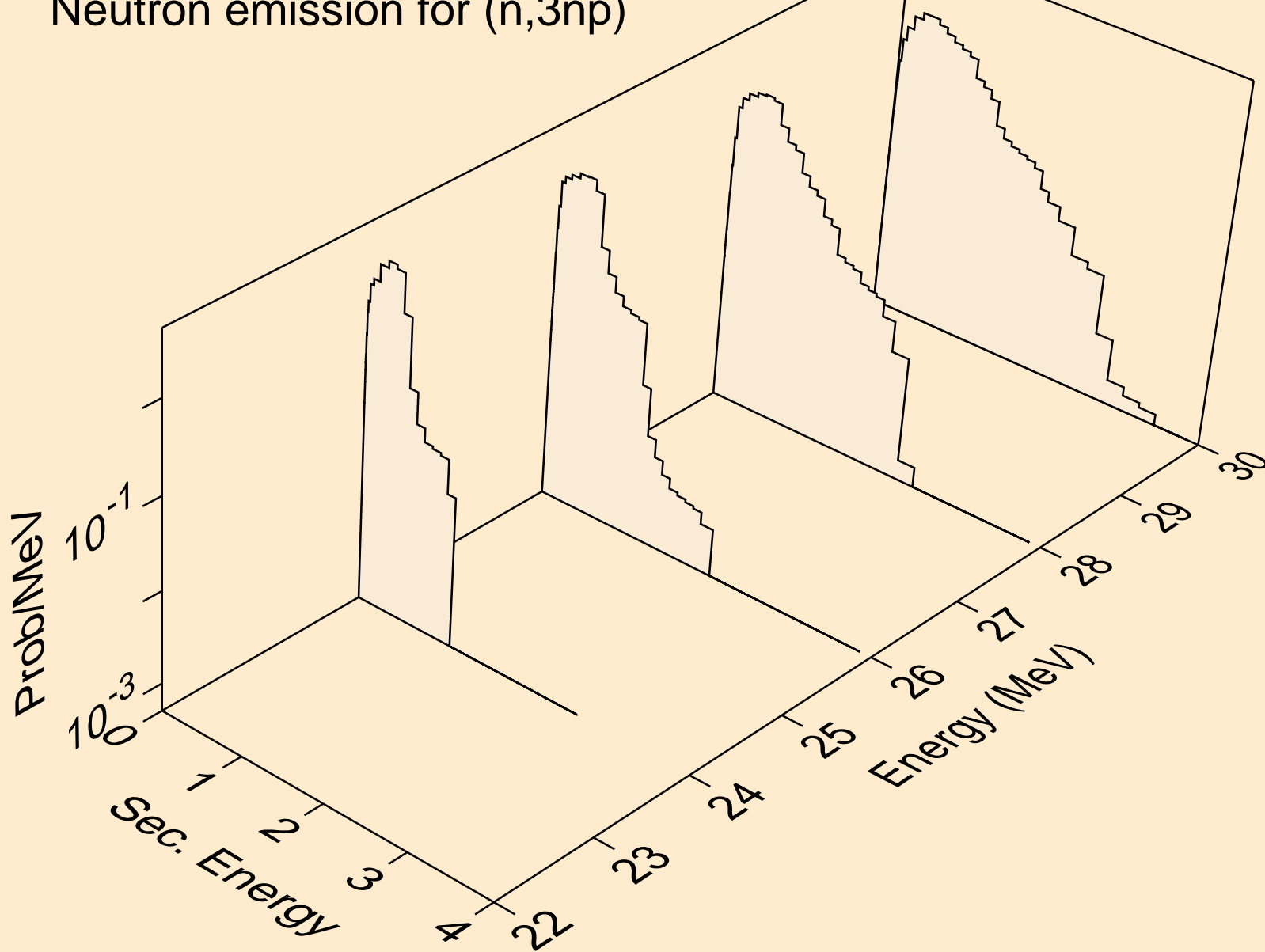

DY159 NEUTRON ACER TENDL-2019 LIBRARY; T=293.16K  
Neutron emission for (n,2np)

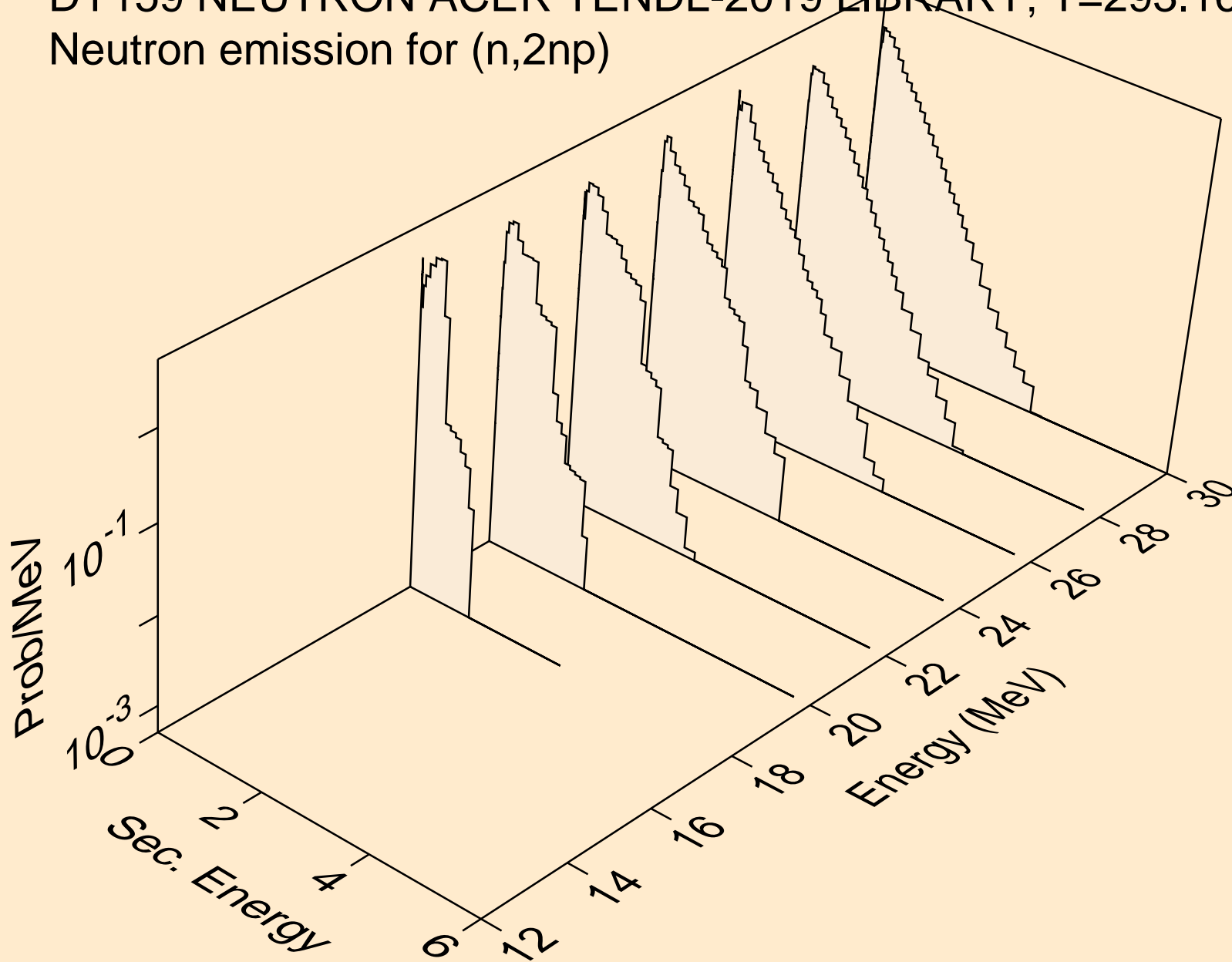

DY159 NEUTRON ACER TENDL-2019 LIBRARY; T=293.16K  
Neutron emission for (n,npa)

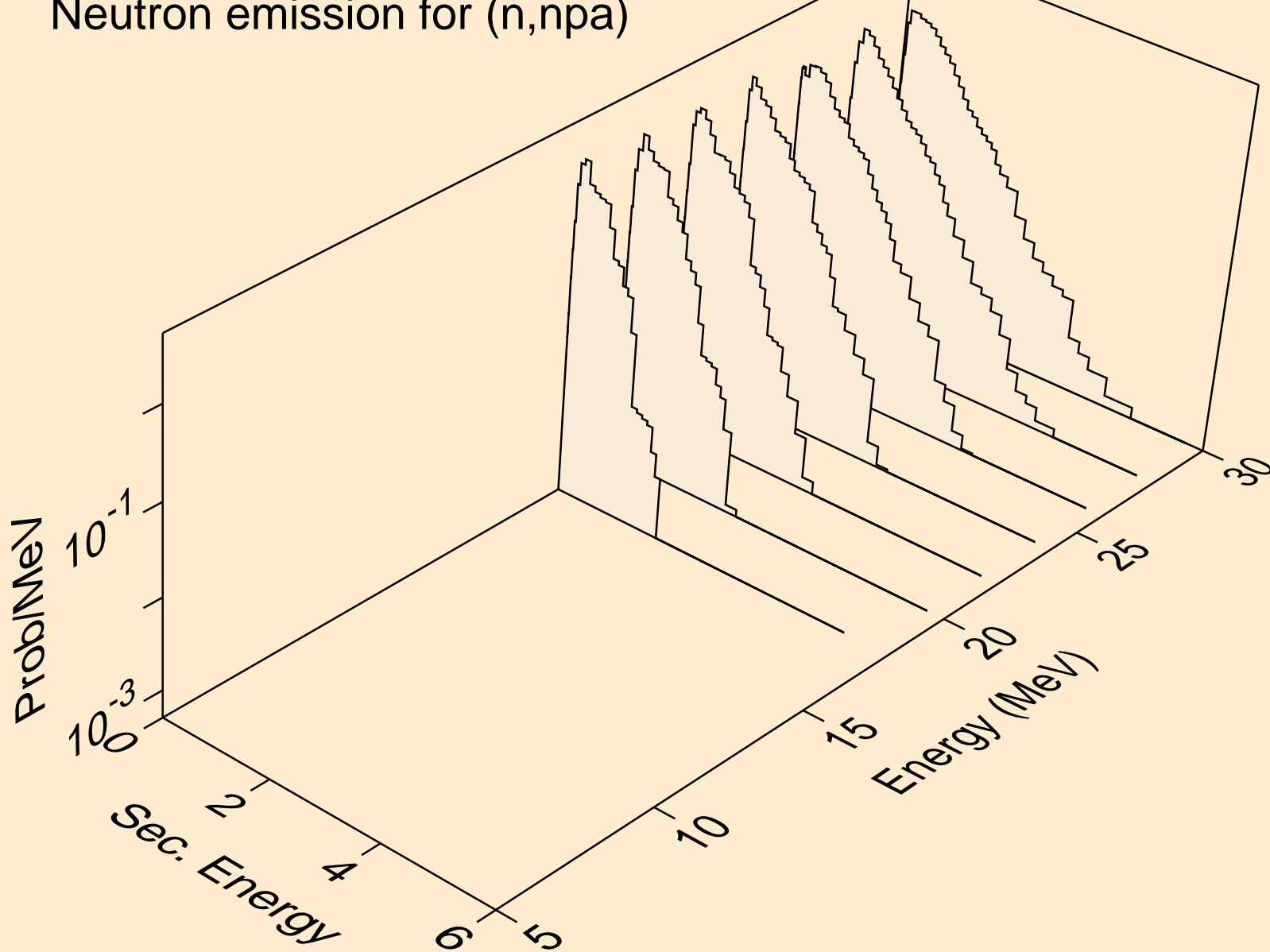

DY159 NEUTRON ACER TENDL-2019 LIBRARY; T=293.16K  
Neutron emission for (n,n\*c)

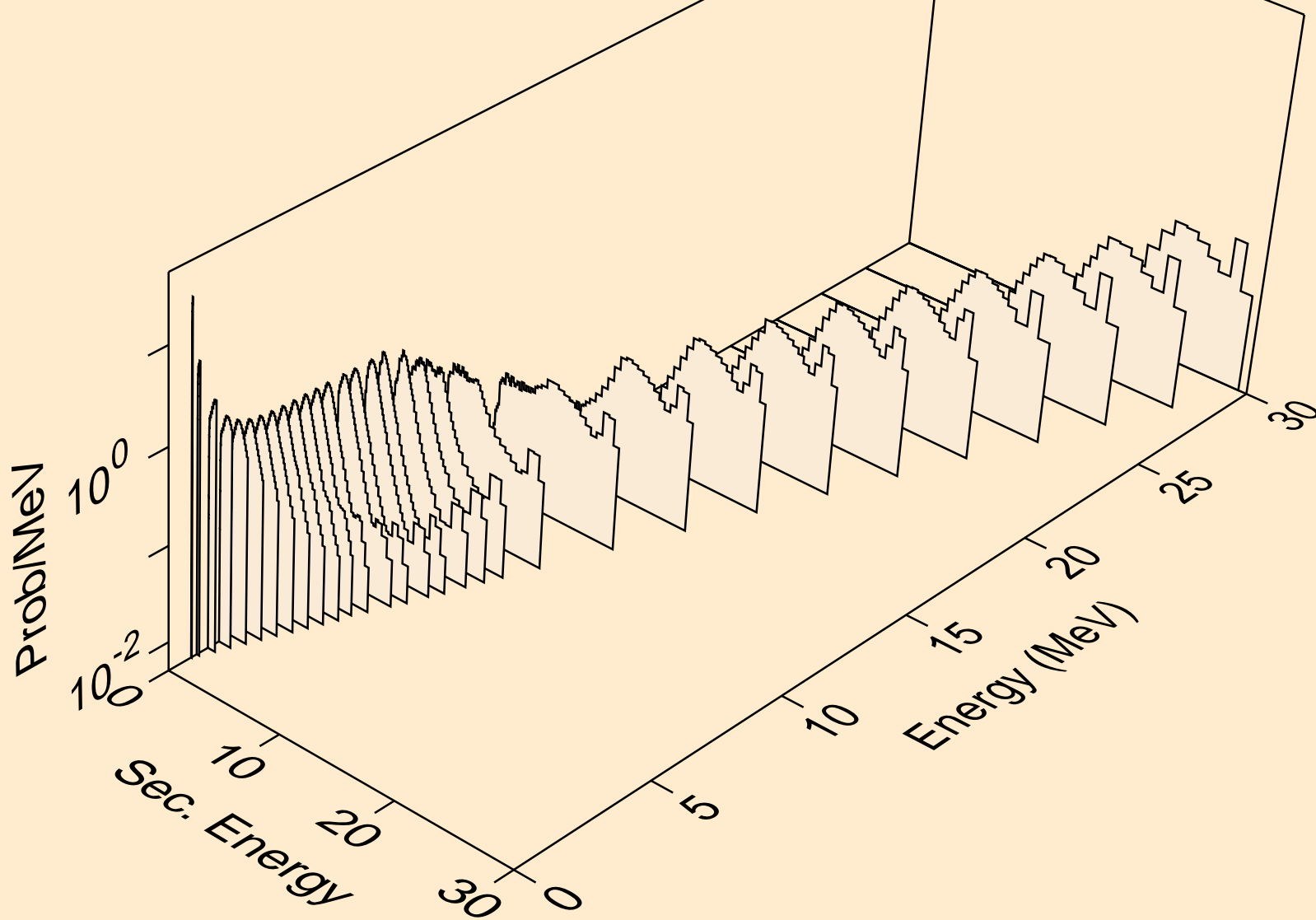

DY159 NEUTRON ACER TENDL-2019 LIBRARY; T=293.16K  
Photon emission for (n,x)

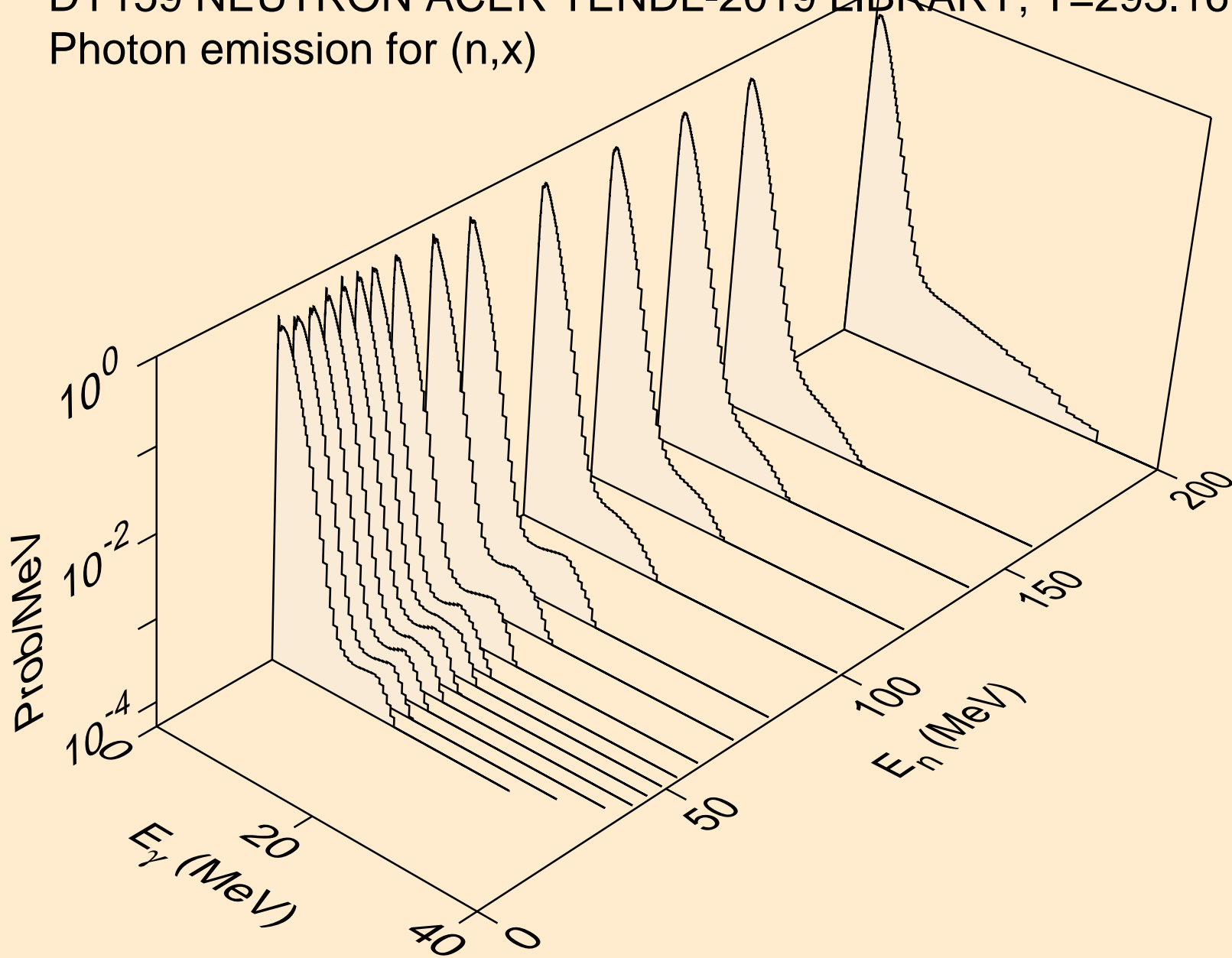

DY159 NEUTRON ACER TENDL-2019 LIBRARY; T=293.16K  
Photon emission for (n,2nd)

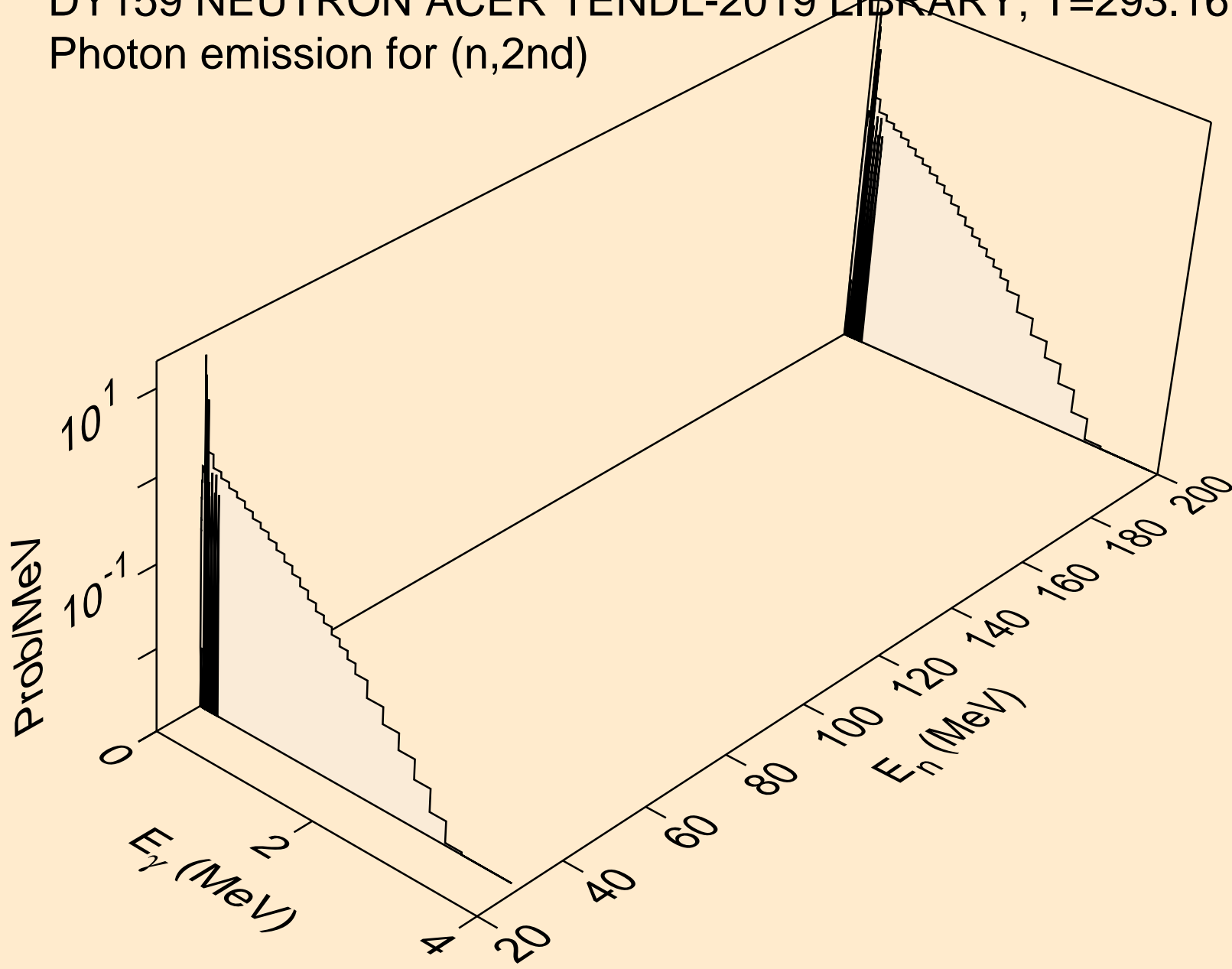



DY159 NEUTRON ACER TENDL-2019 LIBRARY; T=293.16K  
Photon emission for (n,2n)

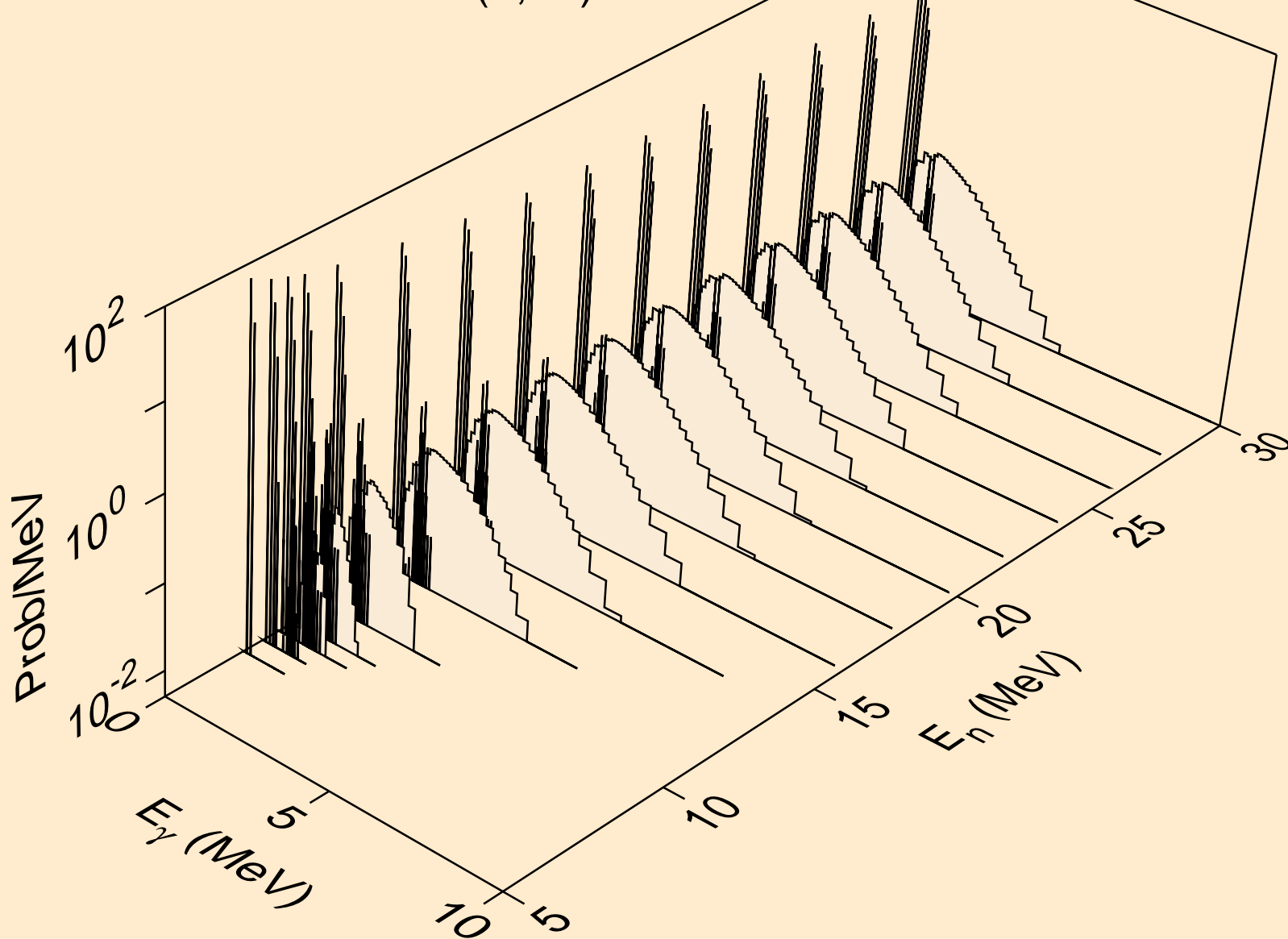

DY159 NEUTRON ACER TENDL-2019 LIBRARY; T=293.16K  
Photon emission for (n,3n)

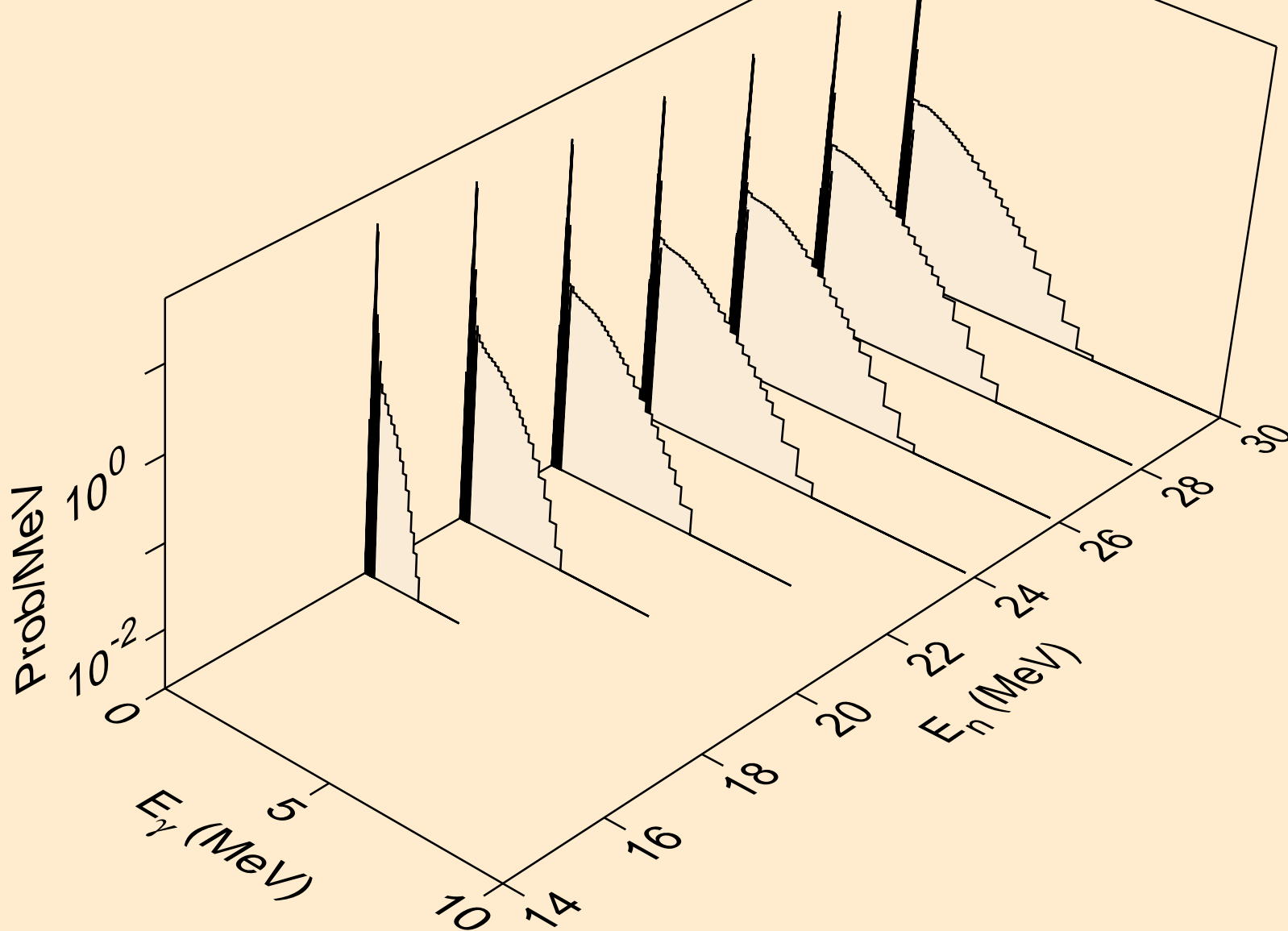

DY159 NEUTRON ACER TENDL-2019 LIBRARY; T=293.16K  
Photon emission for (n,n\*)a

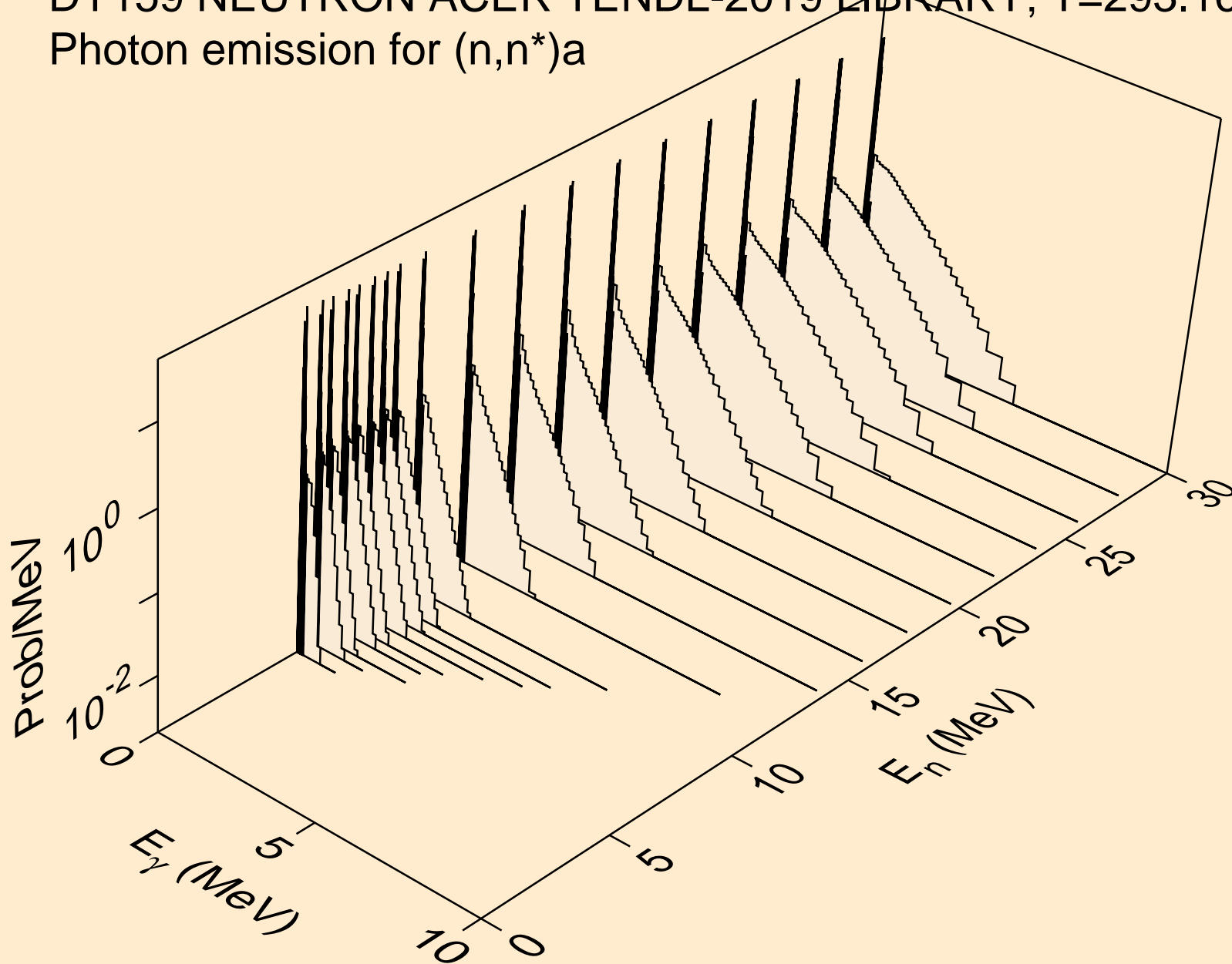

DY159 NEUTRON ACER TENDL-2019 LIBRARY; T=293.16K  
Photon emission for (n,2n)a

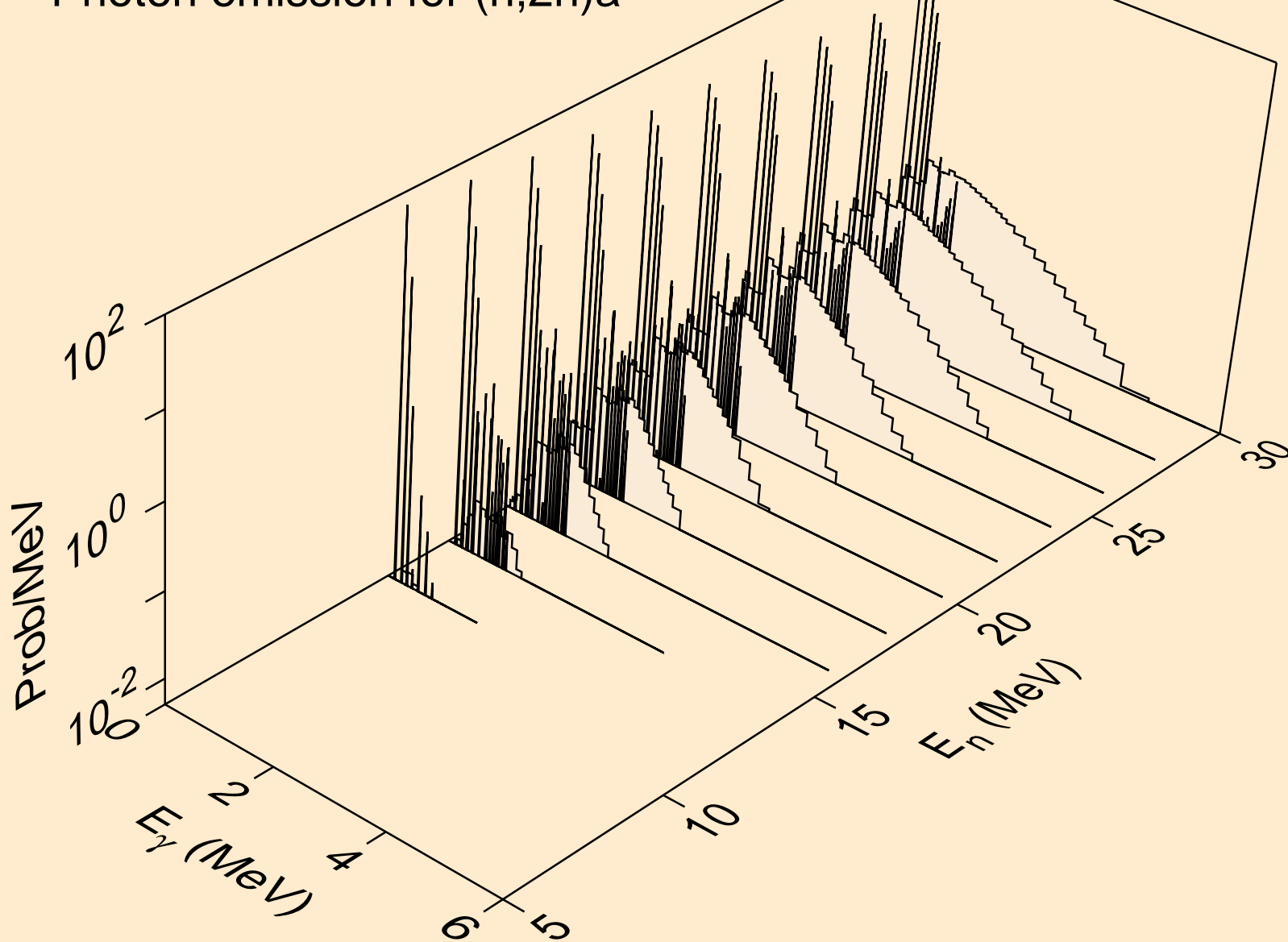

DY159 NEUTRON ACER TENDL-2019 LIBRARY; T=293.16K  
Photon emission for (n,3n)a

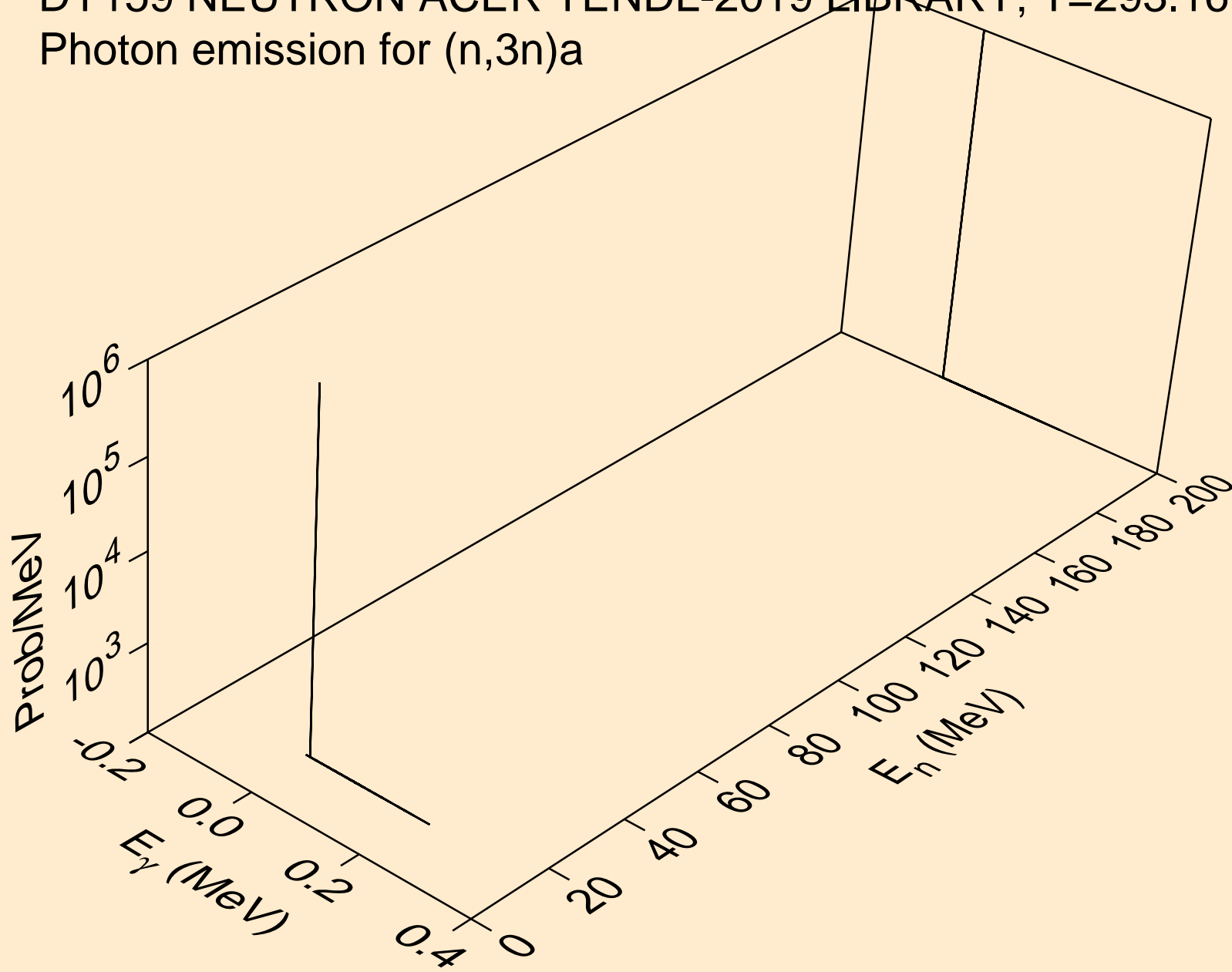

DY159 NEUTRON ACER TENDL-2019 LIBRARY; T=293.16K  
Photon emission for (n,n\*)p

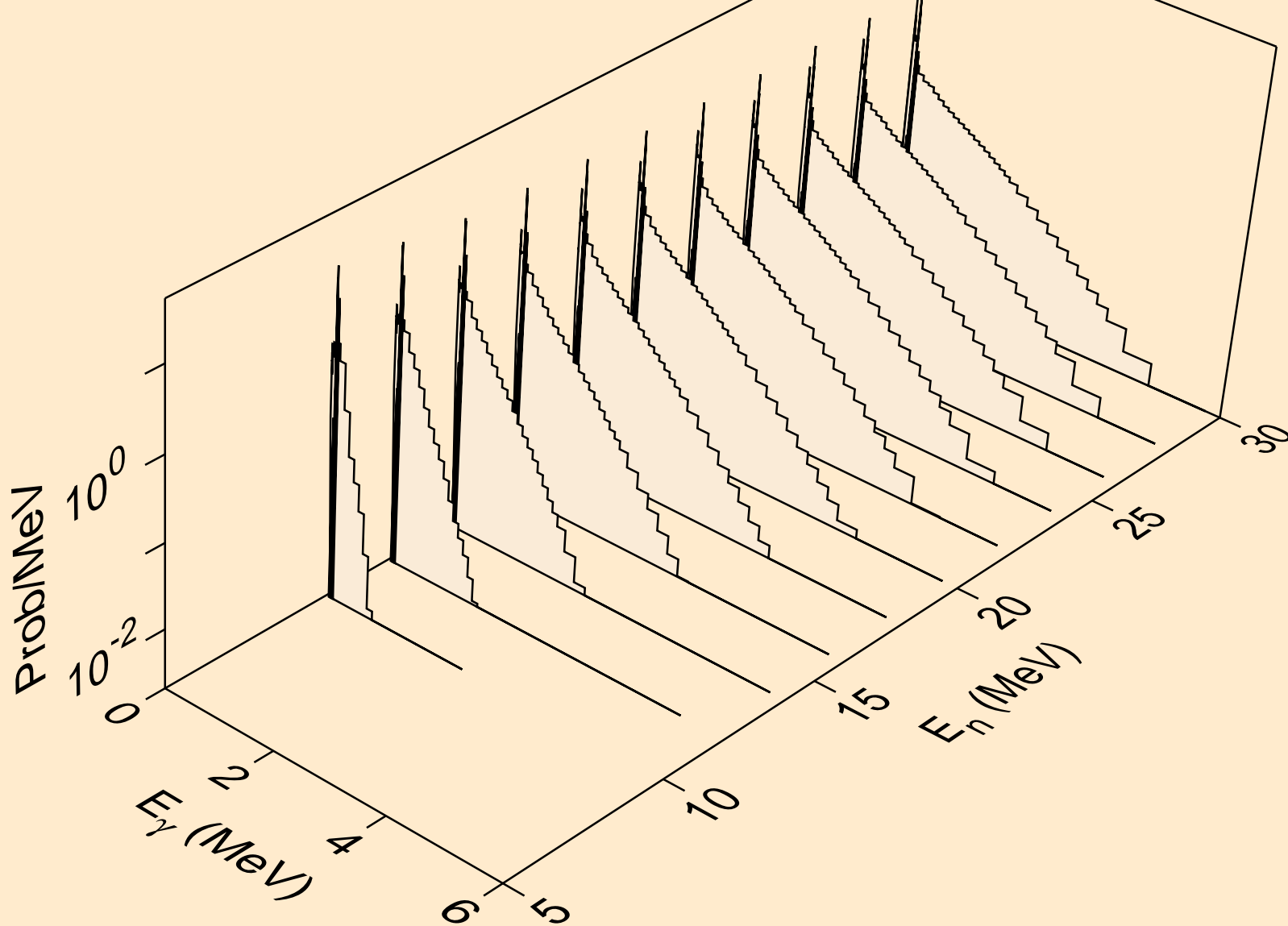

DY159 NEUTRON ACER TENDL-2019 LIBRARY; T=293.16K  
Photon emission for (n,n\*)2a

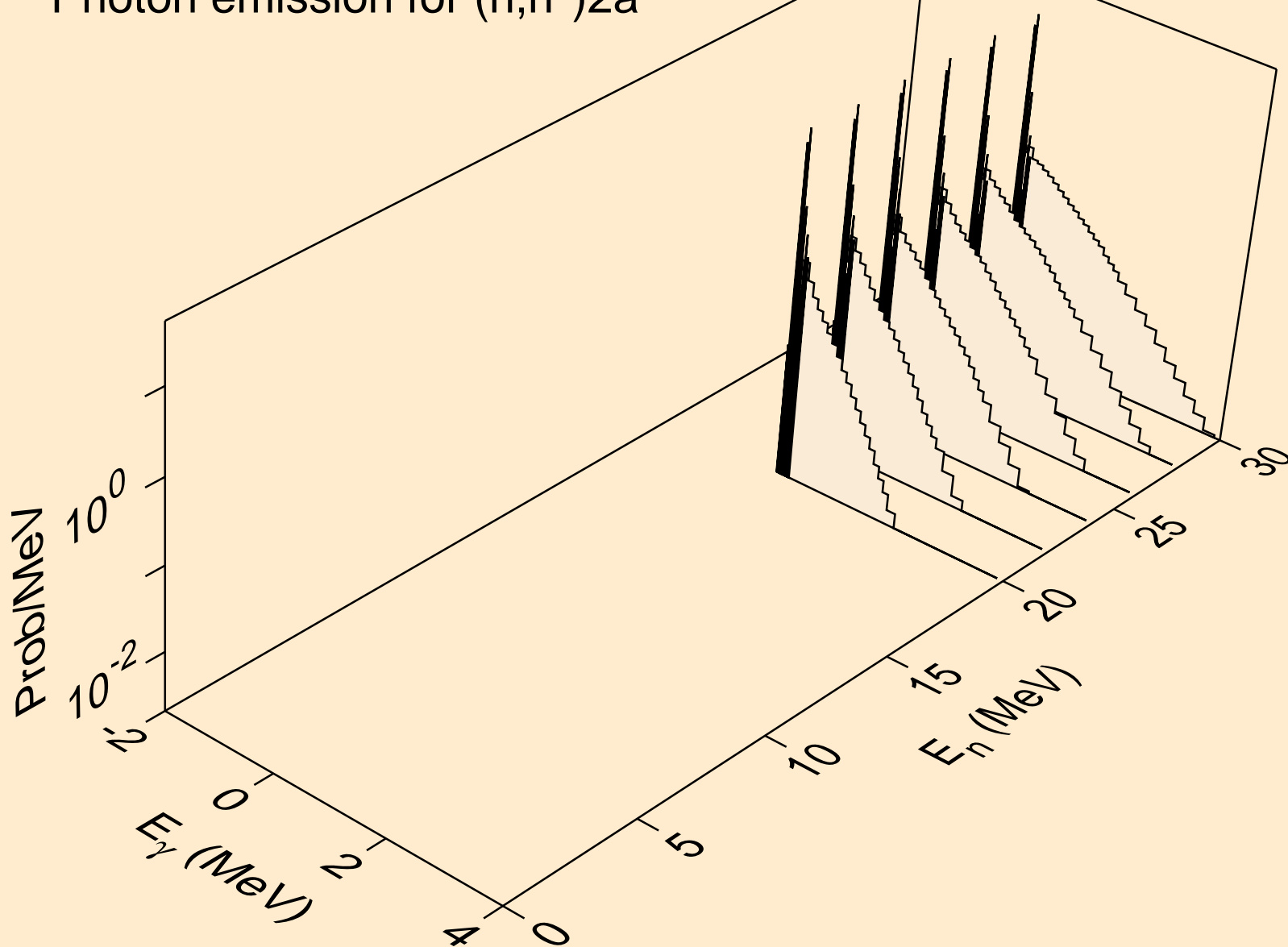

DY159 NEUTRON ACER TENDL-2019 LIBRARY; T=293.16K  
Photon emission for (n,n\*)d

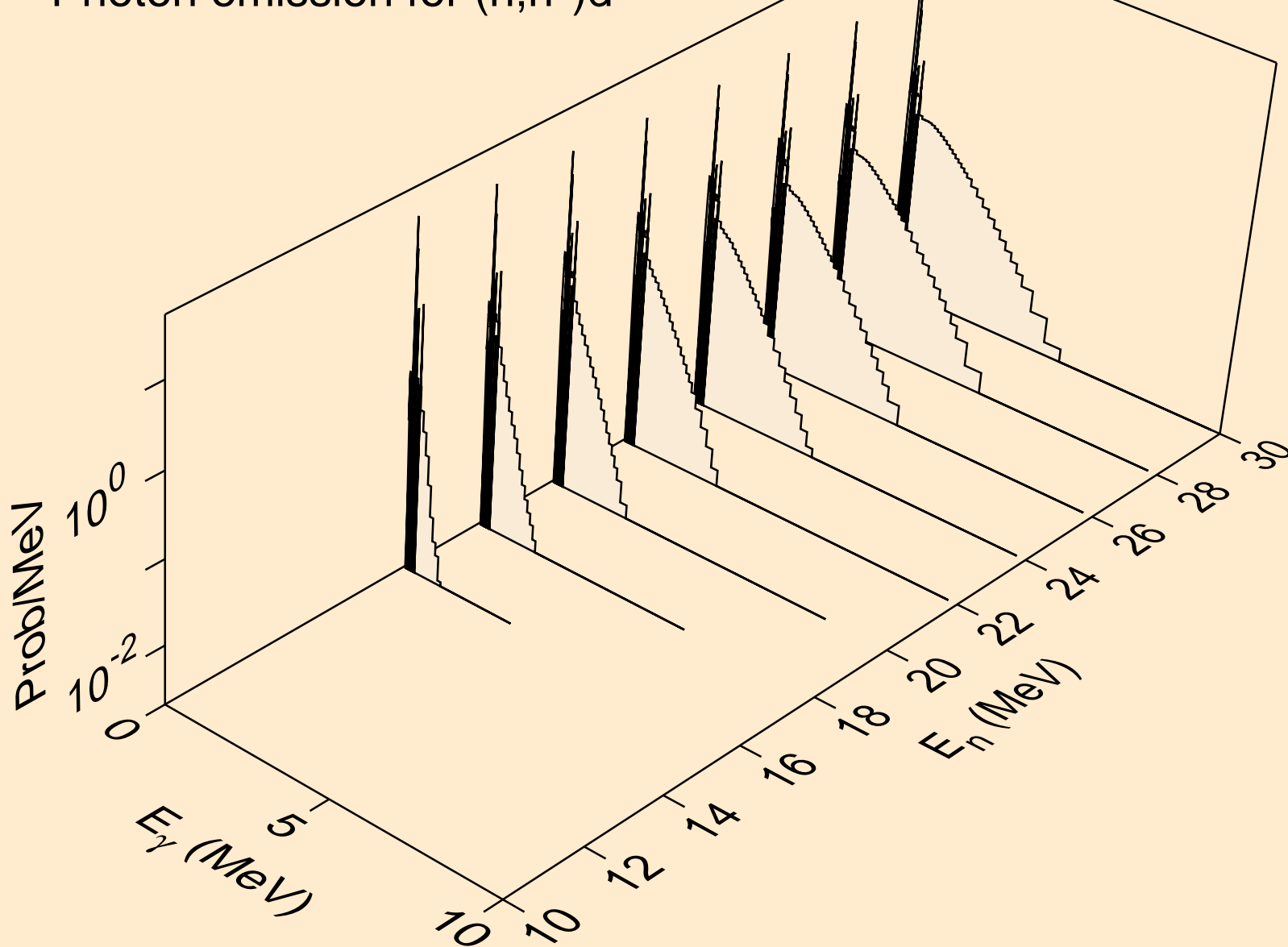



DY159 NEUTRON ACER TENDL-2019 LIBRARY; T=293.16K  
Photon emission for (n,n\*)t

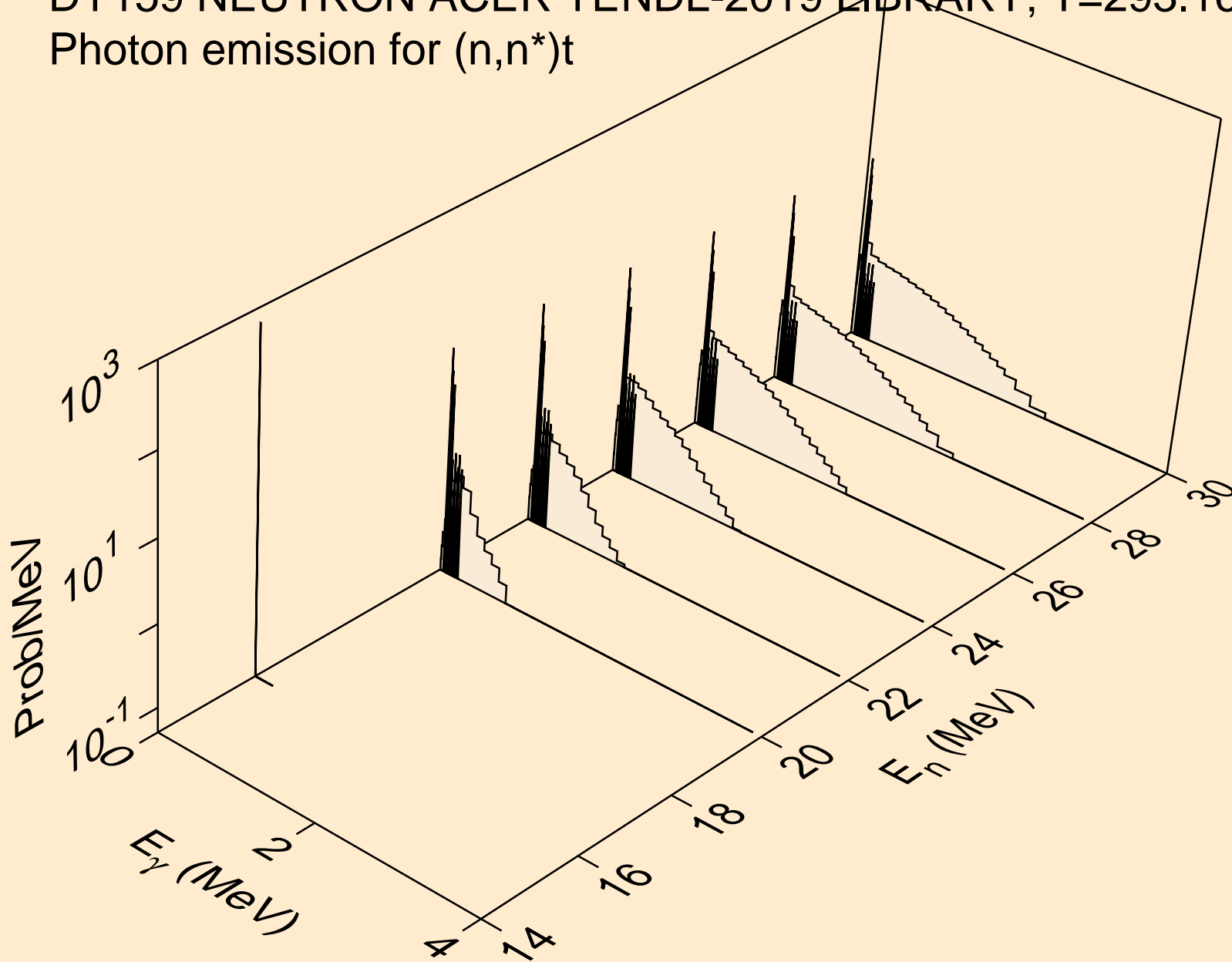

DY159 NEUTRON ACER TENDL-2019 LIBRARY; T=293.16K  
Photon emission for (n,n\*)he3

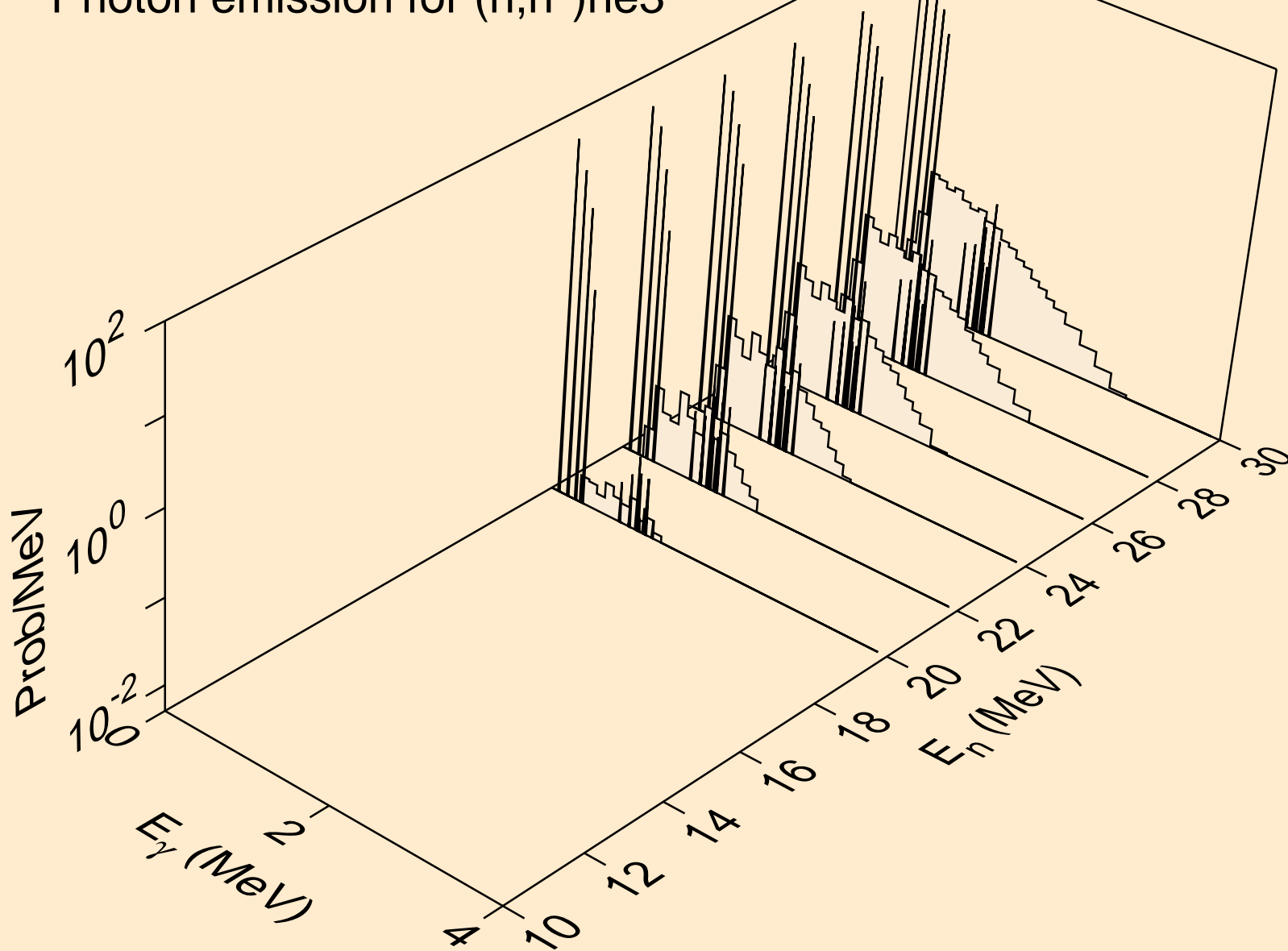

DY159 NEUTRON ACER TENDL-2019 LIBRARY; T=293.16K  
Photon emission for (n,4n)

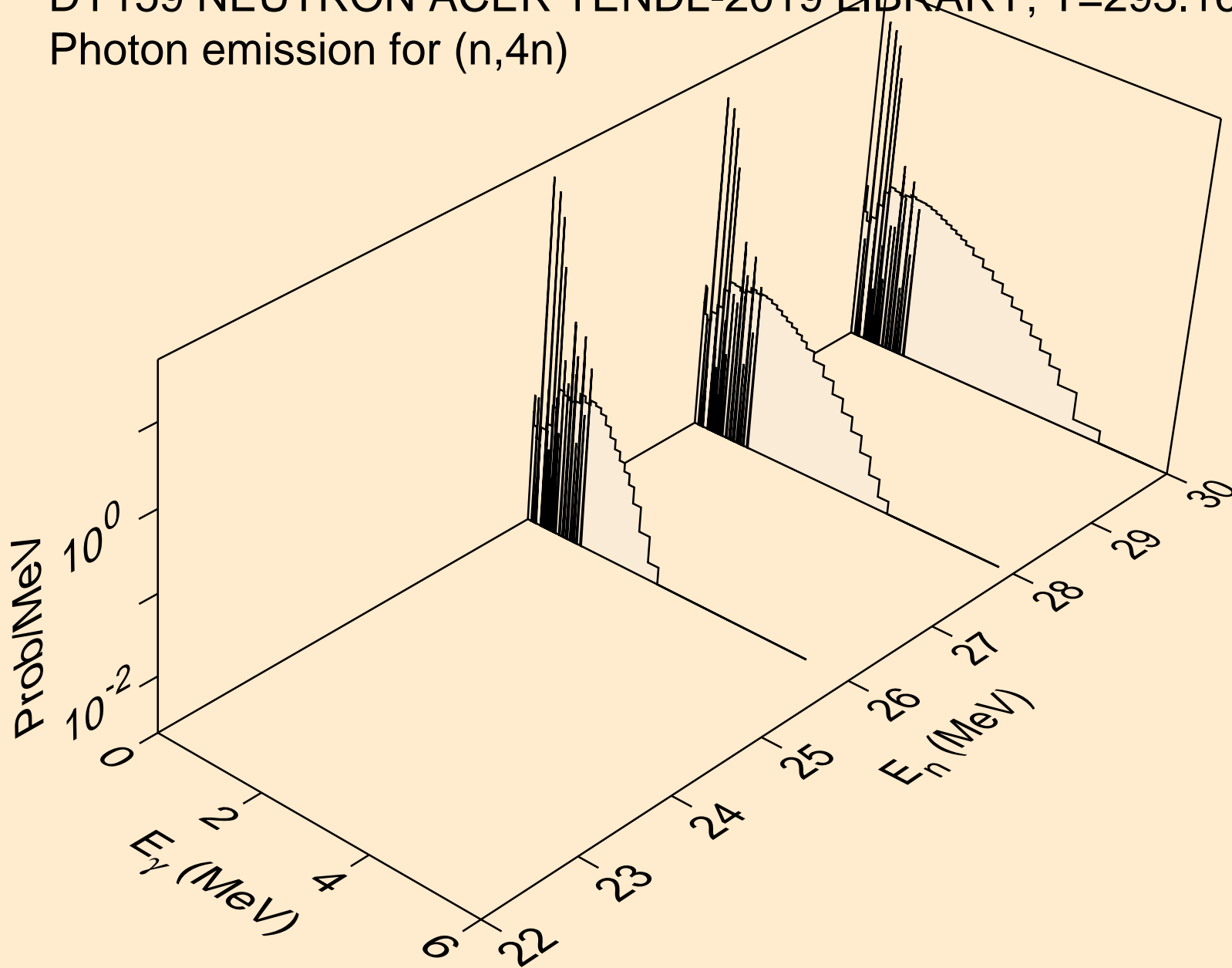

DY159 NEUTRON ACER TENDL-2019 LIBRARY; T=293.16K  
Photon emission for (n,2np)

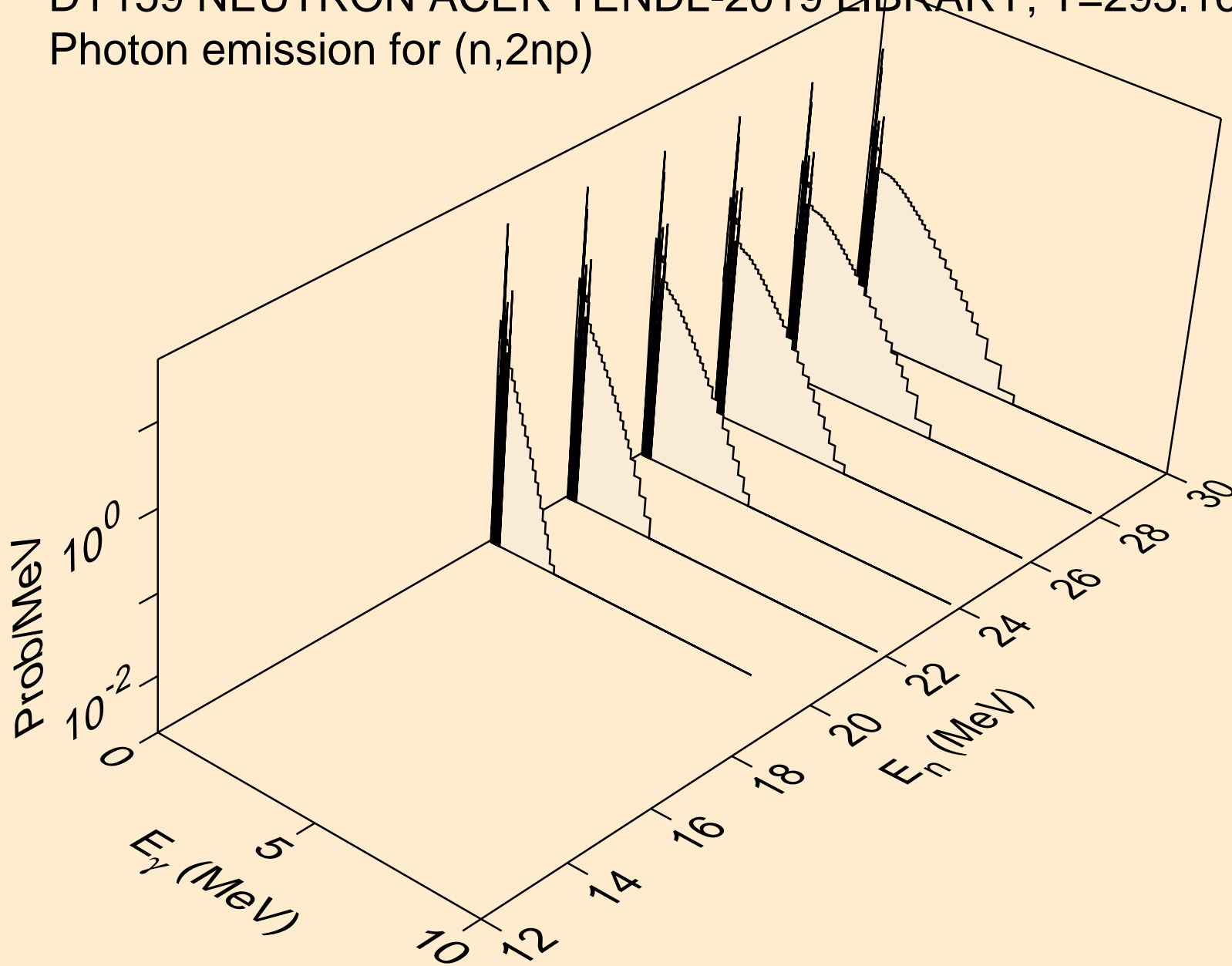

DY159 NEUTRON ACER TENDL-2019 LIBRARY; T=293.16K  
Photon emission for (n,3np)

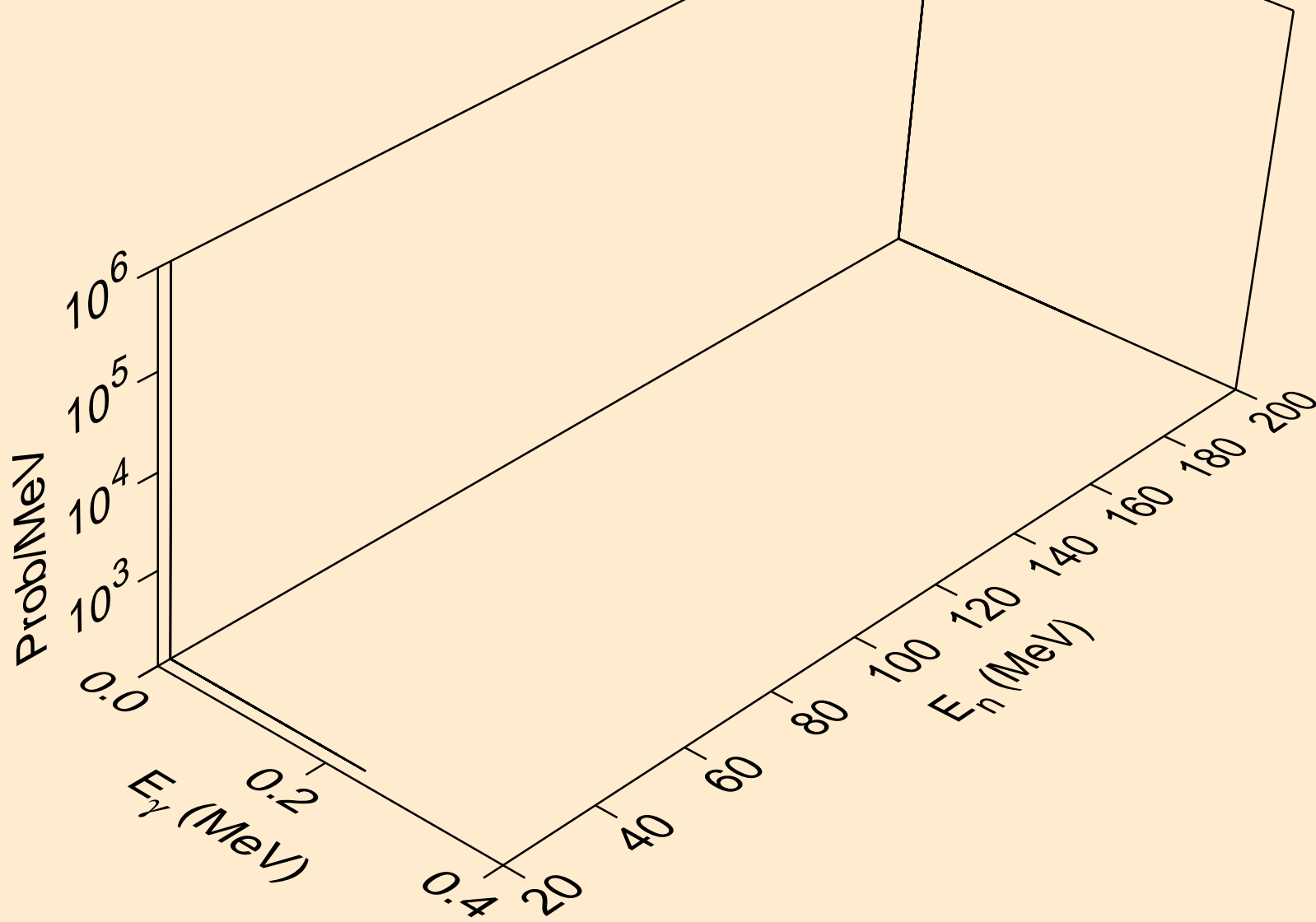

DY159 NEUTRON ACER TENDL-2019 LIBRARY; T=293.16K  
Photon emission for (n,2np)

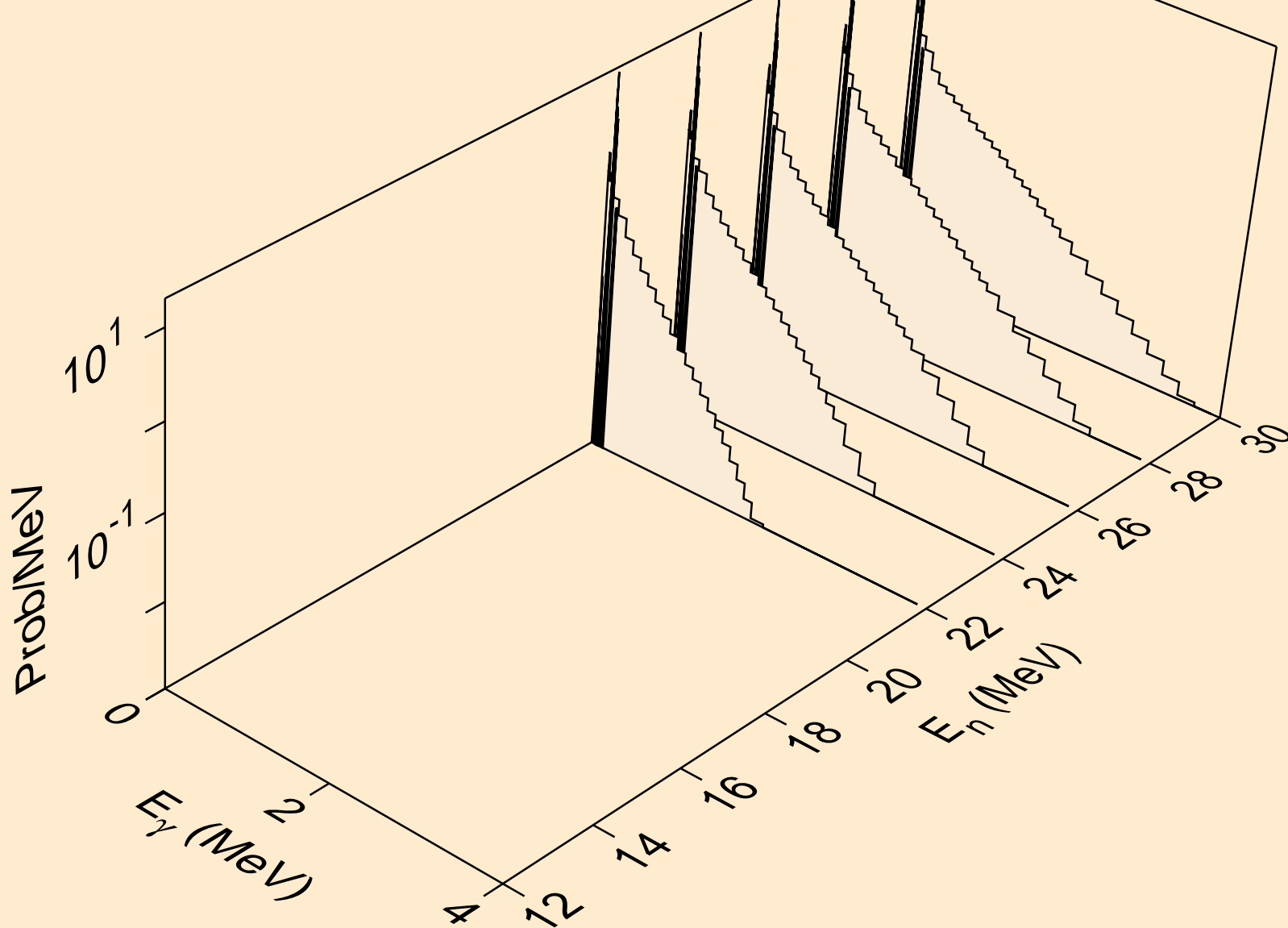

DY159 NEUTRON ACER TENDL-2019 LIBRARY; T=293.16K  
Photon emission for (n,npa)

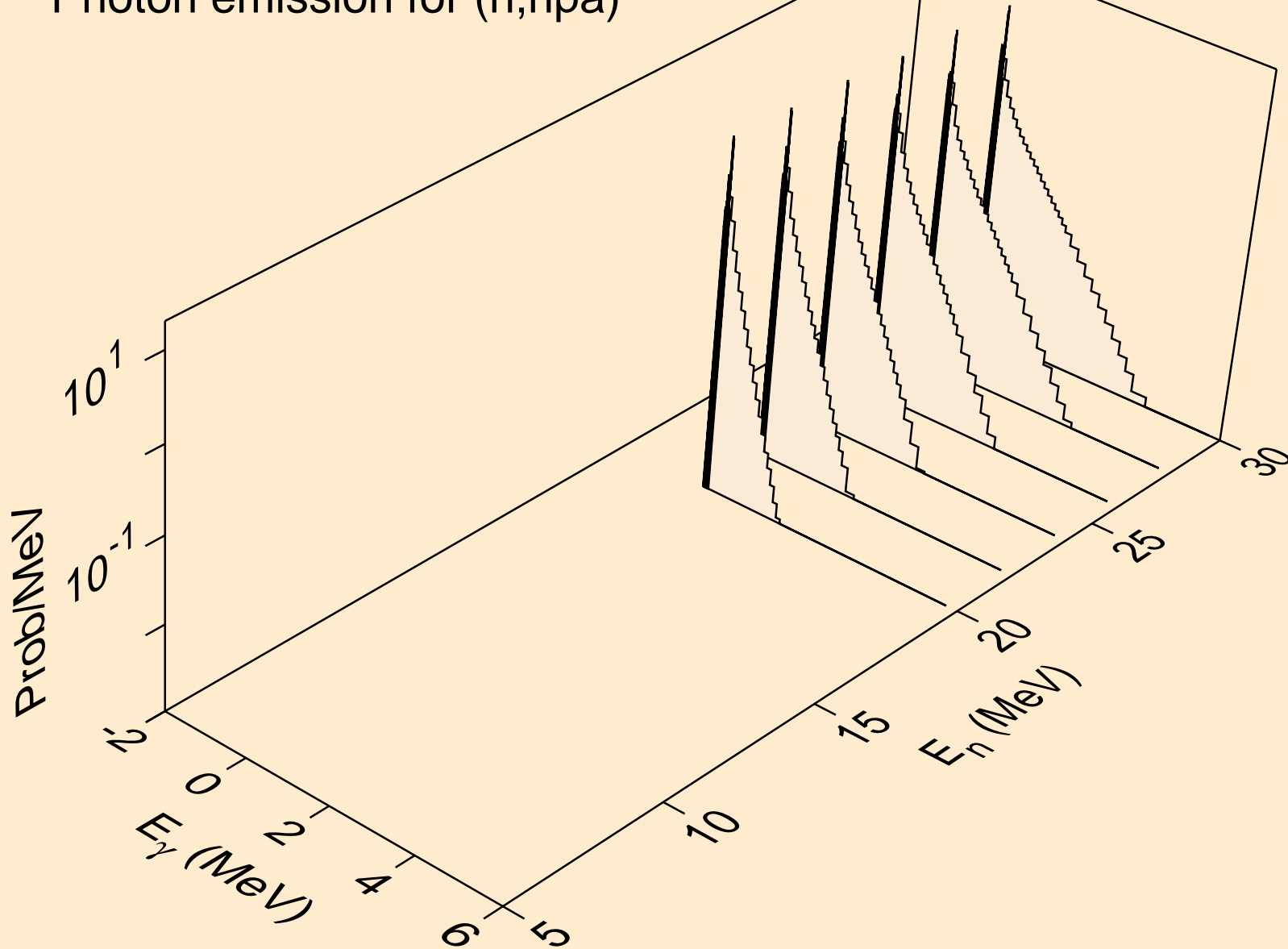

DY159 NEUTRON ACER TENDL-2019 LIBRARY; T=293.16K  
Photon emission for (n,n\*c)

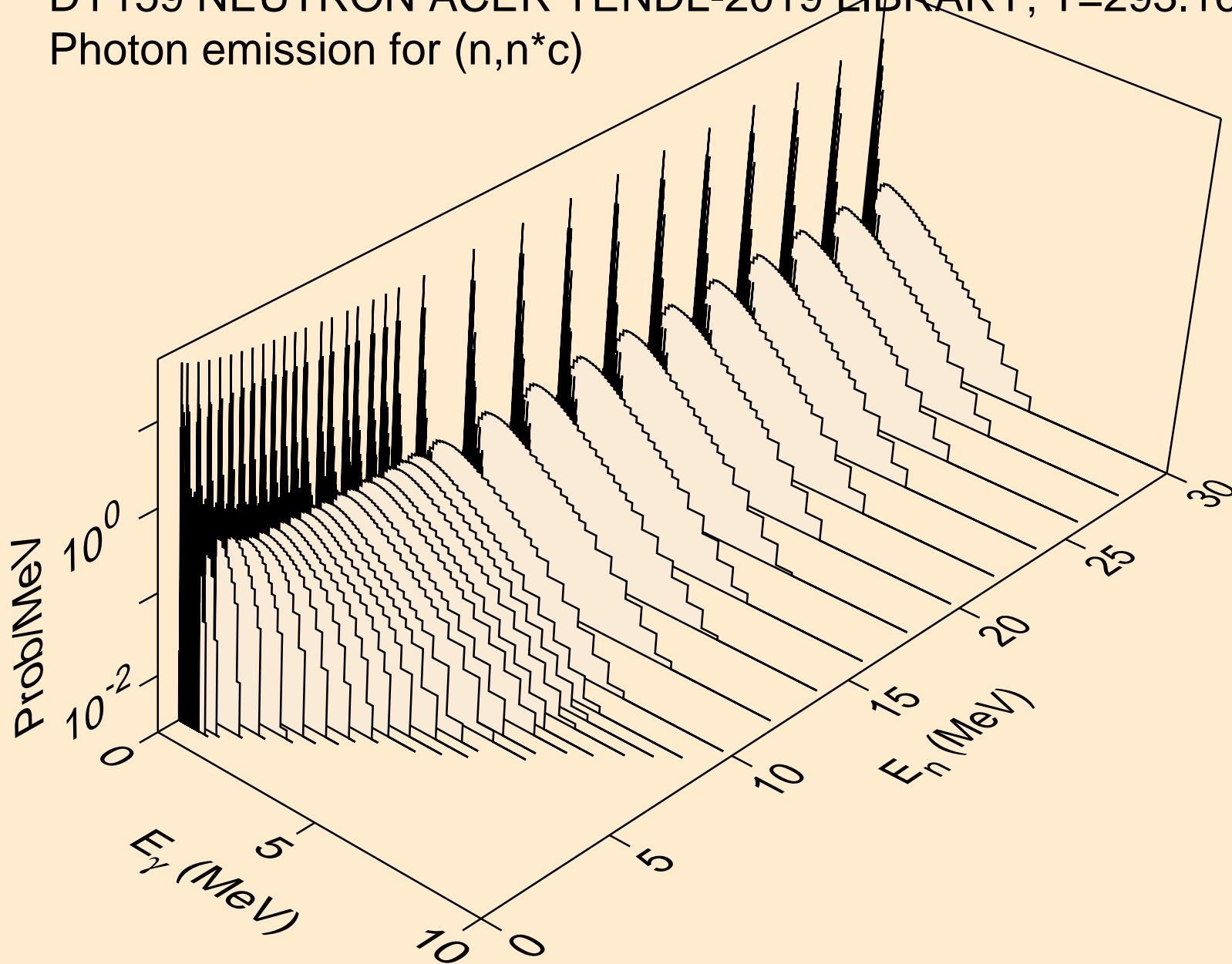



DY159 NEUTRON ACER TENDL-2019 LIBRARY; T=293.16K  
Photon emission for (n,gma)

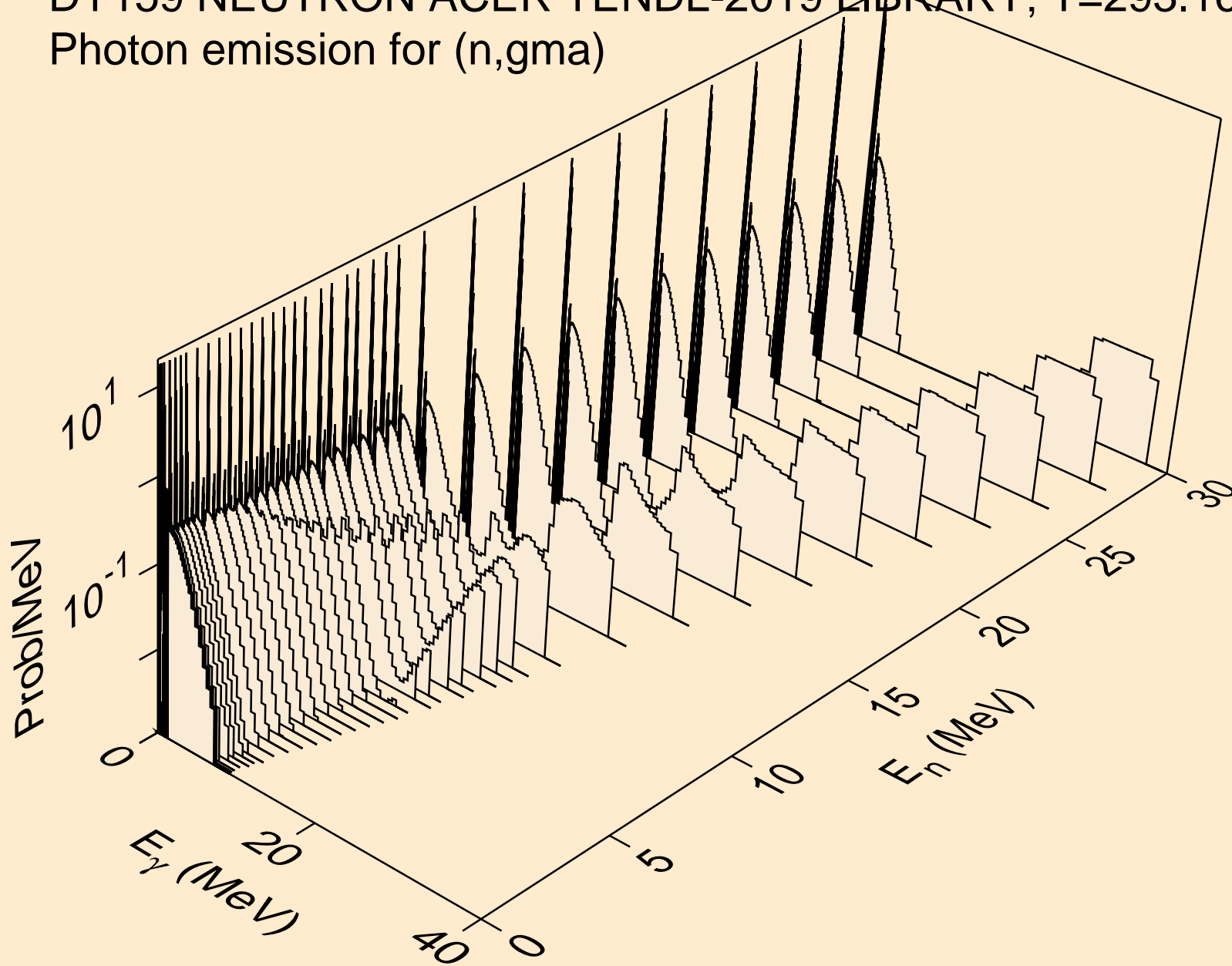

DY159 NEUTRON ACER TENDL-2019 LIBRARY; T=293.16K  
Photon emission for (n,p)

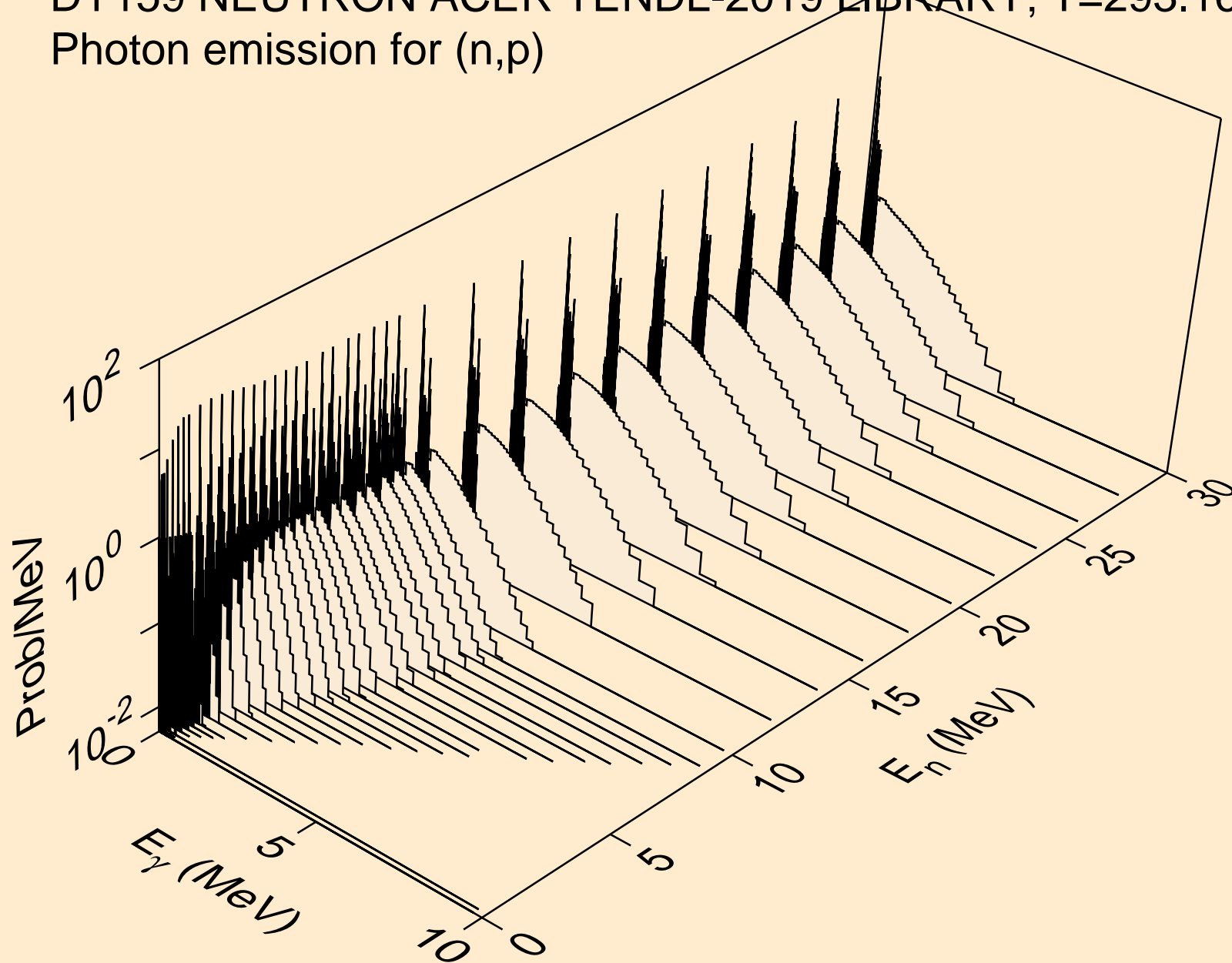

DY159 NEUTRON ACER TENDL-2019 LIBRARY; T=293.16K  
Photon emission for (n,d)

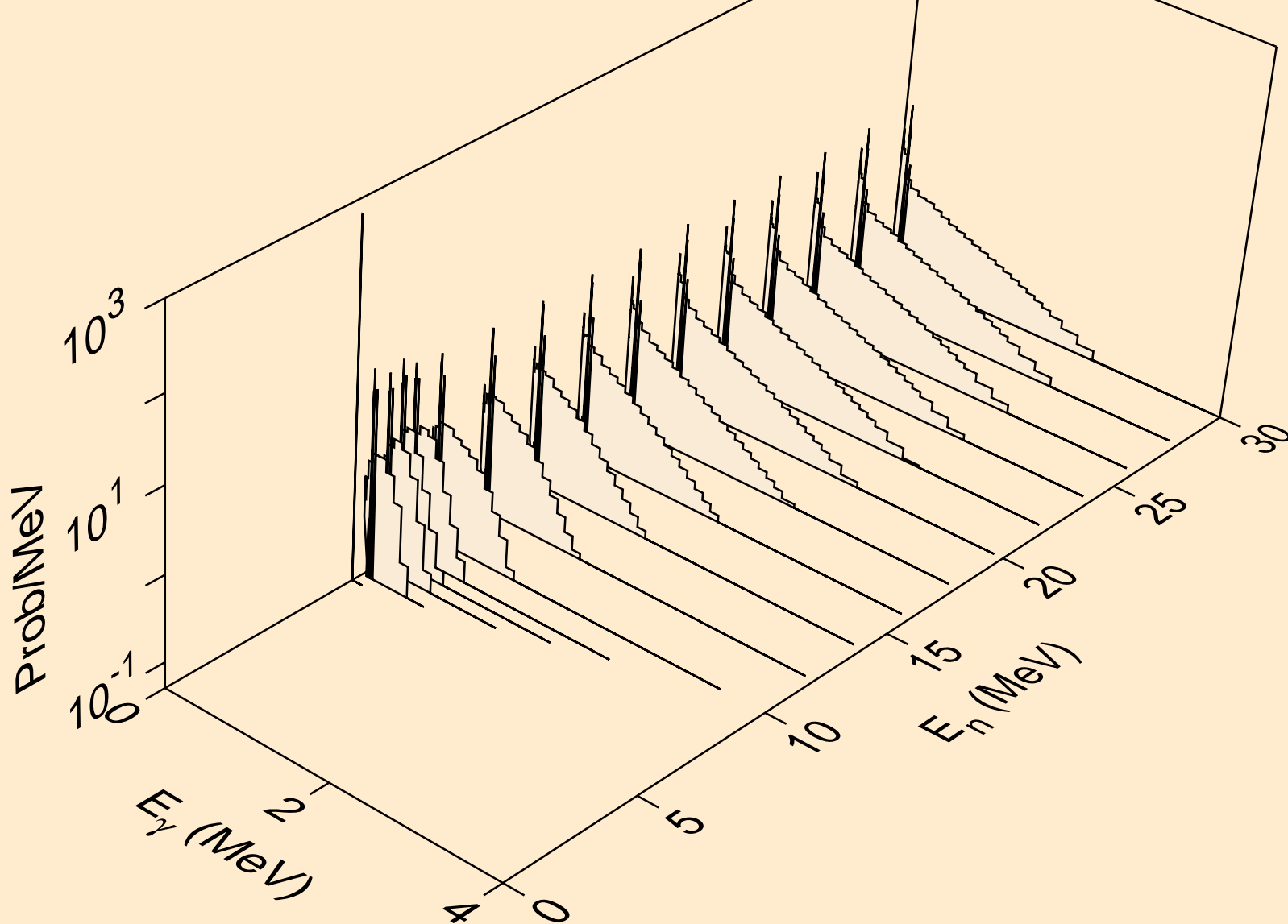

DY159 NEUTRON ACER TENDL-2019 LIBRARY; T=293.16K  
Photon emission for (n,t)

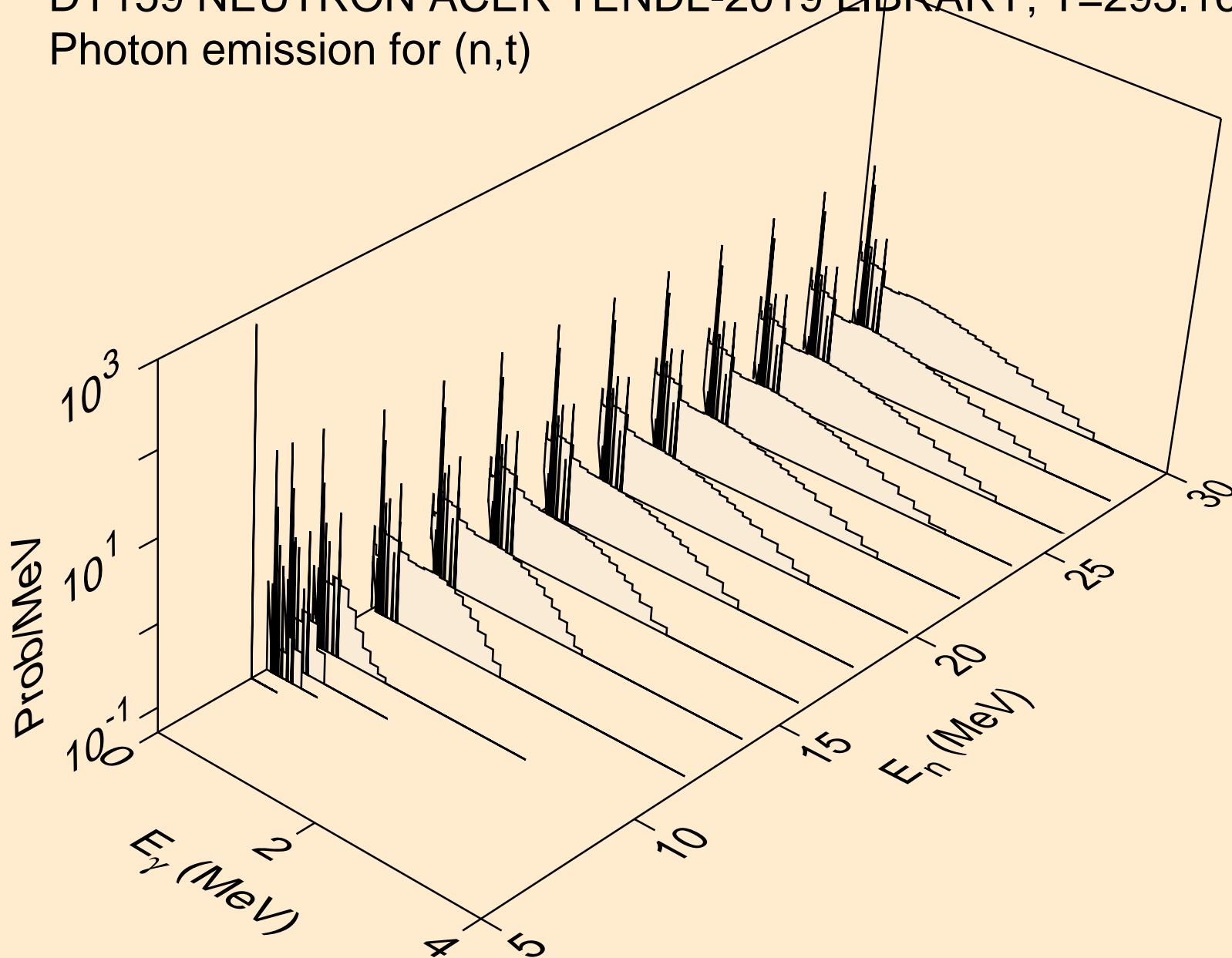

DY159 NEUTRON ACER TENDL-2019 LIBRARY; T=293.16K  
Photon emission for (n,he3)

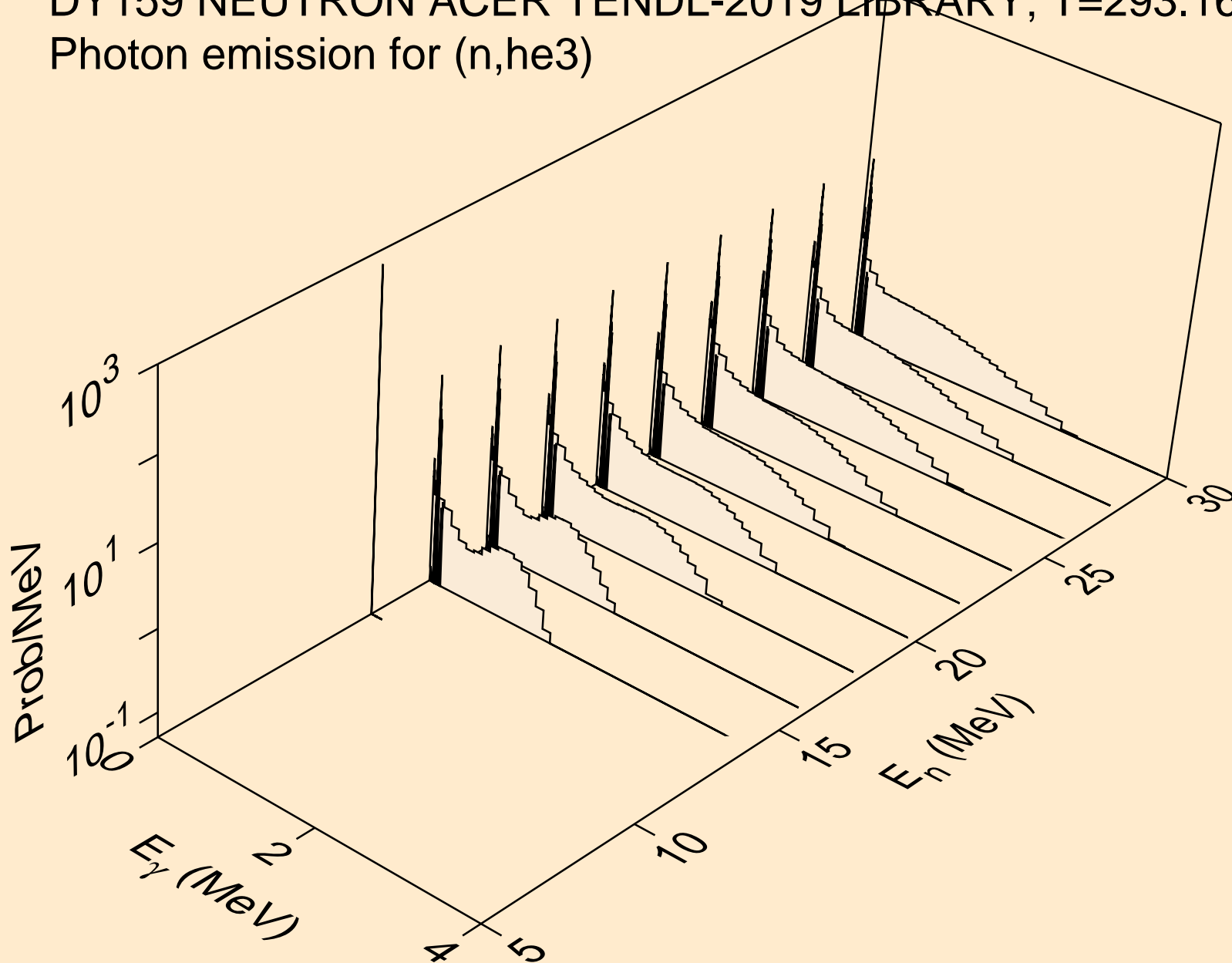

DY159 NEUTRON ACER TENDL-2019 LIBRARY; T=293.16K  
Photon emission for (n,a)

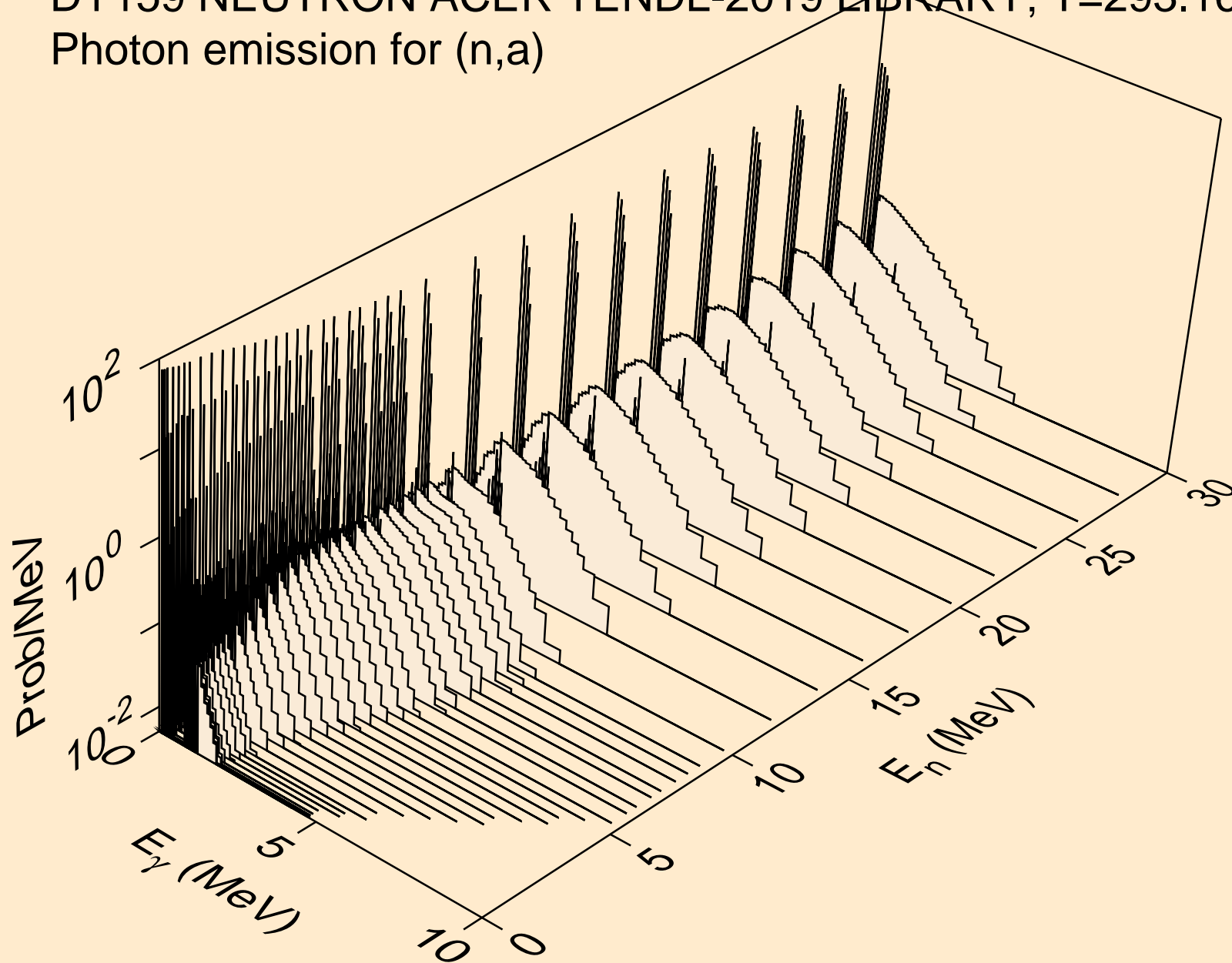

DY159 NEUTRON ACER TENDL-2019 LIBRARY; T=293.16K  
Photon emission for (n,2a)

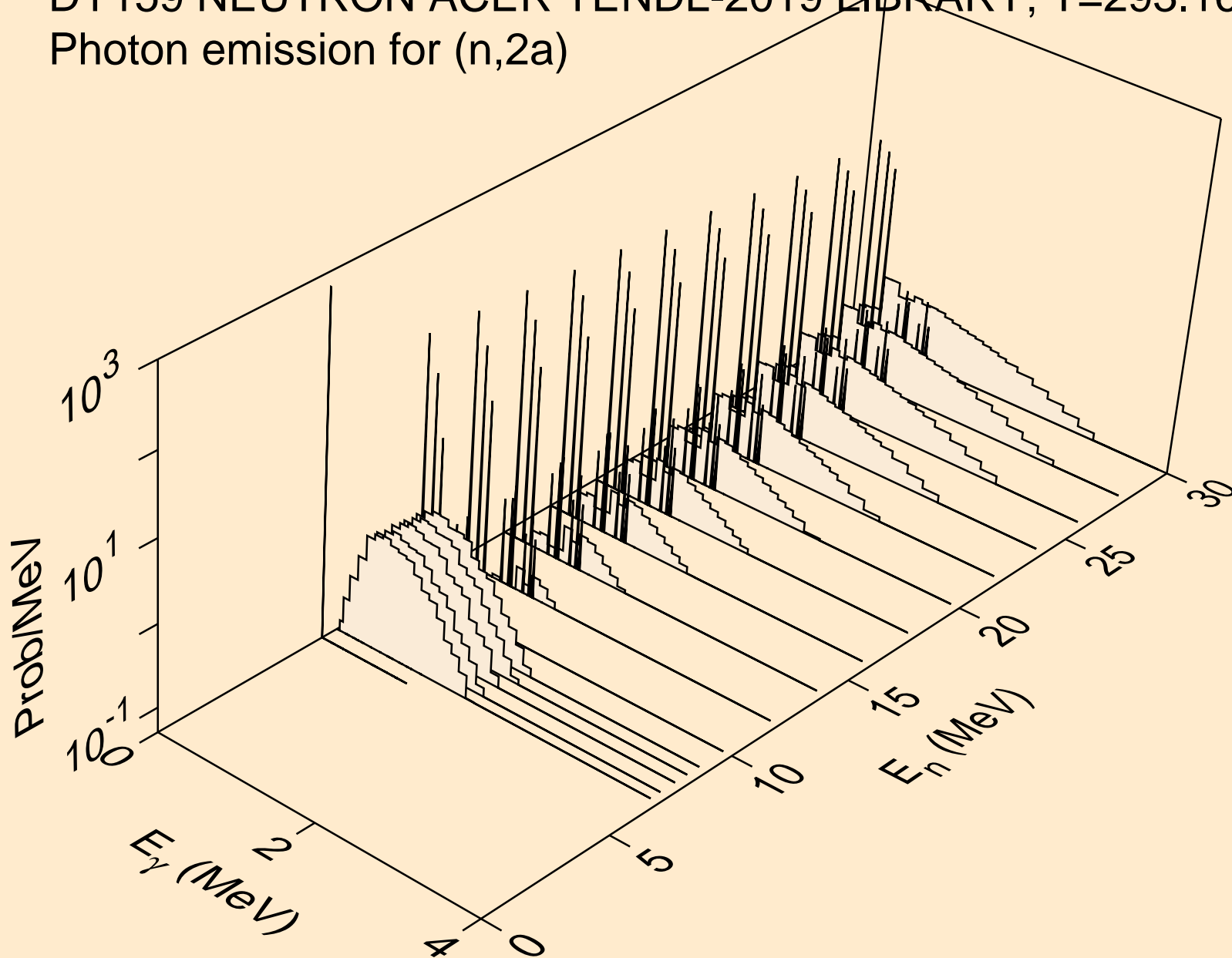

DY159 NEUTRON ACER TENDL-2019 LIBRARY; T=293.16K  
Photon emission for (n,2p)

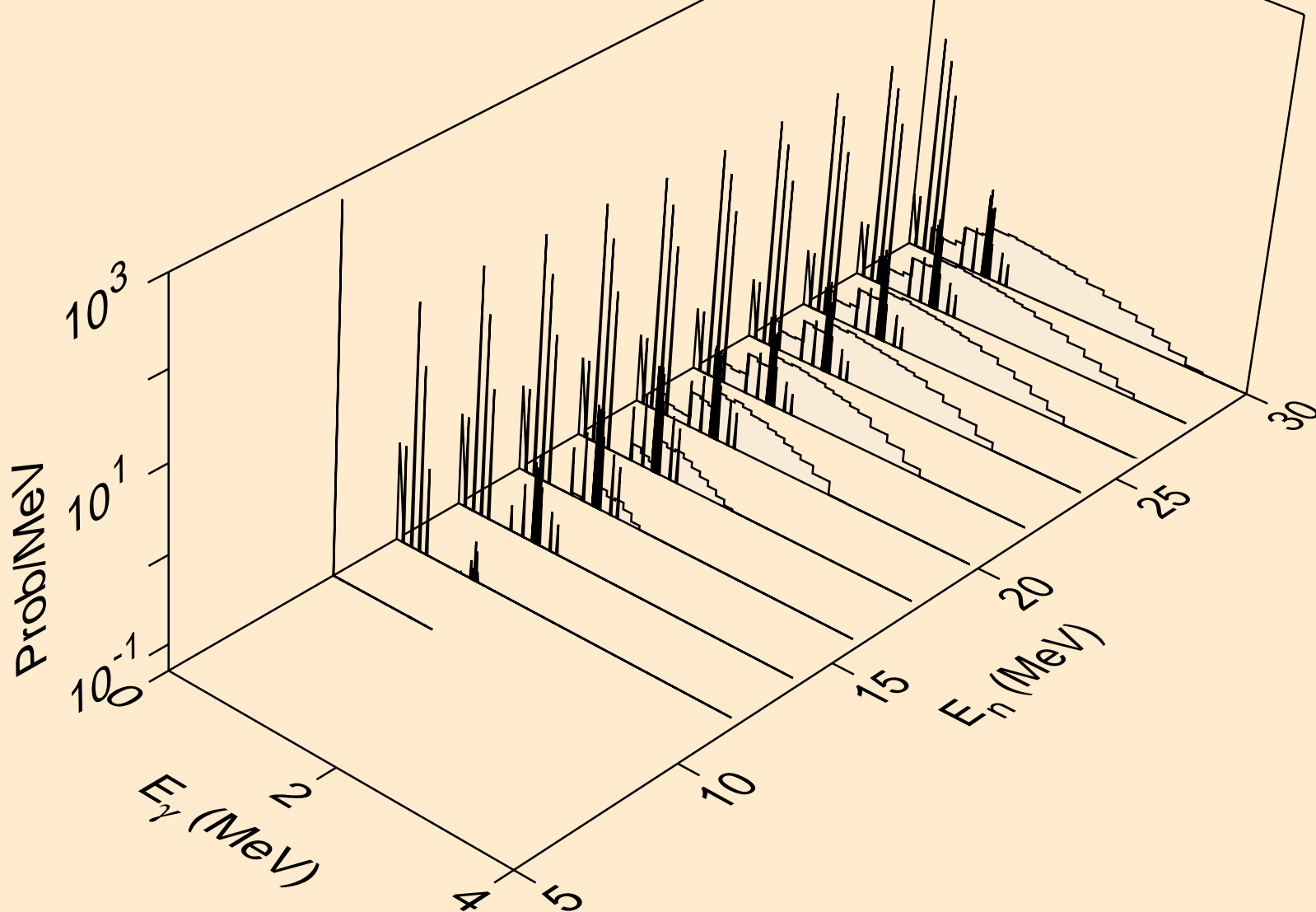



DY159 NEUTRON ACER TENDL-2019 LIBRARY; T=293.16K  
Photon emission for (n,p $\alpha$ )

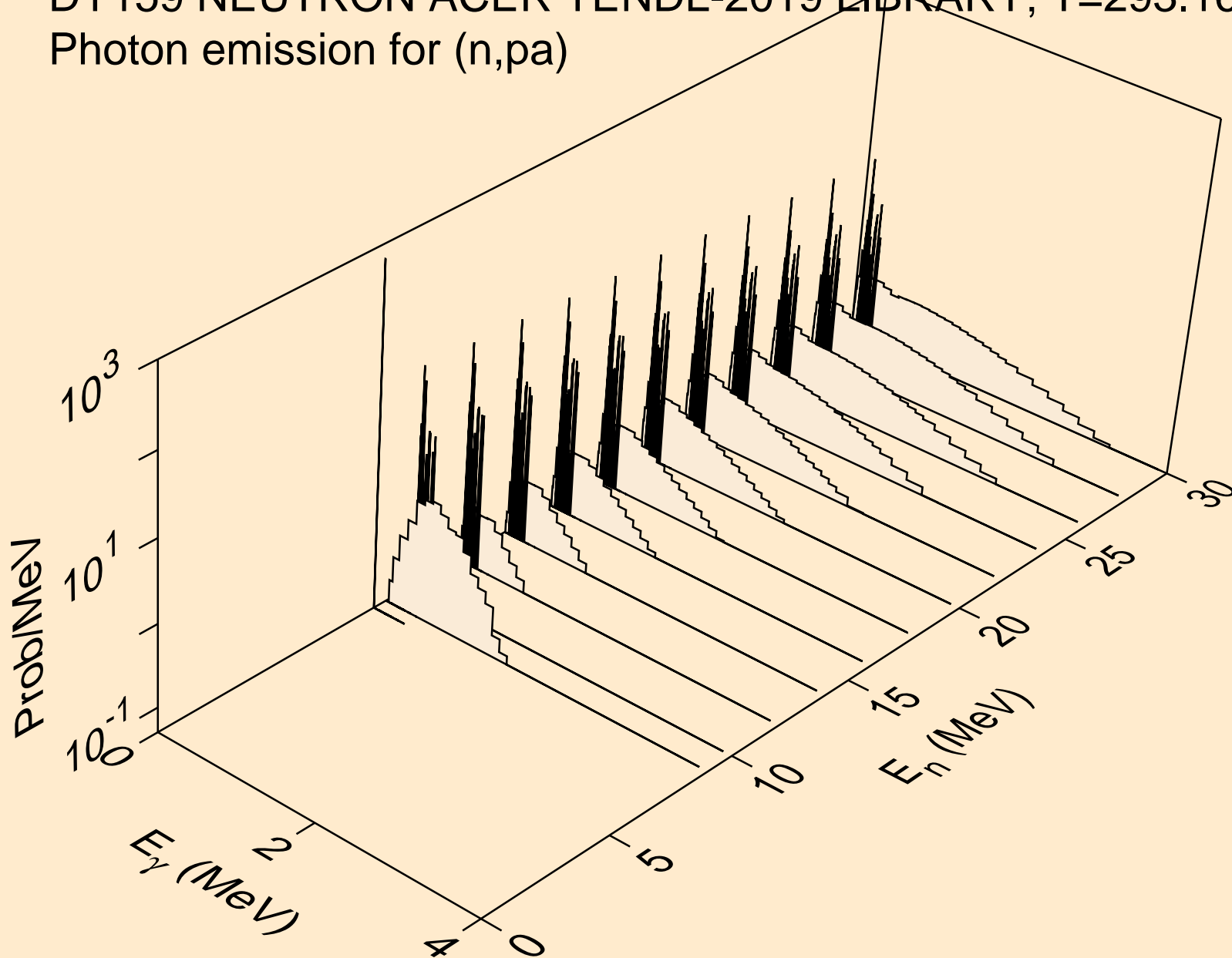

DY159 NEUTRON ACER TENDL-2019 LIBRARY; T=293.16K  
Photon emission for (n,pd)

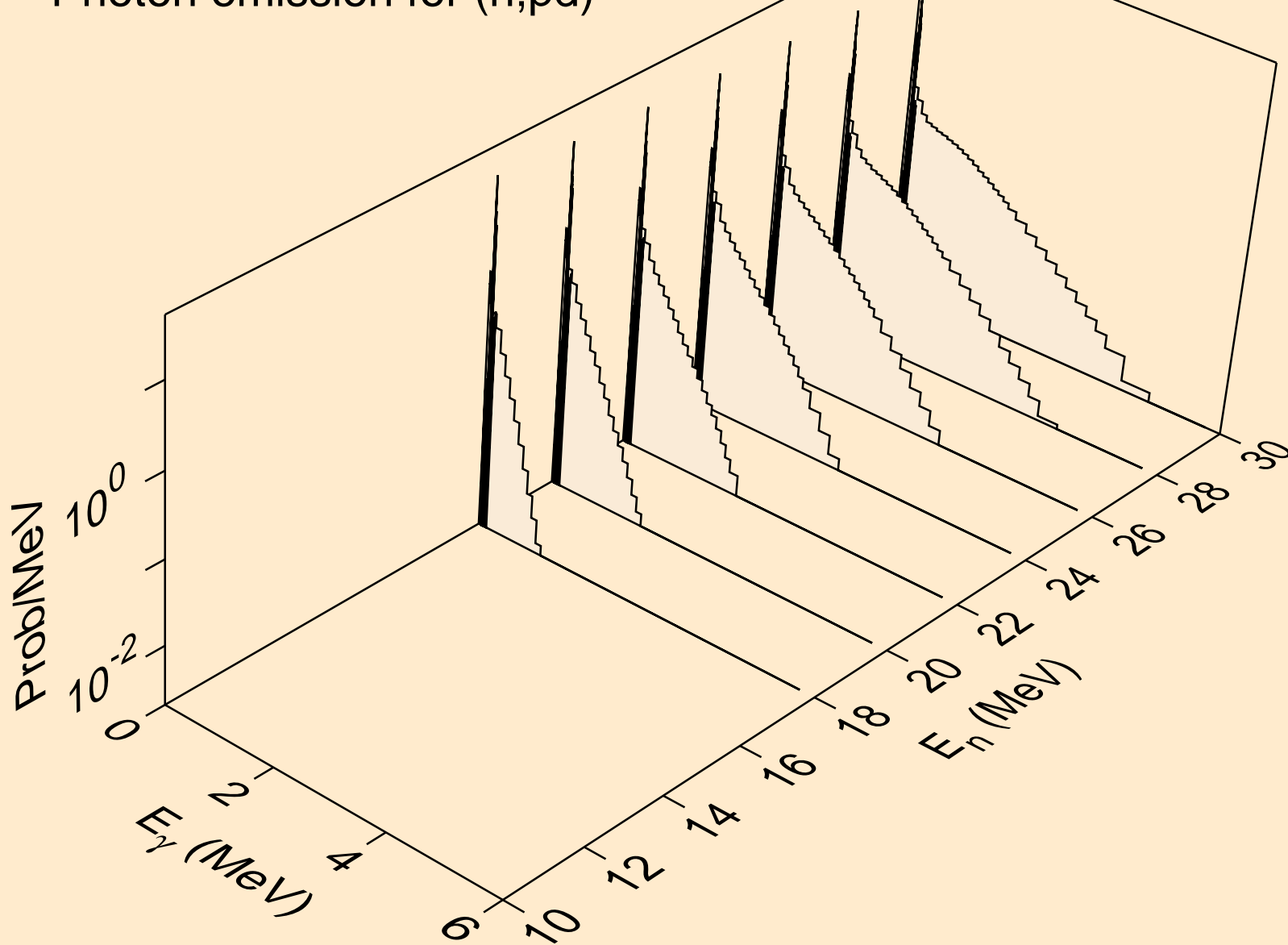

DY159 NEUTRON ACER TENDL-2019 LIBRARY; T=293.16K  
Photon emission for (n,pt)

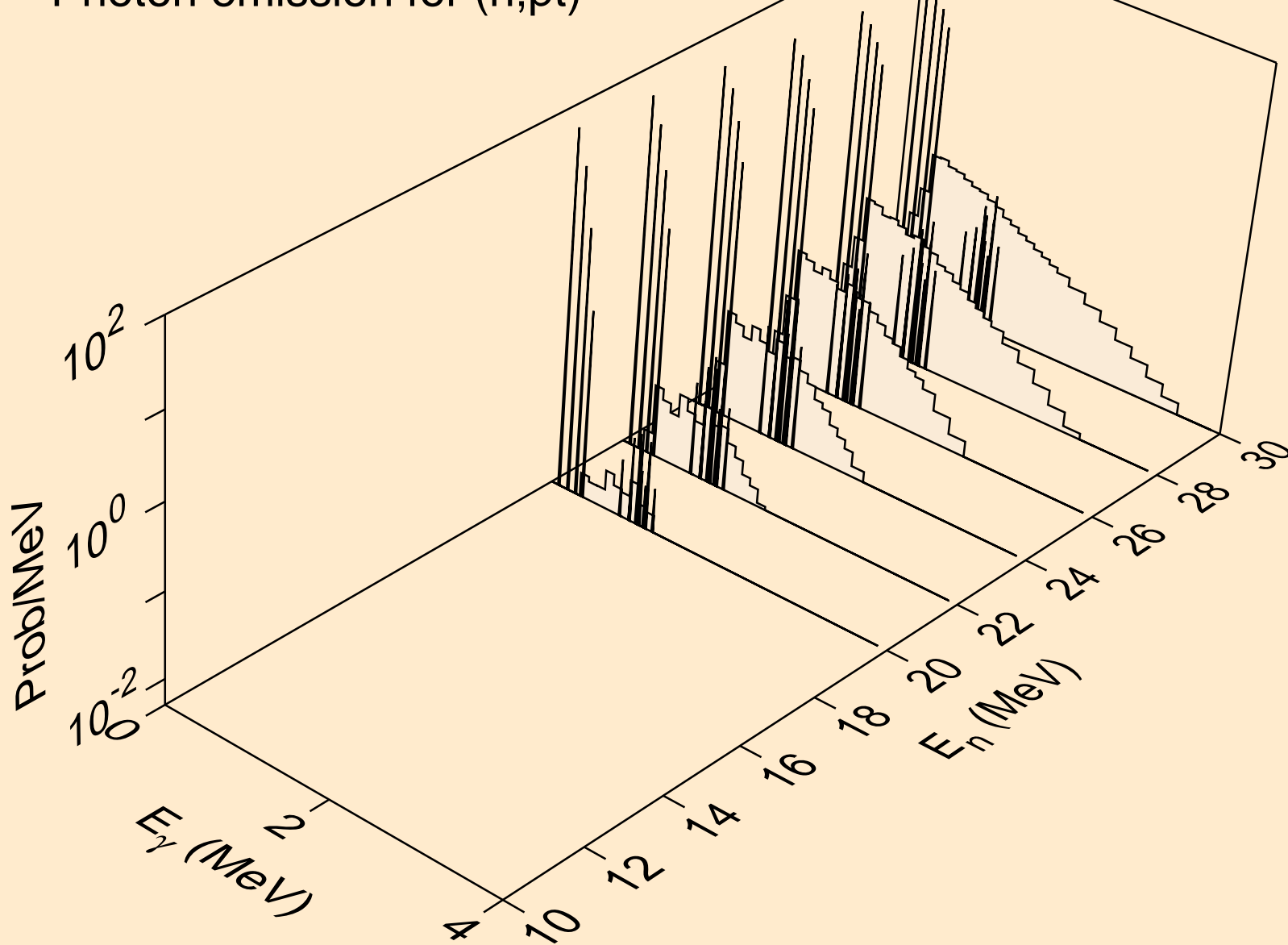

DY159 NEUTRON ACER TENDL-2019 LIBRARY; T=293.16K  
Photon emission for (n,da)

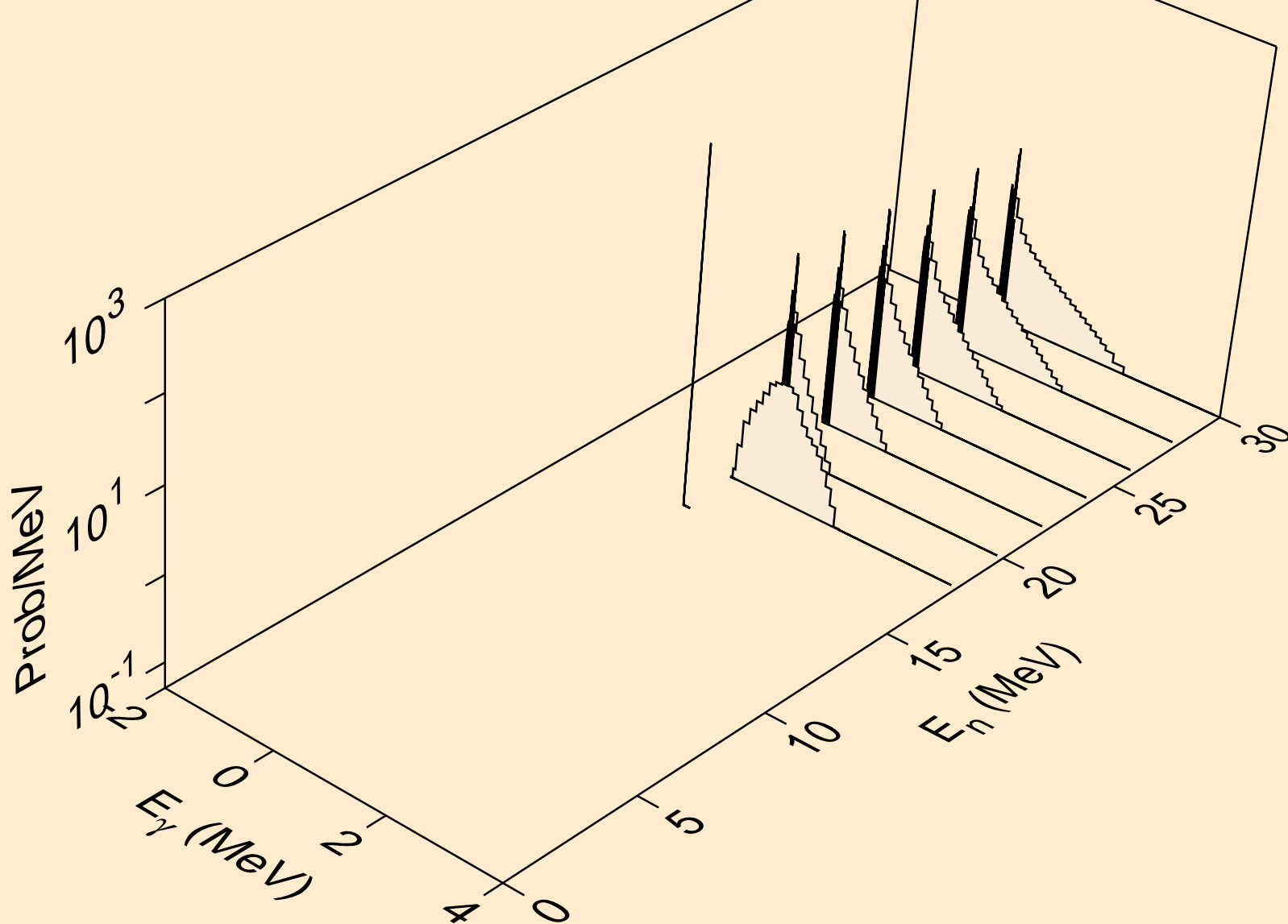

DY159 NEUTRON ACER TENDL-2019 LIBRARY; T=293.16K  
thermal capture photon spectrum

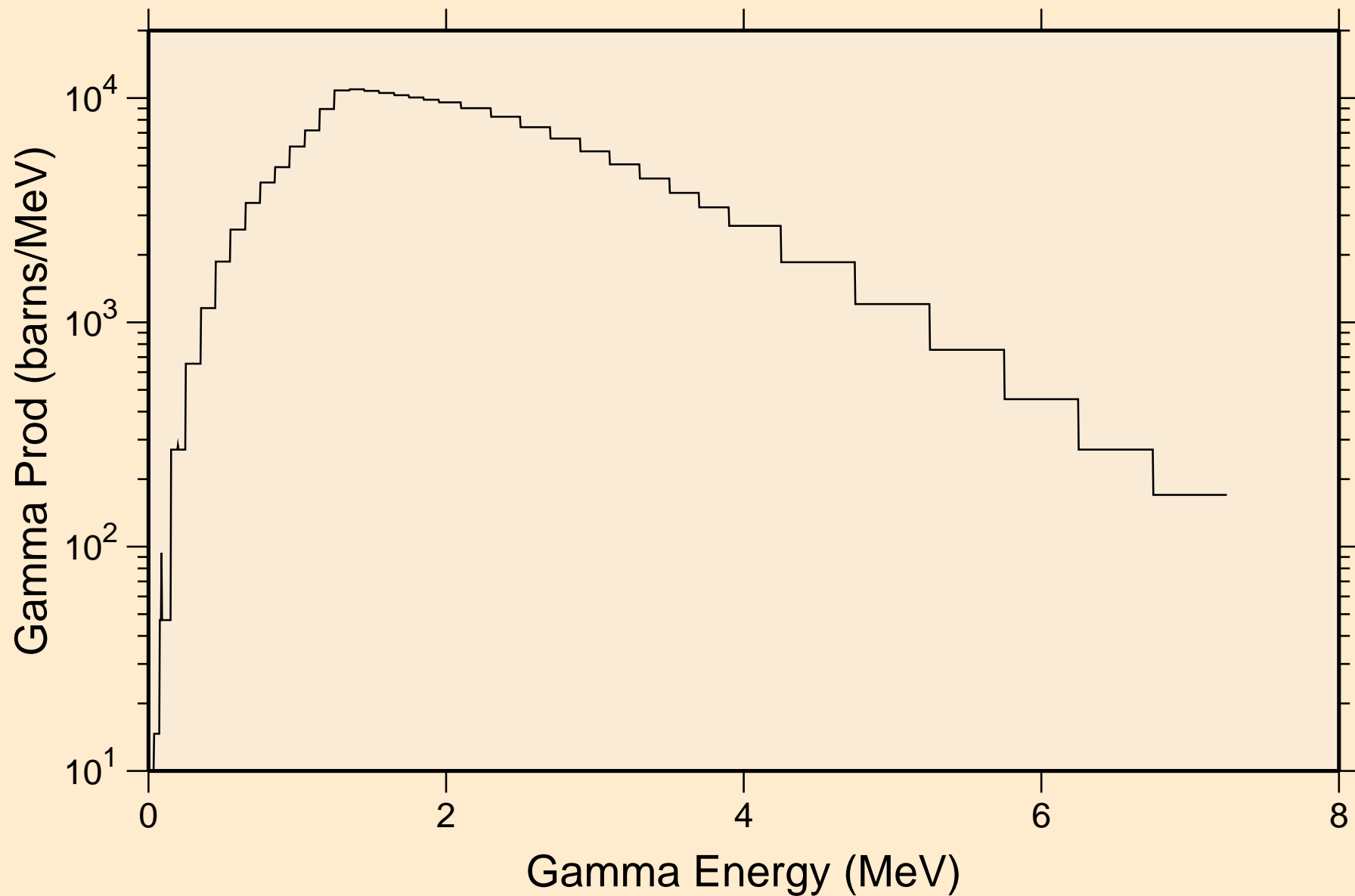

DY159 NEUTRON ACER TENDL-2019 LIBRARY; T=293.16K  
14 MeV photon spectrum

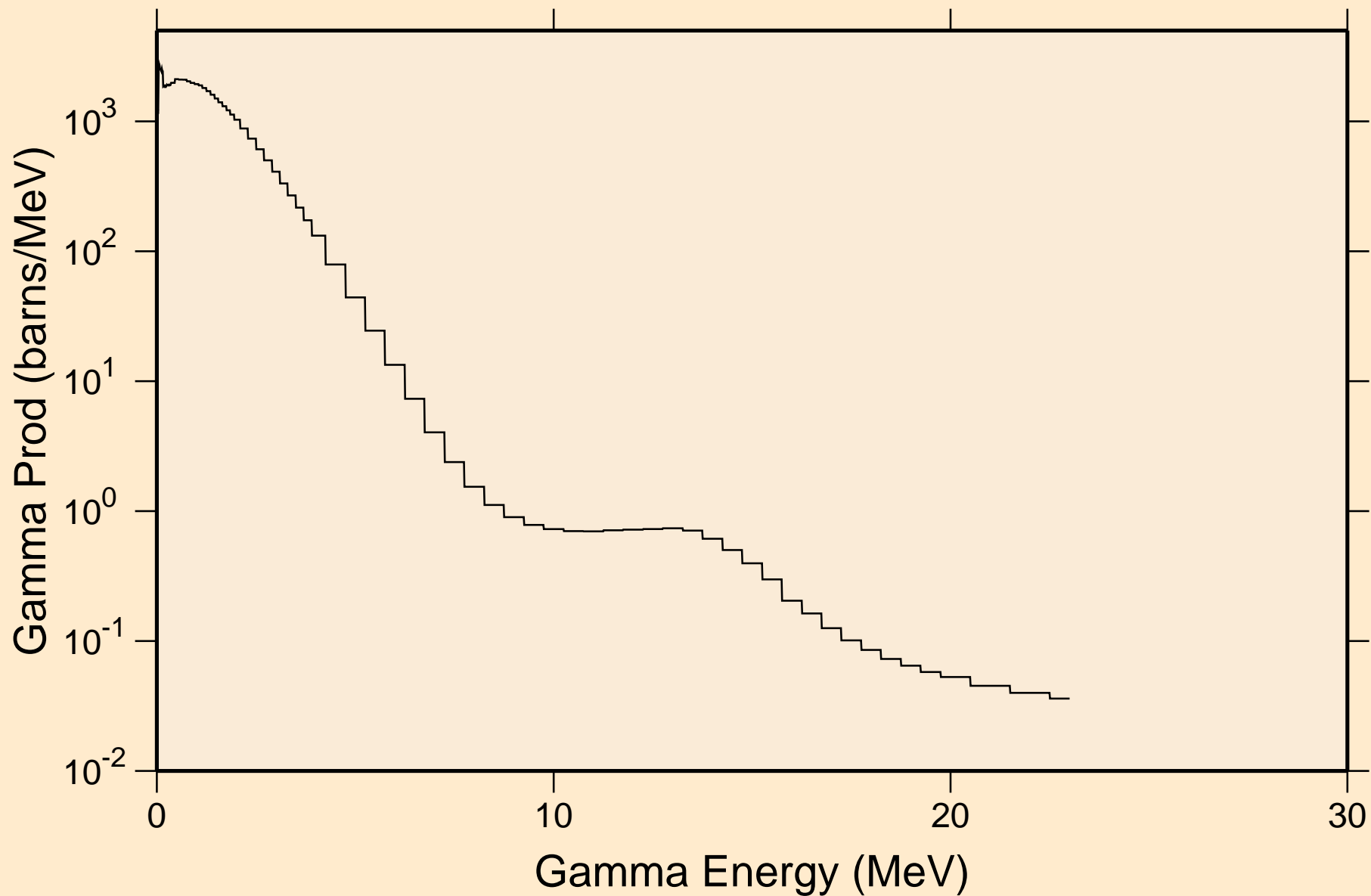

DY159 NEUTRON ACER TENDL-2019 LIBRARY; T=293.16K  
Particle heating contributions

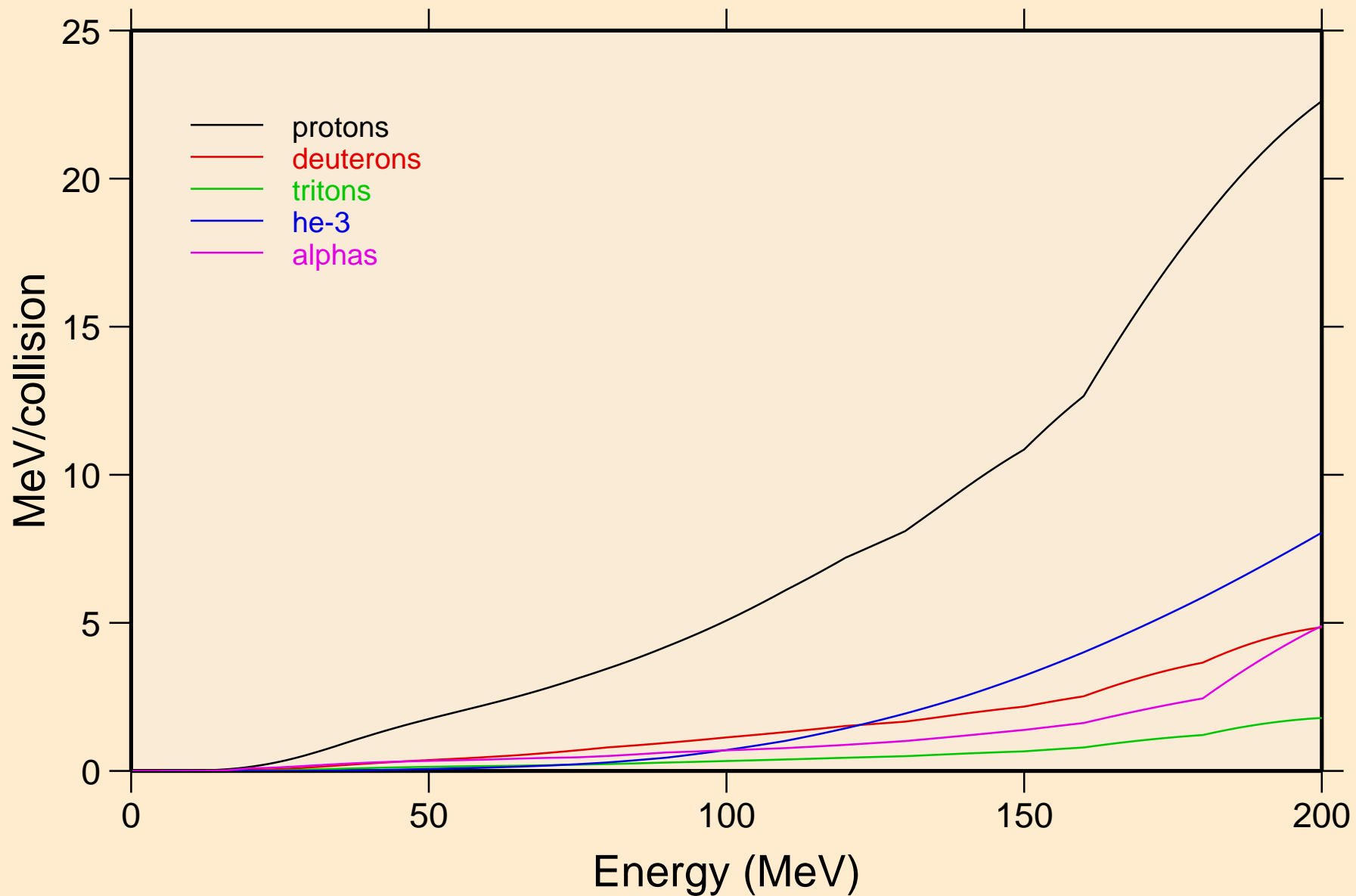

DY159 NEUTRON ACER TENDL-2019 LIBRARY; T=293.16K  
Recoil Heating

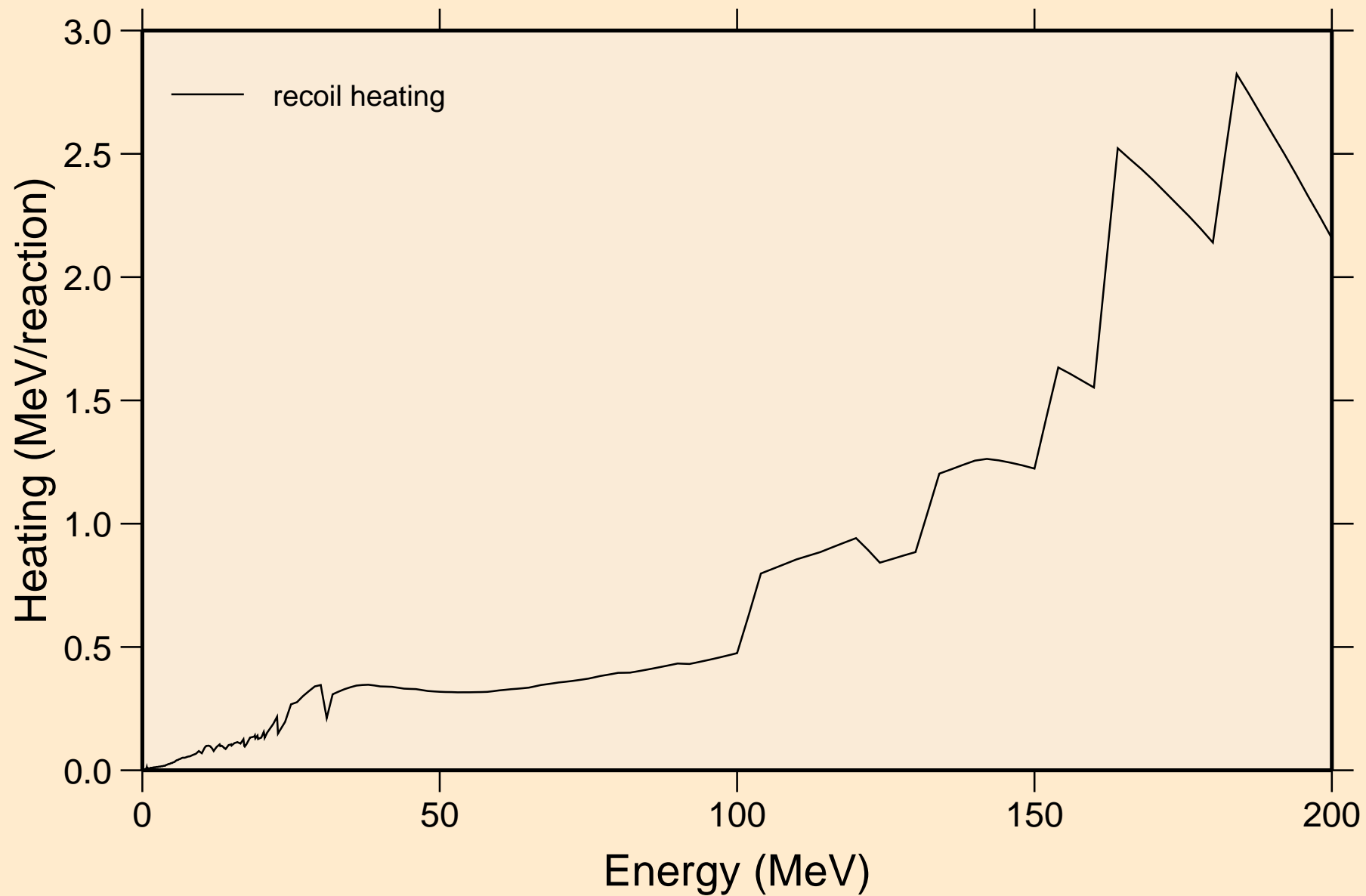



DY159 NEUTRON ACER TENDL-2019 LIBRARY; T=293.16K  
Particle production cross sections

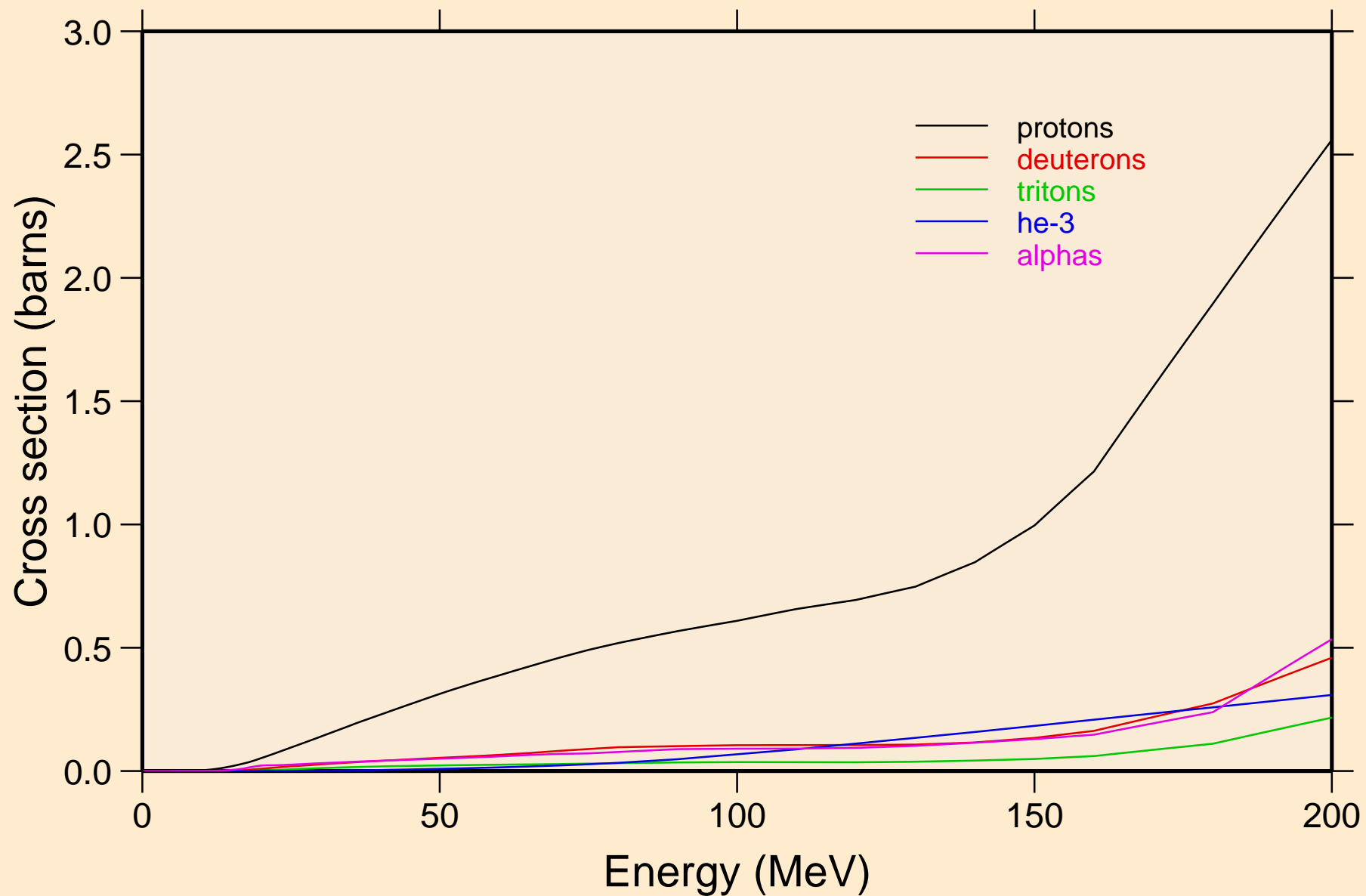

DY159 NEUTRON ACER TENDL-2019 LIBRARY; T=293.16K  
protons from (n,x)

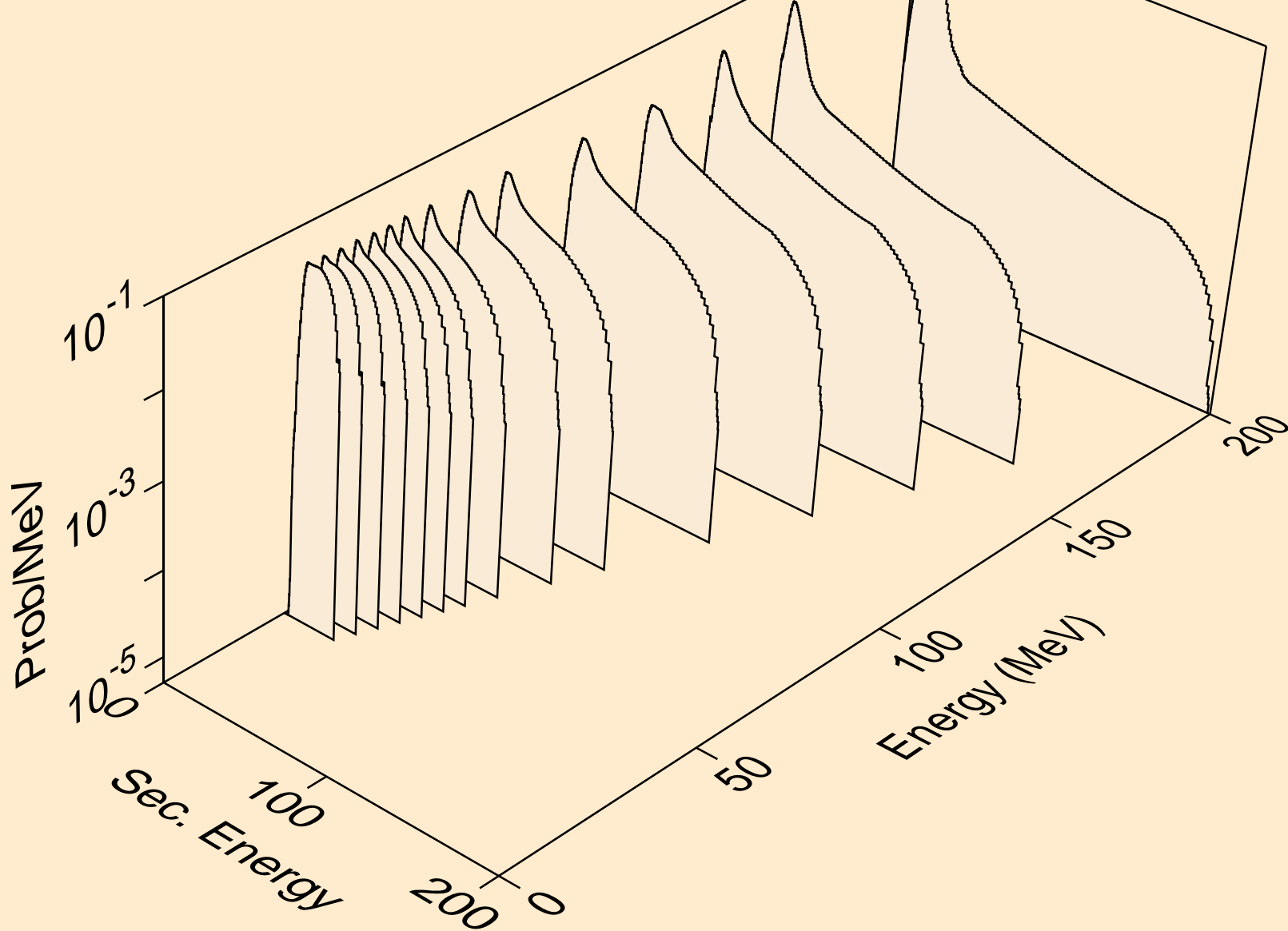

DY159 NEUTRON ACER TENDL-2019 LIBRARY; T=293.16K  
protons from (n,n\*)p

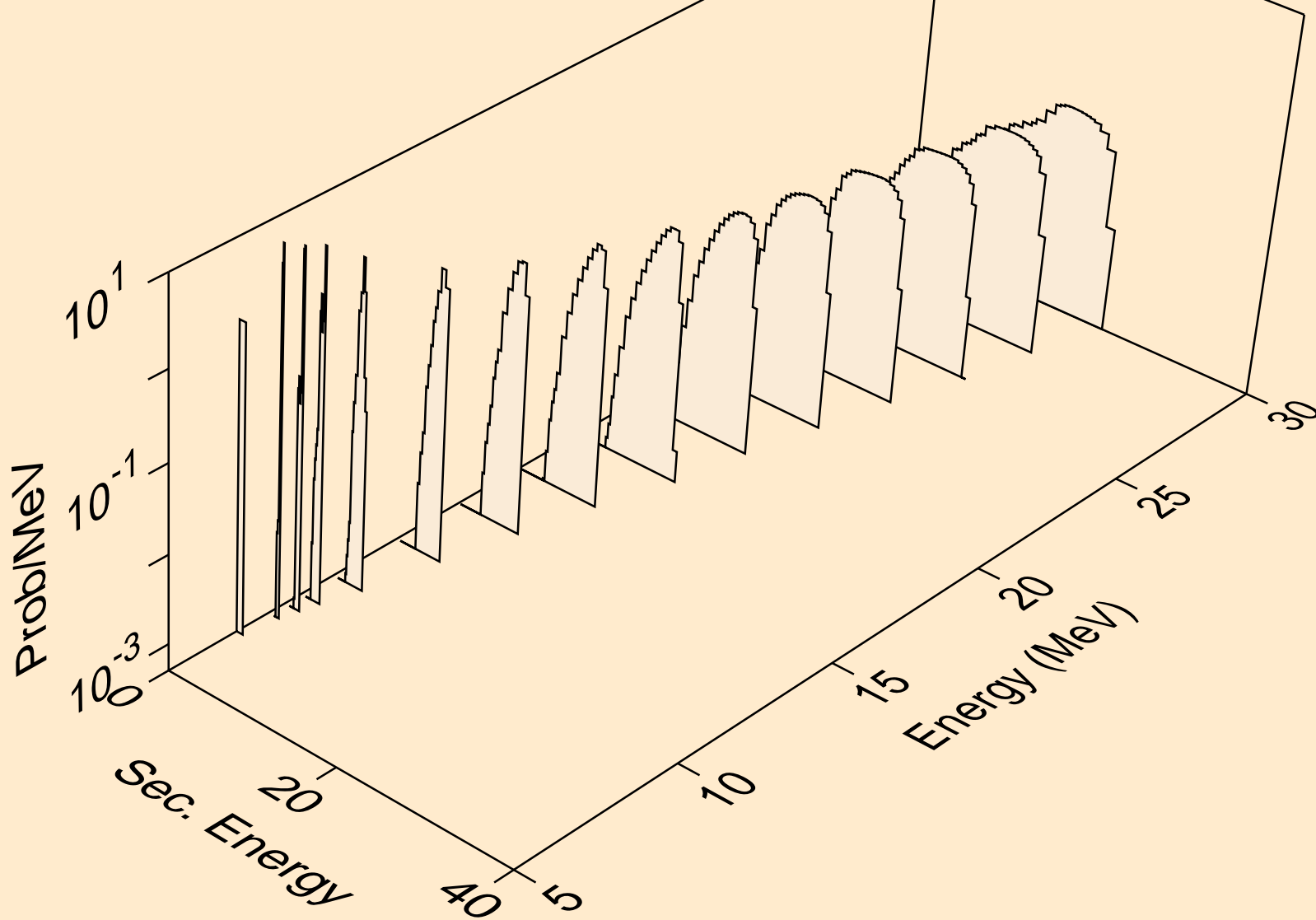

DY159 NEUTRON ACER TENDL-2019 LIBRARY; T=293.16K  
protons from (n,2np)

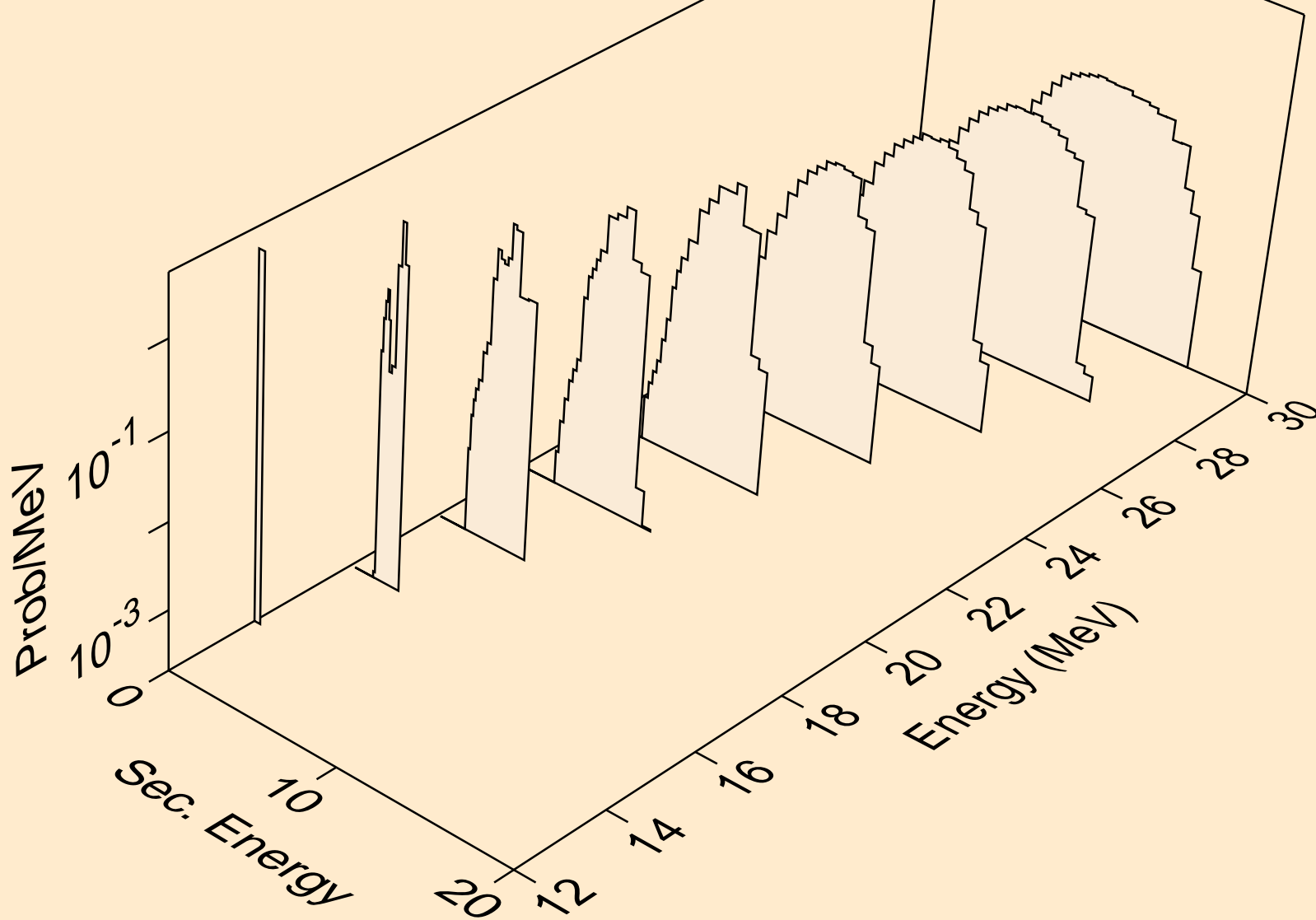

DY159 NEUTRON ACER TENDL-2019 LIBRARY; T=293.16K  
protons from (n,3np)

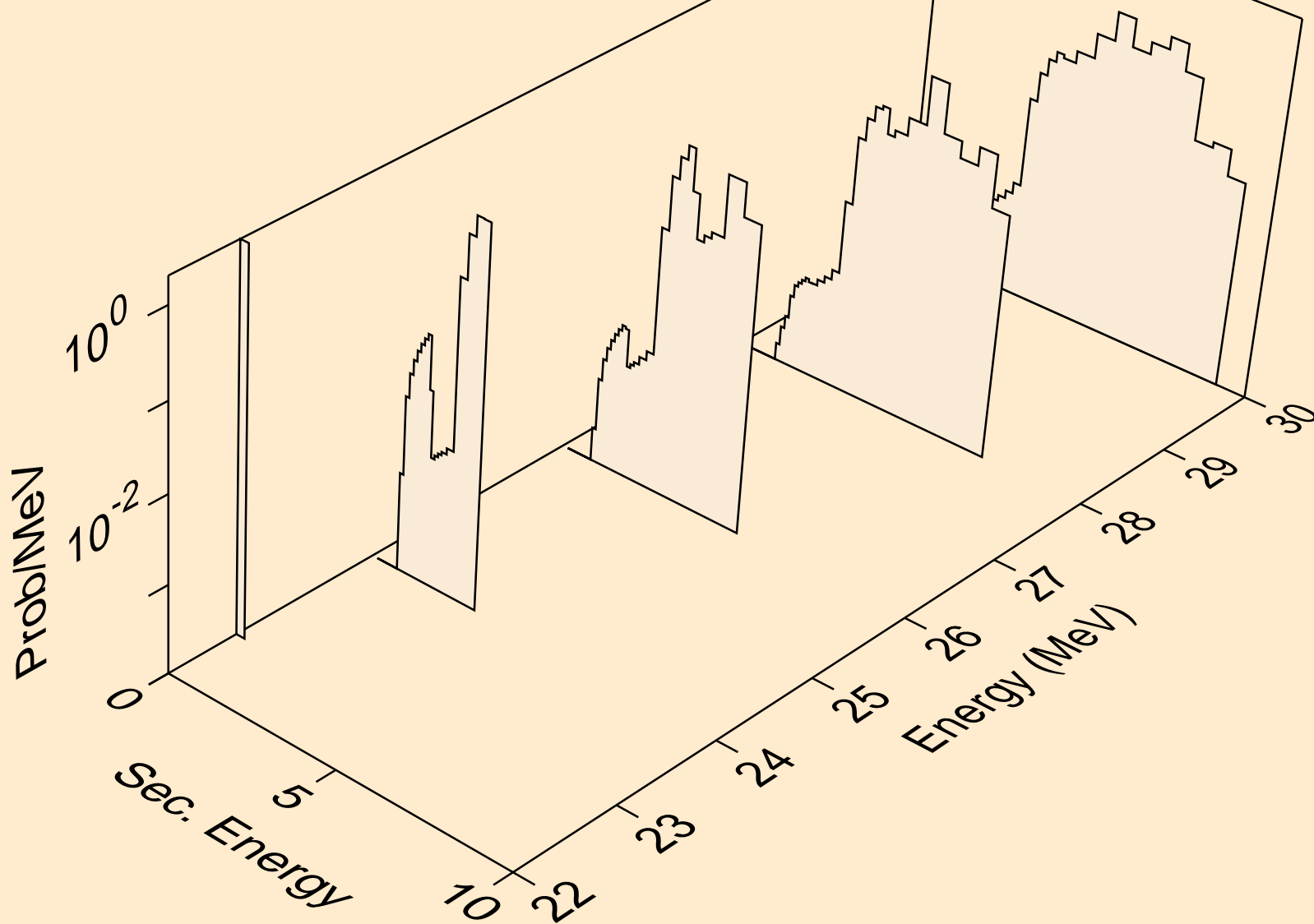

DY159 NEUTRON ACER TENDL-2019 LIBRARY; T=293.16K  
protons from (n,2np)

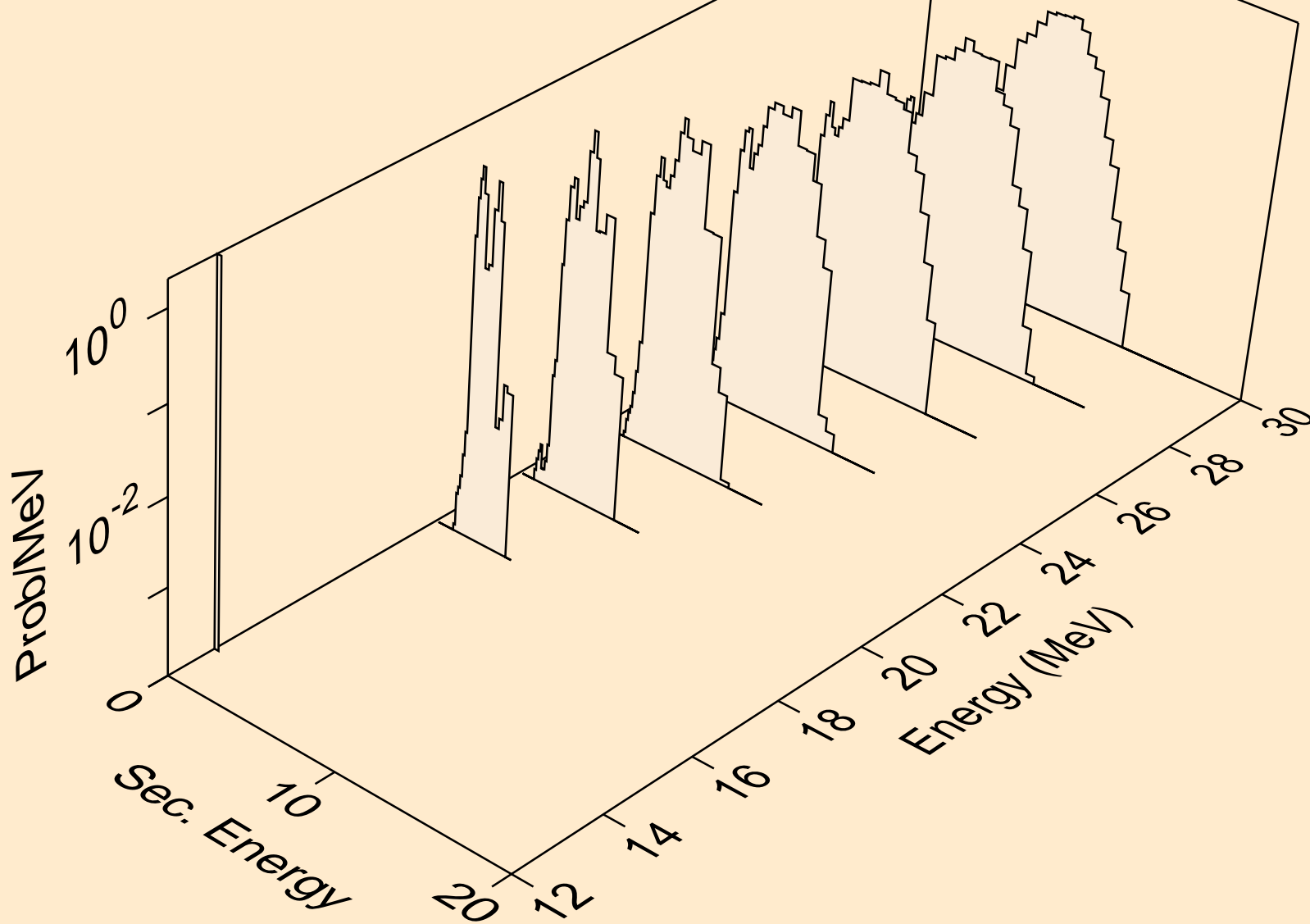

DY159 NEUTRON ACER TENDL-2019 LIBRARY; T=293.16K  
protons from (n,npa)

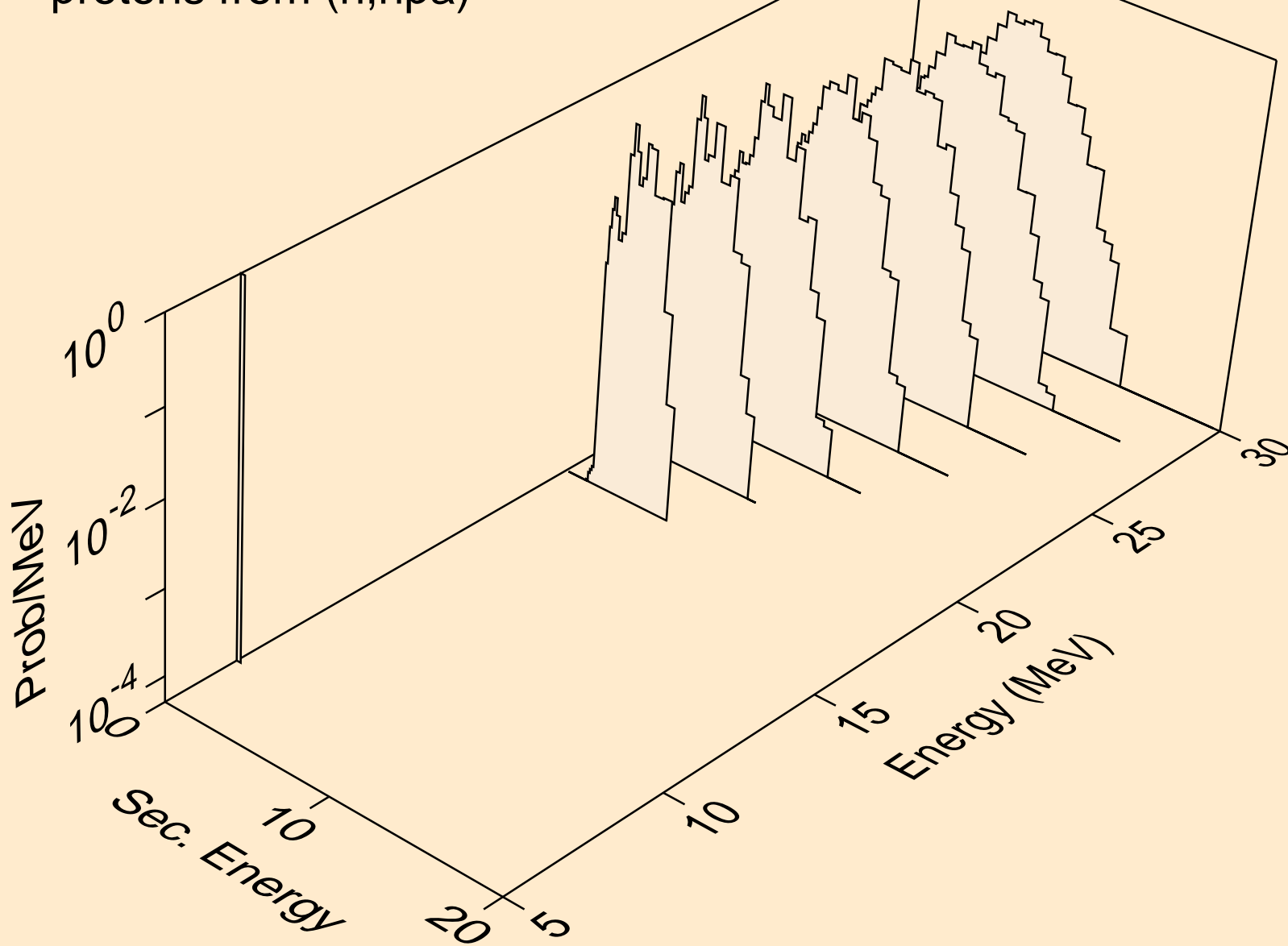

DY159 NEUTRON ACER TENDL-2019 LIBRARY; T=293.16K  
protons from (n,p)

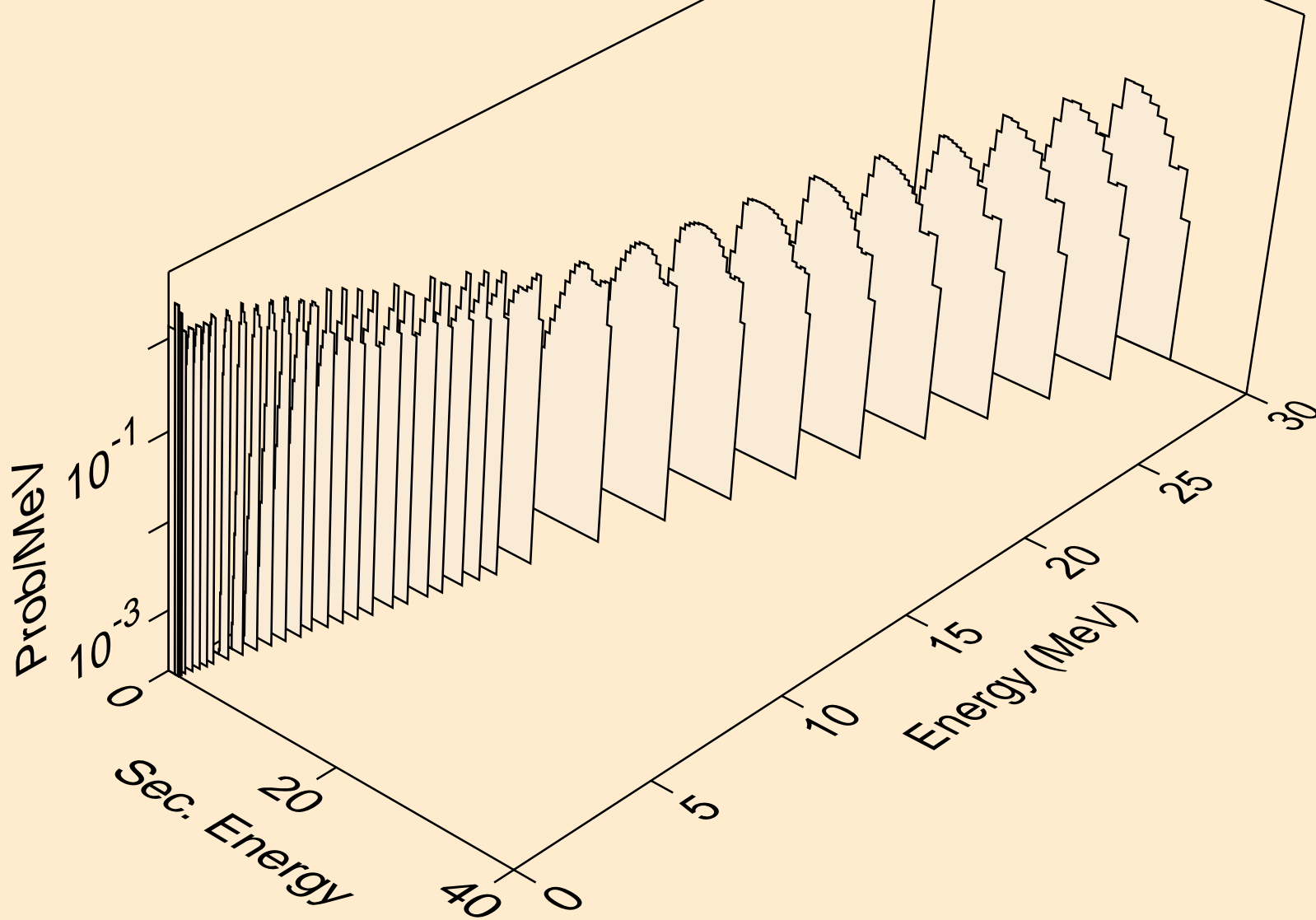



DY159 NEUTRON ACER TENDL-2019 LIBRARY; T=293.16K  
protons from (n,2p)

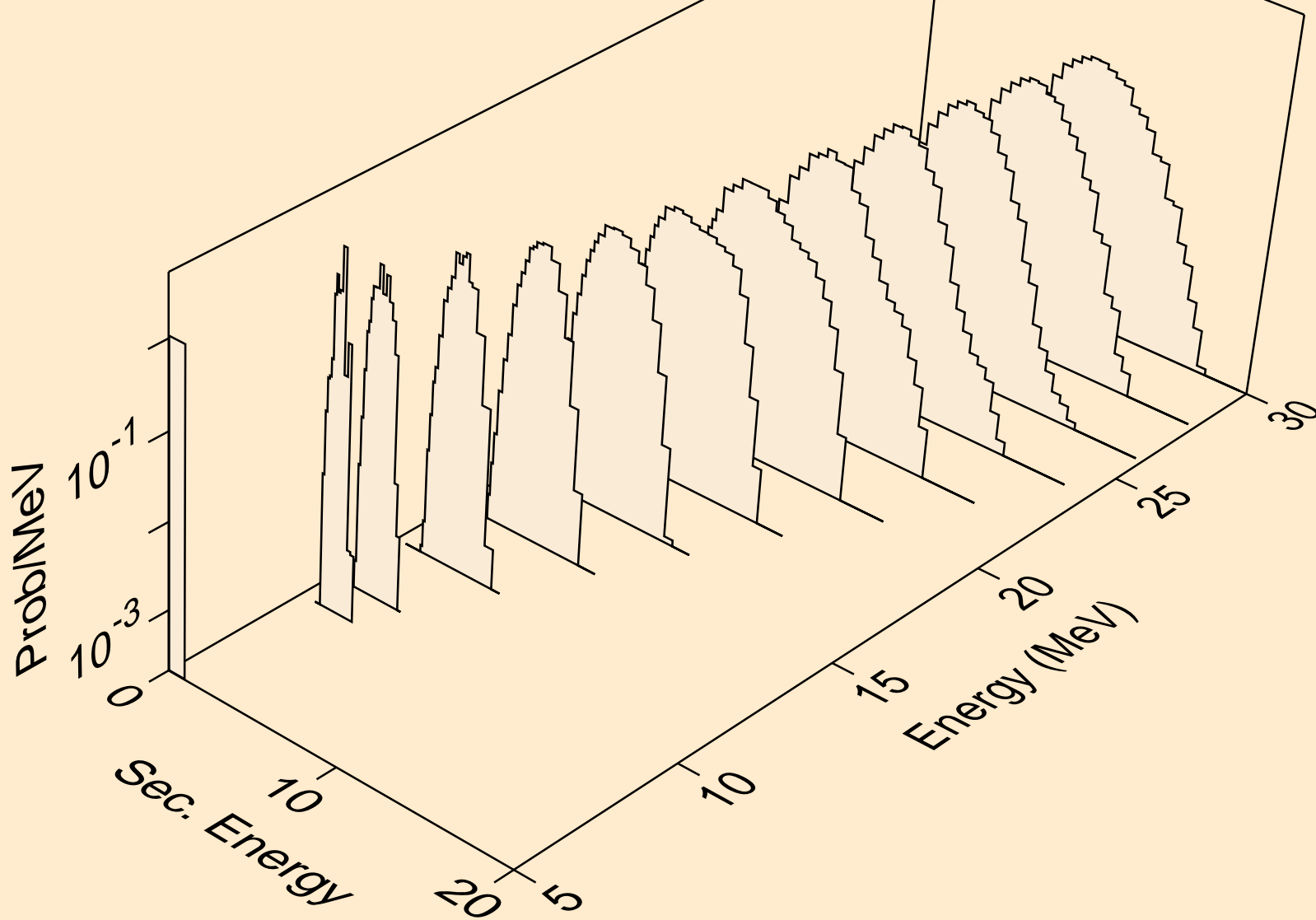

DY159 NEUTRON ACER TENDL-2019 LIBRARY; T=293.16K  
protons from (n,p)

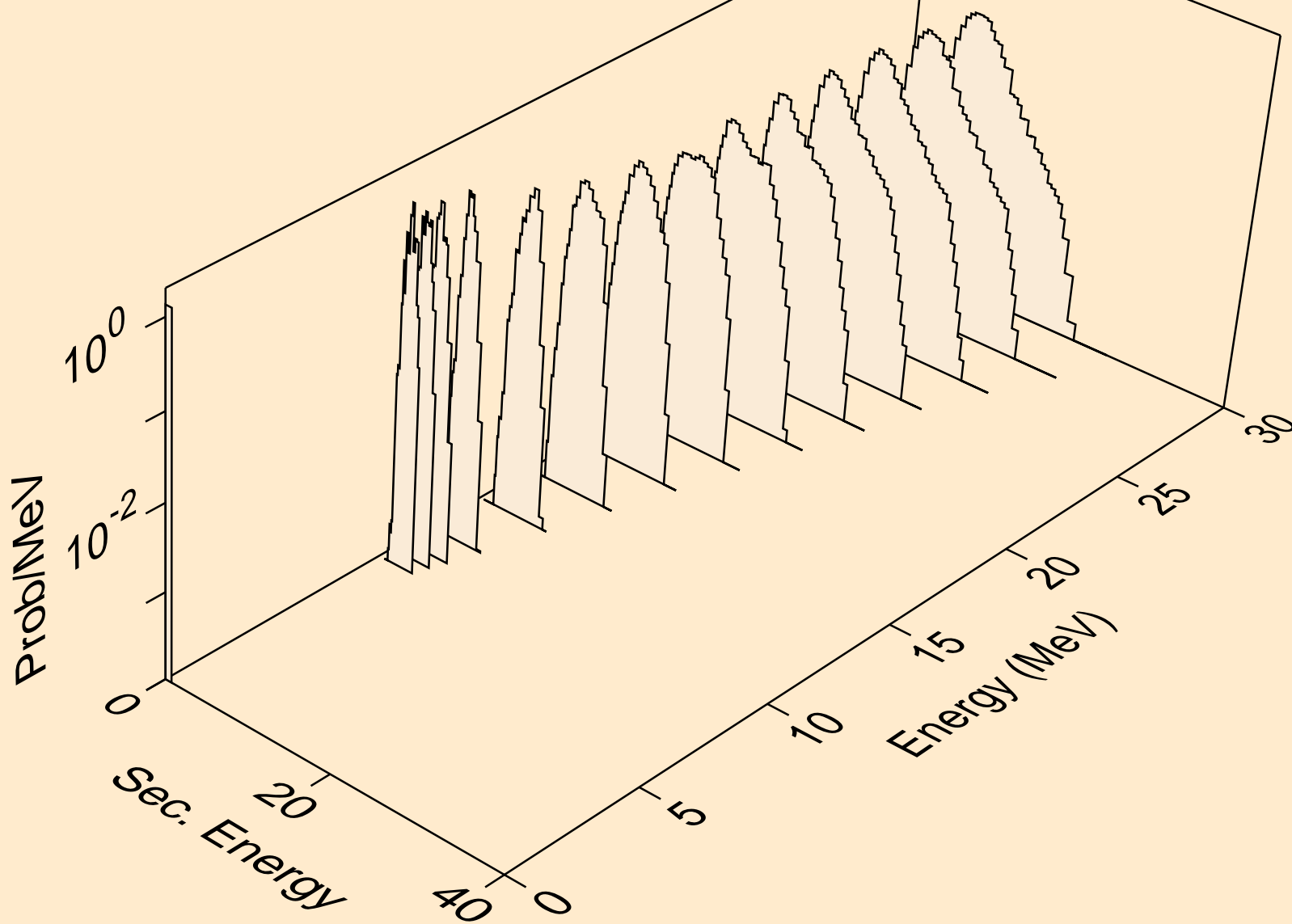

DY159 NEUTRON ACER TENDL-2019 LIBRARY; T=293.16K  
protons from (n,pd)

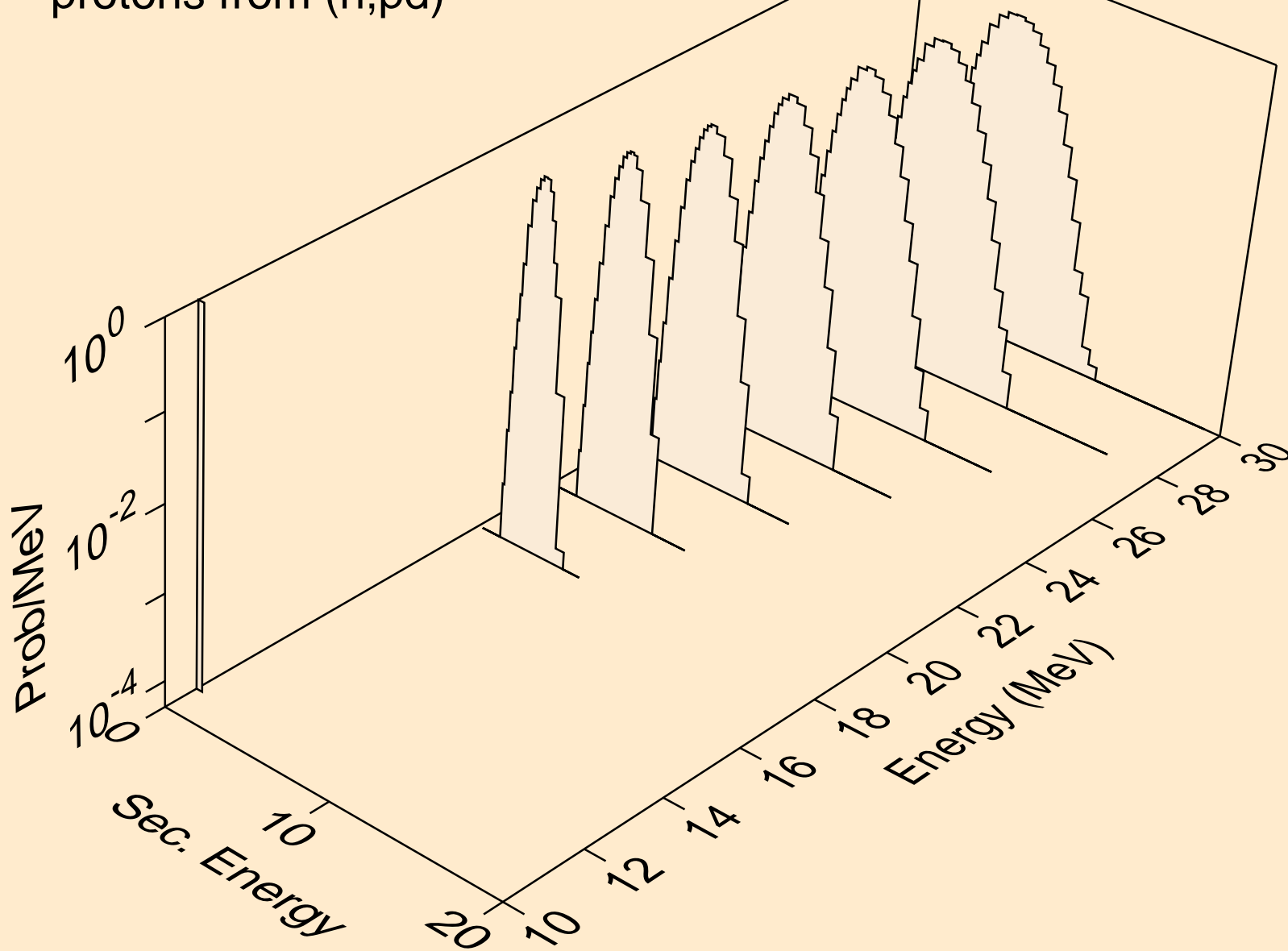

DY159 NEUTRON ACER TENDL-2019 LIBRARY; T=293.16K  
protons from (n,pt)

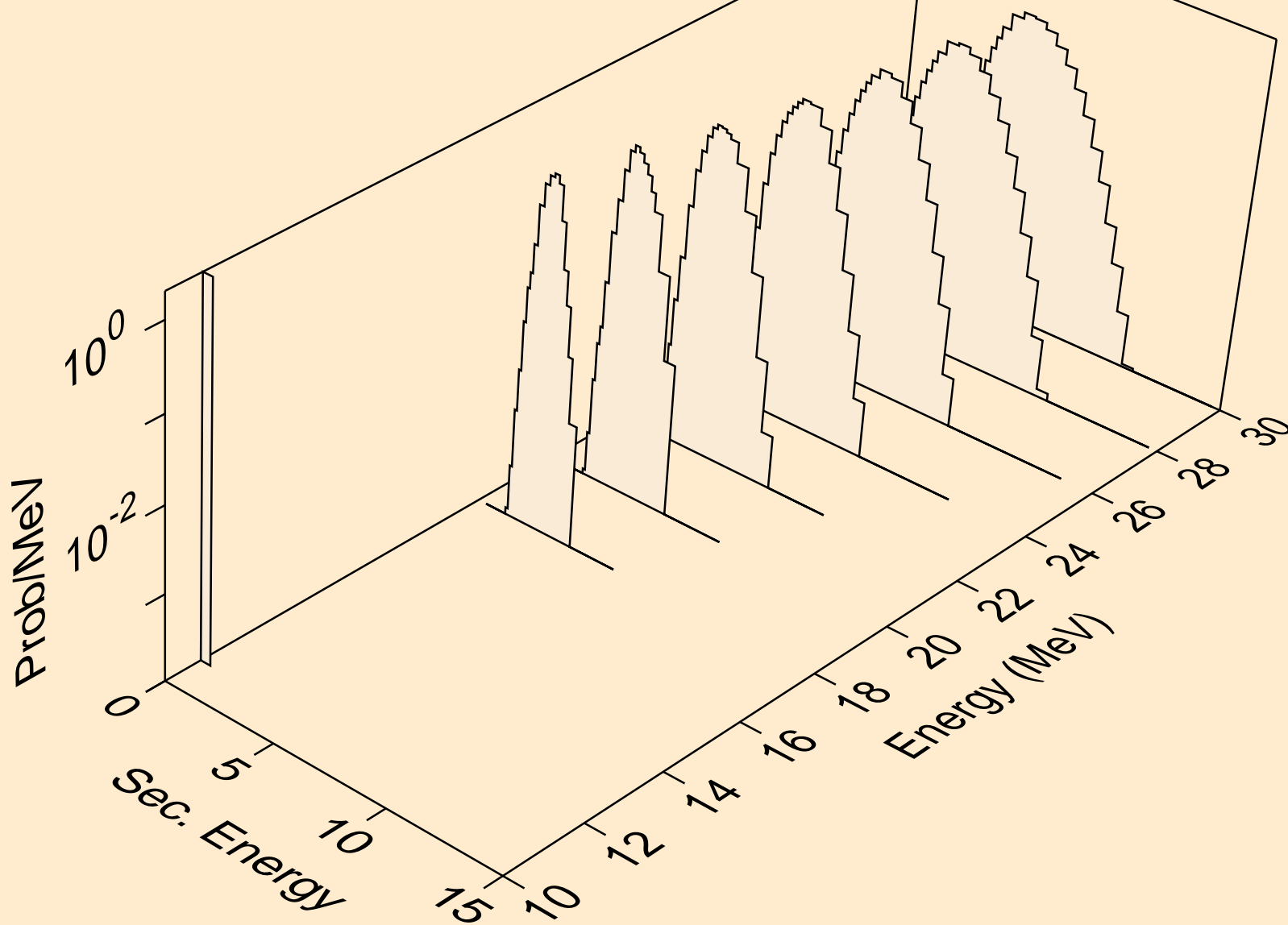

DY159 NEUTRON ACER TENDL-2019 LIBRARY; T=293.16K  
deuterons from (n,x)

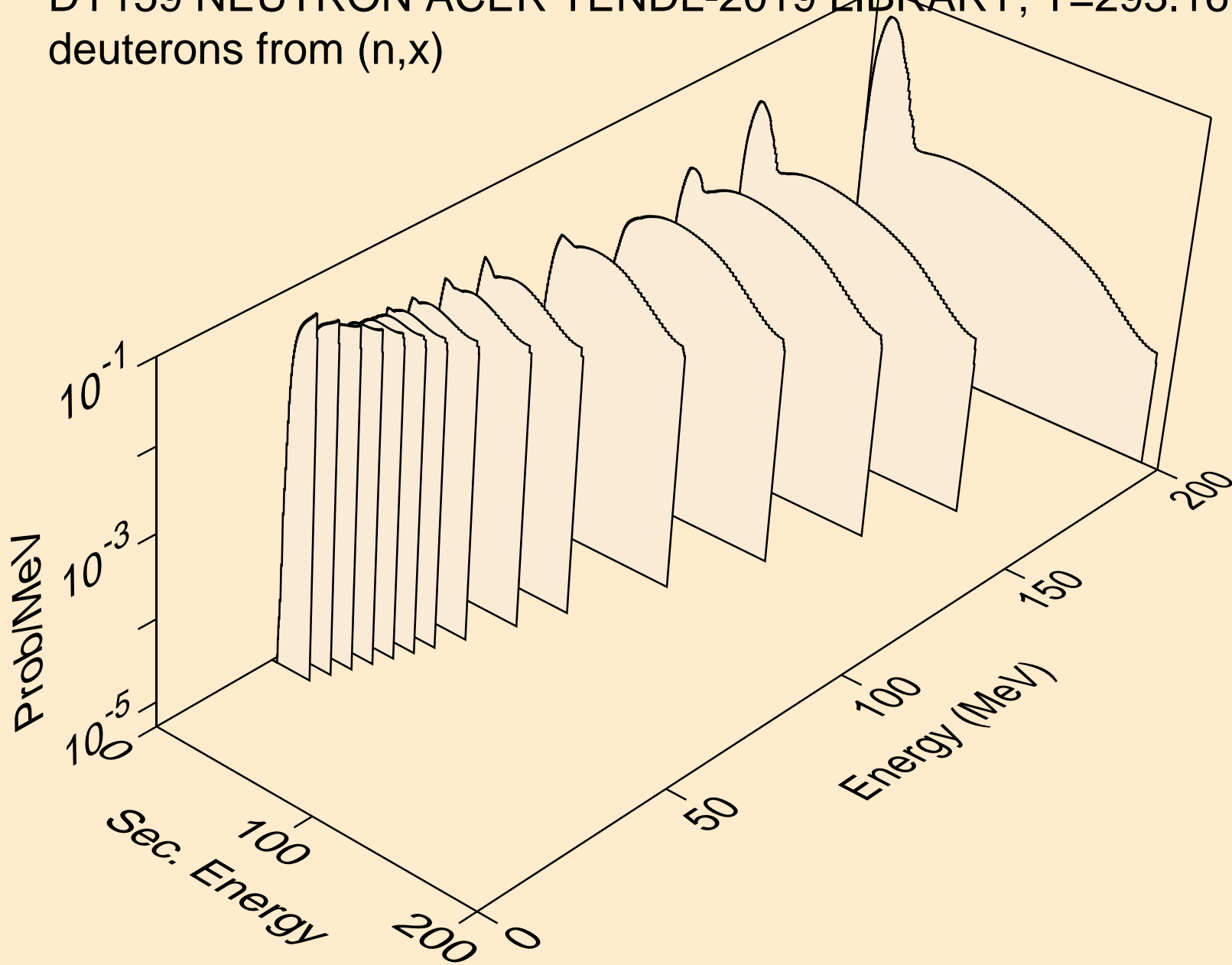

DY159 NEUTRON ACER TENDL-2019 LIBRARY; T=293.16K  
deuterons from (n,2nd)

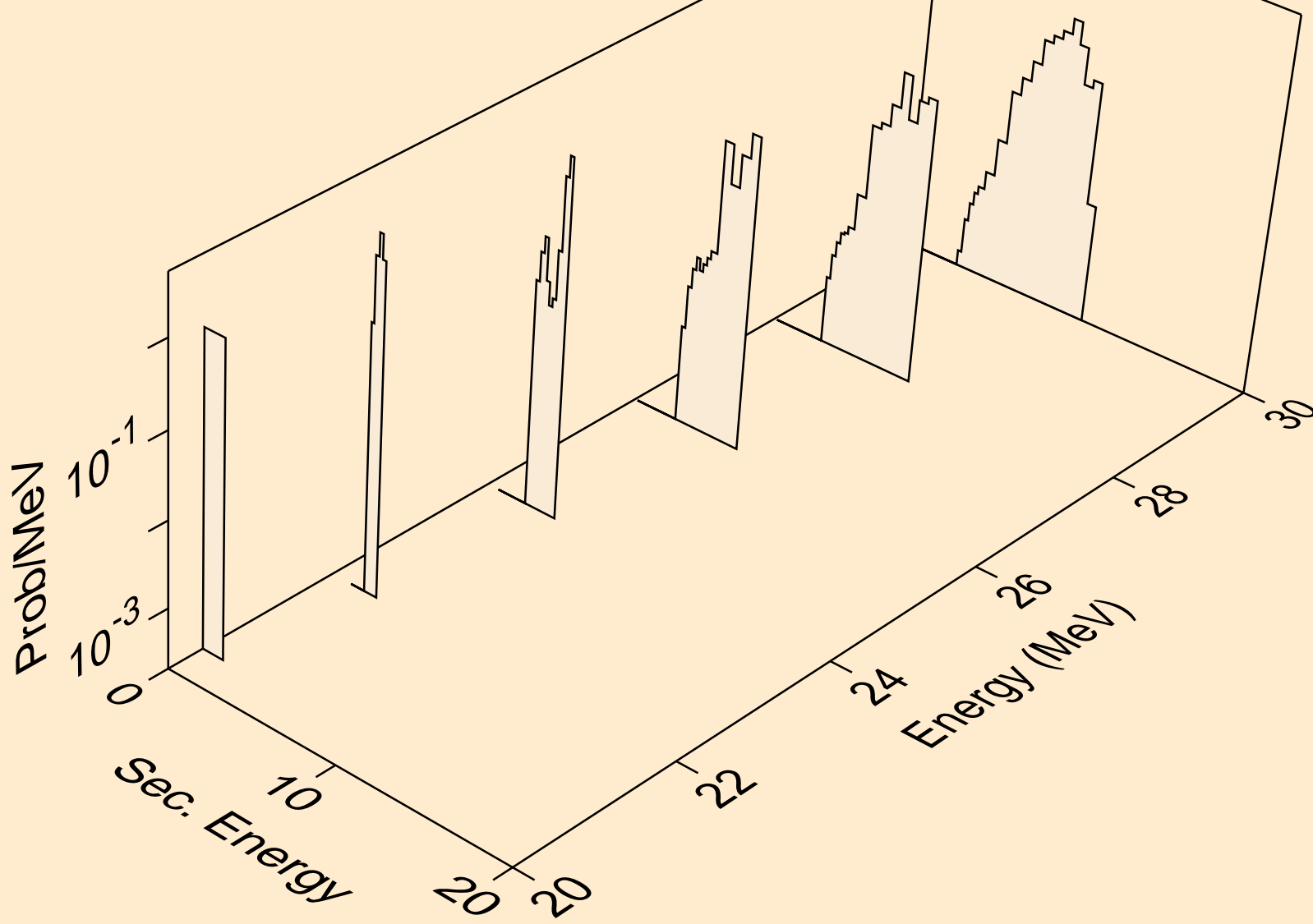

DY159 NEUTRON ACER TENDL-2019 LIBRARY; T=293.16K  
deuterons from (n,n\*)d

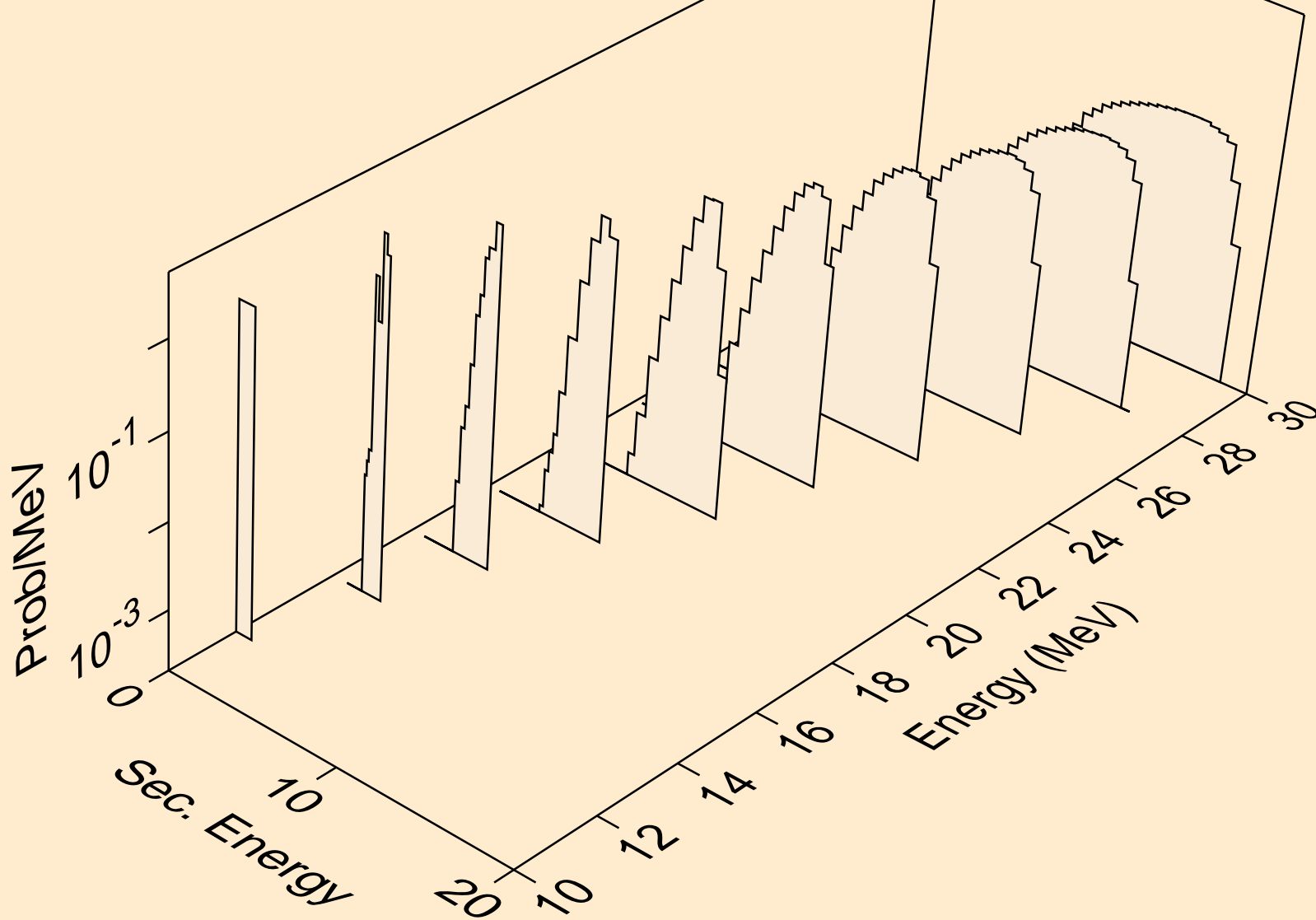

DY159 NEUTRON ACER TENDL-2019 LIBRARY; T=293.16K  
deuterons from (n,d)

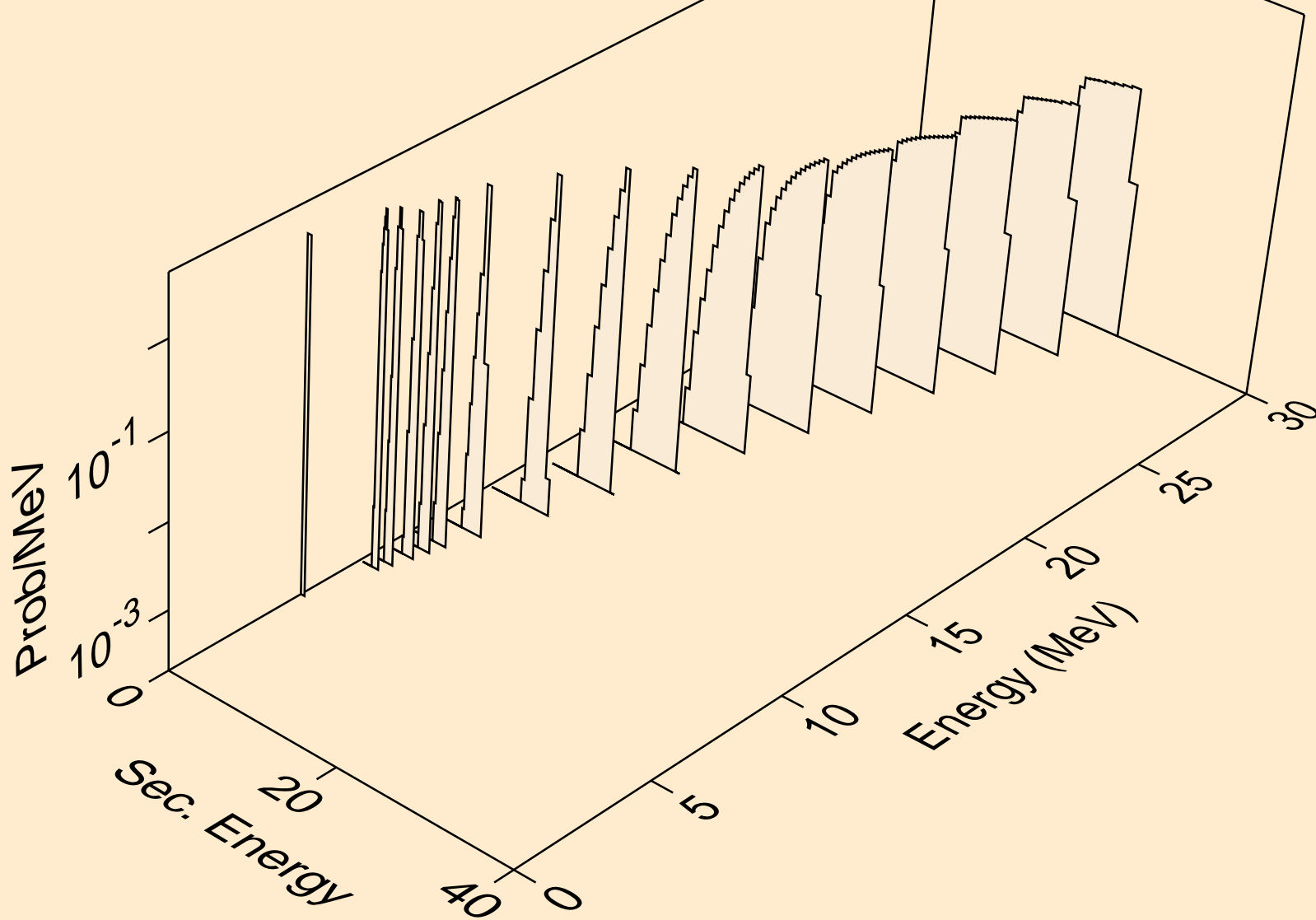



DY159 NEUTRON ACER TENDL-2019 LIBRARY; T=293.16K  
deuterons from (n,pd)

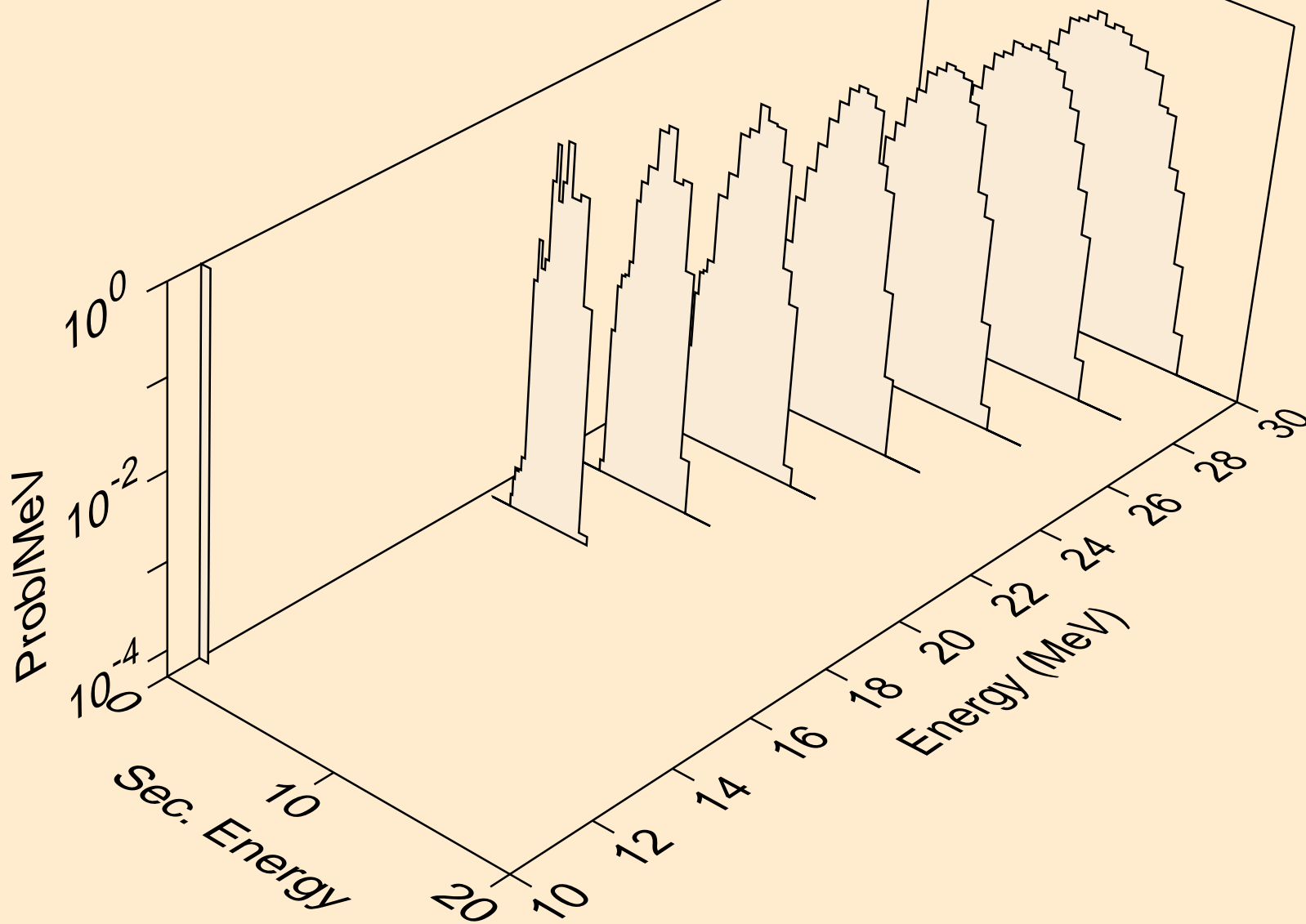

DY159 NEUTRON ACER TENDL-2019 LIBRARY; T=293.16K  
deuterons from (n,da)

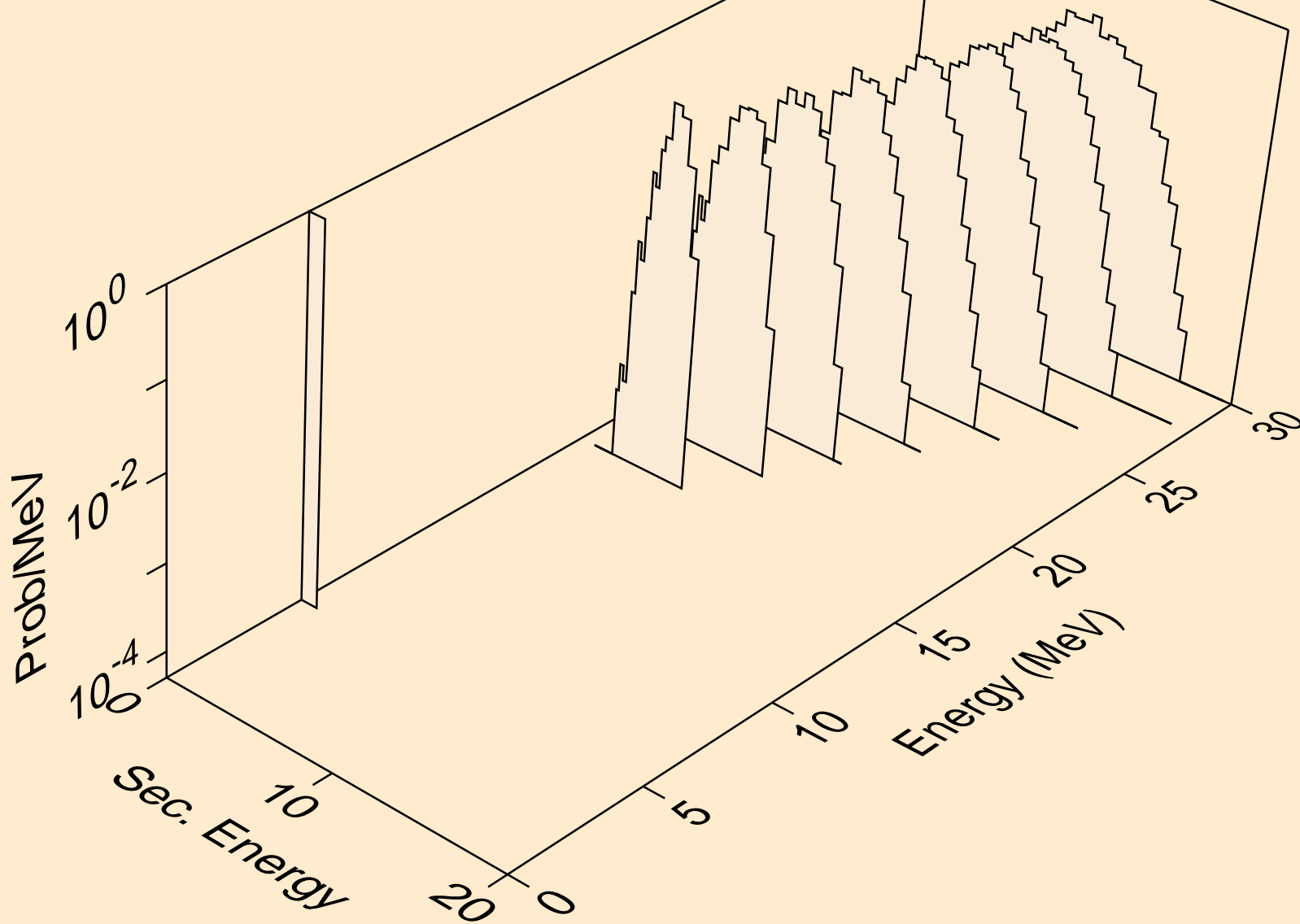

DY159 NEUTRON ACER TENDL-2019 LIBRARY; T=293.16K  
tritons from (n,x)

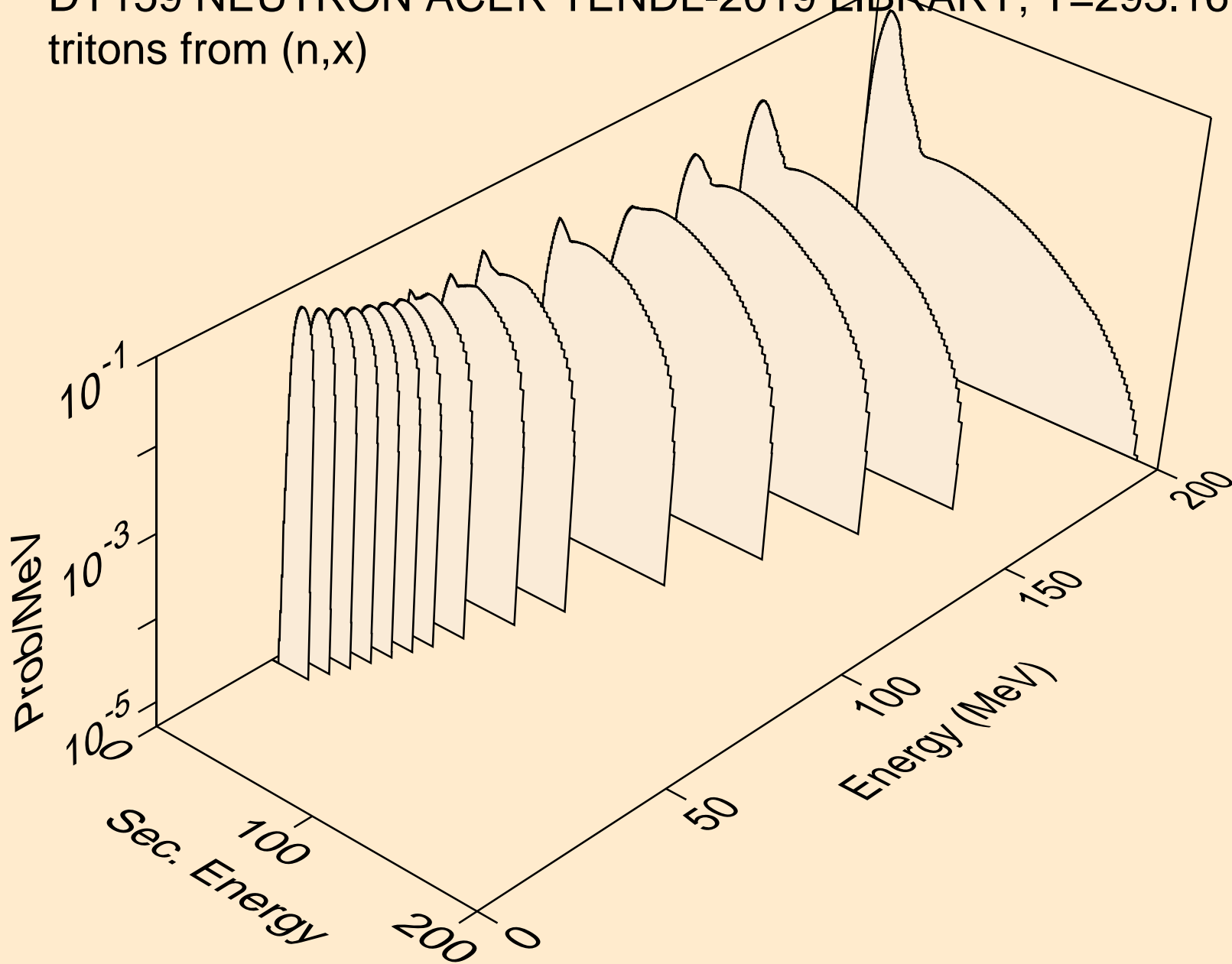

DY159 NEUTRON ACER TENDL-2019 LIBRARY; T=293.16K  
tritons from (n,n\*)t

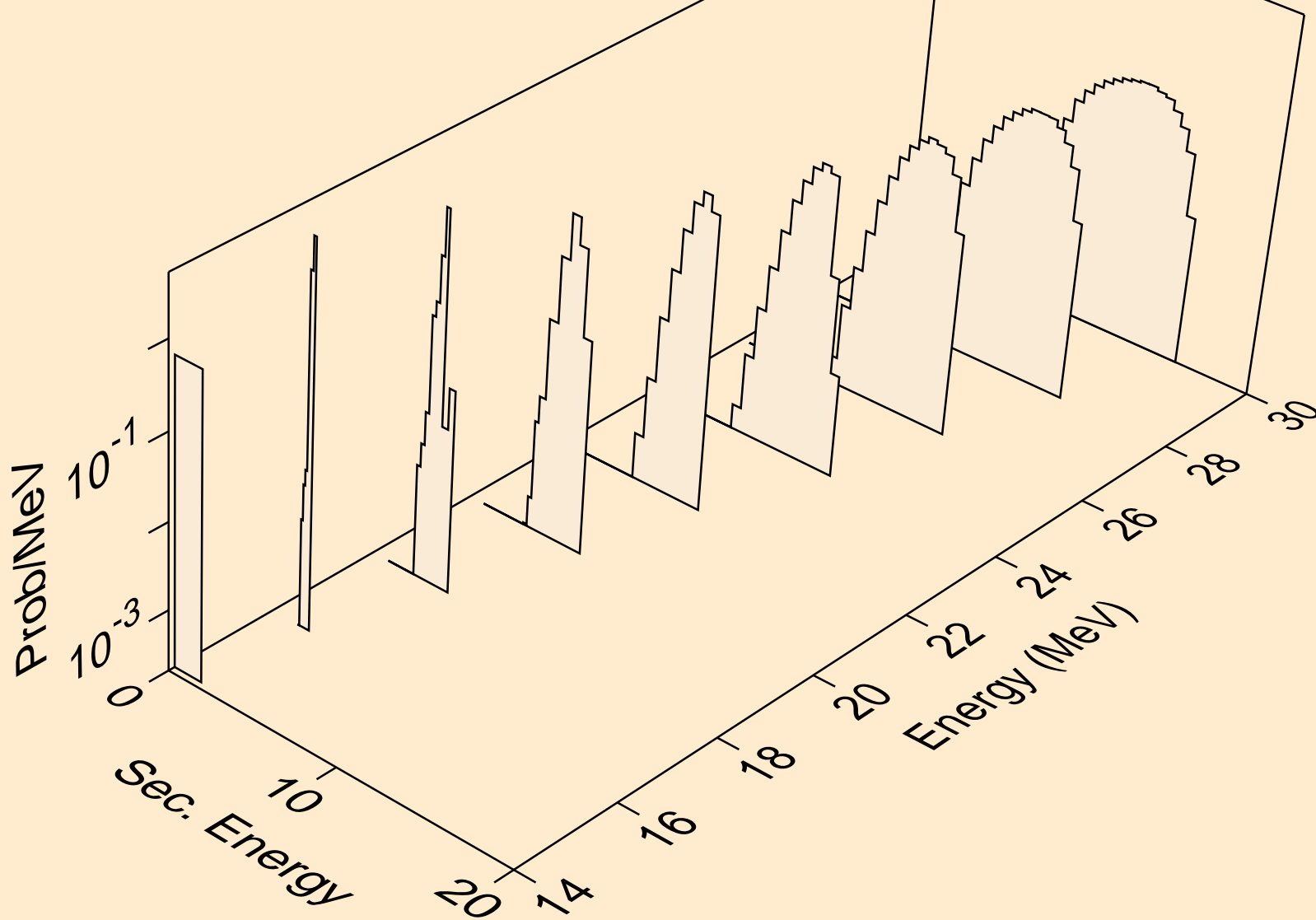

DY159 NEUTRON ACER TENDL-2019 LIBRARY; T=293.16K  
tritons from (n,t)

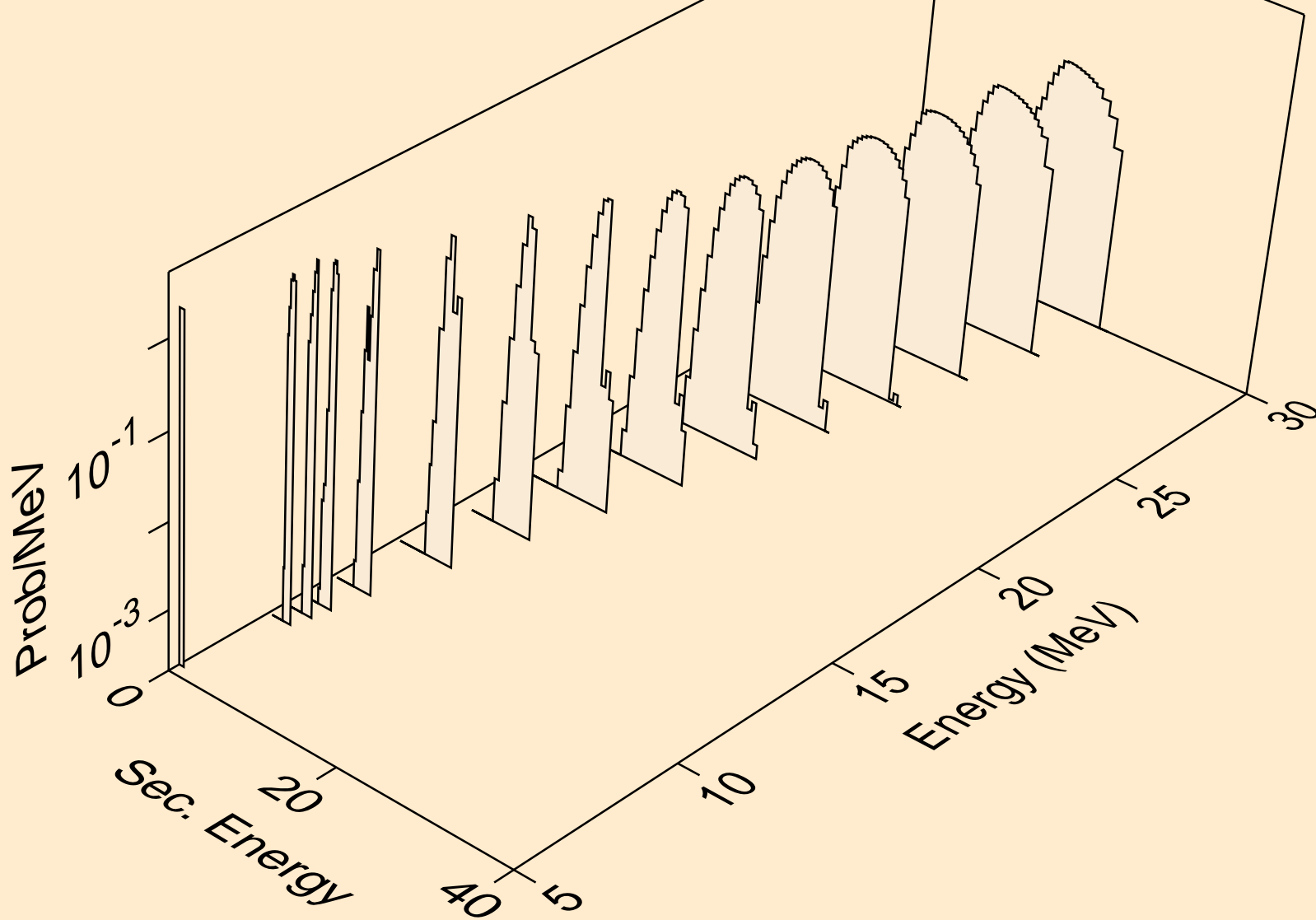

DY159 NEUTRON ACER TENDL-2019 LIBRARY; T=293.16K  
tritons from (n,pt)

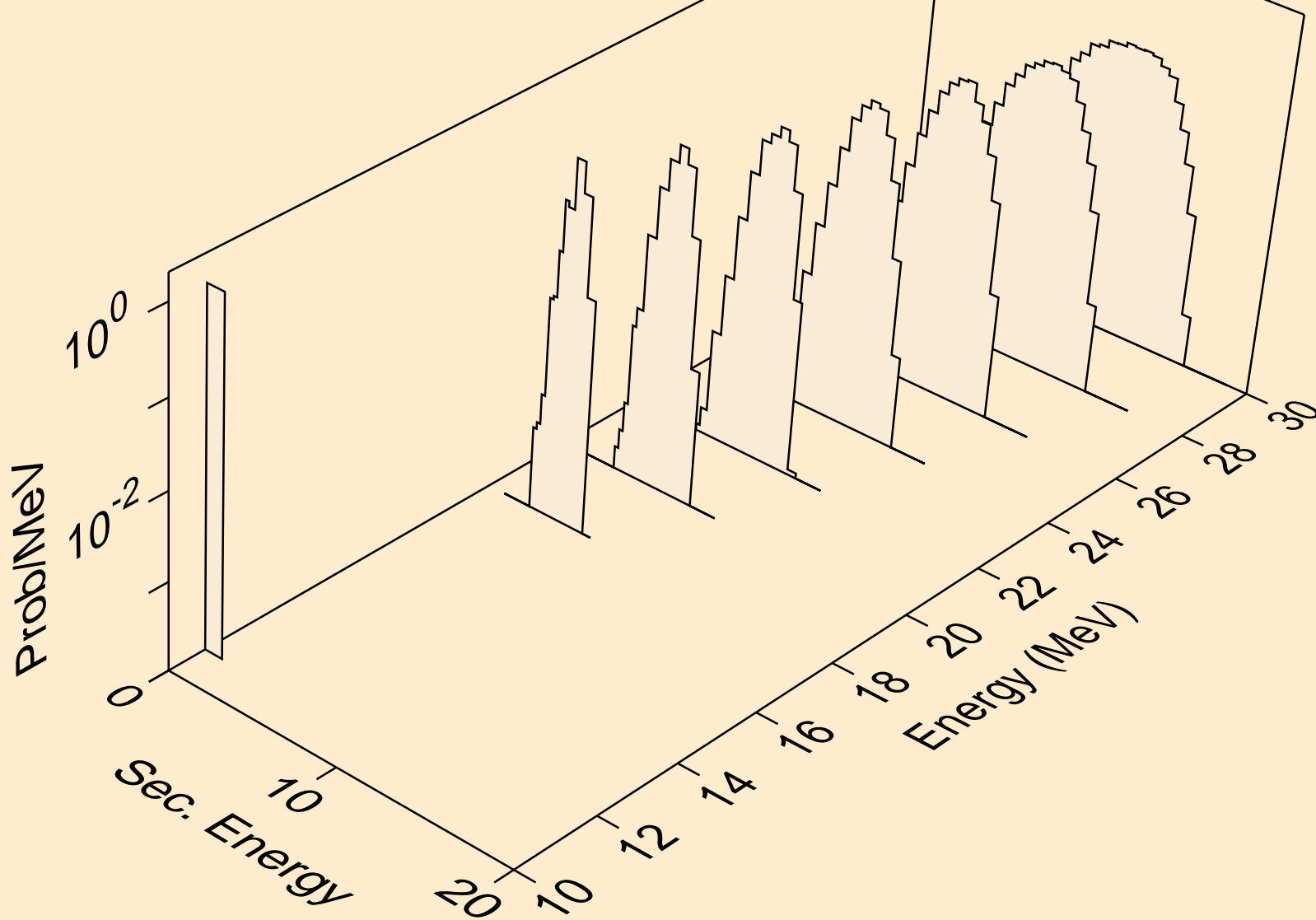

DY159 NEUTRON ACER TENDL-2019 LIBRARY; T=293.16K  
he3s from (n,x)

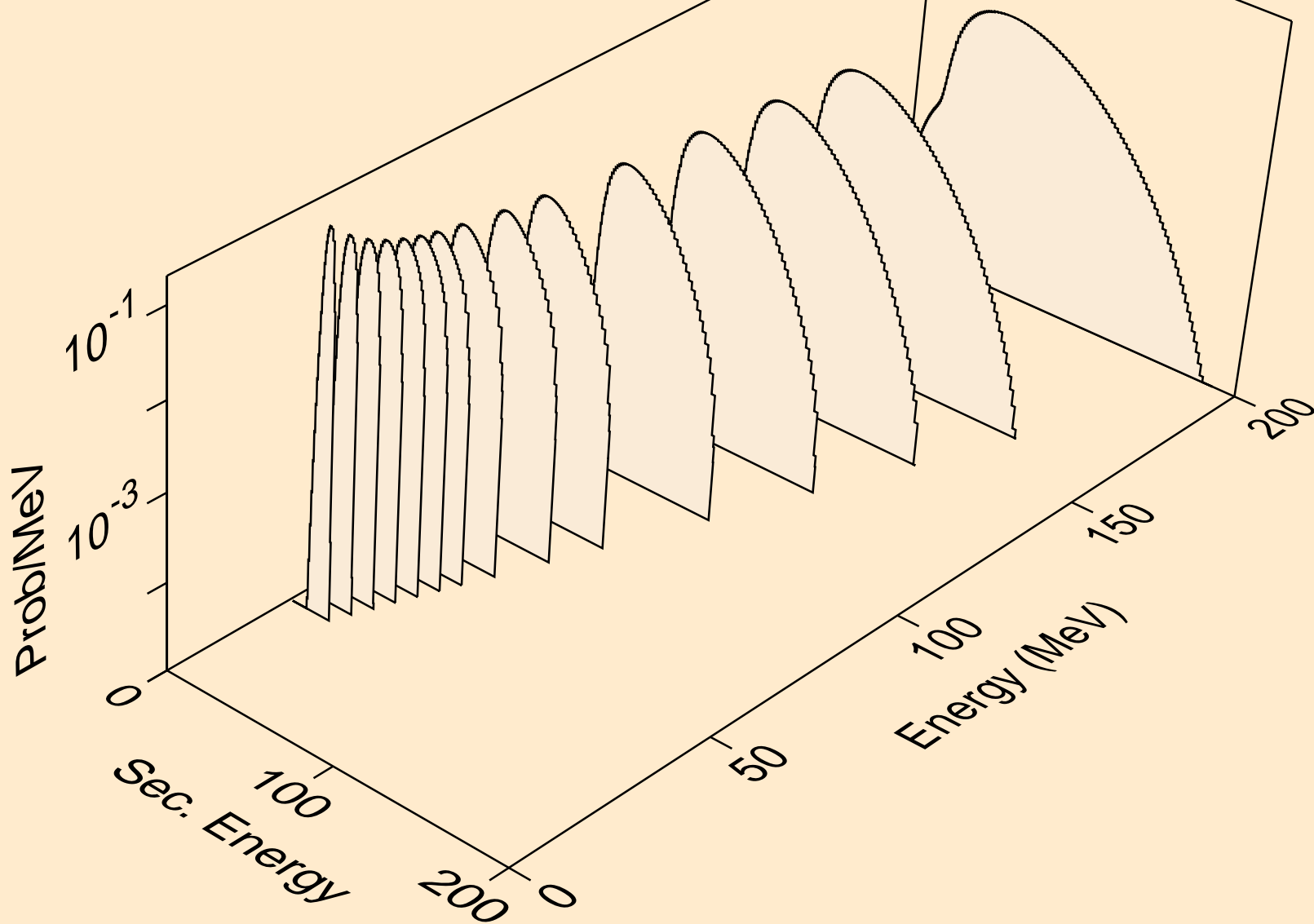

DY159 NEUTRON ACER TENDL-2019 LIBRARY; T=293.16K  
he3s from (n,n\*)he3

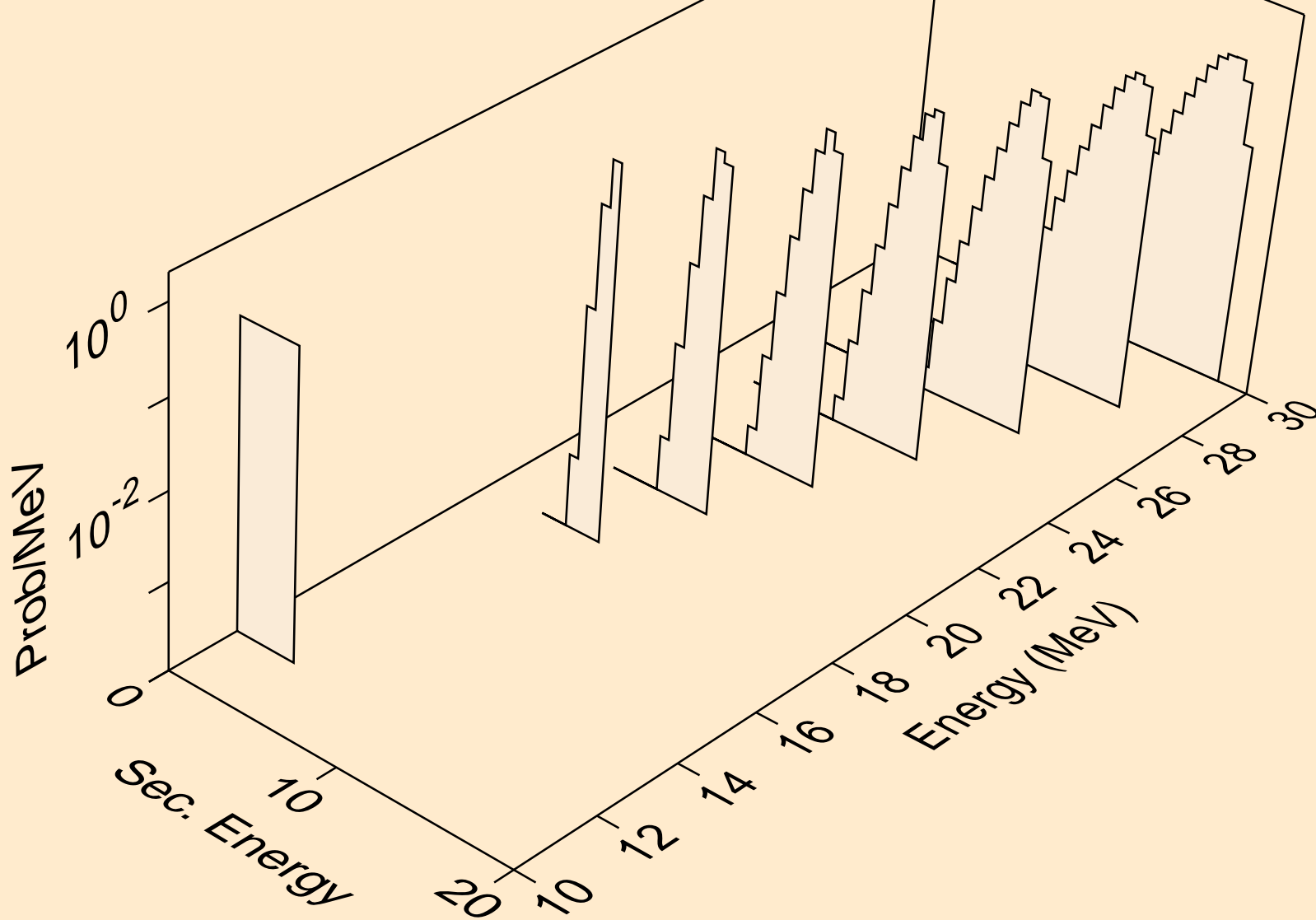



DY159 NEUTRON ACER TENDL-2019 LIBRARY; T=293.16K  
he3s from (n,he3)

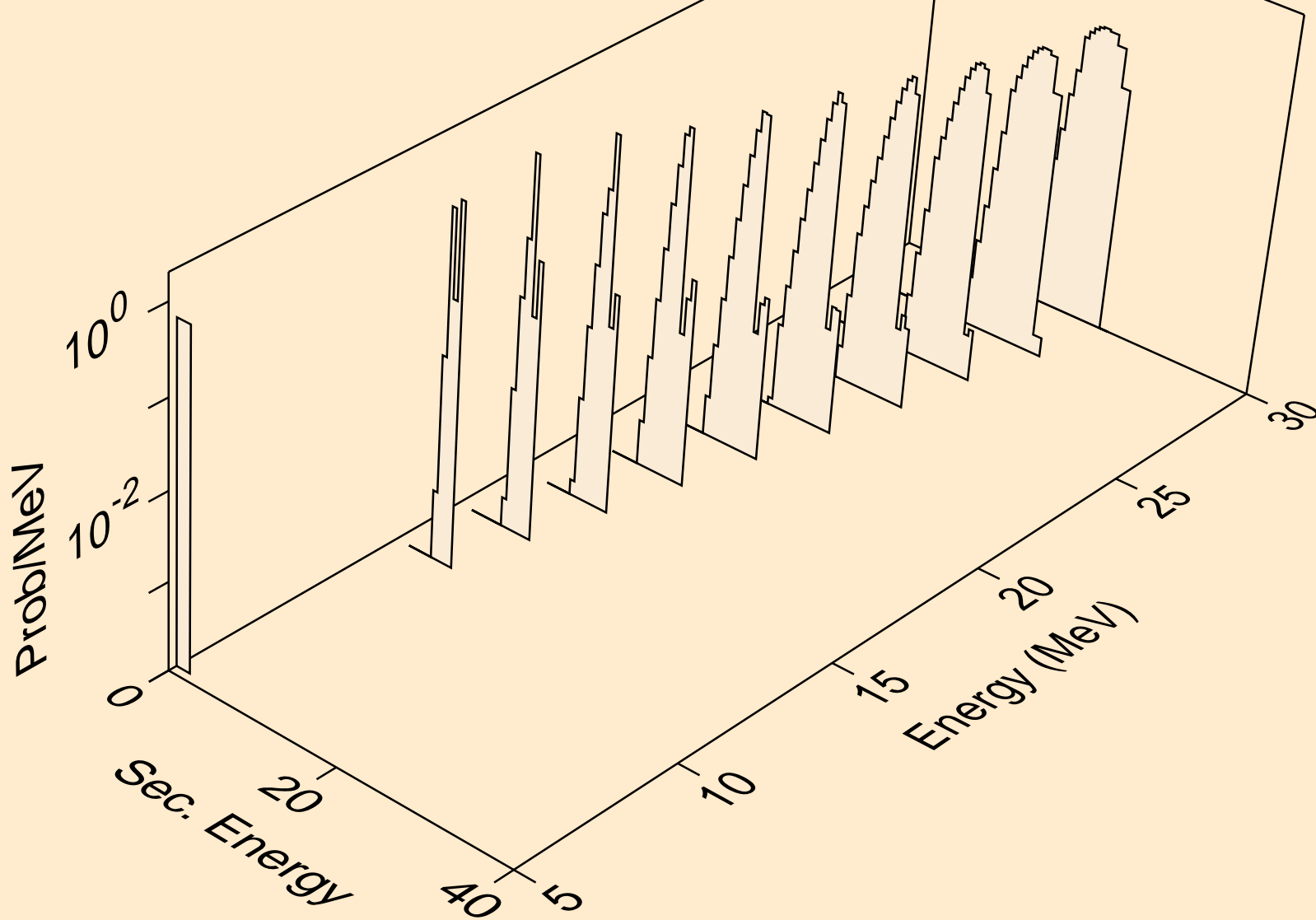

DY159 NEUTRON ACER TENDL-2019 LIBRARY; T=293.16K  
alphas from (n,x)

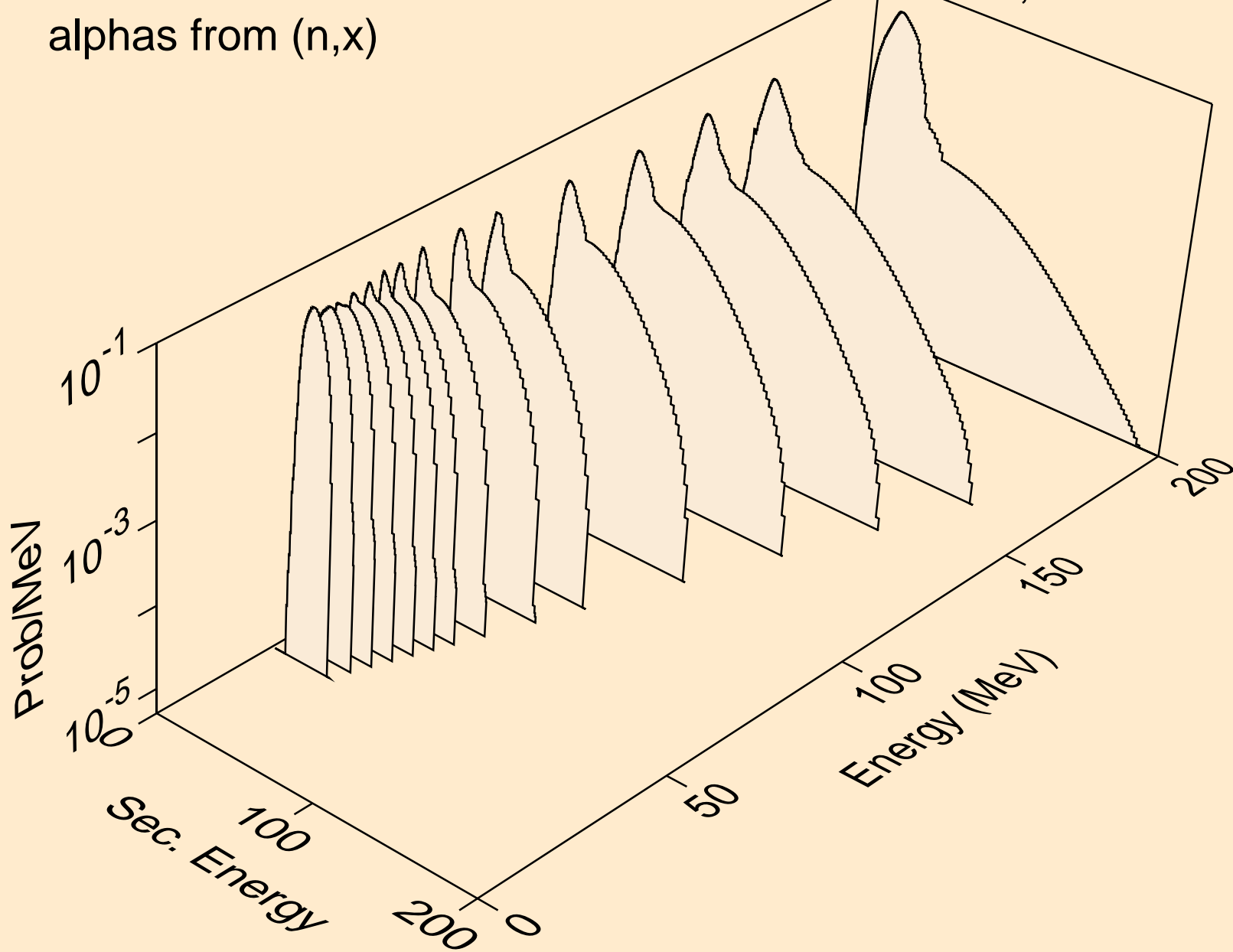

DY159 NEUTRON ACER TENDL-2019 LIBRARY; T=293.16K  
alphas from (n,n\*)a

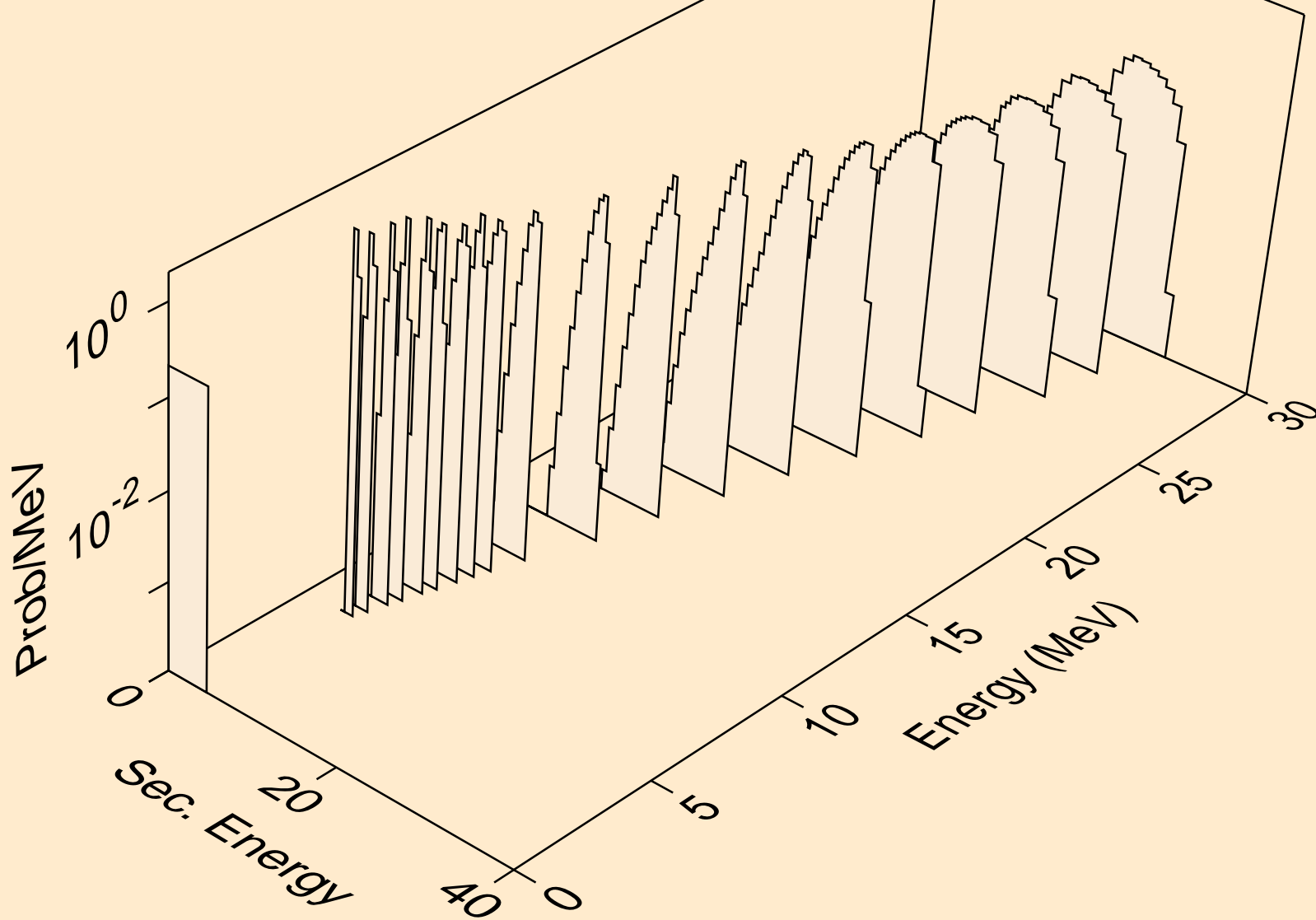

DY159 NEUTRON ACER TENDL-2019 LIBRARY; T=293.16K  
alphas from (n,2n)a

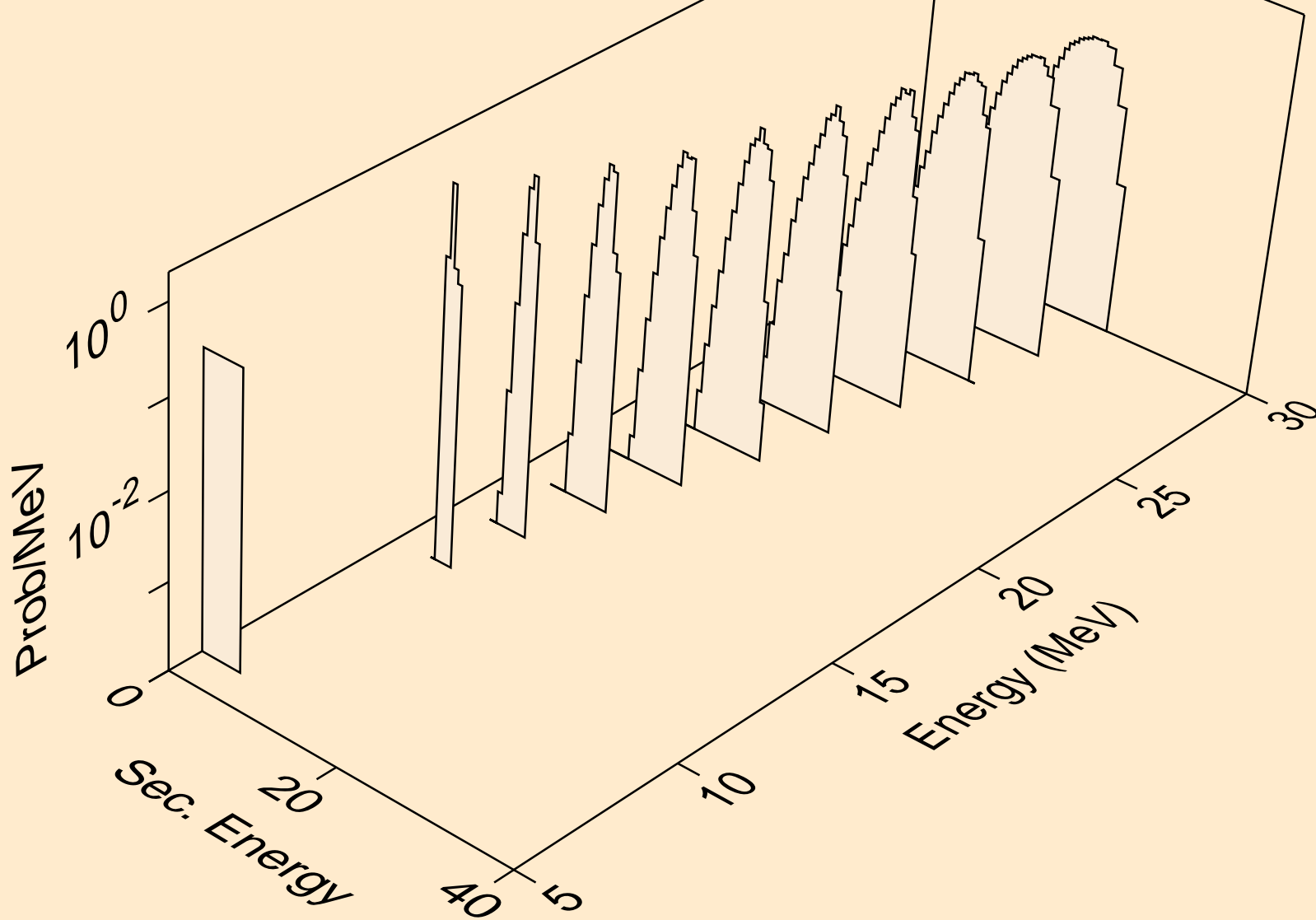

DY159 NEUTRON ACER TENDL-2019 LIBRARY; T=293.16K  
alphas from (n,3n)a

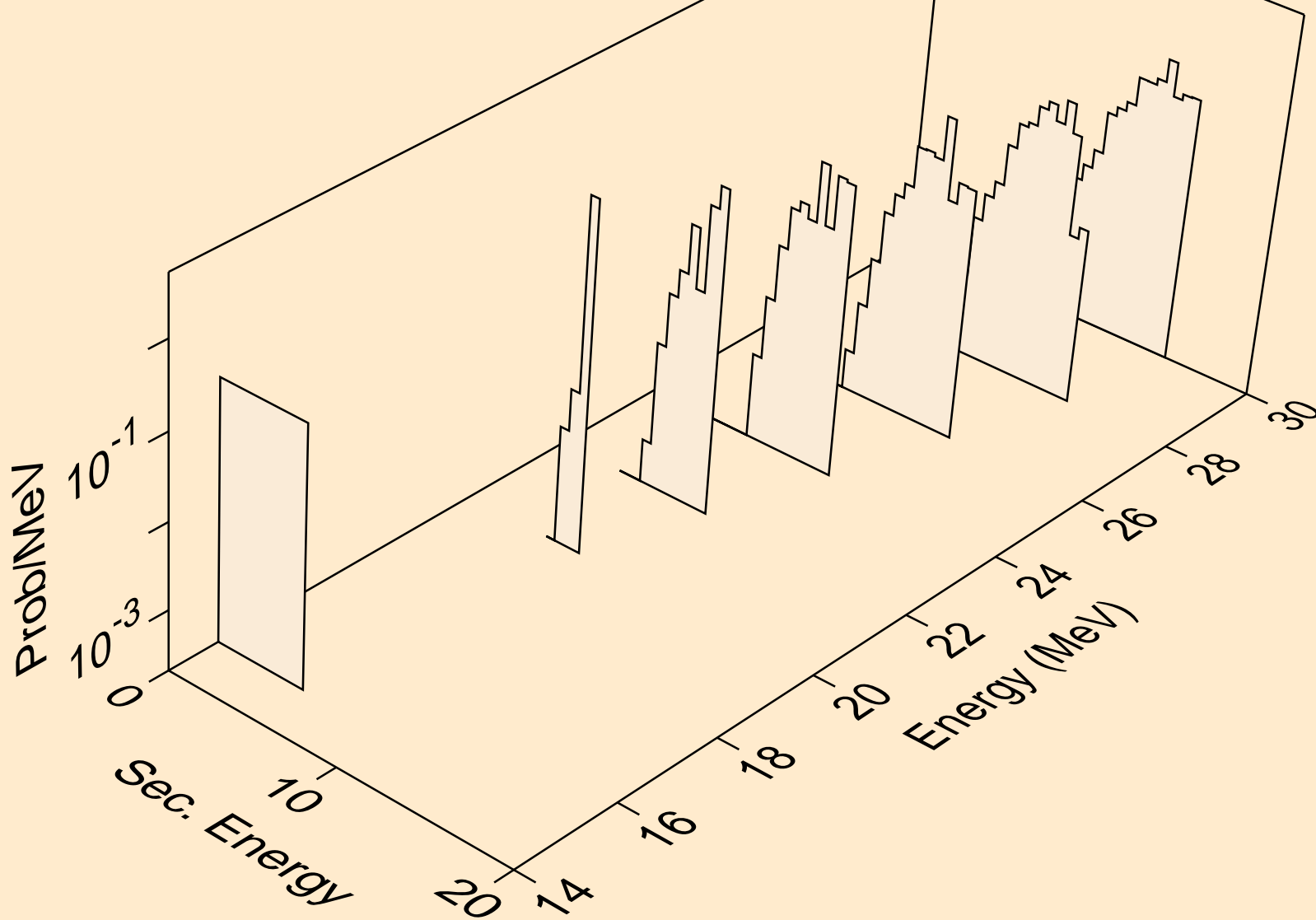

DY159 NEUTRON ACER TENDL-2019 LIBRARY; T=293.16K  
alphas from (n,n\*)2a

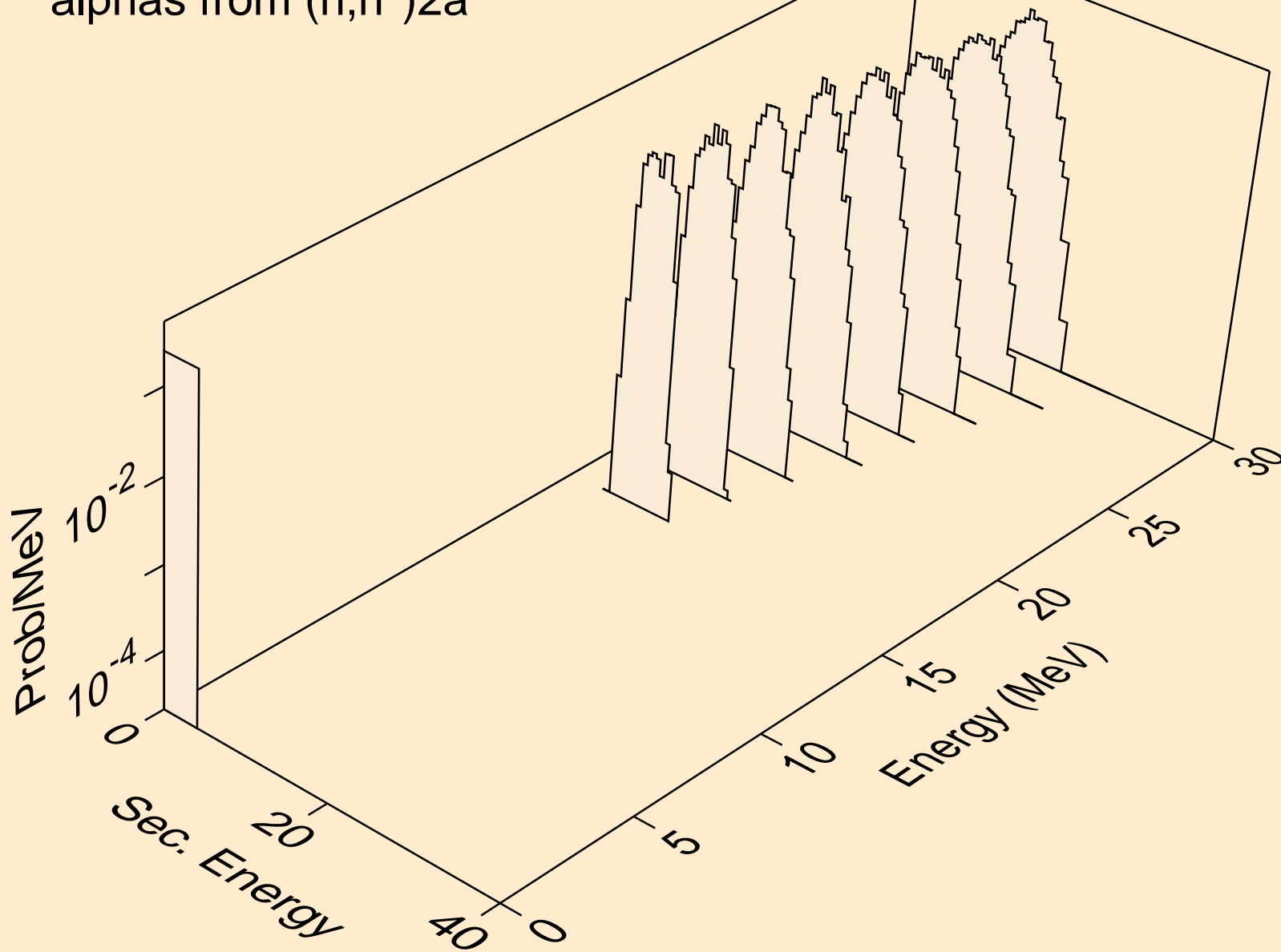

DY159 NEUTRON ACER TENDL-2019 LIBRARY; T=293.16K  
alphas from (n,npa)

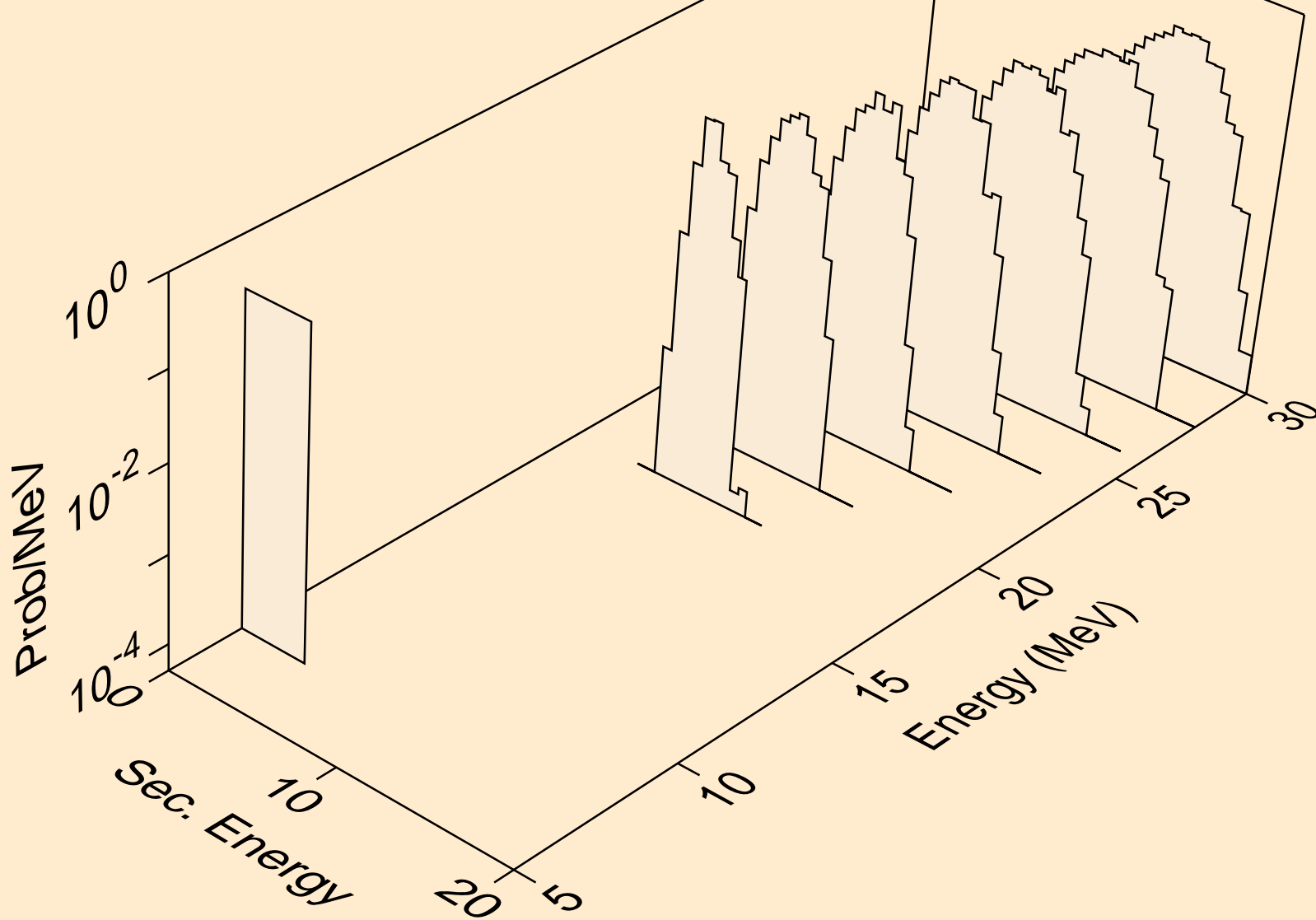

DY159 NEUTRON ACER TENDL-2019 LIBRARY; T=293.16K  
alphas from (n,a)

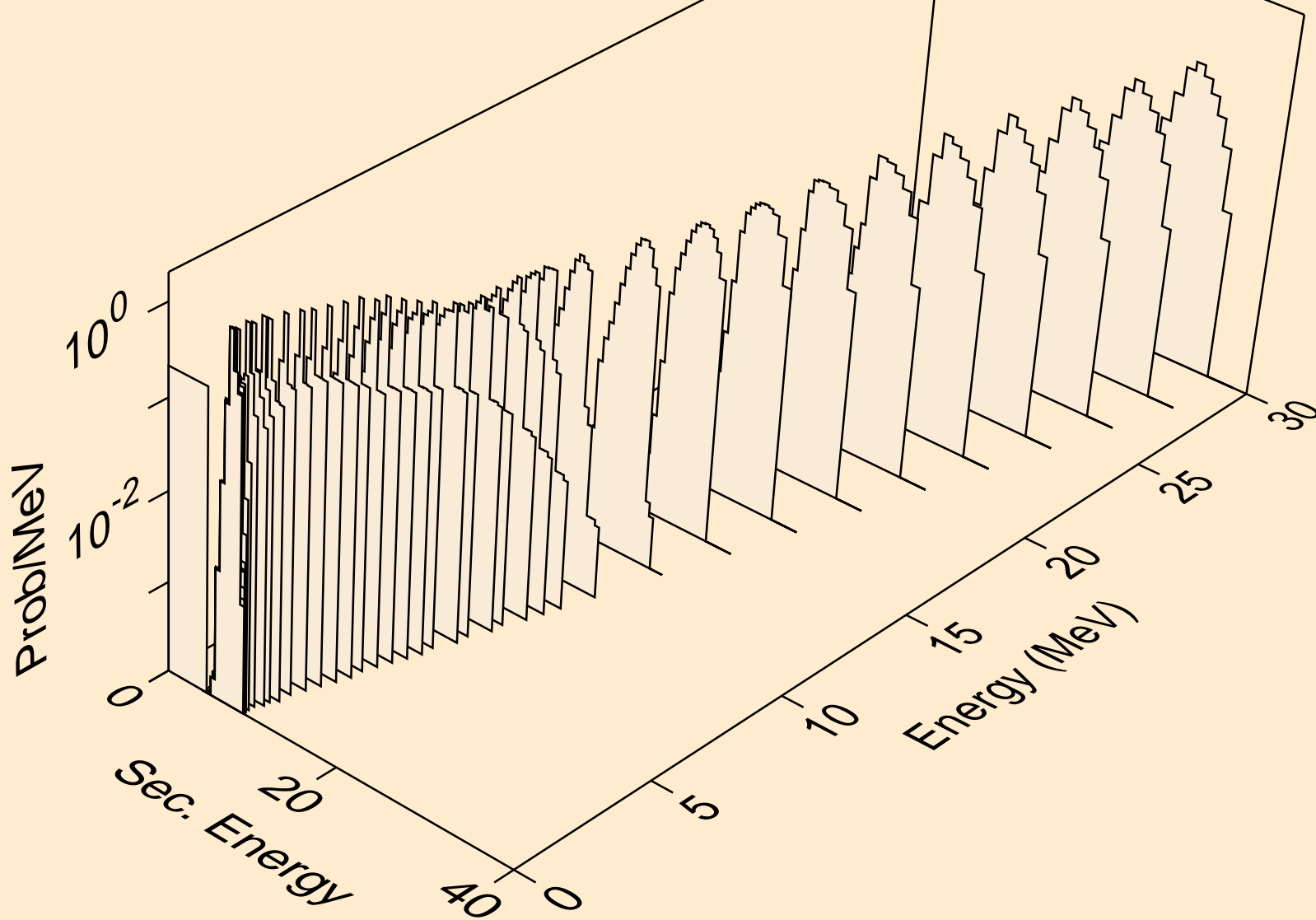



DY159 NEUTRON ACER TENDL-2019 LIBRARY; T=293.16K  
alphas from (n,2a)

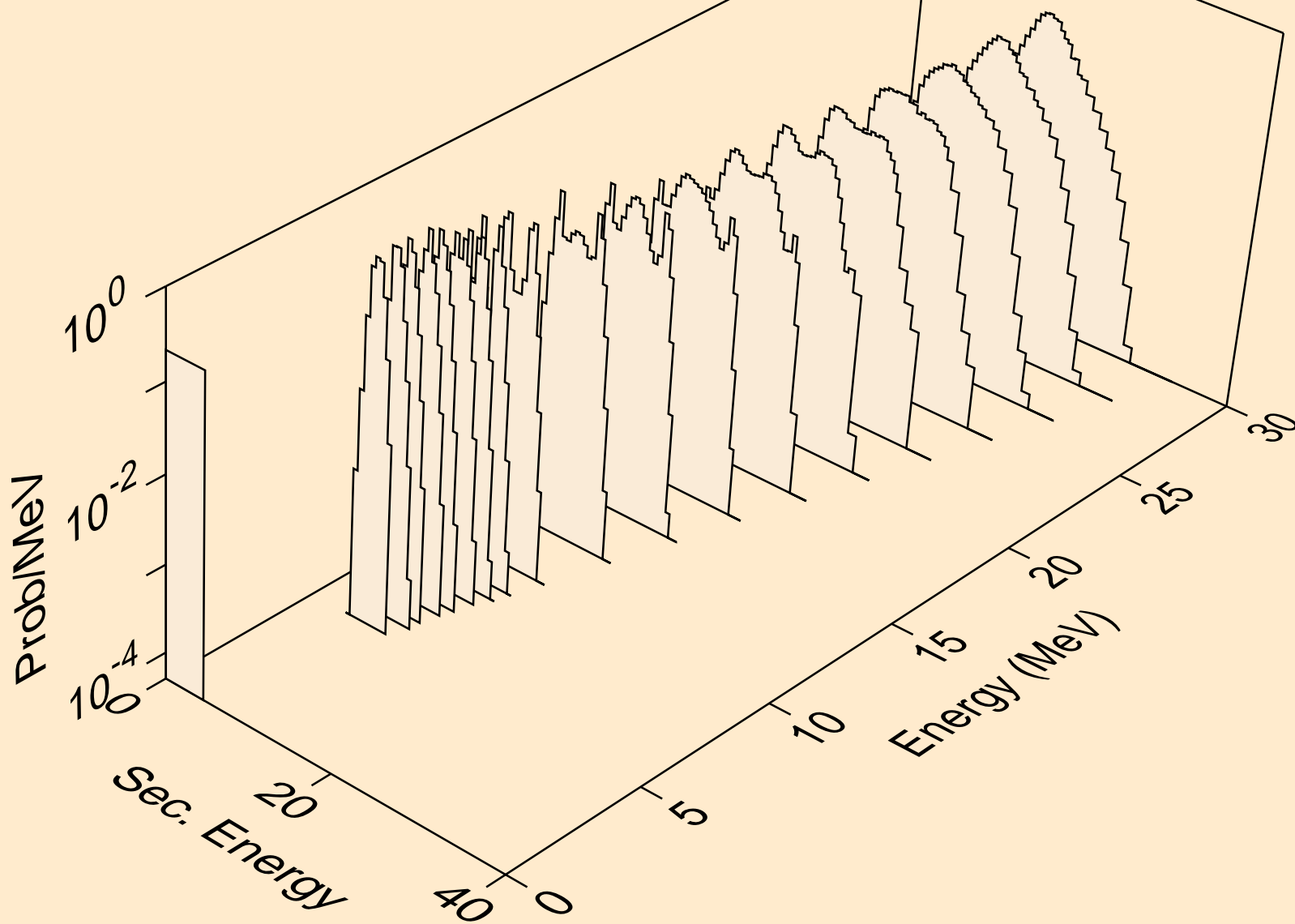

DY159 NEUTRON ACER TENDL-2019 LIBRARY; T=293.16K  
alphas from (n,pa)

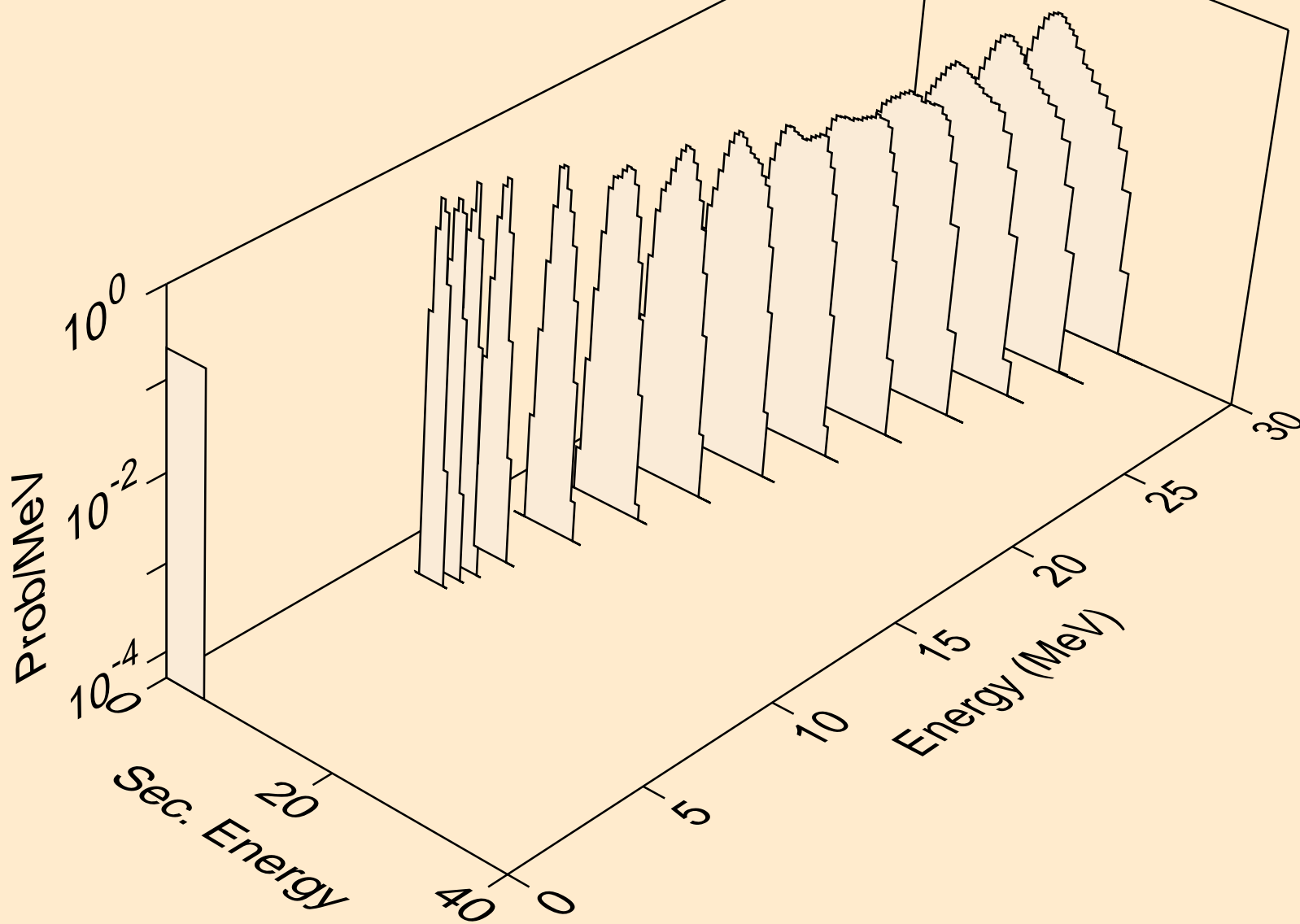

DY159 NEUTRON ACER TENDL-2019 LIBRARY; T=293.16K  
alphas from (n,da)

