

DY160 NEUTRON ACER TENDL-2019 LIBRARY; T=293.16K  
Principal cross sections

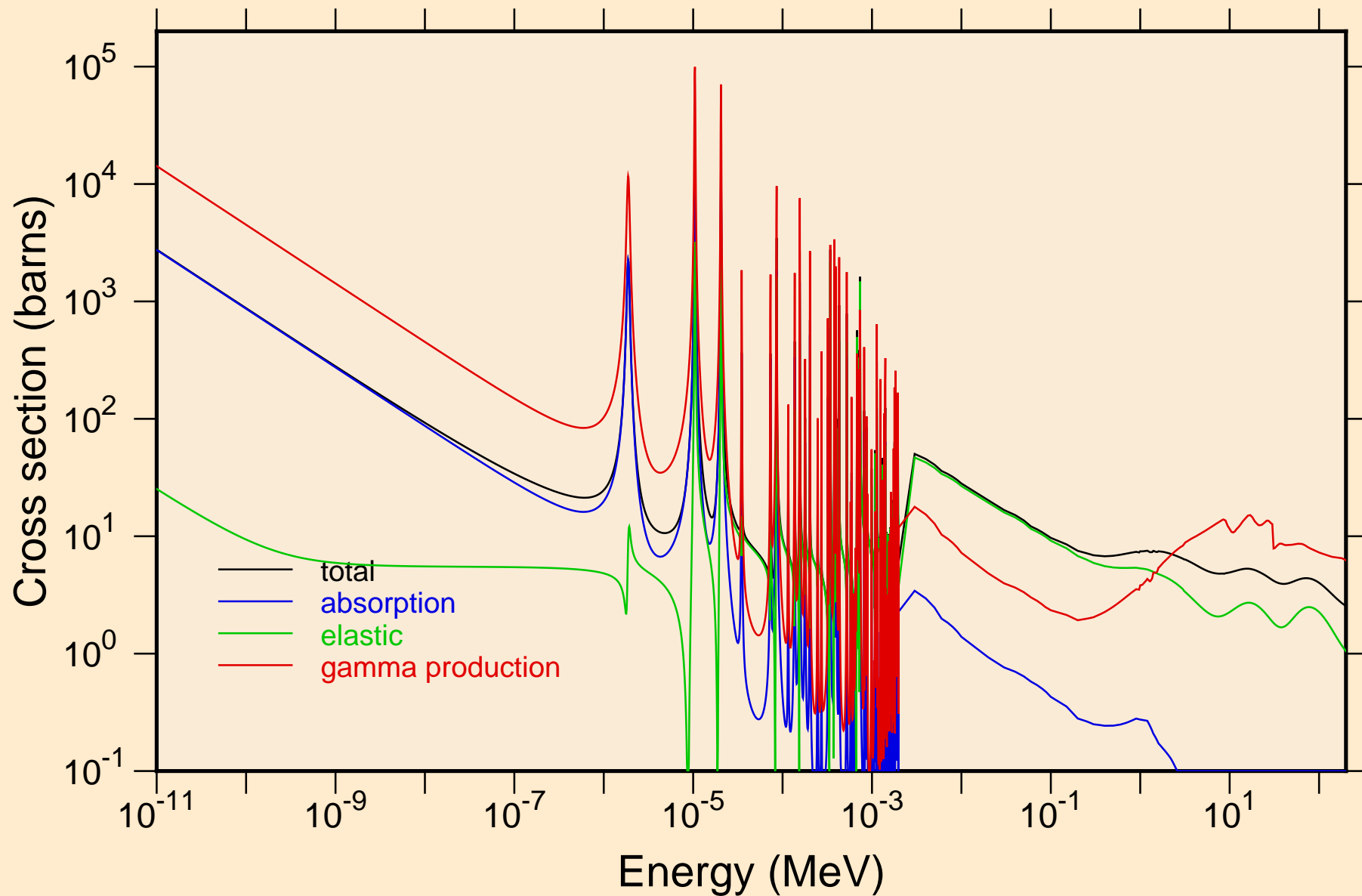

DY160 NEUTRON ACER TENDL-2019 LIBRARY; T=293.16K  
resonance total cross section

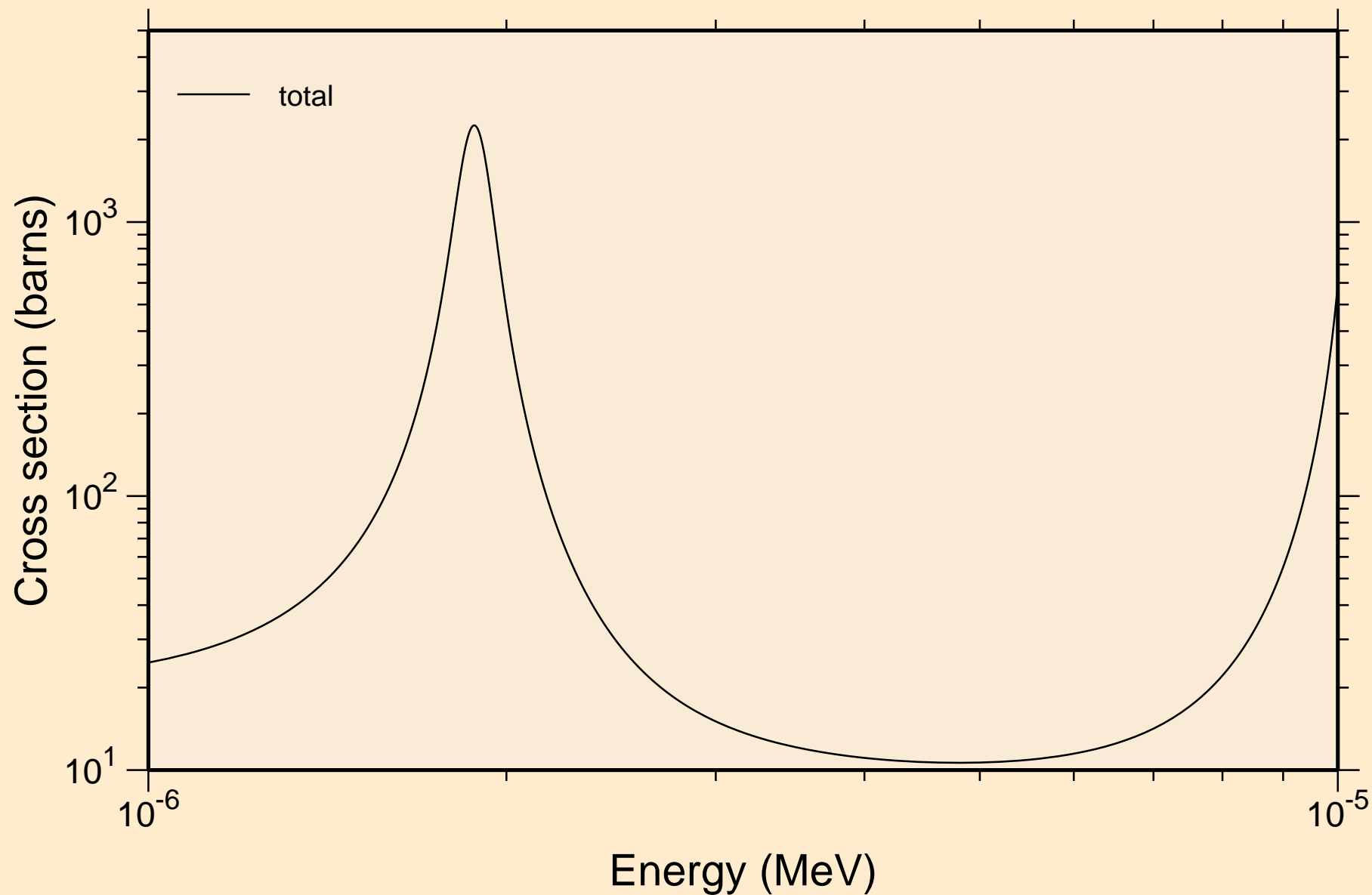

DY160 NEUTRON ACER TENDL-2019 LIBRARY; T=293.16K  
resonance total cross section

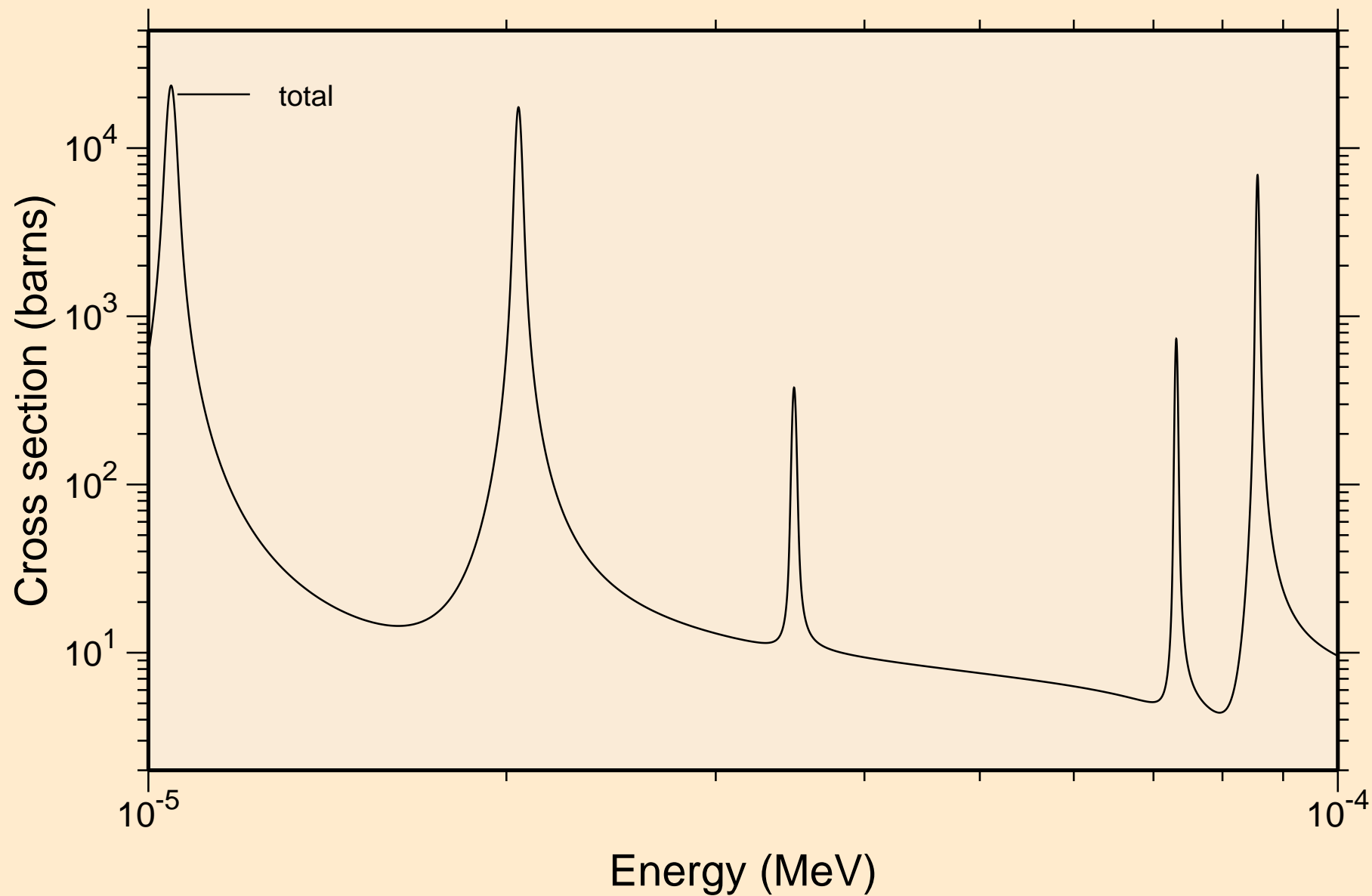

DY160 NEUTRON ACER TENDL-2019 LIBRARY; T=293.16K  
resonance total cross section

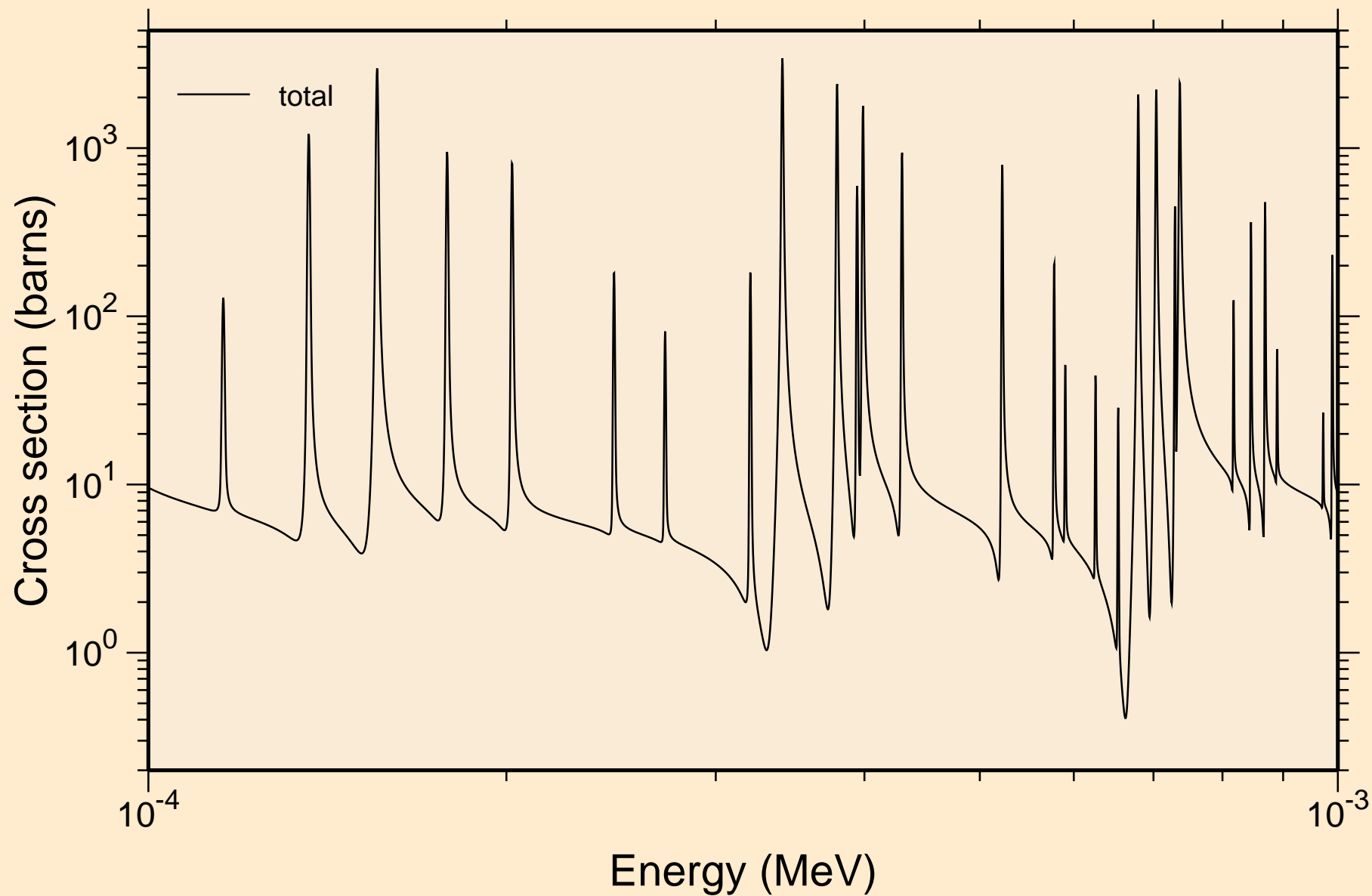

DY160 NEUTRON ACER TENDL-2019 LIBRARY; T=293.16K  
resonance total cross section

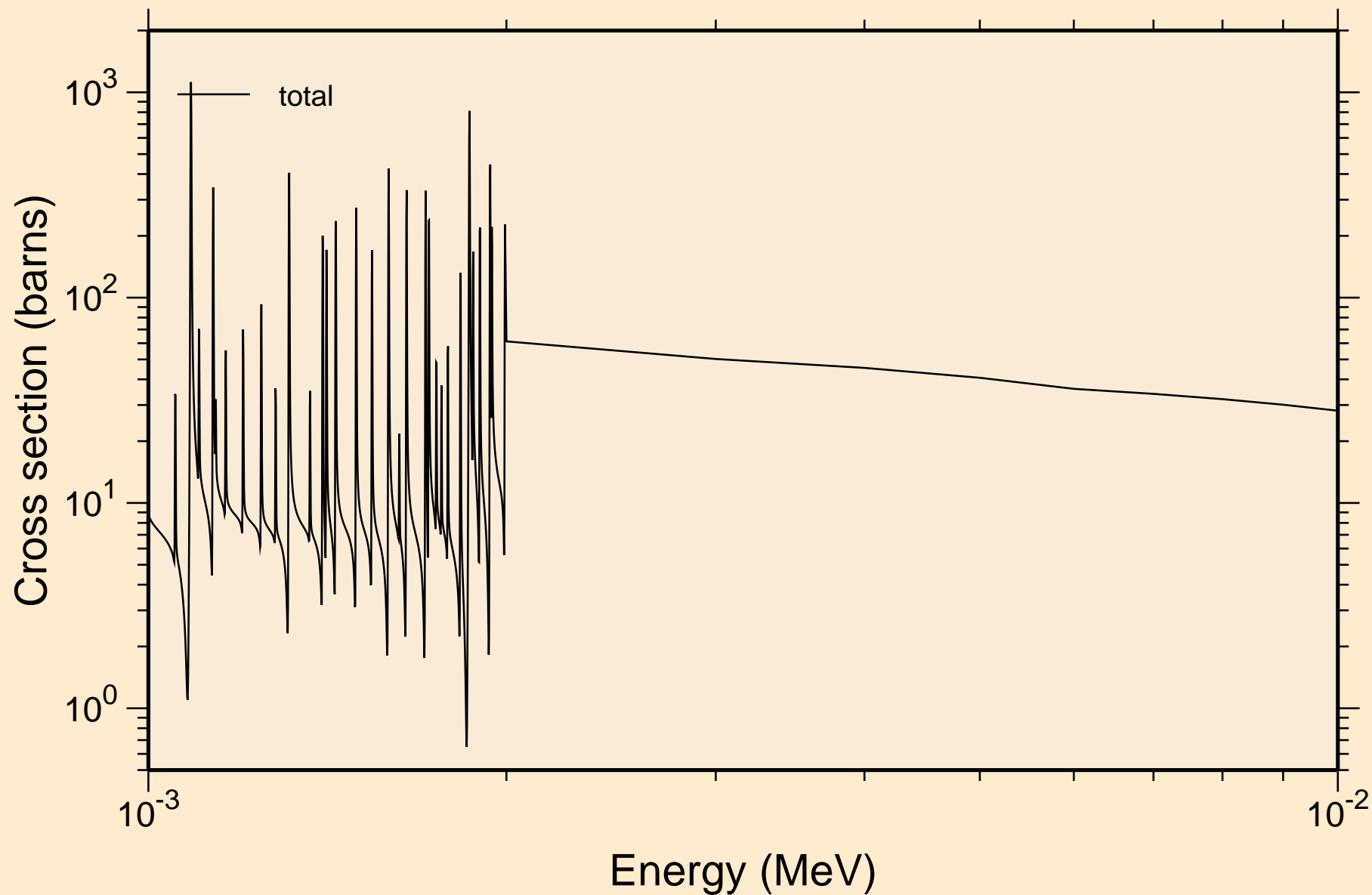

DY160 NEUTRON ACER TENDL-2019 LIBRARY; T=293.16K  
resonance total cross section

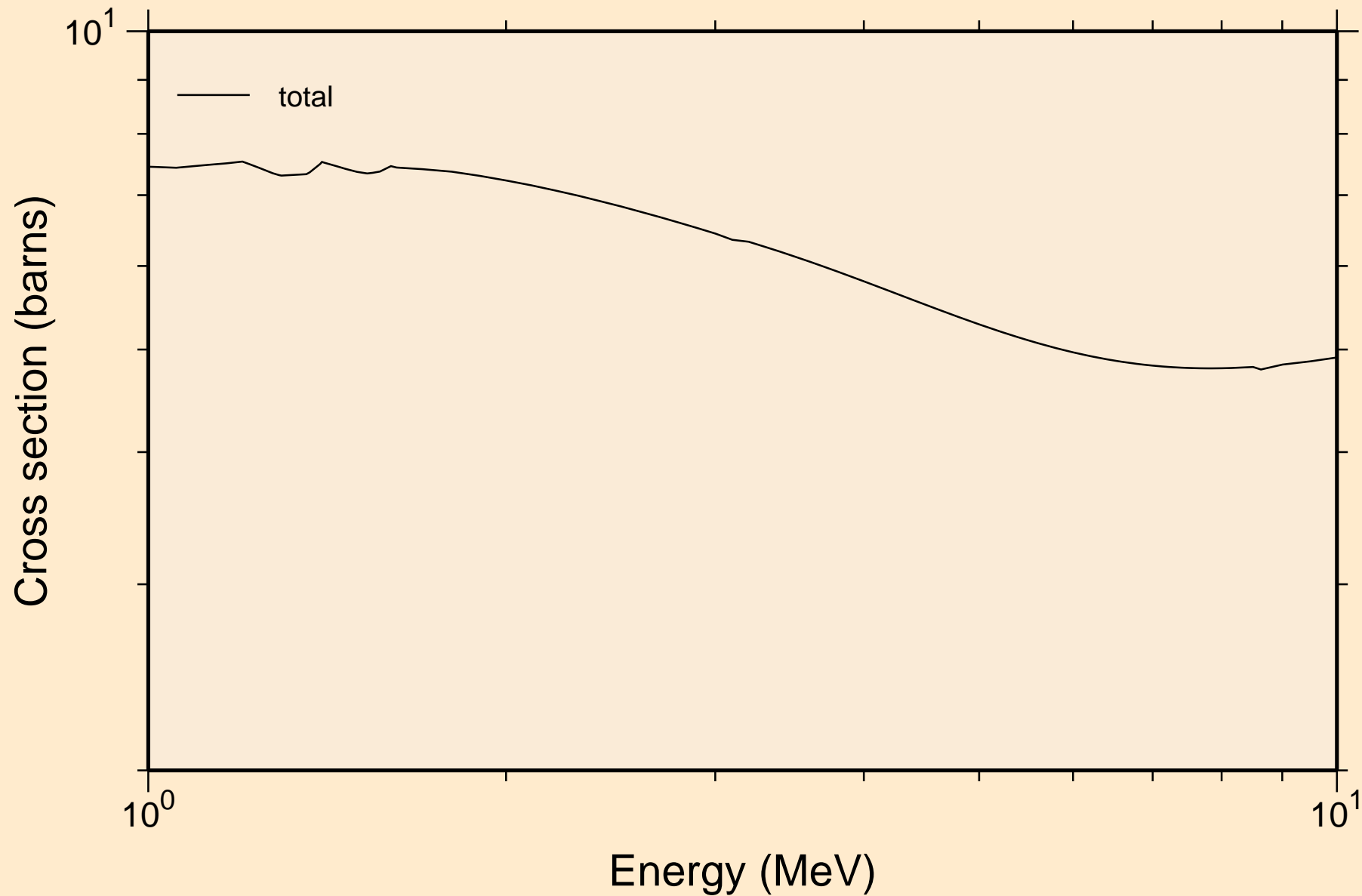

DY160 NEUTRON ACER TENDL-2019 LIBRARY; T=293.16K  
resonance absorption cross sections

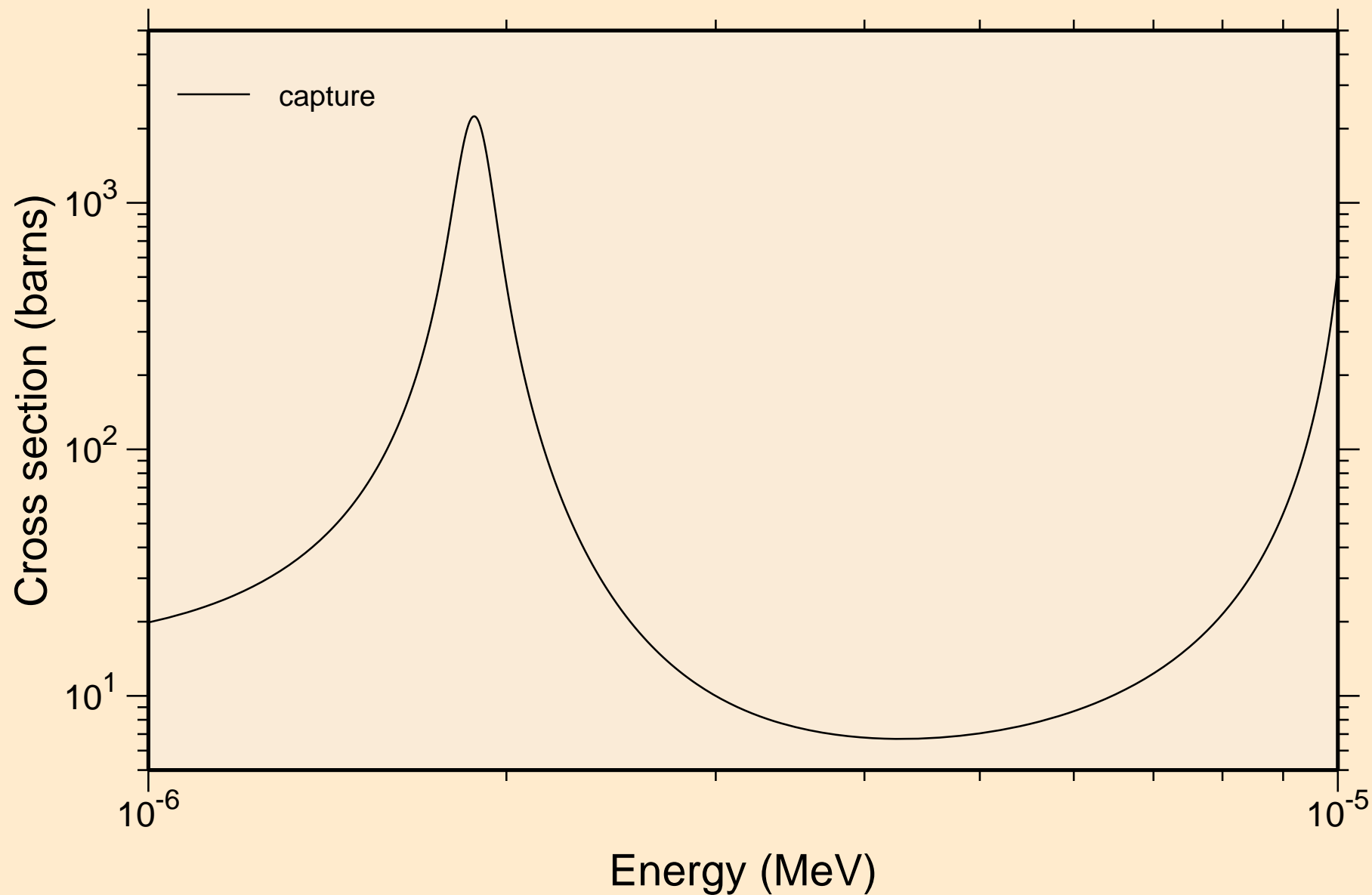

DY160 NEUTRON ACER TENDL-2019 LIBRARY; T=293.16K  
resonance absorption cross sections

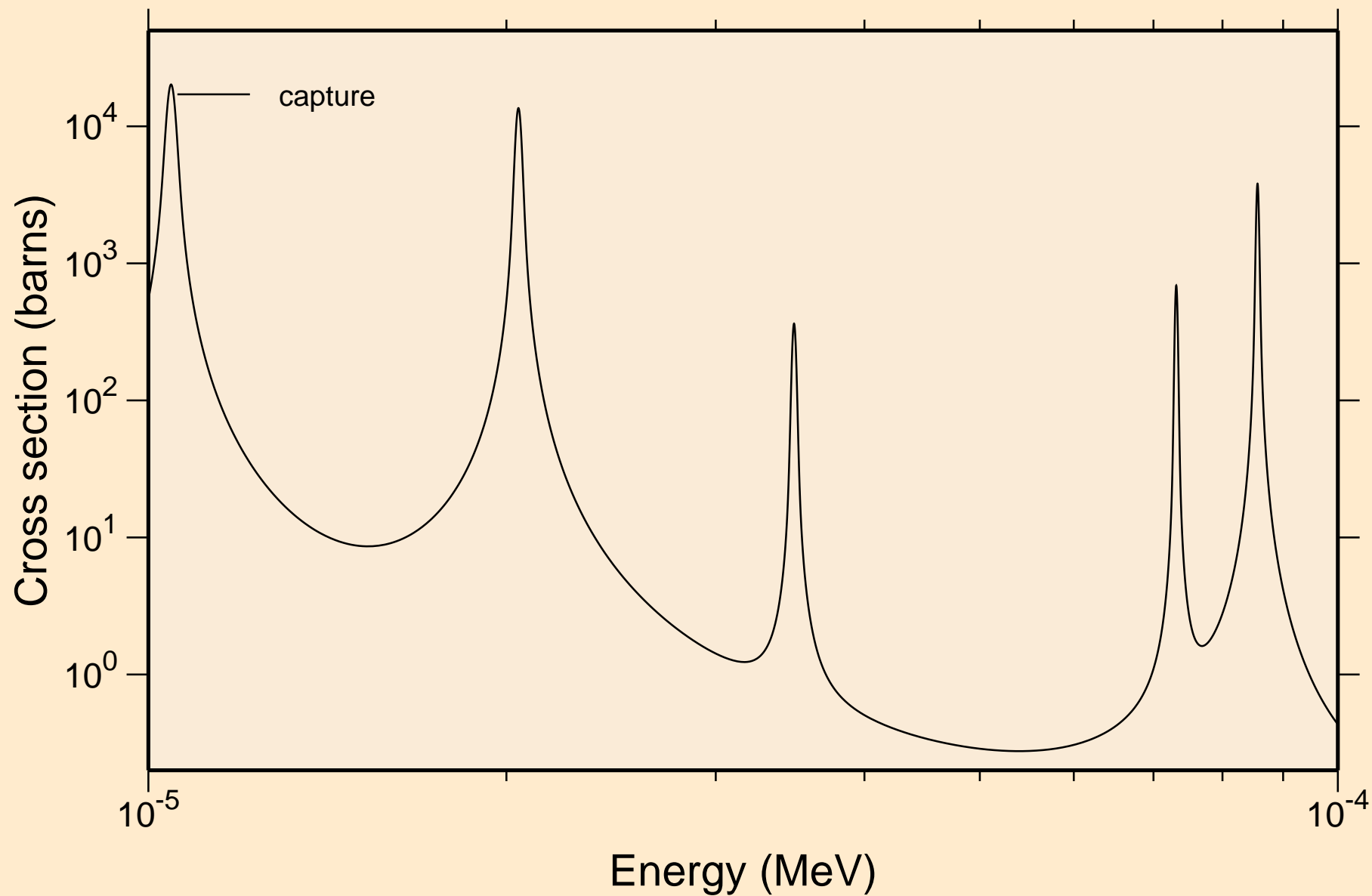



DY160 NEUTRON ACER TENDL-2019 LIBRARY; T=293.16K  
resonance absorption cross sections

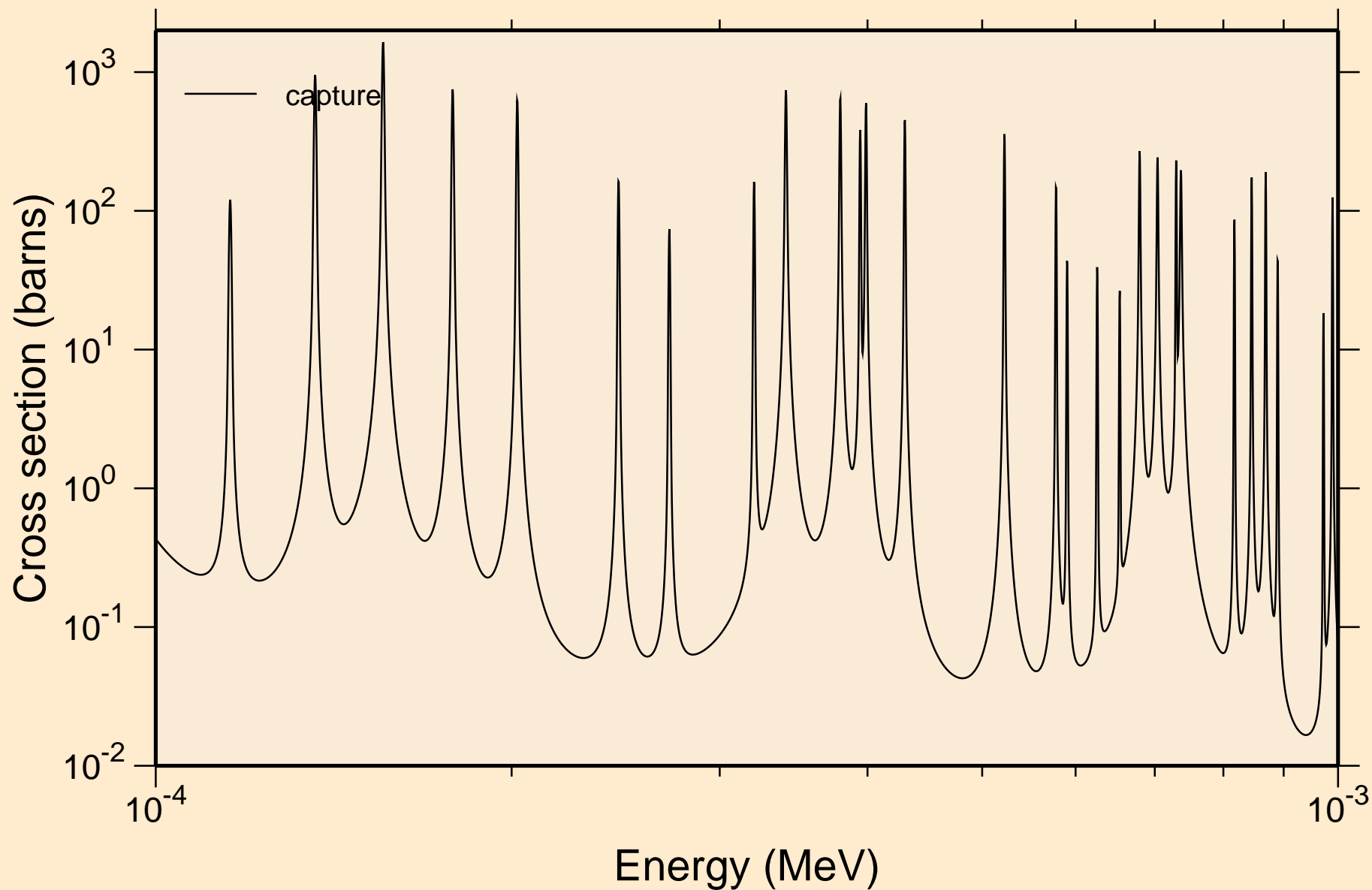

DY160 NEUTRON ACER TENDL-2019 LIBRARY; T=293.16K  
resonance absorption cross sections

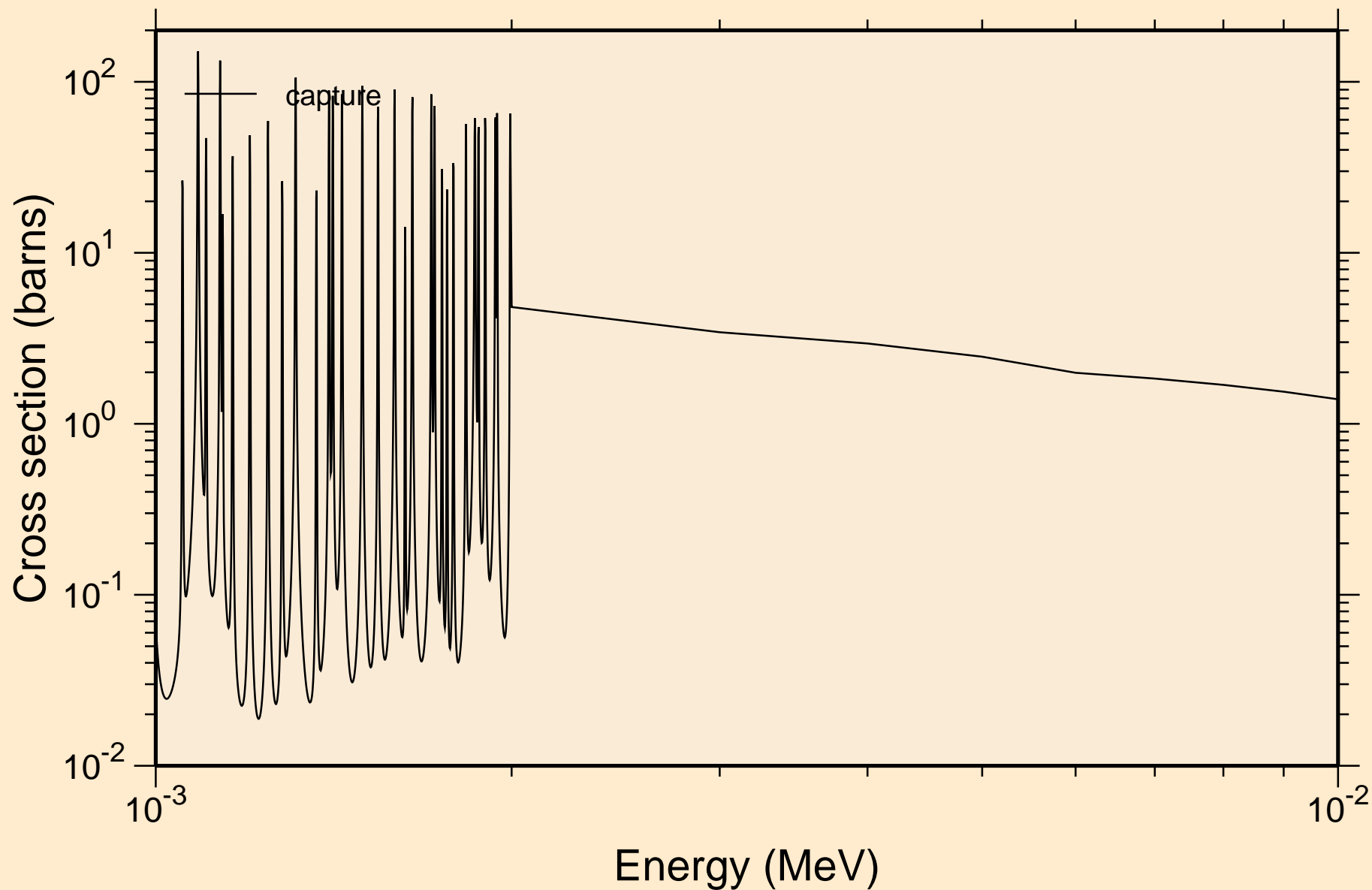

DY160 NEUTRON ACER TENDL-2019 LIBRARY; T=293.16K  
resonance absorption cross sections

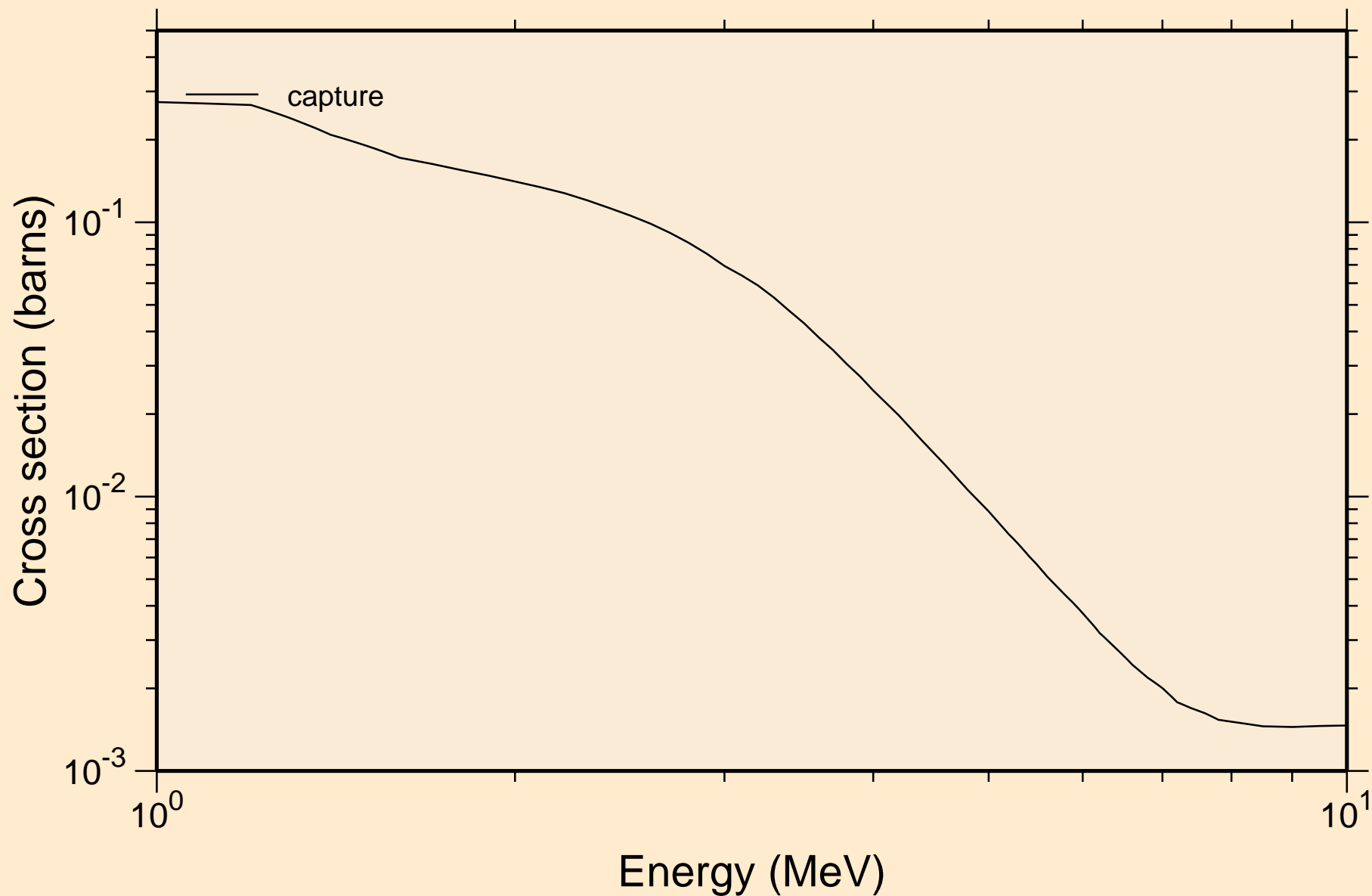

DY160 NEUTRON ACER TENDL-2019 LIBRARY; T=293.16K  
Heating

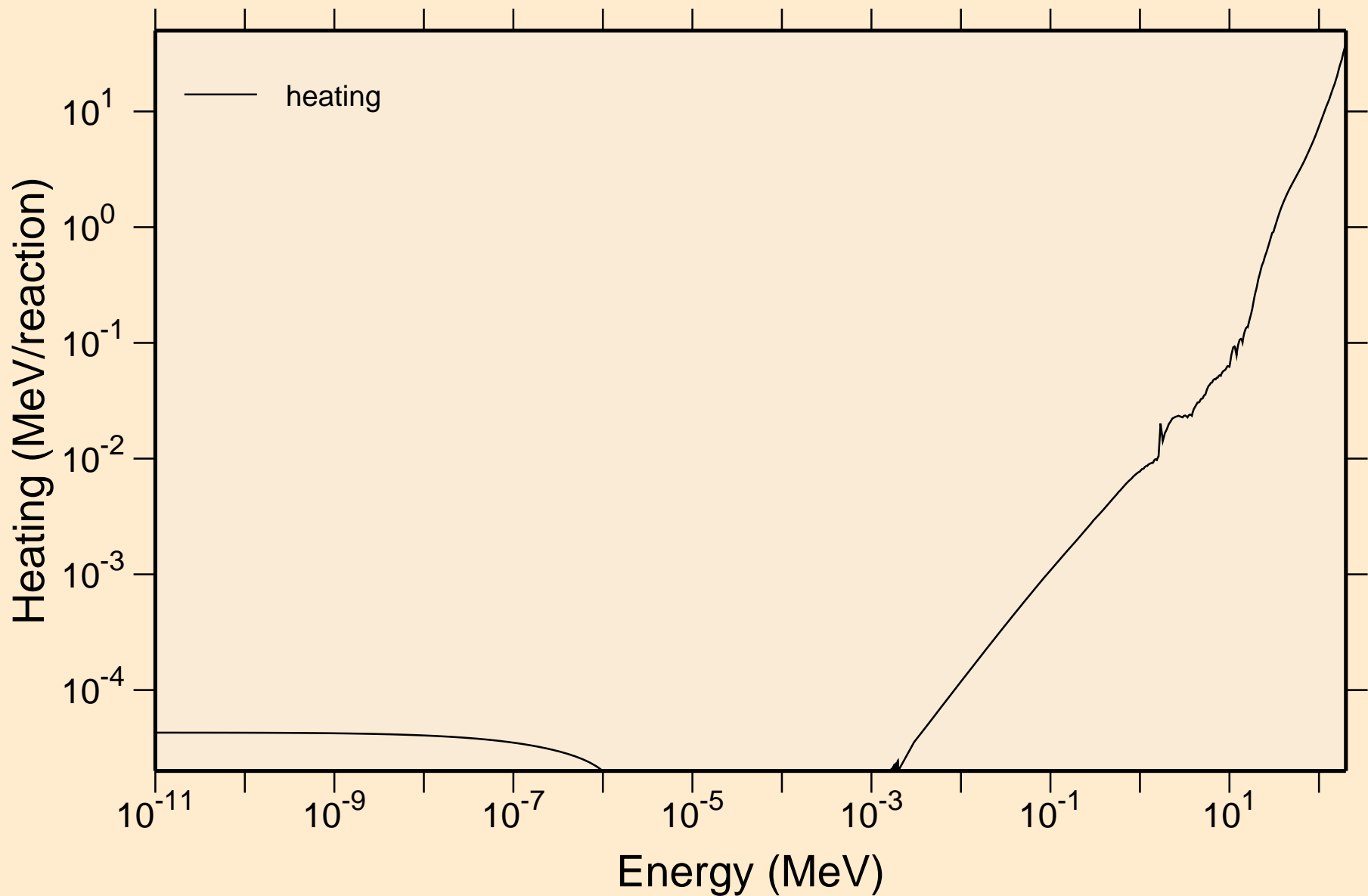

DY160 NEUTRON ACER TENDL-2019 LIBRARY; T=293.16K  
Damage

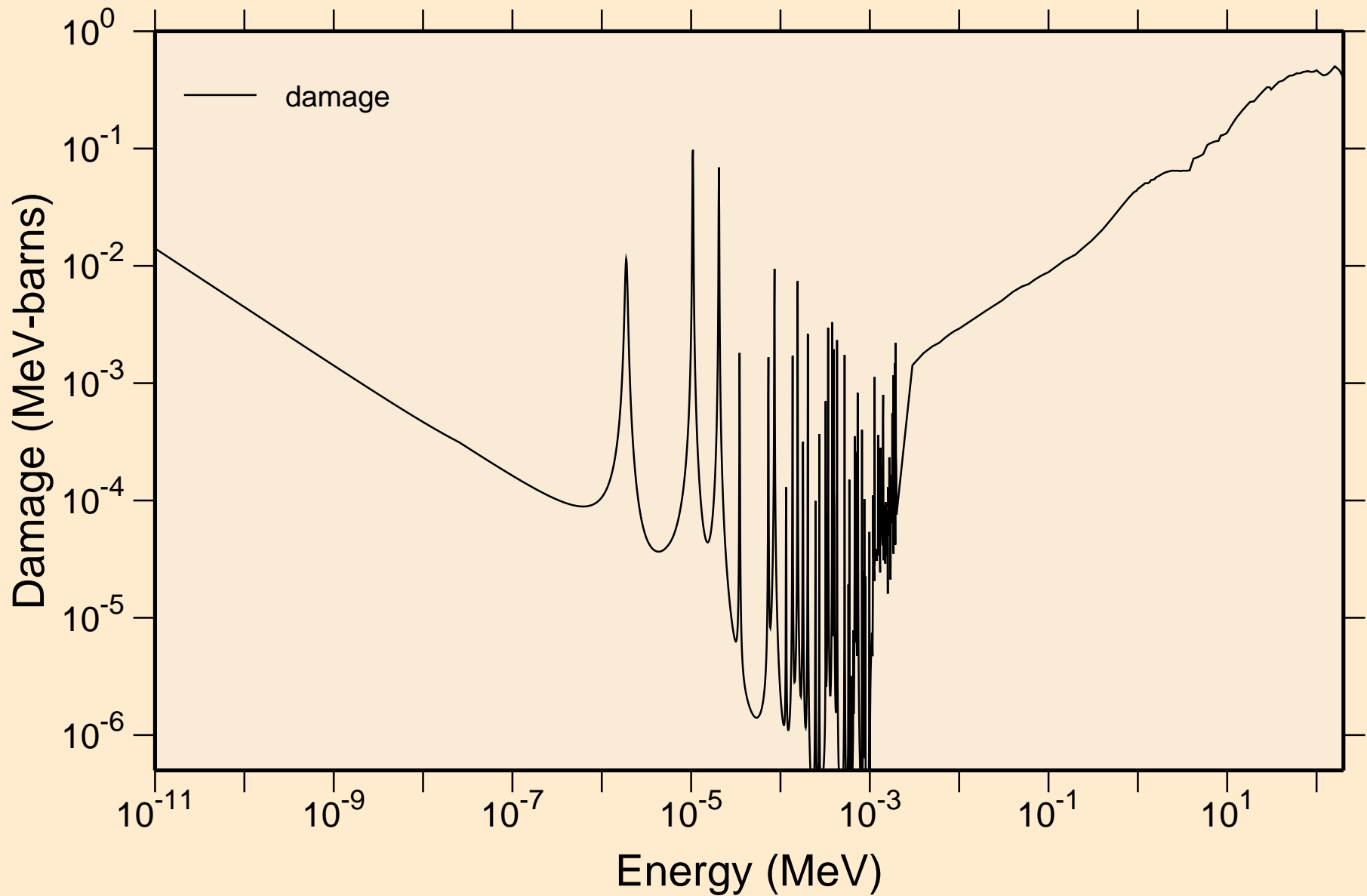

DY160 NEUTRON ACER TENDL-2019 LIBRARY; T=293.16K  
Non-threshold reactions

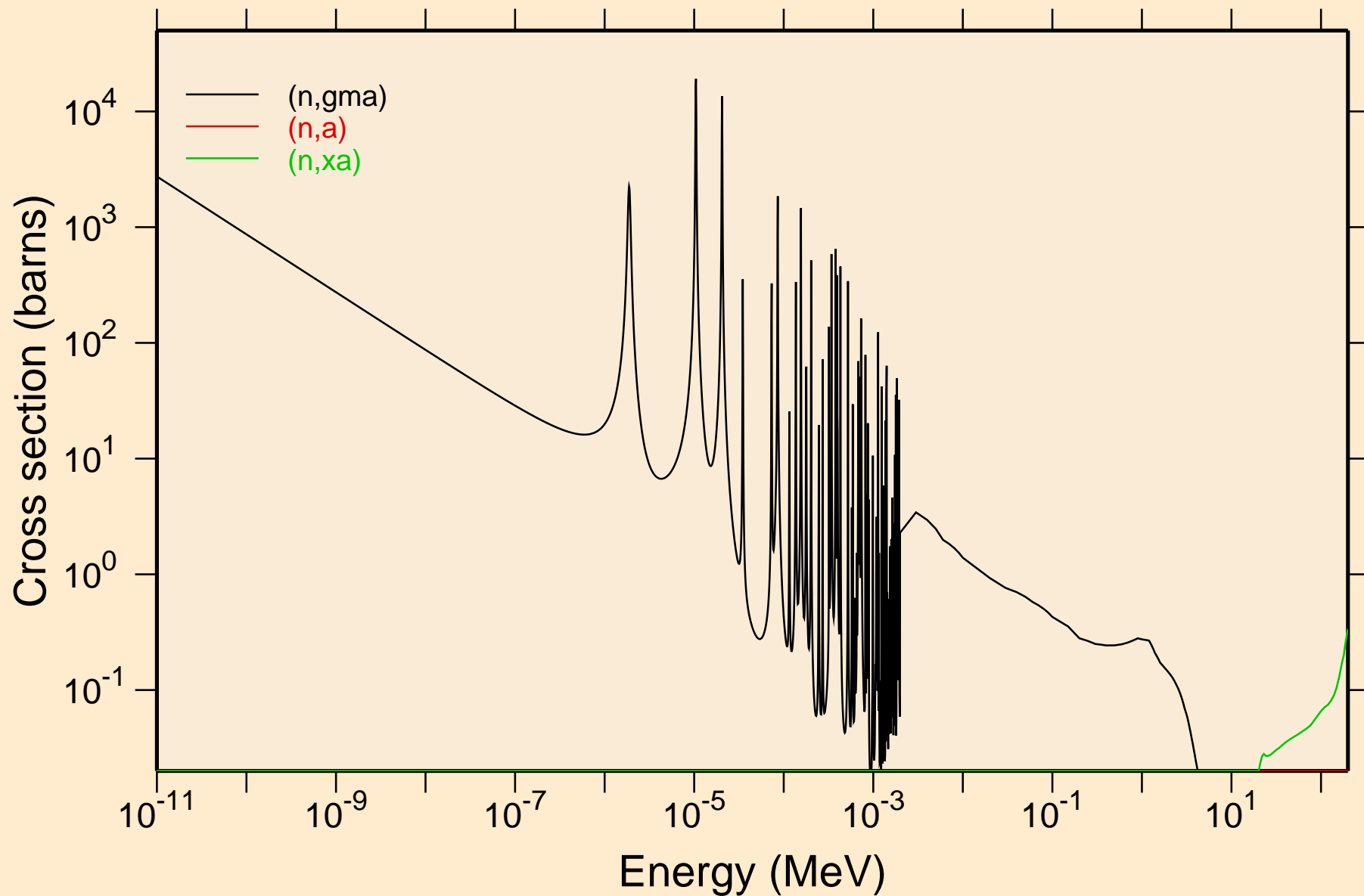

DY160 NEUTRON ACER TENDL-2019 LIBRARY; T=293.16K  
Principal cross sections

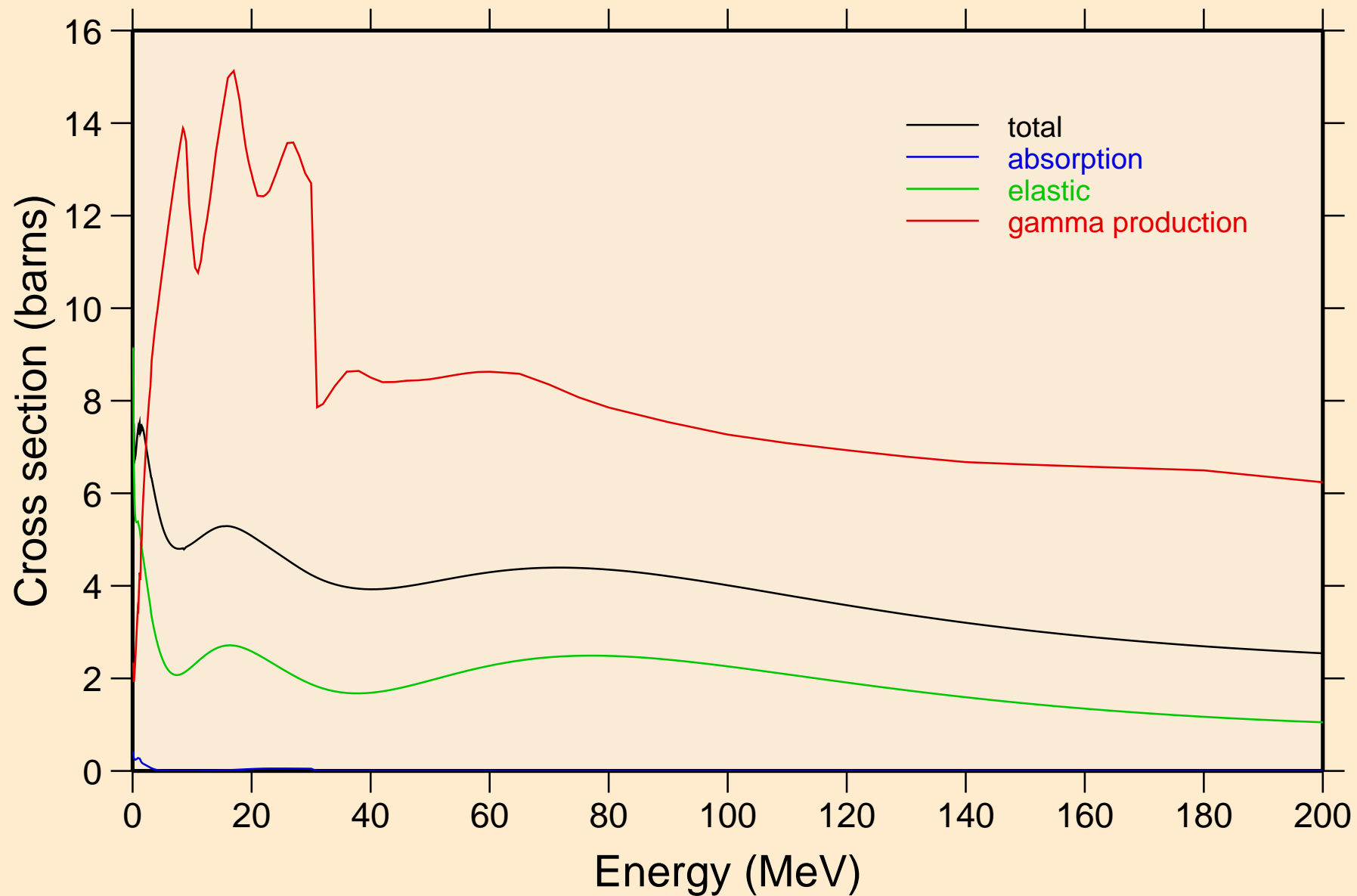

DY160 NEUTRON ACER TENDL-2019 LIBRARY; T=293.16K  
Heating

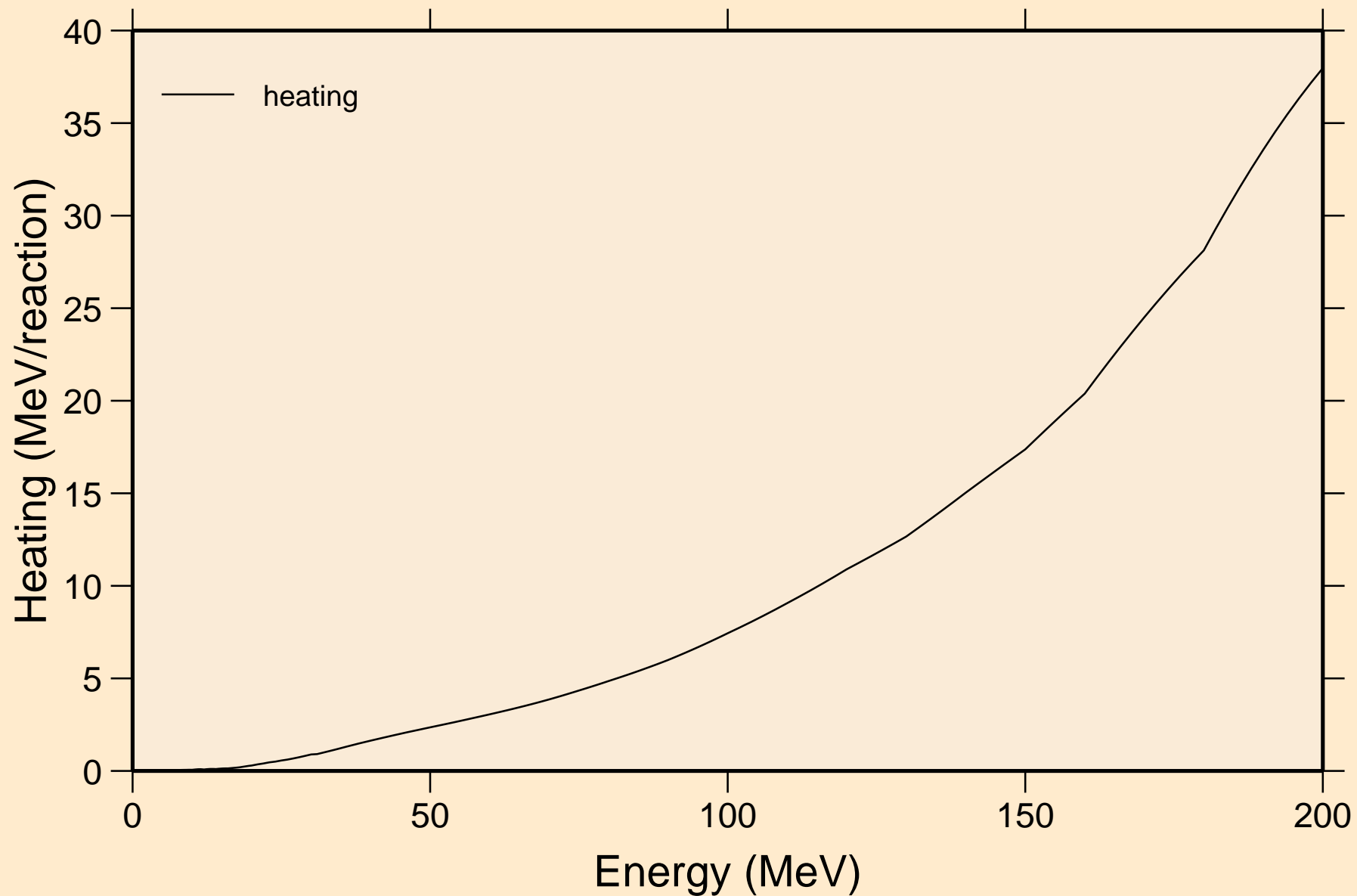



DY160 NEUTRON ACER TENDL-2019 LIBRARY; T=293.16K  
Damage

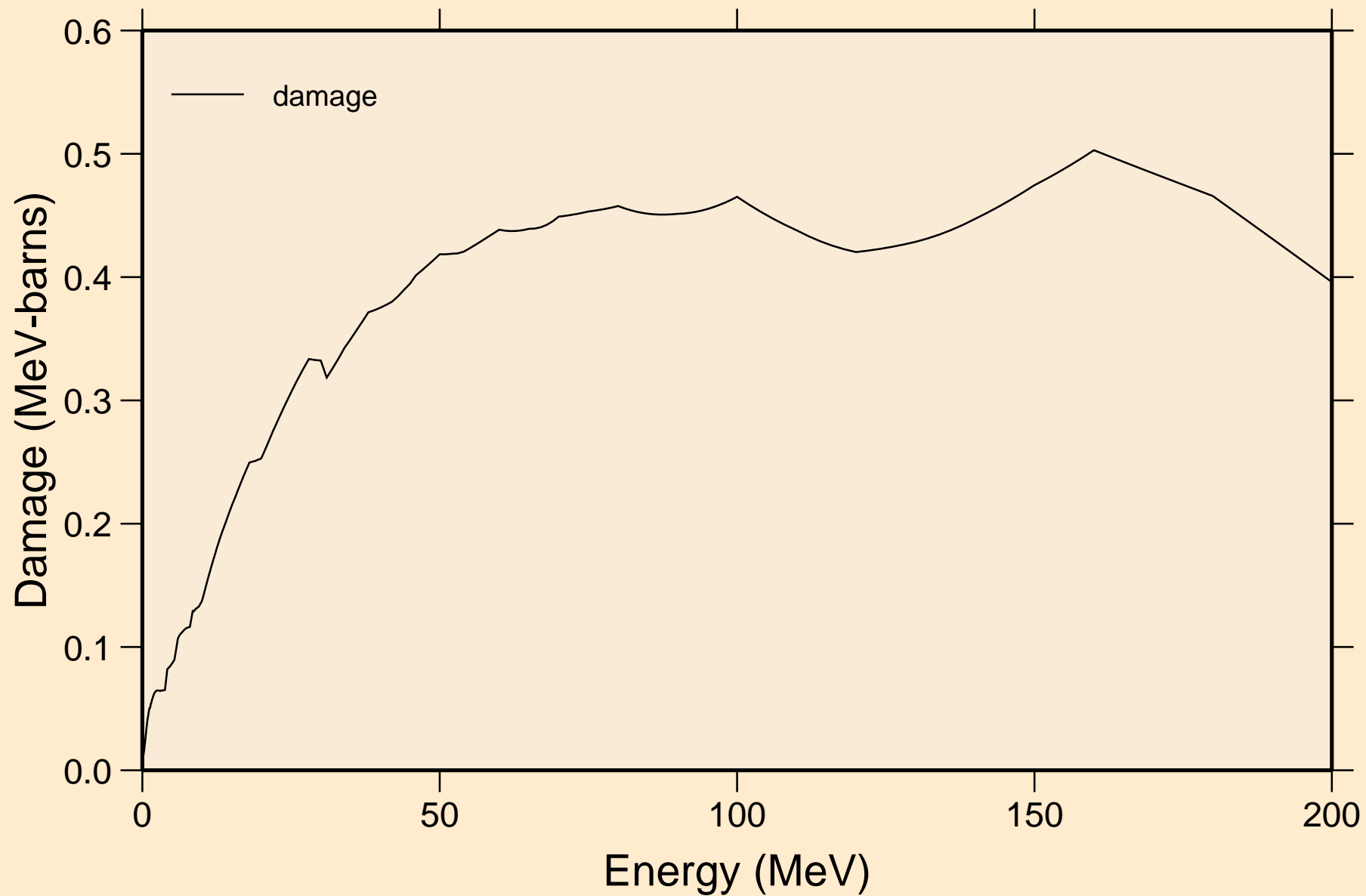

DY160 NEUTRON ACER TENDL-2019 LIBRARY; T=293.16K  
Non-threshold reactions

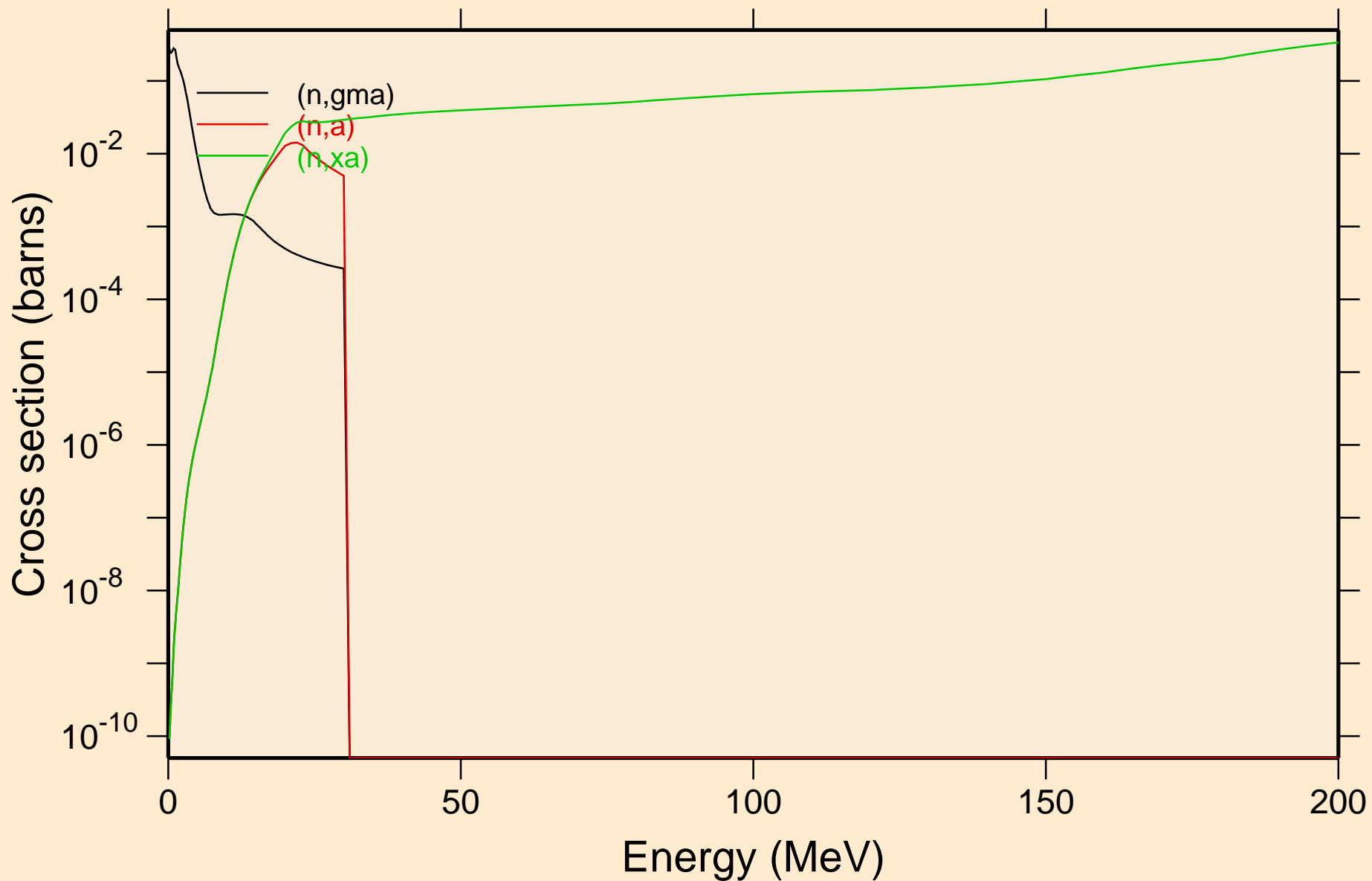

DY160 NEUTRON ACER TENDL-2019 LIBRARY; T=293.16K  
Inelastic levels

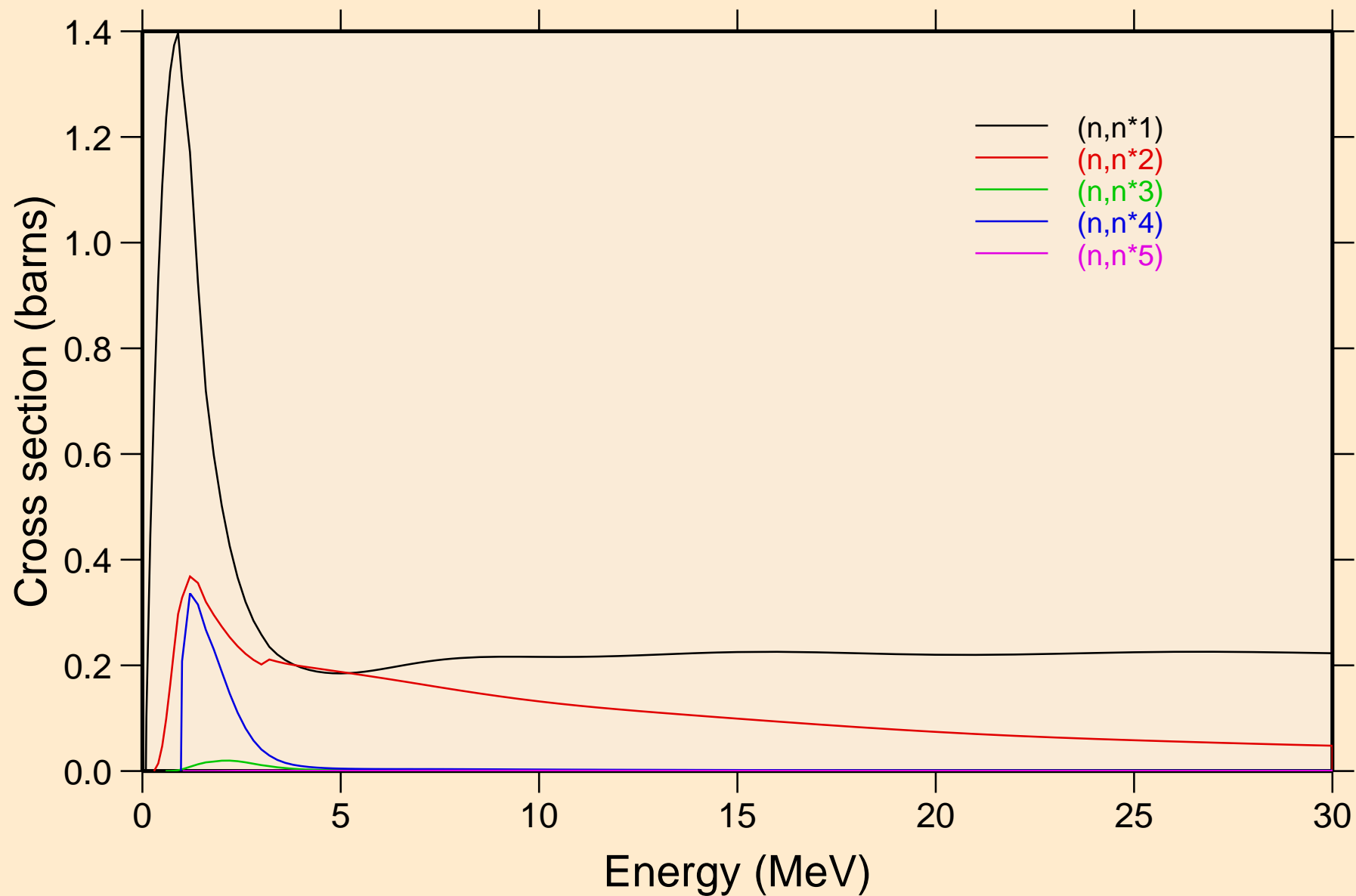

DY160 NEUTRON ACER TENDL-2019 LIBRARY; T=293.16K  
Inelastic levels

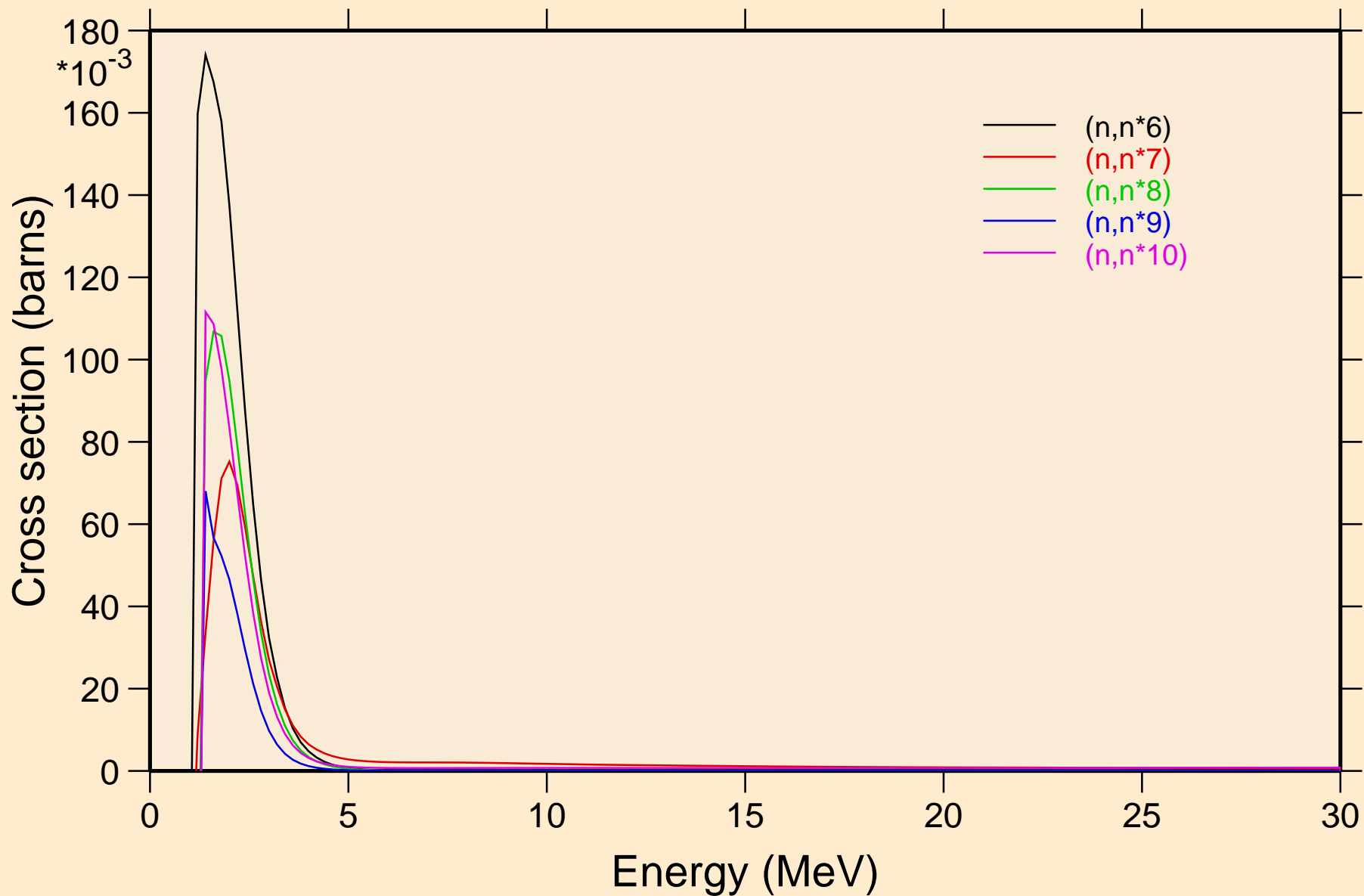

DY160 NEUTRON ACER TENDL-2019 LIBRARY; T=293.16K  
Inelastic levels

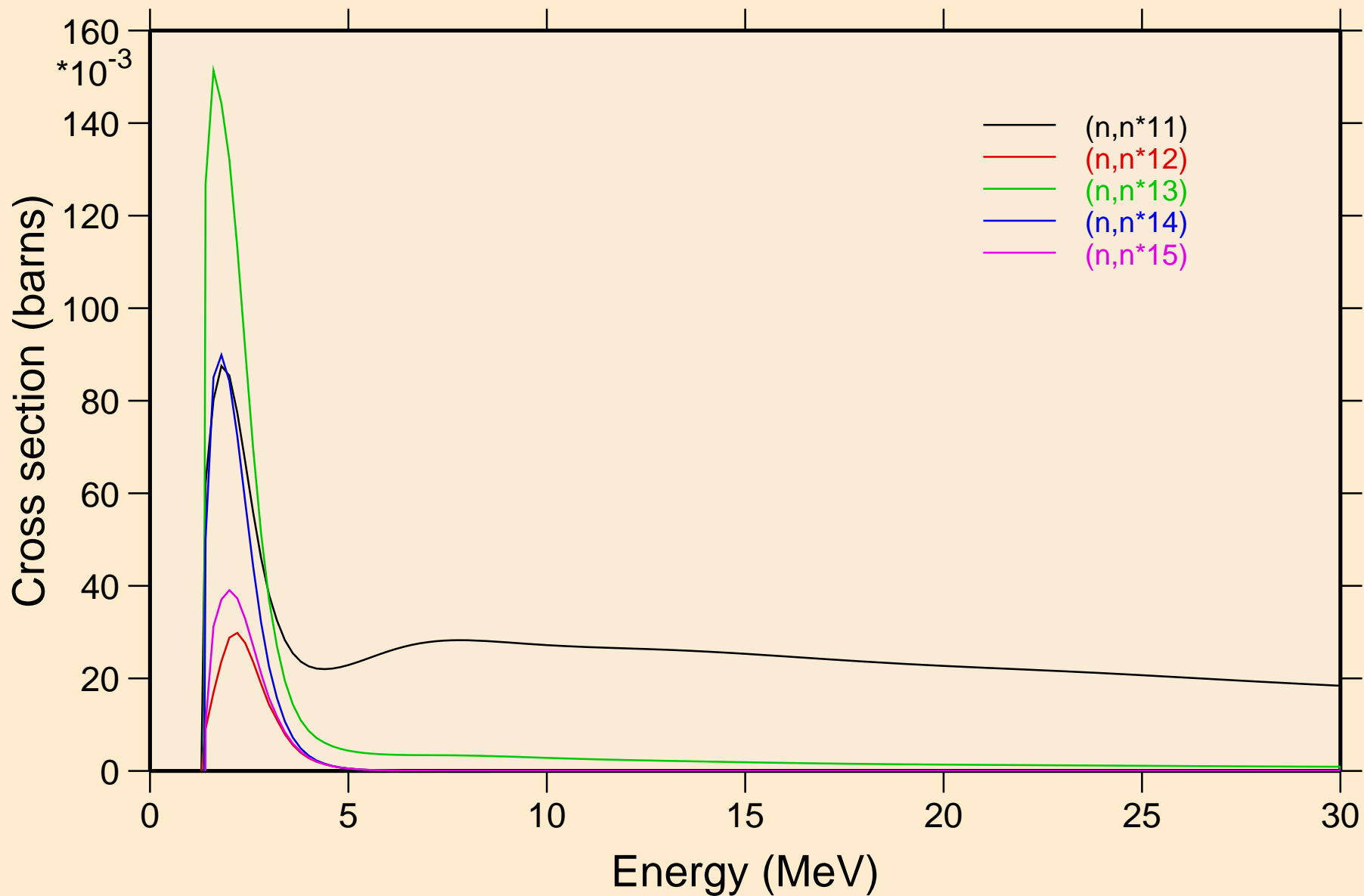

DY160 NEUTRON ACER TENDL-2019 LIBRARY; T=293.16K  
Inelastic levels

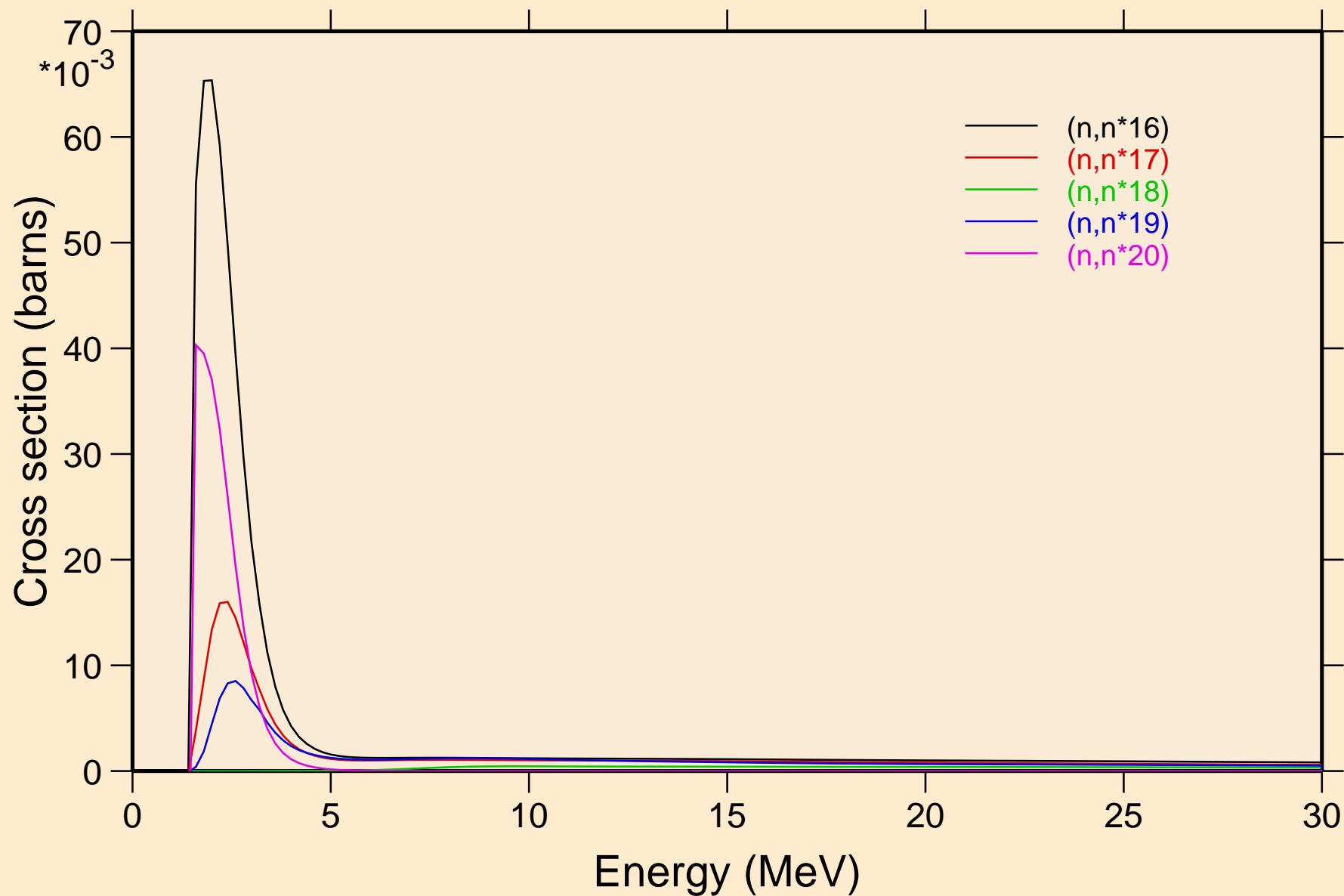

DY160 NEUTRON ACER TENDL-2019 LIBRARY; T=293.16K  
Inelastic levels

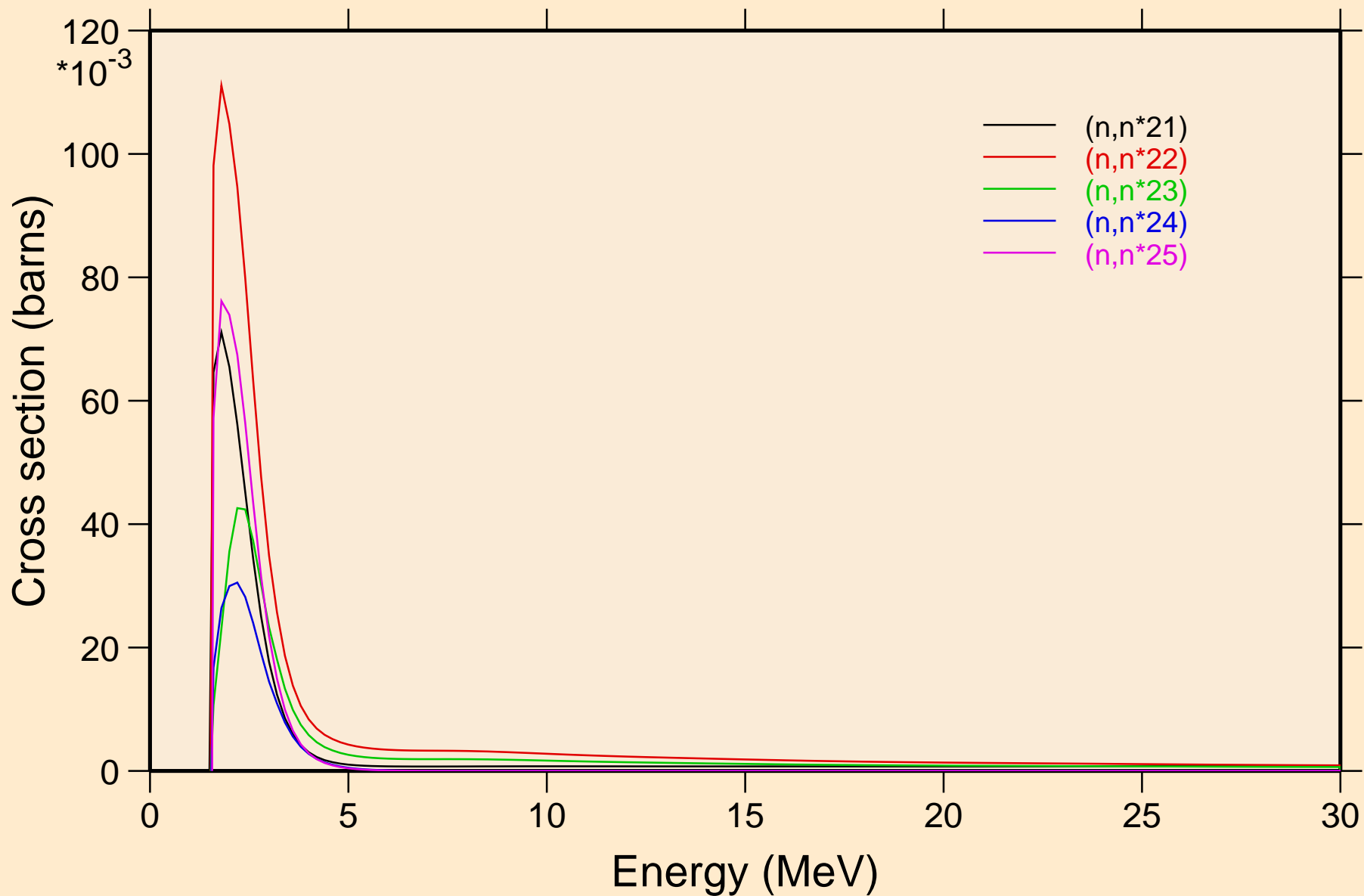

DY160 NEUTRON ACER TENDL-2019 LIBRARY; T=293.16K  
Inelastic levels

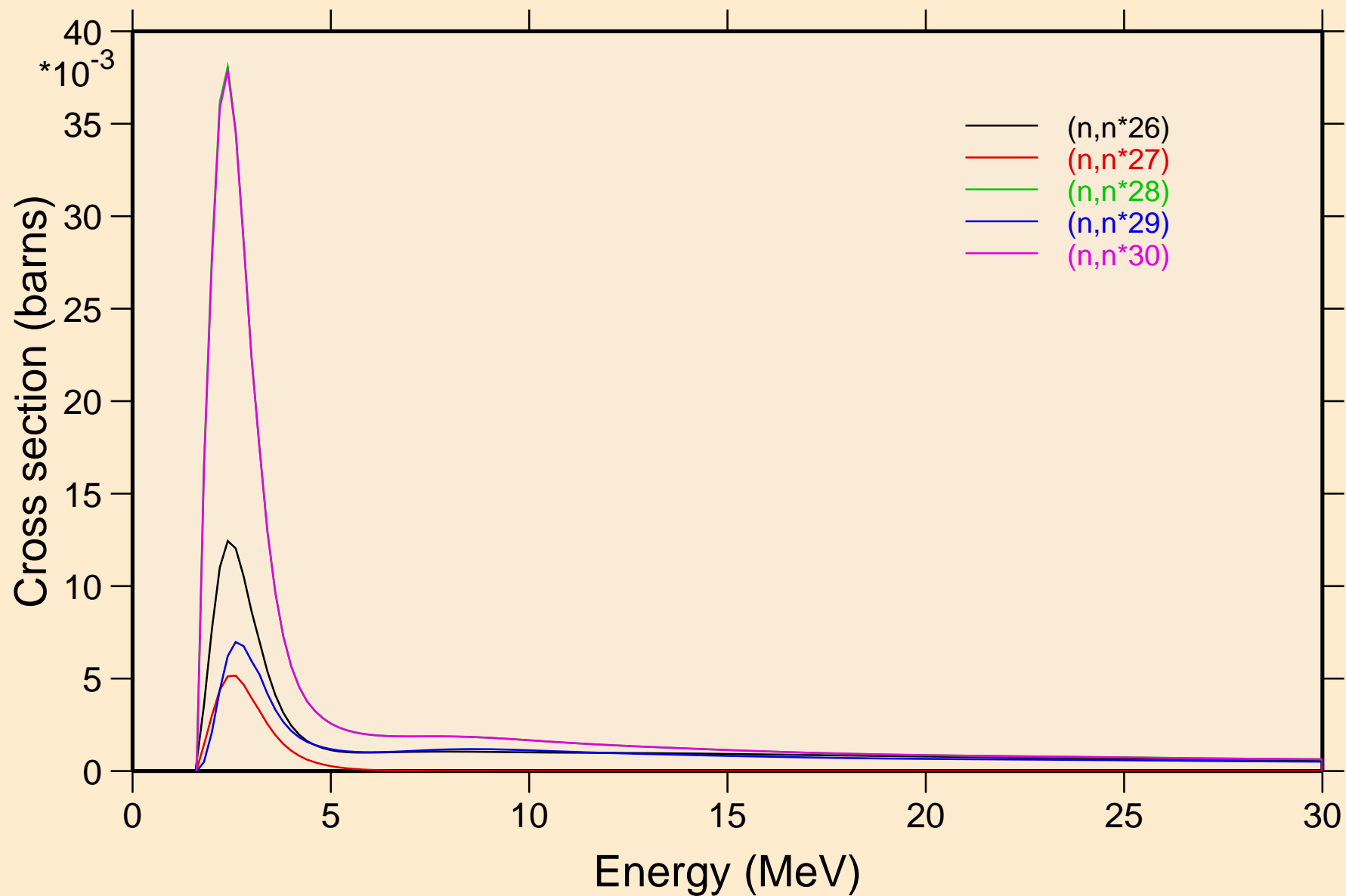



DY160 NEUTRON ACER TENDL-2019 LIBRARY; T=293.16K  
Threshold reactions

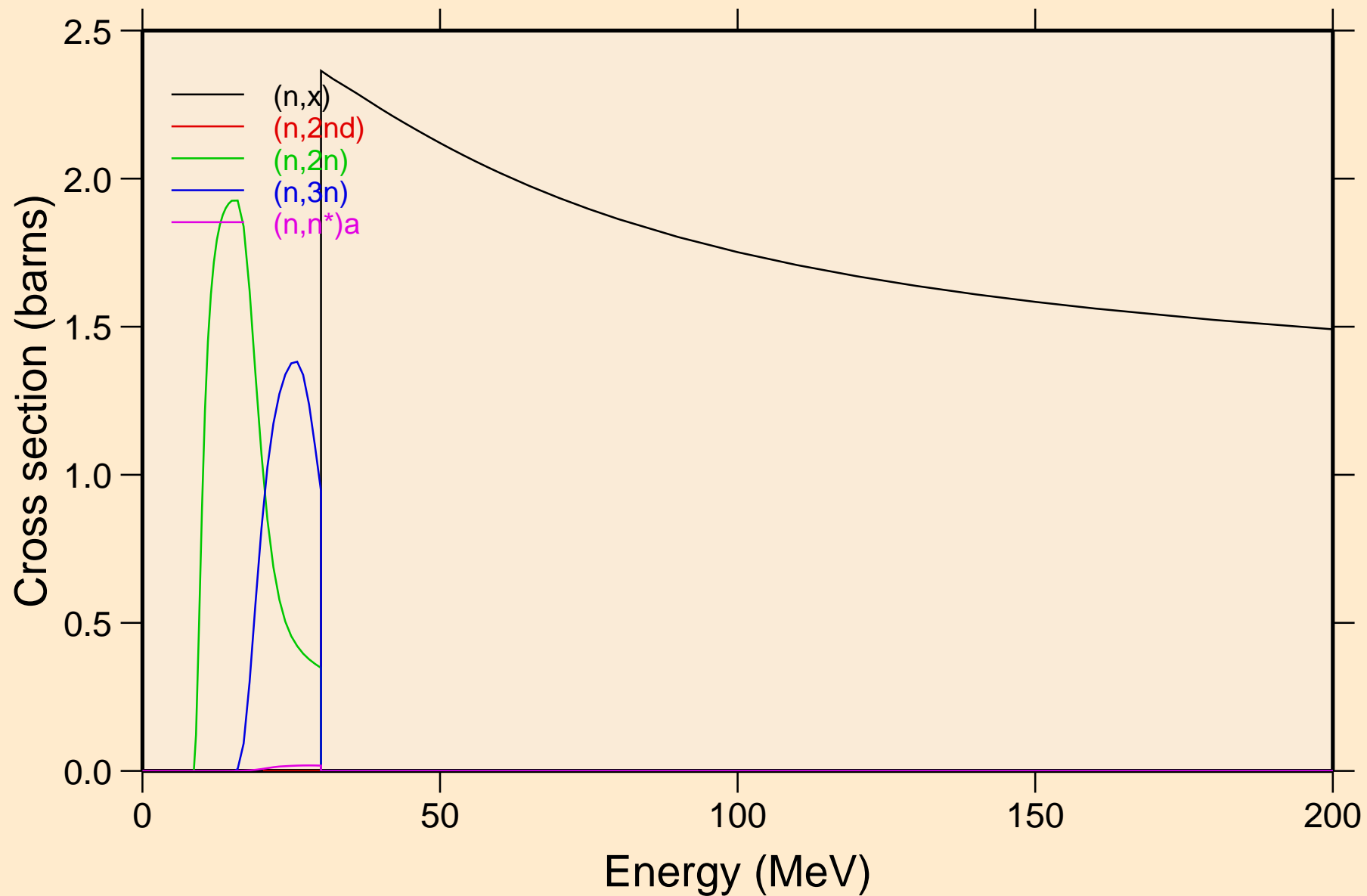

DY160 NEUTRON ACER TENDL-2019 LIBRARY; T=293.16K  
Threshold reactions

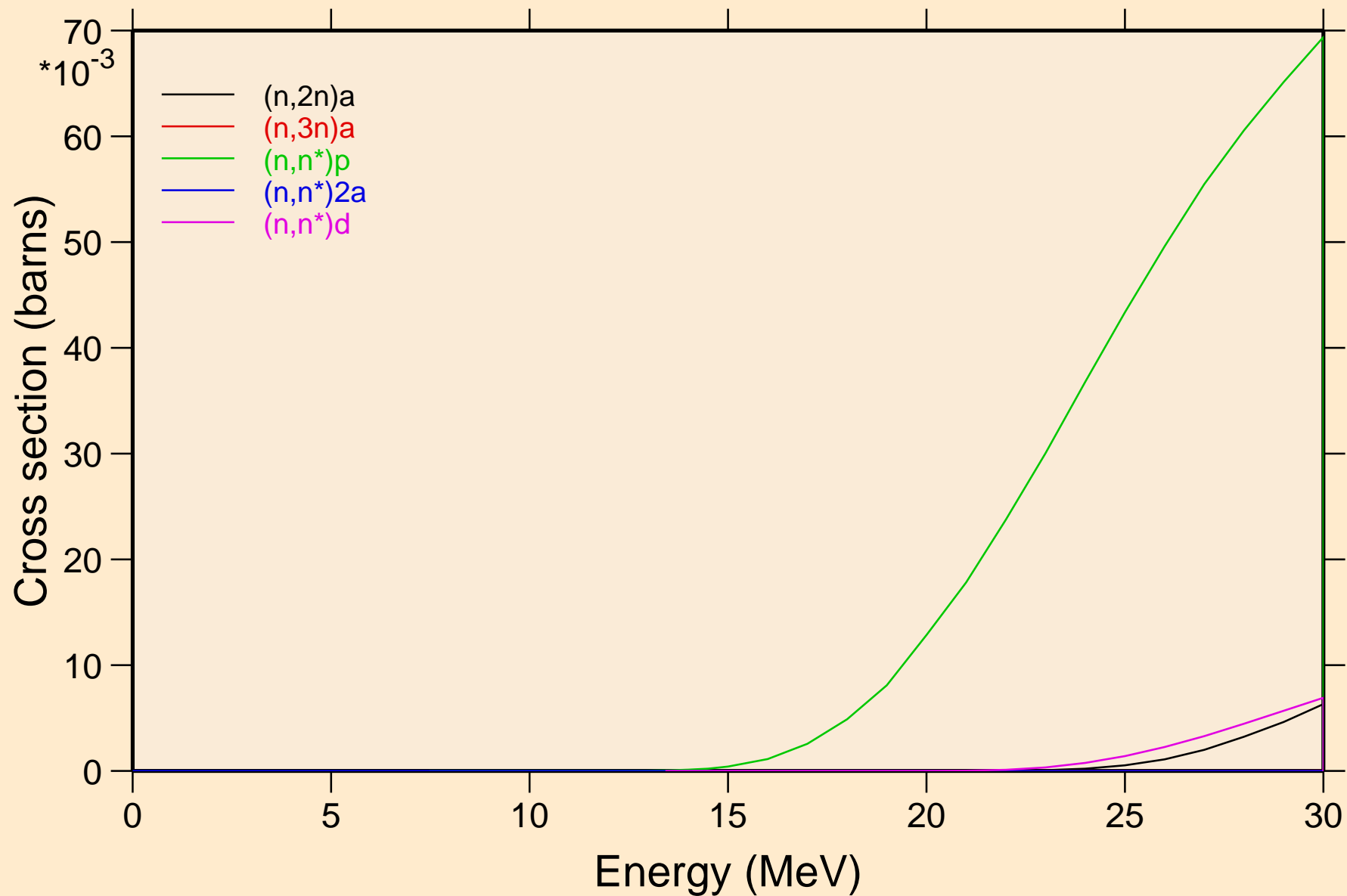

DY160 NEUTRON ACER TENDL-2019 LIBRARY; T=293.16K  
Threshold reactions

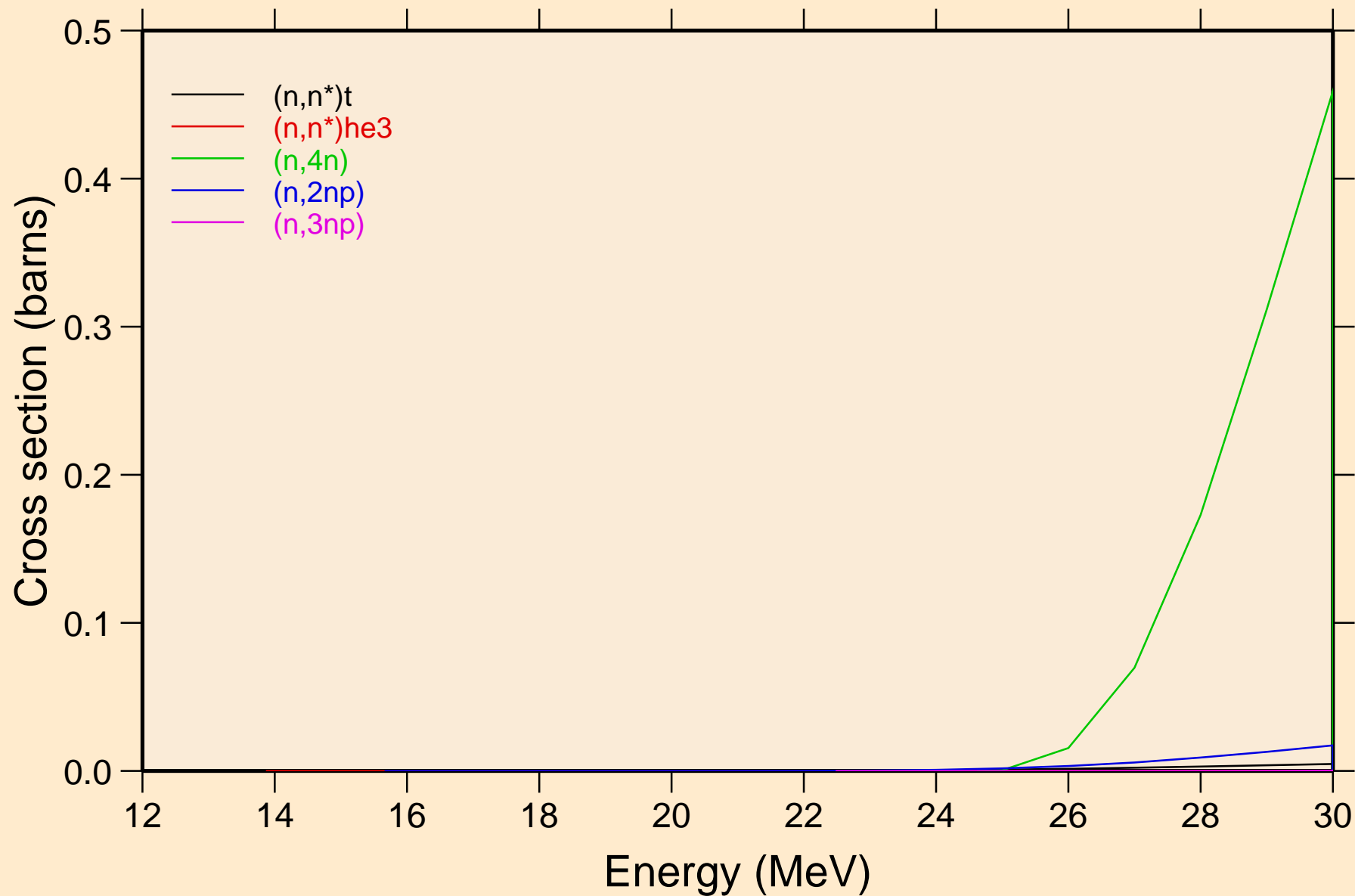

DY160 NEUTRON ACER TENDL-2019 LIBRARY; T=293.16K  
Threshold reactions

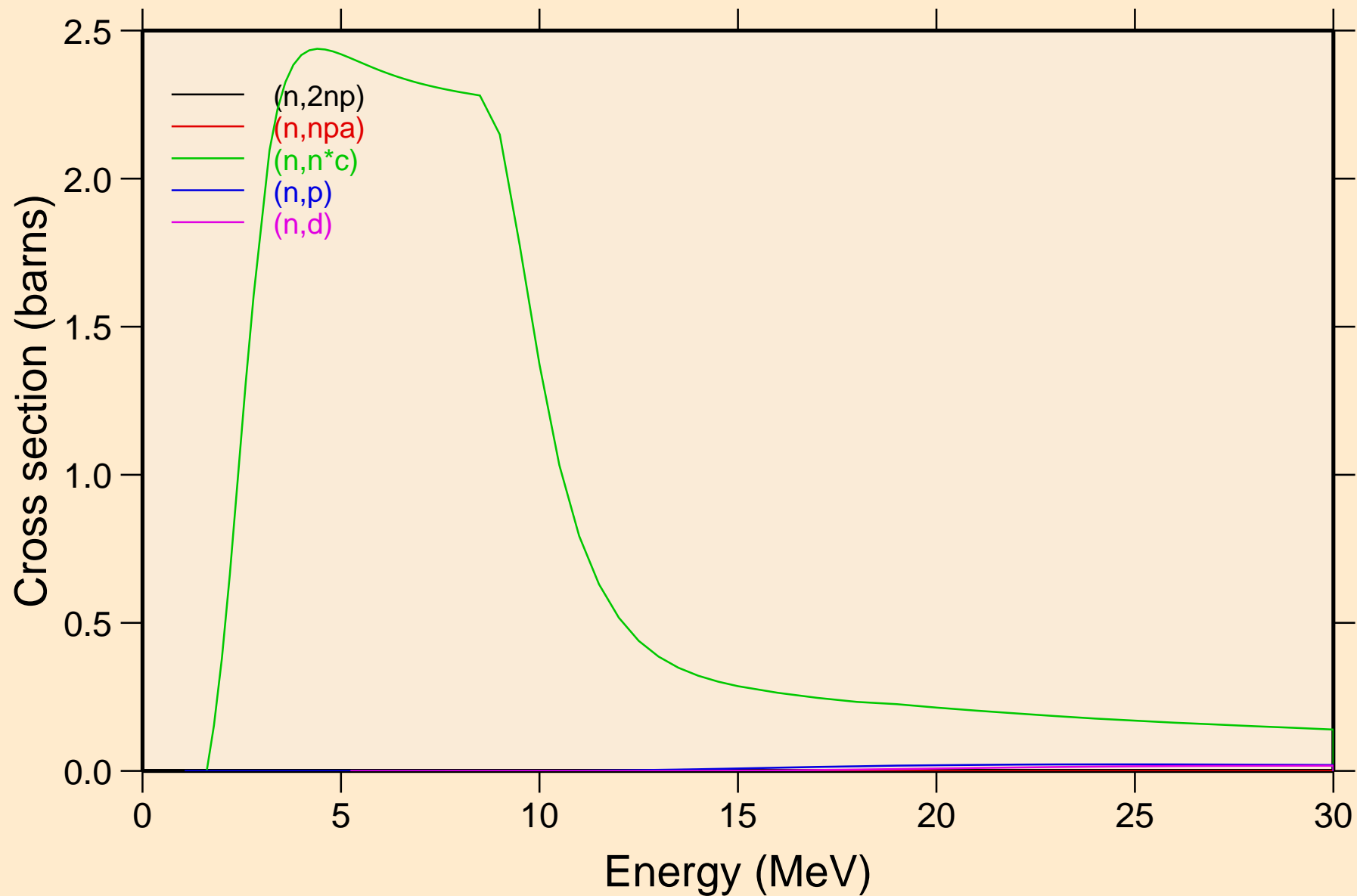

DY160 NEUTRON ACER TENDL-2019 LIBRARY; T=293.16K  
Threshold reactions

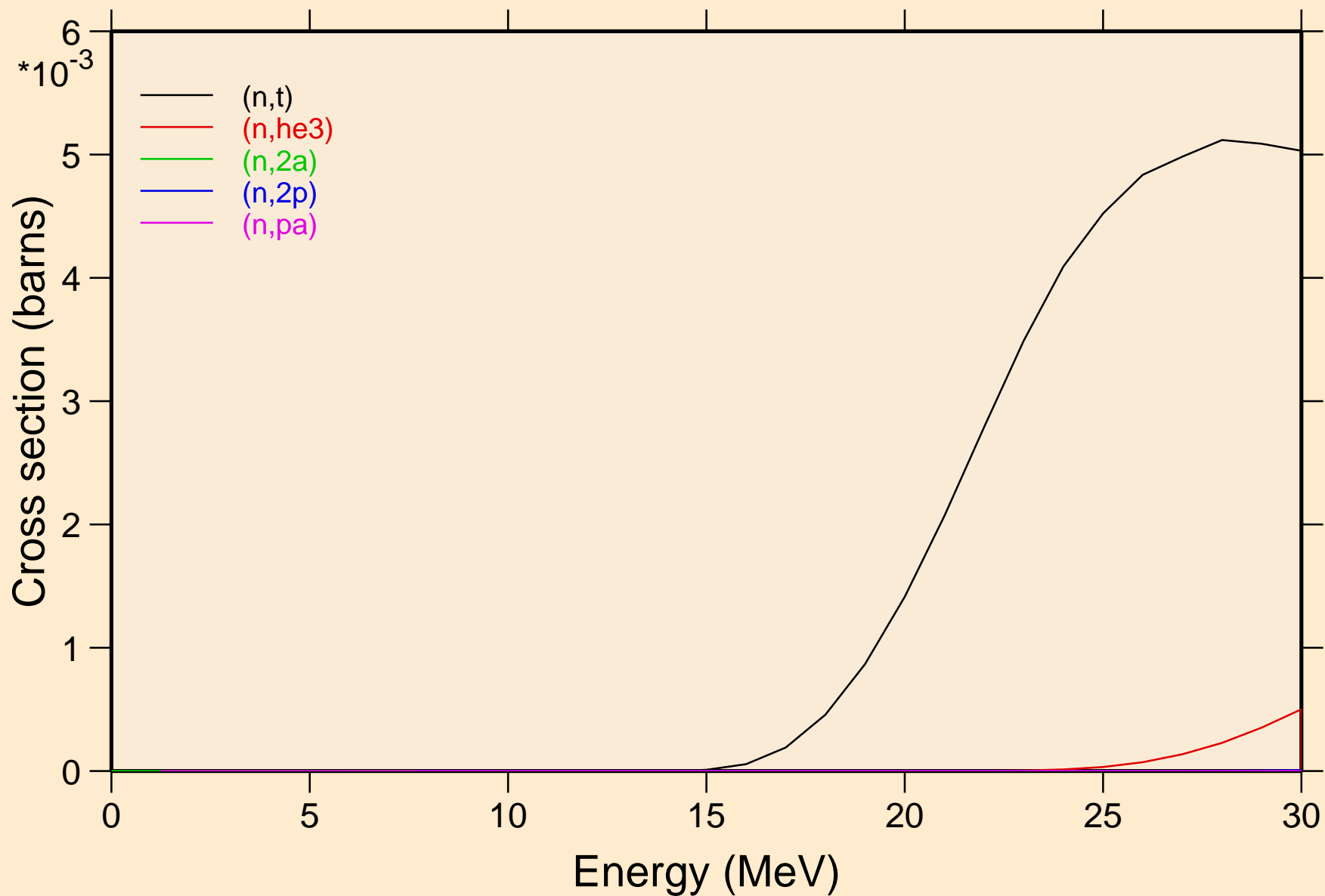

DY160 NEUTRON ACER TENDL-2019 LIBRARY; T=293.16K  
Threshold reactions

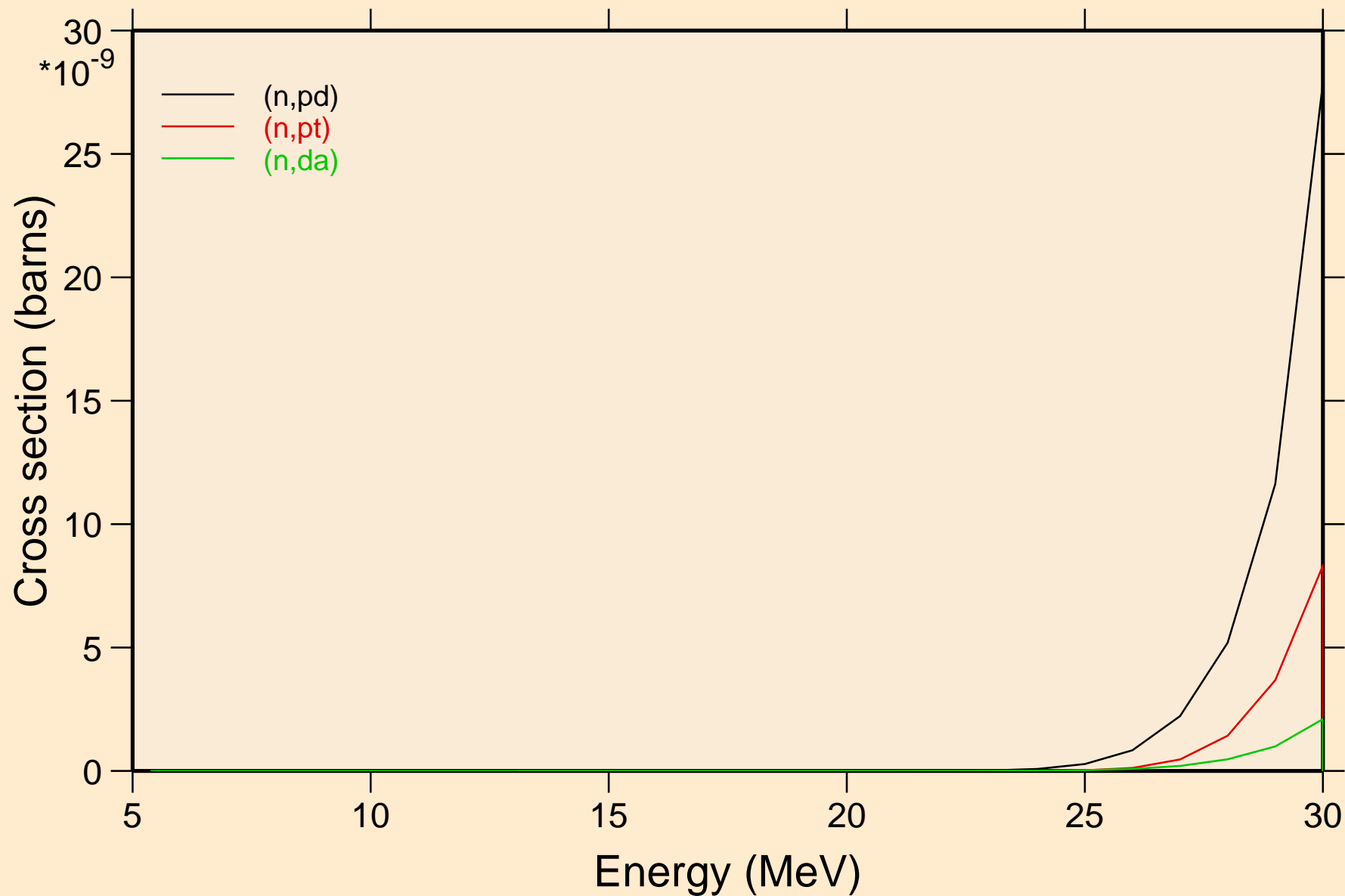

DY160 NEUTRON ACER TENDL-2019 LIBRARY; T=293.16K  
Threshold reactions

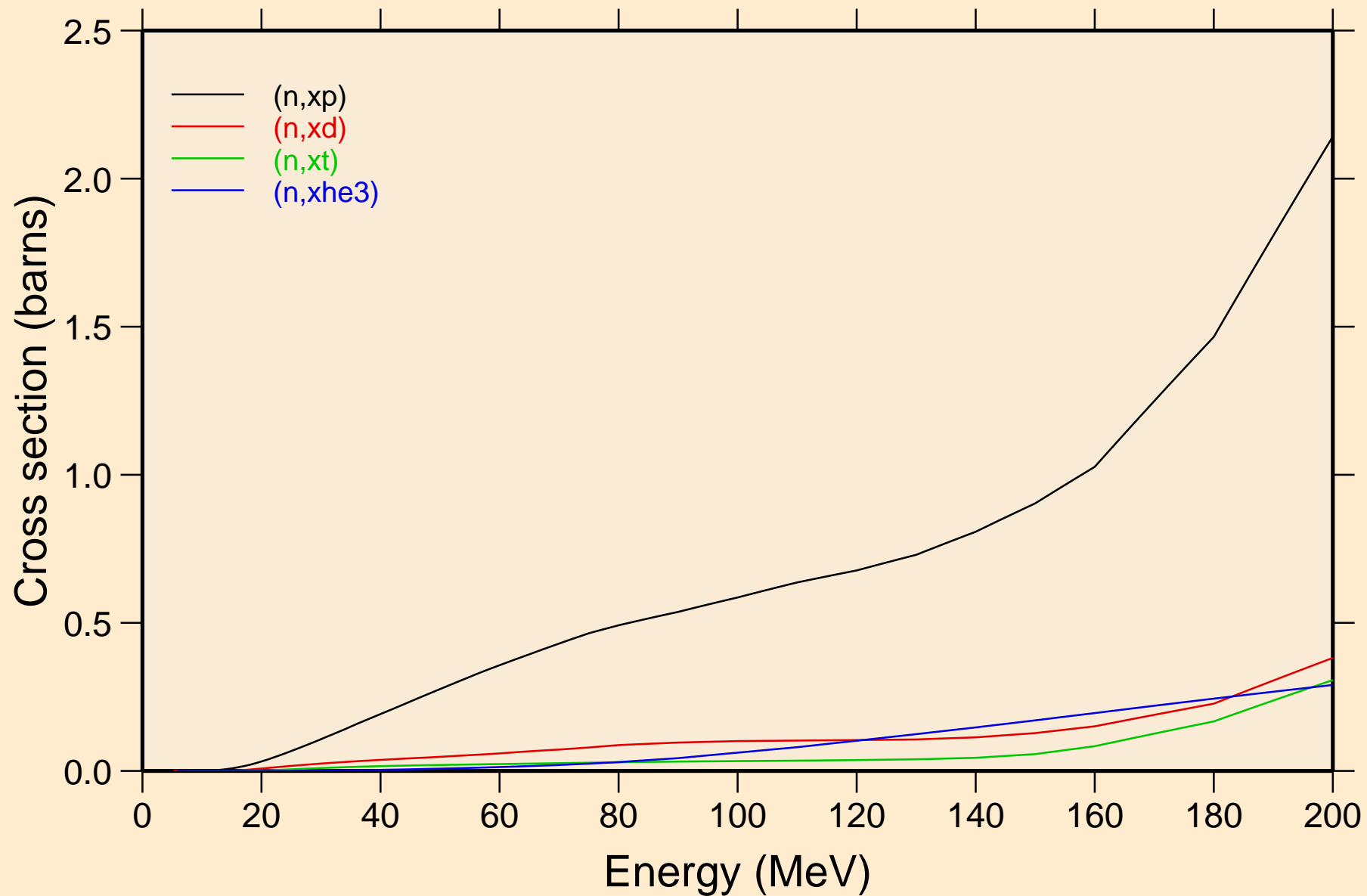

DY160 NEUTRON ACER TENDL-2019 LIBRARY; T=293.16K  
angular distribution for elastic

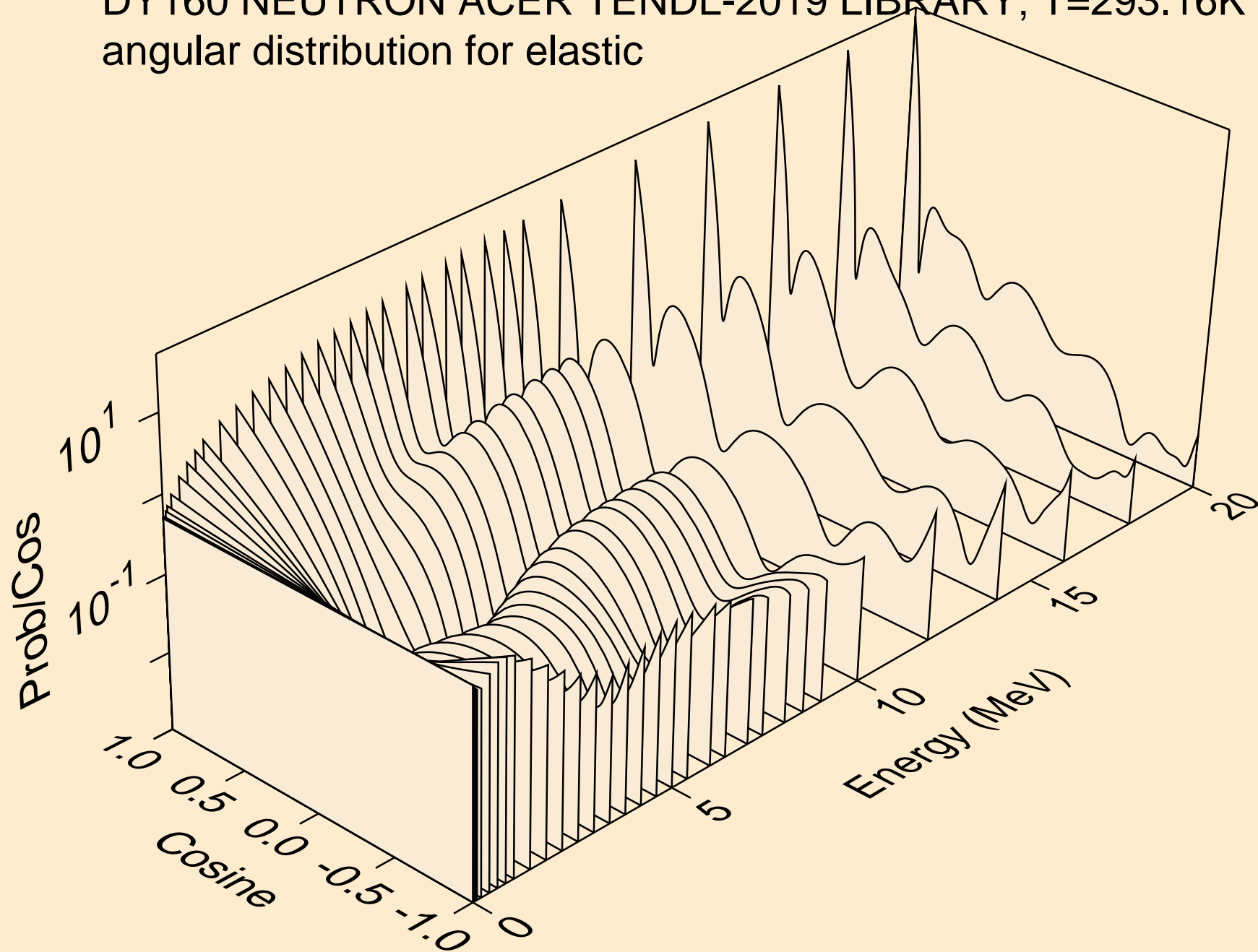



DY160 NEUTRON ACER TENDL-2019 LIBRARY; T=293.16K  
angular distribution for elastic

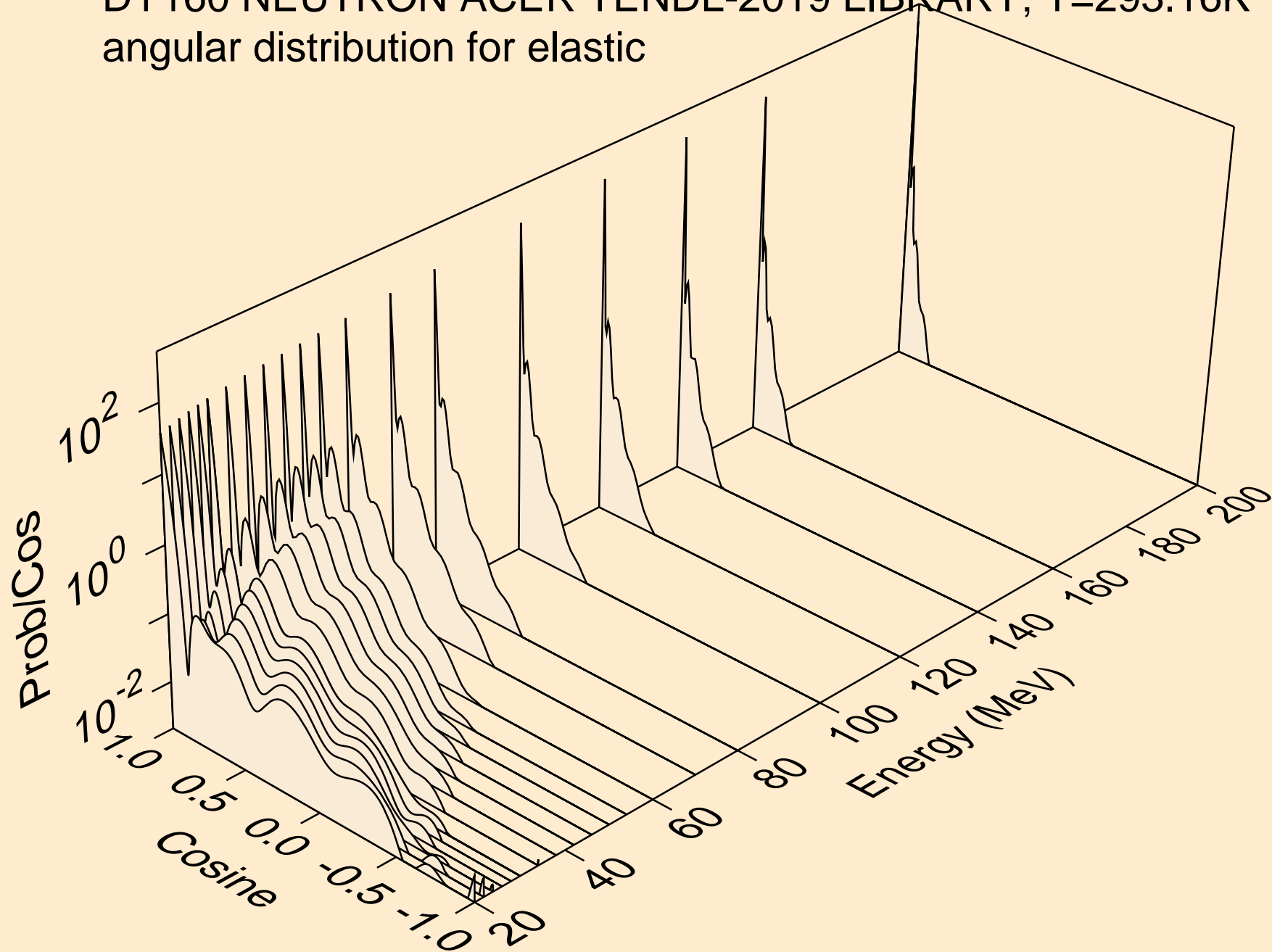

DY160 NEUTRON ACER TENDL-2019 LIBRARY; T=293.16K  
angular distribution for (n,n\*1)

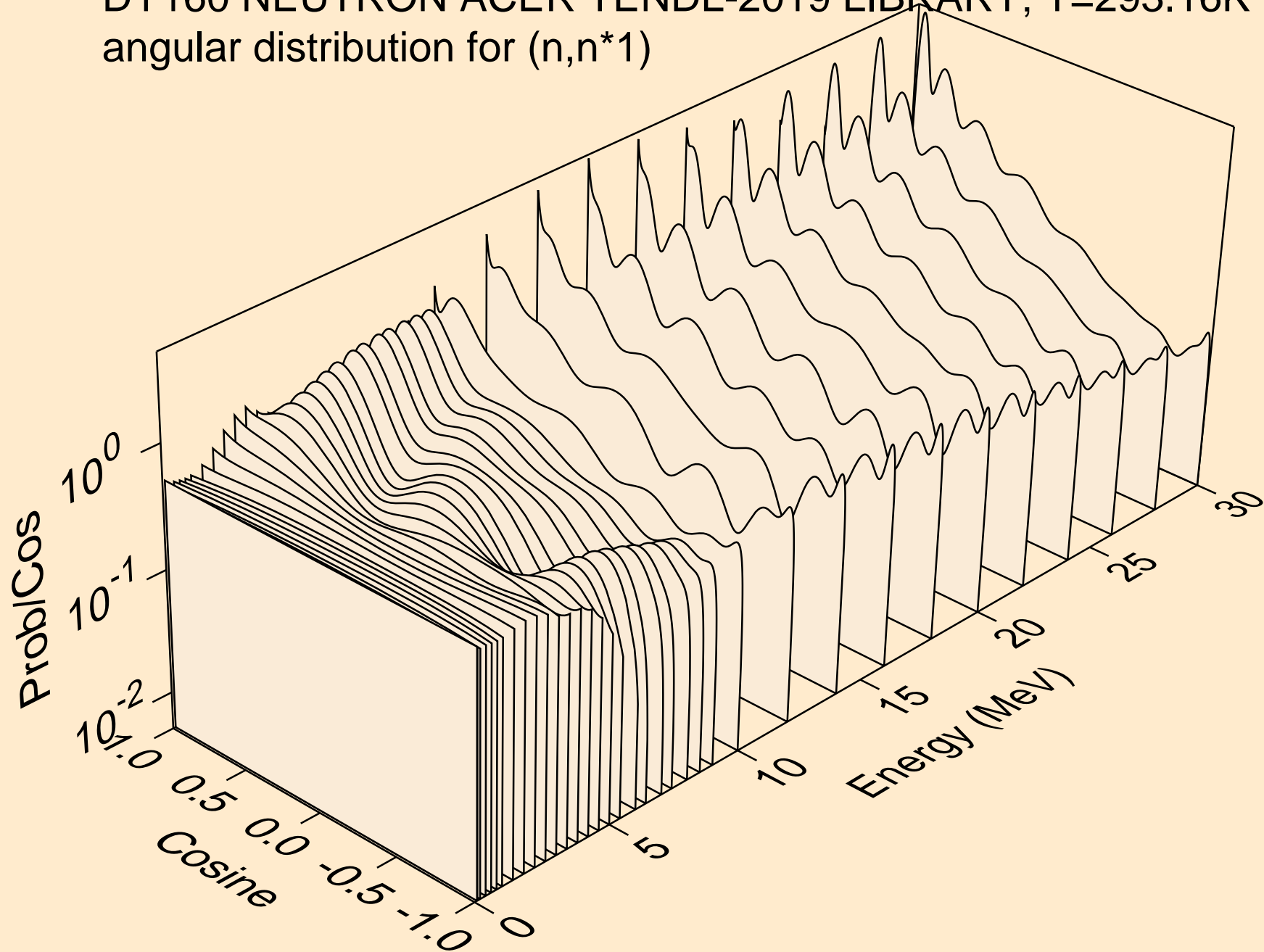

DY160 NEUTRON ACER TENDL-2019 LIBRARY; T=293.16K  
angular distribution for (n,n\*2)

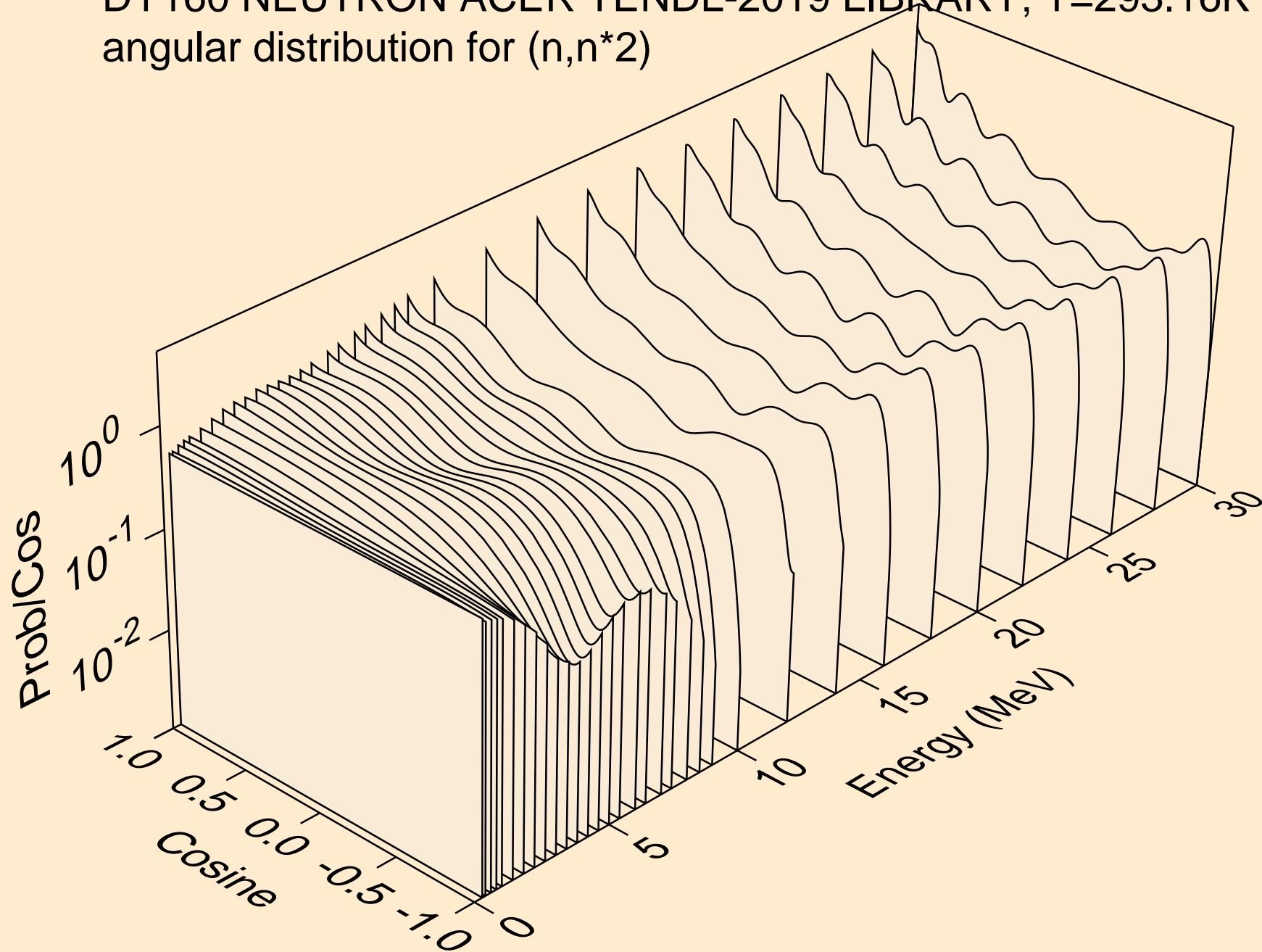

DY160 NEUTRON ACER TENDL-2019 LIBRARY; T=293.16K  
angular distribution for (n,n\*3)

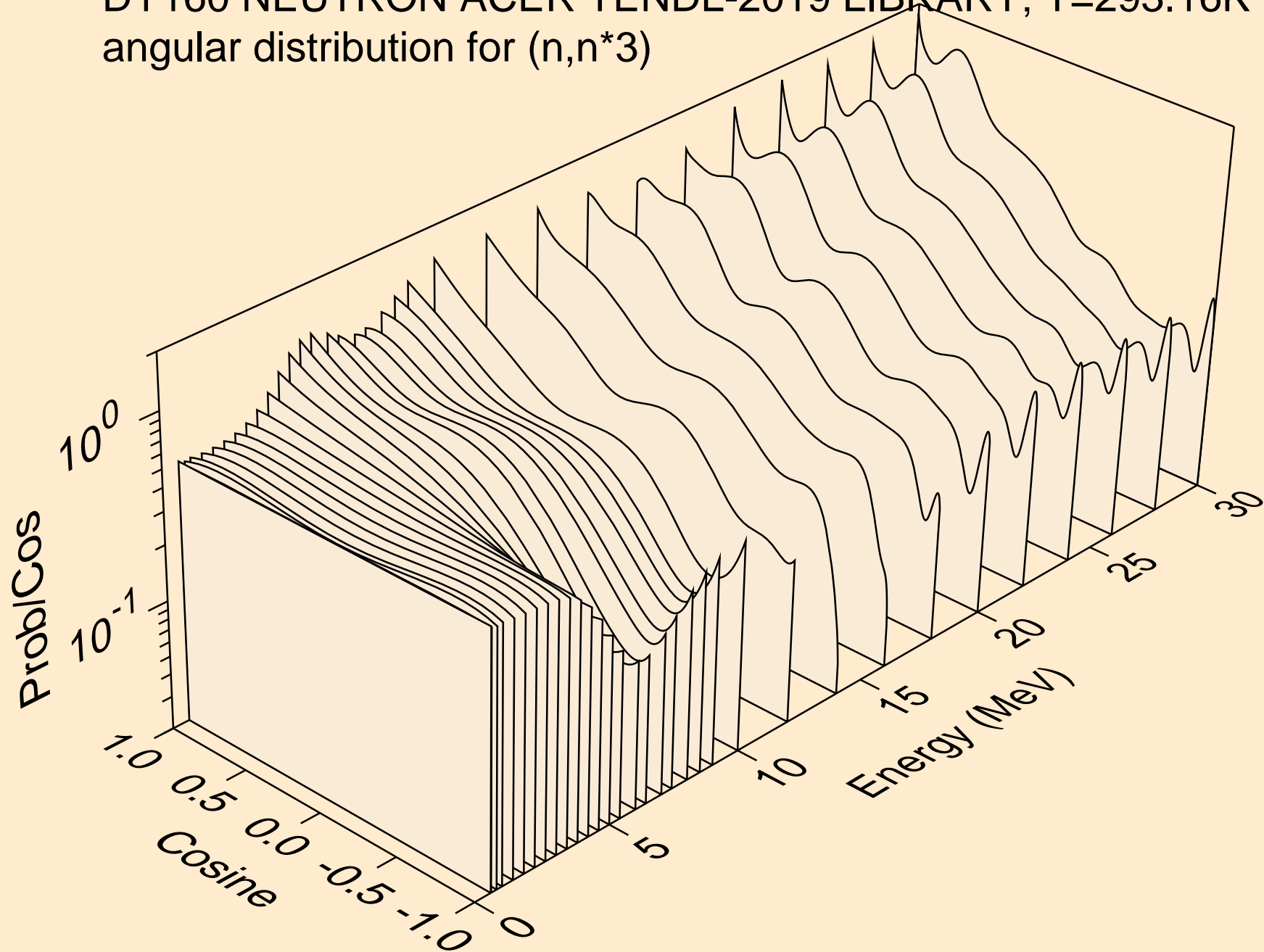

DY160 NEUTRON ACER TENDL-2019 LIBRARY; T=293.16K  
angular distribution for (n,n\*4)

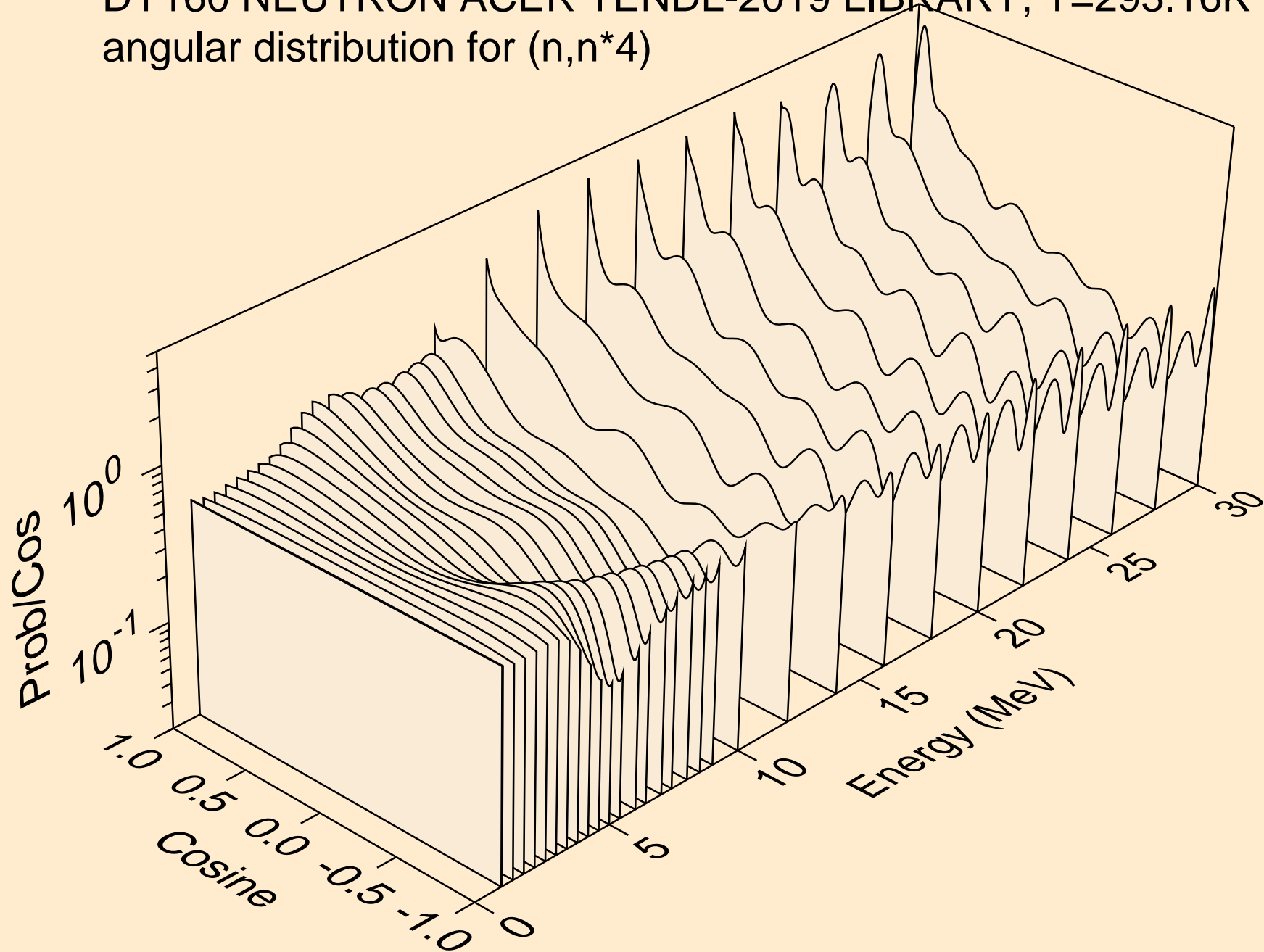

DY160 NEUTRON ACER TENDL-2019 LIBRARY; T=293.16K  
angular distribution for (n,n\*5)

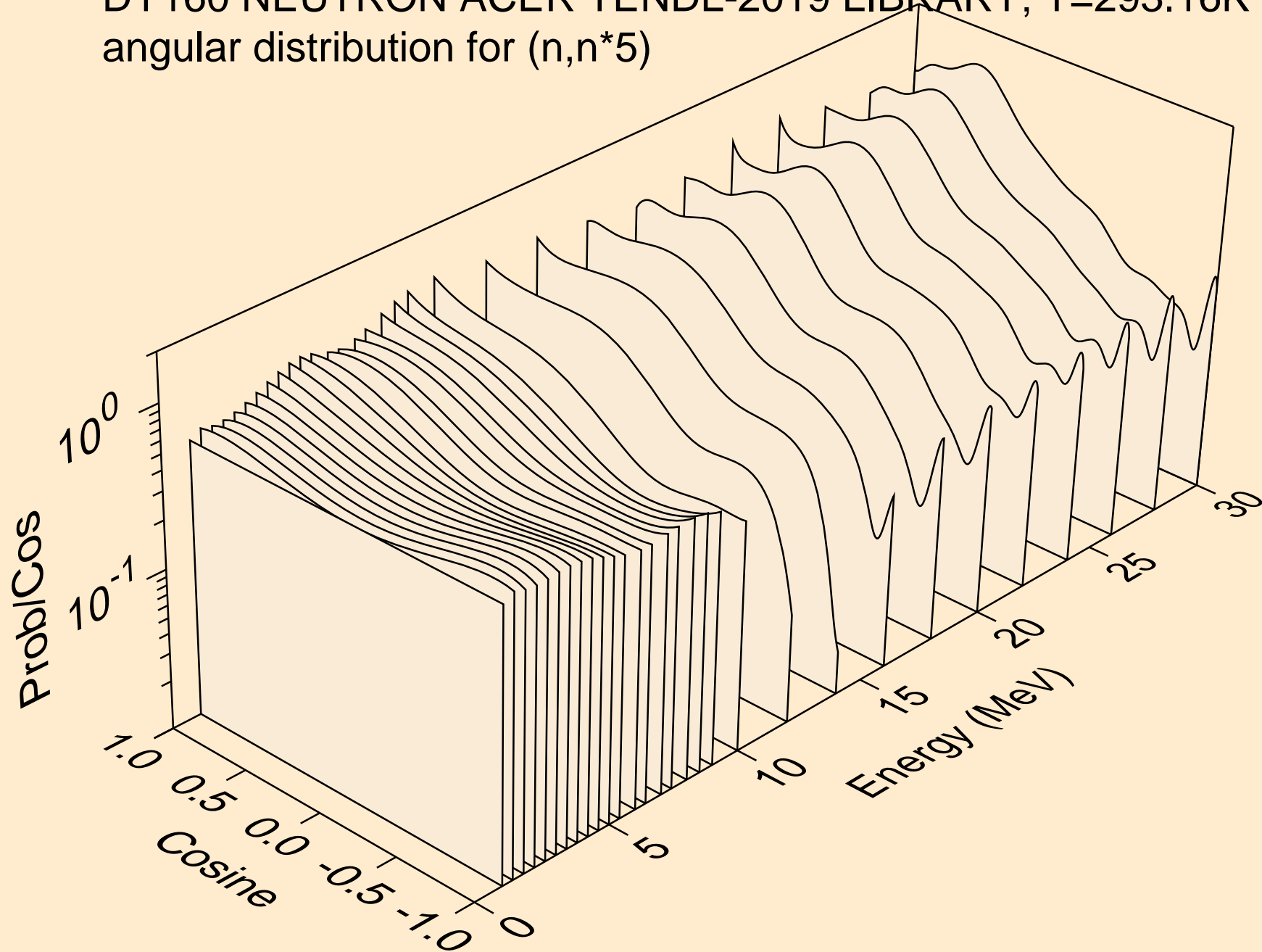

DY160 NEUTRON ACER TENDL-2019 LIBRARY; T=293.16K  
angular distribution for (n,n\*6)

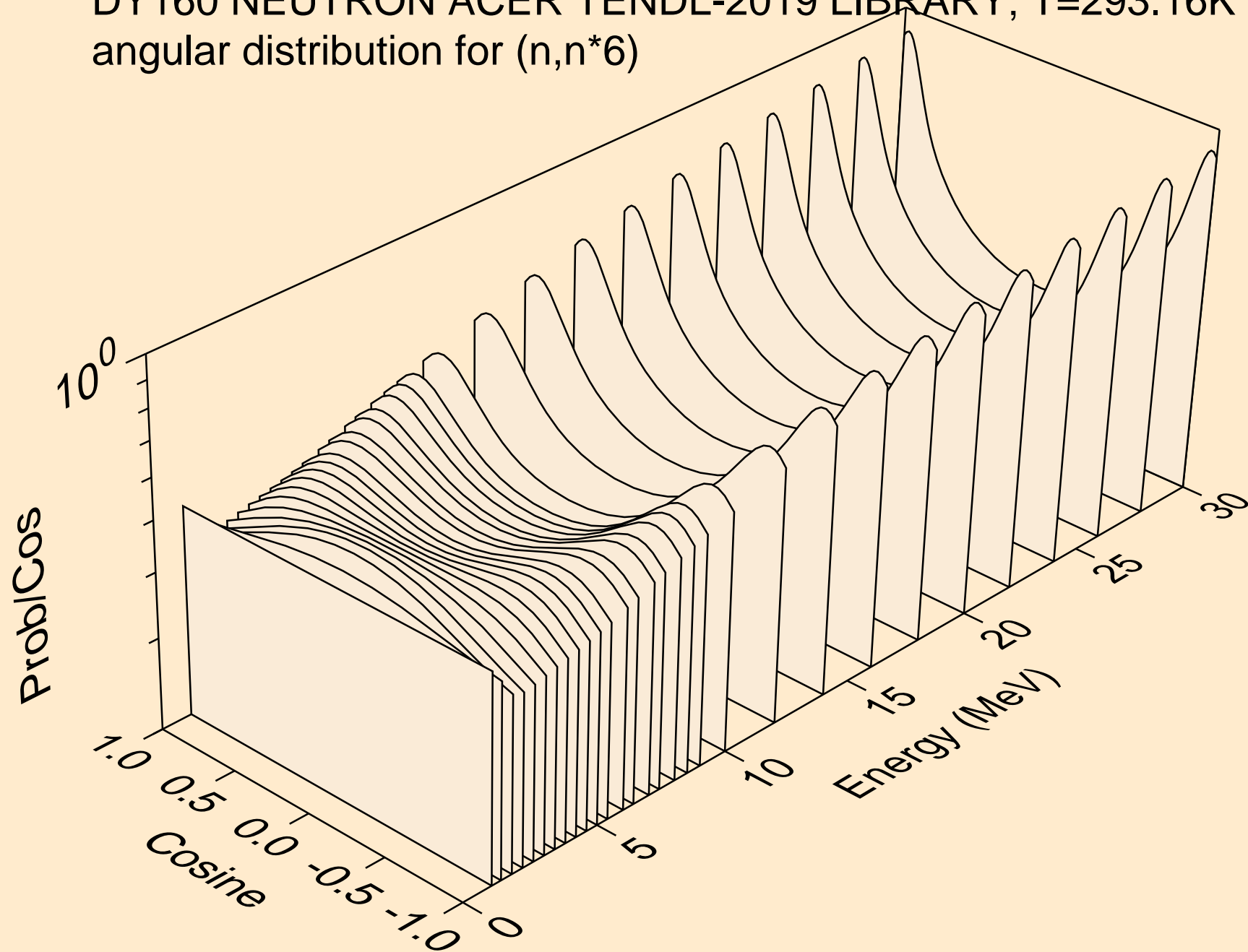

DY160 NEUTRON ACER TENDL-2019 LIBRARY; T=293.16K  
angular distribution for (n,n\*7)

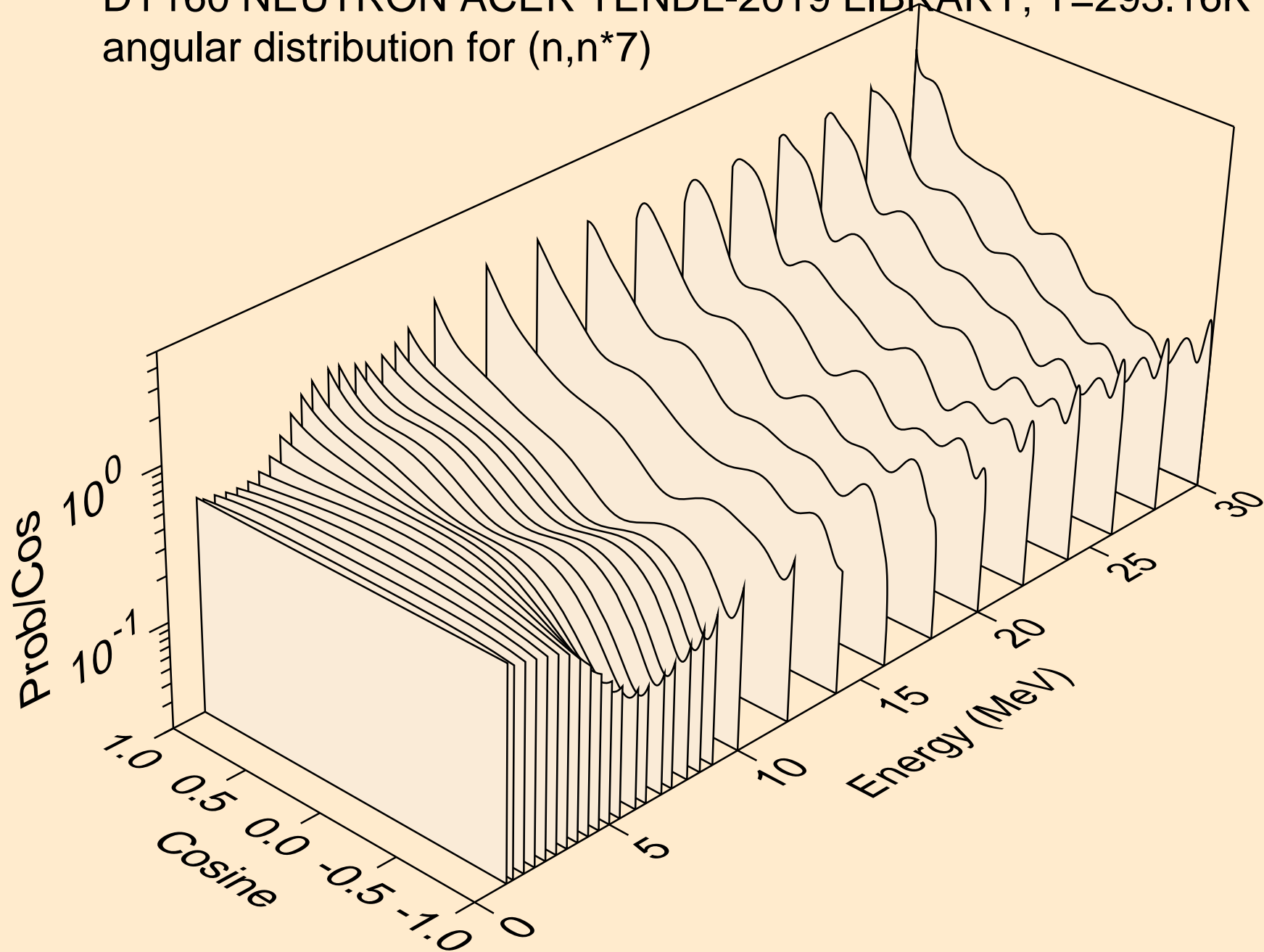



DY160 NEUTRON ACER TENDL-2019 LIBRARY; T=293.16K  
angular distribution for (n,n\*8)

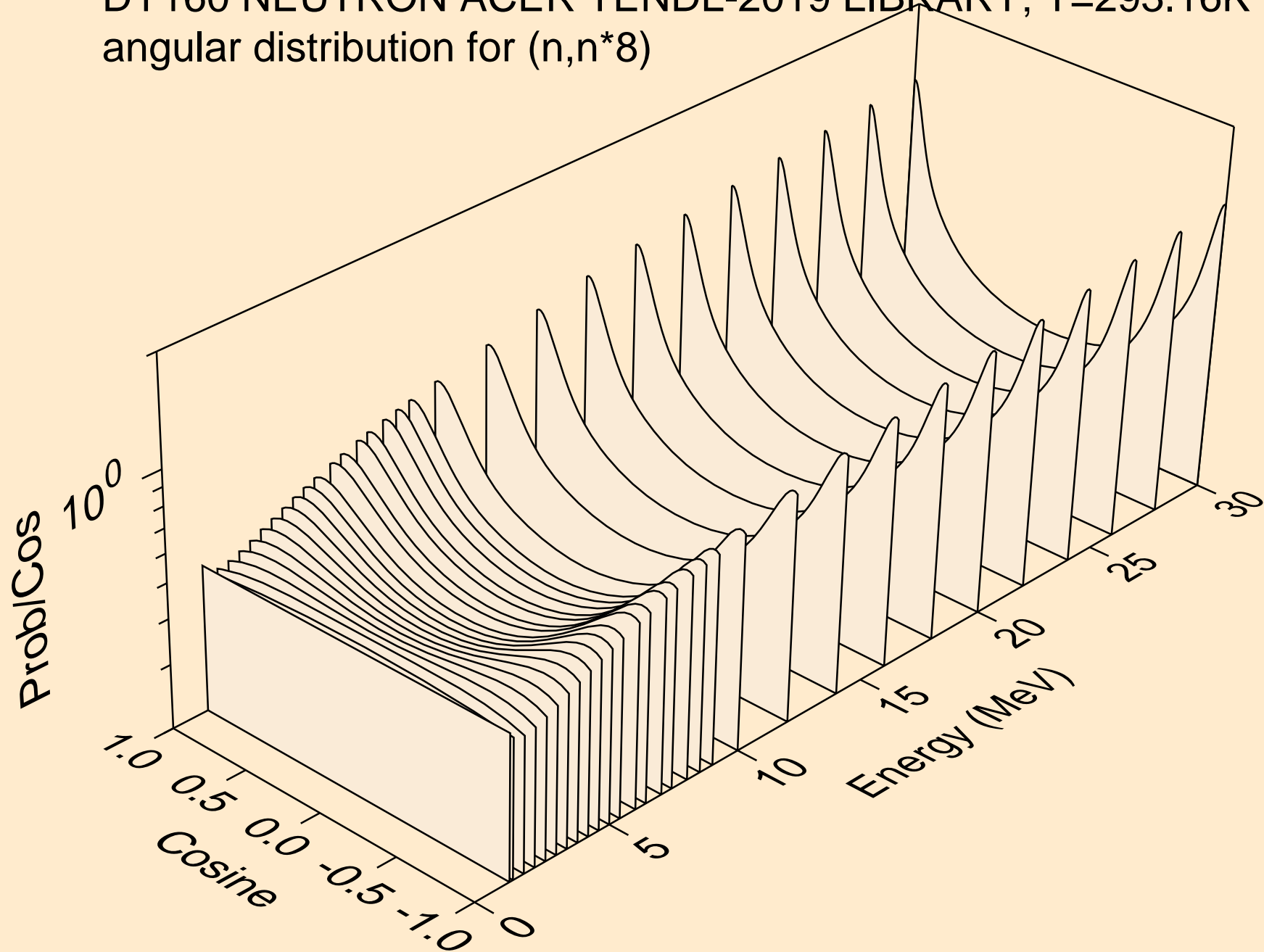

DY160 NEUTRON ACER TENDL-2019 LIBRARY; T=293.16K  
angular distribution for (n,n\*9)

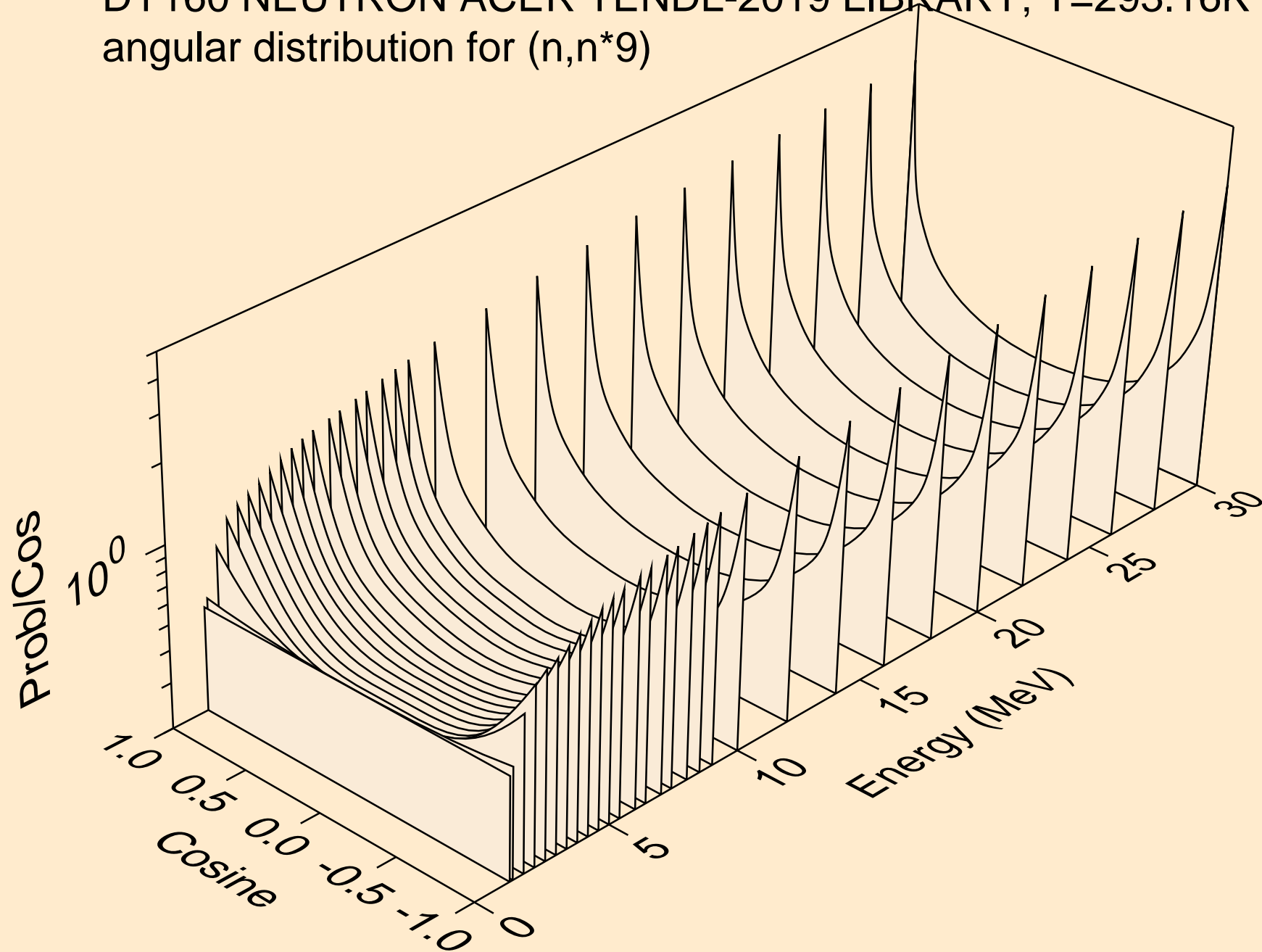

DY160 NEUTRON ACER TENDL-2019 LIBRARY; T=293.16K  
angular distribution for (n,n\*10)

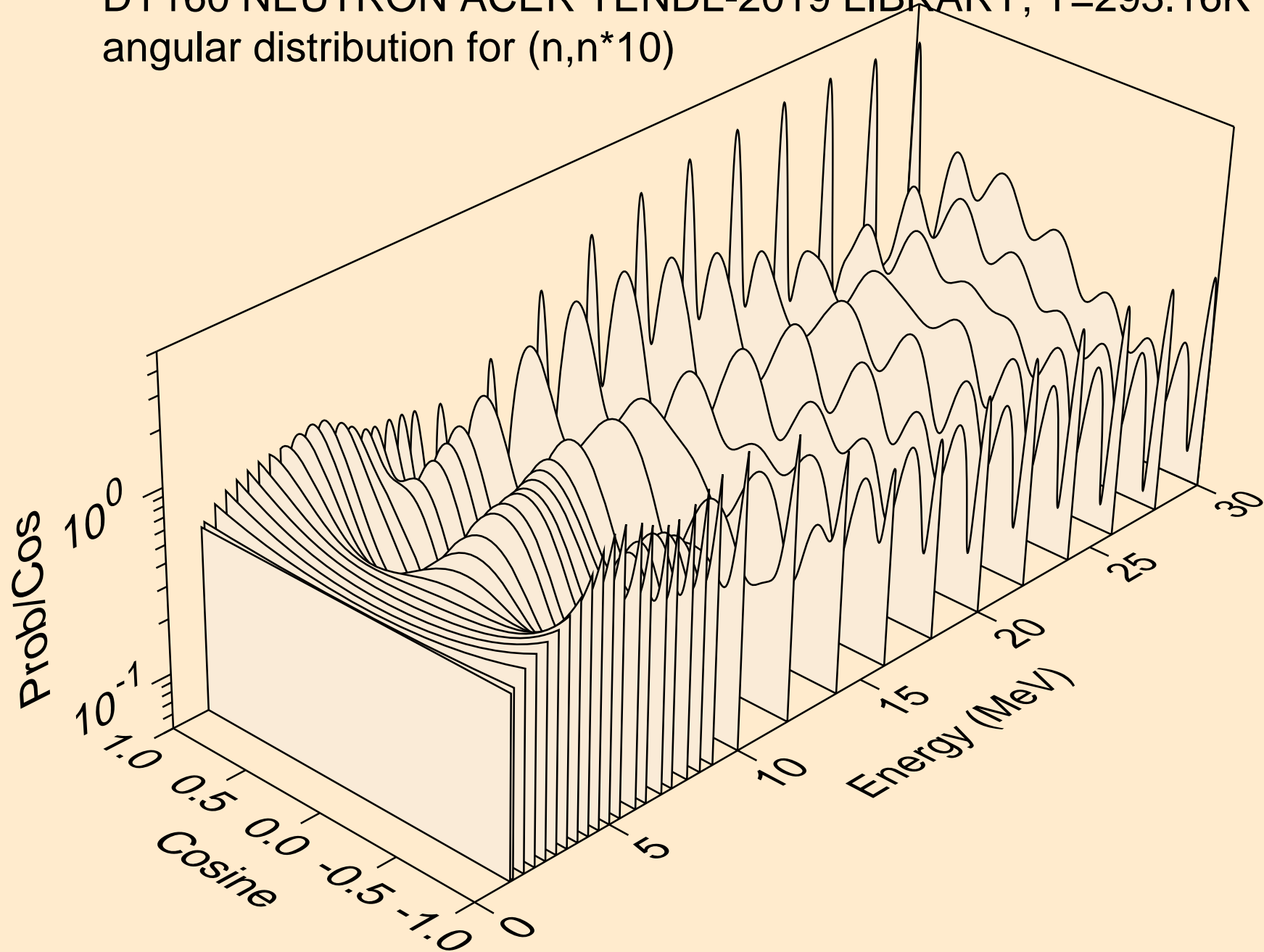

DY160 NEUTRON ACER TENDL-2019 LIBRARY; T=293.16K  
angular distribution for (n,n\*11)

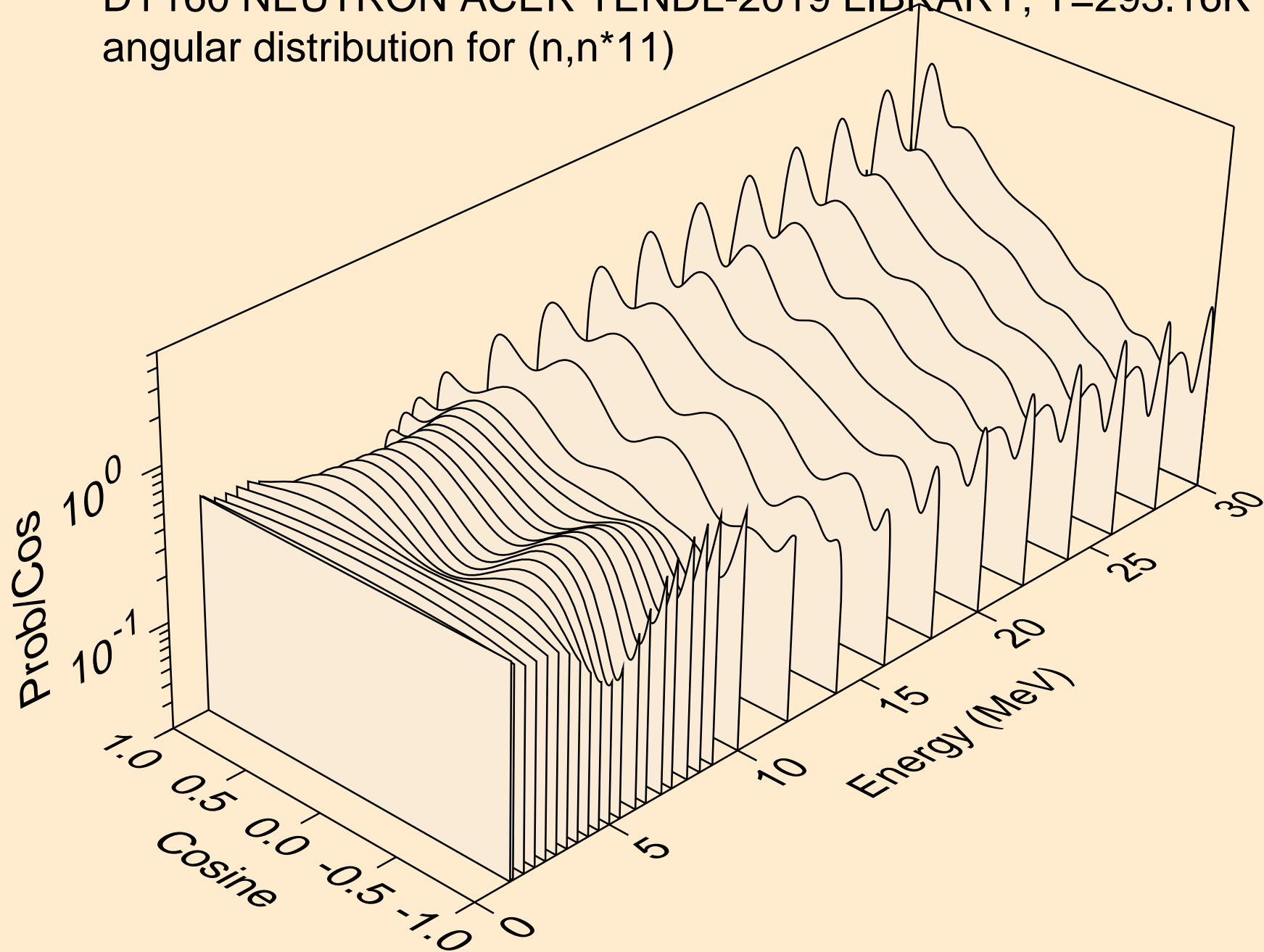

DY160 NEUTRON ACER TENDL-2019 LIBRARY; T=293.16K  
angular distribution for (n,n\*12)

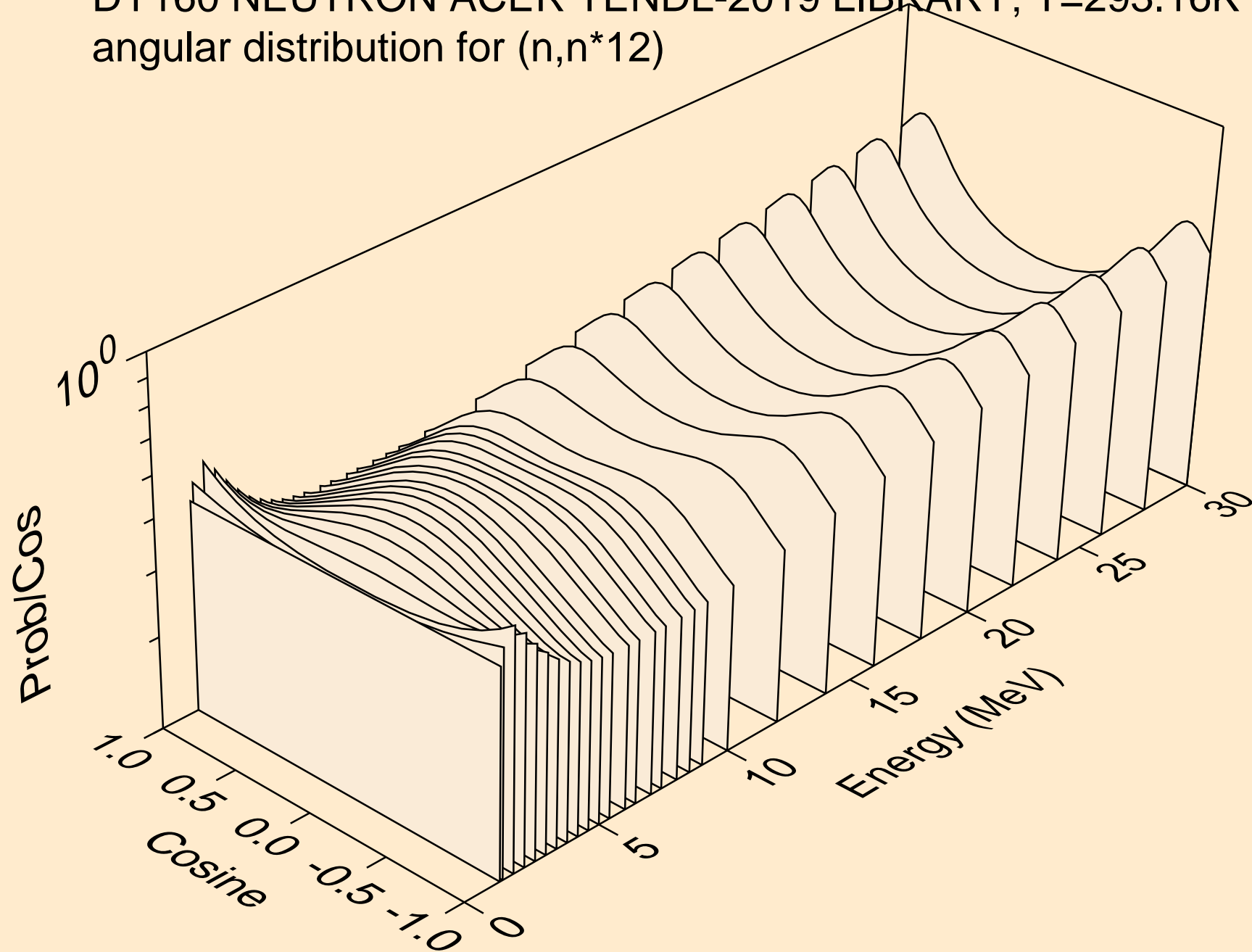

DY160 NEUTRON ACER TENDL-2019 LIBRARY; T=293.16K  
angular distribution for (n,n\*13)

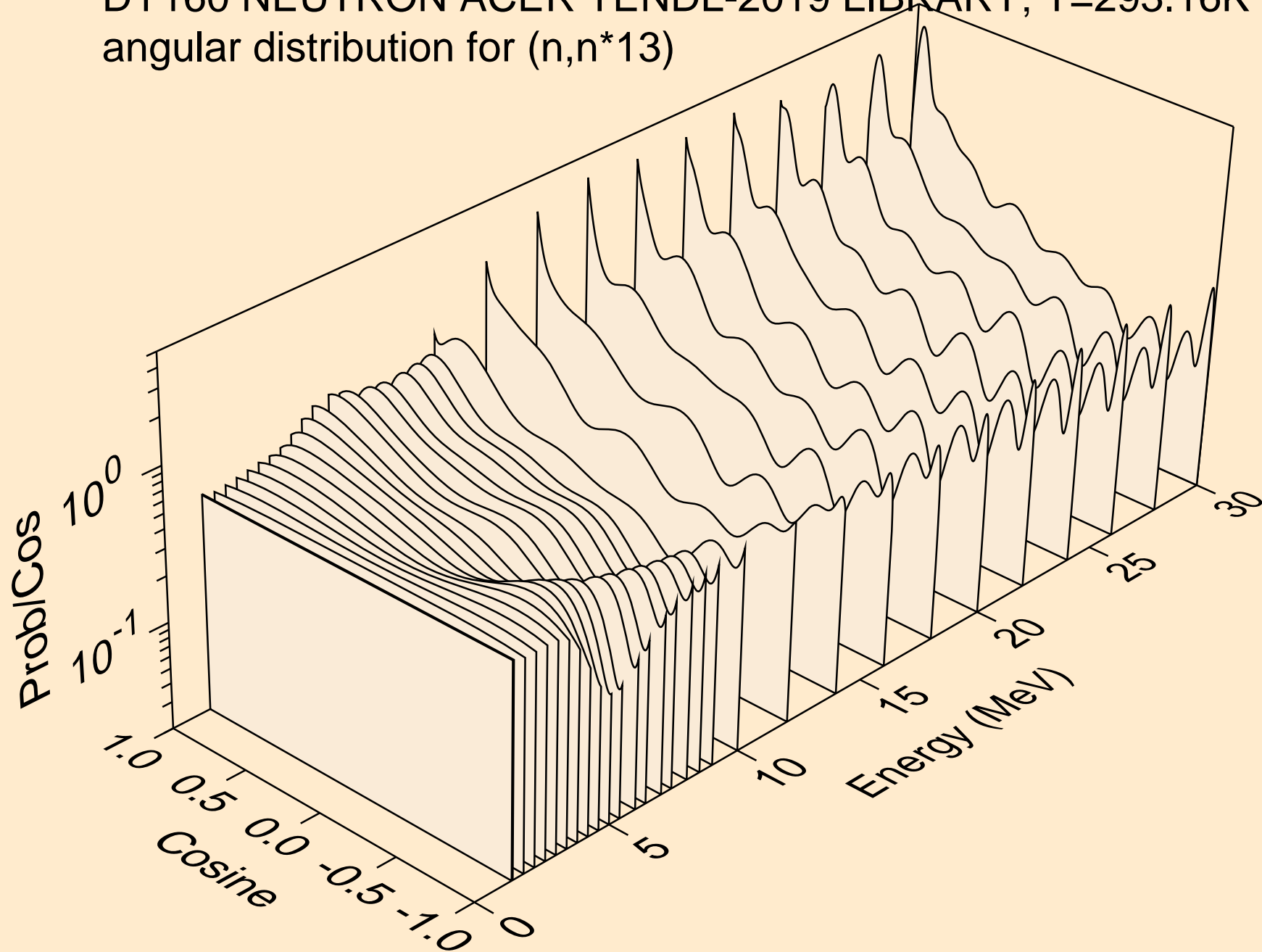

DY160 NEUTRON ACER TENDL-2019 LIBRARY; T=293.16K  
angular distribution for (n,n\*14)

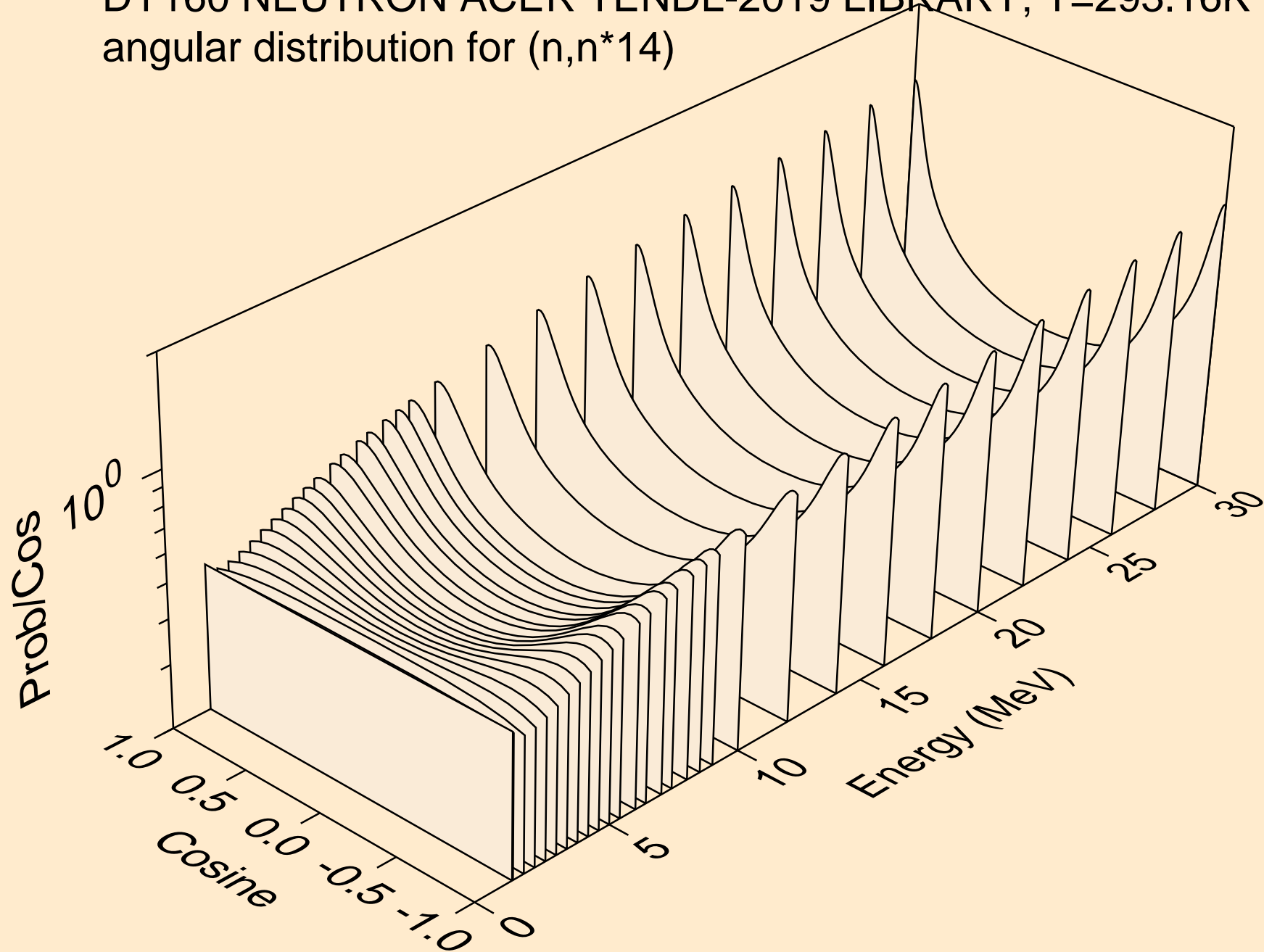

DY160 NEUTRON ACER TENDL-2019 LIBRARY; T=293.16K  
angular distribution for (n,n\*15)

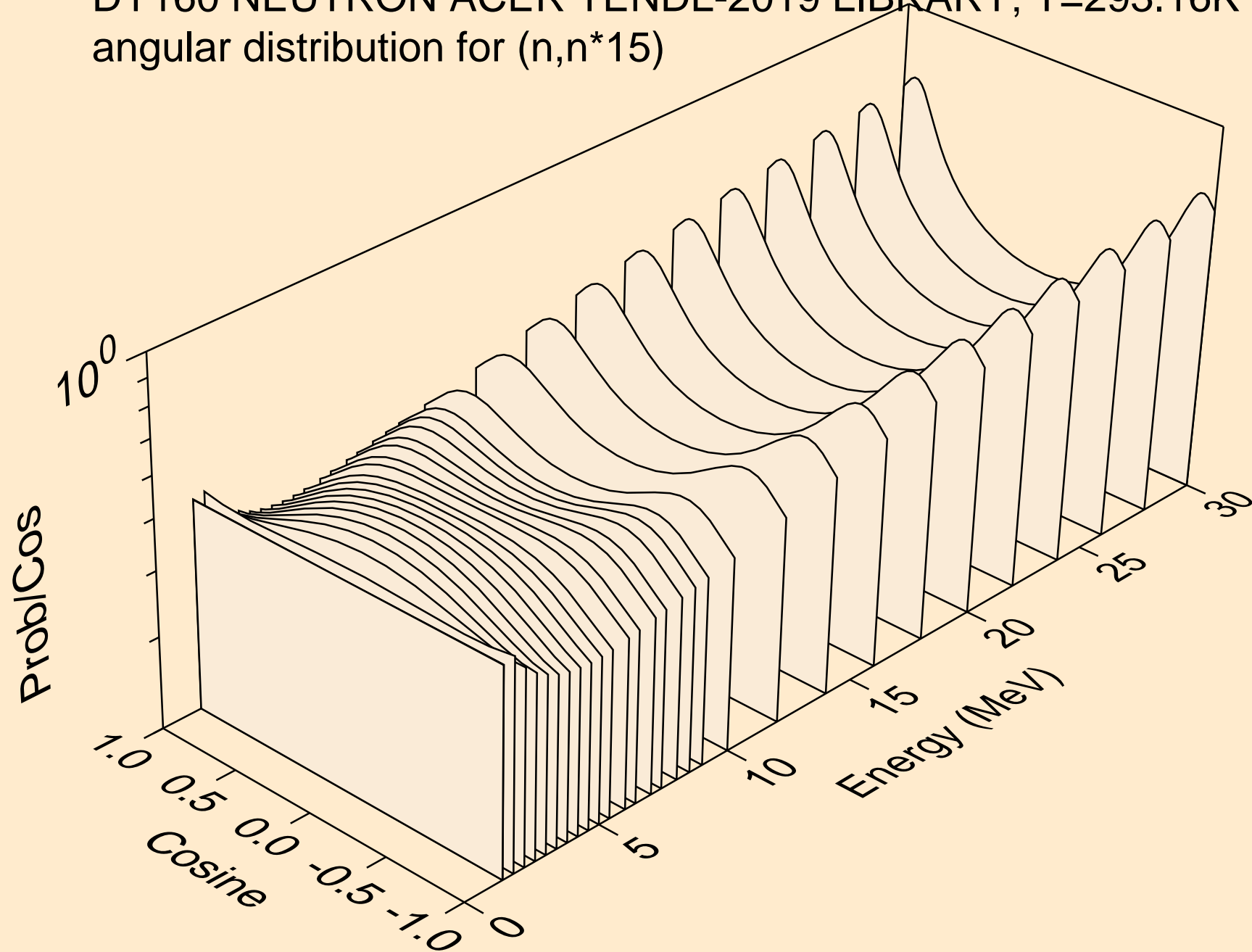



DY160 NEUTRON ACER TENDL-2019 LIBRARY; T=293.16K  
angular distribution for (n,n\*16)

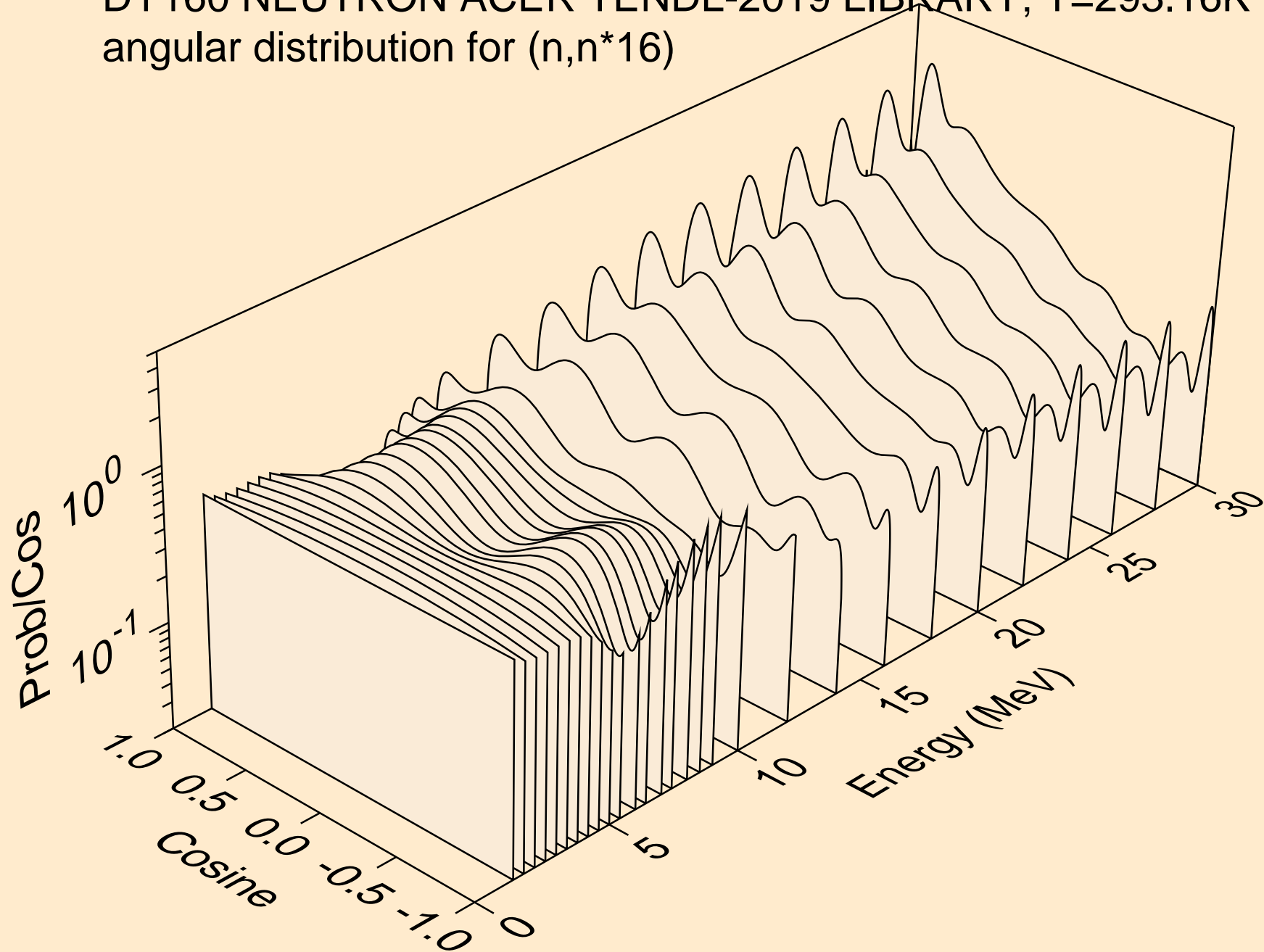

DY160 NEUTRON ACER TENDL-2019 LIBRARY; T=293.16K  
angular distribution for (n,n\*17)

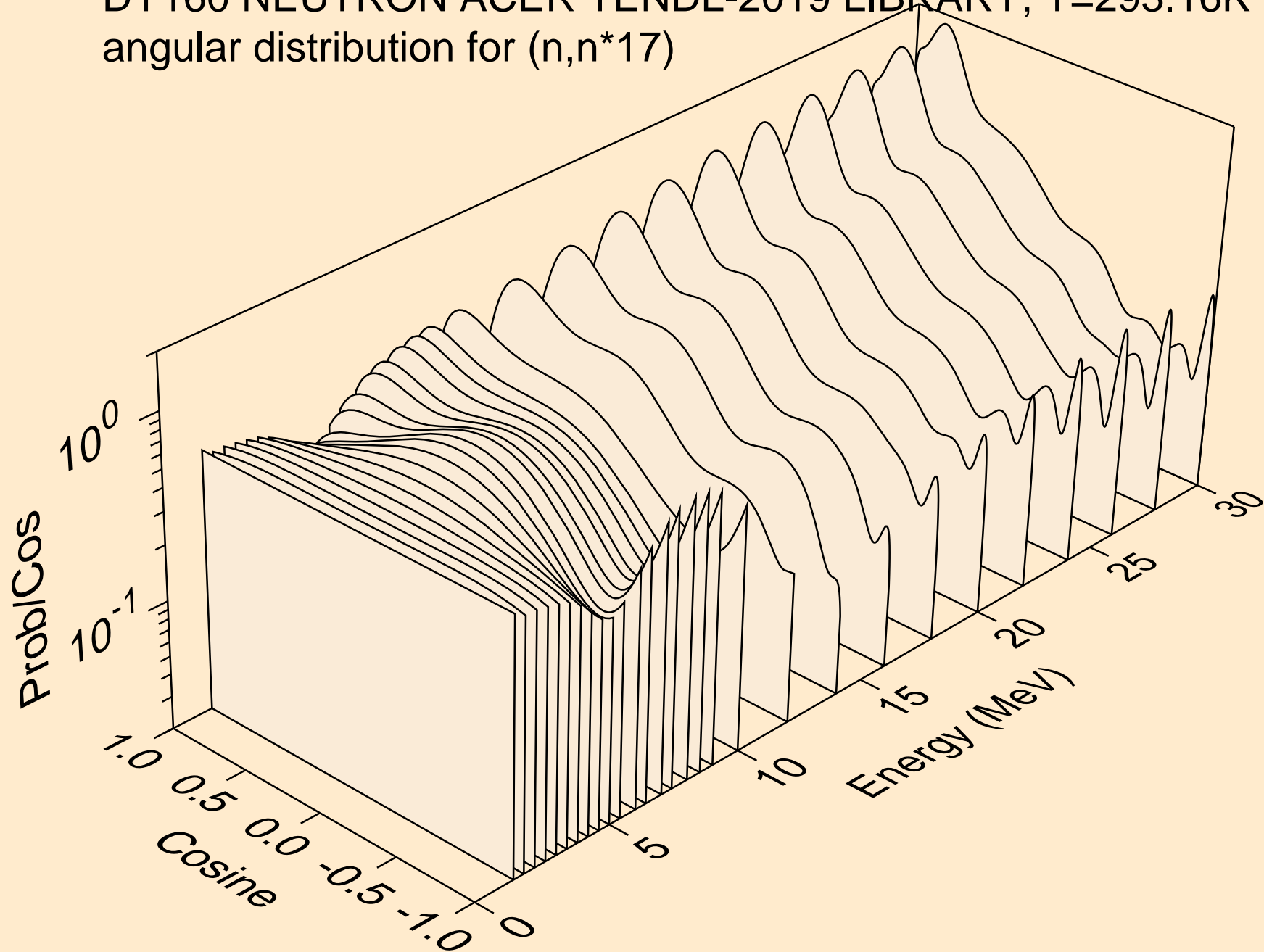

DY160 NEUTRON ACER TENDL-2019 LIBRARY; T=293.16K  
angular distribution for (n,n\*18)

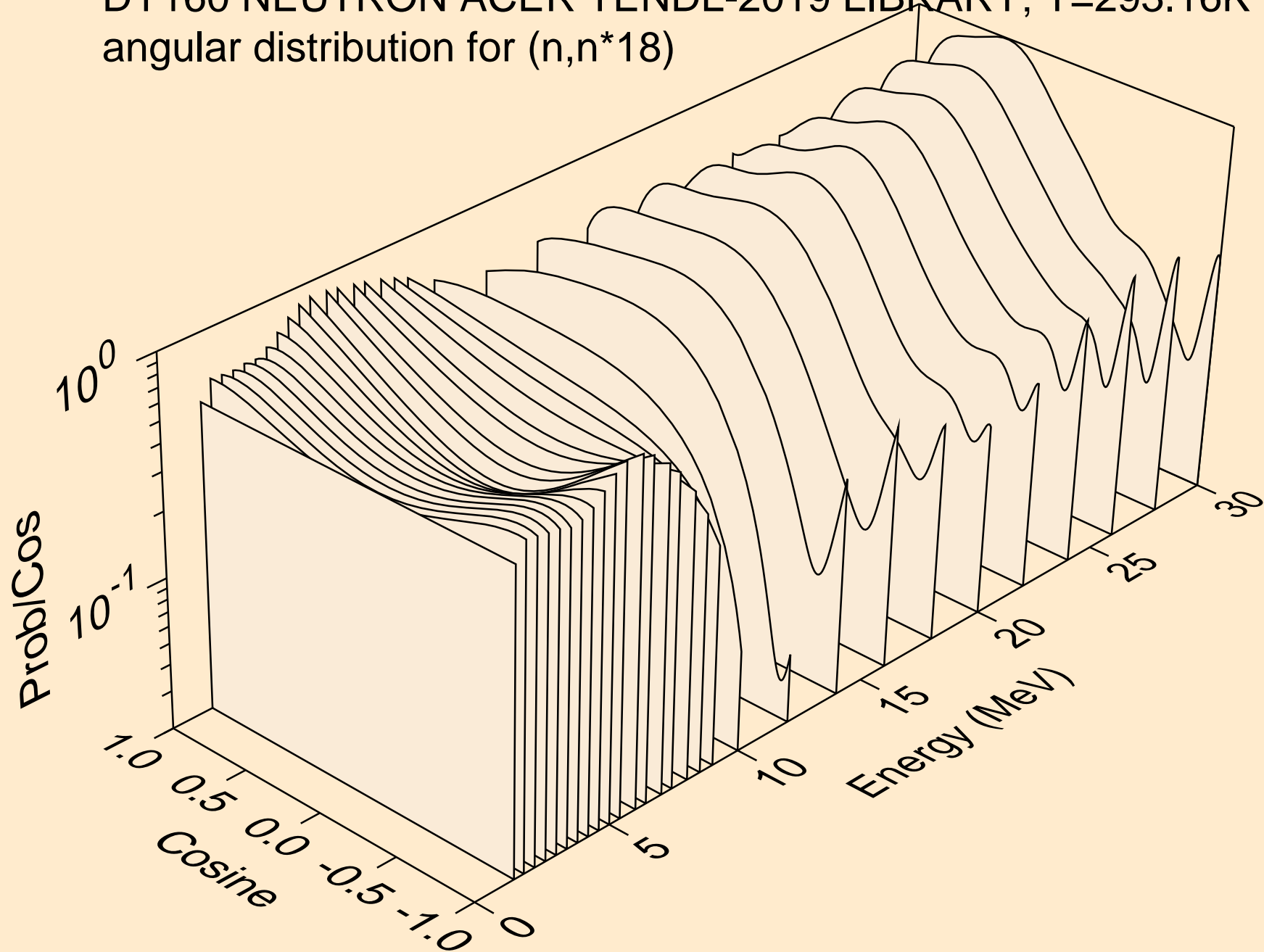

DY160 NEUTRON ACER TENDL-2019 LIBRARY; T=293.16K  
angular distribution for (n,n\*19)

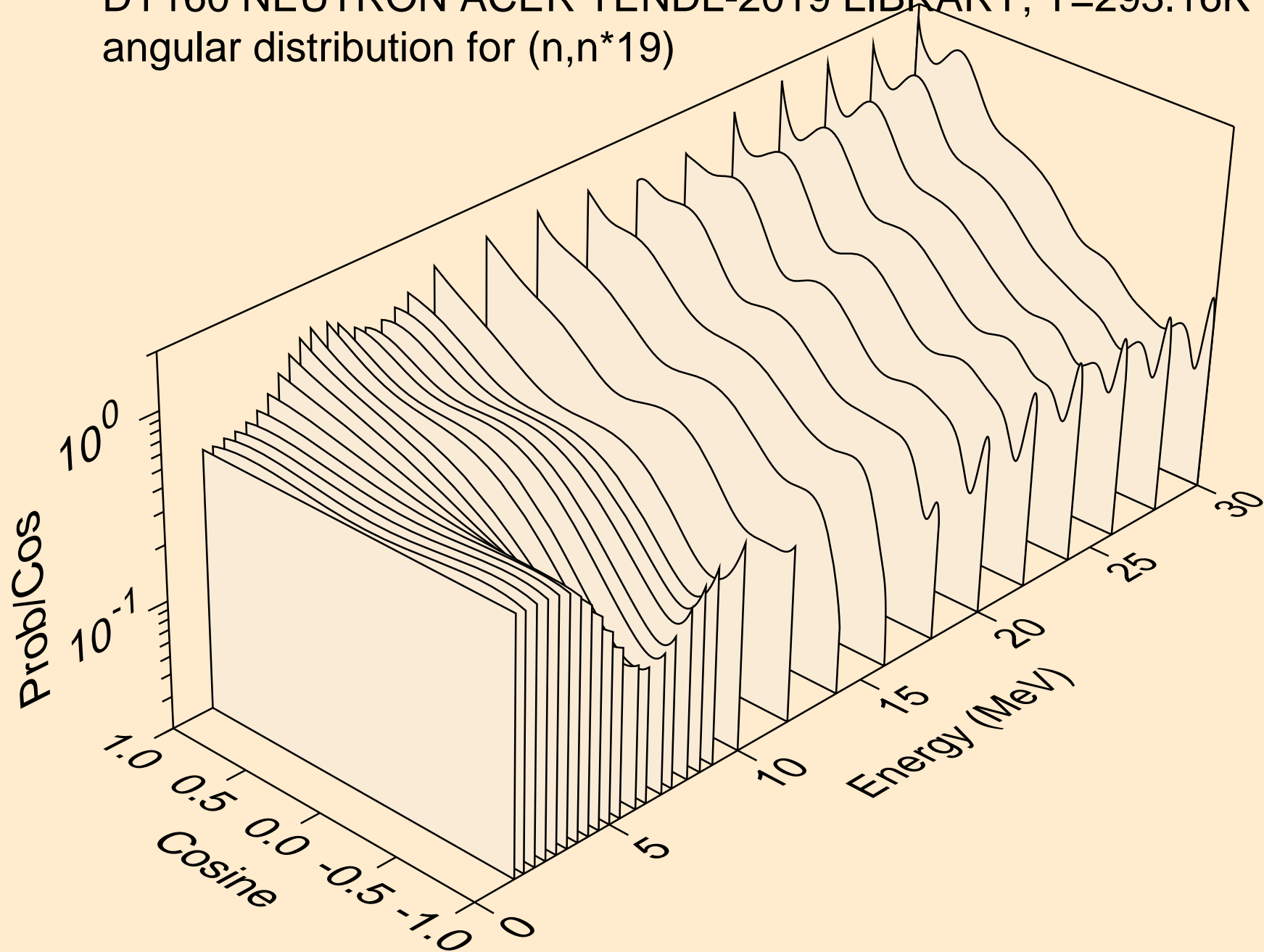

DY160 NEUTRON ACER TENDL-2019 LIBRARY; T=293.16K  
angular distribution for (n,n\*20)

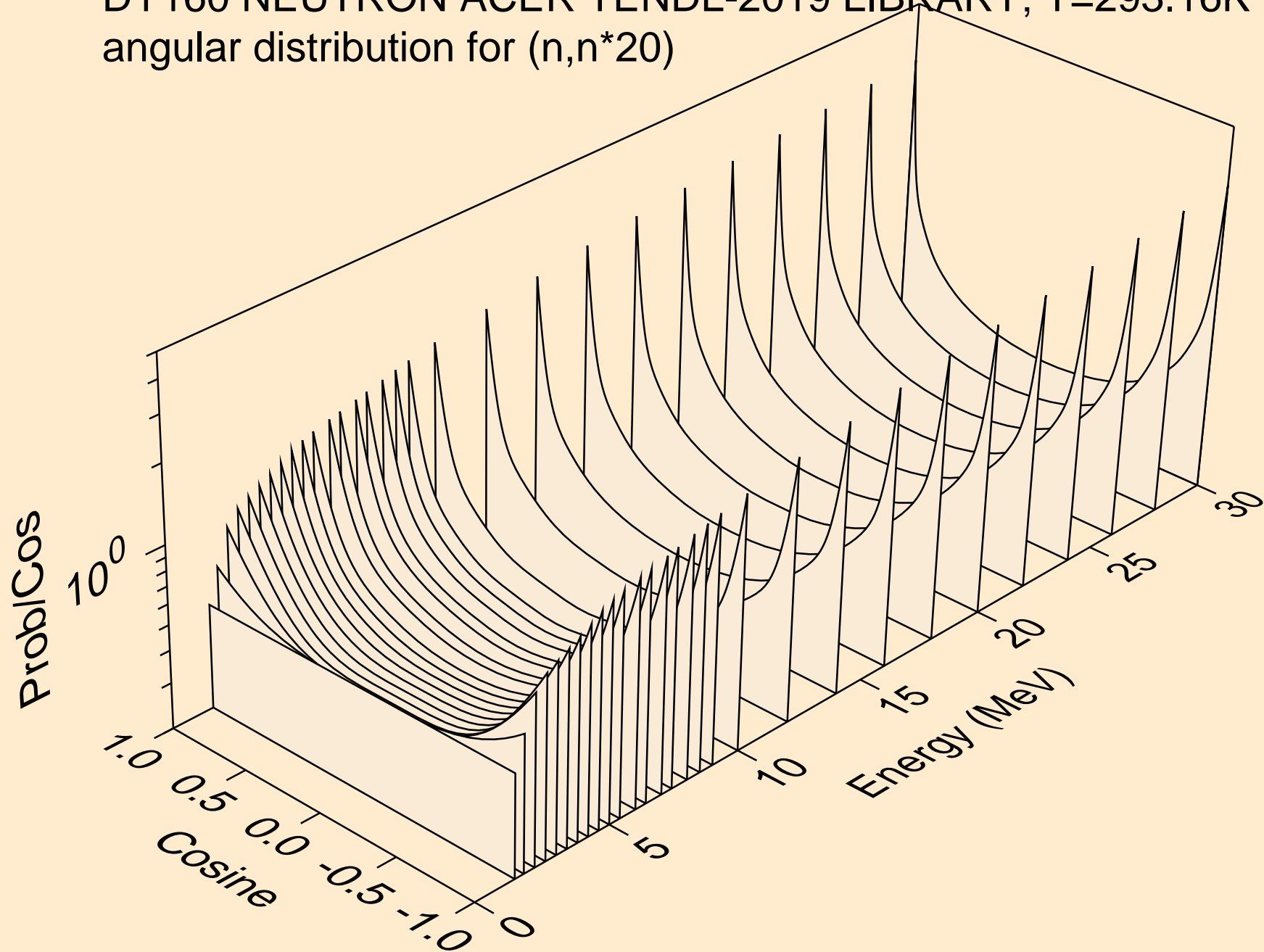

DY160 NEUTRON ACER TENDL-2019 LIBRARY; T=293.16K  
angular distribution for (n,n\*21)

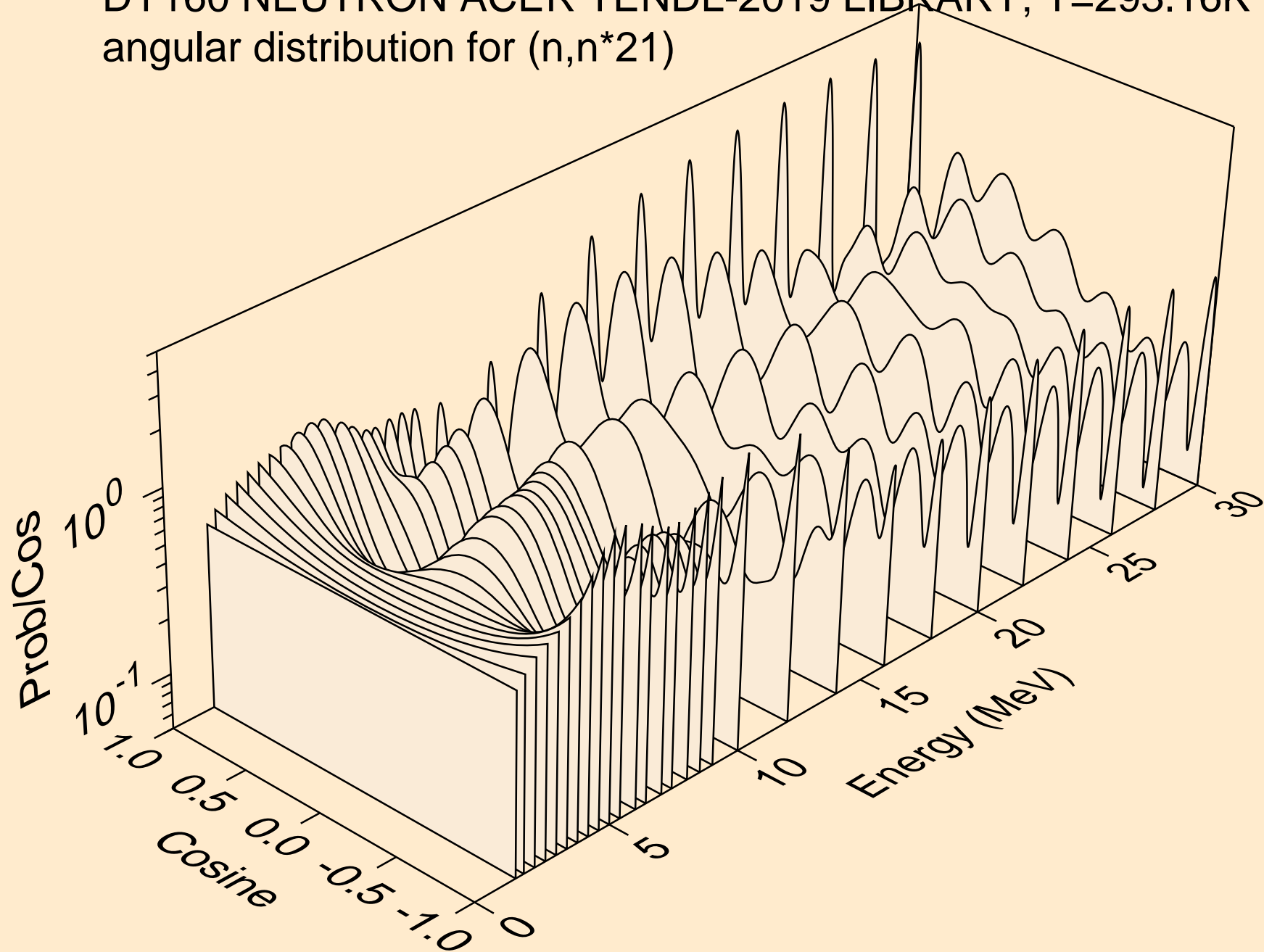

DY160 NEUTRON ACER TENDL-2019 LIBRARY; T=293.16K  
angular distribution for (n,n\*22)

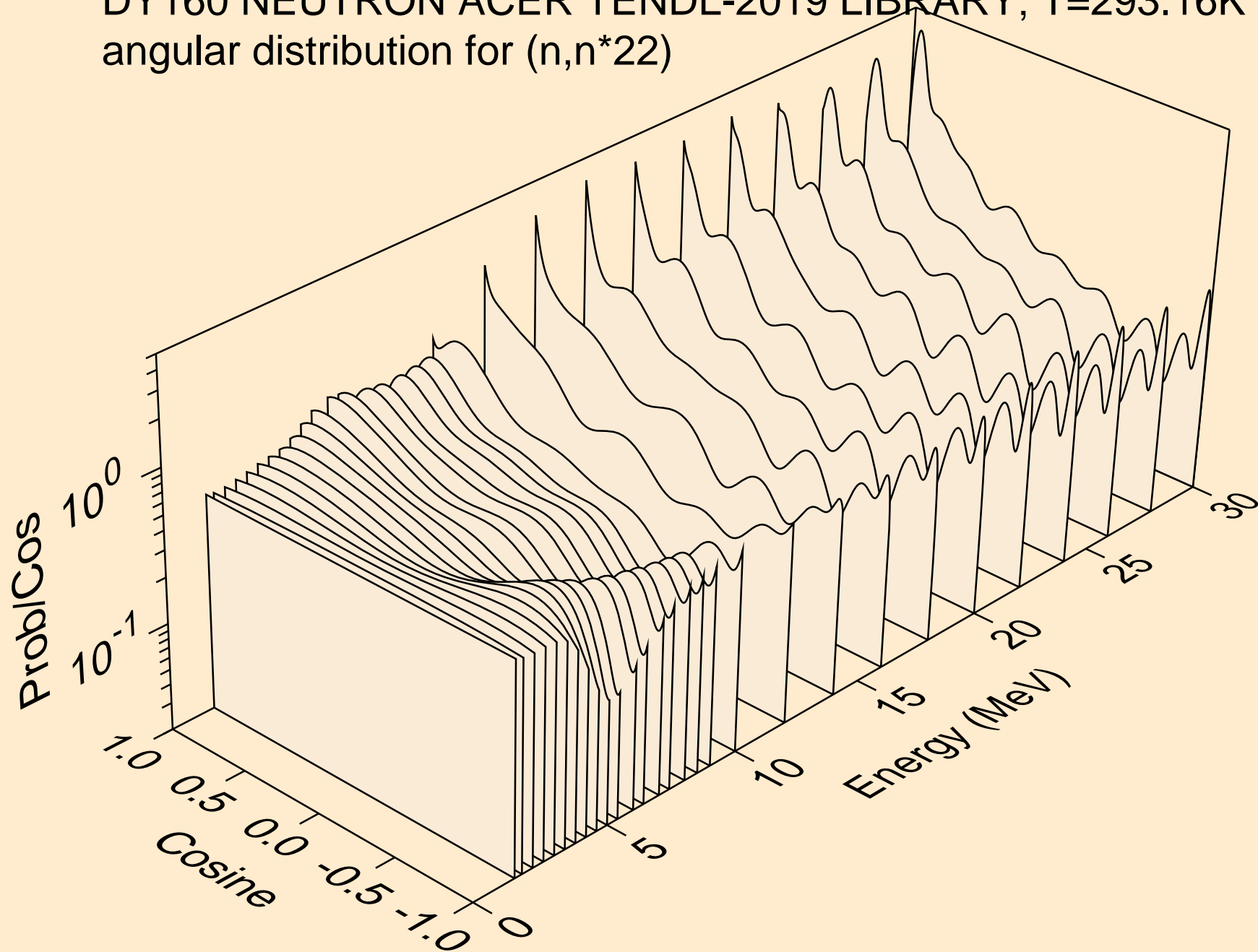

DY160 NEUTRON ACER TENDL-2019 LIBRARY; T=293.16K  
angular distribution for (n,n\*23)

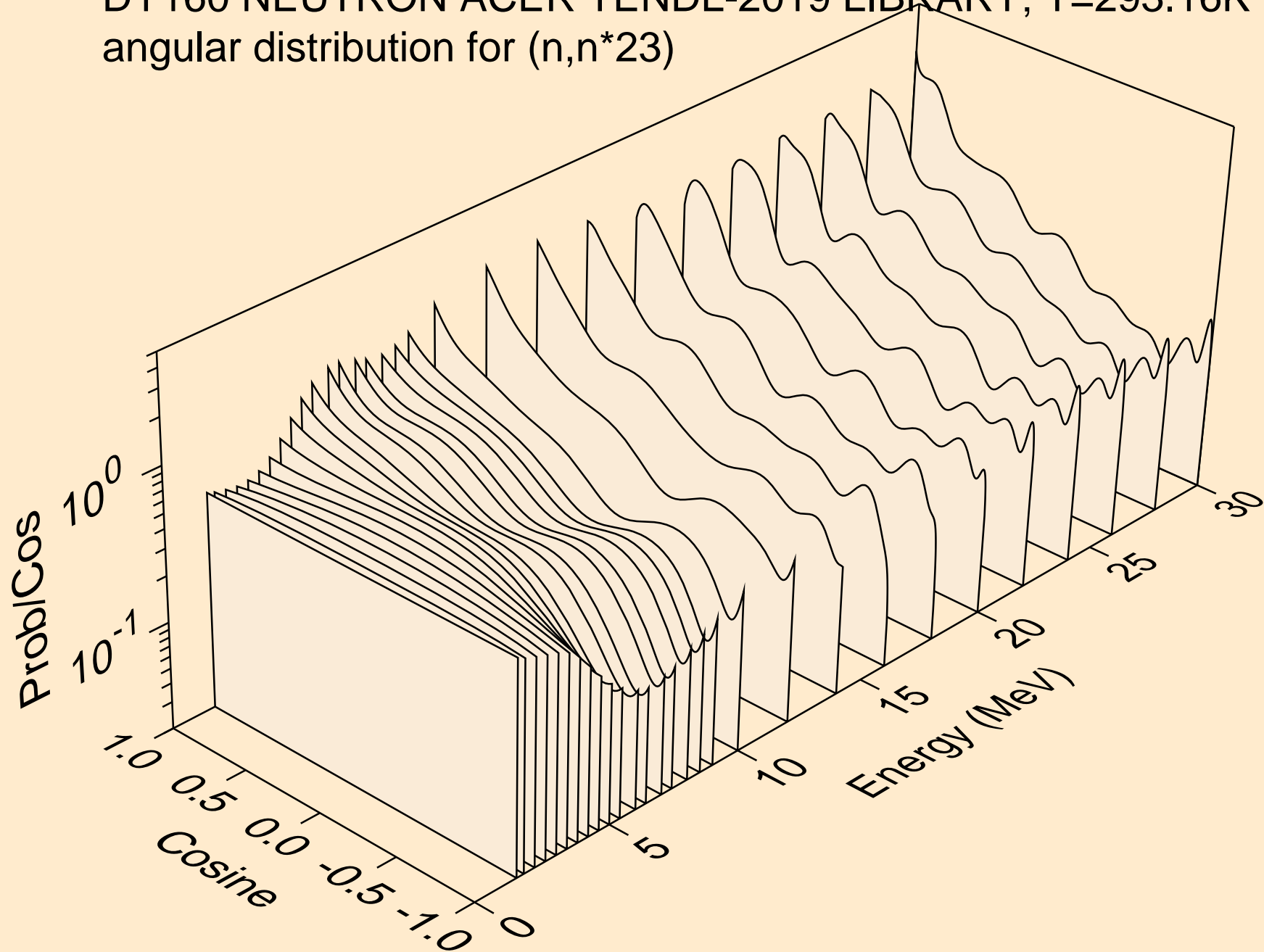



DY160 NEUTRON ACER TENDL-2019 LIBRARY; T=293.16K  
angular distribution for (n,n\*24)

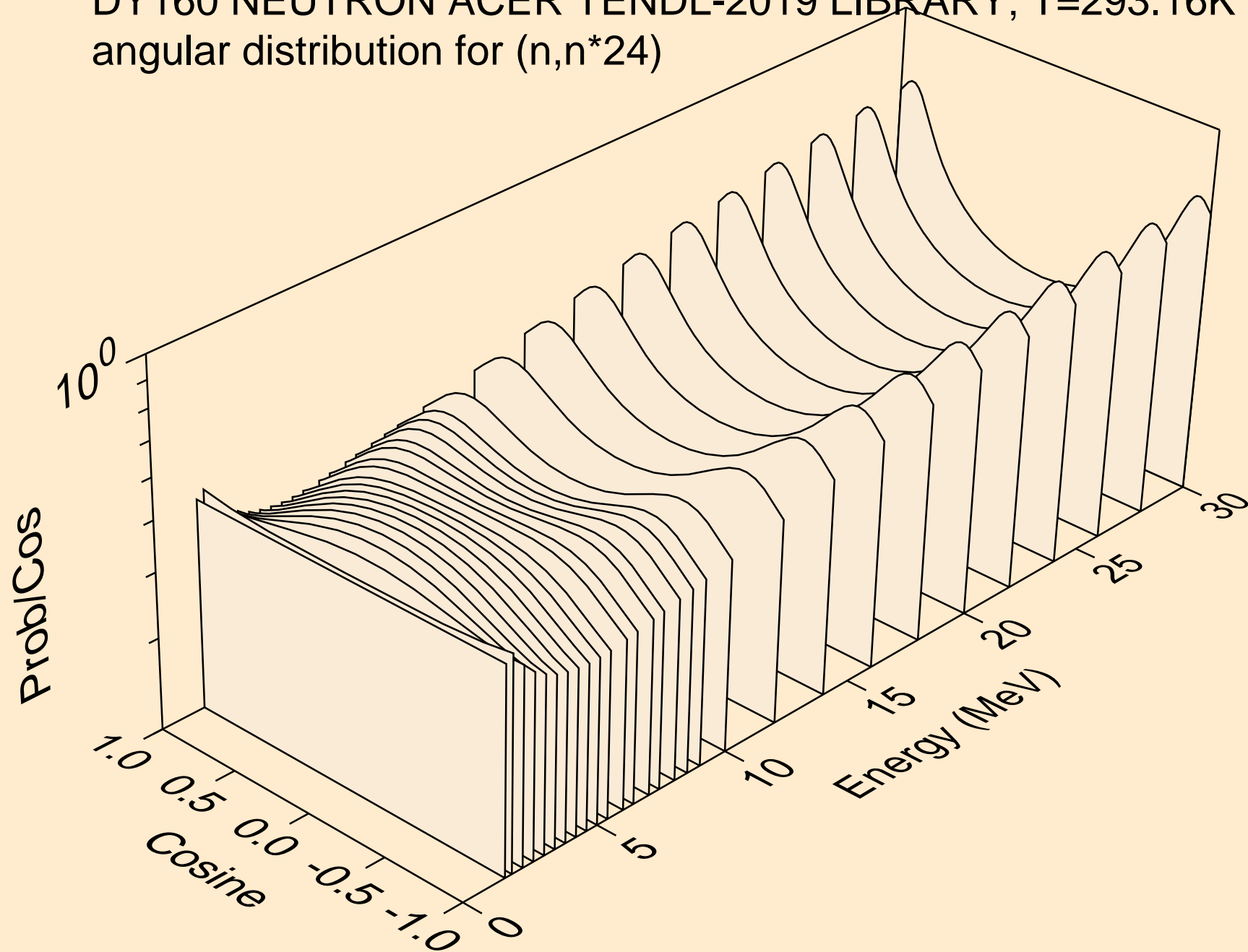

DY160 NEUTRON ACER TENDL-2019 LIBRARY; T=293.16K  
angular distribution for (n,n\*25)

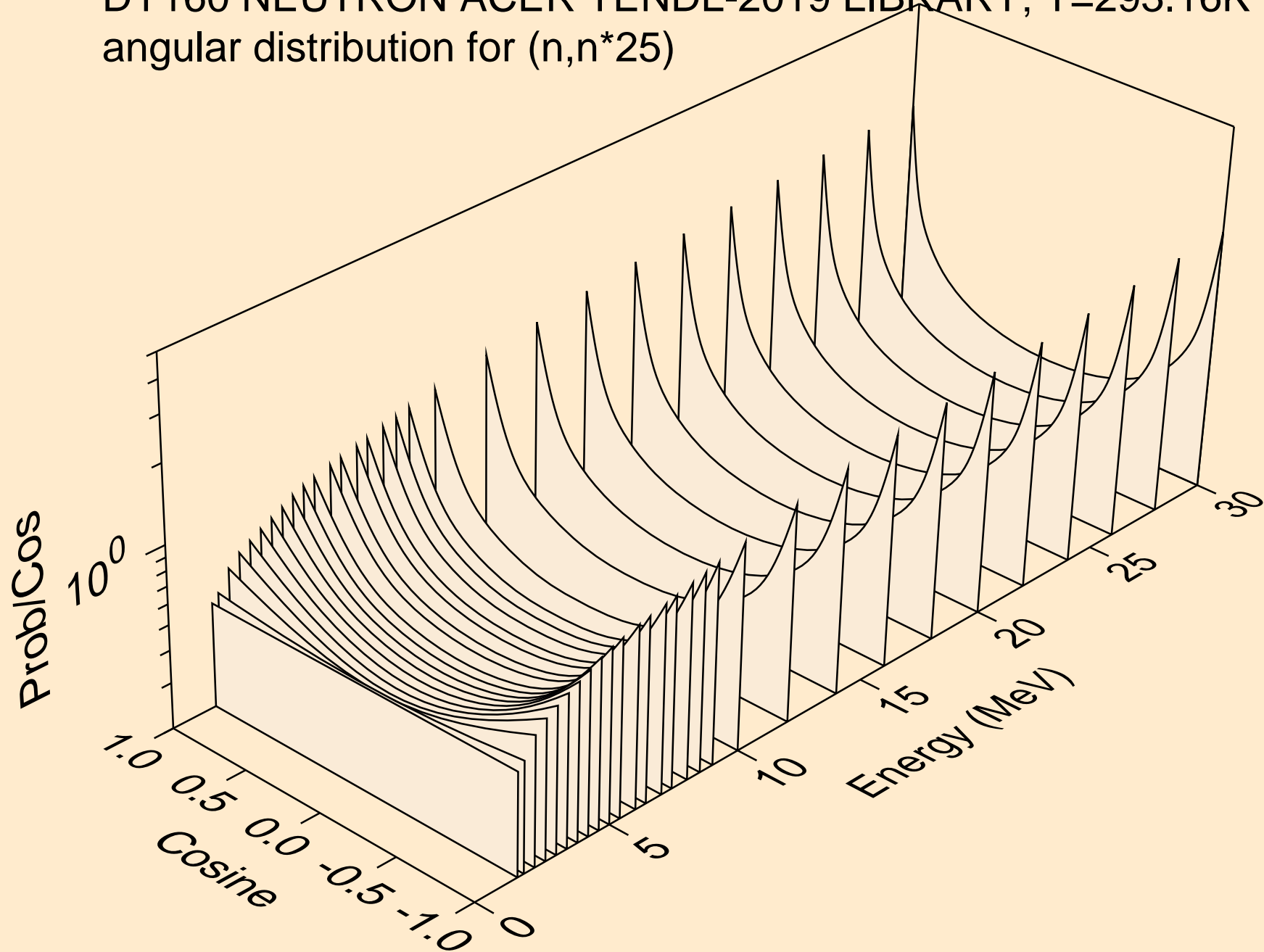

DY160 NEUTRON ACER TENDL-2019 LIBRARY; T=293.16K  
angular distribution for (n,n\*26)

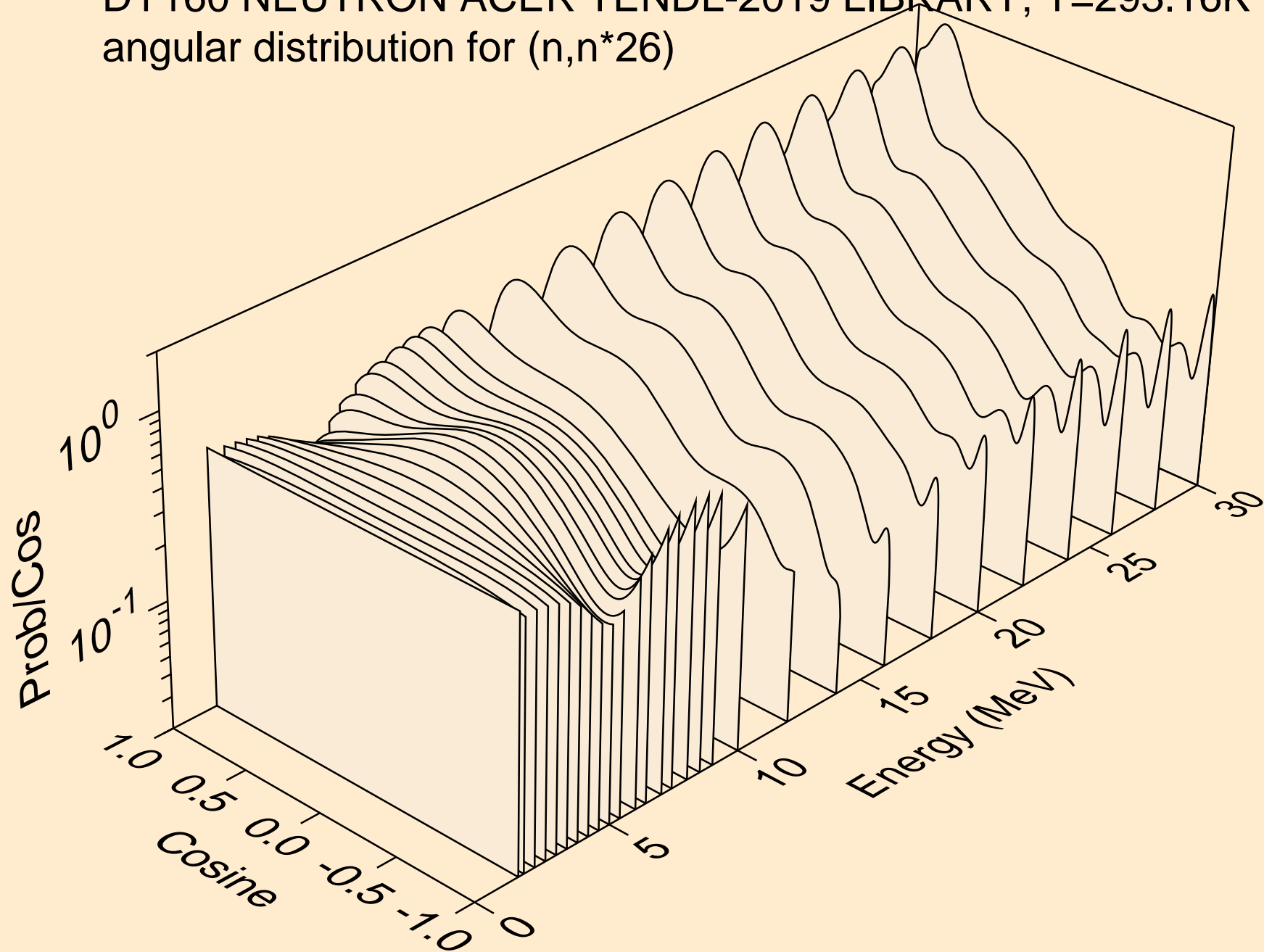

DY160 NEUTRON ACER TENDL-2019 LIBRARY; T=293.16K  
angular distribution for (n,n\*27)

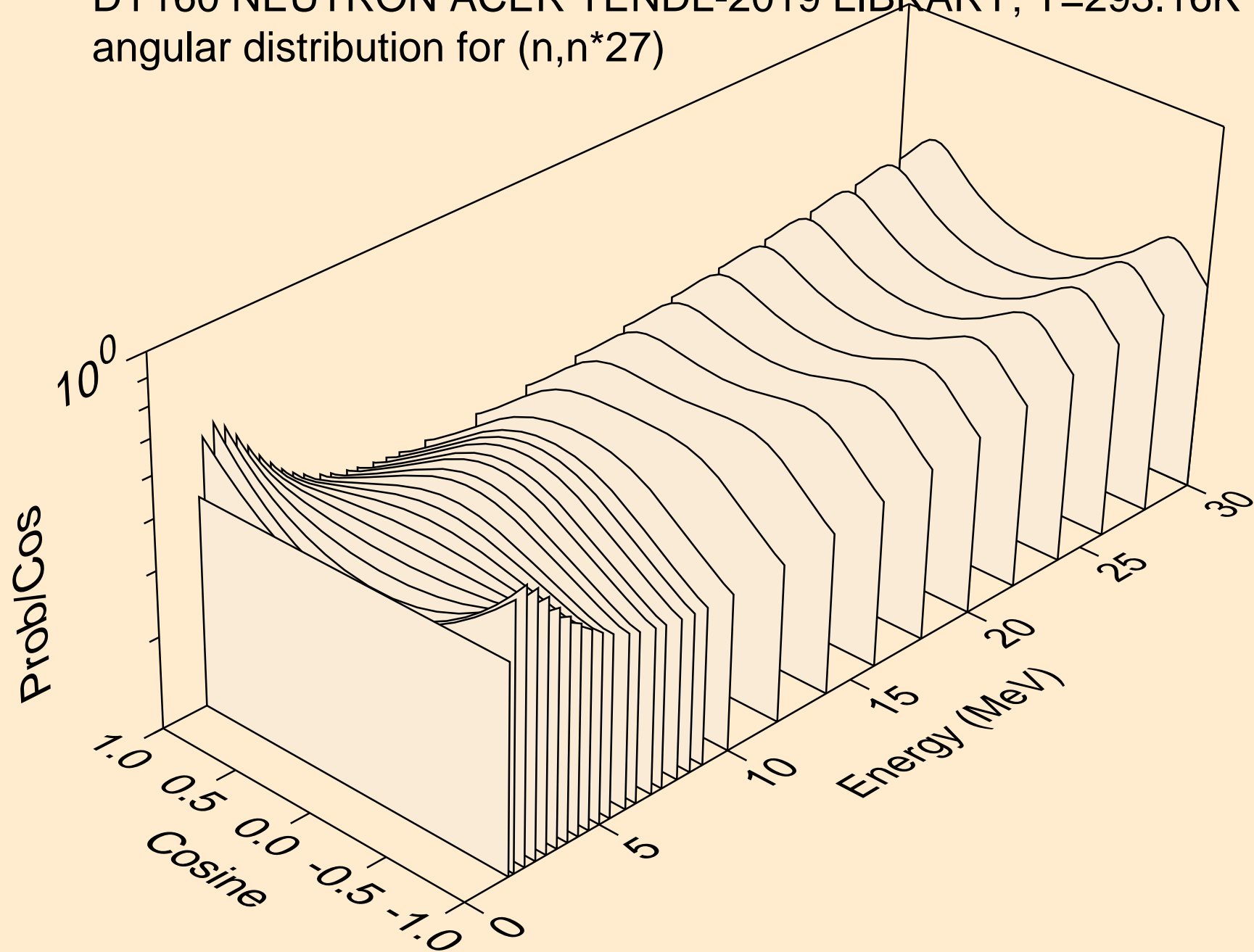

DY160 NEUTRON ACER TENDL-2019 LIBRARY; T=293.16K  
angular distribution for (n,n\*28)

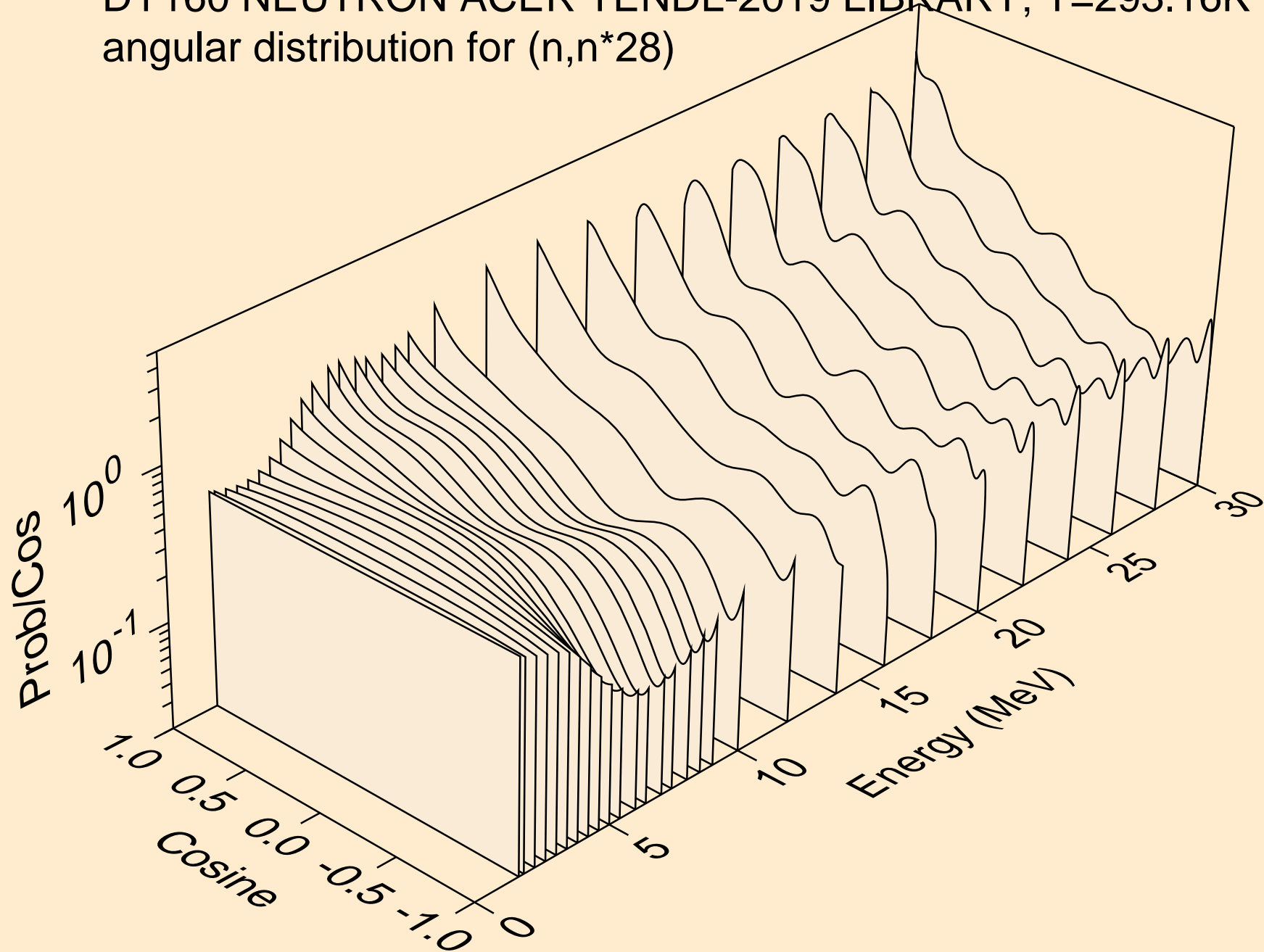

DY160 NEUTRON ACER TENDL-2019 LIBRARY; T=293.16K  
angular distribution for (n,n\*29)

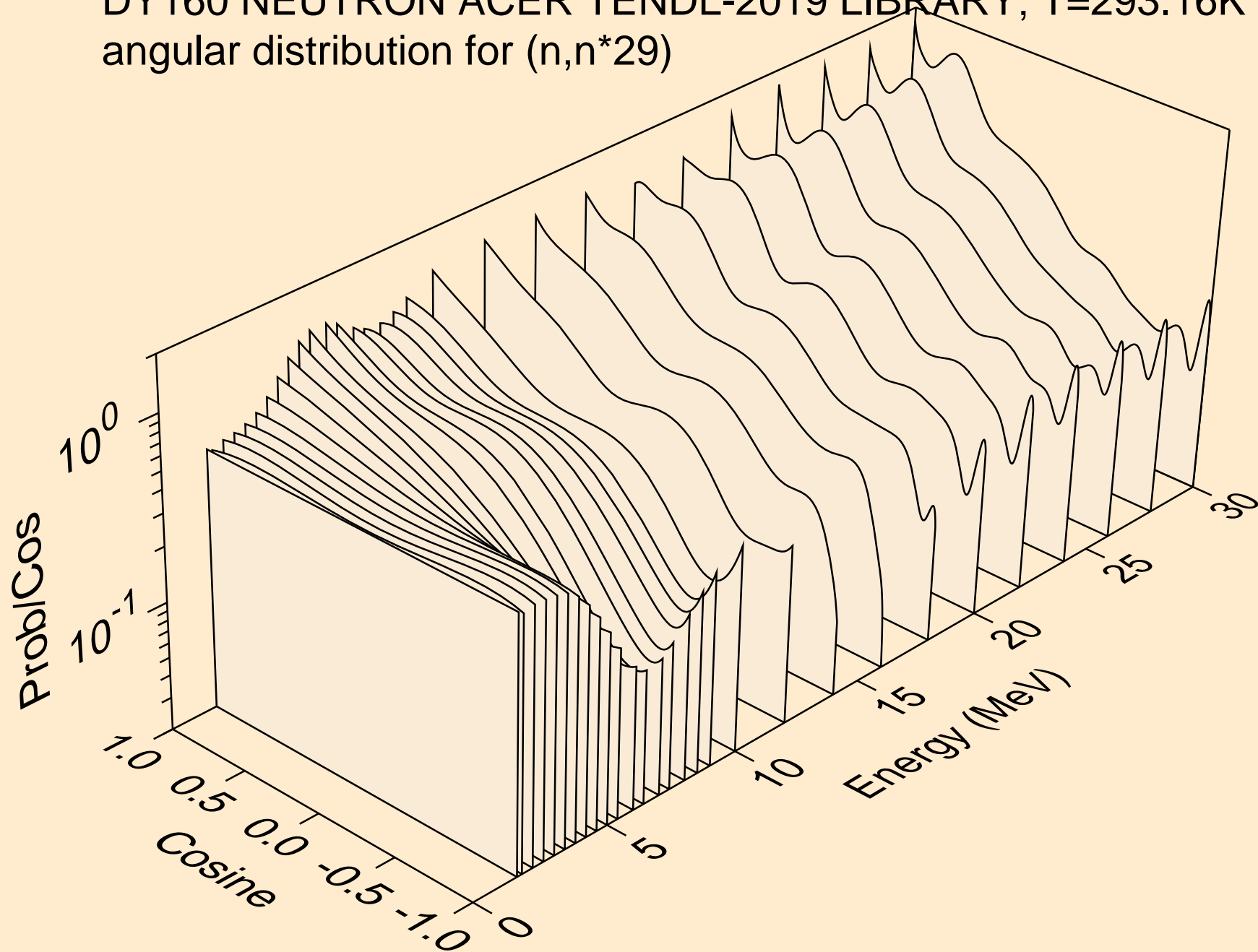

DY160 NEUTRON ACER TENDL-2019 LIBRARY; T=293.16K  
angular distribution for (n,n\*30)

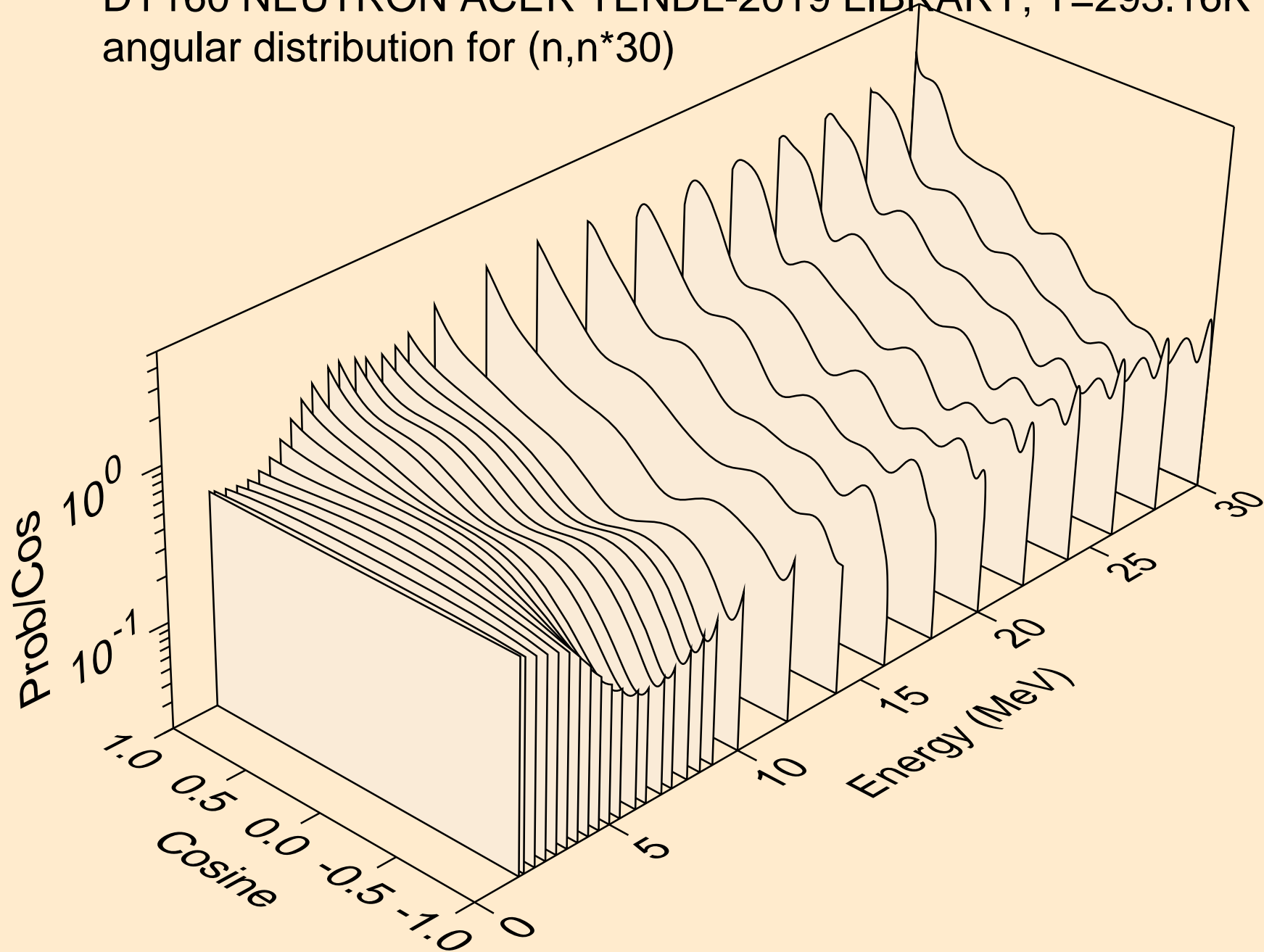

DY160 NEUTRON ACER TENDL-2019 LIBRARY; T=293.16K  
Neutron emission for (n,x)

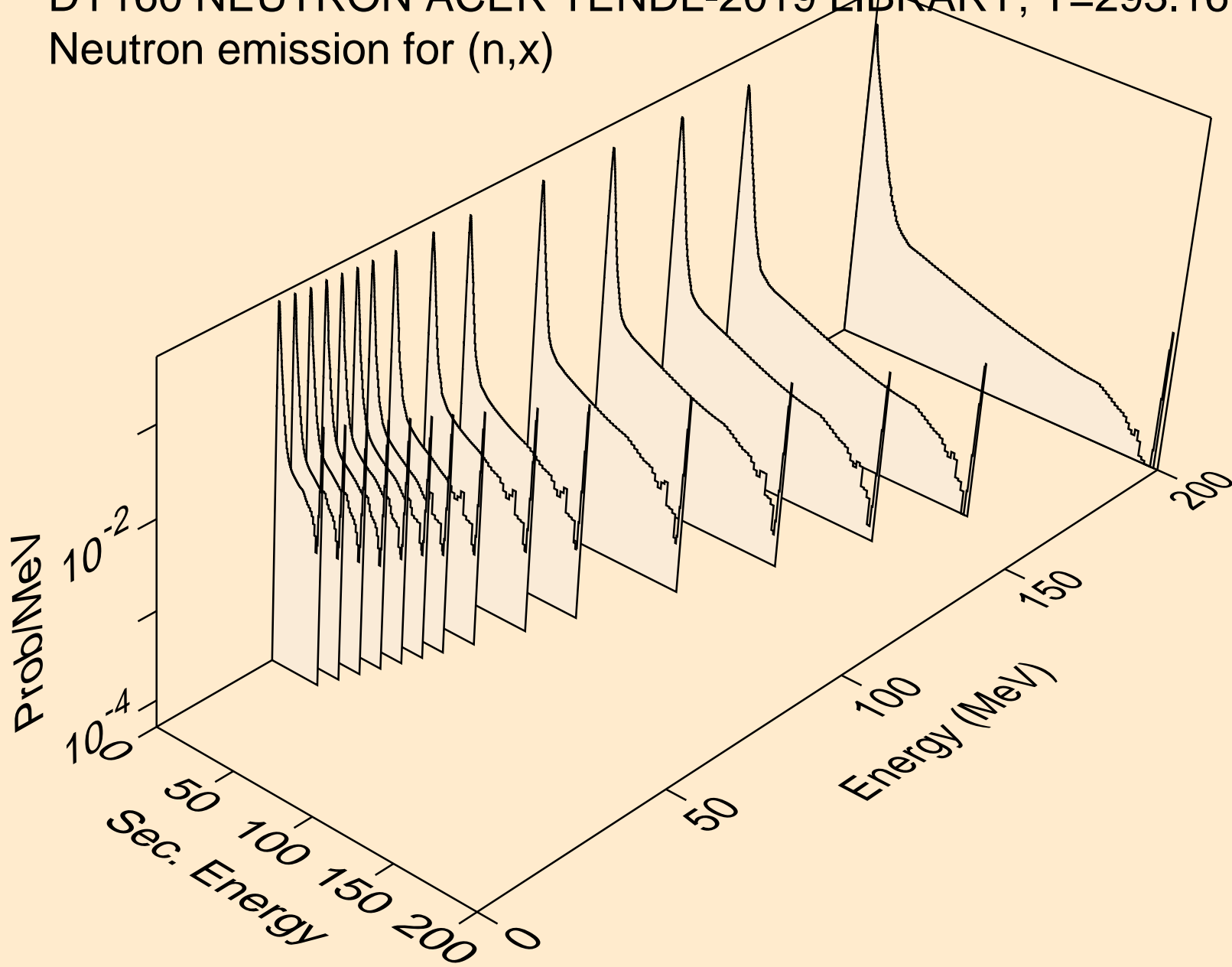



DY160 NEUTRON ACER TENDL-2019 LIBRARY; T=293.16K  
Neutron emission for (n,2nd)

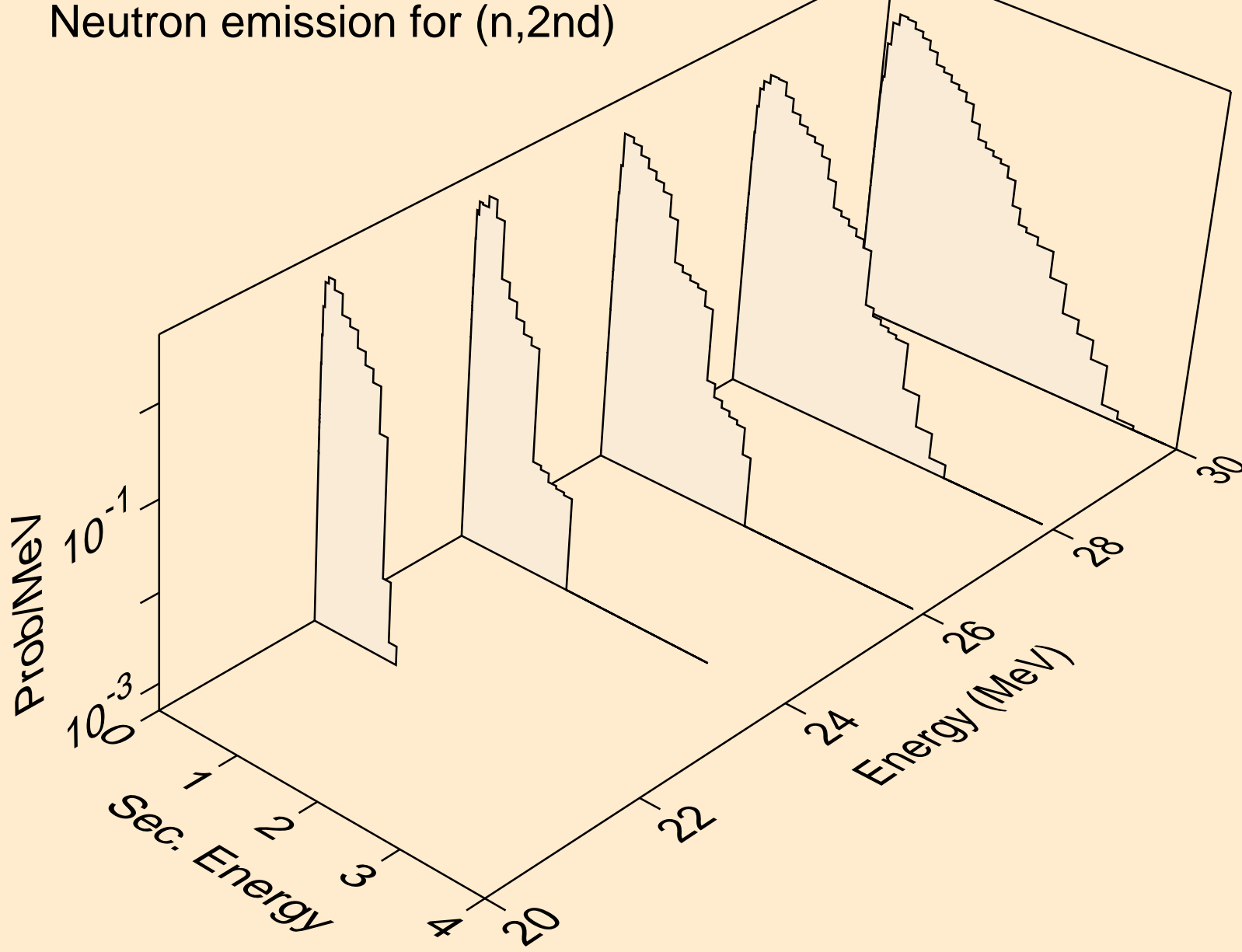

DY160 NEUTRON ACER TENDL-2019 LIBRARY; T=293.16K  
Neutron emission for (n,2n)

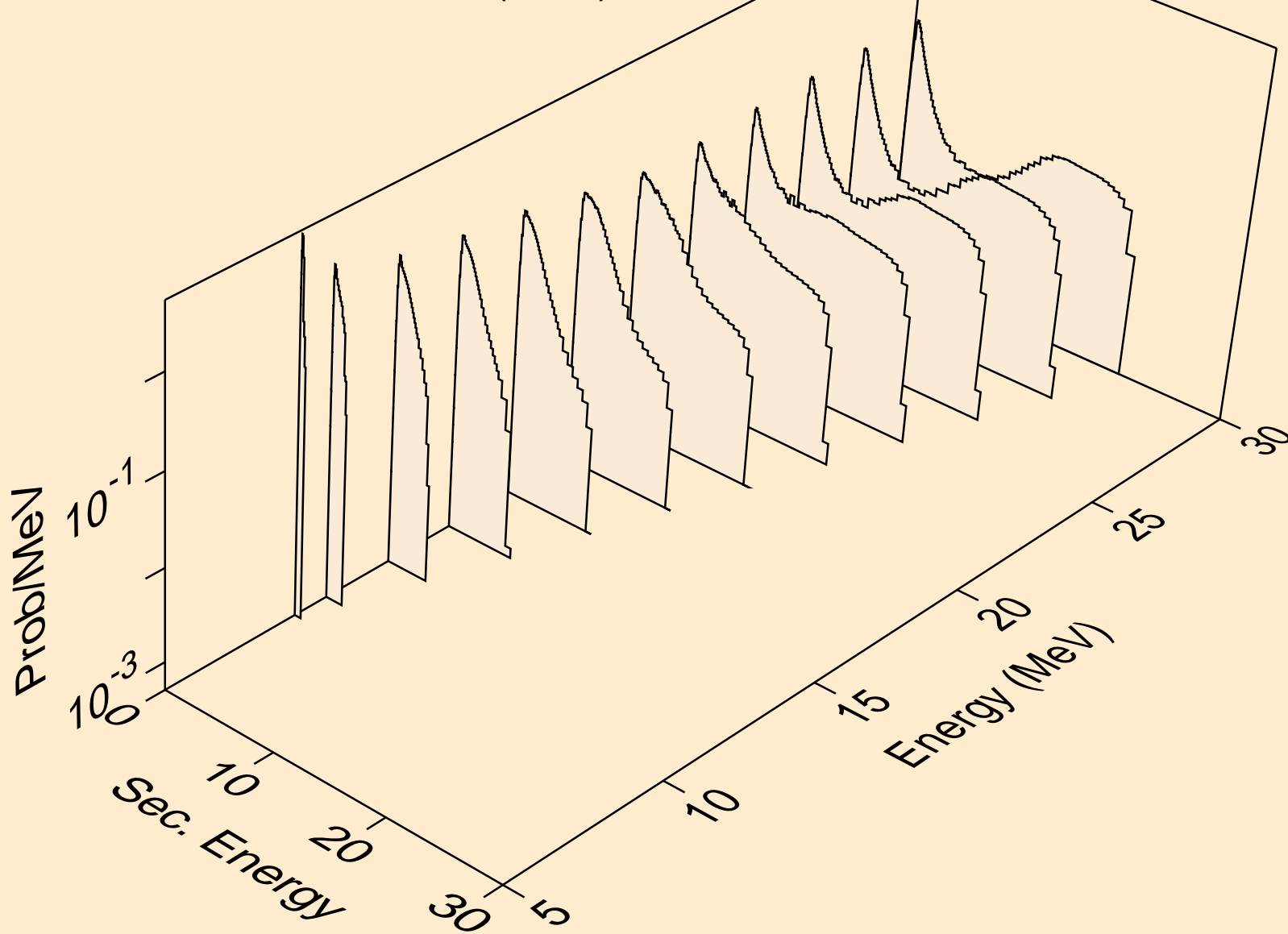

DY160 NEUTRON ACER TENDL-2019 LIBRARY; T=293.16K  
Neutron emission for (n,3n)

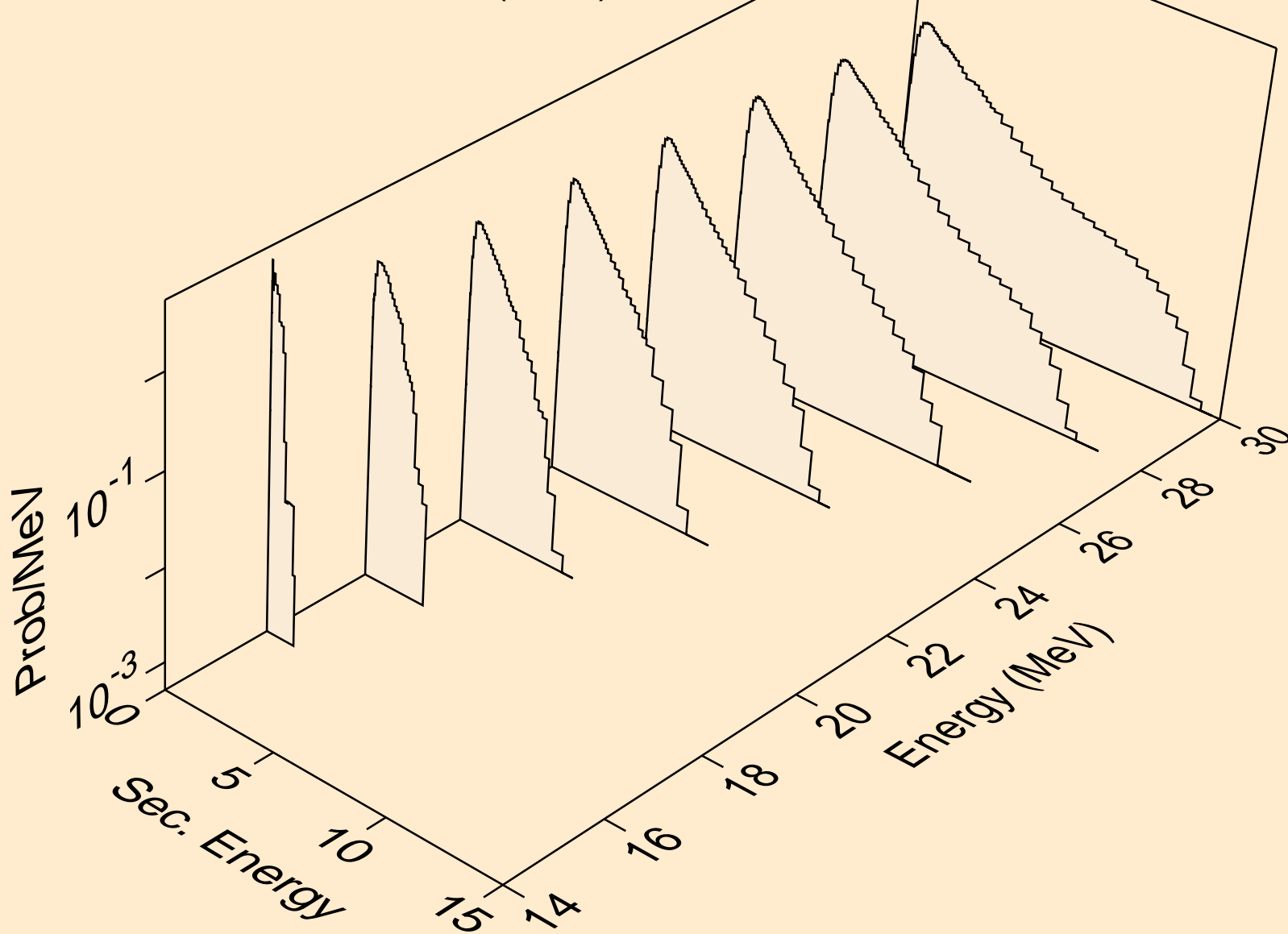

DY160 NEUTRON ACER TENDL-2019 LIBRARY; T=293.16K  
Neutron emission for (n,n\*)a

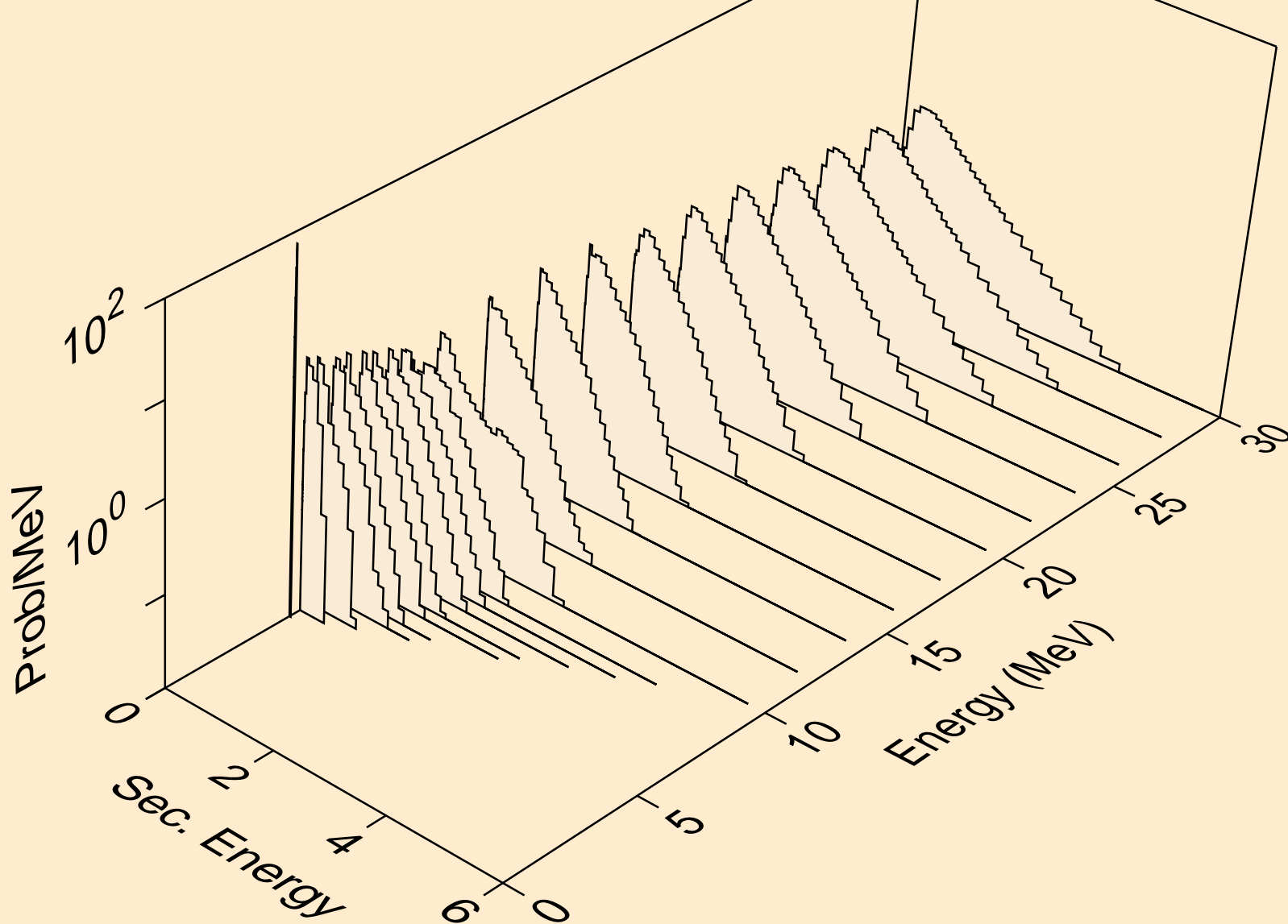

DY160 NEUTRON ACER TENDL-2019 LIBRARY; T=293.16K  
Neutron emission for (n,2n)a

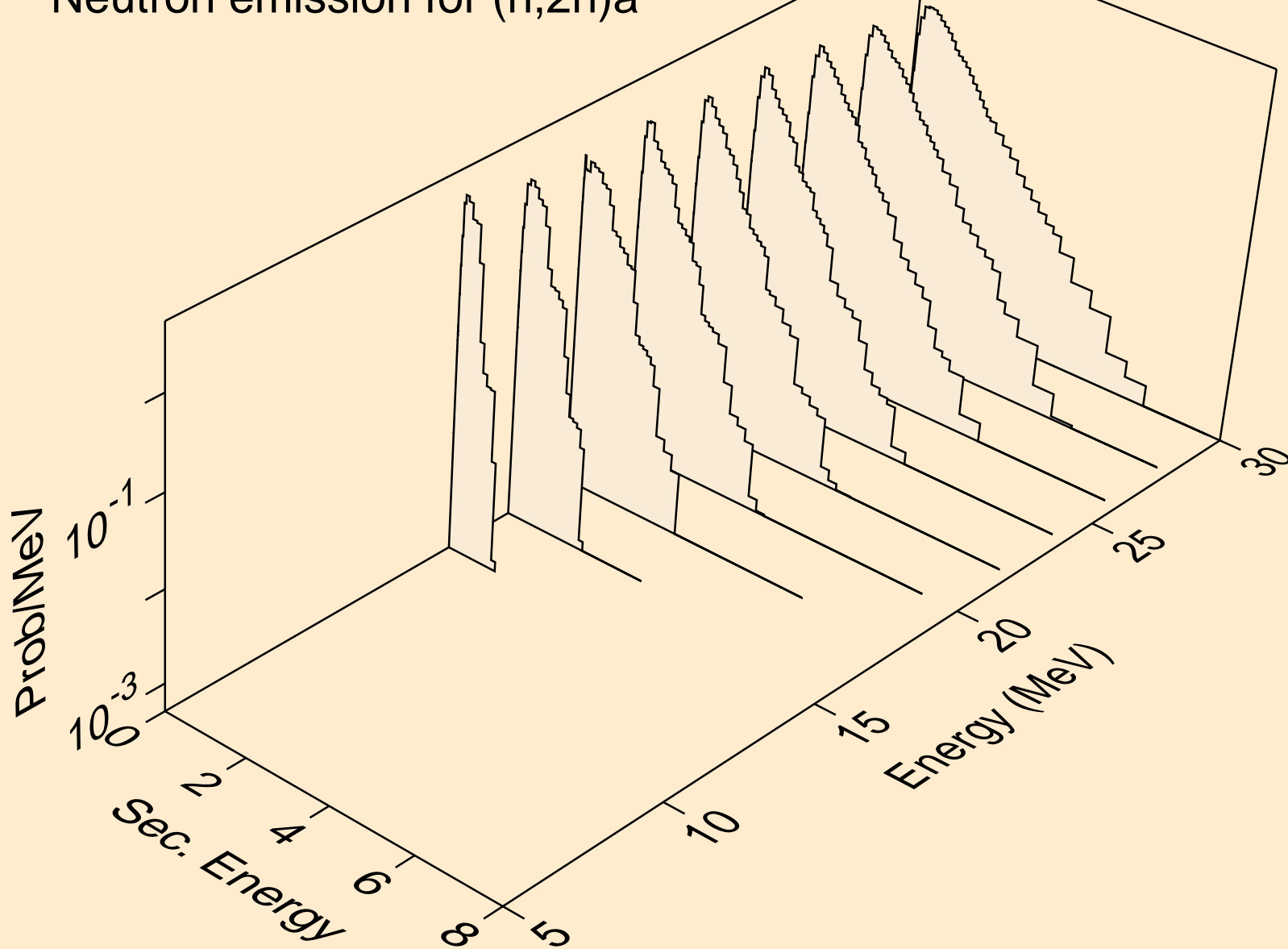

DY160 NEUTRON ACER TENDL-2019 LIBRARY; T=293.16K  
Neutron emission for (n,3n)a

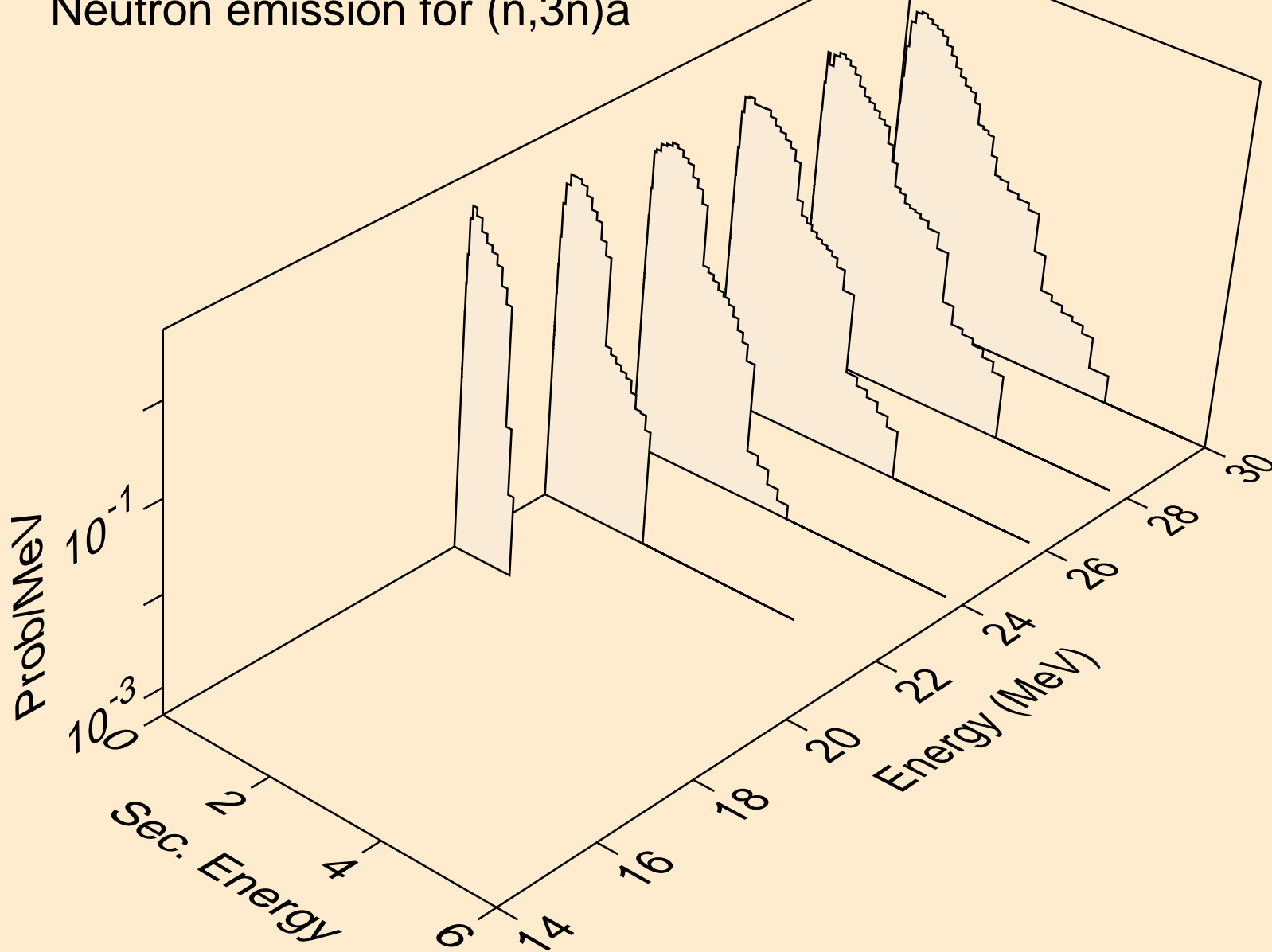

DY160 NEUTRON ACER TENDL-2019 LIBRARY; T=293.16K  
Neutron emission for (n,n\*)p

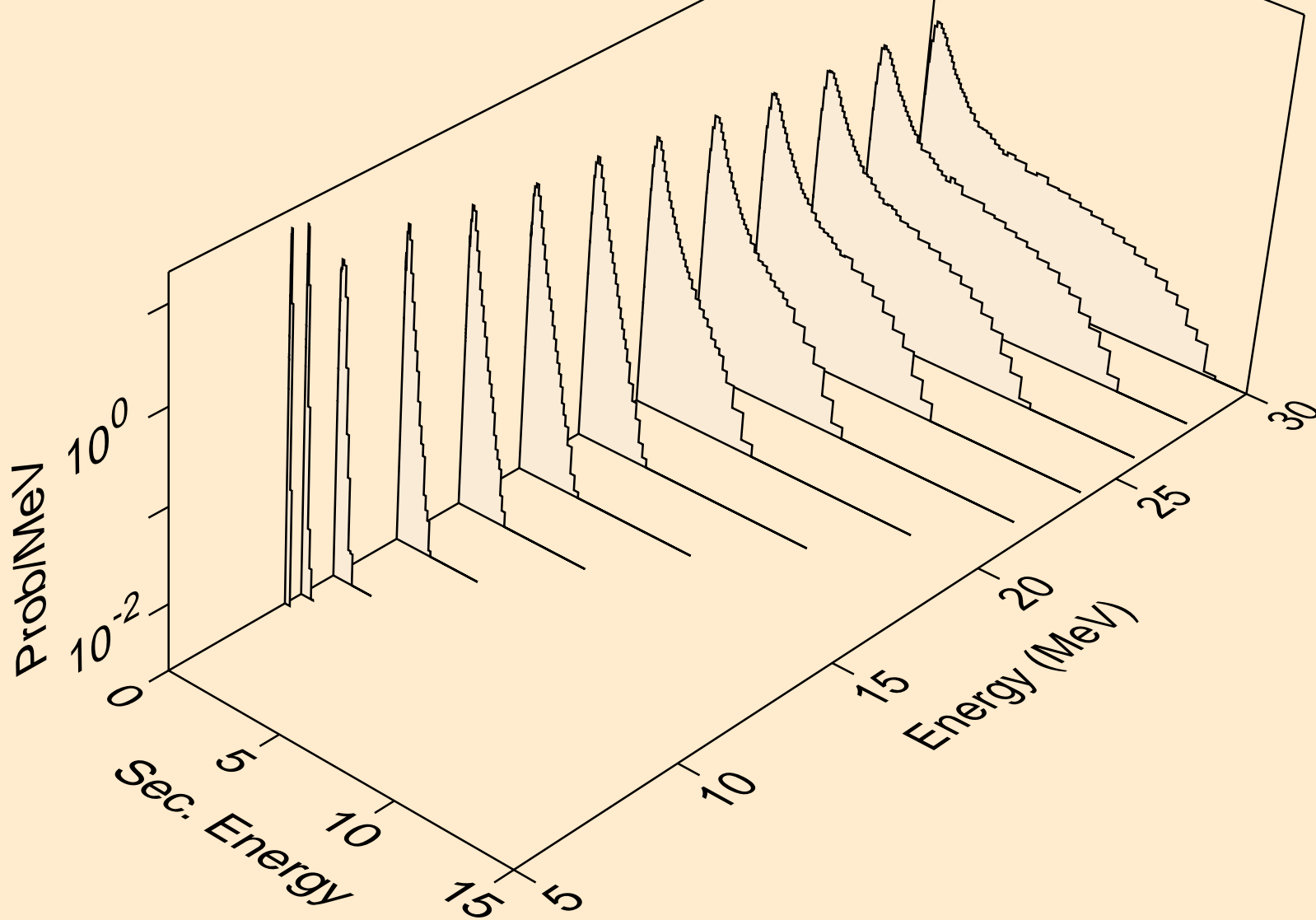

DY160 NEUTRON ACER TENDL-2019 LIBRARY; T=293.16K  
Neutron emission for (n,n\*)2a

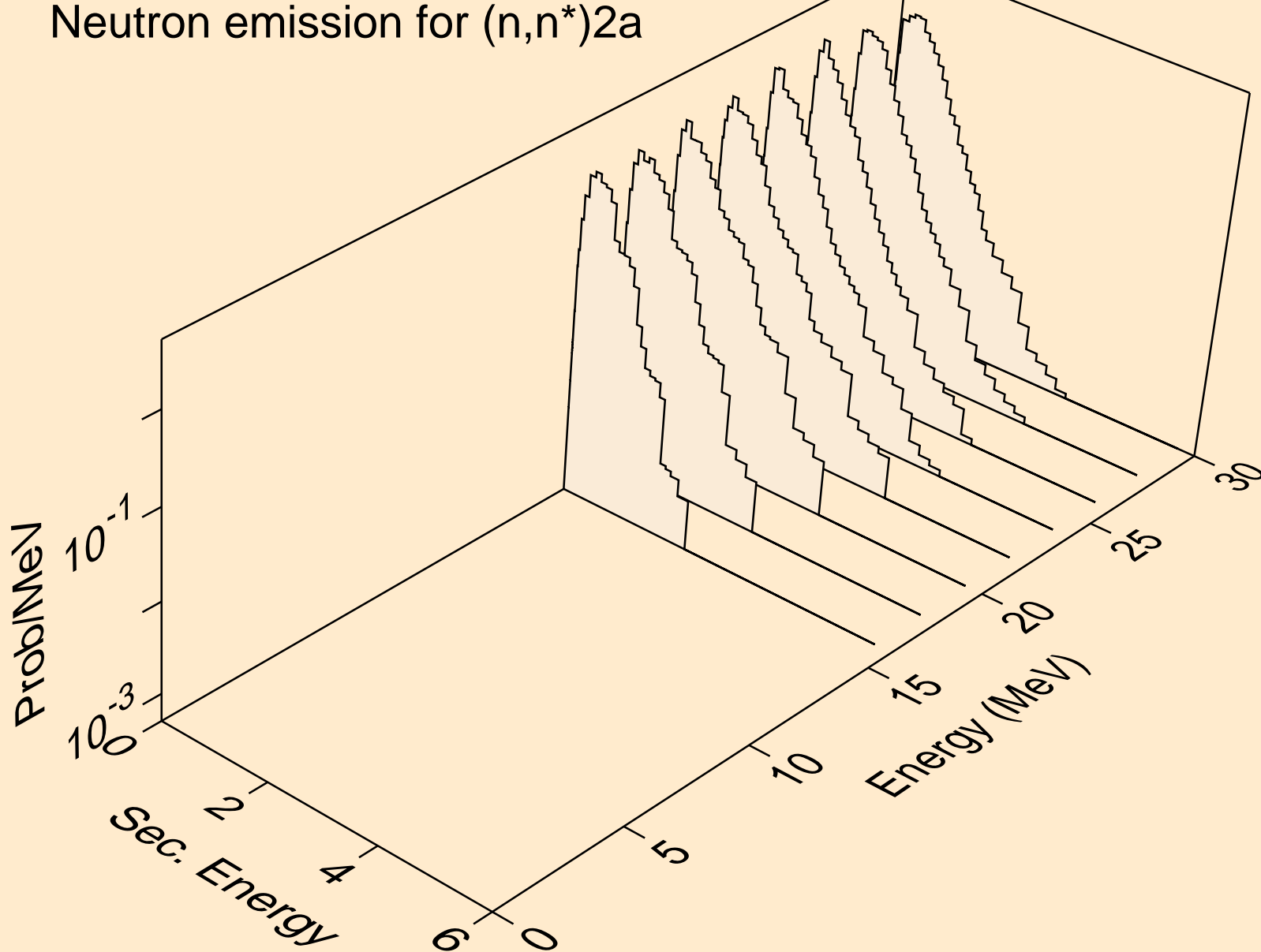



DY160 NEUTRON ACER TENDL-2019 LIBRARY; T=293.16K  
Neutron emission for (n,n\*)d

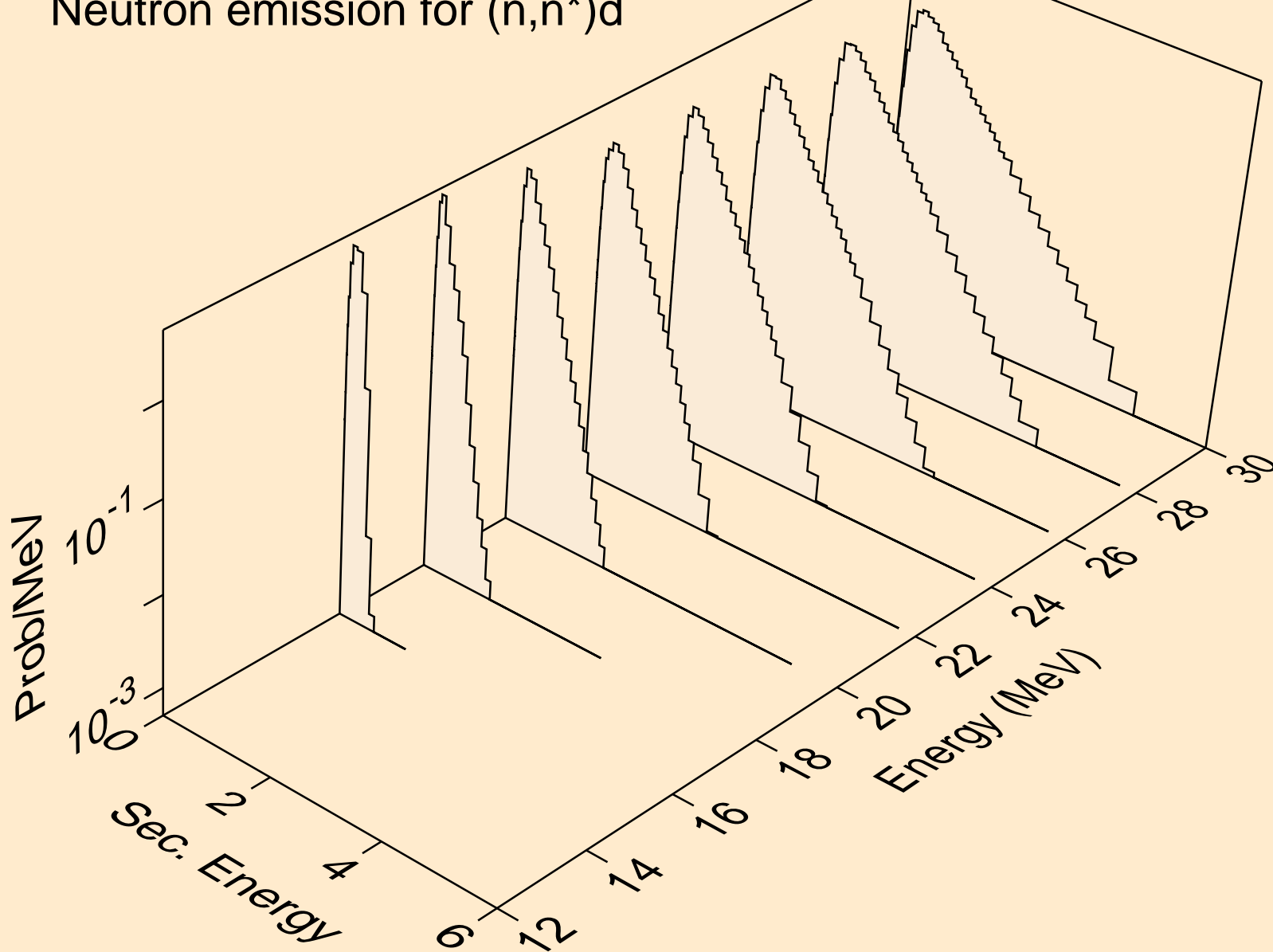

DY160 NEUTRON ACER TENDL-2019 LIBRARY; T=293.16K  
Neutron emission for (n,n\*)t

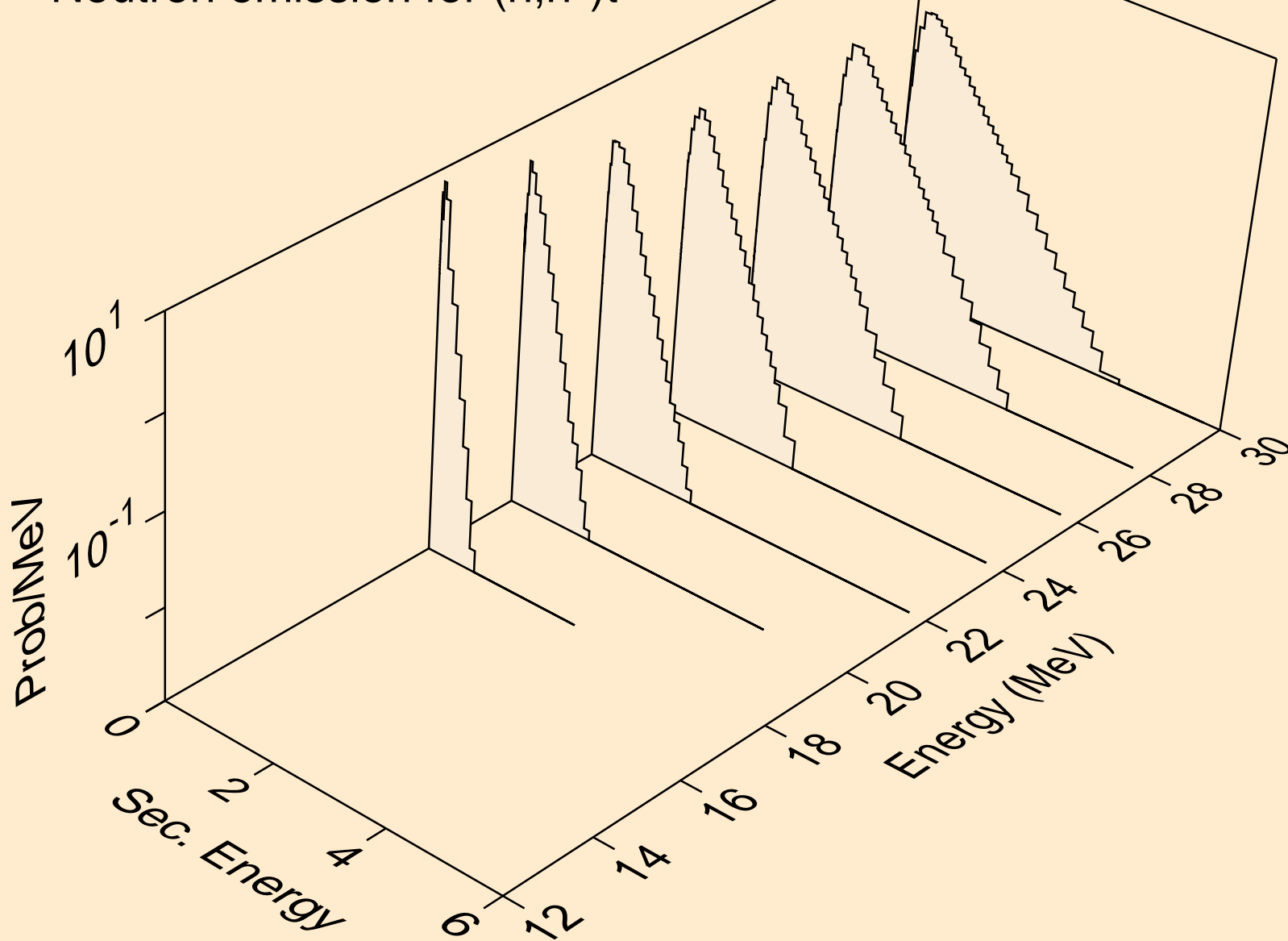

DY160 NEUTRON ACER TENDL-2019 LIBRARY; T=293.16K  
Neutron emission for (n,n\*)he3

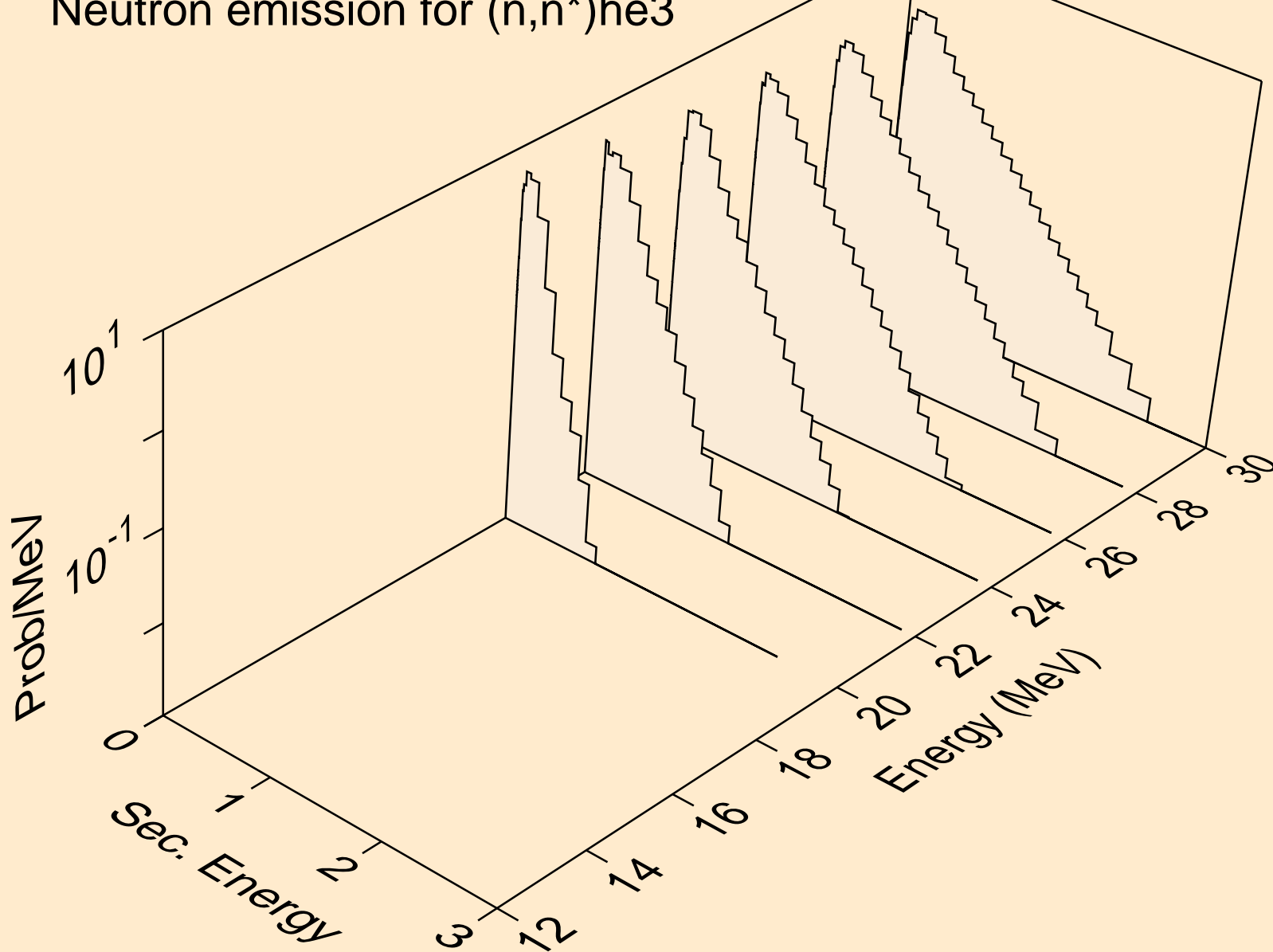

DY160 NEUTRON ACER TENDL-2019 LIBRARY; T=293.16K  
Neutron emission for (n,4n)

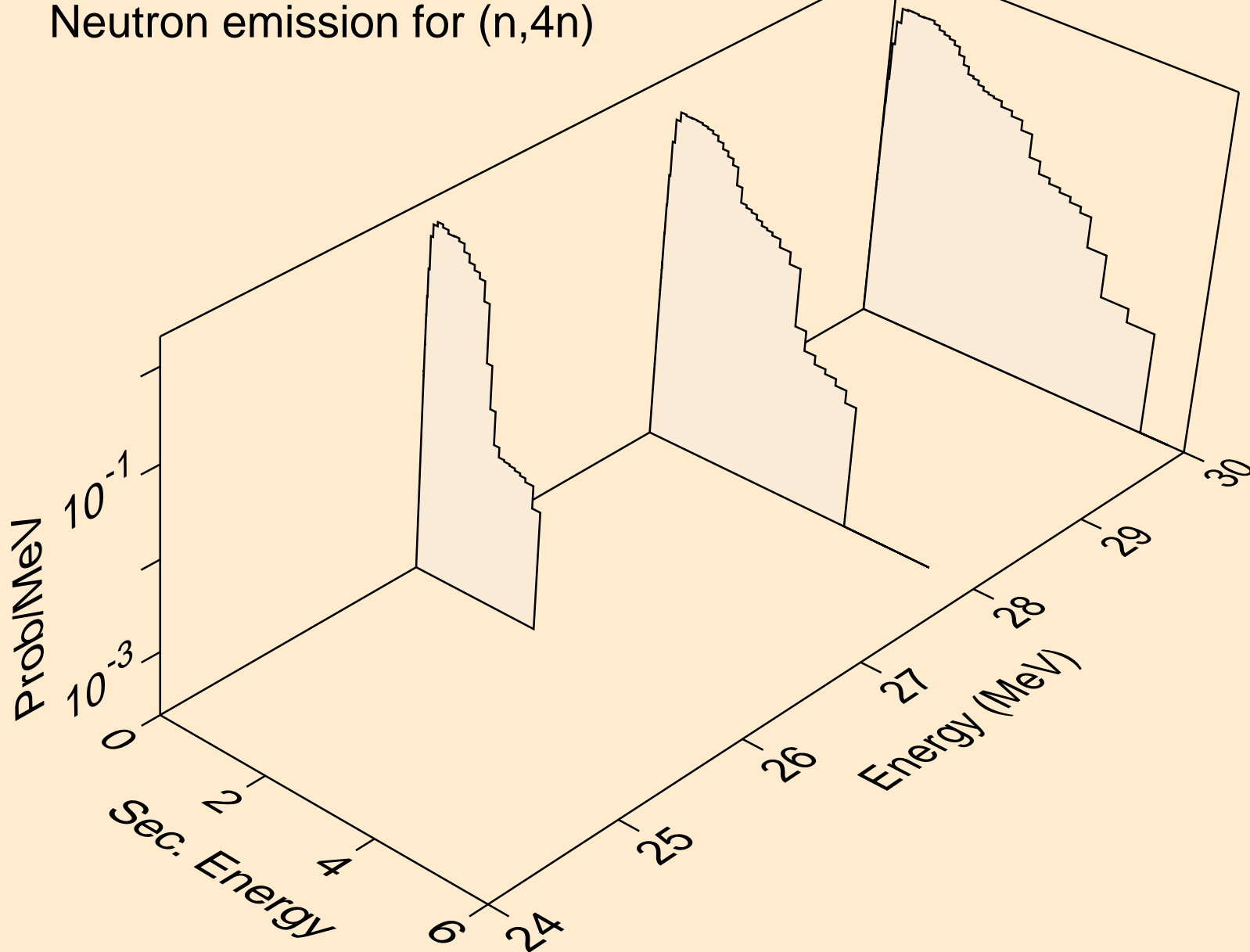

DY160 NEUTRON ACER TENDL-2019 LIBRARY; T=293.16K  
Neutron emission for (n,2np)

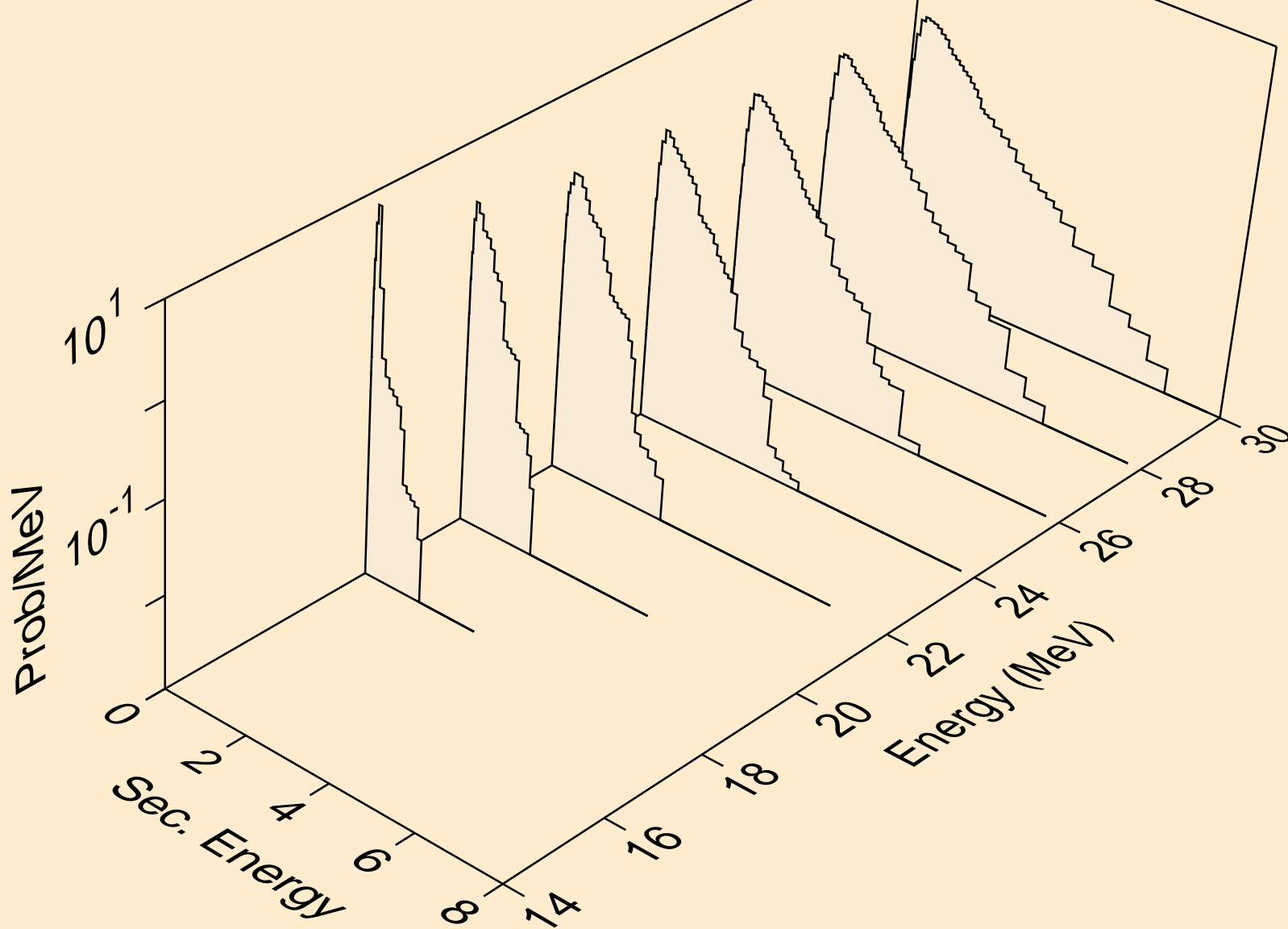

DY160 NEUTRON ACER TENDL-2019 LIBRARY; T=293.16K  
Neutron emission for (n,3np)

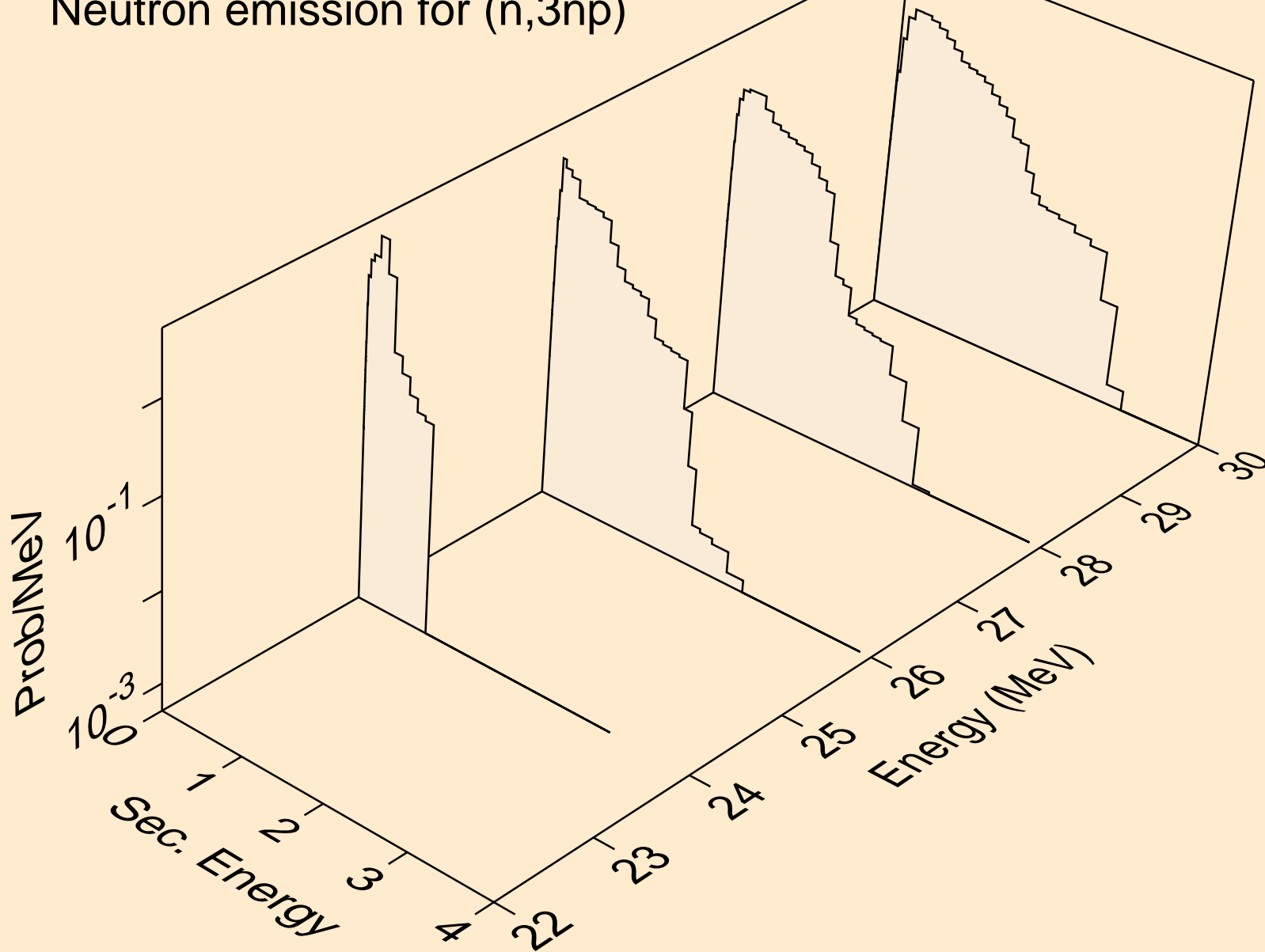

DY160 NEUTRON ACER TENDL-2019 LIBRARY; T=293.16K  
Neutron emission for (n,2np)

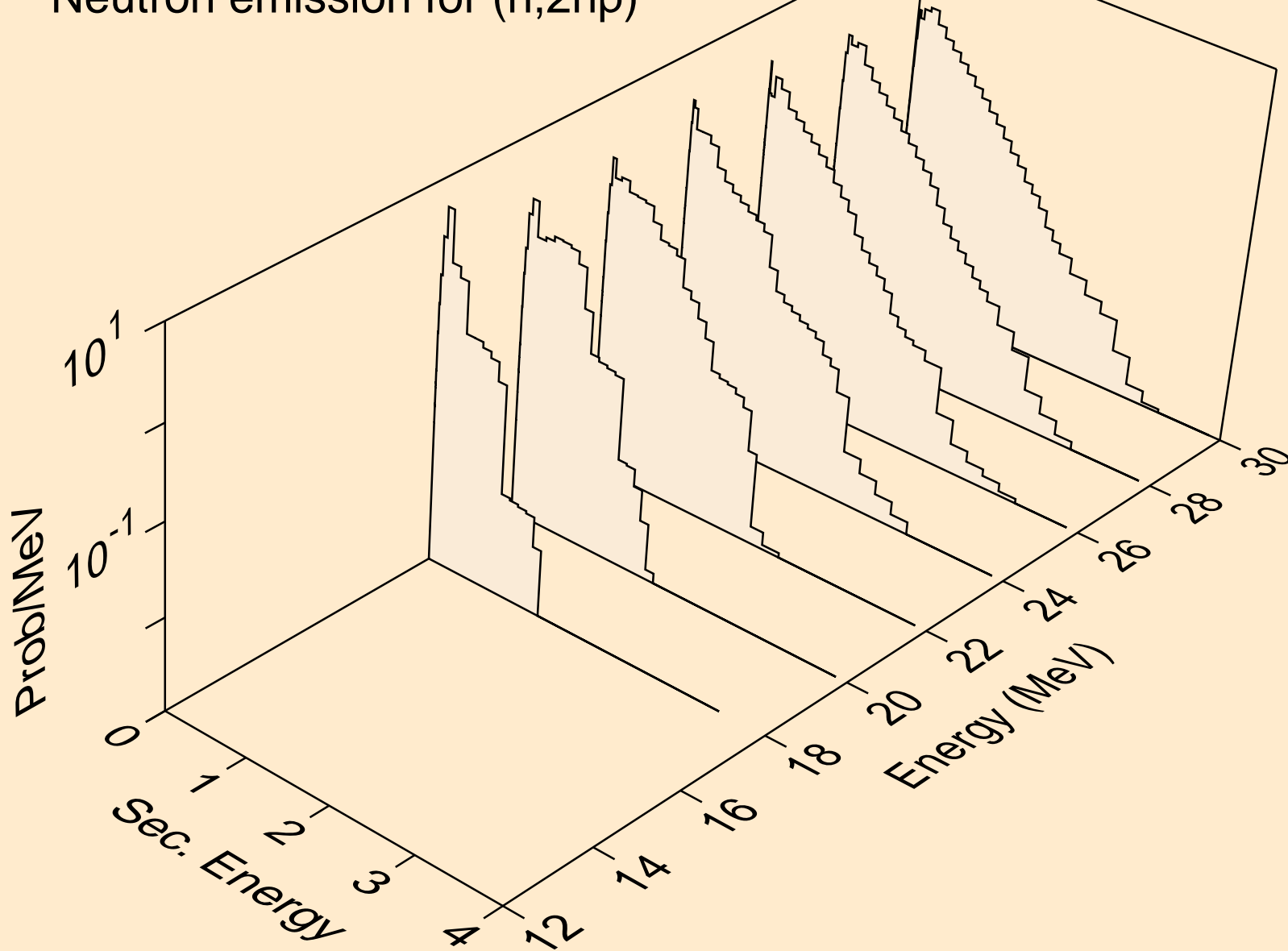

DY160 NEUTRON ACER TENDL-2019 LIBRARY; T=293.16K  
Neutron emission for (n,npa)

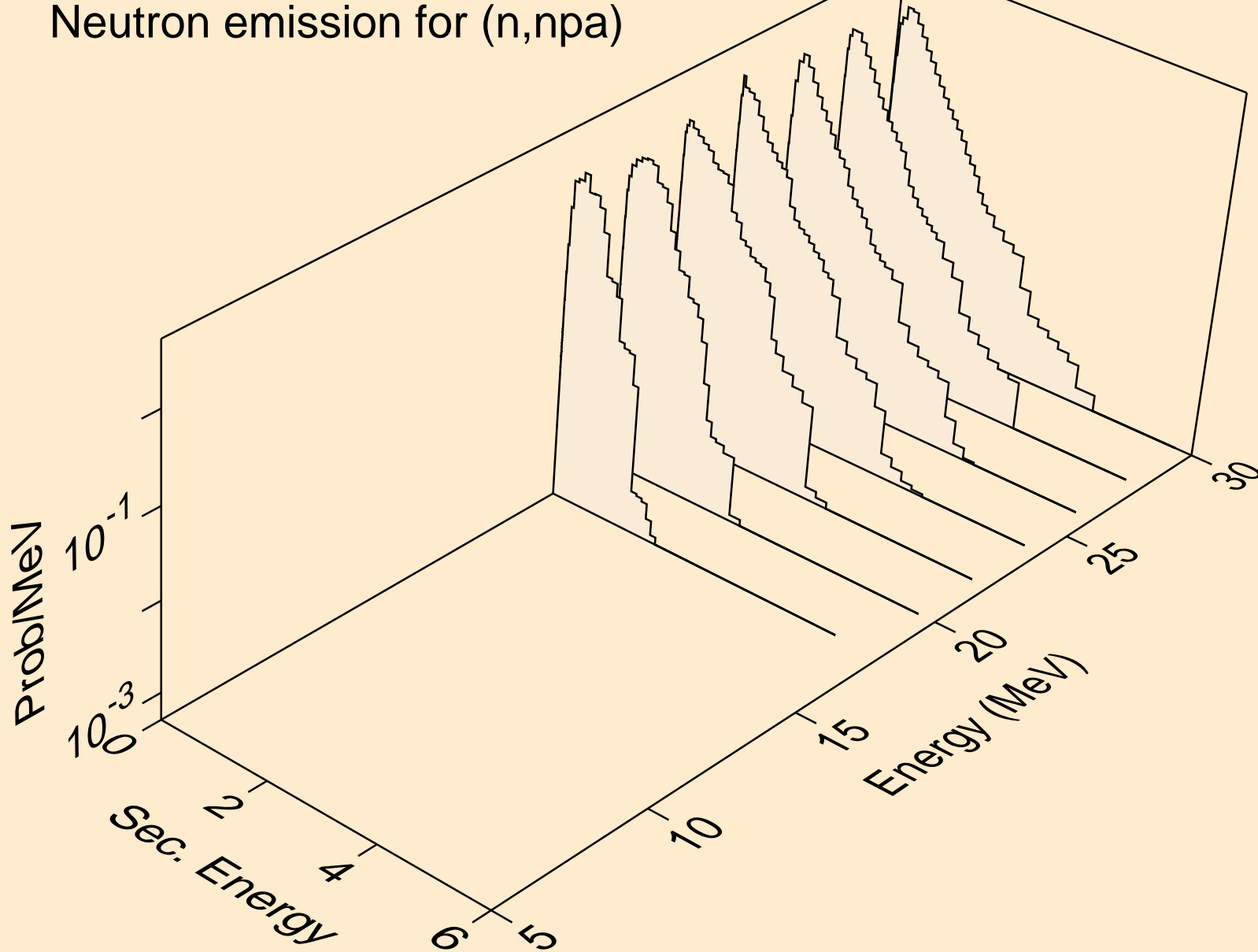



DY160 NEUTRON ACER TENDL-2019 LIBRARY; T=293.16K  
Neutron emission for (n,n\*c)

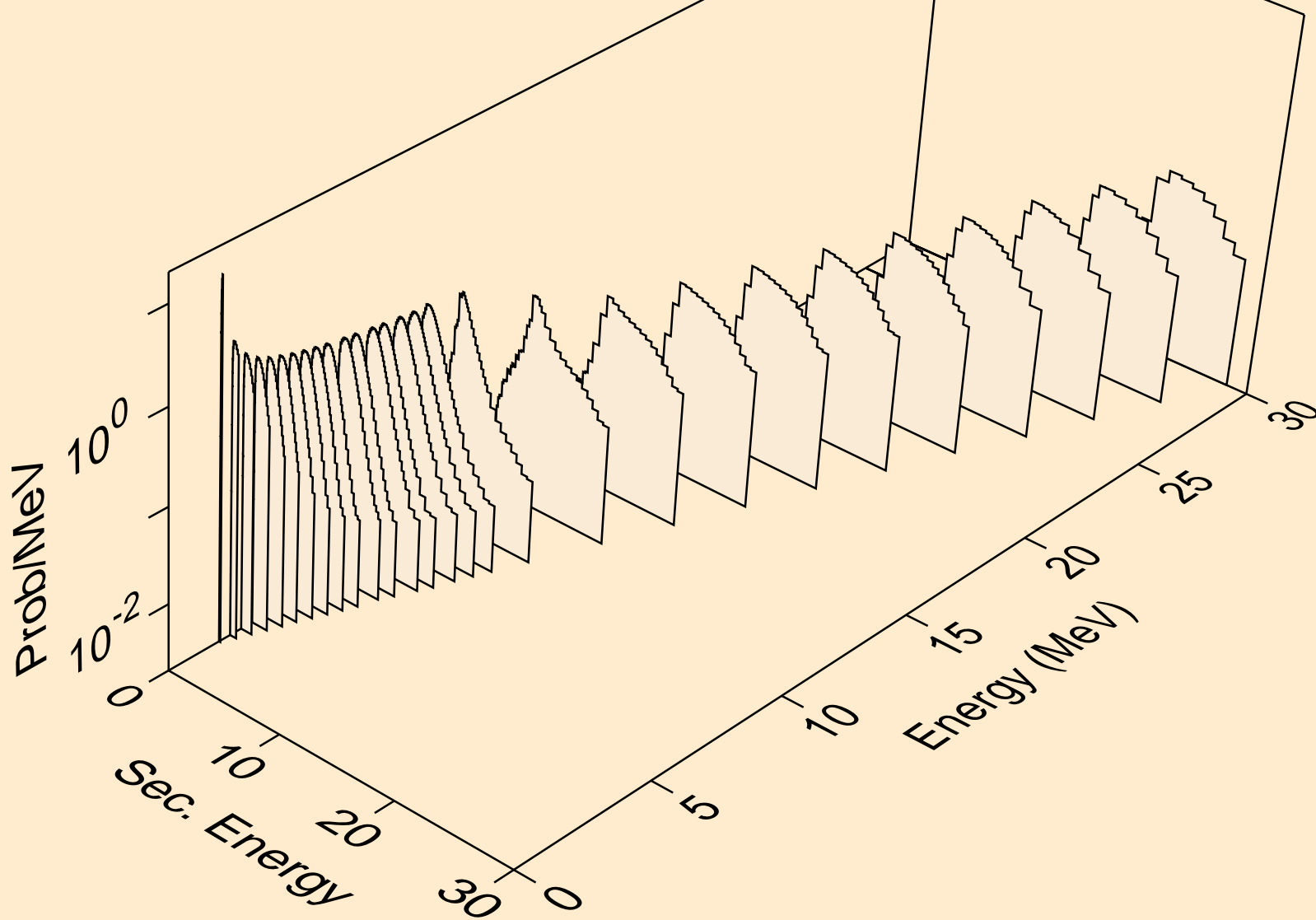

DY160 NEUTRON ACER TENDL-2019 LIBRARY; T=293.16K  
Photon emission for (n,x)

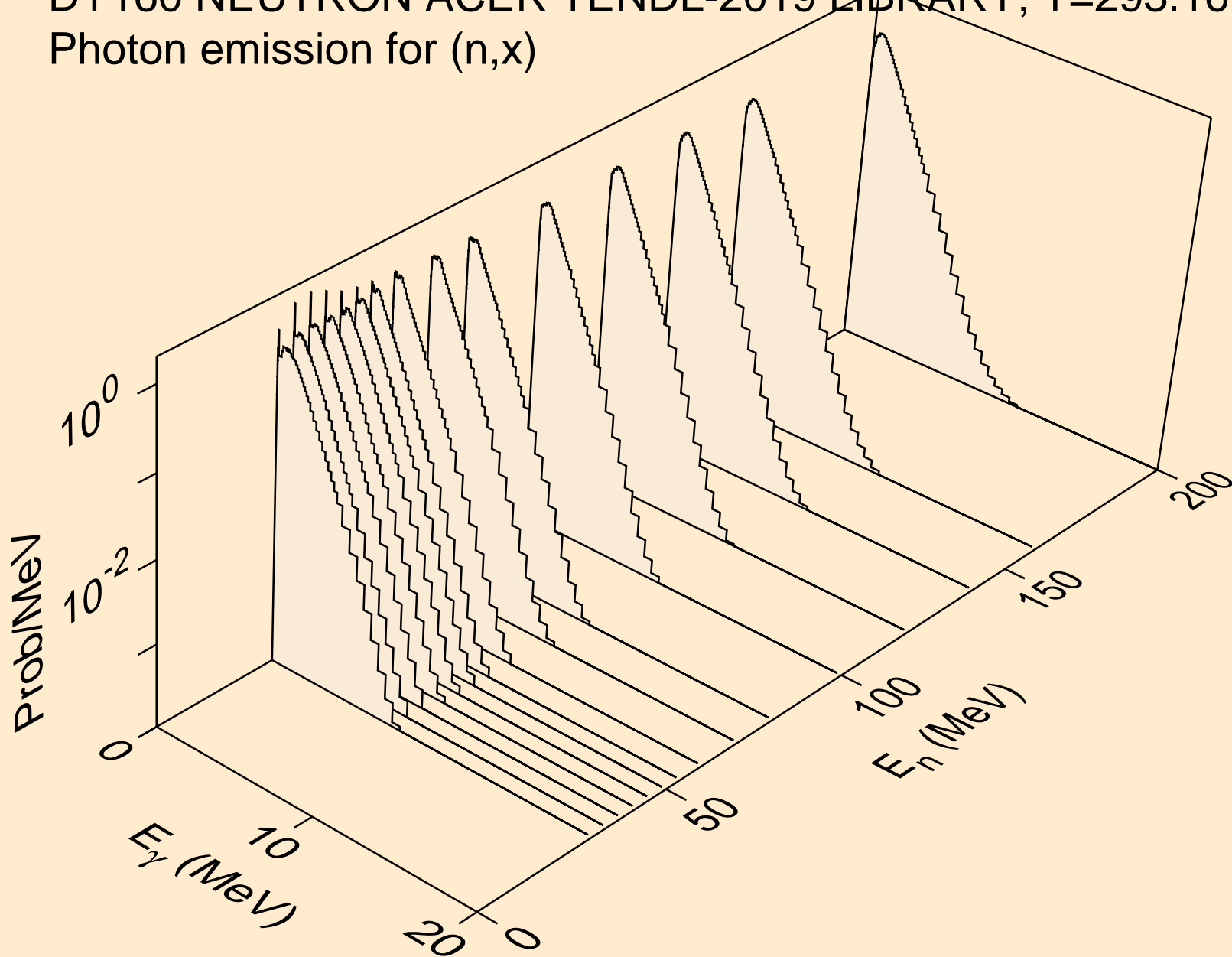

DY160 NEUTRON ACER TENDL-2019 LIBRARY; T=293.16K  
Photon emission for (n,2nd)

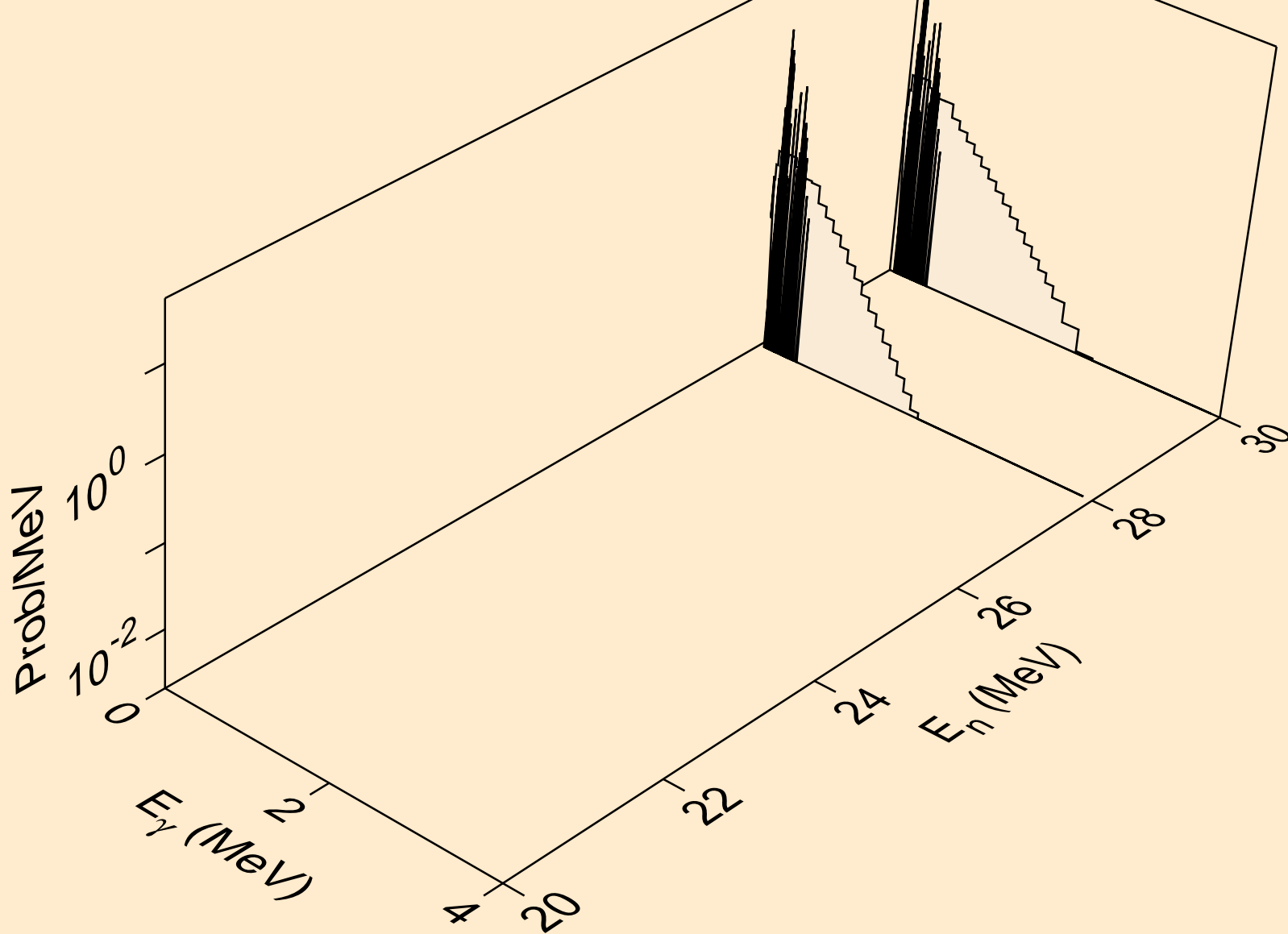

DY160 NEUTRON ACER TENDL-2019 LIBRARY; T=293.16K  
Photon emission for (n,2n)

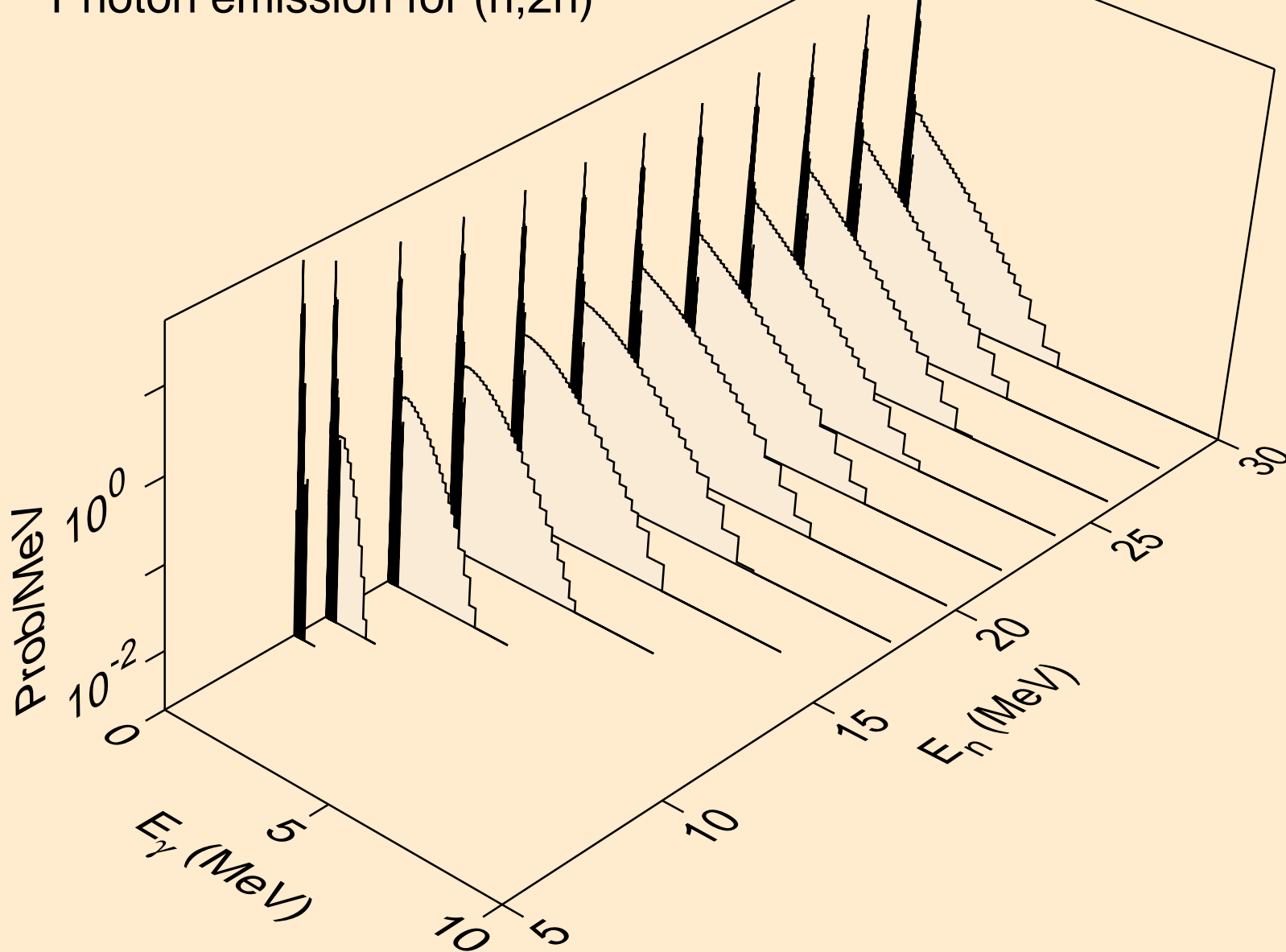

DY160 NEUTRON ACER TENDL-2019 LIBRARY; T=293.16K  
Photon emission for (n,3n)

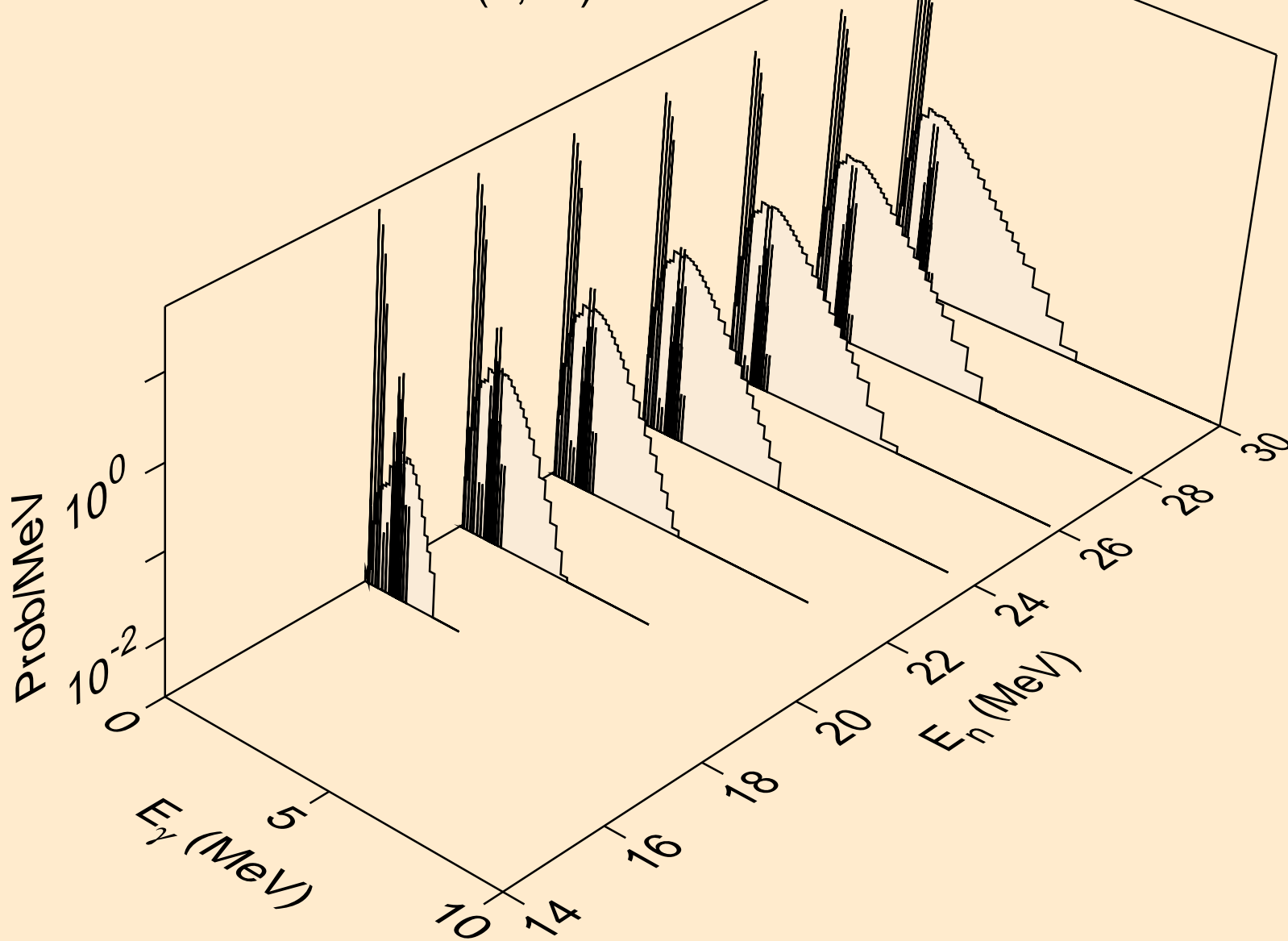

DY160 NEUTRON ACER TENDL-2019 LIBRARY; T=293.16K  
Photon emission for (n,n\*)a

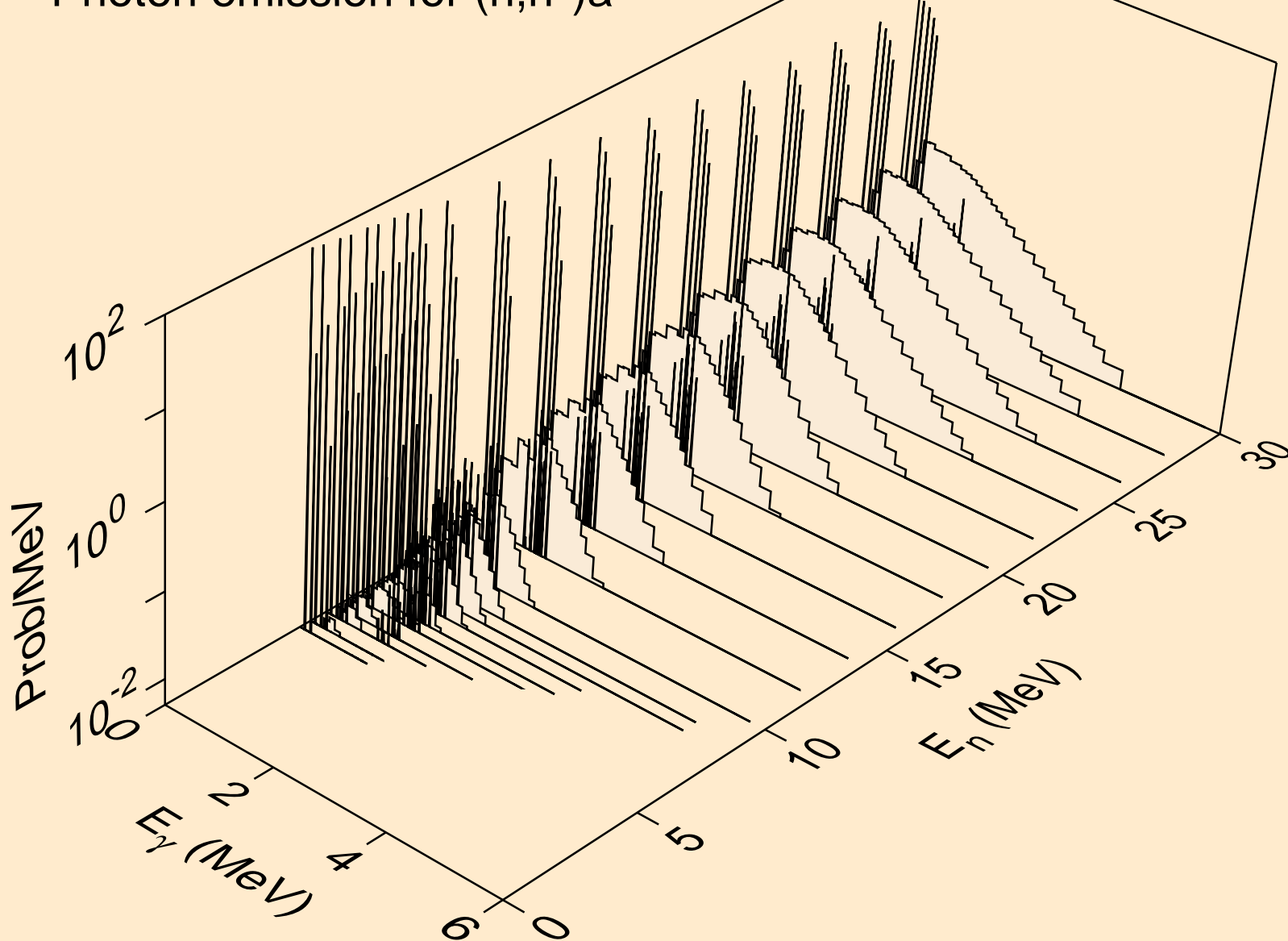

DY160 NEUTRON ACER TENDL-2019 LIBRARY; T=293.16K  
Photon emission for (n,2n)a

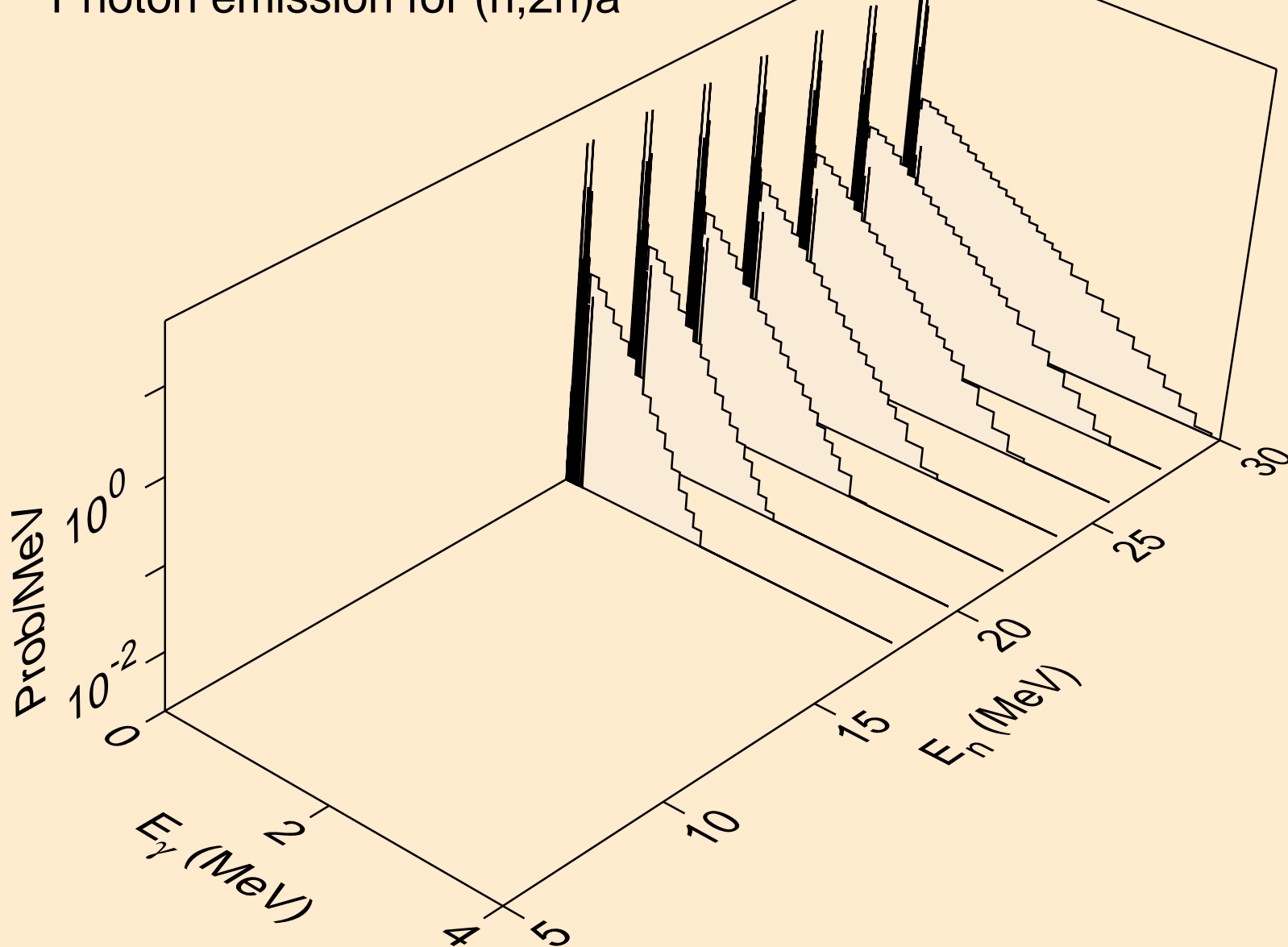

DY160 NEUTRON ACER TENDL-2019 LIBRARY; T=293.16K  
Photon emission for (n,3n)a

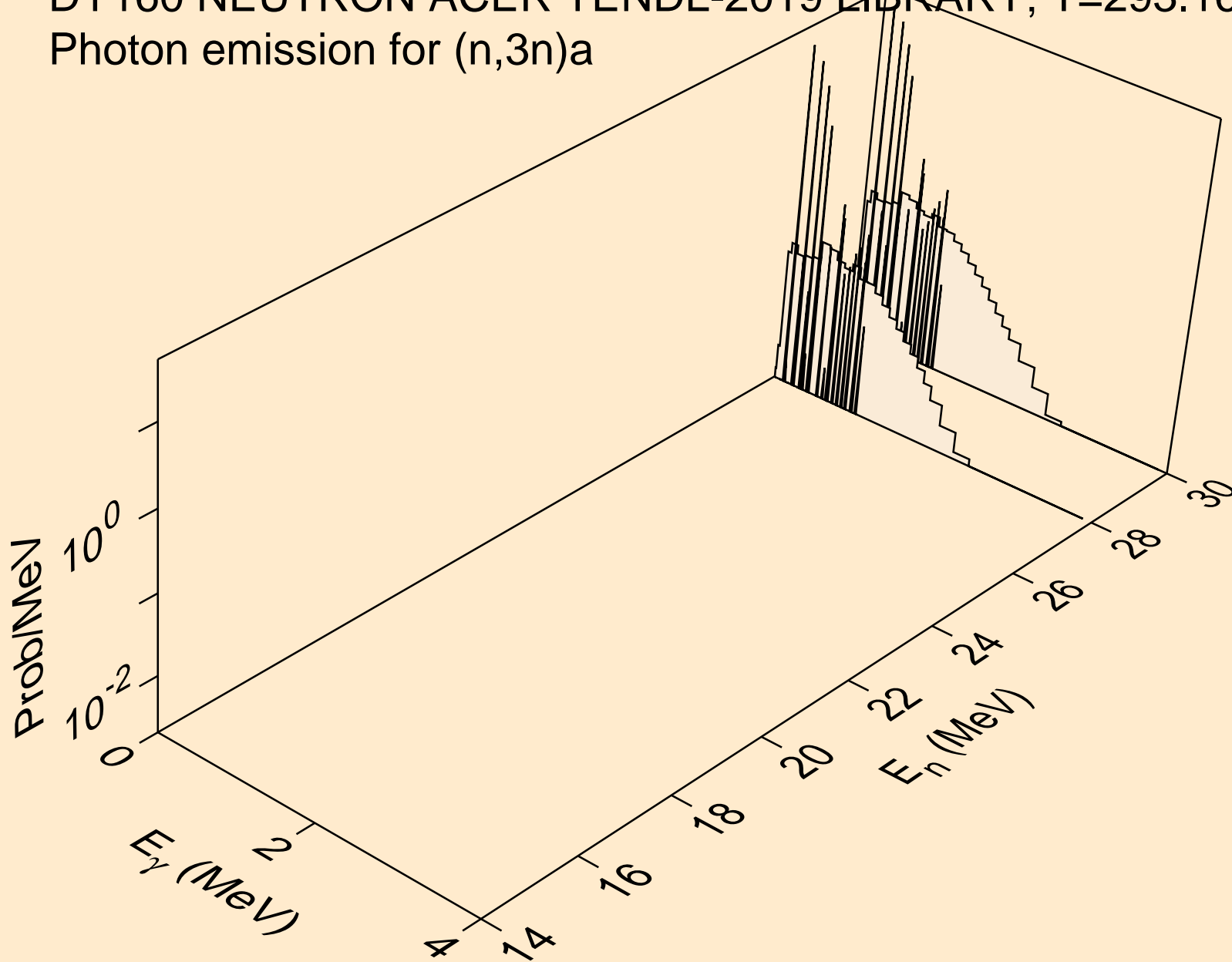



DY160 NEUTRON ACER TENDL-2019 LIBRARY; T=293.16K  
Photon emission for (n,n\*)p

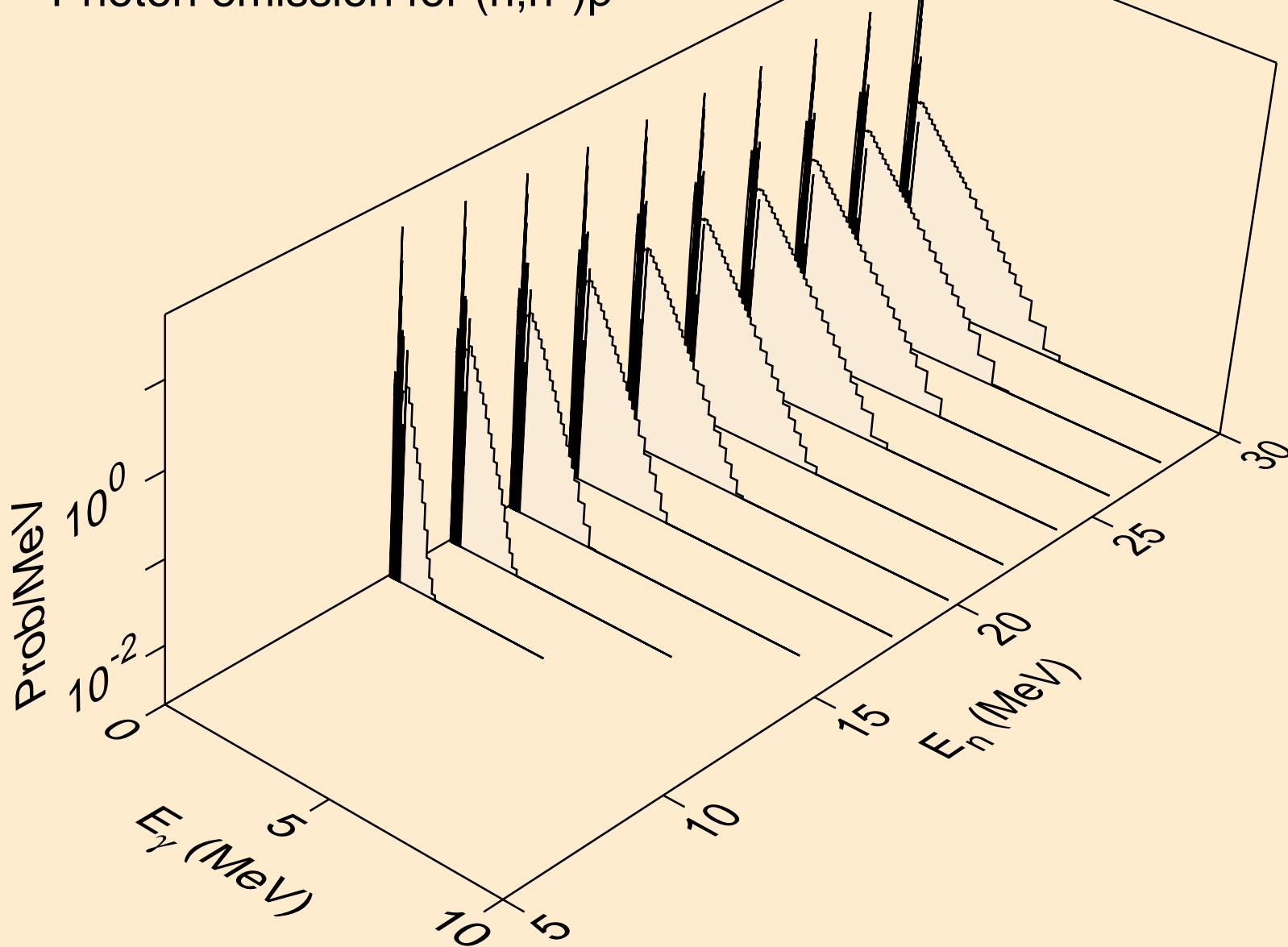

DY160 NEUTRON ACER TENDL-2019 LIBRARY; T=293.16K  
Photon emission for (n,n\*)2a

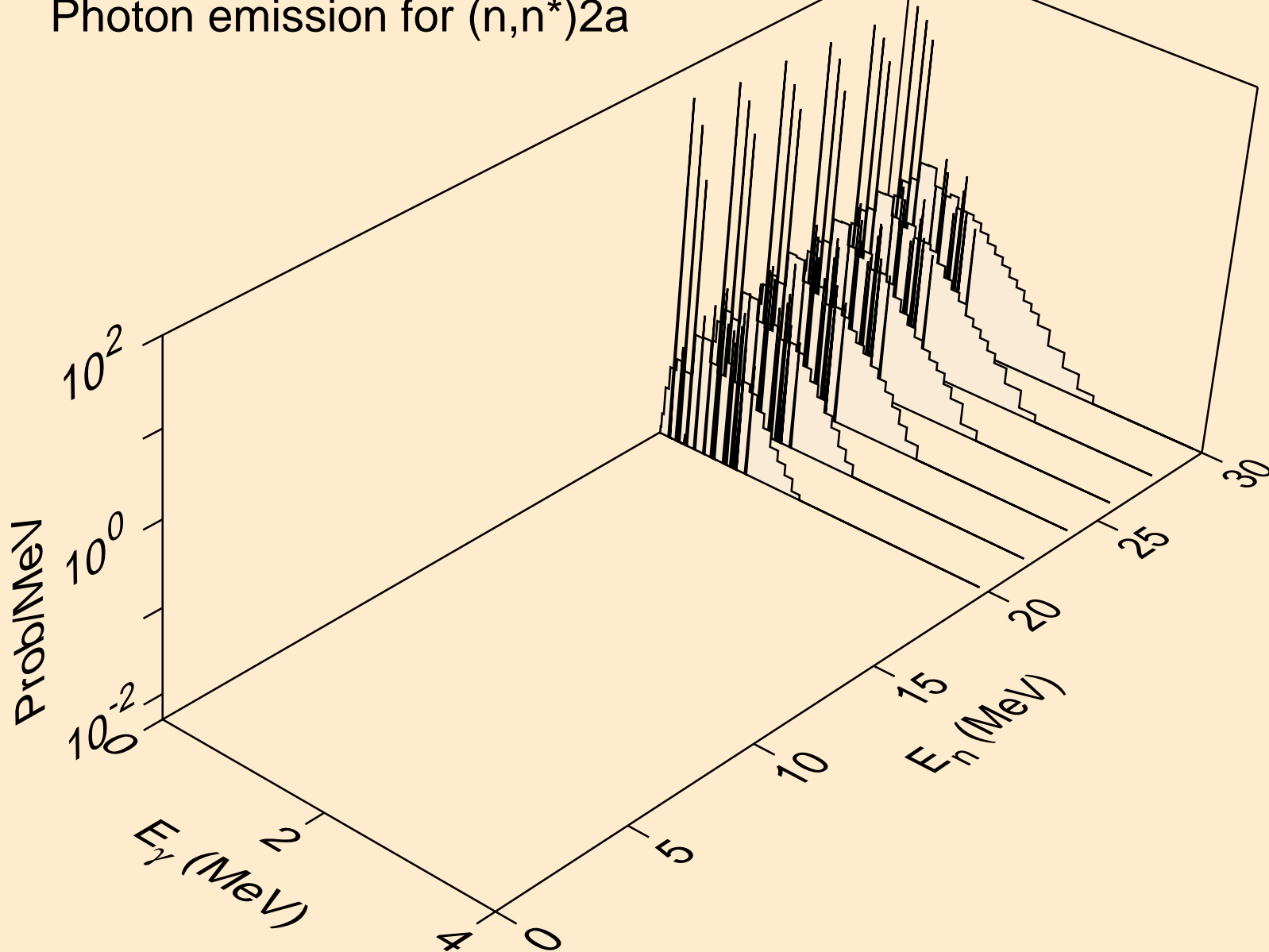

DY160 NEUTRON ACER TENDL-2019 LIBRARY; T=293.16K  
Photon emission for (n,n\*)d

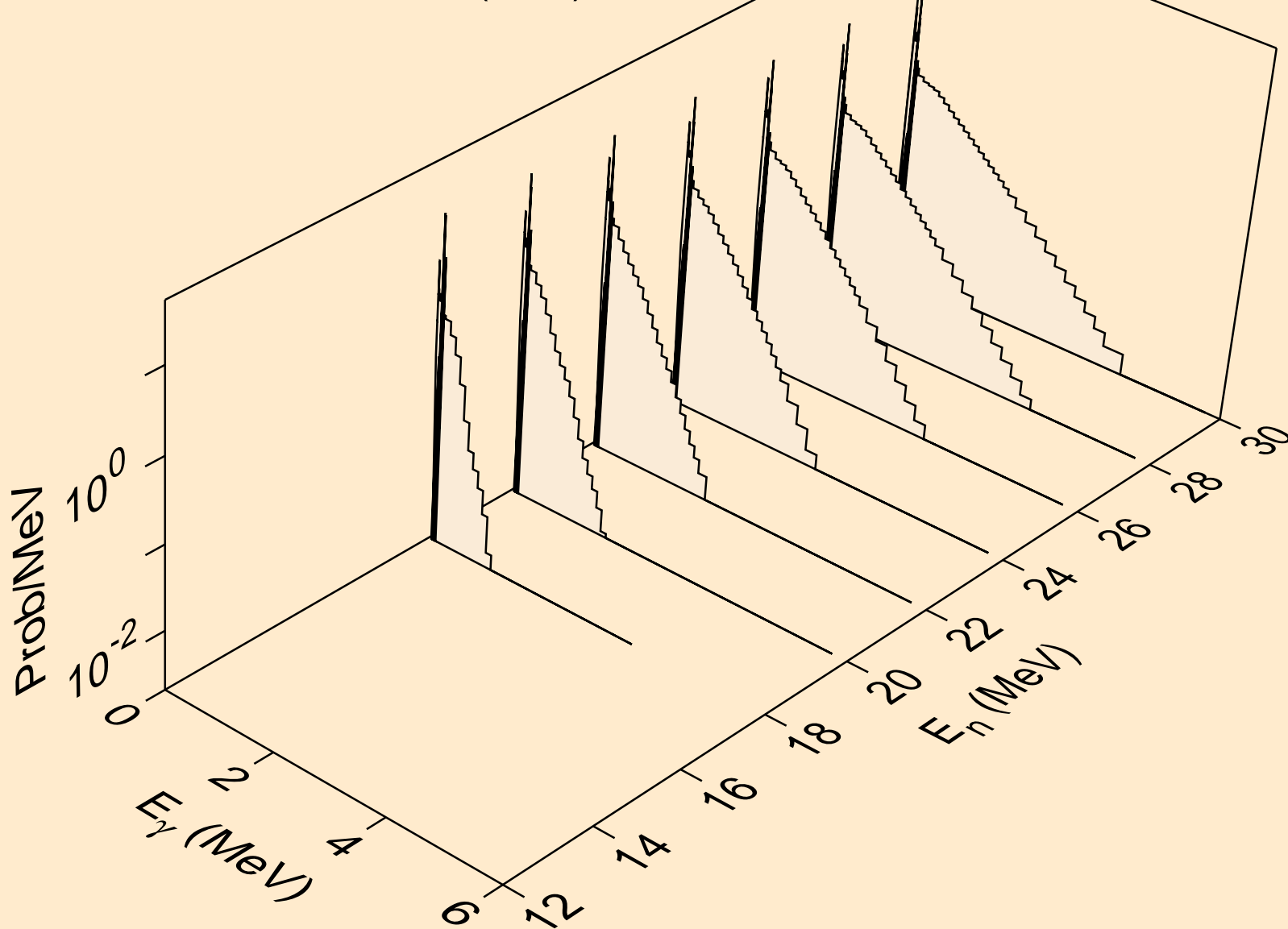

DY160 NEUTRON ACER TENDL-2019 LIBRARY; T=293.16K  
Photon emission for (n,n\*)t

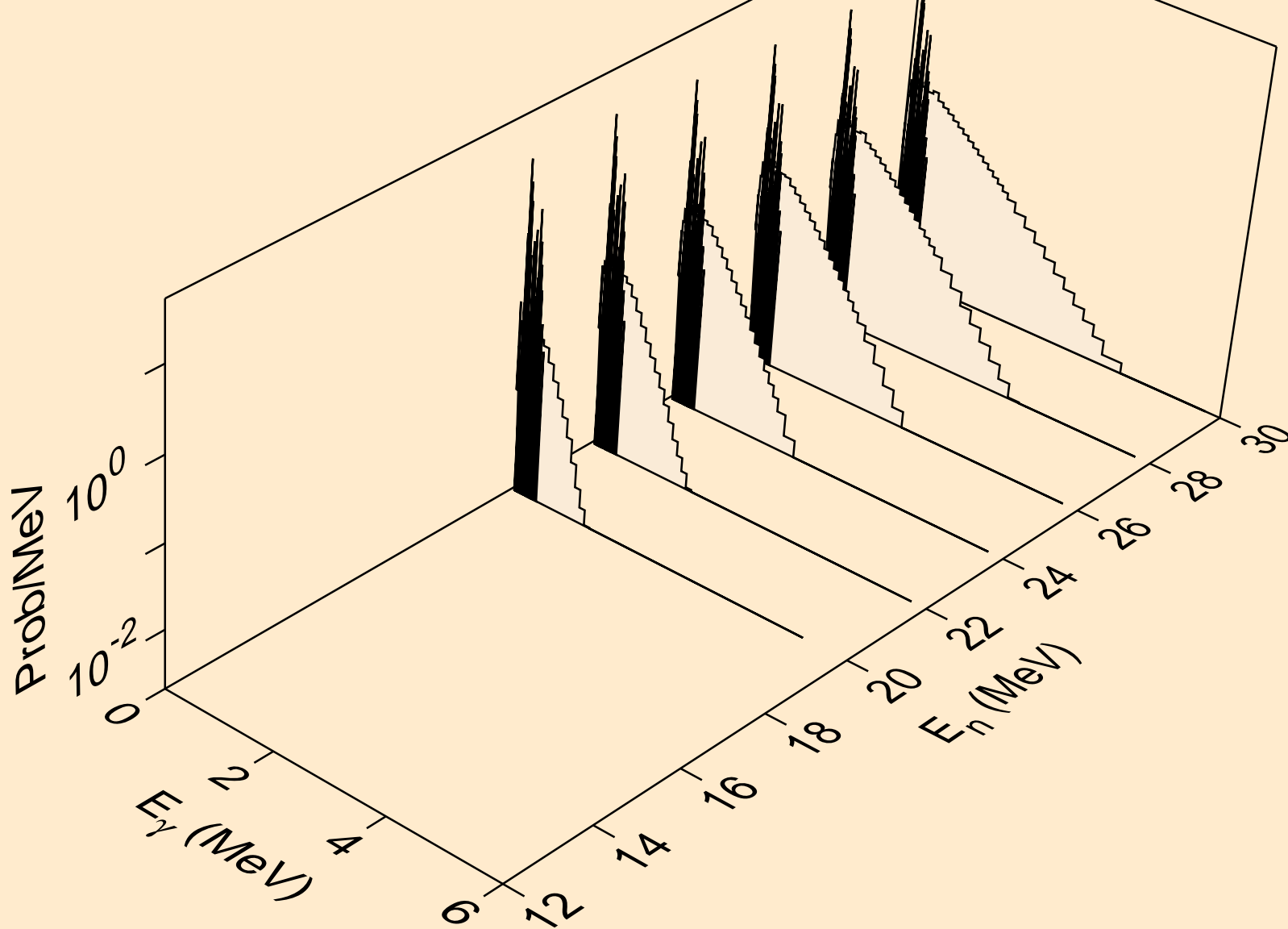

DY160 NEUTRON ACER TENDL-2019 LIBRARY; T=293.16K  
Photon emission for (n,n\*)he3

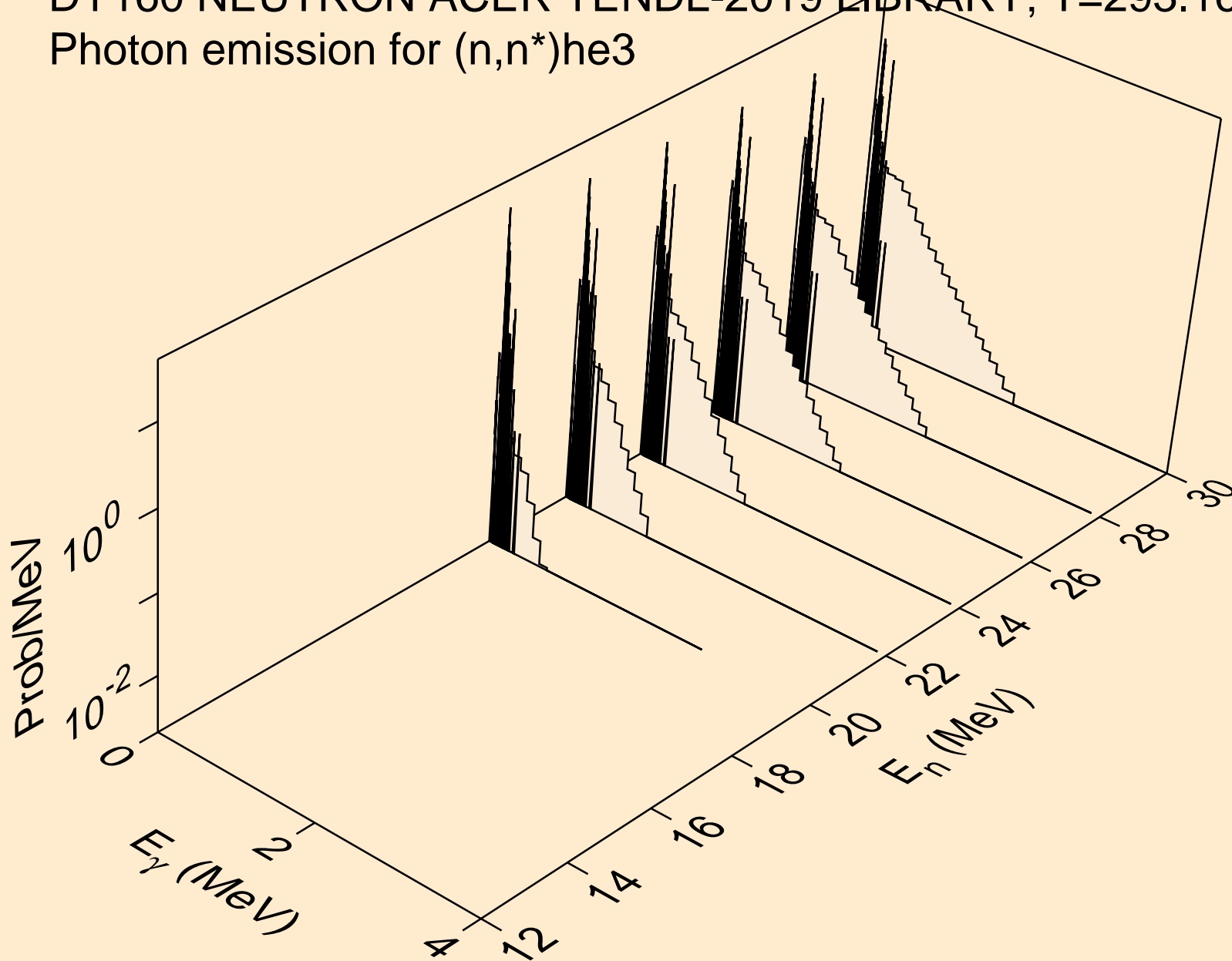

DY160 NEUTRON ACER TENDL-2019 LIBRARY; T=293.16K  
Photon emission for (n,4n)

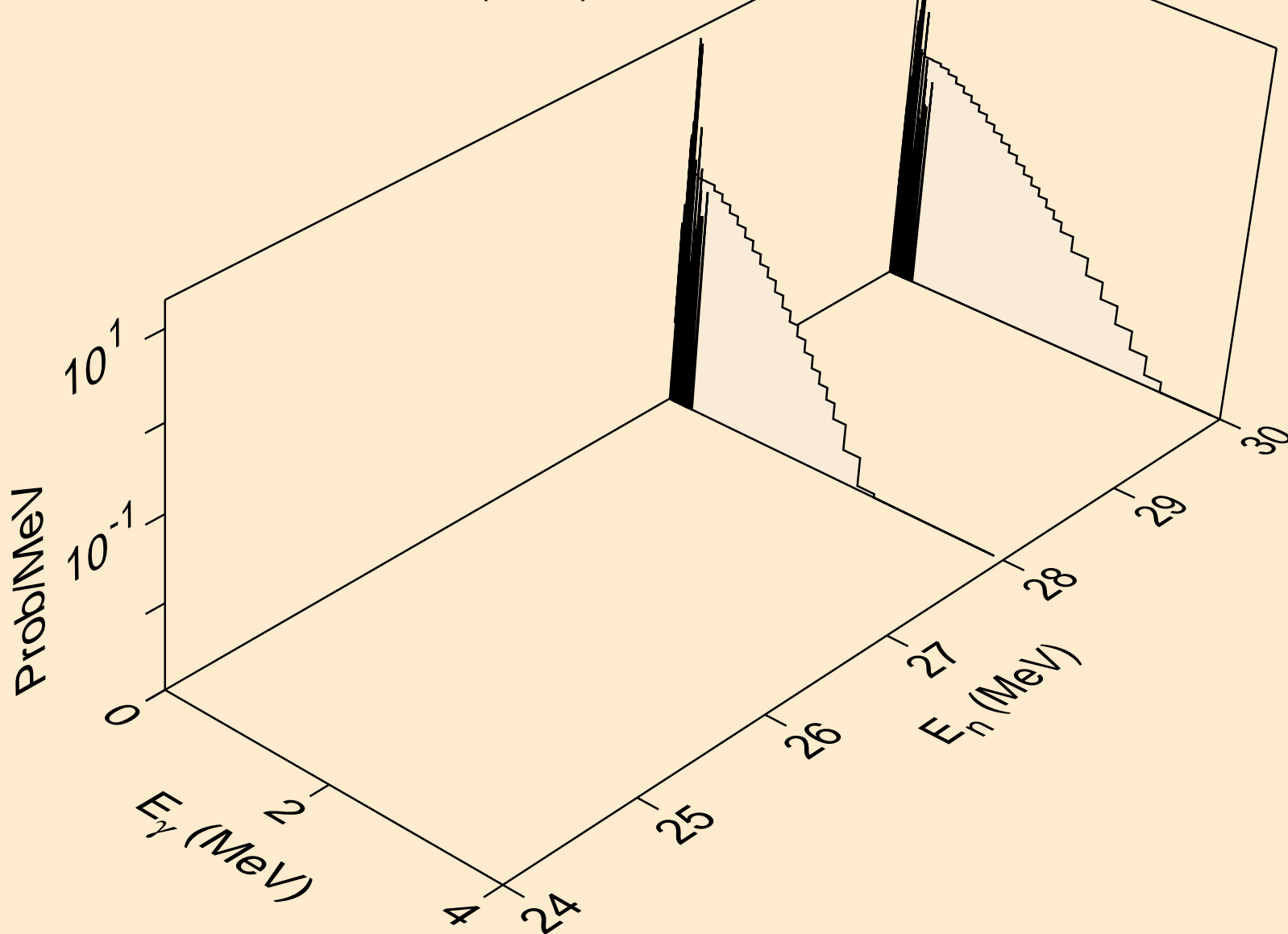

DY160 NEUTRON ACER TENDL-2019 LIBRARY; T=293.16K  
Photon emission for (n,2np)

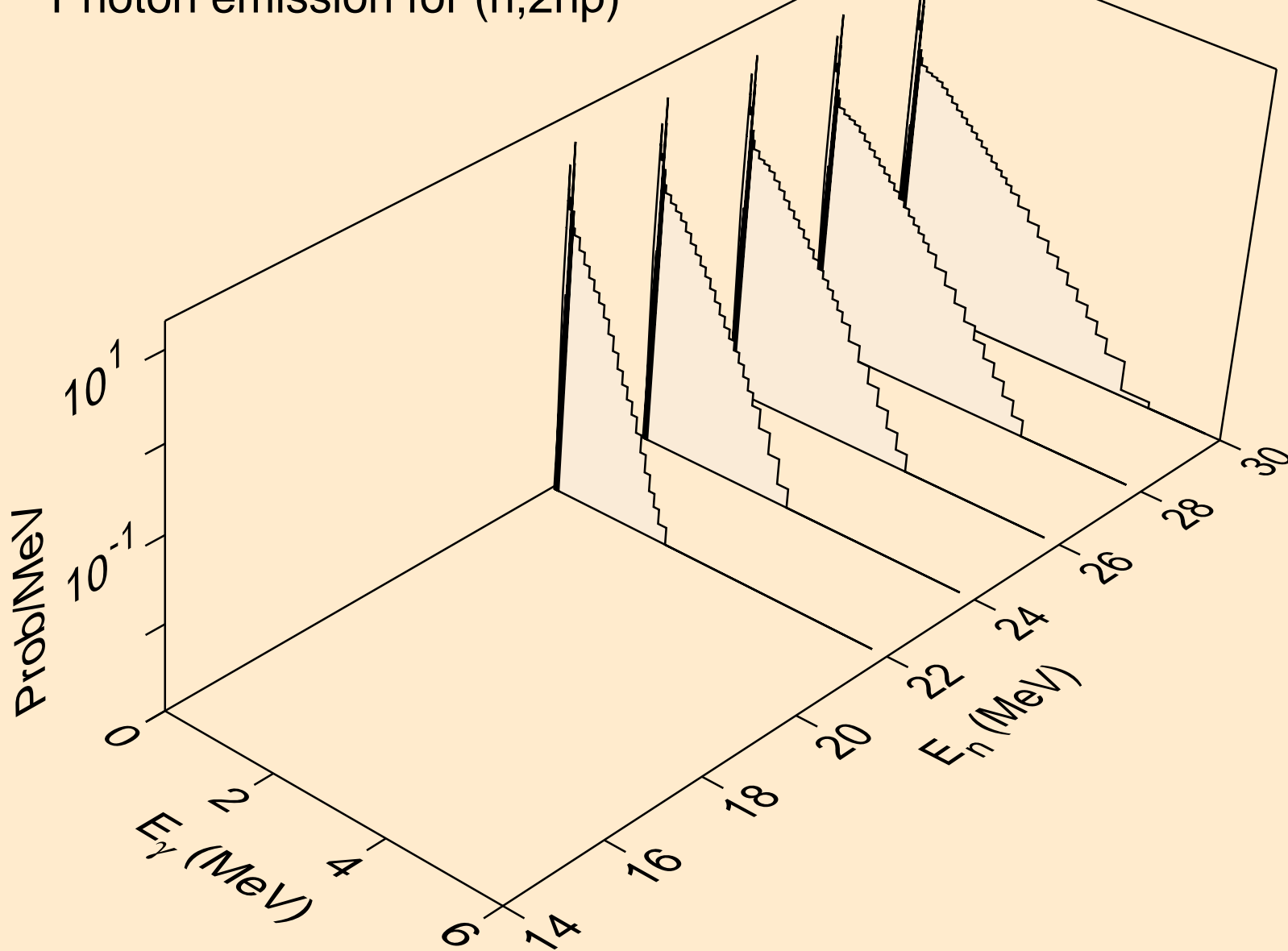

DY160 NEUTRON ACER TENDL-2019 LIBRARY; T=293.16K  
Photon emission for (n,3np)

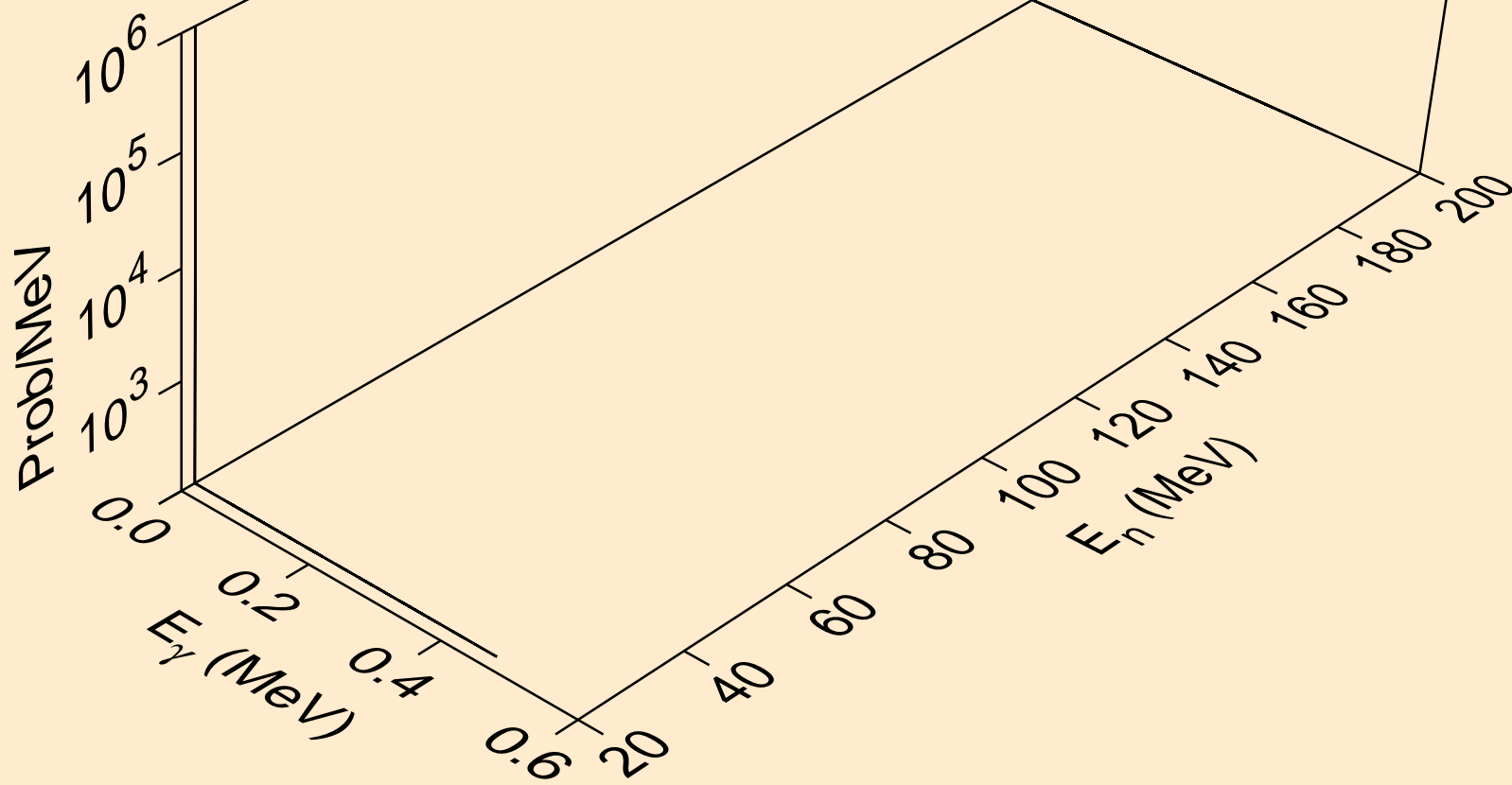



DY160 NEUTRON ACER TENDL-2019 LIBRARY; T=293.16K  
Photon emission for (n,2np)

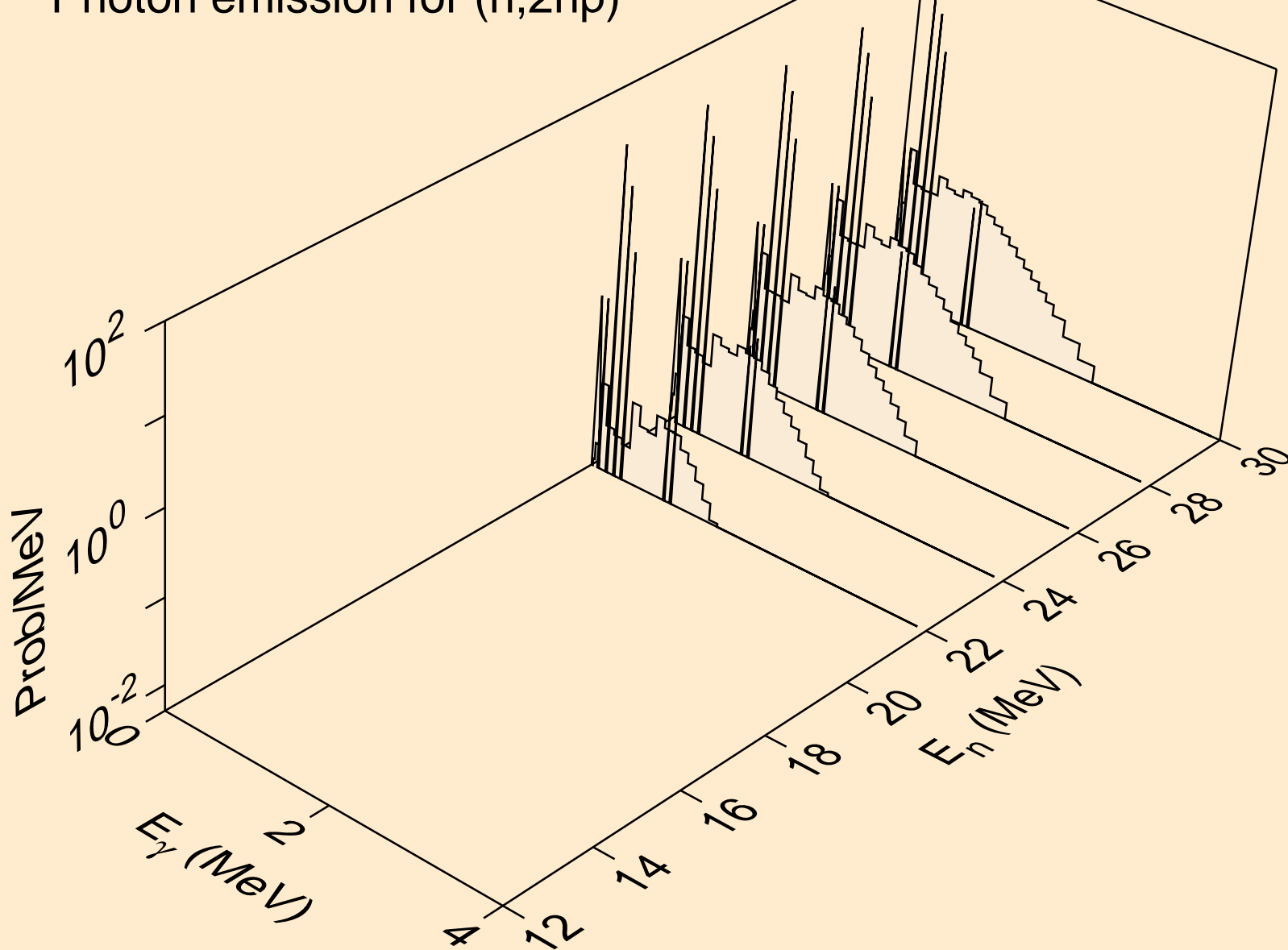

DY160 NEUTRON ACER TENDL-2019 LIBRARY; T=293.16K  
Photon emission for (n,npa)

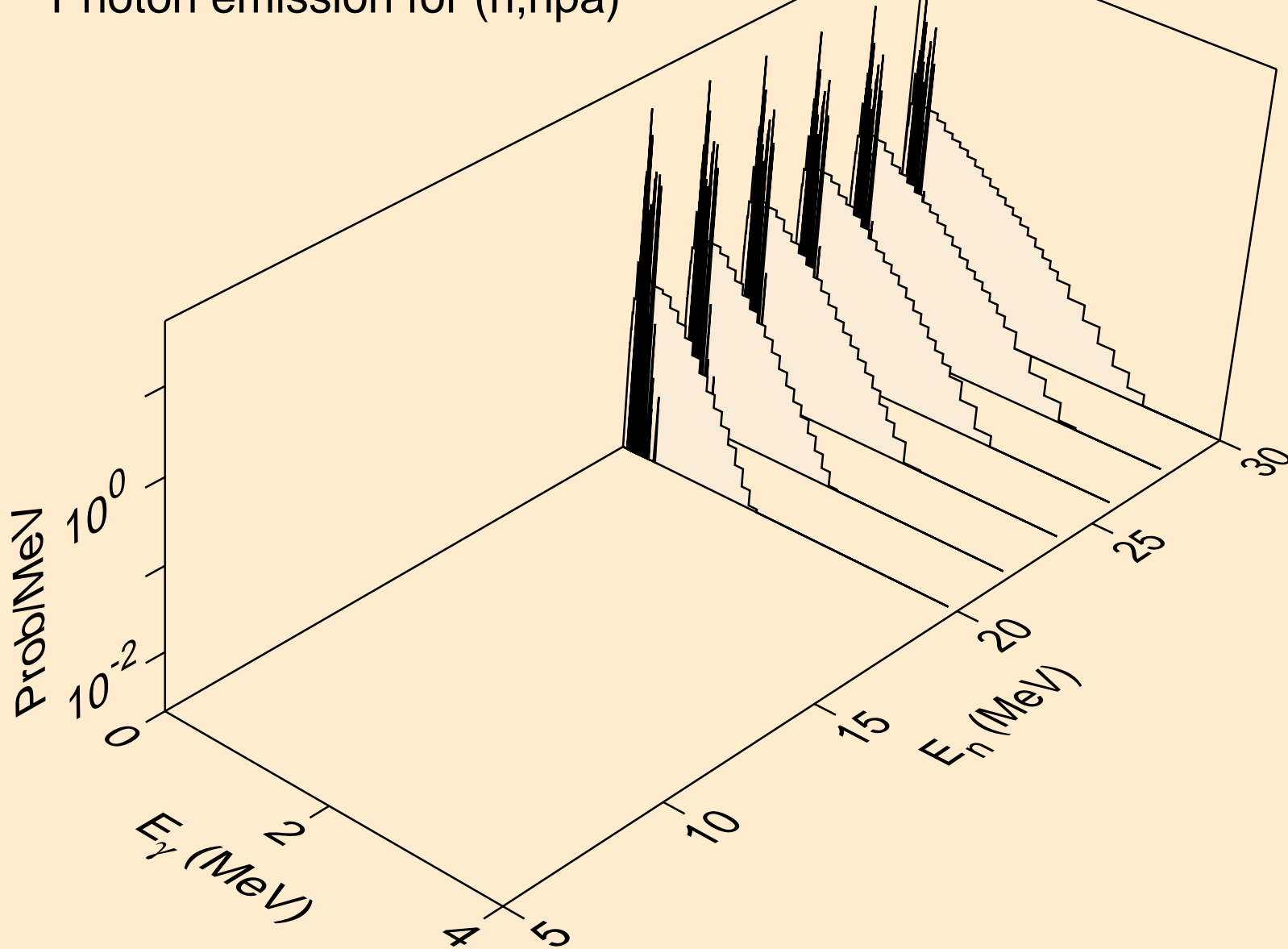

DY160 NEUTRON ACER TENDL-2019 LIBRARY; T=293.16K  
Photon emission for (n,n\*c)

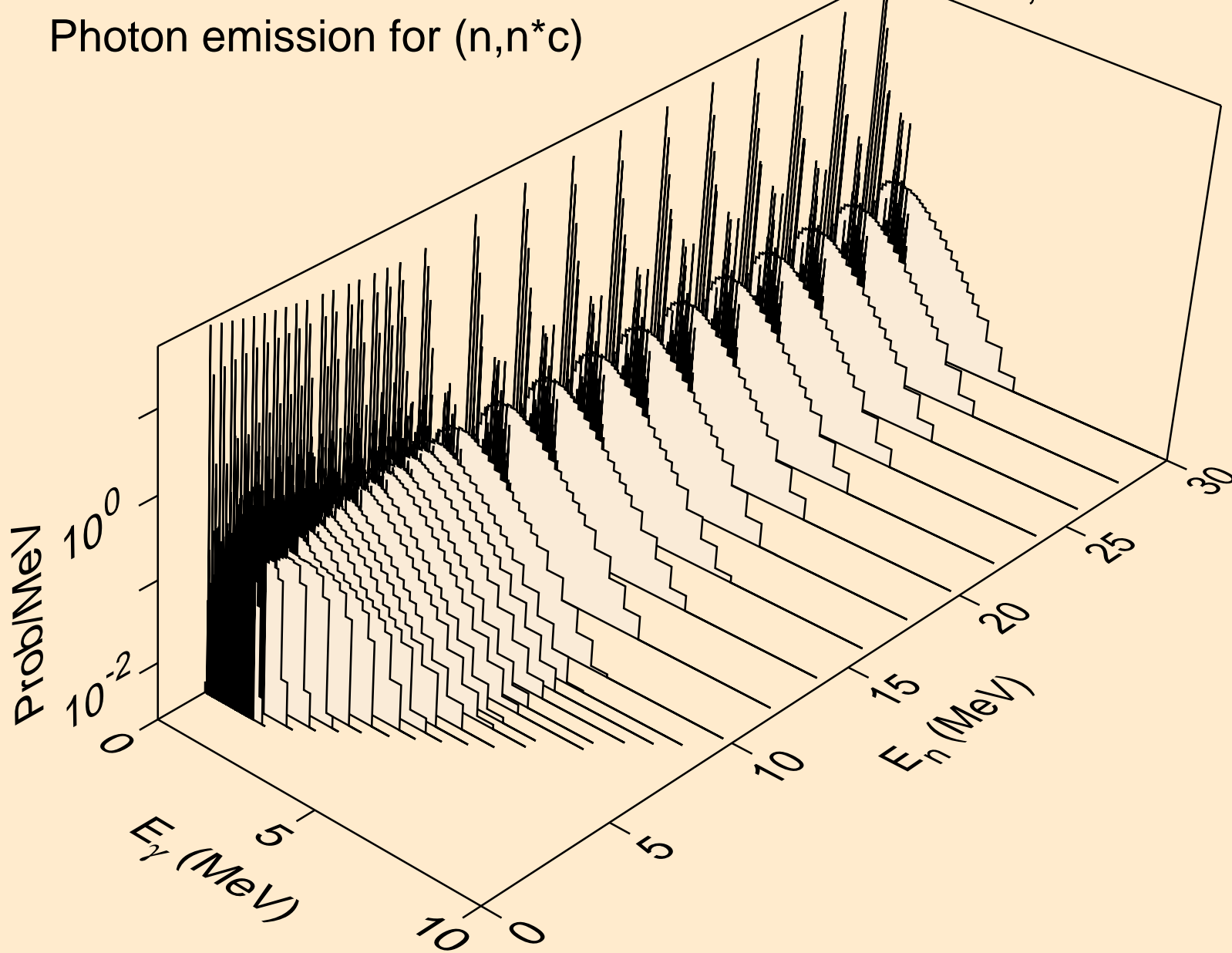

DY160 NEUTRON ACER TENDL-2019 LIBRARY; T=293.16K  
Photon emission for (n,gma)

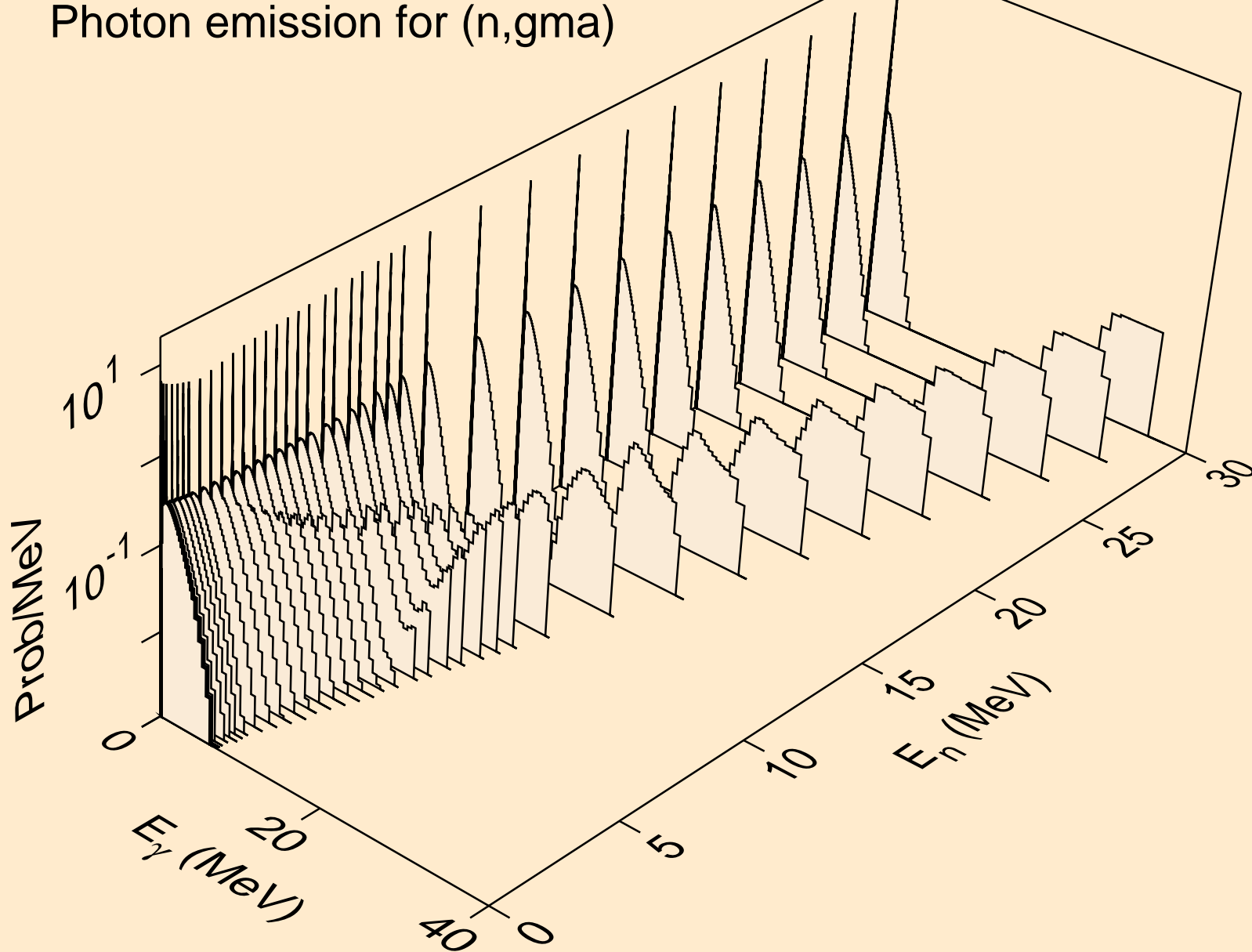

DY160 NEUTRON ACER TENDL-2019 LIBRARY; T=293.16K  
Photon emission for (n,p)

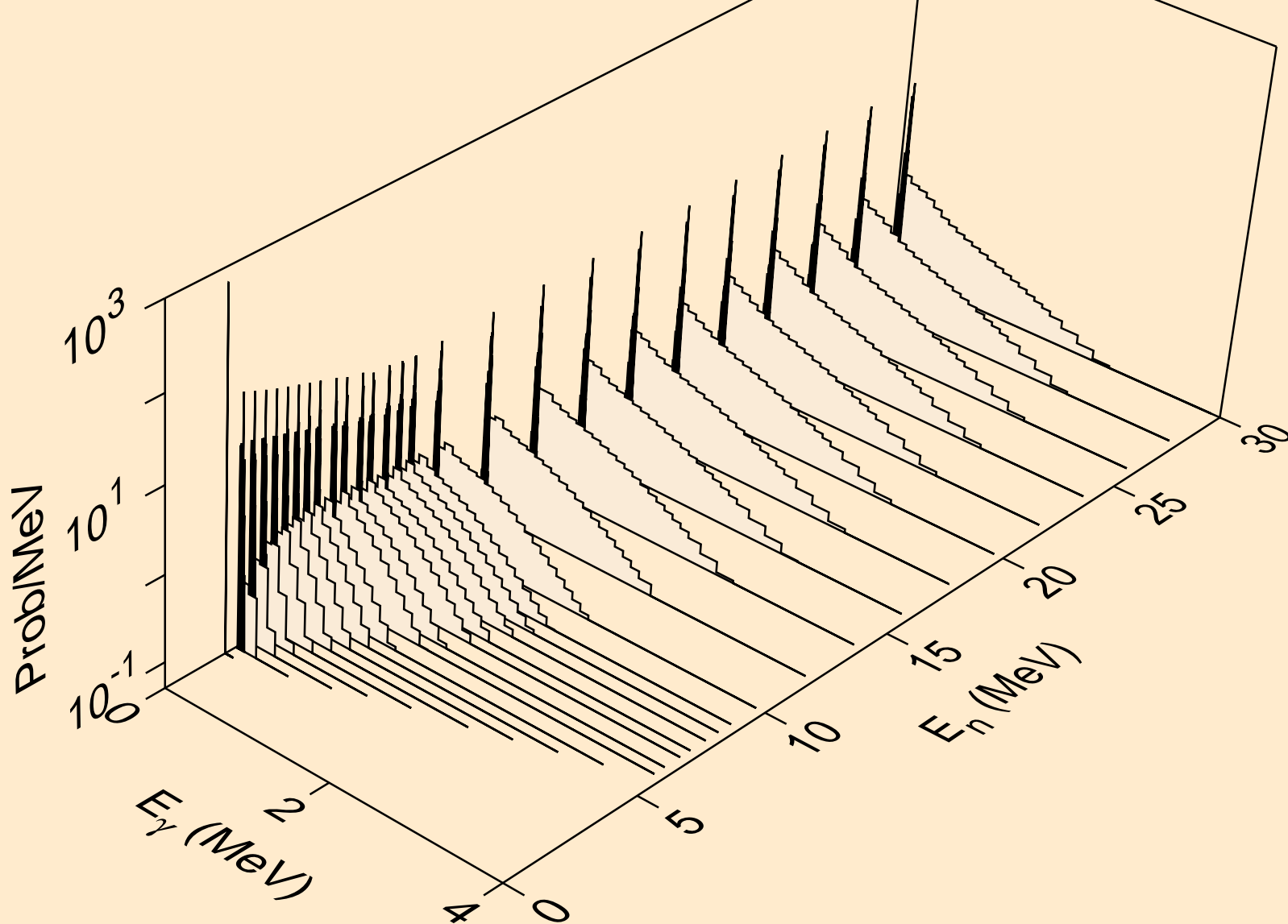

DY160 NEUTRON ACER TENDL-2019 LIBRARY; T=293.16K  
Photon emission for (n,d)

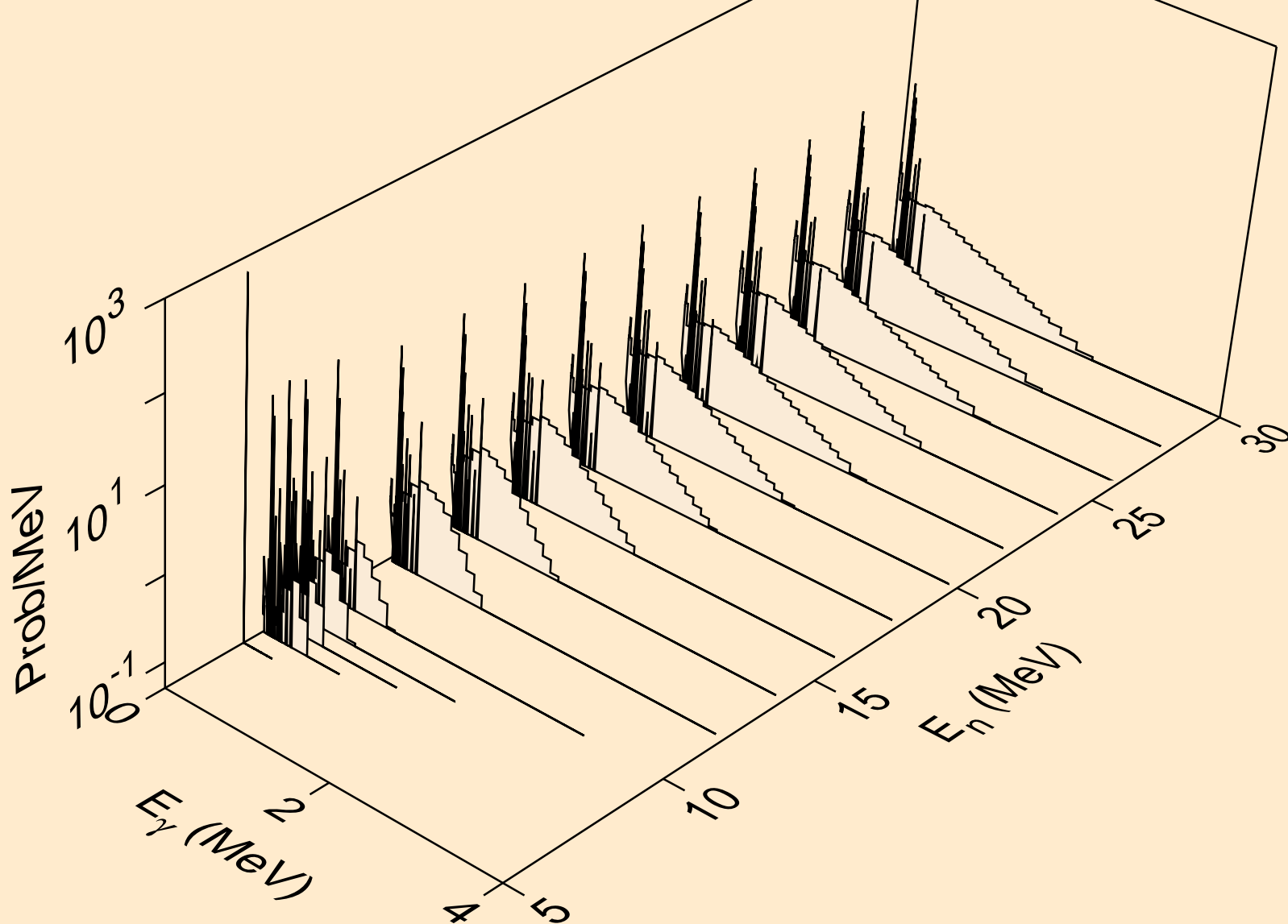

DY160 NEUTRON ACER TENDL-2019 LIBRARY; T=293.16K  
Photon emission for (n,t)

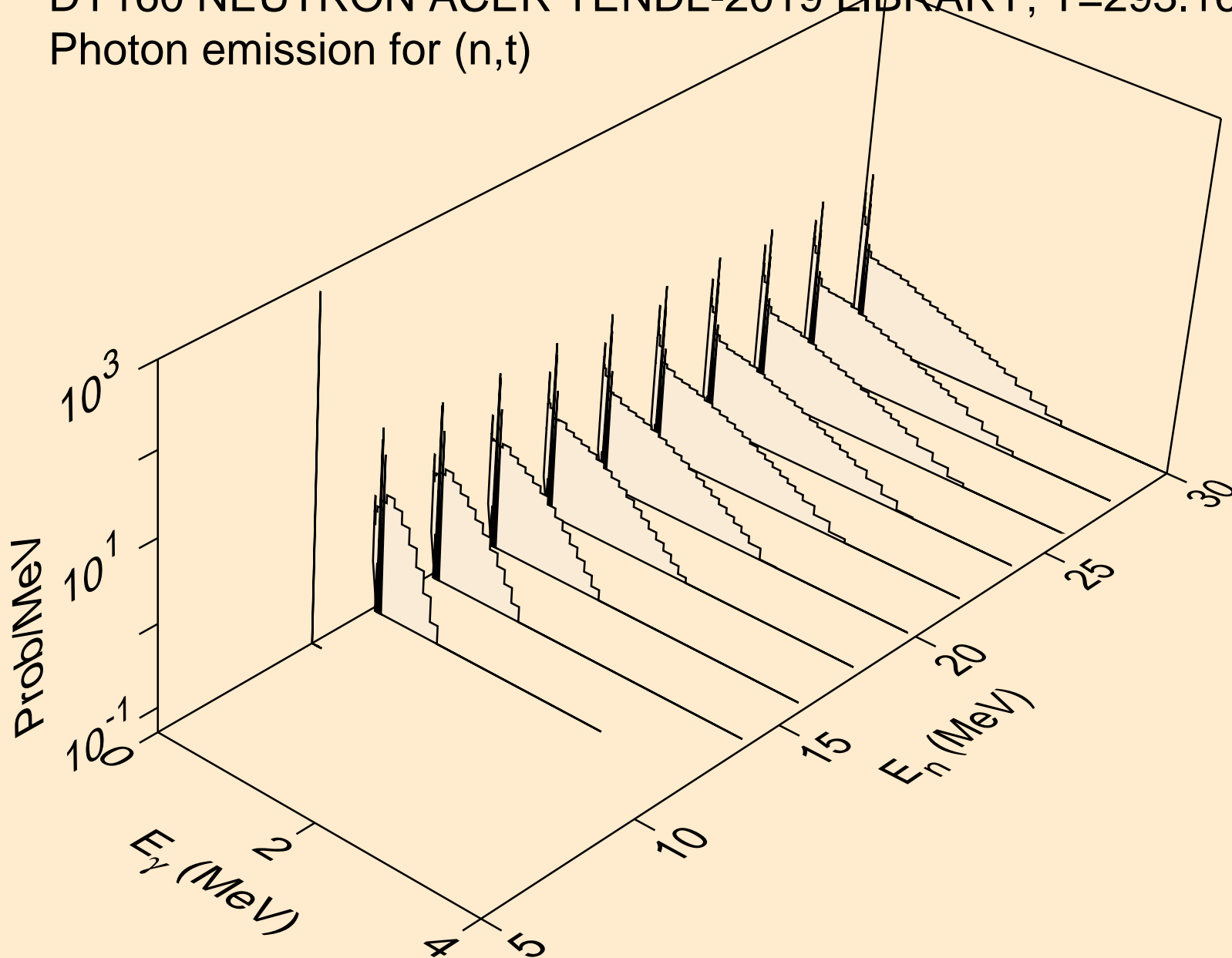

DY160 NEUTRON ACER TENDL-2019 LIBRARY; T=293.16K  
Photon emission for (n,he3)

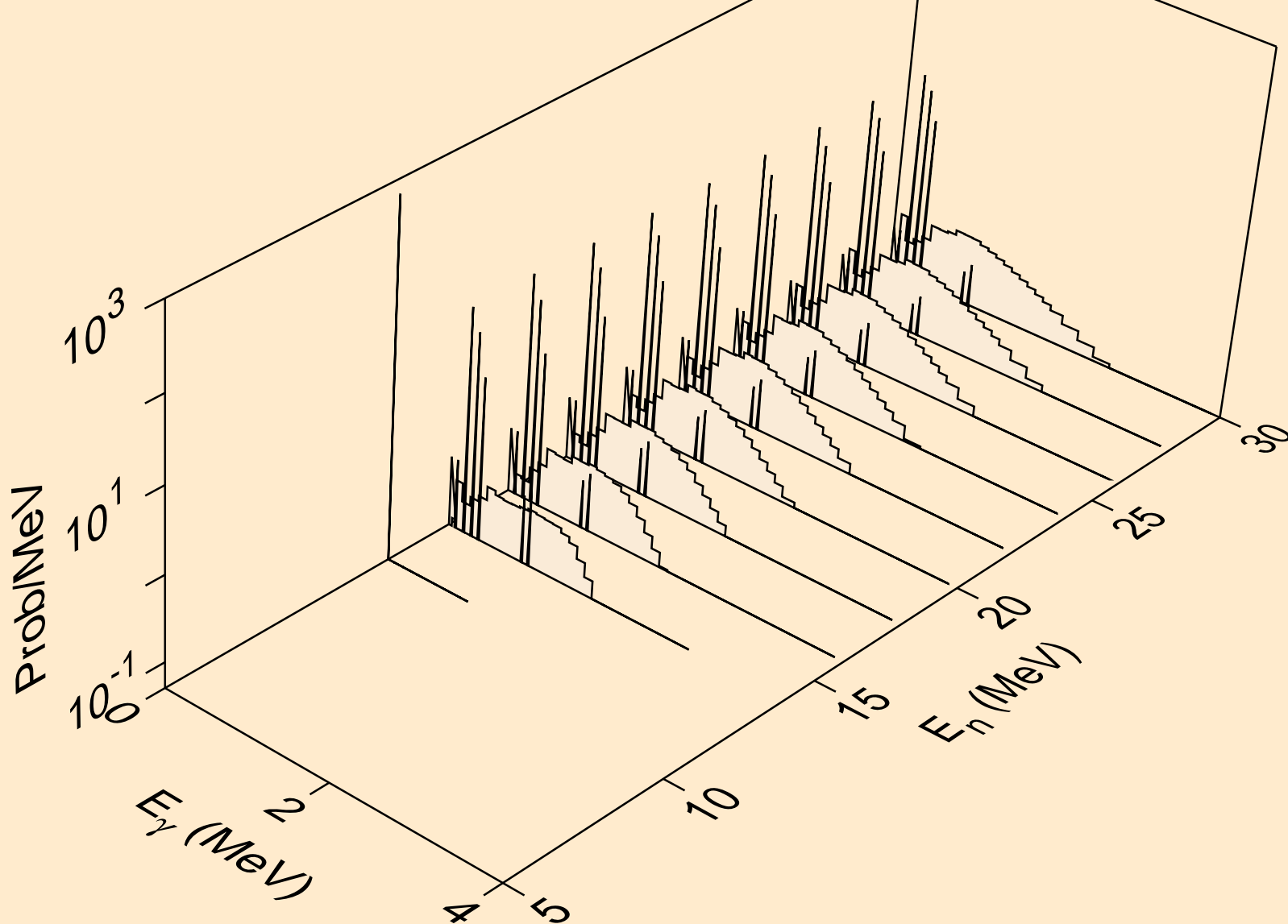



DY160 NEUTRON ACER TENDL-2019 LIBRARY; T=293.16K  
Photon emission for (n,a)

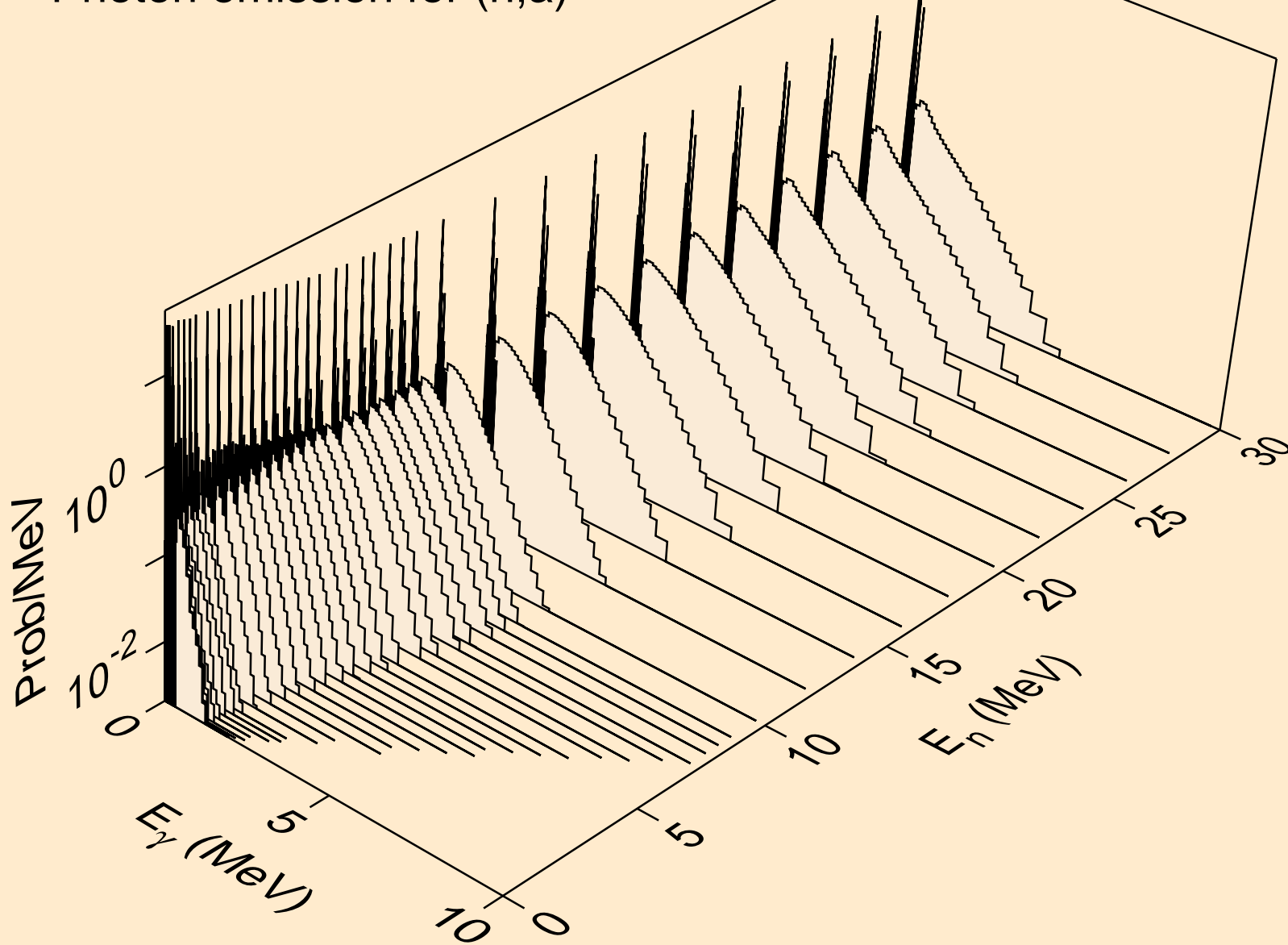

DY160 NEUTRON ACER TENDL-2019 LIBRARY; T=293.16K  
Photon emission for (n,2a)

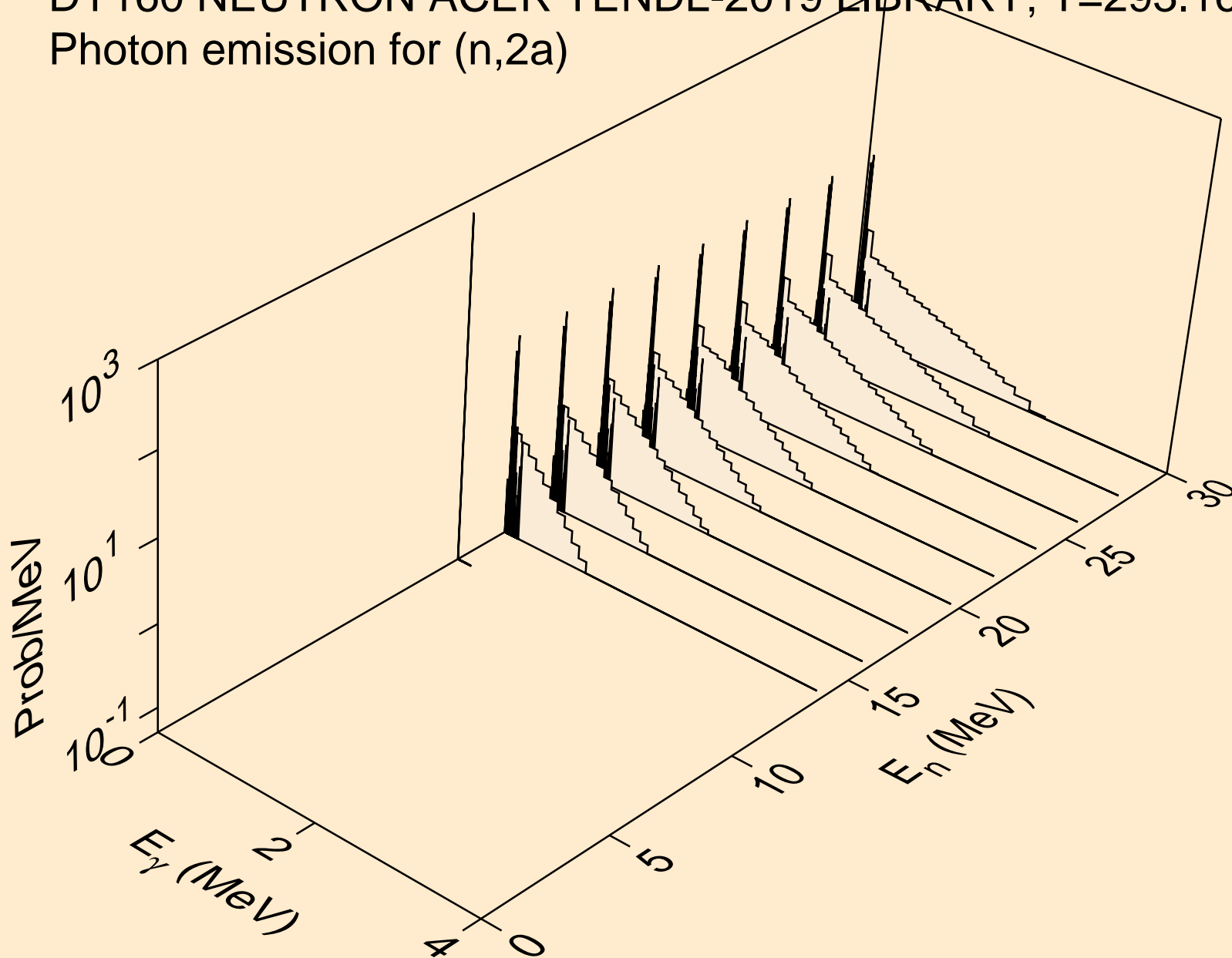

DY160 NEUTRON ACER TENDL-2019 LIBRARY; T=293.16K  
Photon emission for (n,2p)

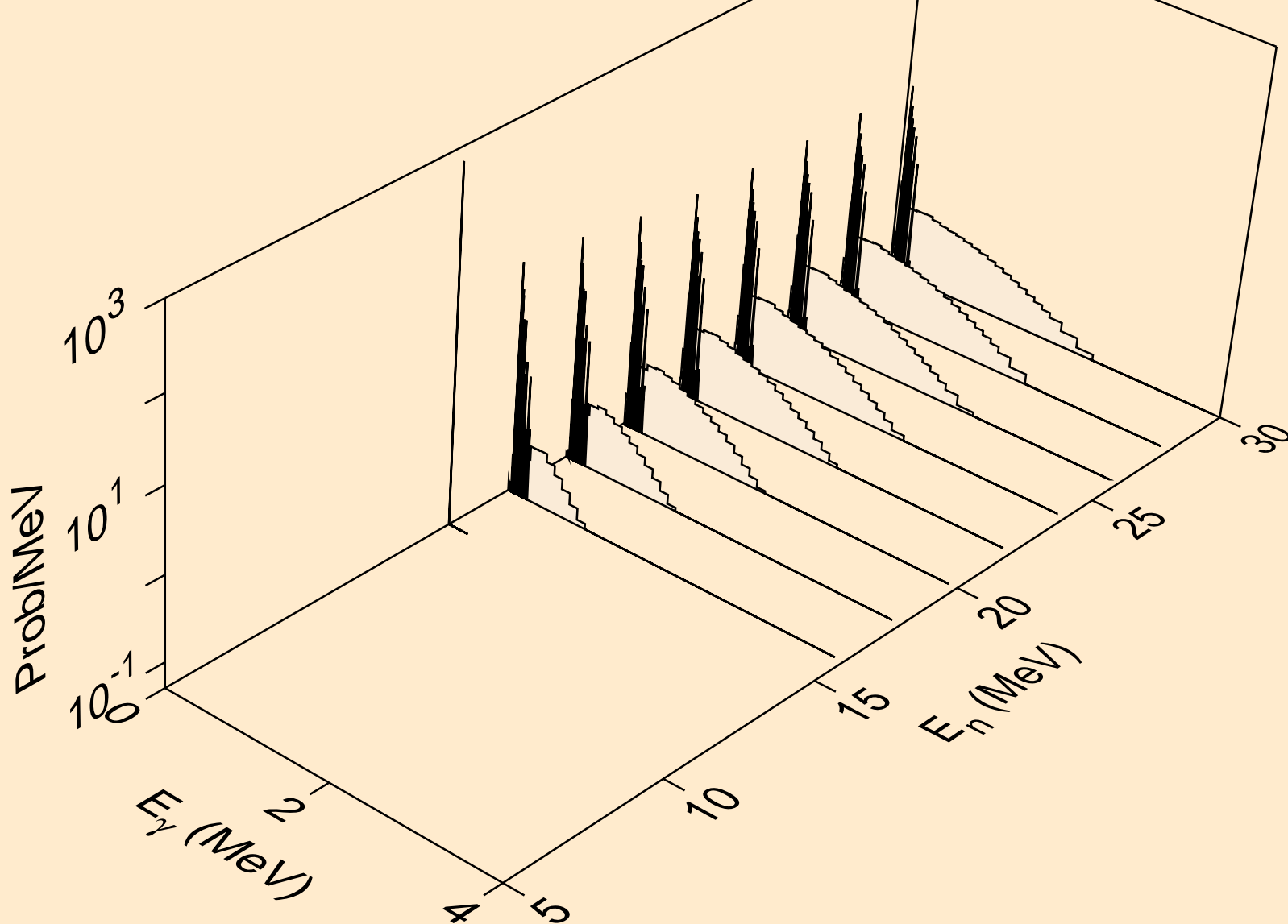

DY160 NEUTRON ACER TENDL-2019 LIBRARY; T=293.16K  
Photon emission for (n,p)

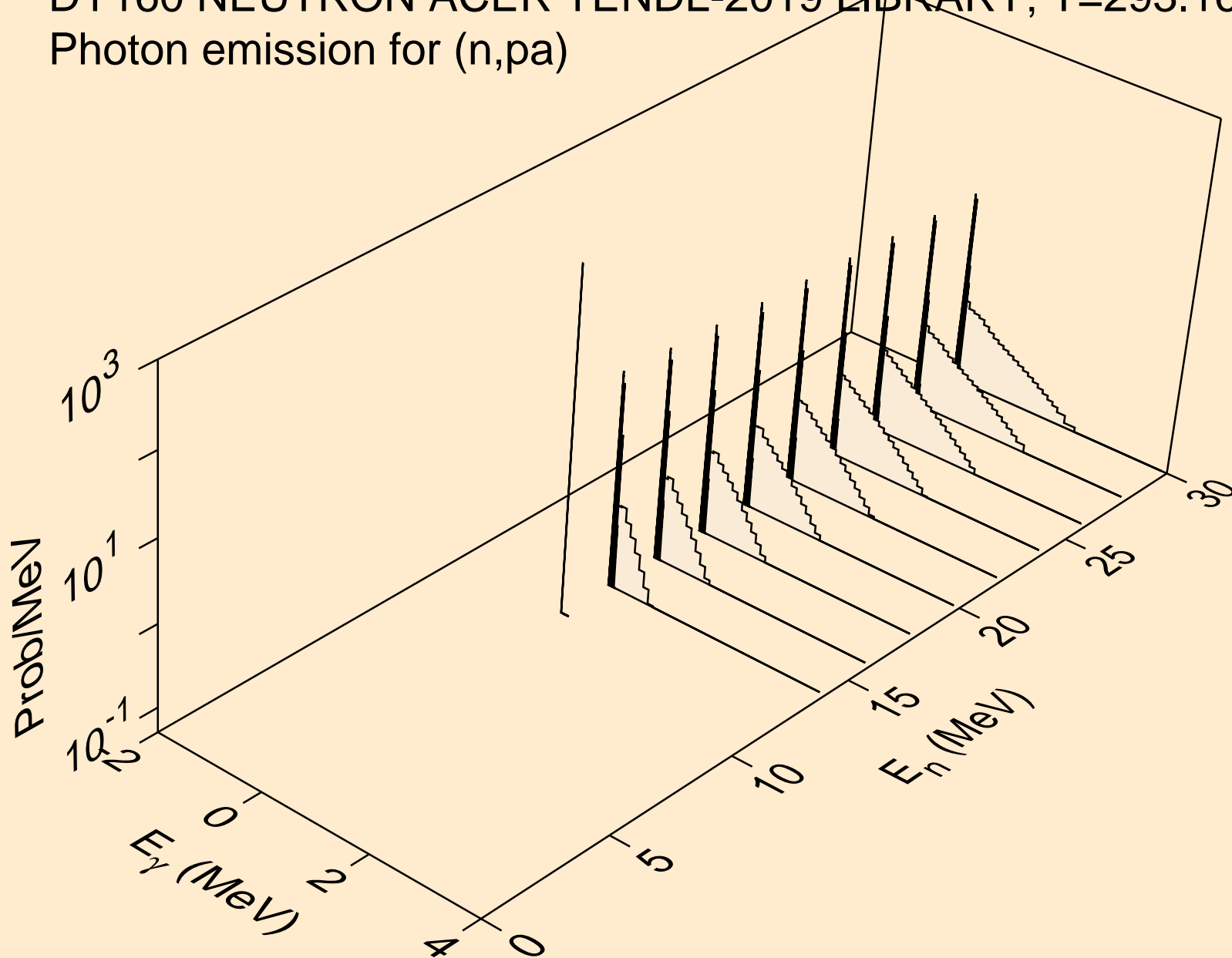

DY160 NEUTRON ACER TENDL-2019 LIBRARY; T=293.16K  
Photon emission for (n,pd)

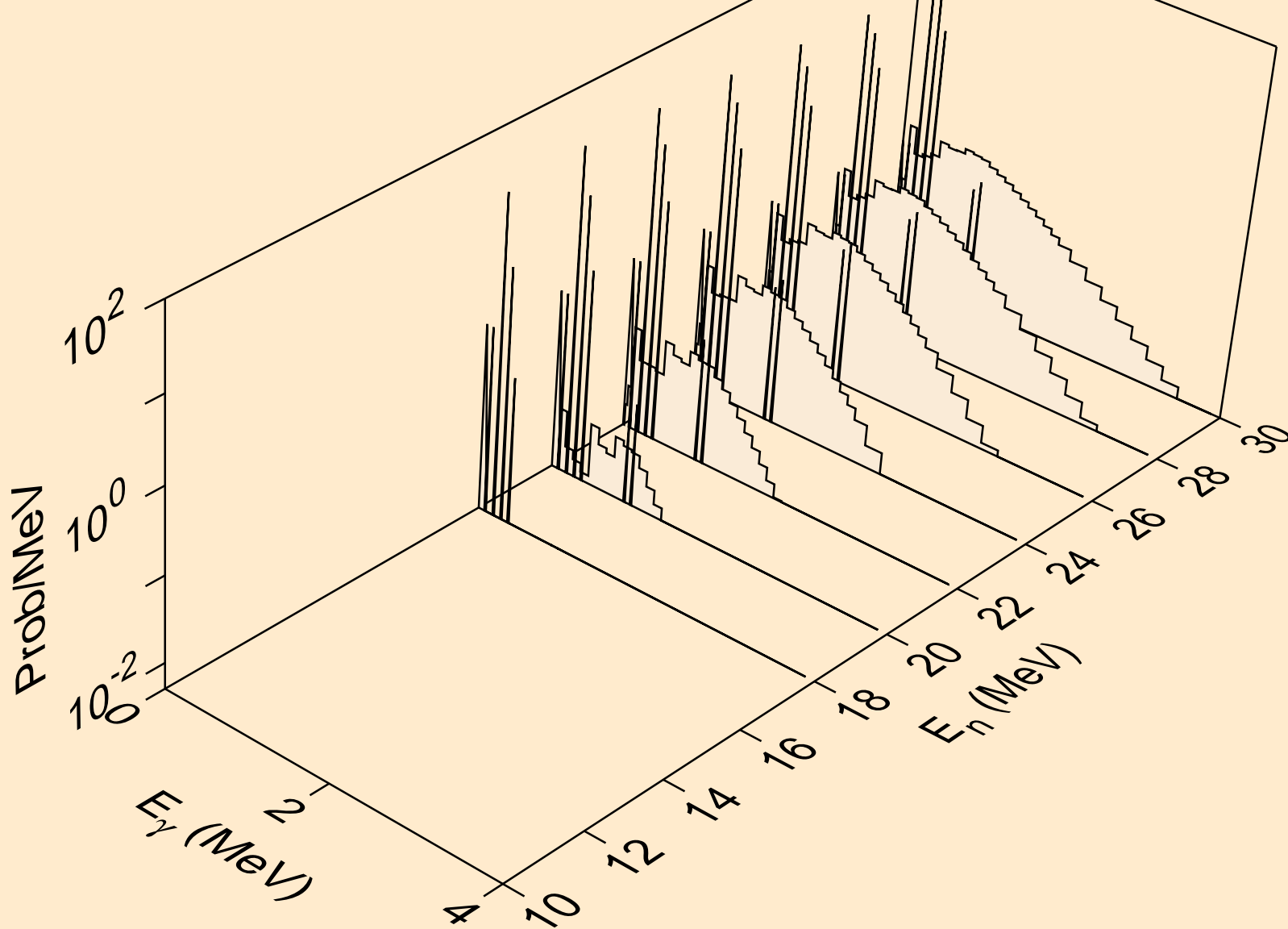

DY160 NEUTRON ACER TENDL-2019 LIBRARY; T=293.16K  
Photon emission for (n,pt)

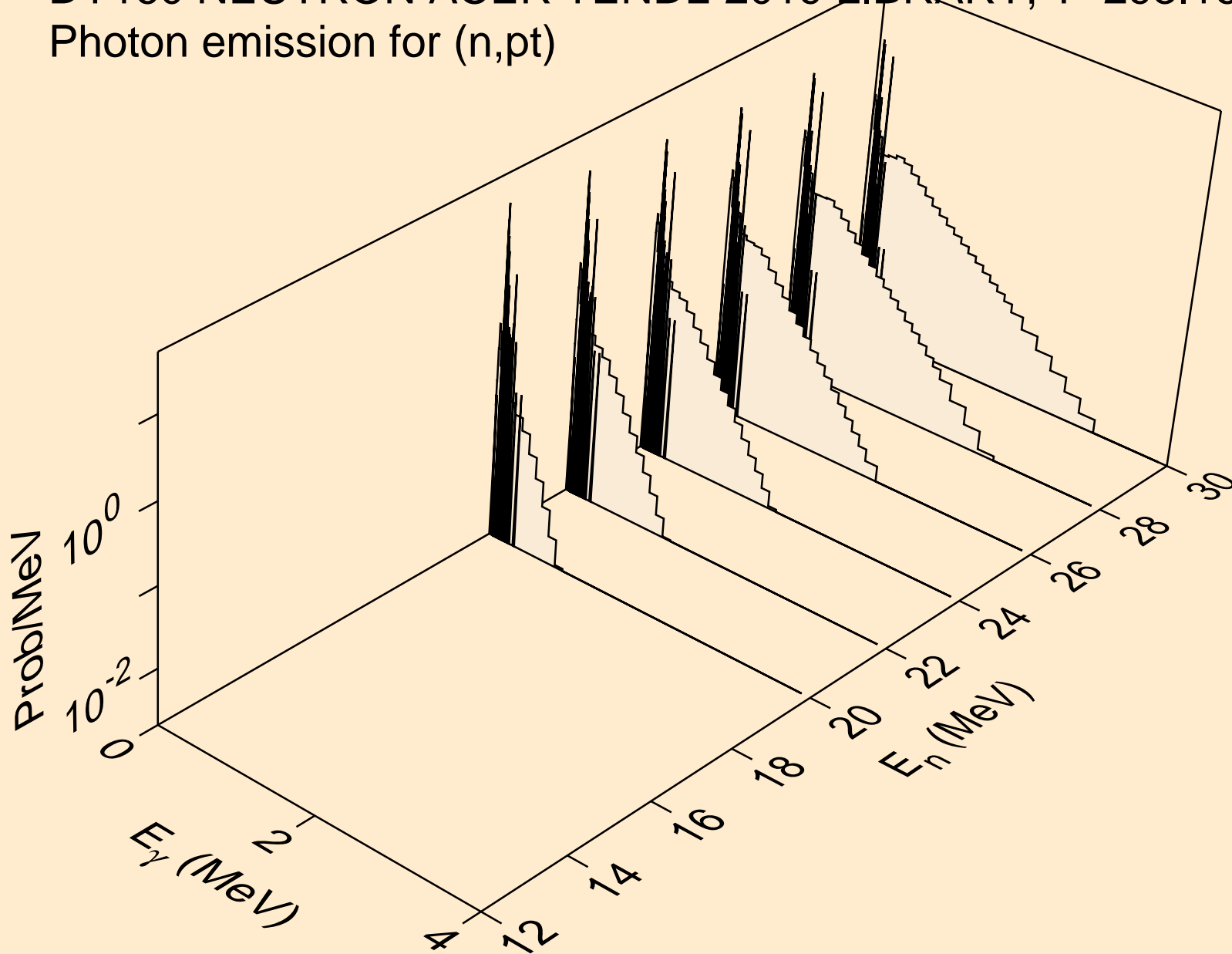

DY160 NEUTRON ACER TENDL-2019 LIBRARY; T=293.16K  
Photon emission for (n,da)

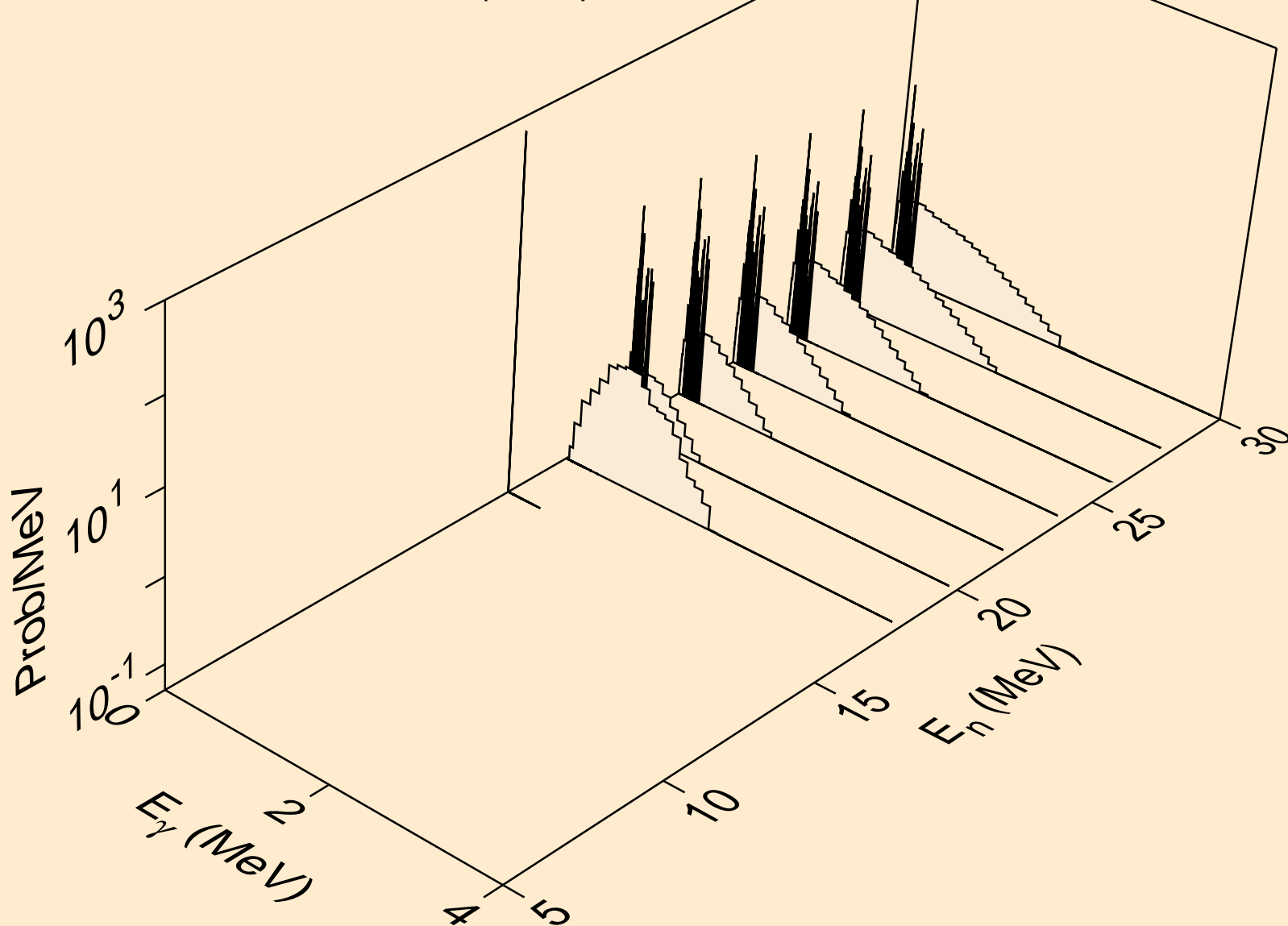

DY160 NEUTRON ACER TENDL-2019 LIBRARY; T=293.16K  
thermal capture photon spectrum

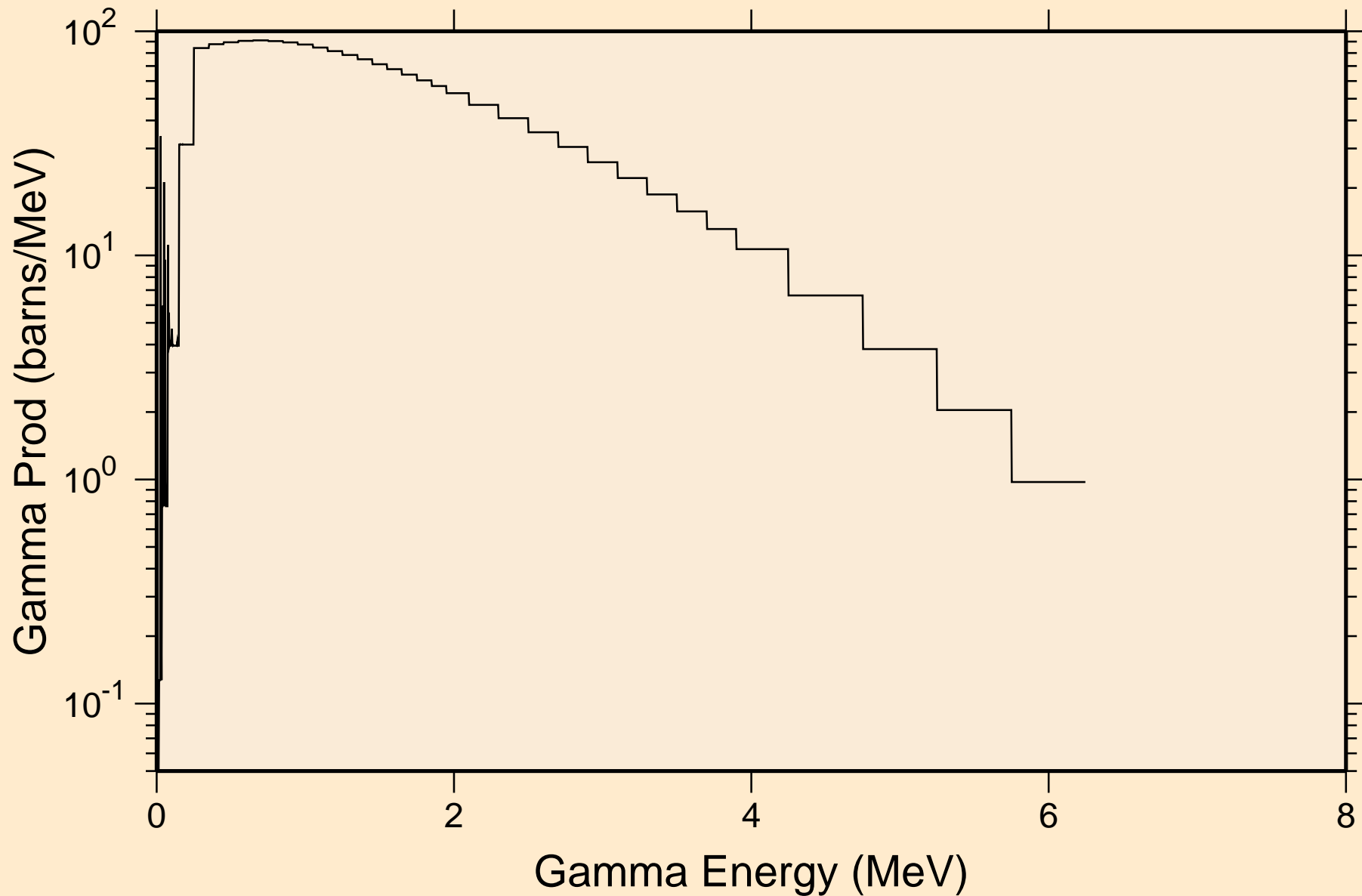



DY160 NEUTRON ACER TENDL-2019 LIBRARY; T=293.16K  
14 MeV photon spectrum

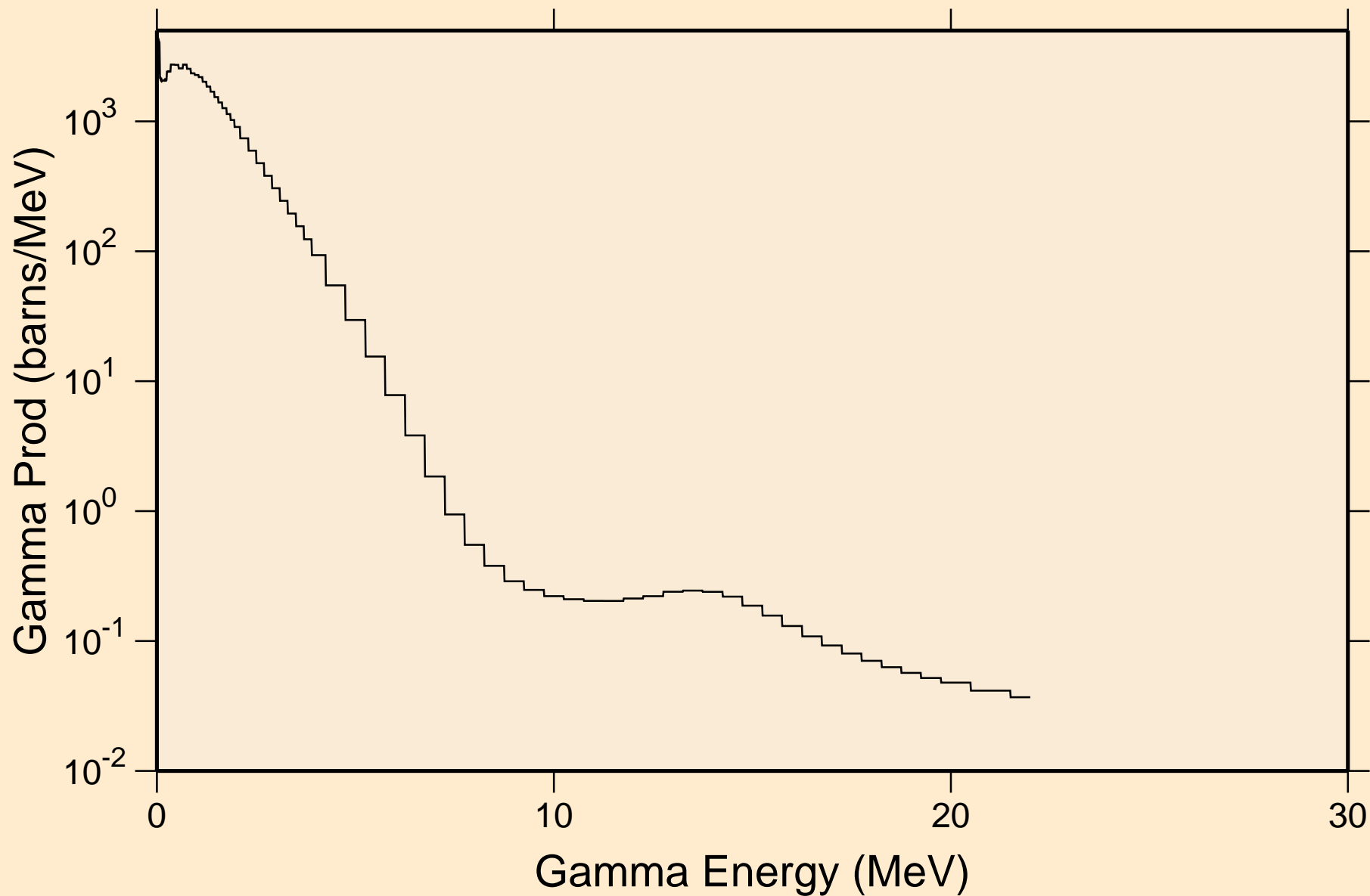

# DY160 NEUTRON ACER TENDL-2019 LIBRARY; T=293.16K

## Particle heating contributions

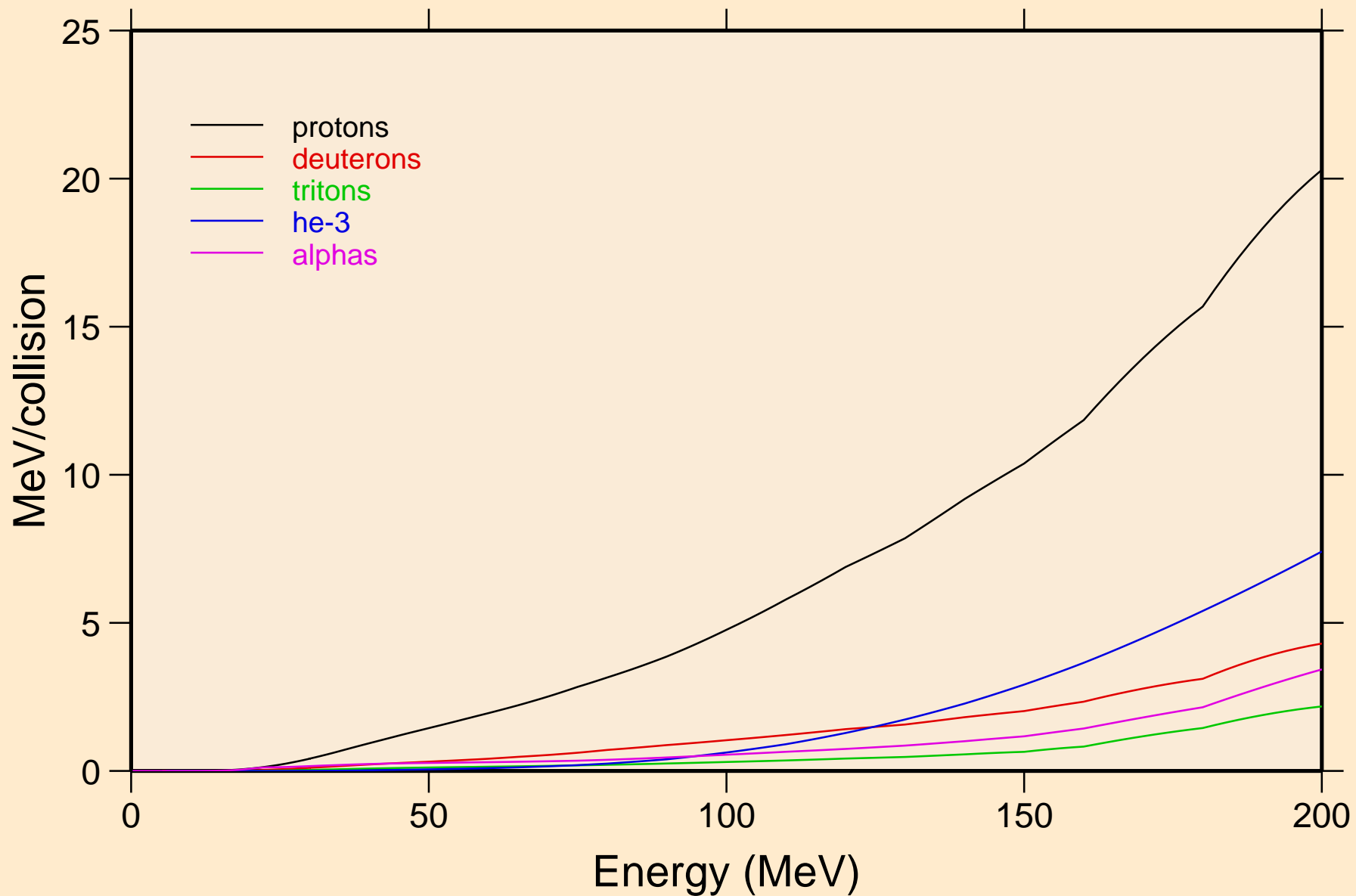

DY160 NEUTRON ACER TENDL-2019 LIBRARY; T=293.16K  
Recoil Heating

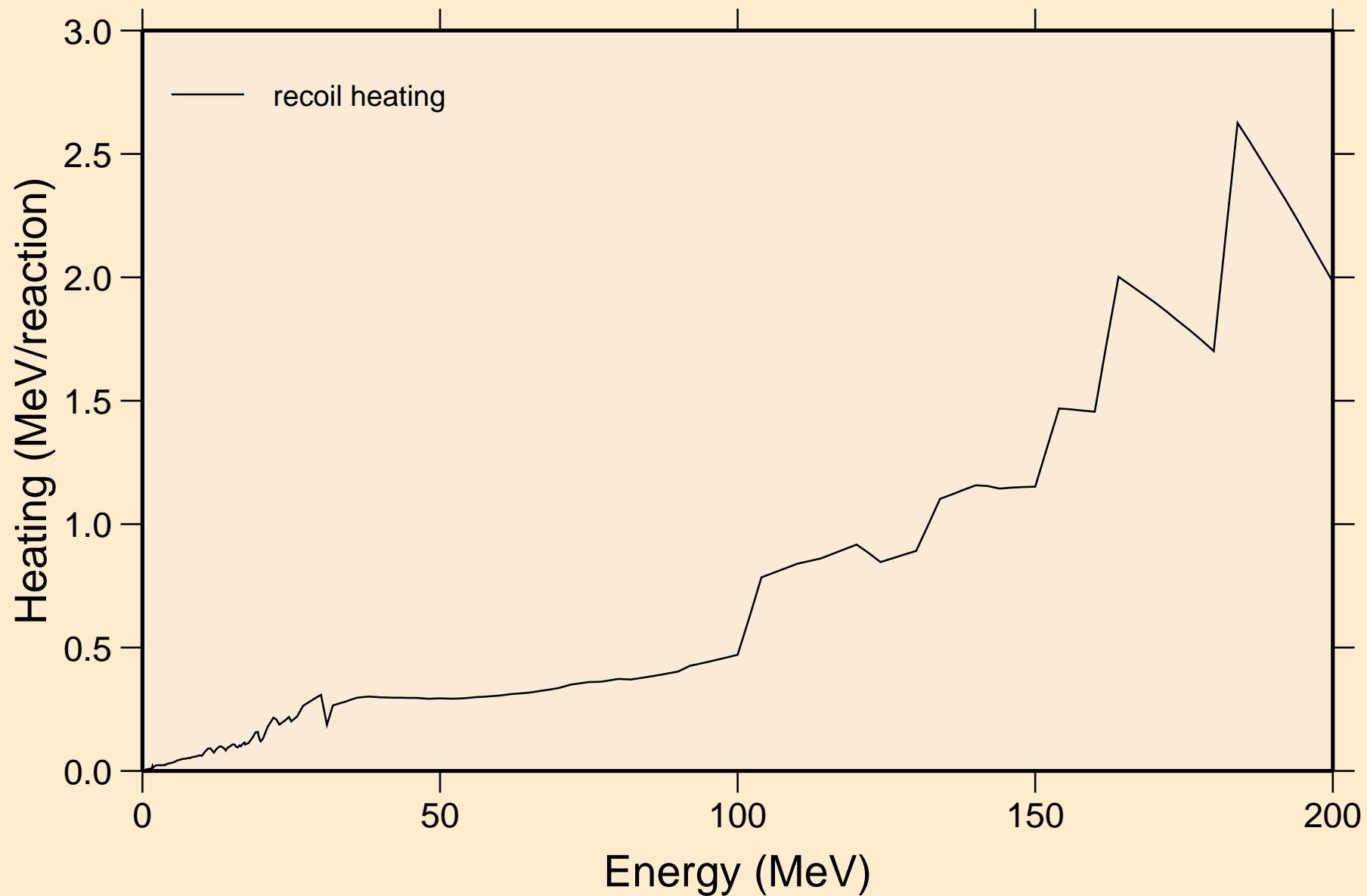

DY160 NEUTRON ACER TENDL-2019 LIBRARY; T=293.16K  
Particle production cross sections

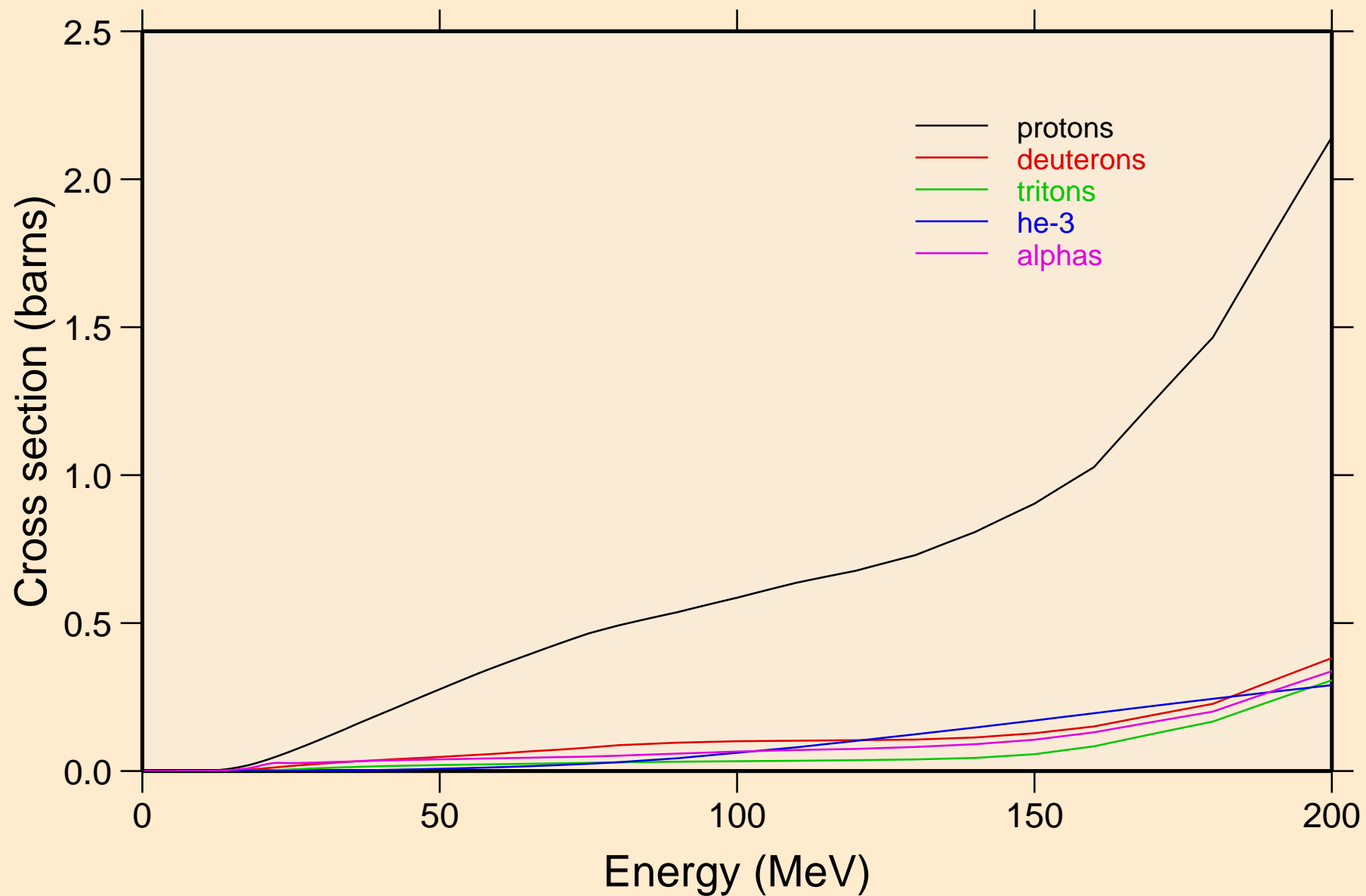

DY160 NEUTRON ACER TENDL-2019 LIBRARY; T=293.16K  
protons from (n,x)

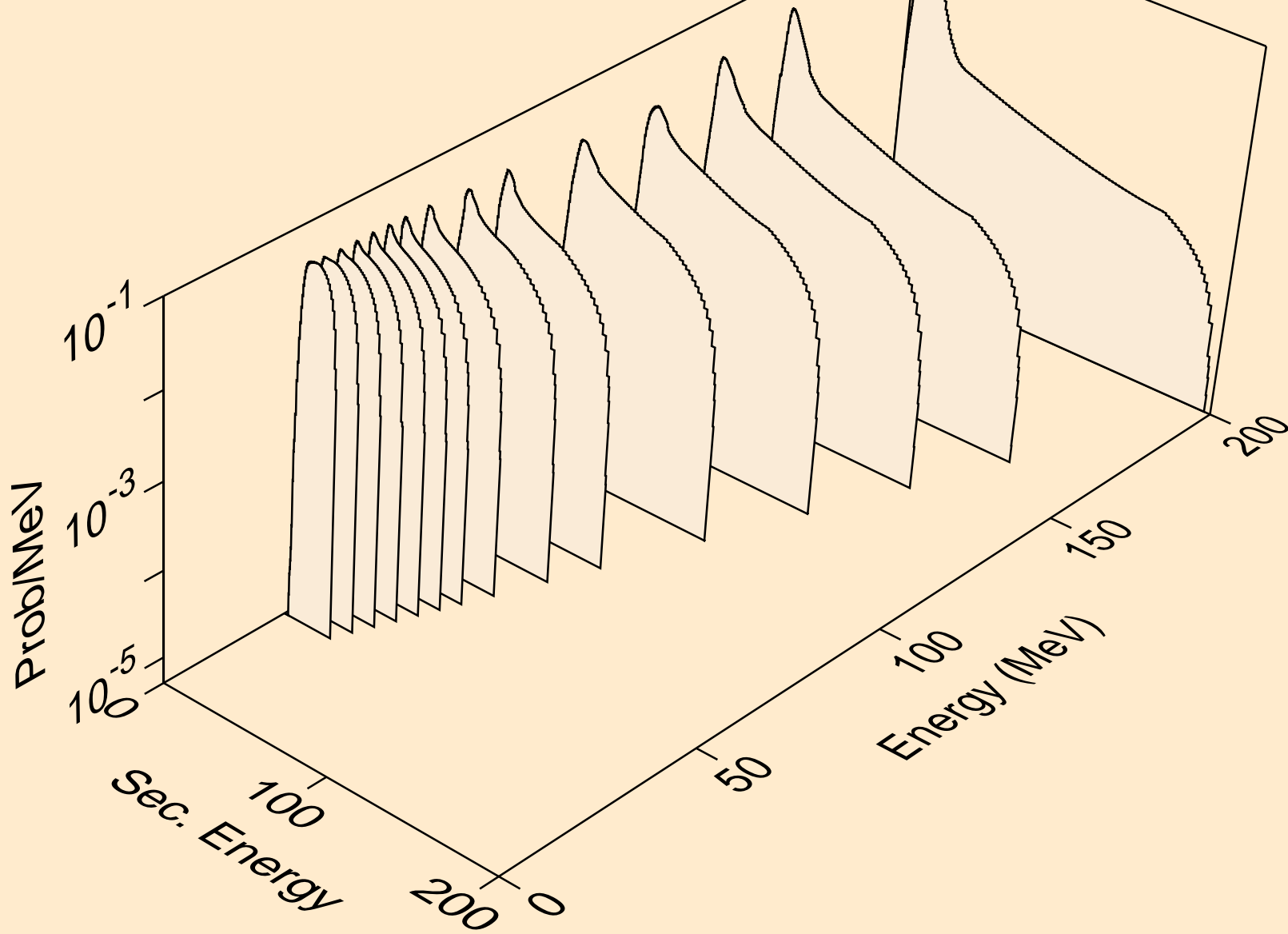

DY160 NEUTRON ACER TENDL-2019 LIBRARY; T=293.16K  
protons from (n,n\*)p

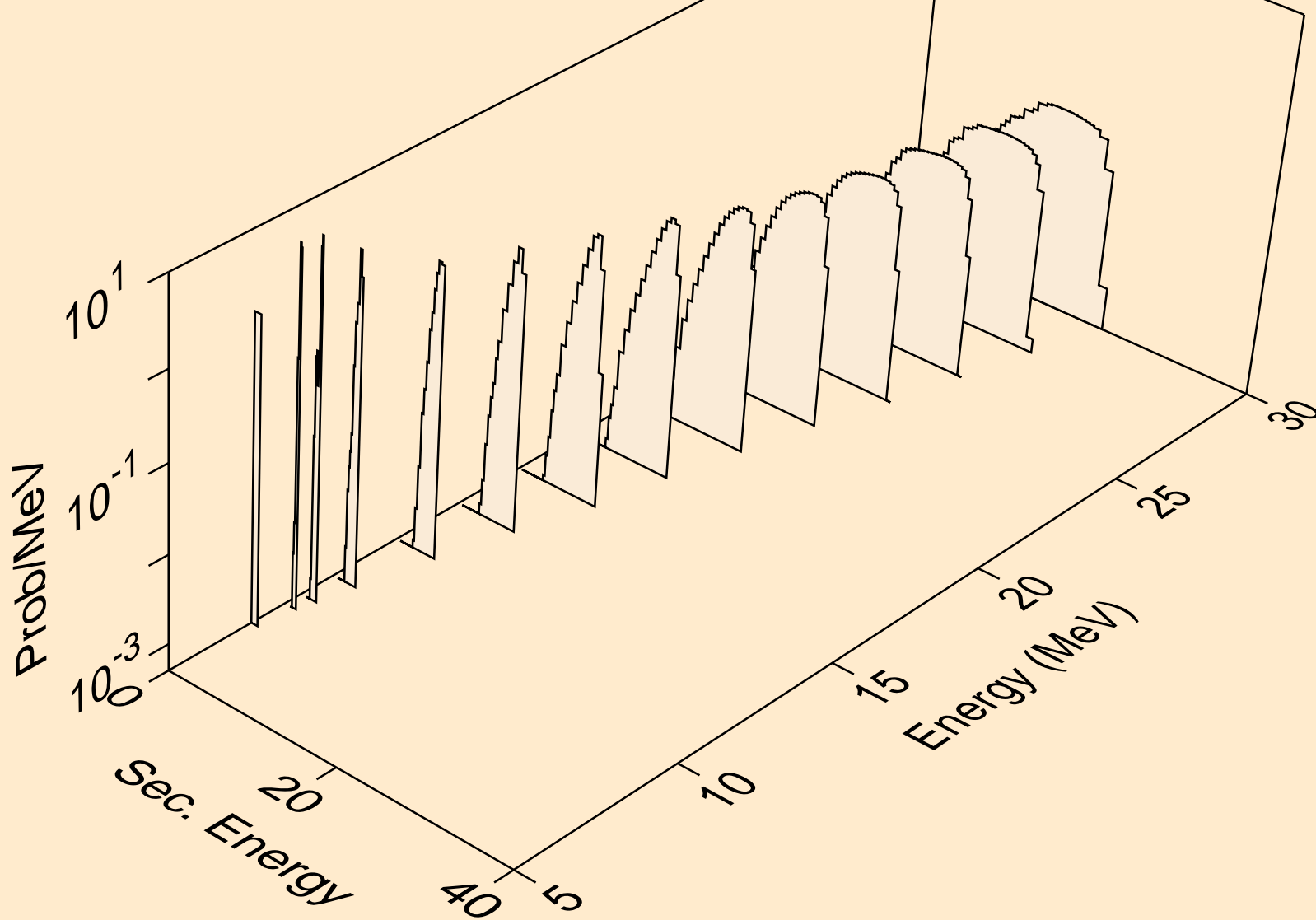

DY160 NEUTRON ACER TENDL-2019 LIBRARY; T=293.16K  
protons from (n,2np)

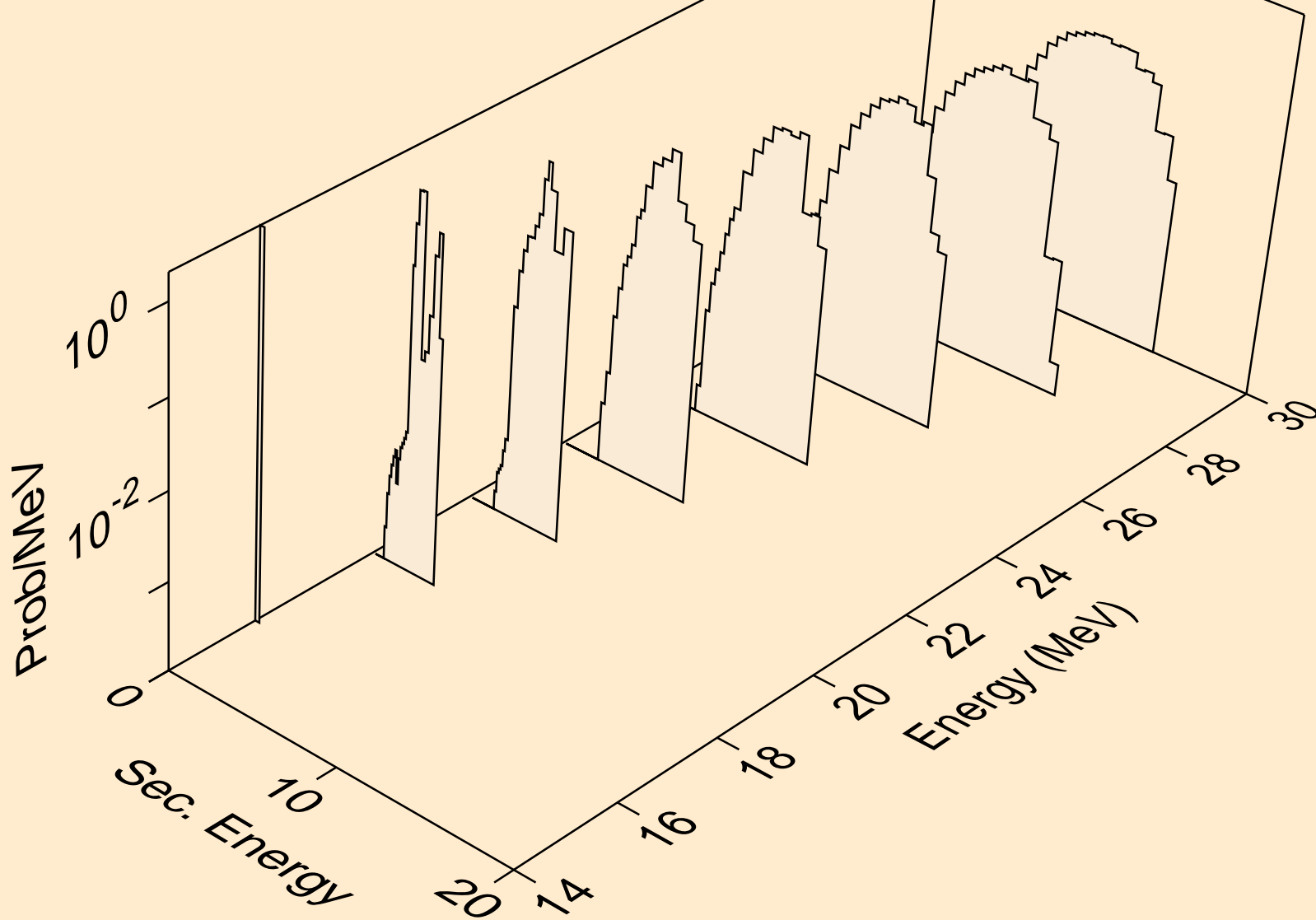

DY160 NEUTRON ACER TENDL-2019 LIBRARY; T=293.16K  
protons from (n,3np)

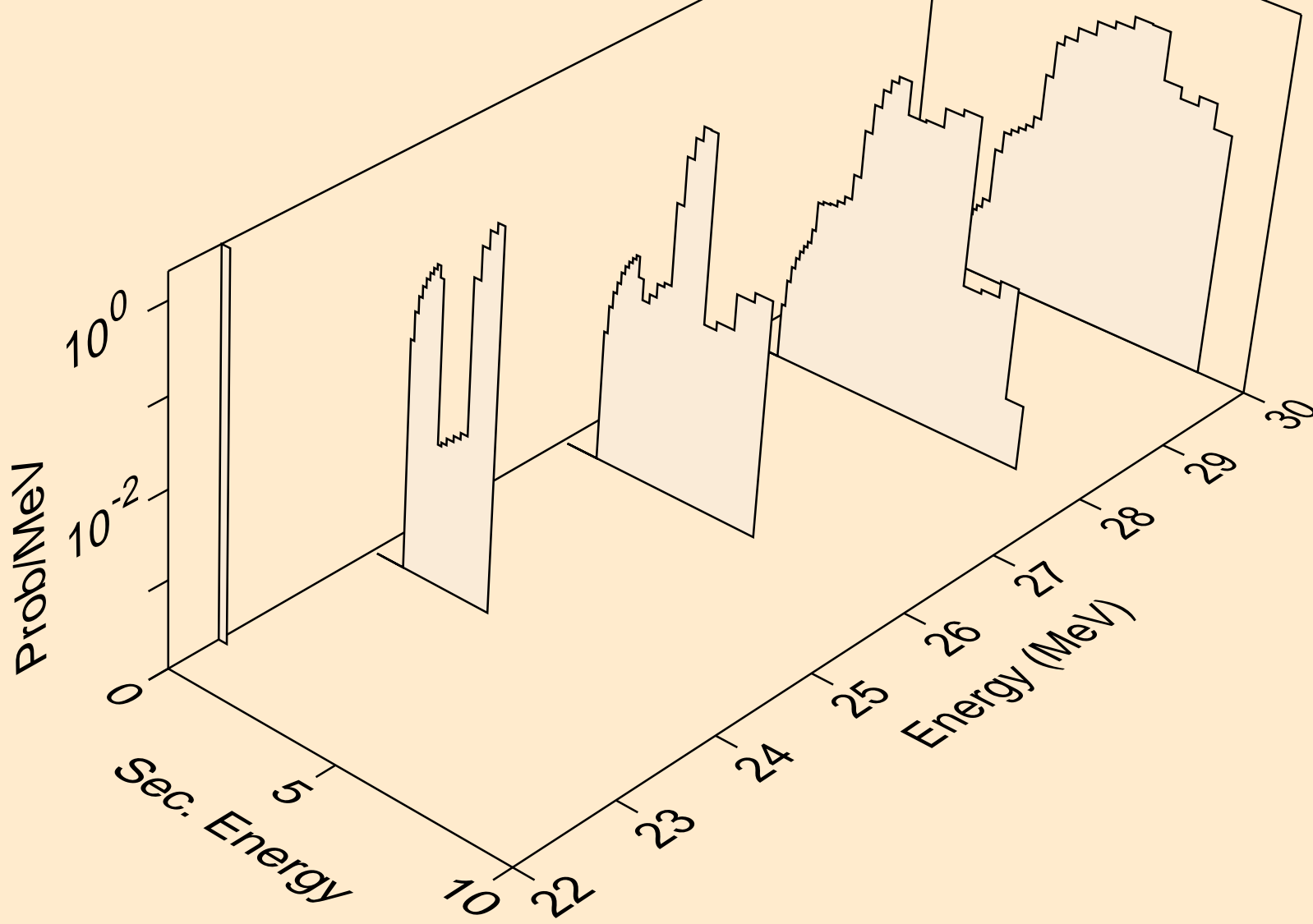



DY160 NEUTRON ACER TENDL-2019 LIBRARY; T=293.16K  
protons from (n,2np)

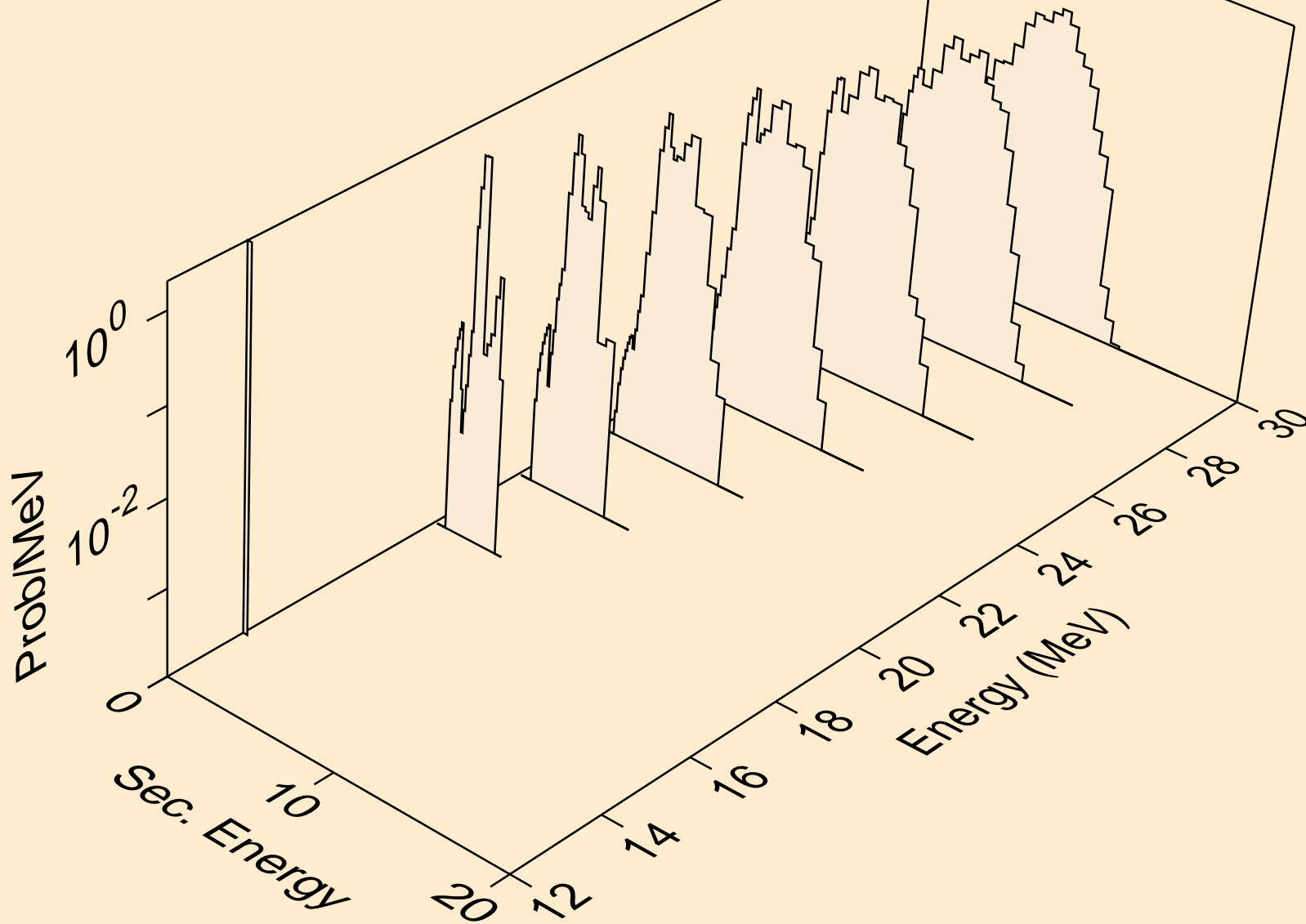

DY160 NEUTRON ACER TENDL-2019 LIBRARY; T=293.16K  
protons from (n,npa)

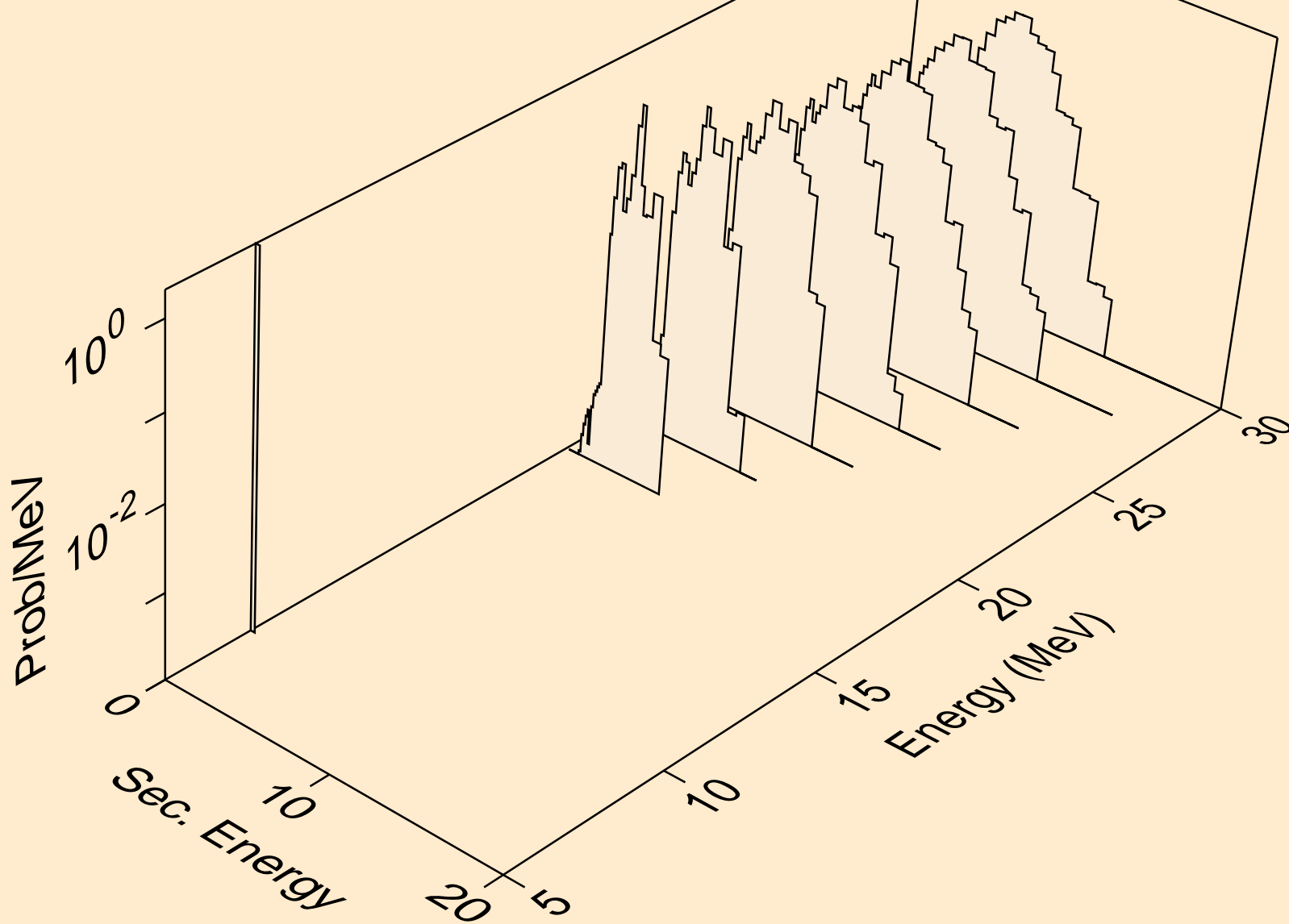

DY160 NEUTRON ACER TENDL-2019 LIBRARY; T=293.16K  
protons from (n,p)

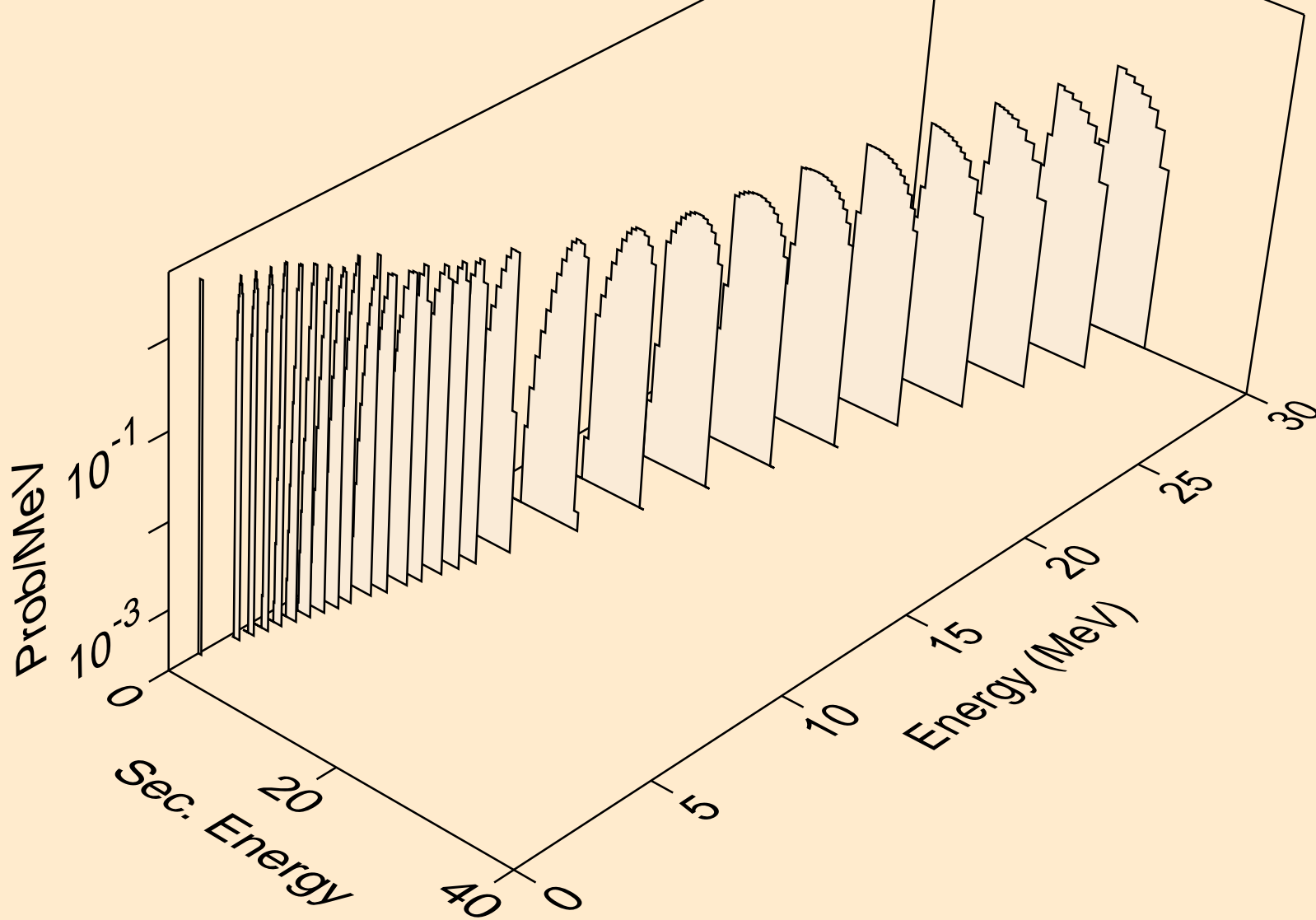

DY160 NEUTRON ACER TENDL-2019 LIBRARY; T=293.16K  
protons from (n,2p)

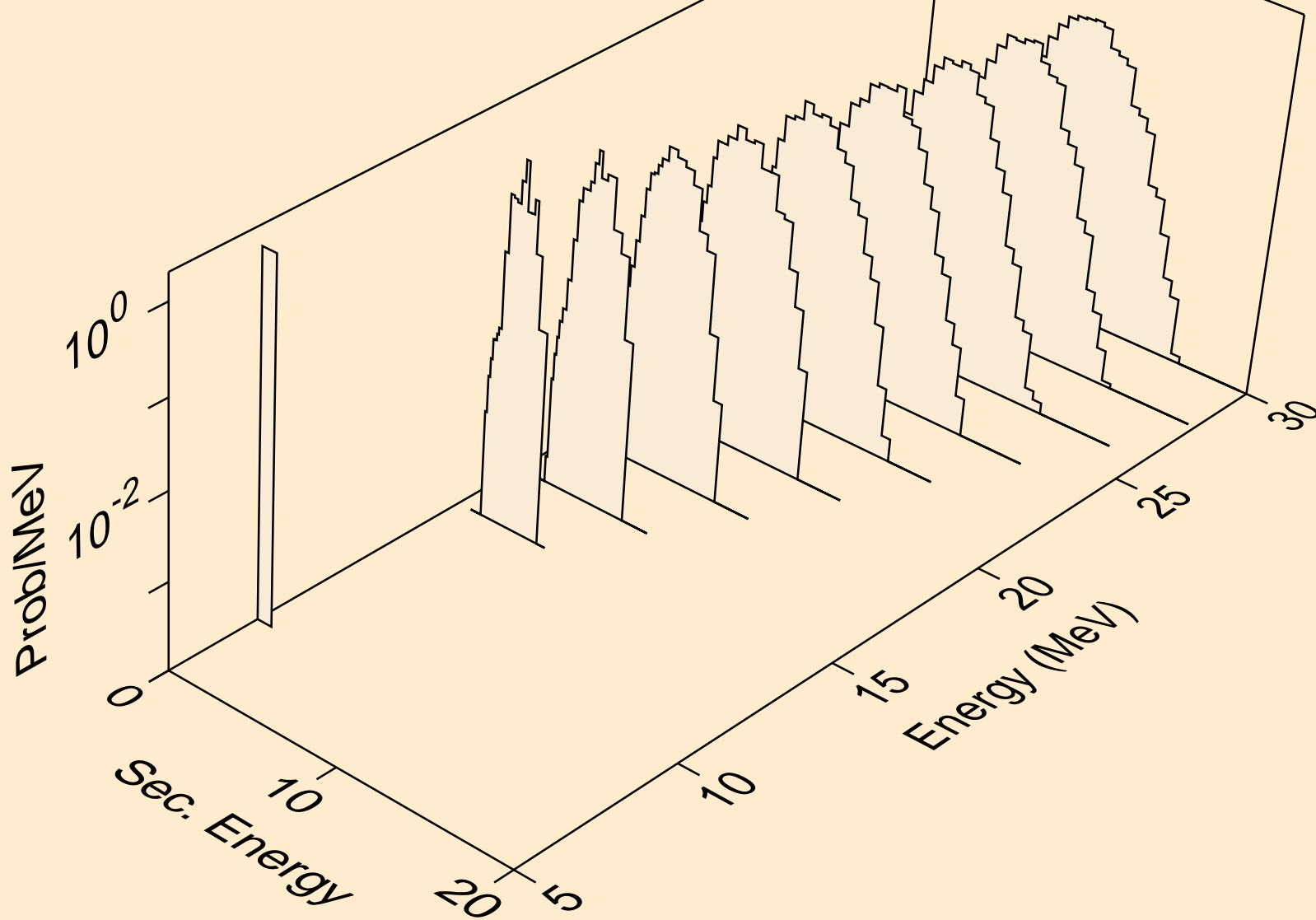

DY160 NEUTRON ACER TENDL-2019 LIBRARY; T=293.16K  
protons from (n,p)

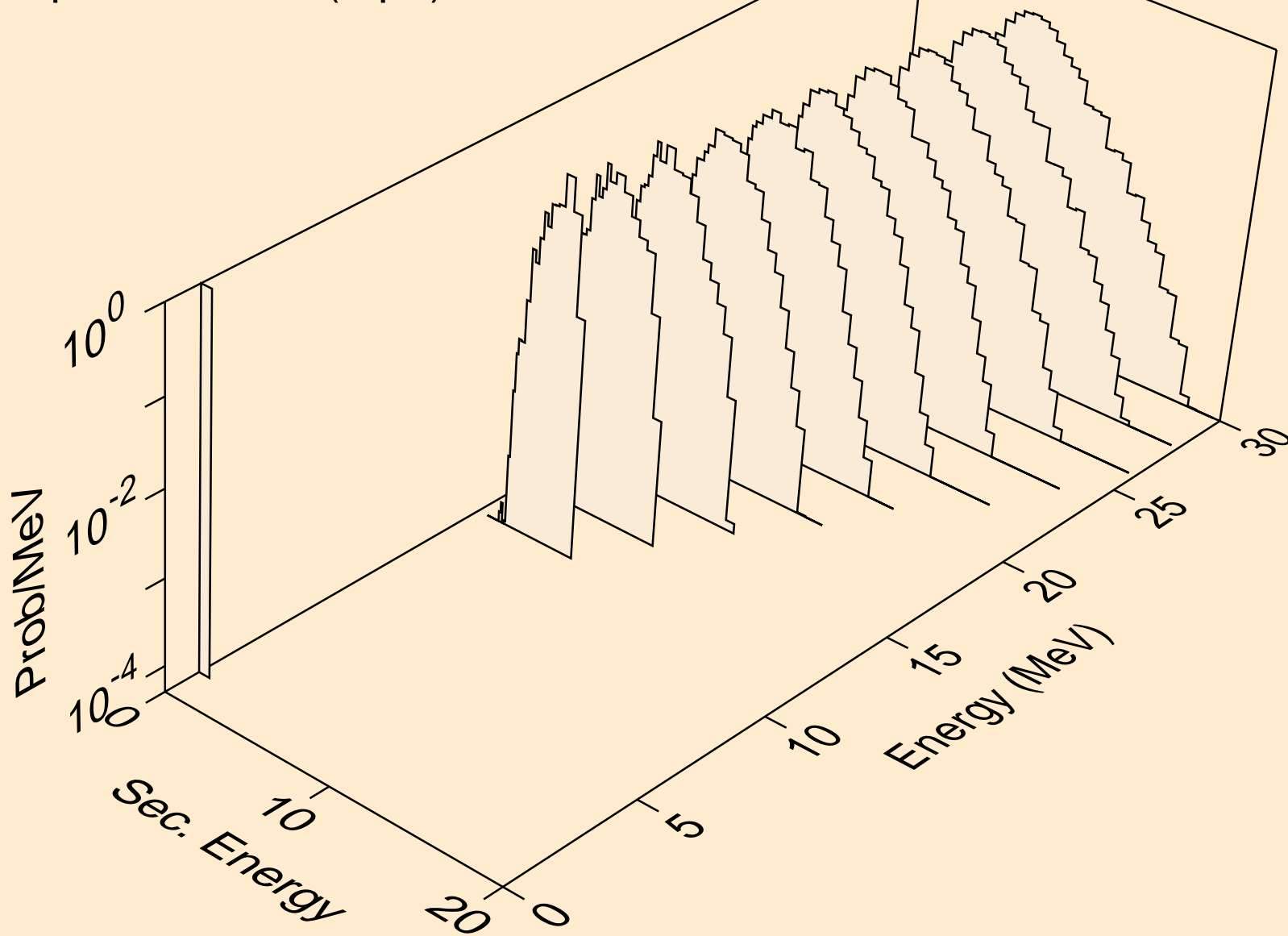

DY160 NEUTRON ACER TENDL-2019 LIBRARY; T=293.16K  
protons from (n,pd)

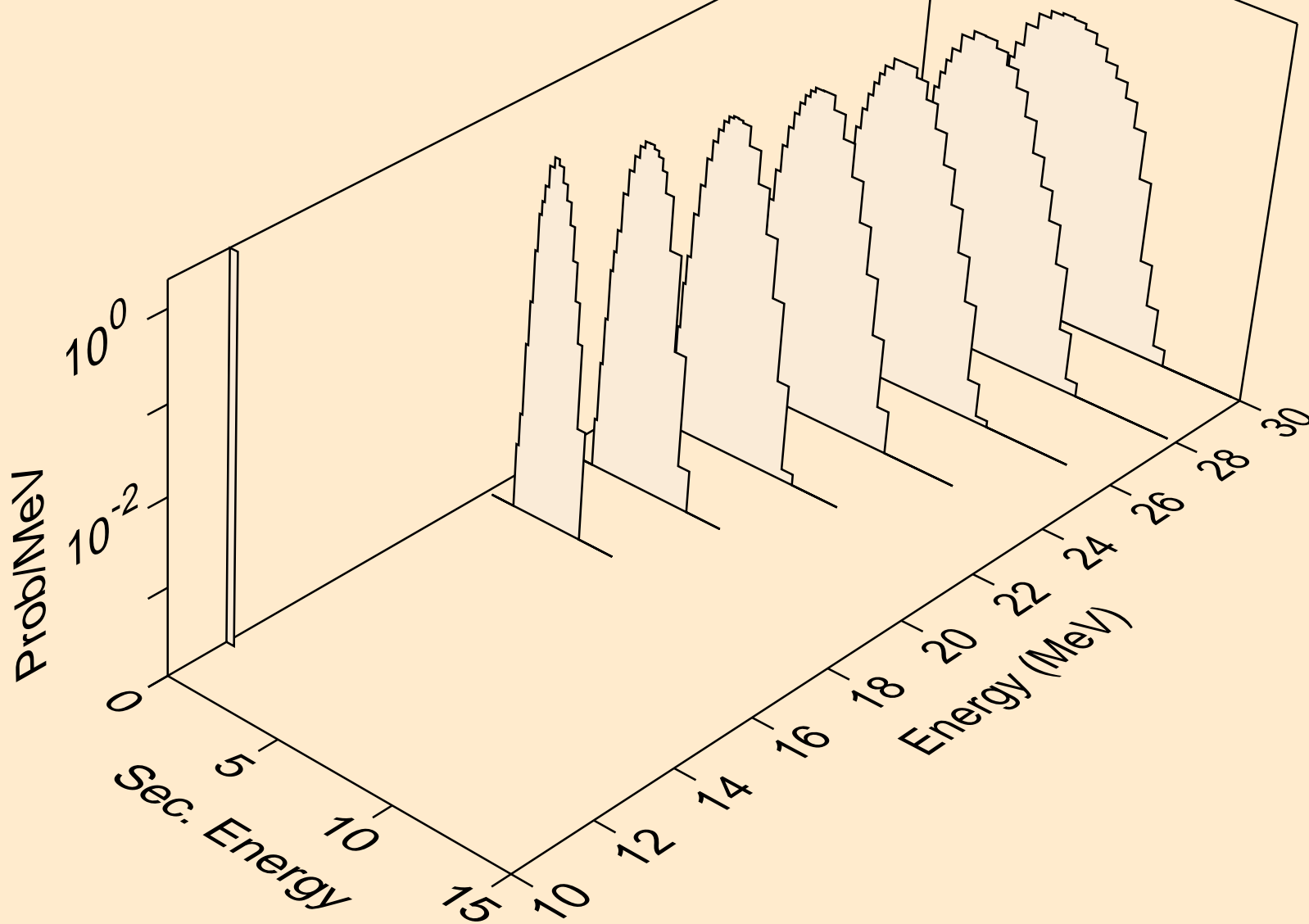

DY160 NEUTRON ACER TENDL-2019 LIBRARY; T=293.16K  
protons from (n,pt)

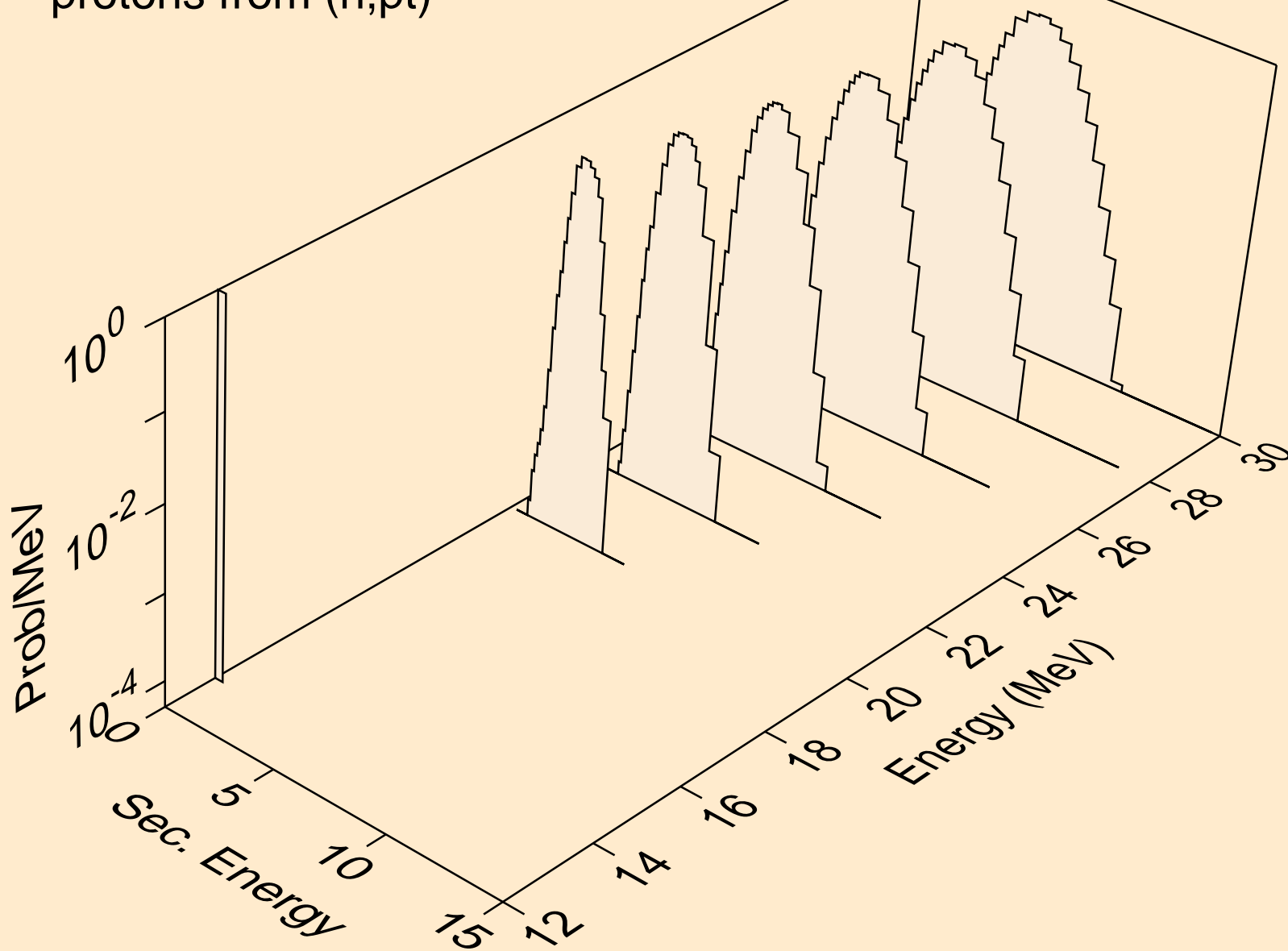

DY160 NEUTRON ACER TENDL-2019 LIBRARY; T=293.16K  
deuterons from (n,x)

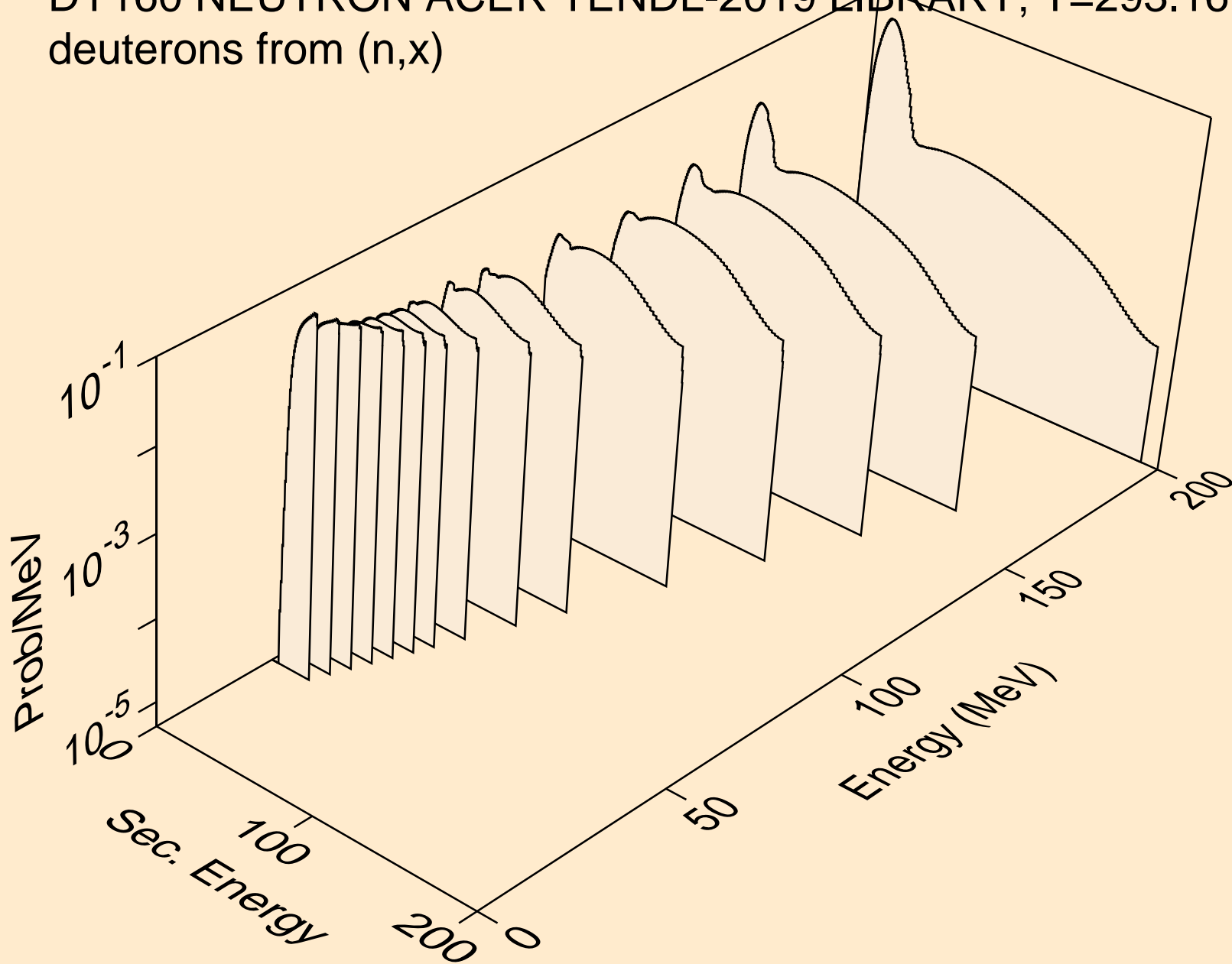



DY160 NEUTRON ACER TENDL-2019 LIBRARY; T=293.16K  
deuterons from (n,2nd)

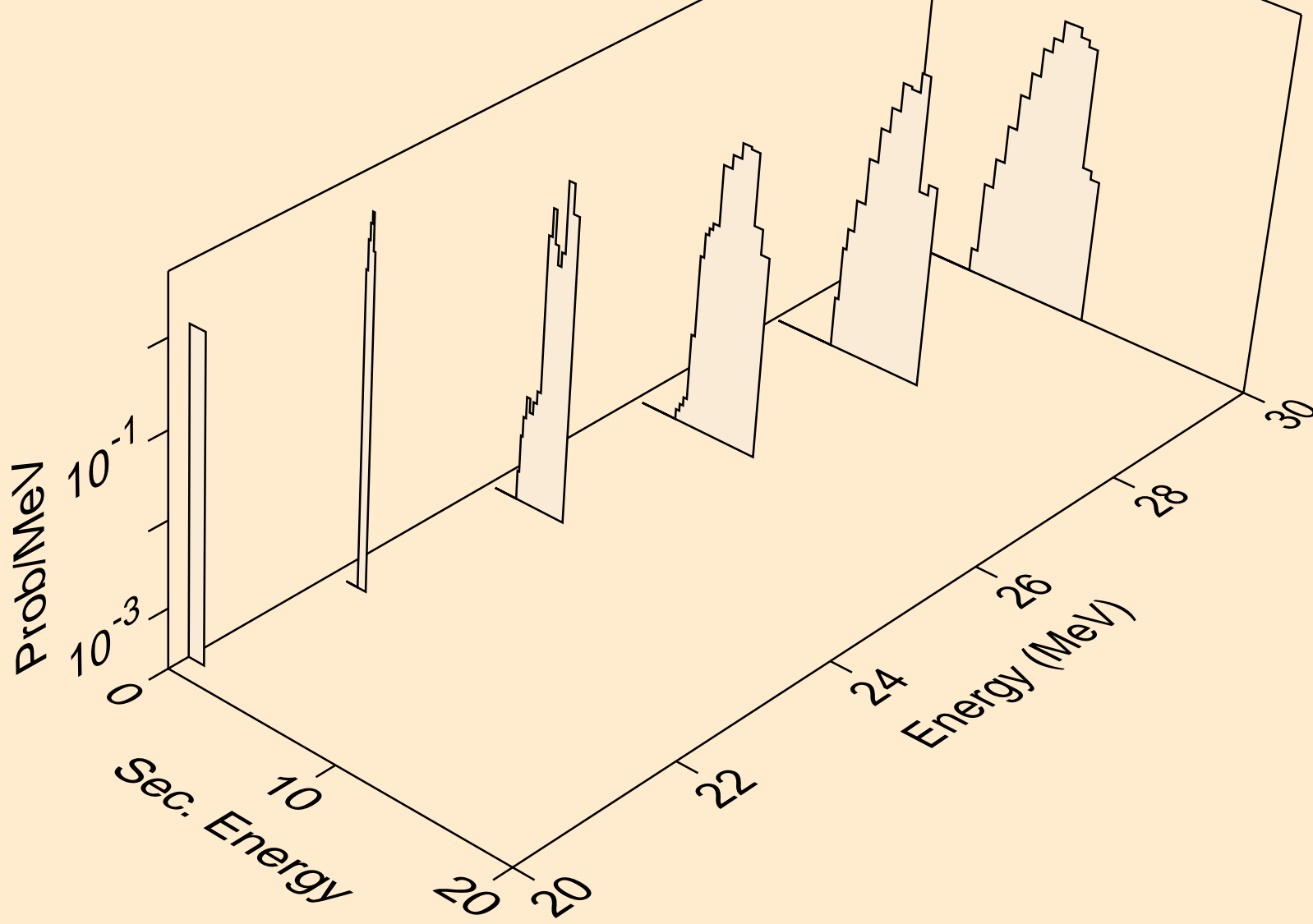

DY160 NEUTRON ACER TENDL-2019 LIBRARY; T=293.16K  
deuterons from (n,n\*)d

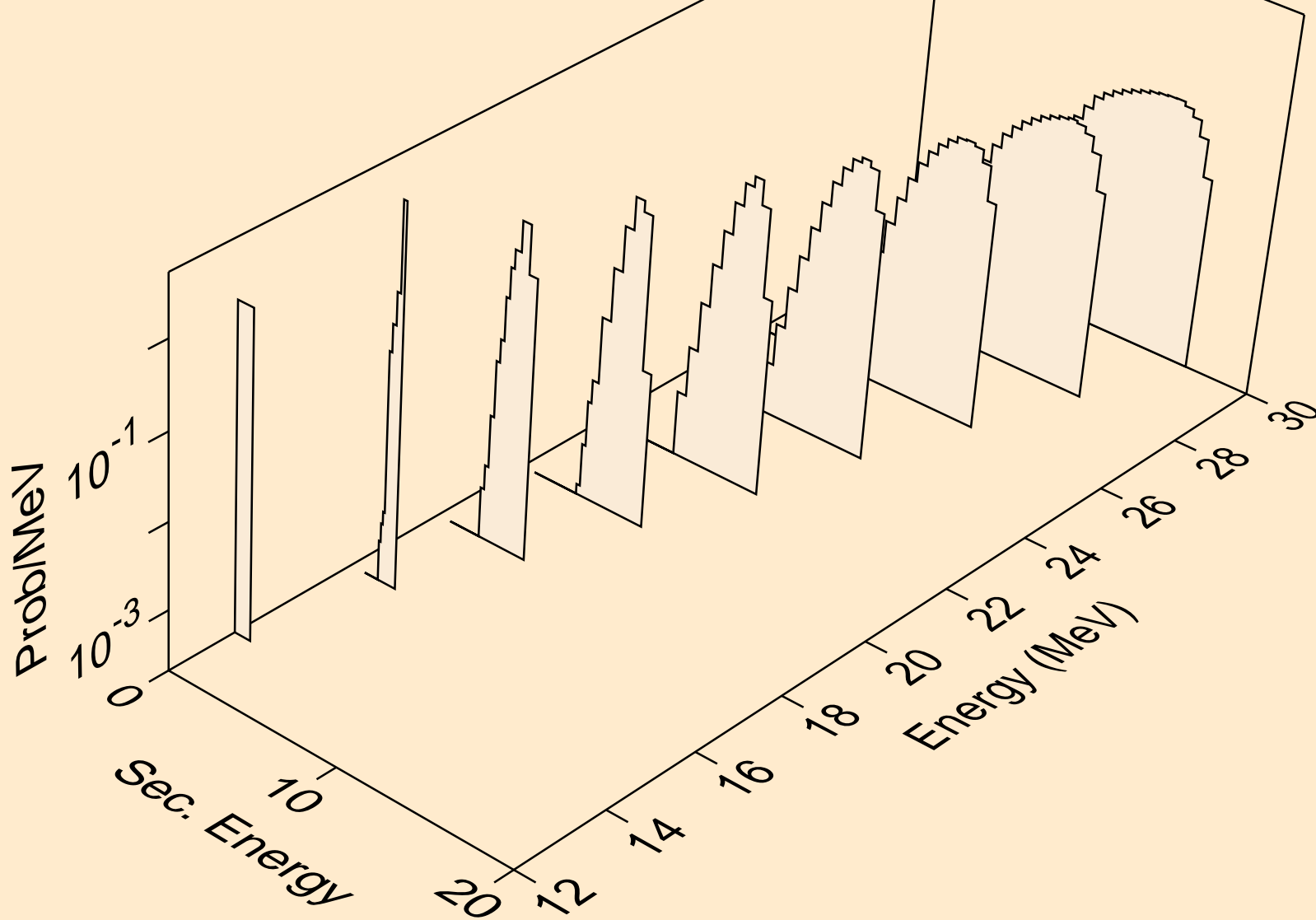

DY160 NEUTRON ACER TENDL-2019 LIBRARY; T=293.16K  
deuterons from (n,d)

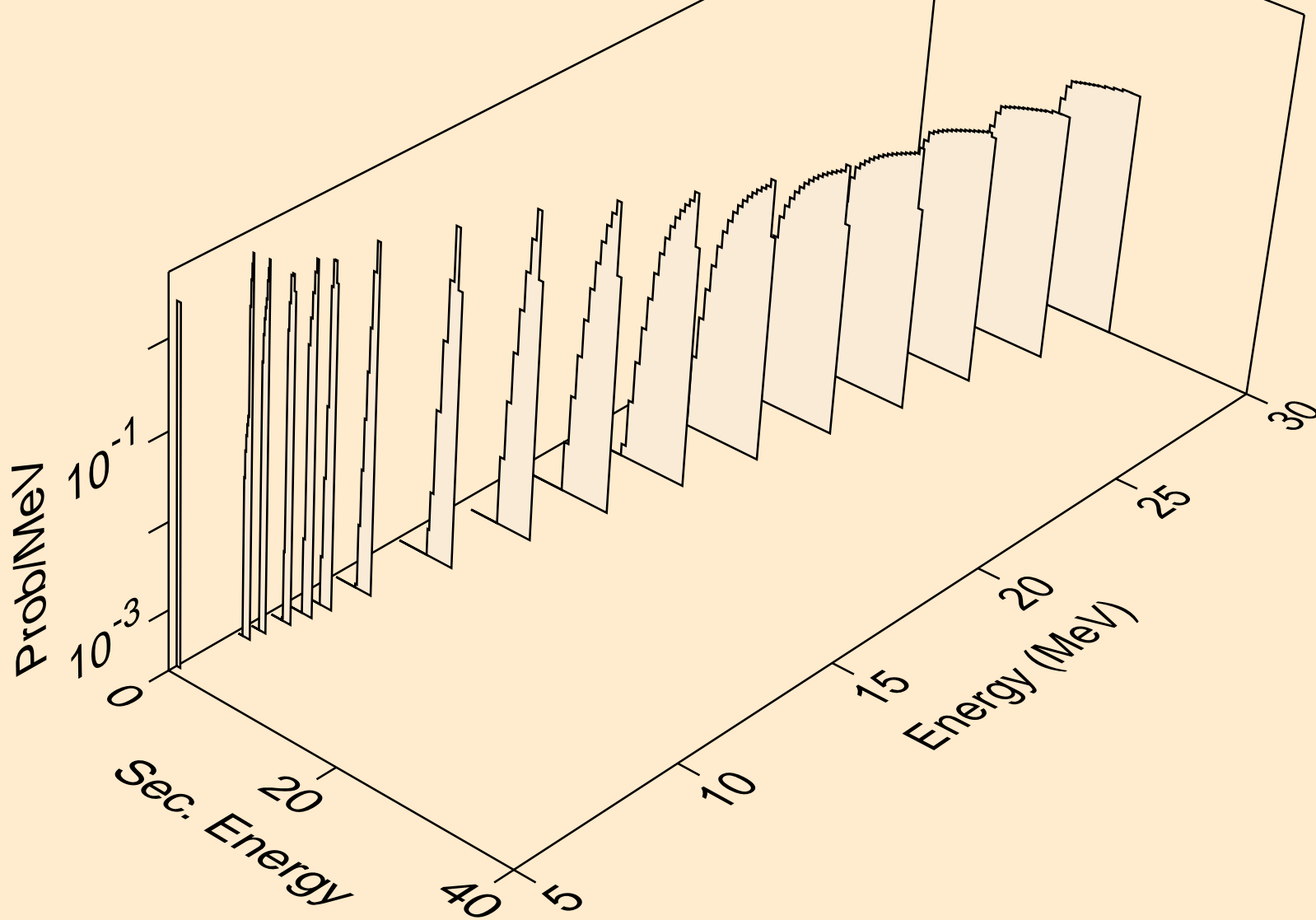

DY160 NEUTRON ACER TENDL-2019 LIBRARY; T=293.16K  
deuterons from (n,pd)

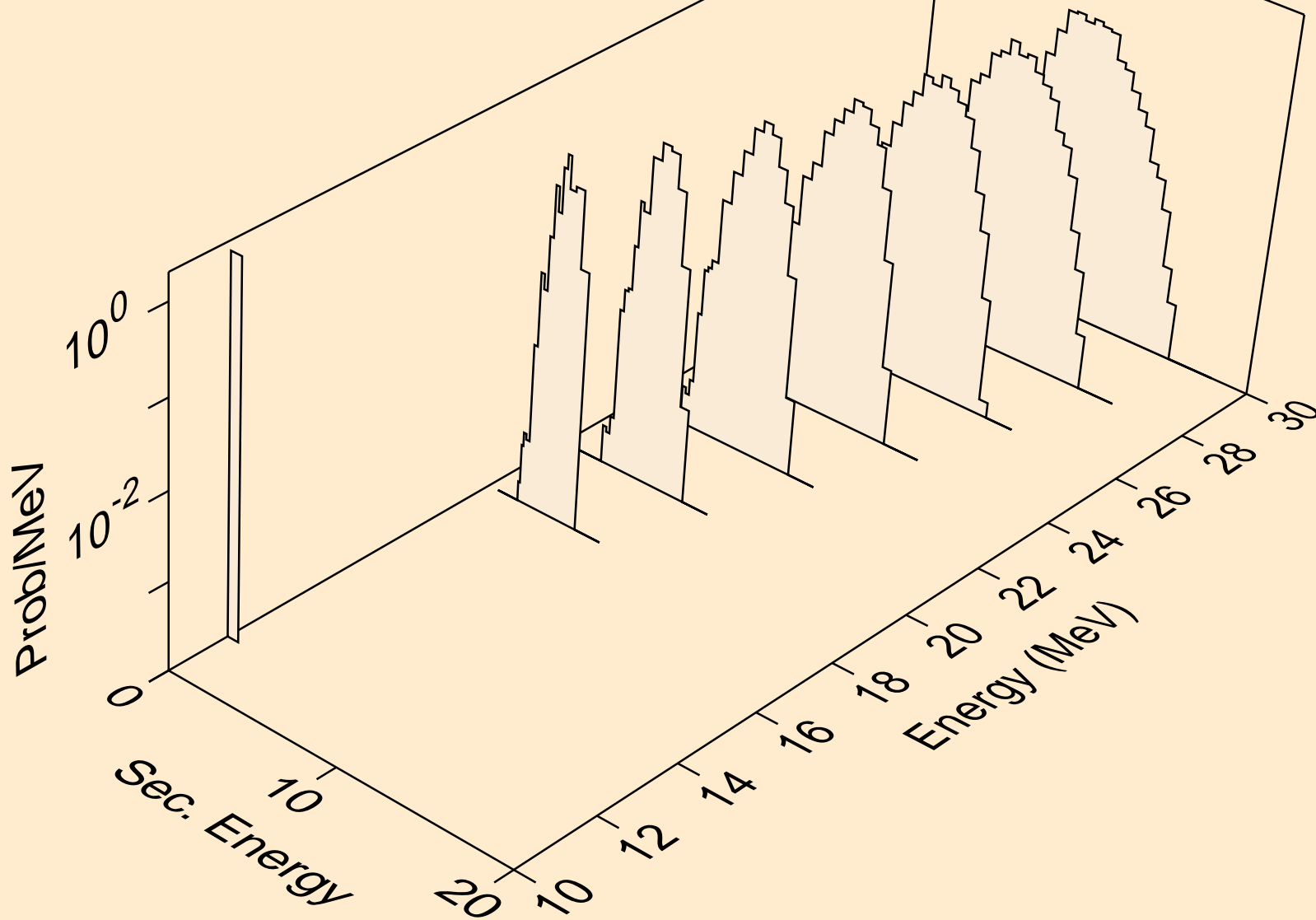

DY160 NEUTRON ACER TENDL-2019 LIBRARY; T=293.16K  
deuterons from (n,da)

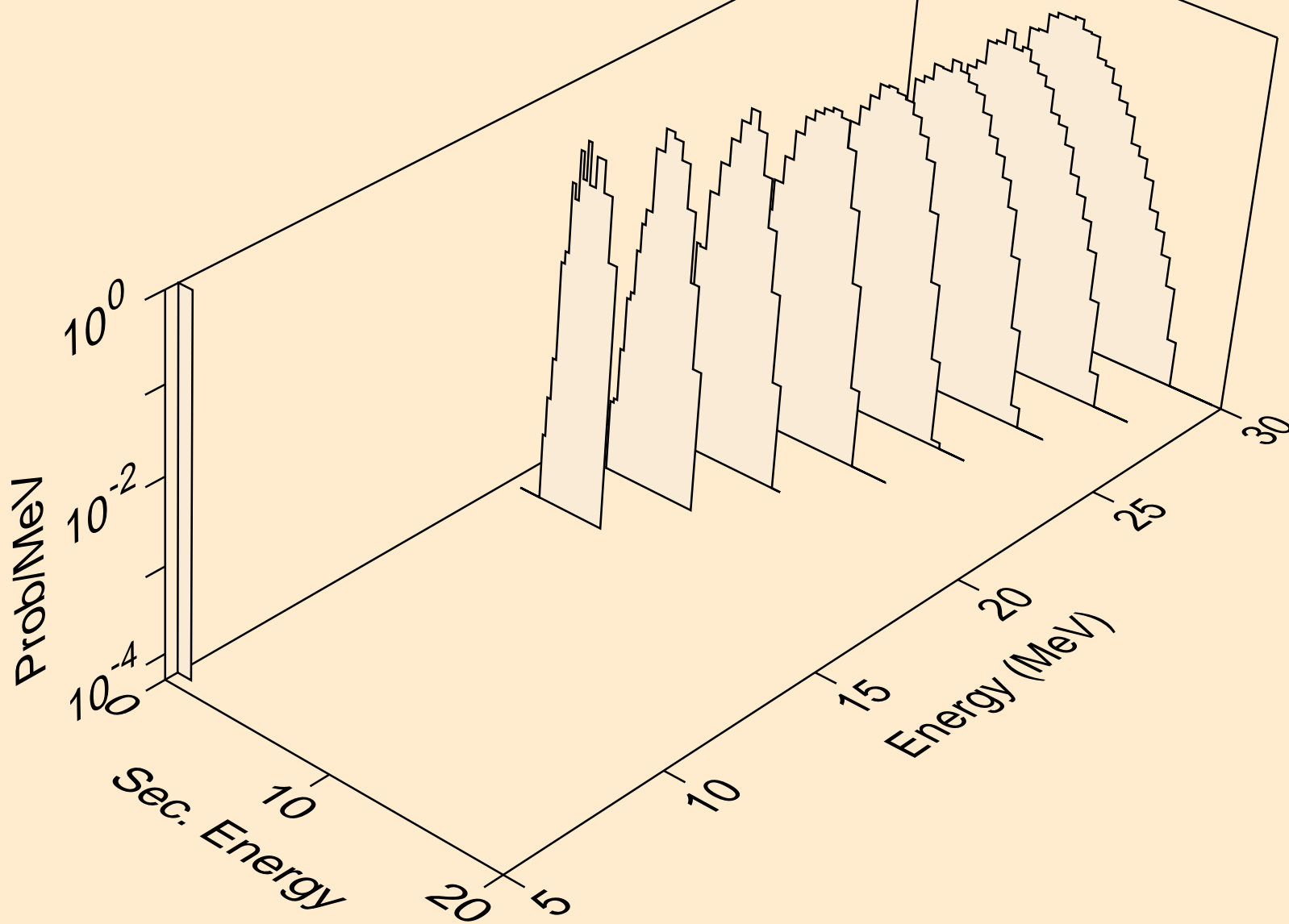

DY160 NEUTRON ACER TENDL-2019 LIBRARY; T=293.16K  
tritons from (n,x)

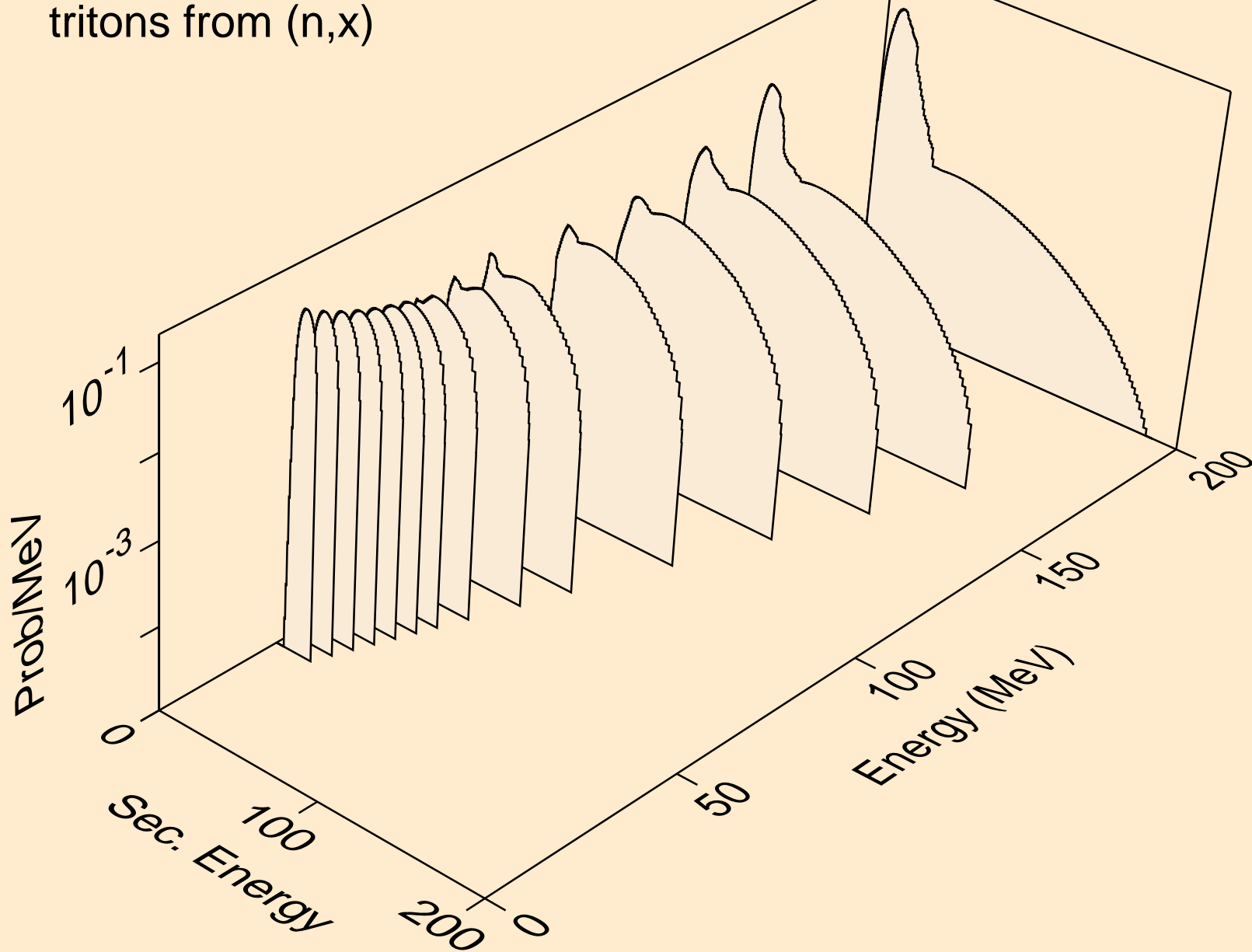

DY160 NEUTRON ACER TENDL-2019 LIBRARY; T=293.16K  
tritons from (n,n\*)t

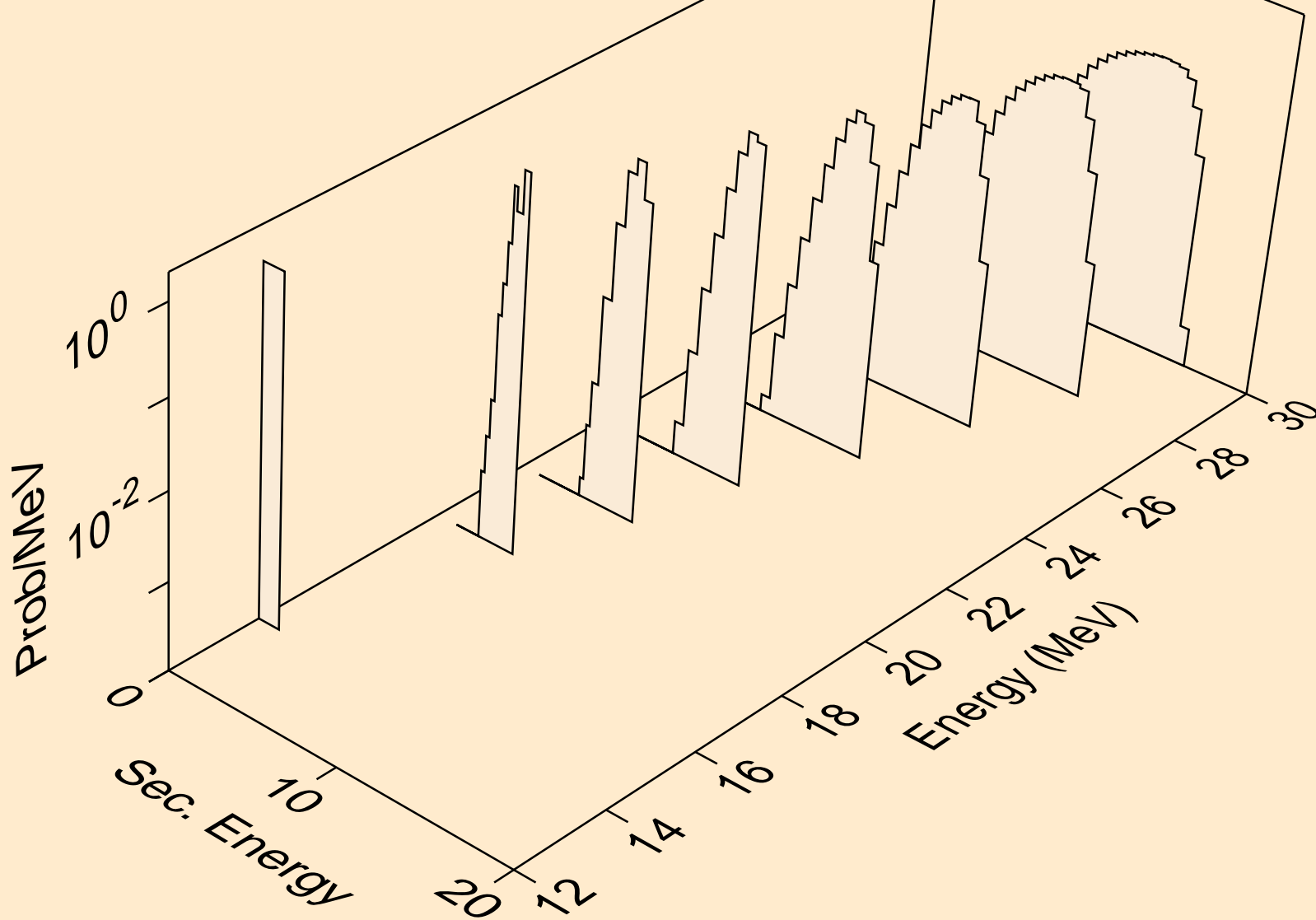

DY160 NEUTRON ACER TENDL-2019 LIBRARY; T=293.16K  
tritons from (n,t)

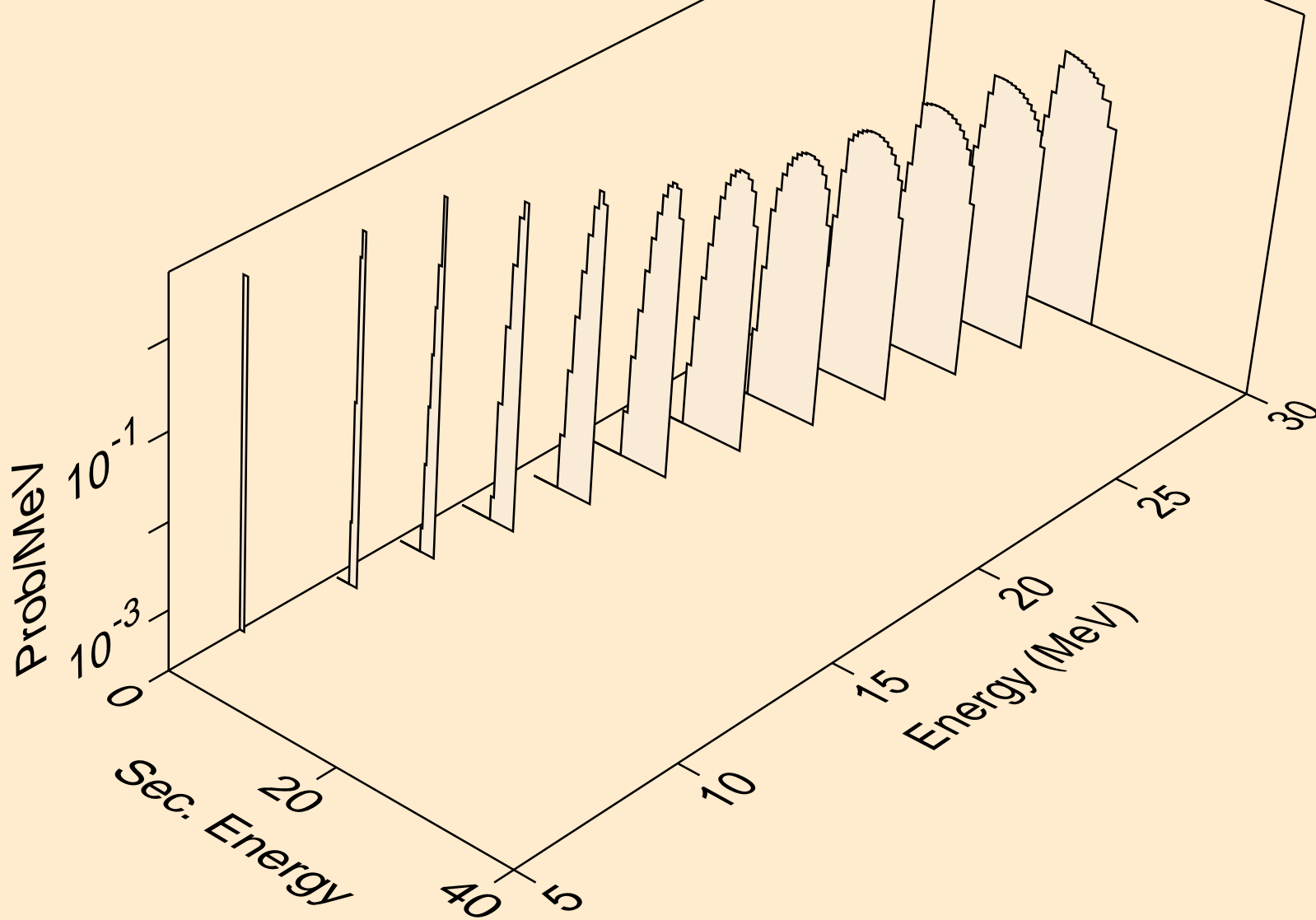



DY160 NEUTRON ACER TENDL-2019 LIBRARY; T=293.16K  
tritons from (n,pt)

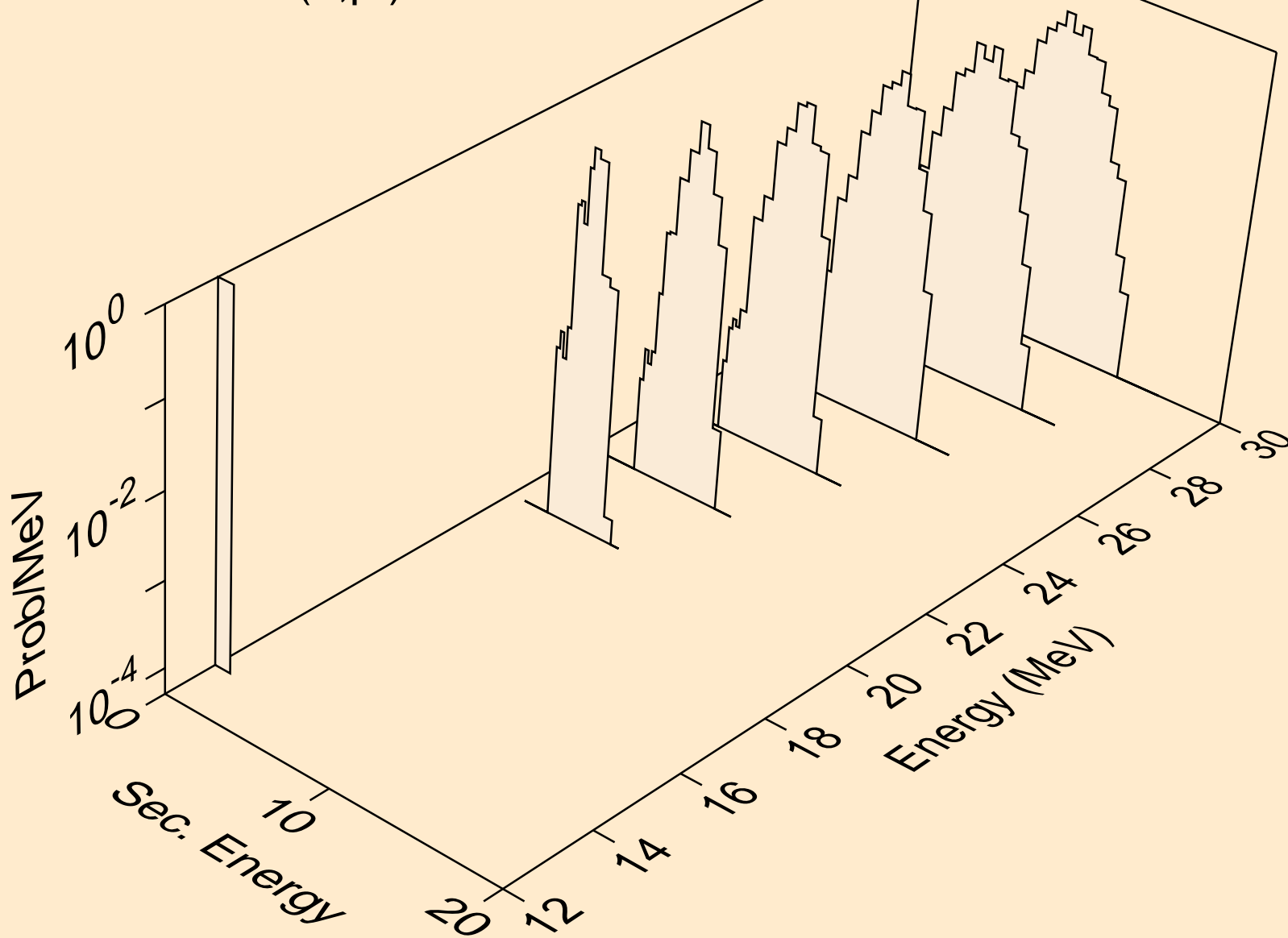

DY160 NEUTRON ACER TENDL-2019 LIBRARY; T=293.16K  
he3s from (n,x)

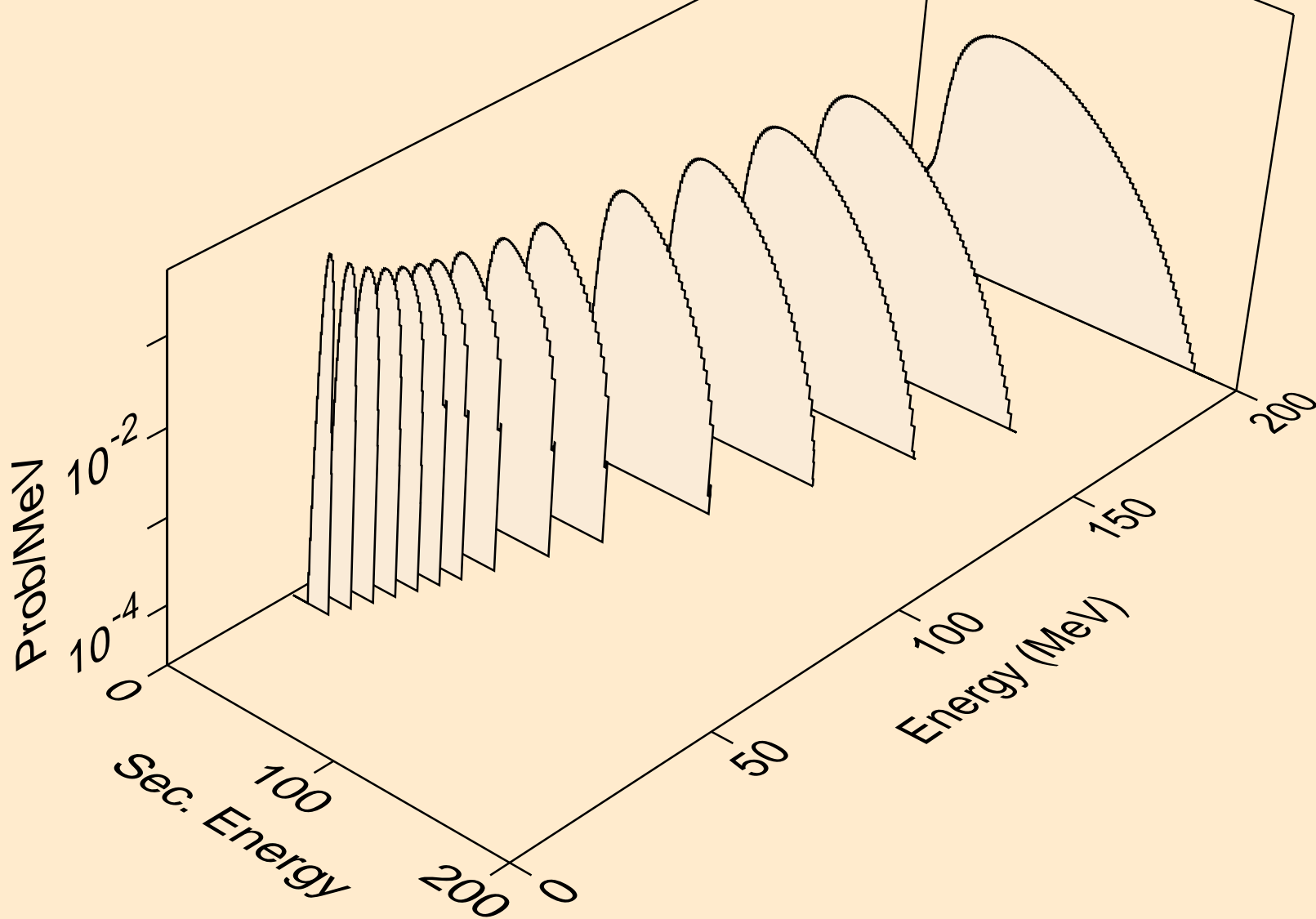

DY160 NEUTRON ACER TENDL-2019 LIBRARY; T=293.16K  
he3s from (n,n\*)he3

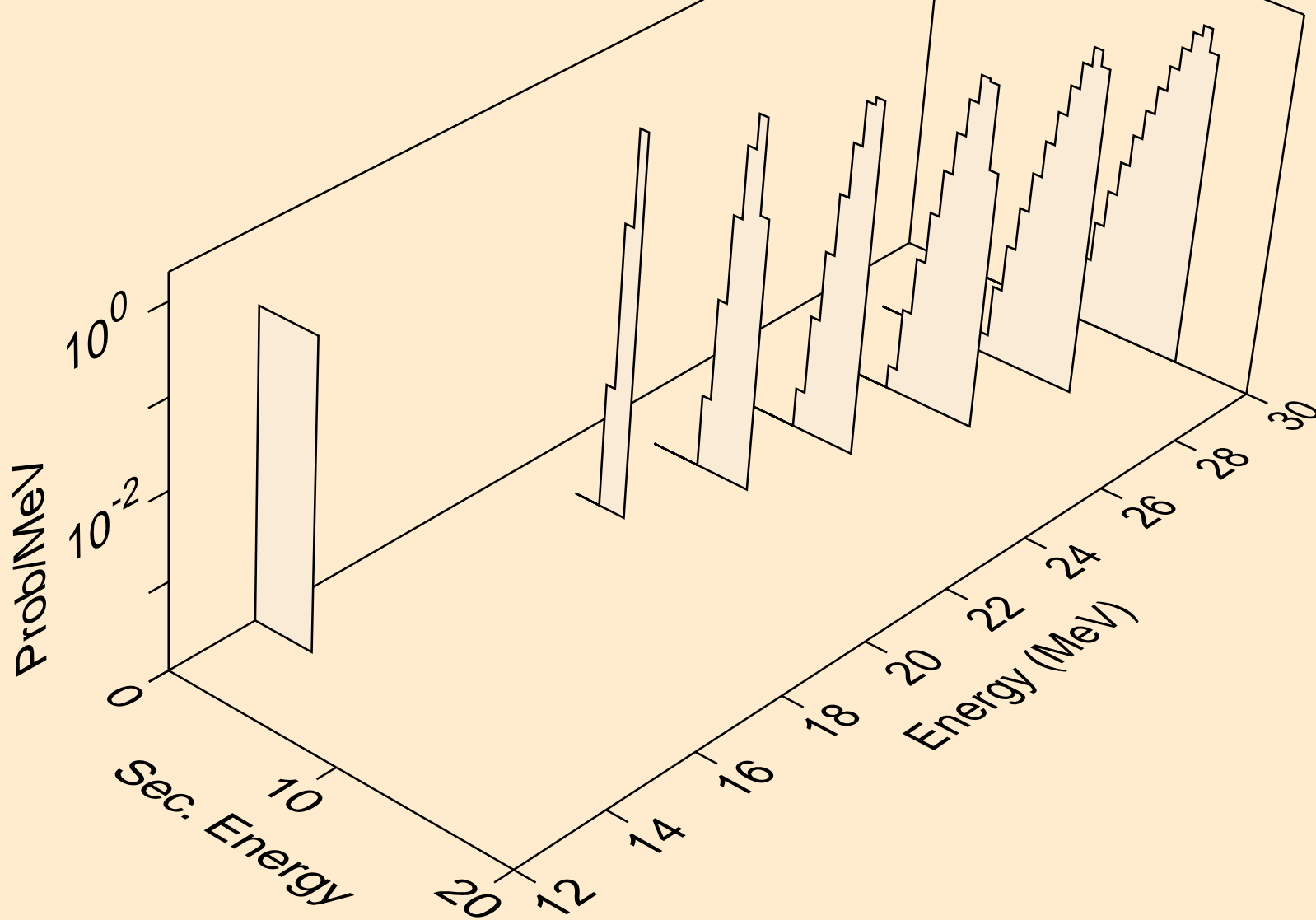

DY160 NEUTRON ACER TENDL-2019 LIBRARY; T=293.16K  
he3s from (n,he3)

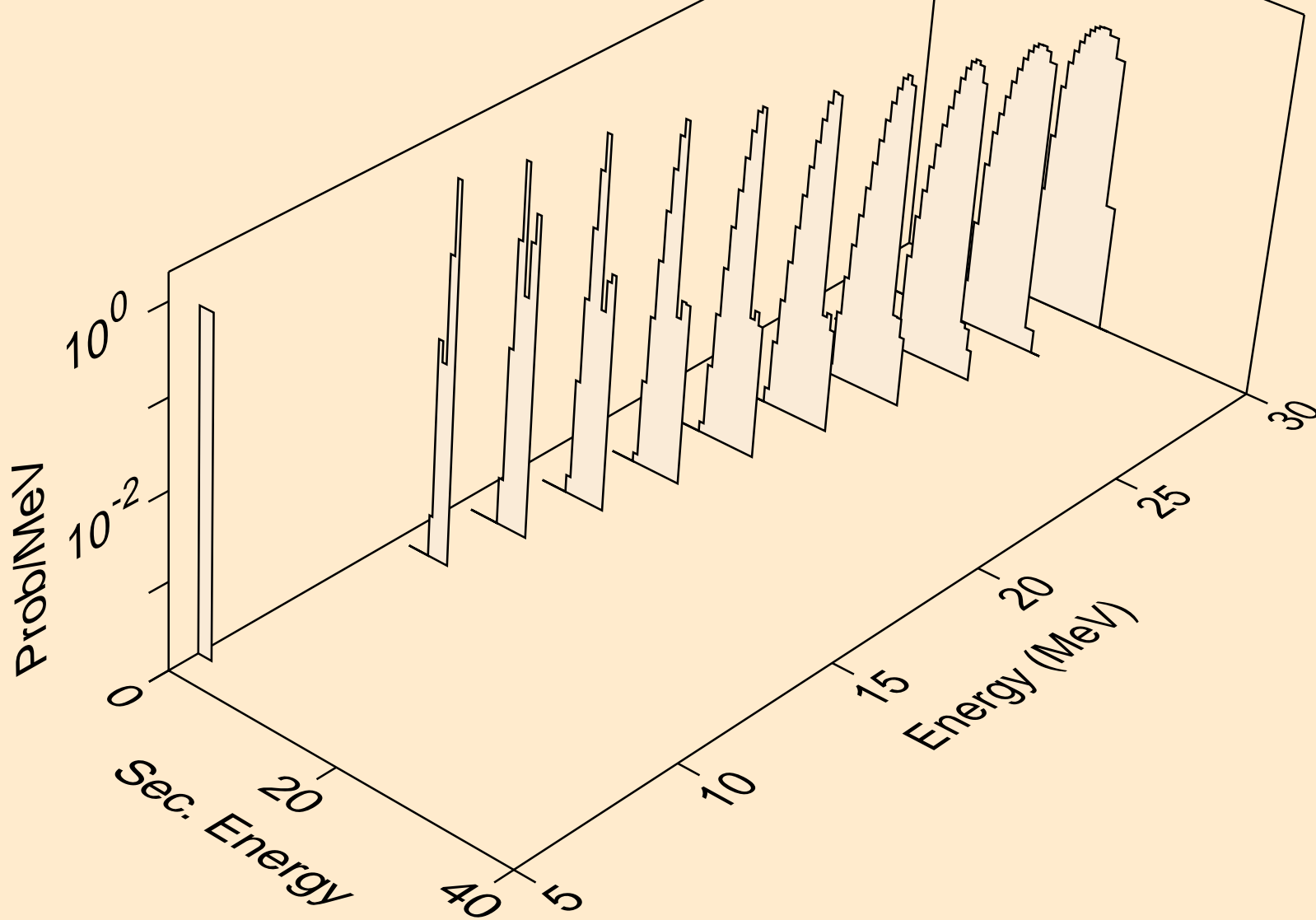

DY160 NEUTRON ACER TENDL-2019 LIBRARY; T=293.16K  
alphas from (n,x)

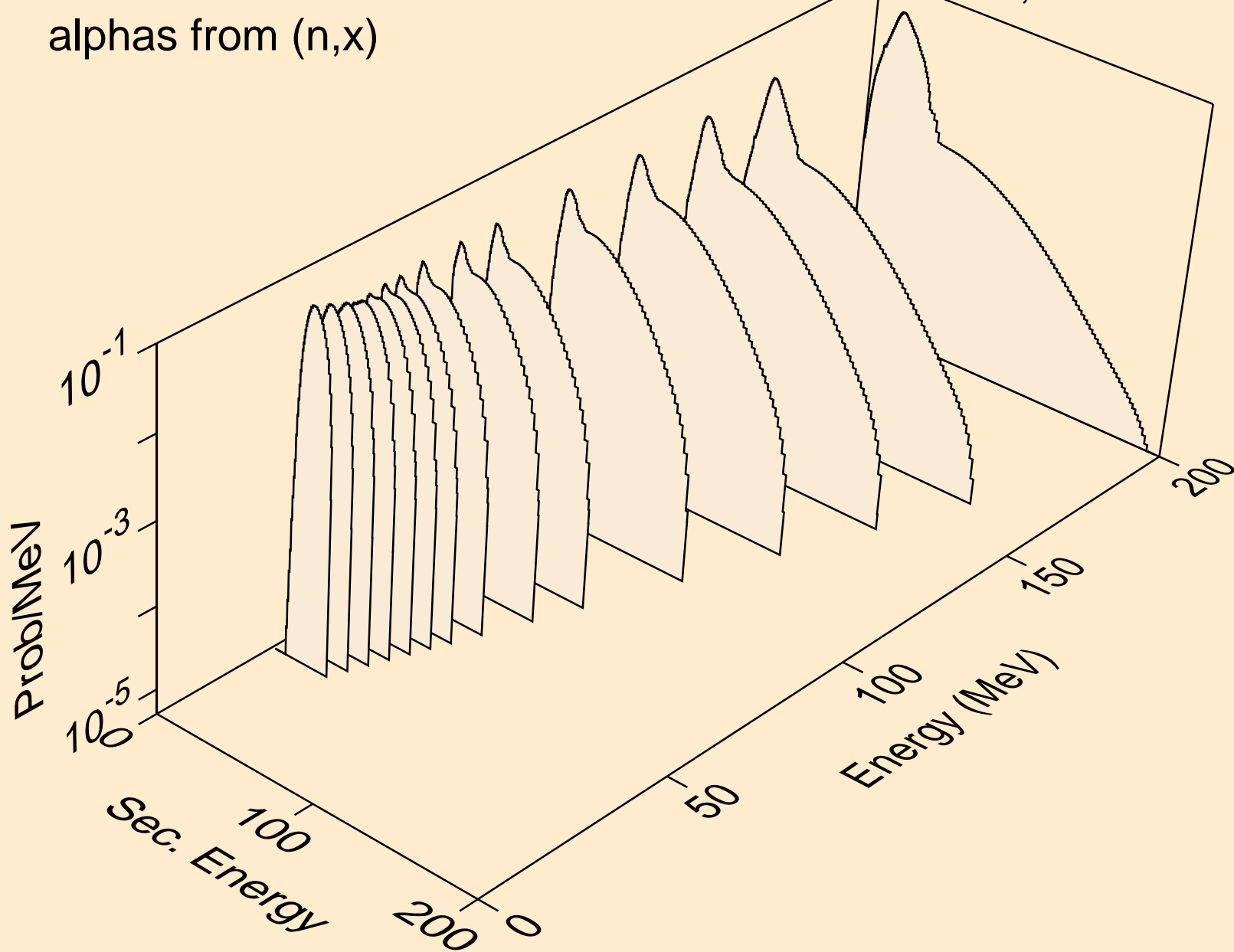

DY160 NEUTRON ACER TENDL-2019 LIBRARY; T=293.16K  
alphas from (n,n\*)a

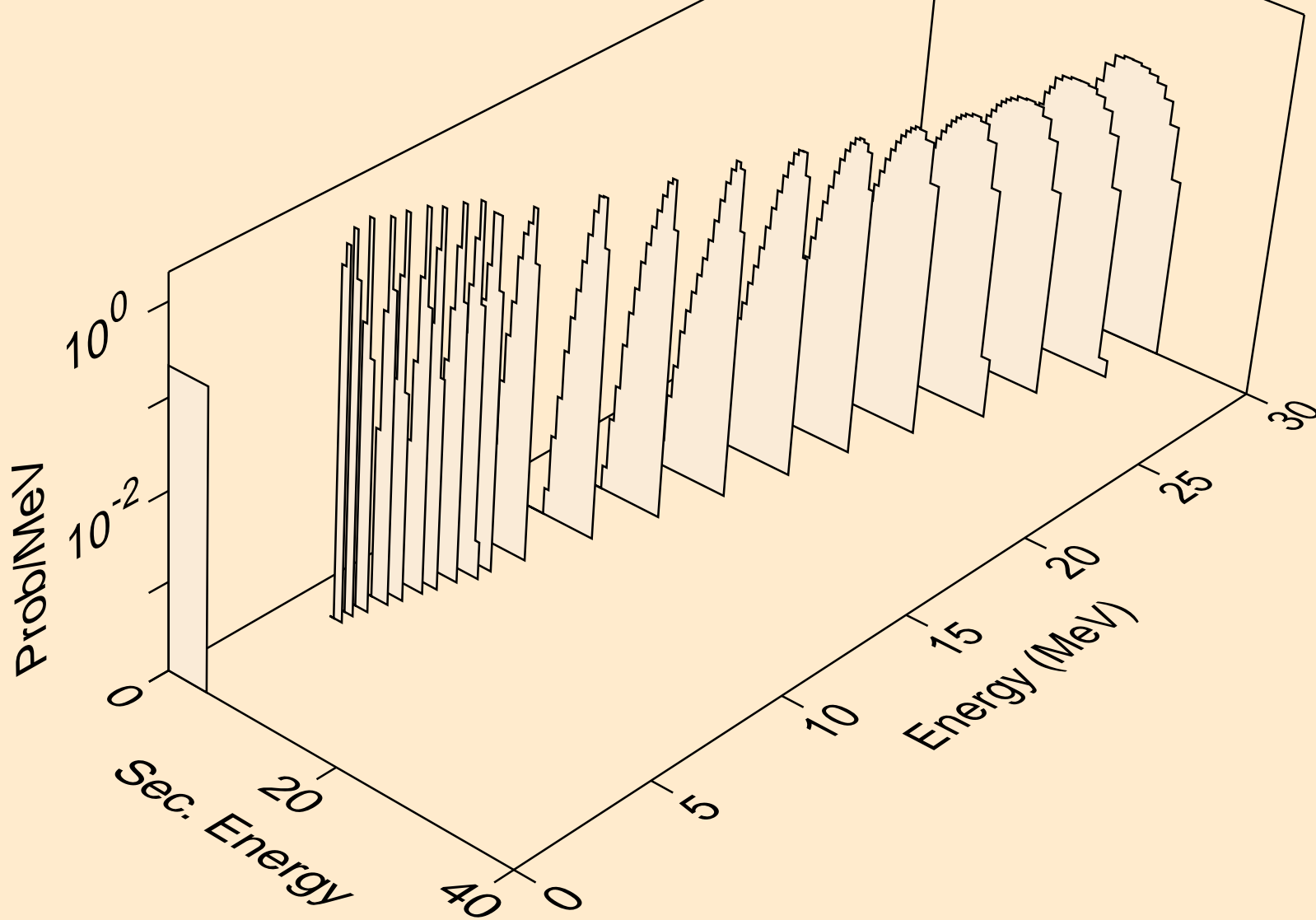

DY160 NEUTRON ACER TENDL-2019 LIBRARY; T=293.16K  
alphas from (n,2n)a

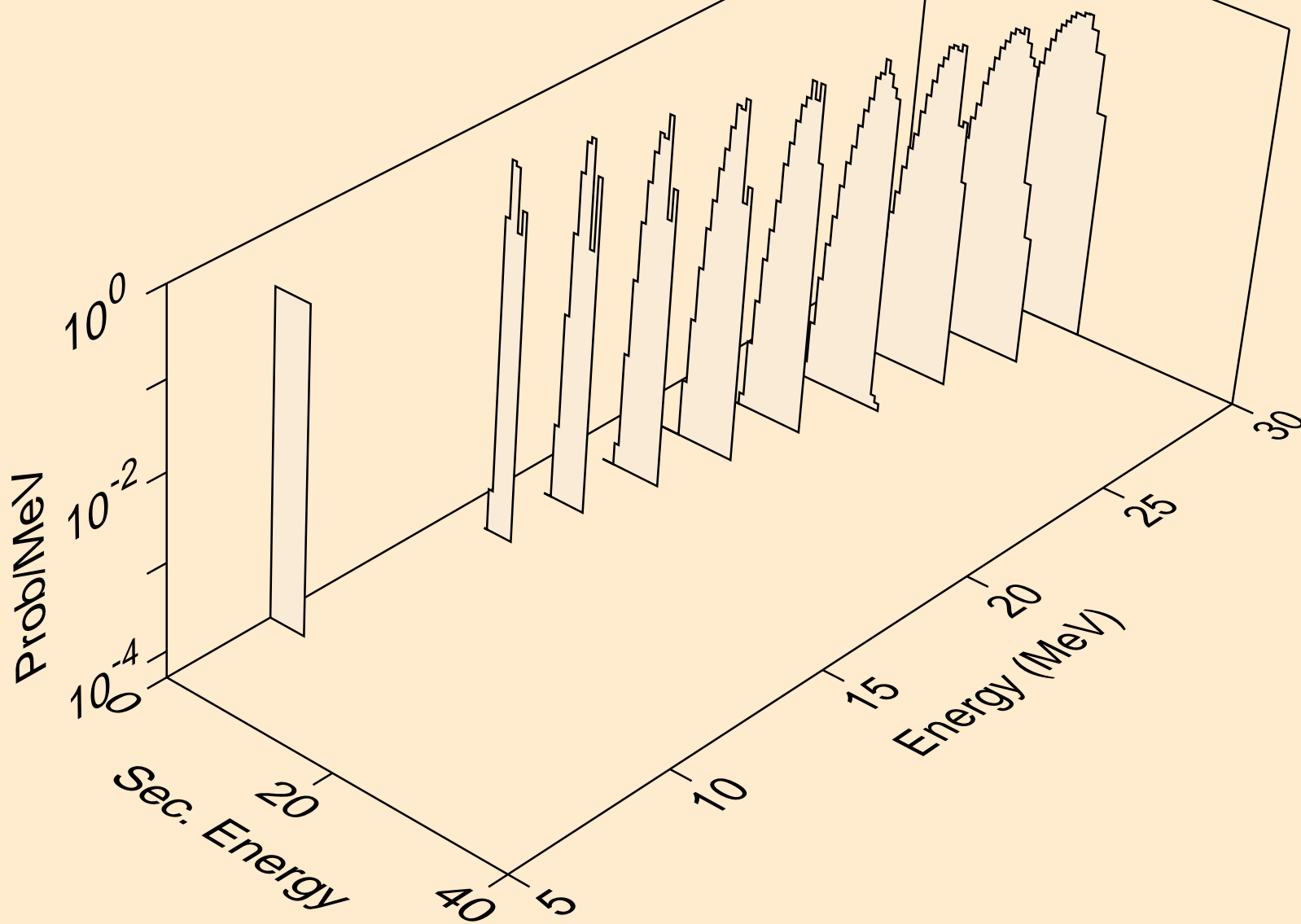

DY160 NEUTRON ACER TENDL-2019 LIBRARY; T=293.16K  
alphas from (n,3n)a

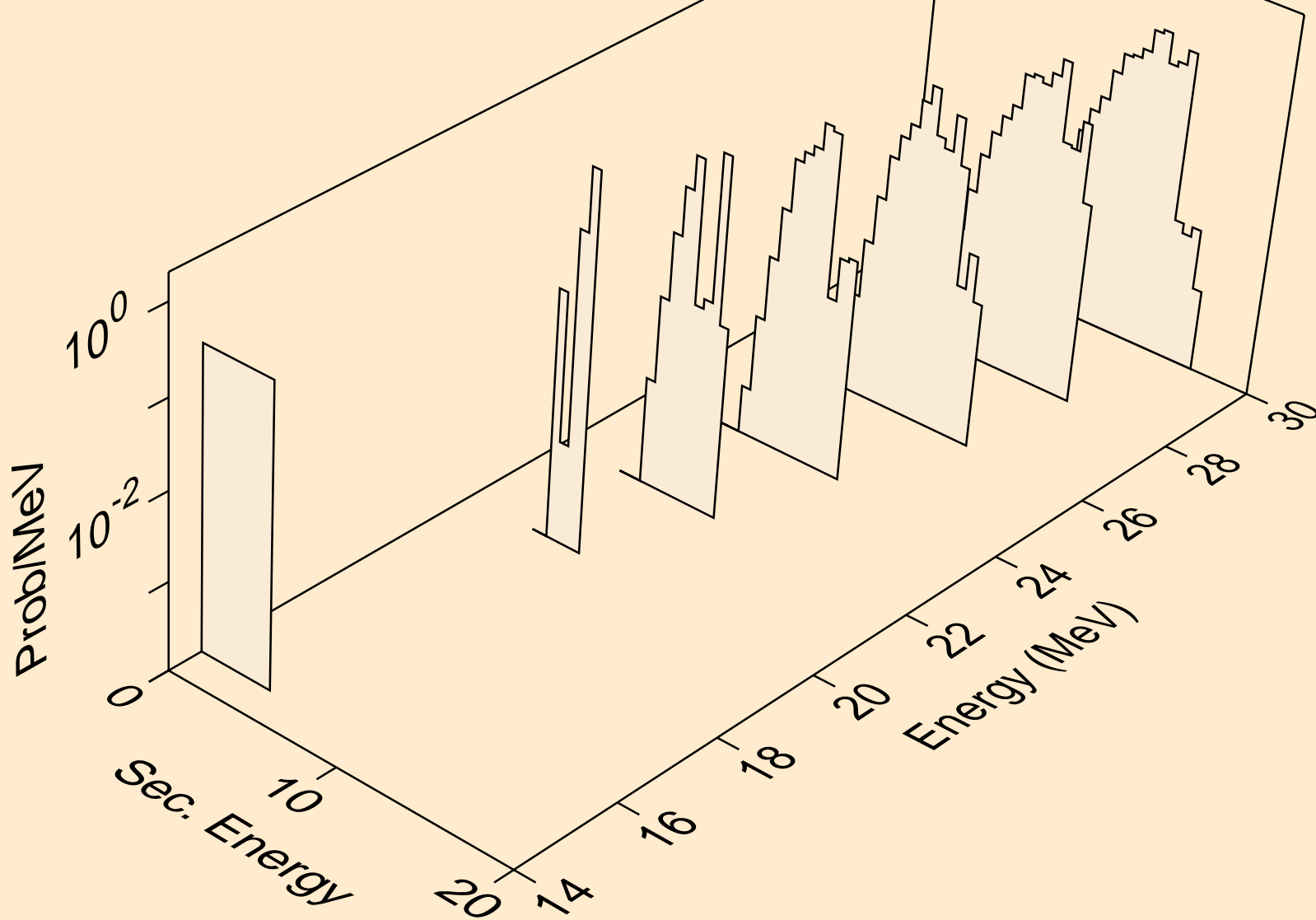



DY160 NEUTRON ACER TENDL-2019 LIBRARY; T=293.16K  
alphas from (n,n\*)2a

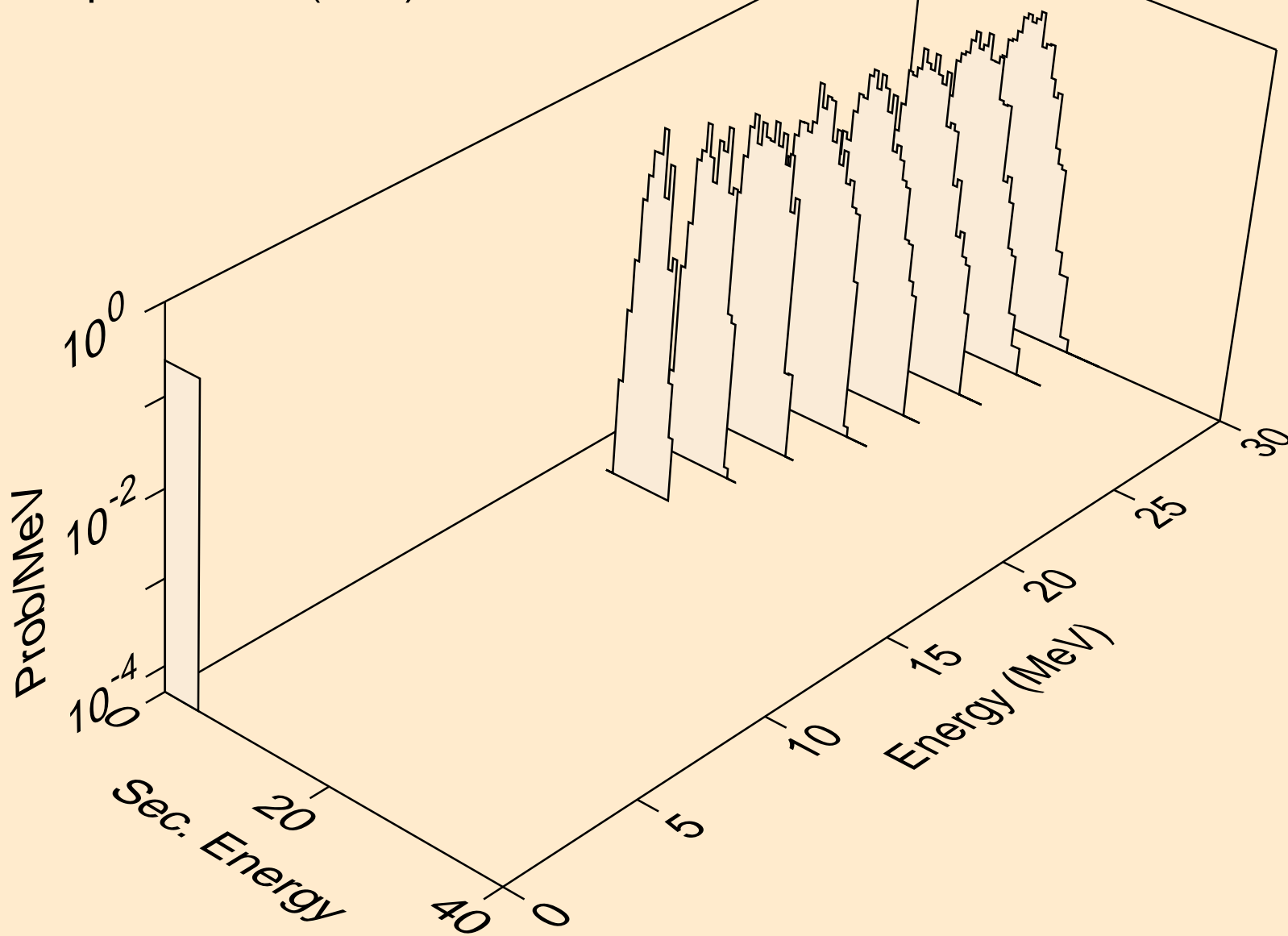

DY160 NEUTRON ACER TENDL-2019 LIBRARY; T=293.16K  
alphas from (n,npa)

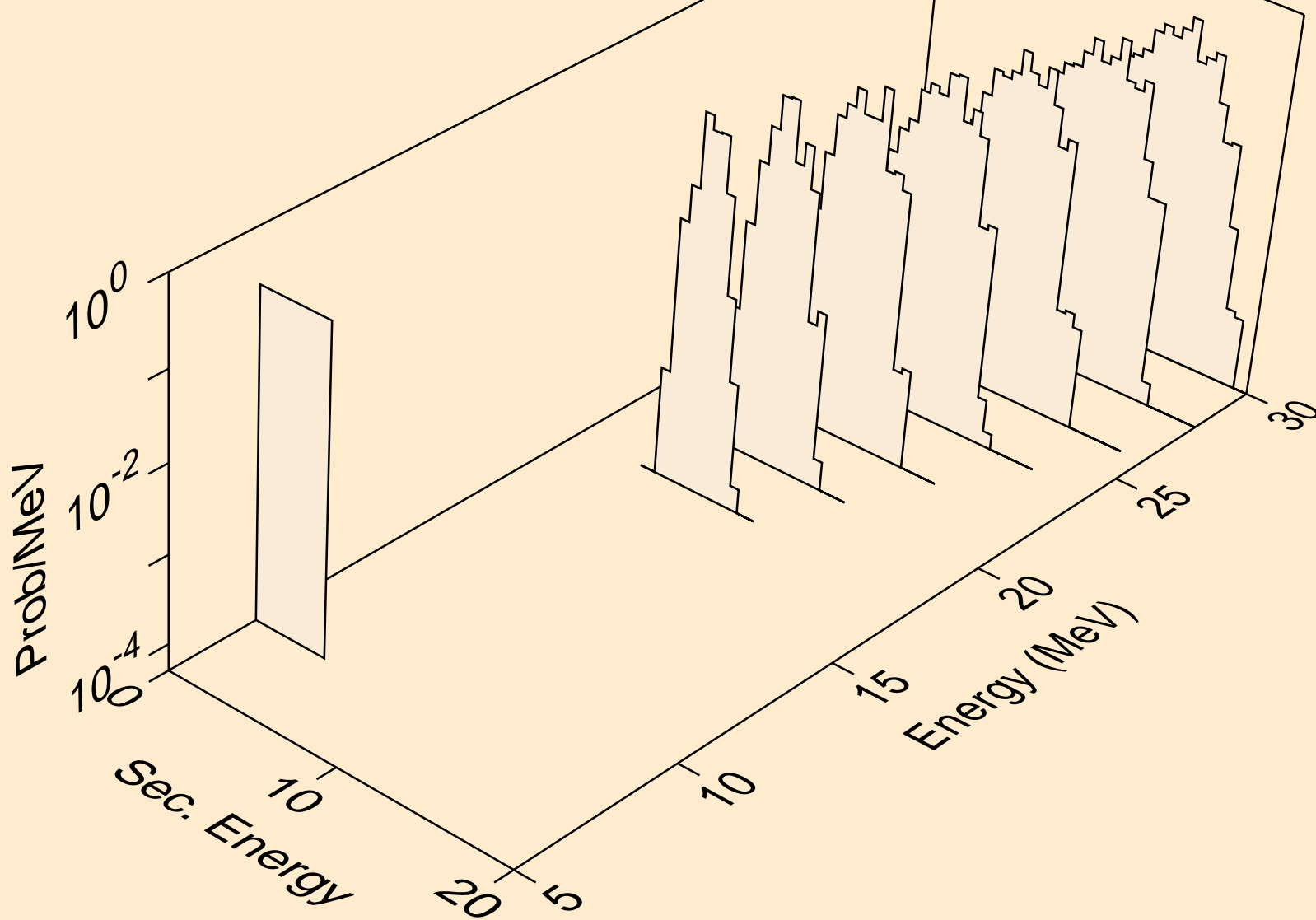

DY160 NEUTRON ACER TENDL-2019 LIBRARY; T=293.16K  
alphas from (n,a)

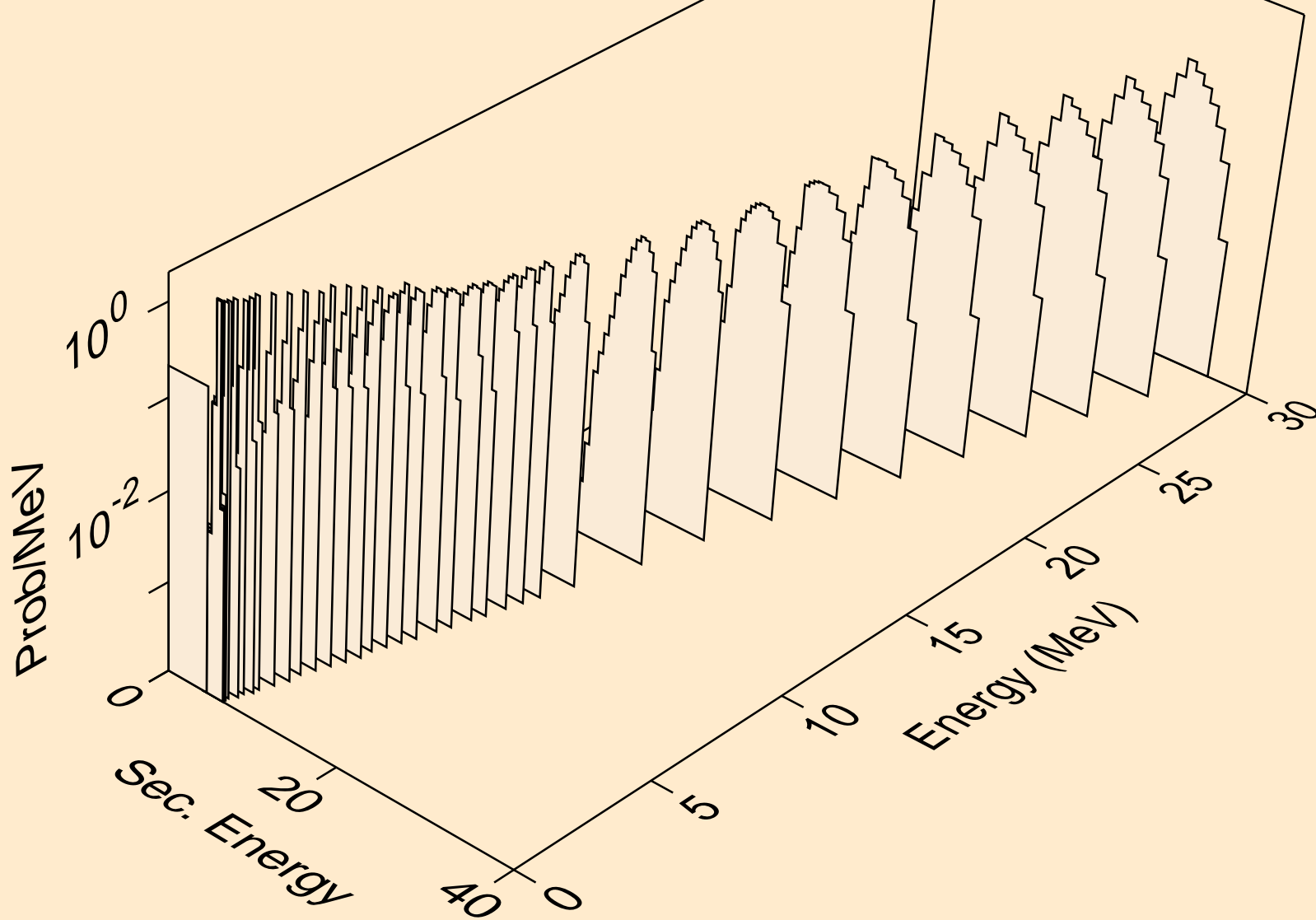

DY160 NEUTRON ACER TENDL-2019 LIBRARY; T=293.16K  
alphas from (n,2a)

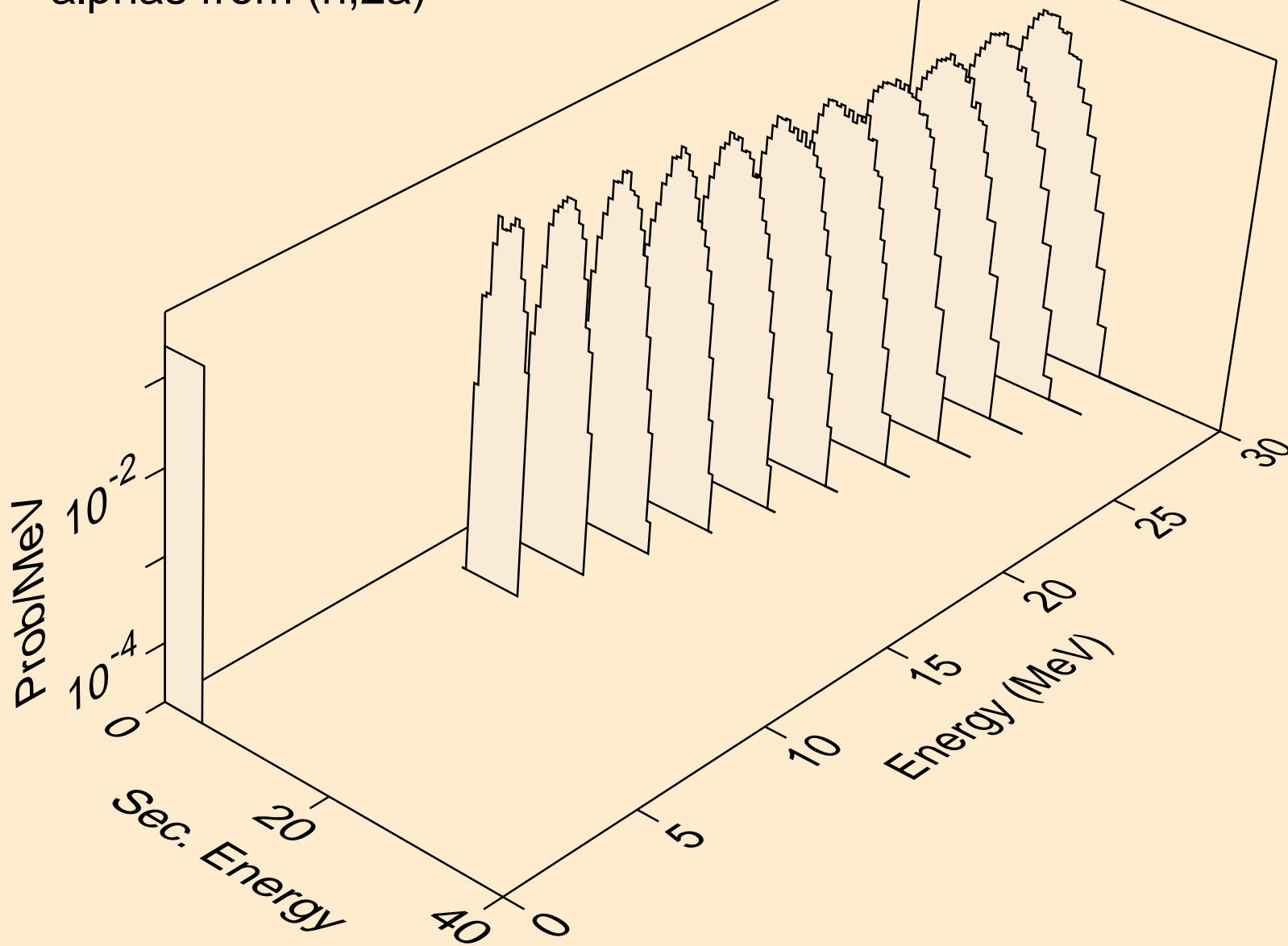

DY160 NEUTRON ACER TENDL-2019 LIBRARY; T=293.16K  
alphas from (n,pa)

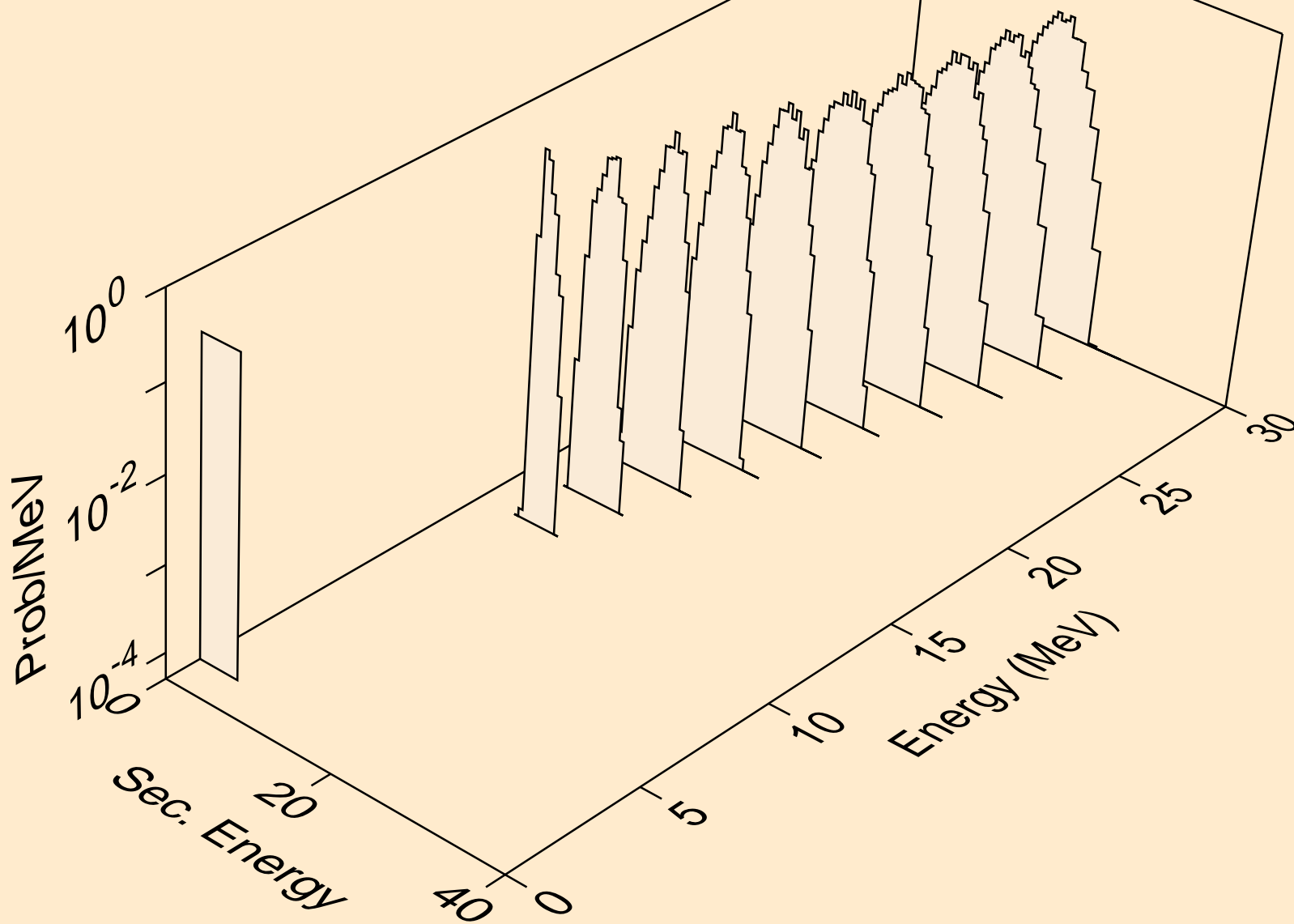

DY160 NEUTRON ACER TENDL-2019 LIBRARY; T=293.16K  
alphas from (n,da)

