

ER149 NEUTRON ACER TENDL-2019 LIBRARY; T=293.16K  
Principal cross sections

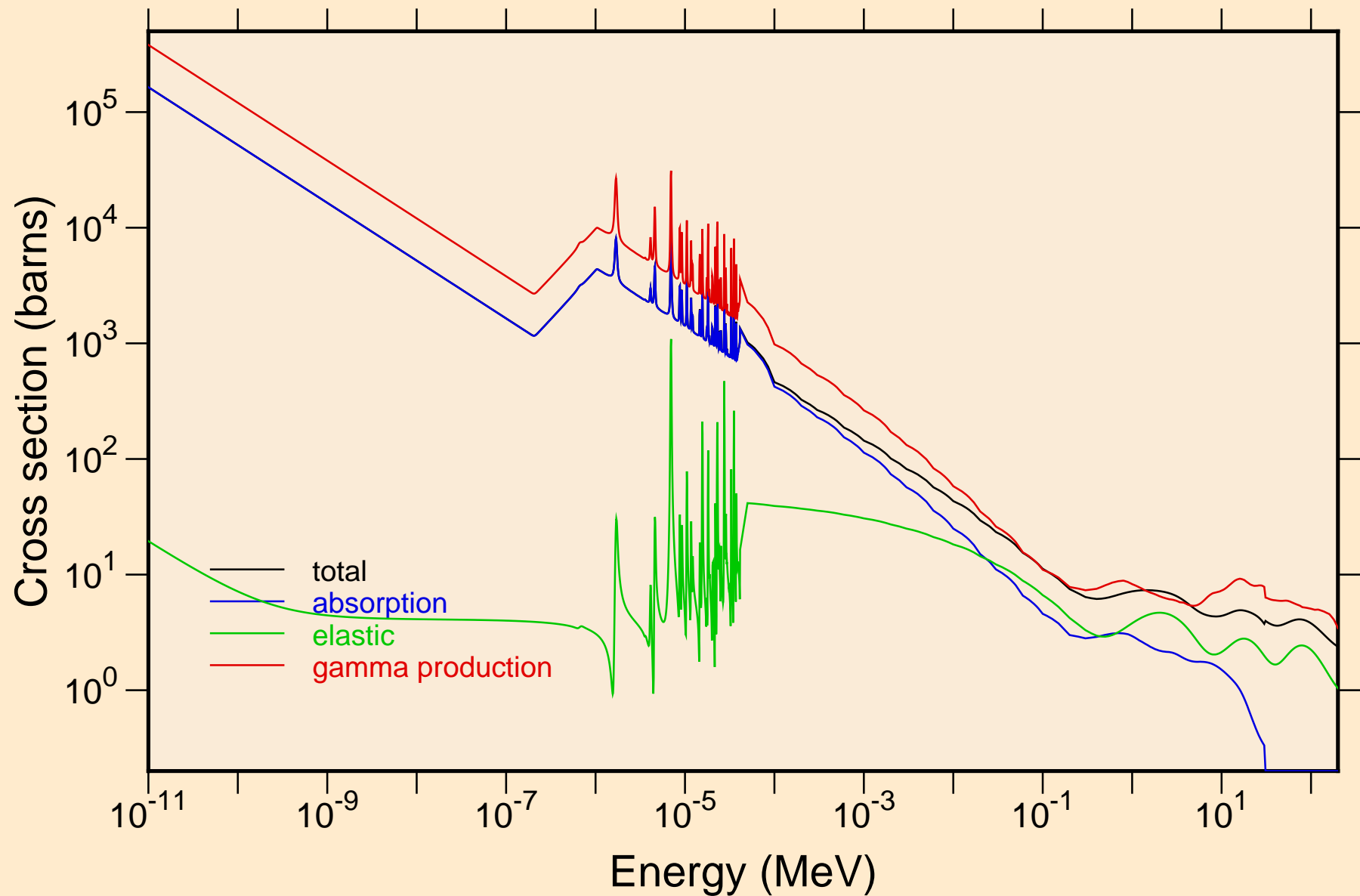

ER149 NEUTRON ACER TENDL-2019 LIBRARY; T=293.16K  
resonance total cross section

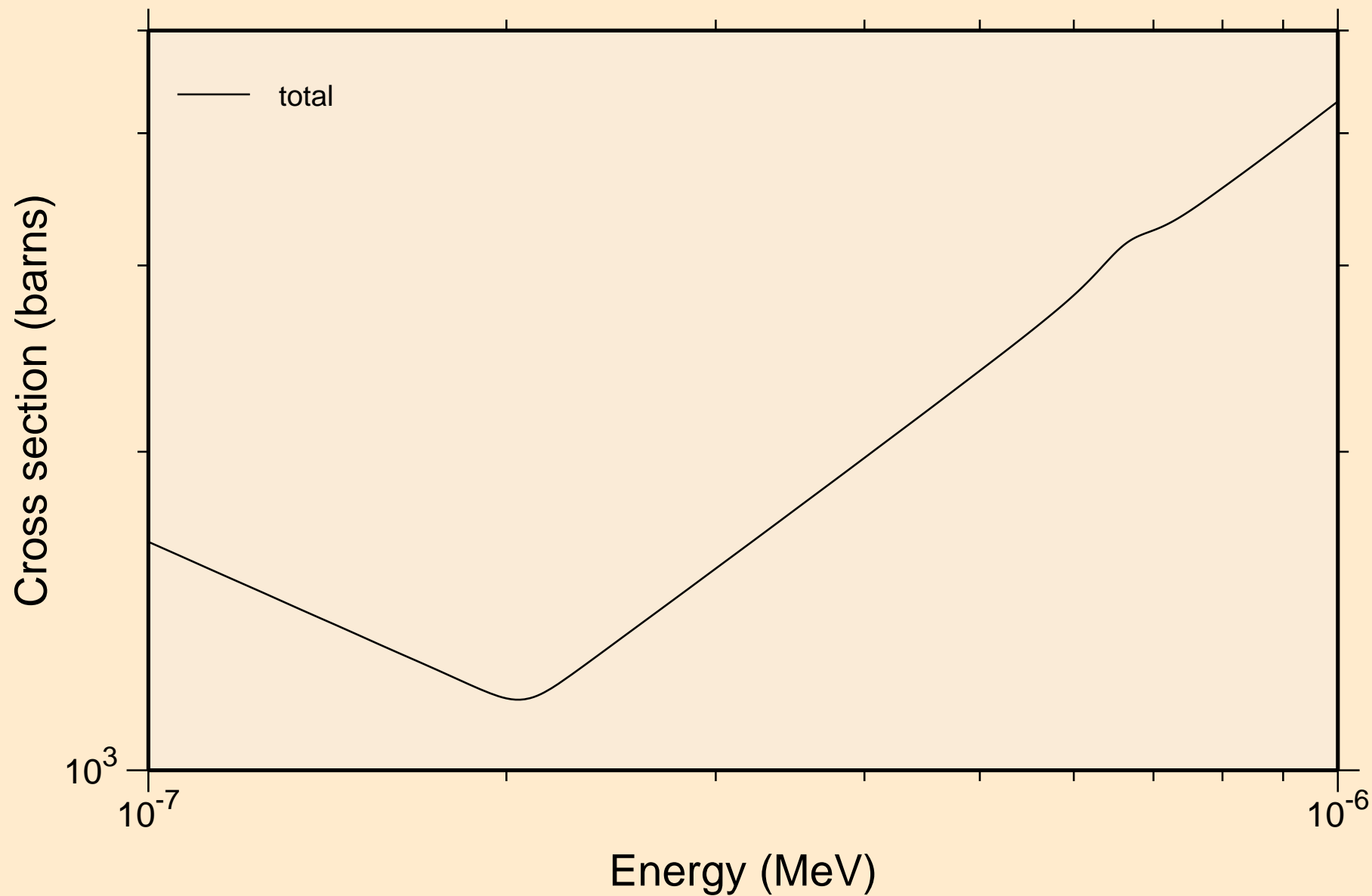

ER149 NEUTRON ACER TENDL-2019 LIBRARY; T=293.16K  
resonance total cross section

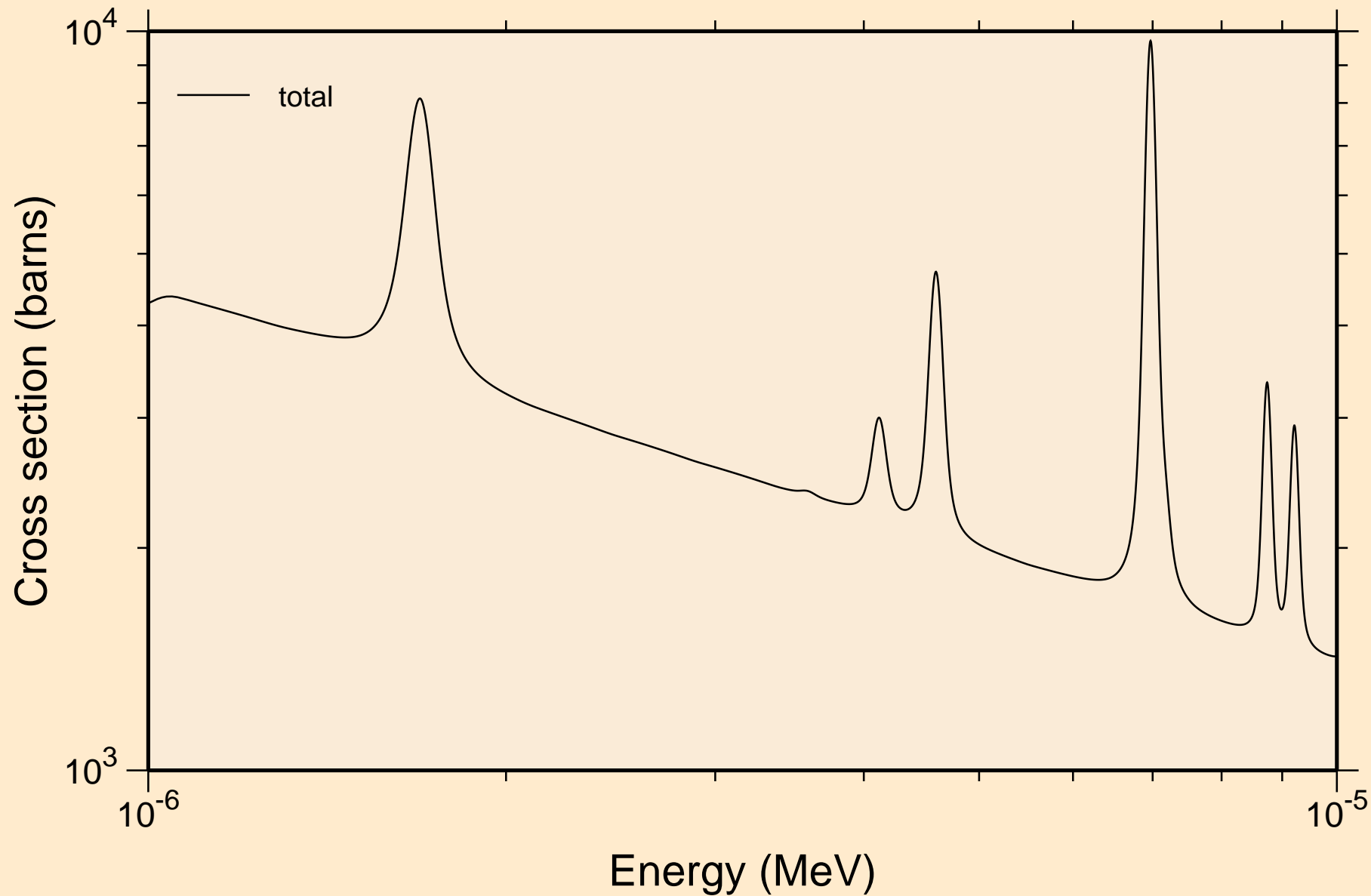

ER149 NEUTRON ACER TENDL-2019 LIBRARY; T=293.16K  
resonance total cross section

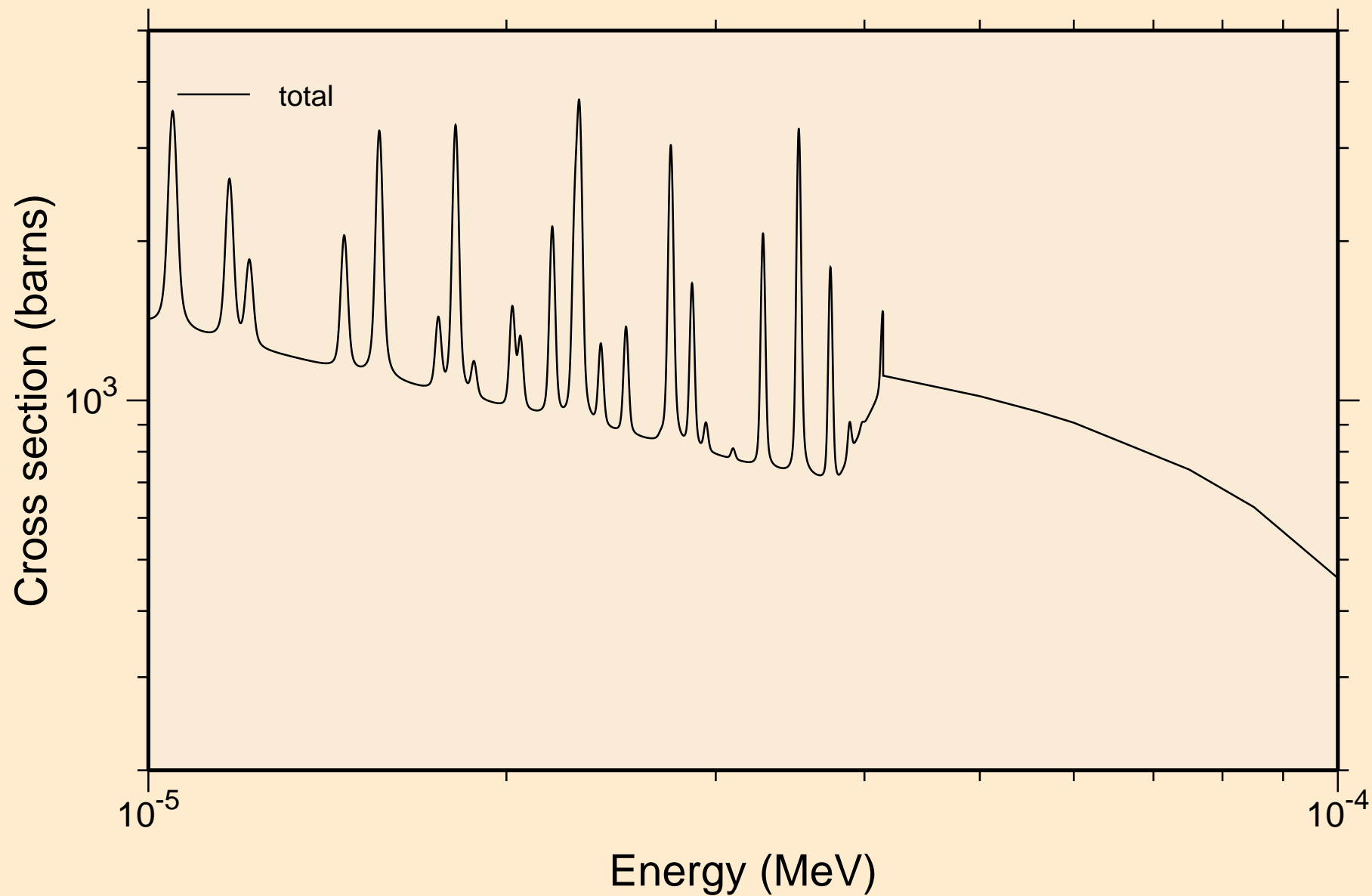

ER149 NEUTRON ACER TENDL-2019 LIBRARY; T=293.16K  
resonance total cross section

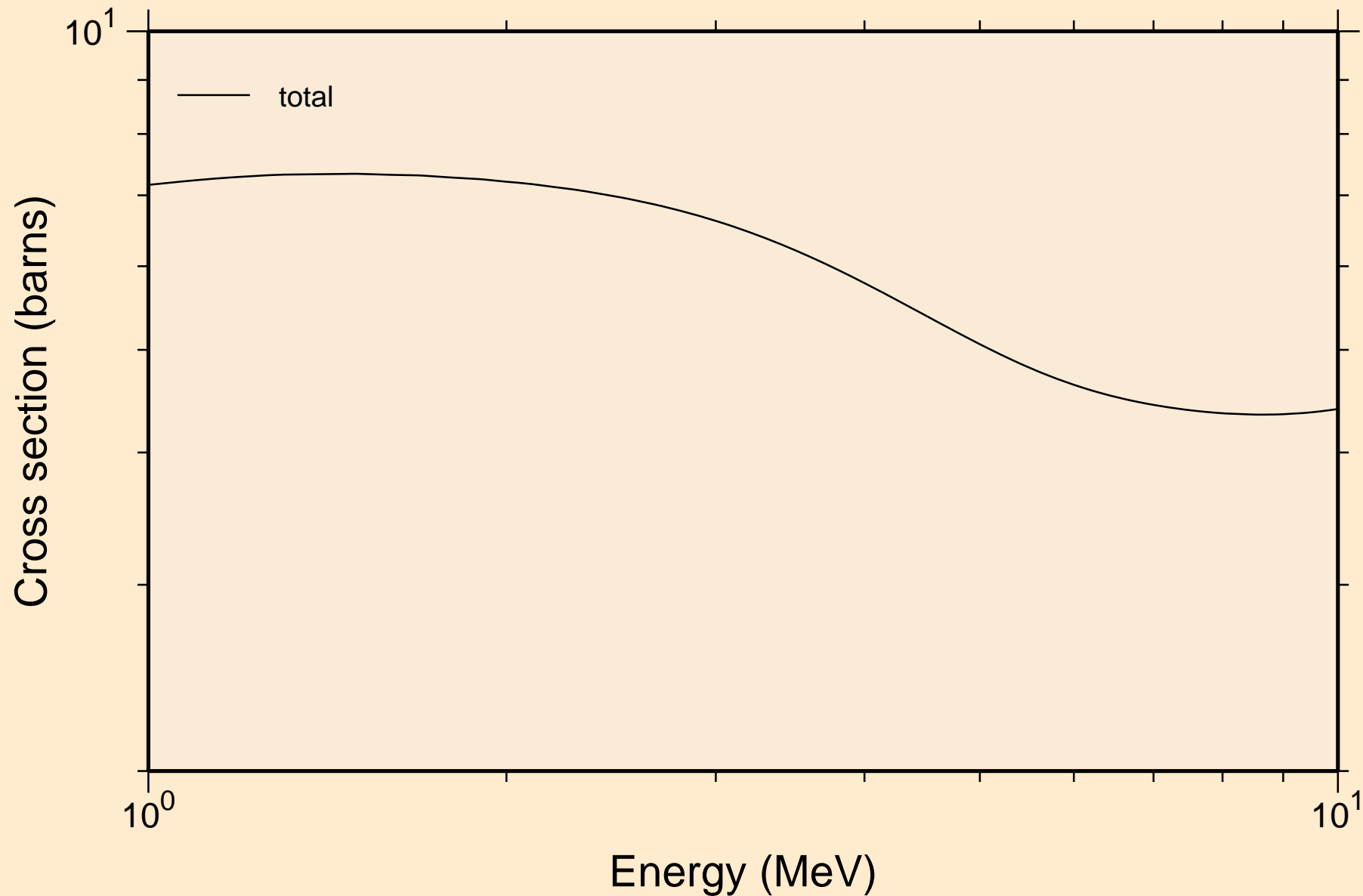

ER149 NEUTRON ACER TENDL-2019 LIBRARY; T=293.16K  
resonance absorption cross sections

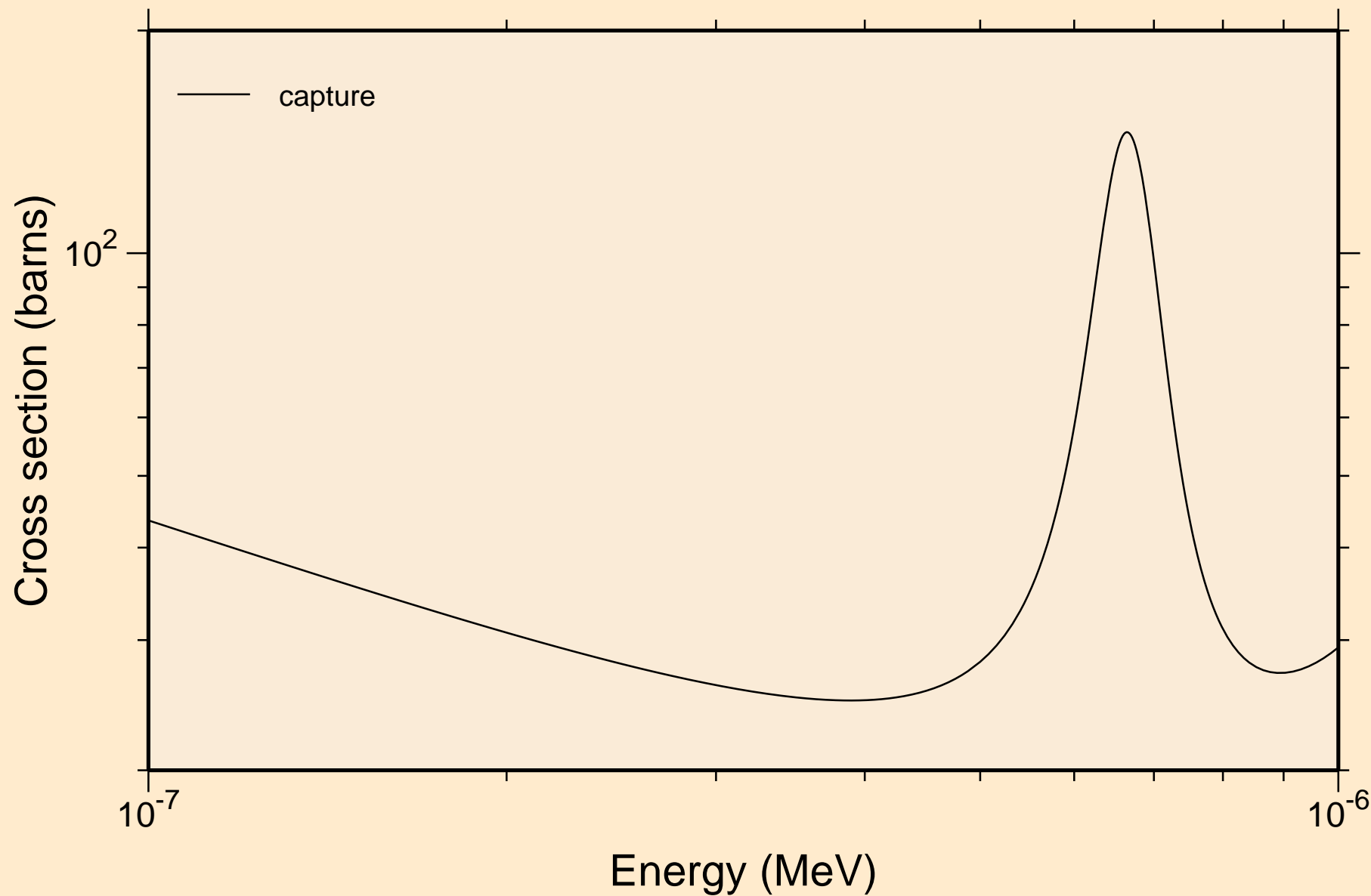

ER149 NEUTRON ACER TENDL-2019 LIBRARY; T=293.16K  
resonance absorption cross sections

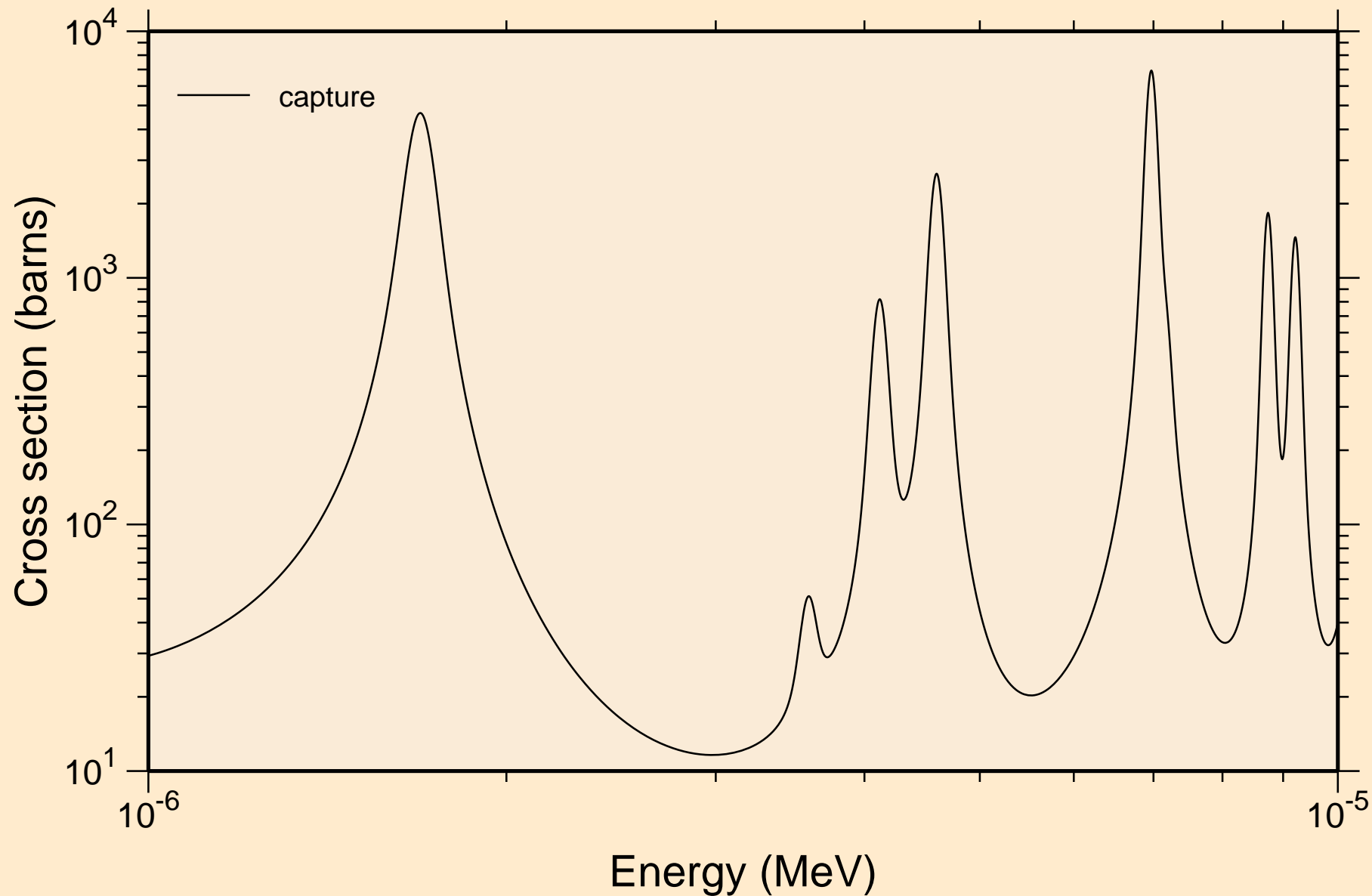

ER149 NEUTRON ACER TENDL-2019 LIBRARY; T=293.16K  
resonance absorption cross sections

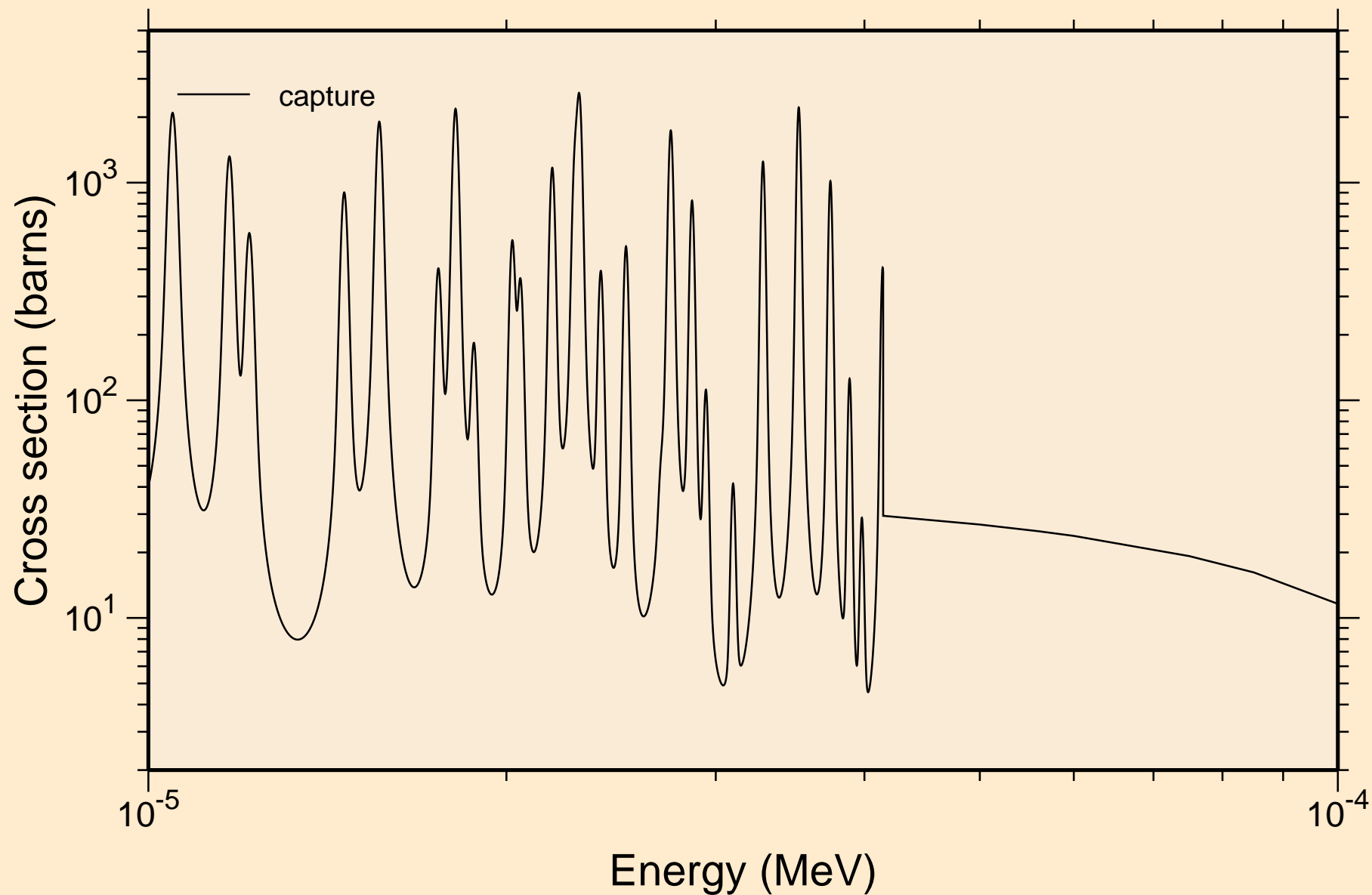



ER149 NEUTRON ACER TENDL-2019 LIBRARY; T=293.16K  
resonance absorption cross sections

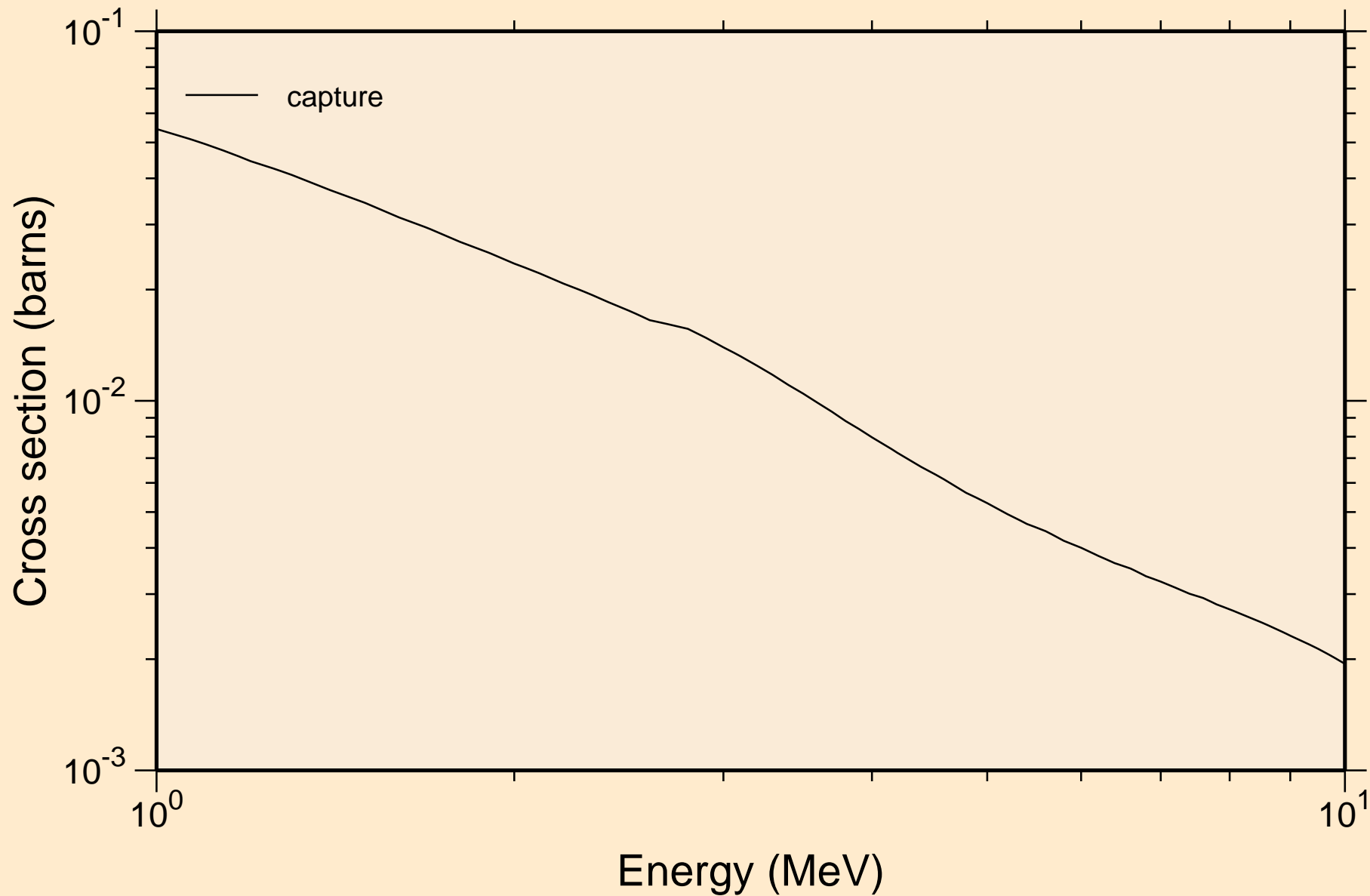

ER149 NEUTRON ACER TENDL-2019 LIBRARY; T=293.16K  
Heating

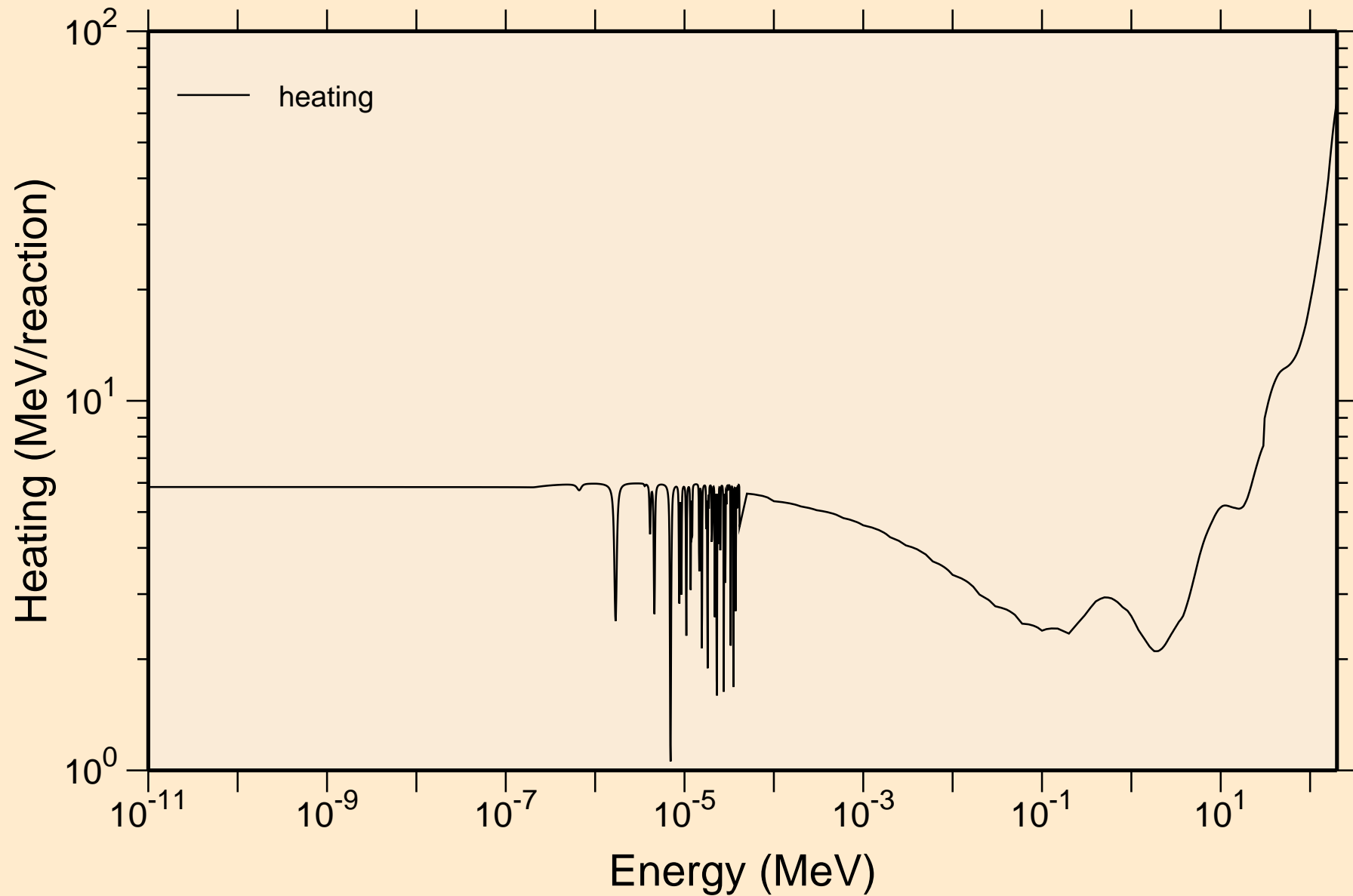

ER149 NEUTRON ACER TENDL-2019 LIBRARY; T=293.16K  
Damage

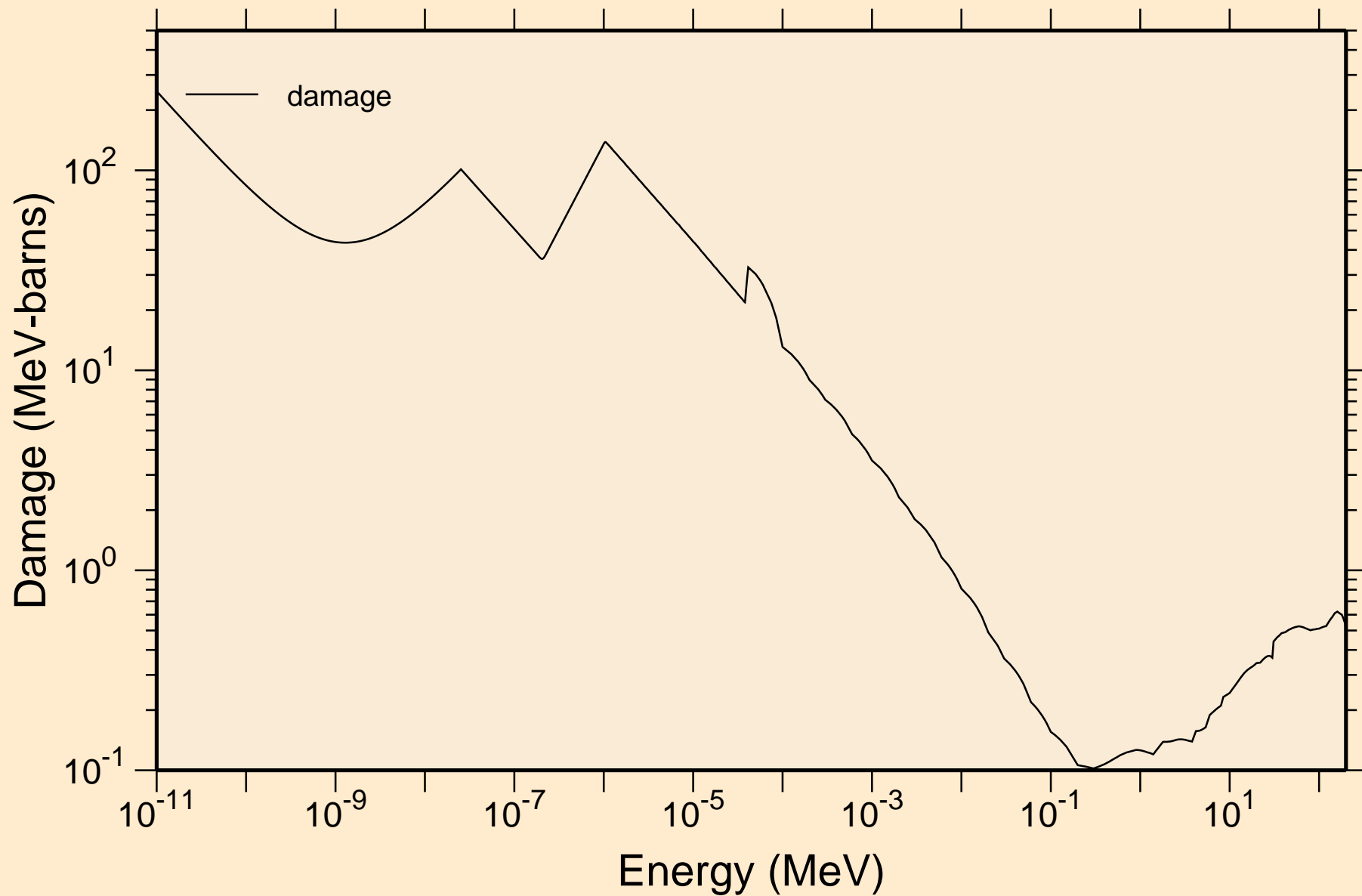

ER149 NEUTRON ACER TENDL-2019 LIBRARY; T=293.16K  
Non-threshold reactions

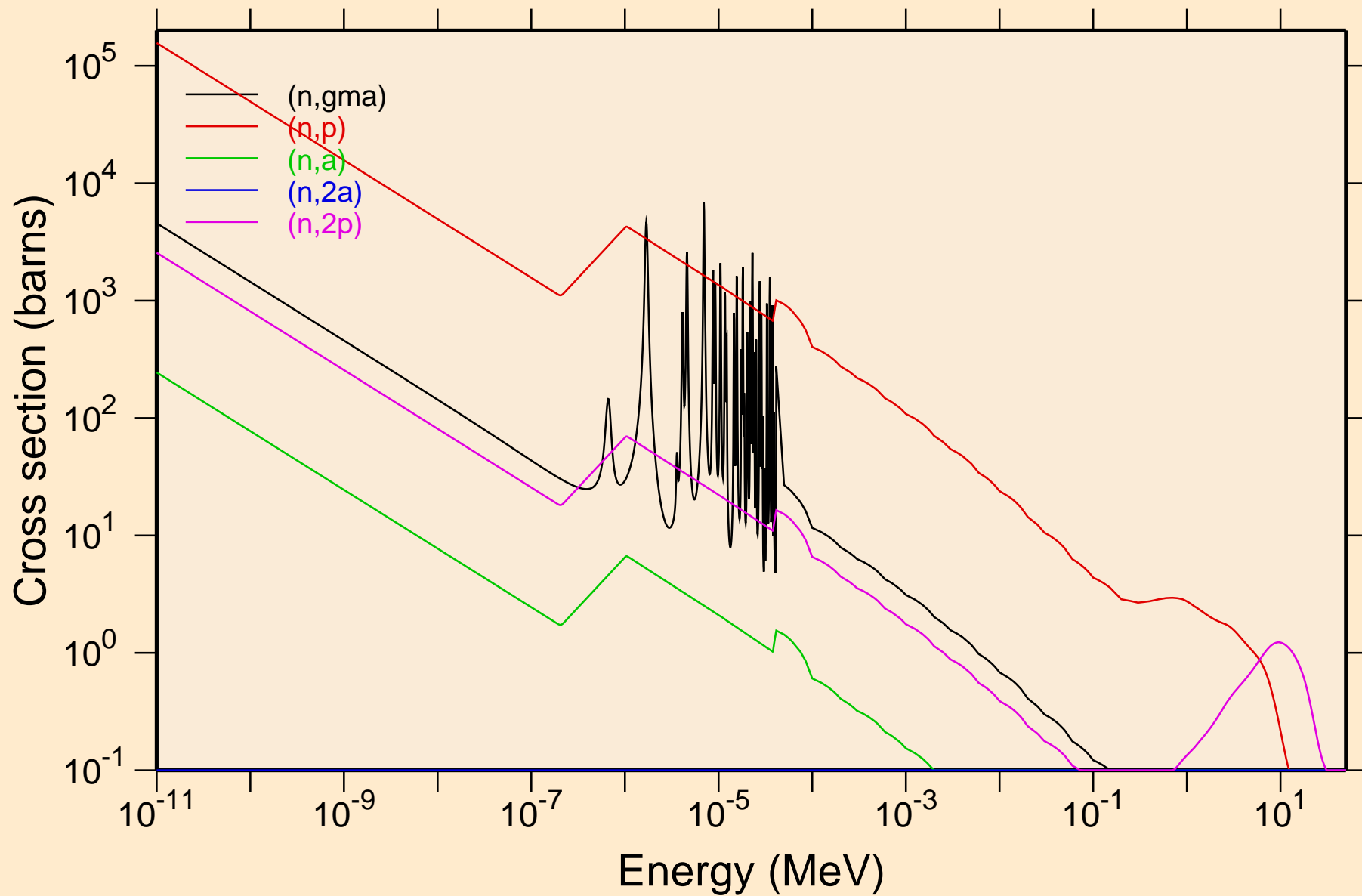

ER149 NEUTRON ACER TENDL-2019 LIBRARY; T=293.16K  
Non-threshold reactions

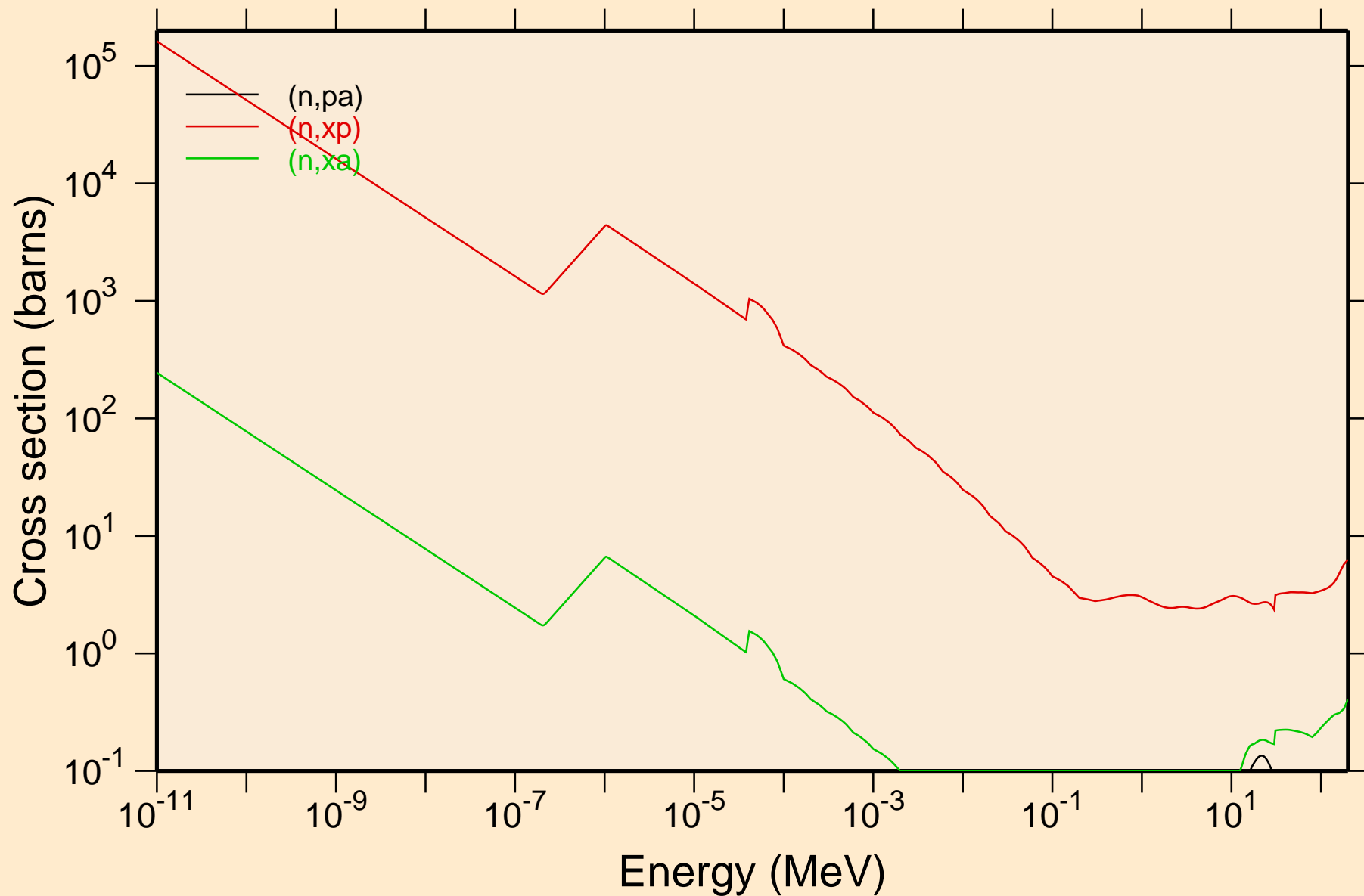

ER149 NEUTRON ACER TENDL-2019 LIBRARY; T=293.16K  
Principal cross sections

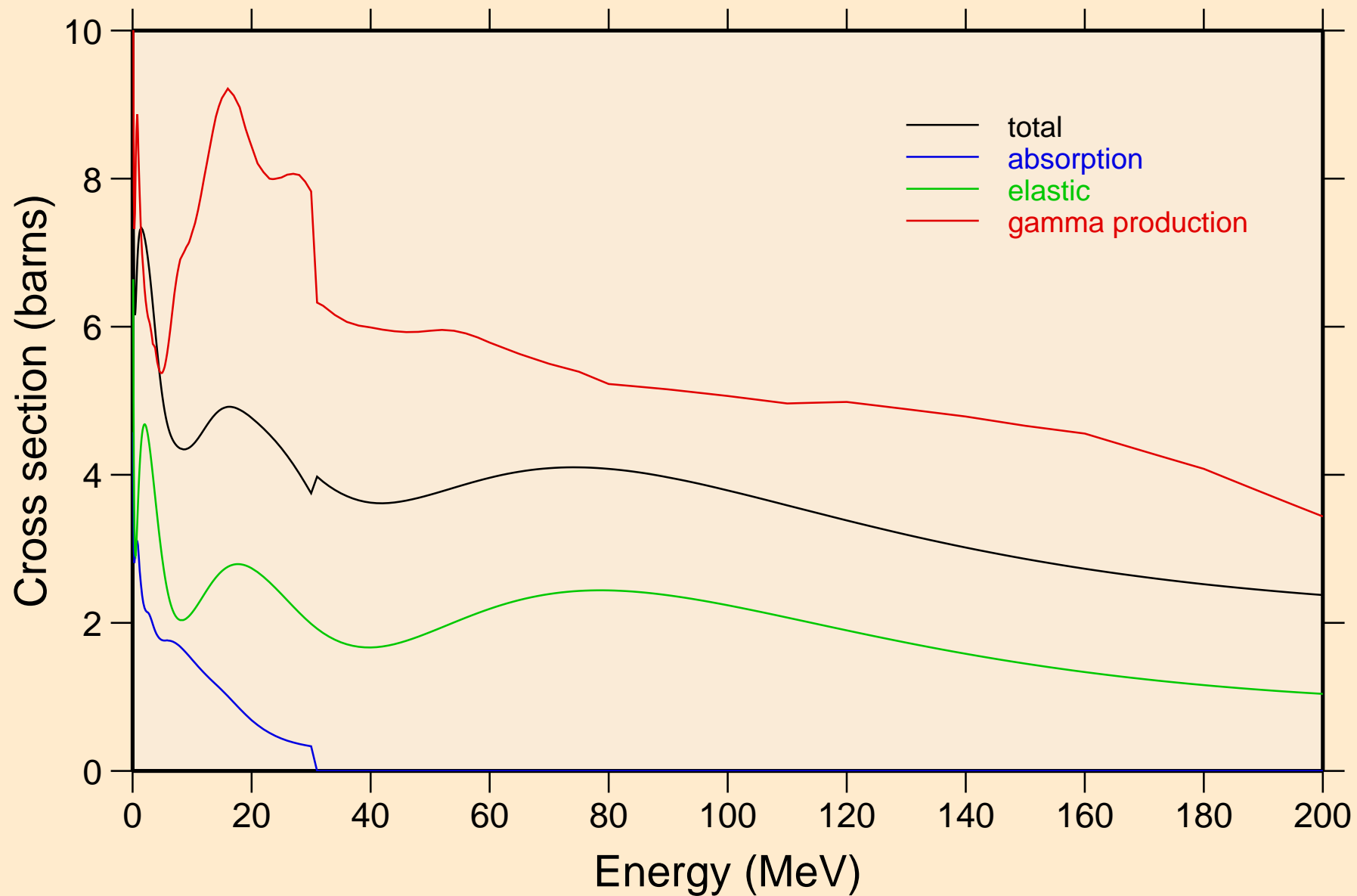

ER149 NEUTRON ACER TENDL-2019 LIBRARY; T=293.16K  
Heating

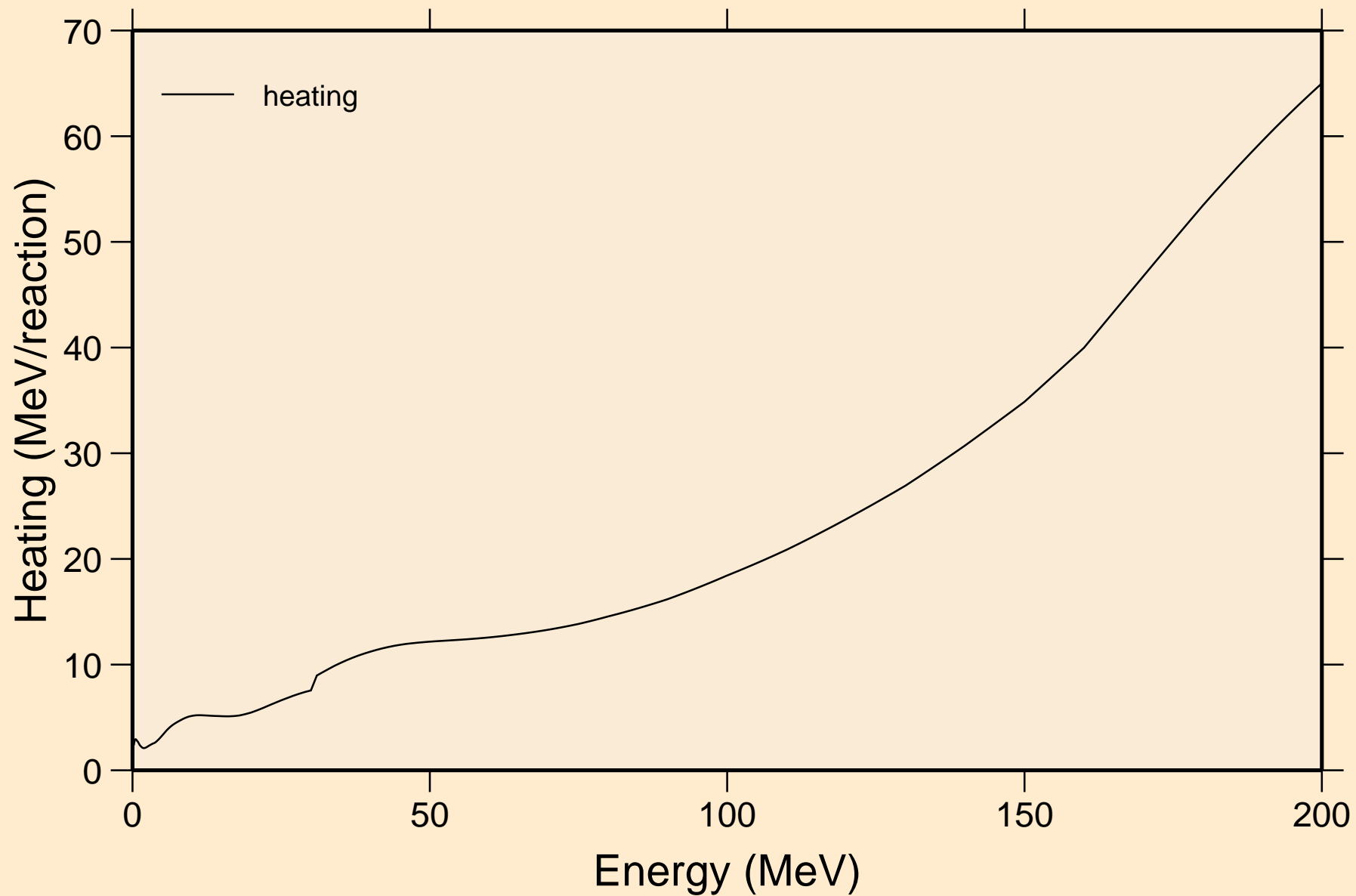

ER149 NEUTRON ACER TENDL-2019 LIBRARY; T=293.16K  
Damage

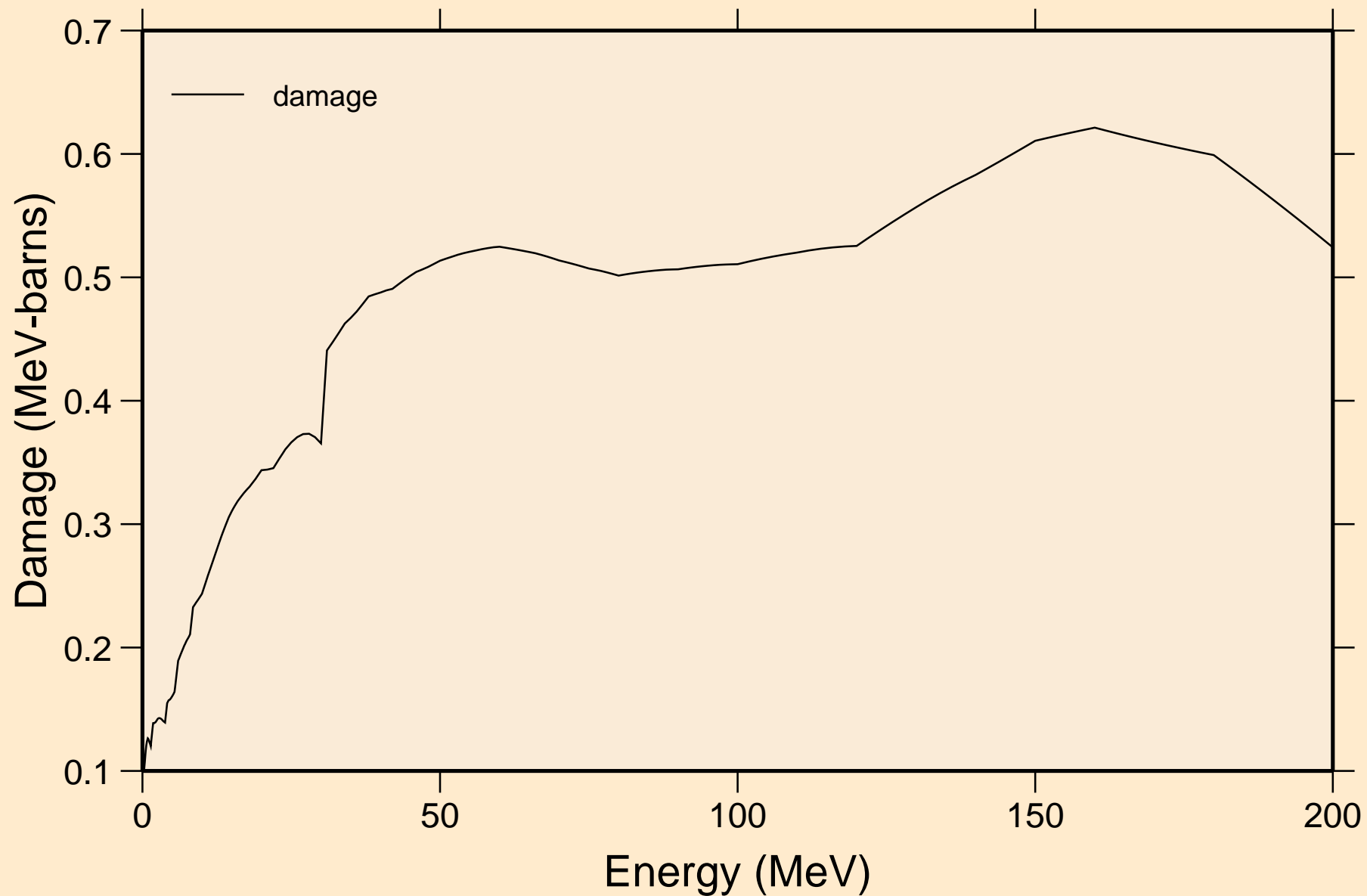



ER149 NEUTRON ACER TENDL-2019 LIBRARY; T=293.16K  
Non-threshold reactions

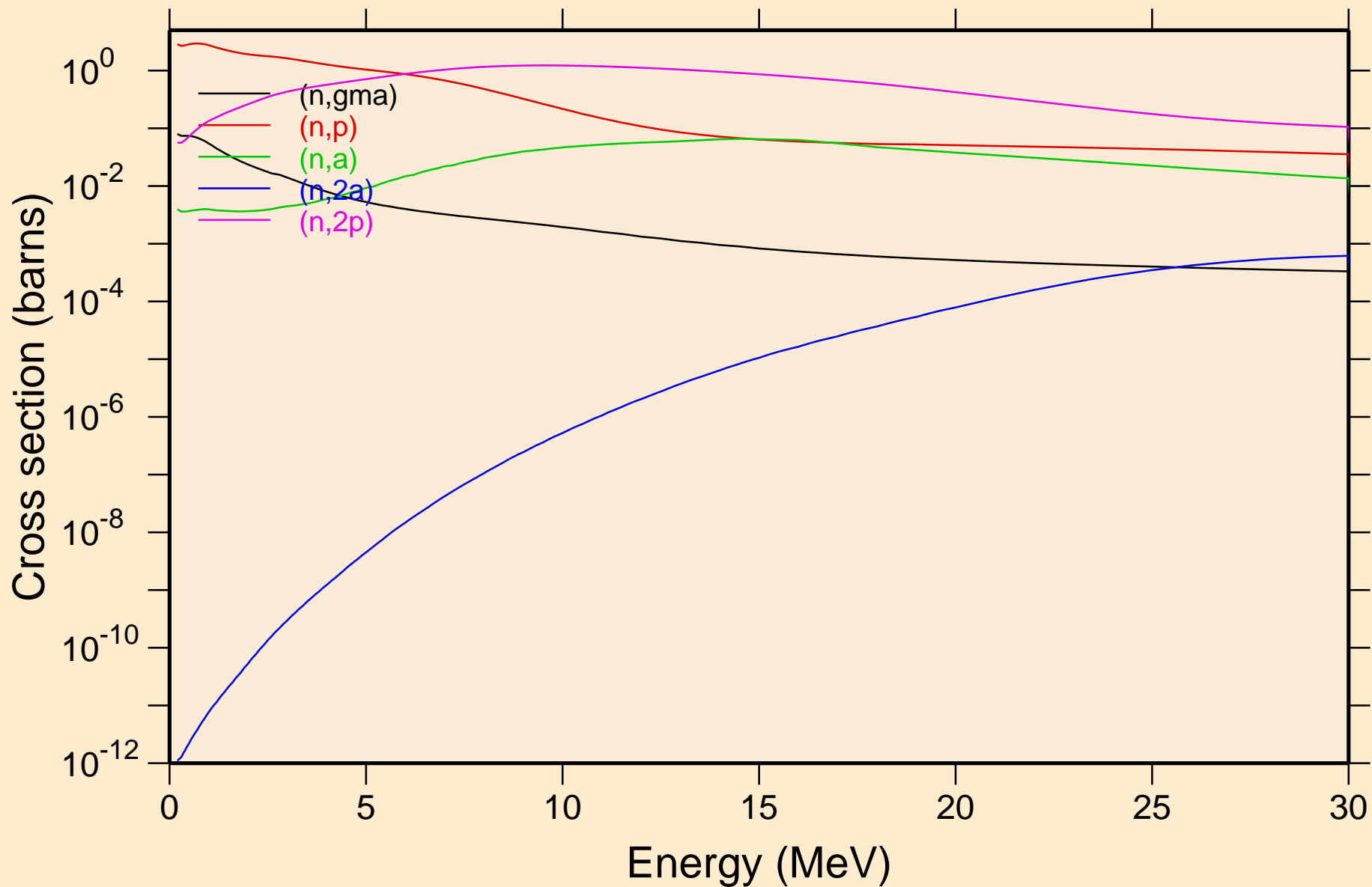

ER149 NEUTRON ACER TENDL-2019 LIBRARY; T=293.16K  
Non-threshold reactions

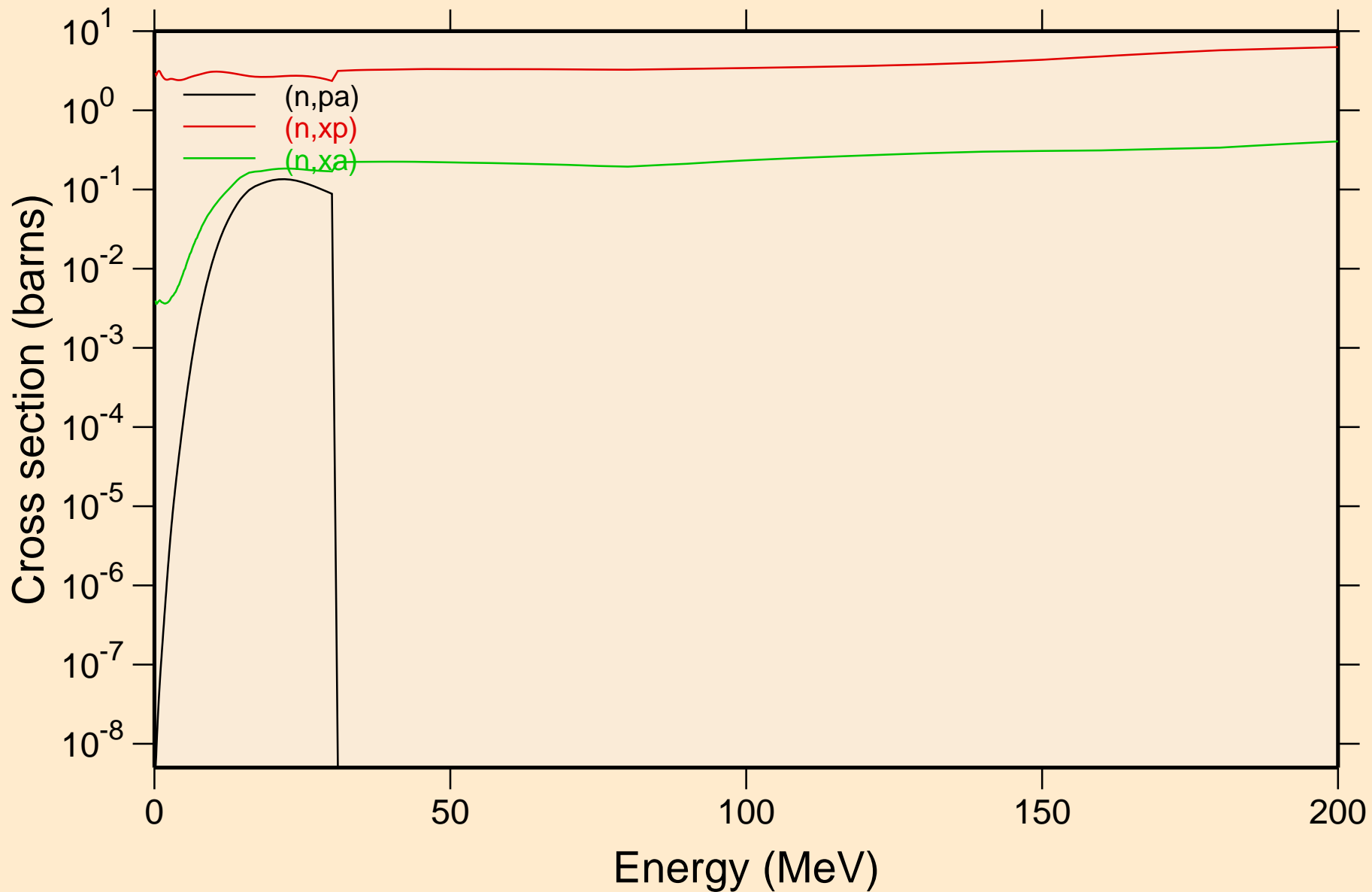

ER149 NEUTRON ACER TENDL-2019 LIBRARY; T=293.16K  
Inelastic levels

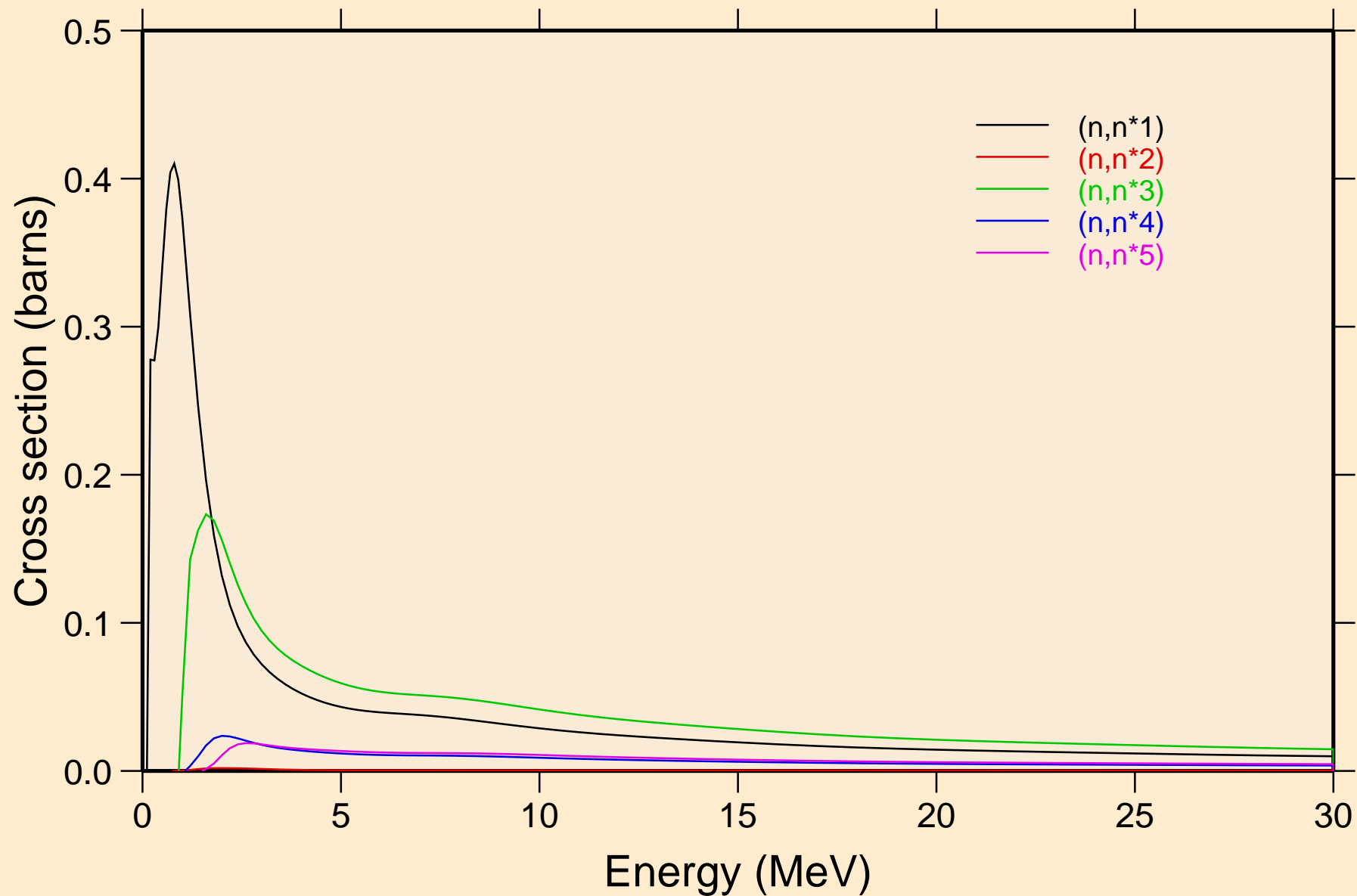

ER149 NEUTRON ACER TENDL-2019 LIBRARY; T=293.16K  
Threshold reactions

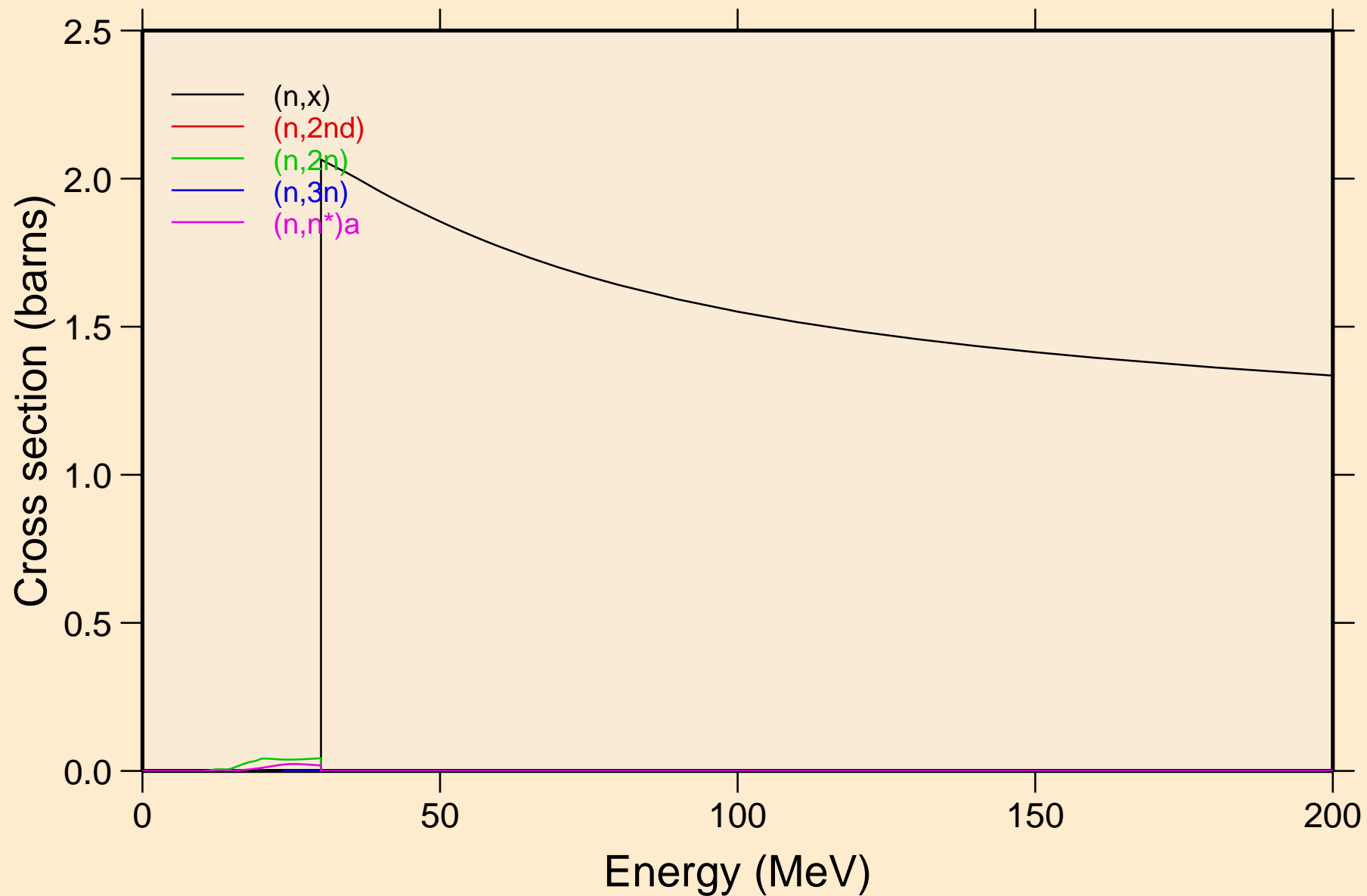

ER149 NEUTRON ACER TENDL-2019 LIBRARY; T=293.16K  
Threshold reactions

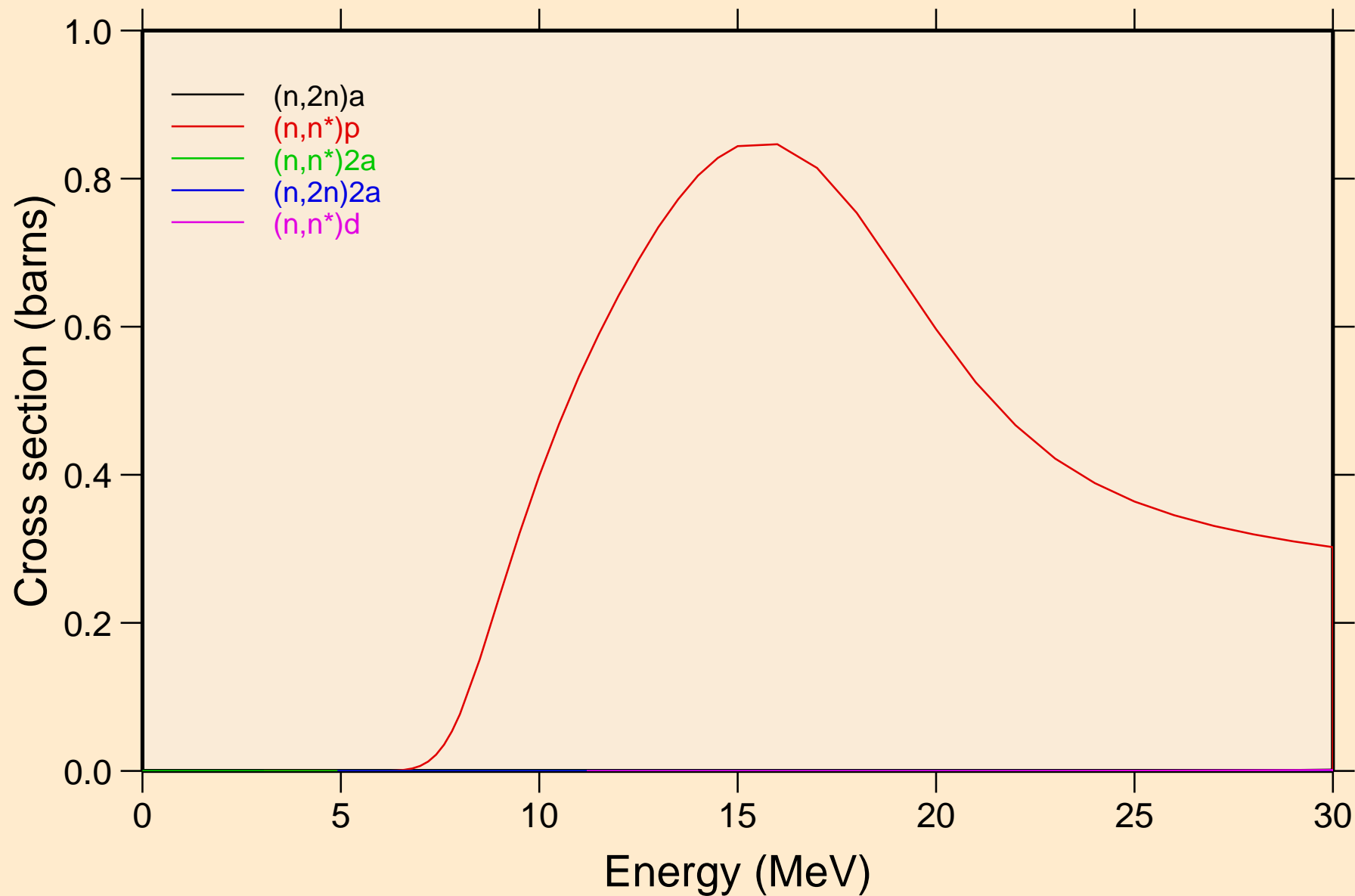

ER149 NEUTRON ACER TENDL-2019 LIBRARY; T=293.16K  
Threshold reactions

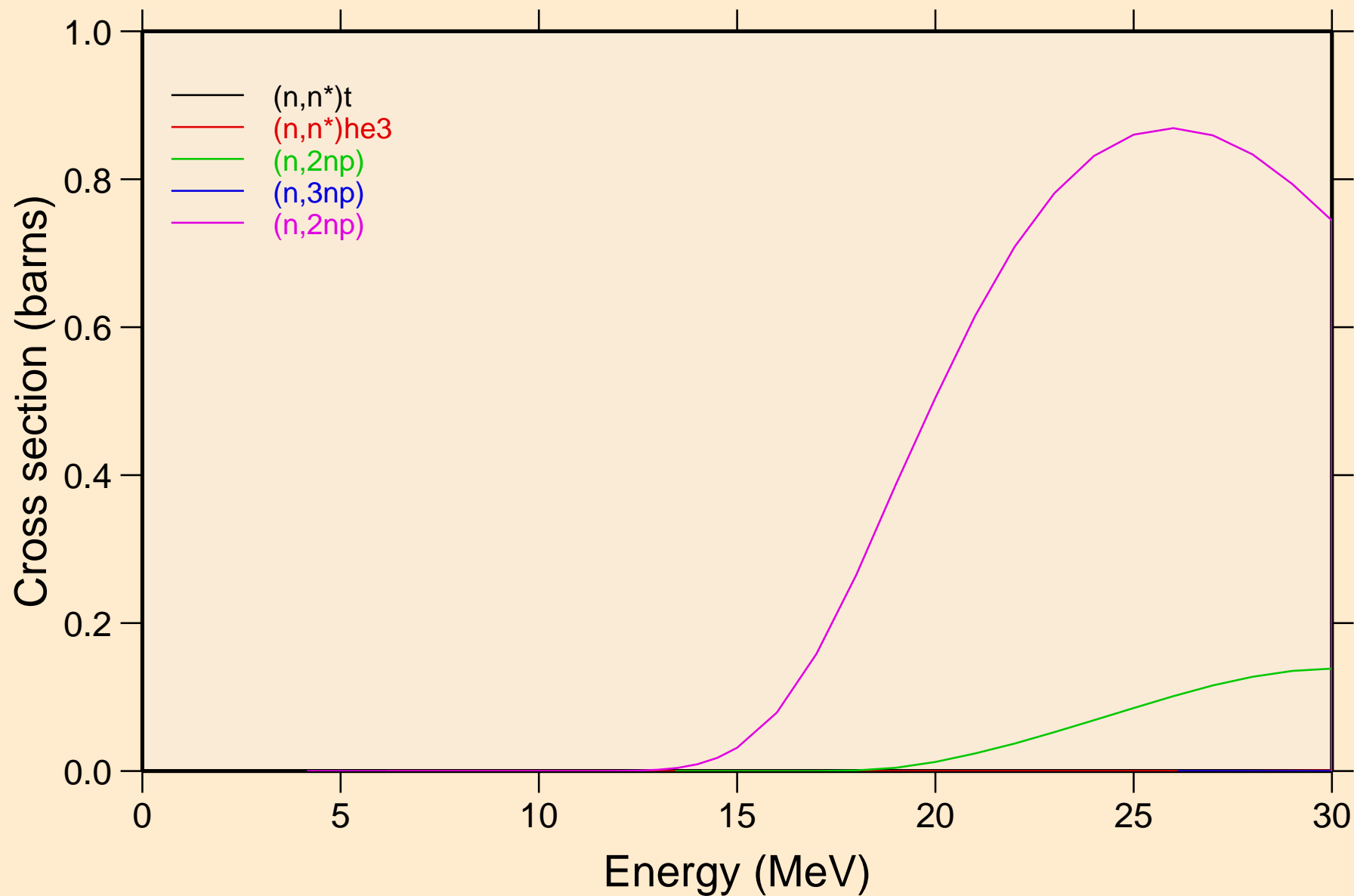

ER149 NEUTRON ACER TENDL-2019 LIBRARY; T=293.16K  
Threshold reactions

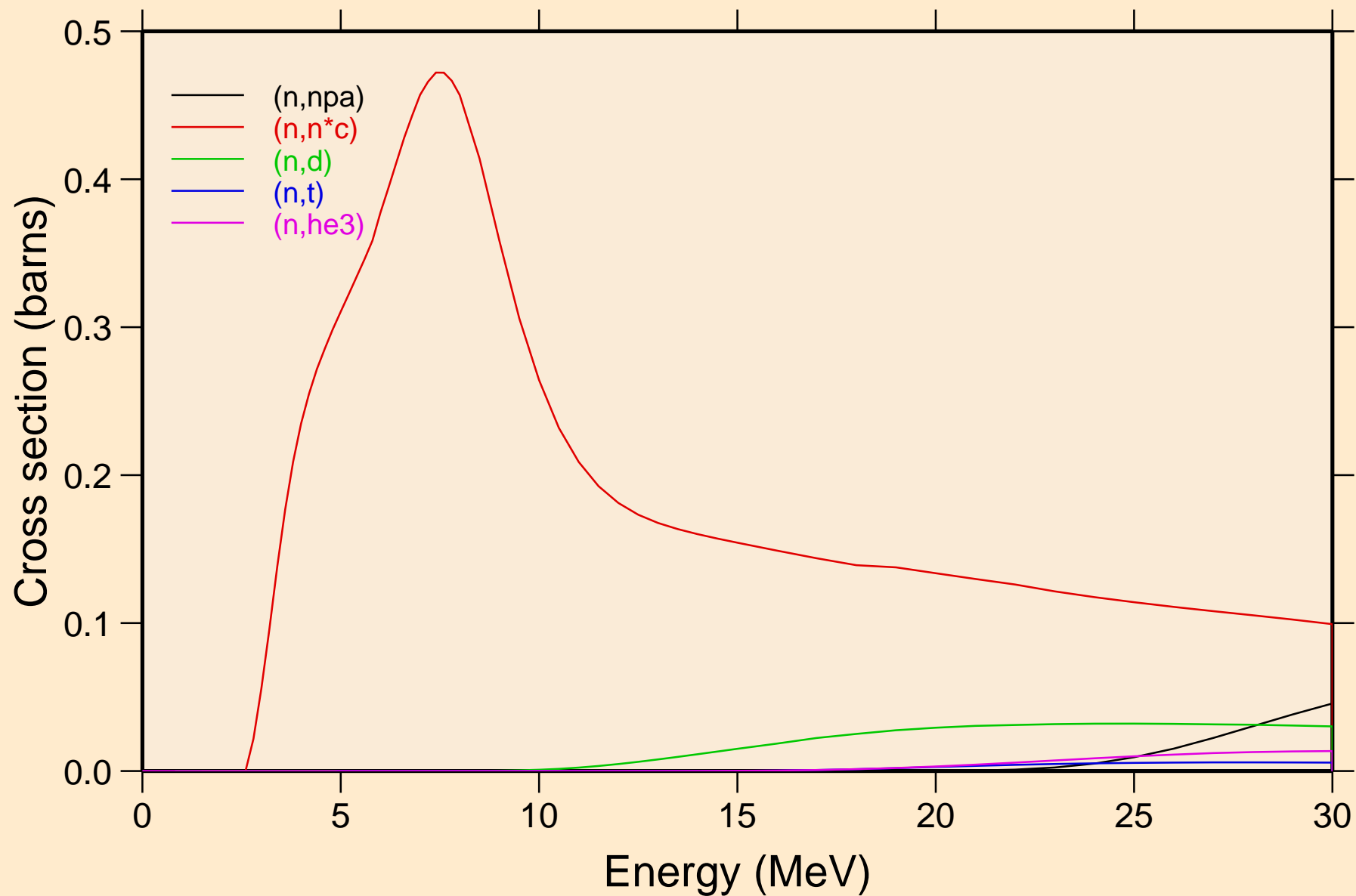

ER149 NEUTRON ACER TENDL-2019 LIBRARY; T=293.16K  
Threshold reactions

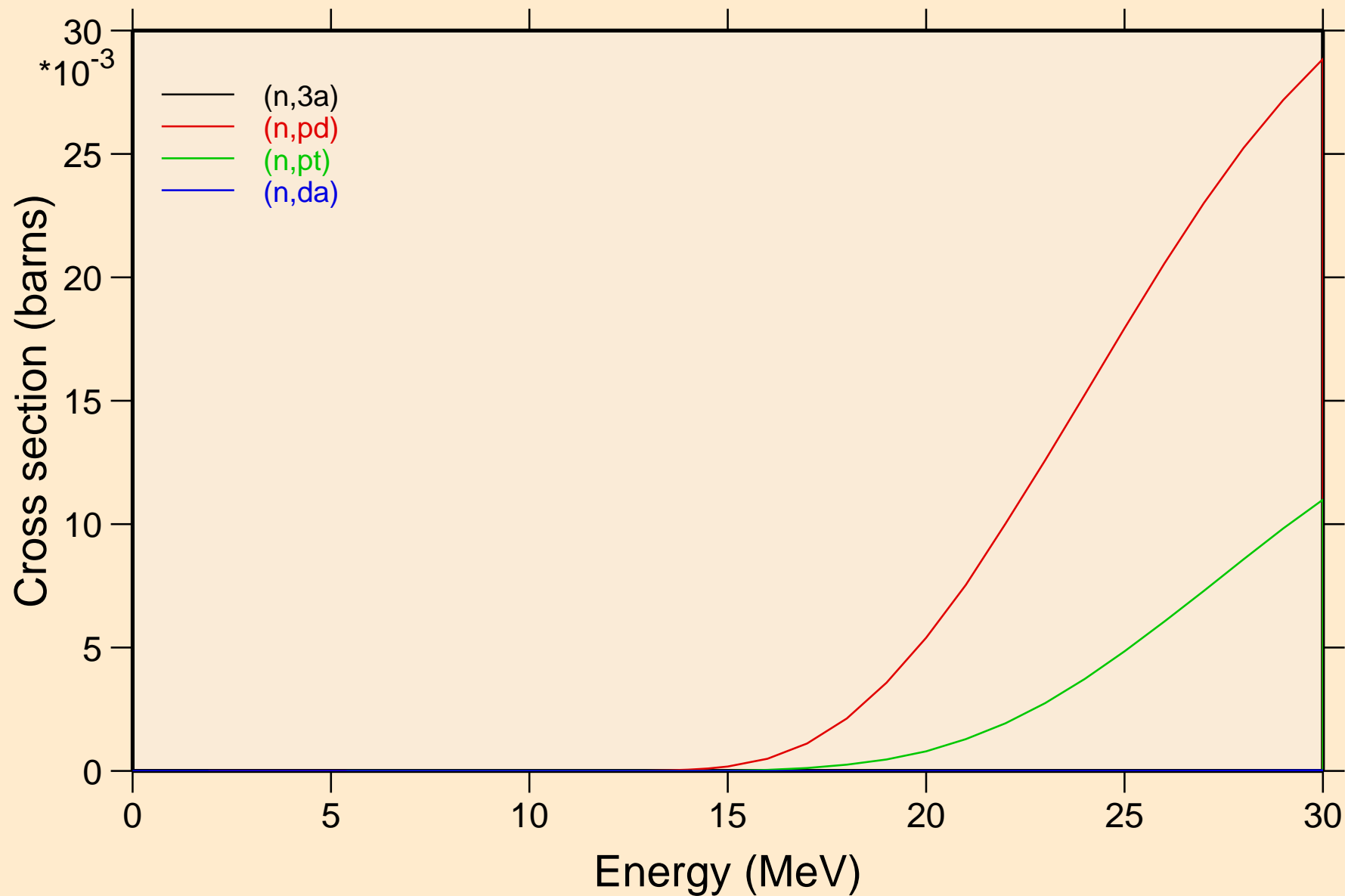



ER149 NEUTRON ACER TENDL-2019 LIBRARY; T=293.16K  
Threshold reactions

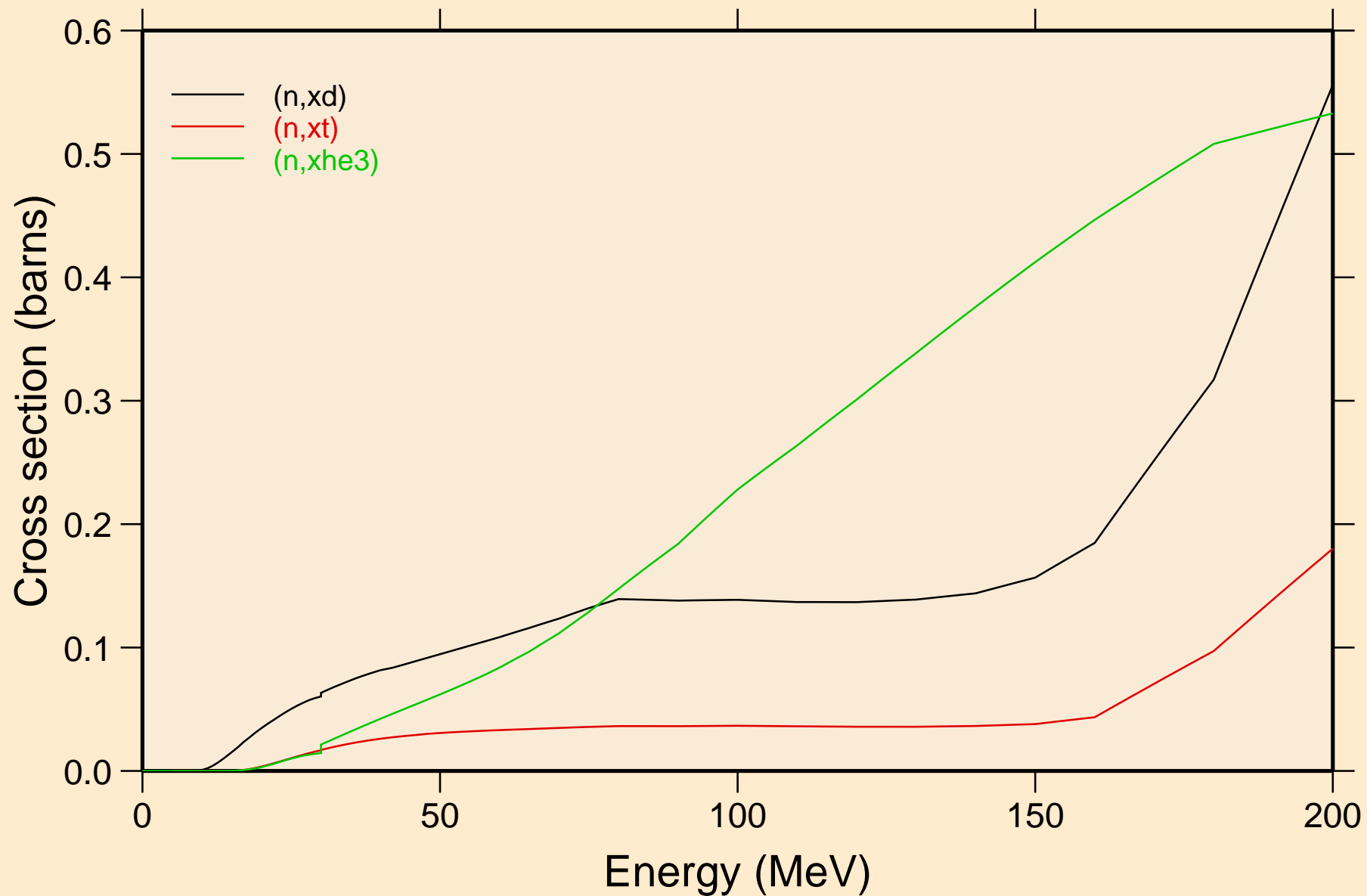

ER149 NEUTRON ACER TENDL-2019 LIBRARY; T=293.16K  
angular distribution for elastic

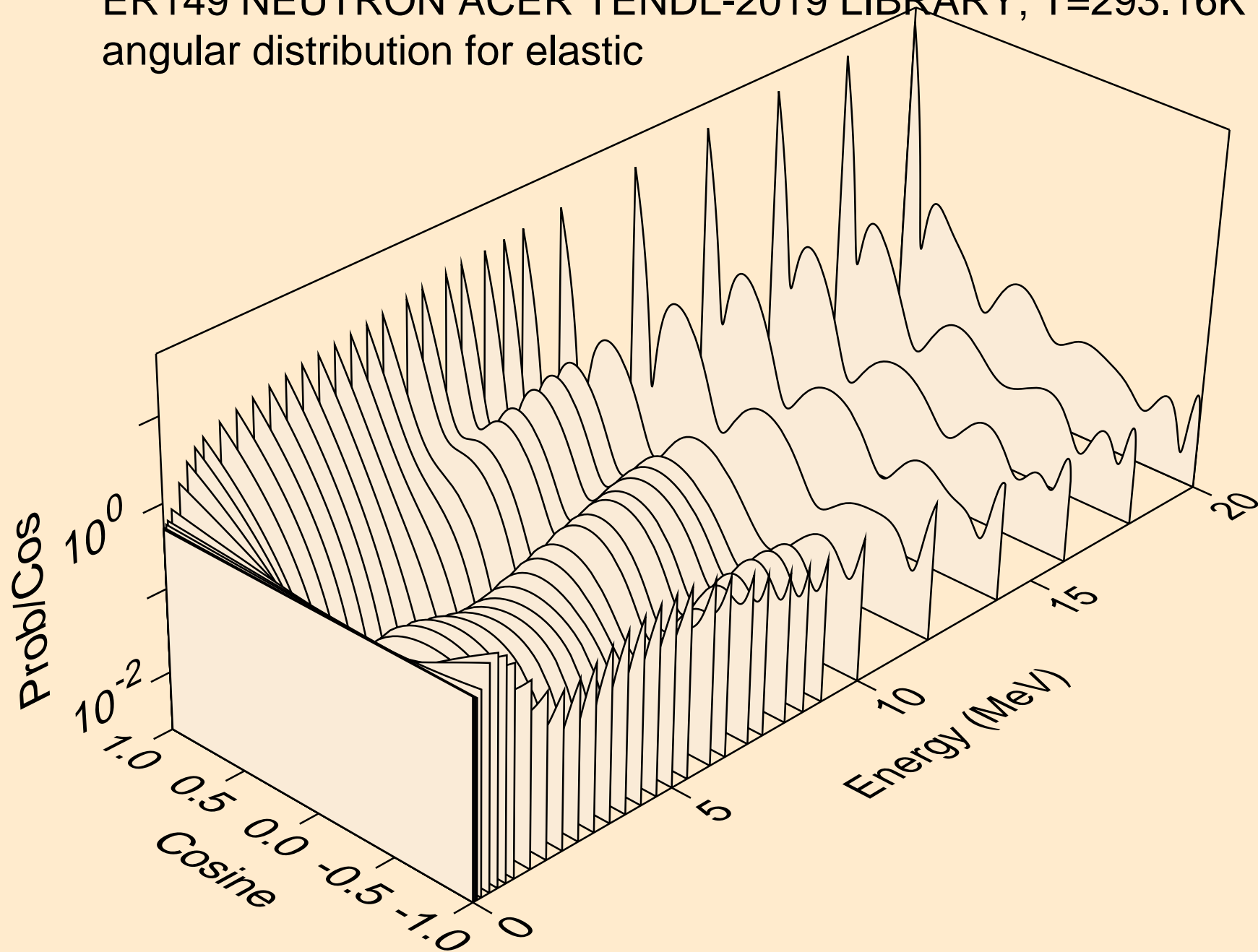

ER149 NEUTRON ACER TENDL-2019 LIBRARY; T=293.16K  
angular distribution for elastic

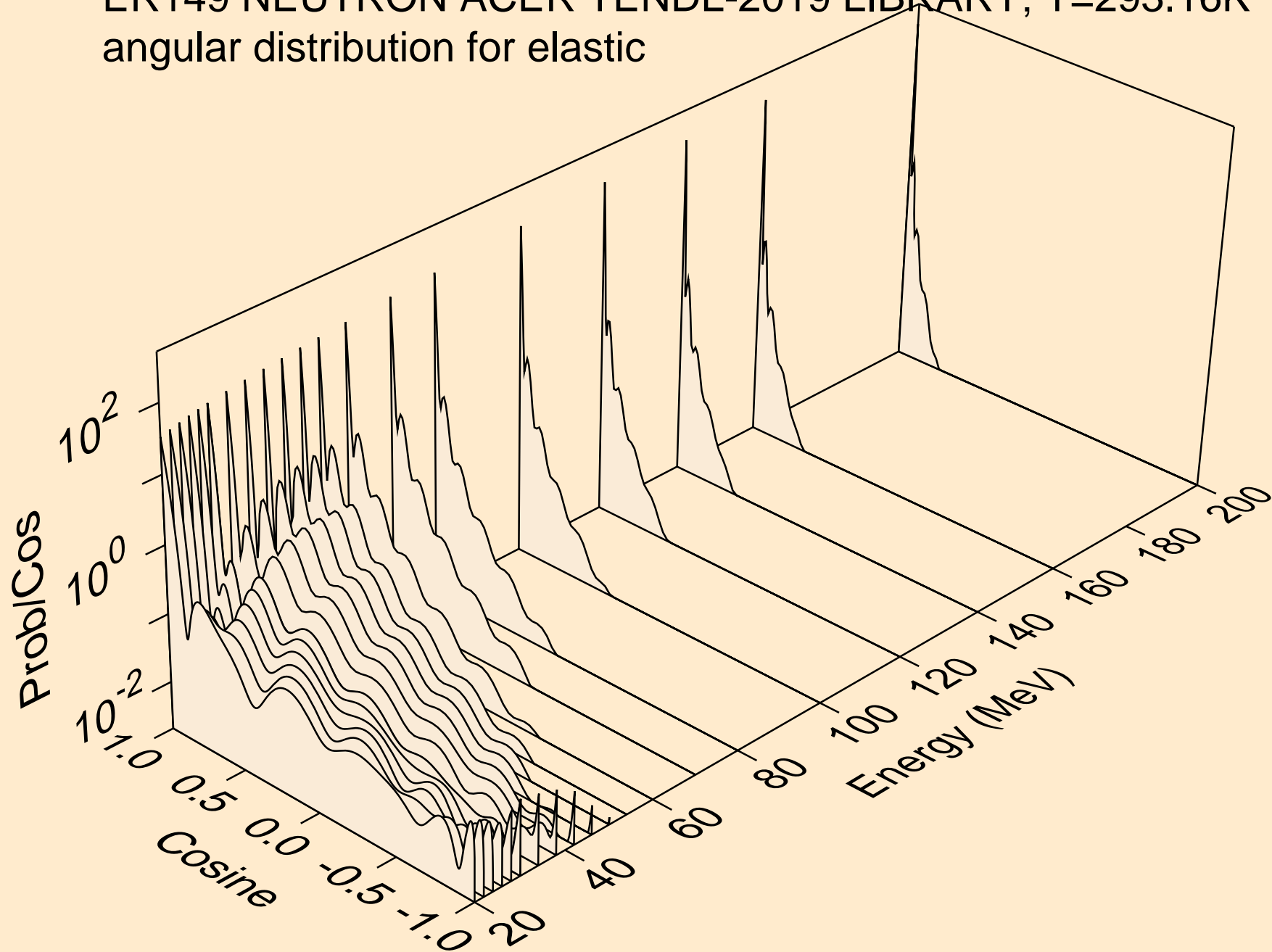

ER149 NEUTRON ACER TENDL-2019 LIBRARY; T=293.16K  
angular distribution for (n,n\*1)

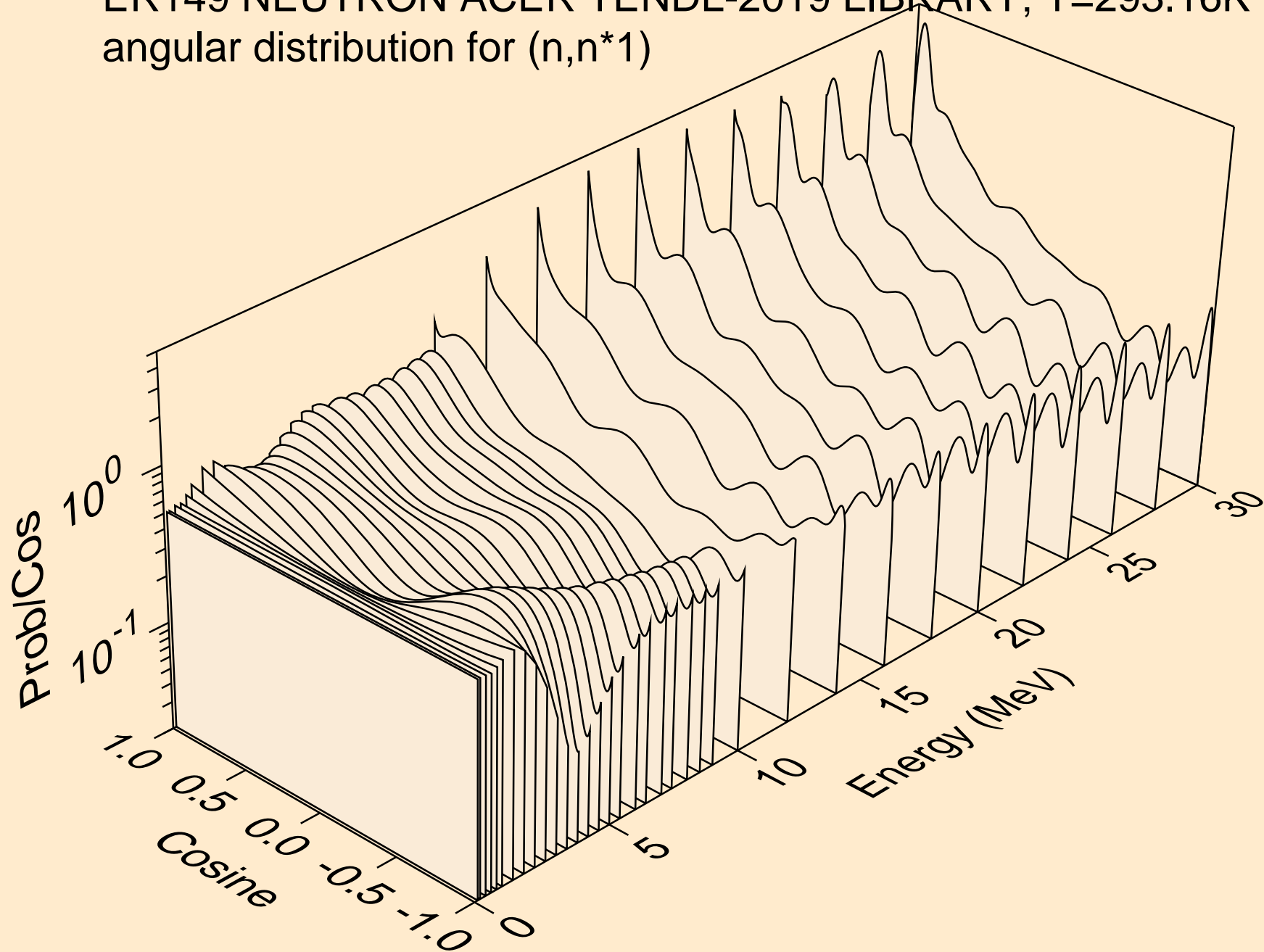

ER149 NEUTRON ACER TENDL-2019 LIBRARY; T=293.16K  
angular distribution for (n,n\*2)

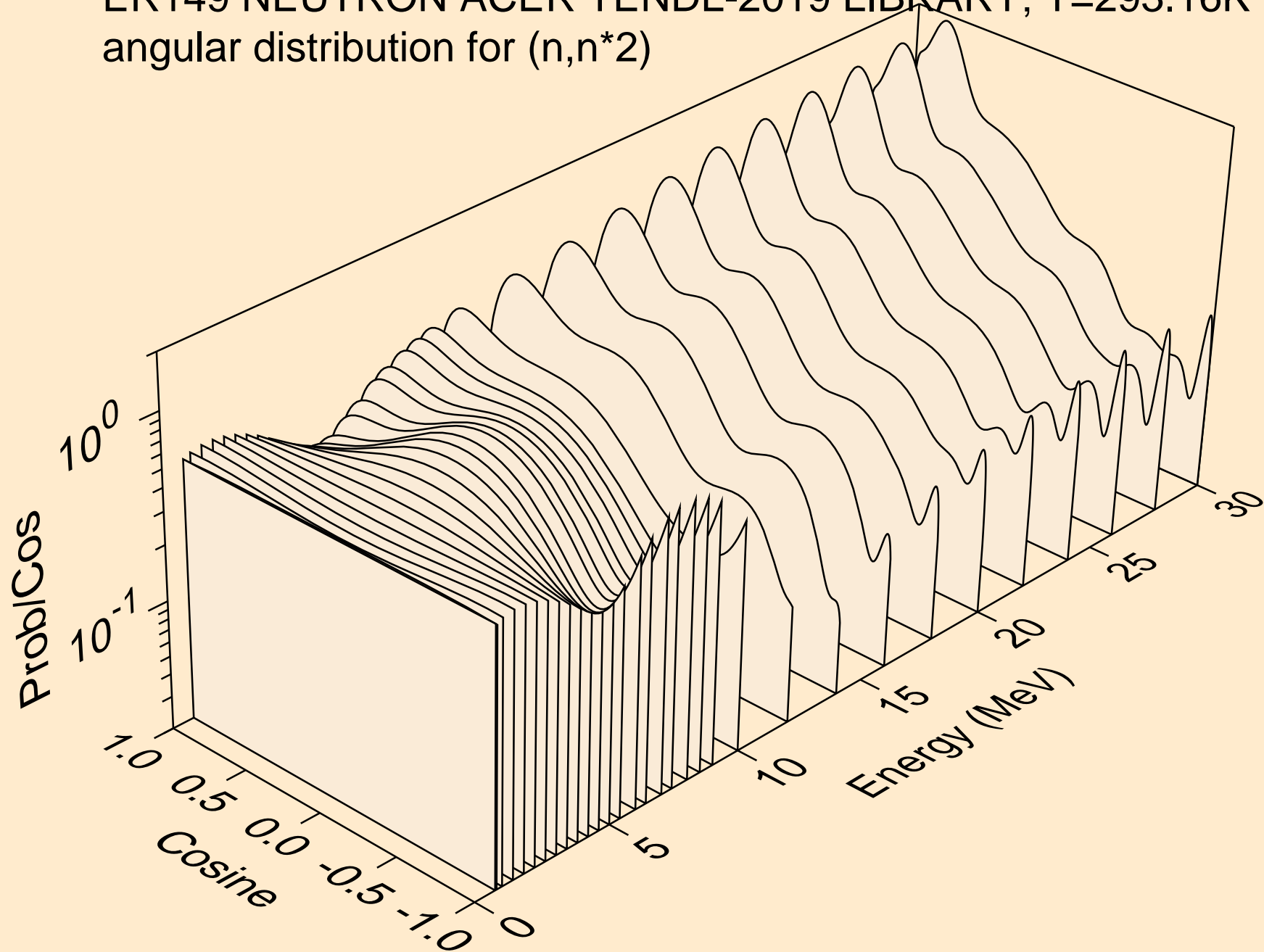

ER149 NEUTRON ACER TENDL-2019 LIBRARY; T=293.16K  
angular distribution for (n,n\*3)

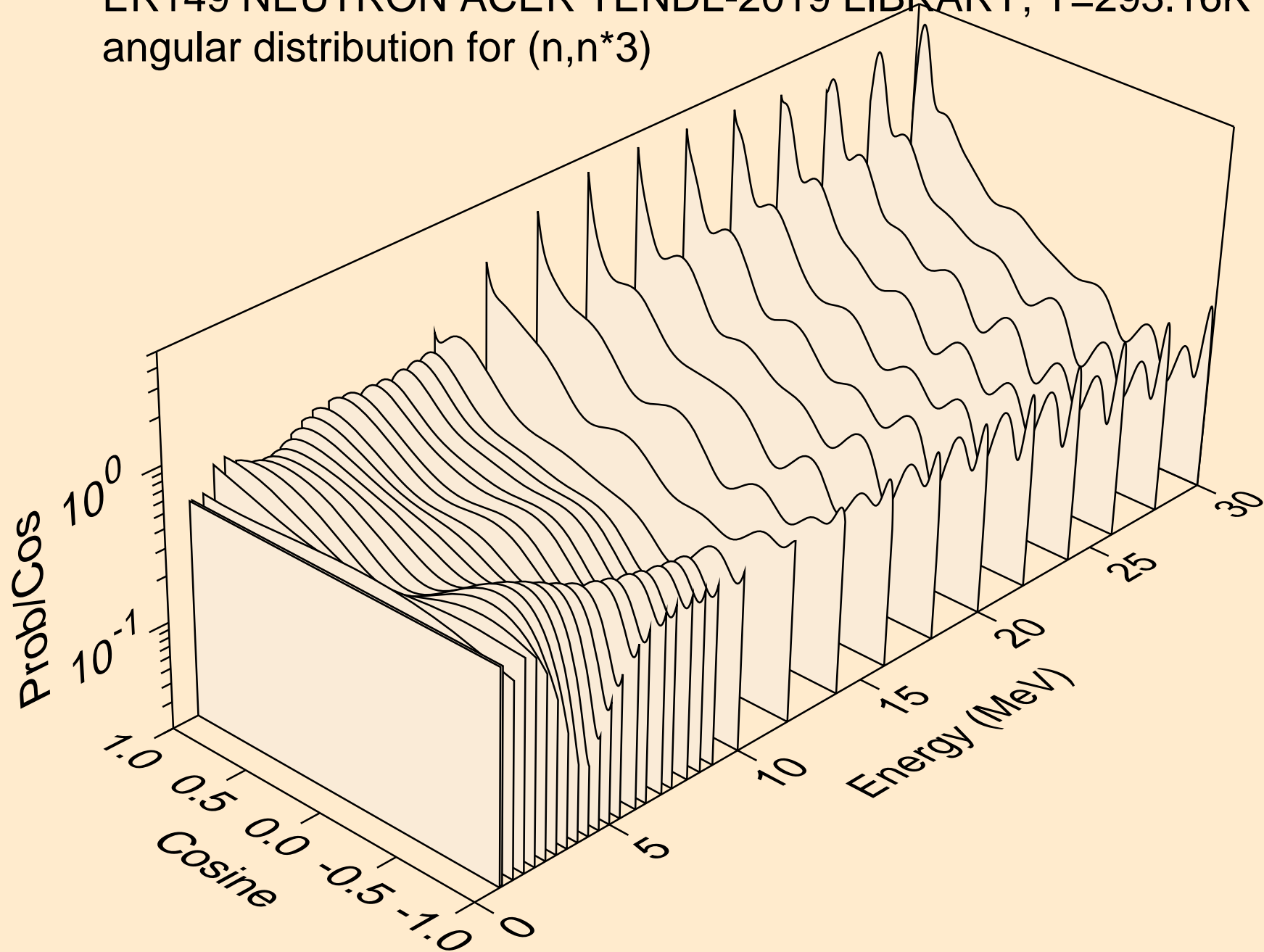

ER149 NEUTRON ACER TENDL-2019 LIBRARY; T=293.16K  
angular distribution for (n,n\*4)

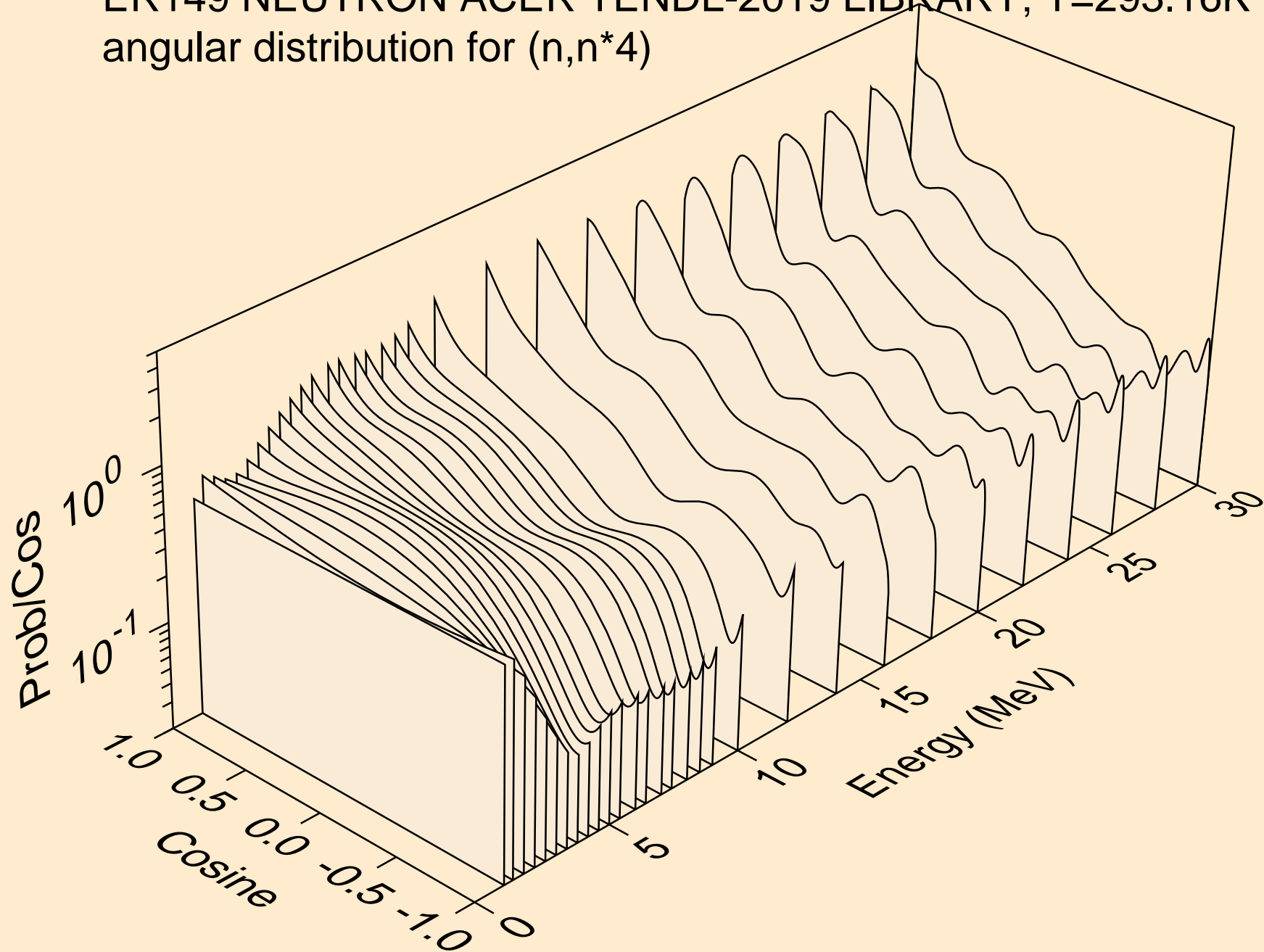

ER149 NEUTRON ACER TENDL-2019 LIBRARY; T=293.16K  
angular distribution for (n,n\*5)

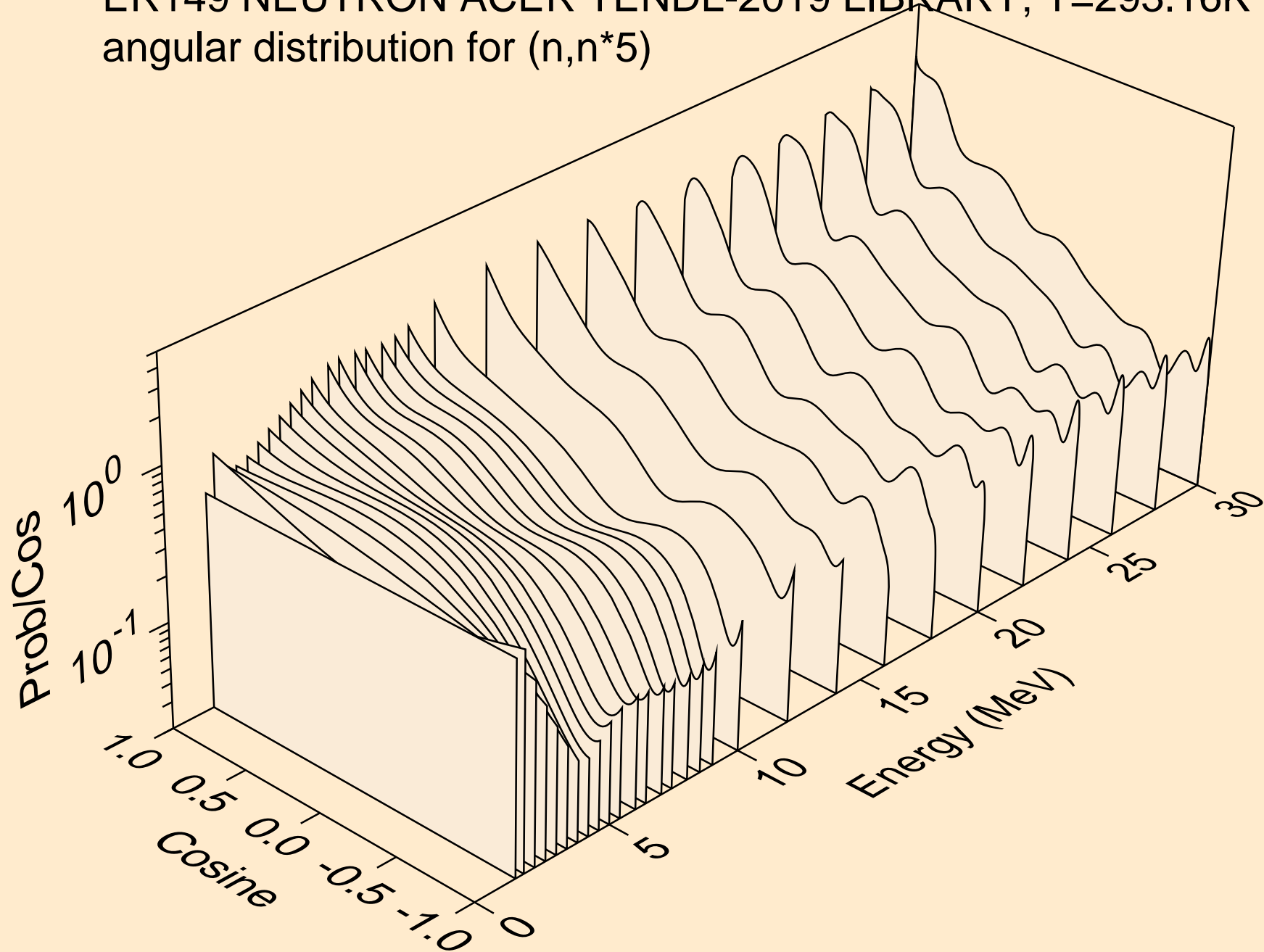



ER149 NEUTRON ACER TENDL-2019 LIBRARY; T=293.16K  
Neutron emission for (n,x)

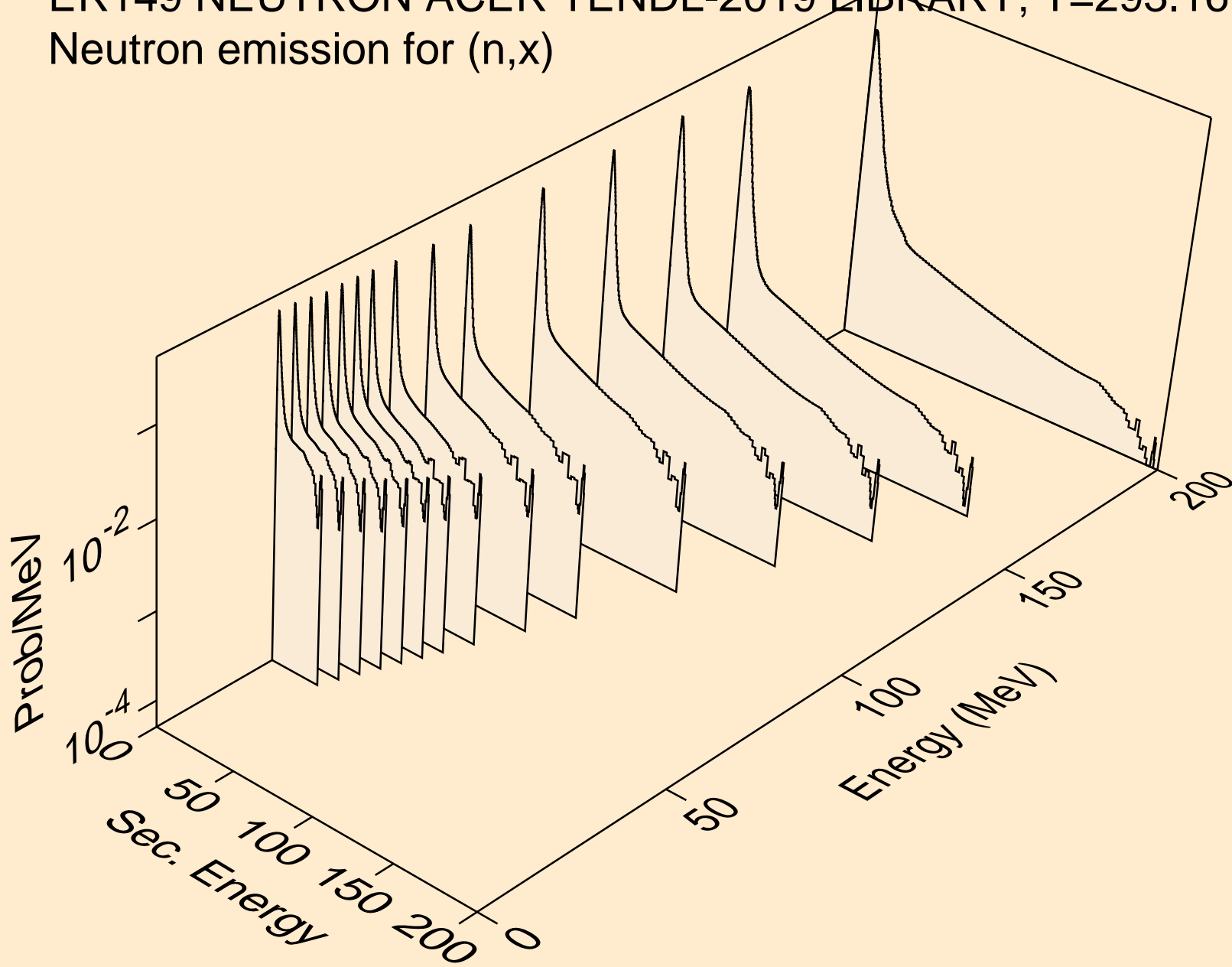

ER149 NEUTRON ACER TENDL-2019 LIBRARY; T=293.16K  
Neutron emission for (n,2nd)

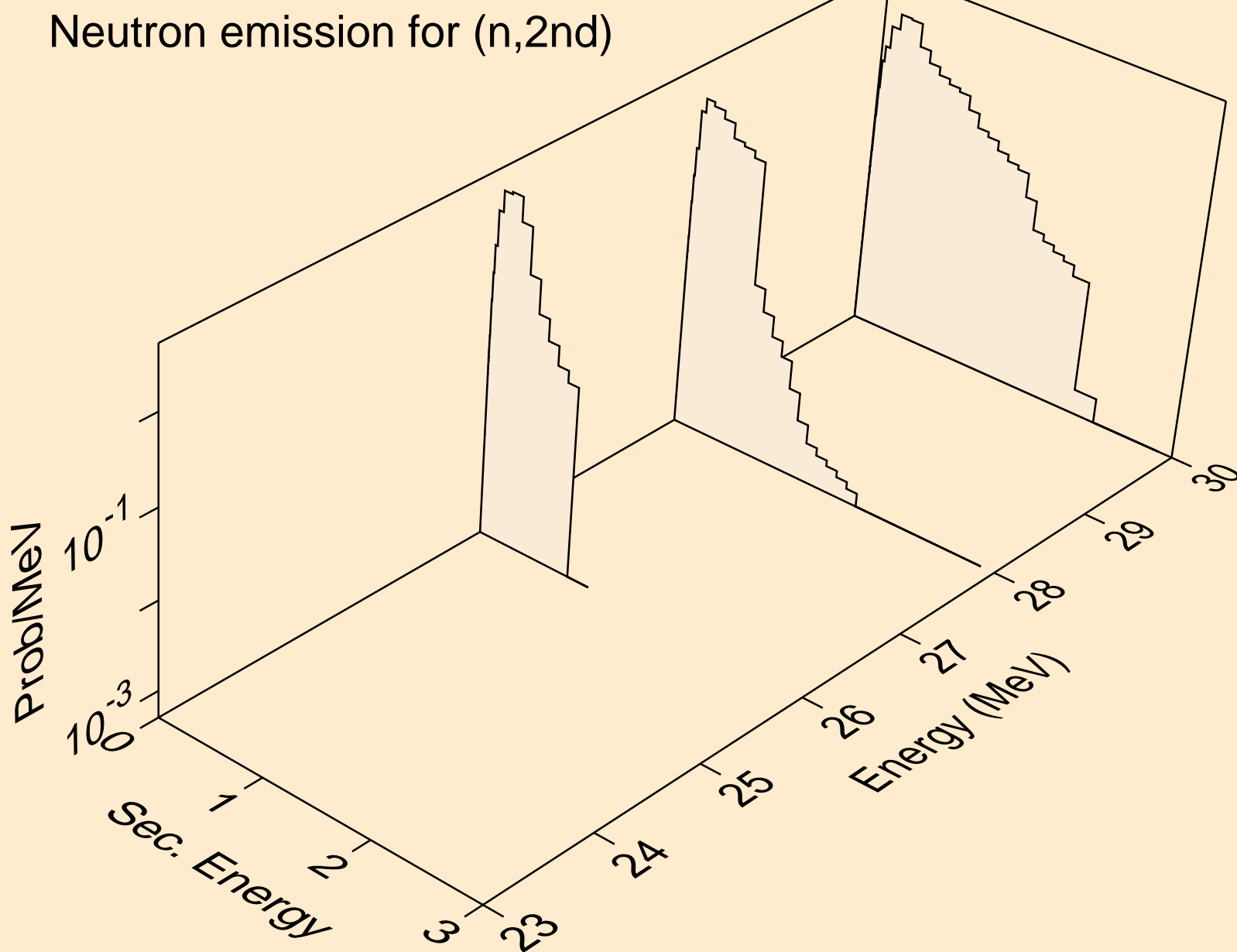

ER149 NEUTRON ACER TENDL-2019 LIBRARY; T=293.16K  
Neutron emission for (n,2n)

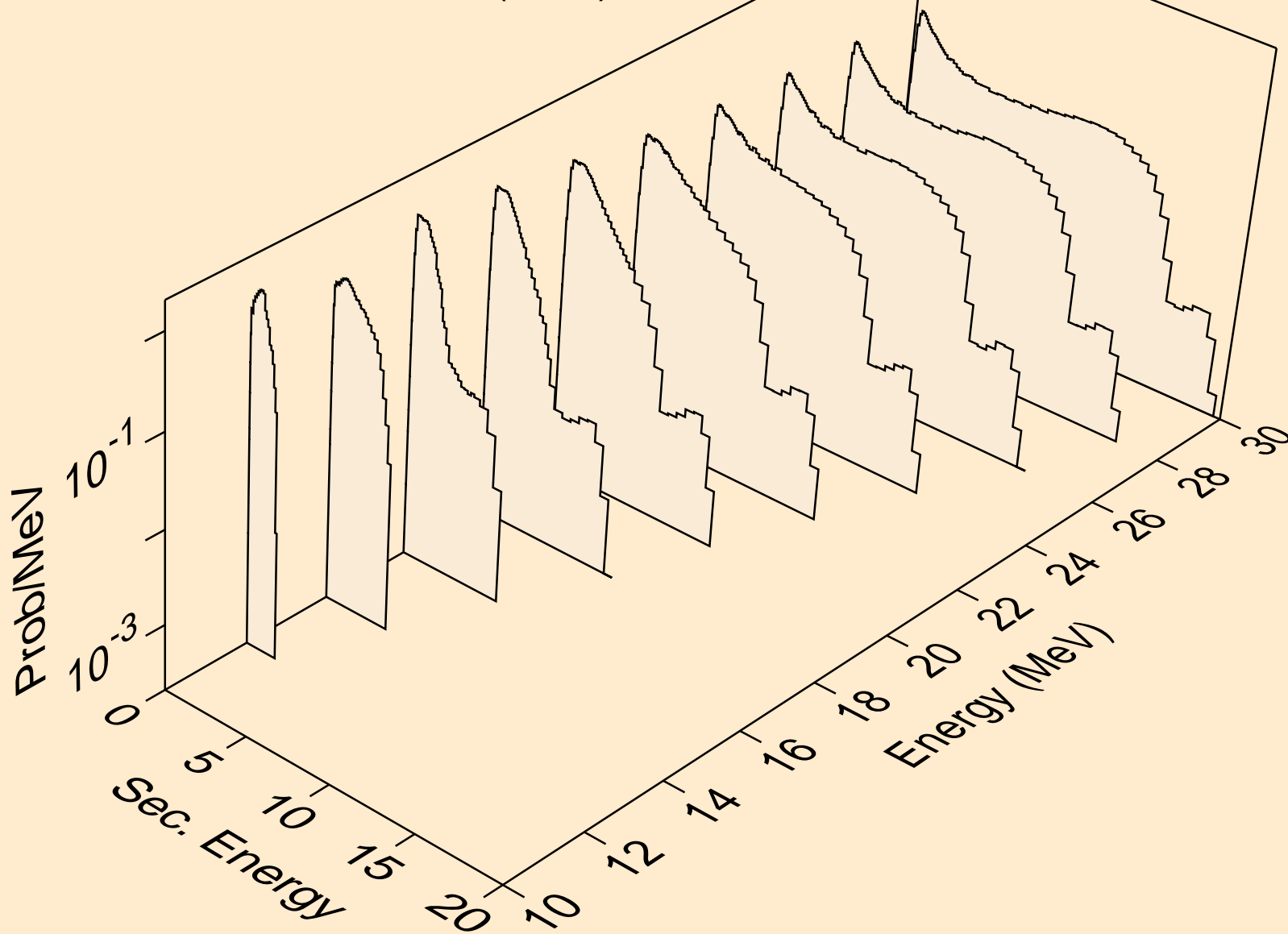

ER149 NEUTRON ACER TENDL-2019 LIBRARY; T=293.16K  
Neutron emission for (n,3n)

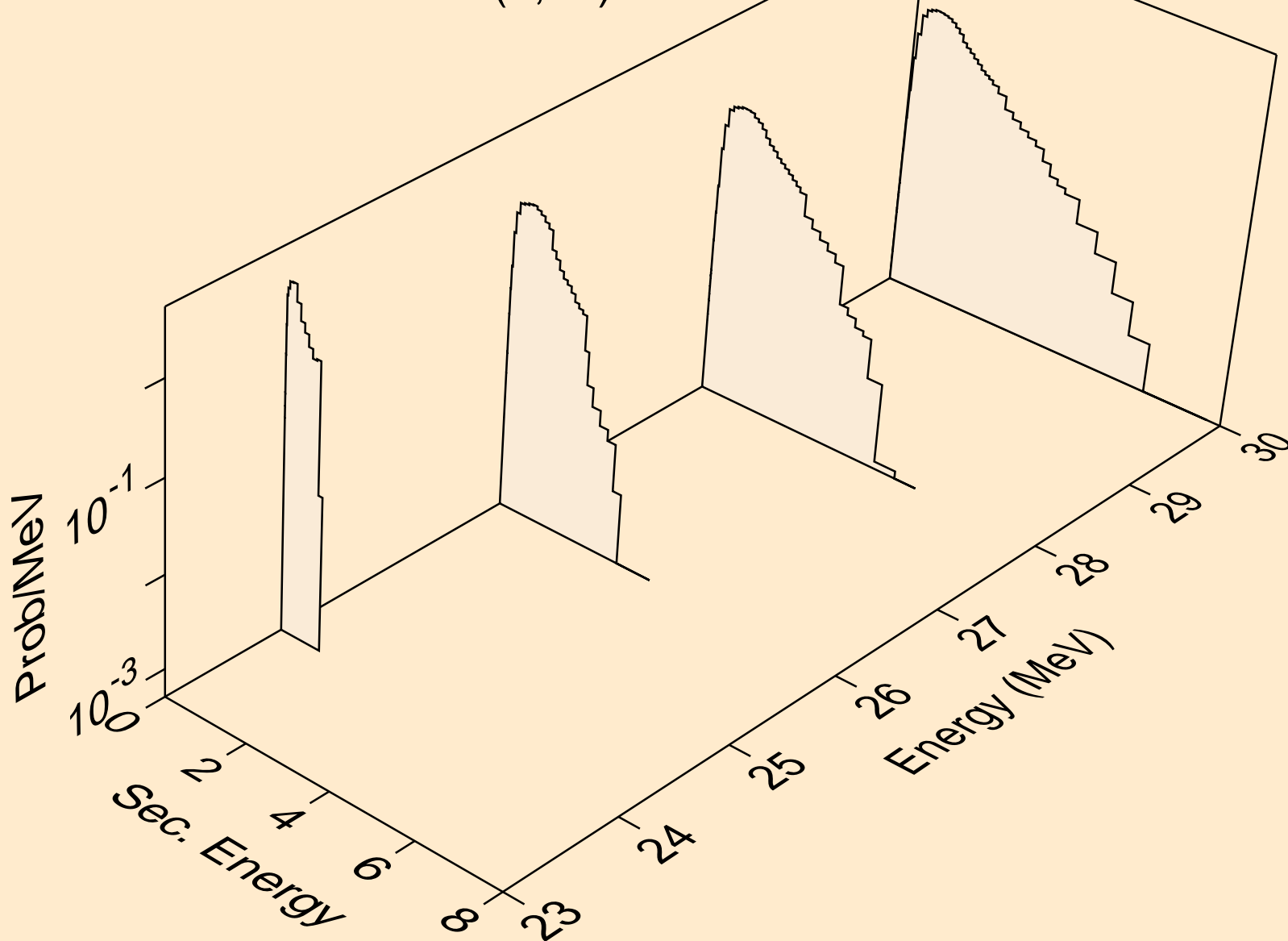

ER149 NEUTRON ACER TENDL-2019 LIBRARY; T=293.16K  
Neutron emission for (n,n\*)a

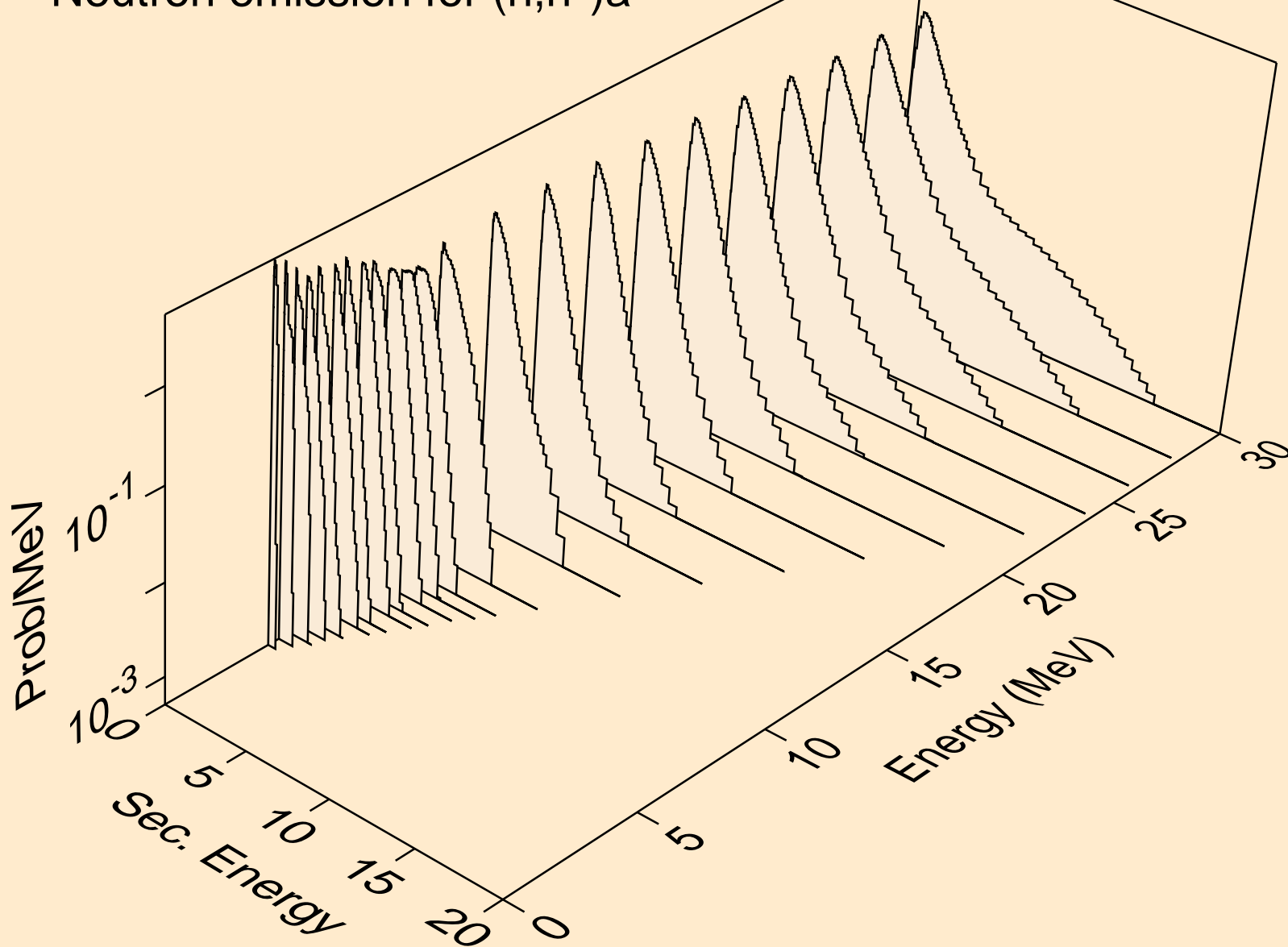

ER149 NEUTRON ACER TENDL-2019 LIBRARY; T=293.16K  
Neutron emission for (n,2n)a

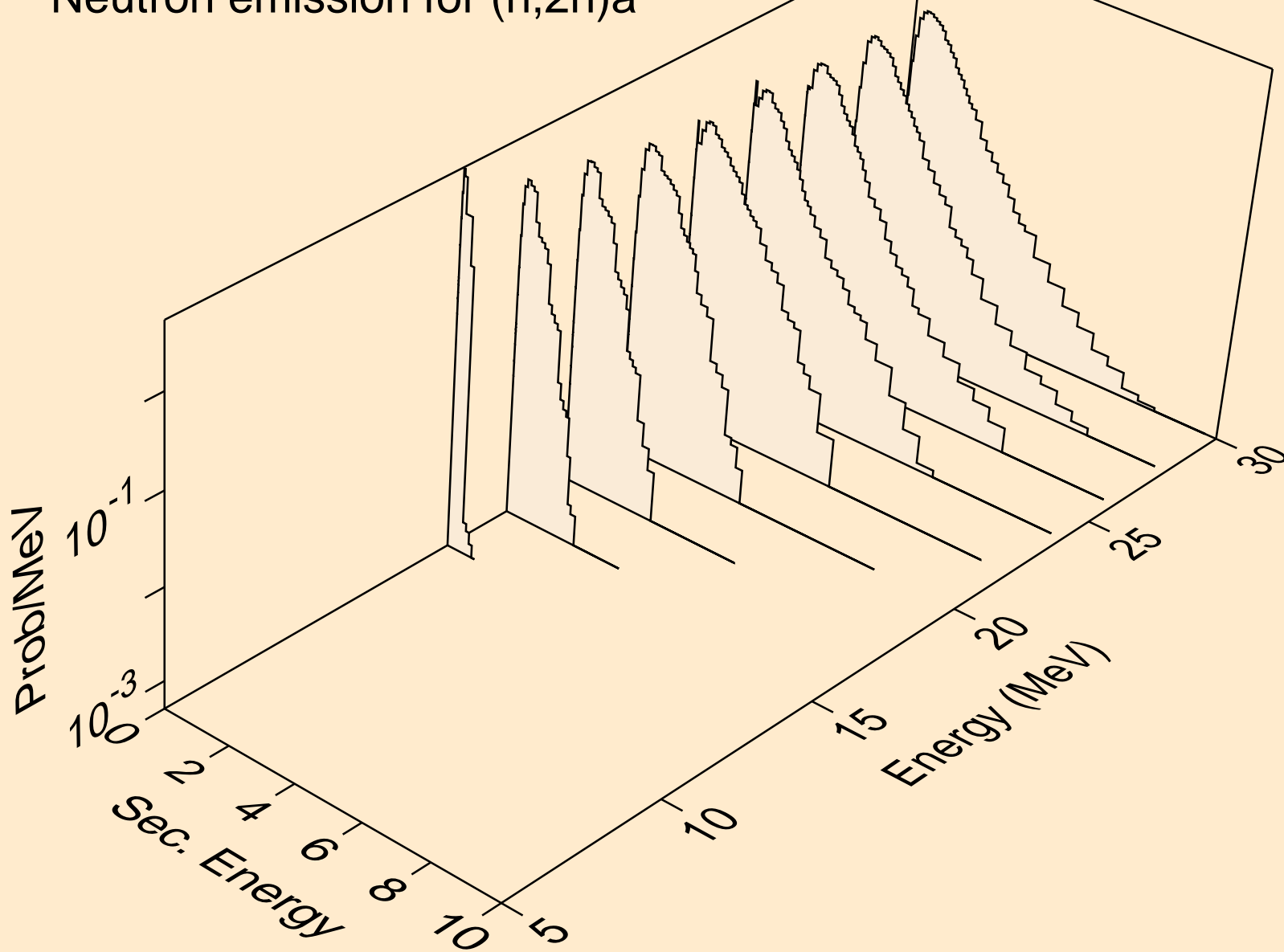

ER149 NEUTRON ACER TENDL-2019 LIBRARY; T=293.16K  
Neutron emission for (n,n\*)p

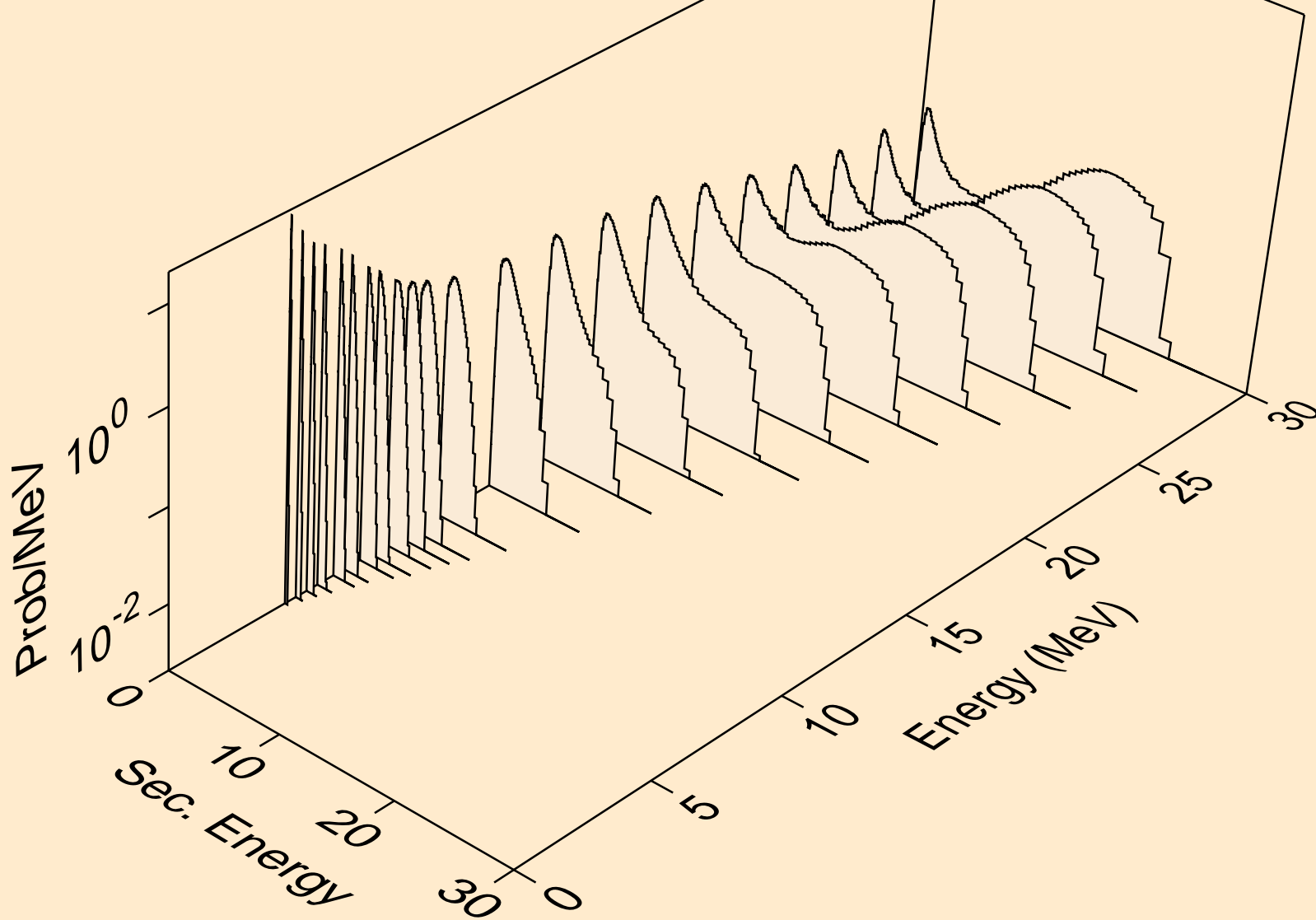

ER149 NEUTRON ACER TENDL-2019 LIBRARY; T=293.16K  
Neutron emission for (n,n\*)2a

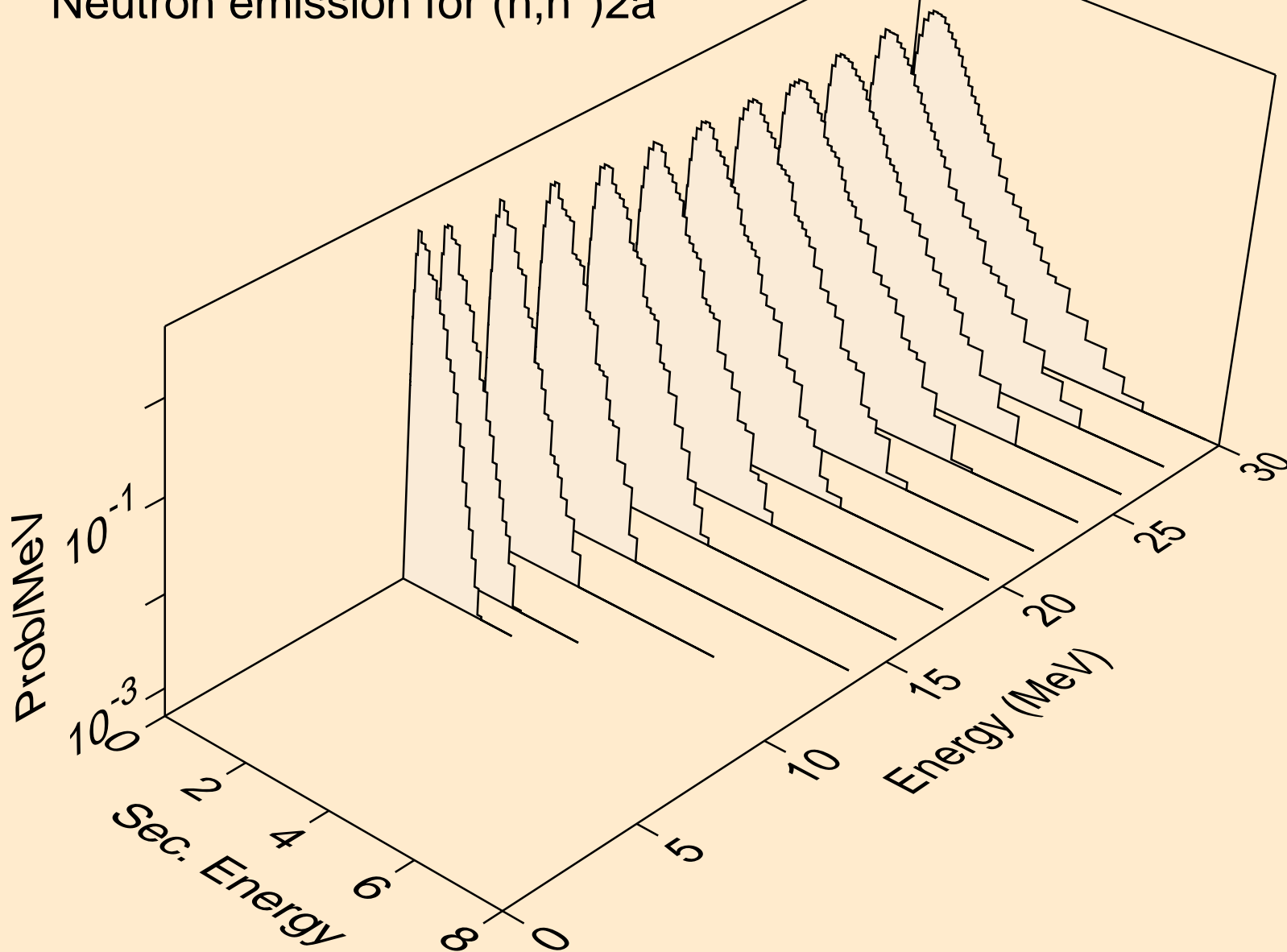



ER149 NEUTRON ACER TENDL-2019 LIBRARY; T=293.16K  
Neutron emission for (n,2n)2a

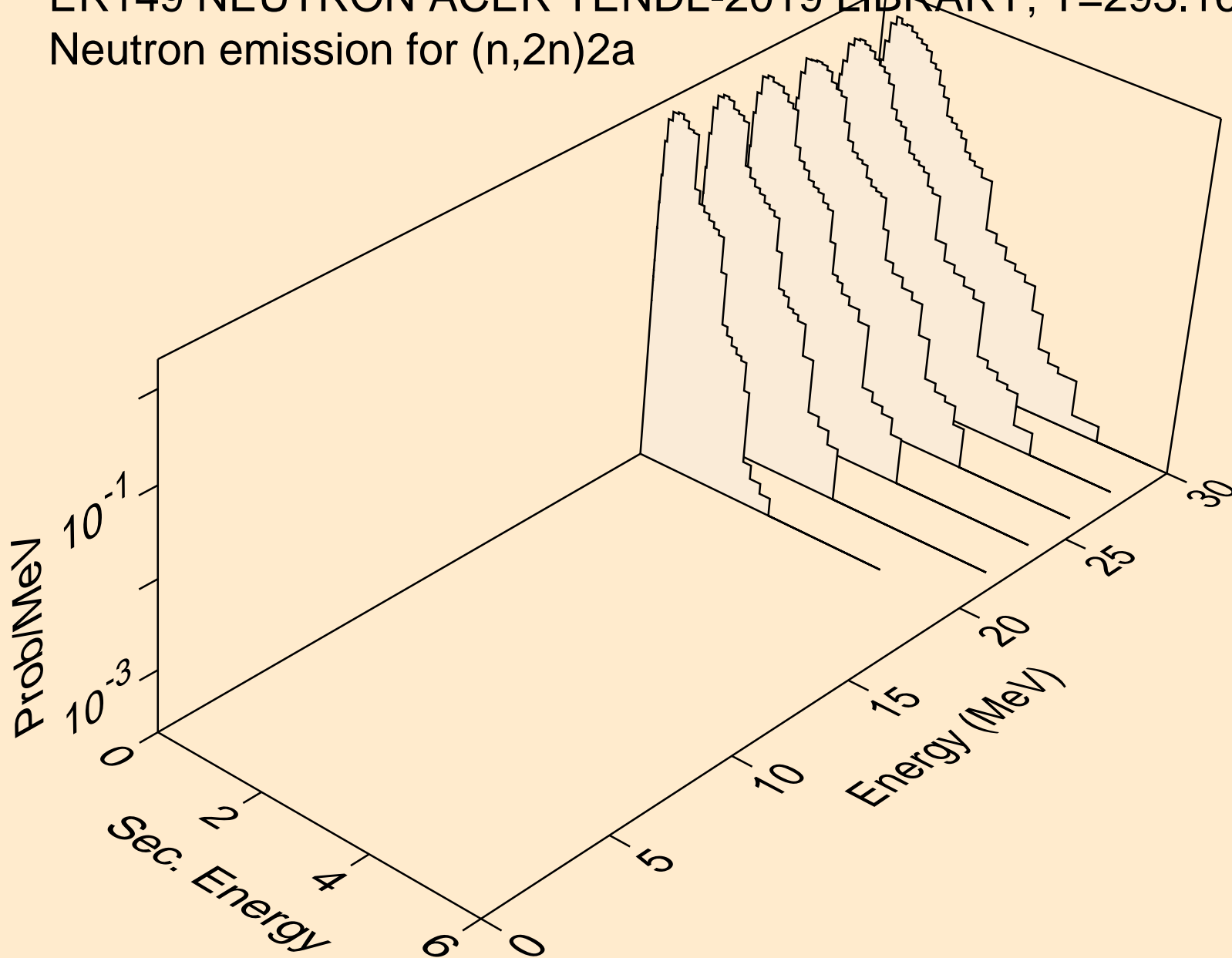

ER149 NEUTRON ACER TENDL-2019 LIBRARY; T=293.16K  
Neutron emission for (n,n\*)d

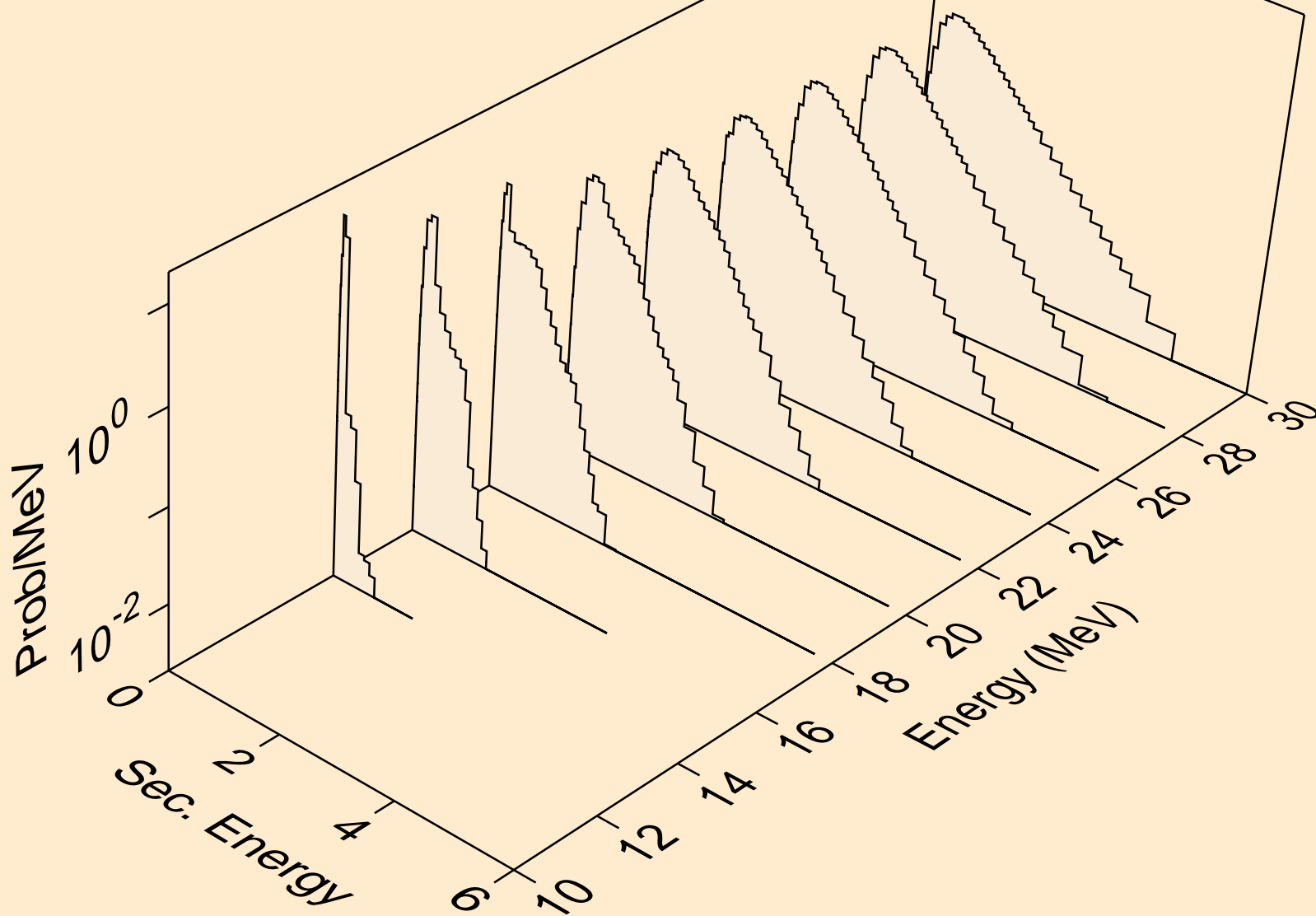

ER149 NEUTRON ACER TENDL-2019 LIBRARY; T=293.16K  
Neutron emission for (n,n\*)t

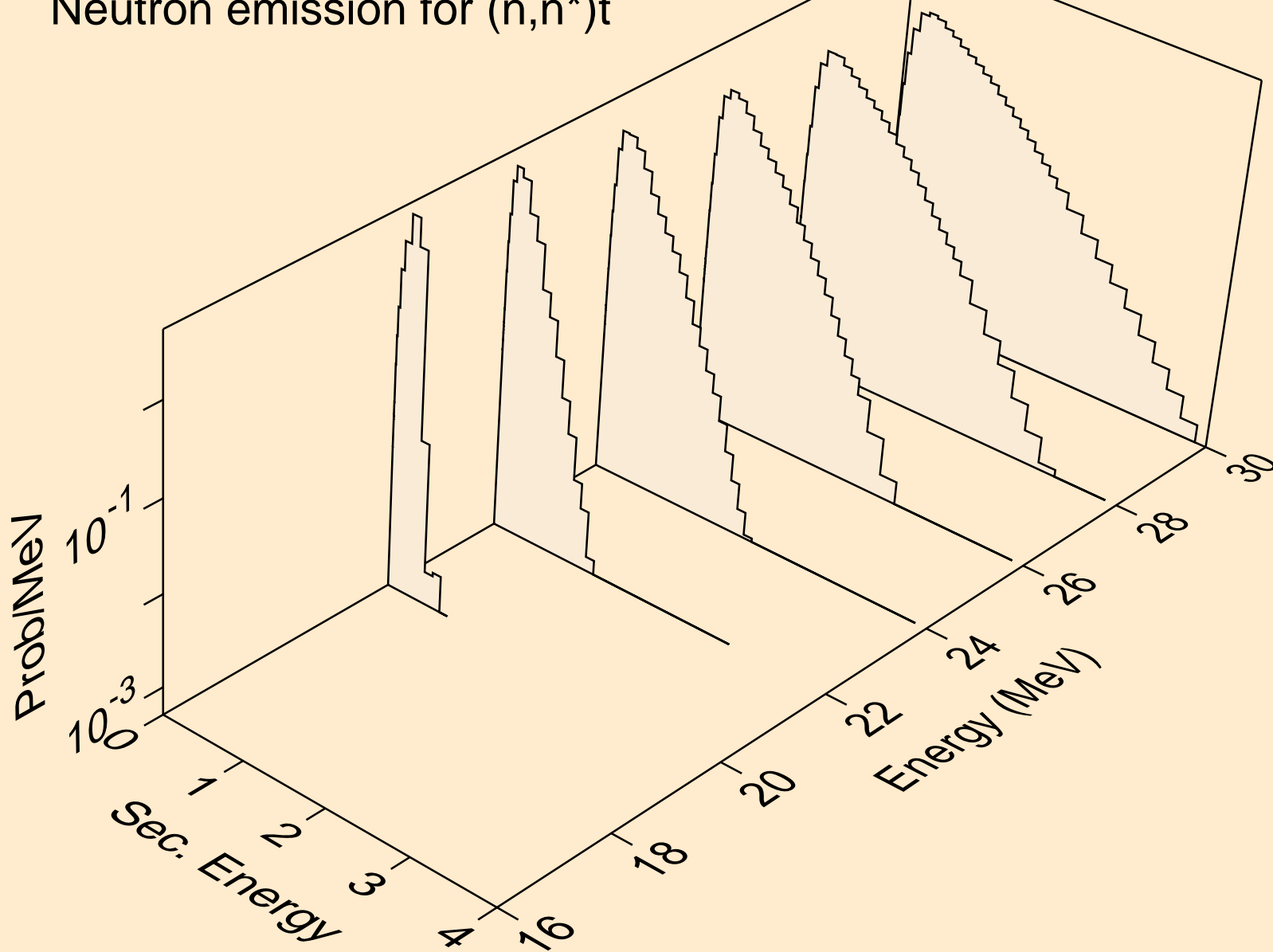

ER149 NEUTRON ACER TENDL-2019 LIBRARY; T=293.16K  
Neutron emission for (n,n\*)he3

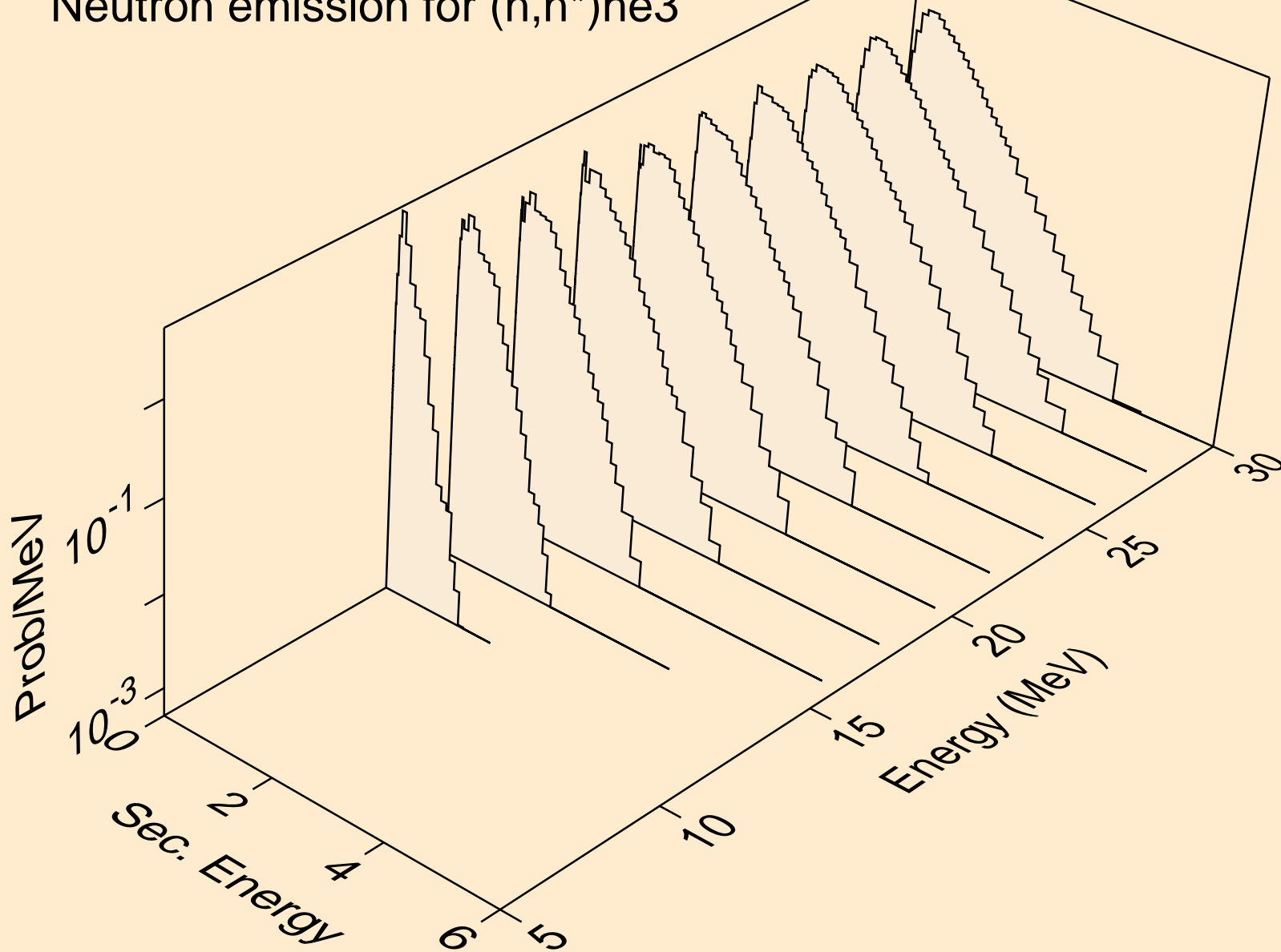

ER149 NEUTRON ACER TENDL-2019 LIBRARY; T=293.16K  
Neutron emission for (n,2np)

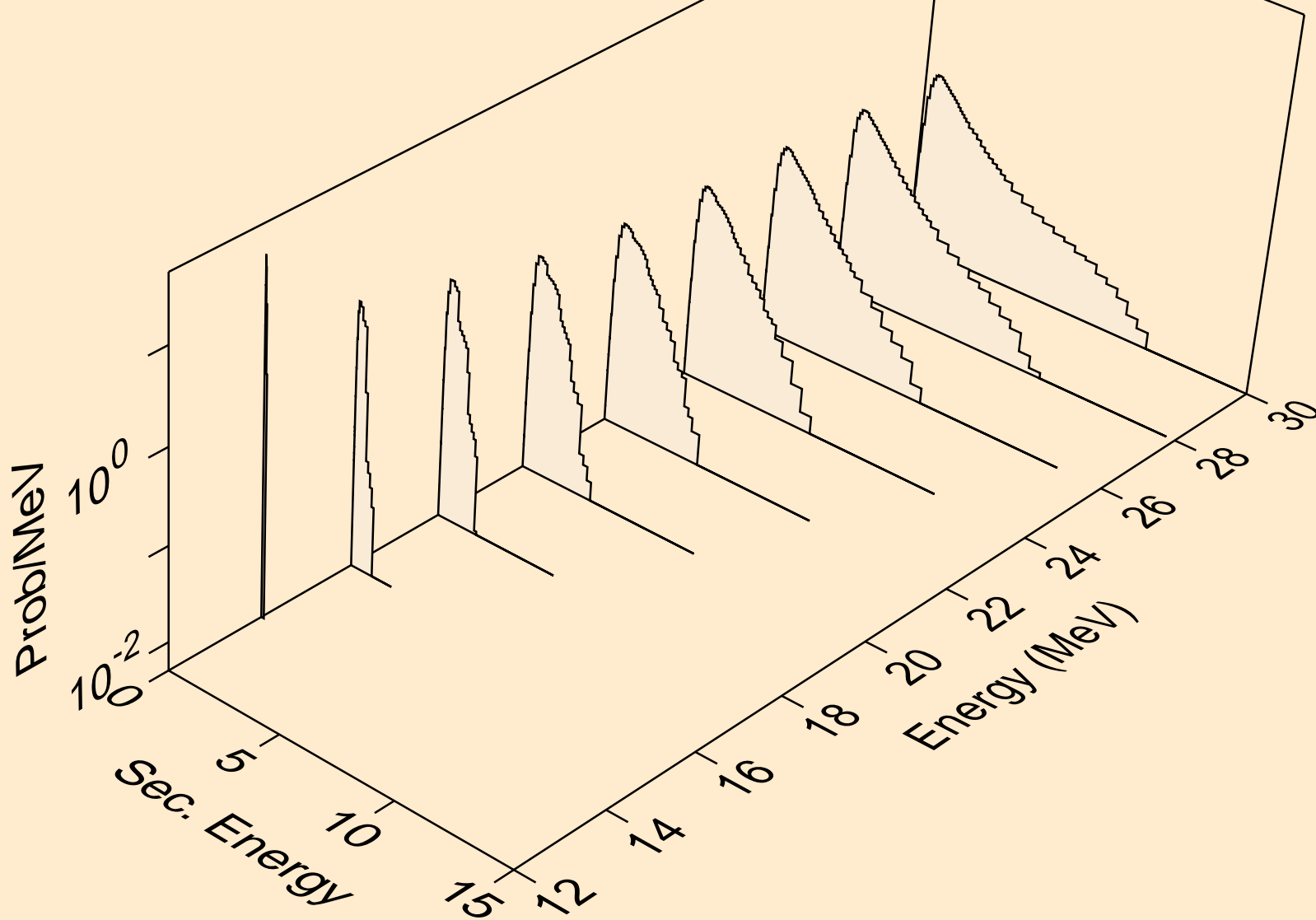

ER149 NEUTRON ACER TENDL-2019 LIBRARY; T=293.16K  
Neutron emission for (n,3np)

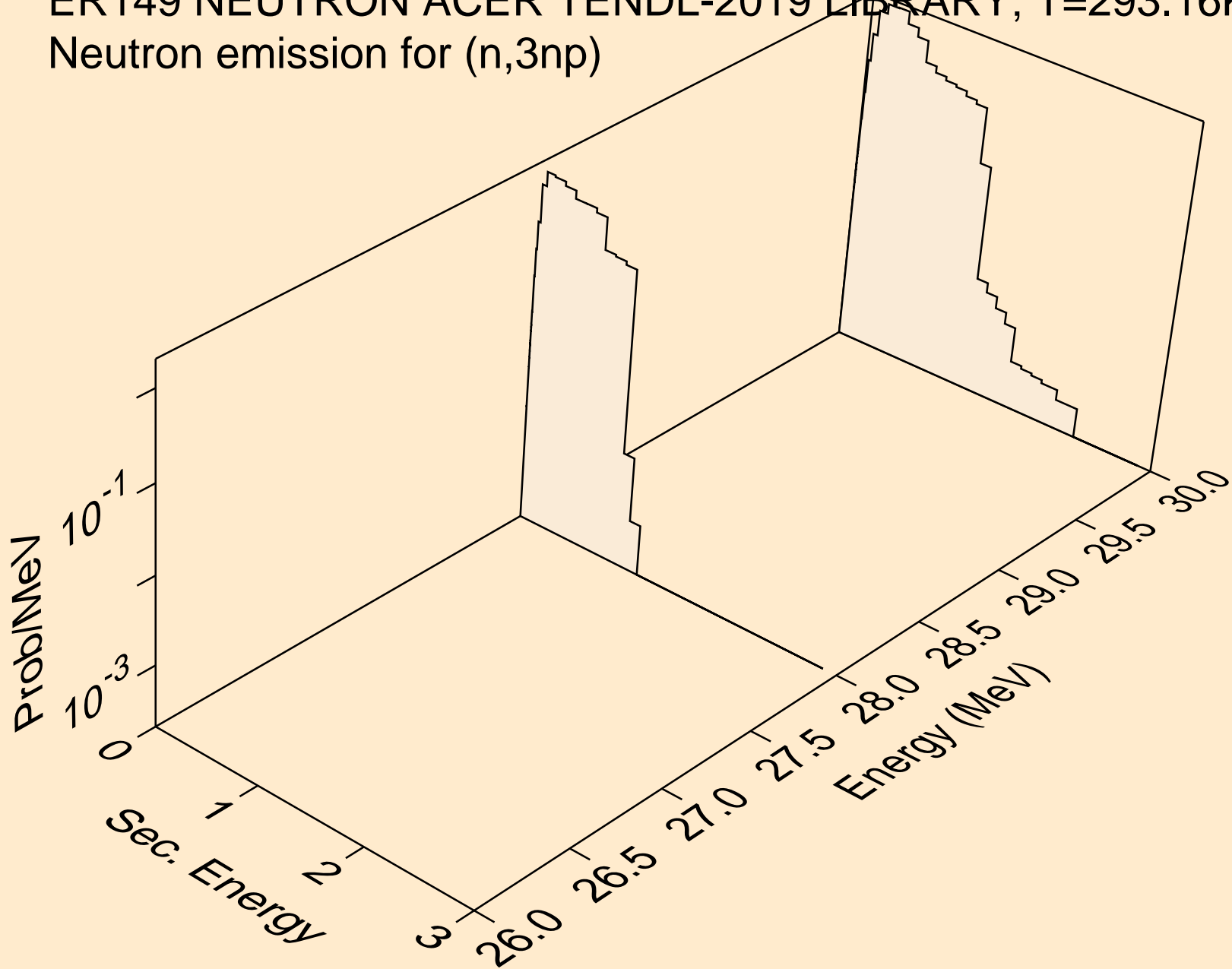

ER149 NEUTRON ACER TENDL-2019 LIBRARY; T=293.16K  
Neutron emission for (n,2np)

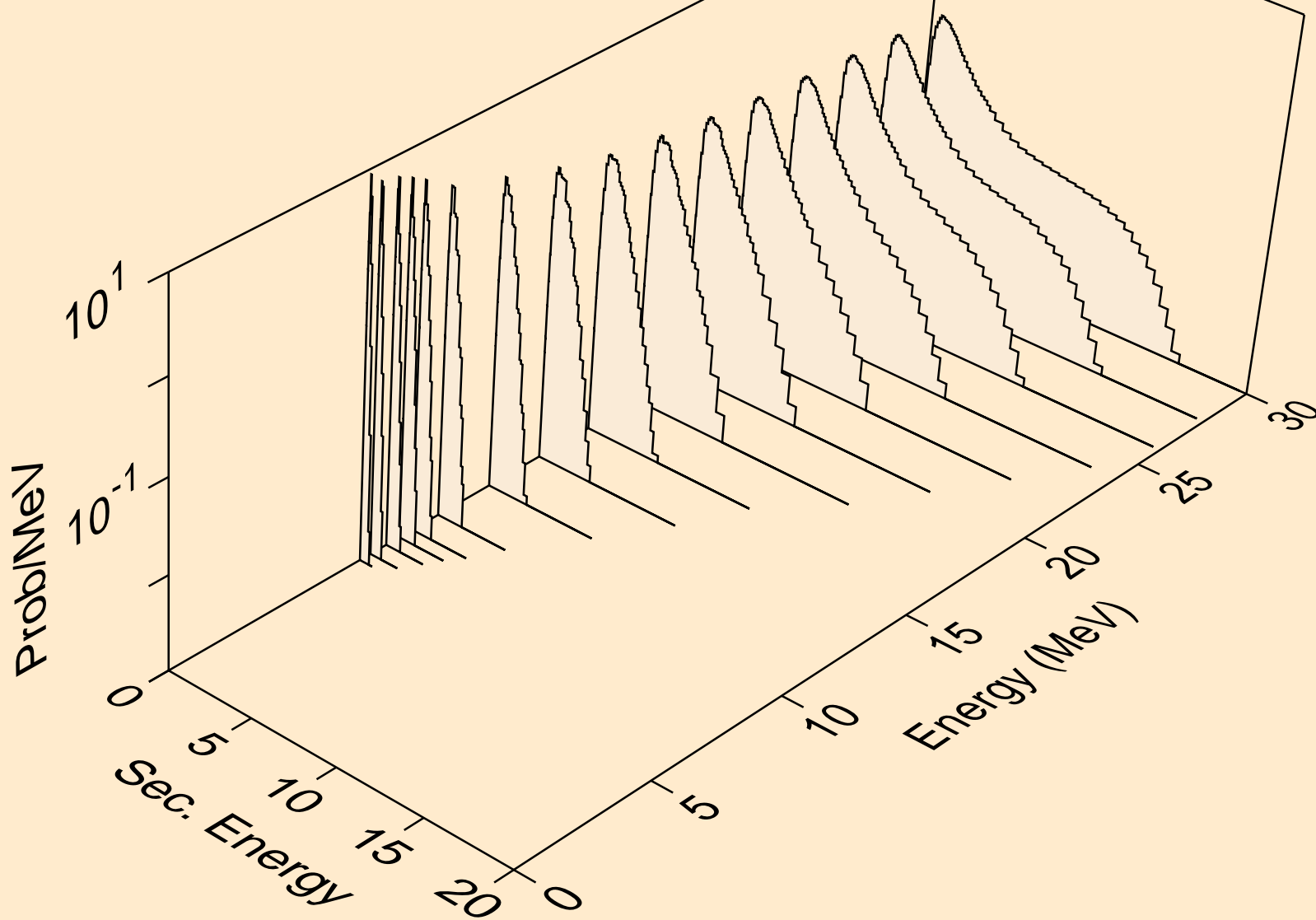

ER149 NEUTRON ACER TENDL-2019 LIBRARY; T=293.16K  
Neutron emission for (n,npa)

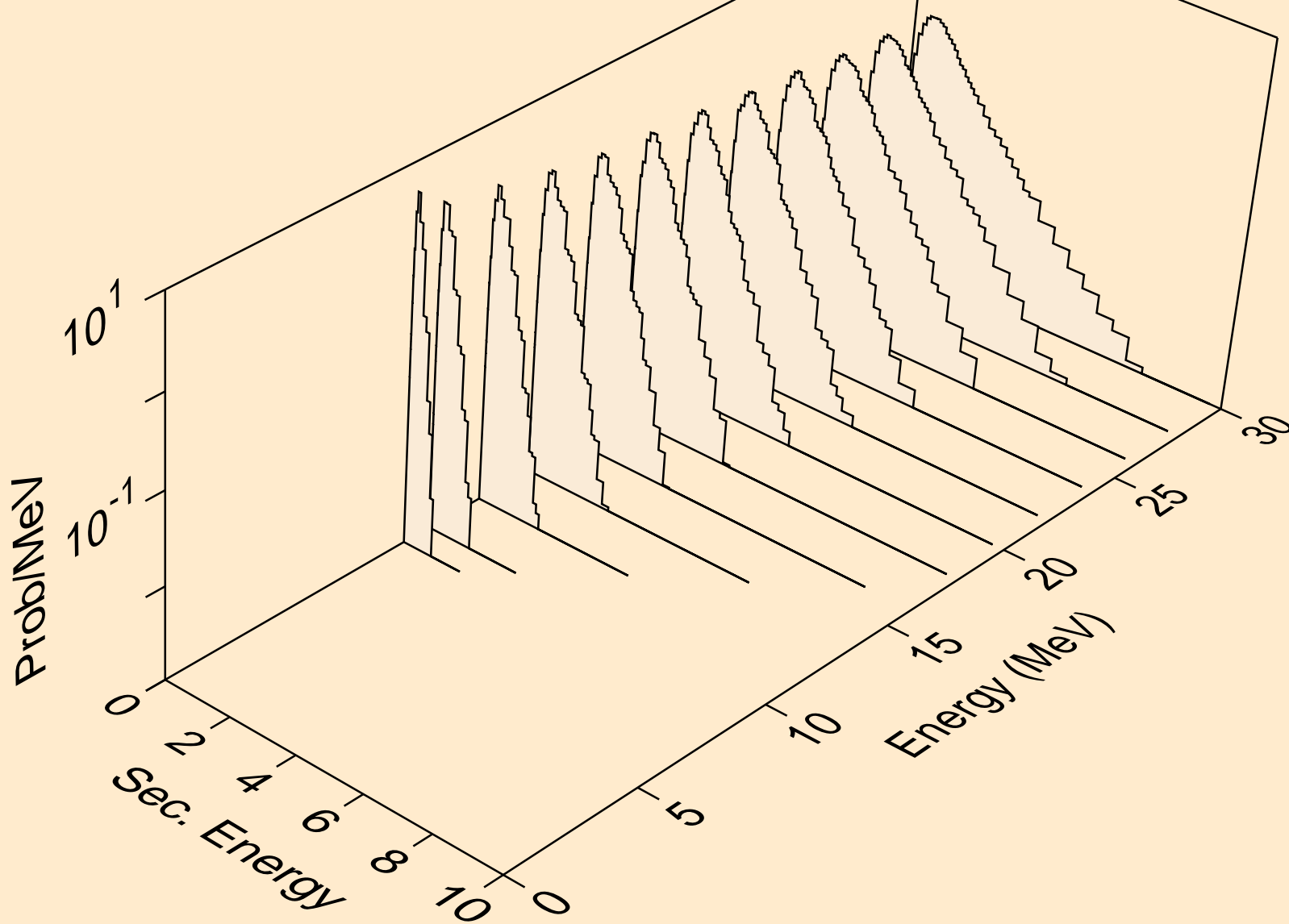



ER149 NEUTRON ACER TENDL-2019 LIBRARY; T=293.16K  
Neutron emission for (n,n\*c)

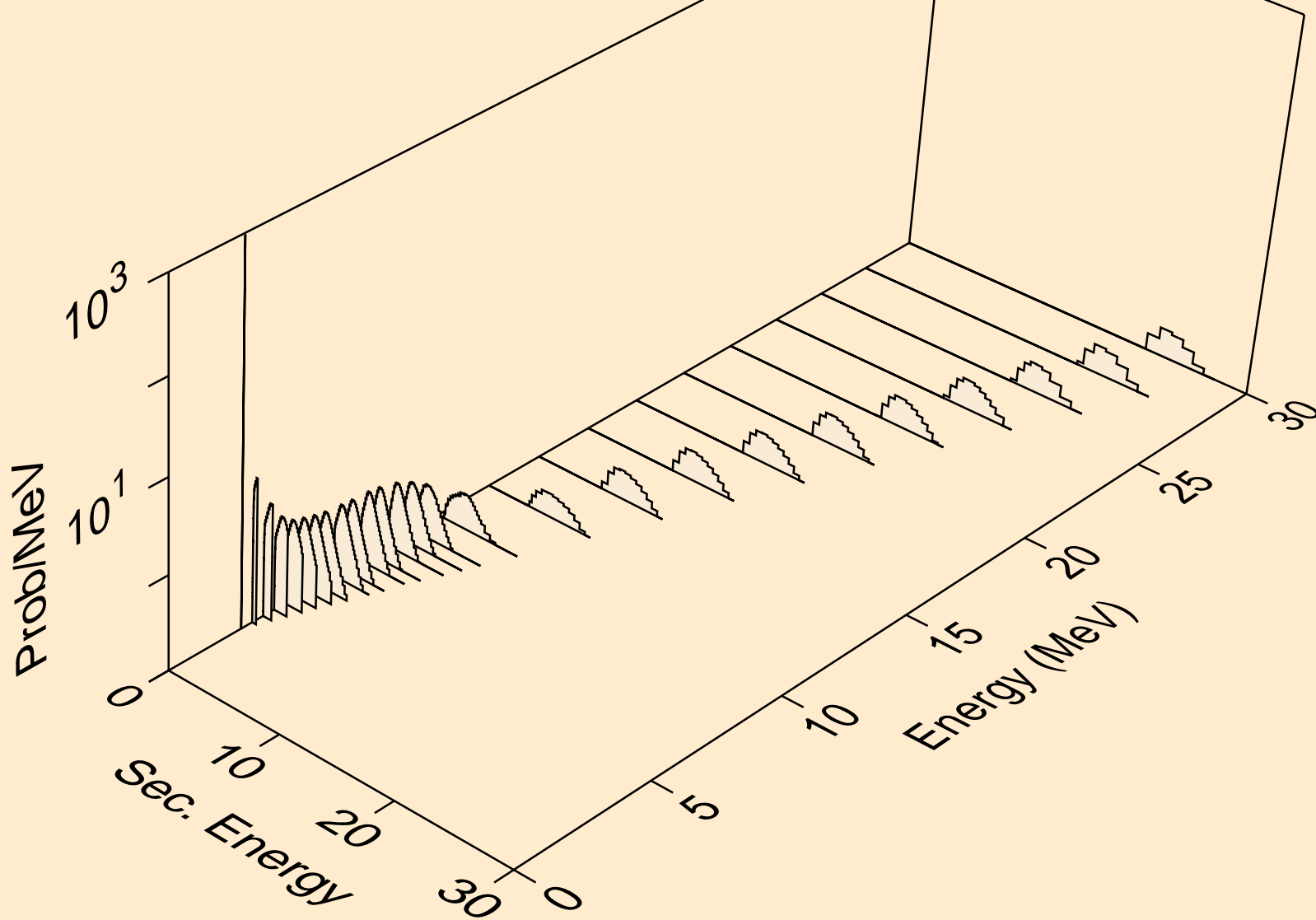

ER149 NEUTRON ACER TENDL-2019 LIBRARY; T=293.16K  
Photon emission for (n,x)

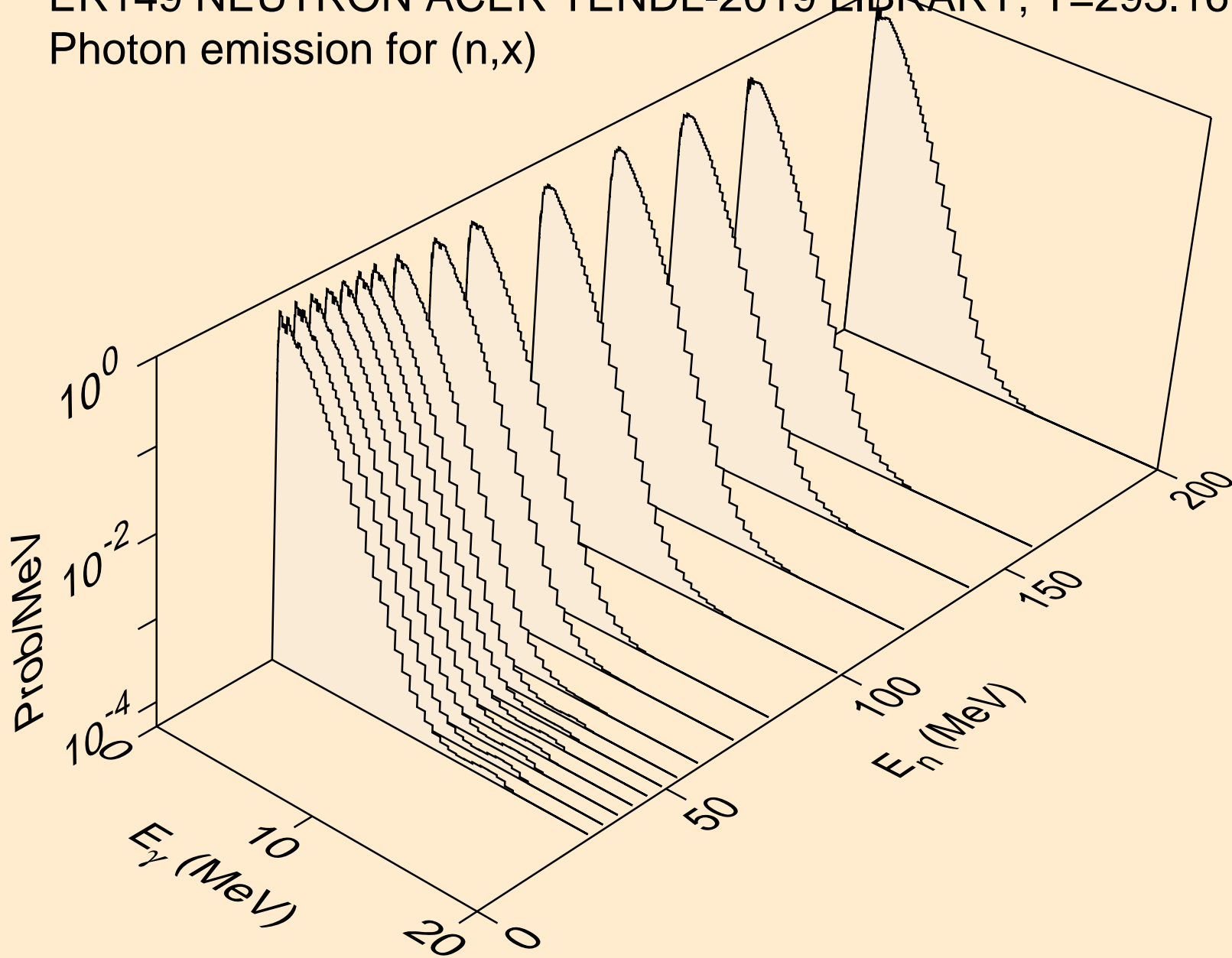

ER149 NEUTRON ACER TENDL-2019 LIBRARY; T=293.16K  
Photon emission for (n,2nd)

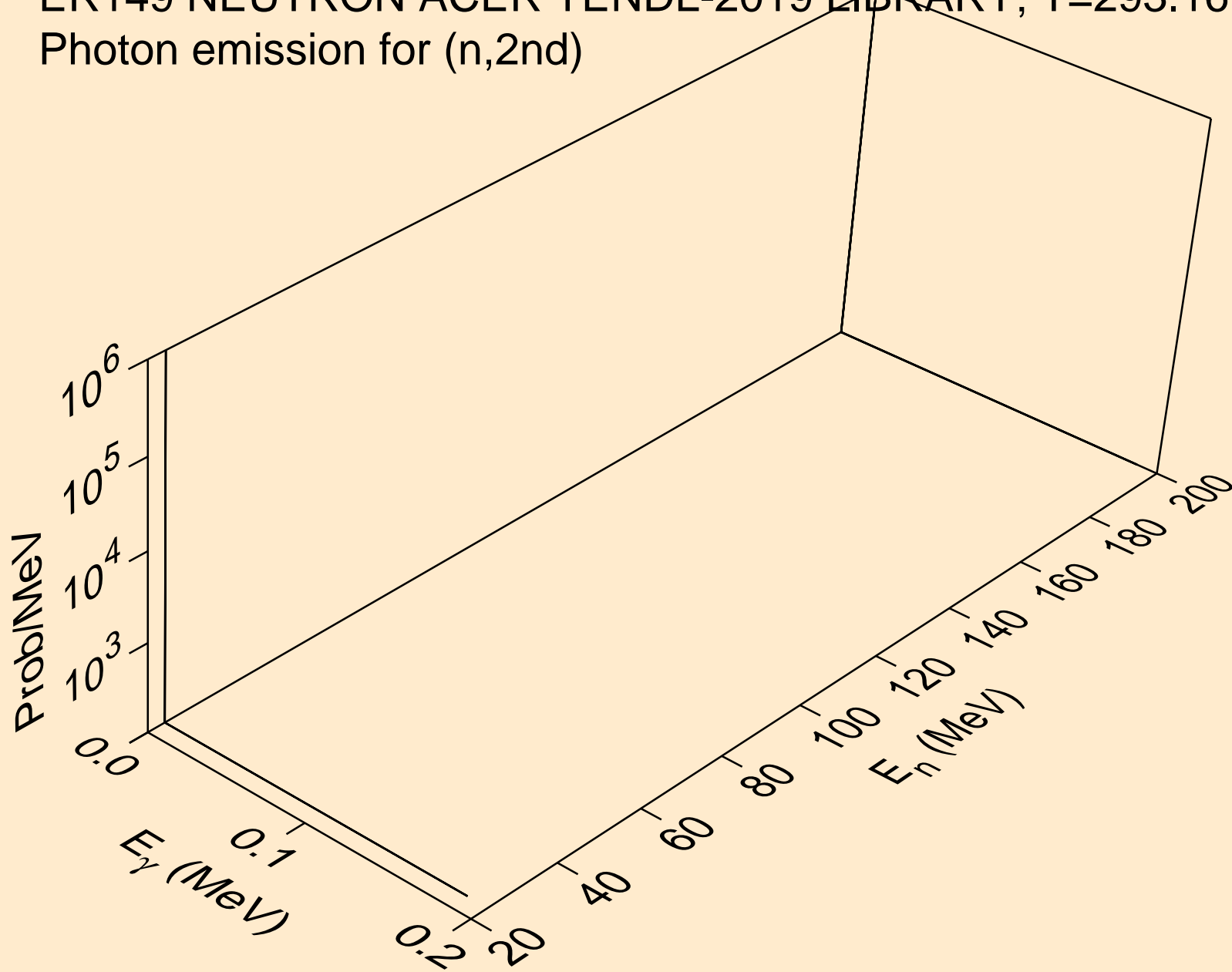

ER149 NEUTRON ACER TENDL-2019 LIBRARY; T=293.16K  
Photon emission for (n,2n)

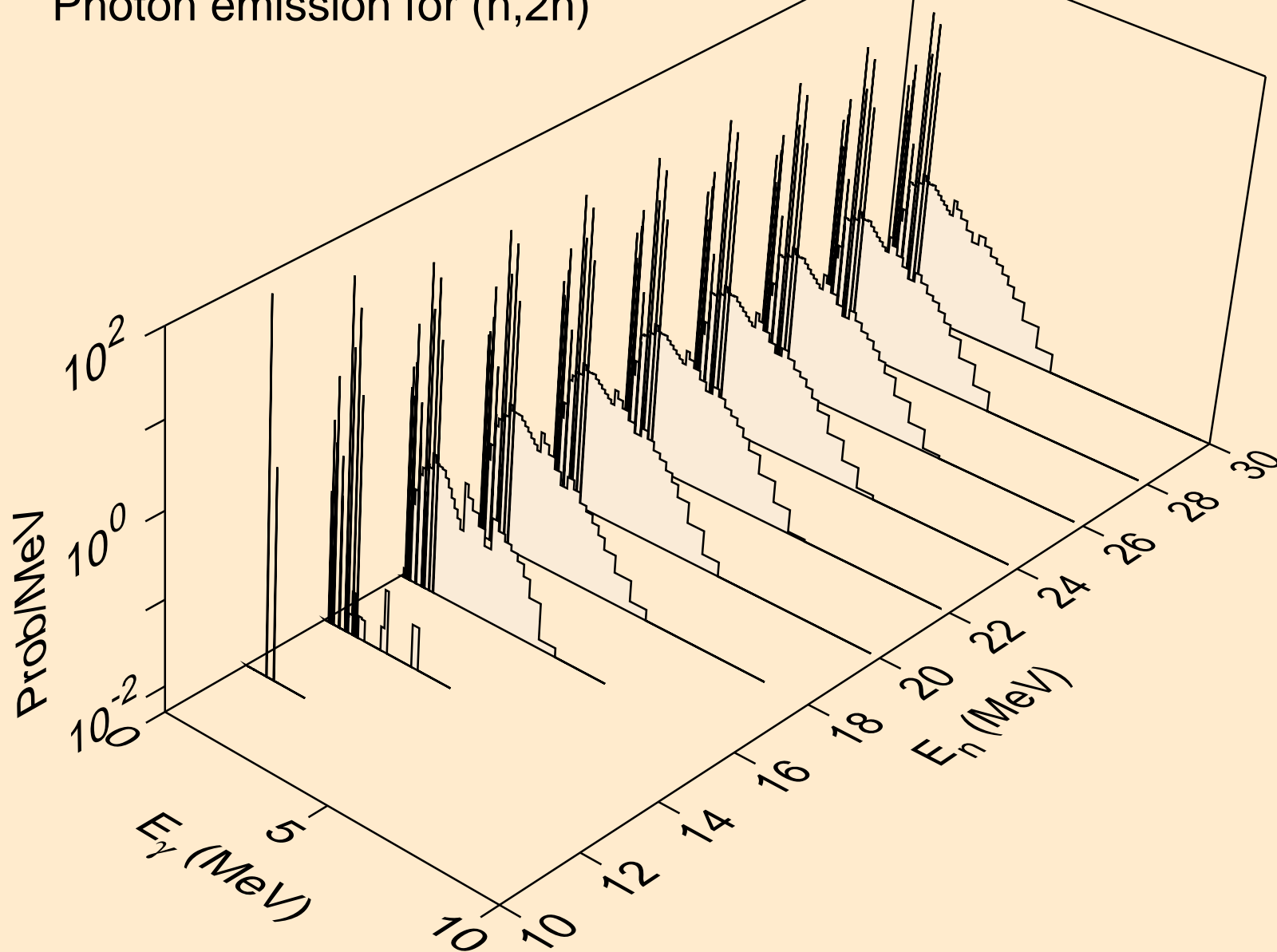

ER149 NEUTRON ACER TENDL-2019 LIBRARY; T=293.16K  
Photon emission for (n,3n)

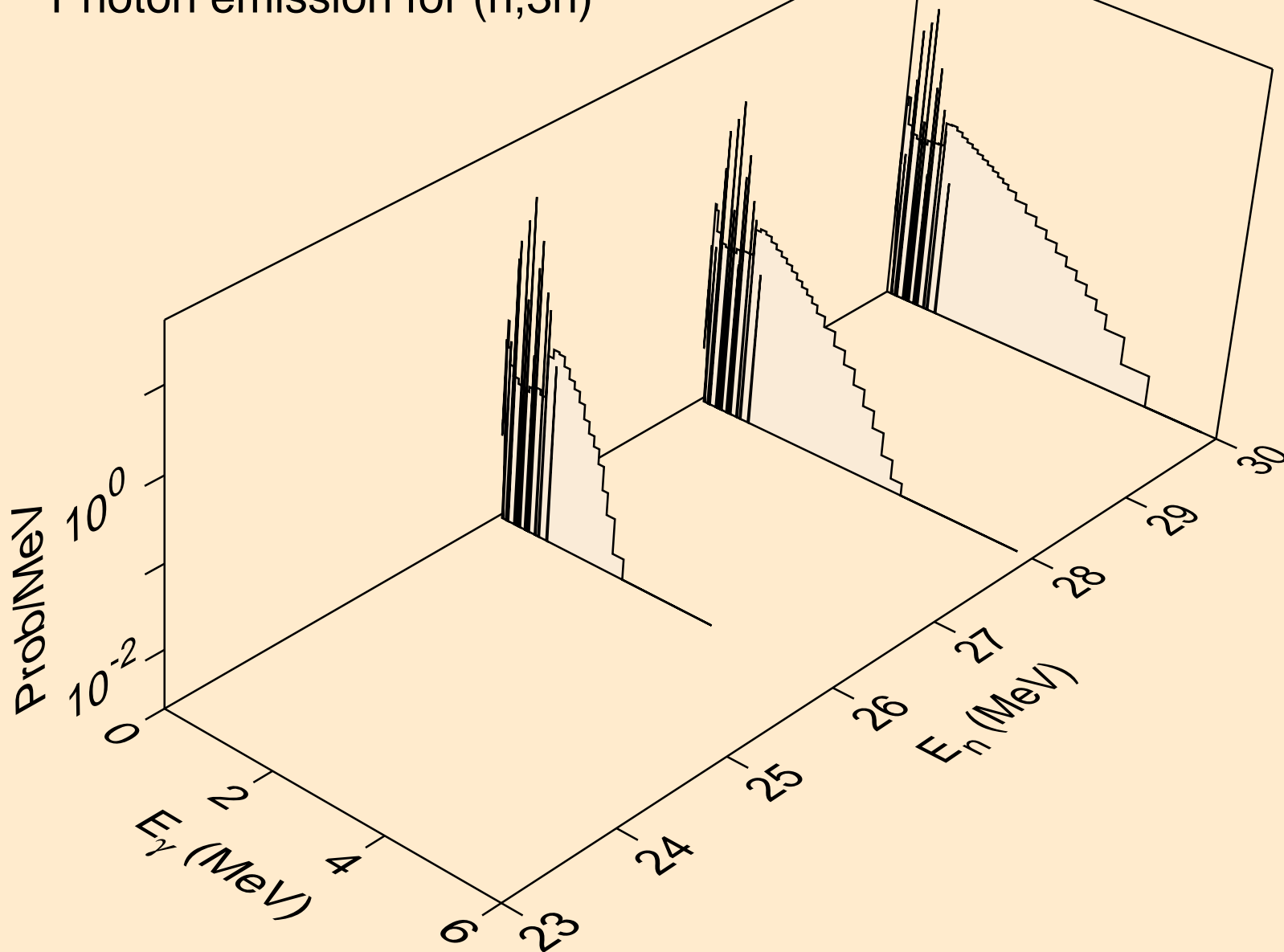

ER149 NEUTRON ACER TENDL-2019 LIBRARY; T=293.16K  
Photon emission for (n,n\*)a

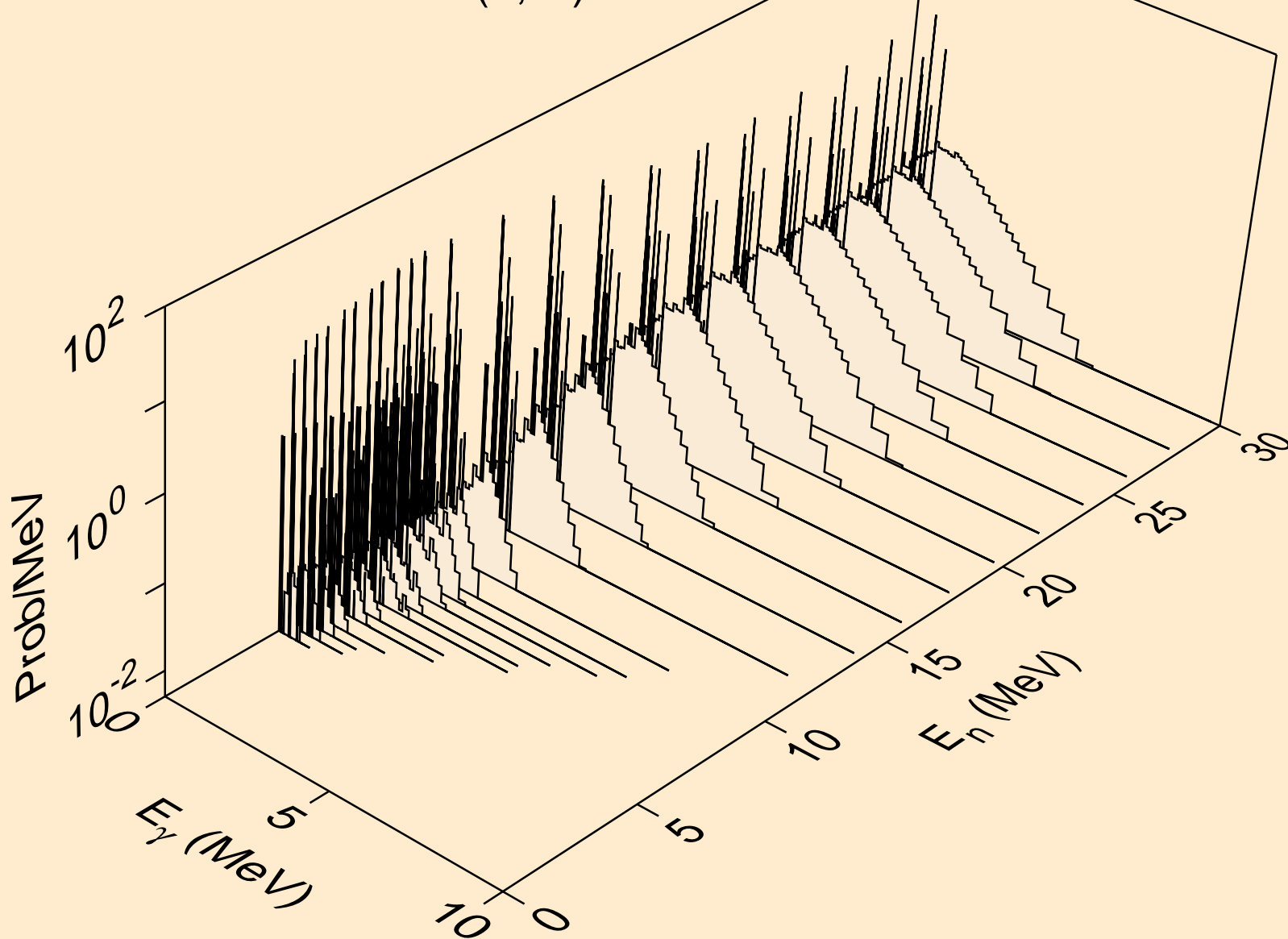

ER149 NEUTRON ACER TENDL-2019 LIBRARY; T=293.16K  
Photon emission for (n,2n)a

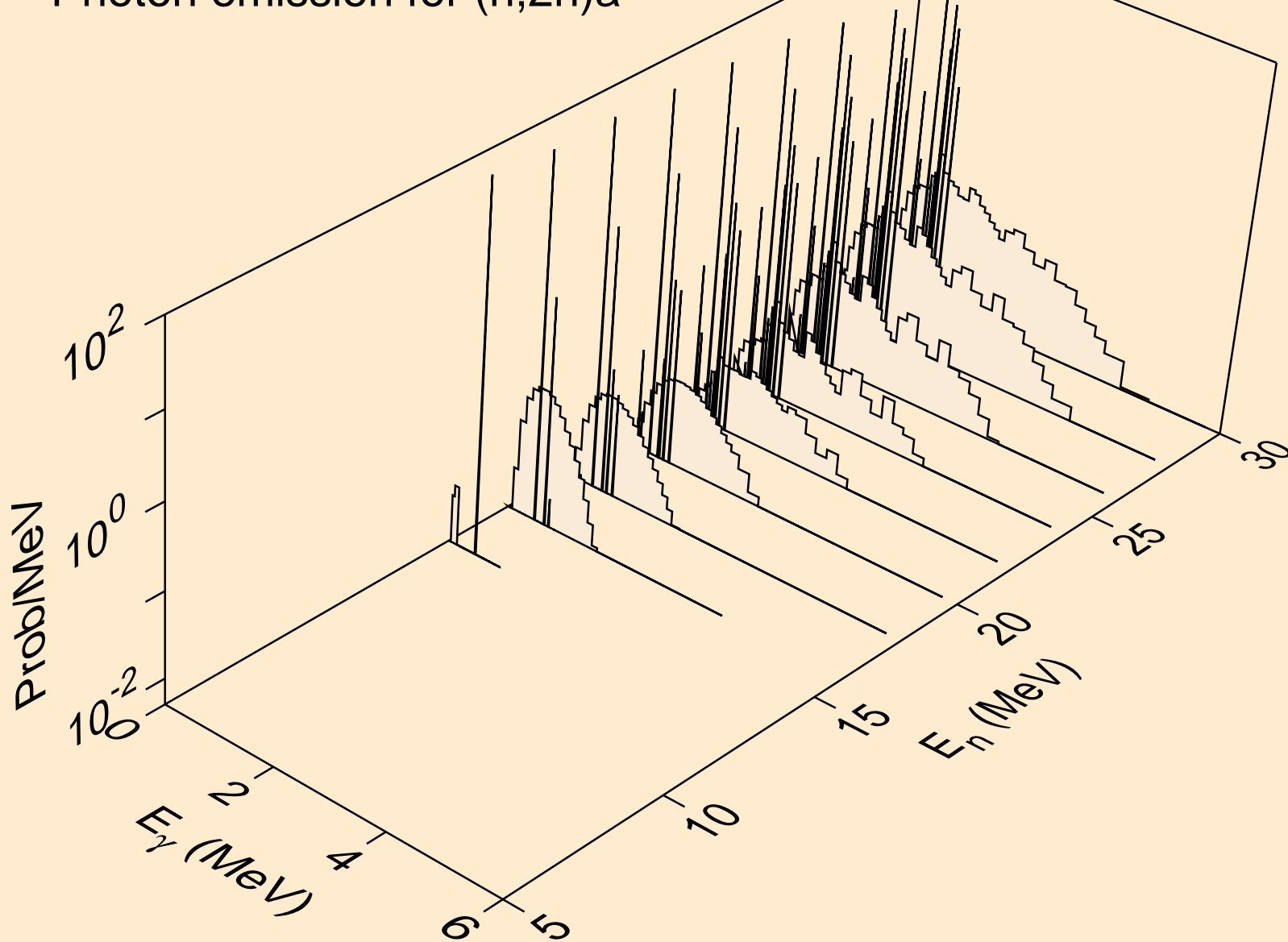

ER149 NEUTRON ACER TENDL-2019 LIBRARY; T=293.16K  
Photon emission for (n,n\*)p

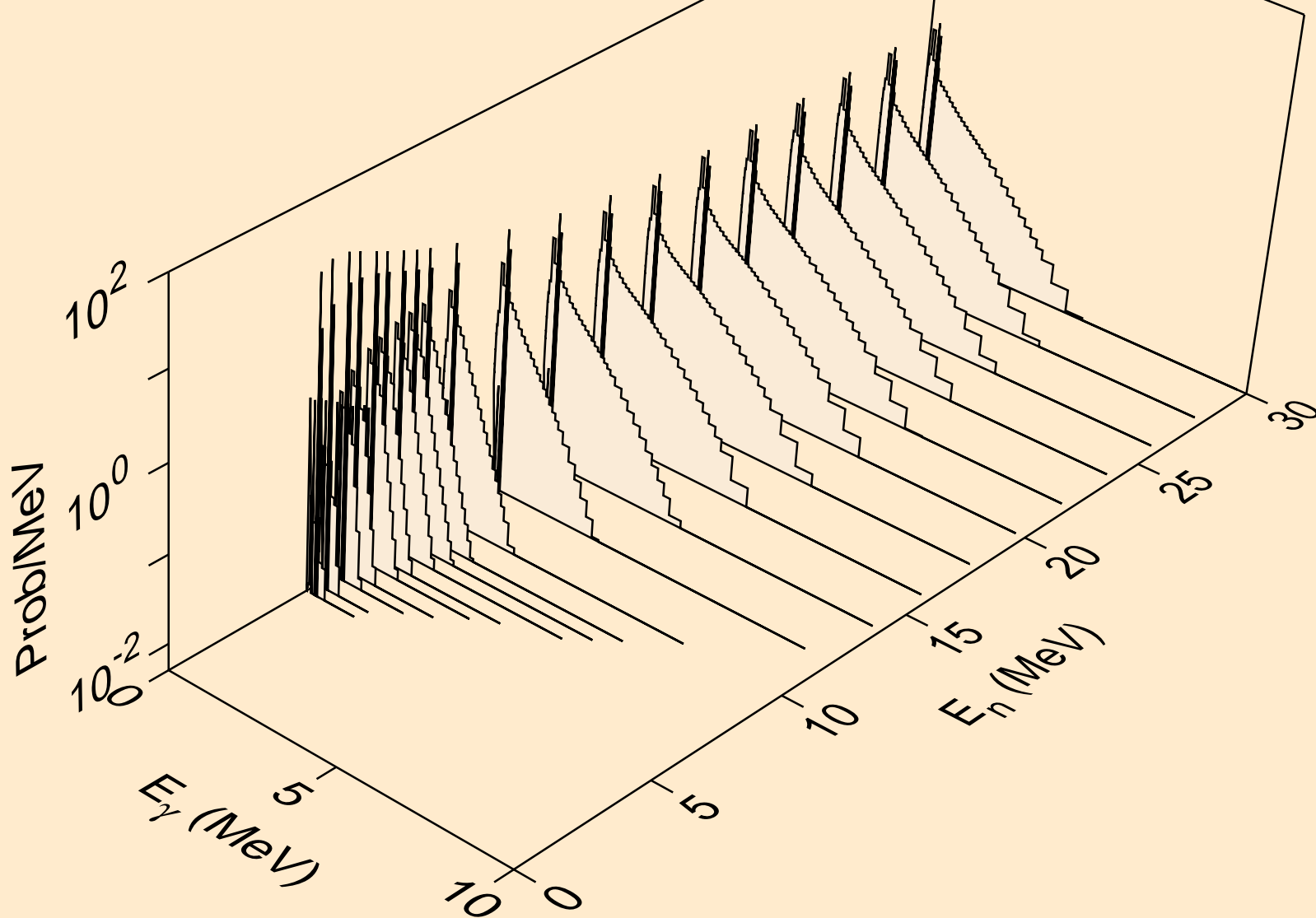



ER149 NEUTRON ACER TENDL-2019 LIBRARY; T=293.16K  
Photon emission for (n,n\*)2a

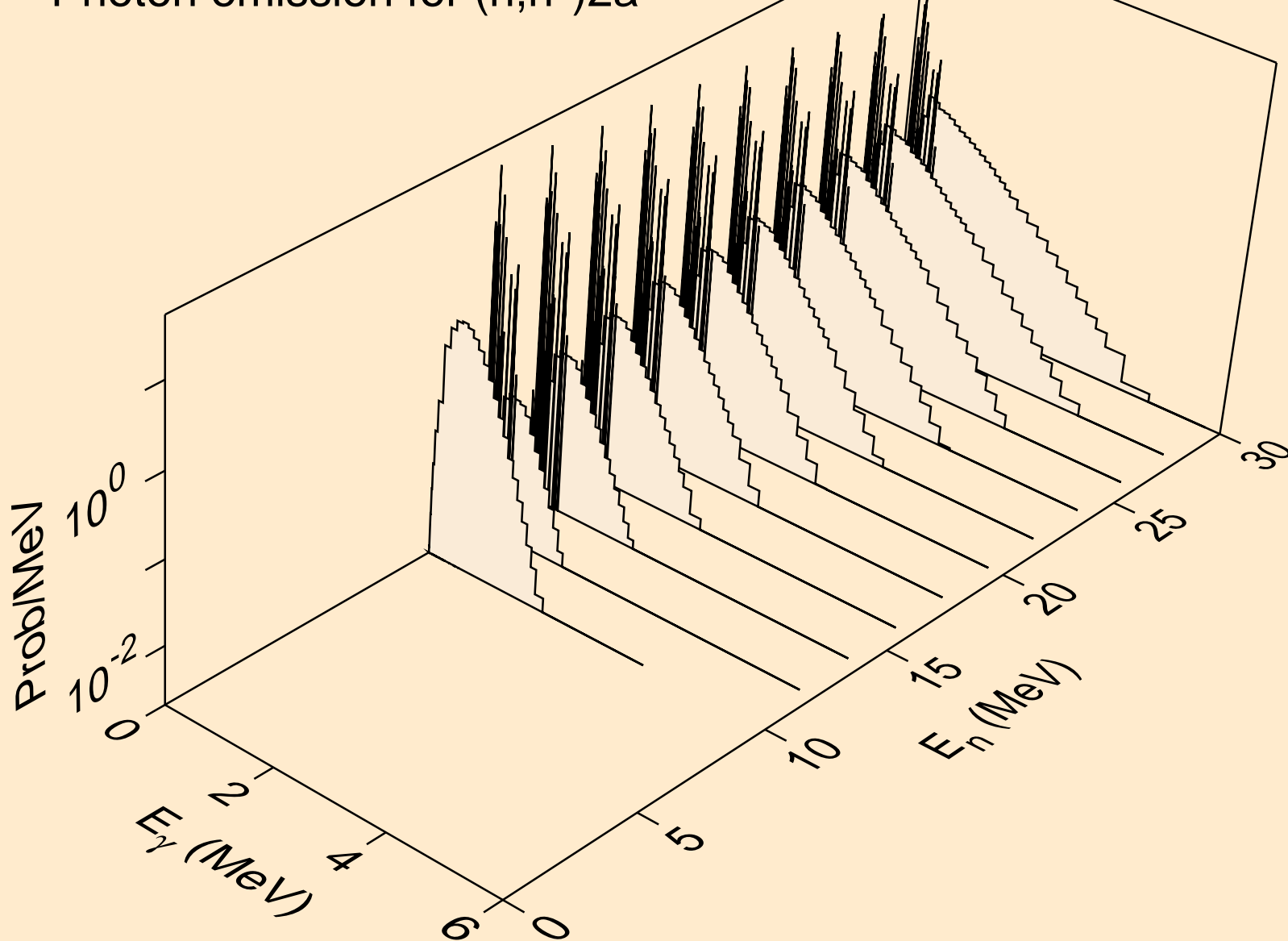

ER149 NEUTRON ACER TENDL-2019 LIBRARY; T=293.16K  
Photon emission for (n,2n)2a

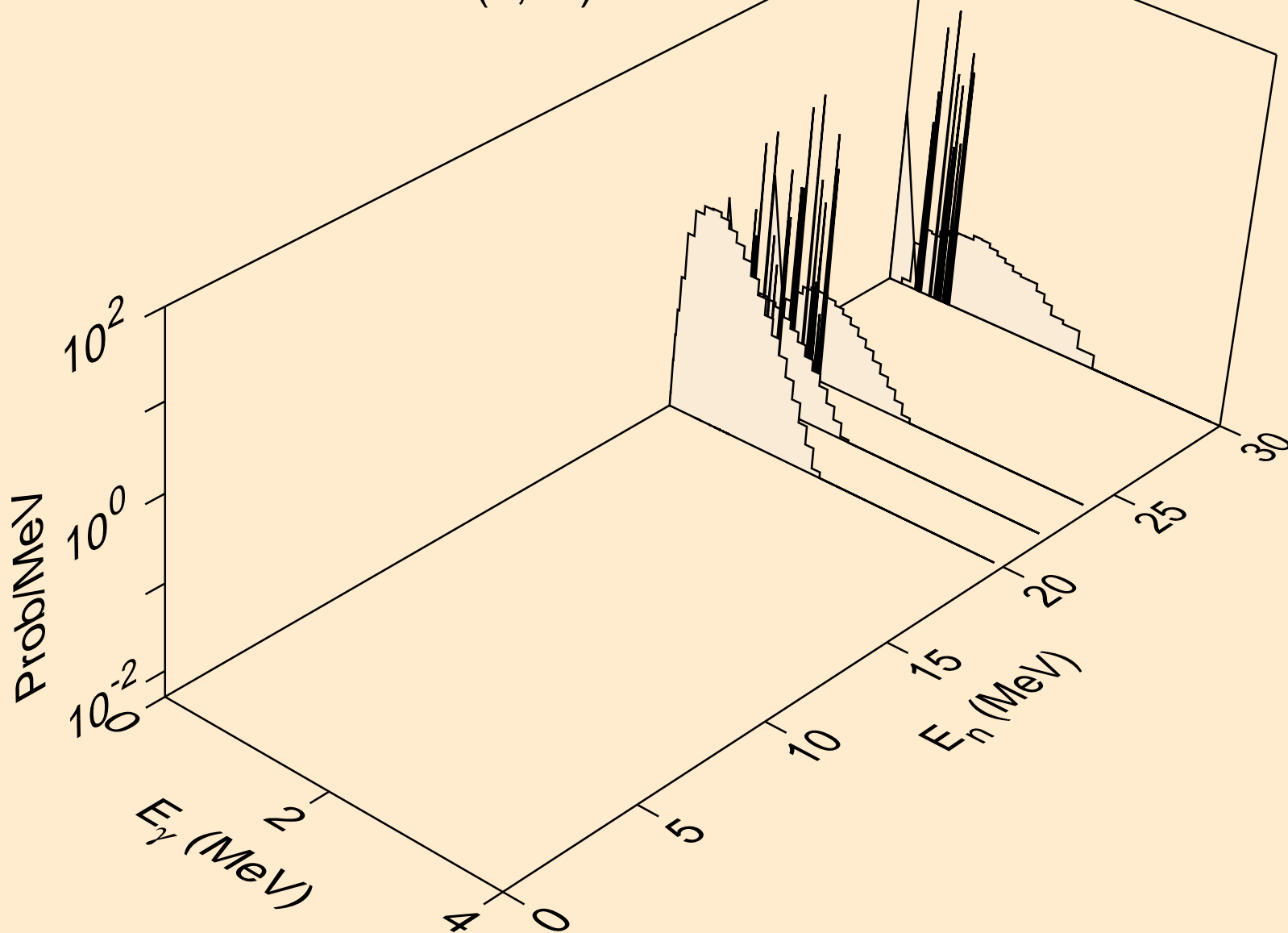

ER149 NEUTRON ACER TENDL-2019 LIBRARY; T=293.16K  
Photon emission for (n,n\*)d

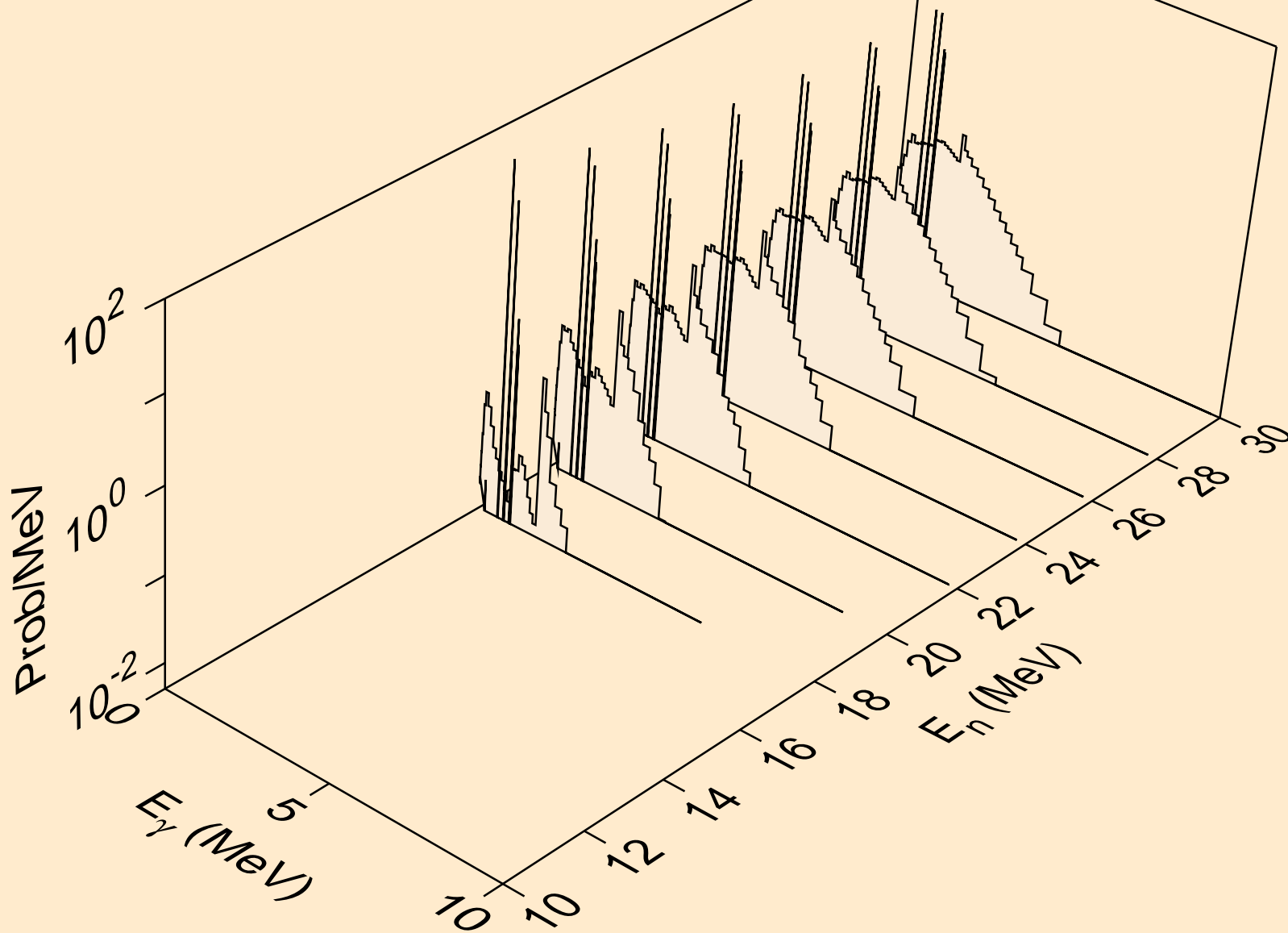

ER149 NEUTRON ACER TENDL-2019 LIBRARY; T=293.16K  
Photon emission for (n,n\*)t

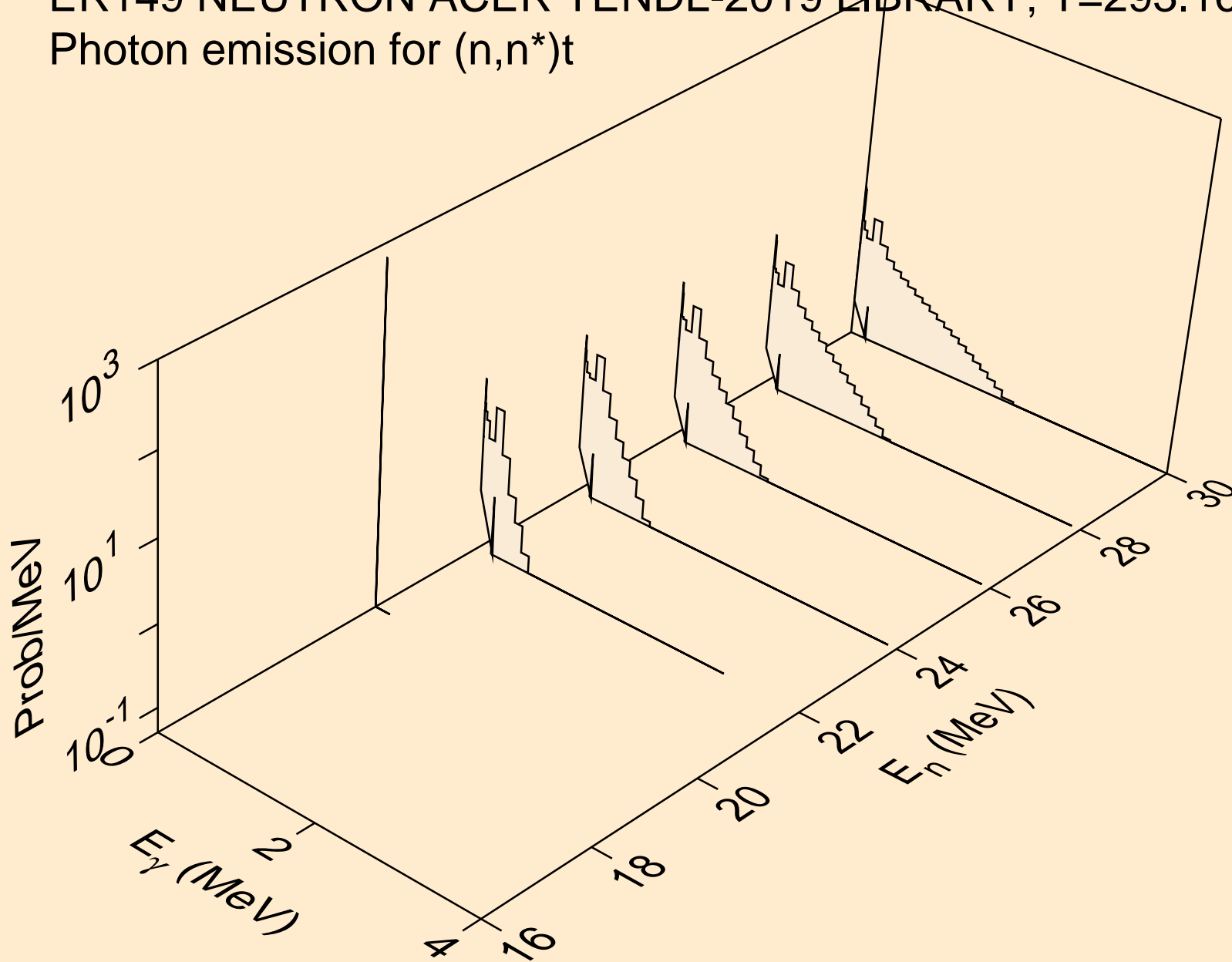

ER149 NEUTRON ACER TENDL-2019 LIBRARY; T=293.16K  
Photon emission for (n,n\*)he3

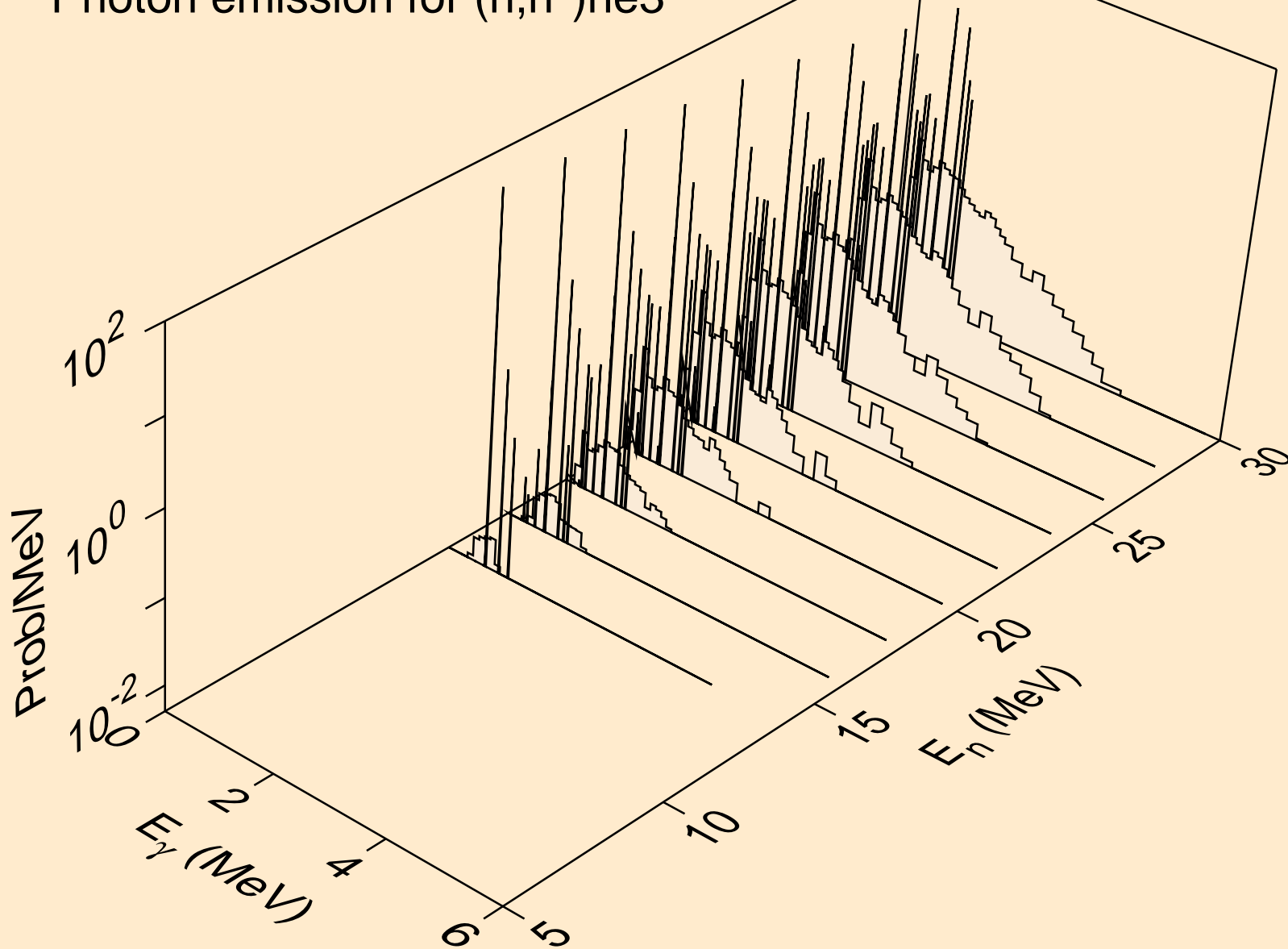

ER149 NEUTRON ACER TENDL-2019 LIBRARY; T=293.16K  
Photon emission for (n,2np)

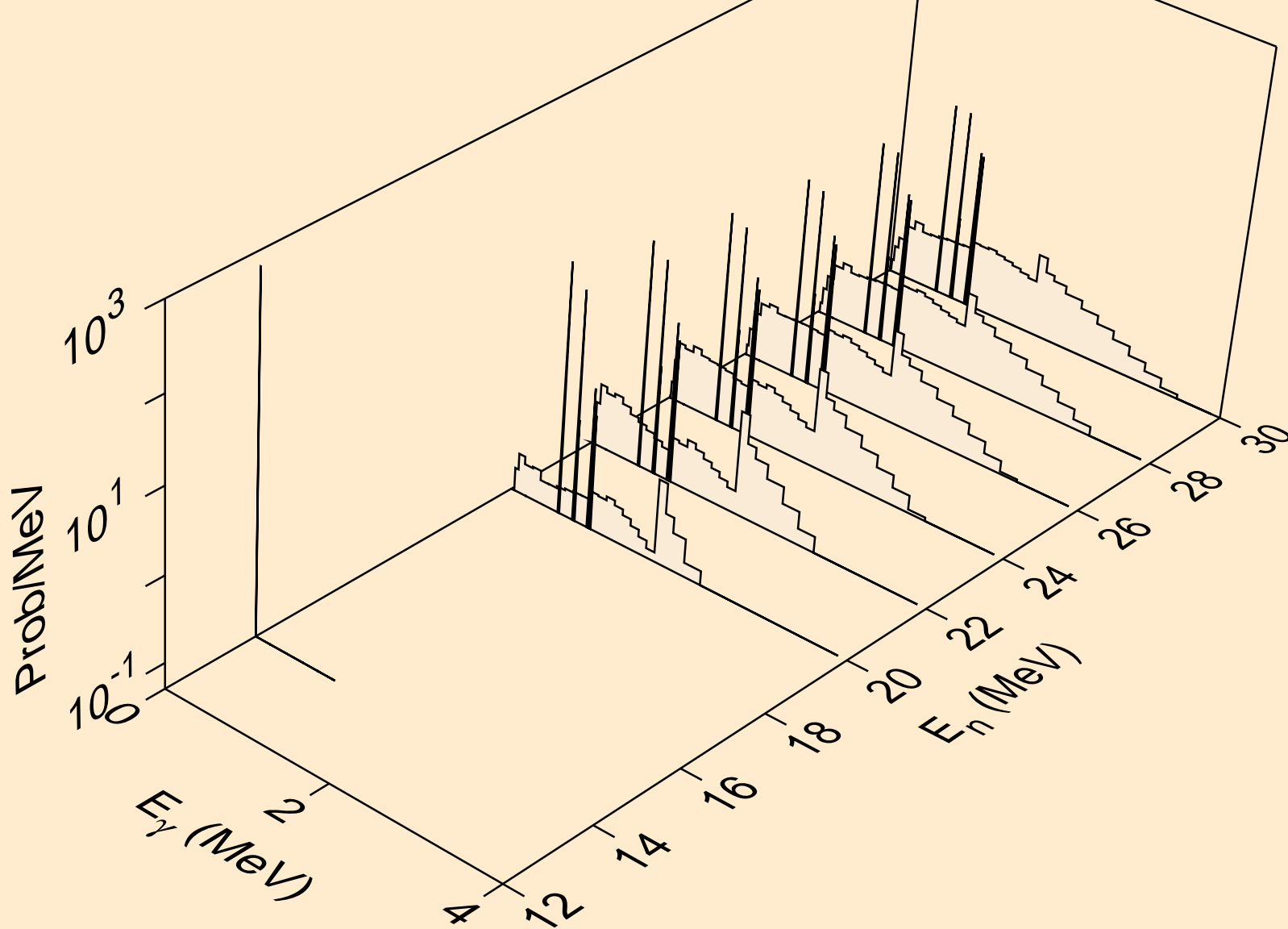

ER149 NEUTRON ACER TENDL-2019 LIBRARY; T=293.16K  
Photon emission for (n,3np)

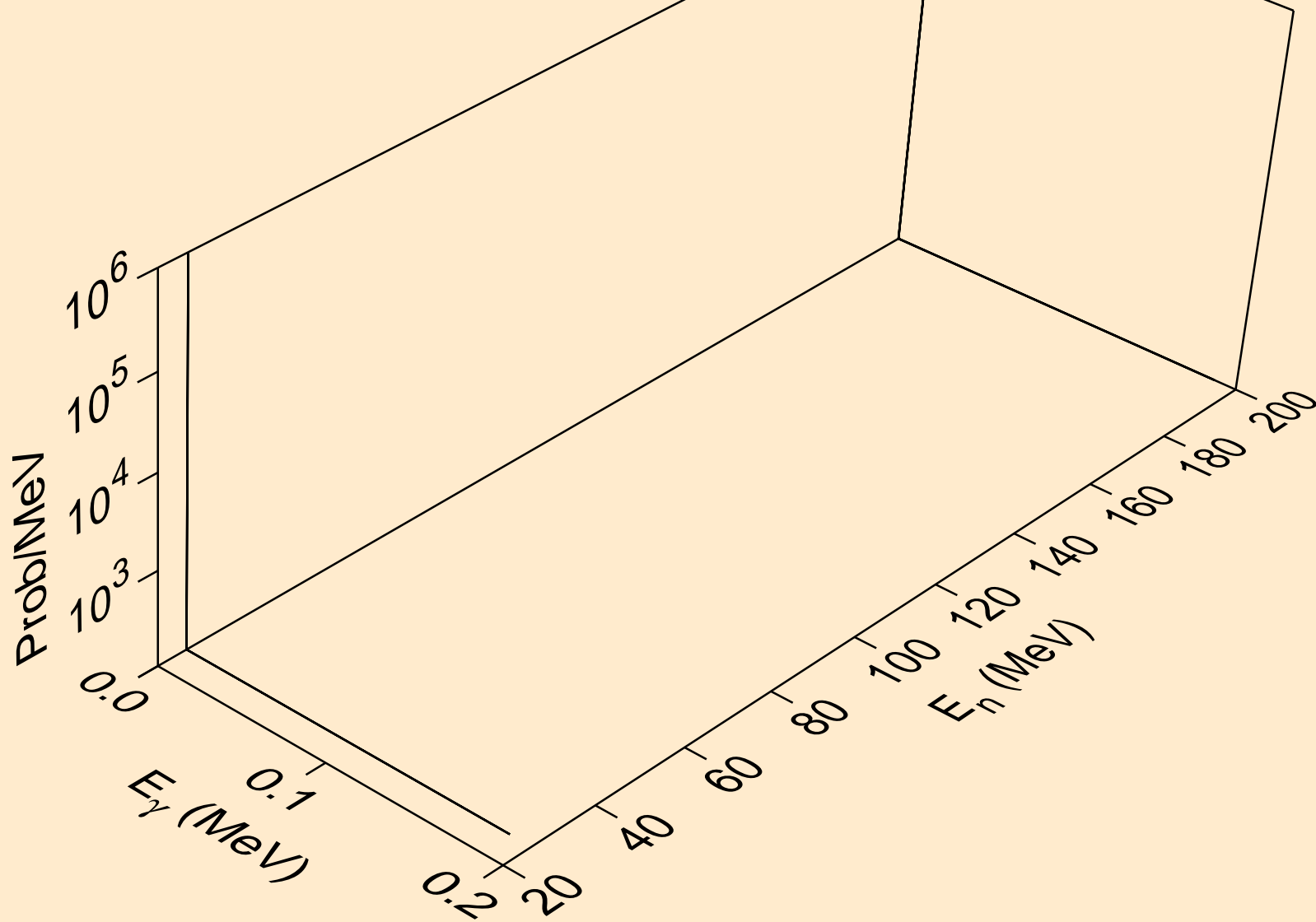

ER149 NEUTRON ACER TENDL-2019 LIBRARY; T=293.16K  
Photon emission for (n,2np)

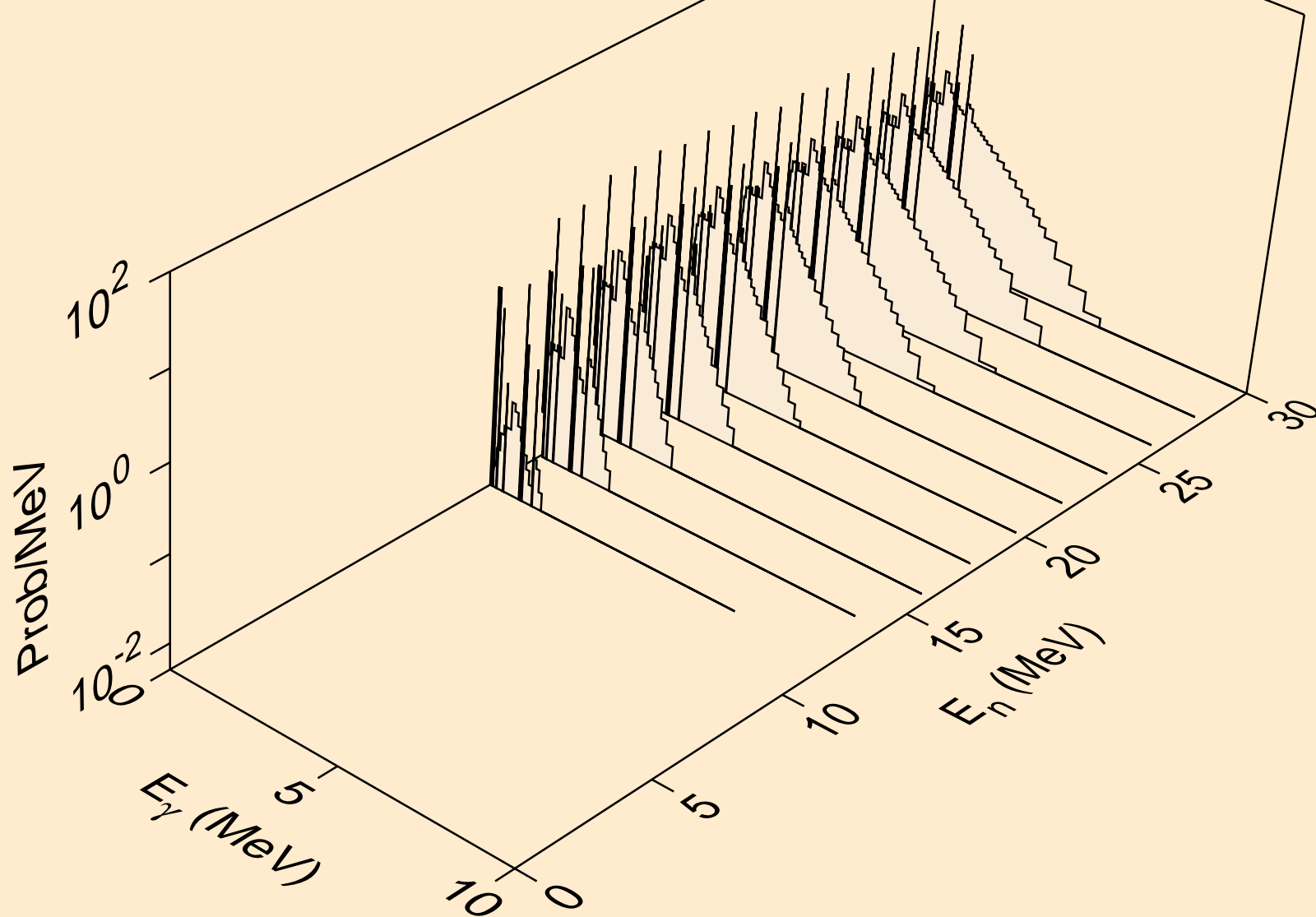



ER149 NEUTRON ACER TENDL-2019 LIBRARY; T=293.16K  
Photon emission for (n,npa)

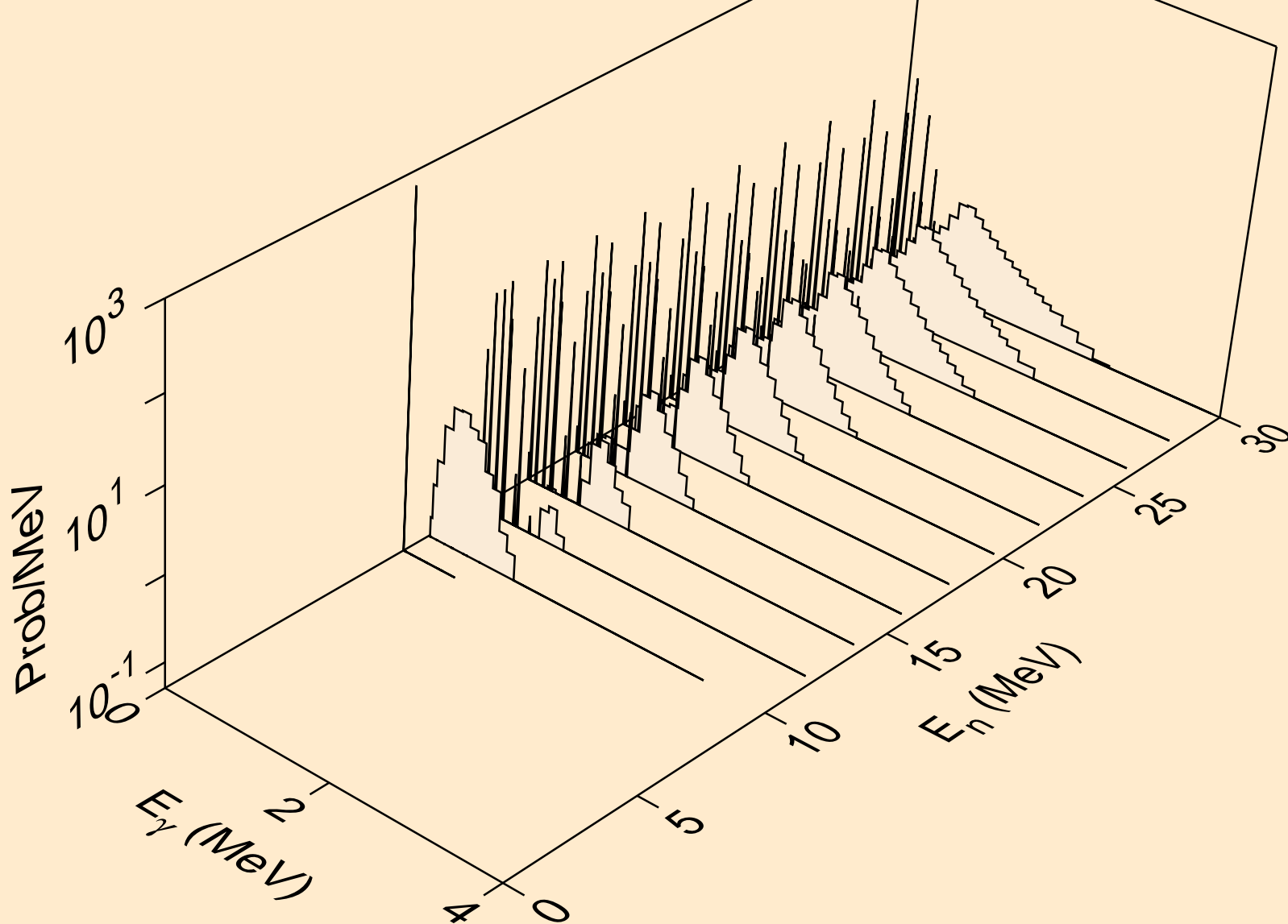

ER149 NEUTRON ACER TENDL-2019 LIBRARY; T=293.16K  
Photon emission for (n,n\*c)

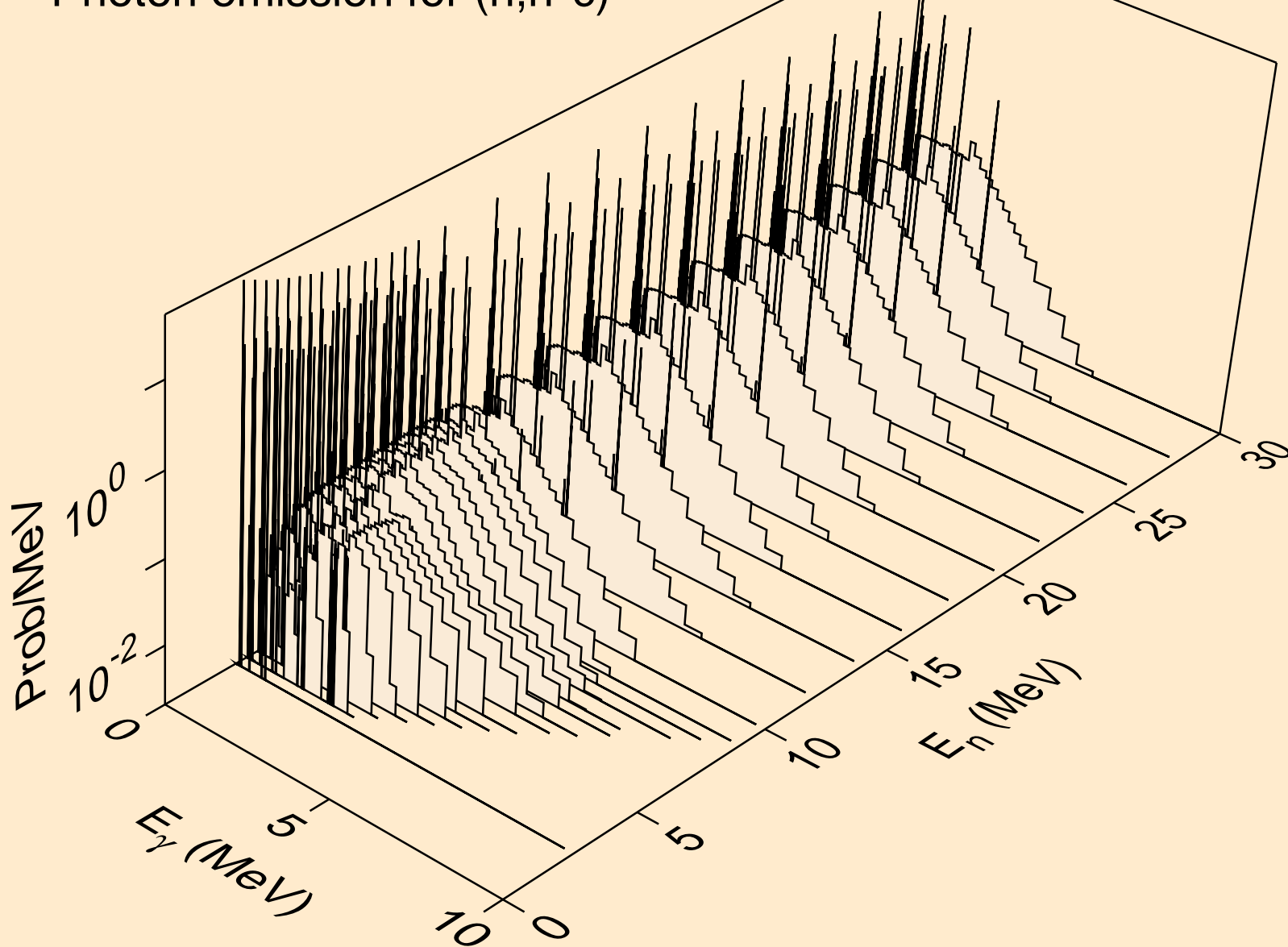

ER149 NEUTRON ACER TENDL-2019 LIBRARY; T=293.16K  
Photon emission for (n,gma)

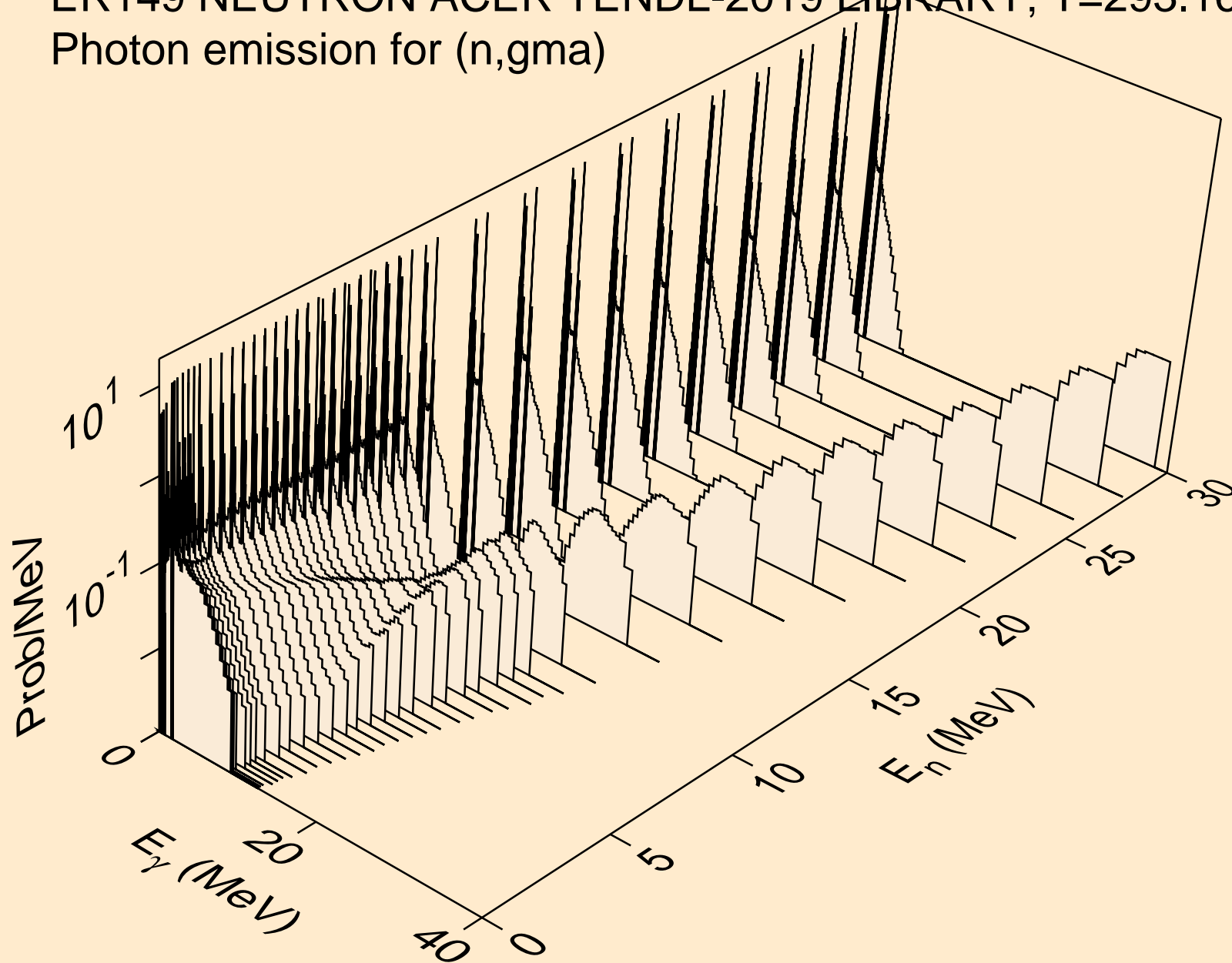

ER149 NEUTRON ACER TENDL-2019 LIBRARY; T=293.16K  
Photon emission for (n,p)

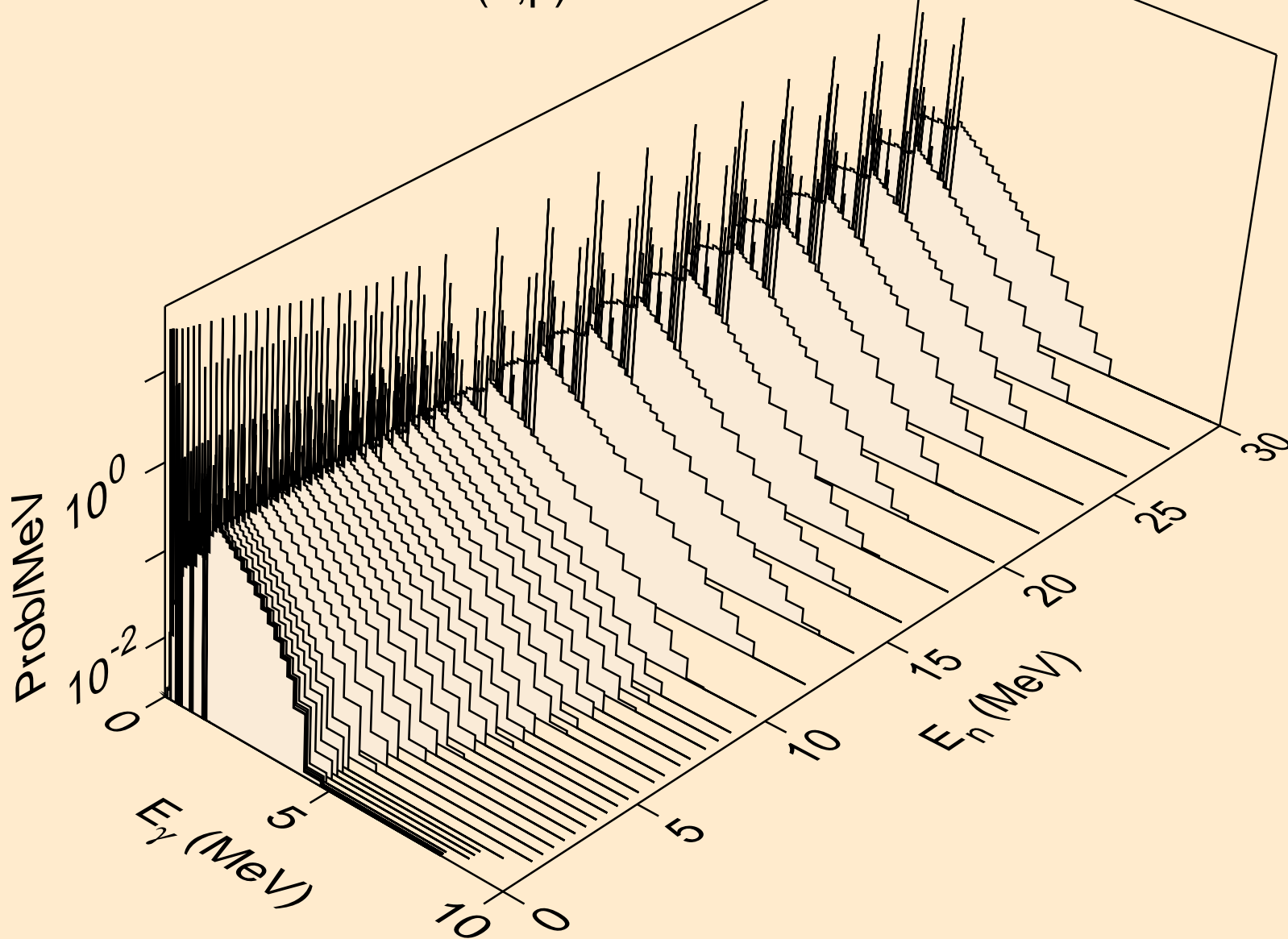

ER149 NEUTRON ACER TENDL-2019 LIBRARY; T=293.16K  
Photon emission for (n,d)

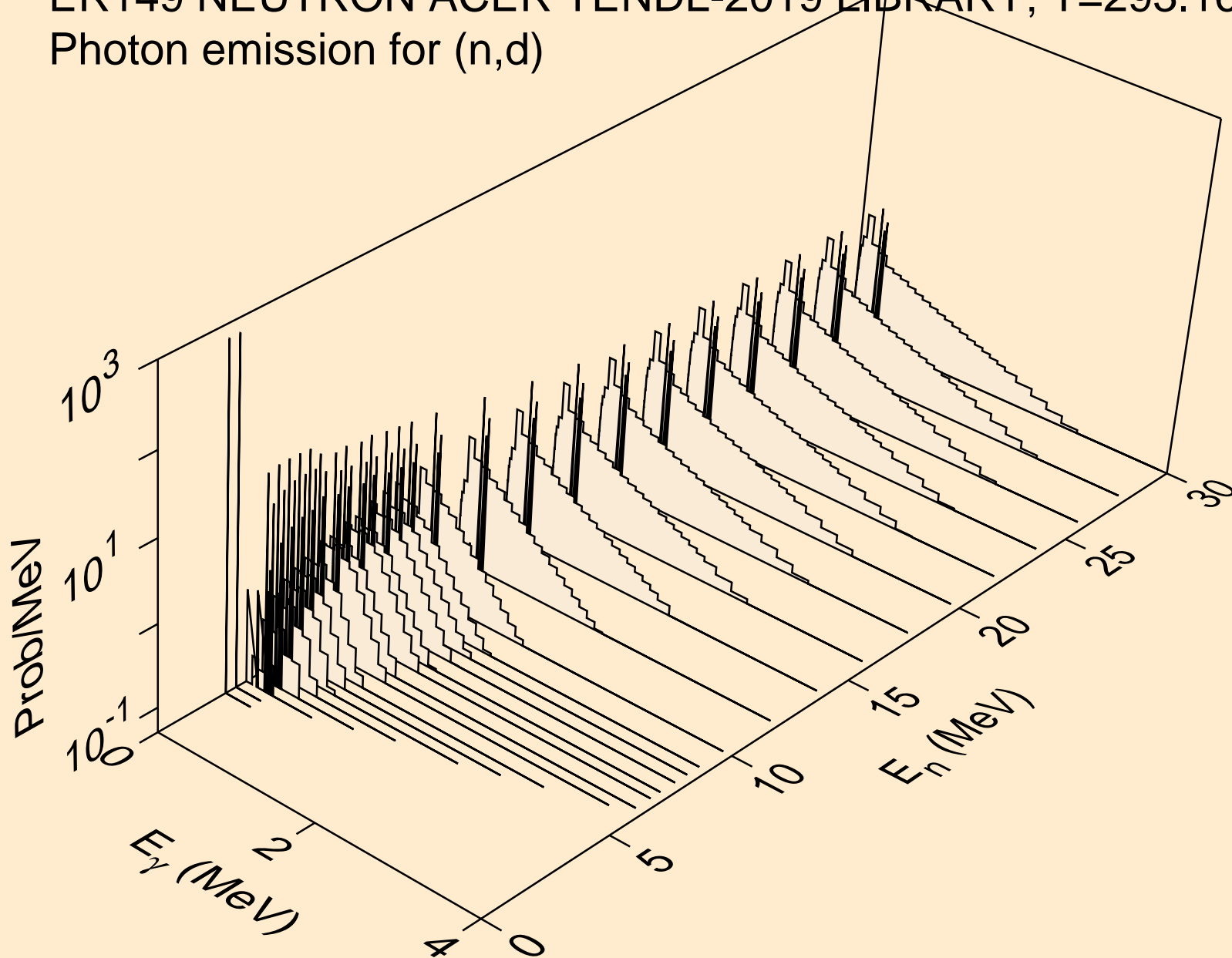

ER149 NEUTRON ACER TENDL-2019 LIBRARY; T=293.16K  
Photon emission for (n,t)

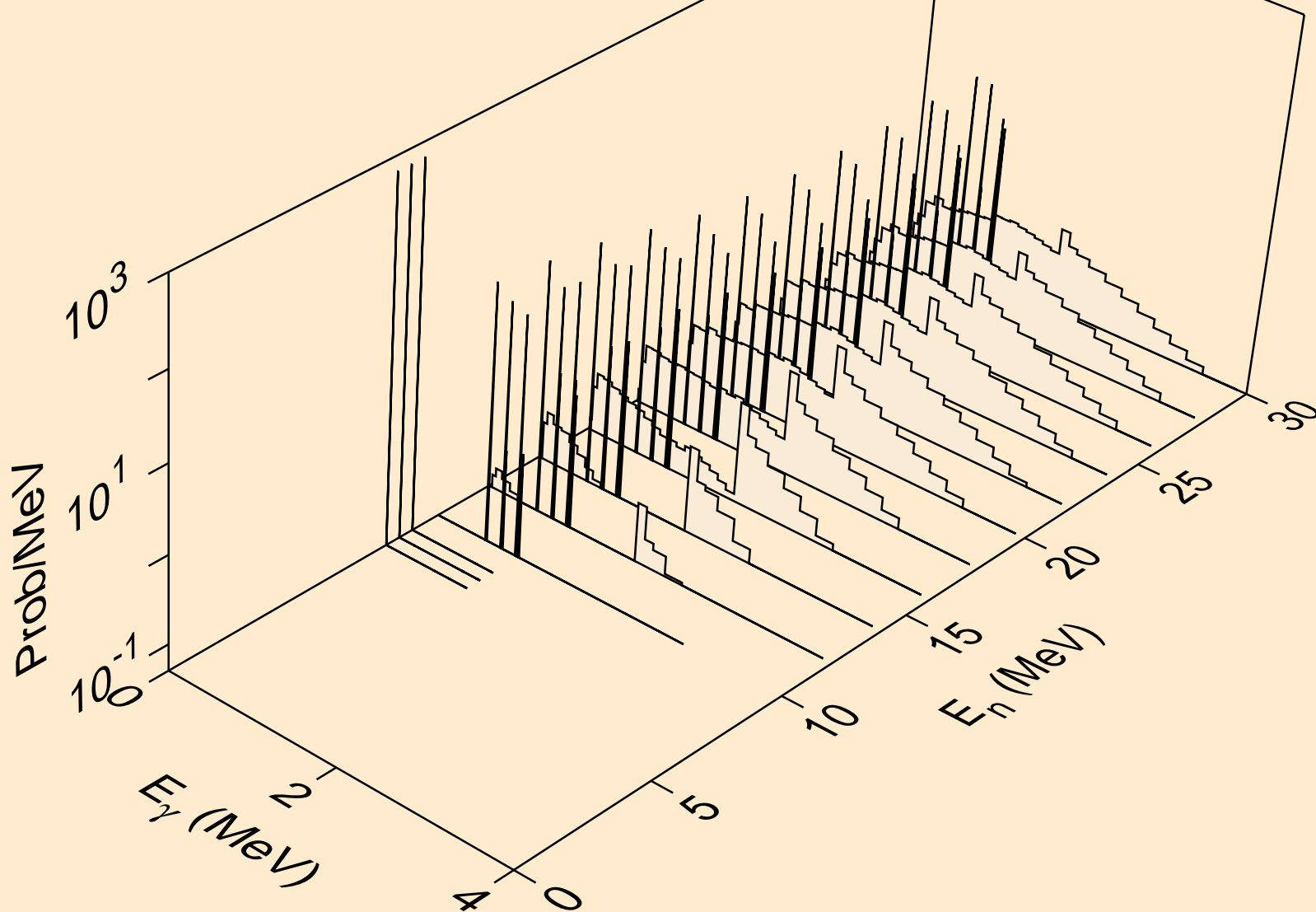

ER149 NEUTRON ACER TENDL-2019 LIBRARY; T=293.16K  
Photon emission for (n,he3)

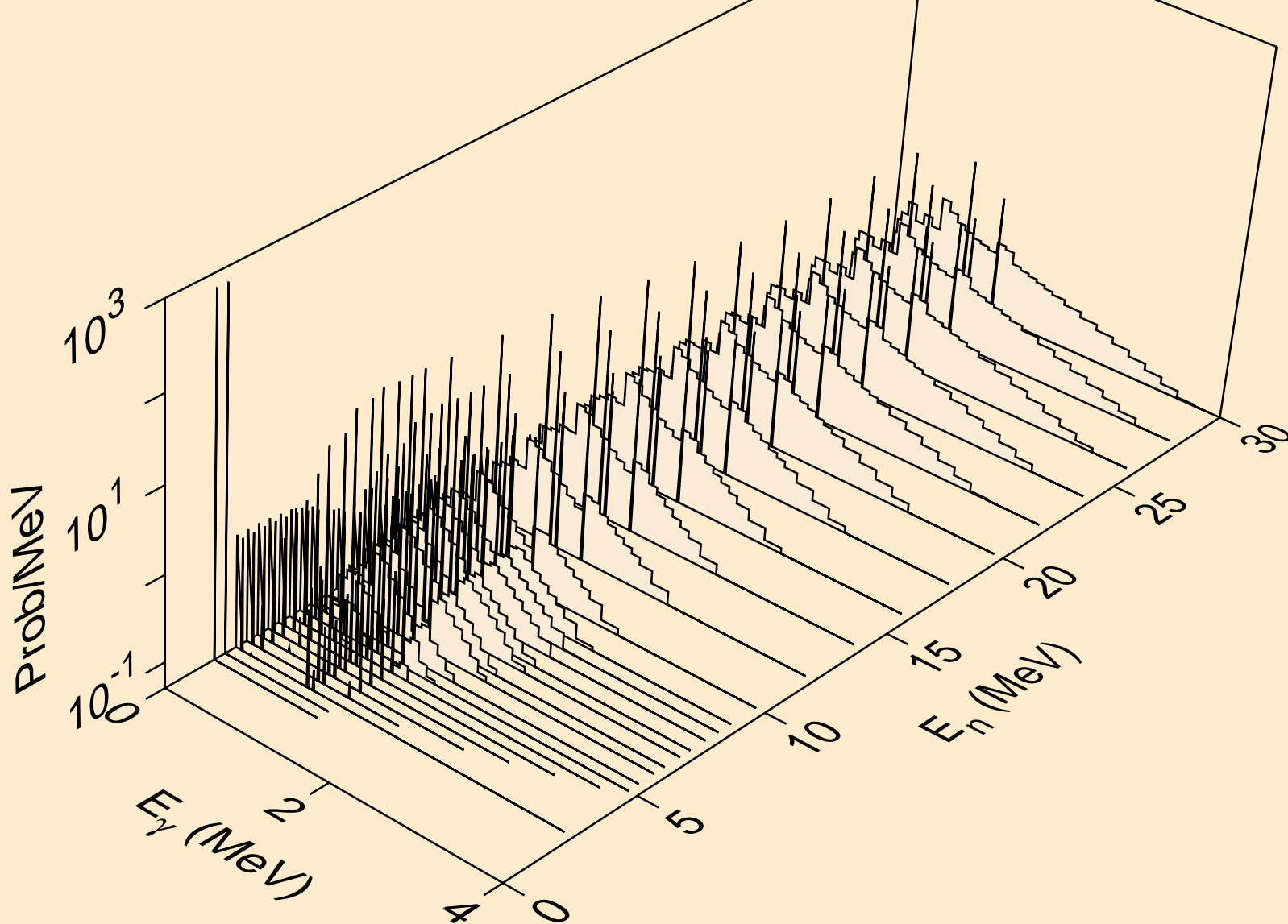

ER149 NEUTRON ACER TENDL-2019 LIBRARY; T=293.16K  
Photon emission for (n,a)

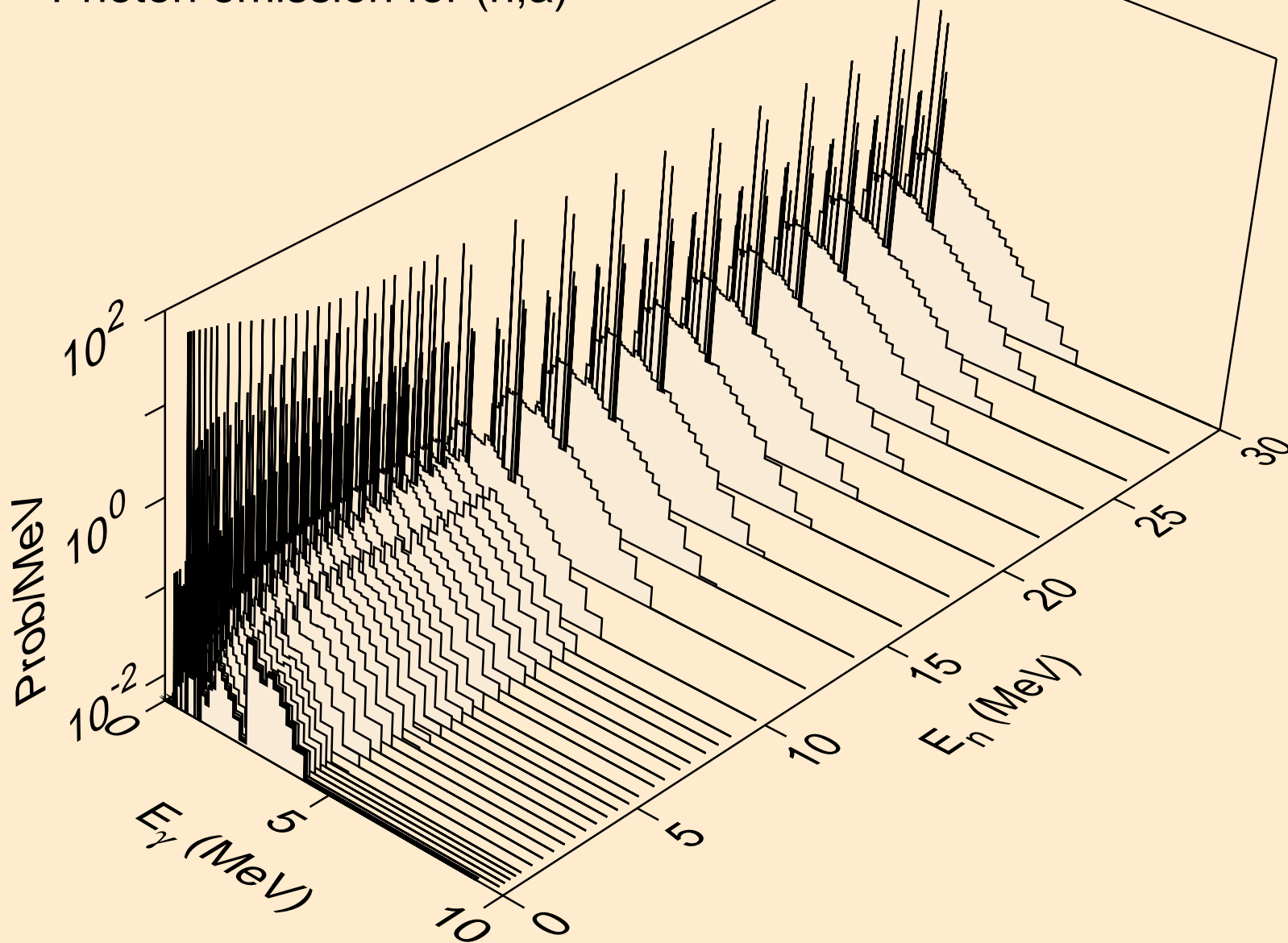



ER149 NEUTRON ACER TENDL-2019 LIBRARY; T=293.16K  
Photon emission for (n,2a)

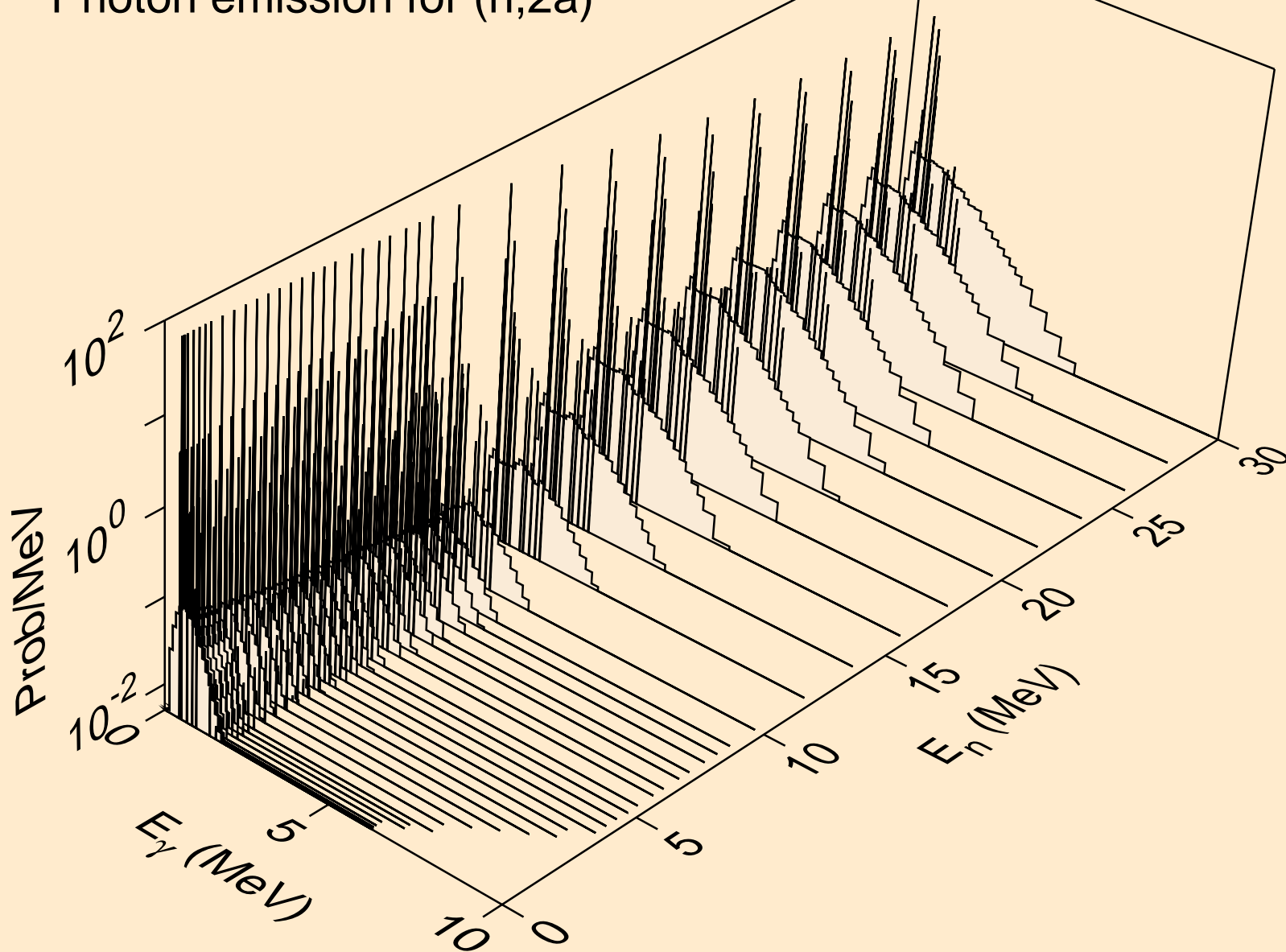

ER149 NEUTRON ACER TENDL-2019 LIBRARY; T=293.16K  
Photon emission for (n,3a)

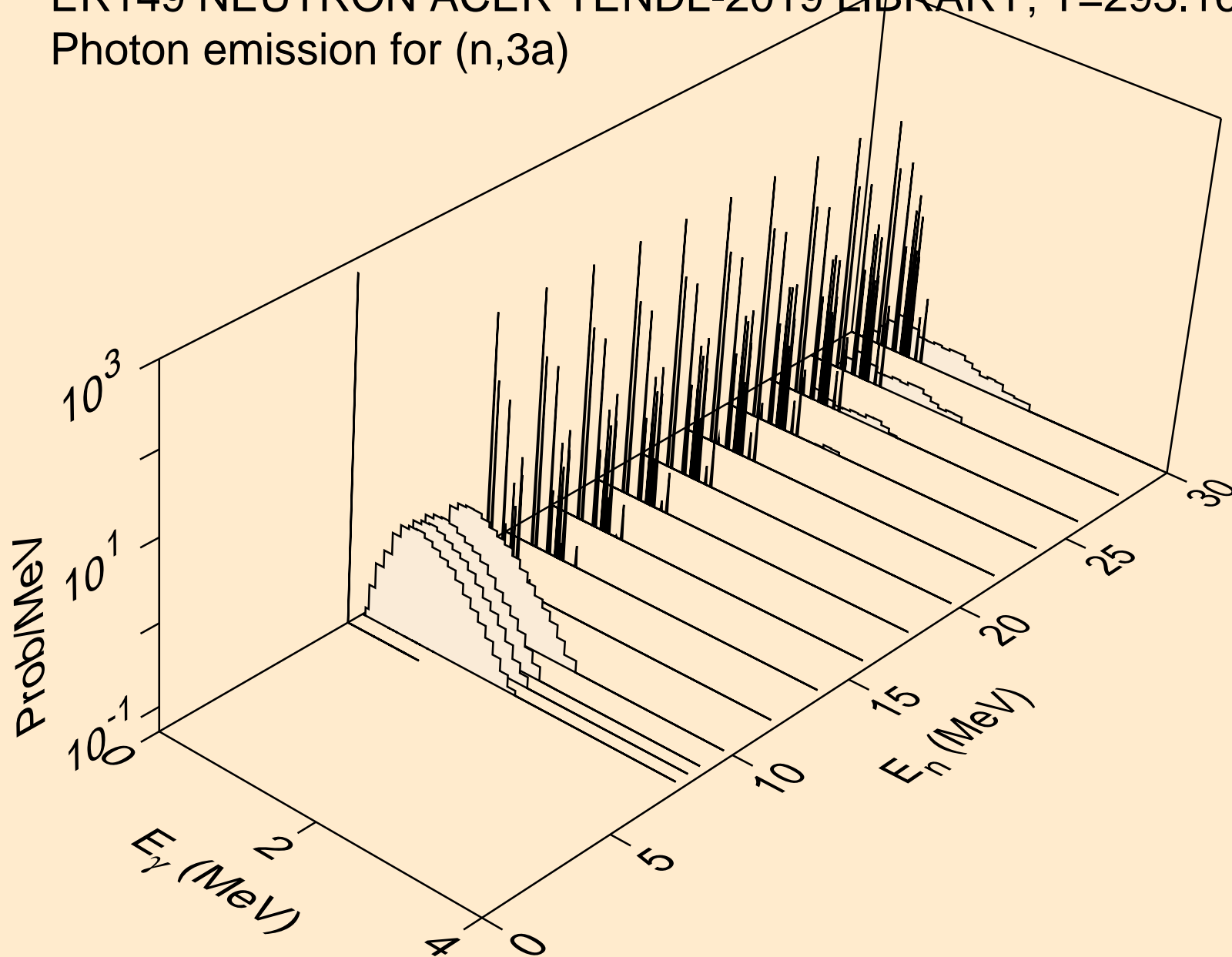

ER149 NEUTRON ACER TENDL-2019 LIBRARY; T=293.16K  
Photon emission for (n,2p)

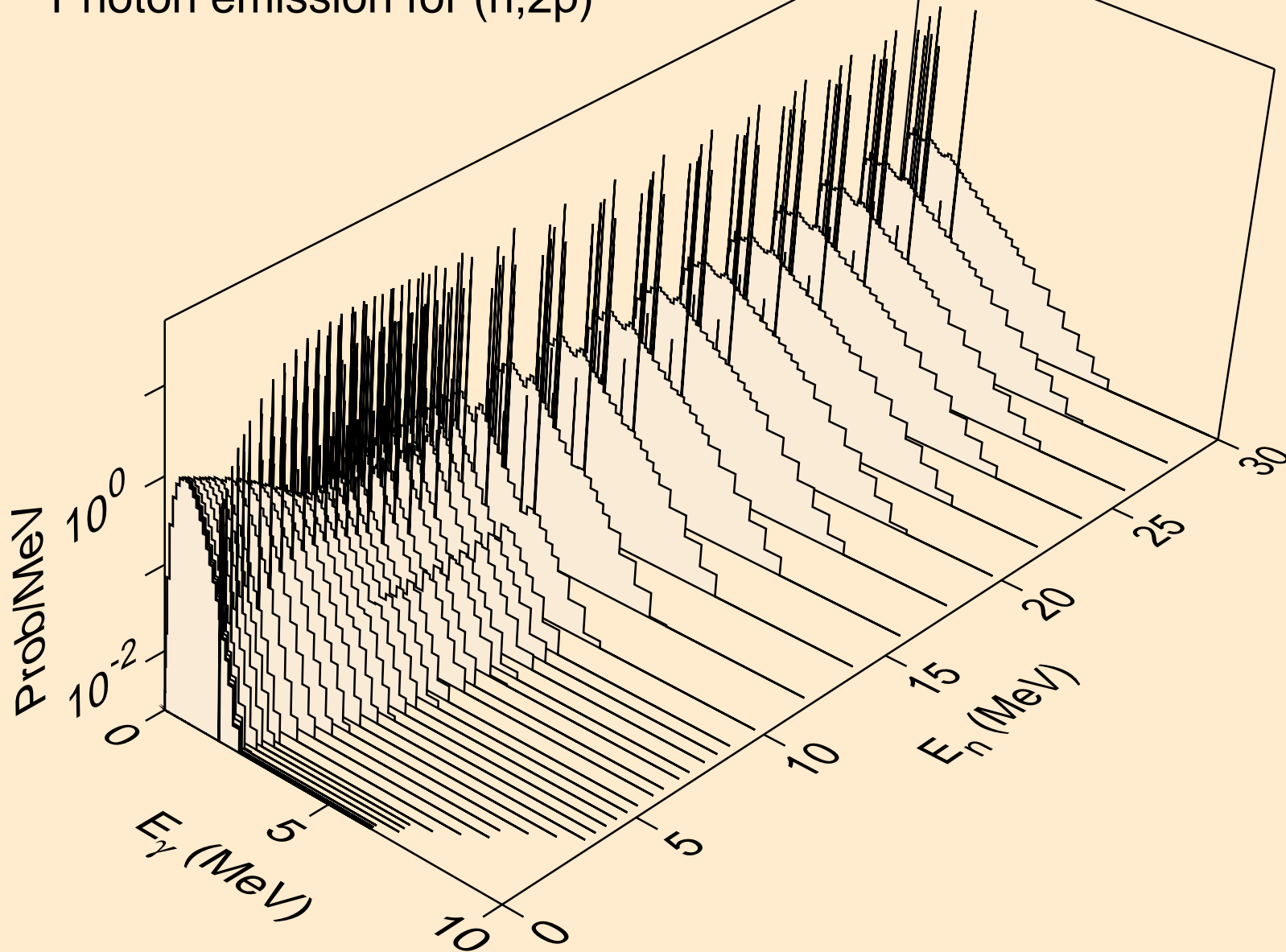

ER149 NEUTRON ACER TENDL-2019 LIBRARY; T=293.16K  
Photon emission for (n,p $\alpha$ )

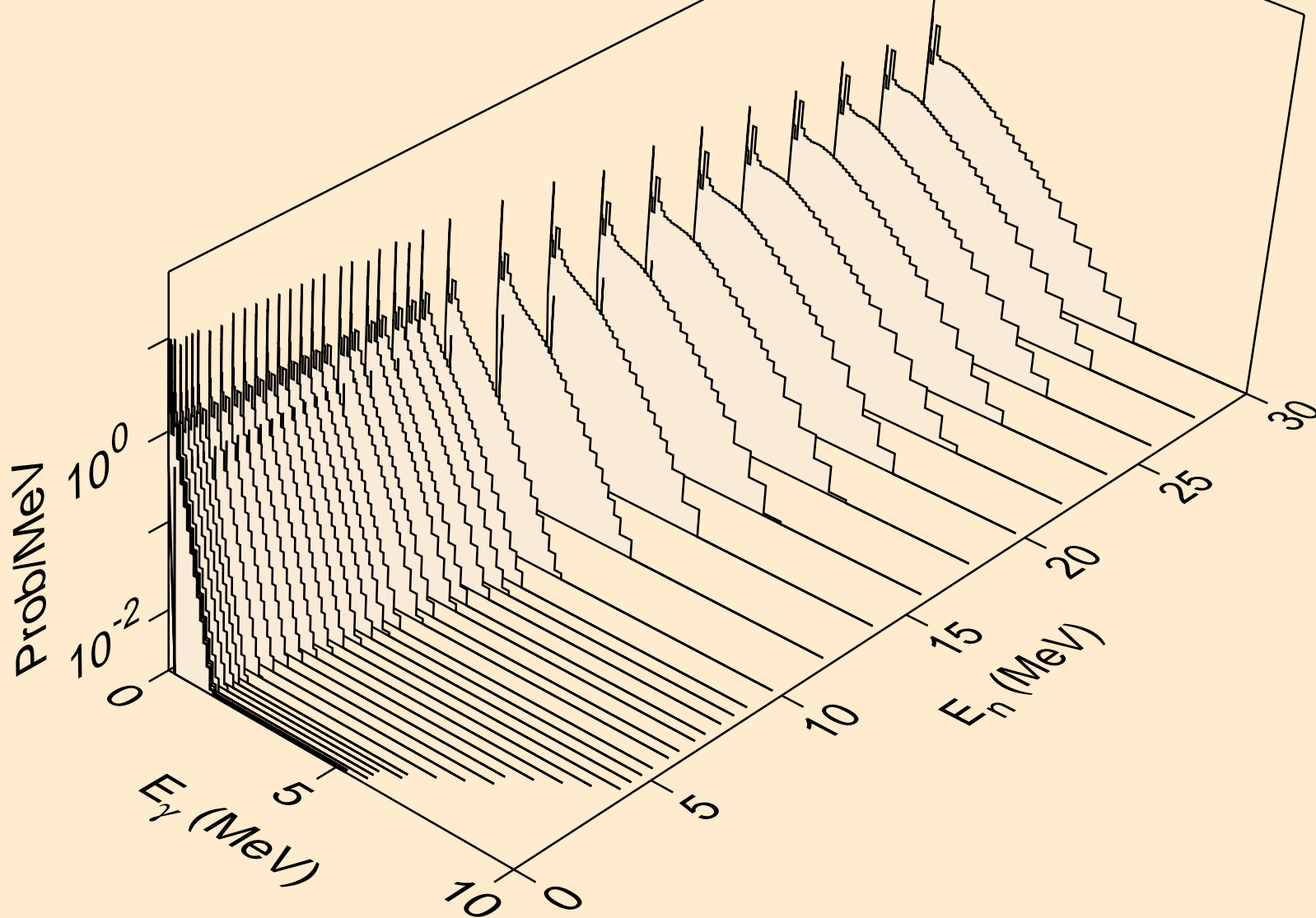

ER149 NEUTRON ACER TENDL-2019 LIBRARY; T=293.16K  
Photon emission for (n,pd)

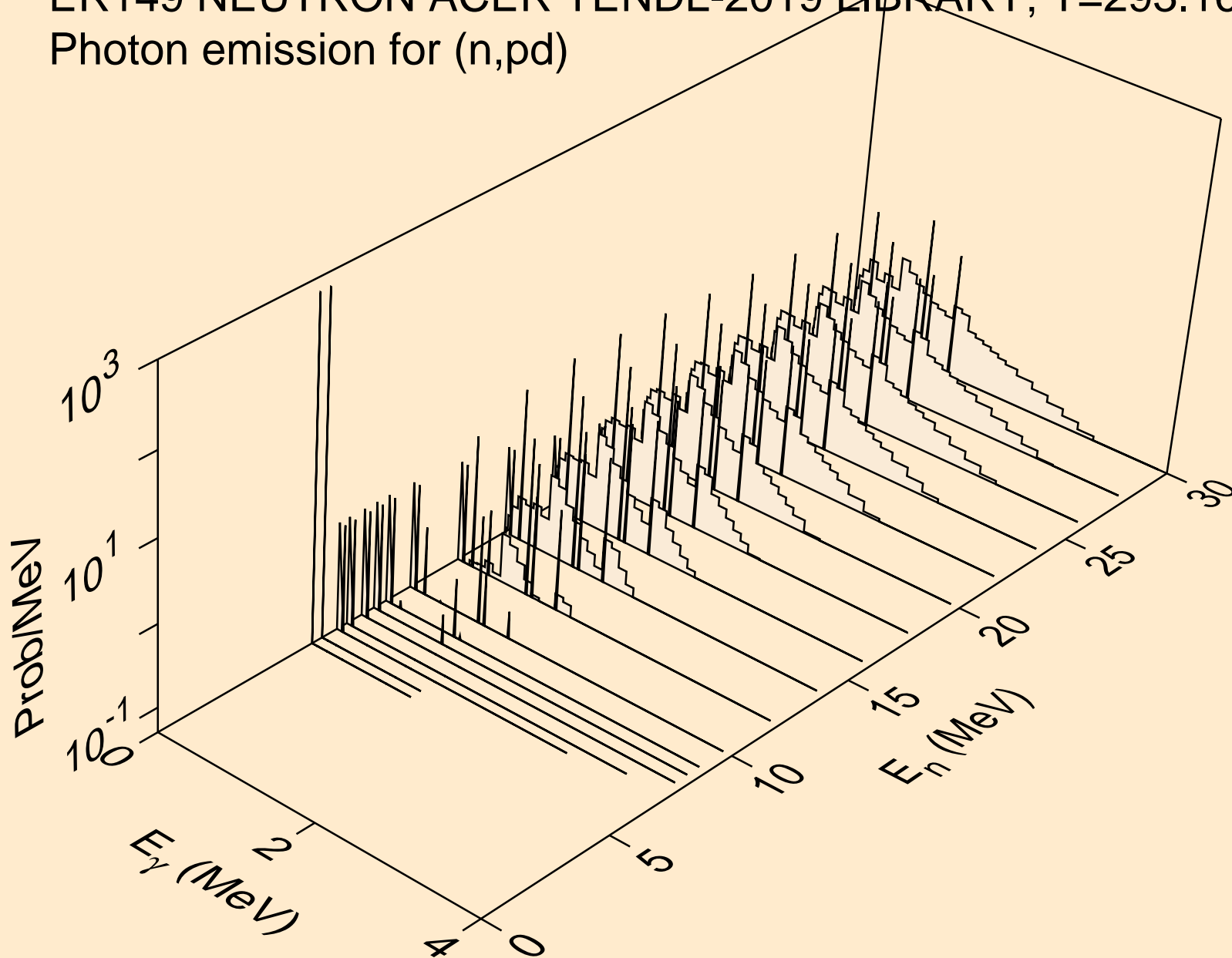

ER149 NEUTRON ACER TENDL-2019 LIBRARY; T=293.16K  
Photon emission for (n,pt)

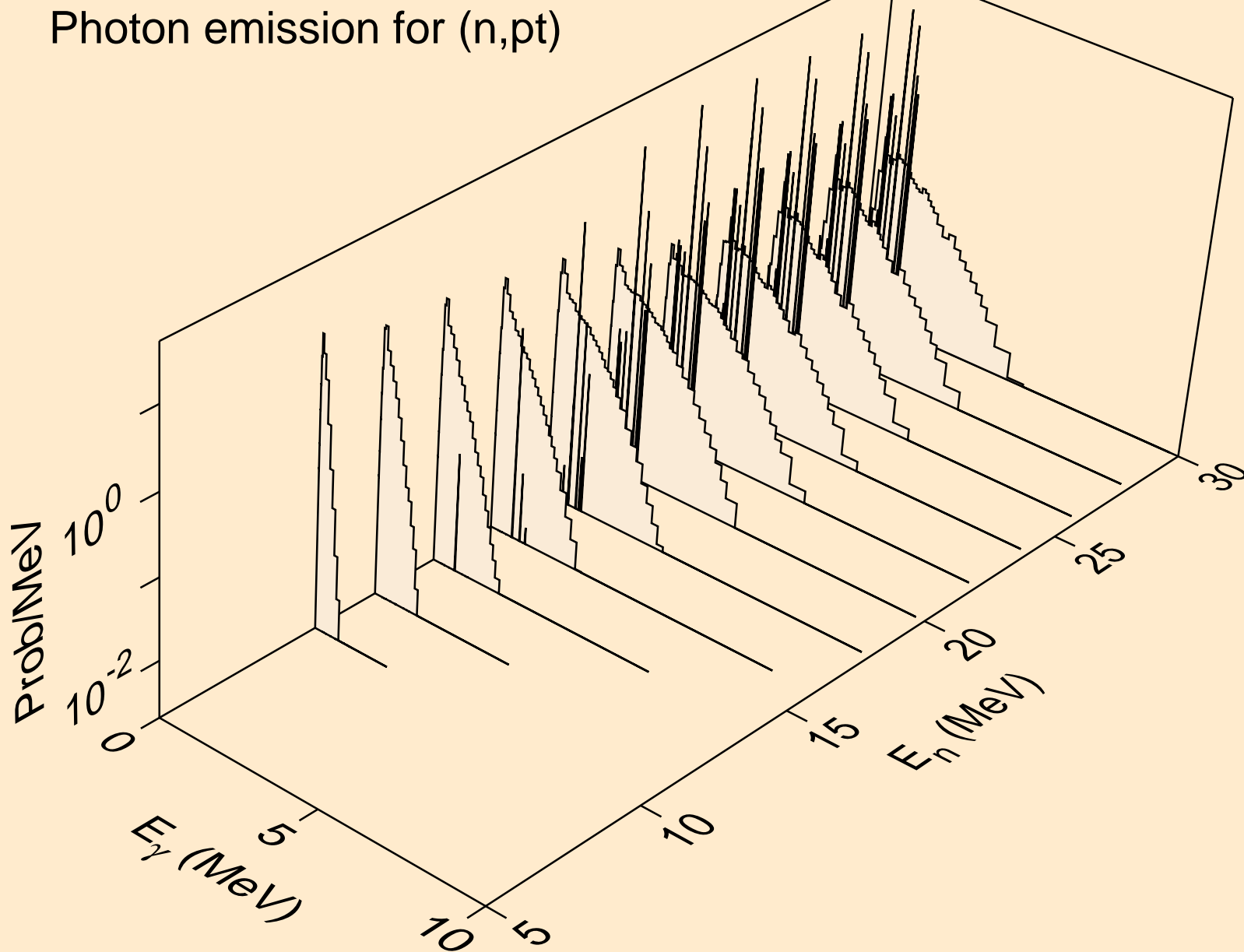

ER149 NEUTRON ACER TENDL-2019 LIBRARY; T=293.16K  
Photon emission for (n,da)

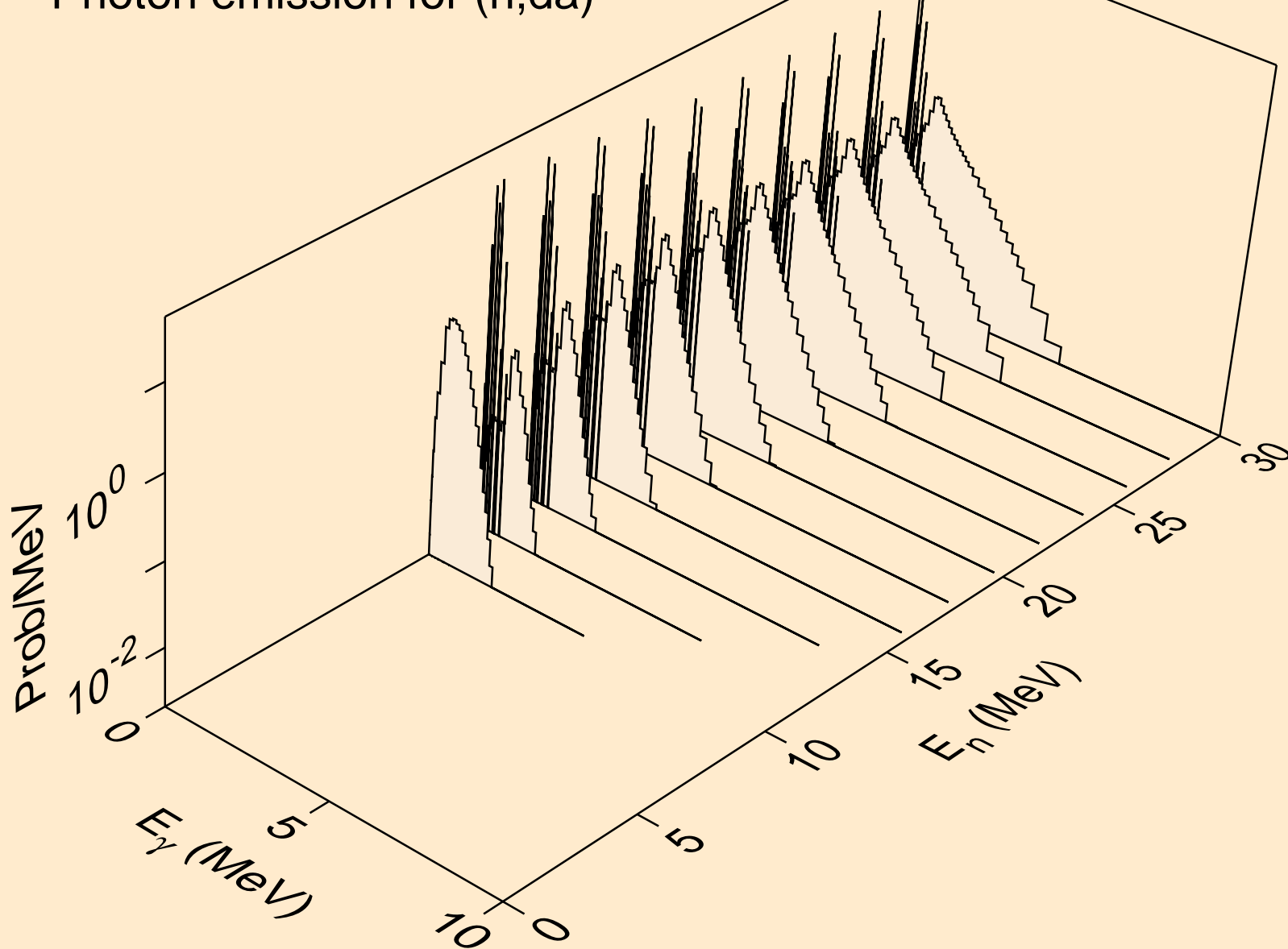

ER149 NEUTRON ACER TENDL-2019 LIBRARY; T=293.16K  
thermal capture photon spectrum

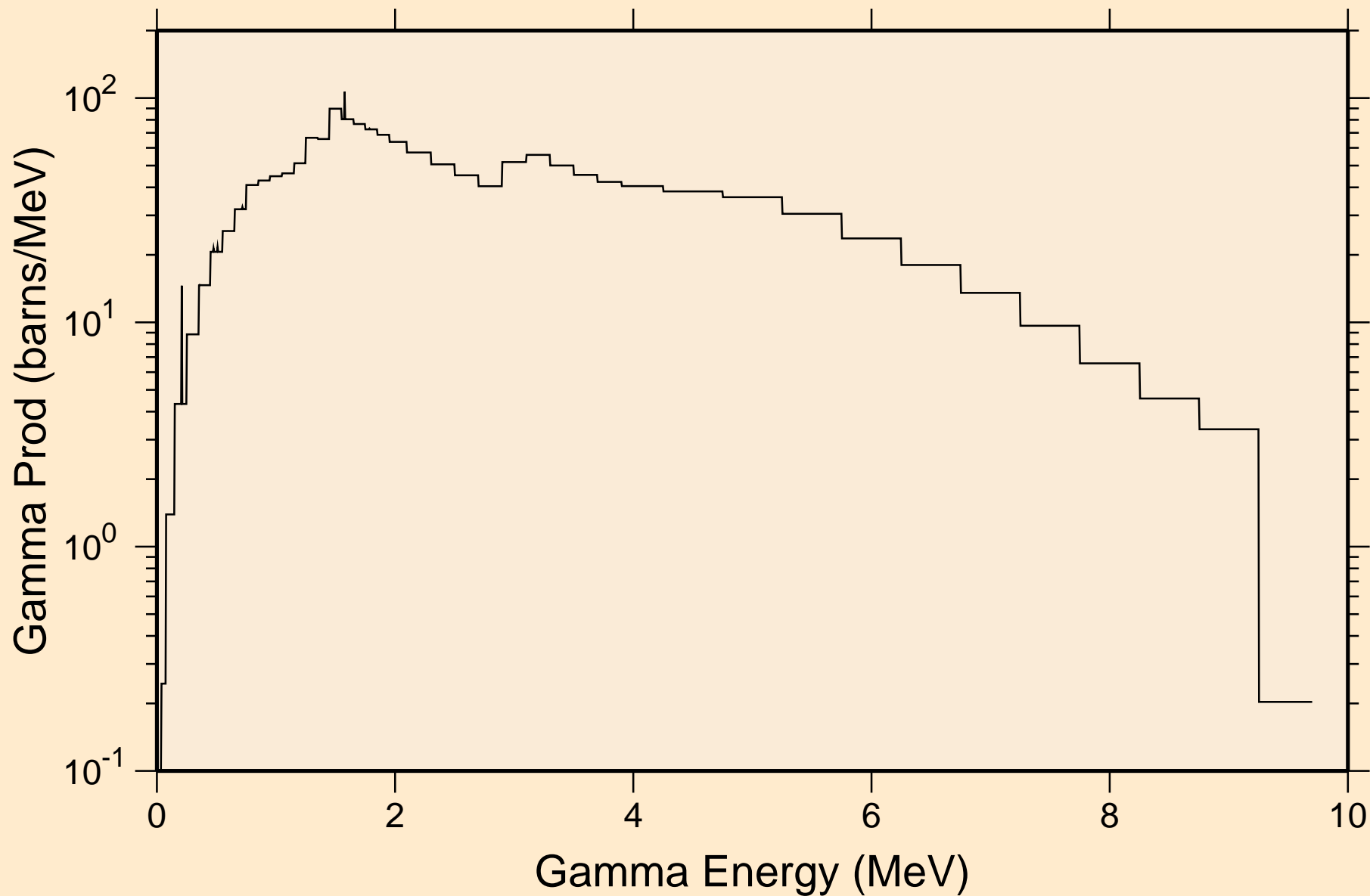



ER149 NEUTRON ACER TENDL-2019 LIBRARY; T=293.16K  
14 MeV photon spectrum

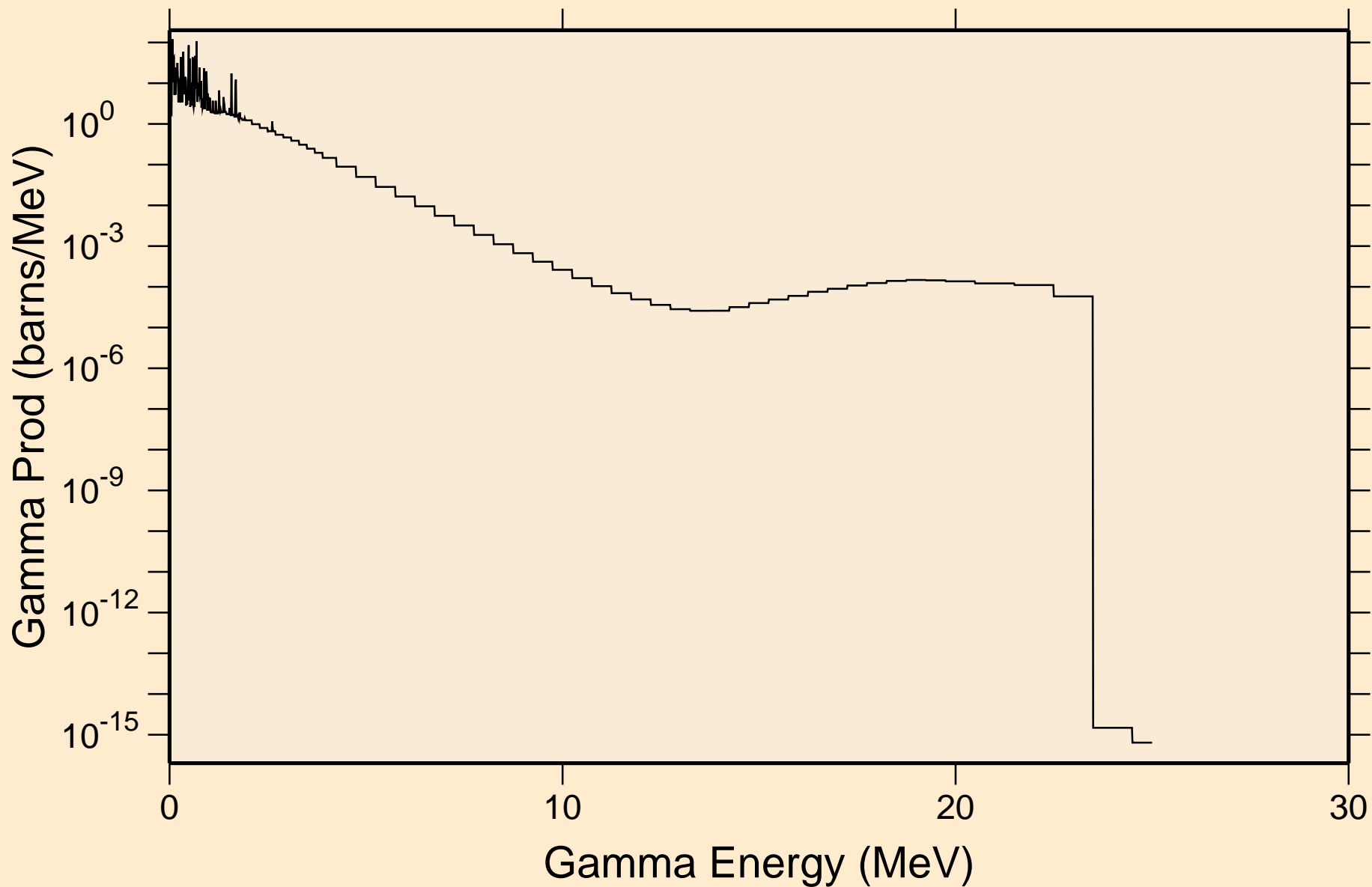

# ER149 NEUTRON ACER TENDL-2019 LIBRARY; T=293.16K

## Particle heating contributions

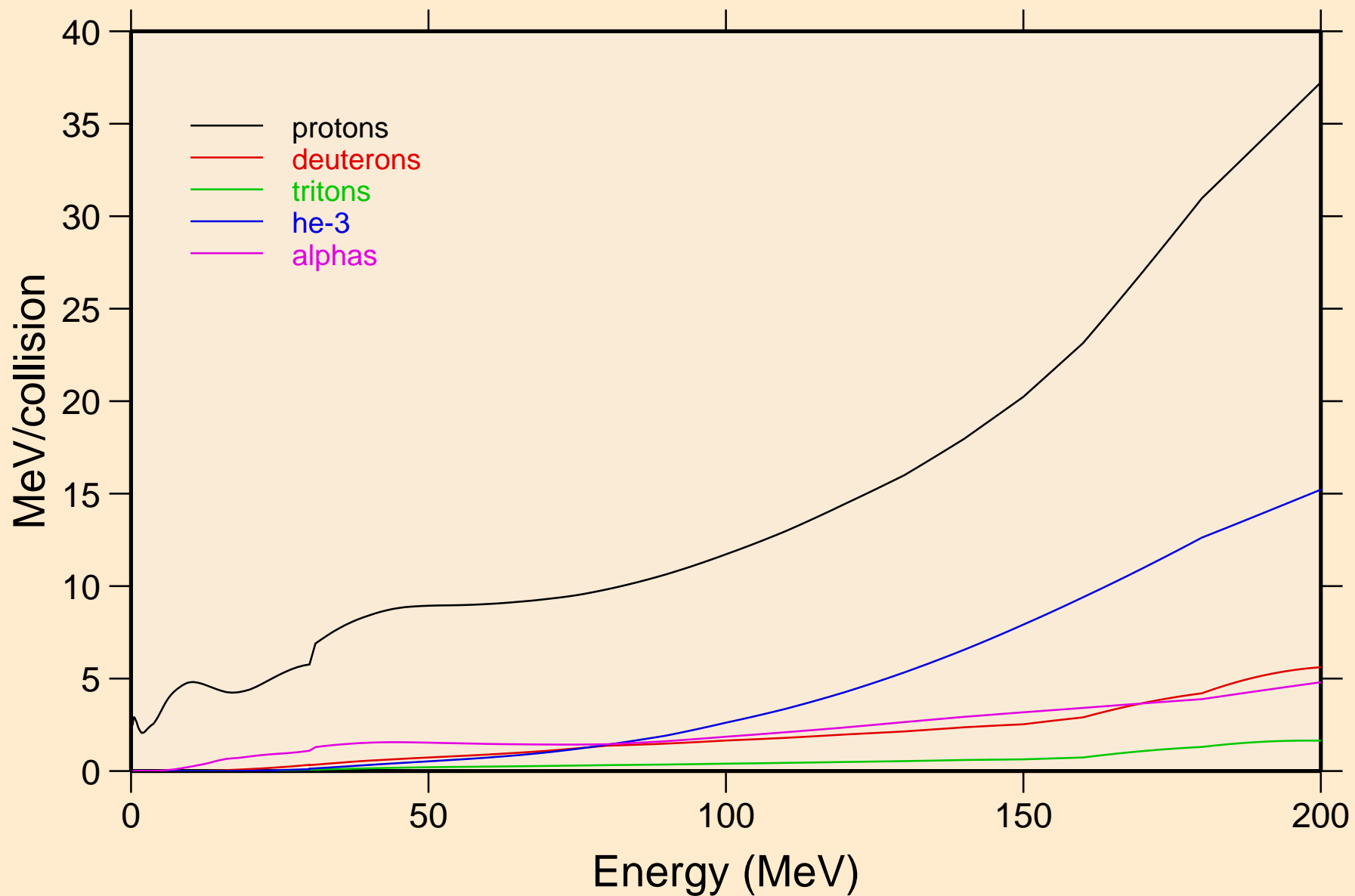

ER149 NEUTRON ACER TENDL-2019 LIBRARY; T=293.16K  
Recoil Heating

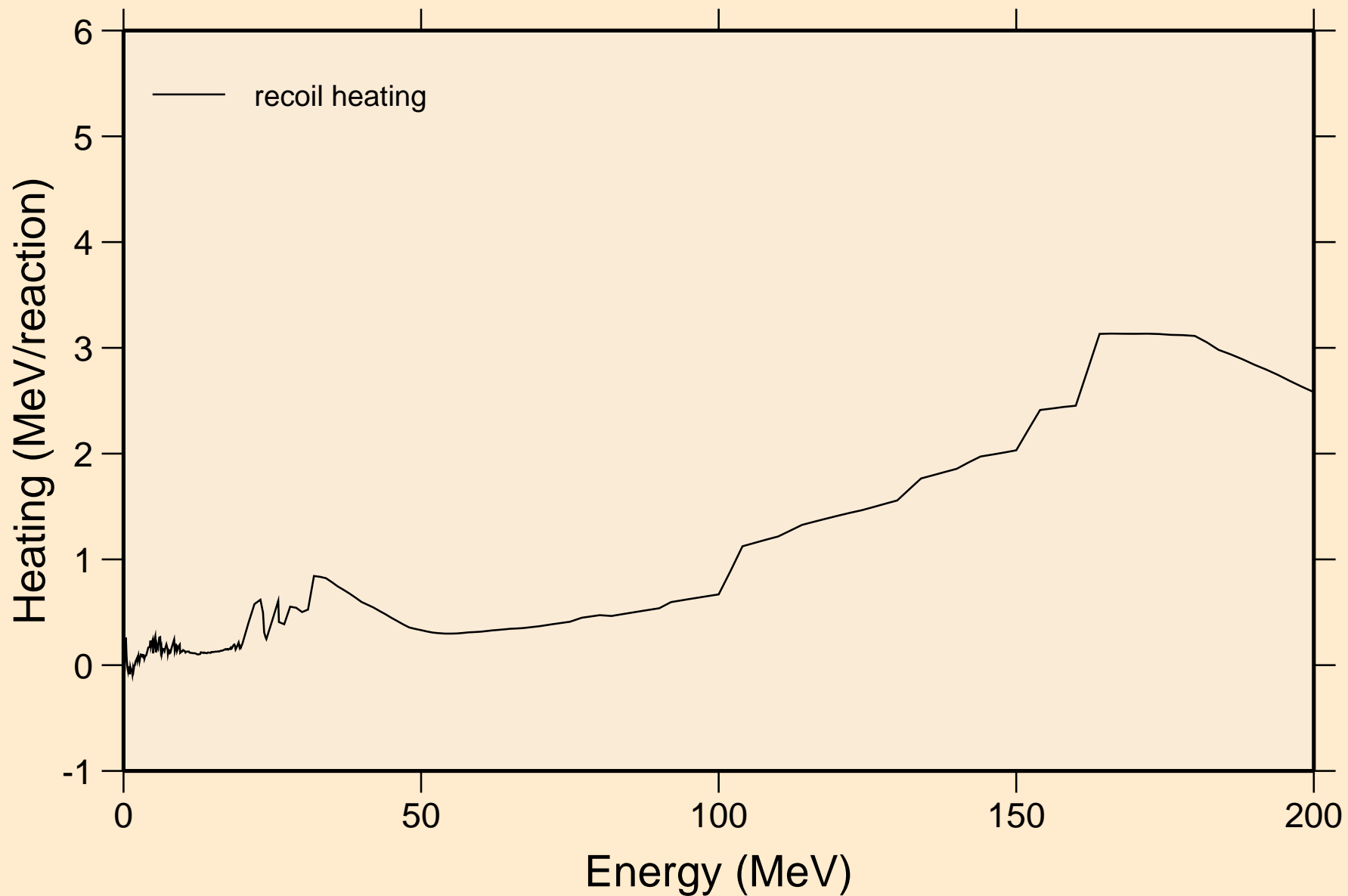

ER149 NEUTRON ACER TENDL-2019 LIBRARY; T=293.16K  
Particle production cross sections

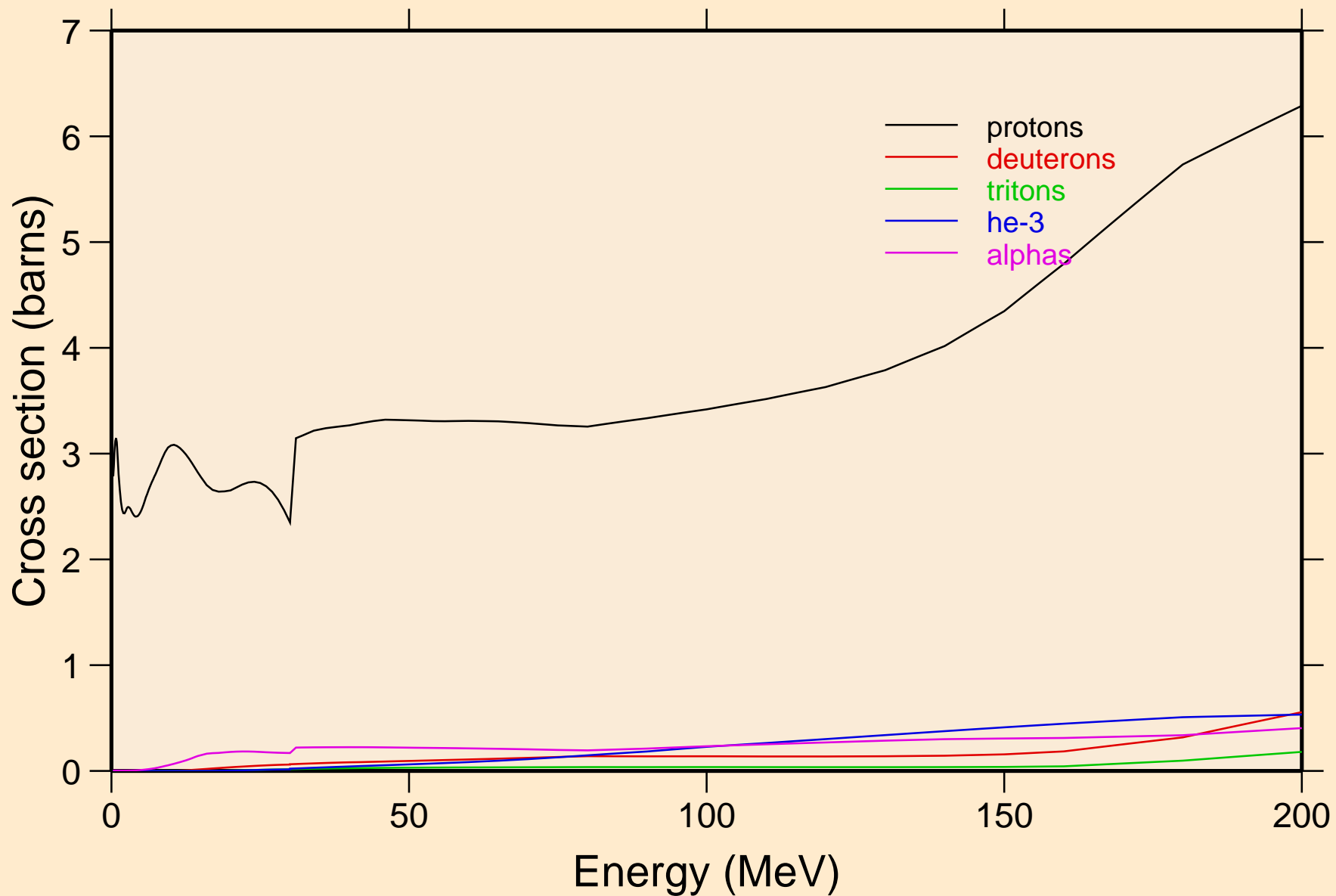

ER149 NEUTRON ACER TENDL-2019 LIBRARY; T=293.16K  
protons from (n,x)

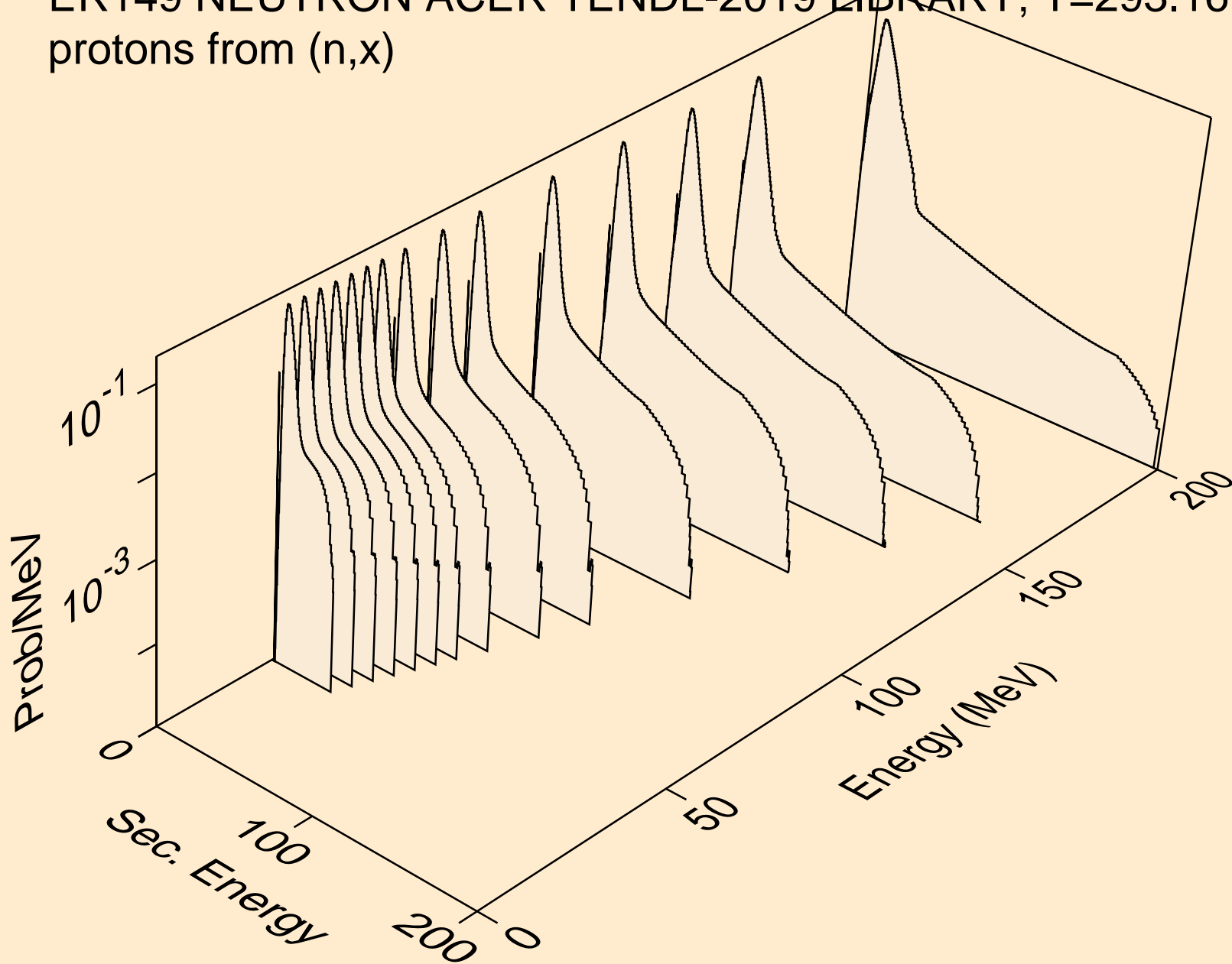

ER149 NEUTRON ACER TENDL-2019 LIBRARY; T=293.16K  
protons from (n,n\*)p

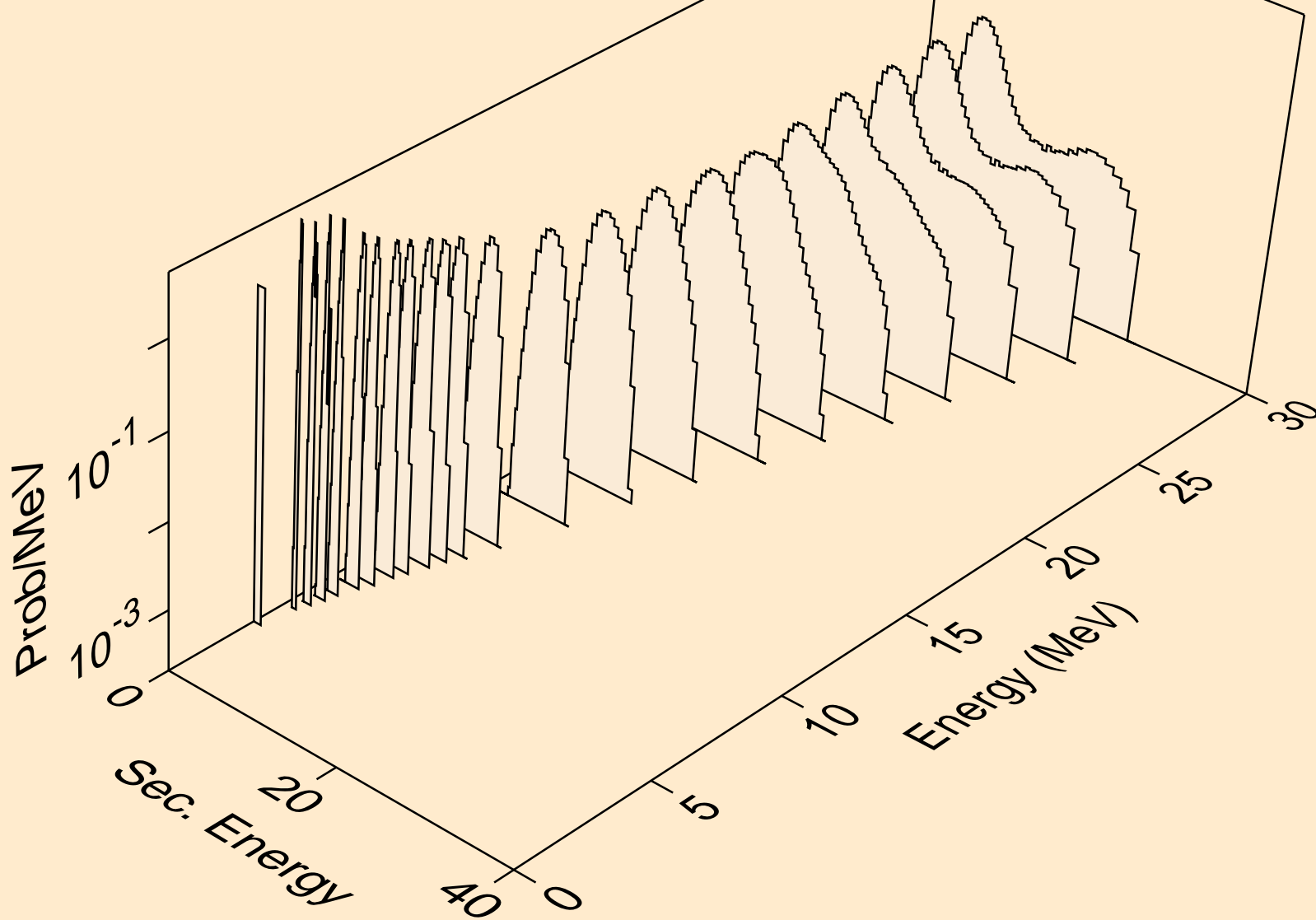

ER149 NEUTRON ACER TENDL-2019 LIBRARY; T=293.16K  
protons from (n,2np)

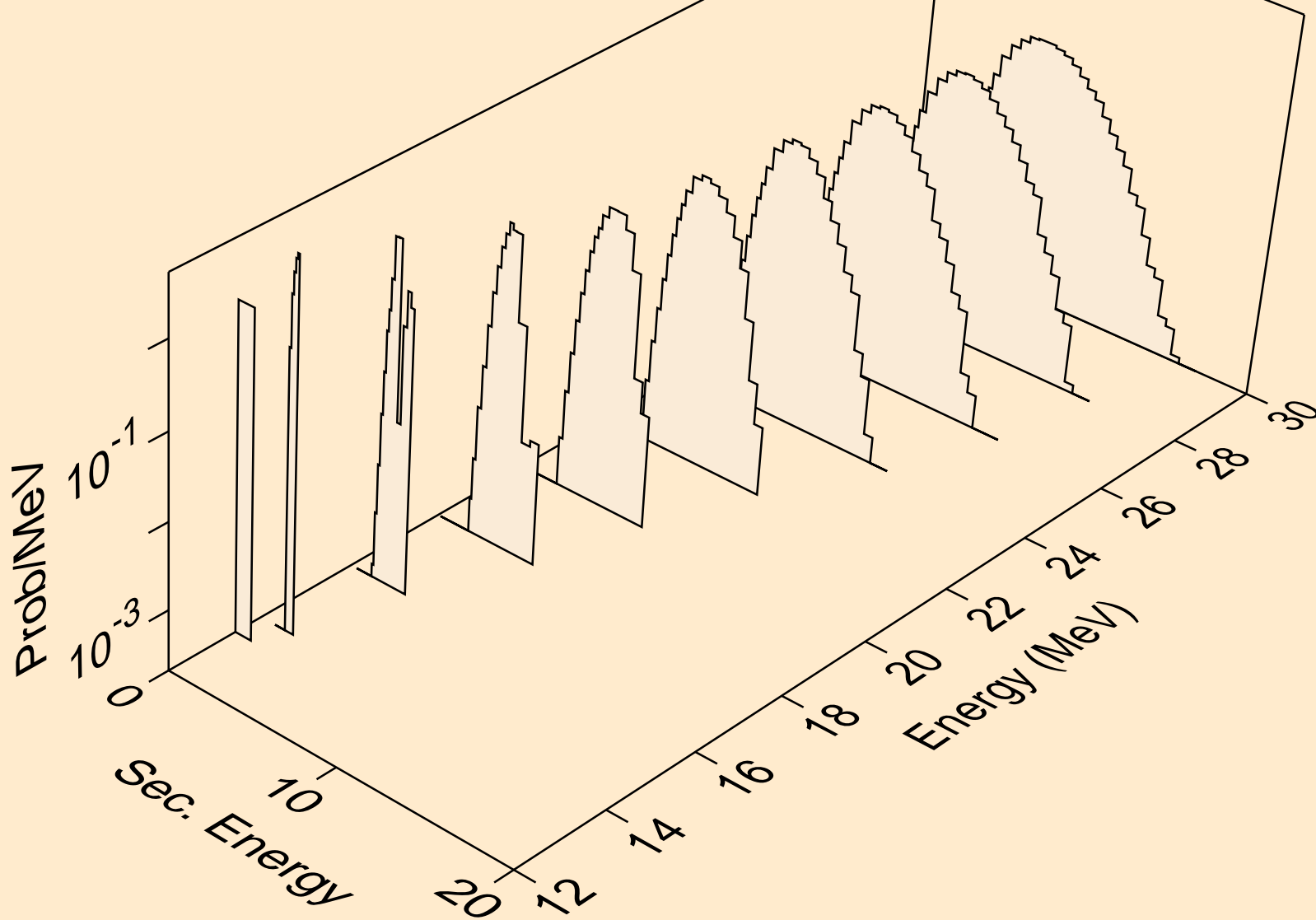

ER149 NEUTRON ACER TENDL-2019 LIBRARY; T=293.16K  
protons from (n,3np)

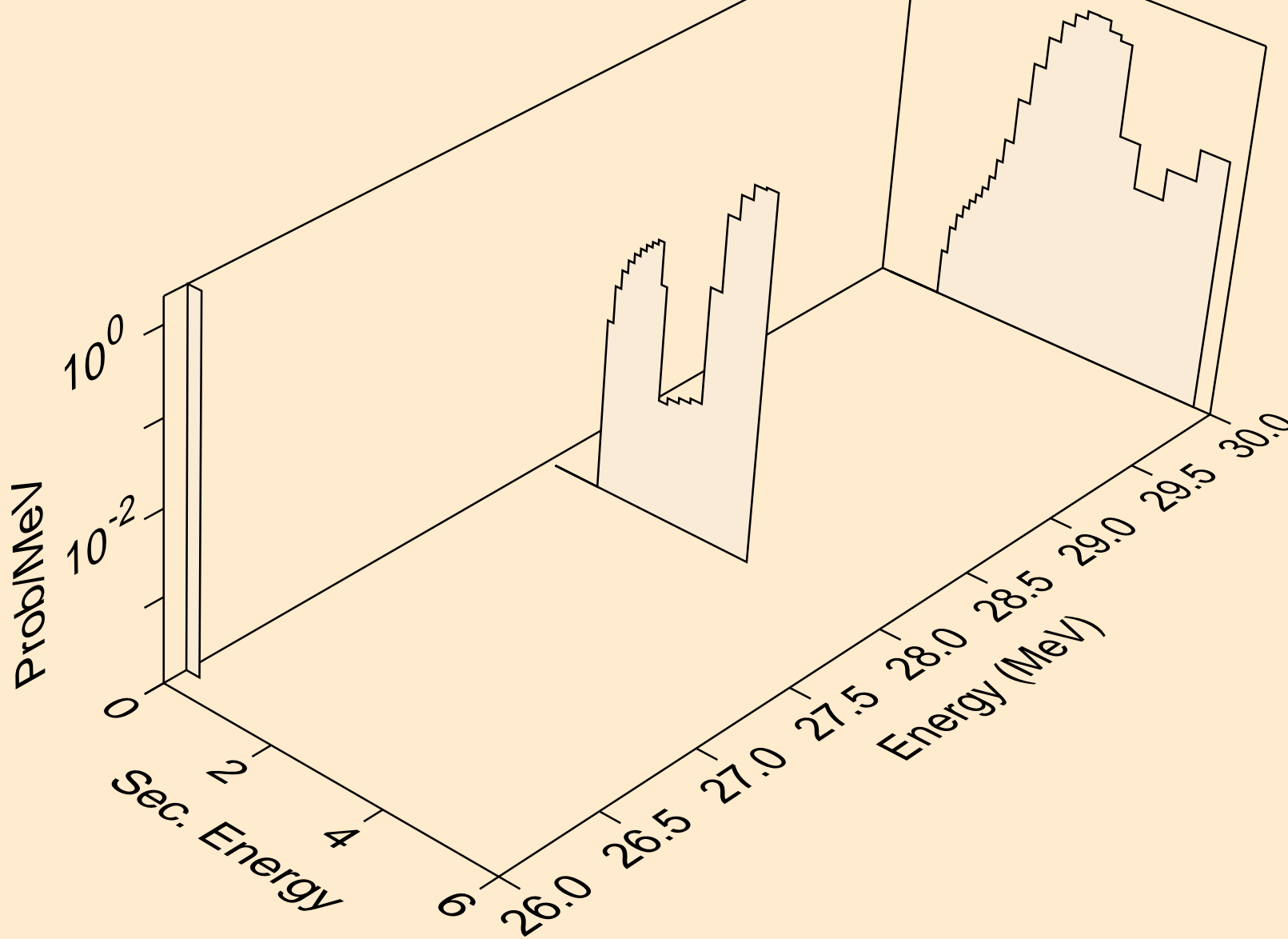



ER149 NEUTRON ACER TENDL-2019 LIBRARY; T=293.16K  
protons from (n,2np)

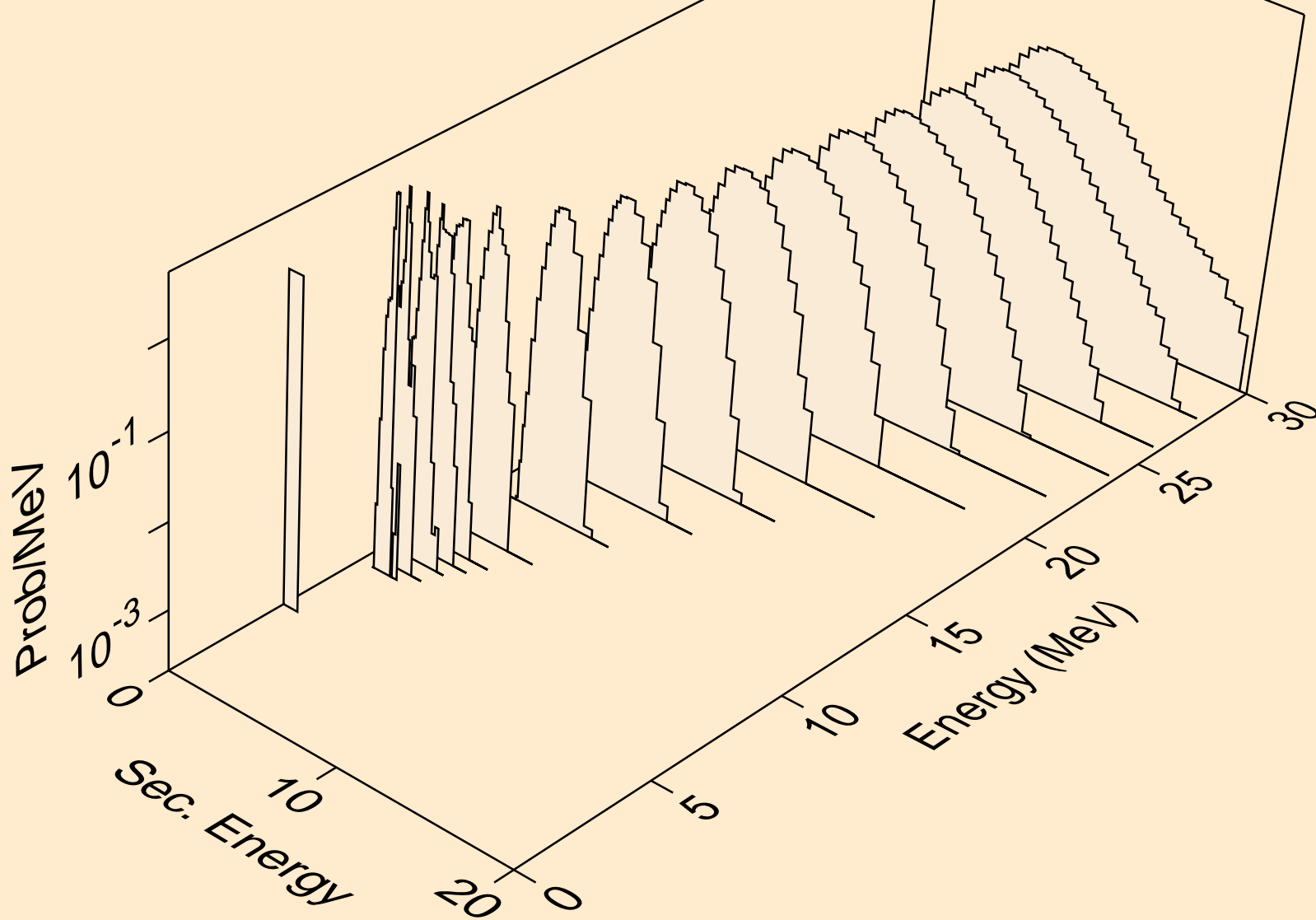

ER149 NEUTRON ACER TENDL-2019 LIBRARY; T=293.16K  
protons from (n,npa)

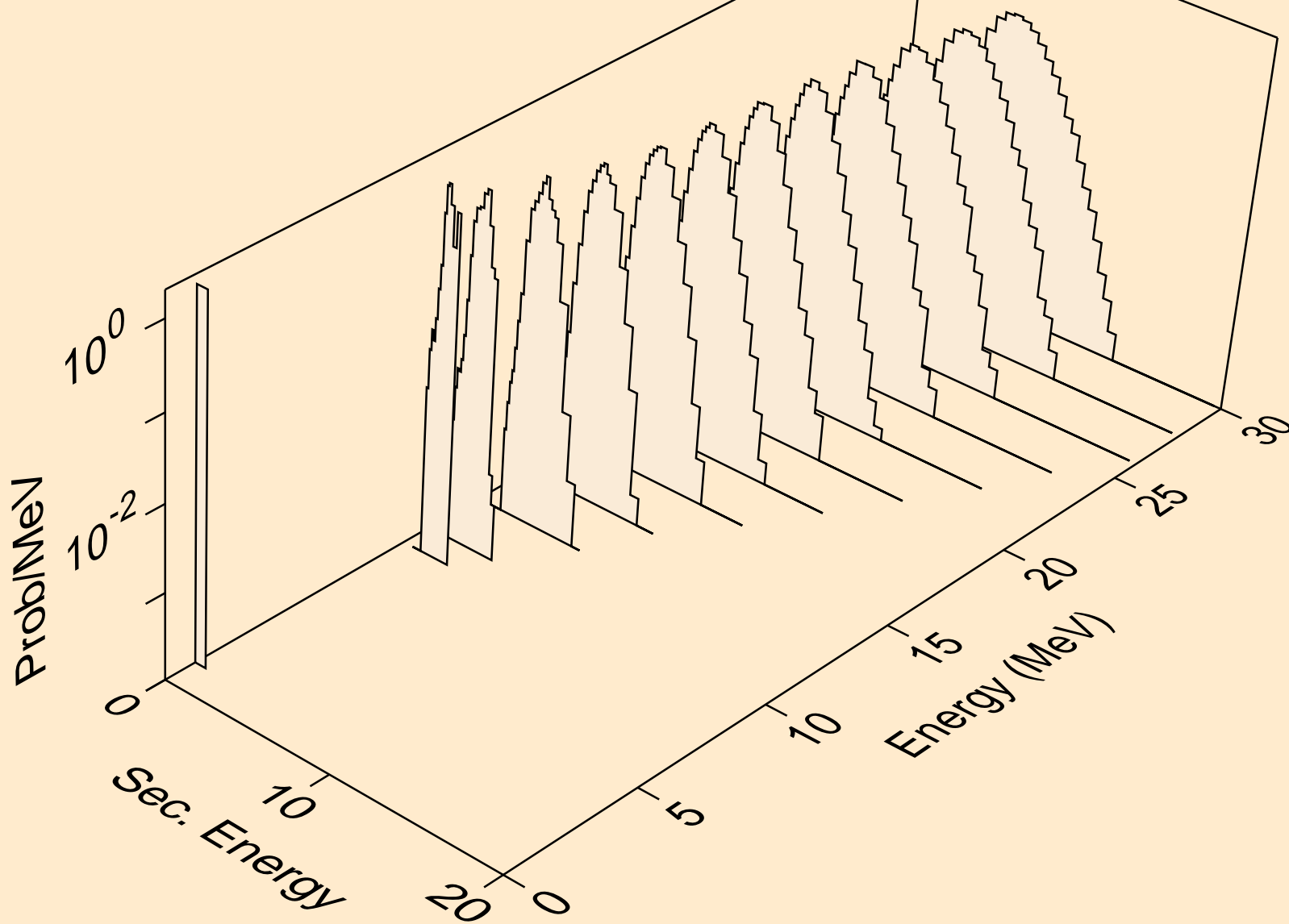

ER149 NEUTRON ACER TENDL-2019 LIBRARY; T=293.16K  
protons from (n,p)

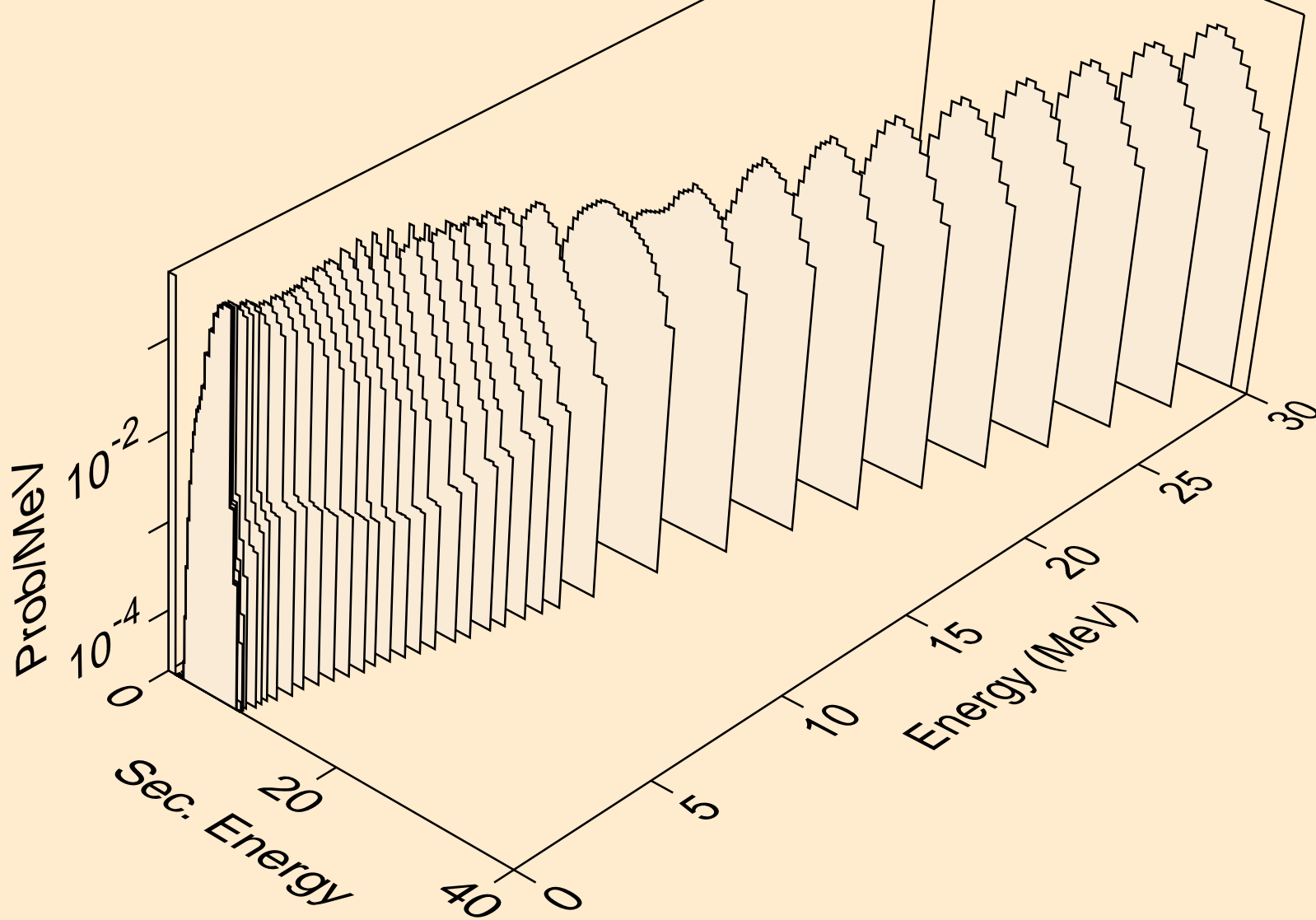

ER149 NEUTRON ACER TENDL-2019 LIBRARY; T=293.16K  
protons from (n,2p)

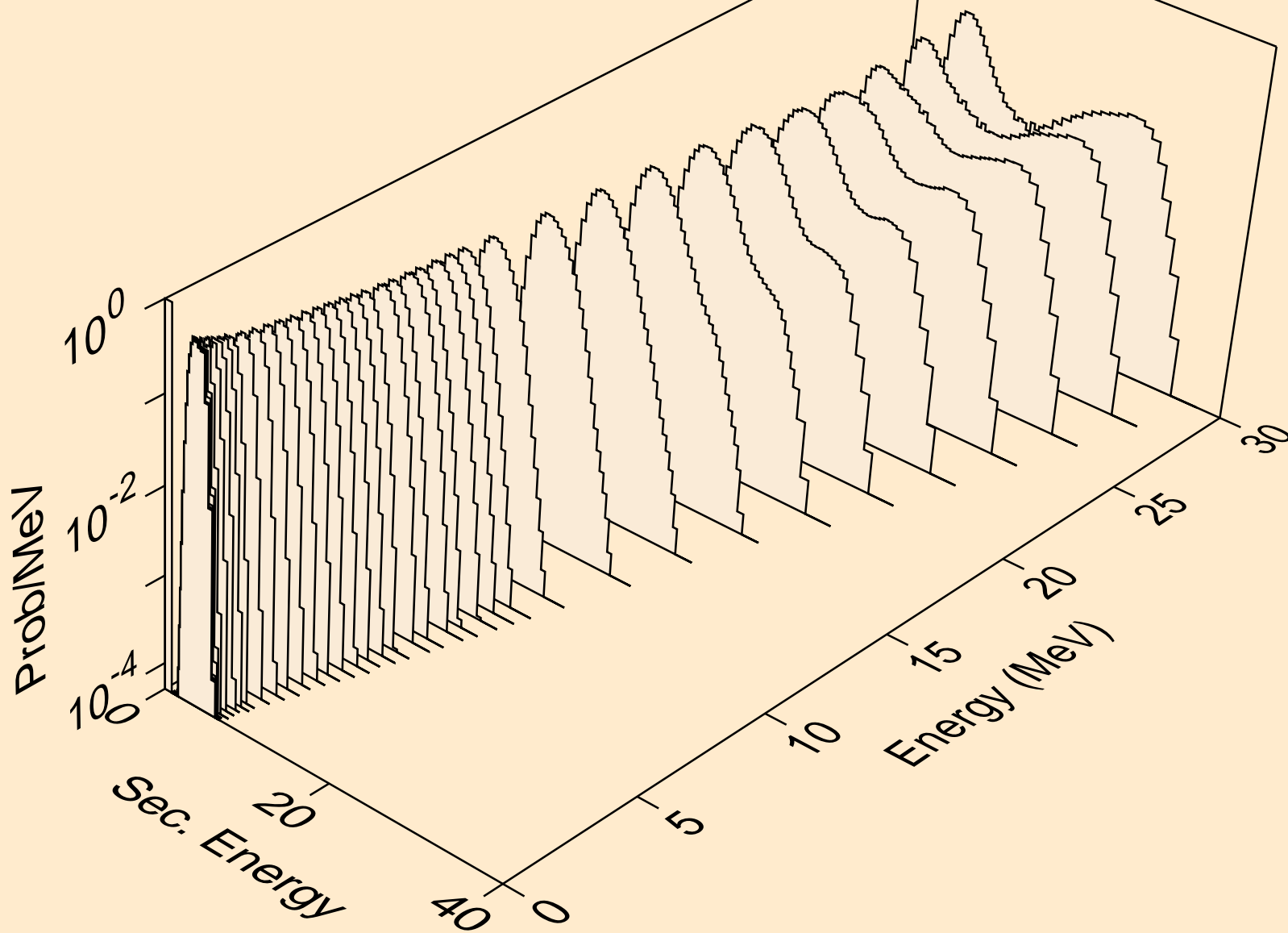

ER149 NEUTRON ACER TENDL-2019 LIBRARY; T=293.16K  
protons from (n,p)

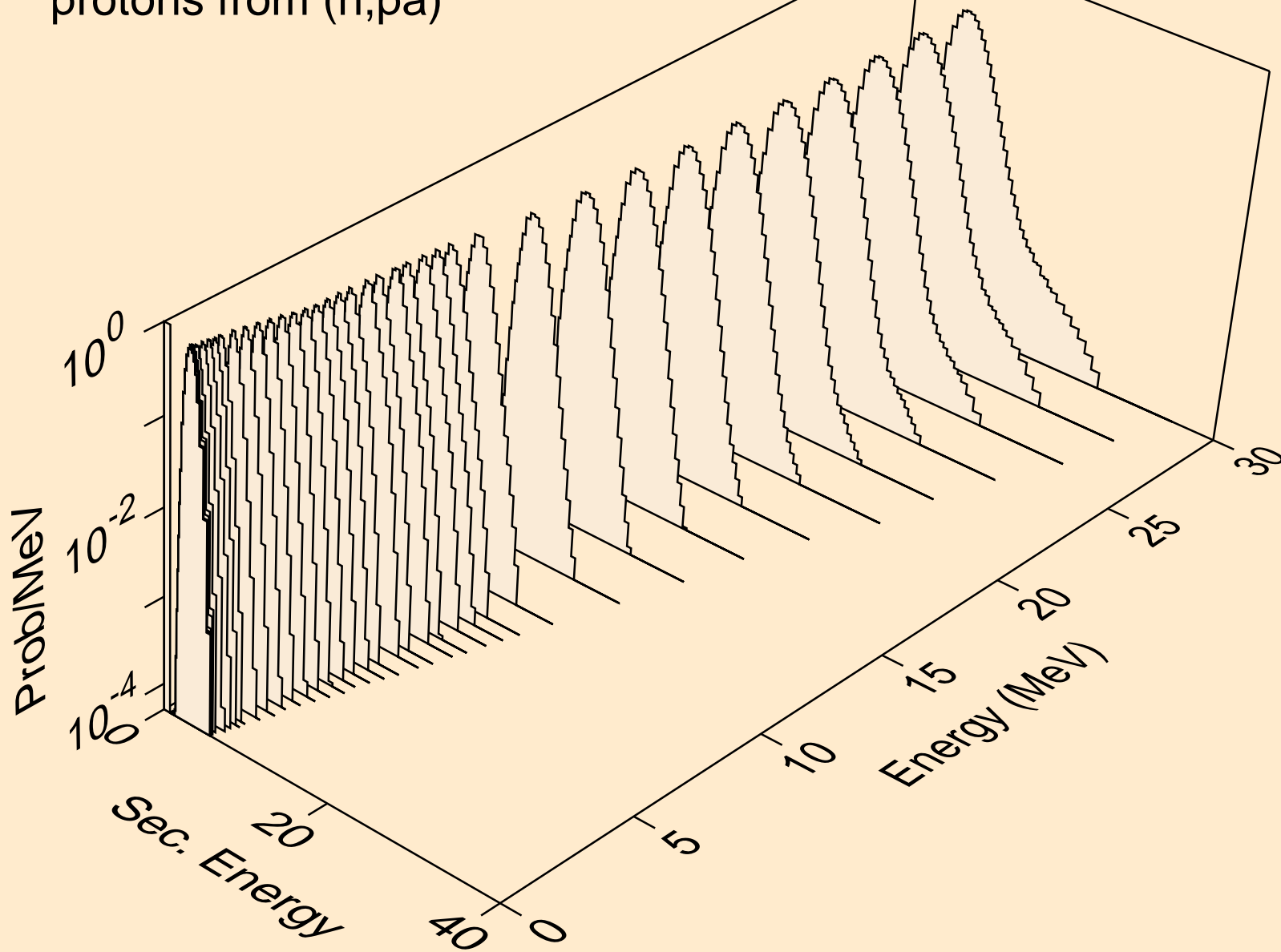

ER149 NEUTRON ACER TENDL-2019 LIBRARY; T=293.16K  
protons from (n,pd)

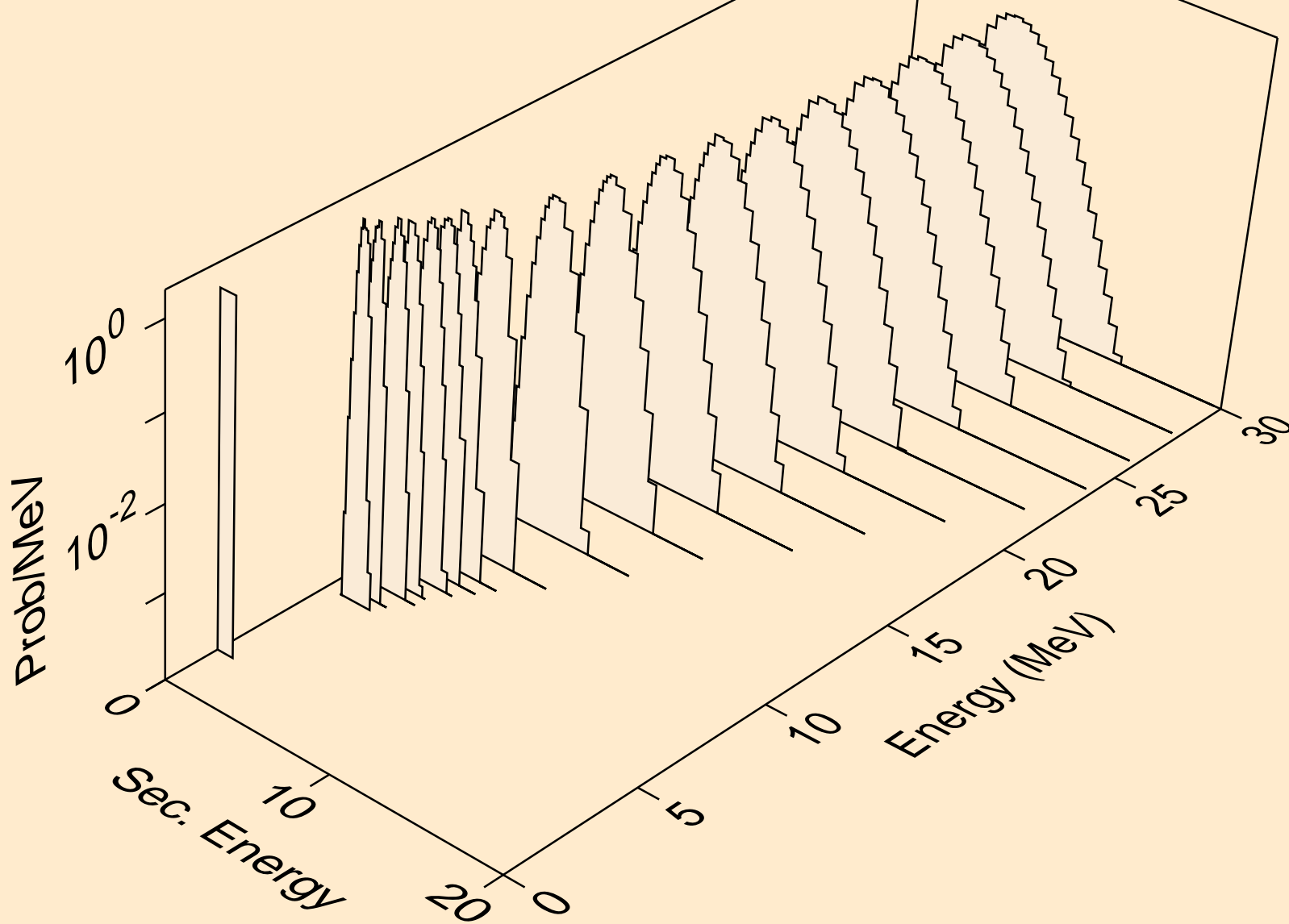

ER149 NEUTRON ACER TENDL-2019 LIBRARY; T=293.16K  
protons from (n,pt)

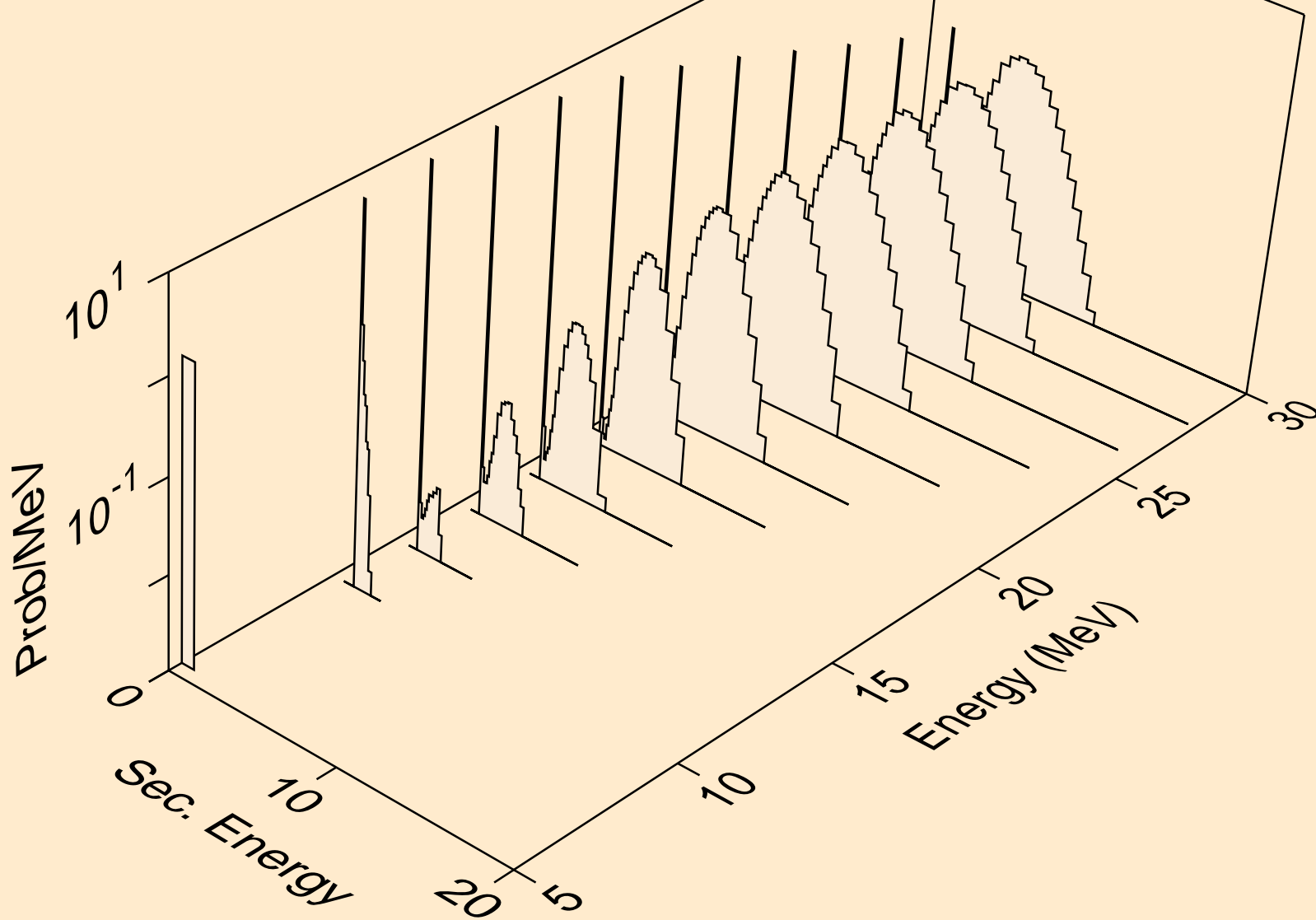

ER149 NEUTRON ACER TENDL-2019 LIBRARY; T=293.16K  
deuterons from (n,x)

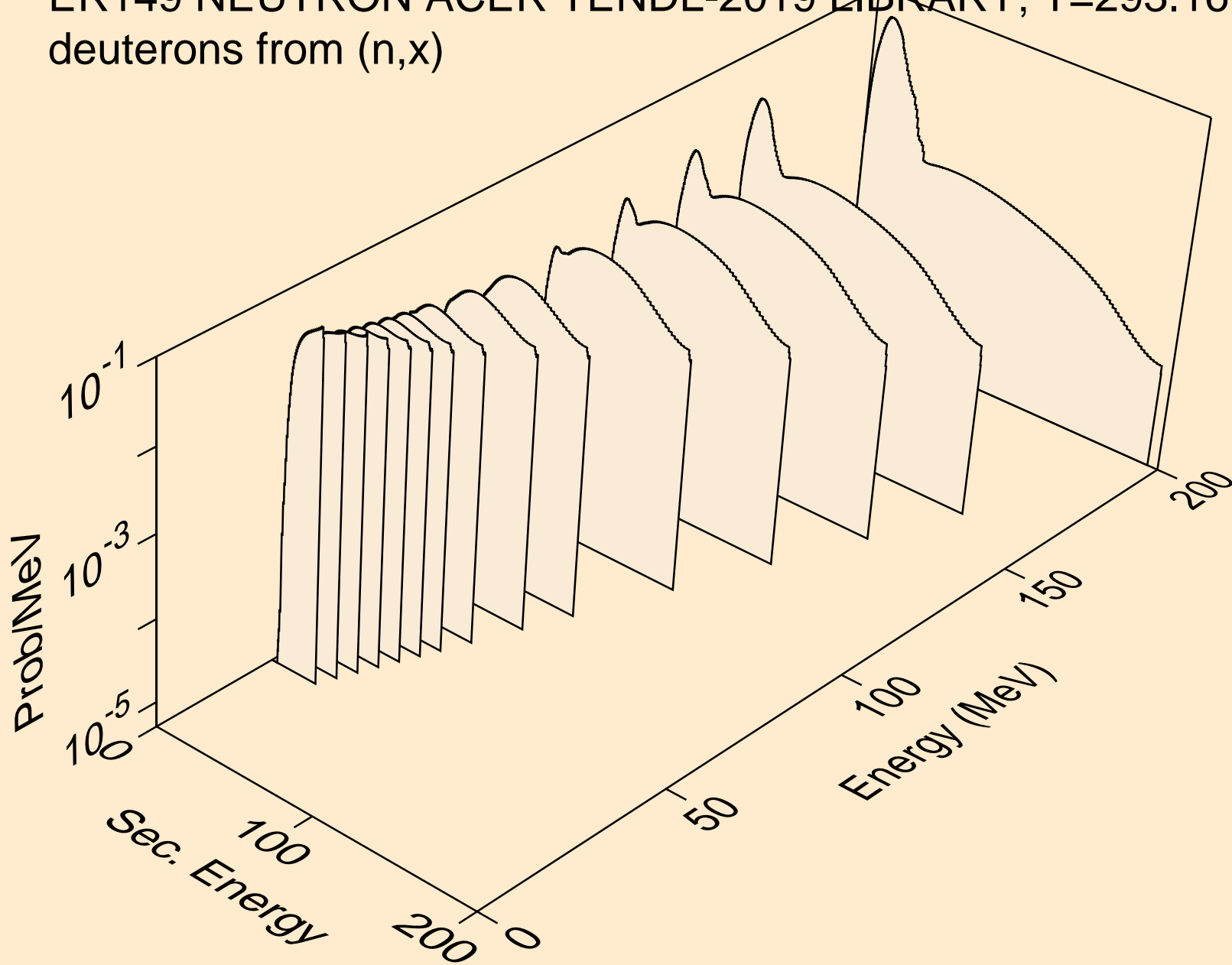



ER149 NEUTRON ACER TENDL-2019 LIBRARY; T=293.16K  
deuterons from (n,2nd)

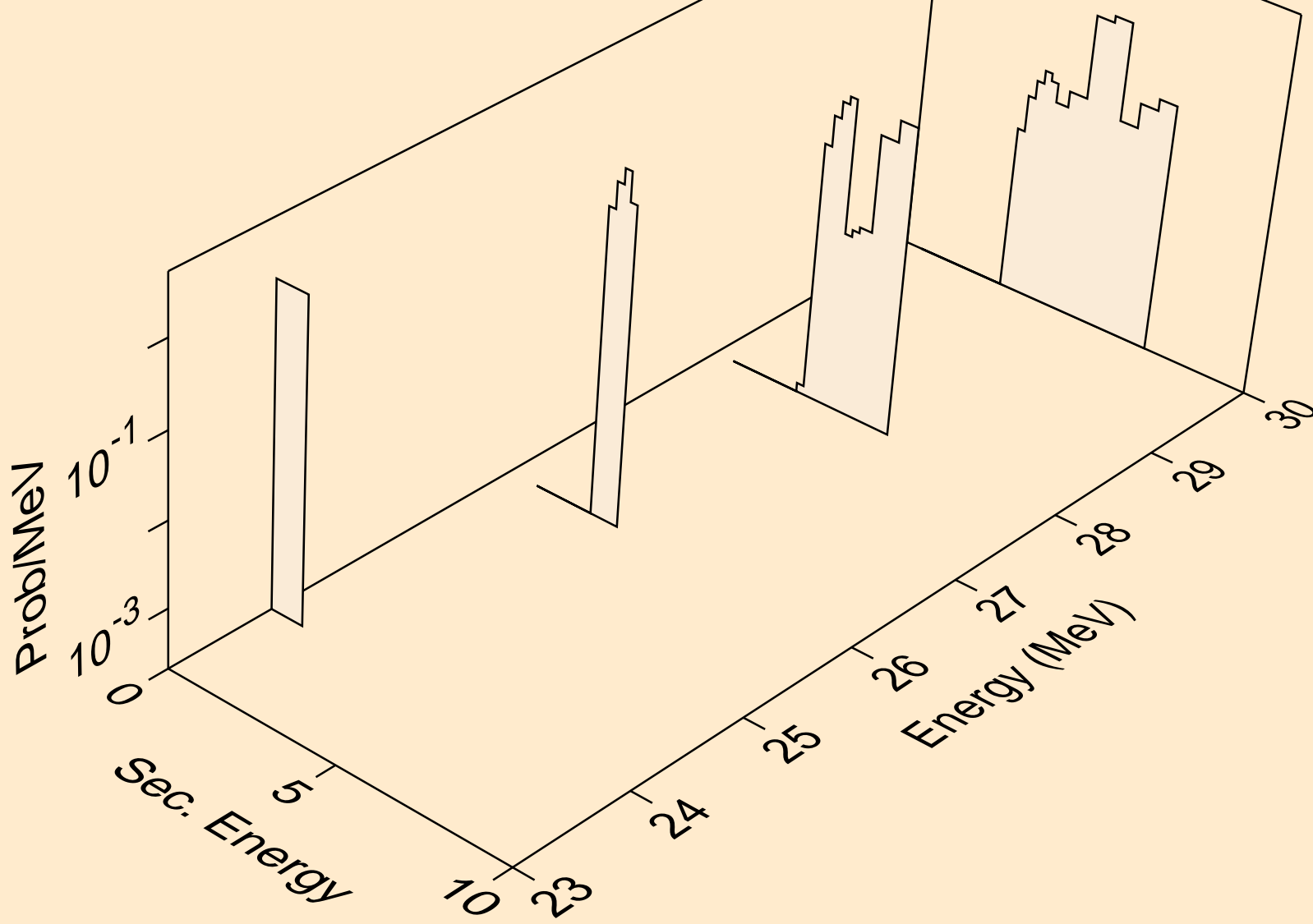

ER149 NEUTRON ACER TENDL-2019 LIBRARY; T=293.16K  
deuterons from (n,n\*)d

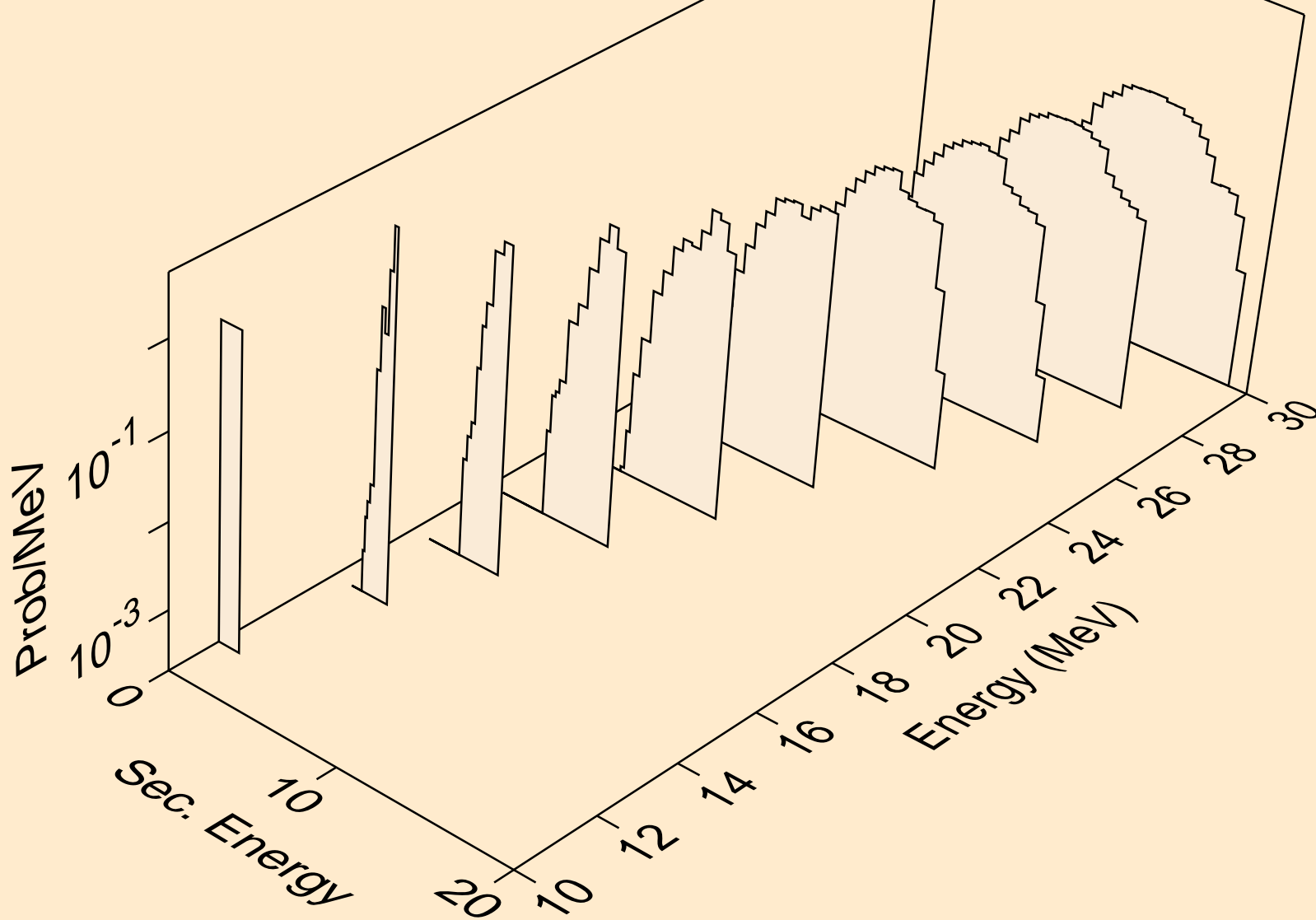

ER149 NEUTRON ACER TENDL-2019 LIBRARY; T=293.16K  
deuterons from (n,d)

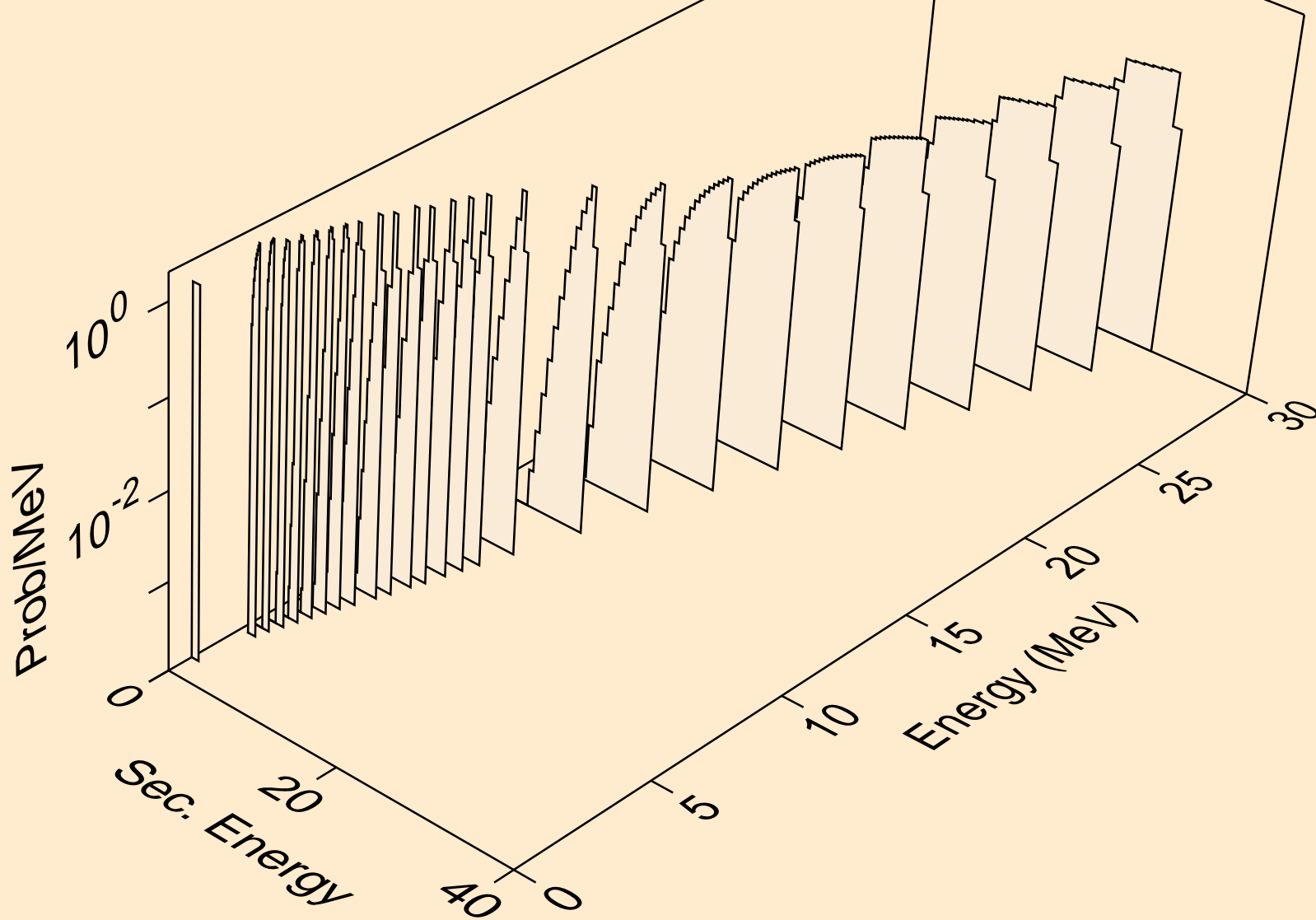

ER149 NEUTRON ACER TENDL-2019 LIBRARY; T=293.16K  
deuterons from (n,pd)

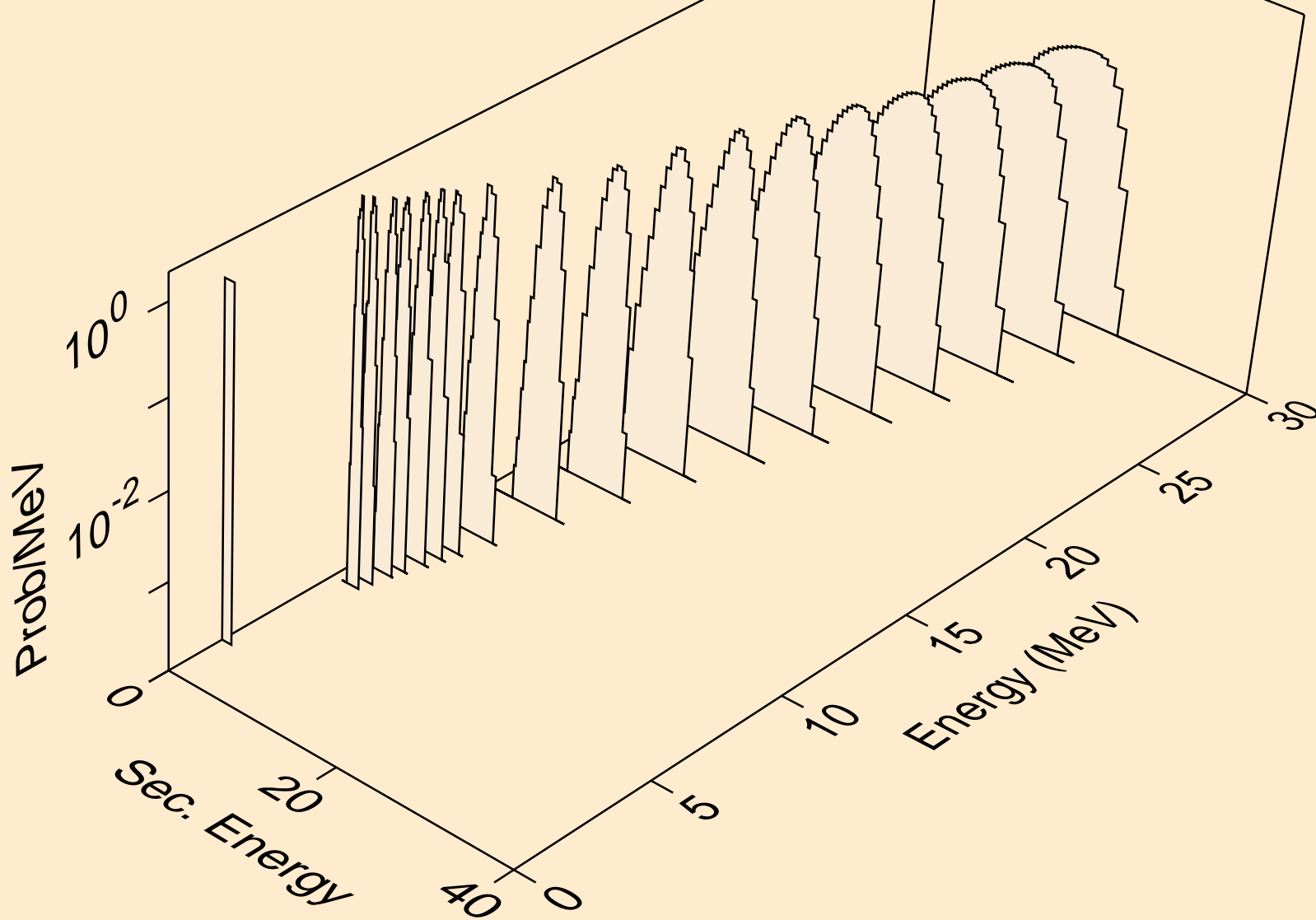

ER149 NEUTRON ACER TENDL-2019 LIBRARY; T=293.16K  
deuterons from (n,da)

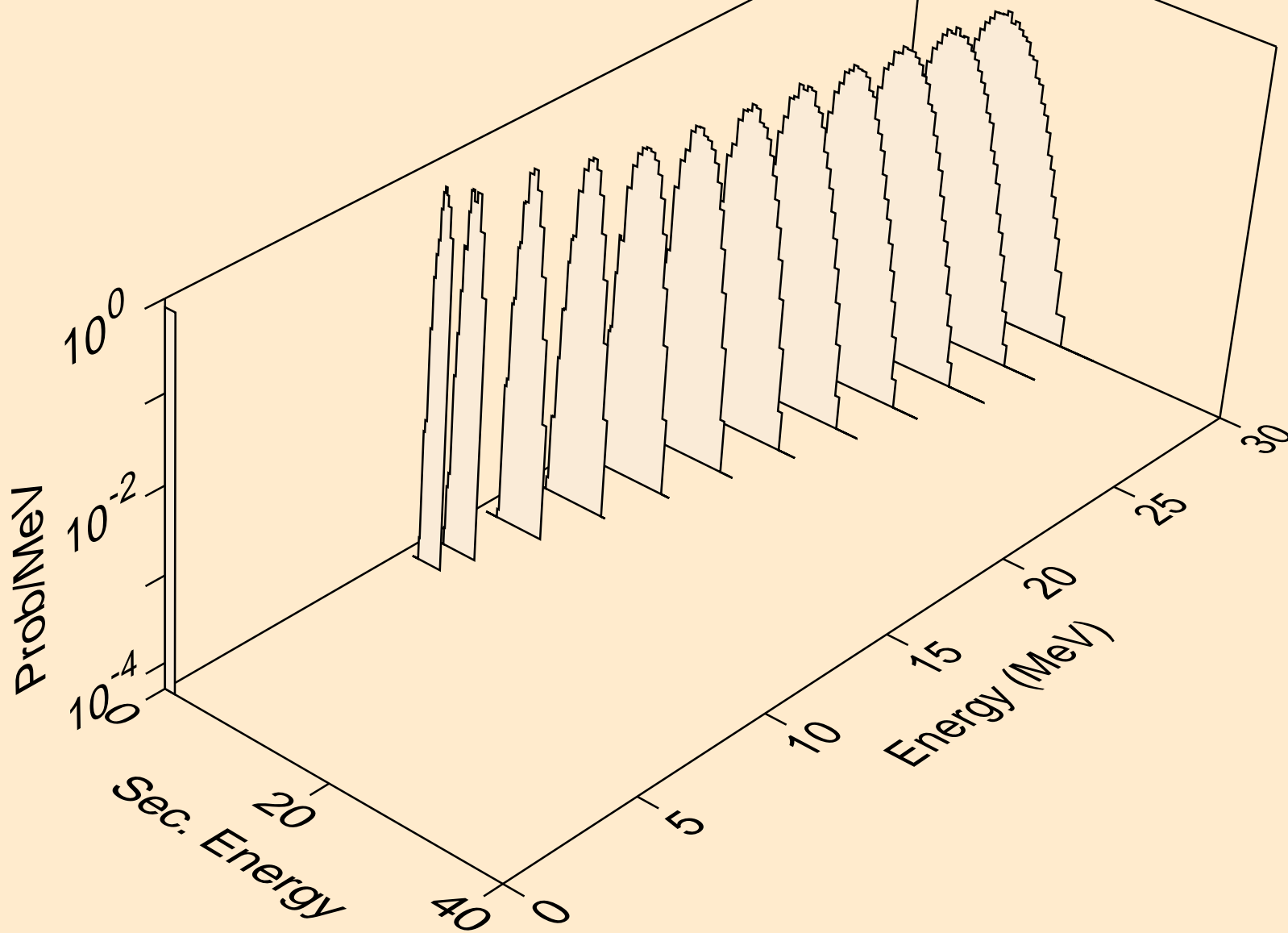

ER149 NEUTRON ACER TENDL-2019 LIBRARY; T=293.16K  
tritons from (n,x)

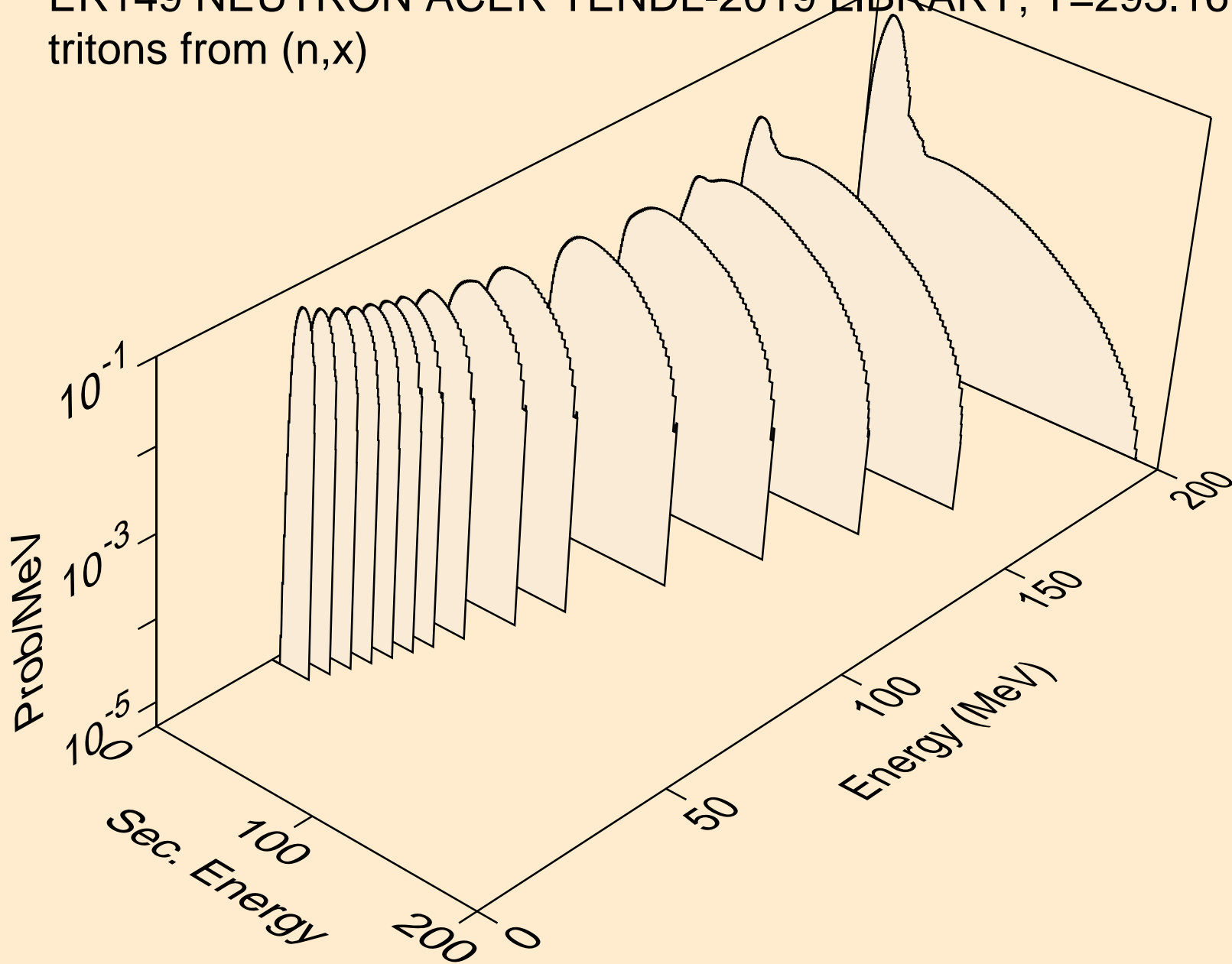

ER149 NEUTRON ACER TENDL-2019 LIBRARY; T=293.16K  
tritons from (n,n\*)t

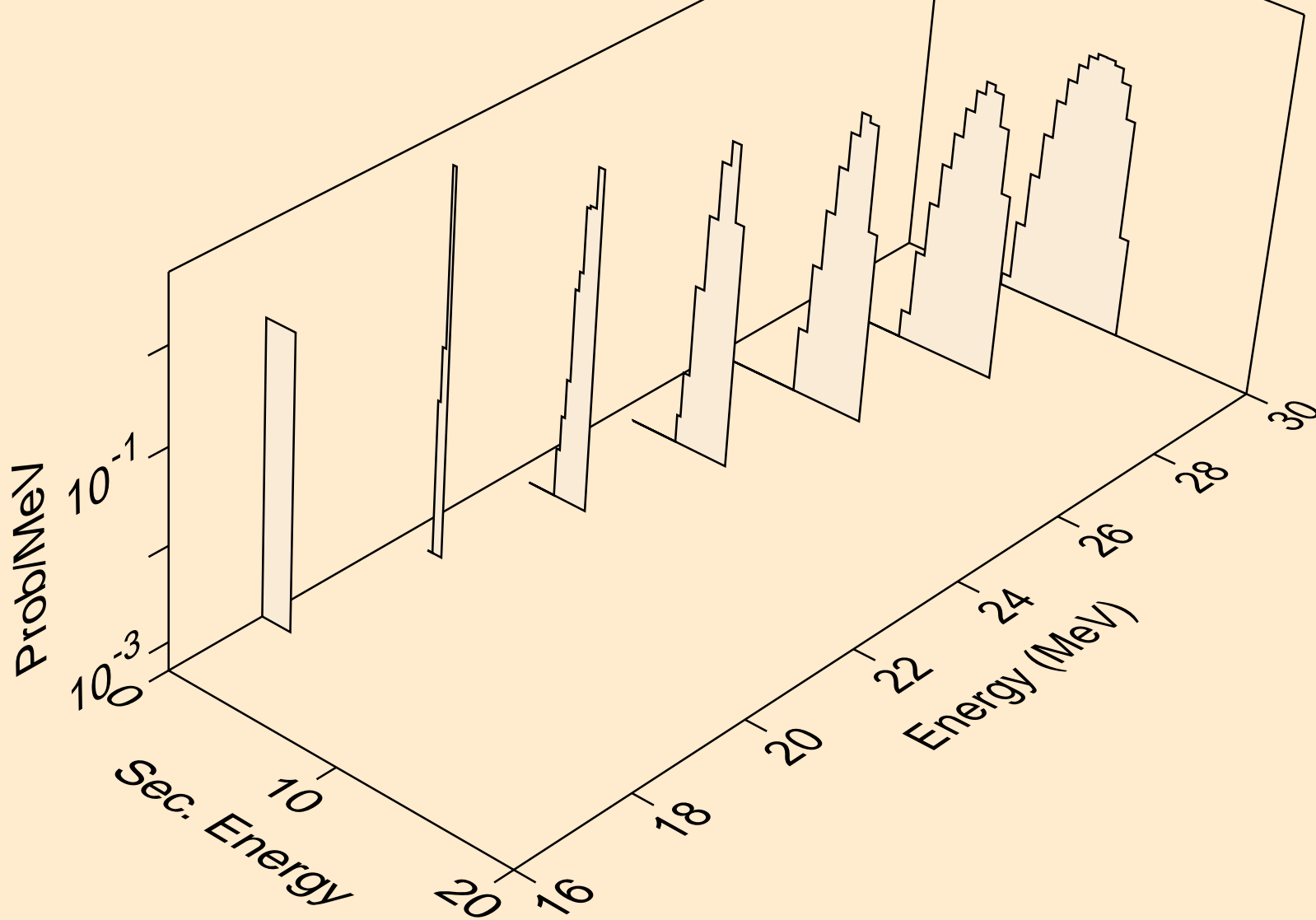

ER149 NEUTRON ACER TENDL-2019 LIBRARY; T=293.16K  
tritons from (n,t)

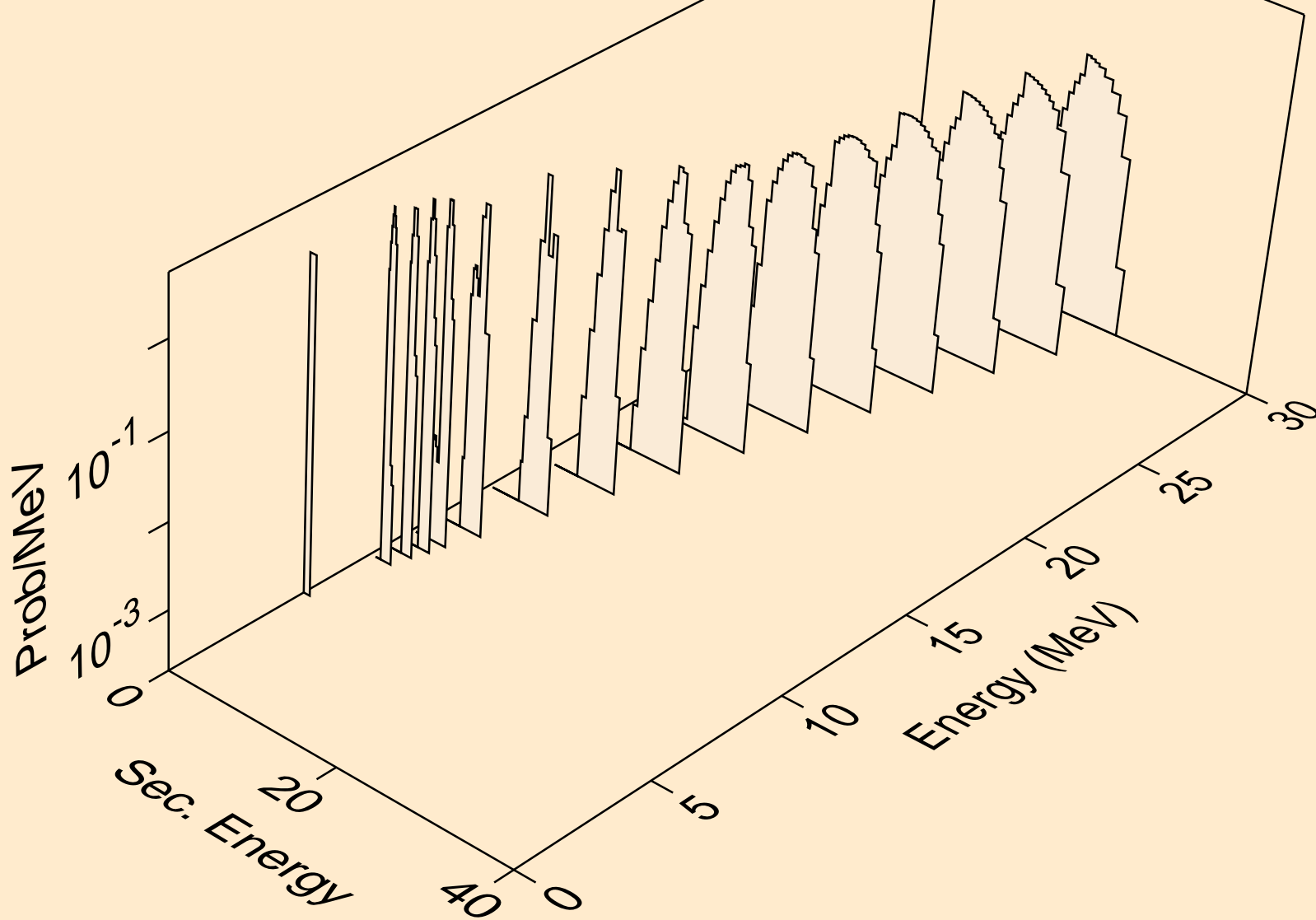



ER149 NEUTRON ACER TENDL-2019 LIBRARY; T=293.16K  
tritons from (n,pt)

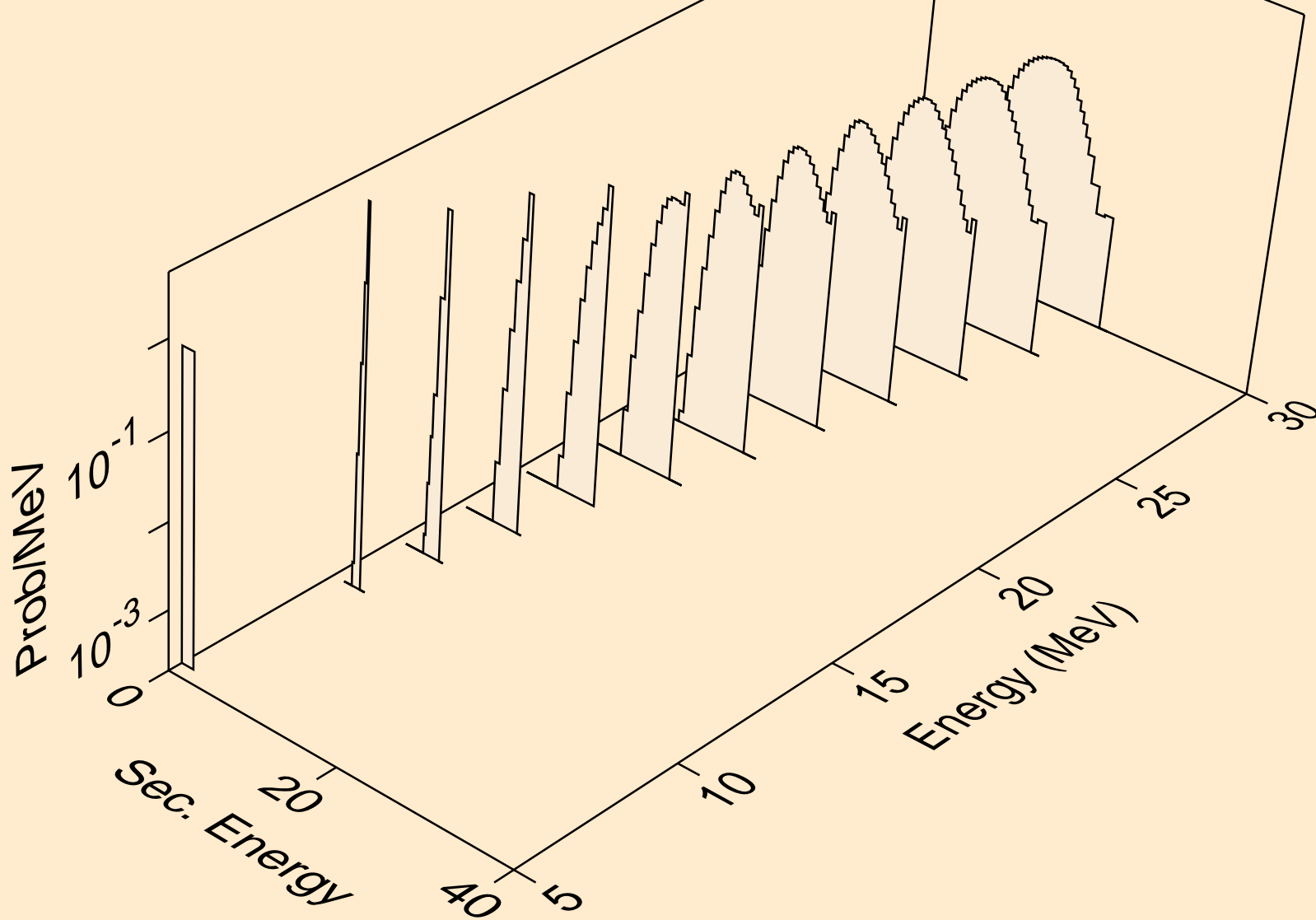

ER149 NEUTRON ACER TENDL-2019 LIBRARY; T=293.16K  
he3s from (n,x)

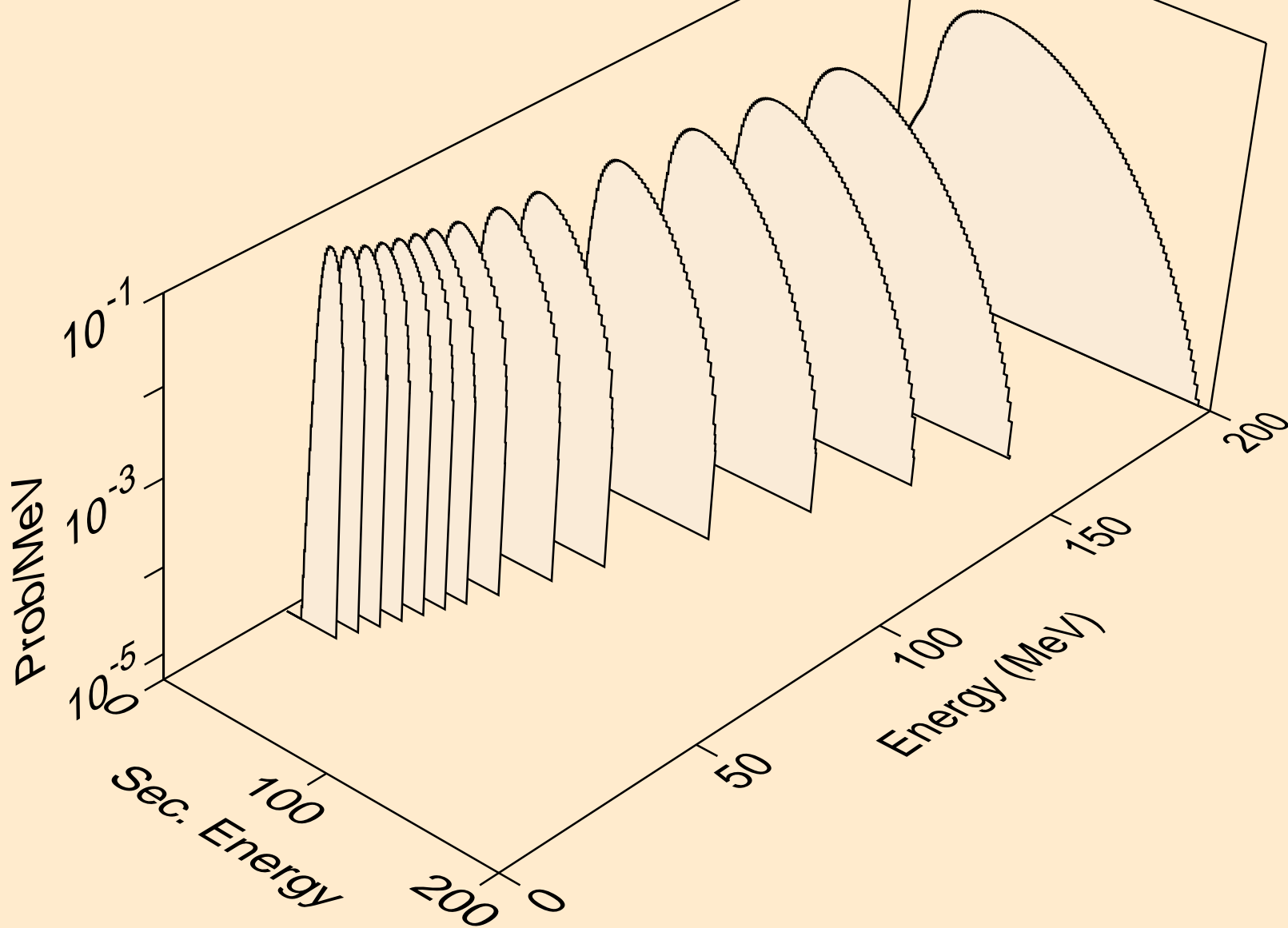

ER149 NEUTRON ACER TENDL-2019 LIBRARY; T=293.16K  
he3s from (n,n\*)he3

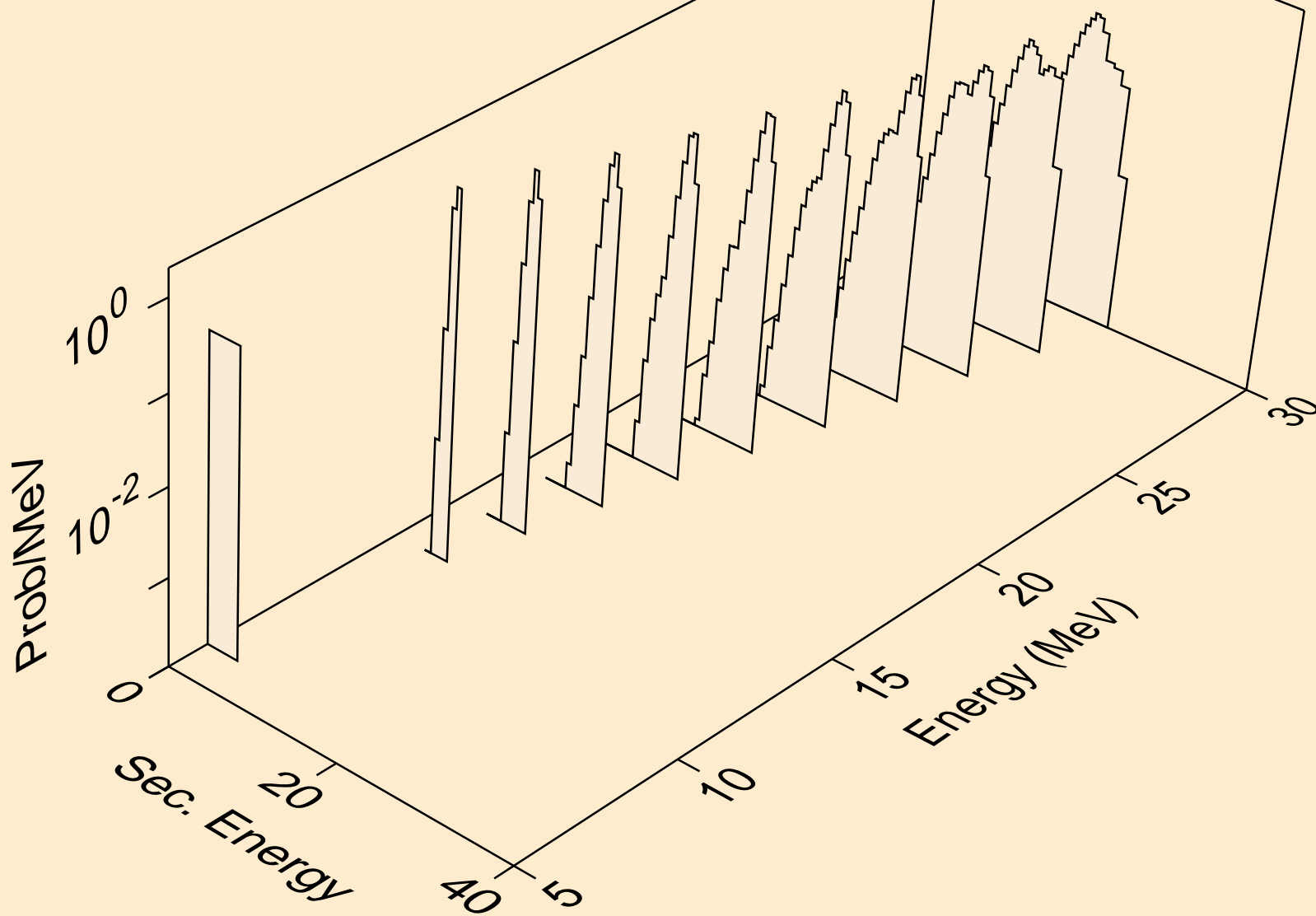

ER149 NEUTRON ACER TENDL-2019 LIBRARY; T=293.16K  
he3s from (n,he3)

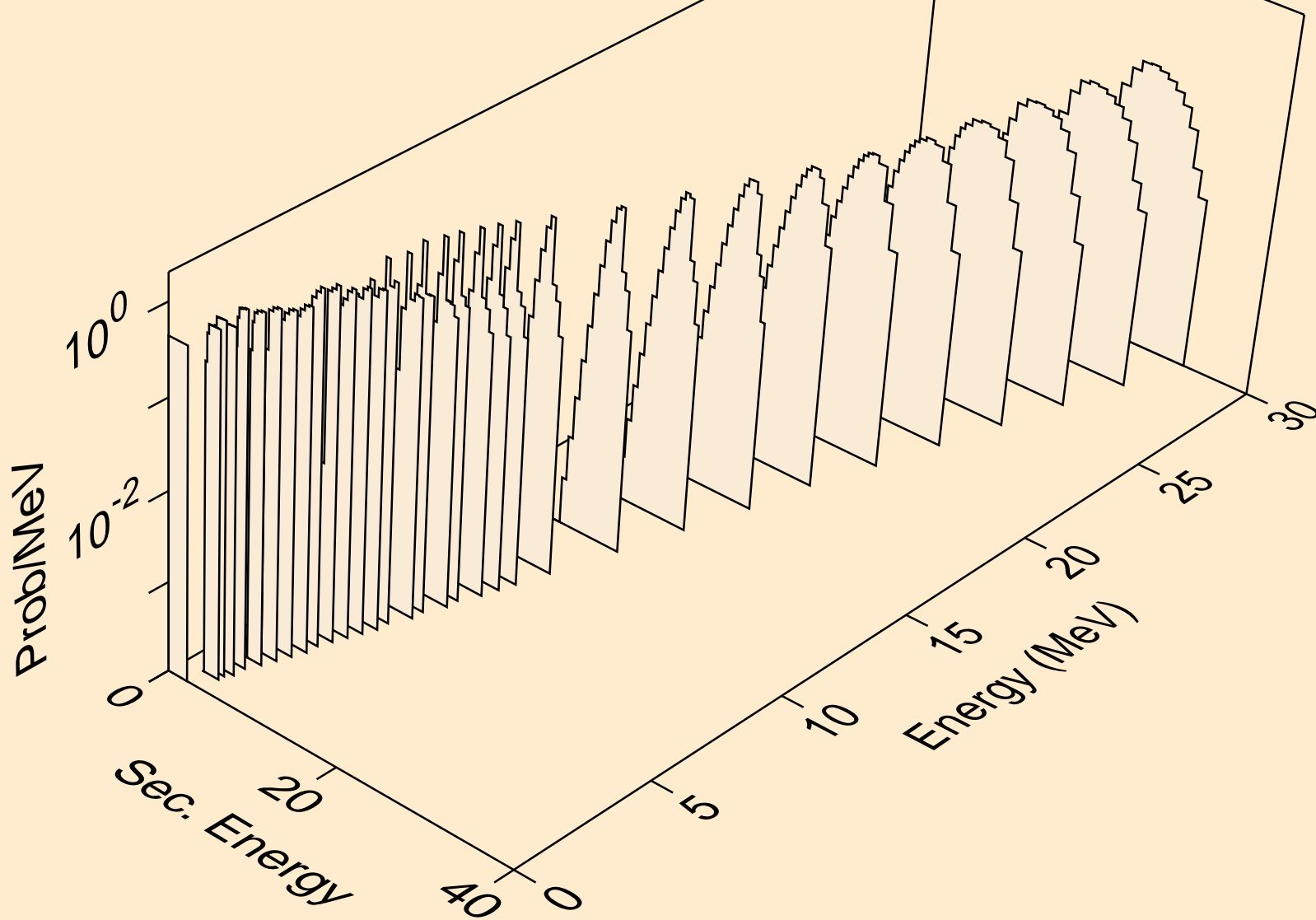

ER149 NEUTRON ACER TENDL-2019 LIBRARY; T=293.16K  
alphas from (n,x)

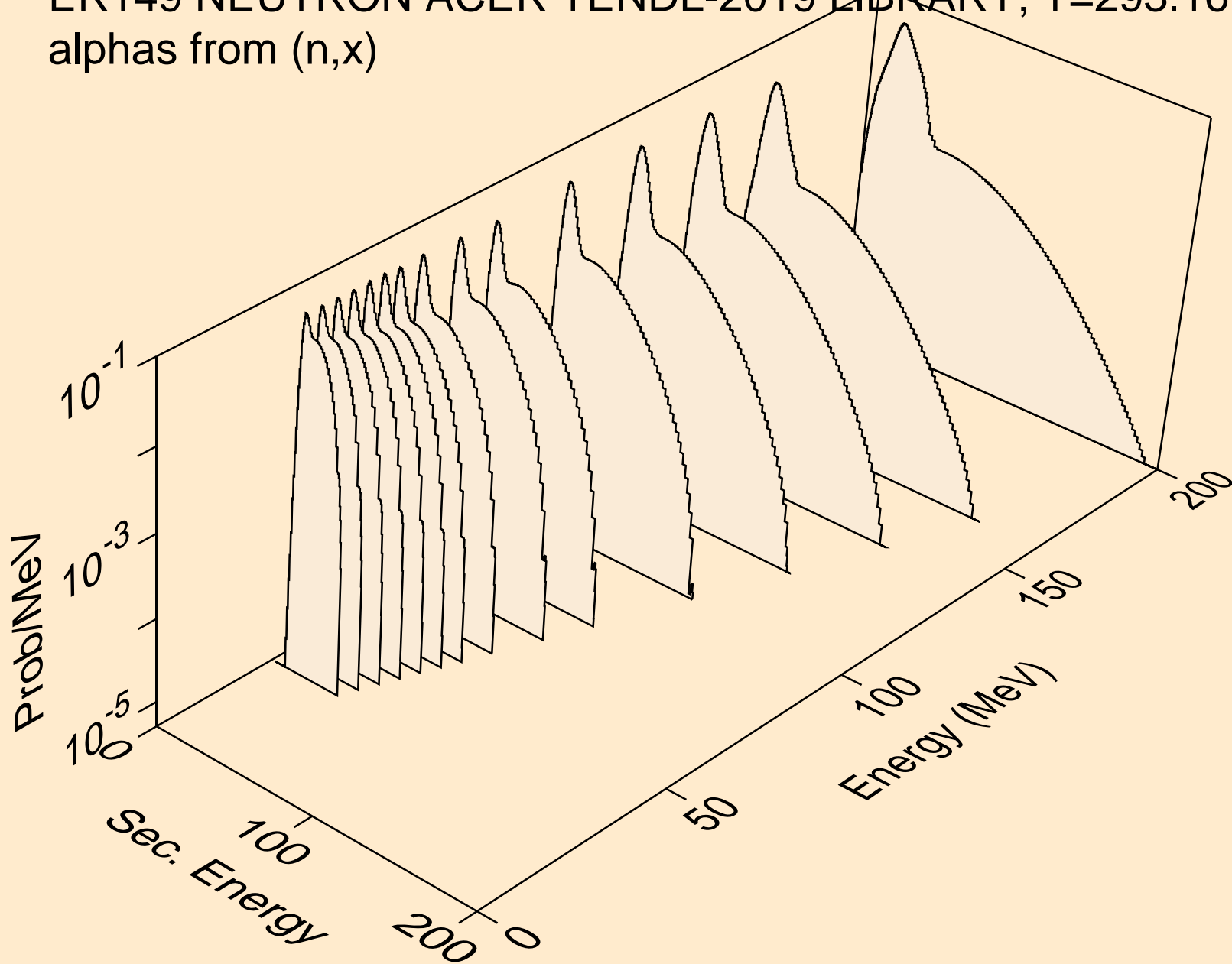

ER149 NEUTRON ACER TENDL-2019 LIBRARY; T=293.16K  
alphas from (n,n\*)a

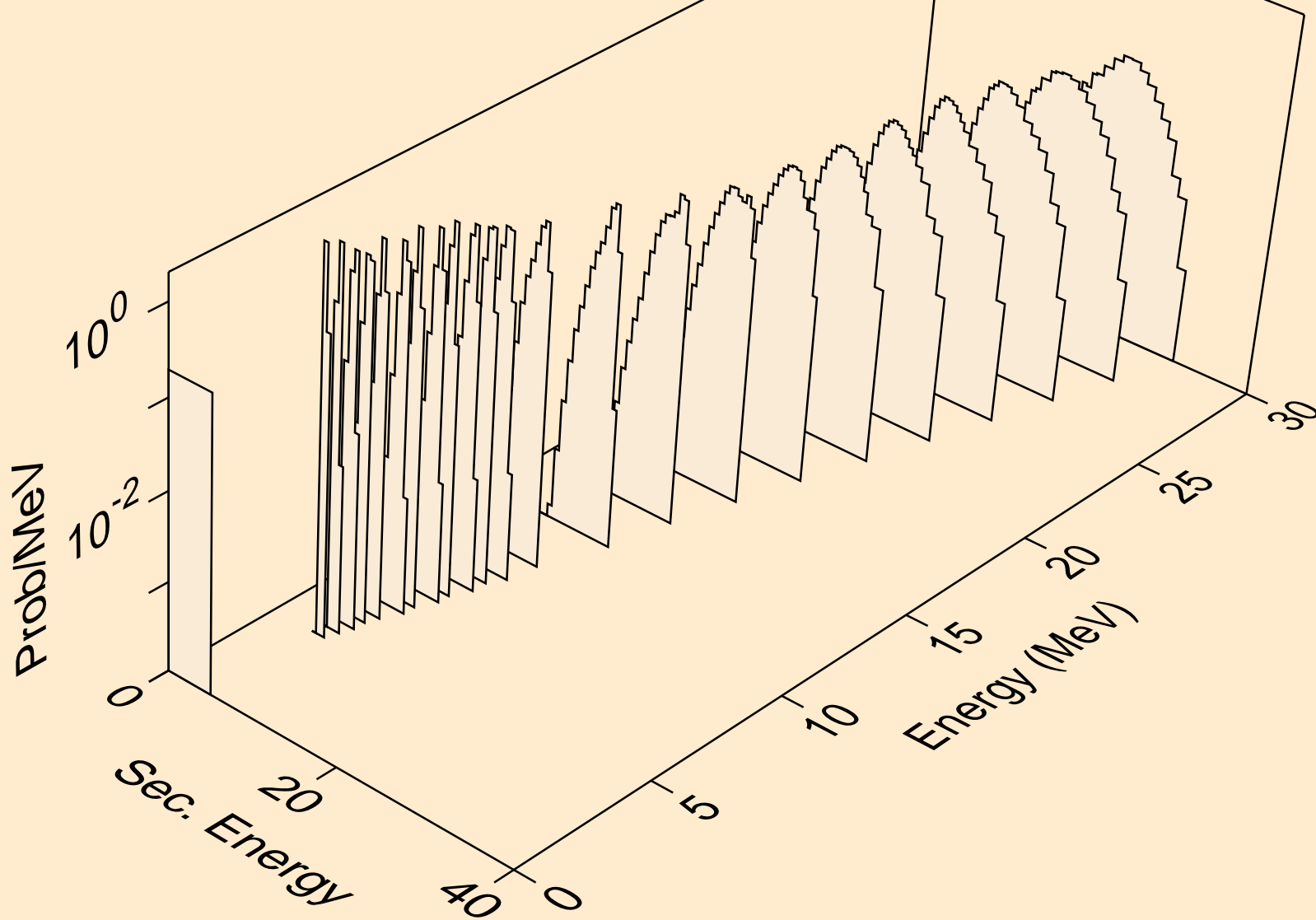

ER149 NEUTRON ACER TENDL-2019 LIBRARY; T=293.16K  
alphas from (n,2n)a

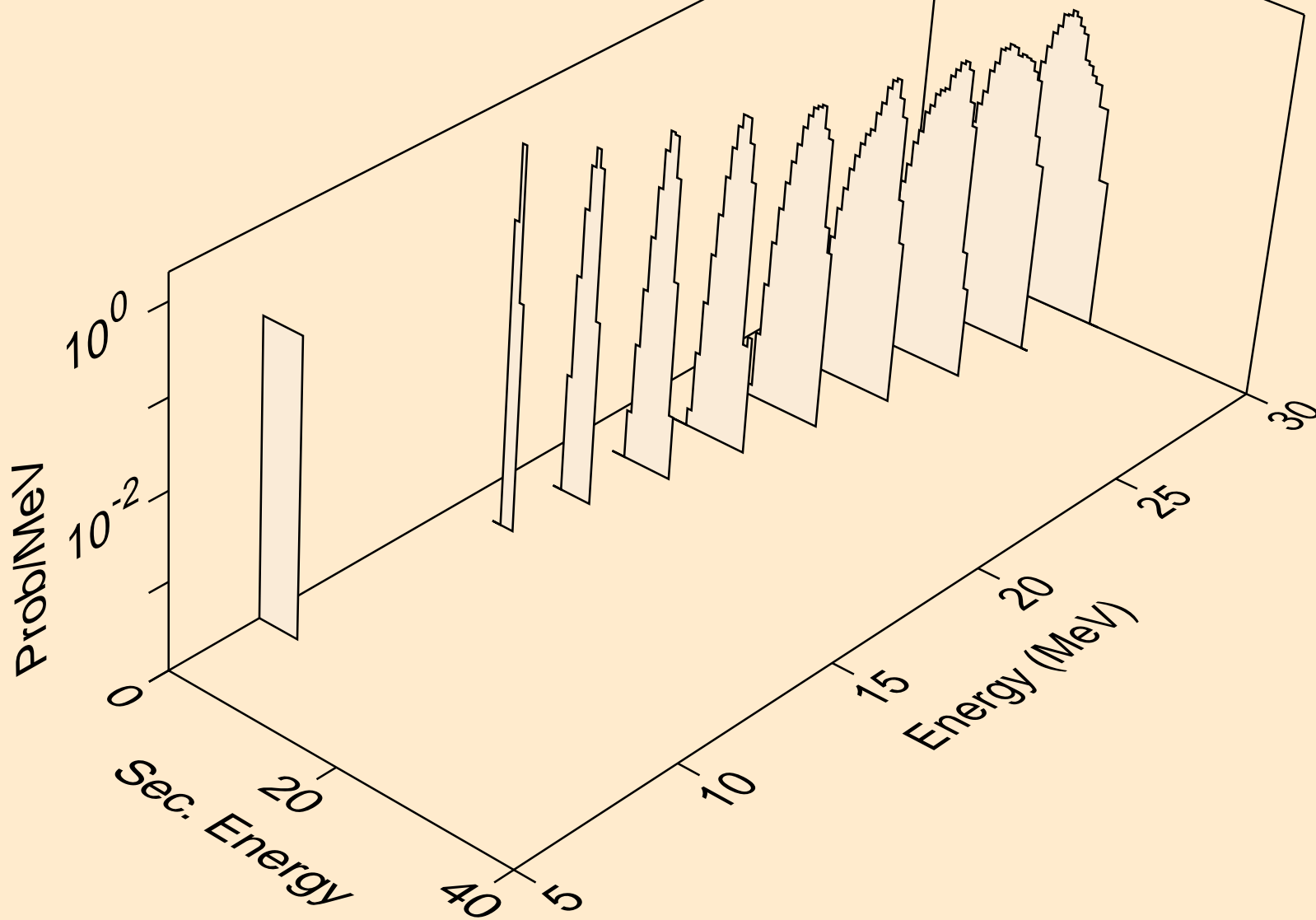

ER149 NEUTRON ACER TENDL-2019 LIBRARY; T=293.16K  
alphas from (n,n\*)2a

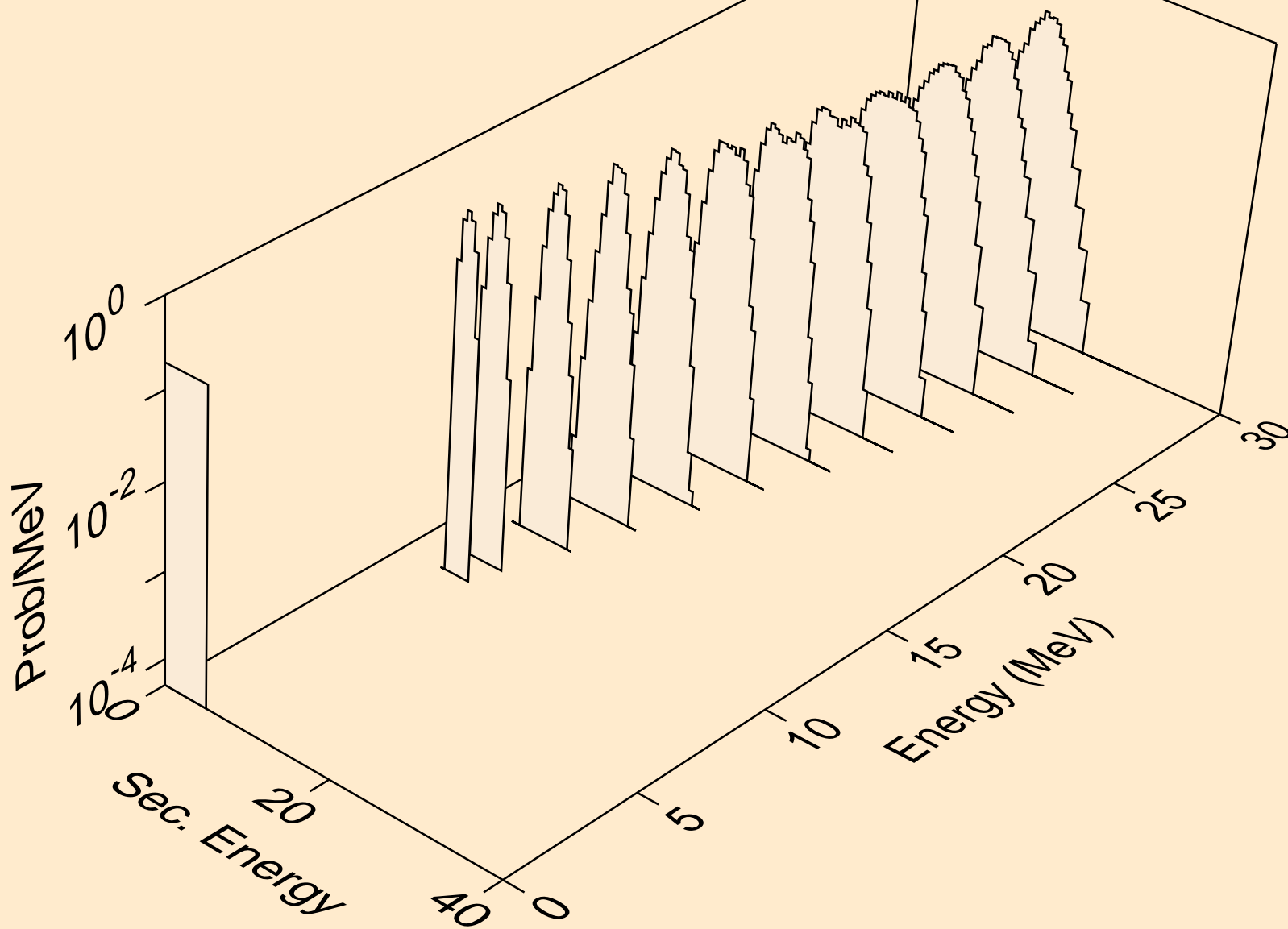



ER149 NEUTRON ACER TENDL-2019 LIBRARY; T=293.16K  
alphas from (n,2n)2a

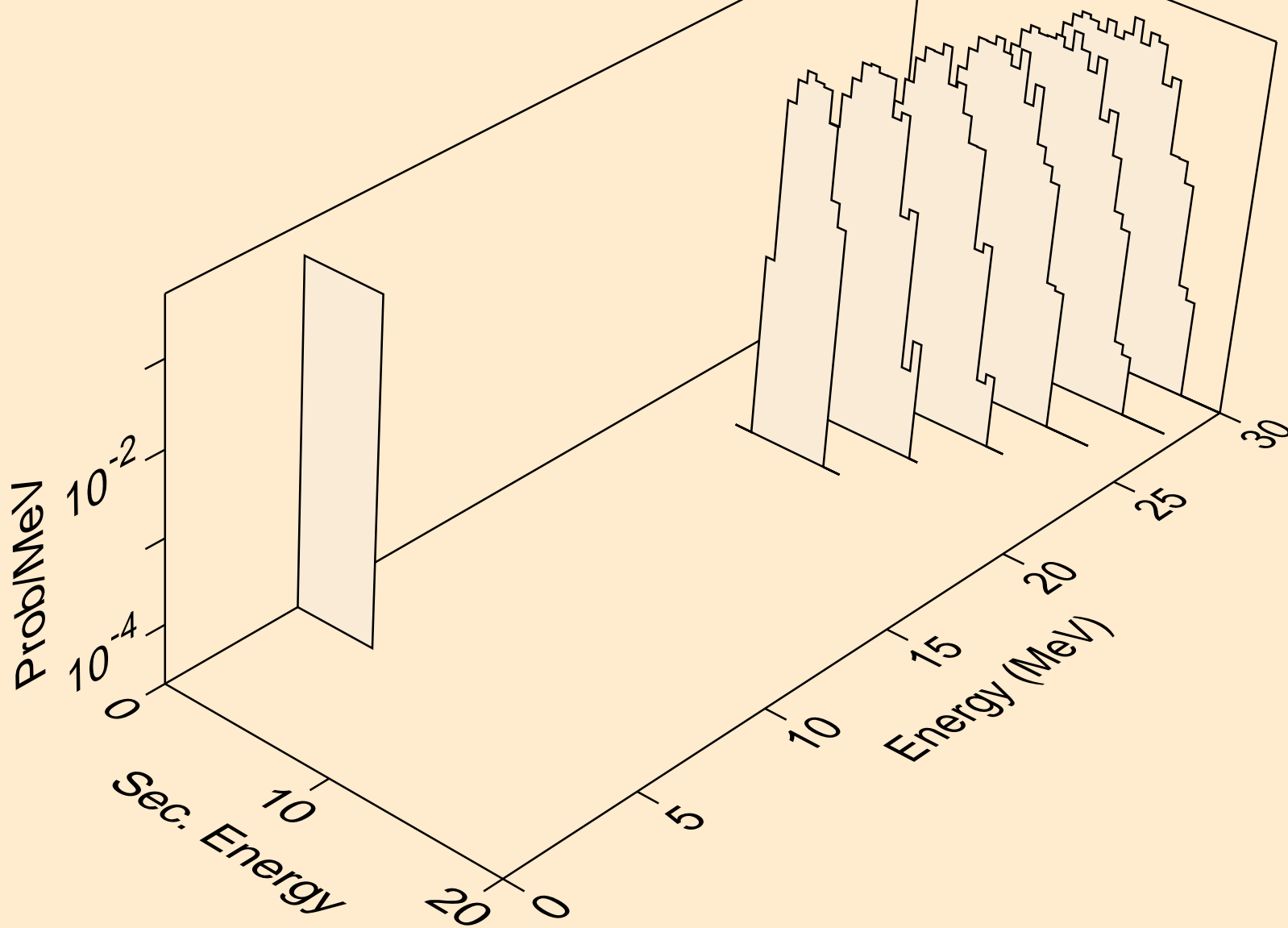

ER149 NEUTRON ACER TENDL-2019 LIBRARY; T=293.16K  
alphas from (n,npa)

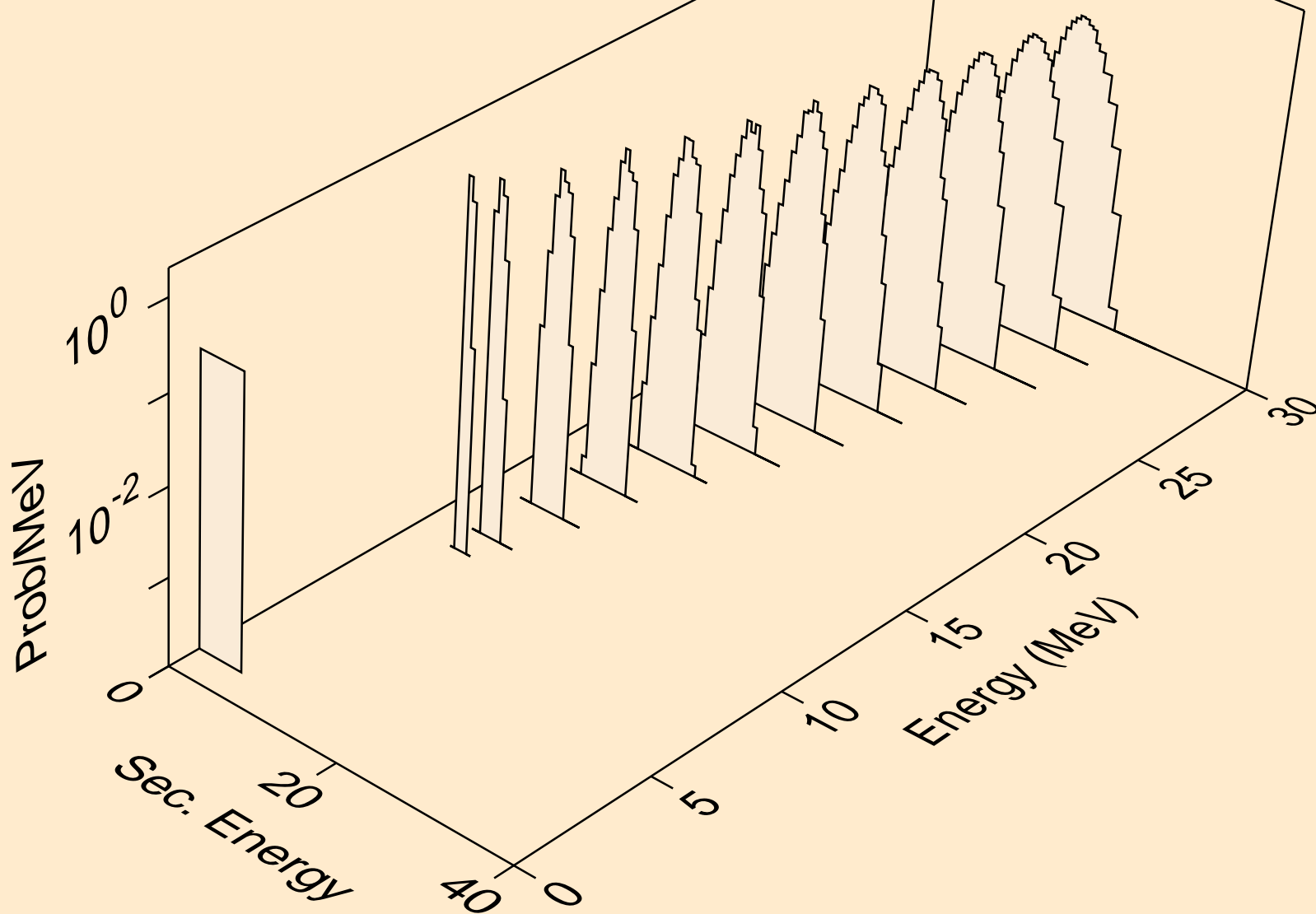

ER149 NEUTRON ACER TENDL-2019 LIBRARY; T=293.16K  
alphas from (n,a)

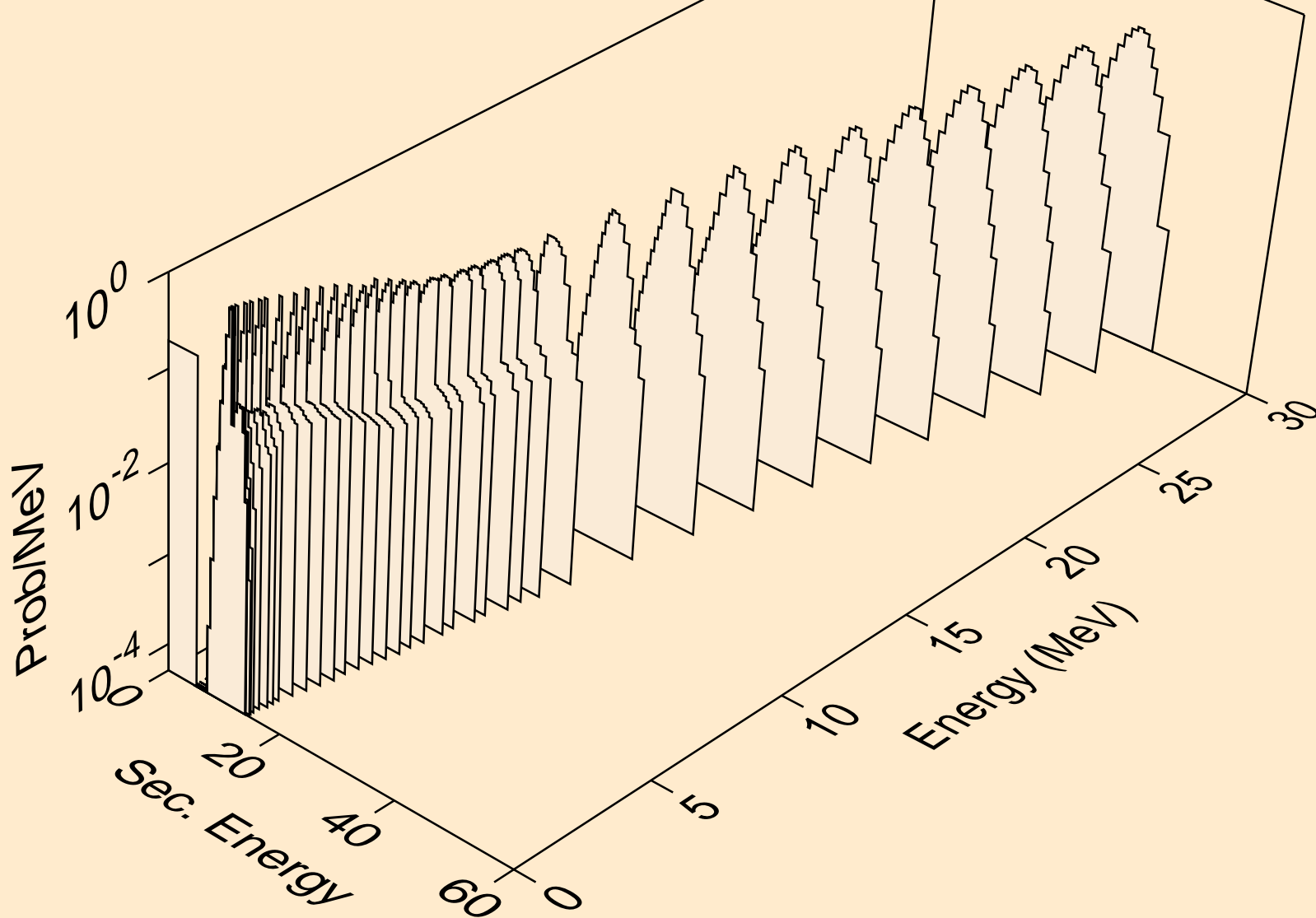

ER149 NEUTRON ACER TENDL-2019 LIBRARY; T=293.16K  
alphas from (n,2a)

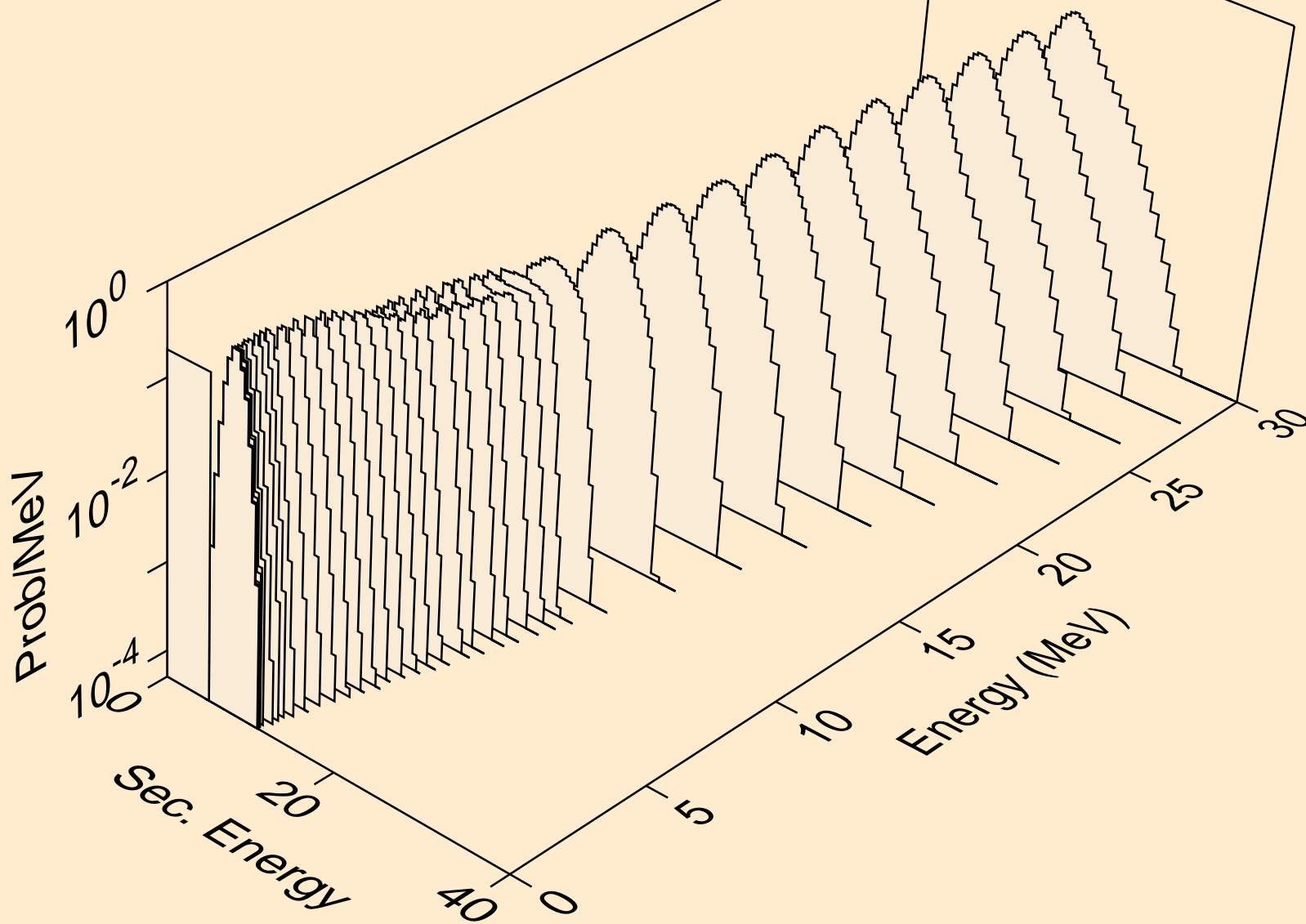

ER149 NEUTRON ACER TENDL-2019 LIBRARY; T=293.16K  
alphas from (n,3a)

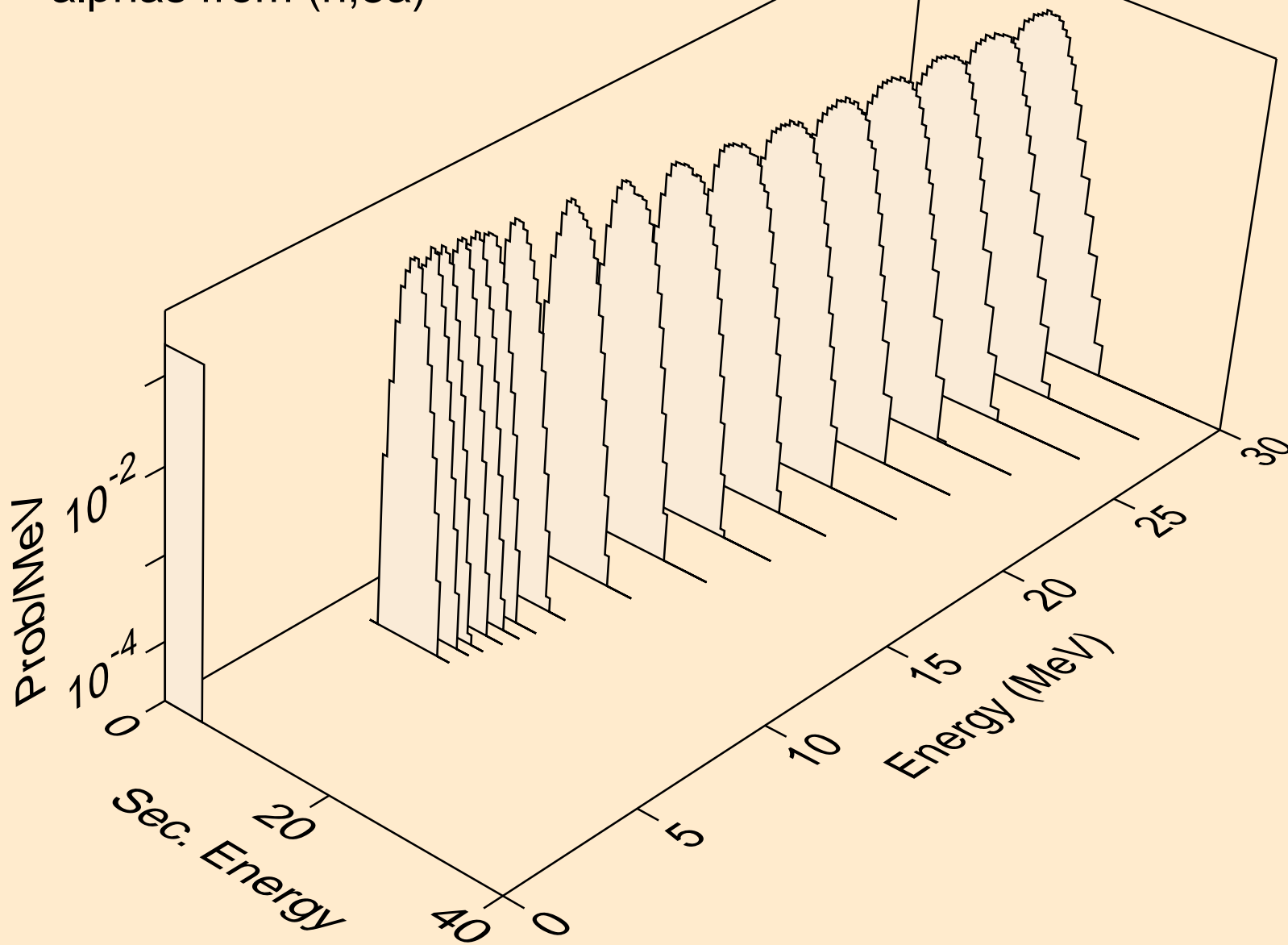

ER149 NEUTRON ACER TENDL-2019 LIBRARY; T=293.16K  
alphas from (n,pa)

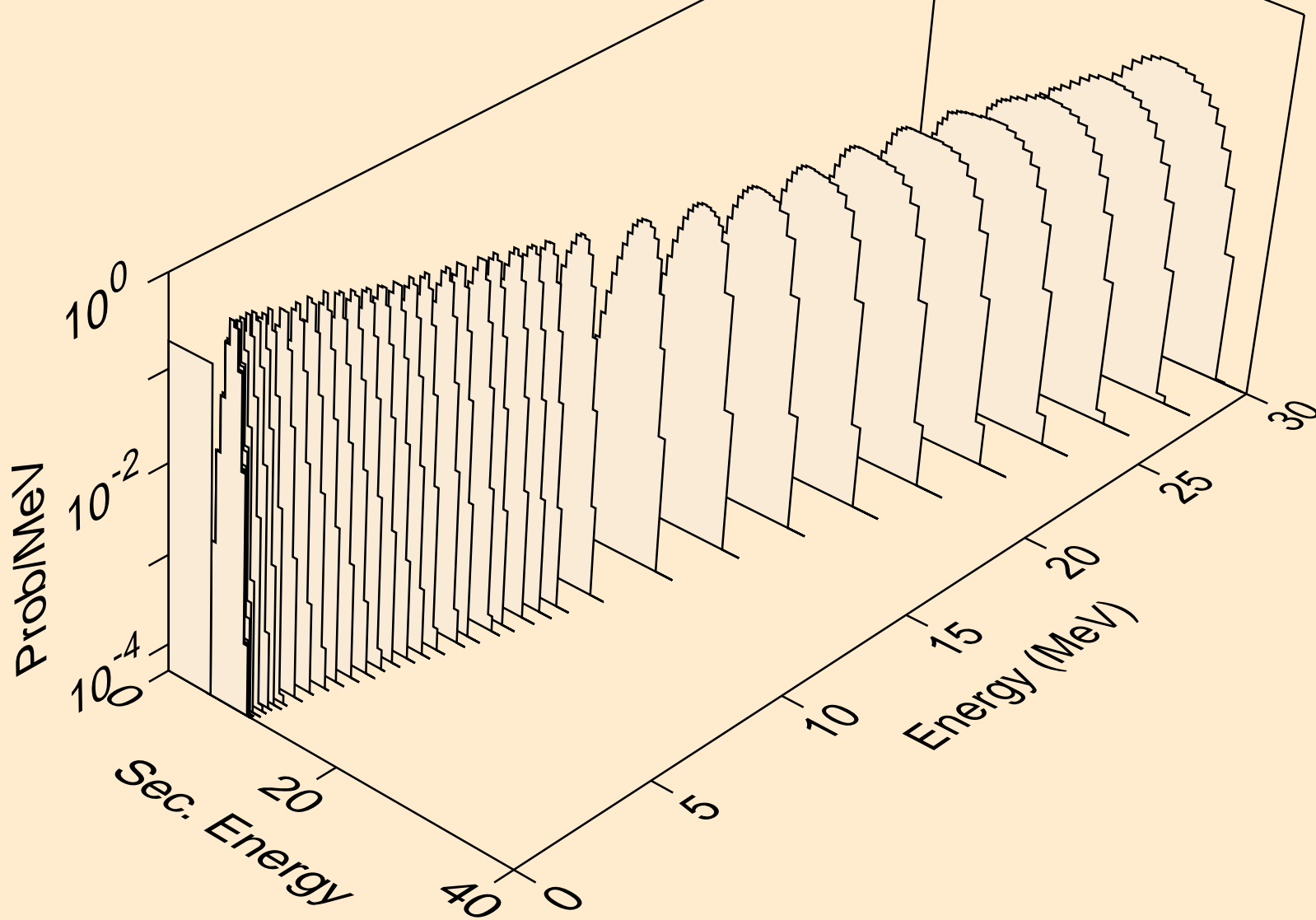

ER149 NEUTRON ACER TENDL-2019 LIBRARY; T=293.16K  
alphas from (n,da)

