

ER149M NEUTRON ACER TENDL-2019 LIBRARY; T=293.16K  
Principal cross sections

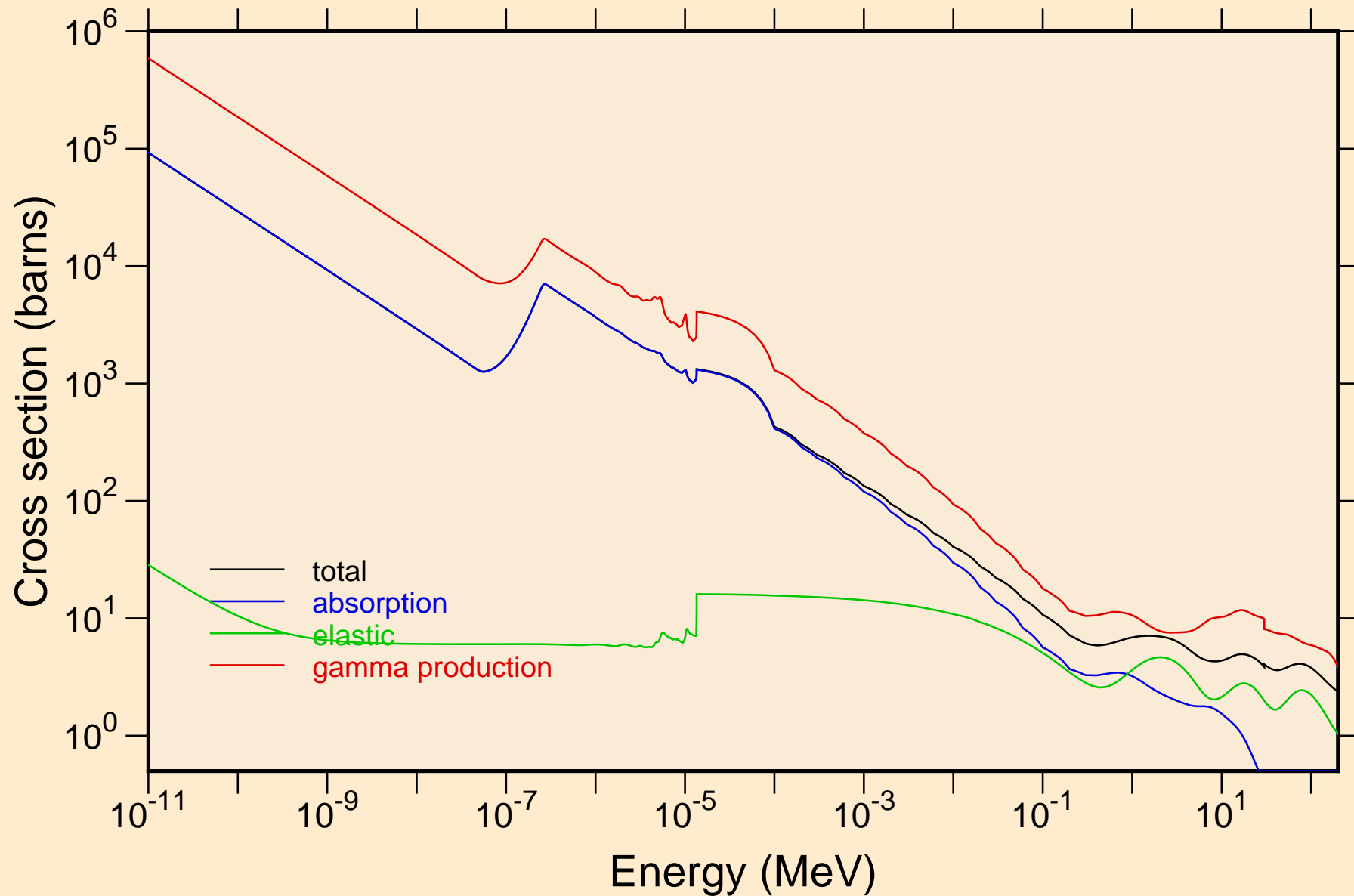

ER149M NEUTRON ACER TENDL-2019 LIBRARY; T=293.16K  
Heating

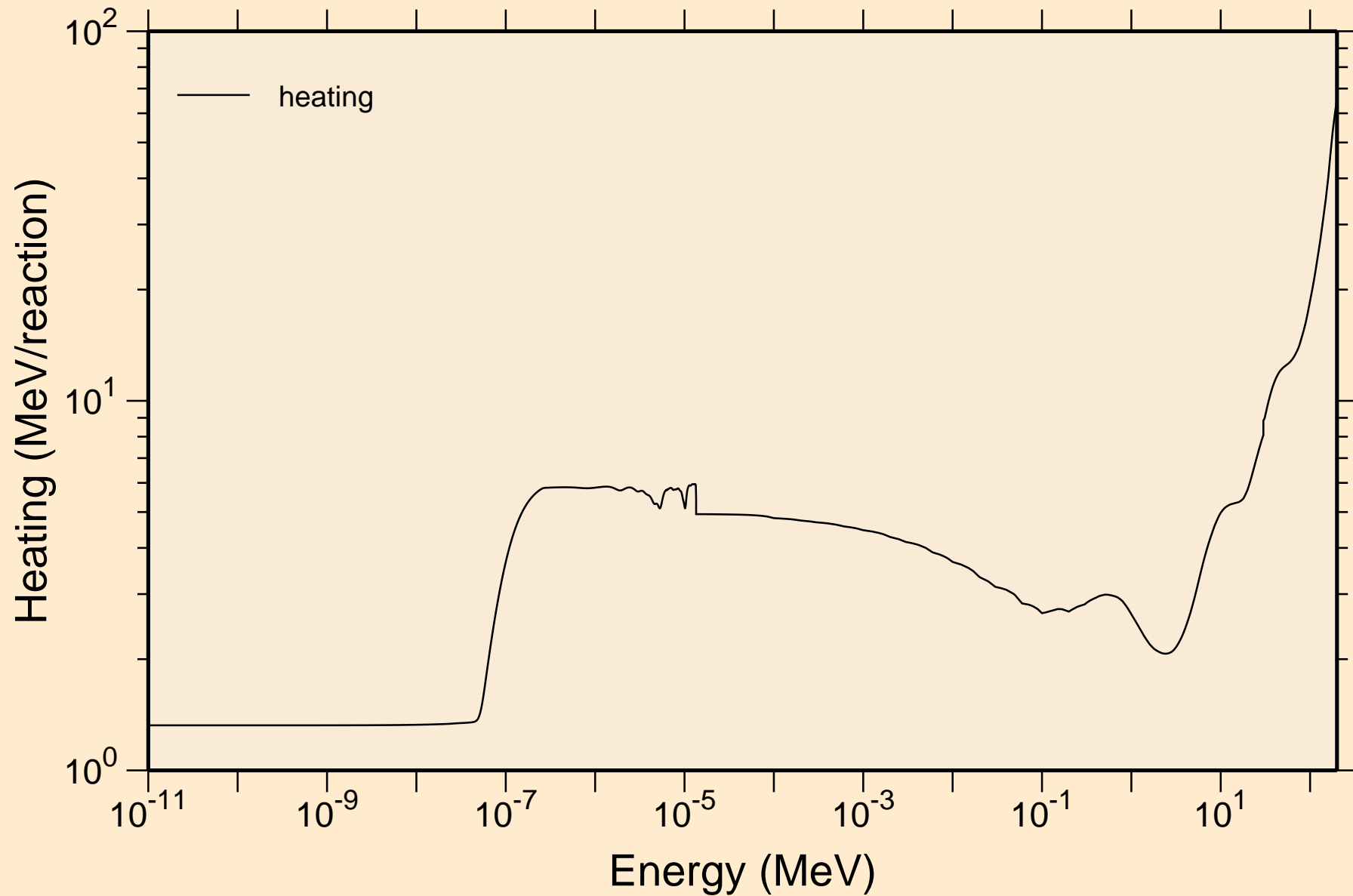

ER149M NEUTRON ACER TENDL-2019 LIBRARY; T=293.16K  
Damage

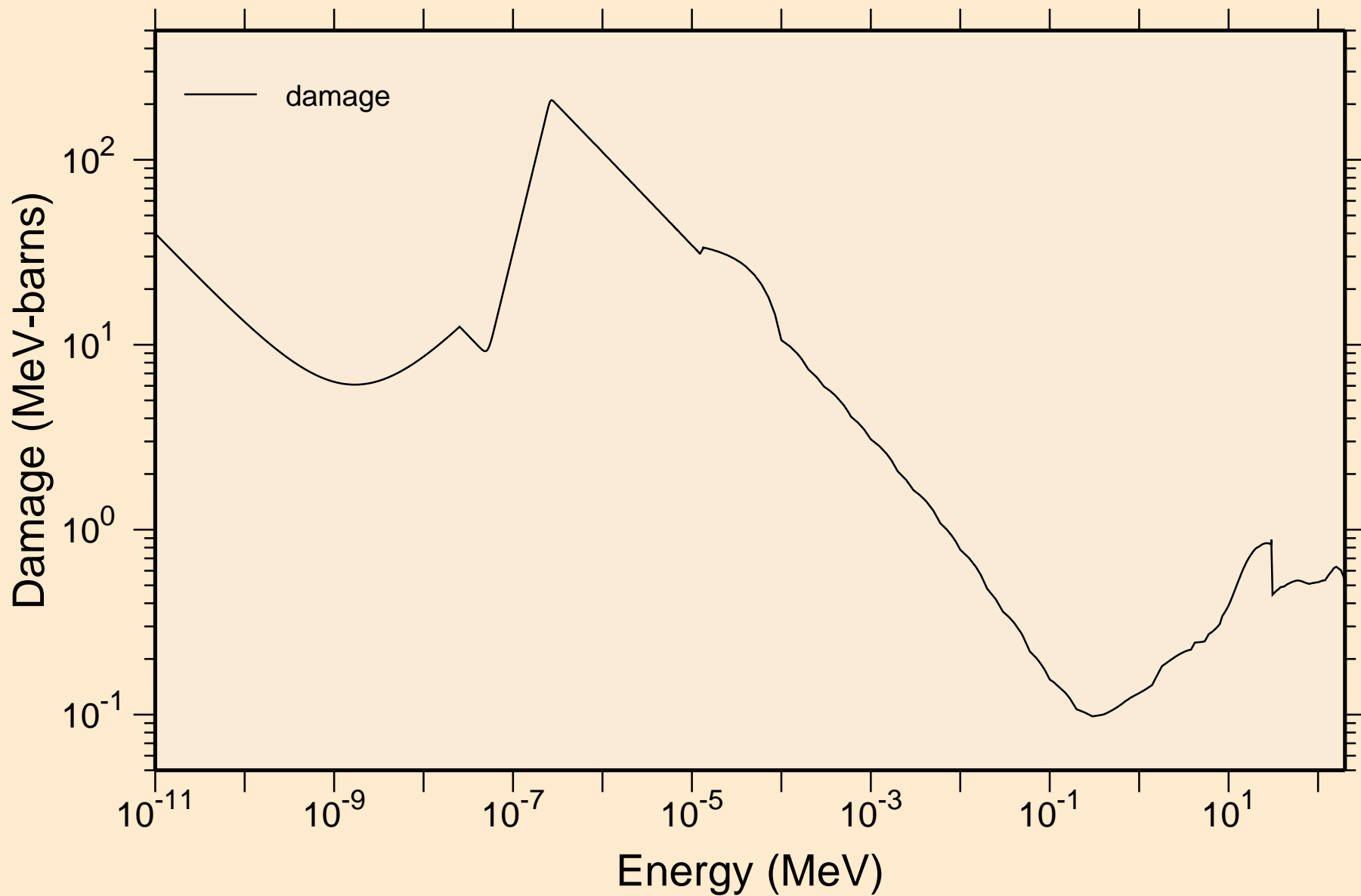

ER149M NEUTRON ACER TENDL-2019 LIBRARY; T=293.16K  
Non-threshold reactions

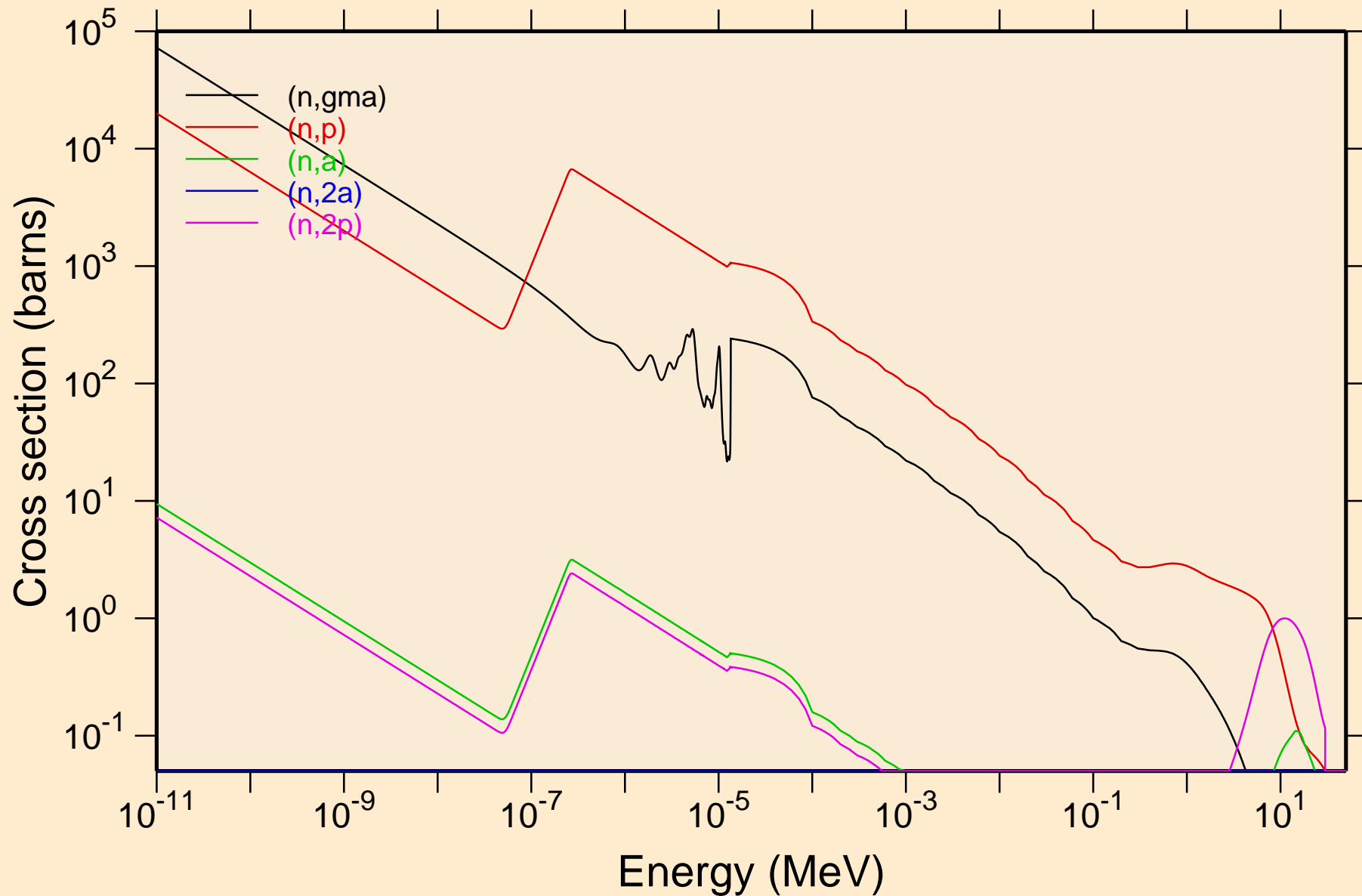

ER149M NEUTRON ACER TENDL-2019 LIBRARY; T=293.16K  
Non-threshold reactions

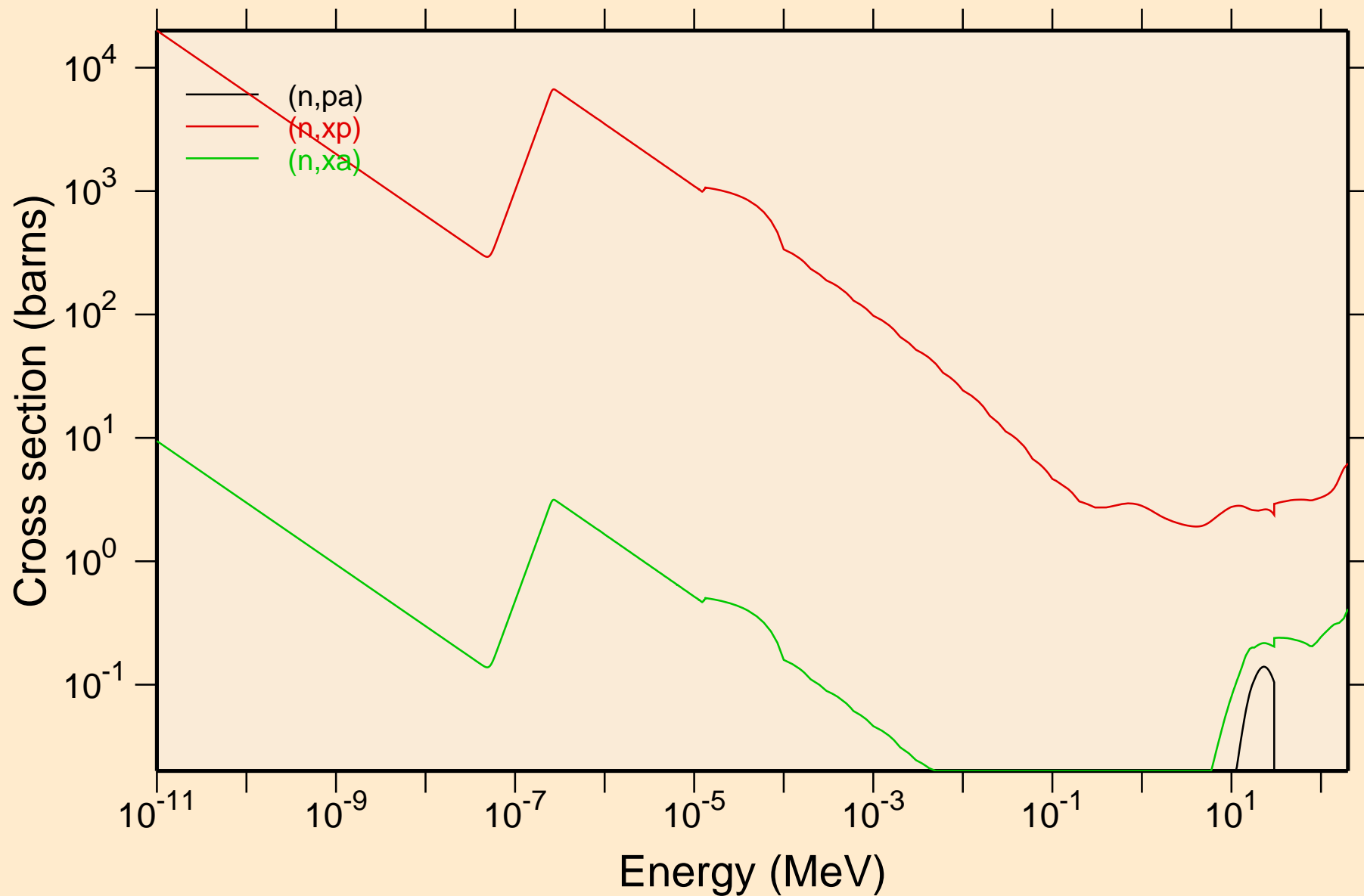

ER149M NEUTRON ACER TENDL-2019 LIBRARY; T=293.16K  
Principal cross sections

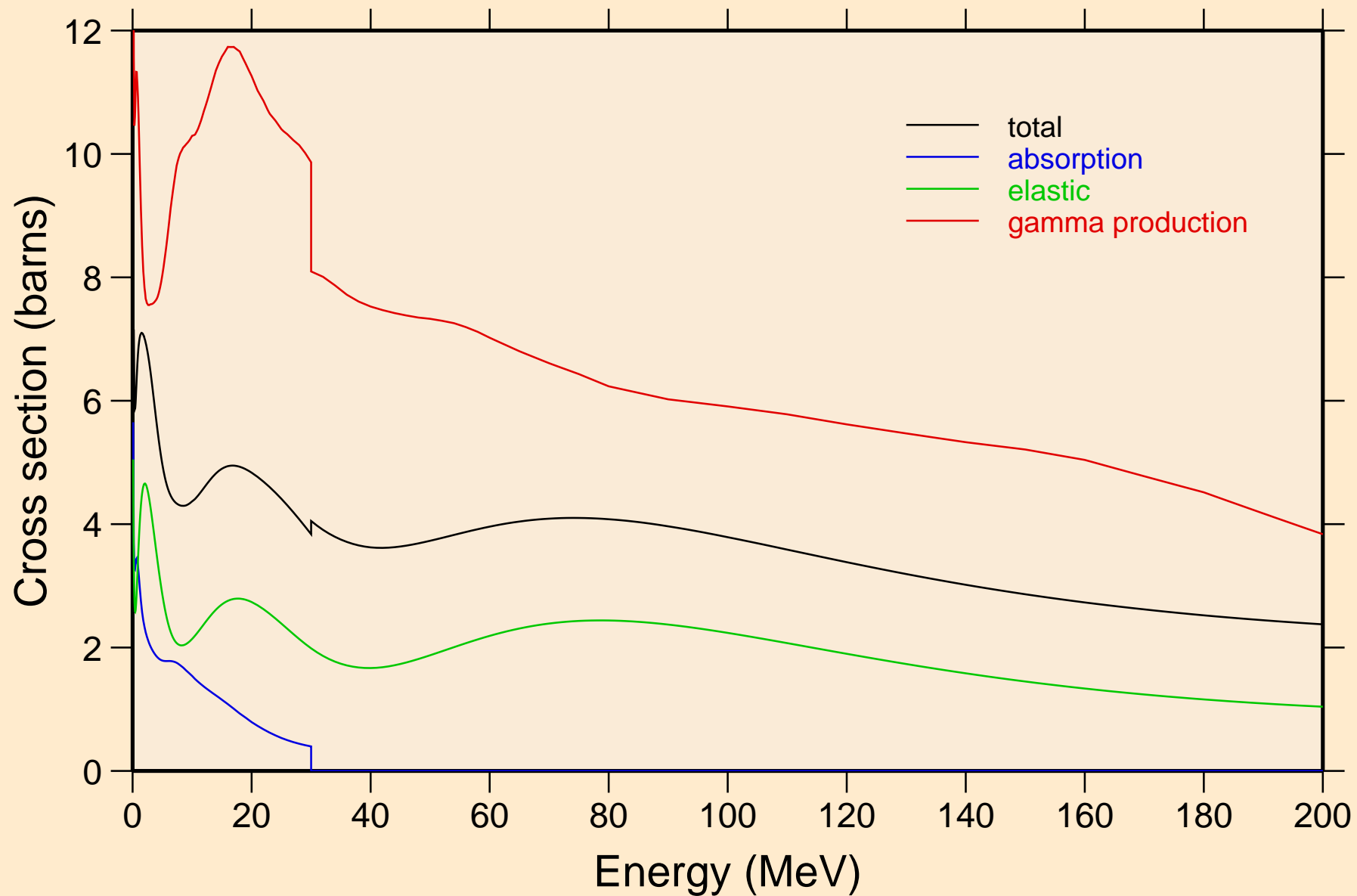

ER149M NEUTRON ACER TENDL-2019 LIBRARY; T=293.16K  
Heating

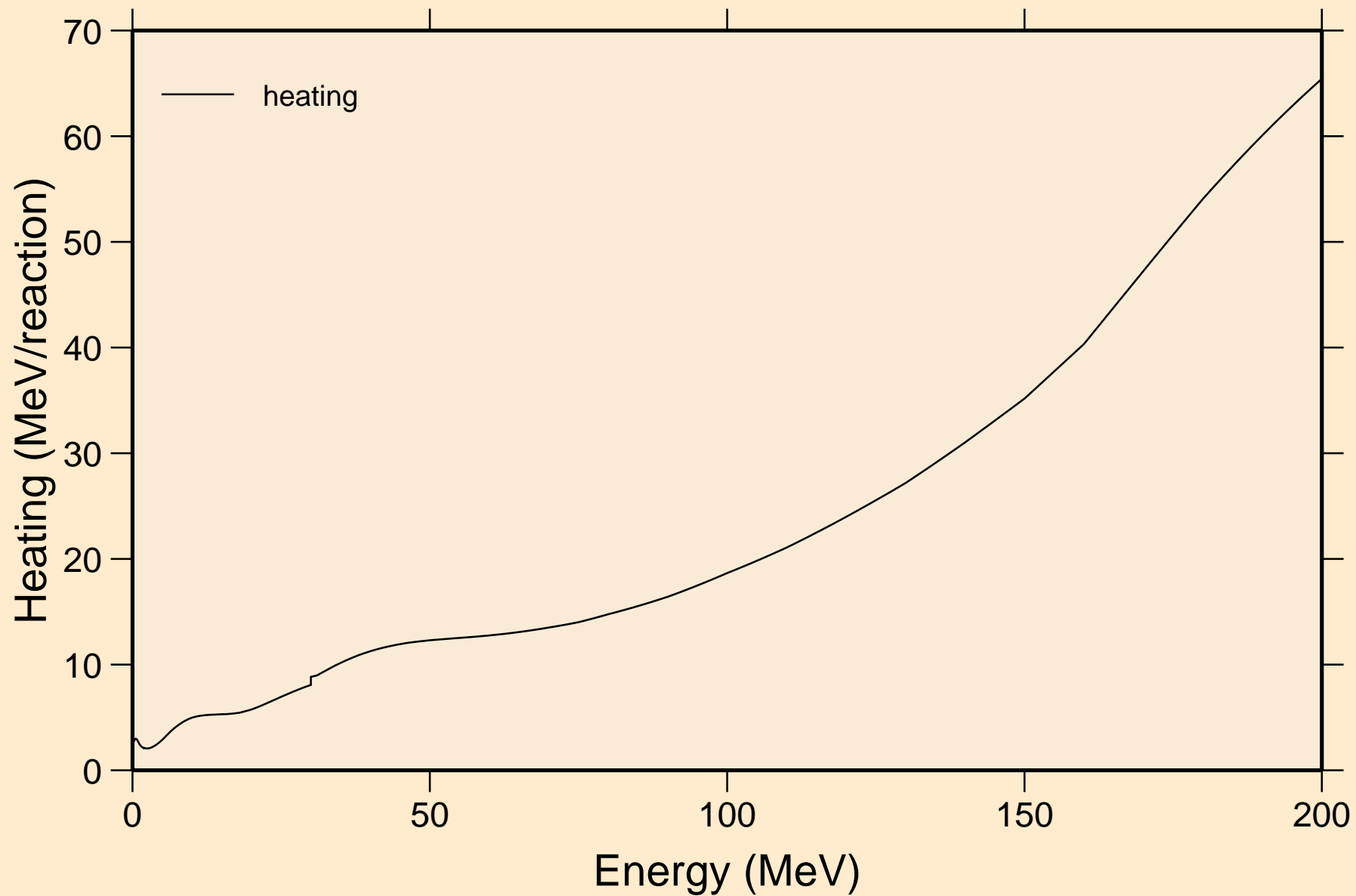

ER149M NEUTRON ACER TENDL-2019 LIBRARY; T=293.16K  
Damage

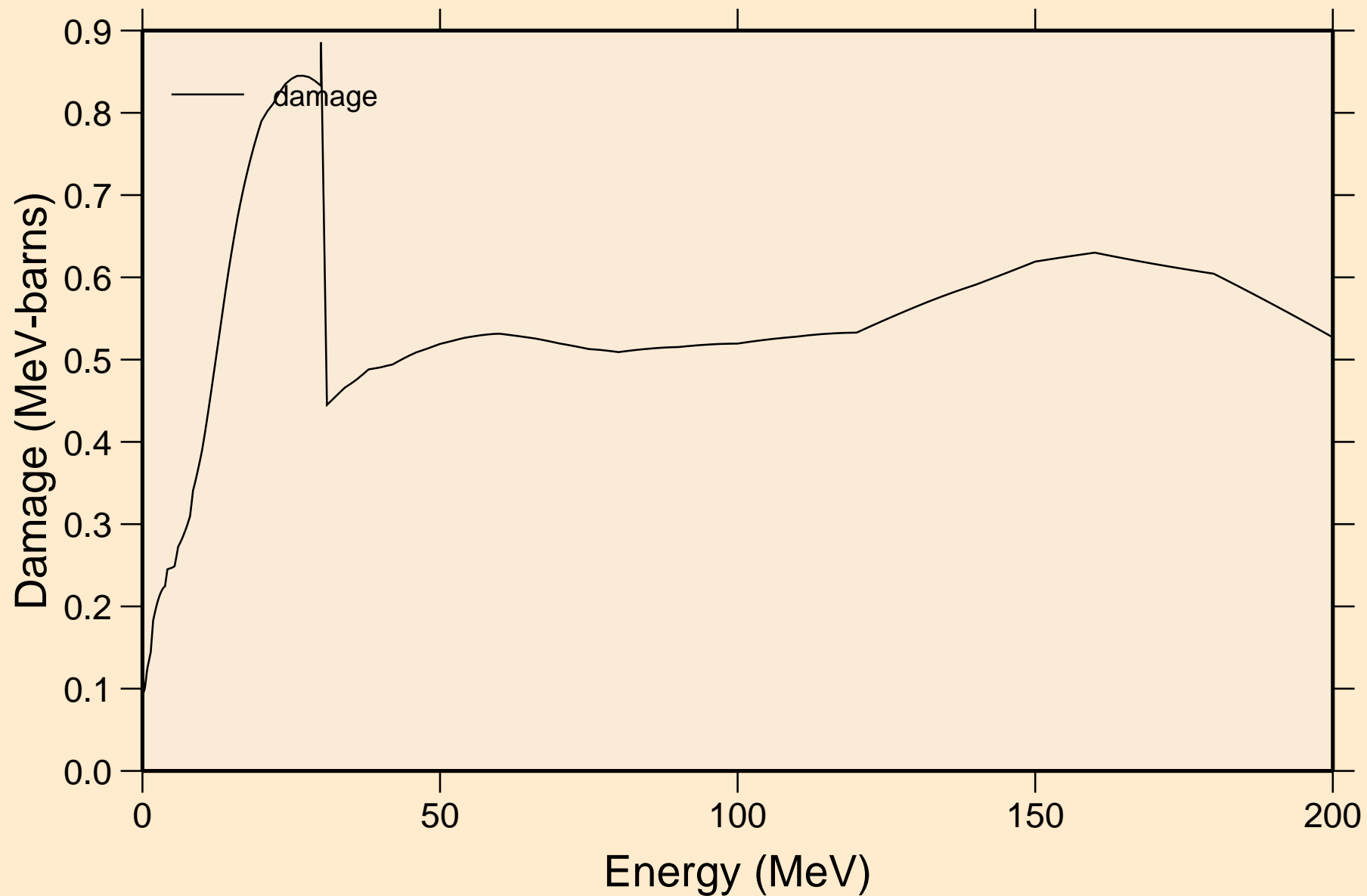



ER149M NEUTRON ACER TENDL-2019 LIBRARY; T=293.16K  
Non-threshold reactions

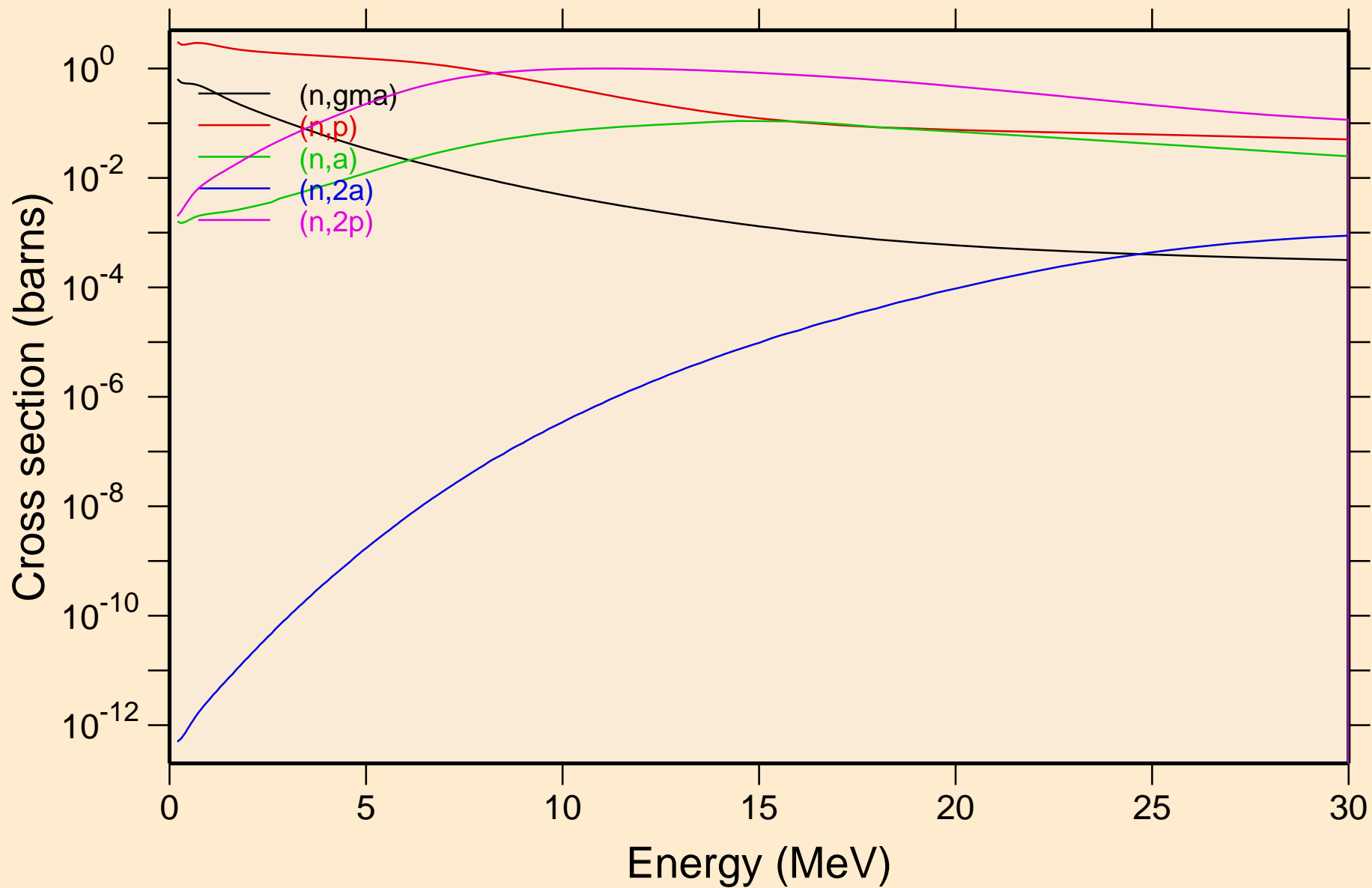

ER149M NEUTRON ACER TENDL-2019 LIBRARY; T=293.16K  
Non-threshold reactions

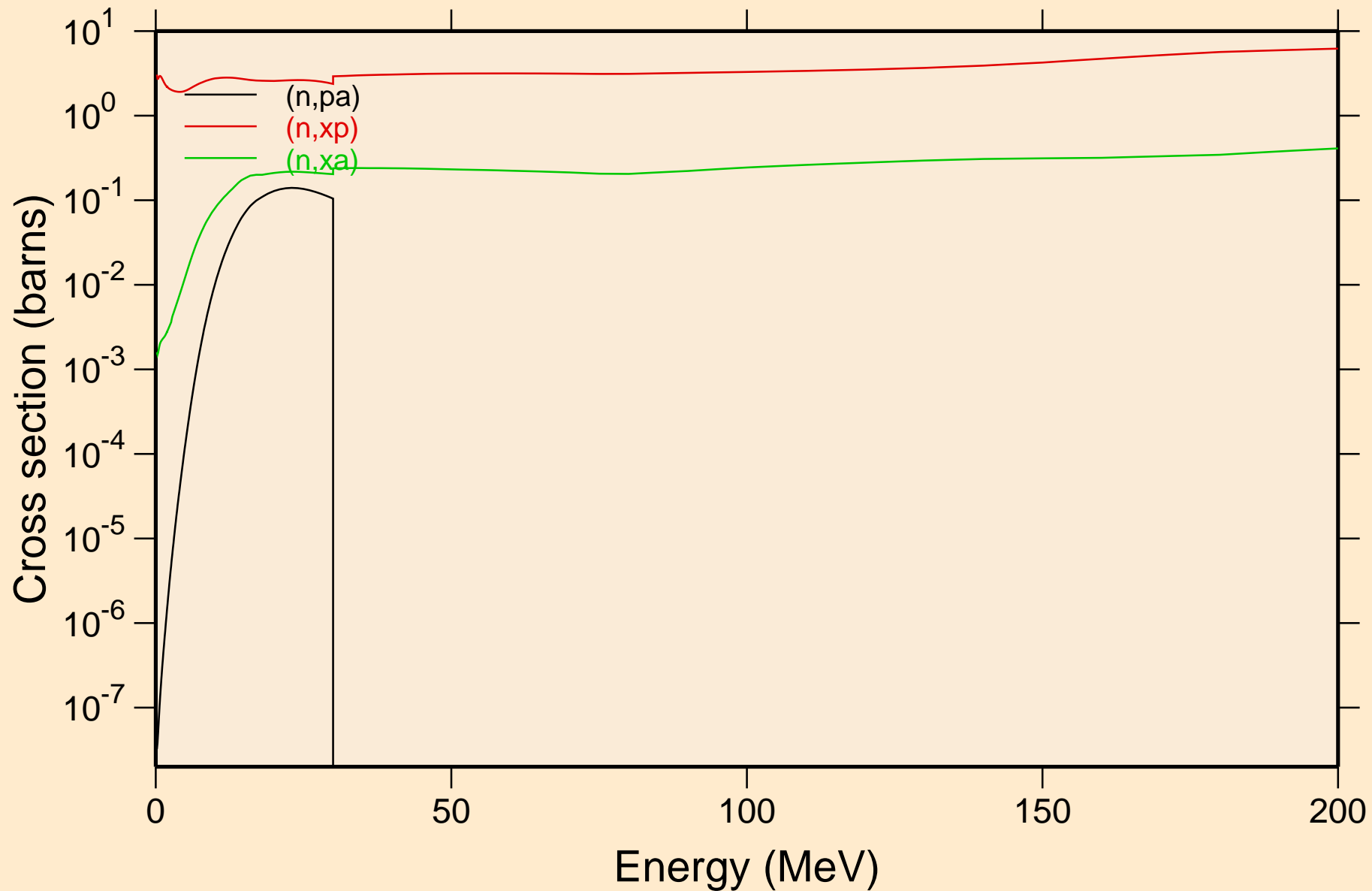

ER149M NEUTRON ACER TENDL-2019 LIBRARY; T=293.16K  
Inelastic levels

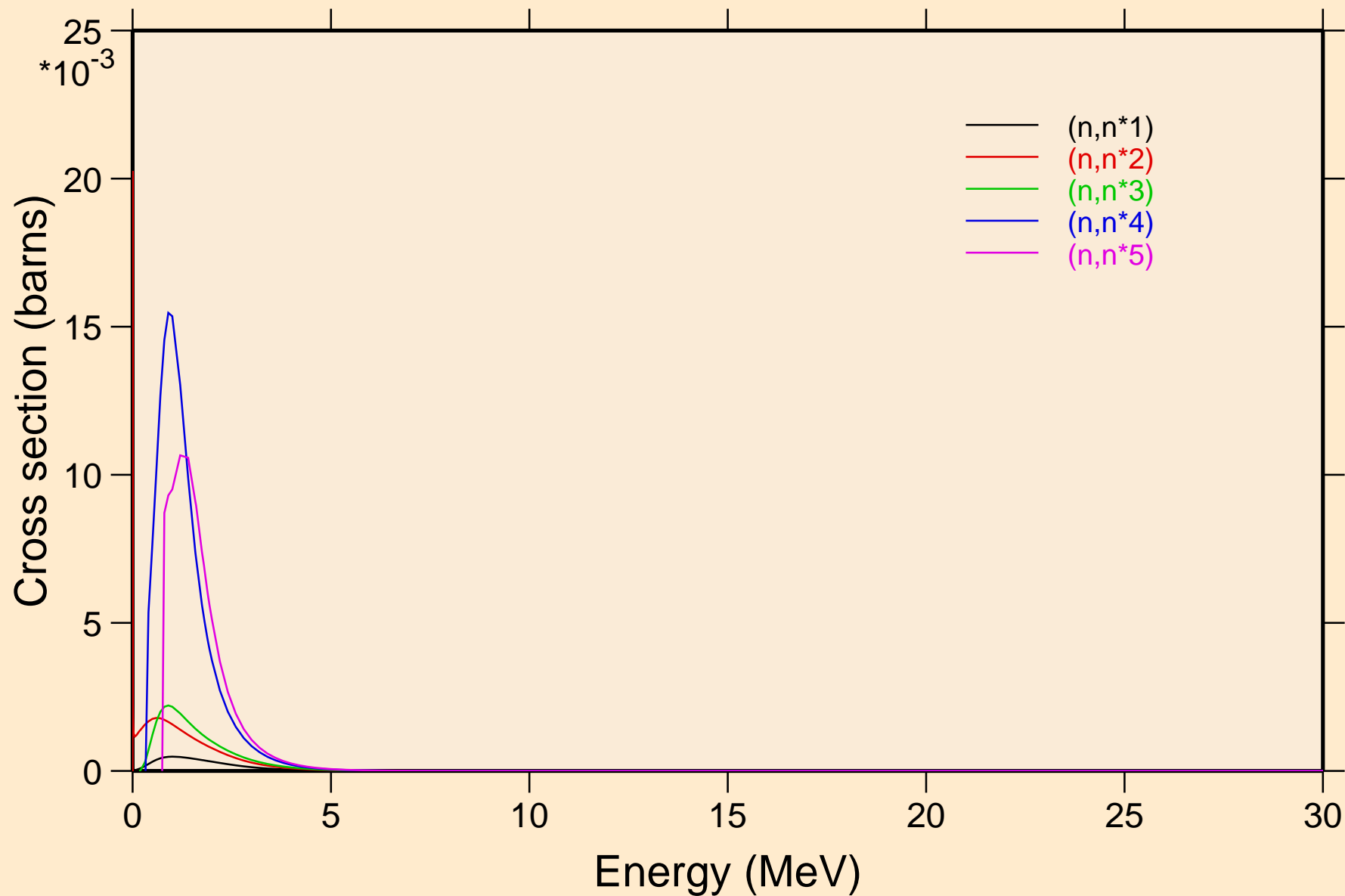

ER149M NEUTRON ACER TENDL-2019 LIBRARY; T=293.16K  
Threshold reactions

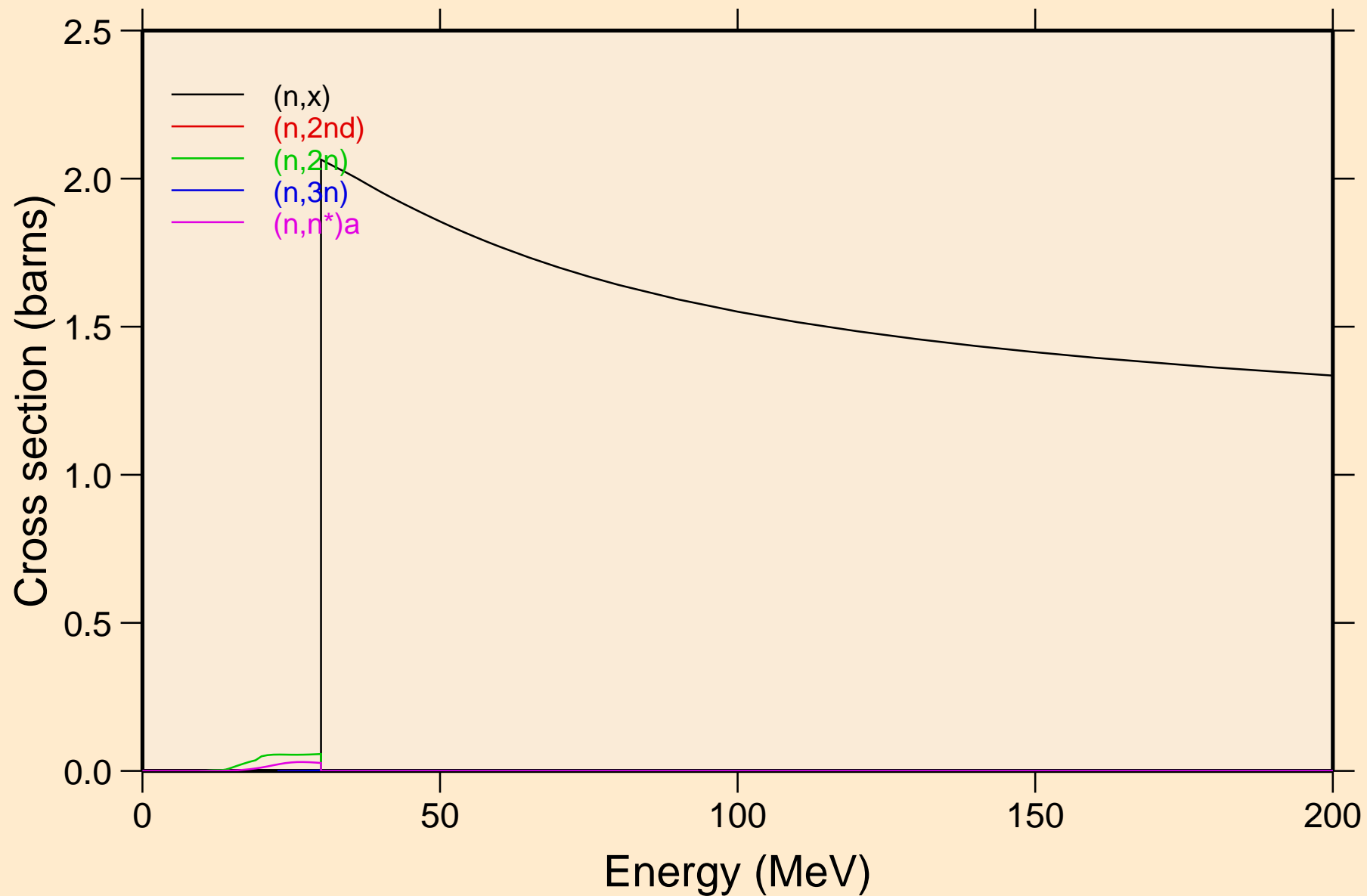

ER149M NEUTRON ACER TENDL-2019 LIBRARY; T=293.16K  
Threshold reactions

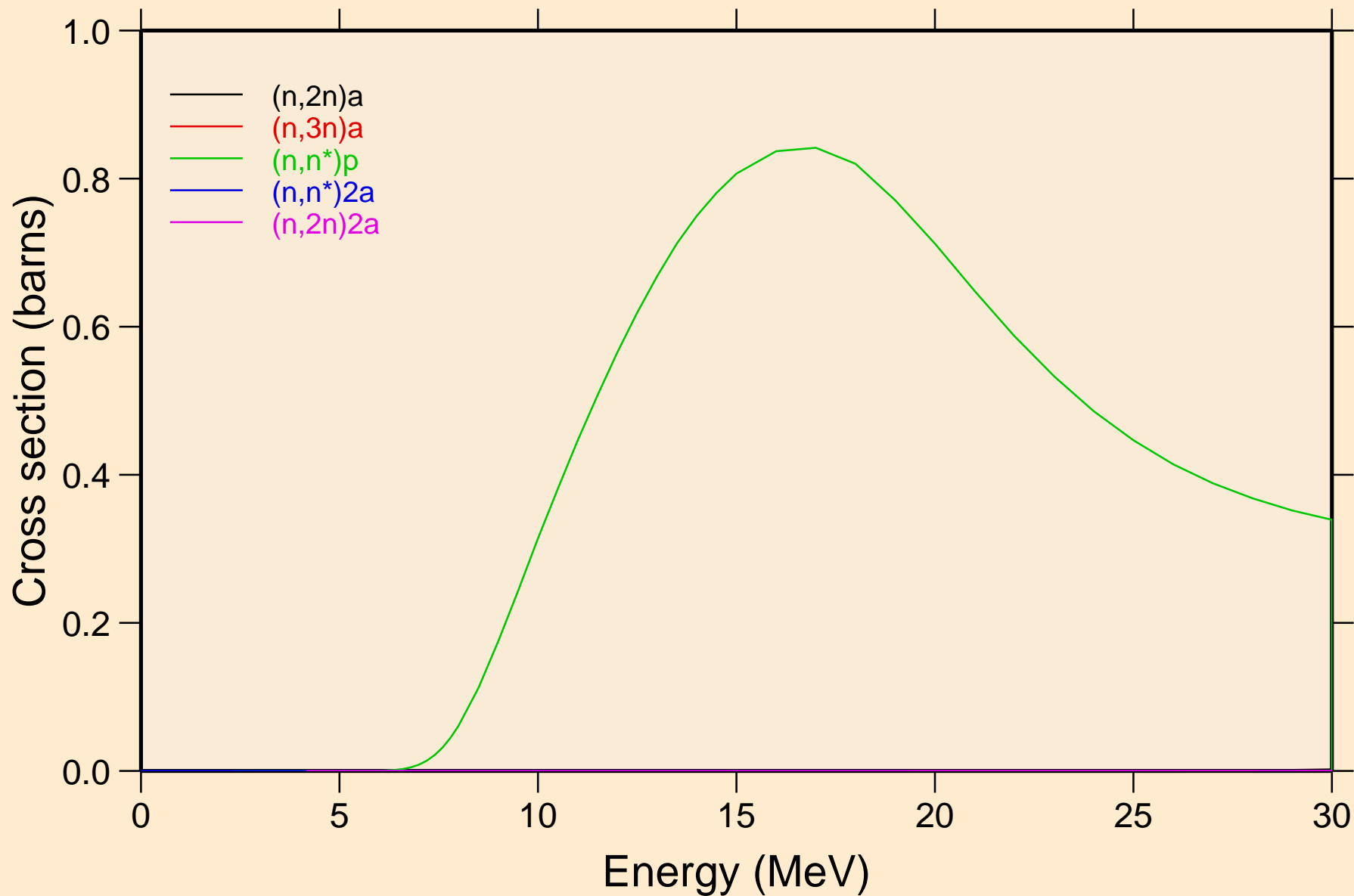

ER149M NEUTRON ACER TENDL-2019 LIBRARY; T=293.16K  
Threshold reactions

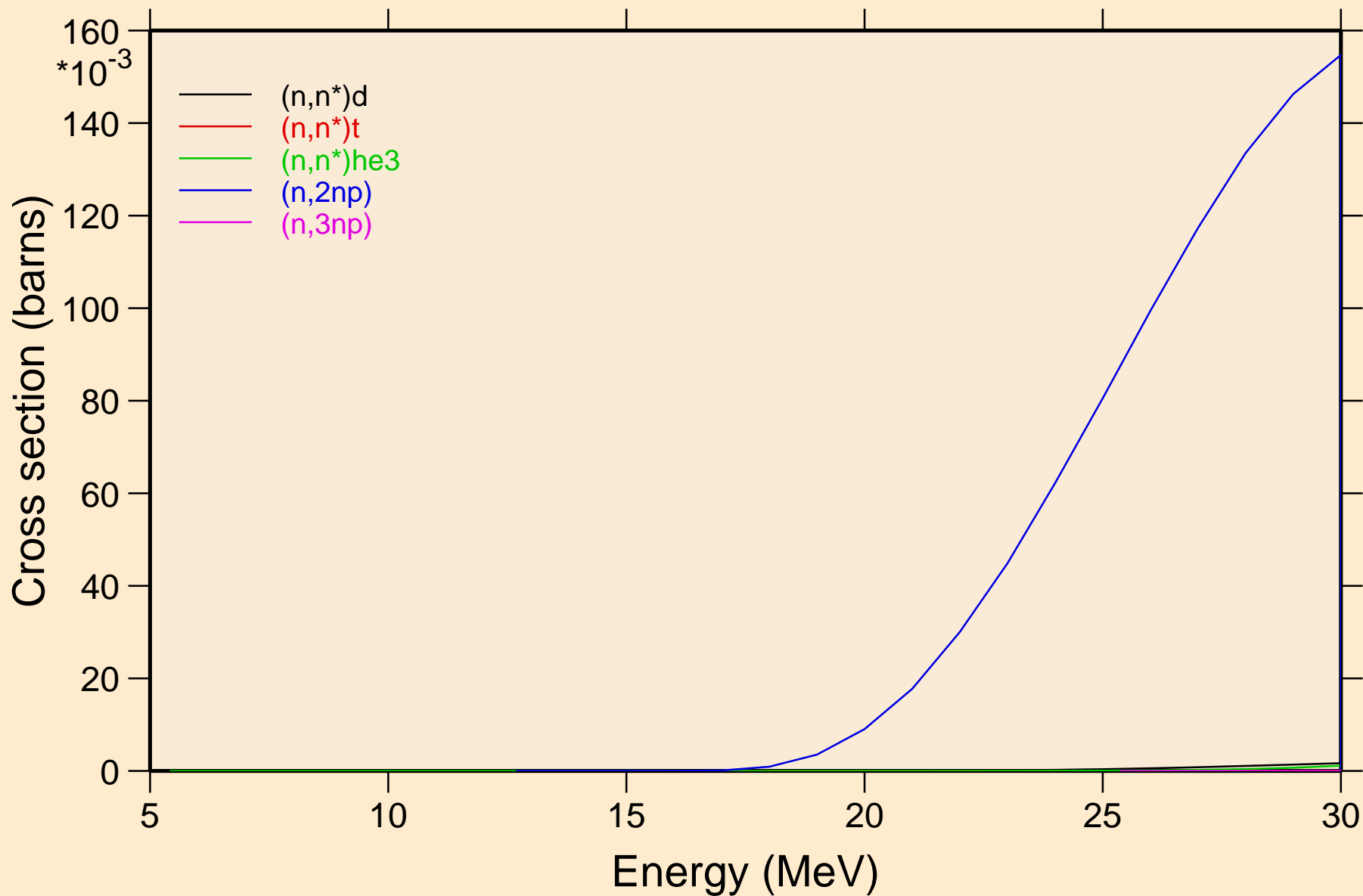

ER149M NEUTRON ACER TENDL-2019 LIBRARY; T=293.16K  
Threshold reactions

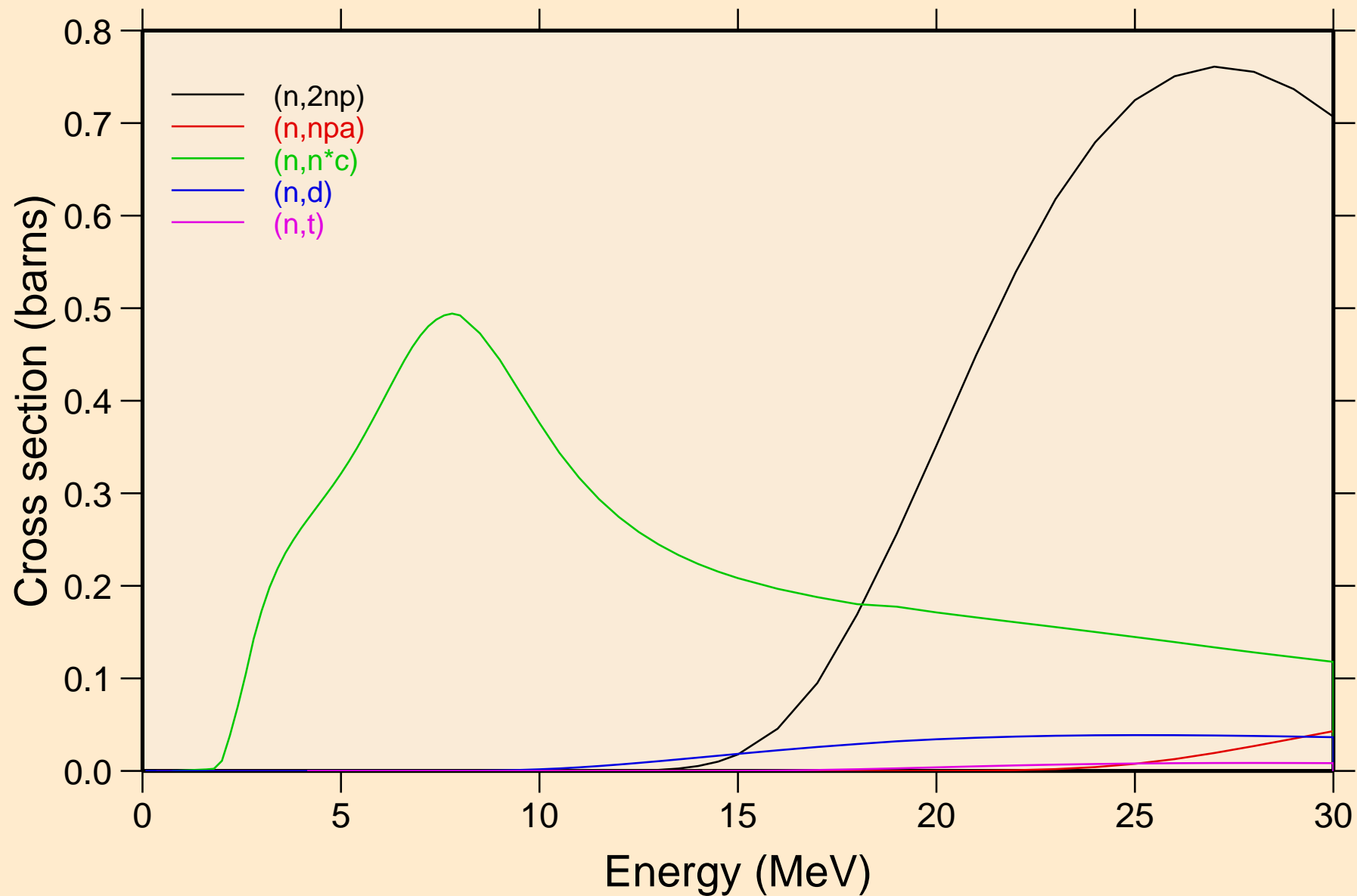

ER149M NEUTRON ACER TENDL-2019 LIBRARY; T=293.16K  
Threshold reactions

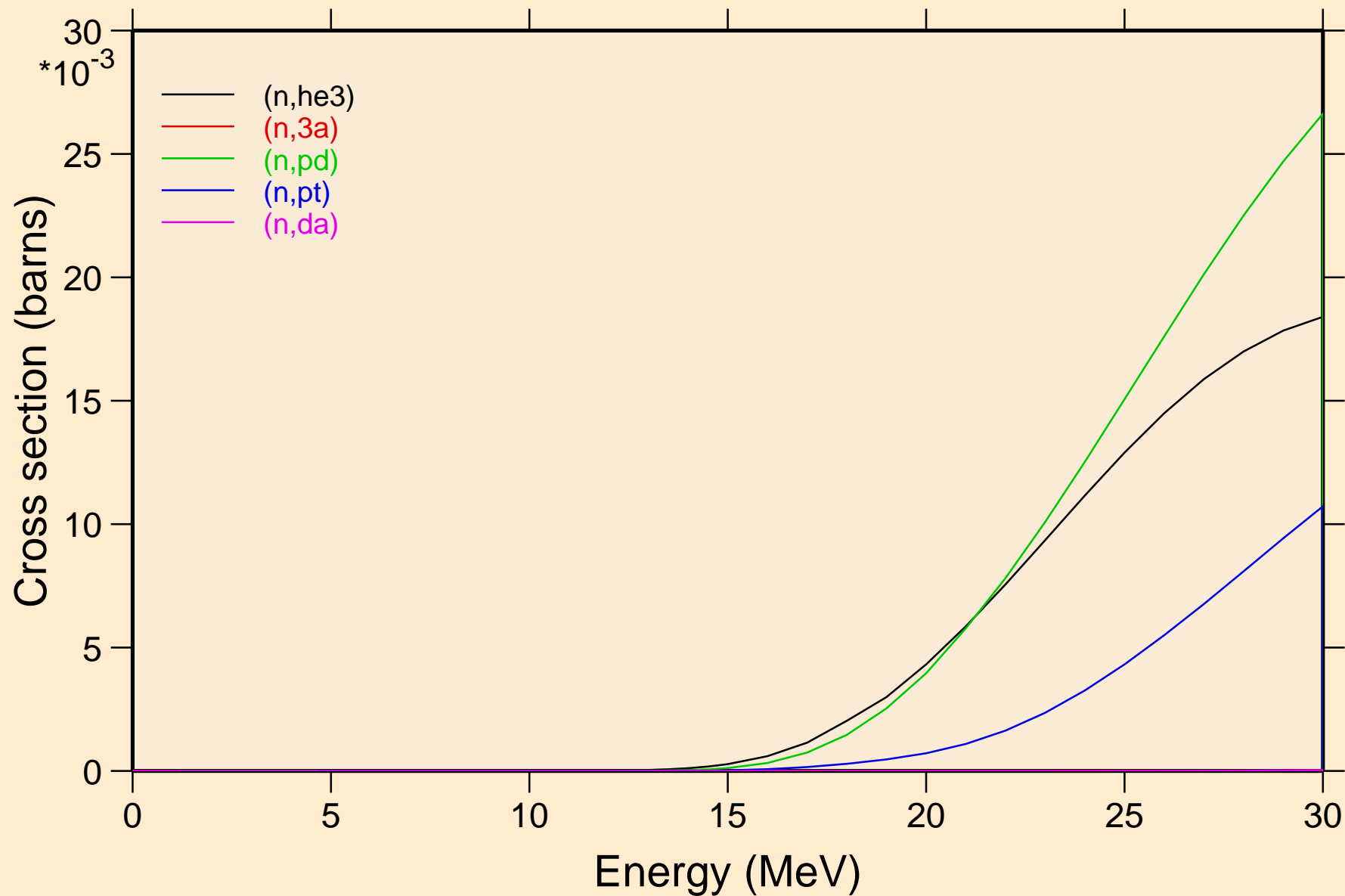



ER149M NEUTRON ACER TENDL-2019 LIBRARY; T=293.16K  
Threshold reactions

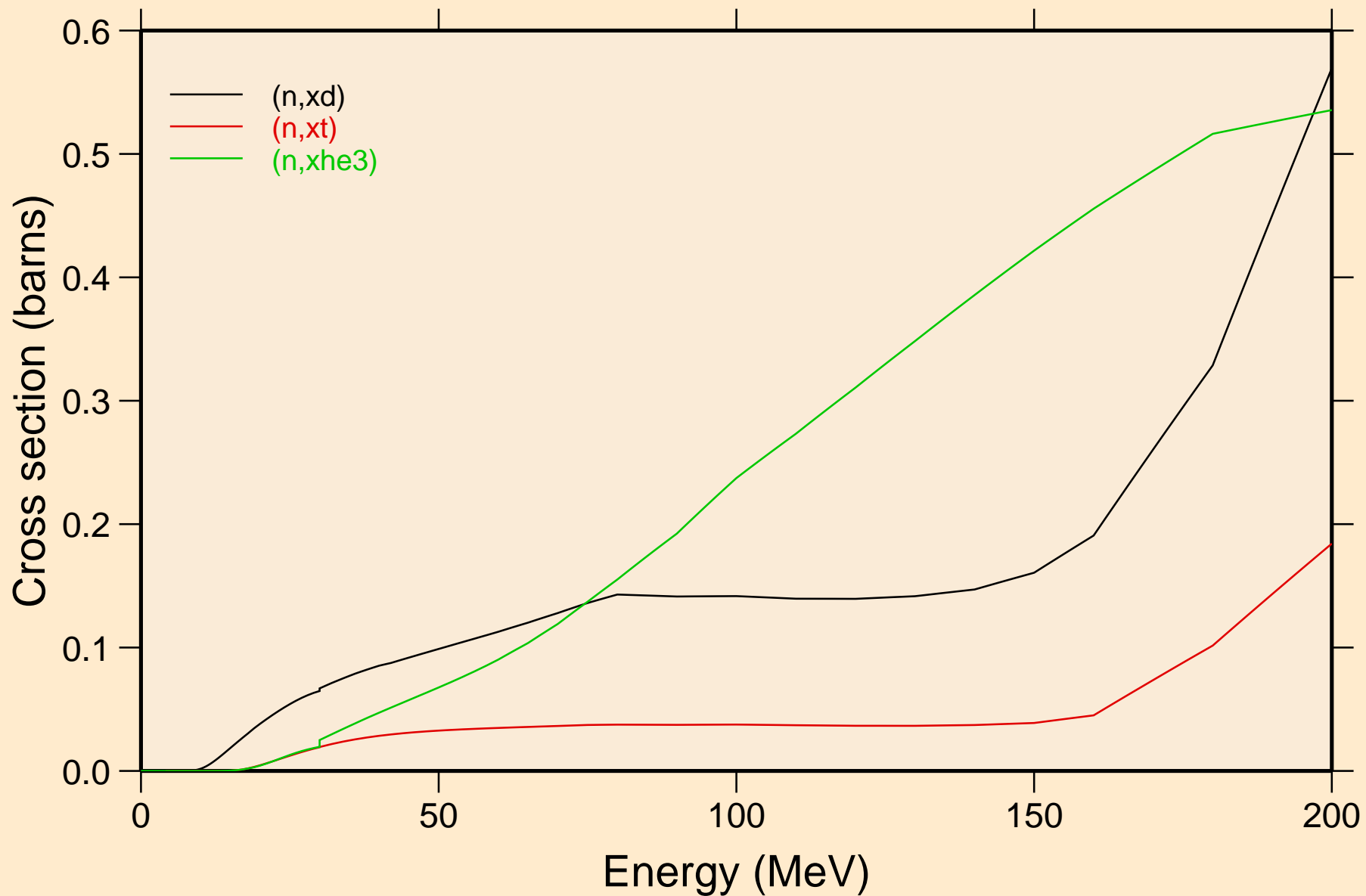

ER149M NEUTRON ACER TENDL-2019 LIBRARY; T=293.16K  
angular distribution for elastic

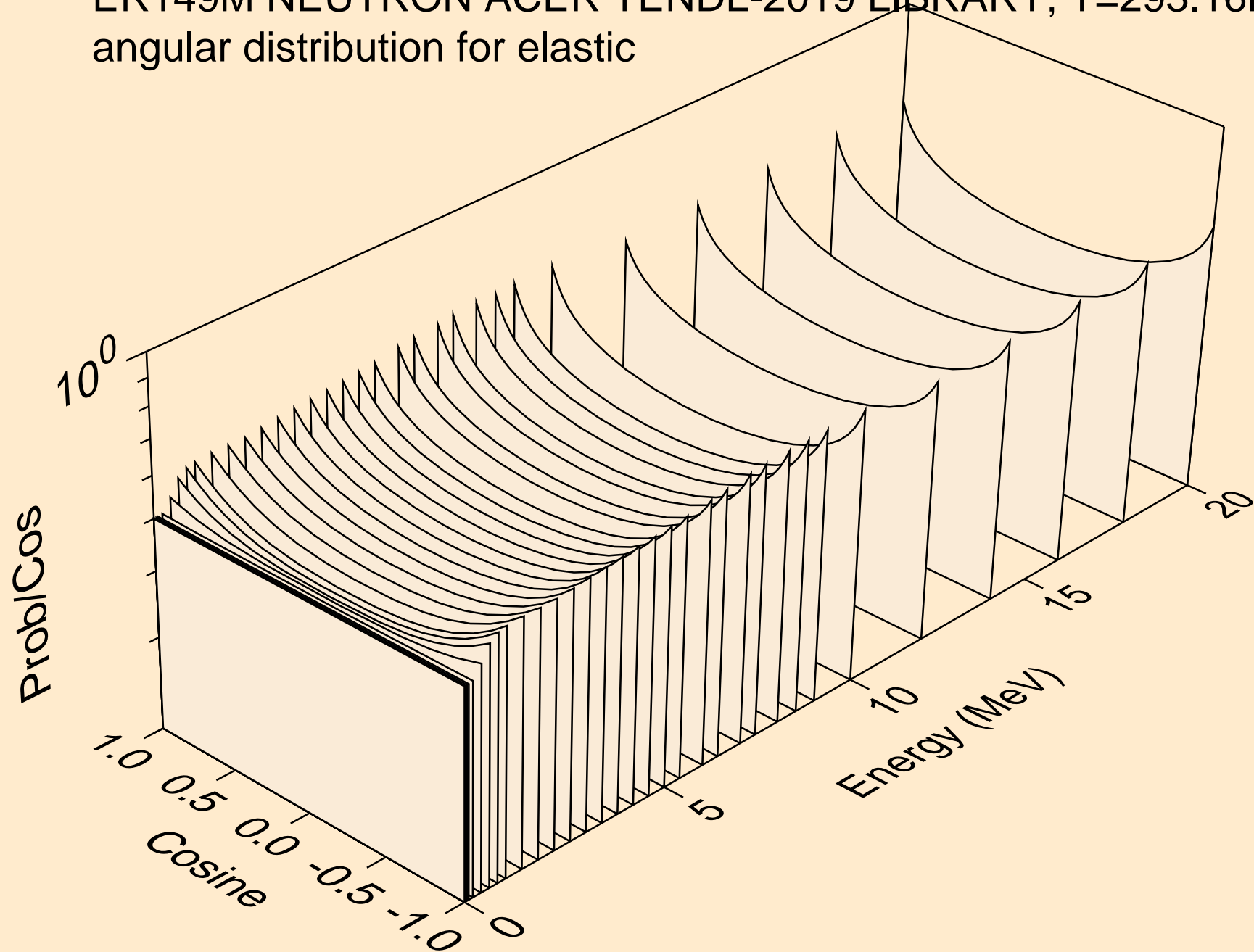

ER149M NEUTRON ACER TENDL-2019 LIBRARY; T=293.16K  
angular distribution for elastic

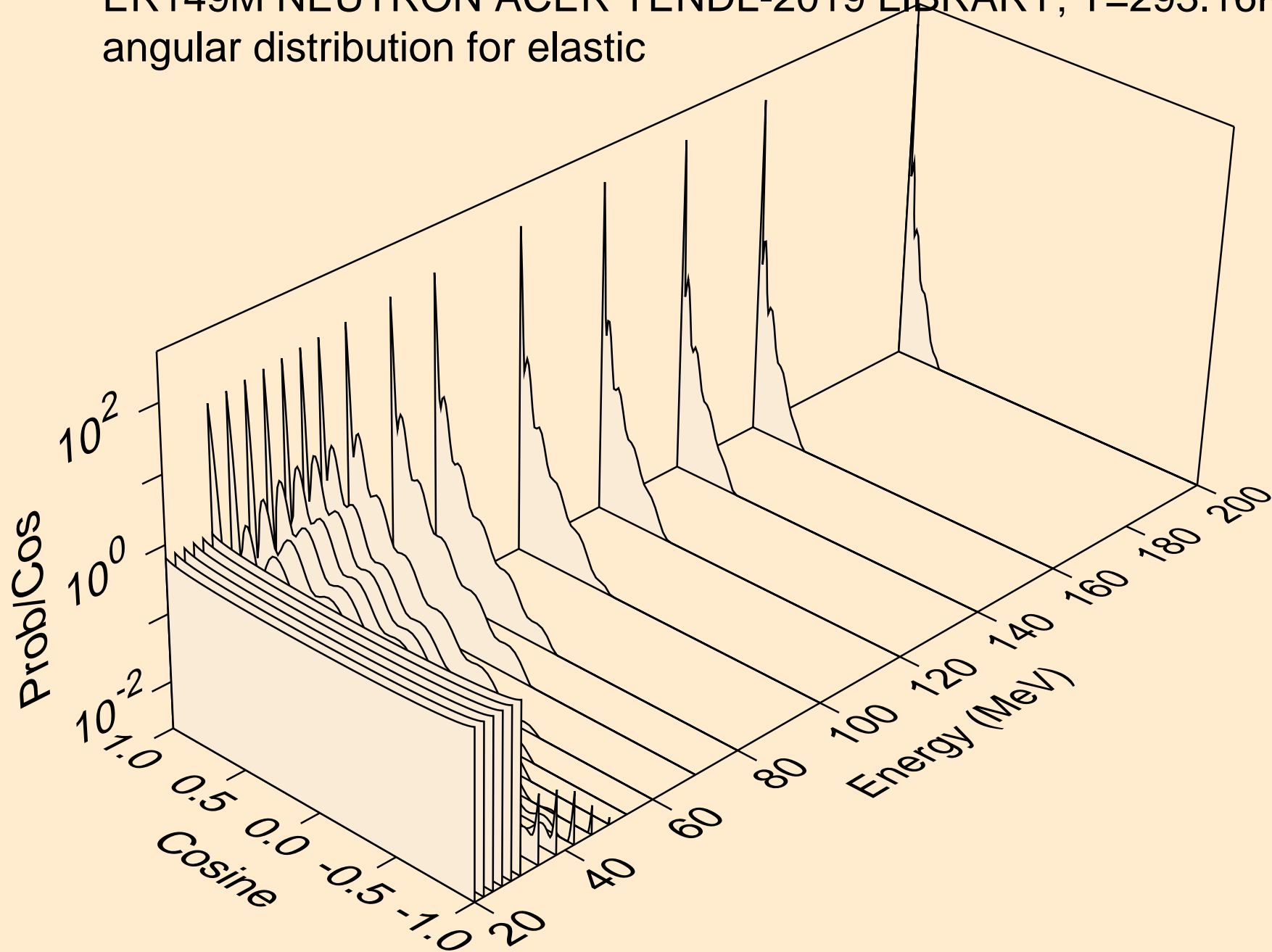

ER149M NEUTRON ACER TENDL-2019 LIBRARY; T=293.16K  
angular distribution for (n,n\*1)

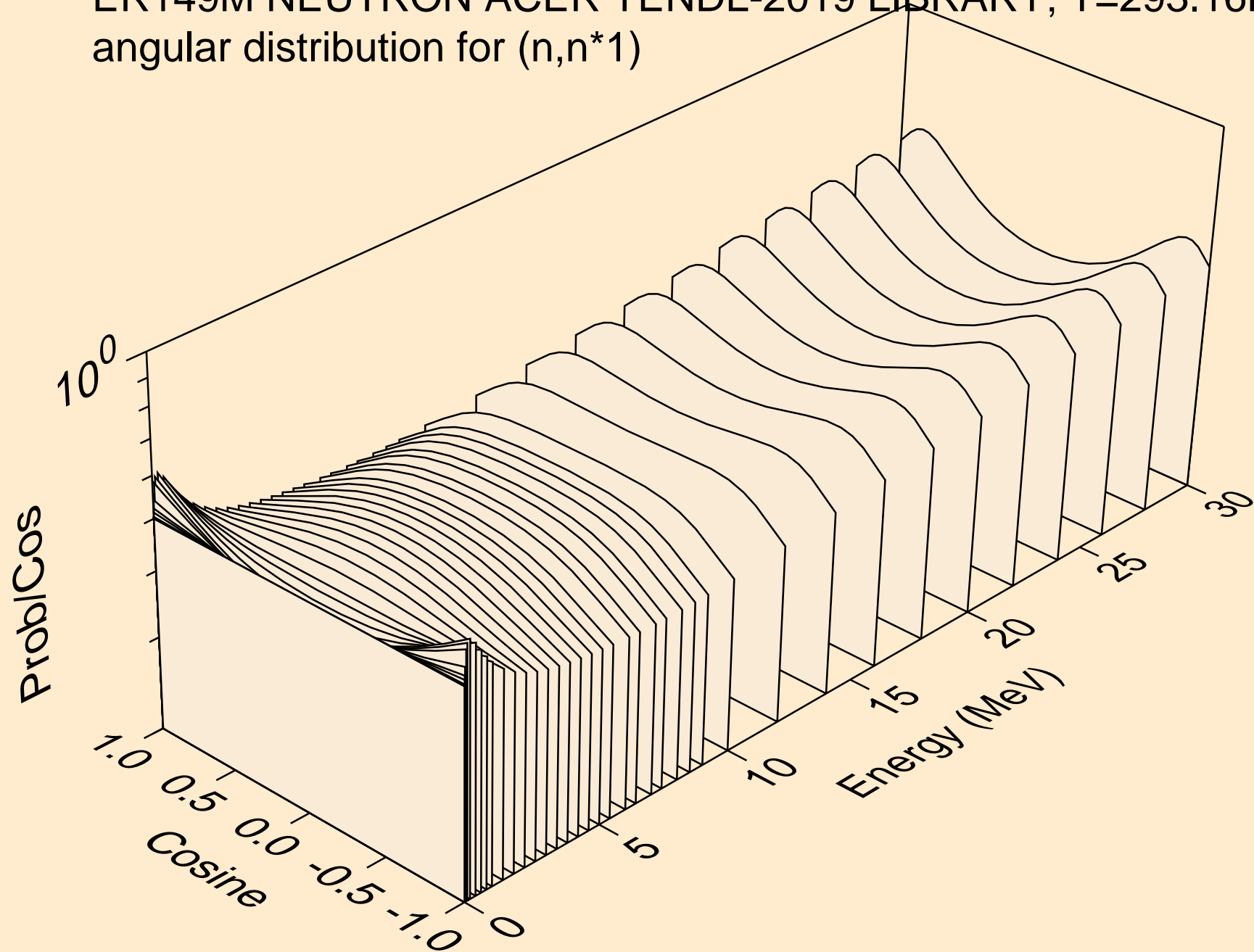

ER149M NEUTRON ACER TENDL-2019 LIBRARY; T=293.16K  
angular distribution for (n,n\*2)

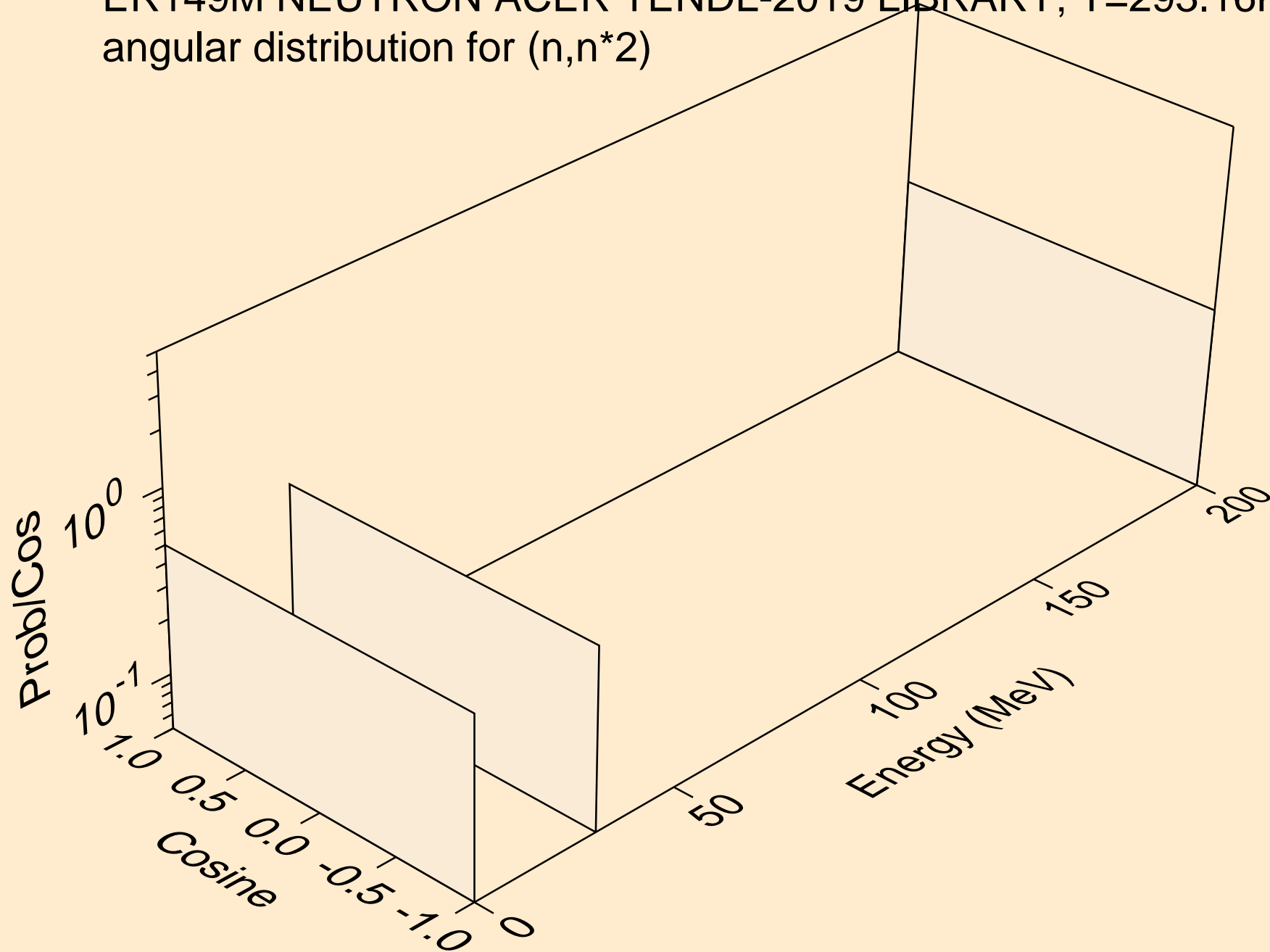

ER149M NEUTRON ACER TENDL-2019 LIBRARY; T=293.16K  
angular distribution for (n,n\*3)

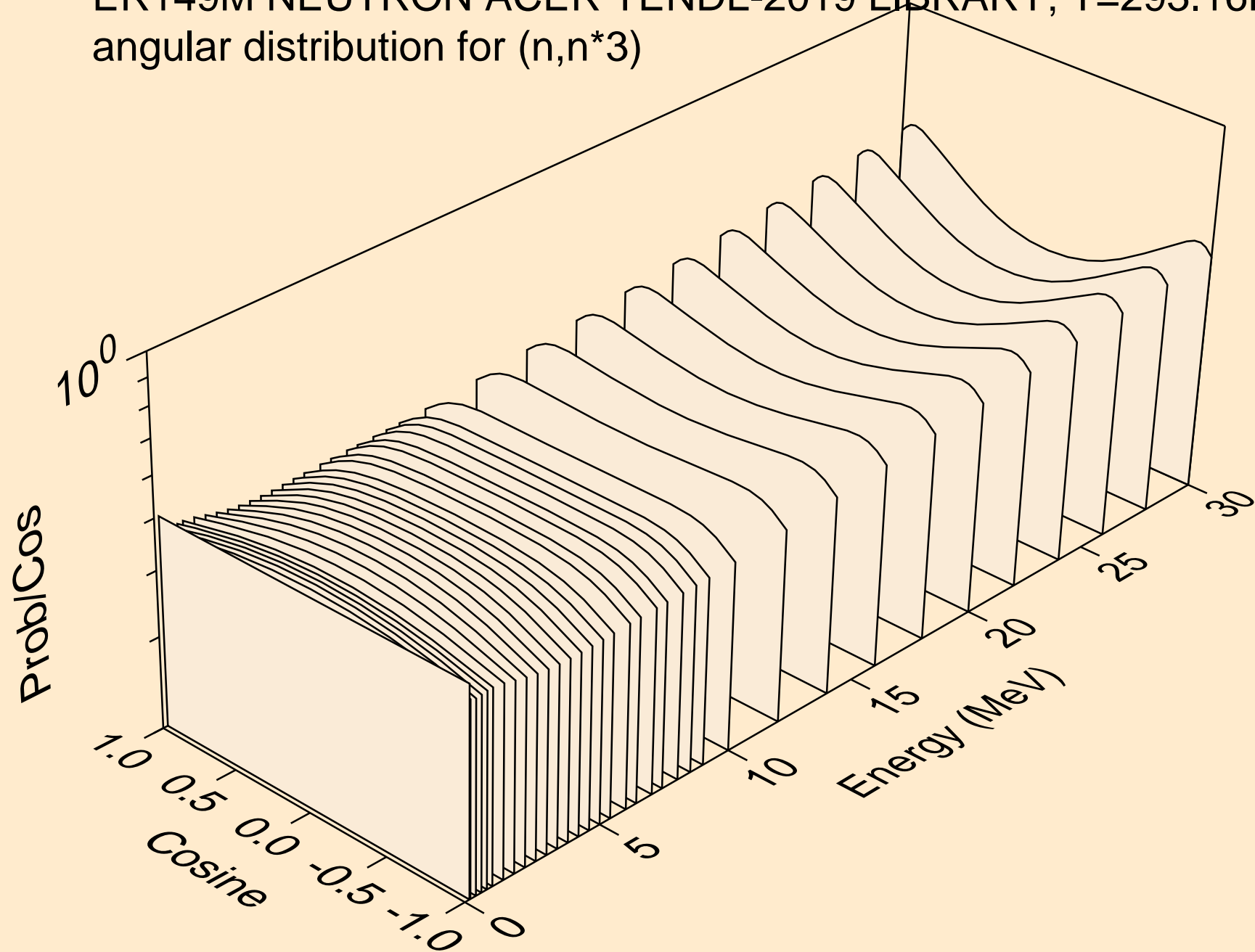

ER149M NEUTRON ACER TENDL-2019 LIBRARY; T=293.16K  
angular distribution for (n,n\*4)

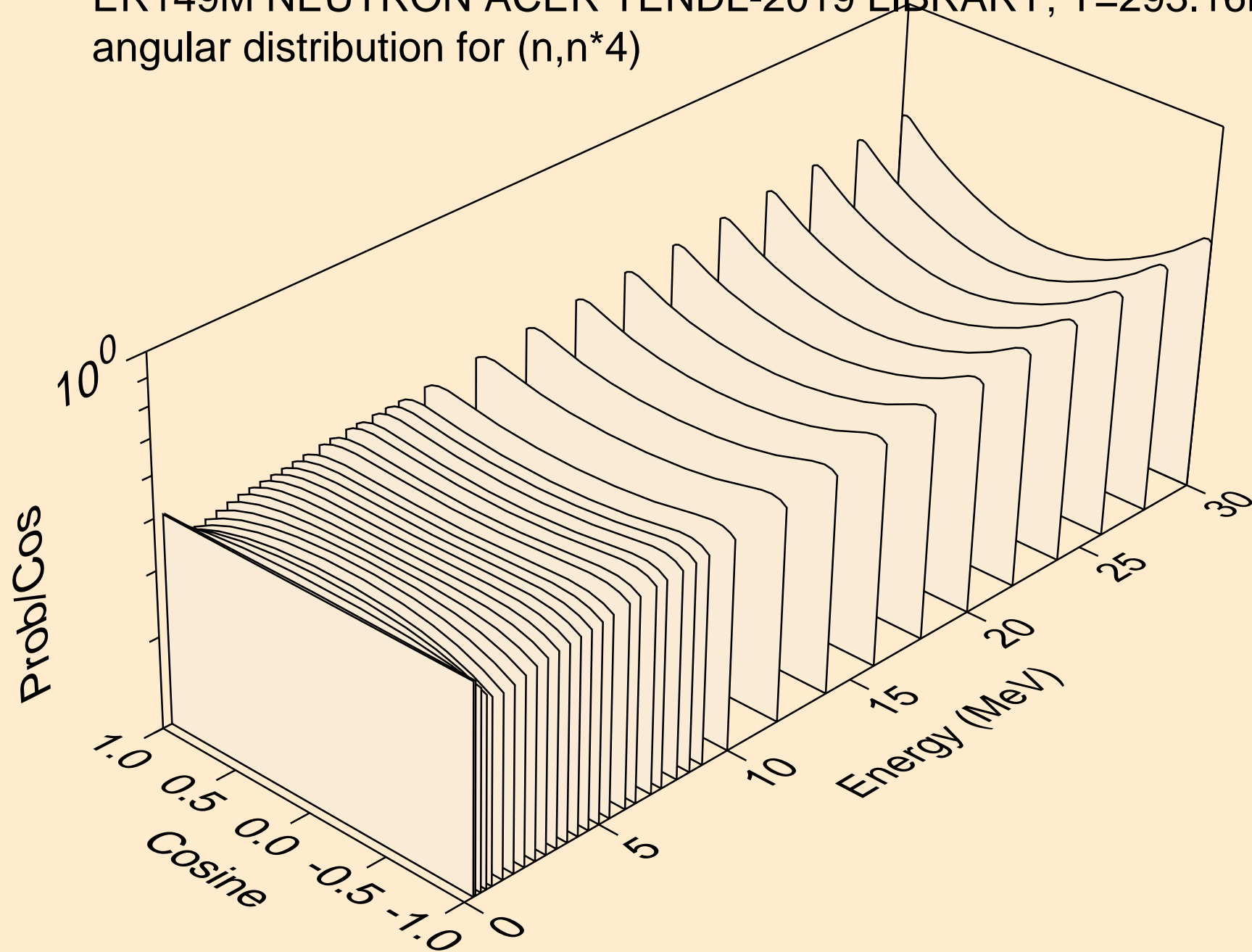

ER149M NEUTRON ACER TENDL-2019 LIBRARY; T=293.16K  
angular distribution for (n,n\*5)

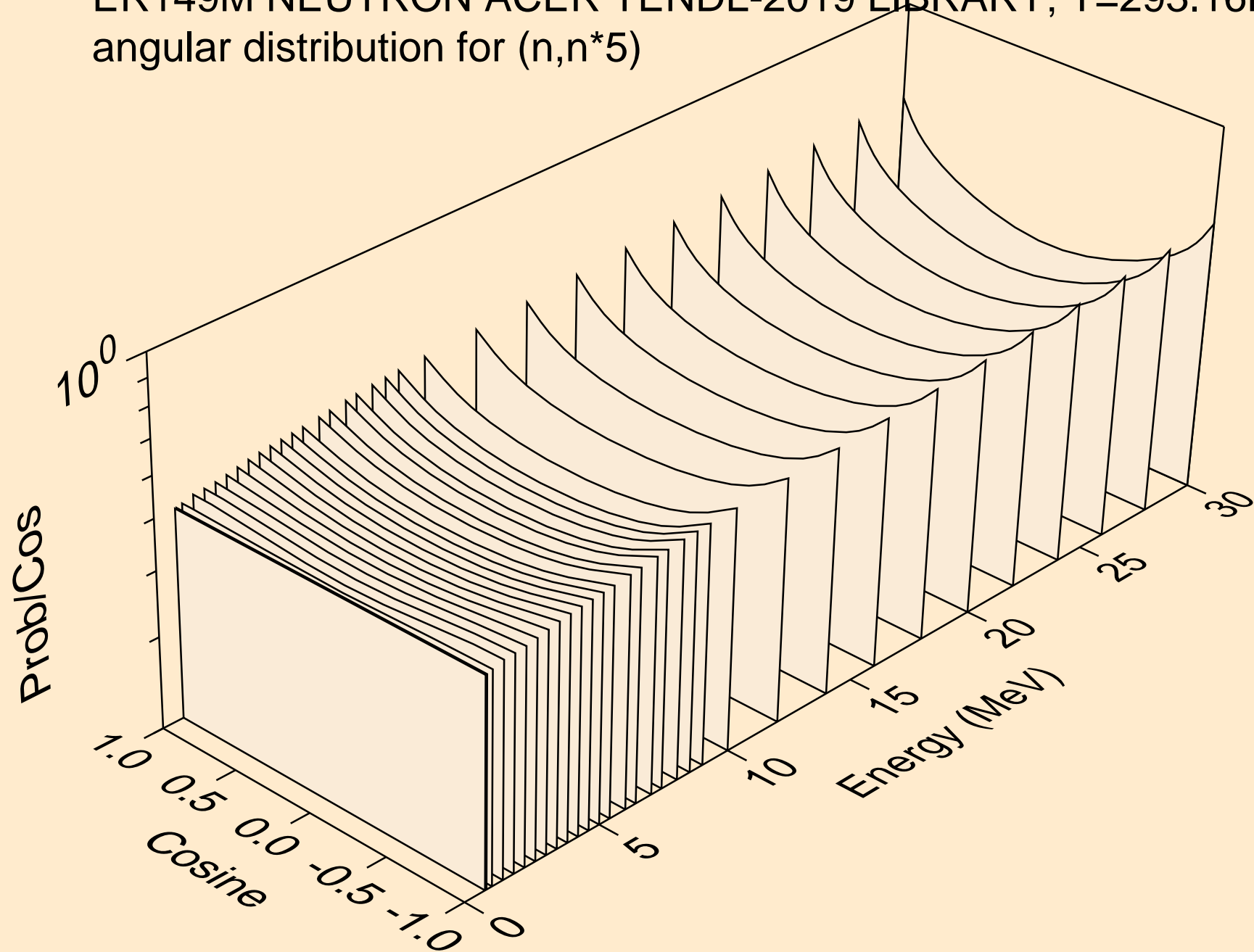



ER149M NEUTRON ACER TENDL-2019 LIBRARY; T=293.16K  
Neutron emission for (n,x)

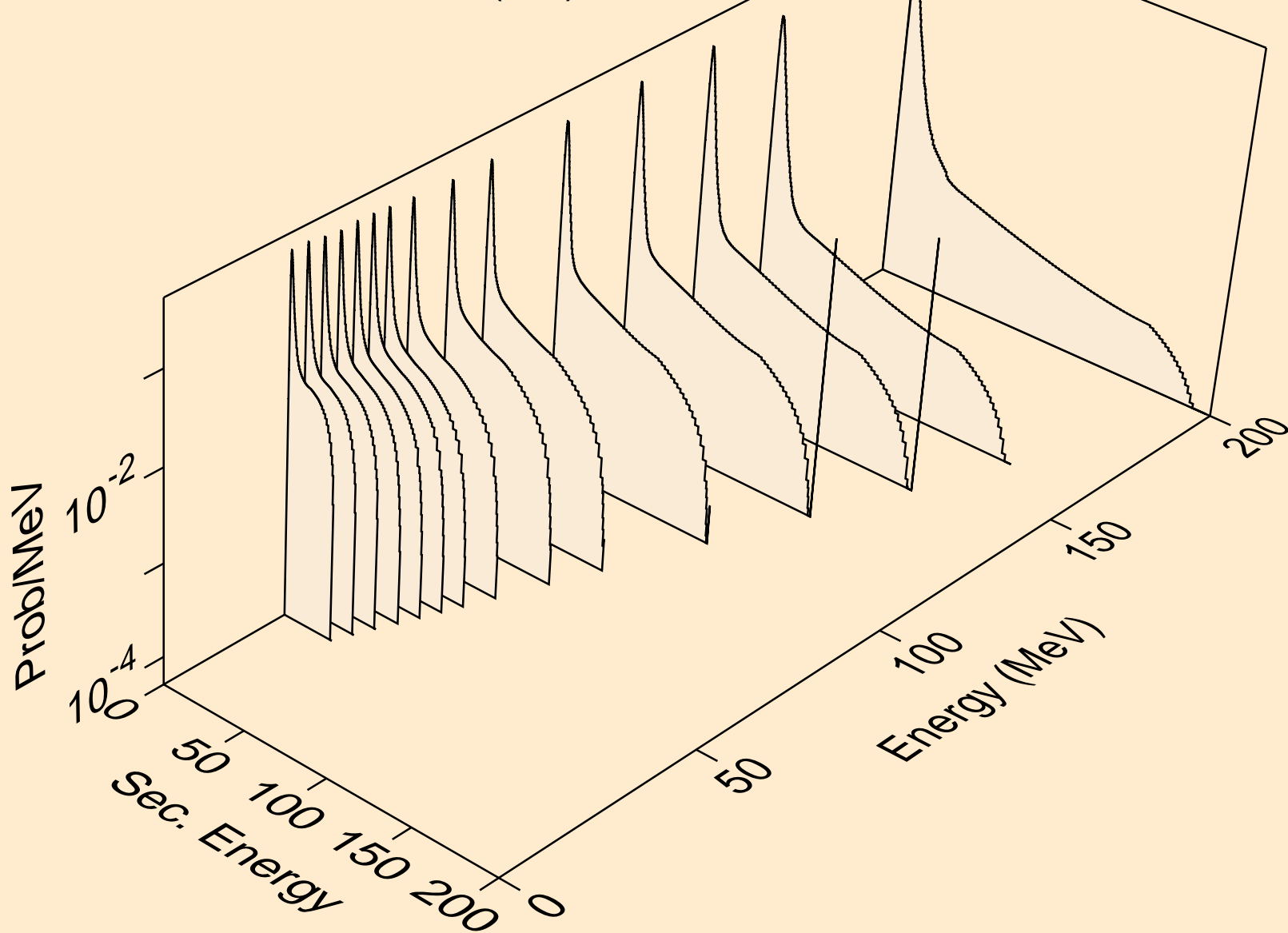

ER149M NEUTRON ACER TENDL-2019 LIBRARY; T=293.16K  
Neutron emission for (n,2nd)

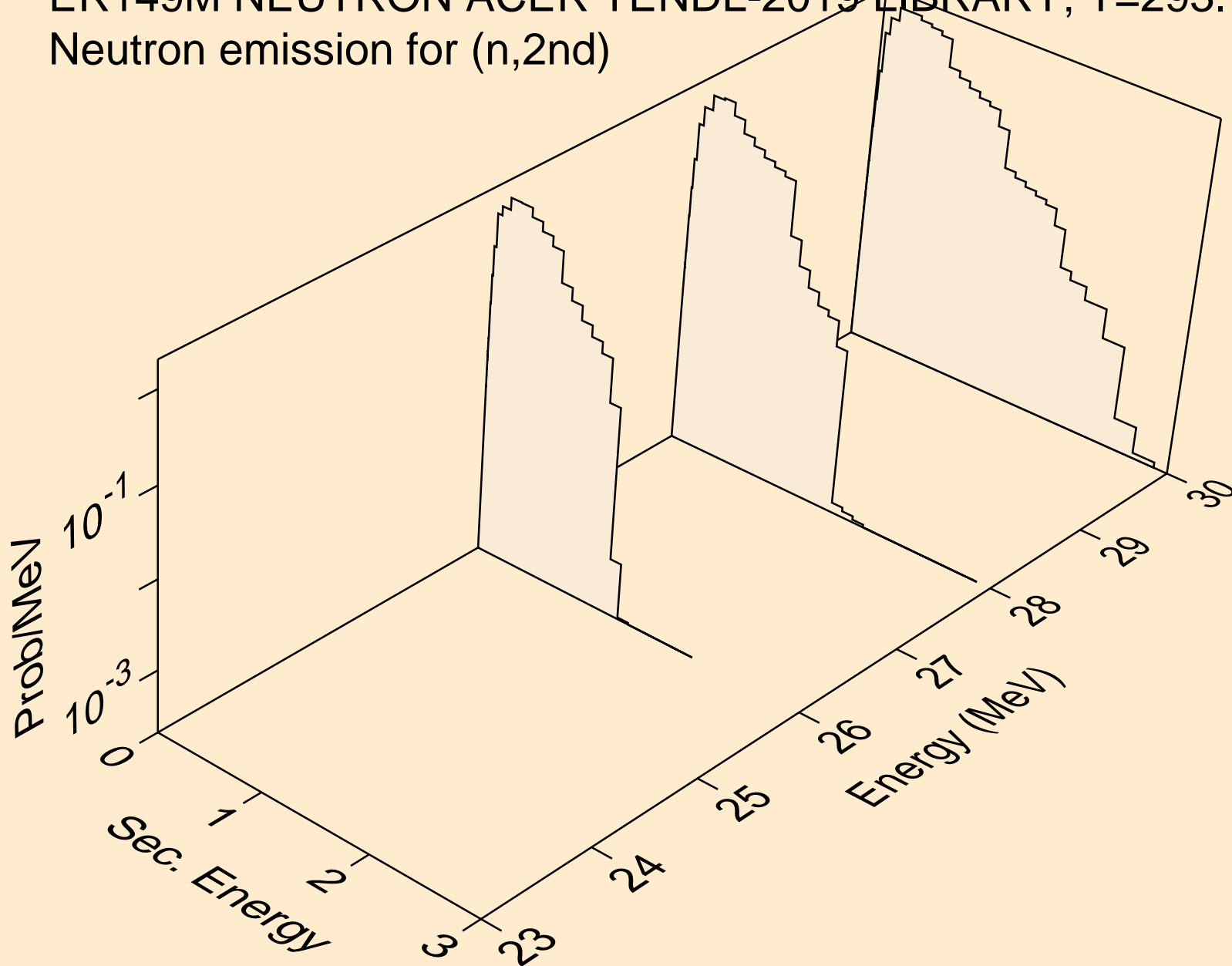

ER149M NEUTRON ACER TENDL-2019 LIBRARY; T=293.16K  
Neutron emission for (n,2n)

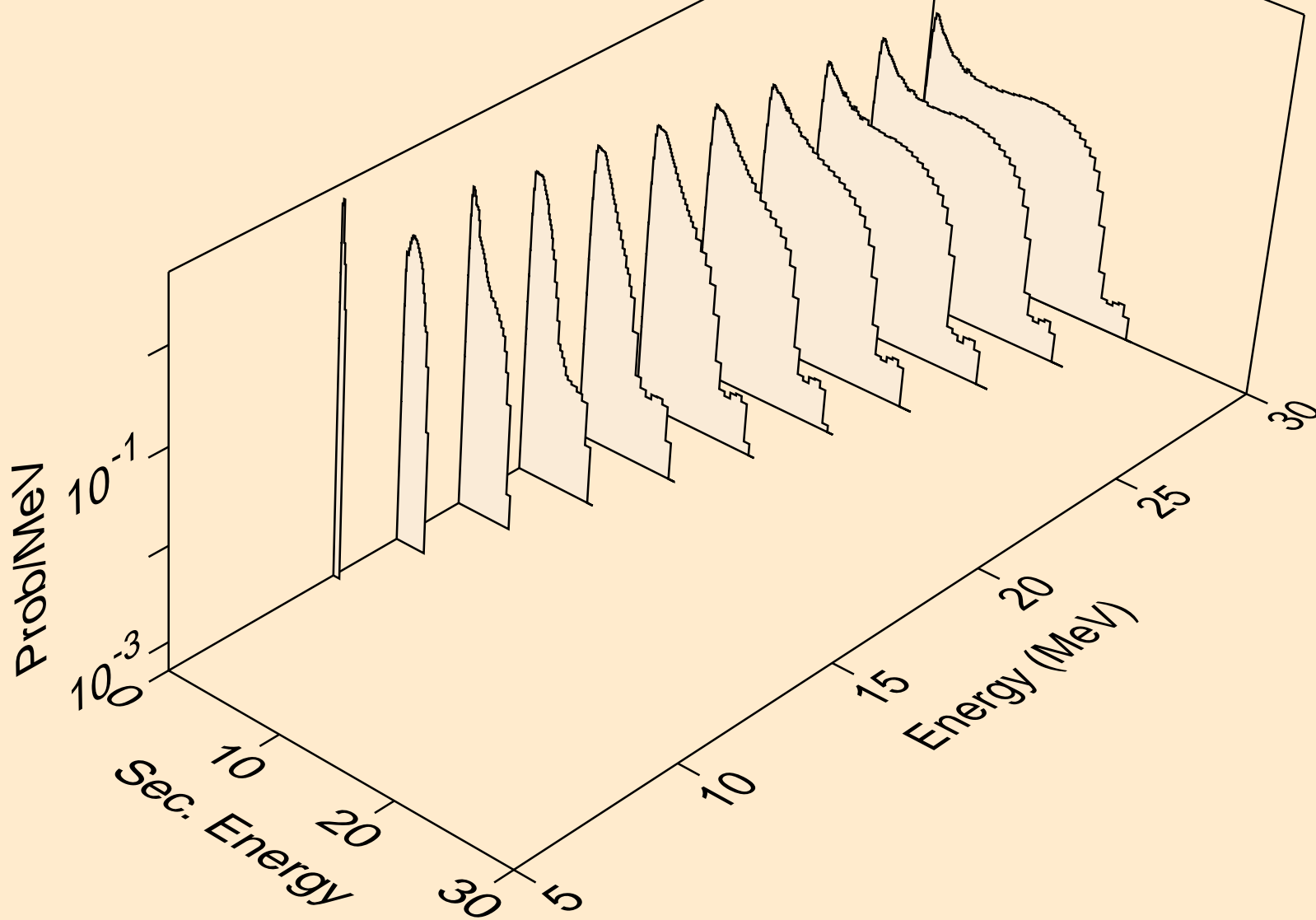

ER149M NEUTRON ACER TENDL-2019 LIBRARY; T=293.16K  
Neutron emission for (n,3n)

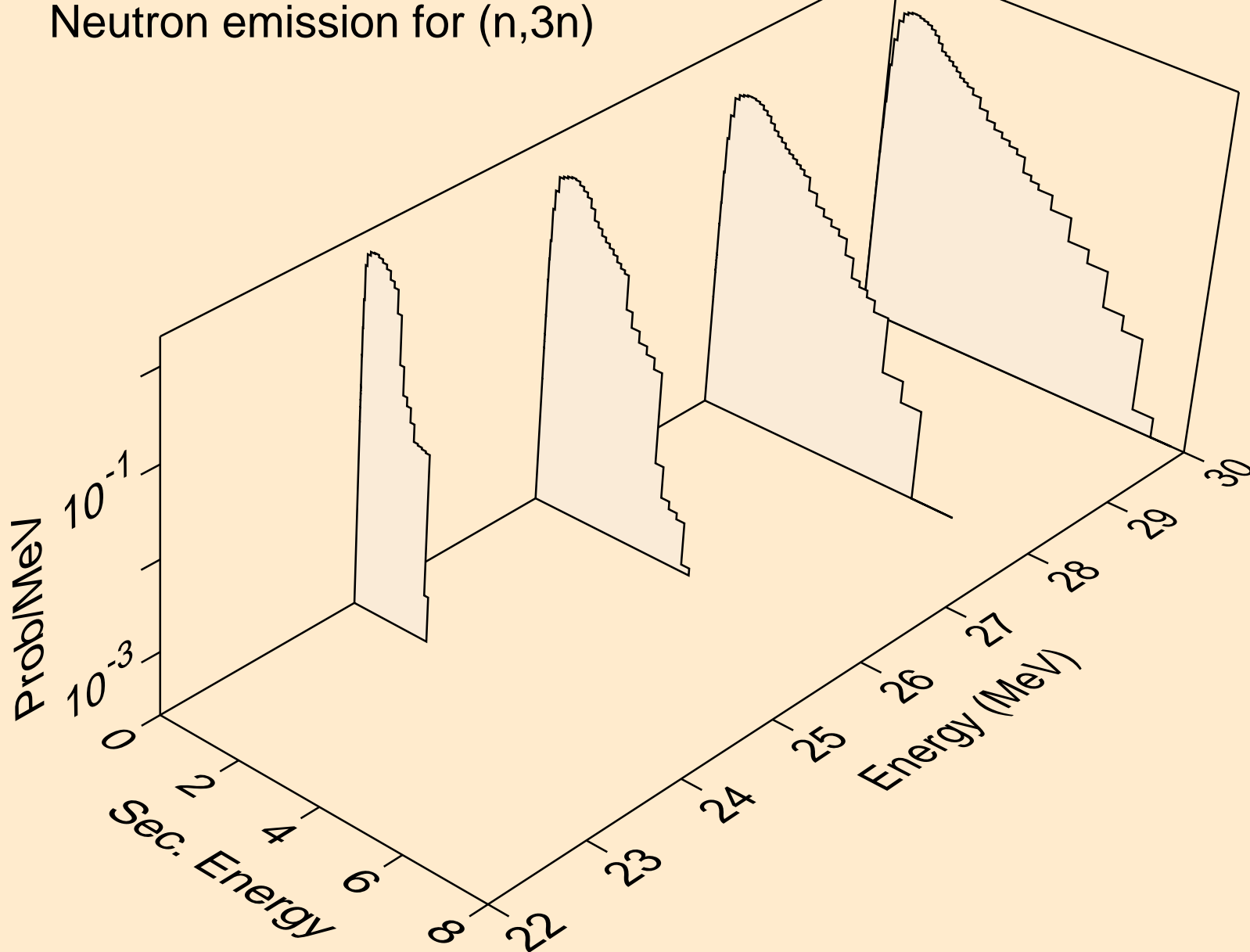

ER149M NEUTRON ACER TENDL-2019 LIBRARY; T=293.16K  
Neutron emission for (n,n\*)a

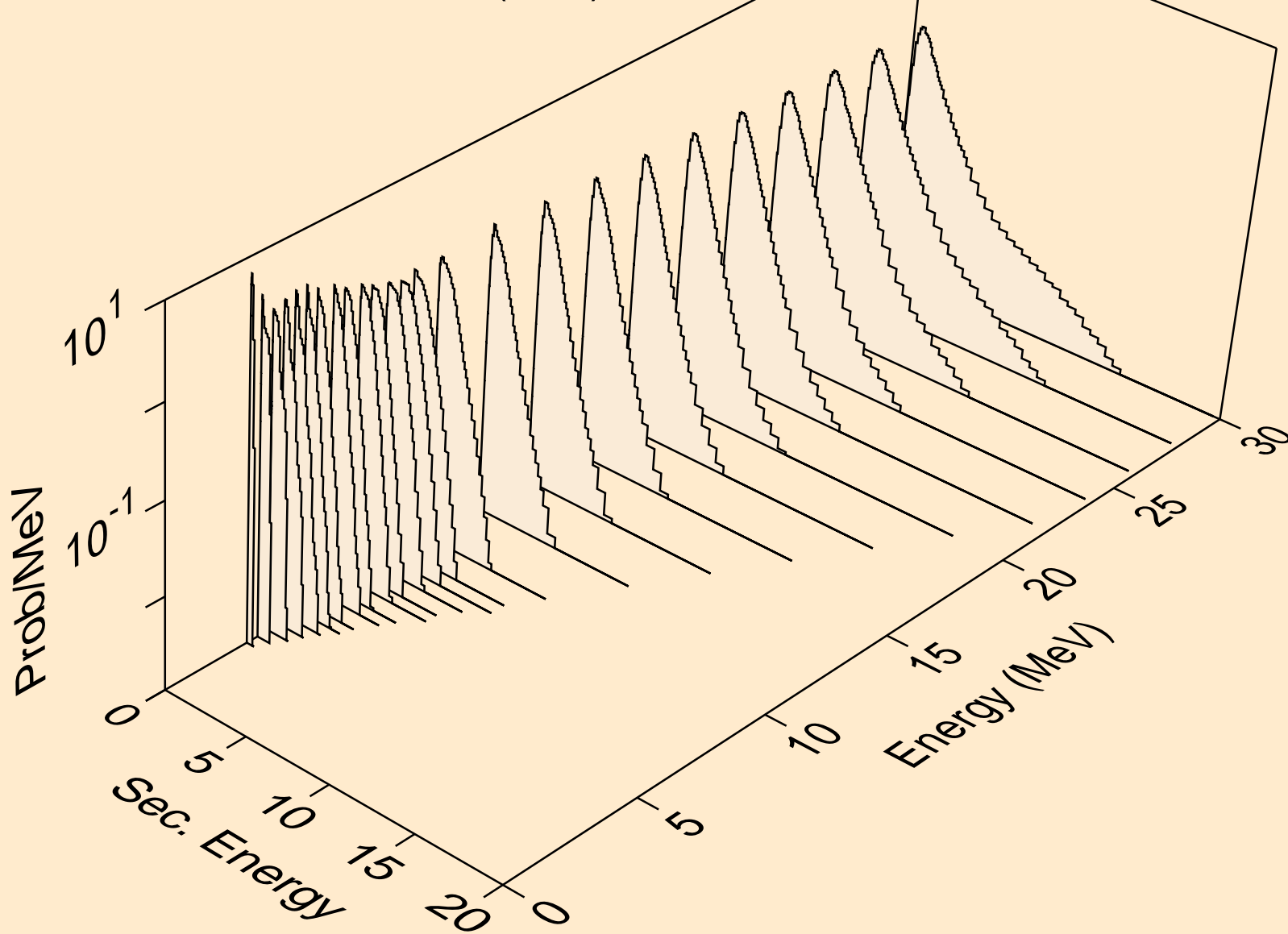

ER149M NEUTRON ACER TENDL-2019 LIBRARY; T=293.16K  
Neutron emission for (n,2n)a

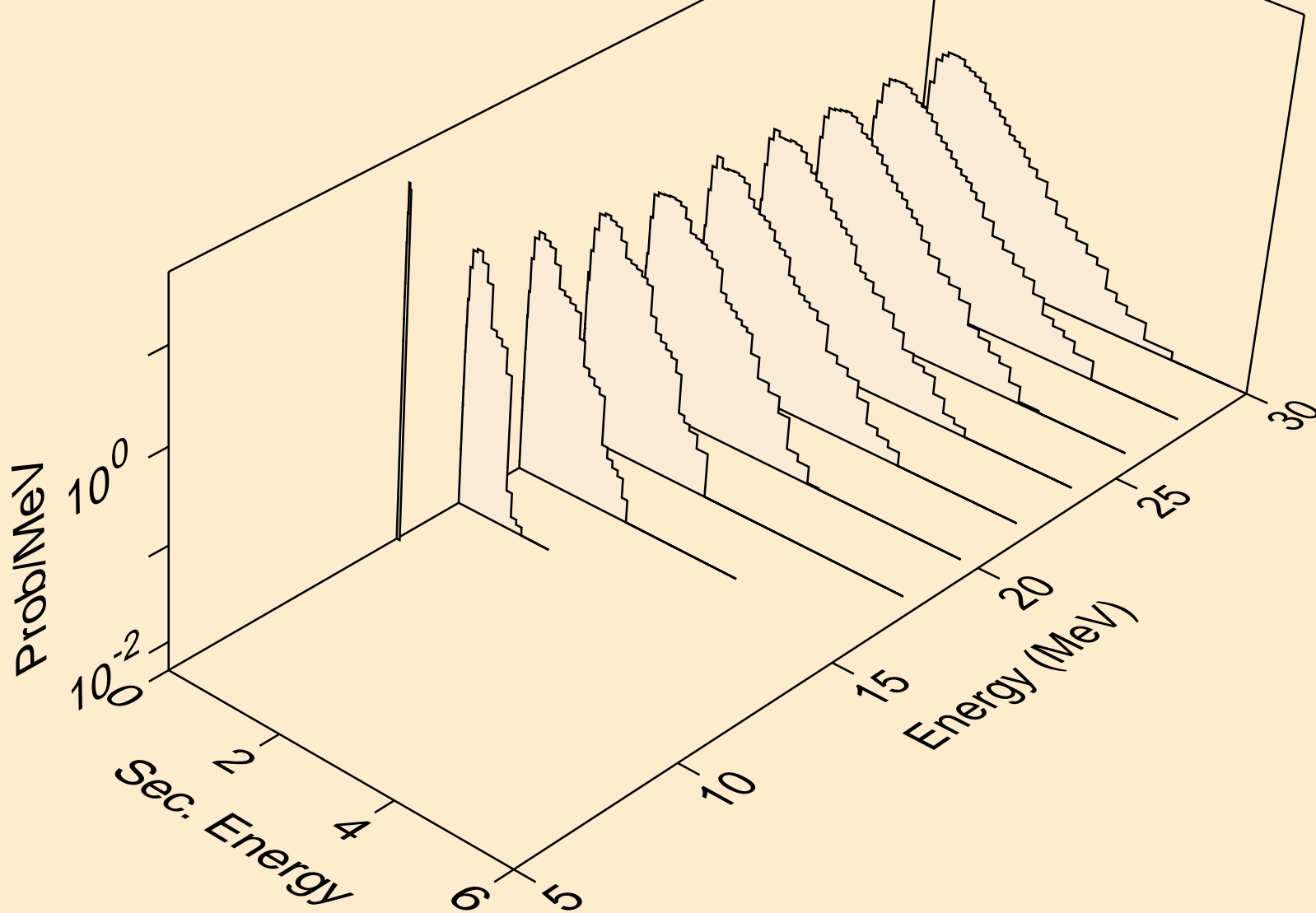

ER149M NEUTRON ACER TENDL-2019 LIBRARY; T=293.16K  
Neutron emission for (n,3n)a

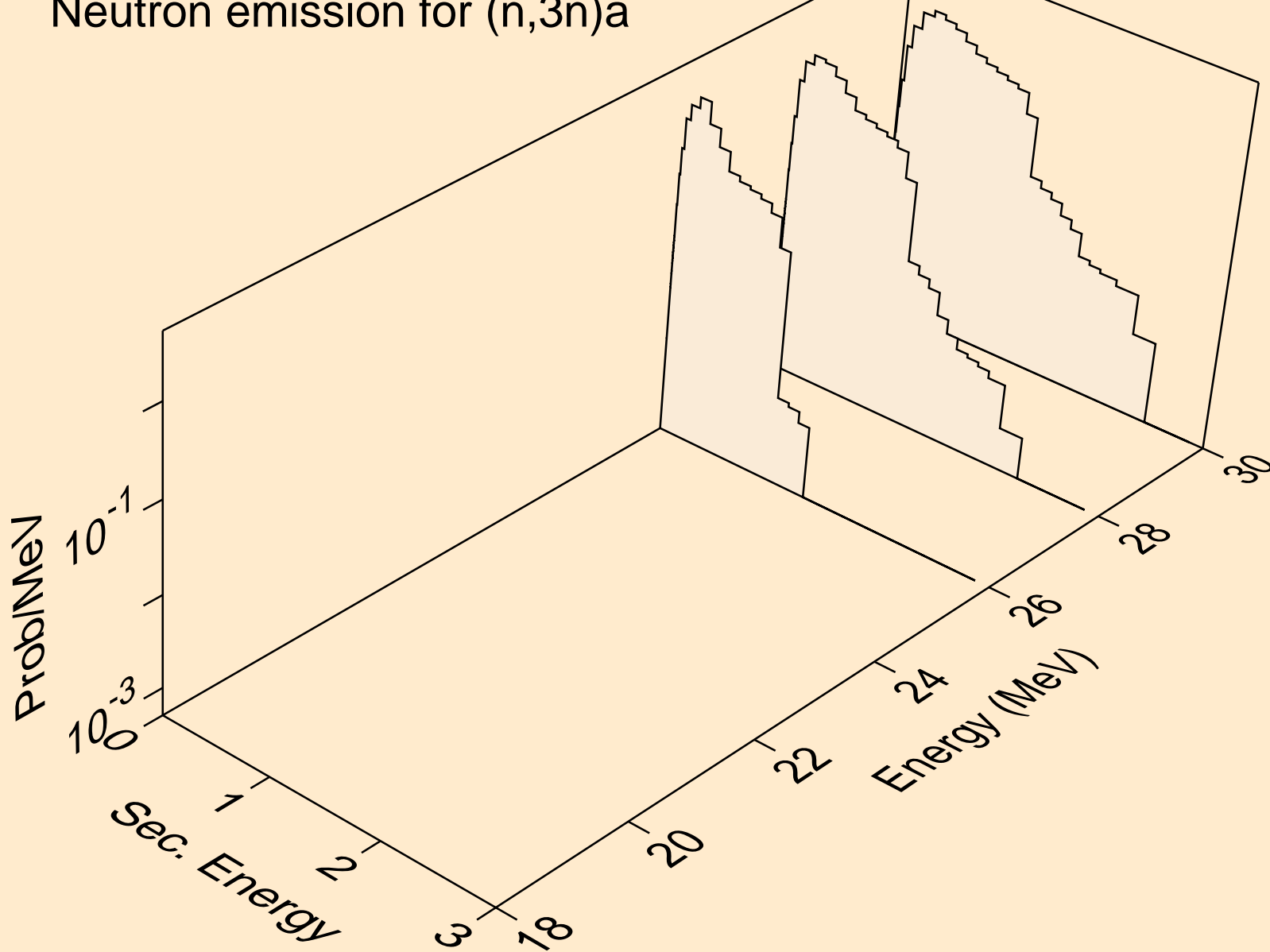

ER149M NEUTRON ACER TENDL-2019 LIBRARY; T=293.16K  
Neutron emission for (n,n\*)p

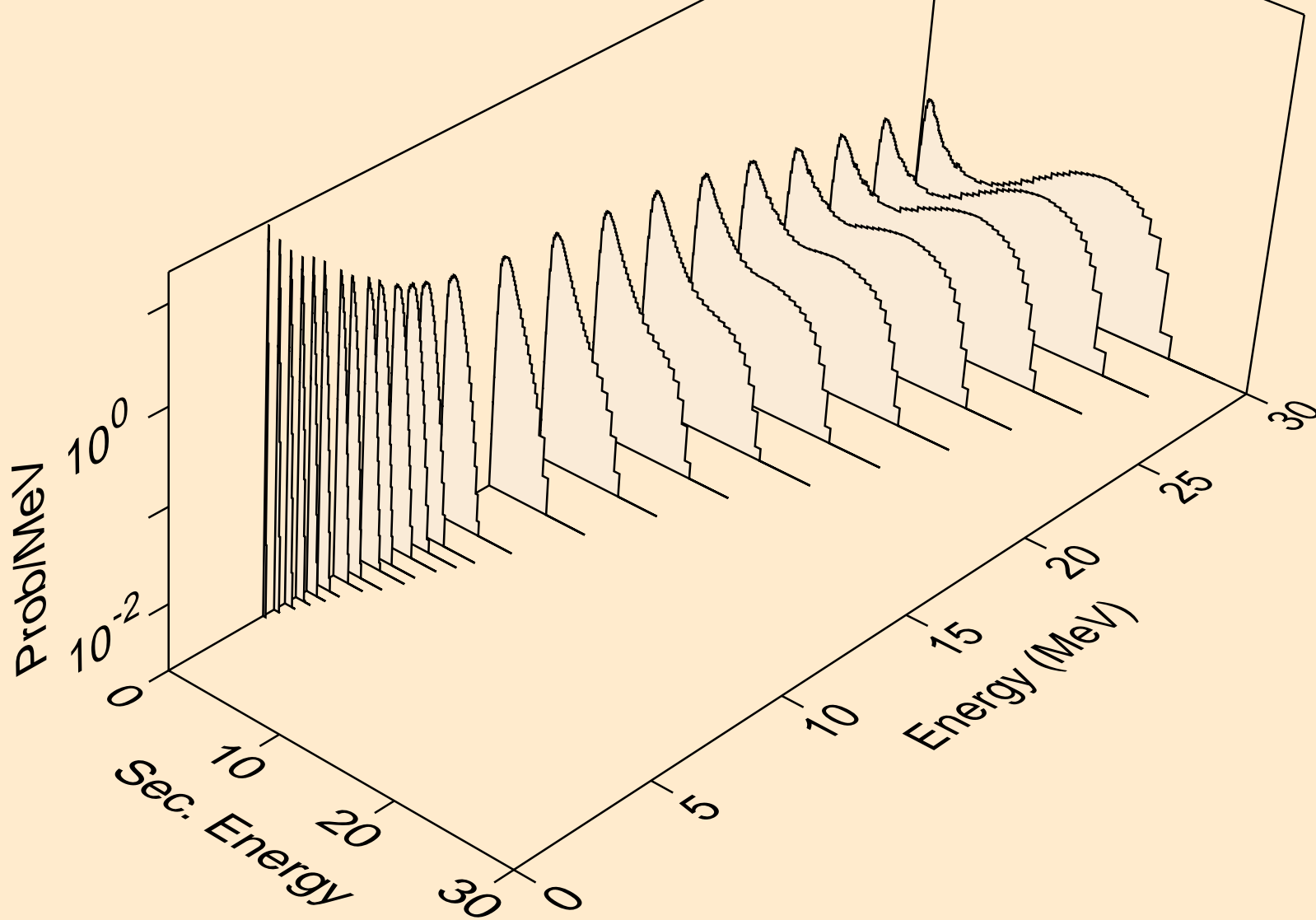



ER149M NEUTRON ACER TENDL-2019 LIBRARY; T=293.16K  
Neutron emission for (n,n\*)2a

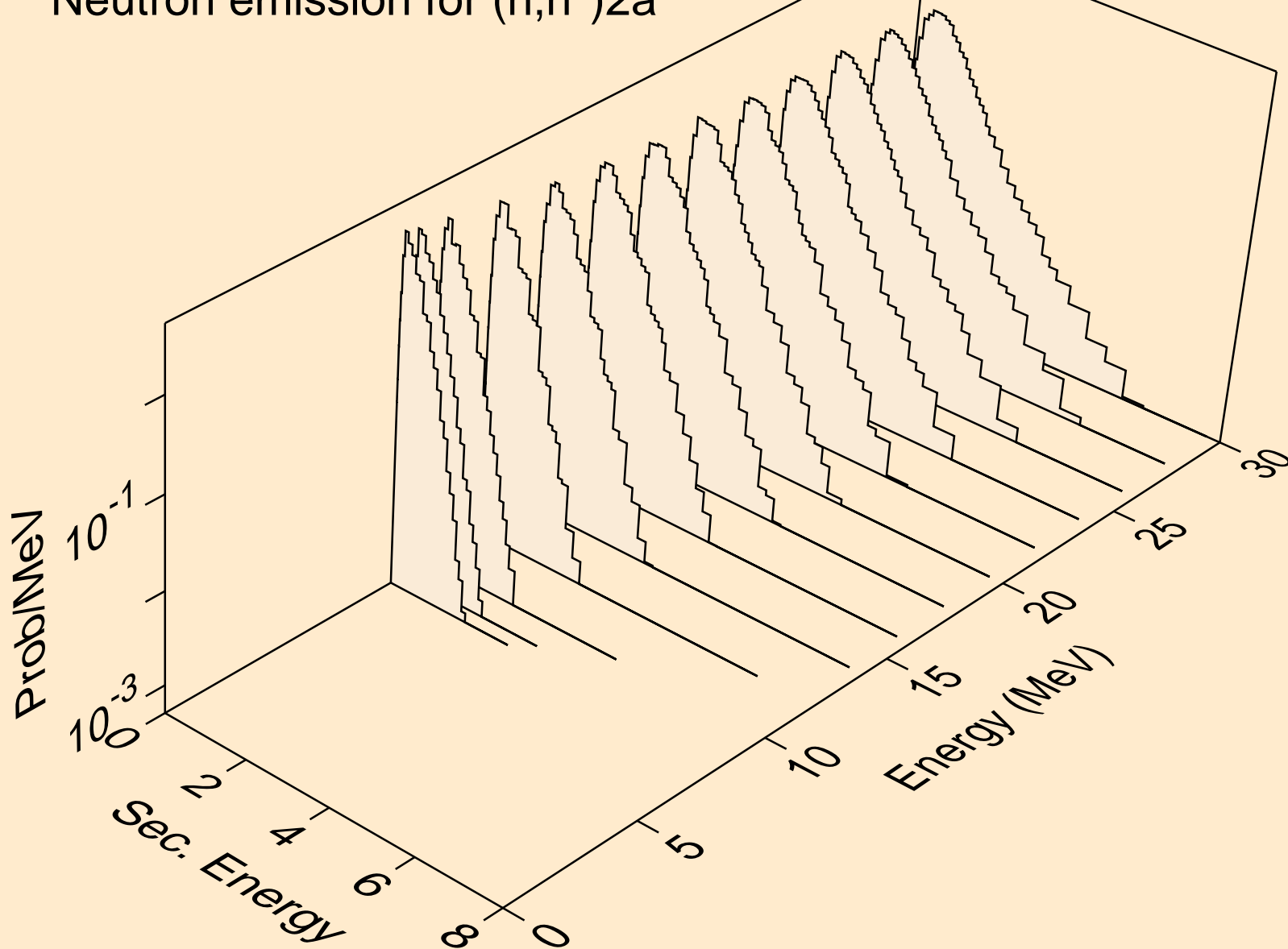

ER149M NEUTRON ACER TENDL-2019 LIBRARY; T=293.16K  
Neutron emission for (n,2n)2a

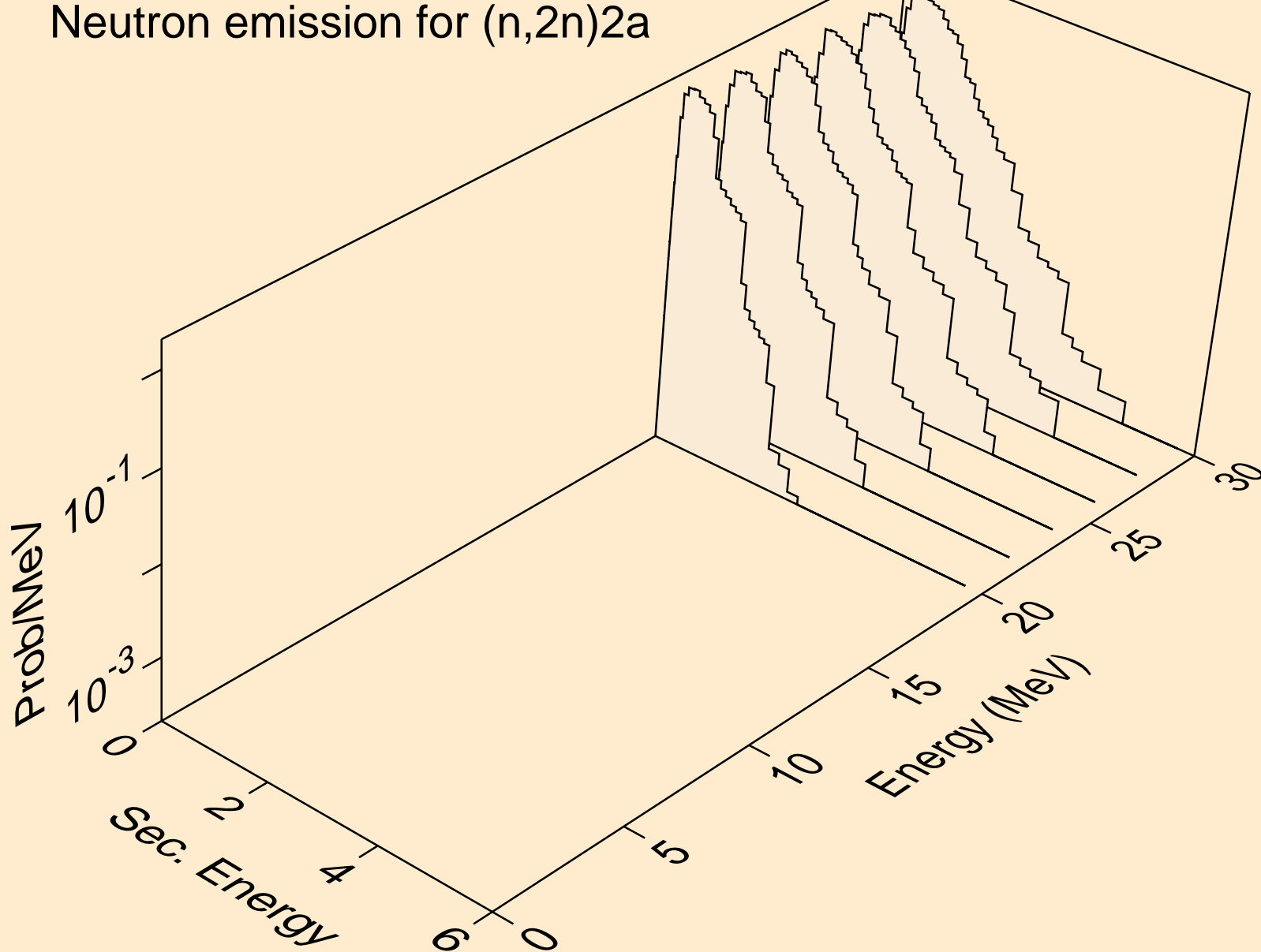

ER149M NEUTRON ACER TENDL-2019 LIBRARY; T=293.16K  
Neutron emission for (n,n\*)d

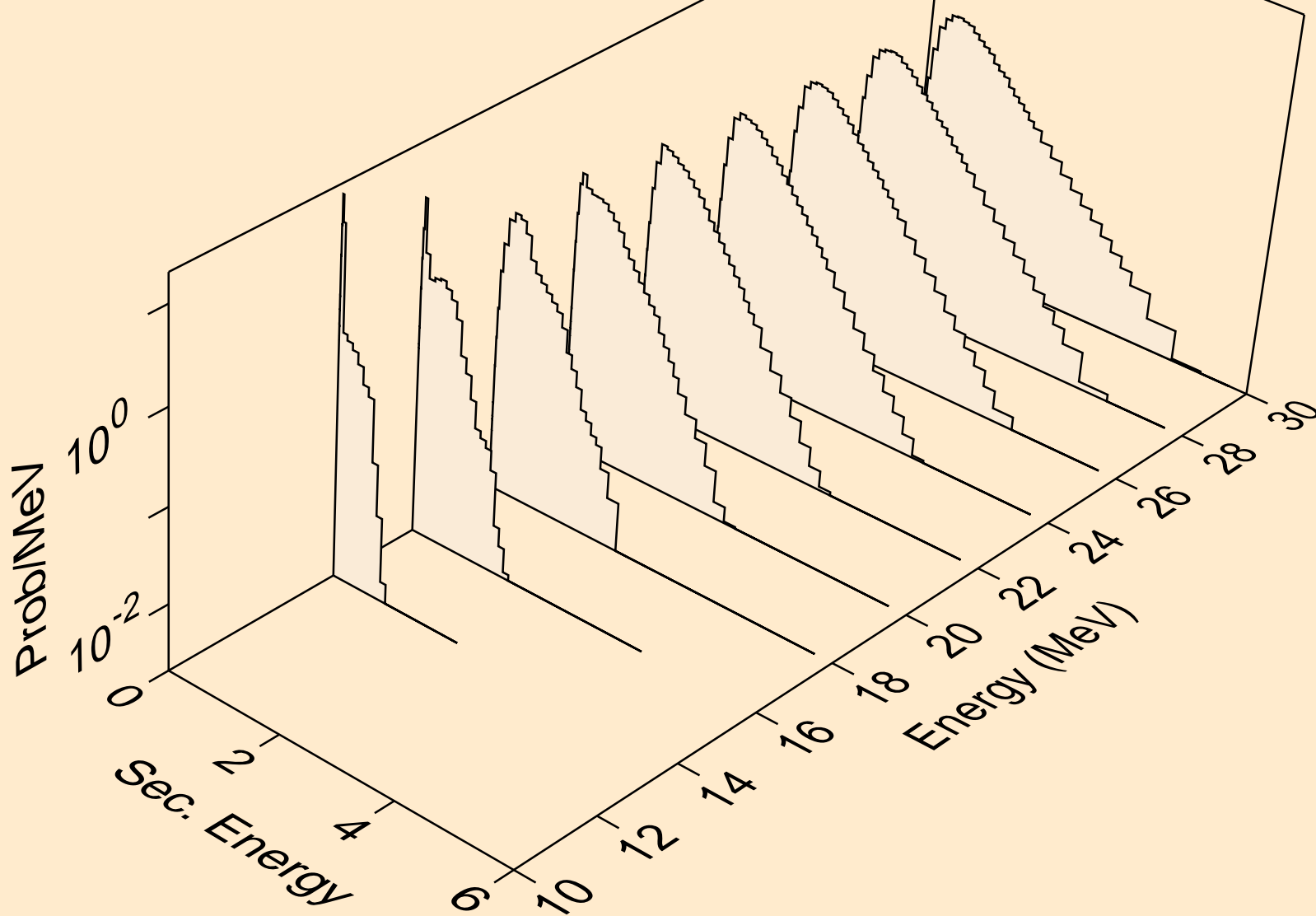

ER149M NEUTRON ACER TENDL-2019 LIBRARY; T=293.16K  
Neutron emission for (n,n\*)t

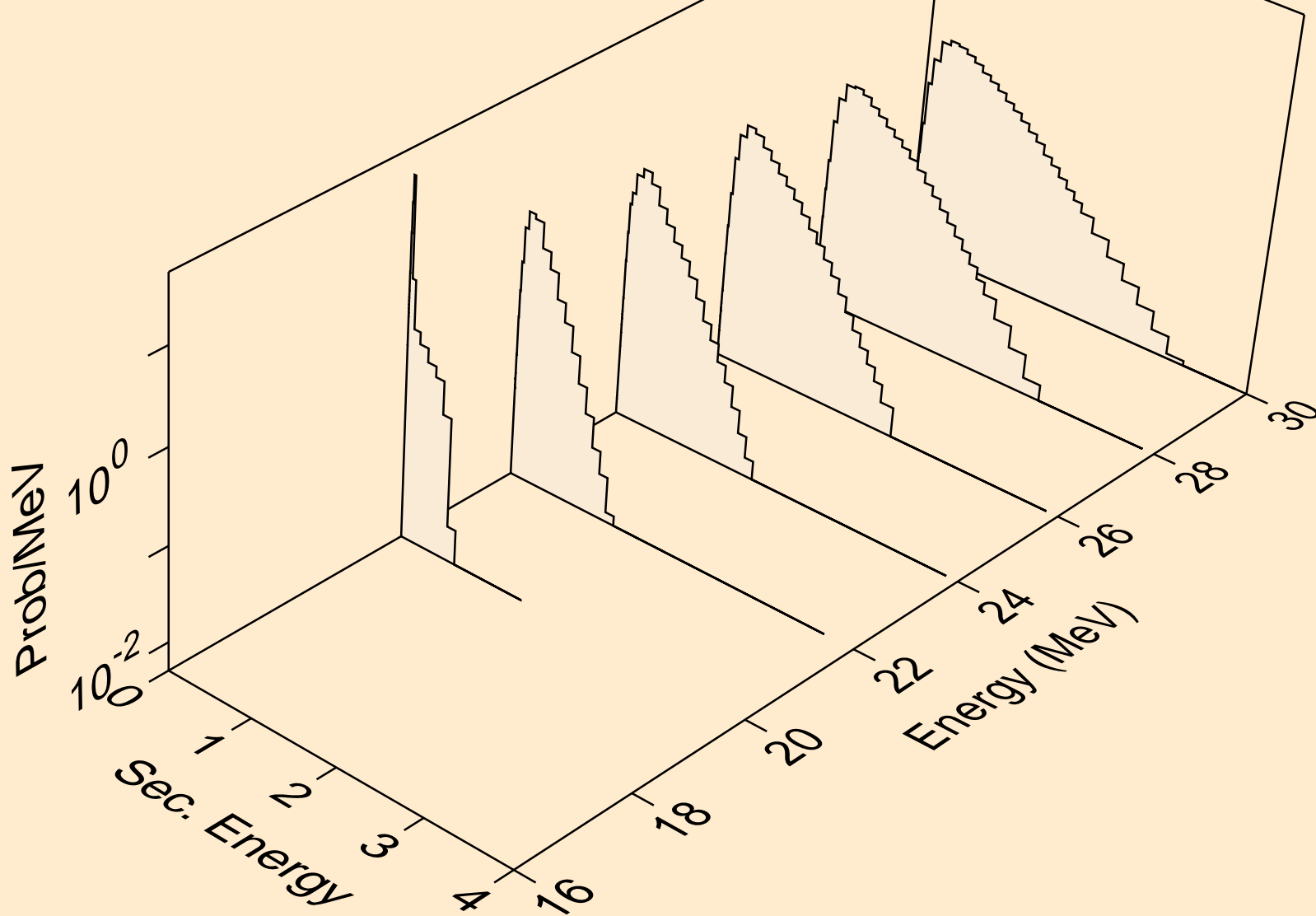

ER149M NEUTRON ACER TENDL-2019 LIBRARY; T=293.16K  
Neutron emission for (n,n\*)he3

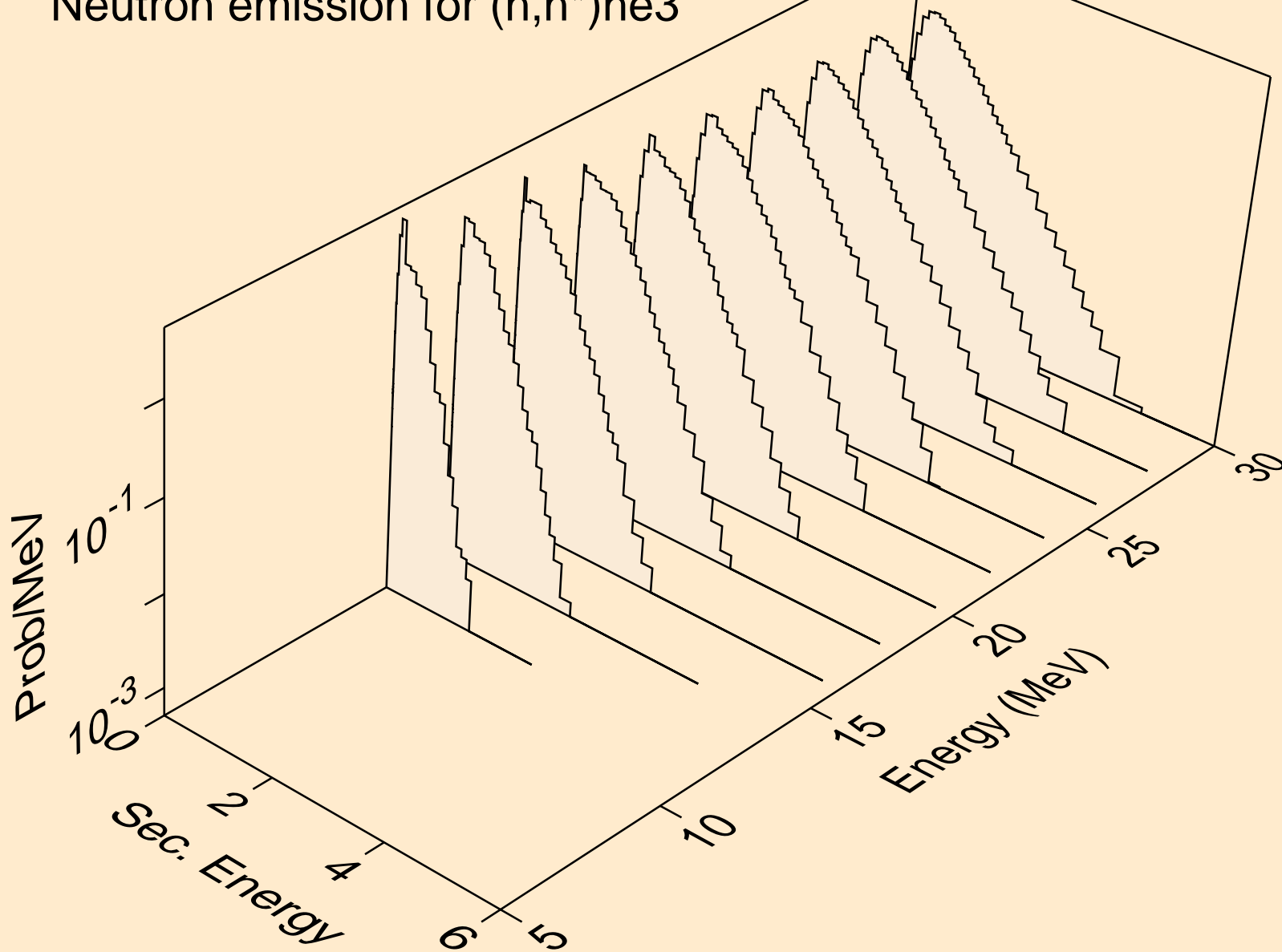

ER149M NEUTRON ACER TENDL-2019 LIBRARY; T=293.16K  
Neutron emission for (n,2np)

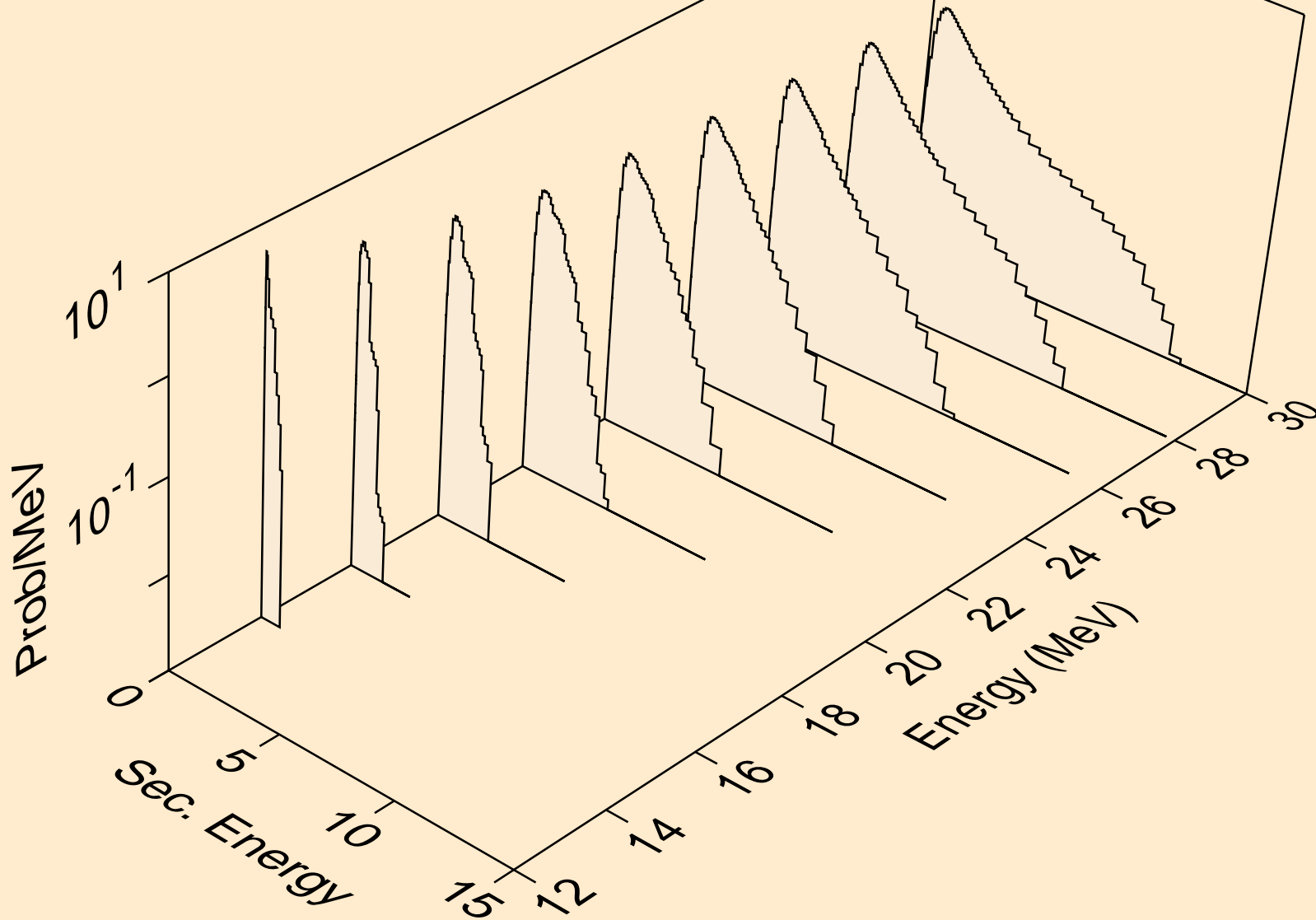

ER149M NEUTRON ACER TENDL-2019 LIBRARY; T=293.16K  
Neutron emission for (n,3np)

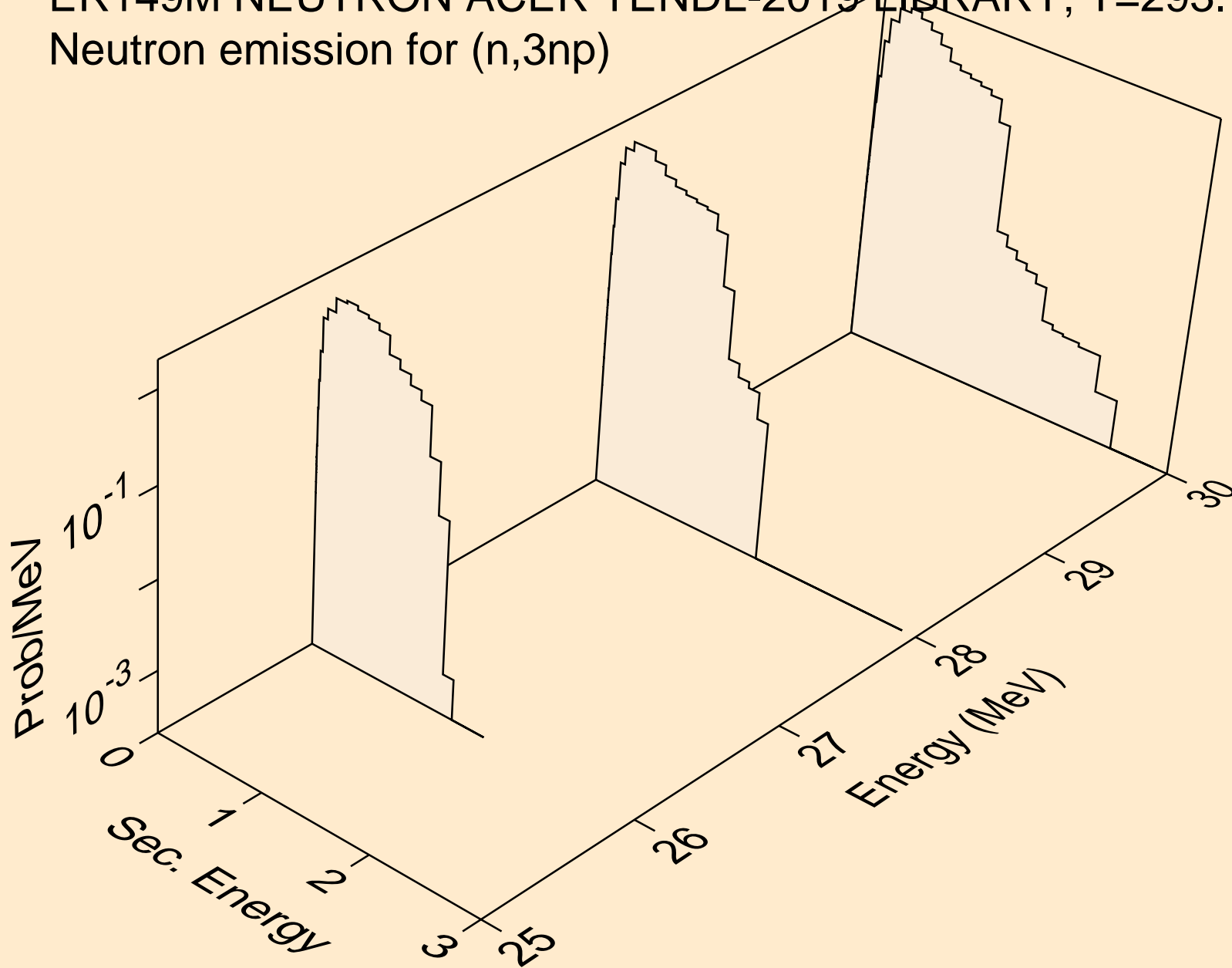

ER149M NEUTRON ACER TENDL-2019 LIBRARY; T=293.16K  
Neutron emission for (n,2np)

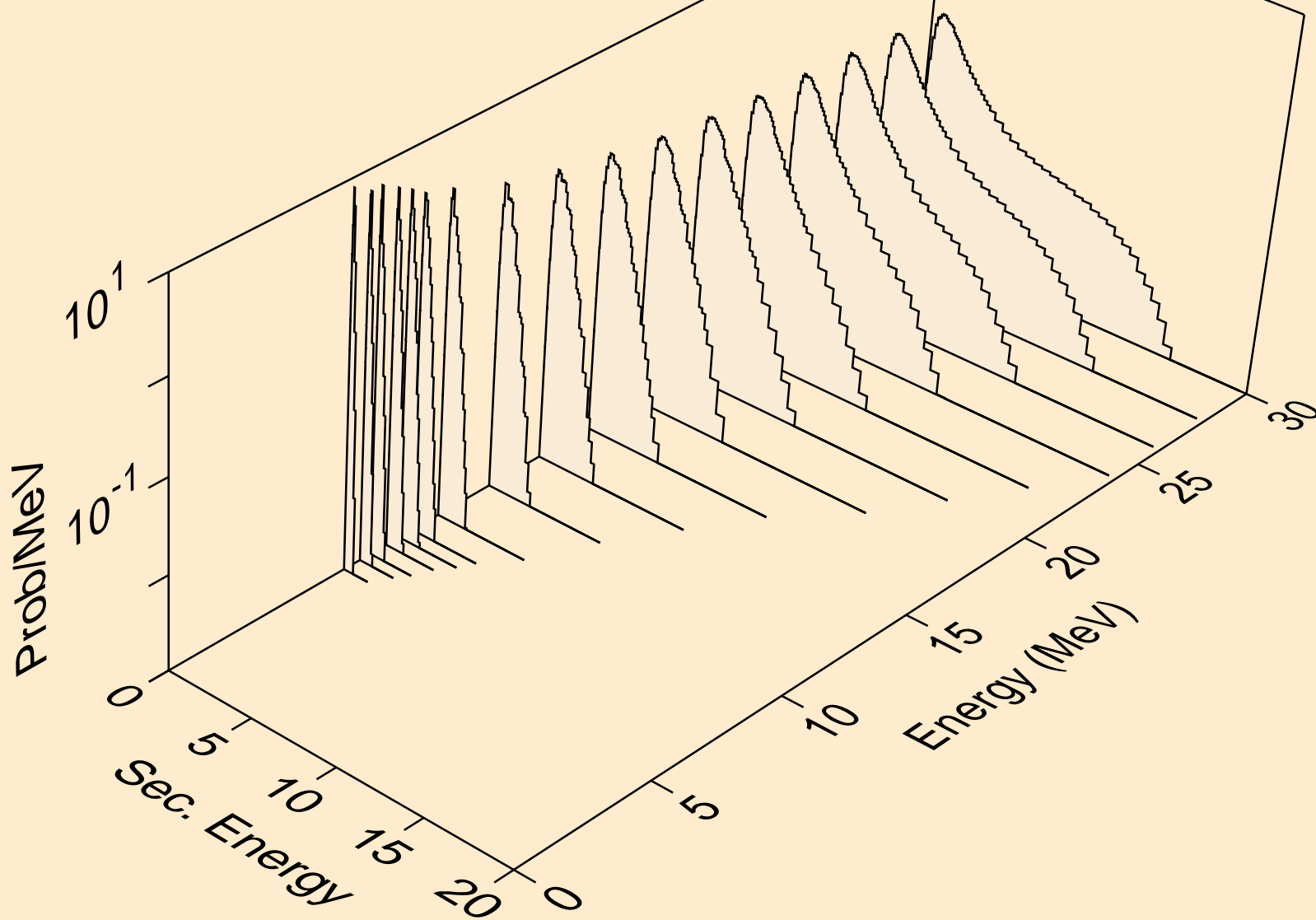



ER149M NEUTRON ACER TENDL-2019 LIBRARY; T=293.16K  
Neutron emission for (n,npa)

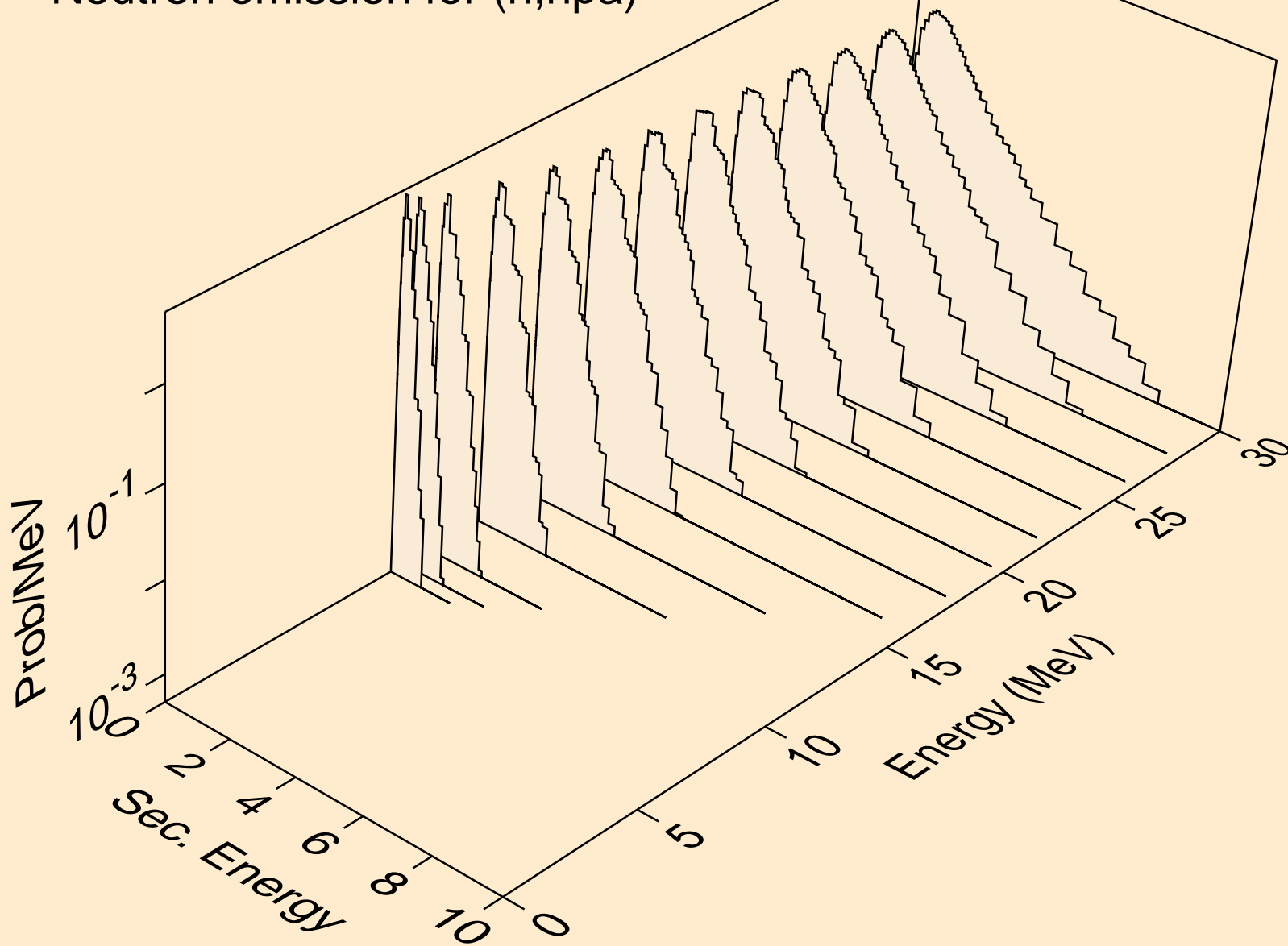

ER149M NEUTRON ACER TENDL-2019 LIBRARY; T=293.16K  
Neutron emission for (n,n\*c)

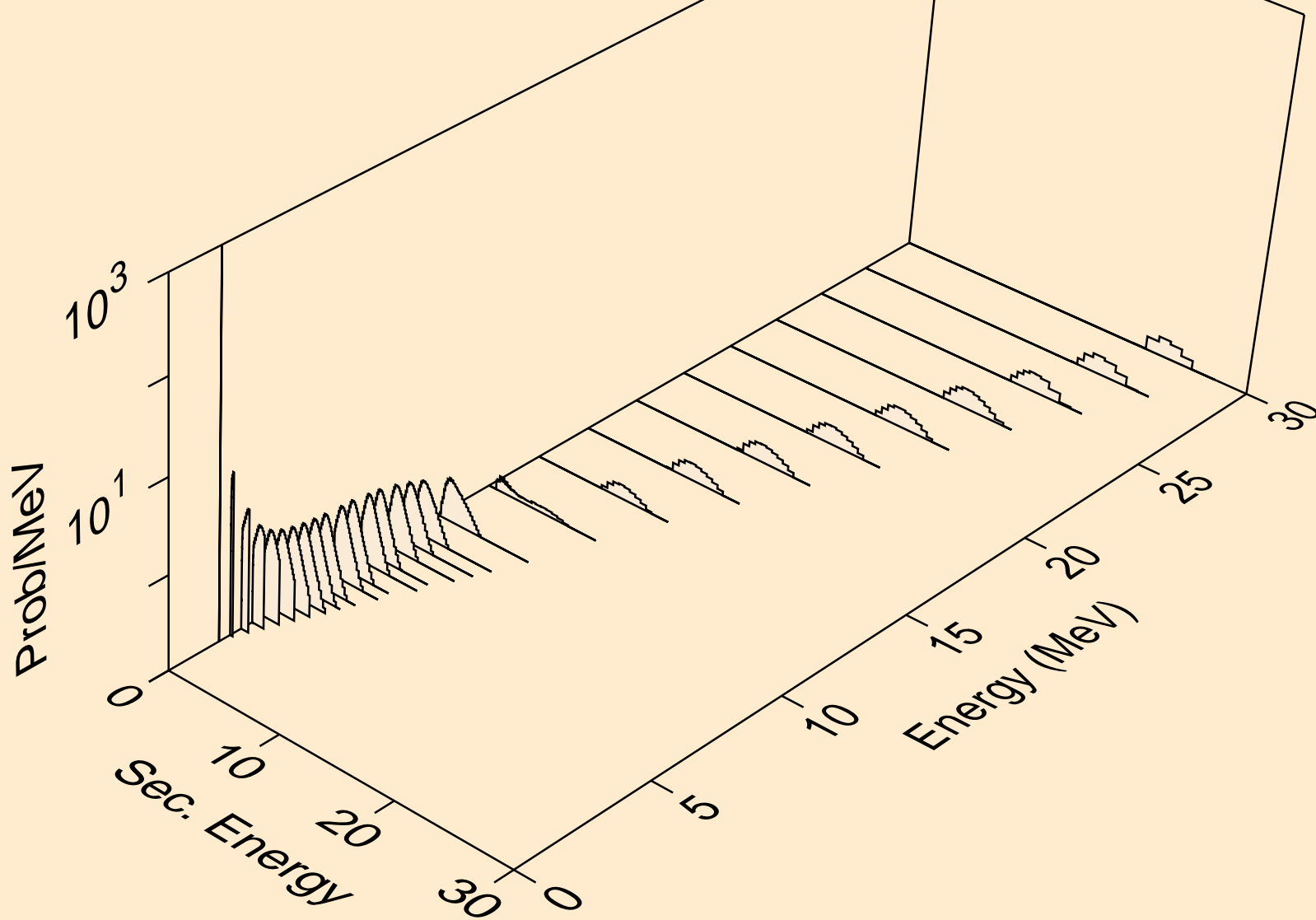

ER149M NEUTRON ACER TENDL-2019 LIBRARY; T=293.16K  
Photon emission for (n,x)

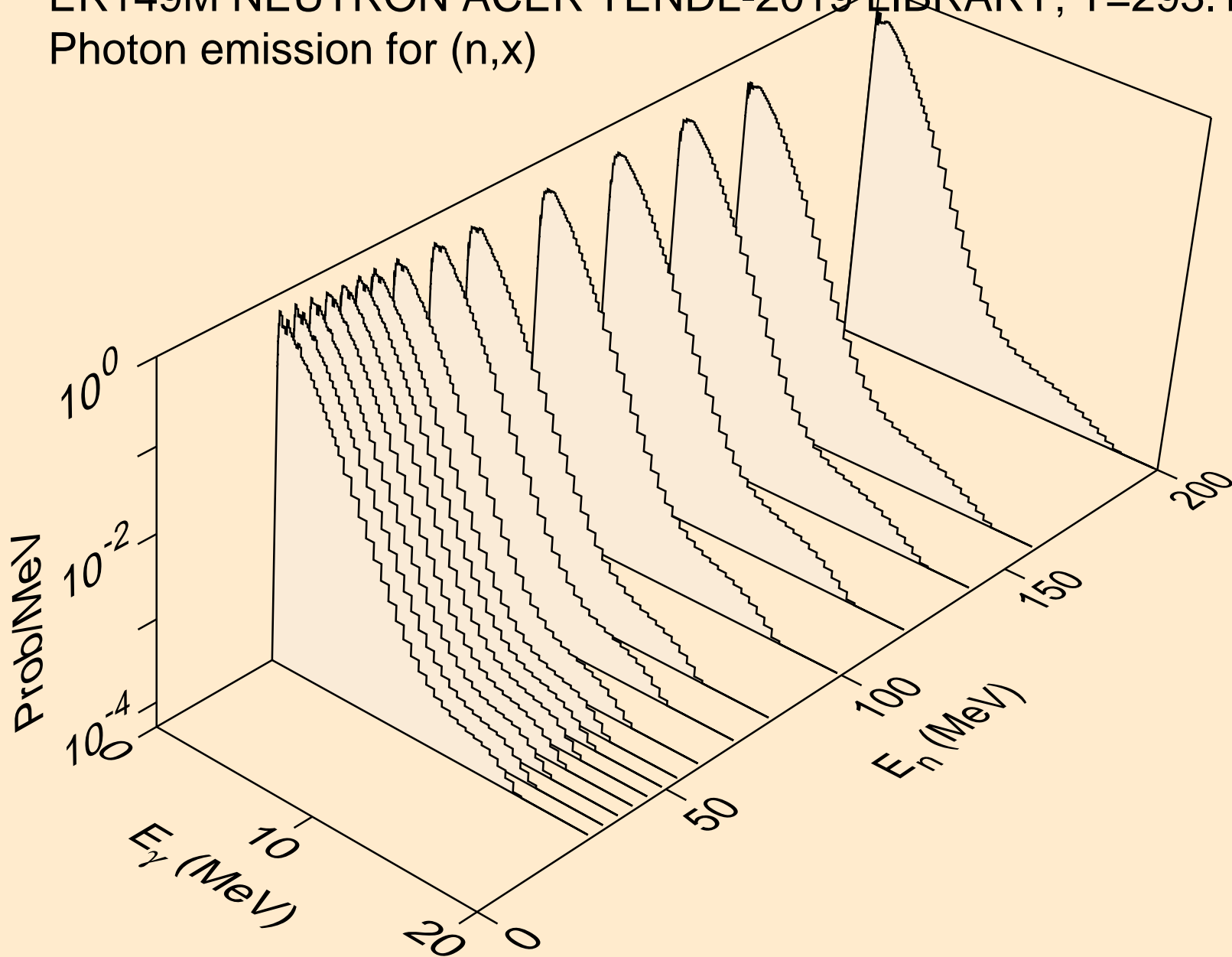

ER149M NEUTRON ACER TENDL-2019 LIBRARY; T=293.16K  
Photon emission for (n,2nd)

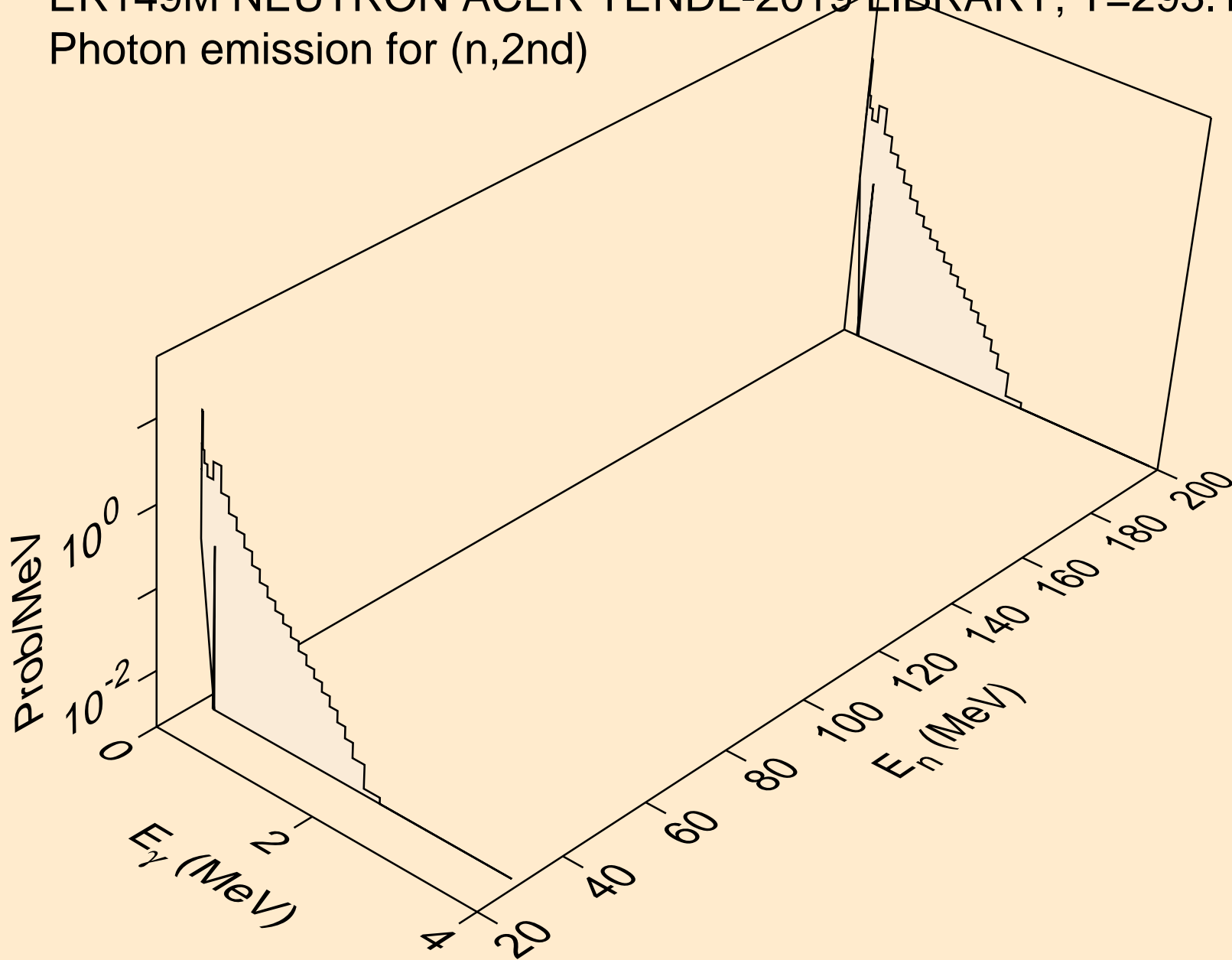

ER149M NEUTRON ACER TENDL-2019 LIBRARY; T=293.16K  
Photon emission for (n,2n)

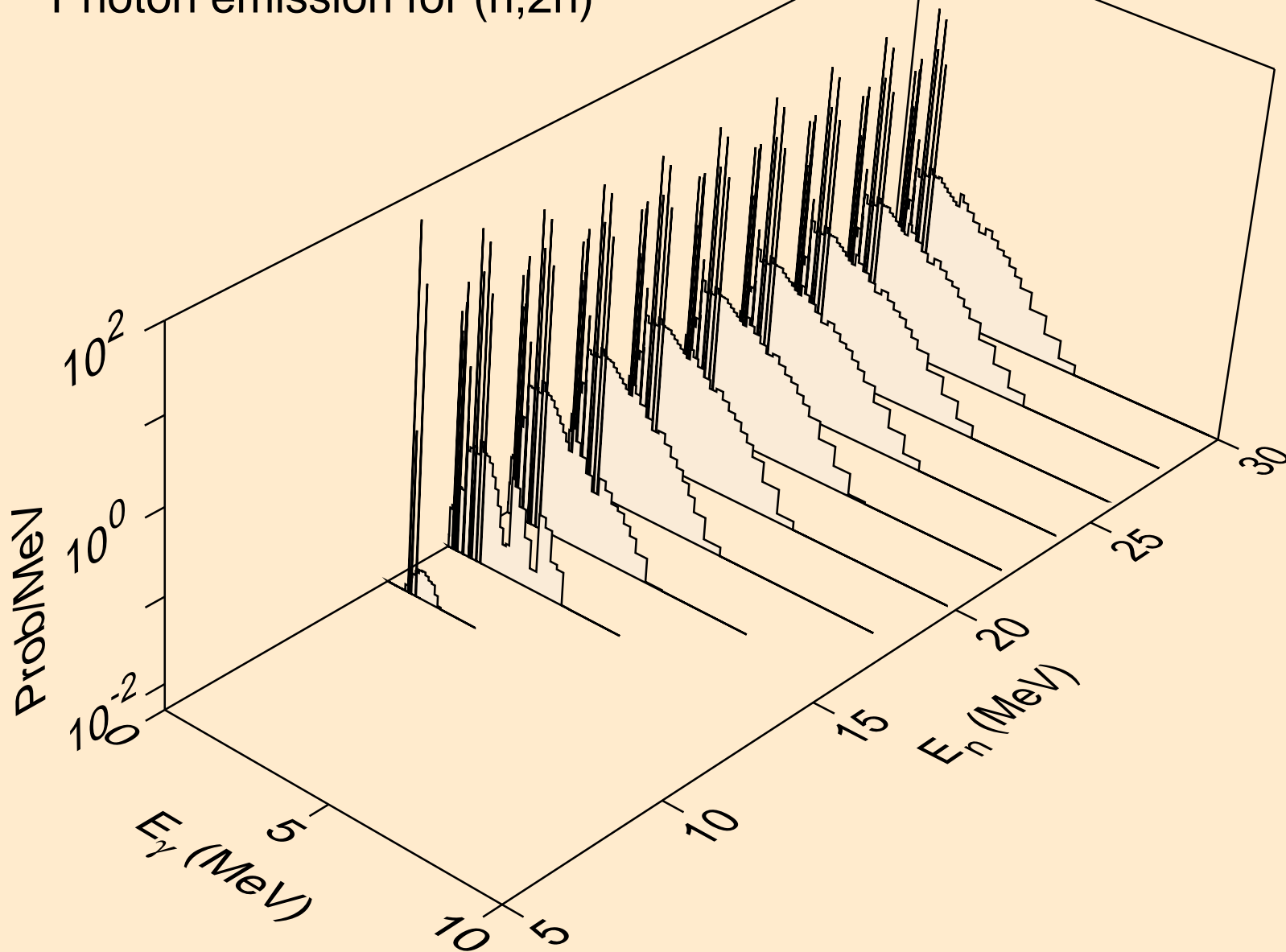

ER149M NEUTRON ACER TENDL-2019 LIBRARY; T=293.16K  
Photon emission for (n,3n)

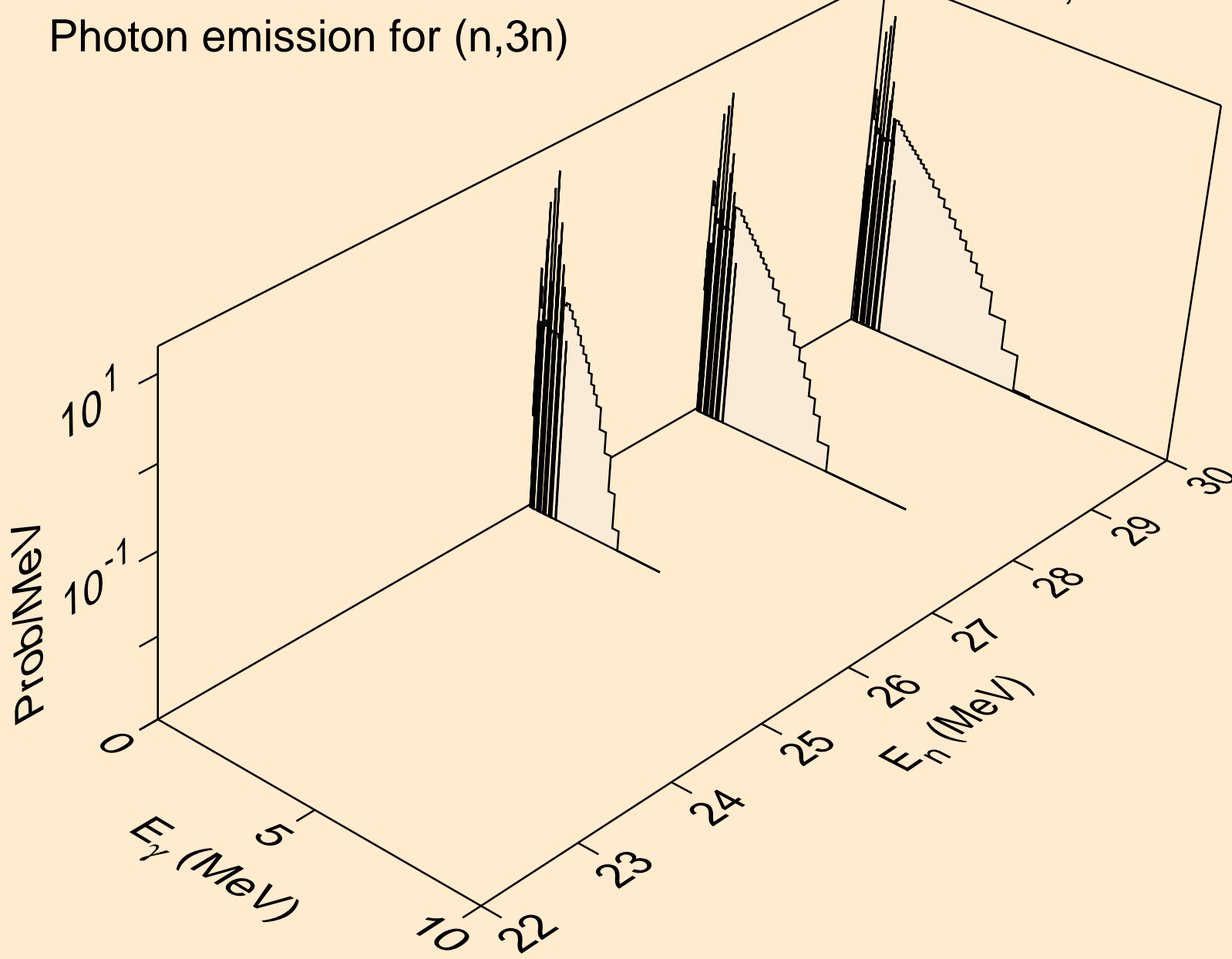

ER149M NEUTRON ACER TENDL-2019 LIBRARY; T=293.16K  
Photon emission for (n,n\*)a

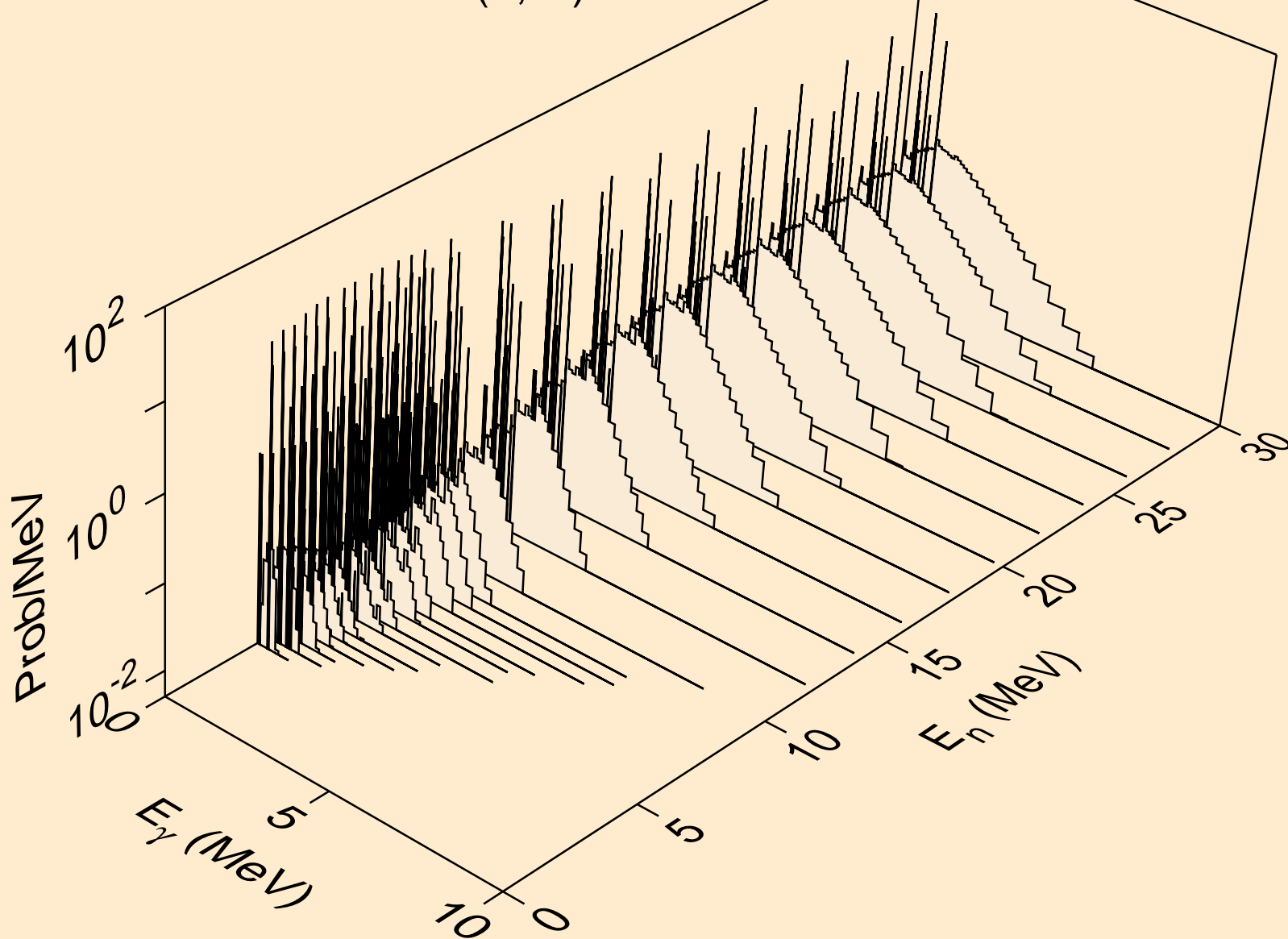

ER149M NEUTRON ACER TENDL-2019 LIBRARY; T=293.16K  
Photon emission for (n,2n)a

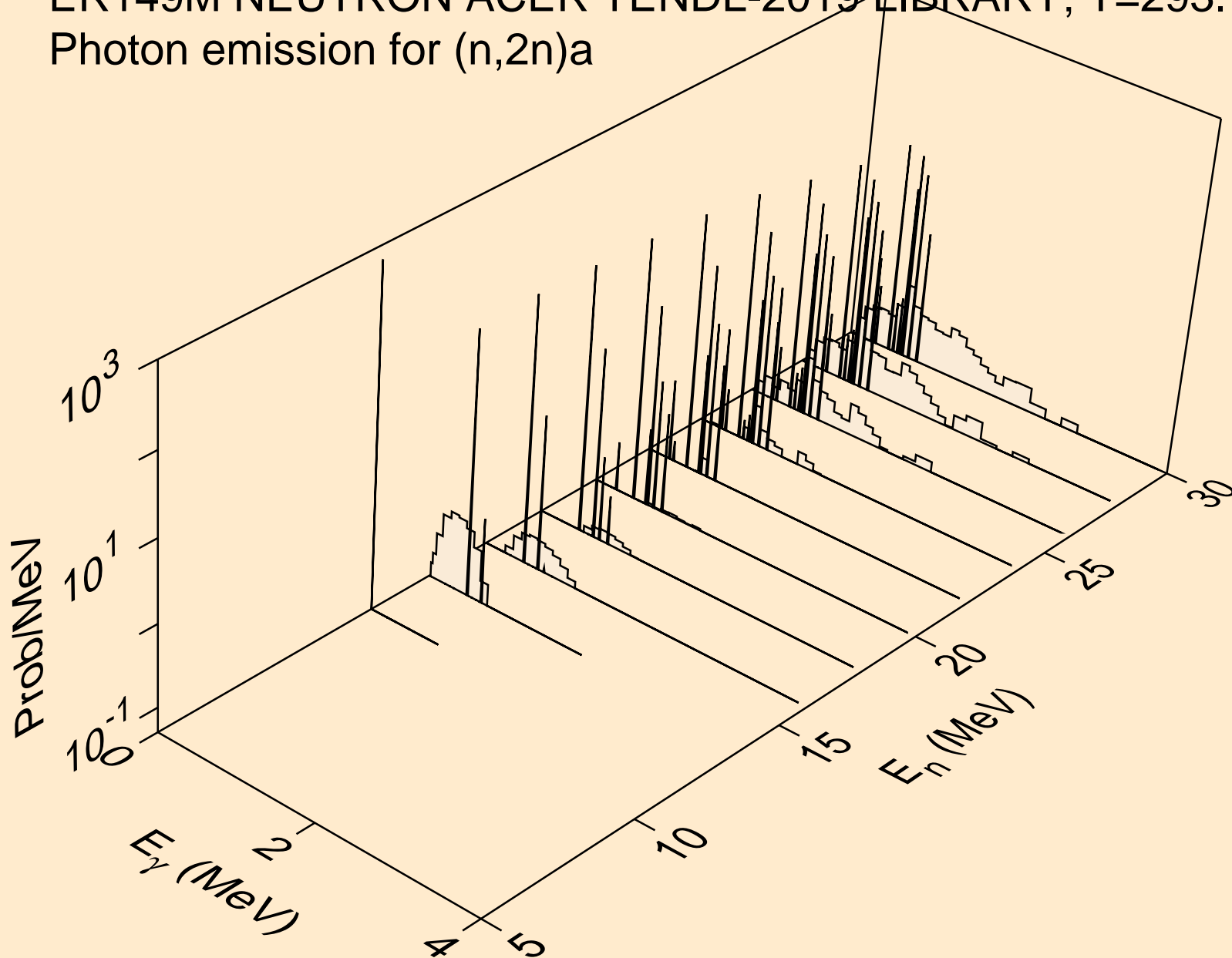



ER149M NEUTRON ACER TENDL-2019 LIBRARY; T=293.16K  
Photon emission for (n,3n)a

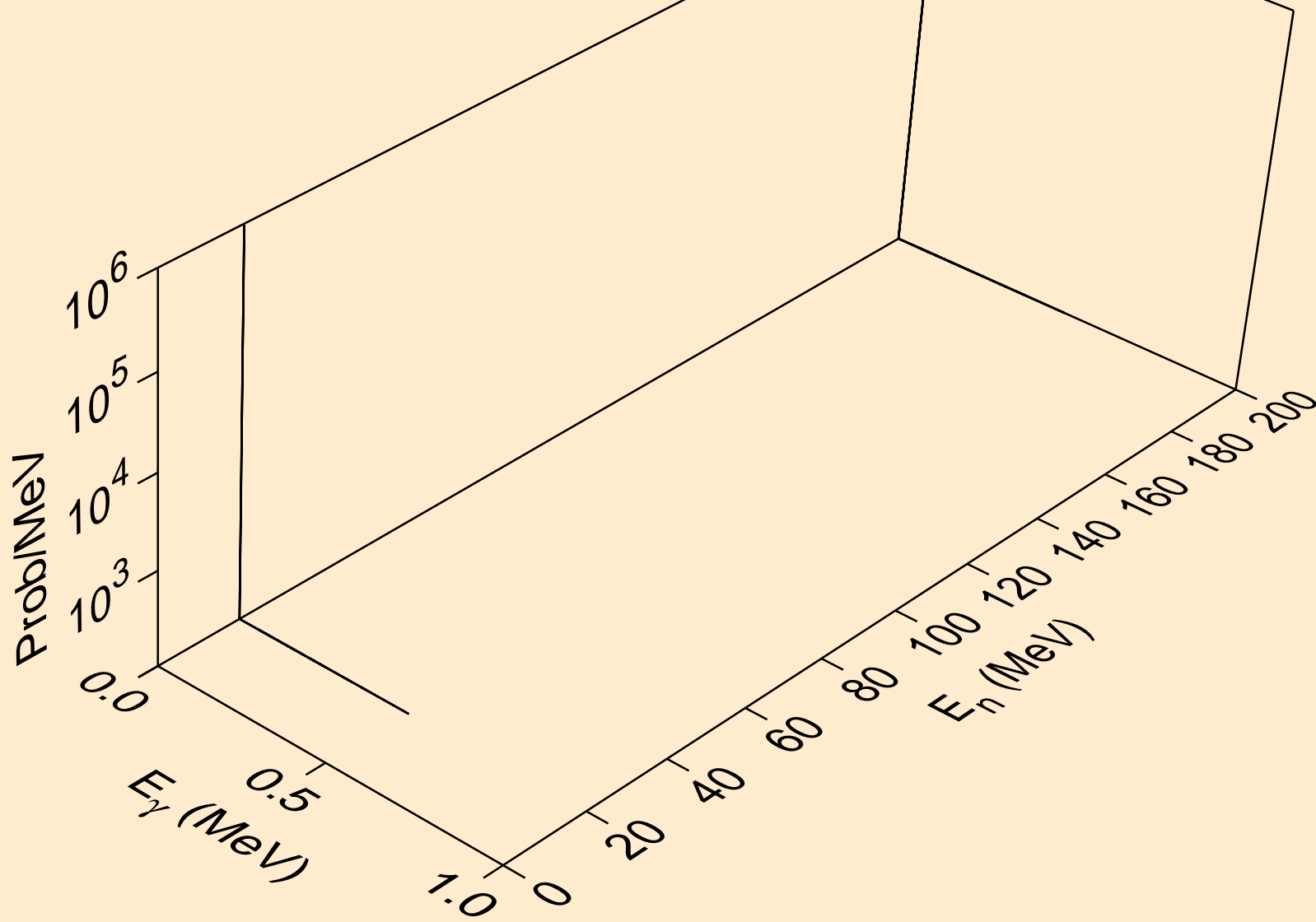

ER149M NEUTRON ACER TENDL-2019 LIBRARY; T=293.16K  
Photon emission for (n,n\*)p

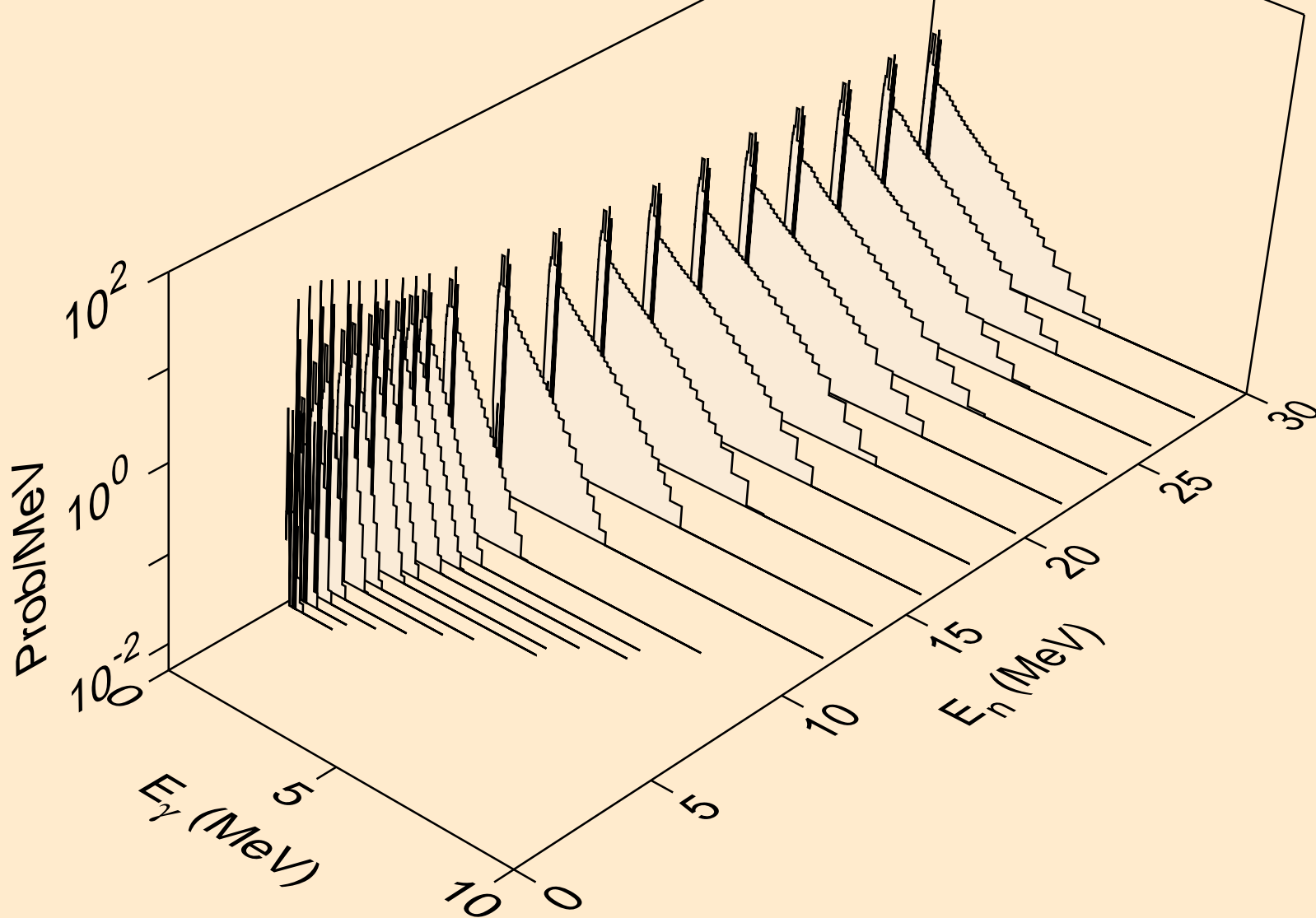

ER149M NEUTRON ACER TENDL-2019 LIBRARY; T=293.16K  
Photon emission for (n,n\*)2a

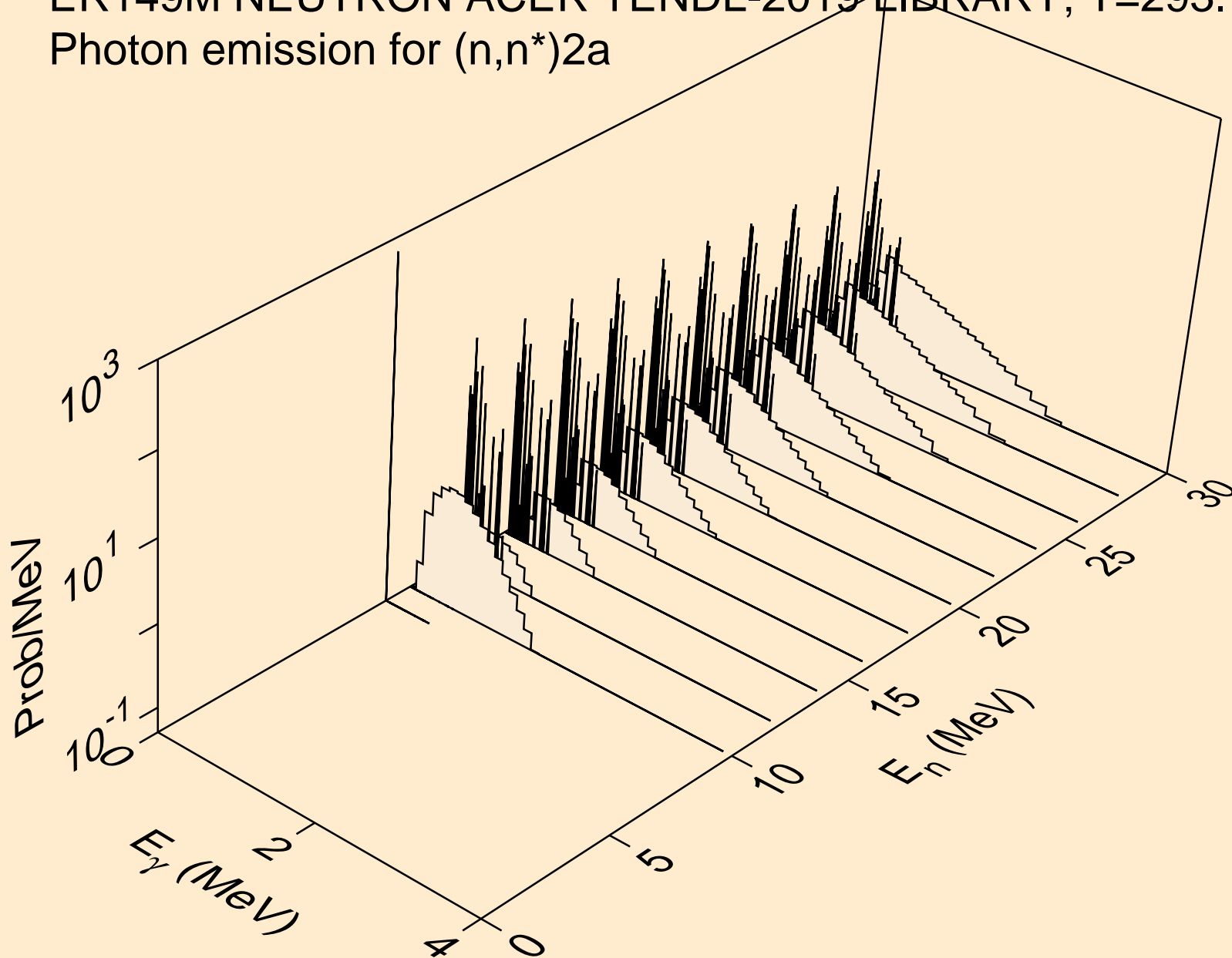

ER149M NEUTRON ACER TENDL-2019 LIBRARY; T=293.16K  
Photon emission for (n,2n)2a

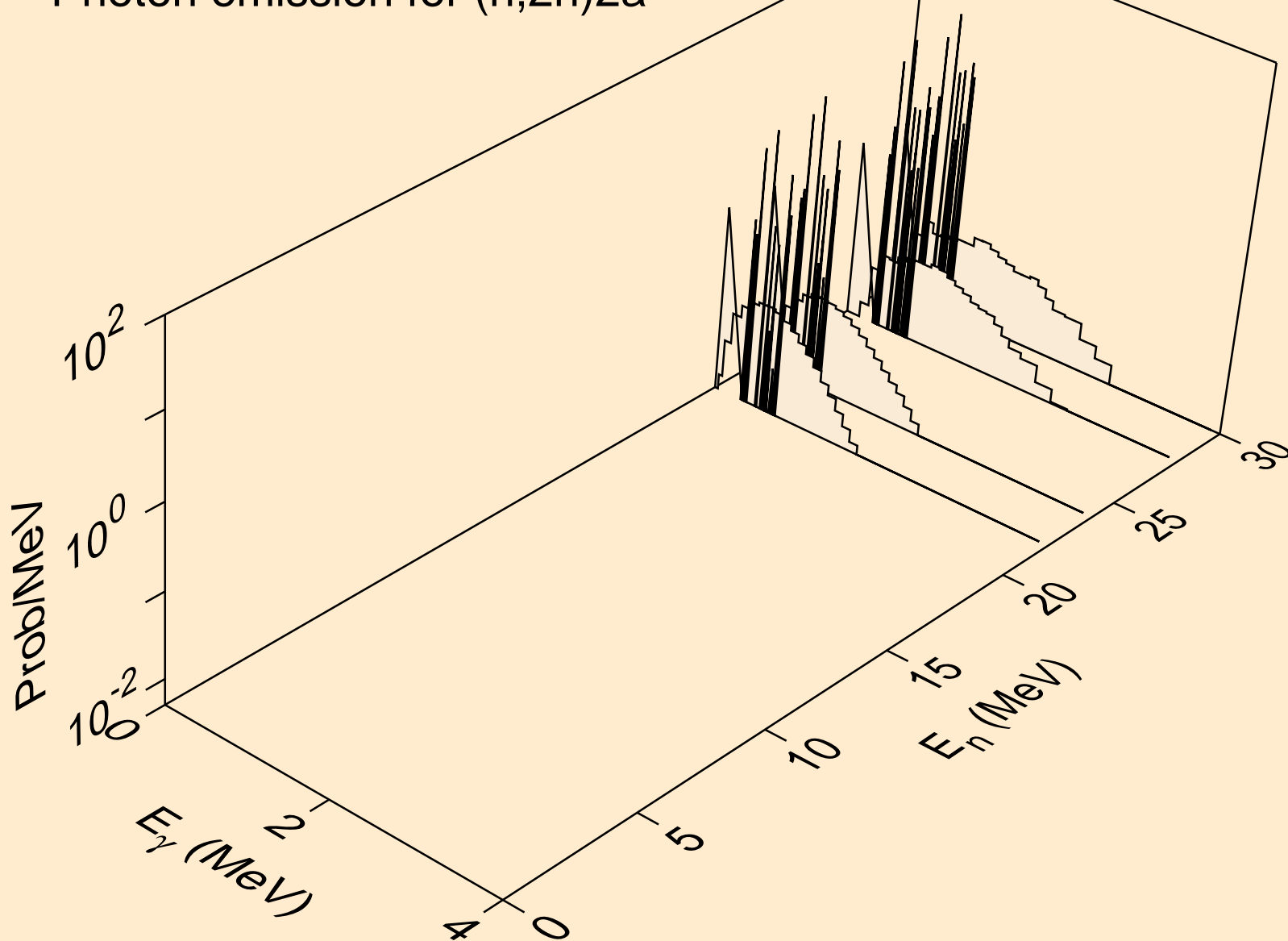

ER149M NEUTRON ACER TENDL-2019 LIBRARY; T=293.16K  
Photon emission for (n,n\*)d

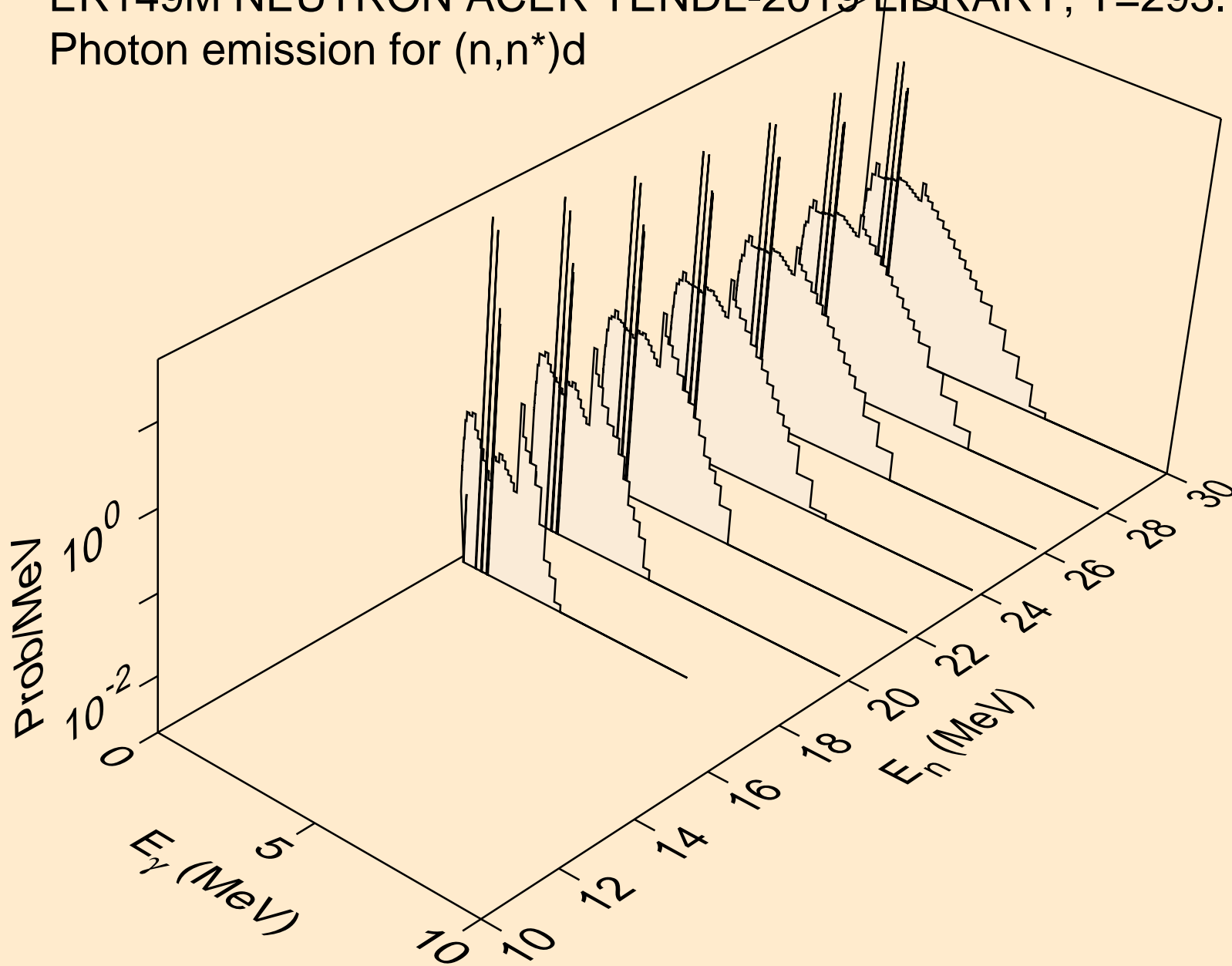

ER149M NEUTRON ACER TENDL-2019 LIBRARY; T=293.16K  
Photon emission for (n,n\*)t

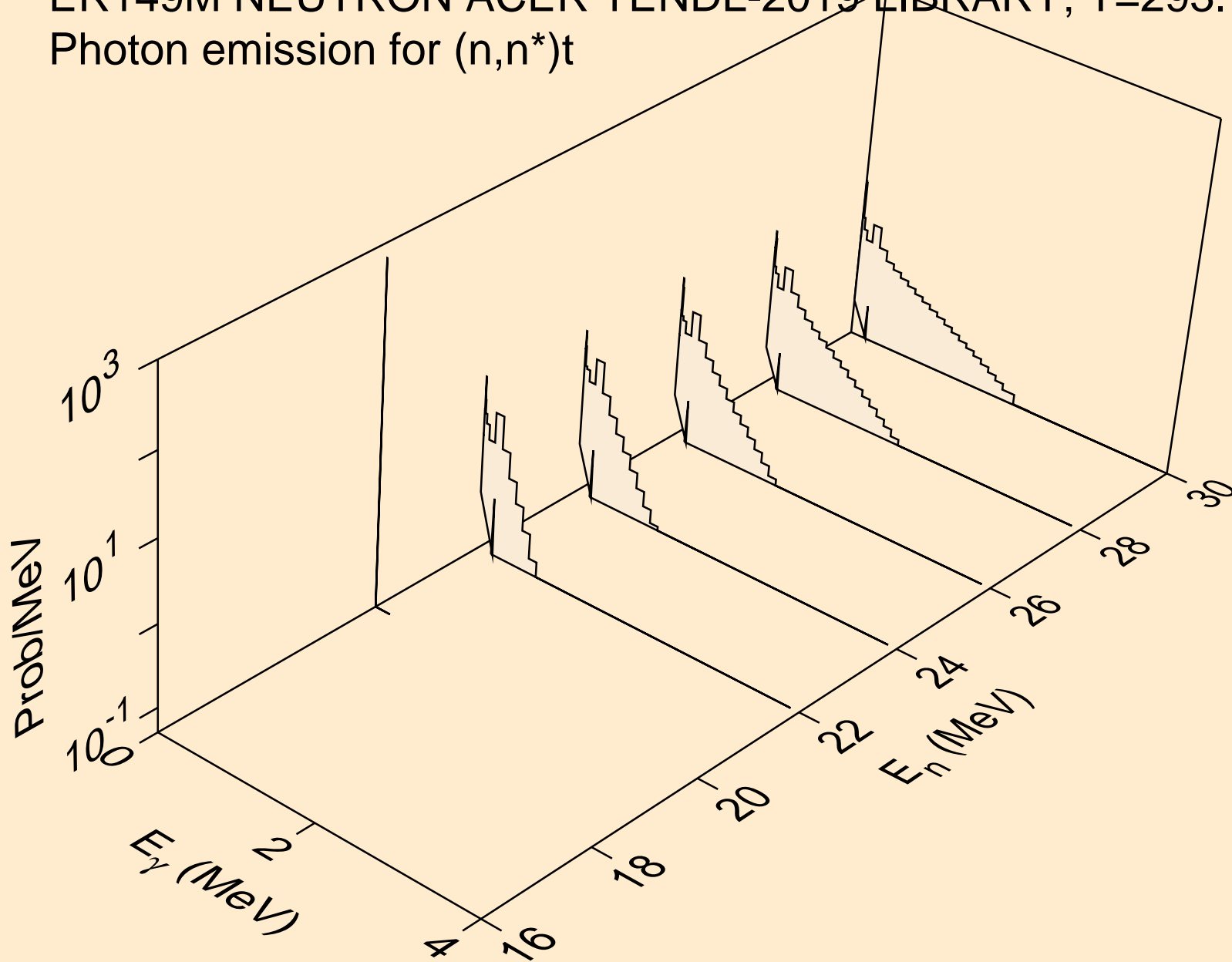

ER149M NEUTRON ACER TENDL-2019 LIBRARY; T=293.16K  
Photon emission for (n,n\*)he3

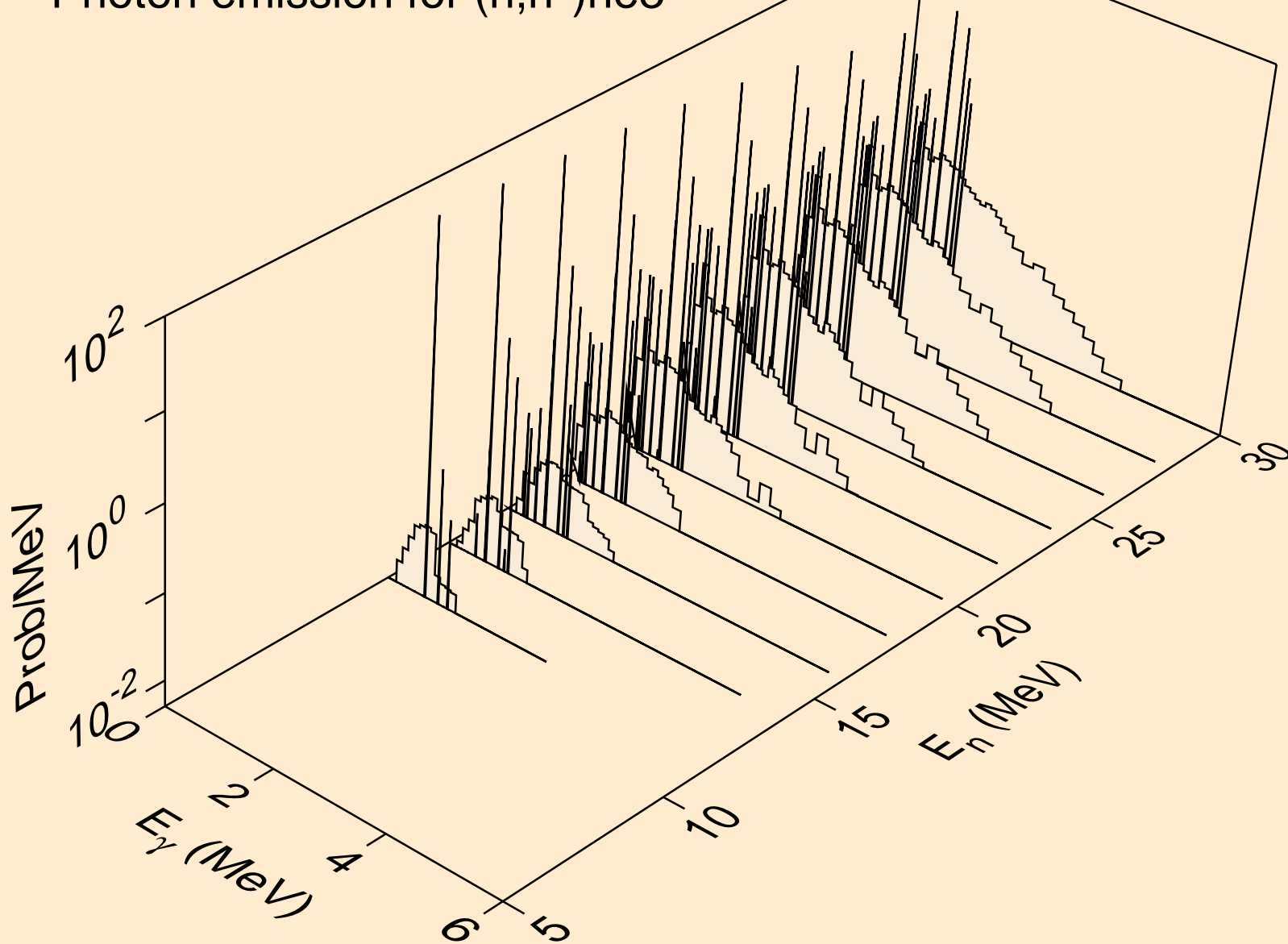

ER149M NEUTRON ACER TENDL-2019 LIBRARY; T=293.16K  
Photon emission for (n,2np)

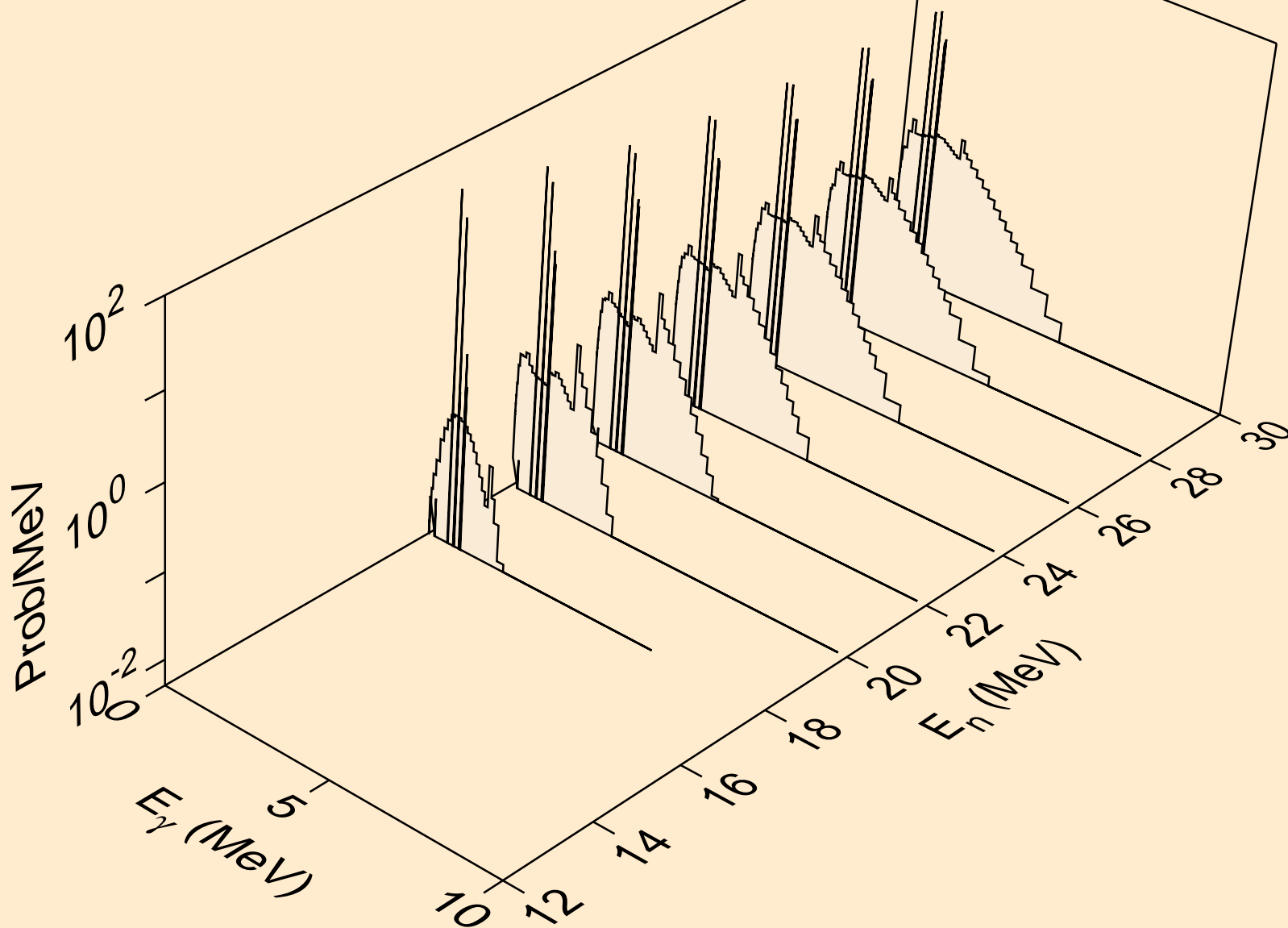



ER149M NEUTRON ACER TENDL-2019 LIBRARY; T=293.16K  
Photon emission for (n,3np)

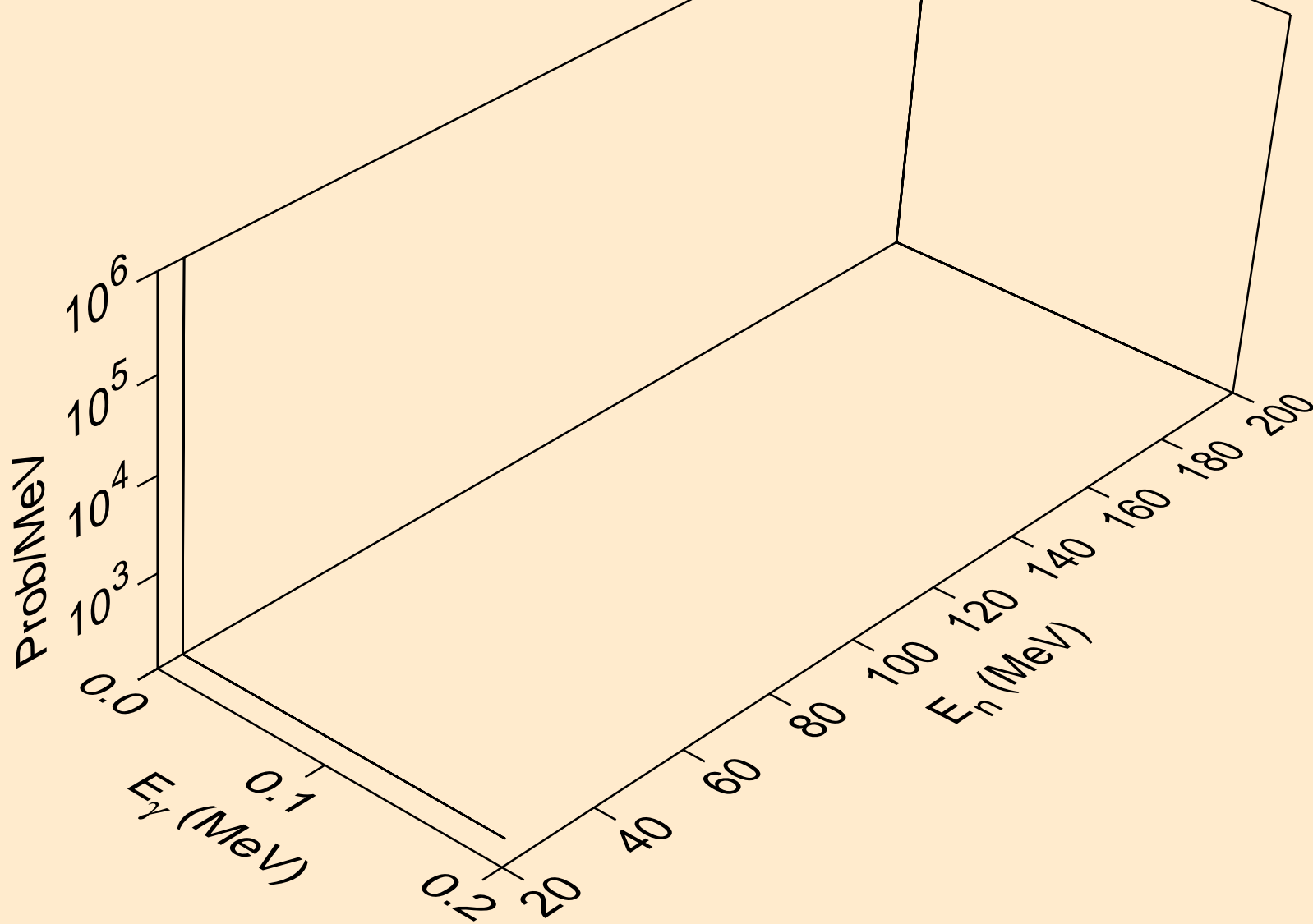

ER149M NEUTRON ACER TENDL-2019 LIBRARY; T=293.16K  
Photon emission for (n,2np)

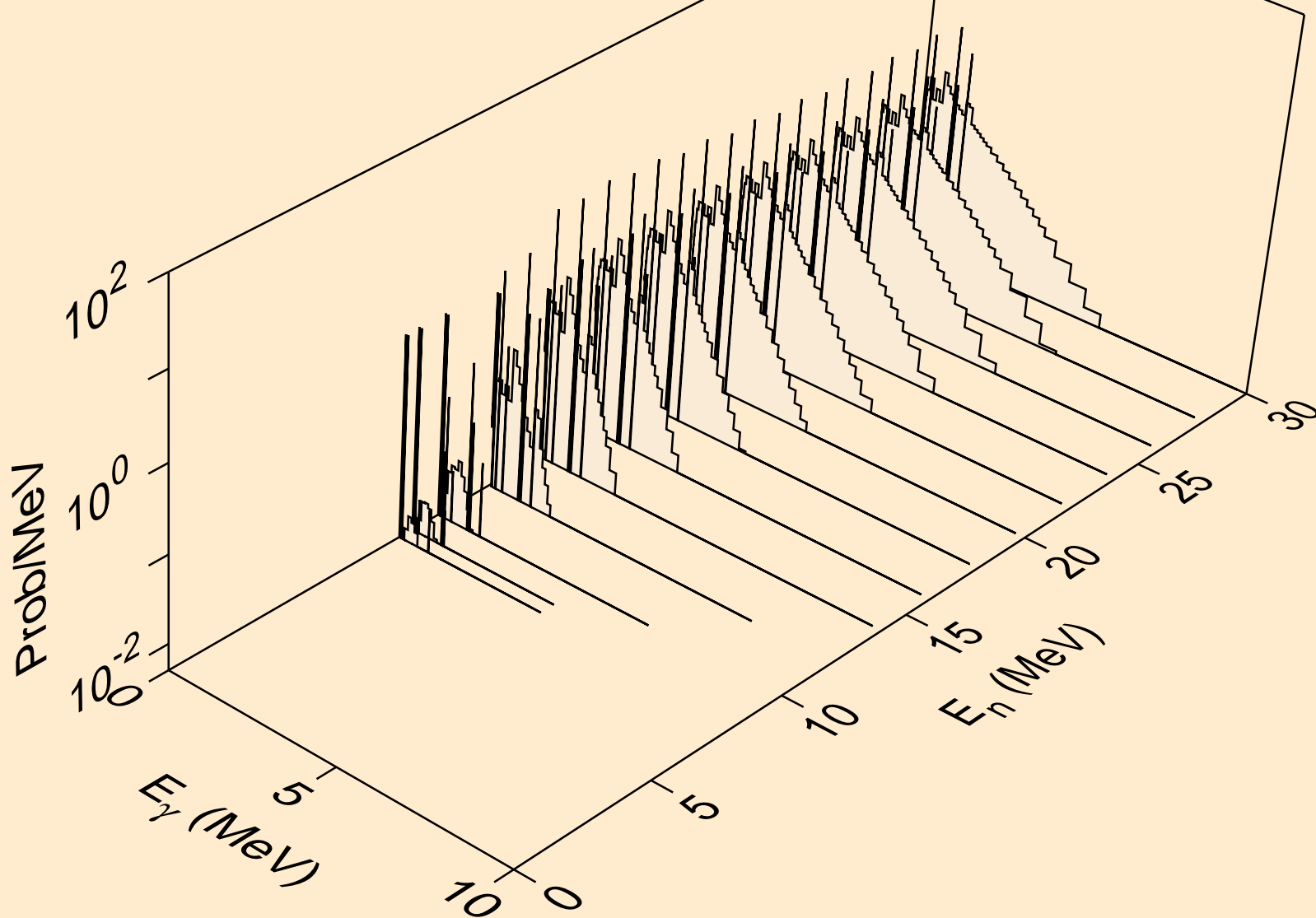

ER149M NEUTRON ACER TENDL-2019 LIBRARY; T=293.16K  
Photon emission for (n,npa)

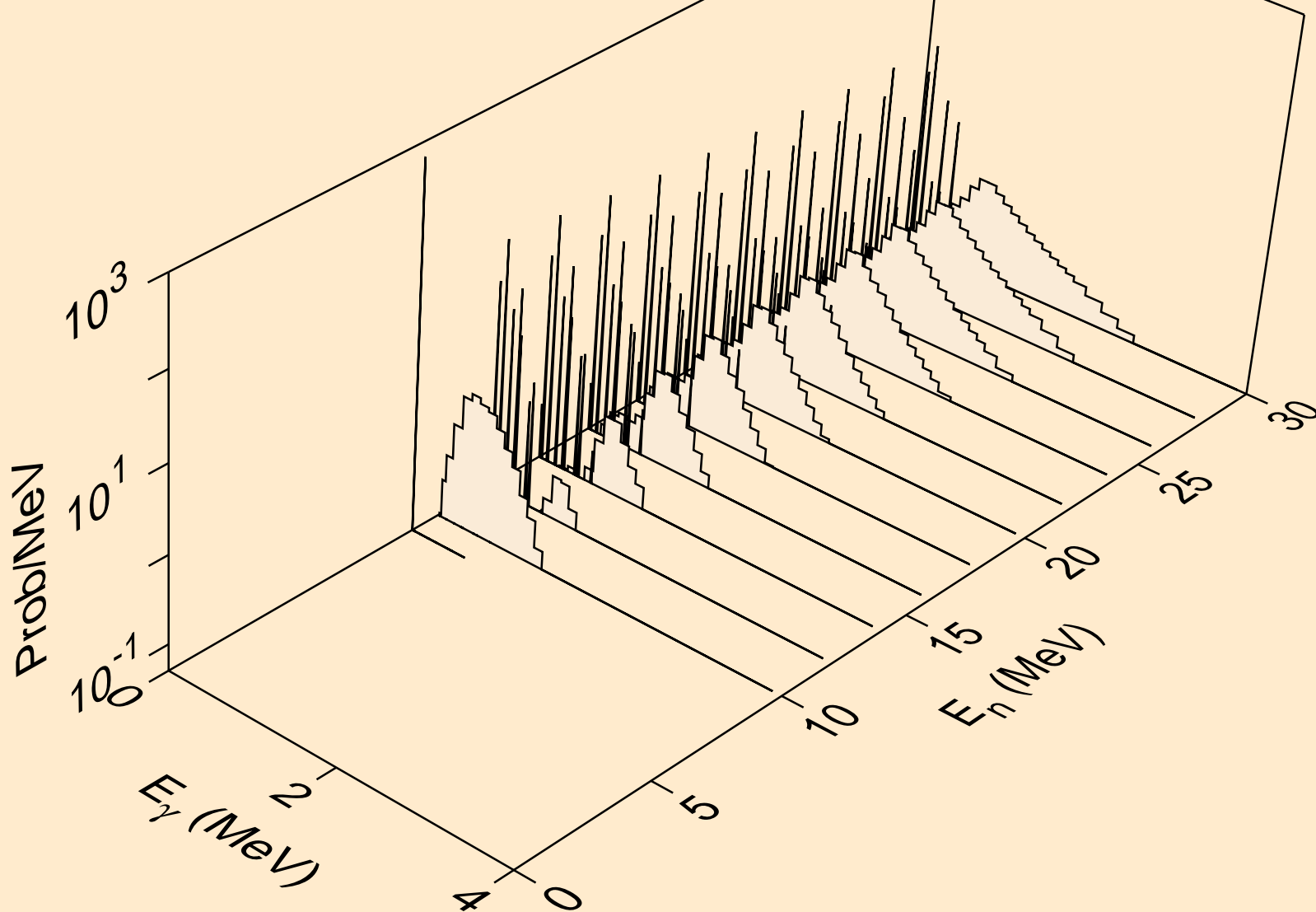

ER149M NEUTRON ACER TENDL-2019 LIBRARY; T=293.16K  
Photon emission for (n,n\*1)

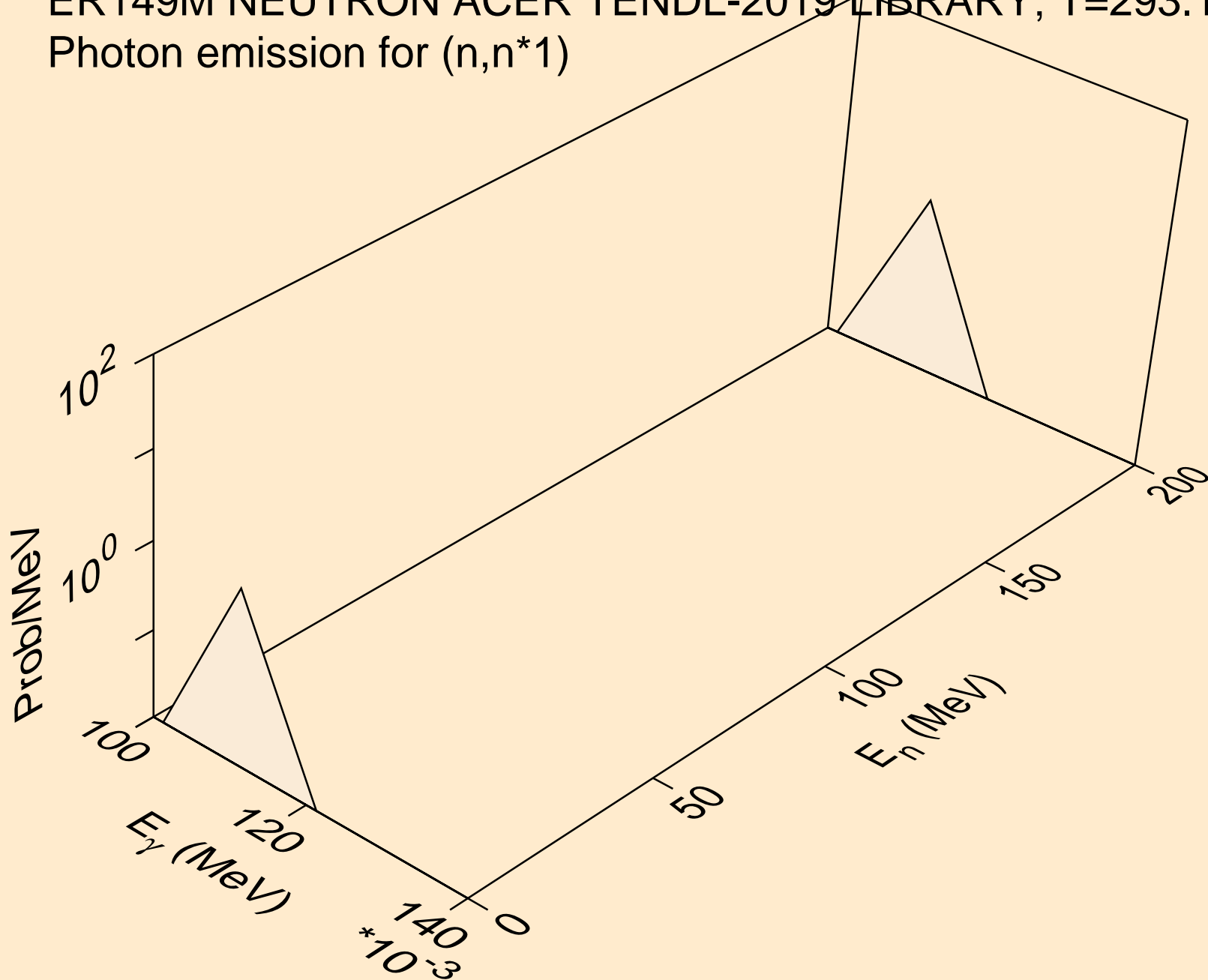

ER149M NEUTRON ACER TENDL-2019 LIBRARY; T=293.16K  
Photon emission for (n,n\*3)

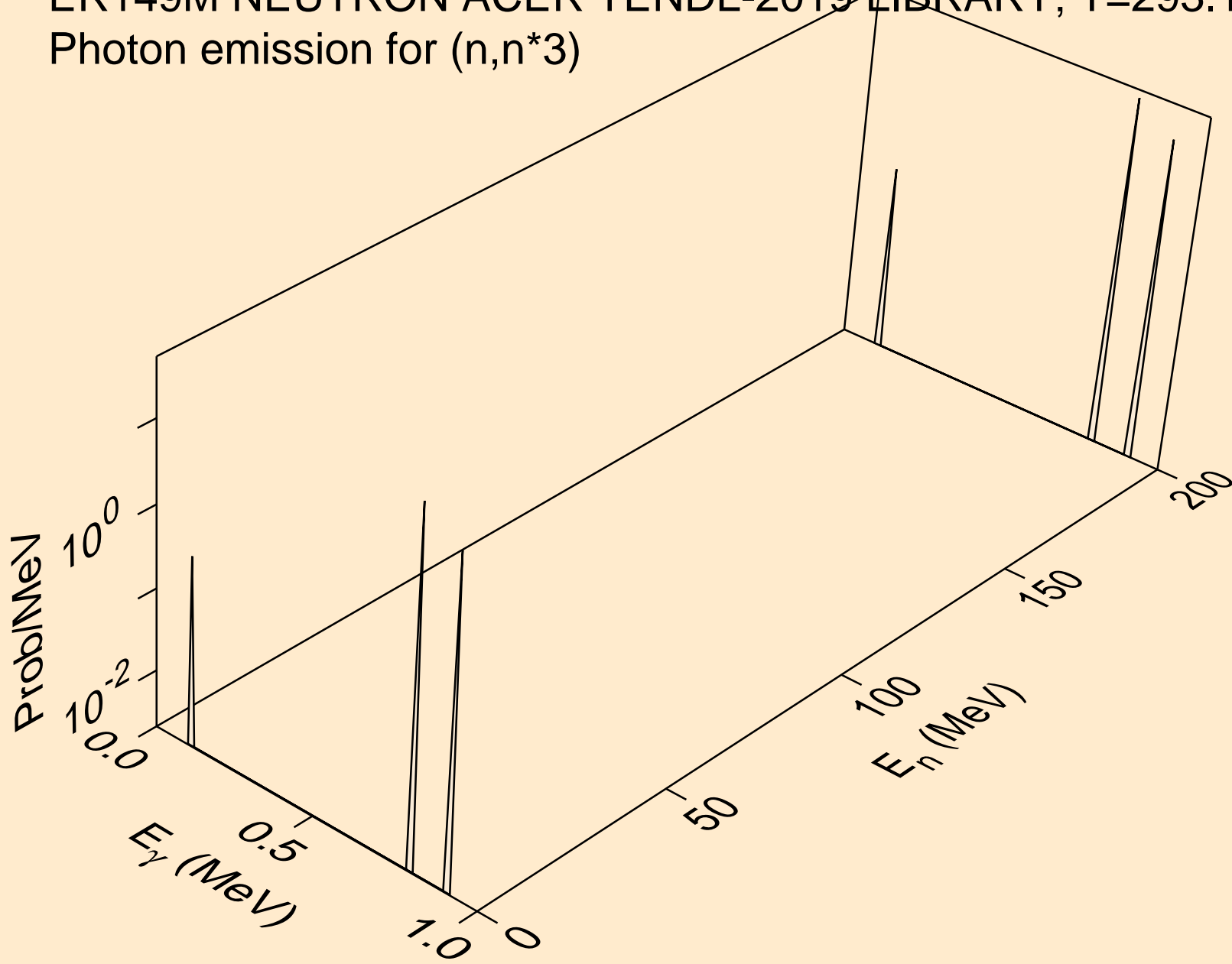

ER149M NEUTRON ACER TENDL-2019 LIBRARY; T=293.16K  
Photon emission for (n,n\*4)

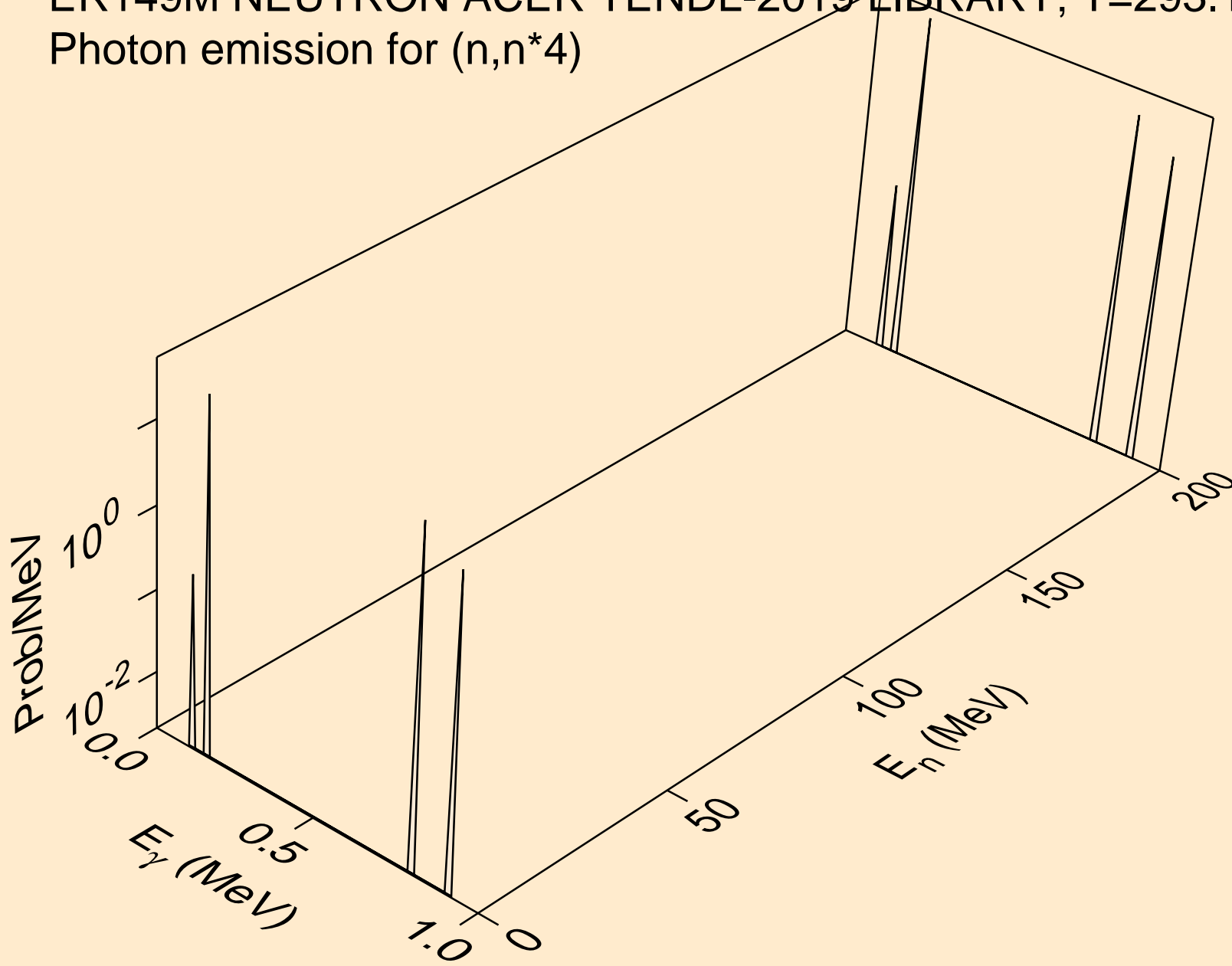

ER149M NEUTRON ACER TENDL-2019 LIBRARY; T=293.16K  
Photon emission for (n,n\*5)

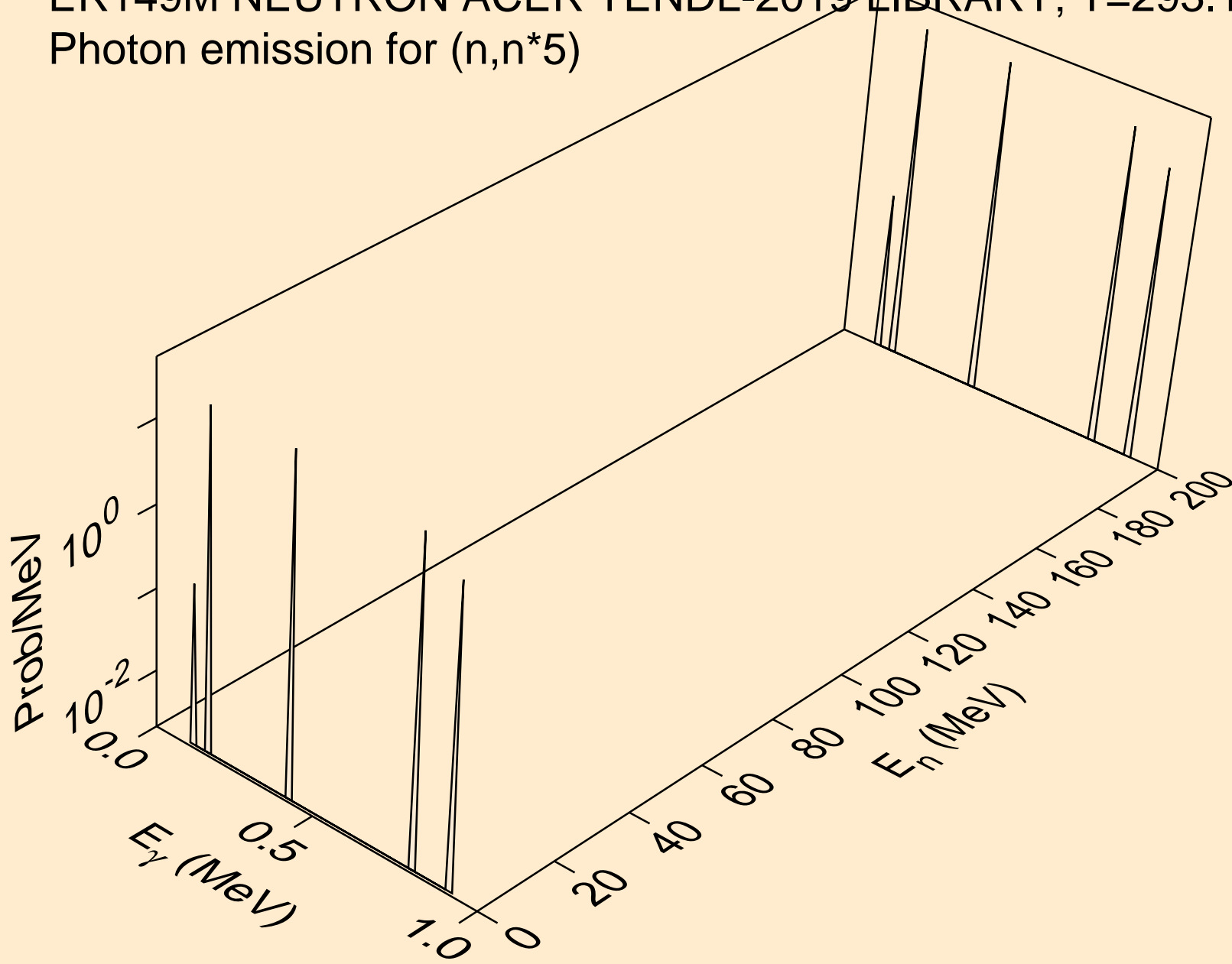

ER149M NEUTRON ACER TENDL-2019 LIBRARY; T=293.16K  
Photon emission for (n,n\*c)

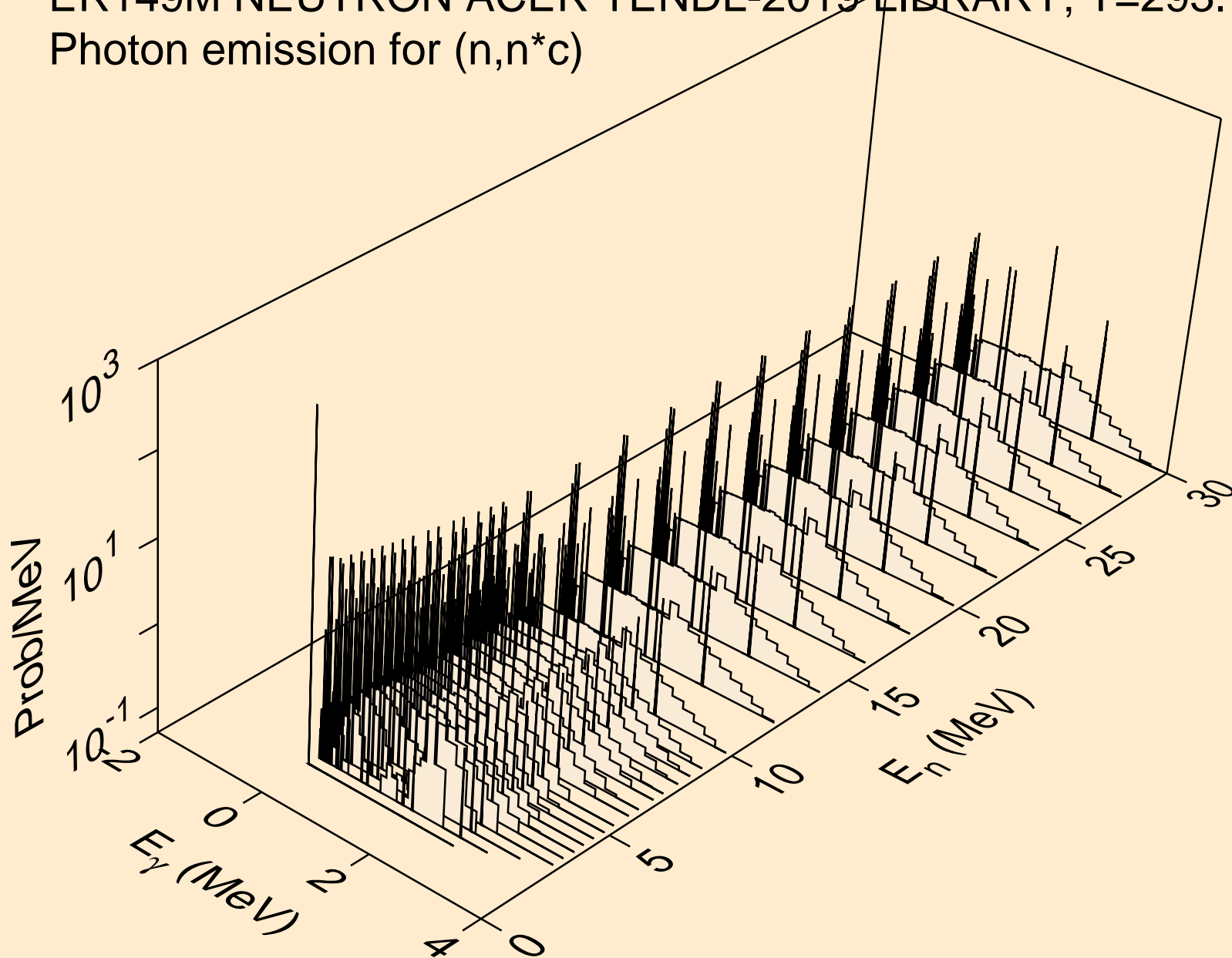



ER149M NEUTRON ACER TENDL-2019 LIBRARY; T=293.16K  
Photon emission for (n,gma)

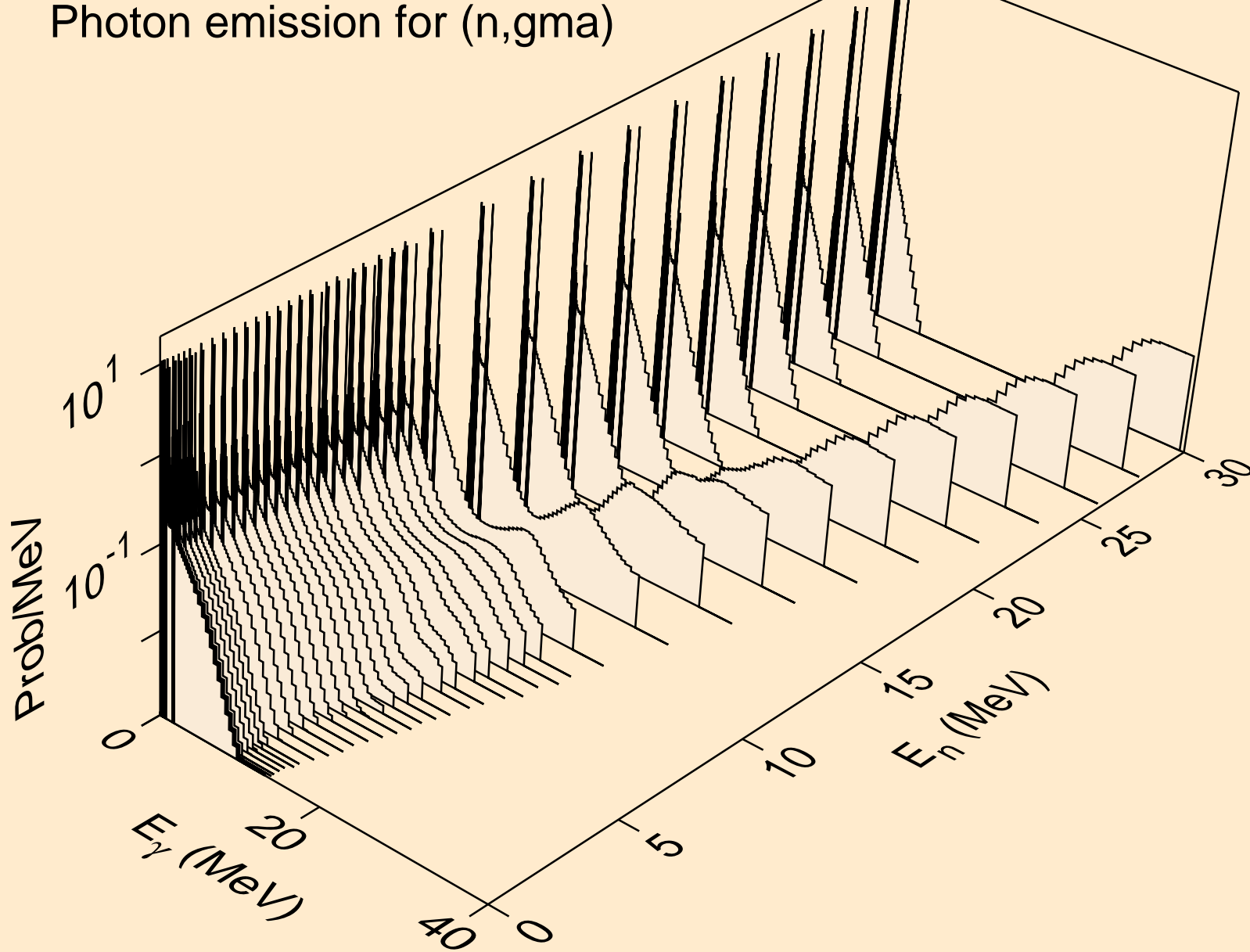

ER149M NEUTRON ACER TENDL-2019 LIBRARY; T=293.16K  
Photon emission for (n,p)

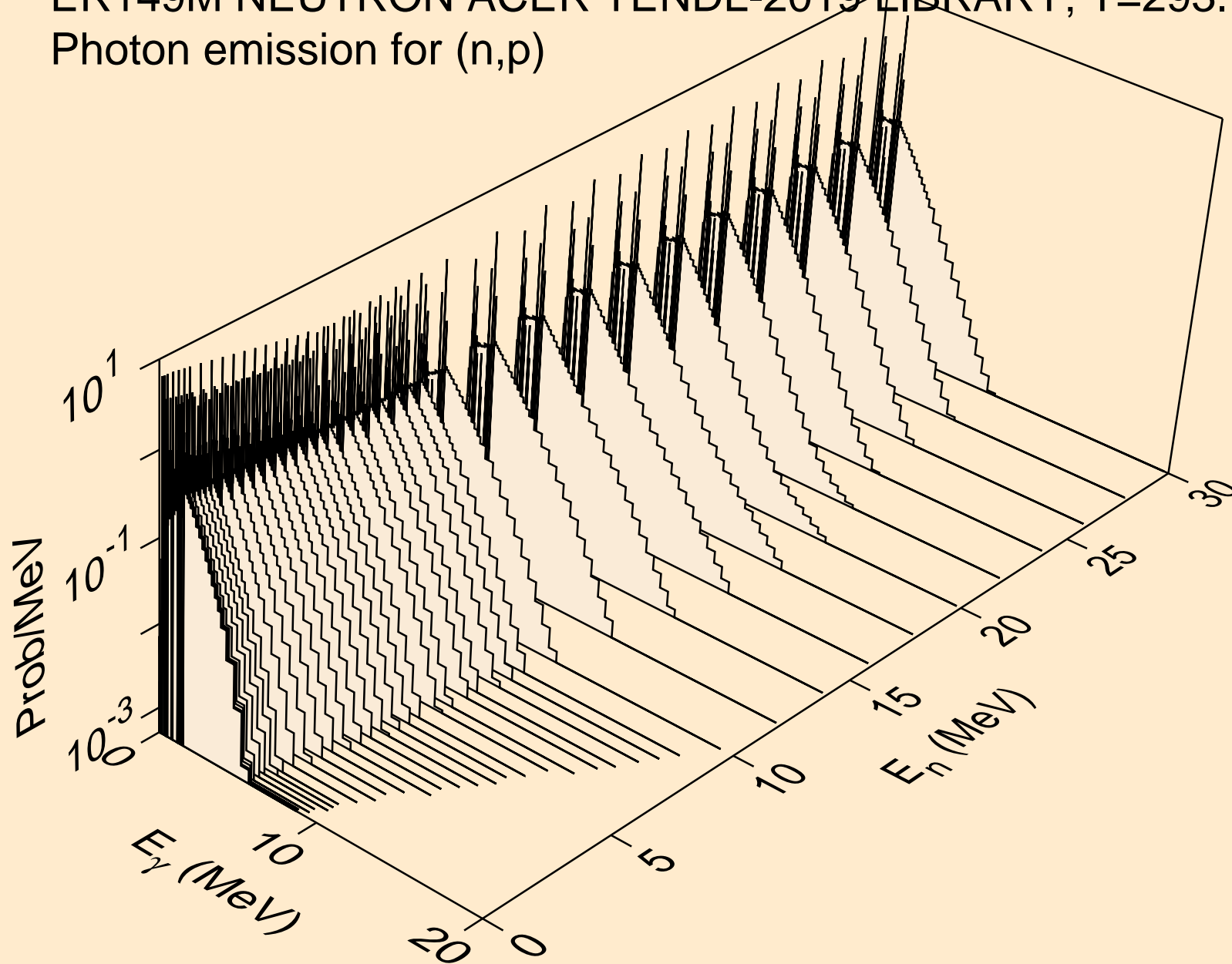

ER149M NEUTRON ACER TENDL-2019 LIBRARY; T=293.16K  
Photon emission for (n,d)

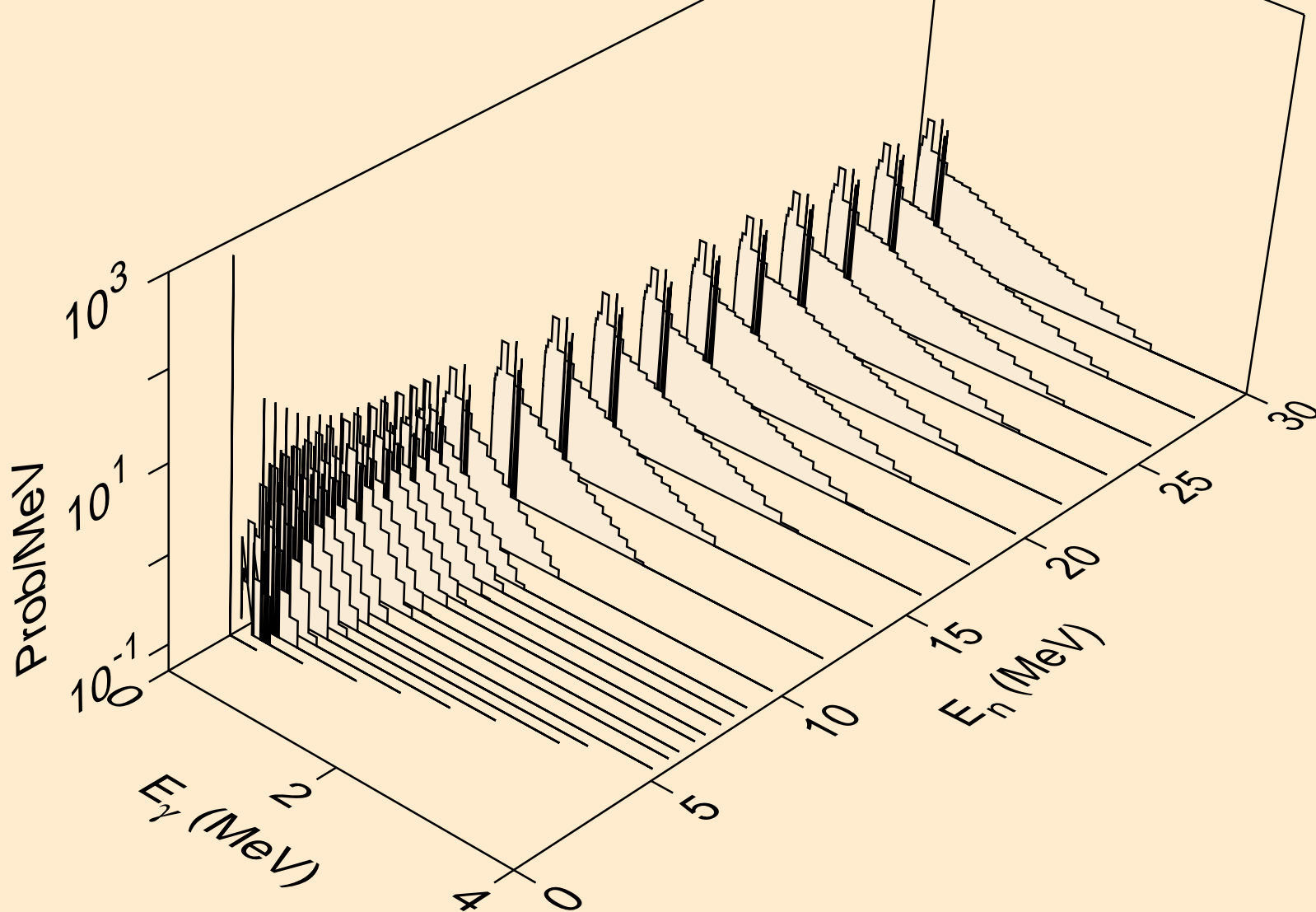

ER149M NEUTRON ACER TENDL-2019 LIBRARY; T=293.16K  
Photon emission for (n,t)

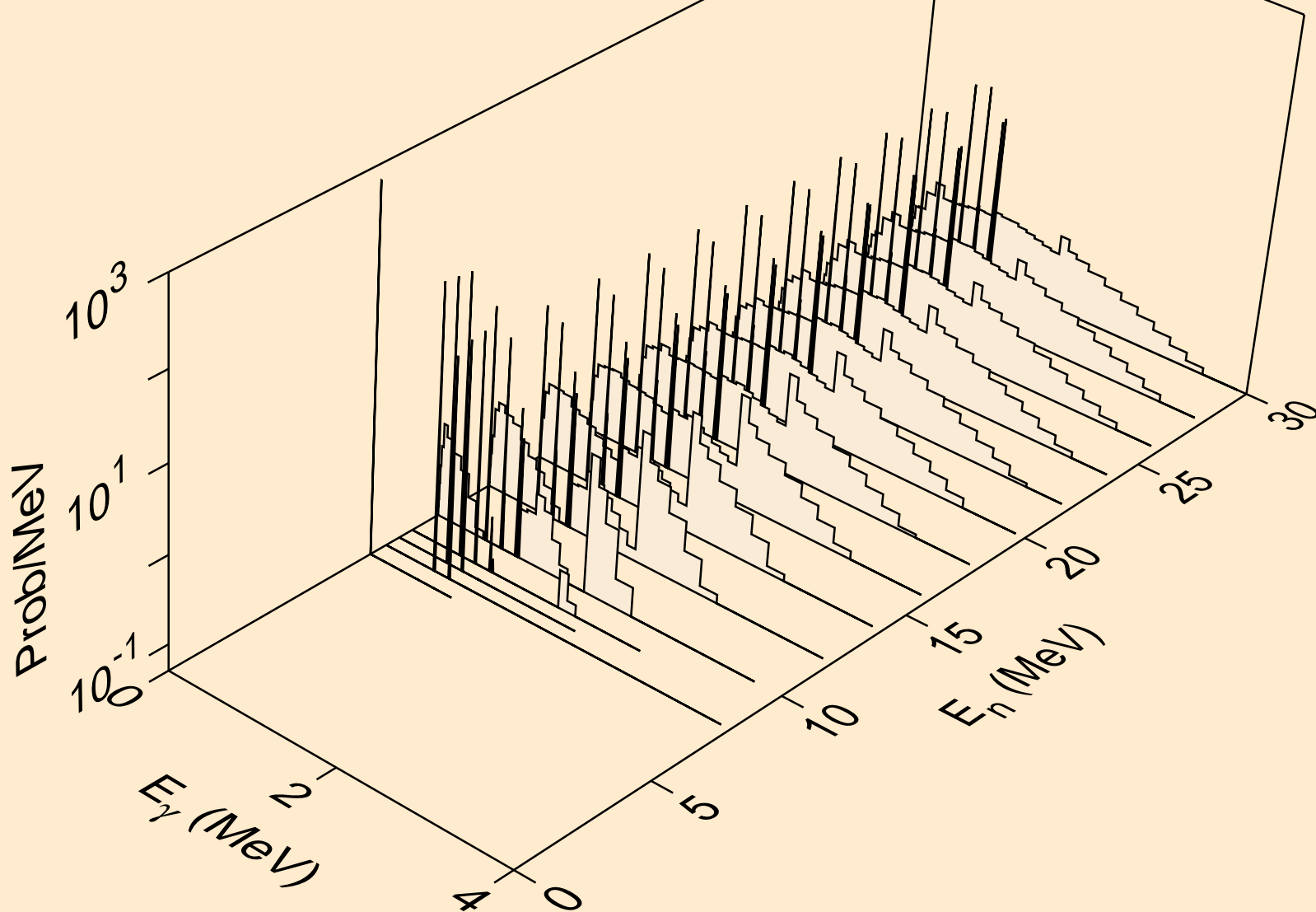

ER149M NEUTRON ACER TENDL-2019 LIBRARY; T=293.16K  
Photon emission for (n,he3)

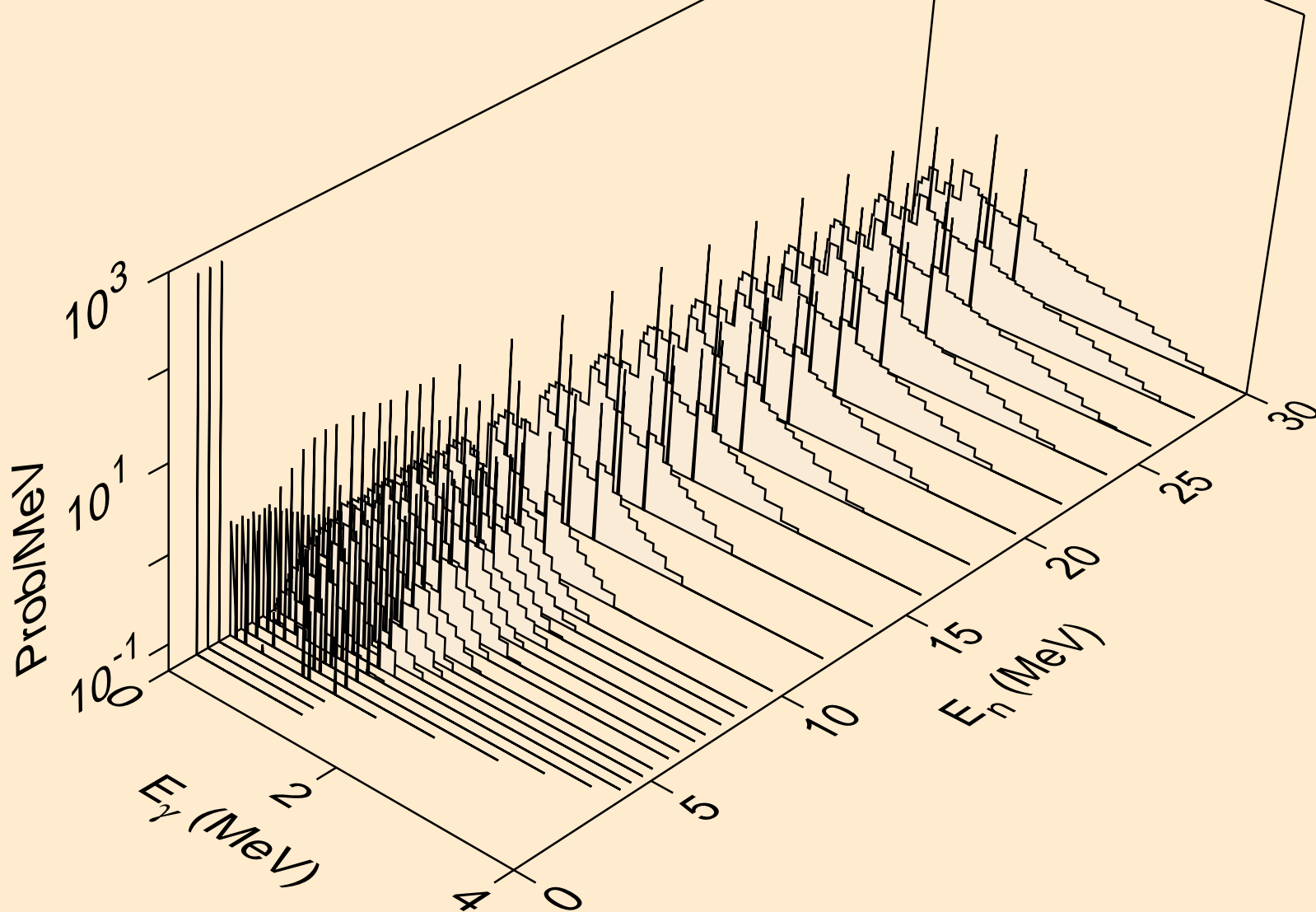

ER149M NEUTRON ACER TENDL-2019 LIBRARY; T=293.16K  
Photon emission for (n,a)

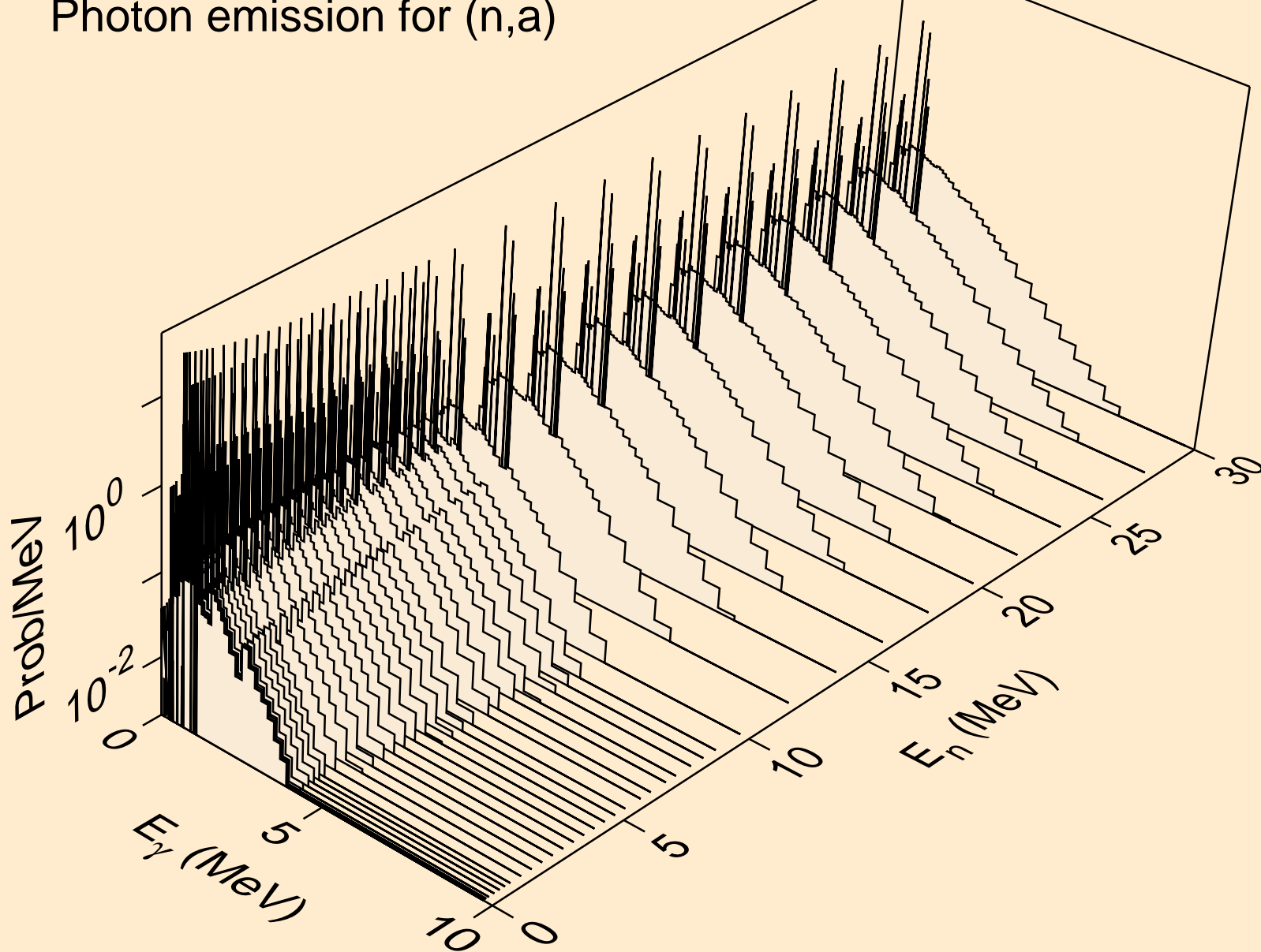

ER149M NEUTRON ACER TENDL-2019 LIBRARY; T=293.16K  
Photon emission for (n,2a)

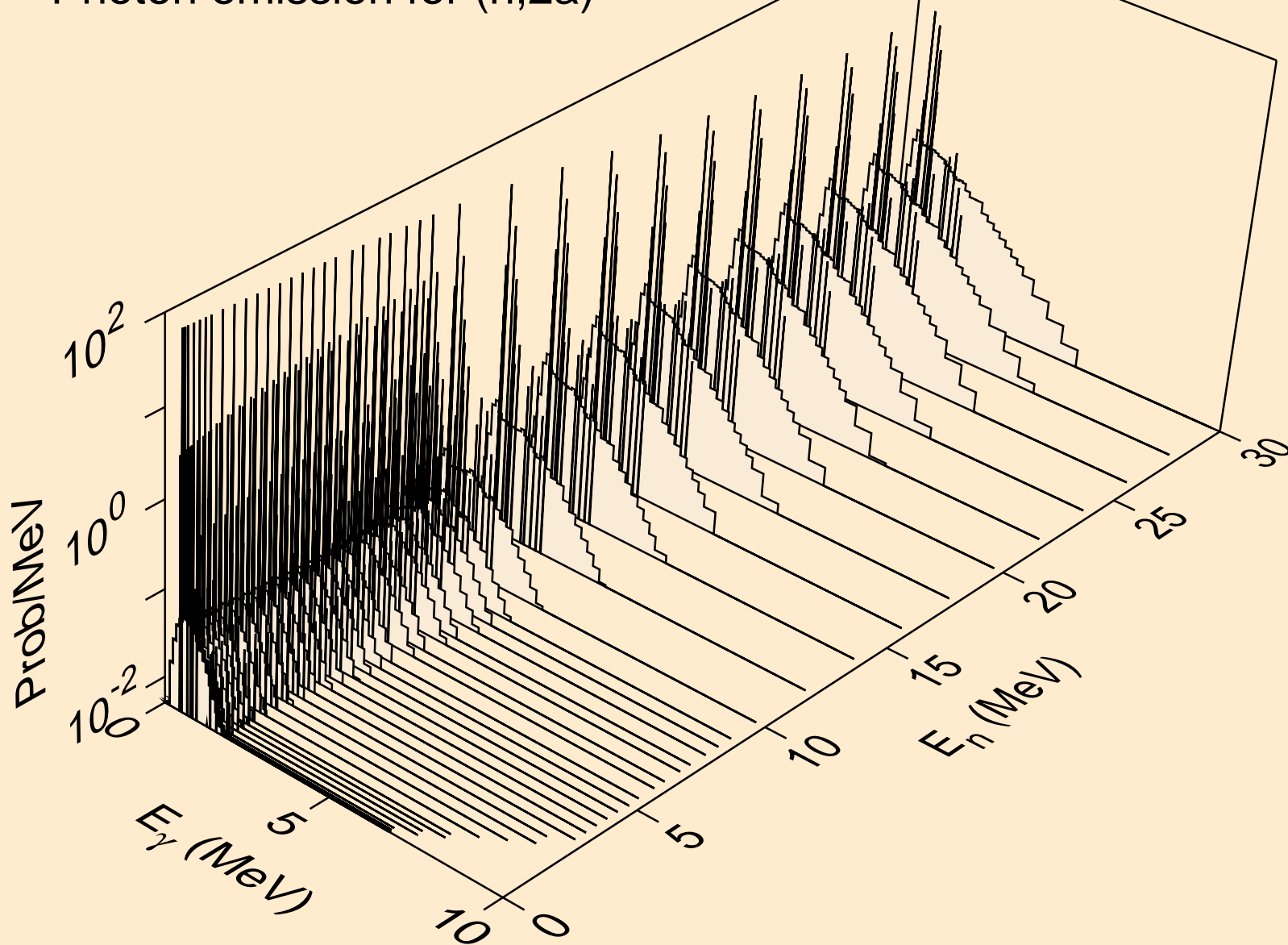

ER149M NEUTRON ACER TENDL-2019 LIBRARY; T=293.16K  
Photon emission for (n,3a)

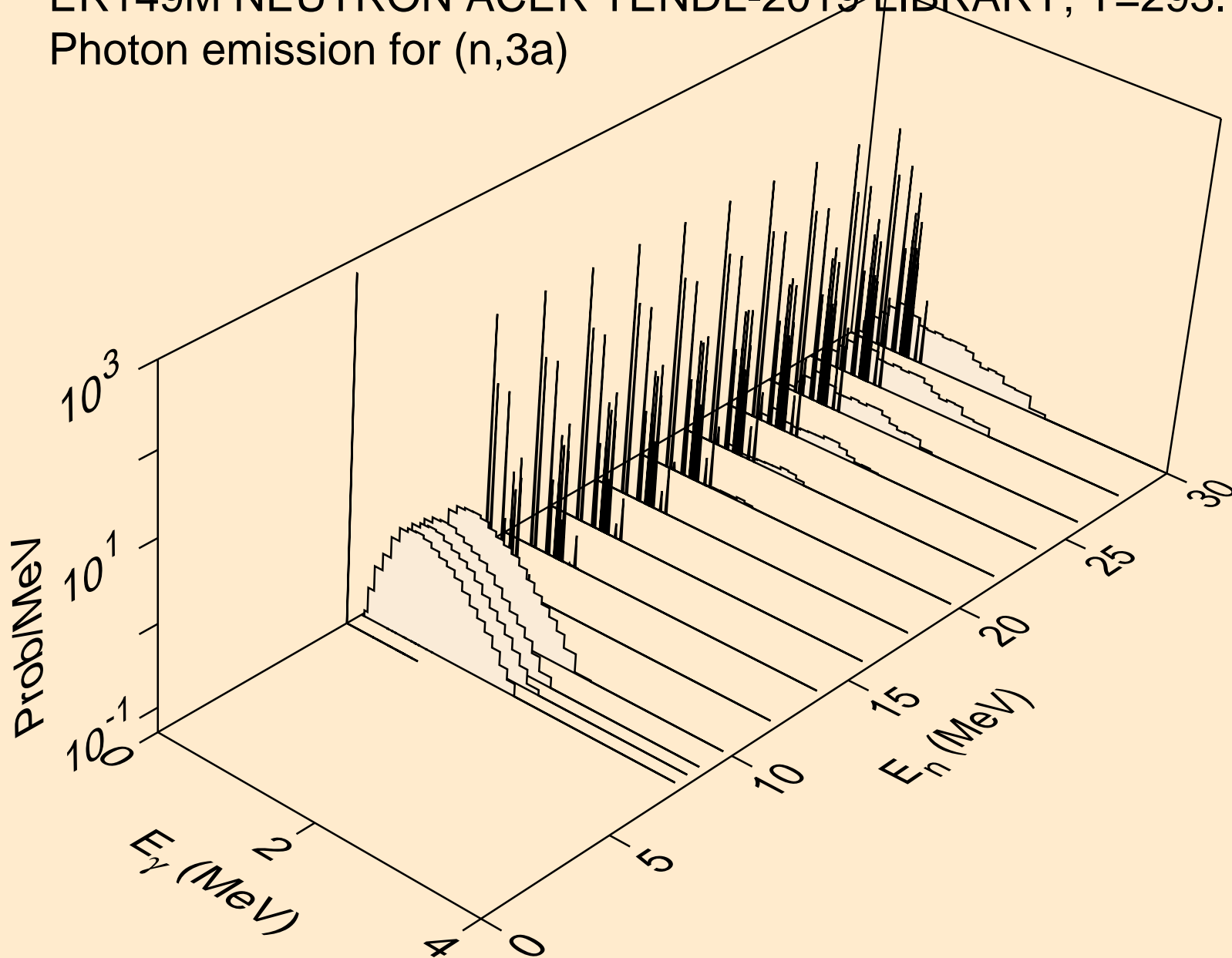



ER149M NEUTRON ACER TENDL-2019 LIBRARY; T=293.16K  
Photon emission for (n,2p)

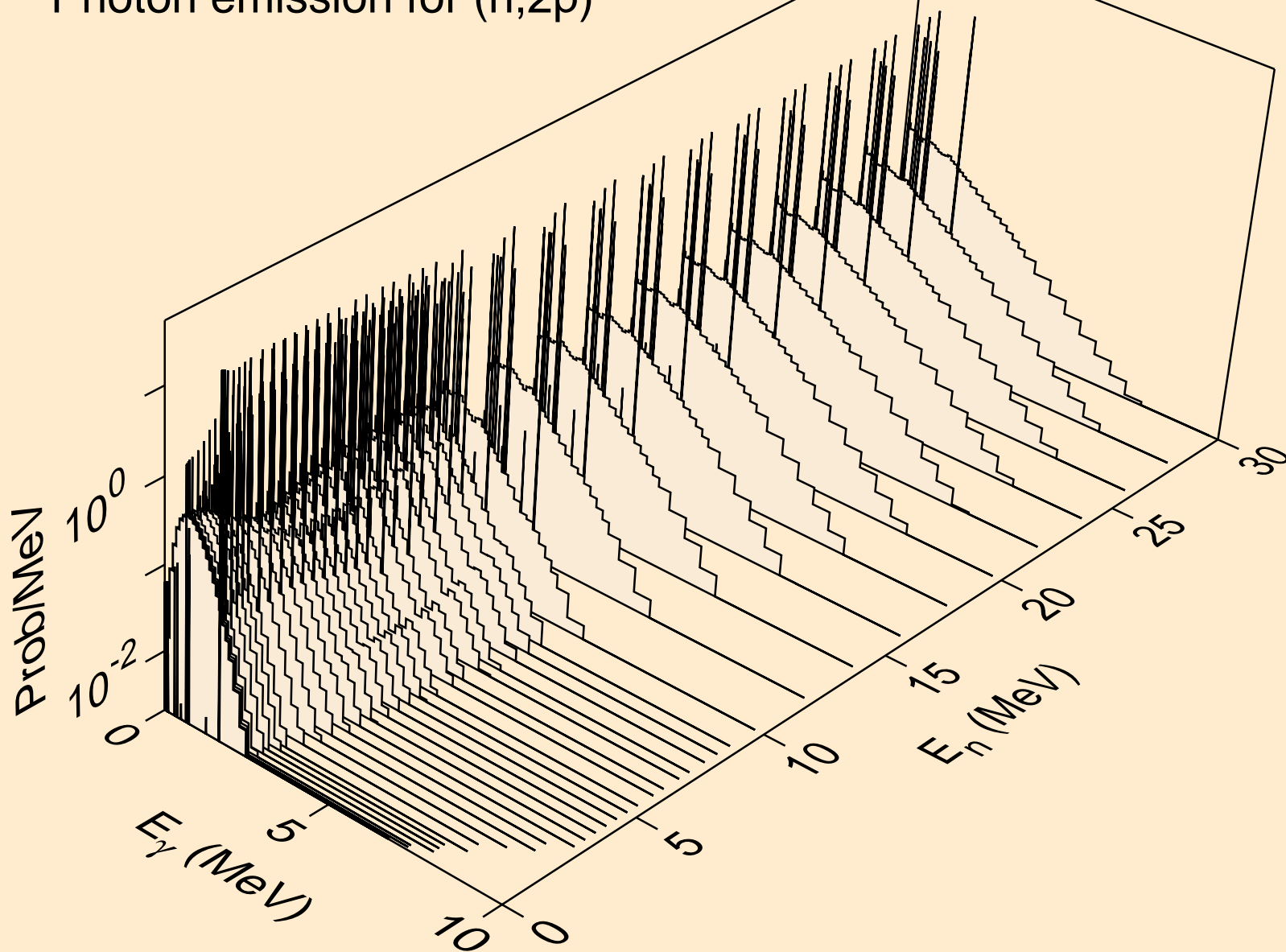

ER149M NEUTRON ACER TENDL-2019 LIBRARY; T=293.16K  
Photon emission for (n,p $\alpha$ )

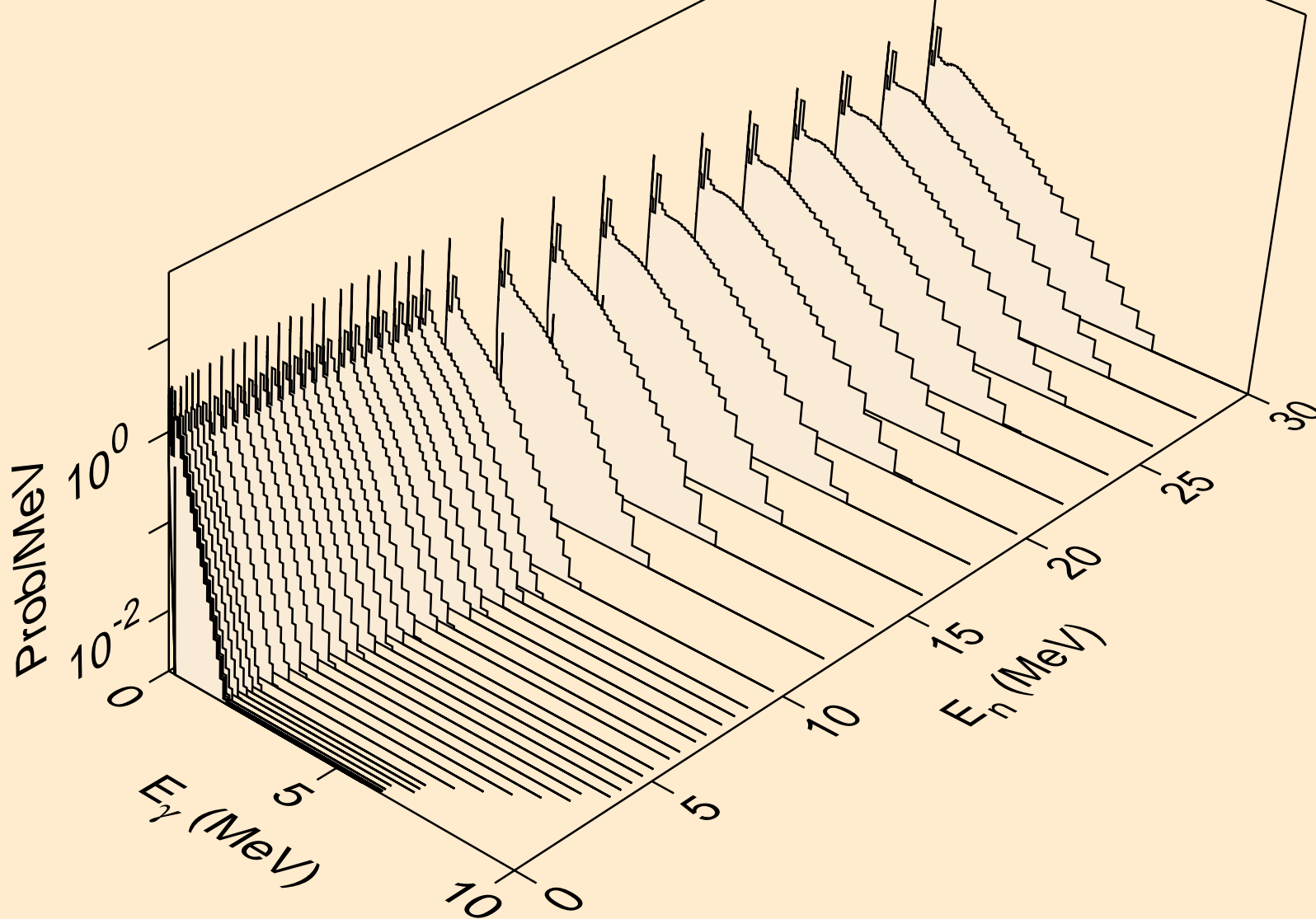

ER149M NEUTRON ACER TENDL-2019 LIBRARY; T=293.16K  
Photon emission for (n,pd)

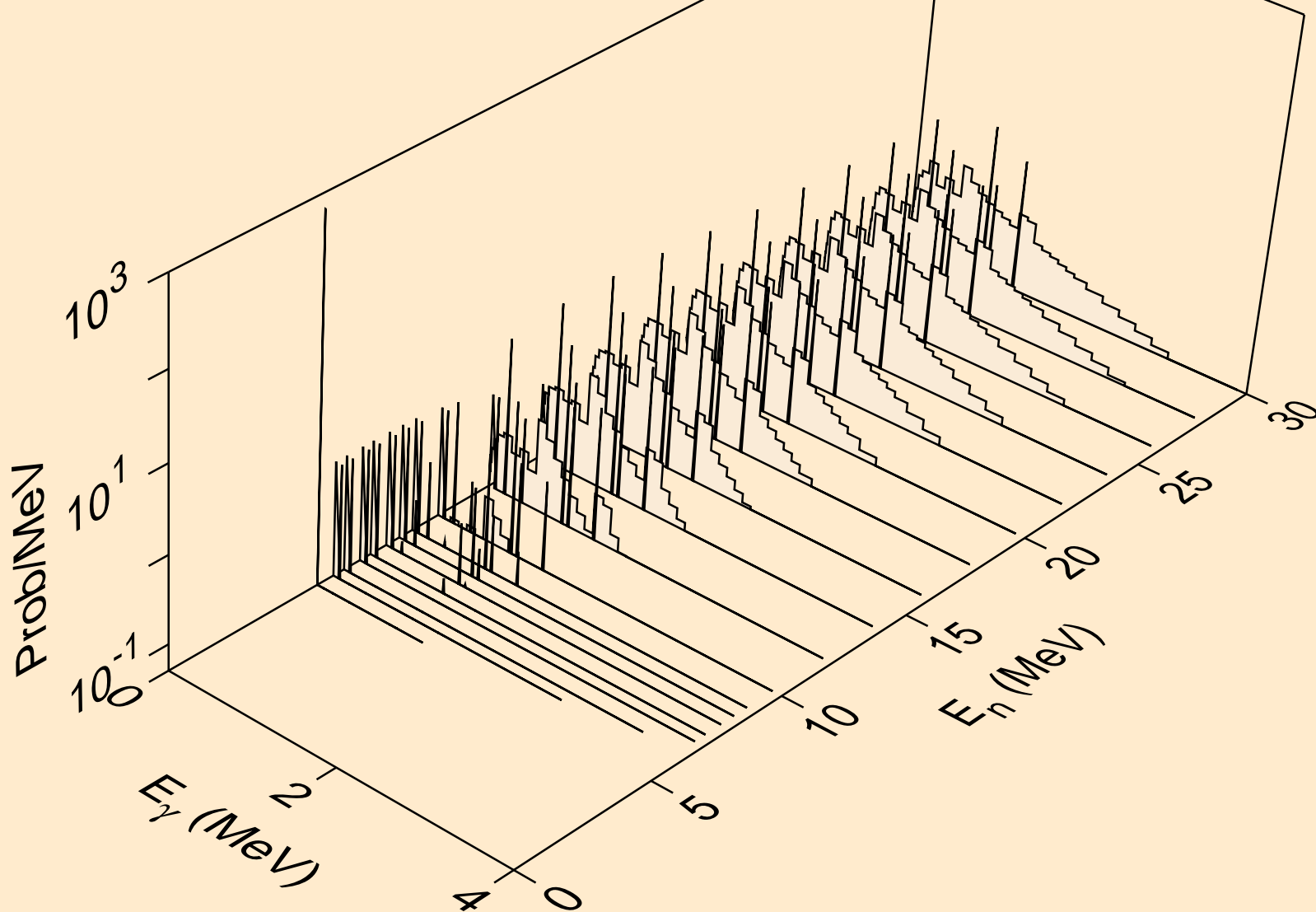

ER149M NEUTRON ACER TENDL-2019 LIBRARY; T=293.16K  
Photon emission for (n,pt)

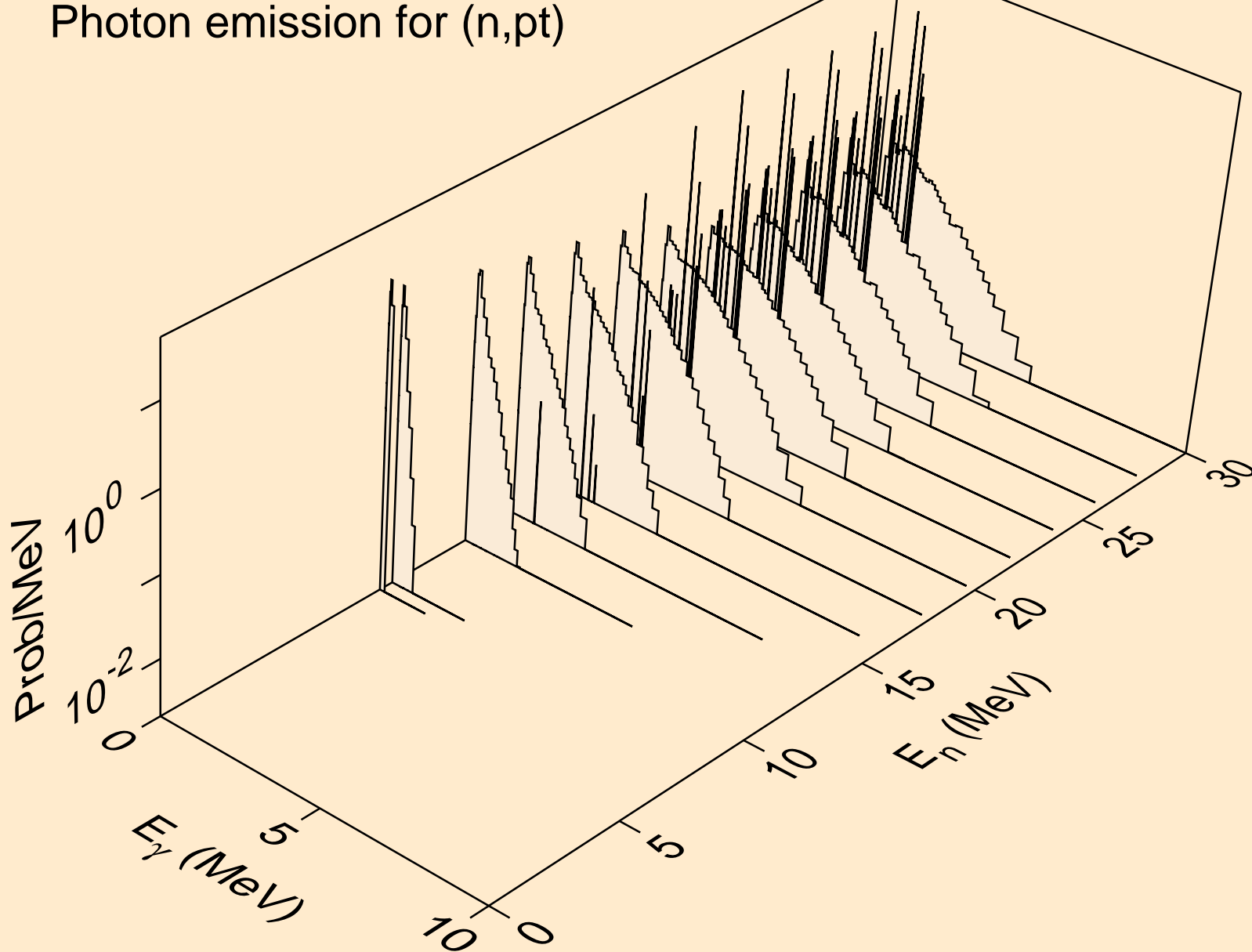

ER149M NEUTRON ACER TENDL-2019 LIBRARY; T=293.16K  
Photon emission for (n,da)

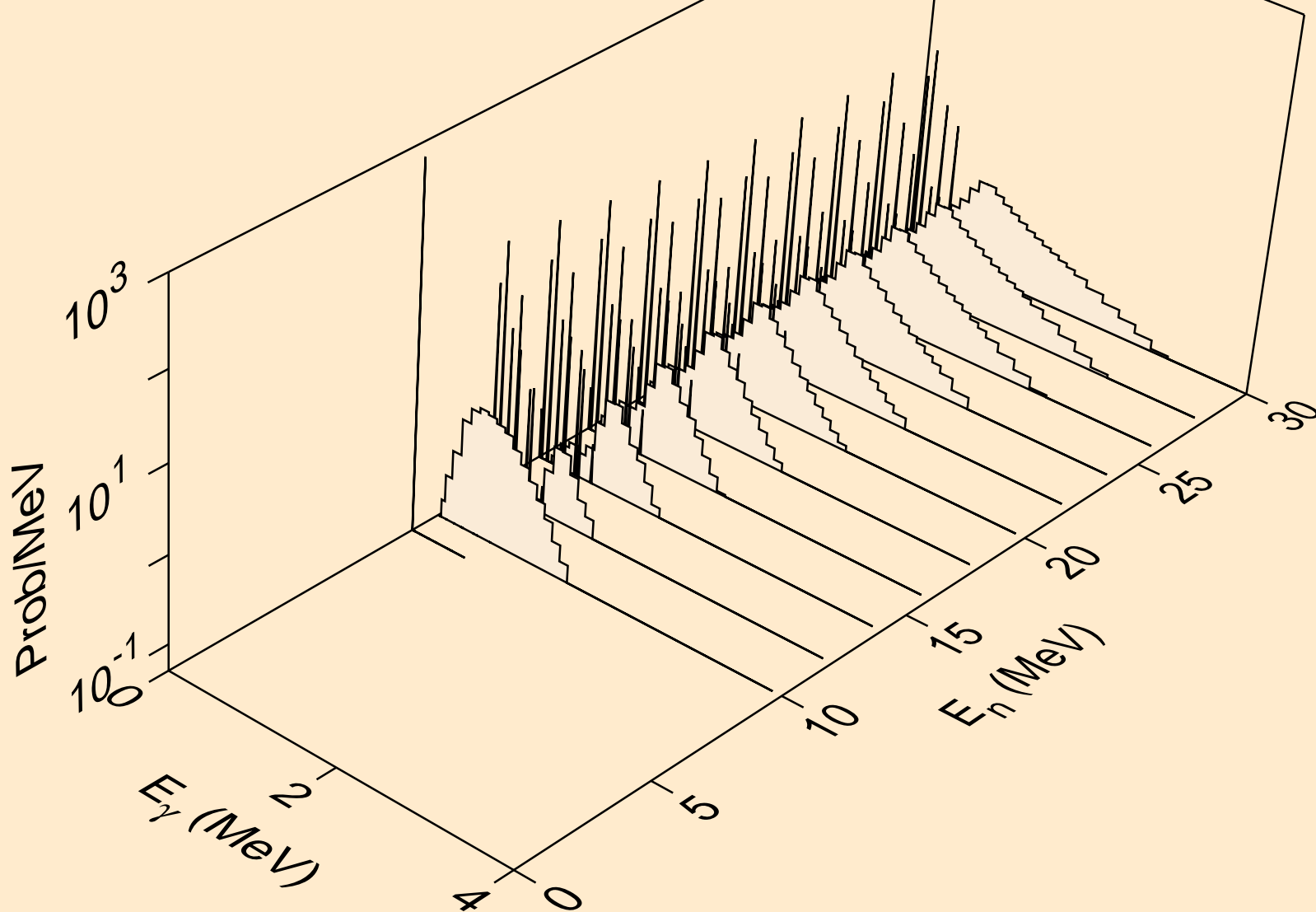

ER149M NEUTRON ACER TENDL-2019 LIBRARY; T=293.16K  
thermal capture photon spectrum

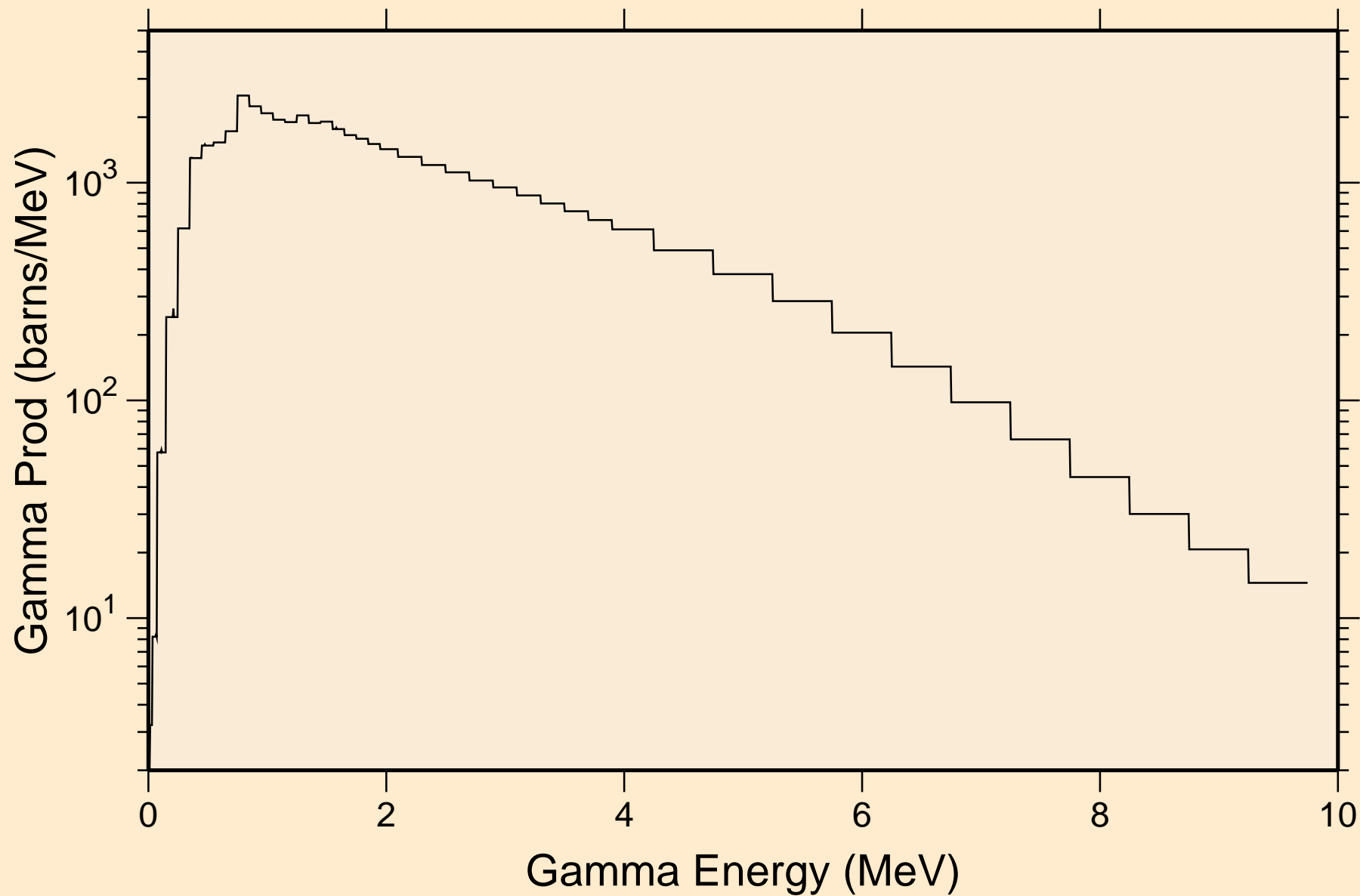

ER149M NEUTRON ACER TENDL-2019 LIBRARY; T=293.16K  
14 MeV photon spectrum

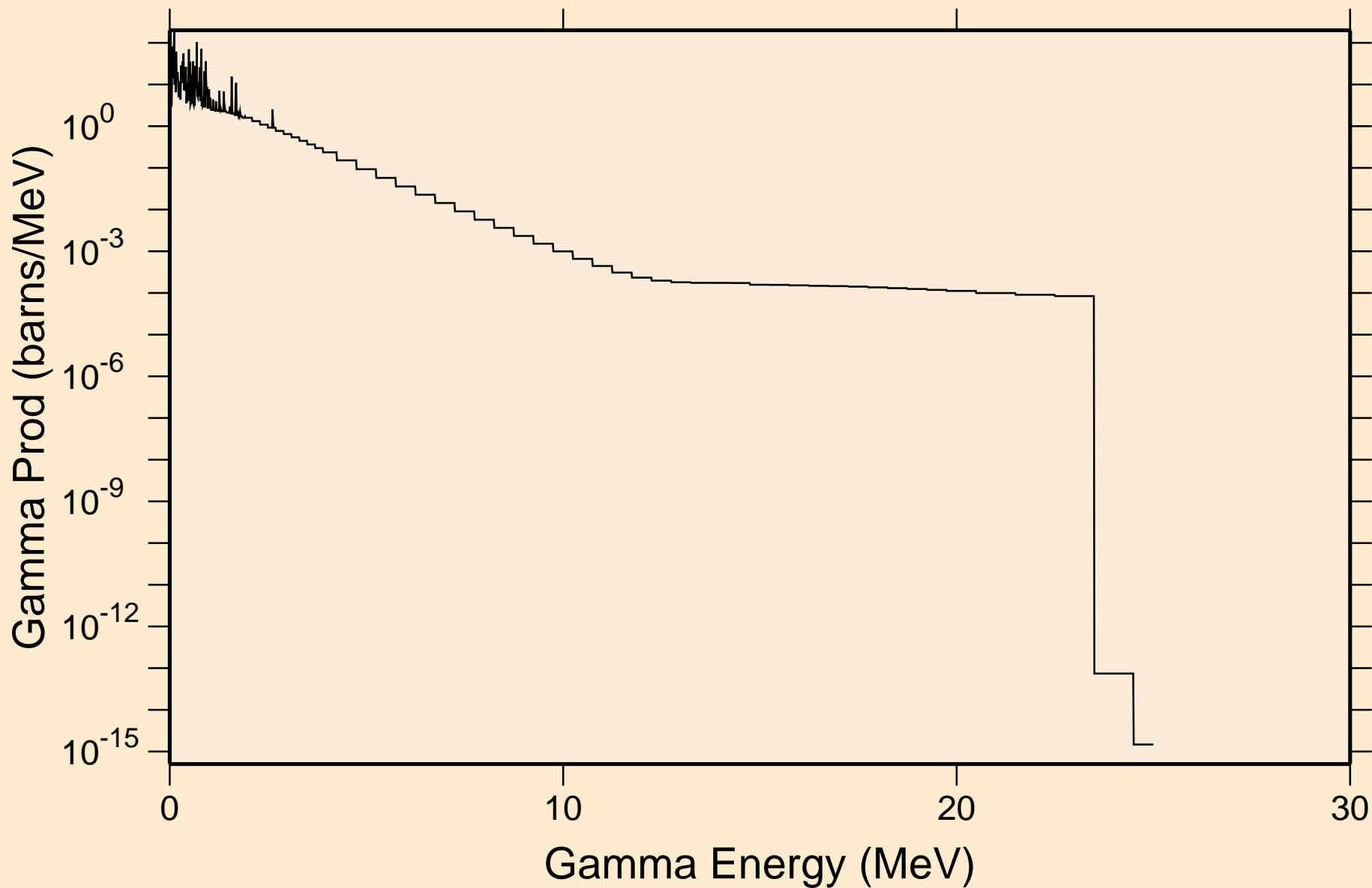

# ER149M NEUTRON ACER TENDL-2019 LIBRARY; T=293.16K

## Particle heating contributions

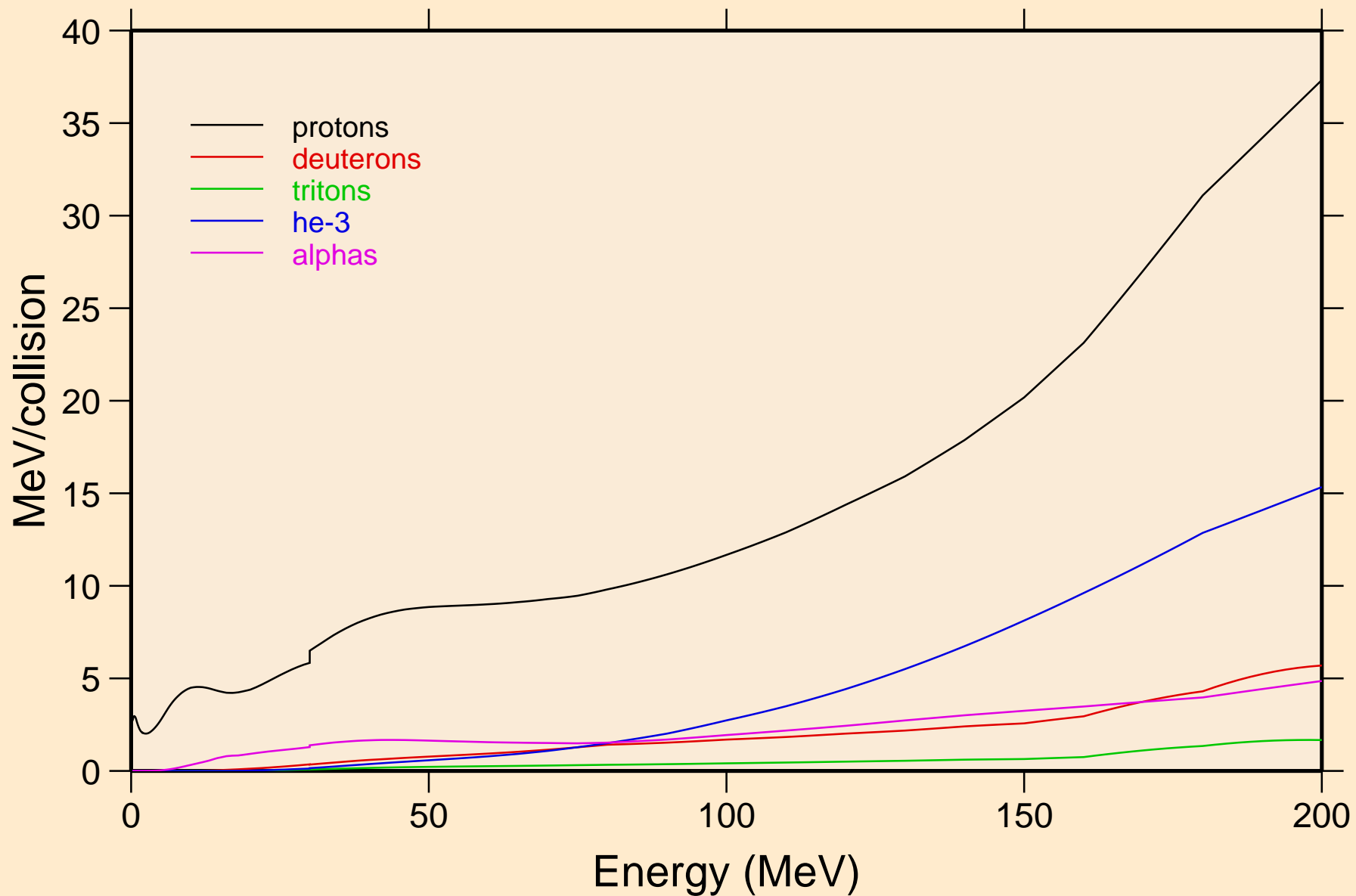



ER149M NEUTRON ACER TENDL-2019 LIBRARY; T=293.16K  
Recoil Heating

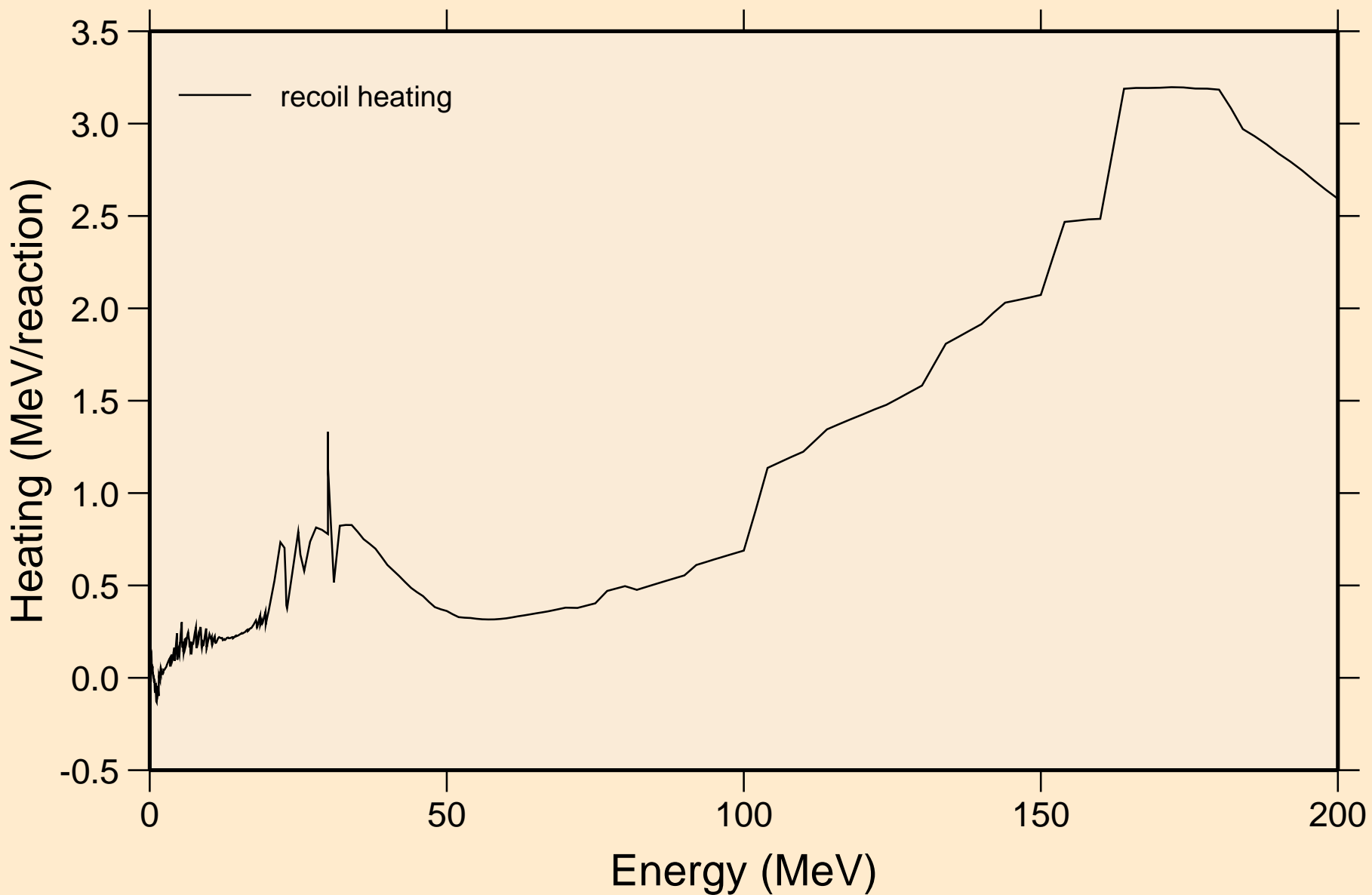

ER149M NEUTRON ACER TENDL-2019 LIBRARY; T=293.16K  
Particle production cross sections

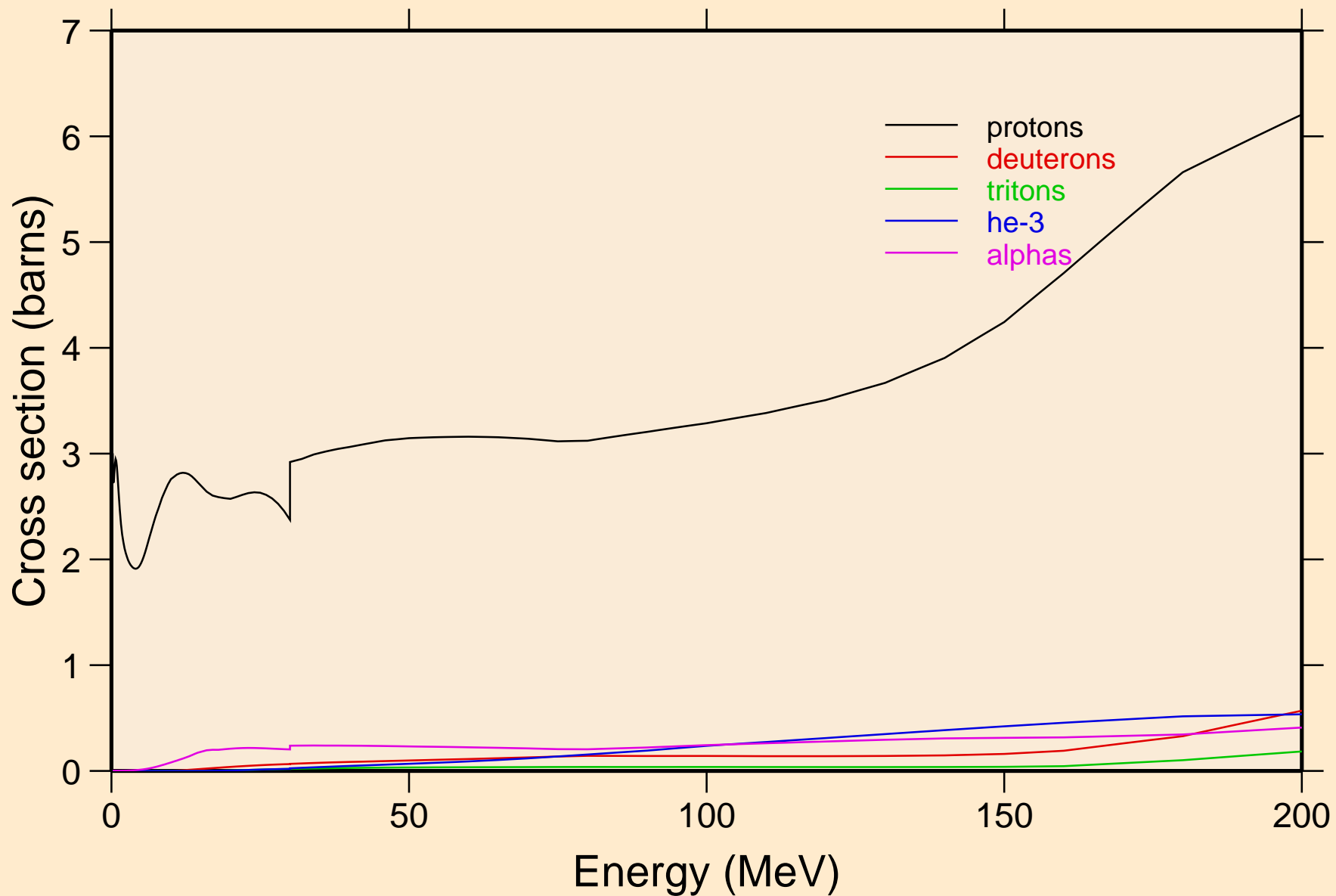

ER149M NEUTRON ACER TENDL-2019 LIBRARY; T=293.16K  
protons from (n,x)

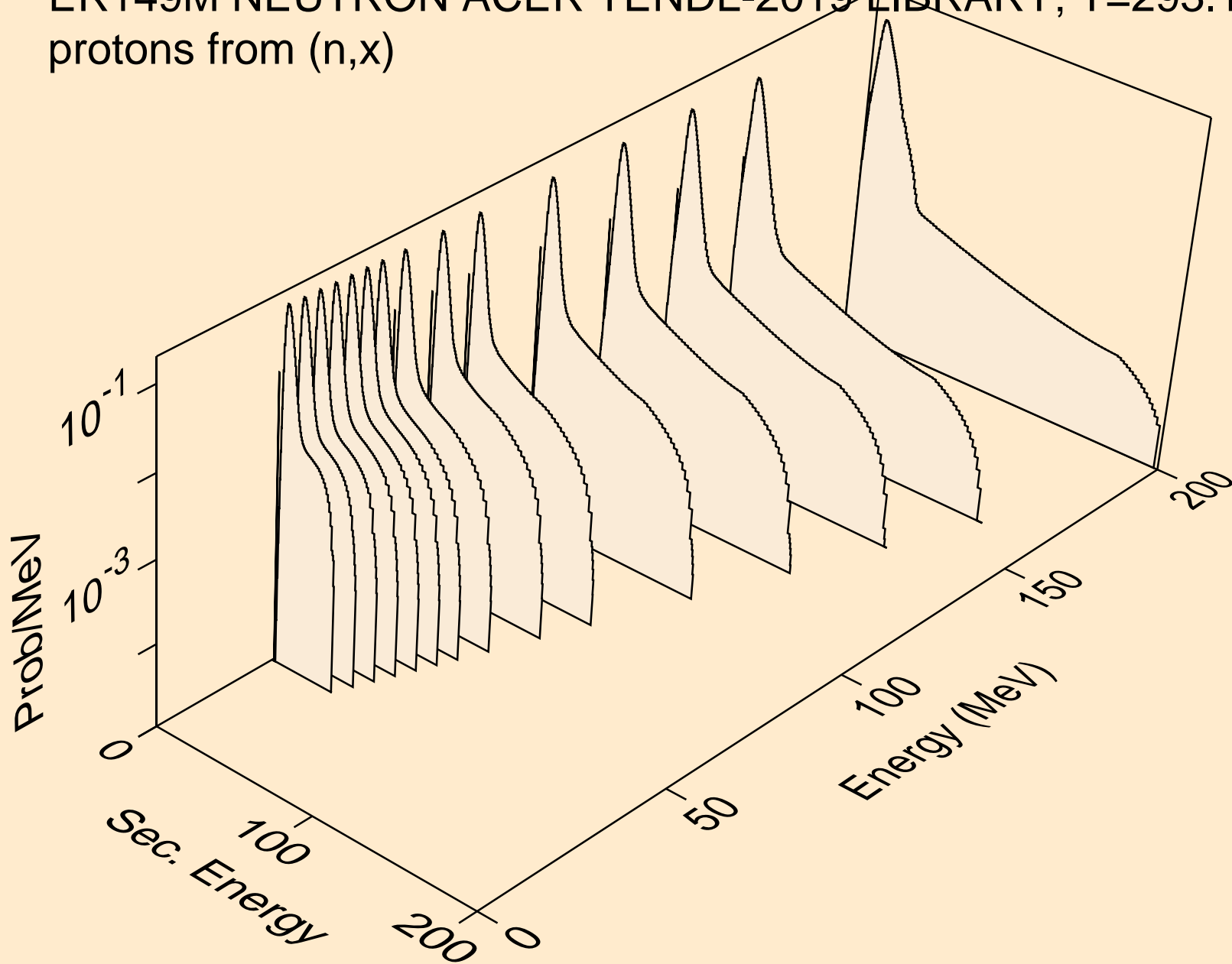

ER149M NEUTRON ACER TENDL-2019 LIBRARY; T=293.16K  
protons from (n,n\*)p

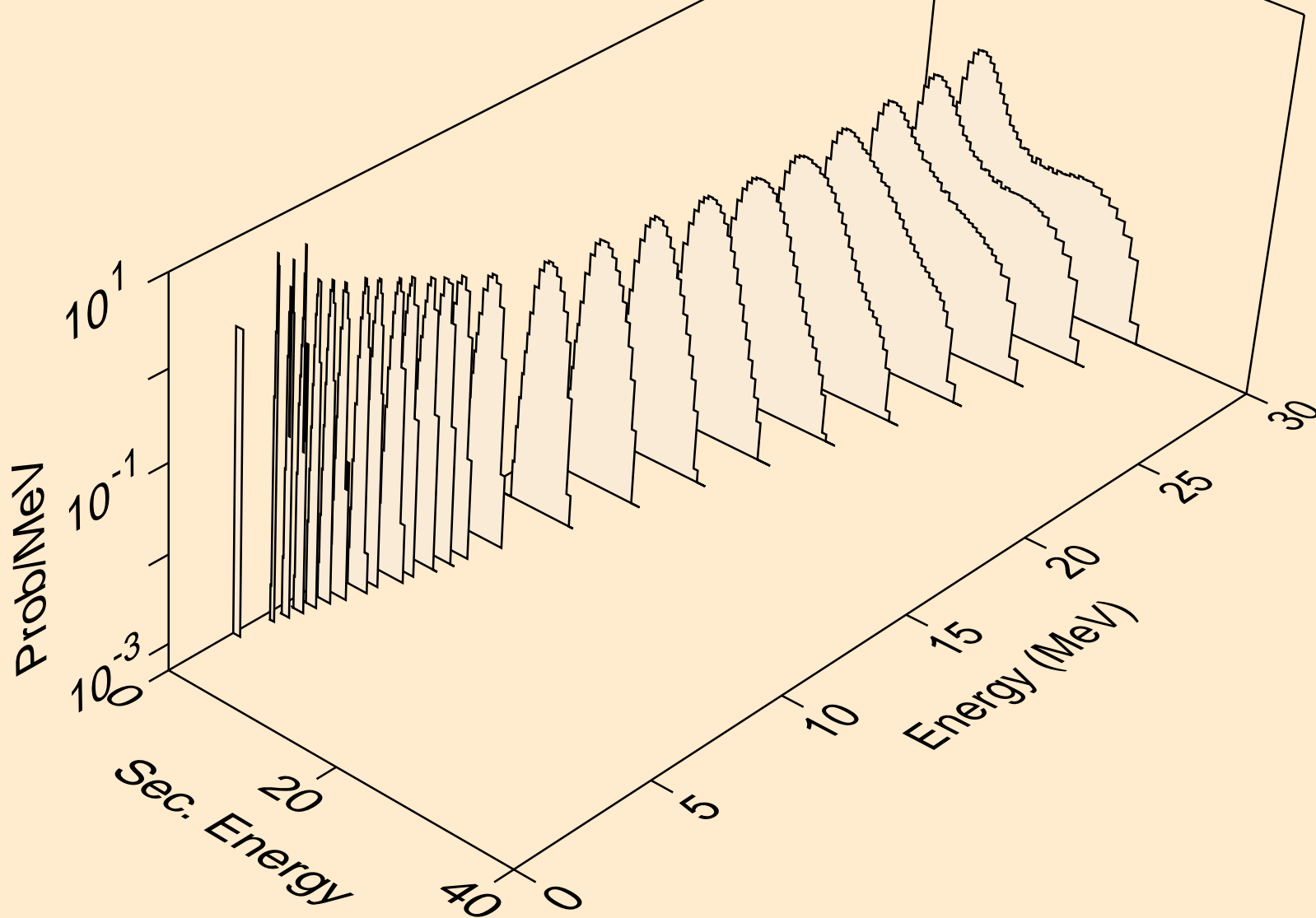

ER149M NEUTRON ACER TENDL-2019 LIBRARY; T=293.16K  
protons from (n,2np)

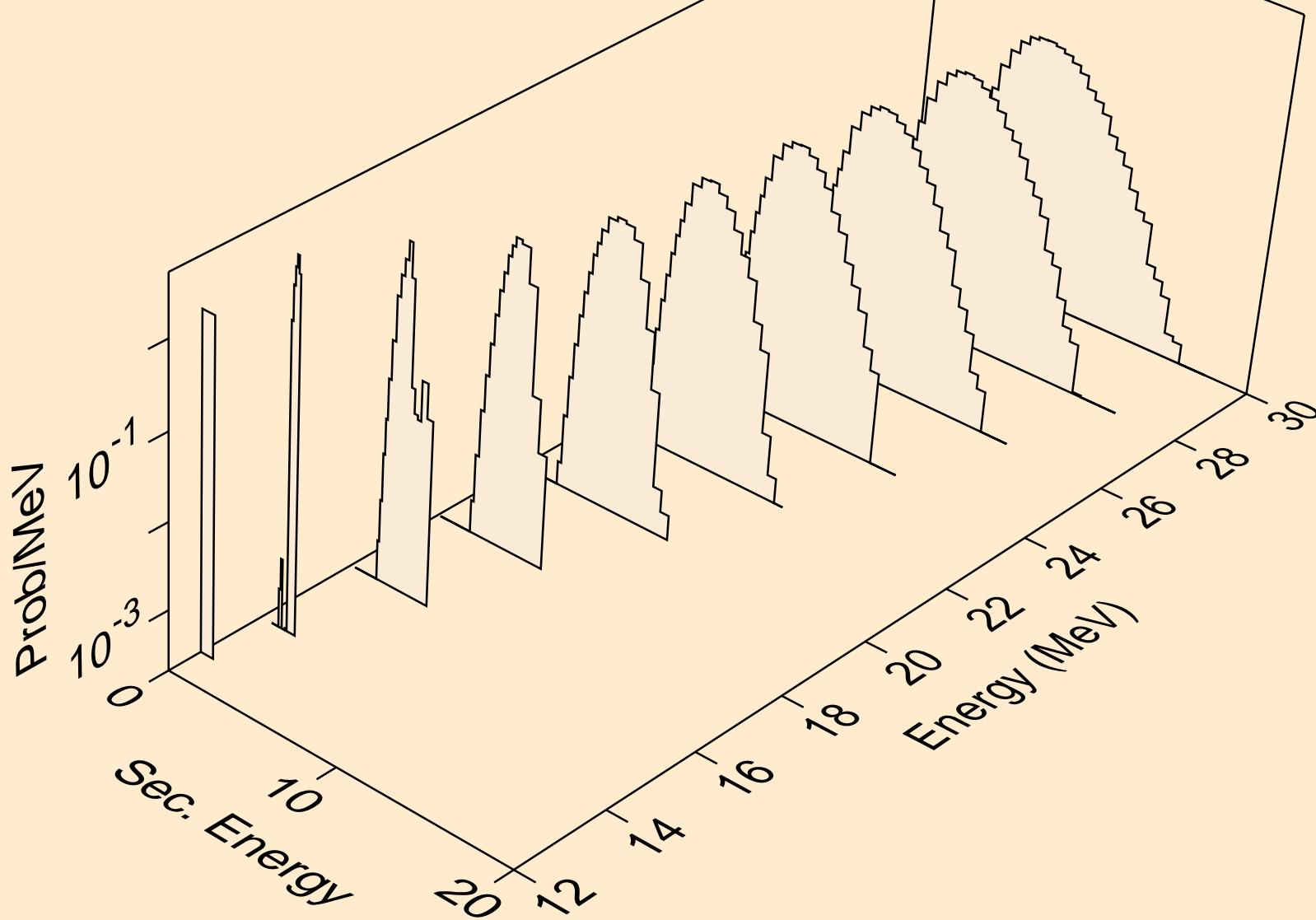

ER149M NEUTRON ACER TENDL-2019 LIBRARY; T=293.16K  
protons from (n,3np)

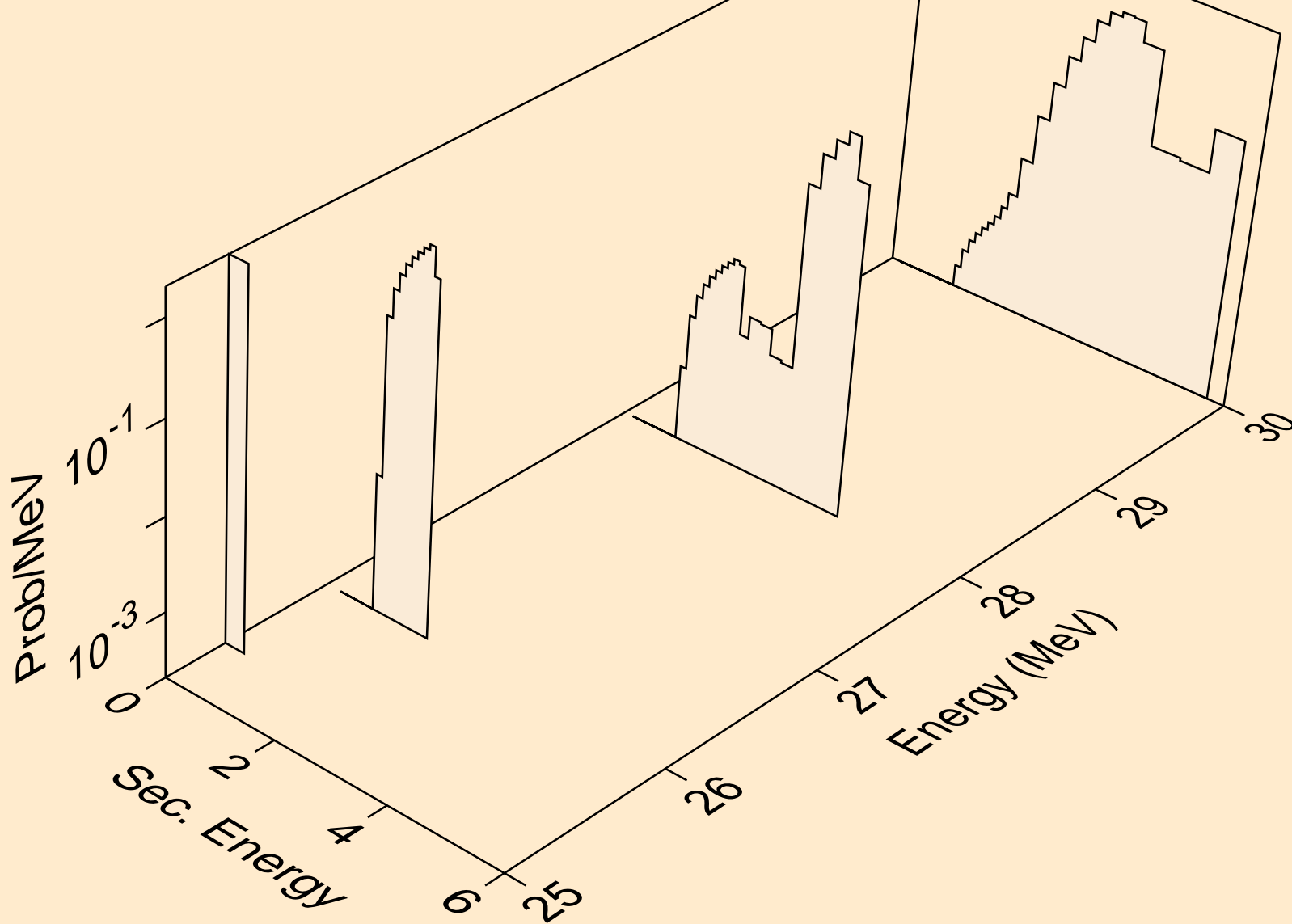

ER149M NEUTRON ACER TENDL-2019 LIBRARY; T=293.16K  
protons from (n,2np)

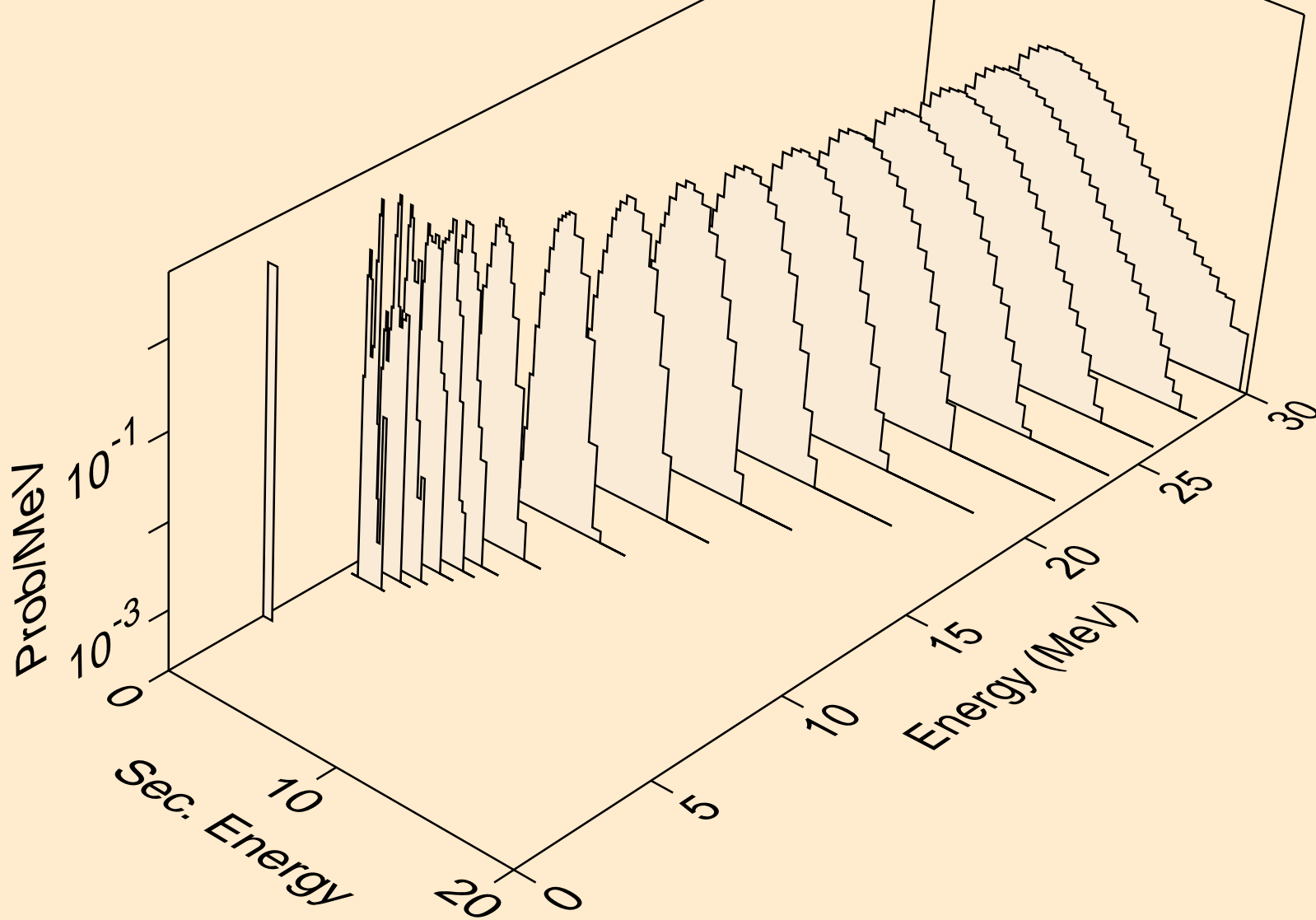

ER149M NEUTRON ACER TENDL-2019 LIBRARY; T=293.16K  
protons from (n,npa)

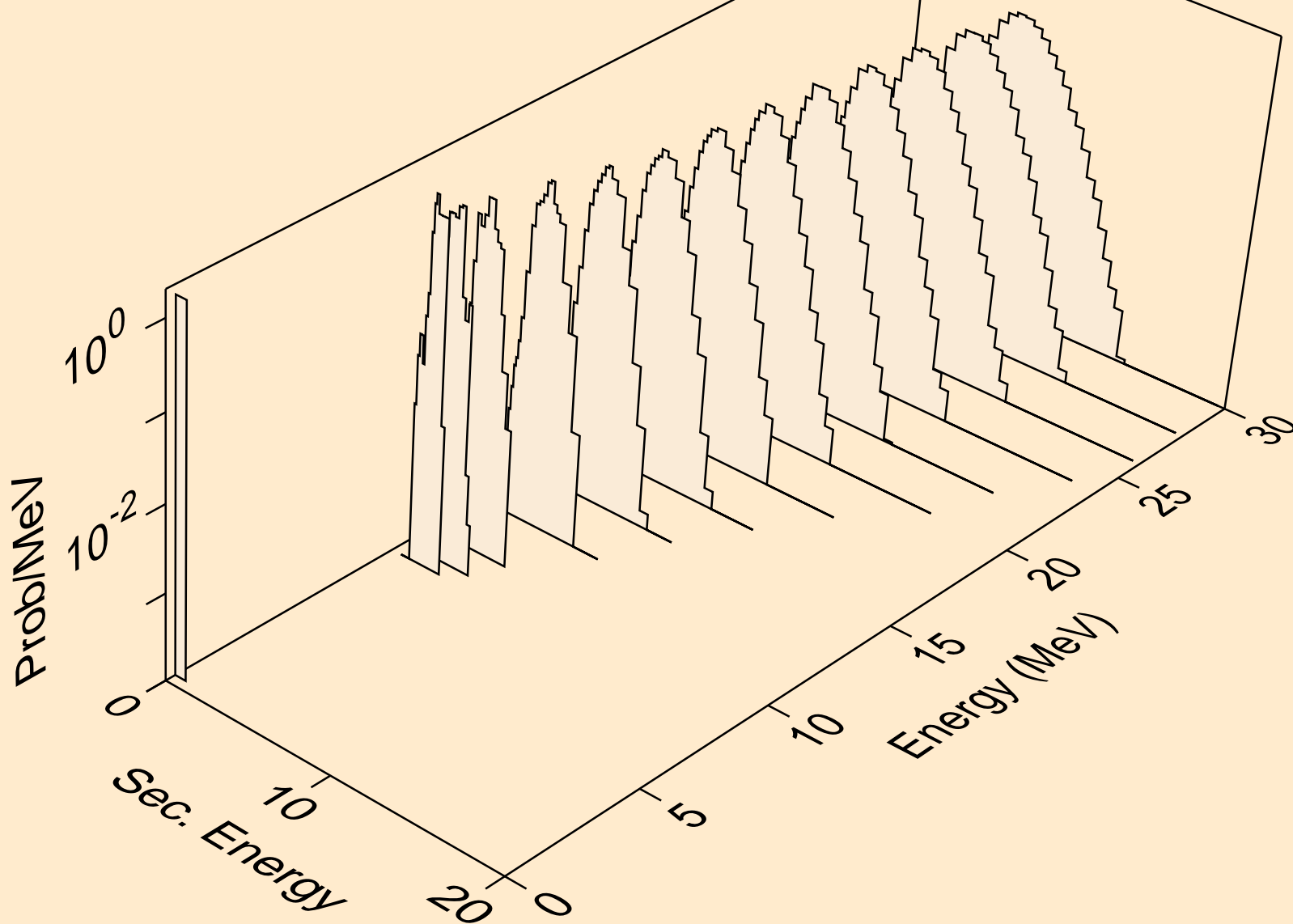



ER149M NEUTRON ACER TENDL-2019 LIBRARY; T=293.16K  
protons from (n,p)

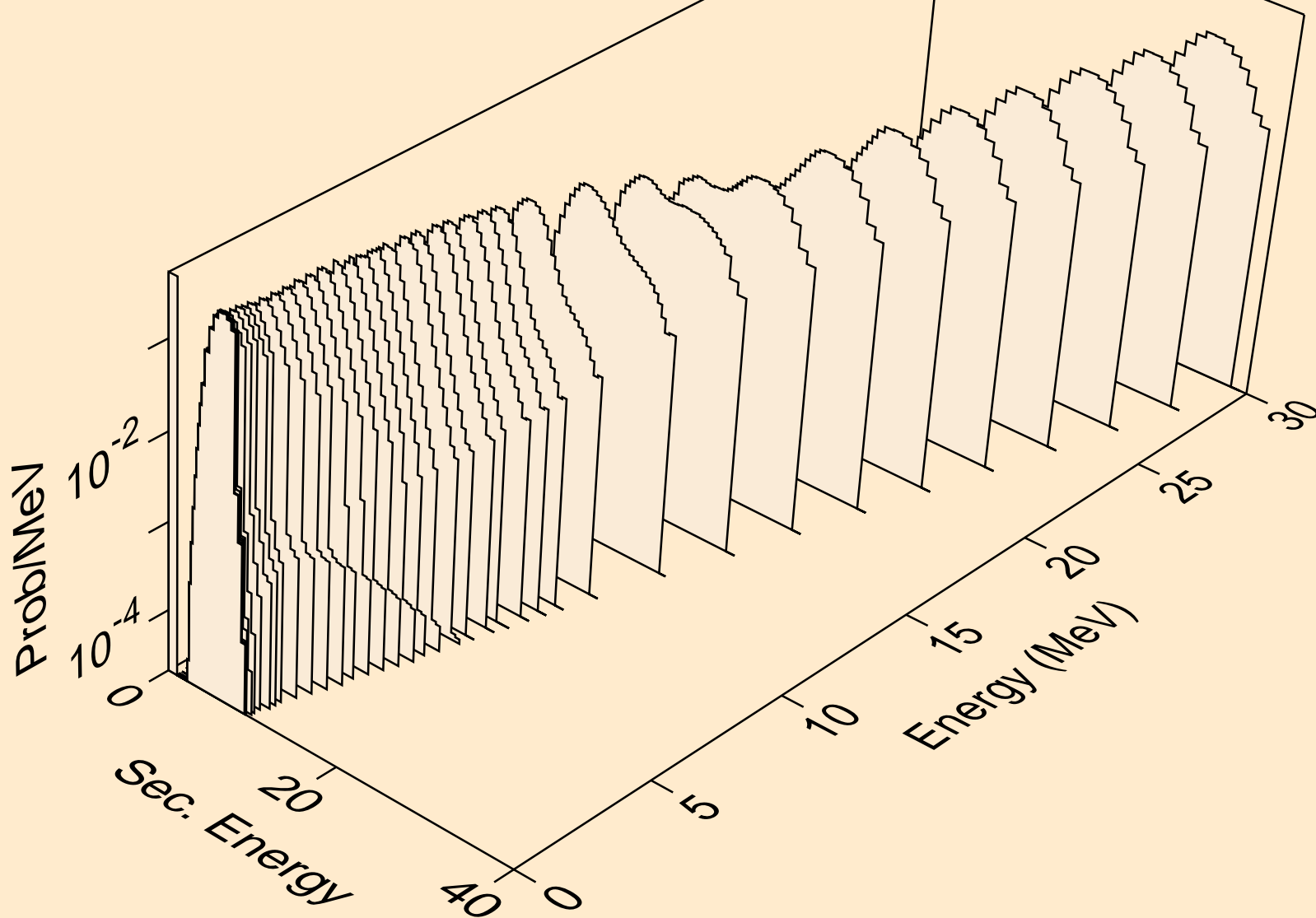

ER149M NEUTRON ACER TENDL-2019 LIBRARY; T=293.16K  
protons from (n,2p)

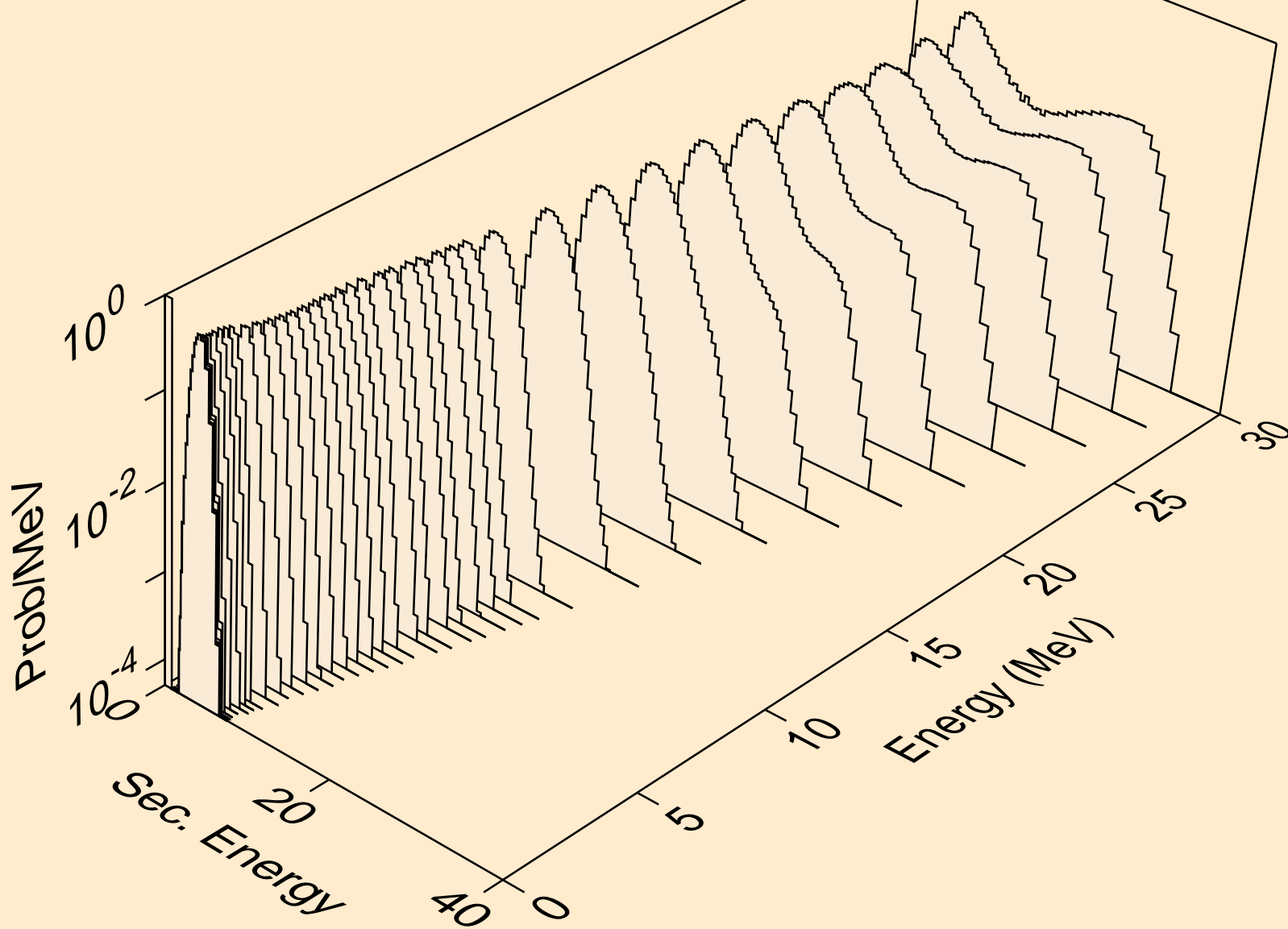

ER149M NEUTRON ACER TENDL-2019 LIBRARY; T=293.16K  
protons from (n,p)

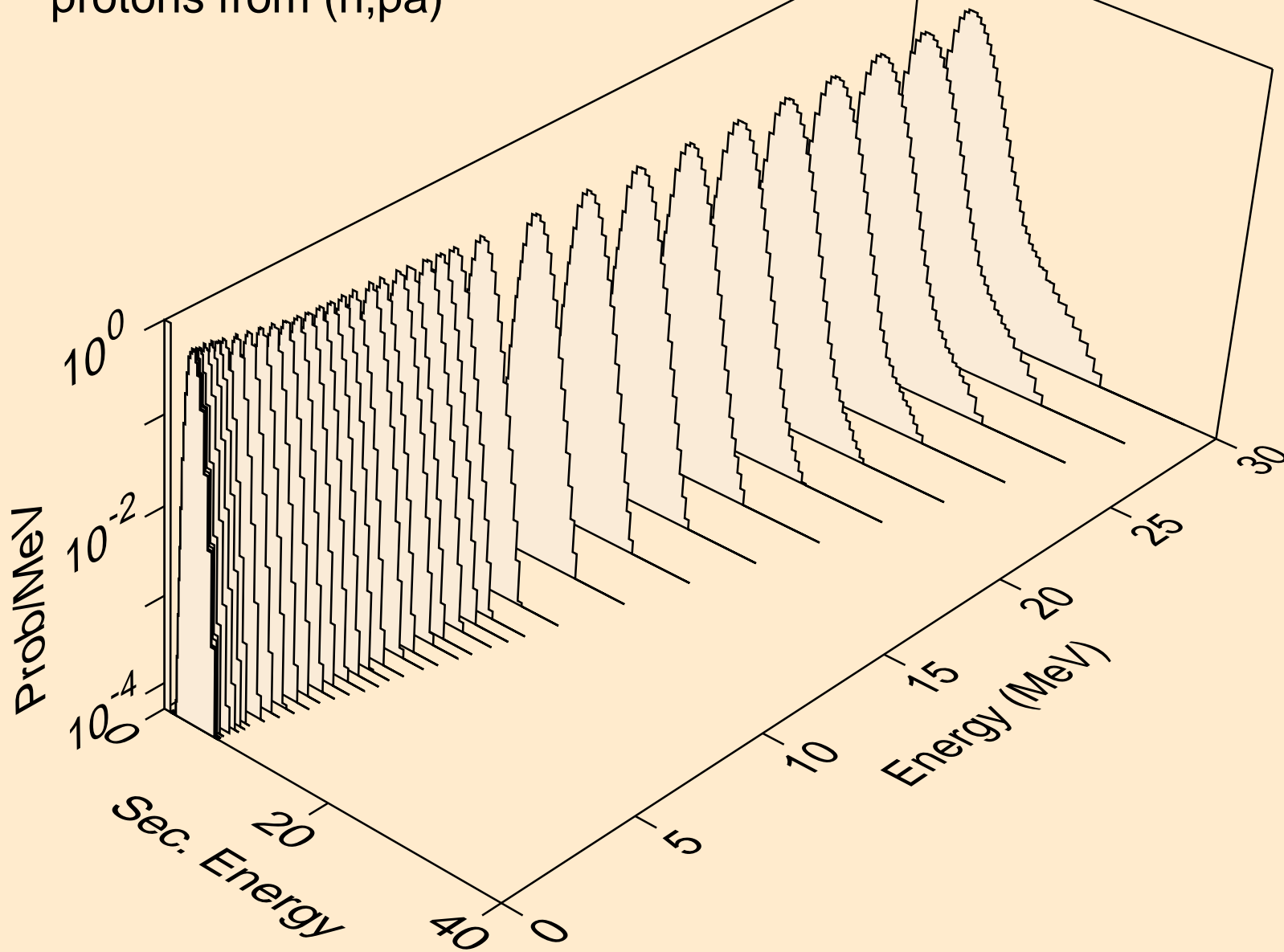

ER149M NEUTRON ACER TENDL-2019 LIBRARY; T=293.16K  
protons from (n,pd)

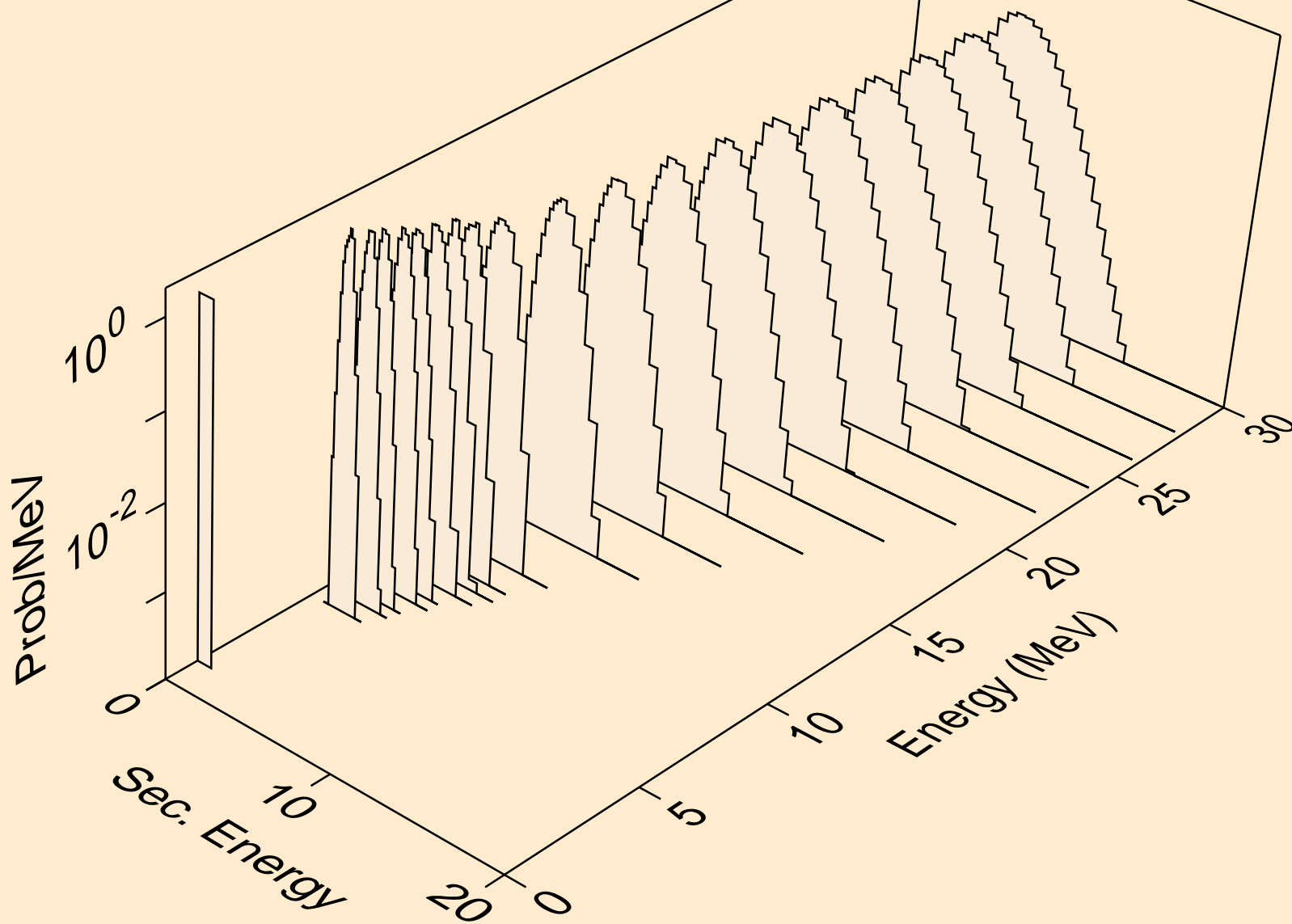

ER149M NEUTRON ACER TENDL-2019 LIBRARY; T=293.16K  
protons from (n,pt)

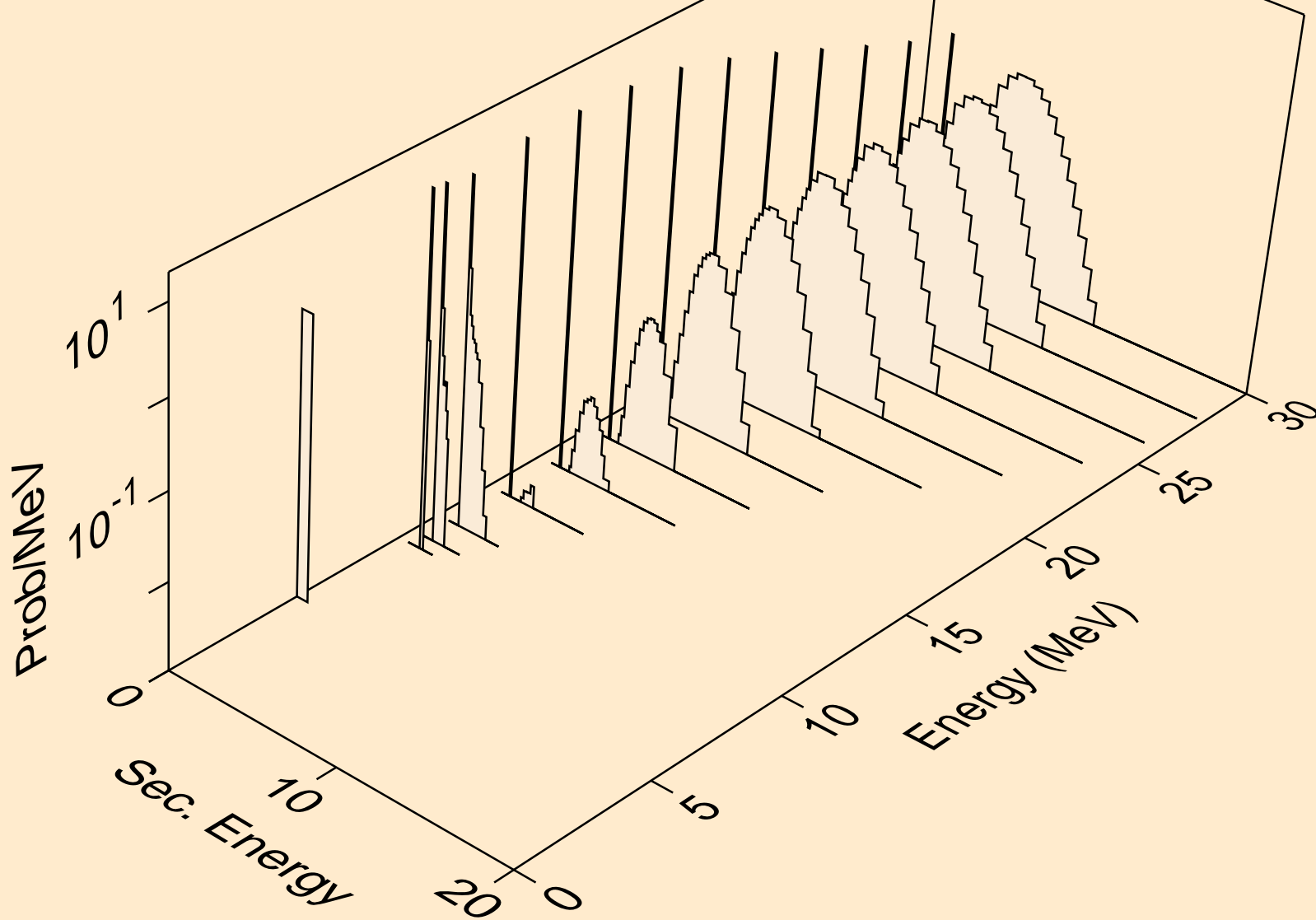

ER149M NEUTRON ACER TENDL-2019 LIBRARY; T=293.16K  
deuterons from (n,x)

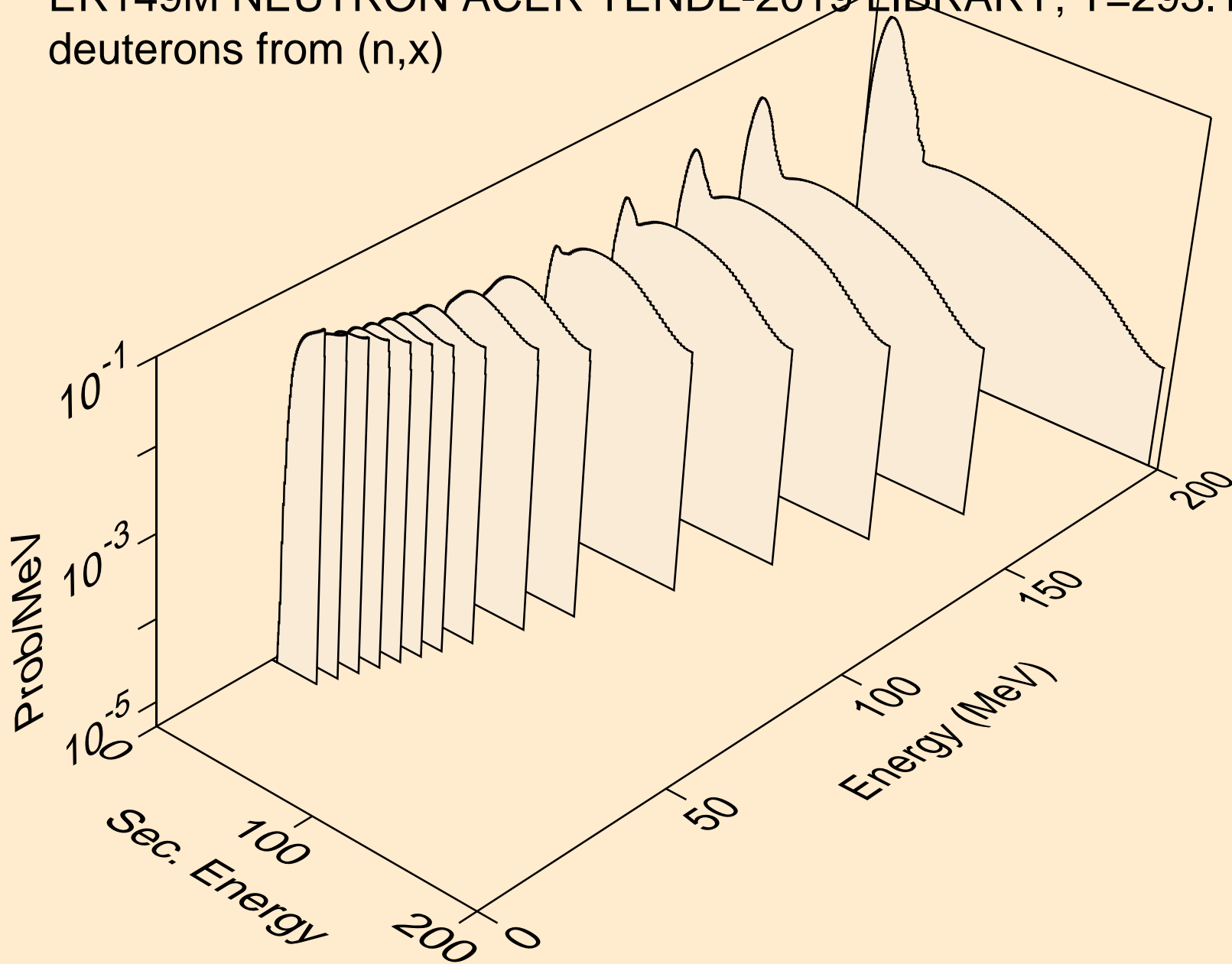

ER149M NEUTRON ACER TENDL-2019 LIBRARY; T=293.16K  
deuterons from (n,2nd)

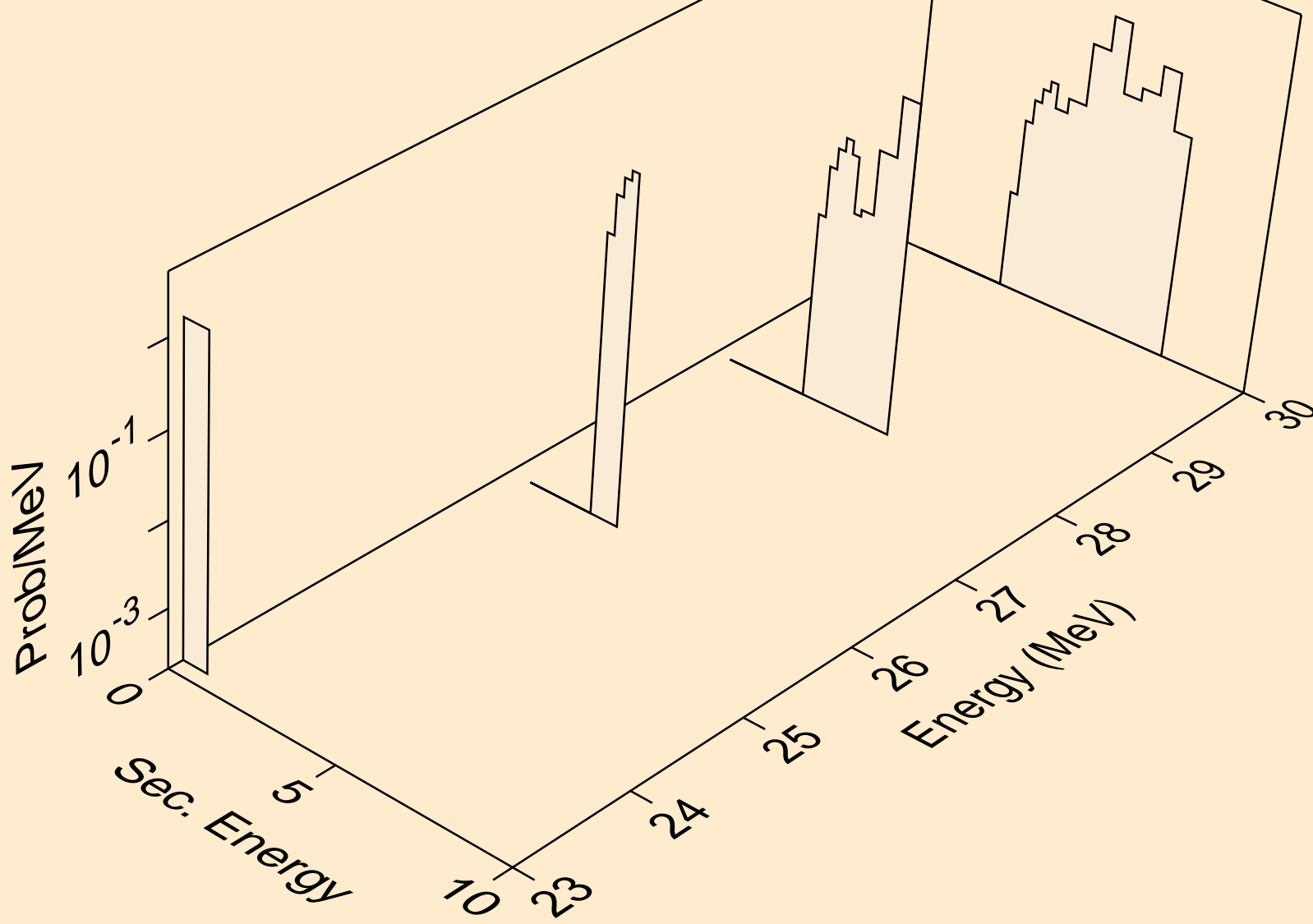

ER149M NEUTRON ACER TENDL-2019 LIBRARY; T=293.16K  
deuterons from (n,n\*)d

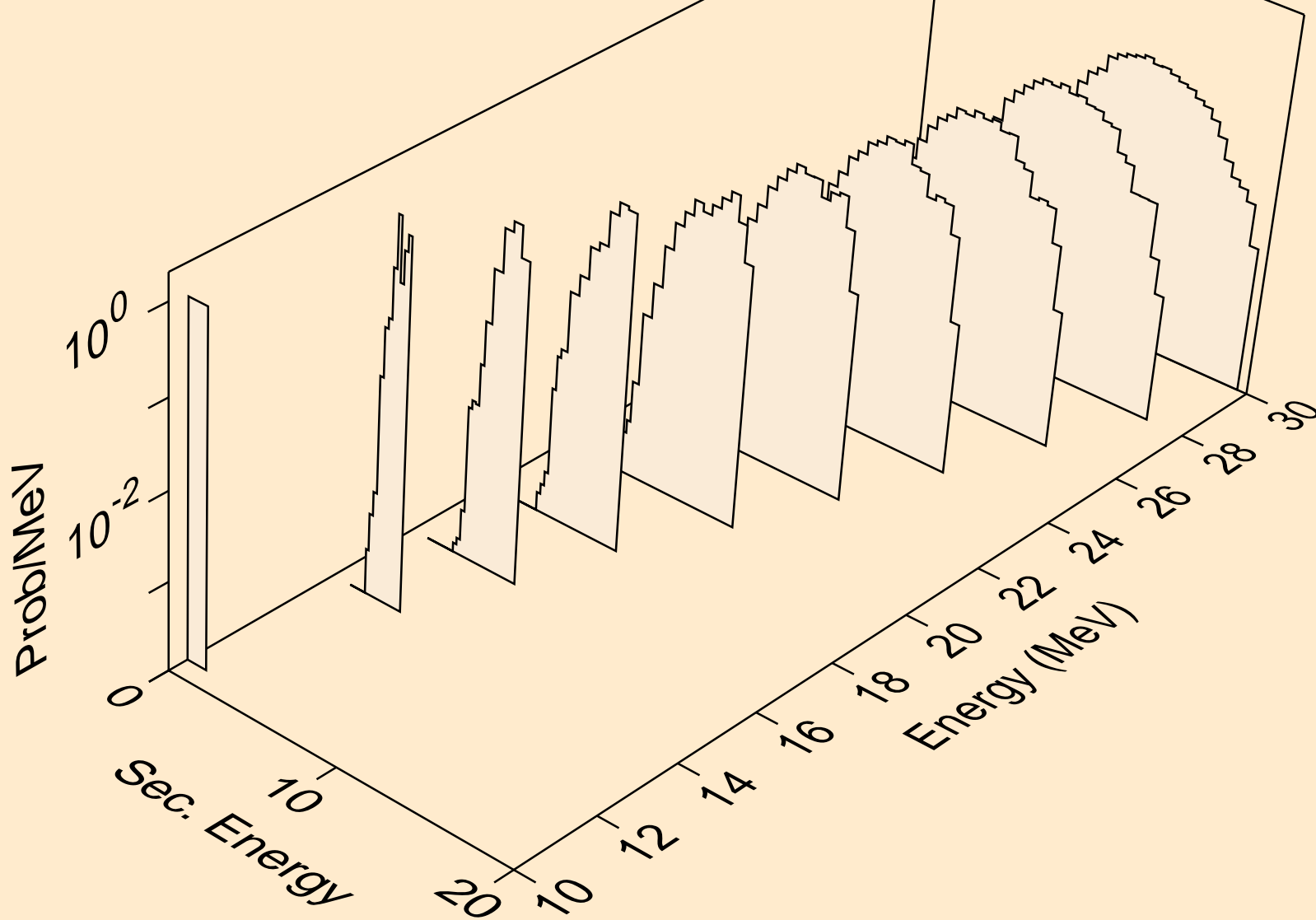



ER149M NEUTRON ACER TENDL-2019 LIBRARY; T=293.16K  
deuterons from (n,d)

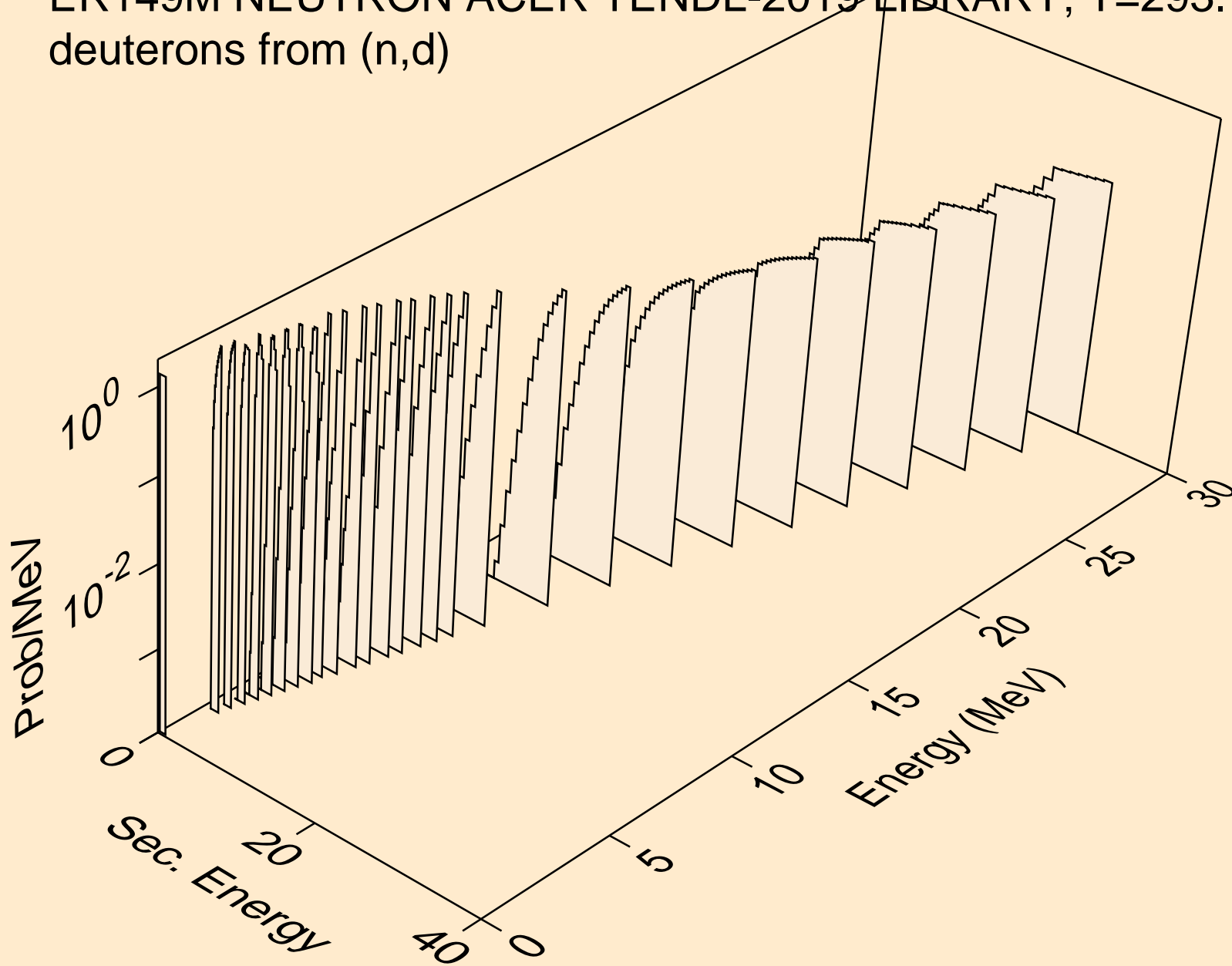

ER149M NEUTRON ACER TENDL-2019 LIBRARY; T=293.16K  
deuterons from (n,pd)

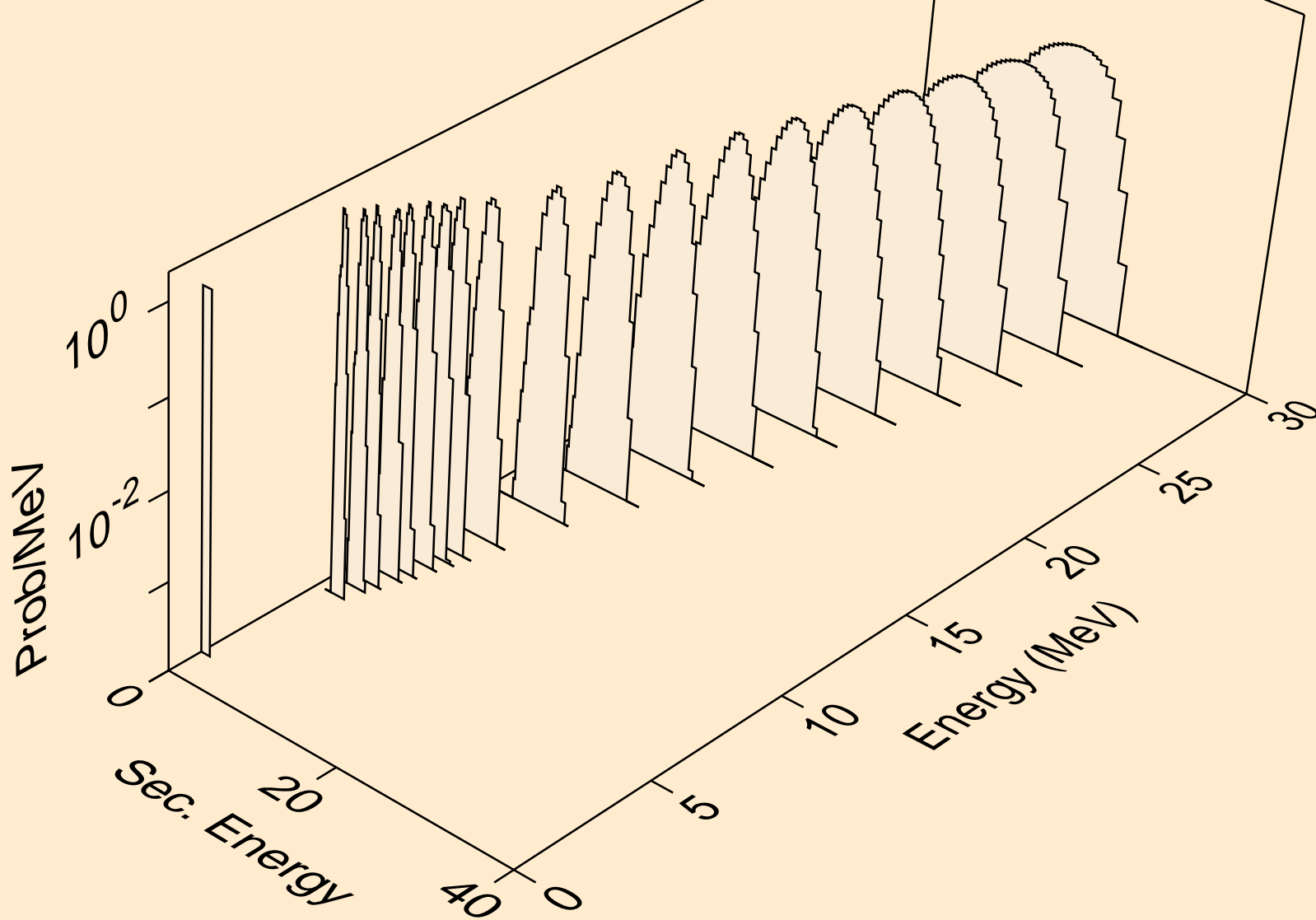

ER149M NEUTRON ACER TENDL-2019 LIBRARY; T=293.16K  
deuterons from (n,da)

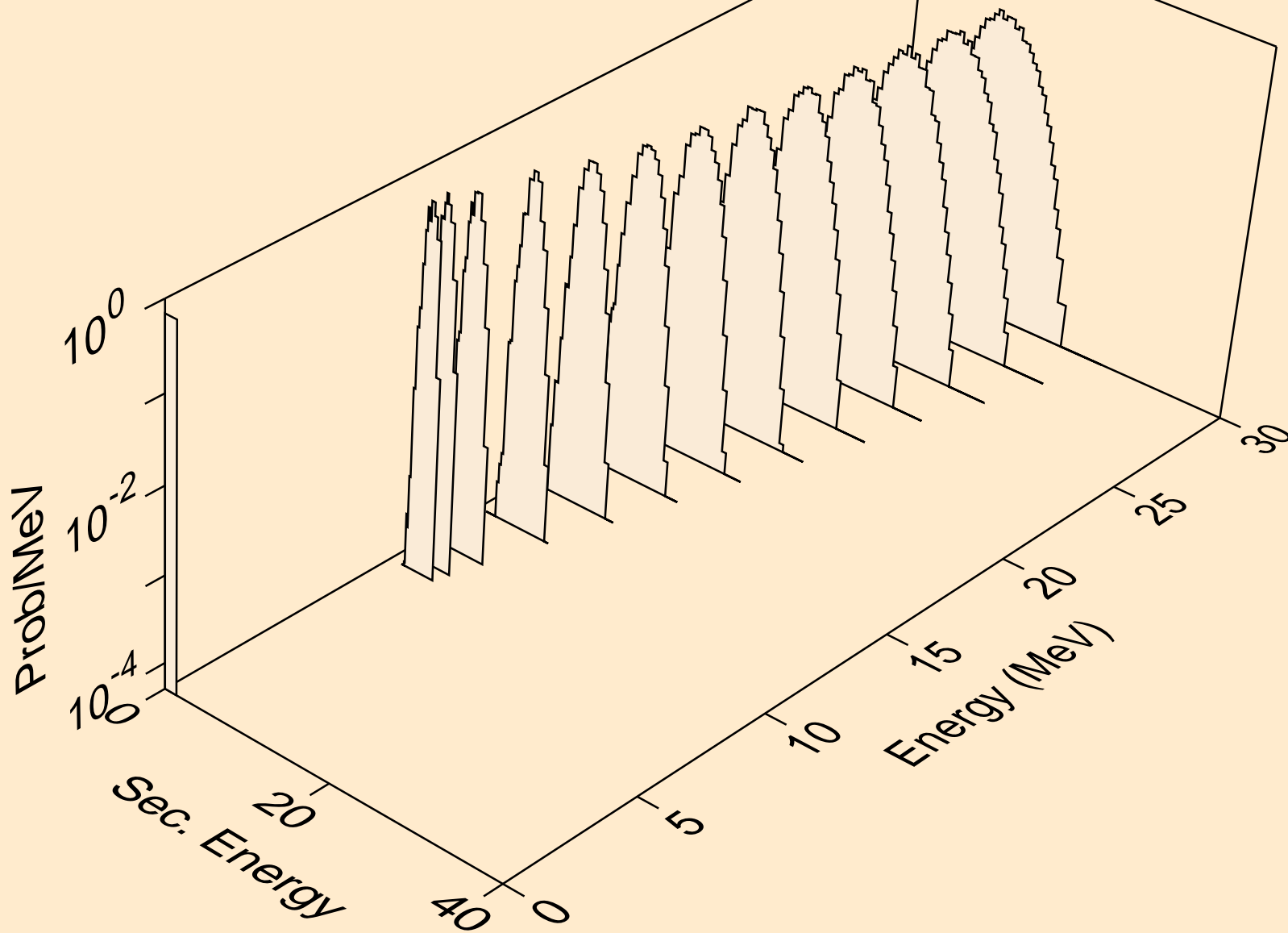

ER149M NEUTRON ACER TENDL-2019 LIBRARY; T=293.16K  
tritons from (n,x)

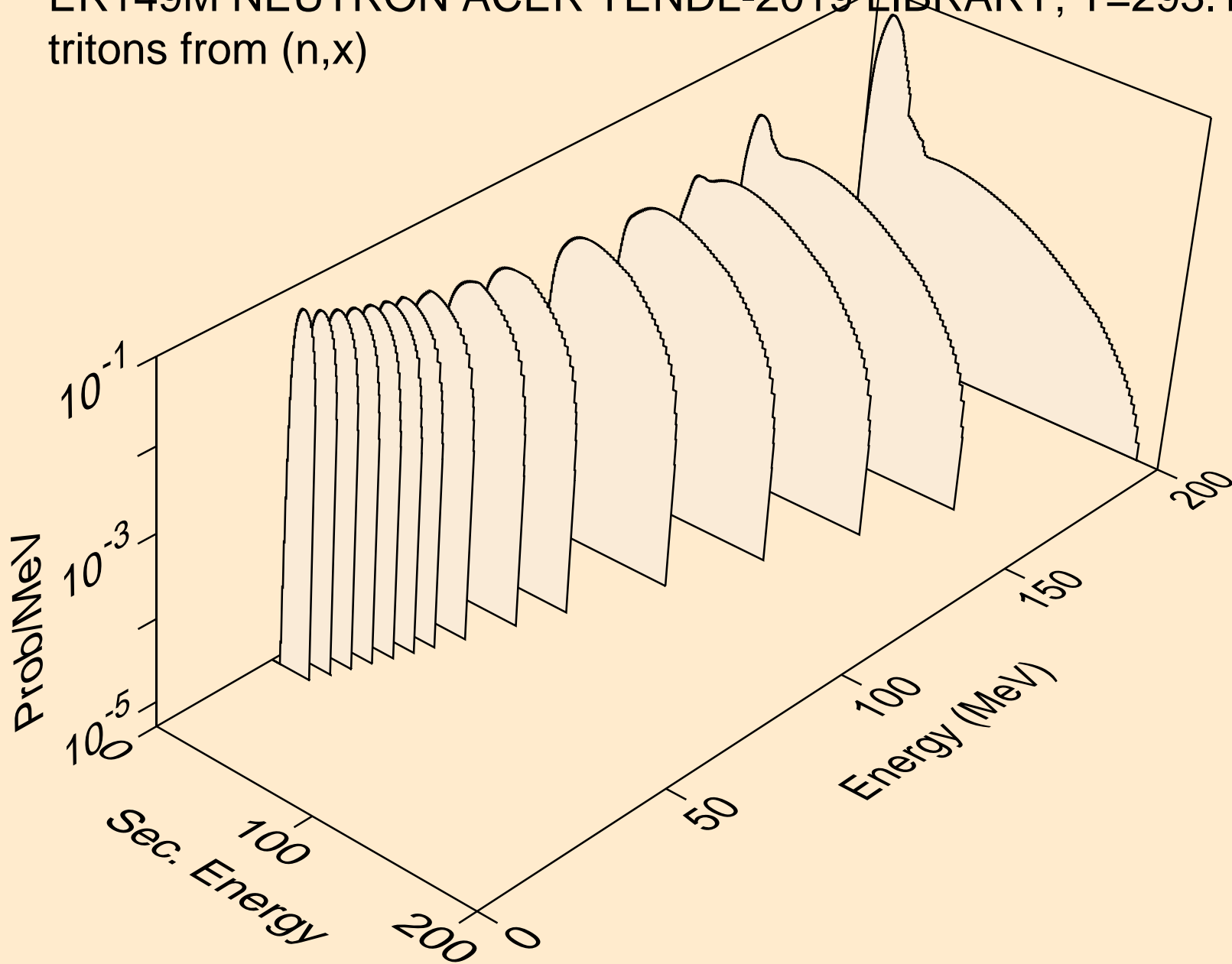

ER149M NEUTRON ACER TENDL-2019 LIBRARY; T=293.16K  
tritons from (n,n\*)t

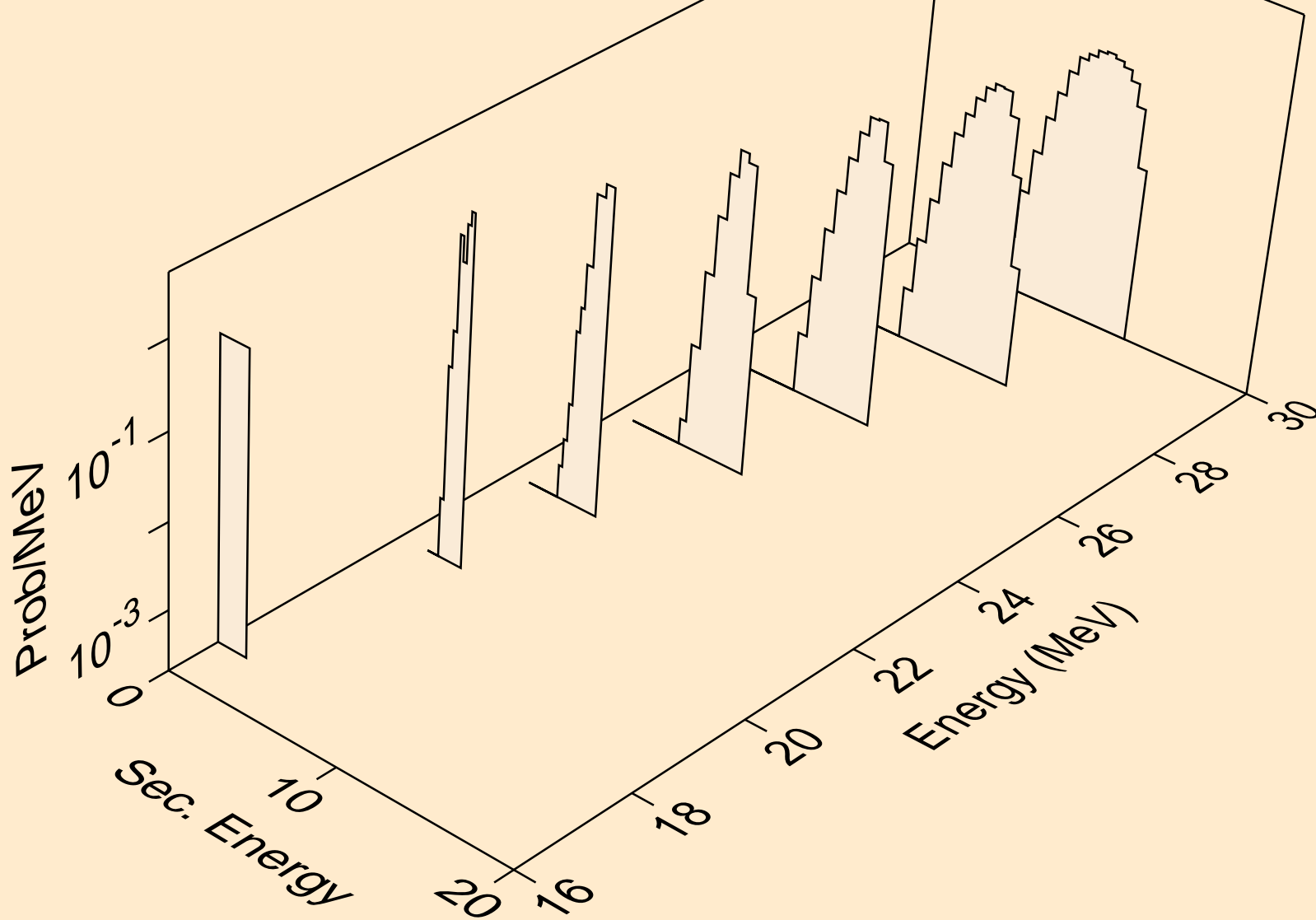

ER149M NEUTRON ACER TENDL-2019 LIBRARY; T=293.16K  
tritons from (n,t)

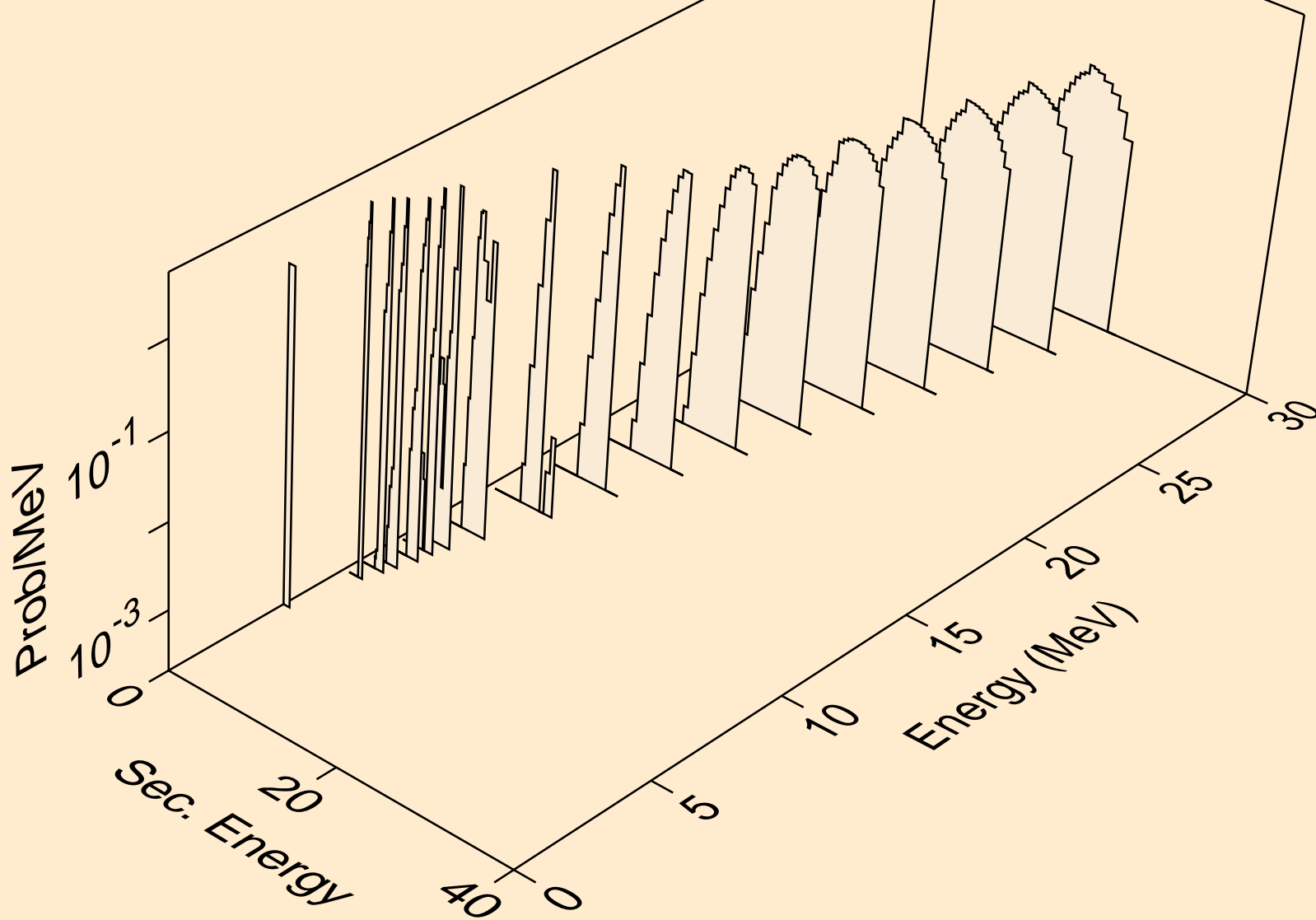

ER149M NEUTRON ACER TENDL-2019 LIBRARY; T=293.16K  
tritons from (n,pt)

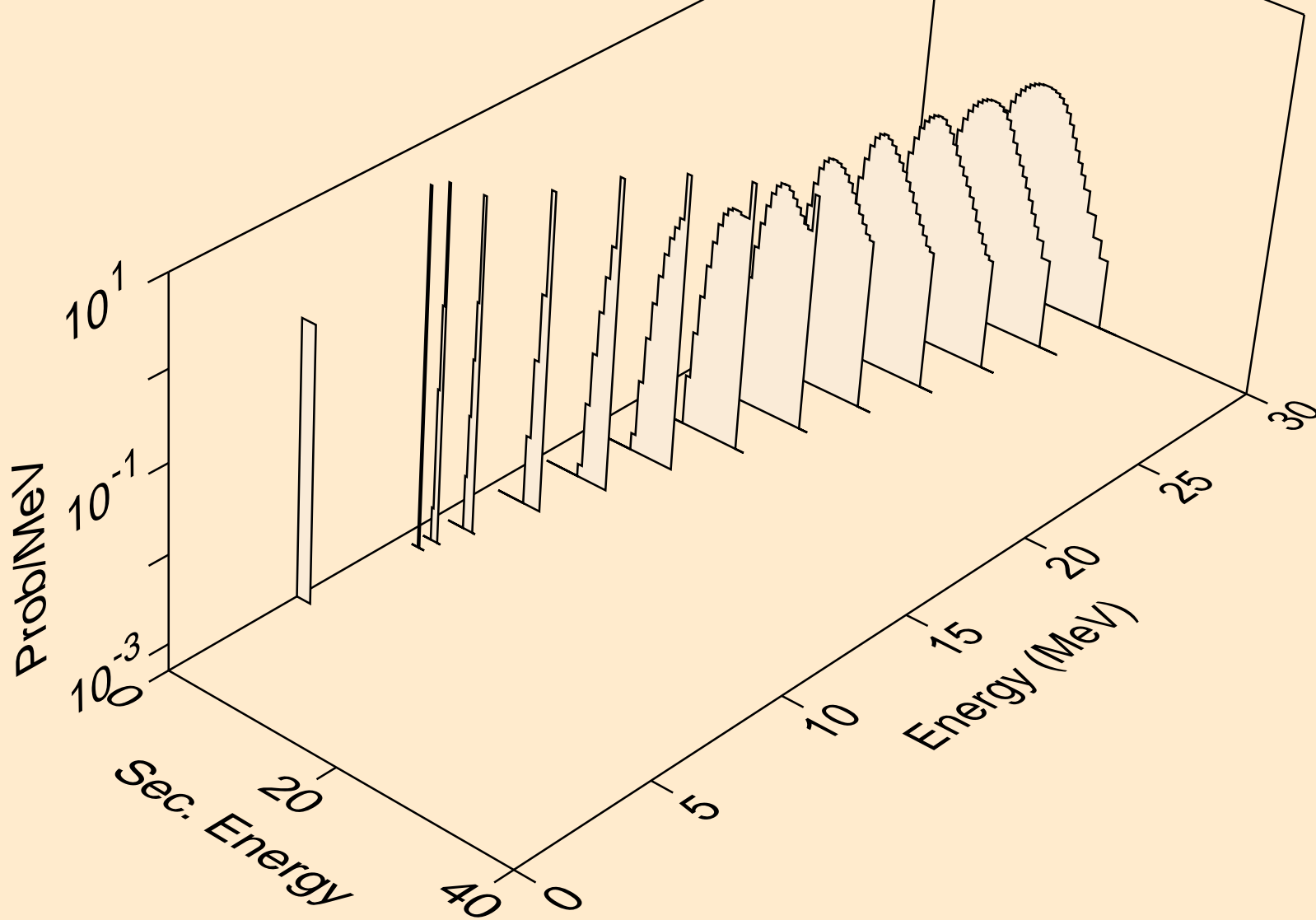

ER149M NEUTRON ACER TENDL-2019 LIBRARY; T=293.16K  
he3s from (n,x)

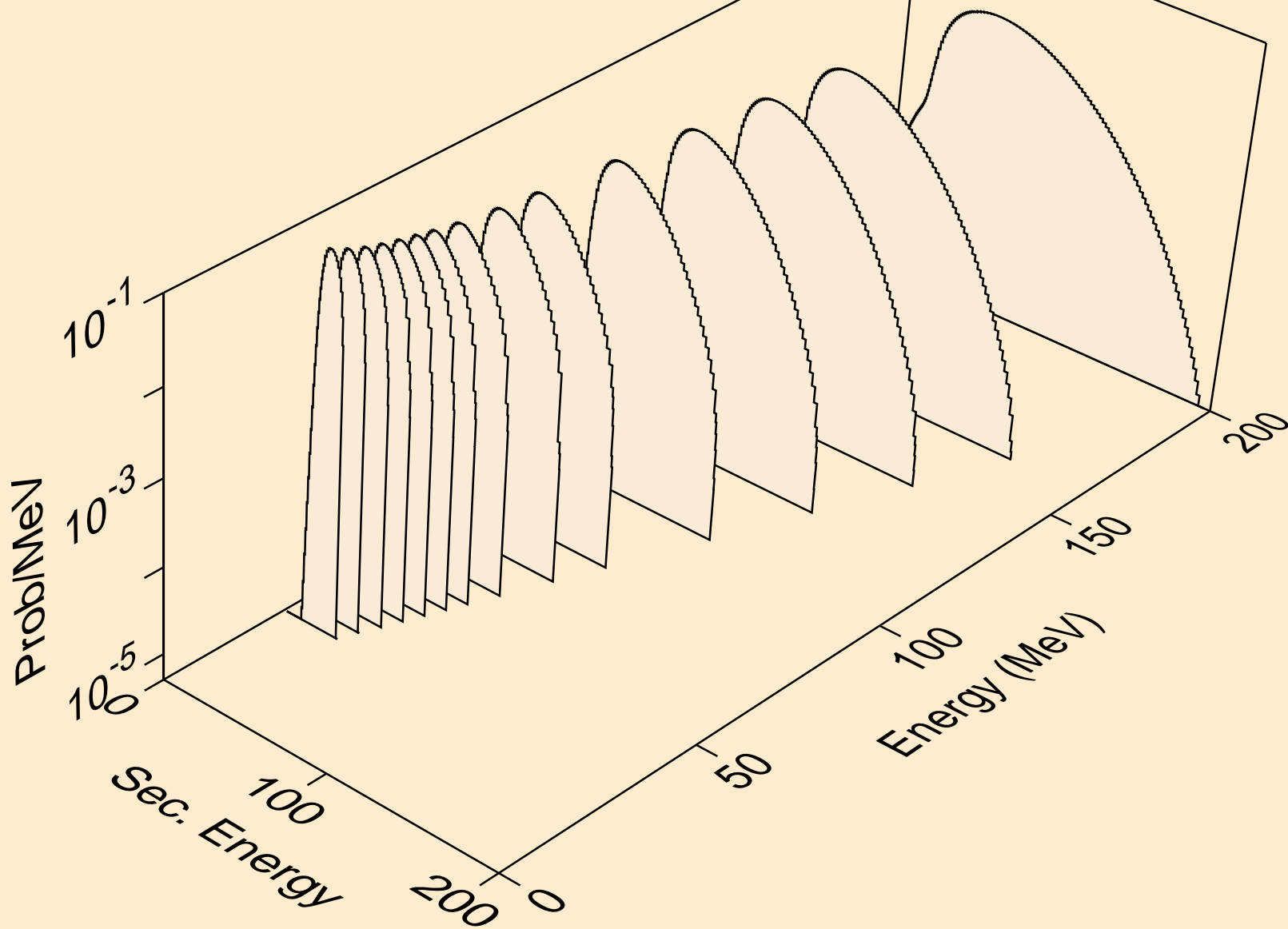



ER149M NEUTRON ACER TENDL-2019 LIBRARY; T=293.16K  
he3s from (n,n\*)he3

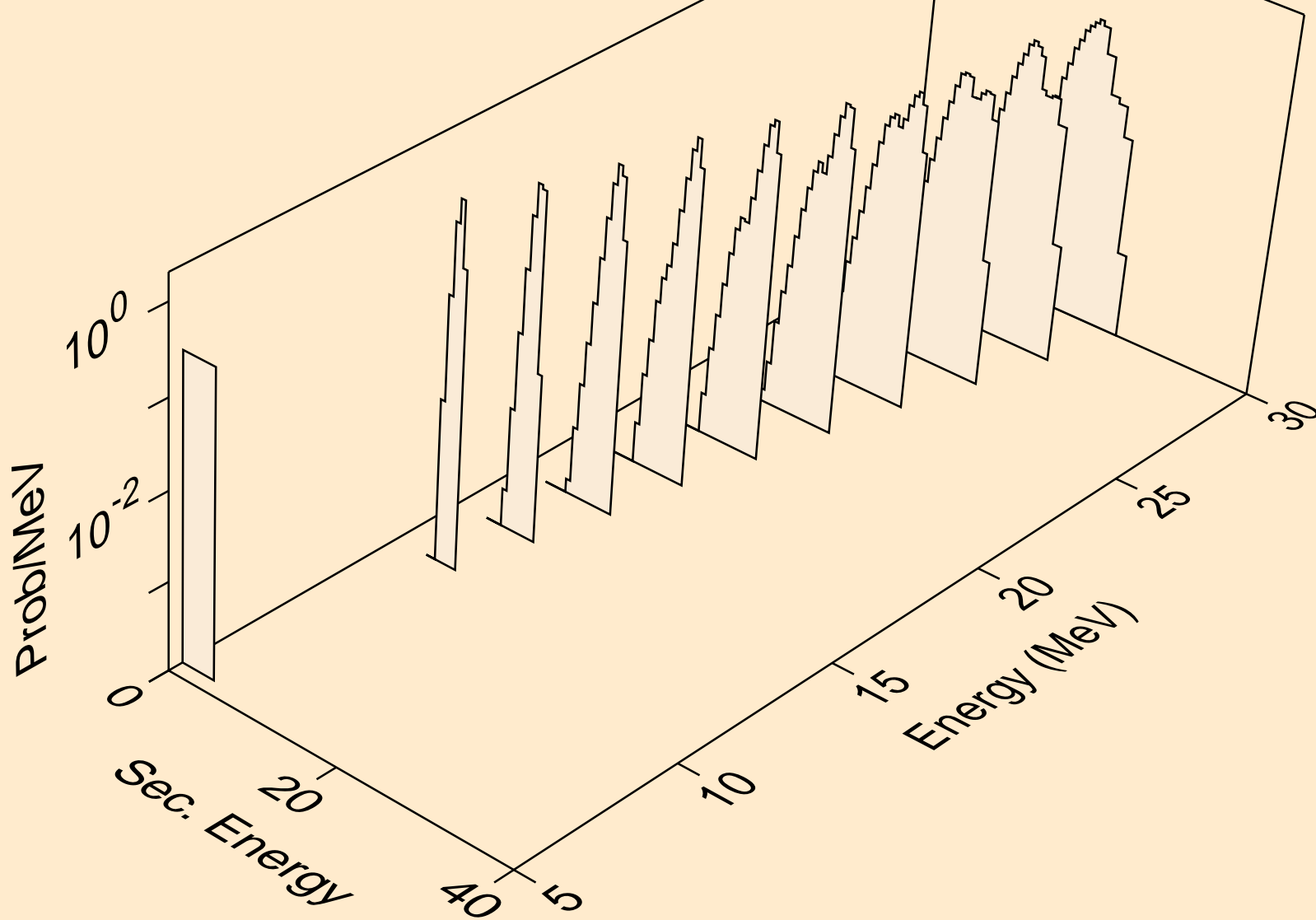

ER149M NEUTRON ACER TENDL-2019 LIBRARY; T=293.16K  
he3s from (n,he3)

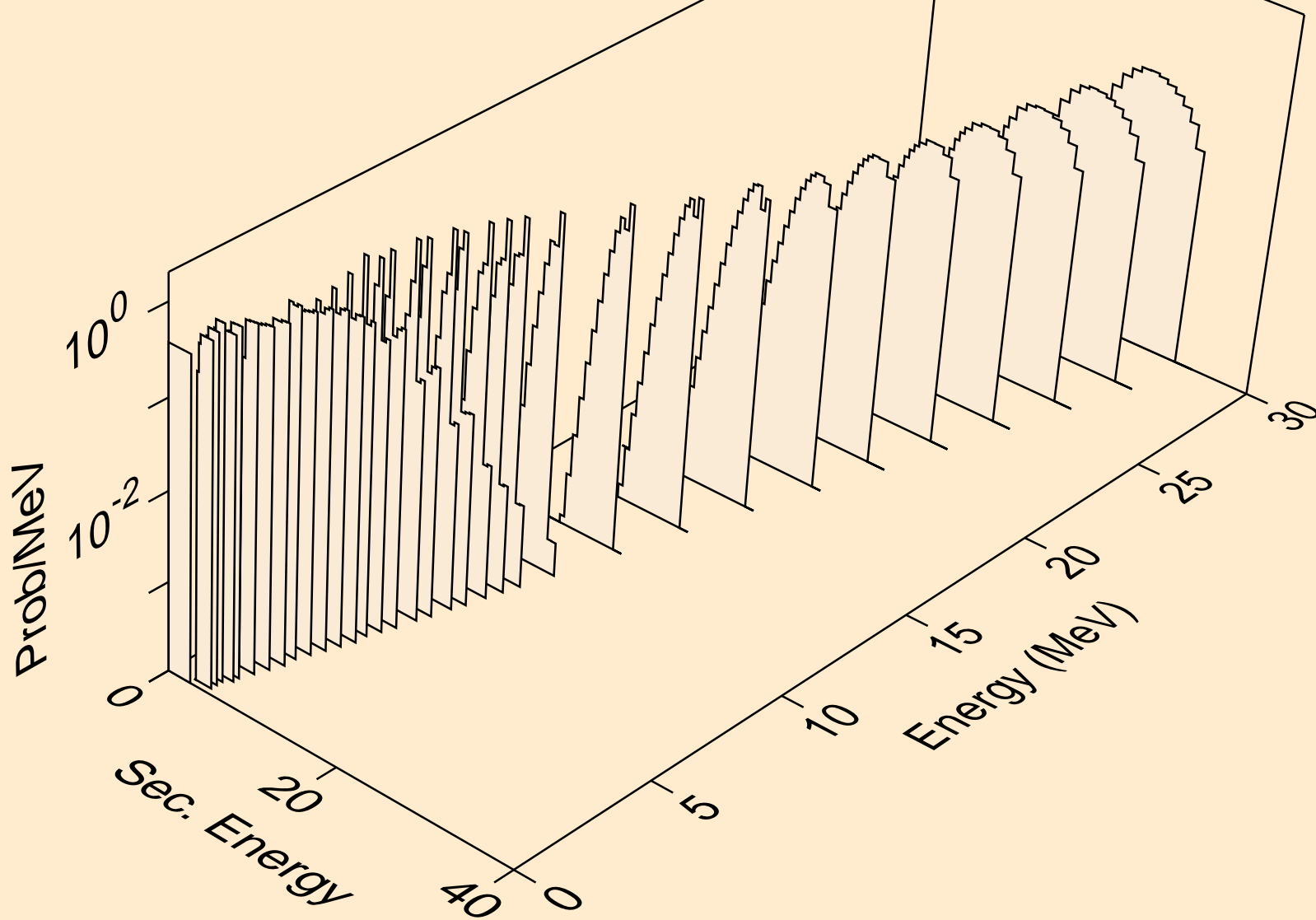

ER149M NEUTRON ACER TENDL-2019 LIBRARY; T=293.16K  
alphas from (n,x)

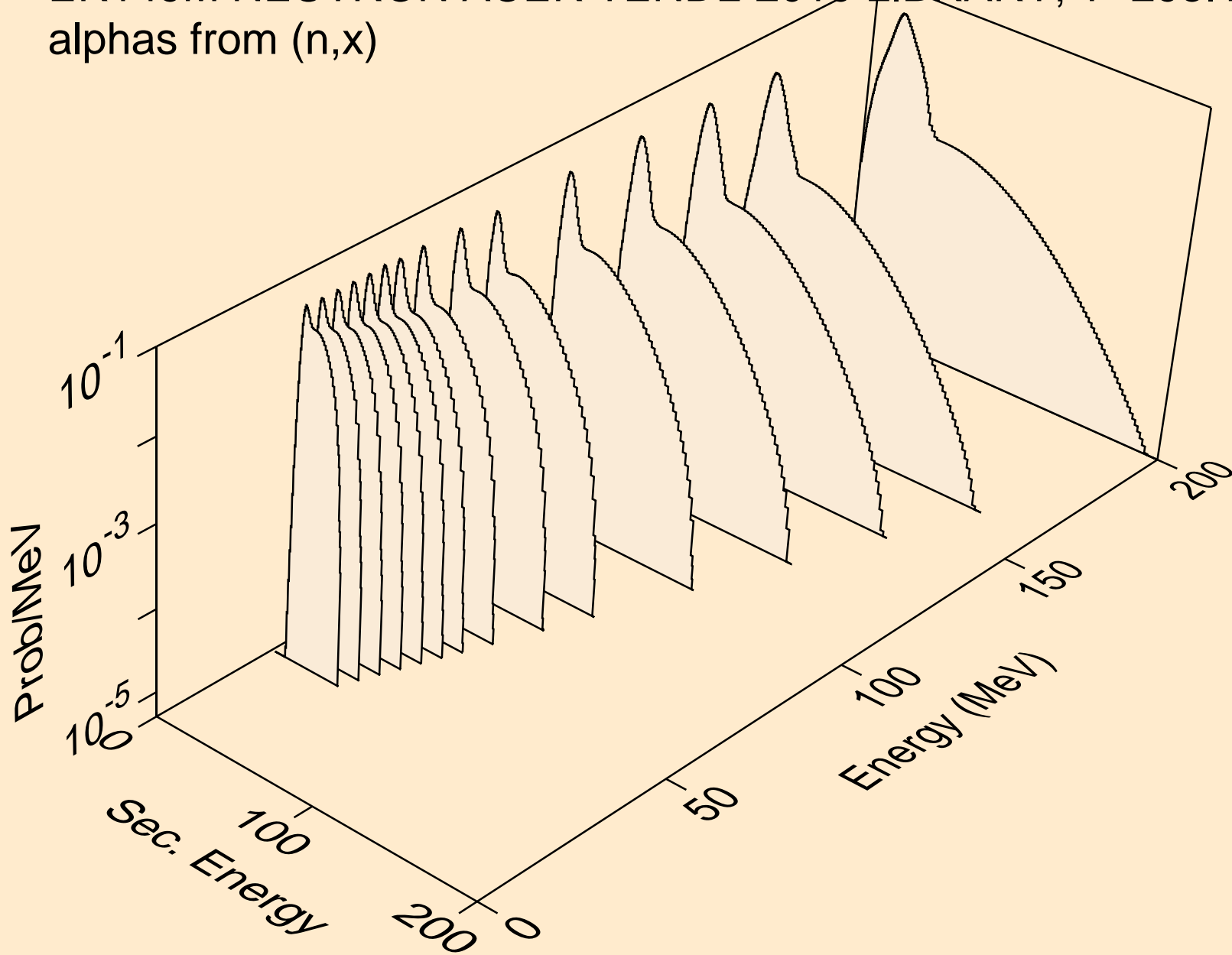

ER149M NEUTRON ACER TENDL-2019 LIBRARY; T=293.16K  
alphas from (n,n\*)a

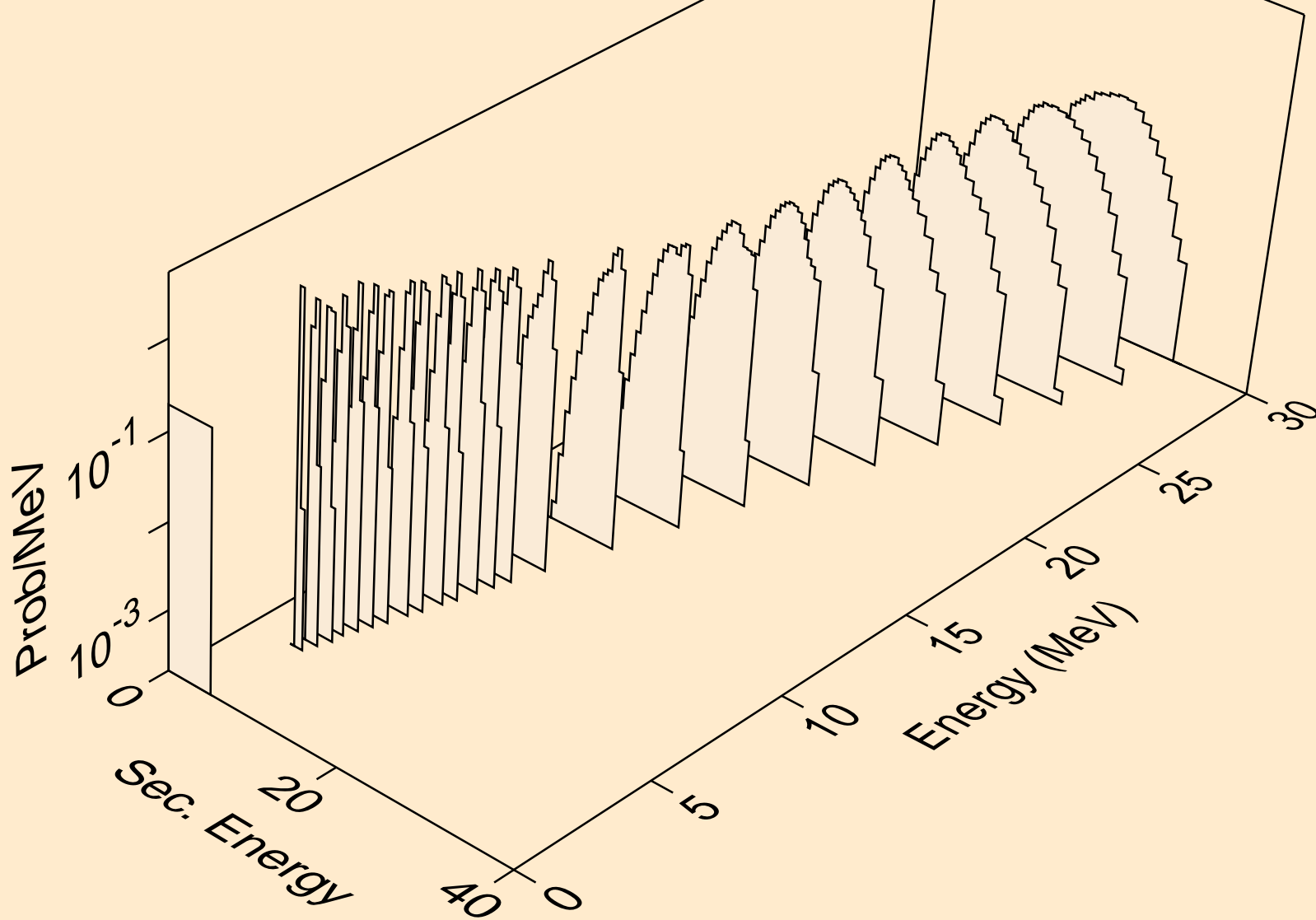

ER149M NEUTRON ACER TENDL-2019 LIBRARY; T=293.16K  
alphas from (n,2n)a

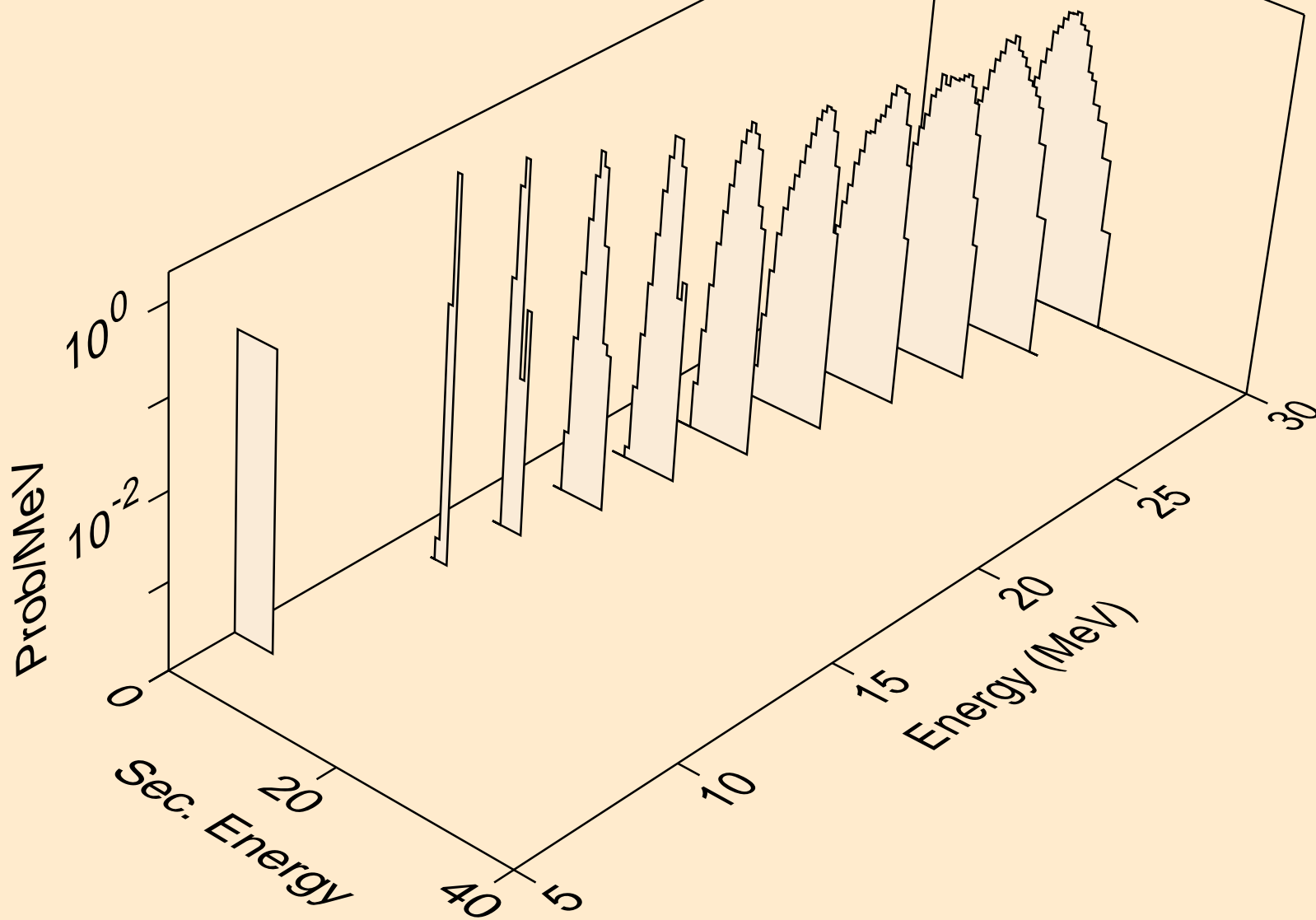

ER149M NEUTRON ACER TENDL-2019 LIBRARY; T=293.16K  
alphas from (n,3n)a

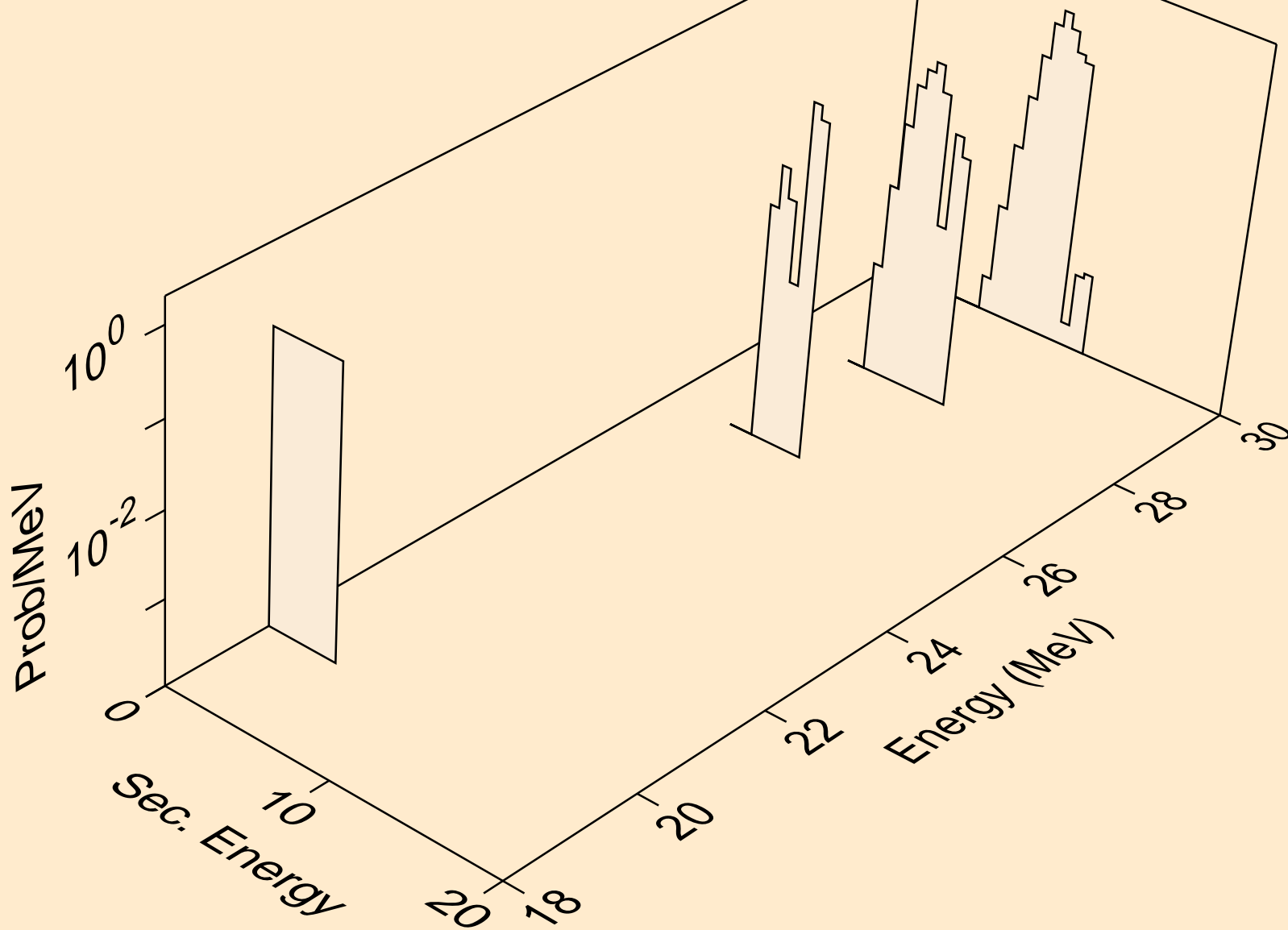

ER149M NEUTRON ACER TENDL-2019 LIBRARY; T=293.16K  
alphas from (n,n\*)2a

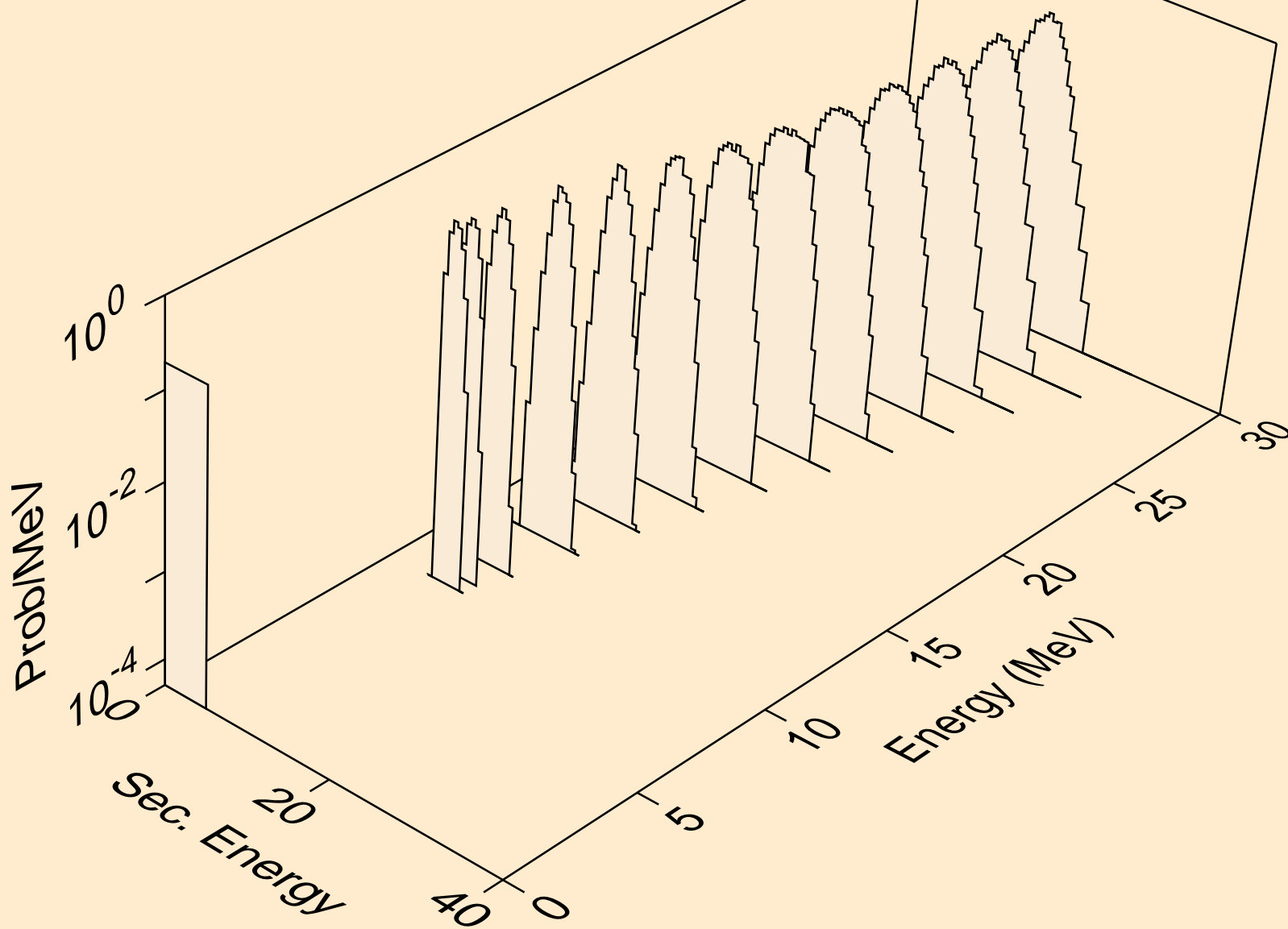

ER149M NEUTRON ACER TENDL-2019 LIBRARY; T=293.16K  
alphas from (n,2n)2a

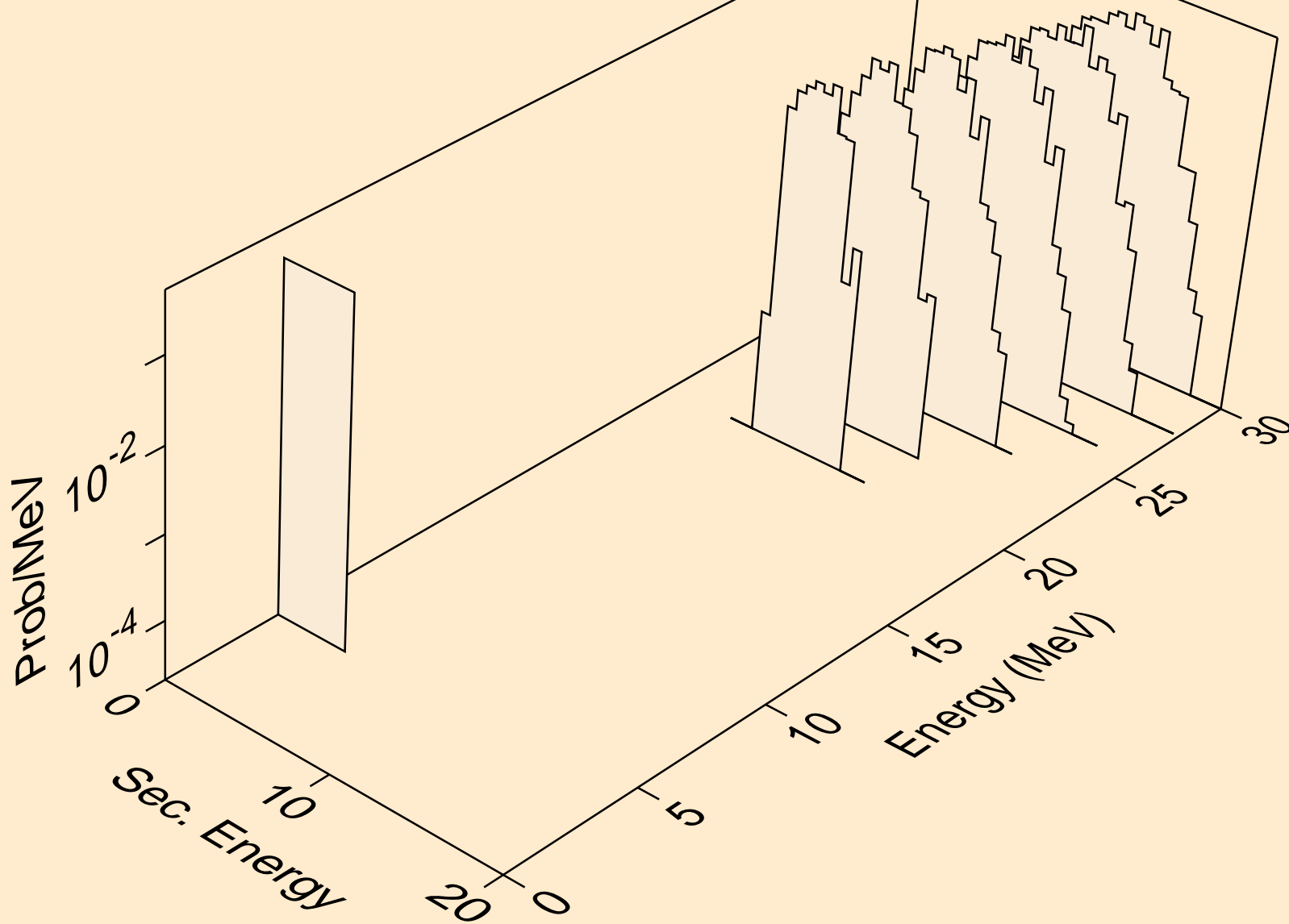



ER149M NEUTRON ACER TENDL-2019 LIBRARY; T=293.16K  
alphas from (n,npa)

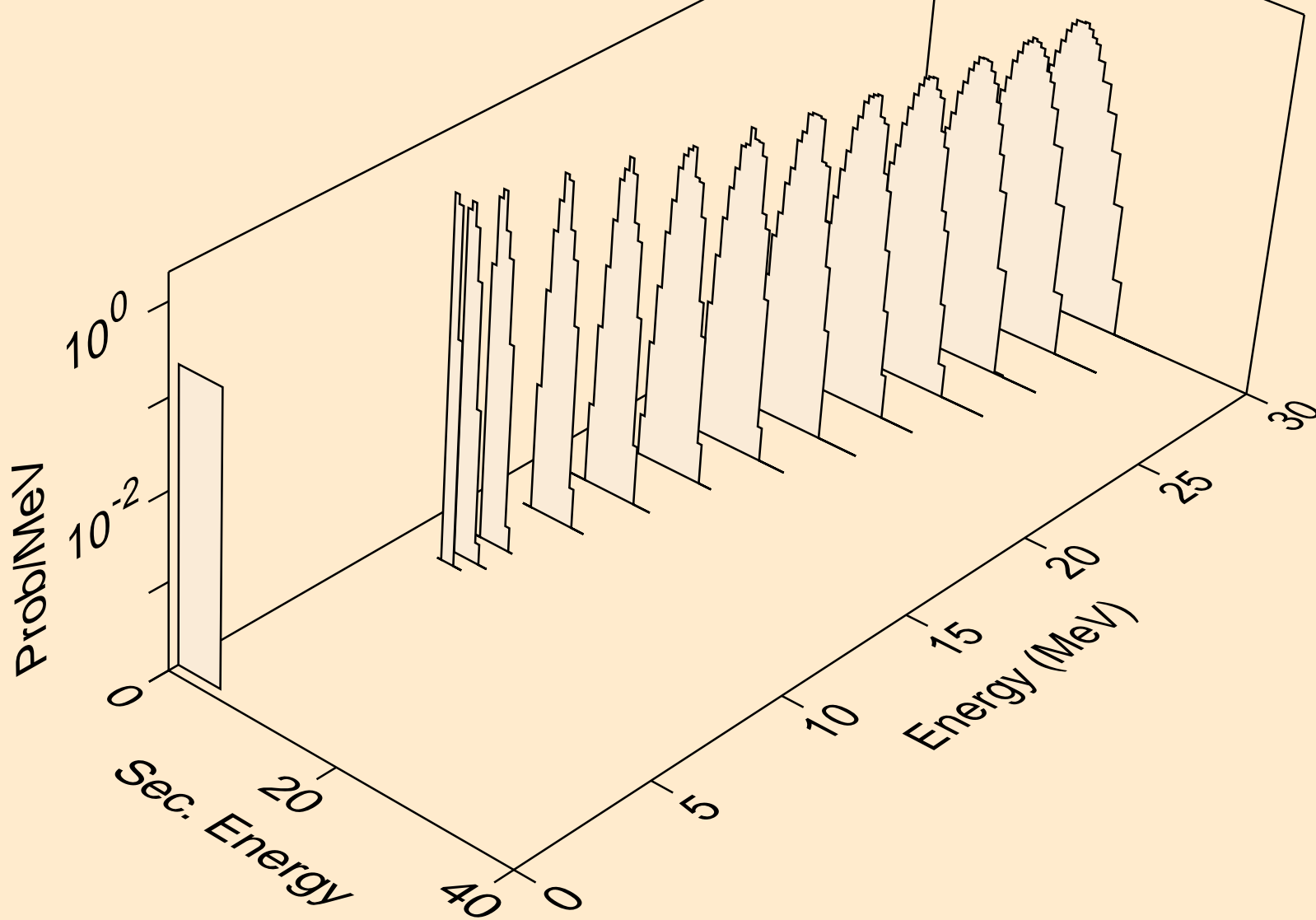

ER149M NEUTRON ACER TENDL-2019 LIBRARY; T=293.16K  
alphas from (n,a)

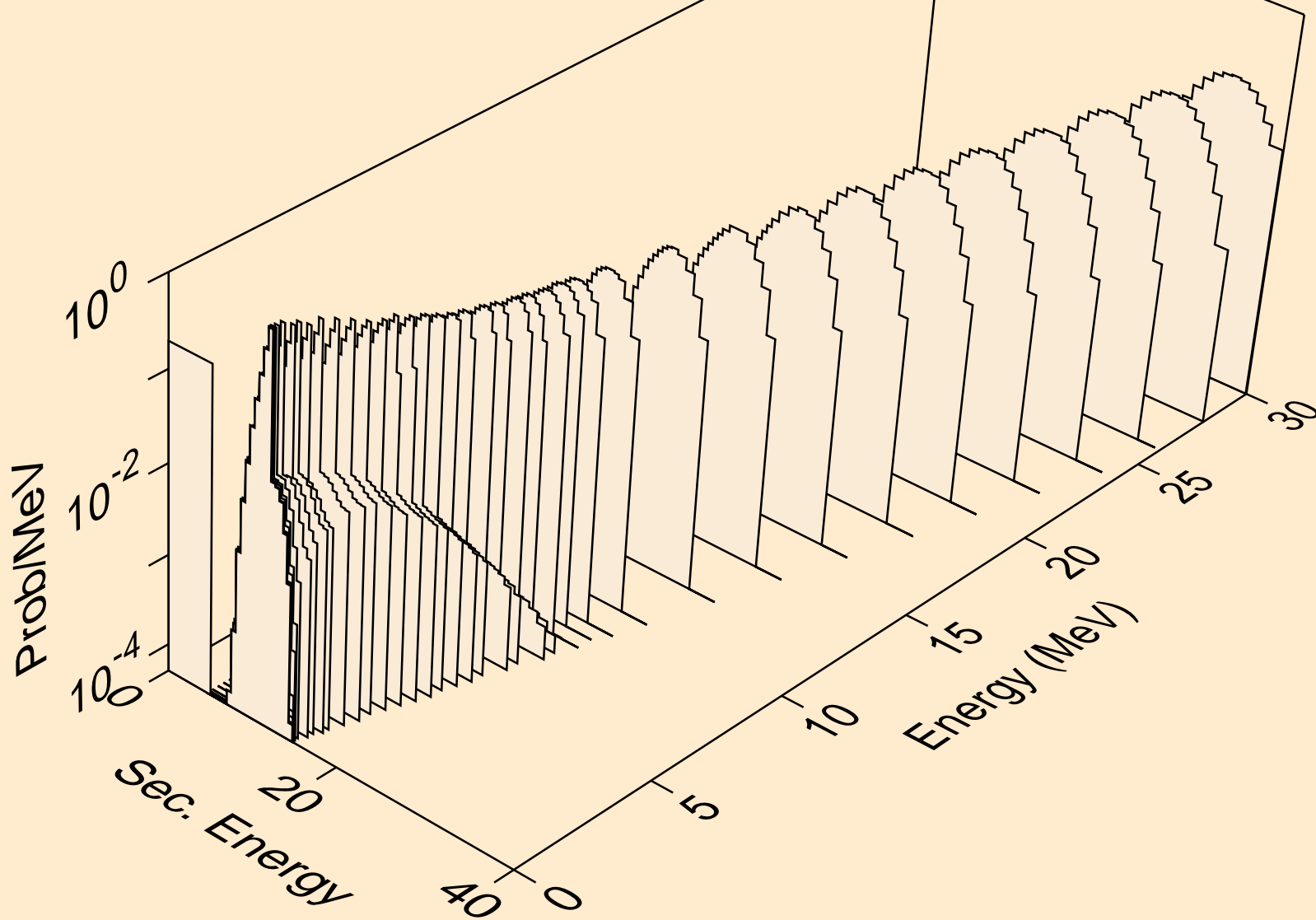

ER149M NEUTRON ACER TENDL-2019 LIBRARY; T=293.16K  
alphas from (n,2a)

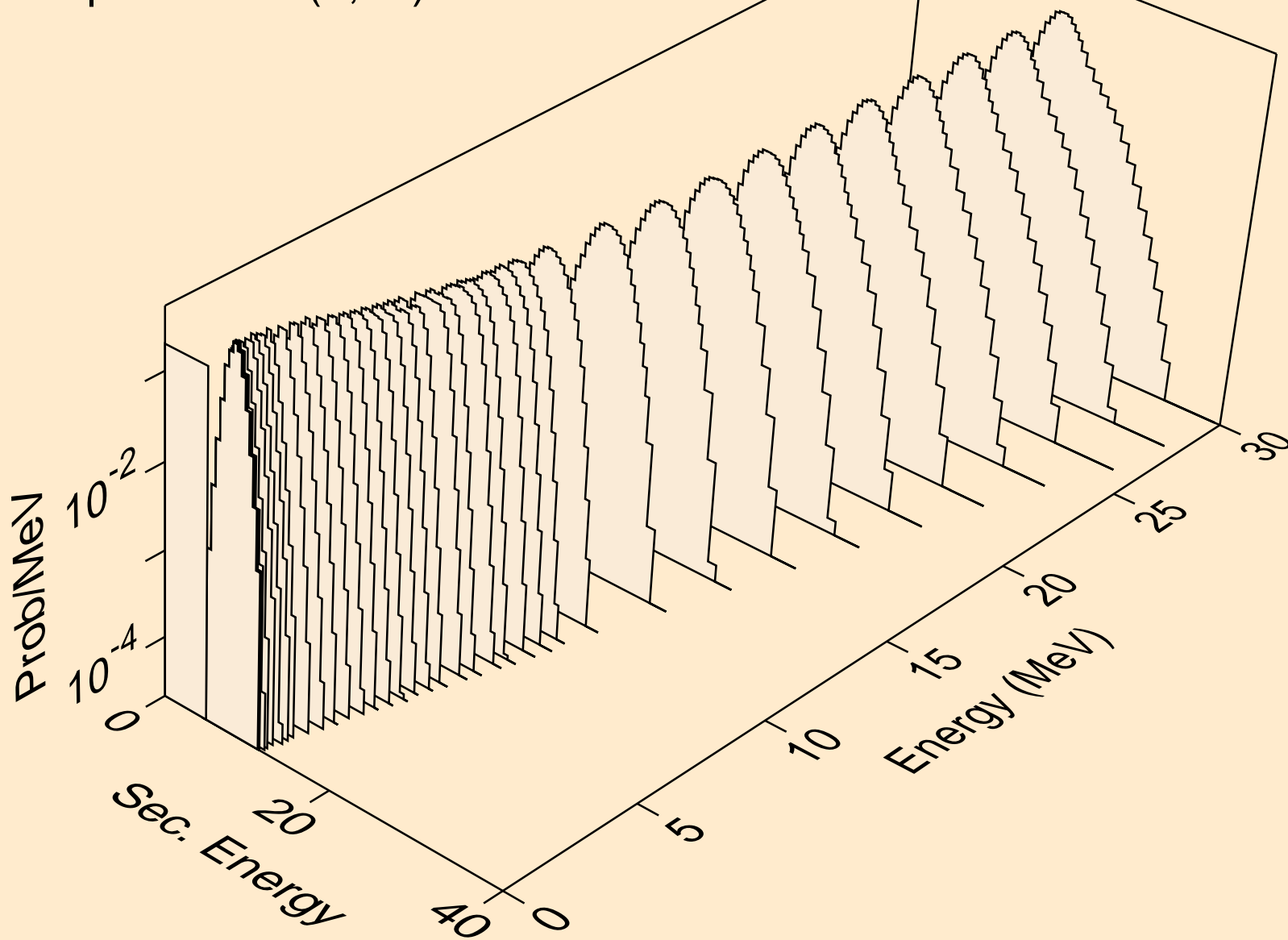

ER149M NEUTRON ACER TENDL-2019 LIBRARY; T=293.16K  
alphas from (n,3a)

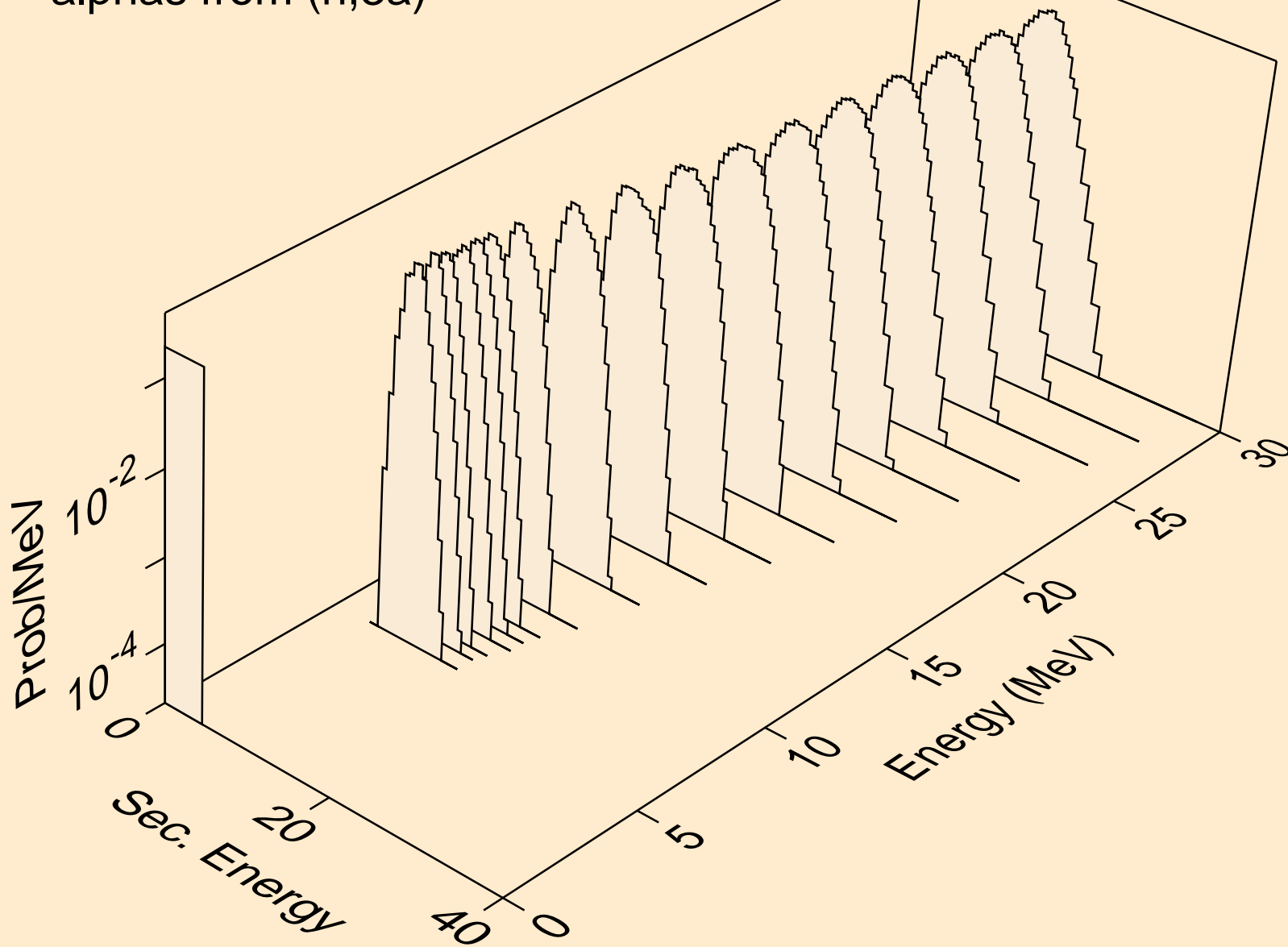

ER149M NEUTRON ACER TENDL-2019 LIBRARY; T=293.16K  
alphas from (n,p)

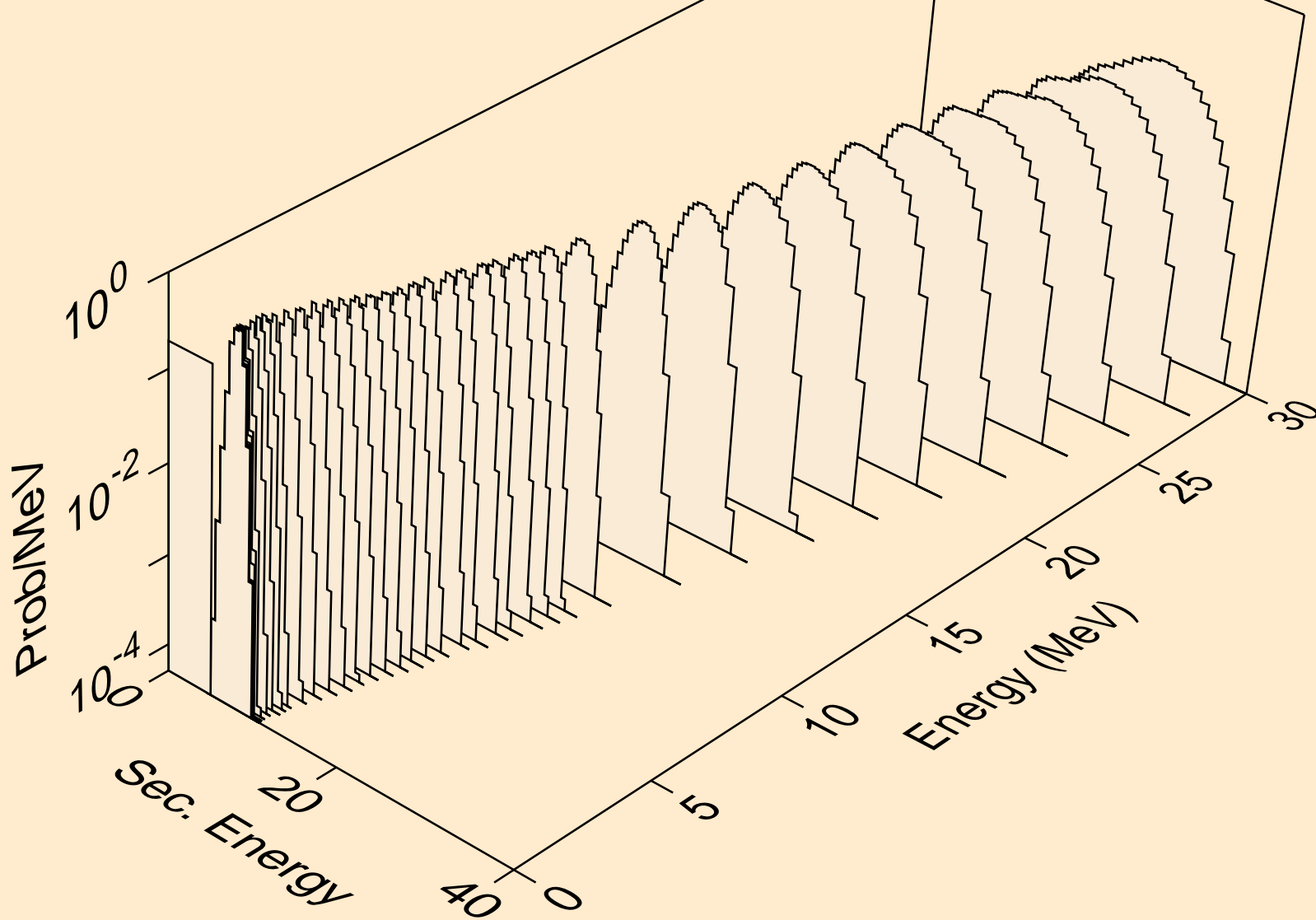

ER149M NEUTRON ACER TENDL-2019 LIBRARY; T=293.16K  
alphas from (n,da)

