

ER157 NEUTRON ACER TENDL-2019 LIBRARY; T=293.16K
Principal cross sections

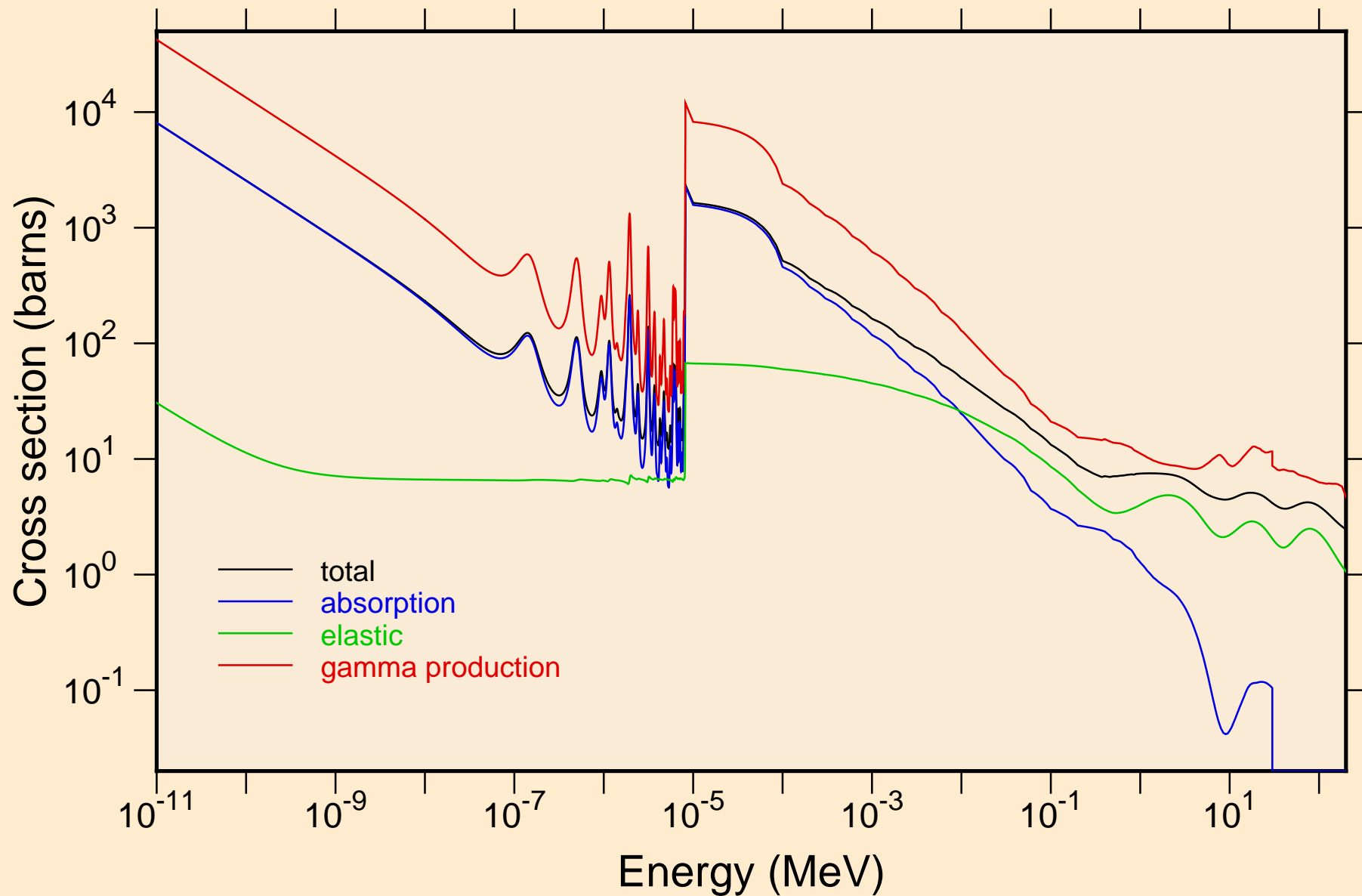

ER157 NEUTRON ACER TENDL-2019 LIBRARY; T=293.16K
resonance total cross section

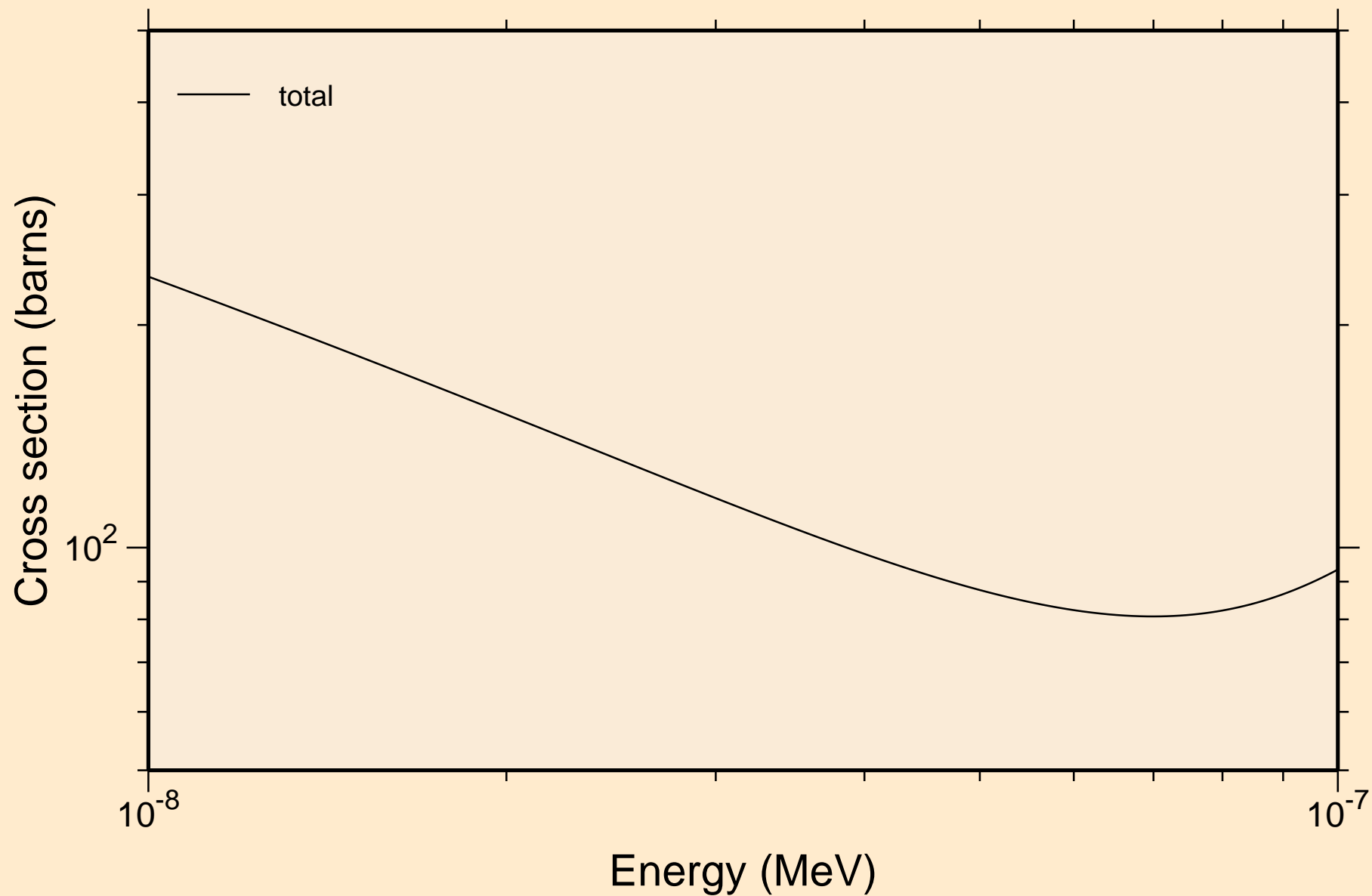

ER157 NEUTRON ACER TENDL-2019 LIBRARY; T=293.16K
resonance total cross section

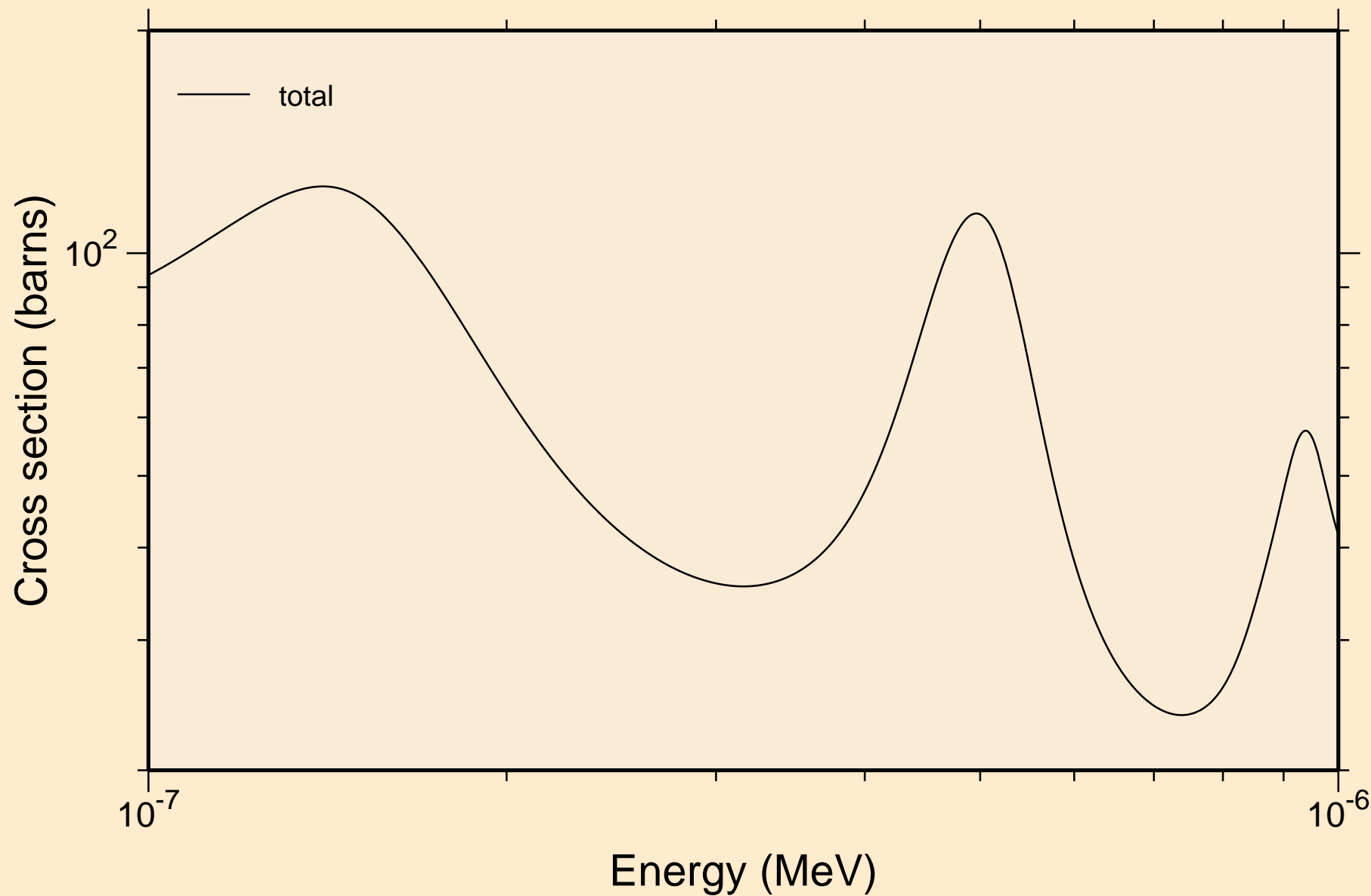

ER157 NEUTRON ACER TENDL-2019 LIBRARY; T=293.16K
resonance total cross section

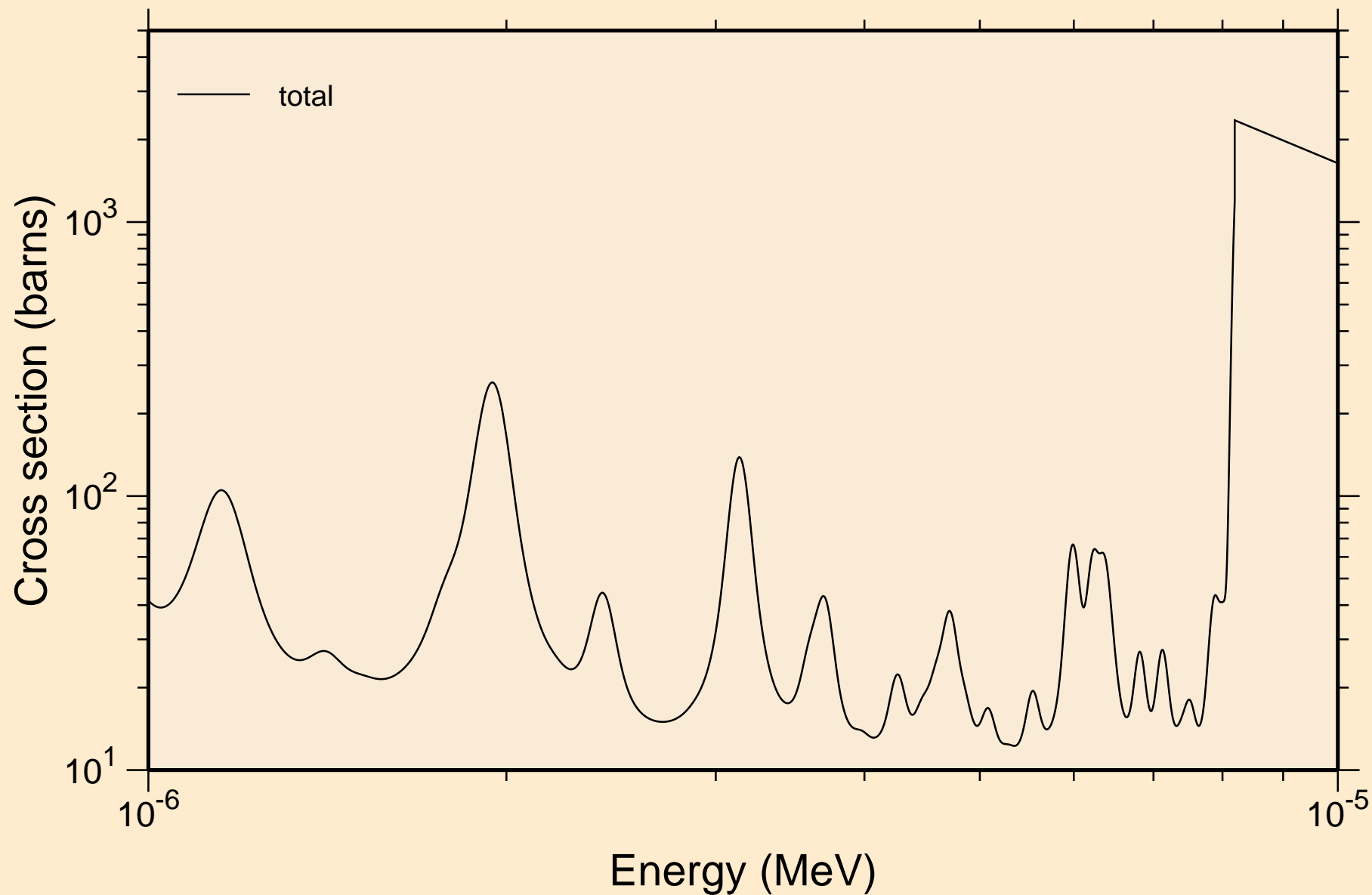

ER157 NEUTRON ACER TENDL-2019 LIBRARY; T=293.16K
resonance total cross section

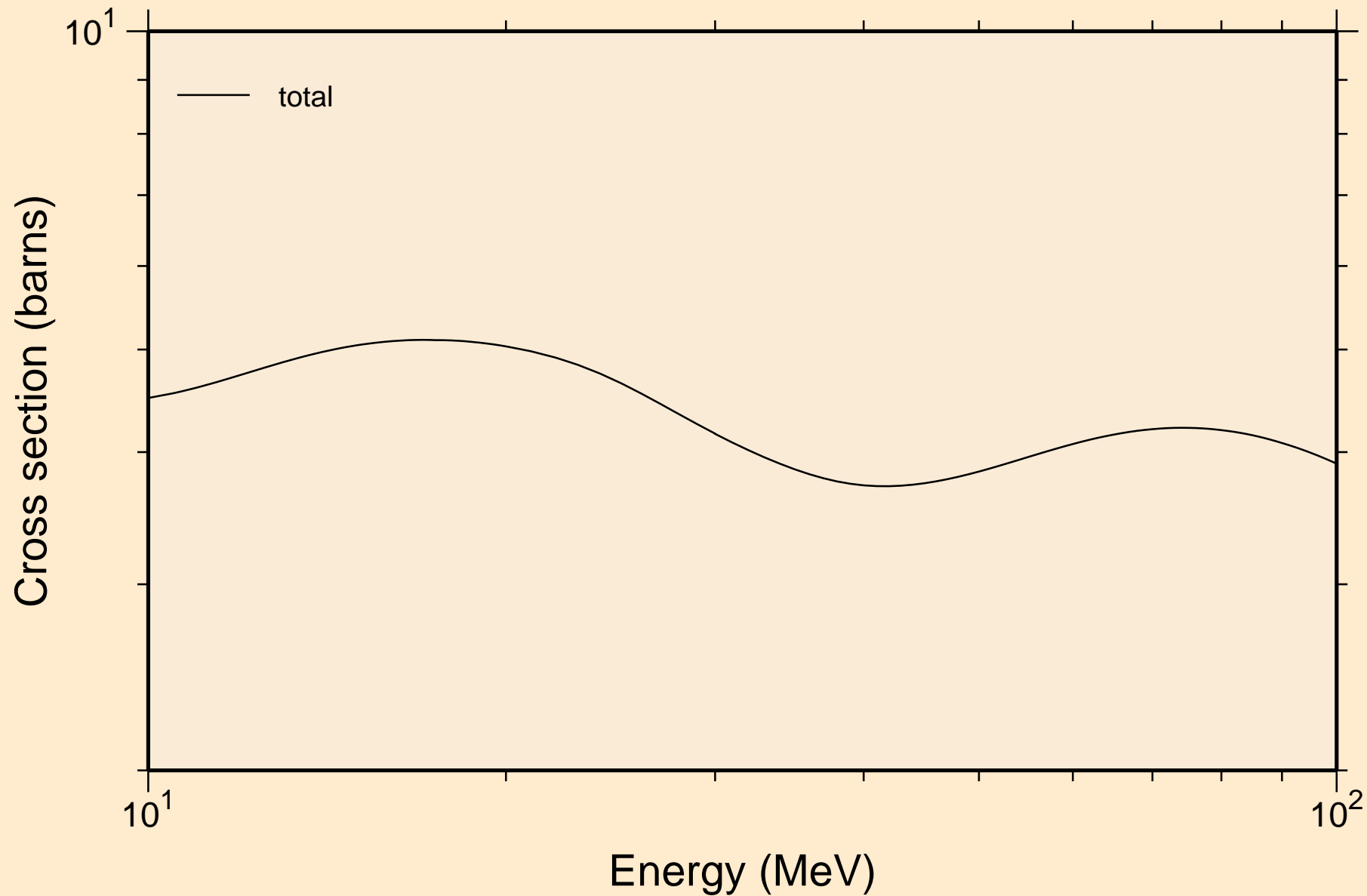

ER157 NEUTRON ACER TENDL-2019 LIBRARY; T=293.16K
resonance absorption cross sections

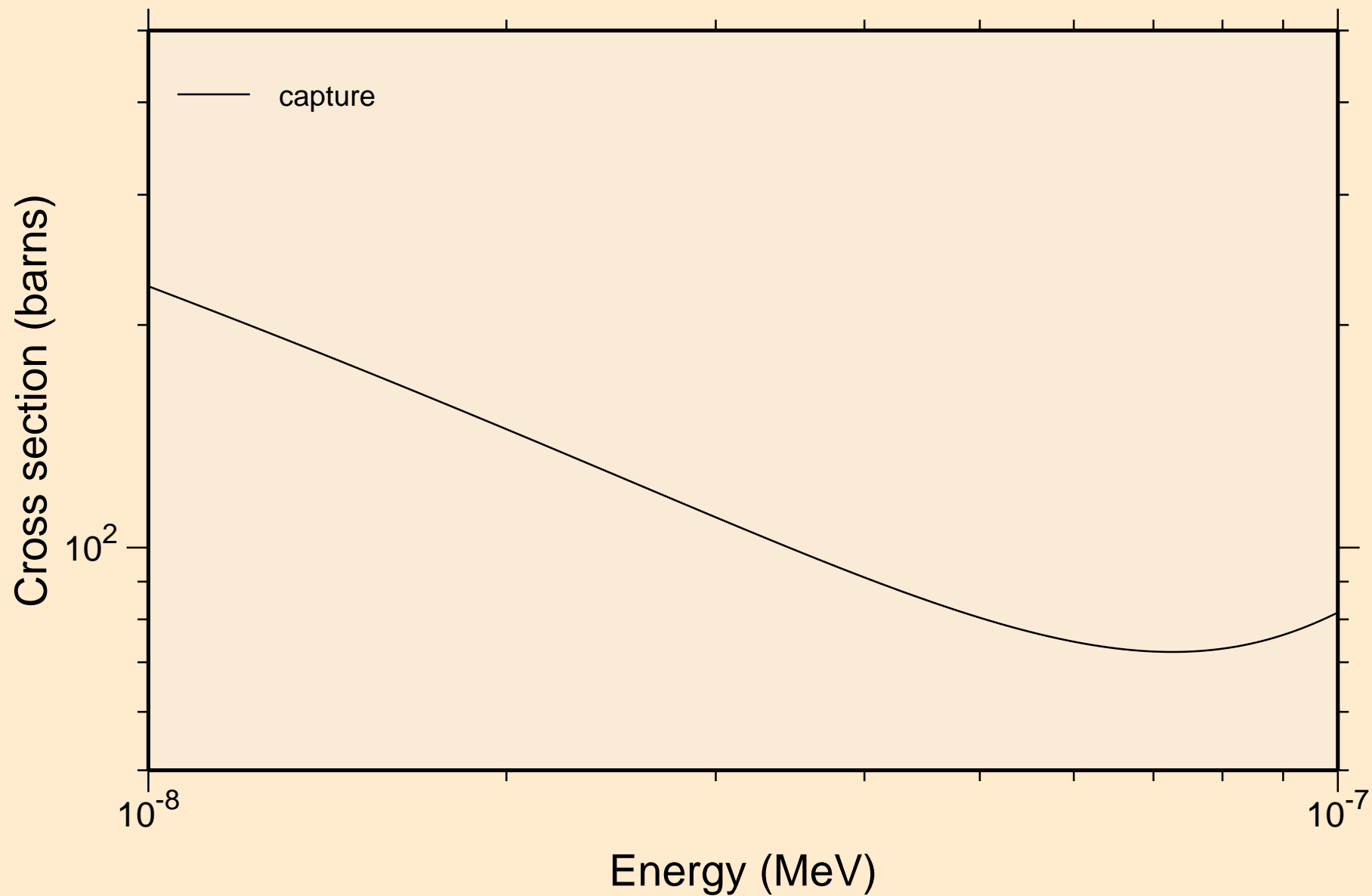

ER157 NEUTRON ACER TENDL-2019 LIBRARY; T=293.16K
resonance absorption cross sections

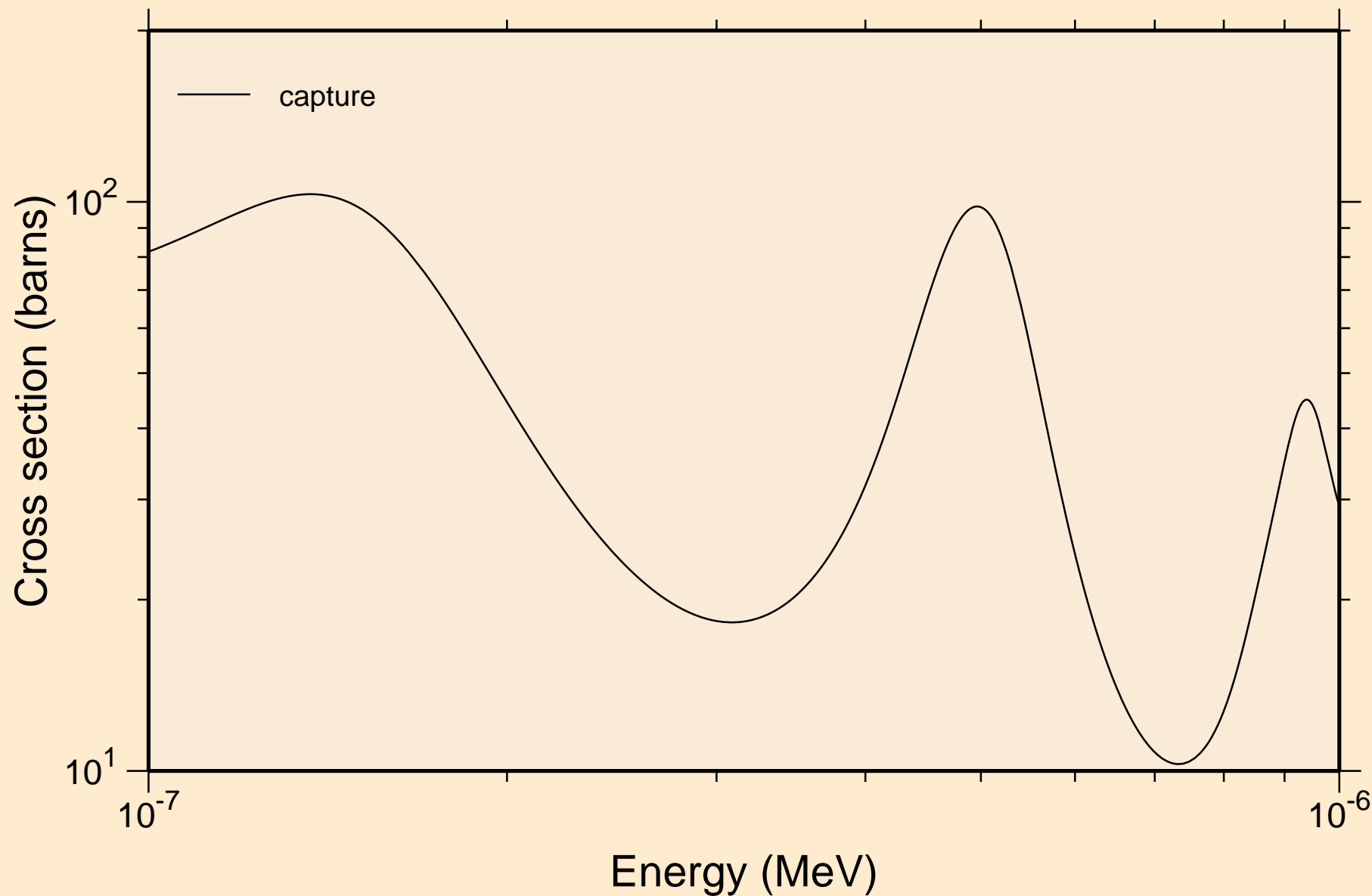

ER157 NEUTRON ACER TENDL-2019 LIBRARY; T=293.16K
resonance absorption cross sections

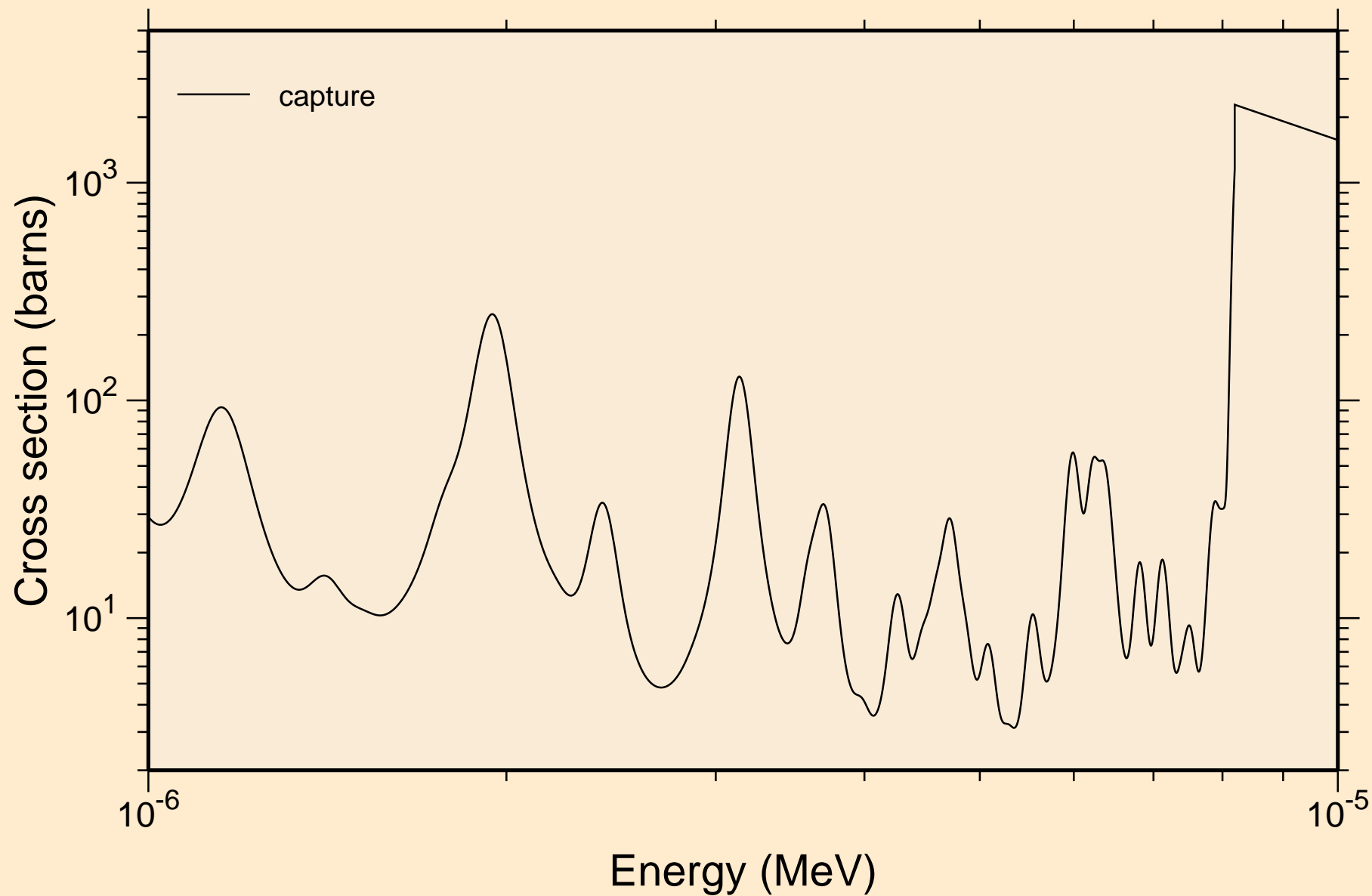

ER157 NEUTRON ACER TENDL-2019 LIBRARY; T=293.16K
resonance absorption cross sections

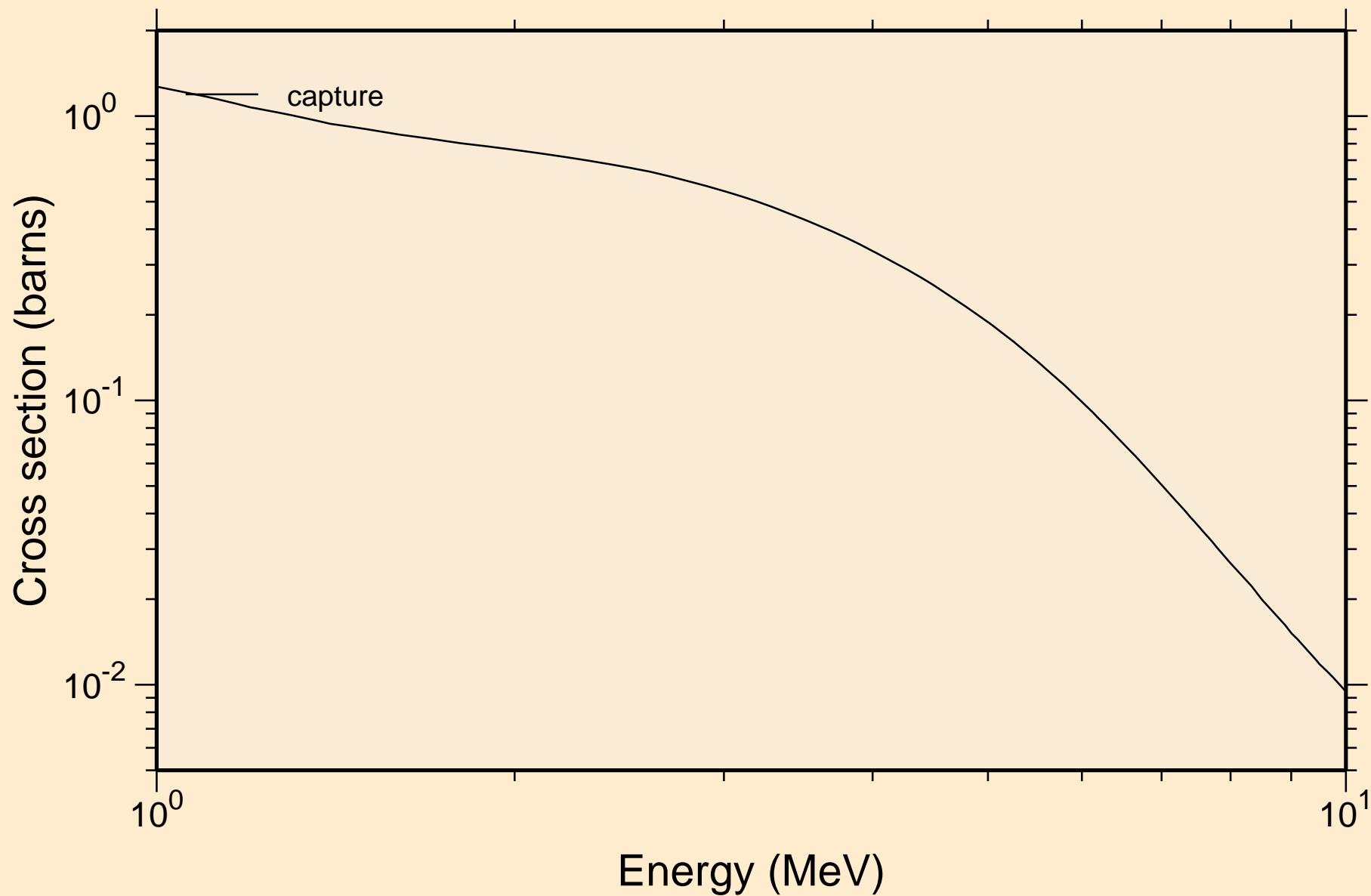

ER157 NEUTRON ACER TENDL-2019 LIBRARY; T=293.16K
Heating

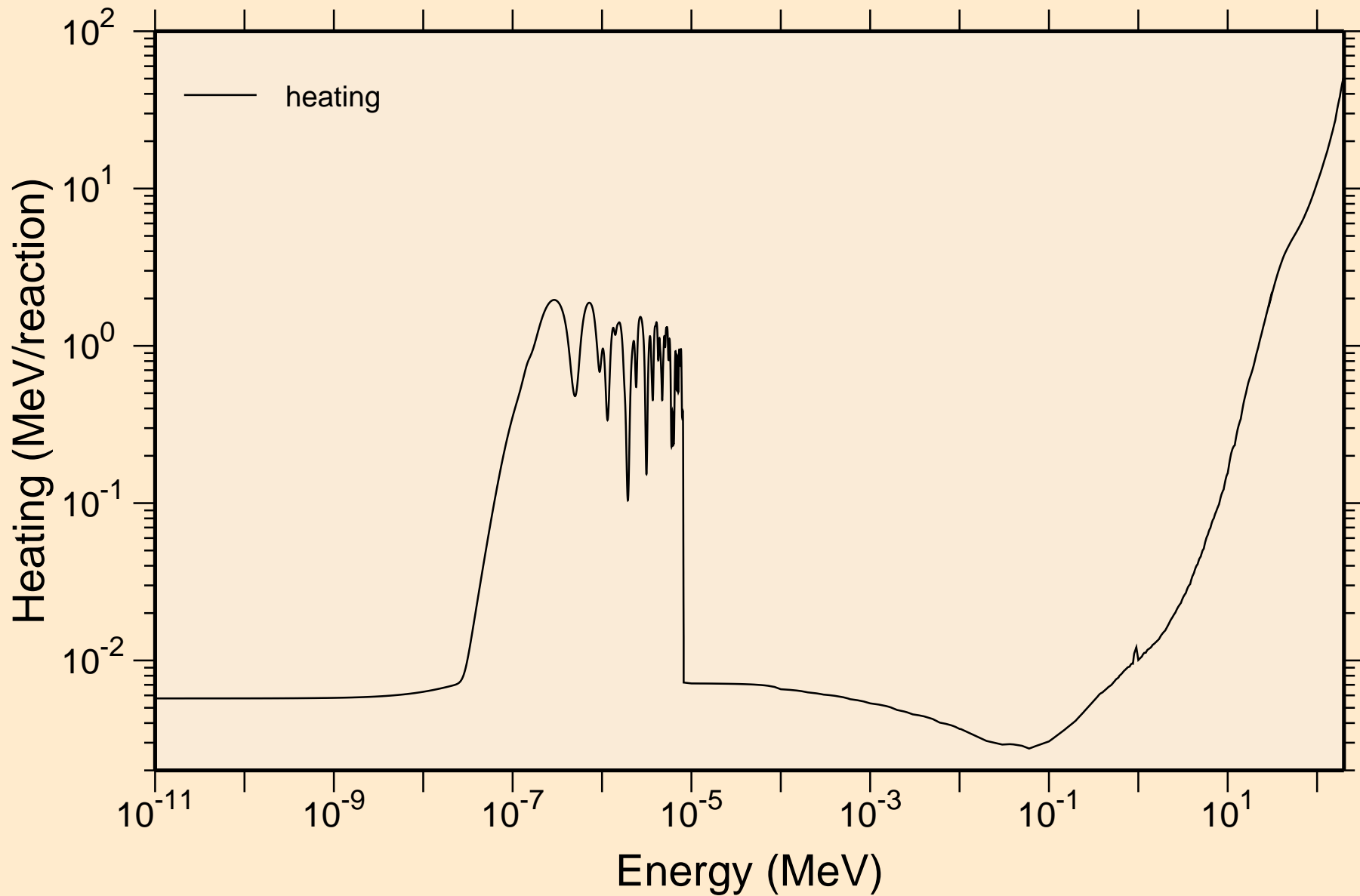

ER157 NEUTRON ACER TENDL-2019 LIBRARY; T=293.16K
Damage

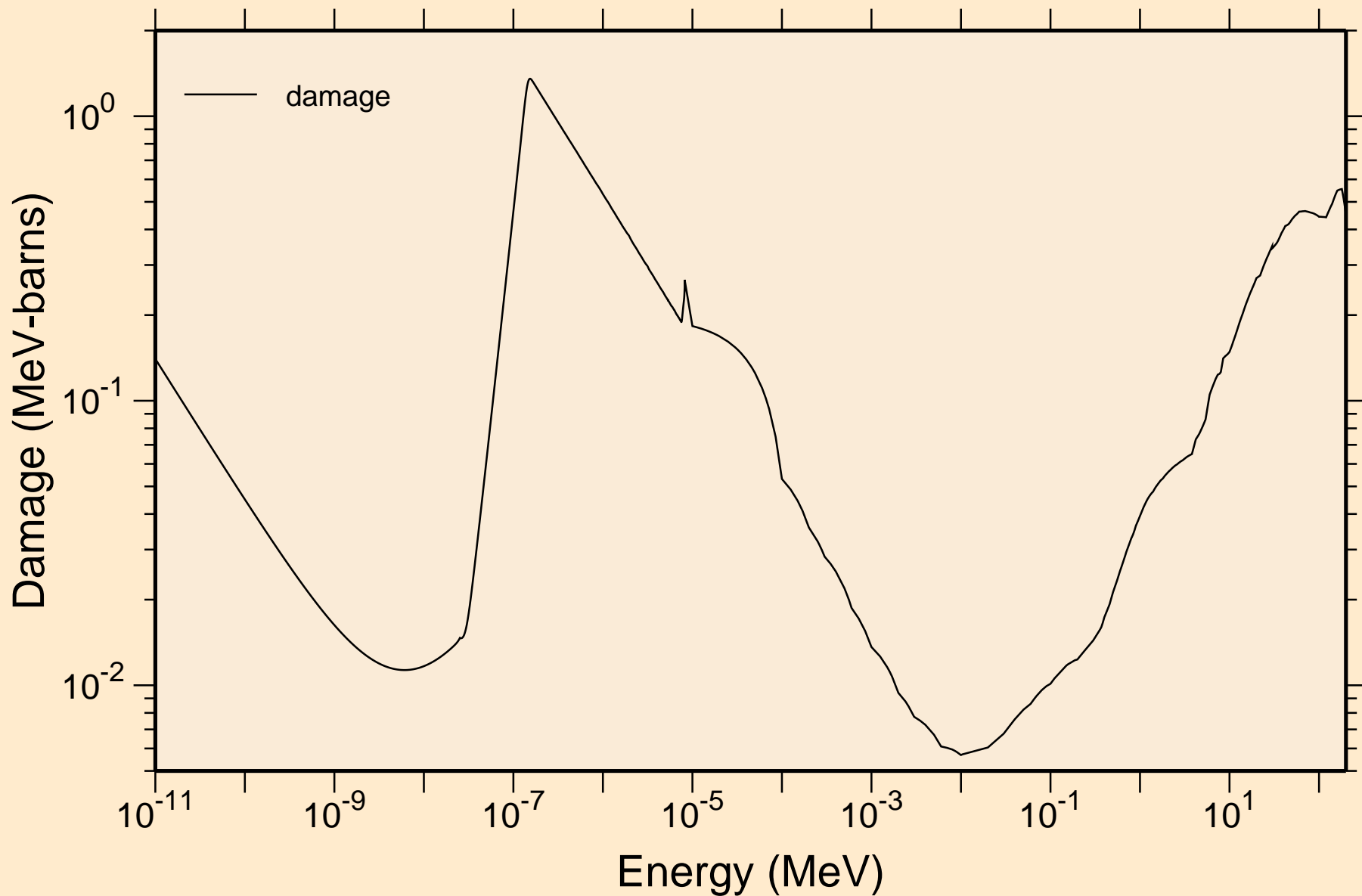

ER157 NEUTRON ACER TENDL-2019 LIBRARY; T=293.16K
Non-threshold reactions

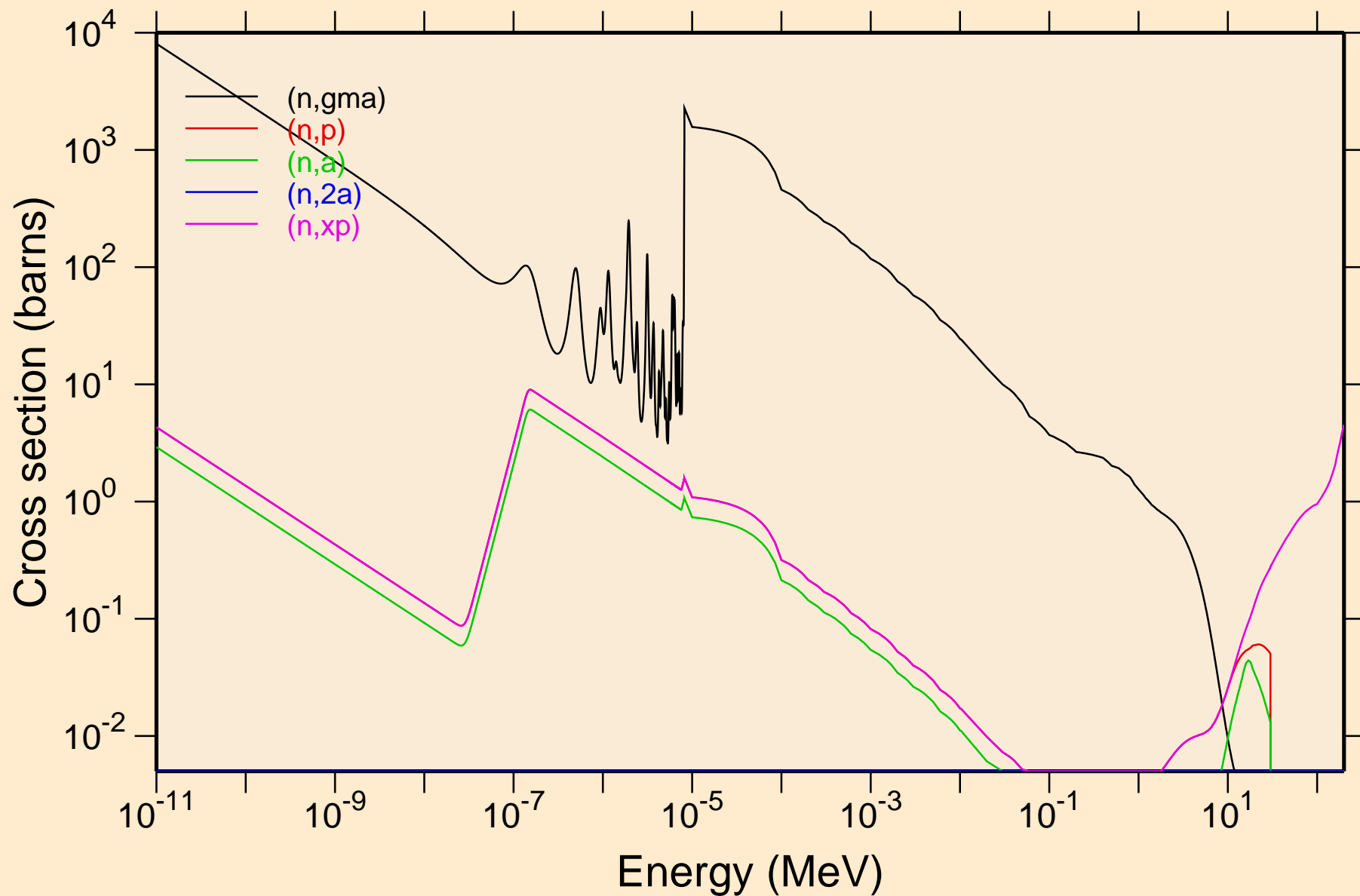

ER157 NEUTRON ACER TENDL-2019 LIBRARY; T=293.16K
Non-threshold reactions

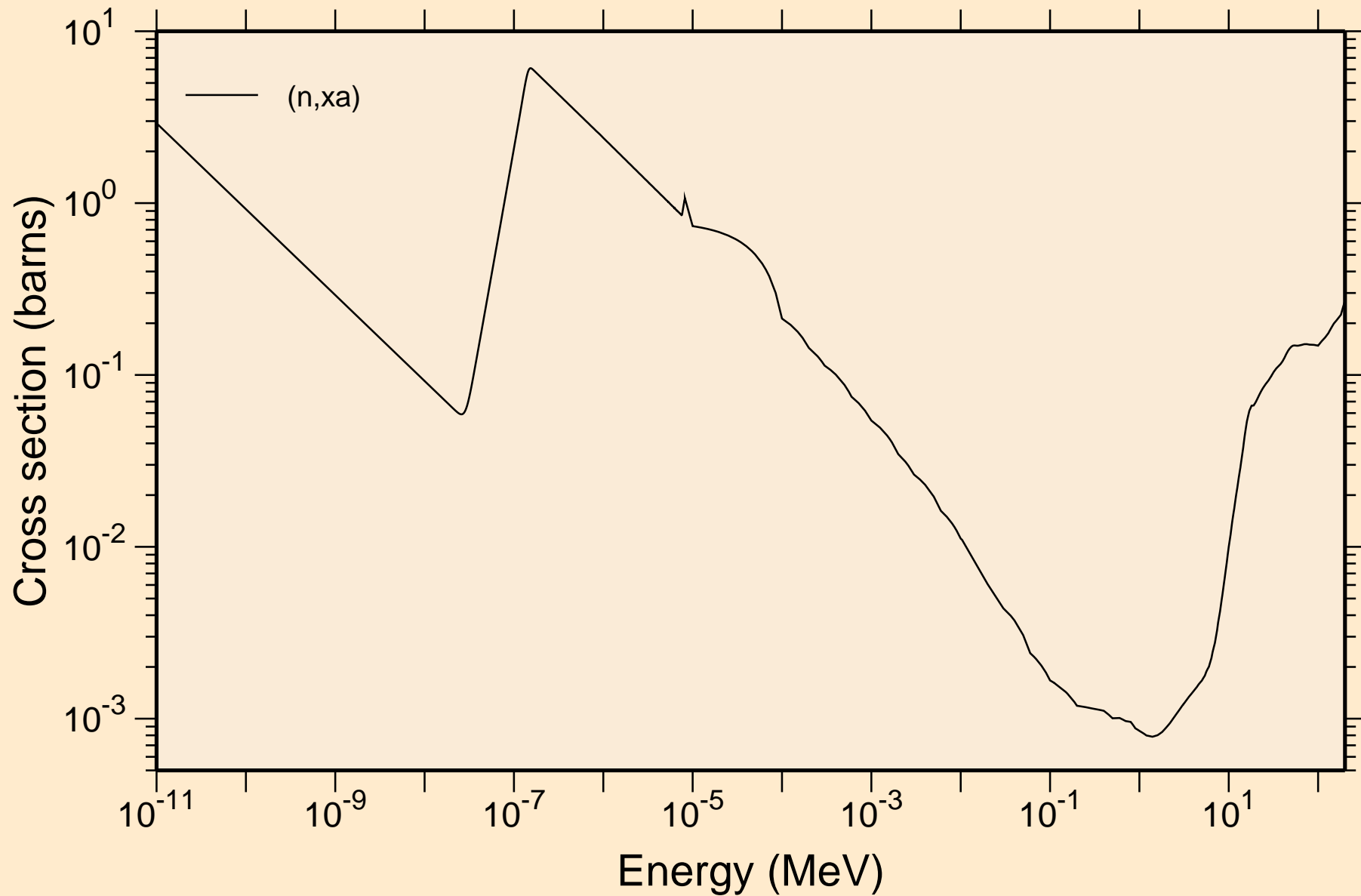

ER157 NEUTRON ACER TENDL-2019 LIBRARY; T=293.16K

Principal cross sections

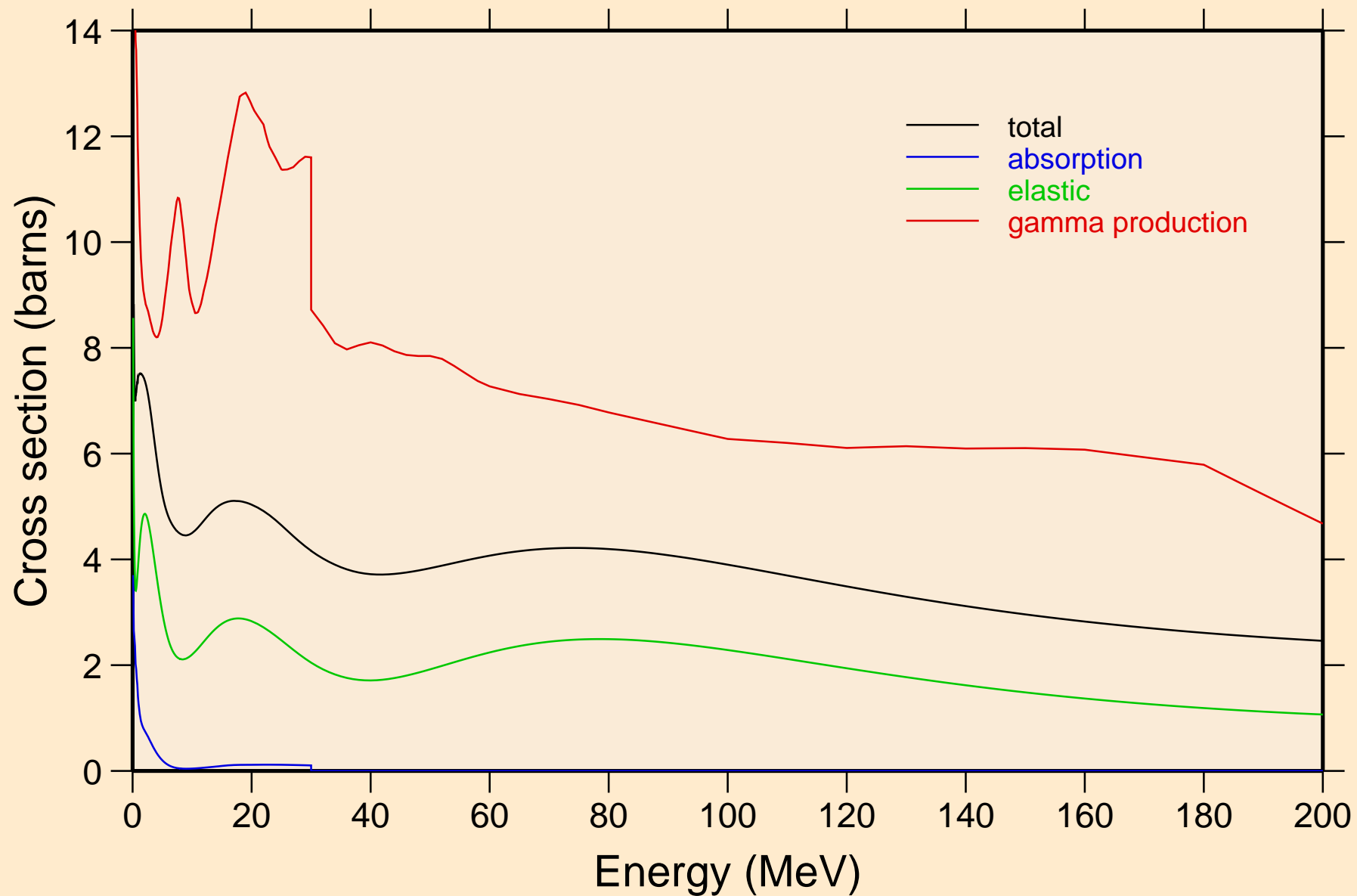

ER157 NEUTRON ACER TENDL-2019 LIBRARY; T=293.16K
Heating

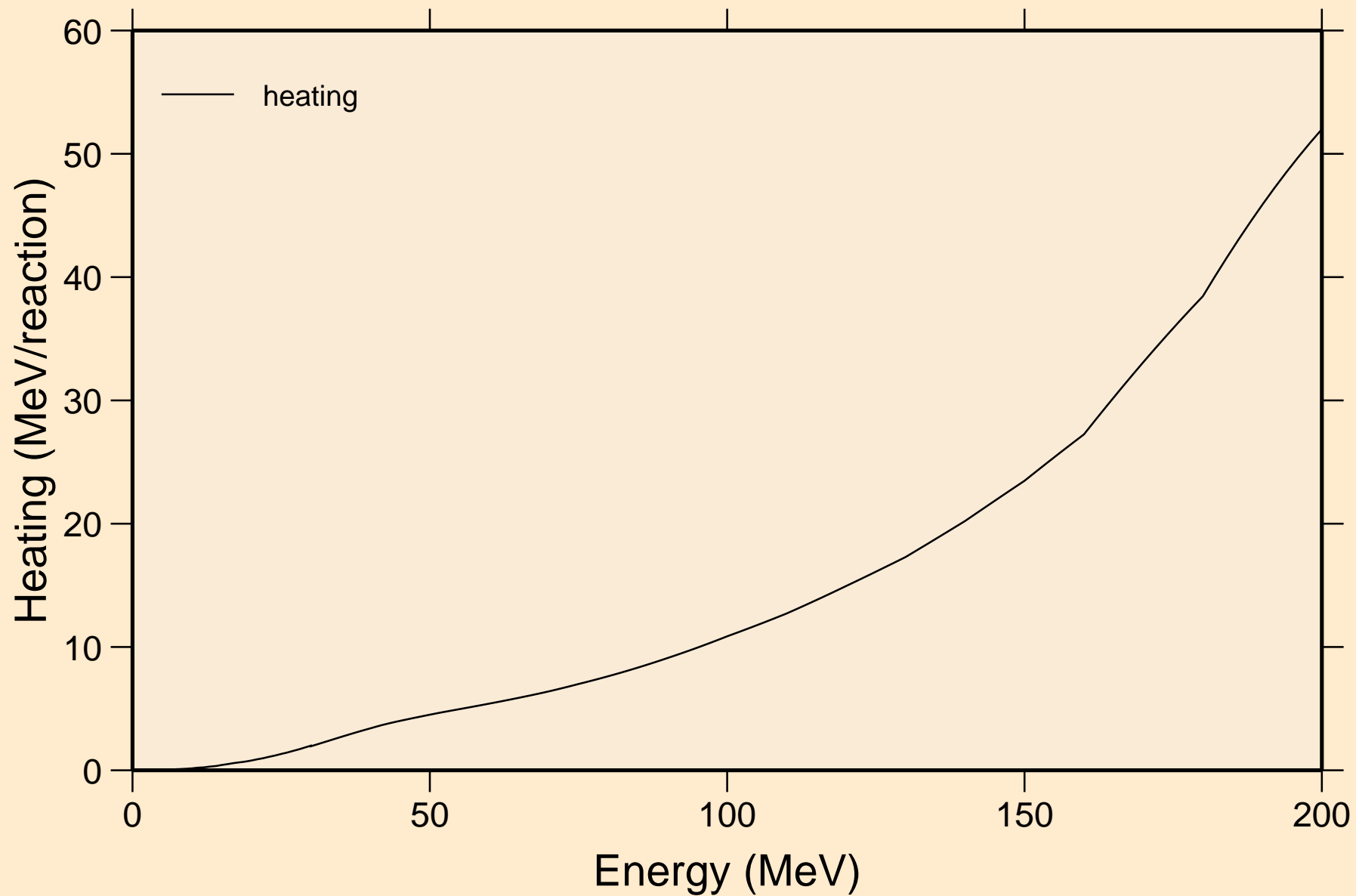

ER157 NEUTRON ACER TENDL-2019 LIBRARY; T=293.16K
Damage

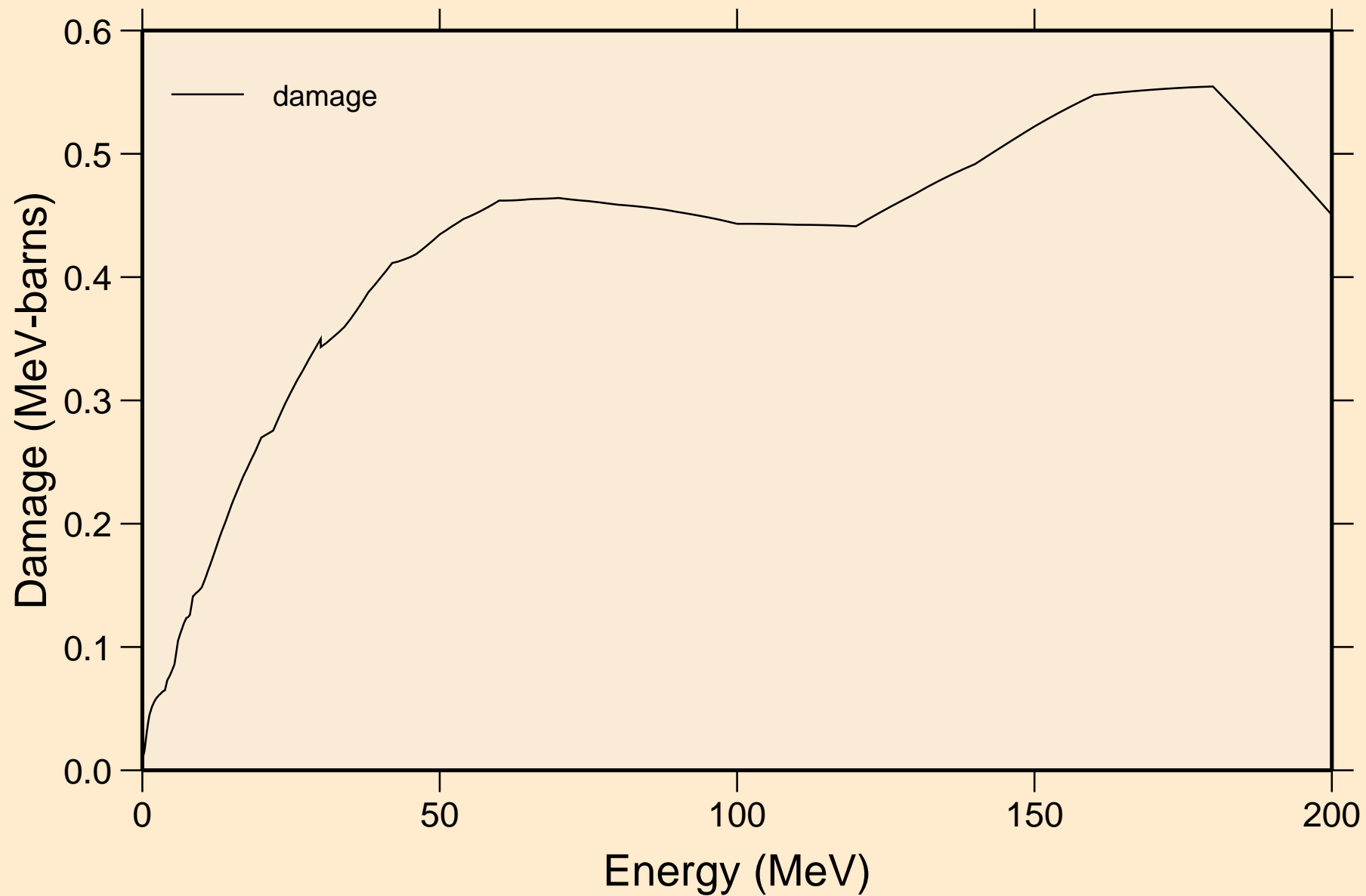

ER157 NEUTRON ACER TENDL-2019 LIBRARY; T=293.16K
Non-threshold reactions

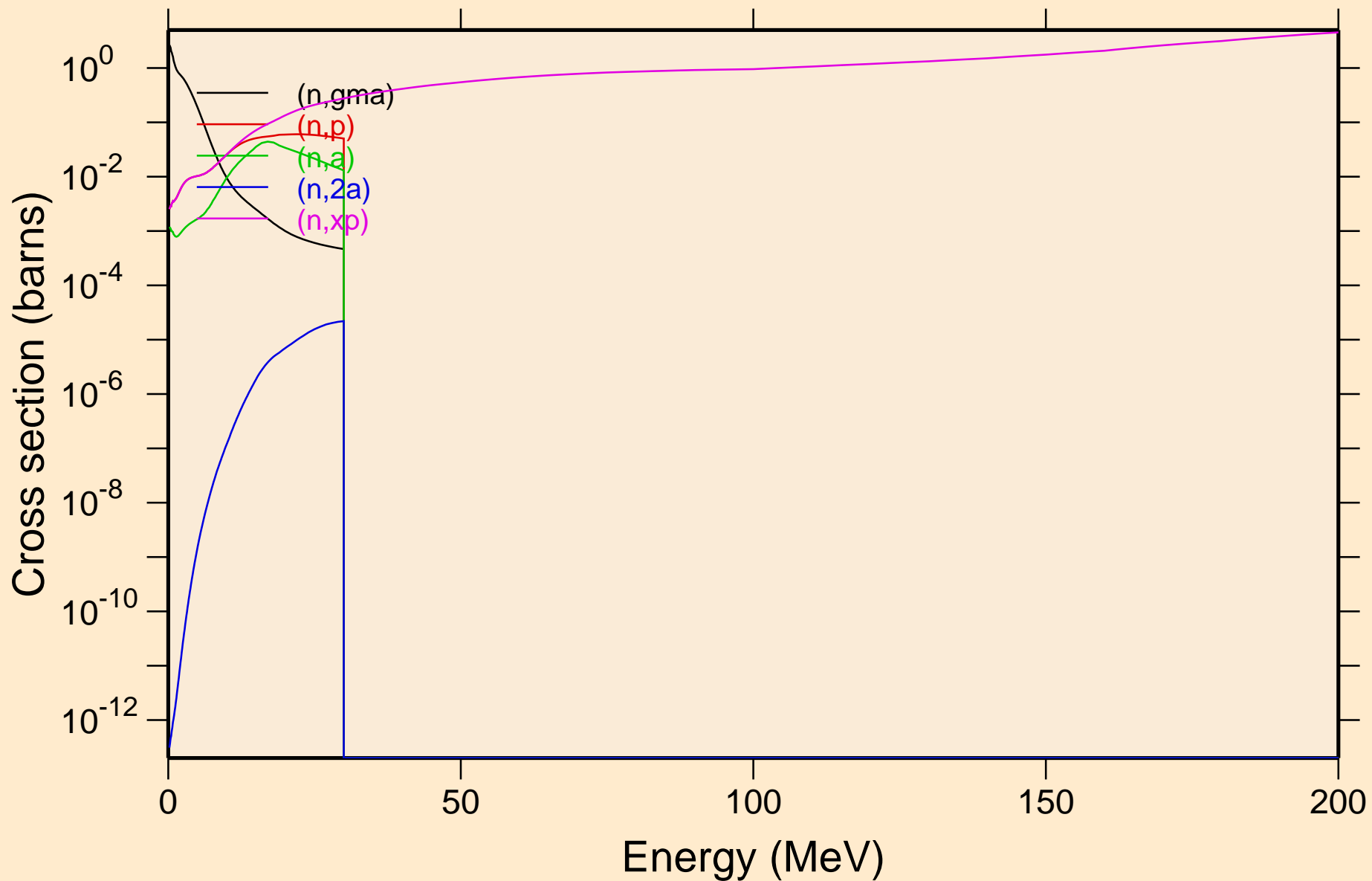

ER157 NEUTRON ACER TENDL-2019 LIBRARY; T=293.16K
Non-threshold reactions

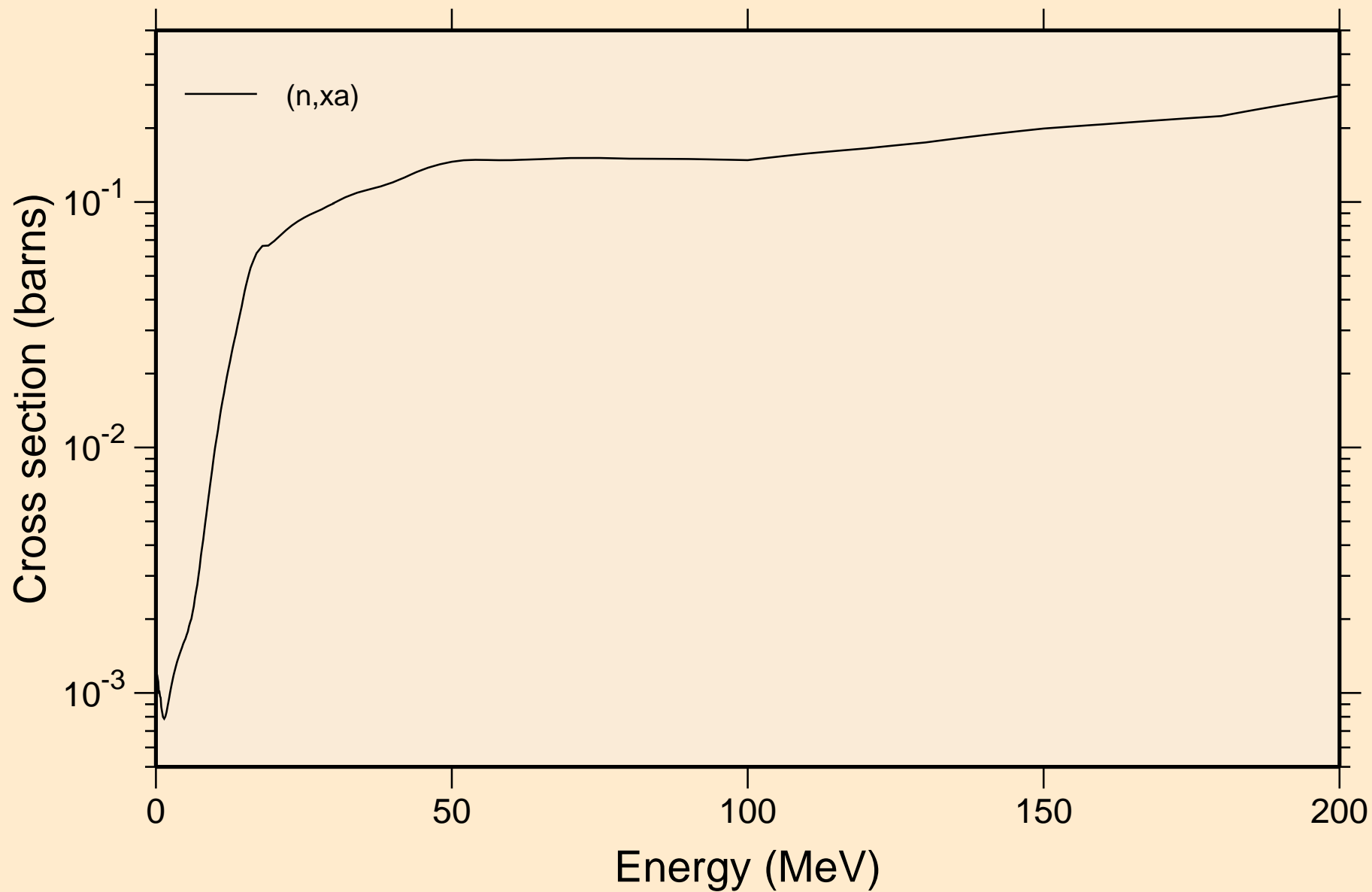

ER157 NEUTRON ACER TENDL-2019 LIBRARY; T=293.16K
Inelastic levels

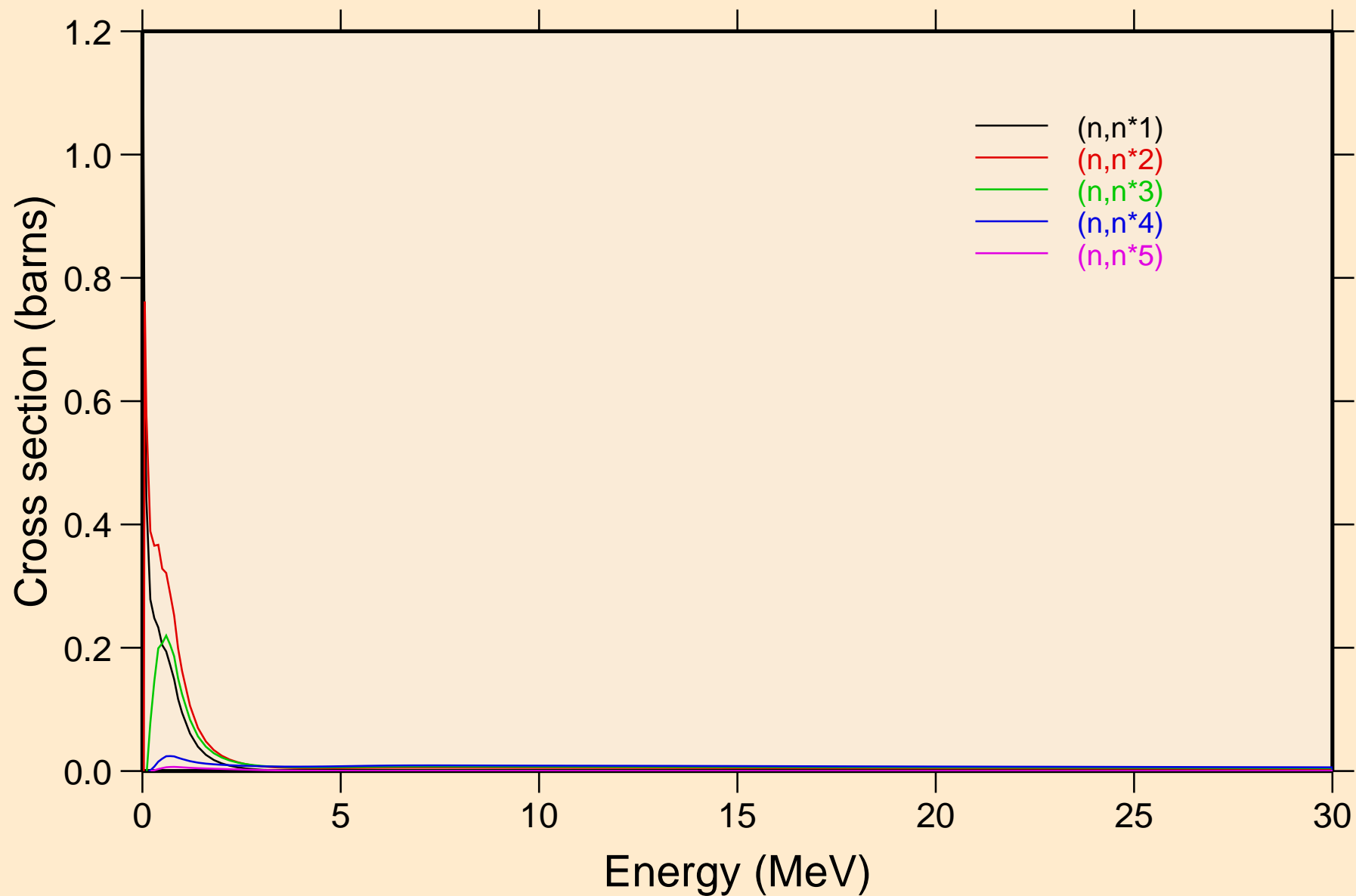

ER157 NEUTRON ACER TENDL-2019 LIBRARY; T=293.16K
Inelastic levels

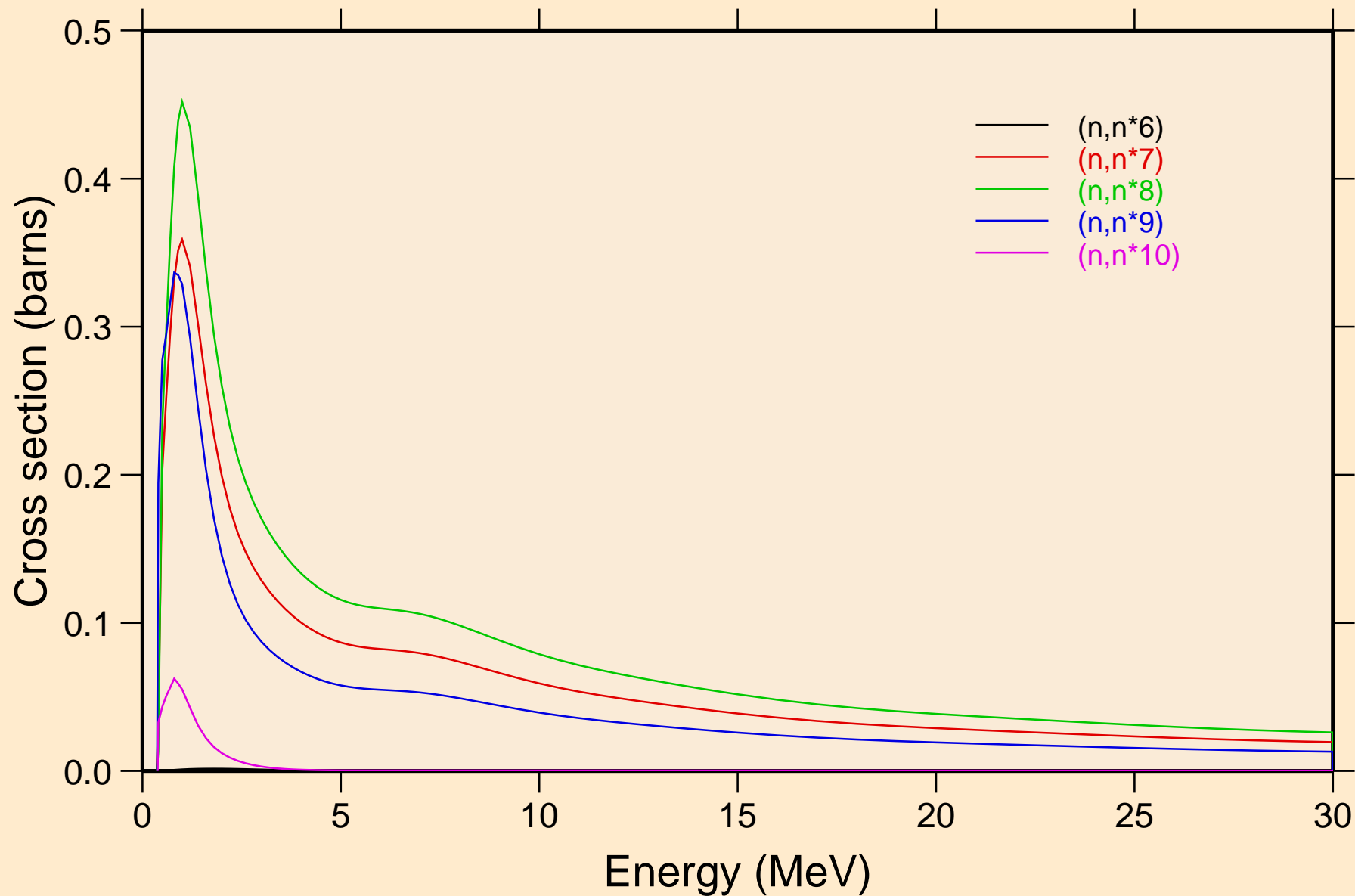

ER157 NEUTRON ACER TENDL-2019 LIBRARY; T=293.16K
Inelastic levels

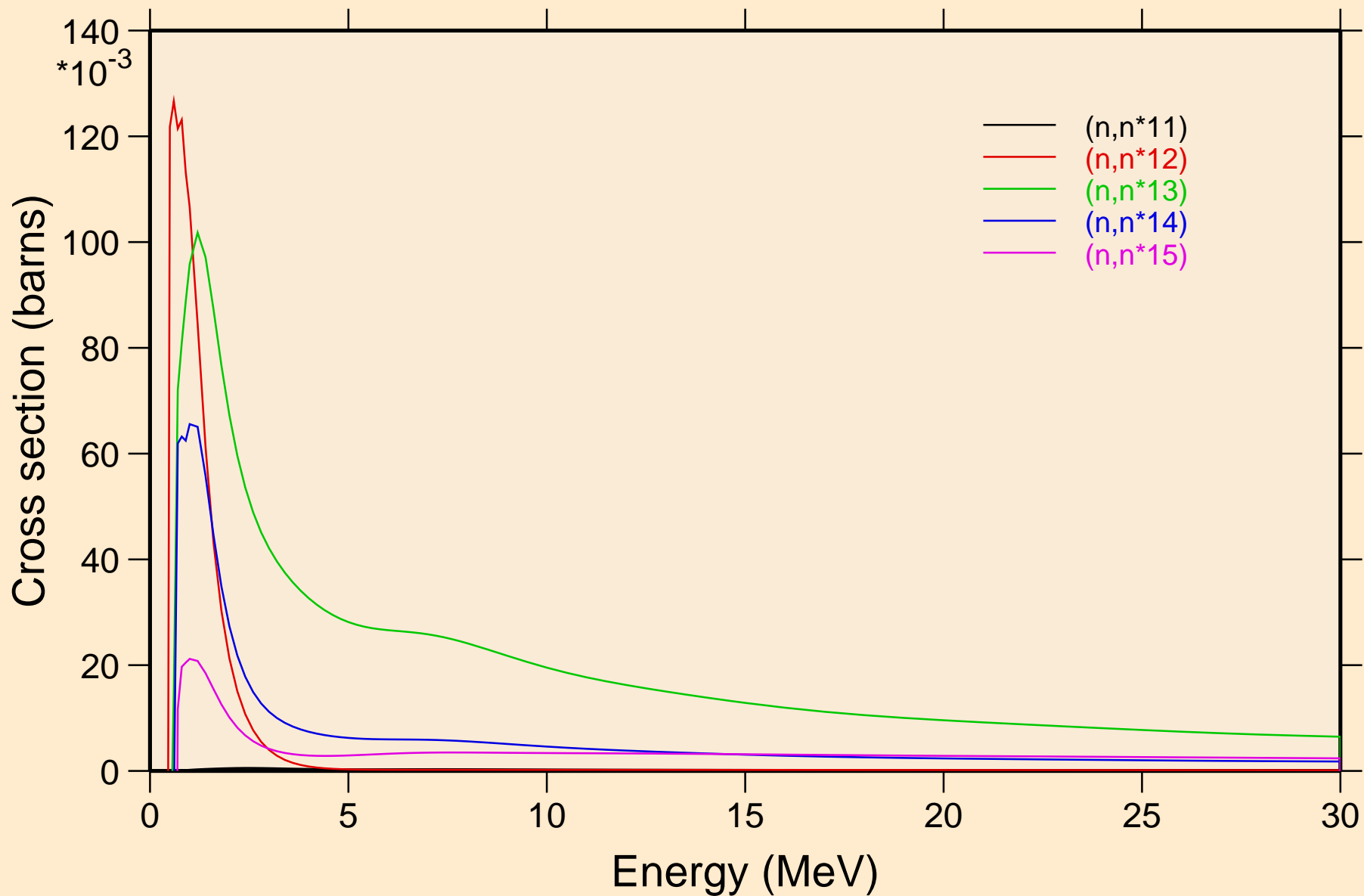

ER157 NEUTRON ACER TENDL-2019 LIBRARY; T=293.16K
Inelastic levels

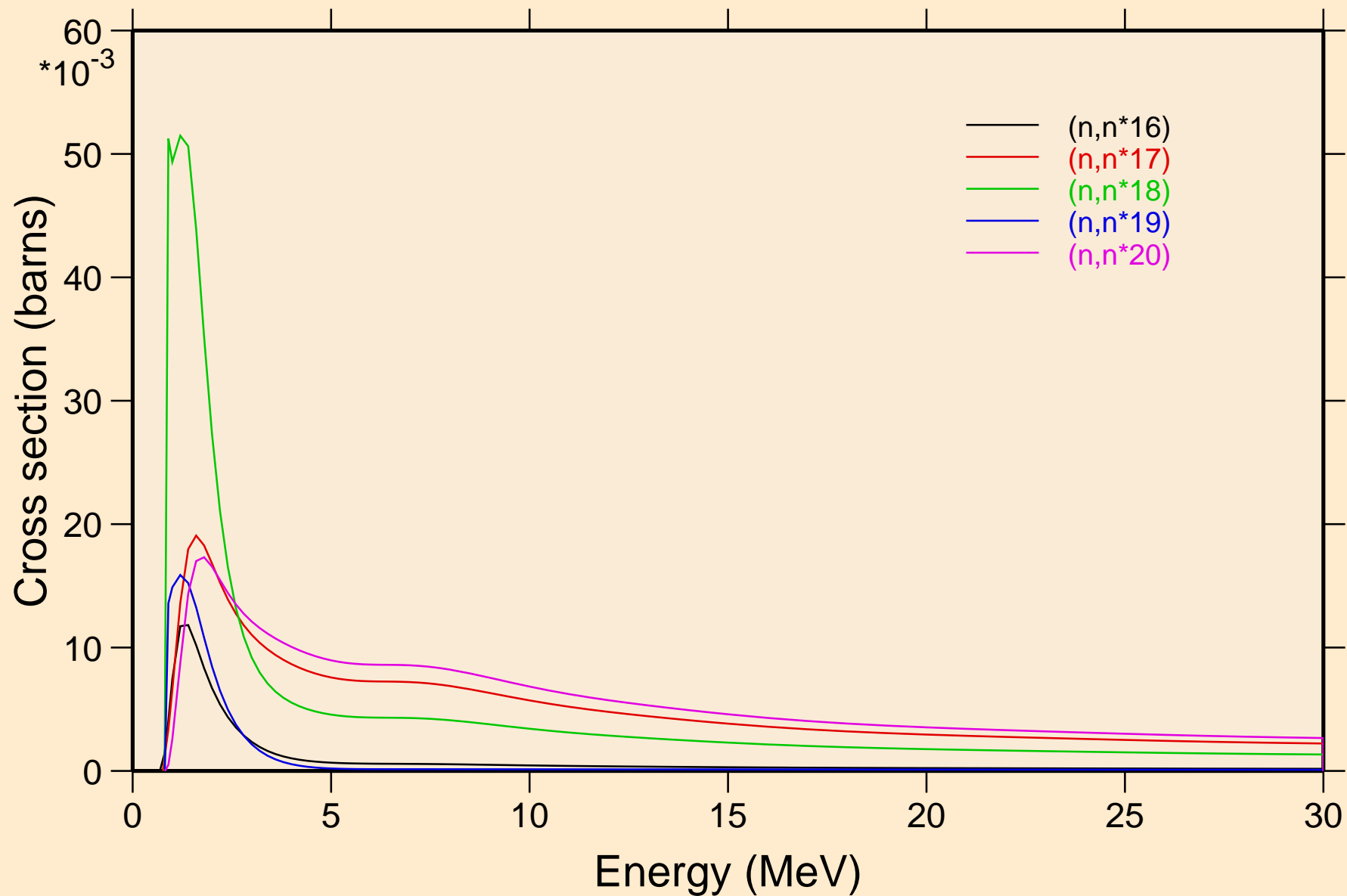

ER157 NEUTRON ACER TENDL-2019 LIBRARY; T=293.16K
Inelastic levels

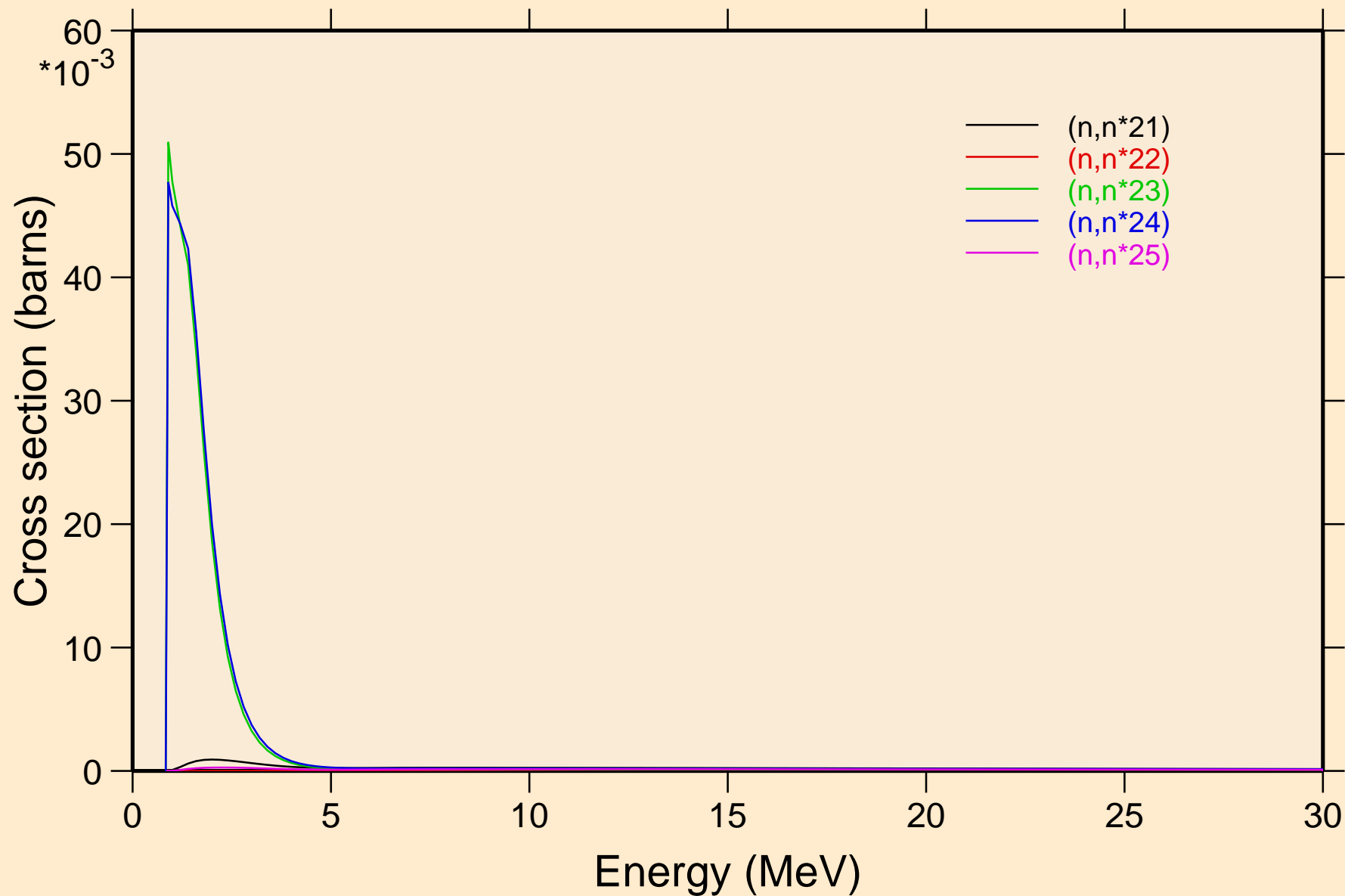

ER157 NEUTRON ACER TENDL-2019 LIBRARY; T=293.16K
Inelastic levels

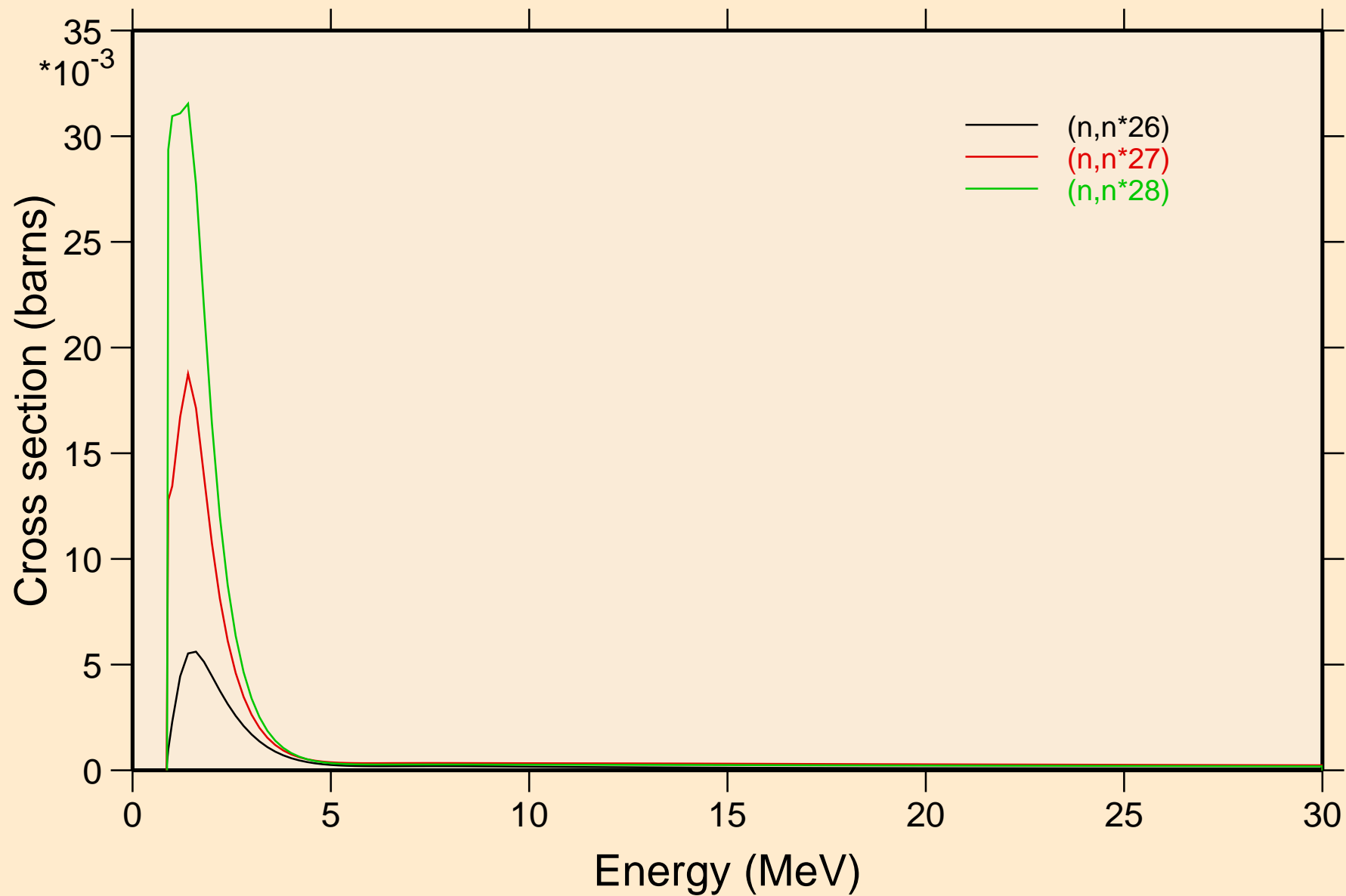

ER157 NEUTRON ACER TENDL-2019 LIBRARY; T=293.16K
Threshold reactions

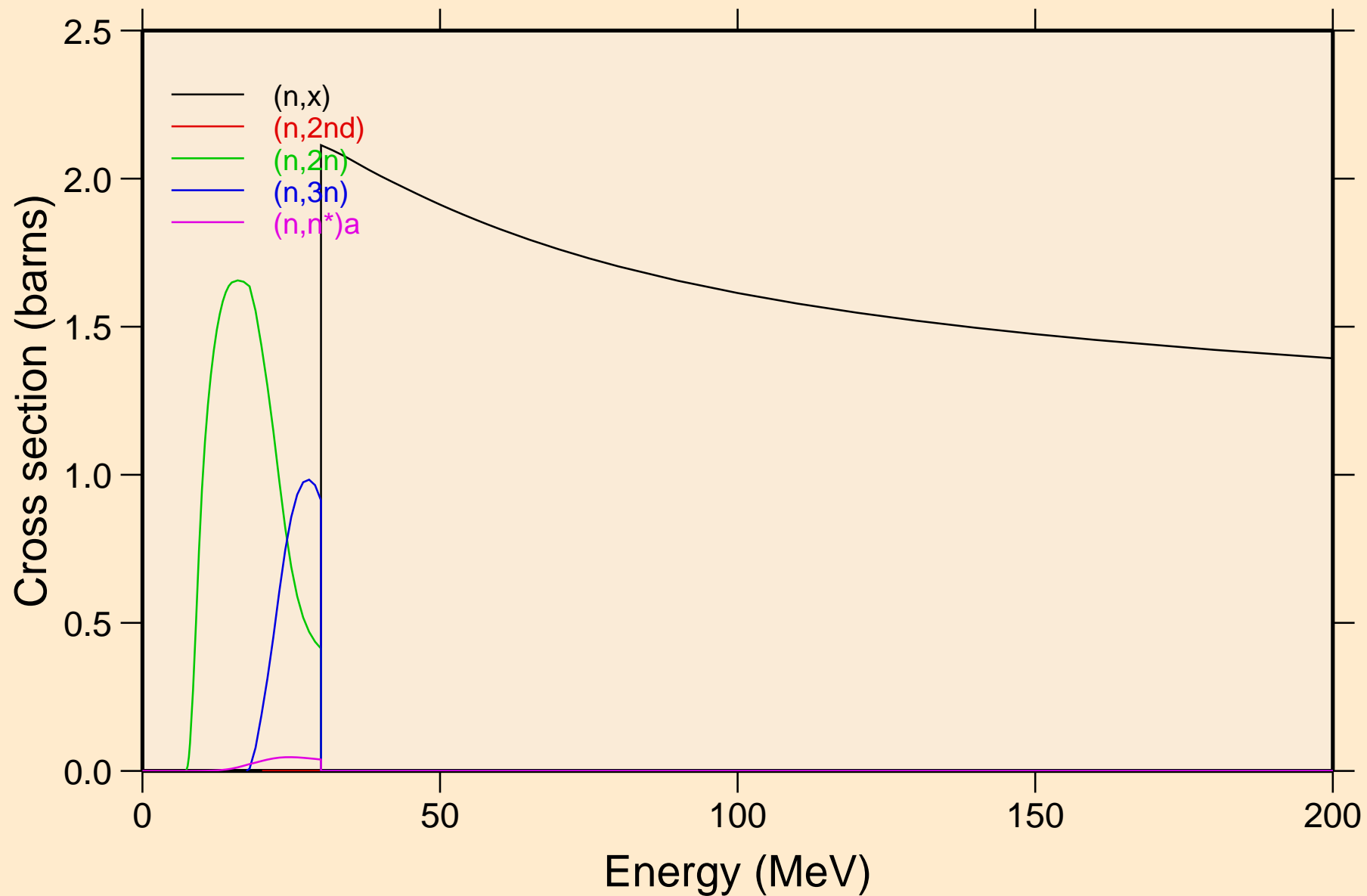

ER157 NEUTRON ACER TENDL-2019 LIBRARY; T=293.16K
Threshold reactions

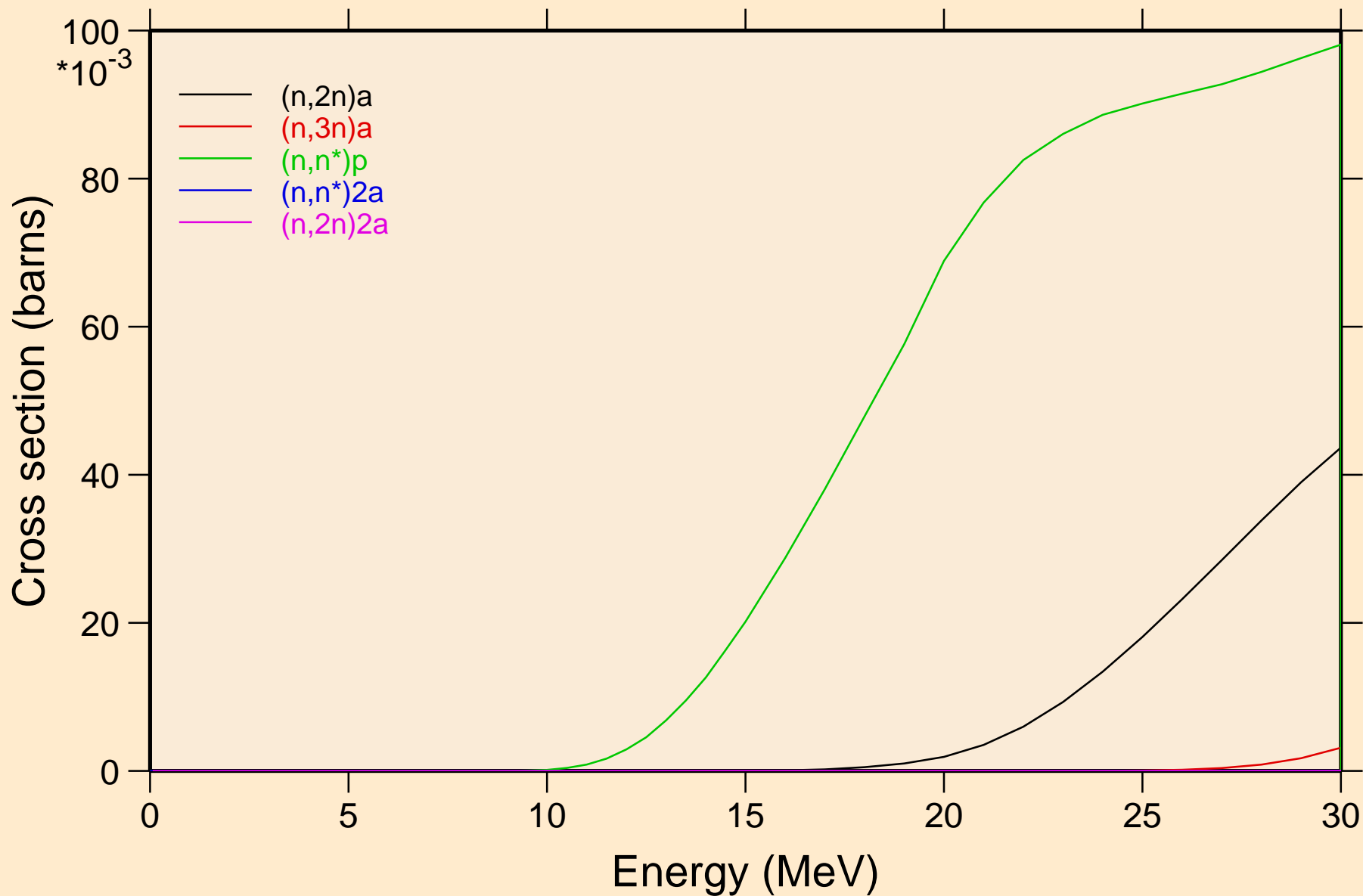

ER157 NEUTRON ACER TENDL-2019 LIBRARY; T=293.16K

Threshold reactions

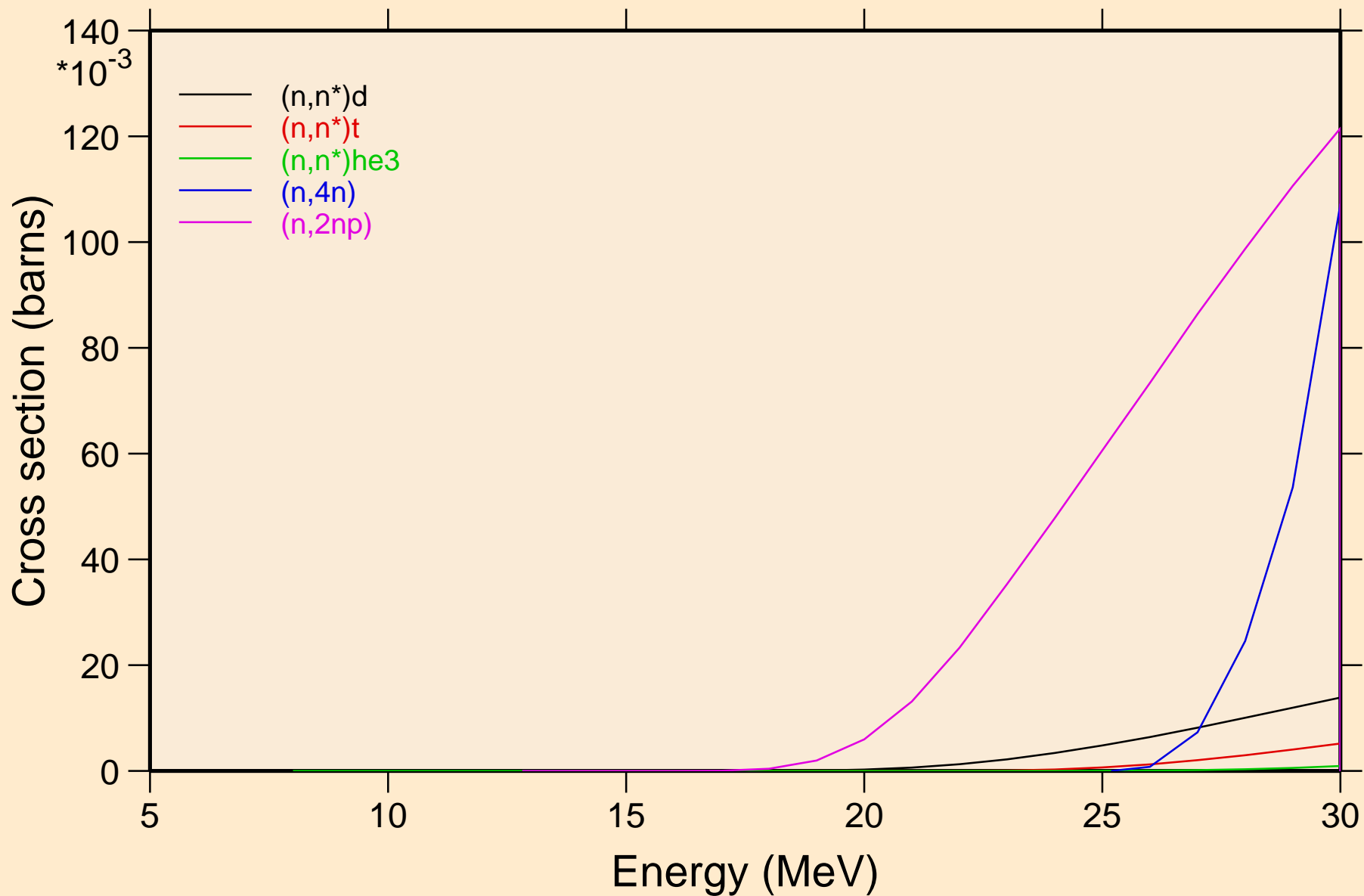

ER157 NEUTRON ACER TENDL-2019 LIBRARY; T=293.16K
Threshold reactions

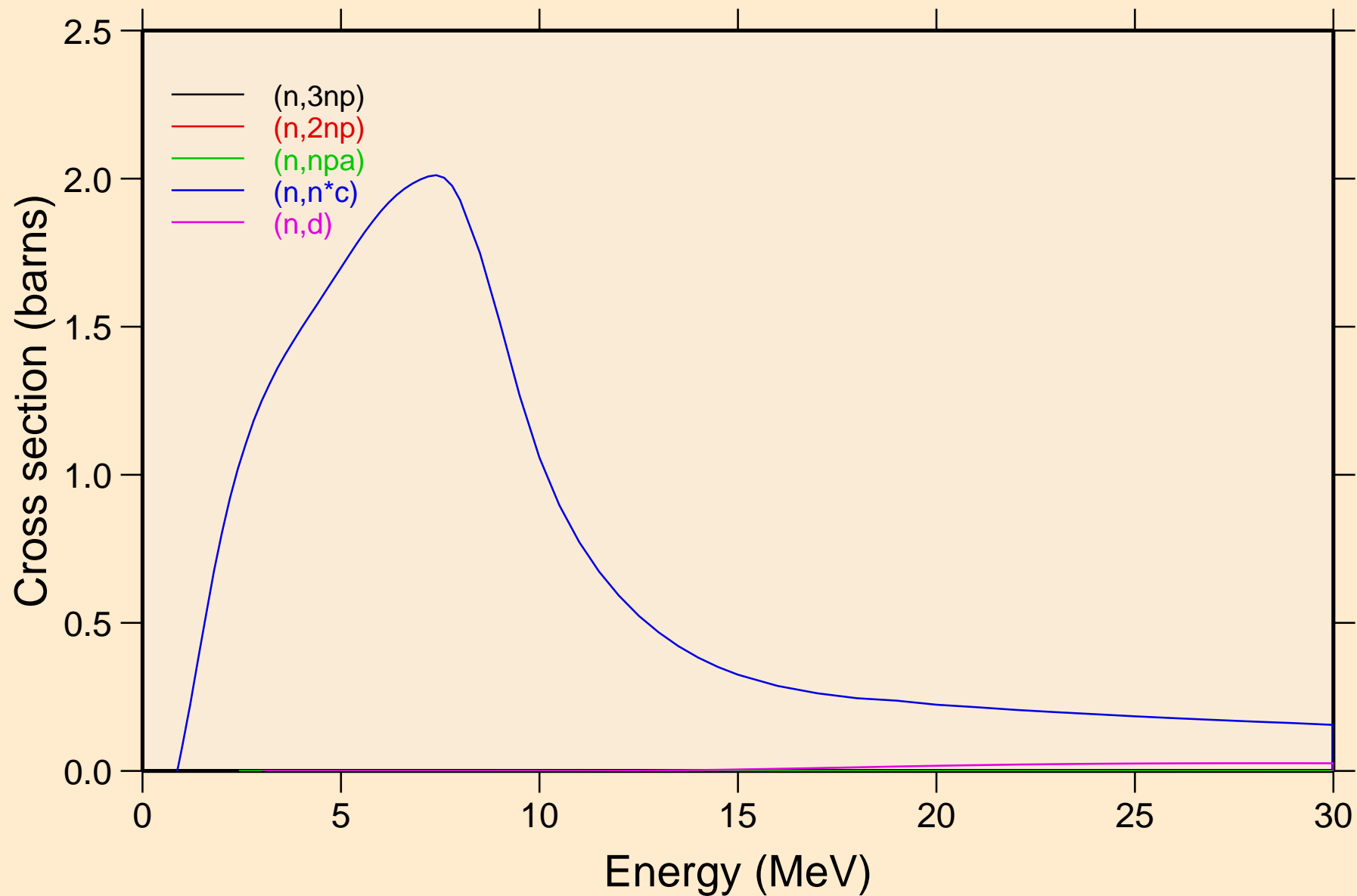

ER157 NEUTRON ACER TENDL-2019 LIBRARY; T=293.16K
Threshold reactions

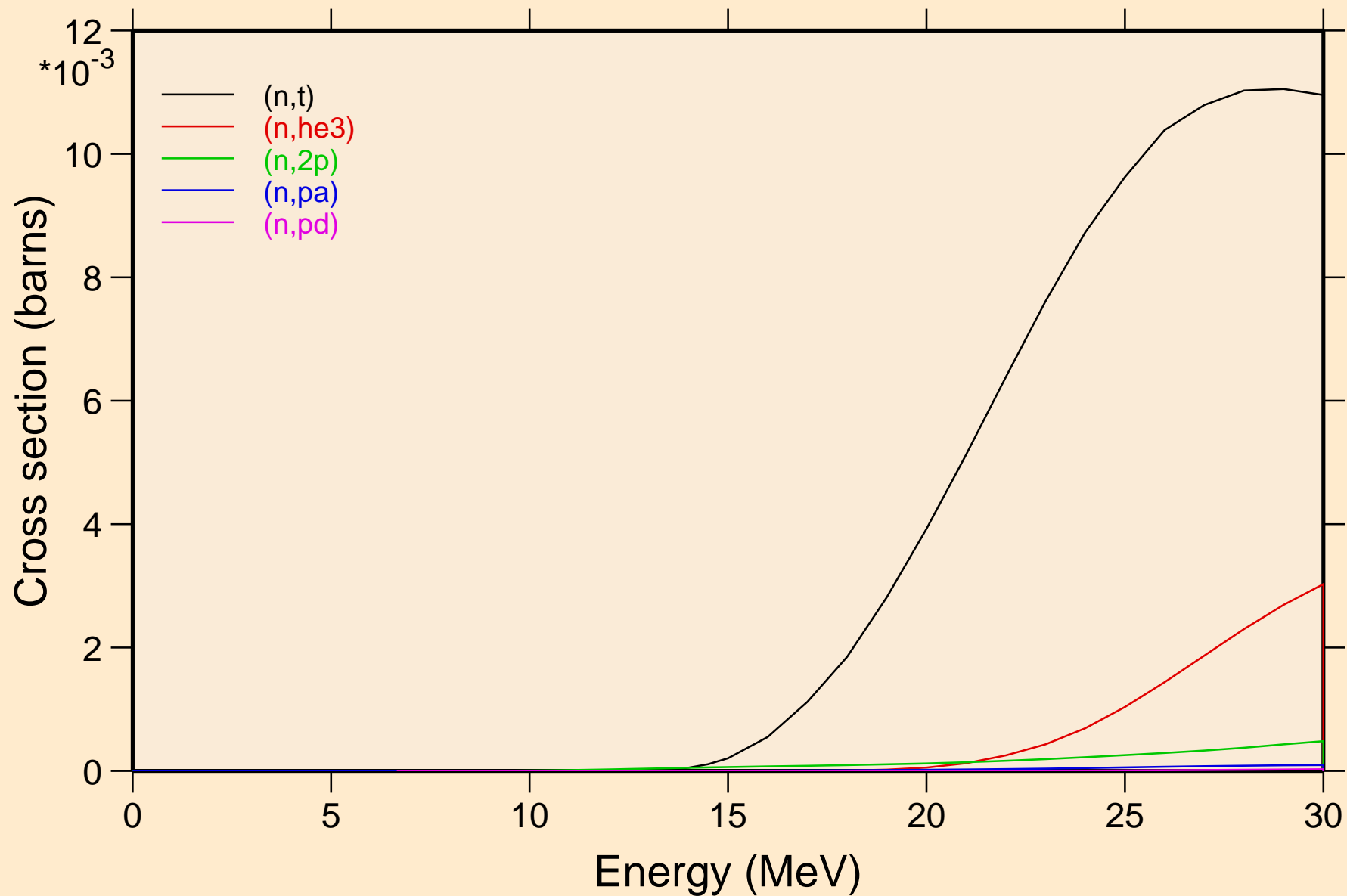

ER157 NEUTRON ACER TENDL-2019 LIBRARY; T=293.16K
Threshold reactions

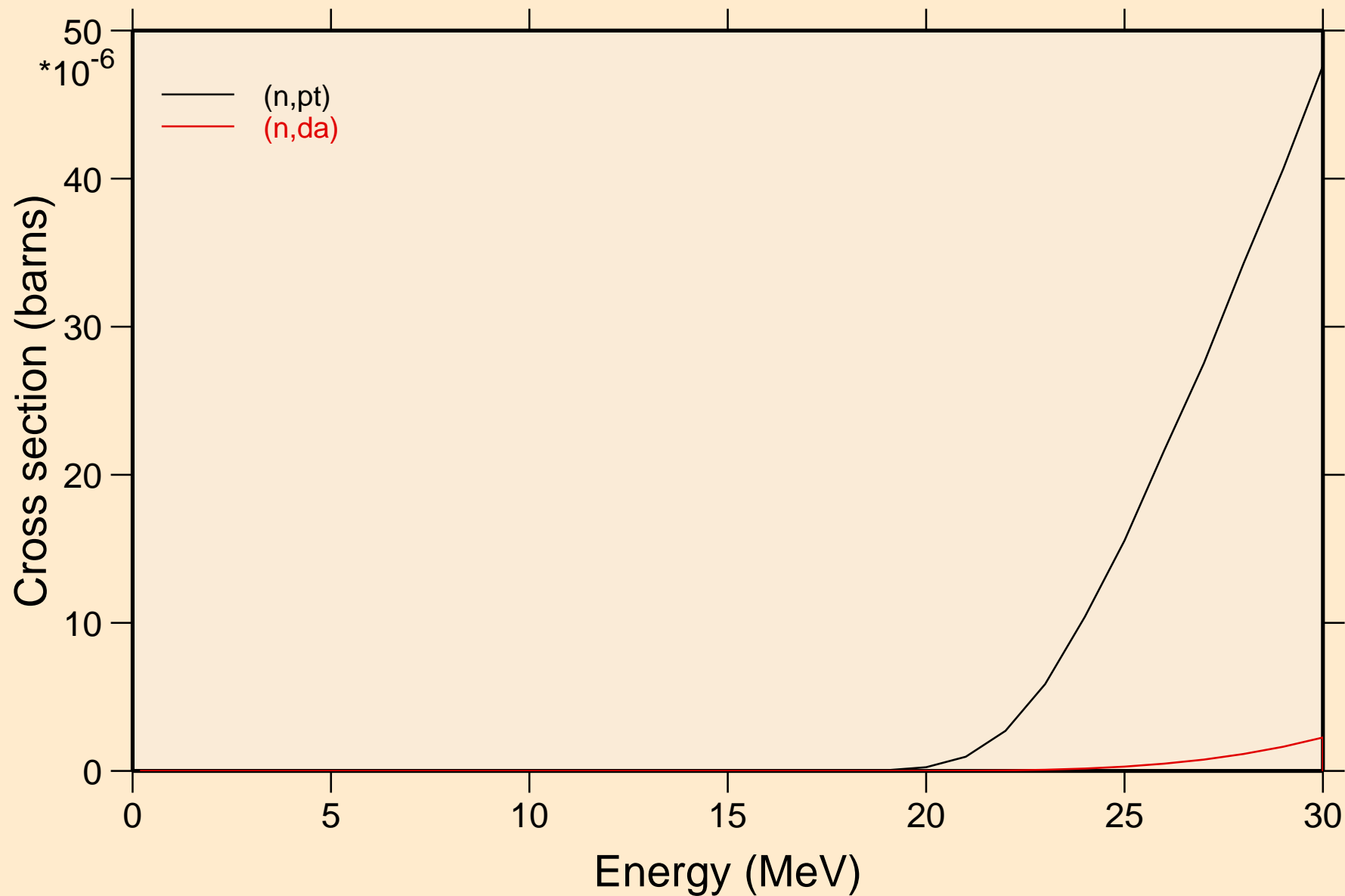

ER157 NEUTRON ACER TENDL-2019 LIBRARY; T=293.16K
Threshold reactions

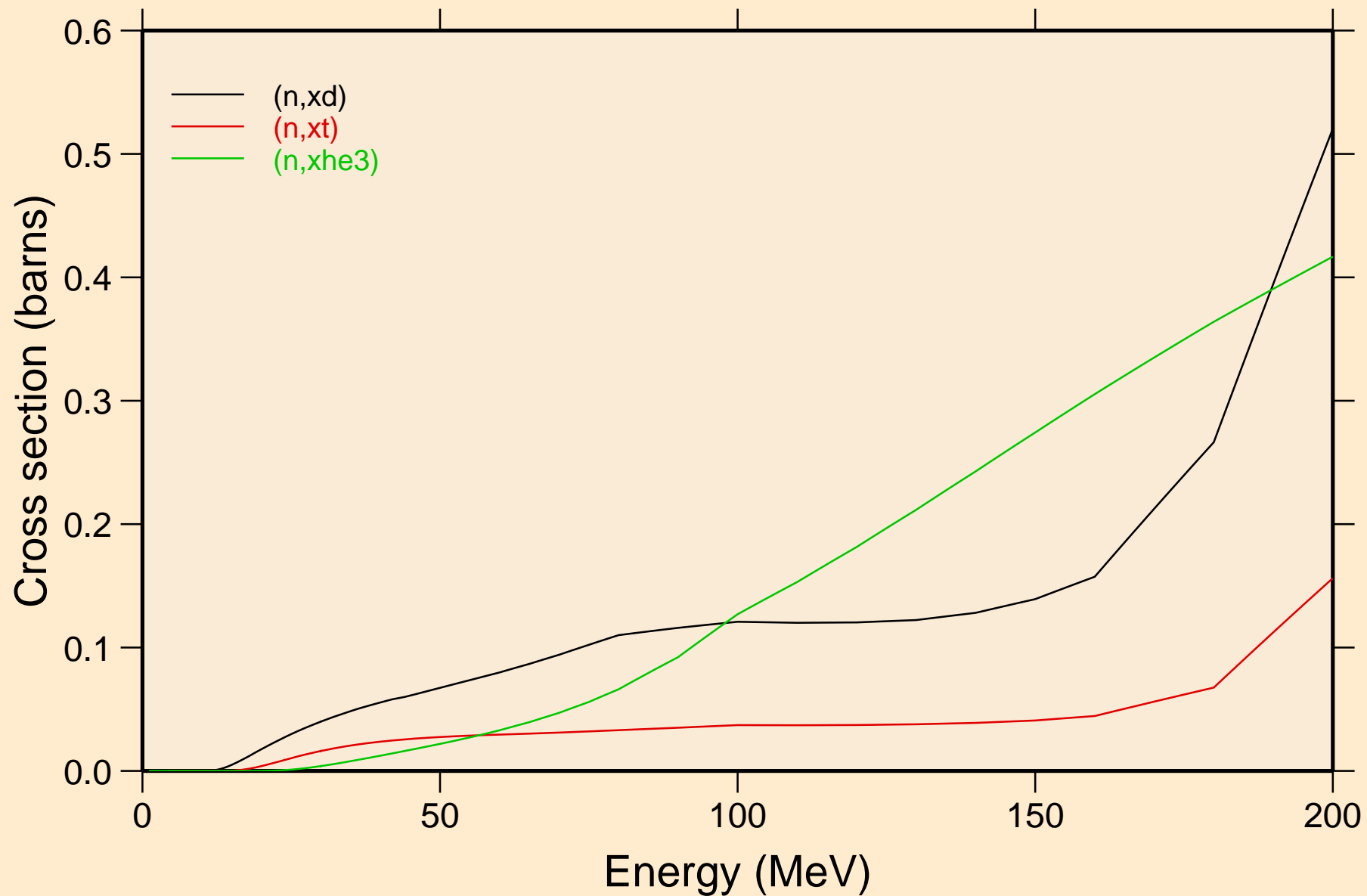

ER157 NEUTRON ACER TENDL-2019 LIBRARY; T=293.16K
angular distribution for elastic

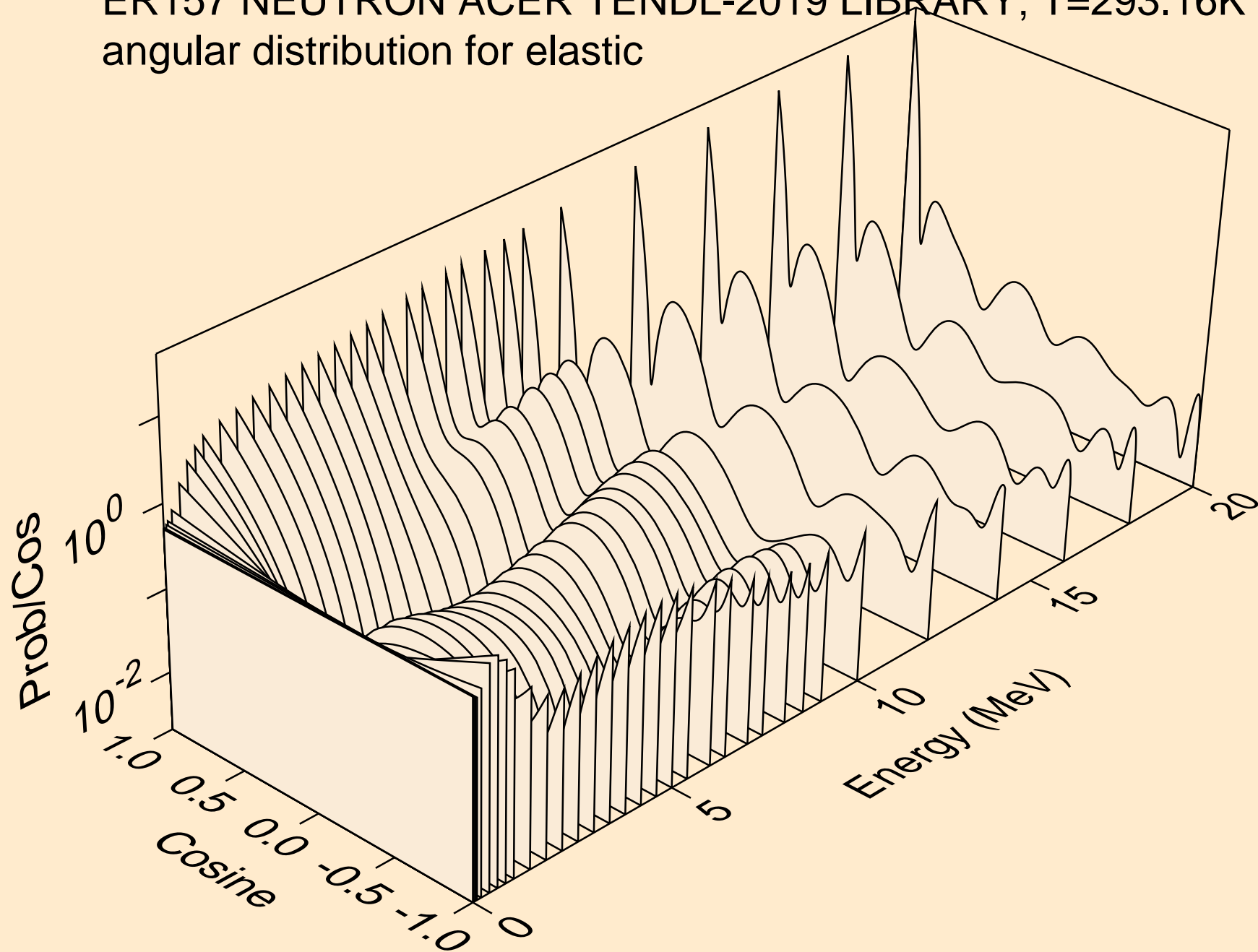

ER157 NEUTRON ACER TENDL-2019 LIBRARY; T=293.16K
angular distribution for elastic

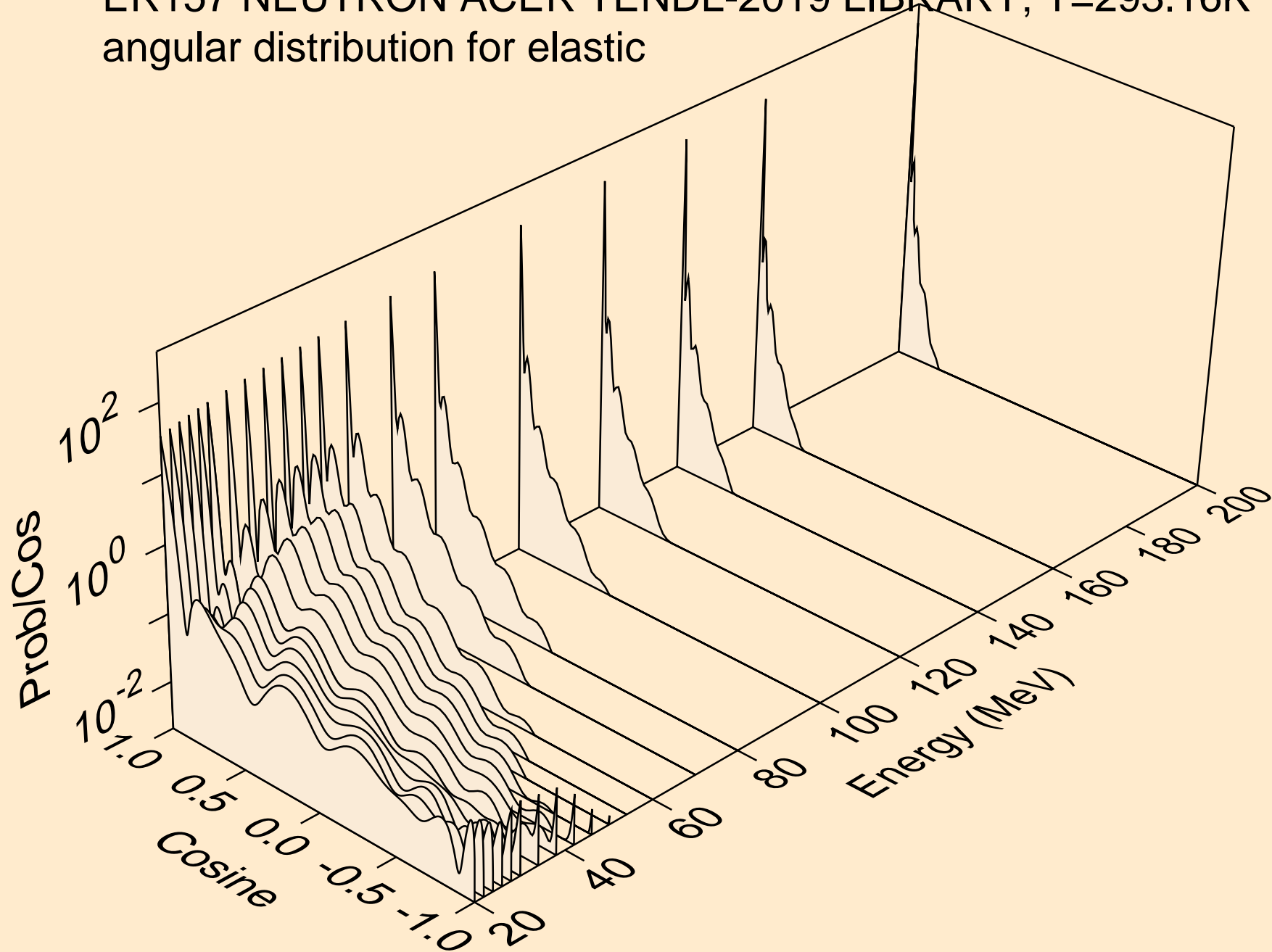

ER157 NEUTRON ACER TENDL-2019 LIBRARY; T=293.16K
angular distribution for (n,n*1)

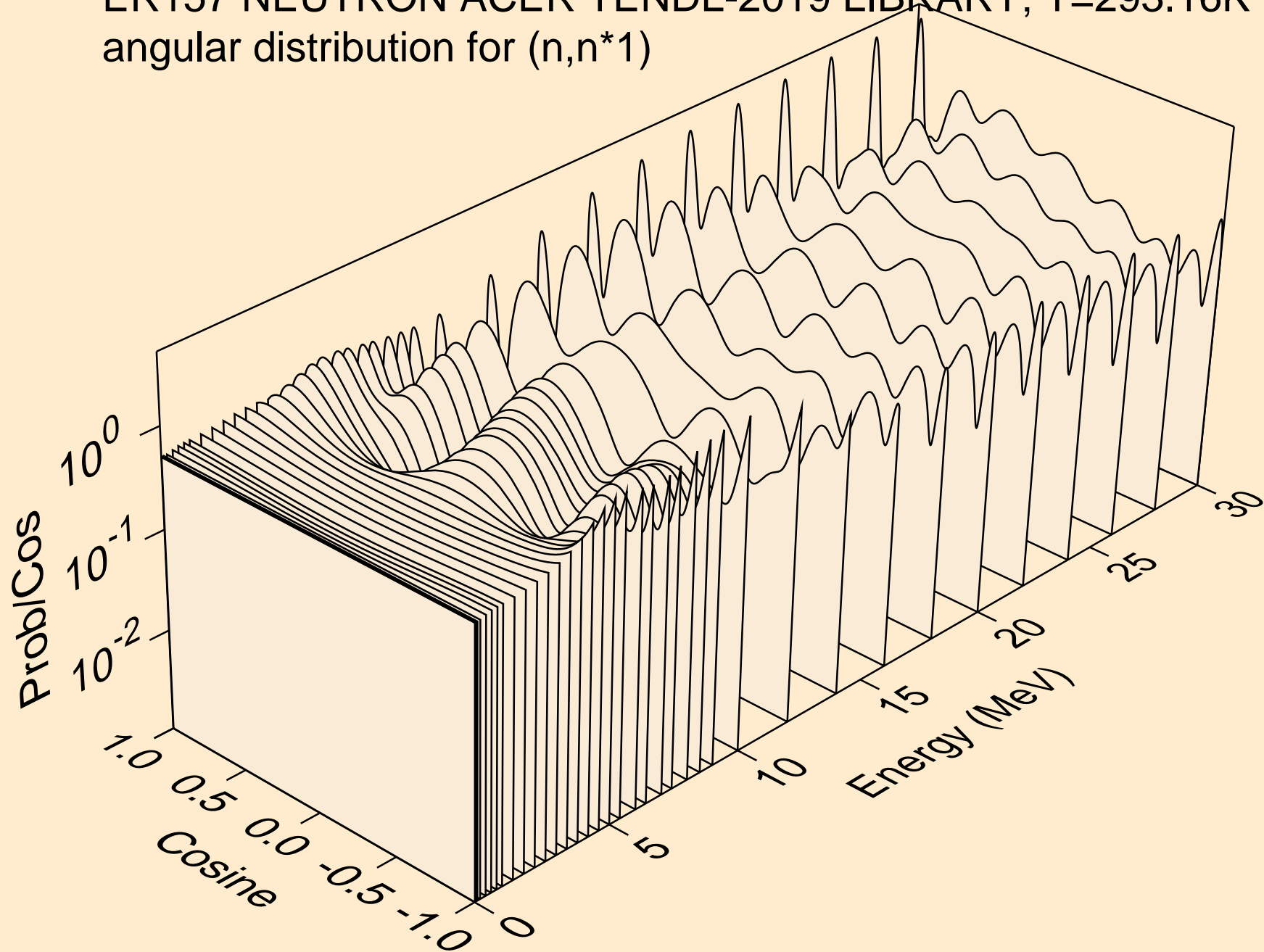

ER157 NEUTRON ACER TENDL-2019 LIBRARY; T=293.16K
angular distribution for (n,n*2)

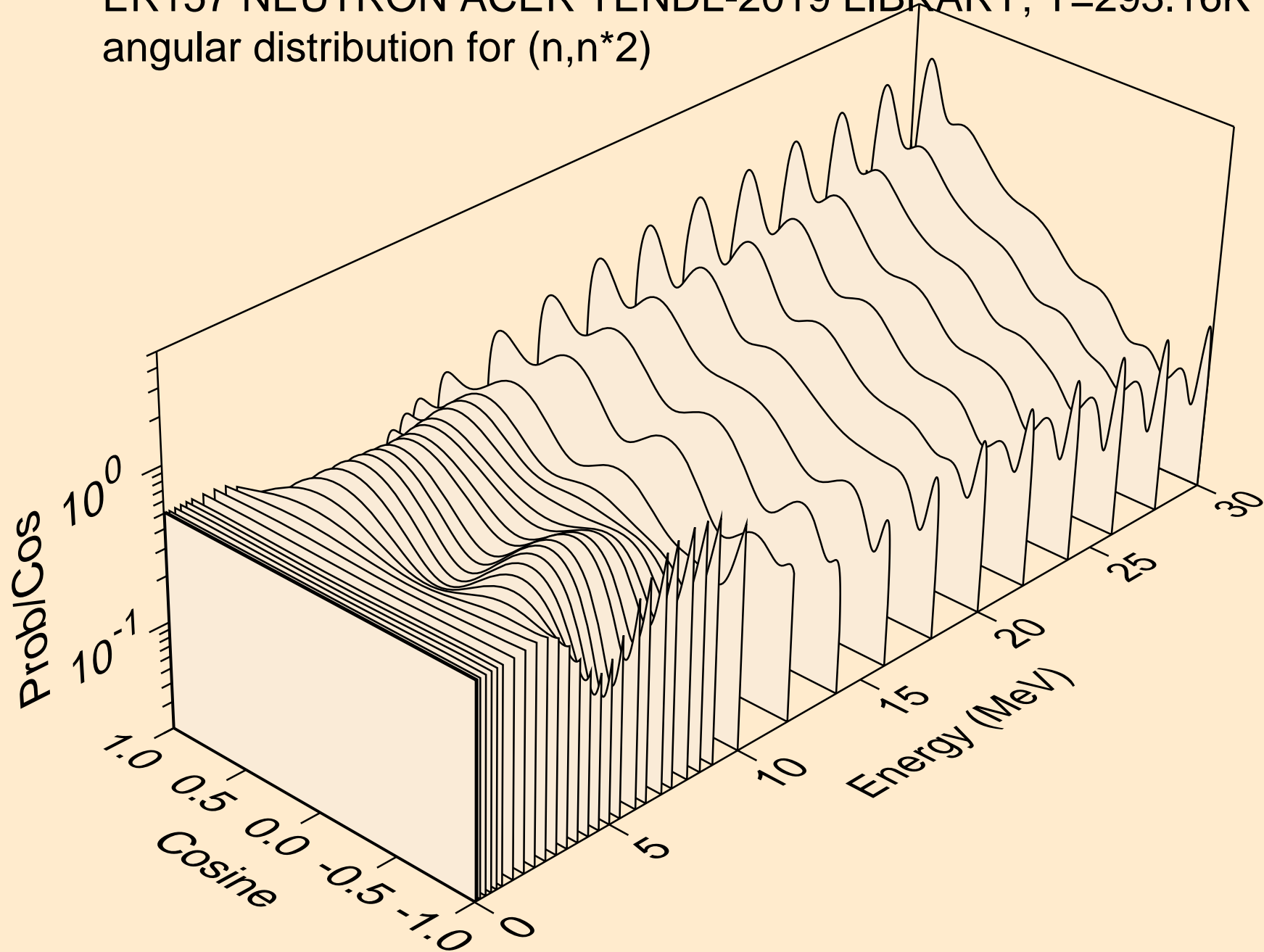

ER157 NEUTRON ACER TENDL-2019 LIBRARY; T=293.16K
angular distribution for (n,n*3)

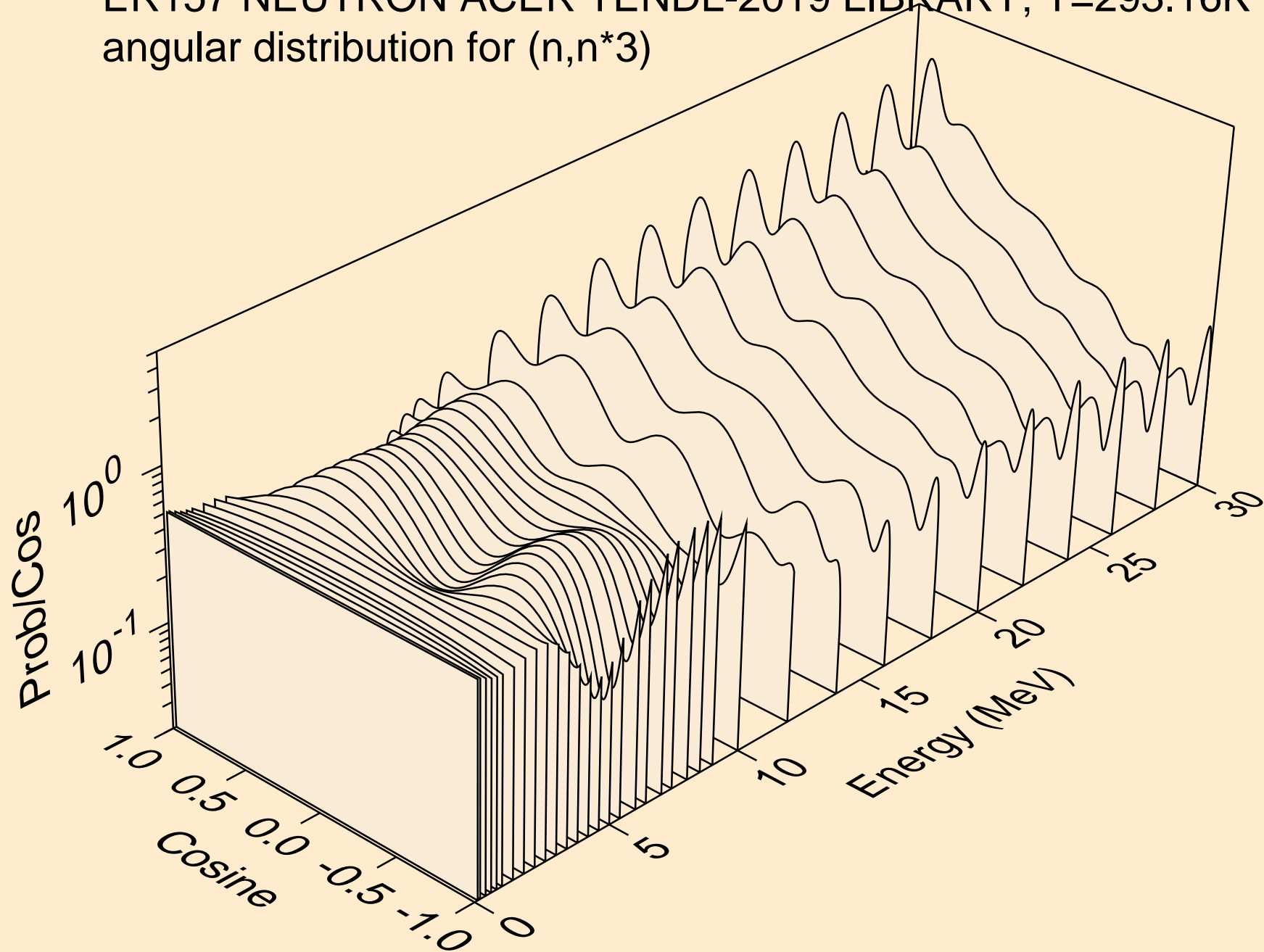

ER157 NEUTRON ACER TENDL-2019 LIBRARY; T=293.16K
angular distribution for (n,n*4)

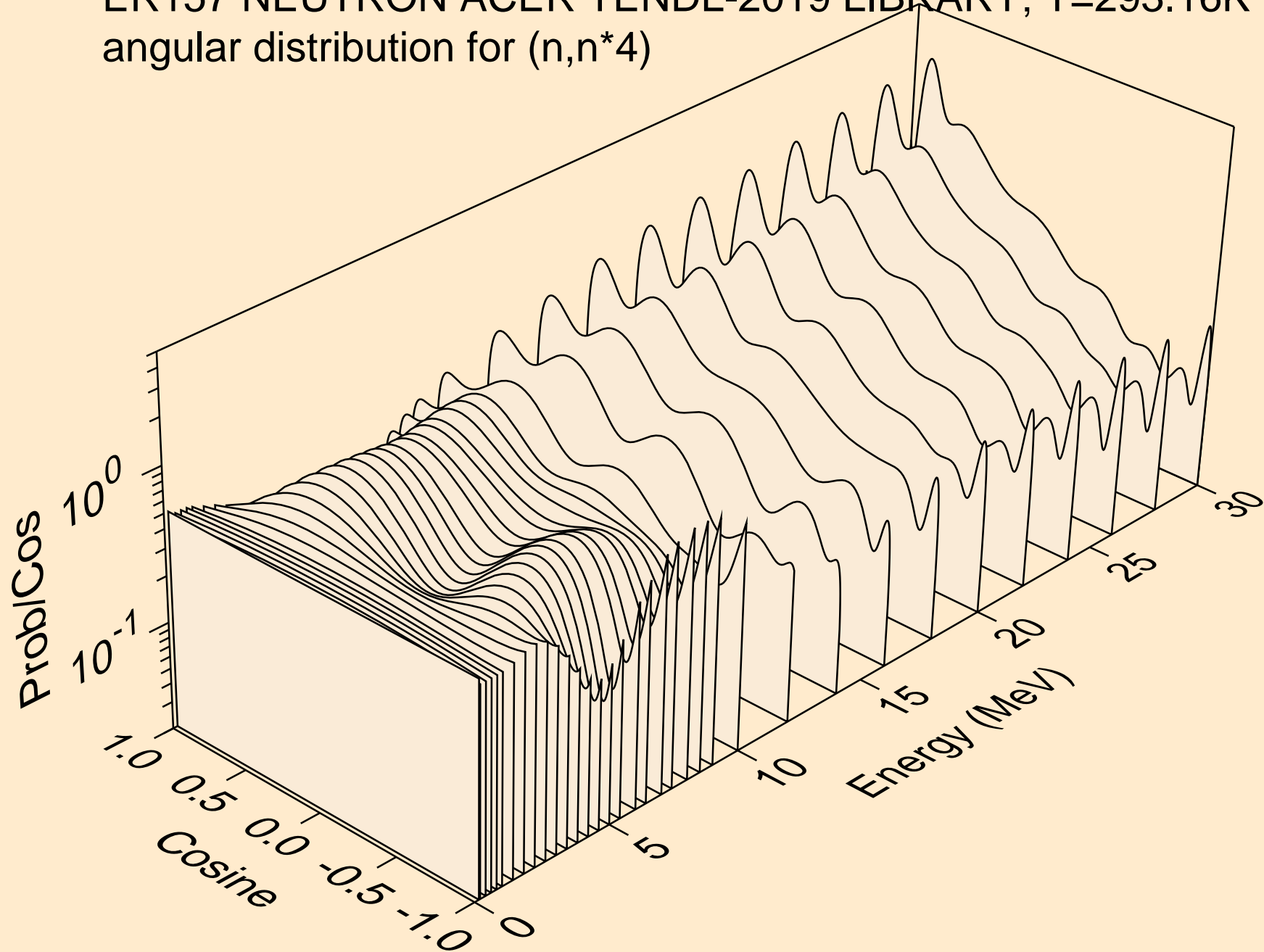

ER157 NEUTRON ACER TENDL-2019 LIBRARY; T=293.16K
angular distribution for (n,n*5)

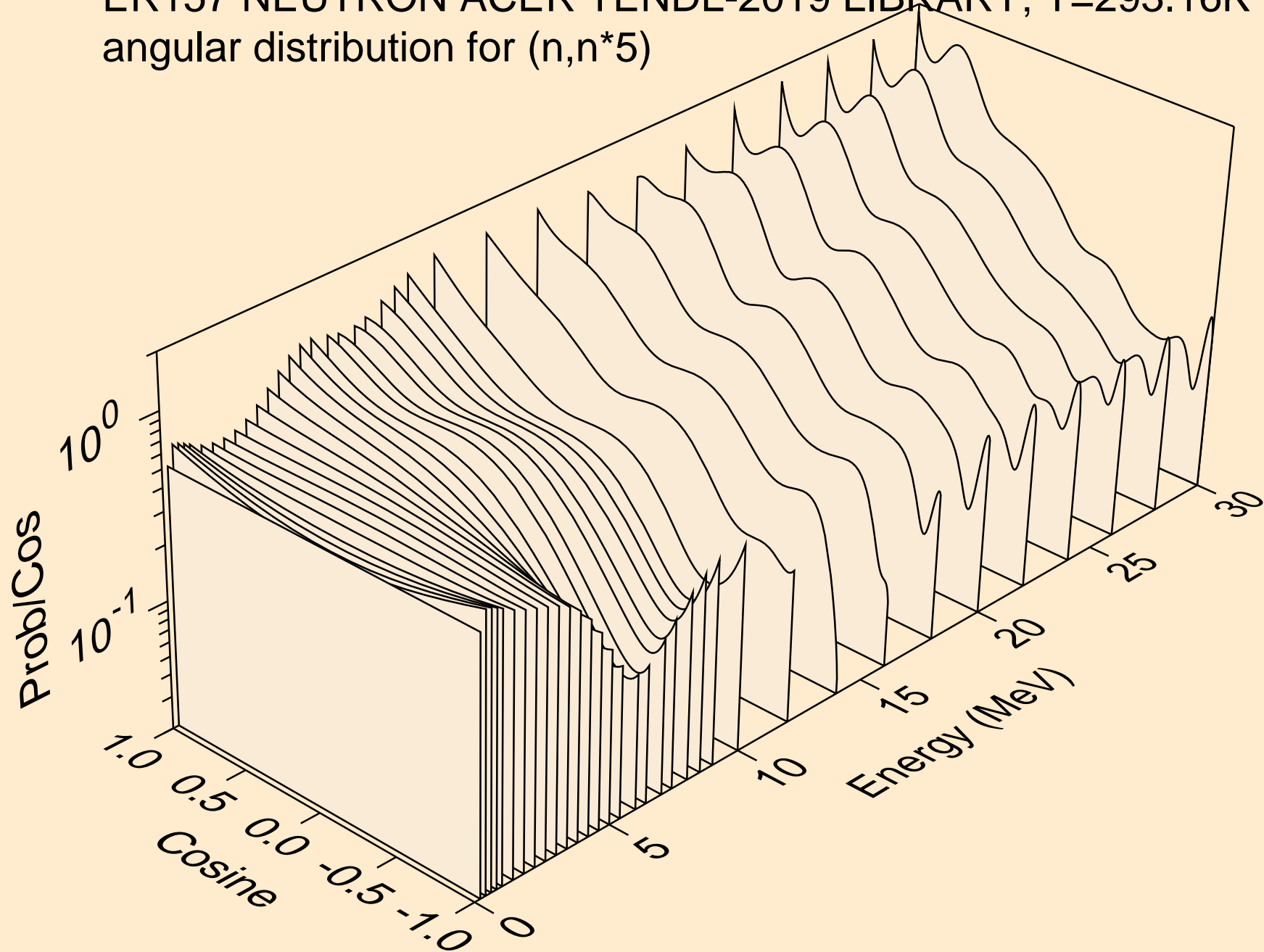

ER157 NEUTRON ACER TENDL-2019 LIBRARY; T=293.16K
angular distribution for (n,n*6)

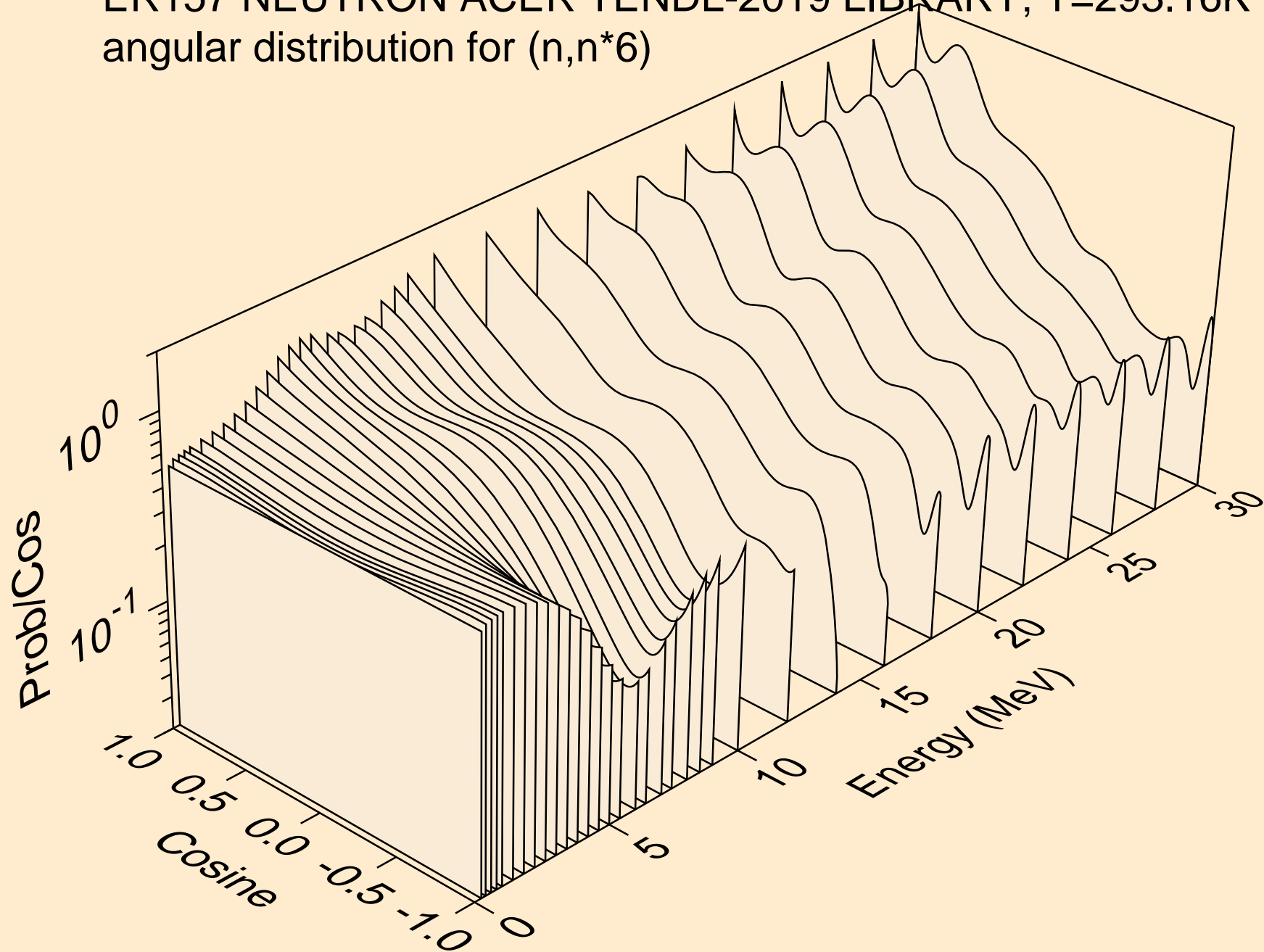

ER157 NEUTRON ACER TENDL-2019 LIBRARY; T=293.16K
angular distribution for (n,n*7)

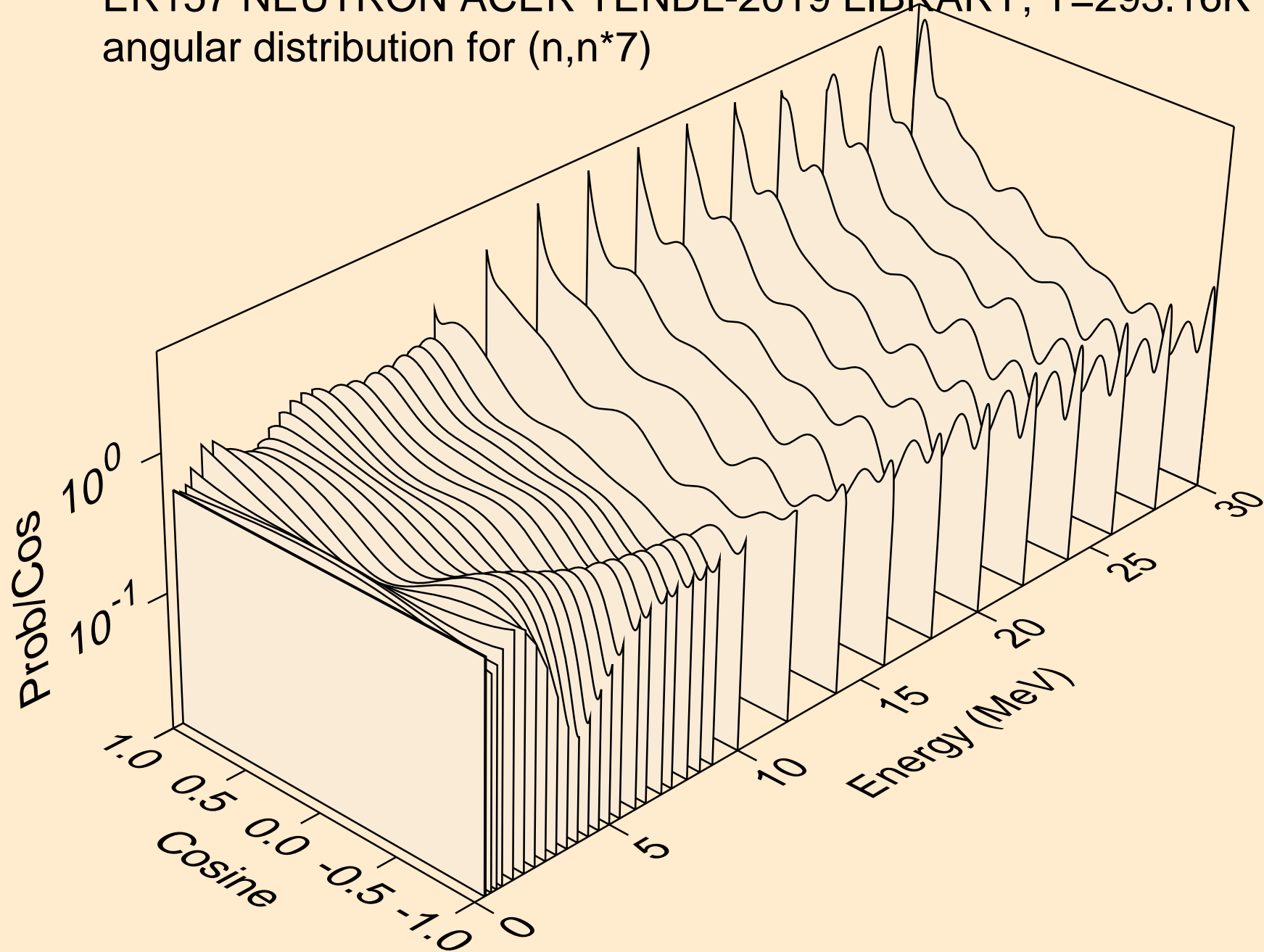

ER157 NEUTRON ACER TENDL-2019 LIBRARY; T=293.16K
angular distribution for (n,n*8)

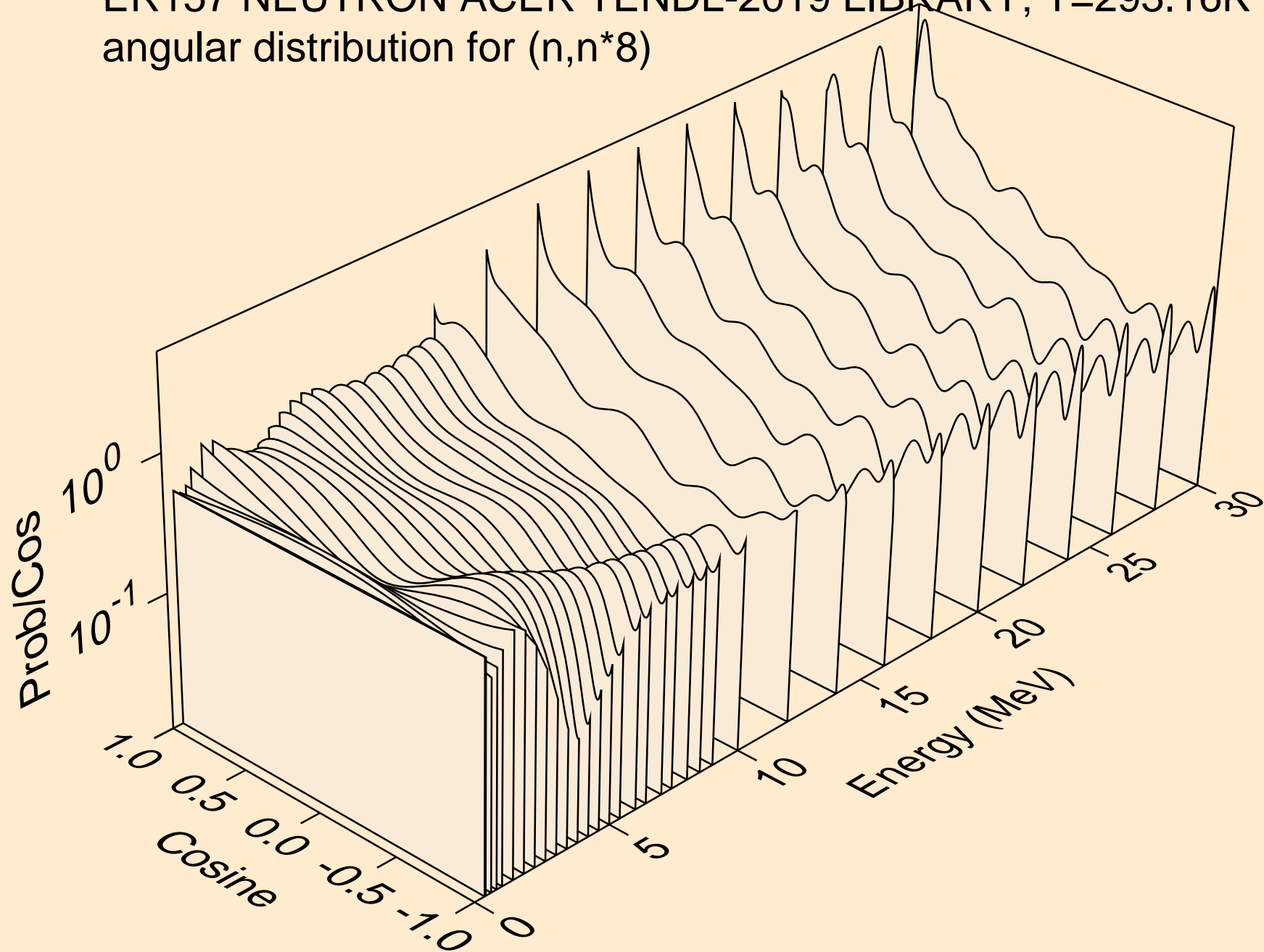

ER157 NEUTRON ACER TENDL-2019 LIBRARY; T=293.16K
angular distribution for (n,n*9)

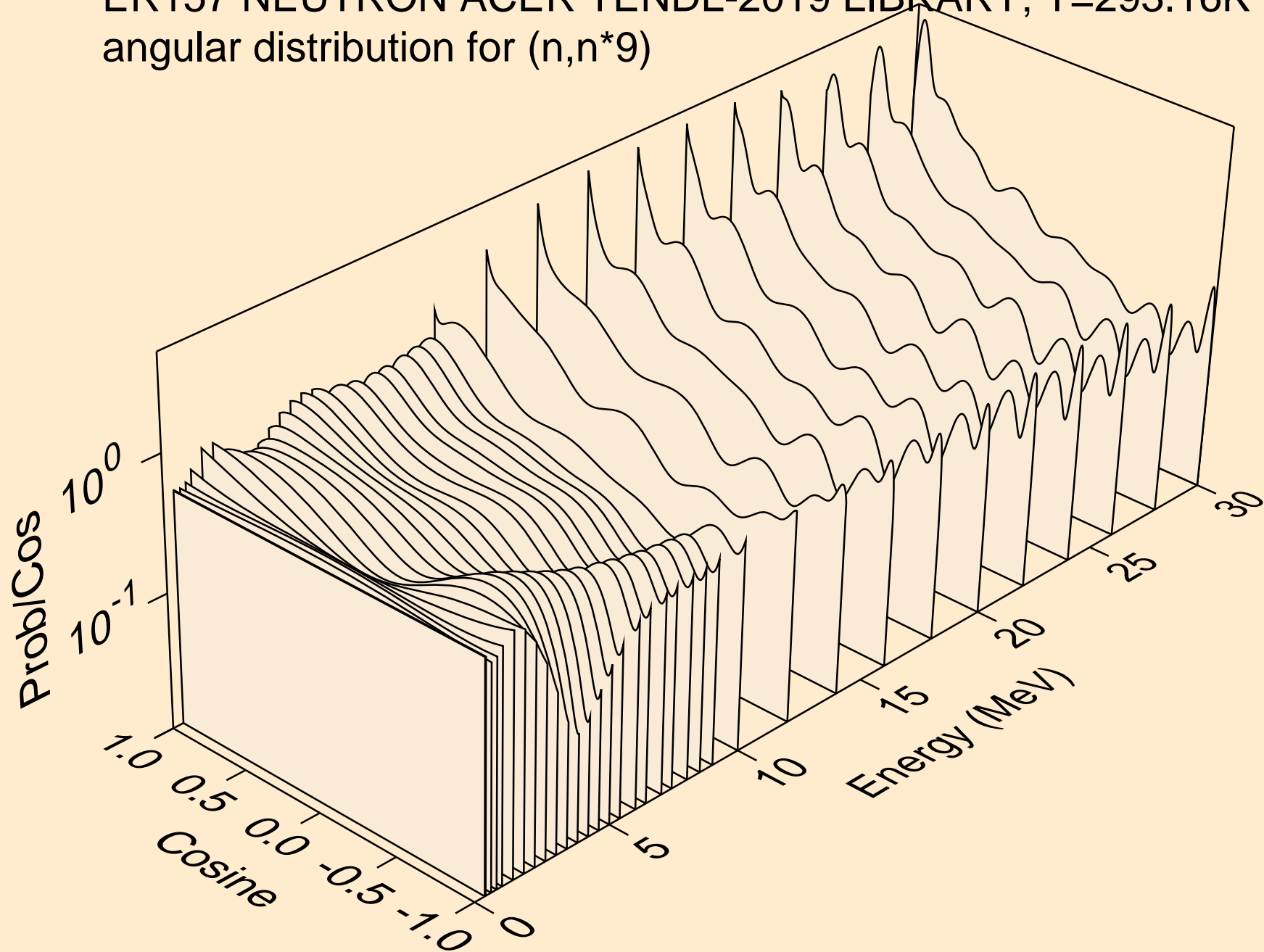

ER157 NEUTRON ACER TENDL-2019 LIBRARY; T=293.16K
angular distribution for (n,n*10)

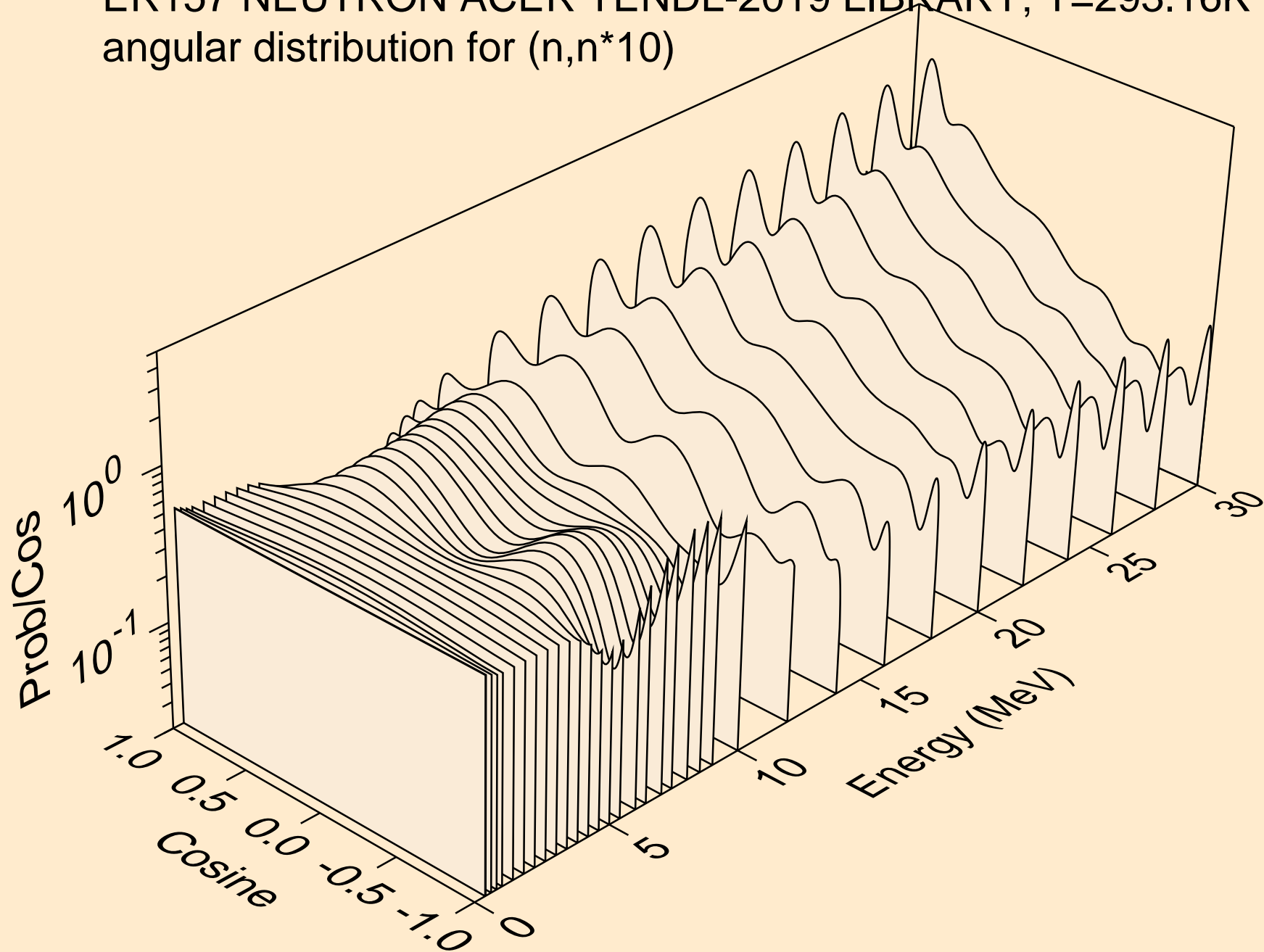

ER157 NEUTRON ACER TENDL-2019 LIBRARY; T=293.16K
angular distribution for (n,n*11)

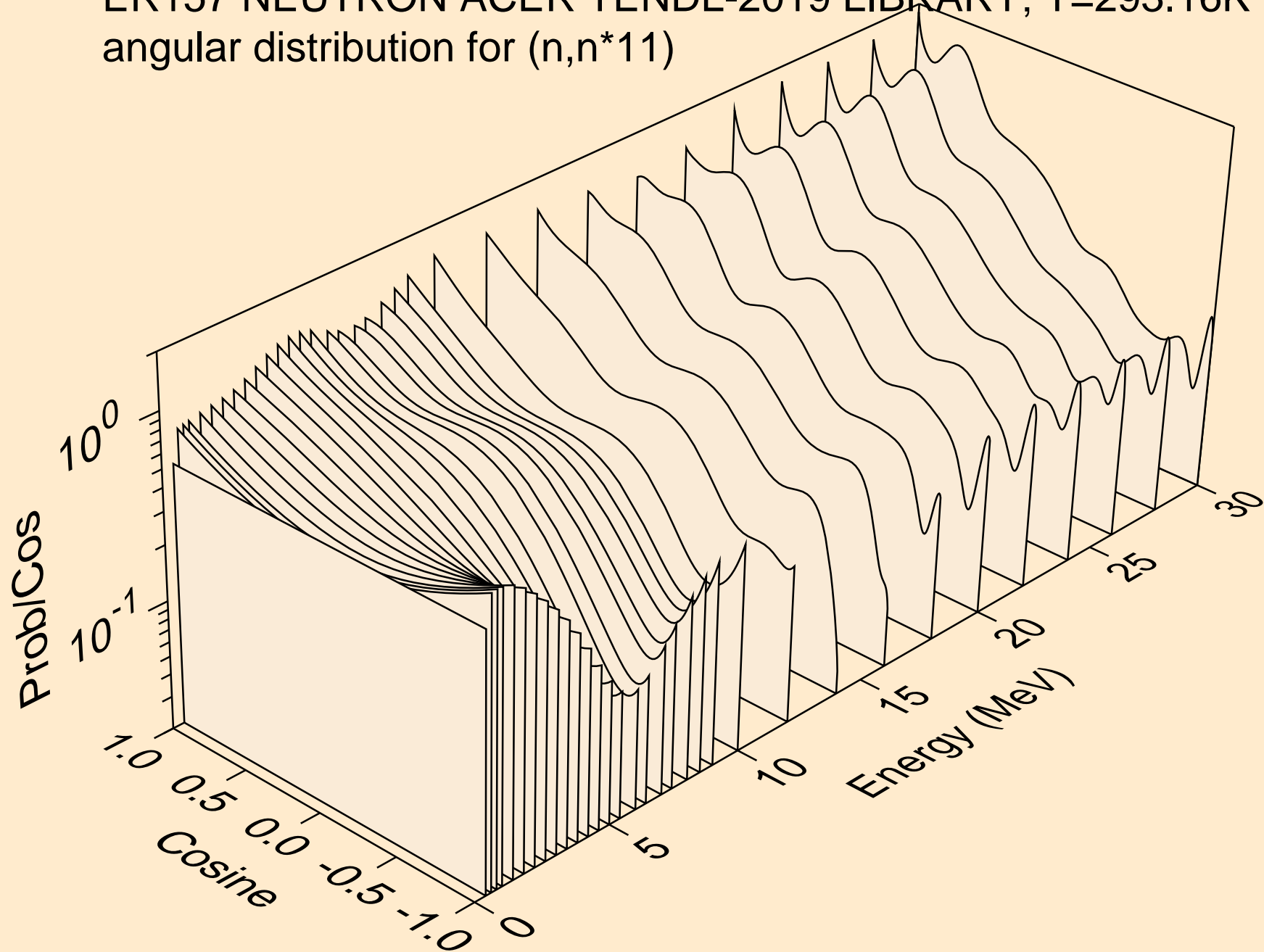

ER157 NEUTRON ACER TENDL-2019 LIBRARY; T=293.16K
angular distribution for (n,n*12)

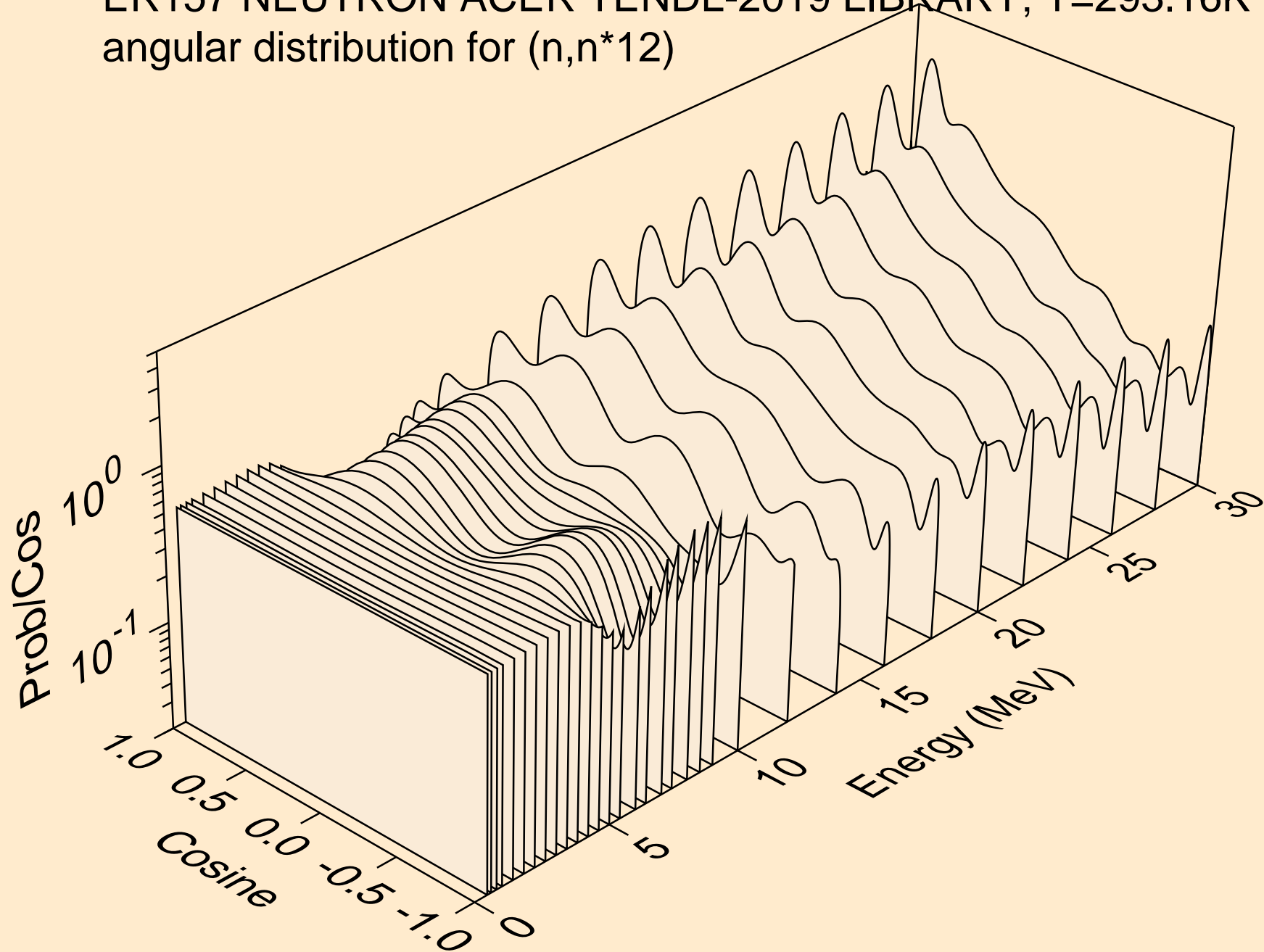

ER157 NEUTRON ACER TENDL-2019 LIBRARY; T=293.16K
angular distribution for (n,n*13)

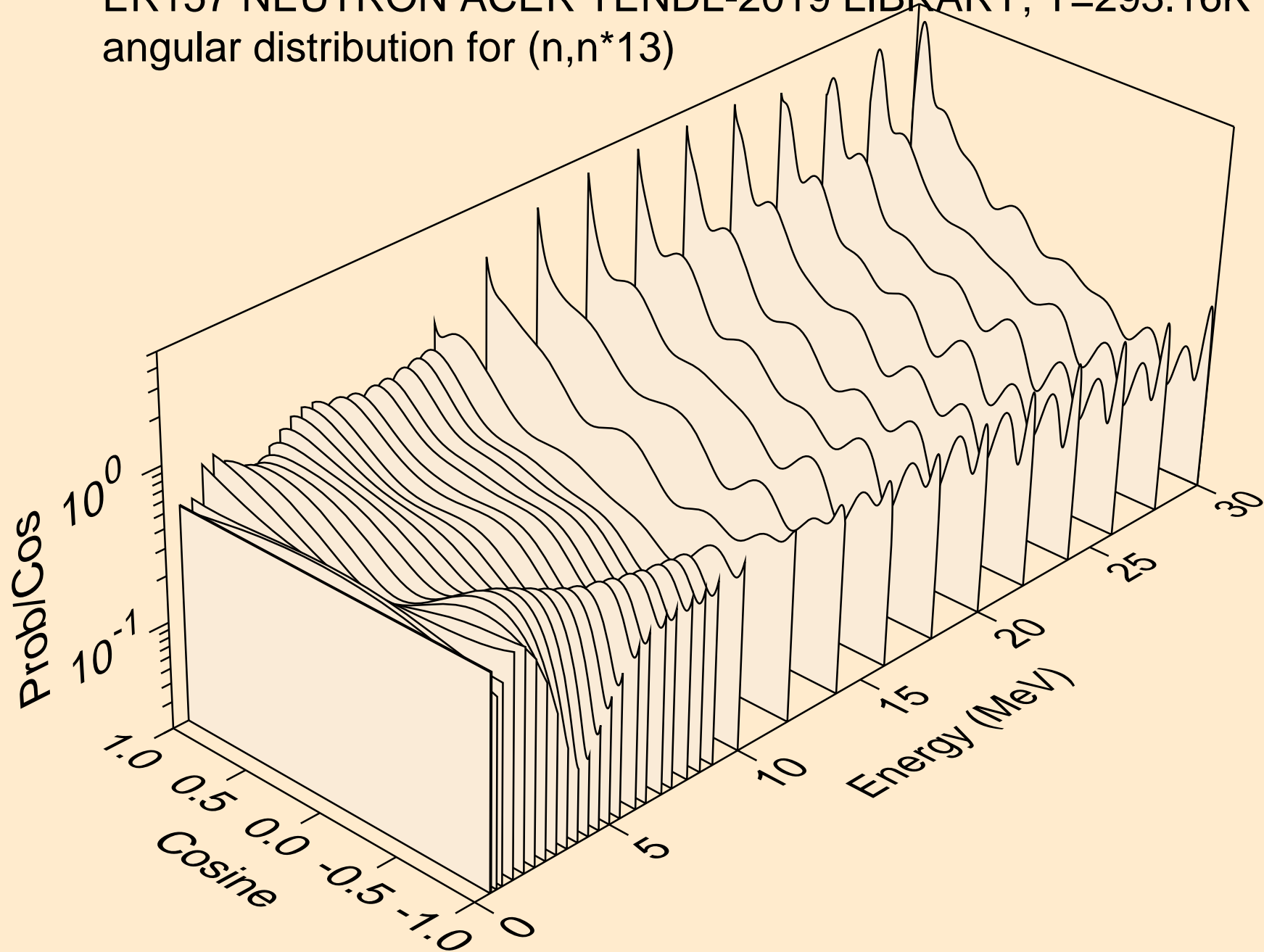

ER157 NEUTRON ACER TENDL-2019 LIBRARY; T=293.16K
angular distribution for (n,n*14)

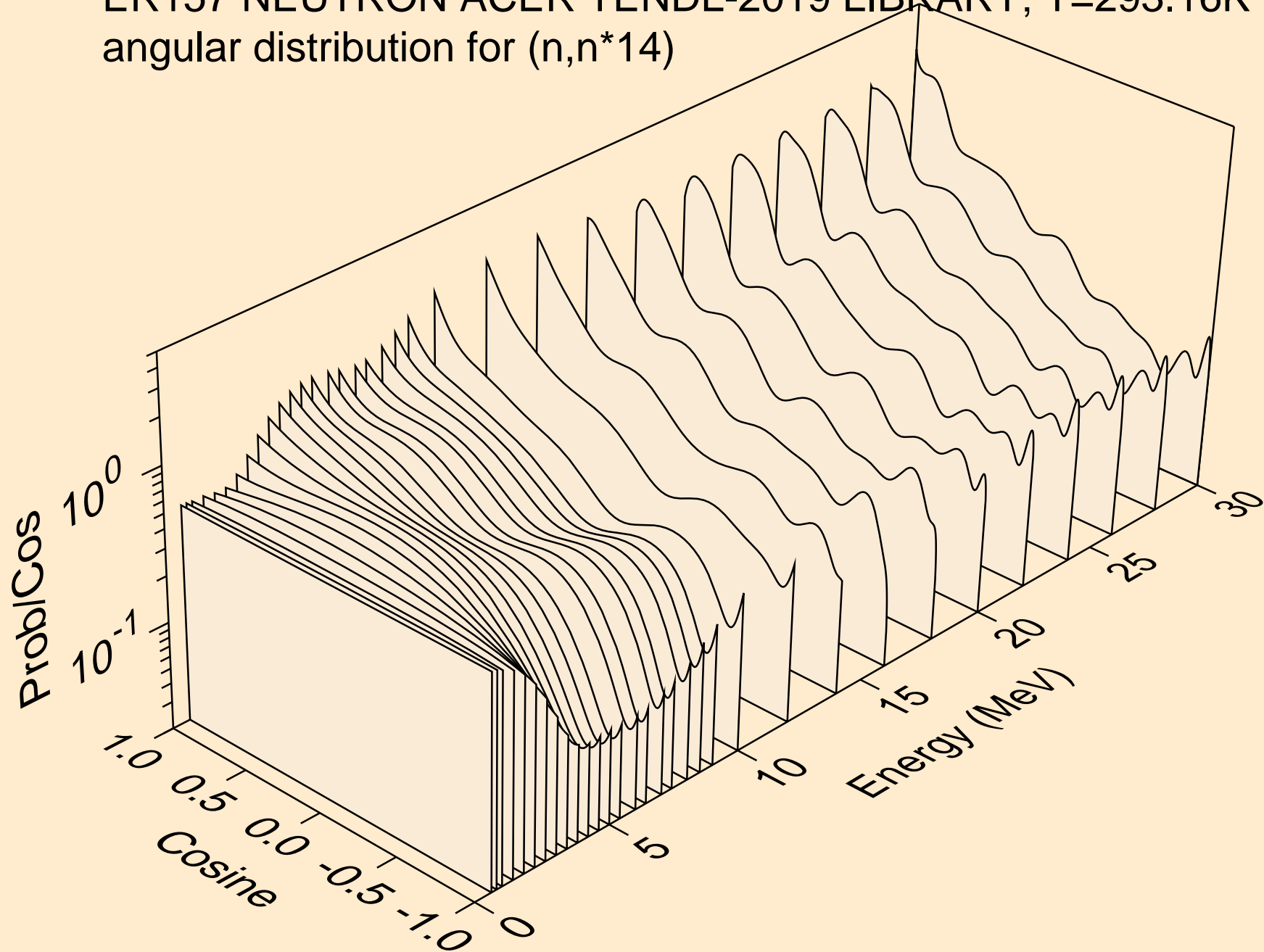

ER157 NEUTRON ACER TENDL-2019 LIBRARY; T=293.16K
angular distribution for (n,n*15)

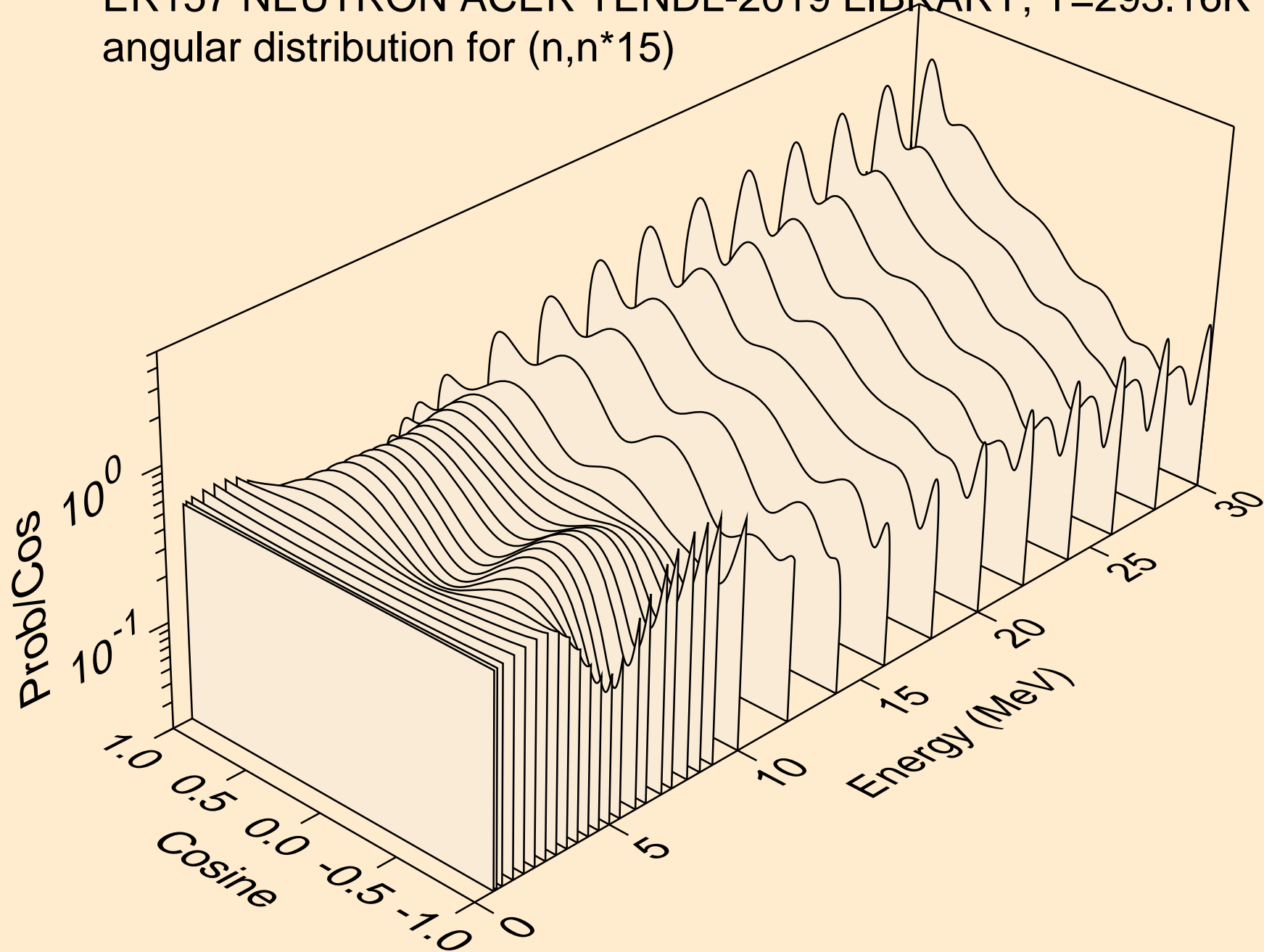

ER157 NEUTRON ACER TENDL-2019 LIBRARY; T=293.16K
angular distribution for (n,n*16)

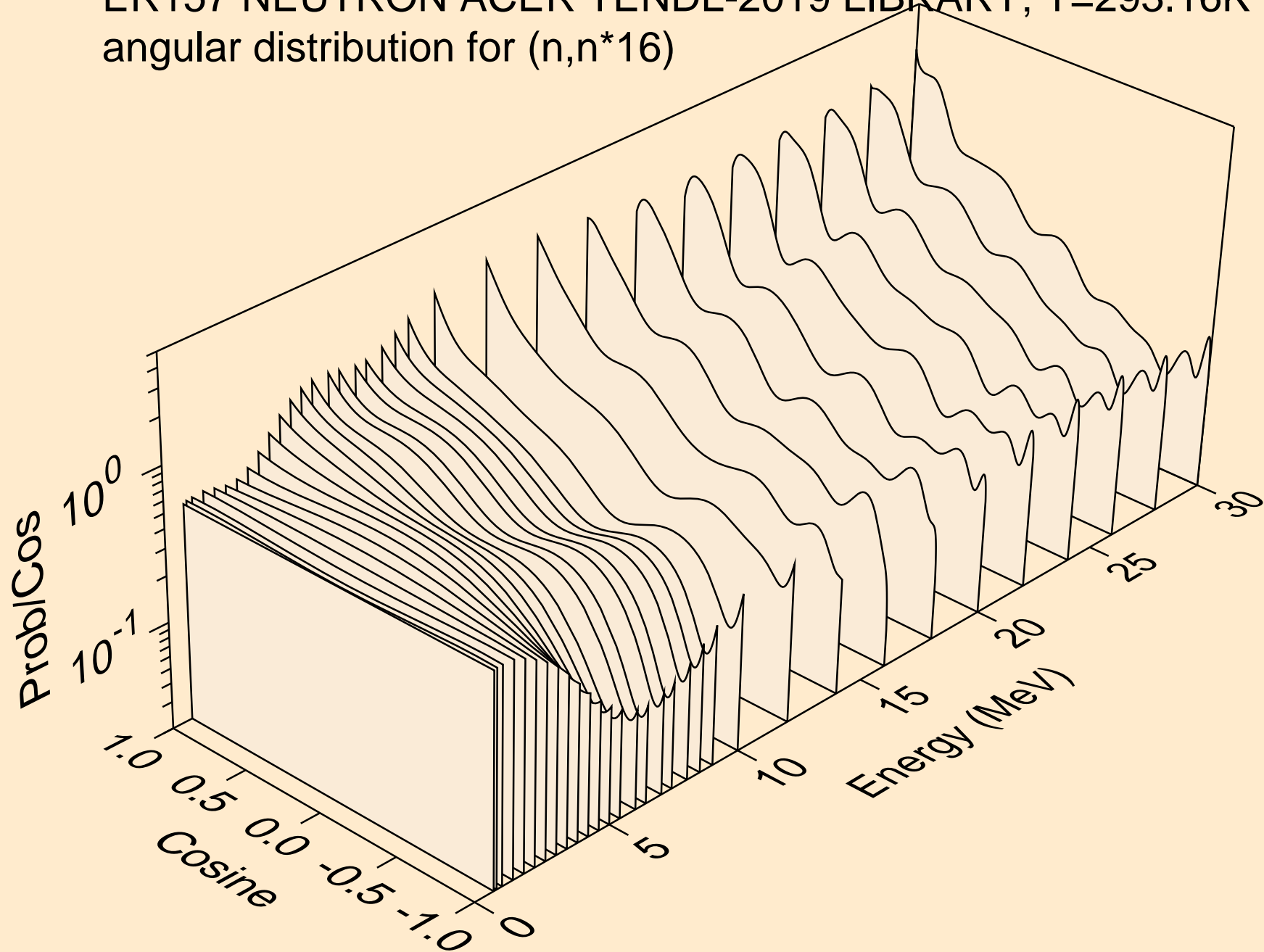

ER157 NEUTRON ACER TENDL-2019 LIBRARY; T=293.16K
angular distribution for (n,n*17)

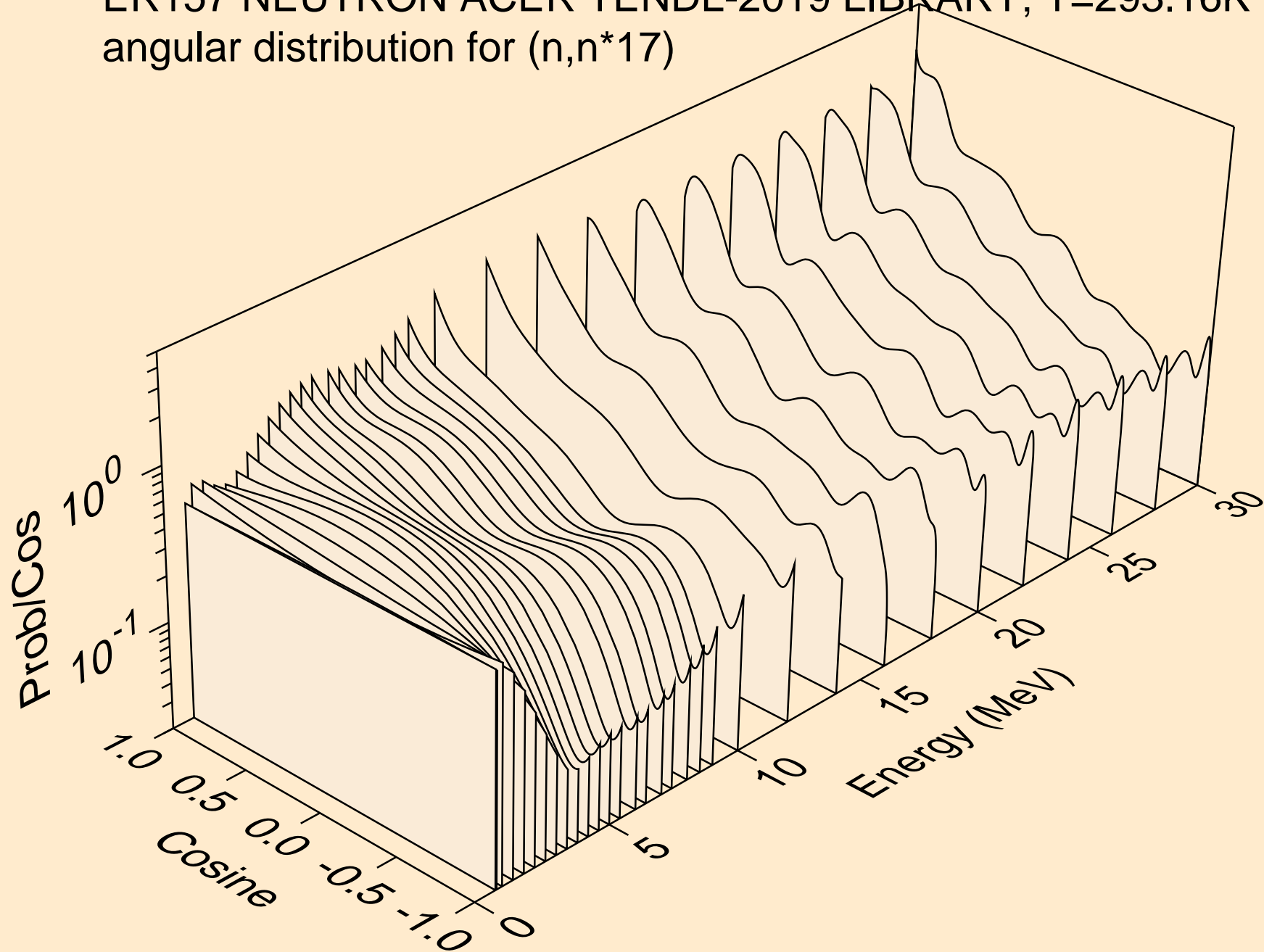

ER157 NEUTRON ACER TENDL-2019 LIBRARY; T=293.16K
angular distribution for (n,n*18)

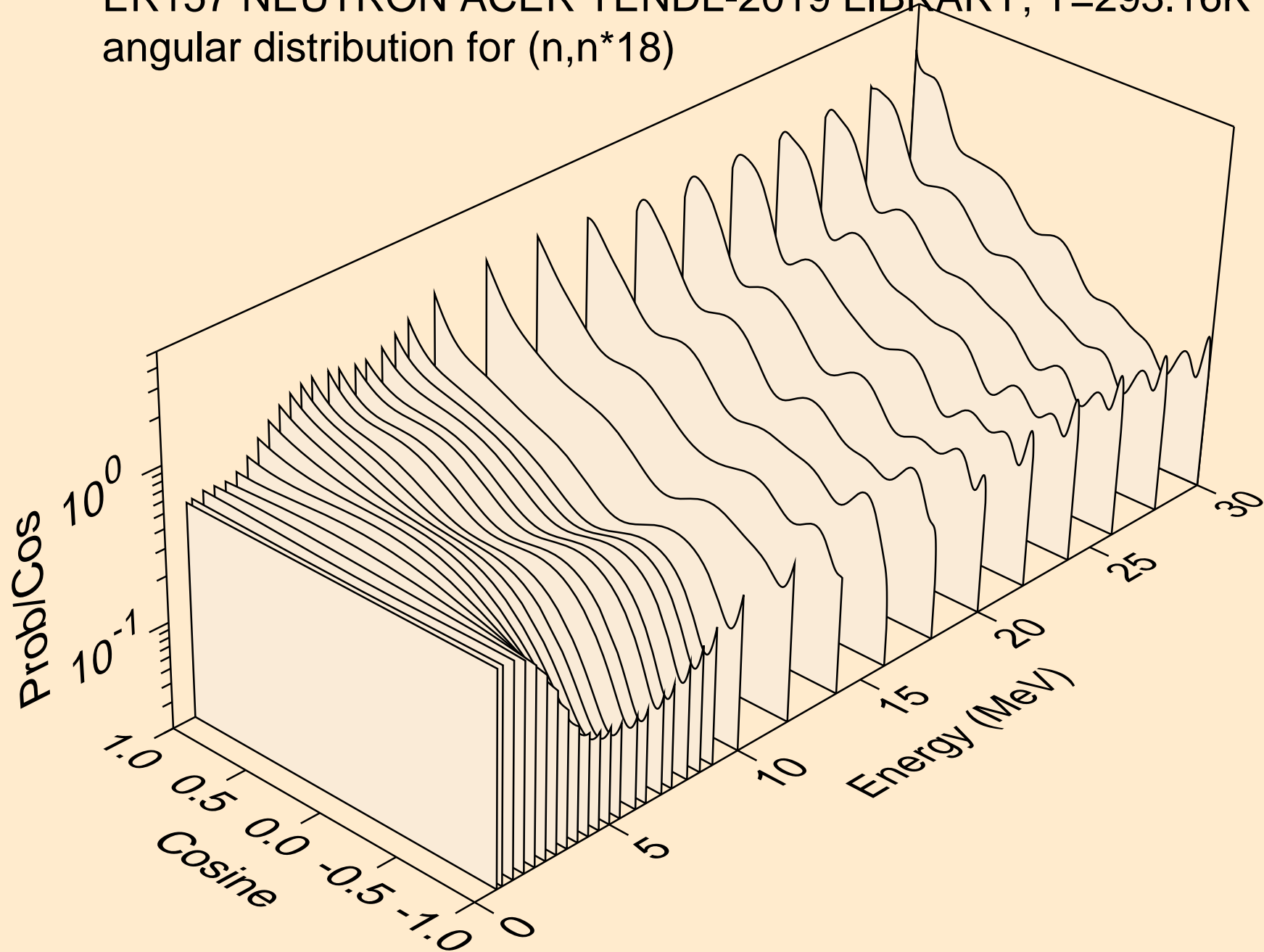

ER157 NEUTRON ACER TENDL-2019 LIBRARY; T=293.16K
angular distribution for (n,n*19)

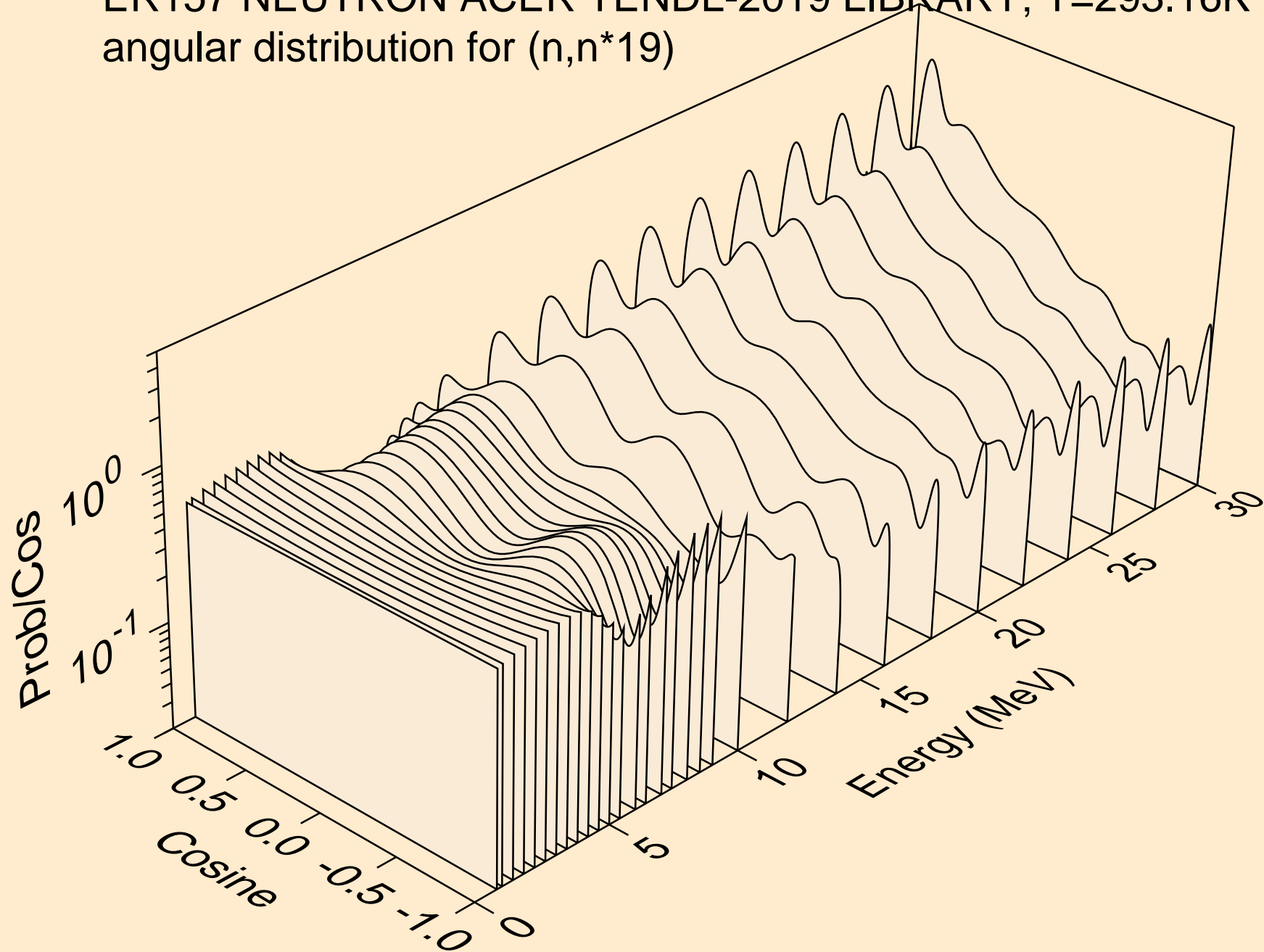

ER157 NEUTRON ACER TENDL-2019 LIBRARY; T=293.16K
angular distribution for (n,n*20)

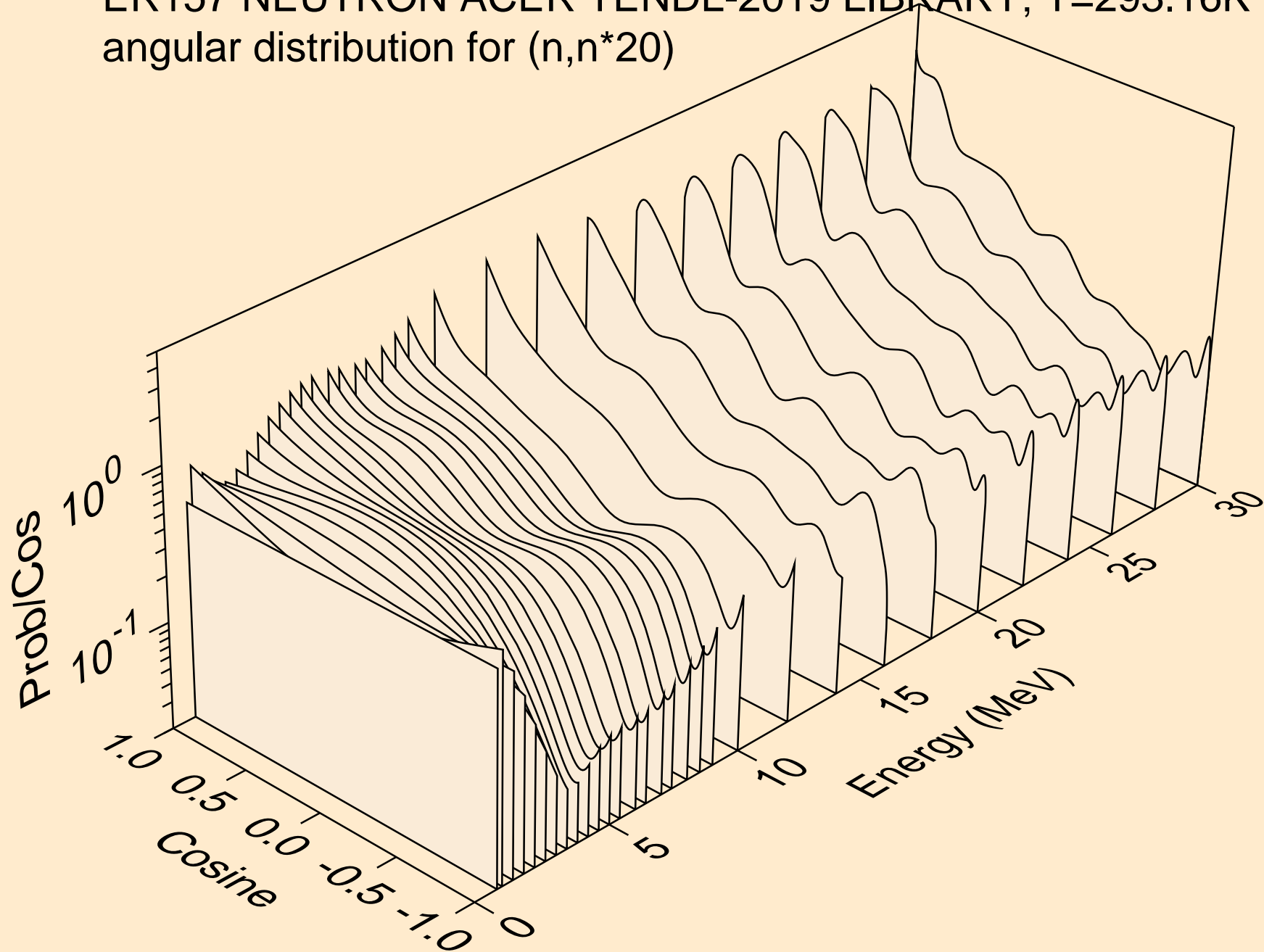

ER157 NEUTRON ACER TENDL-2019 LIBRARY; T=293.16K
angular distribution for (n,n*21)

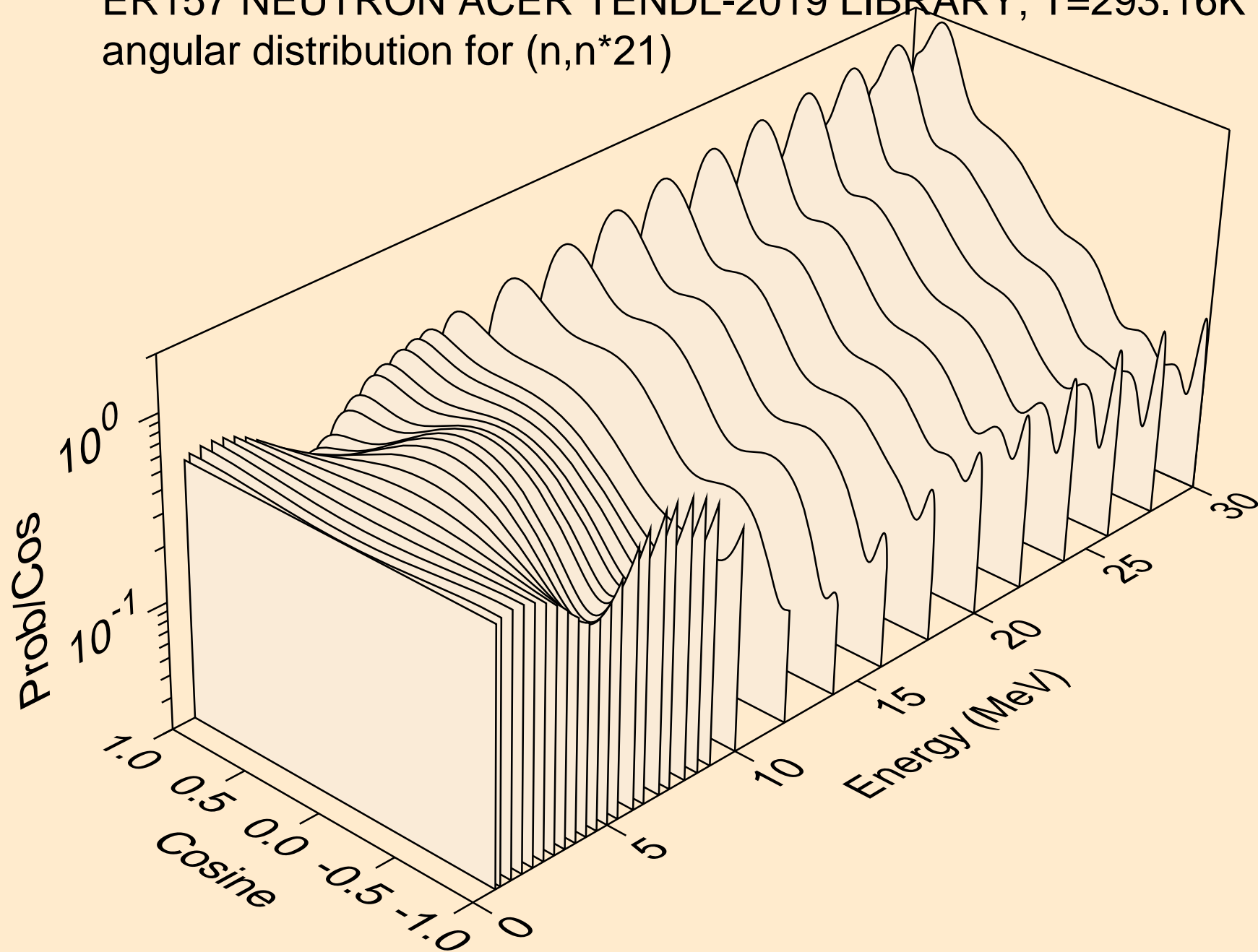

ER157 NEUTRON ACER TENDL-2019 LIBRARY; T=293.16K
angular distribution for (n,n*22)

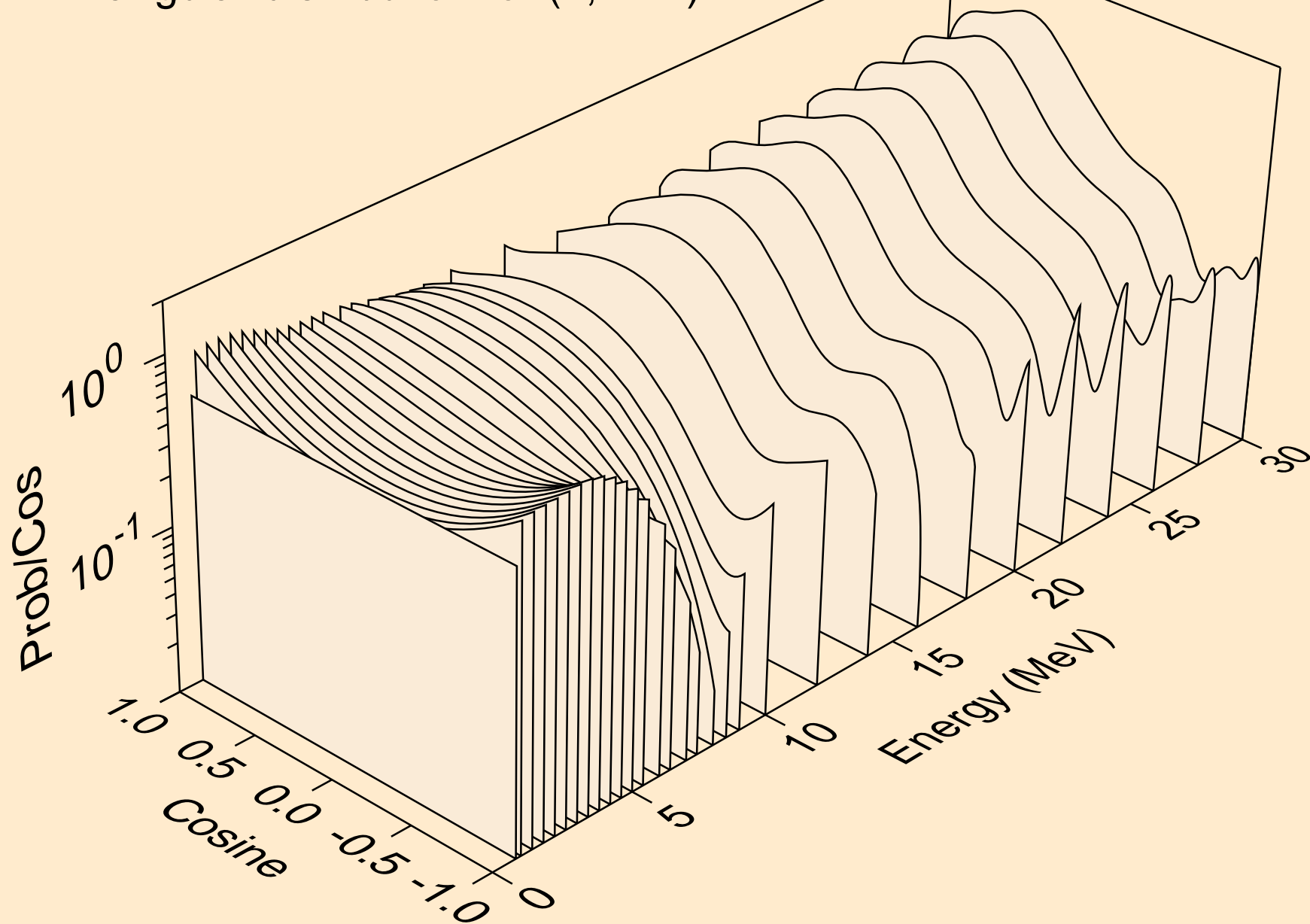

ER157 NEUTRON ACER TENDL-2019 LIBRARY; T=293.16K
angular distribution for (n,n*23)

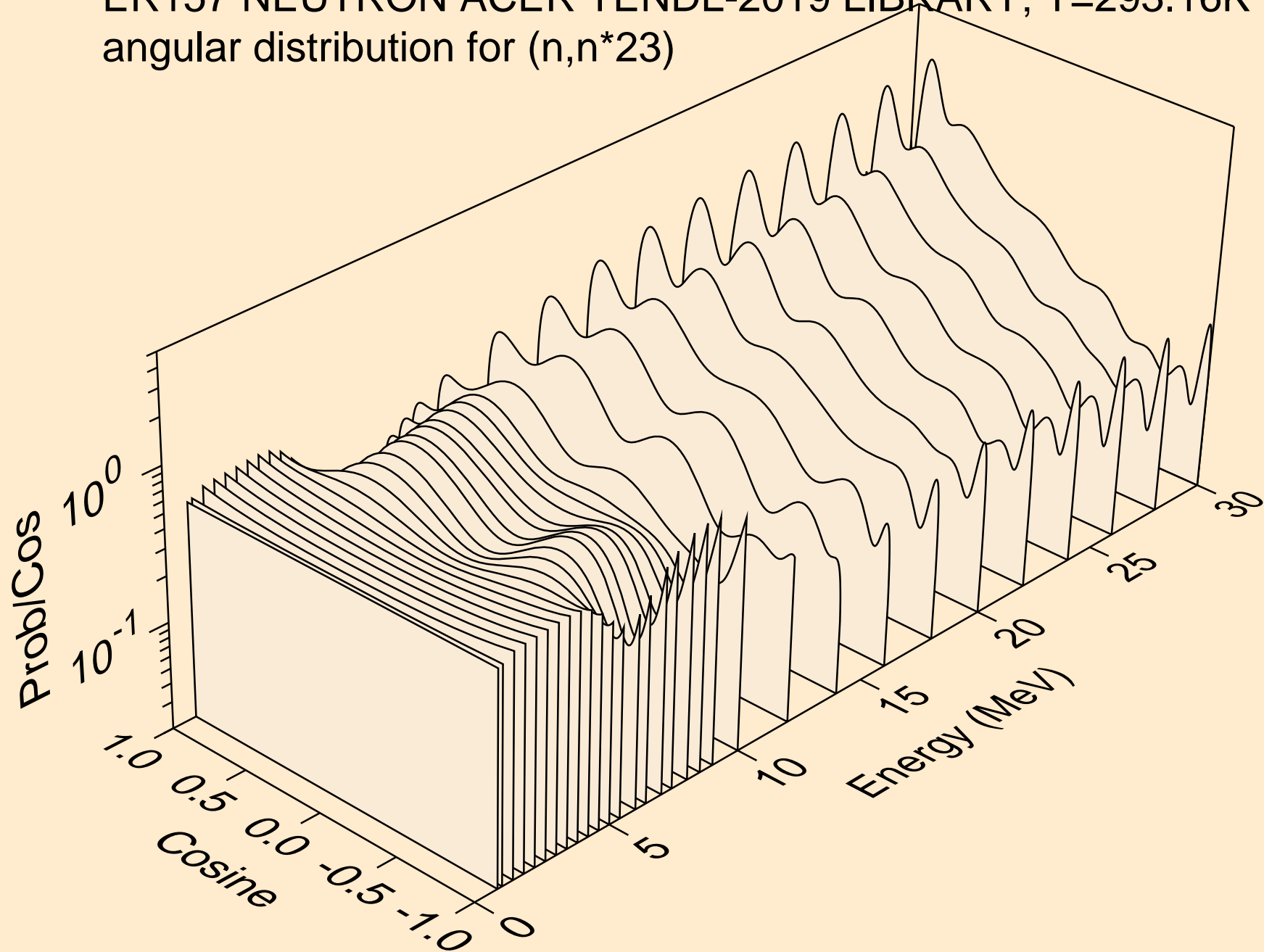

ER157 NEUTRON ACER TENDL-2019 LIBRARY; T=293.16K
angular distribution for (n,n*24)

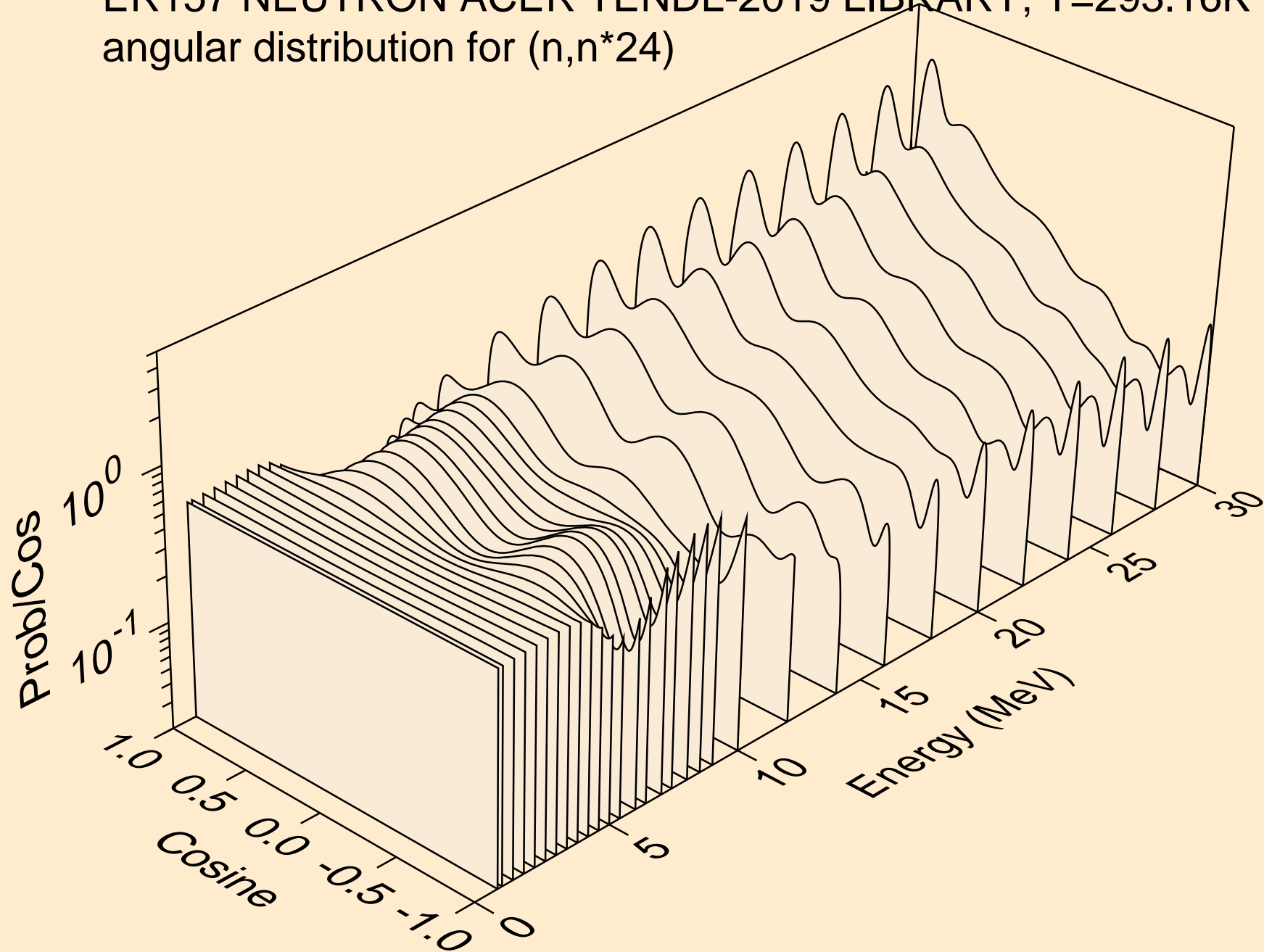

ER157 NEUTRON ACER TENDL-2019 LIBRARY; T=293.16K
angular distribution for (n,n*25)

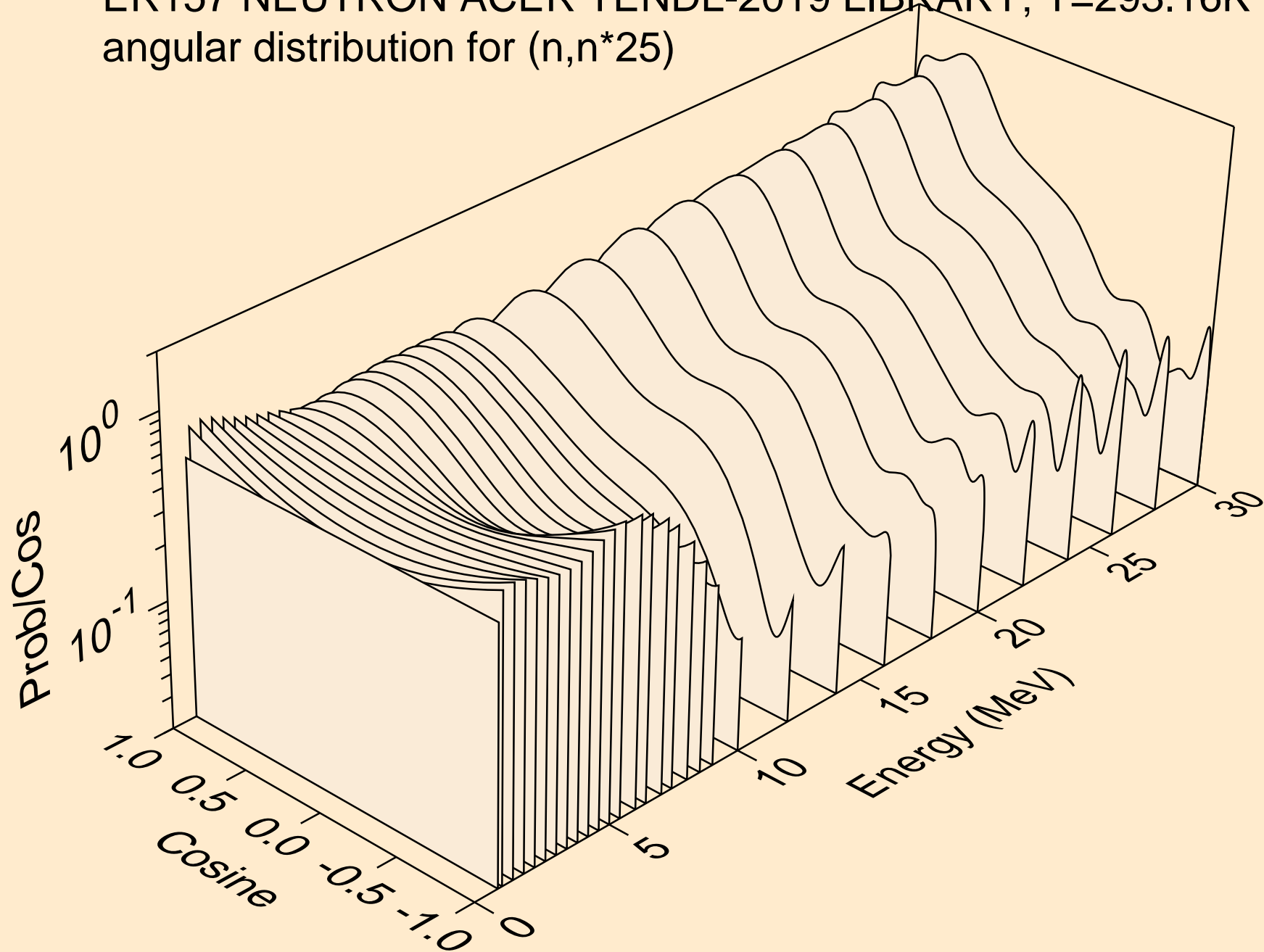

ER157 NEUTRON ACER TENDL-2019 LIBRARY; T=293.16K
angular distribution for (n,n*26)

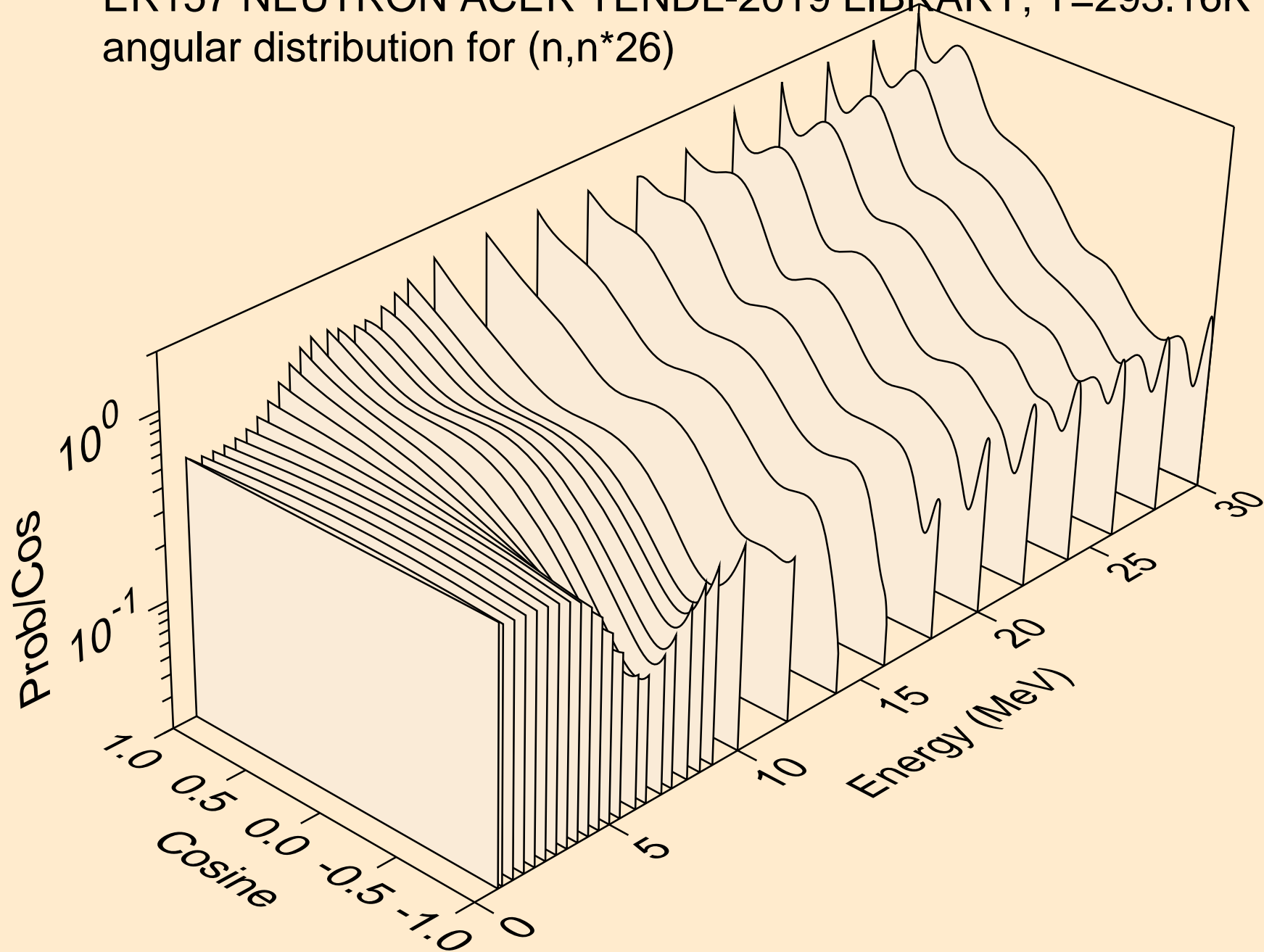

ER157 NEUTRON ACER TENDL-2019 LIBRARY; T=293.16K
angular distribution for (n,n*27)

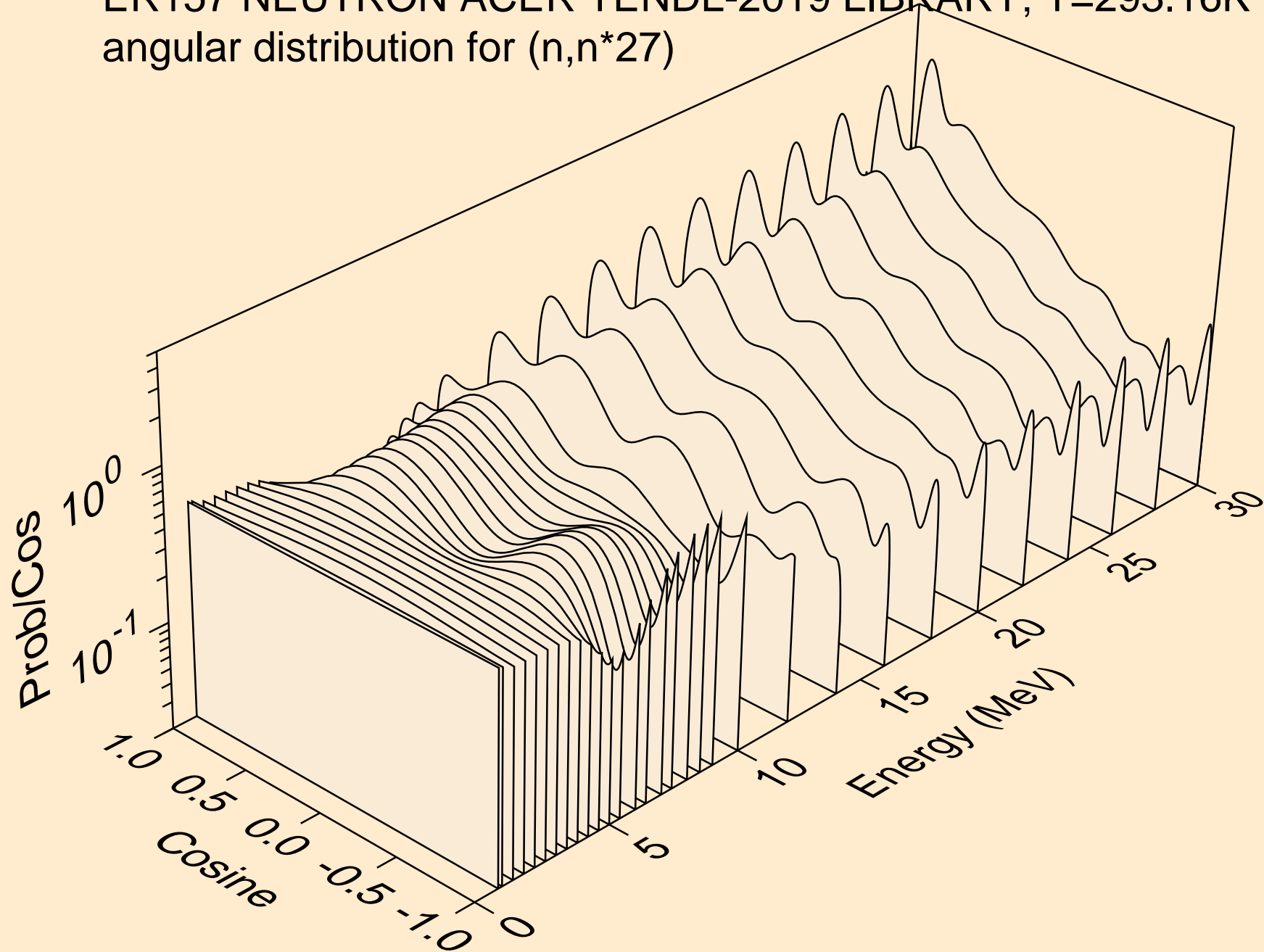

ER157 NEUTRON ACER TENDL-2019 LIBRARY; T=293.16K
angular distribution for (n,n*28)

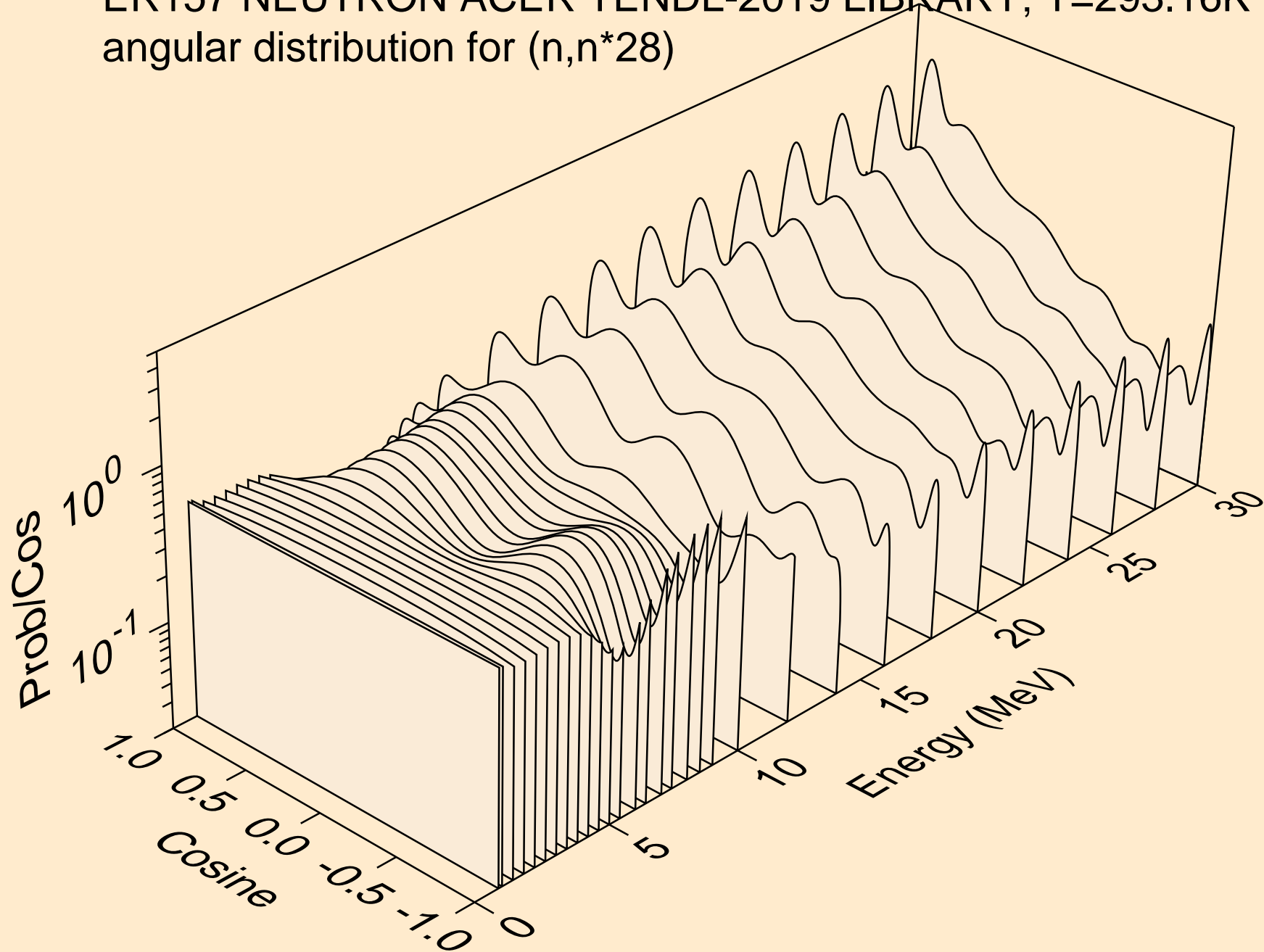

ER157 NEUTRON ACER TENDL-2019 LIBRARY; T=293.16K
Neutron emission for (n,x)

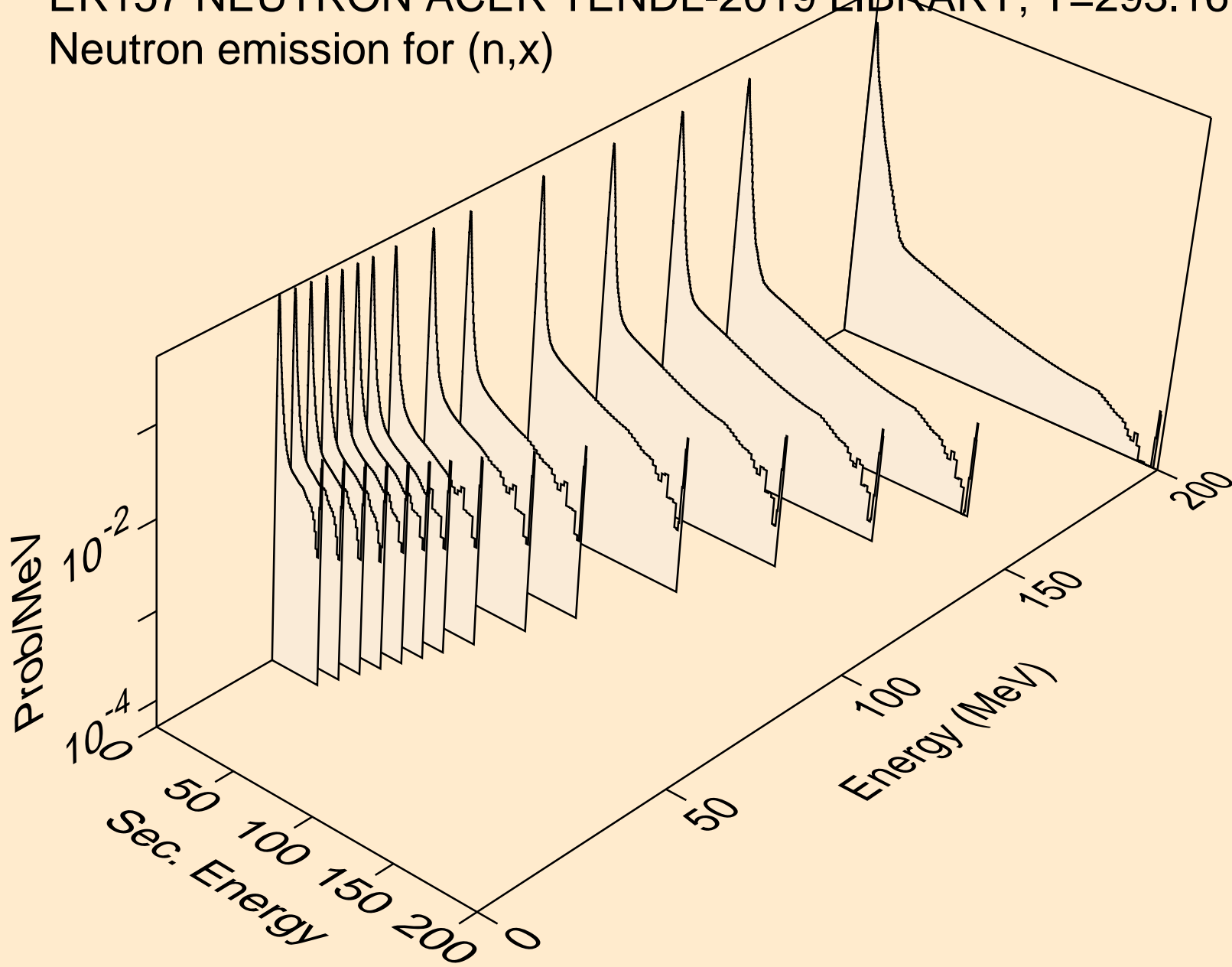

ER157 NEUTRON ACER TENDL-2019 LIBRARY; T=293.16K
Neutron emission for (n,2nd)

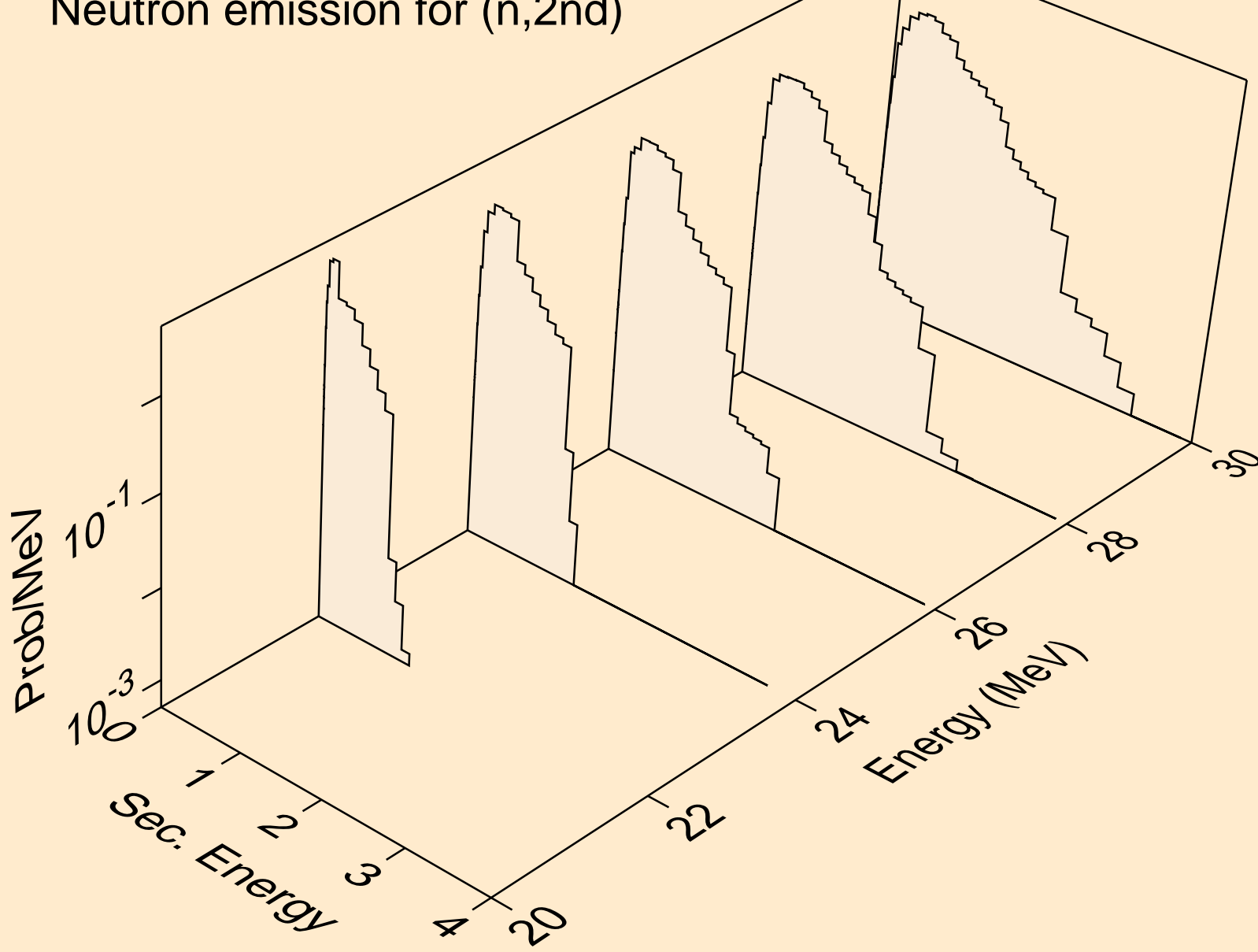

ER157 NEUTRON ACER TENDL-2019 LIBRARY; T=293.16K
Neutron emission for (n,2n)

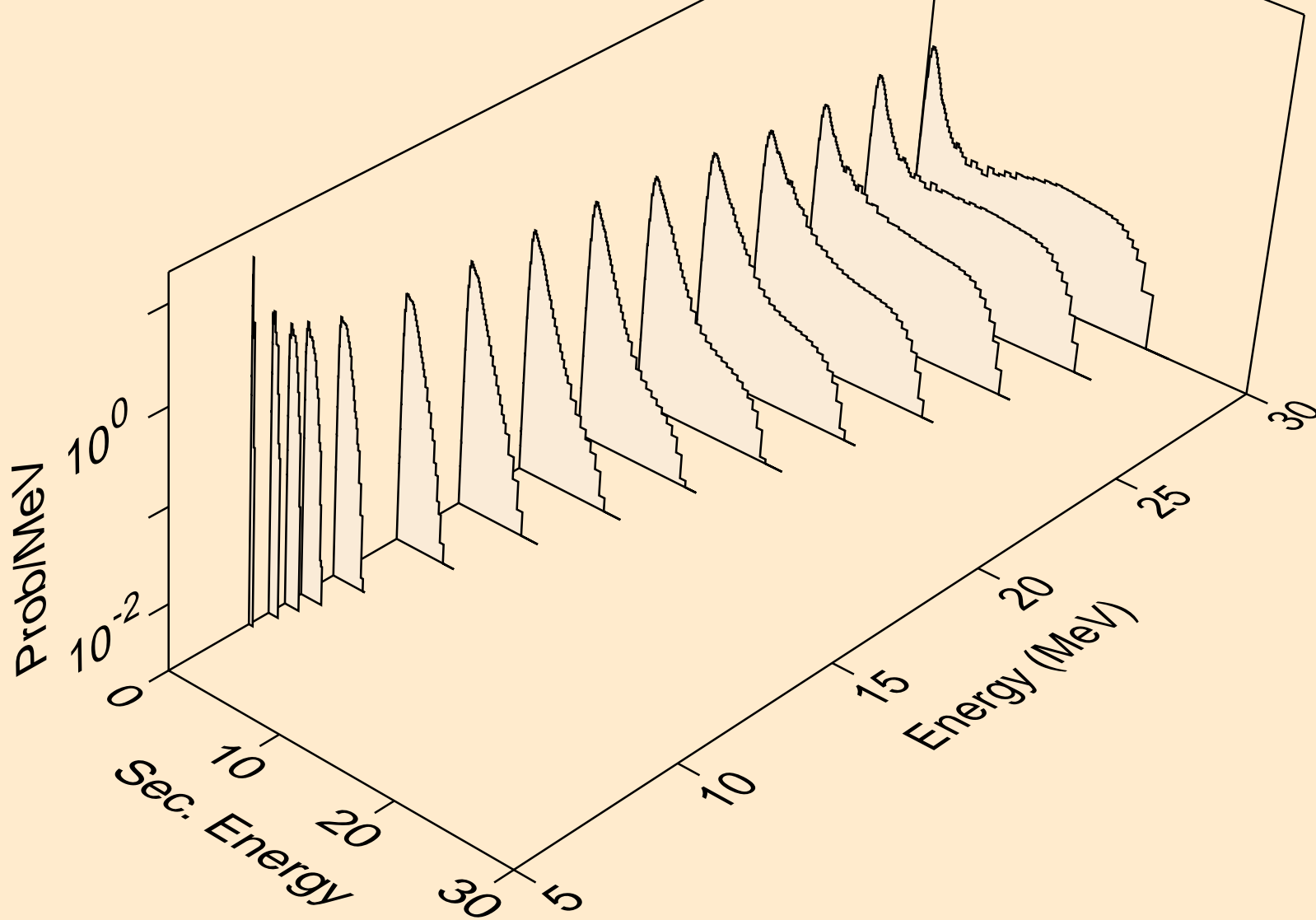

ER157 NEUTRON ACER TENDL-2019 LIBRARY; T=293.16K
Neutron emission for (n,3n)

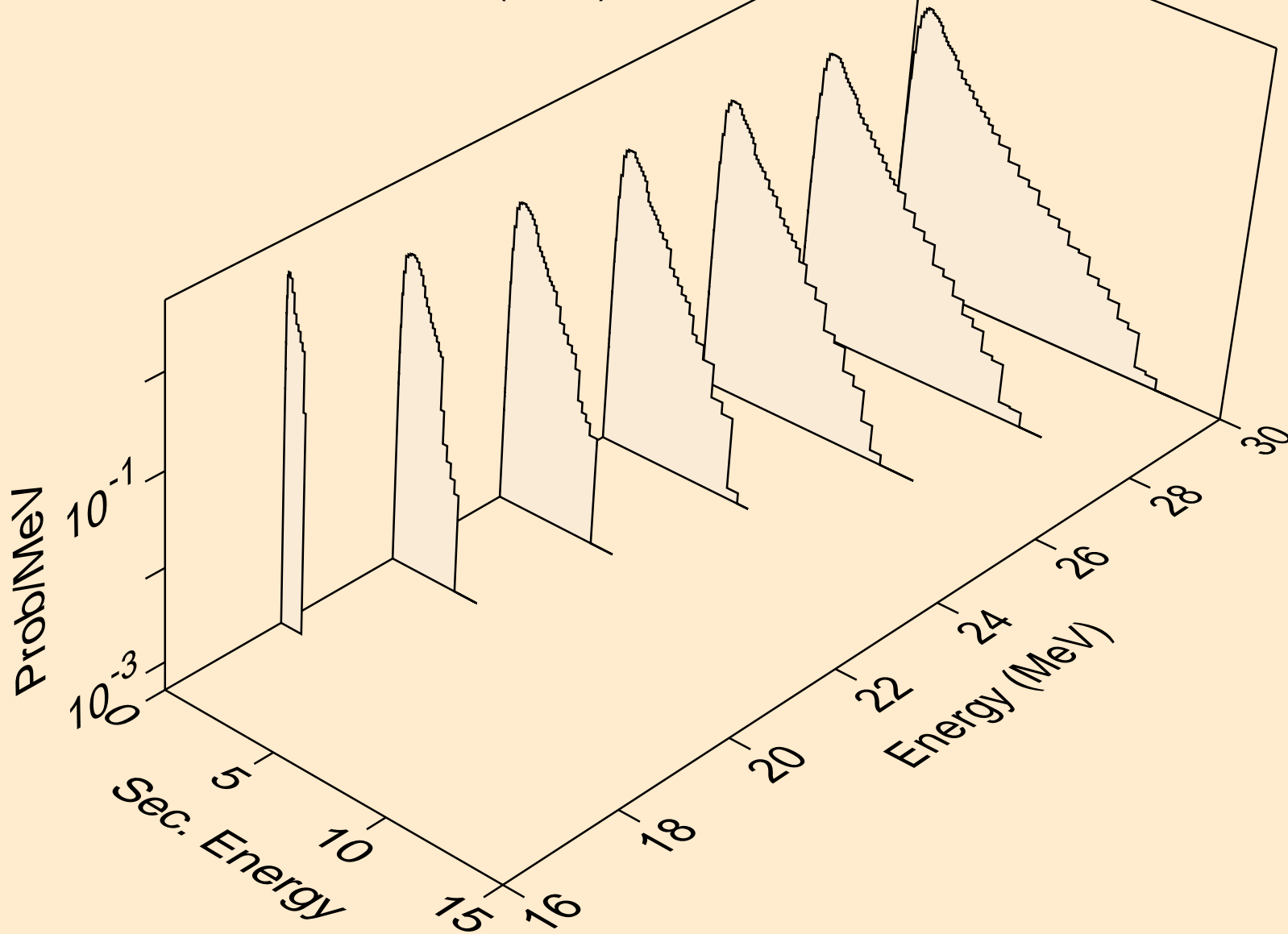

ER157 NEUTRON ACER TENDL-2019 LIBRARY; T=293.16K
Neutron emission for (n,n*)a

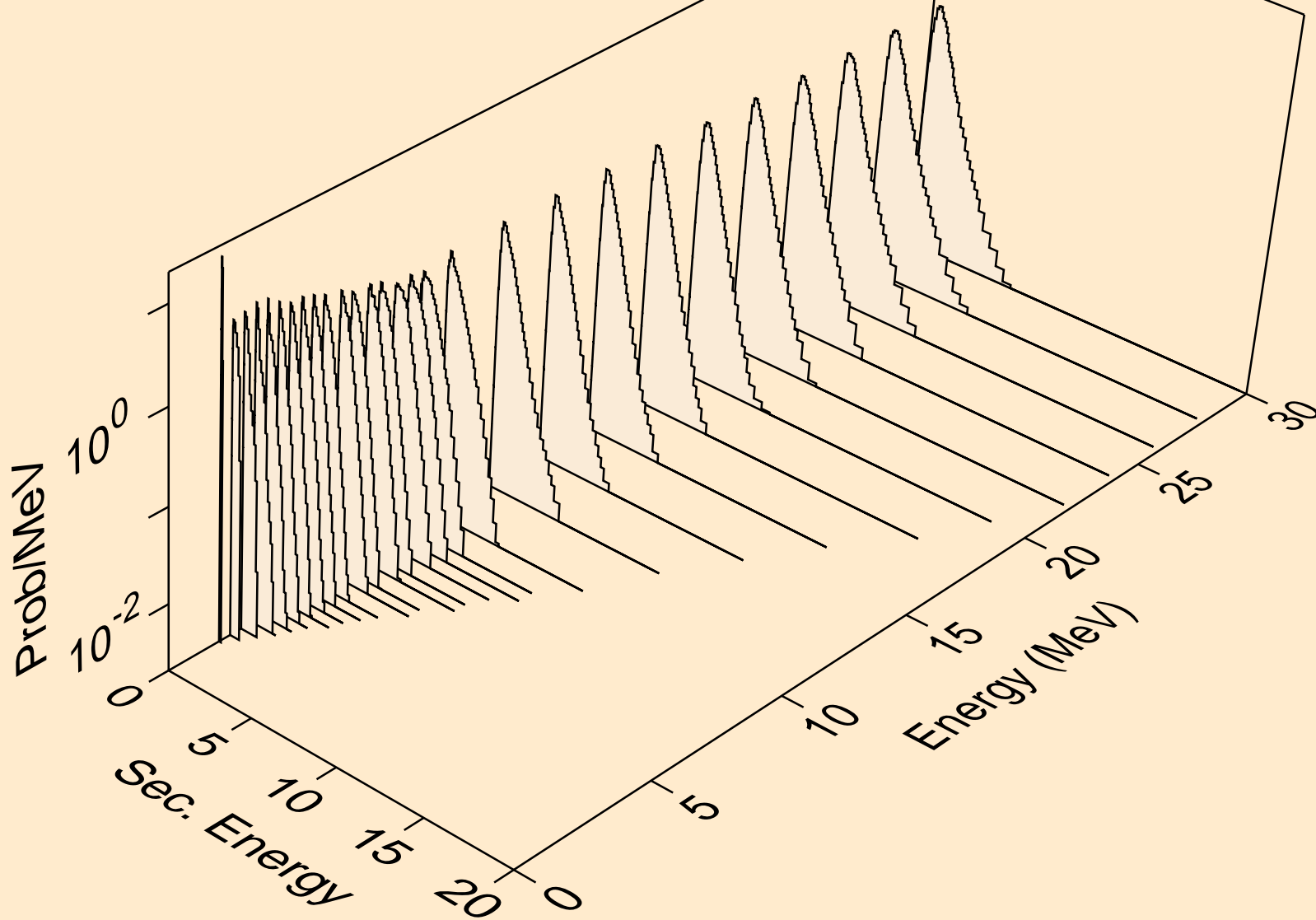

ER157 NEUTRON ACER TENDL-2019 LIBRARY; T=293.16K
Neutron emission for (n,2n)a

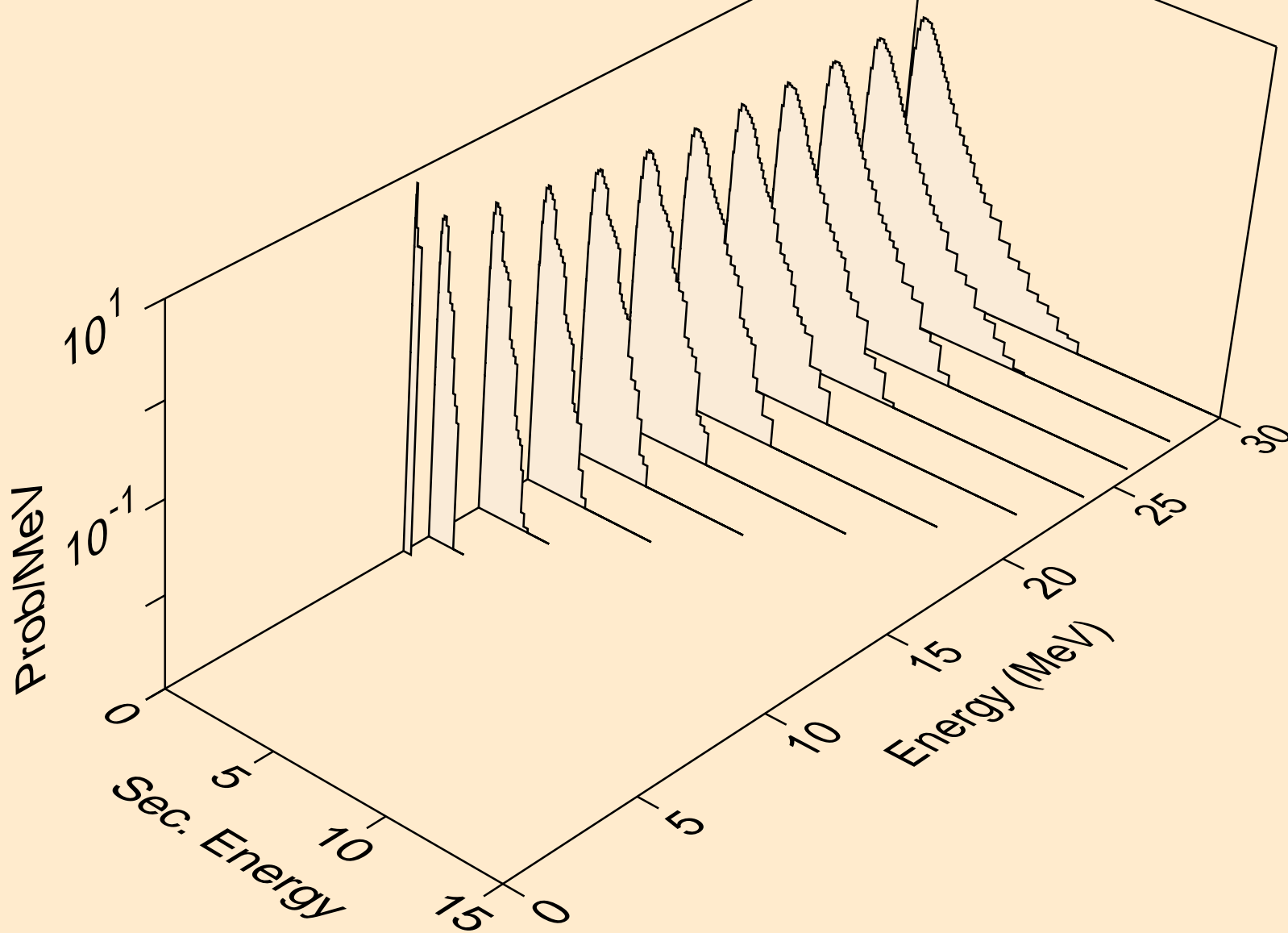

ER157 NEUTRON ACER TENDL-2019 LIBRARY; T=293.16K
Neutron emission for (n,3n)a

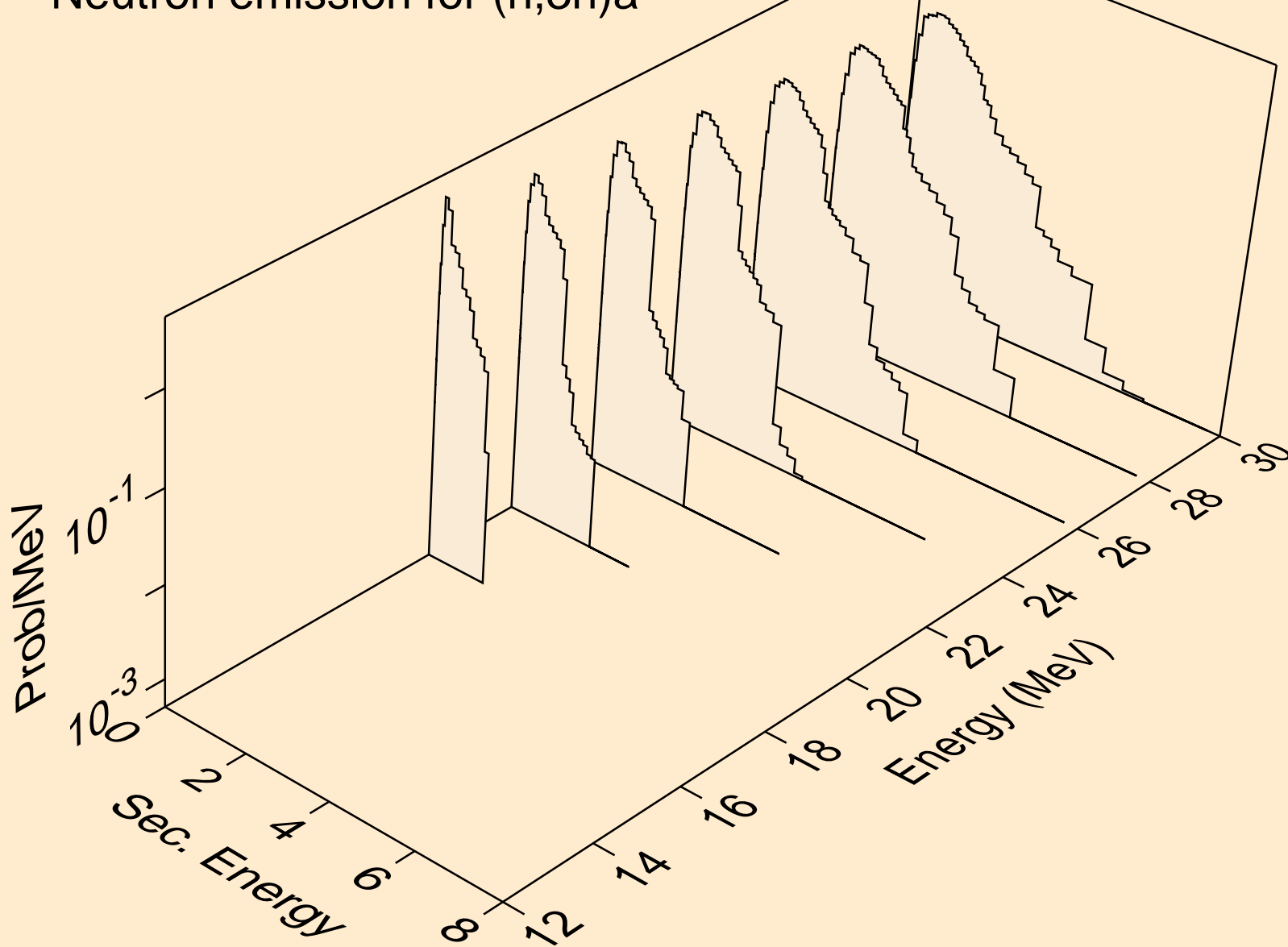

ER157 NEUTRON ACER TENDL-2019 LIBRARY; T=293.16K
Neutron emission for (n,n*)p

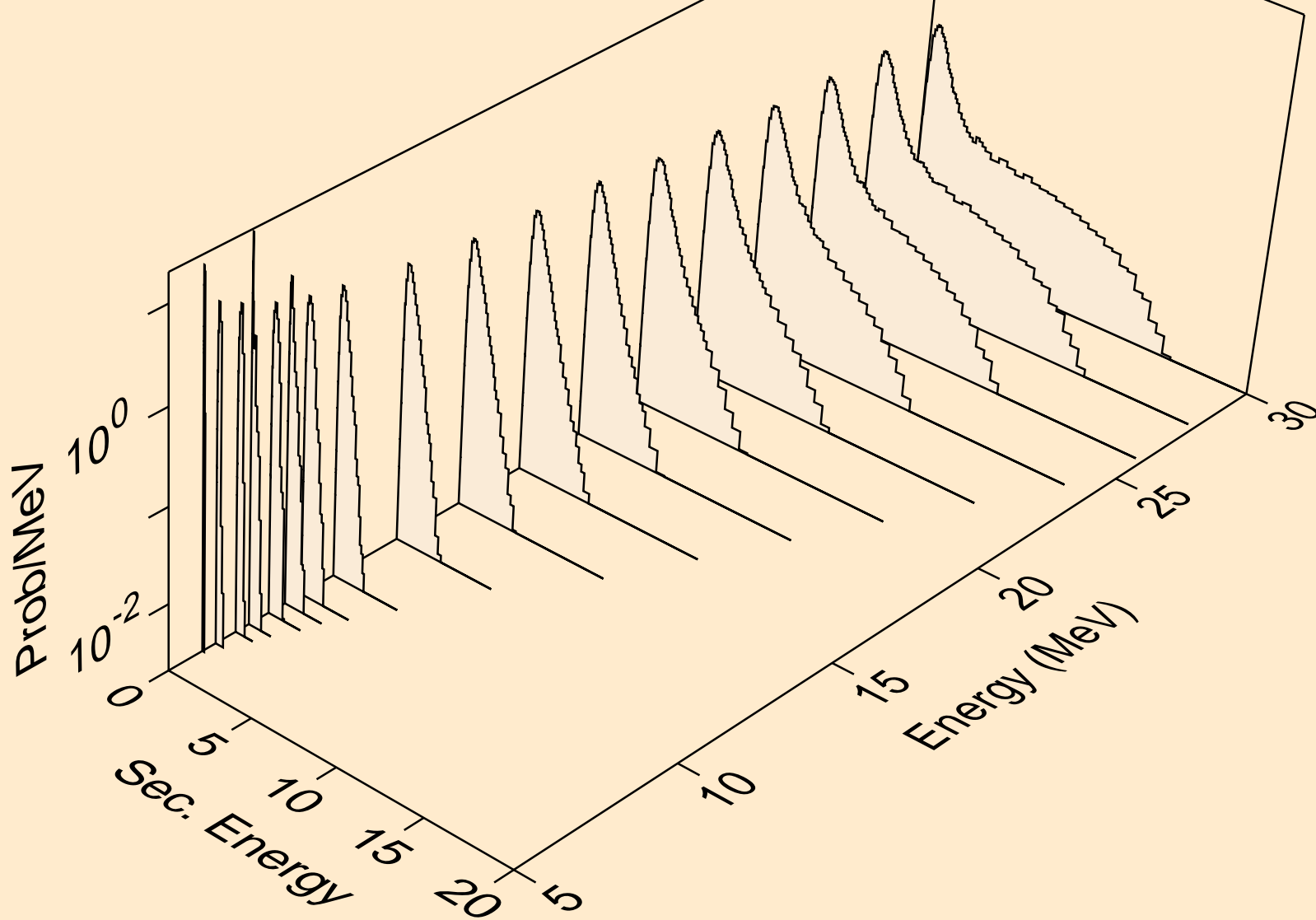

ER157 NEUTRON ACER TENDL-2019 LIBRARY; T=293.16K
Neutron emission for (n,n*)2a

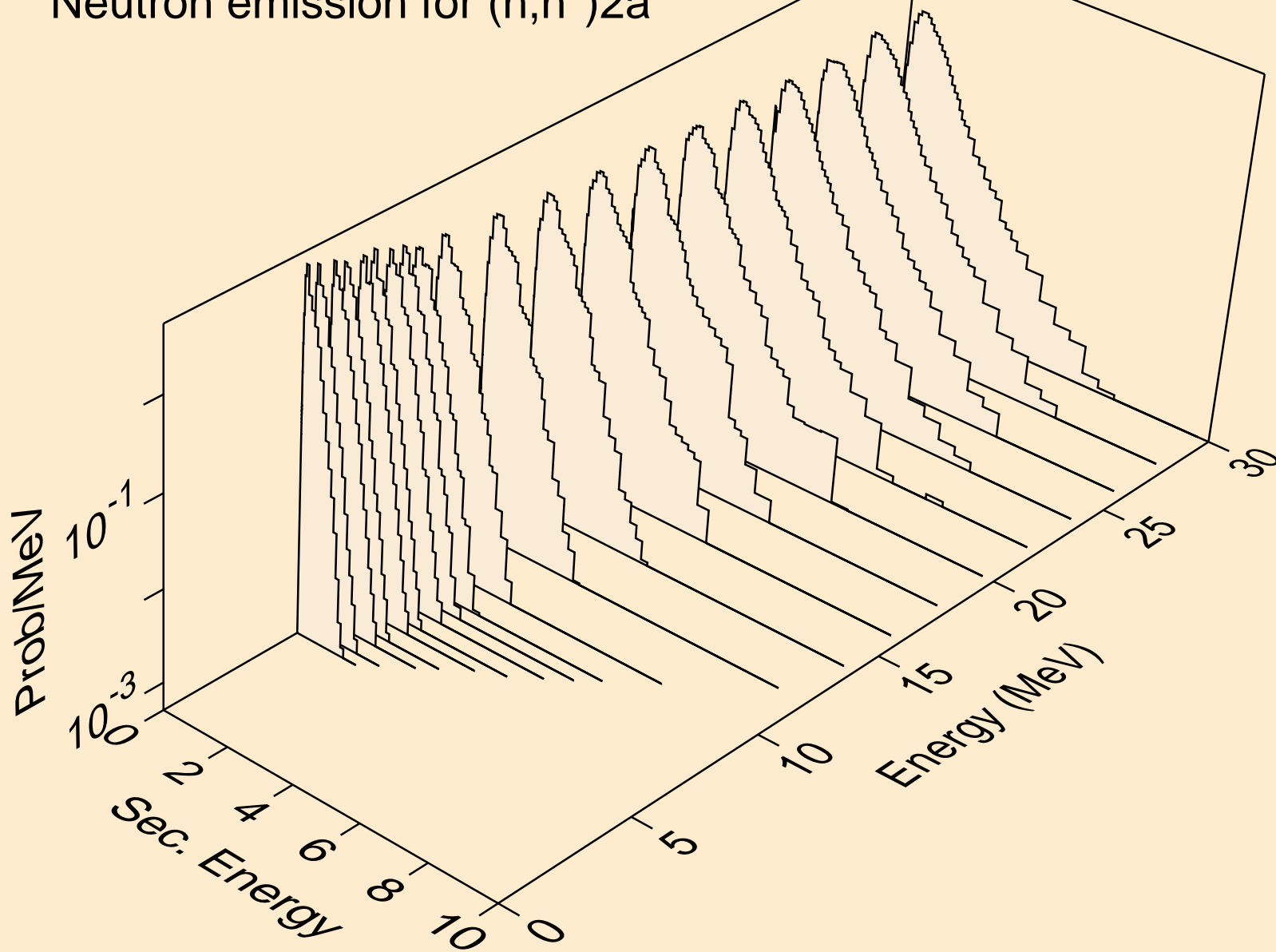

ER157 NEUTRON ACER TENDL-2019 LIBRARY; T=293.16K
Neutron emission for (n,2n)2a

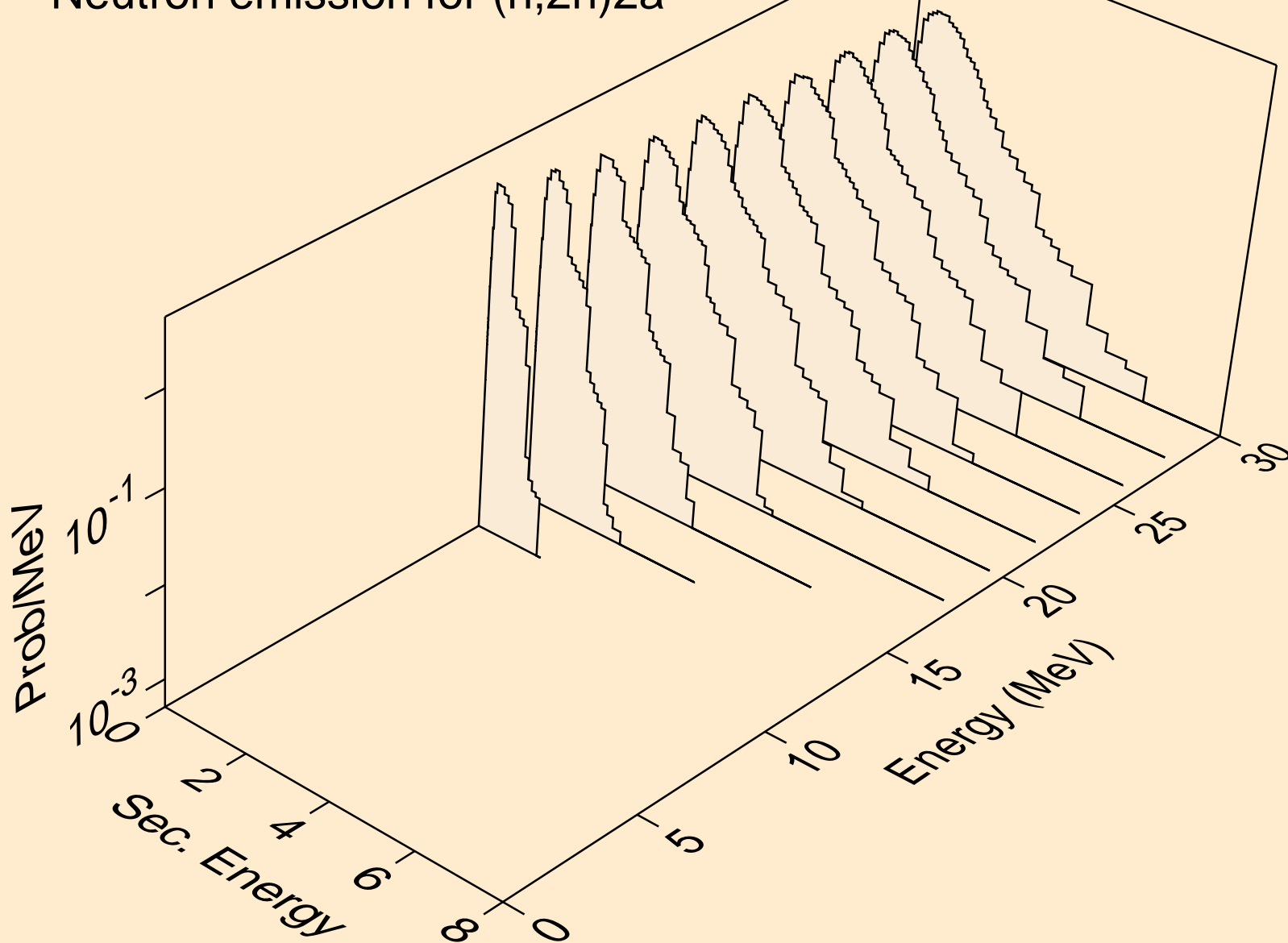

ER157 NEUTRON ACER TENDL-2019 LIBRARY; T=293.16K
Neutron emission for (n,n*)d

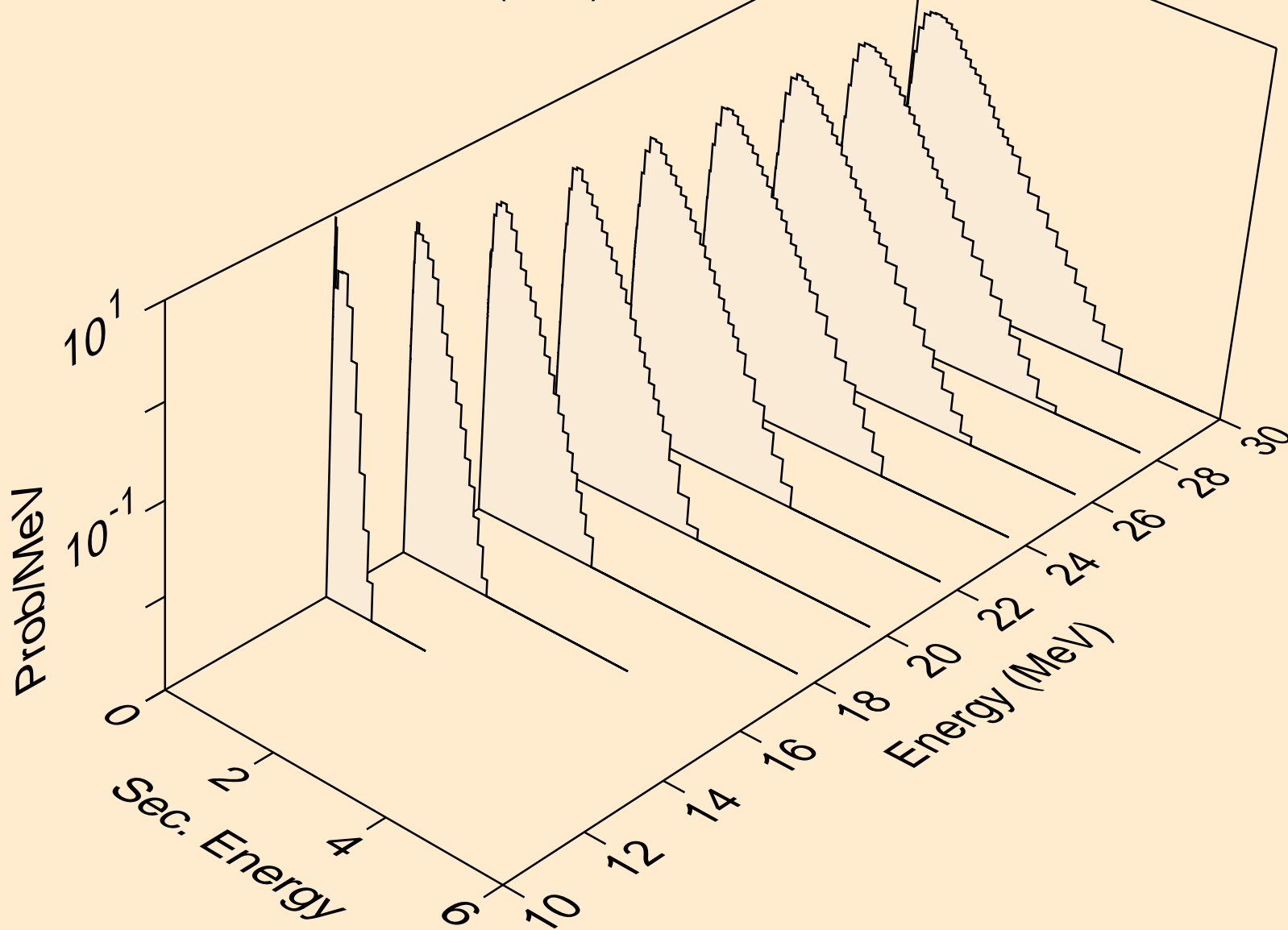

ER157 NEUTRON ACER TENDL-2019 LIBRARY; T=293.16K
Neutron emission for (n,n*)t

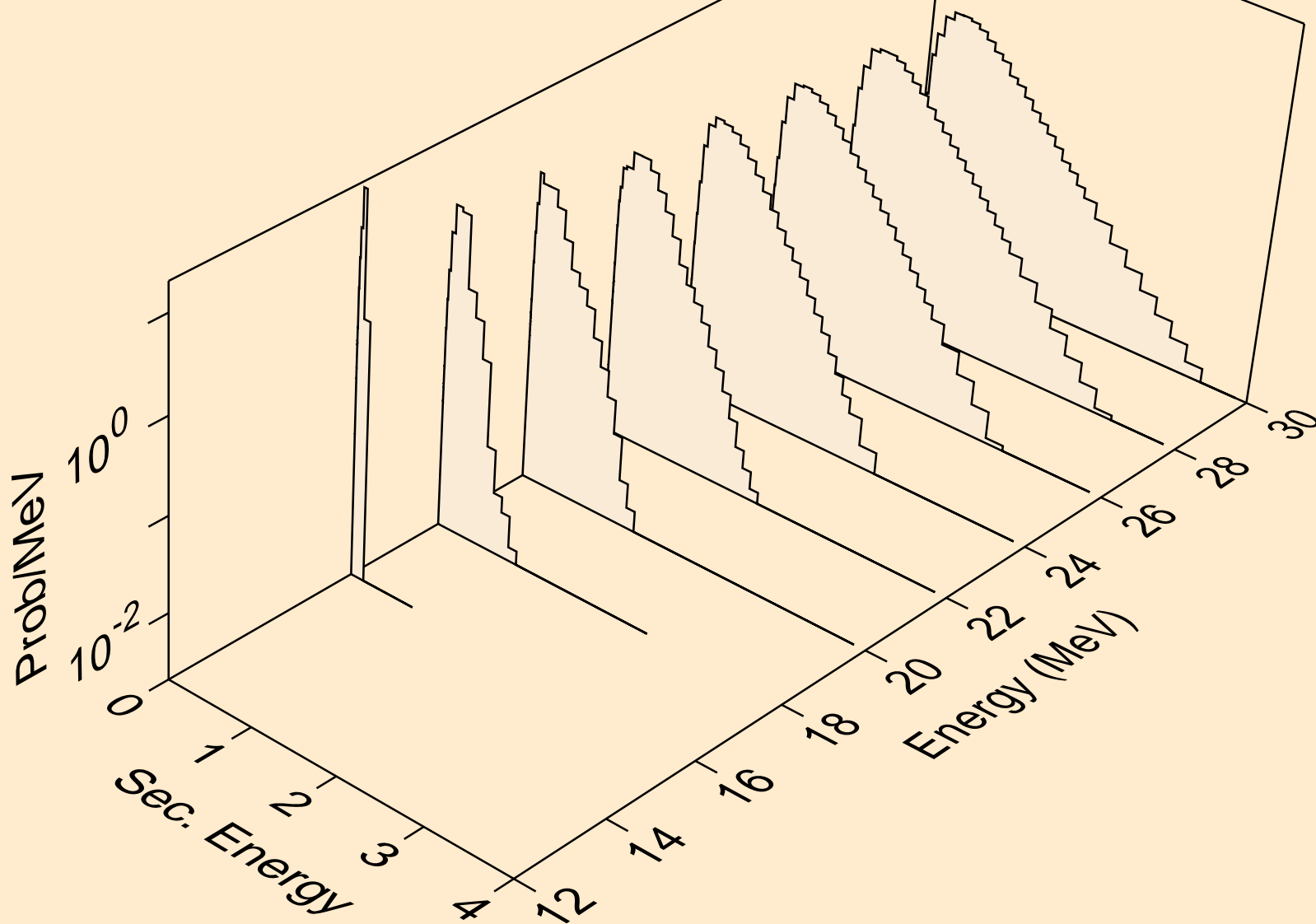

ER157 NEUTRON ACER TENDL-2019 LIBRARY; T=293.16K
Neutron emission for (n,n*)he3

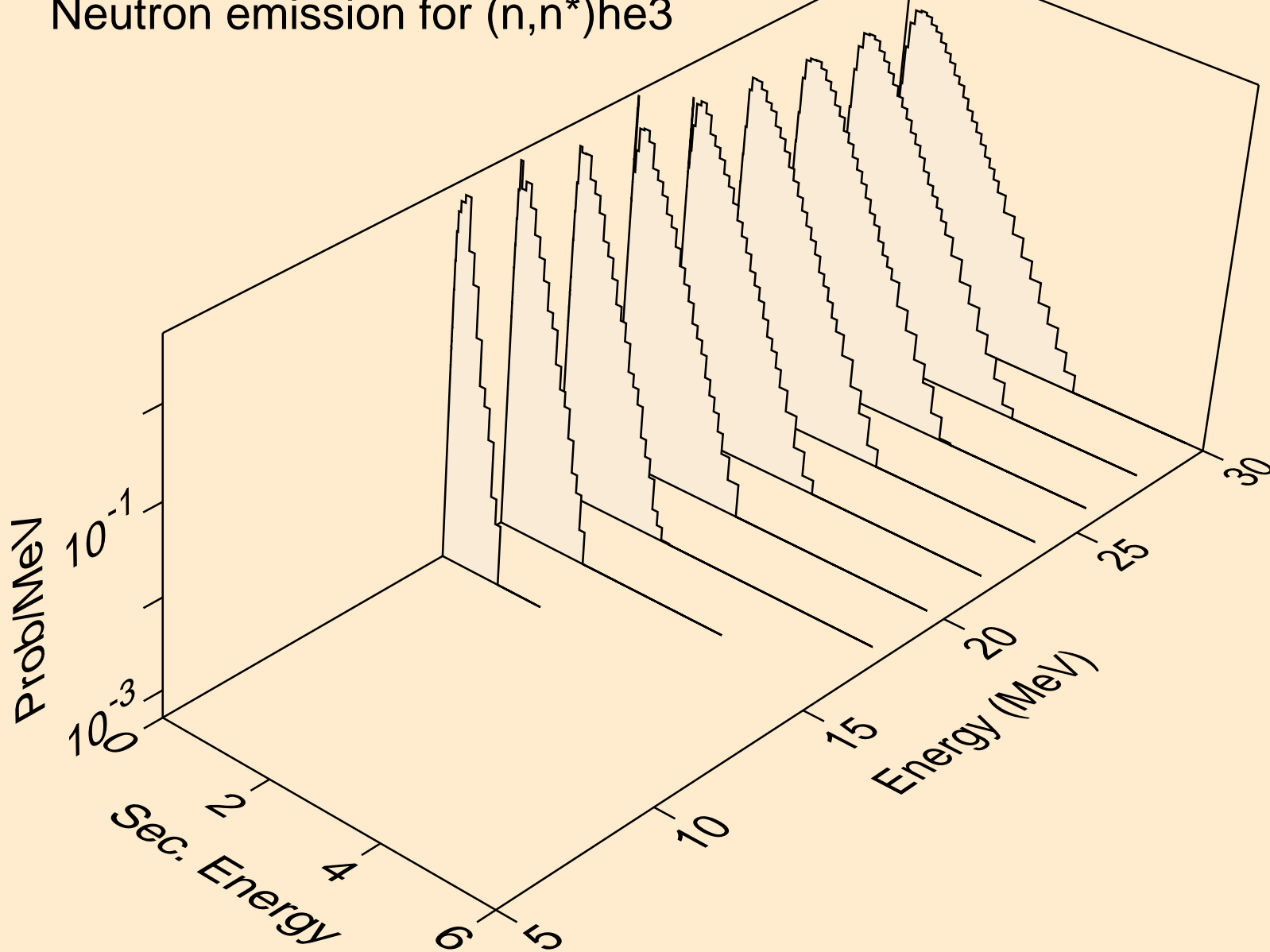

ER157 NEUTRON ACER TENDL-2019 LIBRARY; T=293.16K
Neutron emission for (n,4n)

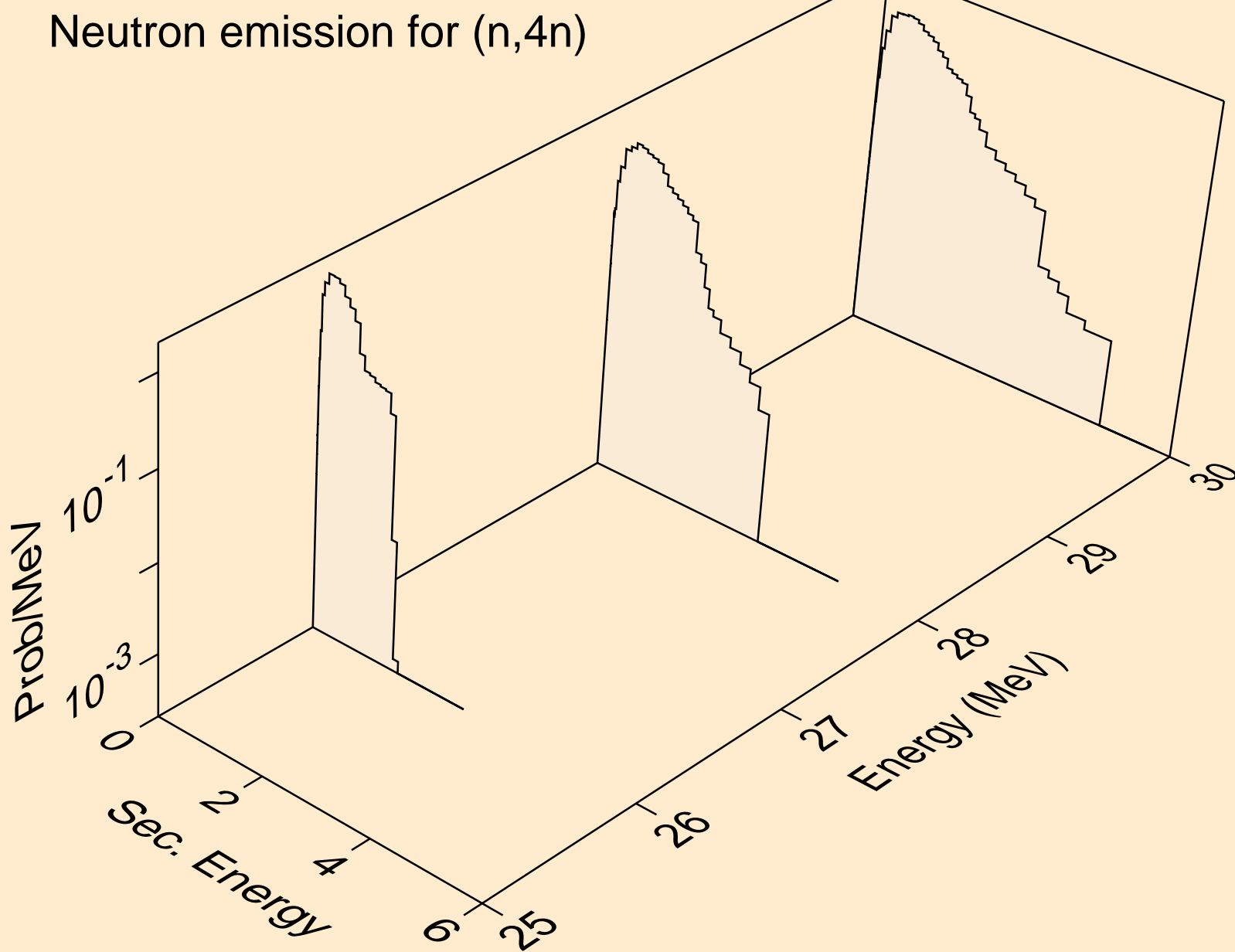

ER157 NEUTRON ACER TENDL-2019 LIBRARY; T=293.16K
Neutron emission for (n,2np)

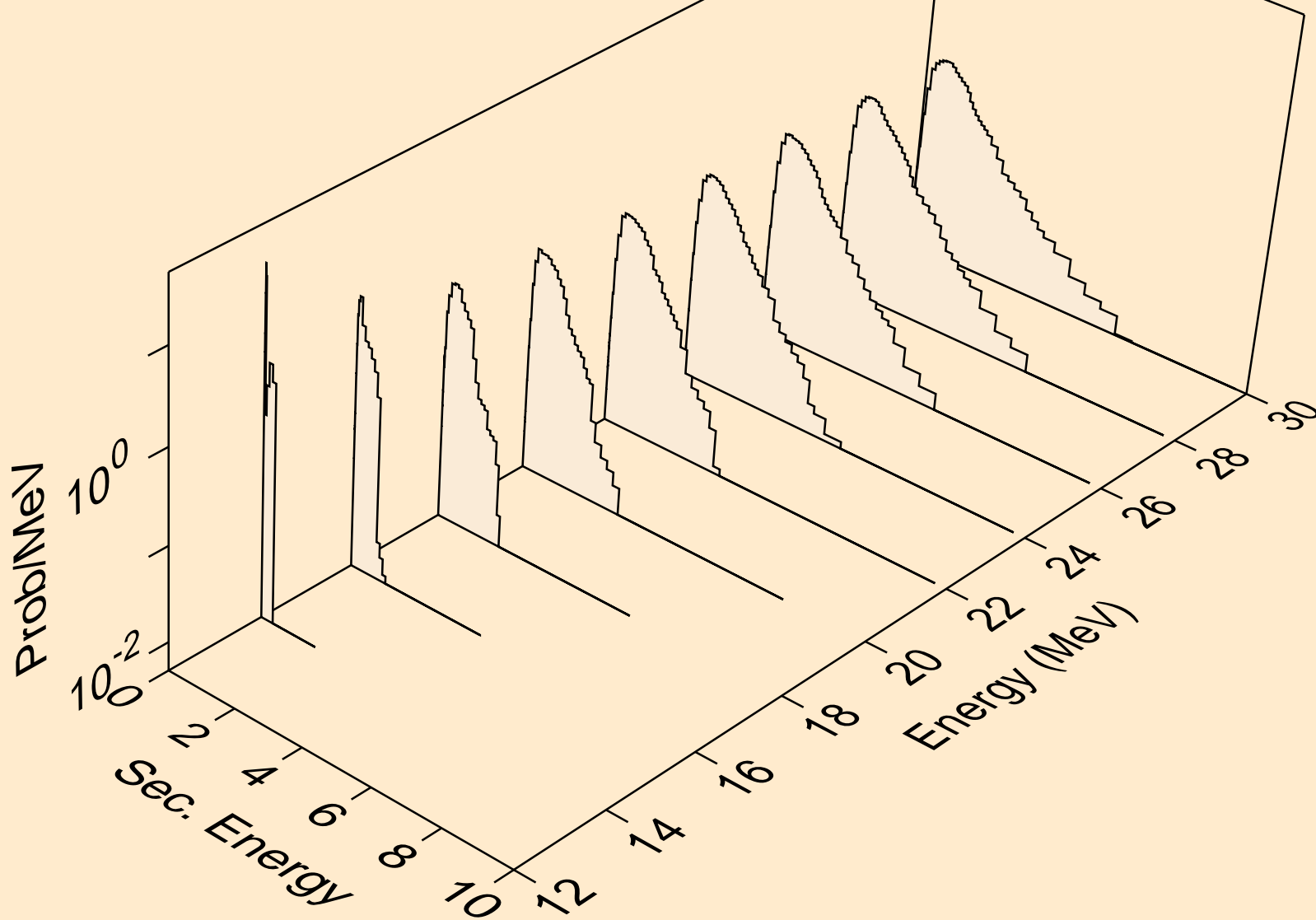

ER157 NEUTRON ACER TENDL-2019 LIBRARY; T=293.16K
Neutron emission for (n,3np)

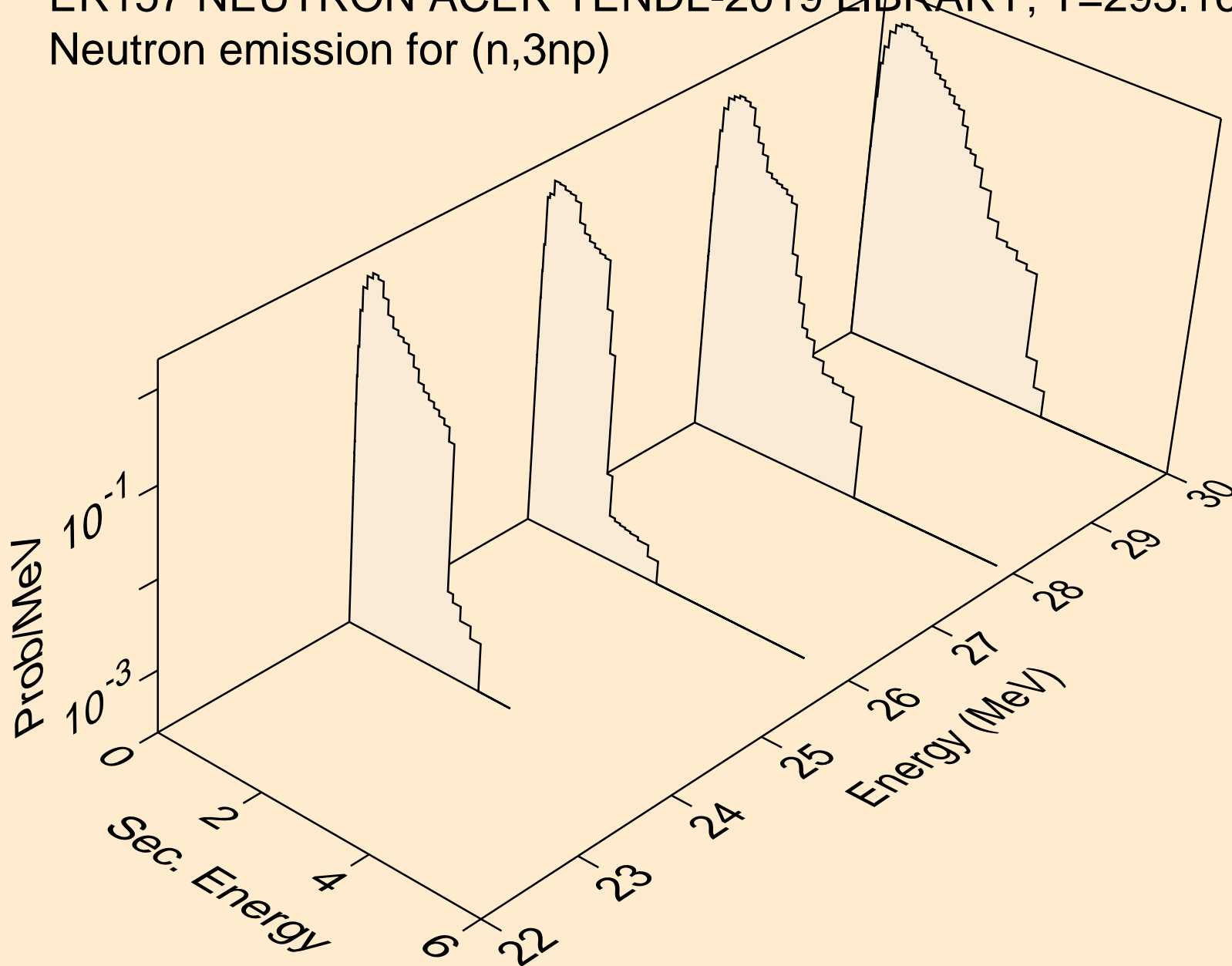

ER157 NEUTRON ACER TENDL-2019 LIBRARY; T=293.16K
Neutron emission for (n,2np)

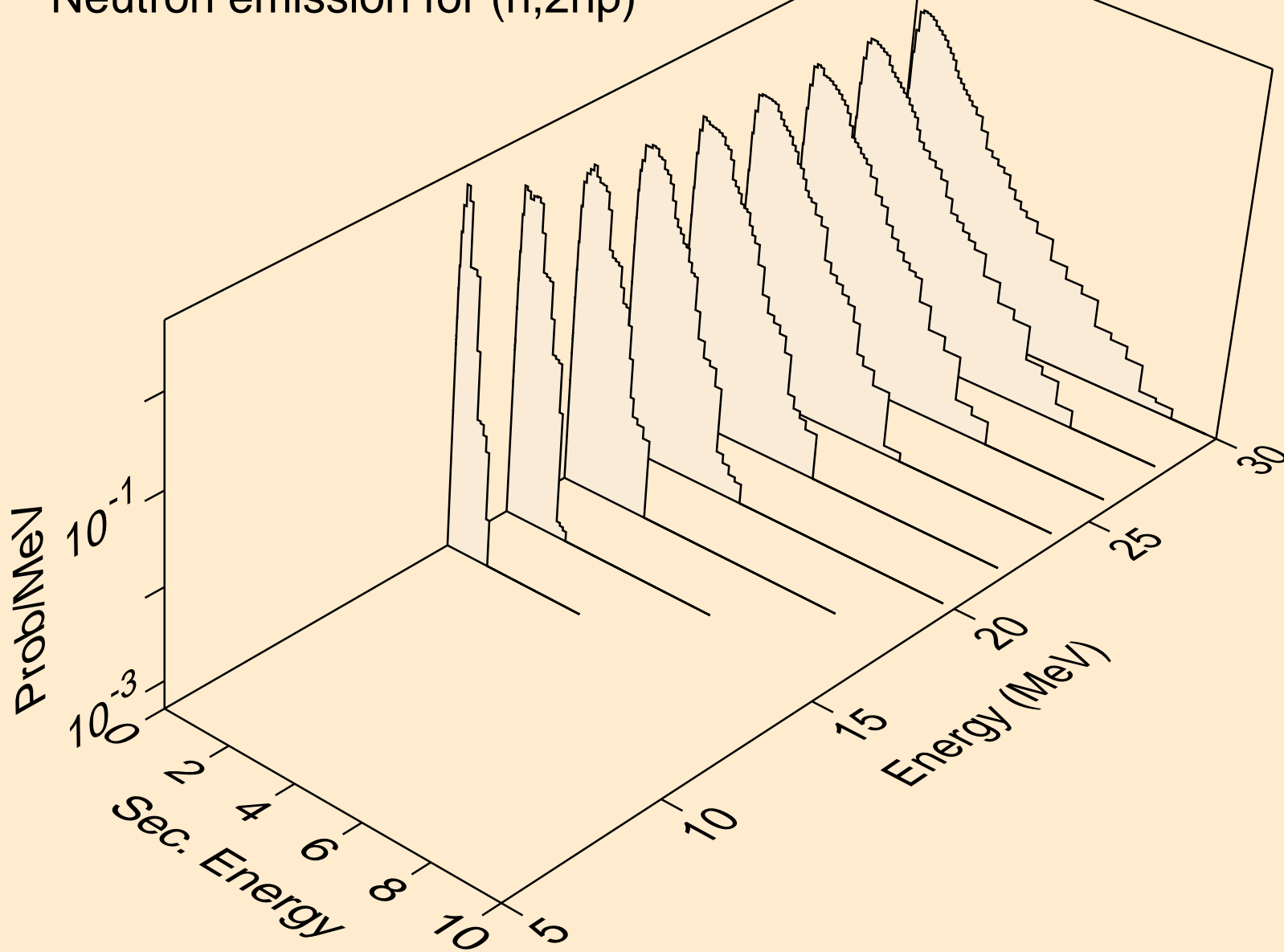

ER157 NEUTRON ACER TENDL-2019 LIBRARY; T=293.16K
Neutron emission for (n,npa)

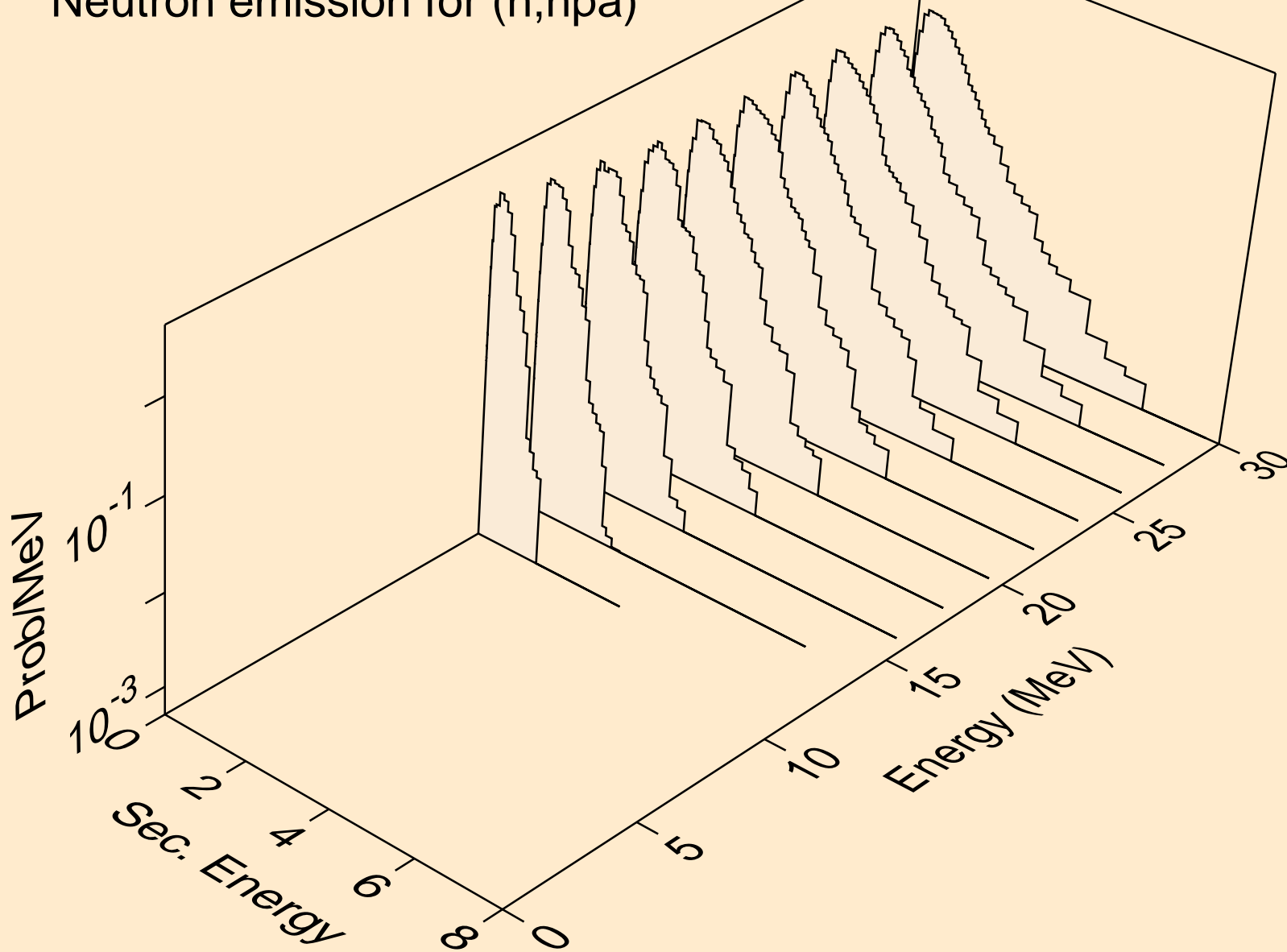

ER157 NEUTRON ACER TENDL-2019 LIBRARY; T=293.16K
Neutron emission for (n,n*c)

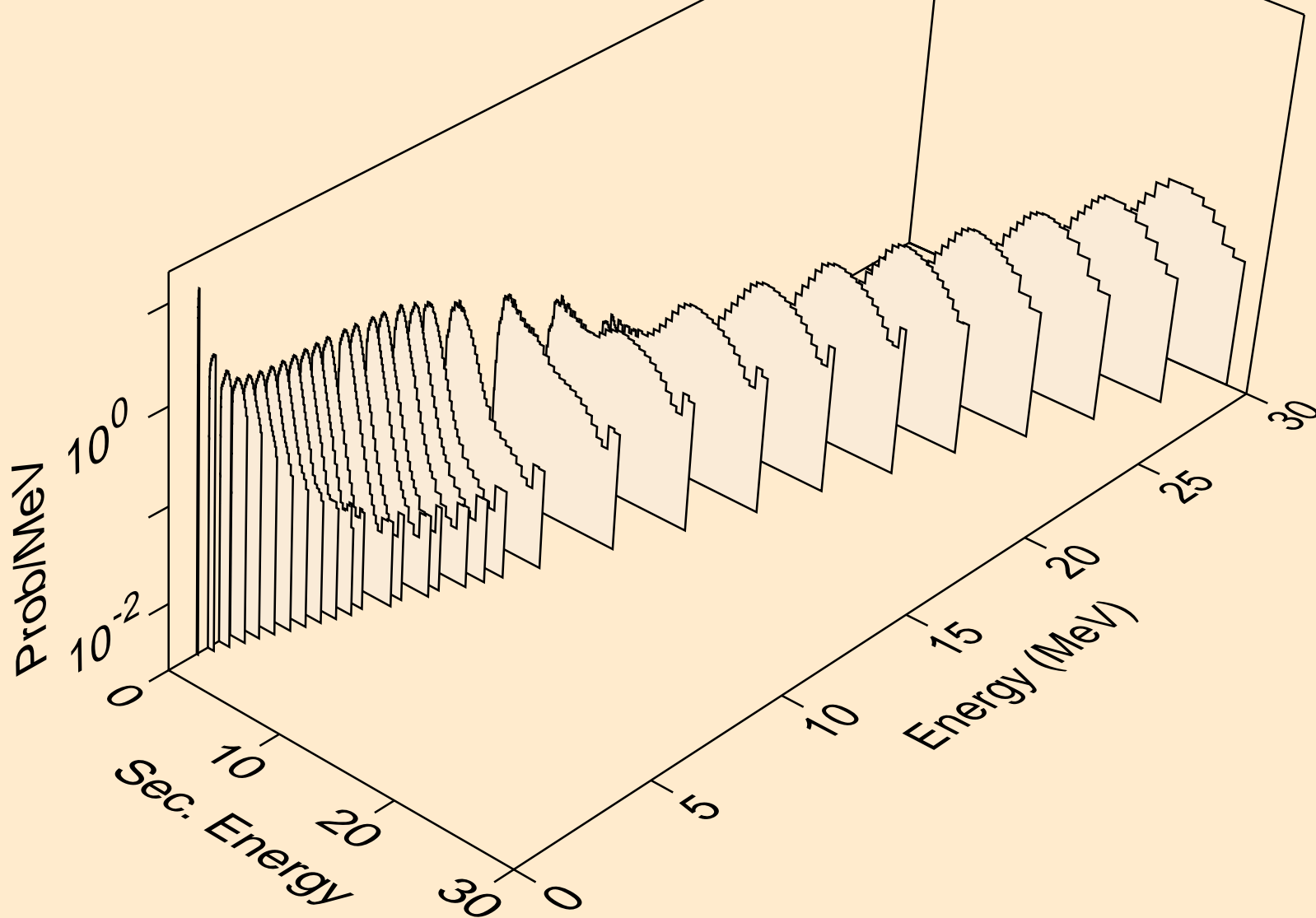

ER157 NEUTRON ACER TENDL-2019 LIBRARY; T=293.16K
Photon emission for (n,x)

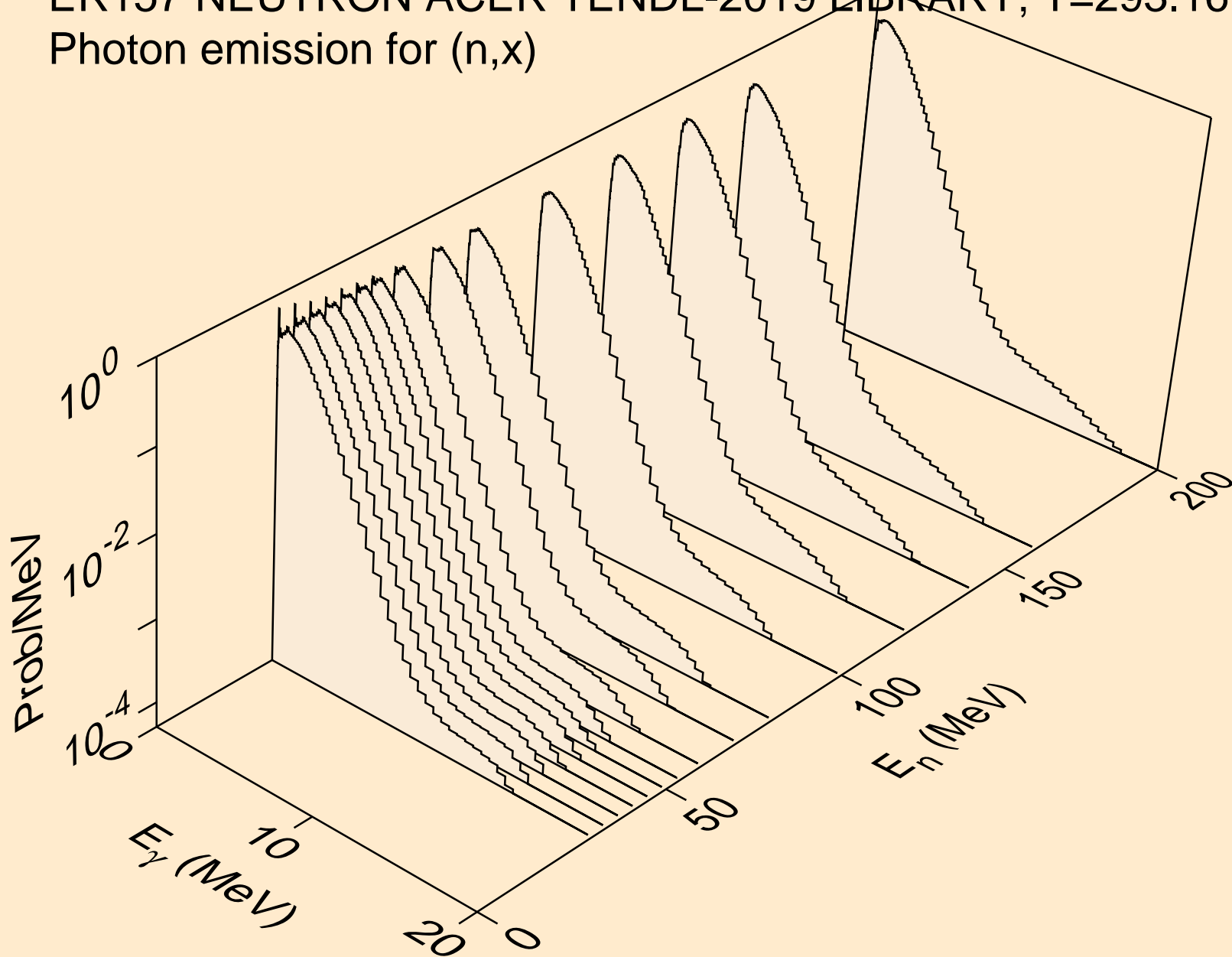

ER157 NEUTRON ACER TENDL-2019 LIBRARY; T=293.16K
Photon emission for (n,2nd)

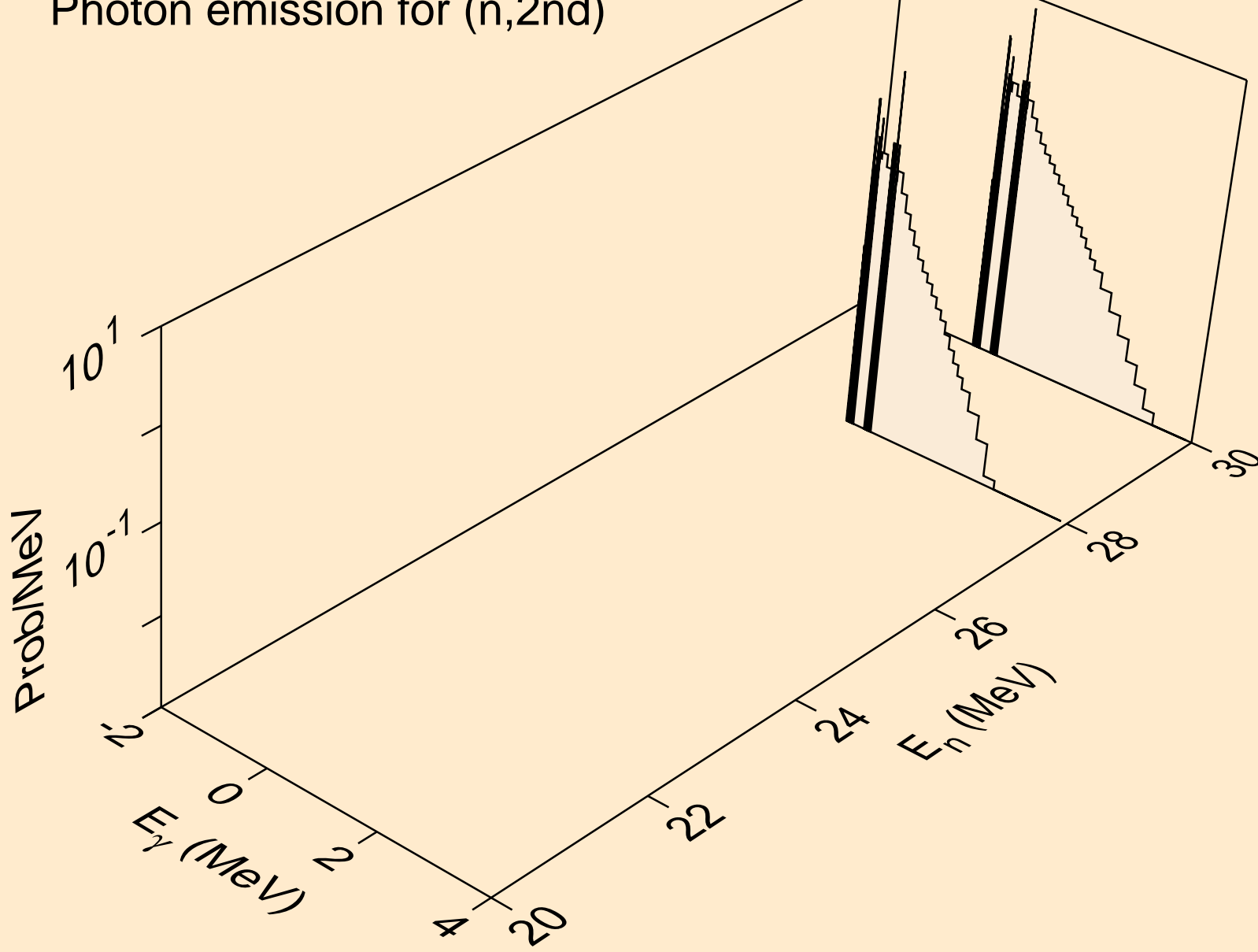

ER157 NEUTRON ACER TENDL-2019 LIBRARY; T=293.16K
Photon emission for (n,2n)

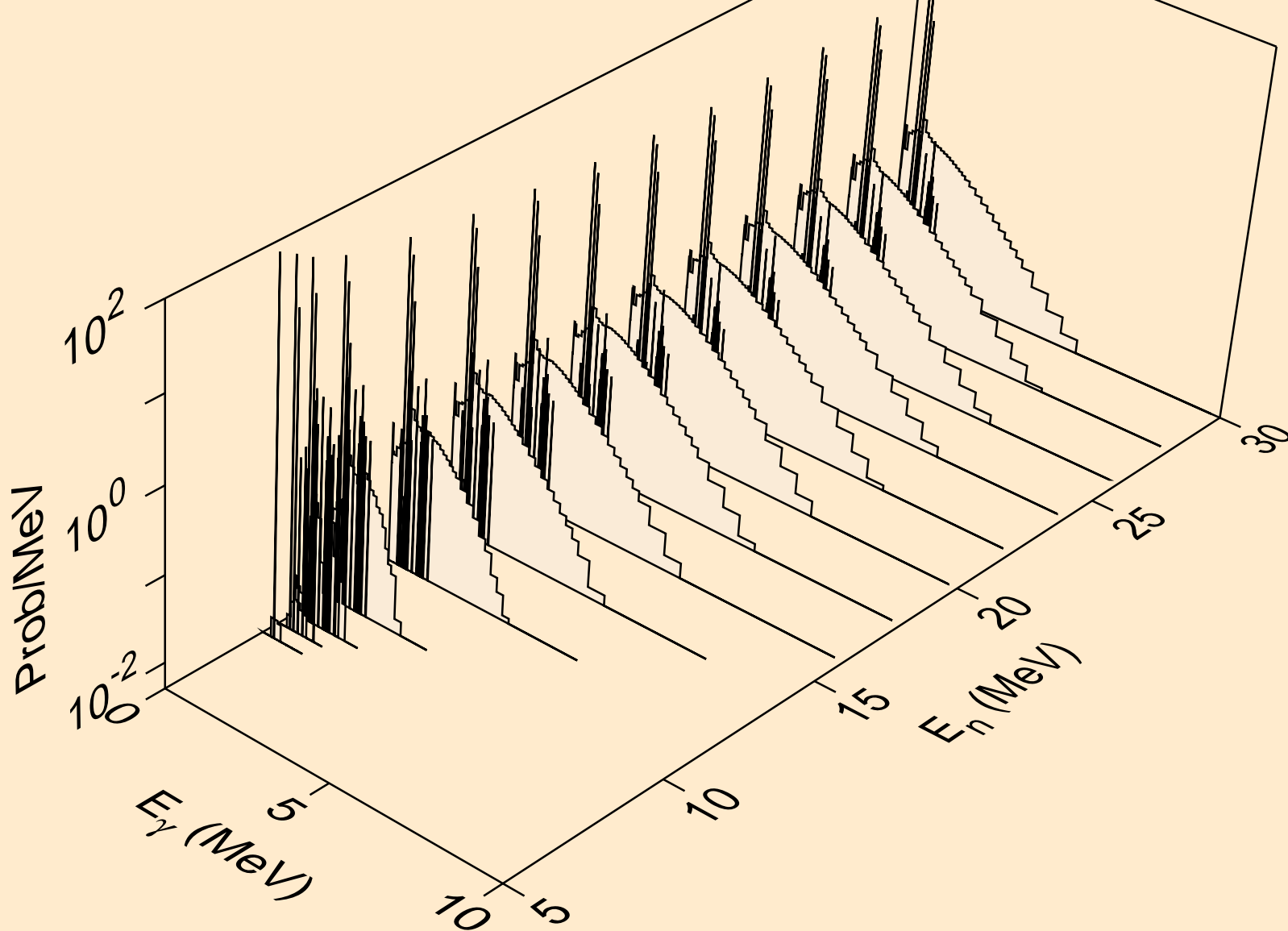

ER157 NEUTRON ACER TENDL-2019 LIBRARY; T=293.16K
Photon emission for (n,3n)

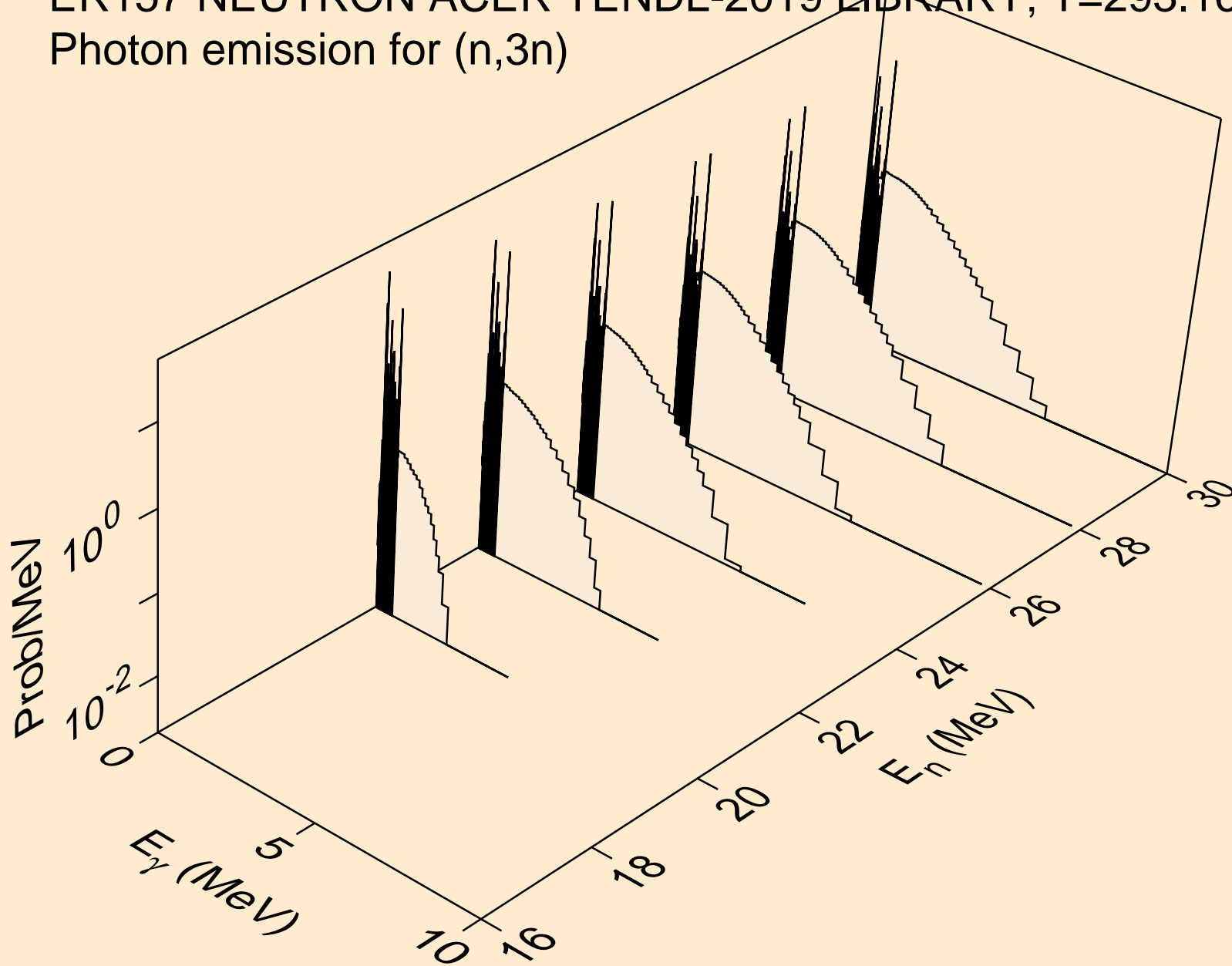

ER157 NEUTRON ACER TENDL-2019 LIBRARY; T=293.16K
Photon emission for (n,n*)a

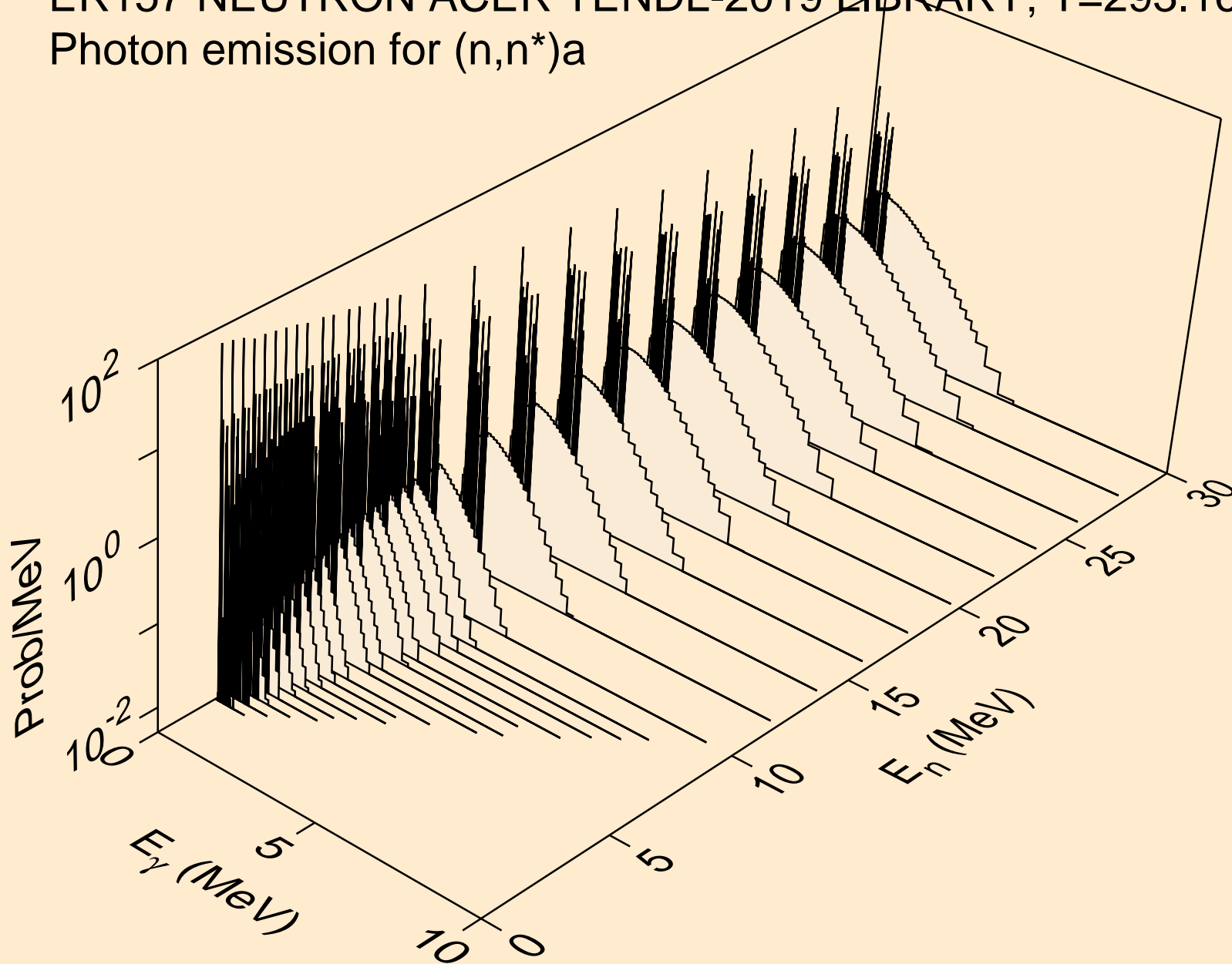

ER157 NEUTRON ACER TENDL-2019 LIBRARY; T=293.16K
Photon emission for (n,2n)a

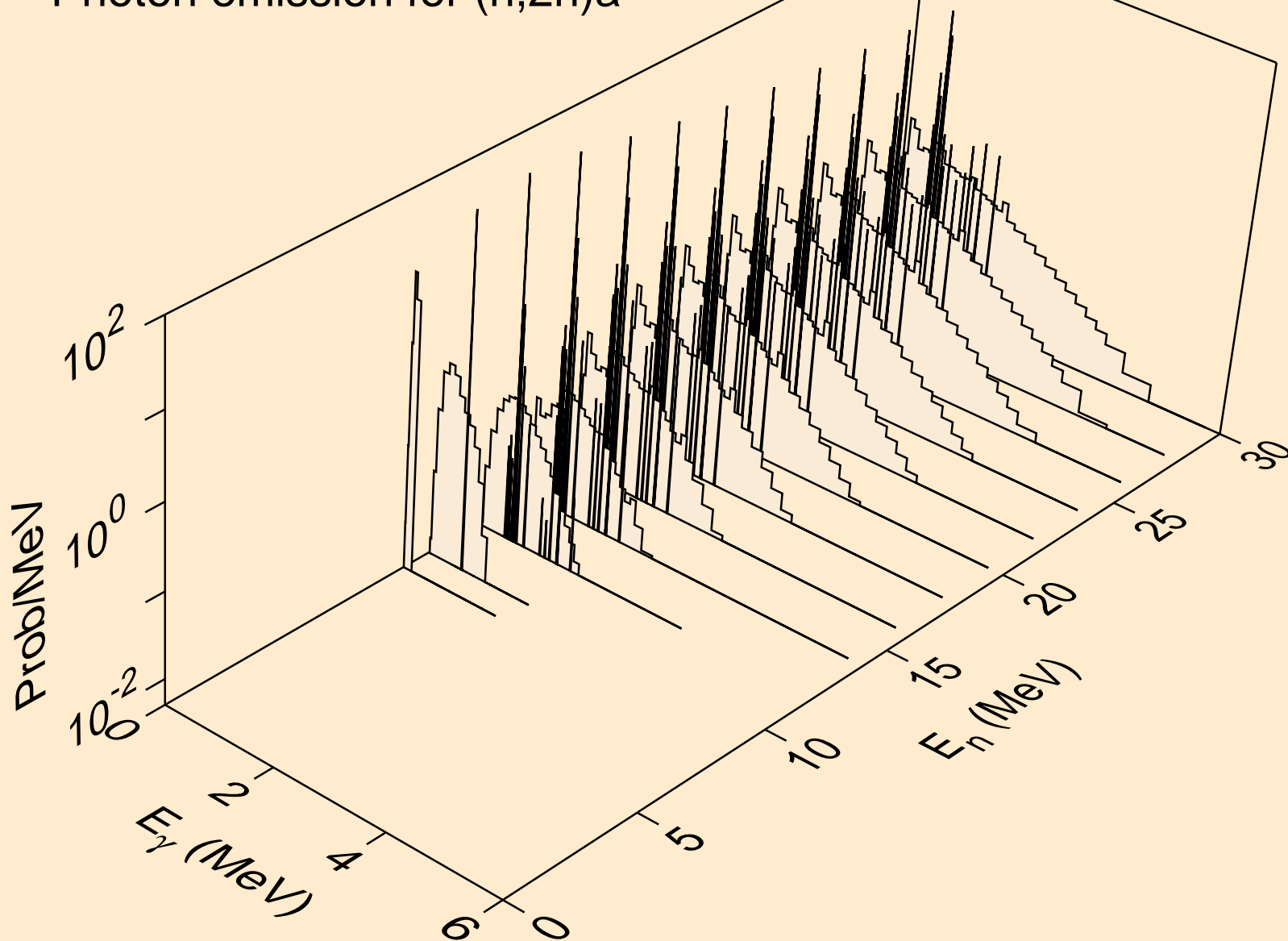

ER157 NEUTRON ACER TENDL-2019 LIBRARY; T=293.16K
Photon emission for (n,3n)a

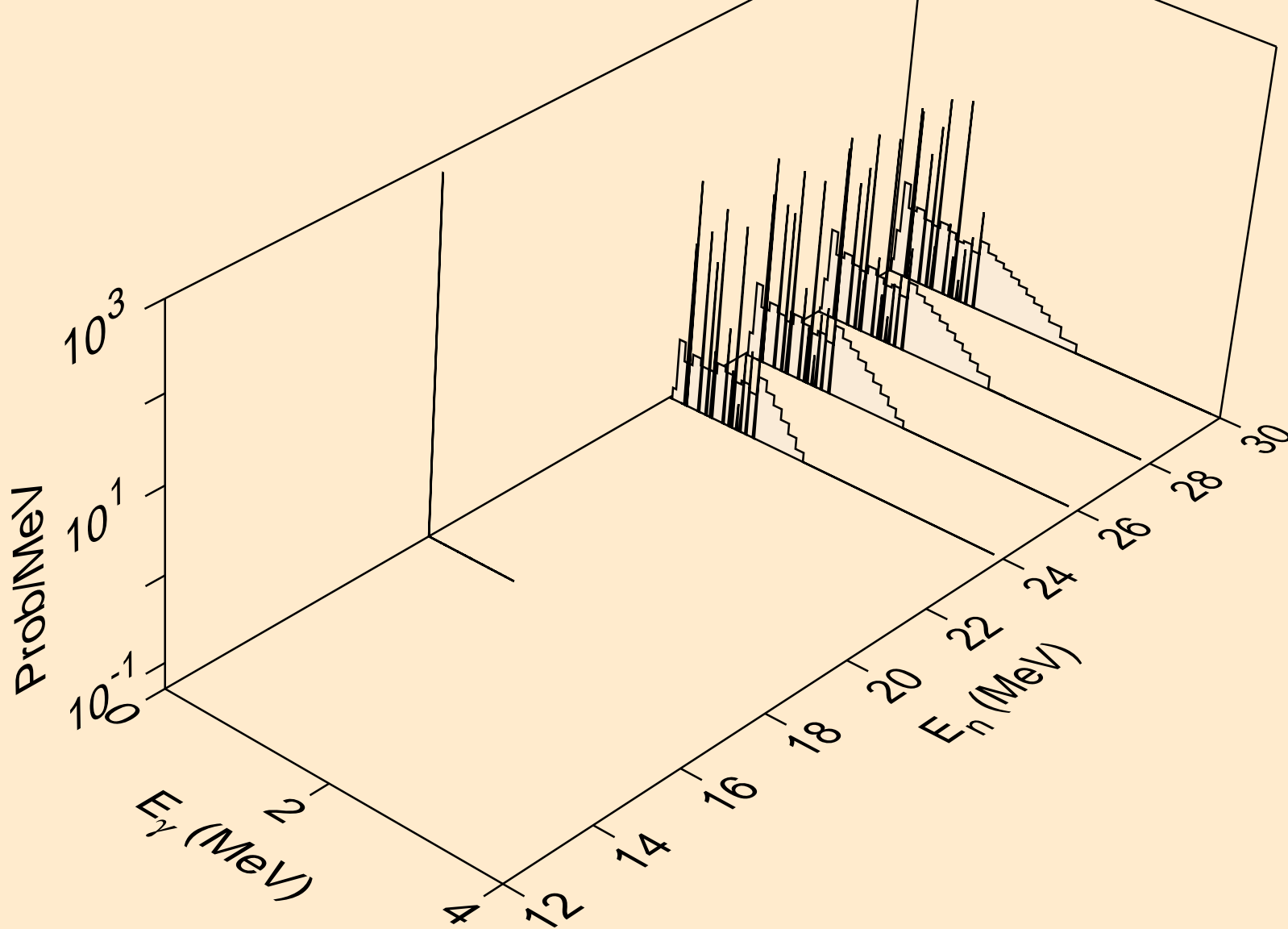

ER157 NEUTRON ACER TENDL-2019 LIBRARY; T=293.16K
Photon emission for (n,n*)p

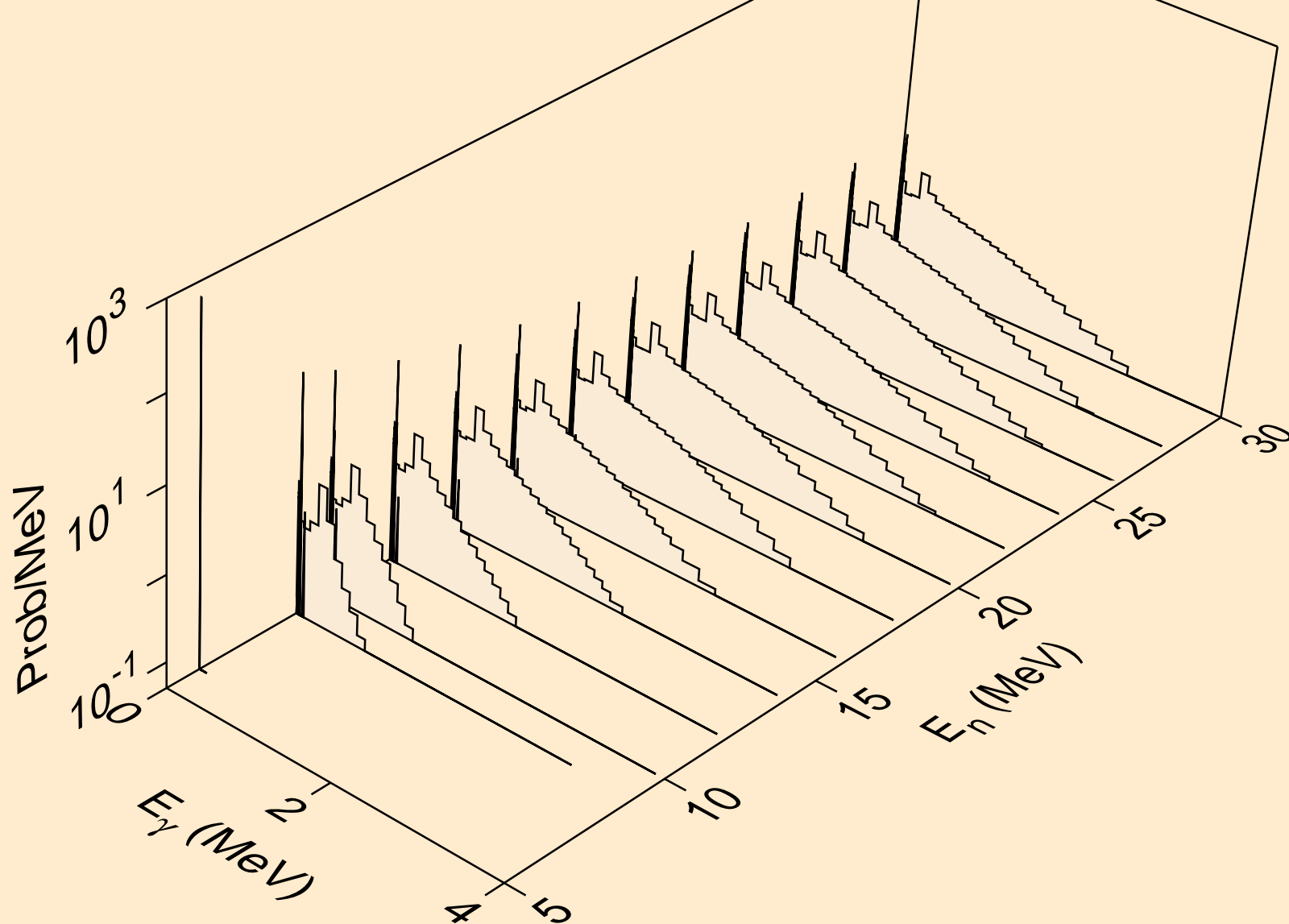

ER157 NEUTRON ACER TENDL-2019 LIBRARY; T=293.16K
Photon emission for (n,n*)2a

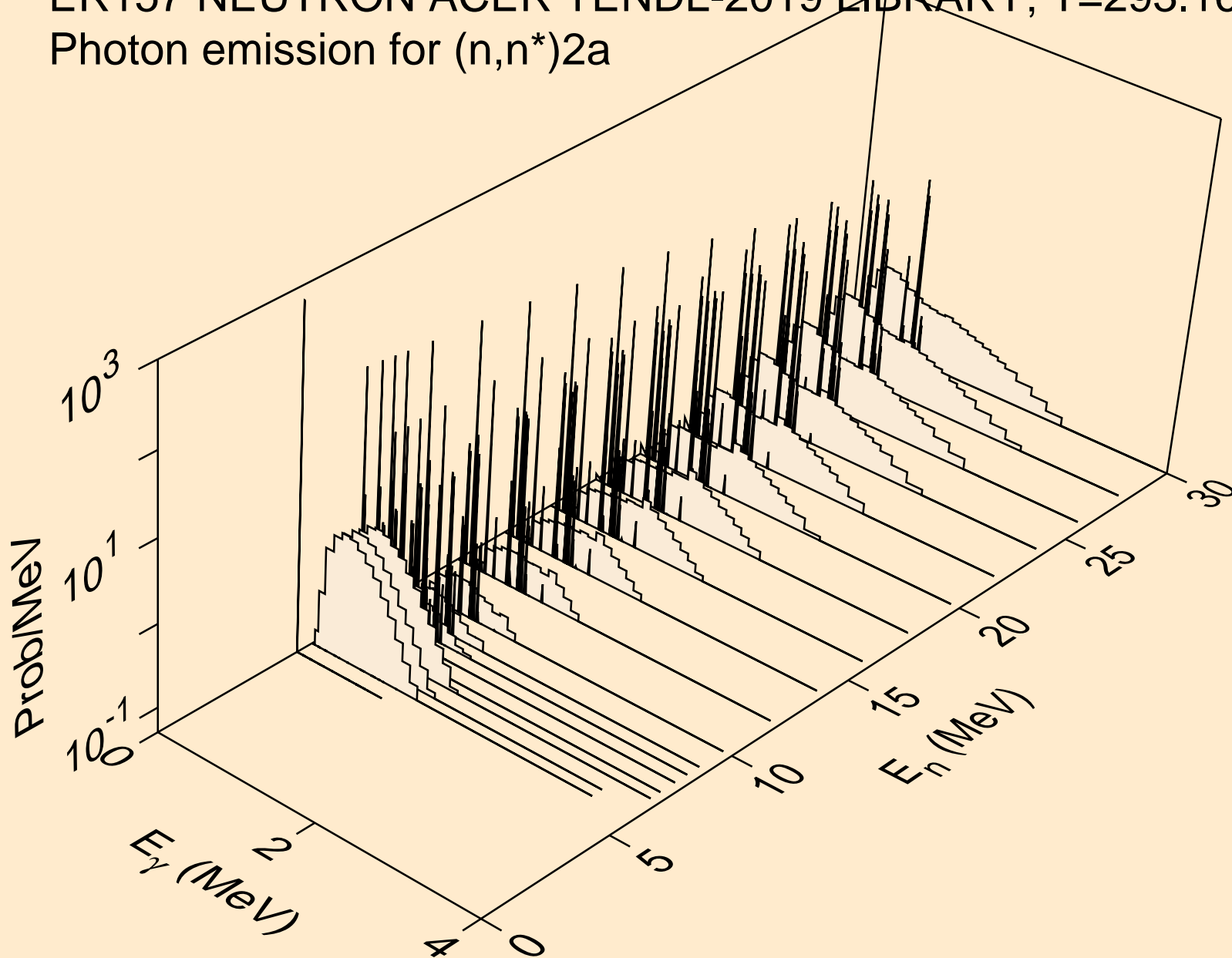

ER157 NEUTRON ACER TENDL-2019 LIBRARY; T=293.16K
Photon emission for (n,2n)2a

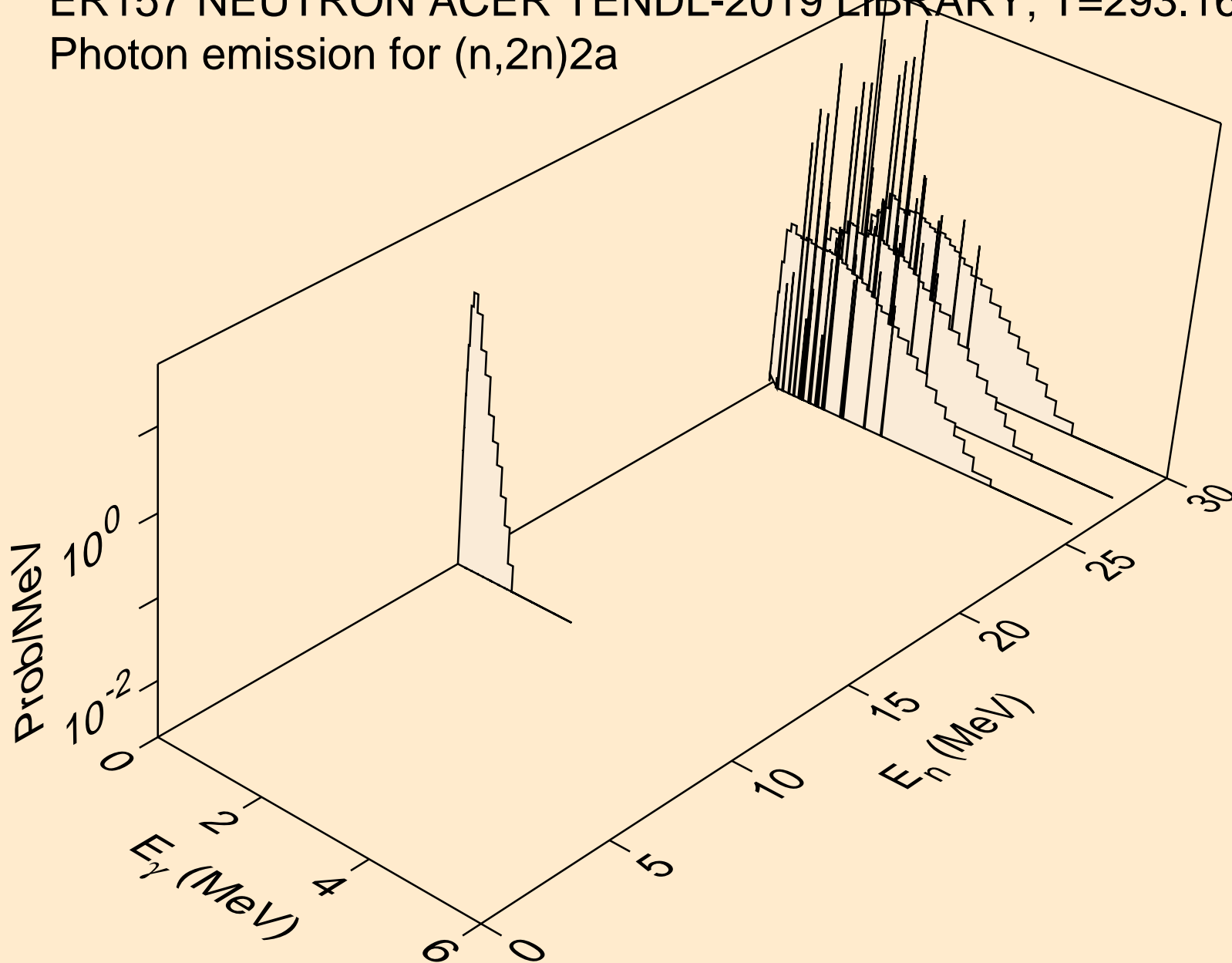

ER157 NEUTRON ACER TENDL-2019 LIBRARY; T=293.16K
Photon emission for (n,n*)d

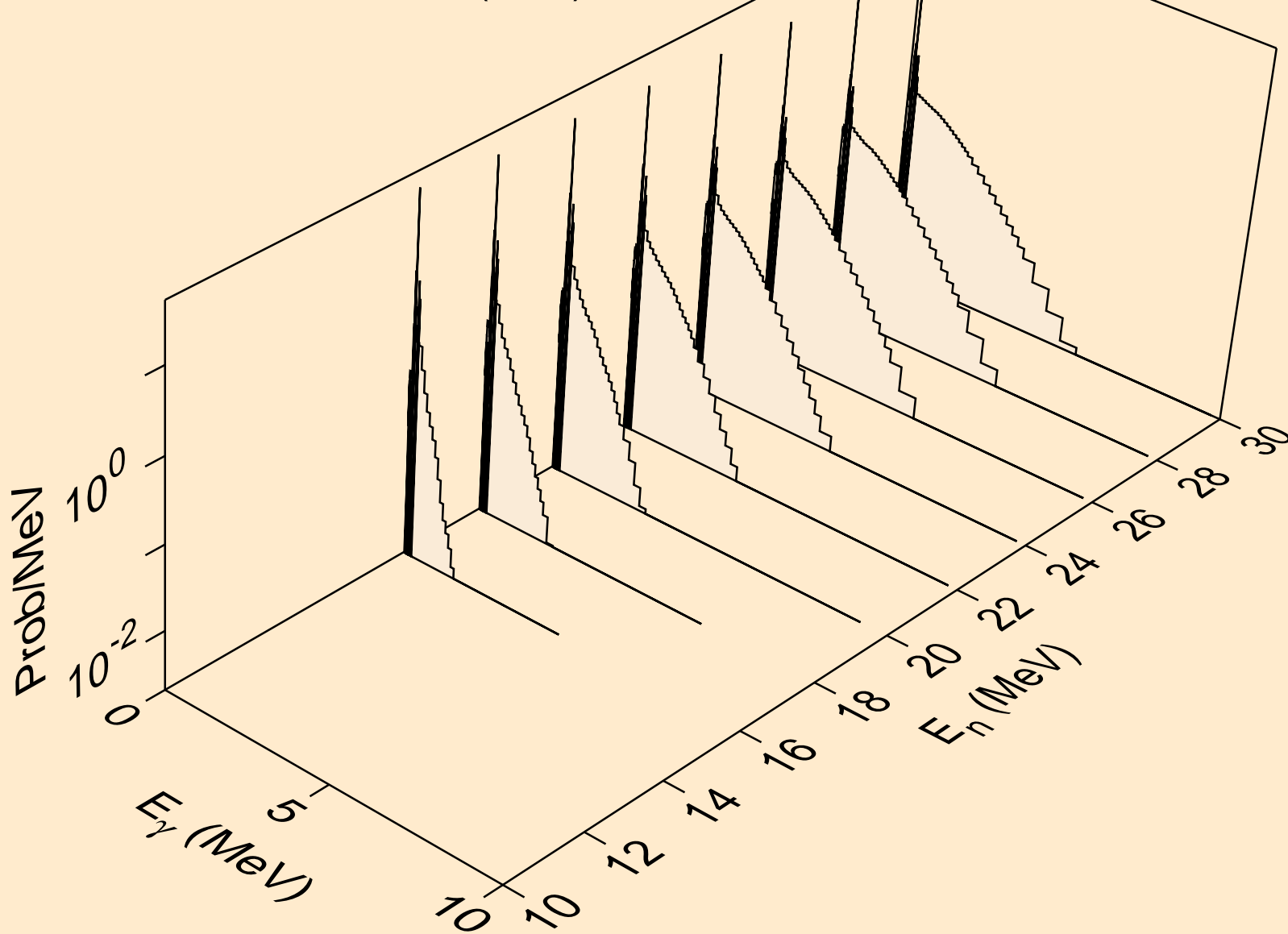

ER157 NEUTRON ACER TENDL-2019 LIBRARY; T=293.16K
Photon emission for (n,n*)t

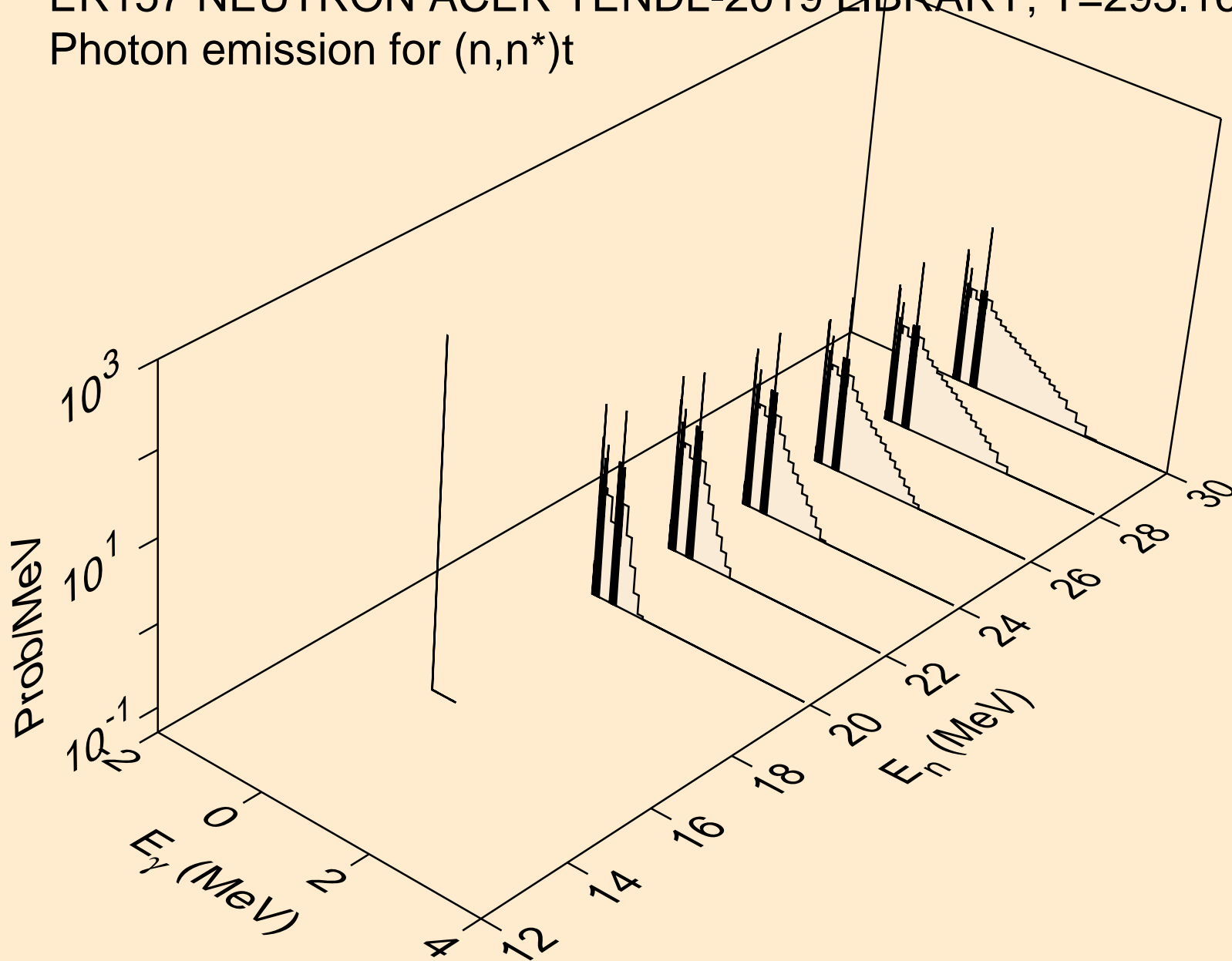

ER157 NEUTRON ACER TENDL-2019 LIBRARY; T=293.16K
Photon emission for (n,n*)he3

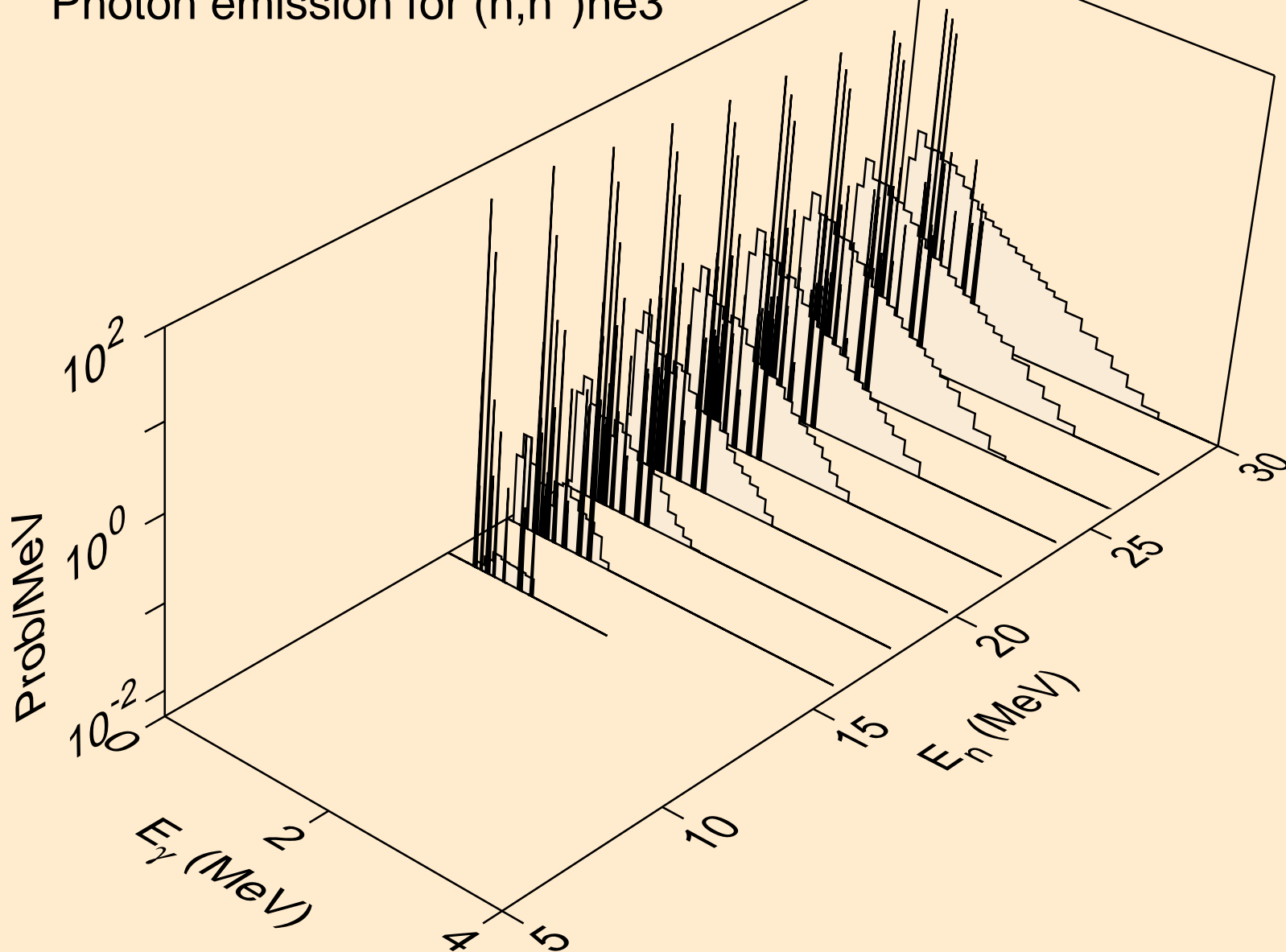

ER157 NEUTRON ACER TENDL-2019 LIBRARY; T=293.16K
Photon emission for (n,4n)

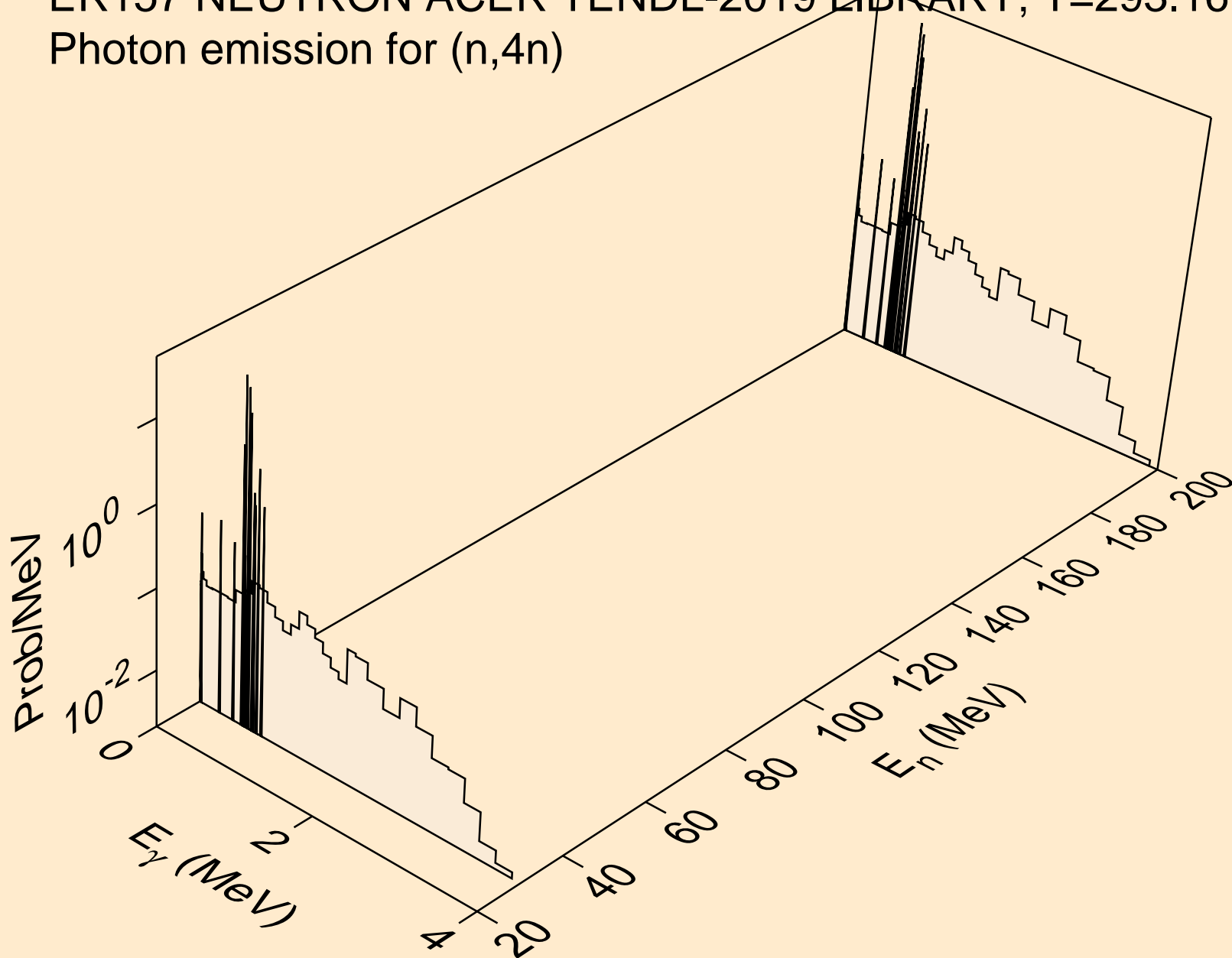

ER157 NEUTRON ACER TENDL-2019 LIBRARY; T=293.16K
Photon emission for (n,2np)

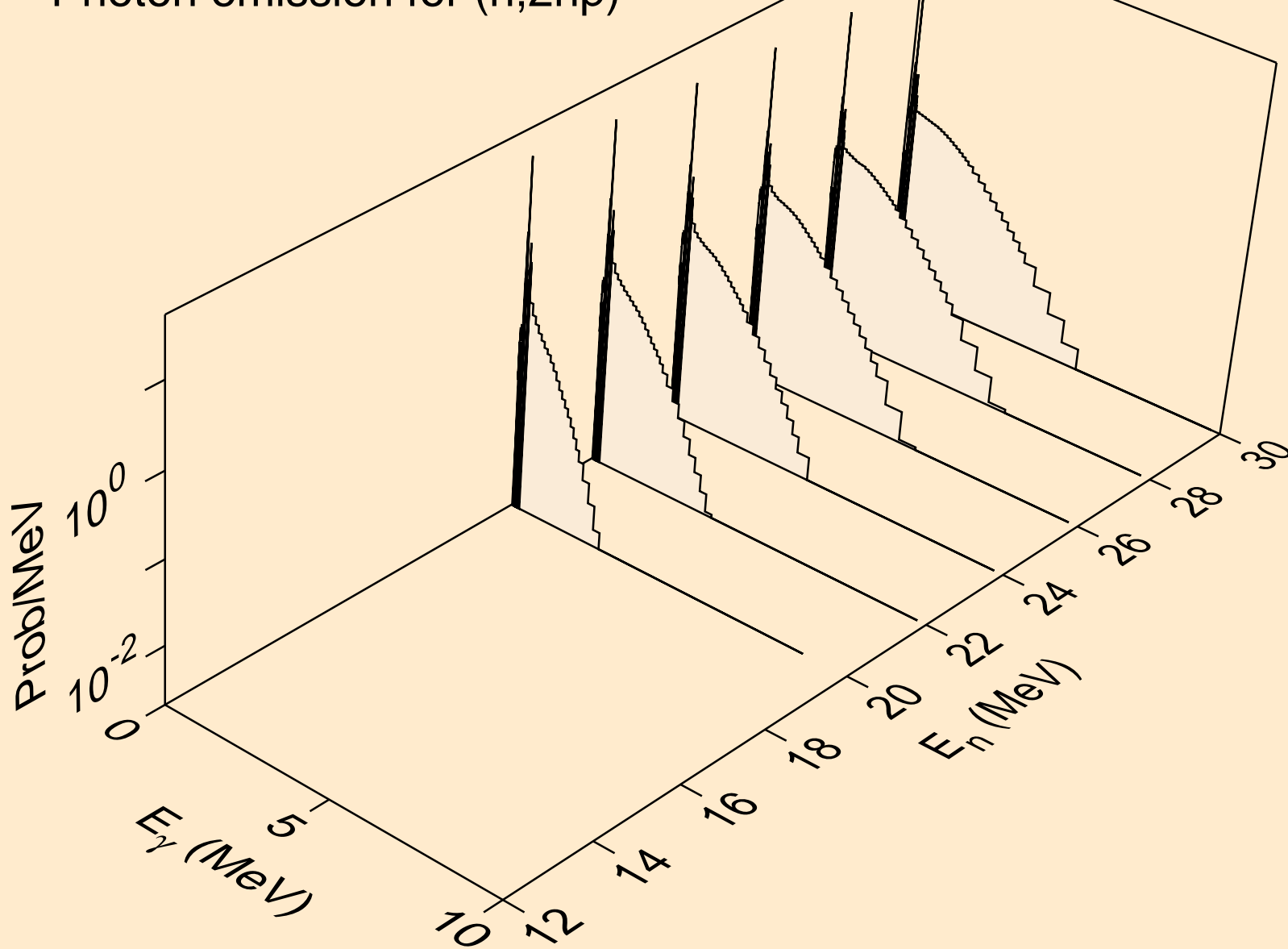

ER157 NEUTRON ACER TENDL-2019 LIBRARY; T=293.16K
Photon emission for (n,3np)

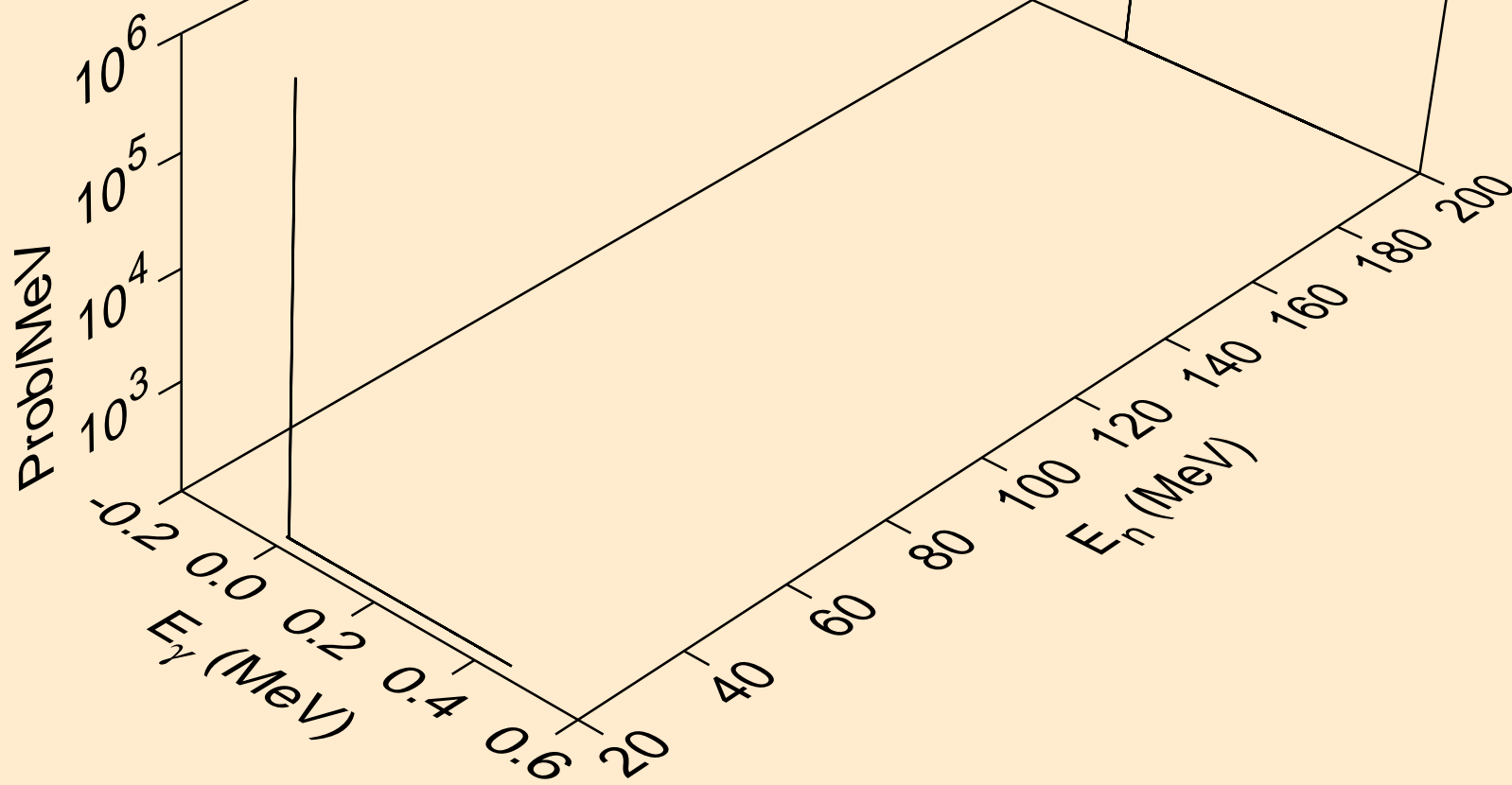

ER157 NEUTRON ACER TENDL-2019 LIBRARY; T=293.16K
Photon emission for (n,2np)

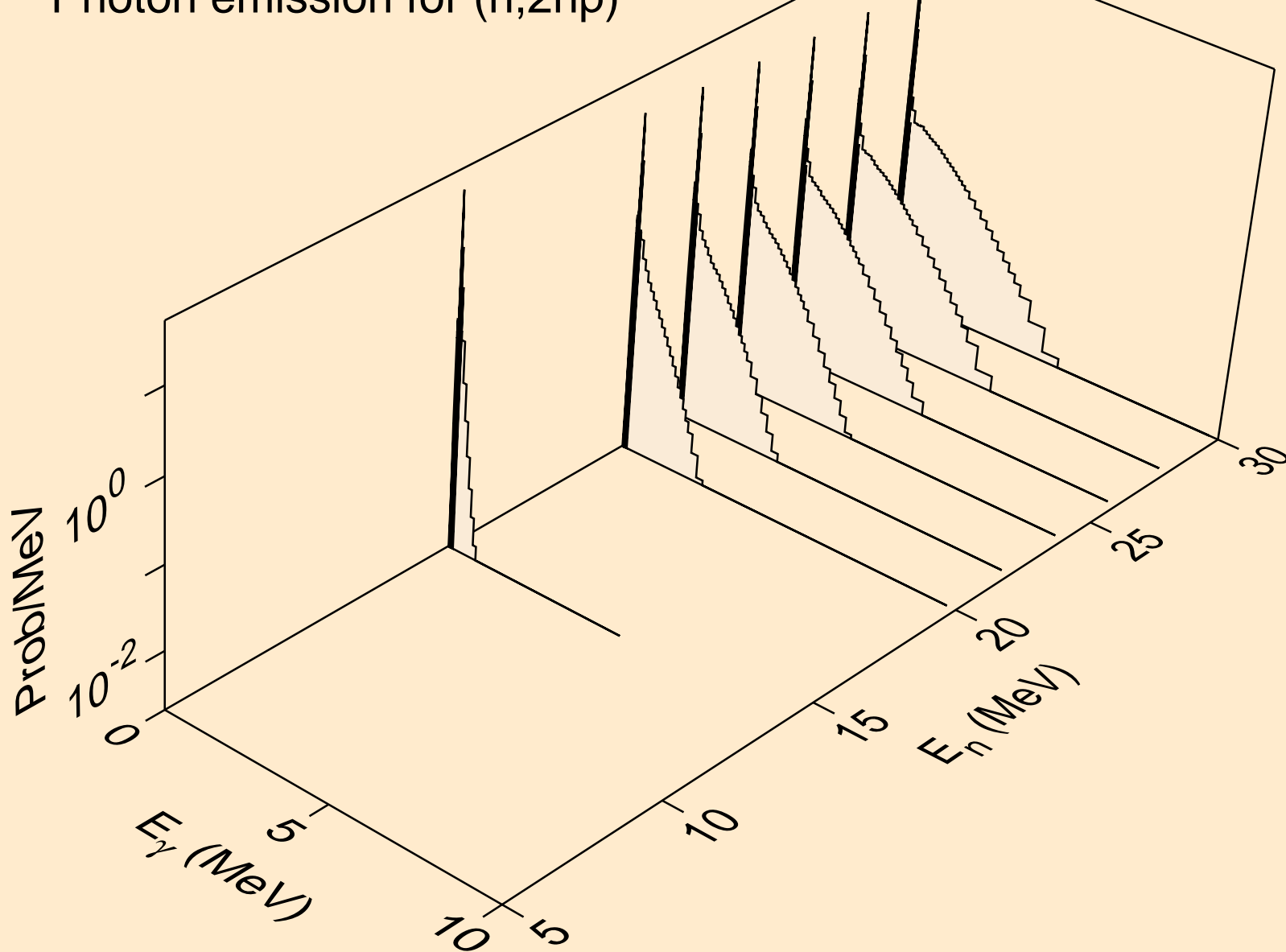

ER157 NEUTRON ACER TENDL-2019 LIBRARY; T=293.16K
Photon emission for (n,npa)

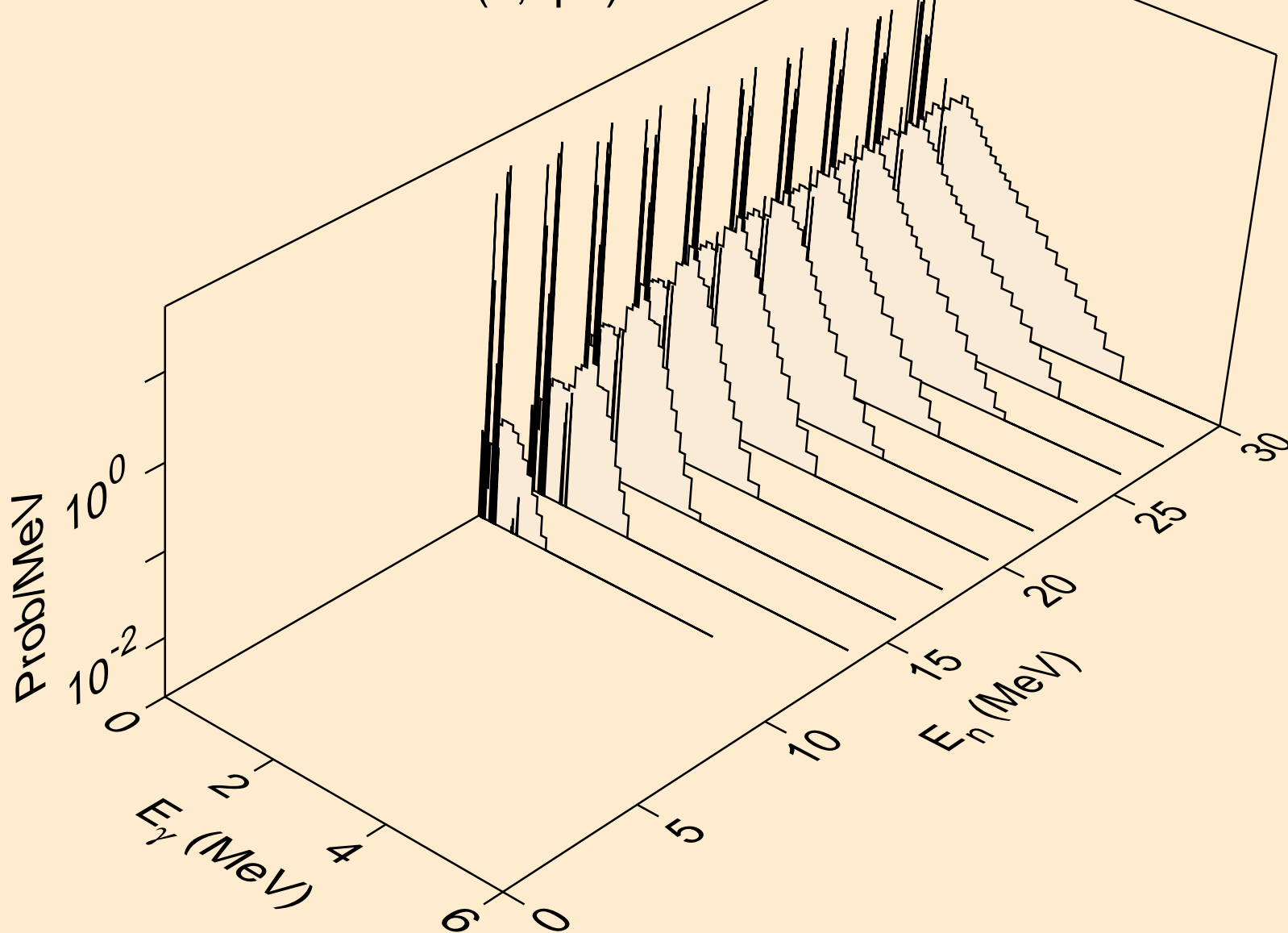

ER157 NEUTRON ACER TENDL-2019 LIBRARY; T=293.16K
Photon emission for (n,n*c)

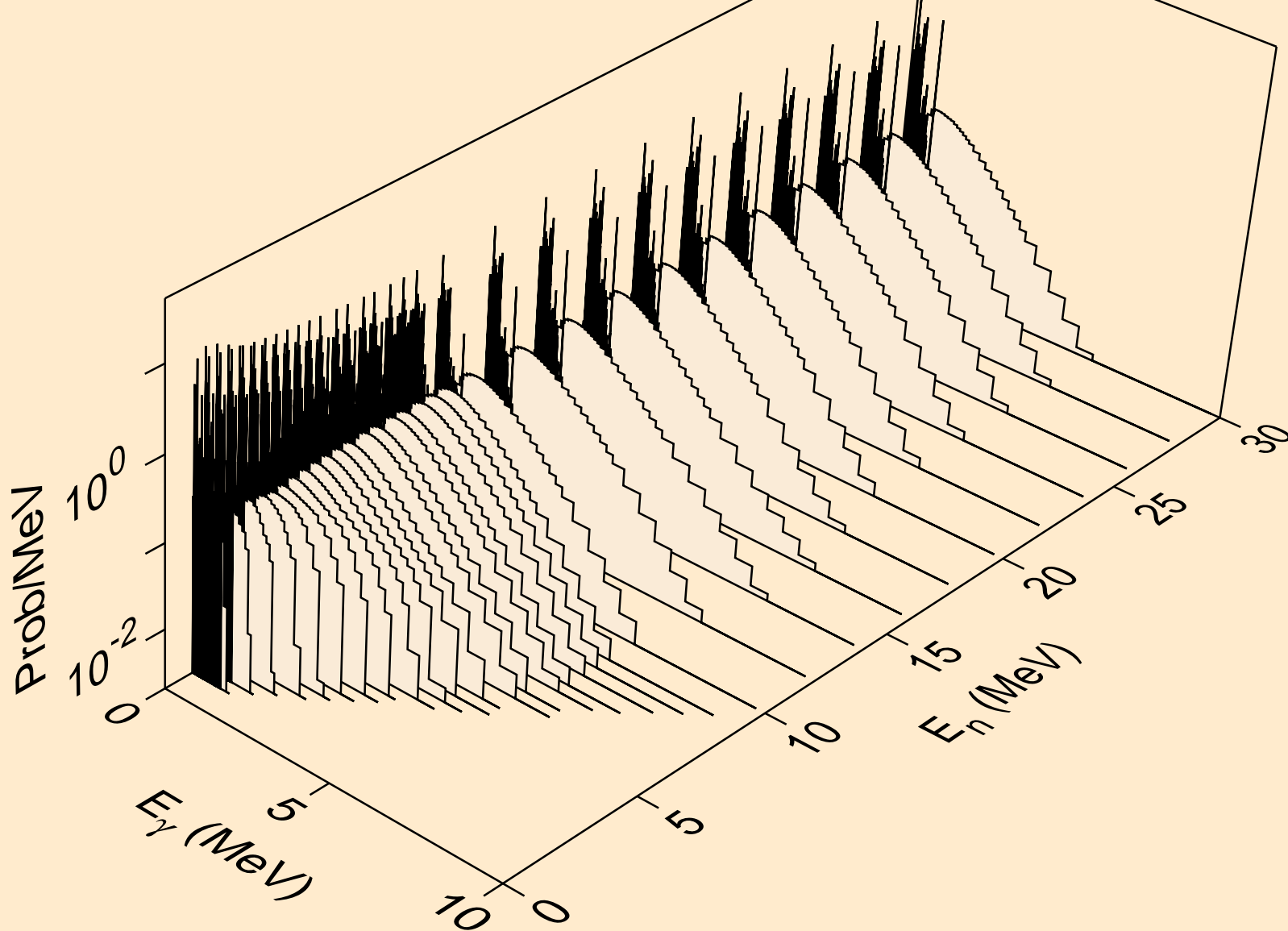

ER157 NEUTRON ACER TENDL-2019 LIBRARY; T=293.16K
Photon emission for (n,gma)

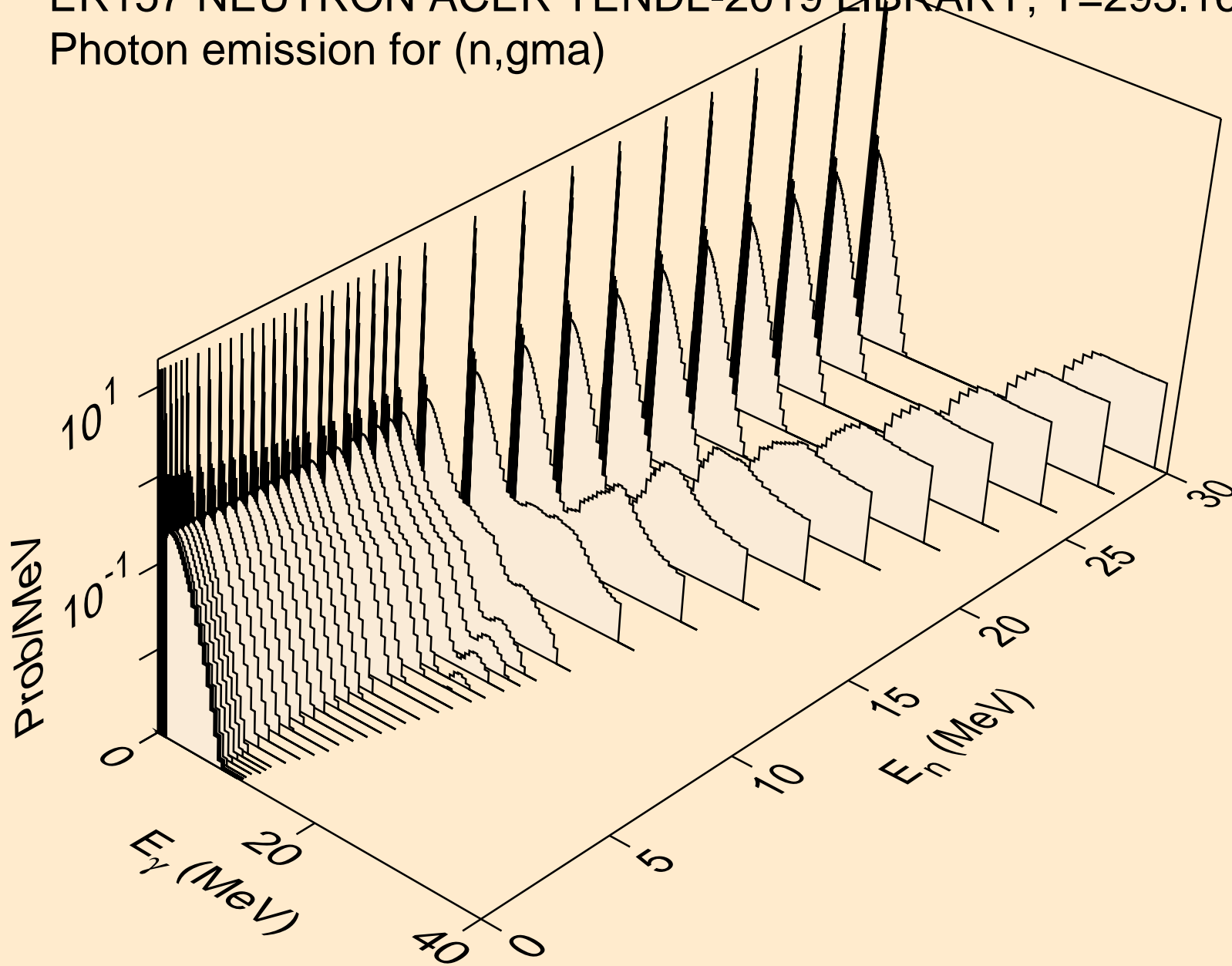

ER157 NEUTRON ACER TENDL-2019 LIBRARY; T=293.16K
Photon emission for (n,p)

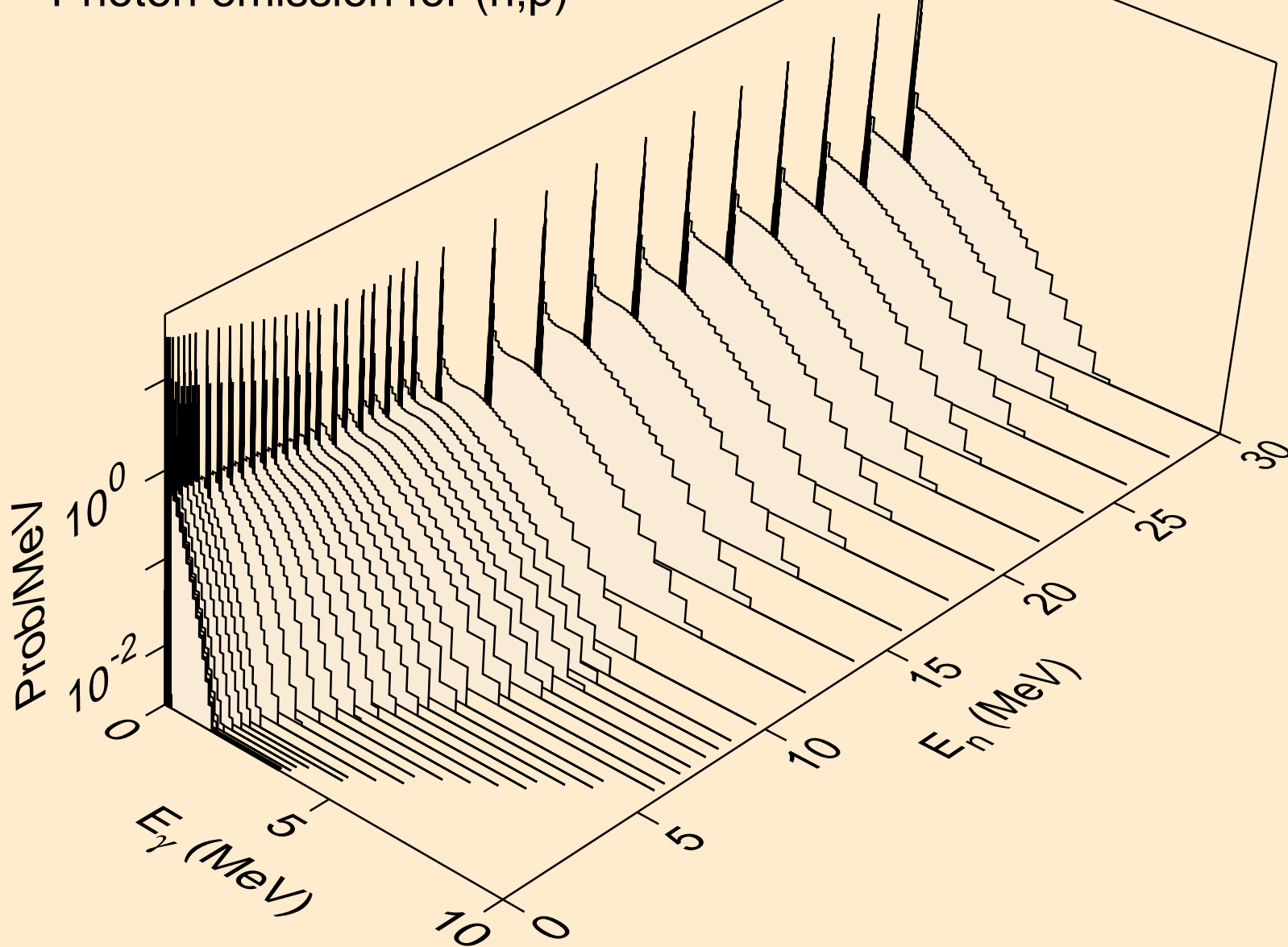

ER157 NEUTRON ACER TENDL-2019 LIBRARY; T=293.16K
Photon emission for (n,d)

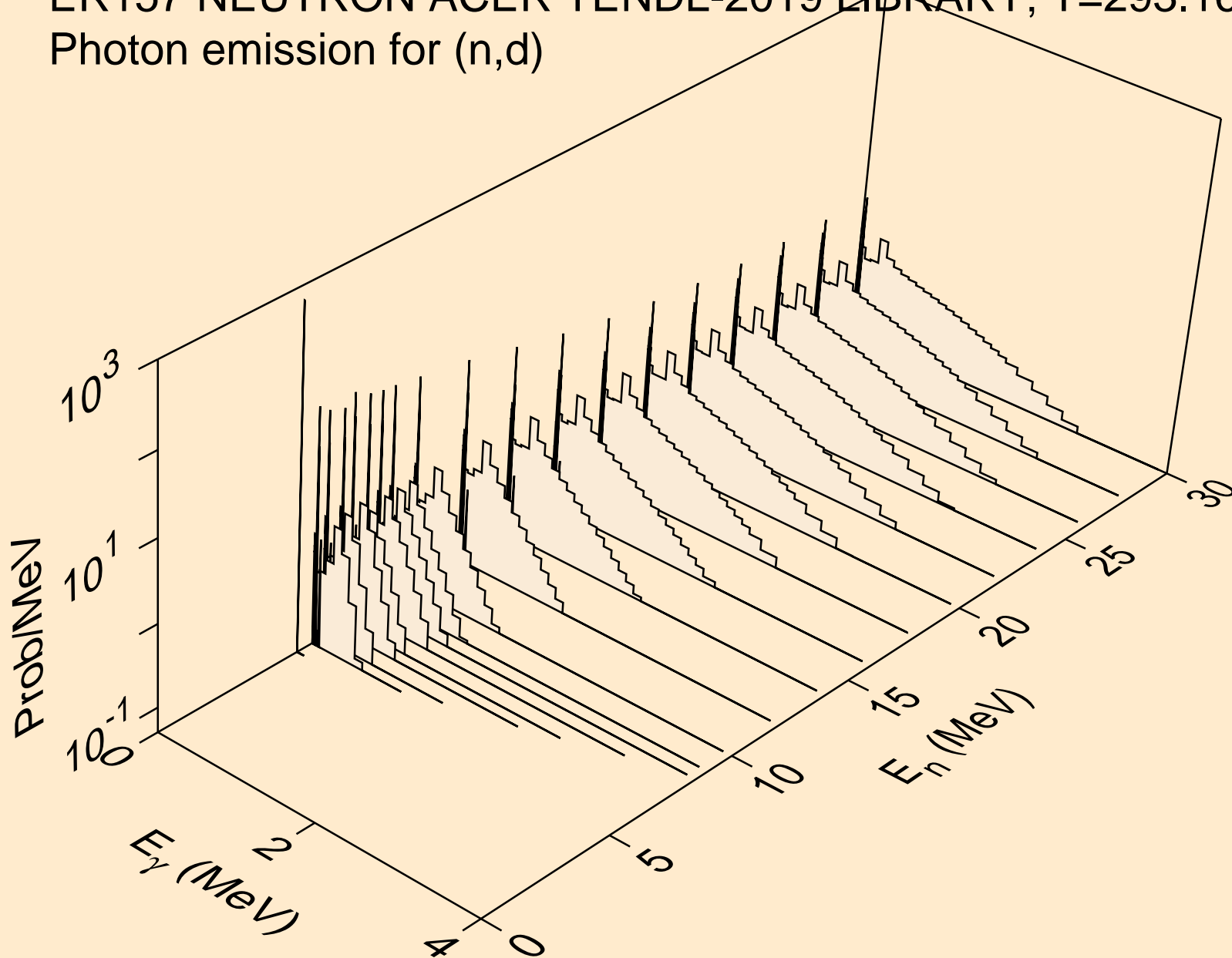

ER157 NEUTRON ACER TENDL-2019 LIBRARY; T=293.16K
Photon emission for (n,t)

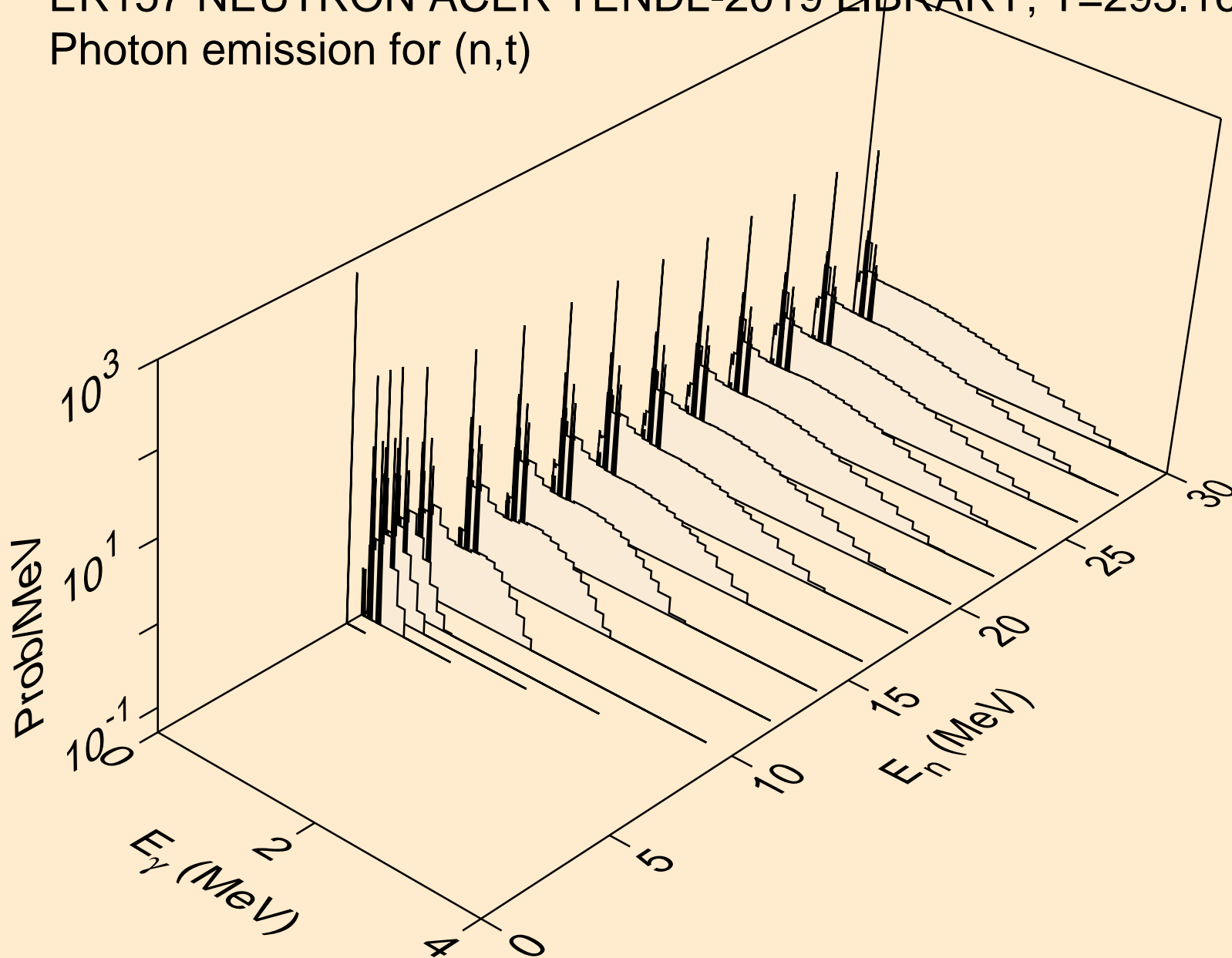

ER157 NEUTRON ACER TENDL-2019 LIBRARY; T=293.16K
Photon emission for (n,he3)

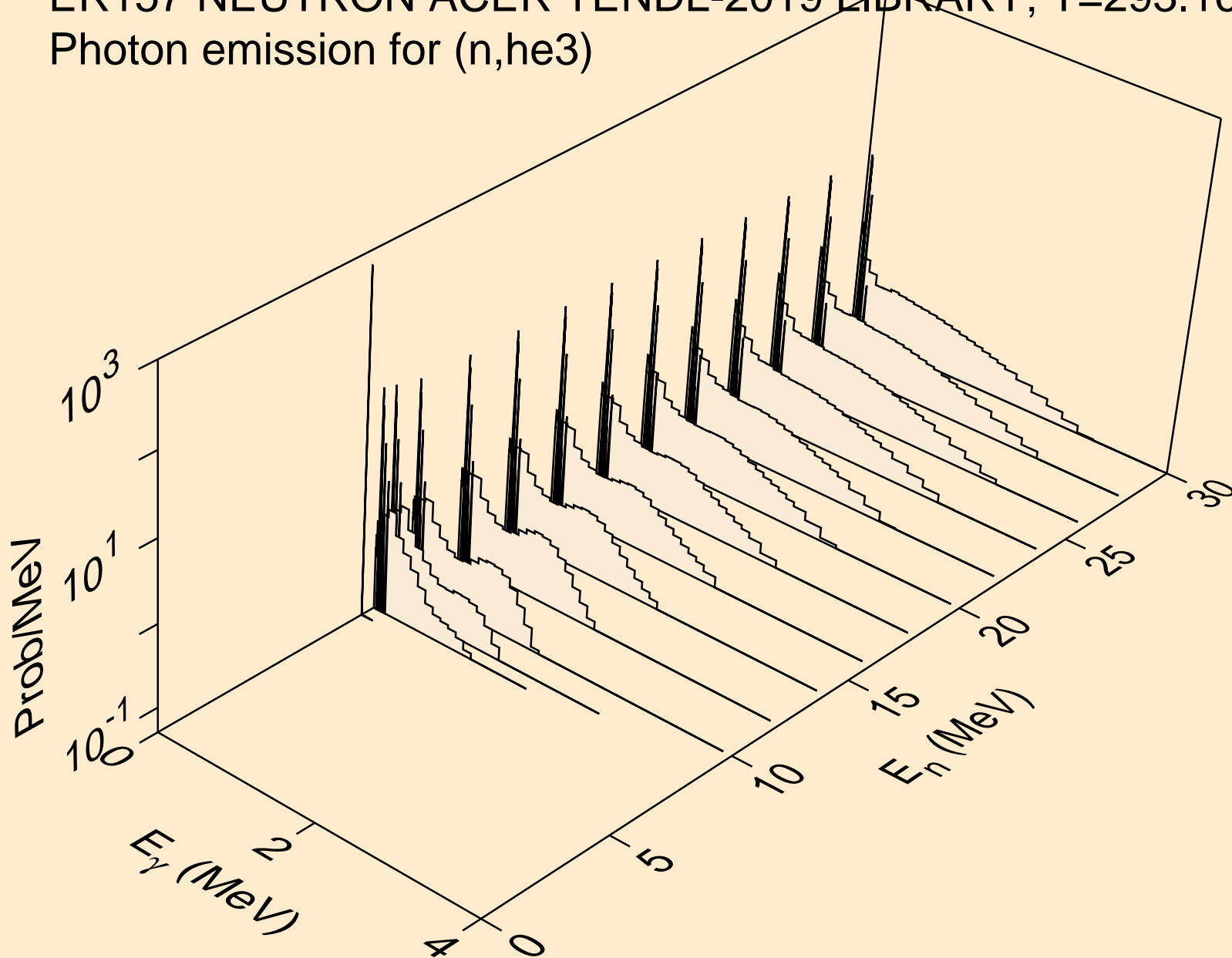

ER157 NEUTRON ACER TENDL-2019 LIBRARY; T=293.16K
Photon emission for (n,a)

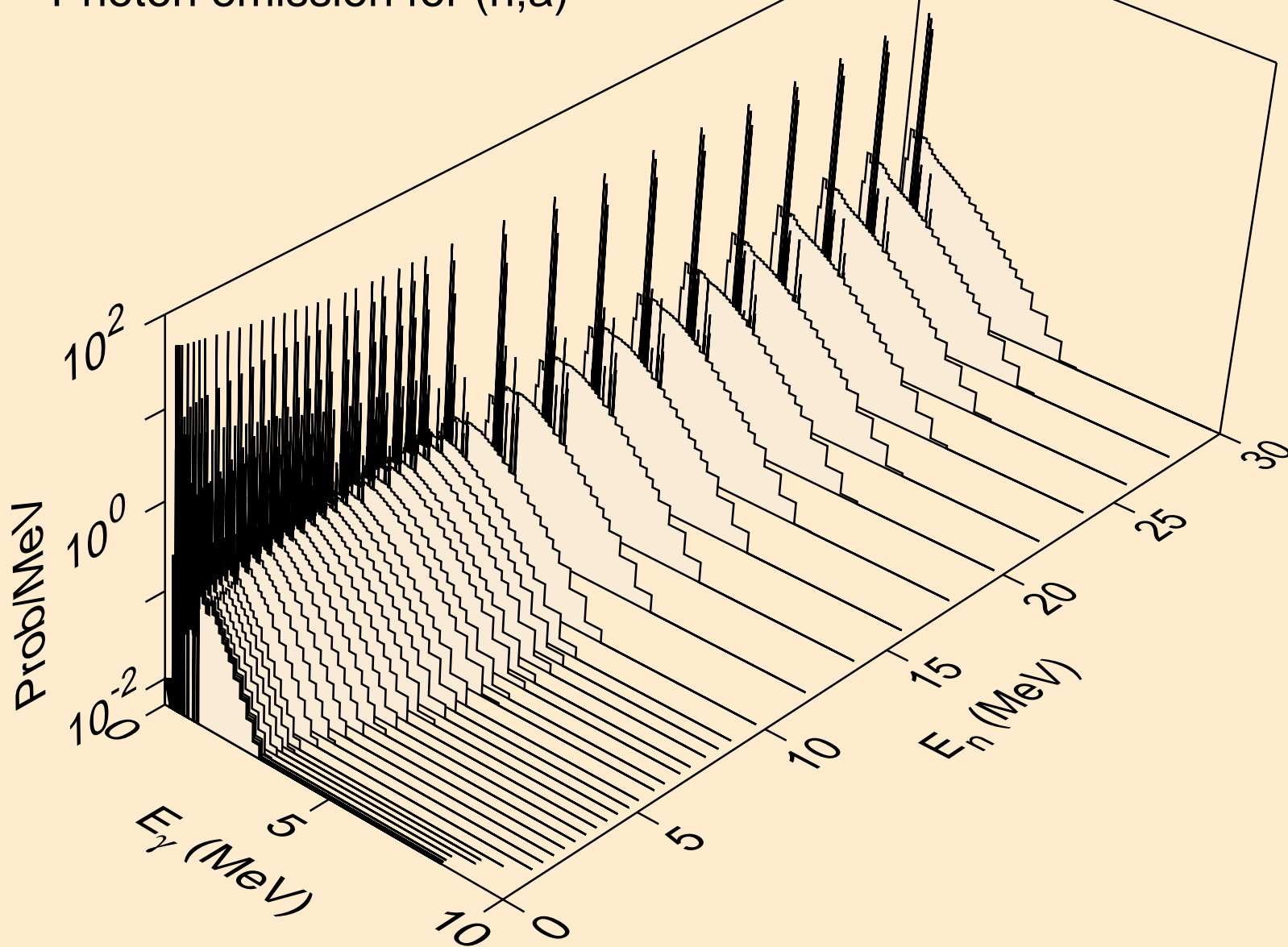

ER157 NEUTRON ACER TENDL-2019 LIBRARY; T=293.16K
Photon emission for (n,2a)

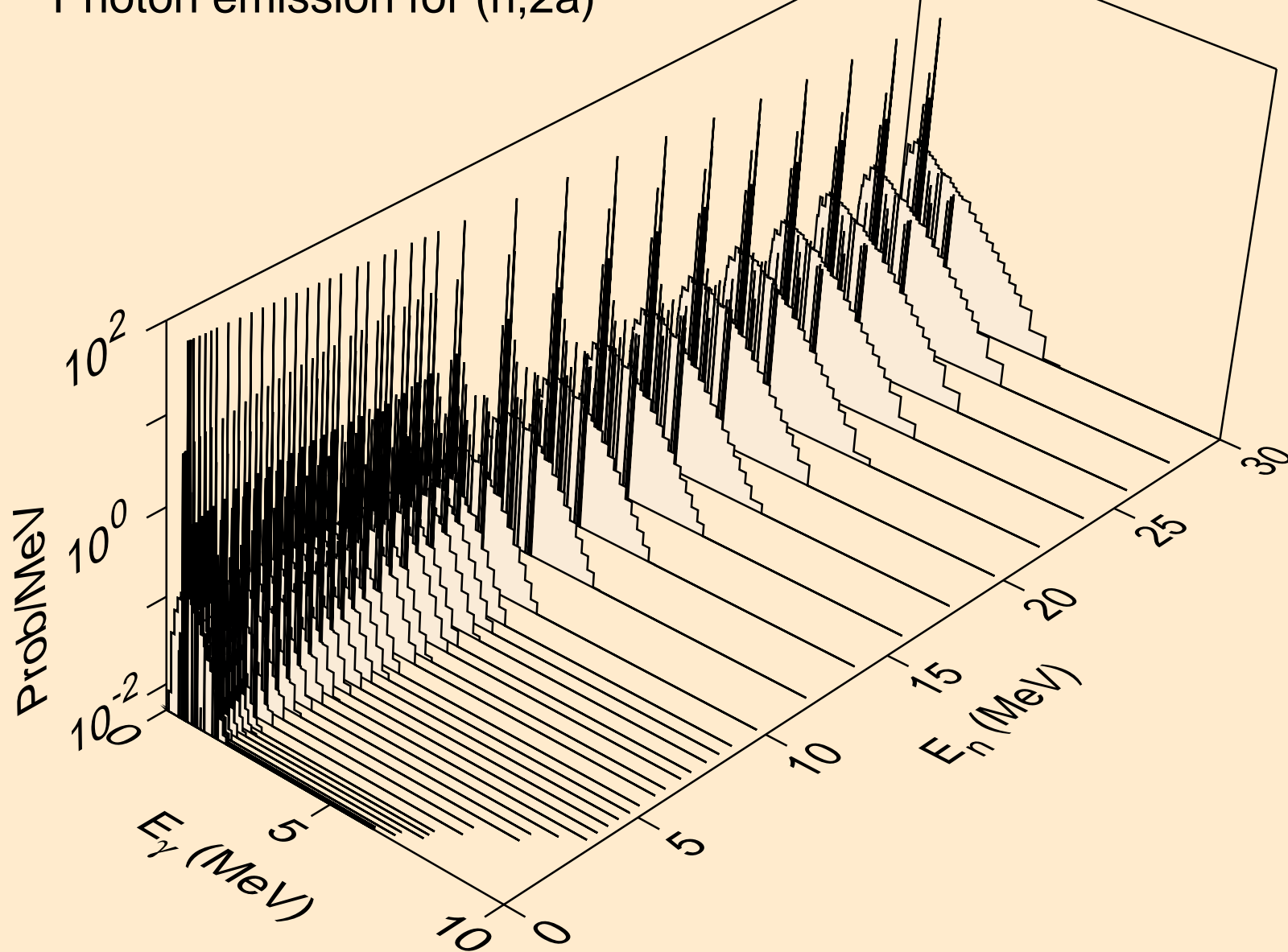

ER157 NEUTRON ACER TENDL-2019 LIBRARY; T=293.16K
Photon emission for (n,2p)

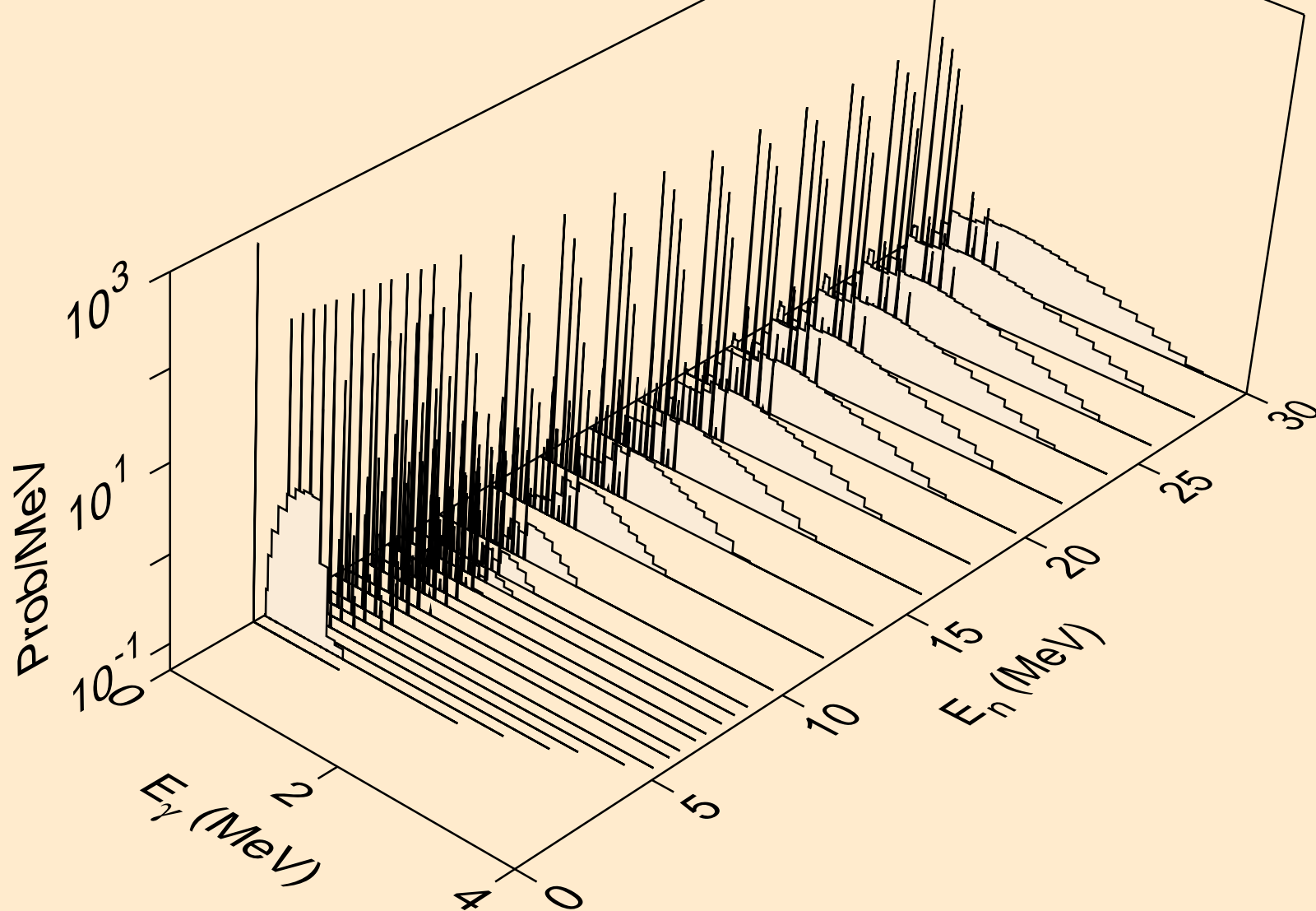

ER157 NEUTRON ACER TENDL-2019 LIBRARY; T=293.16K
Photon emission for (n,p α)

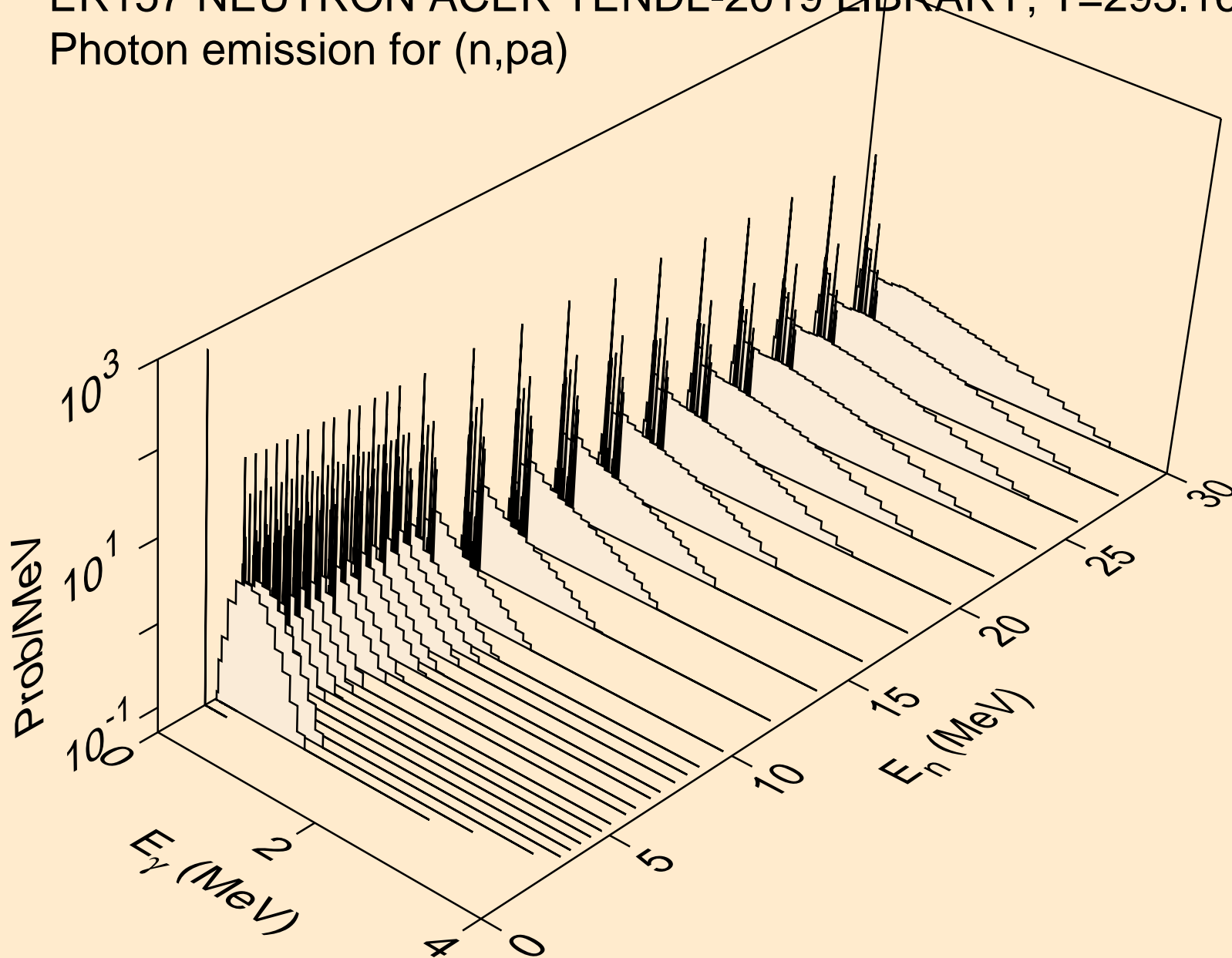

ER157 NEUTRON ACER TENDL-2019 LIBRARY; T=293.16K
Photon emission for (n,pd)

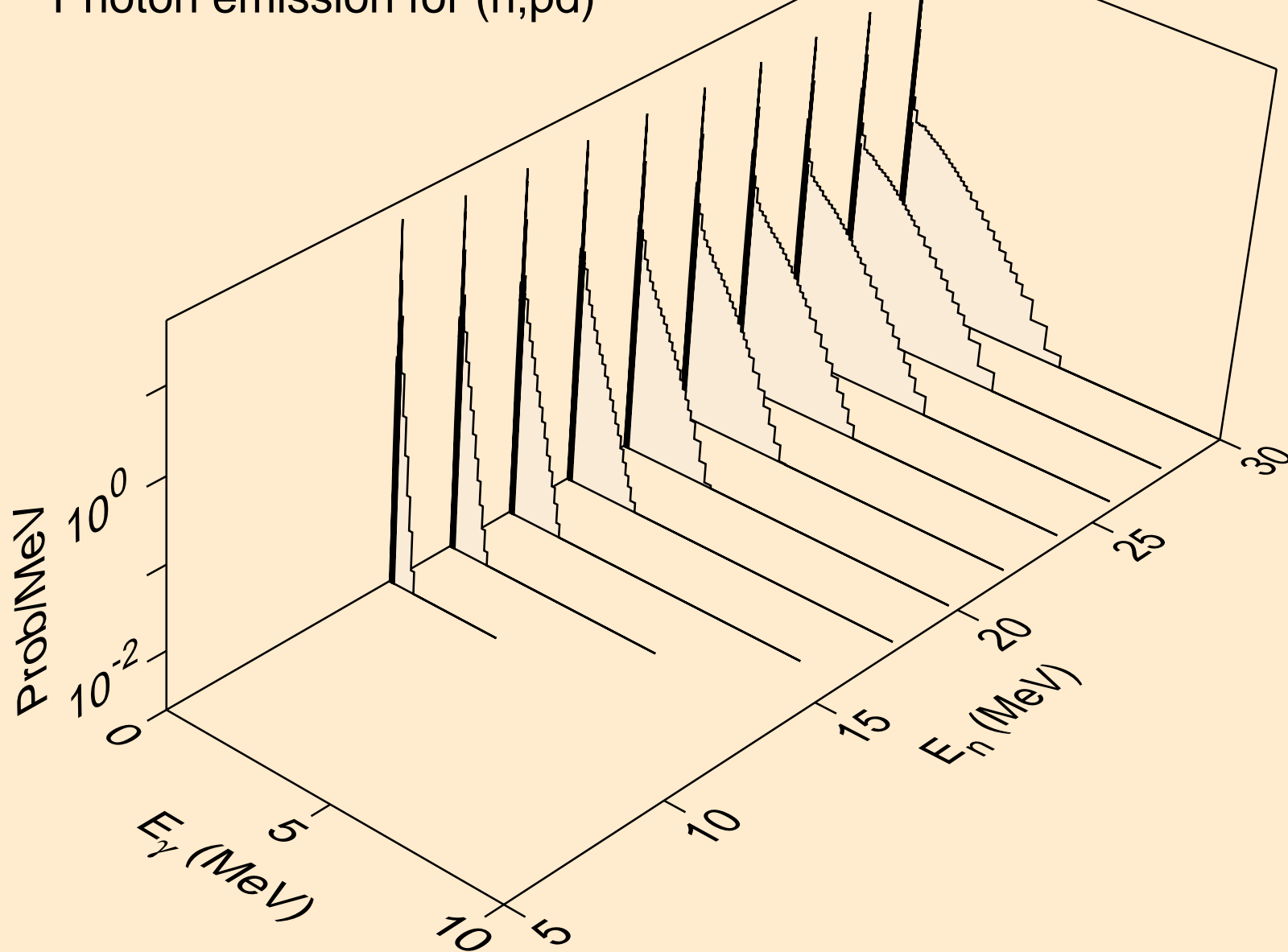

ER157 NEUTRON ACER TENDL-2019 LIBRARY; T=293.16K
Photon emission for (n,pt)

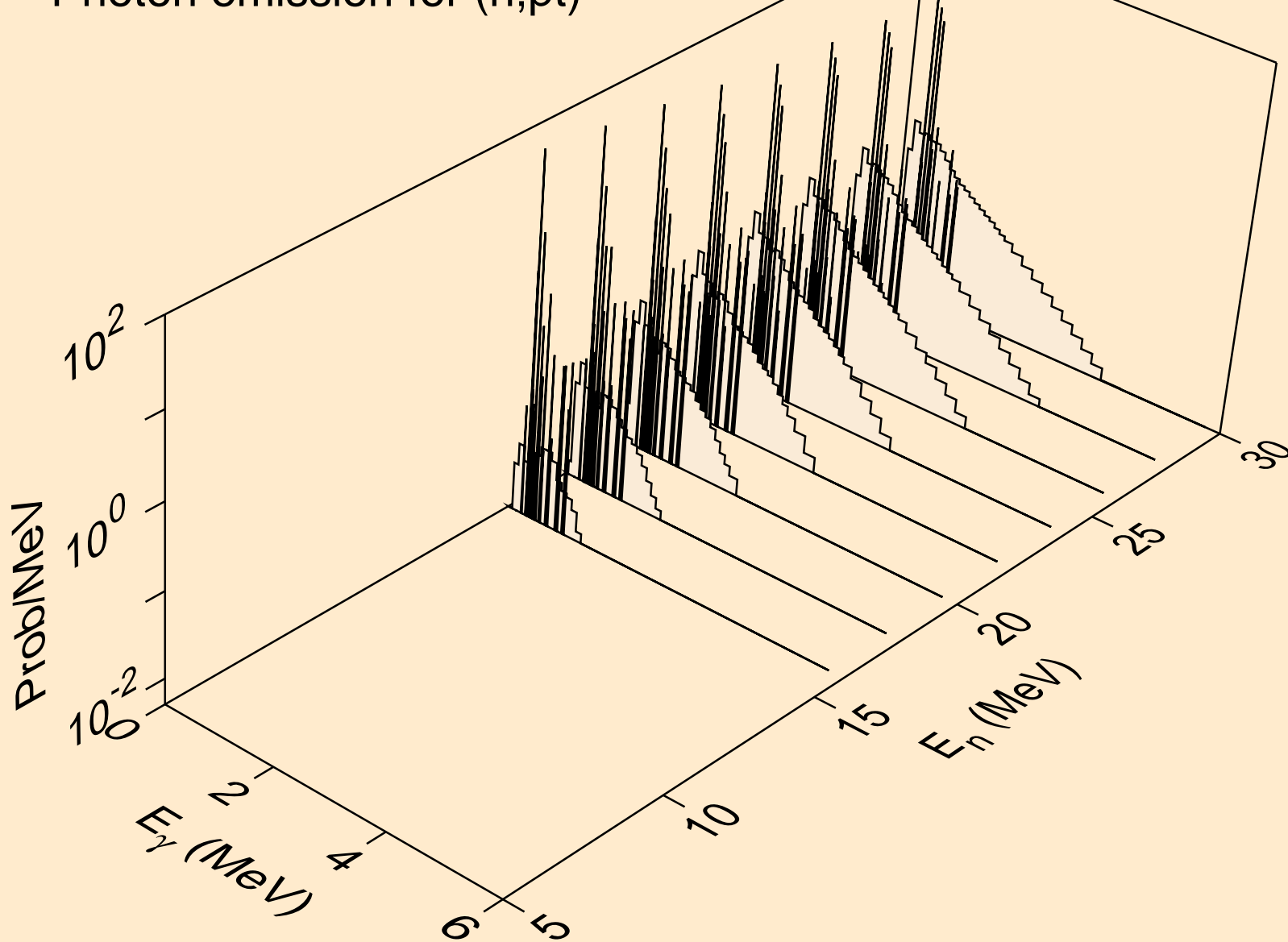

ER157 NEUTRON ACER TENDL-2019 LIBRARY; T=293.16K
Photon emission for (n,da)

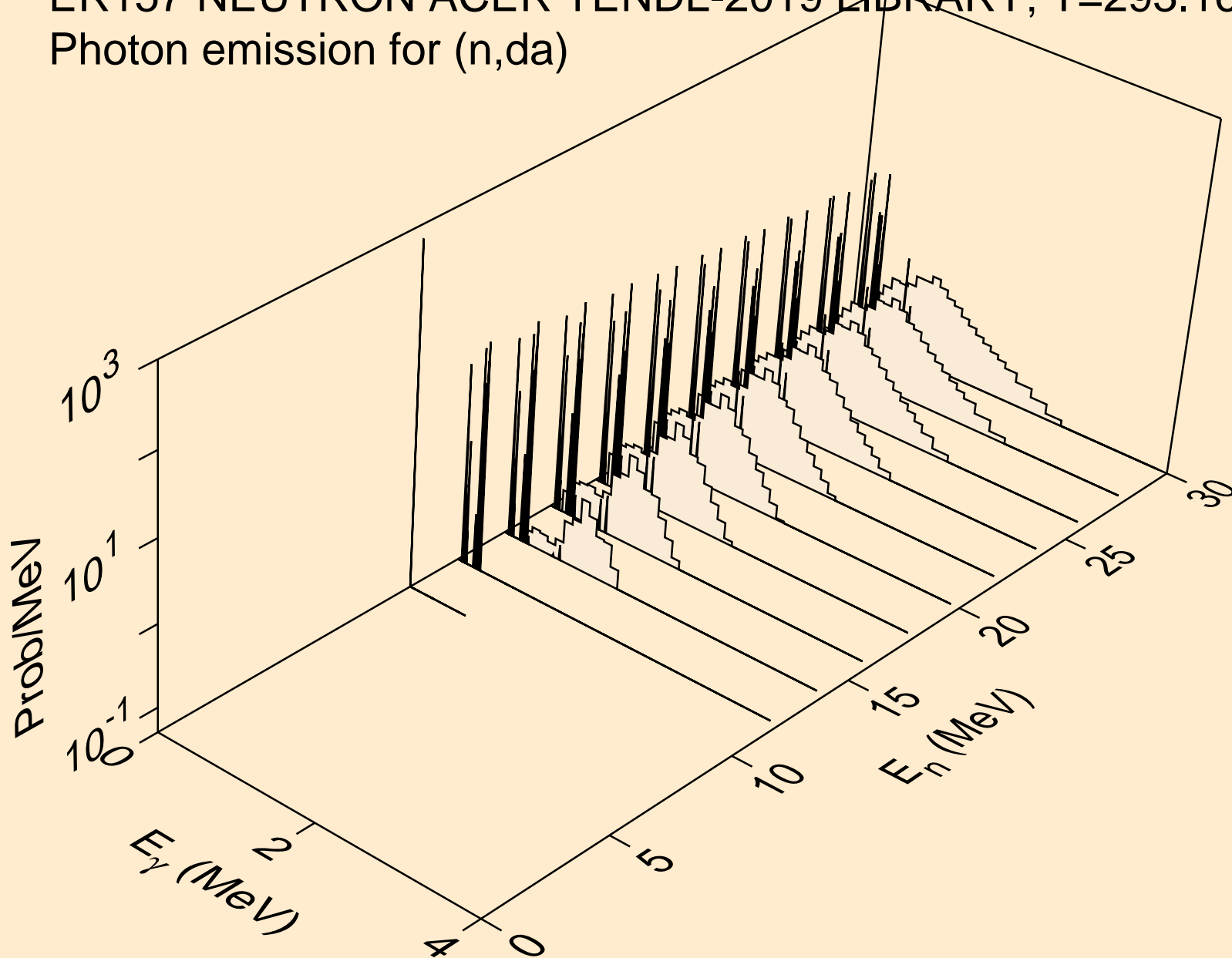

ER157 NEUTRON ACER TENDL-2019 LIBRARY; T=293.16K
thermal capture photon spectrum

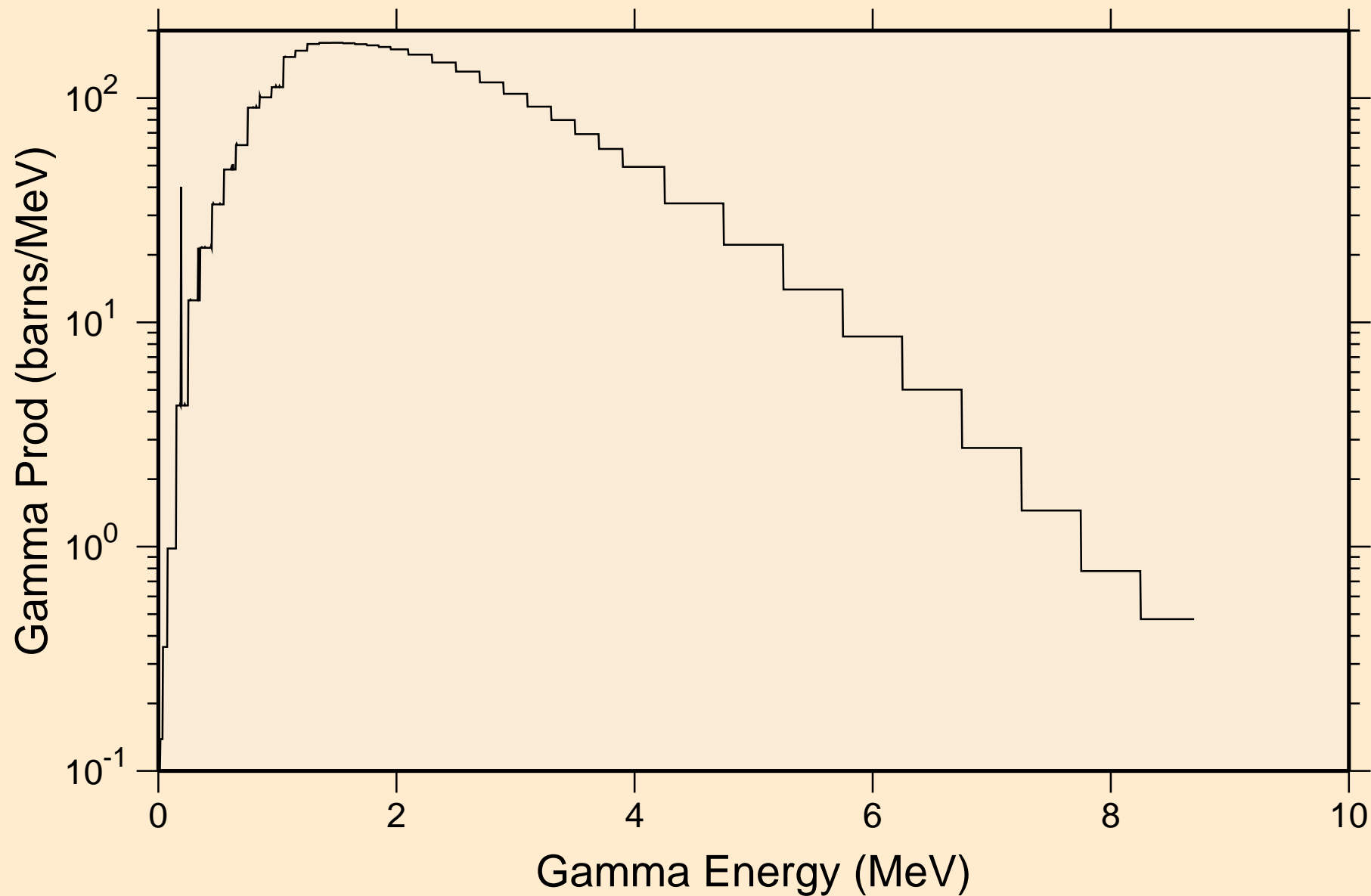

ER157 NEUTRON ACER TENDL-2019 LIBRARY; T=293.16K
14 MeV photon spectrum

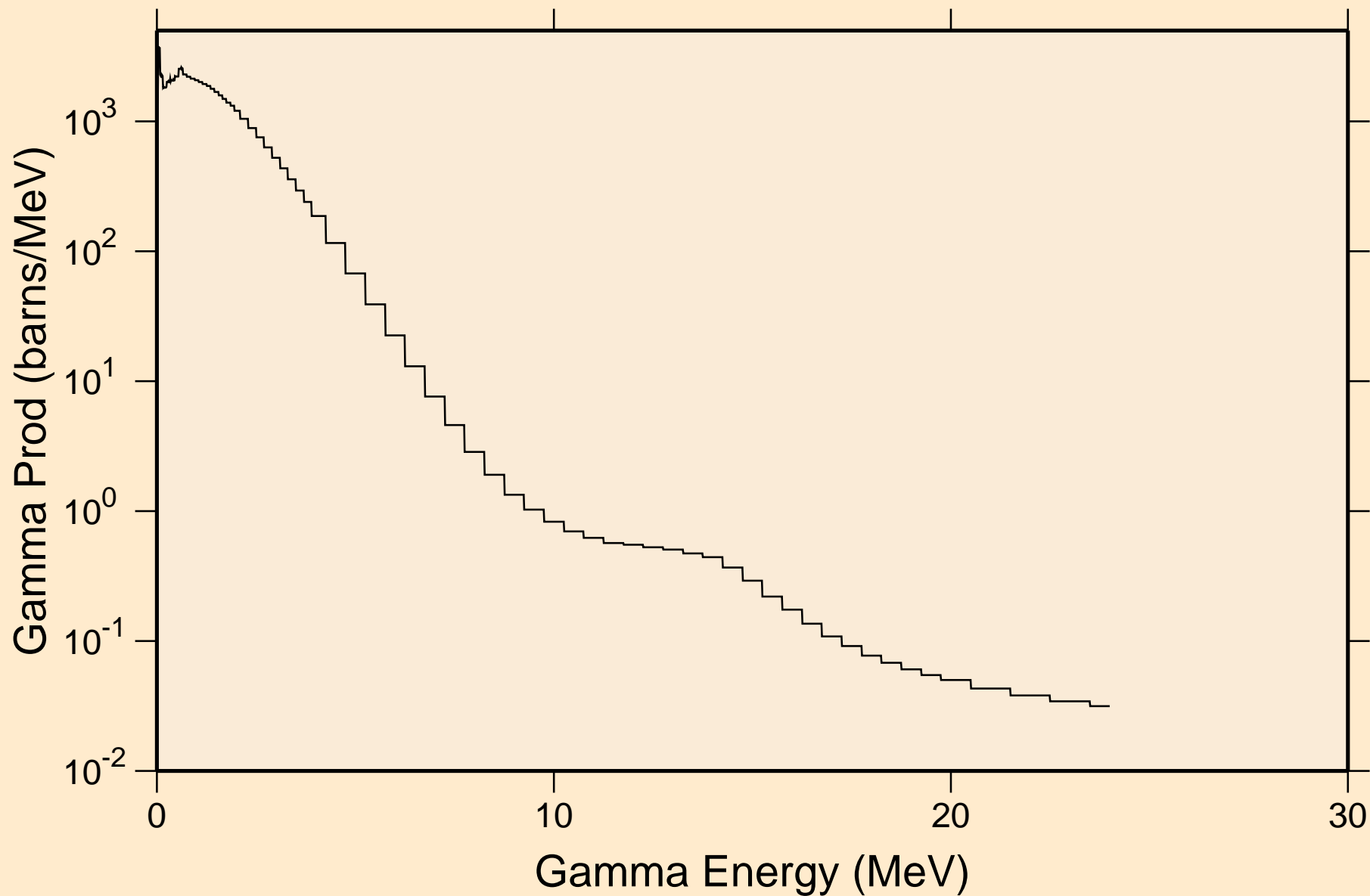

ER157 NEUTRON ACER TENDL-2019 LIBRARY; T=293.16K

Particle heating contributions

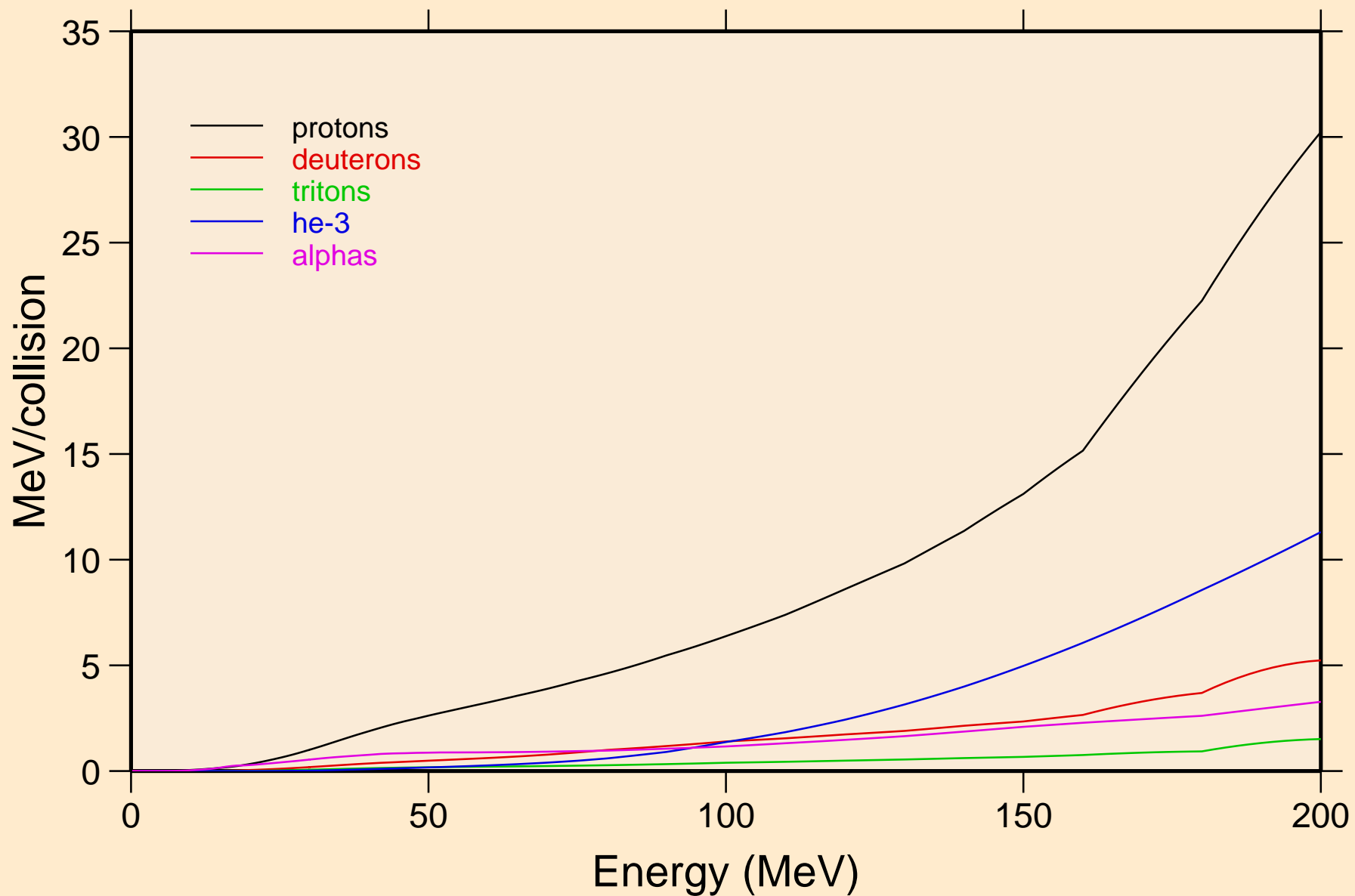

ER157 NEUTRON ACER TENDL-2019 LIBRARY; T=293.16K
Recoil Heating

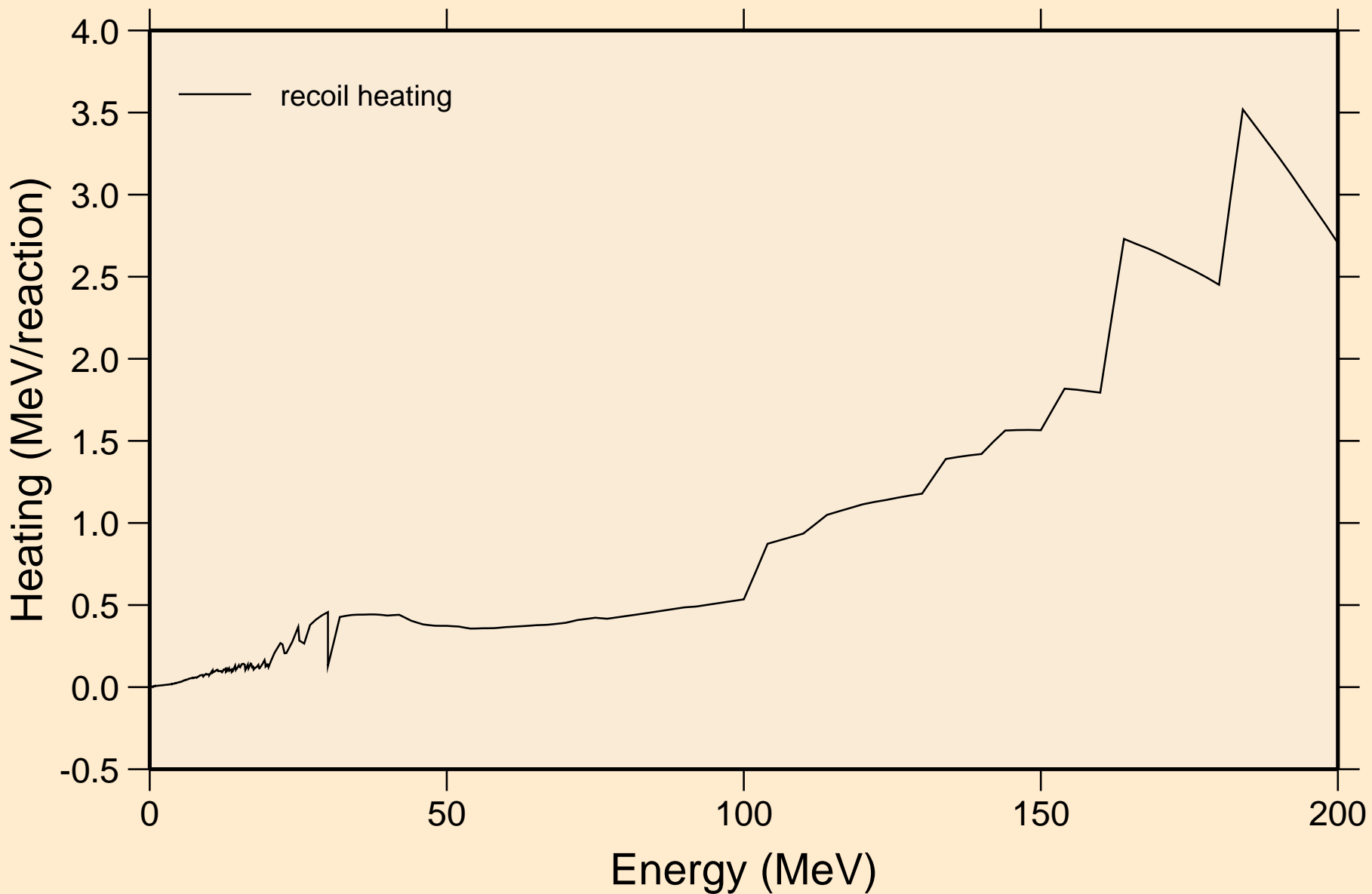

ER157 NEUTRON ACER TENDL-2019 LIBRARY; T=293.16K
Particle production cross sections

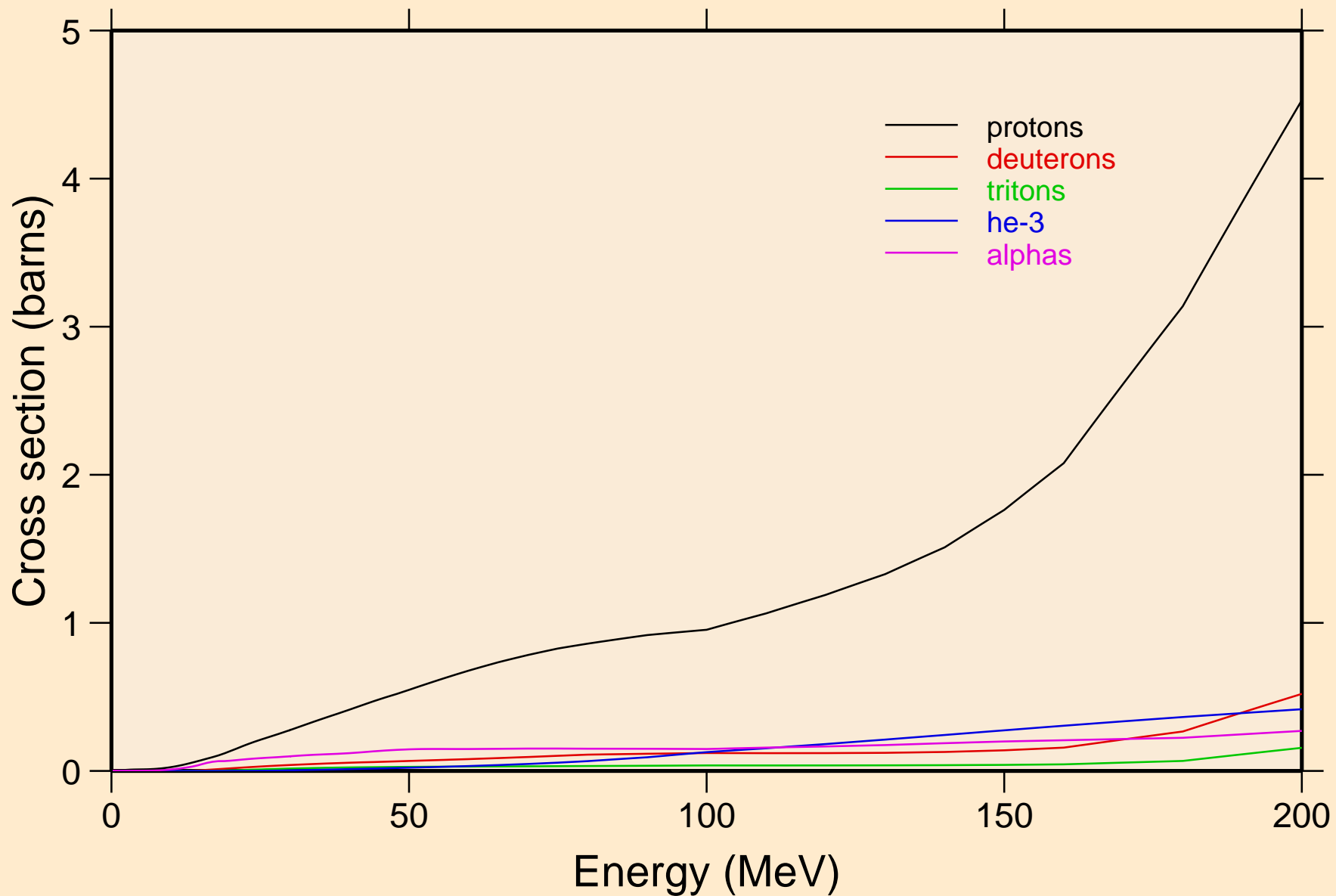

ER157 NEUTRON ACER TENDL-2019 LIBRARY; T=293.16K
protons from (n,x)

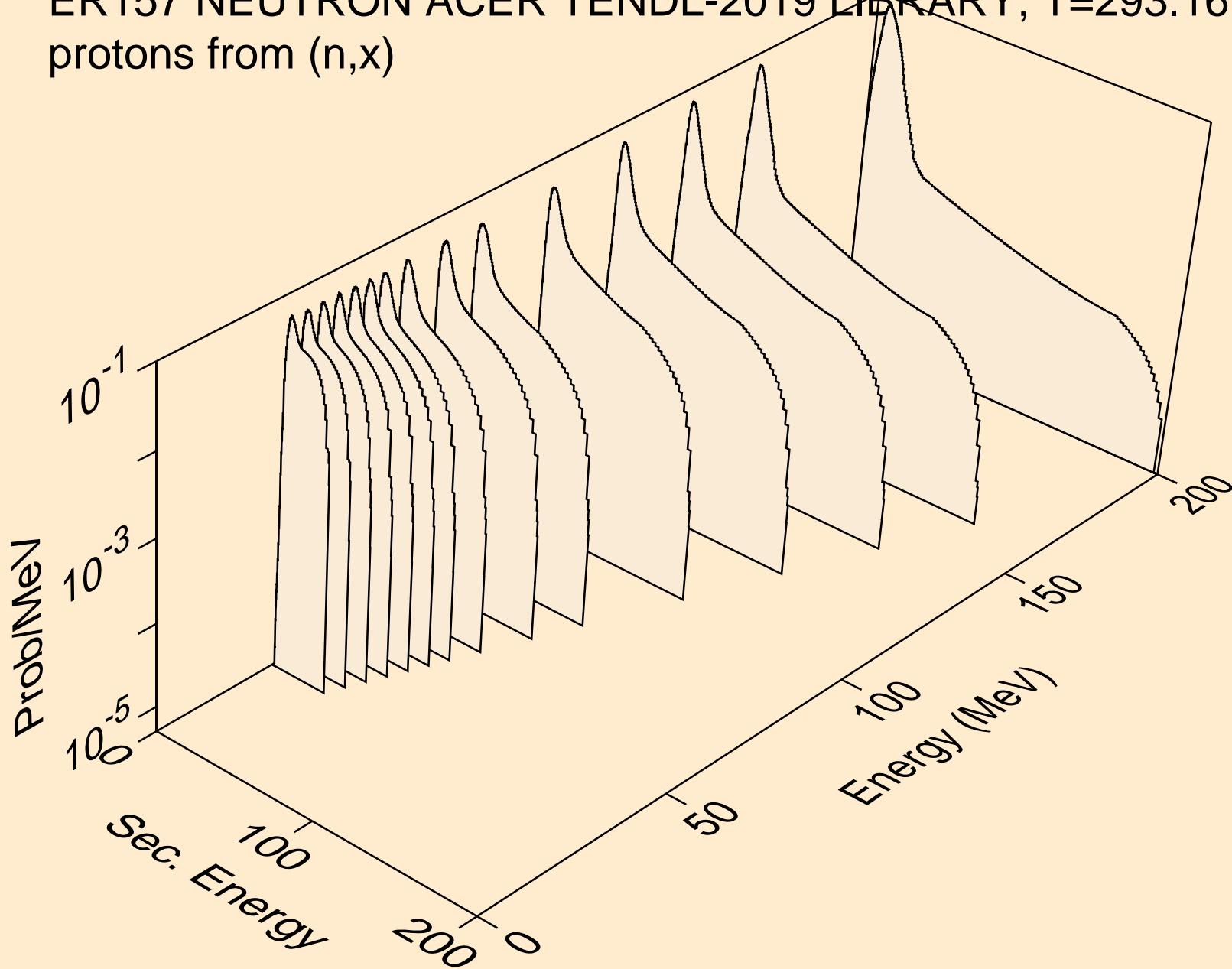

ER157 NEUTRON ACER TENDL-2019 LIBRARY; T=293.16K
protons from (n,n*)p

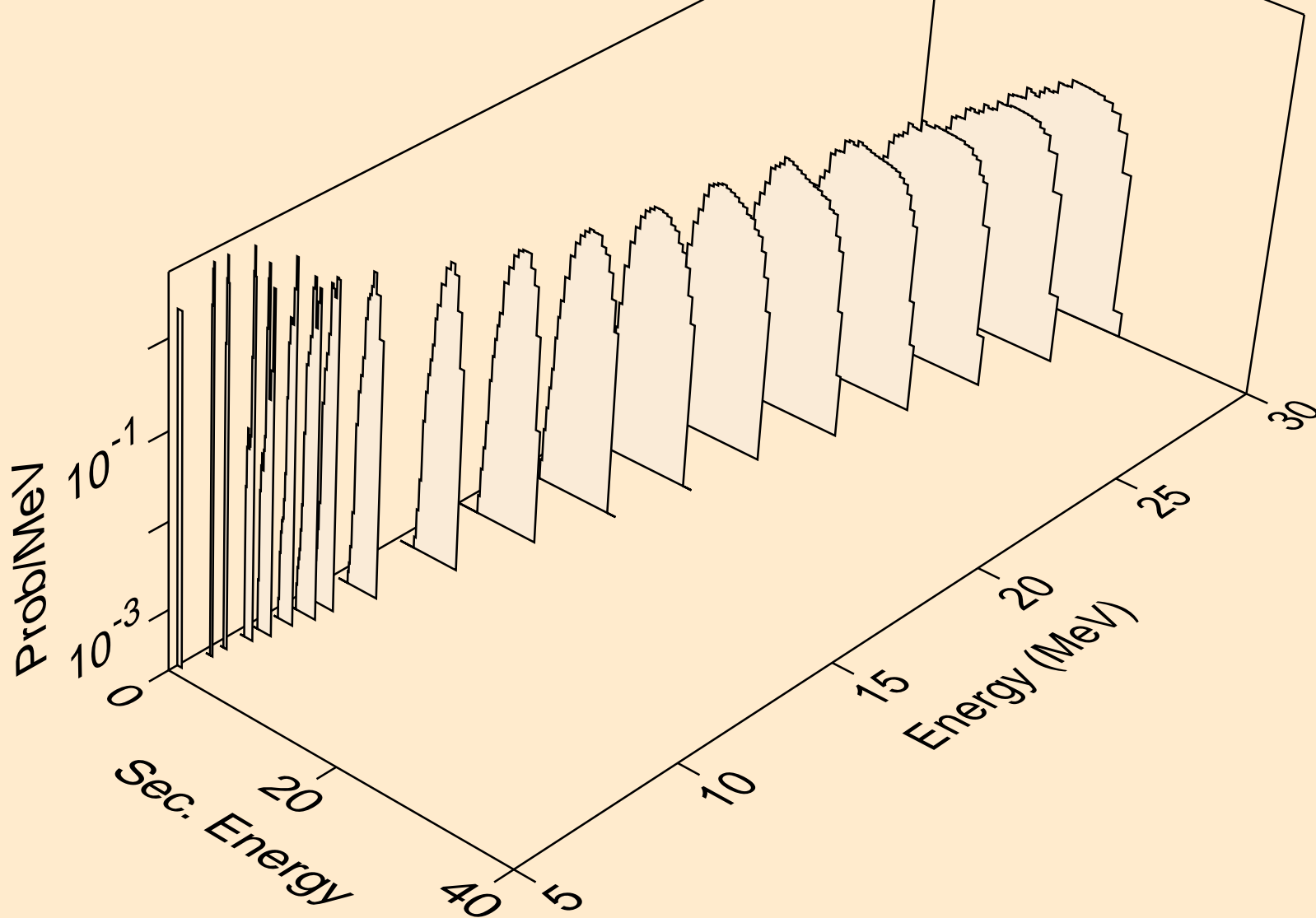

ER157 NEUTRON ACER TENDL-2019 LIBRARY; T=293.16K
protons from (n,2np)

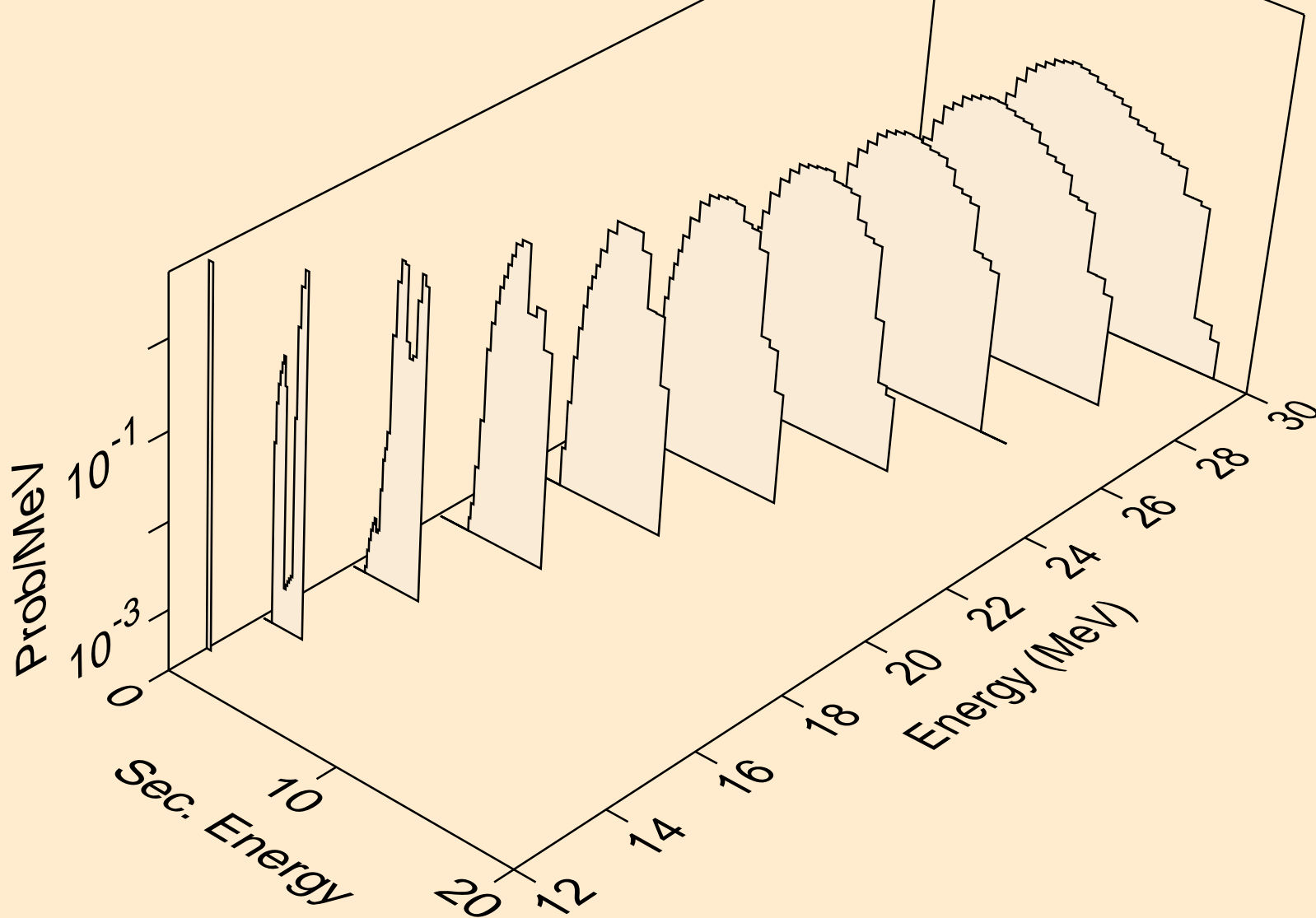

ER157 NEUTRON ACER TENDL-2019 LIBRARY; T=293.16K
protons from (n,3np)

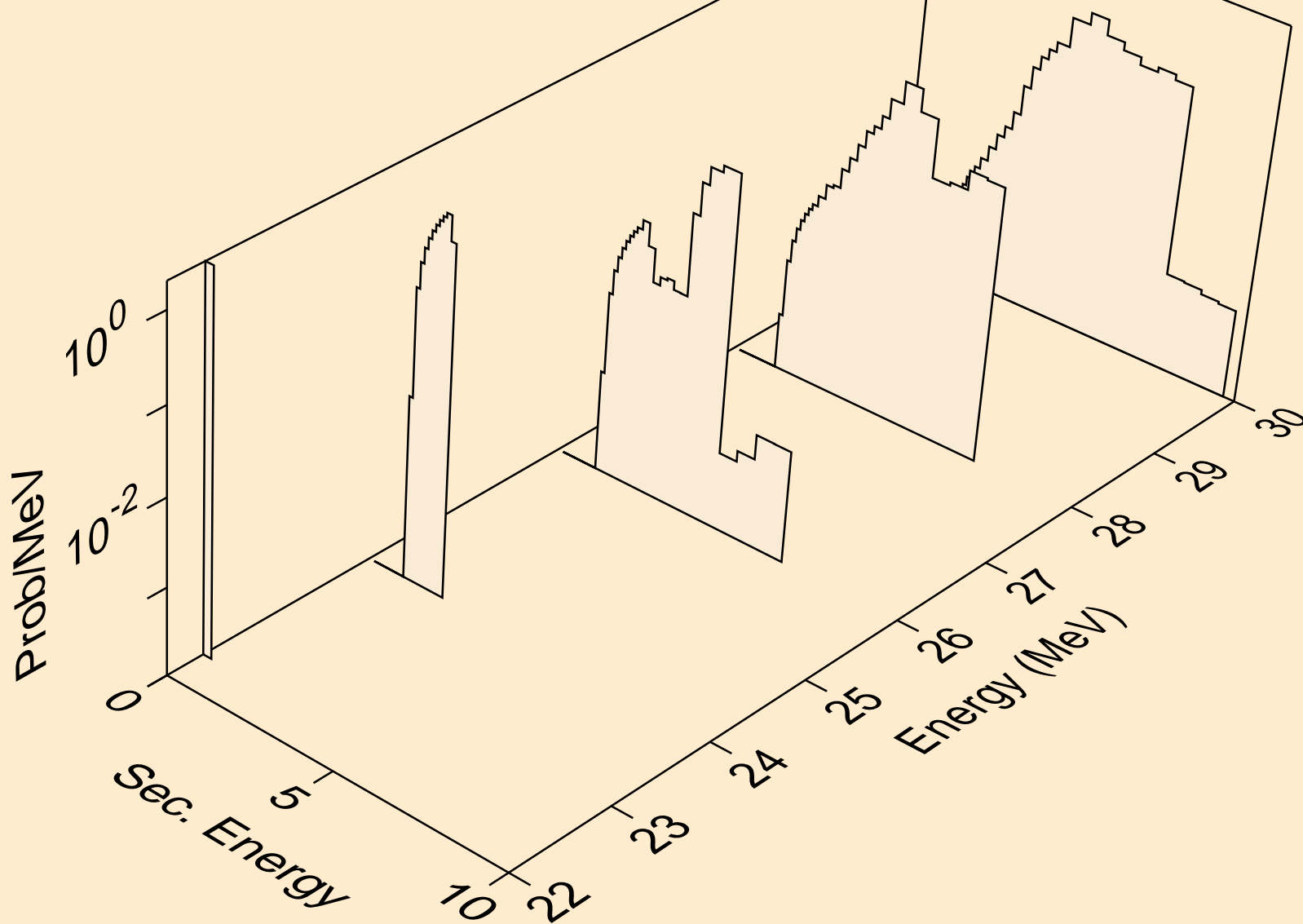

ER157 NEUTRON ACER TENDL-2019 LIBRARY; T=293.16K
protons from (n,2np)

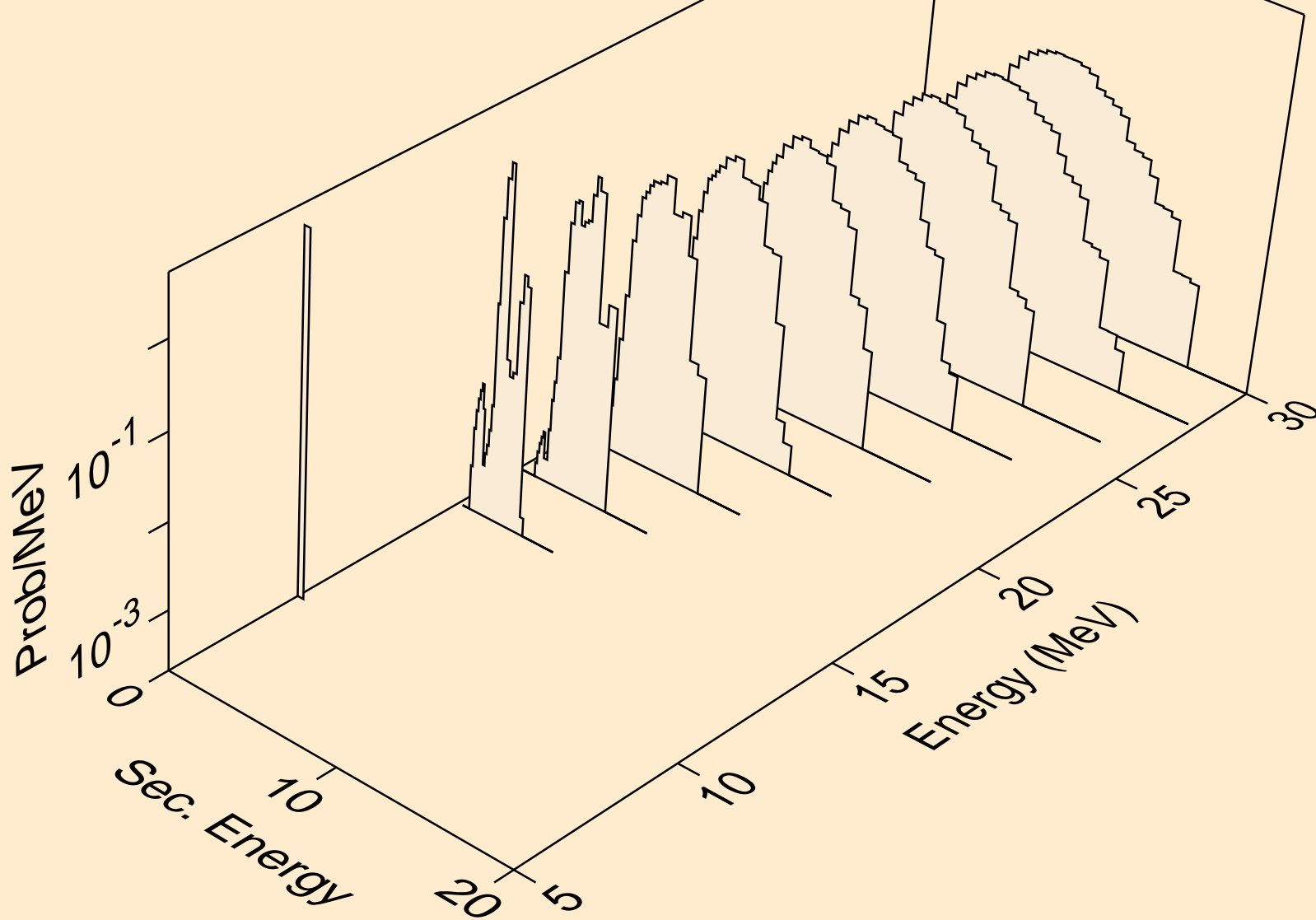

ER157 NEUTRON ACER TENDL-2019 LIBRARY; T=293.16K
protons from (n,npa)

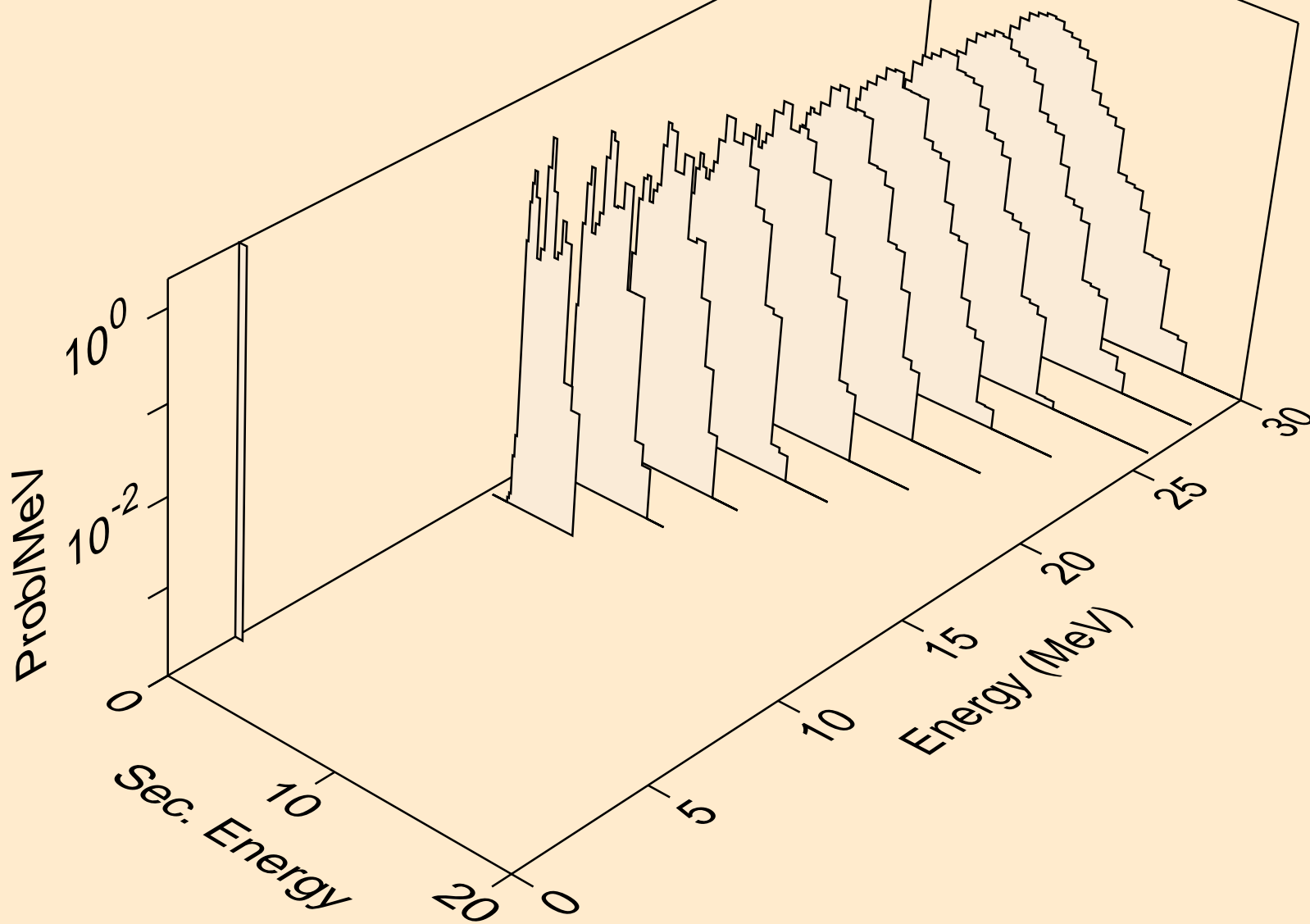

ER157 NEUTRON ACER TENDL-2019 LIBRARY; T=293.16K
protons from (n,p)

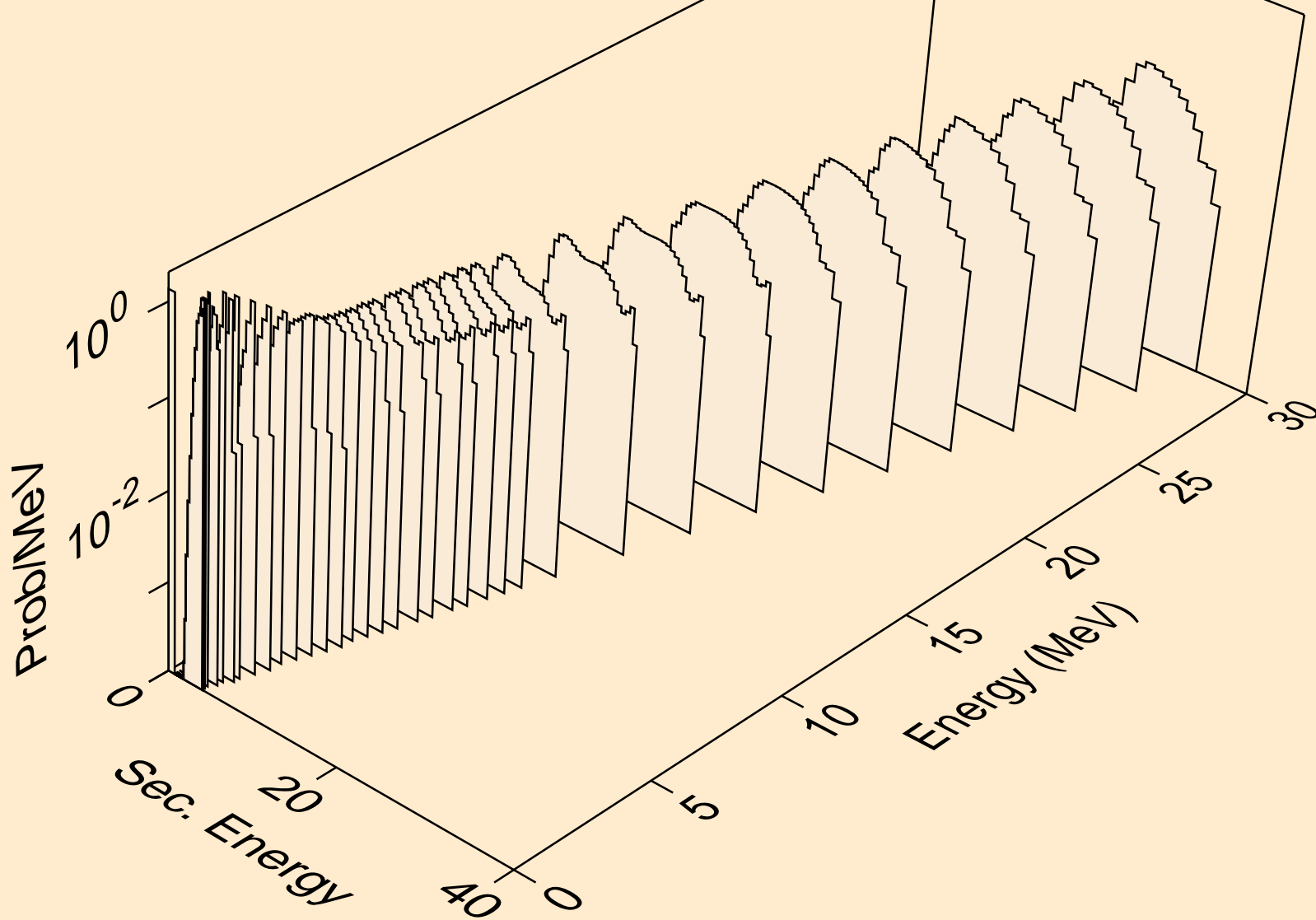

ER157 NEUTRON ACER TENDL-2019 LIBRARY; T=293.16K
protons from (n,2p)

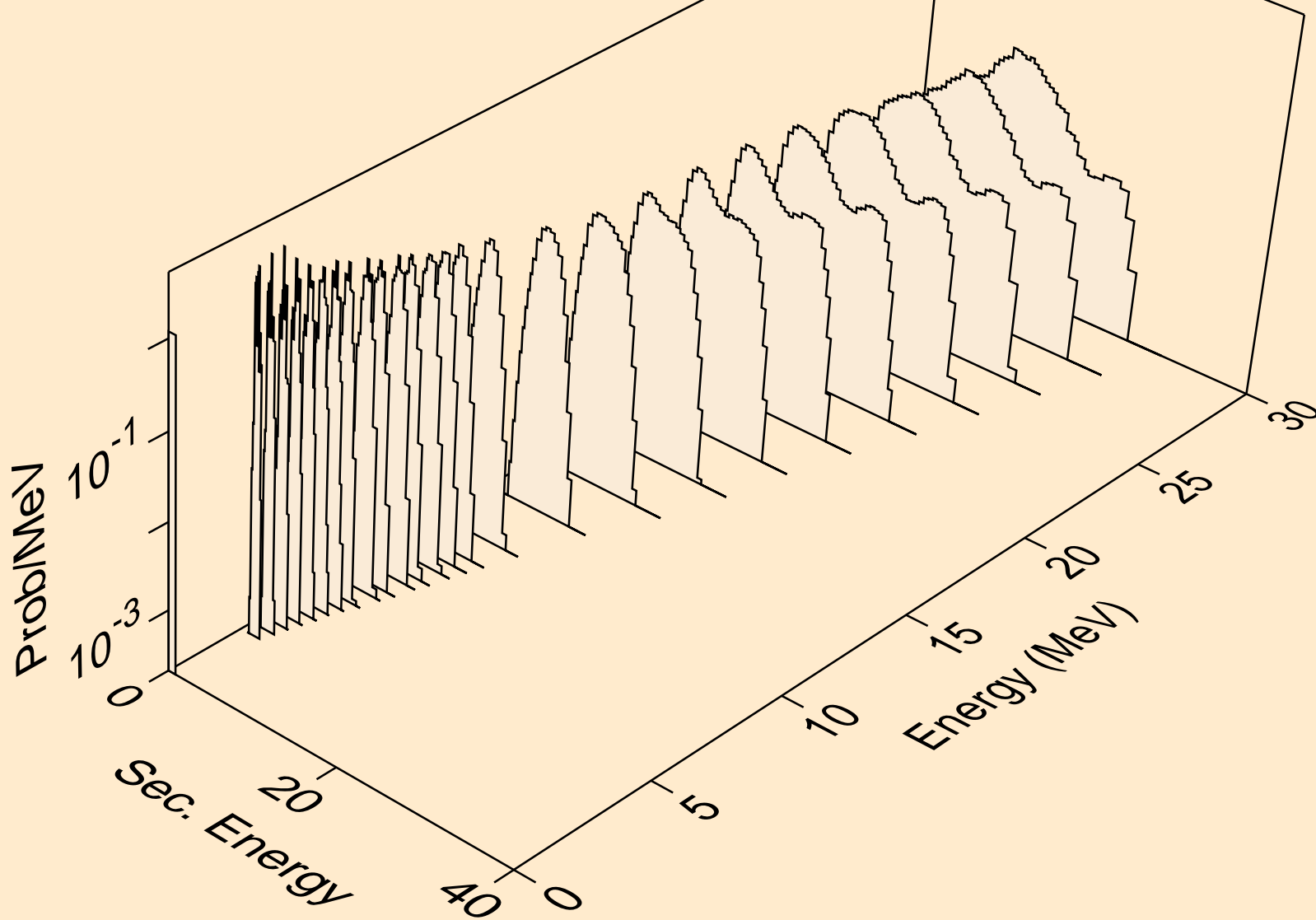

ER157 NEUTRON ACER TENDL-2019 LIBRARY; T=293.16K
protons from (n,p)

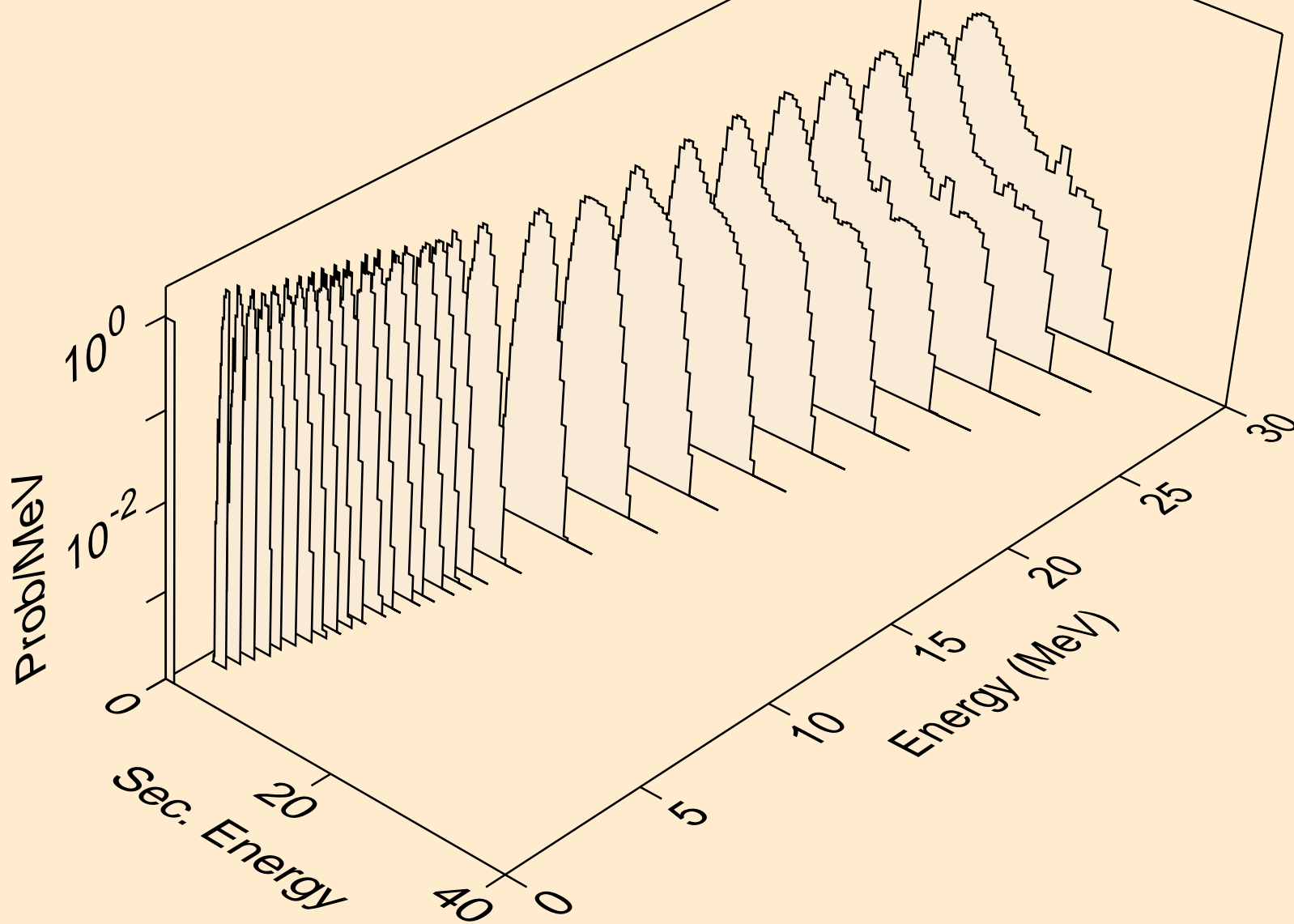

ER157 NEUTRON ACER TENDL-2019 LIBRARY; T=293.16K
protons from (n,pd)

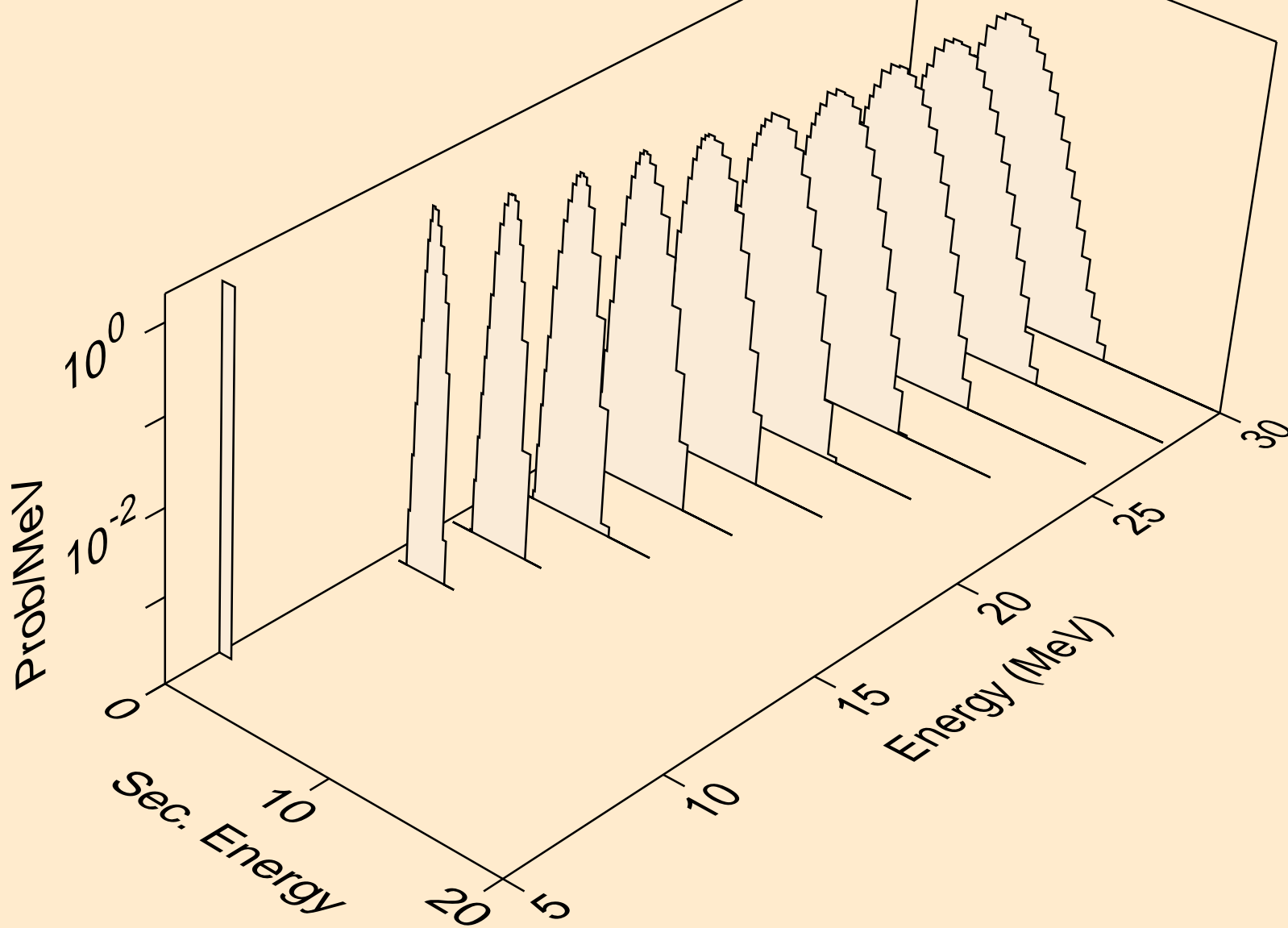

ER157 NEUTRON ACER TENDL-2019 LIBRARY; T=293.16K
protons from (n,pt)

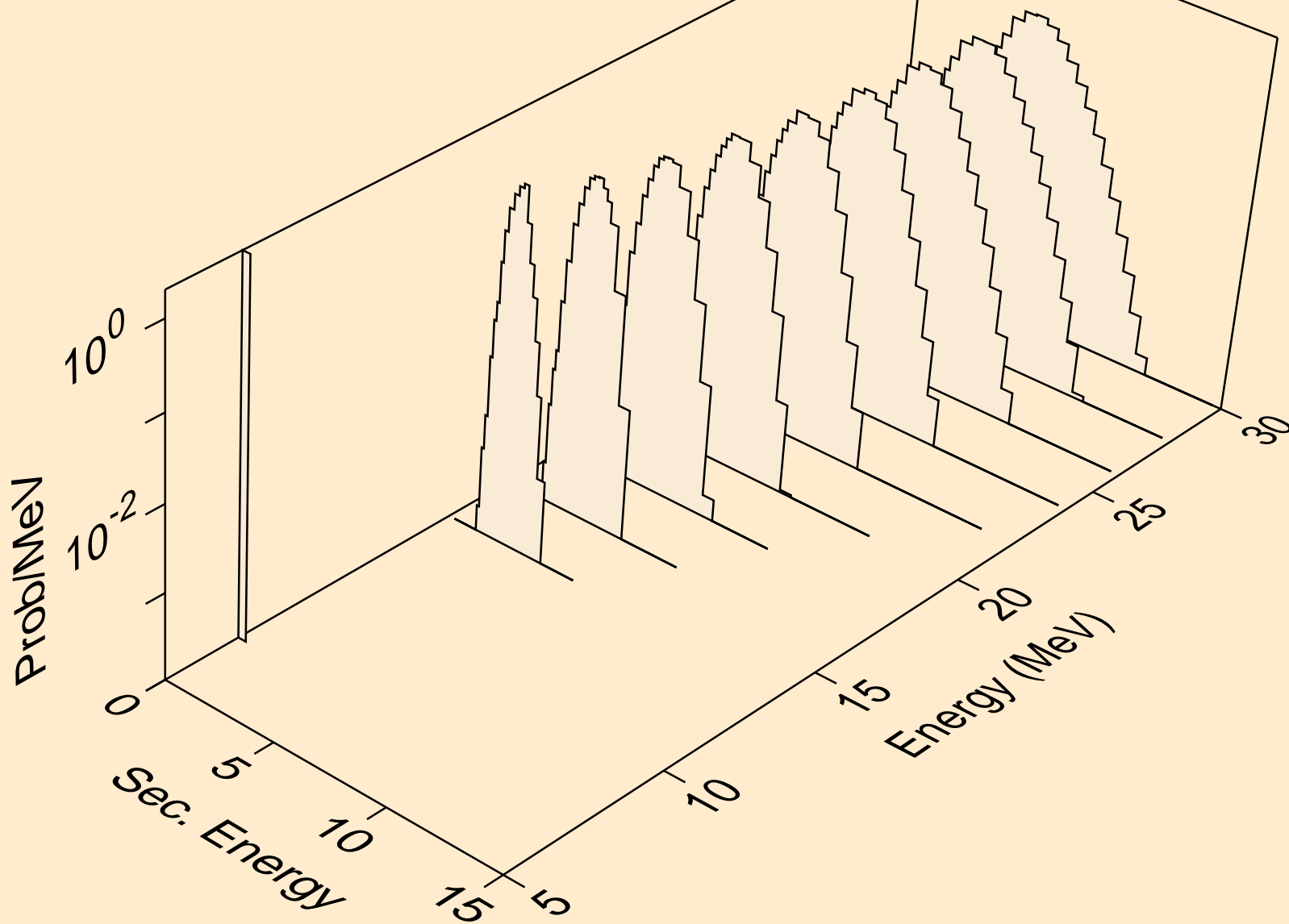

ER157 NEUTRON ACER TENDL-2019 LIBRARY; T=293.16K
deuterons from (n,x)

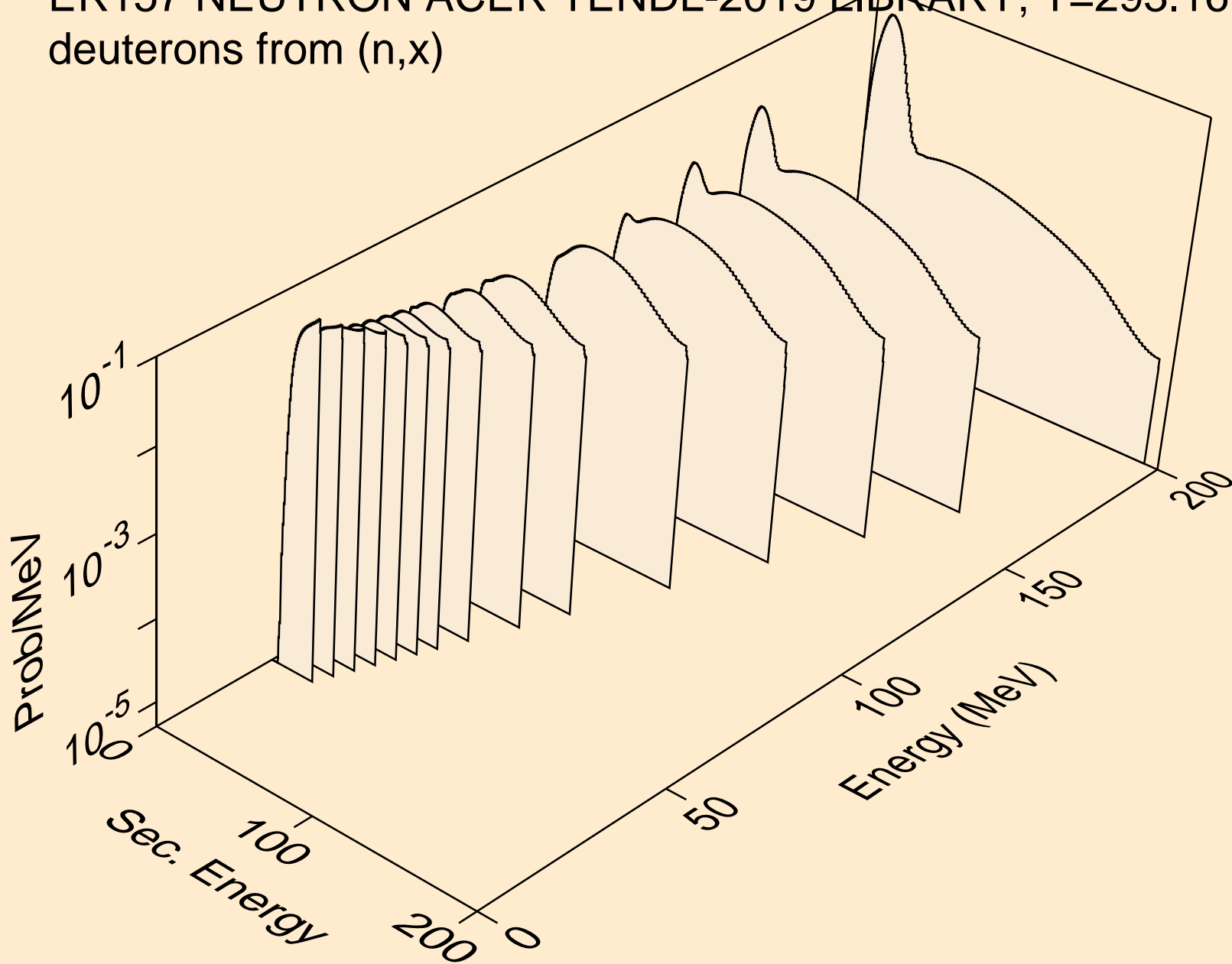

ER157 NEUTRON ACER TENDL-2019 LIBRARY; T=293.16K
deuterons from (n,2nd)

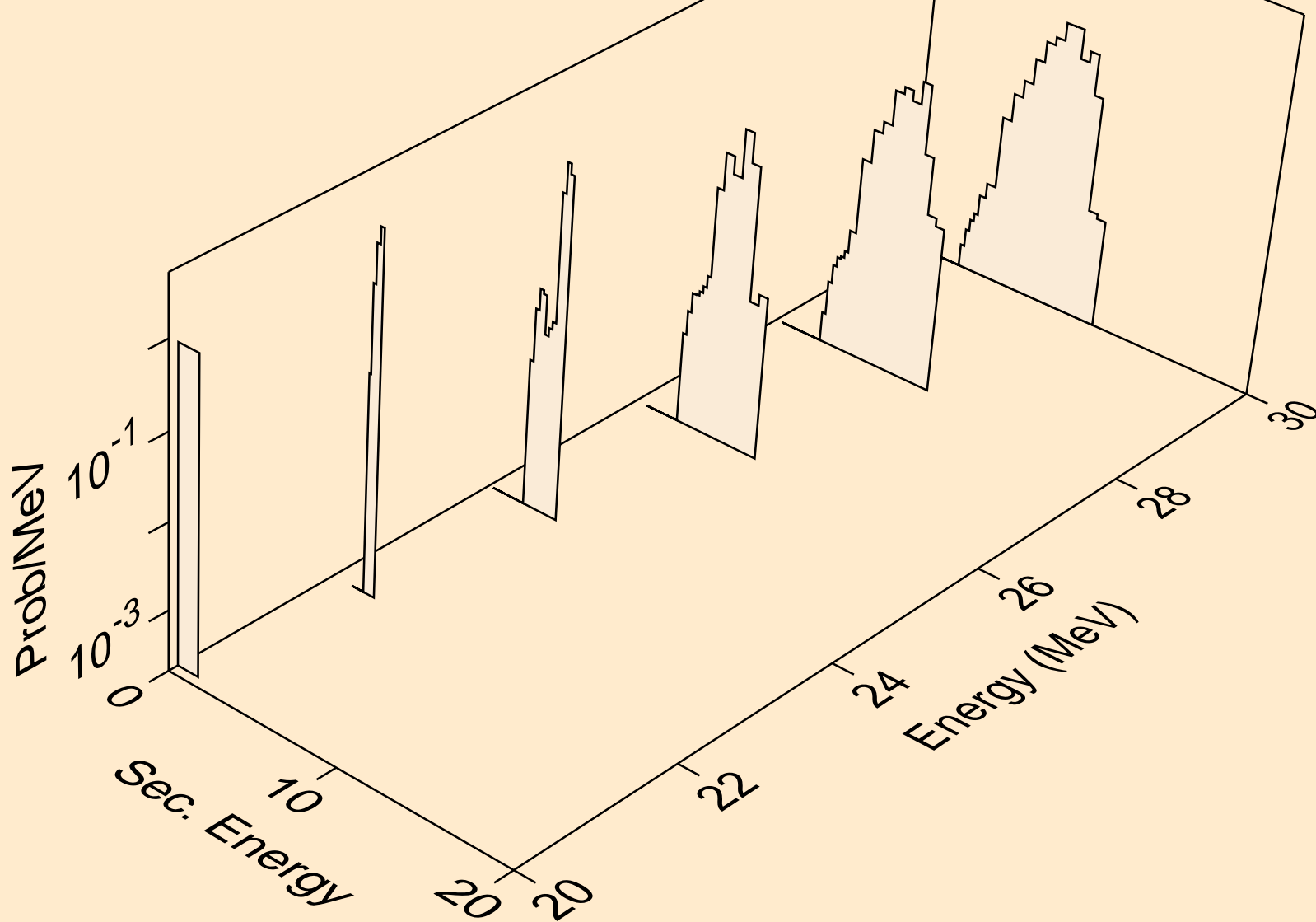

ER157 NEUTRON ACER TENDL-2019 LIBRARY; T=293.16K
deuterons from (n,n*)d

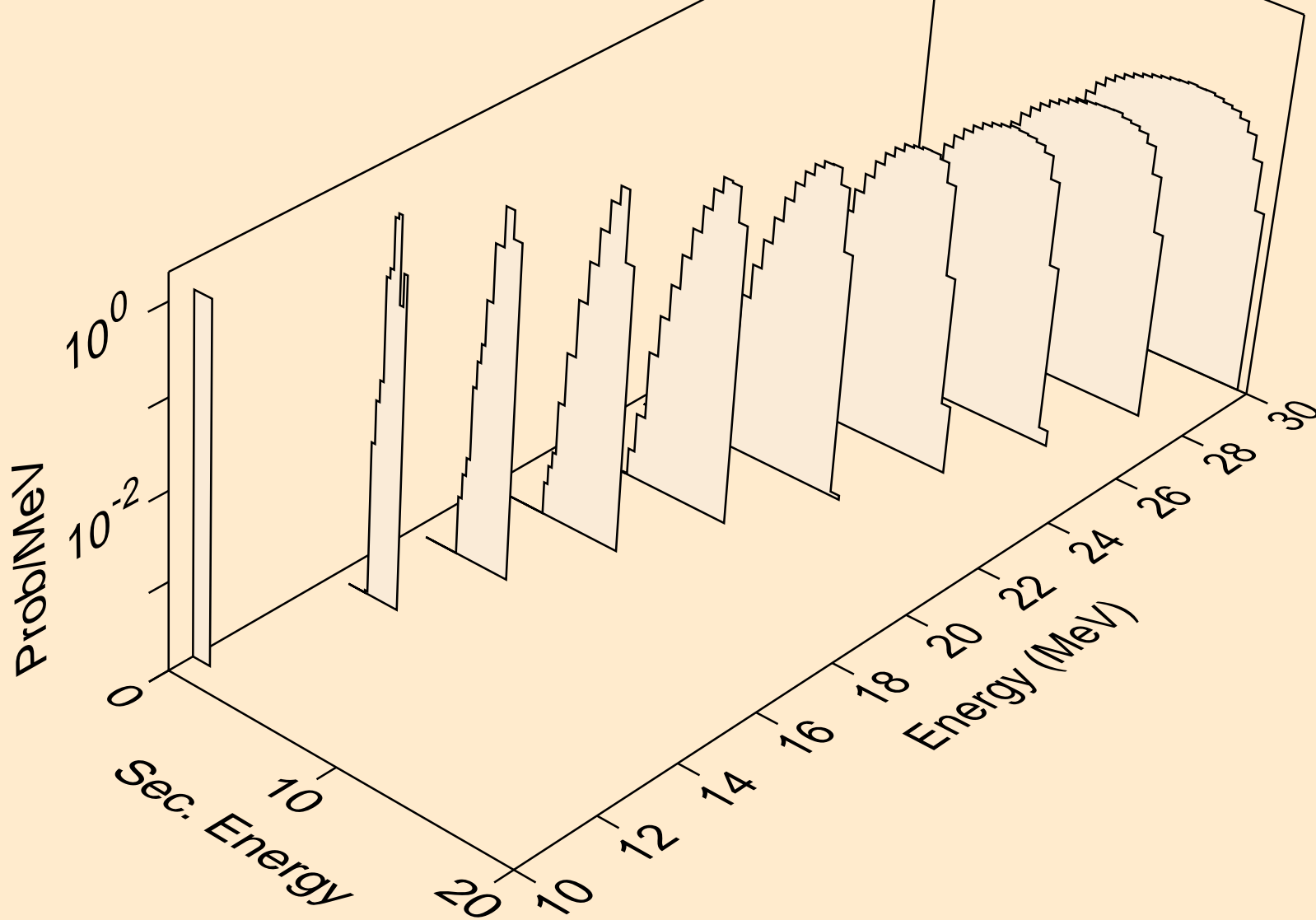

ER157 NEUTRON ACER TENDL-2019 LIBRARY; T=293.16K
deuterons from (n,d)

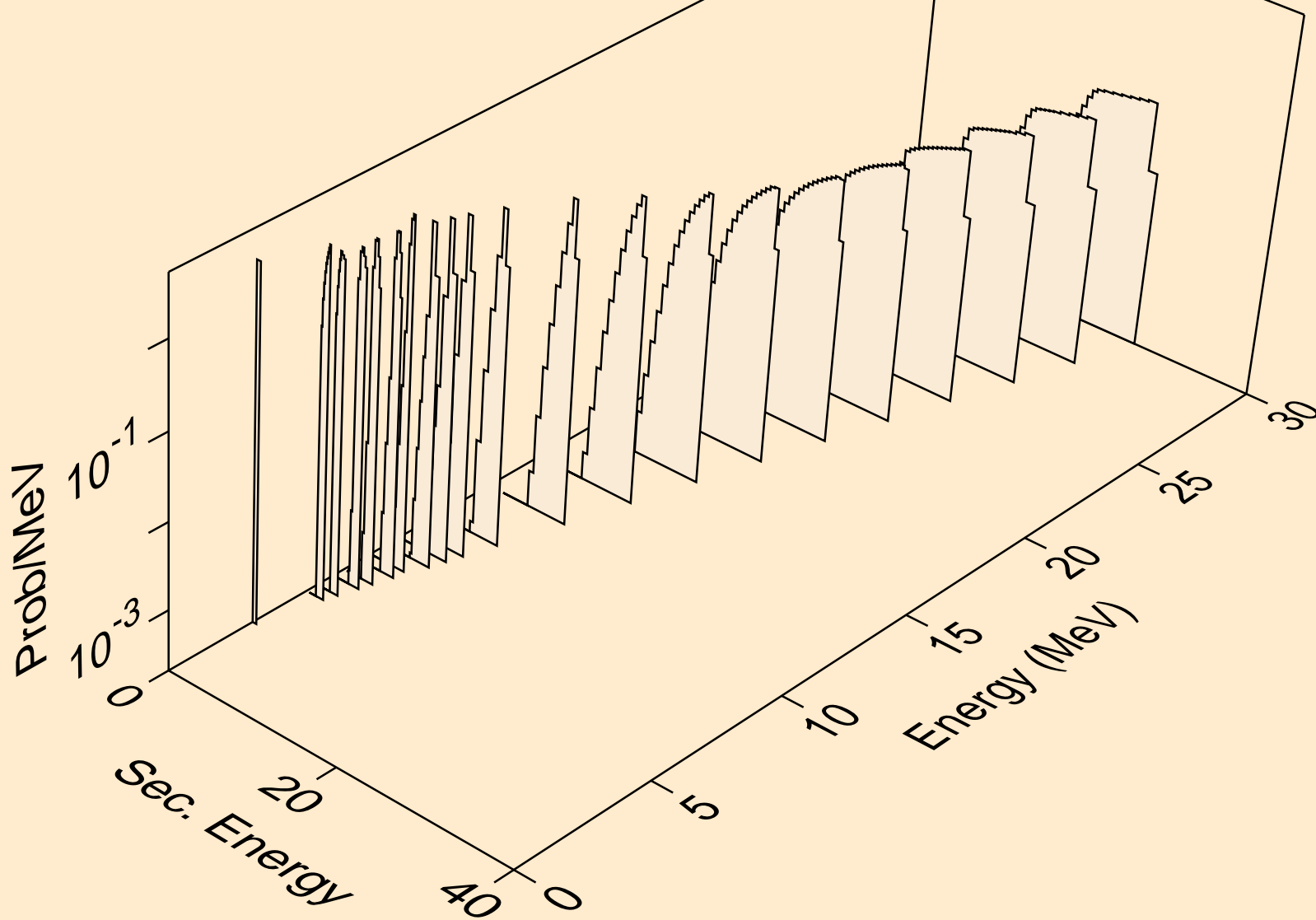

ER157 NEUTRON ACER TENDL-2019 LIBRARY; T=293.16K
deuterons from (n,pd)

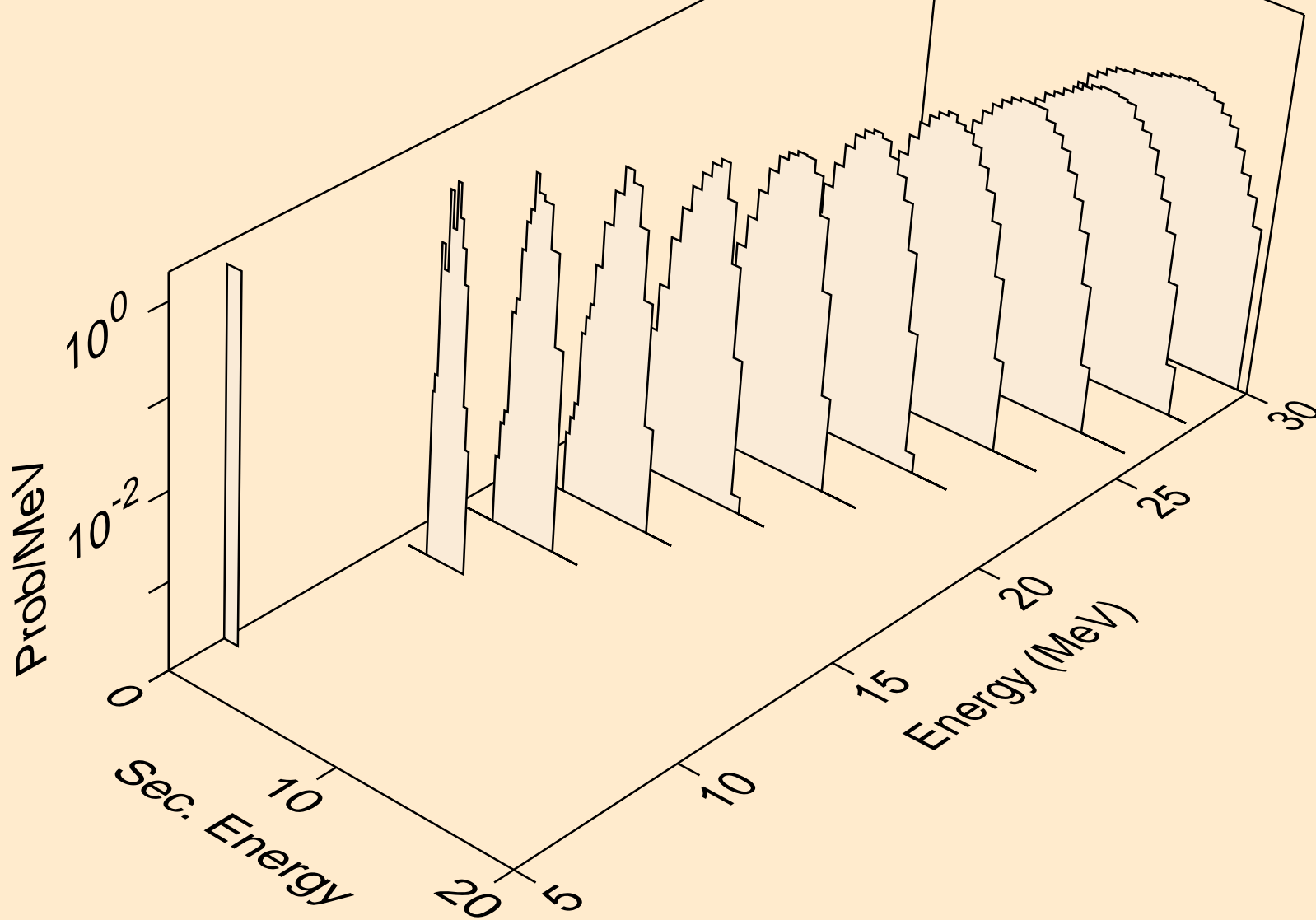

ER157 NEUTRON ACER TENDL-2019 LIBRARY; T=293.16K
deuterons from (n,da)

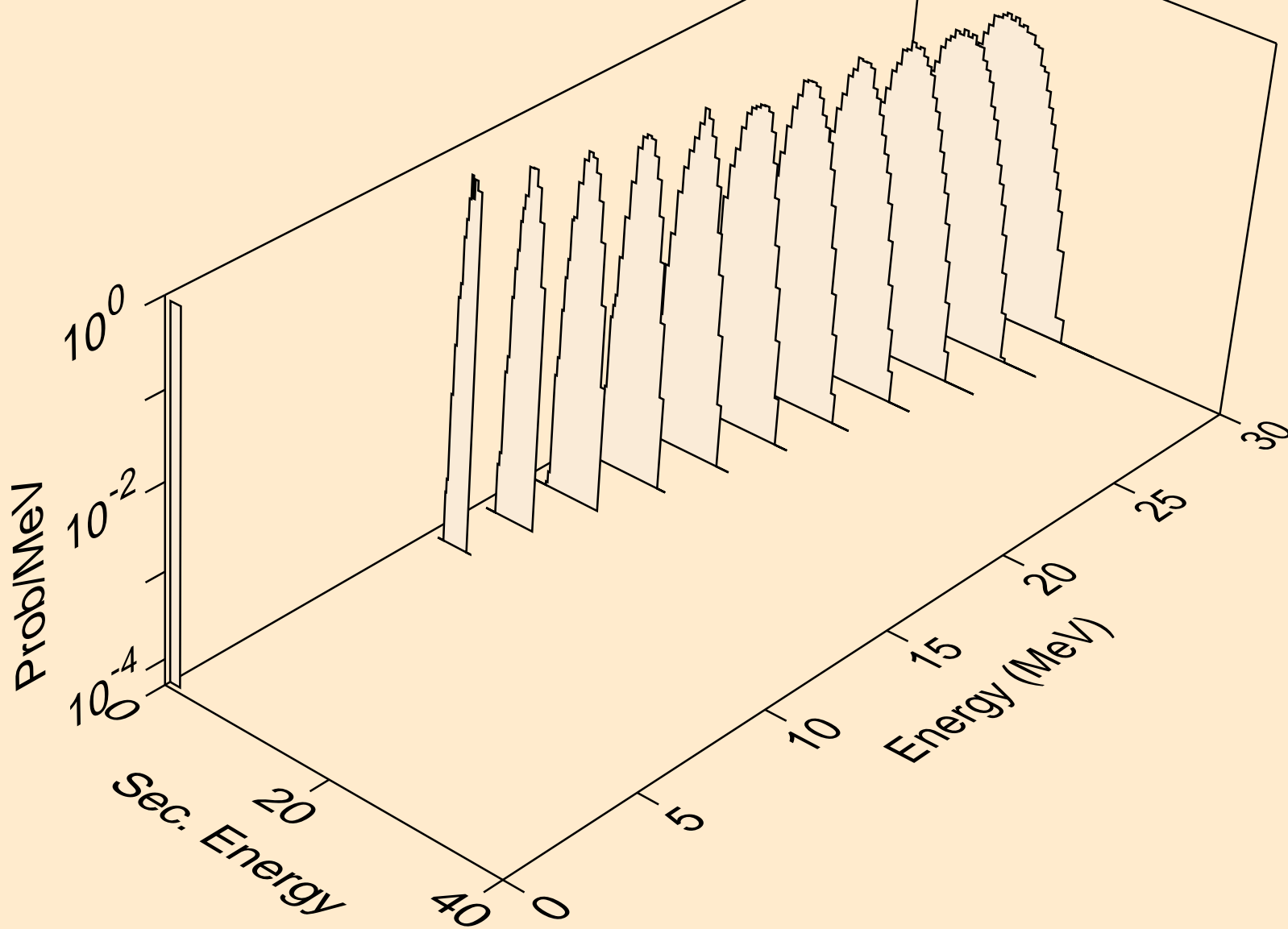

ER157 NEUTRON ACER TENDL-2019 LIBRARY; T=293.16K
tritons from (n,x)

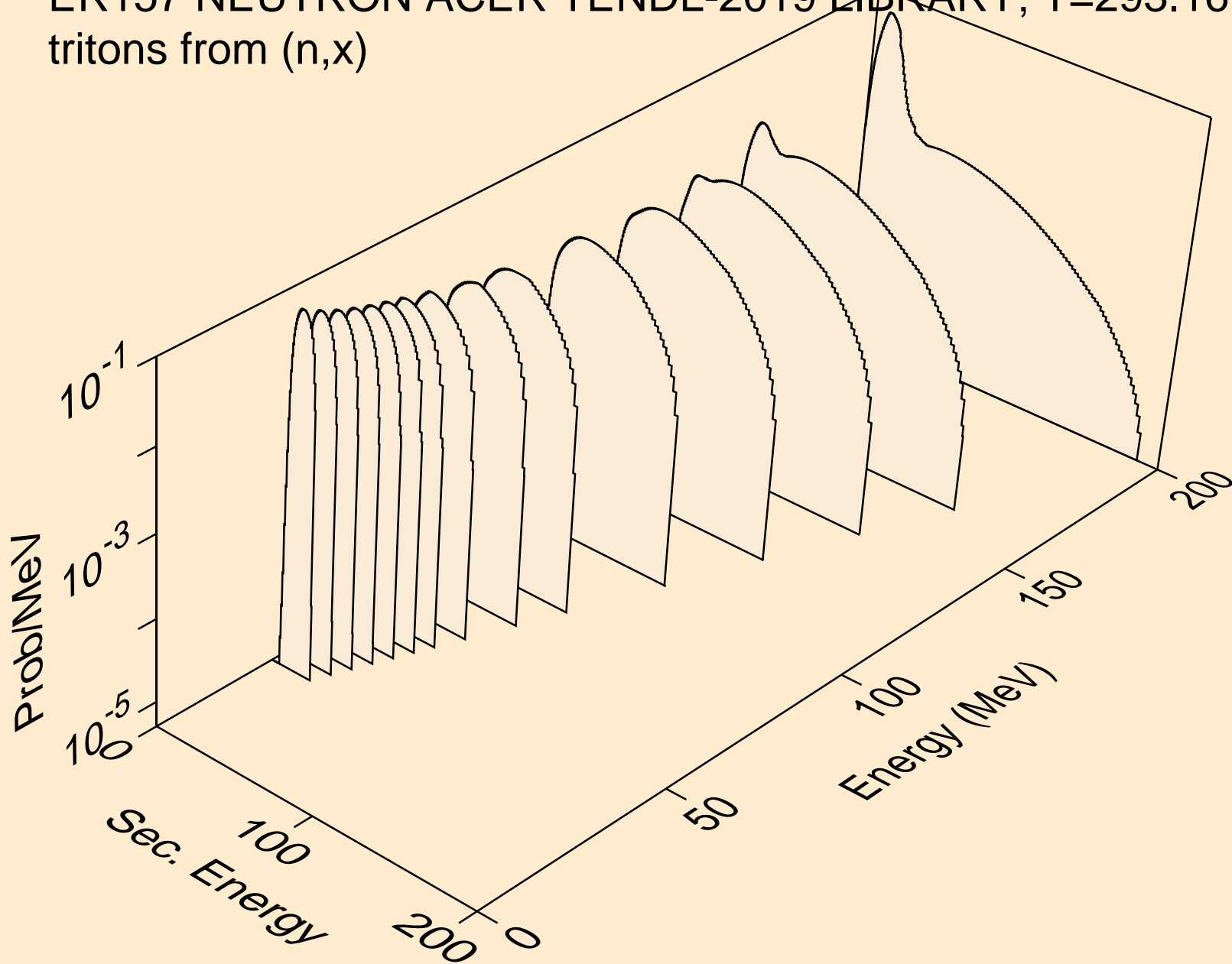

ER157 NEUTRON ACER TENDL-2019 LIBRARY; T=293.16K
tritons from (n,n*)t

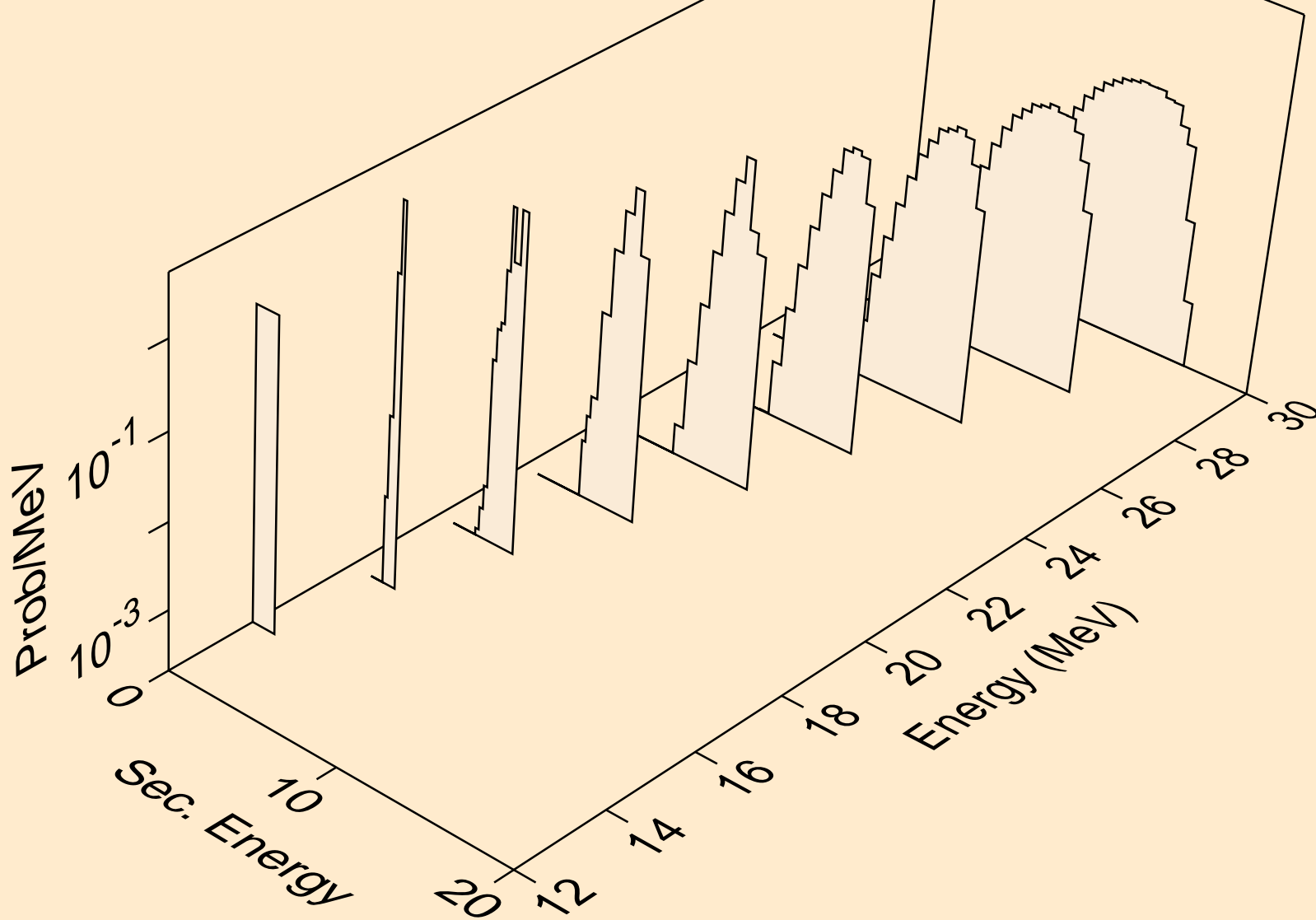

ER157 NEUTRON ACER TENDL-2019 LIBRARY; T=293.16K
tritons from (n,t)

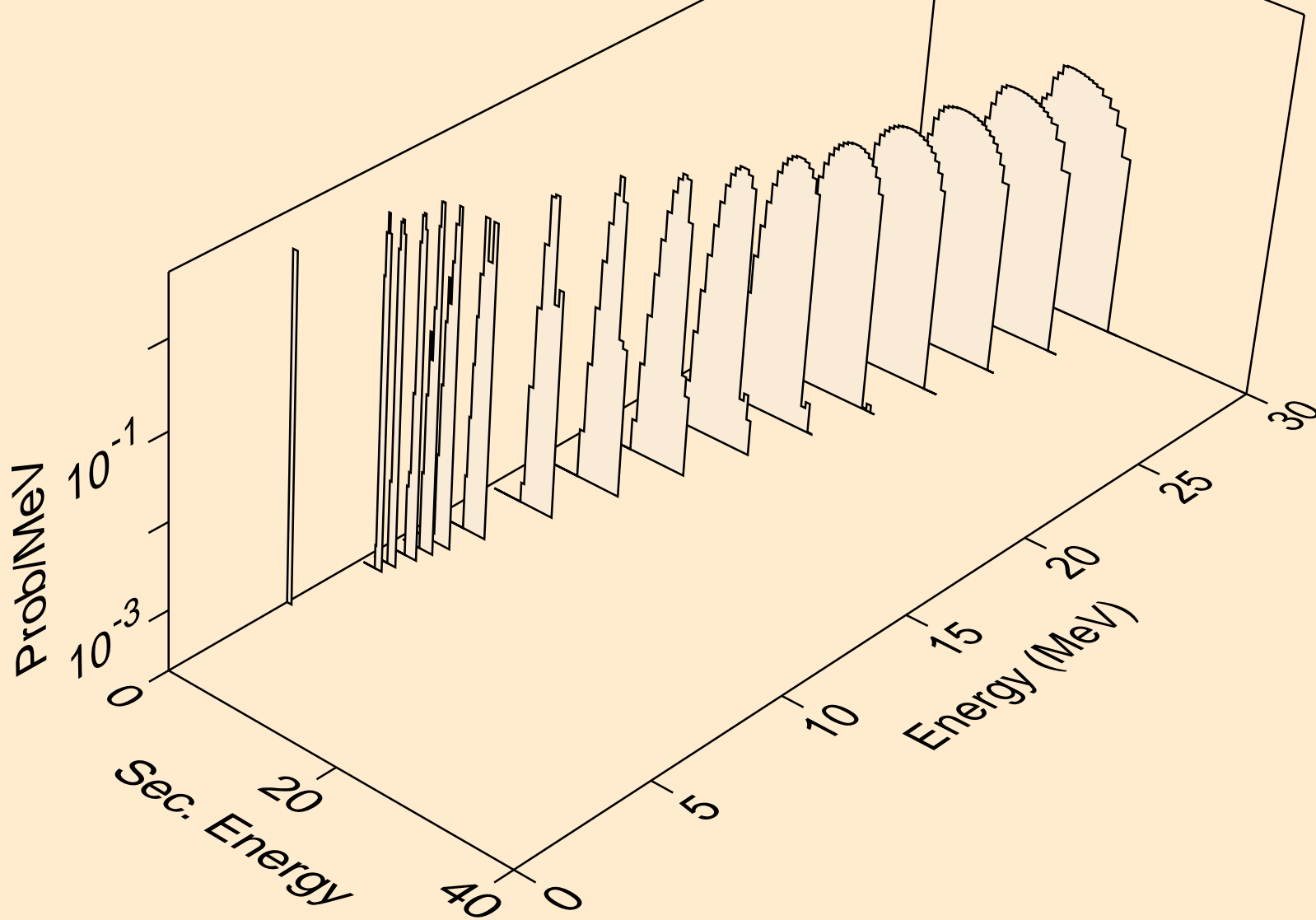

ER157 NEUTRON ACER TENDL-2019 LIBRARY; T=293.16K
tritons from (n,pt)

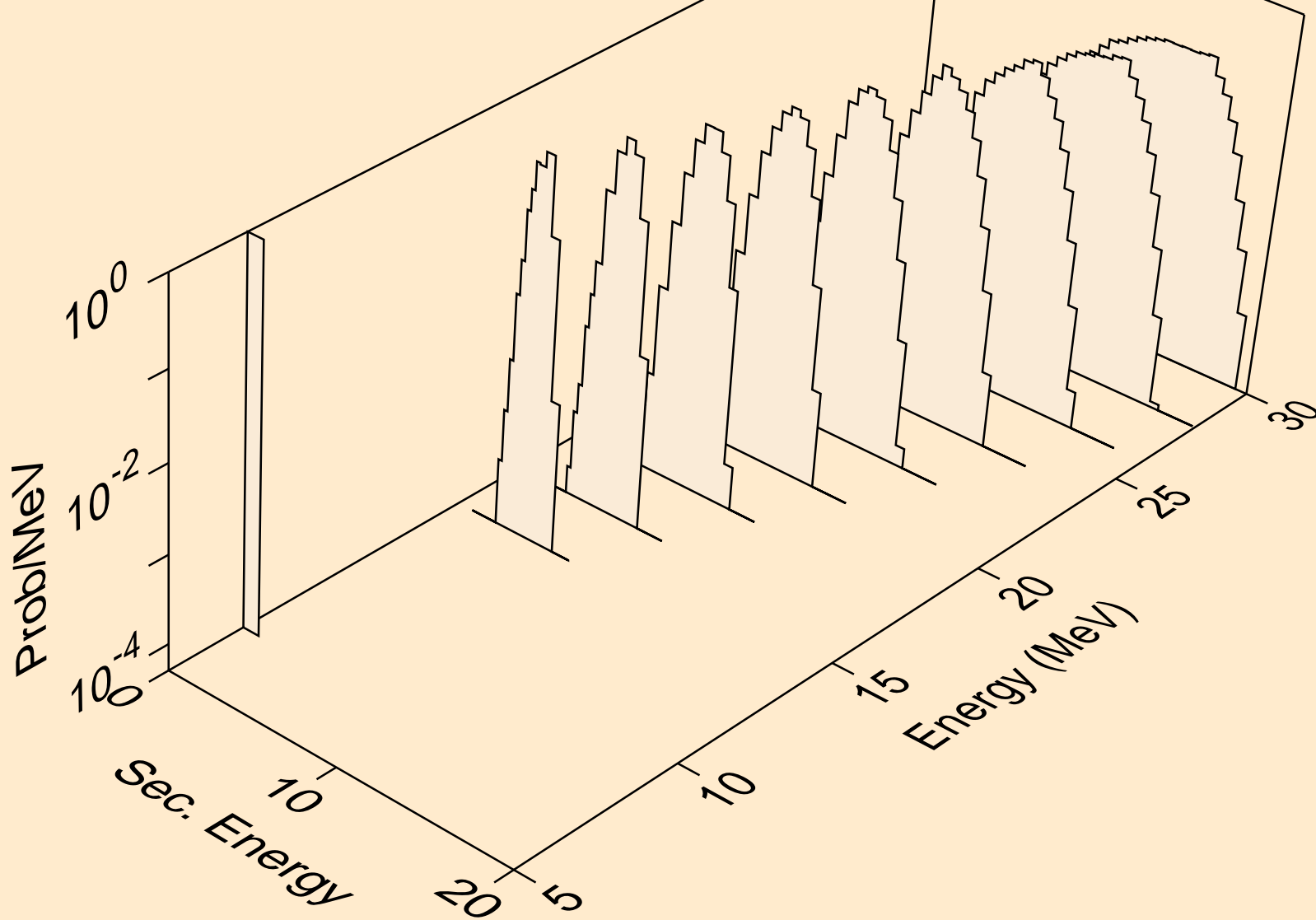

ER157 NEUTRON ACER TENDL-2019 LIBRARY; T=293.16K
he3s from (n,x)

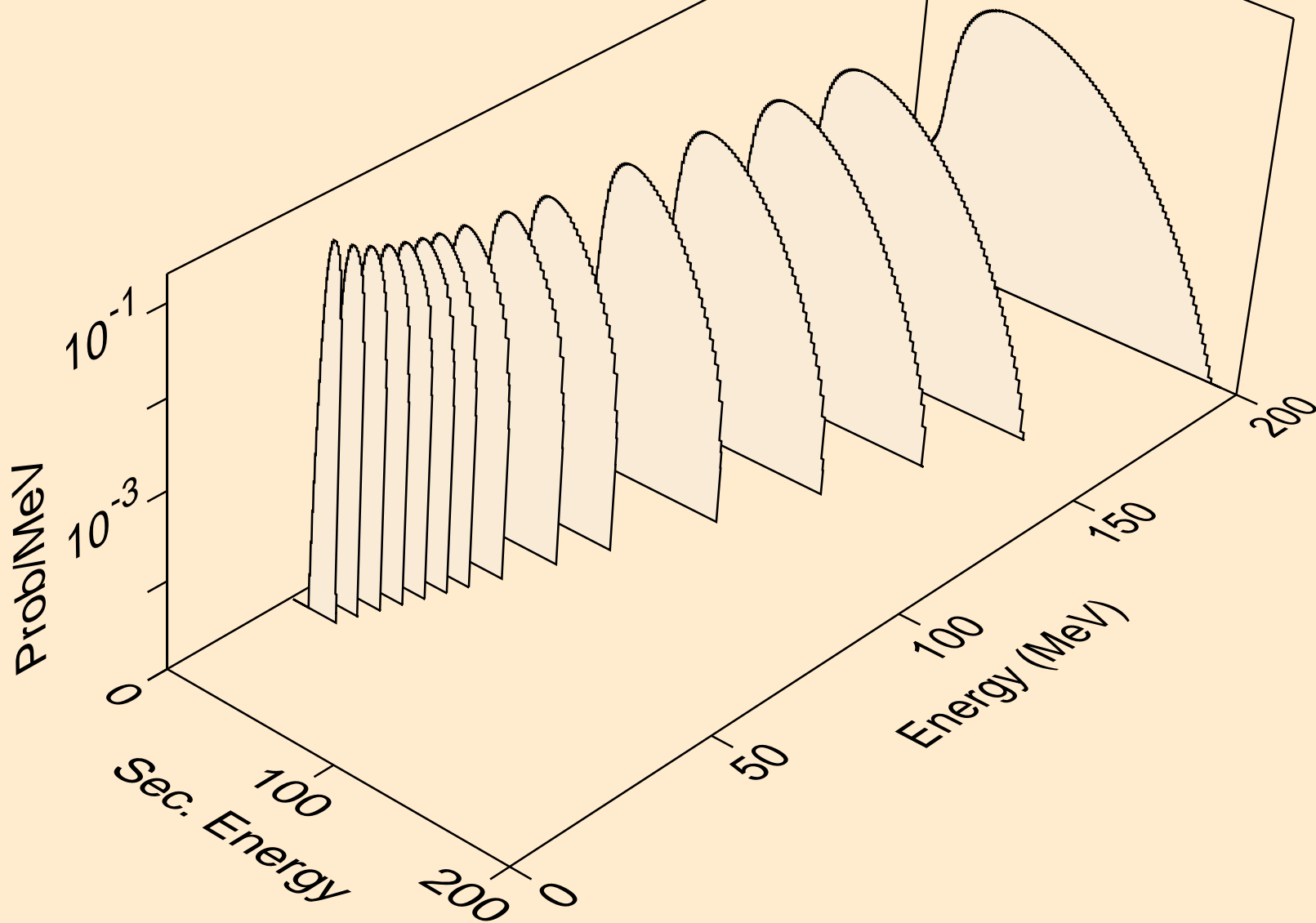

ER157 NEUTRON ACER TENDL-2019 LIBRARY; T=293.16K
he3s from (n,n*)he3

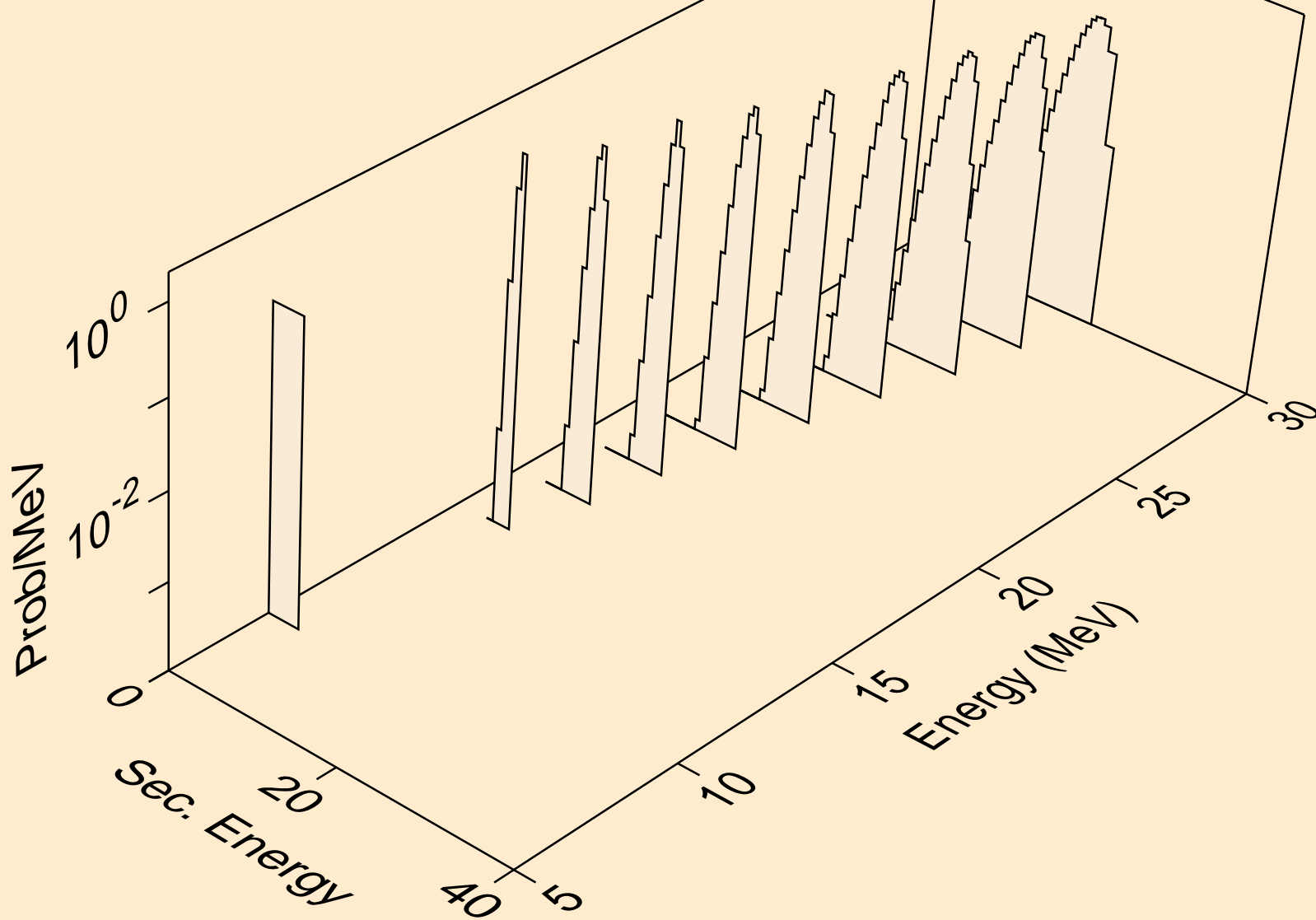

ER157 NEUTRON ACER TENDL-2019 LIBRARY; T=293.16K
he3s from (n,he3)

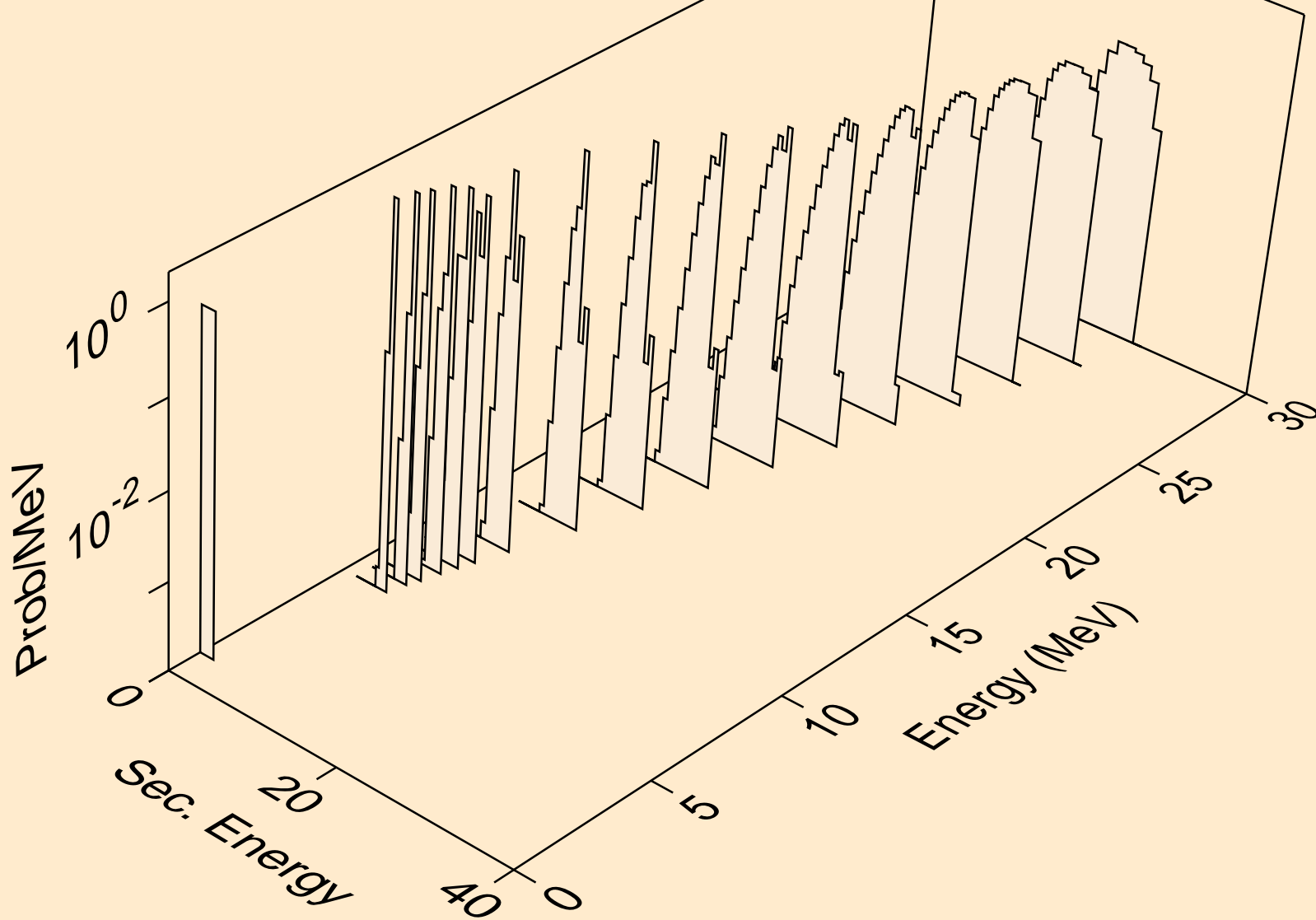

ER157 NEUTRON ACER TENDL-2019 LIBRARY; T=293.16K
alphas from (n,x)

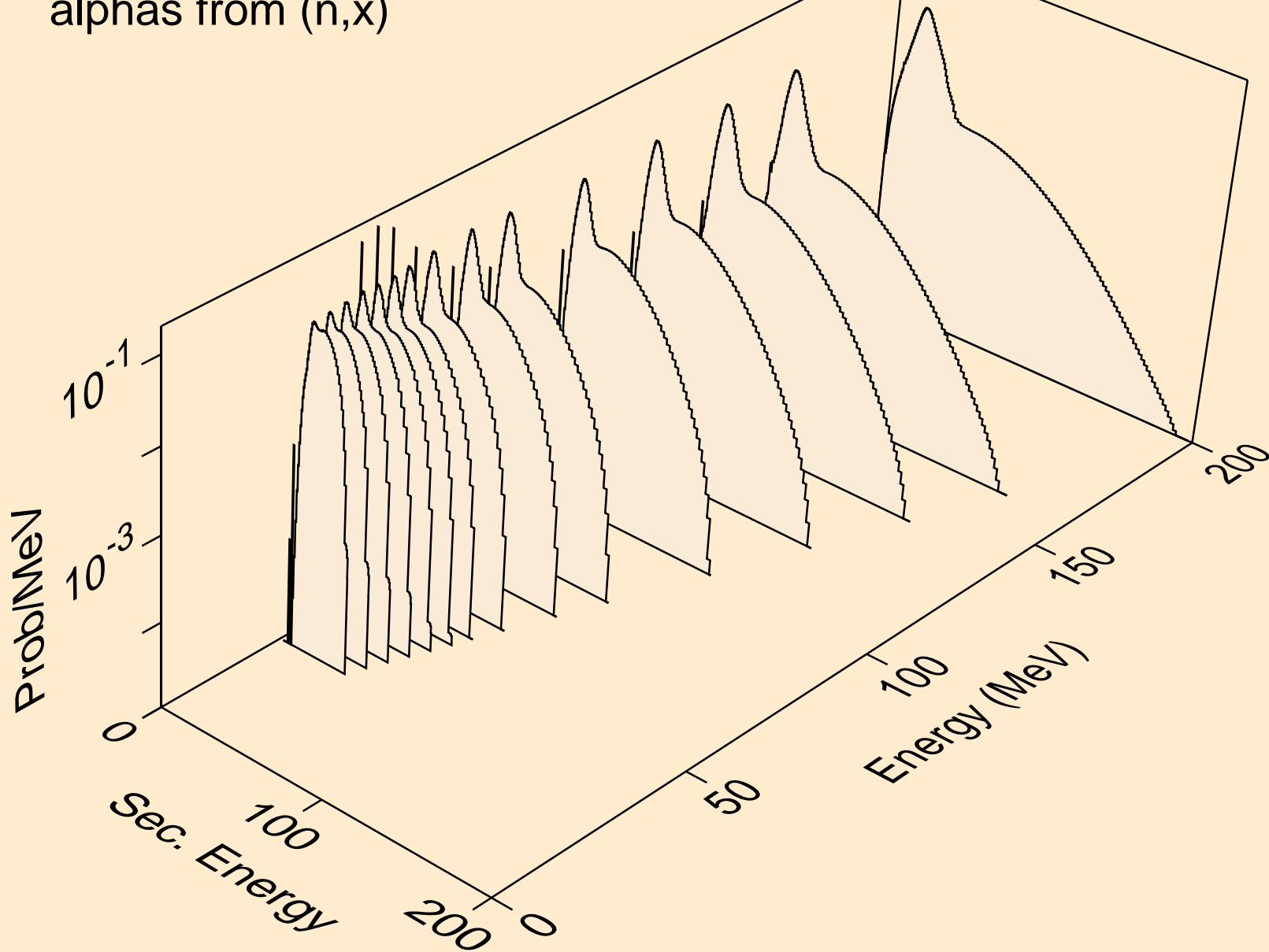

ER157 NEUTRON ACER TENDL-2019 LIBRARY; T=293.16K
alphas from (n,n*)a

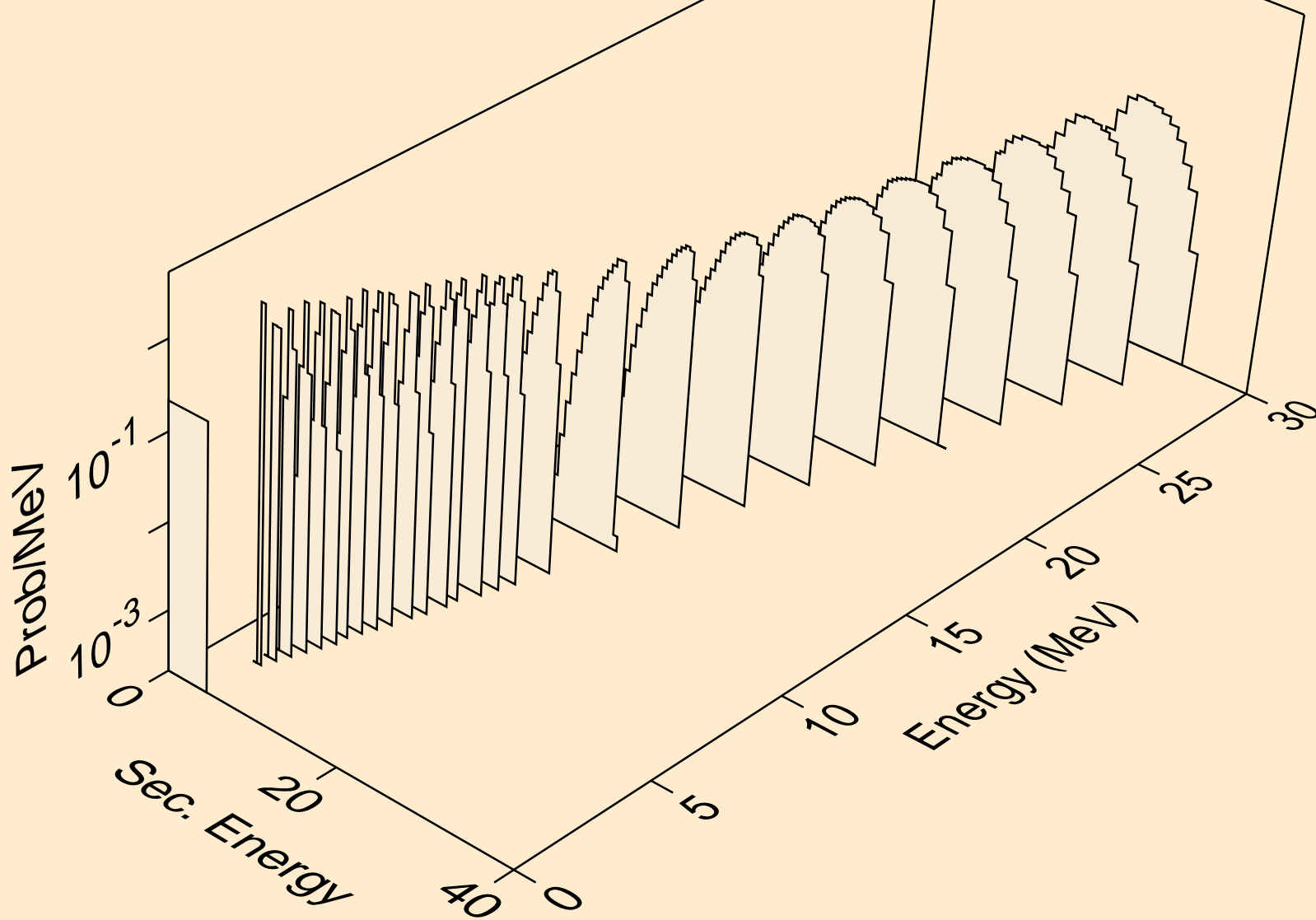

ER157 NEUTRON ACER TENDL-2019 LIBRARY; T=293.16K
alphas from (n,2n)a

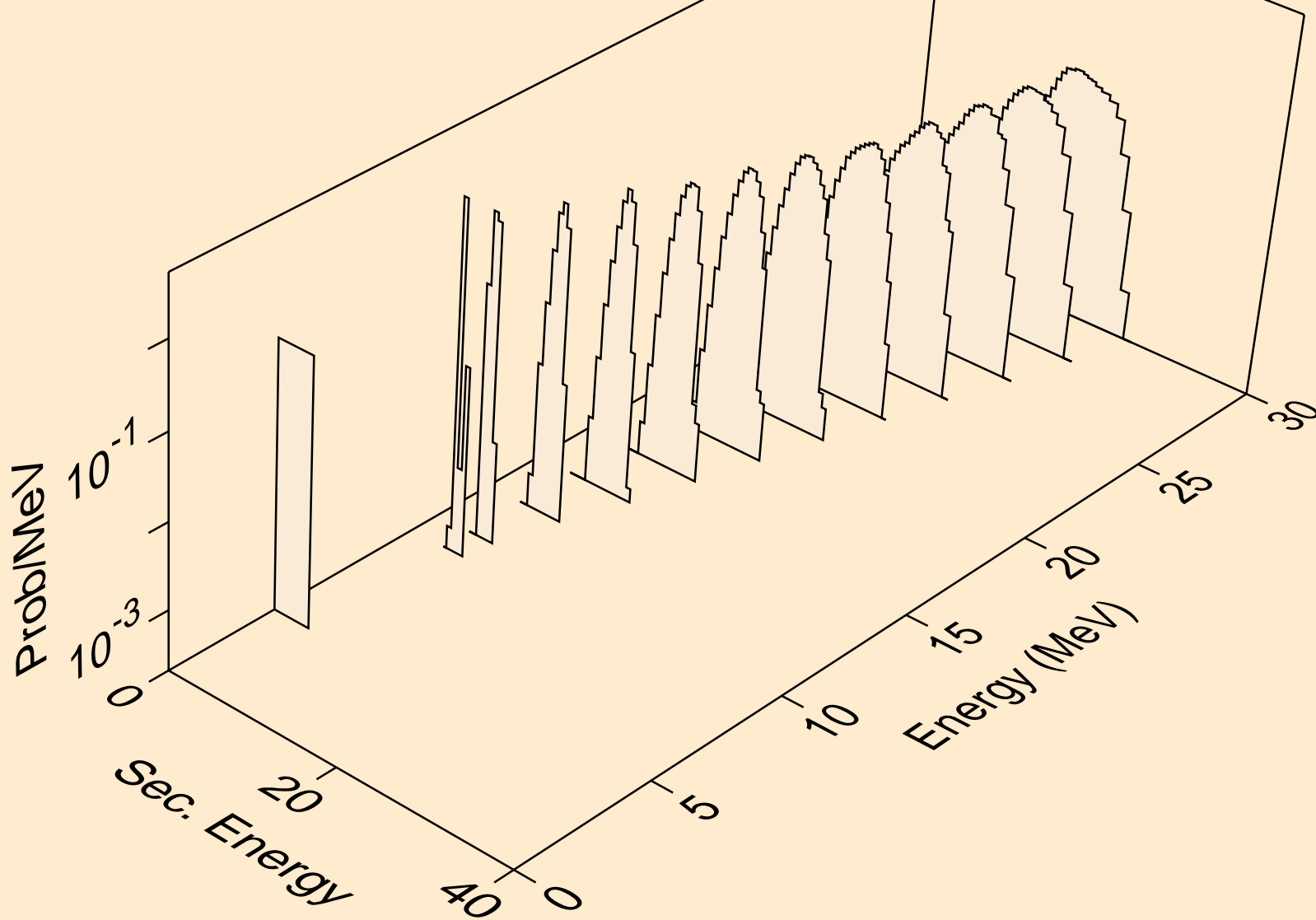

ER157 NEUTRON ACER TENDL-2019 LIBRARY; T=293.16K
alphas from (n,3n)a

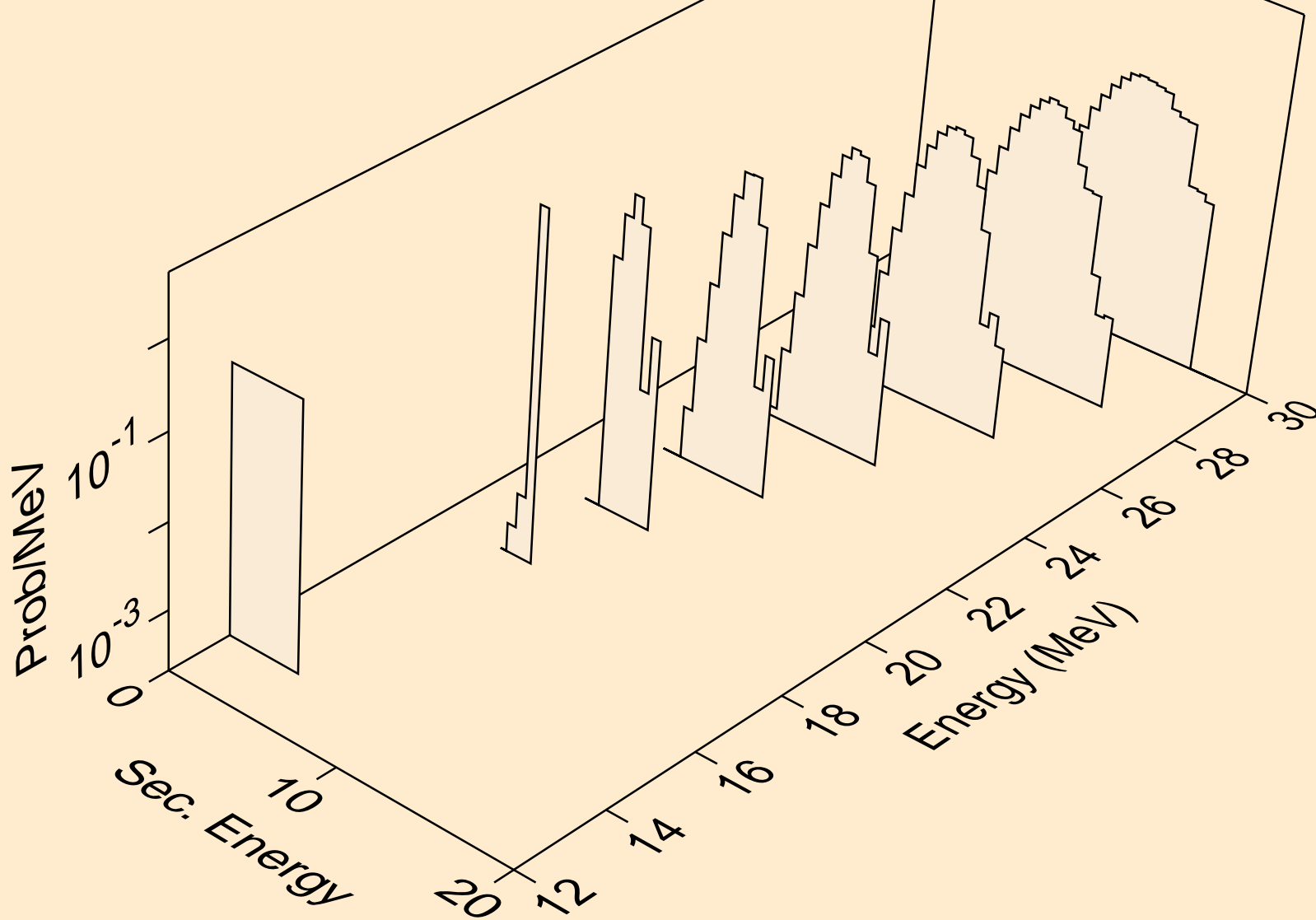

ER157 NEUTRON ACER TENDL-2019 LIBRARY; T=293.16K
alphas from (n,n*)2a

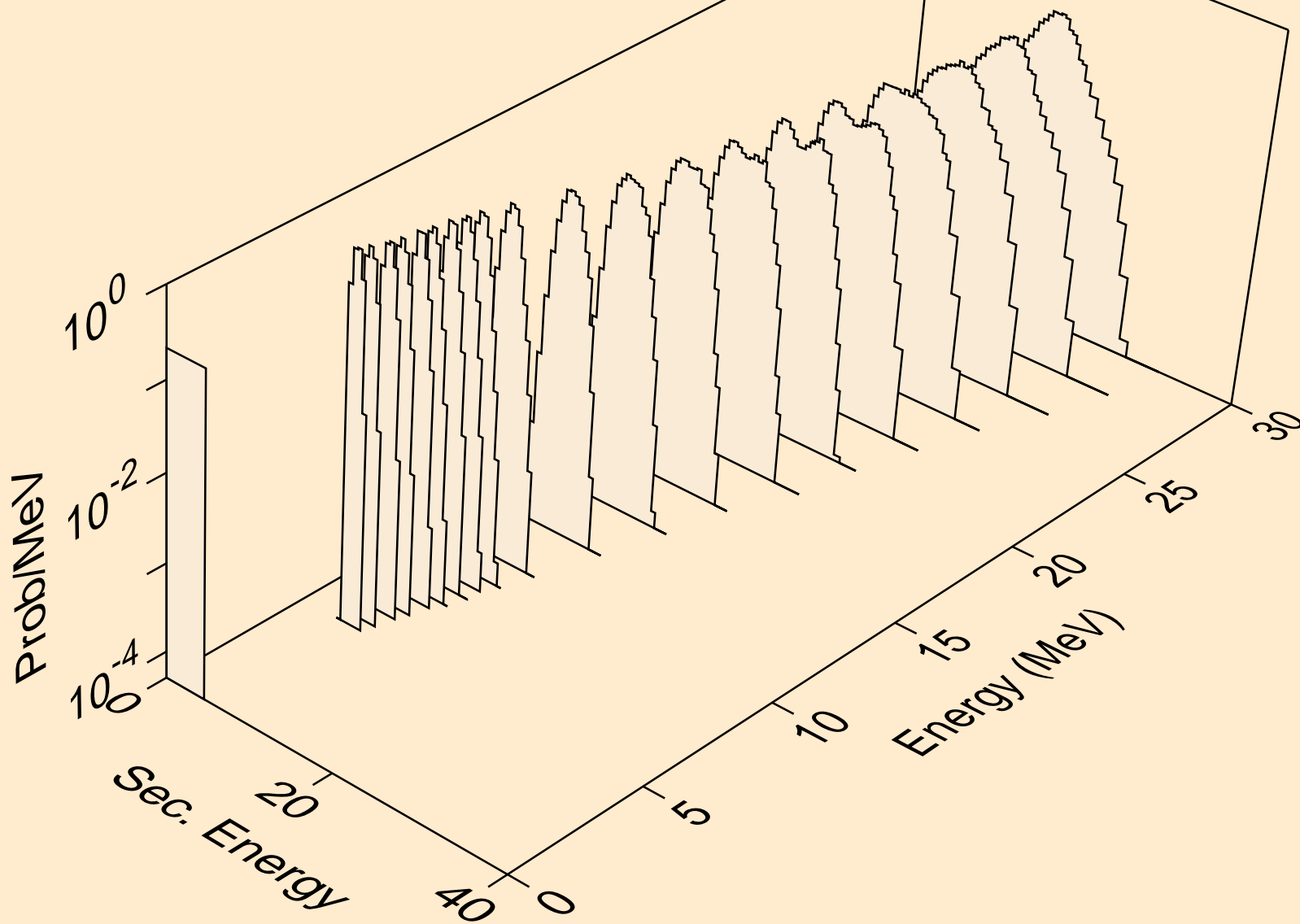

ER157 NEUTRON ACER TENDL-2019 LIBRARY; T=293.16K
alphas from (n,2n)2a

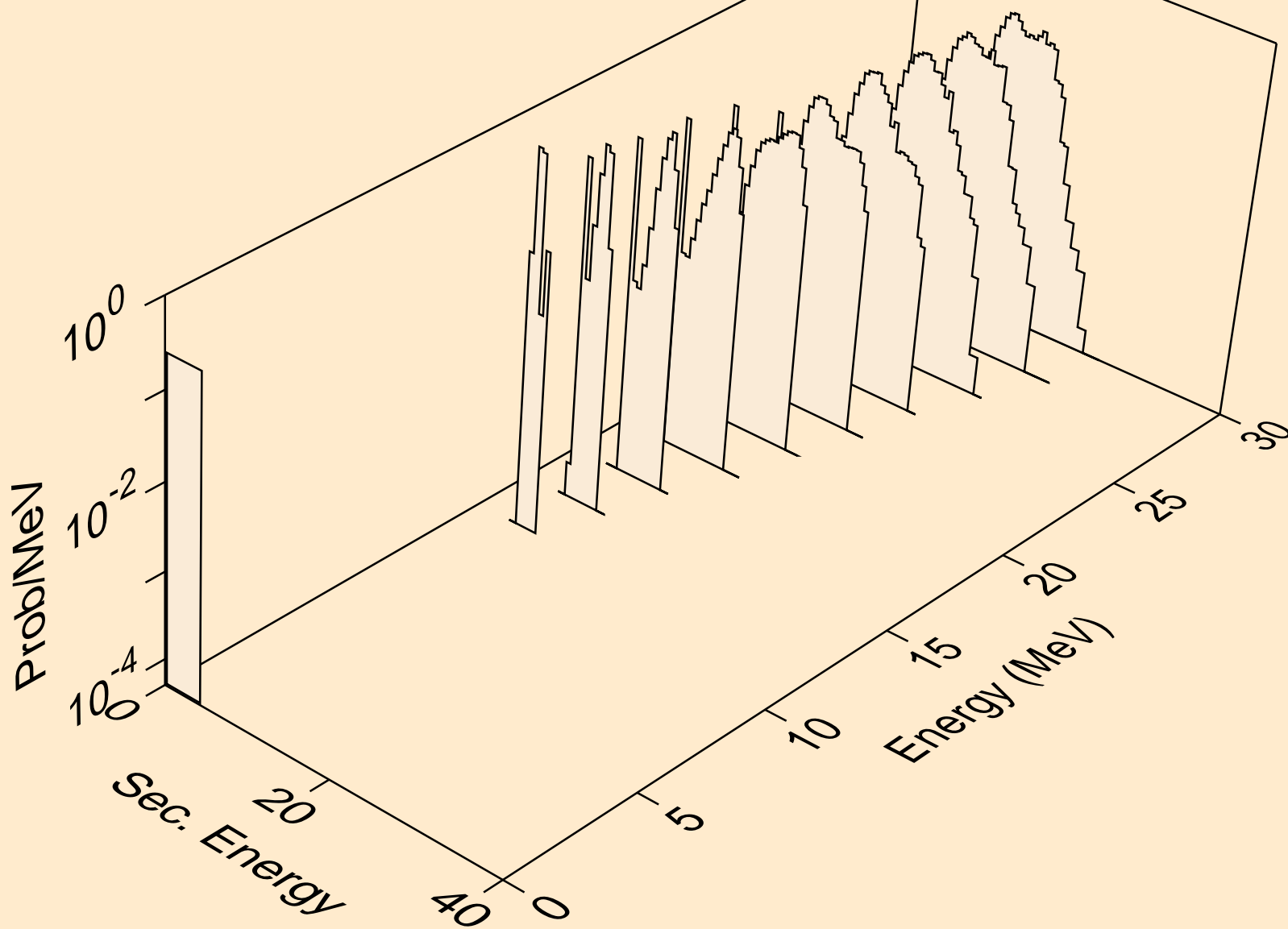

ER157 NEUTRON ACER TENDL-2019 LIBRARY; T=293.16K
alphas from (n,npa)

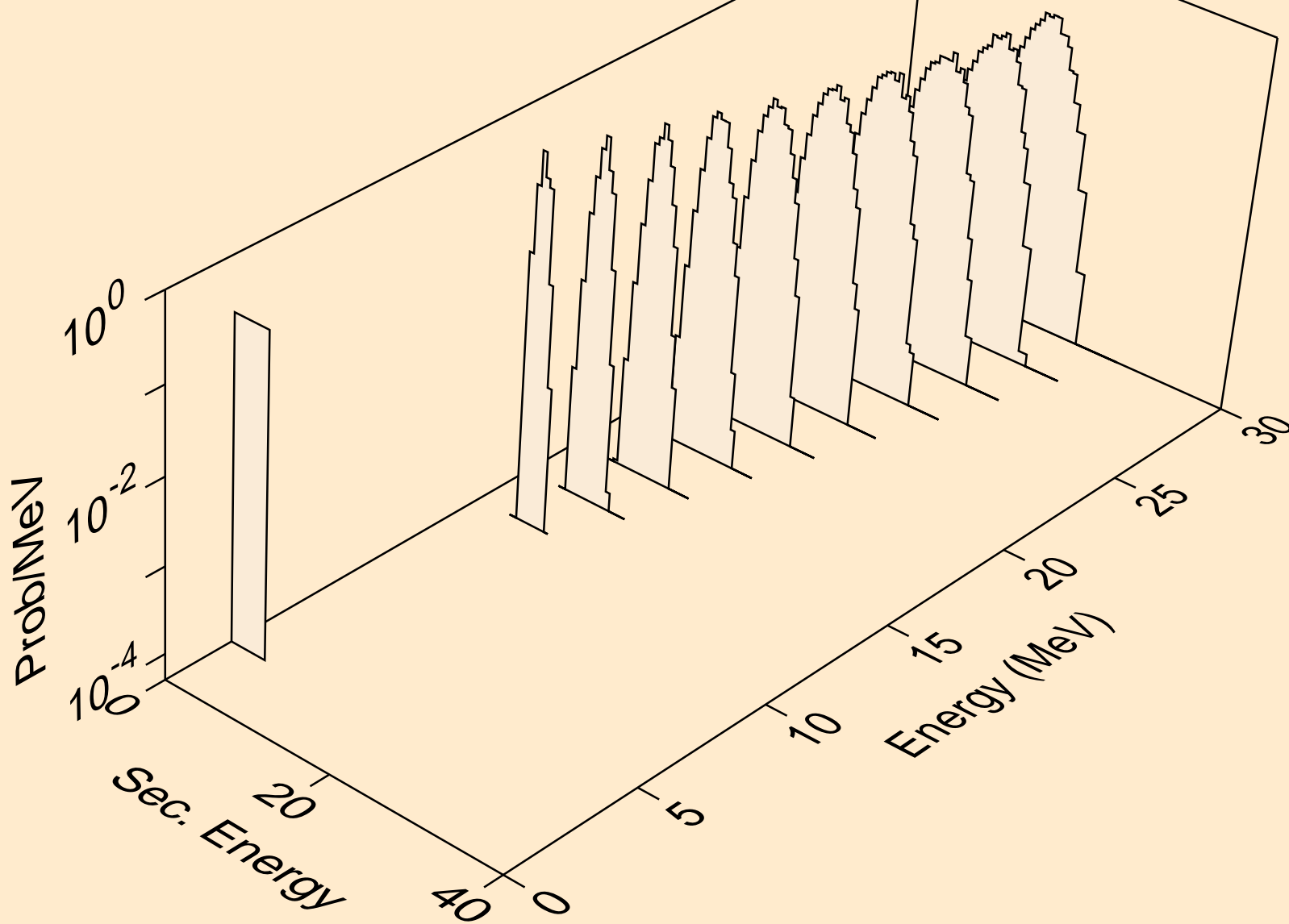

ER157 NEUTRON ACER TENDL-2019 LIBRARY; T=293.16K
alphas from (n,a)

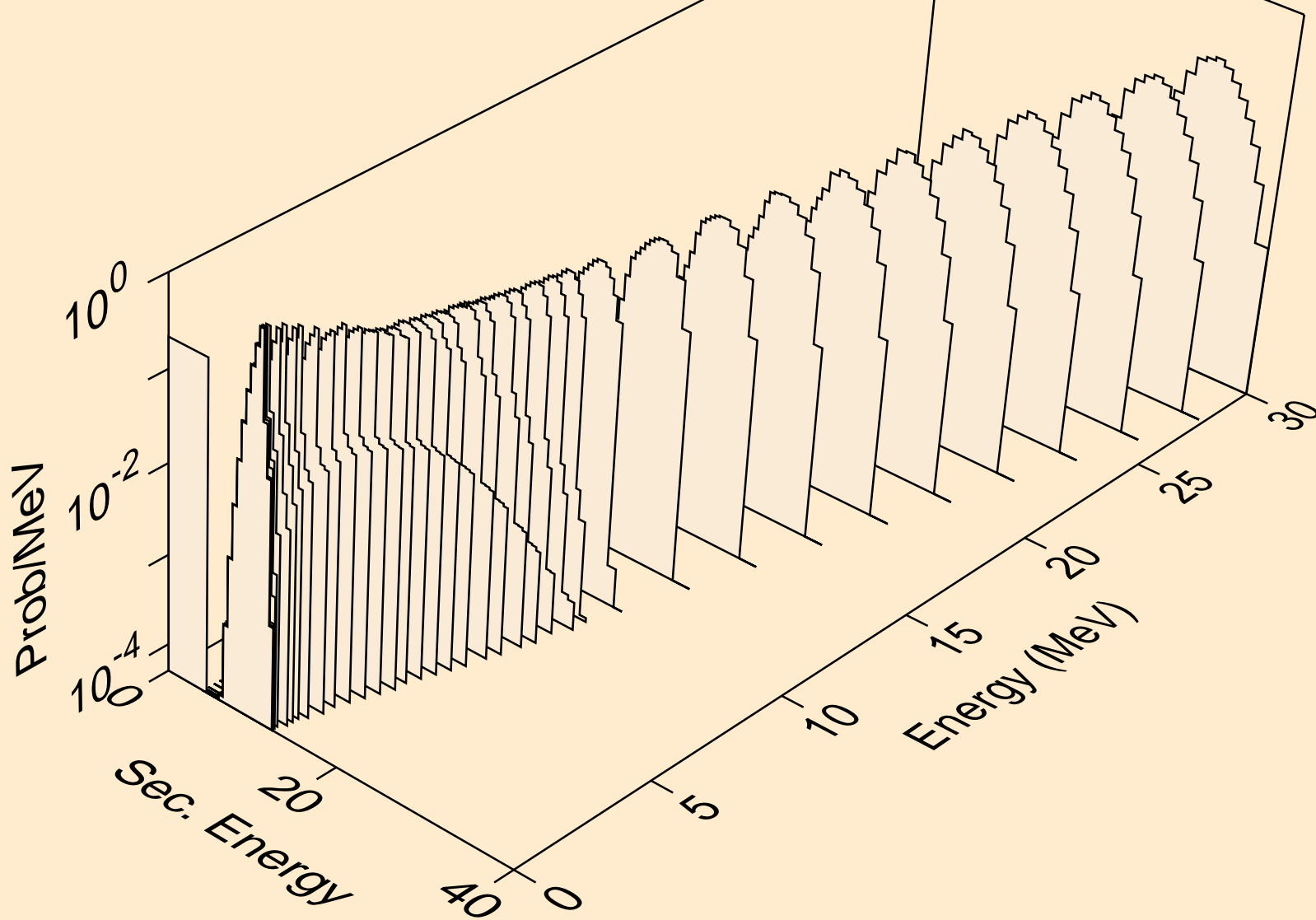

ER157 NEUTRON ACER TENDL-2019 LIBRARY; T=293.16K
alphas from (n,2a)

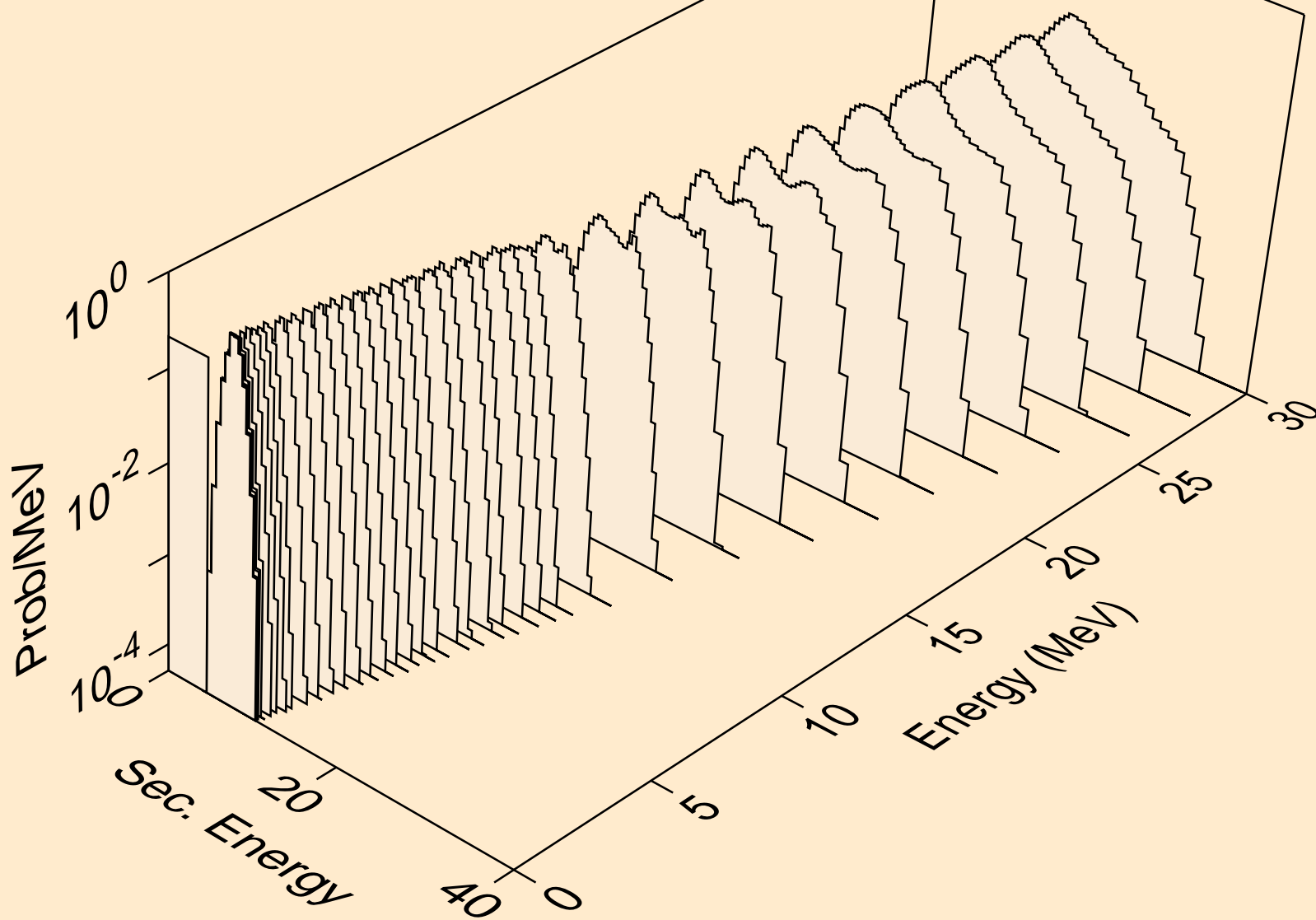

ER157 NEUTRON ACER TENDL-2019 LIBRARY; T=293.16K
alphas from (n,pa)

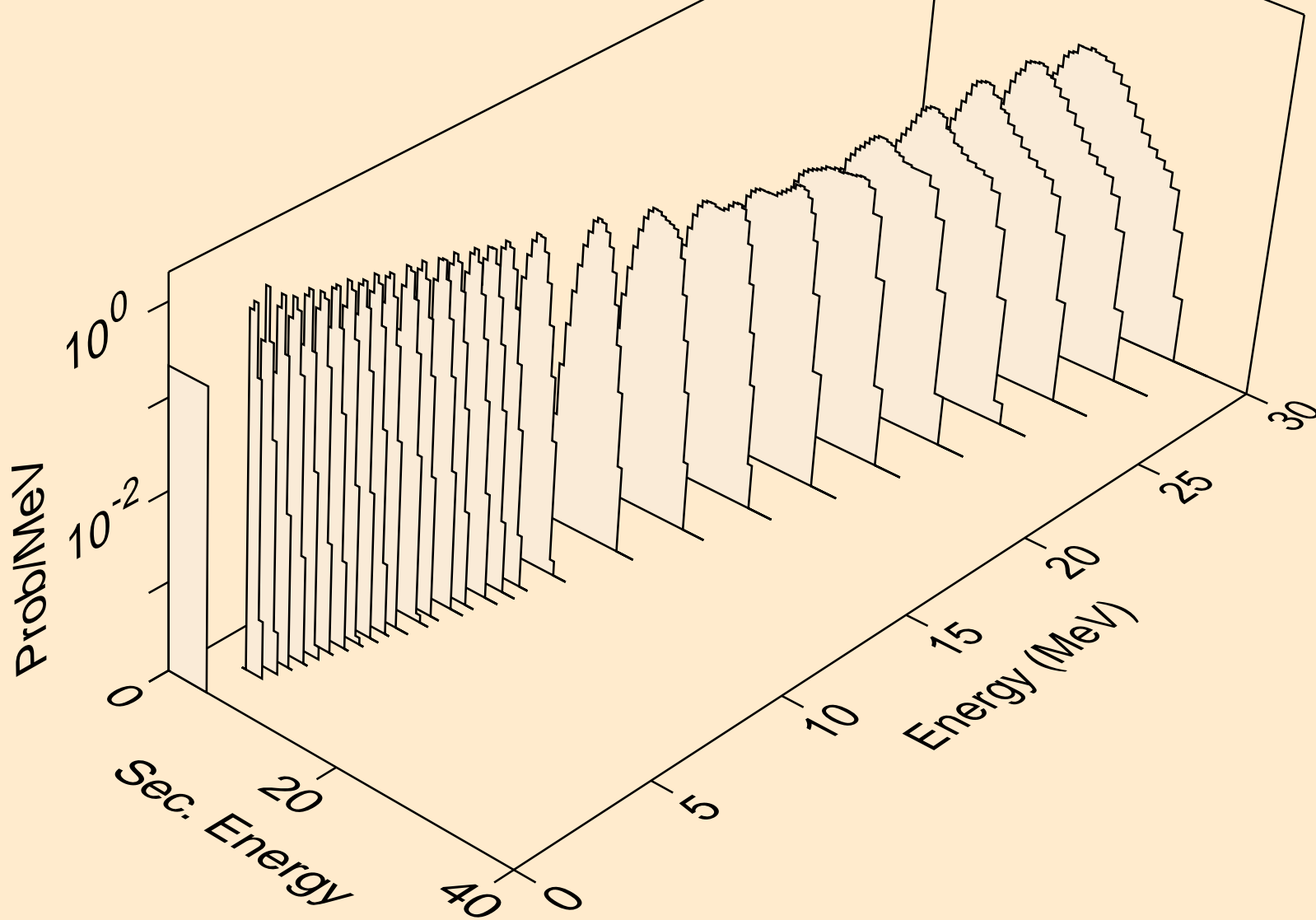

ER157 NEUTRON ACER TENDL-2019 LIBRARY; T=293.16K
alphas from (n,da)

