

ES249 NEUTRON ACER TENDL-2019 LIBRARY; T=293.16K
Principal cross sections

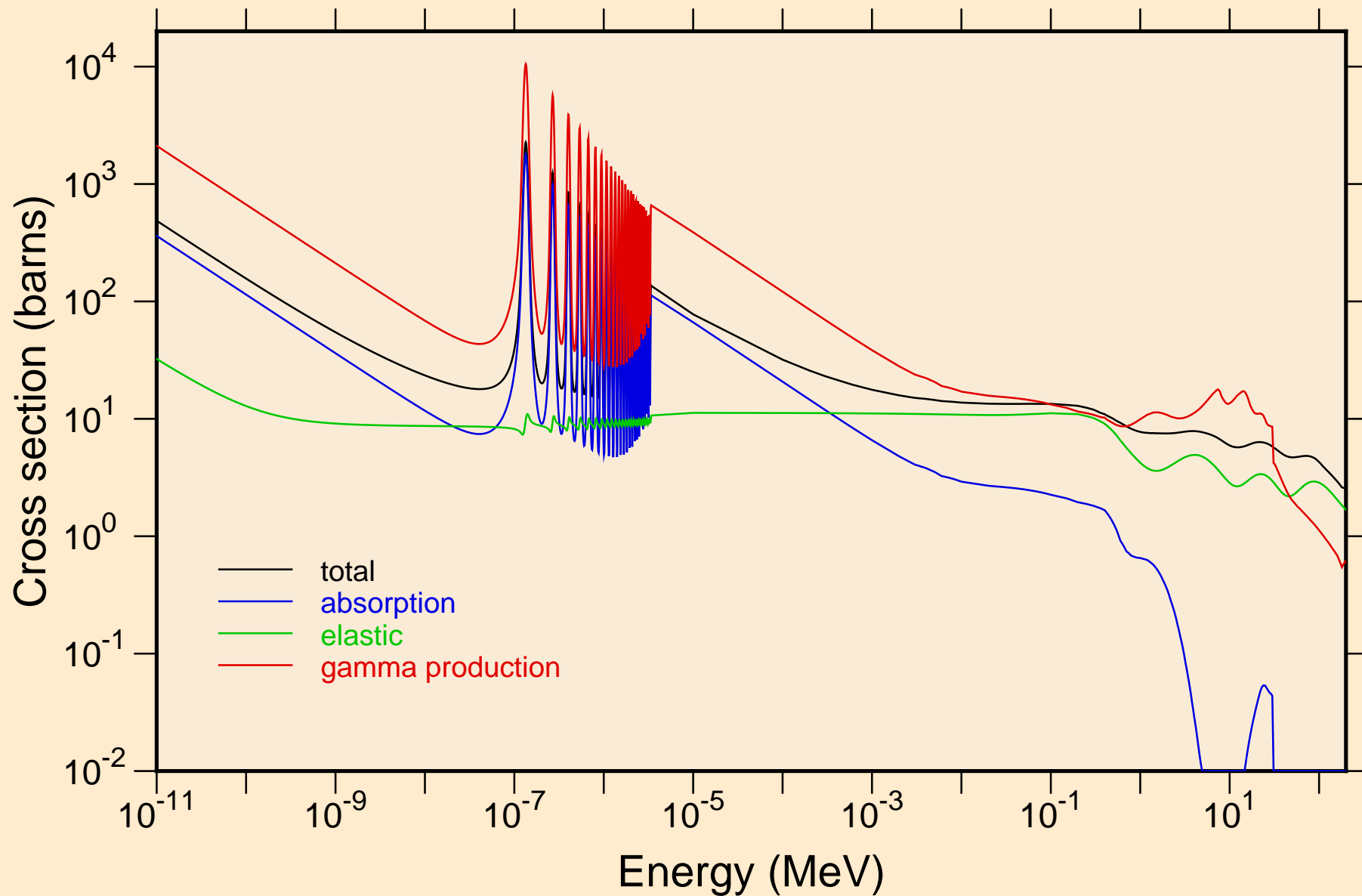

ES249 NEUTRON ACER TENDL-2019 LIBRARY; T=293.16K
resonance total cross section

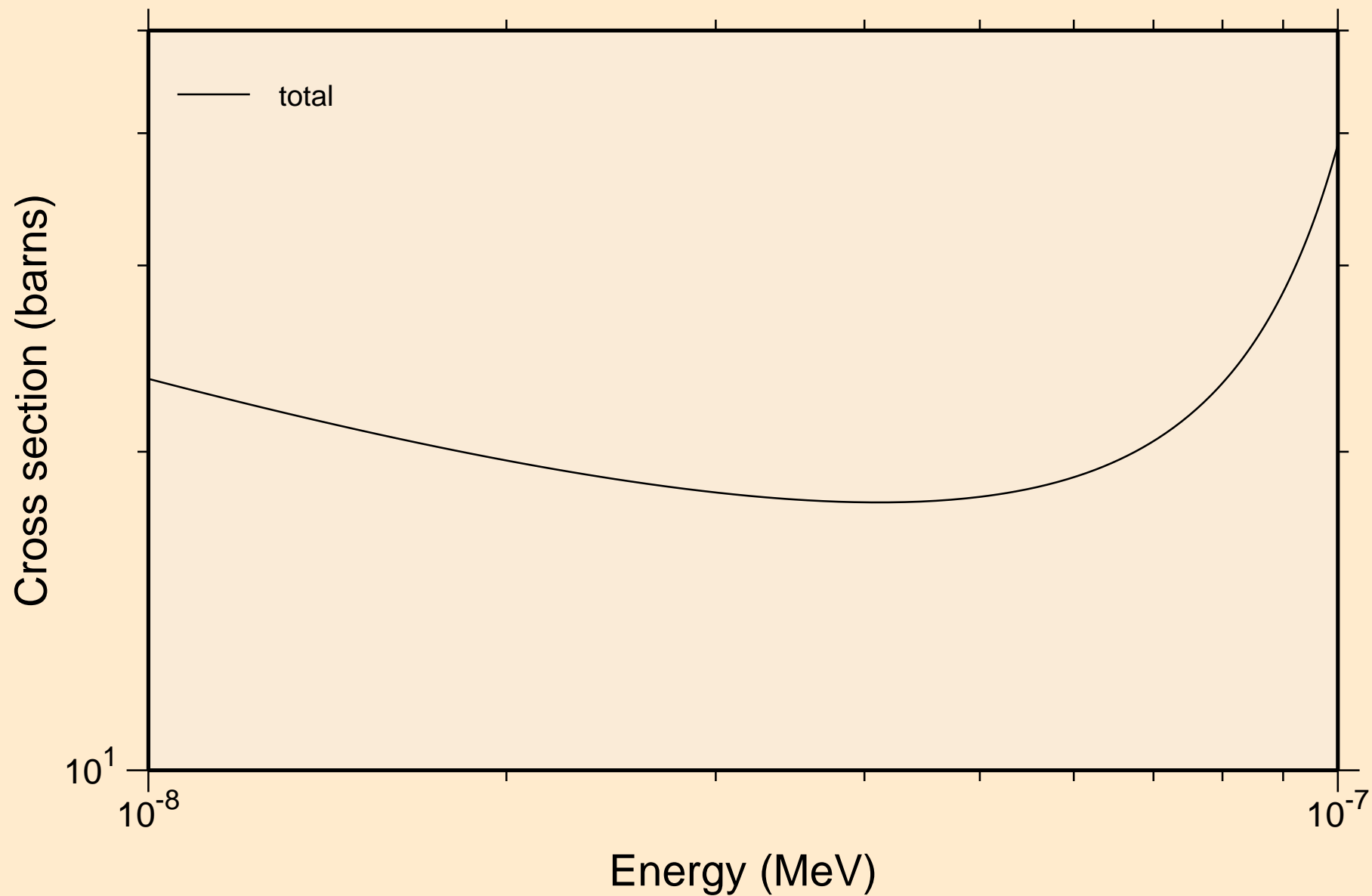

ES249 NEUTRON ACER TENDL-2019 LIBRARY; T=293.16K
resonance total cross section

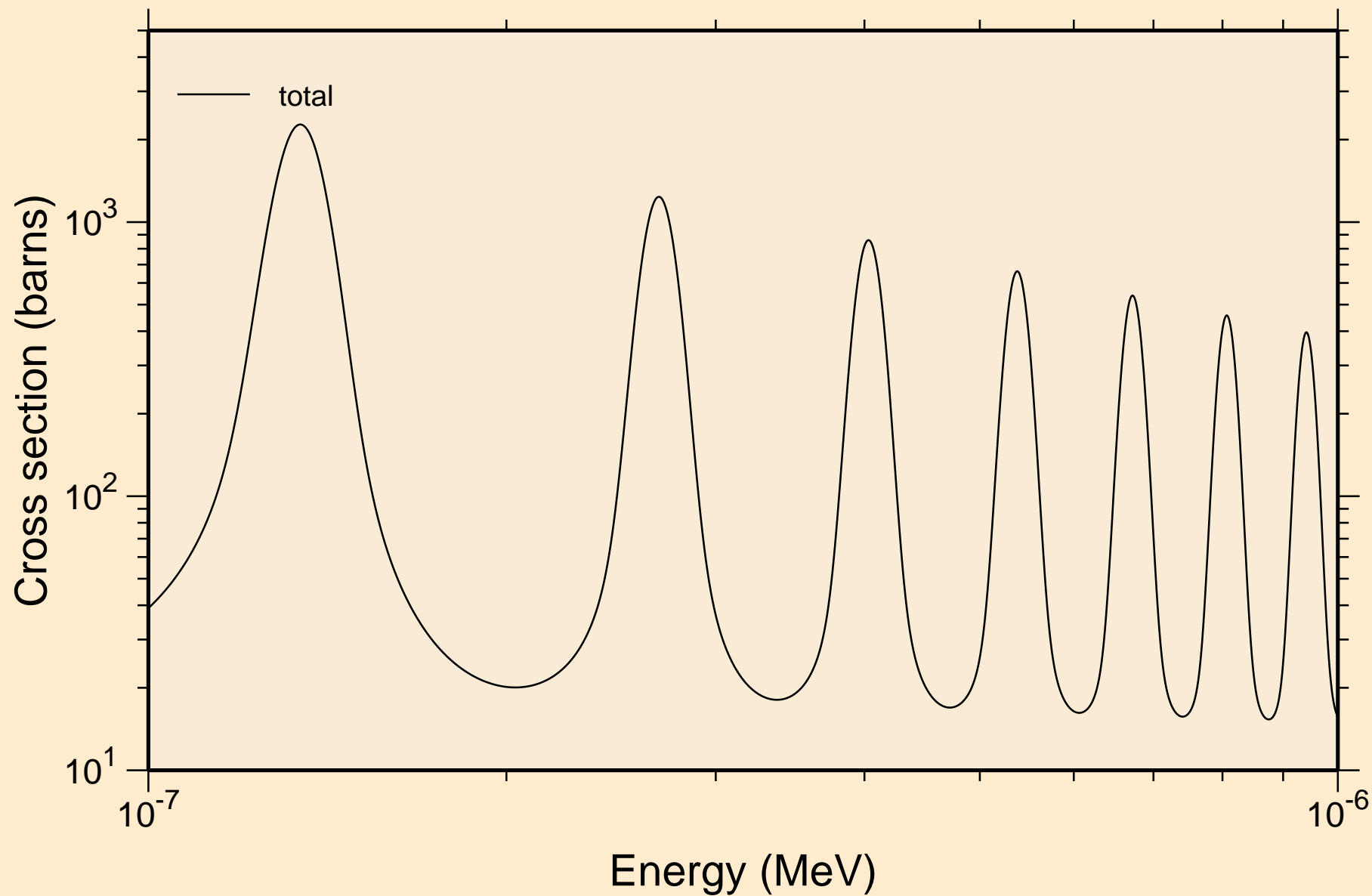

ES249 NEUTRON ACER TENDL-2019 LIBRARY; T=293.16K
resonance total cross section

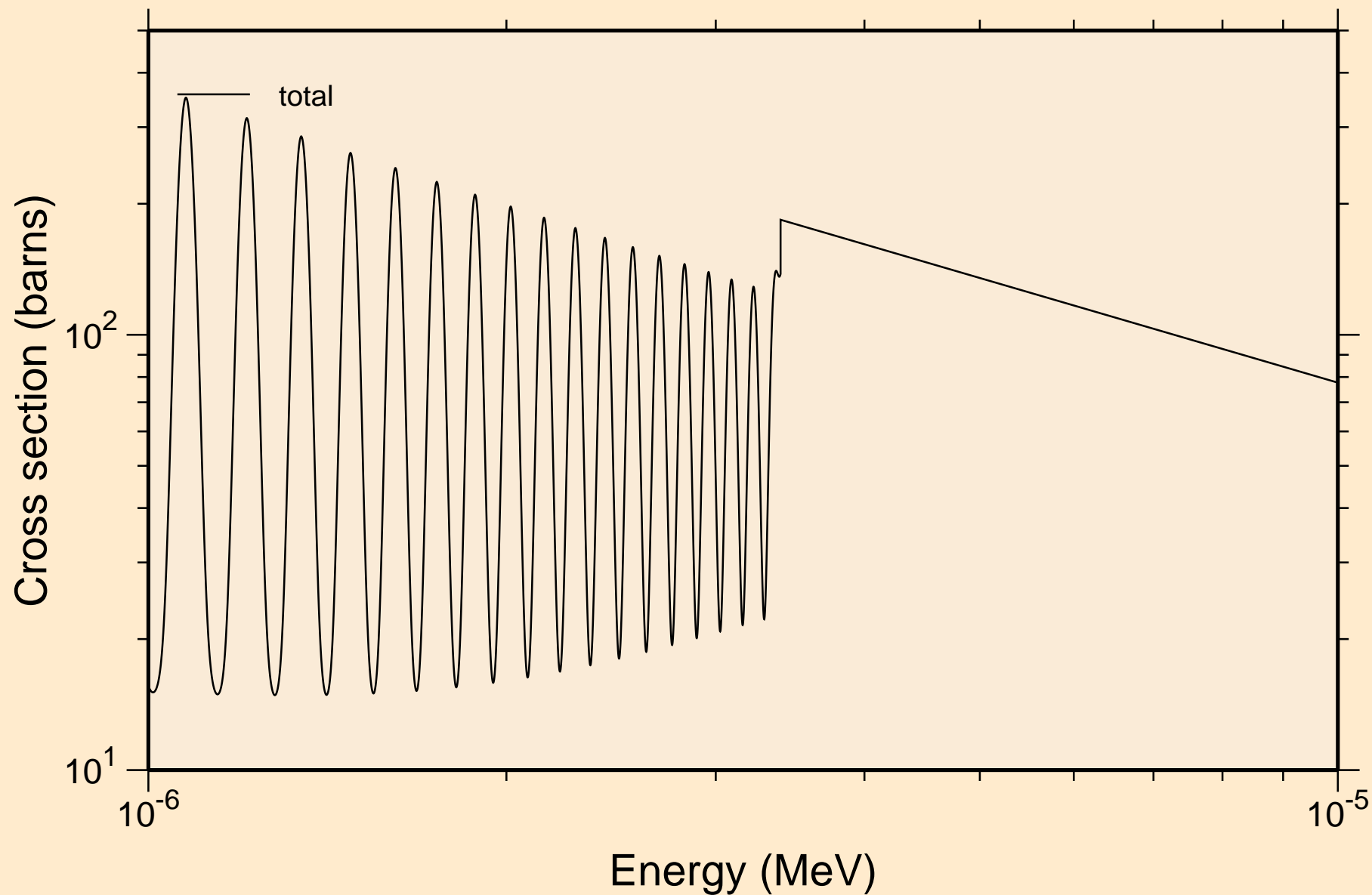

ES249 NEUTRON ACER TENDL-2019 LIBRARY; T=293.16K
resonance total cross section

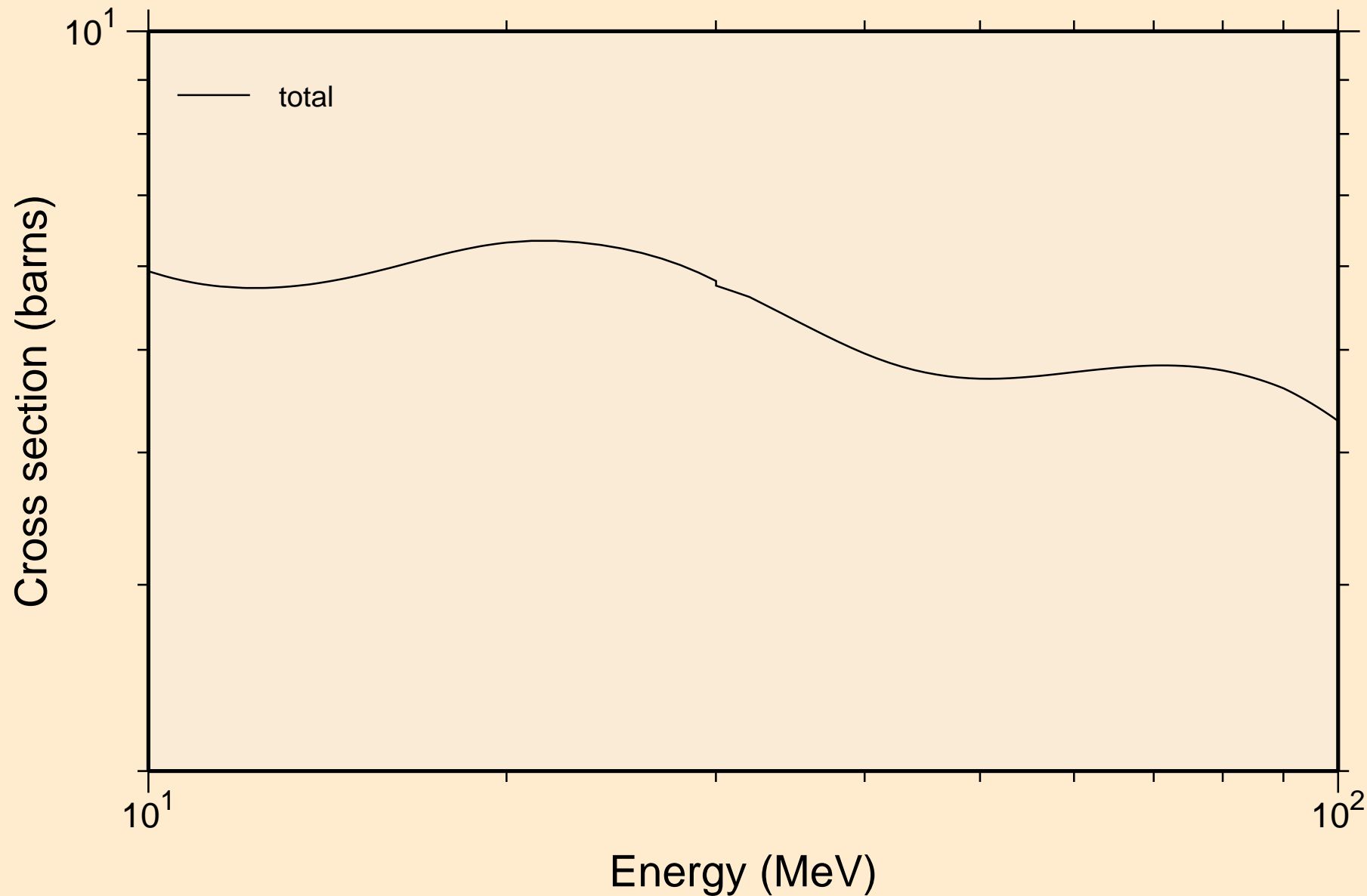

ES249 NEUTRON ACER TENDL-2019 LIBRARY; T=293.16K
resonance absorption cross sections

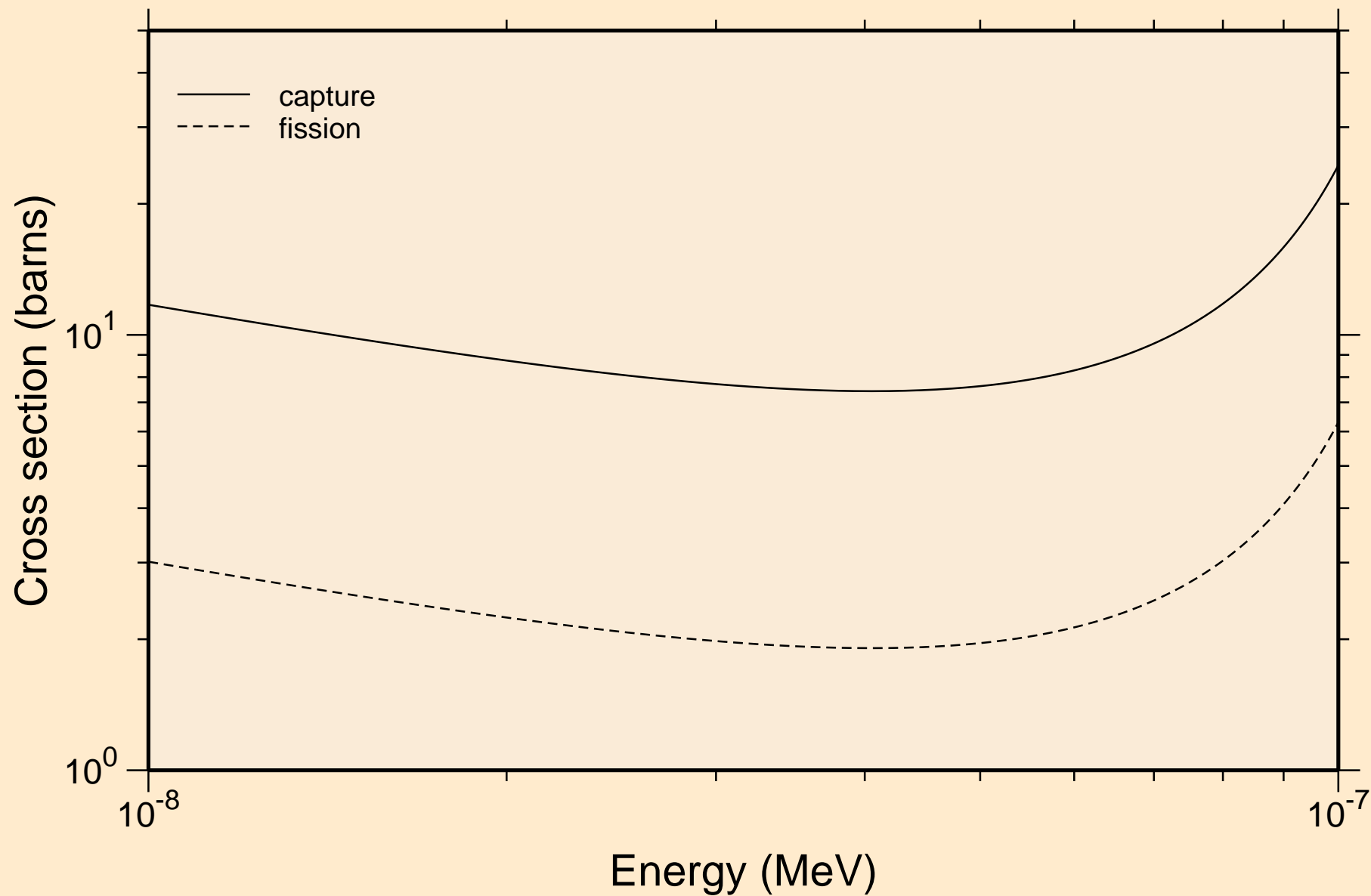

ES249 NEUTRON ACER TENDL-2019 LIBRARY; T=293.16K
resonance absorption cross sections

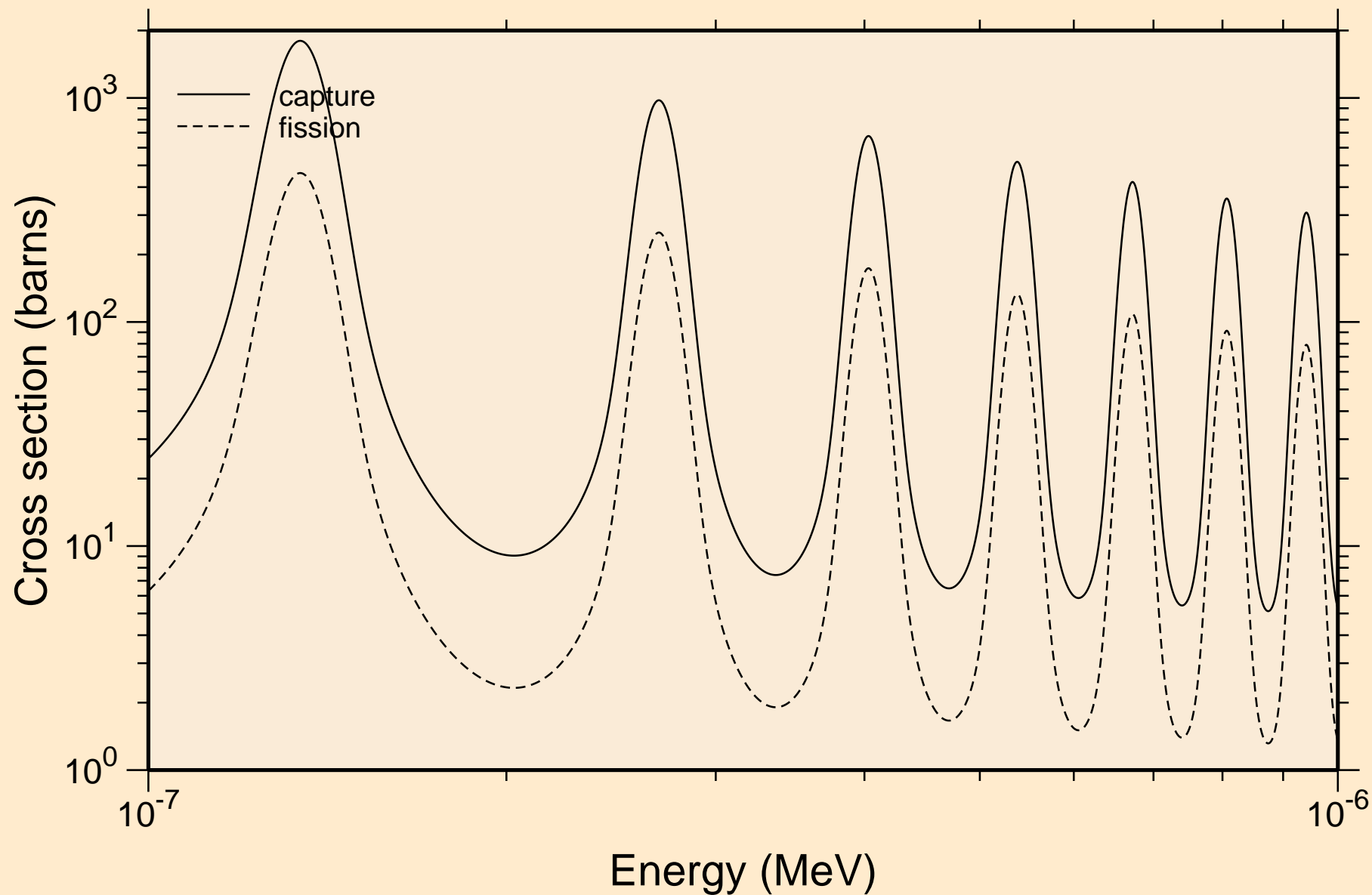

ES249 NEUTRON ACER TENDL-2019 LIBRARY; T=293.16K
resonance absorption cross sections

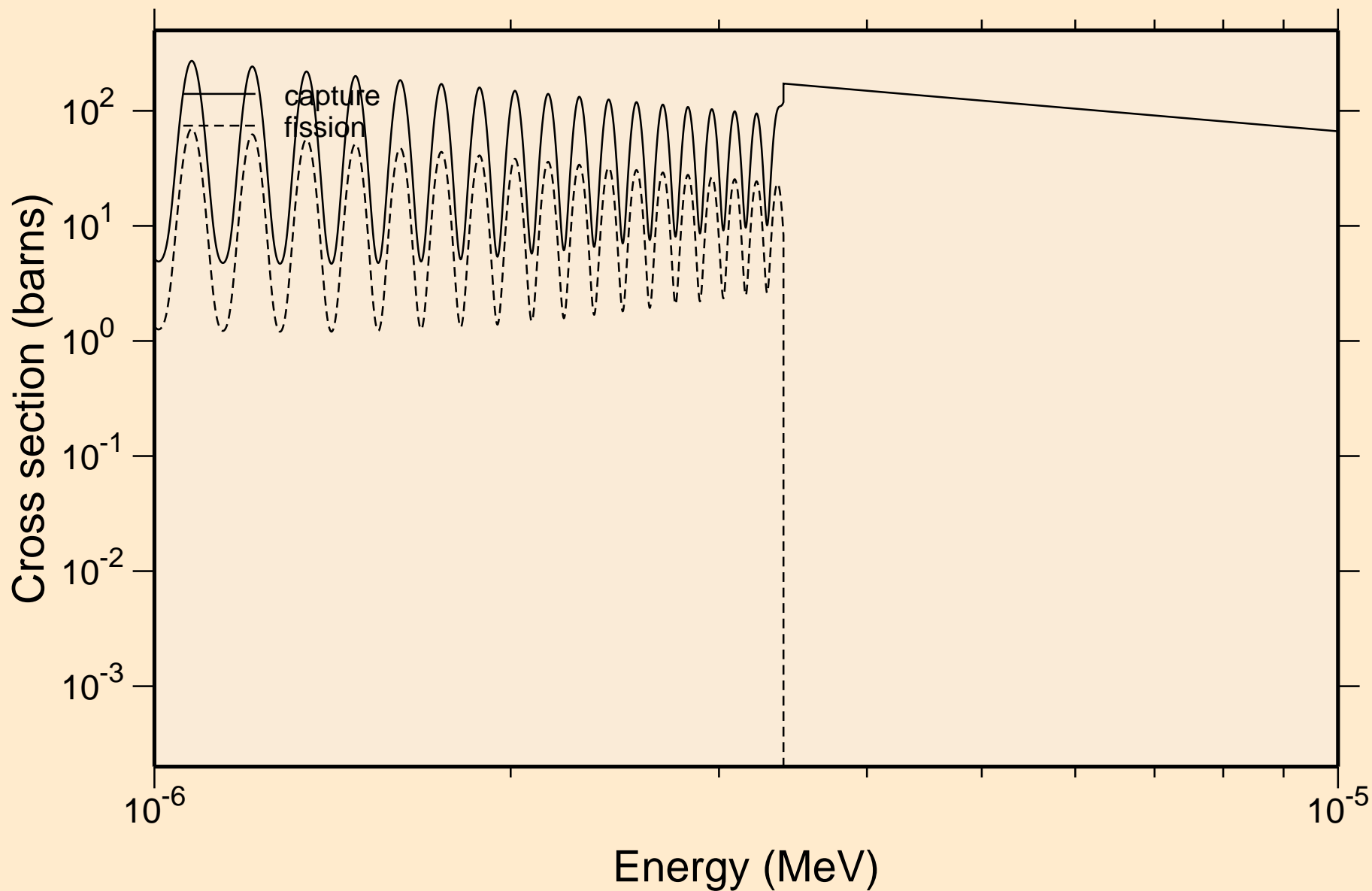

ES249 NEUTRON ACER TENDL-2019 LIBRARY; T=293.16K
resonance absorption cross sections

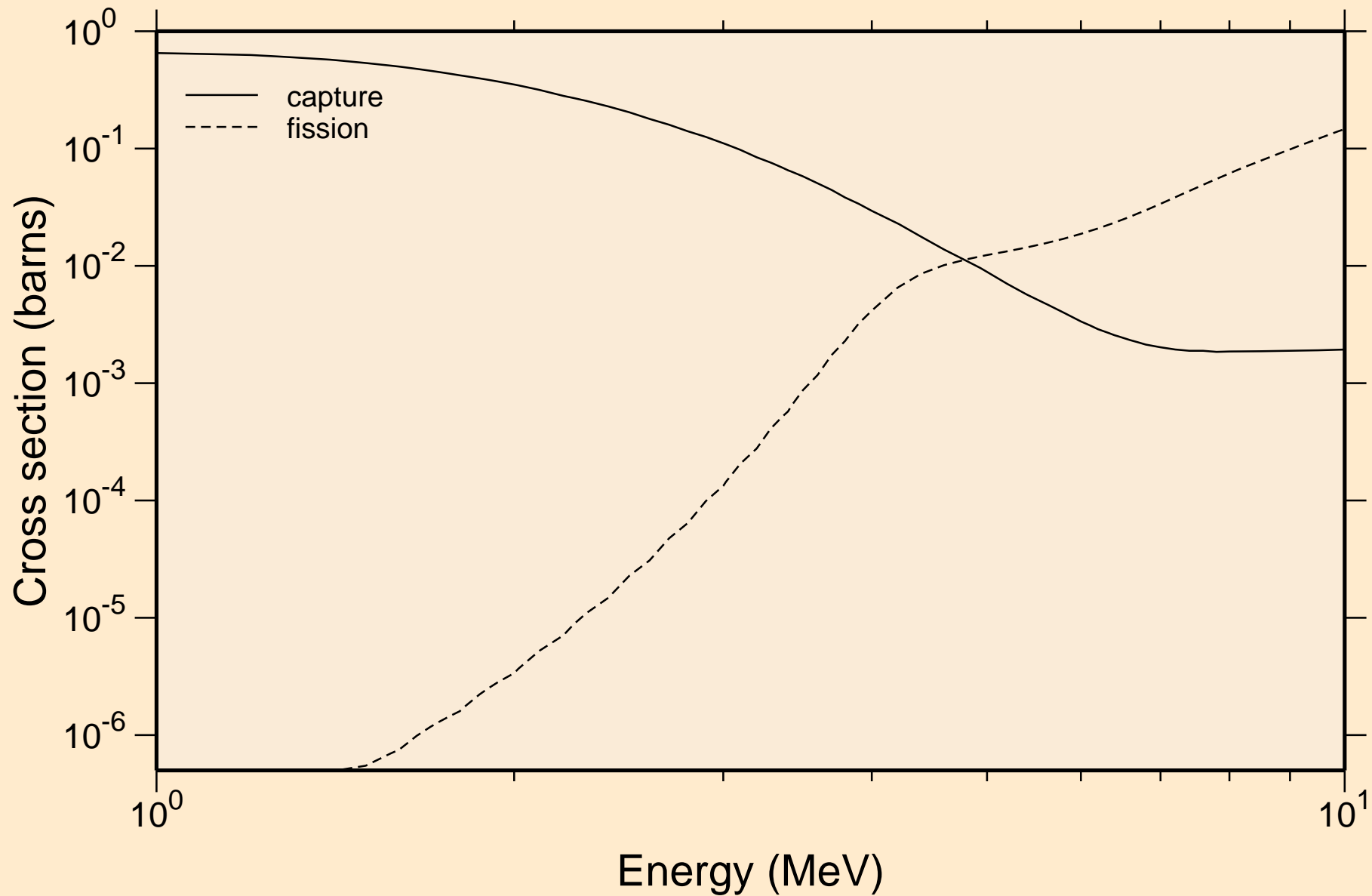

ES249 NEUTRON ACER TENDL-2019 LIBRARY; T=293.16K
Heating

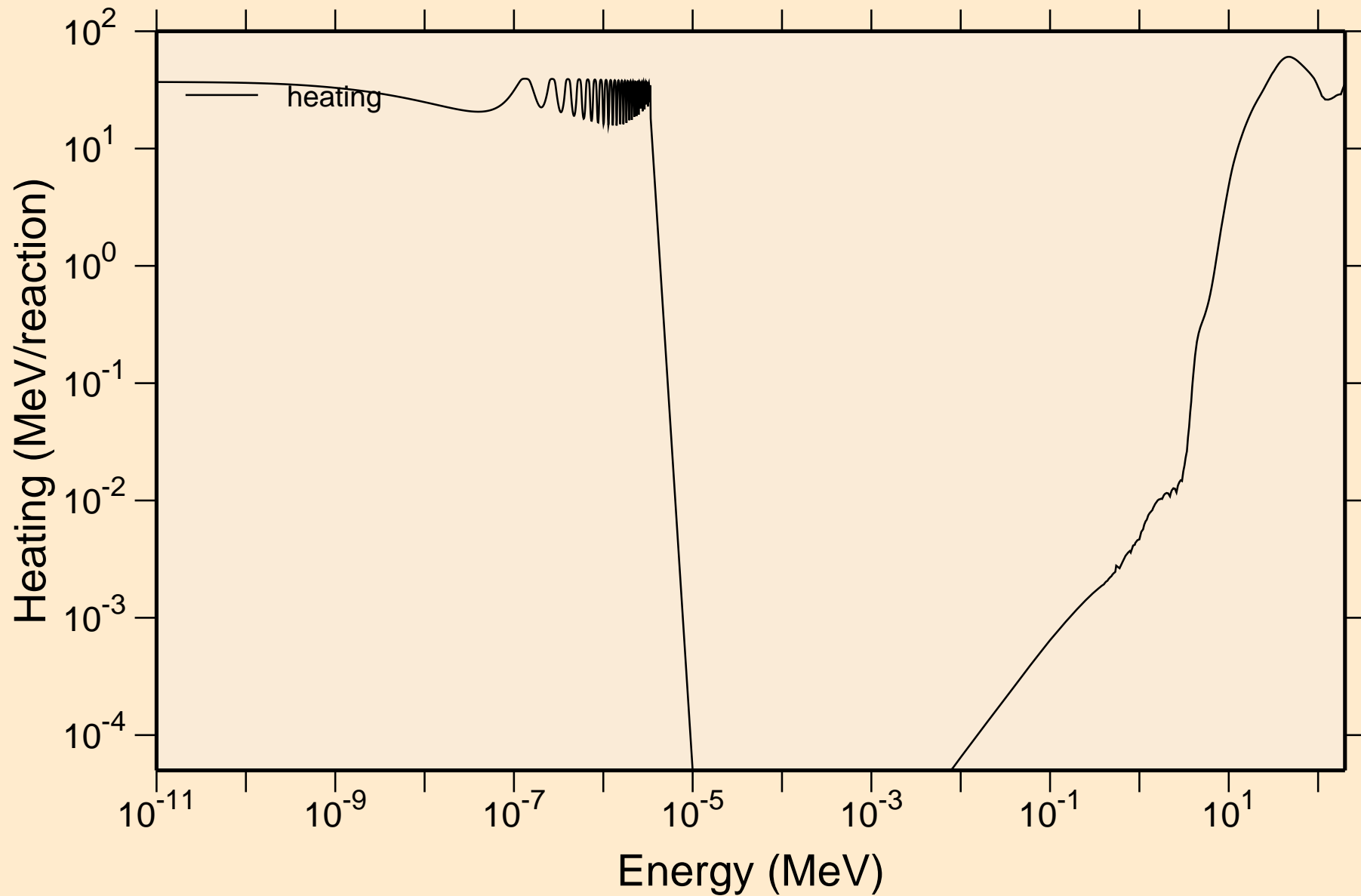

ES249 NEUTRON ACER TENDL-2019 LIBRARY; T=293.16K
Damage

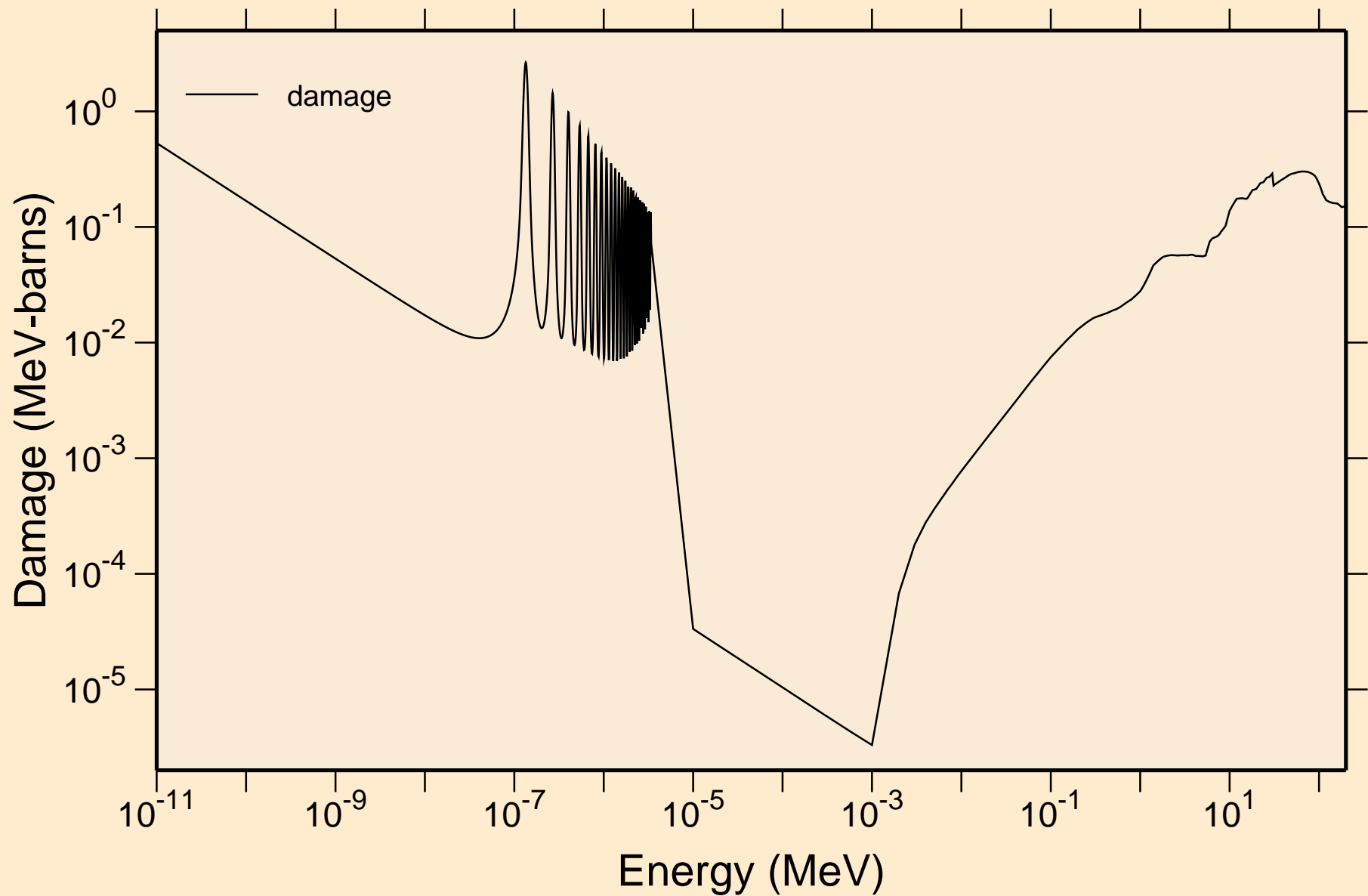

ES249 NEUTRON ACER TENDL-2019 LIBRARY; T=293.16K

Non-threshold reactions

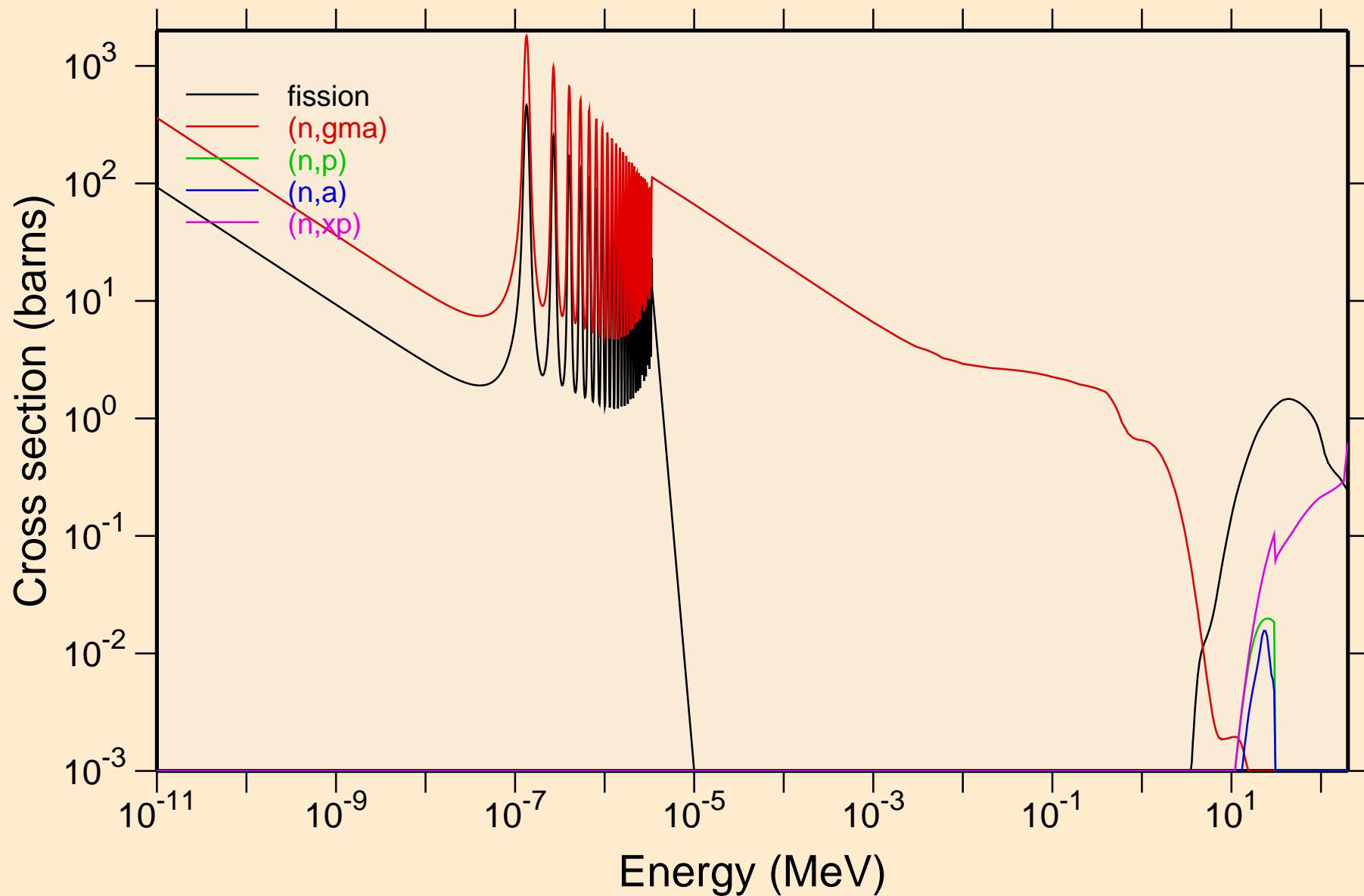

ES249 NEUTRON ACER TENDL-2019 LIBRARY; T=293.16K
Non-threshold reactions

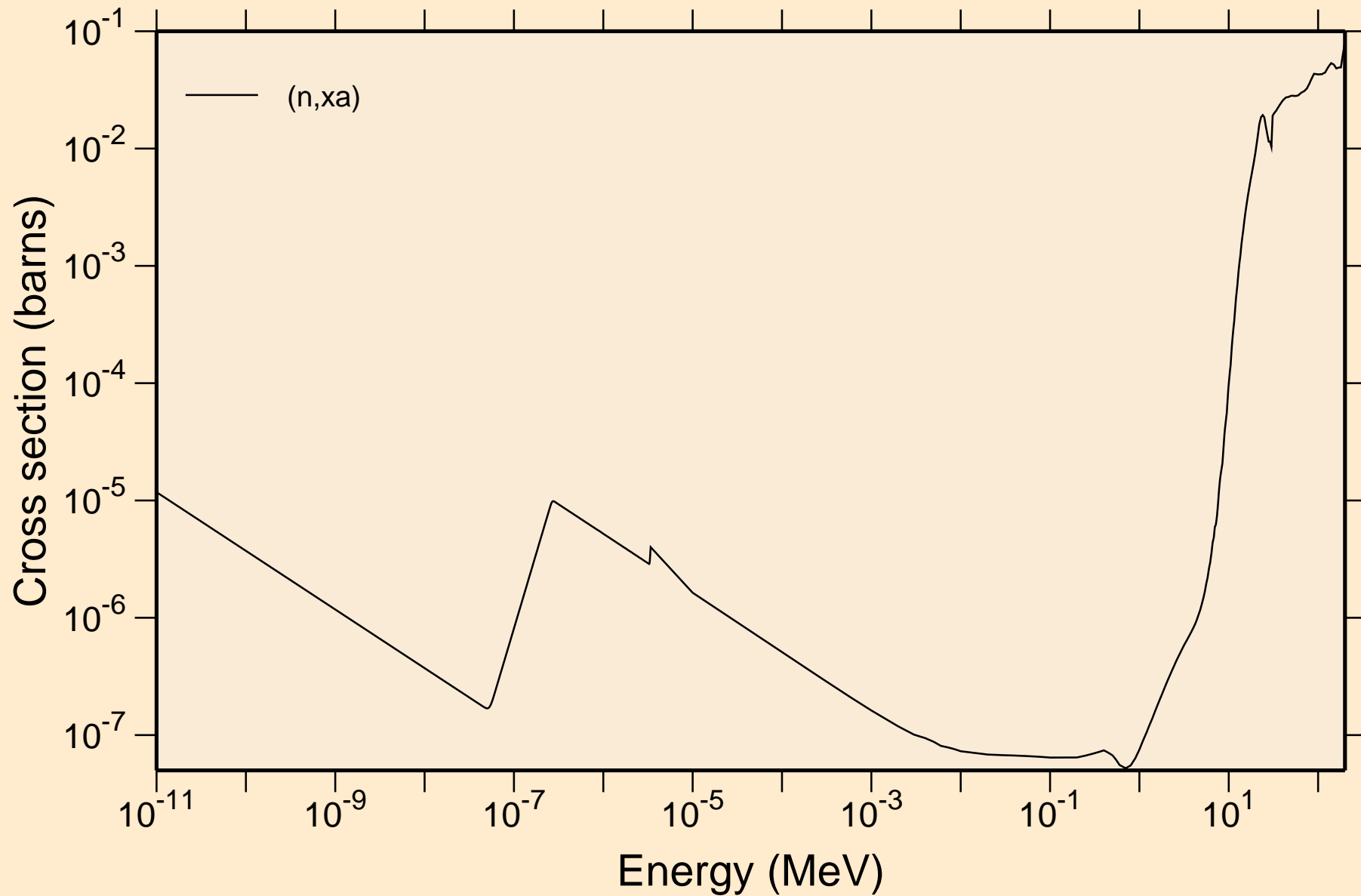

ES249 NEUTRON ACER TENDL-2019 LIBRARY; T=293.16K
Principal cross sections

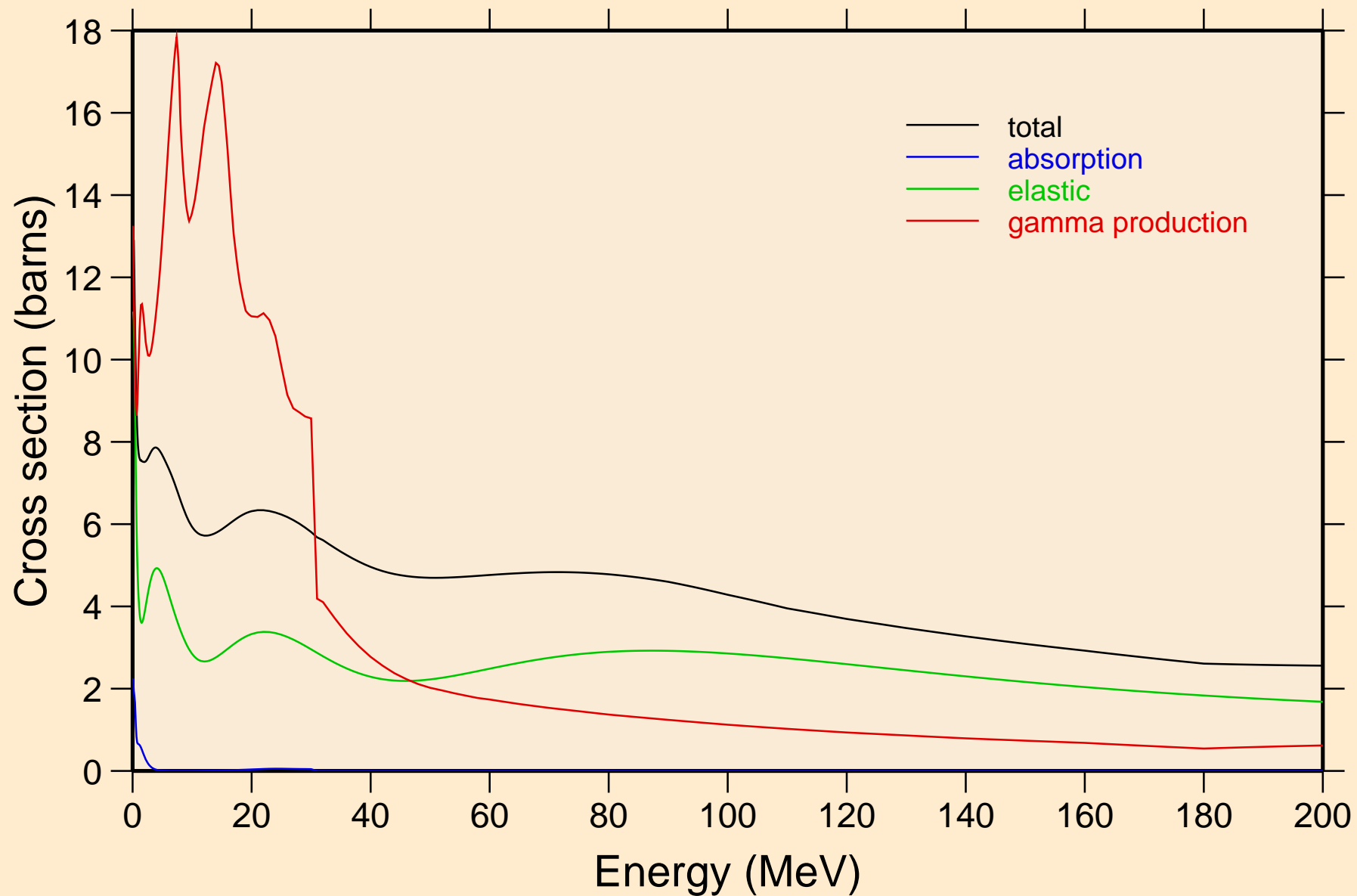

ES249 NEUTRON ACER TENDL-2019 LIBRARY; T=293.16K
Heating

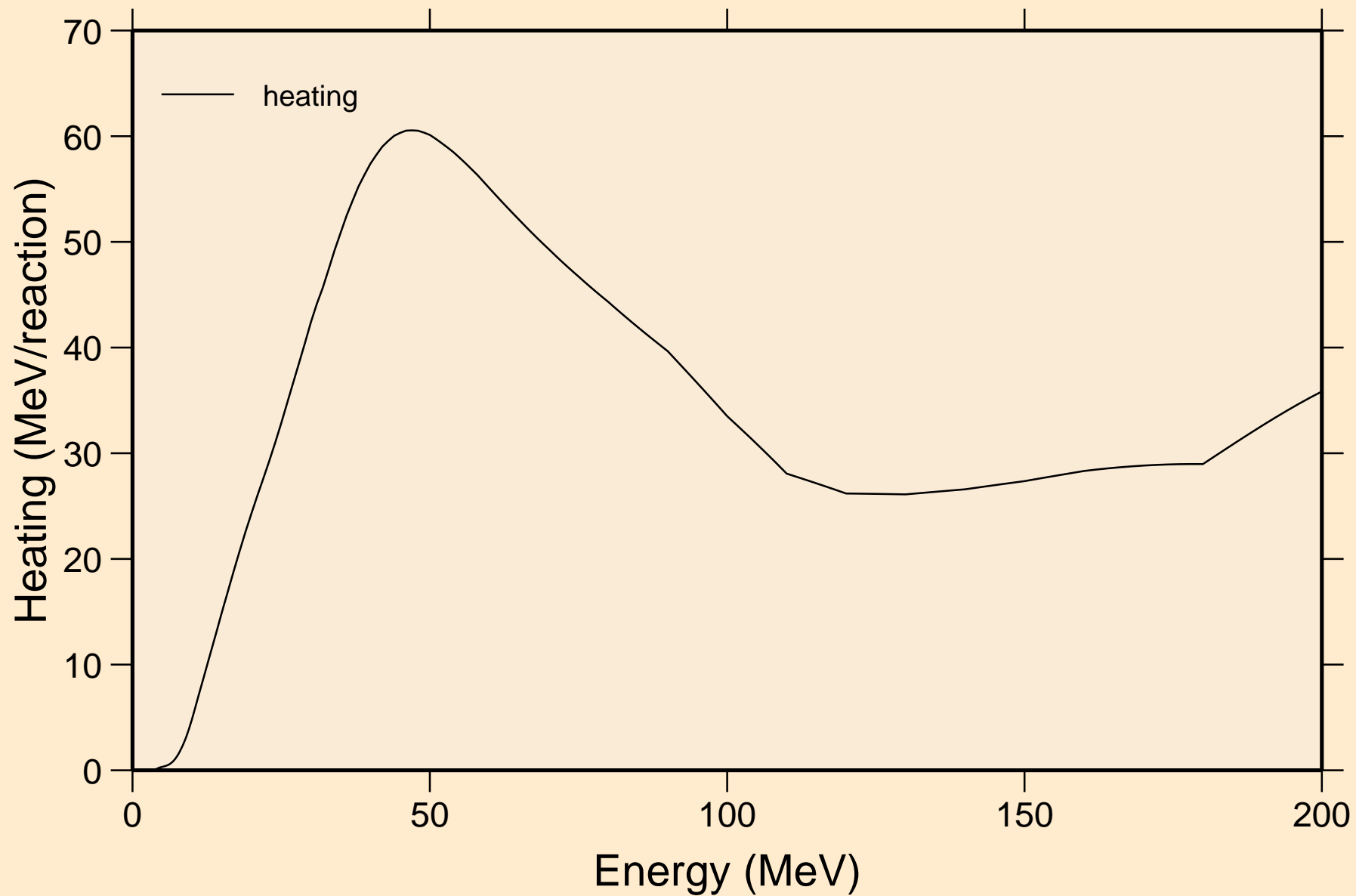

ES249 NEUTRON ACER TENDL-2019 LIBRARY; T=293.16K Damage

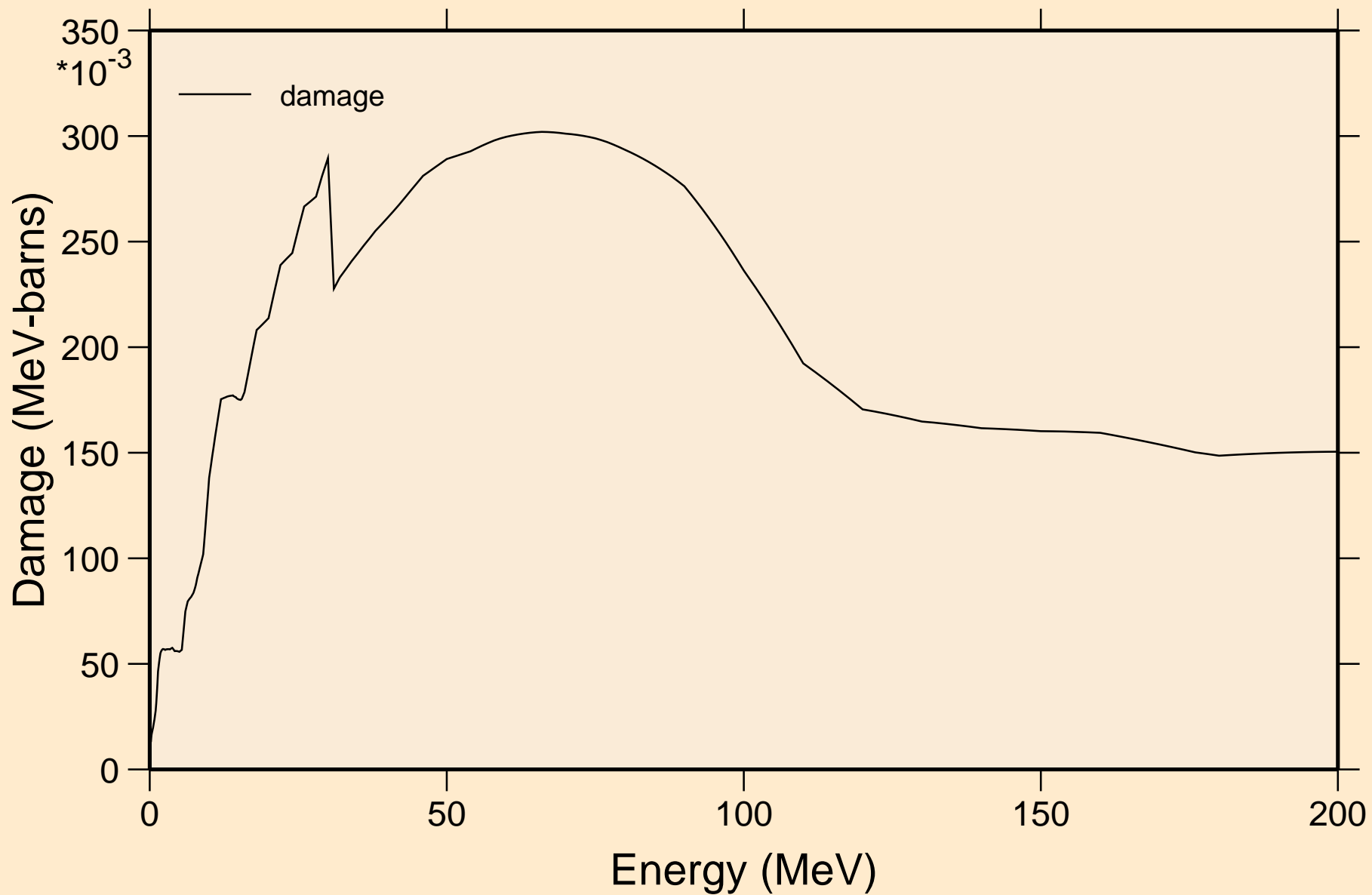

ES249 NEUTRON ACER TENDL-2019 LIBRARY; T=293.16K
Non-threshold reactions

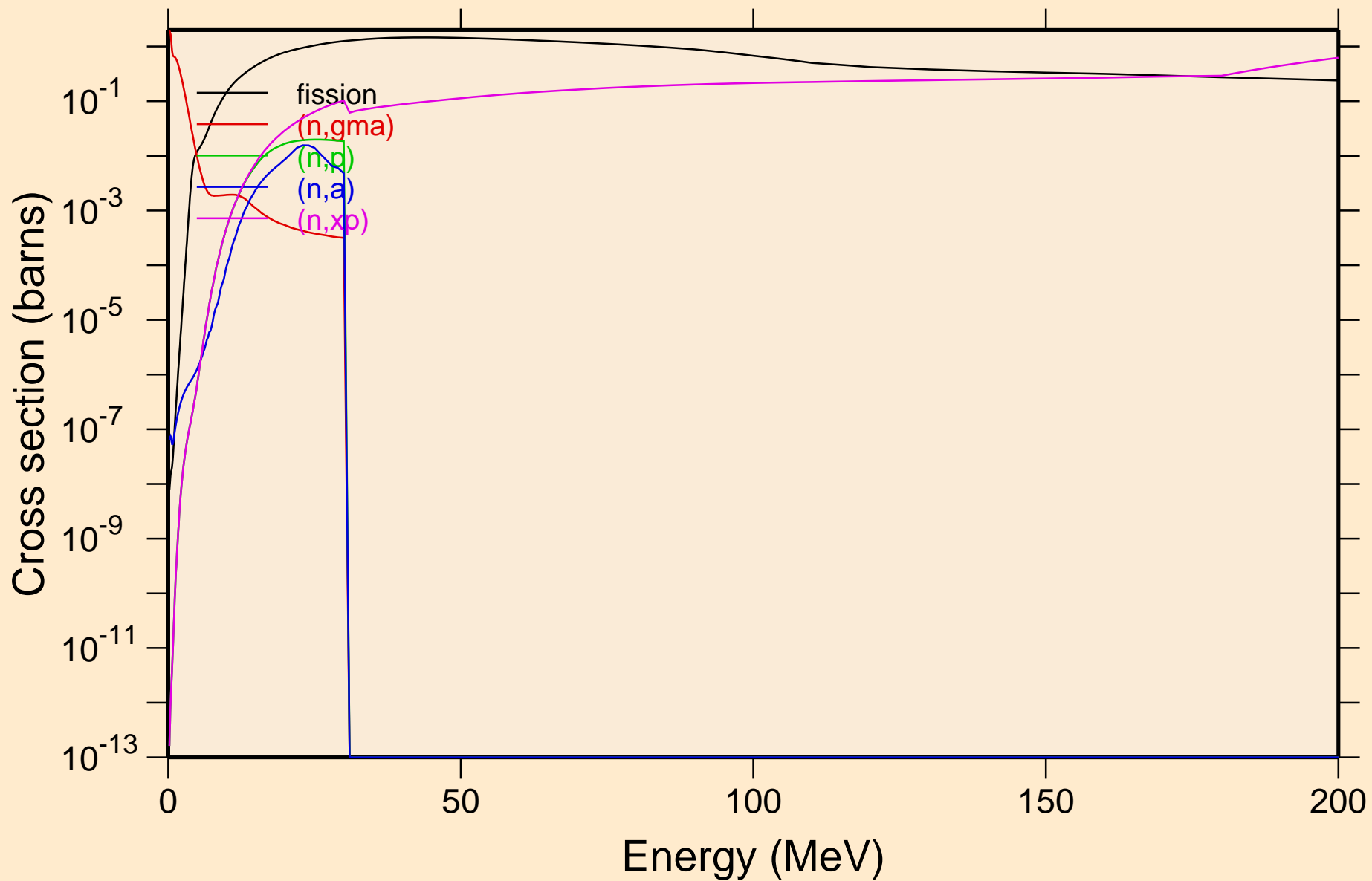

ES249 NEUTRON ACER TENDL-2019 LIBRARY; T=293.16K
Non-threshold reactions

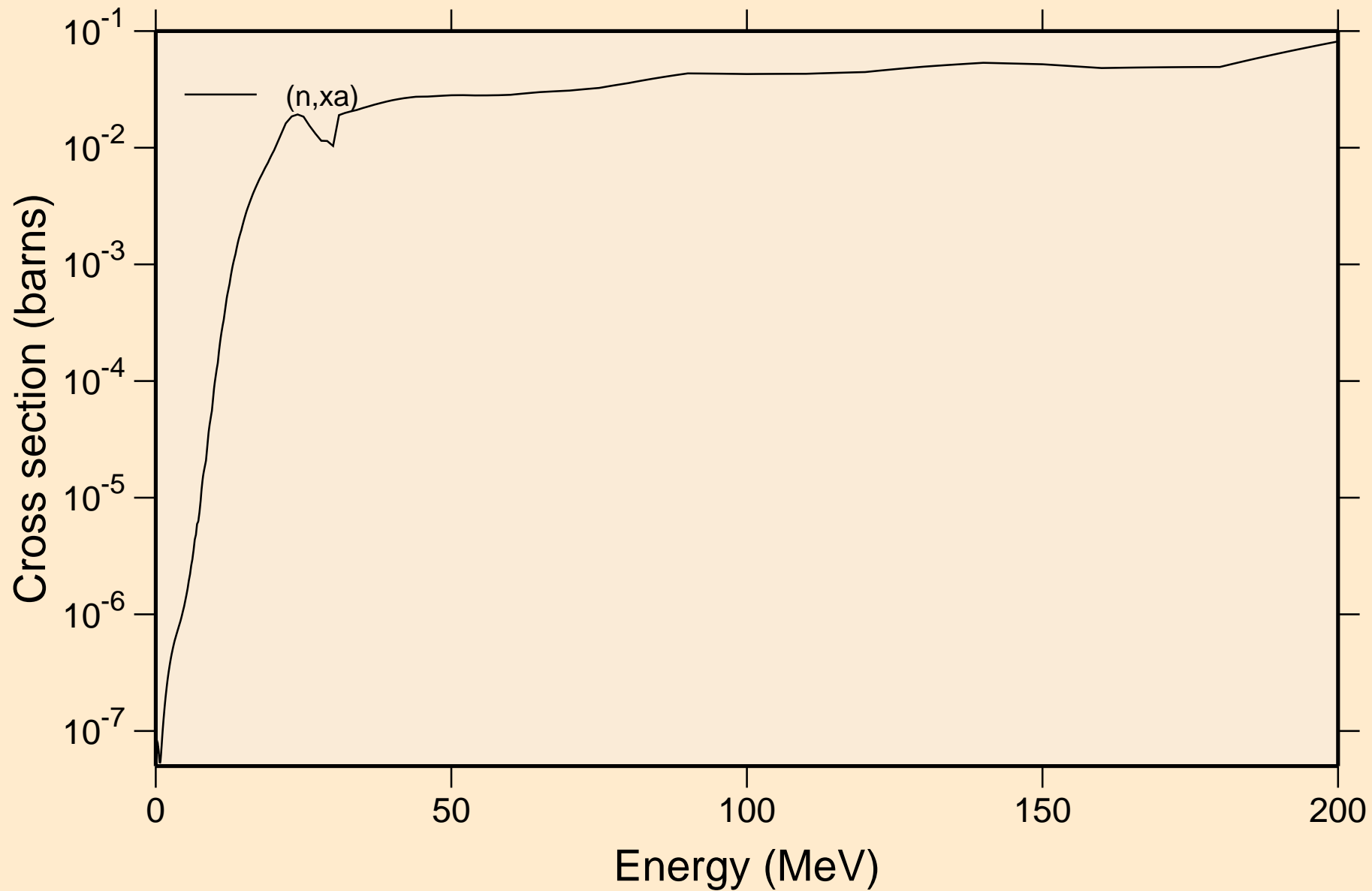

ES249 NEUTRON ACER TENDL-2019 LIBRARY; T=293.16K
Inelastic levels

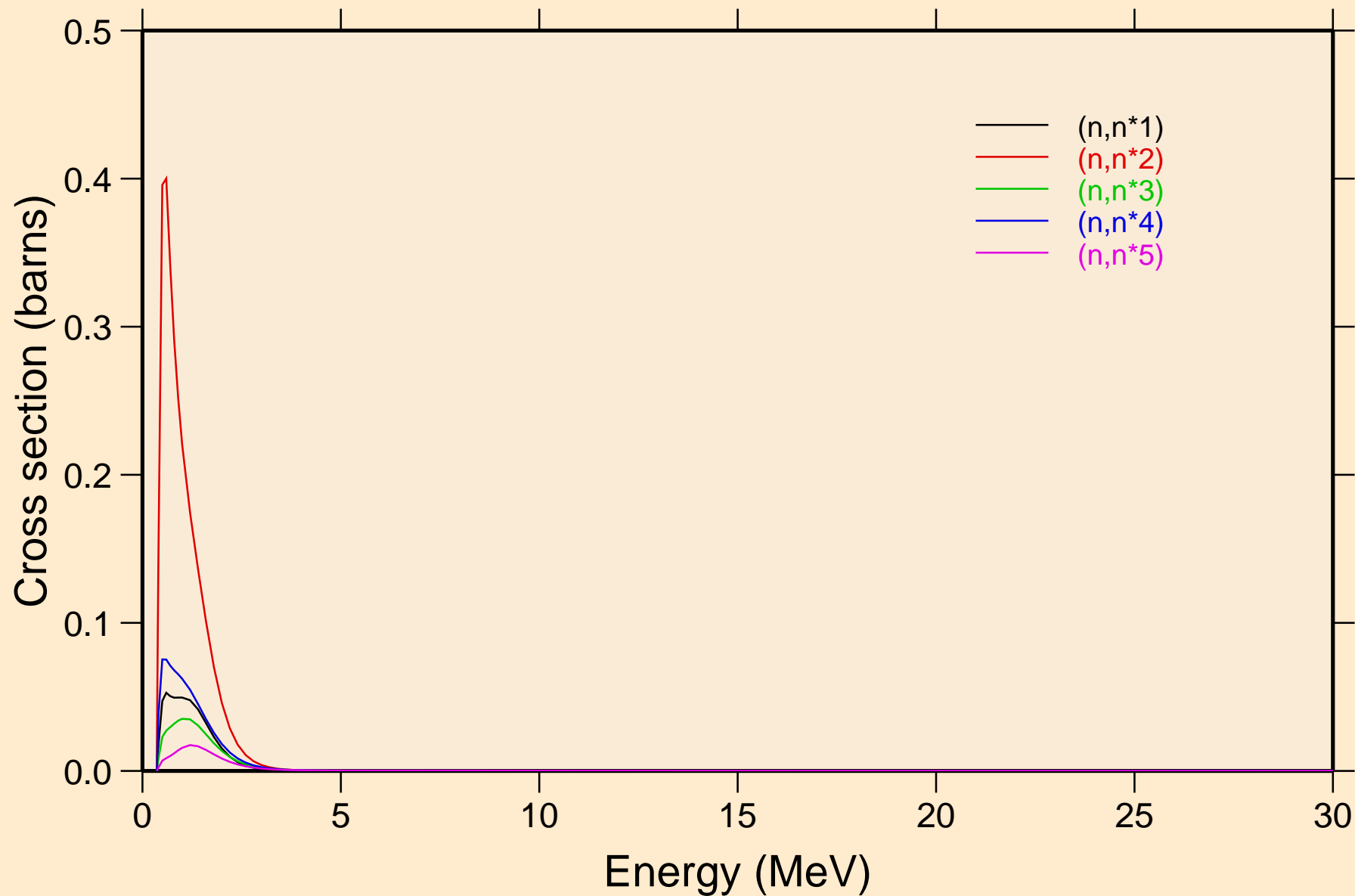

ES249 NEUTRON ACER TENDL-2019 LIBRARY; T=293.16K
Inelastic levels

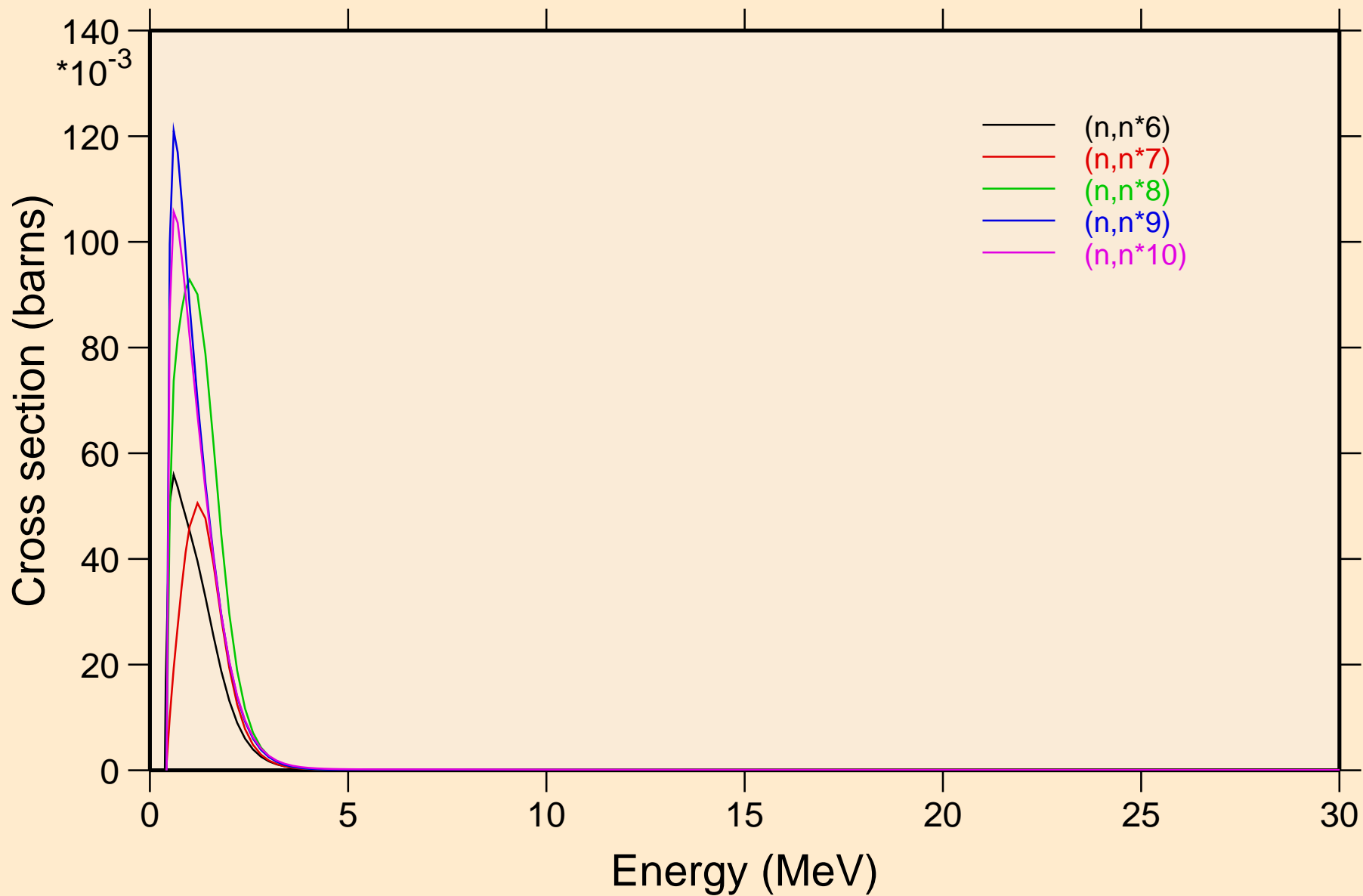

ES249 NEUTRON ACER TENDL-2019 LIBRARY; T=293.16K
Inelastic levels

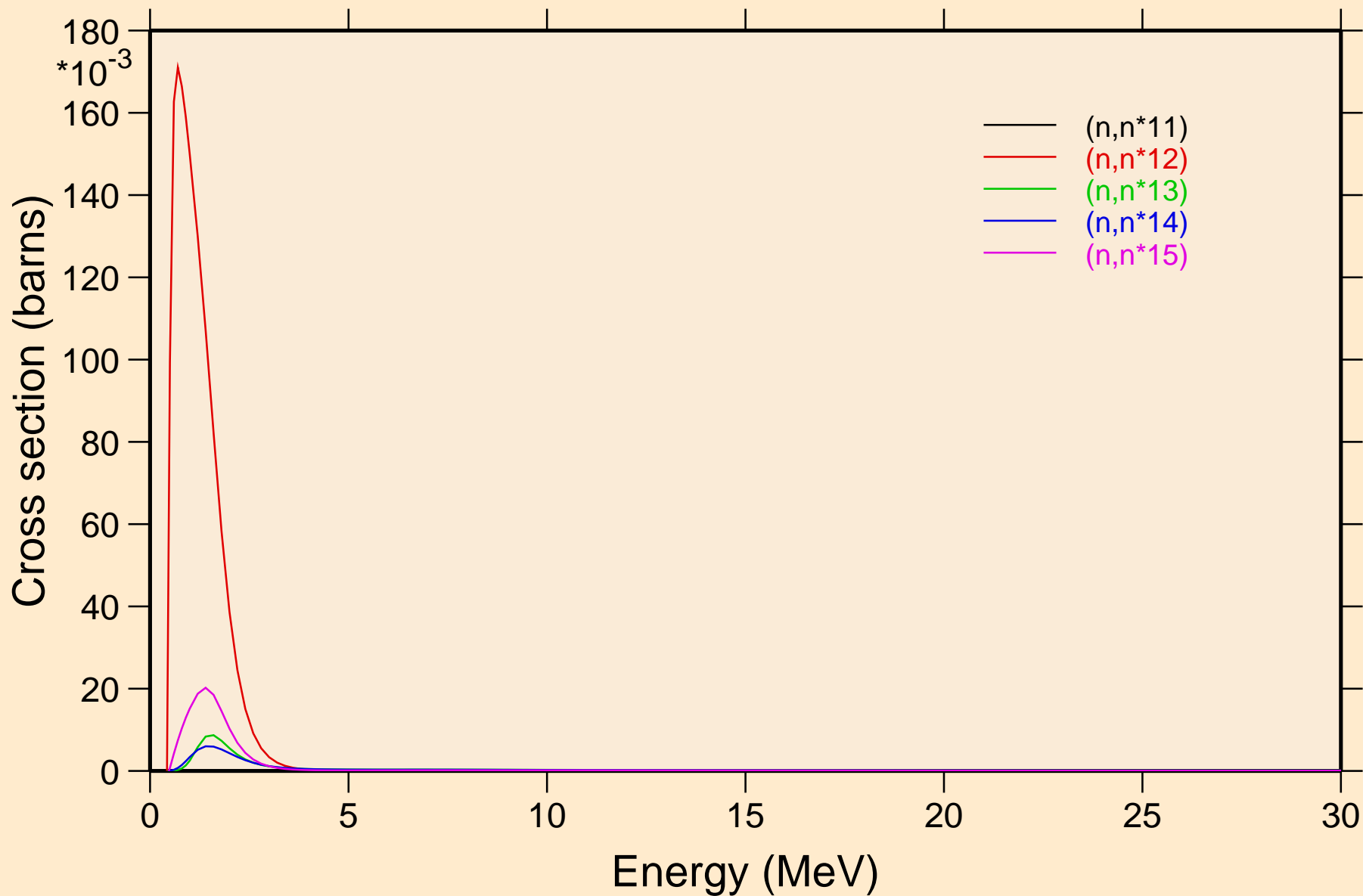

ES249 NEUTRON ACER TENDL-2019 LIBRARY; T=293.16K
Inelastic levels

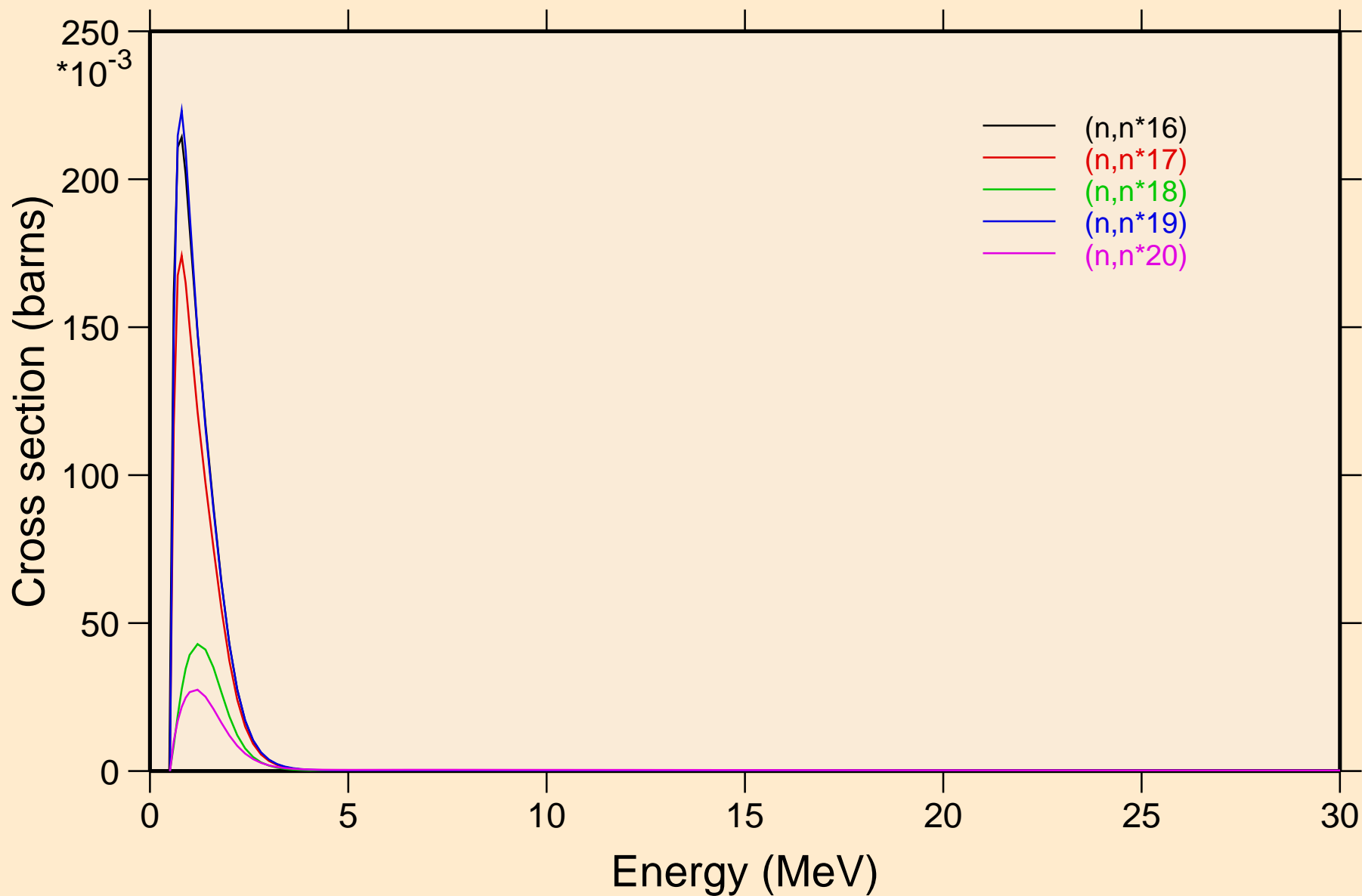

ES249 NEUTRON ACER TENDL-2019 LIBRARY; T=293.16K
Inelastic levels

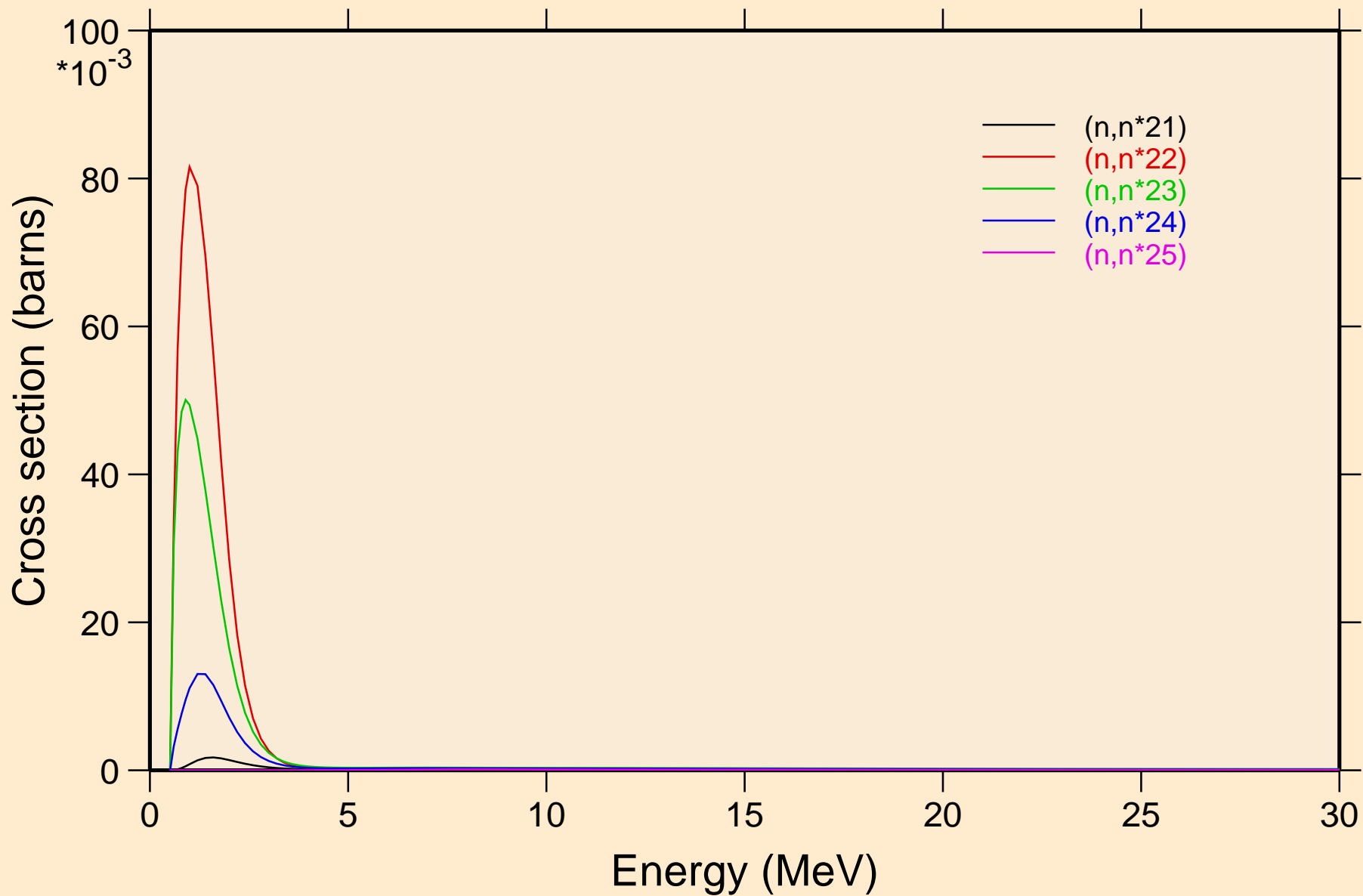

ES249 NEUTRON ACER TENDL-2019 LIBRARY; T=293.16K
Inelastic levels

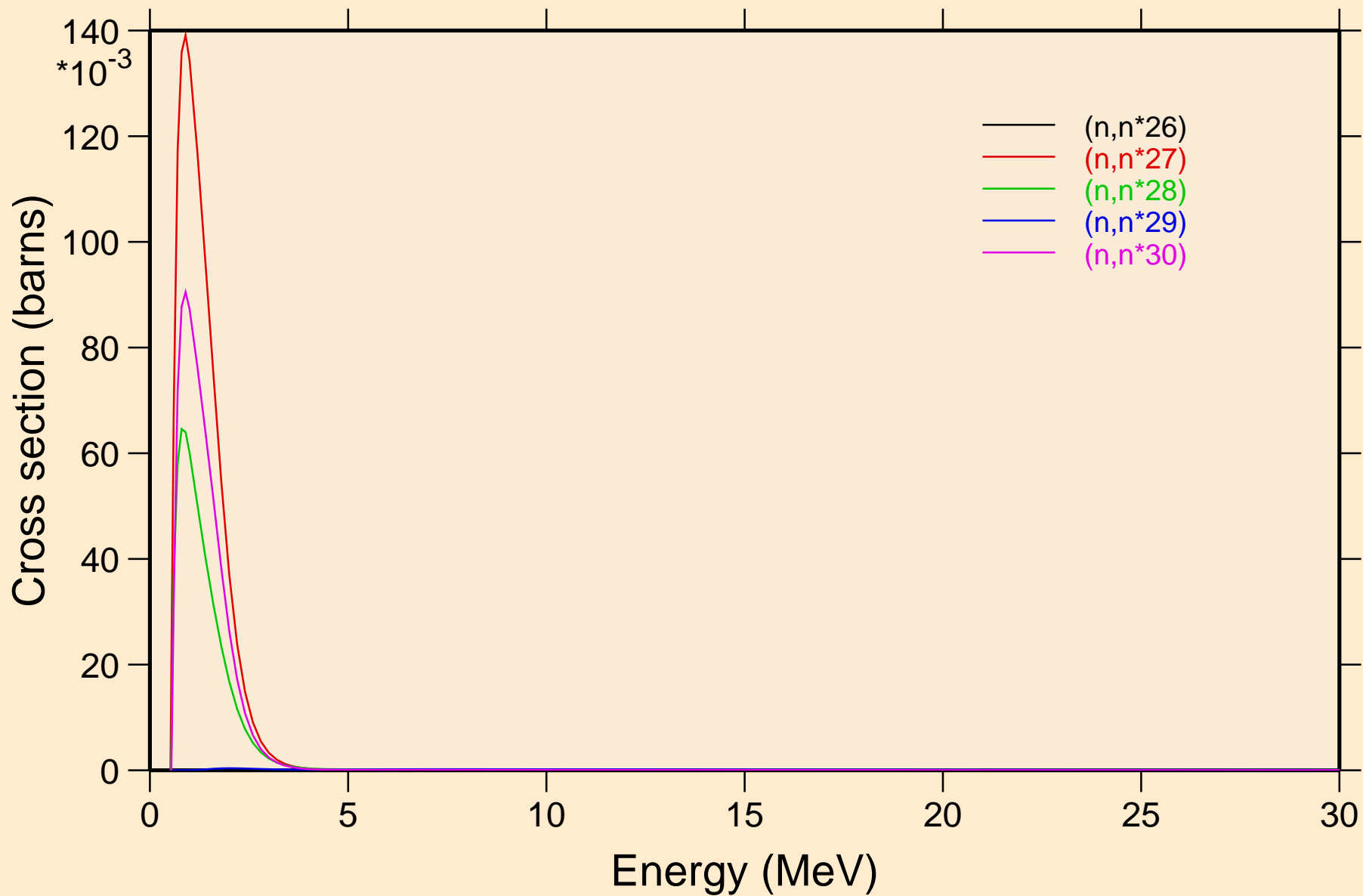

ES249 NEUTRON ACER TENDL-2019 LIBRARY; T=293.16K
Threshold reactions

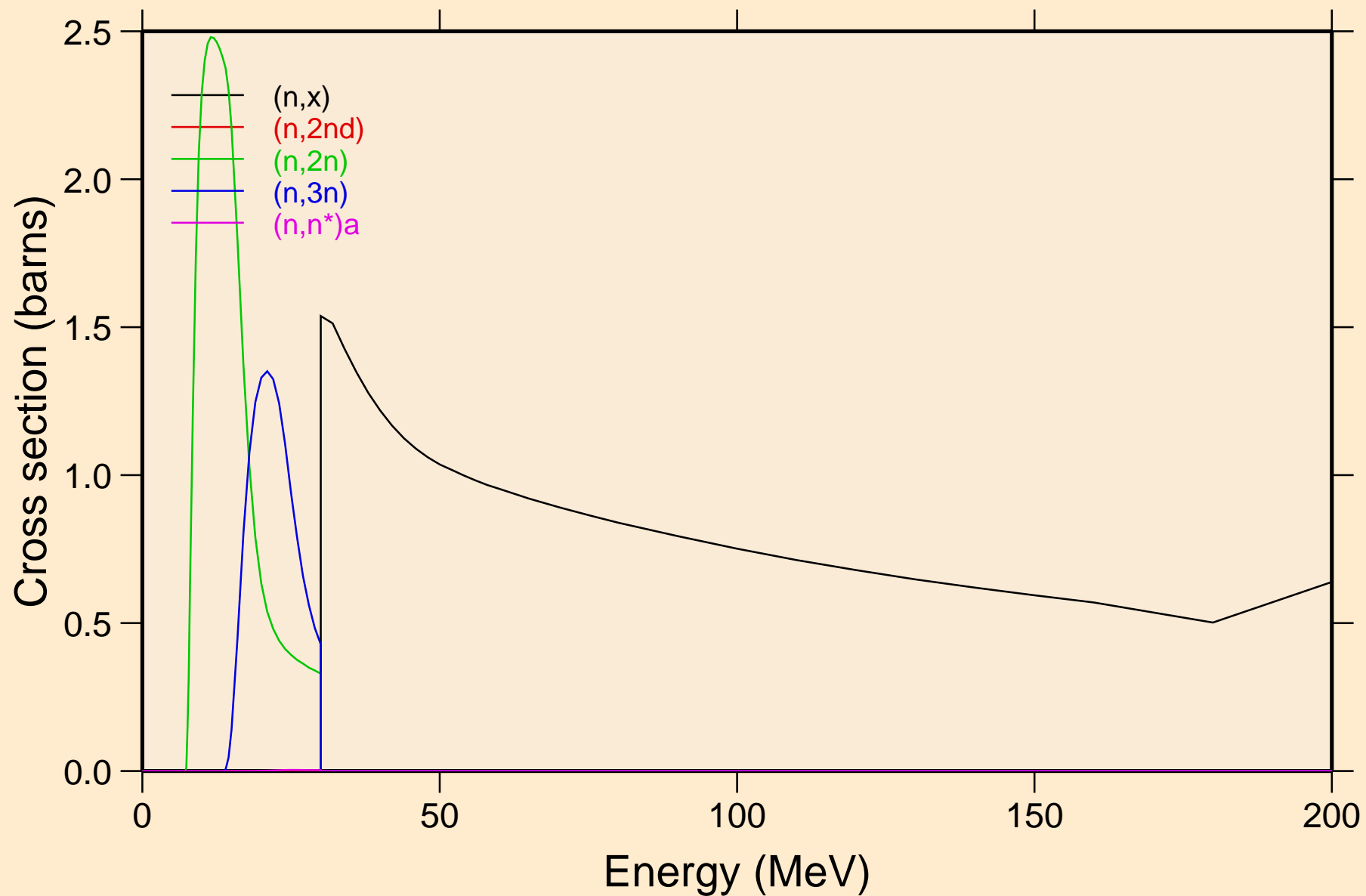

ES249 NEUTRON ACER TENDL-2019 LIBRARY; T=293.16K
Threshold reactions

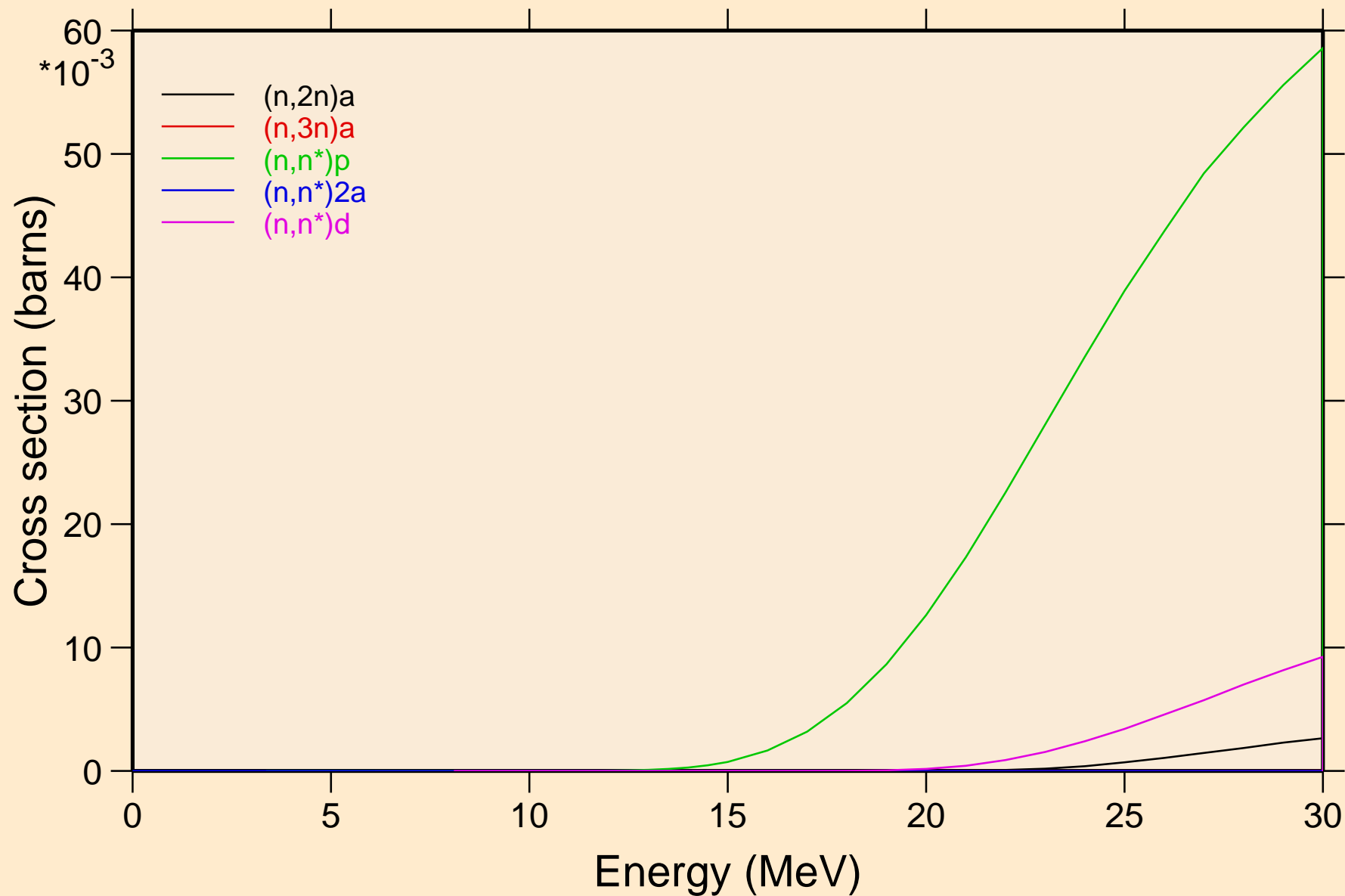

ES249 NEUTRON ACER TENDL-2019 LIBRARY; T=293.16K
Threshold reactions

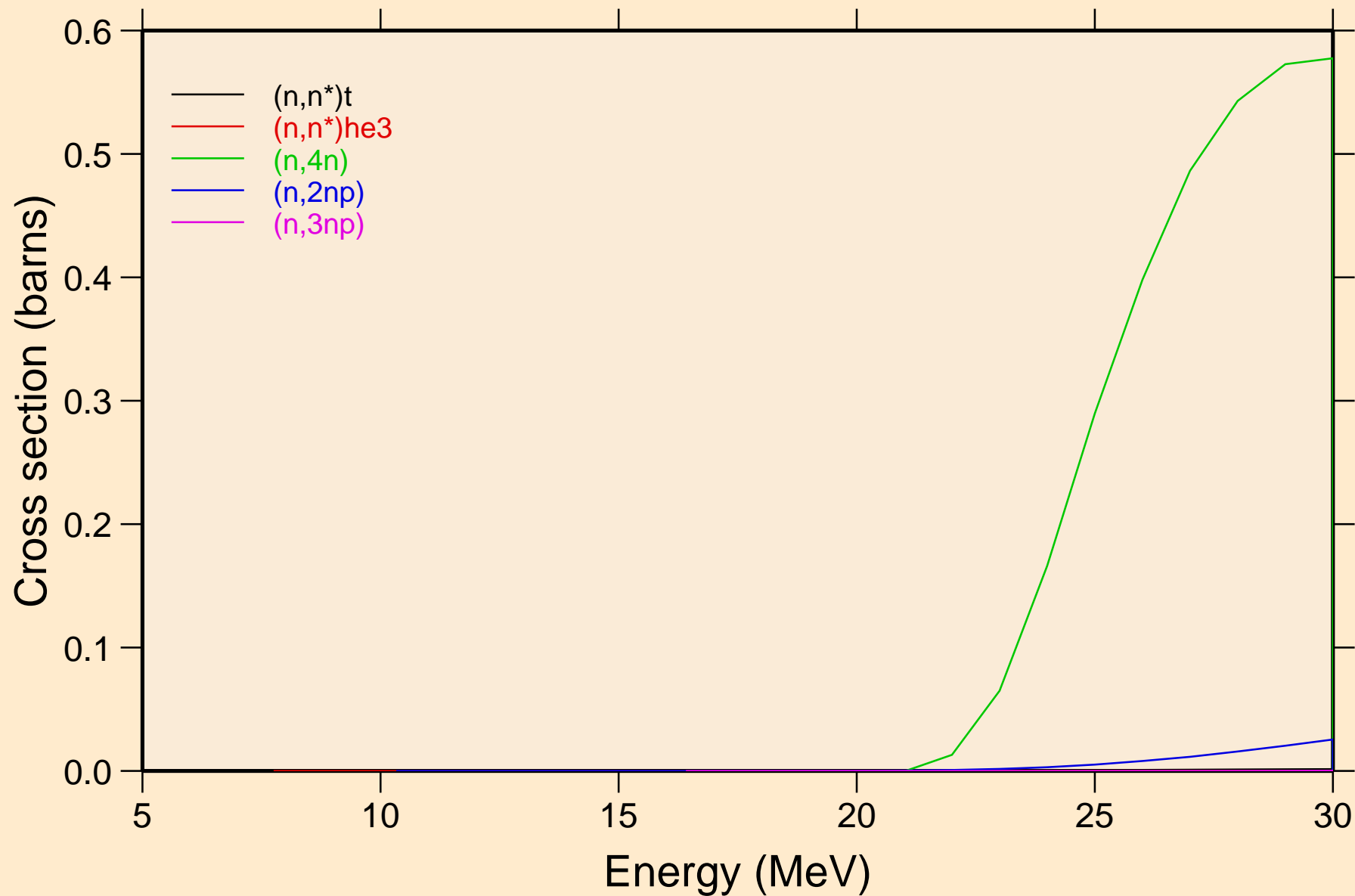

ES249 NEUTRON ACER TENDL-2019 LIBRARY; T=293.16K
Threshold reactions

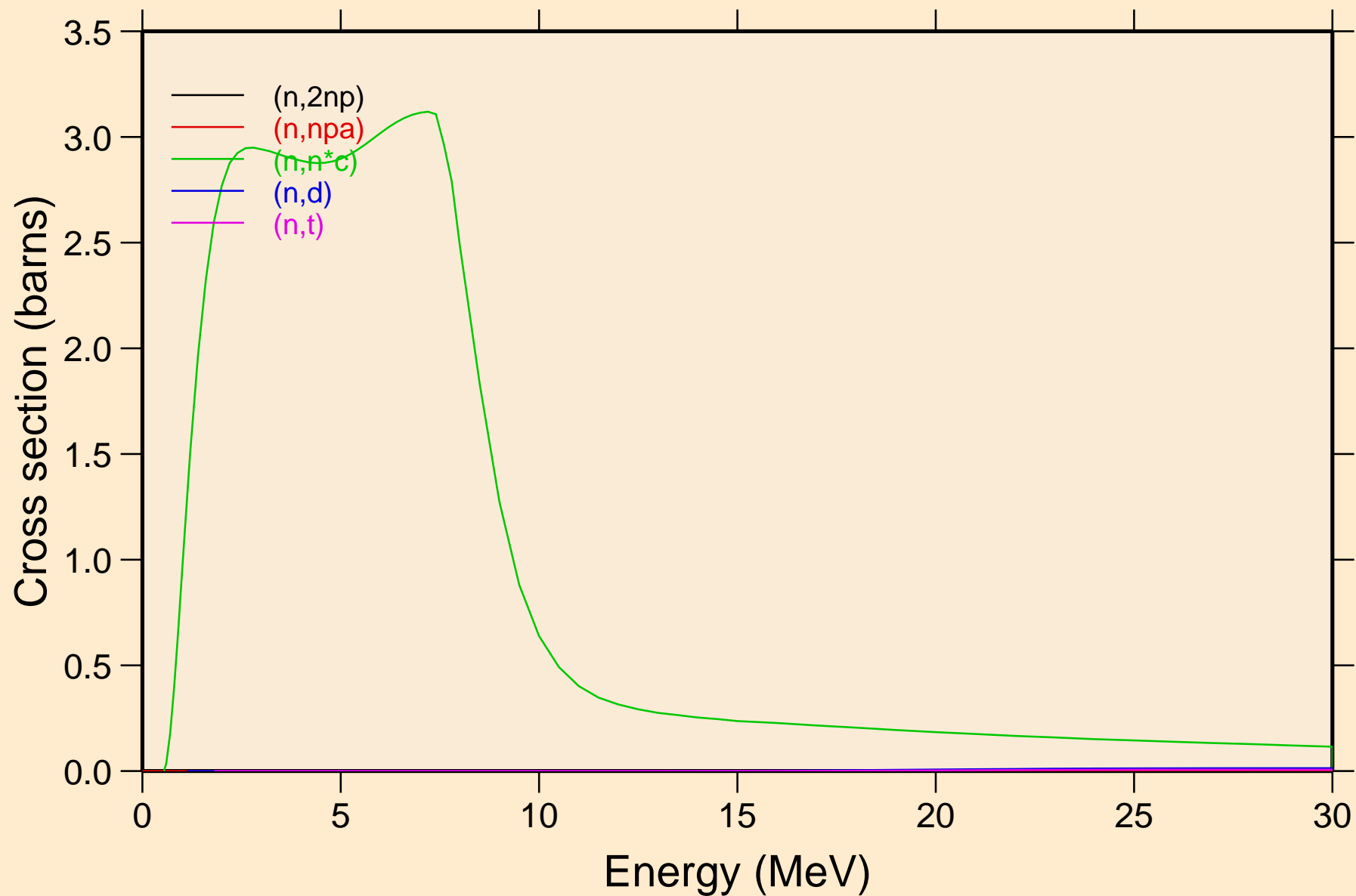

ES249 NEUTRON ACER TENDL-2019 LIBRARY; T=293.16K

Threshold reactions

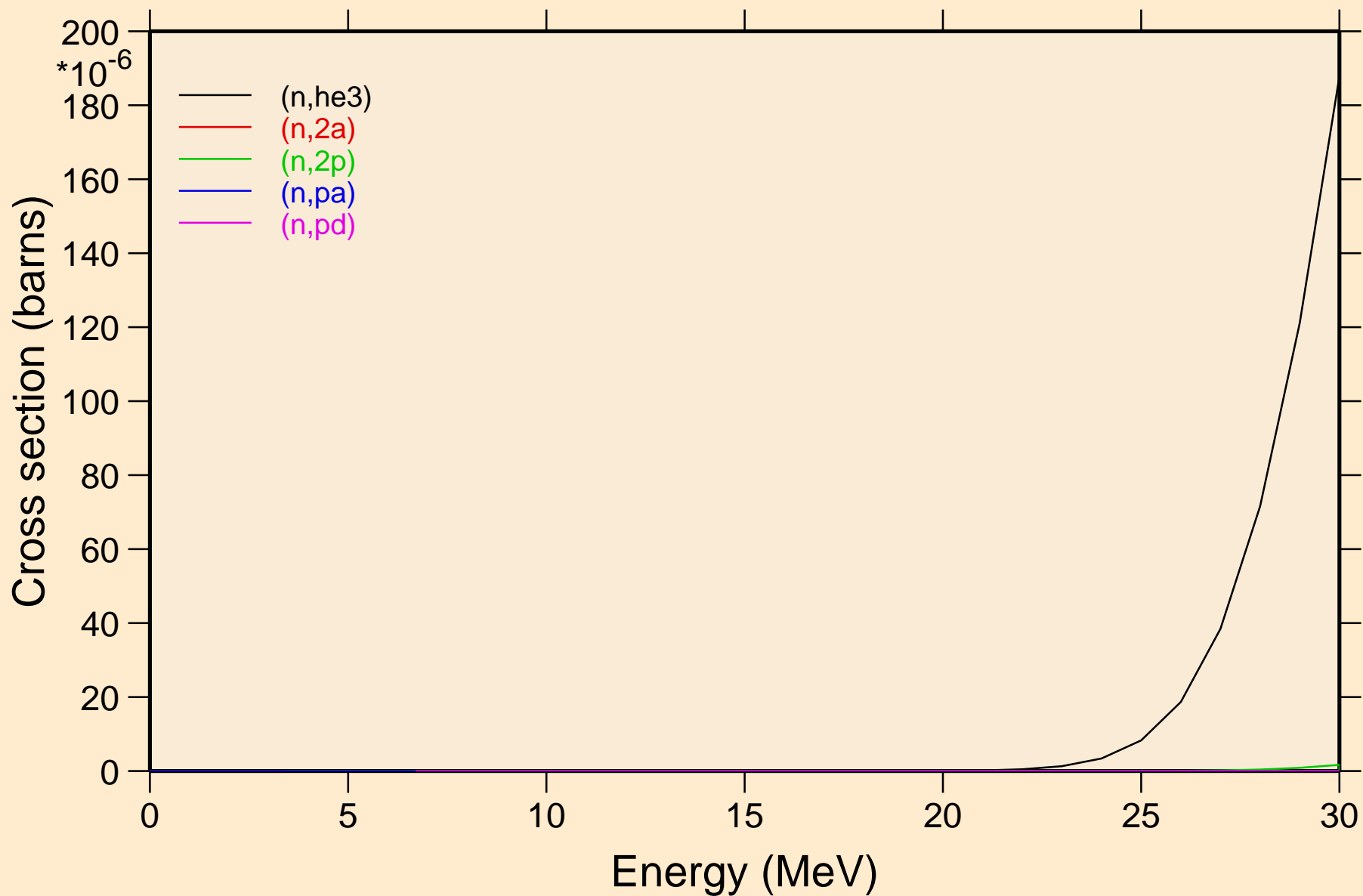

ES249 NEUTRON ACER TENDL-2019 LIBRARY; T=293.16K
Threshold reactions

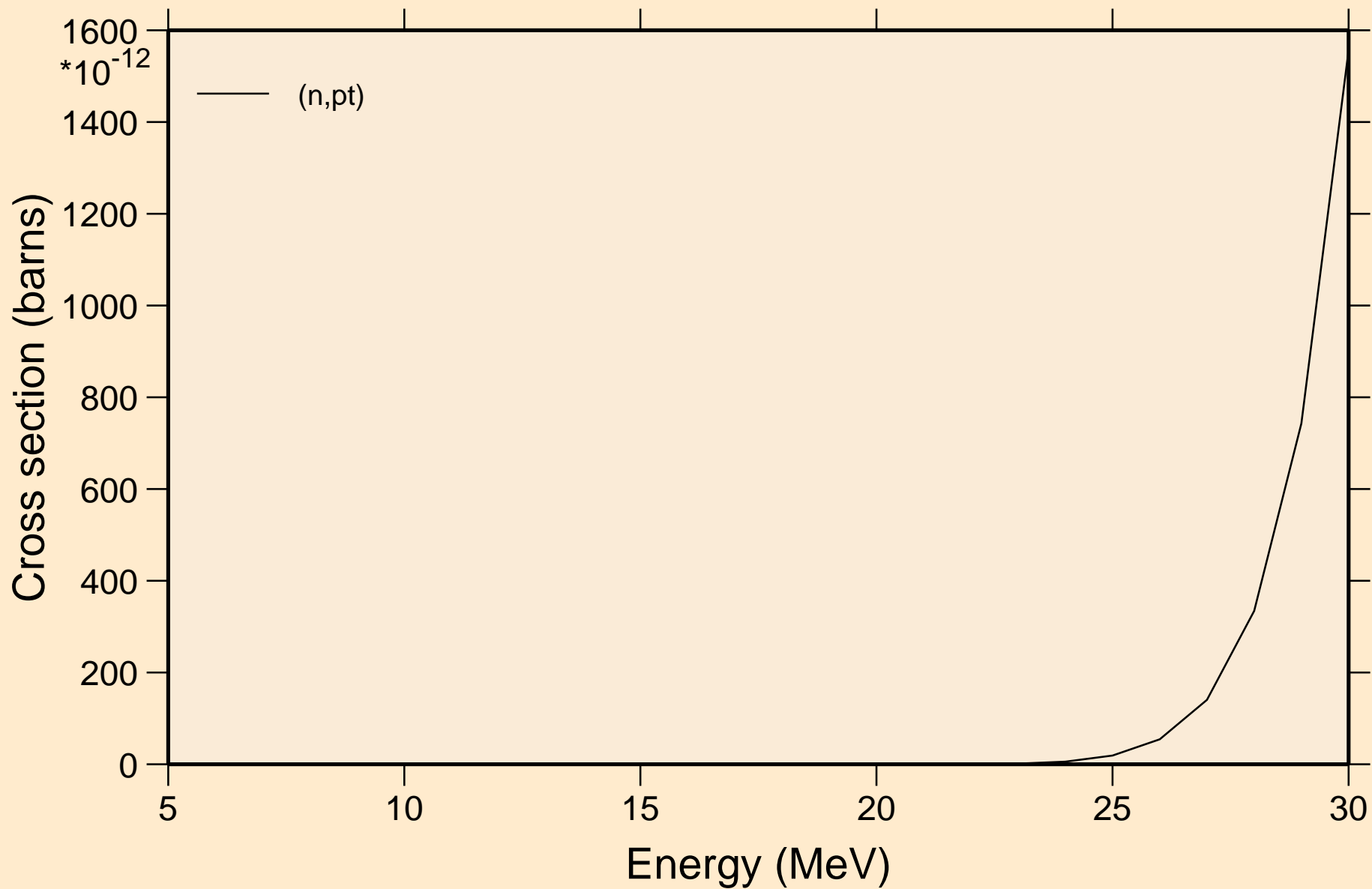

ES249 NEUTRON ACER TENDL-2019 LIBRARY; T=293.16K

Threshold reactions

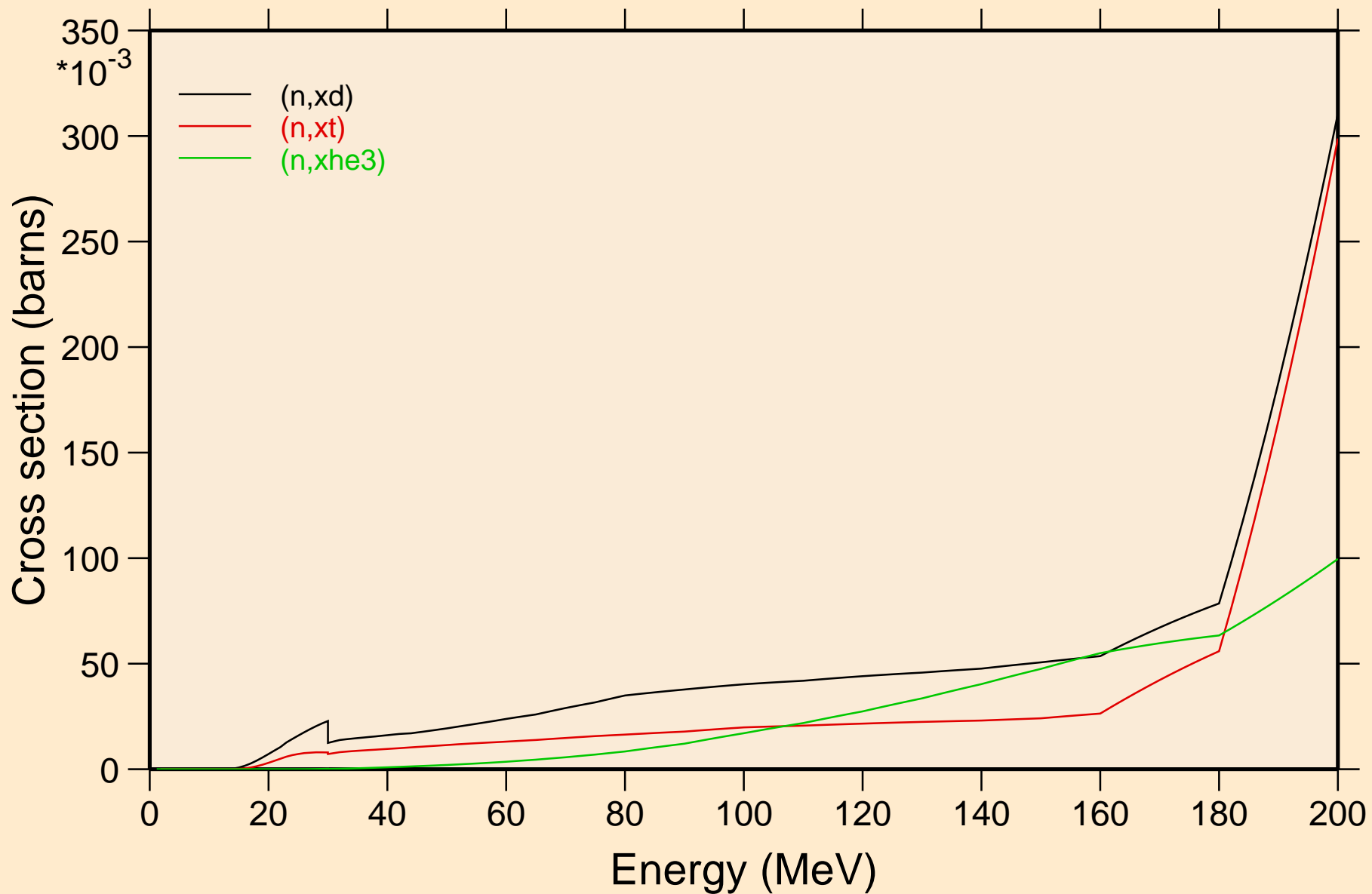

ES249 NEUTRON ACER TENDL-2019 LIBRARY; T=293.16K
angular distribution for elastic

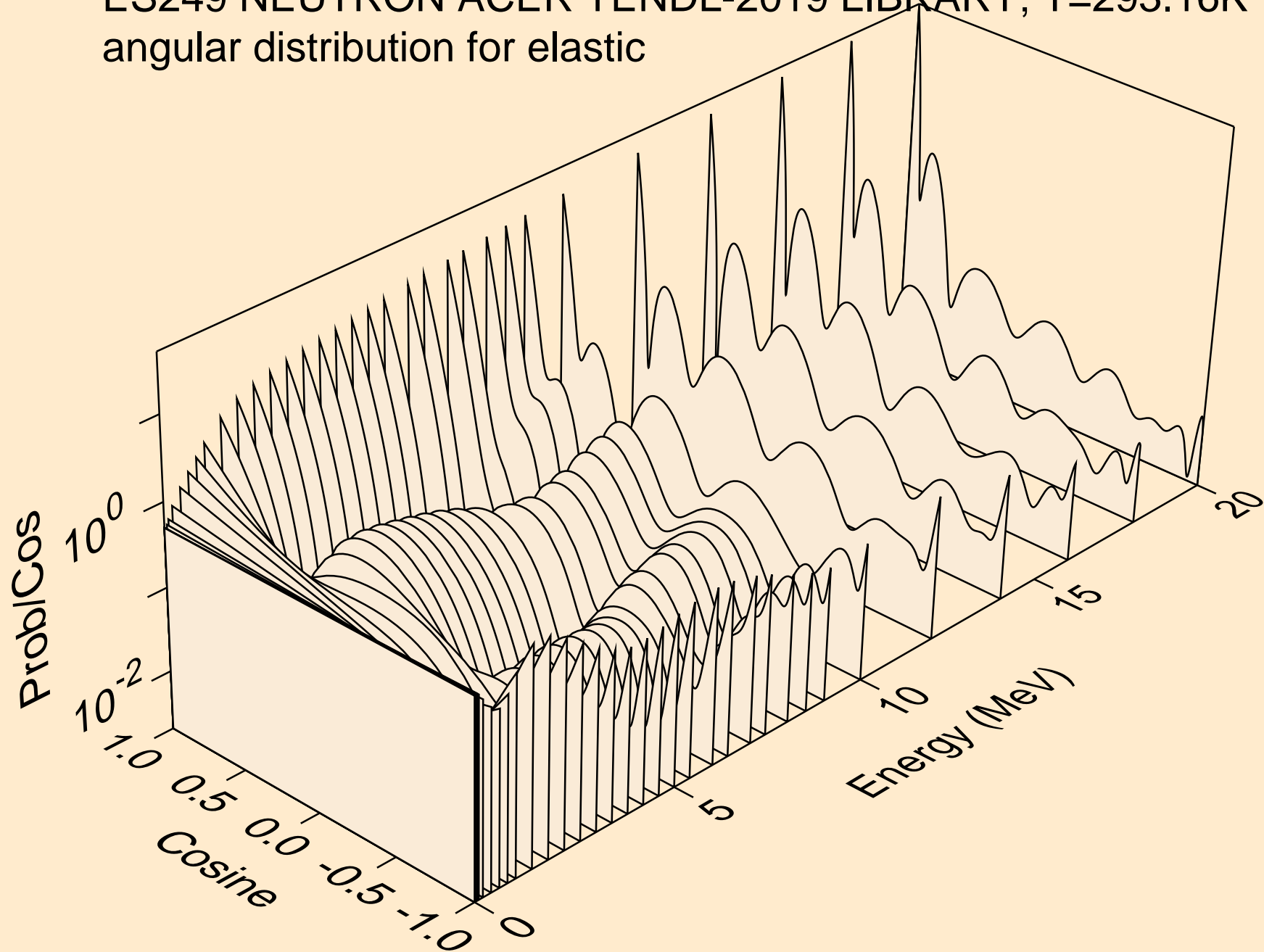

ES249 NEUTRON ACER TENDL-2019 LIBRARY; T=293.16K
angular distribution for elastic

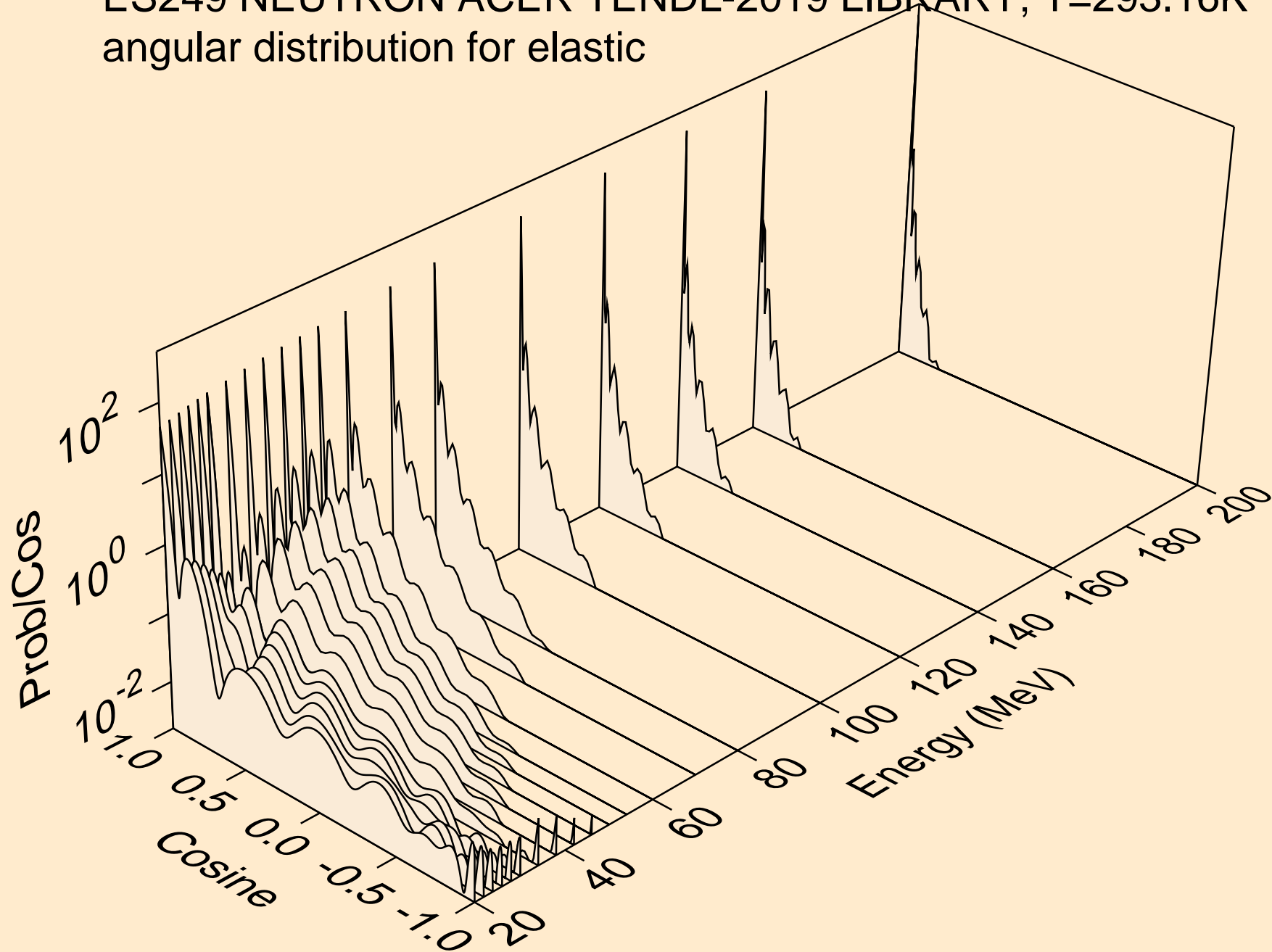

ES249 NEUTRON ACER TENDL-2019 LIBRARY; T=293.16K
angular distribution for (n,n*1)

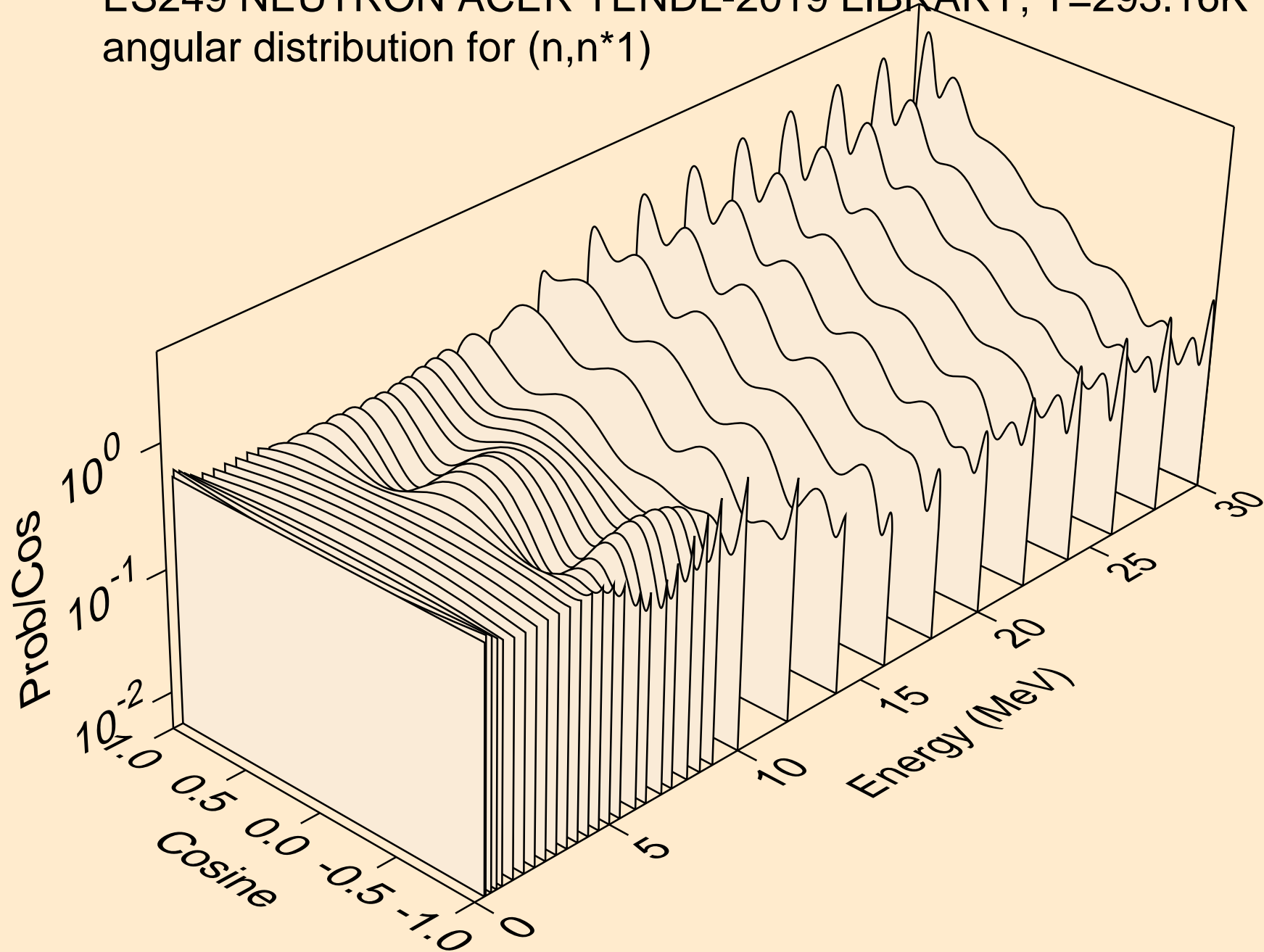

ES249 NEUTRON ACER TENDL-2019 LIBRARY; T=293.16K
angular distribution for (n,n*2)

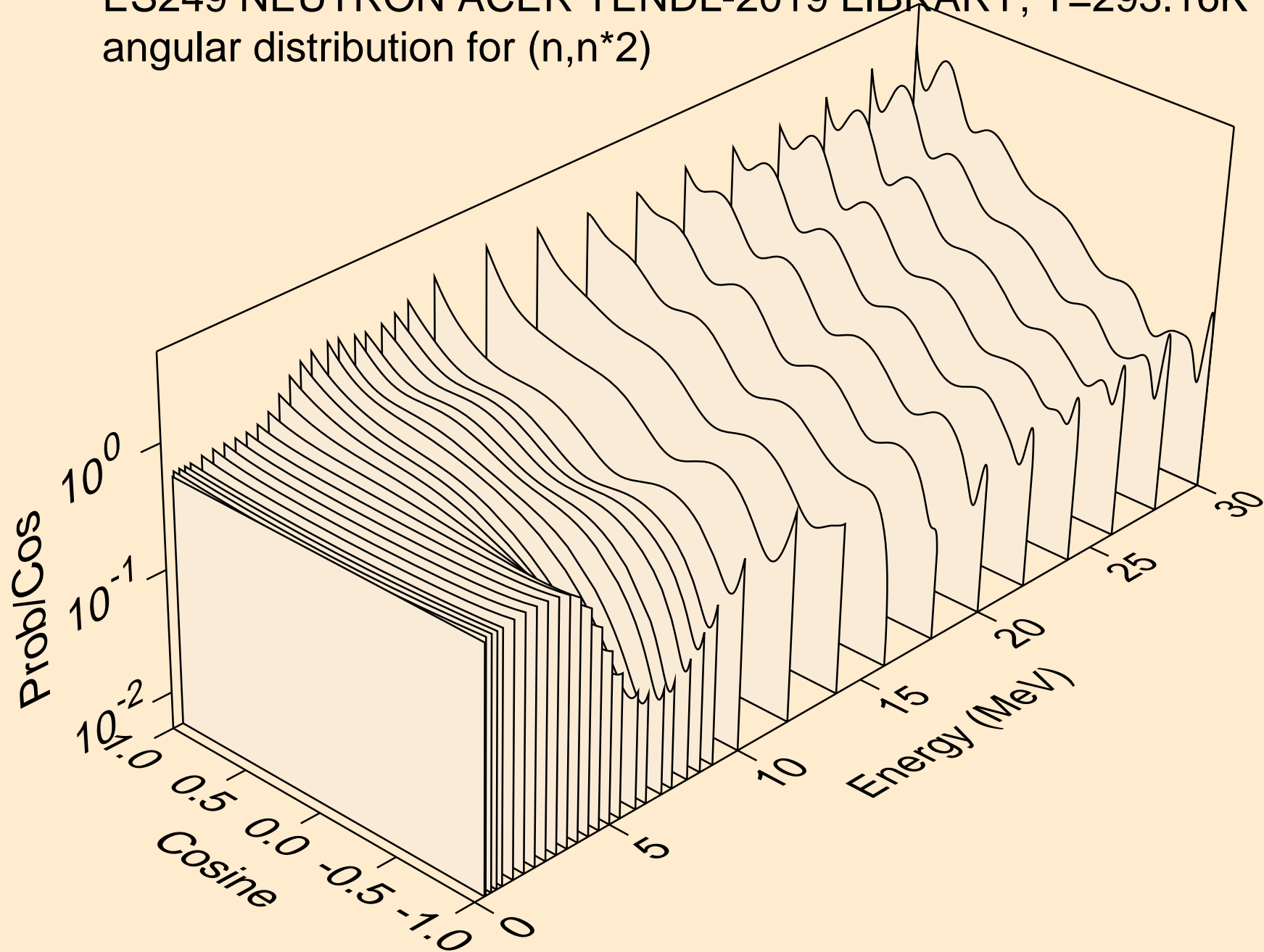

ES249 NEUTRON ACER TENDL-2019 LIBRARY; T=293.16K
angular distribution for (n,n*3)

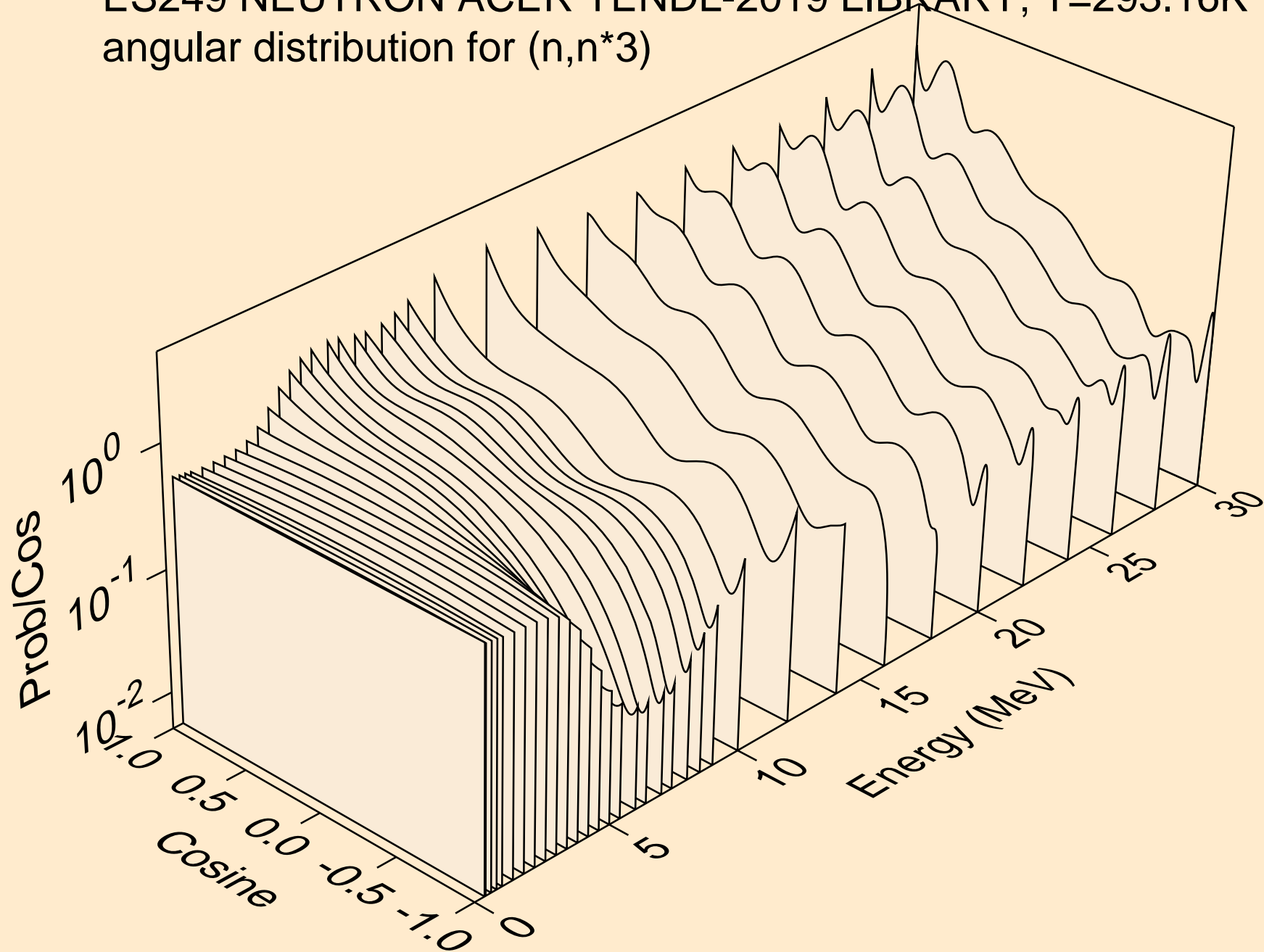

ES249 NEUTRON ACER TENDL-2019 LIBRARY; T=293.16K
angular distribution for (n,n*4)

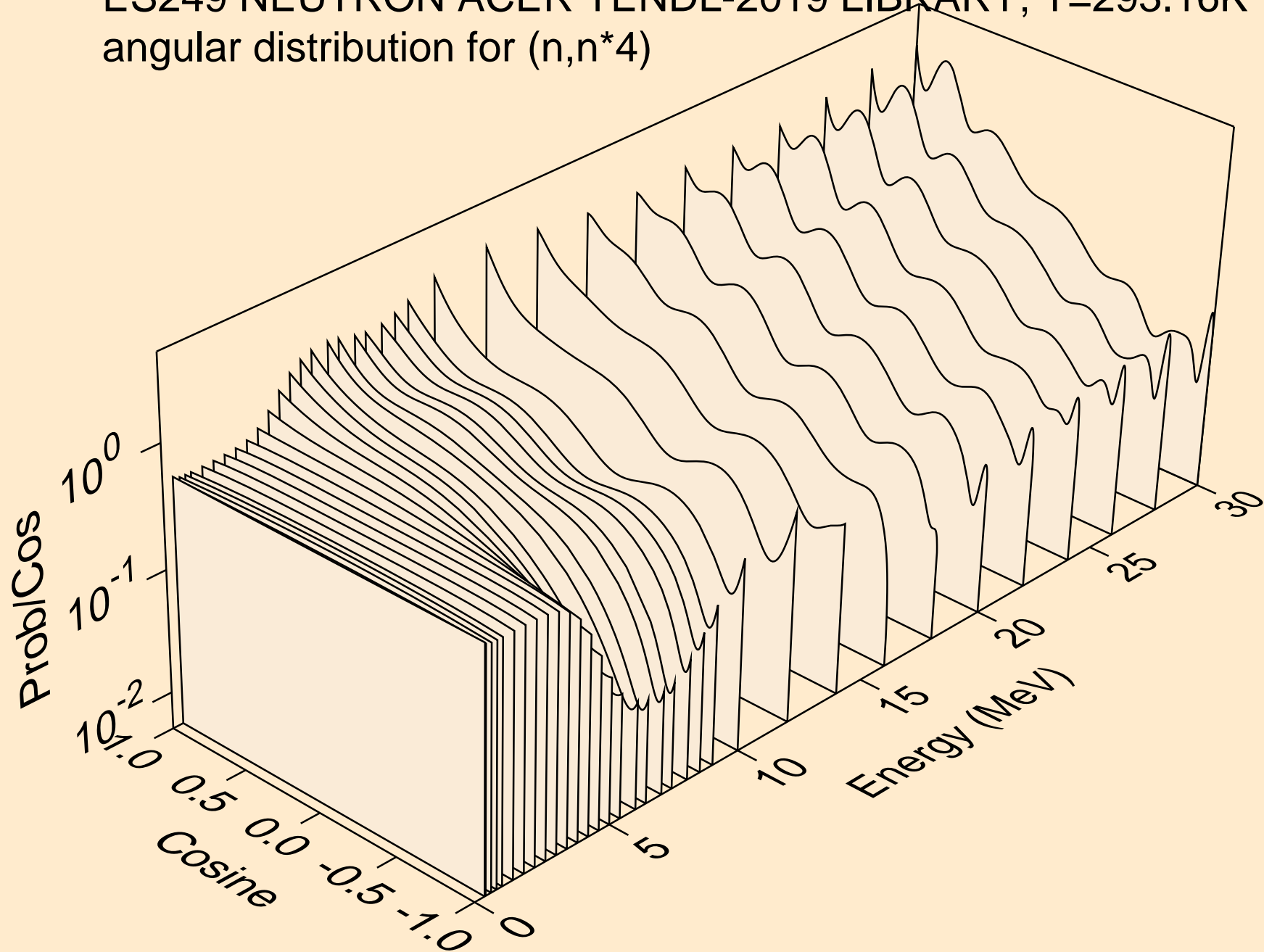

ES249 NEUTRON ACER TENDL-2019 LIBRARY; T=293.16K
angular distribution for (n,n*5)

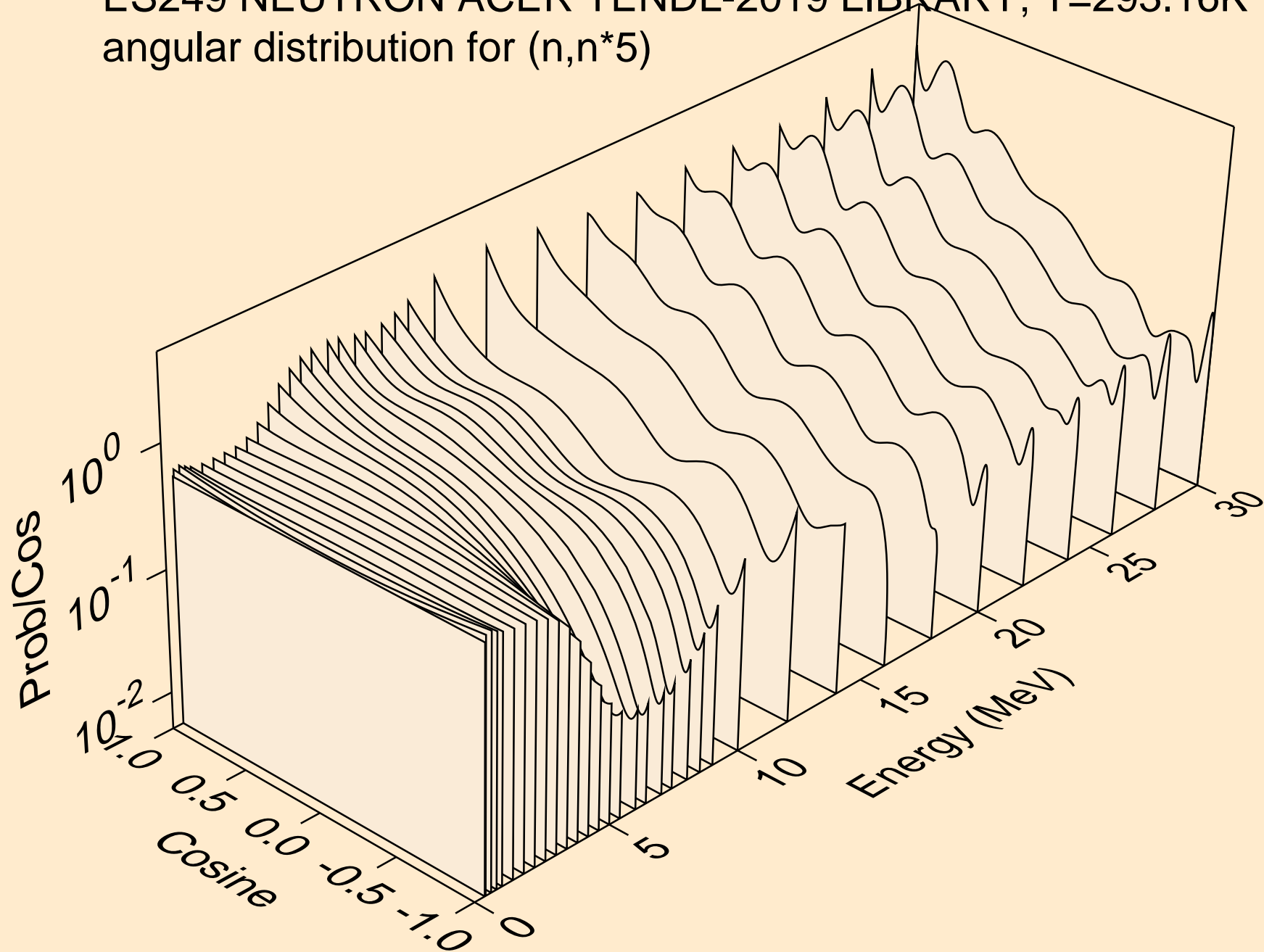

ES249 NEUTRON ACER TENDL-2019 LIBRARY; T=293.16K
angular distribution for (n,n*6)

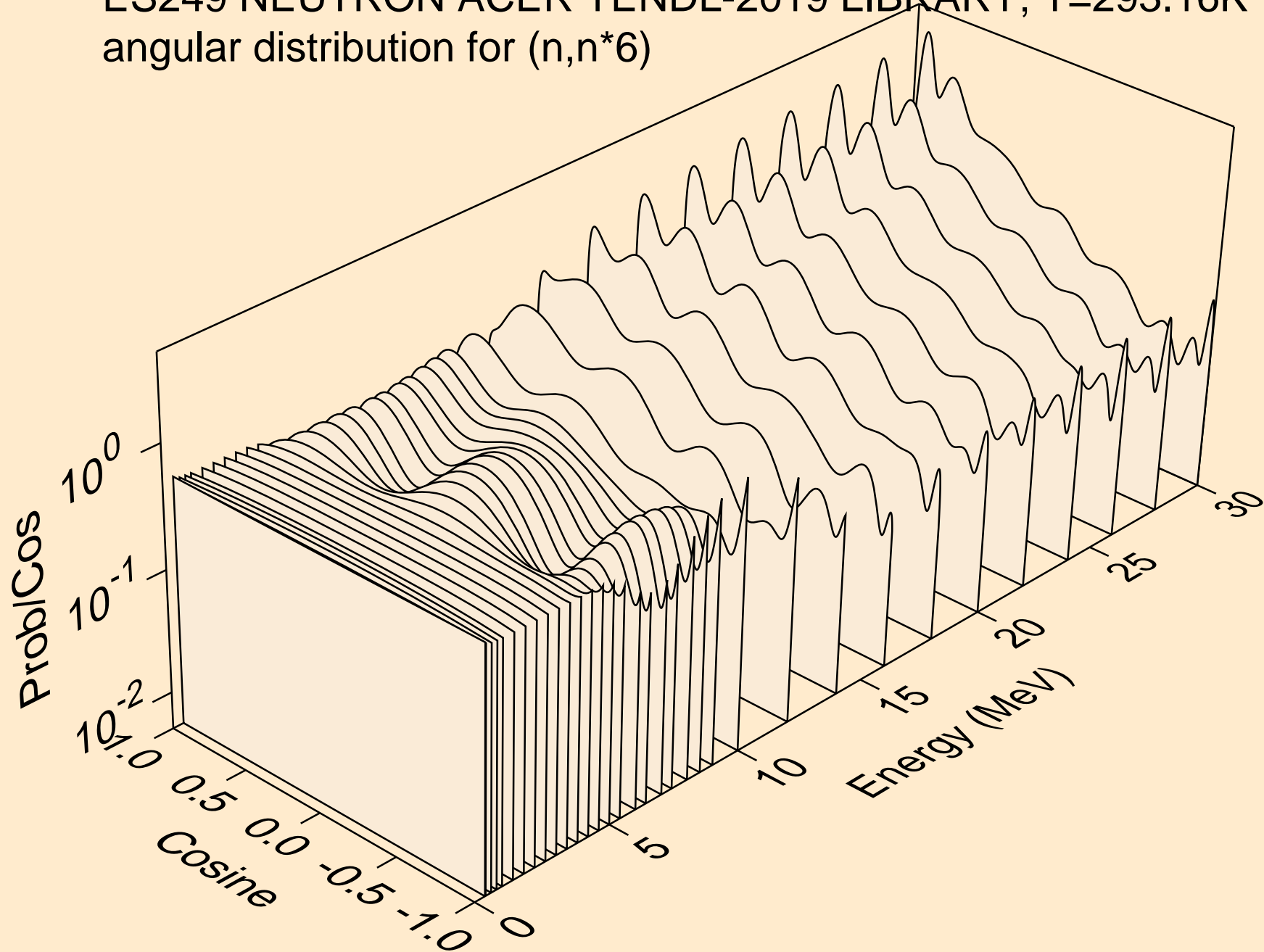

ES249 NEUTRON ACER TENDL-2019 LIBRARY; T=293.16K
angular distribution for (n,n*7)

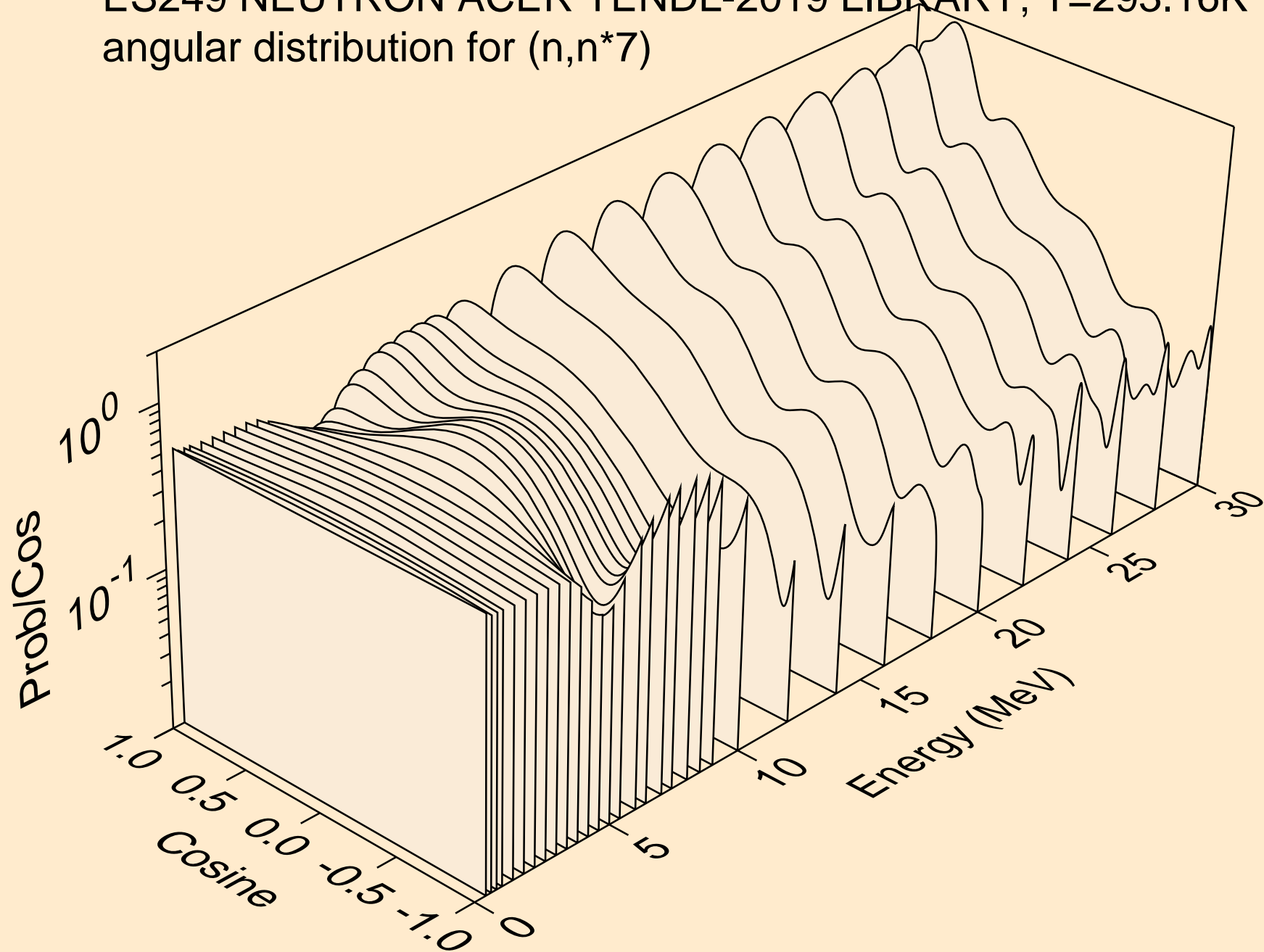

ES249 NEUTRON ACER TENDL-2019 LIBRARY; T=293.16K
angular distribution for (n,n*8)

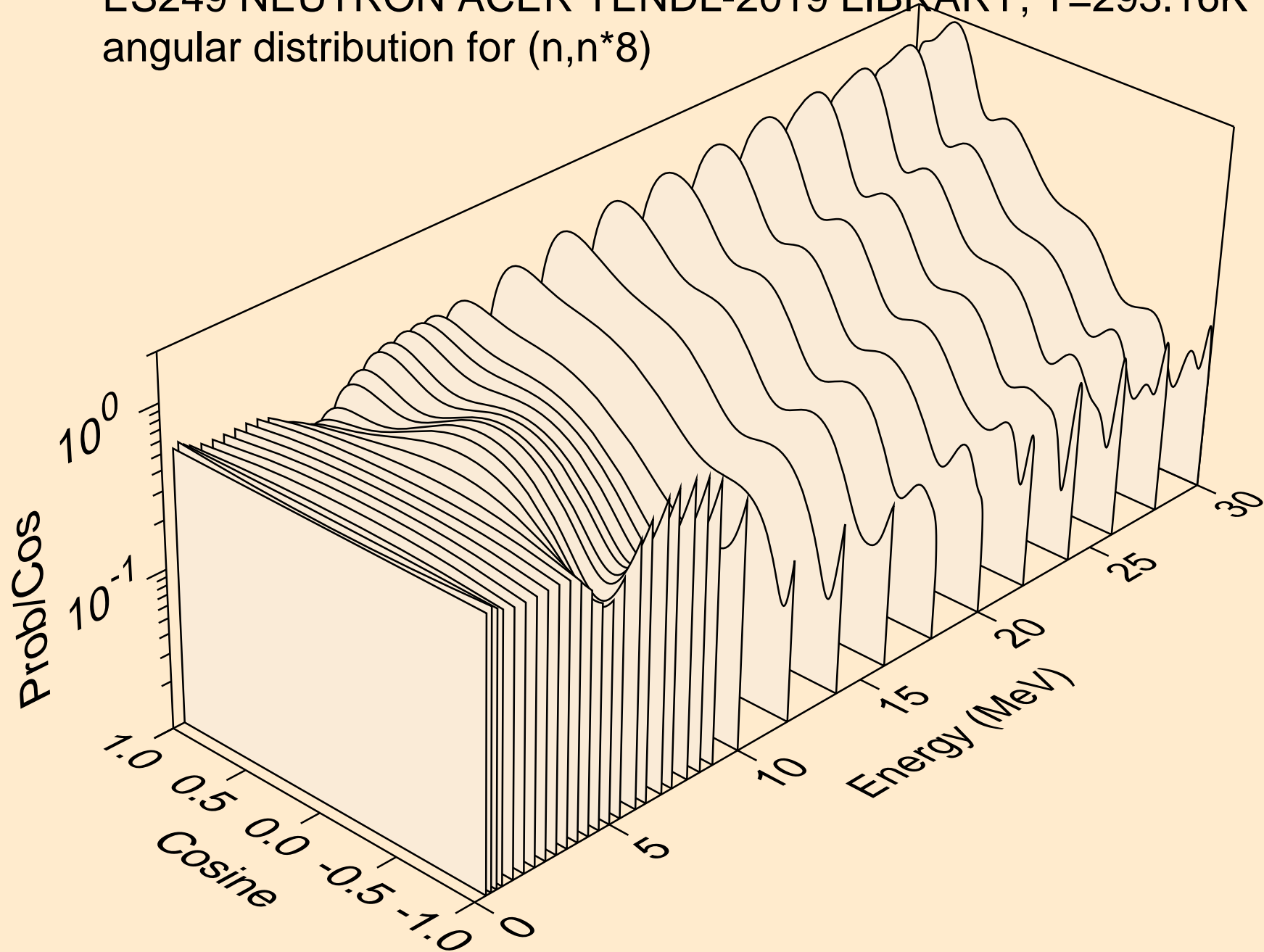

ES249 NEUTRON ACER TENDL-2019 LIBRARY; T=293.16K
angular distribution for (n,n*9)

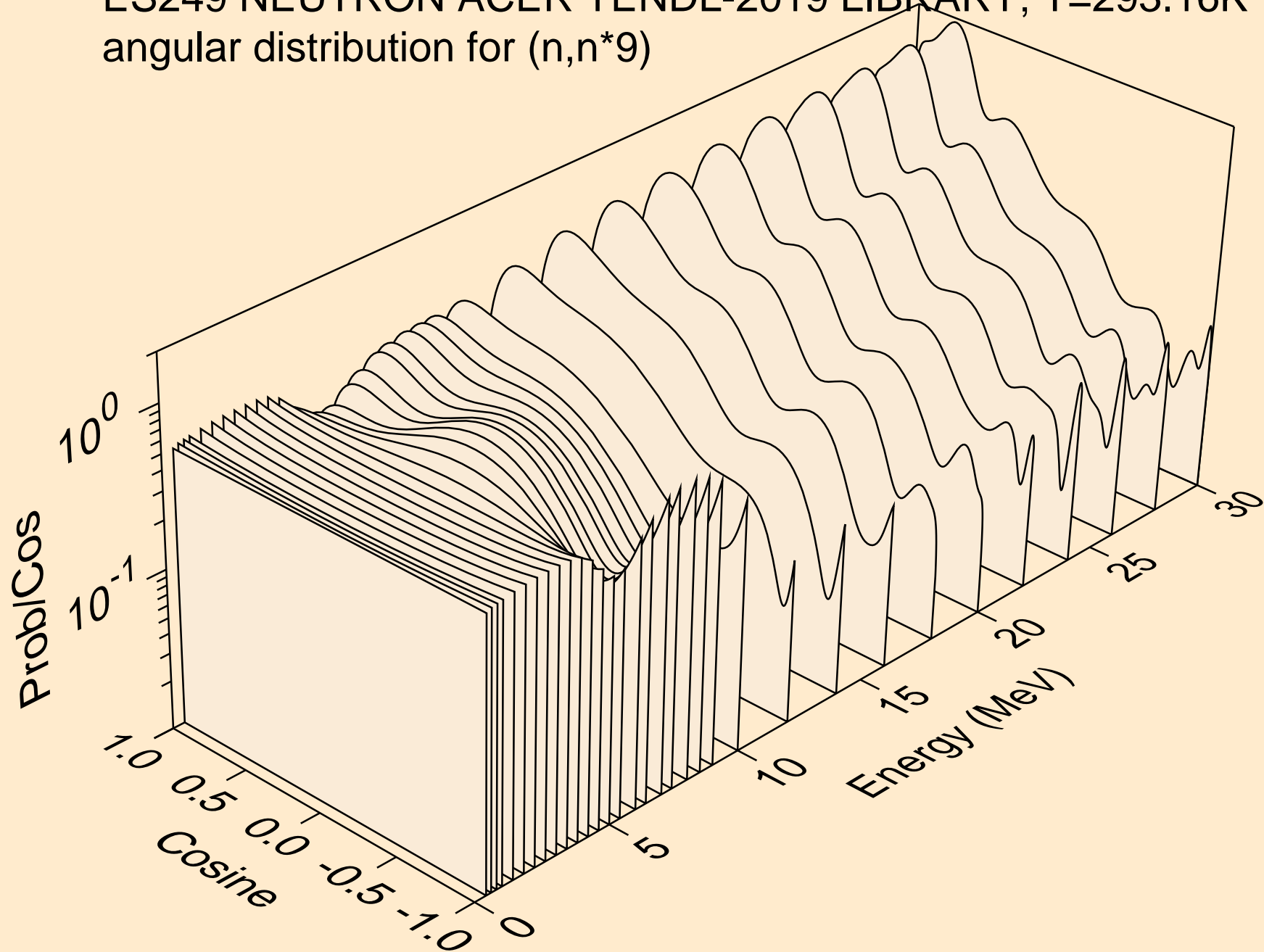

ES249 NEUTRON ACER TENDL-2019 LIBRARY; T=293.16K
angular distribution for (n,n*10)

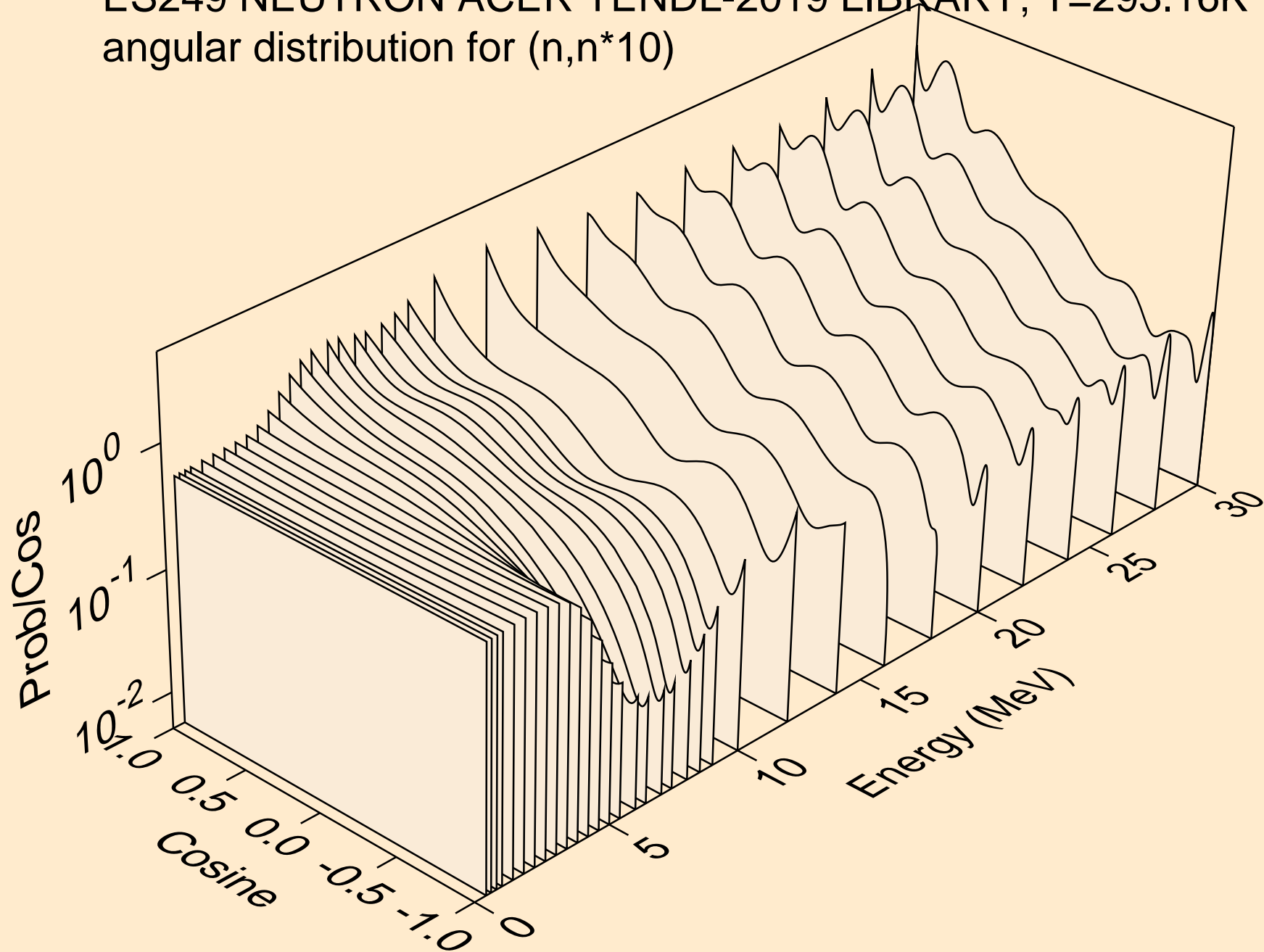

ES249 NEUTRON ACER TENDL-2019 LIBRARY; T=293.16K
angular distribution for (n,n*11)

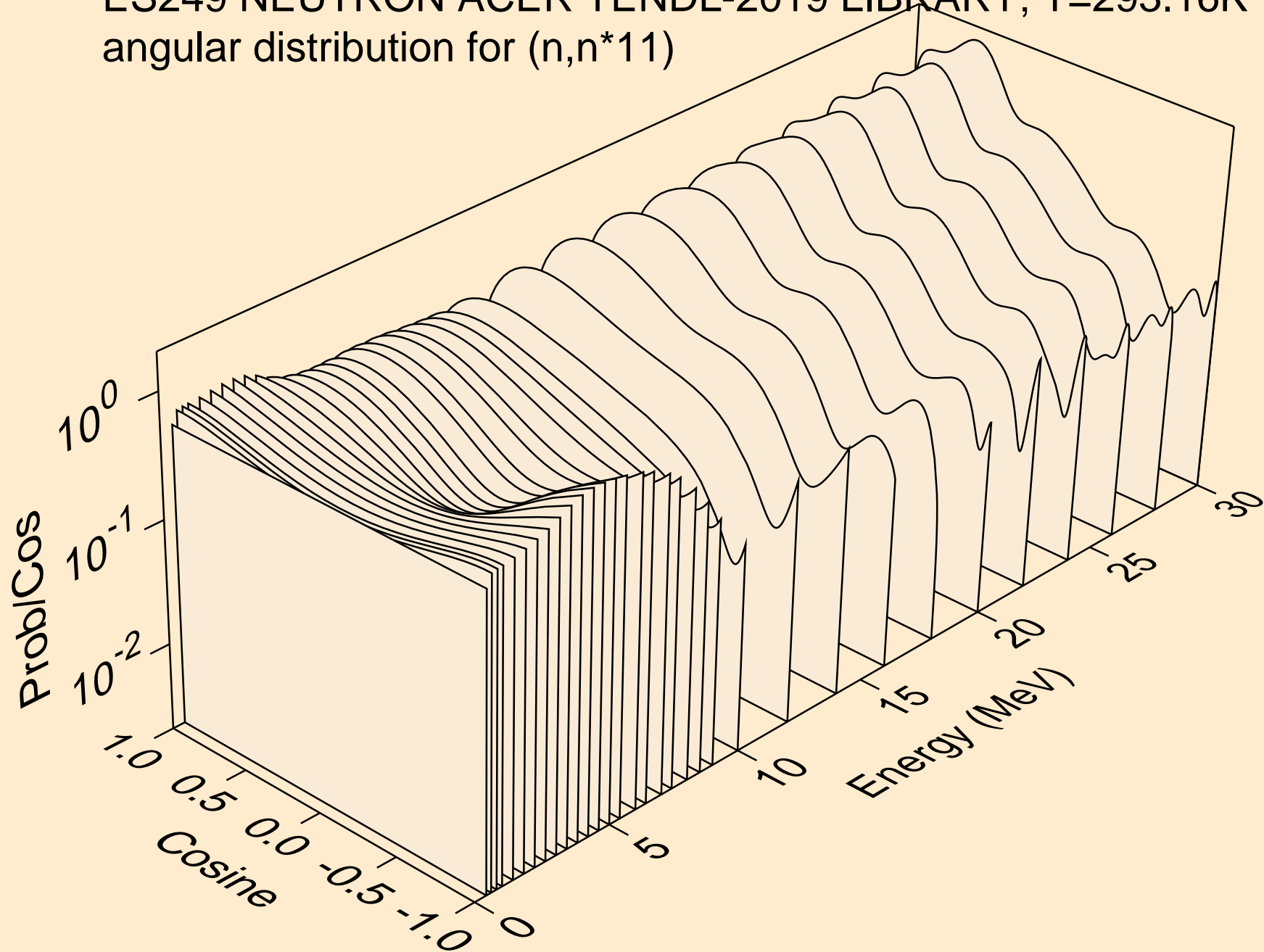

ES249 NEUTRON ACER TENDL-2019 LIBRARY; T=293.16K
angular distribution for (n,n*12)

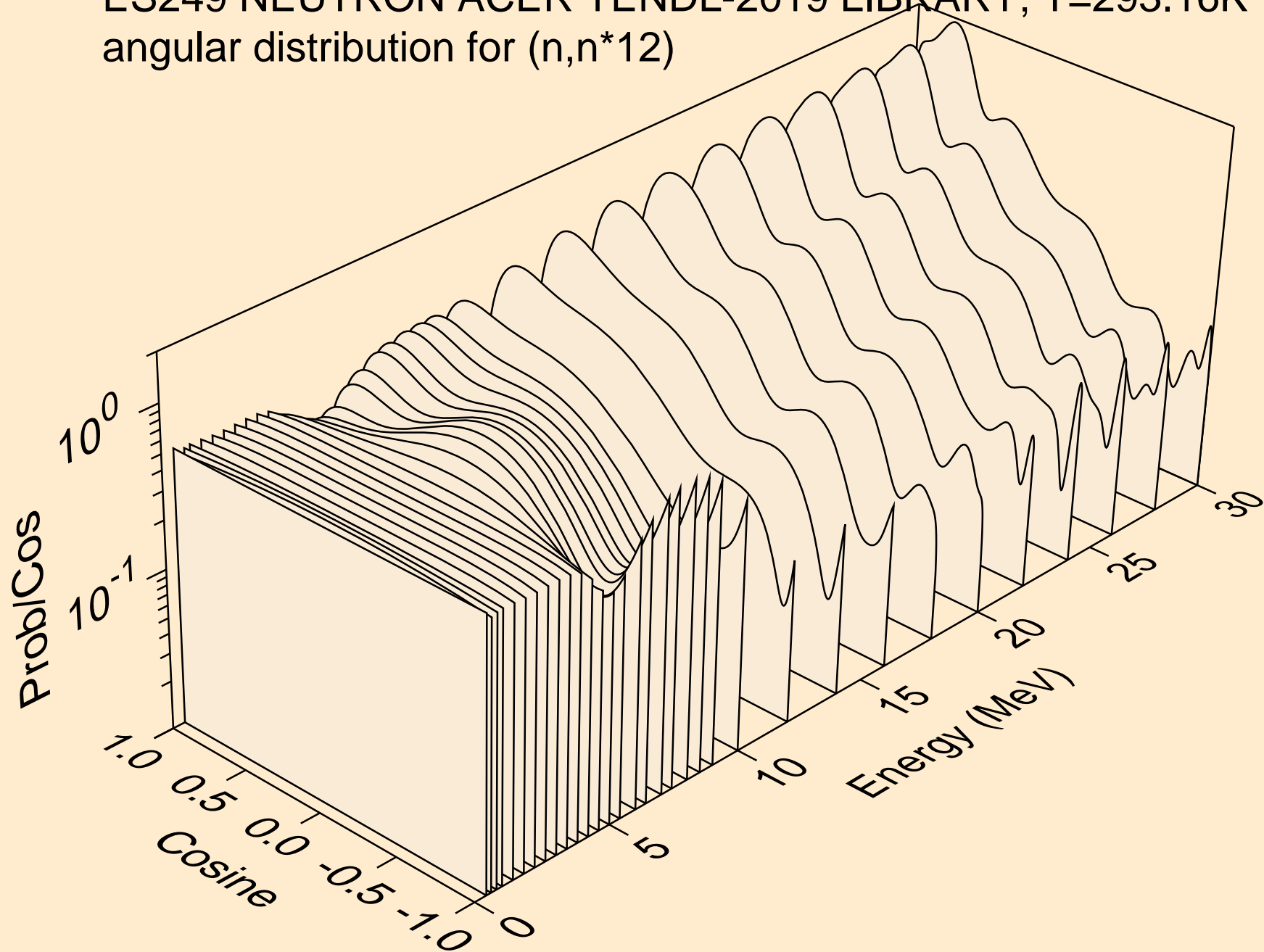

ES249 NEUTRON ACER TENDL-2019 LIBRARY; T=293.16K
angular distribution for (n,n*13)

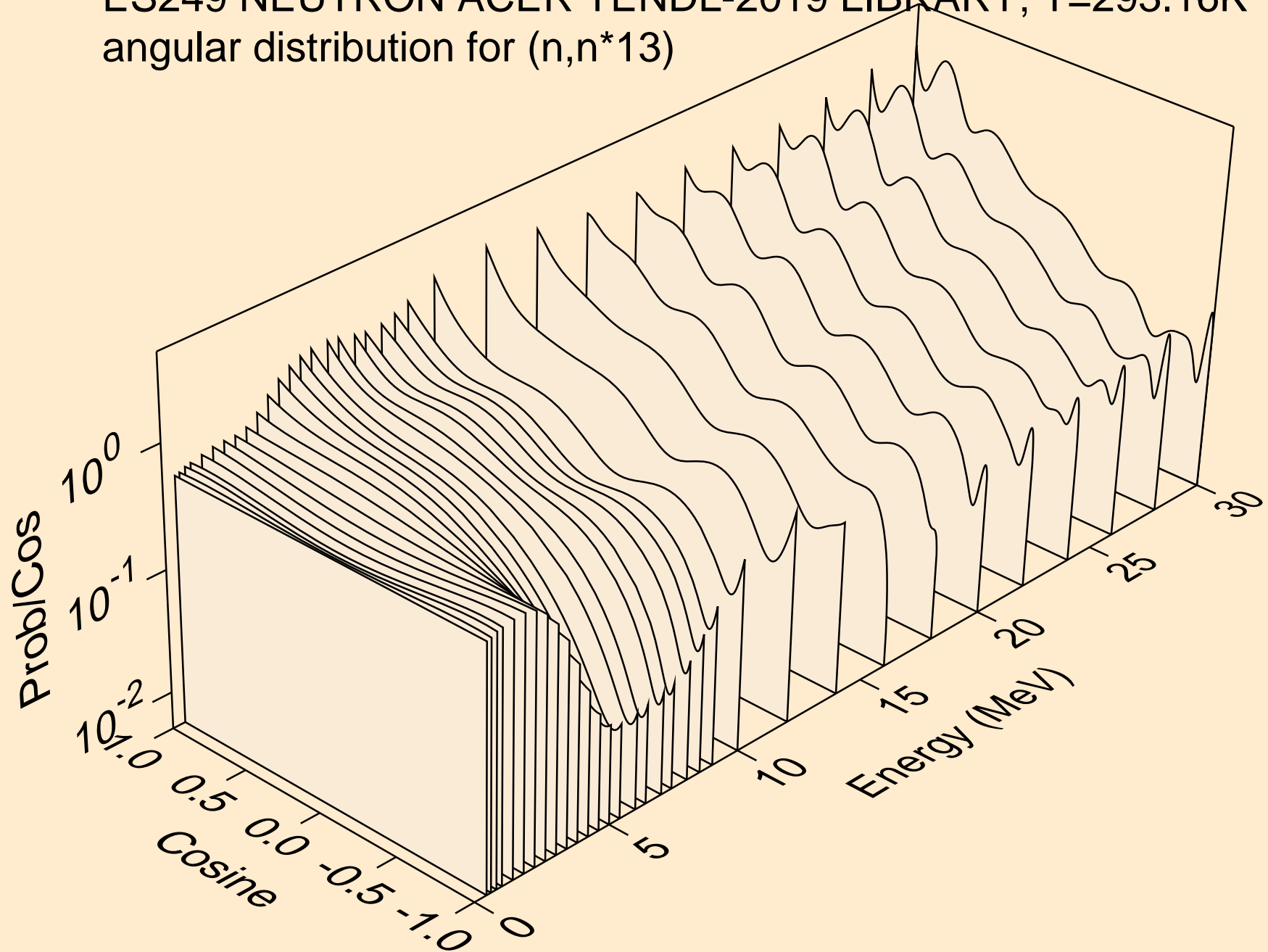

ES249 NEUTRON ACER TENDL-2019 LIBRARY; T=293.16K
angular distribution for (n,n*14)

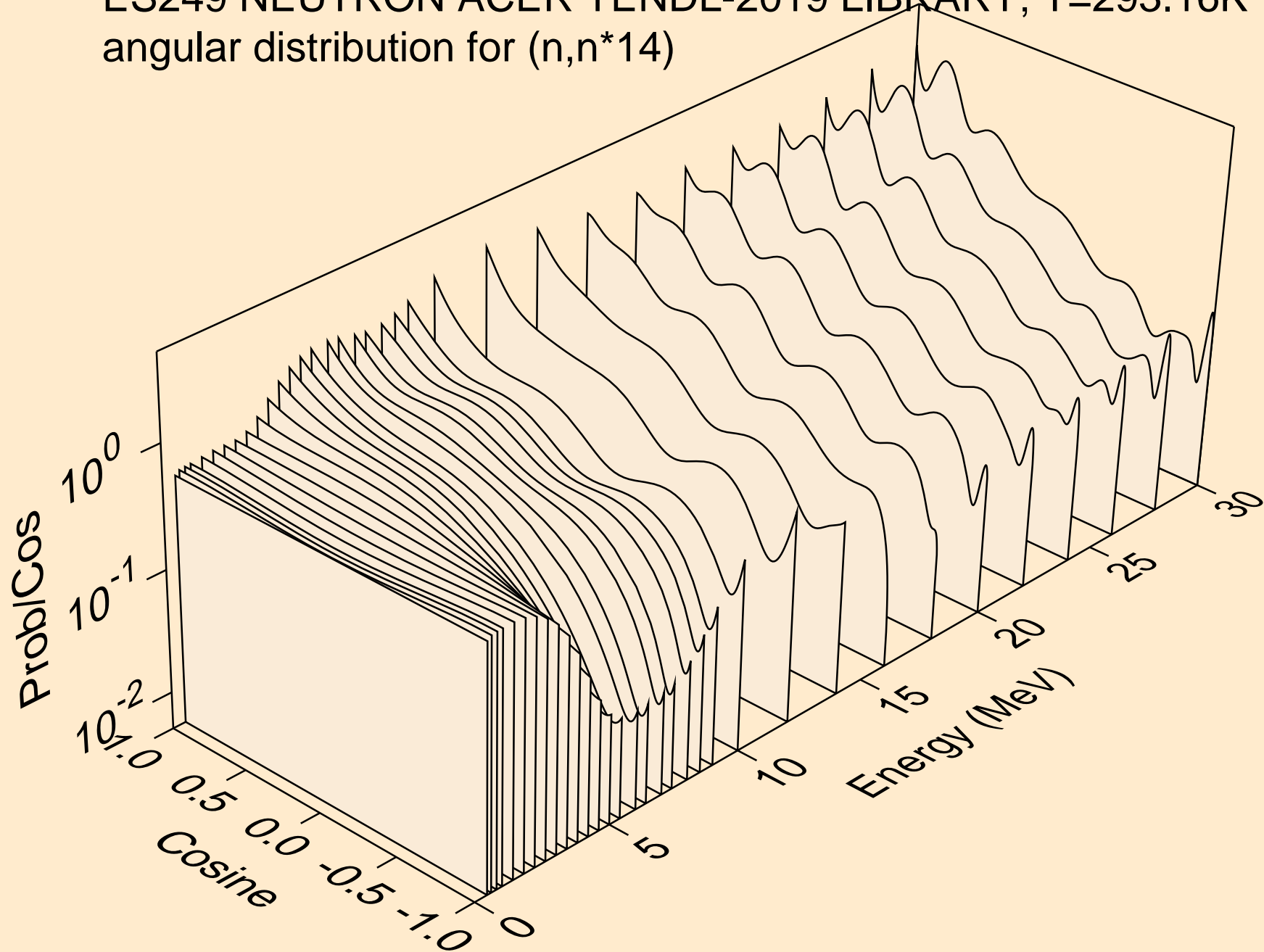

ES249 NEUTRON ACER TENDL-2019 LIBRARY; T=293.16K
angular distribution for (n,n*15)

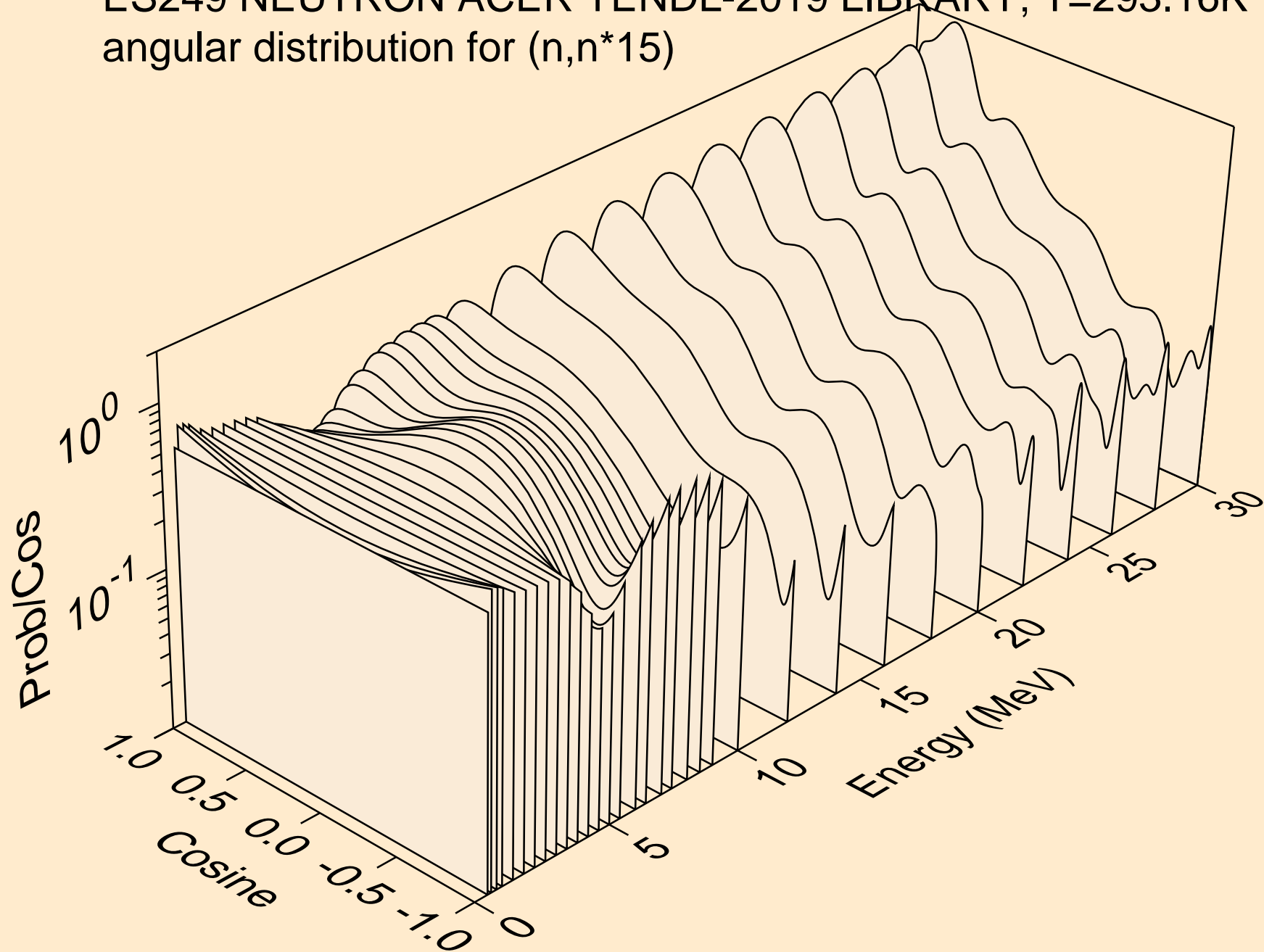

ES249 NEUTRON ACER TENDL-2019 LIBRARY; T=293.16K
angular distribution for (n,n*16)

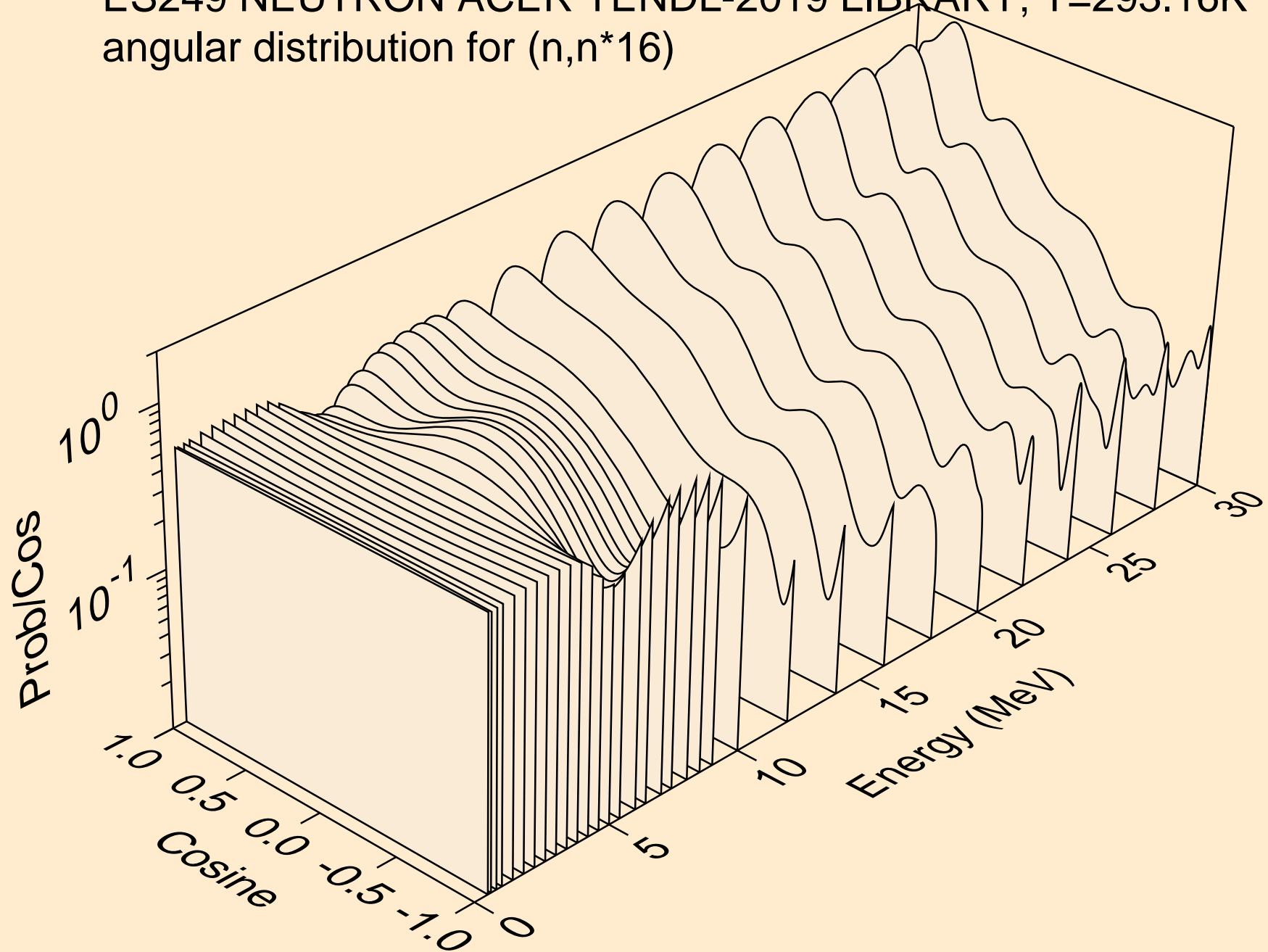

ES249 NEUTRON ACER TENDL-2019 LIBRARY; T=293.16K
angular distribution for (n,n*17)

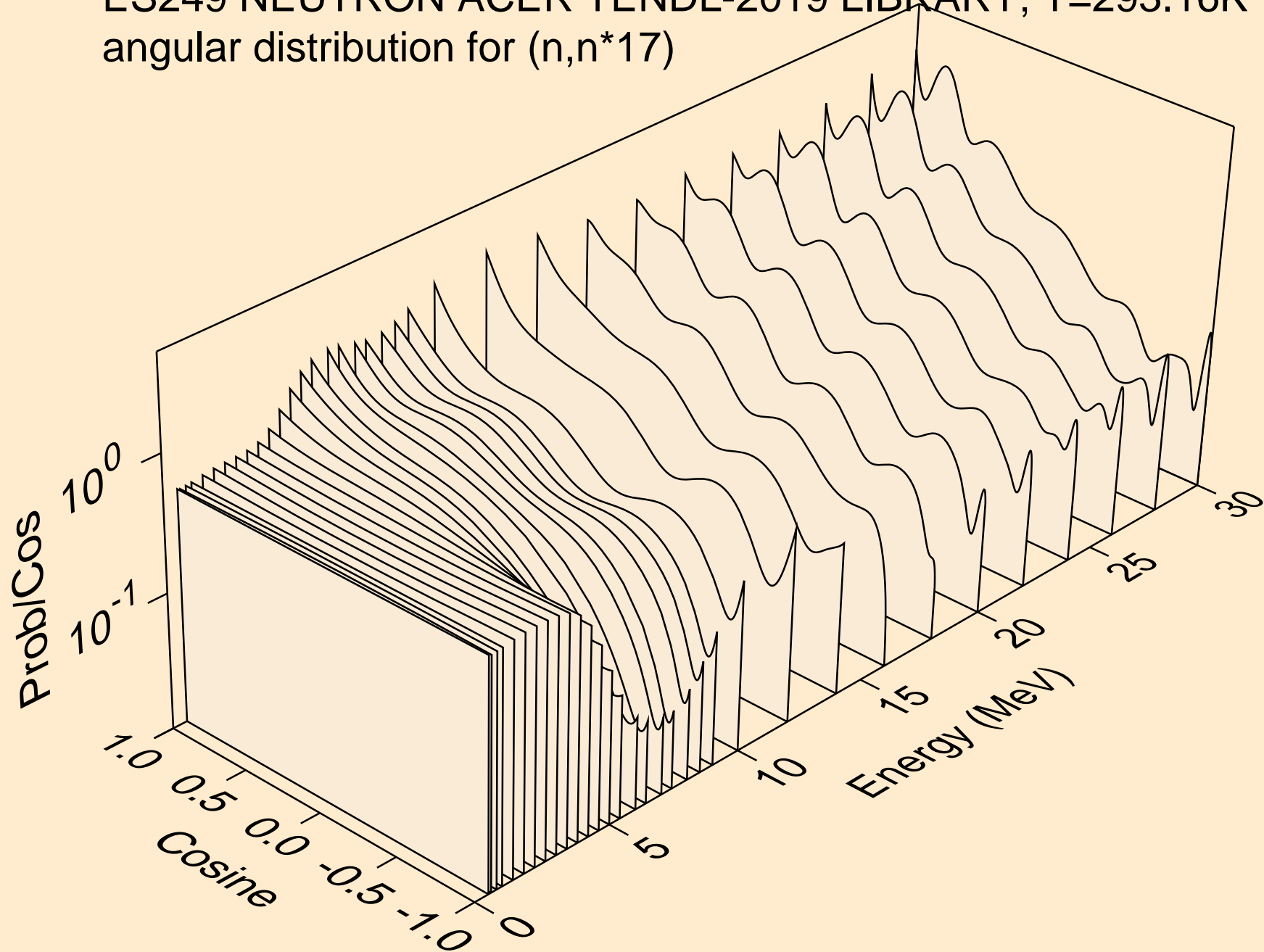

ES249 NEUTRON ACER TENDL-2019 LIBRARY; T=293.16K
angular distribution for (n,n*18)

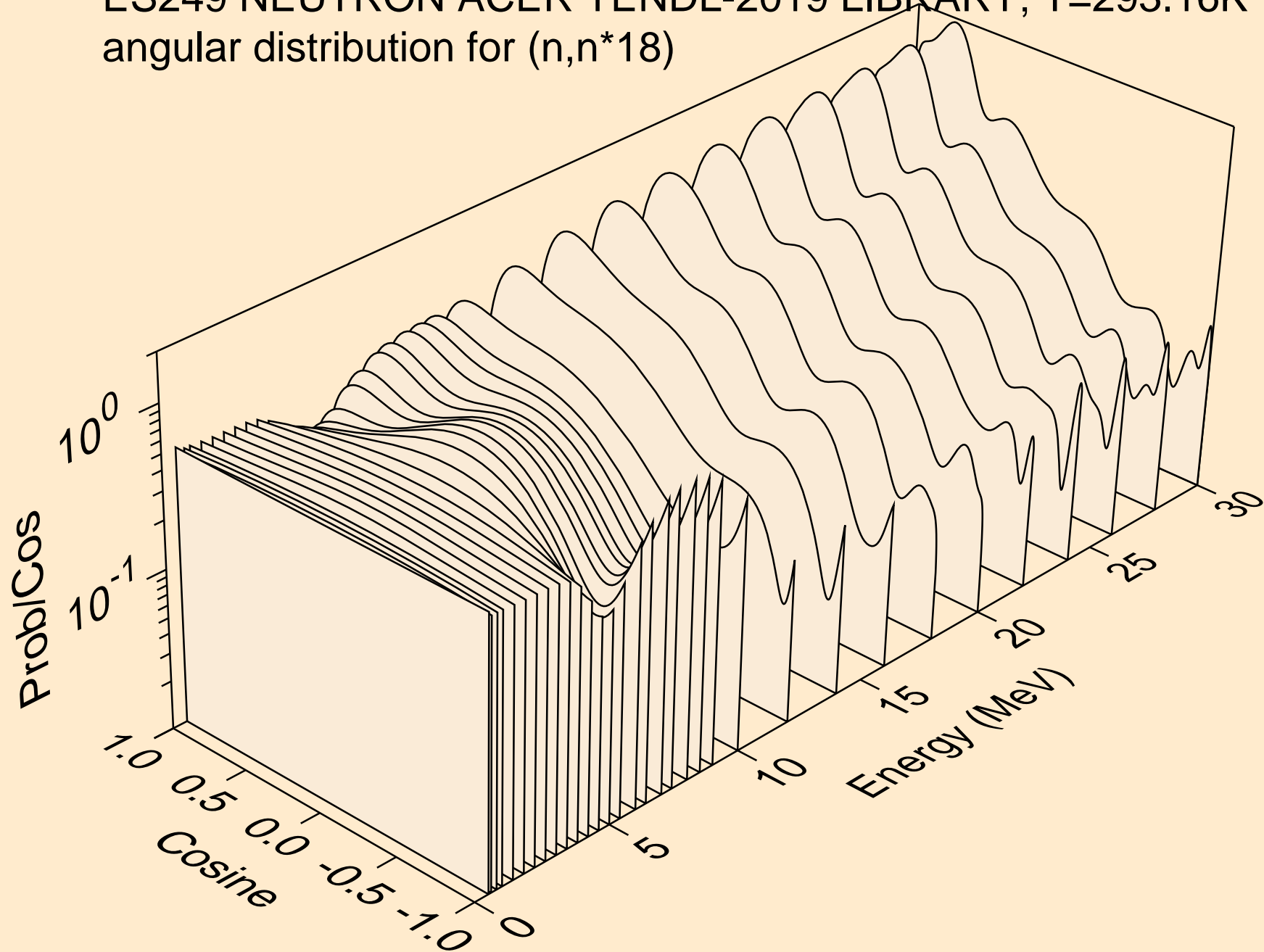

ES249 NEUTRON ACER TENDL-2019 LIBRARY; T=293.16K
angular distribution for (n,n*19)

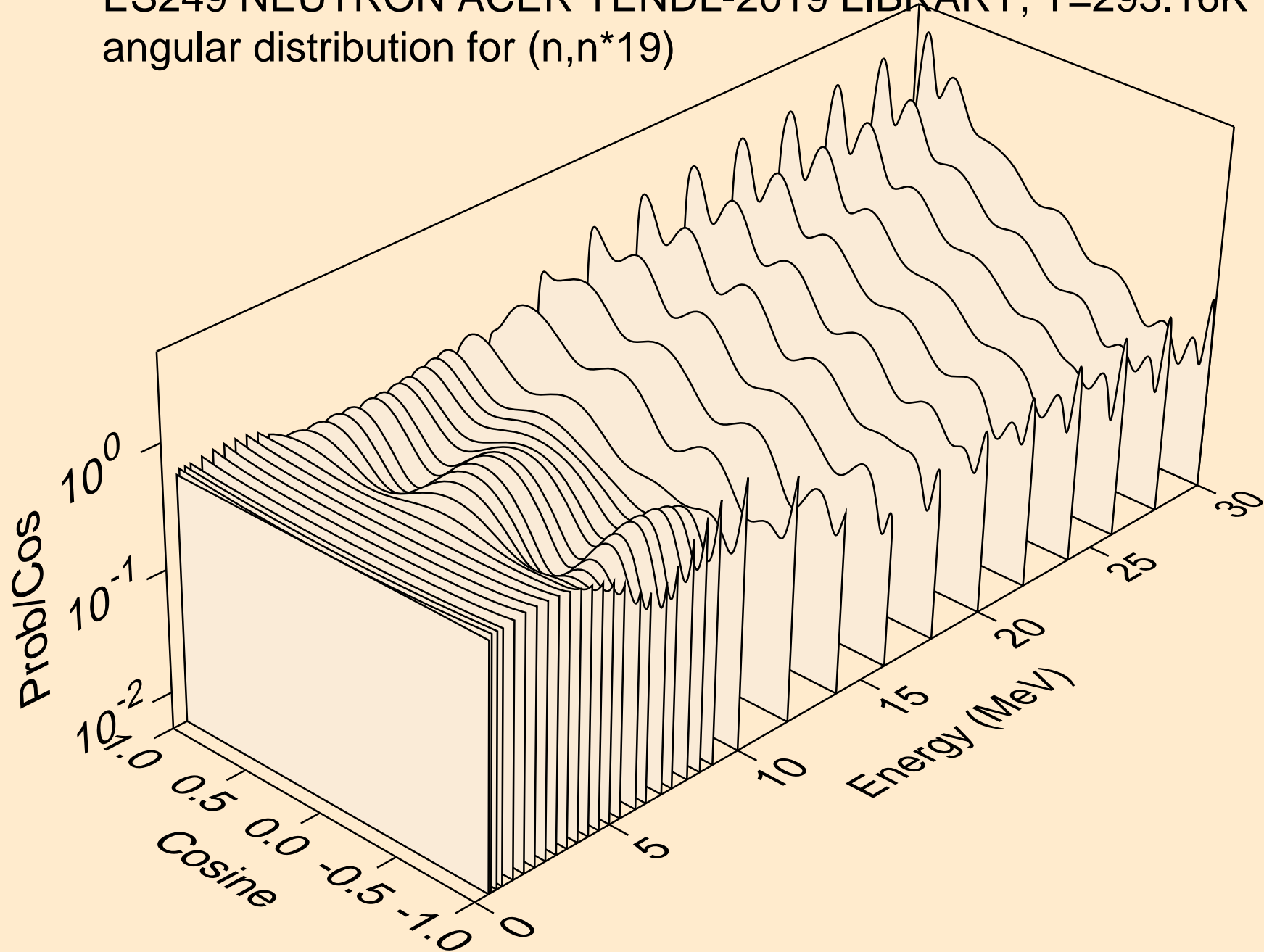

ES249 NEUTRON ACER TENDL-2019 LIBRARY; T=293.16K
angular distribution for (n,n*20)

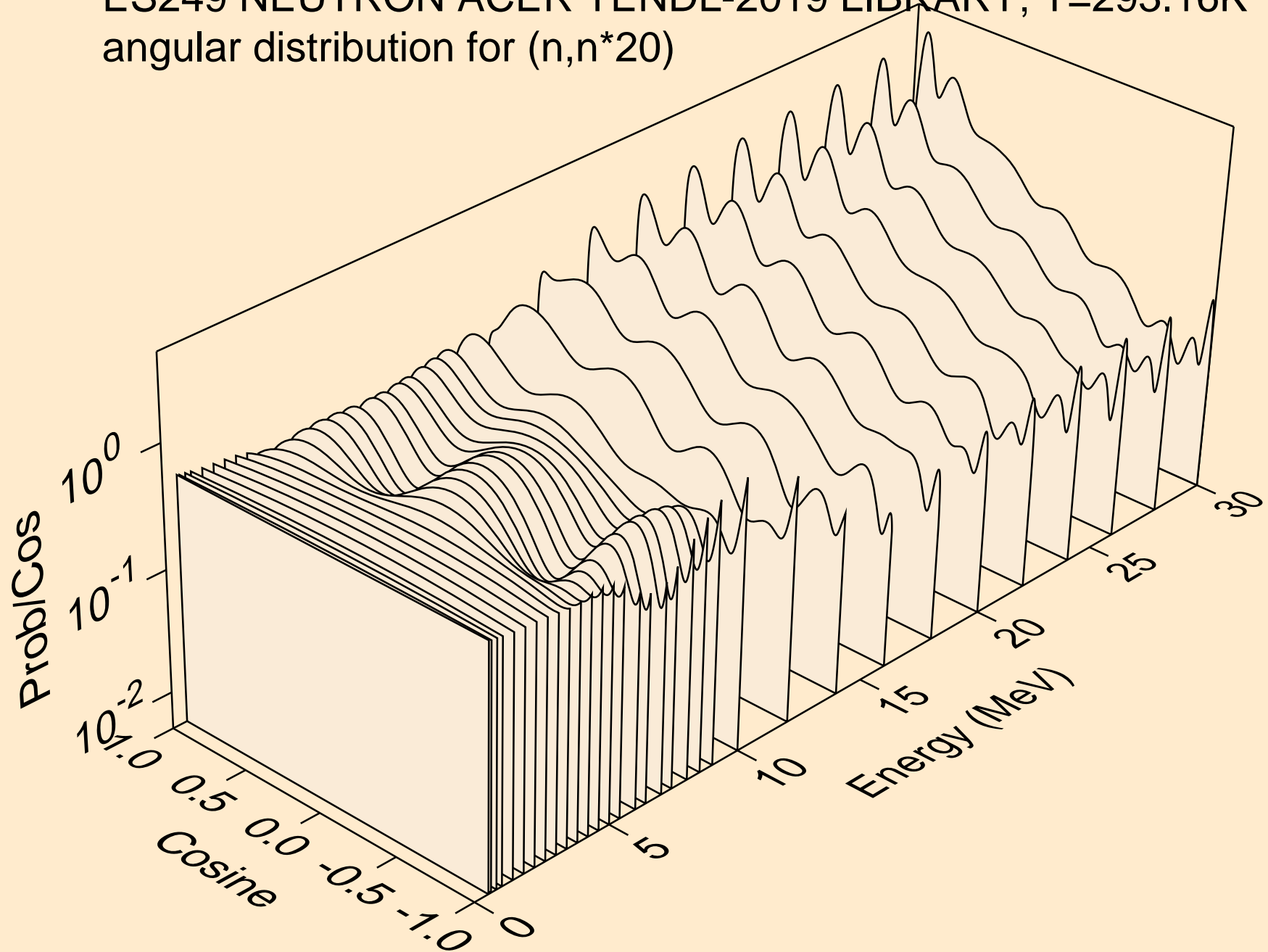

ES249 NEUTRON ACER TENDL-2019 LIBRARY; T=293.16K
angular distribution for (n,n*21)

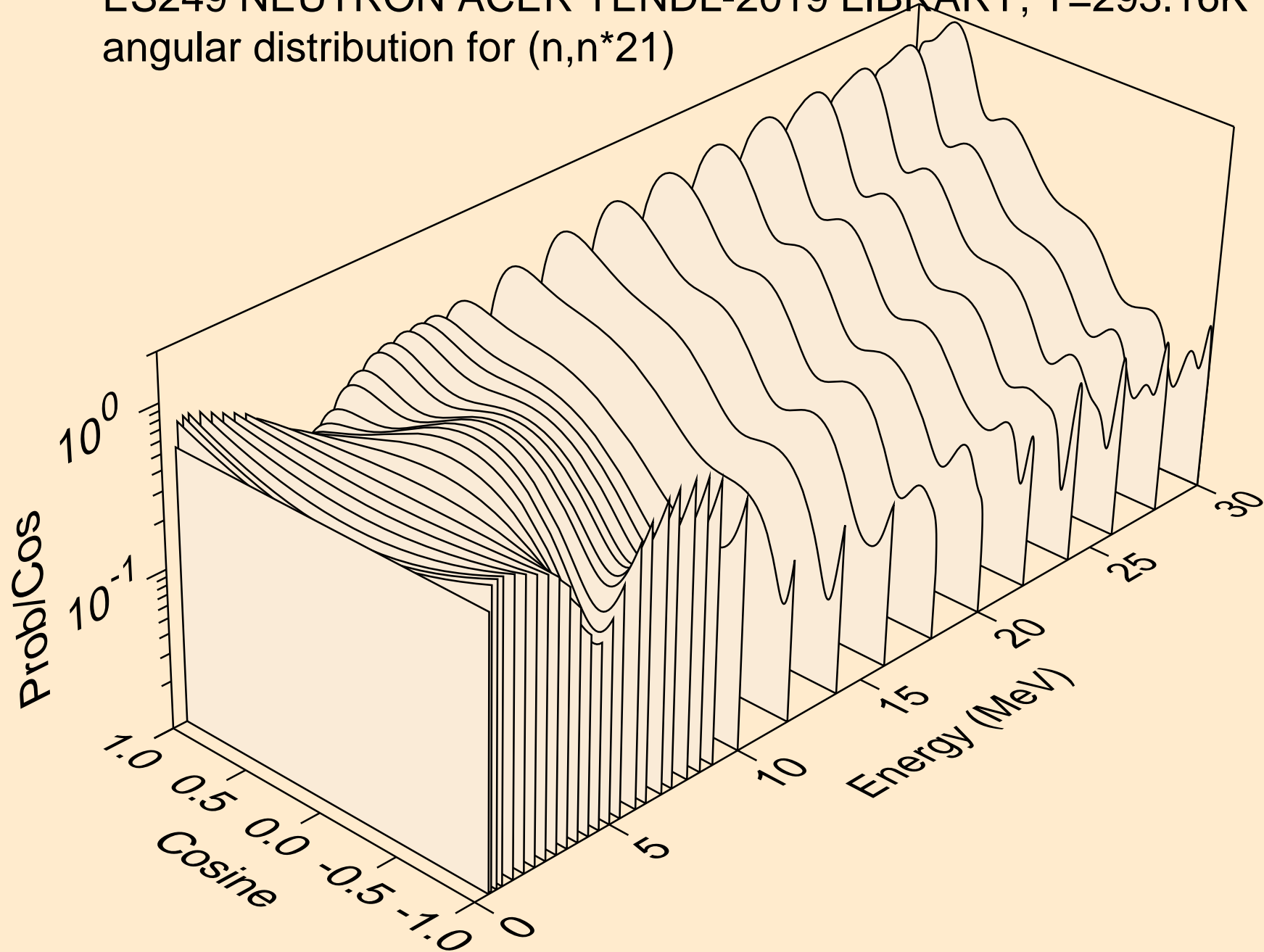

ES249 NEUTRON ACER TENDL-2019 LIBRARY; T=293.16K
angular distribution for (n,n*22)

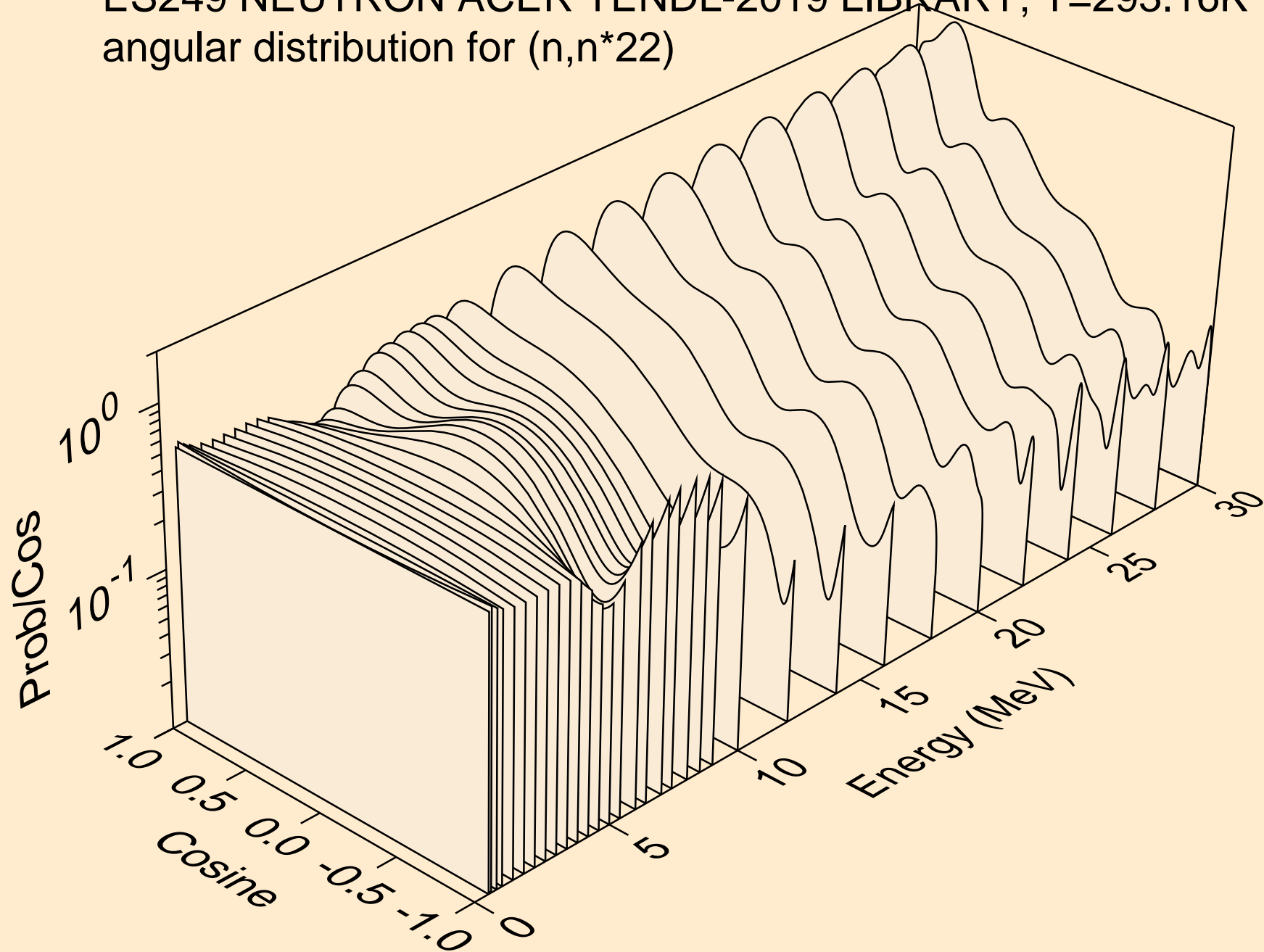

ES249 NEUTRON ACER TENDL-2019 LIBRARY; T=293.16K
angular distribution for (n,n*23)

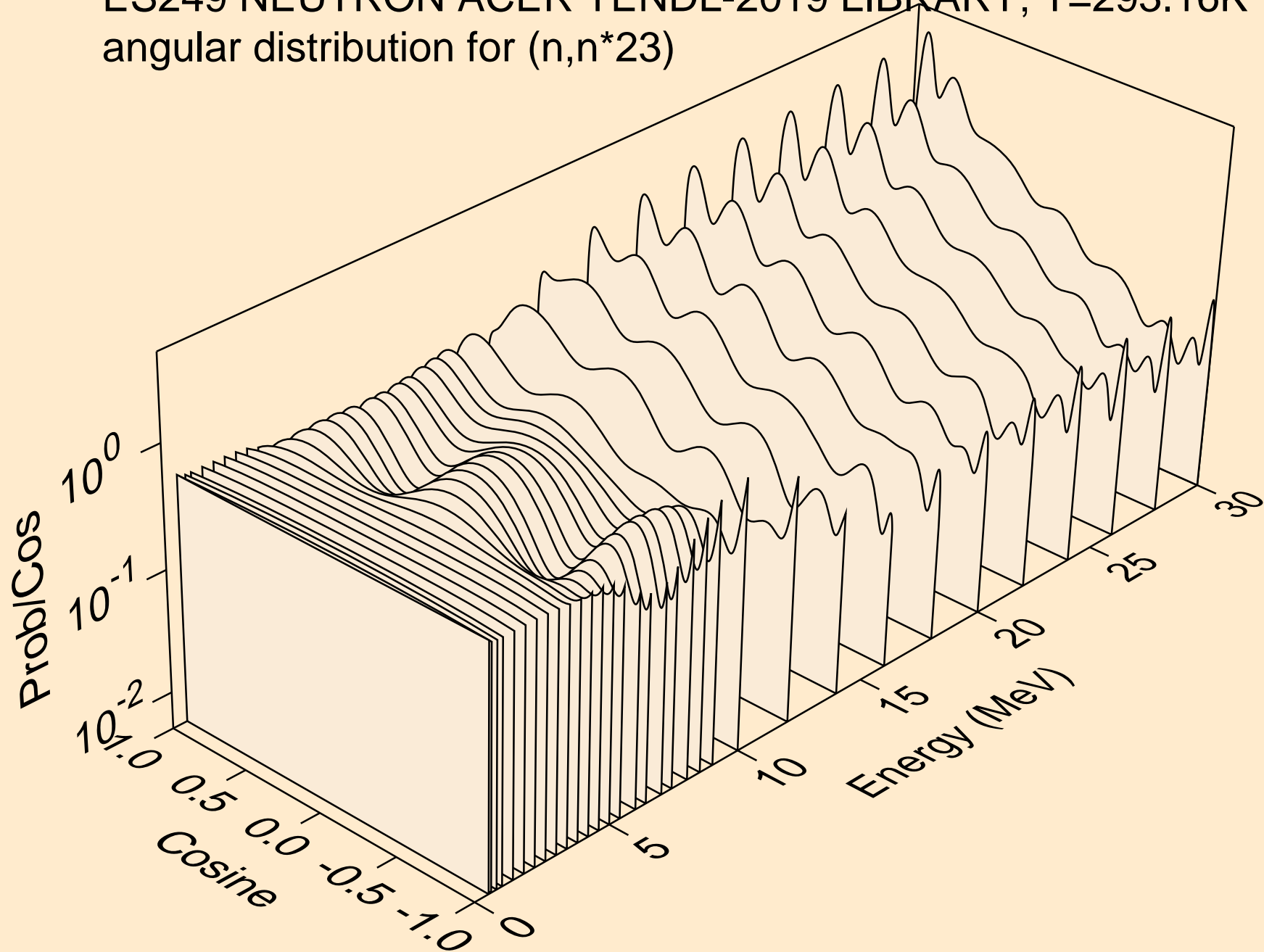

ES249 NEUTRON ACER TENDL-2019 LIBRARY; T=293.16K
angular distribution for (n,n*24)

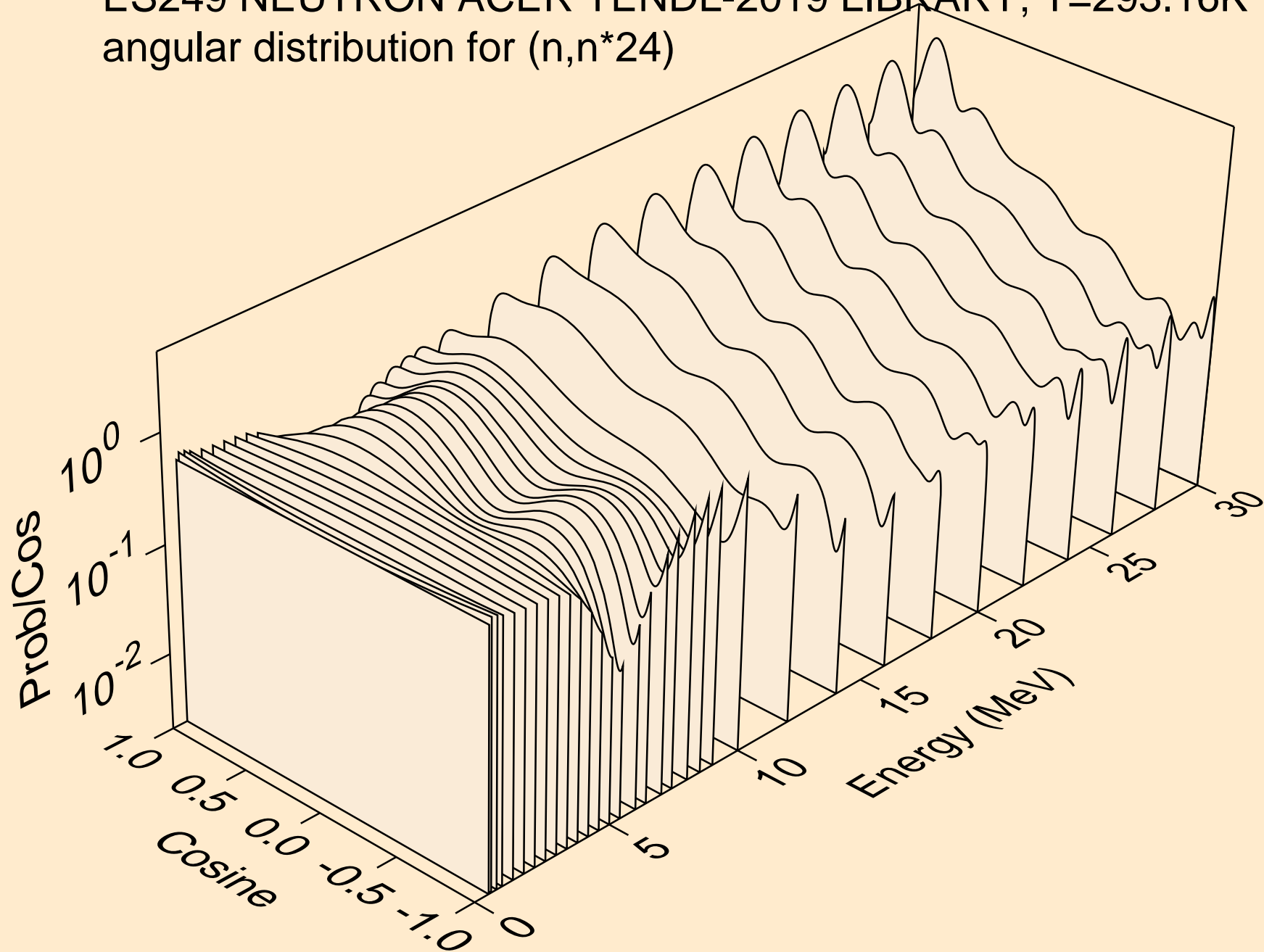

ES249 NEUTRON ACER TENDL-2019 LIBRARY; T=293.16K
angular distribution for (n,n*25)

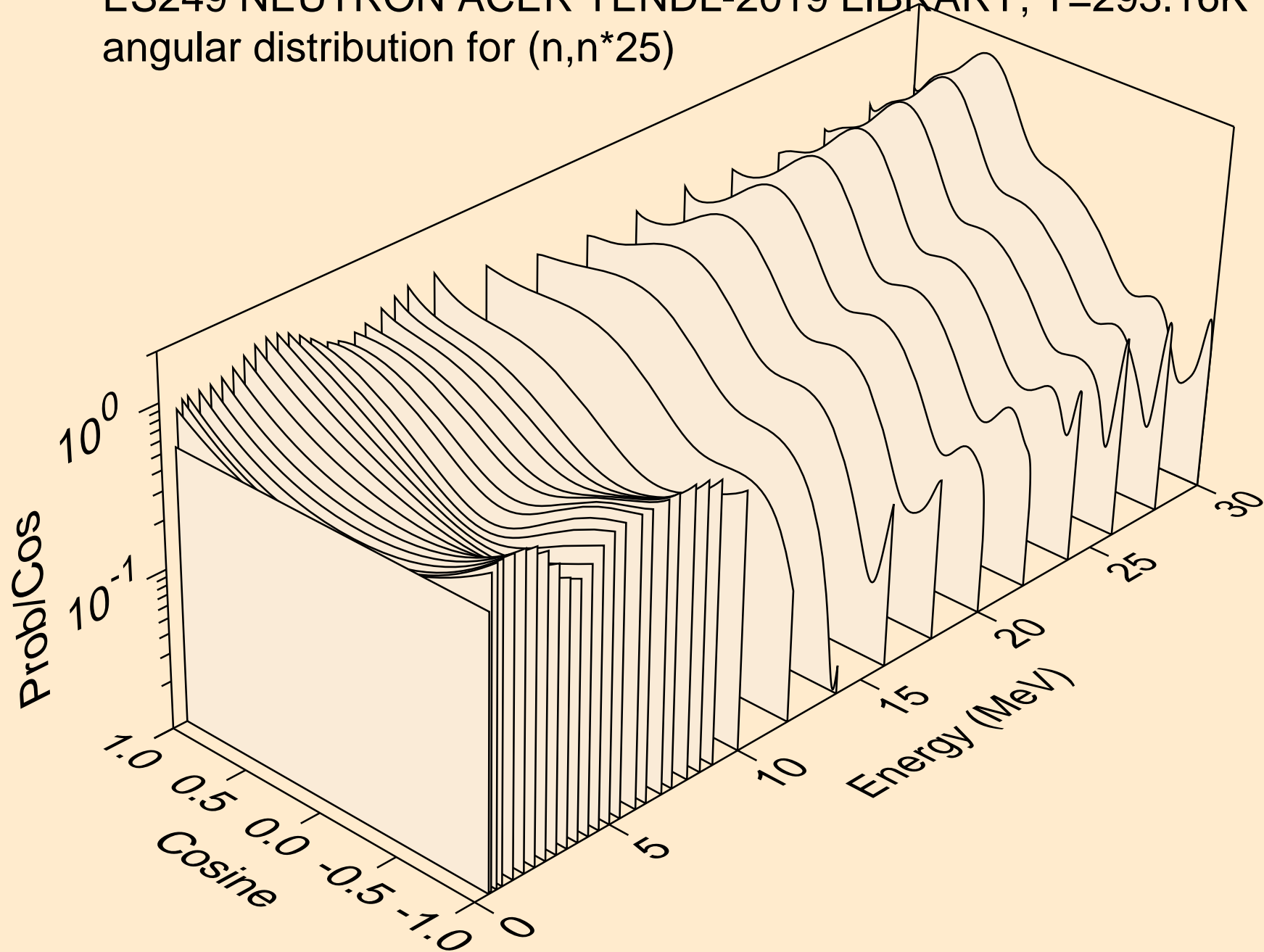

ES249 NEUTRON ACER TENDL-2019 LIBRARY; T=293.16K
angular distribution for (n,n*26)

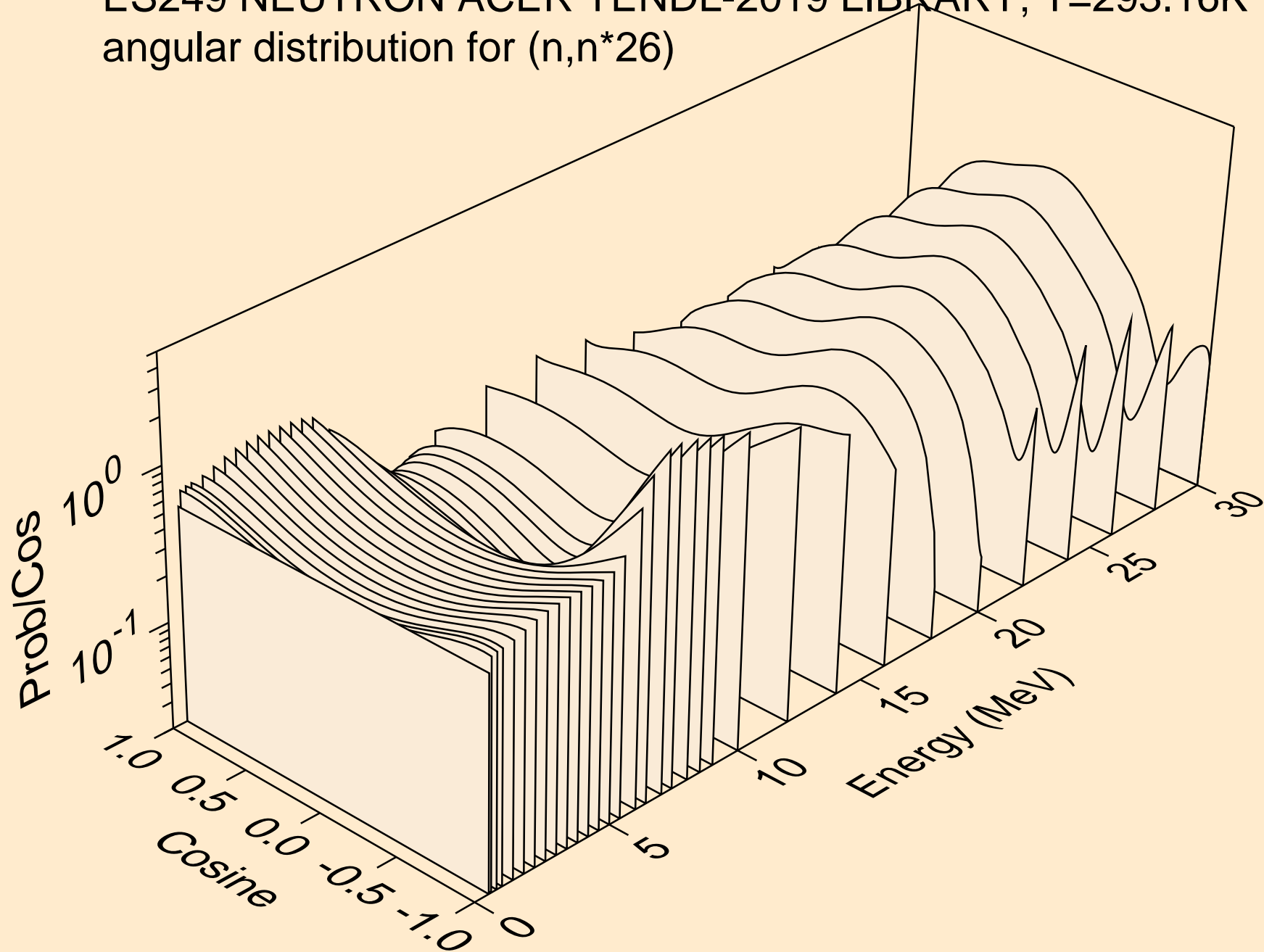

ES249 NEUTRON ACER TENDL-2019 LIBRARY; T=293.16K
angular distribution for (n,n*27)

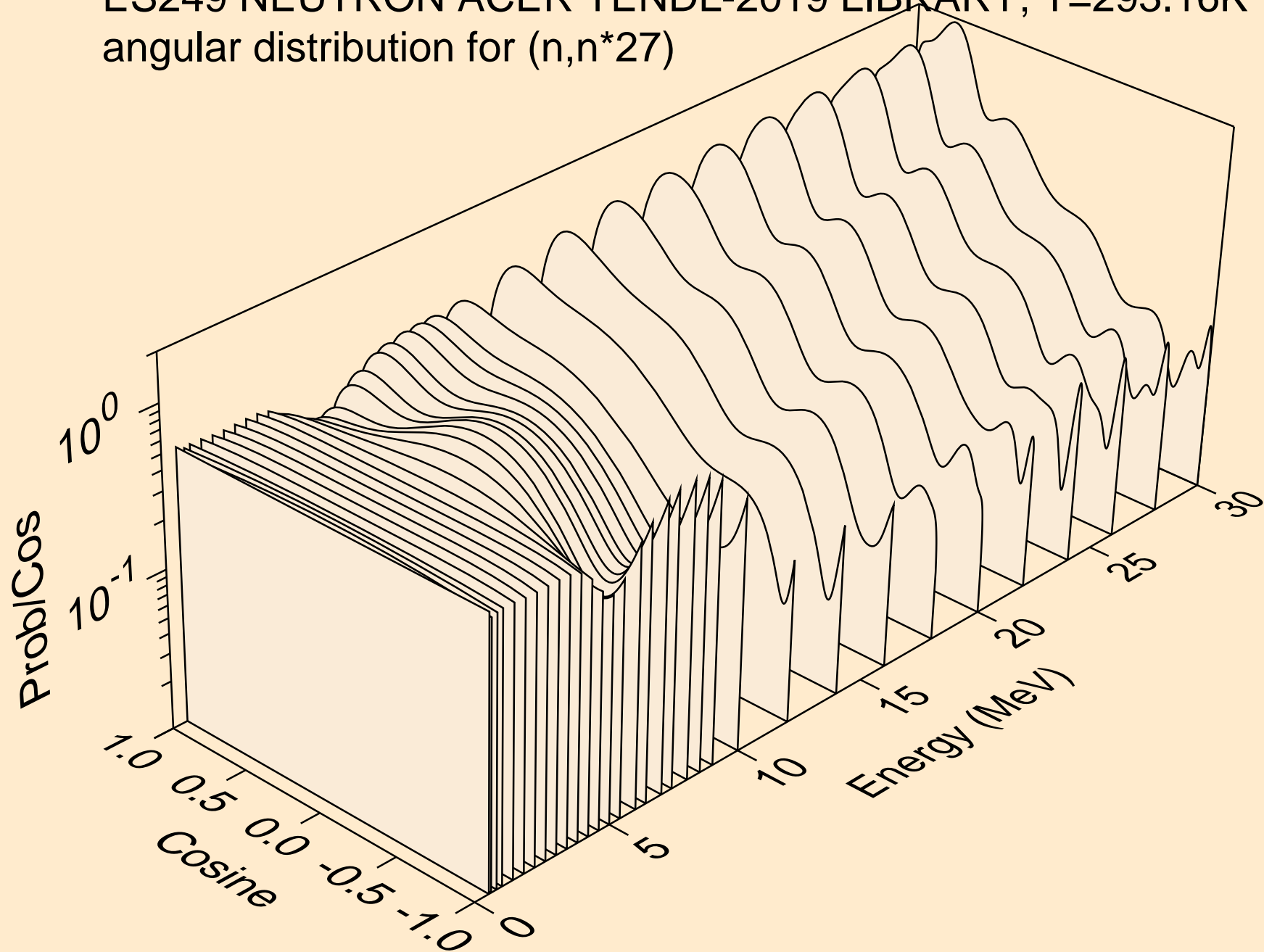

ES249 NEUTRON ACER TENDL-2019 LIBRARY; T=293.16K
angular distribution for (n,n*28)

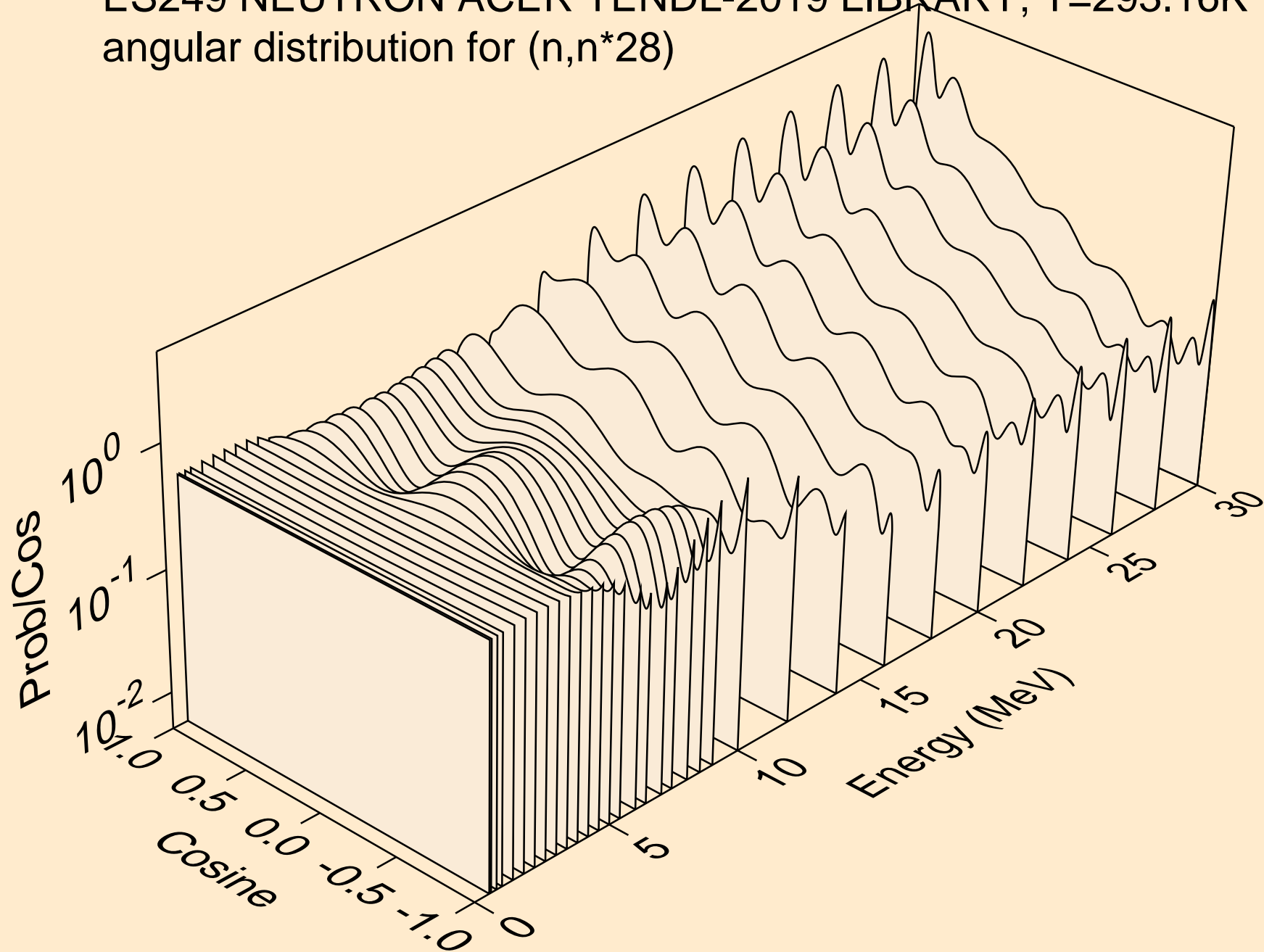

ES249 NEUTRON ACER TENDL-2019 LIBRARY; T=293.16K
angular distribution for (n,n*29)

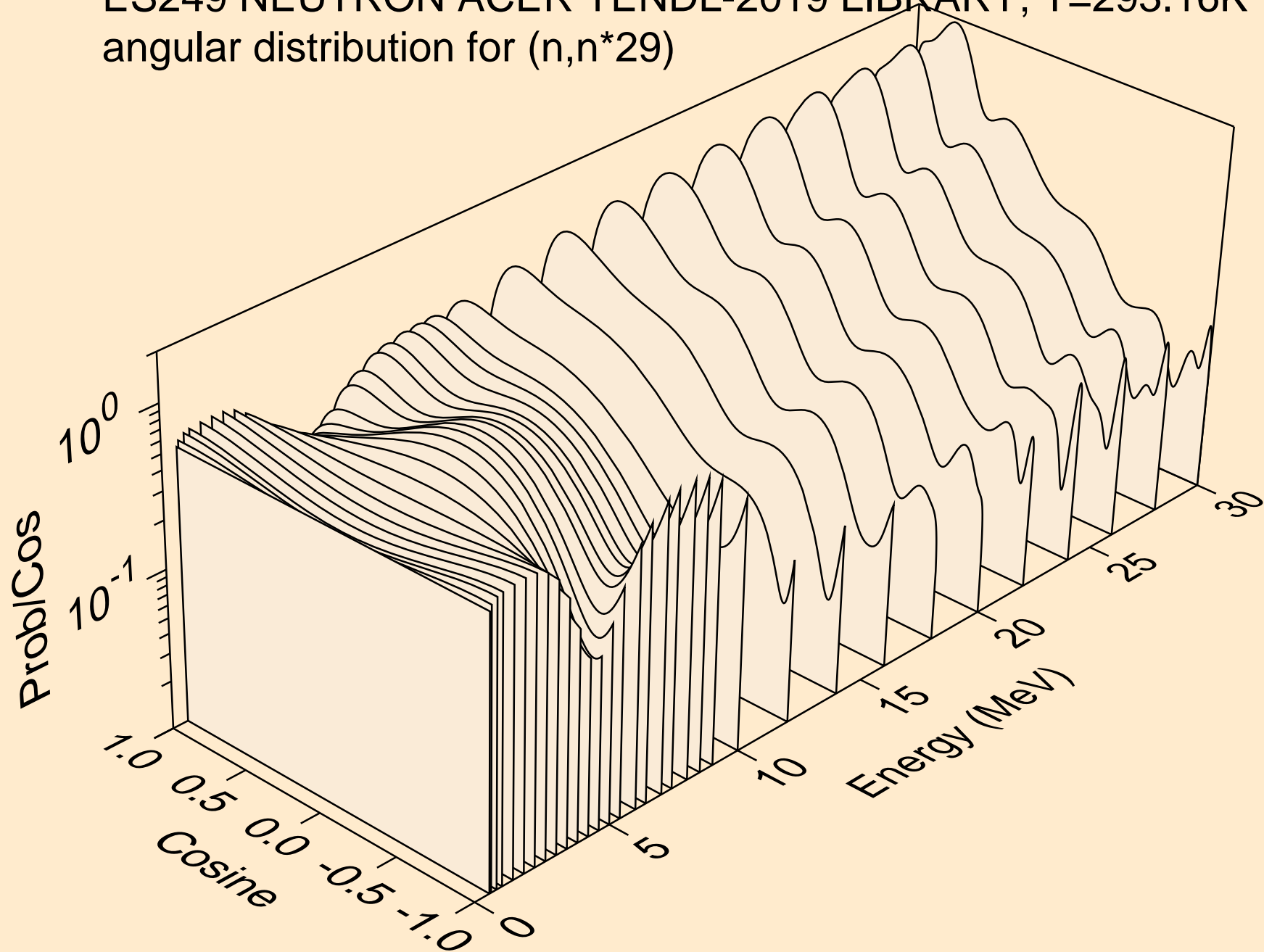

ES249 NEUTRON ACER TENDL-2019 LIBRARY; T=293.16K
angular distribution for (n,n*30)

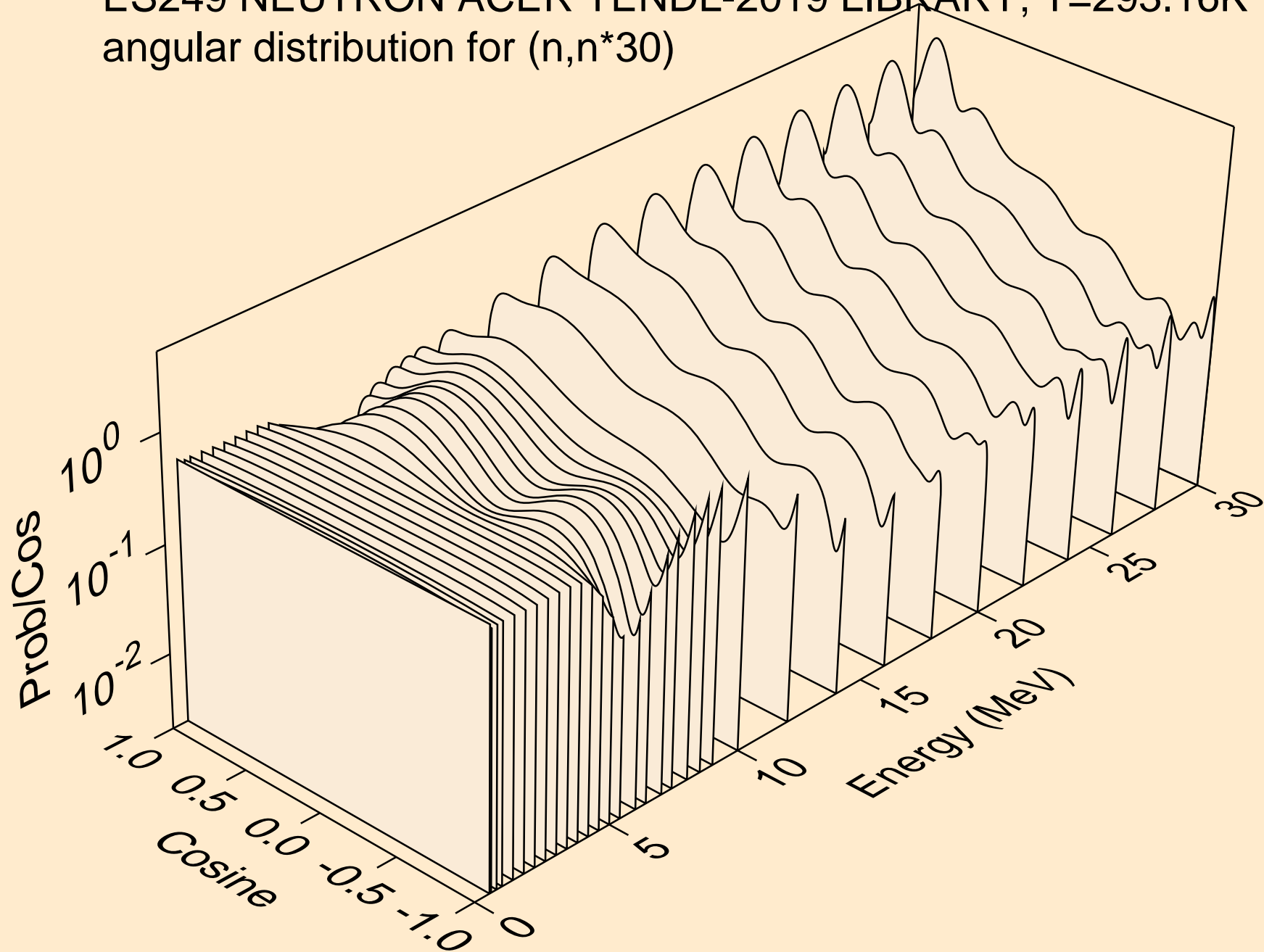

ES249 NEUTRON ACER TENDL-2019 LIBRARY; T=293.16K
Total fission nubar

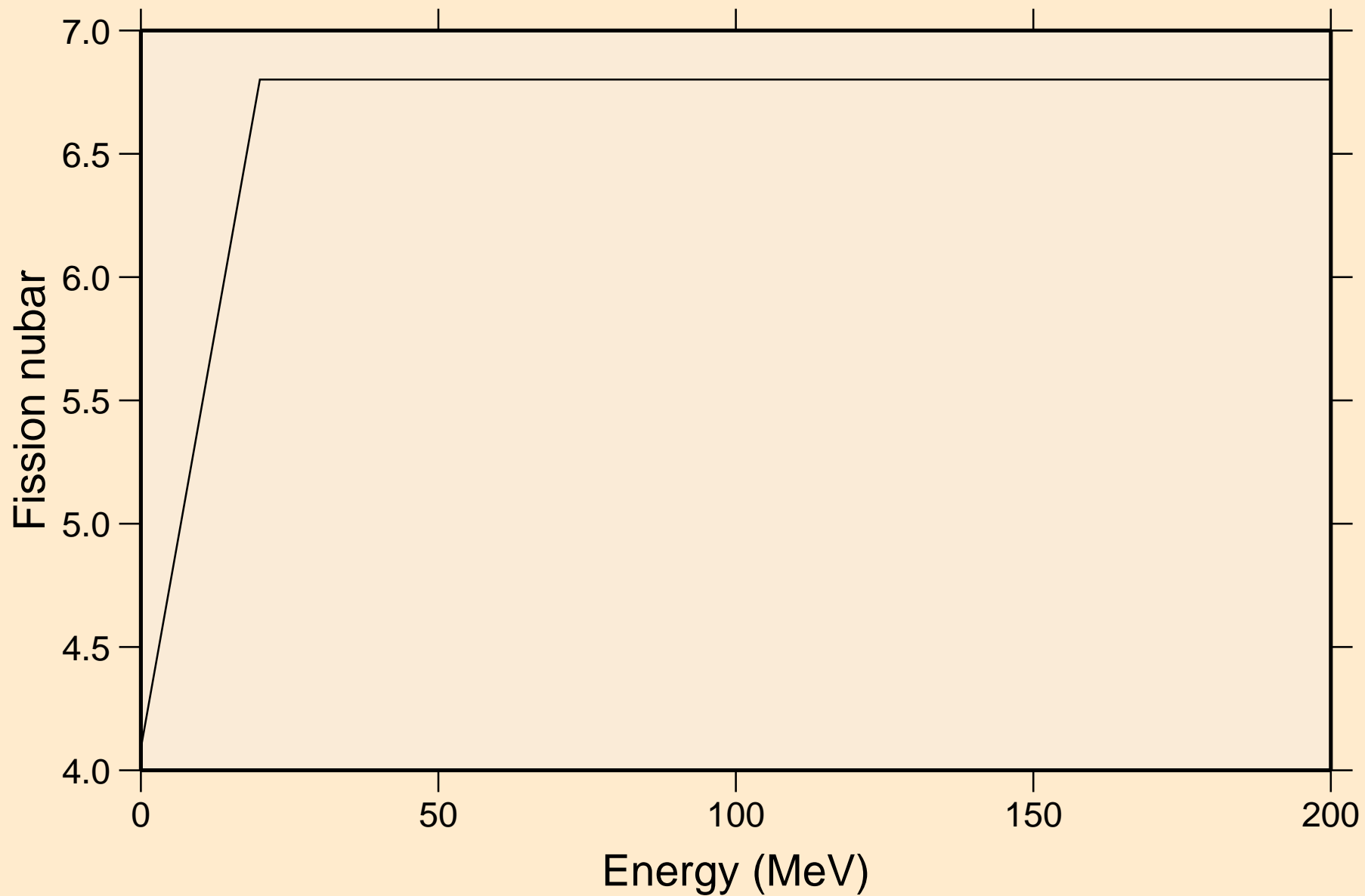

ES249 NEUTRON ACER TENDL-2019 LIBRARY; T=293.16K
Neutron emission for (n,x)

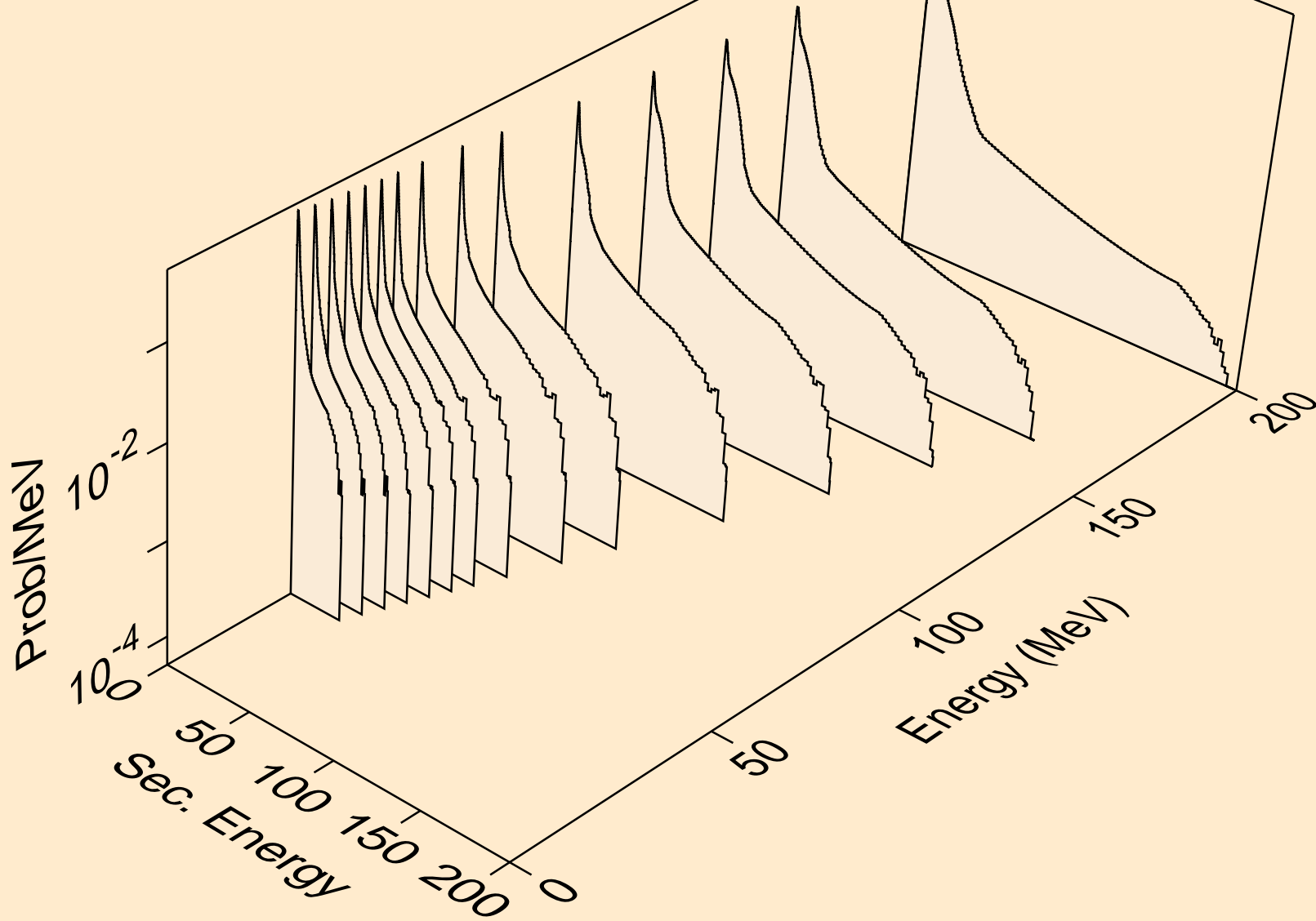

ES249 NEUTRON ACER TENDL-2019 LIBRARY; T=293.16K
Neutron emission for (n,2nd)

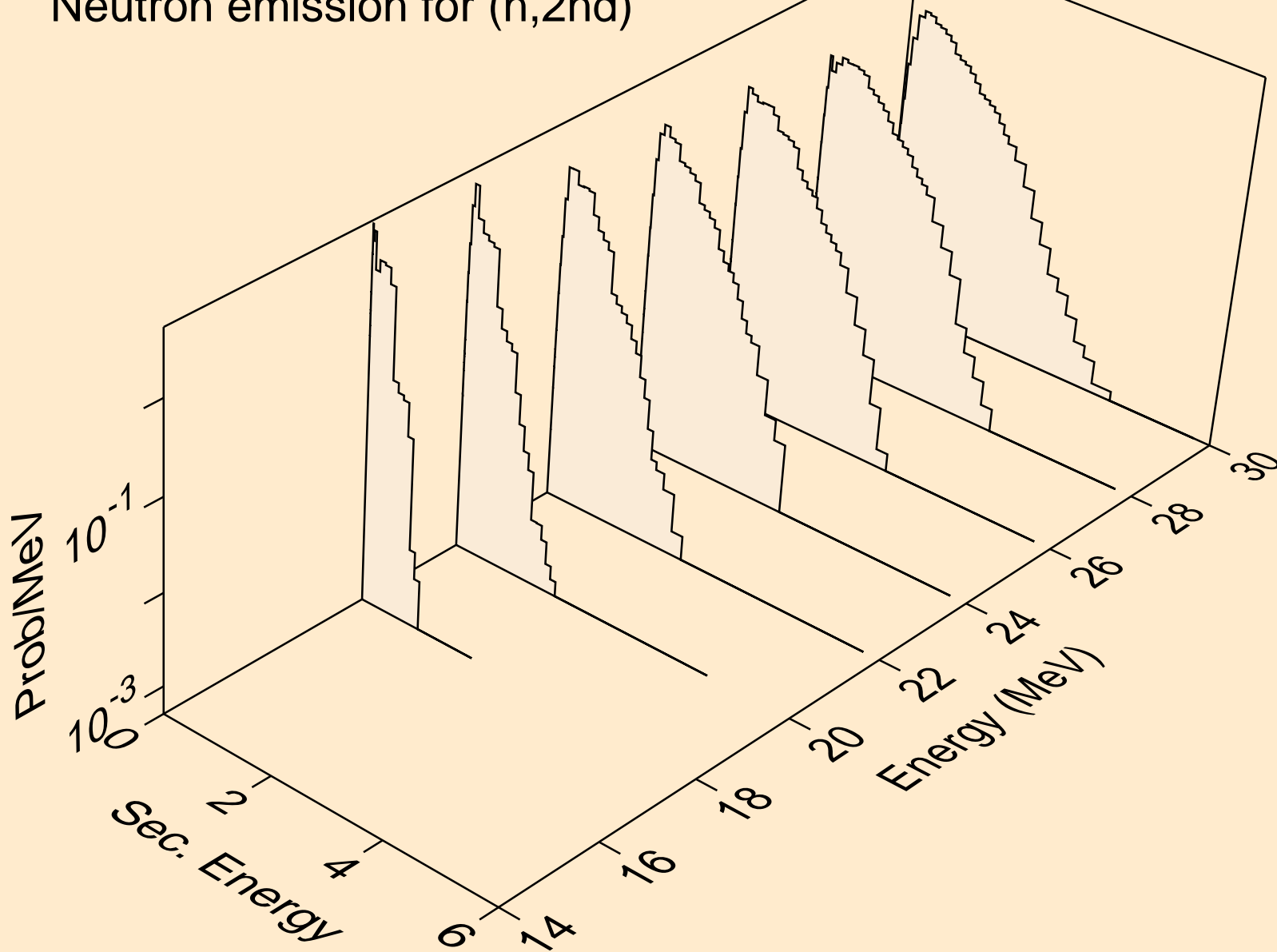

ES249 NEUTRON ACER TENDL-2019 LIBRARY; T=293.16K
Neutron emission for (n,2n)

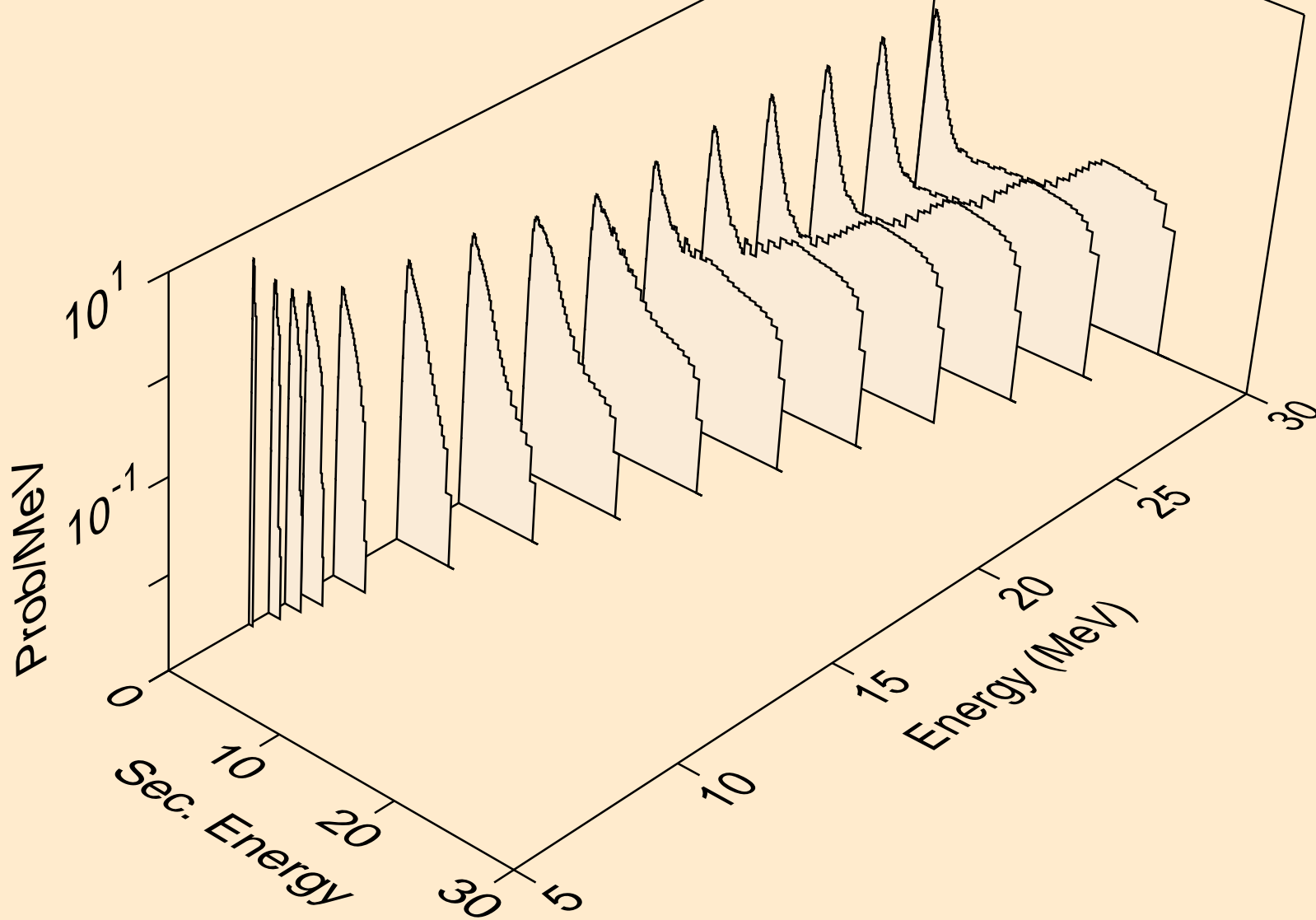

ES249 NEUTRON ACER TENDL-2019 LIBRARY; T=293.16K
Neutron emission for (n,3n)

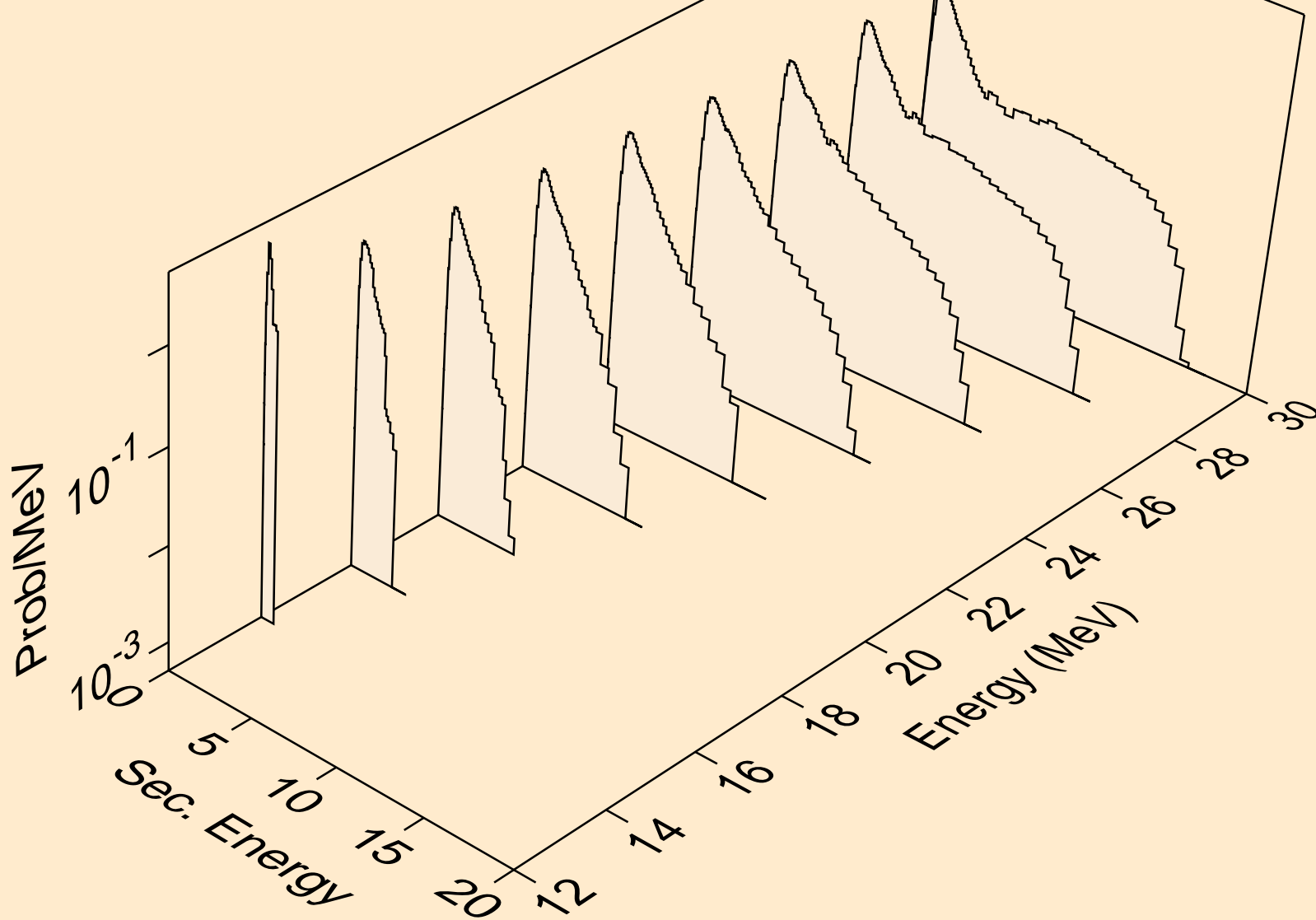

ES249 NEUTRON ACER TENDL-2019 LIBRARY; T=293.16K
Neutron emission for fission

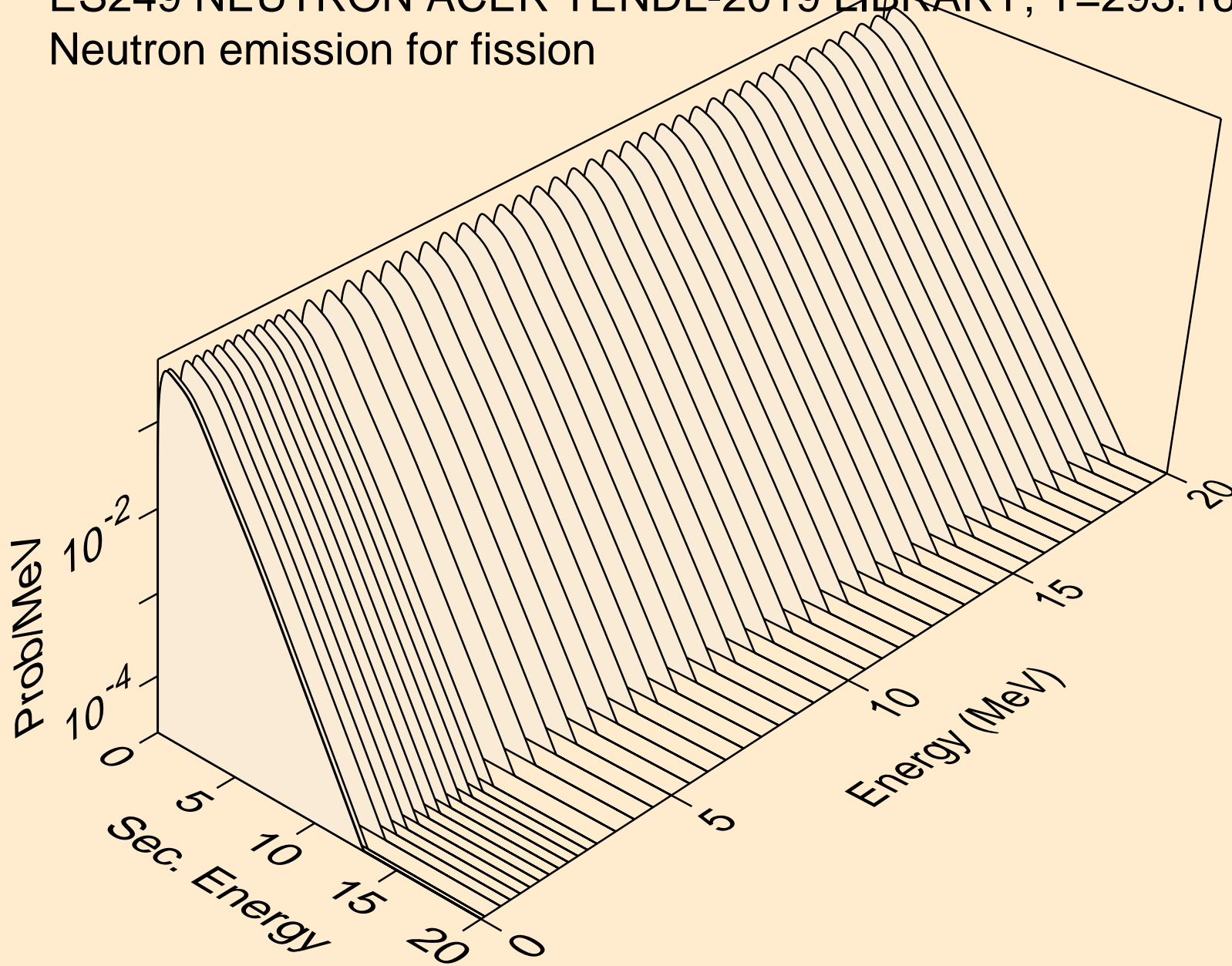

ES249 NEUTRON ACER TENDL-2019 LIBRARY; T=293.16K
Neutron emission for (n,n*)a

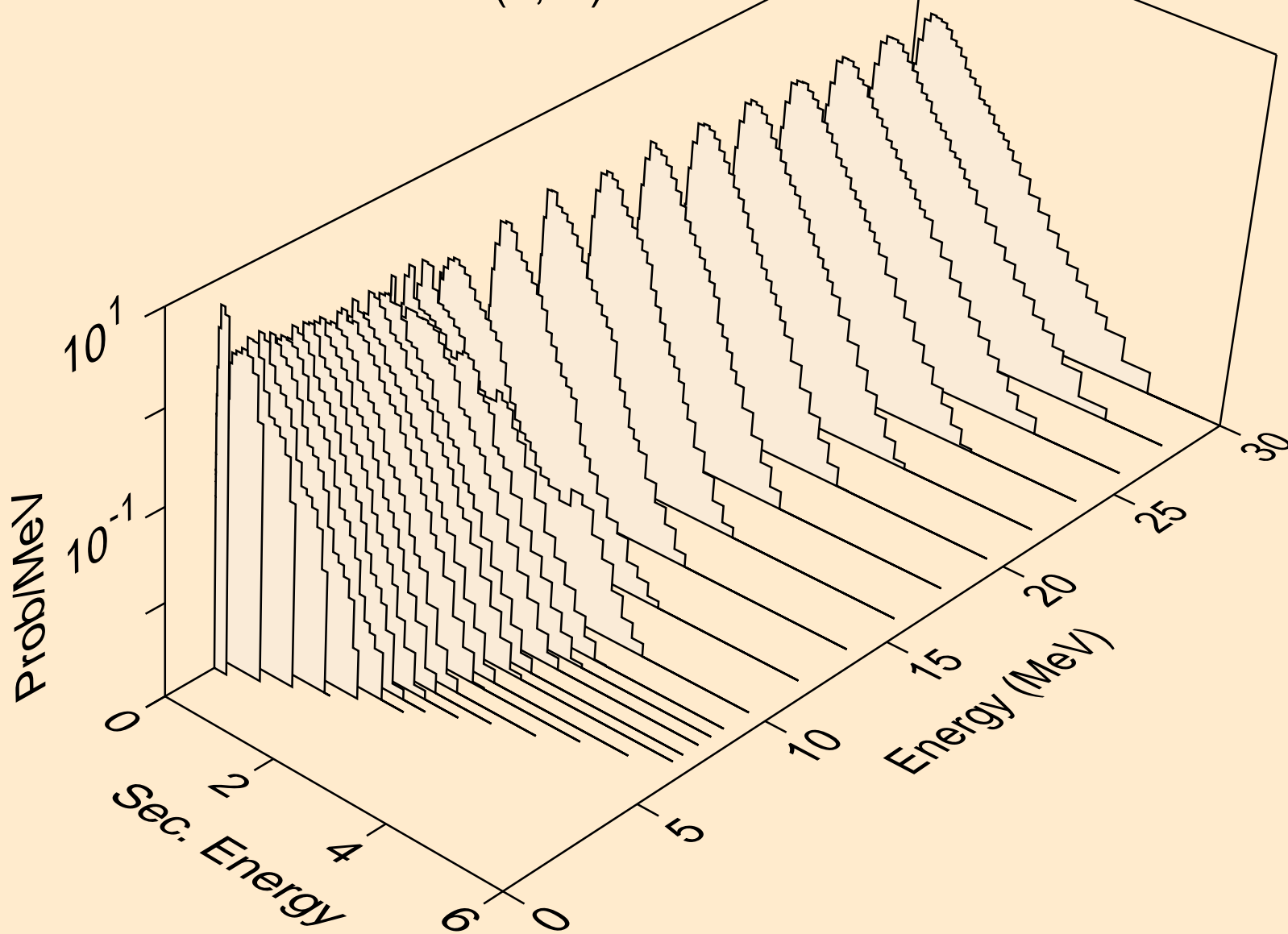

ES249 NEUTRON ACER TENDL-2019 LIBRARY; T=293.16K
Neutron emission for (n,2n)a

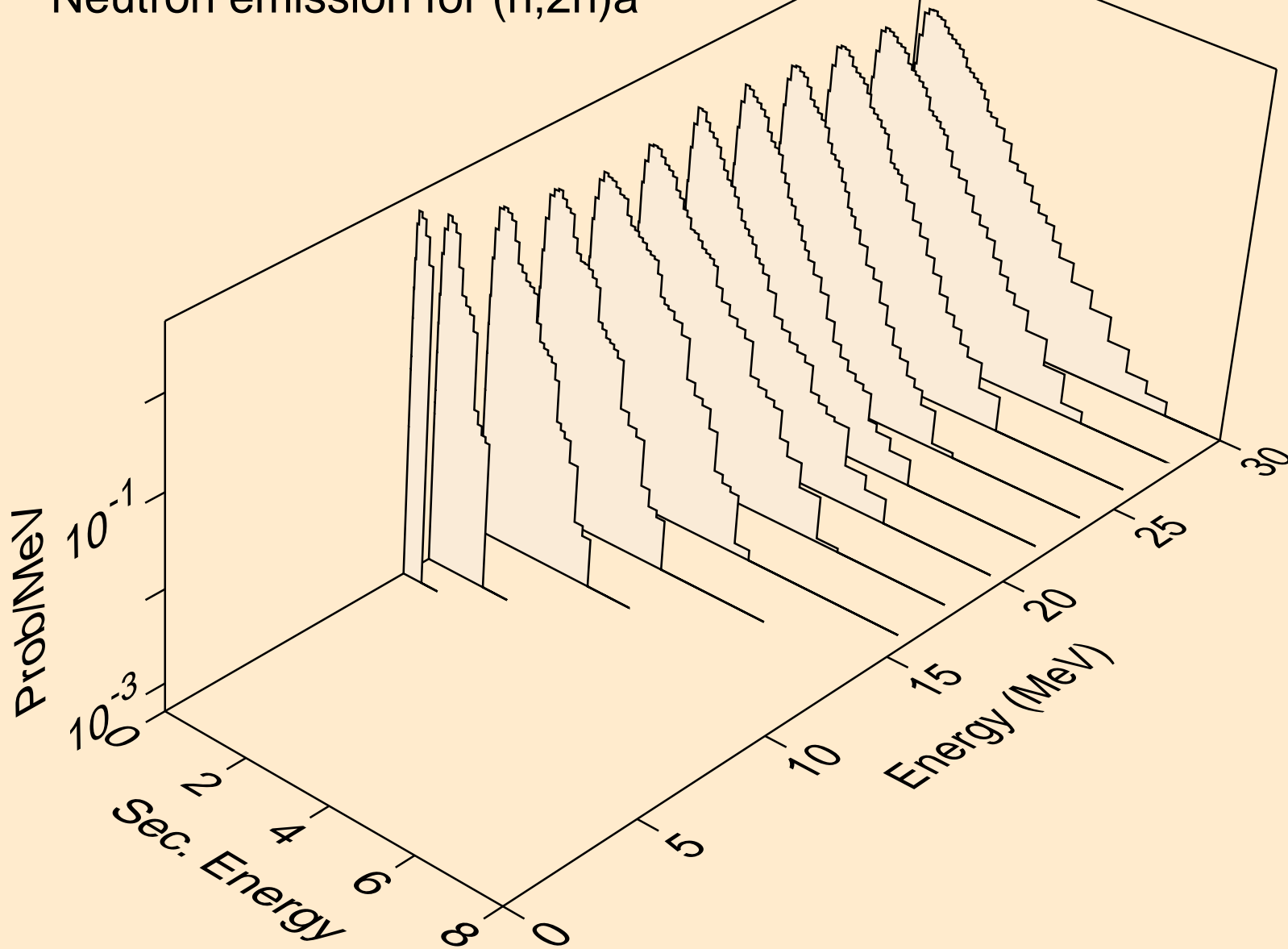

ES249 NEUTRON ACER TENDL-2019 LIBRARY; T=293.16K
Neutron emission for (n,3n)a

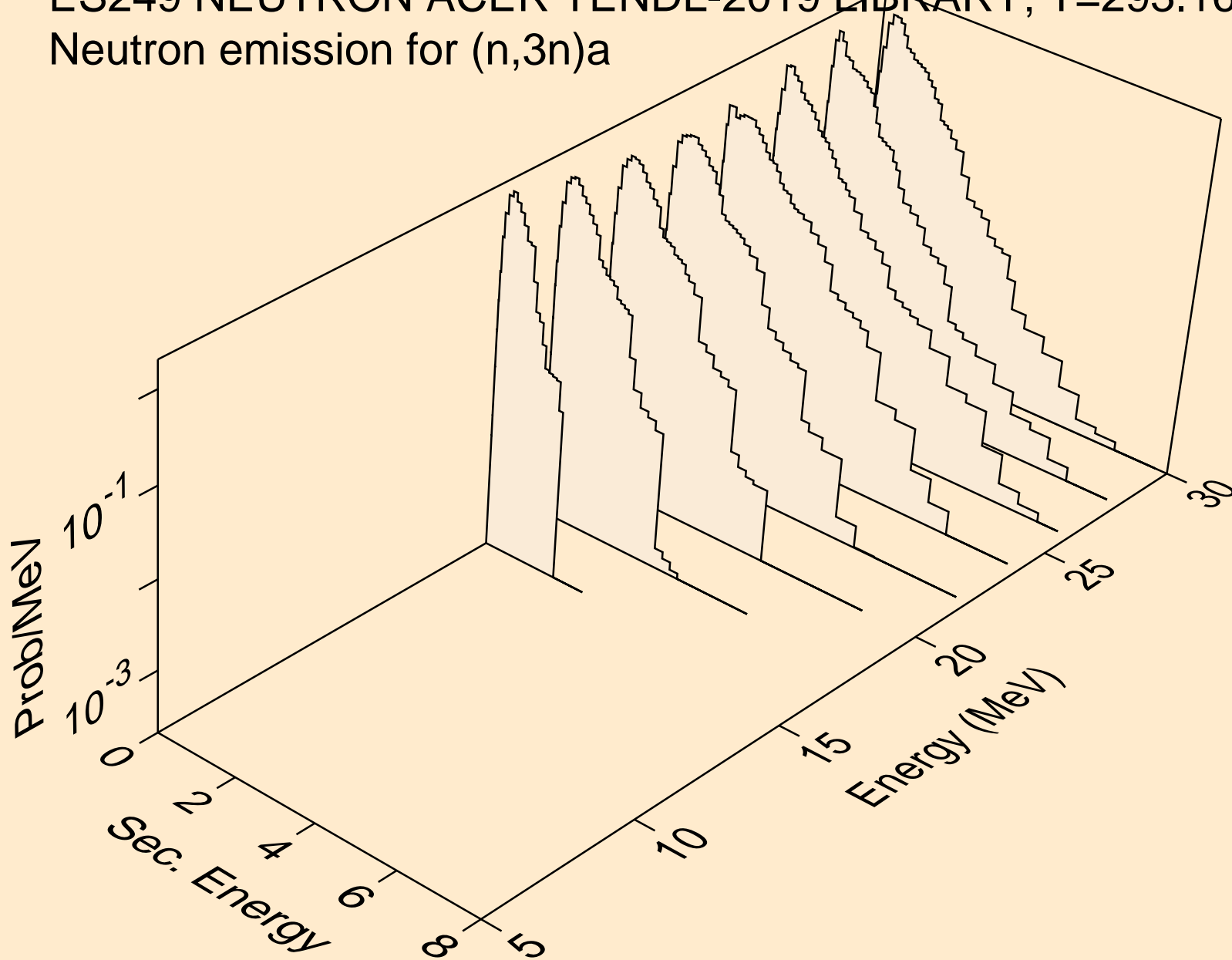

ES249 NEUTRON ACER TENDL-2019 LIBRARY; T=293.16K
Neutron emission for (n,n*)p

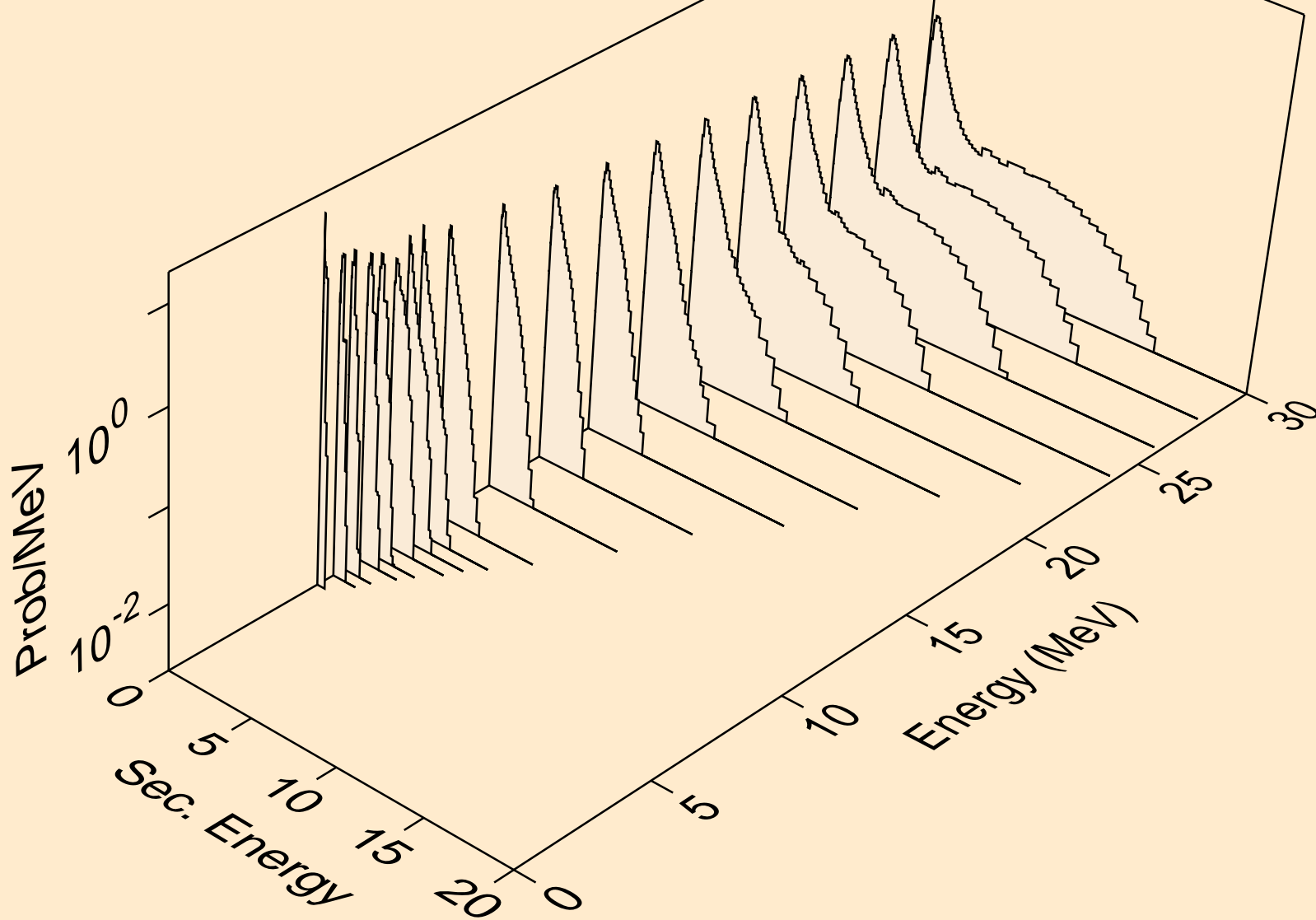

ES249 NEUTRON ACER TENDL-2019 LIBRARY; T=293.16K
Neutron emission for (n,n*)2a

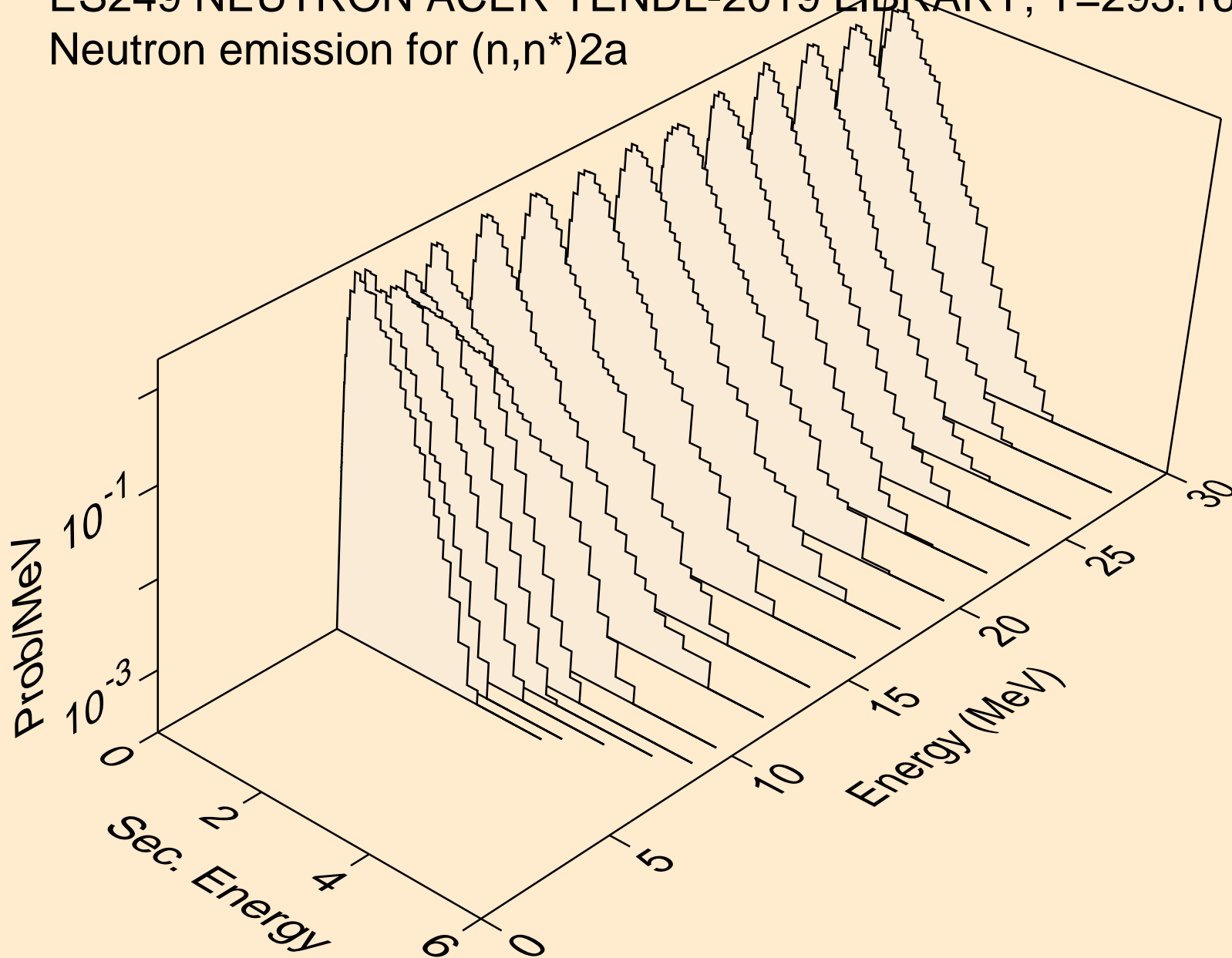

ES249 NEUTRON ACER TENDL-2019 LIBRARY; T=293.16K
Neutron emission for (n,n*)d

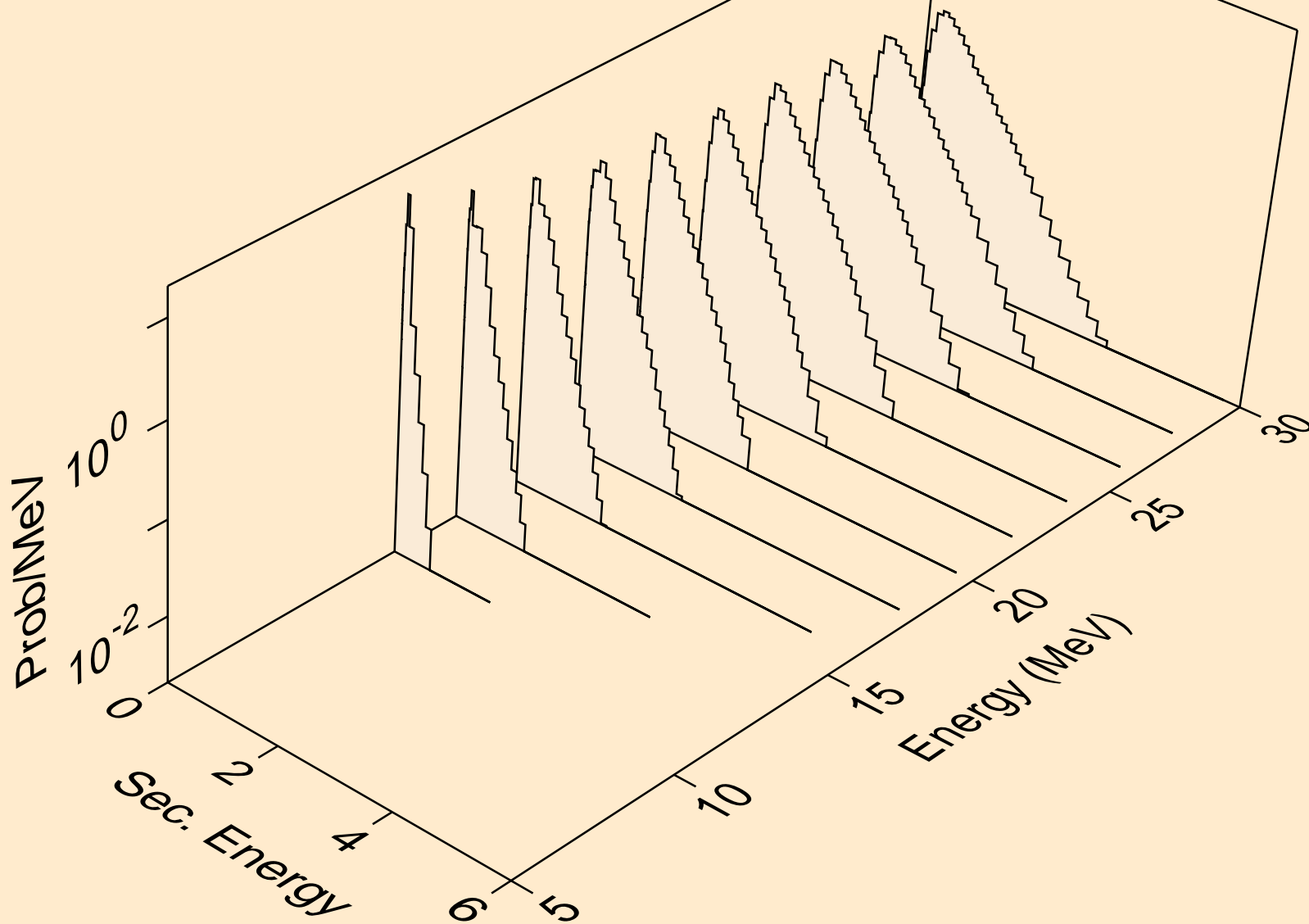

ES249 NEUTRON ACER TENDL-2019 LIBRARY; T=293.16K
Neutron emission for (n,n*)t

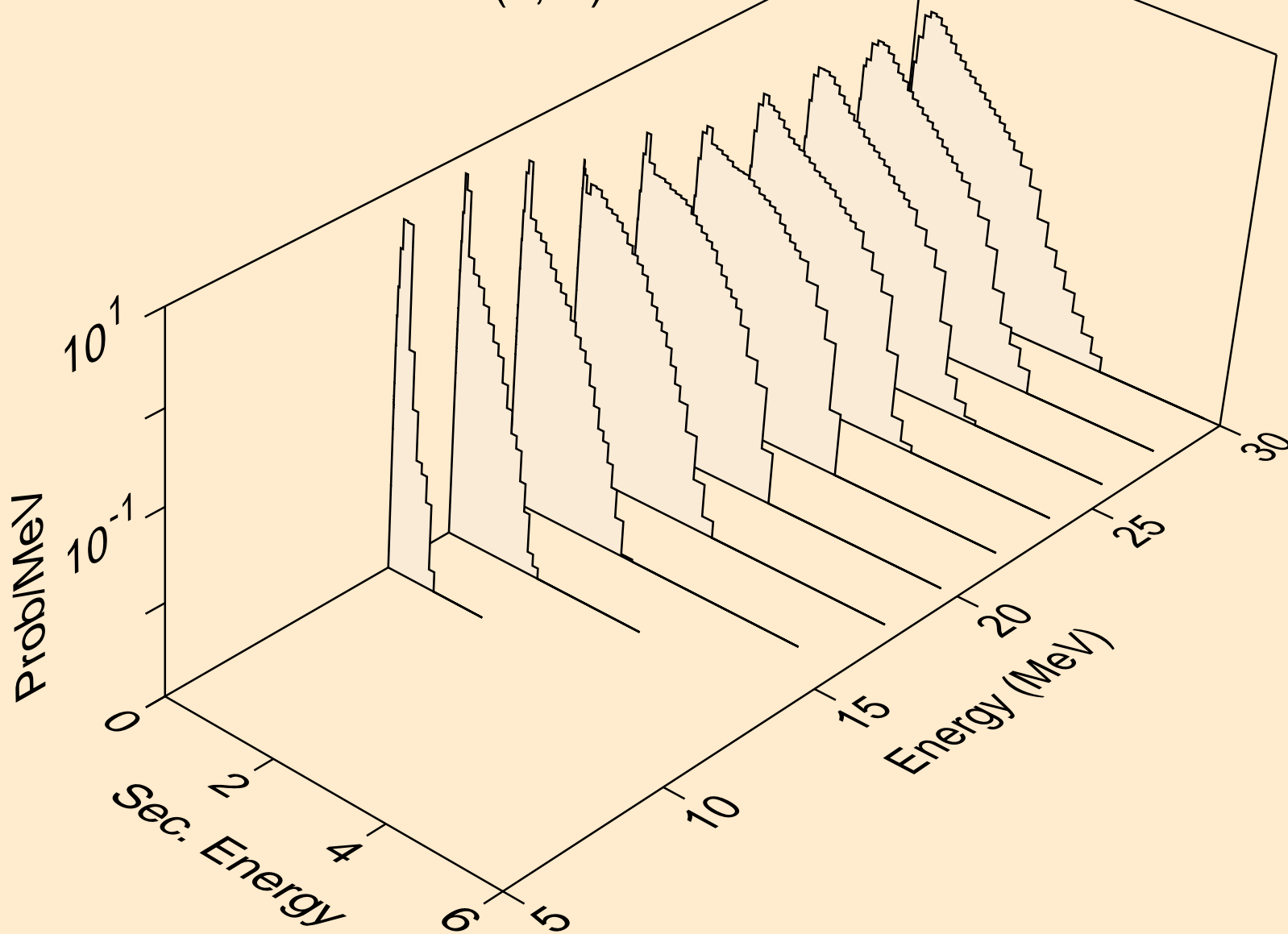

ES249 NEUTRON ACER TENDL-2019 LIBRARY; T=293.16K
Neutron emission for (n,n*)he3

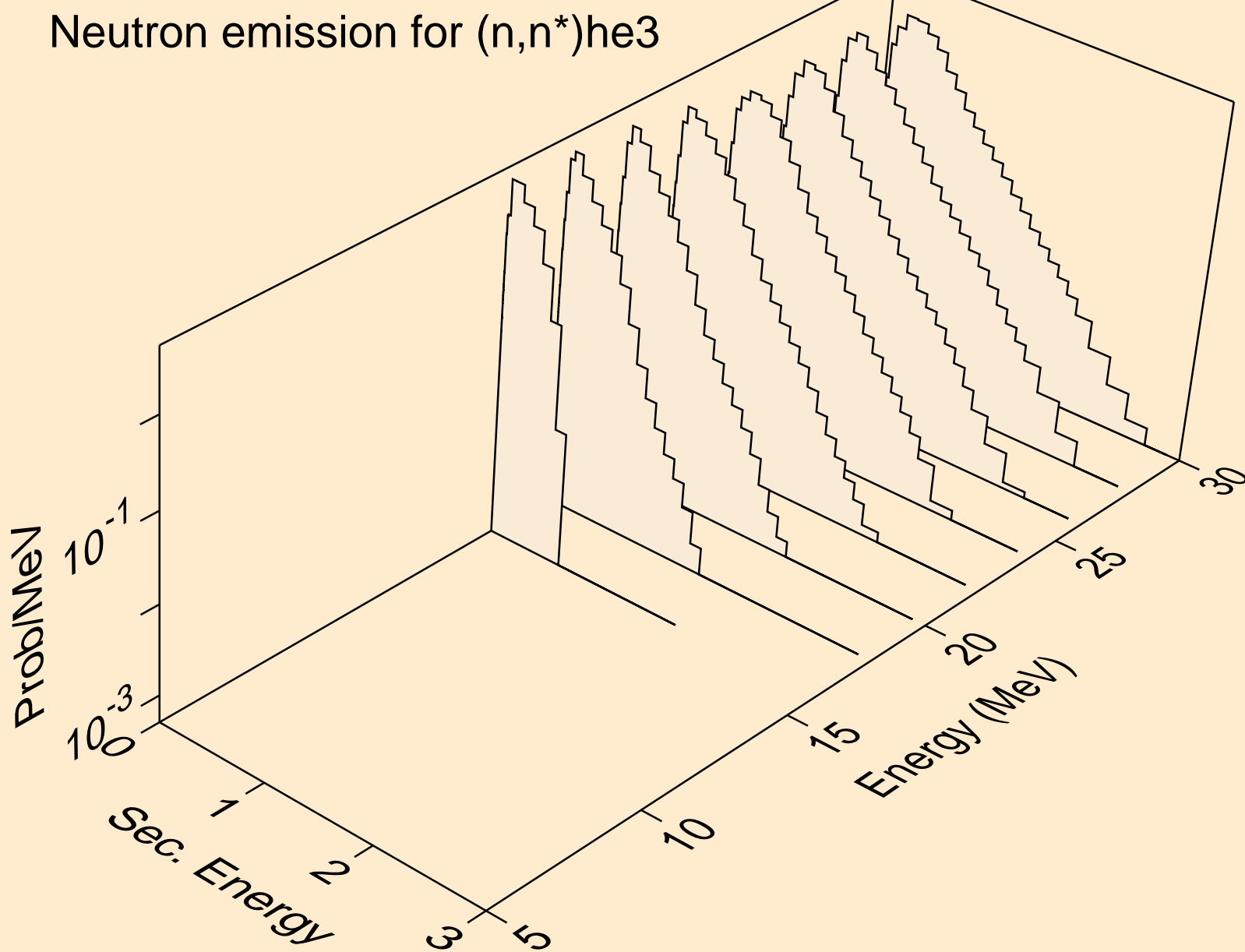

ES249 NEUTRON ACER TENDL-2019 LIBRARY; T=293.16K
Neutron emission for (n,4n)

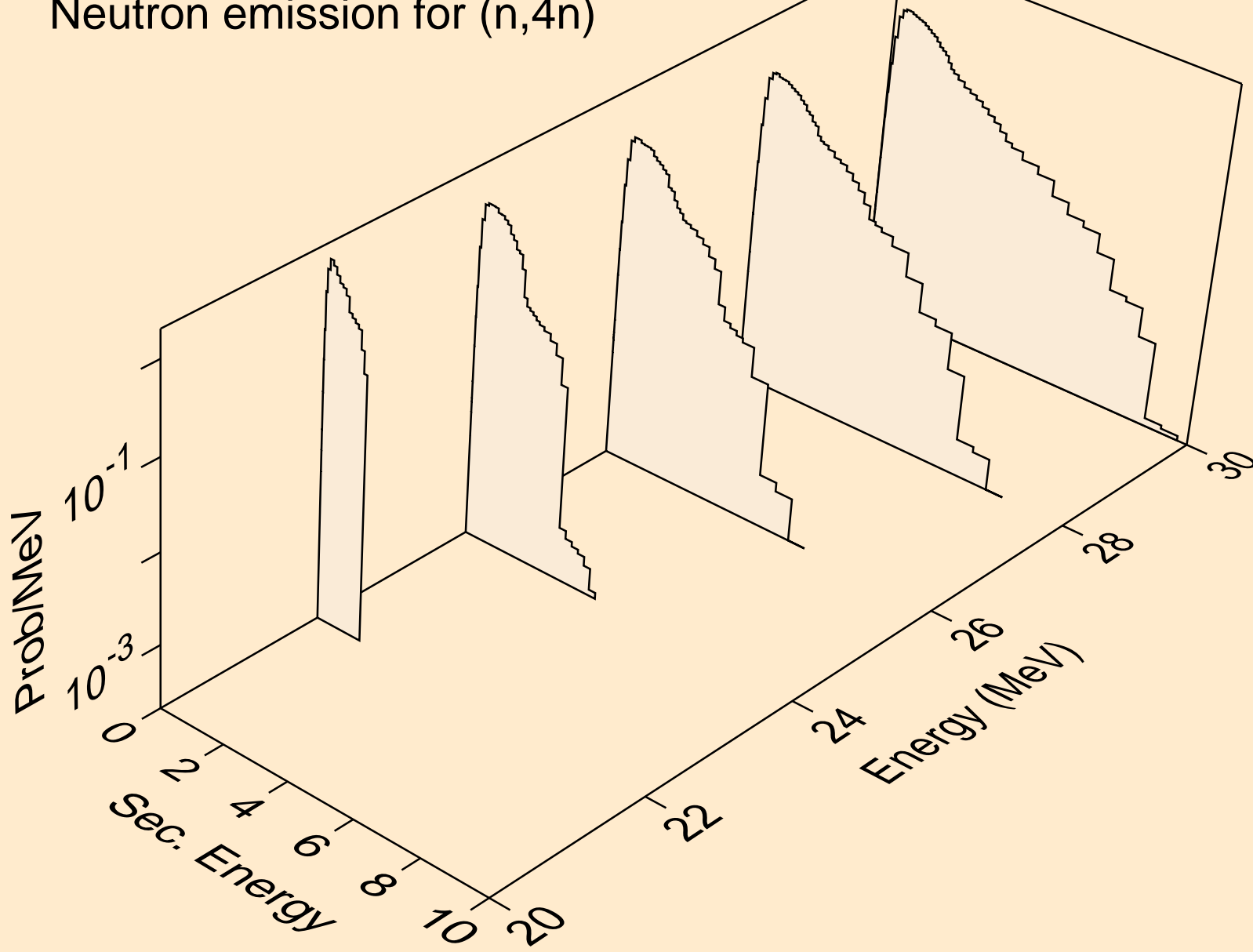

ES249 NEUTRON ACER TENDL-2019 LIBRARY; T=293.16K
Neutron emission for (n,2np)

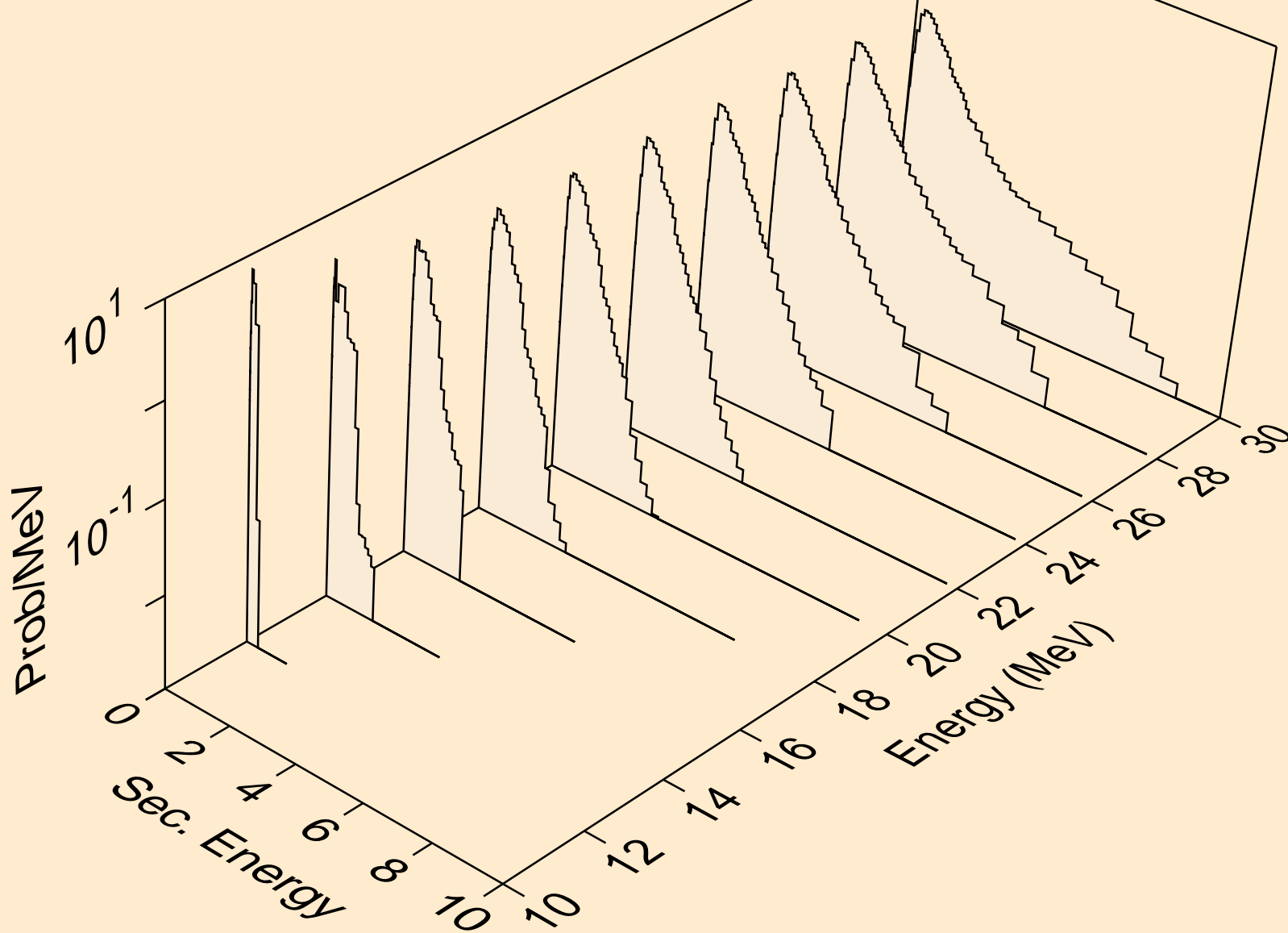

ES249 NEUTRON ACER TENDL-2019 LIBRARY; T=293.16K
Neutron emission for (n,3np)

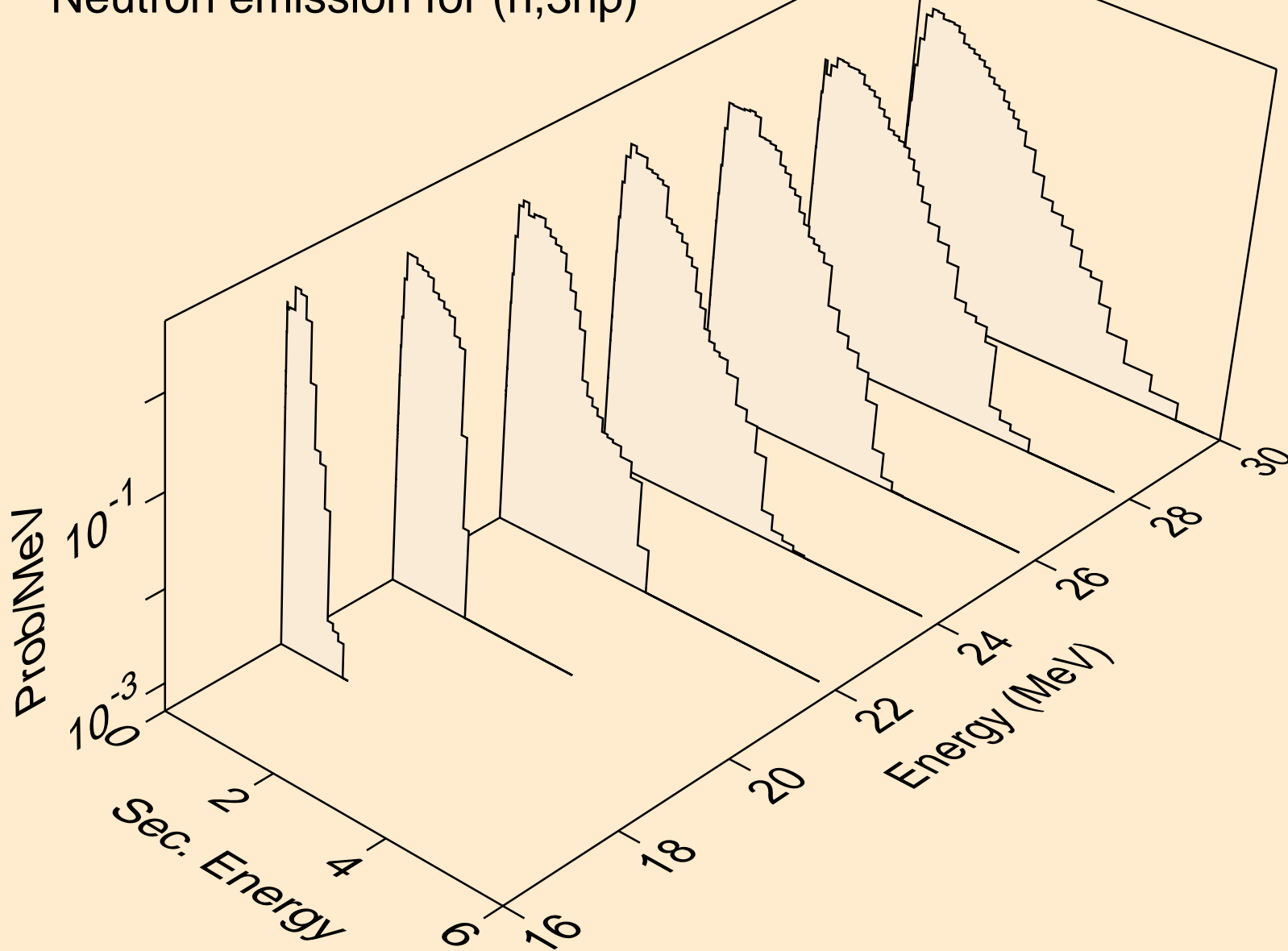

ES249 NEUTRON ACER TENDL-2019 LIBRARY; T=293.16K
Neutron emission for (n,2np)

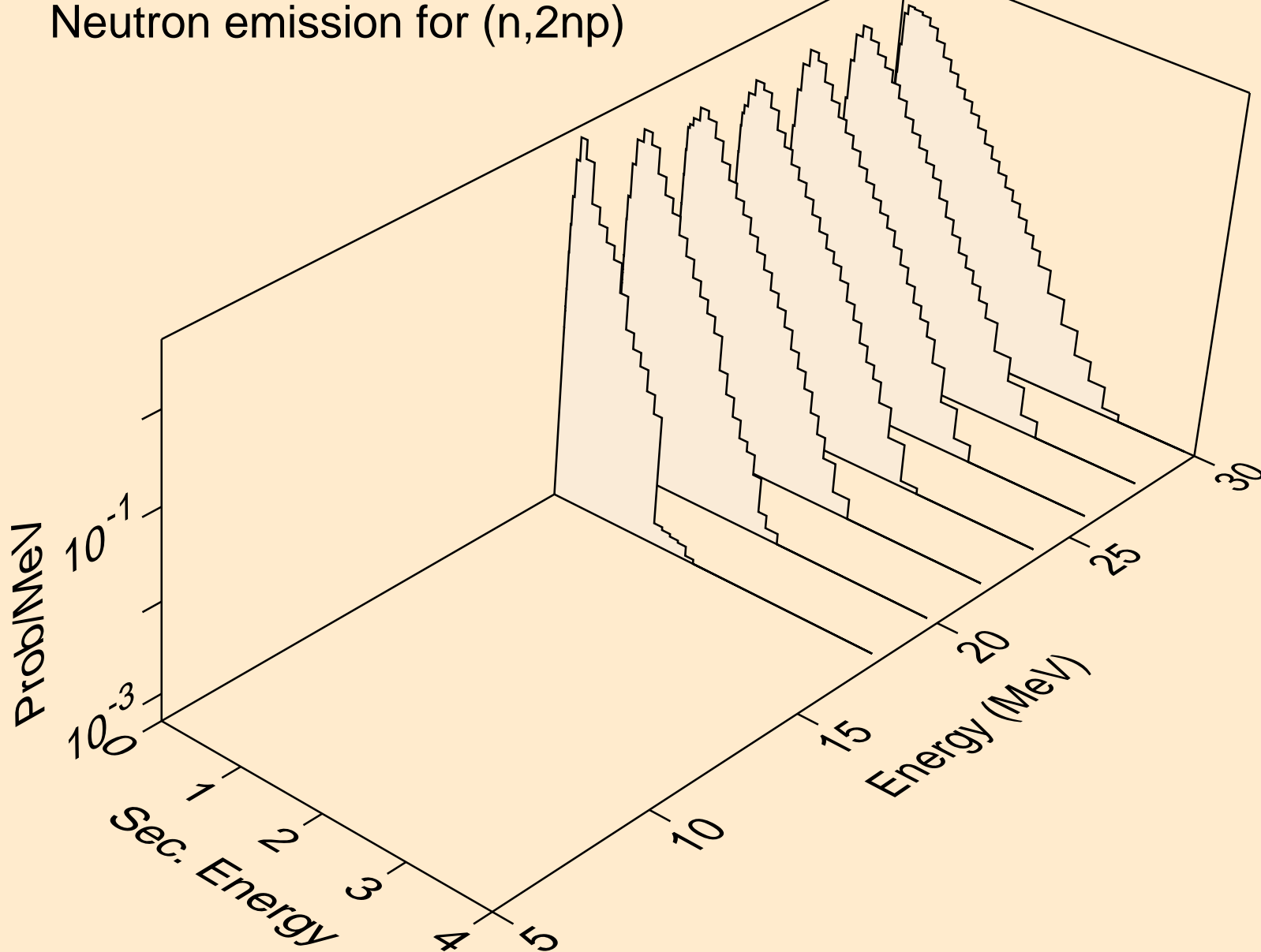

ES249 NEUTRON ACER TENDL-2019 LIBRARY; T=293.16K
Neutron emission for (n,npa)

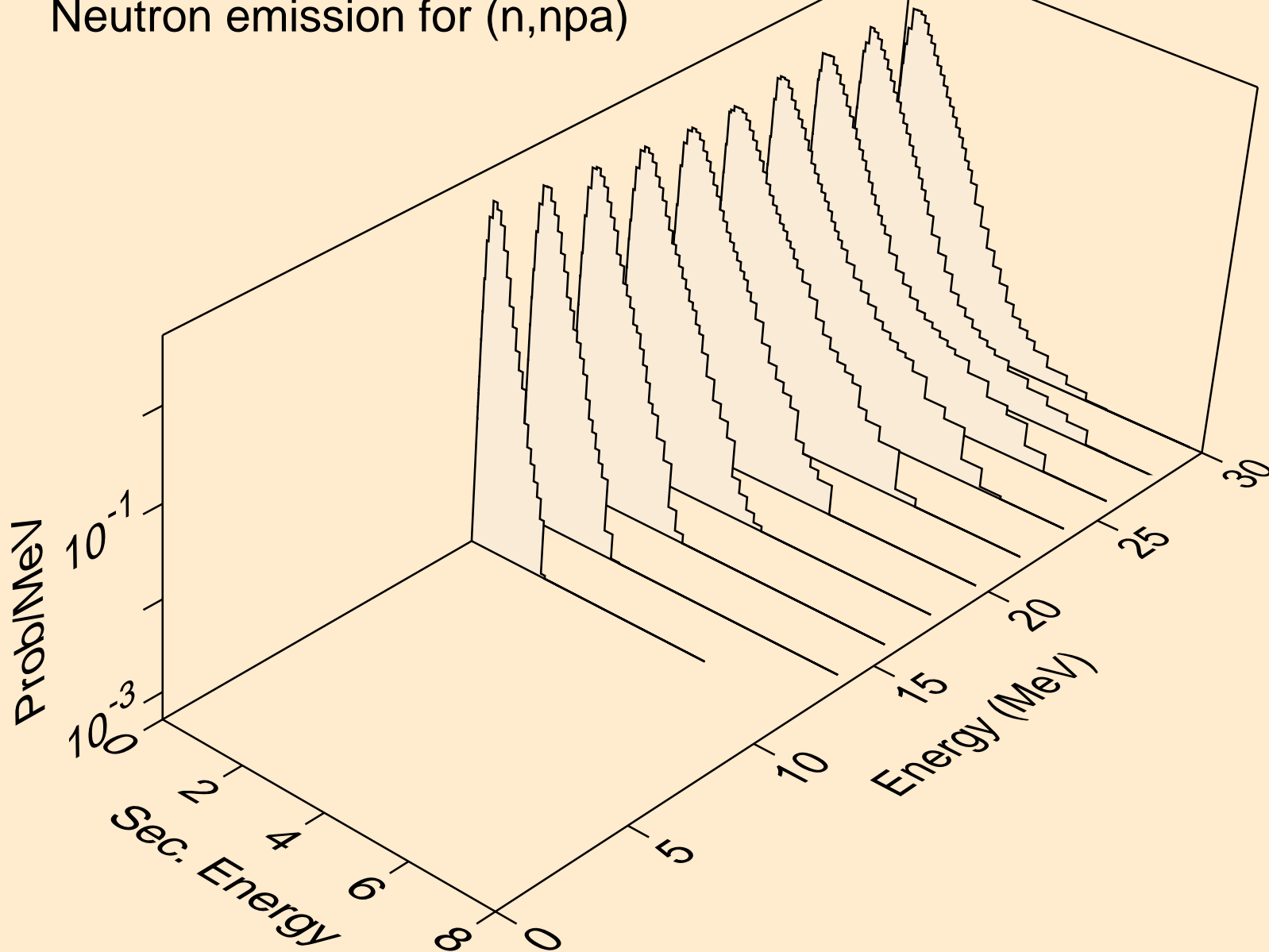

ES249 NEUTRON ACER TENDL-2019 LIBRARY; T=293.16K
Neutron emission for (n,n*c)

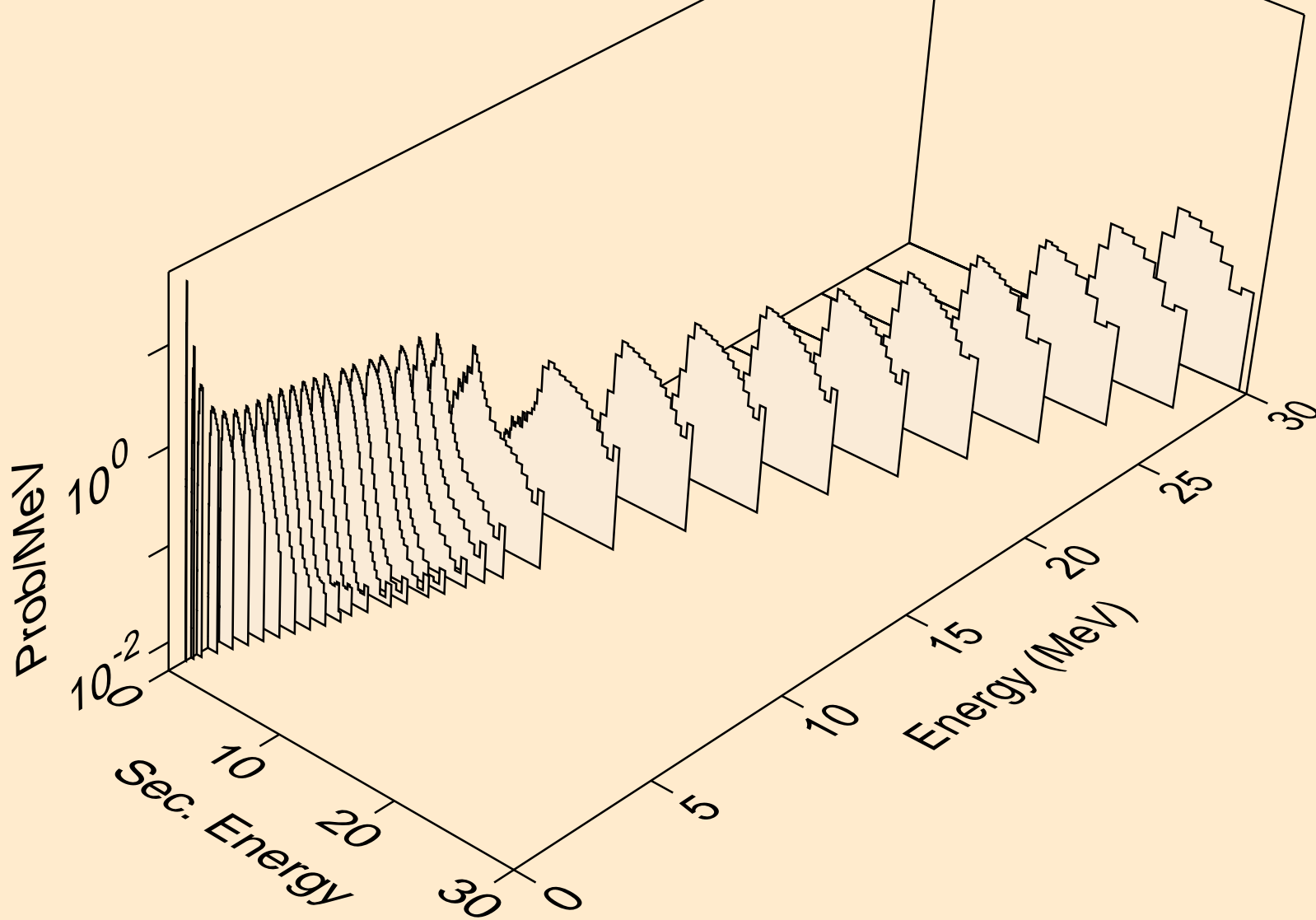

ES249 NEUTRON ACER TENDL-2019 LIBRARY; T=293.16K

Delayed nubar

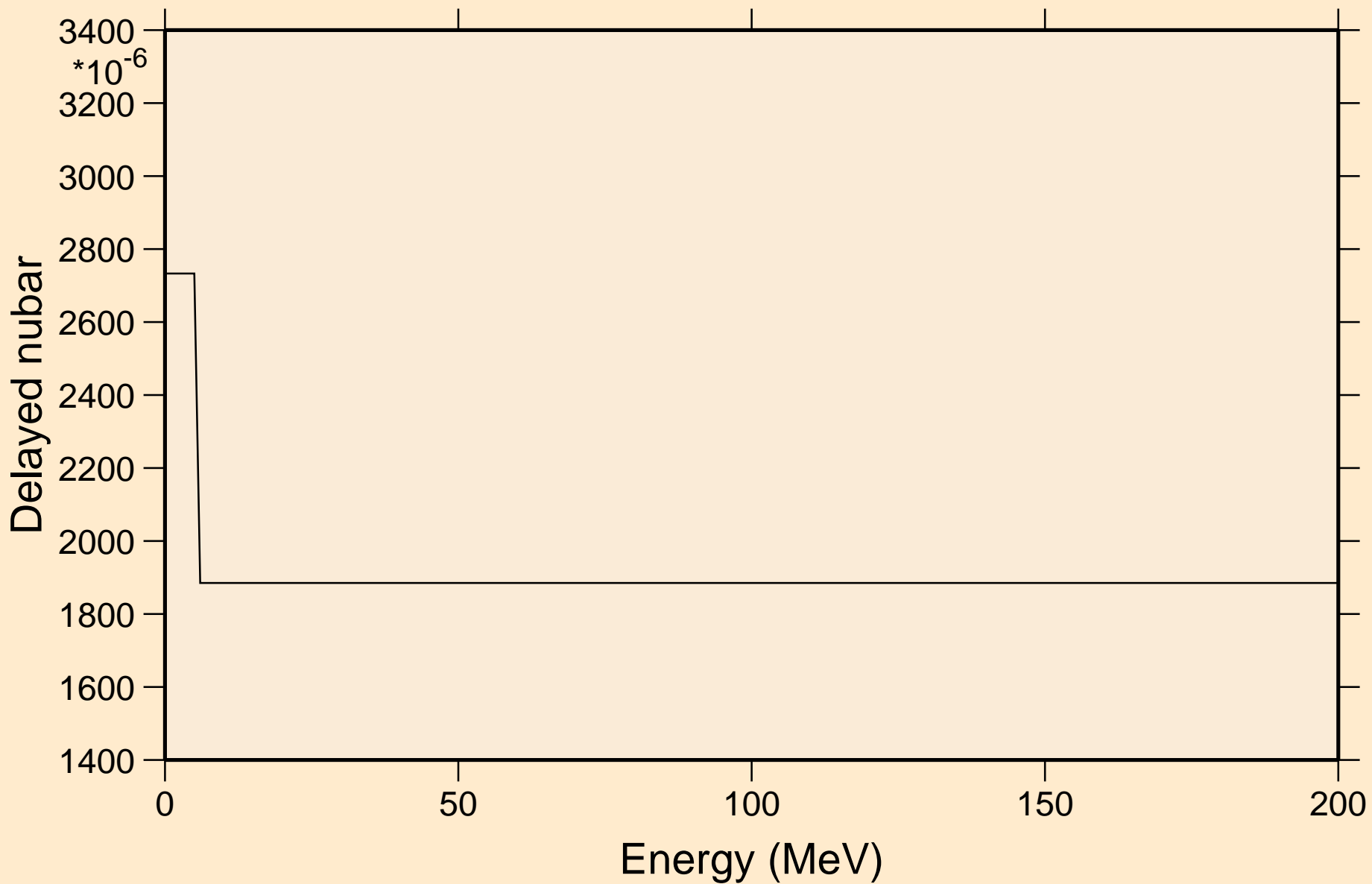

ES249 NEUTRON ACER TENDL-2019 LIBRARY; T=293.16K

Delayed neutron spectra

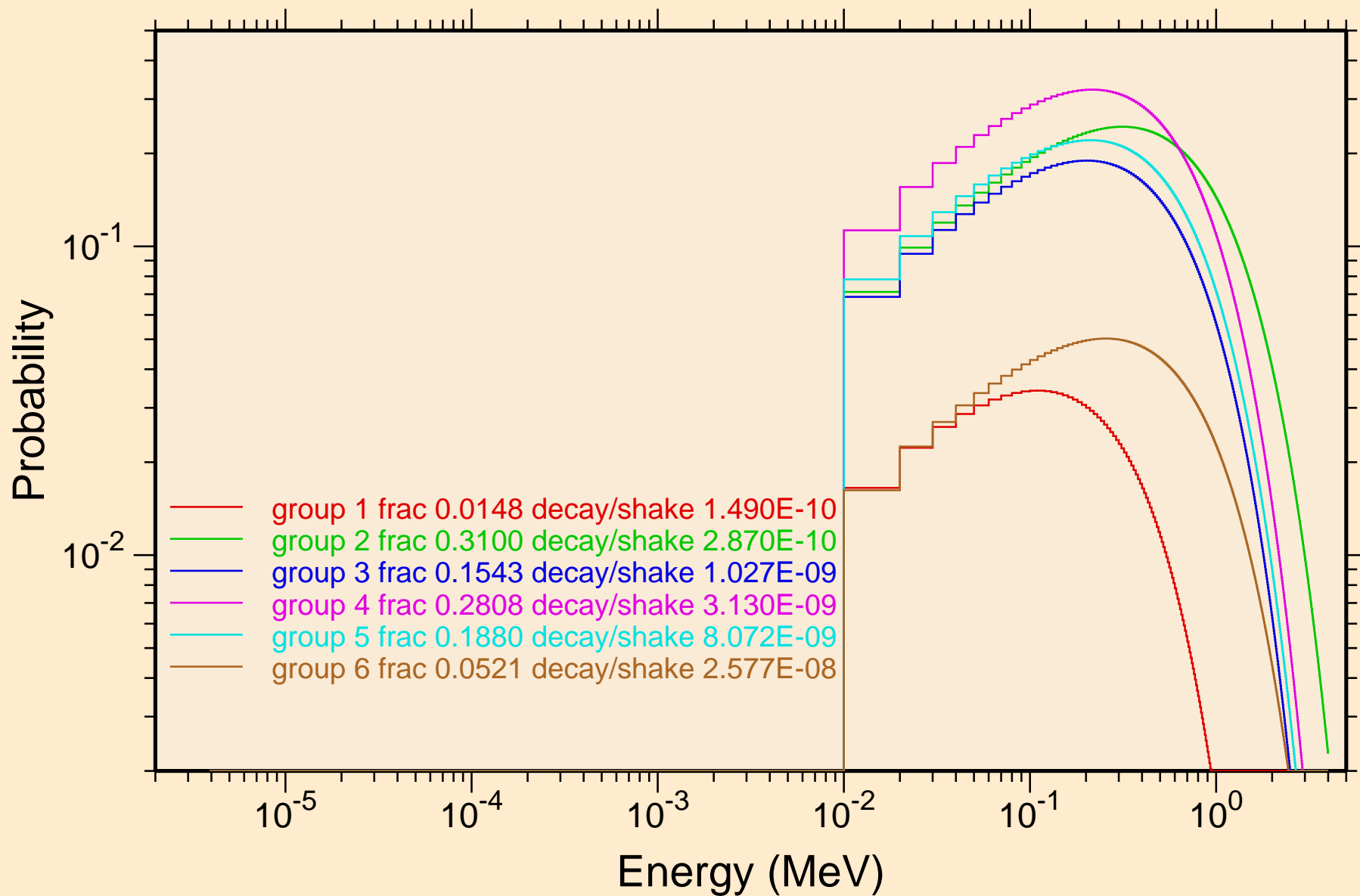

ES249 NEUTRON ACER TENDL-2019 LIBRARY; T=293.16K
Photon emission for (n,x)

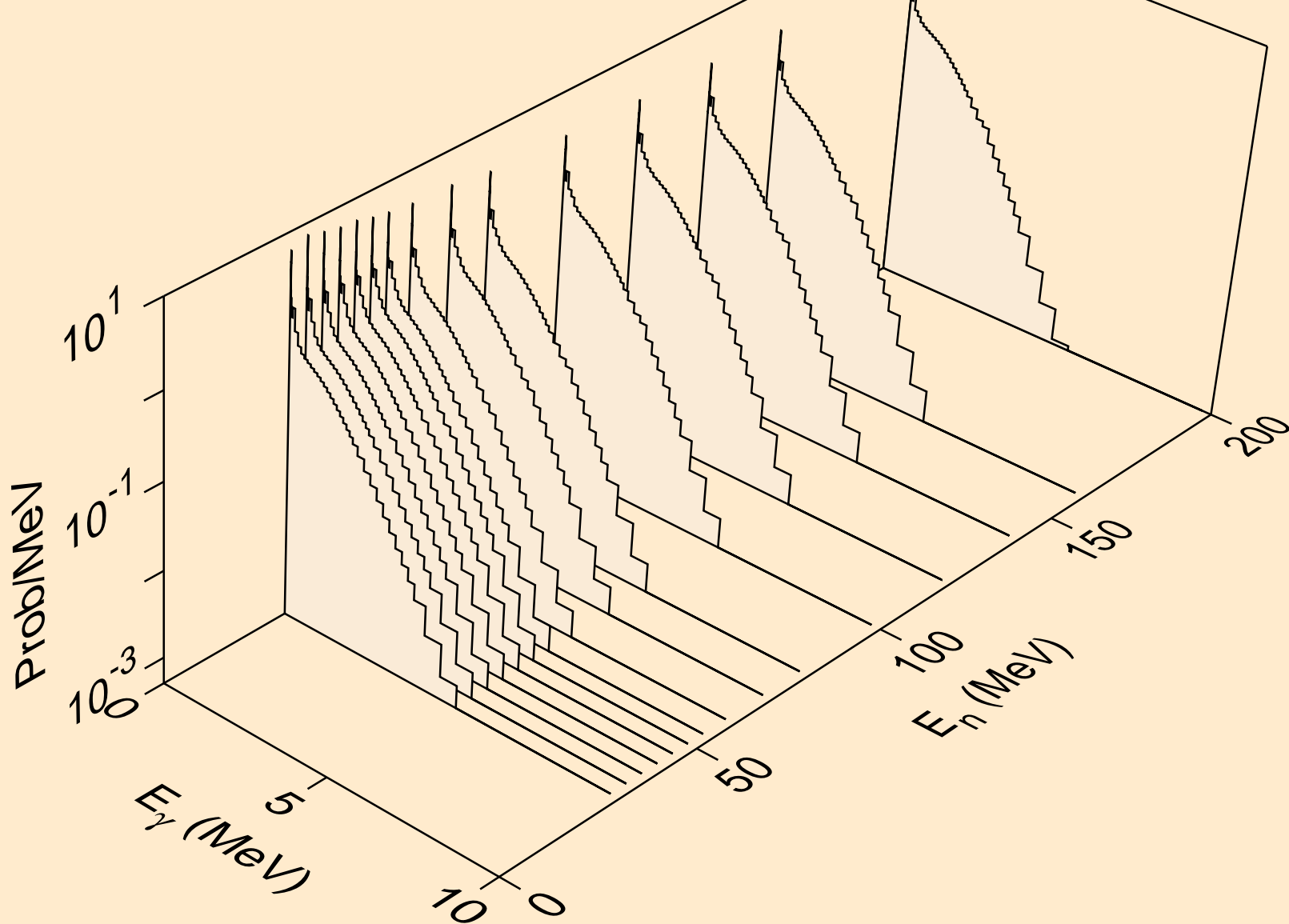

ES249 NEUTRON ACER TENDL-2019 LIBRARY; T=293.16K
Photon emission for (n,2nd)

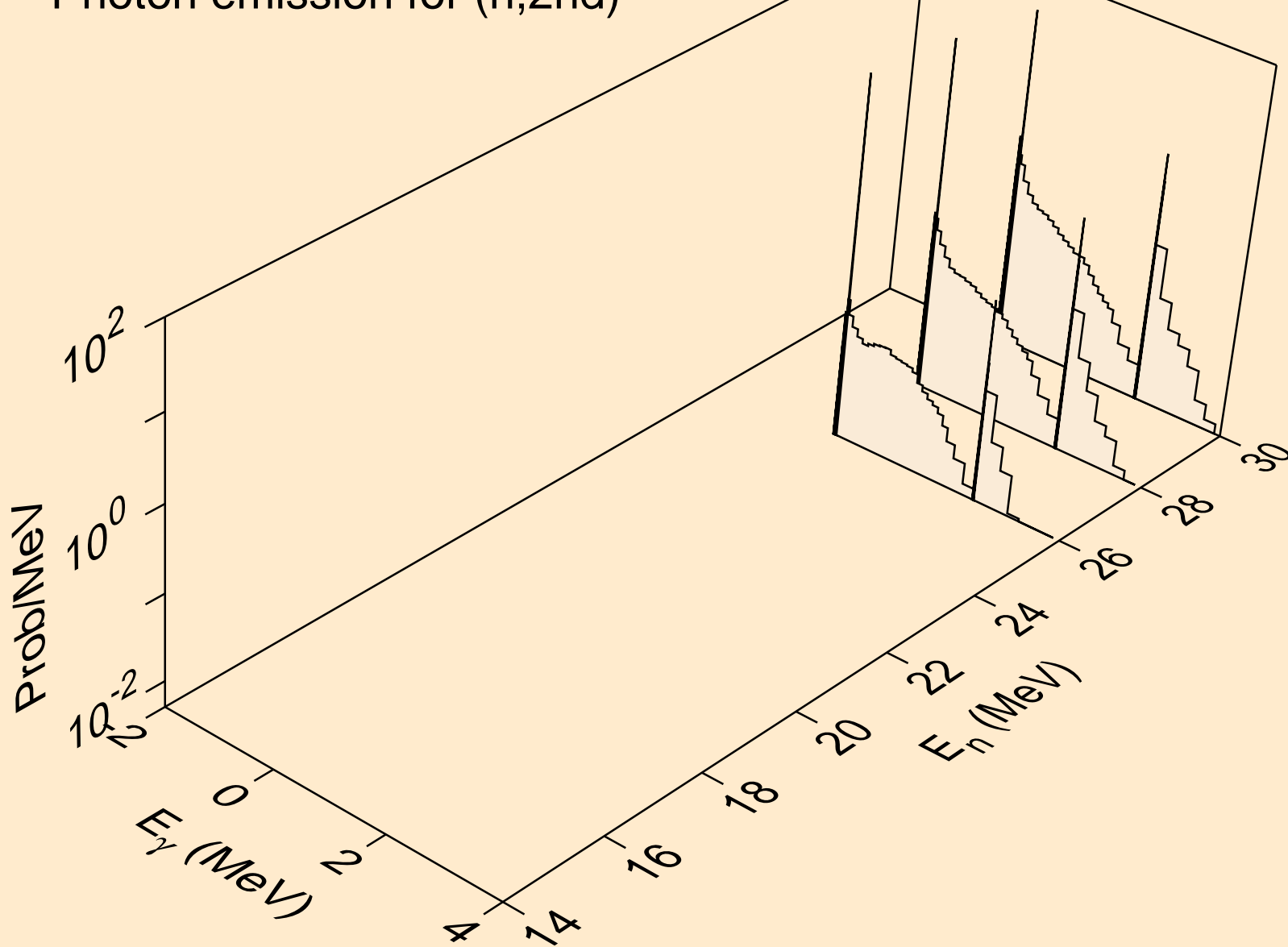

ES249 NEUTRON ACER TENDL-2019 LIBRARY; T=293.16K
Photon emission for (n,2n)

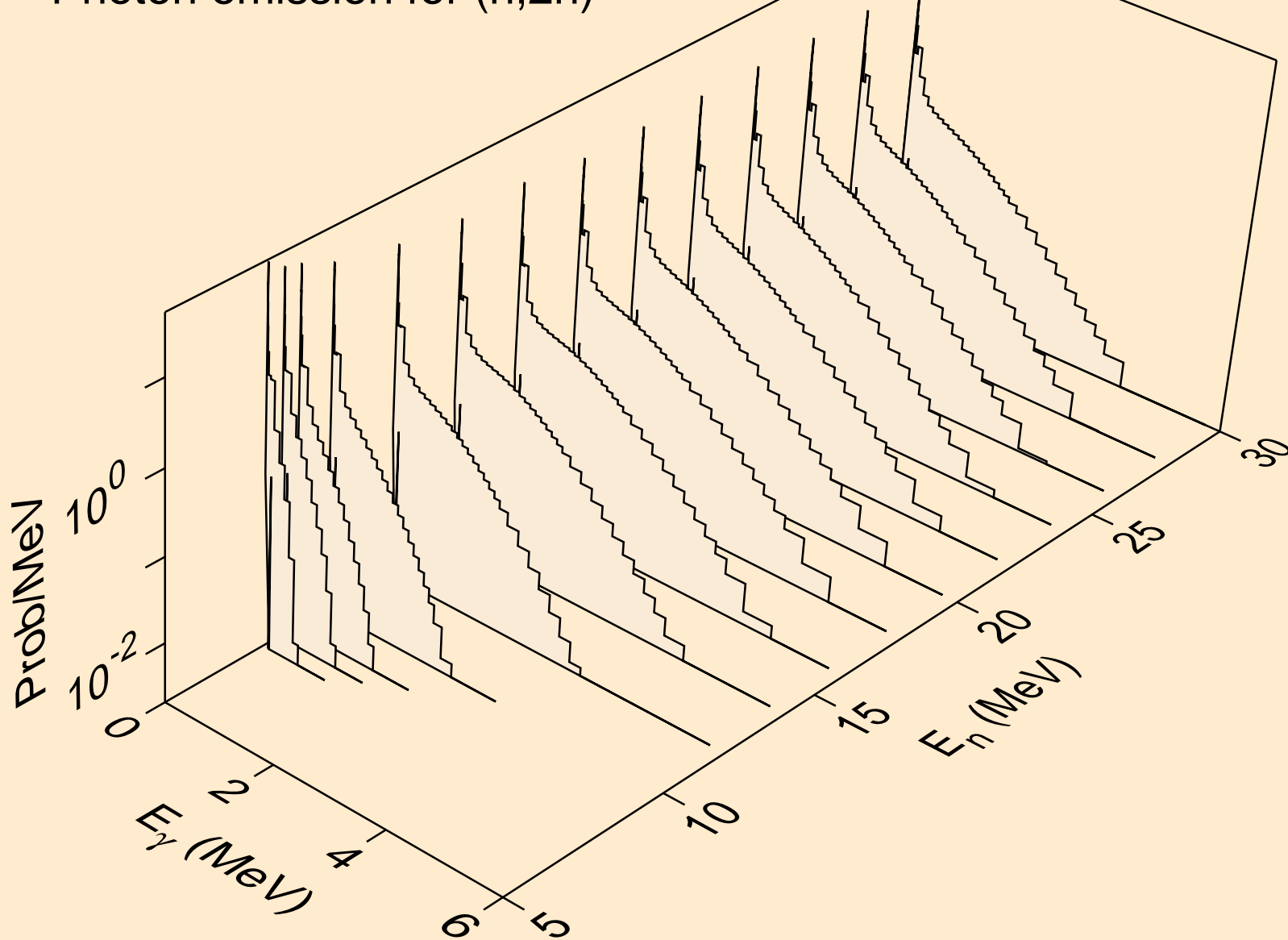

ES249 NEUTRON ACER TENDL-2019 LIBRARY; T=293.16K
Photon emission for (n,3n)

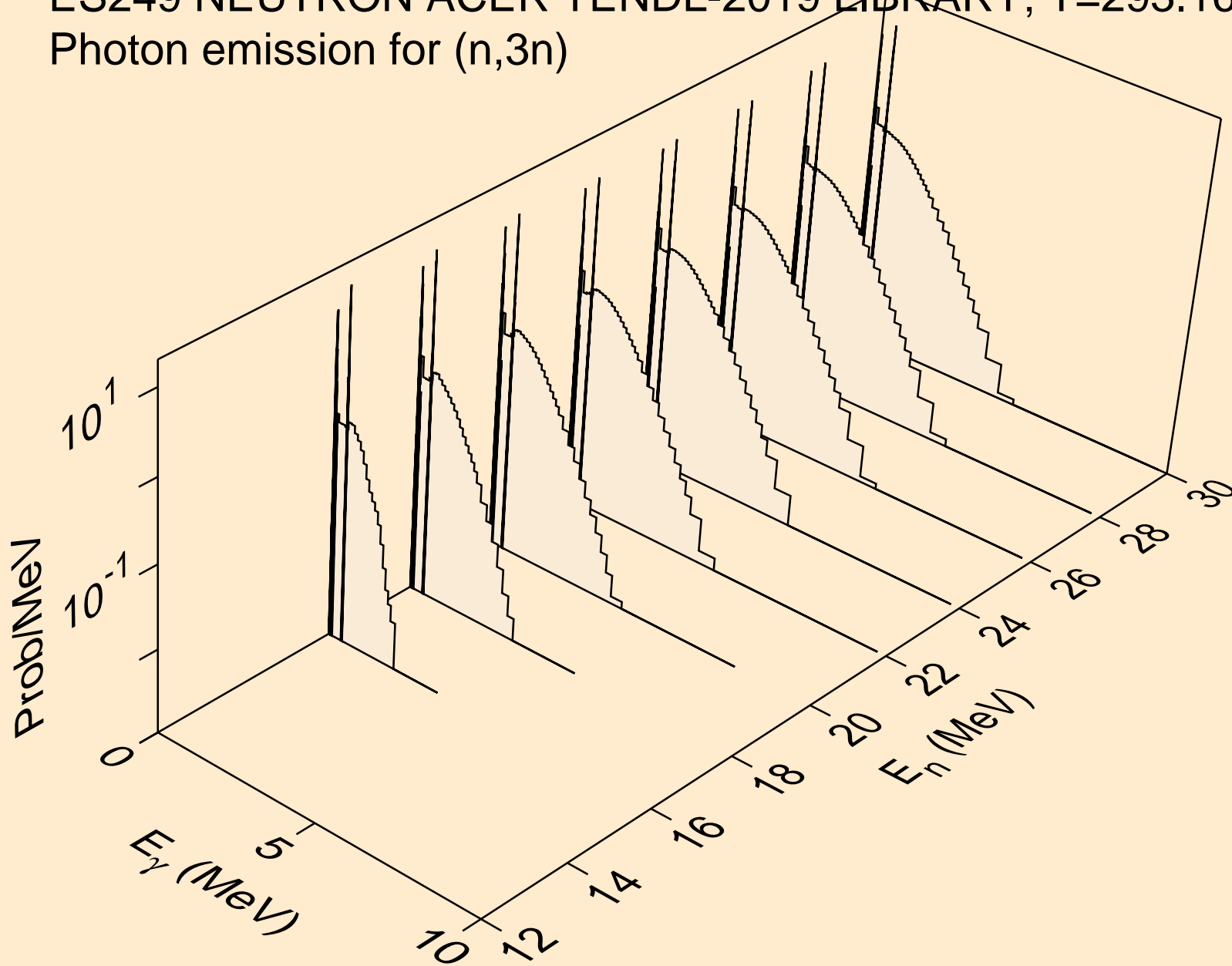

ES249 NEUTRON ACER TENDL-2019 LIBRARY; T=293.16K
Photon emission for (n,n*)a

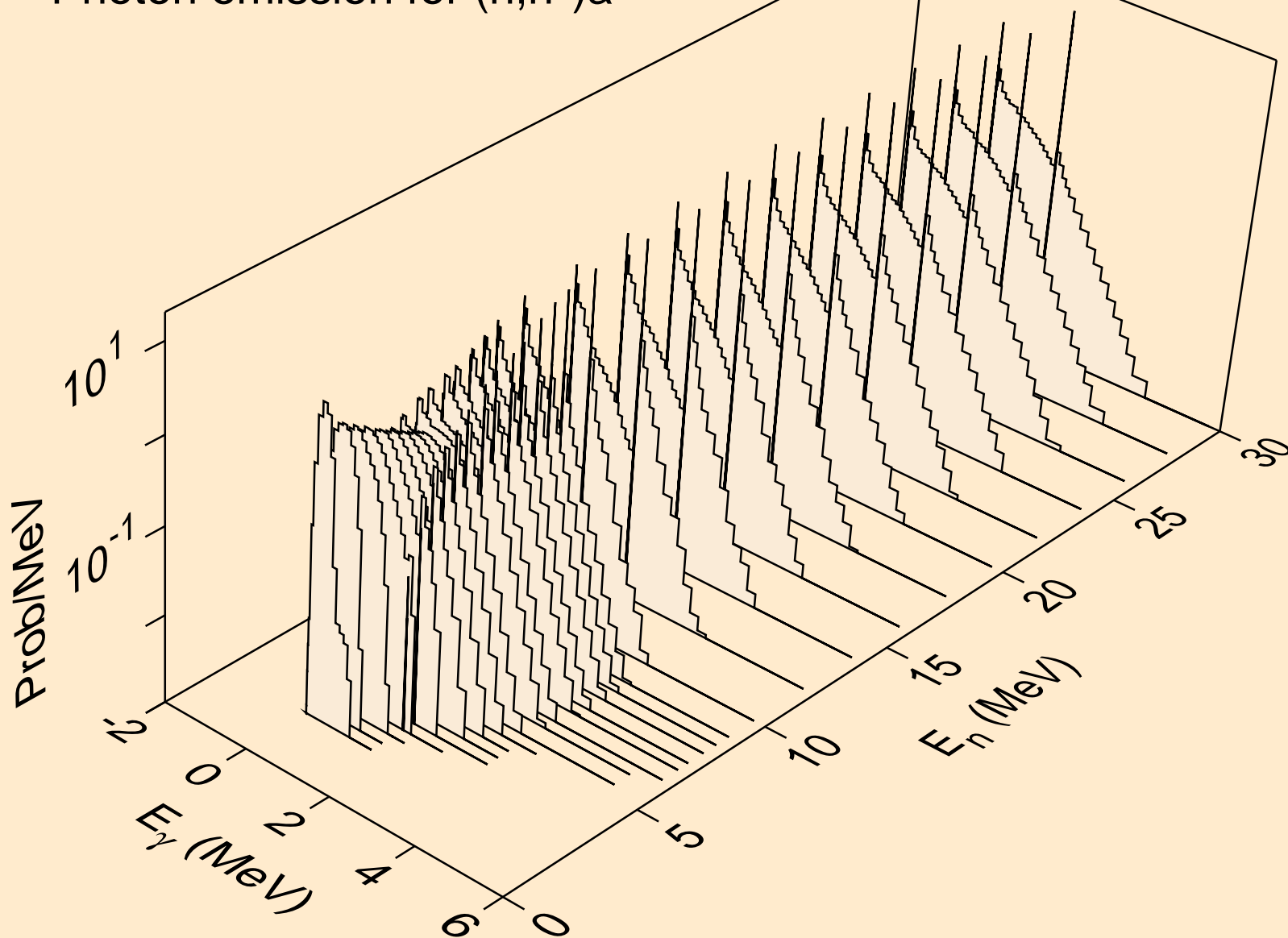

ES249 NEUTRON ACER TENDL-2019 LIBRARY; T=293.16K
Photon emission for (n,2n)a

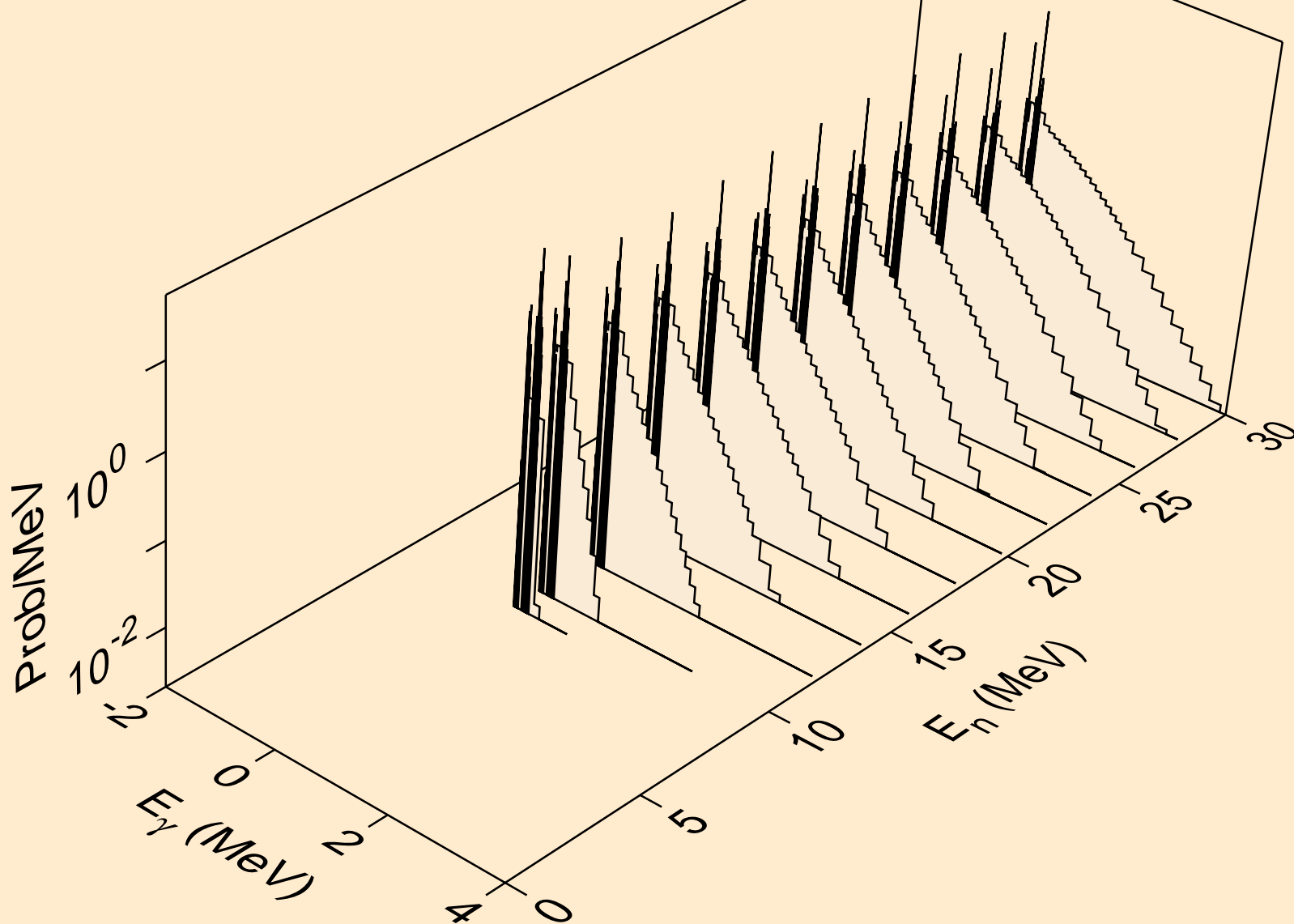

ES249 NEUTRON ACER TENDL-2019 LIBRARY; T=293.16K
Photon emission for (n,3n)a

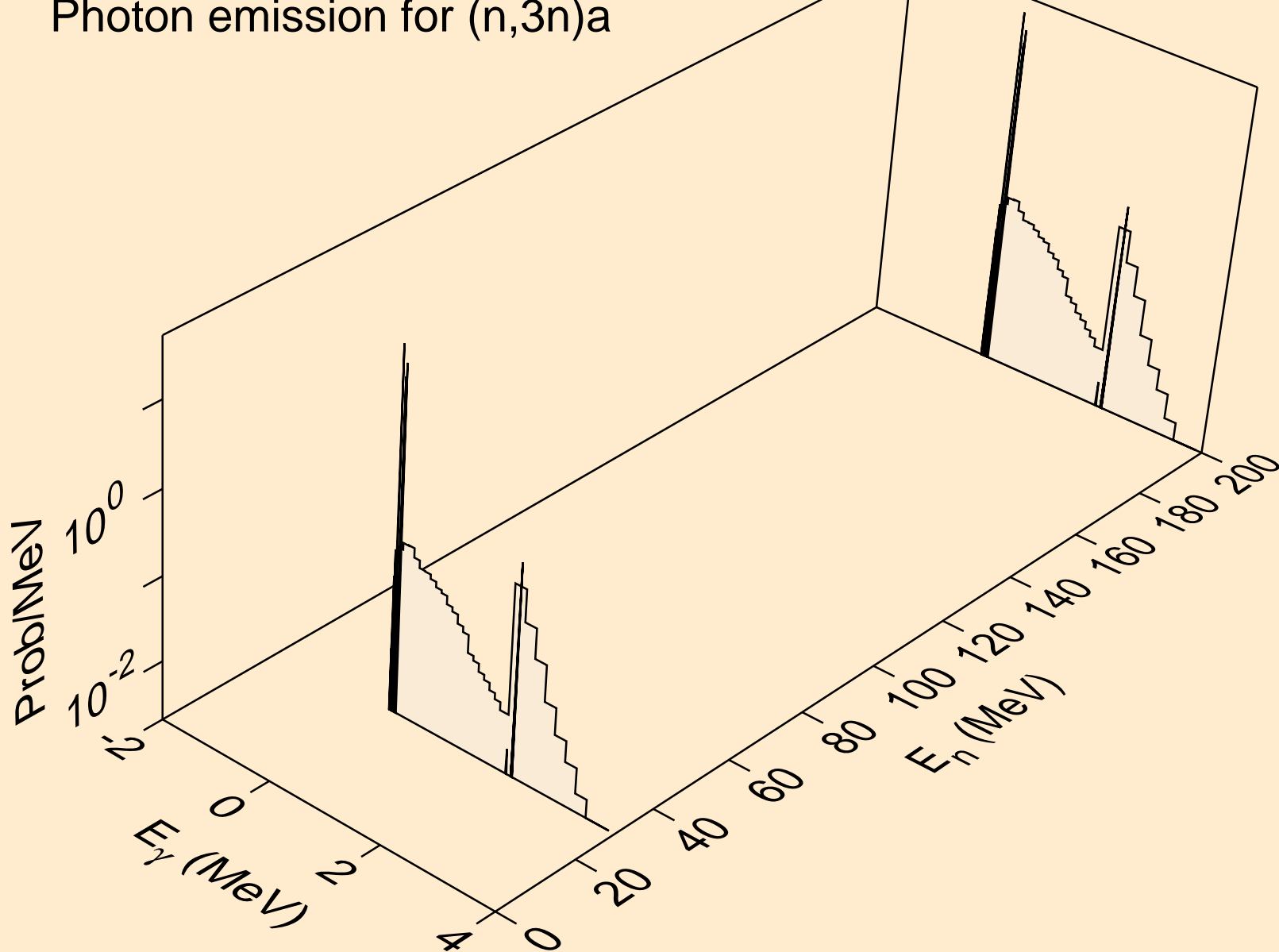

ES249 NEUTRON ACER TENDL-2019 LIBRARY; T=293.16K
Photon emission for (n,n*)p

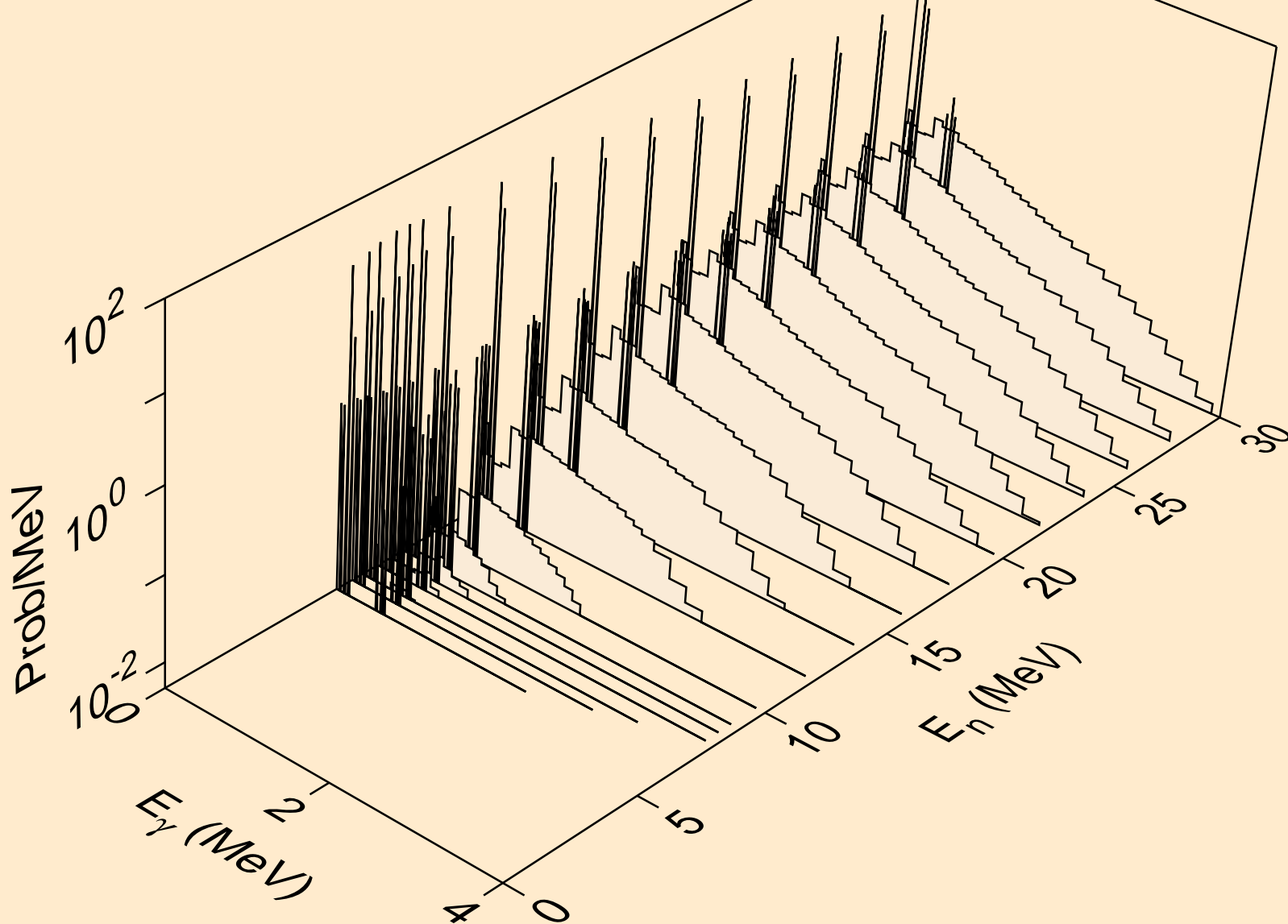

ES249 NEUTRON ACER TENDL-2019 LIBRARY; T=293.16K
Photon emission for (n,n*)2a

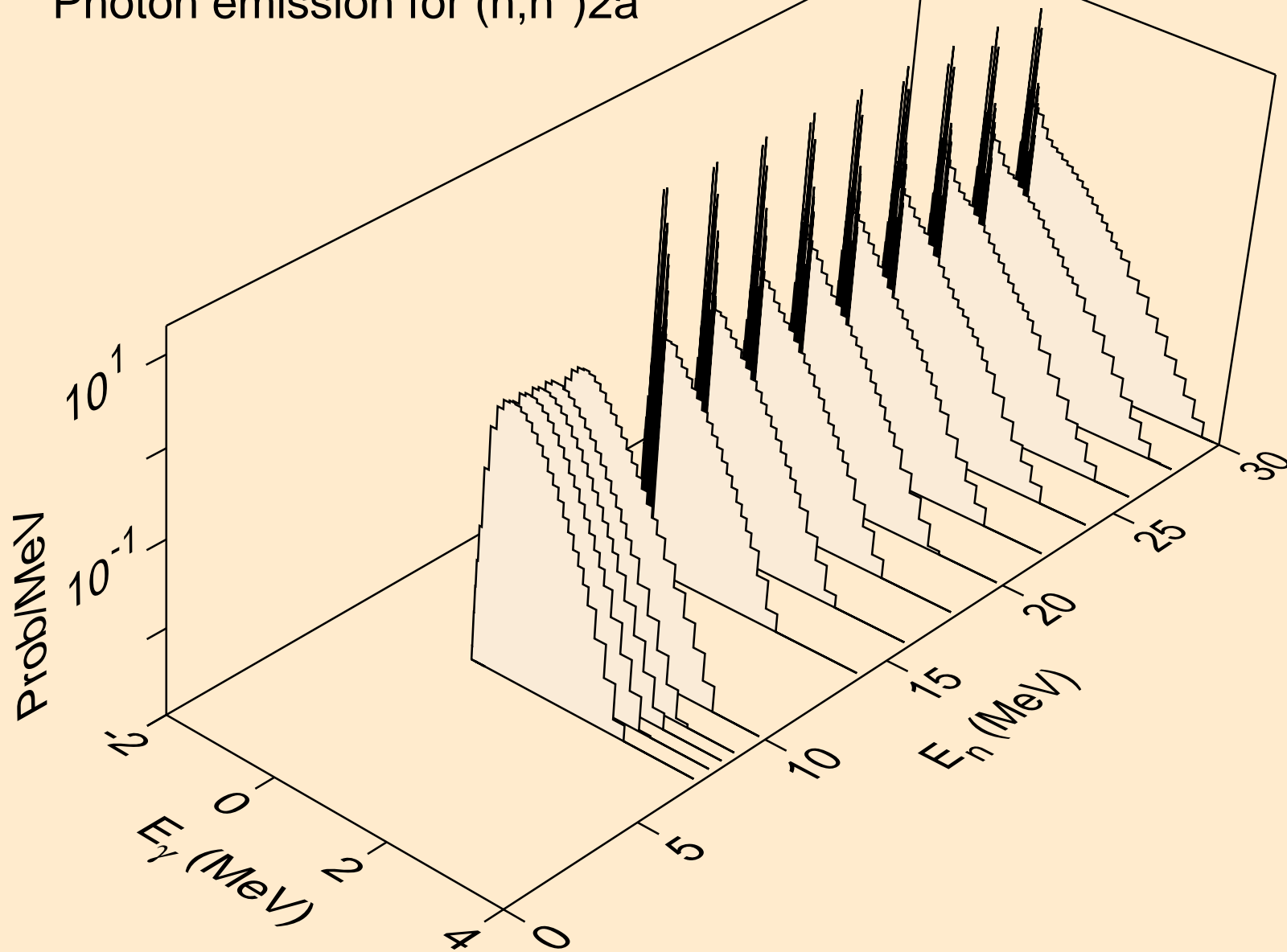

ES249 NEUTRON ACER TENDL-2019 LIBRARY; T=293.16K
Photon emission for (n,n*)d

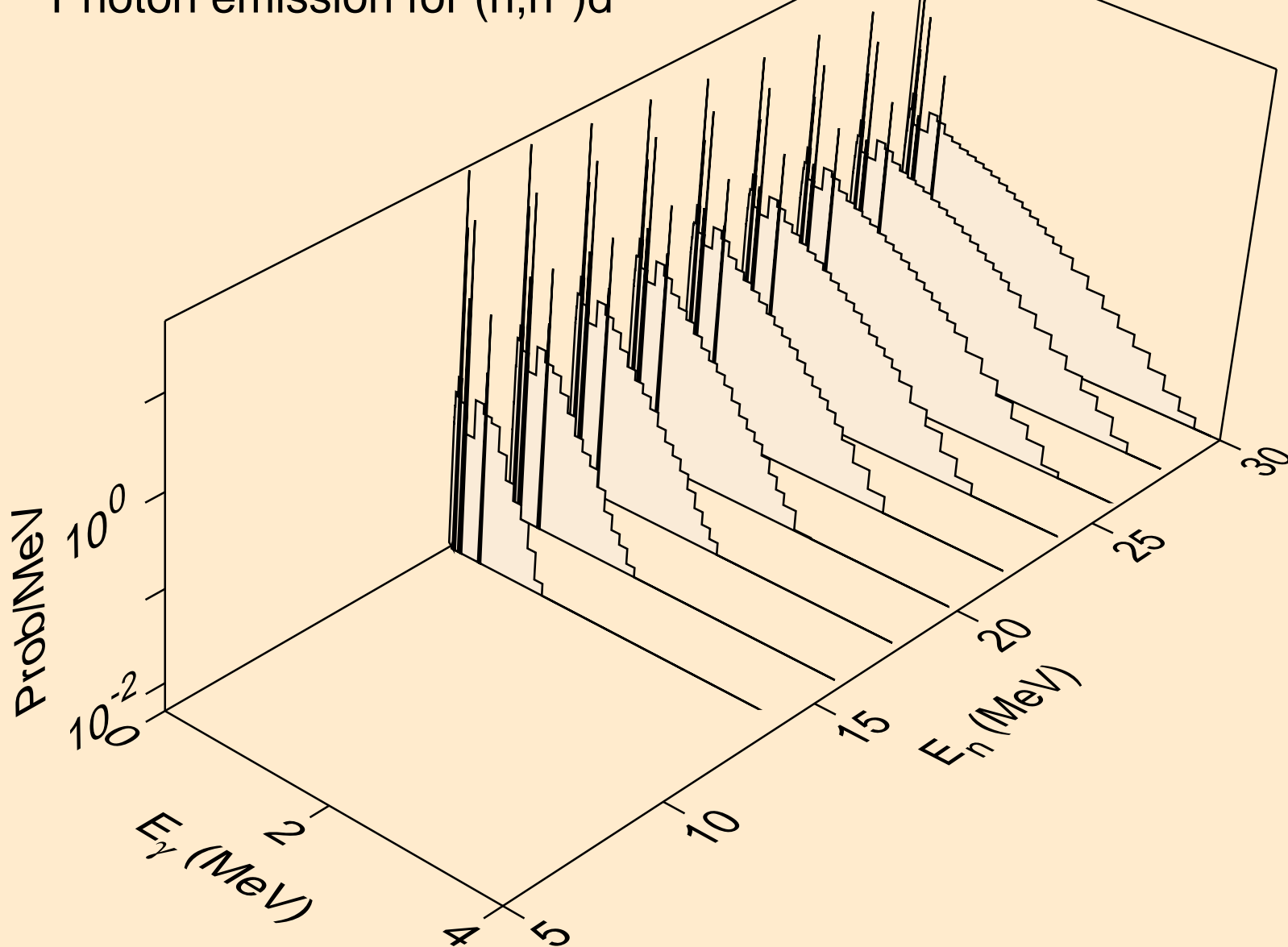

ES249 NEUTRON ACER TENDL-2019 LIBRARY; T=293.16K
Photon emission for (n,n*)t

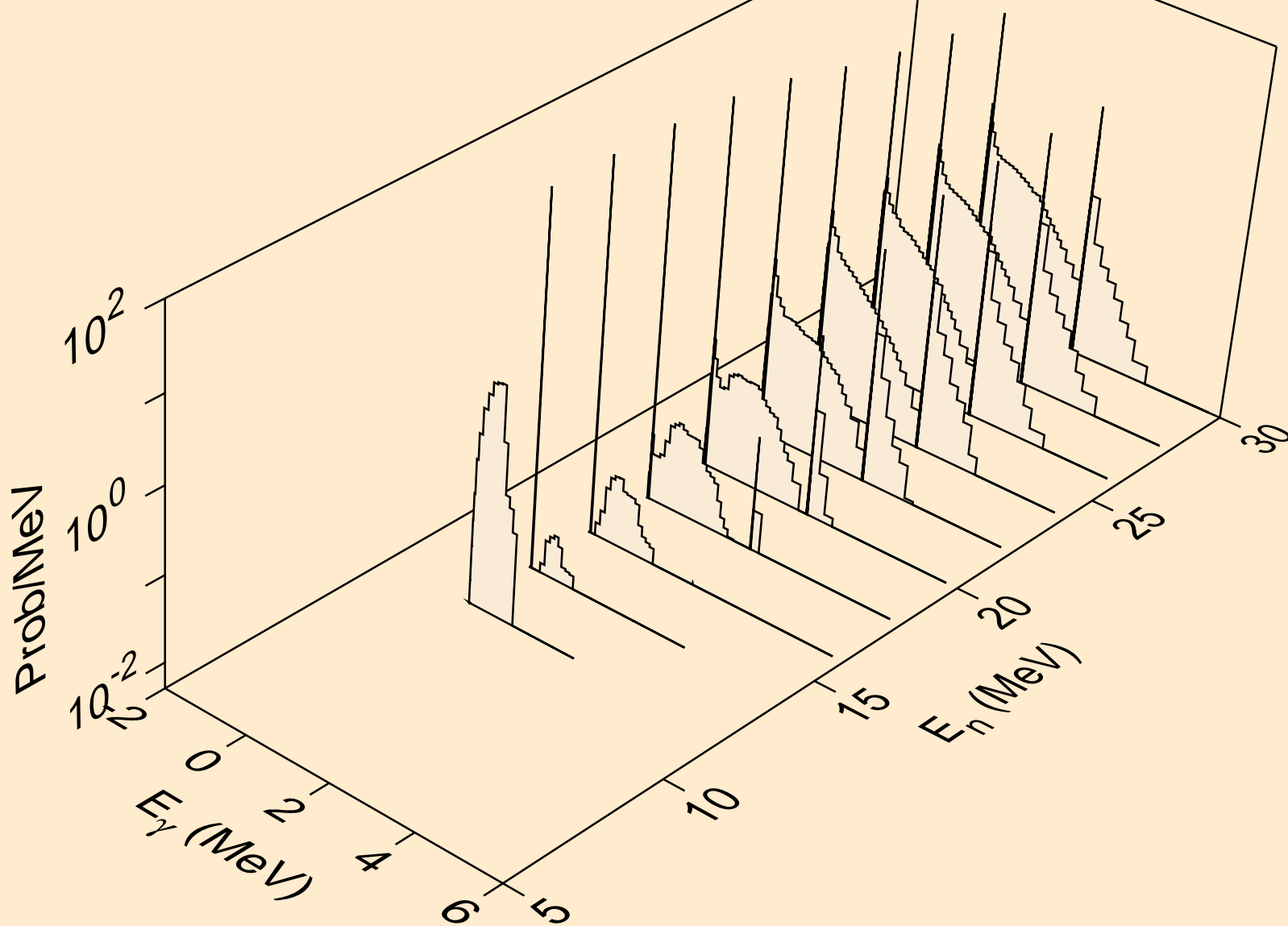

ES249 NEUTRON ACER TENDL-2019 LIBRARY; T=293.16K
Photon emission for (n,n*)he3

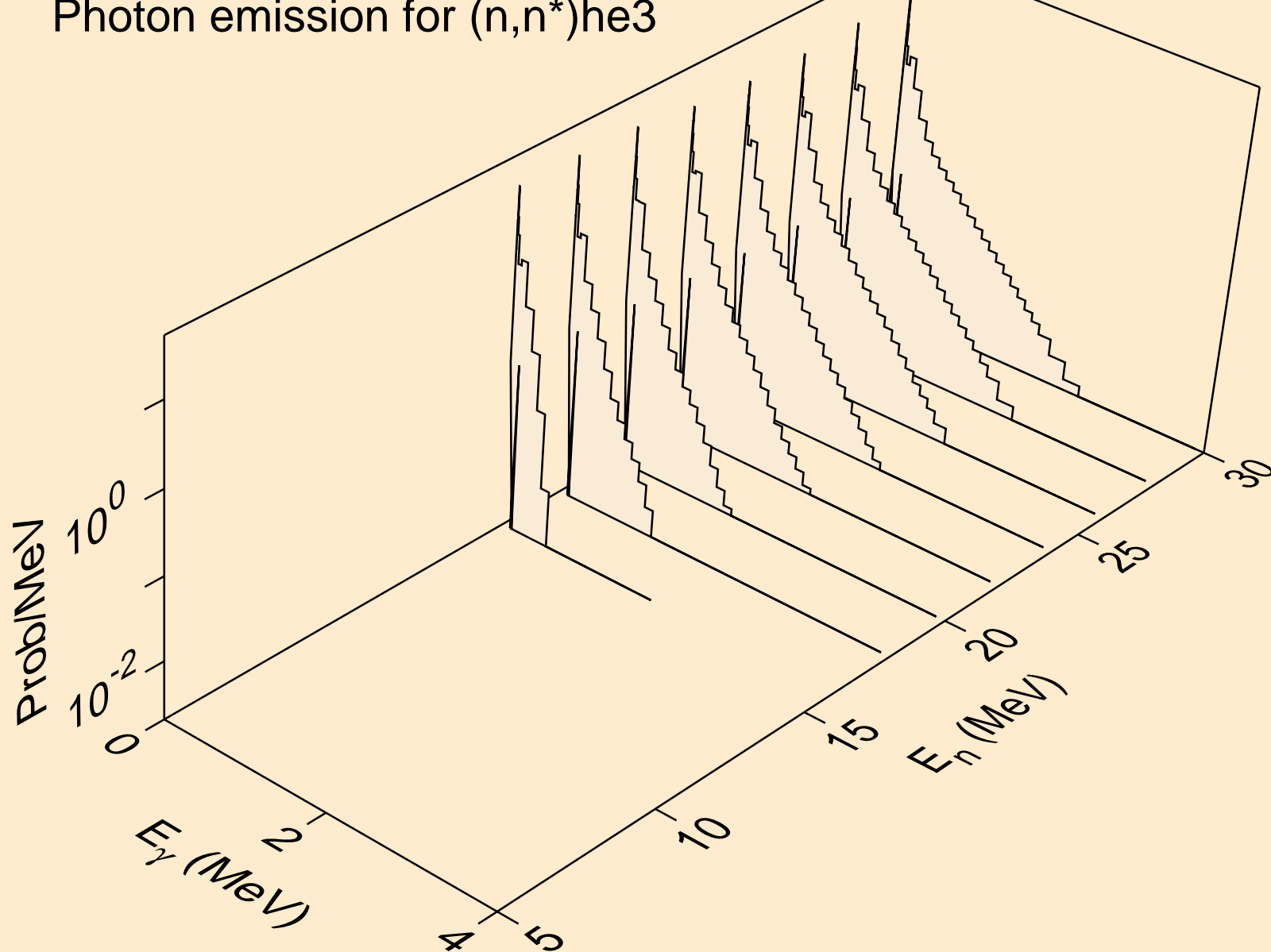

ES249 NEUTRON ACER TENDL-2019 LIBRARY; T=293.16K
Photon emission for (n,4n)

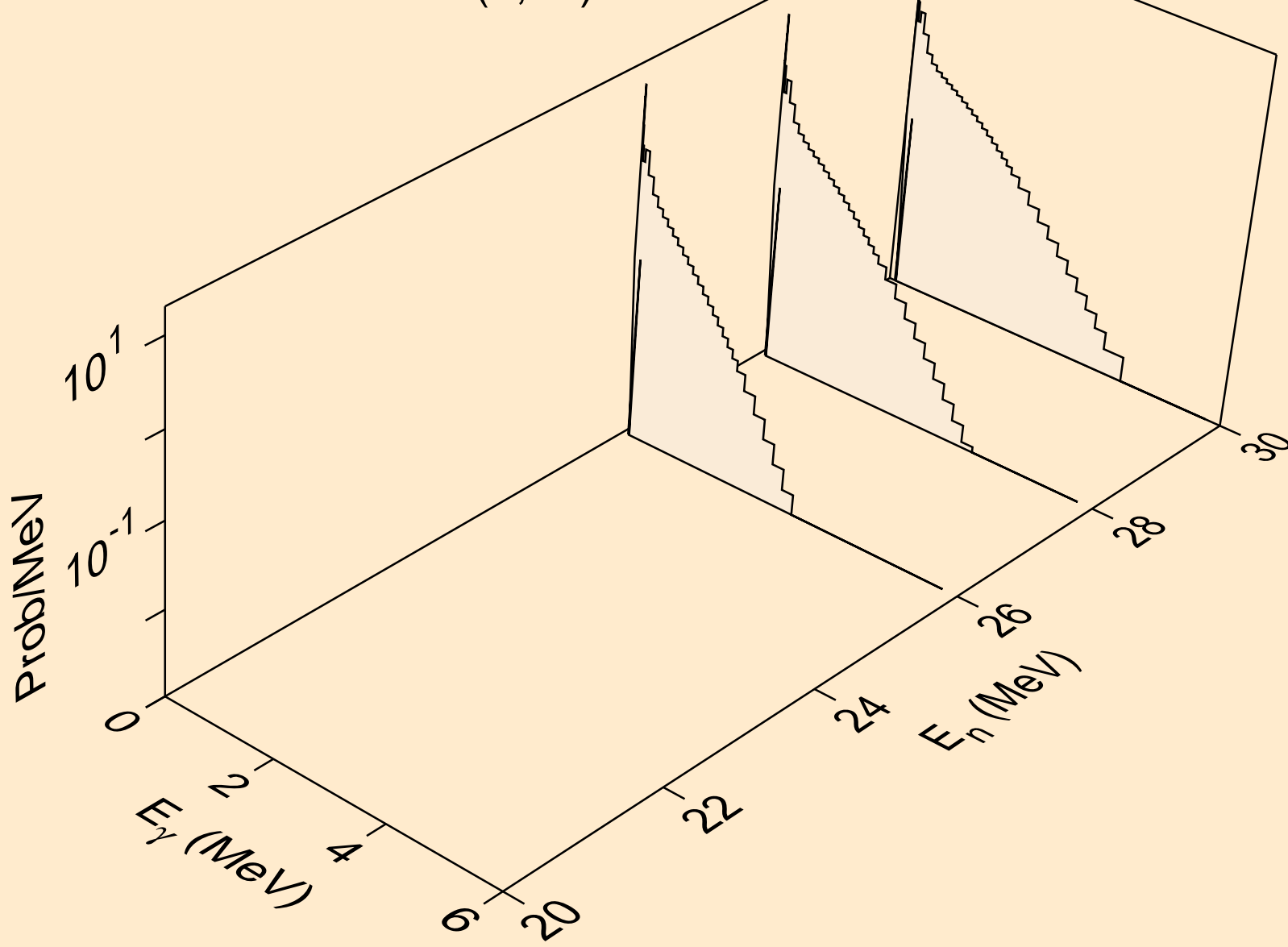

ES249 NEUTRON ACER TENDL-2019 LIBRARY; T=293.16K
Photon emission for (n,2np)

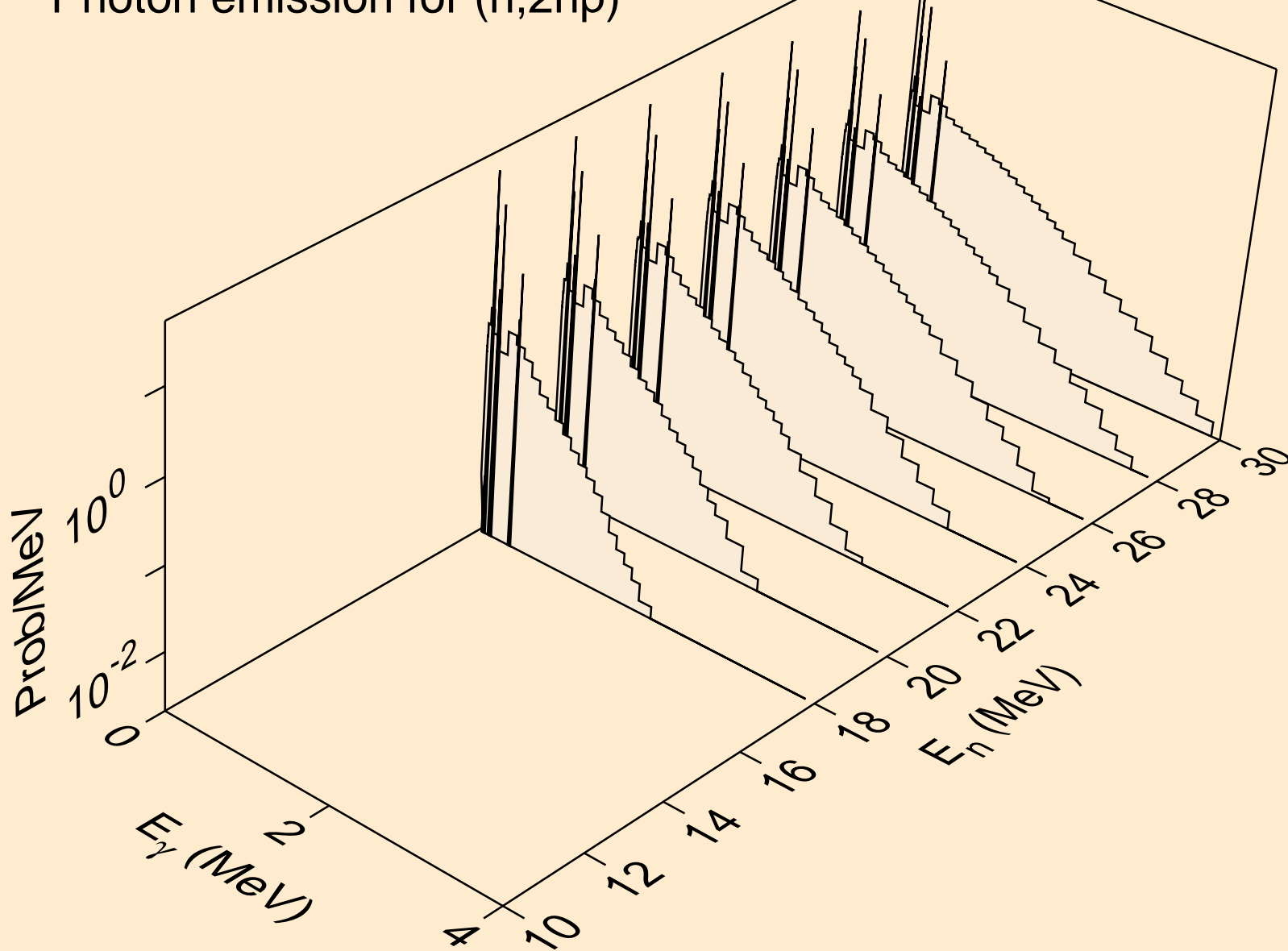

ES249 NEUTRON ACER TENDL-2019 LIBRARY; T=293.16K
Photon emission for (n,3np)

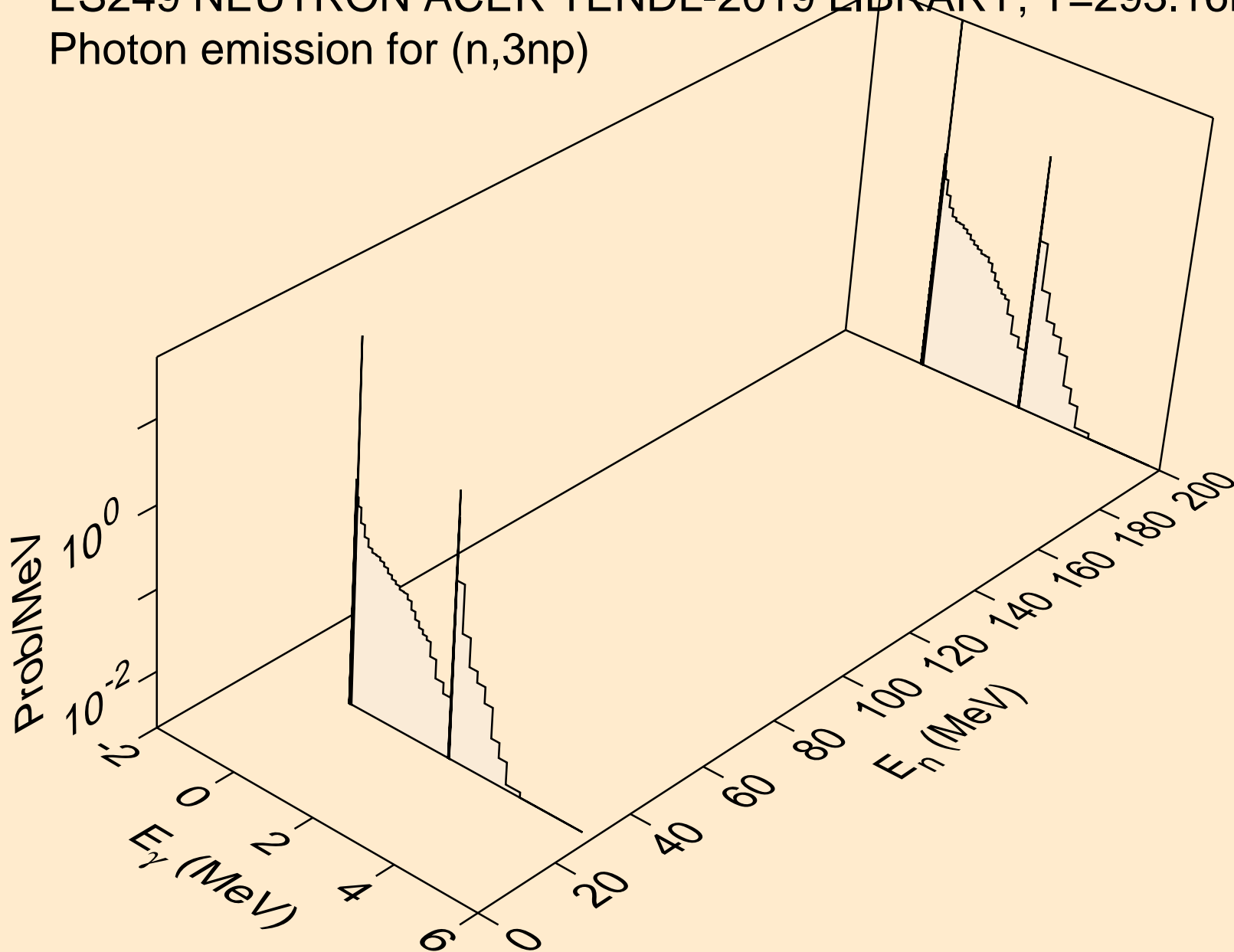

ES249 NEUTRON ACER TENDL-2019 LIBRARY; T=293.16K
Photon emission for (n,2np)

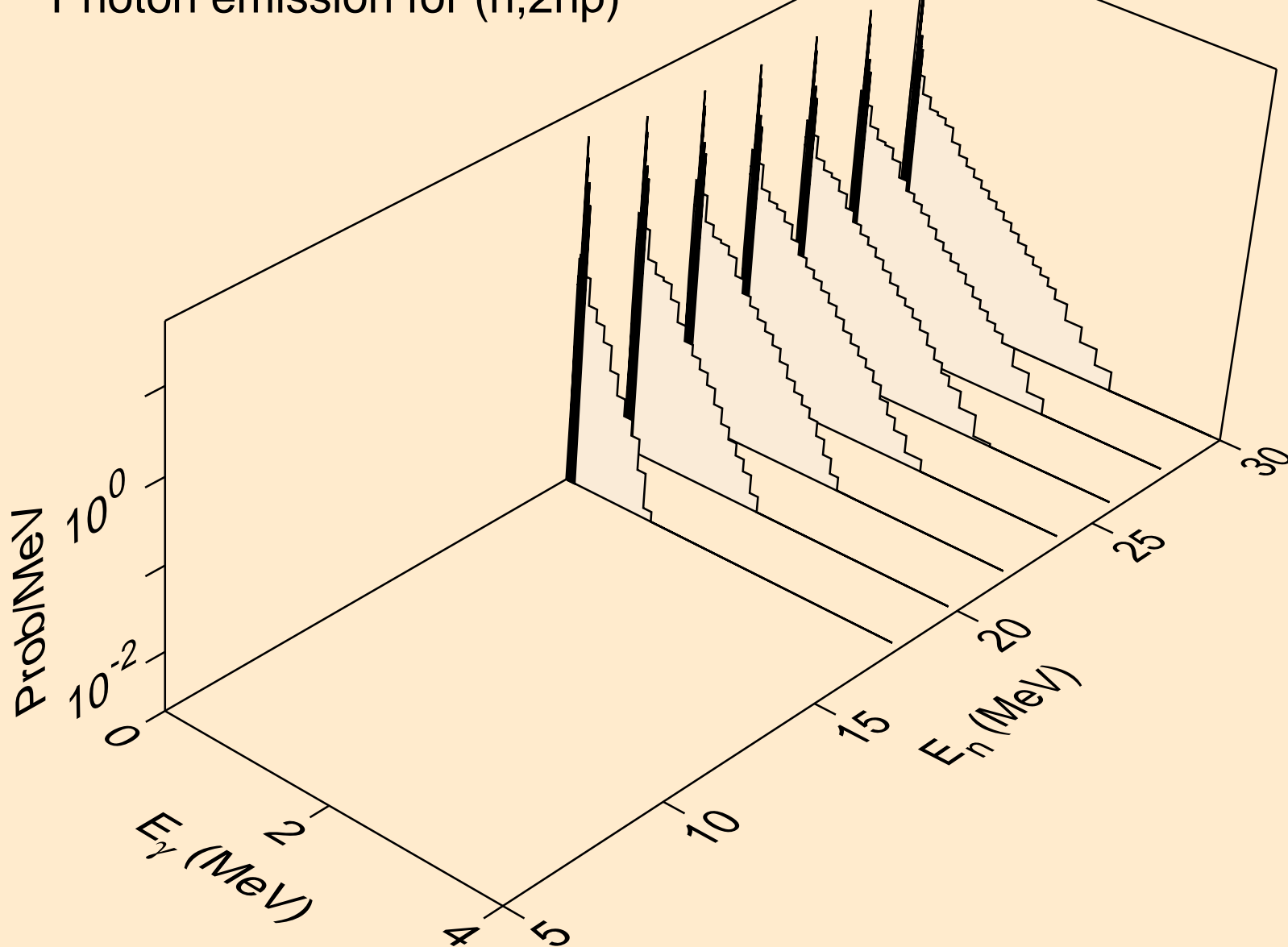

ES249 NEUTRON ACER TENDL-2019 LIBRARY; T=293.16K
Photon emission for (n,npa)

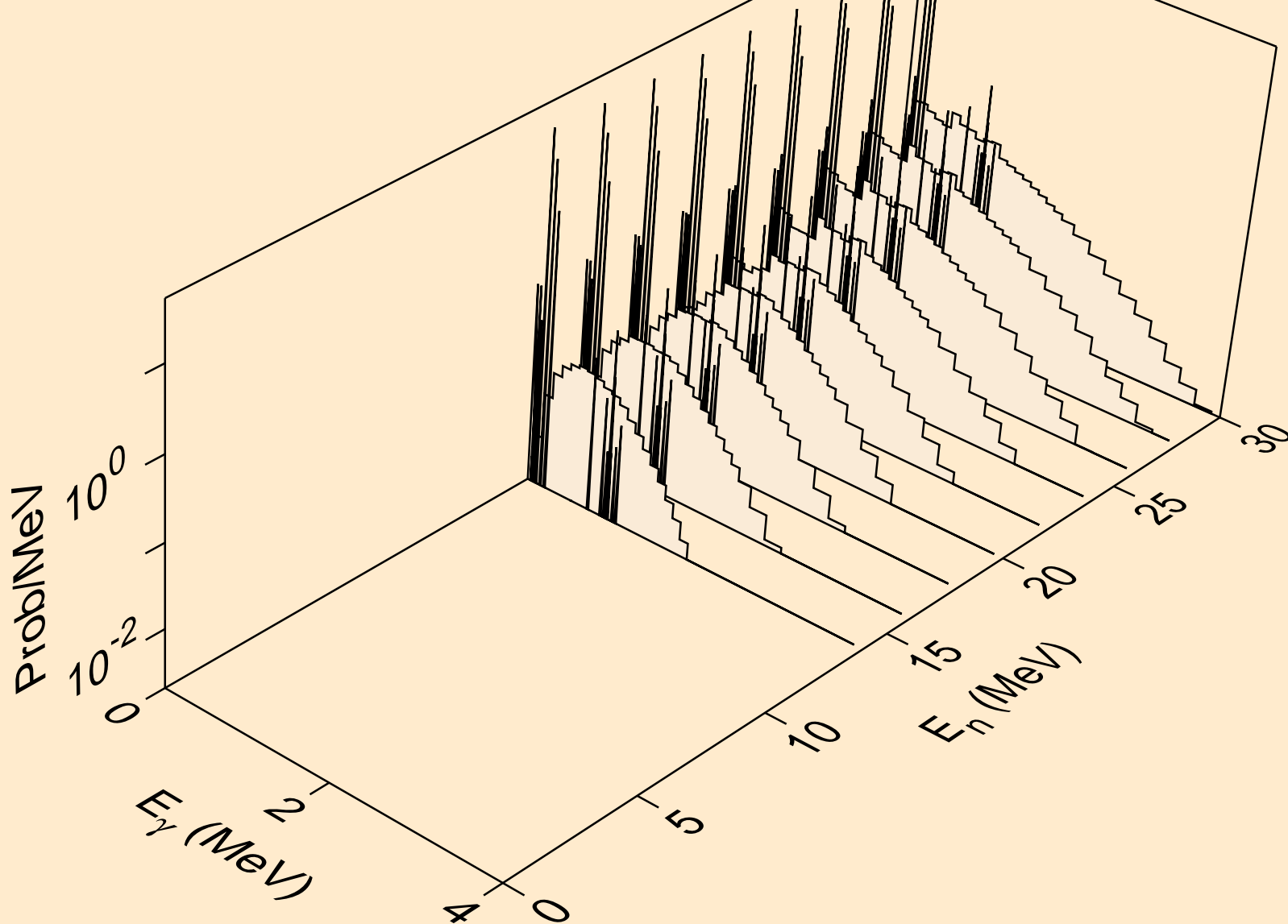

ES249 NEUTRON ACER TENDL-2019 LIBRARY; T=293.16K
Photon emission for (n,n*c)

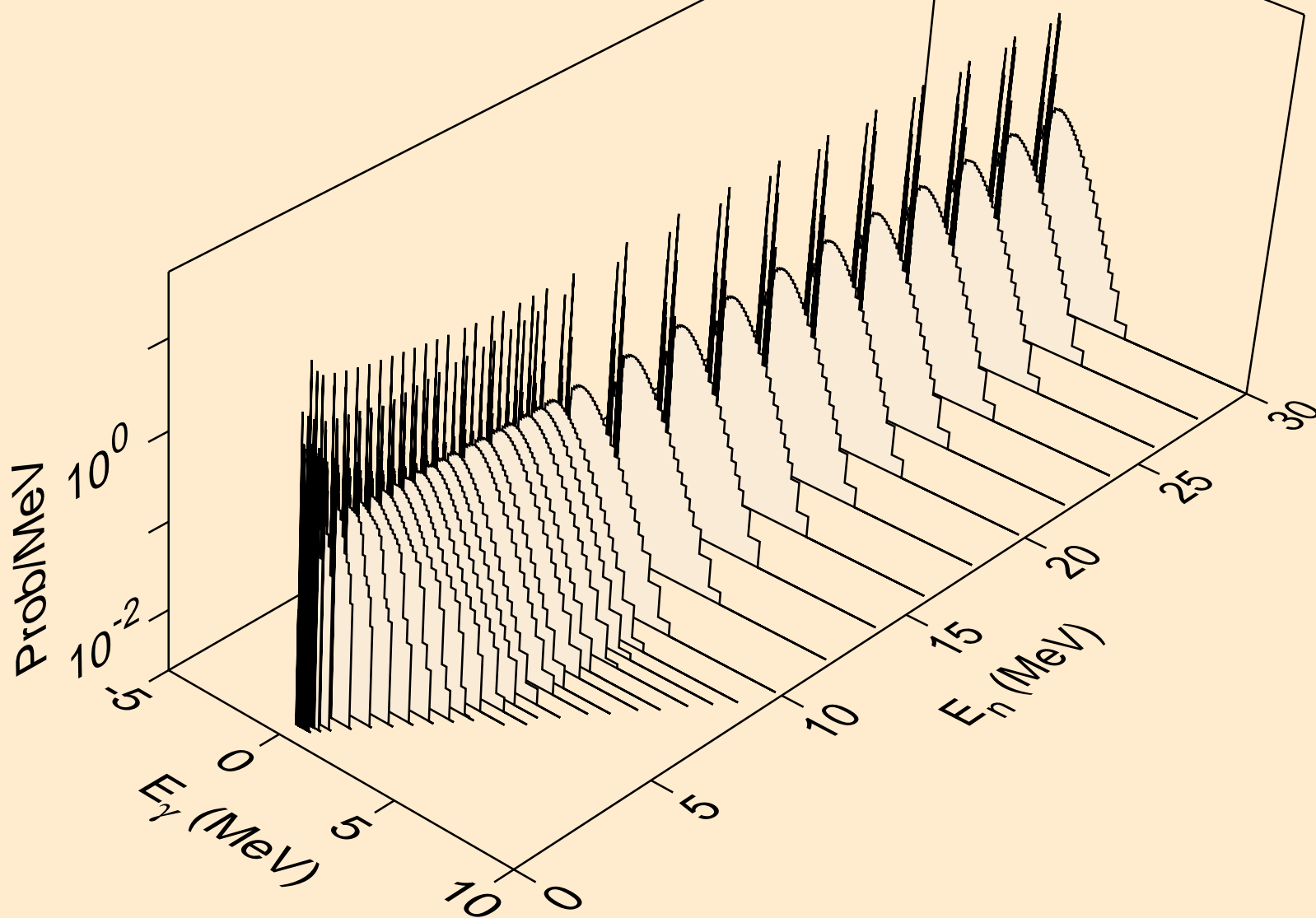

ES249 NEUTRON ACER TENDL-2019 LIBRARY; T=293.16K
Photon emission for (n,gma)

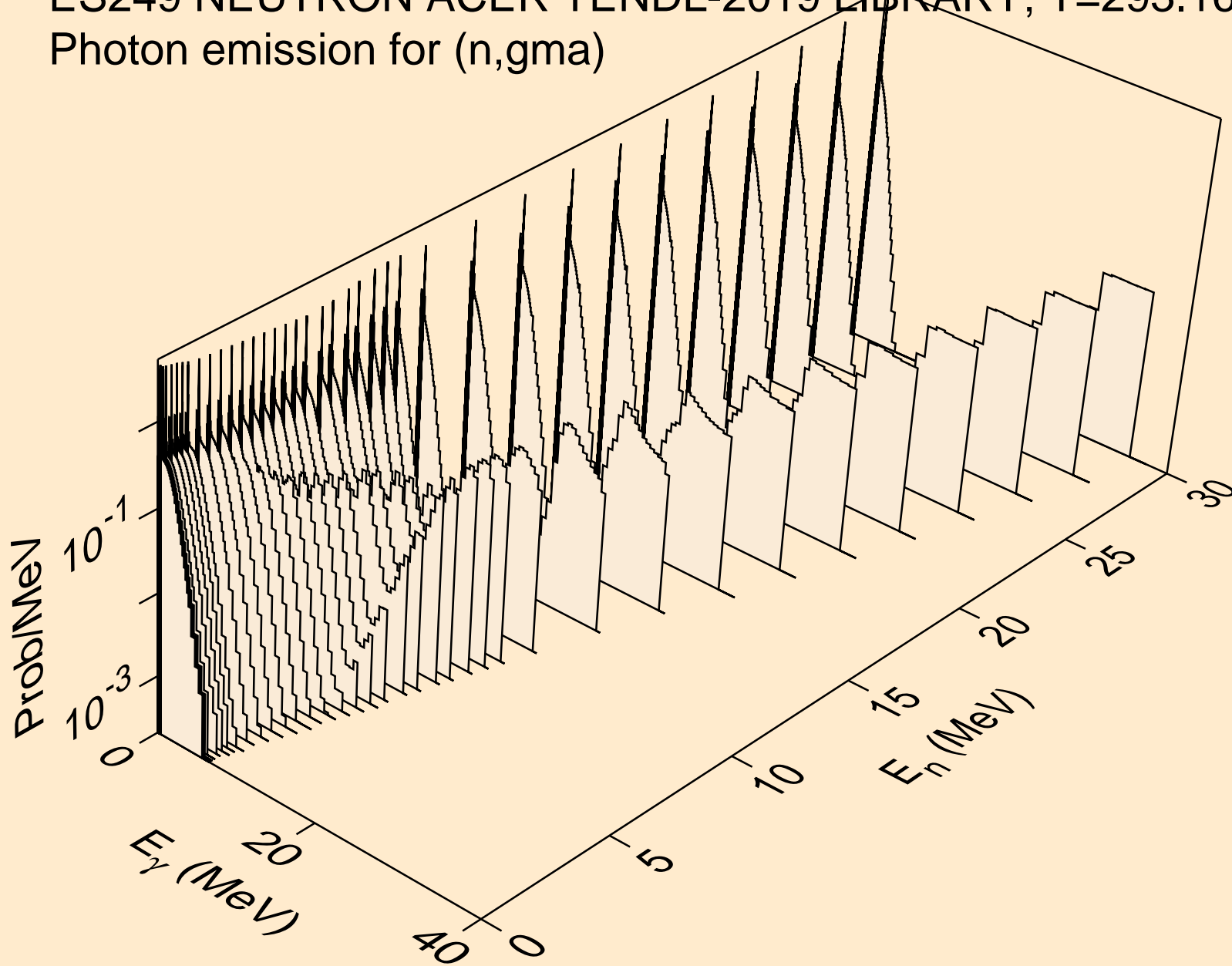

ES249 NEUTRON ACER TENDL-2019 LIBRARY; T=293.16K
Photon emission for (n,p)

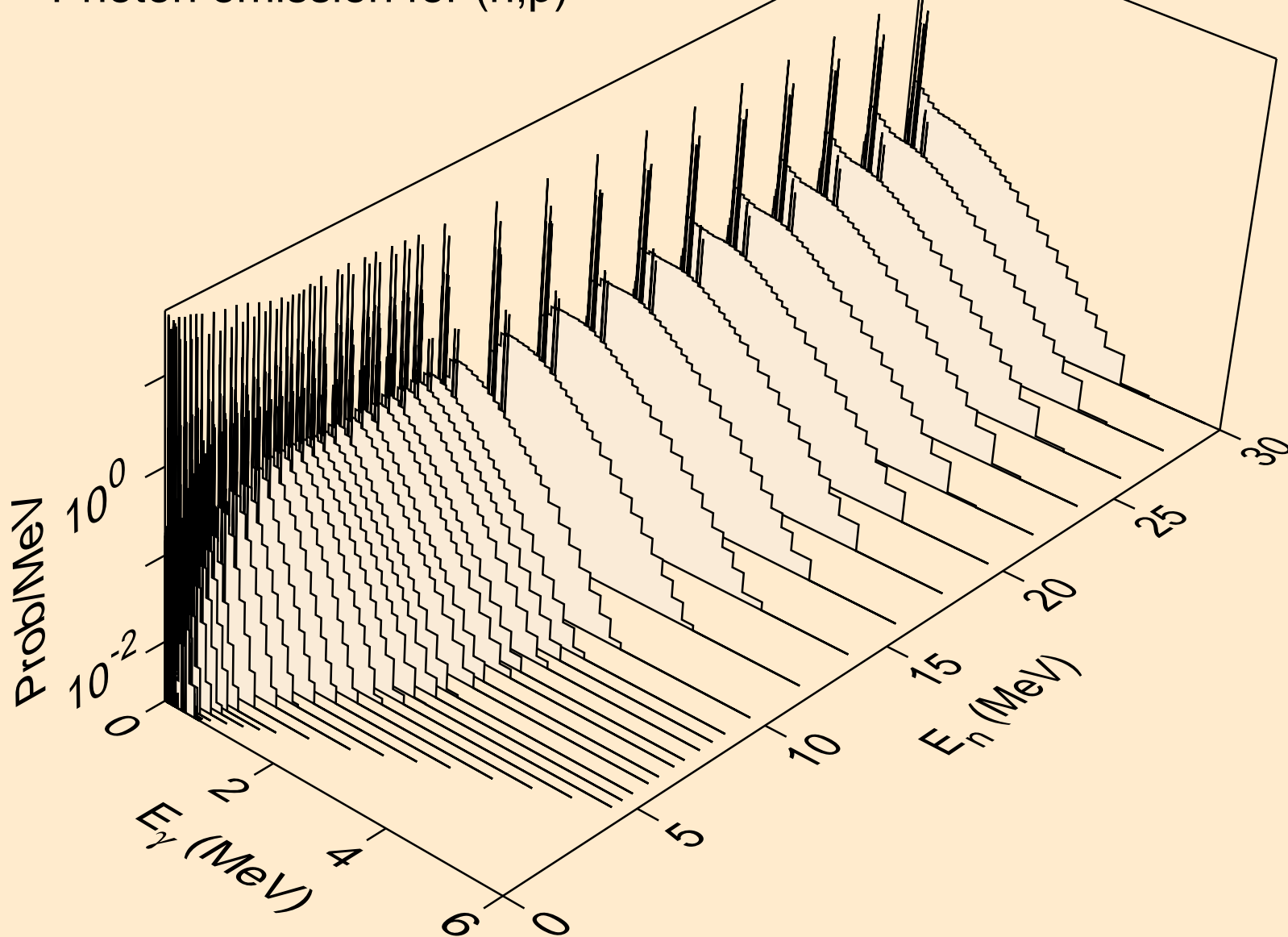

ES249 NEUTRON ACER TENDL-2019 LIBRARY; T=293.16K
Photon emission for (n,d)

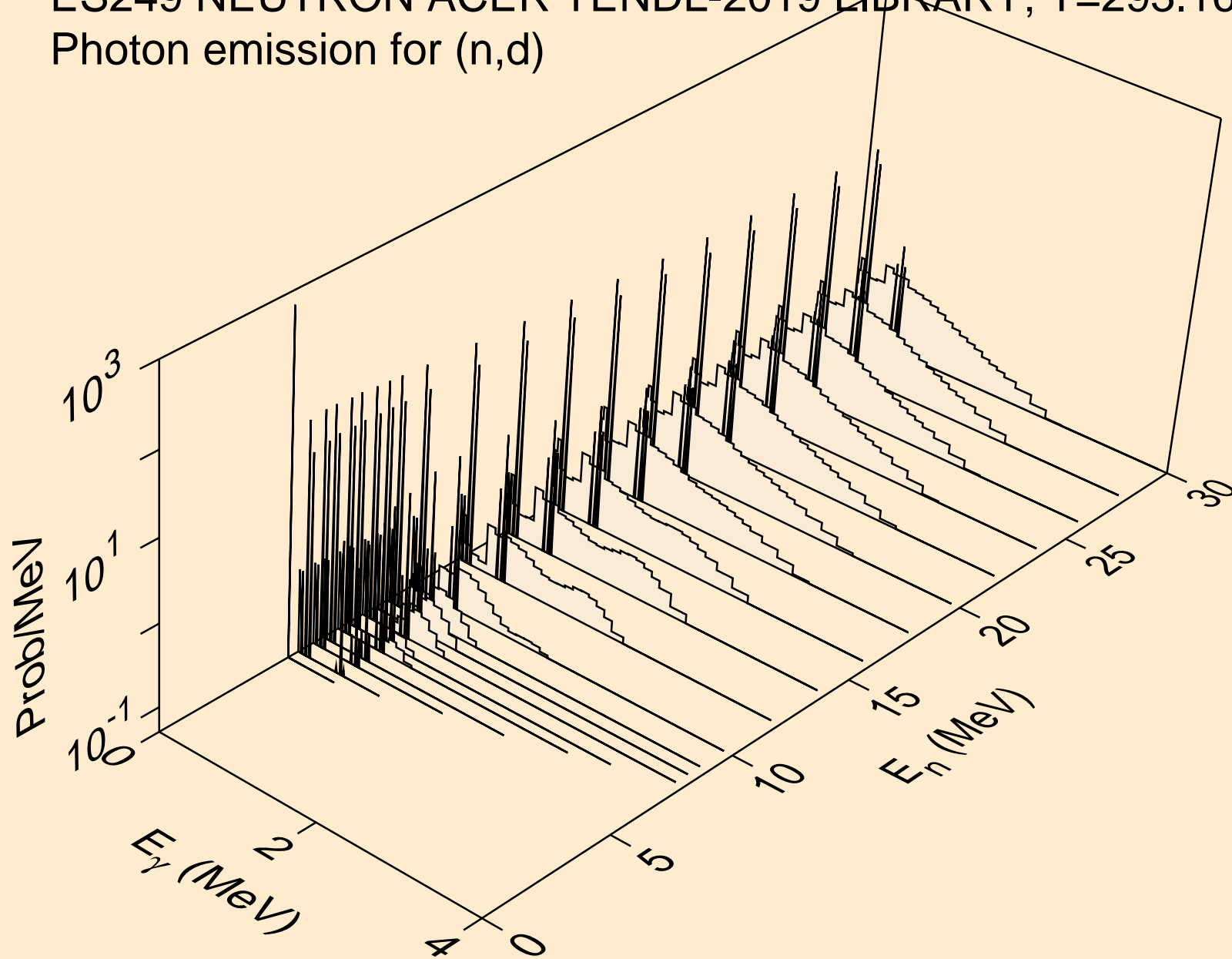

ES249 NEUTRON ACER TENDL-2019 LIBRARY; T=293.16K
Photon emission for (n,t)

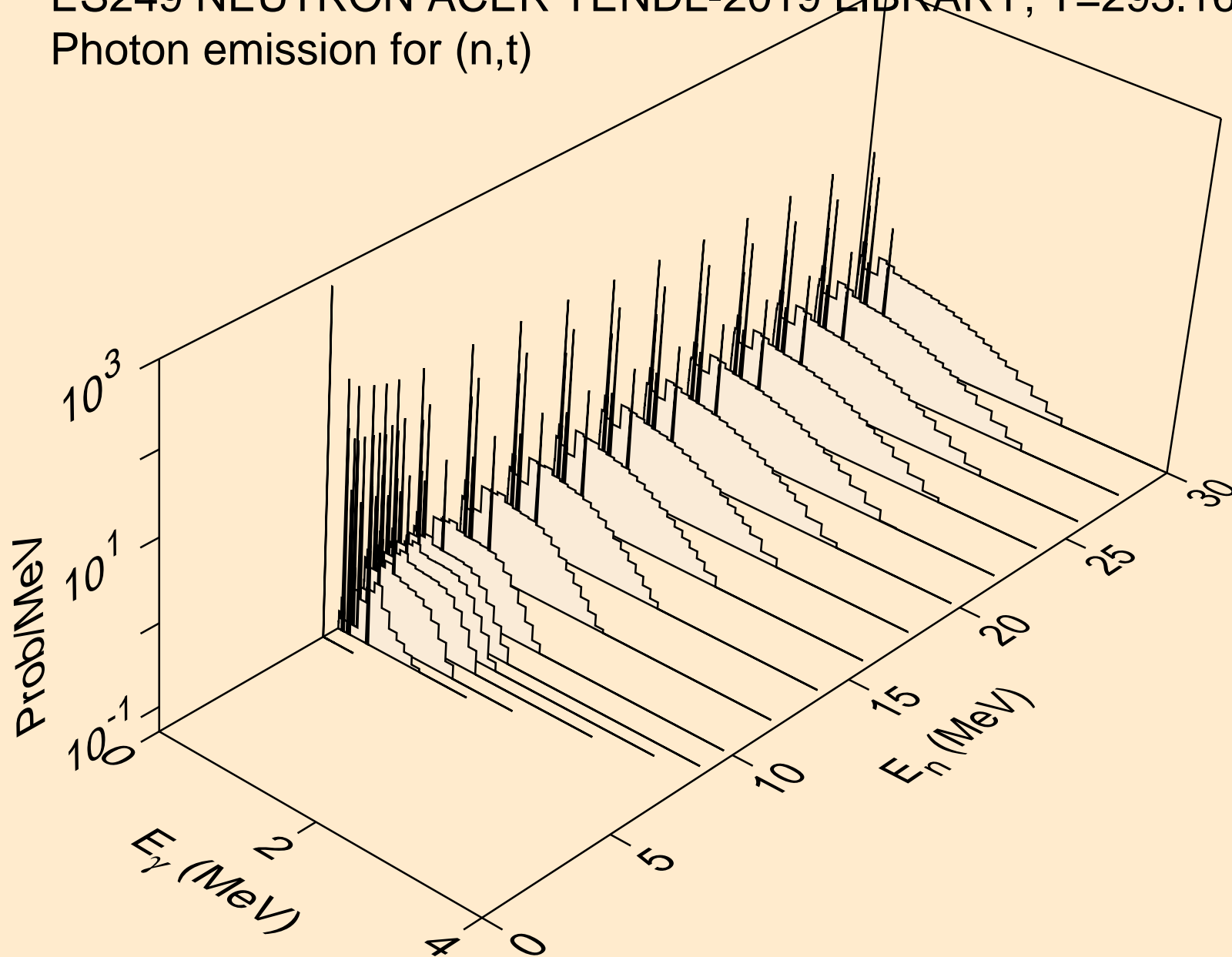

ES249 NEUTRON ACER TENDL-2019 LIBRARY; T=293.16K
Photon emission for (n,he3)

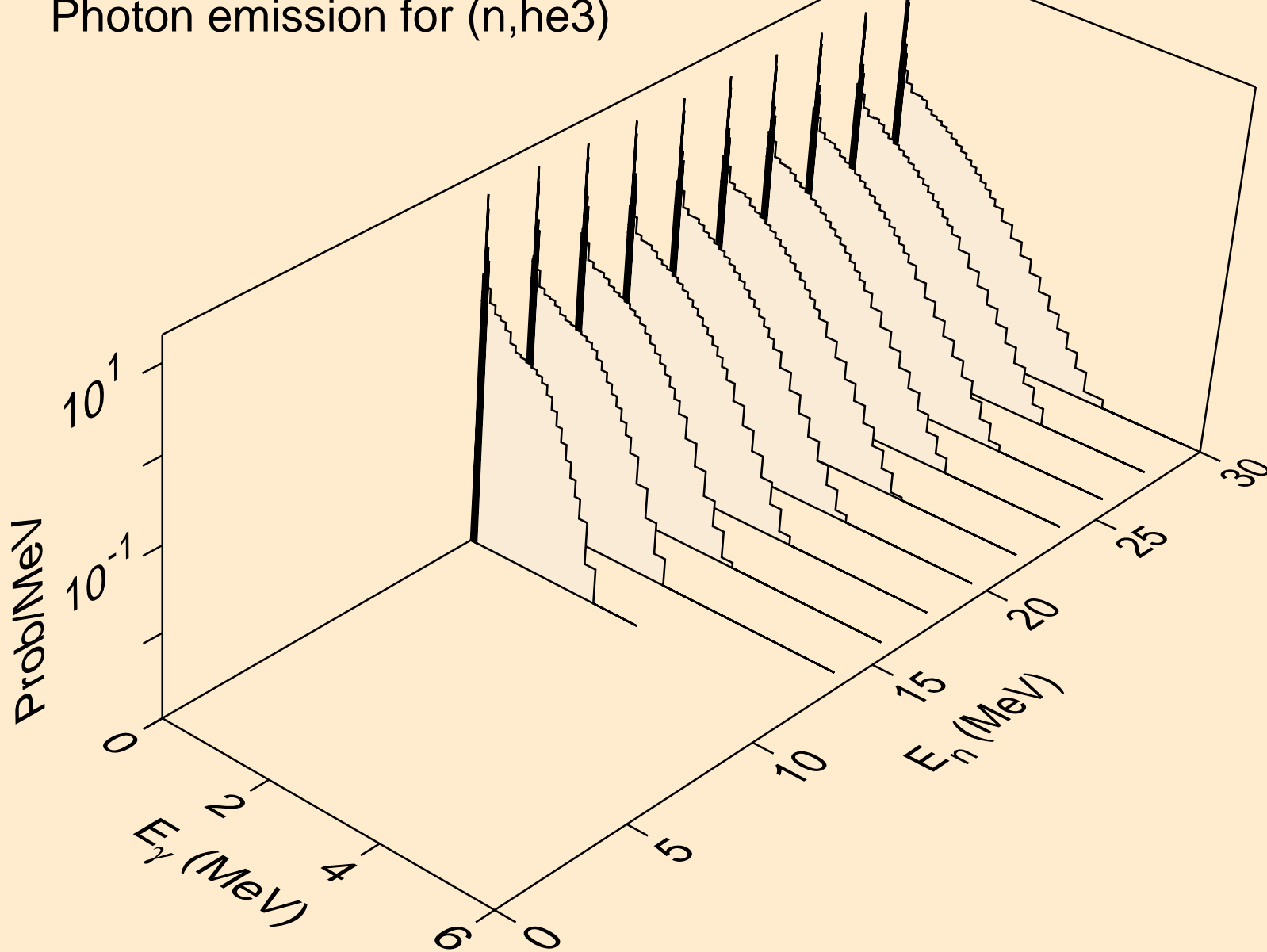

ES249 NEUTRON ACER TENDL-2019 LIBRARY; T=293.16K
Photon emission for (n,a)

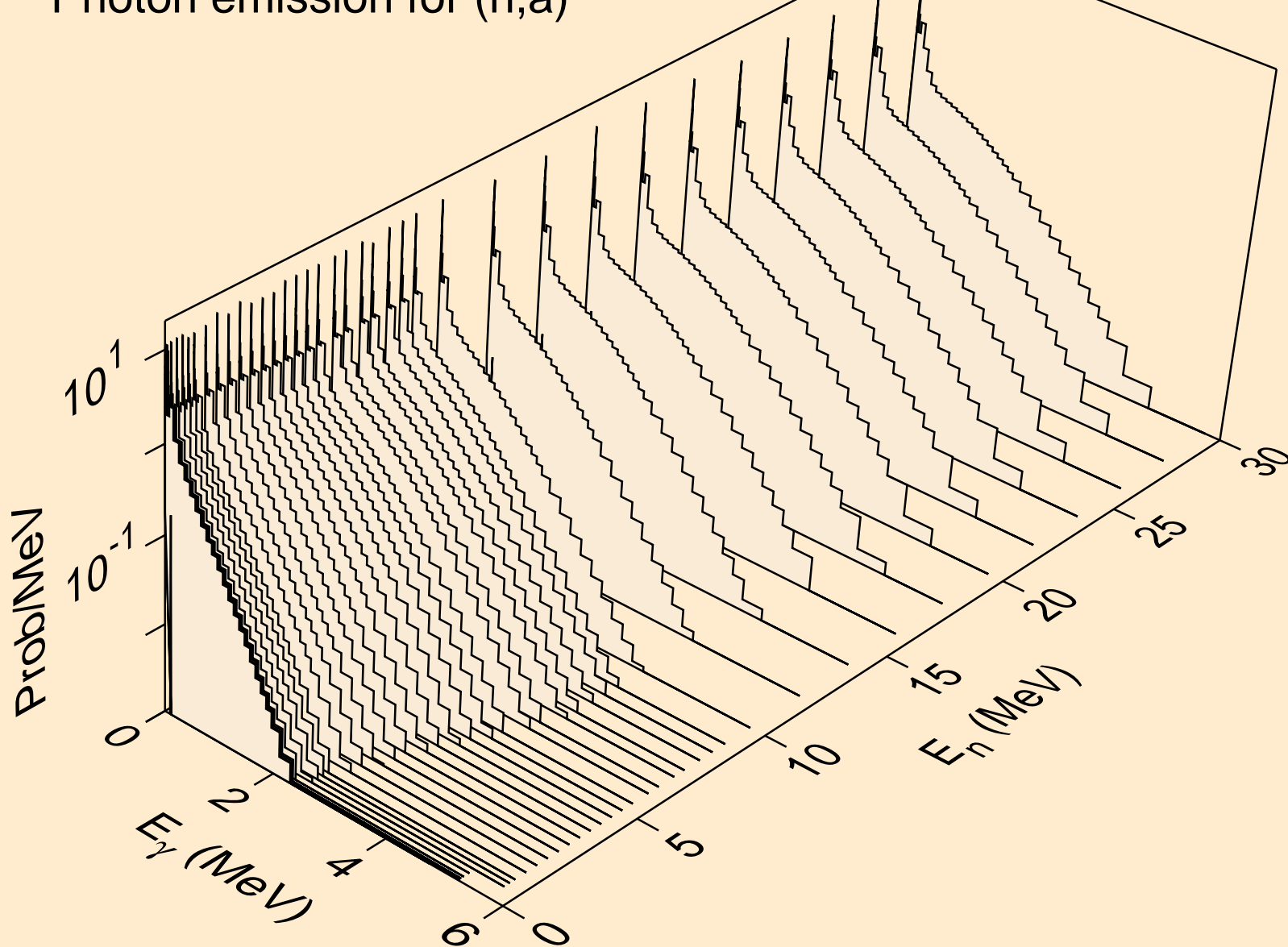

ES249 NEUTRON ACER TENDL-2019 LIBRARY; T=293.16K
Photon emission for (n,2a)

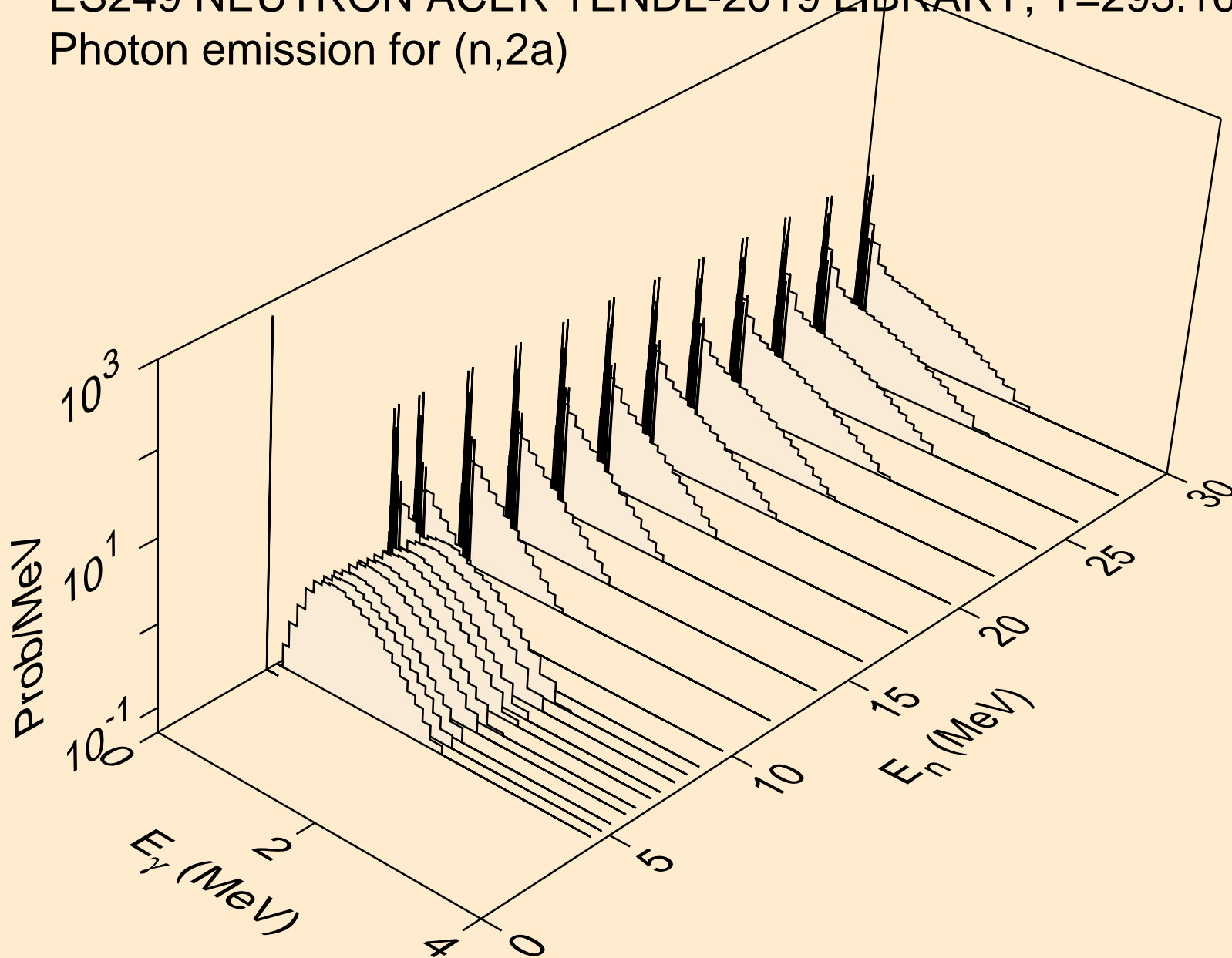

ES249 NEUTRON ACER TENDL-2019 LIBRARY; T=293.16K
Photon emission for (n,2p)

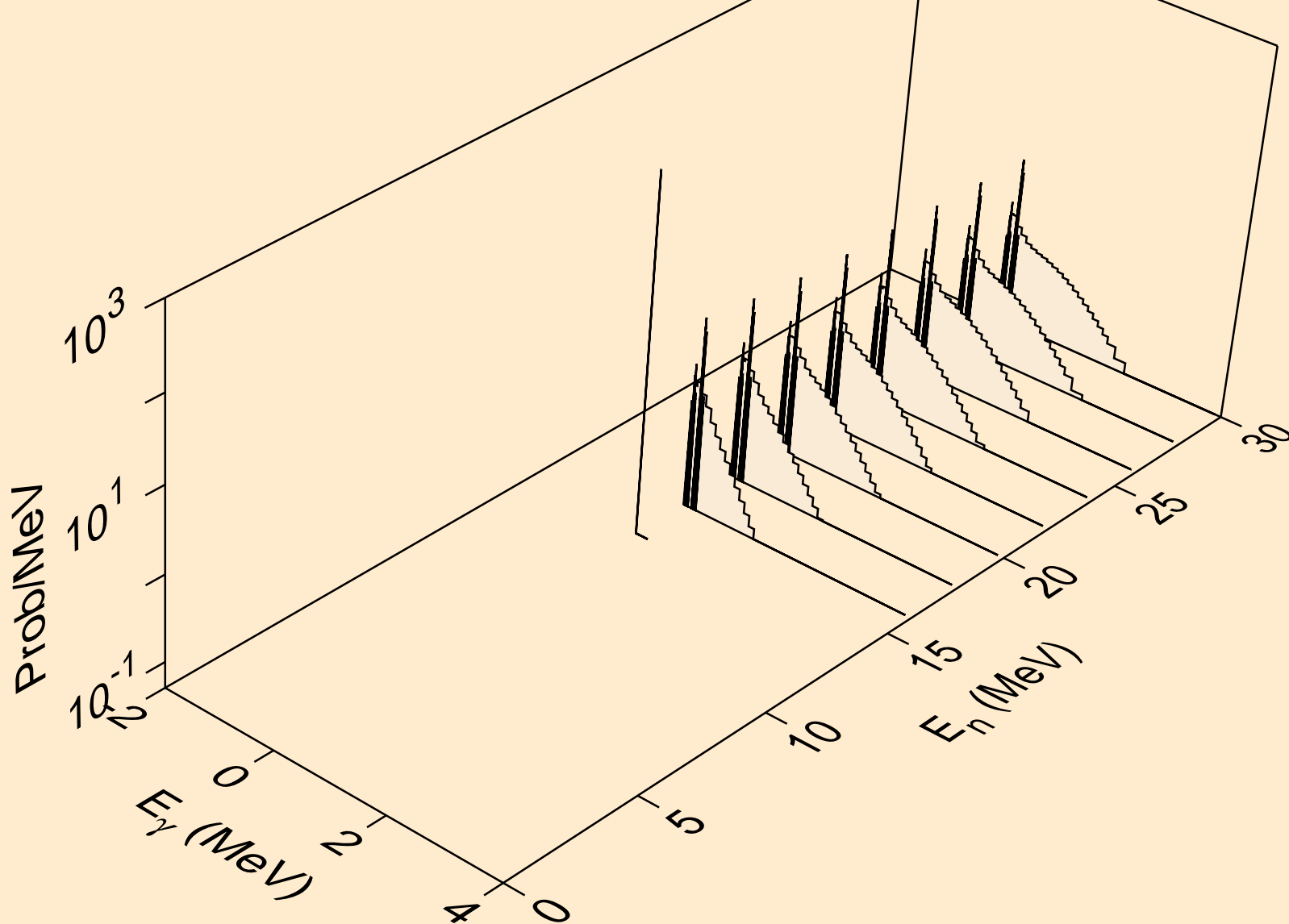

ES249 NEUTRON ACER TENDL-2019 LIBRARY; T=293.16K
Photon emission for (n,p α)

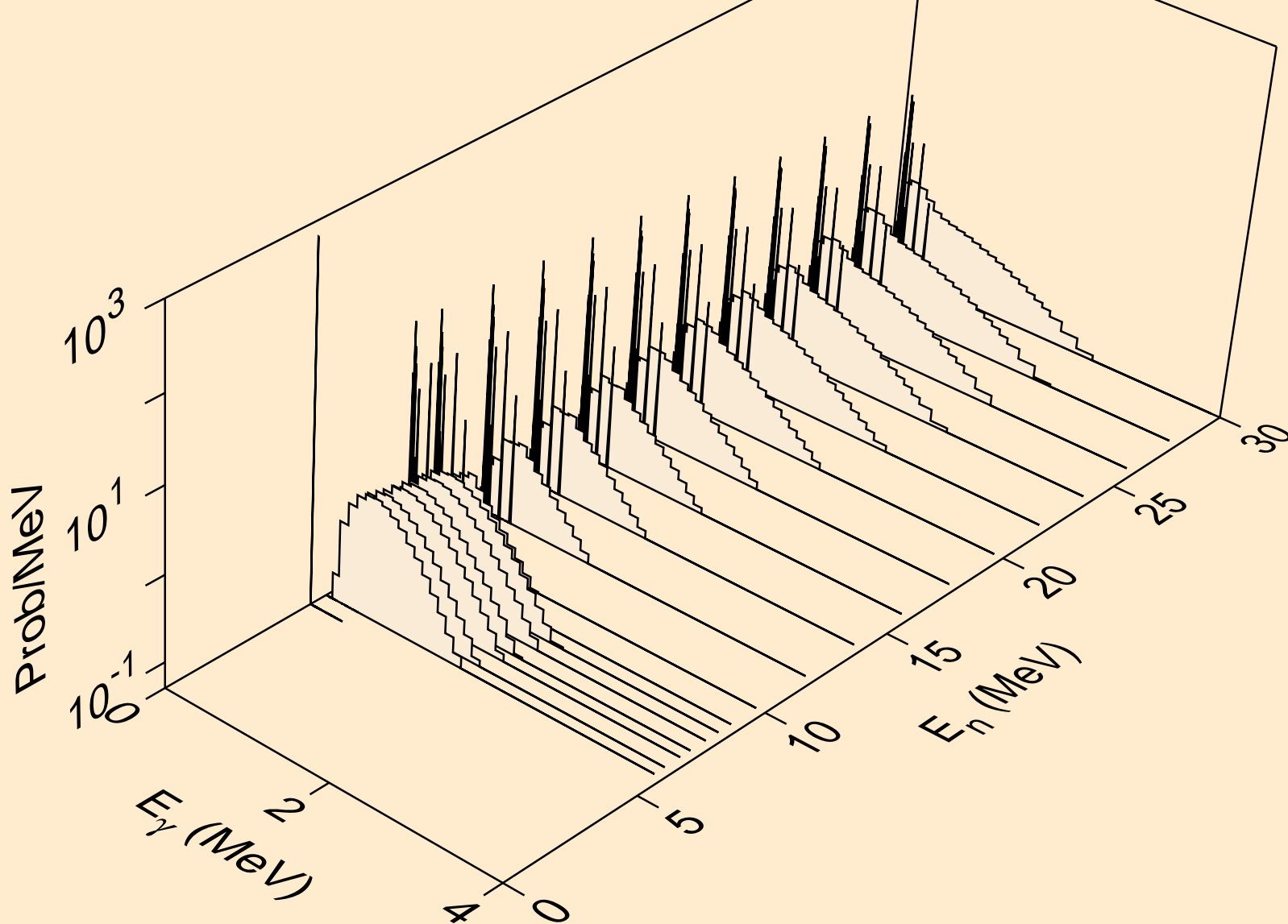

ES249 NEUTRON ACER TENDL-2019 LIBRARY; T=293.16K
Photon emission for (n,pd)

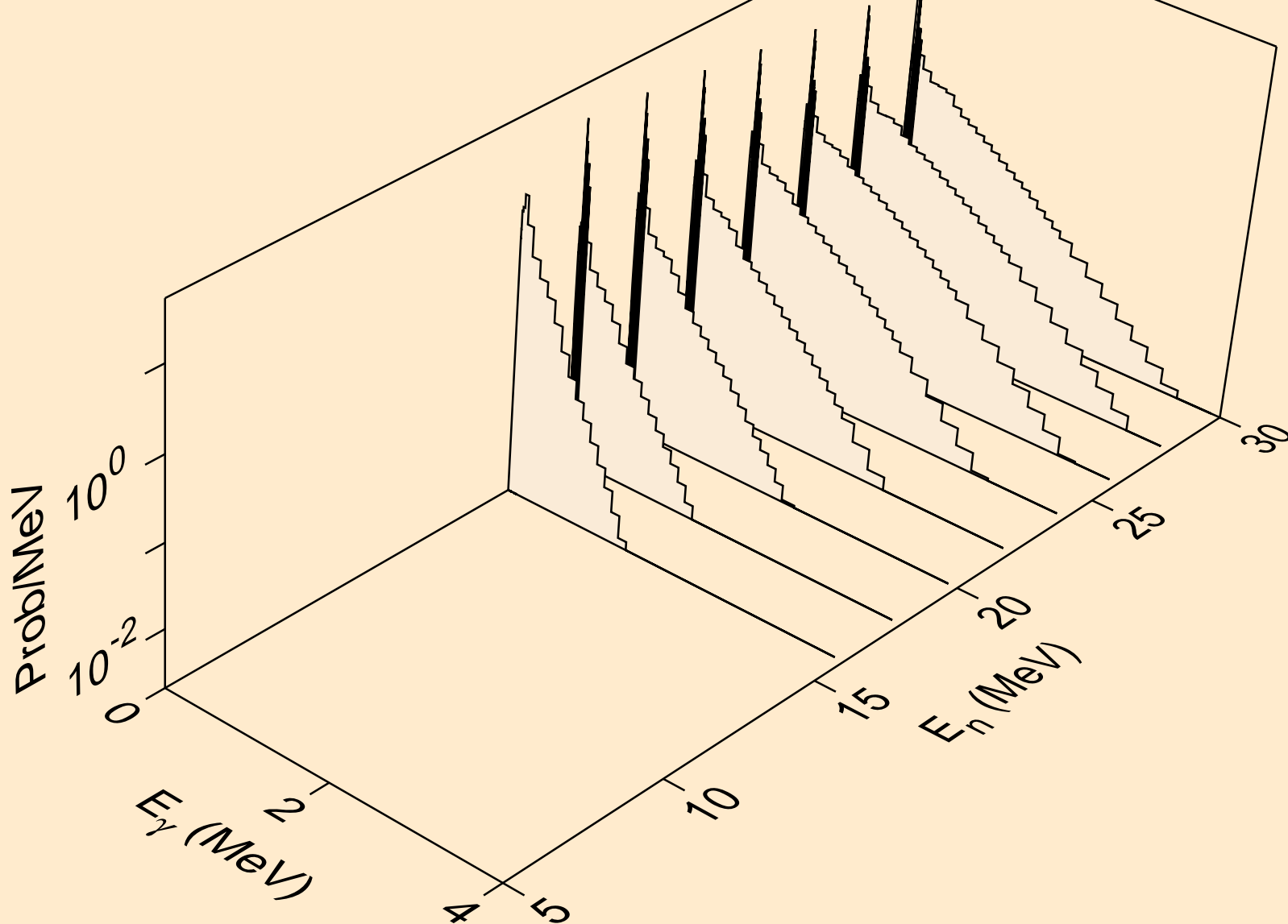

ES249 NEUTRON ACER TENDL-2019 LIBRARY; T=293.16K
Photon emission for (n,pt)

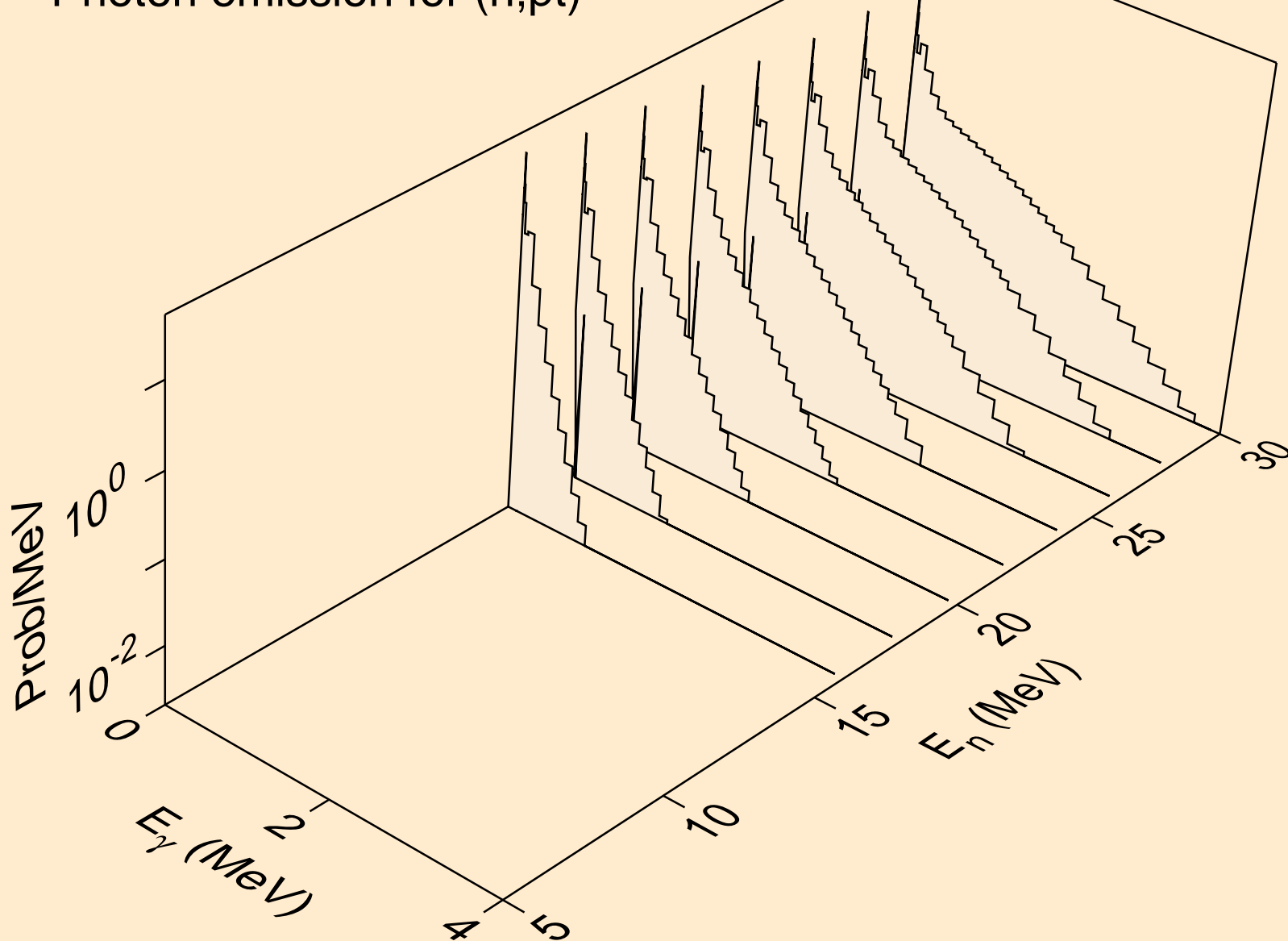

ES249 NEUTRON ACER TENDL-2019 LIBRARY; T=293.16K
thermal capture photon spectrum

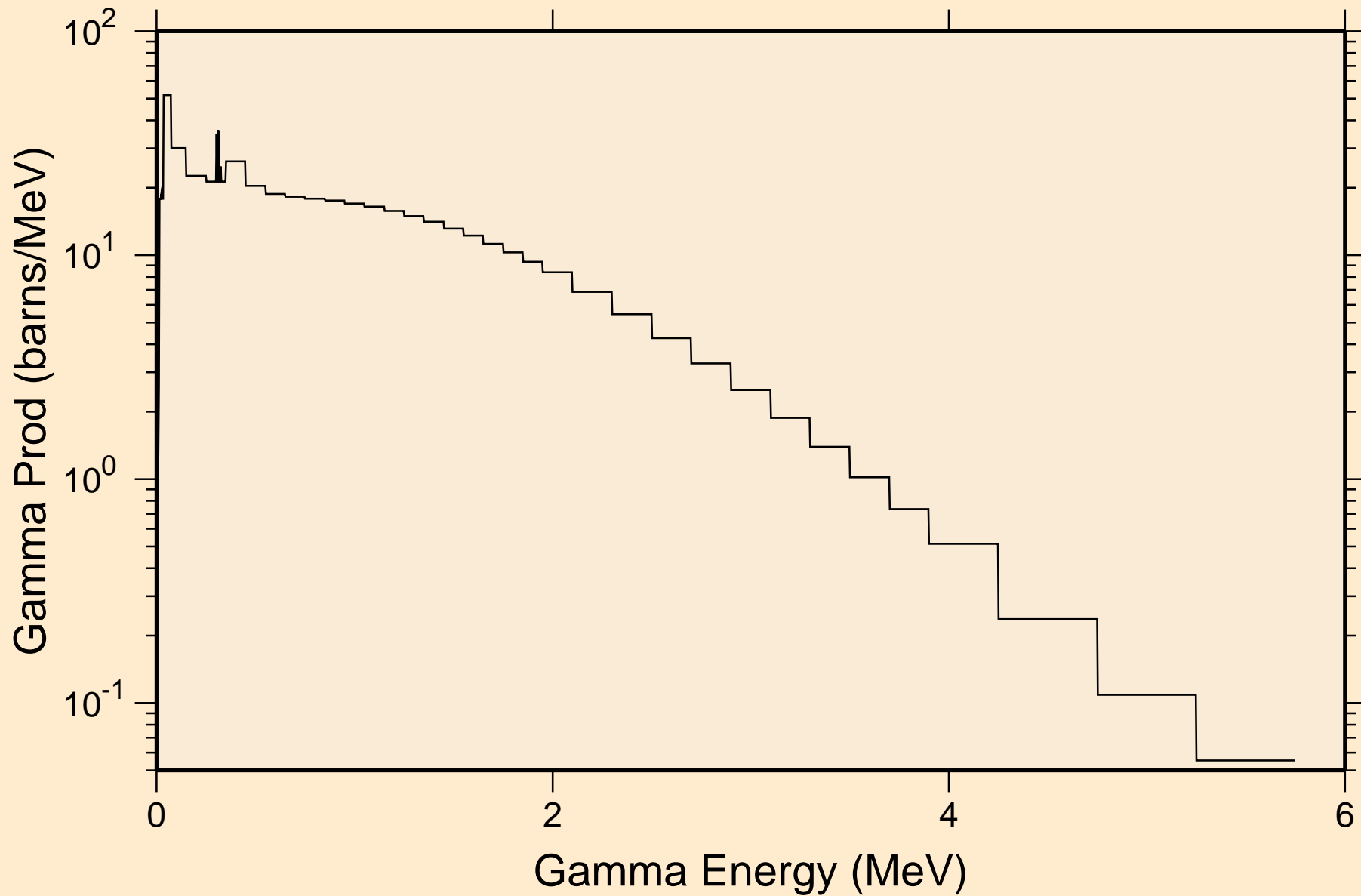

ES249 NEUTRON ACER TENDL-2019 LIBRARY; T=293.16K
14 MeV photon spectrum

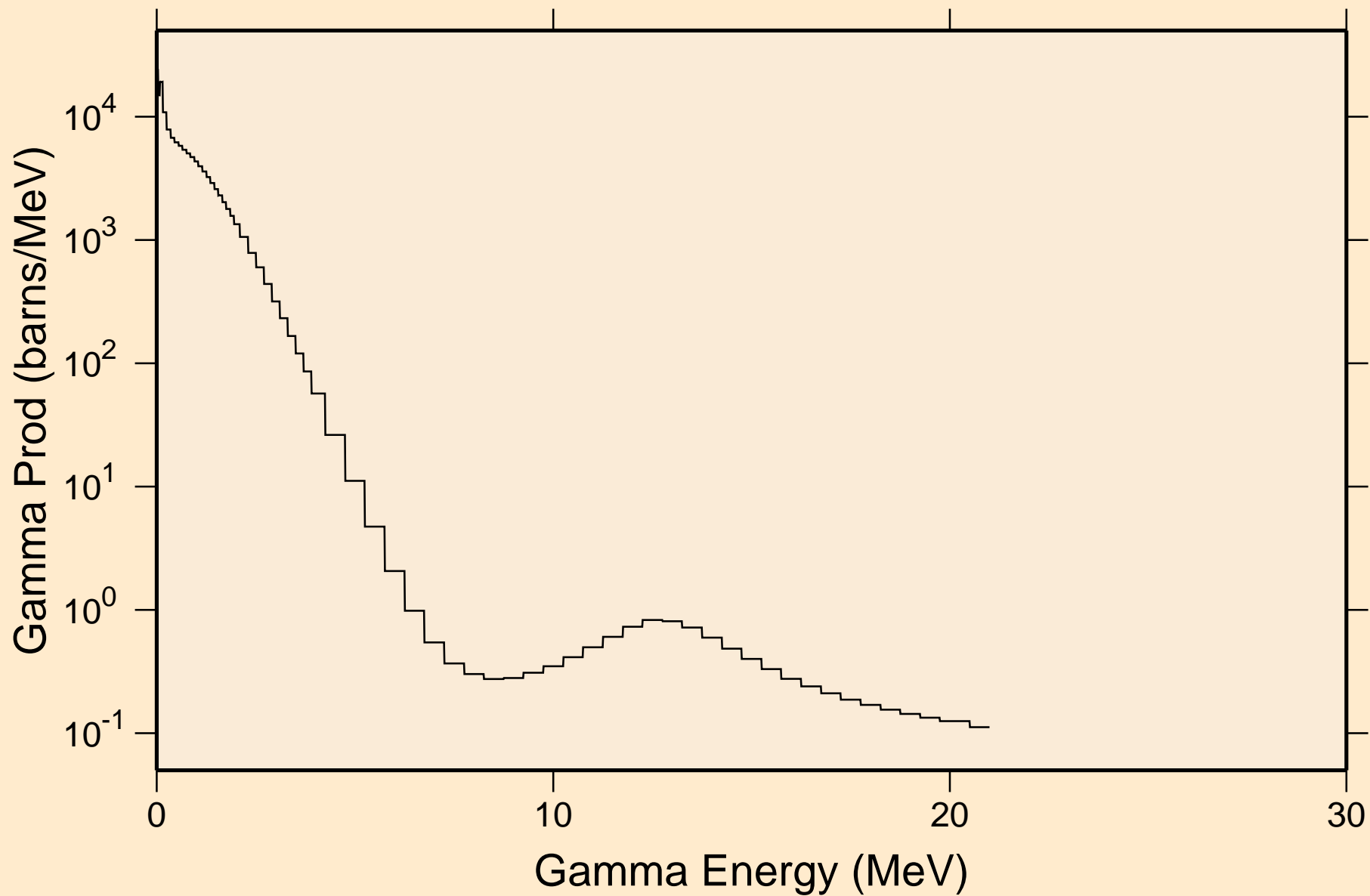

ES249 NEUTRON ACER TENDL-2019 LIBRARY; T=293.16K

Particle heating contributions

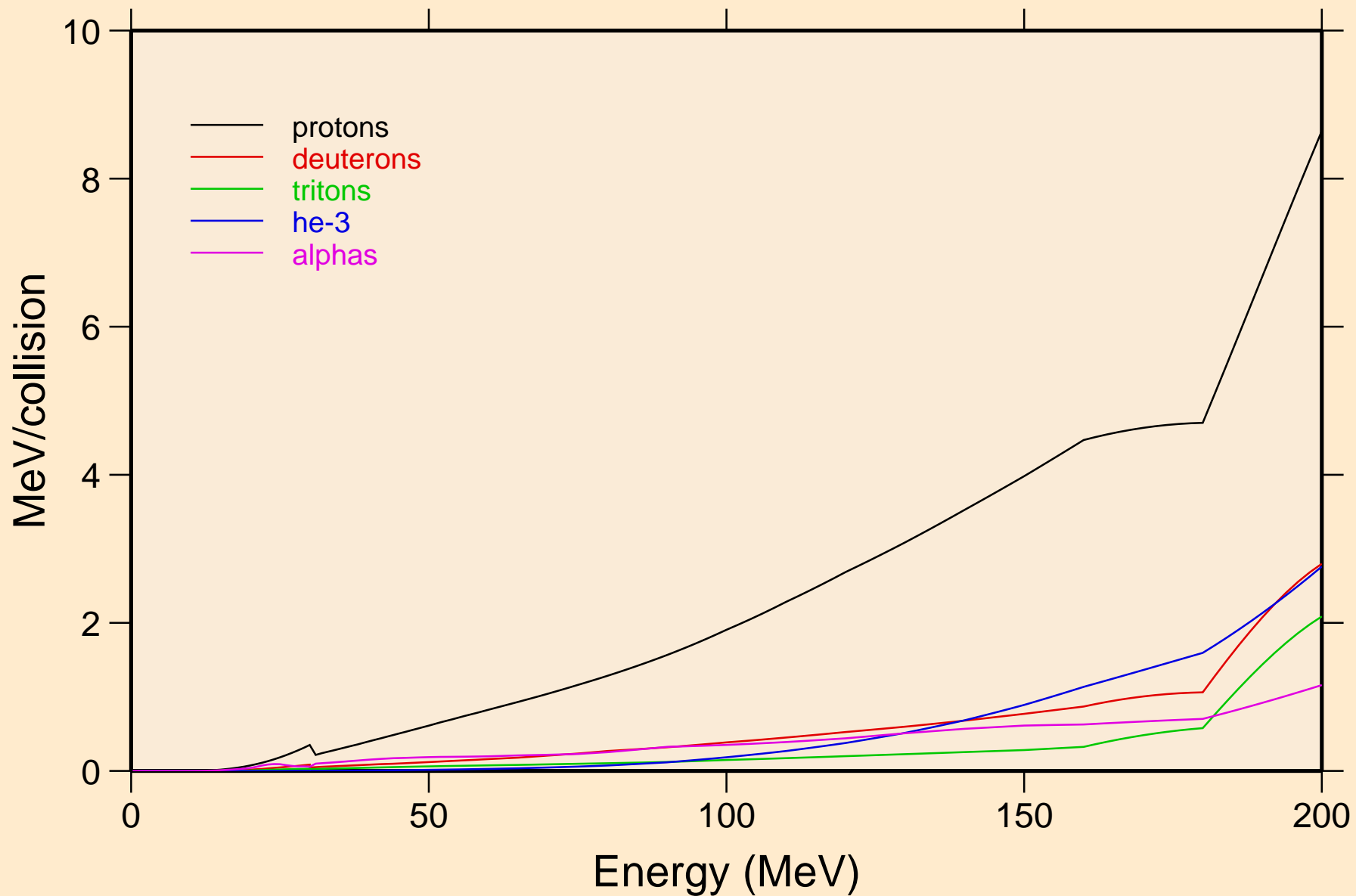

ES249 NEUTRON ACER TENDL-2019 LIBRARY; T=293.16K
Recoil Heating

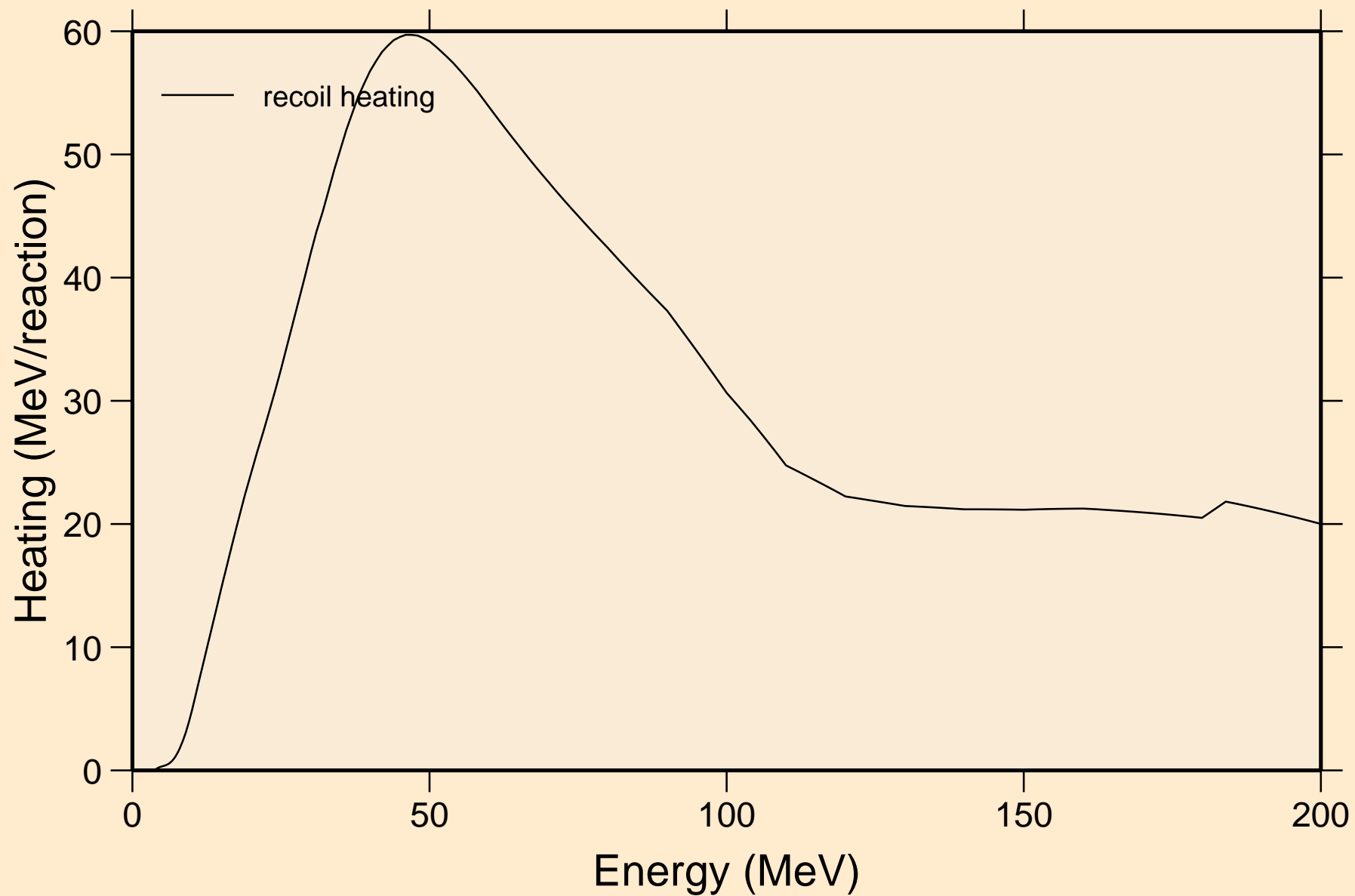

ES249 NEUTRON ACER TENDL-2019 LIBRARY; T=293.16K
Particle production cross sections

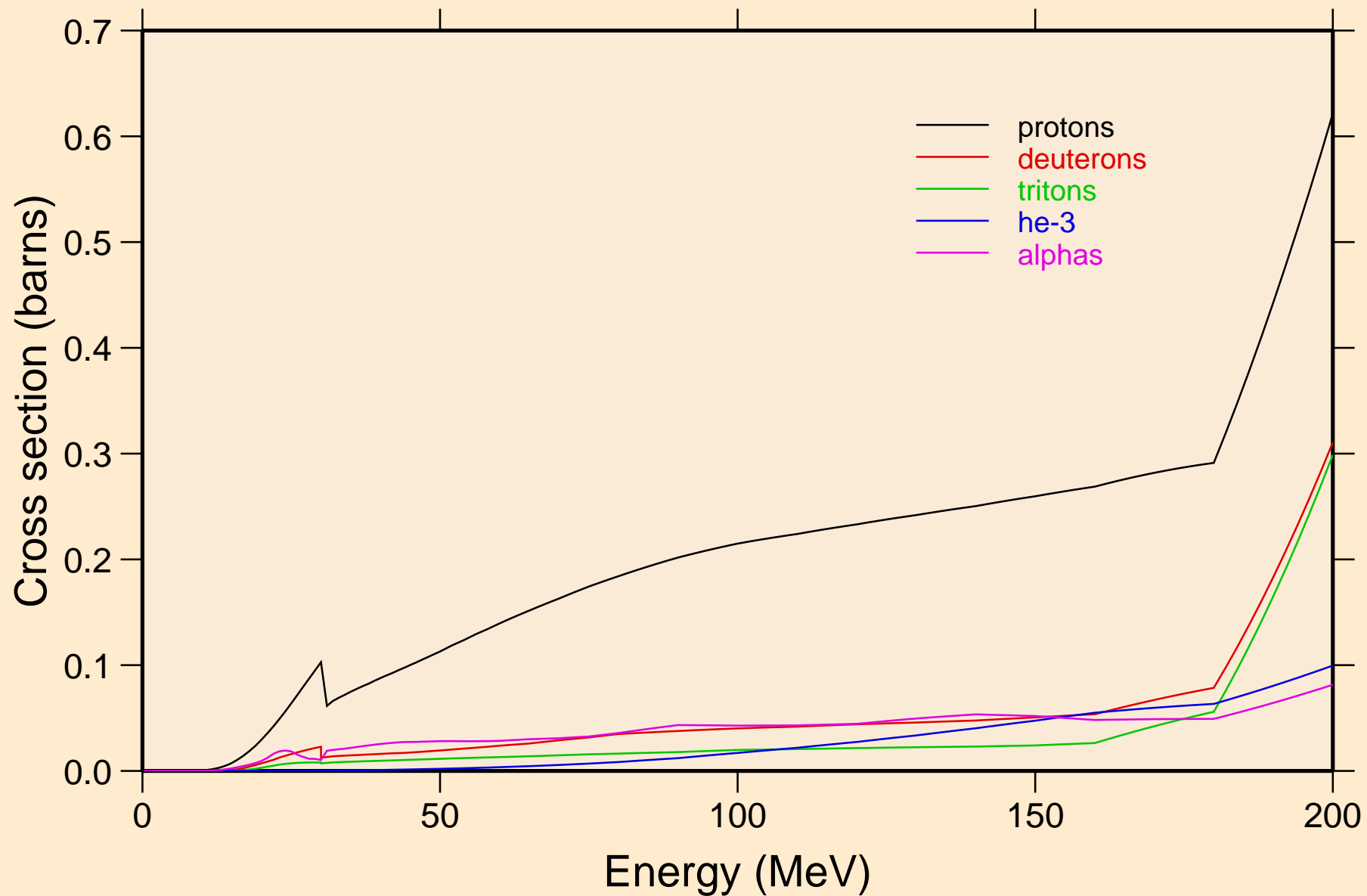

ES249 NEUTRON ACER TENDL-2019 LIBRARY; T=293.16K
protons from (n,x)

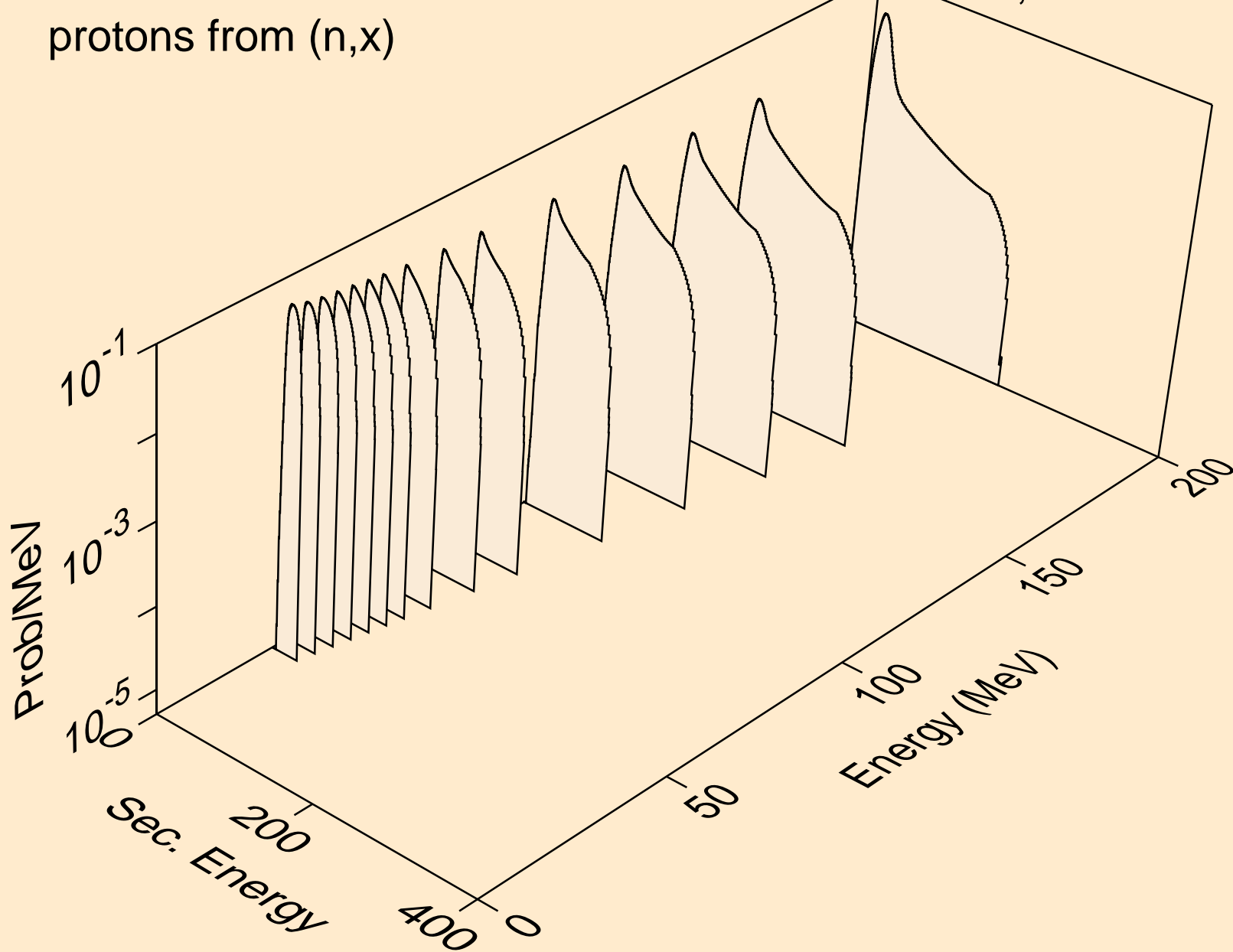

ES249 NEUTRON ACER TENDL-2019 LIBRARY; T=293.16K
protons from (n,n*)p

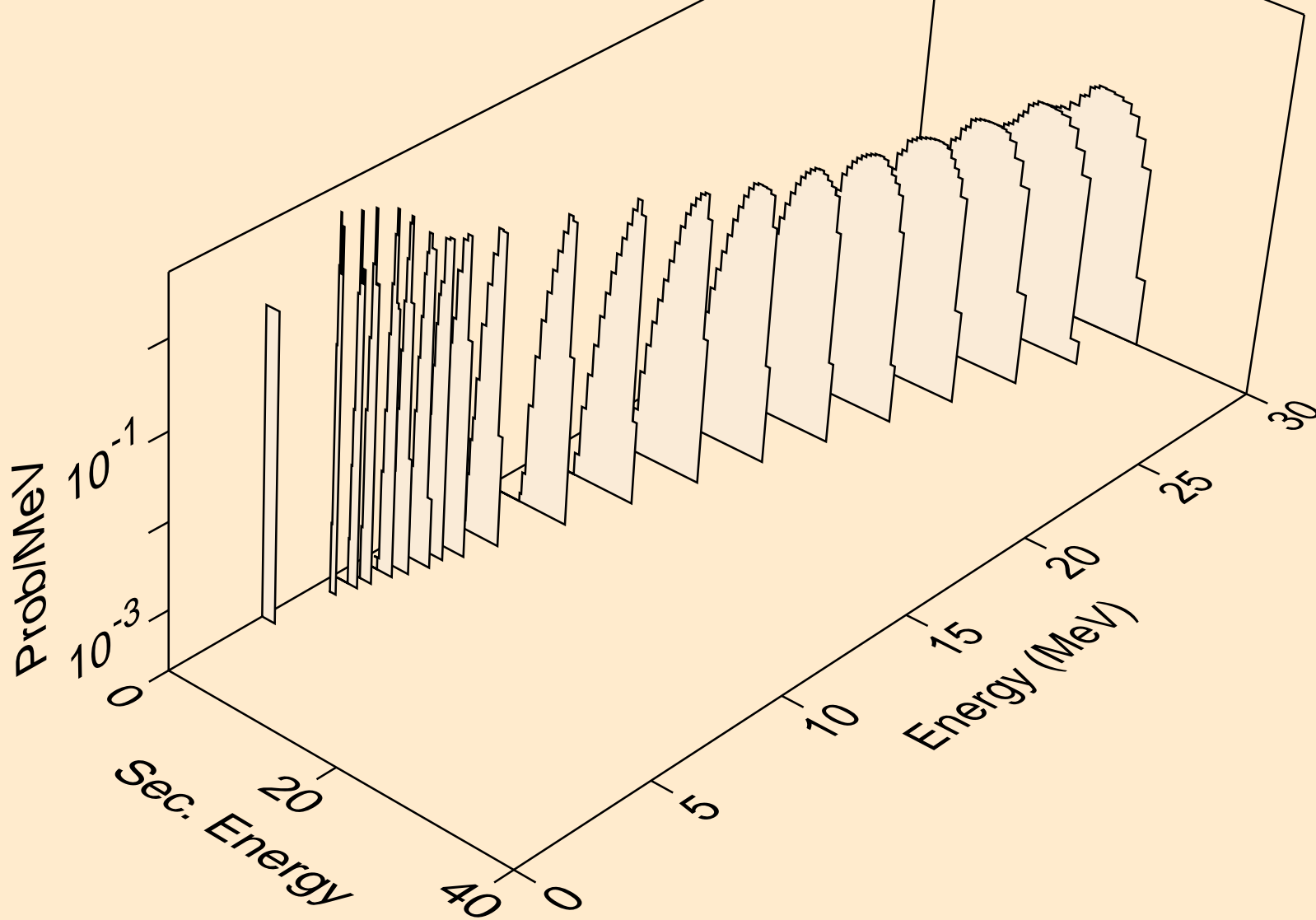

ES249 NEUTRON ACER TENDL-2019 LIBRARY; T=293.16K
protons from (n,2np)

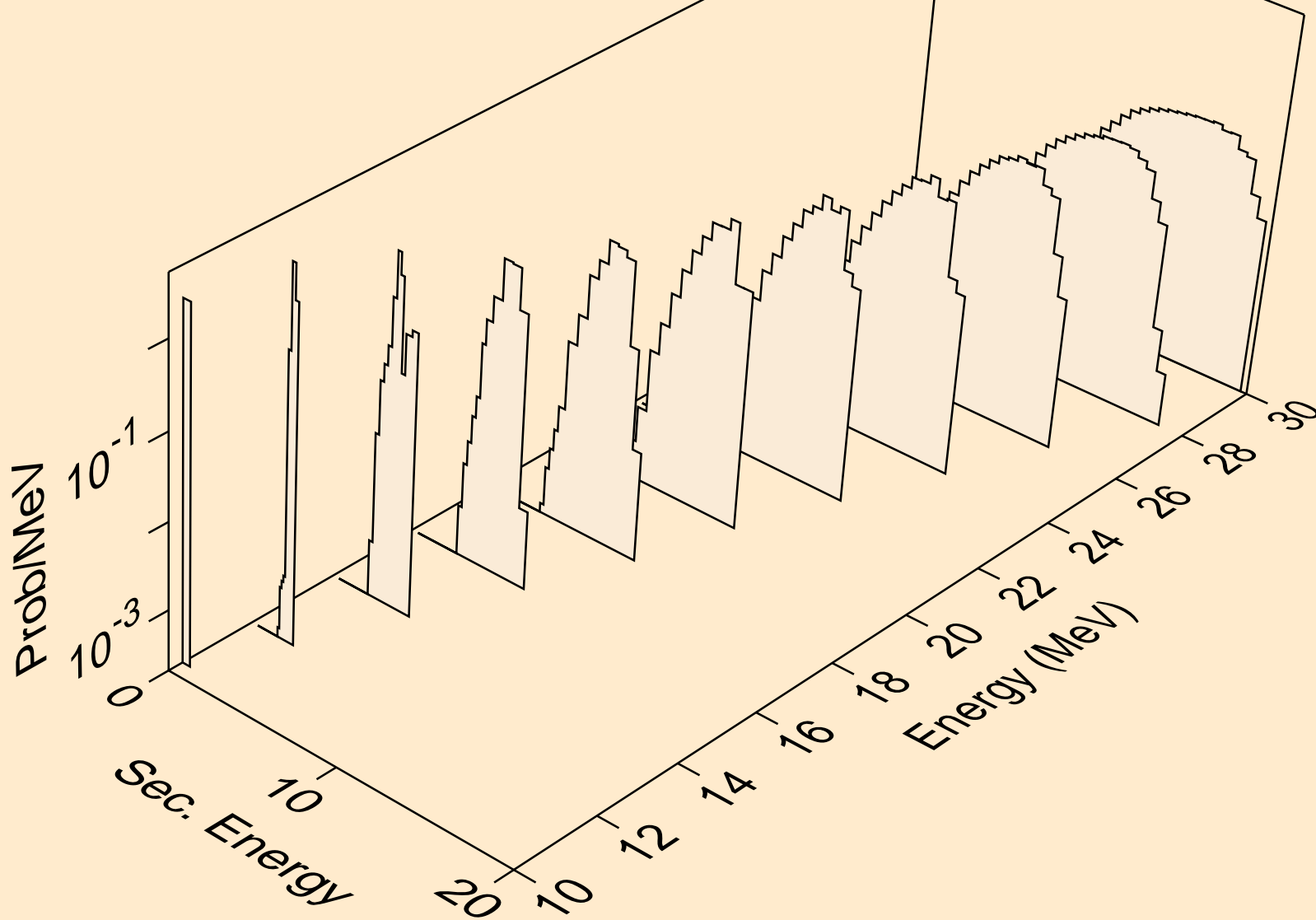

ES249 NEUTRON ACER TENDL-2019 LIBRARY; T=293.16K
protons from (n,3np)

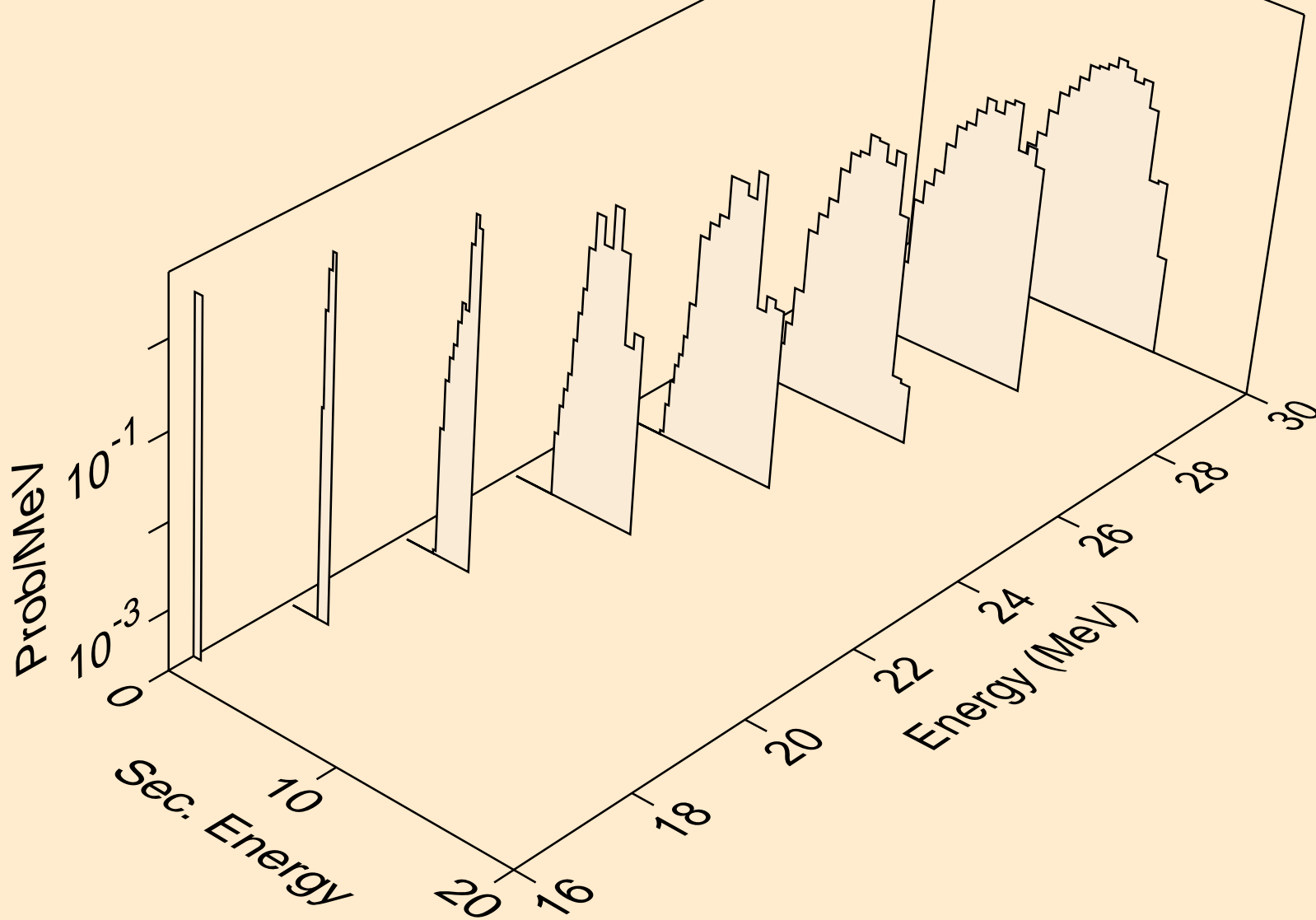

ES249 NEUTRON ACER TENDL-2019 LIBRARY; T=293.16K
protons from (n,2np)

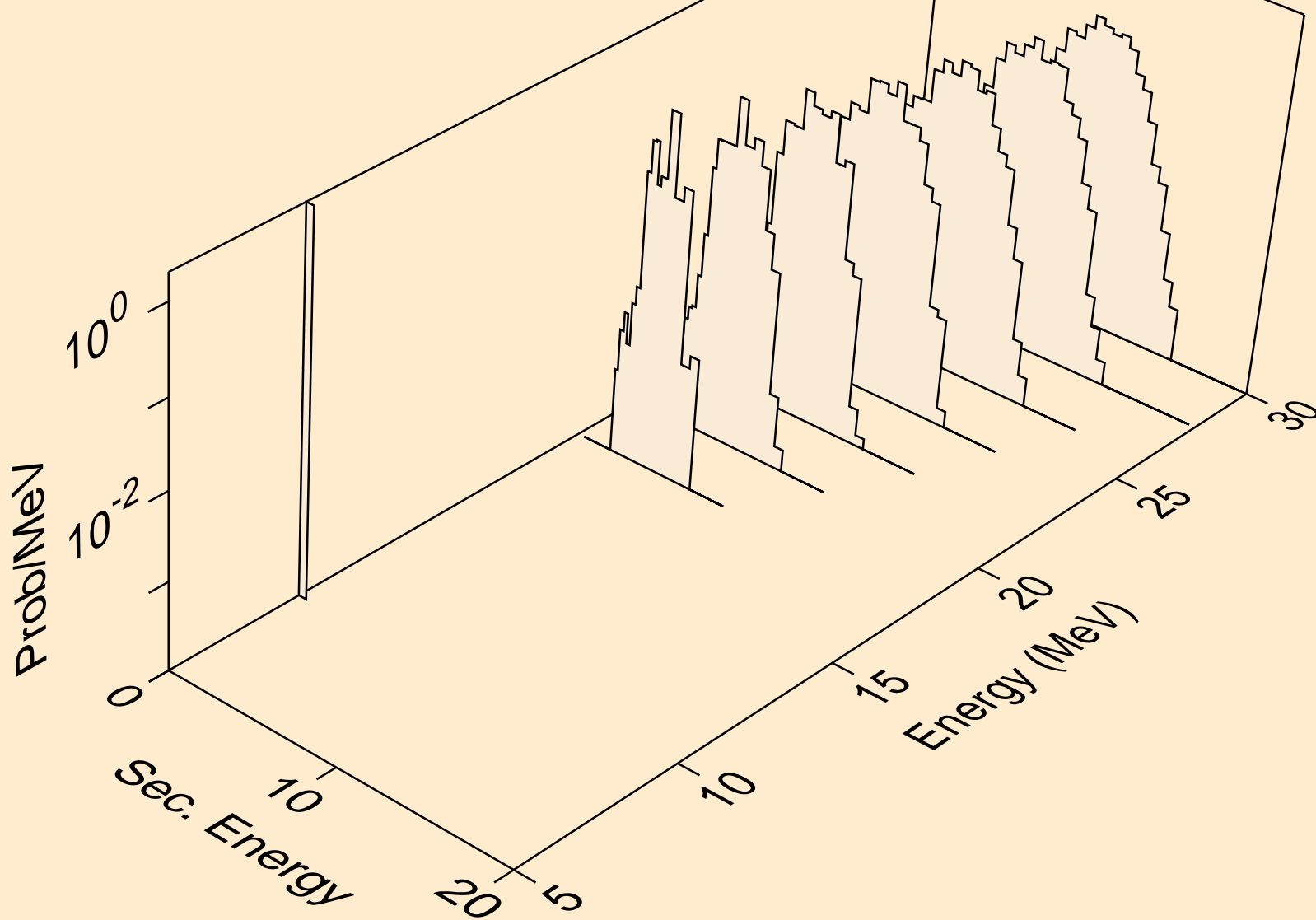

ES249 NEUTRON ACER TENDL-2019 LIBRARY; T=293.16K
protons from (n,npa)

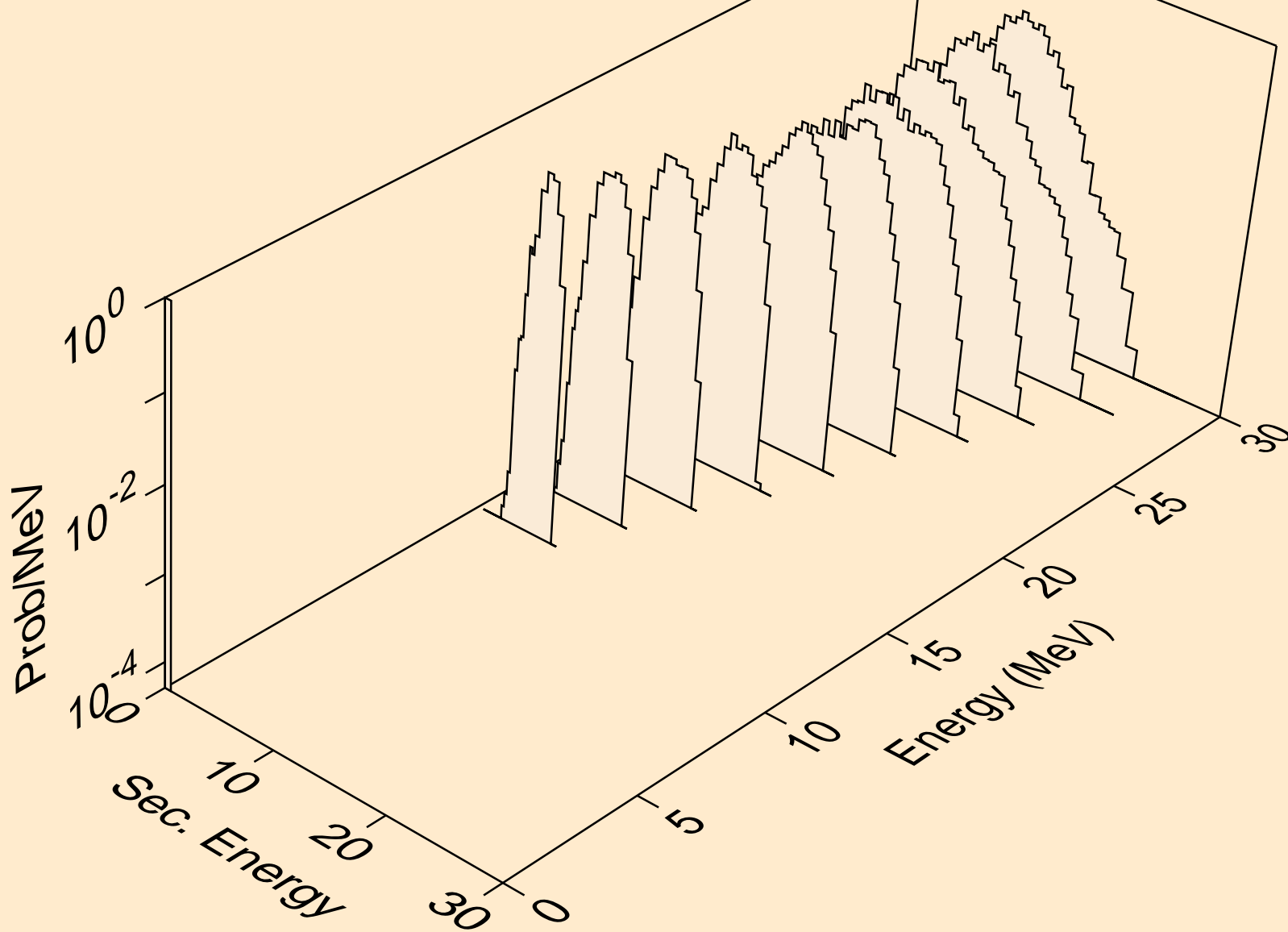

ES249 NEUTRON ACER TENDL-2019 LIBRARY; T=293.16K
protons from (n,p)

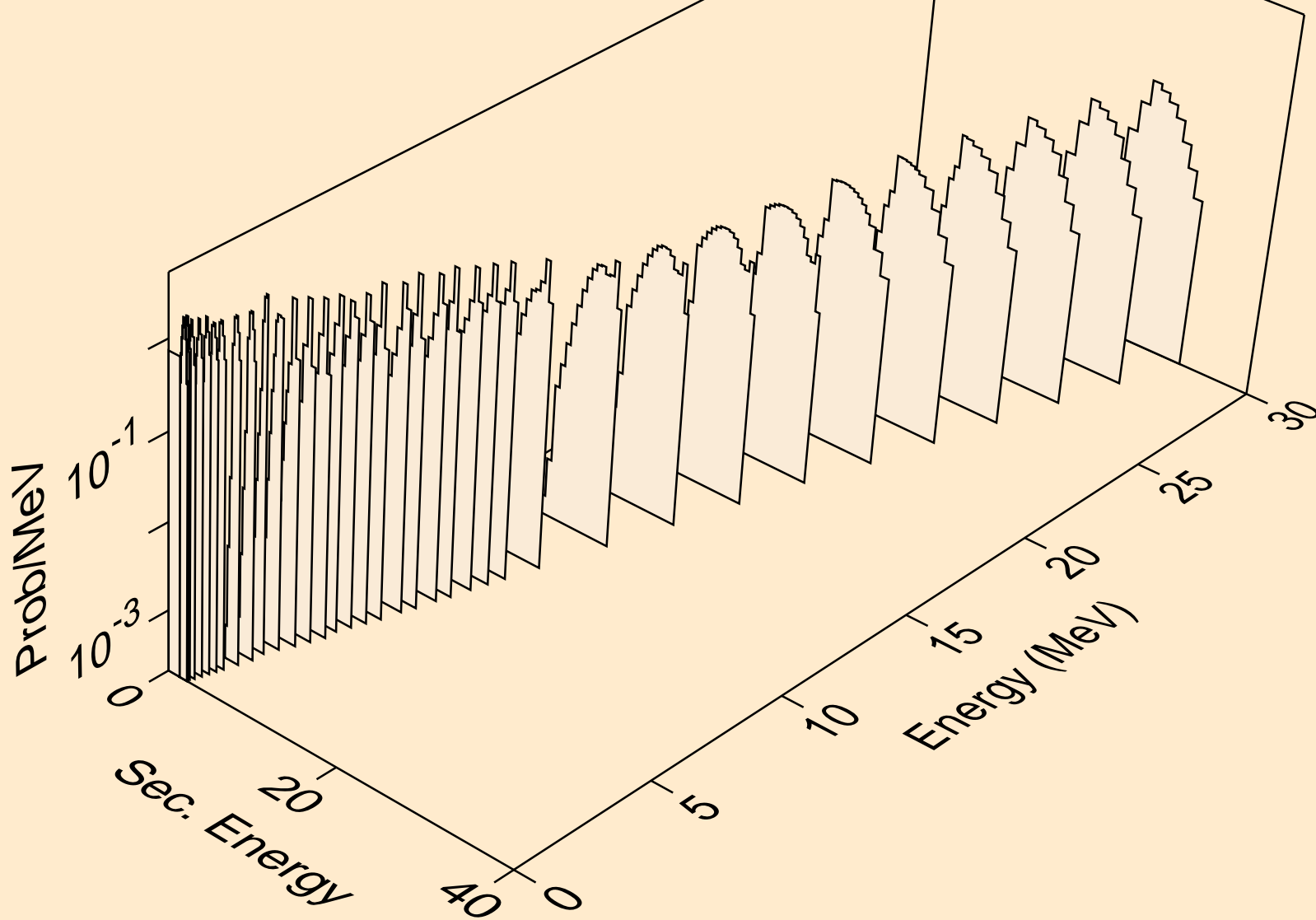

ES249 NEUTRON ACER TENDL-2019 LIBRARY; T=293.16K
protons from (n,2p)

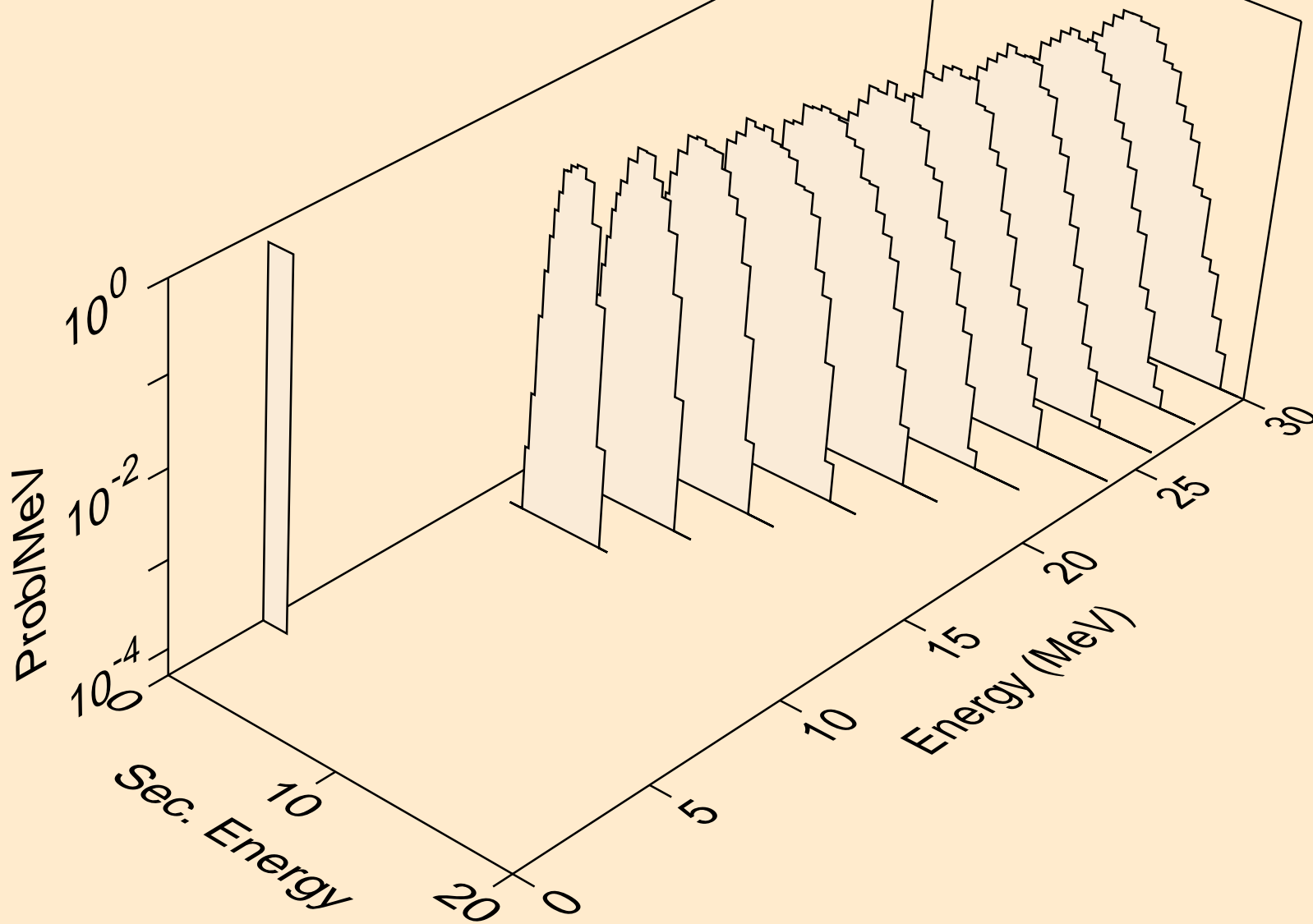

ES249 NEUTRON ACER TENDL-2019 LIBRARY; T=293.16K
protons from (n,p)

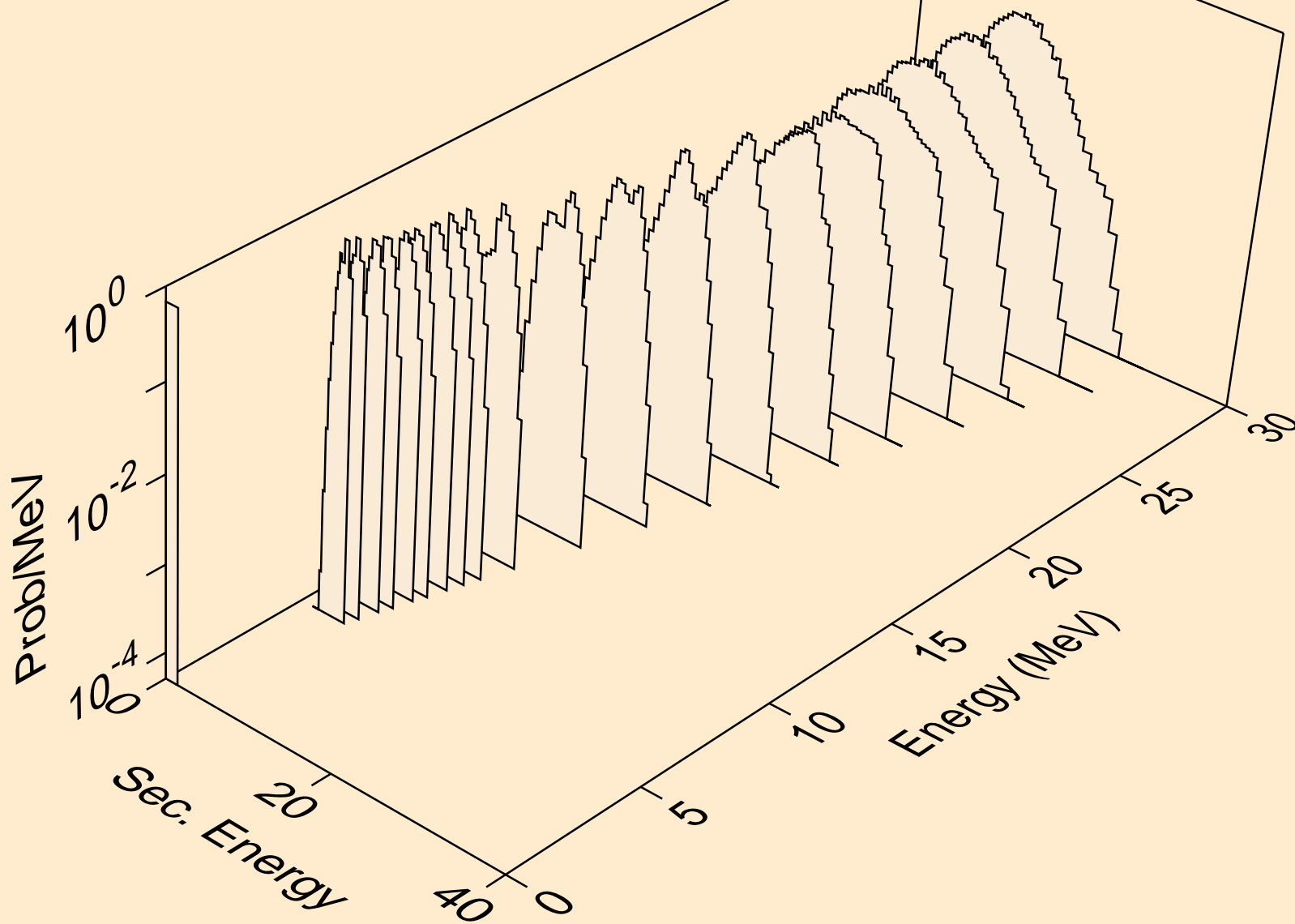

ES249 NEUTRON ACER TENDL-2019 LIBRARY; T=293.16K
protons from (n,pd)

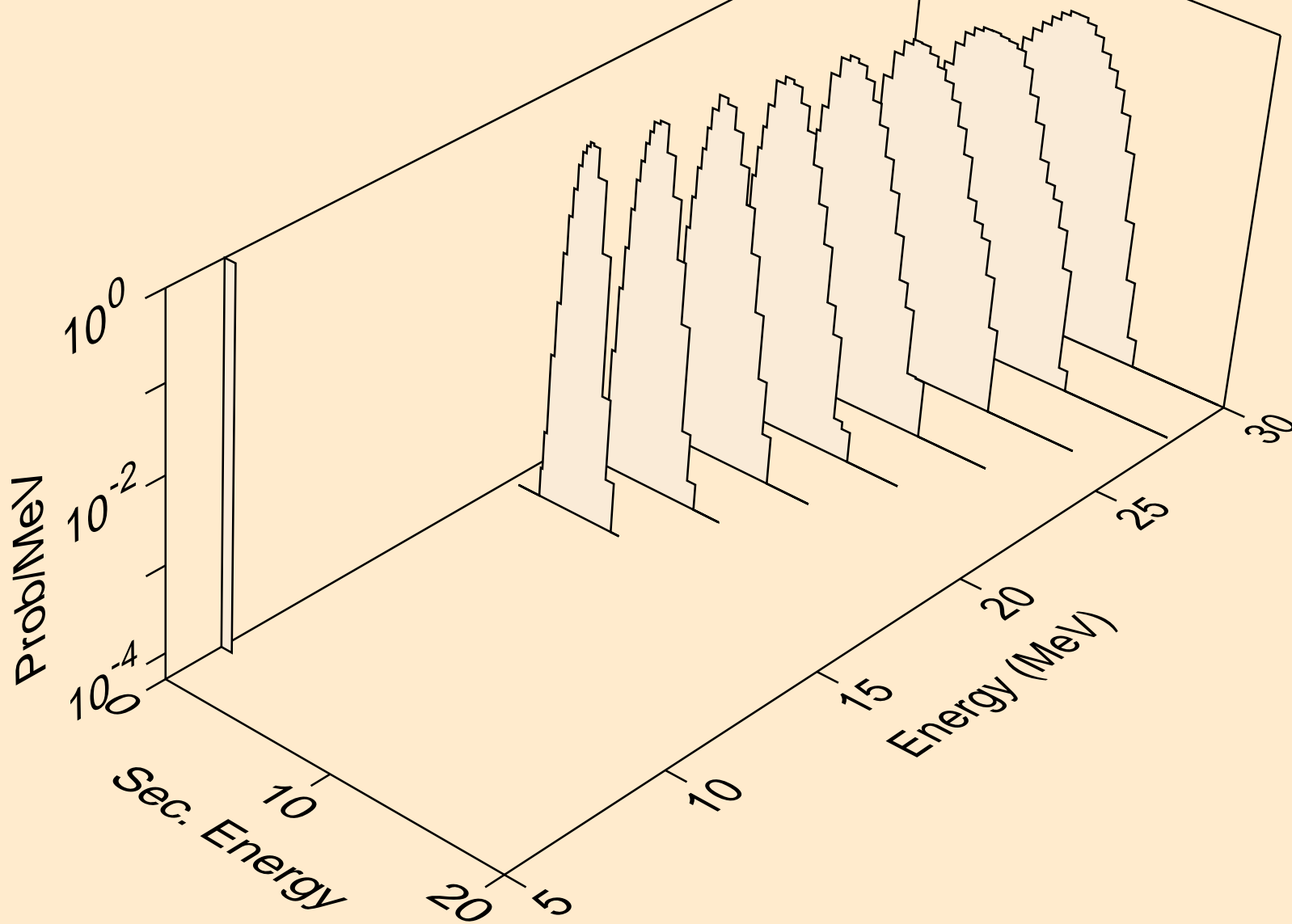

ES249 NEUTRON ACER TENDL-2019 LIBRARY; T=293.16K
protons from (n,pt)

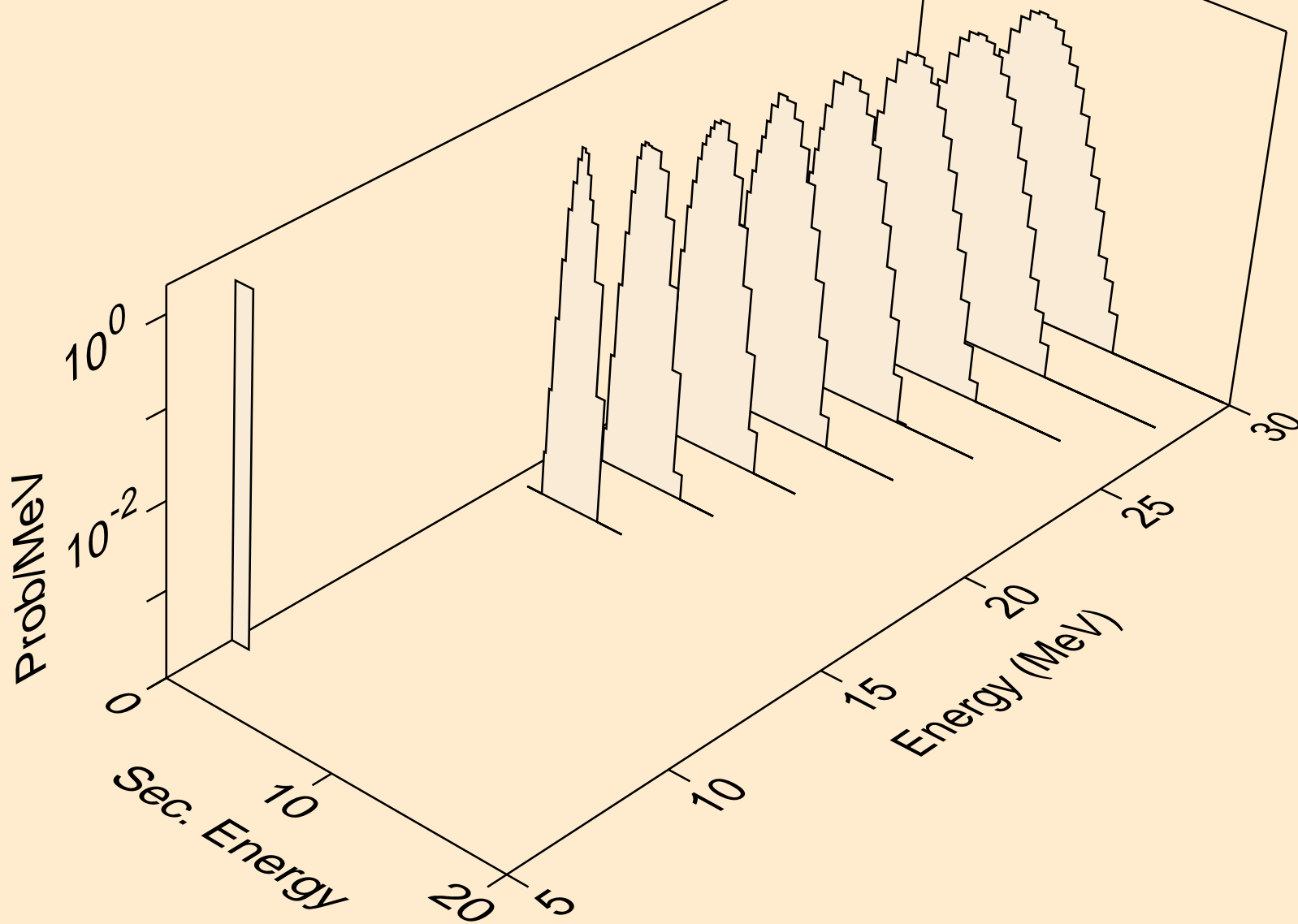

ES249 NEUTRON ACER TENDL-2019 LIBRARY; T=293.16K
deuterons from (n,x)

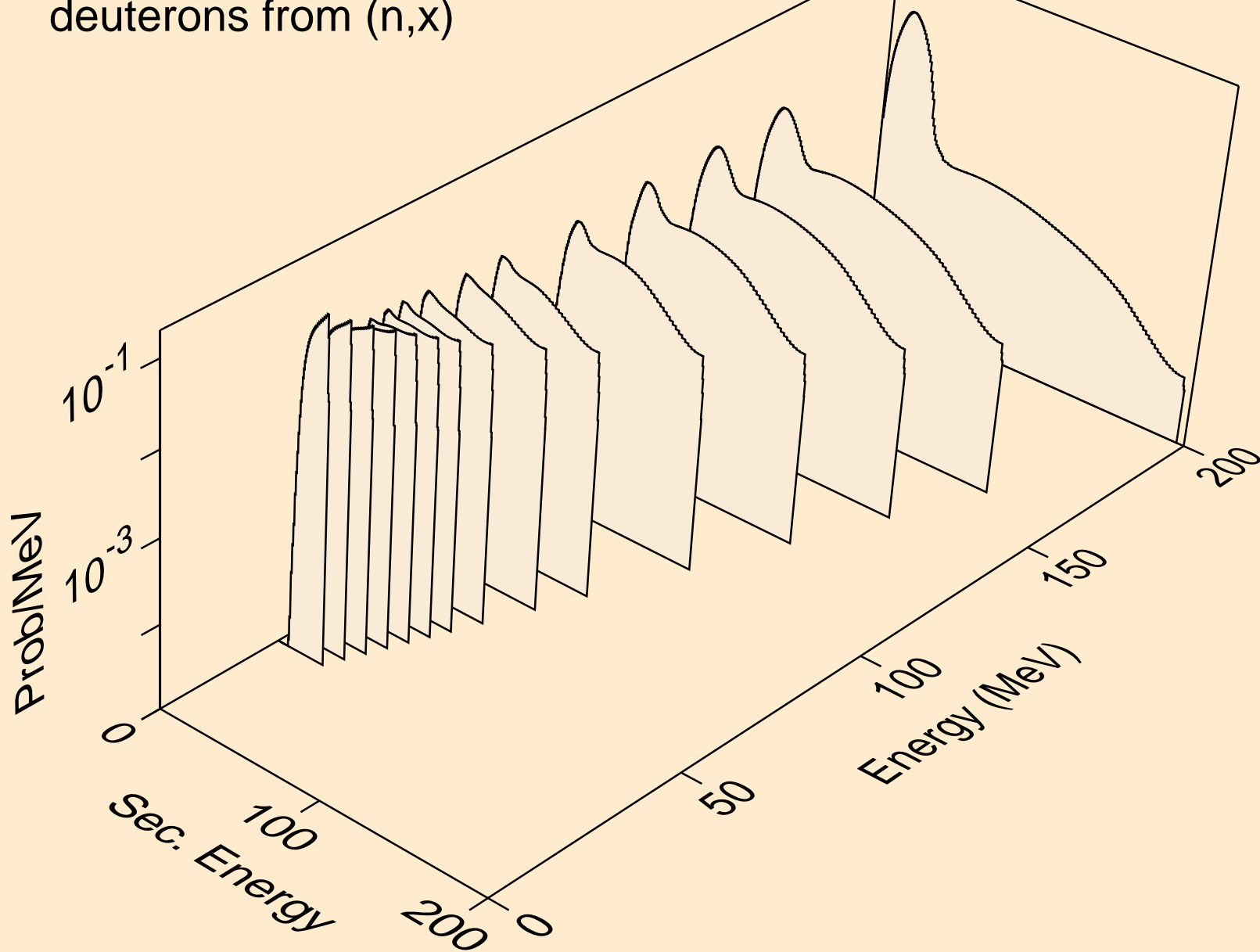

ES249 NEUTRON ACER TENDL-2019 LIBRARY; T=293.16K
deuterons from (n,2nd)

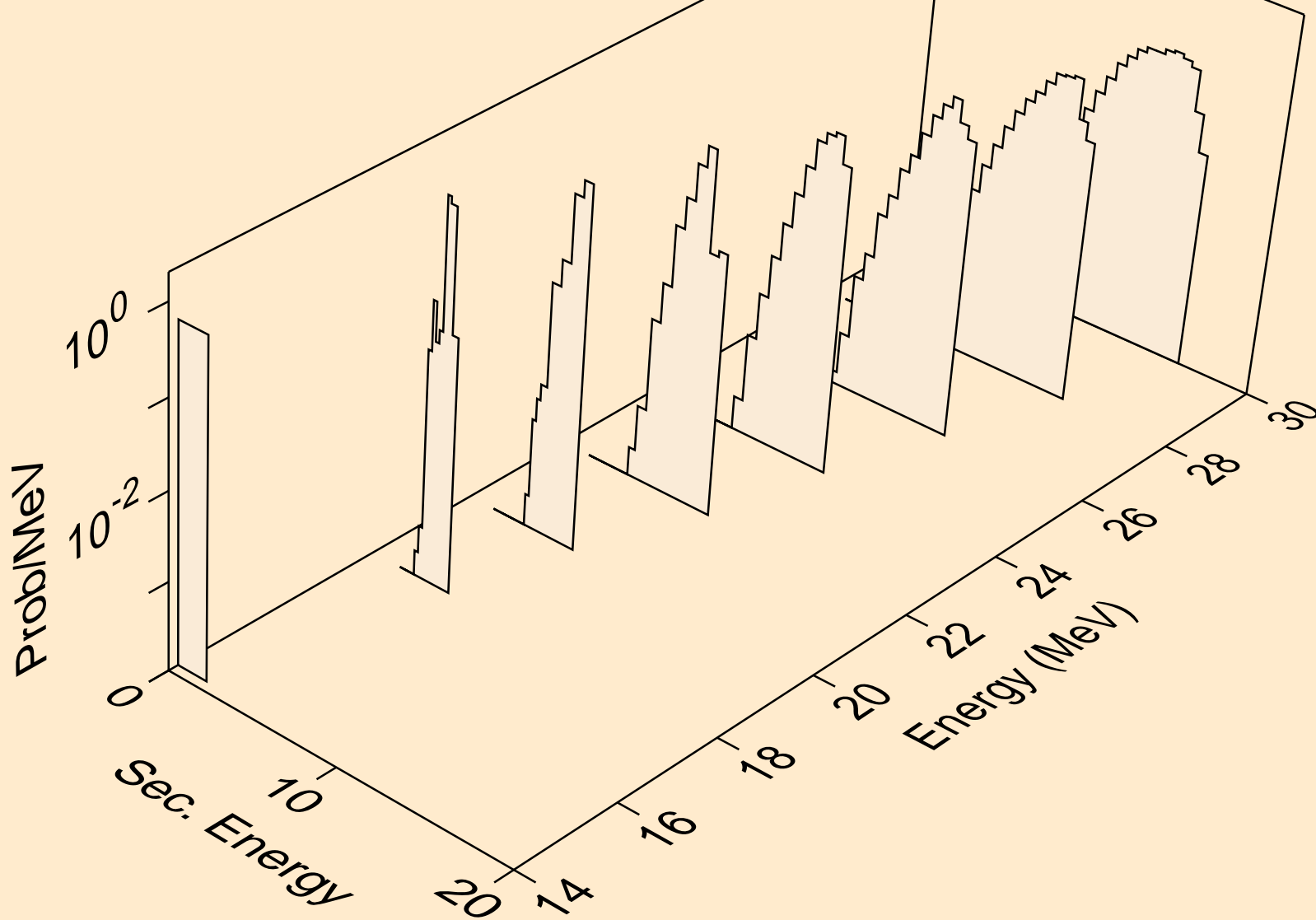

ES249 NEUTRON ACER TENDL-2019 LIBRARY; T=293.16K
deuterons from (n,n*)d

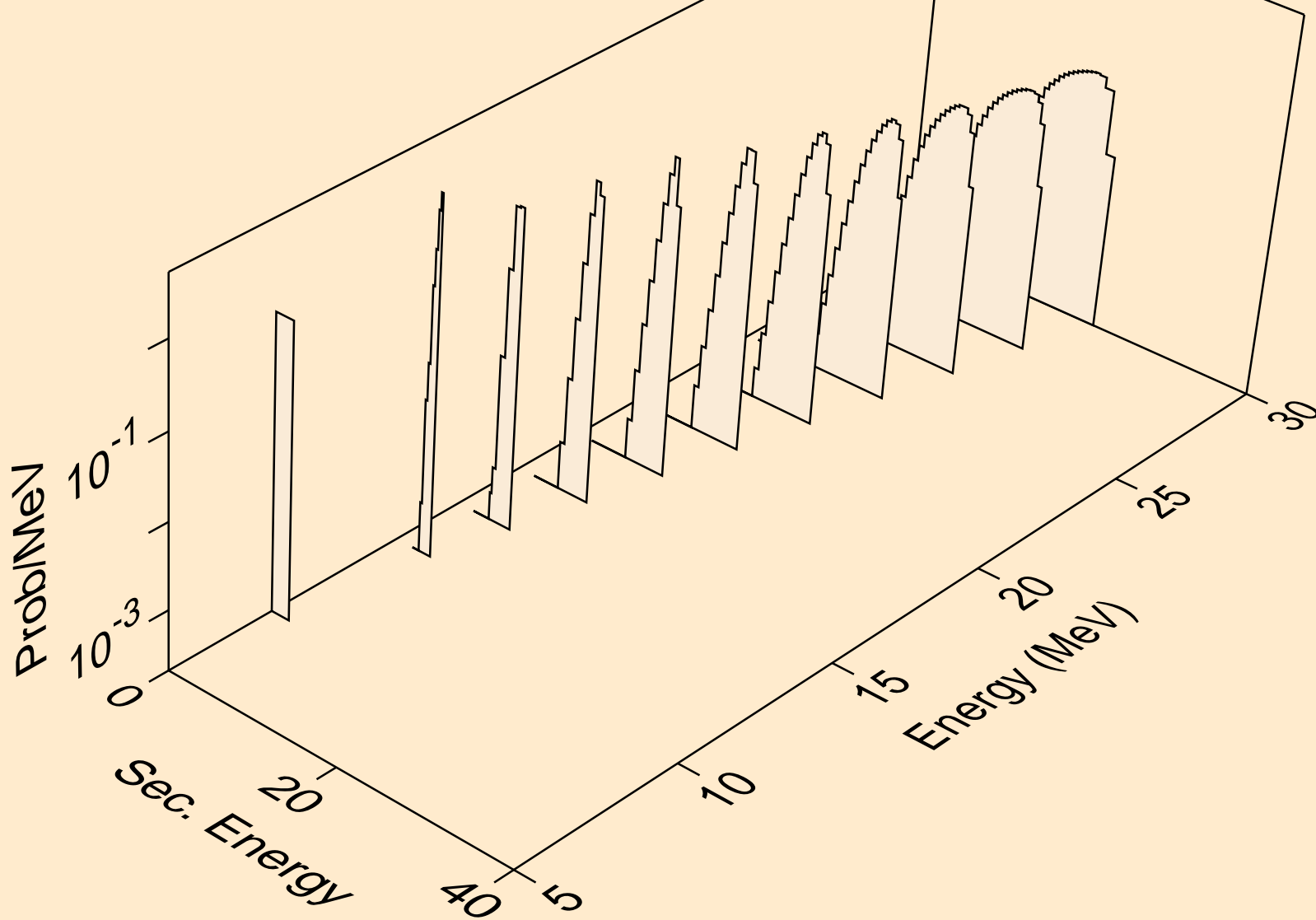

ES249 NEUTRON ACER TENDL-2019 LIBRARY; T=293.16K
deuterons from (n,d)

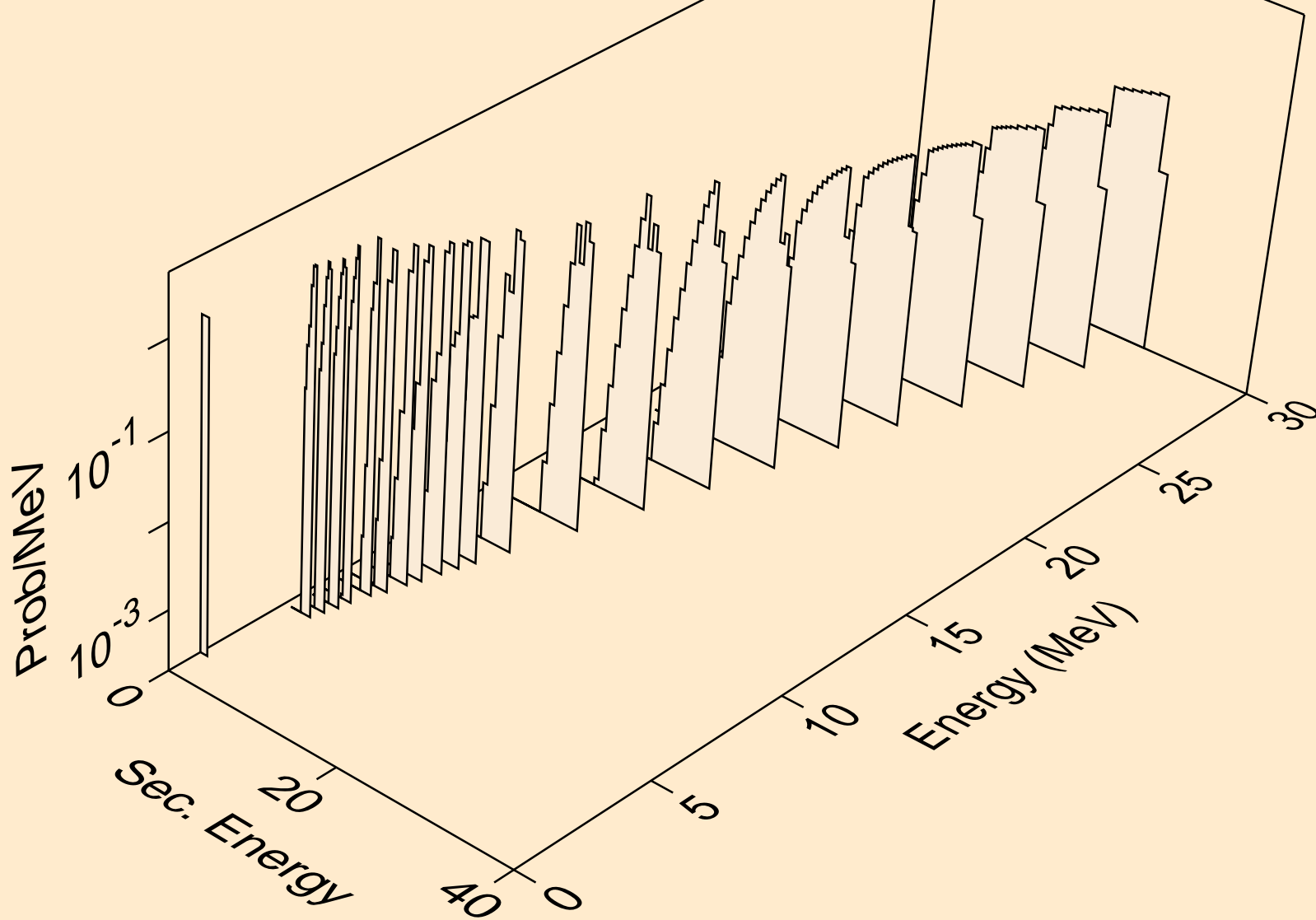

ES249 NEUTRON ACER TENDL-2019 LIBRARY; T=293.16K
deuterons from (n,pd)

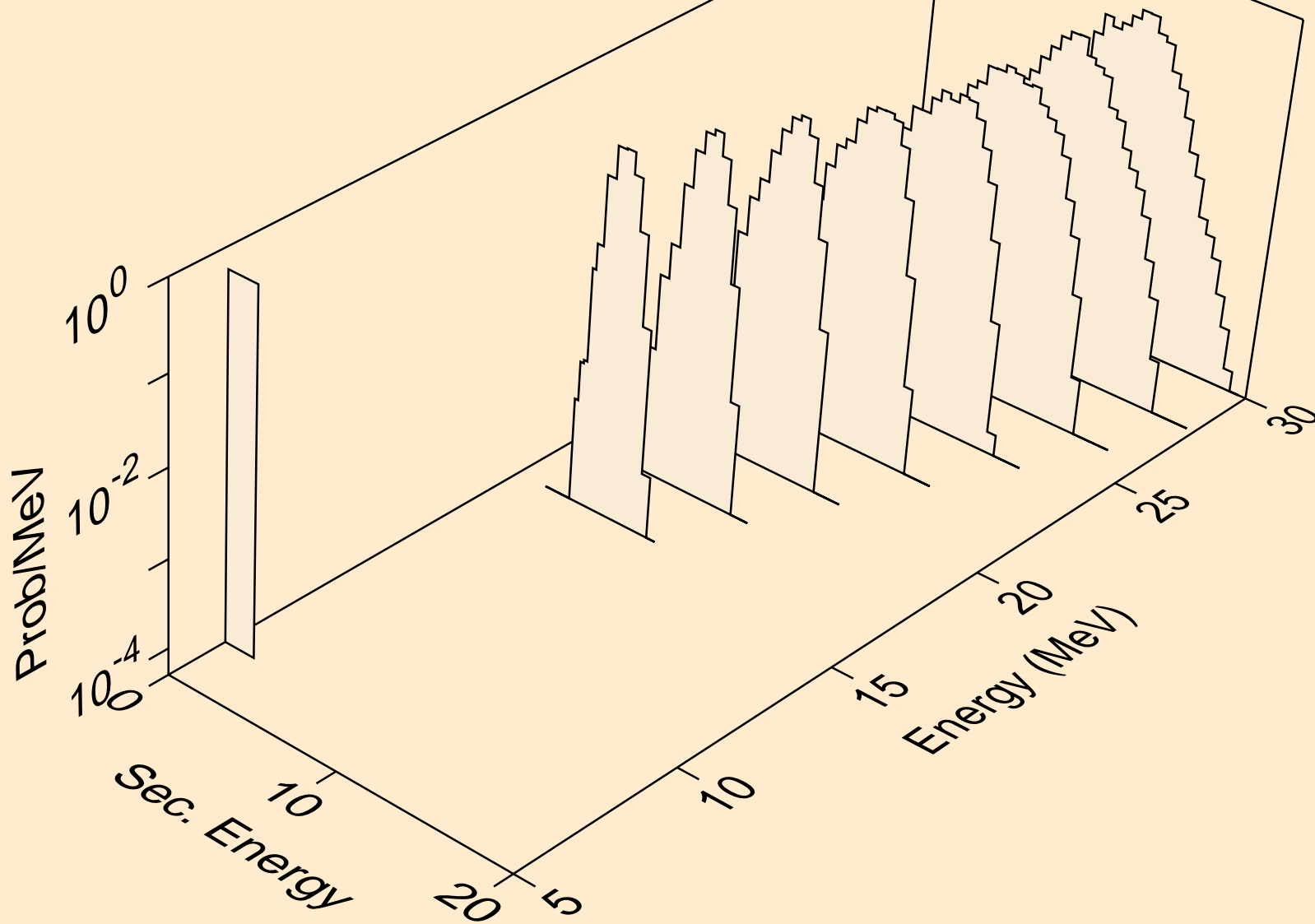

ES249 NEUTRON ACER TENDL-2019 LIBRARY; T=293.16K
tritons from (n,x)

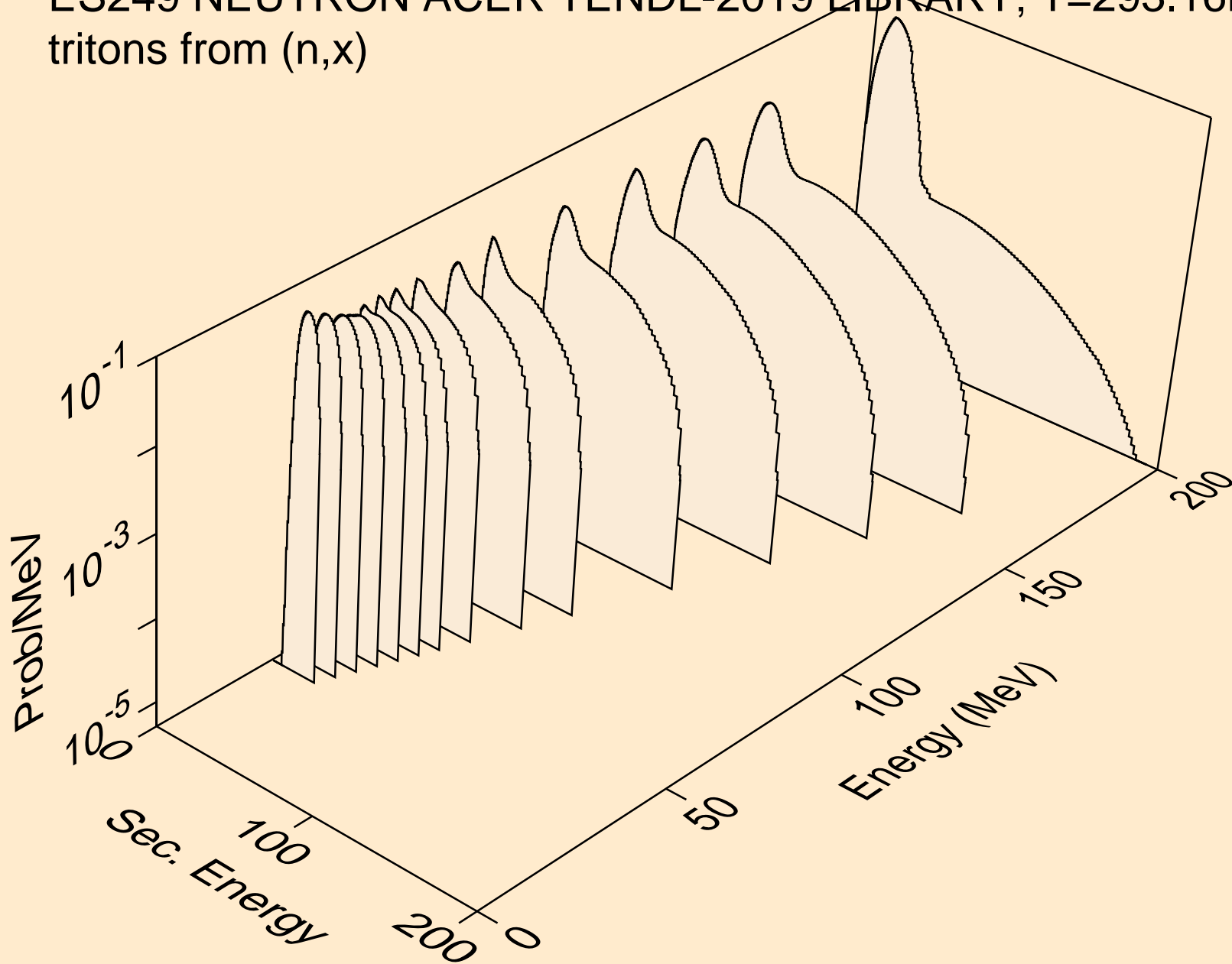

ES249 NEUTRON ACER TENDL-2019 LIBRARY; T=293.16K
tritons from (n,n*)t

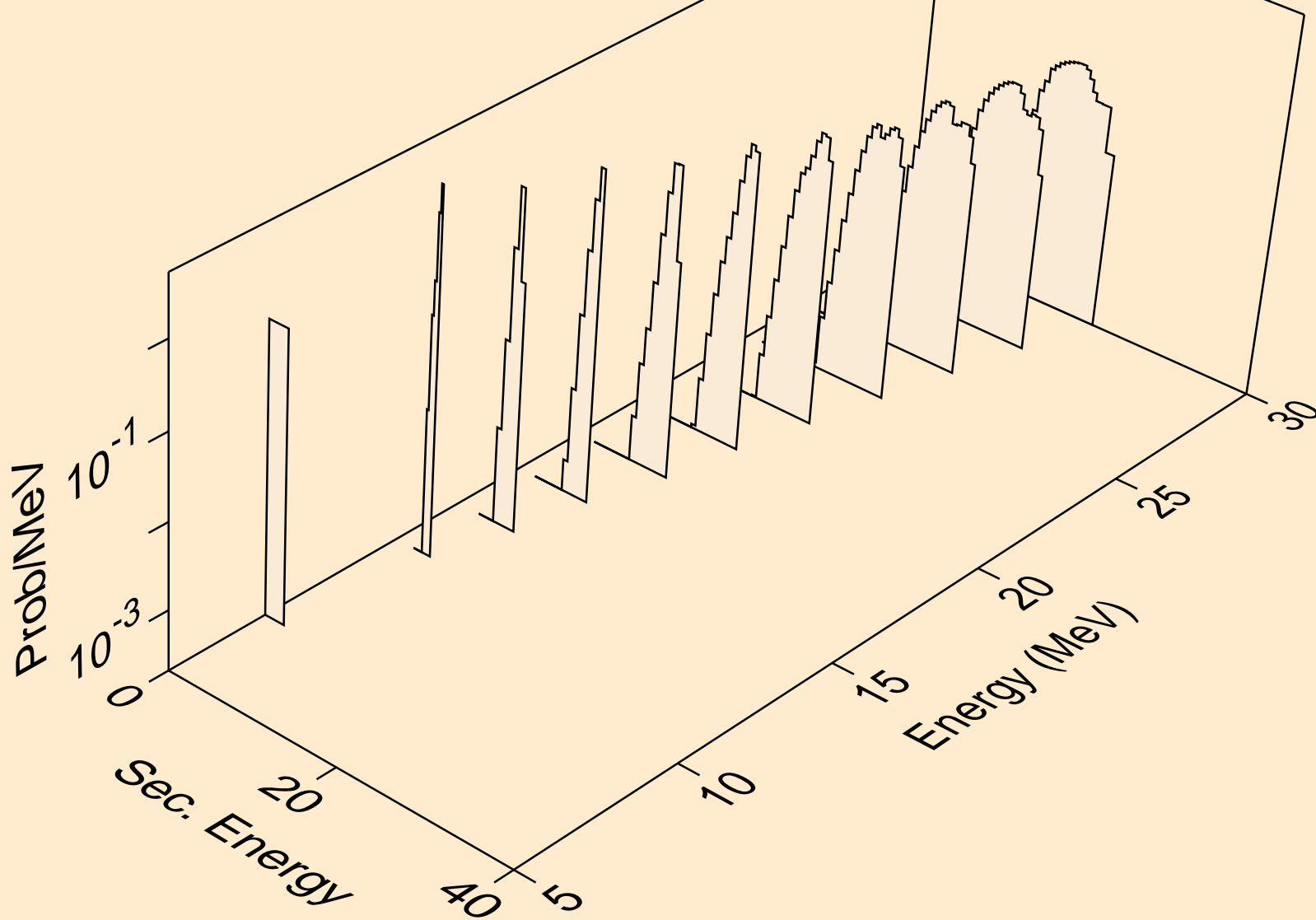

ES249 NEUTRON ACER TENDL-2019 LIBRARY; T=293.16K
tritons from (n,t)

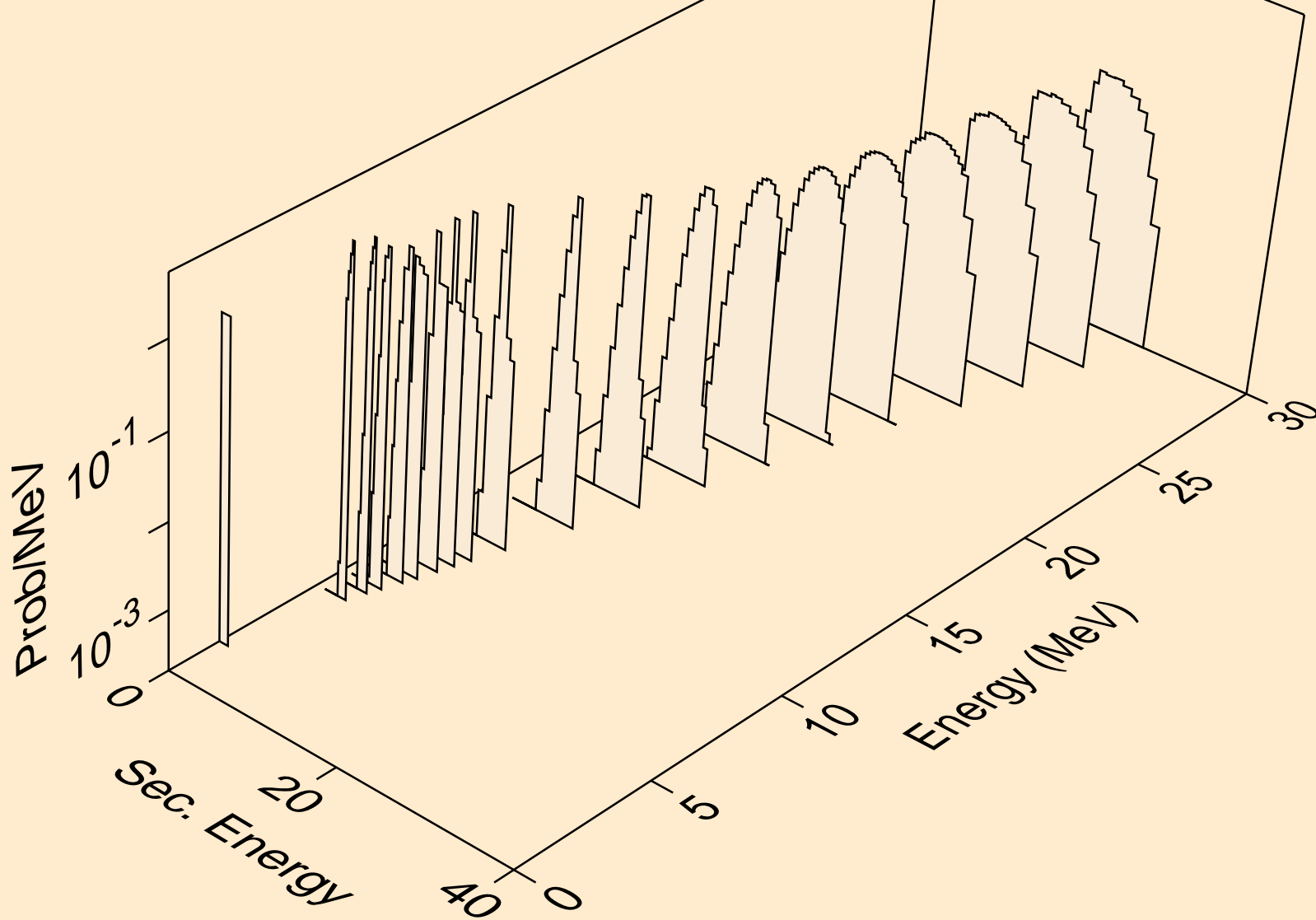

ES249 NEUTRON ACER TENDL-2019 LIBRARY; T=293.16K
tritons from (n,pt)

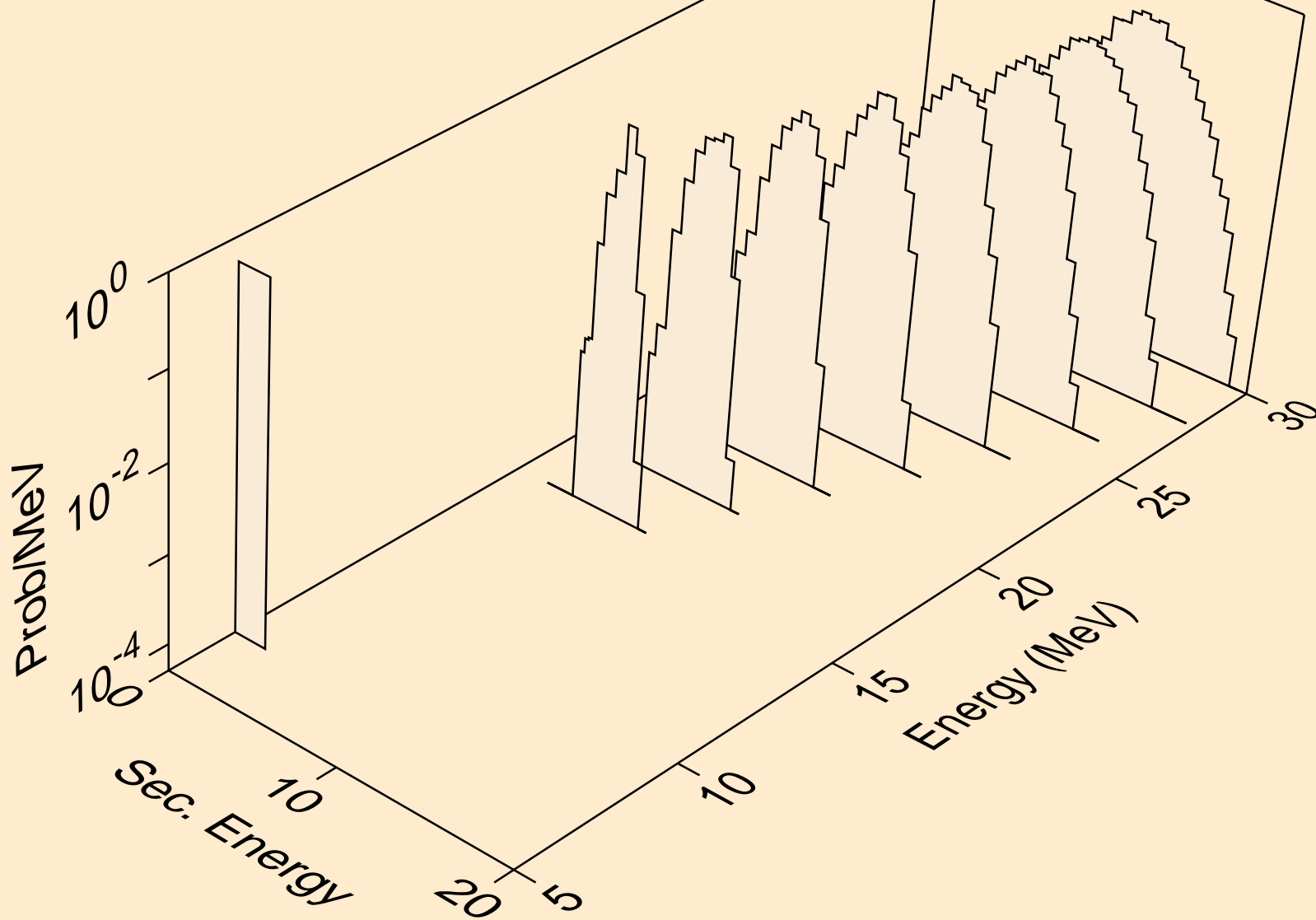

ES249 NEUTRON ACER TENDL-2019 LIBRARY; T=293.16K
he3s from (n,x)

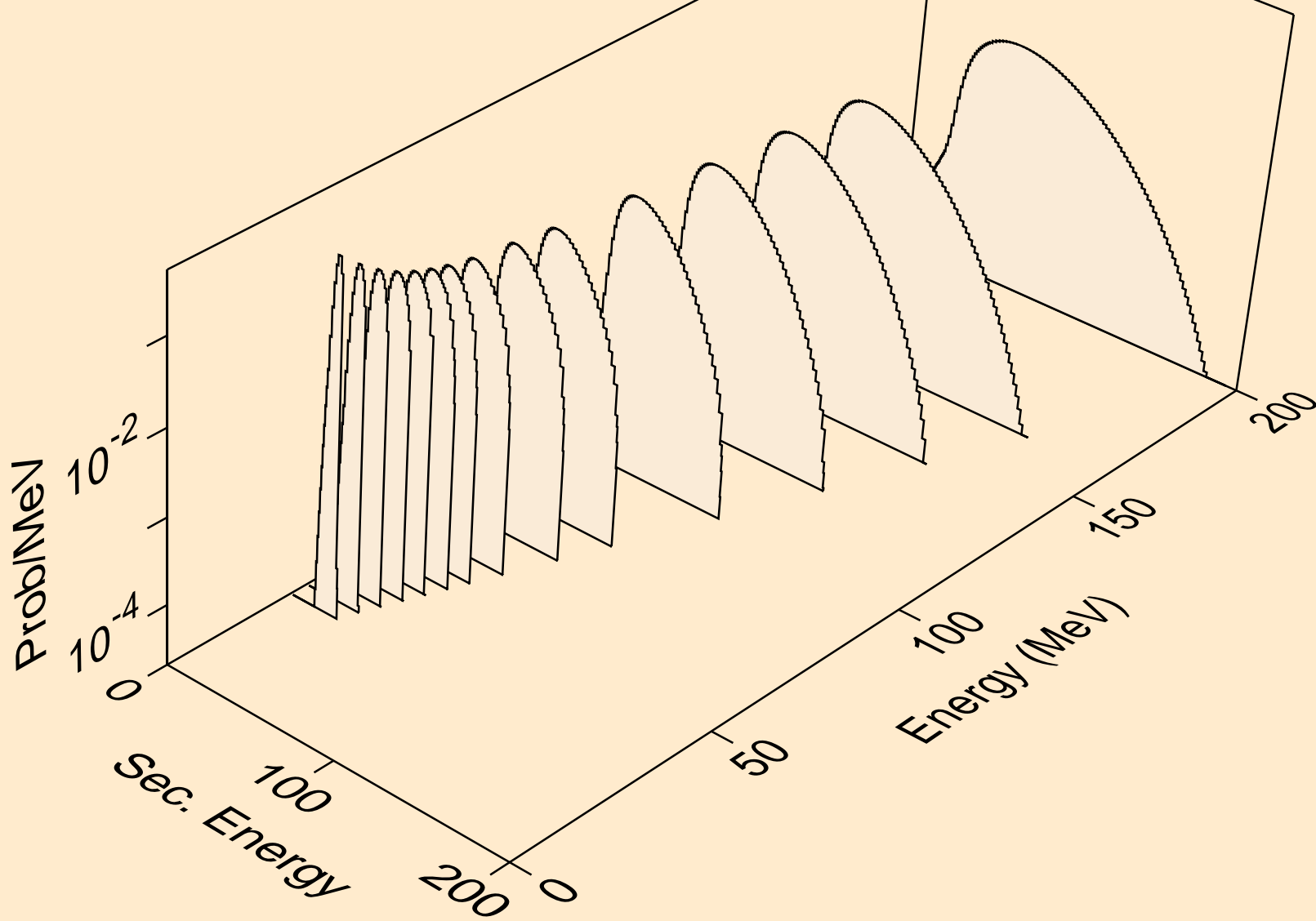

ES249 NEUTRON ACER TENDL-2019 LIBRARY; T=293.16K
he3s from (n,n*)he3

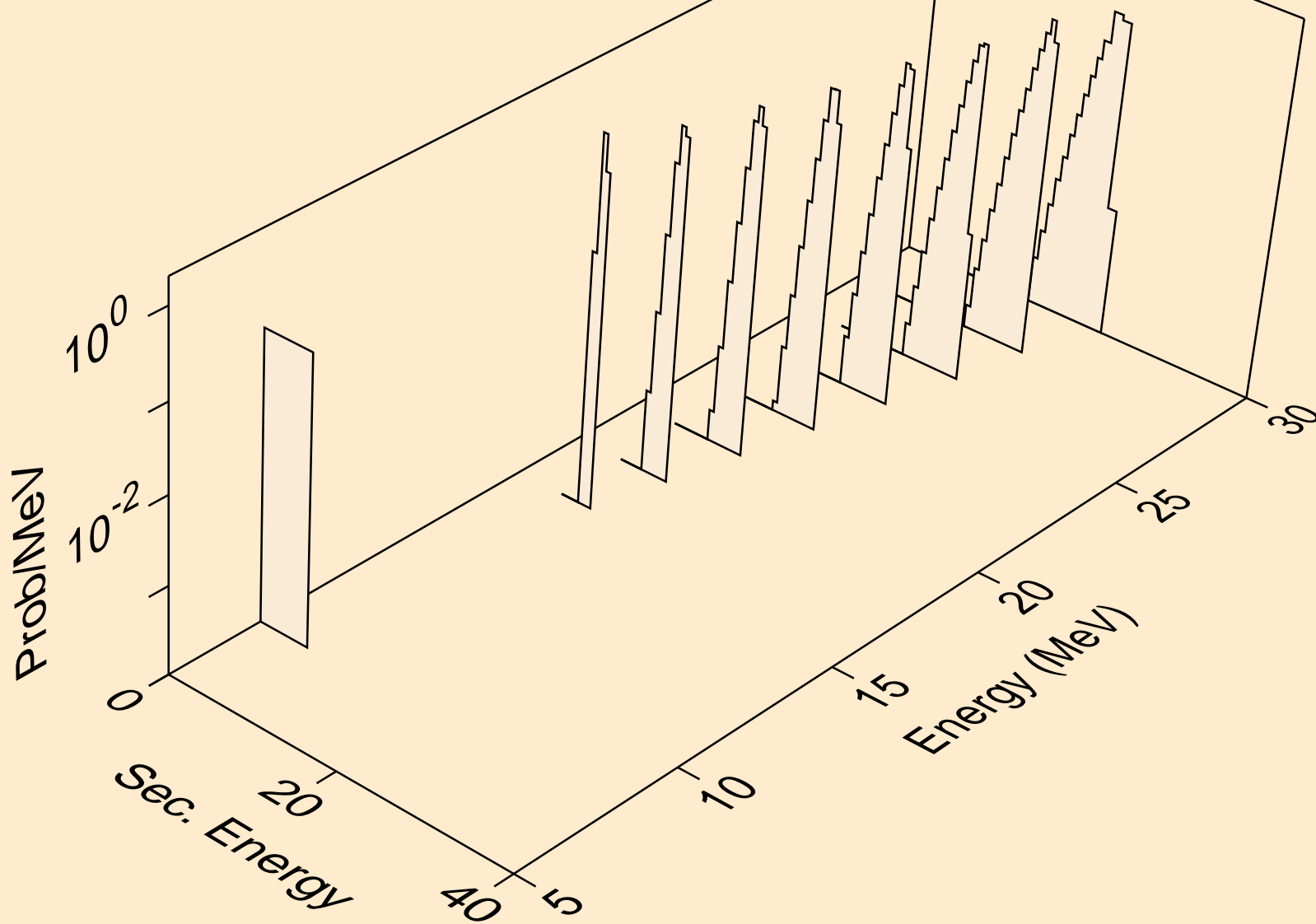

ES249 NEUTRON ACER TENDL-2019 LIBRARY; T=293.16K
he3s from (n,he3)

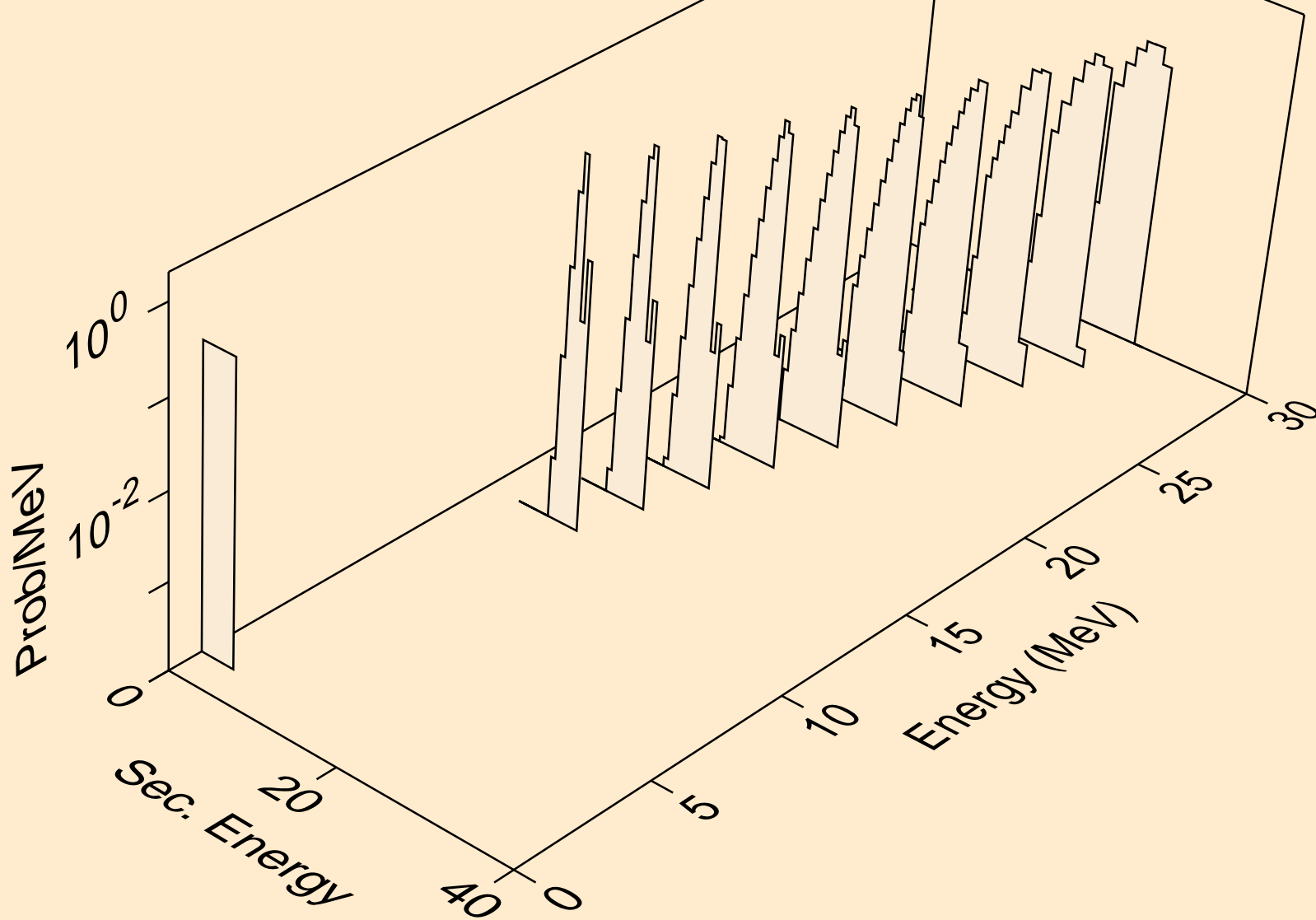

ES249 NEUTRON ACER TENDL-2019 LIBRARY; T=293.16K
alphas from (n,x)

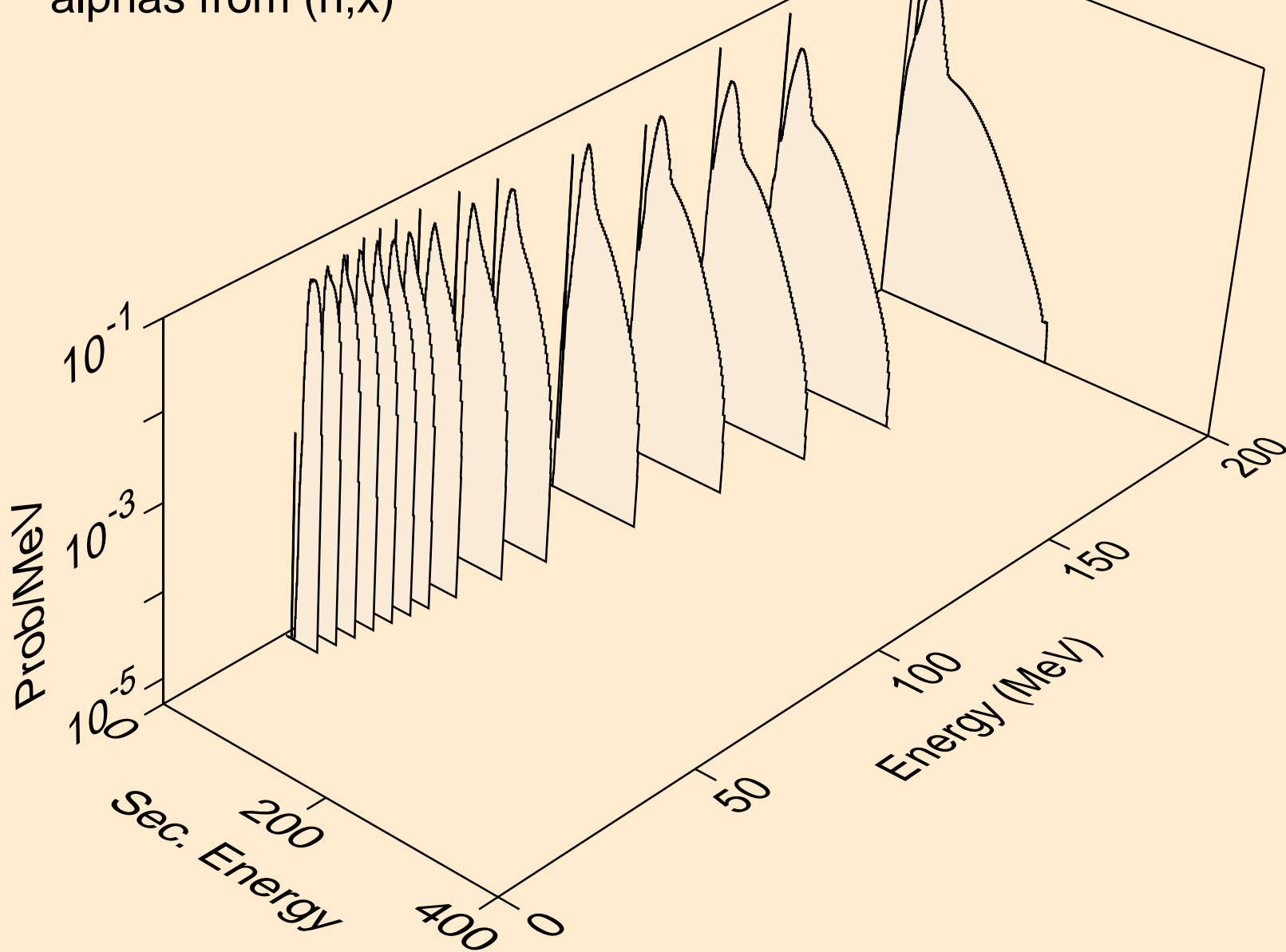

ES249 NEUTRON ACER TENDL-2019 LIBRARY; T=293.16K
alphas from (n,n*)a

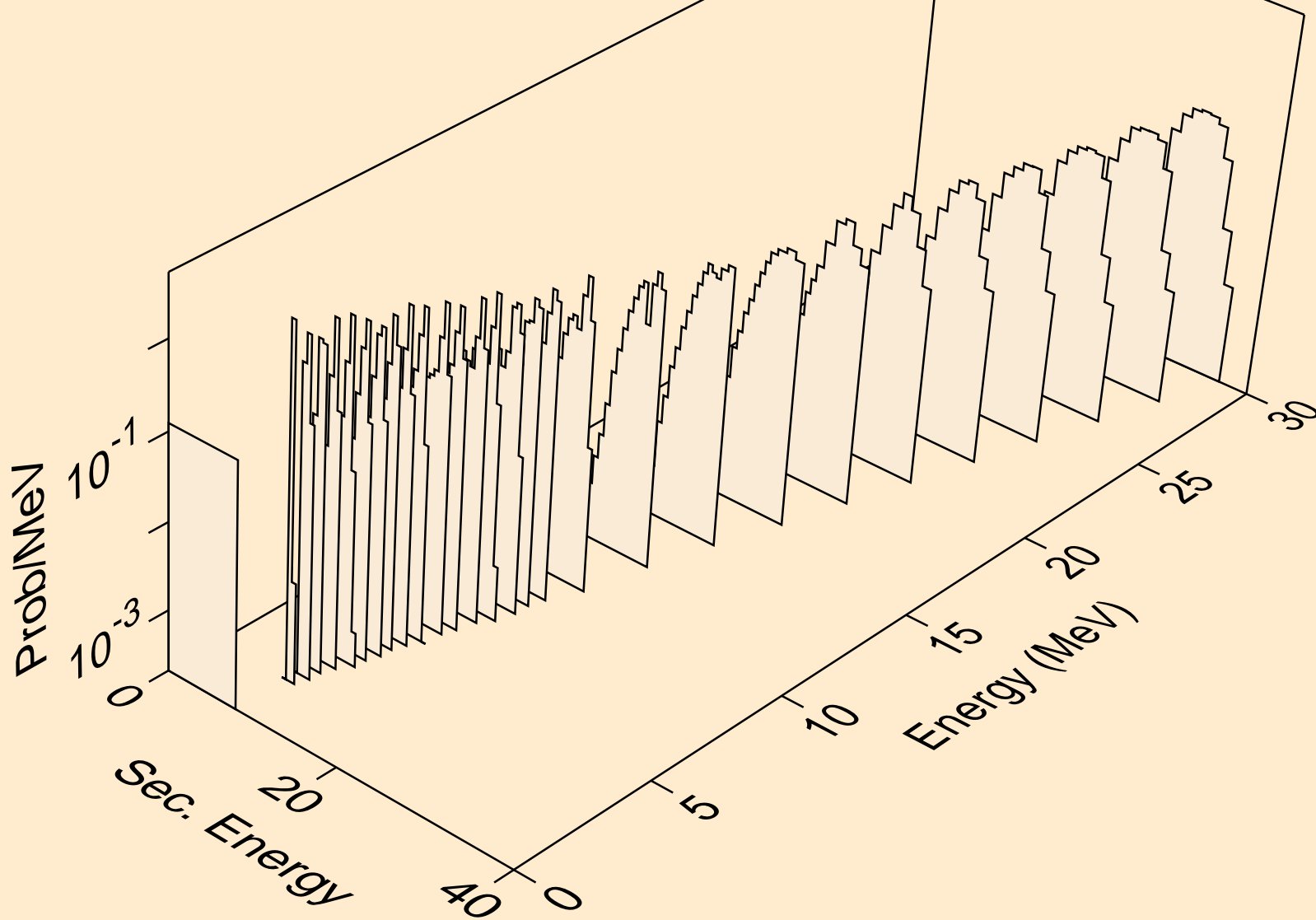

ES249 NEUTRON ACER TENDL-2019 LIBRARY; T=293.16K
alphas from (n,2n)a

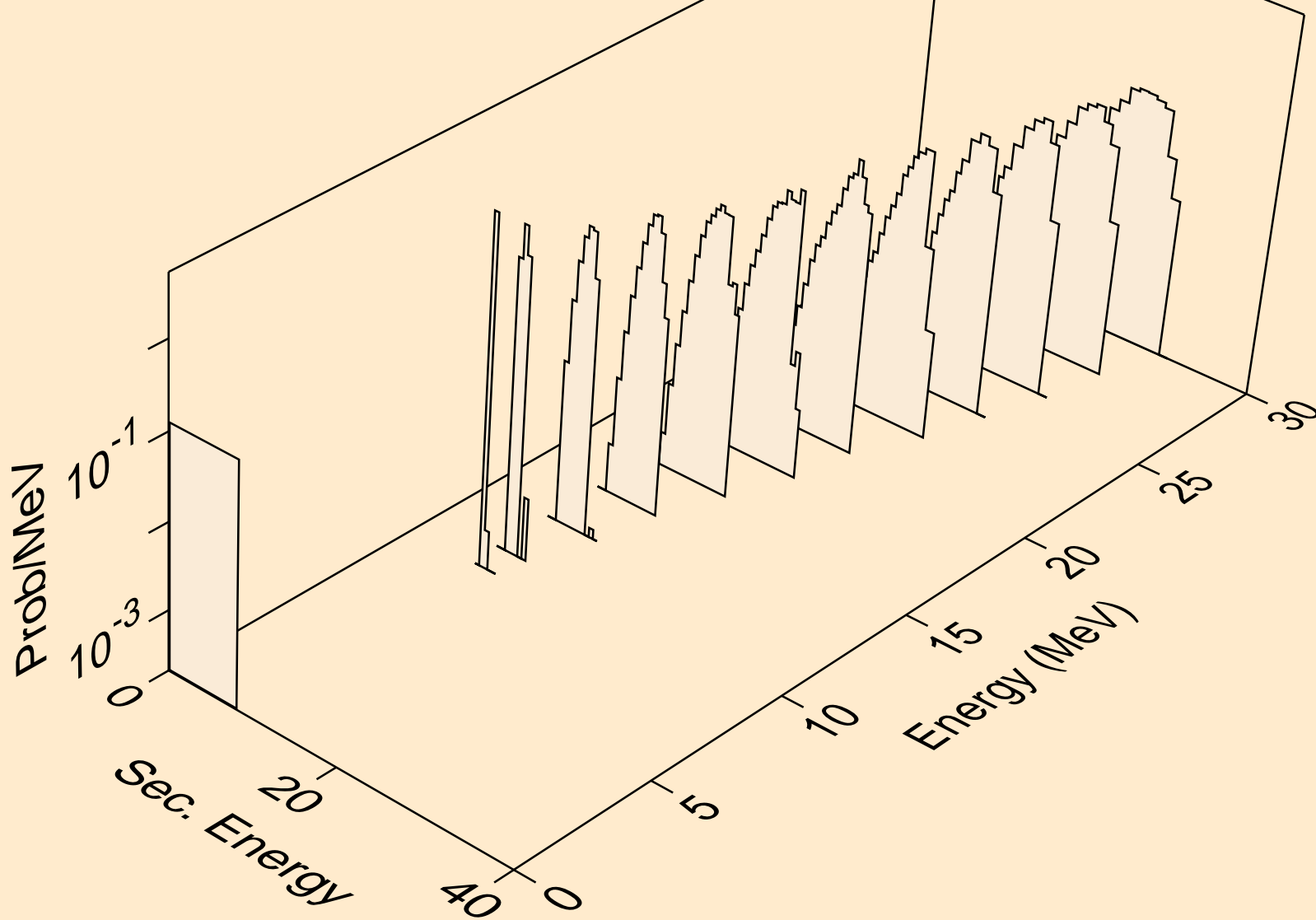

ES249 NEUTRON ACER TENDL-2019 LIBRARY; T=293.16K
alphas from (n,3n)a

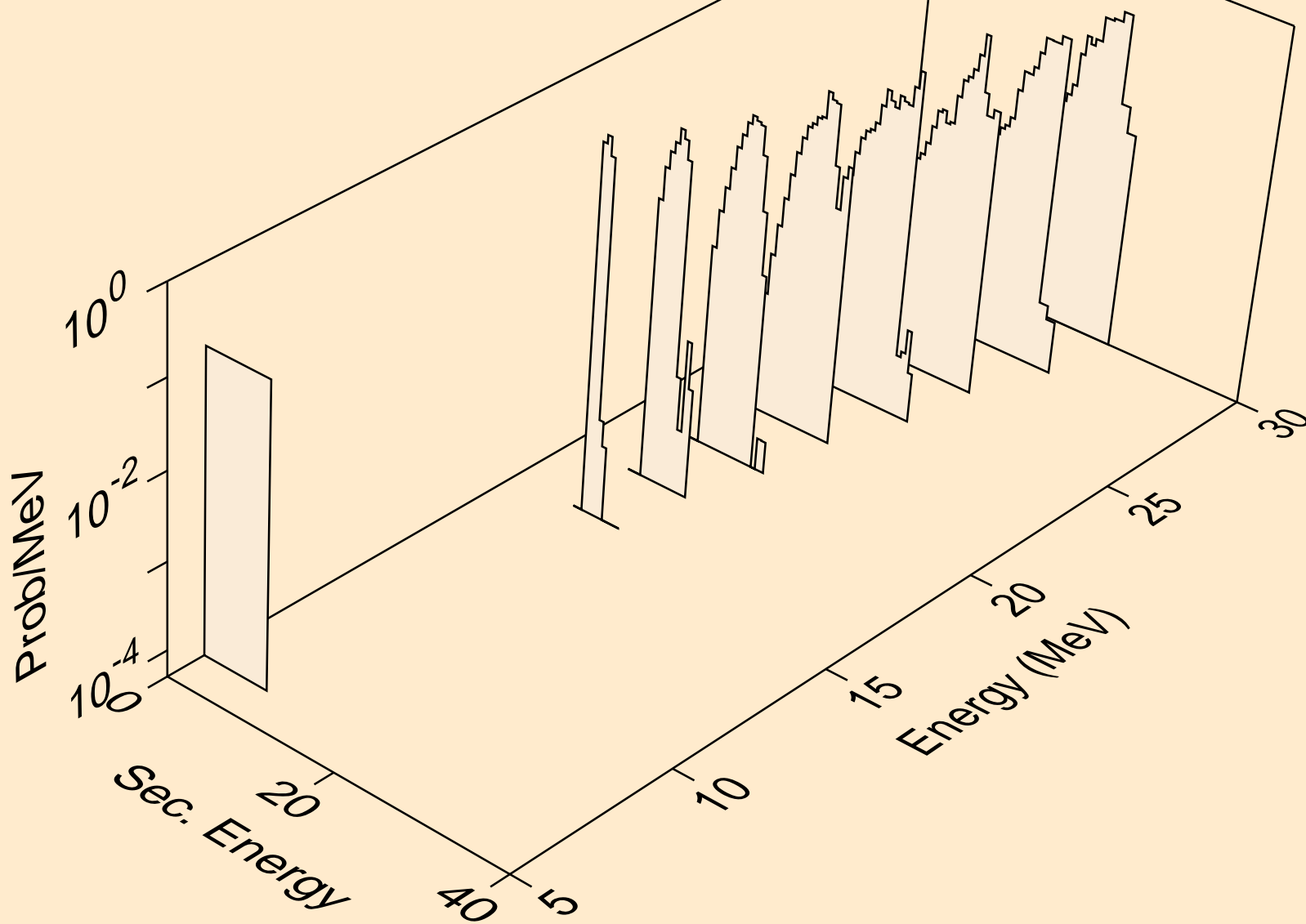

ES249 NEUTRON ACER TENDL-2019 LIBRARY; T=293.16K
alphas from (n,n*)2a

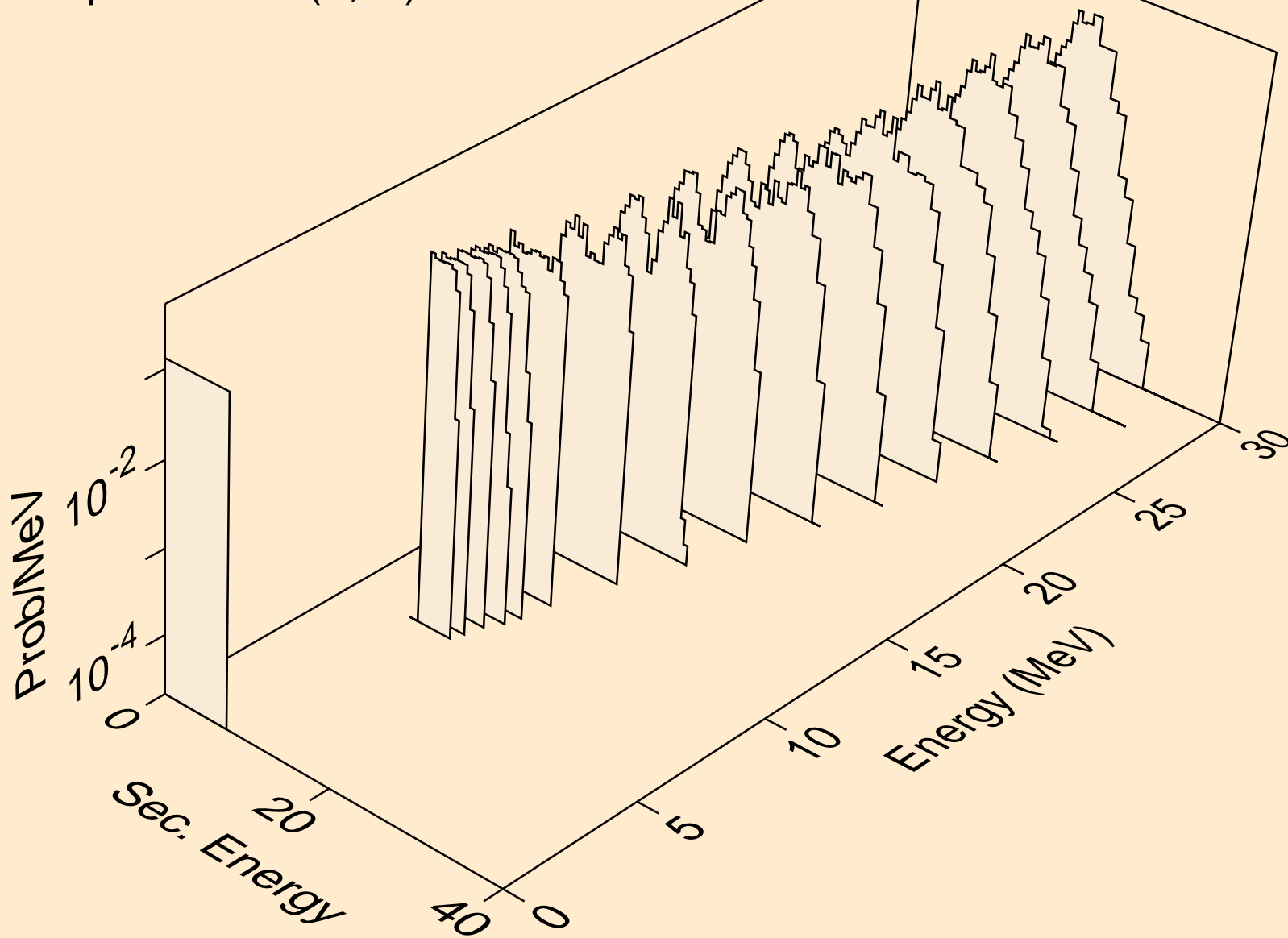

ES249 NEUTRON ACER TENDL-2019 LIBRARY; T=293.16K
alphas from (n,npa)

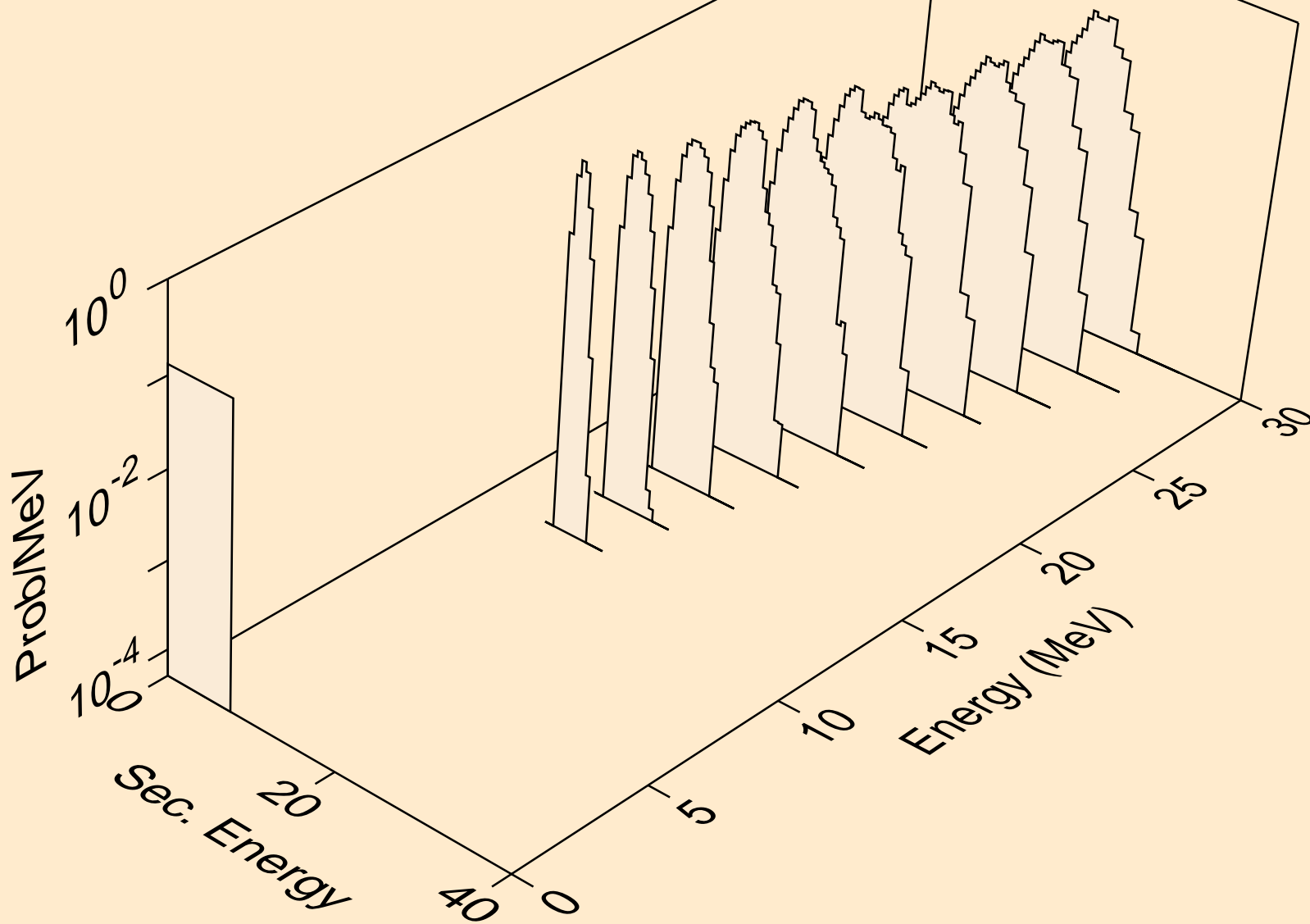

ES249 NEUTRON ACER TENDL-2019 LIBRARY; T=293.16K
alphas from (n,a)

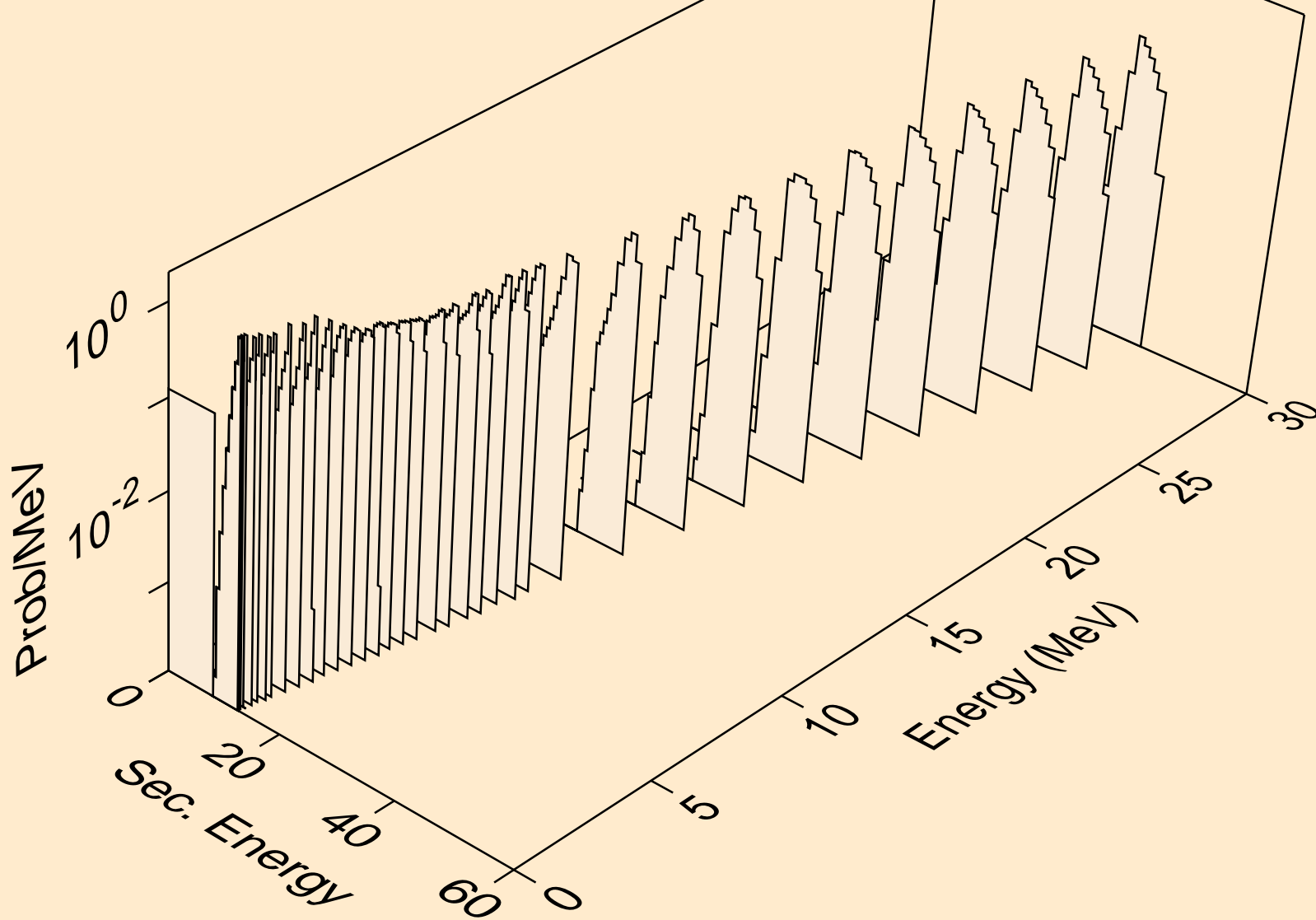

ES249 NEUTRON ACER TENDL-2019 LIBRARY; T=293.16K
alphas from (n,2a)

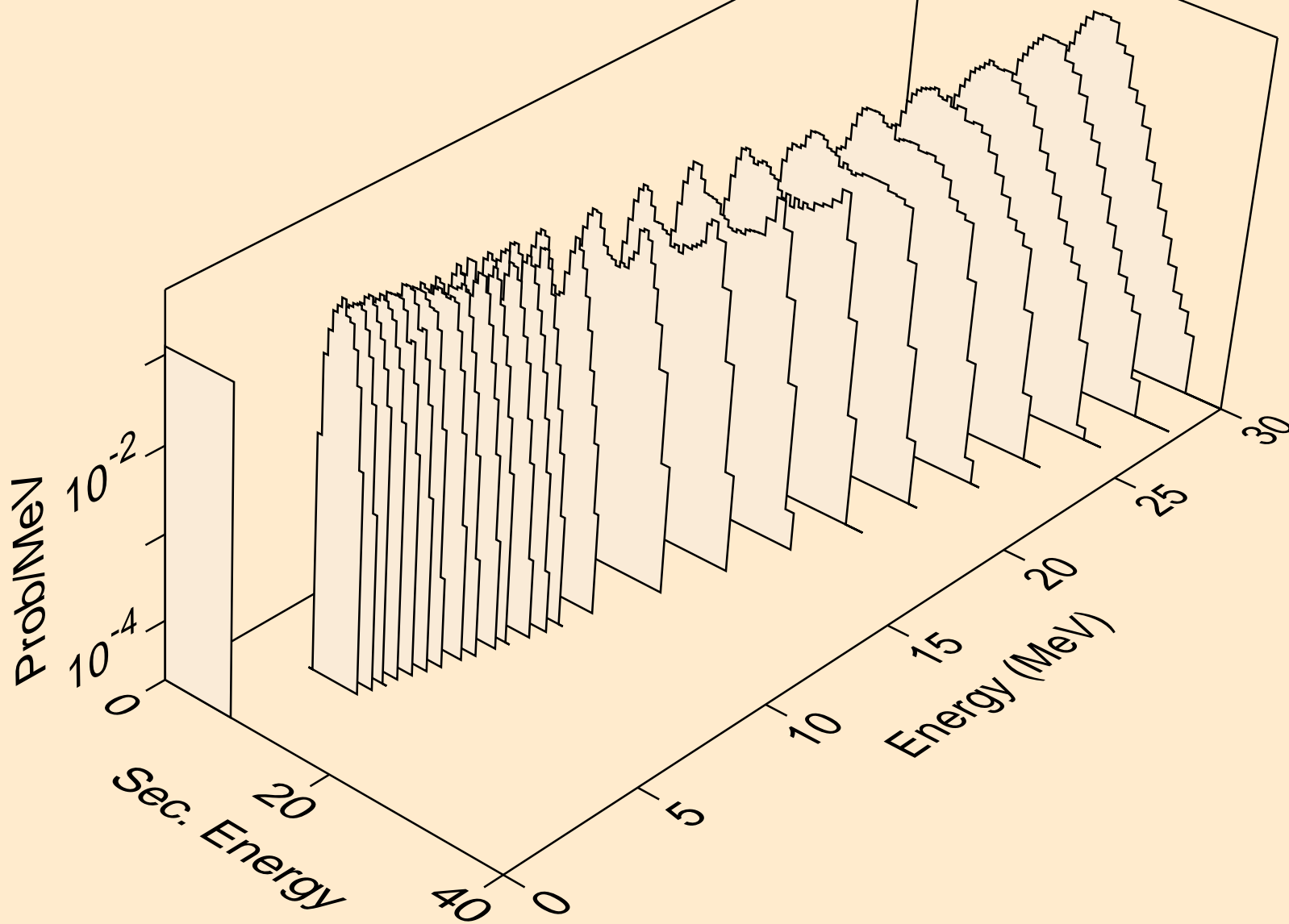

ES249 NEUTRON ACER TENDL-2019 LIBRARY; T=293.16K
alphas from (n,pa)

