

EU165 NEUTRON ACER TENDL-2019 LIBRARY; T=293.16K
Principal cross sections

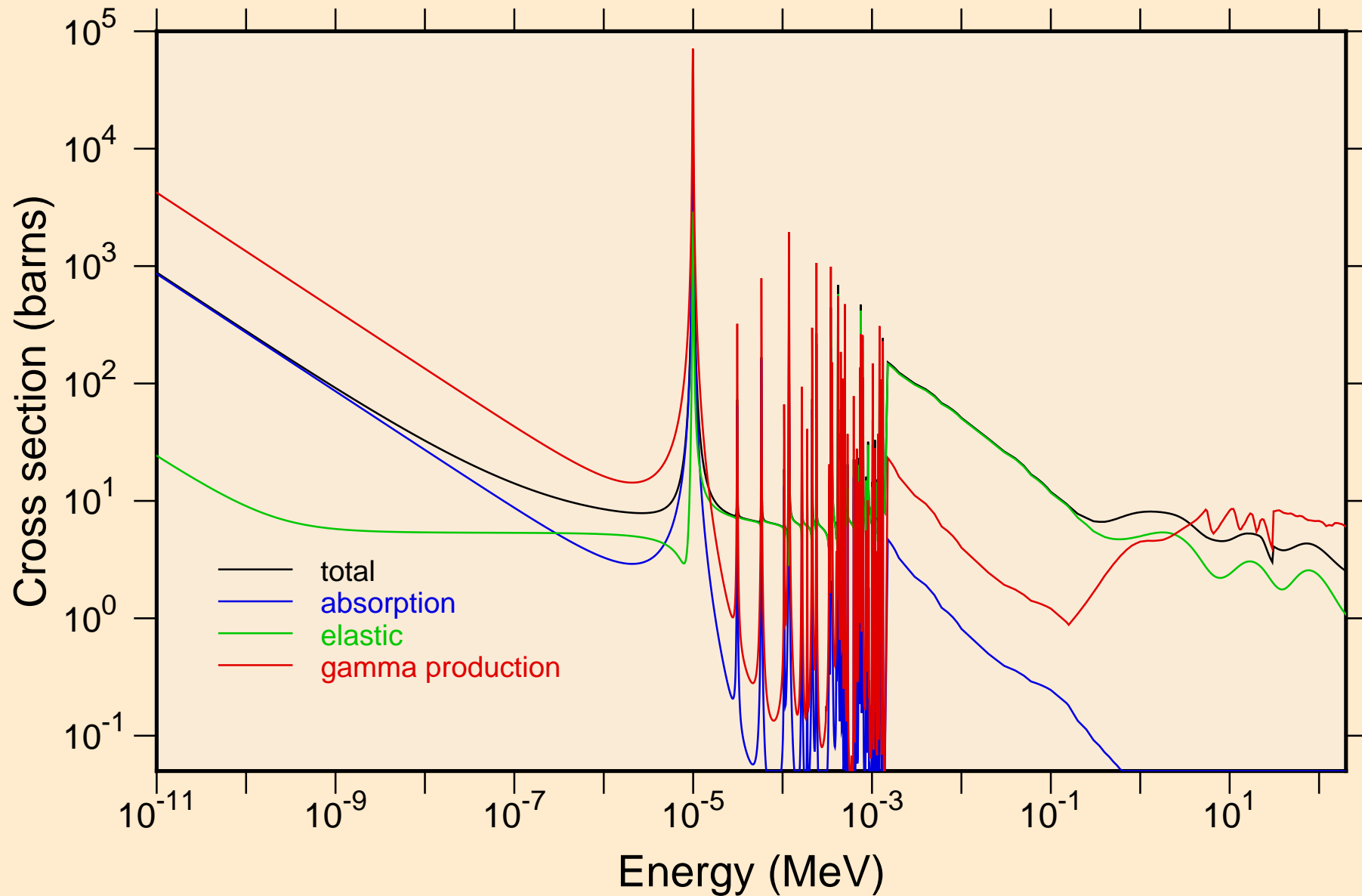

EU165 NEUTRON ACER TENDL-2019 LIBRARY; T=293.16K
resonance total cross section

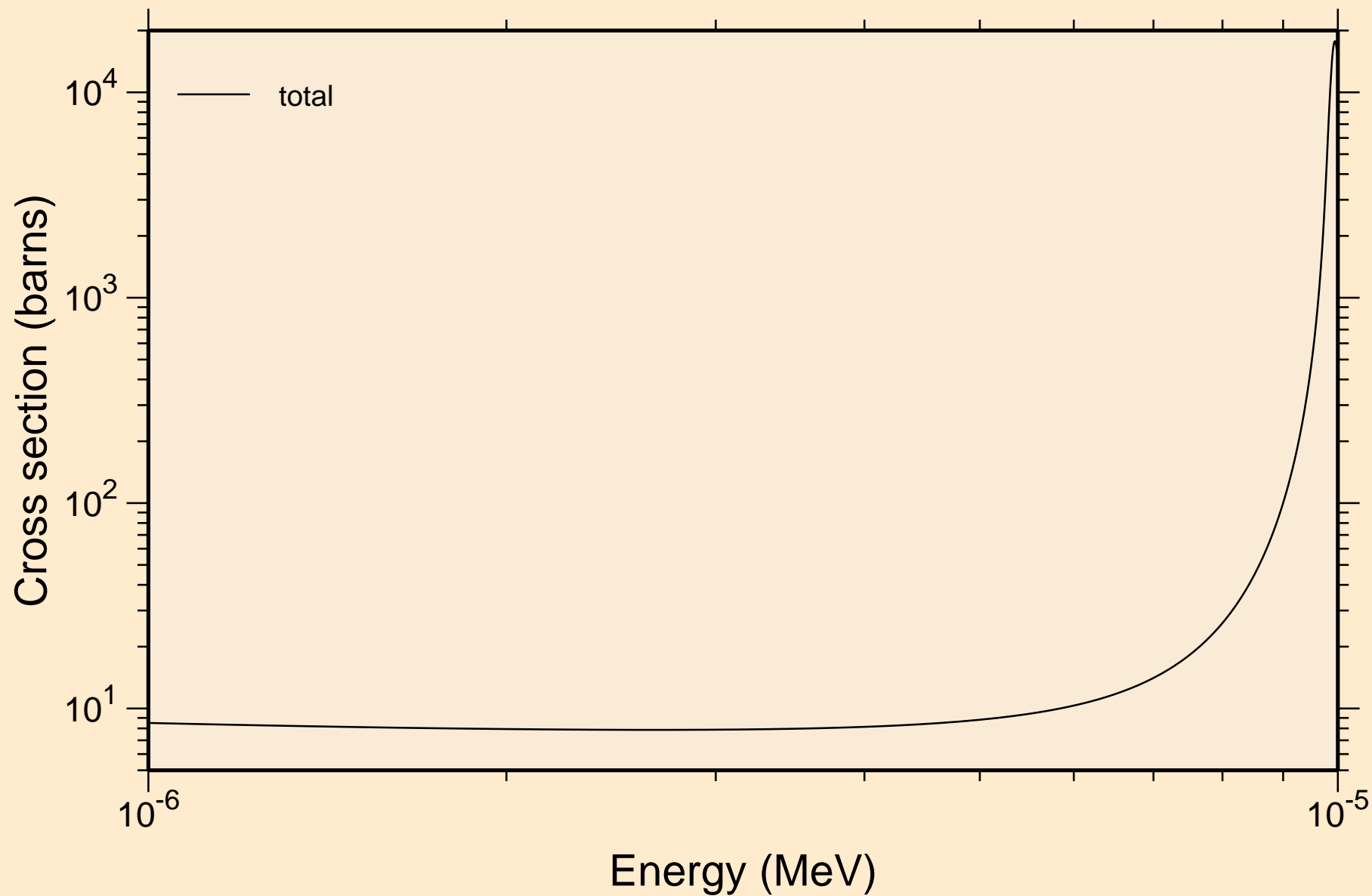

EU165 NEUTRON ACER TENDL-2019 LIBRARY; T=293.16K
resonance total cross section

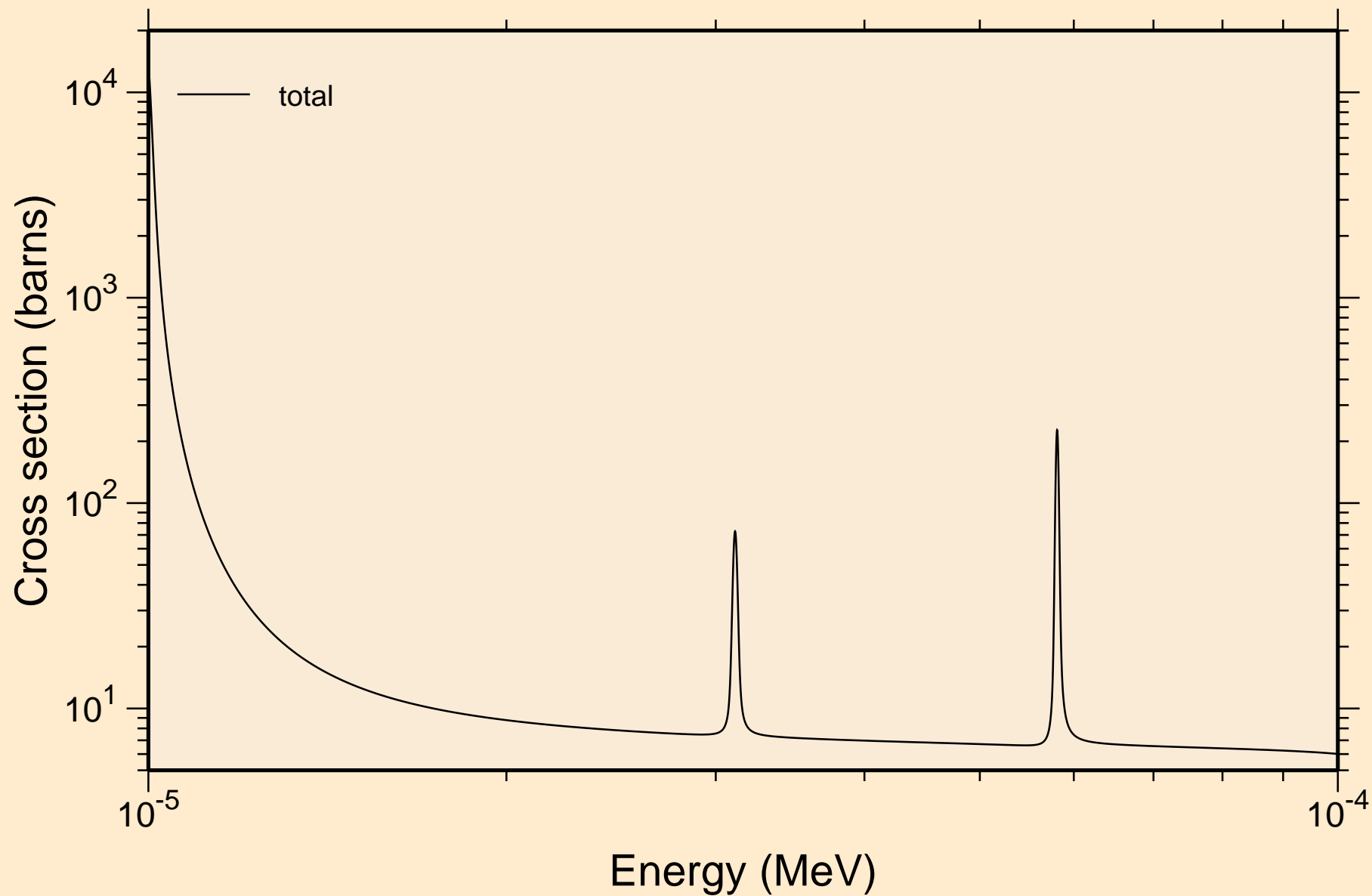

EU165 NEUTRON ACER TENDL-2019 LIBRARY; T=293.16K
resonance total cross section

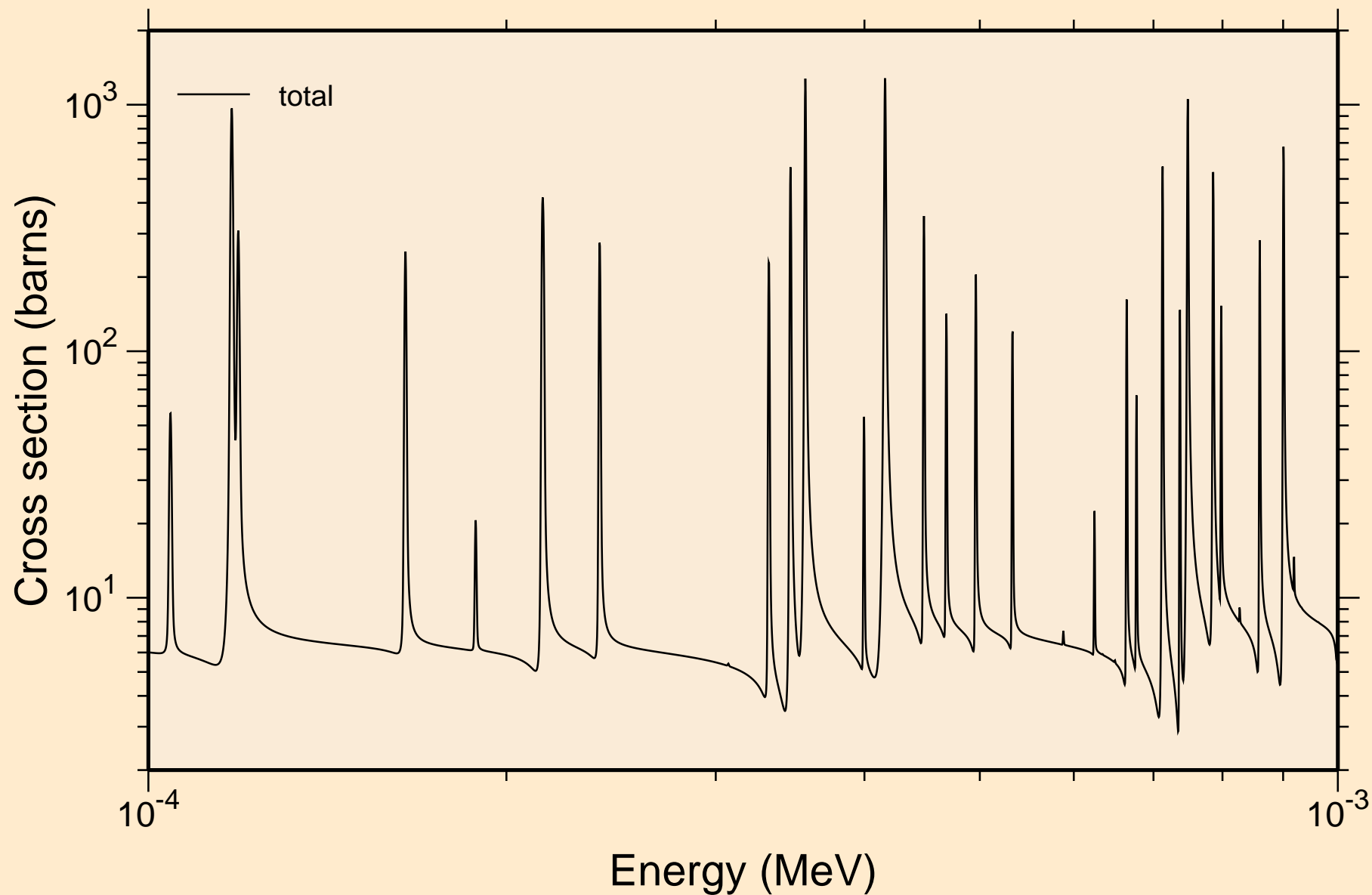

EU165 NEUTRON ACER TENDL-2019 LIBRARY; T=293.16K
resonance total cross section

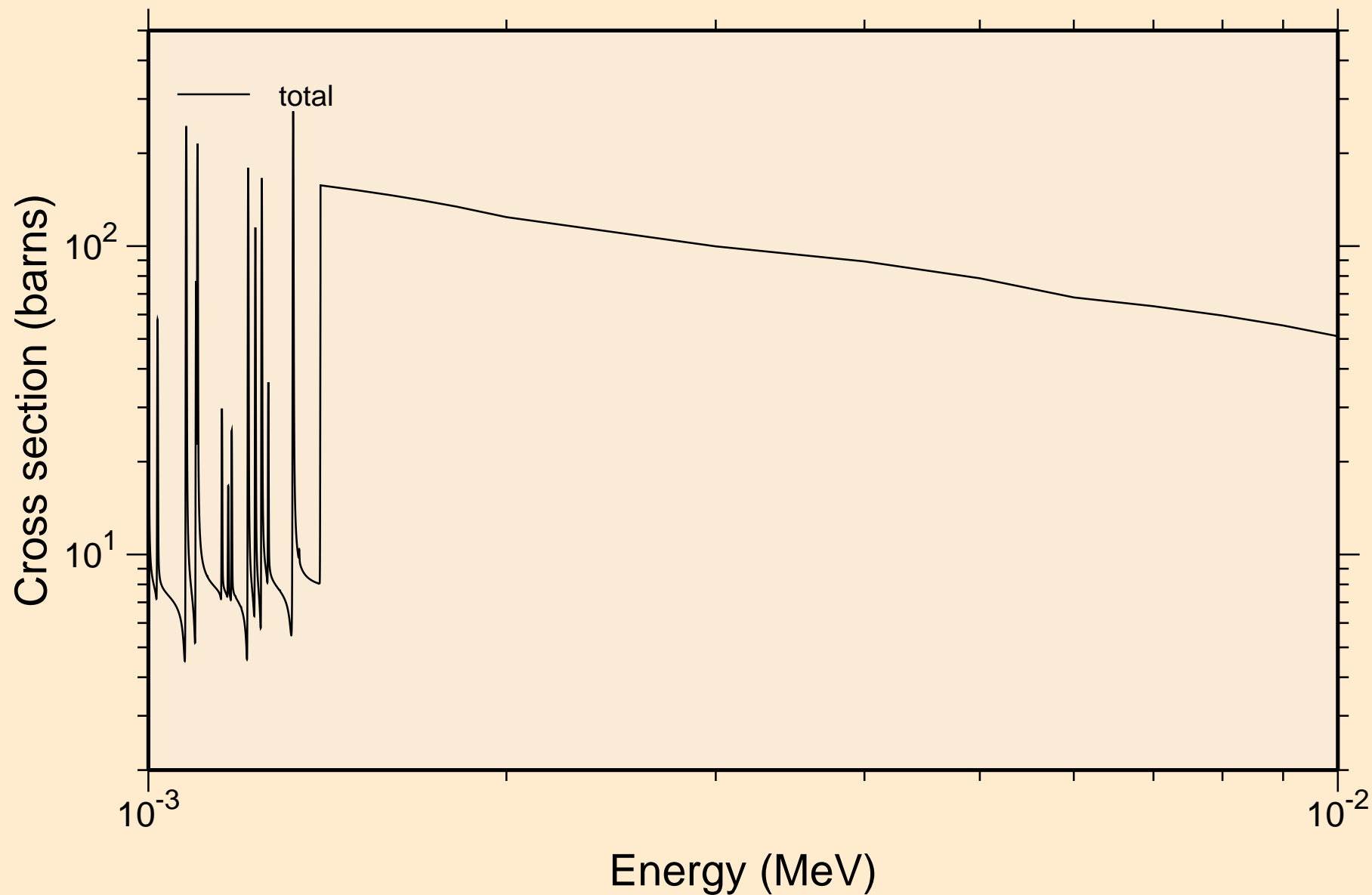

EU165 NEUTRON ACER TENDL-2019 LIBRARY; T=293.16K
resonance total cross section

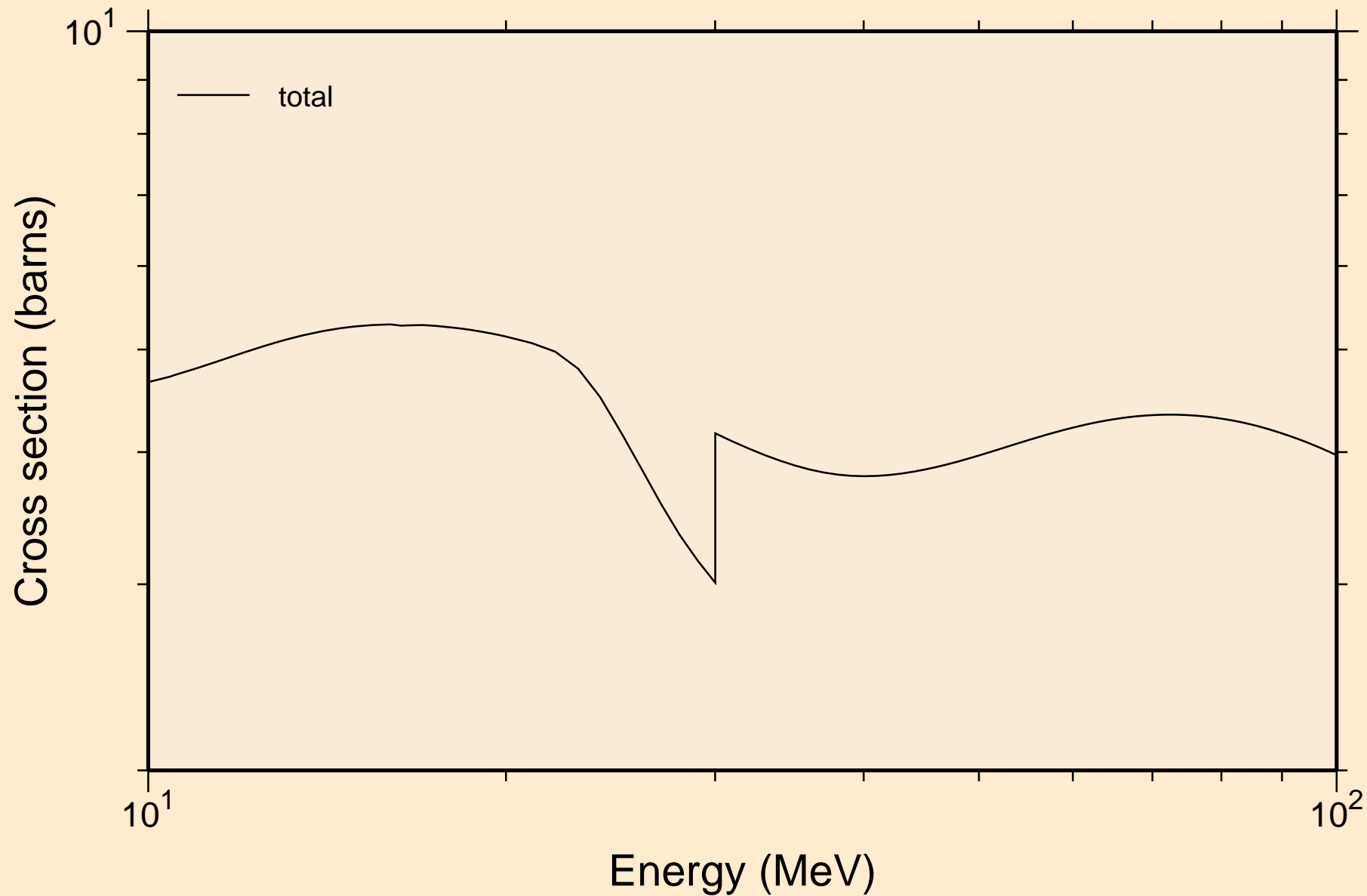

EU165 NEUTRON ACER TENDL-2019 LIBRARY; T=293.16K
resonance absorption cross sections

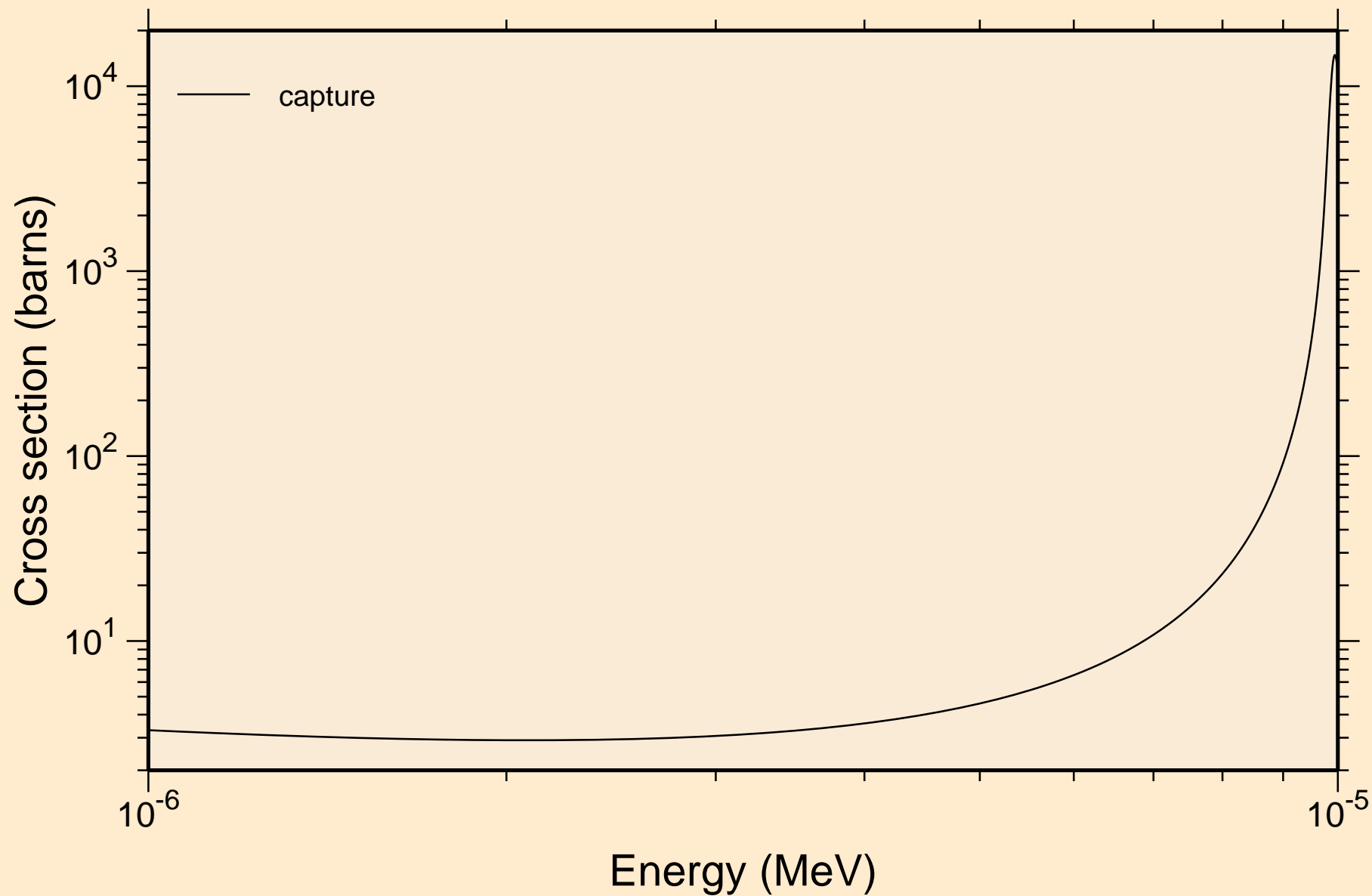

EU165 NEUTRON ACER TENDL-2019 LIBRARY; T=293.16K
resonance absorption cross sections

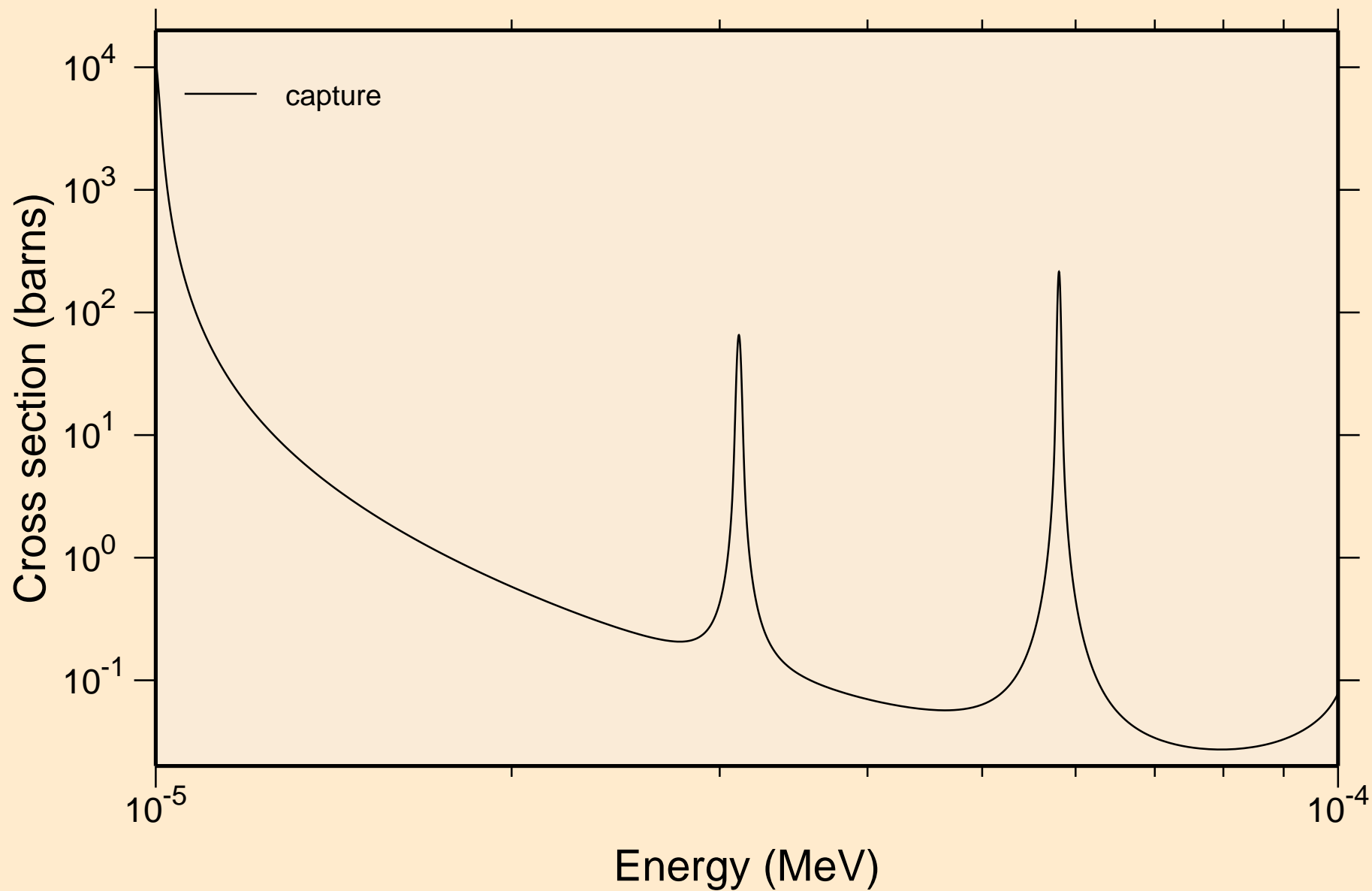

EU165 NEUTRON ACER TENDL-2019 LIBRARY; T=293.16K
resonance absorption cross sections

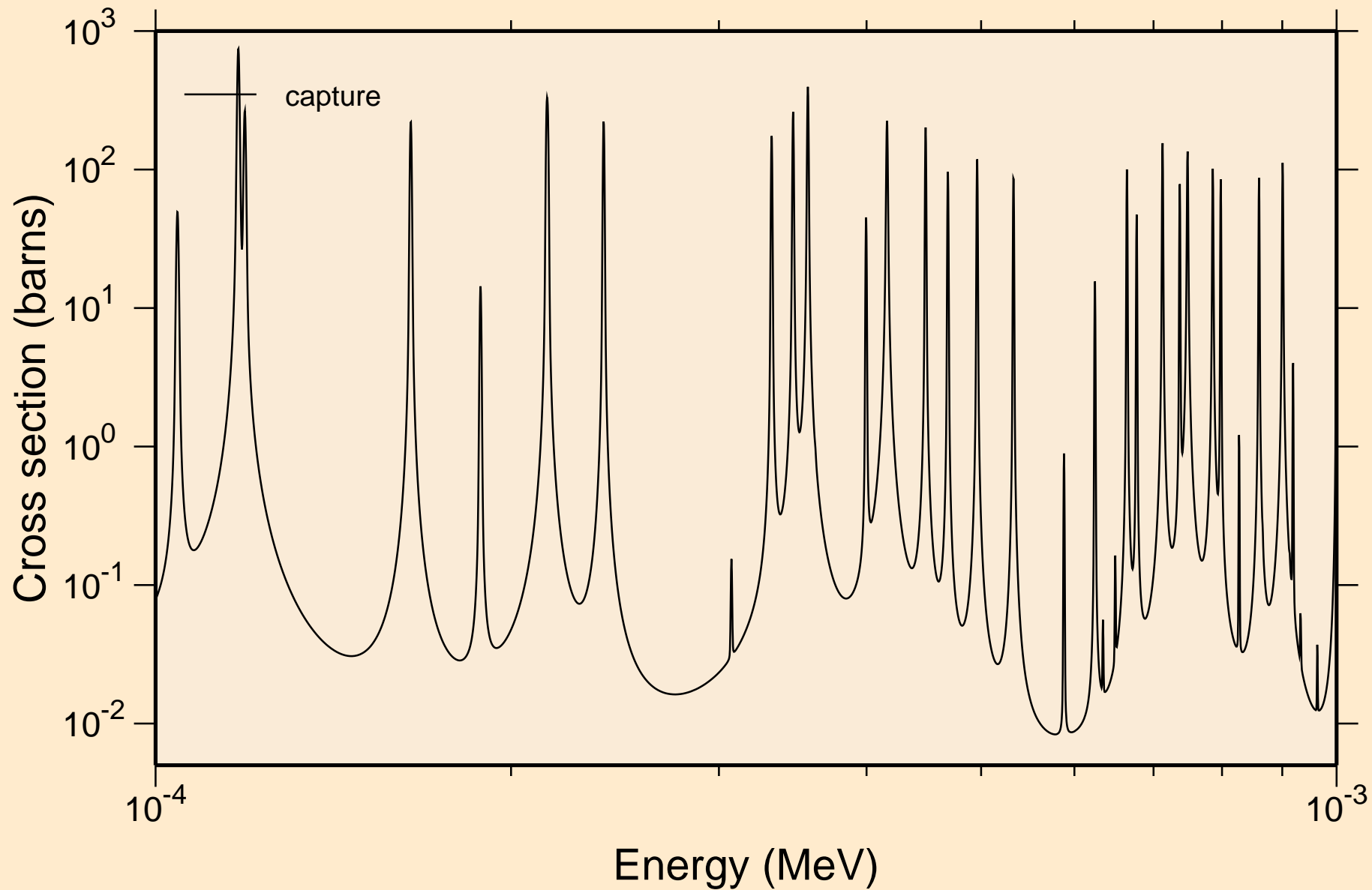

EU165 NEUTRON ACER TENDL-2019 LIBRARY; T=293.16K
resonance absorption cross sections

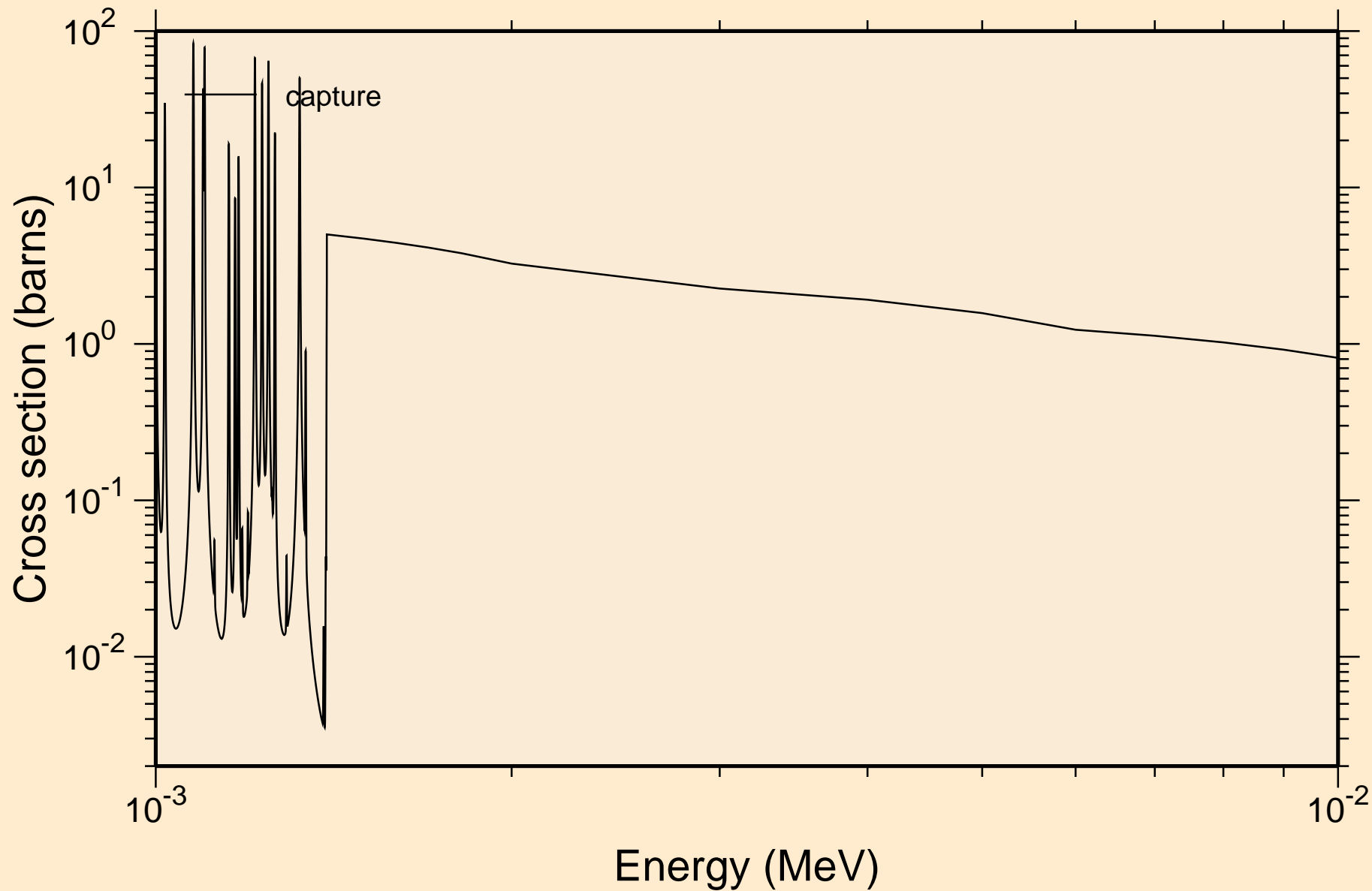

EU165 NEUTRON ACER TENDL-2019 LIBRARY; T=293.16K
resonance absorption cross sections

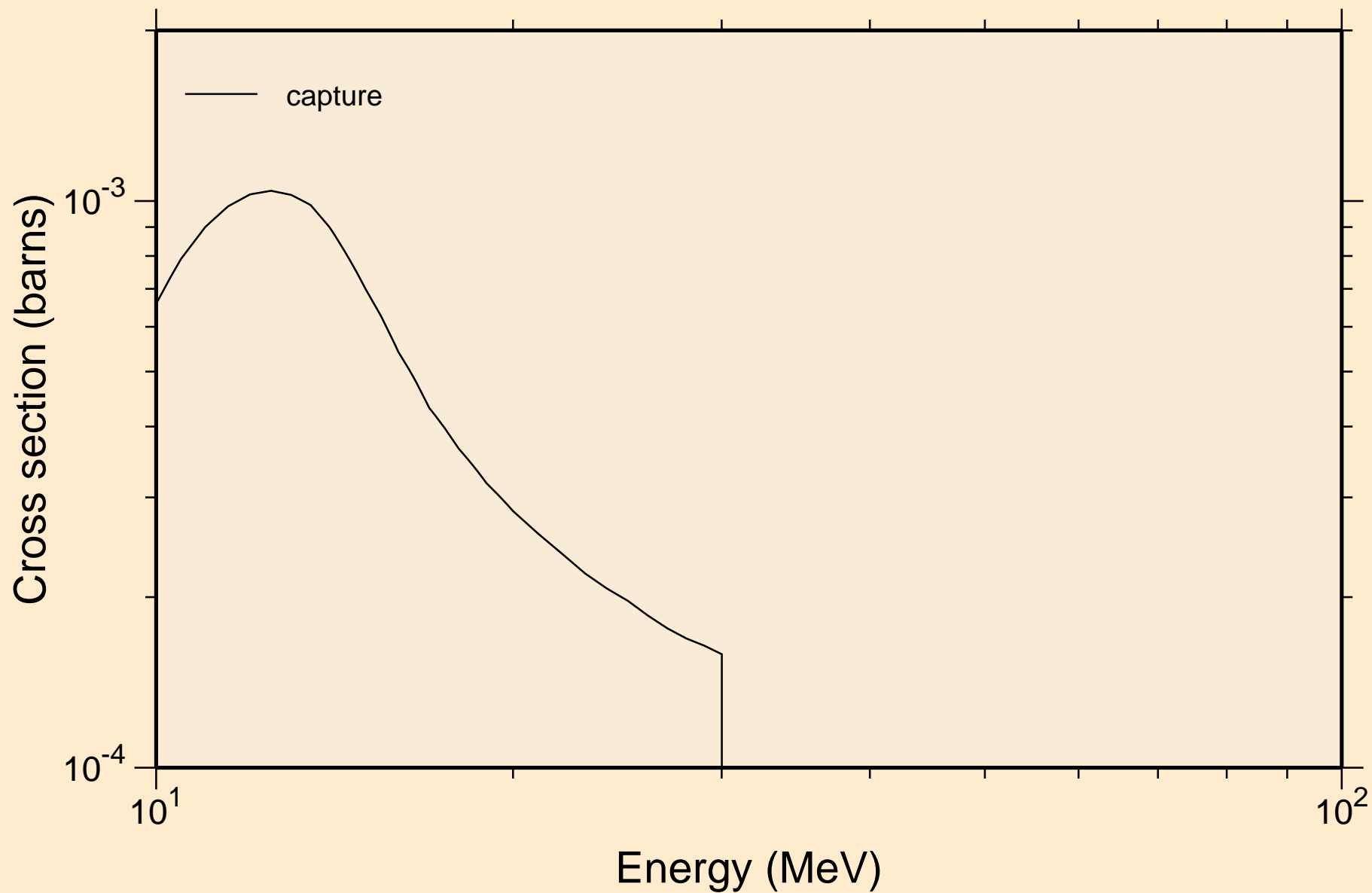

EU165 NEUTRON ACER TENDL-2019 LIBRARY; T=293.16K
Heating

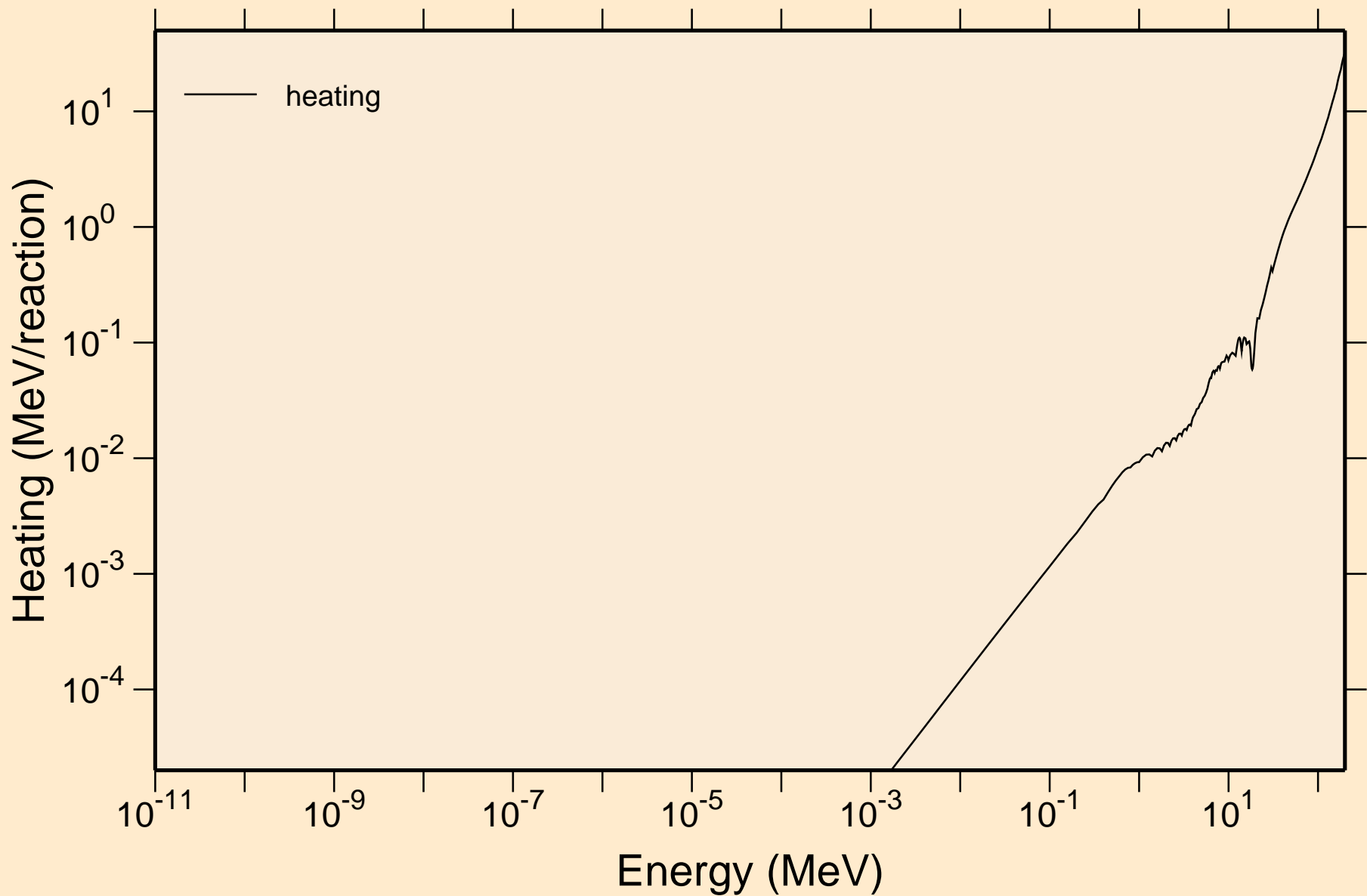

EU165 NEUTRON ACER TENDL-2019 LIBRARY; T=293.16K
Damage

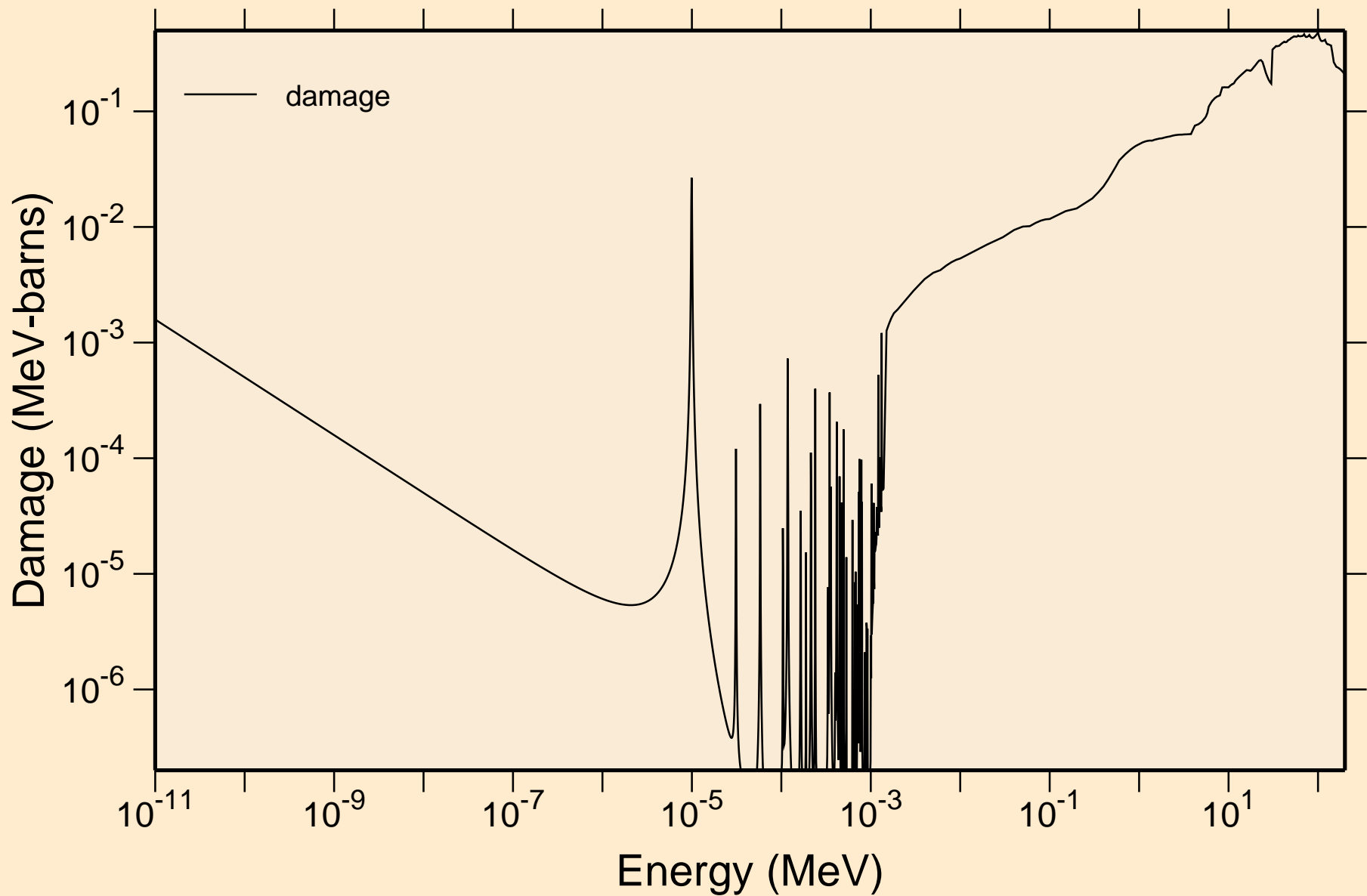

EU165 NEUTRON ACER TENDL-2019 LIBRARY; T=293.16K
Non-threshold reactions

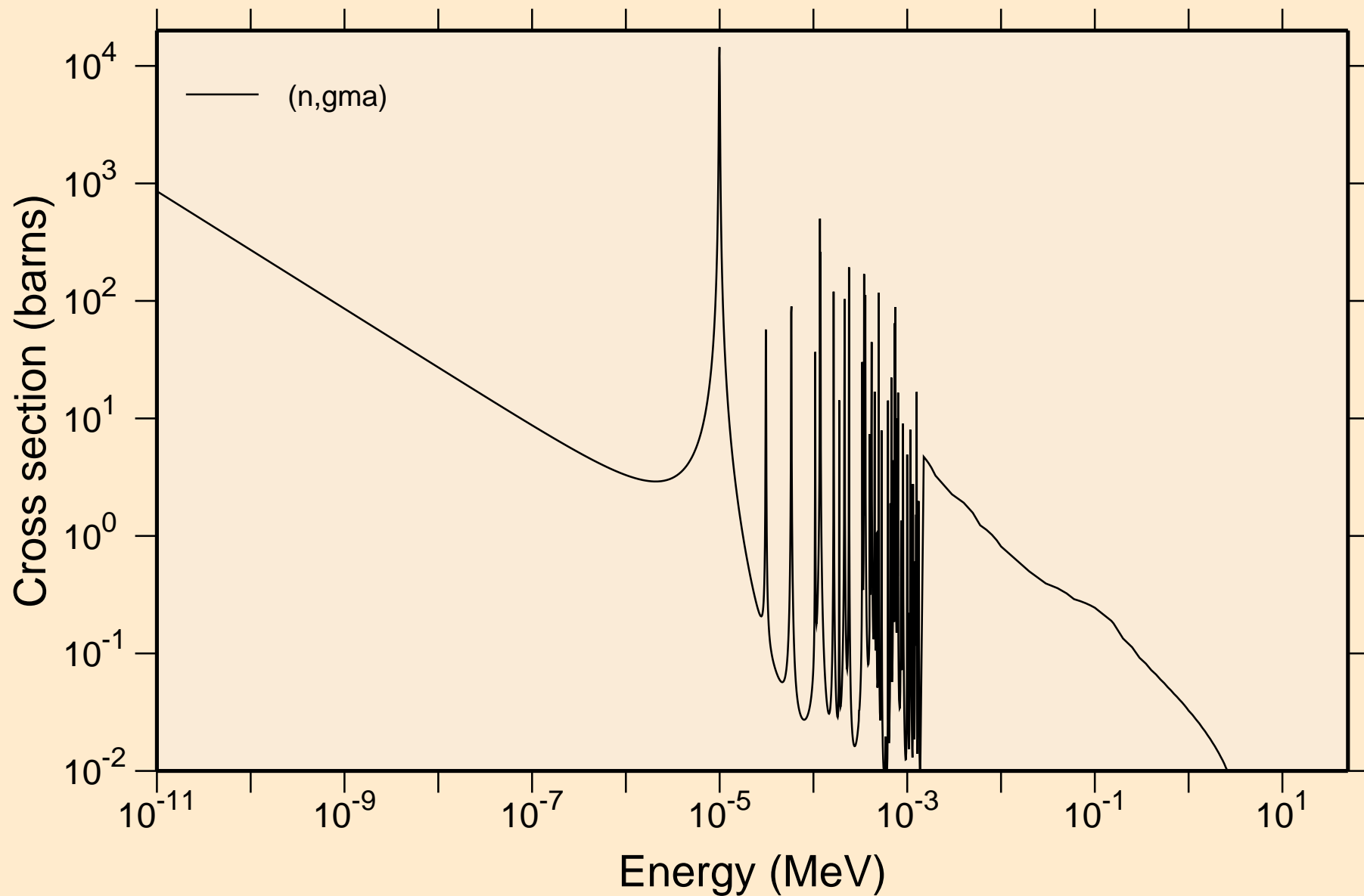

EU165 NEUTRON ACER TENDL-2019 LIBRARY; T=293.16K
Principal cross sections

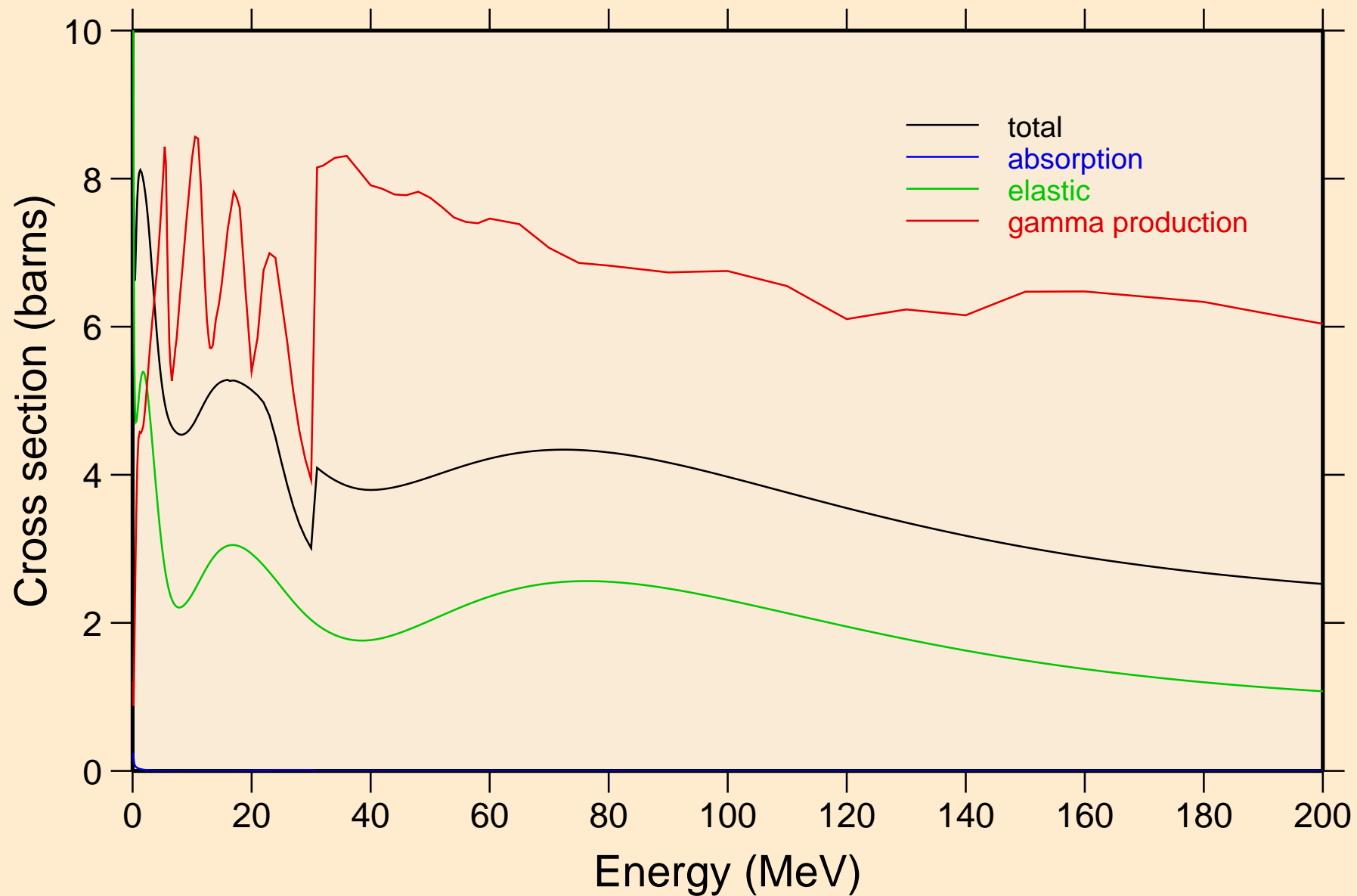

EU165 NEUTRON ACER TENDL-2019 LIBRARY; T=293.16K
Heating

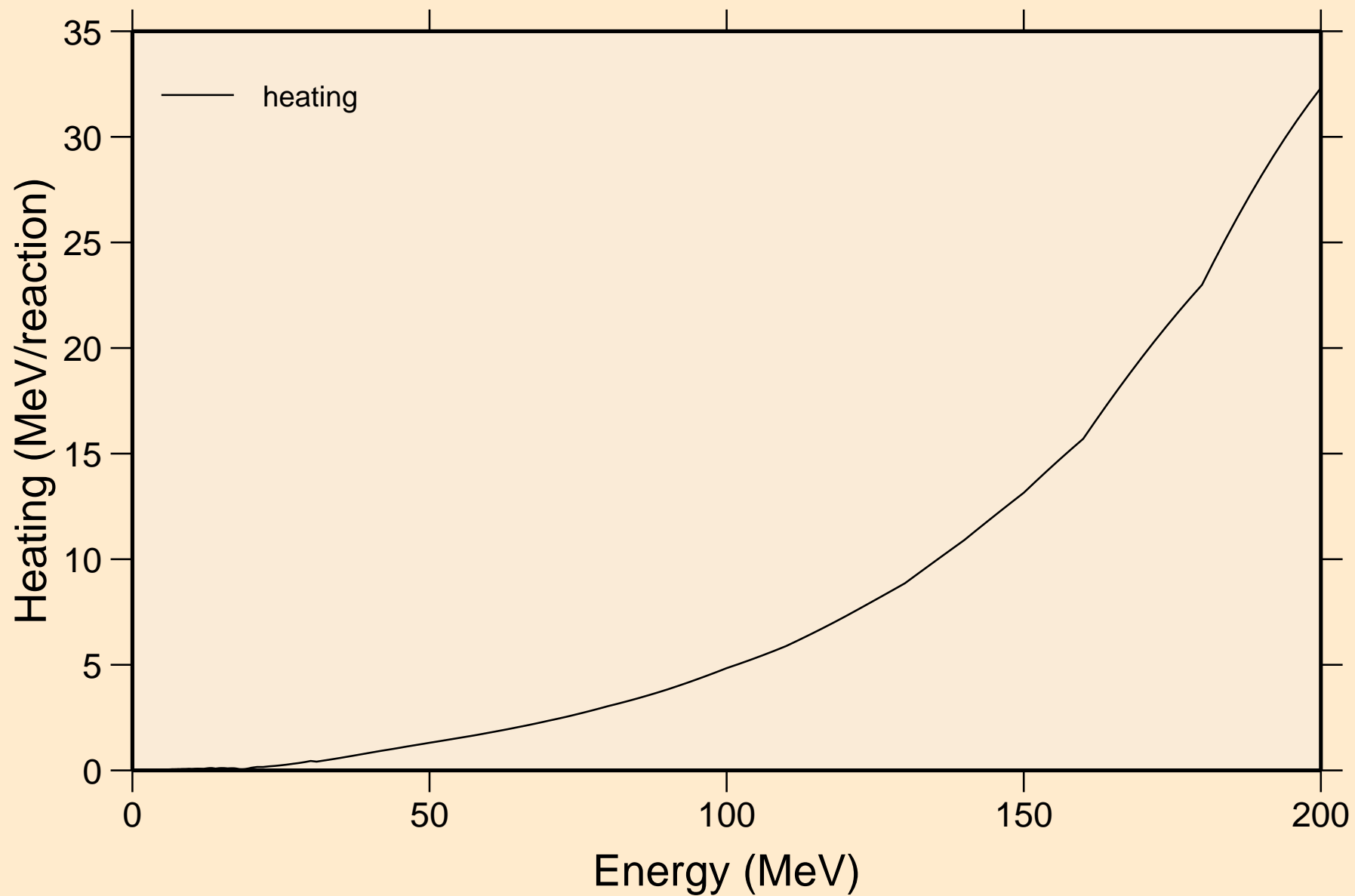

EU165 NEUTRON ACER TENDL-2019 LIBRARY; T=293.16K
Damage

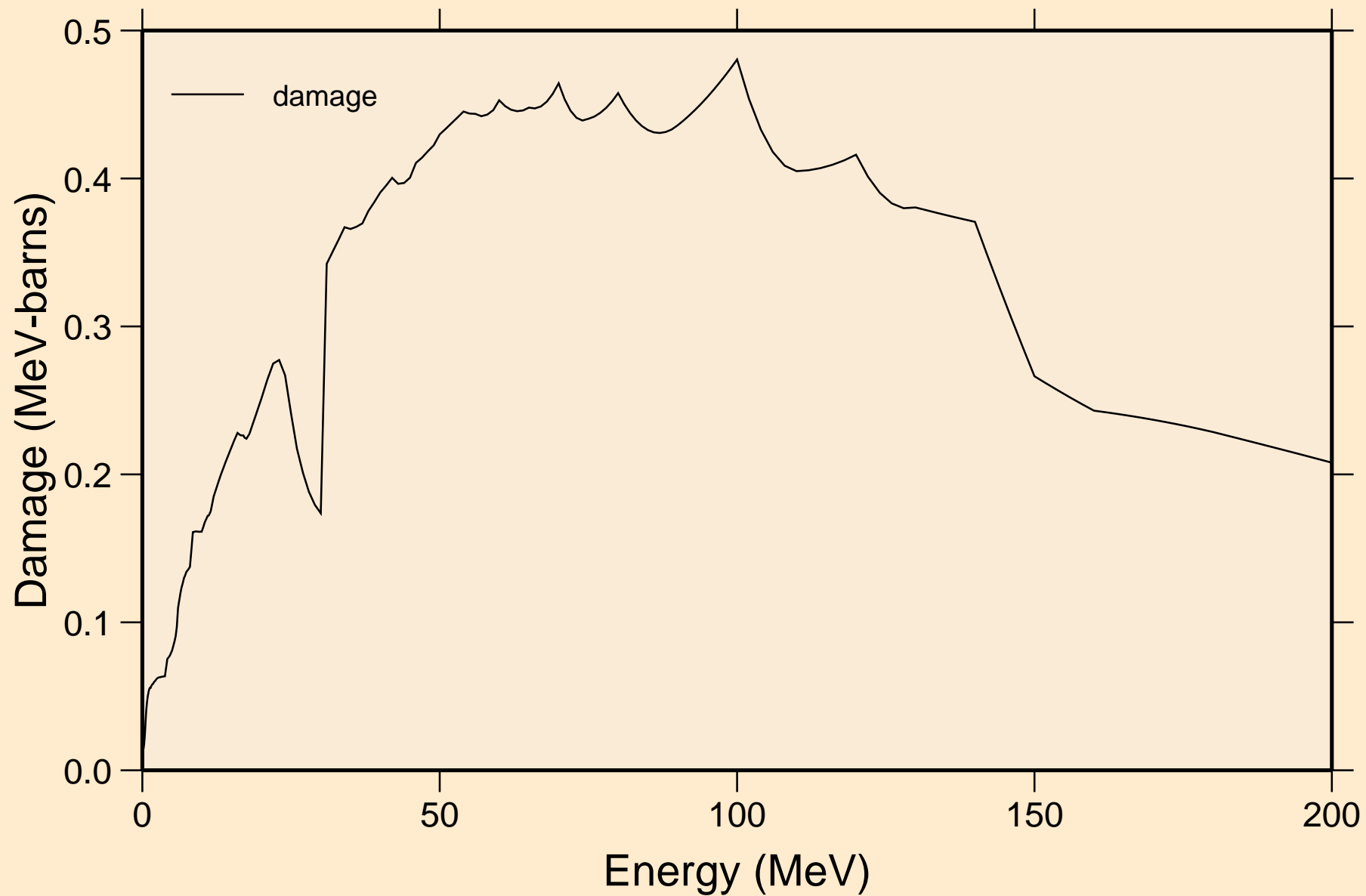

EU165 NEUTRON ACER TENDL-2019 LIBRARY; T=293.16K
Non-threshold reactions

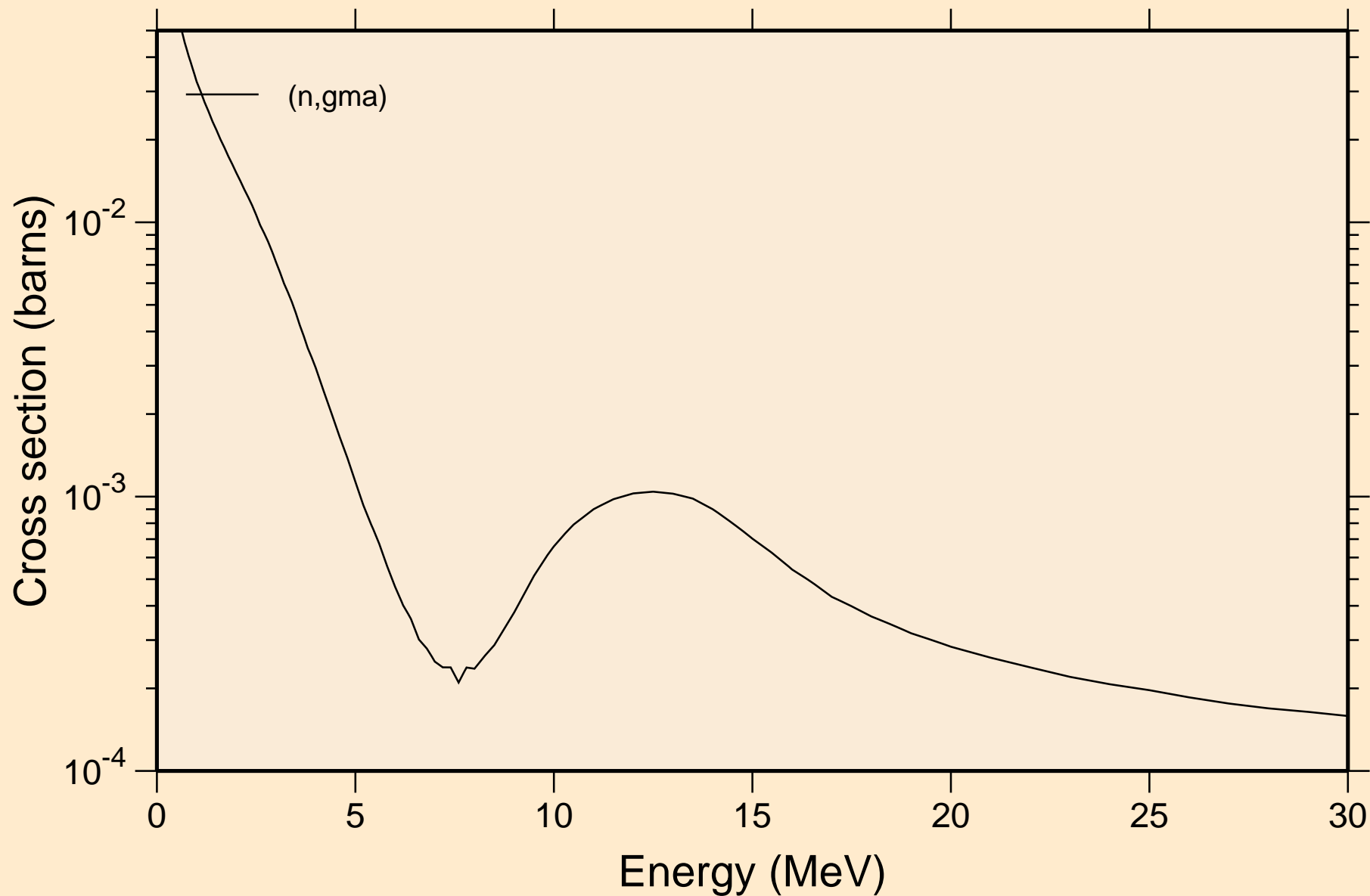

EU165 NEUTRON ACER TENDL-2019 LIBRARY; T=293.16K
Inelastic levels

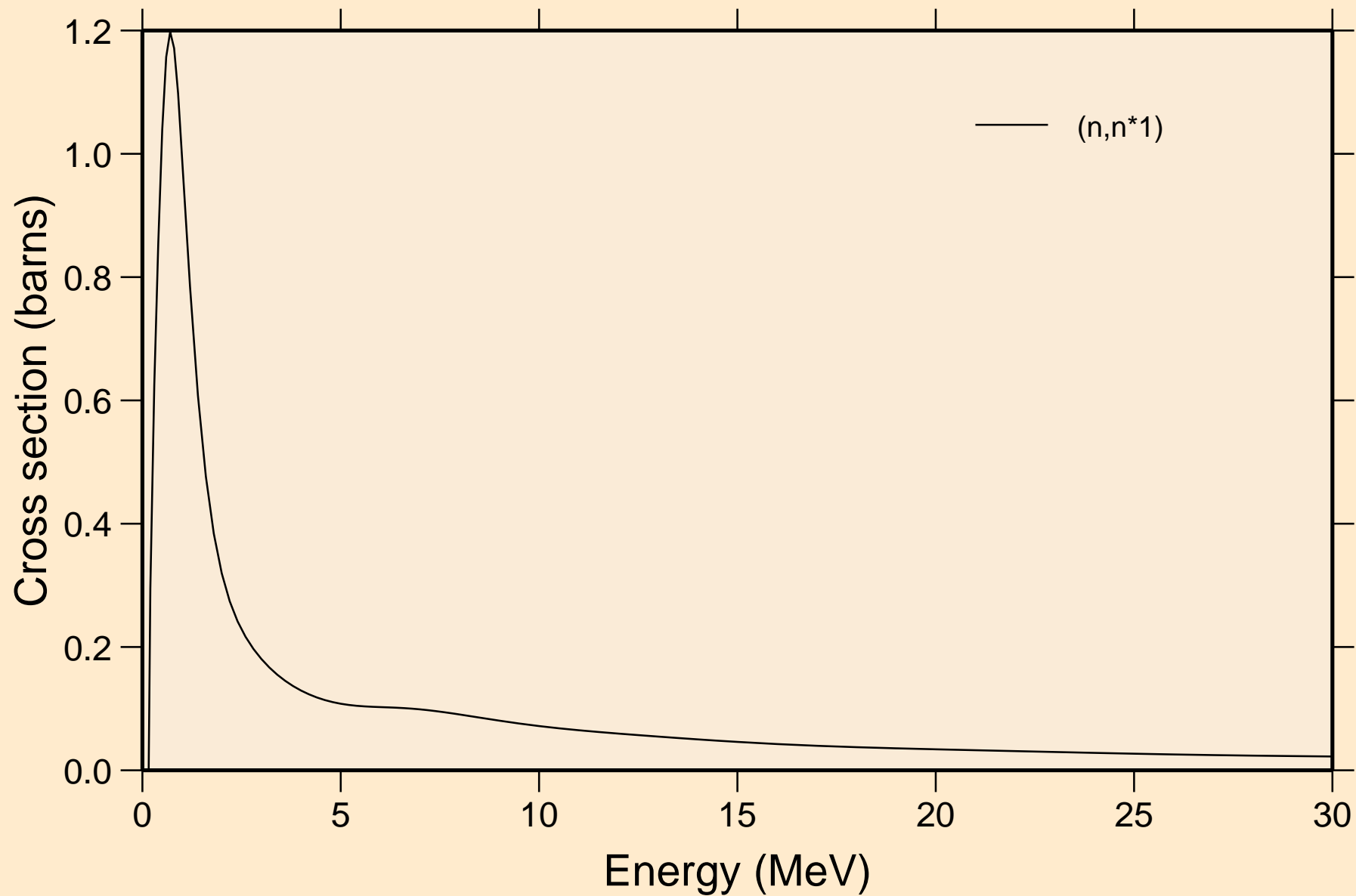

EU165 NEUTRON ACER TENDL-2019 LIBRARY; T=293.16K
Threshold reactions

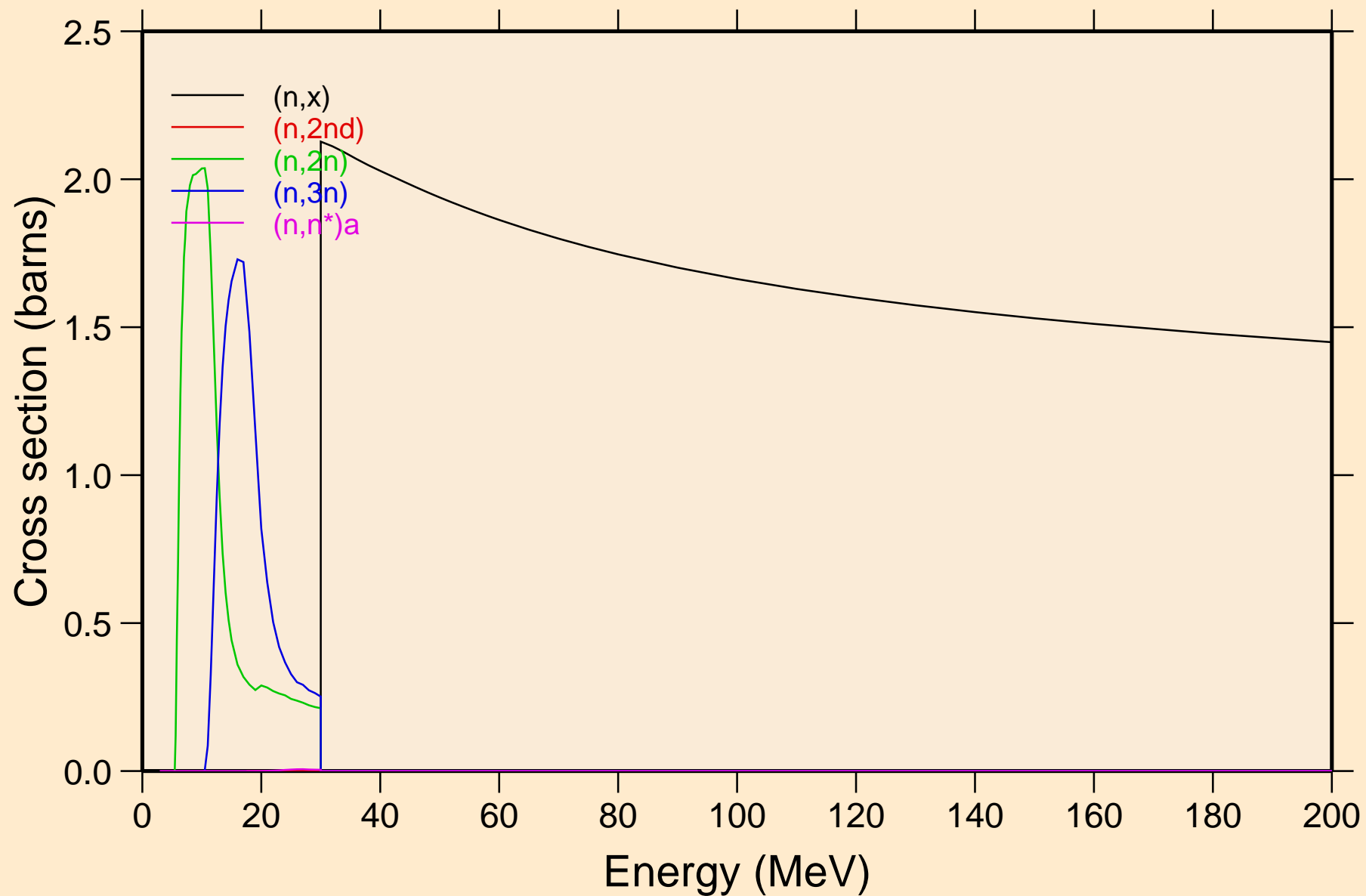

EU165 NEUTRON ACER TENDL-2019 LIBRARY; T=293.16K
Threshold reactions

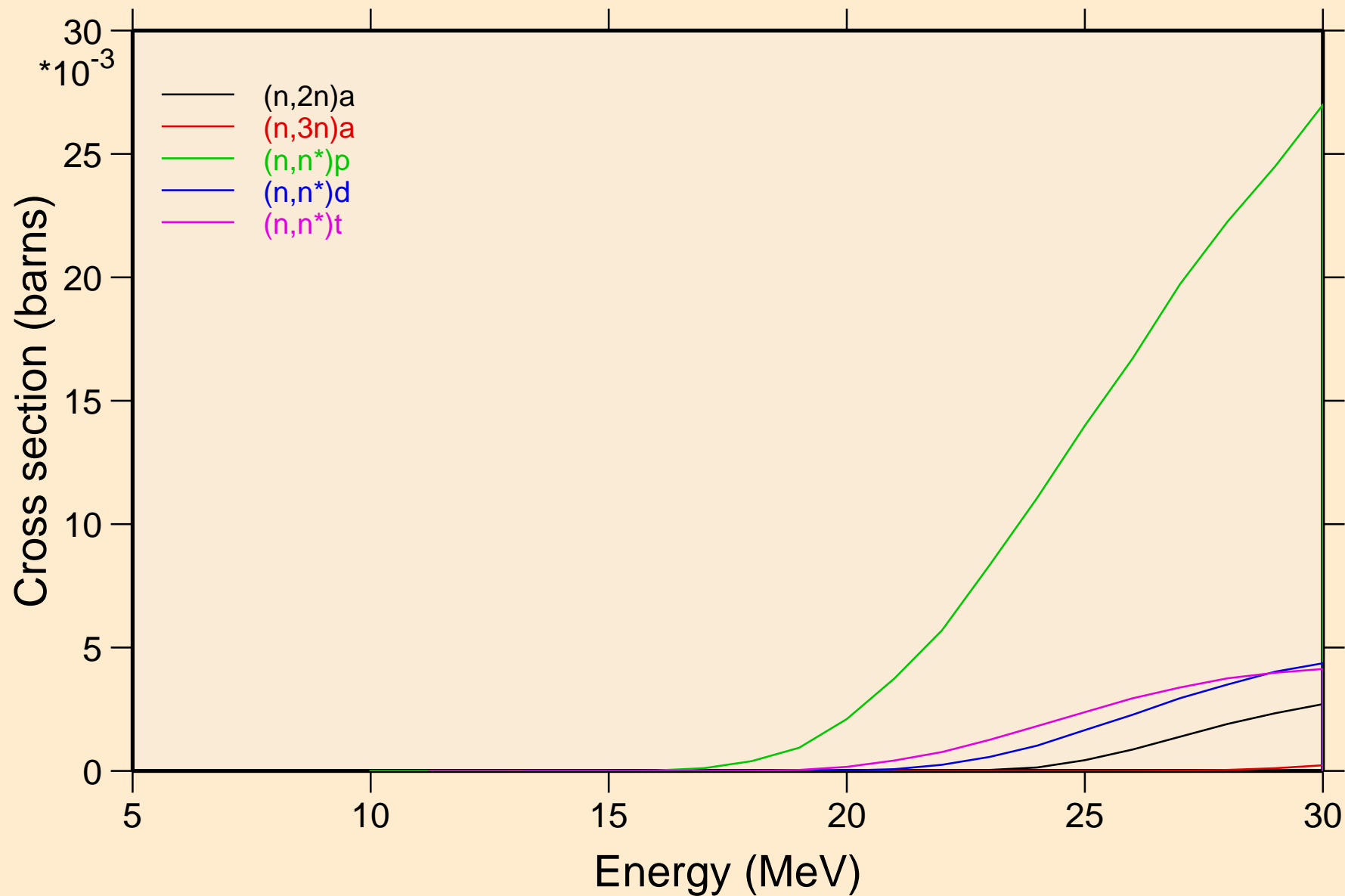

EU165 NEUTRON ACER TENDL-2019 LIBRARY; T=293.16K
Threshold reactions

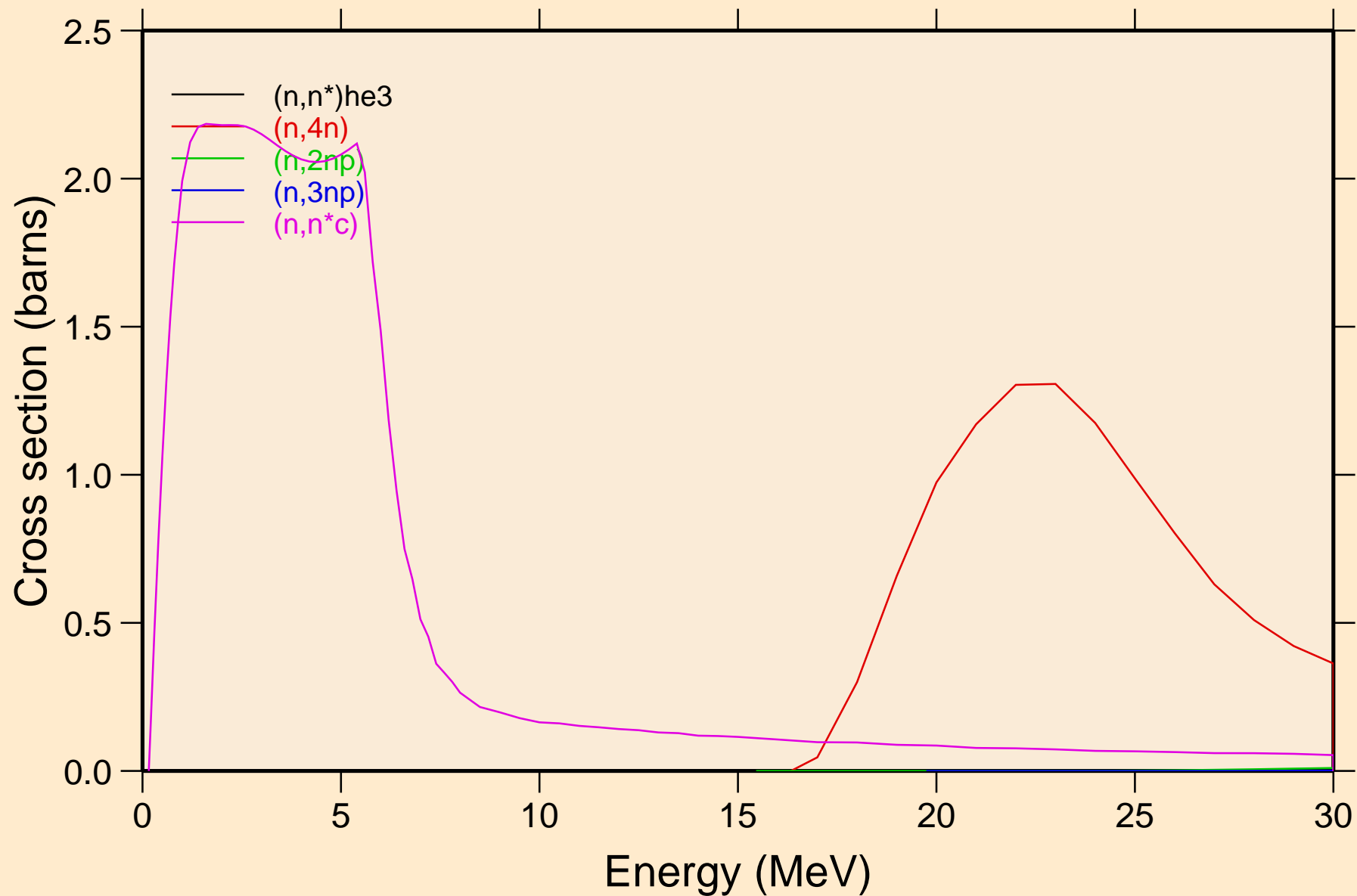

EU165 NEUTRON ACER TENDL-2019 LIBRARY; T=293.16K
Threshold reactions

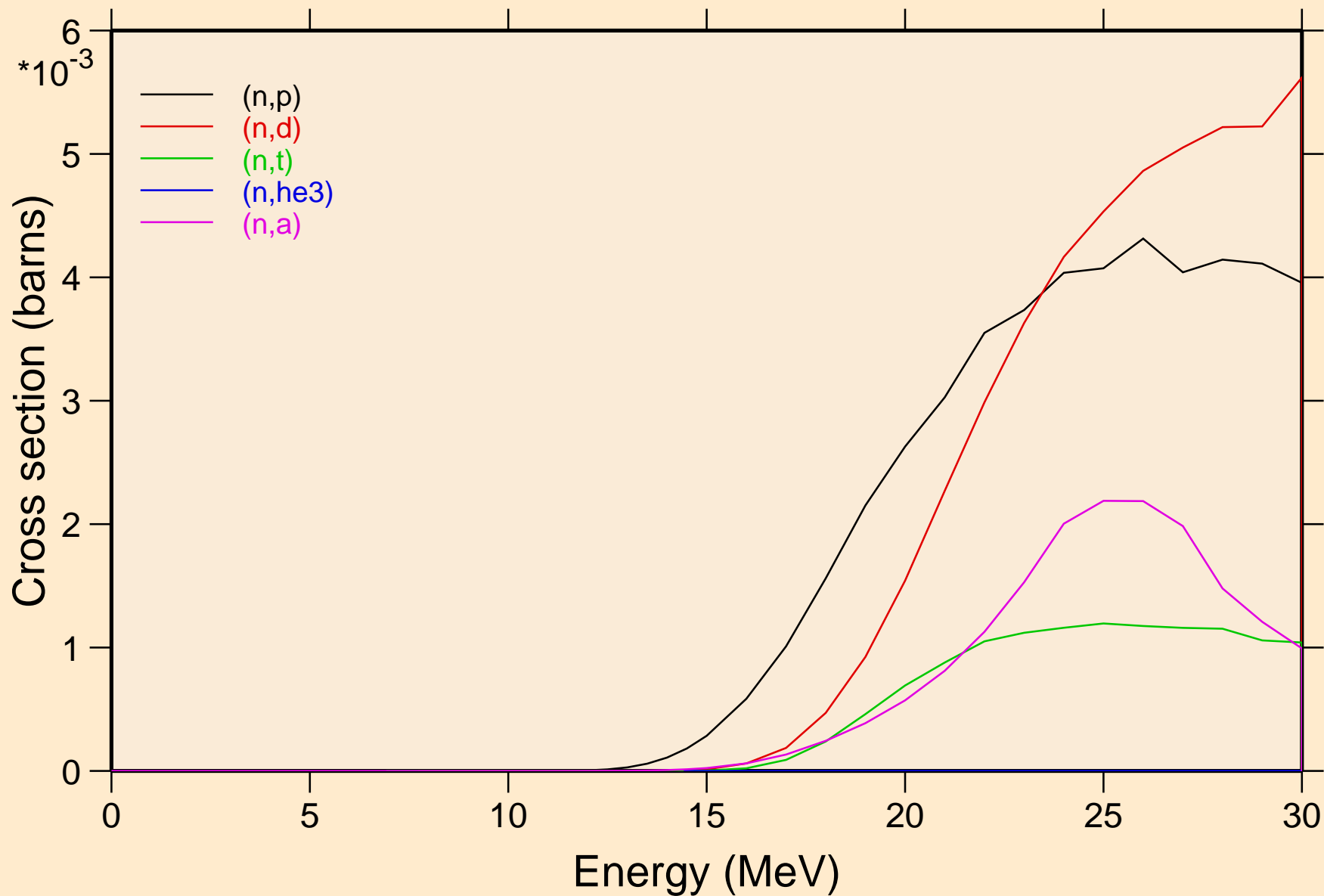

EU165 NEUTRON ACER TENDL-2019 LIBRARY; T=293.16K
Threshold reactions

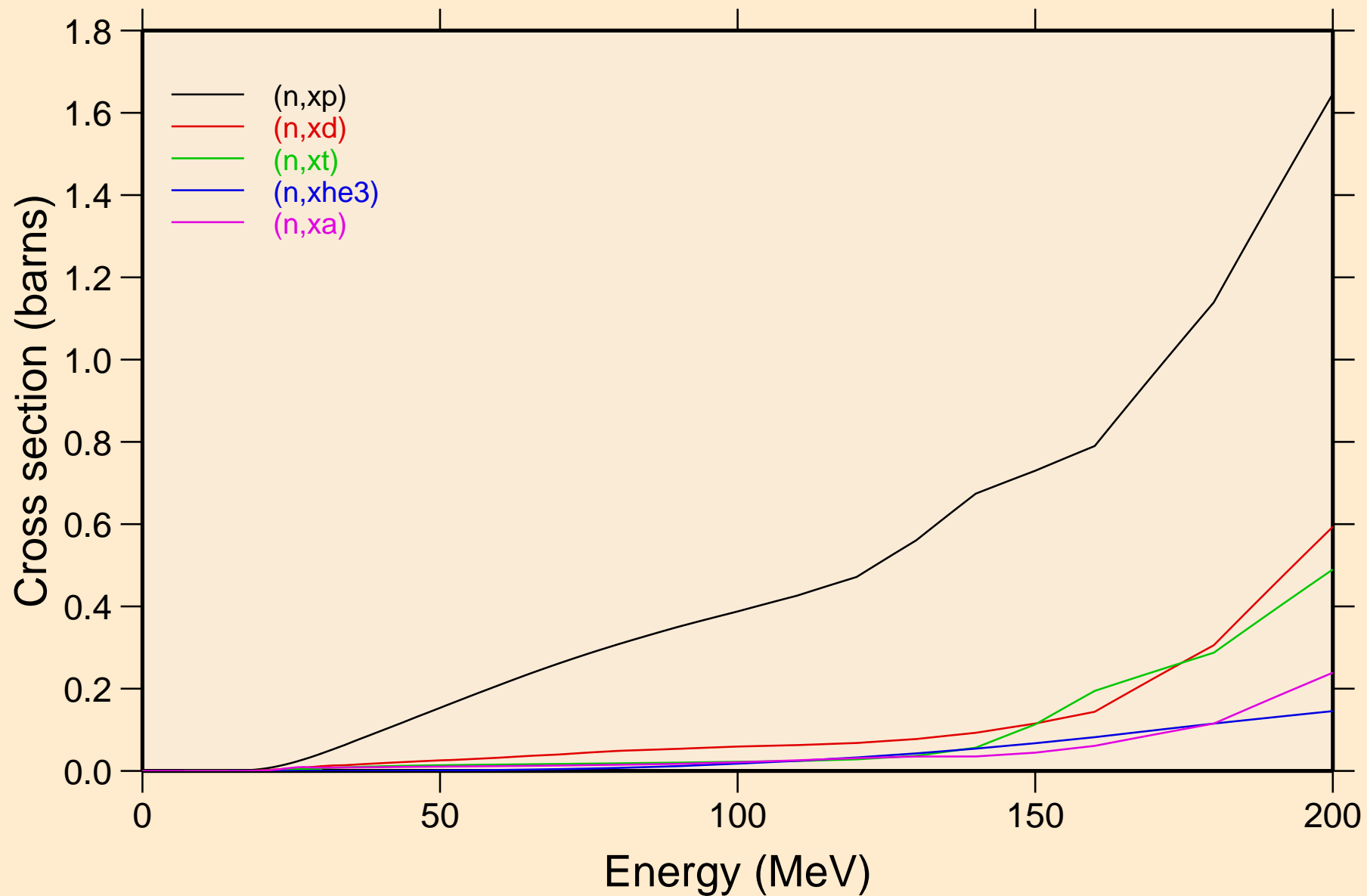

EU165 NEUTRON ACER TENDL-2019 LIBRARY; T=293.16K
angular distribution for elastic

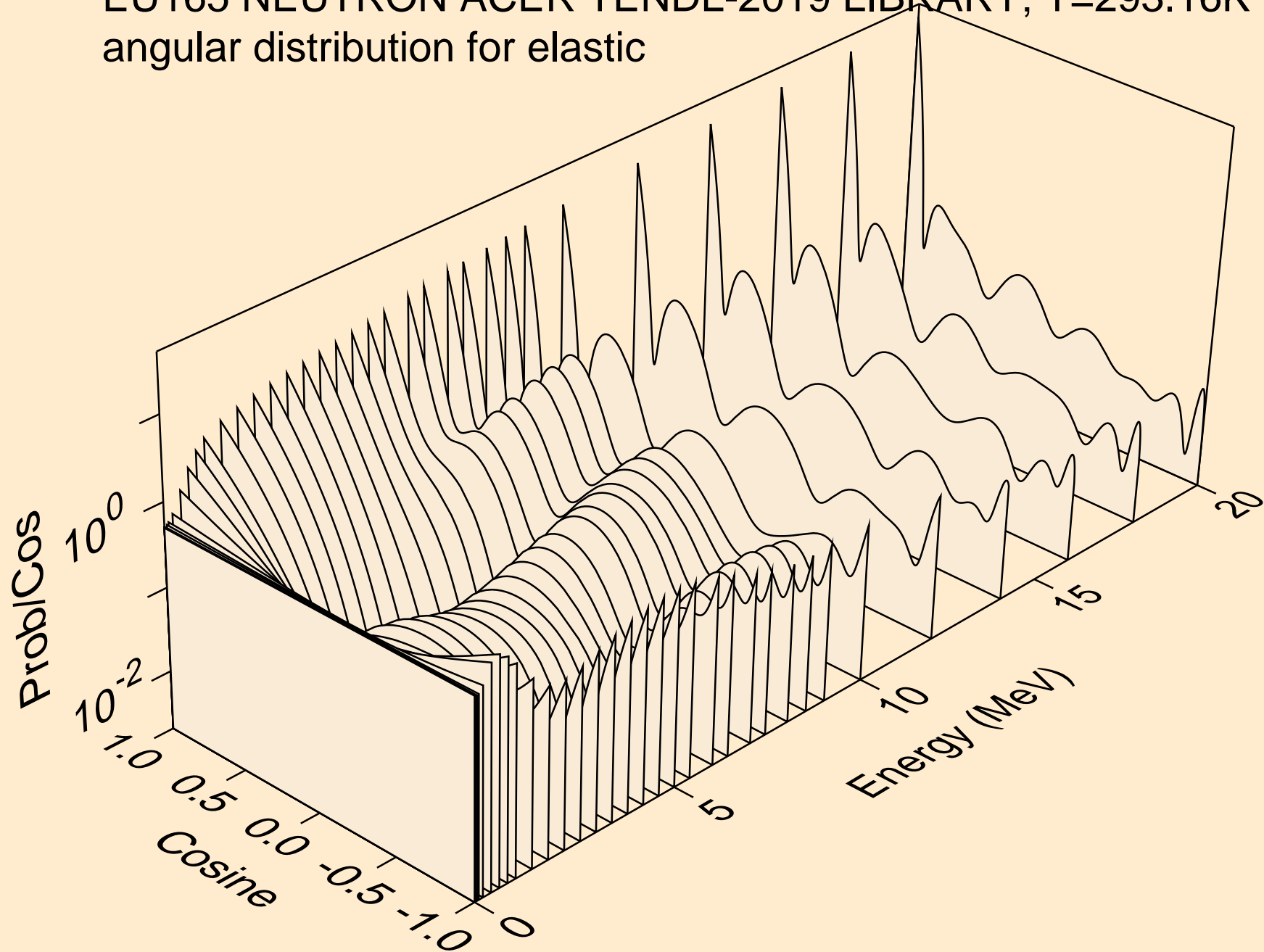

EU165 NEUTRON ACER TENDL-2019 LIBRARY; T=293.16K
angular distribution for elastic

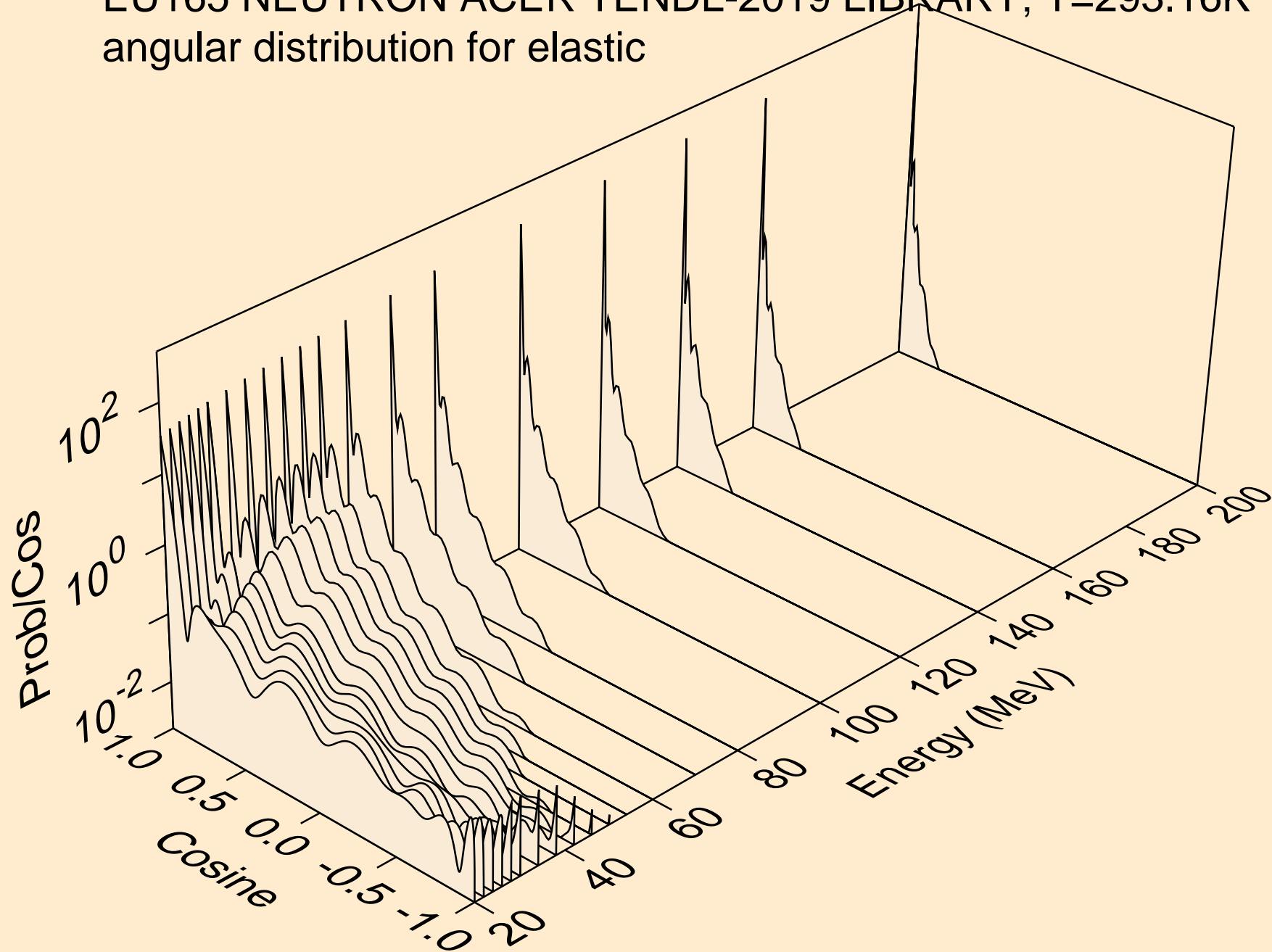

EU165 NEUTRON ACER TENDL-2019 LIBRARY; T=293.16K
angular distribution for (n,n*1)

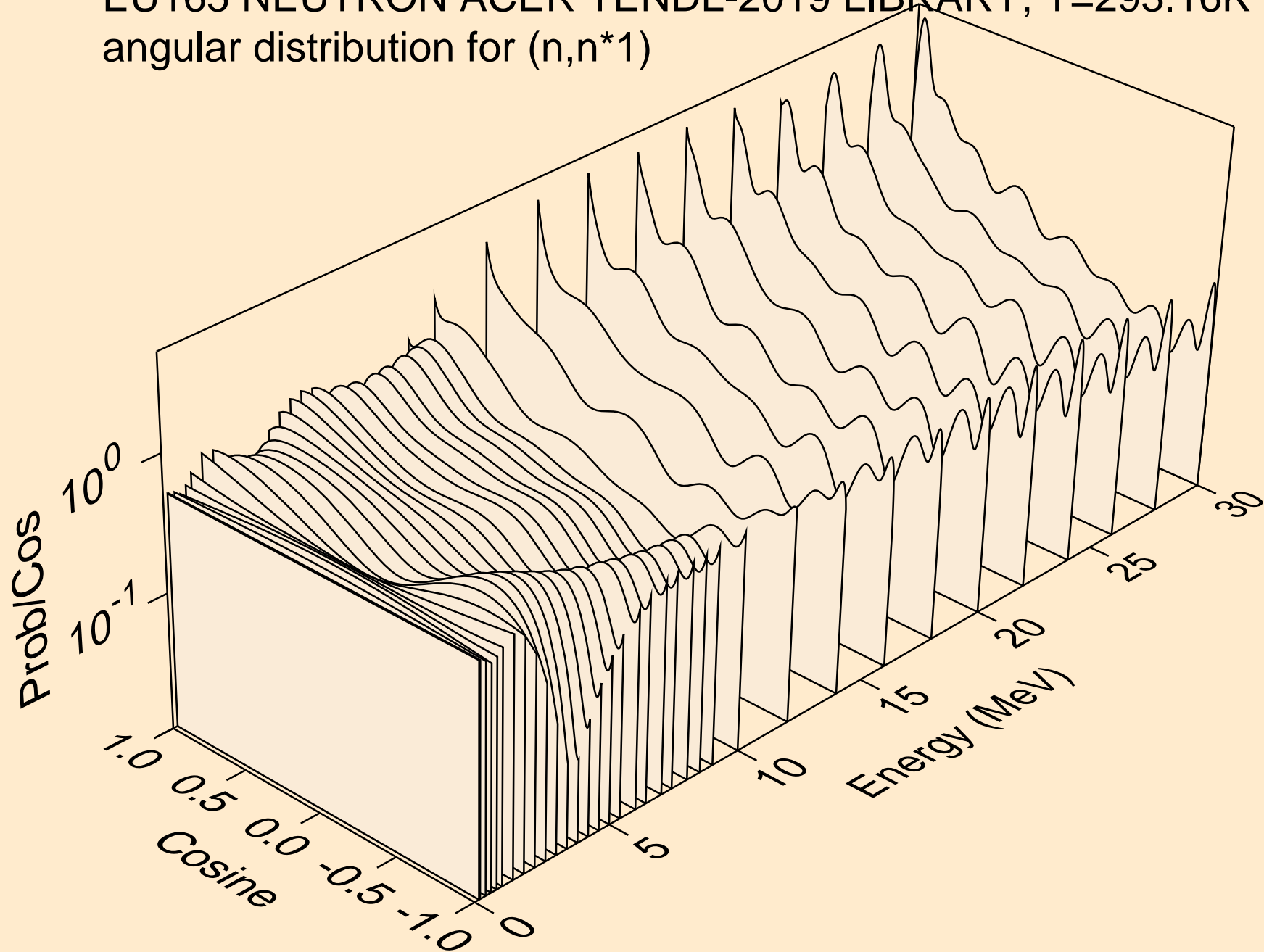

EU165 NEUTRON ACER TENDL-2019 LIBRARY; T=293.16K
Neutron emission for (n,x)

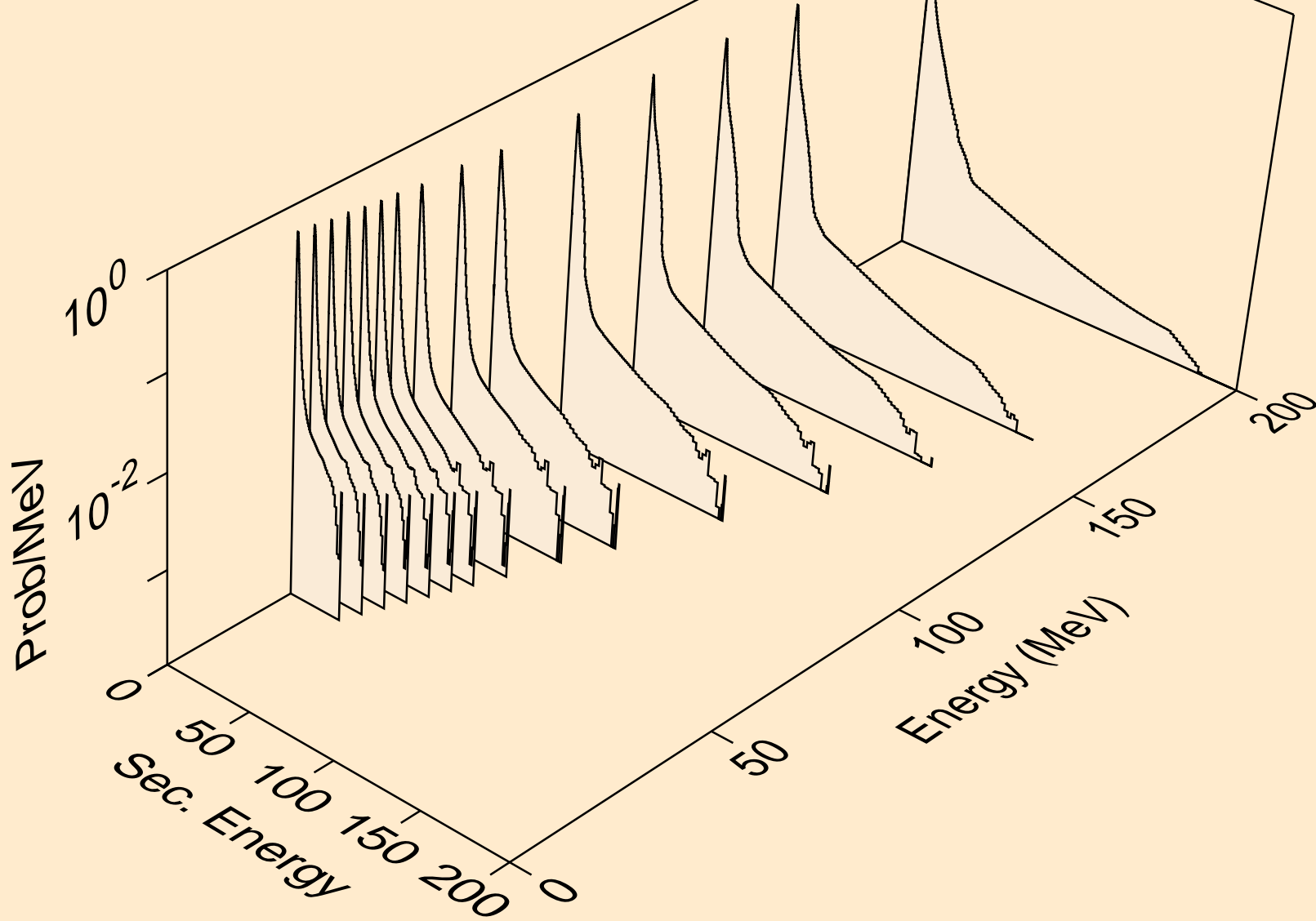

EU165 NEUTRON ACER TENDL-2019 LIBRARY; T=293.16K
Neutron emission for (n,2nd)

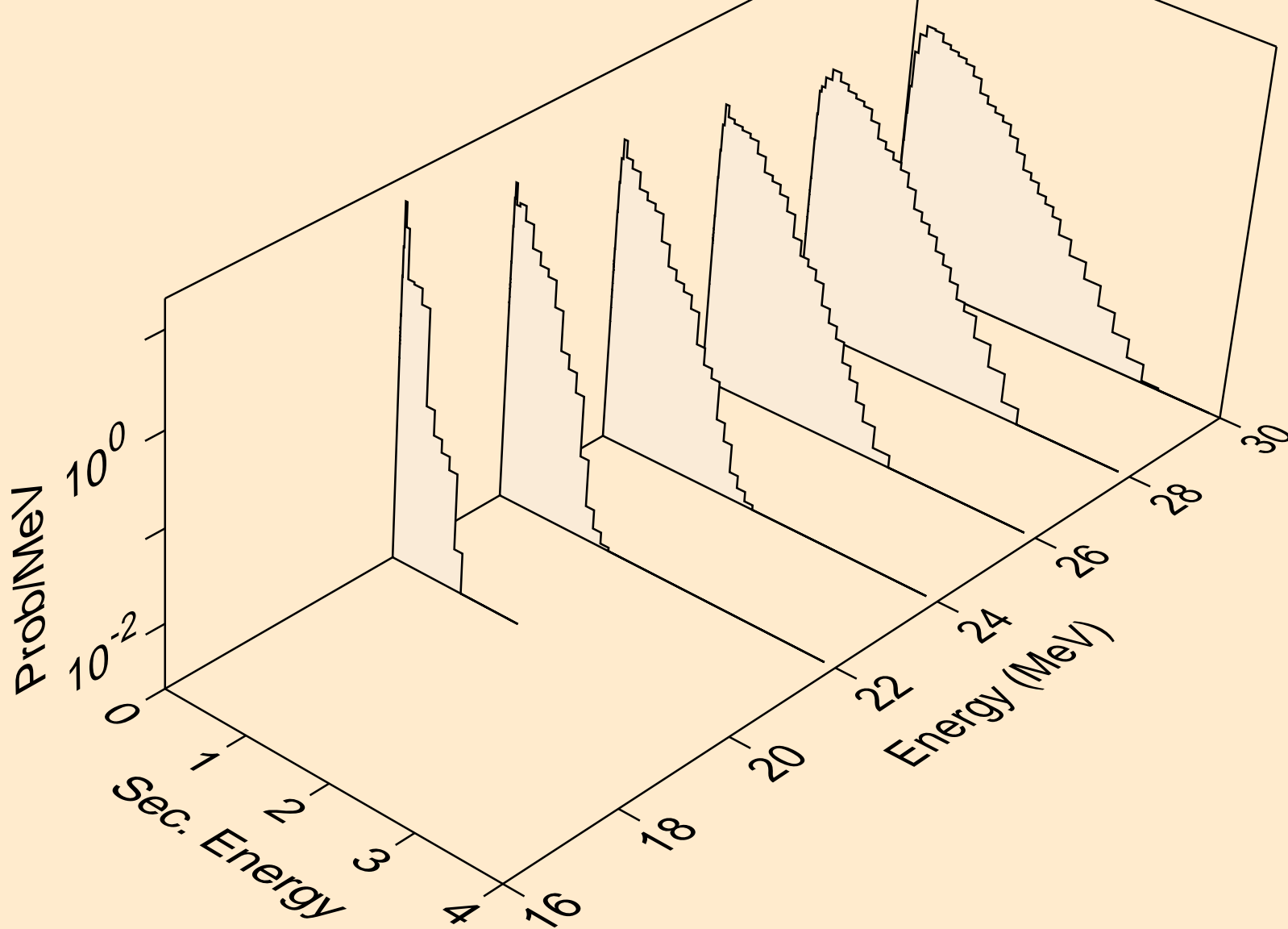

EU165 NEUTRON ACER TENDL-2019 LIBRARY; T=293.16K
Neutron emission for (n,2n)

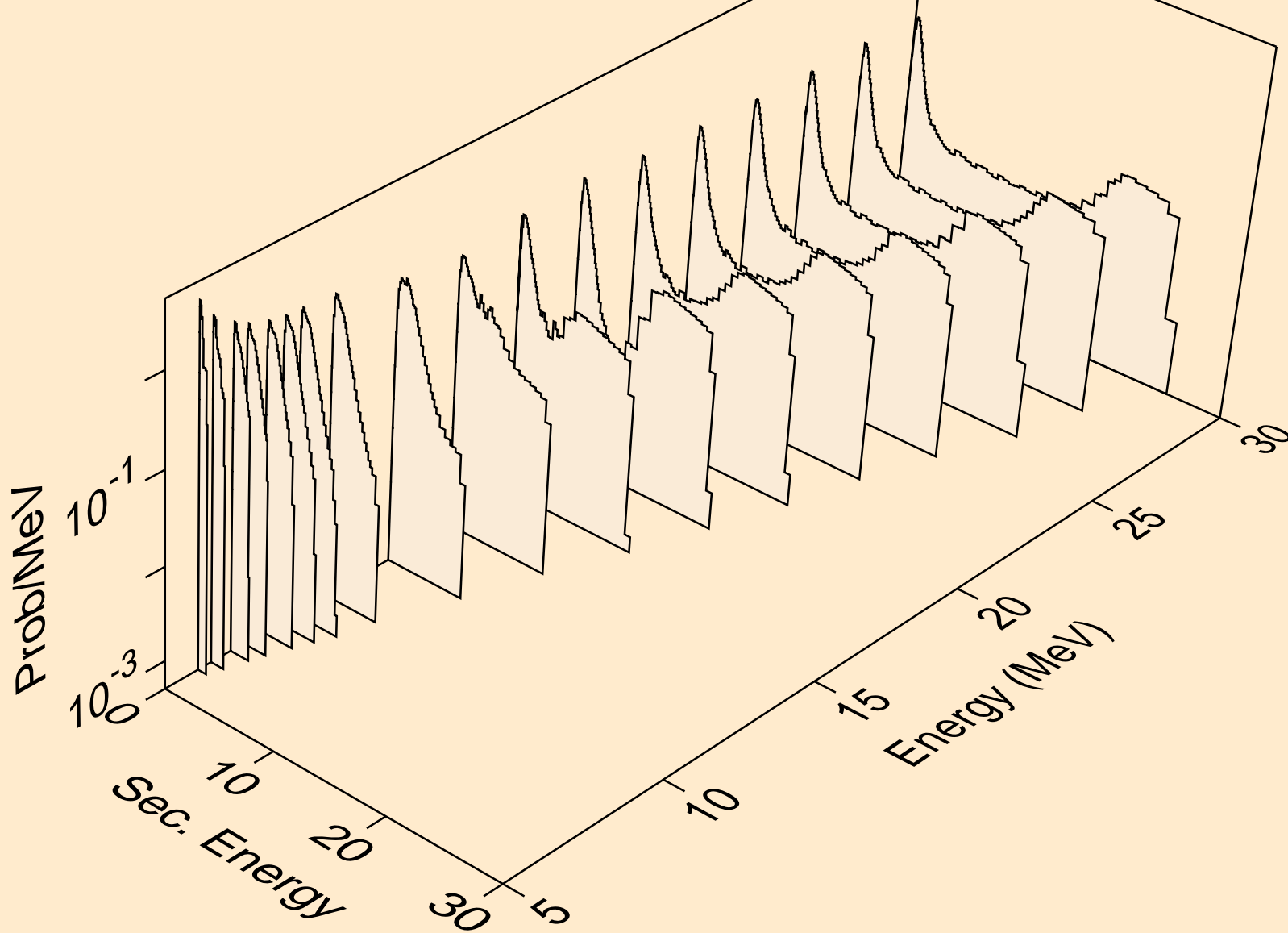

EU165 NEUTRON ACER TENDL-2019 LIBRARY; T=293.16K
Neutron emission for (n,3n)

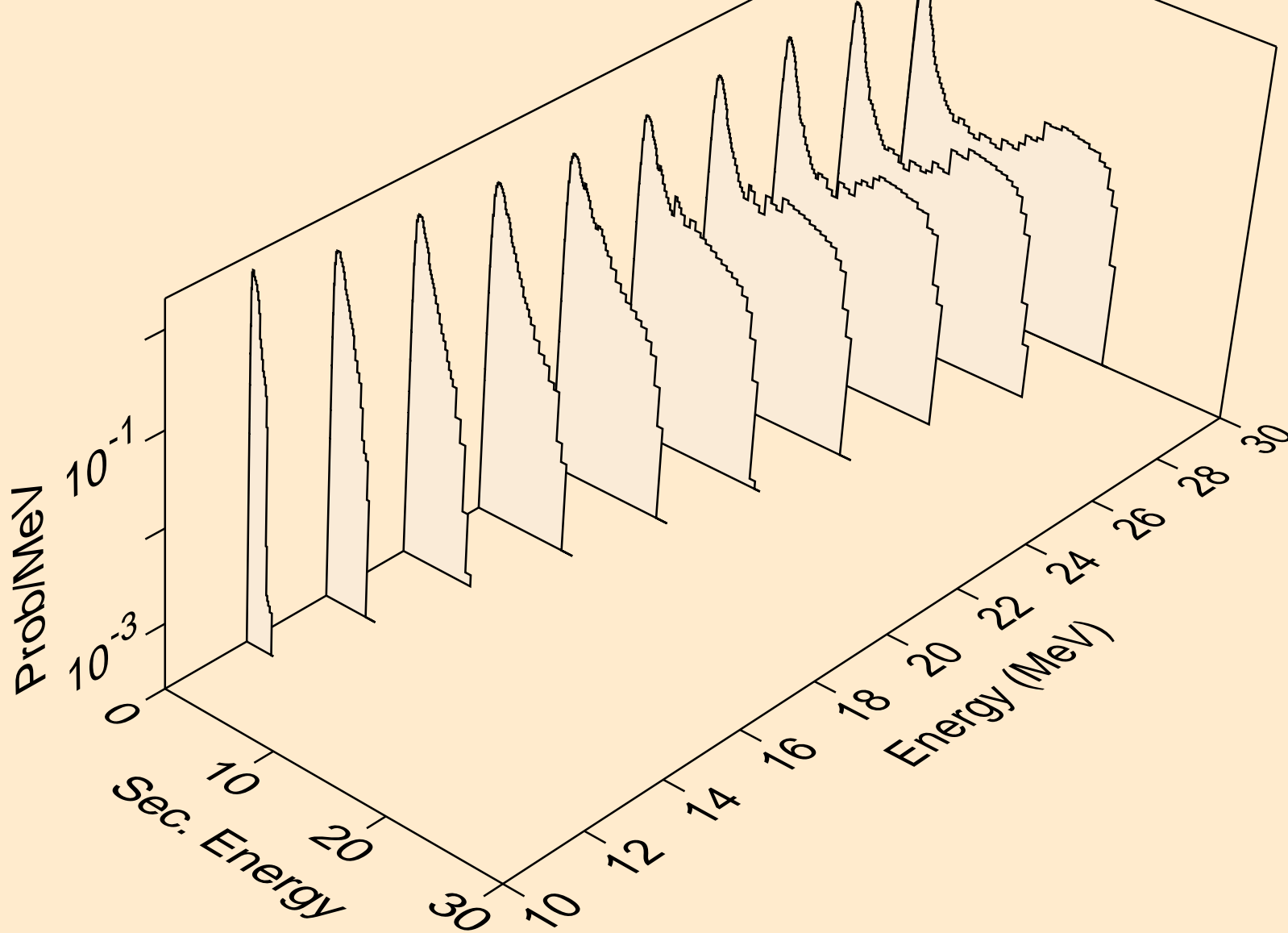

EU165 NEUTRON ACER TENDL-2019 LIBRARY; T=293.16K
Neutron emission for (n,n*)a

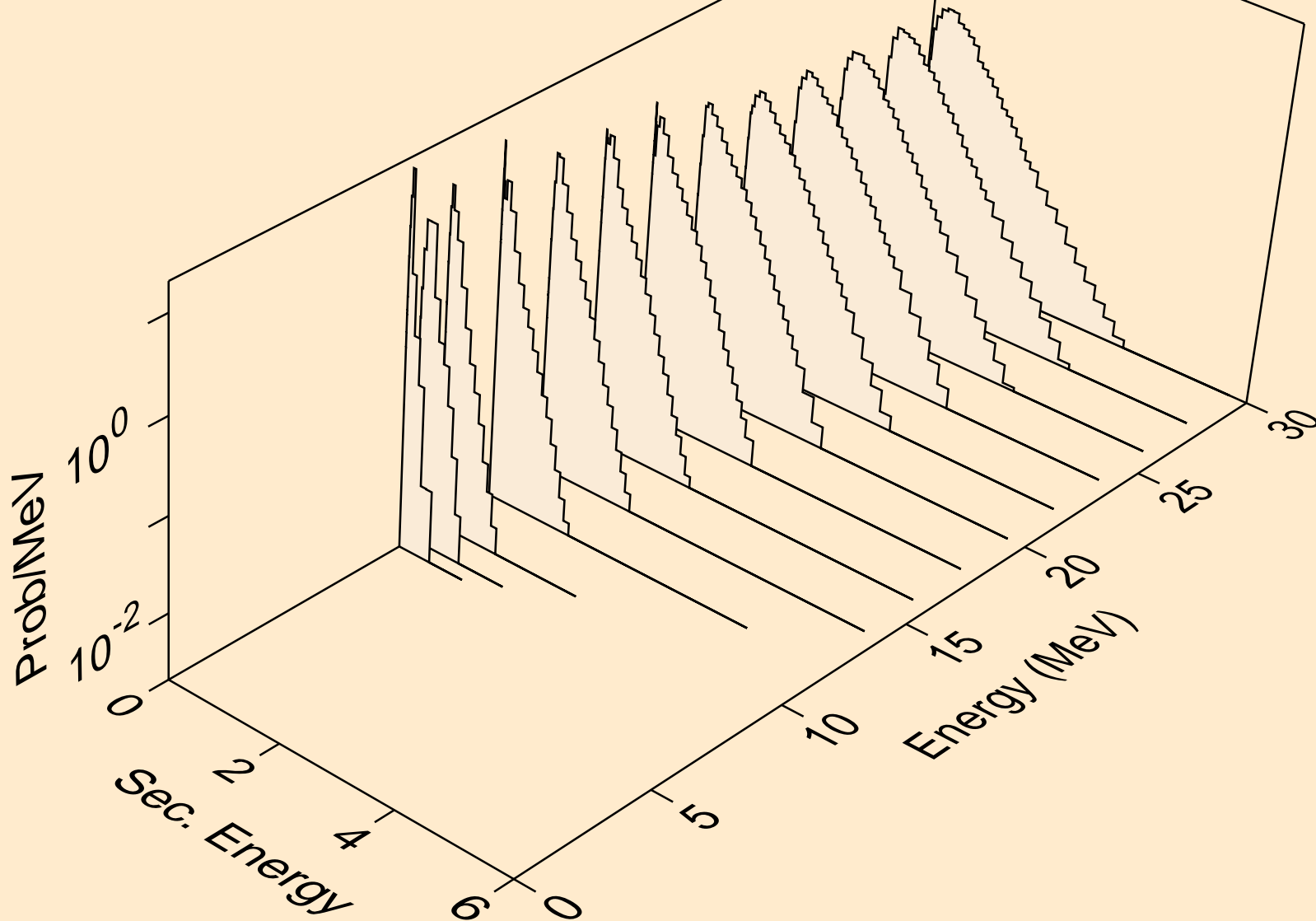

EU165 NEUTRON ACER TENDL-2019 LIBRARY; T=293.16K
Neutron emission for (n,2n)a

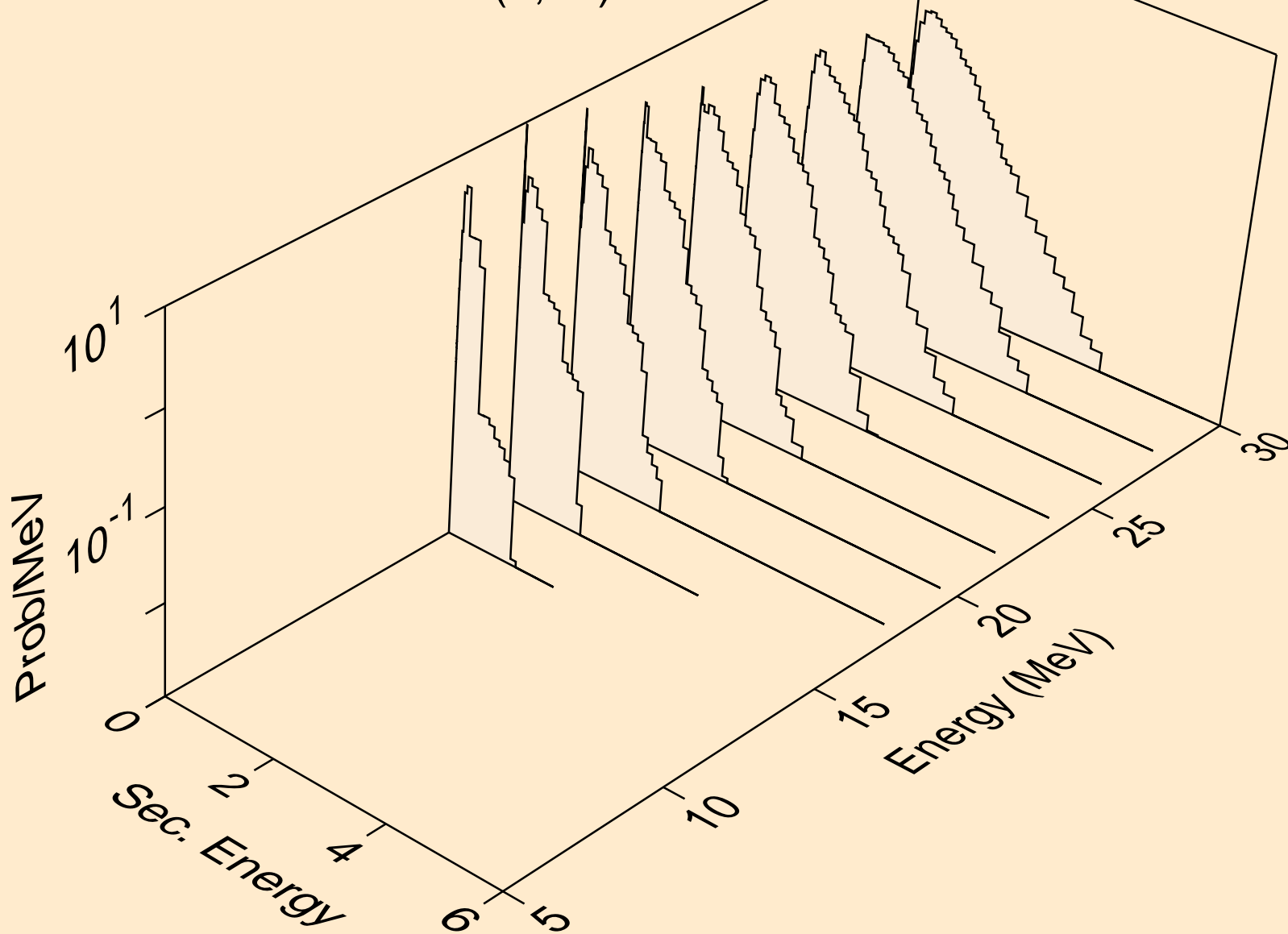

EU165 NEUTRON ACER TENDL-2019 LIBRARY; T=293.16K
Neutron emission for (n,3n)a

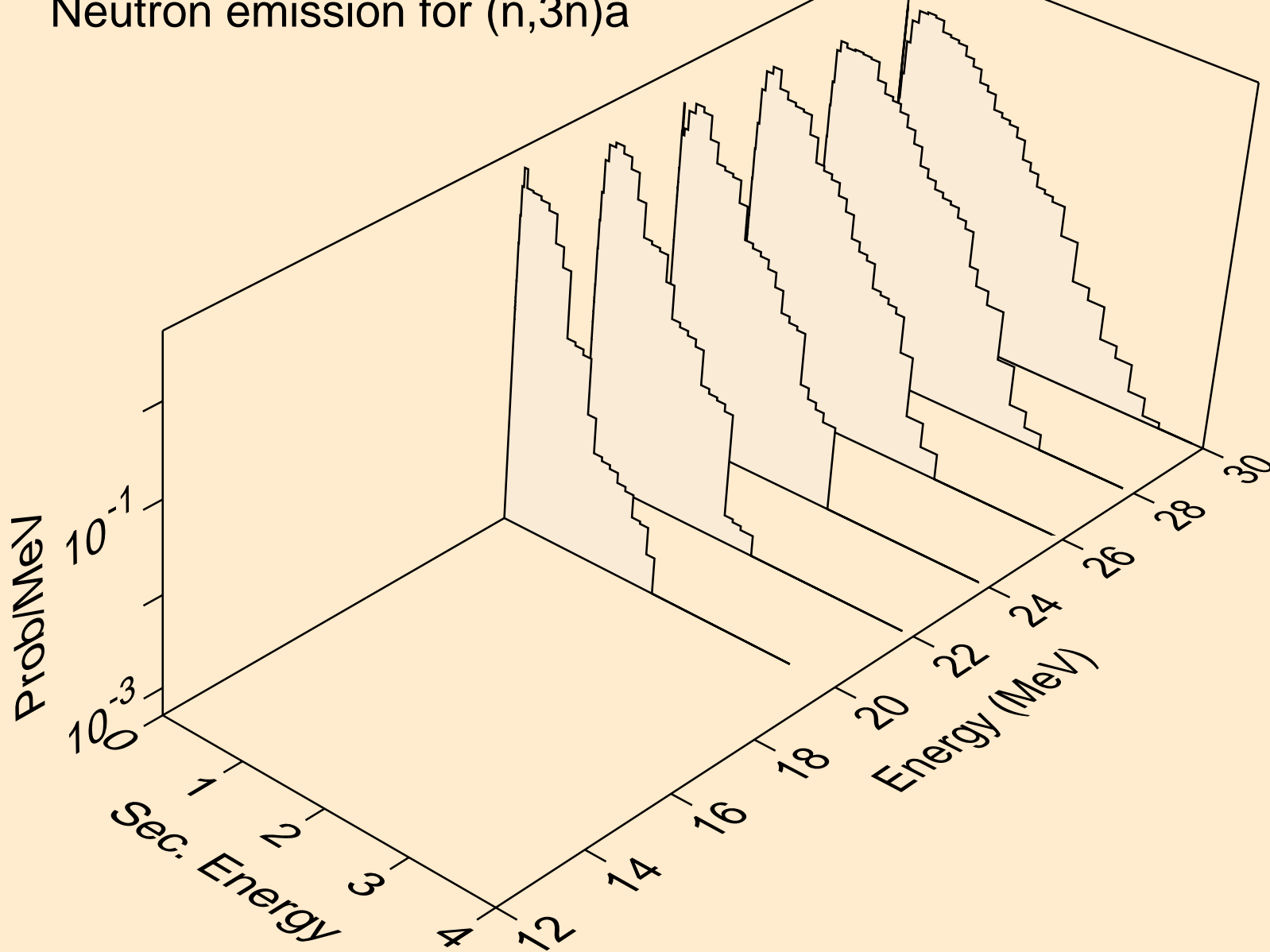

EU165 NEUTRON ACER TENDL-2019 LIBRARY; T=293.16K
Neutron emission for (n,n*)p

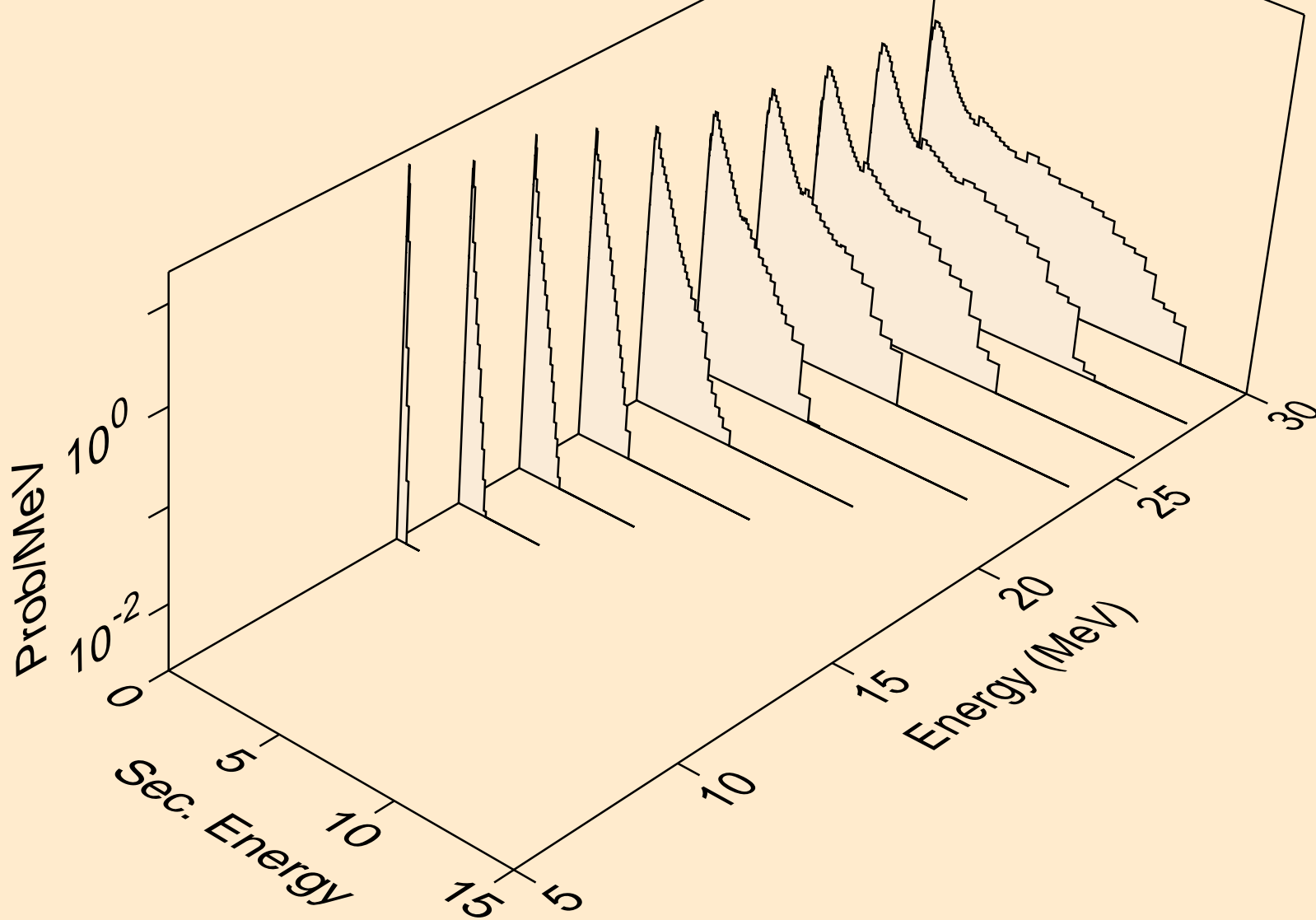

EU165 NEUTRON ACER TENDL-2019 LIBRARY; T=293.16K
Neutron emission for (n,n*)d

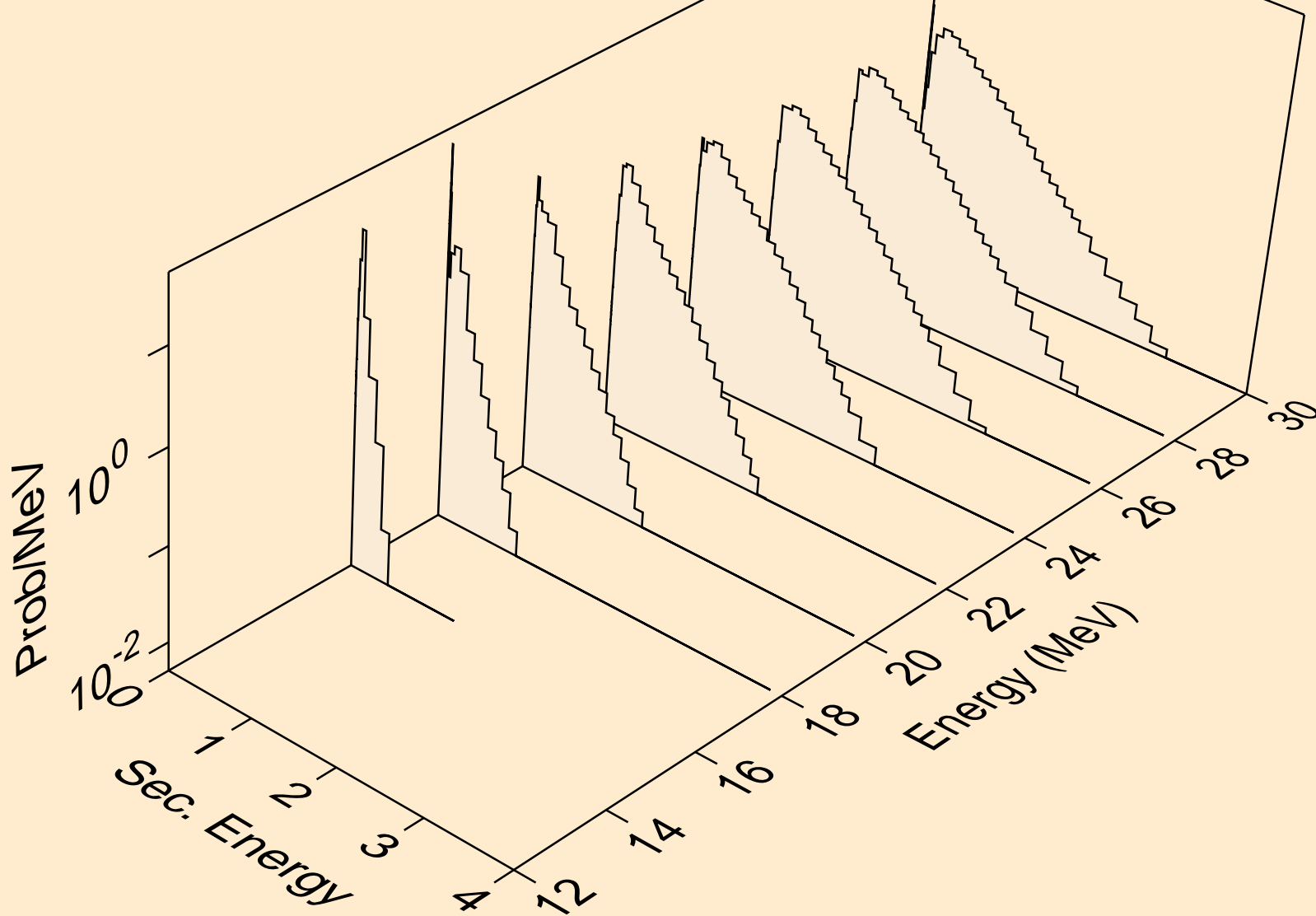

EU165 NEUTRON ACER TENDL-2019 LIBRARY; T=293.16K
Neutron emission for (n,n*)t

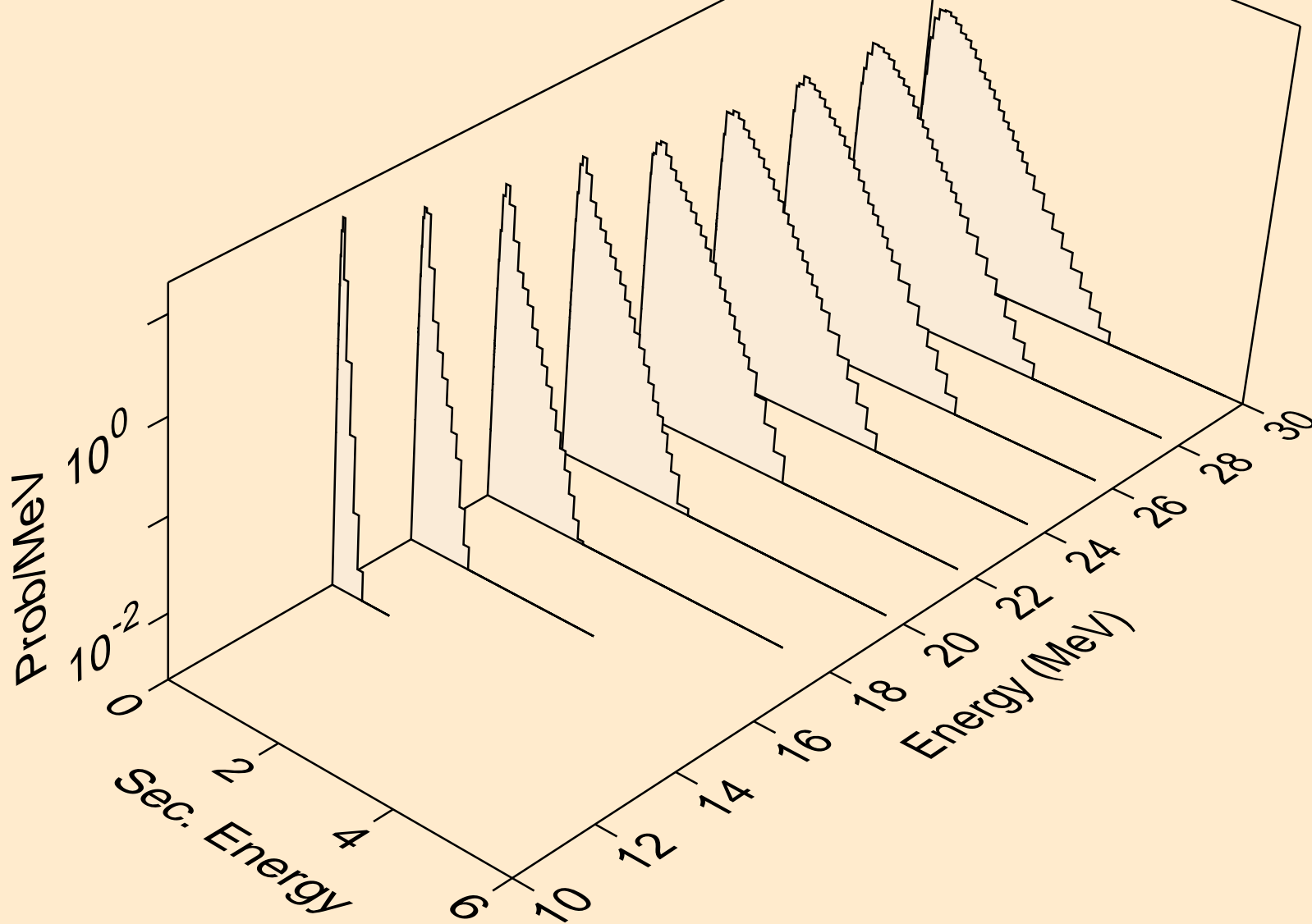

EU165 NEUTRON ACER TENDL-2019 LIBRARY; T=293.16K
Neutron emission for (n,n*)he3

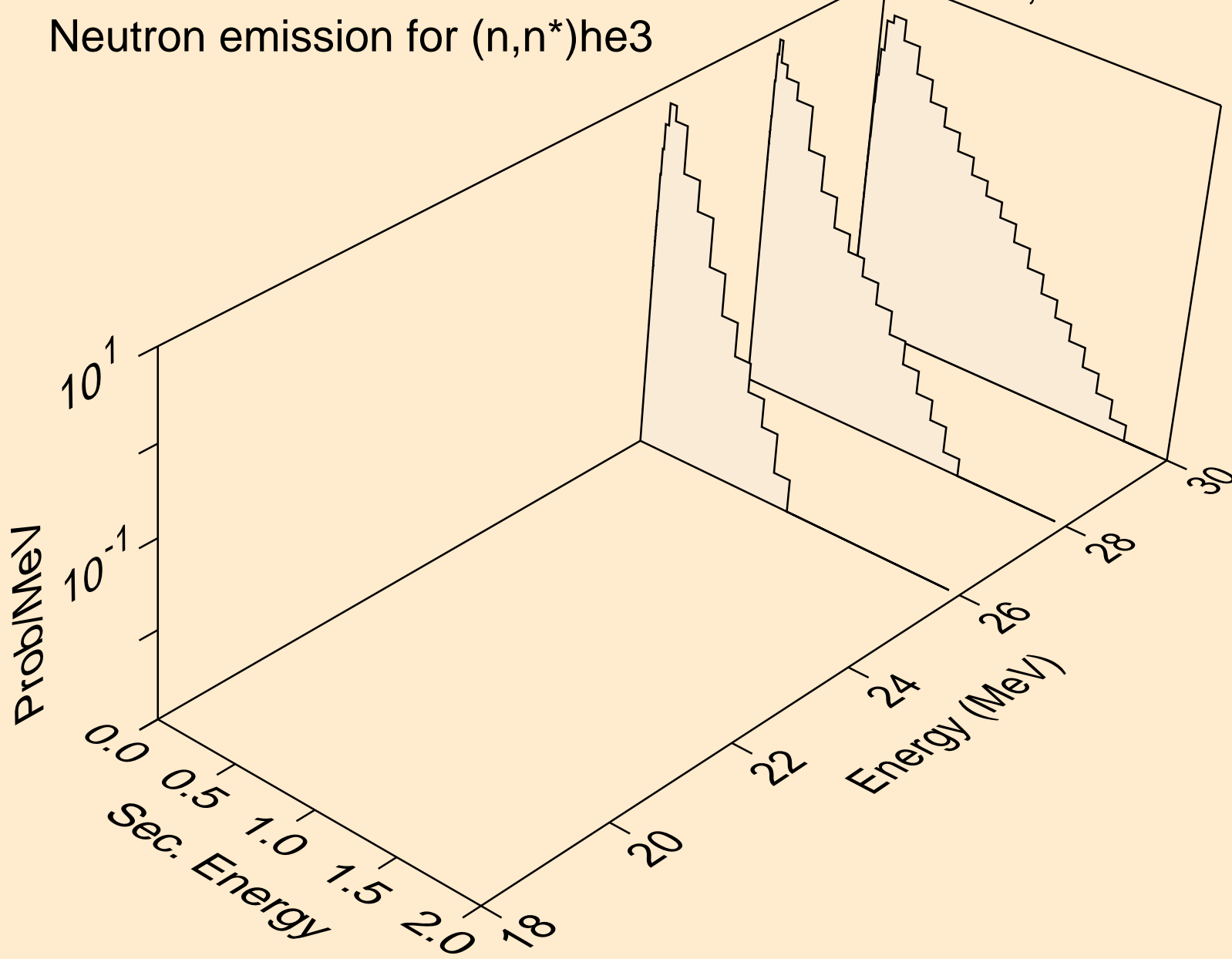

EU165 NEUTRON ACER TENDL-2019 LIBRARY; T=293.16K
Neutron emission for (n,4n)

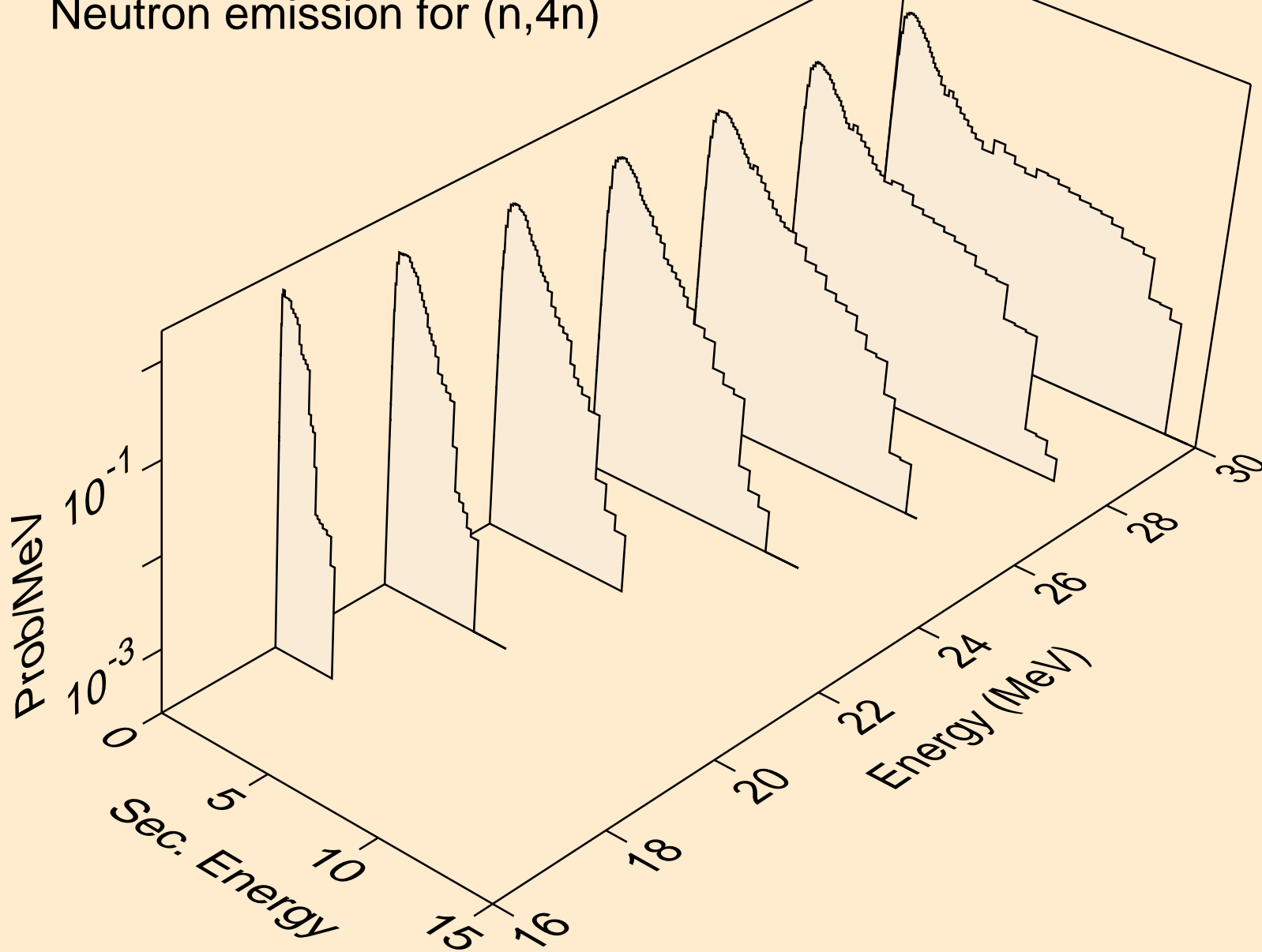

EU165 NEUTRON ACER TENDL-2019 LIBRARY; T=293.16K
Neutron emission for (n,2np)

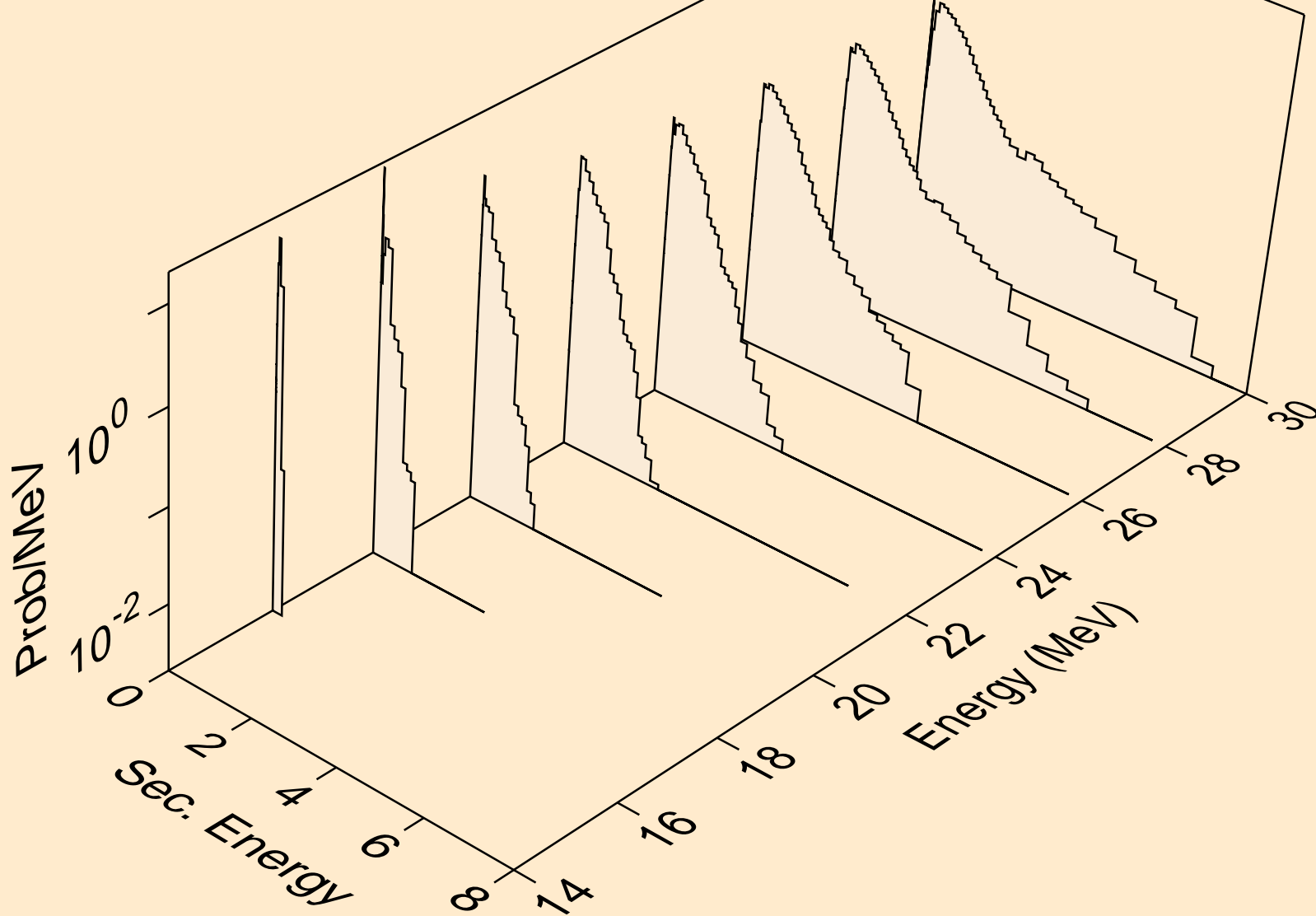

EU165 NEUTRON ACER TENDL-2019 LIBRARY; T=293.16K
Neutron emission for (n,3np)

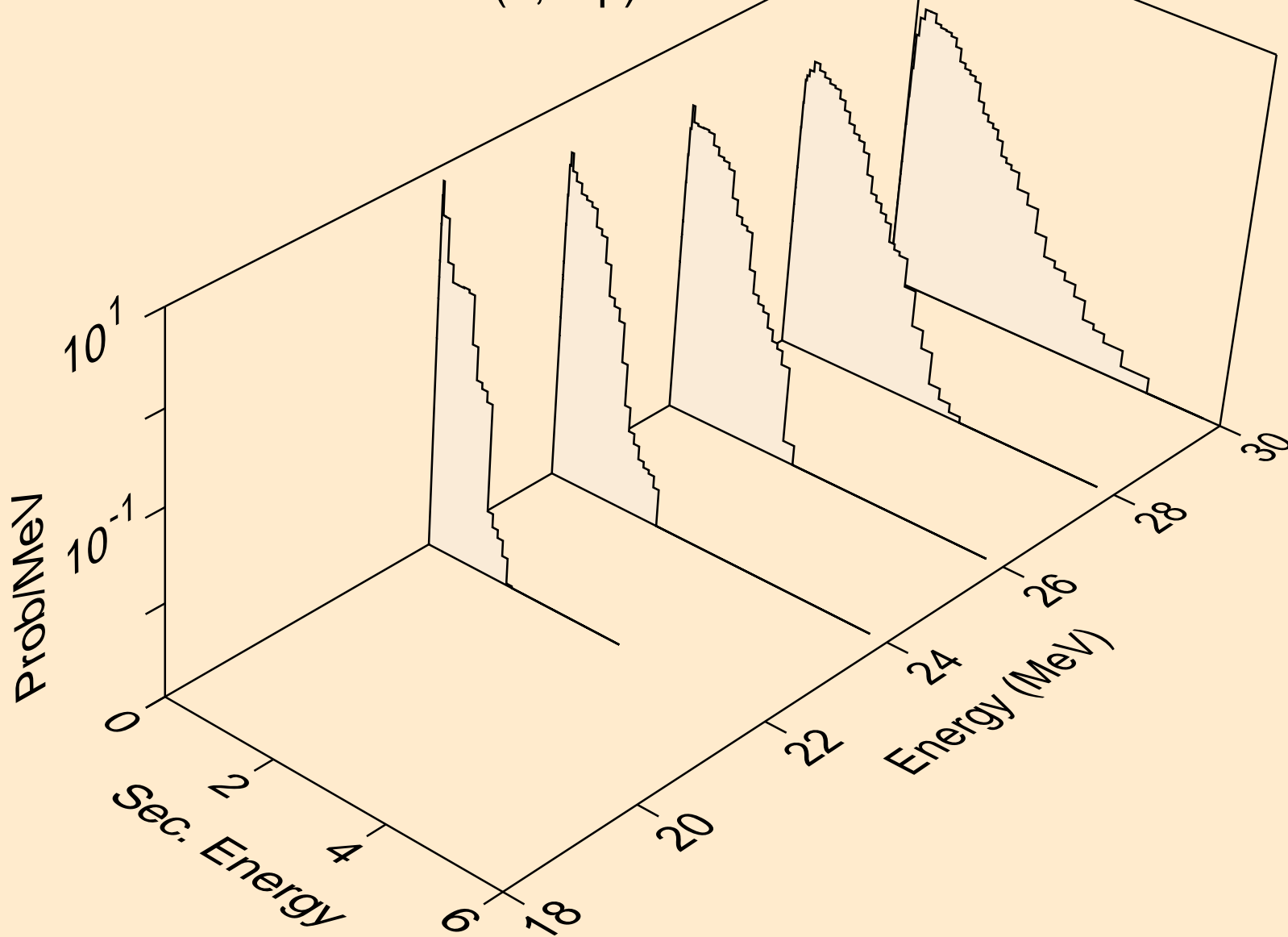

EU165 NEUTRON ACER TENDL-2019 LIBRARY; T=293.16K
Neutron emission for (n,n*c)

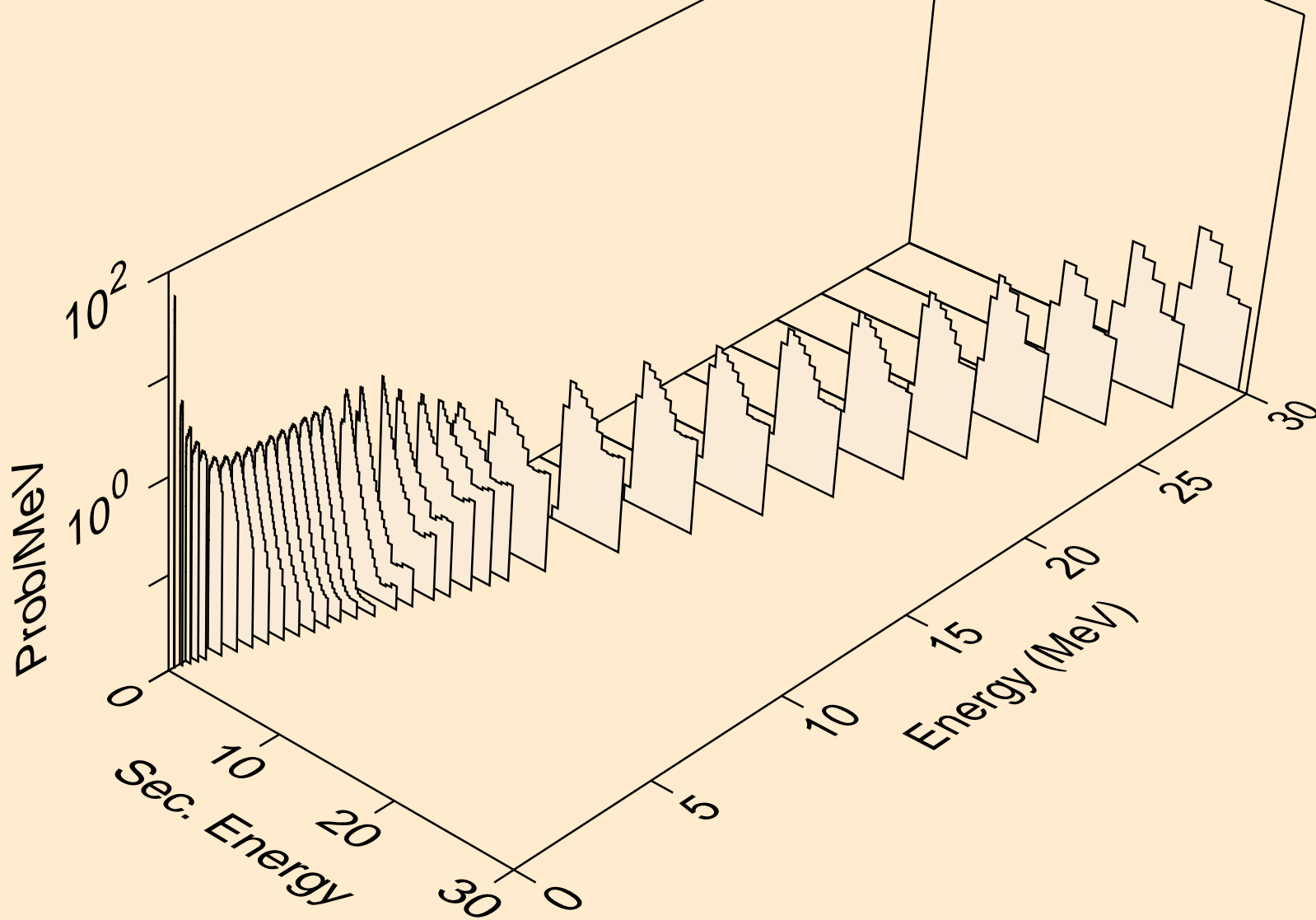

EU165 NEUTRON ACER TENDL-2019 LIBRARY; T=293.16K
Photon emission for (n,x)

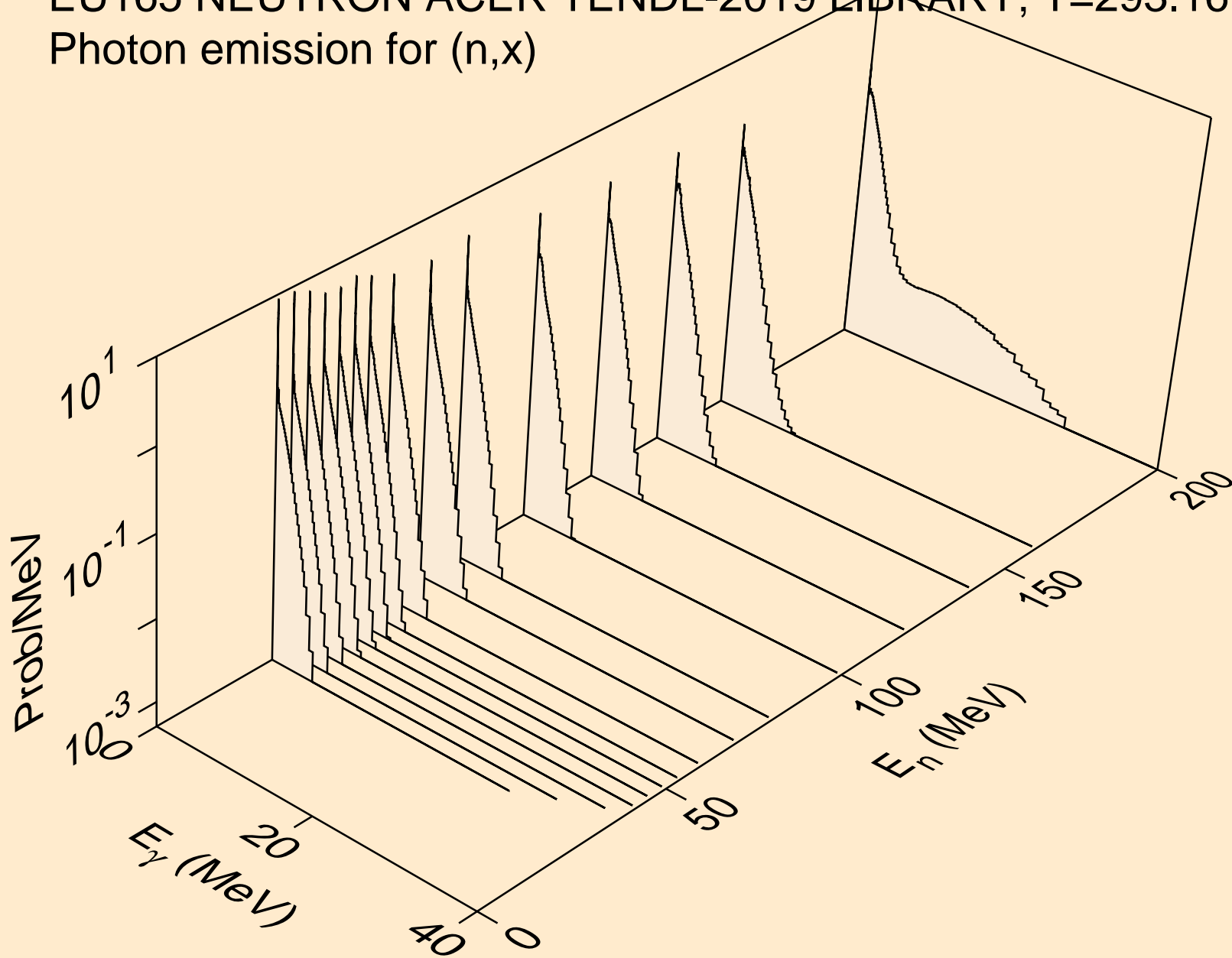

EU165 NEUTRON ACER TENDL-2019 LIBRARY; T=293.16K
Photon emission for (n,2nd)

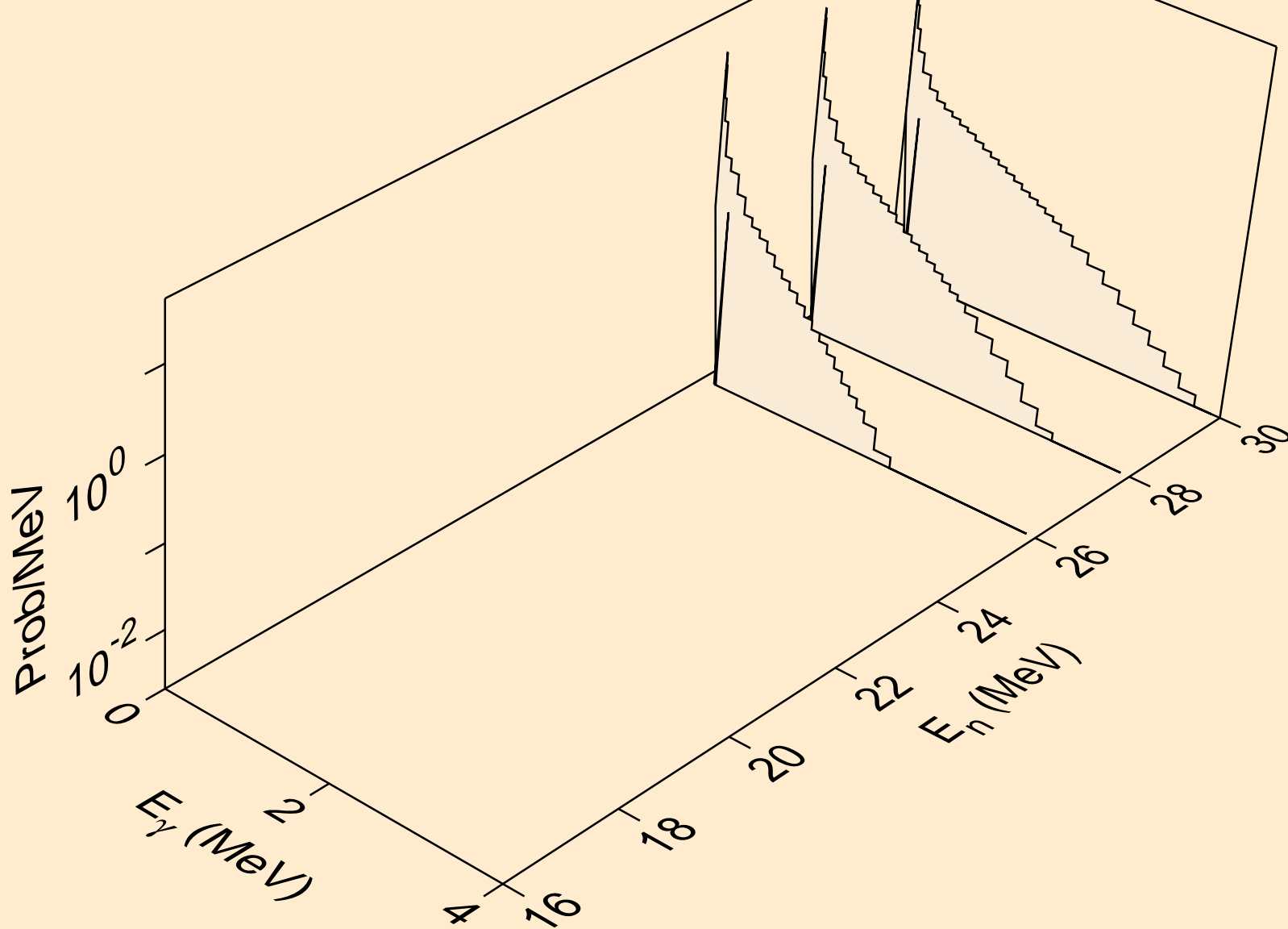

EU165 NEUTRON ACER TENDL-2019 LIBRARY; T=293.16K
Photon emission for (n,2n)

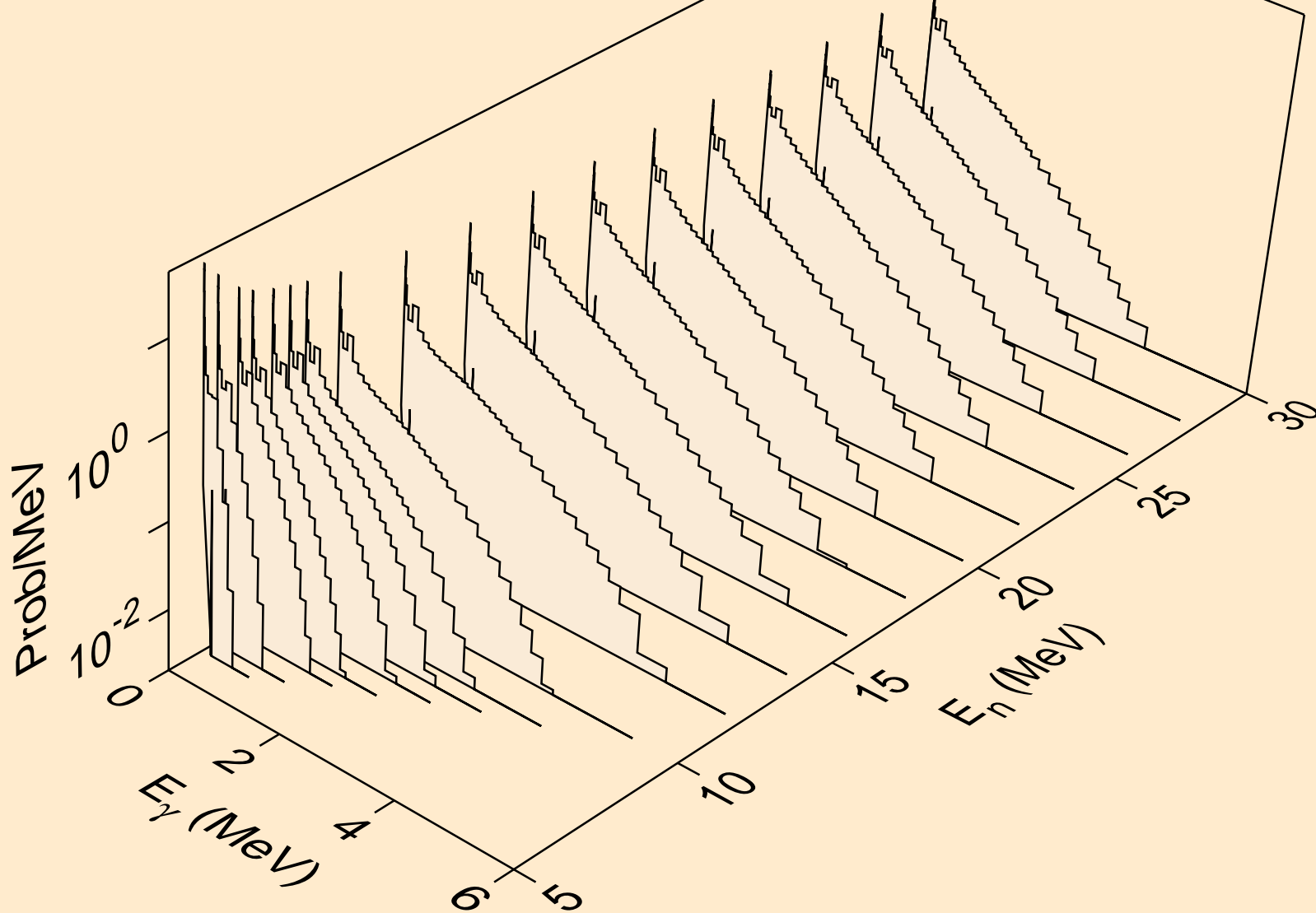

EU165 NEUTRON ACER TENDL-2019 LIBRARY; T=293.16K
Photon emission for (n,3n)

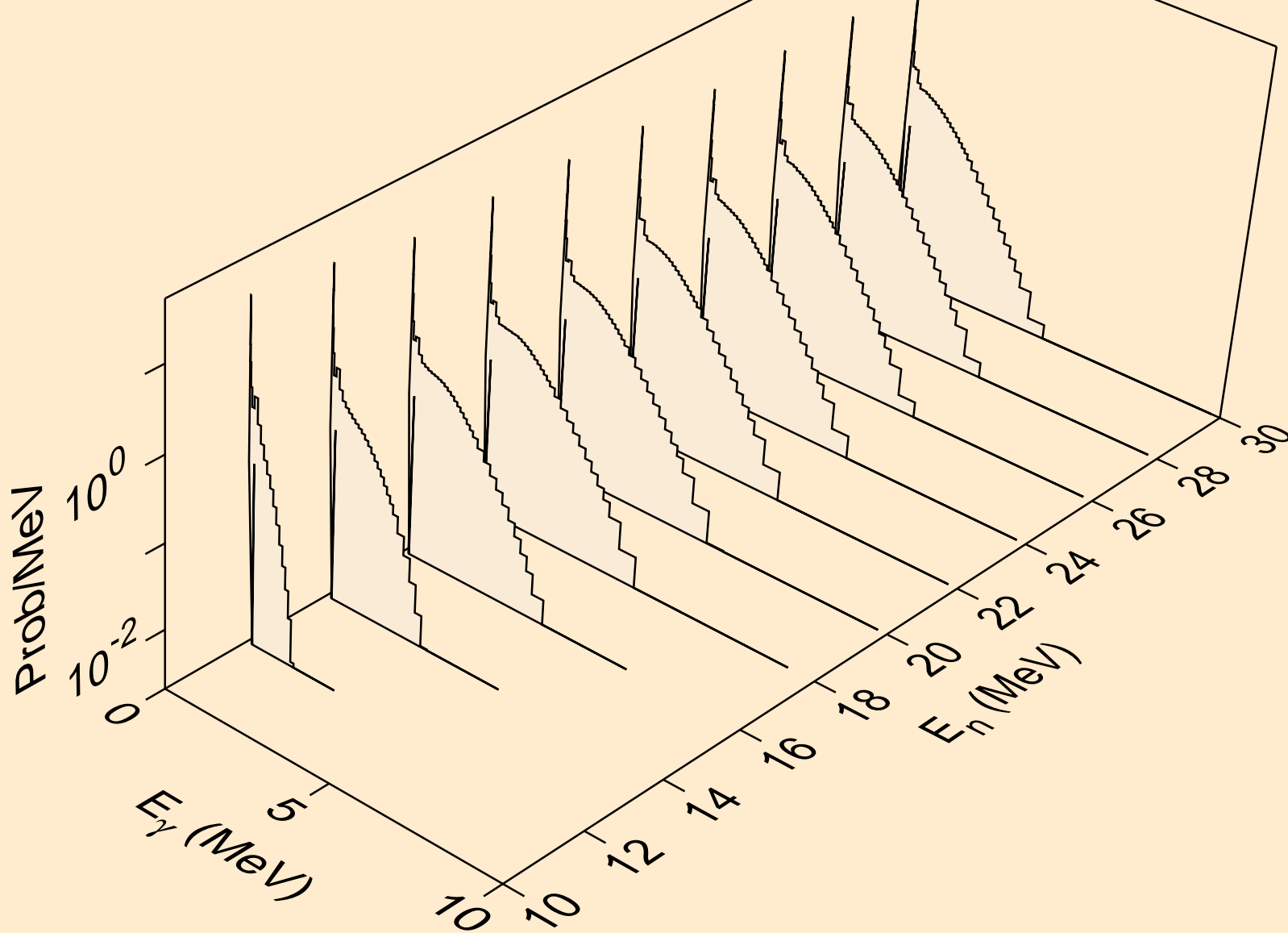

EU165 NEUTRON ACER TENDL-2019 LIBRARY; T=293.16K
Photon emission for (n,n*)a

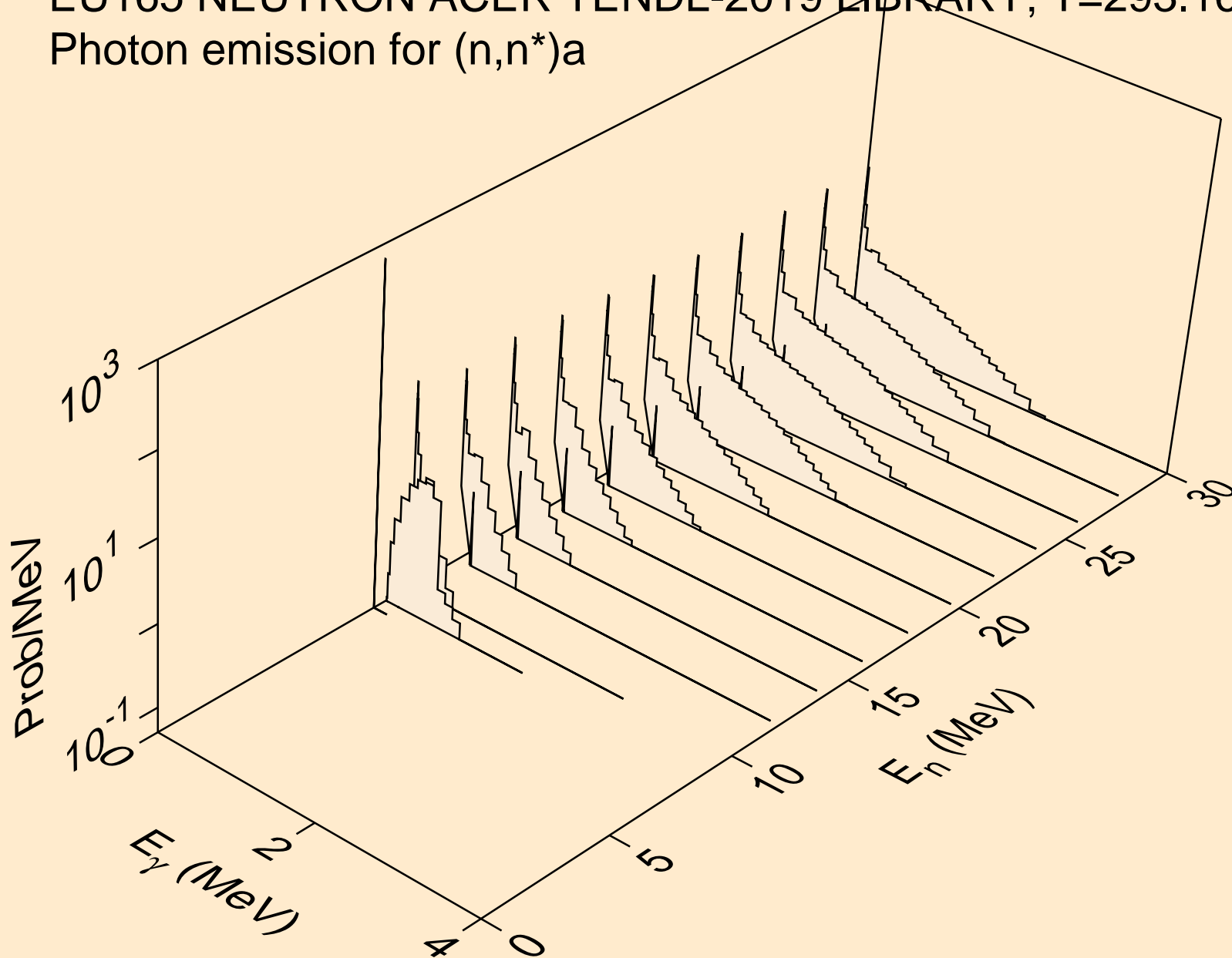

EU165 NEUTRON ACER TENDL-2019 LIBRARY; T=293.16K
Photon emission for (n,2n) α

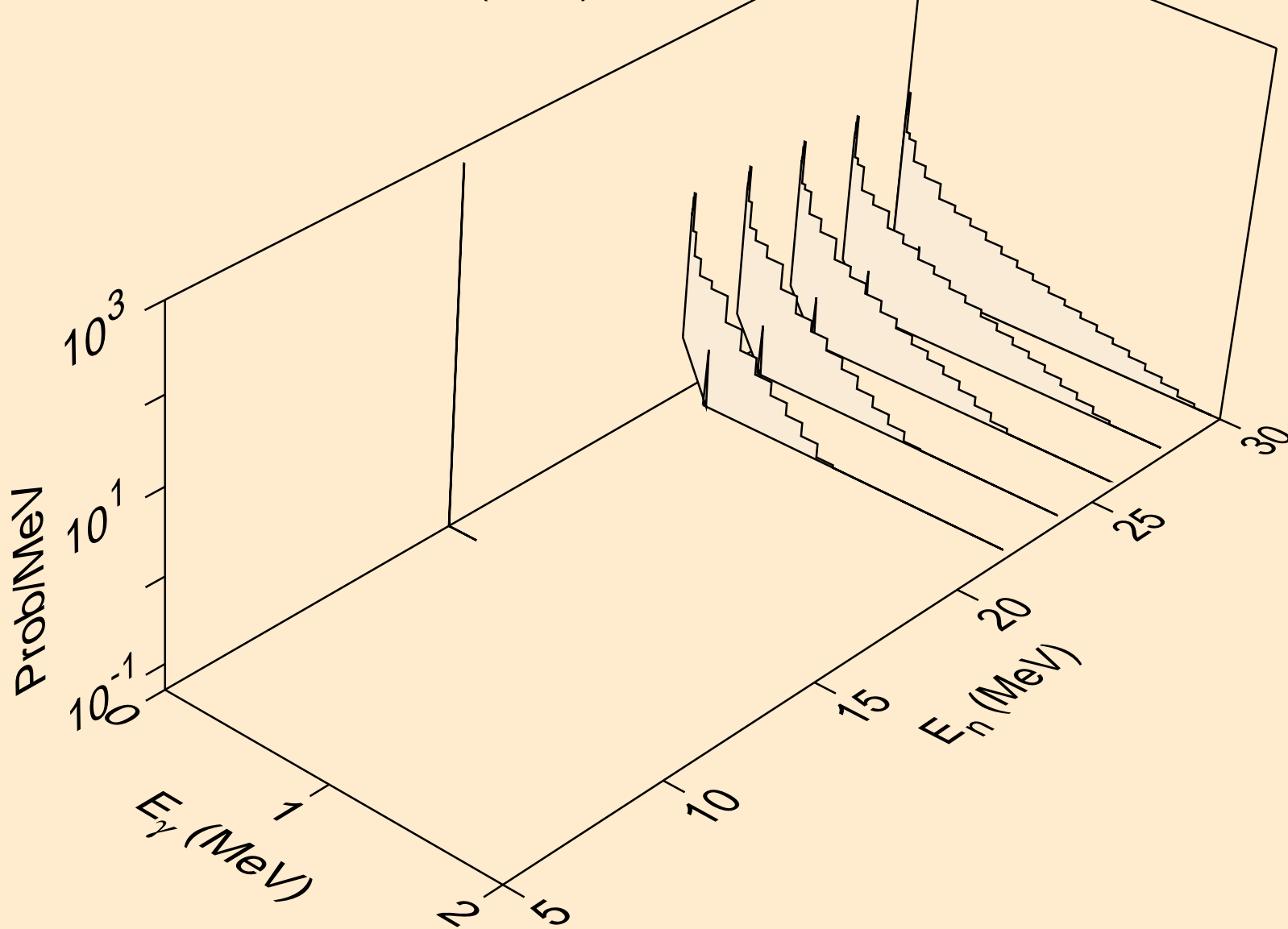

EU165 NEUTRON ACER TENDL-2019 LIBRARY; T=293.16K
Photon emission for (n,3n)a

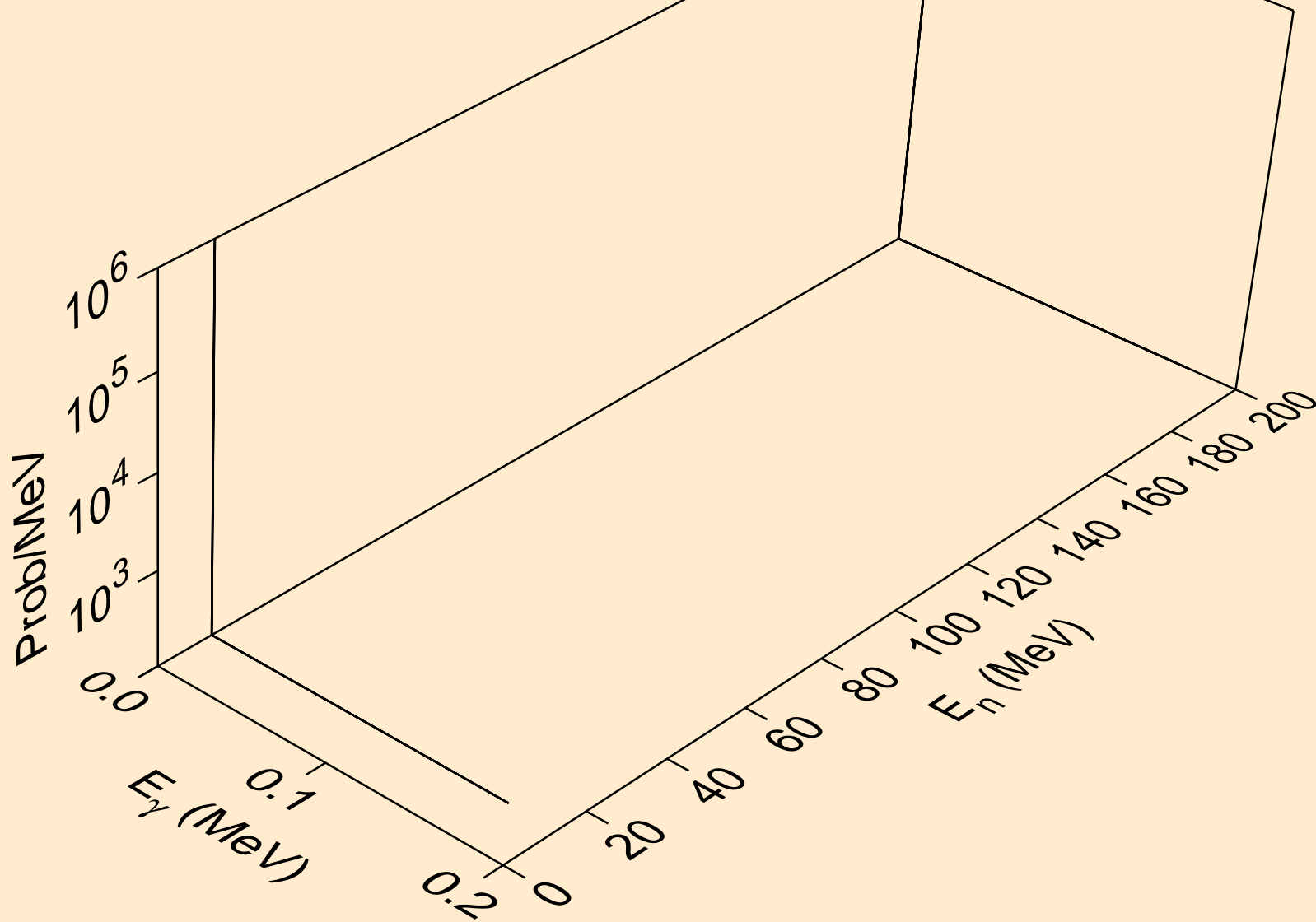

EU165 NEUTRON ACER TENDL-2019 LIBRARY; T=293.16K
Photon emission for (n,n*)p

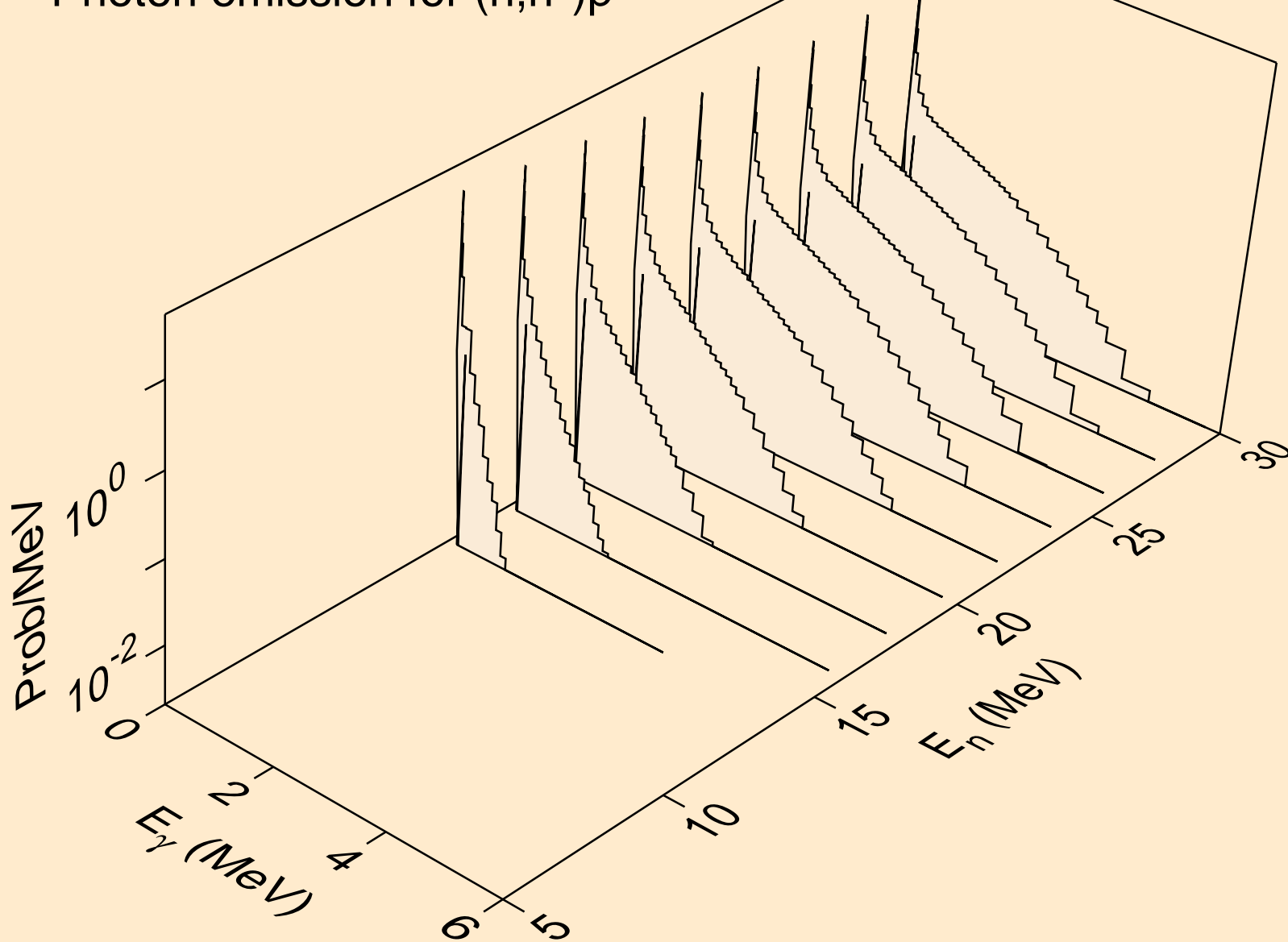

EU165 NEUTRON ACER TENDL-2019 LIBRARY; T=293.16K
Photon emission for (n,n*)d

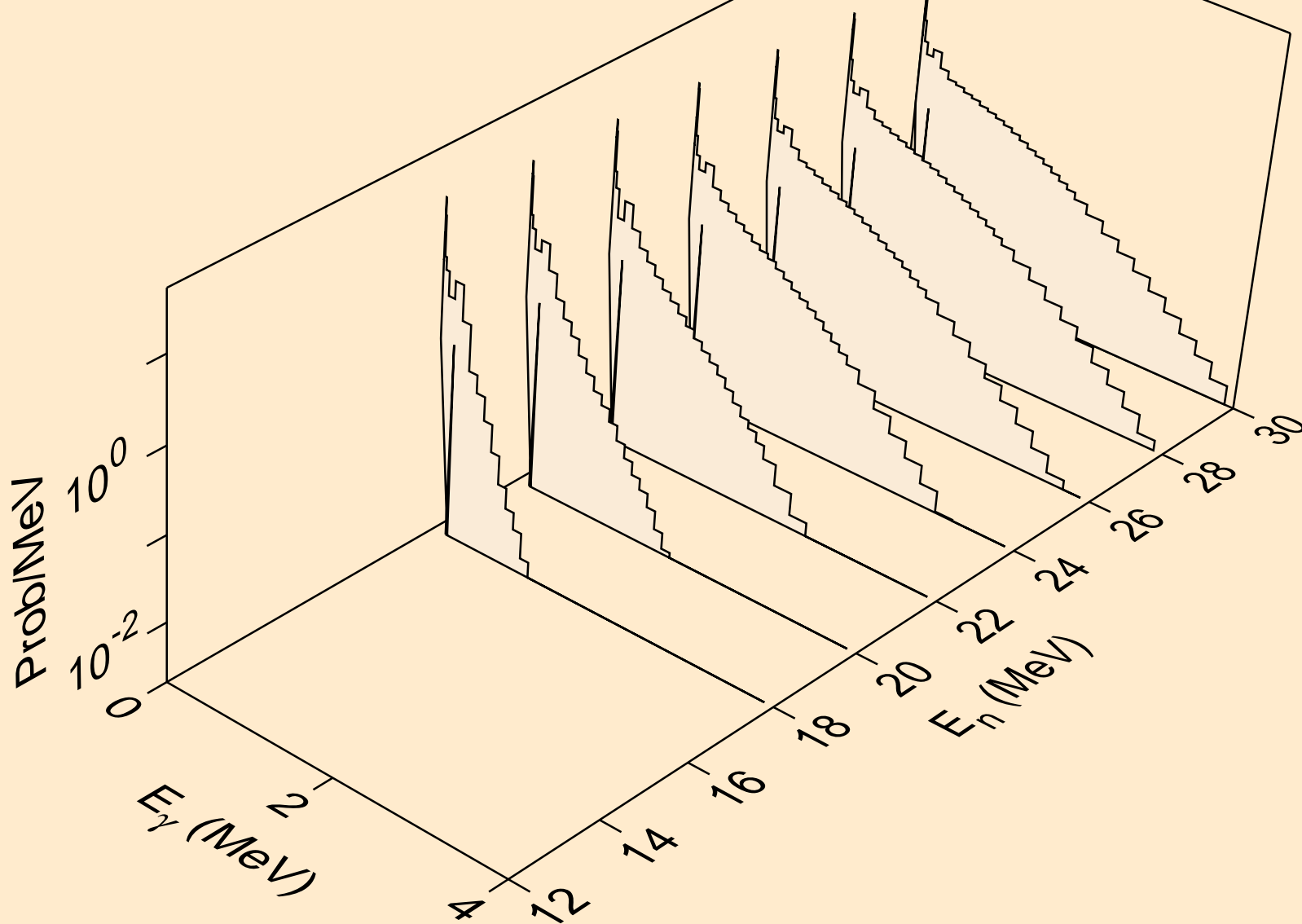

EU165 NEUTRON ACER TENDL-2019 LIBRARY; T=293.16K
Photon emission for (n,n*)t

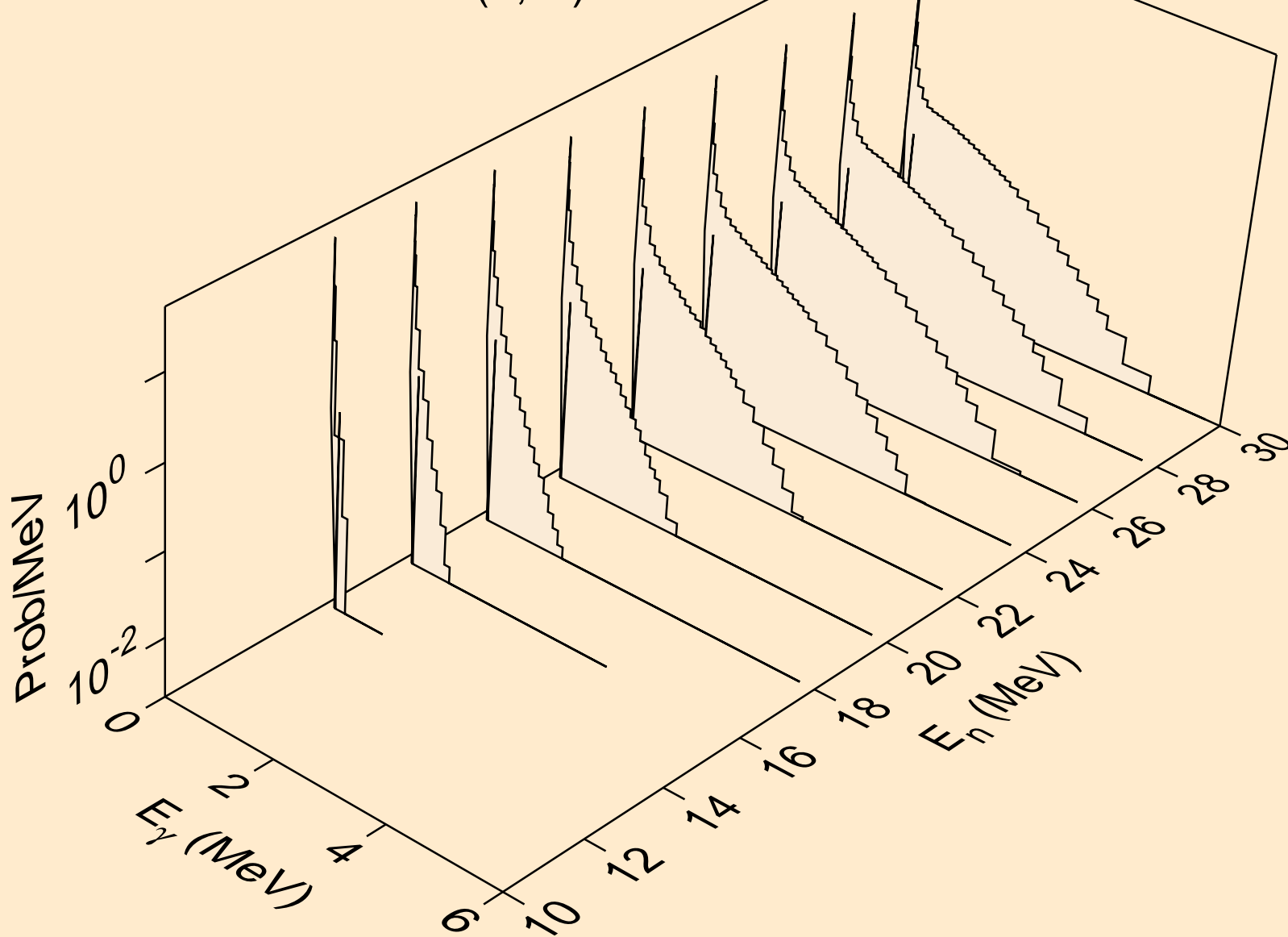

EU165 NEUTRON ACER TENDL-2019 LIBRARY; T=293.16K
Photon emission for (n,n*)he3

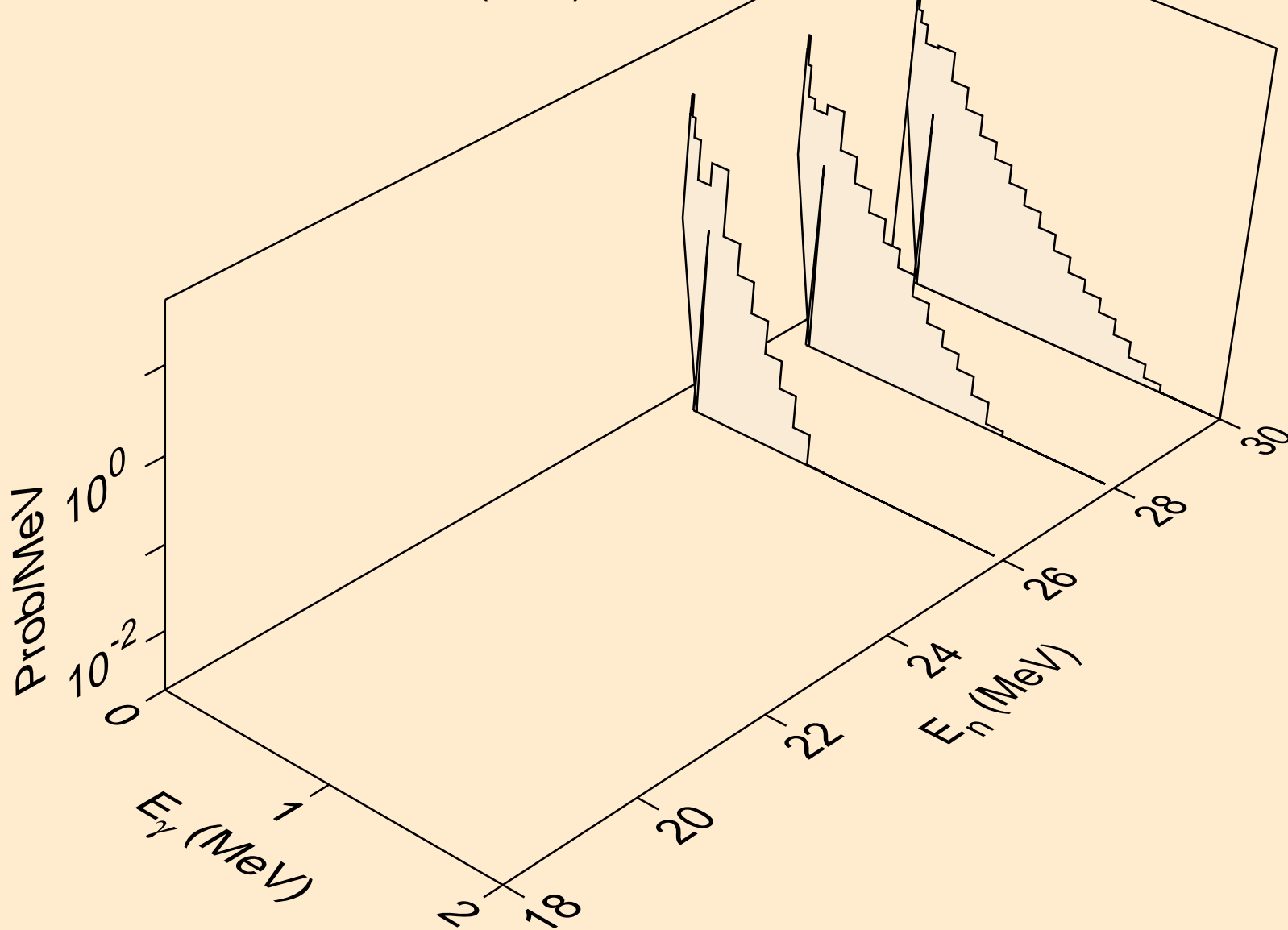

EU165 NEUTRON ACER TENDL-2019 LIBRARY; T=293.16K
Photon emission for (n,4n)

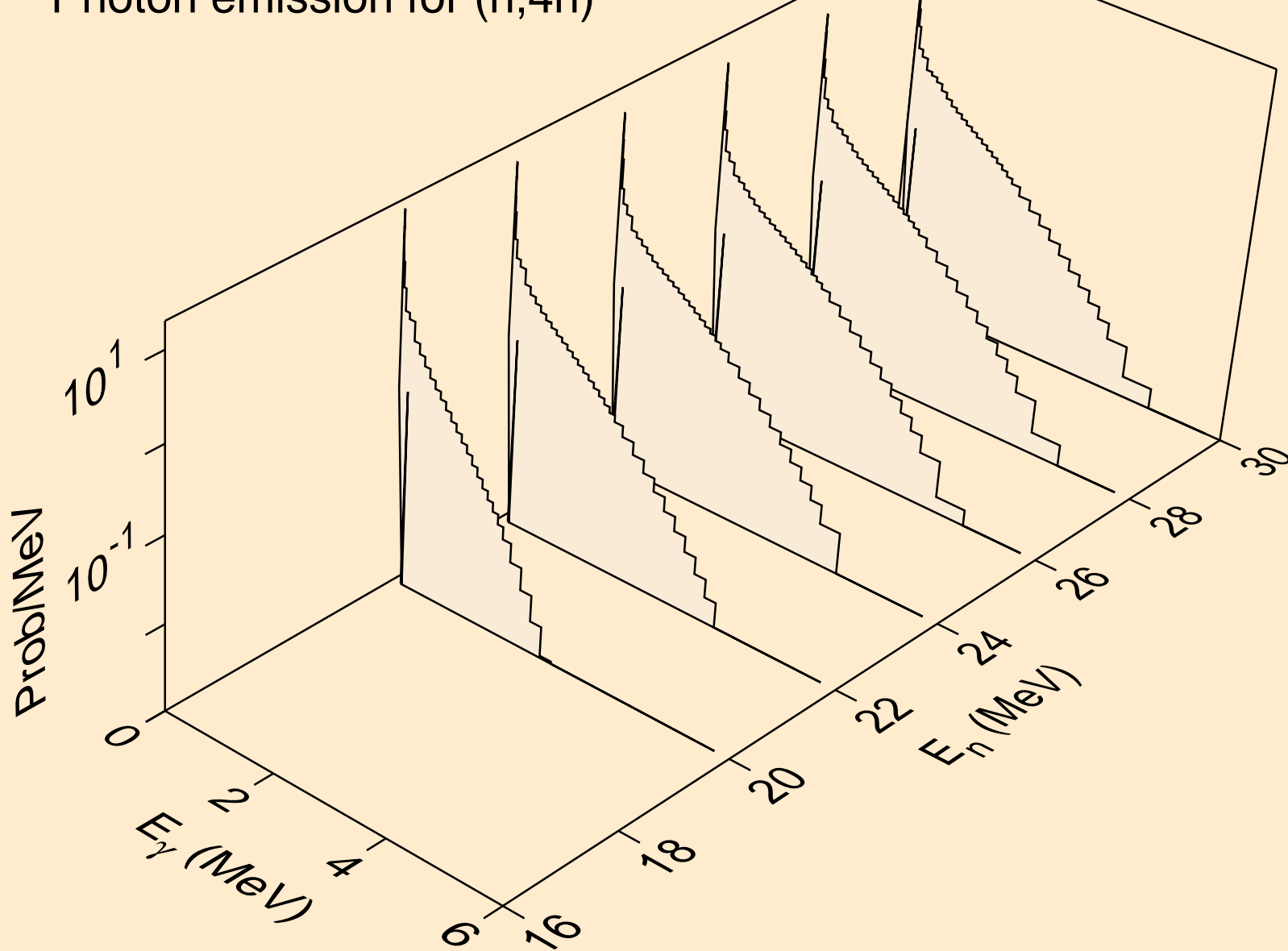

EU165 NEUTRON ACER TENDL-2019 LIBRARY; T=293.16K
Photon emission for (n,2np)

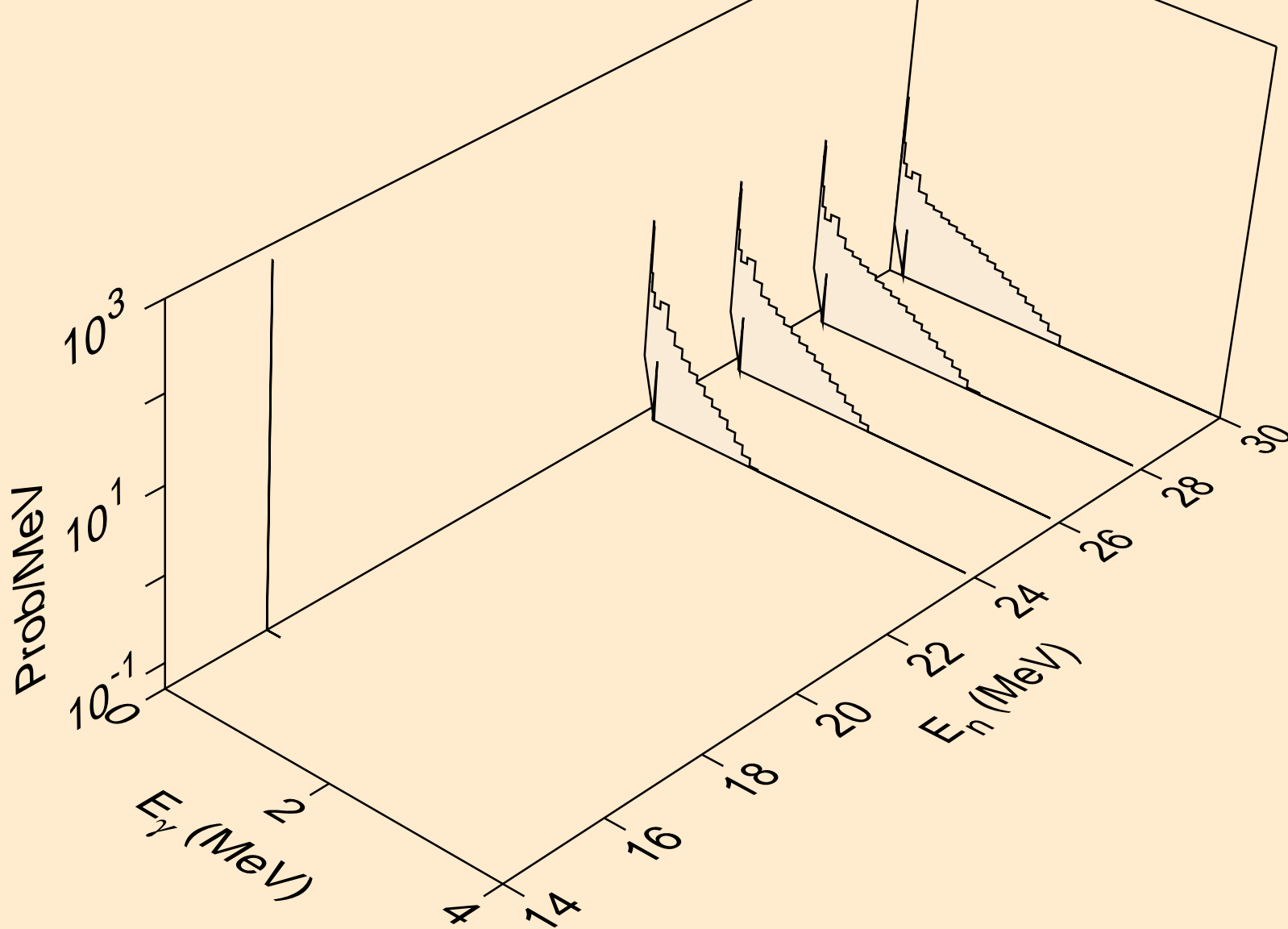

EU165 NEUTRON ACER TENDL-2019 LIBRARY; T=293.16K
Photon emission for (n,3np)

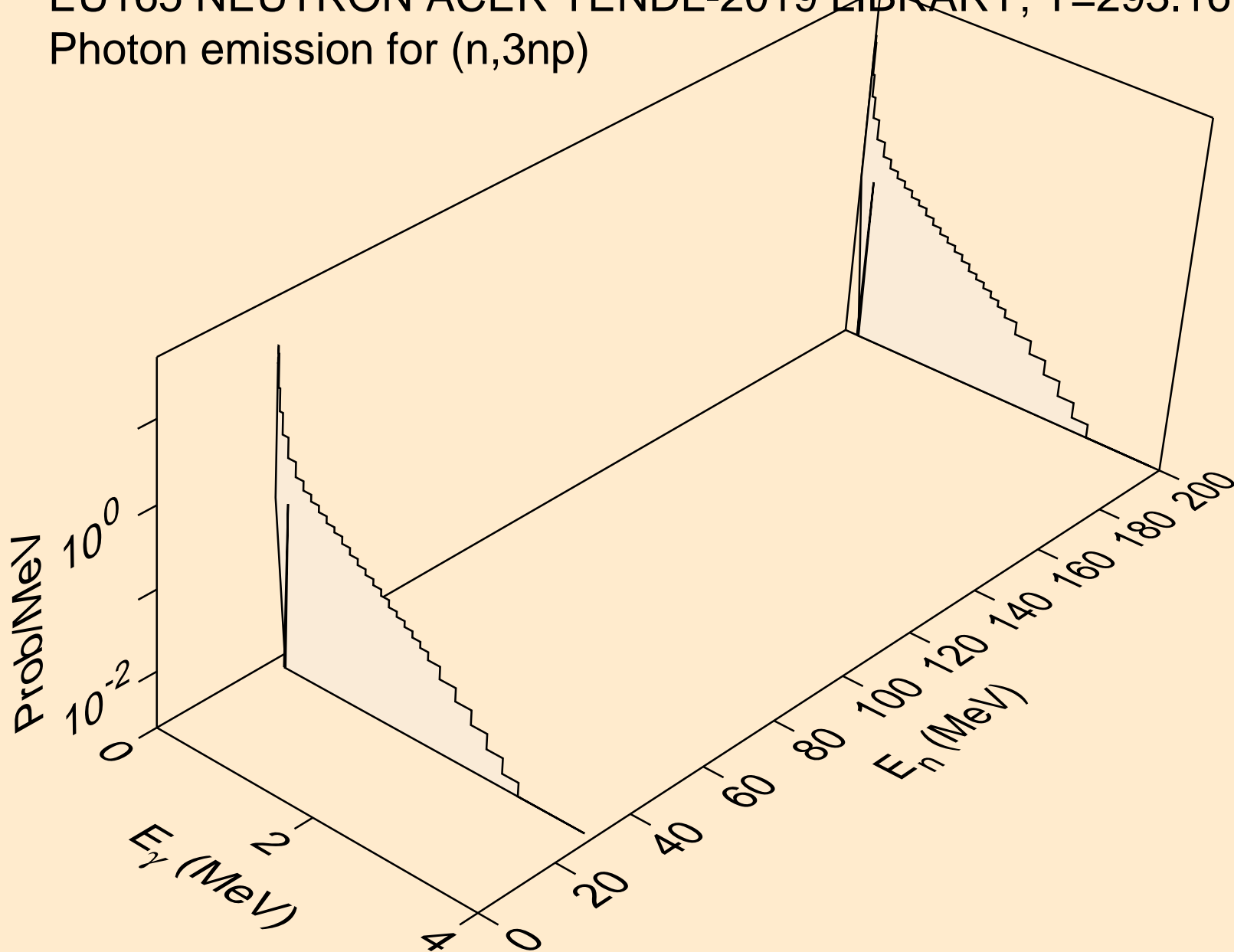

EU165 NEUTRON ACER TENDL-2019 LIBRARY; T=293.16K
Photon emission for (n,n*c)

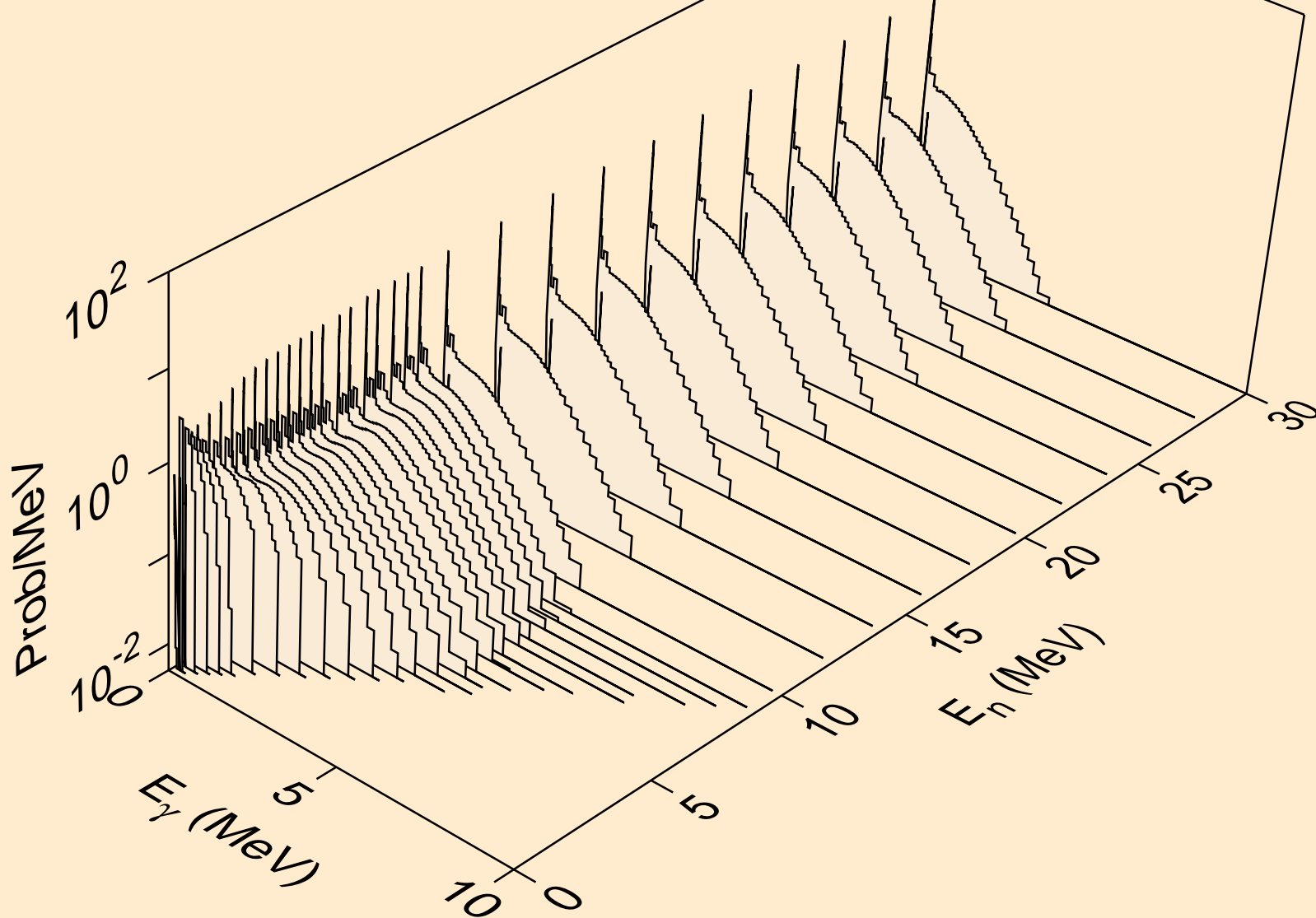

EU165 NEUTRON ACER TENDL-2019 LIBRARY; T=293.16K
Photon emission for (n,gma)

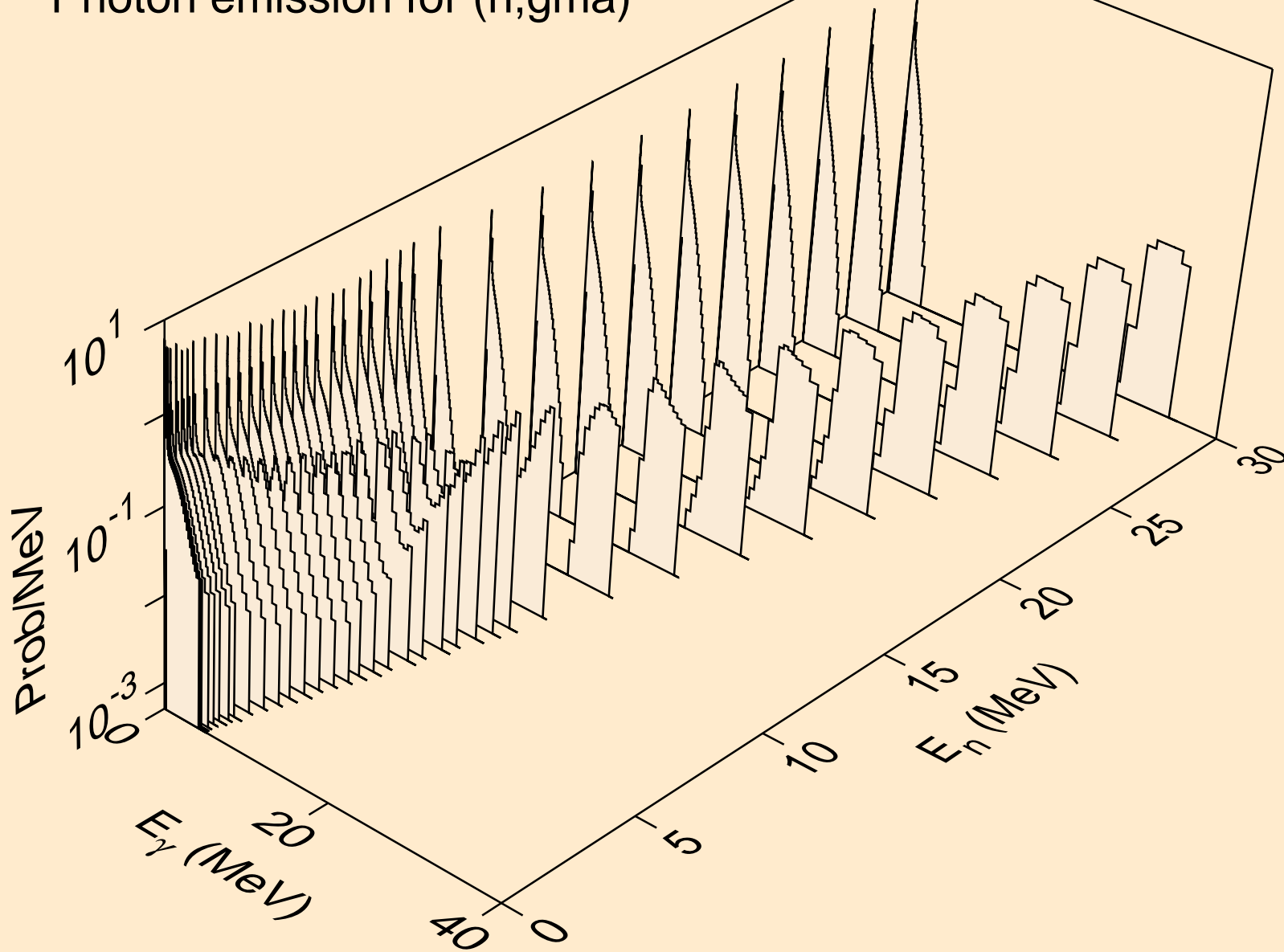

EU165 NEUTRON ACER TENDL-2019 LIBRARY; T=293.16K
Photon emission for (n,p)

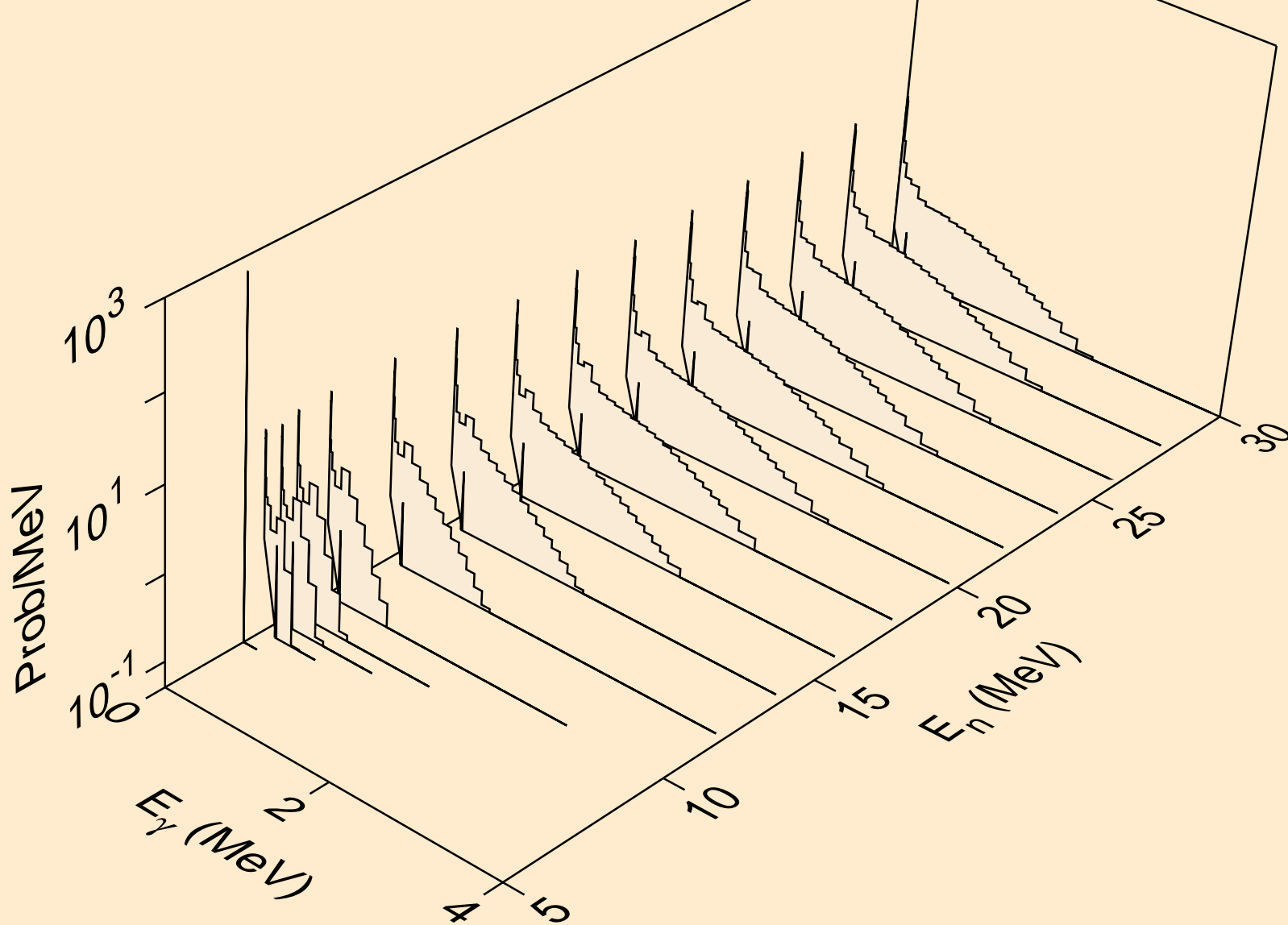

EU165 NEUTRON ACER TENDL-2019 LIBRARY; T=293.16K
Photon emission for (n,d)

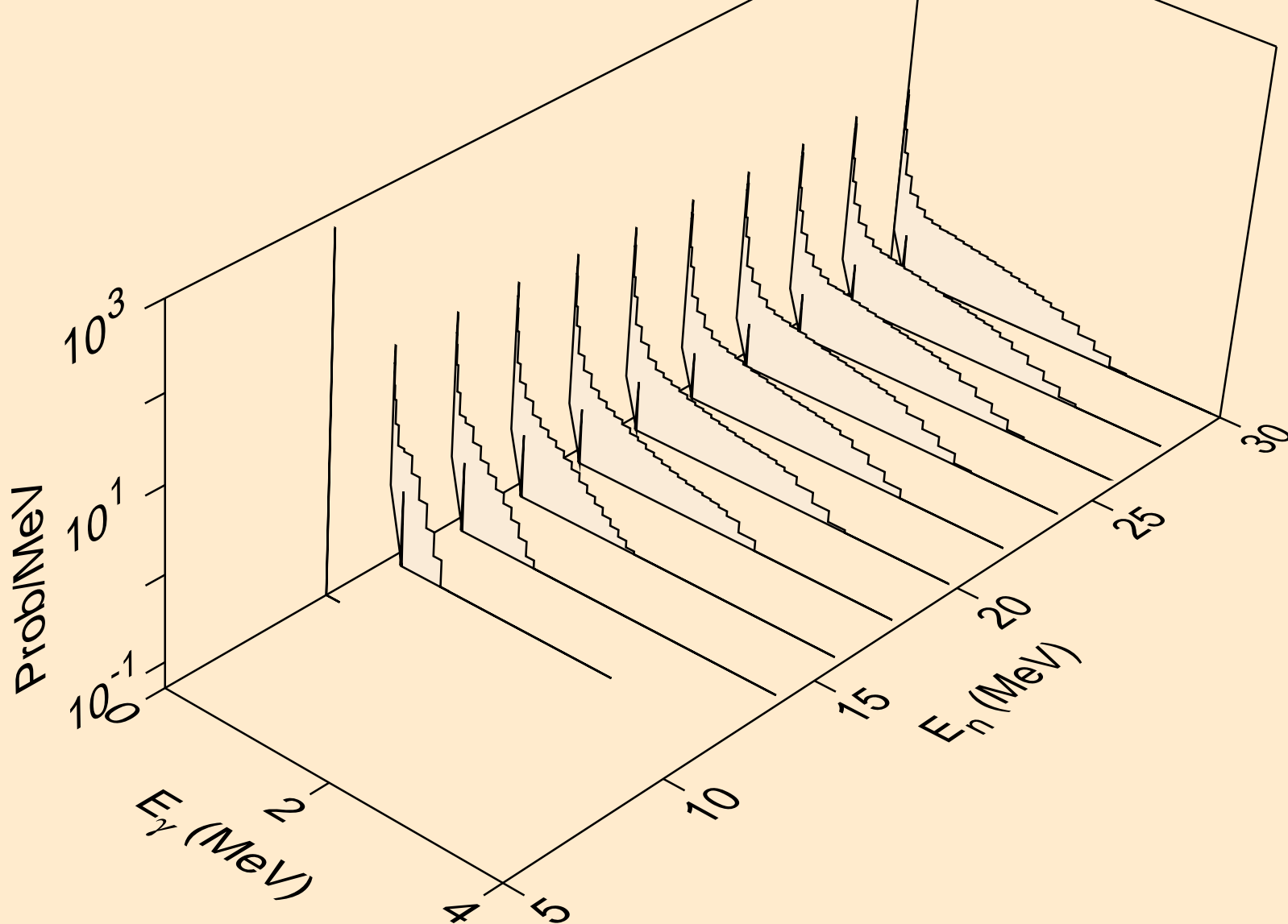

EU165 NEUTRON ACER TENDL-2019 LIBRARY; T=293.16K
Photon emission for (n,t)

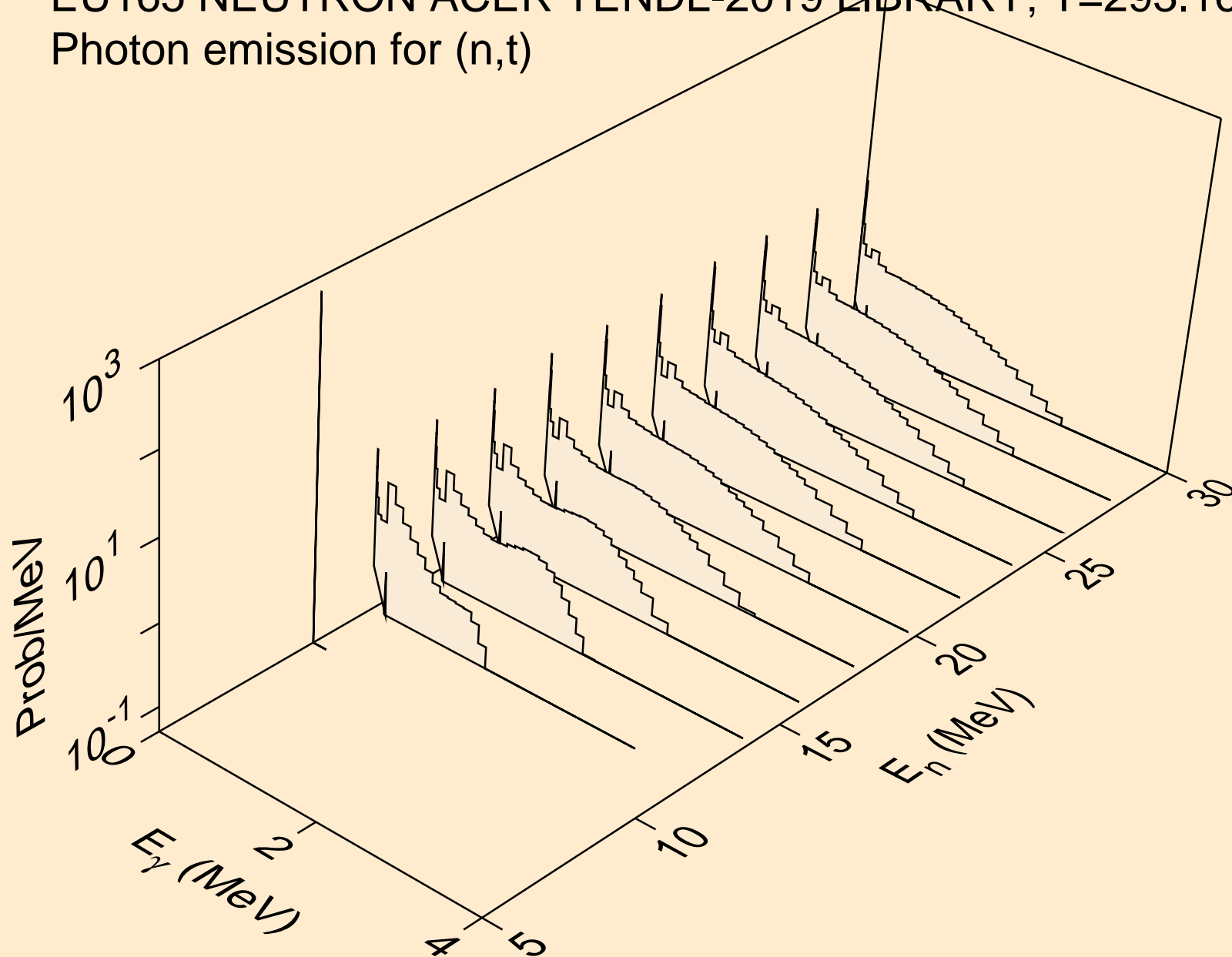

EU165 NEUTRON ACER TENDL-2019 LIBRARY; T=293.16K
Photon emission for (n,he3)

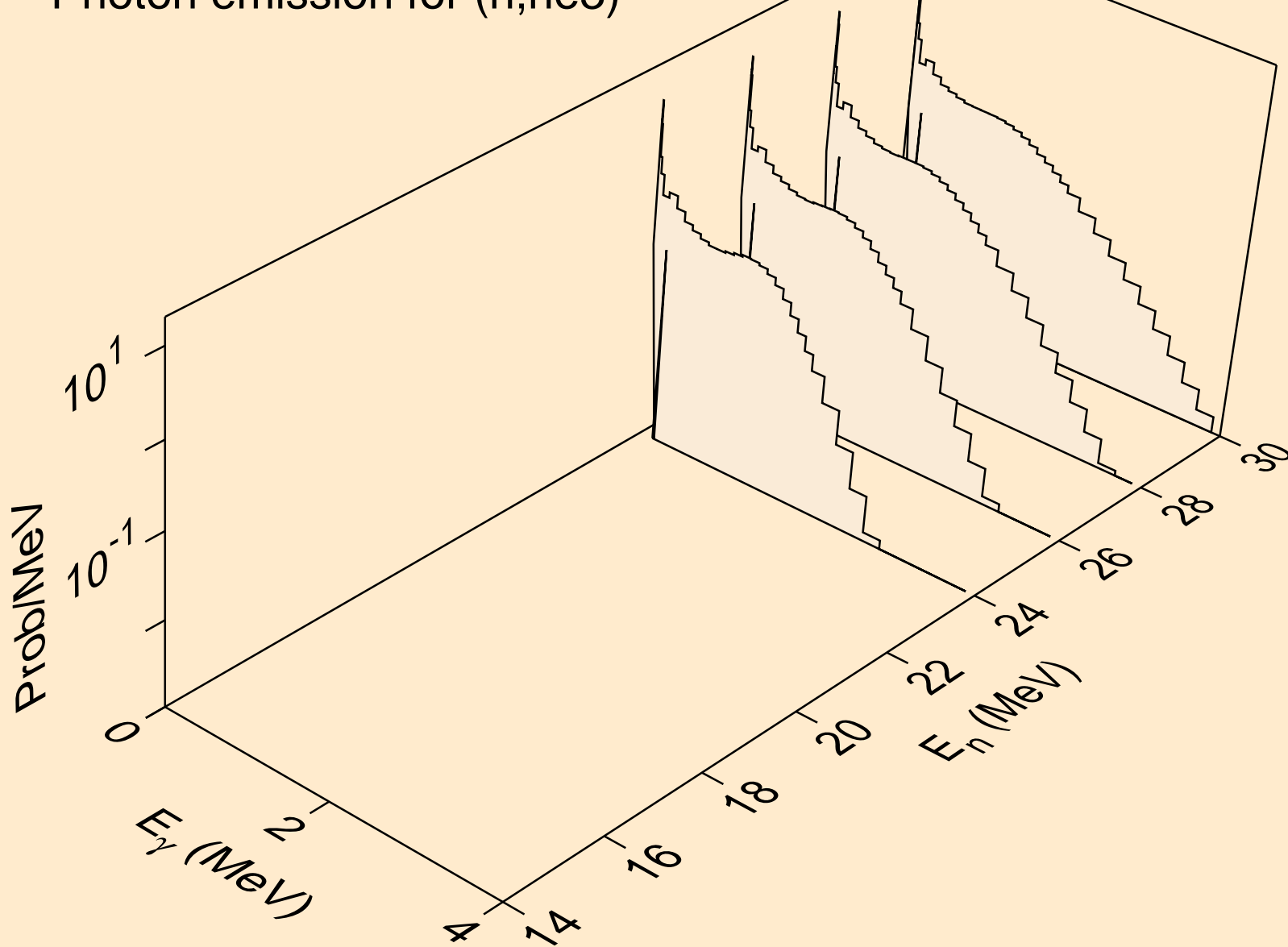

EU165 NEUTRON ACER TENDL-2019 LIBRARY; T=293.16K
Photon emission for (n,a)

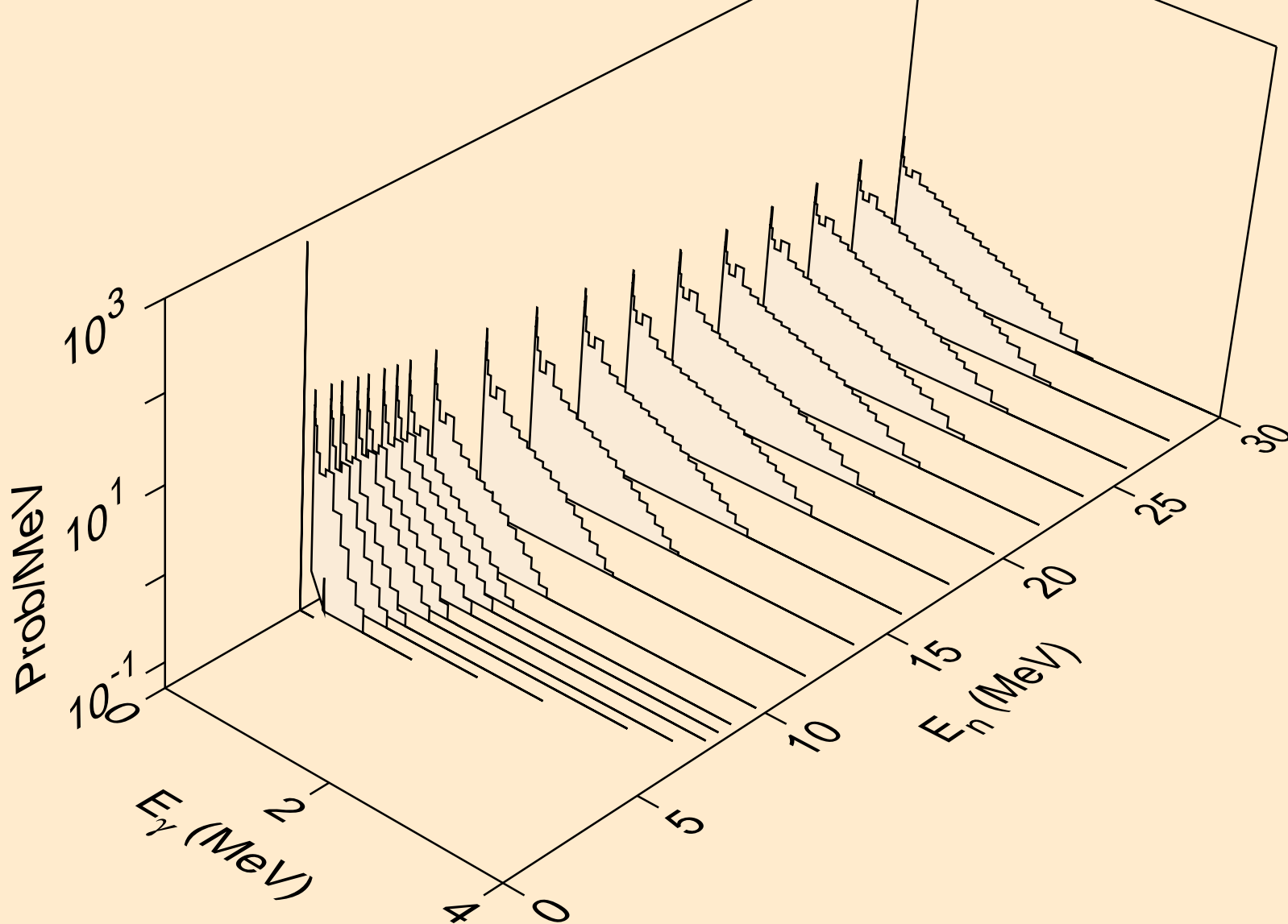

EU165 NEUTRON ACER TENDL-2019 LIBRARY; T=293.16K
thermal capture photon spectrum

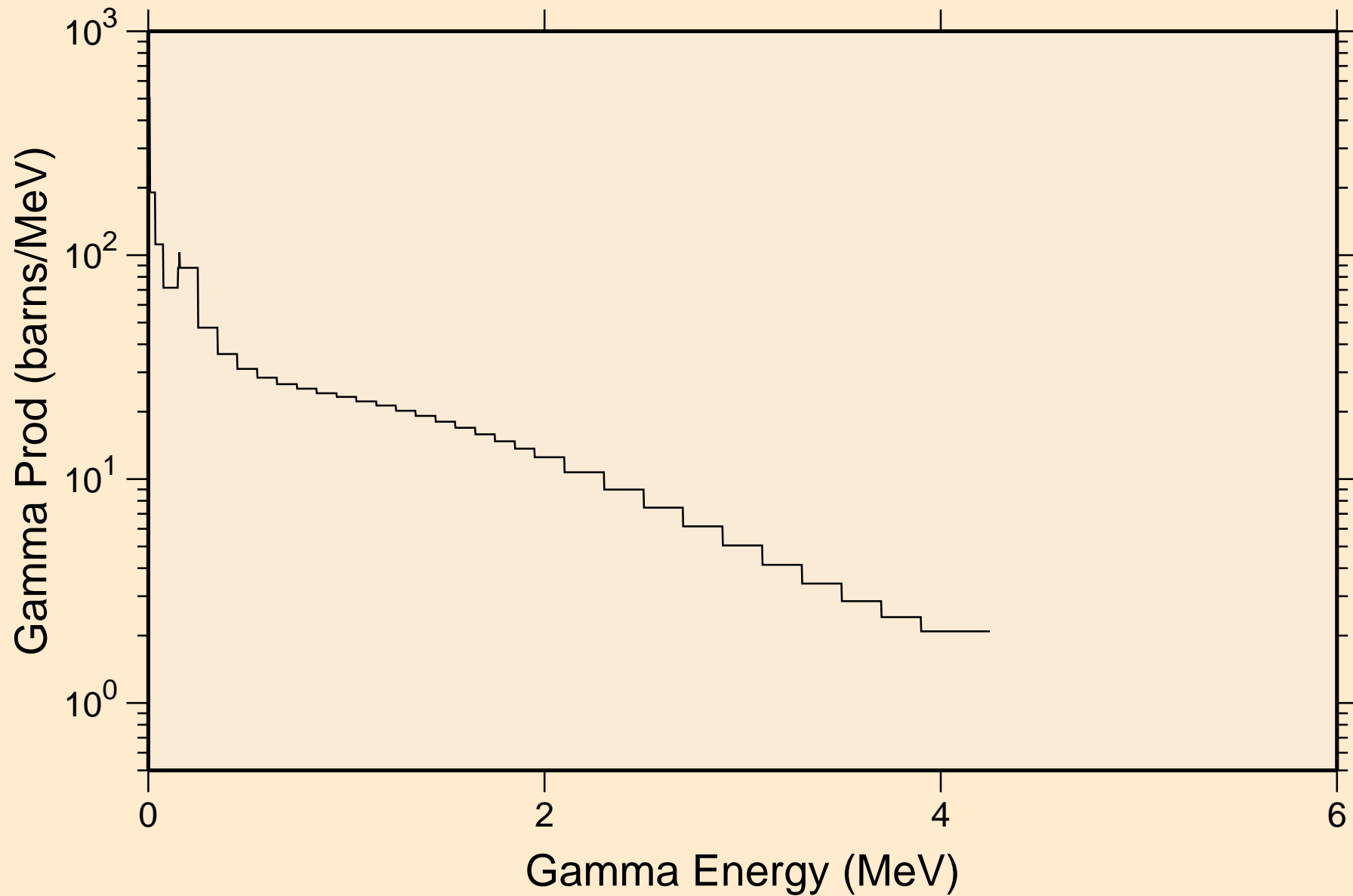

EU165 NEUTRON ACER TENDL-2019 LIBRARY; T=293.16K
14 MeV photon spectrum

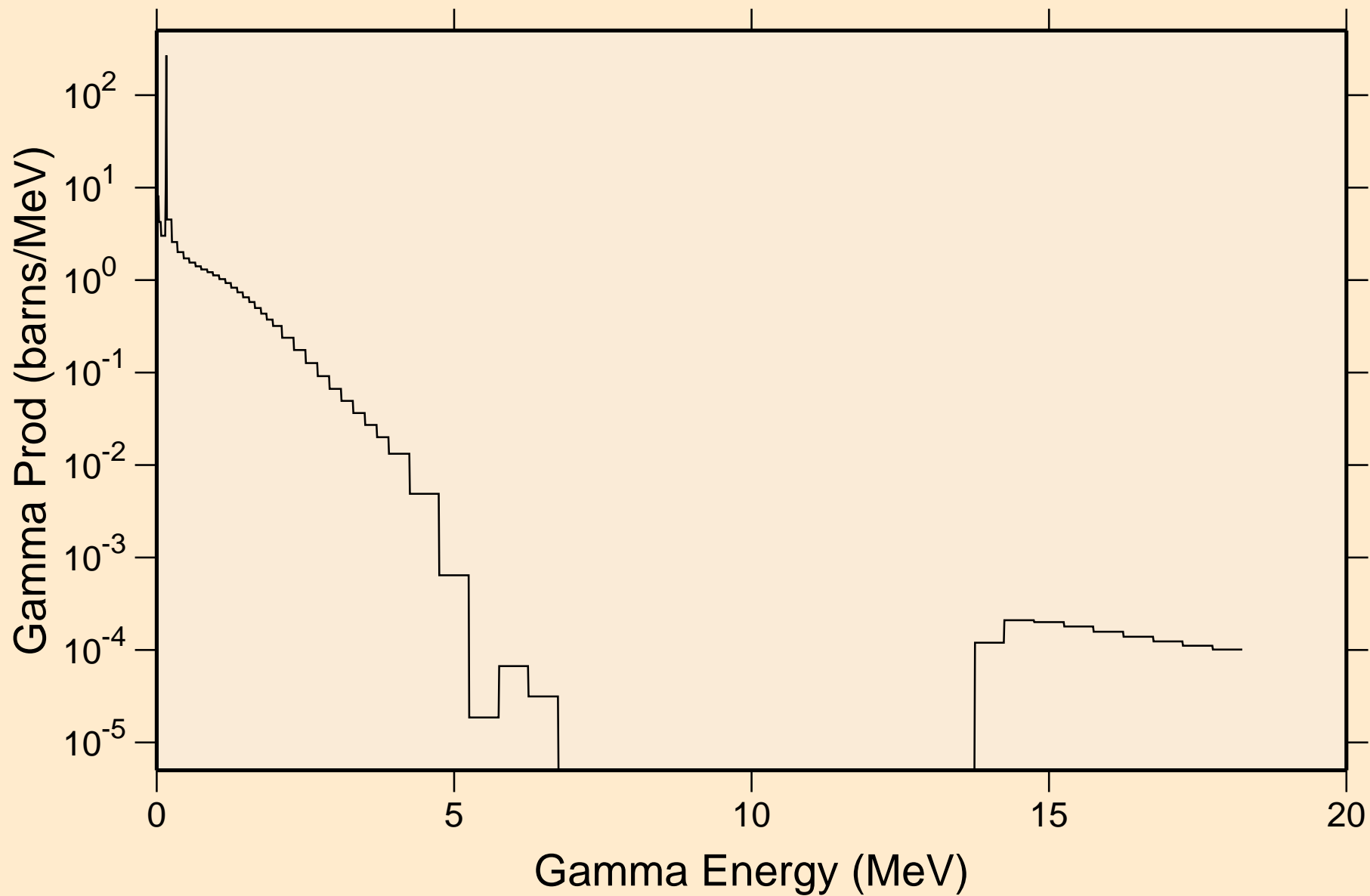

EU165 NEUTRON ACER TENDL-2019 LIBRARY; T=293.16K

Particle heating contributions

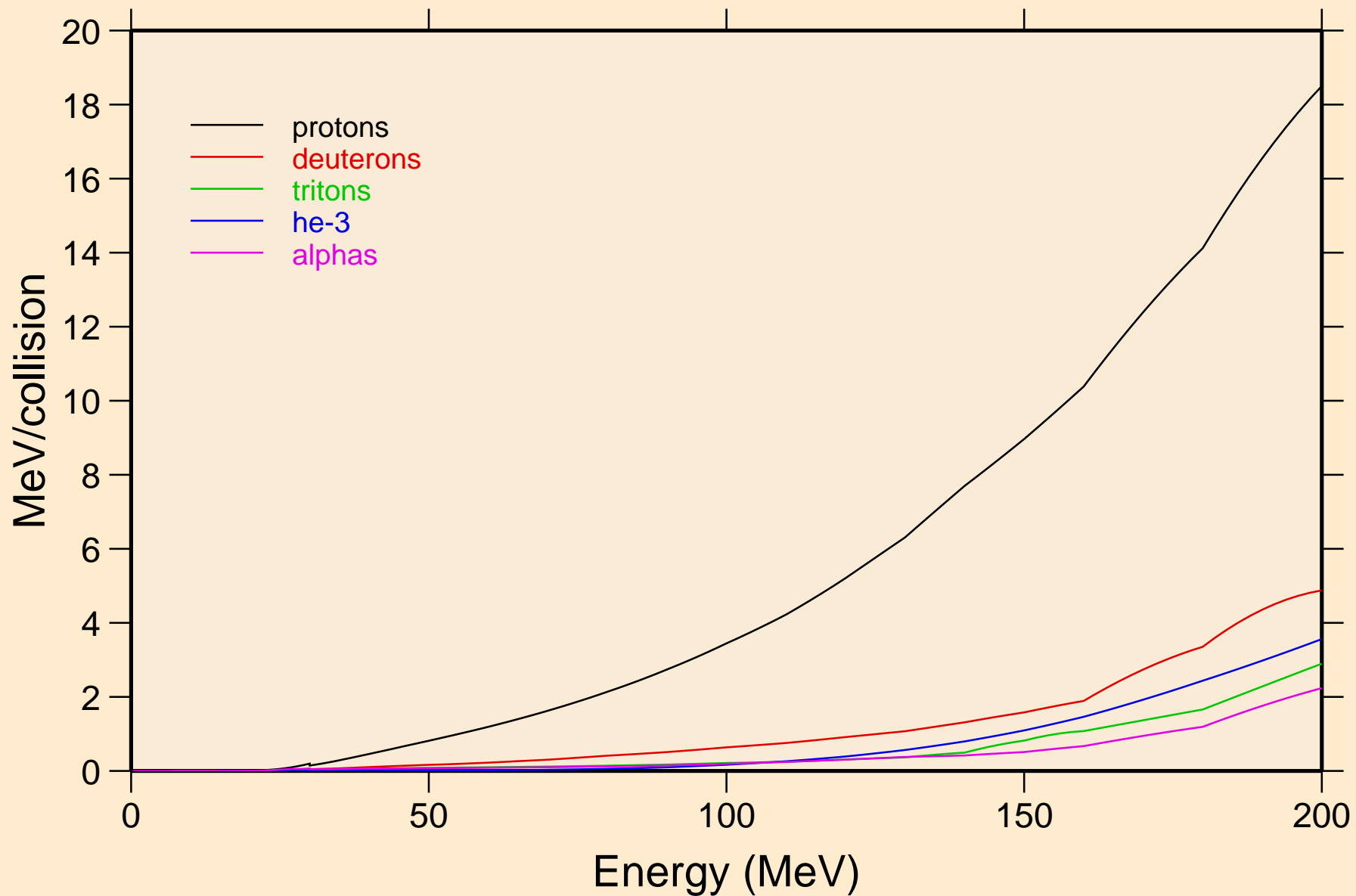

EU165 NEUTRON ACER TENDL-2019 LIBRARY; T=293.16K
Recoil Heating

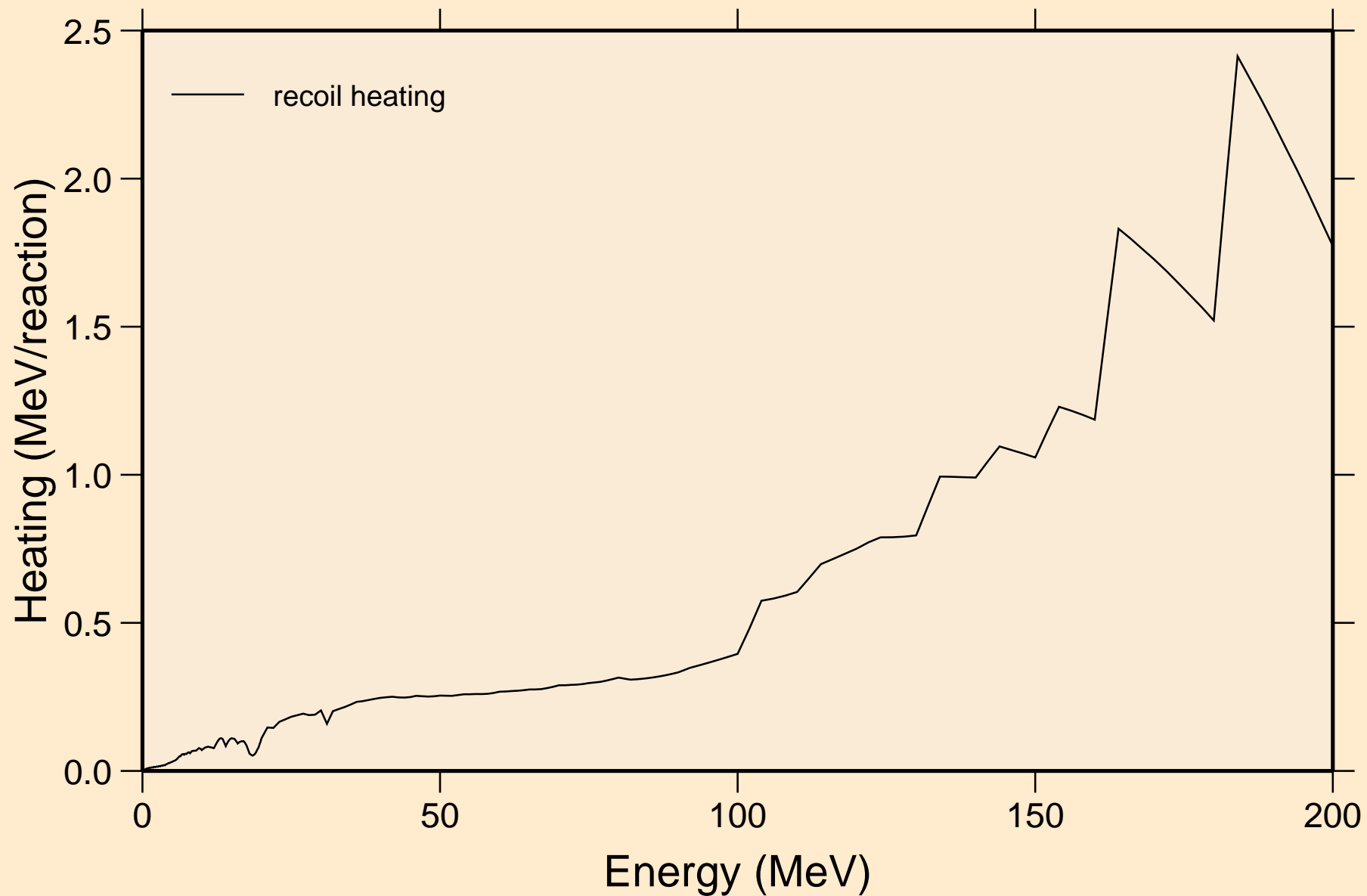

EU165 NEUTRON ACER TENDL-2019 LIBRARY; T=293.16K
Particle production cross sections

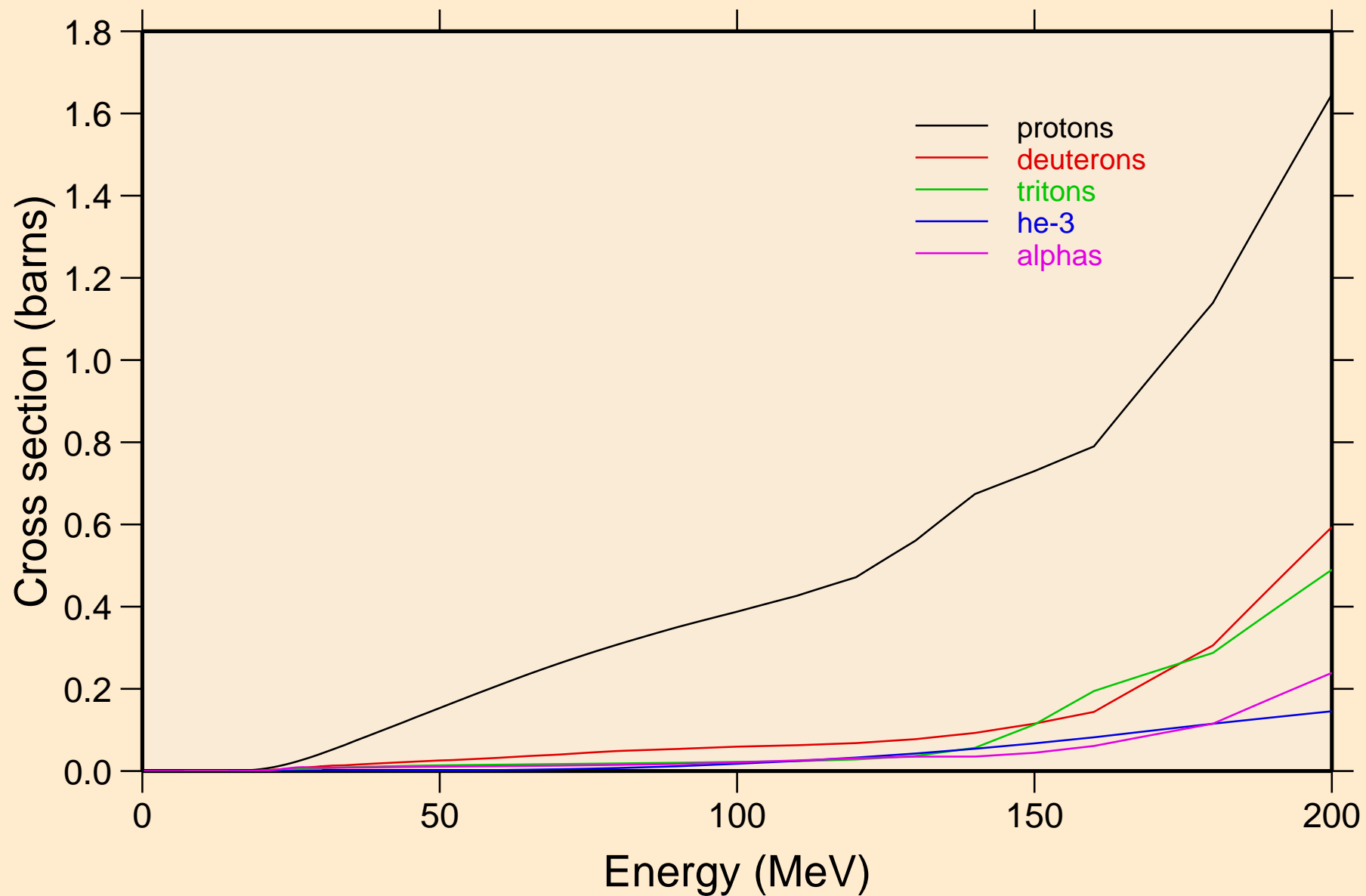

EU165 NEUTRON ACER TENDL-2019 LIBRARY; T=293.16K
protons from (n,x)

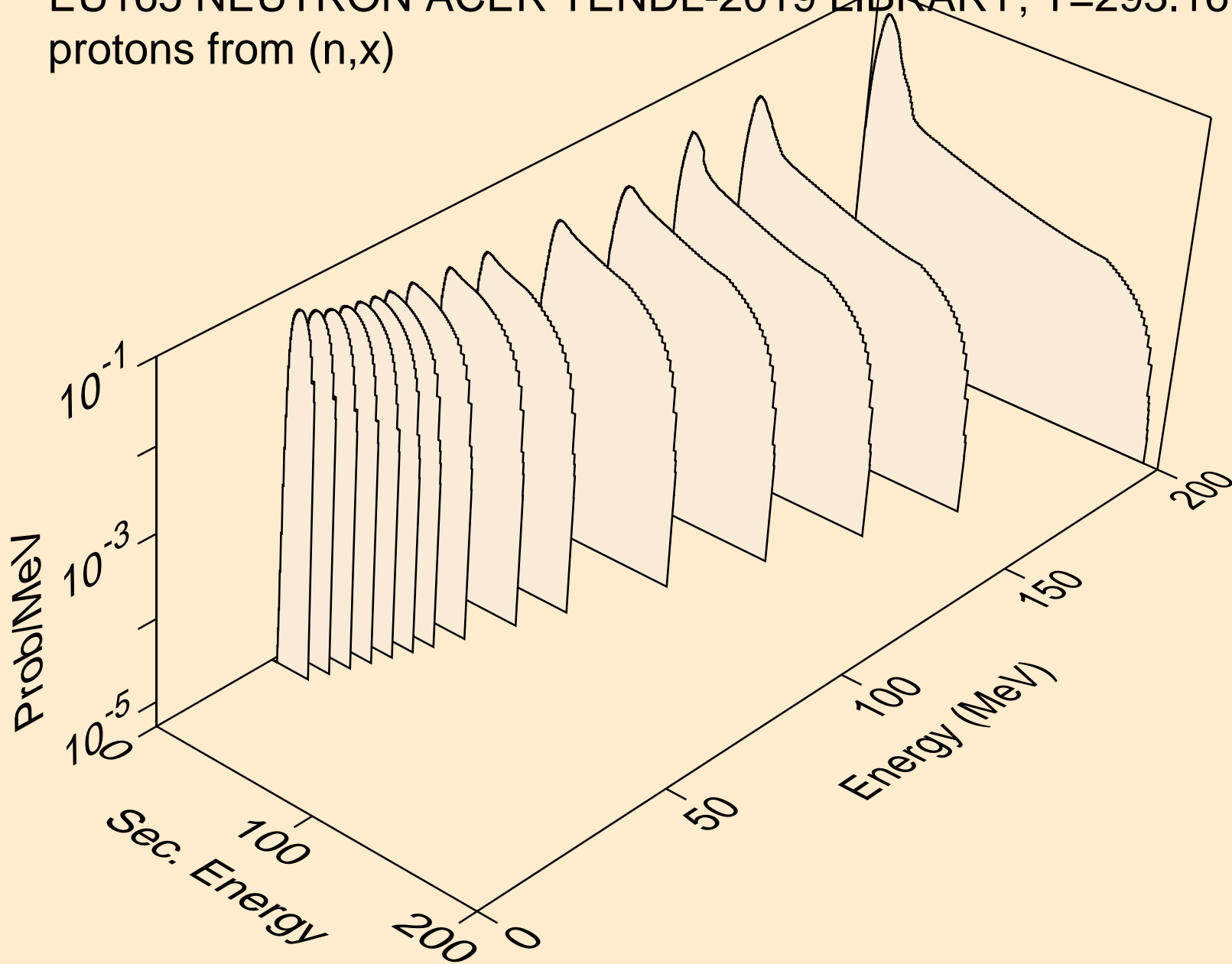

EU165 NEUTRON ACER TENDL-2019 LIBRARY; T=293.16K
protons from (n,n*)p

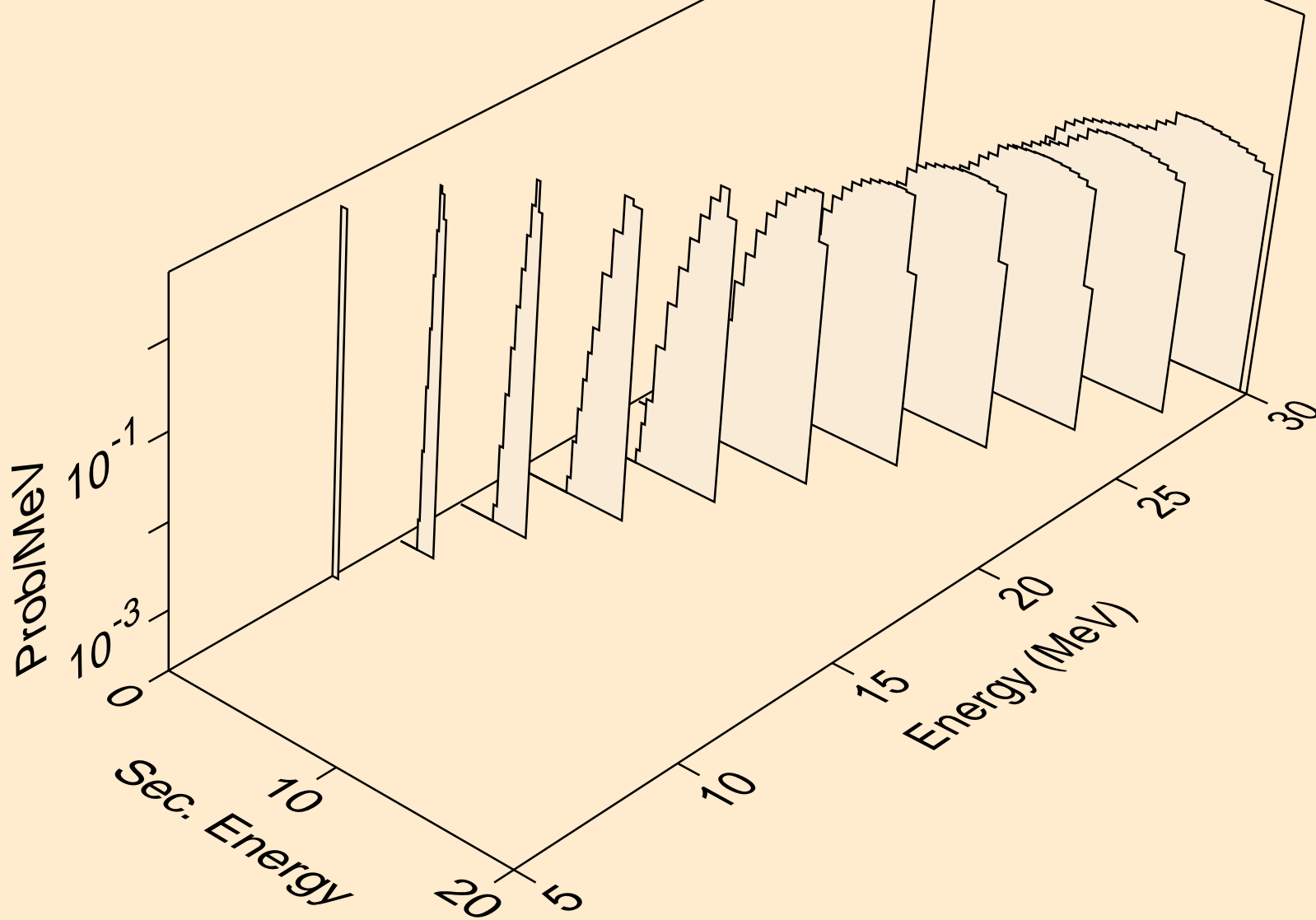

EU165 NEUTRON ACER TENDL-2019 LIBRARY; T=293.16K
protons from (n,2np)

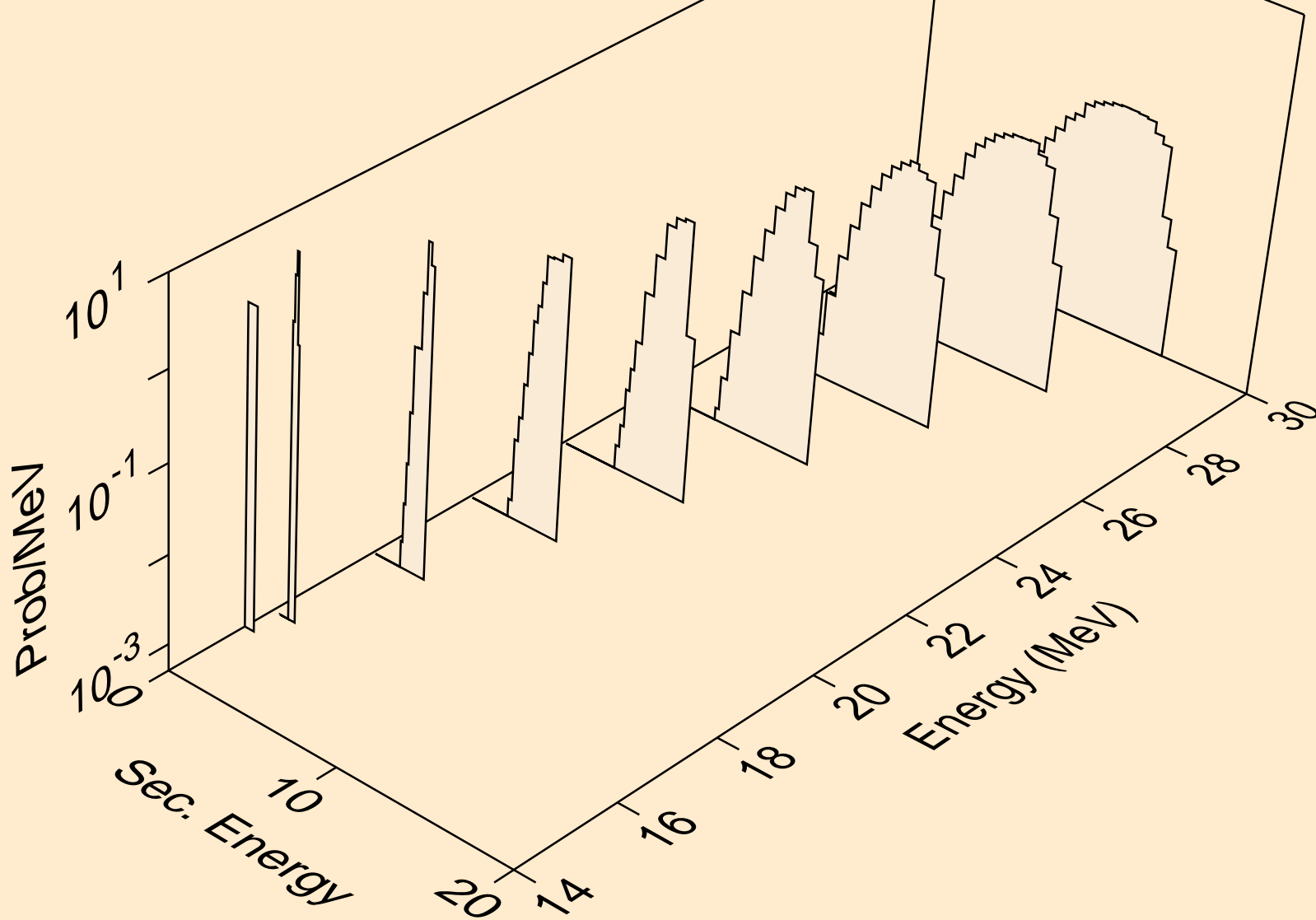

EU165 NEUTRON ACER TENDL-2019 LIBRARY; T=293.16K
protons from (n,3np)

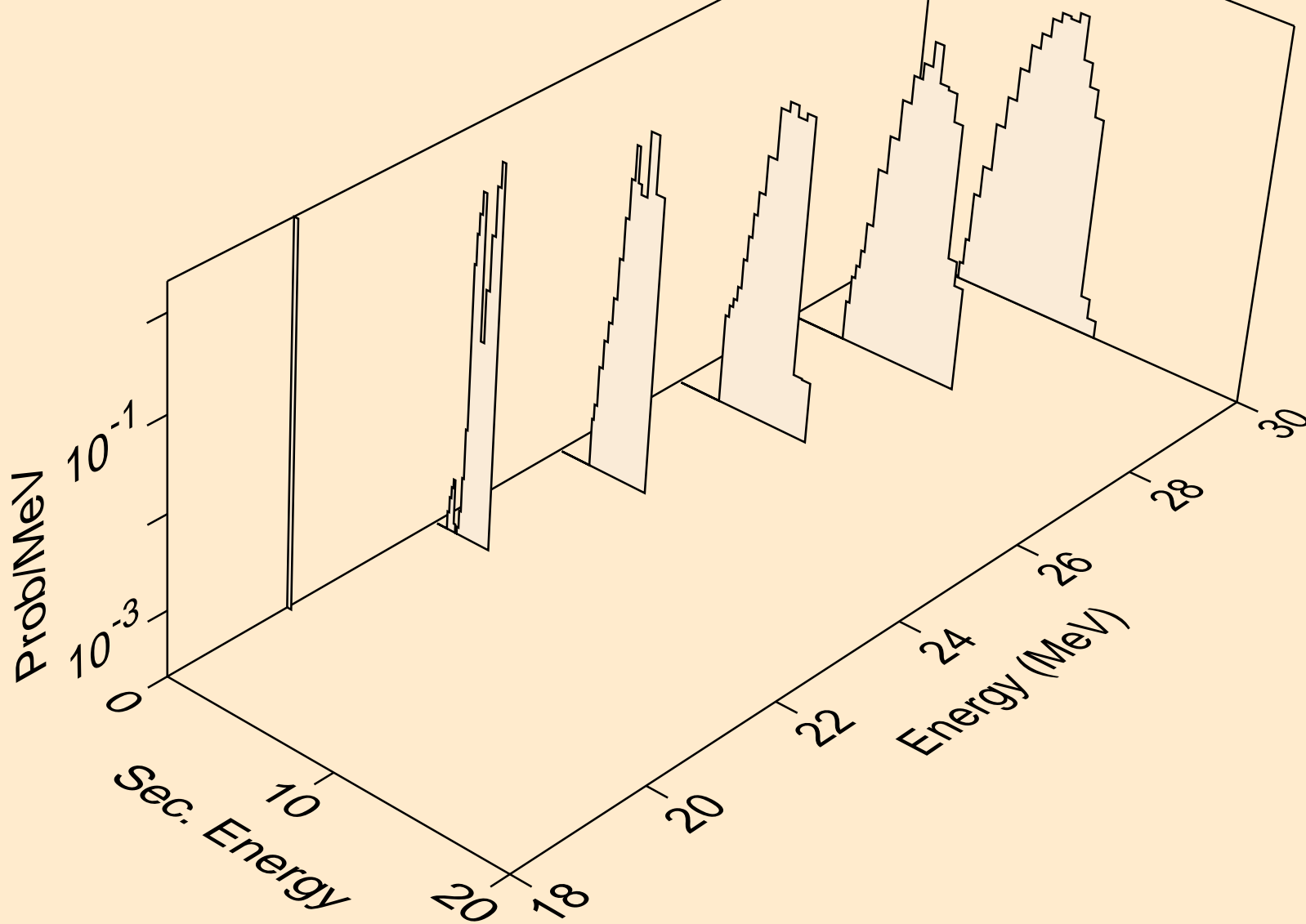

EU165 NEUTRON ACER TENDL-2019 LIBRARY; T=293.16K
protons from (n,p)

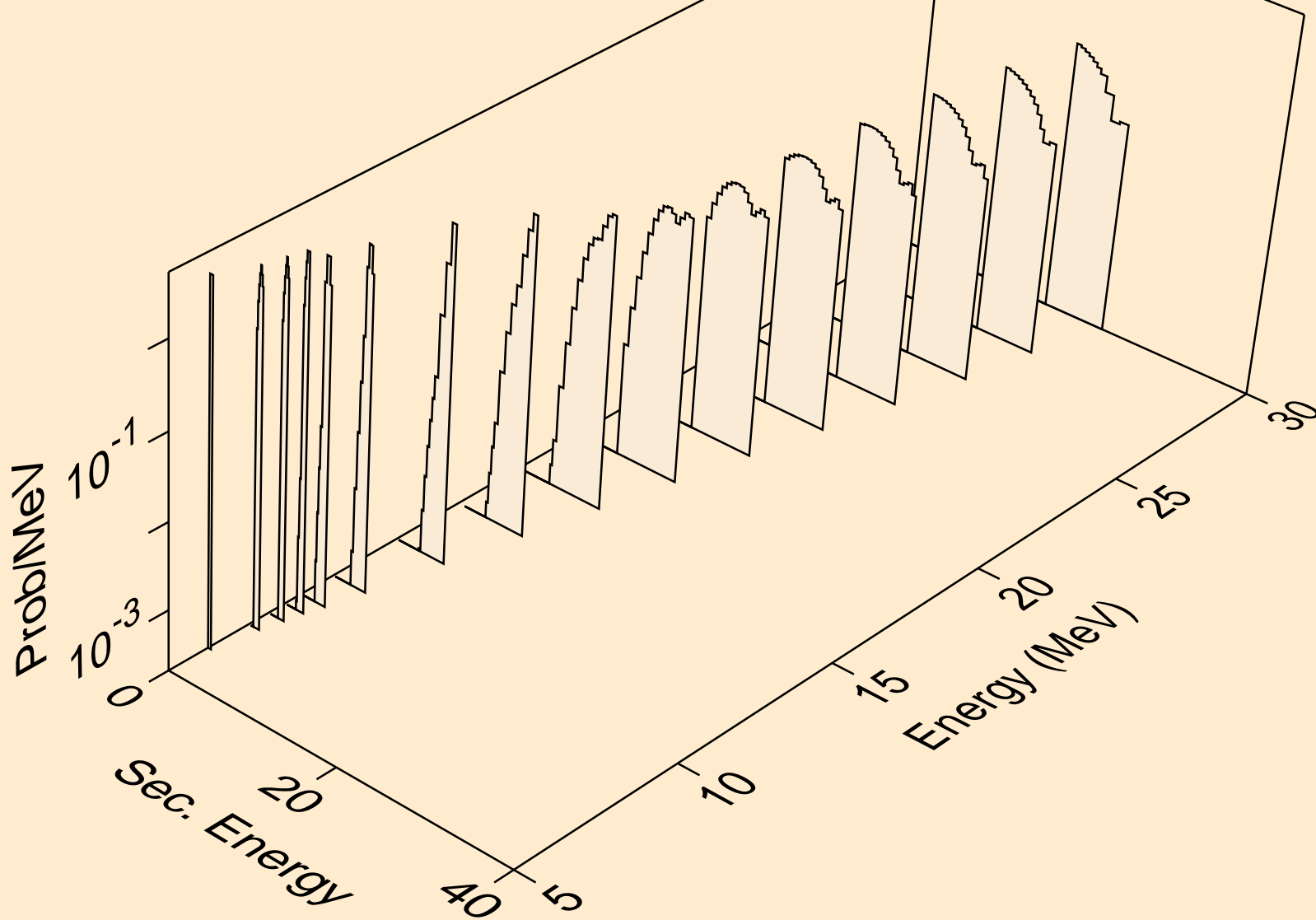

EU165 NEUTRON ACER TENDL-2019 LIBRARY; T=293.16K
deuterons from (n,x)

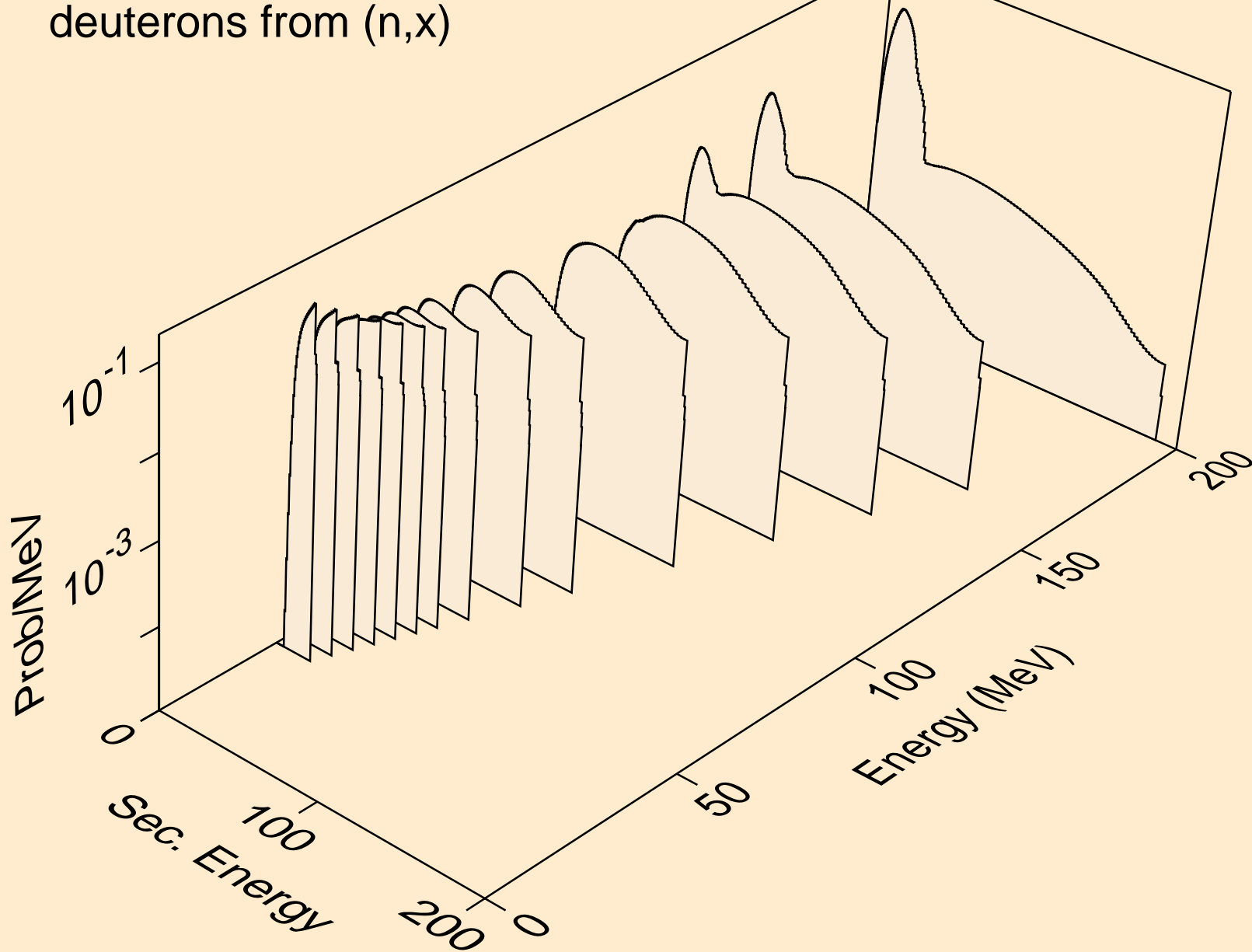

EU165 NEUTRON ACER TENDL-2019 LIBRARY; T=293.16K
deuterons from (n,2nd)

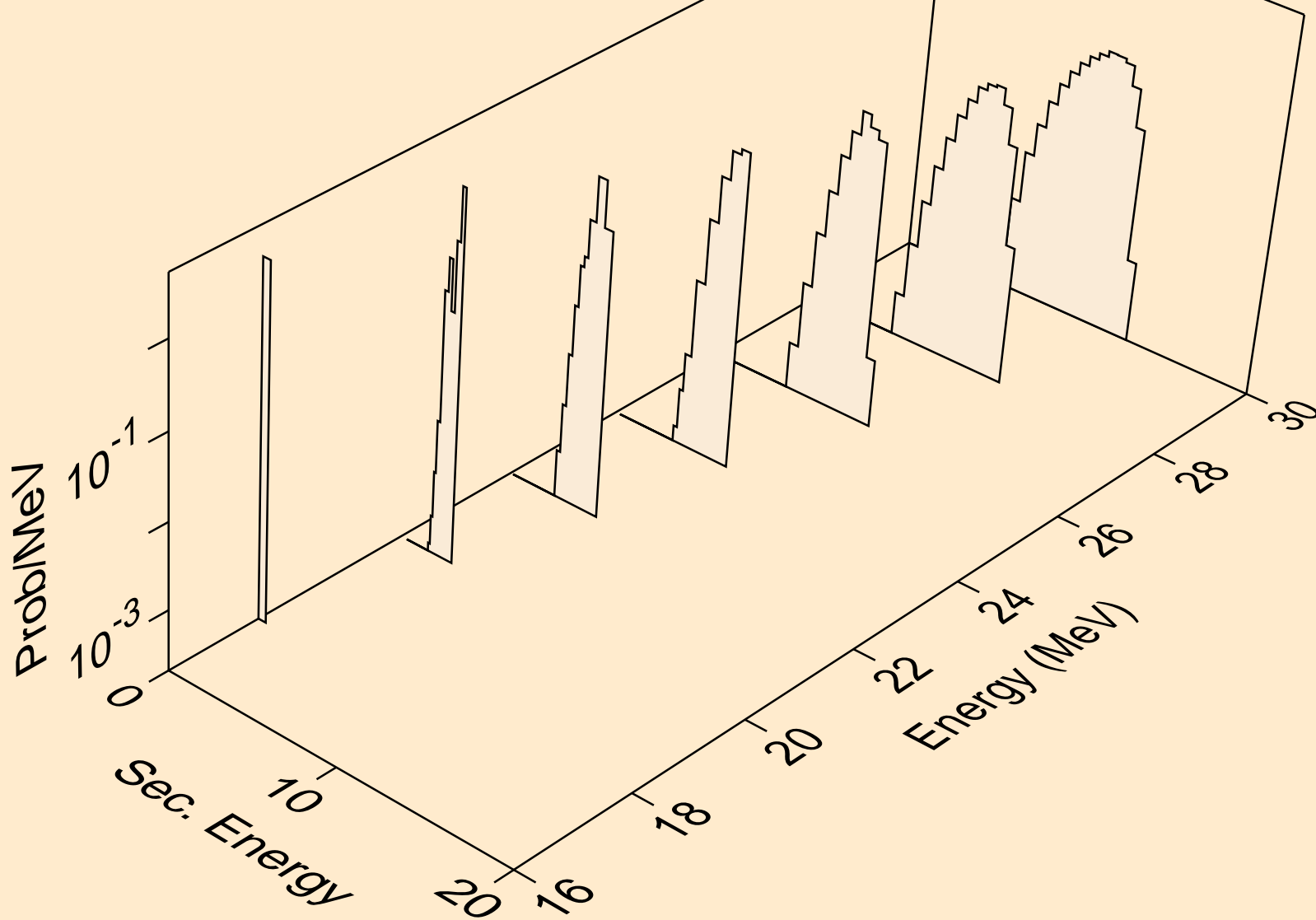

EU165 NEUTRON ACER TENDL-2019 LIBRARY; T=293.16K
deuterons from (n,n*)d

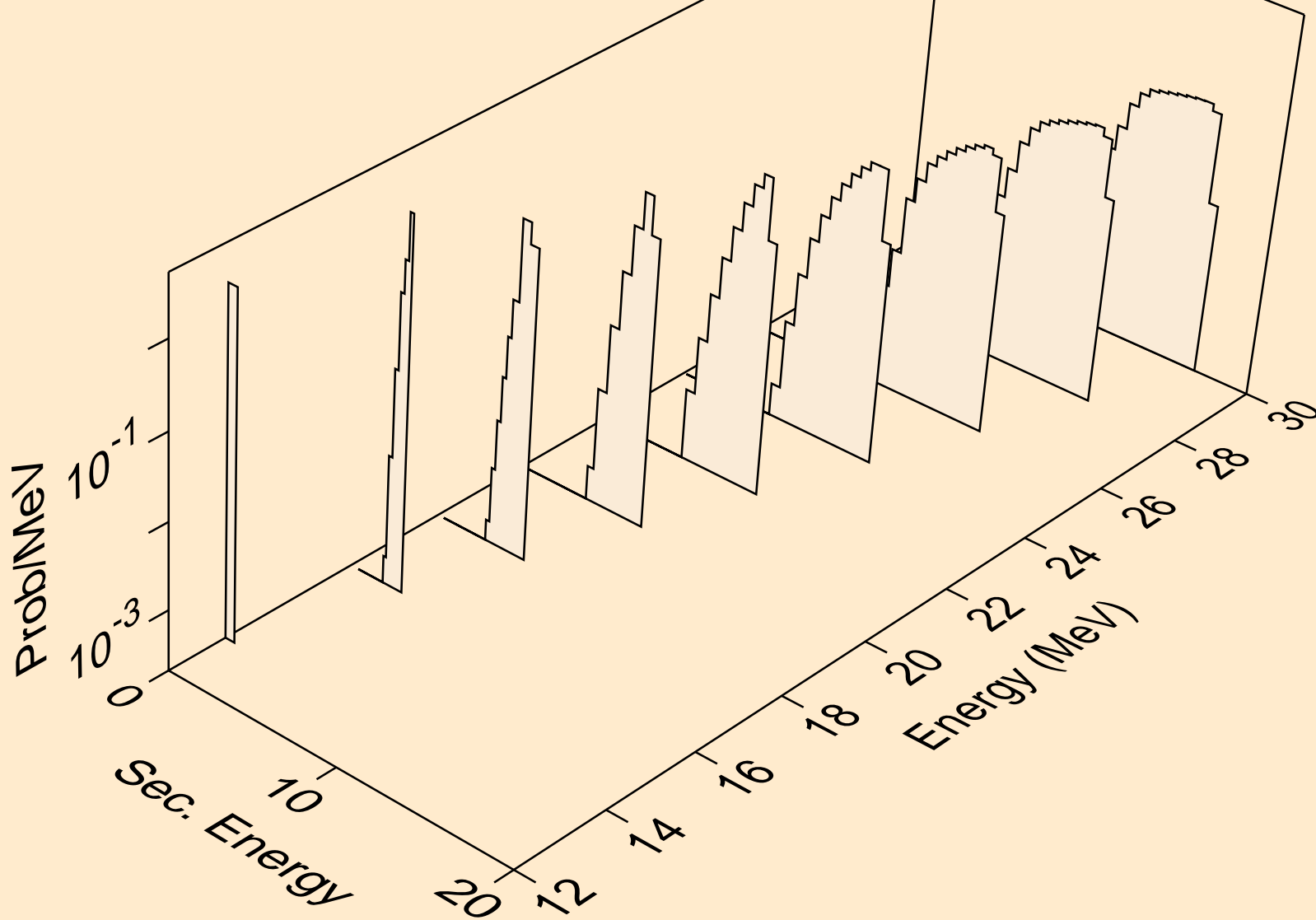

EU165 NEUTRON ACER TENDL-2019 LIBRARY; T=293.16K
deuterons from (n,d)

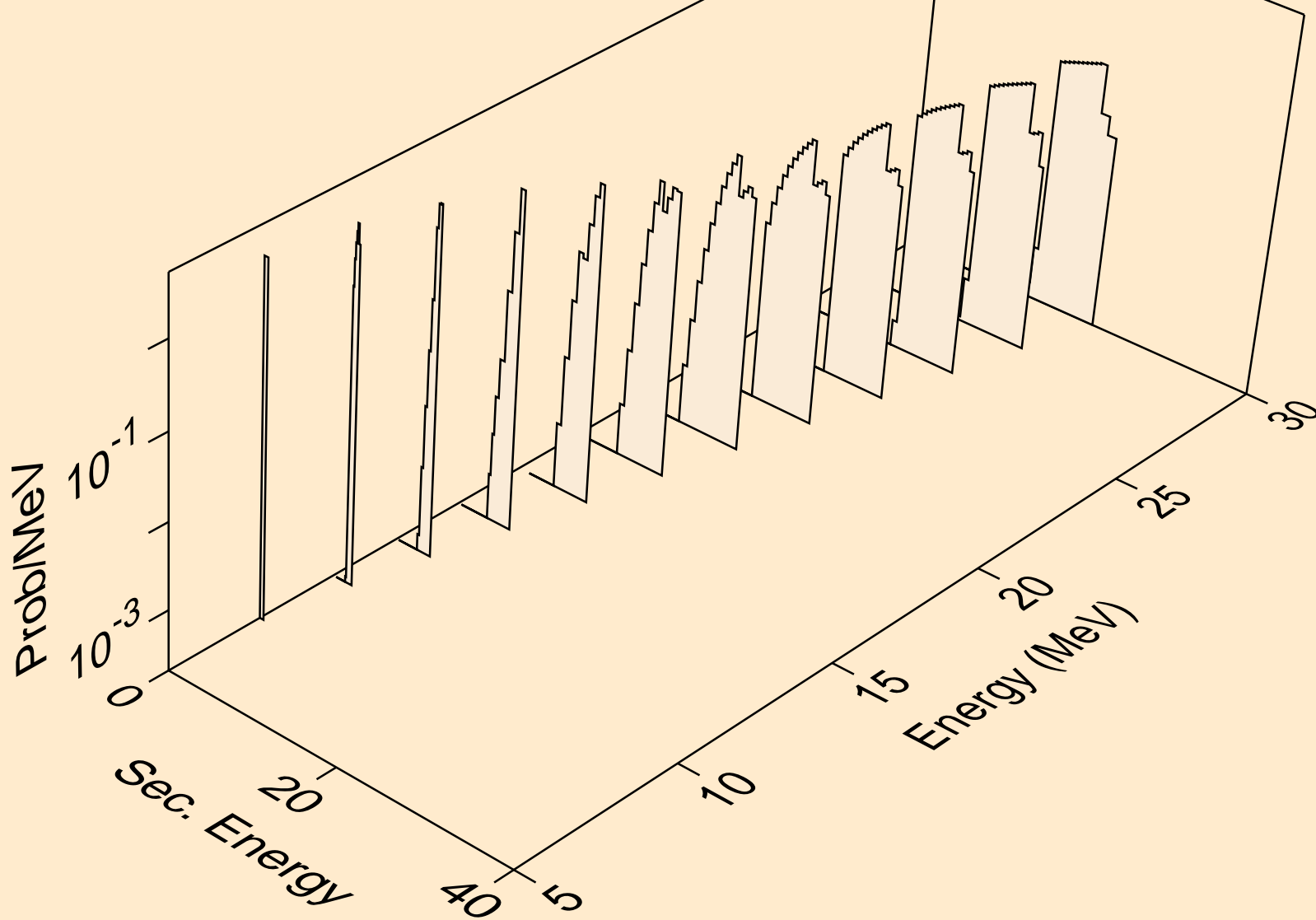

EU165 NEUTRON ACER TENDL-2019 LIBRARY; T=293.16K
tritons from (n,x)

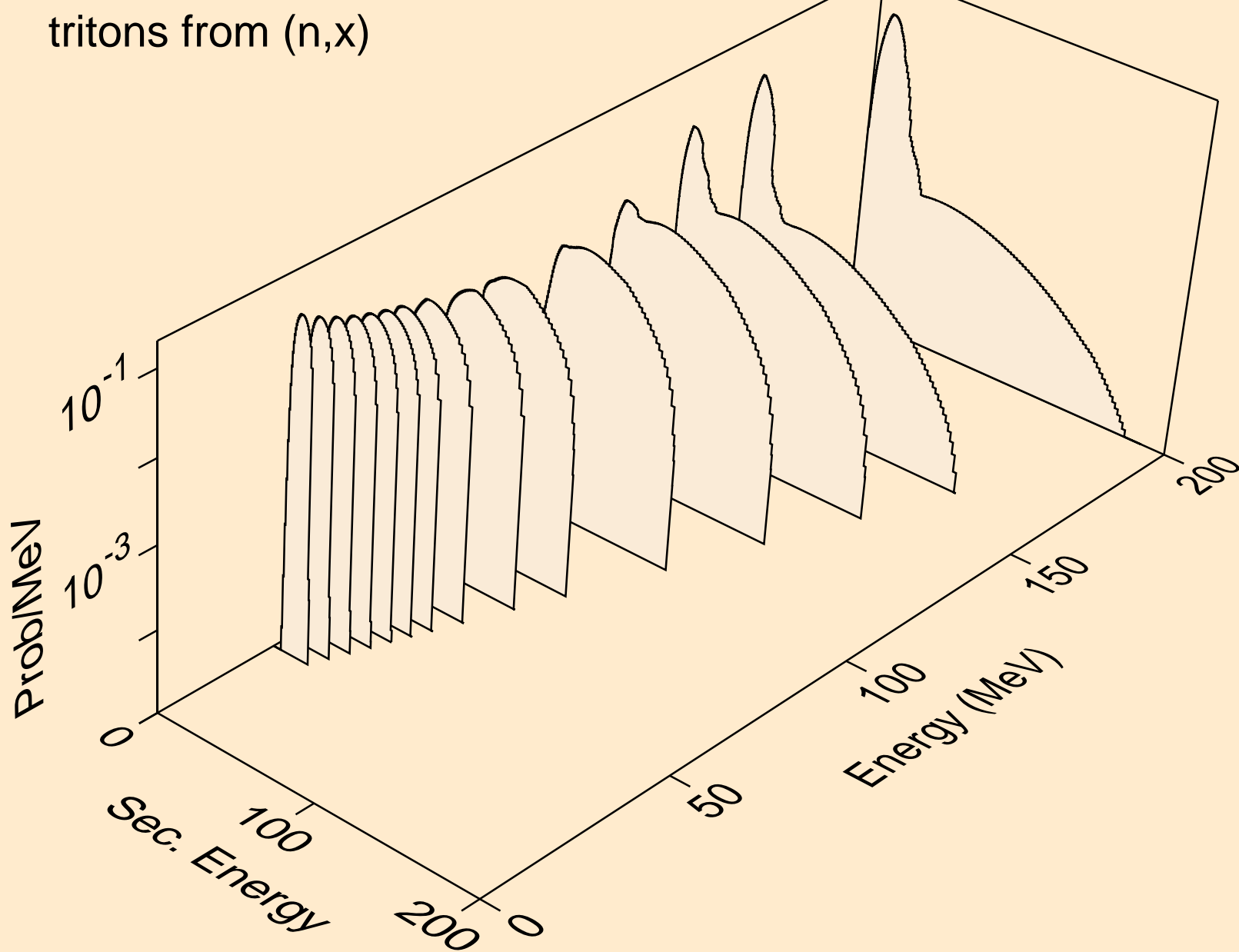

EU165 NEUTRON ACER TENDL-2019 LIBRARY; T=293.16K
tritons from (n,n*)t

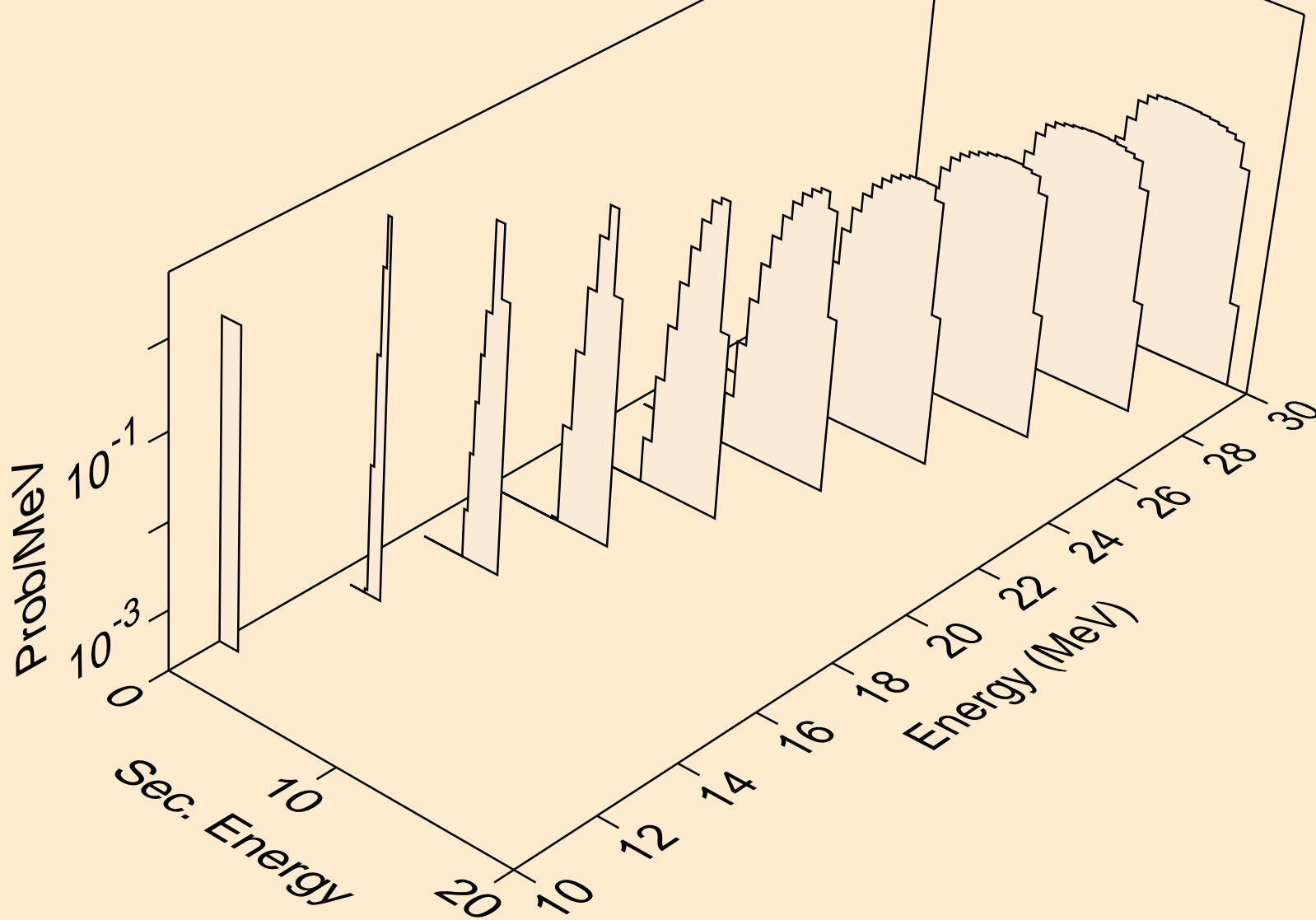

EU165 NEUTRON ACER TENDL-2019 LIBRARY; T=293.16K
tritons from (n,t)

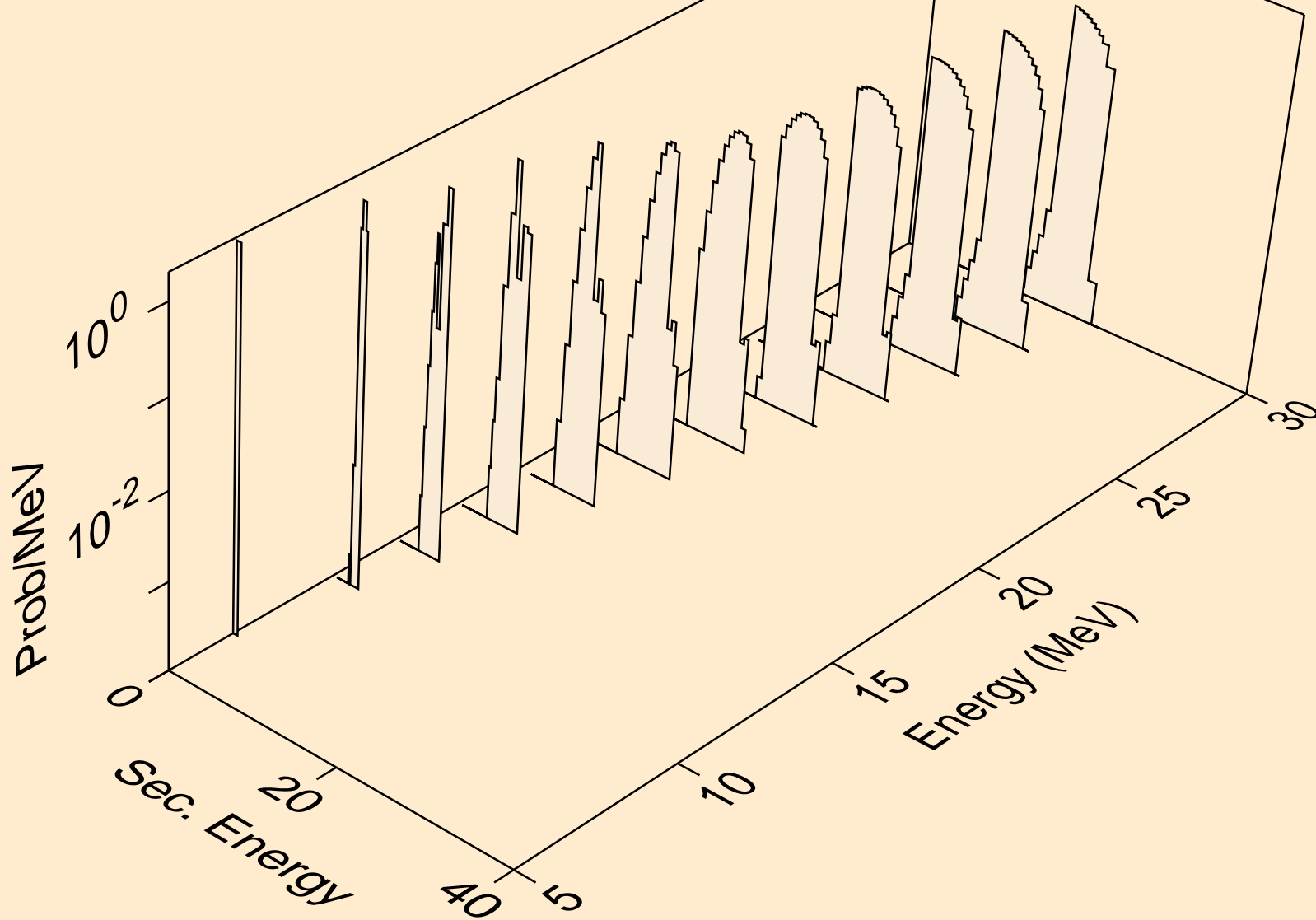

EU165 NEUTRON ACER TENDL-2019 LIBRARY; T=293.16K
he3s from (n,x)

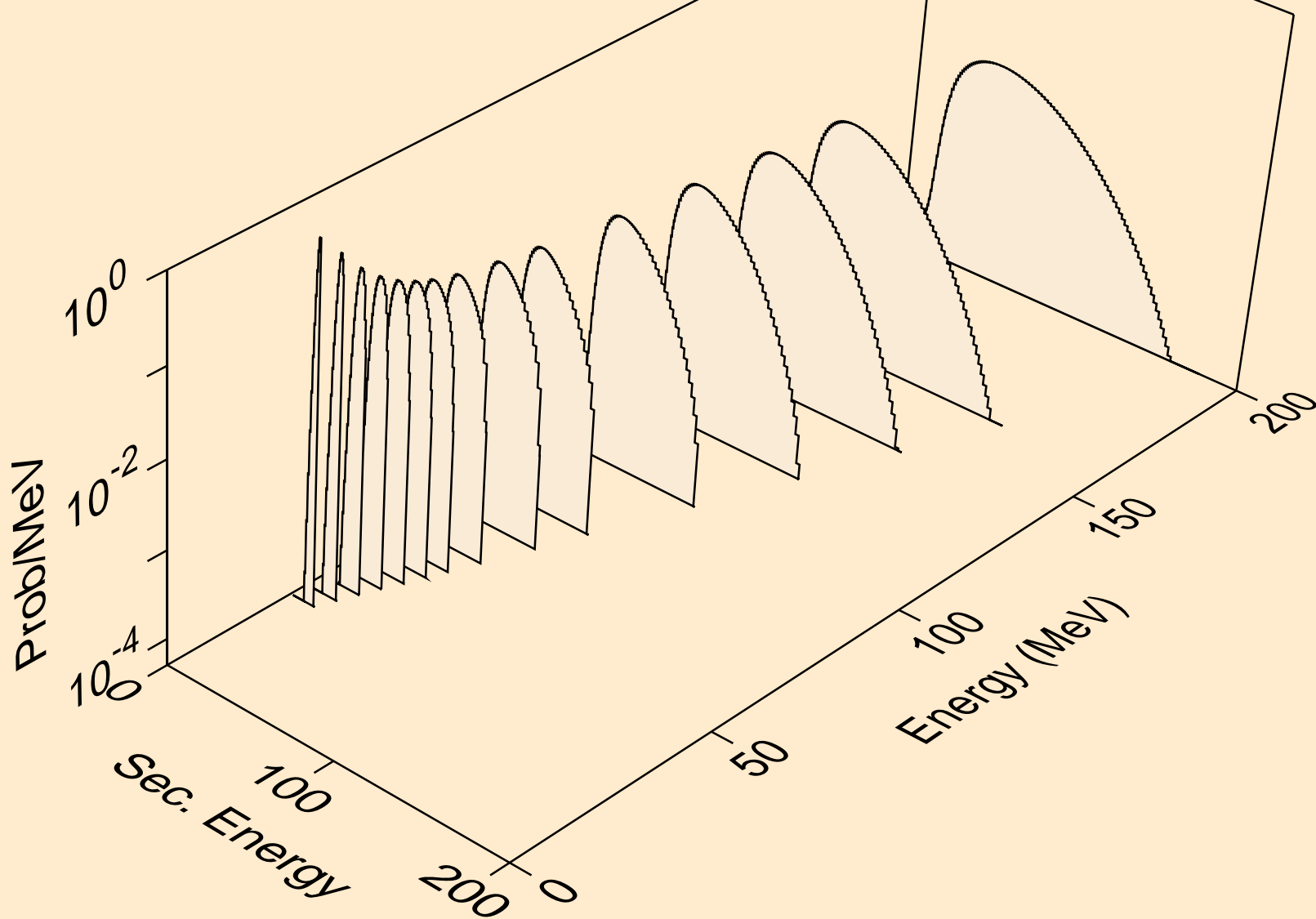

EU165 NEUTRON ACER TENDL-2019 LIBRARY; T=293.16K
he3s from (n,n*)he3

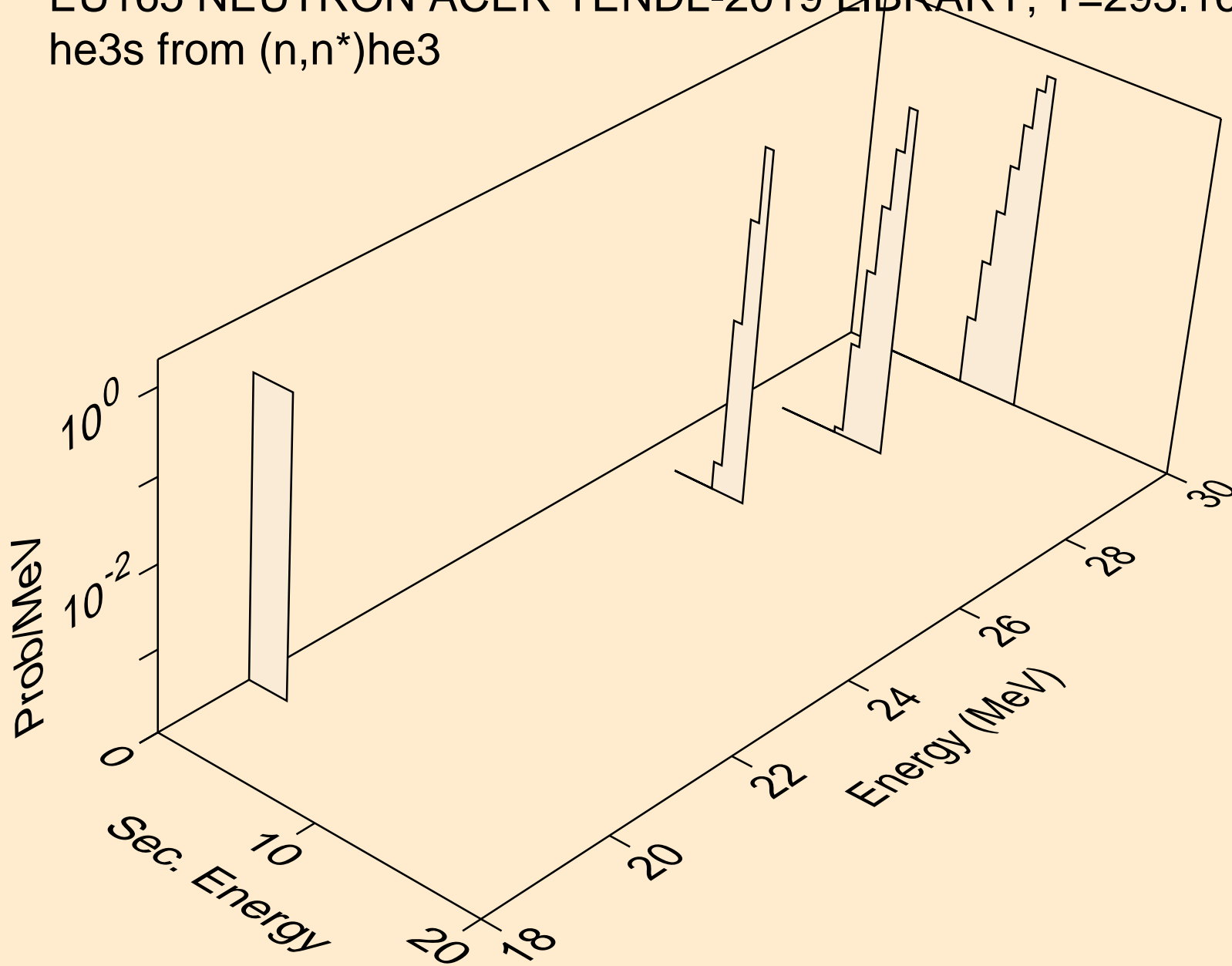

EU165 NEUTRON ACER TENDL-2019 LIBRARY; T=293.16K
he3s from (n,he3)

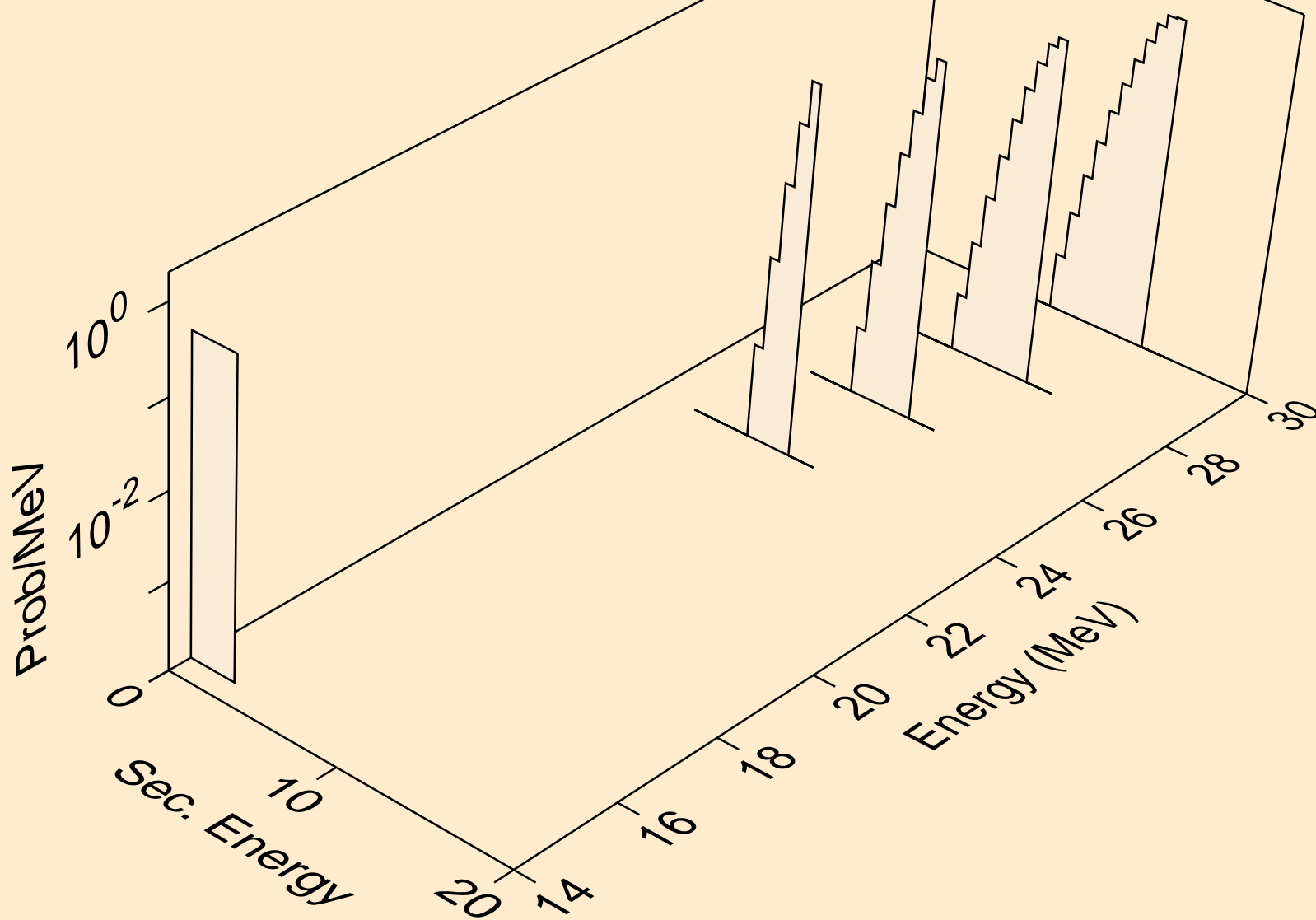

EU165 NEUTRON ACER TENDL-2019 LIBRARY; T=293.16K
alphas from (n,x)

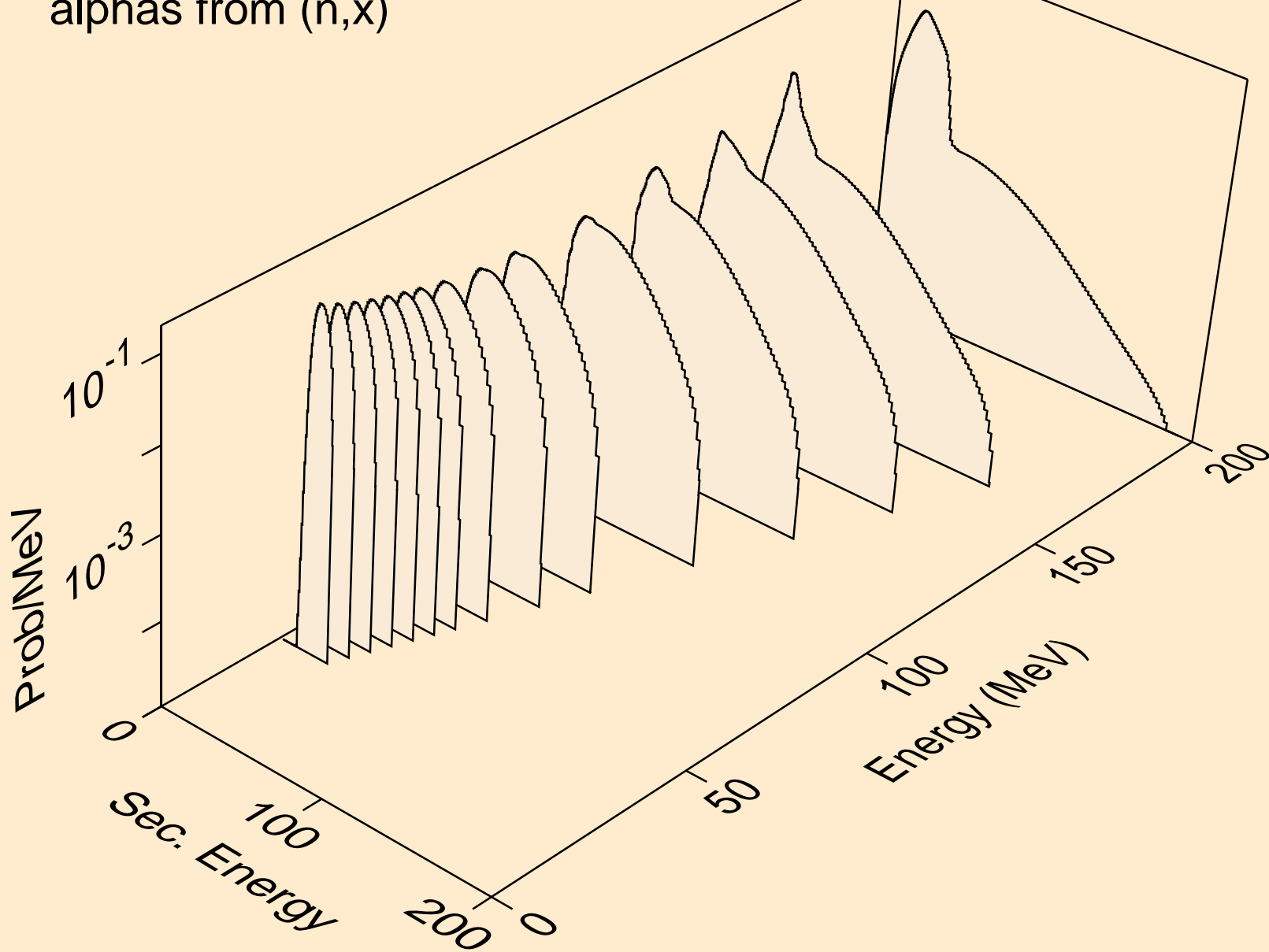

EU165 NEUTRON ACER TENDL-2019 LIBRARY; T=293.16K
alphas from (n,n*)a

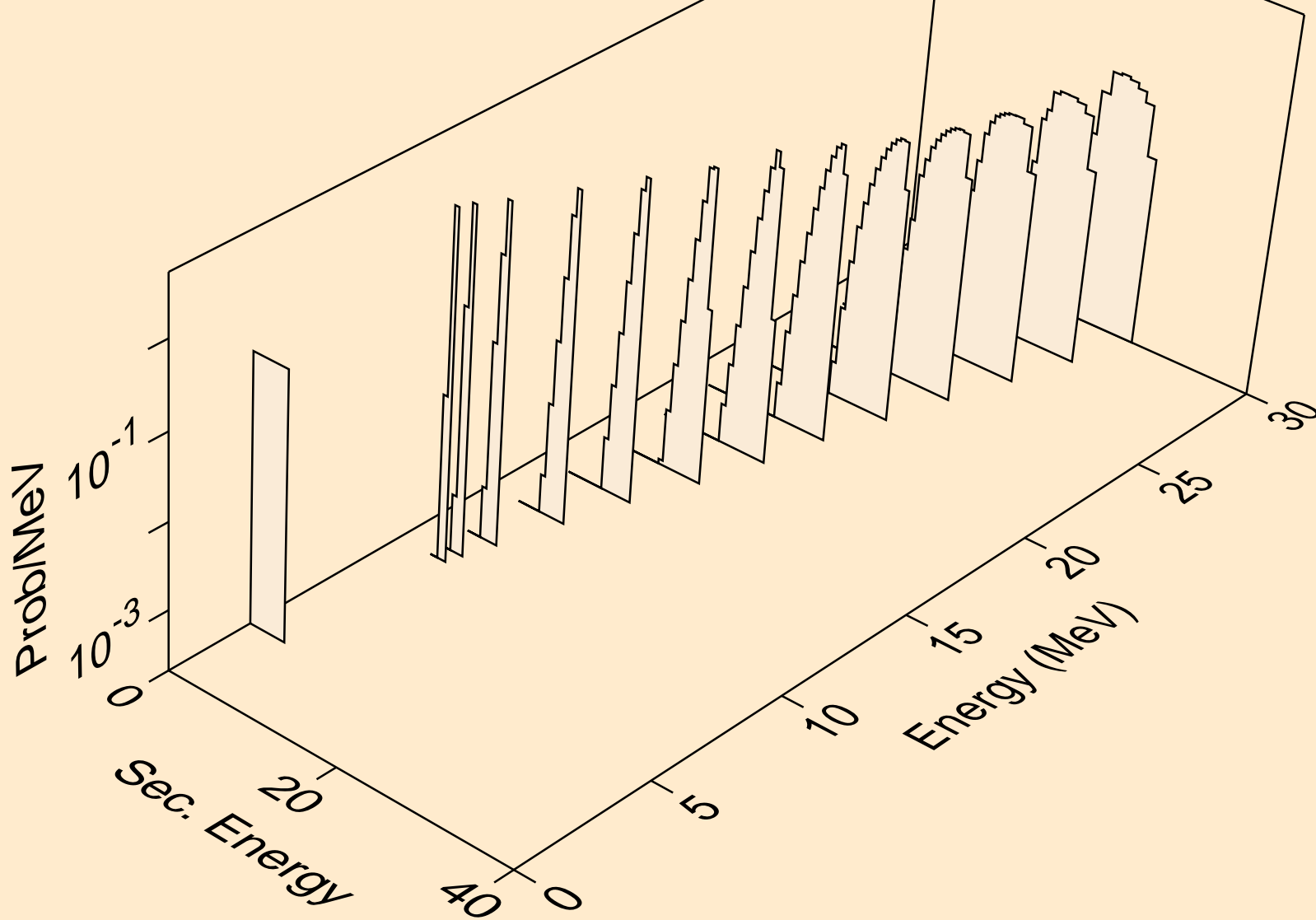

EU165 NEUTRON ACER TENDL-2019 LIBRARY; T=293.16K
alphas from (n,2n)a

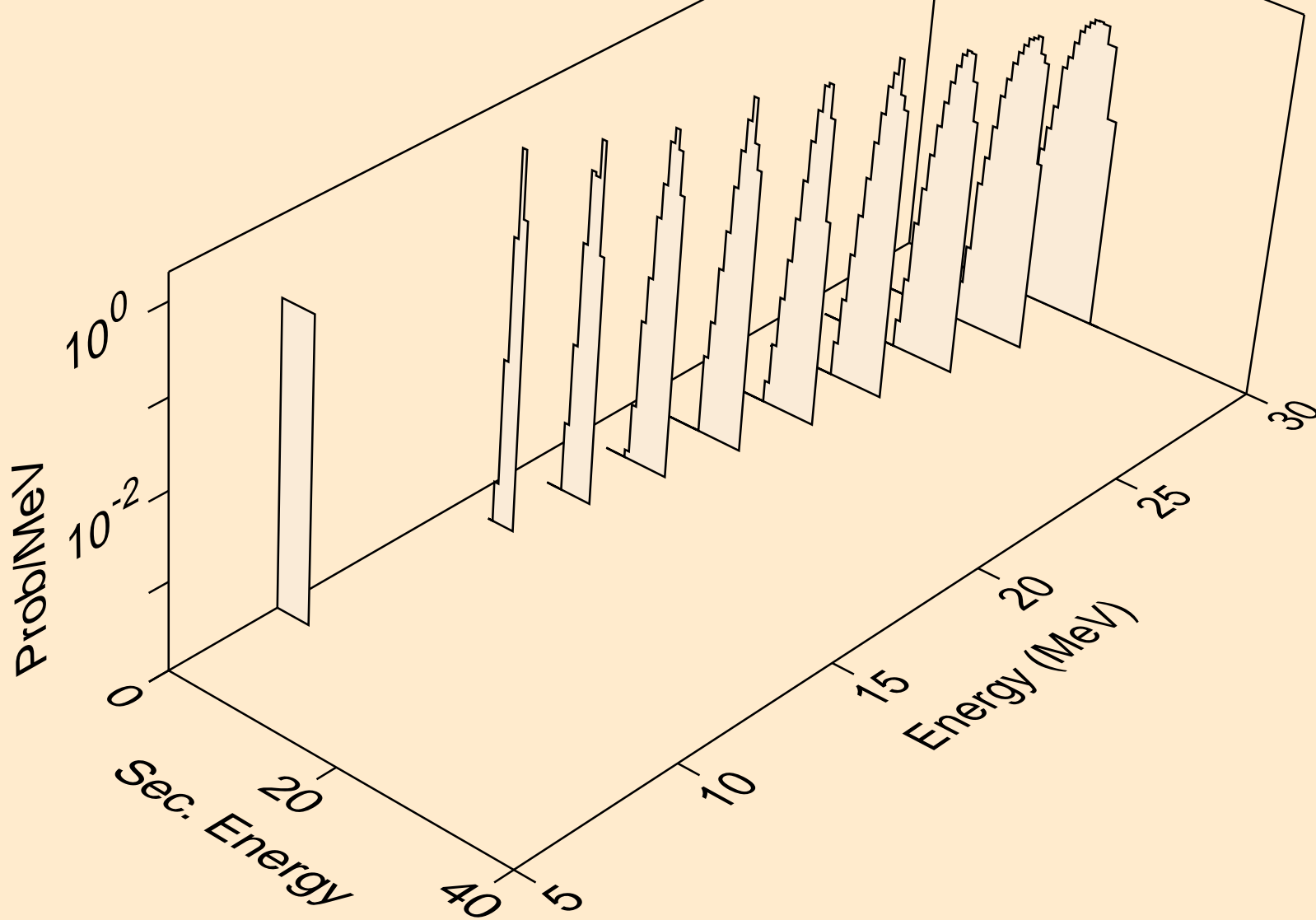

EU165 NEUTRON ACER TENDL-2019 LIBRARY; T=293.16K
alphas from (n,3n)a

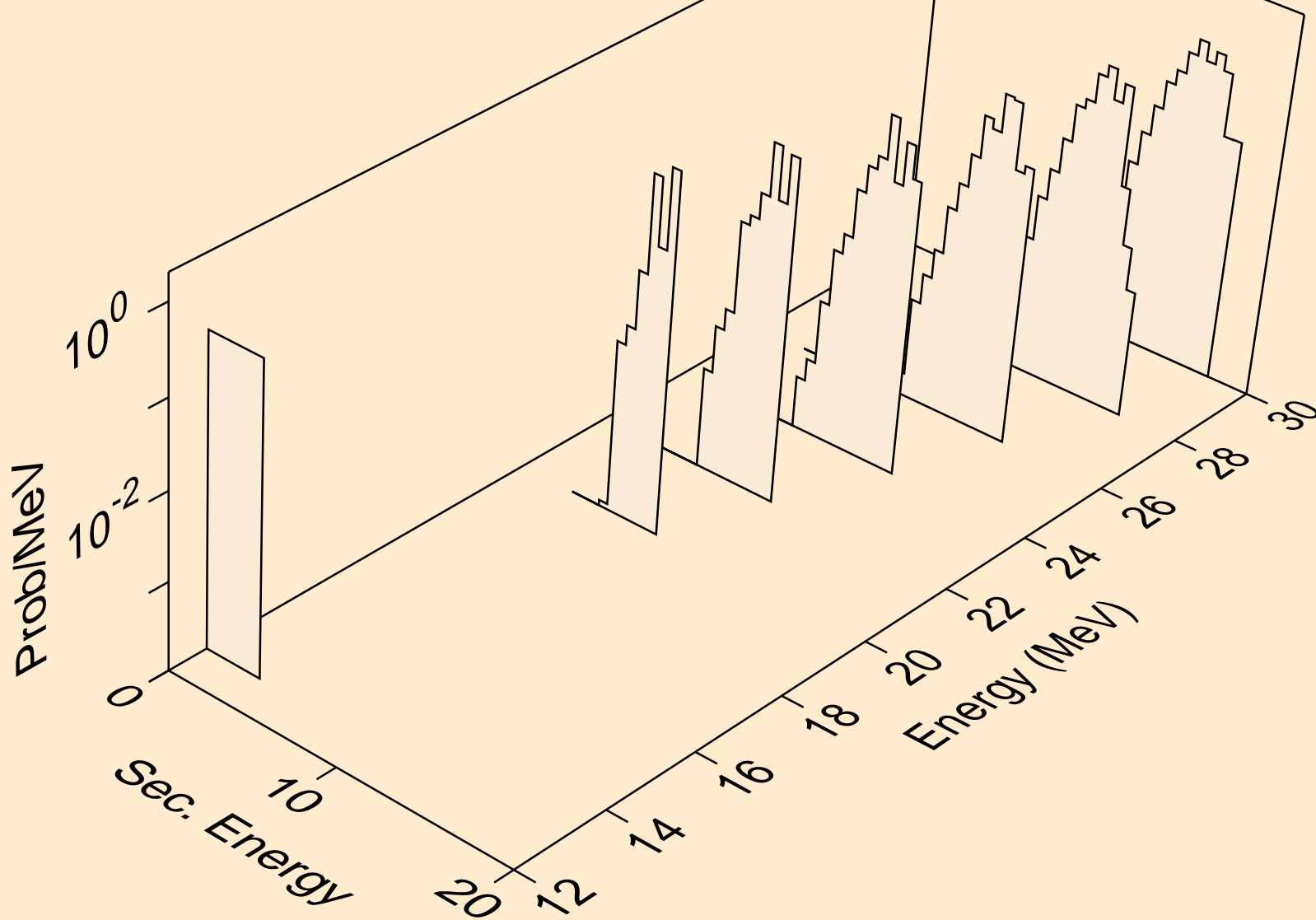

EU165 NEUTRON ACER TENDL-2019 LIBRARY; T=293.16K
alphas from (n,a)

