

FM255 NEUTRON ACER TENDL-2019 LIBRARY; T=293.16K
Principal cross sections

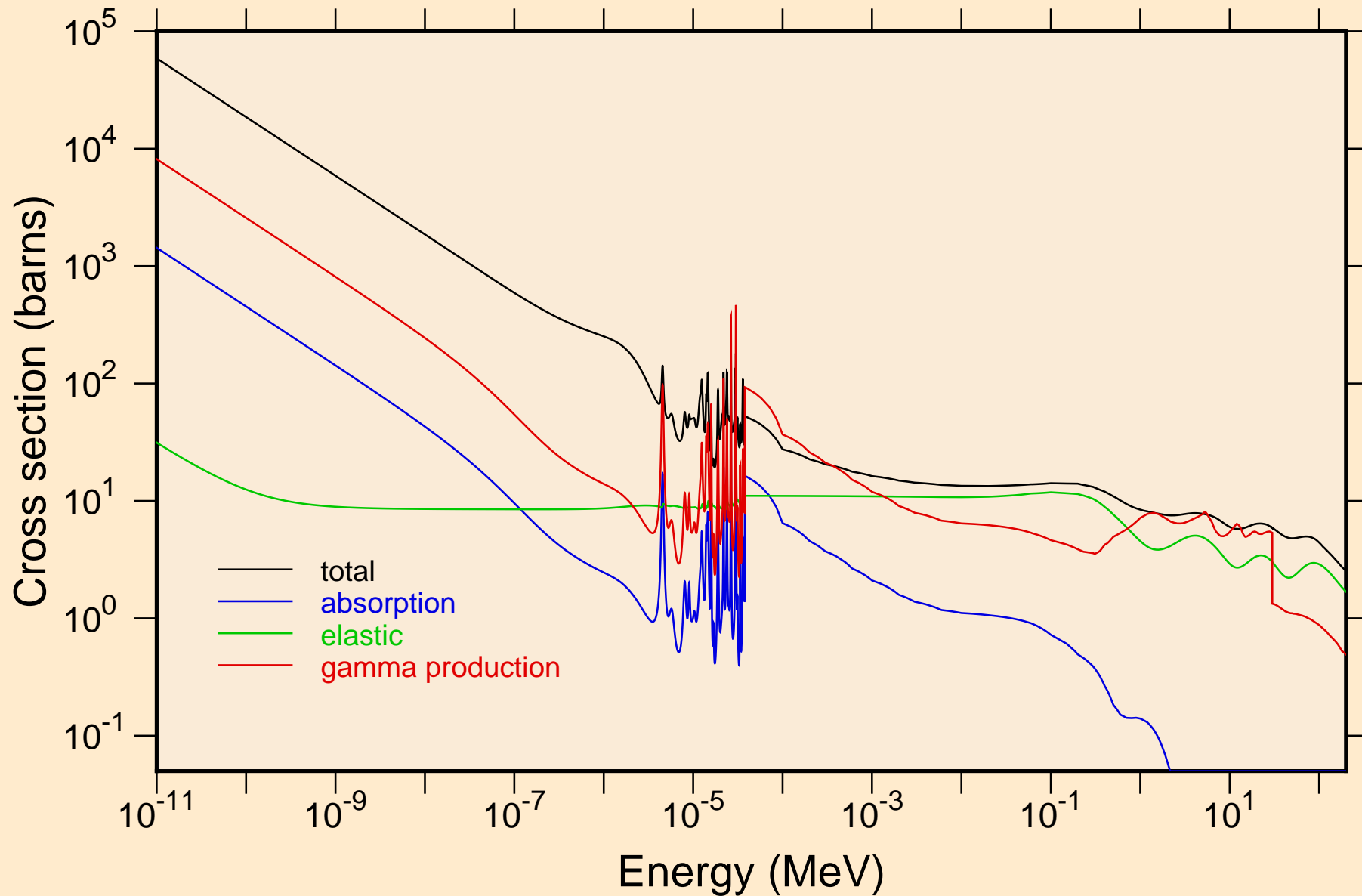

FM255 NEUTRON ACER TENDL-2019 LIBRARY; T=293.16K
resonance total cross section

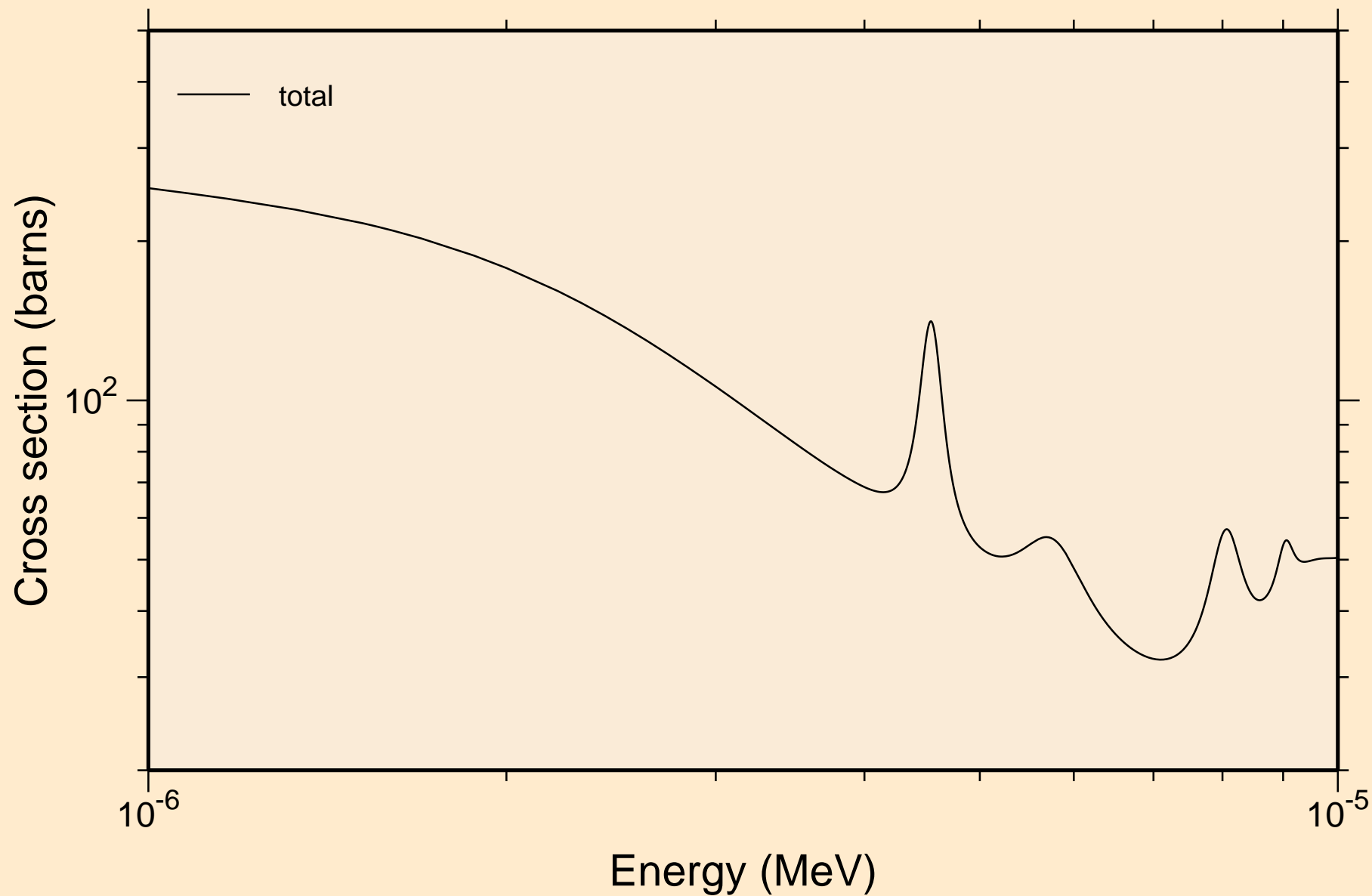

FM255 NEUTRON ACER TENDL-2019 LIBRARY; T=293.16K
resonance total cross section

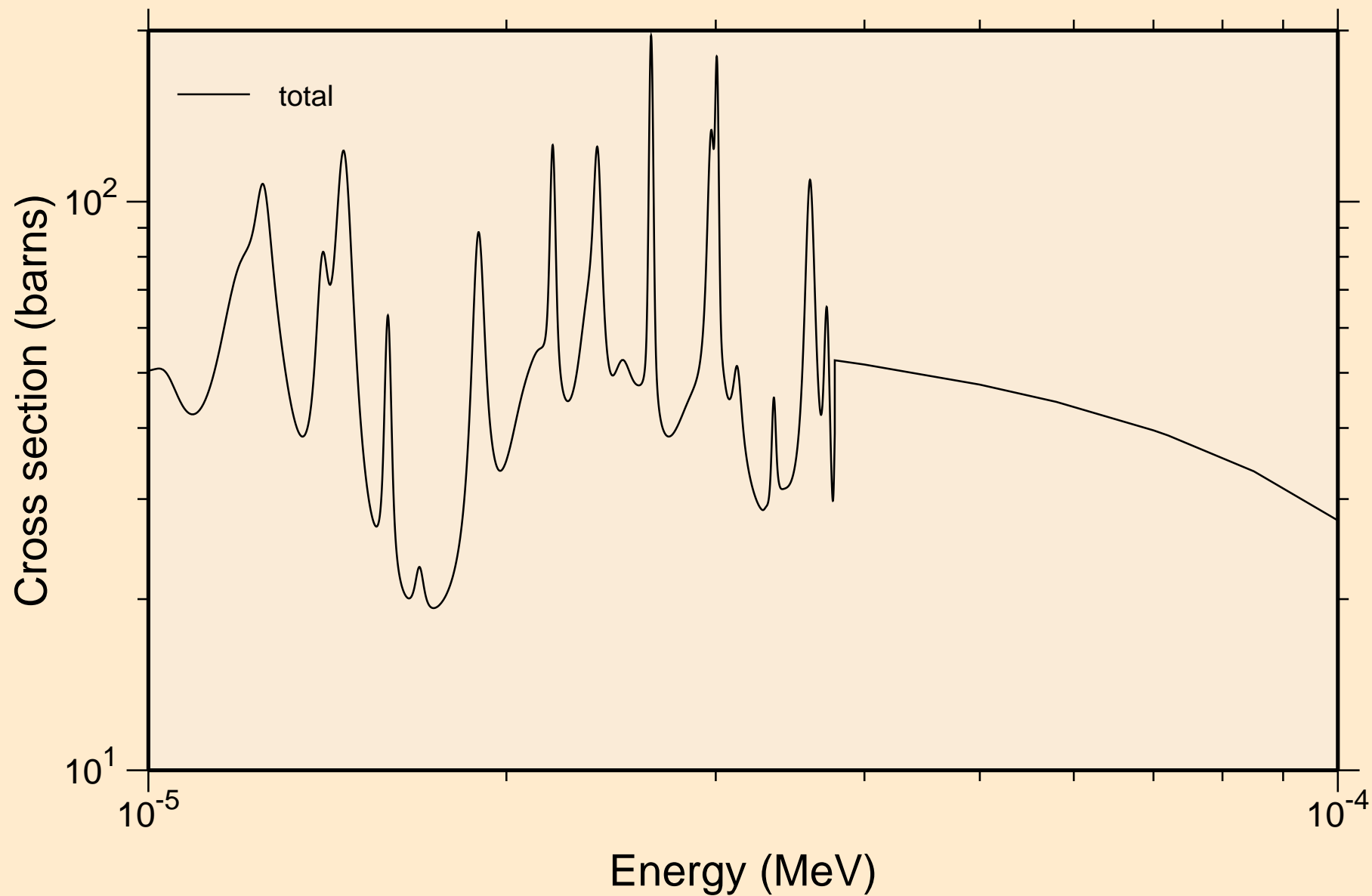

FM255 NEUTRON ACER TENDL-2019 LIBRARY; T=293.16K
resonance total cross section

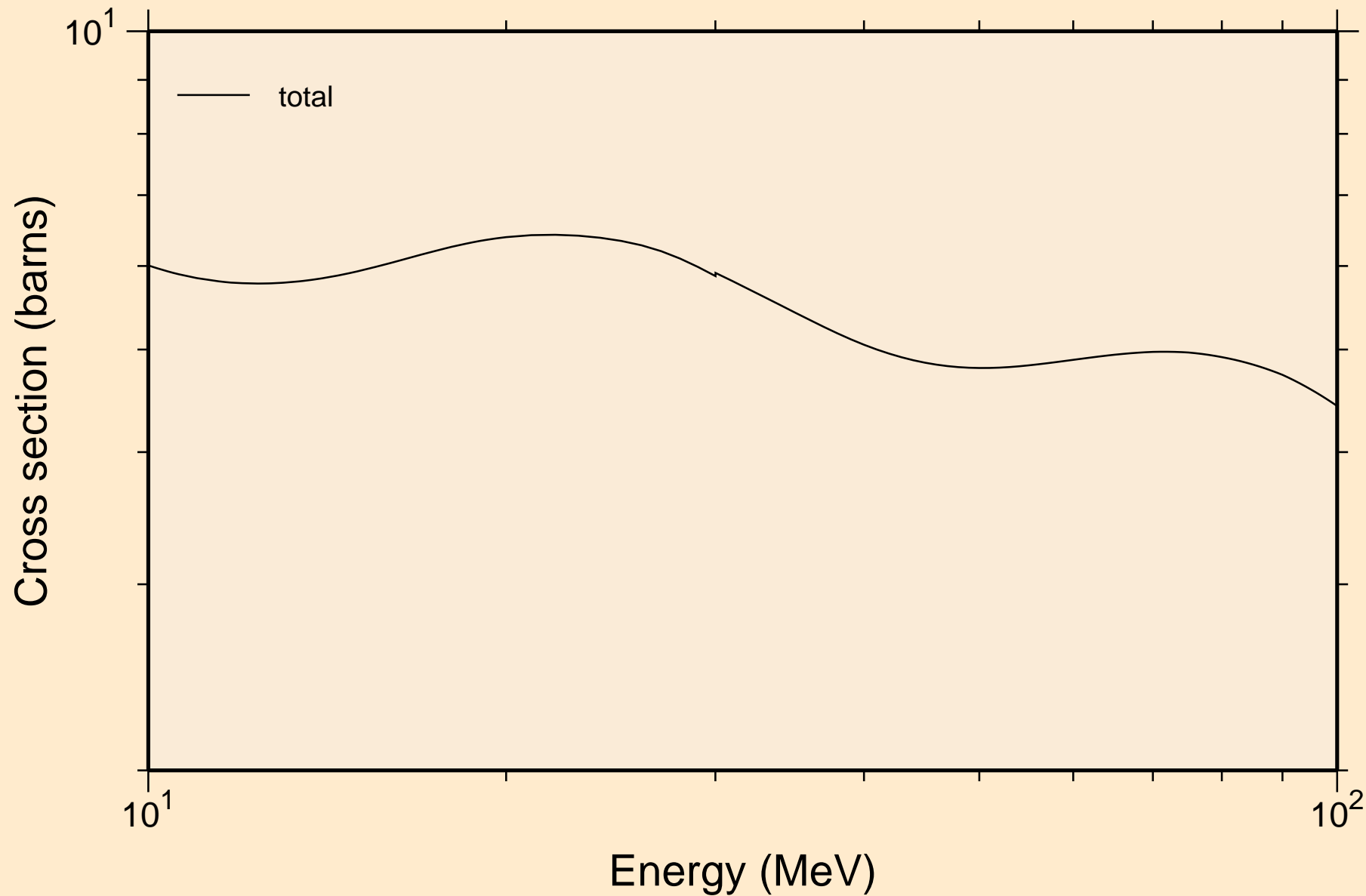

FM255 NEUTRON ACER TENDL-2019 LIBRARY; T=293.16K
resonance absorption cross sections

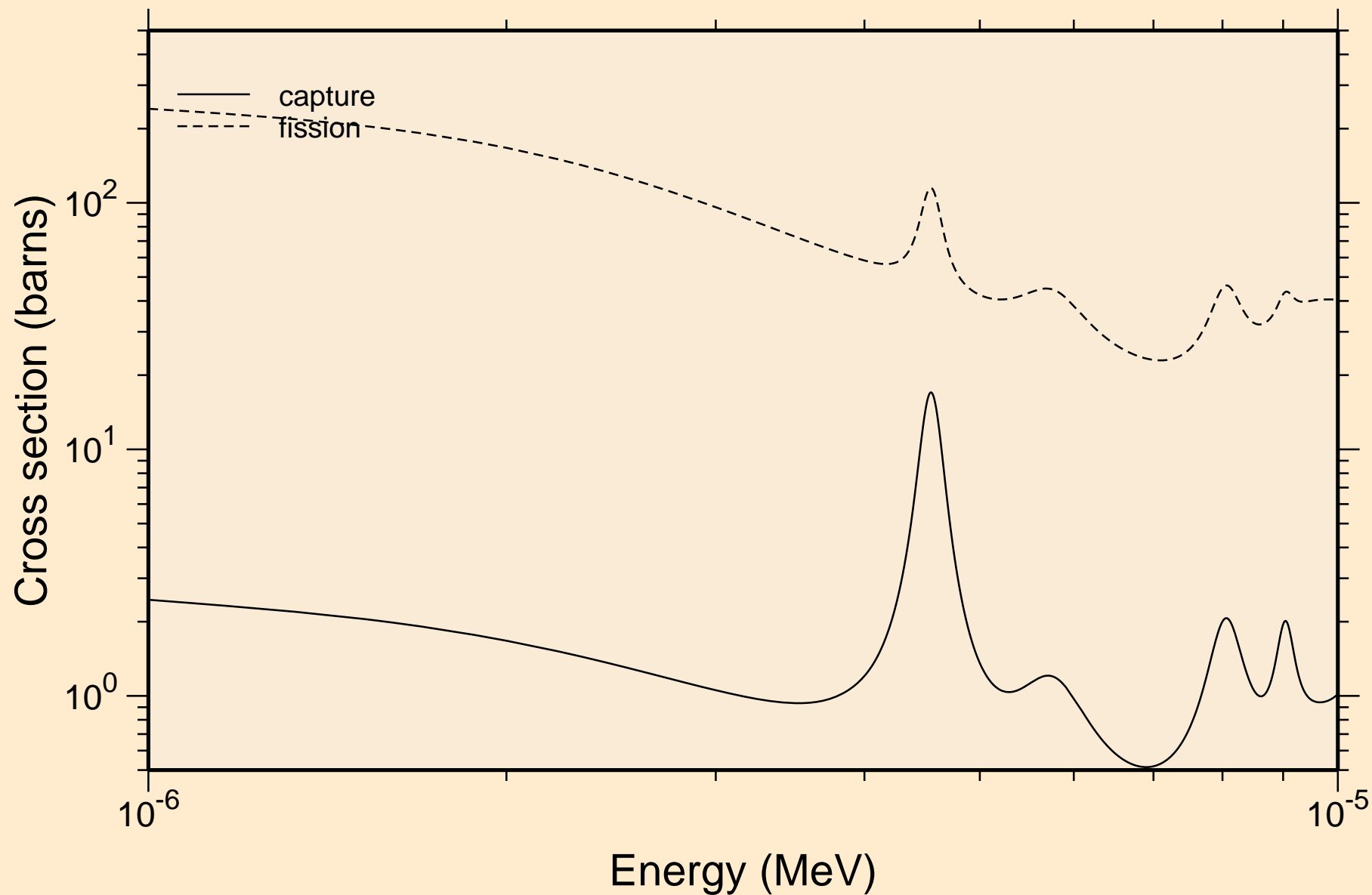

FM255 NEUTRON ACER TENDL-2019 LIBRARY; T=293.16K
resonance absorption cross sections

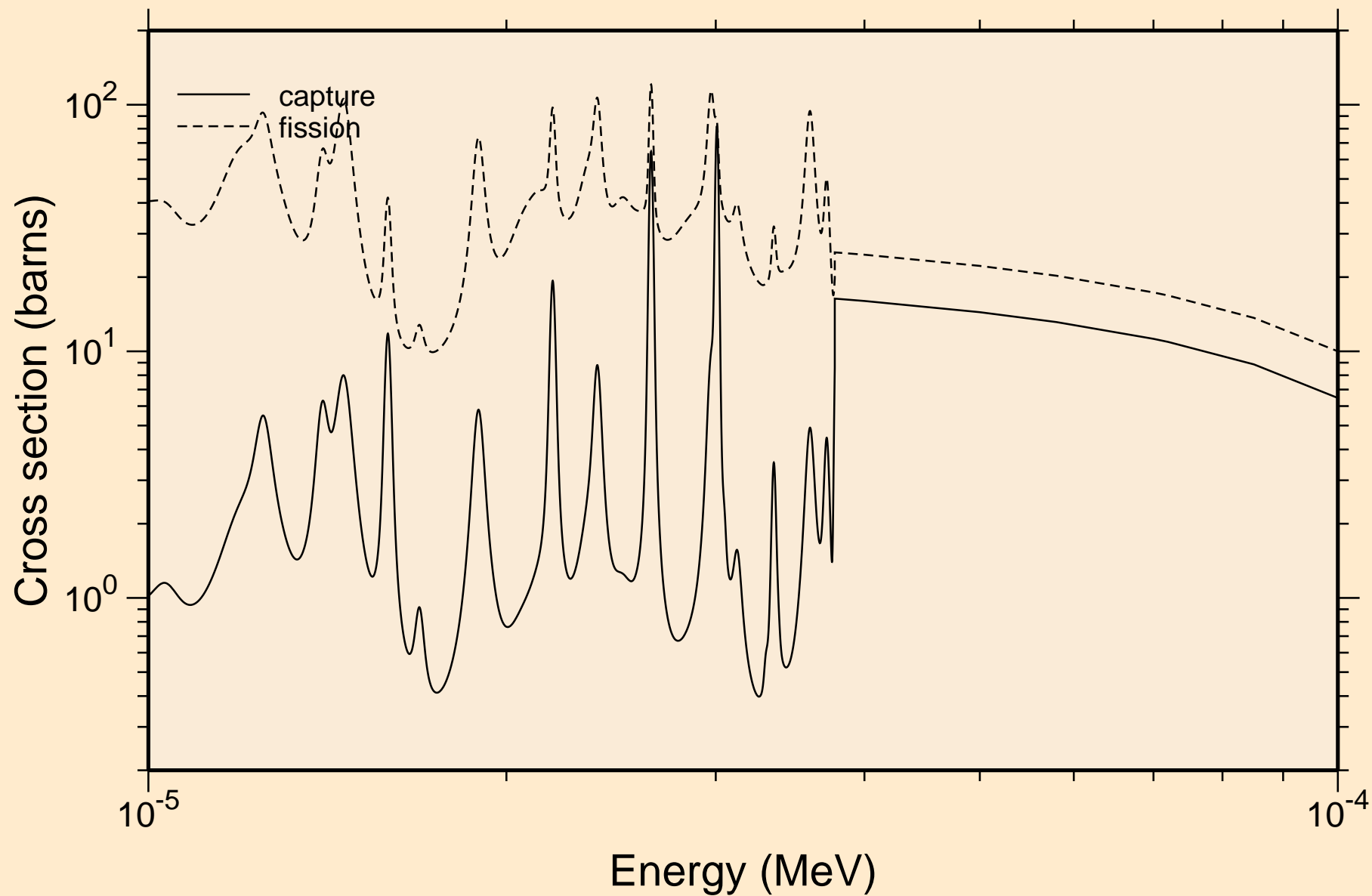

FM255 NEUTRON ACER TENDL-2019 LIBRARY; T=293.16K
resonance absorption cross sections

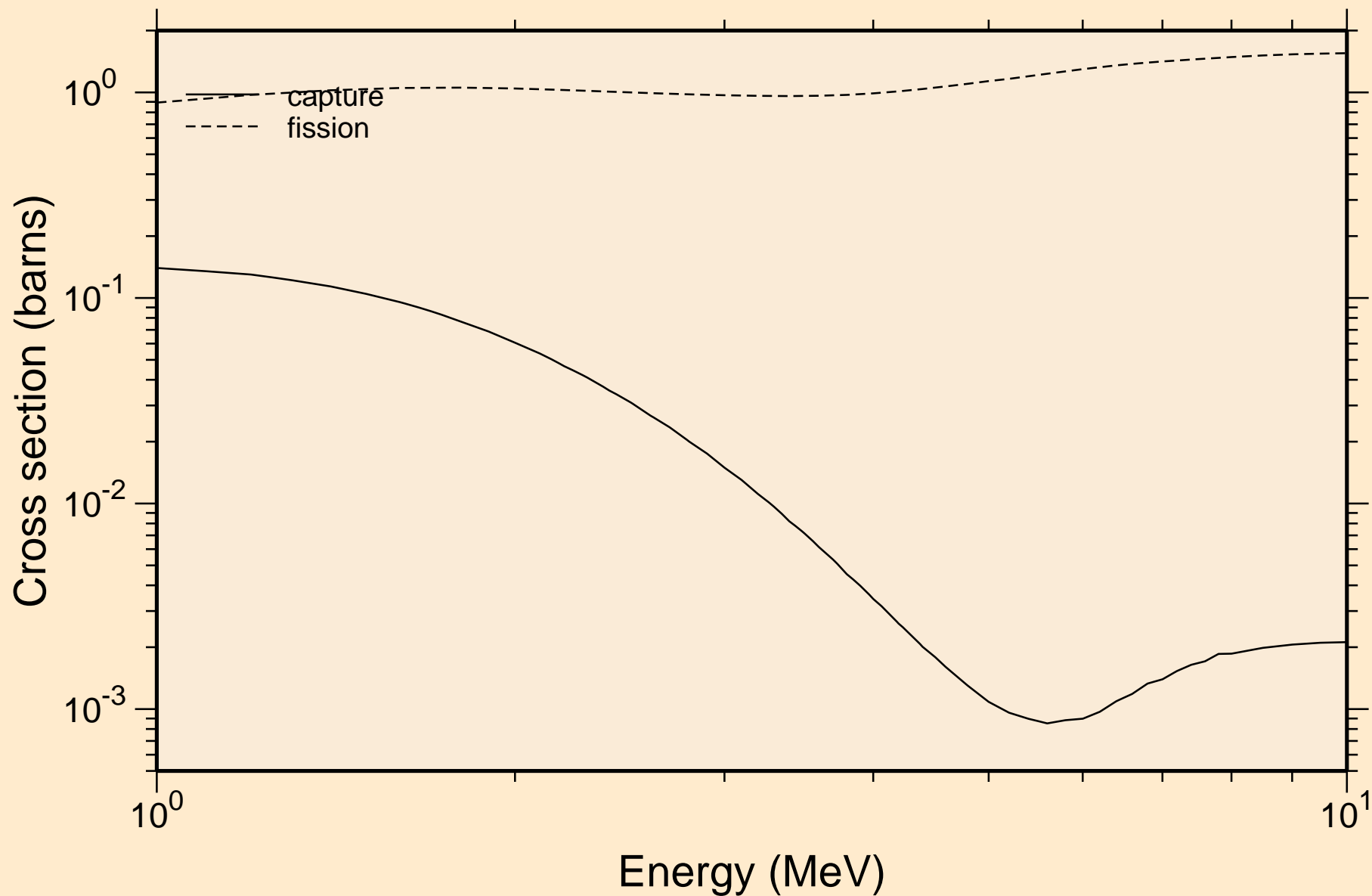

FM255 NEUTRON ACER TENDL-2019 LIBRARY; T=293.16K
Heating

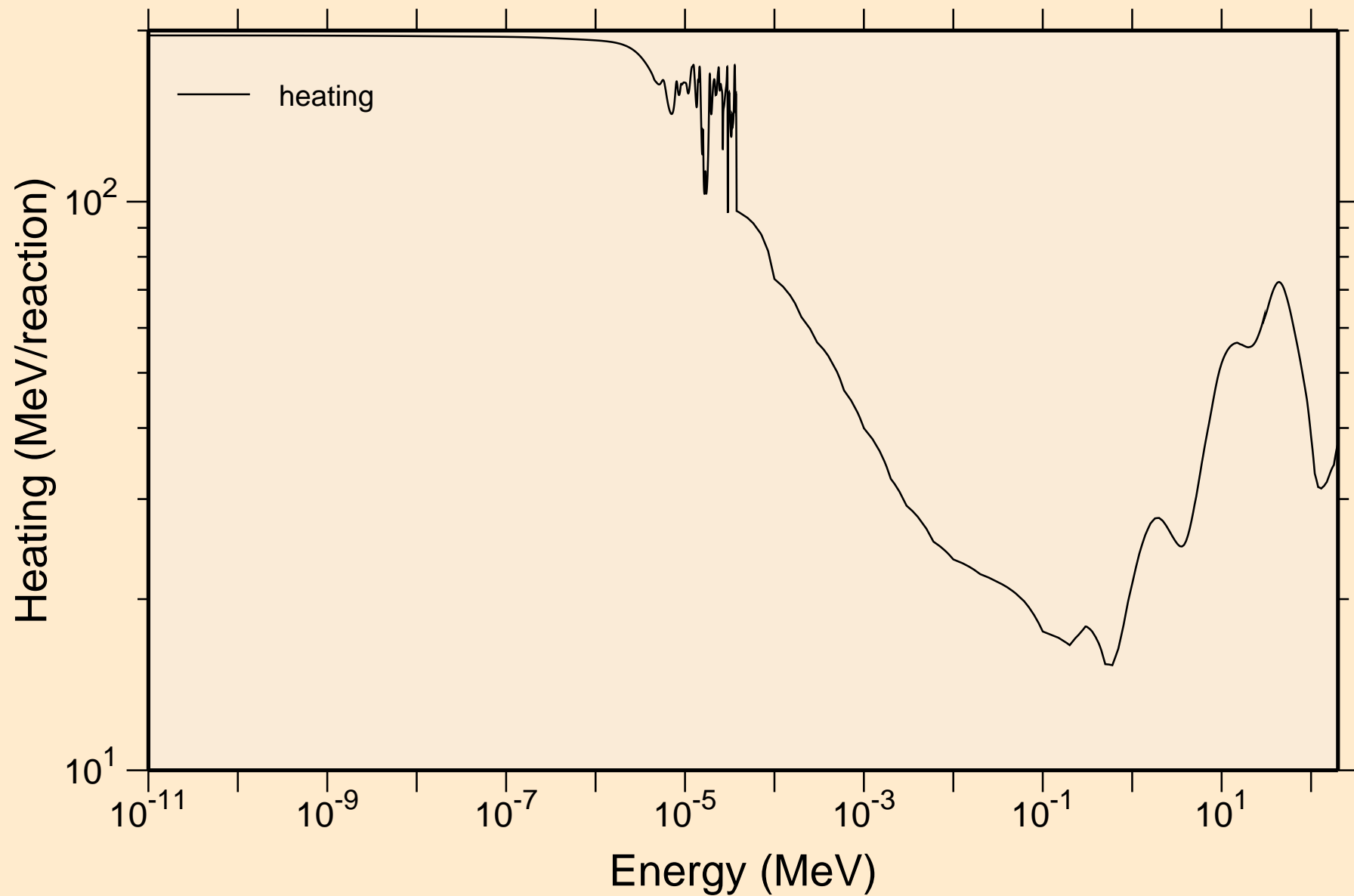

FM255 NEUTRON ACER TENDL-2019 LIBRARY; T=293.16K
Damage

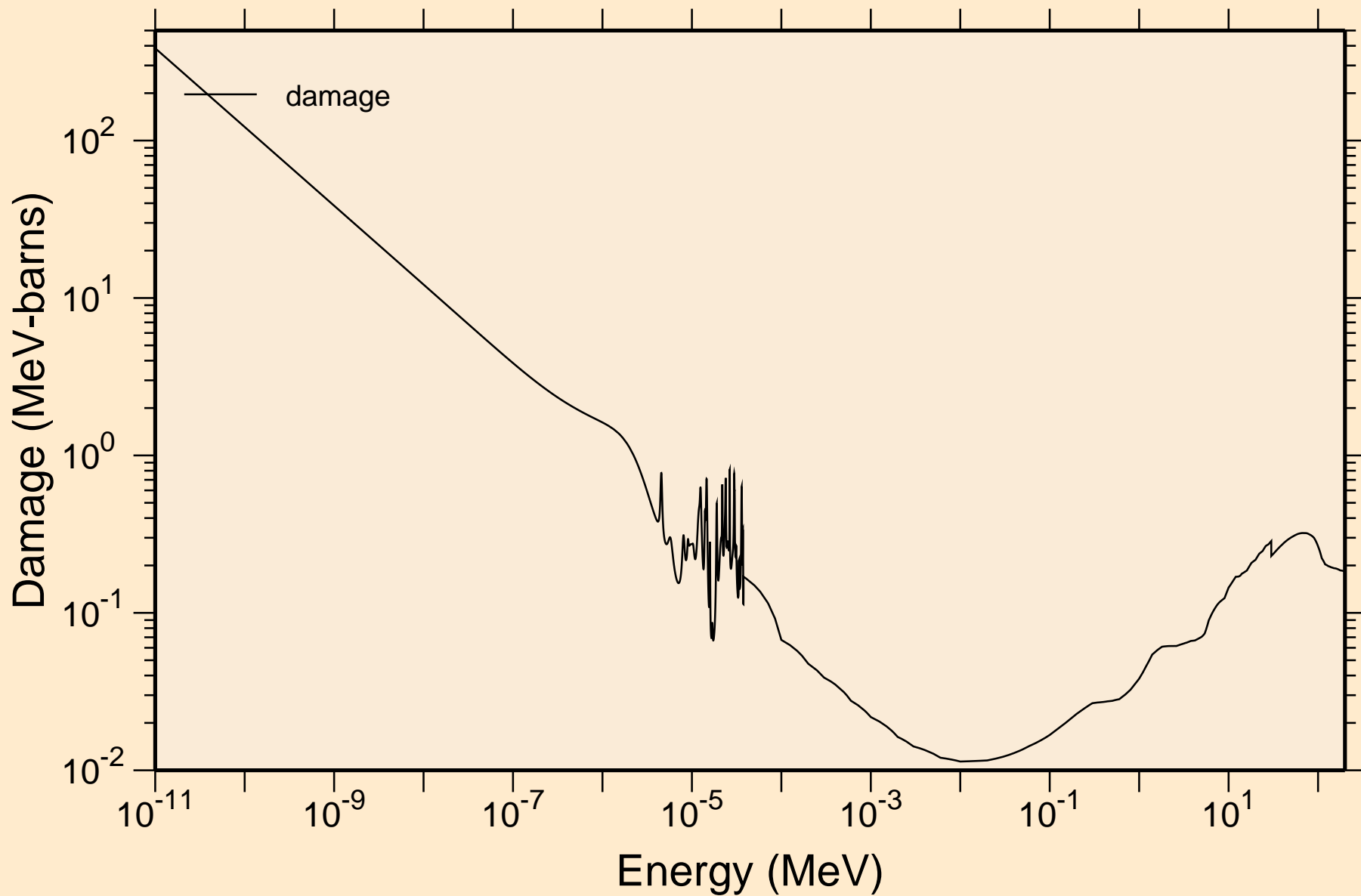

FM255 NEUTRON ACER TENDL-2019 LIBRARY; T=293.16K
Non-threshold reactions

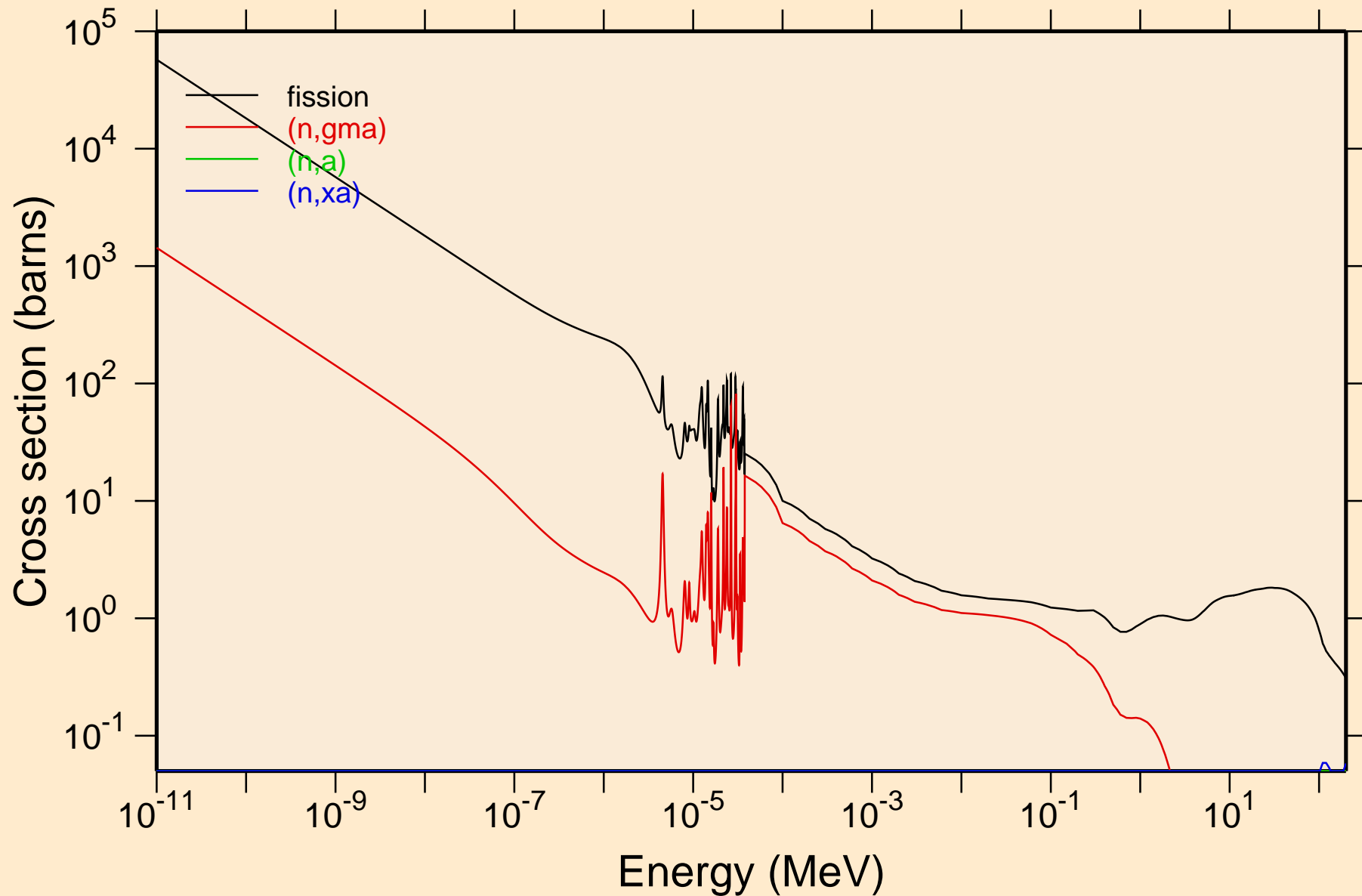

FM255 NEUTRON ACER TENDL-2019 LIBRARY; T=293.16K
Principal cross sections

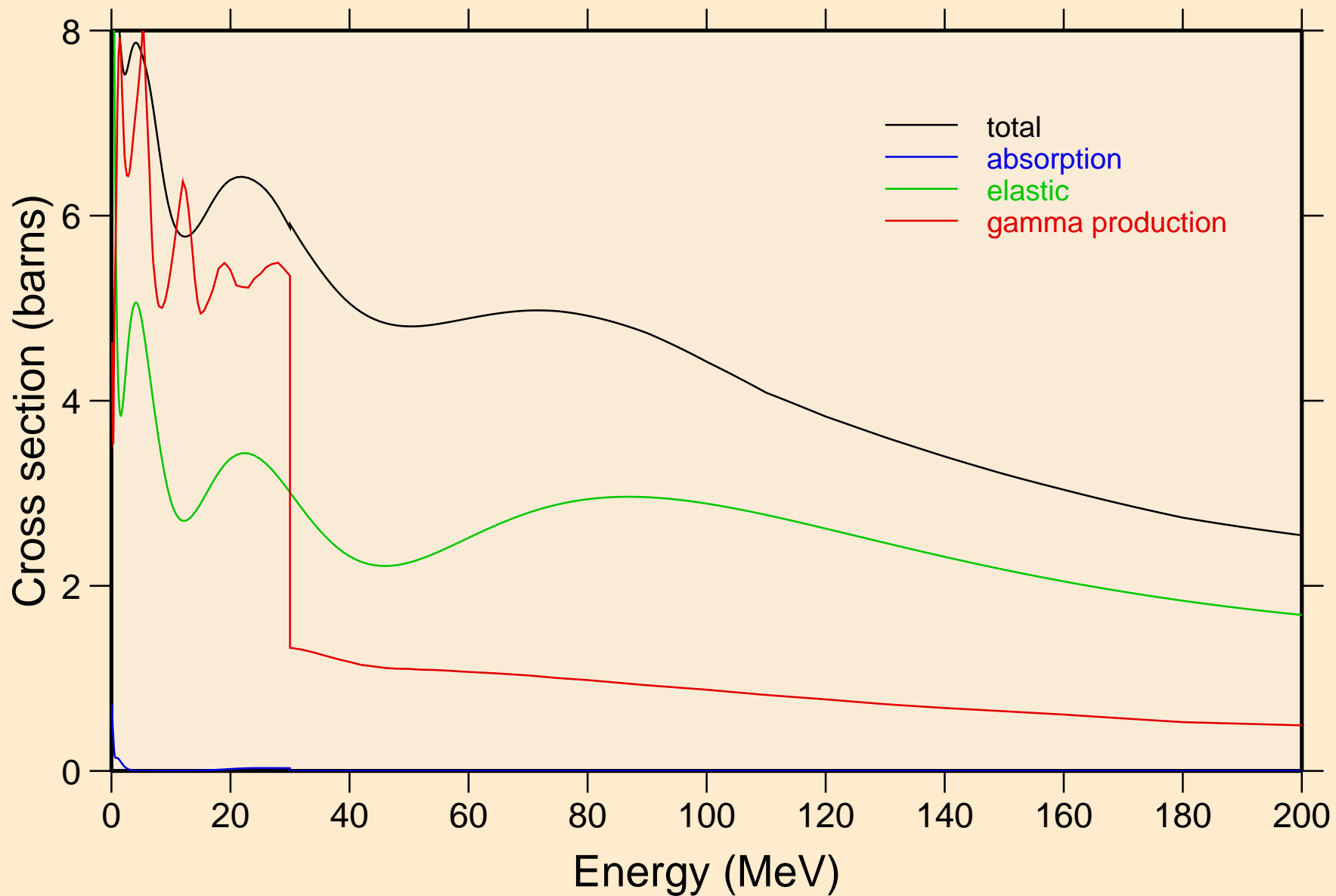

FM255 NEUTRON ACER TENDL-2019 LIBRARY; T=293.16K
Heating

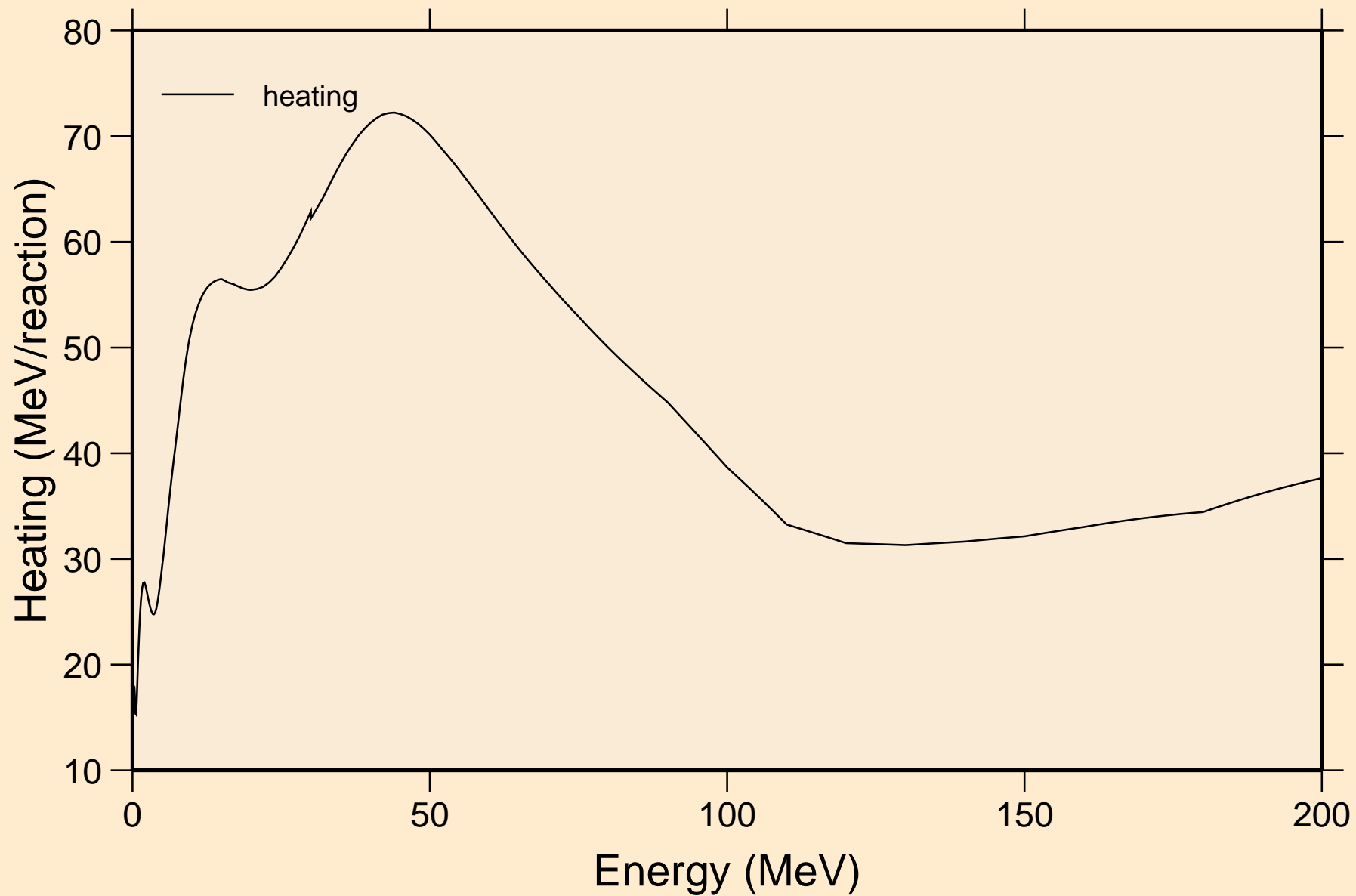

FM255 NEUTRON ACER TENDL-2019 LIBRARY; T=293.16K
Damage

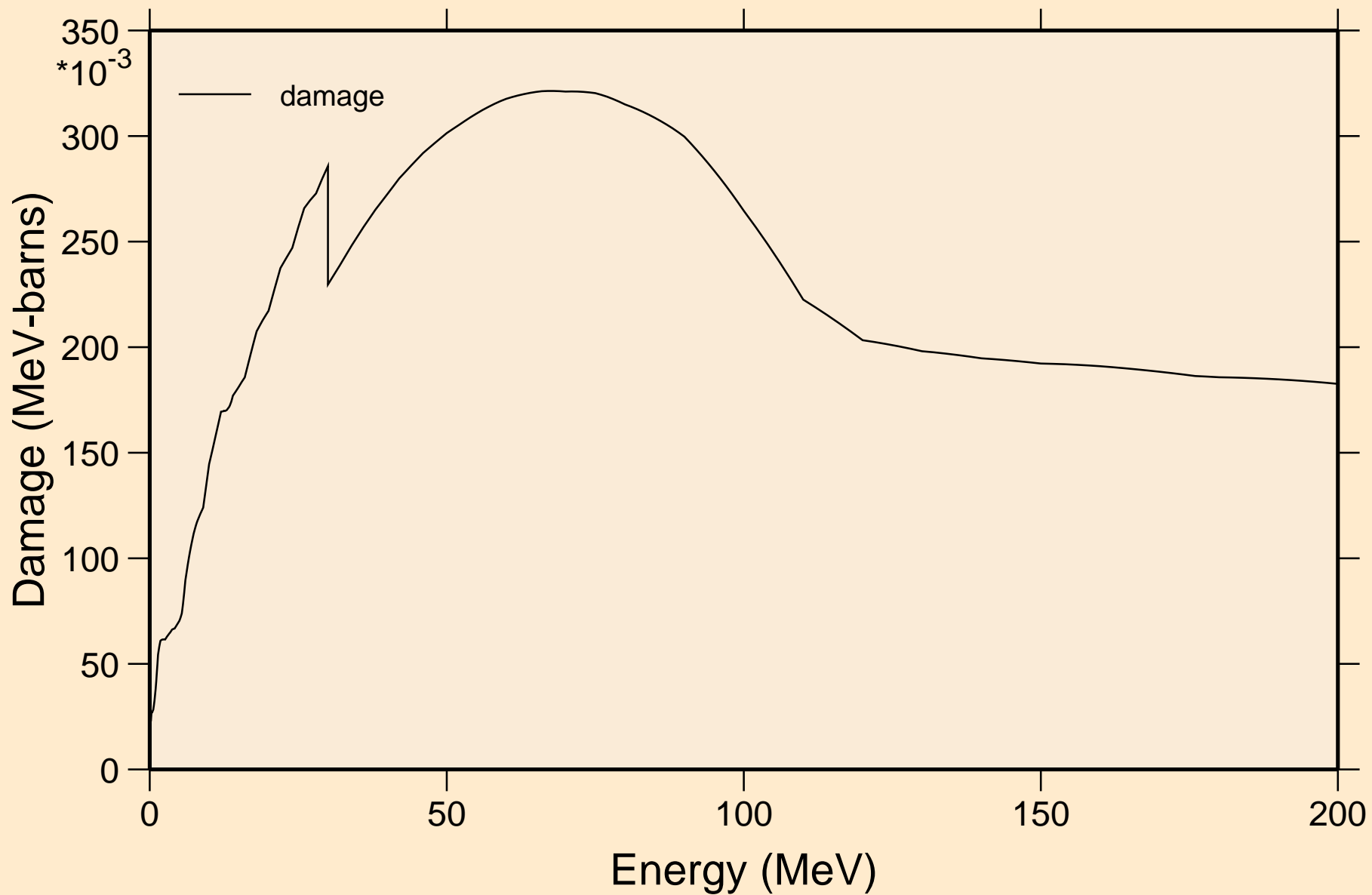

FM255 NEUTRON ACER TENDL-2019 LIBRARY; T=293.16K
Non-threshold reactions

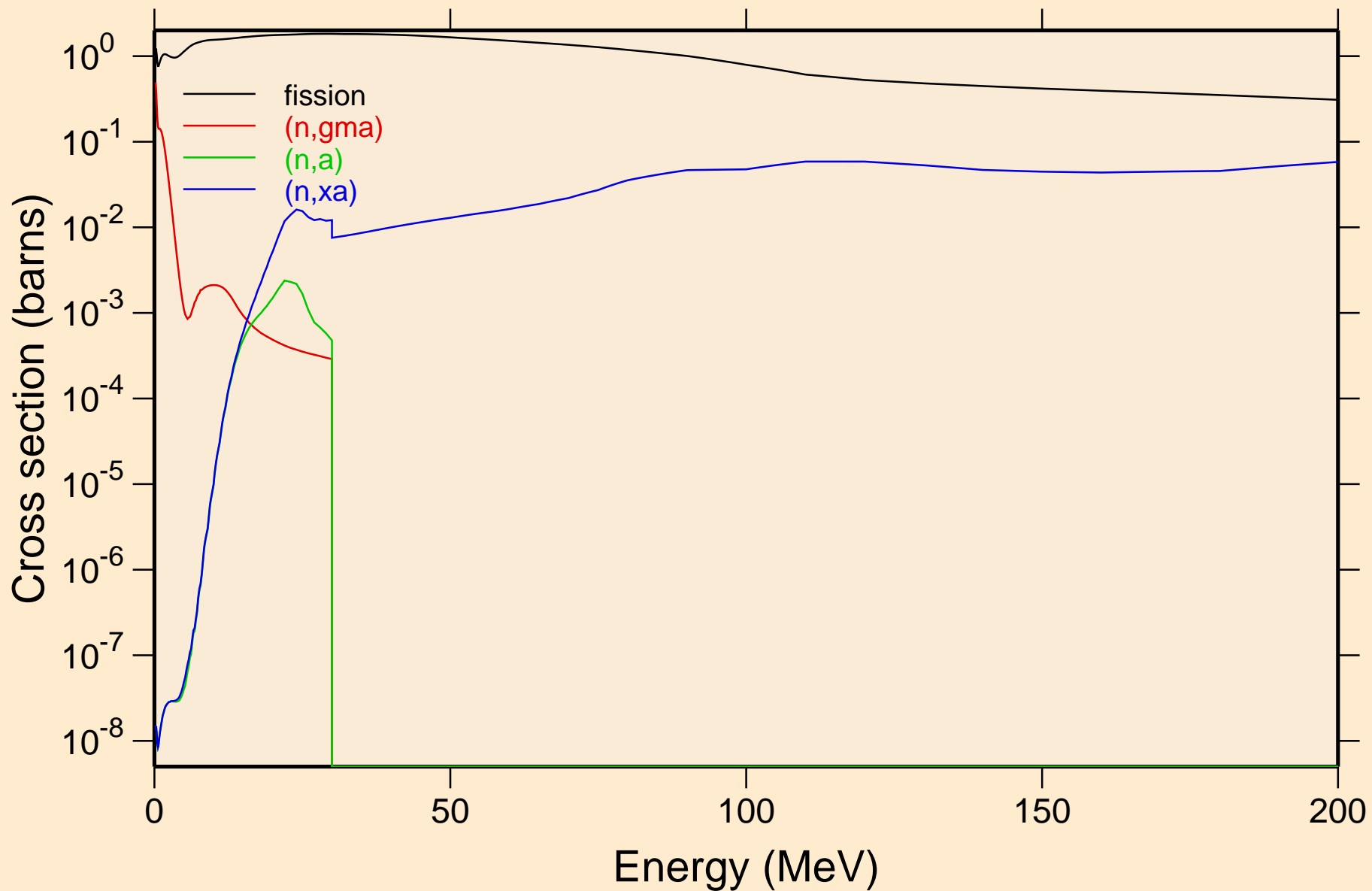

FM255 NEUTRON ACER TENDL-2019 LIBRARY; T=293.16K
Inelastic levels

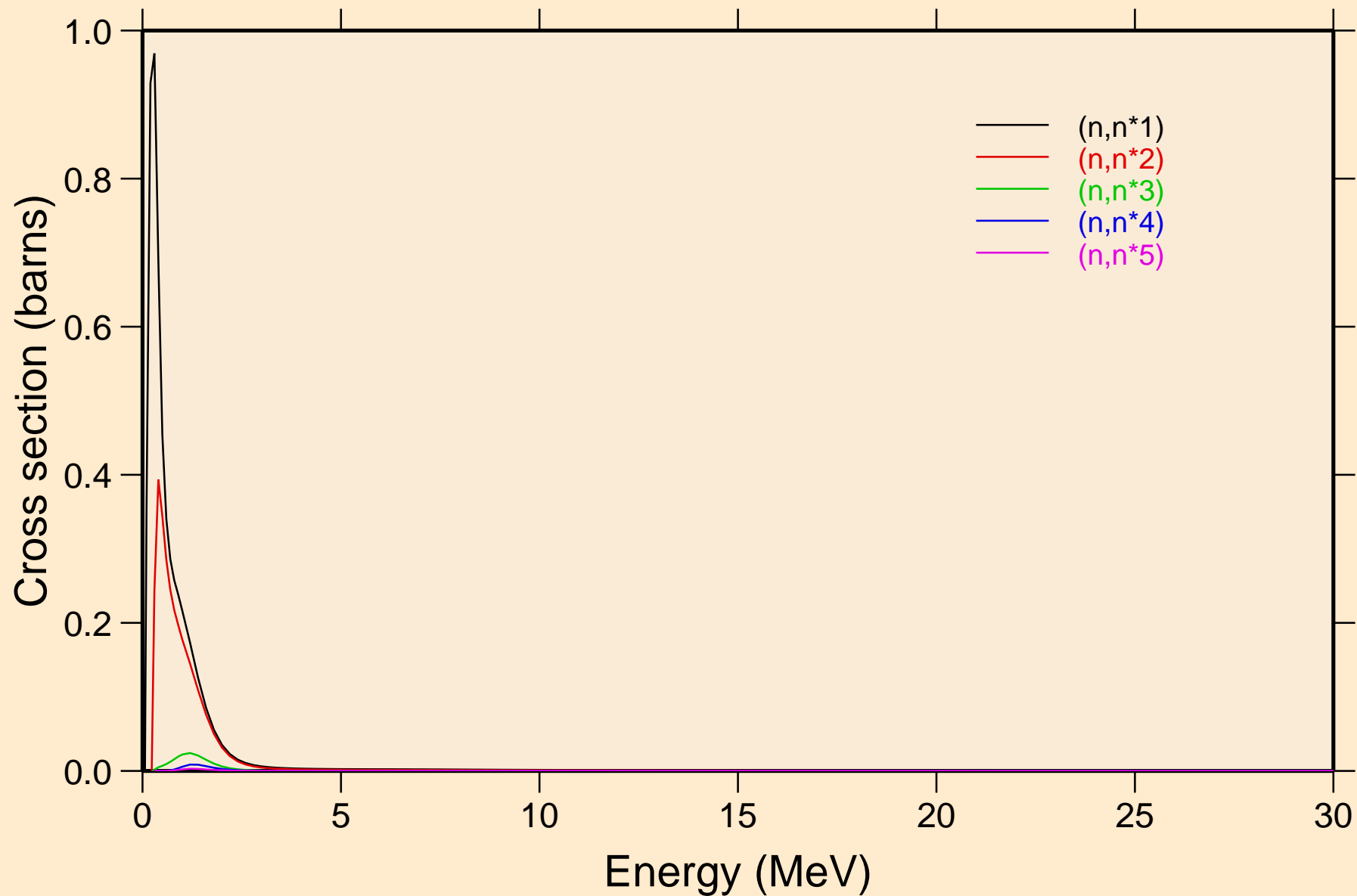

FM255 NEUTRON ACER TENDL-2019 LIBRARY; T=293.16K
Inelastic levels

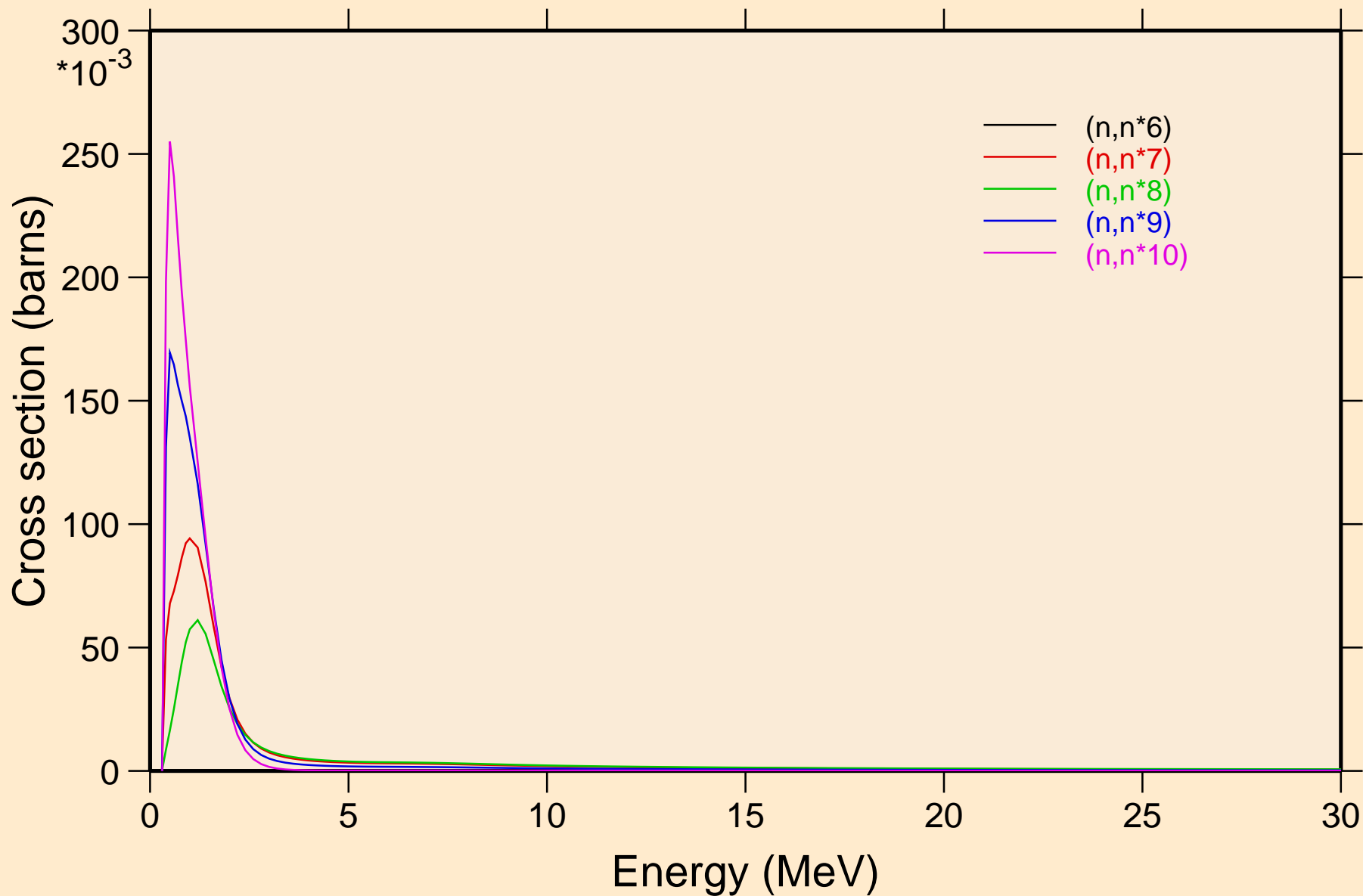

FM255 NEUTRON ACER TENDL-2019 LIBRARY; T=293.16K
Inelastic levels

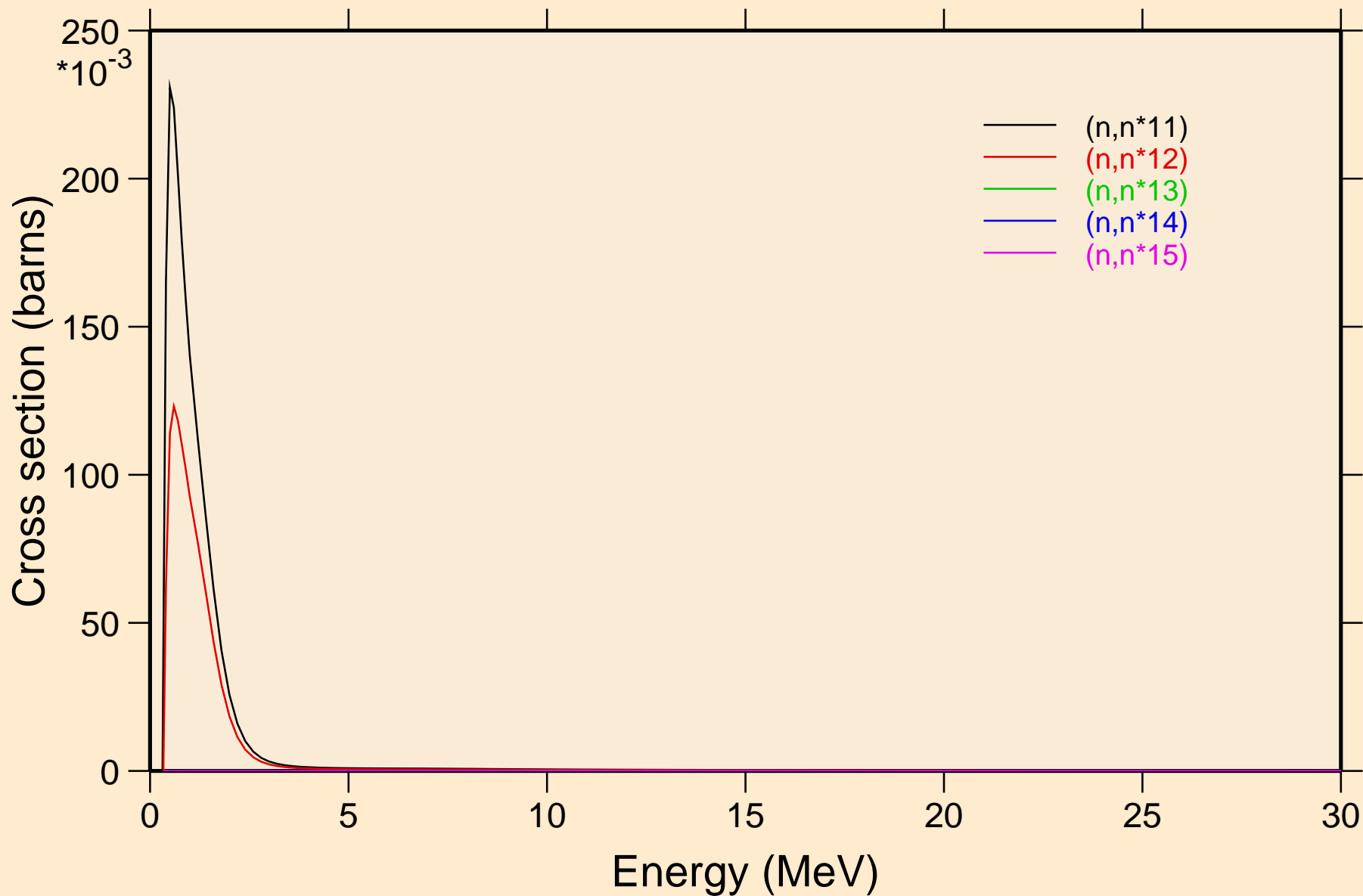

FM255 NEUTRON ACER TENDL-2019 LIBRARY; T=293.16K
Inelastic levels

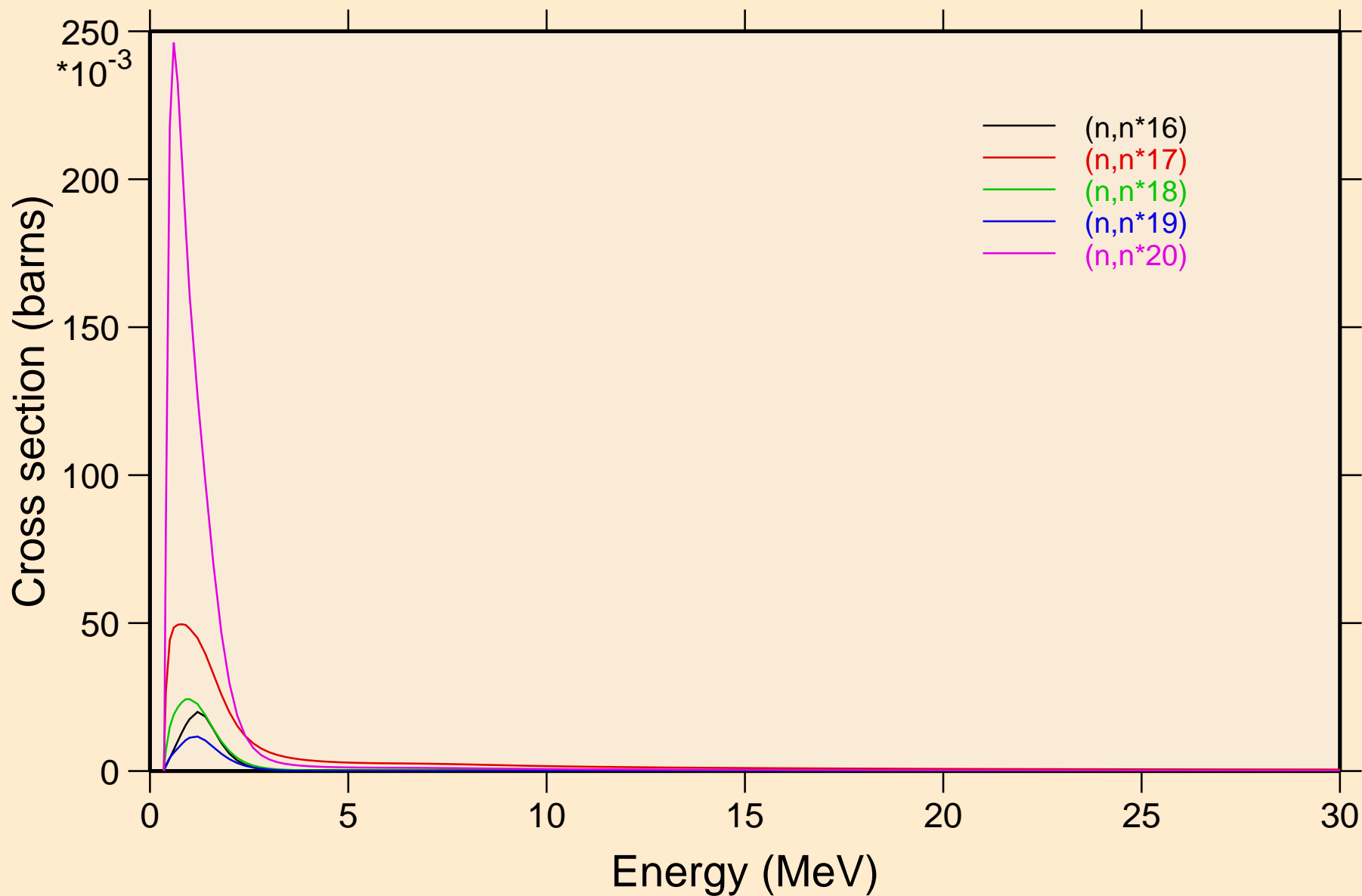

FM255 NEUTRON ACER TENDL-2019 LIBRARY; T=293.16K
Inelastic levels

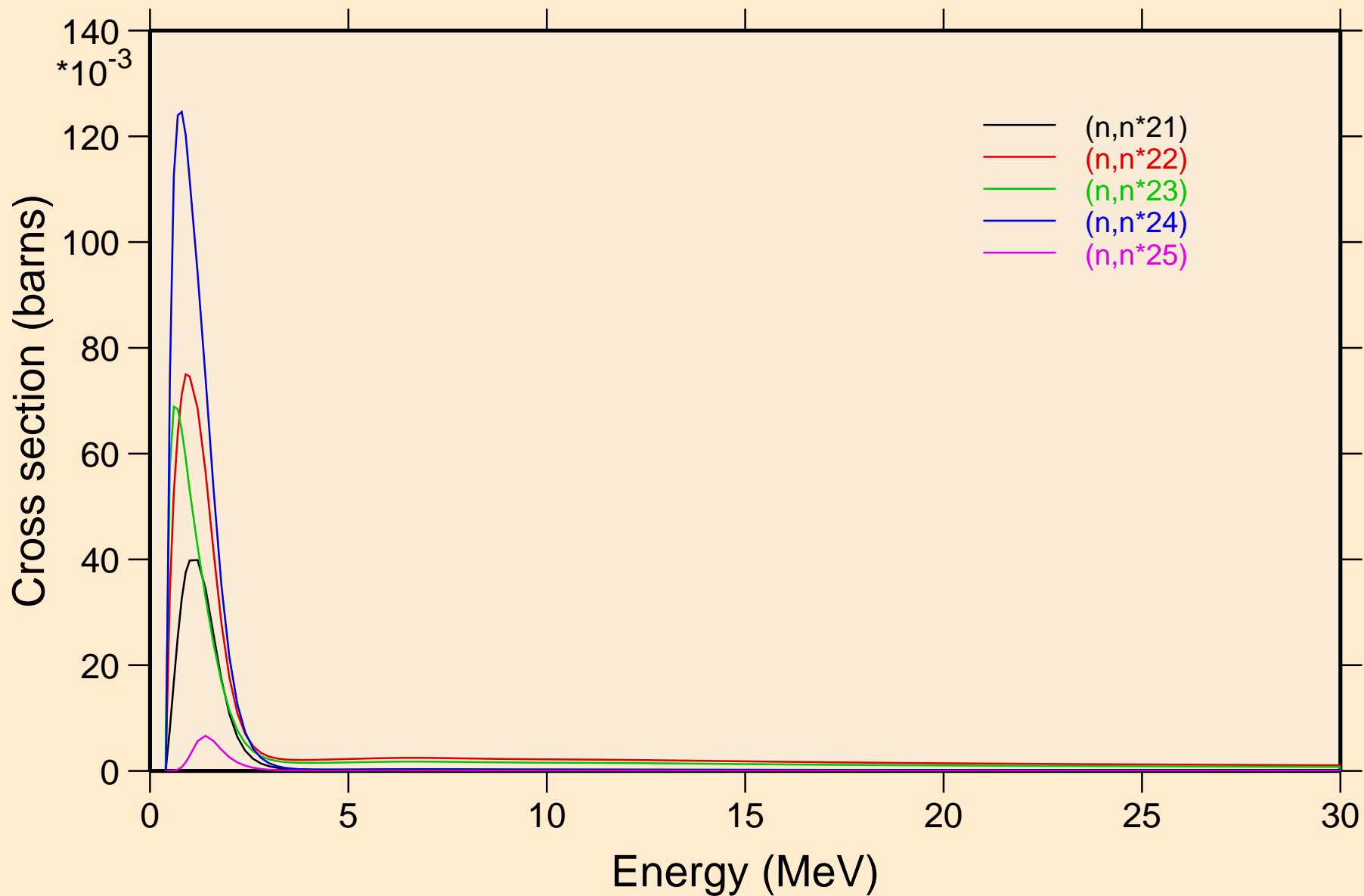

FM255 NEUTRON ACER TENDL-2019 LIBRARY; T=293.16K
Inelastic levels

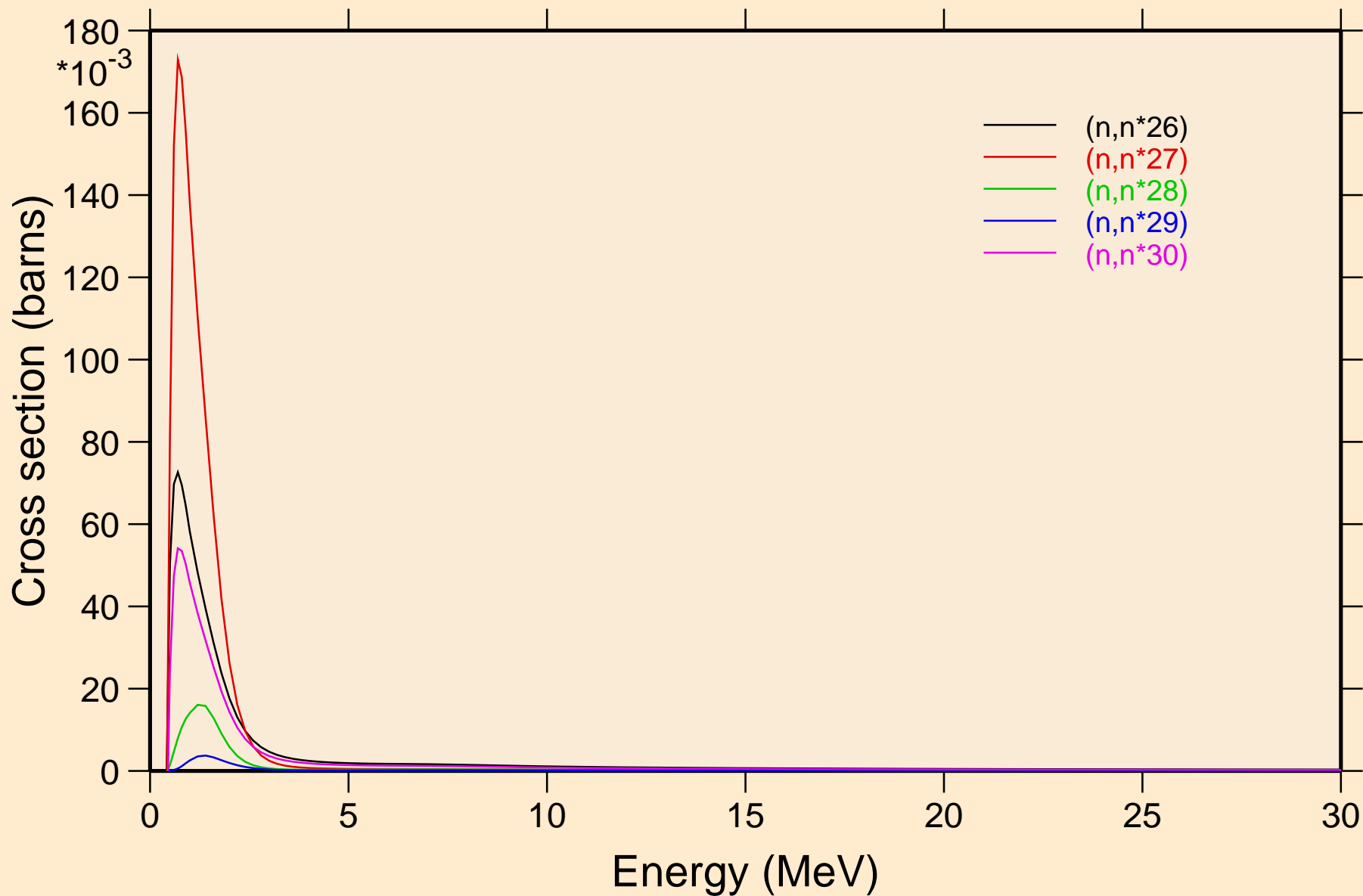

FM255 NEUTRON ACER TENDL-2019 LIBRARY; T=293.16K
Threshold reactions

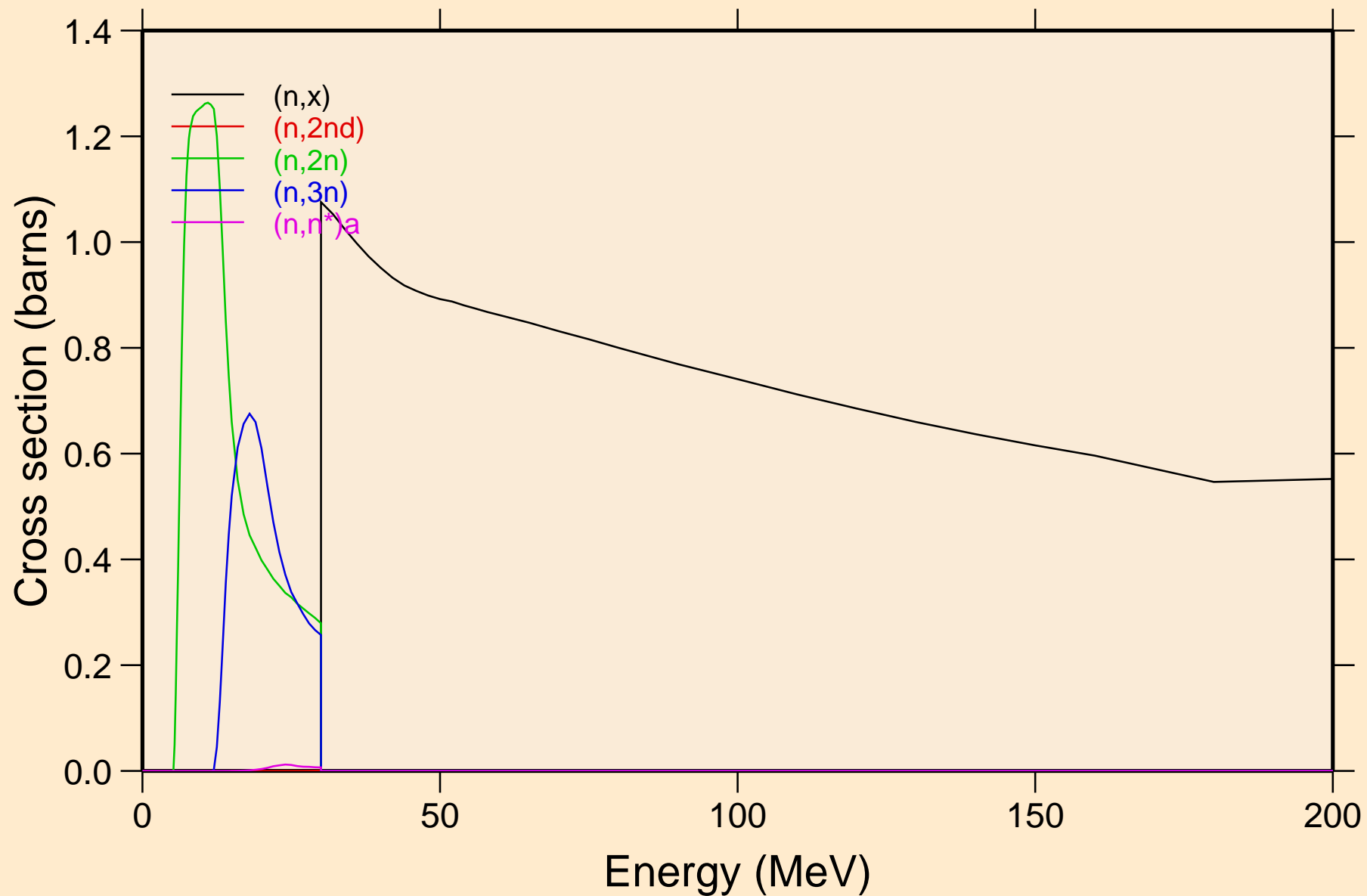

FM255 NEUTRON ACER TENDL-2019 LIBRARY; T=293.16K
Threshold reactions

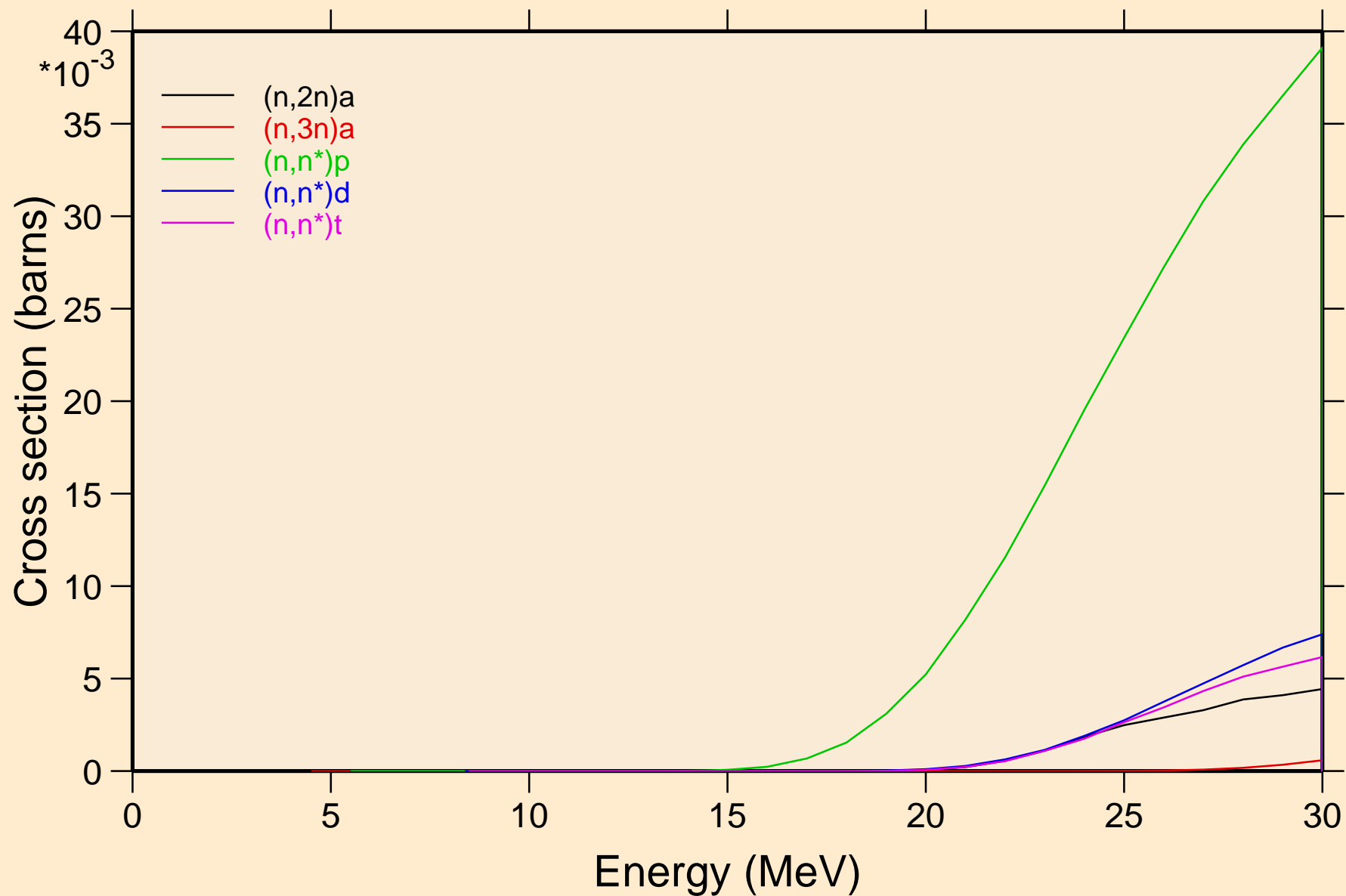

FM255 NEUTRON ACER TENDL-2019 LIBRARY; T=293.16K
Threshold reactions

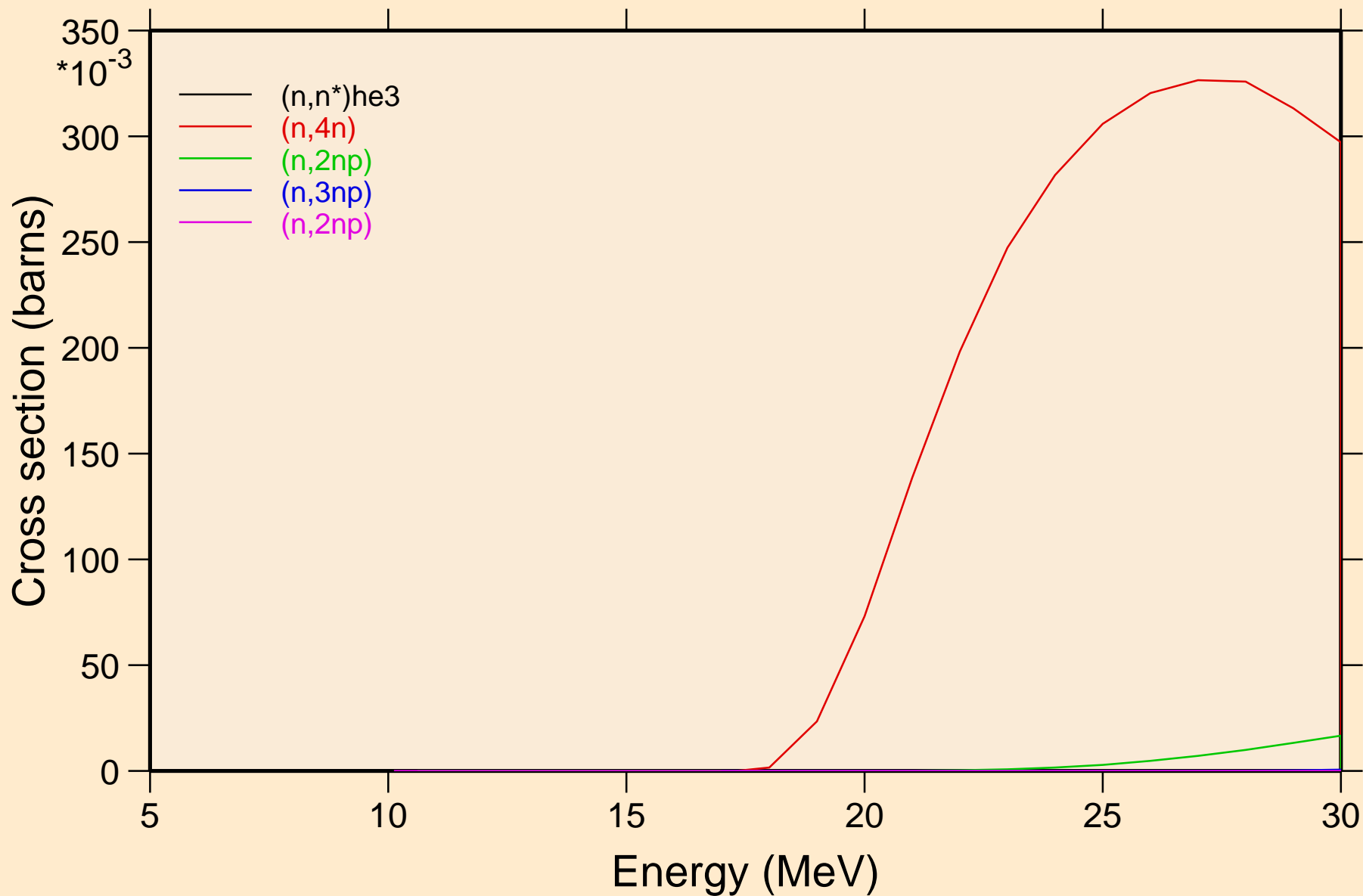

FM255 NEUTRON ACER TENDL-2019 LIBRARY; T=293.16K
Threshold reactions

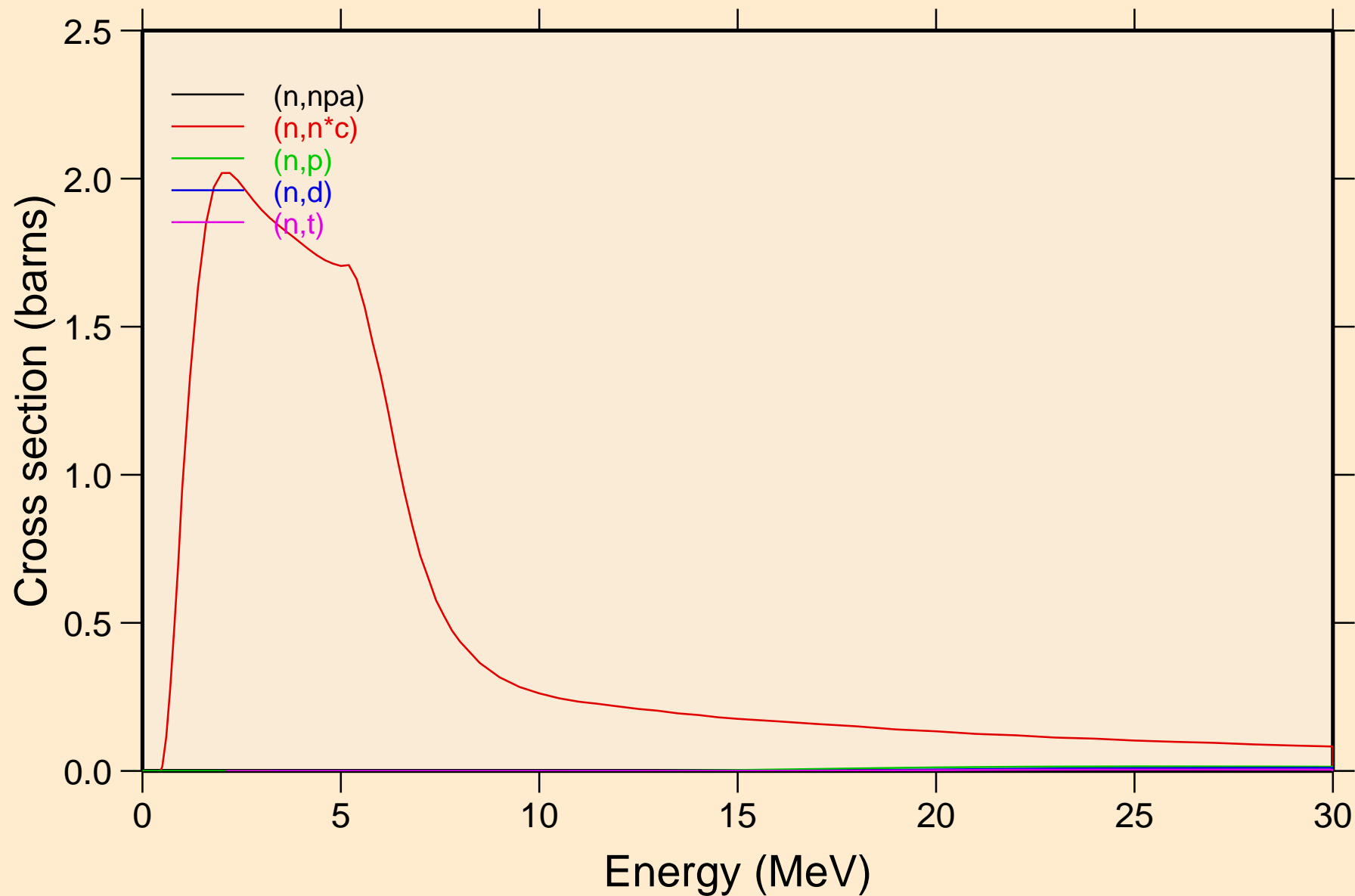

FM255 NEUTRON ACER TENDL-2019 LIBRARY; T=293.16K
Threshold reactions

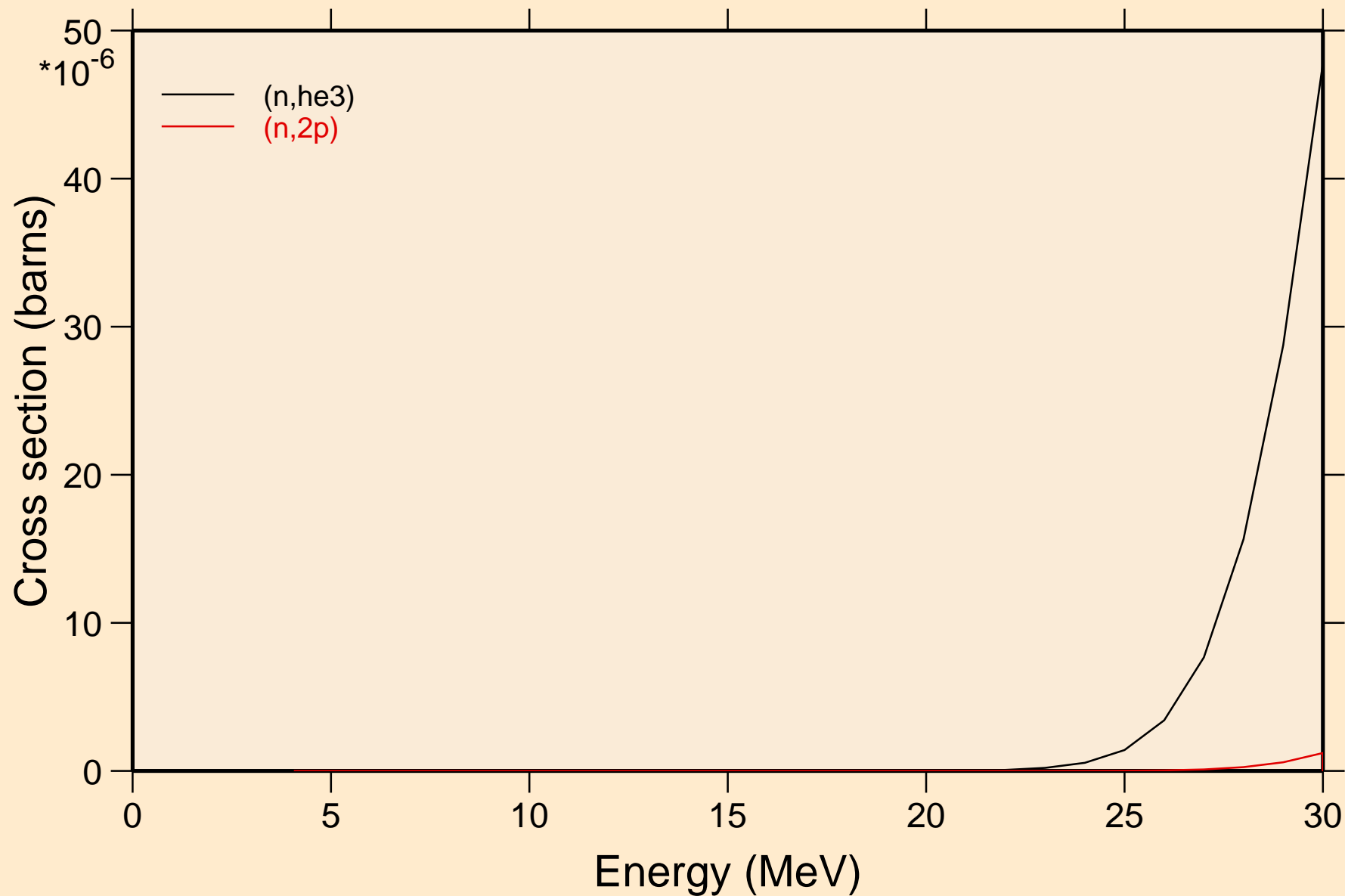

FM255 NEUTRON ACER TENDL-2019 LIBRARY; T=293.16K
Threshold reactions

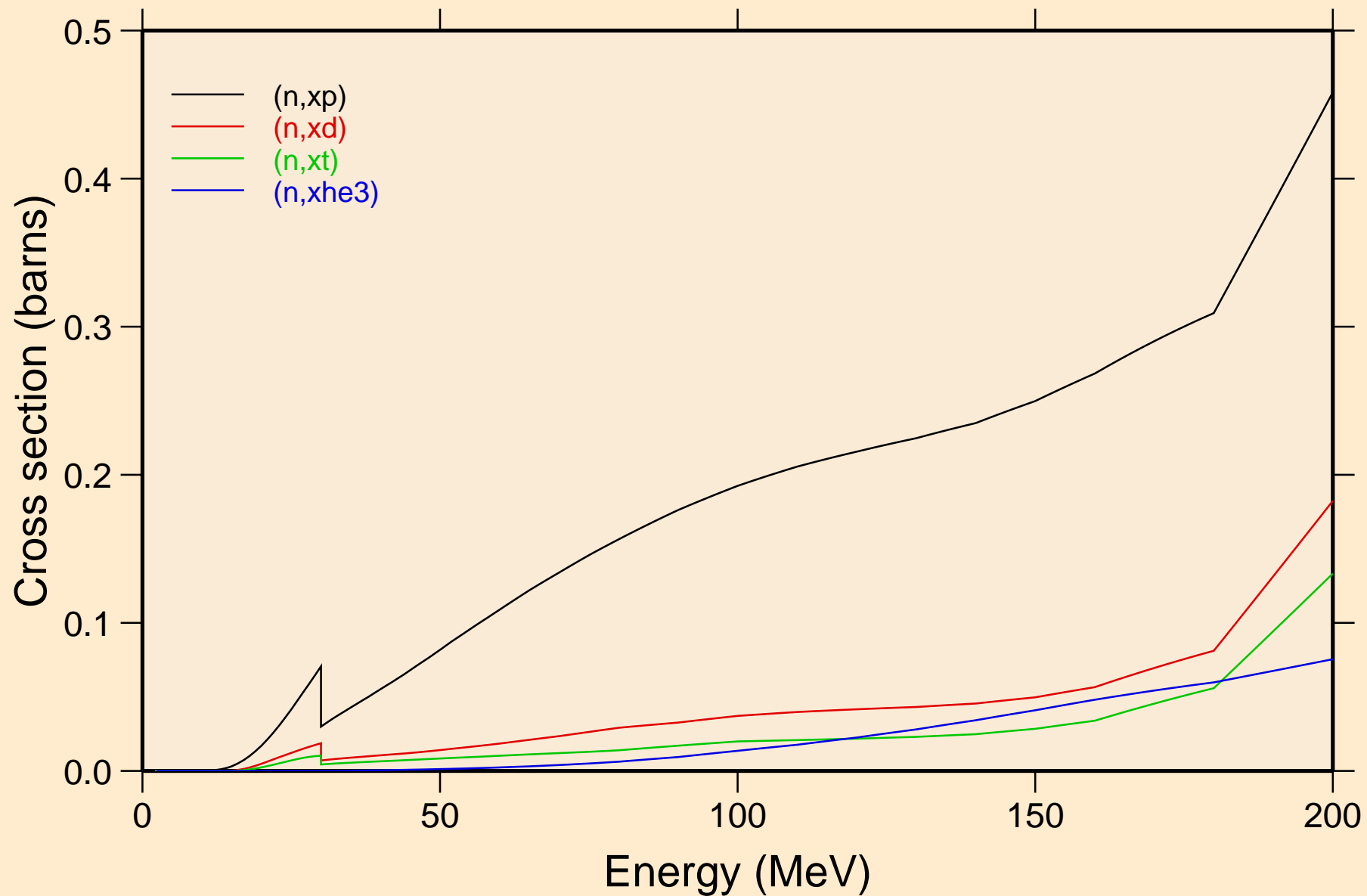

FM255 NEUTRON ACER TENDL-2019 LIBRARY; T=293.16K
angular distribution for elastic

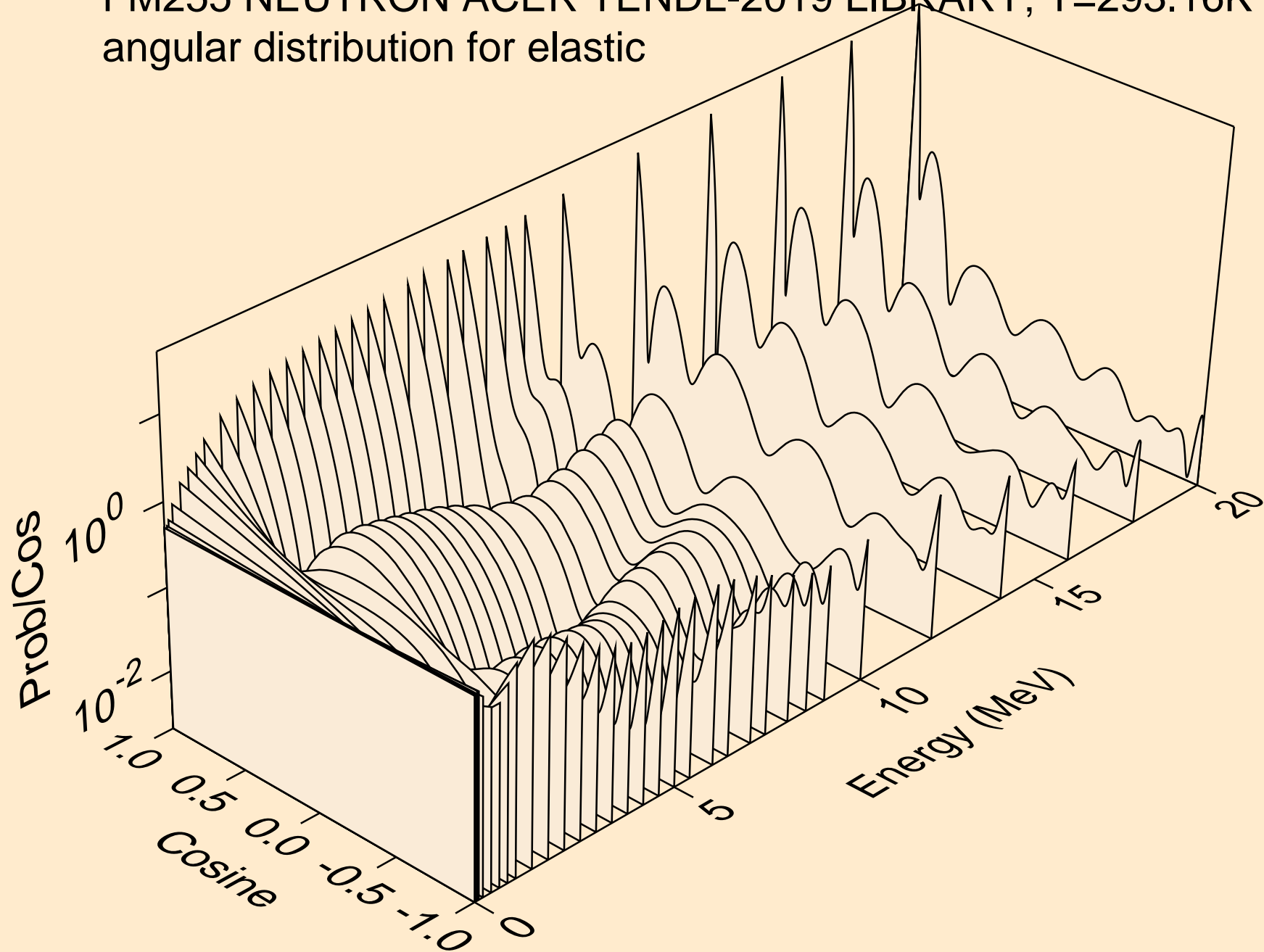

FM255 NEUTRON ACER TENDL-2019 LIBRARY; T=293.16K
angular distribution for elastic

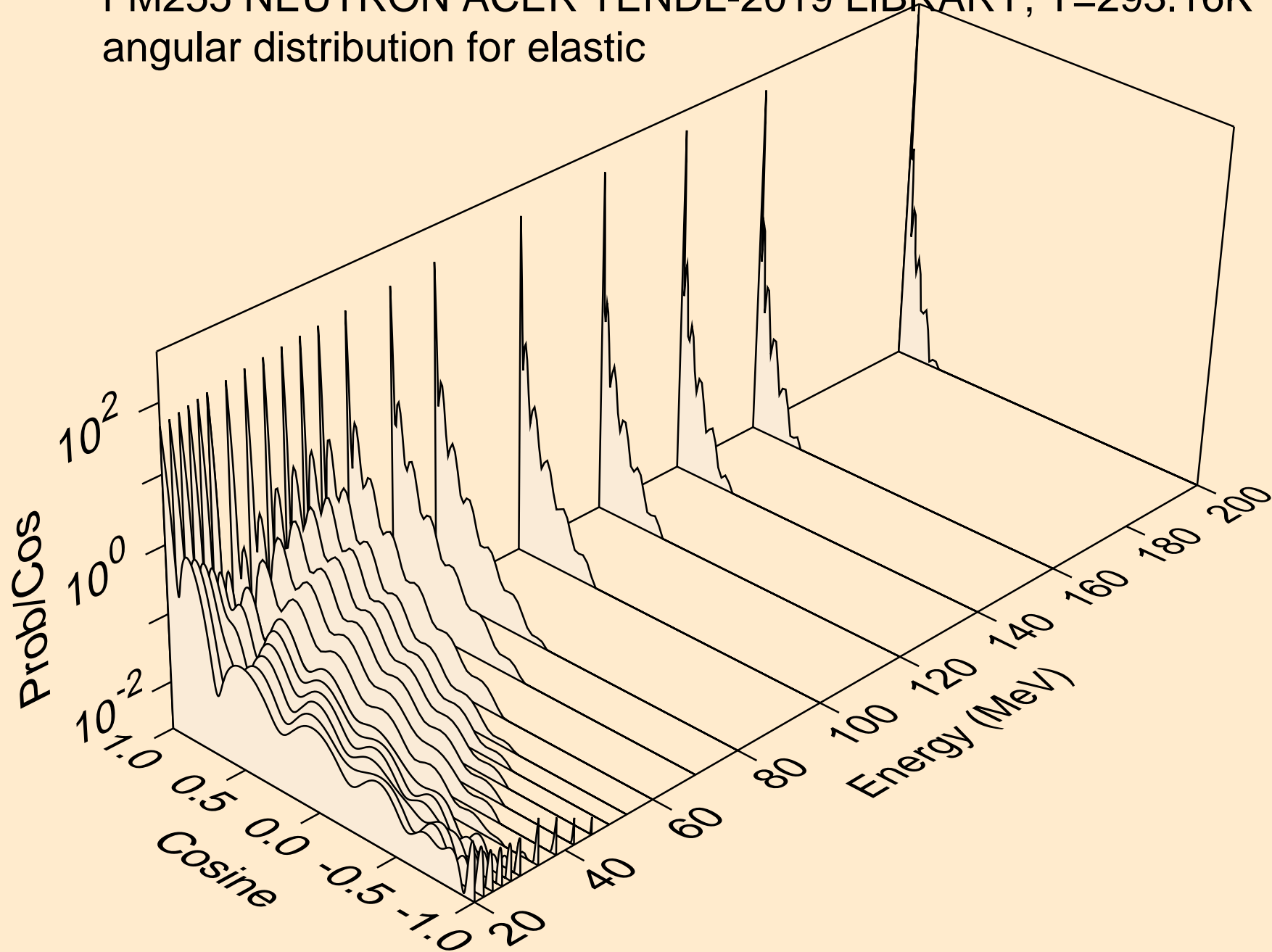

FM255 NEUTRON ACER TENDL-2019 LIBRARY; T=293.16K
angular distribution for (n,n*1)

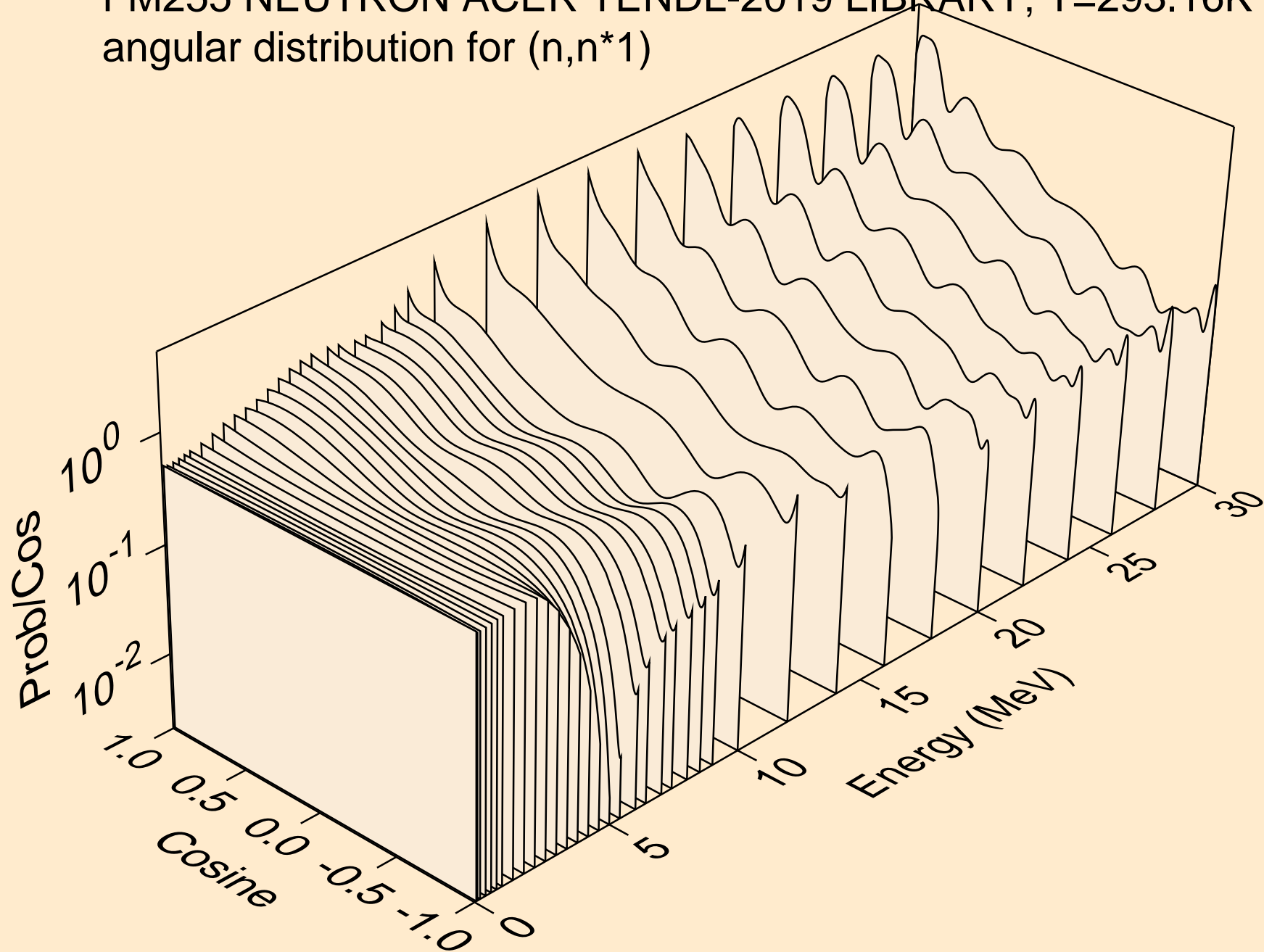

FM255 NEUTRON ACER TENDL-2019 LIBRARY; T=293.16K
angular distribution for (n,n*2)

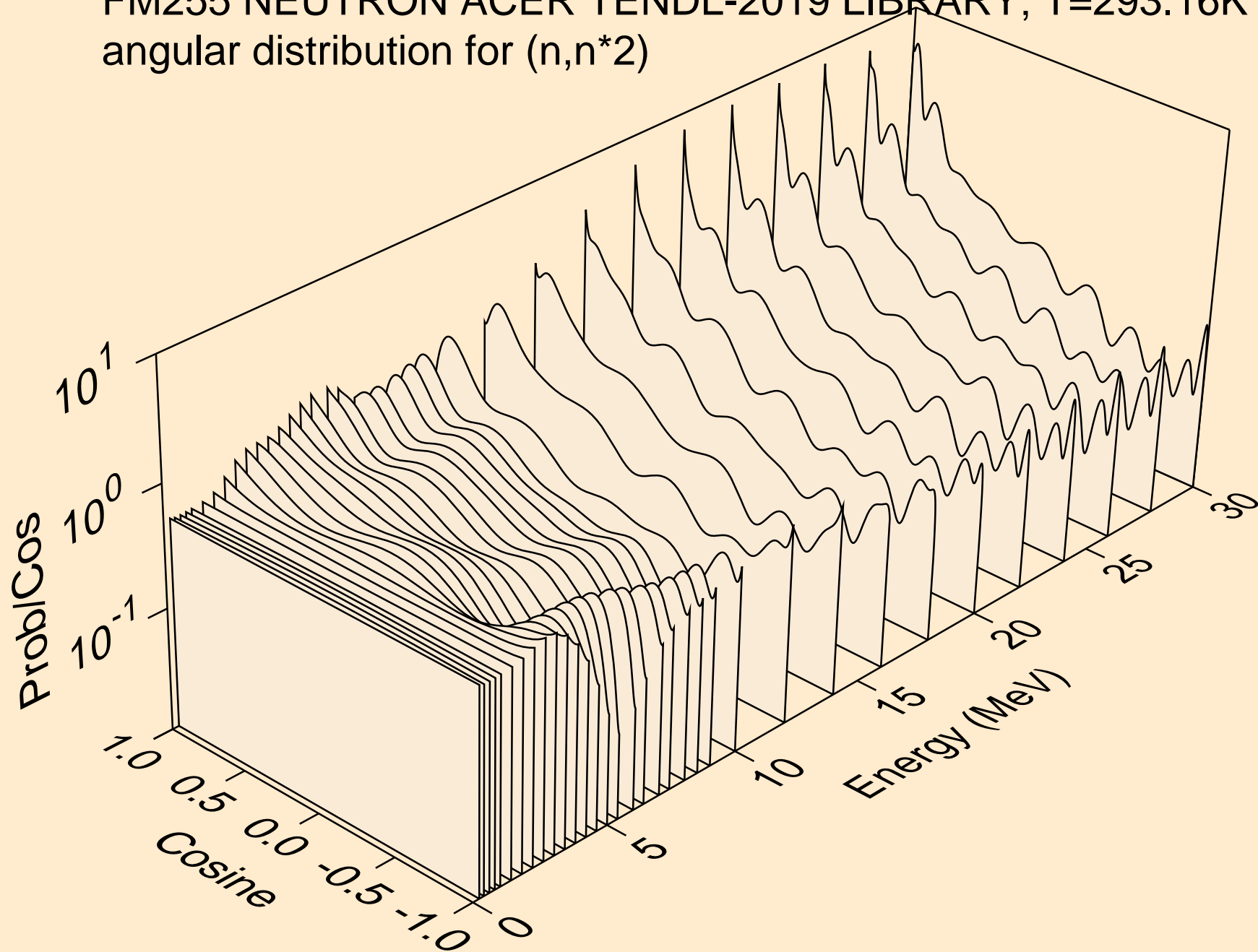

FM255 NEUTRON ACER TENDL-2019 LIBRARY; T=293.16K
angular distribution for (n,n*3)

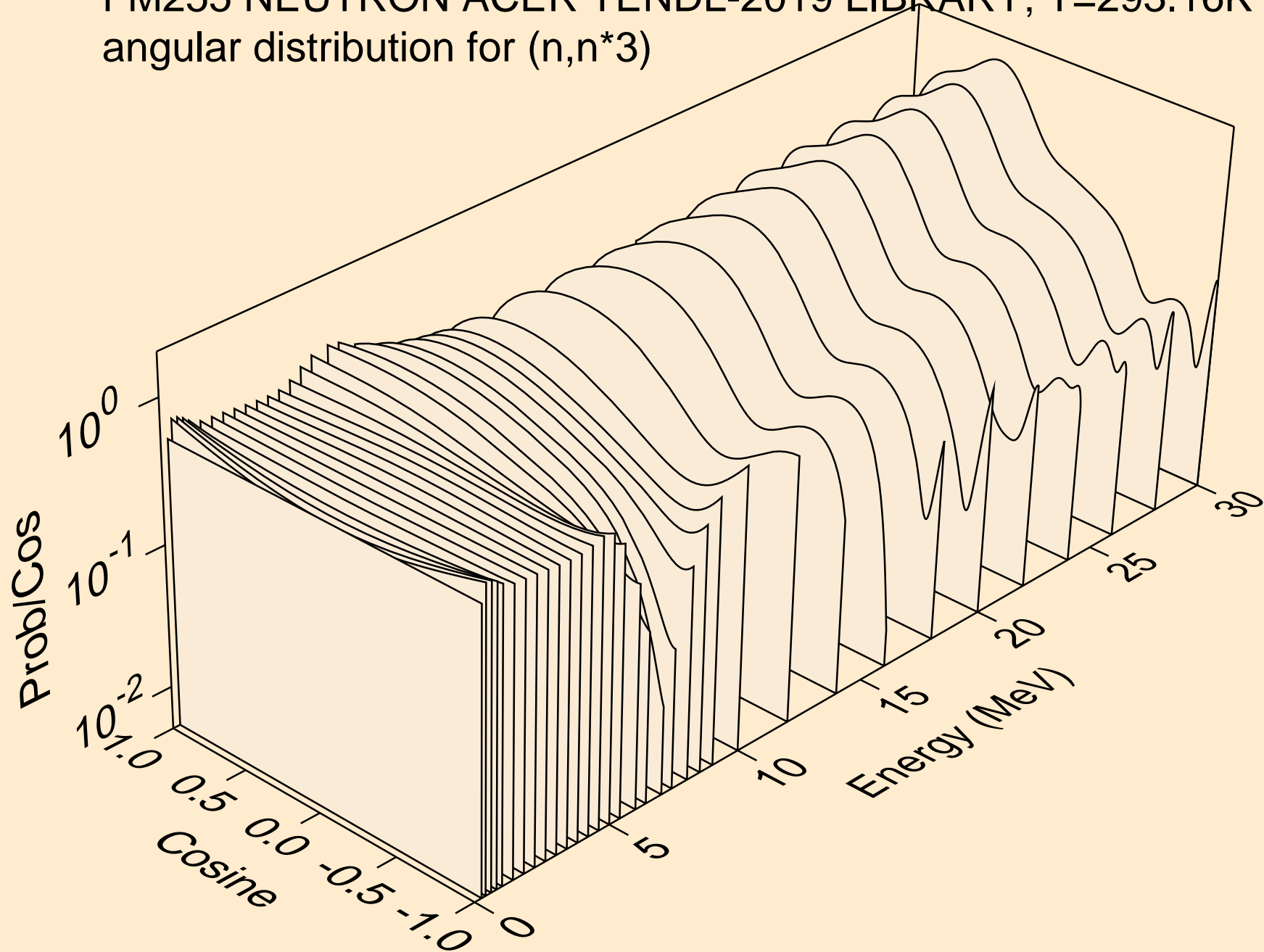

FM255 NEUTRON ACER TENDL-2019 LIBRARY; T=293.16K
angular distribution for (n,n*4)

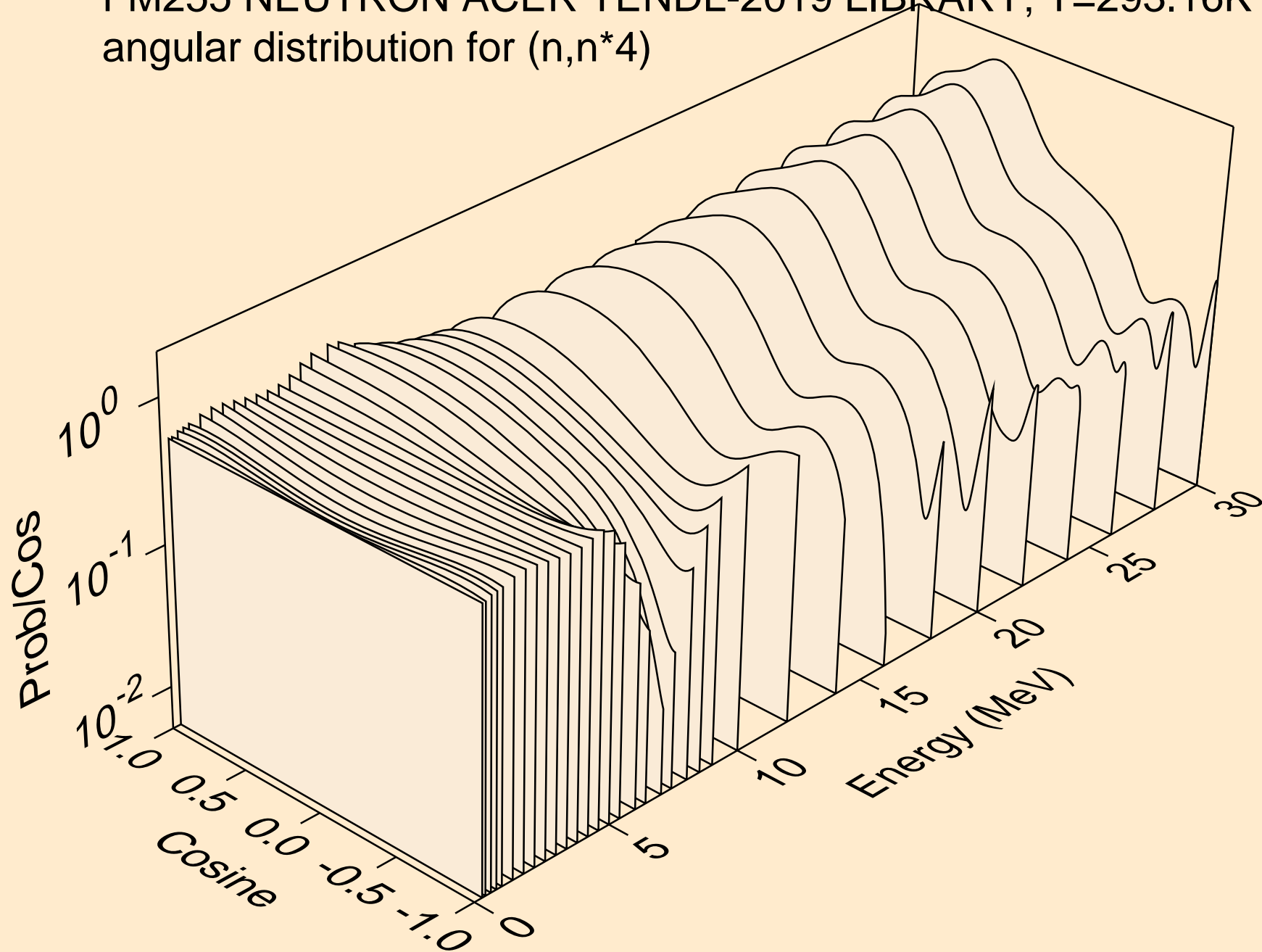

FM255 NEUTRON ACER TENDL-2019 LIBRARY; T=293.16K
angular distribution for (n,n*5)

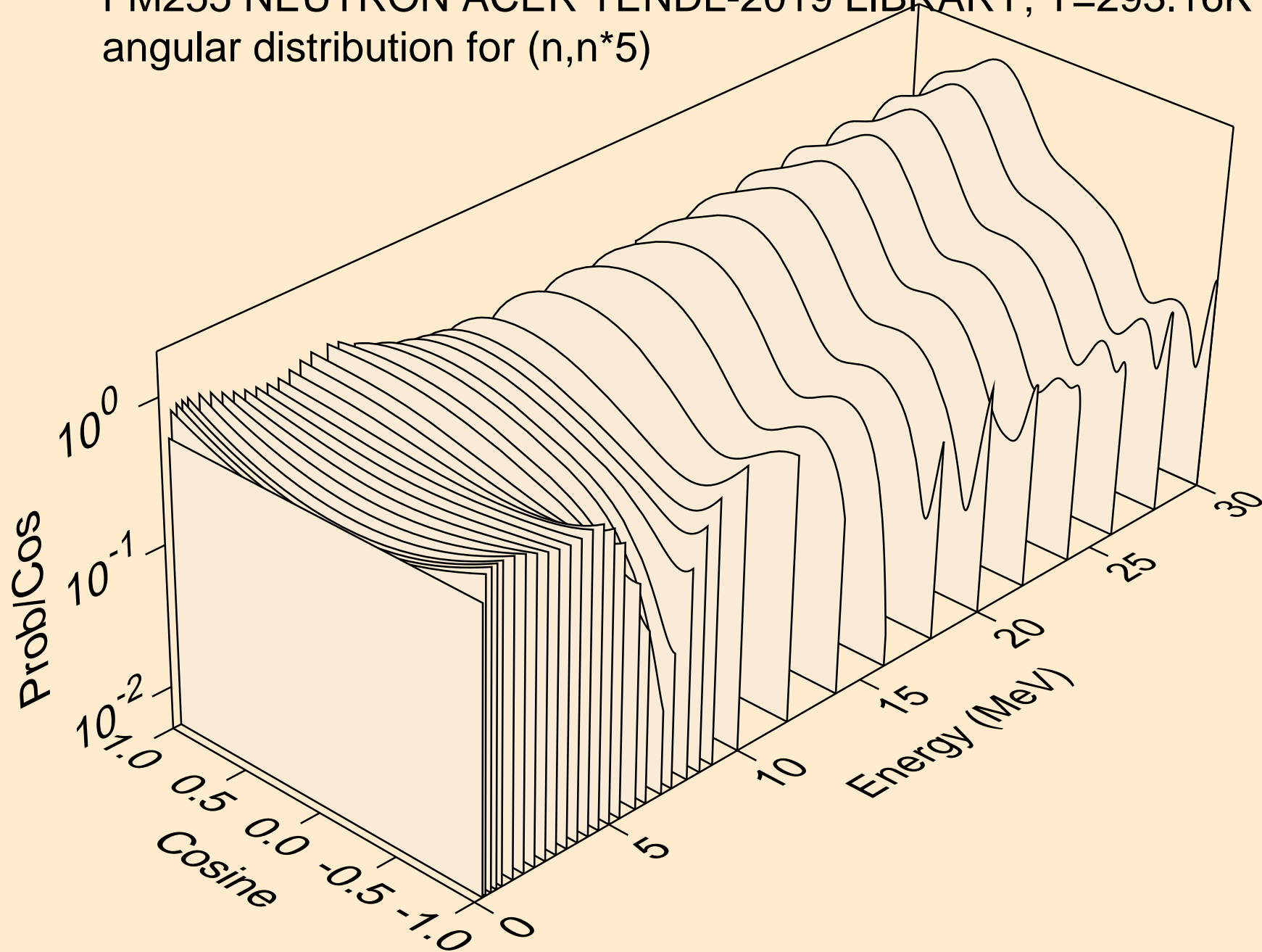

FM255 NEUTRON ACER TENDL-2019 LIBRARY; T=293.16K
angular distribution for (n,n*6)

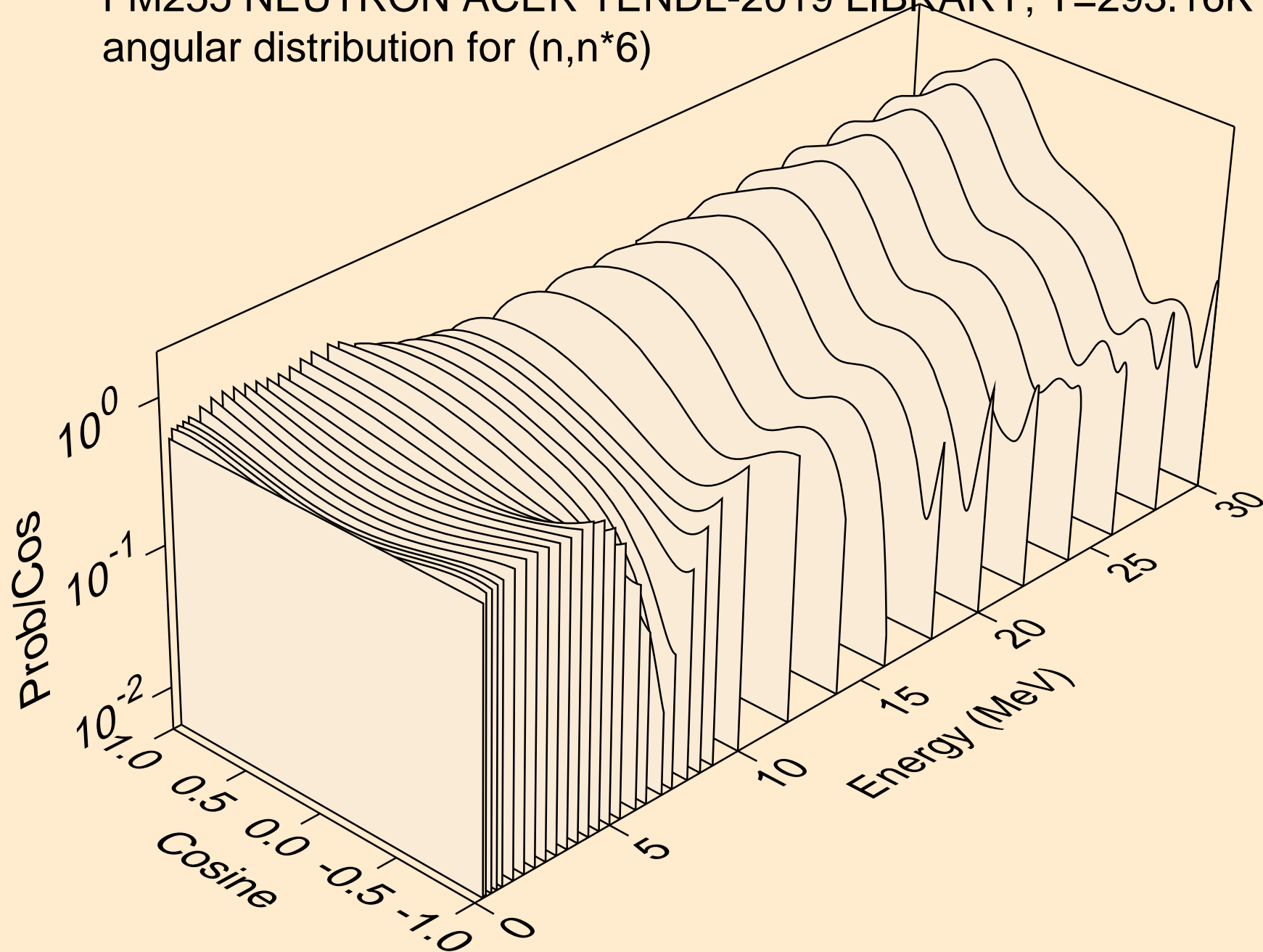

FM255 NEUTRON ACER TENDL-2019 LIBRARY; T=293.16K
angular distribution for (n,n*7)

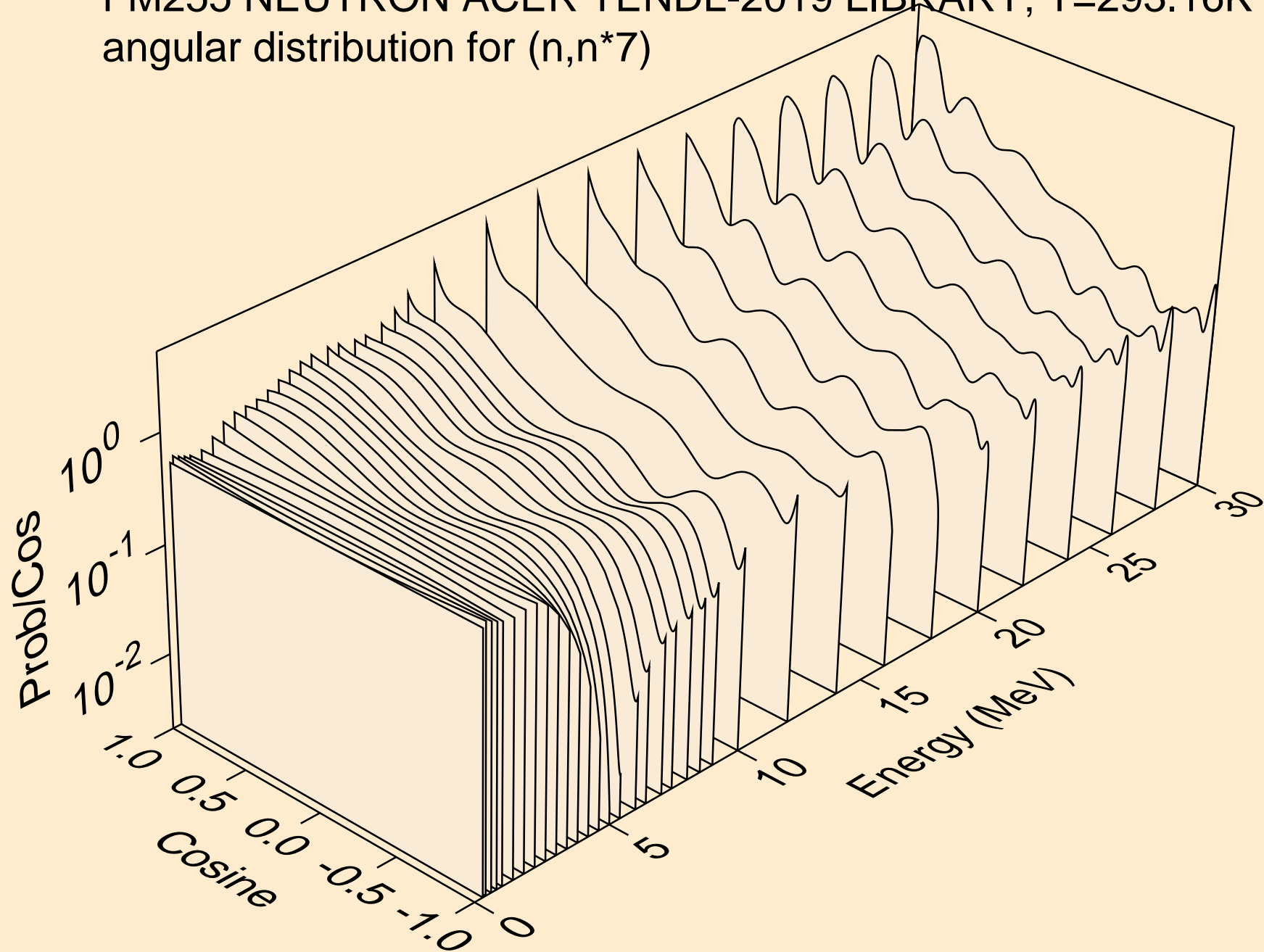

FM255 NEUTRON ACER TENDL-2019 LIBRARY; T=293.16K
angular distribution for (n,n*8)

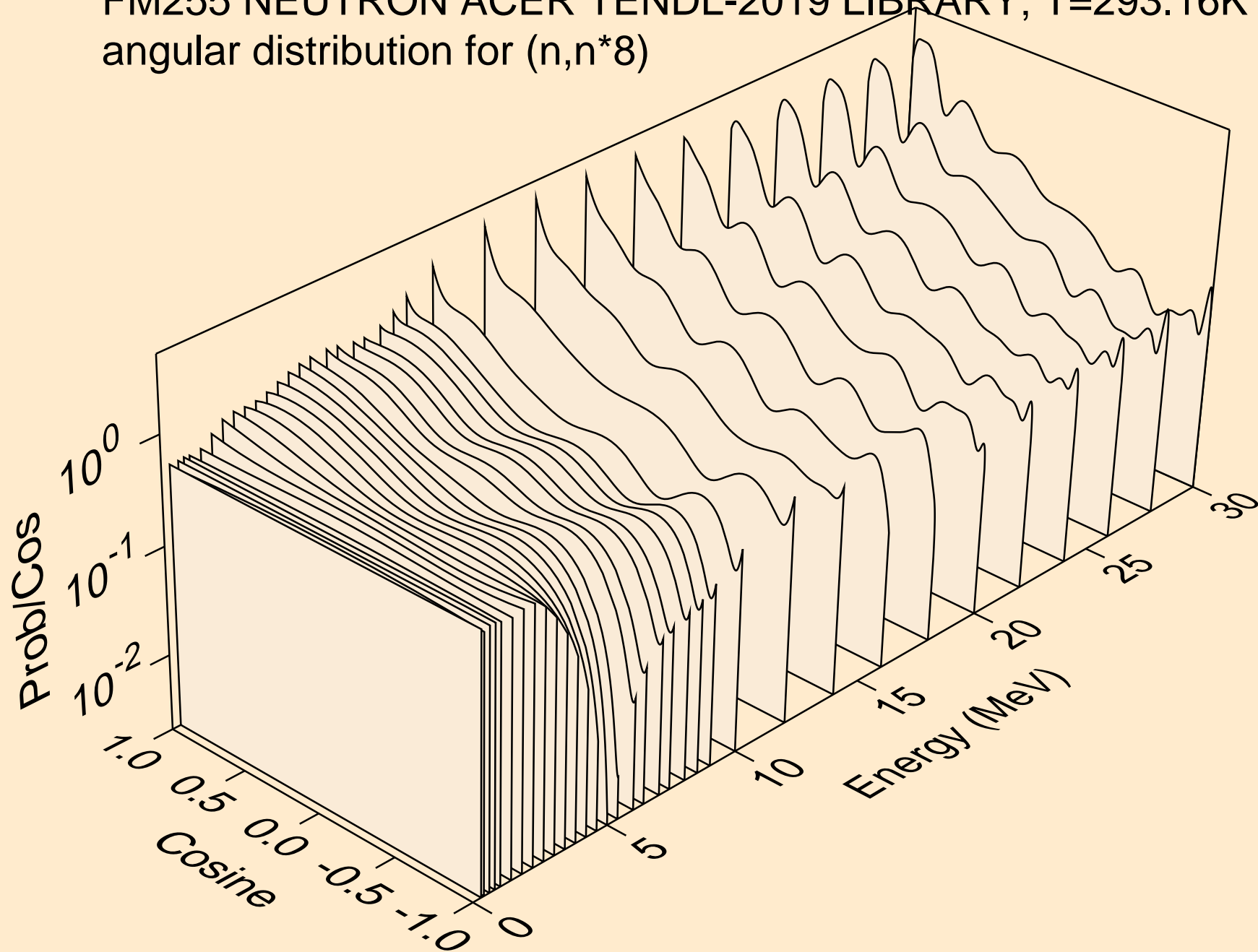

FM255 NEUTRON ACER TENDL-2019 LIBRARY; T=293.16K
angular distribution for (n,n*9)

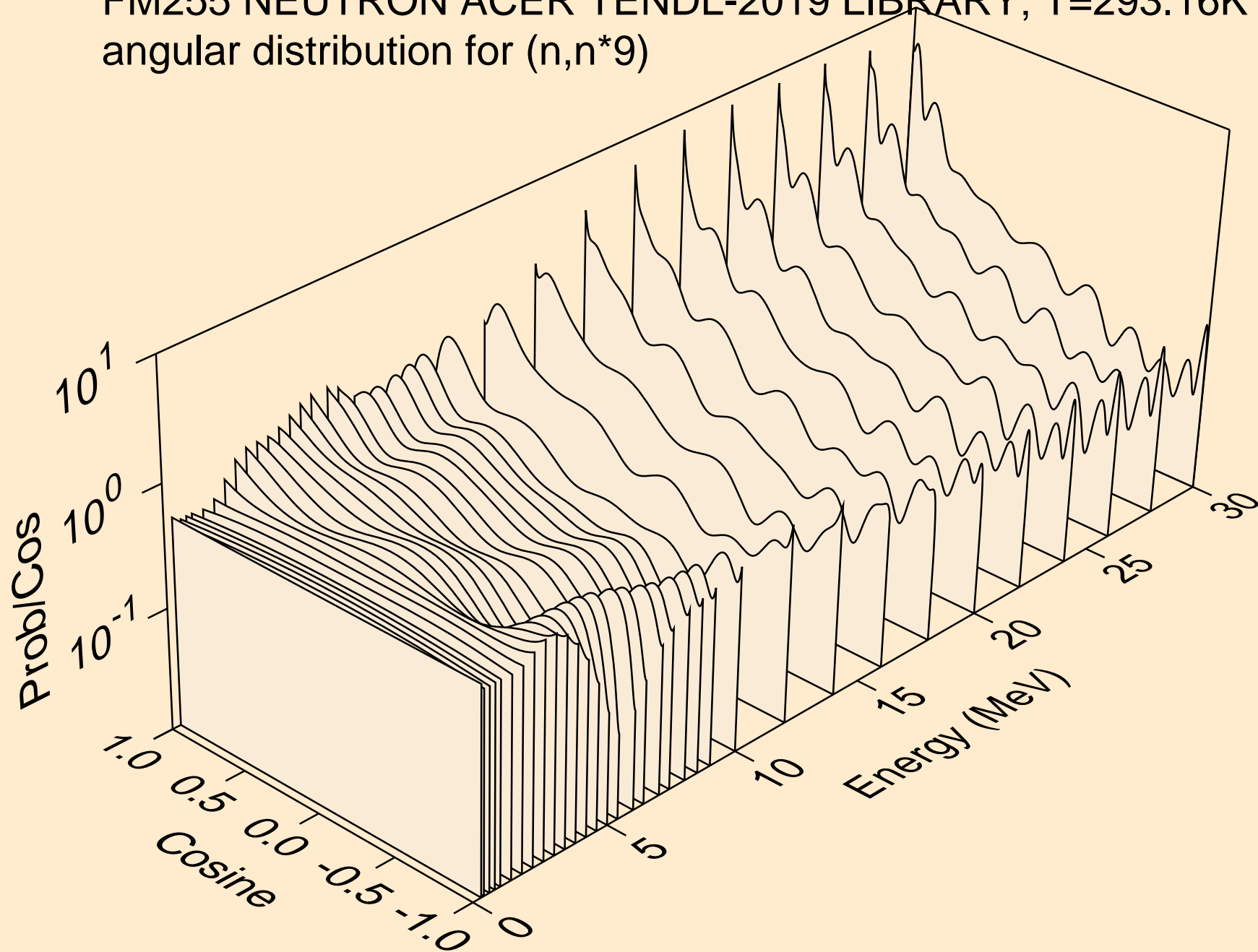

FM255 NEUTRON ACER TENDL-2019 LIBRARY; T=293.16K
angular distribution for (n,n*10)

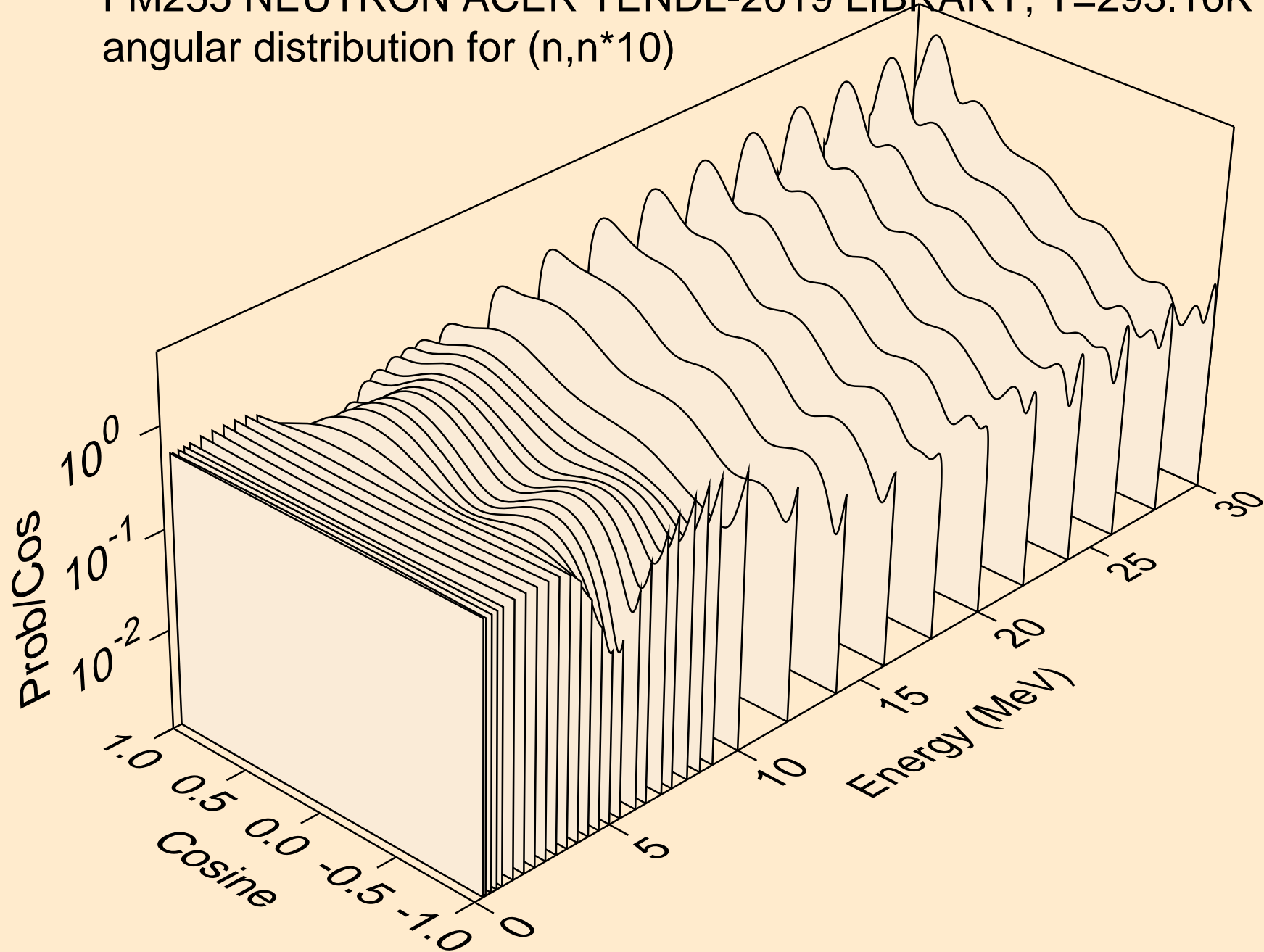

FM255 NEUTRON ACER TENDL-2019 LIBRARY; T=293.16K
angular distribution for (n,n*11)

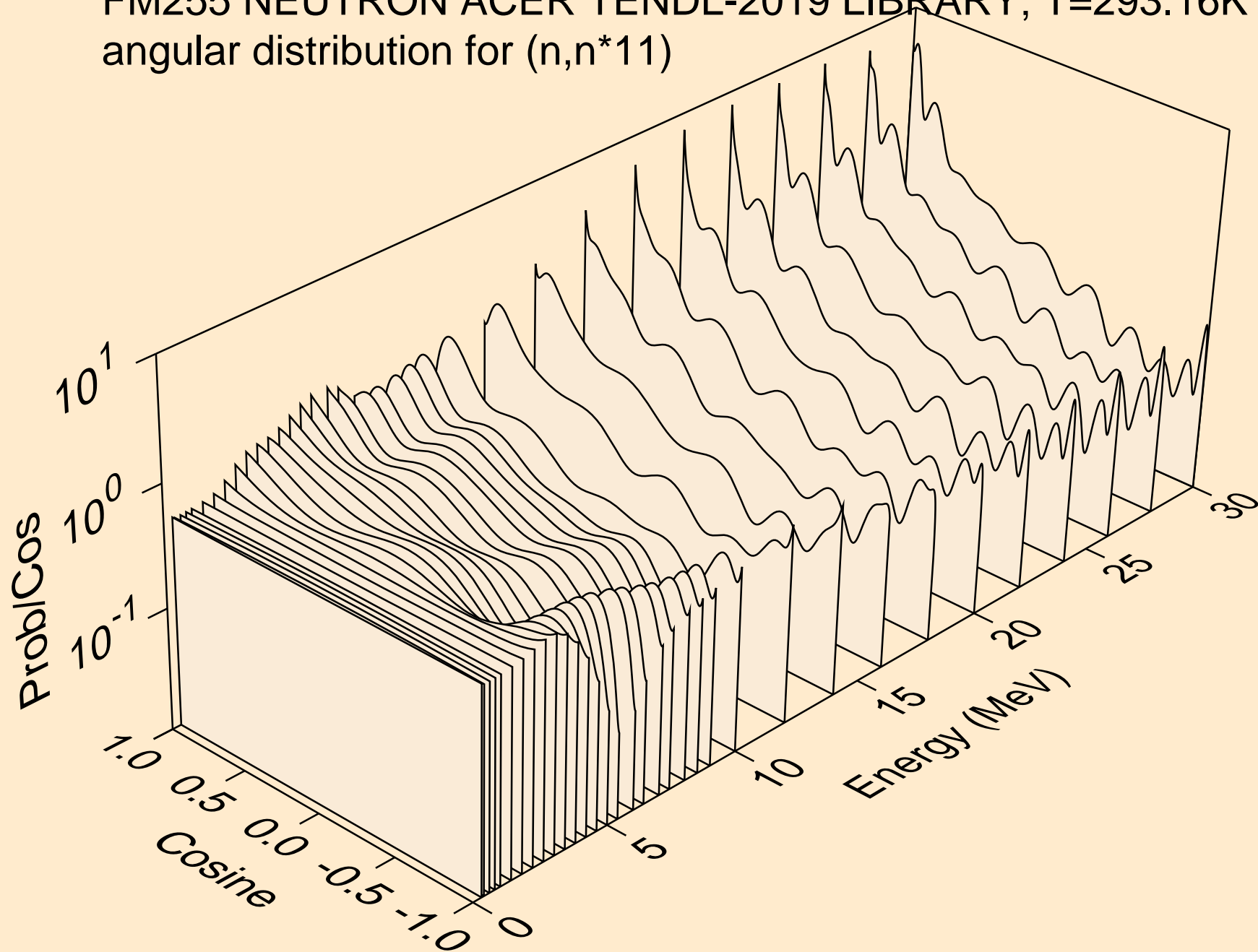

FM255 NEUTRON ACER TENDL-2019 LIBRARY; T=293.16K
angular distribution for (n,n*12)

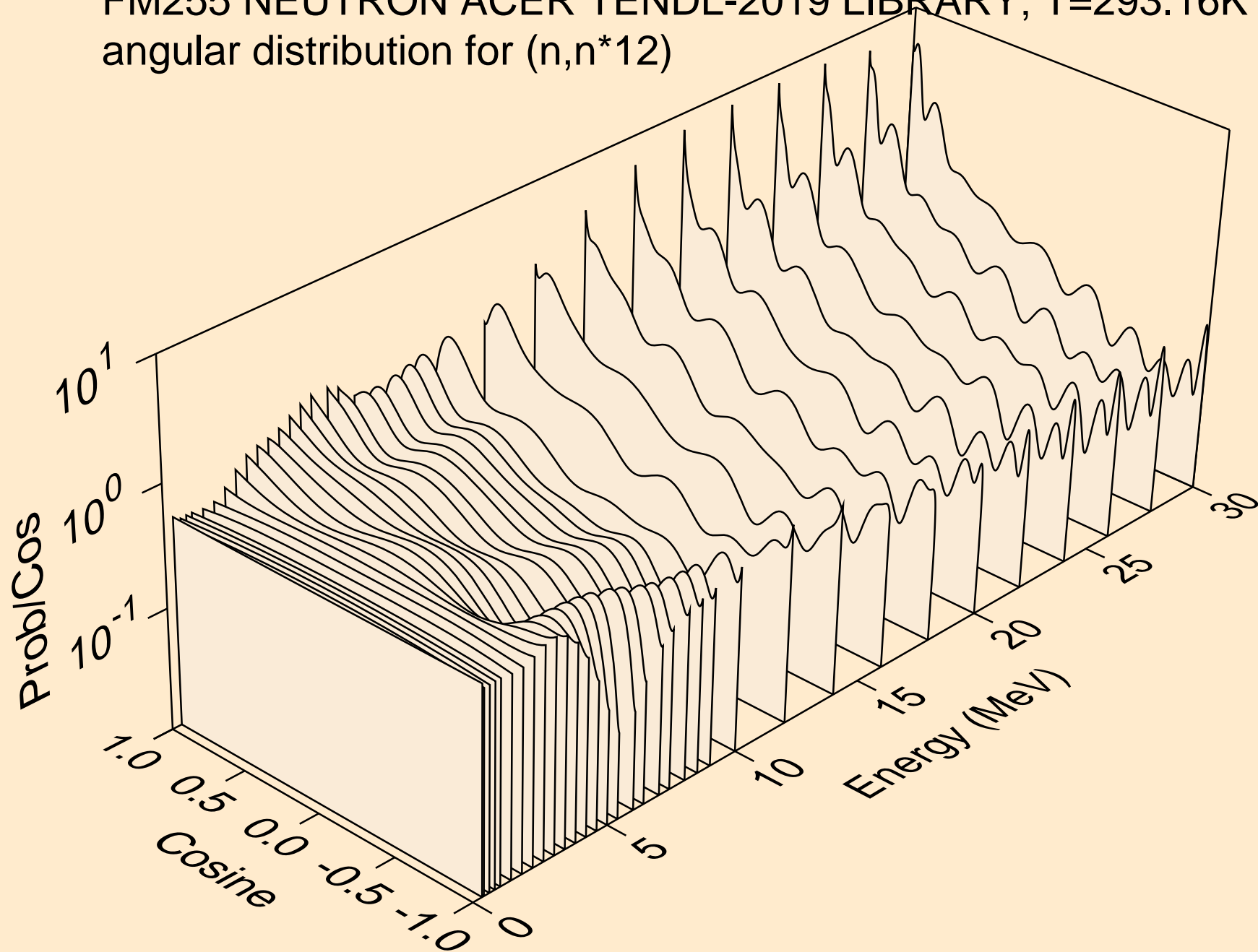

FM255 NEUTRON ACER TENDL-2019 LIBRARY; T=293.16K
angular distribution for (n,n*13)

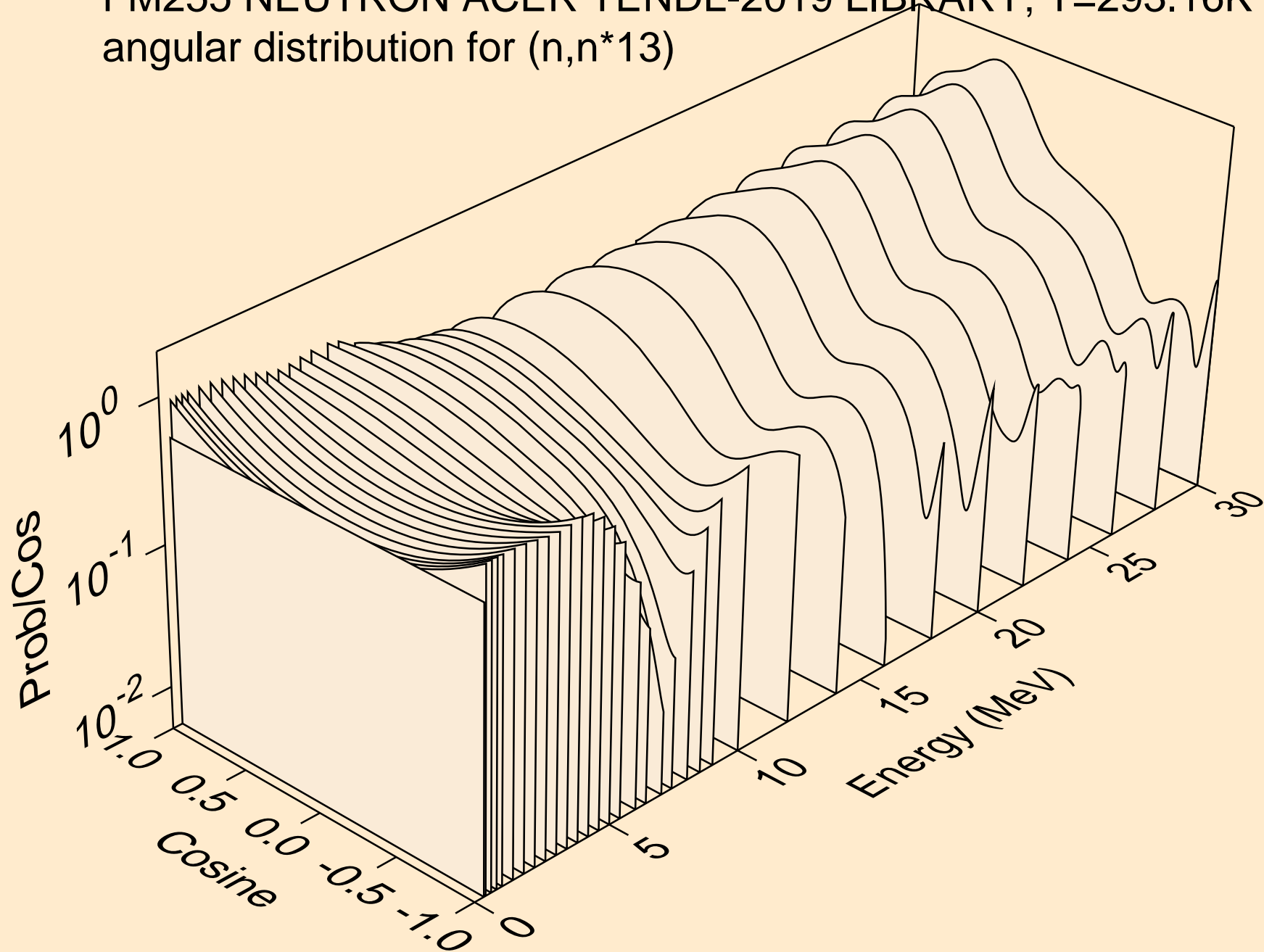

FM255 NEUTRON ACER TENDL-2019 LIBRARY; T=293.16K
angular distribution for (n,n*14)

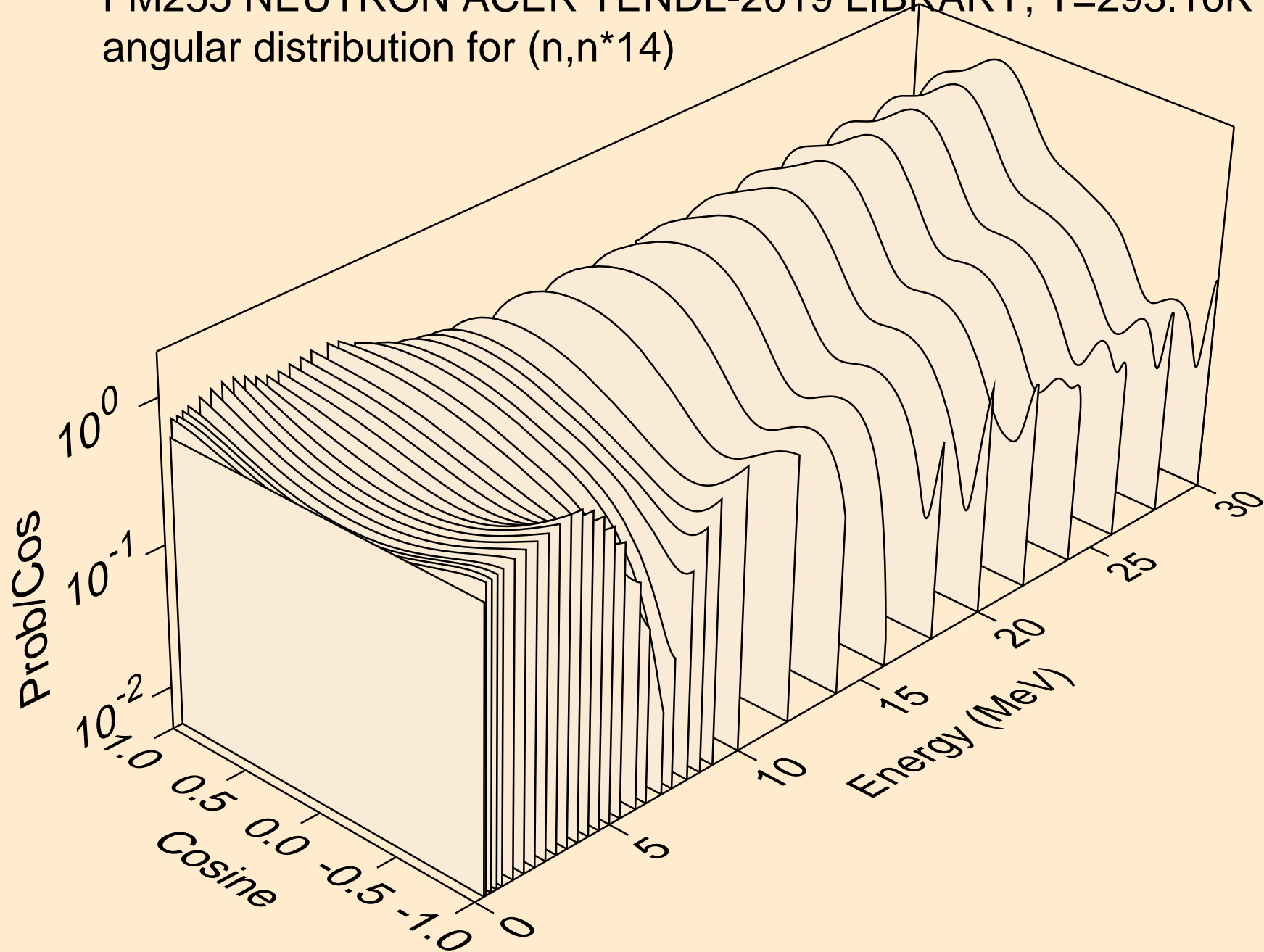

FM255 NEUTRON ACER TENDL-2019 LIBRARY; T=293.16K
angular distribution for (n,n*15)

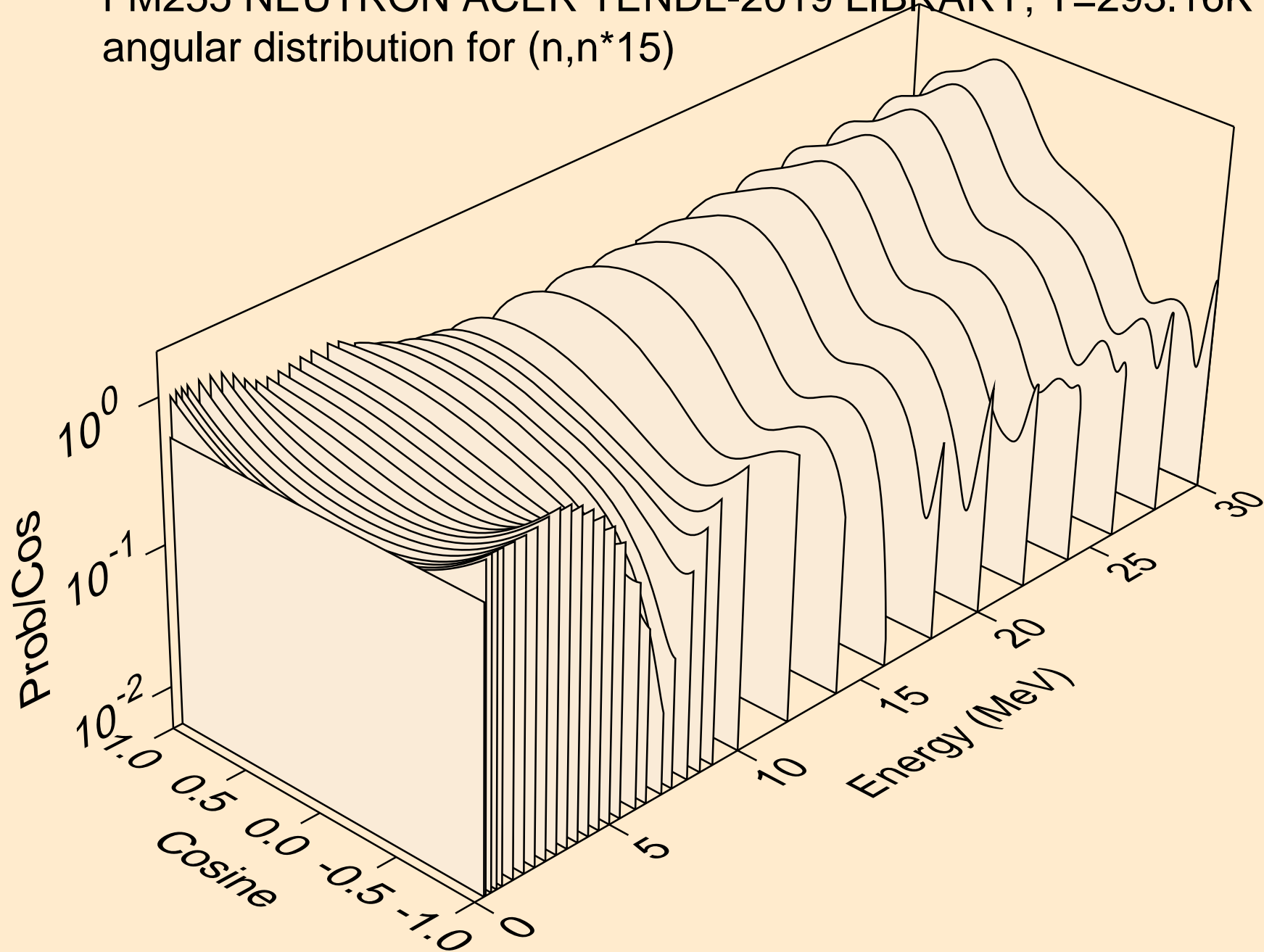

FM255 NEUTRON ACER TENDL-2019 LIBRARY; T=293.16K
angular distribution for (n,n*16)

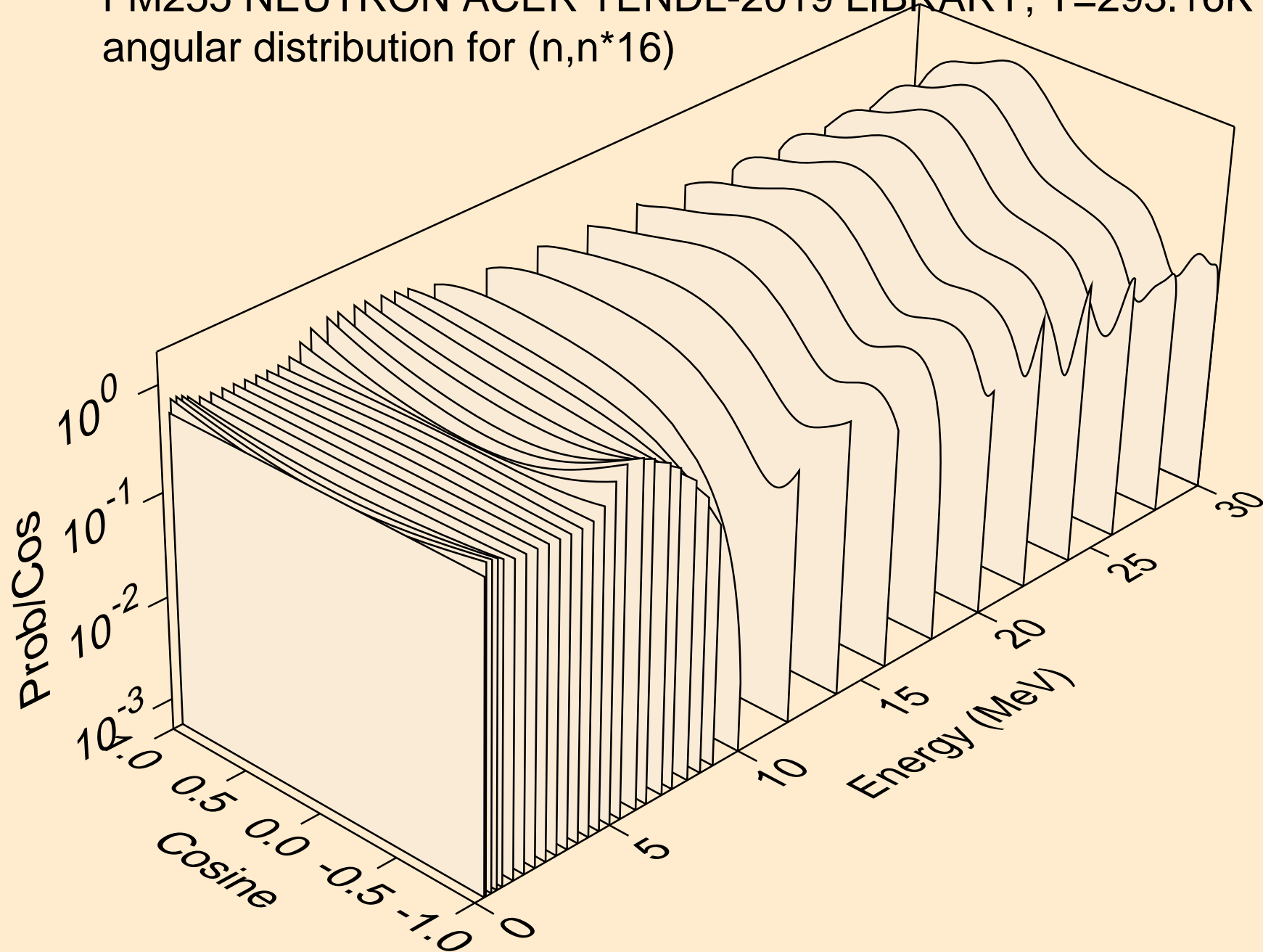

FM255 NEUTRON ACER TENDL-2019 LIBRARY; T=293.16K
angular distribution for (n,n*17)

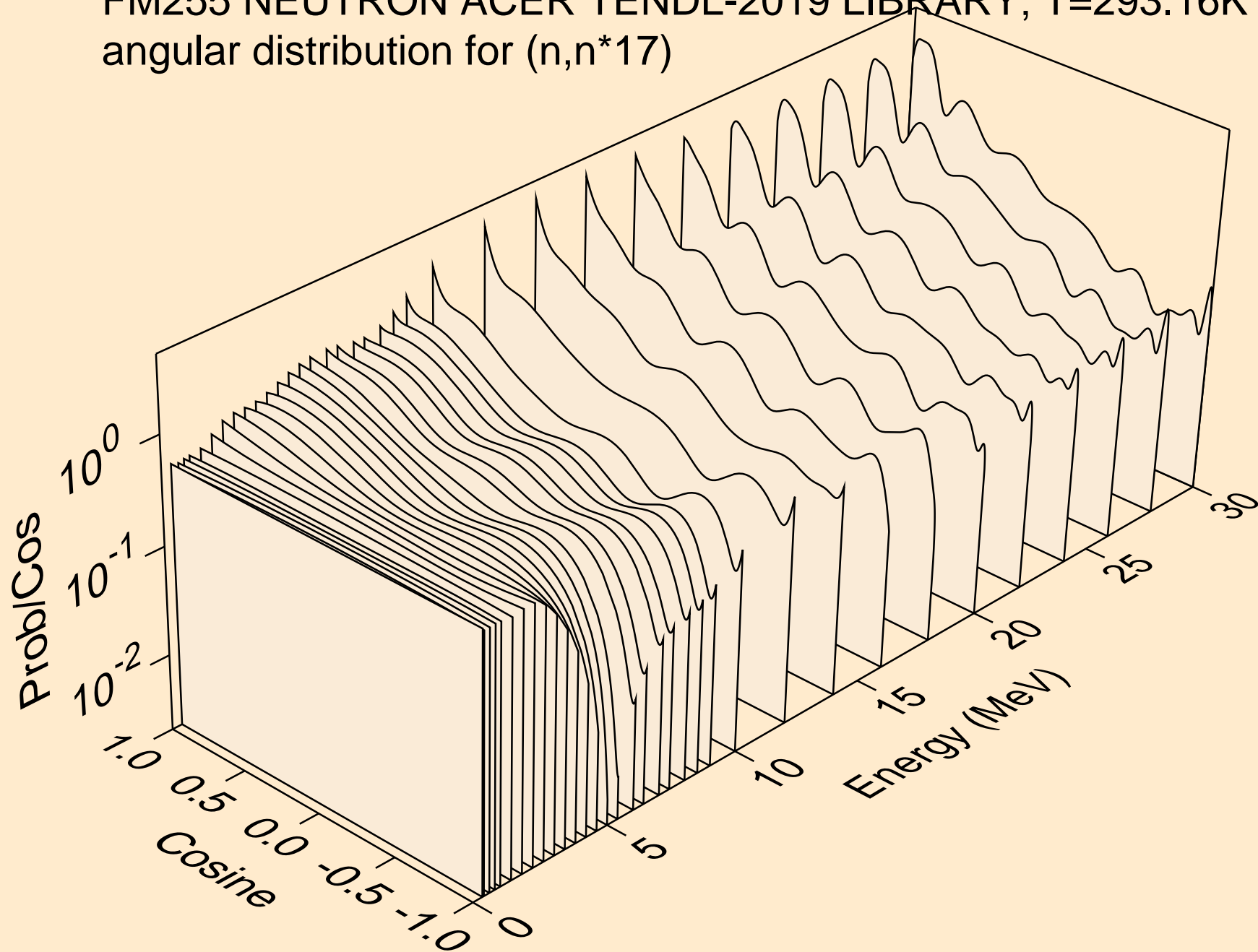

FM255 NEUTRON ACER TENDL-2019 LIBRARY; T=293.16K
angular distribution for (n,n*18)

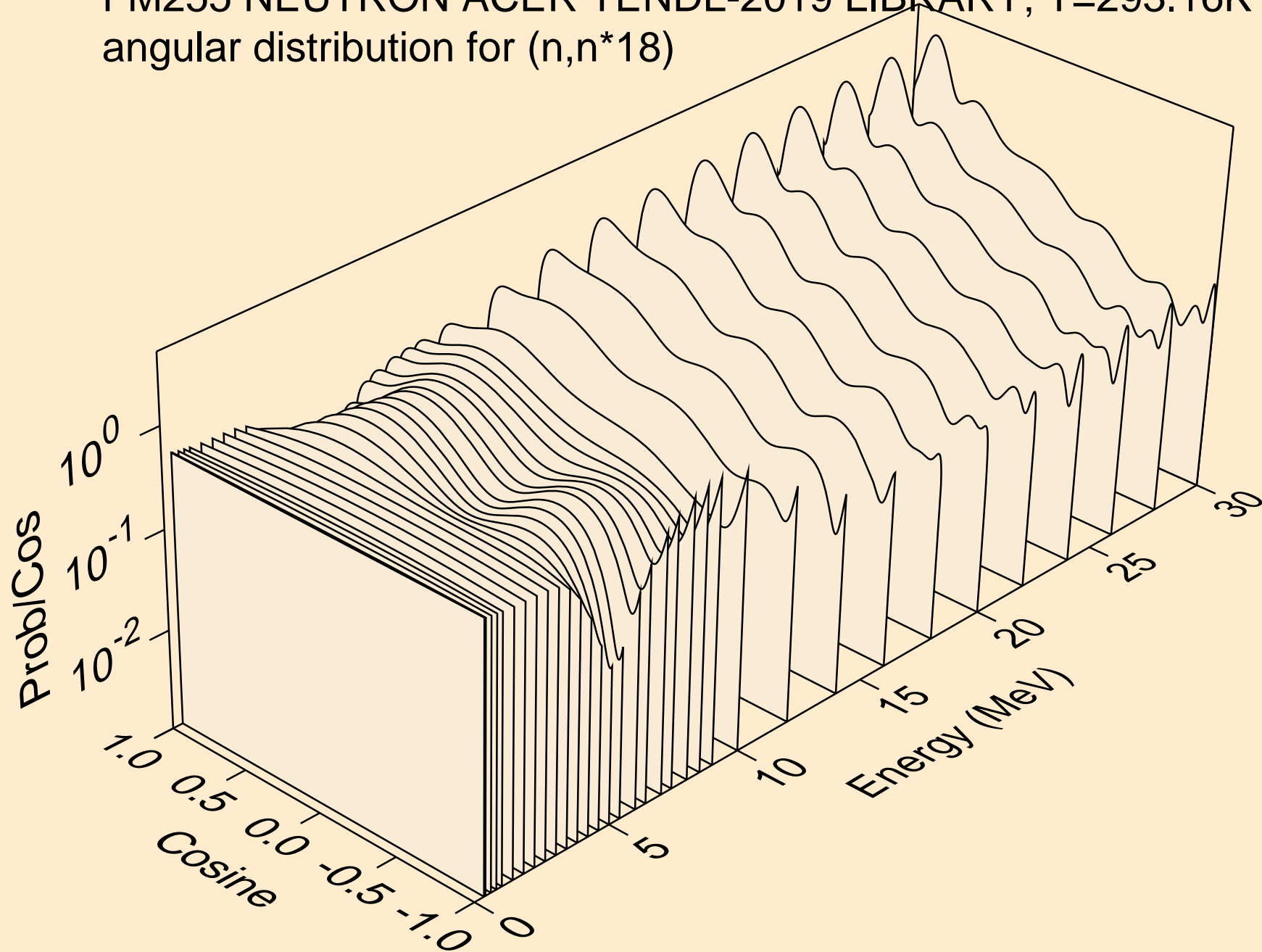

FM255 NEUTRON ACER TENDL-2019 LIBRARY; T=293.16K
angular distribution for (n,n*19)

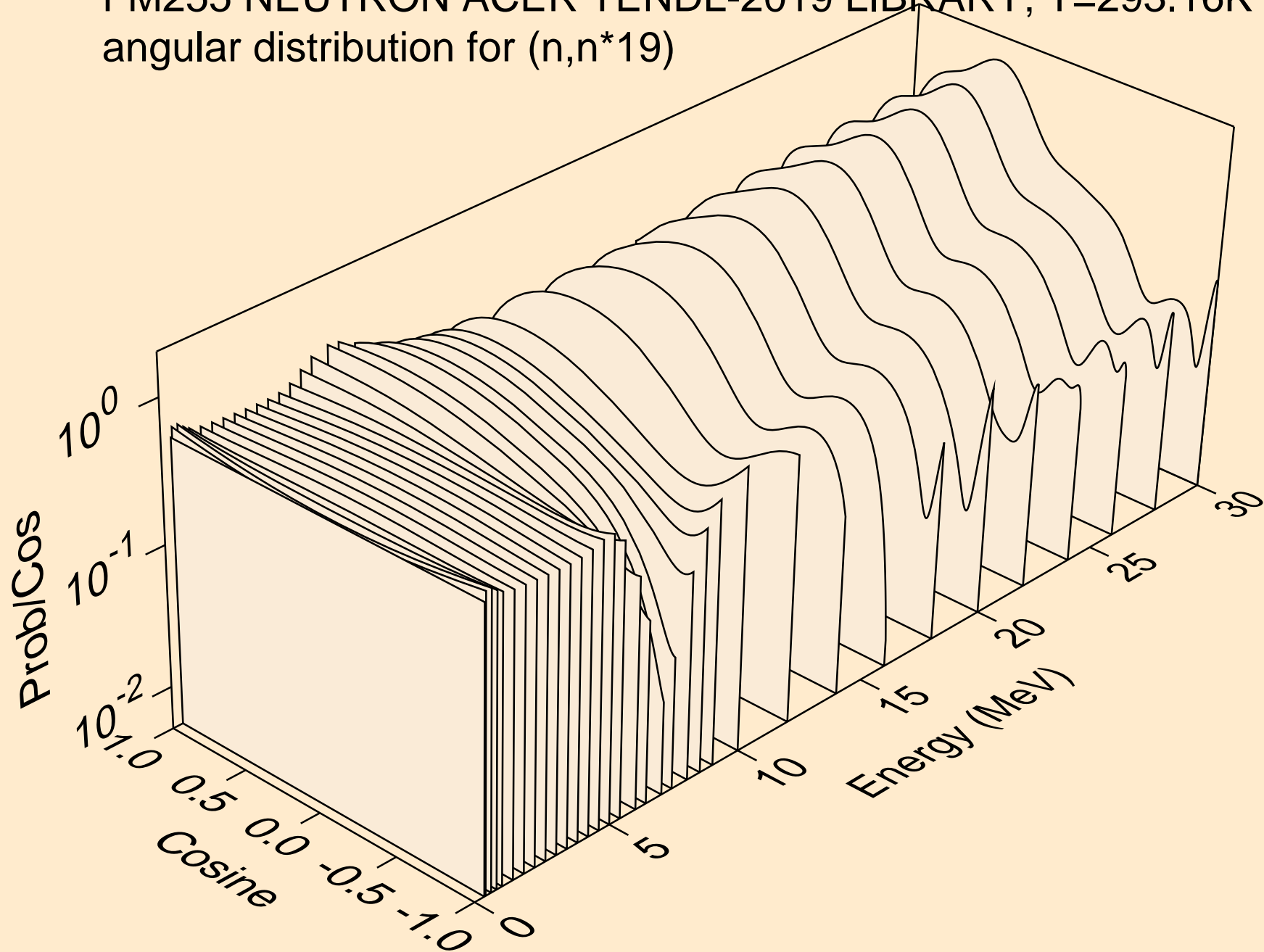

FM255 NEUTRON ACER TENDL-2019 LIBRARY; T=293.16K
angular distribution for (n,n*20)

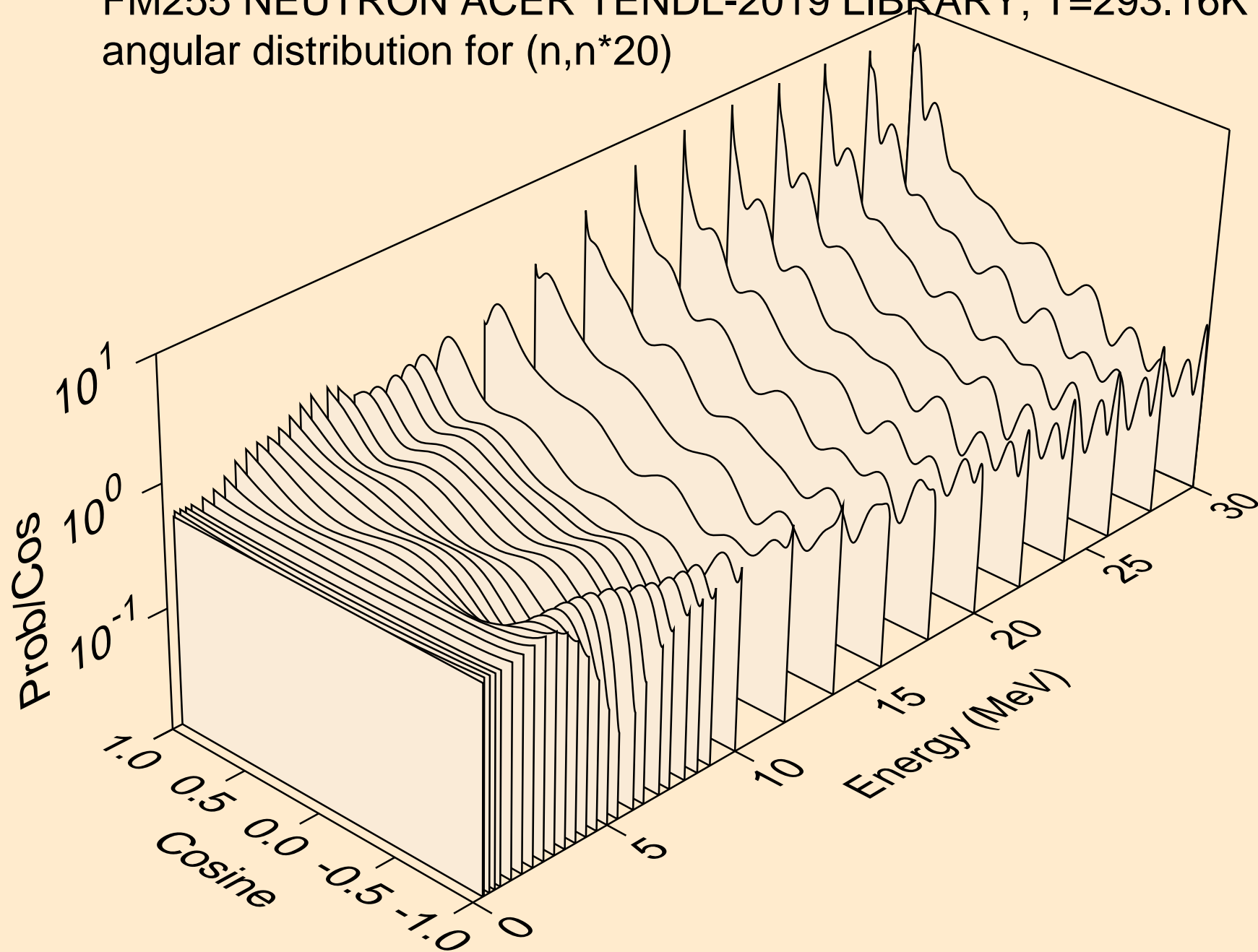

FM255 NEUTRON ACER TENDL-2019 LIBRARY; T=293.16K
angular distribution for (n,n*21)

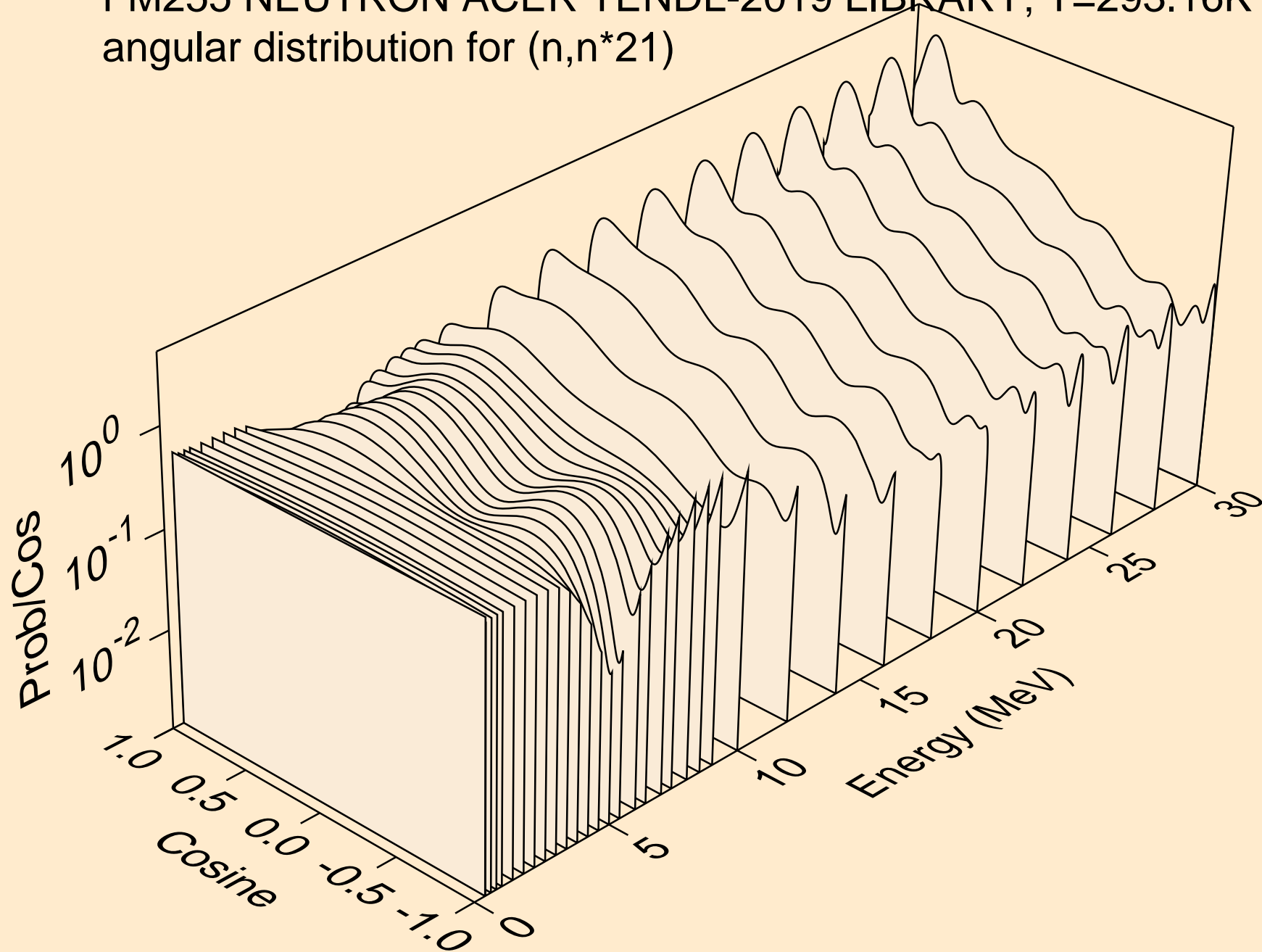

FM255 NEUTRON ACER TENDL-2019 LIBRARY; T=293.16K
angular distribution for (n,n*22)

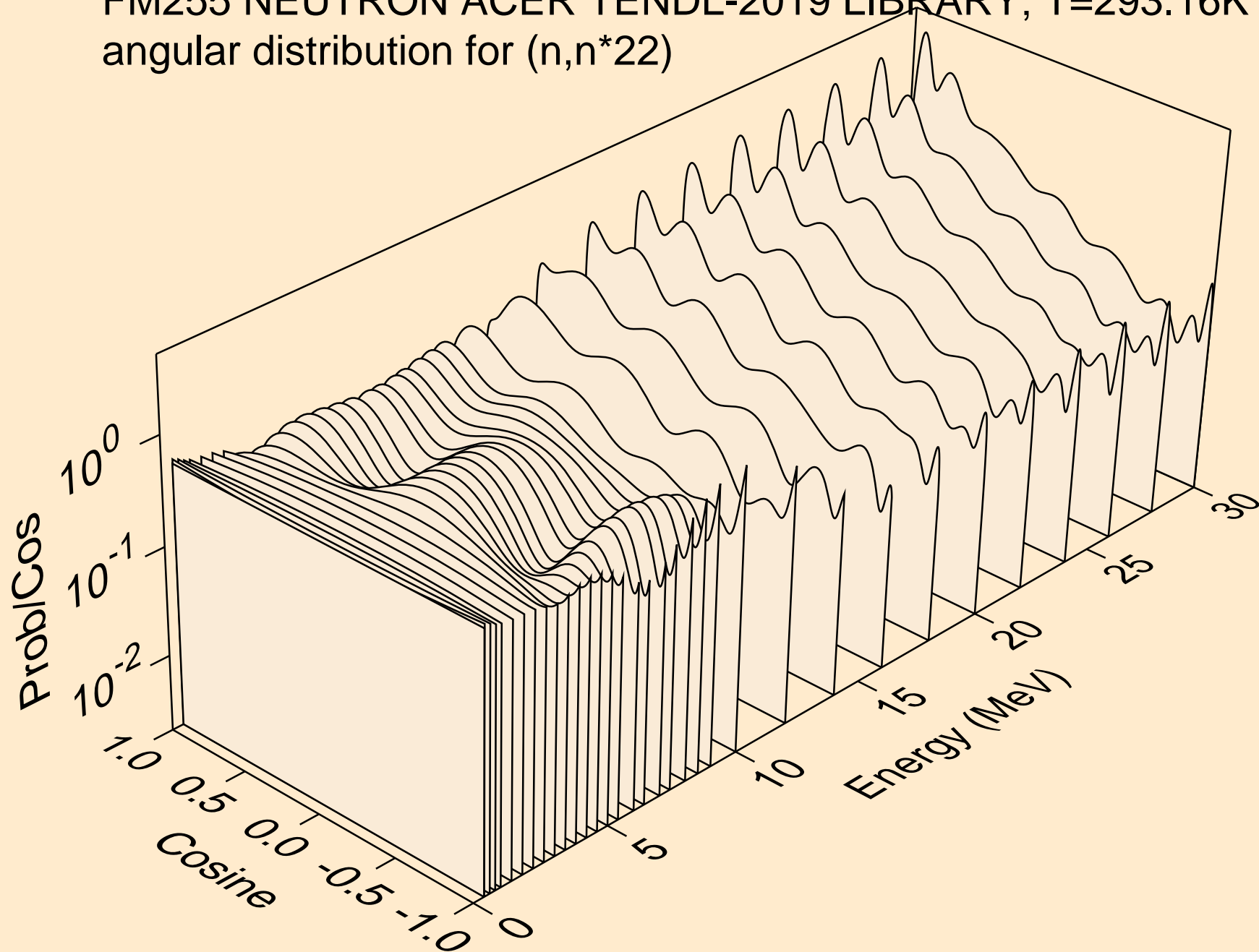

FM255 NEUTRON ACER TENDL-2019 LIBRARY; T=293.16K
angular distribution for (n,n*23)

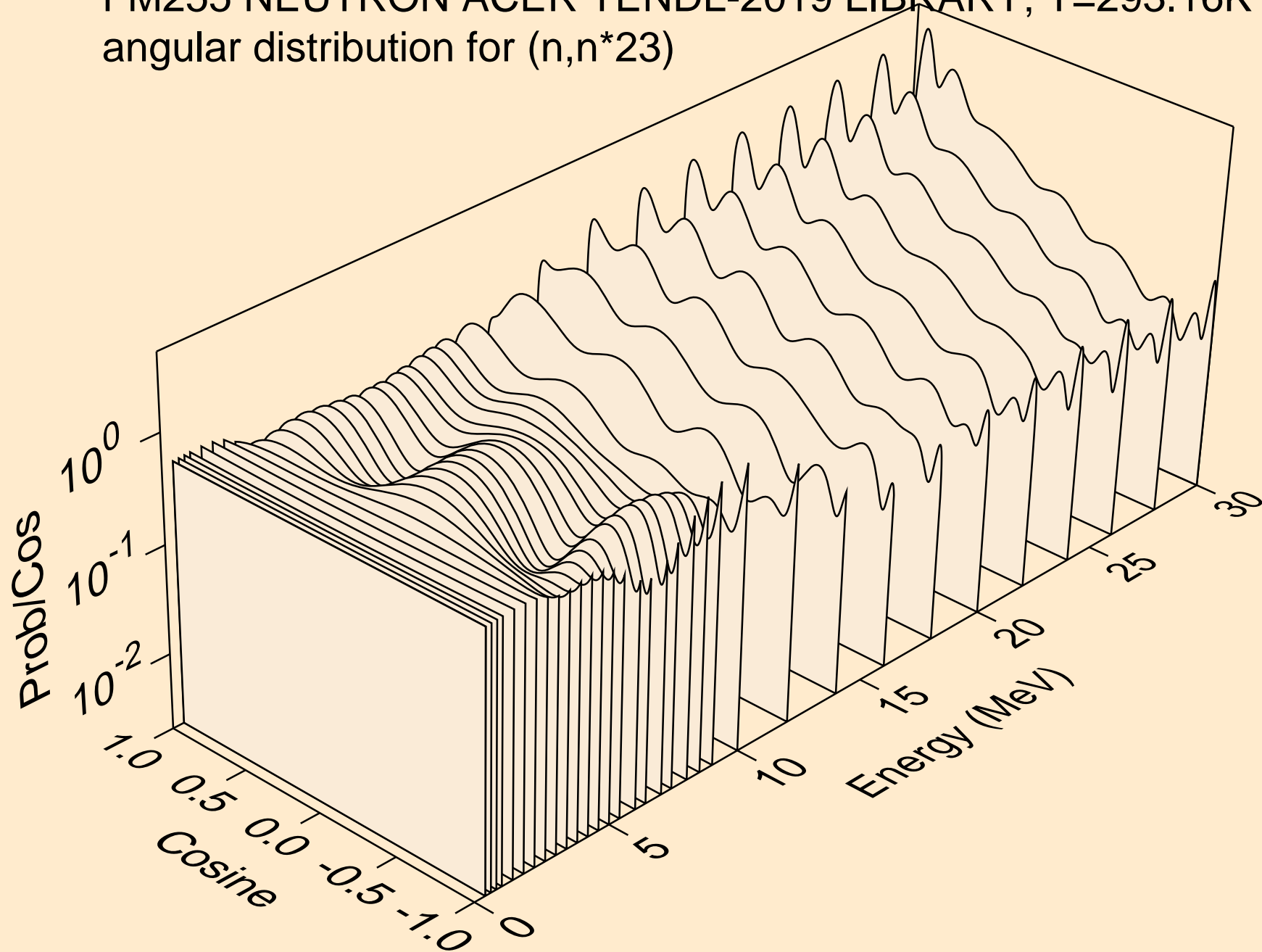

FM255 NEUTRON ACER TENDL-2019 LIBRARY; T=293.16K
angular distribution for (n,n*24)

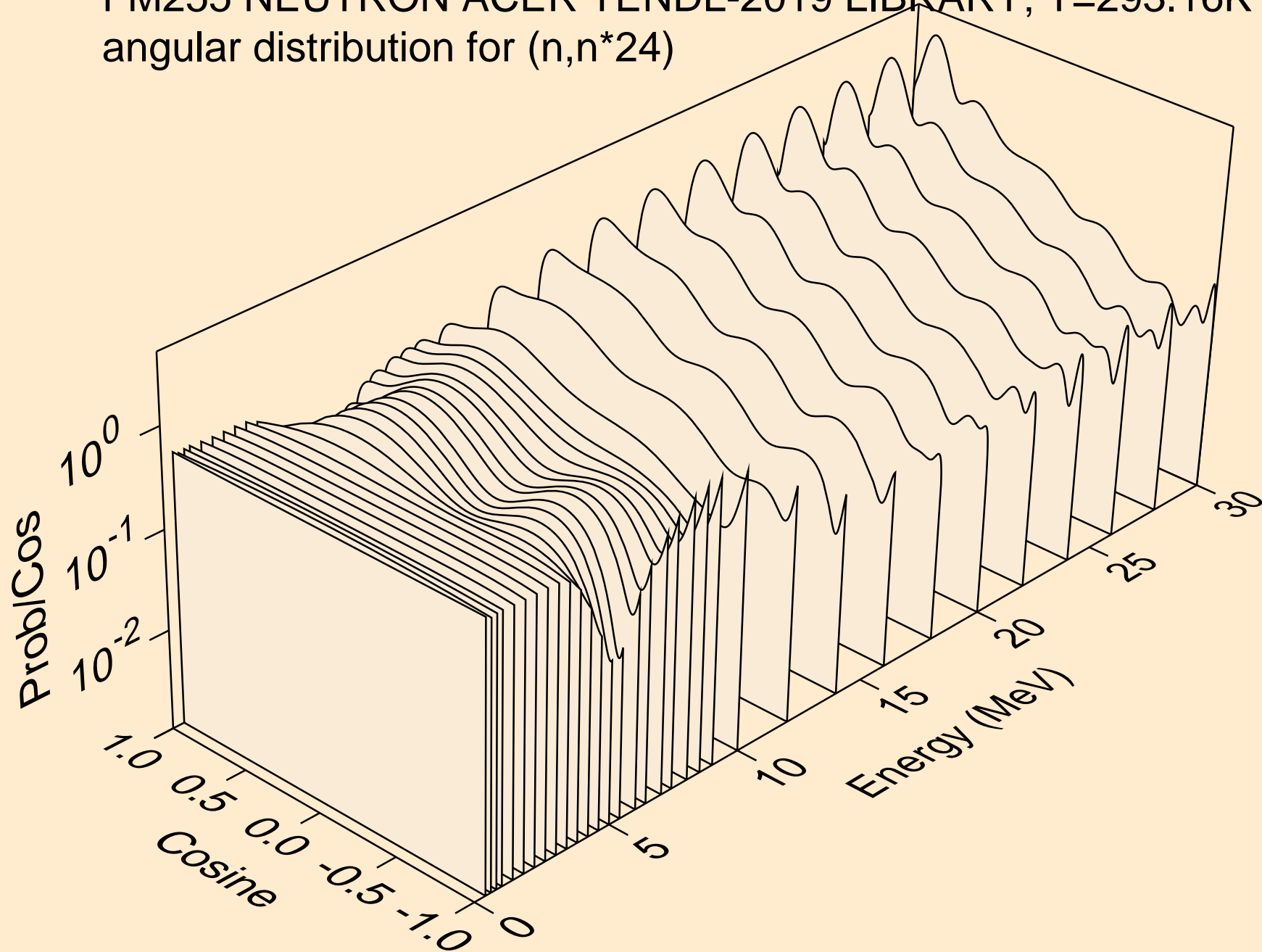

FM255 NEUTRON ACER TENDL-2019 LIBRARY; T=293.16K
angular distribution for (n,n*25)

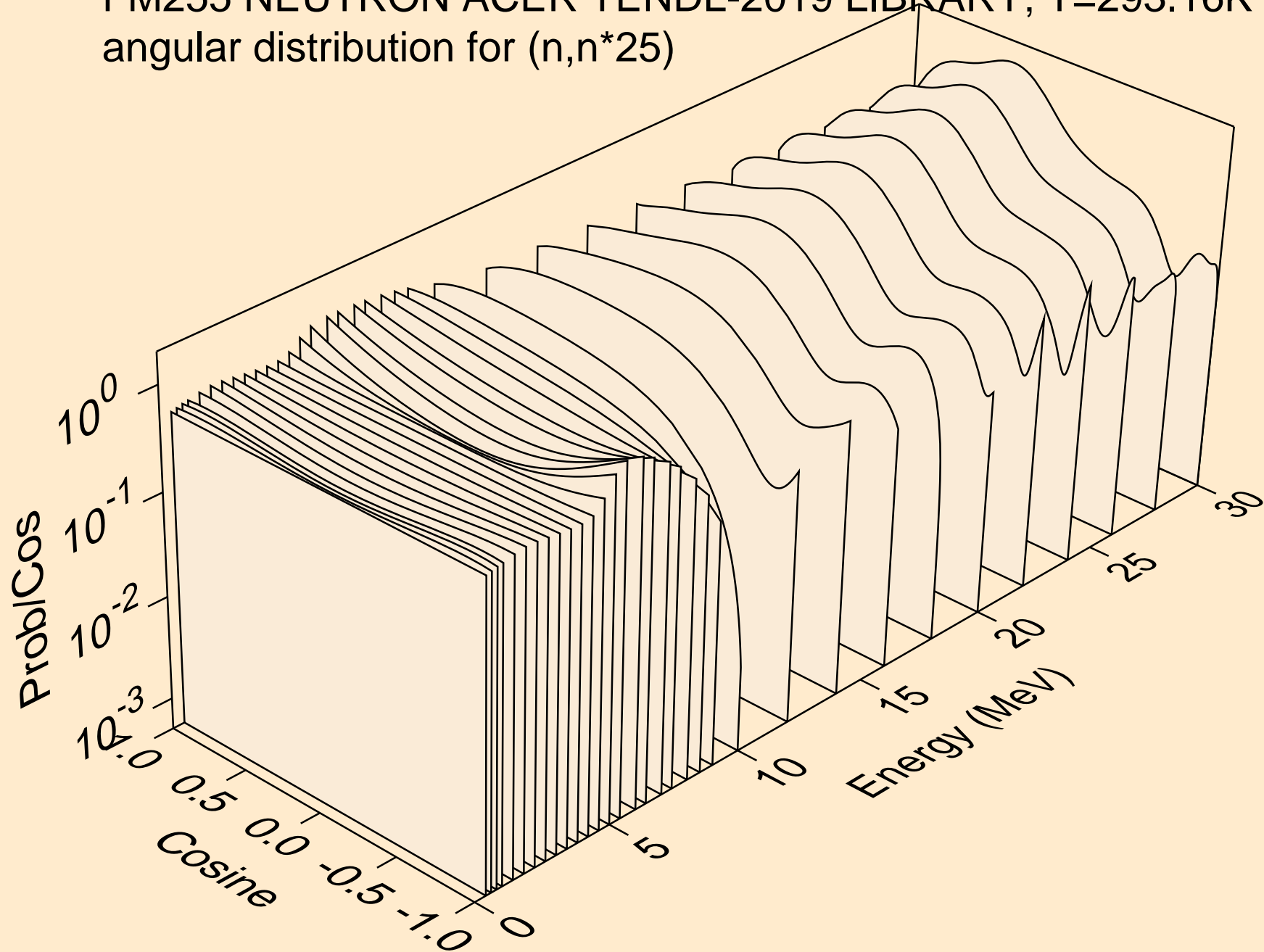

FM255 NEUTRON ACER TENDL-2019 LIBRARY; T=293.16K
angular distribution for (n,n*26)

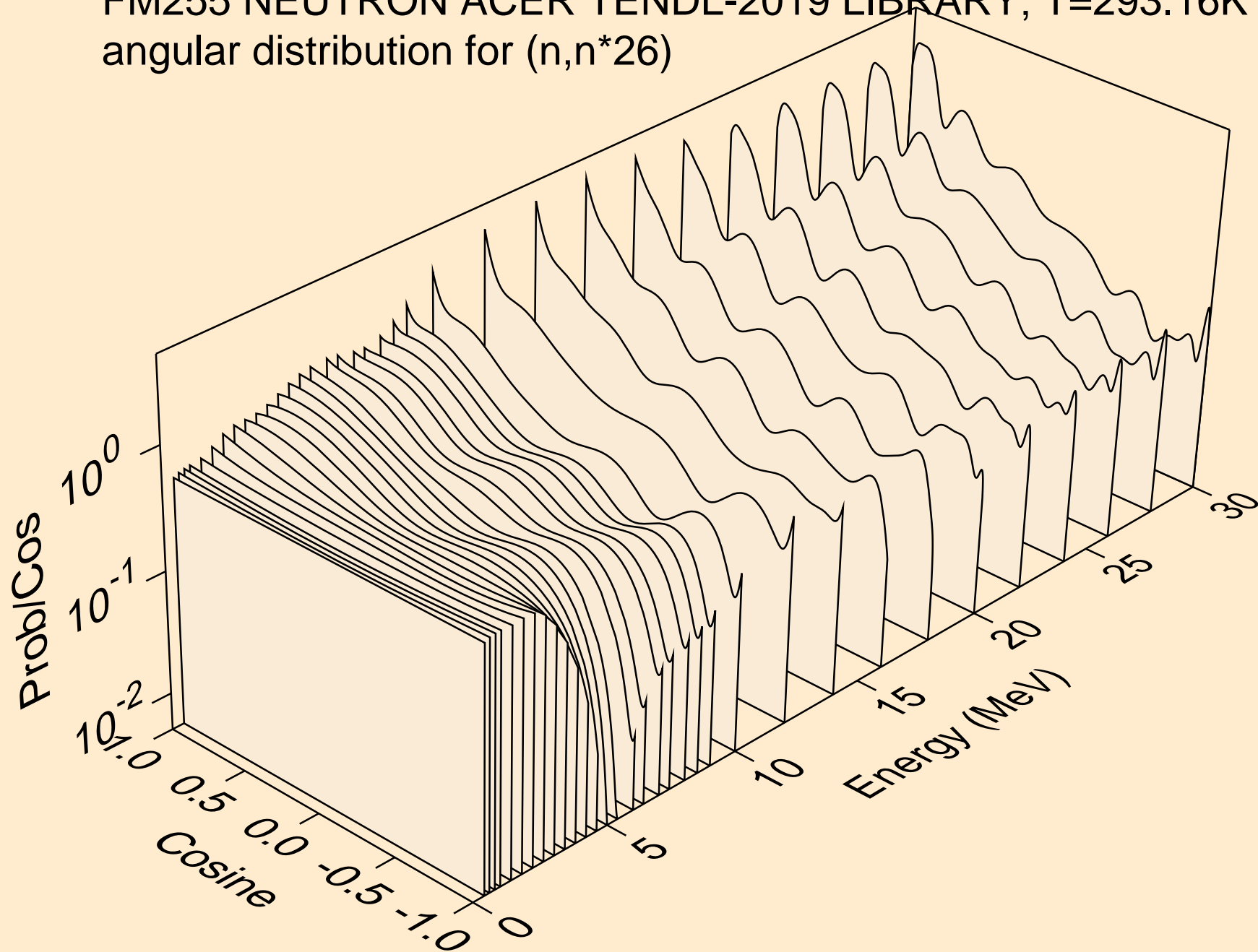

FM255 NEUTRON ACER TENDL-2019 LIBRARY; T=293.16K
angular distribution for (n,n*27)

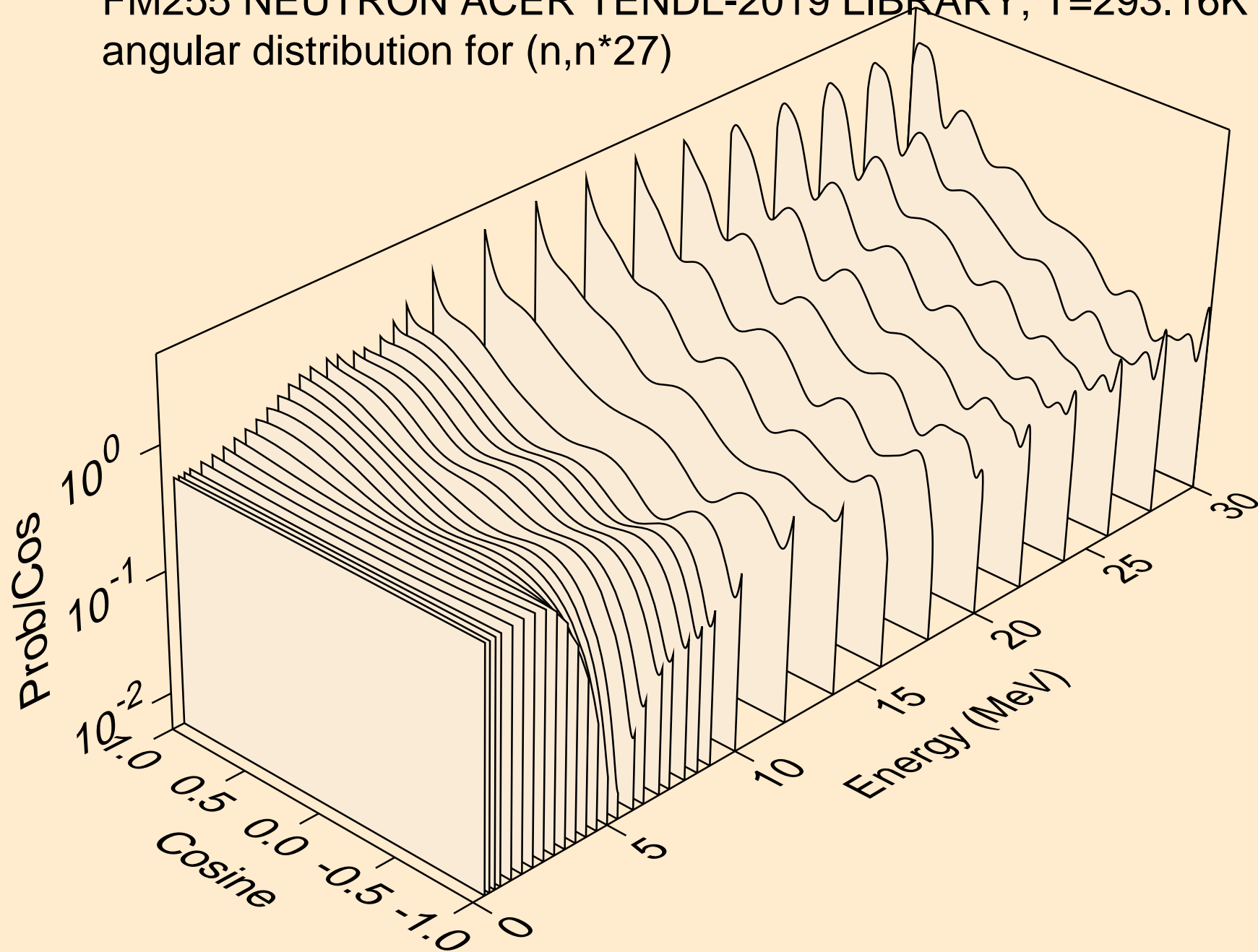

FM255 NEUTRON ACER TENDL-2019 LIBRARY; T=293.16K
angular distribution for (n,n*28)

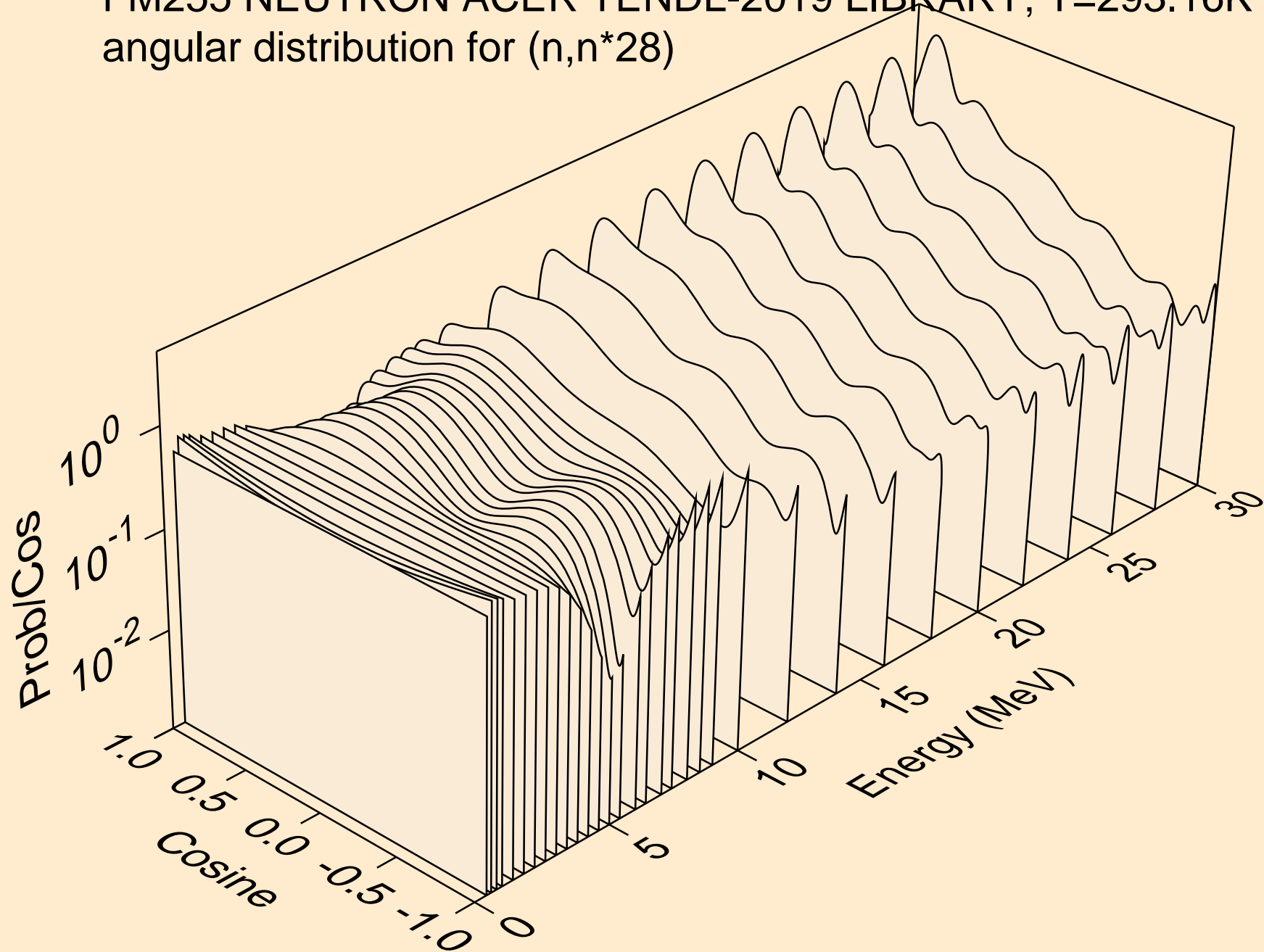

FM255 NEUTRON ACER TENDL-2019 LIBRARY; T=293.16K
angular distribution for (n,n*29)

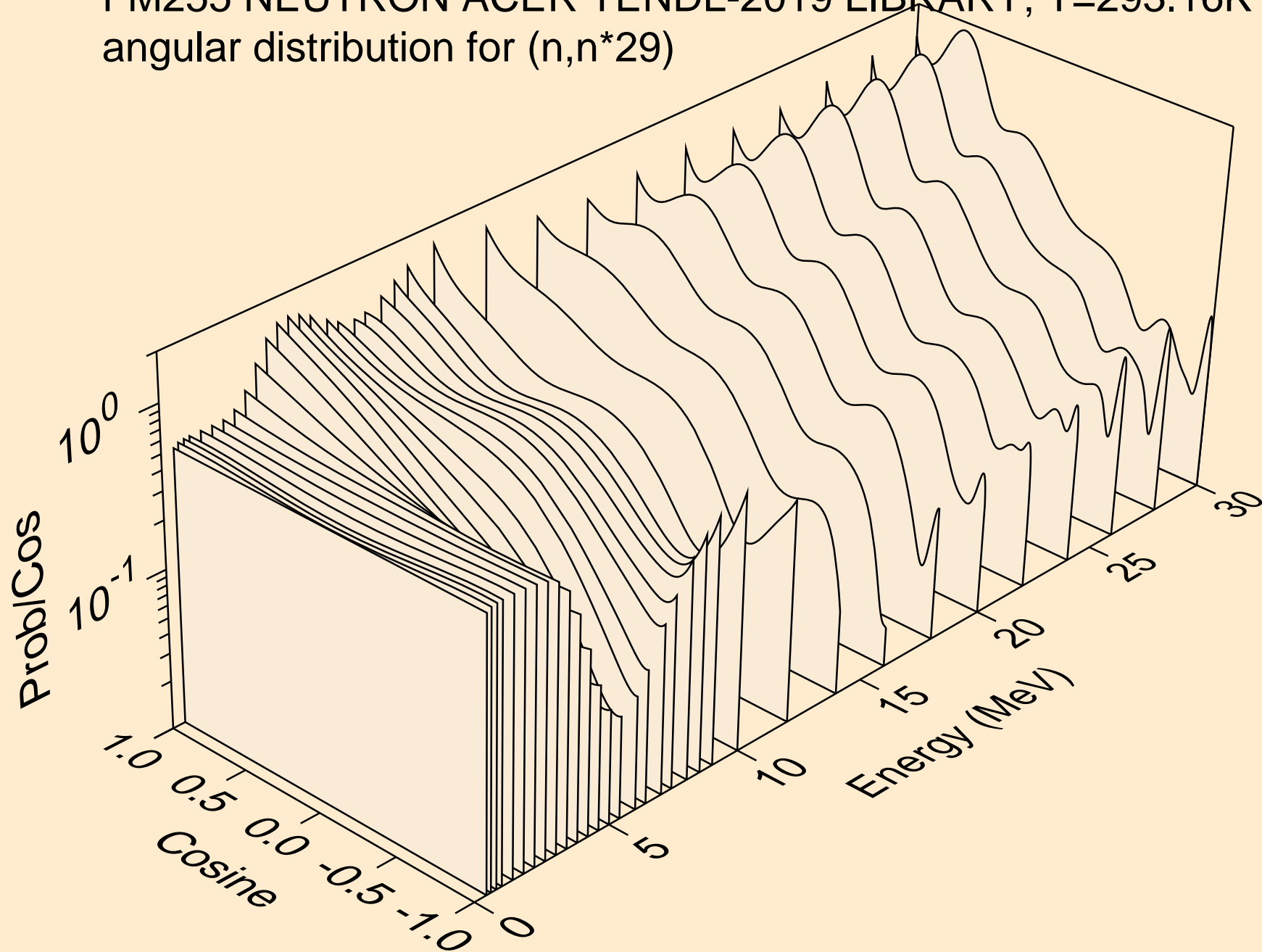

FM255 NEUTRON ACER TENDL-2019 LIBRARY; T=293.16K
angular distribution for (n,n*30)

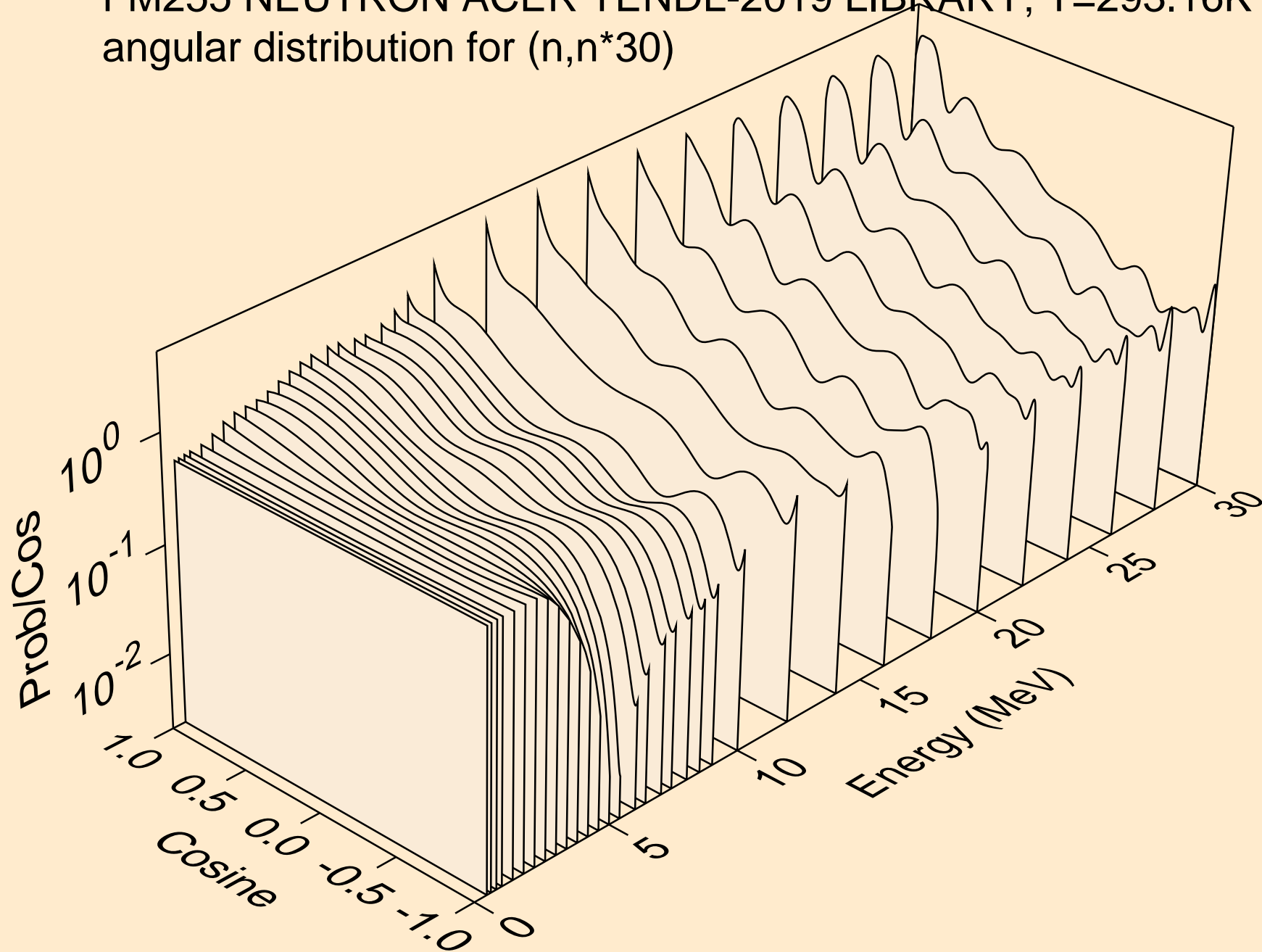

FM255 NEUTRON ACER TENDL-2019 LIBRARY; T=293.16K
Total fission nubar

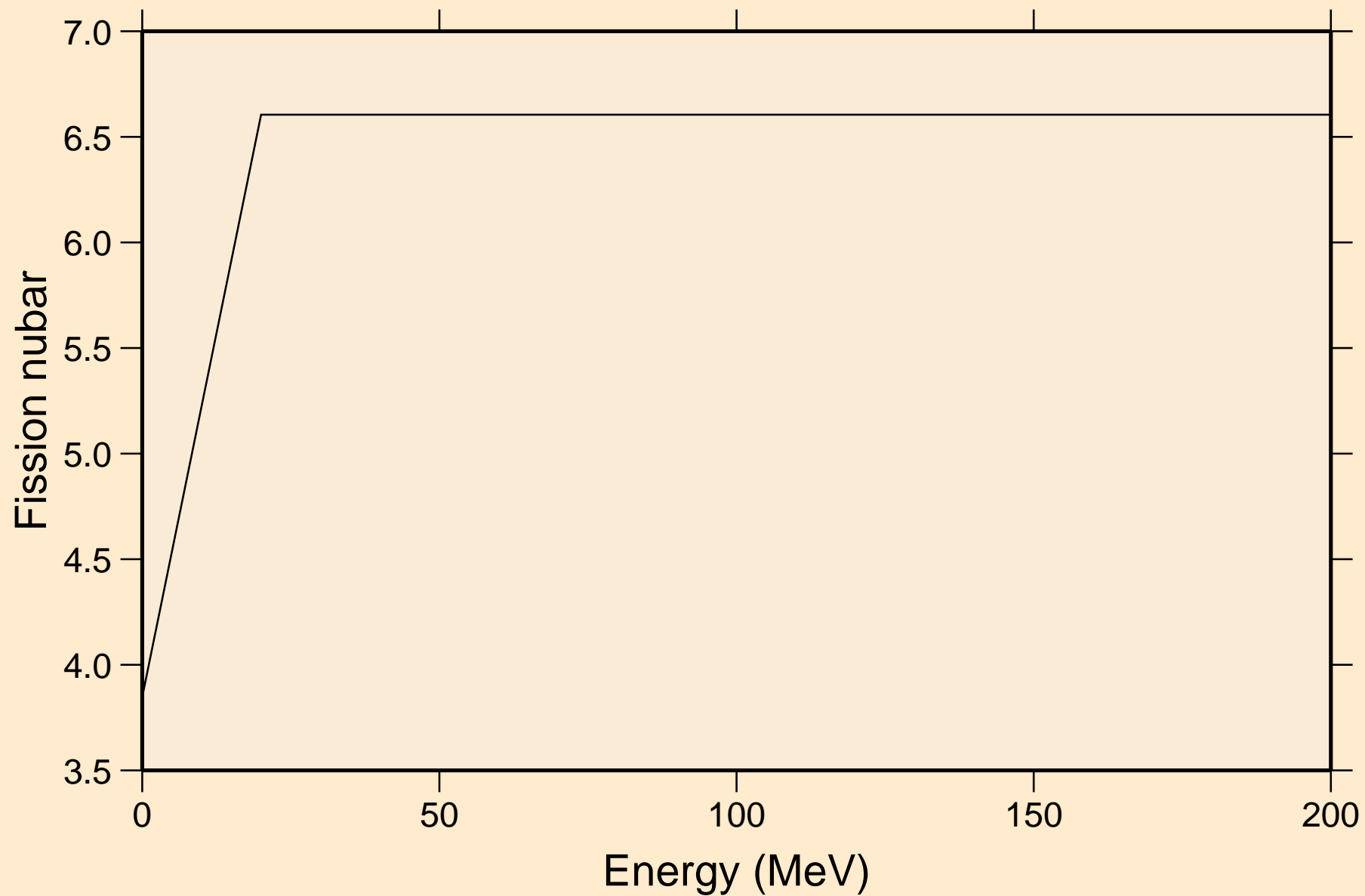

FM255 NEUTRON ACER TENDL-2019 LIBRARY; T=293.16K
Neutron emission for (n,x)

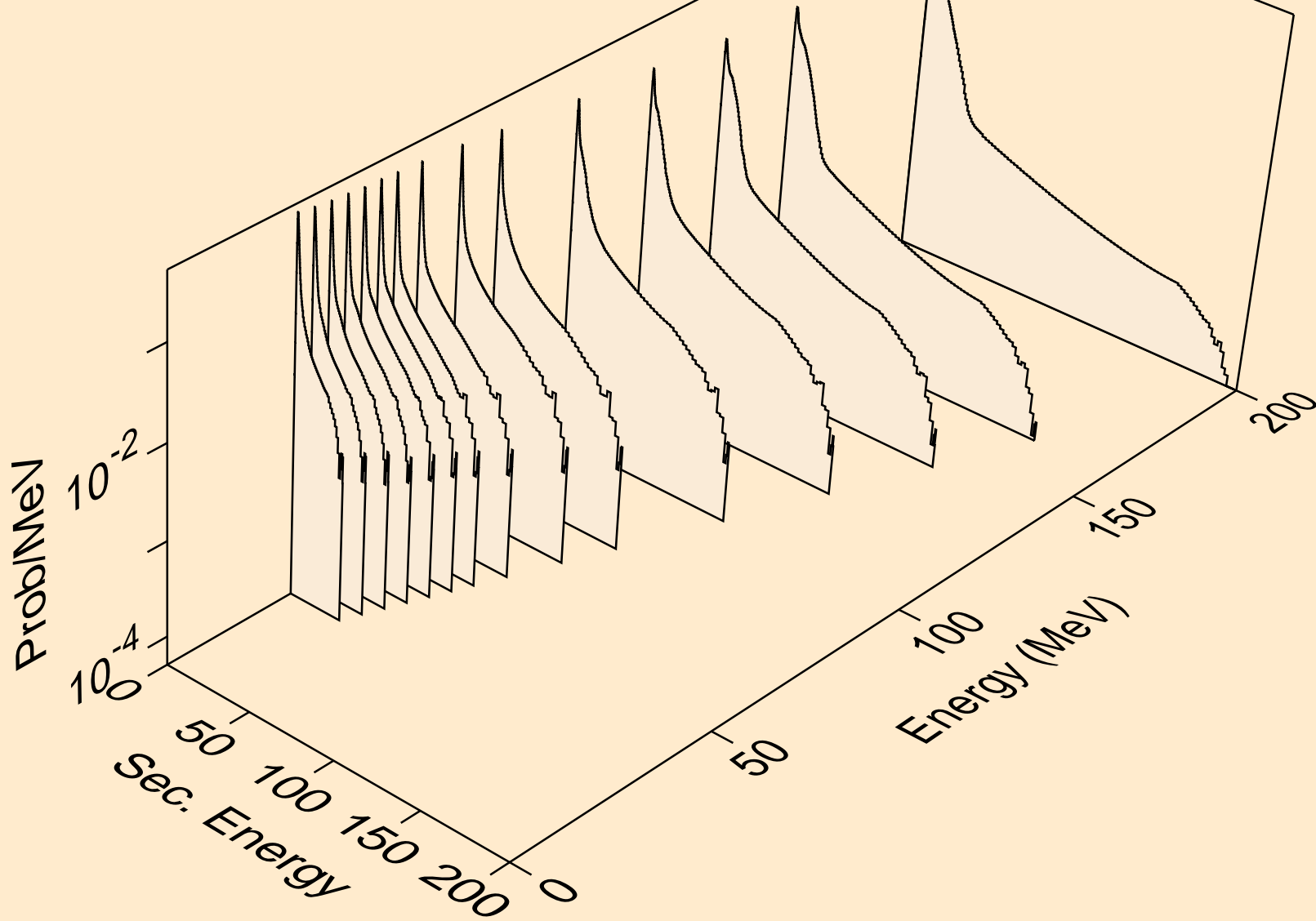

FM255 NEUTRON ACER TENDL-2019 LIBRARY; T=293.16K
Neutron emission for (n,2nd)

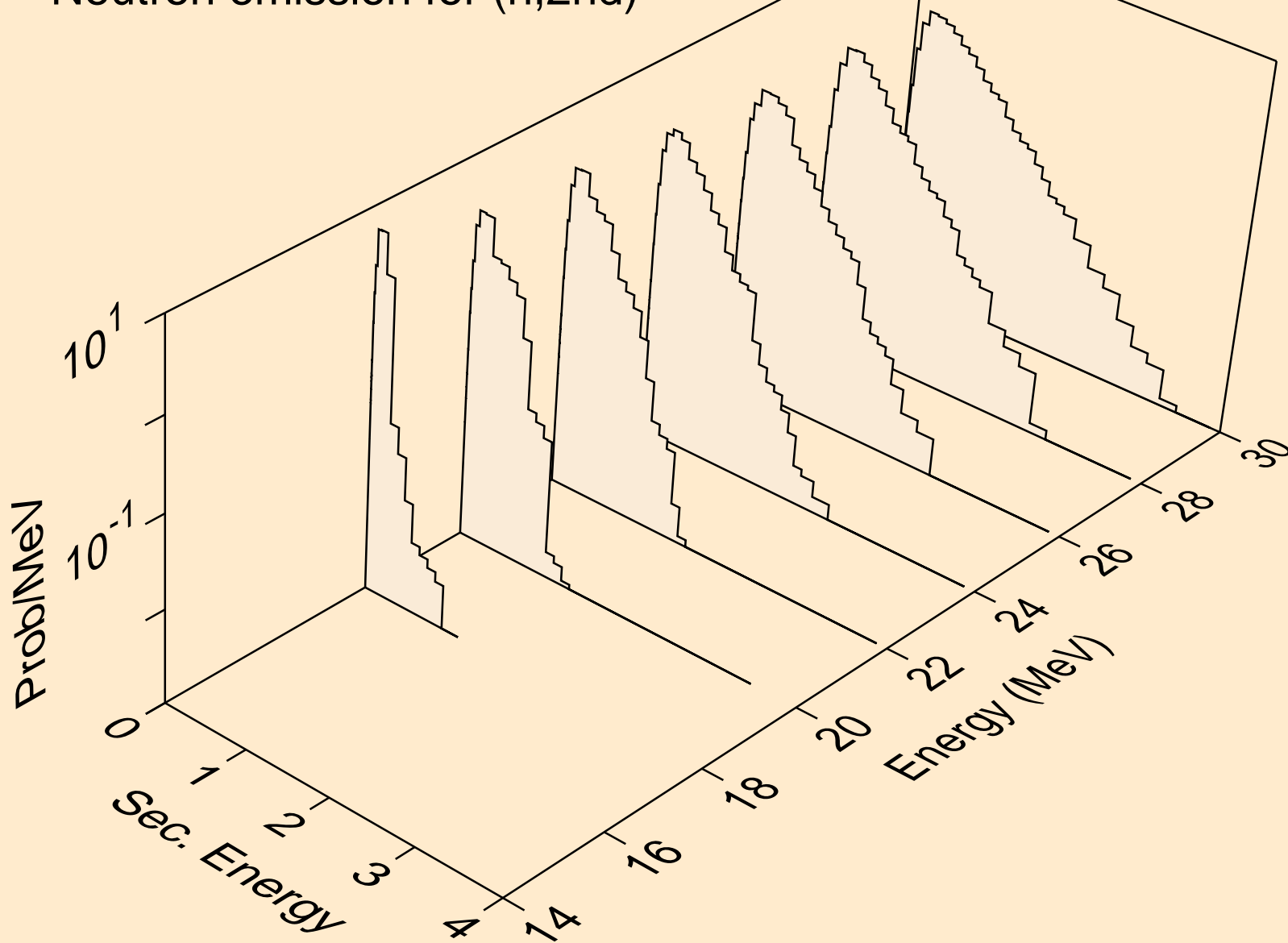

FM255 NEUTRON ACER TENDL-2019 LIBRARY; T=293.16K
Neutron emission for (n,2n)

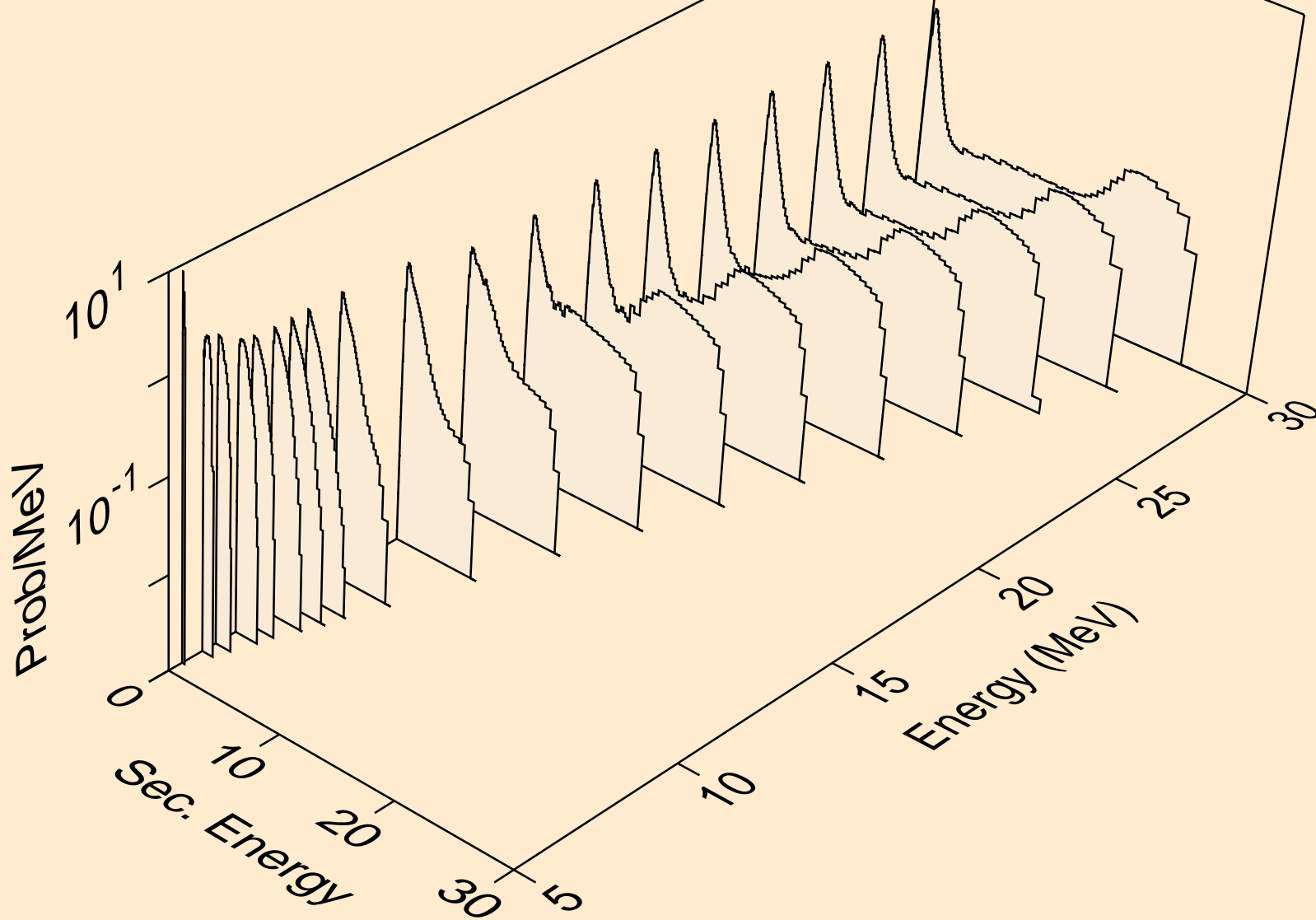

FM255 NEUTRON ACER TENDL-2019 LIBRARY; T=293.16K
Neutron emission for (n,3n)

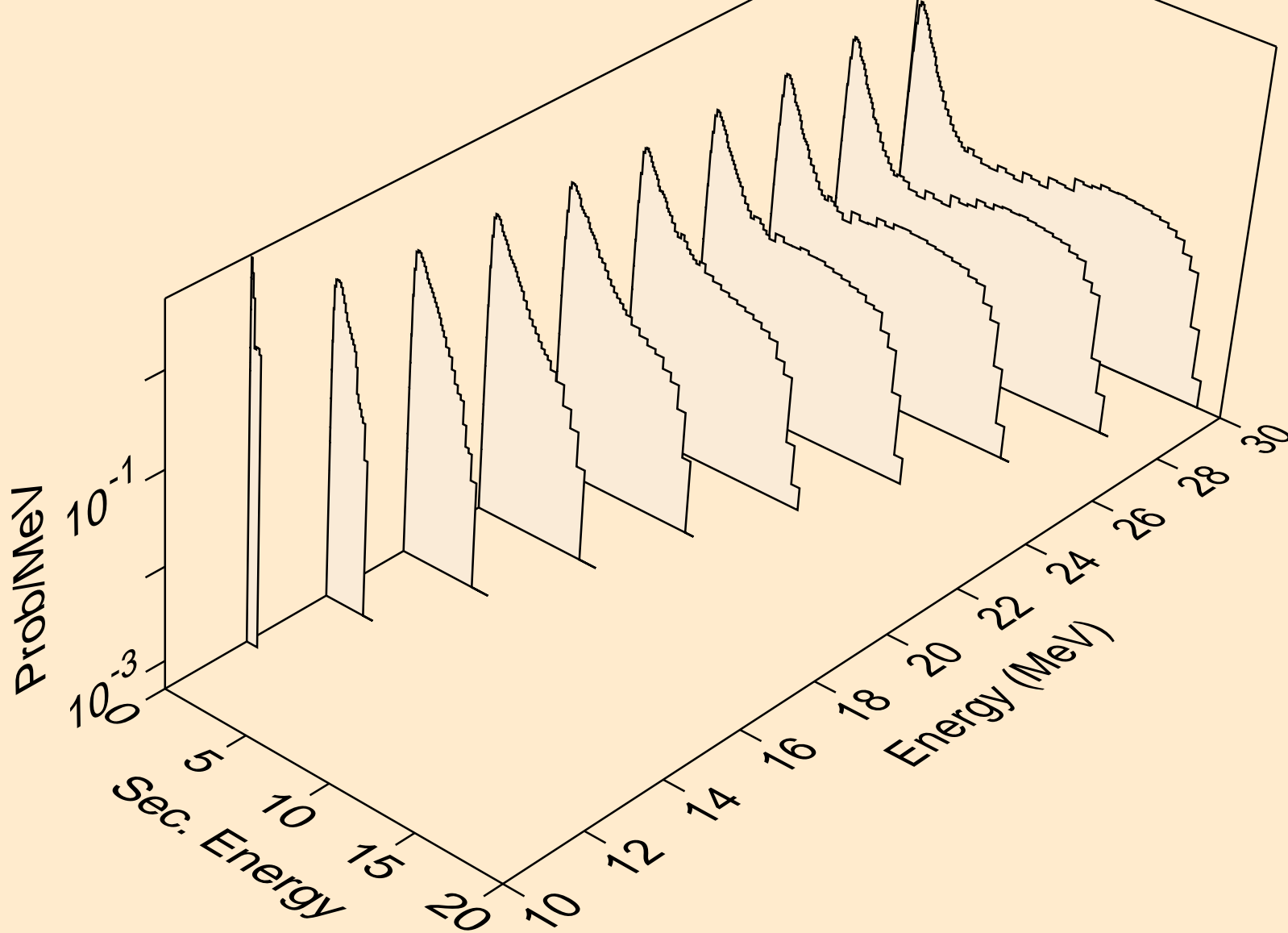

FM255 NEUTRON ACER TENDL-2019 LIBRARY; T=293.16K
Neutron emission for fission

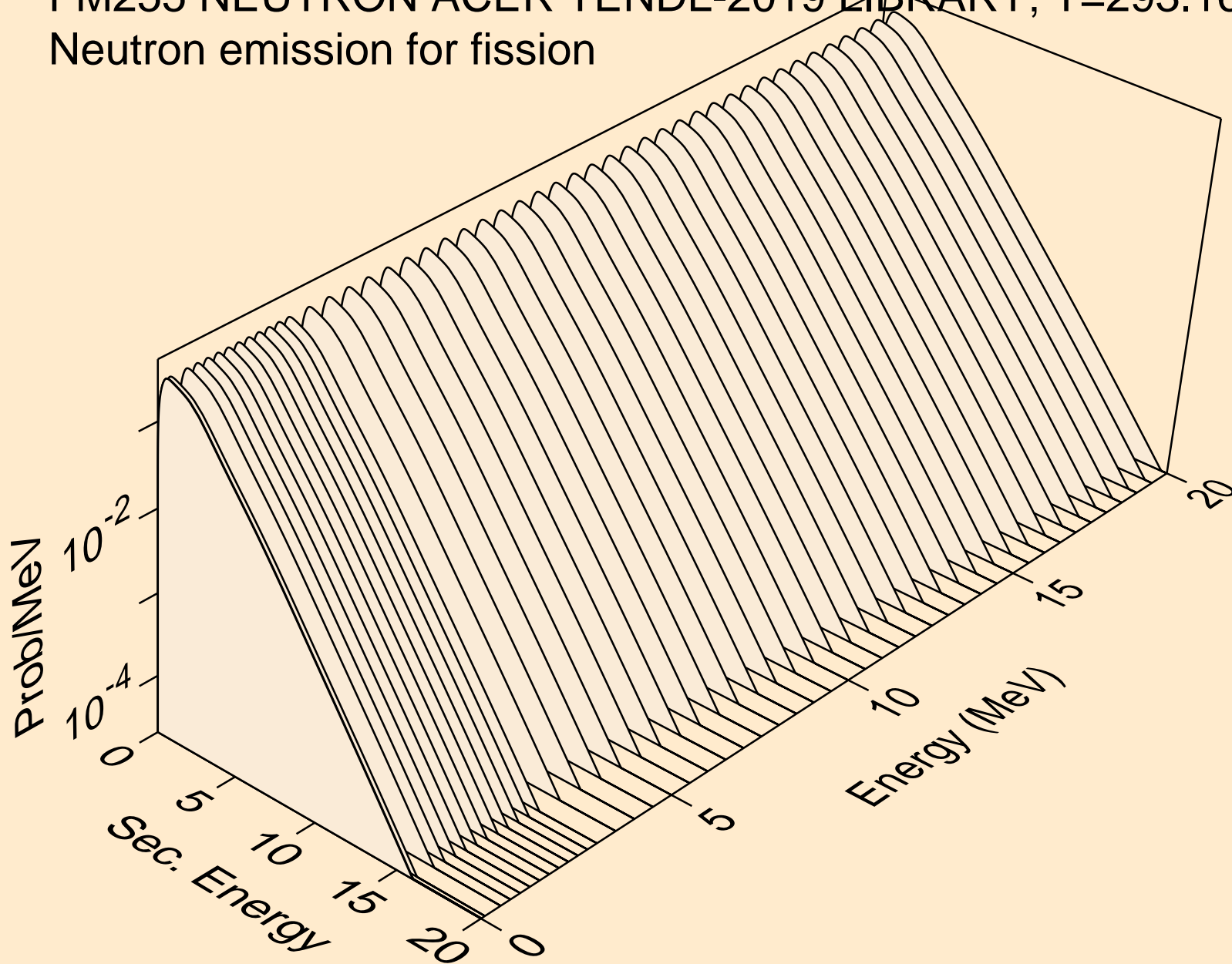

FM255 NEUTRON ACER TENDL-2019 LIBRARY; T=293.16K
Neutron emission for (n,n*)a

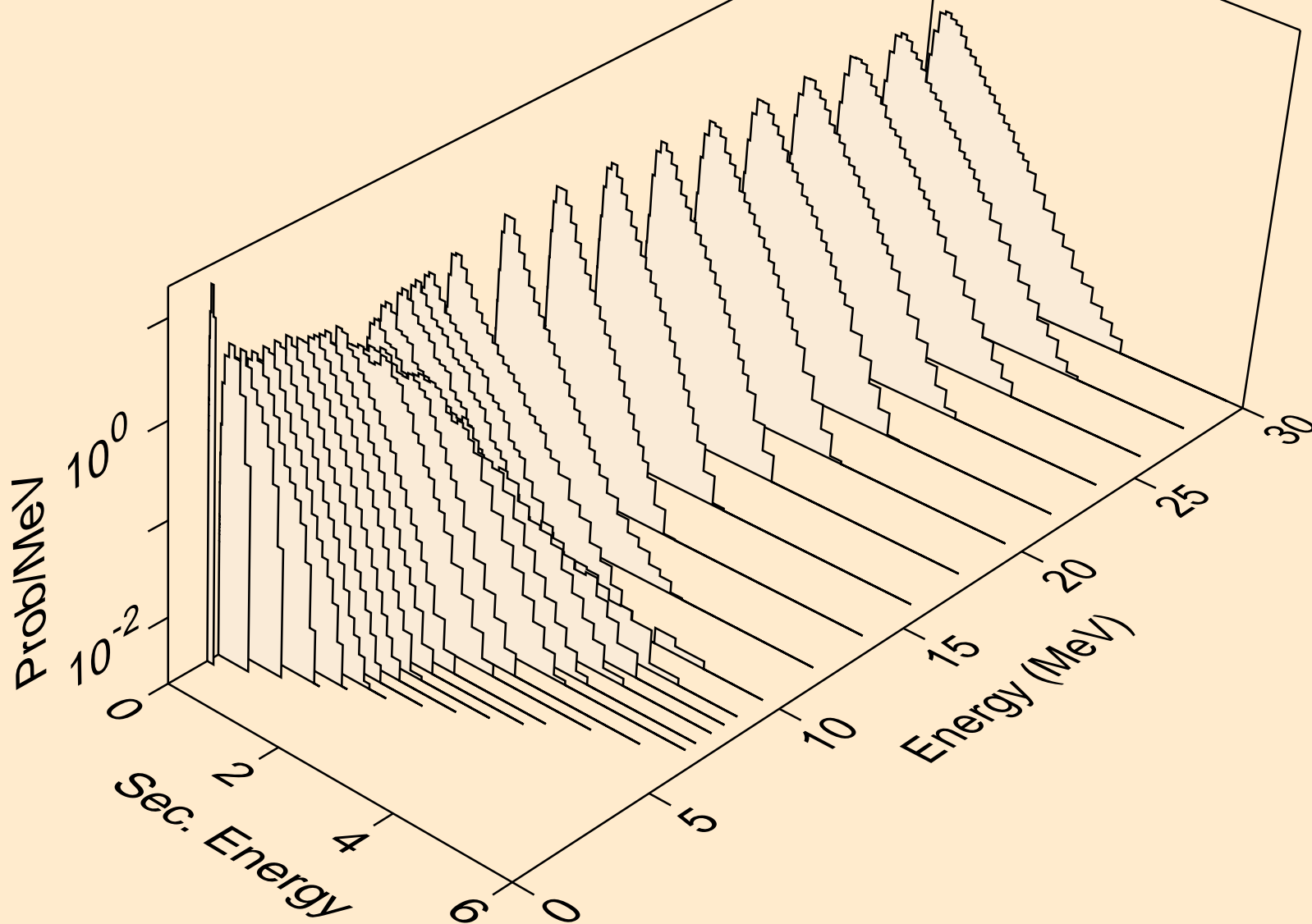

FM255 NEUTRON ACER TENDL-2019 LIBRARY; T=293.16K
Neutron emission for (n,2n)a

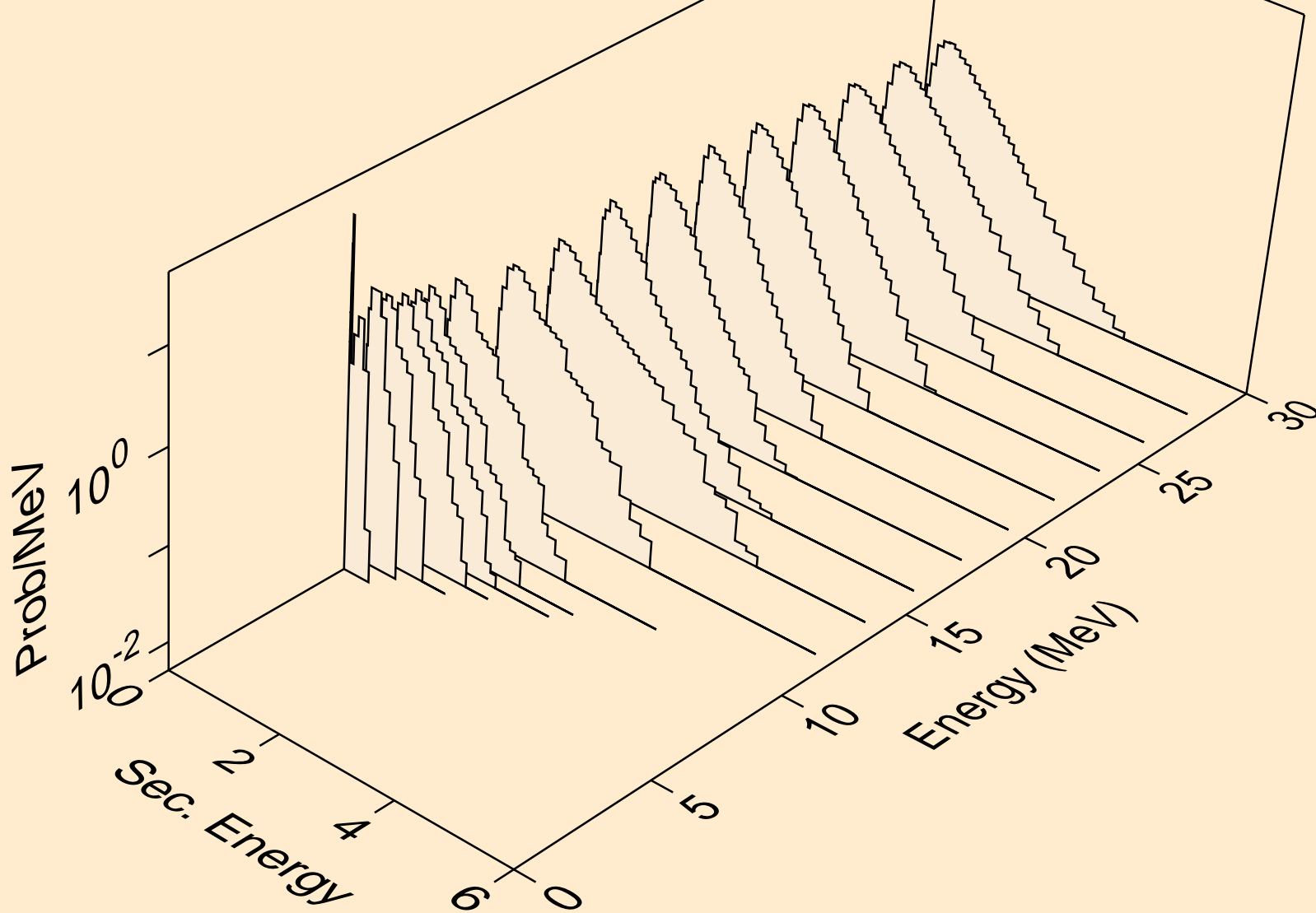

FM255 NEUTRON ACER TENDL-2019 LIBRARY; T=293.16K
Neutron emission for (n,3n)a

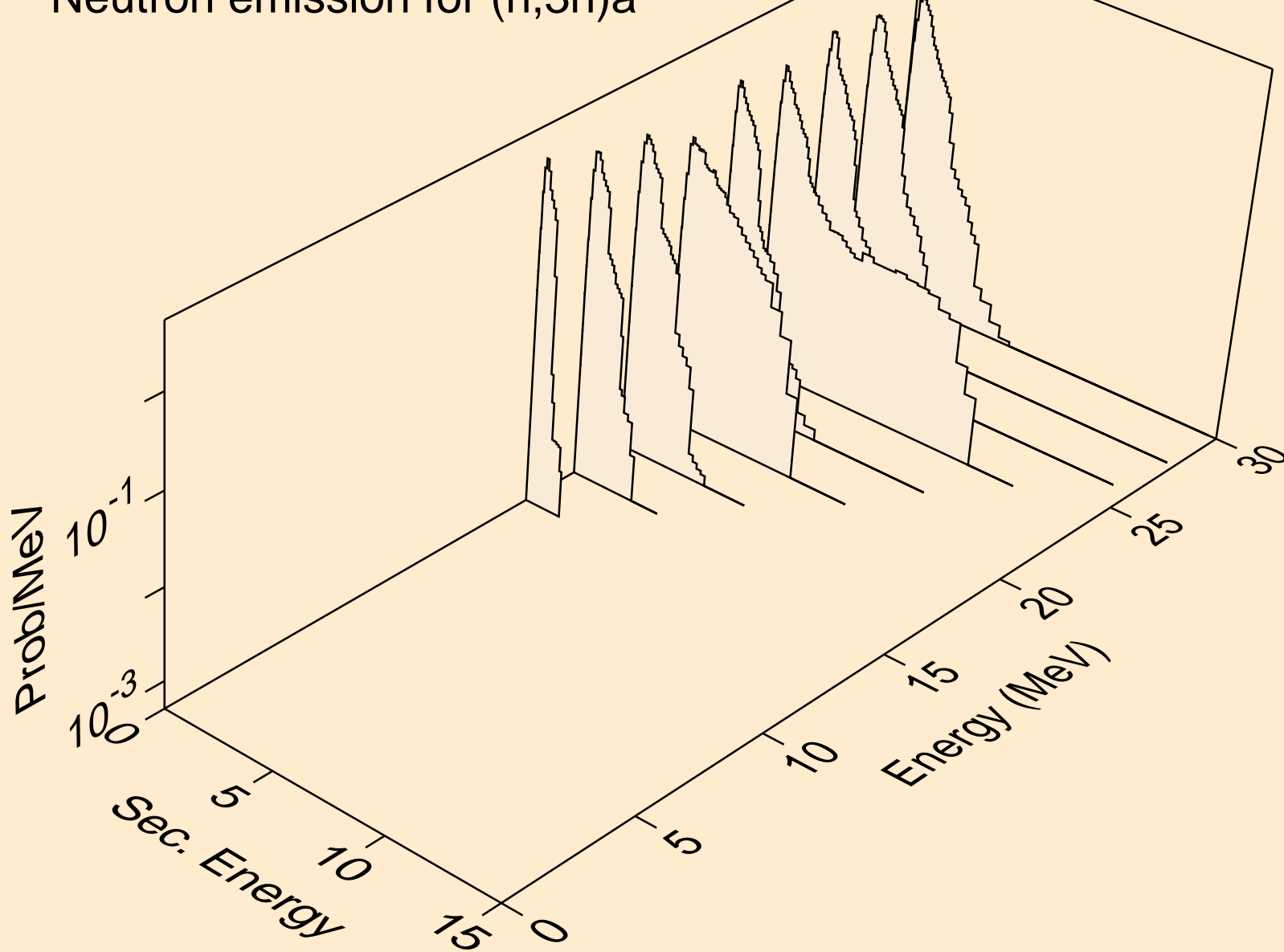

FM255 NEUTRON ACER TENDL-2019 LIBRARY; T=293.16K
Neutron emission for (n,n*)p

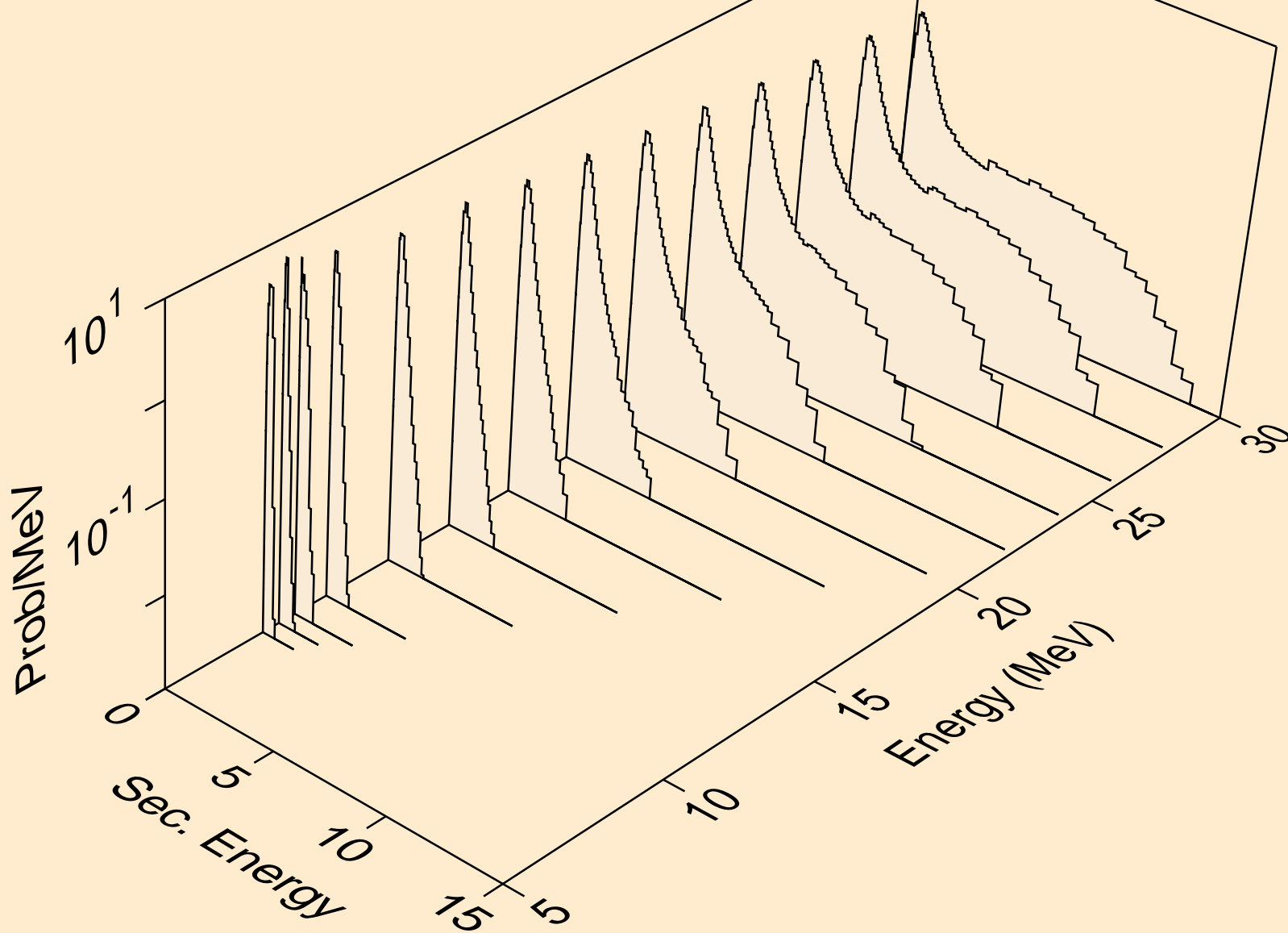

FM255 NEUTRON ACER TENDL-2019 LIBRARY; T=293.16K
Neutron emission for (n,n*)d

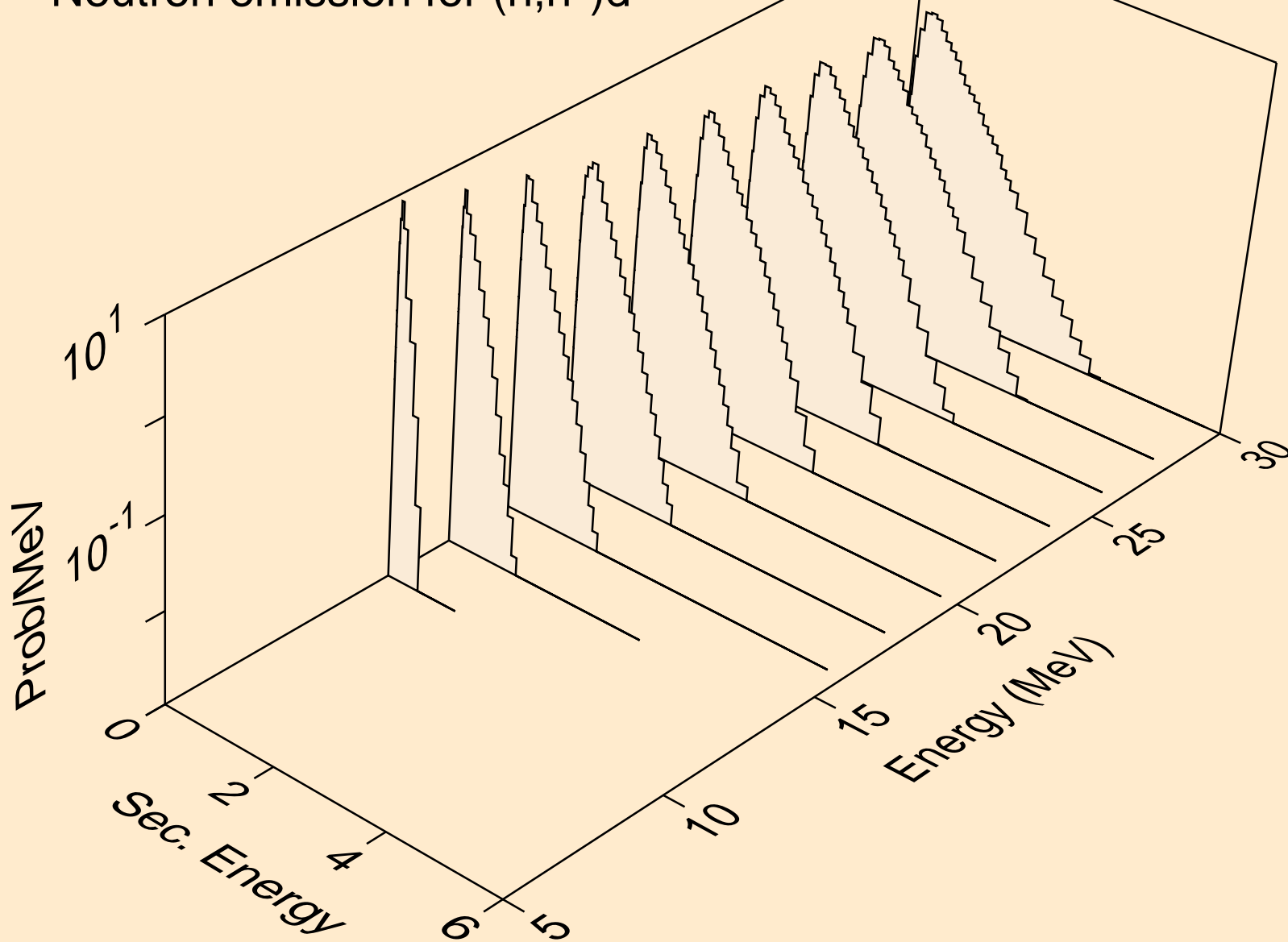

FM255 NEUTRON ACER TENDL-2019 LIBRARY; T=293.16K
Neutron emission for (n,n*)t

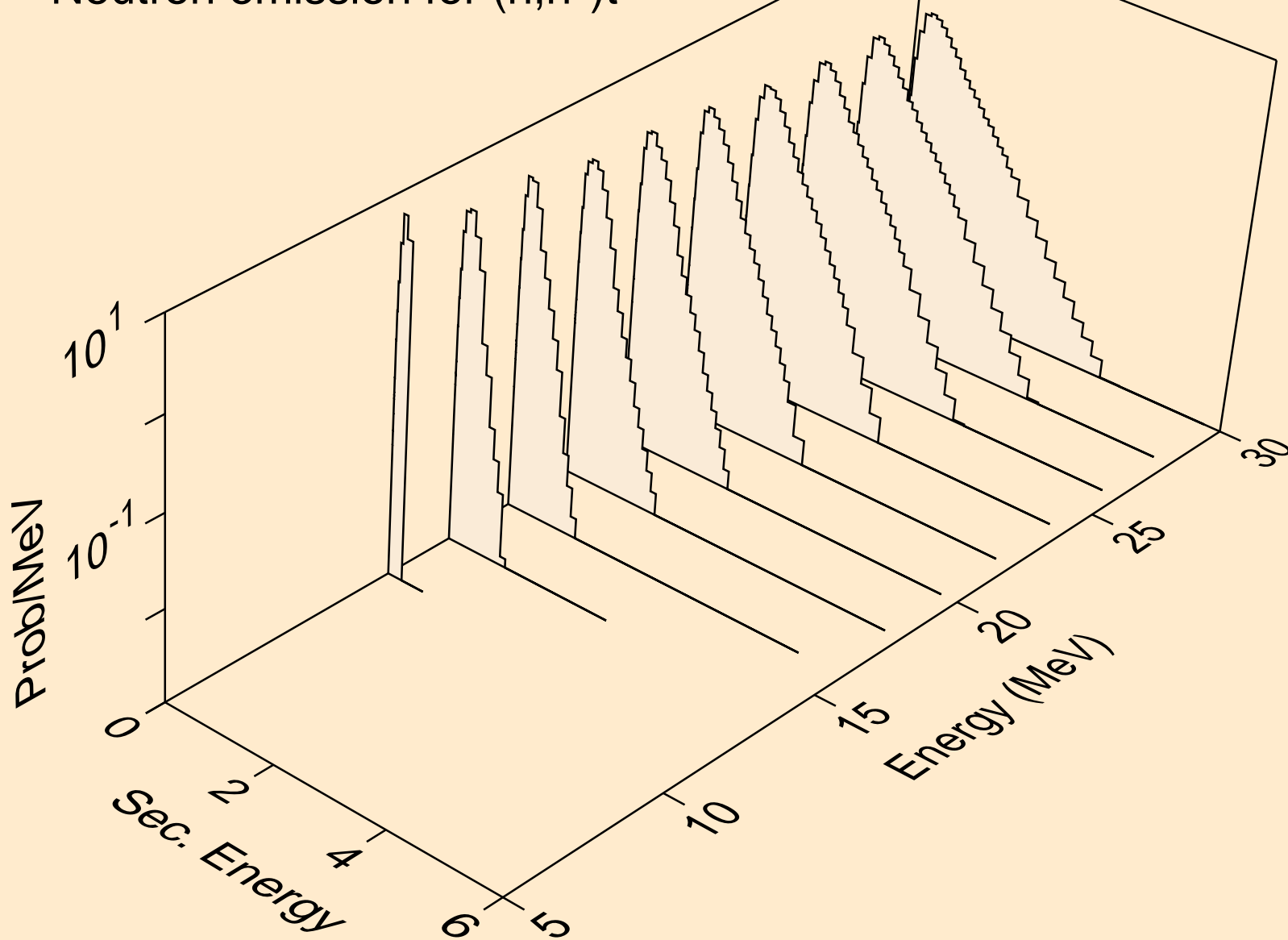

FM255 NEUTRON ACER TENDL-2019 LIBRARY; T=293.16K
Neutron emission for (n,n*)he3

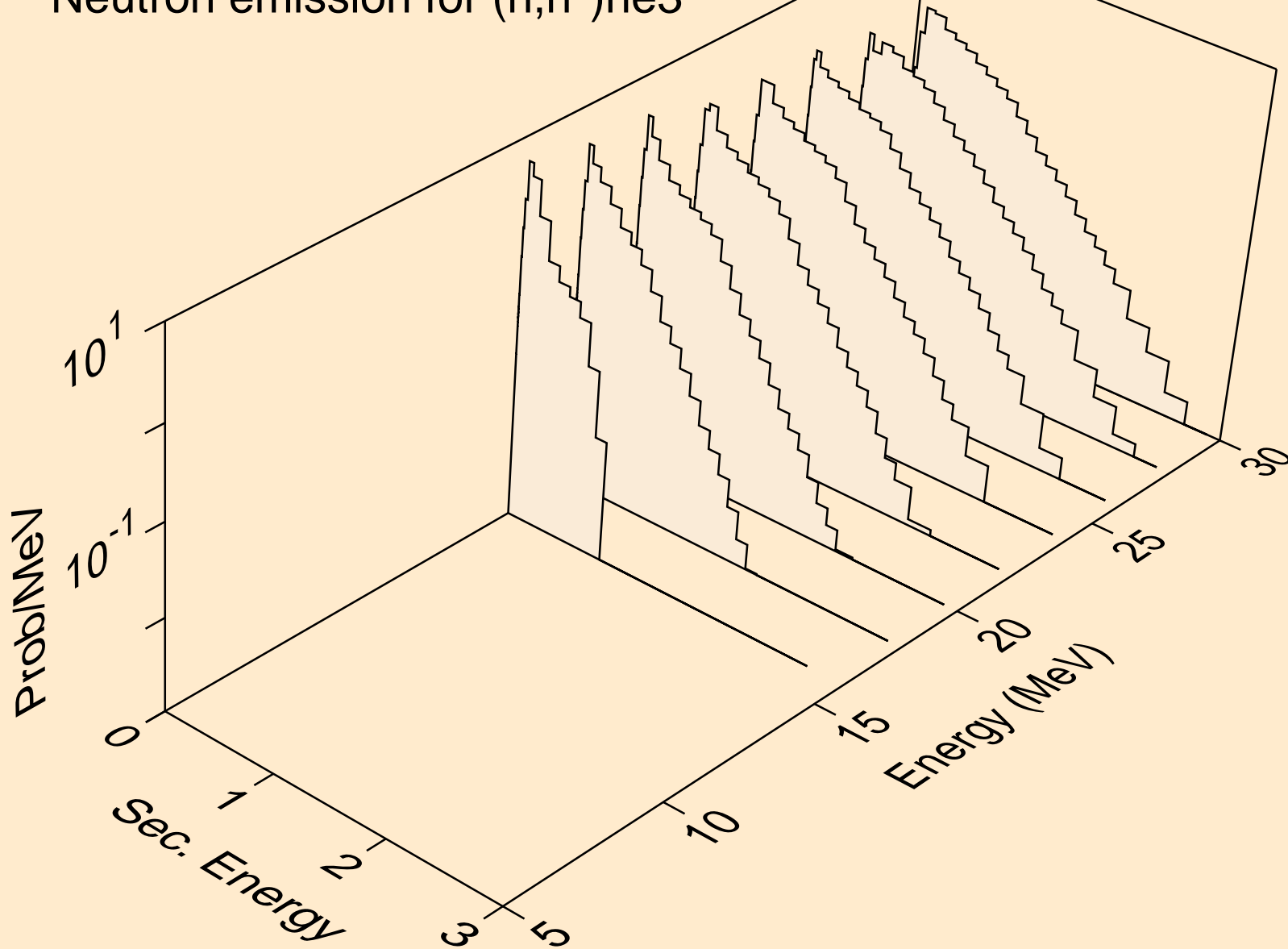

FM255 NEUTRON ACER TENDL-2019 LIBRARY; T=293.16K
Neutron emission for (n,4n)

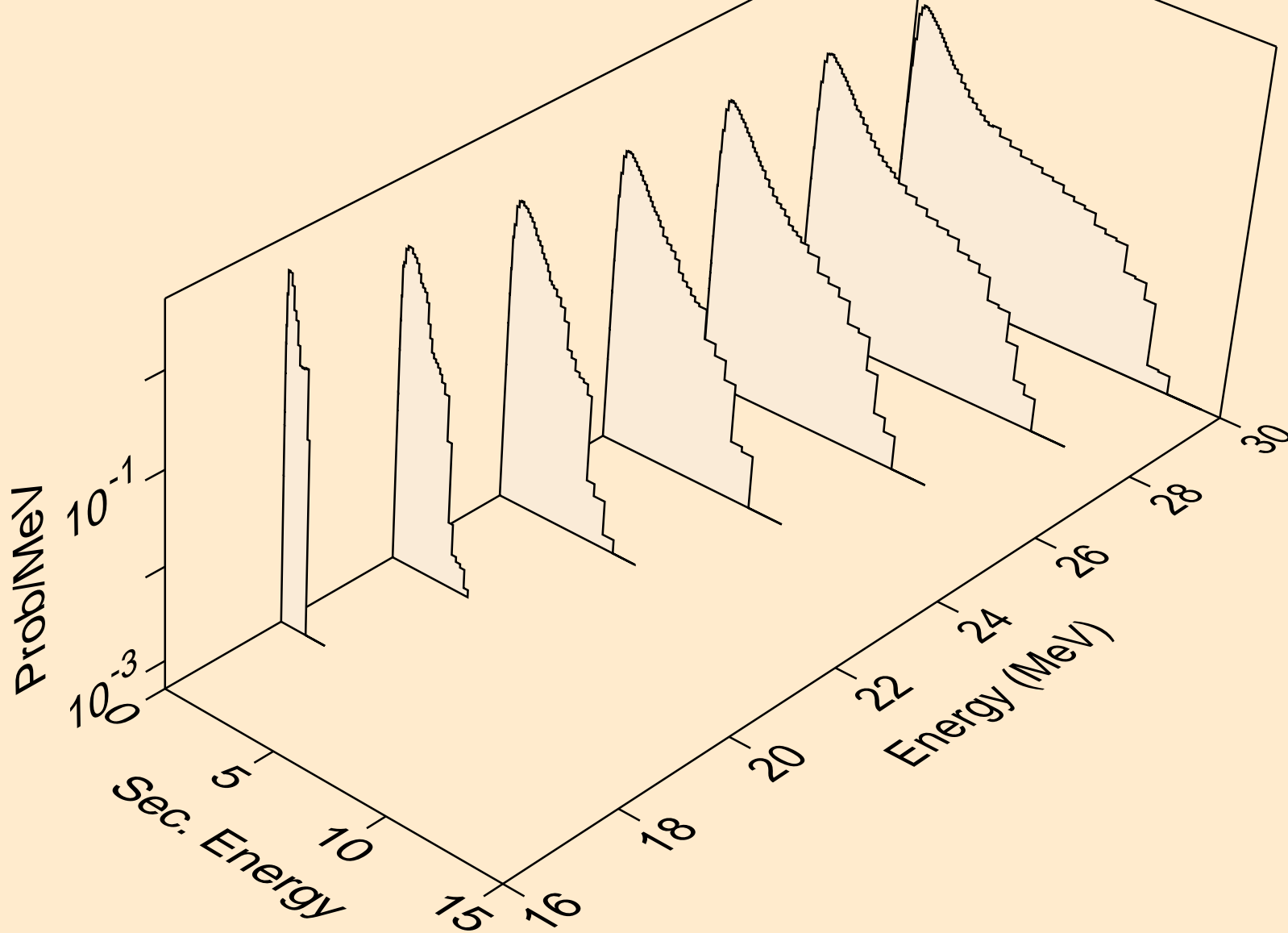

FM255 NEUTRON ACER TENDL-2019 LIBRARY; T=293.16K
Neutron emission for (n,2np)

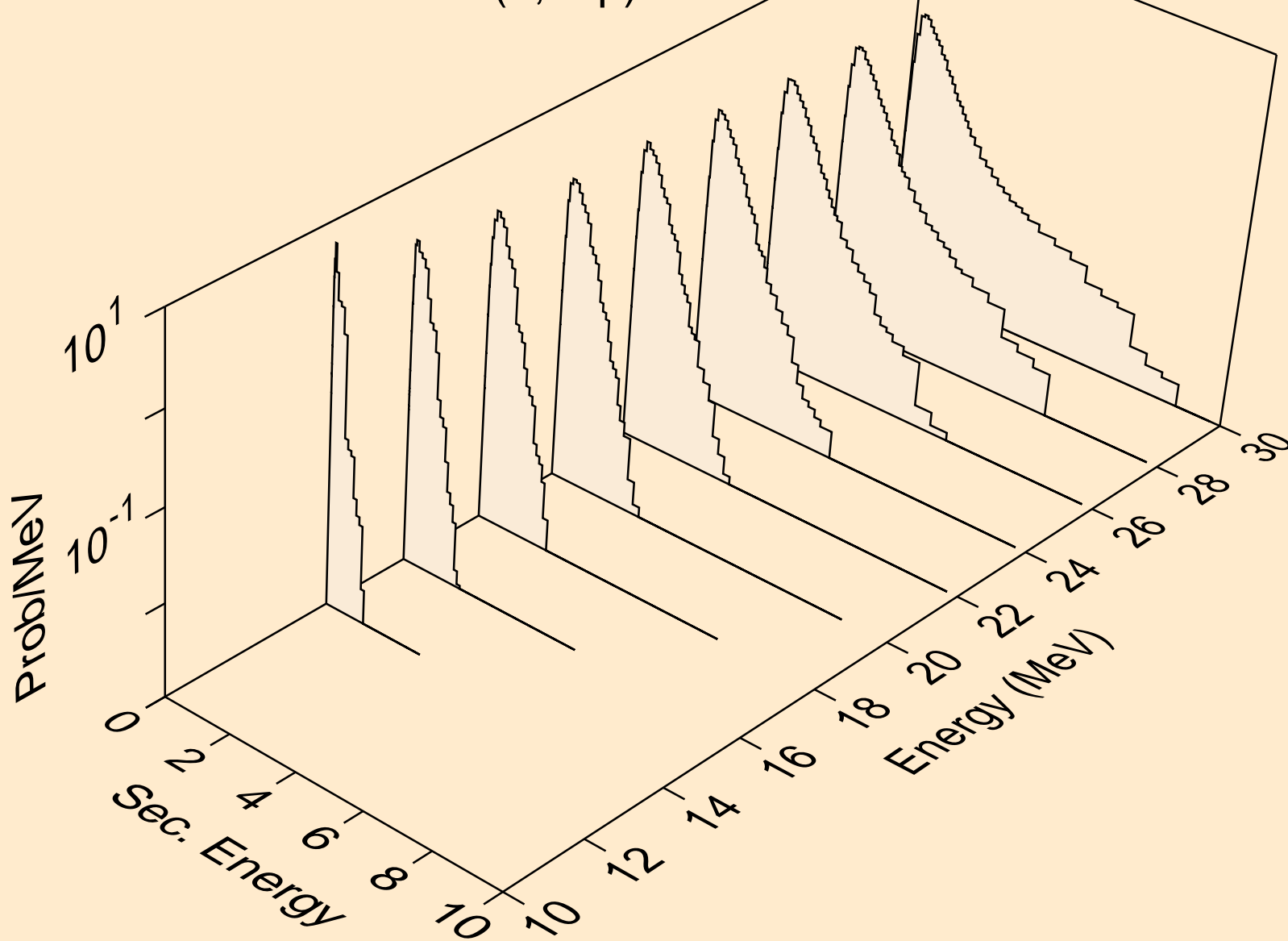

FM255 NEUTRON ACER TENDL-2019 LIBRARY; T=293.16K
Neutron emission for (n,3np)

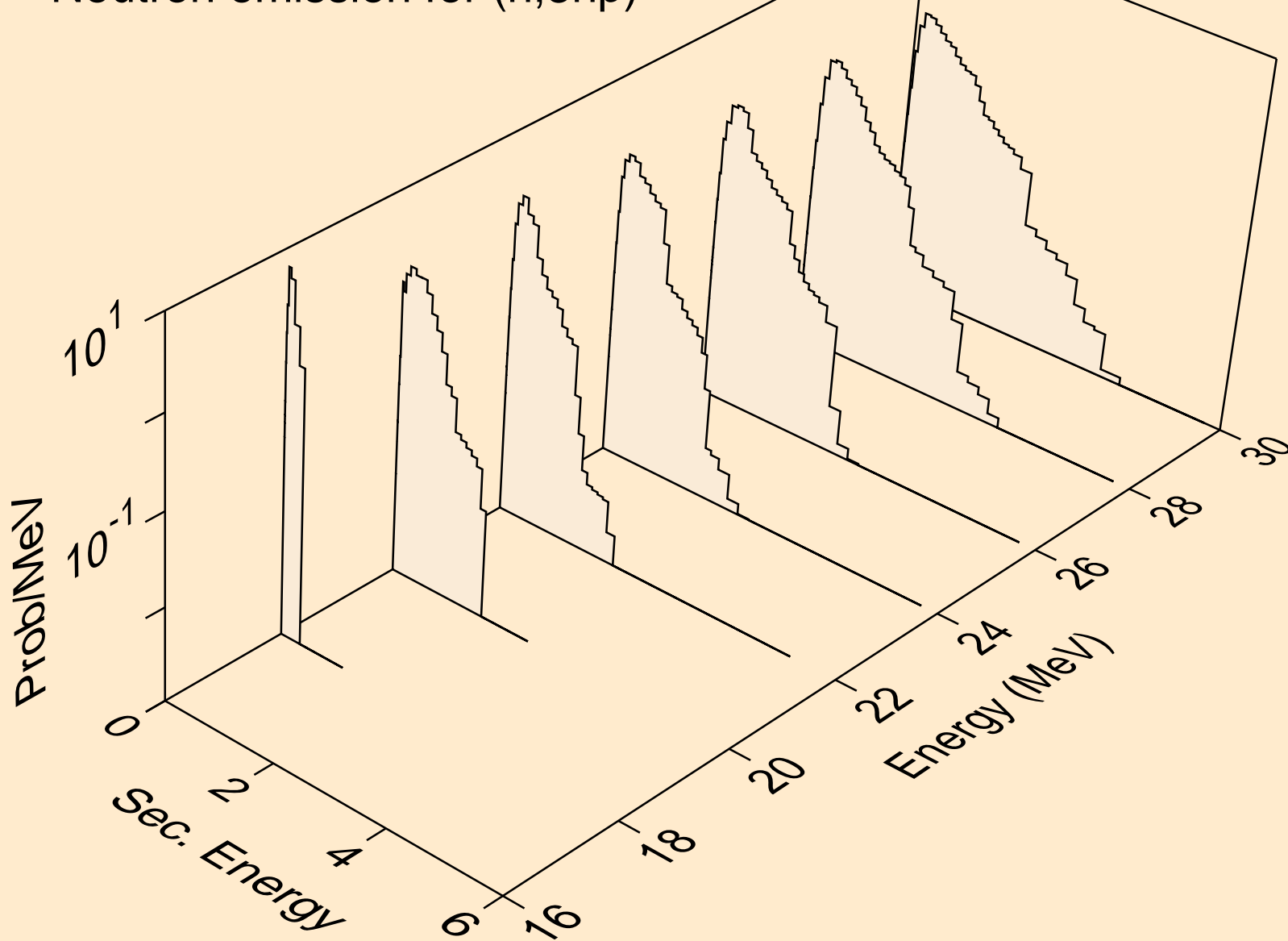

FM255 NEUTRON ACER TENDL-2019 LIBRARY; T=293.16K
Neutron emission for (n,2np)

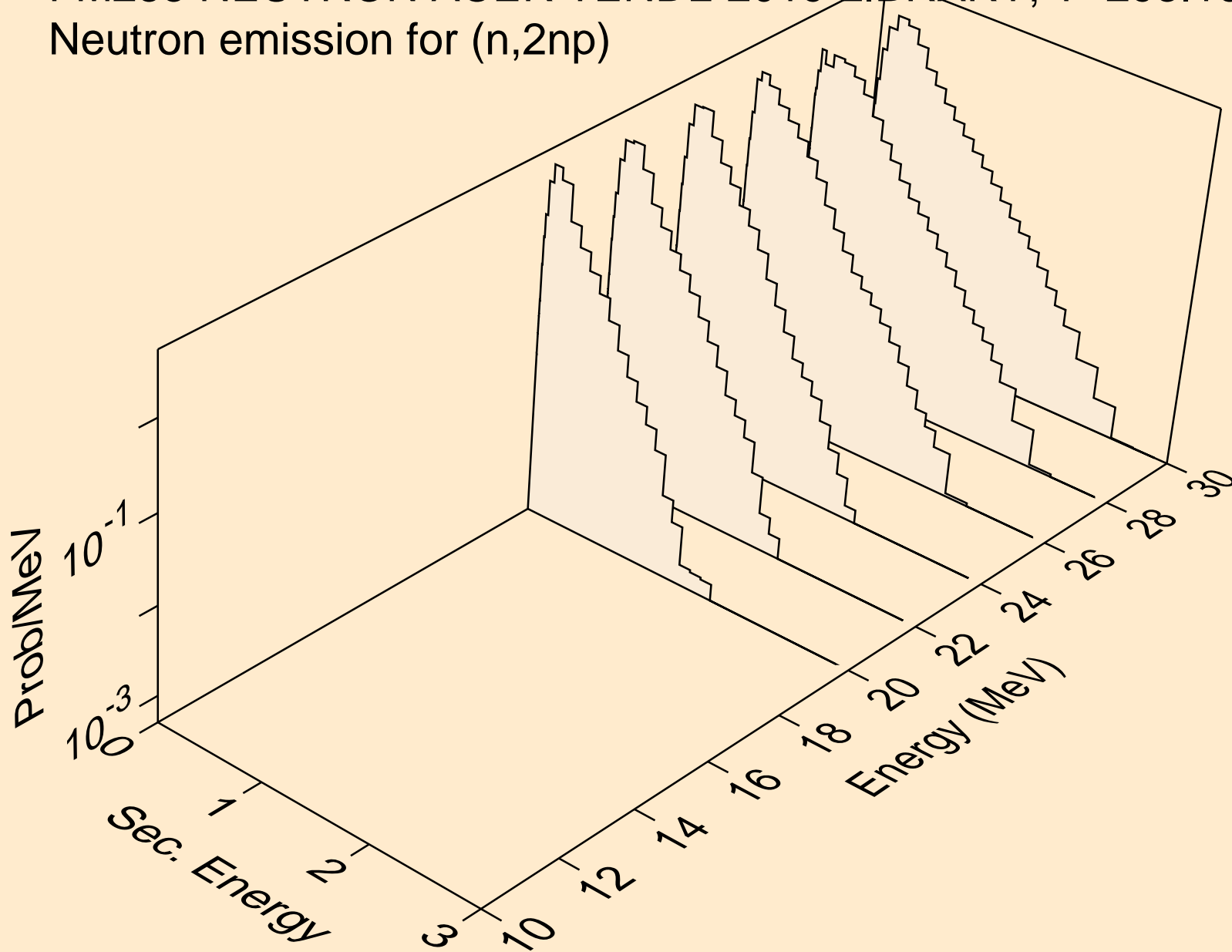

FM255 NEUTRON ACER TENDL-2019 LIBRARY; T=293.16K
Neutron emission for (n,npa)

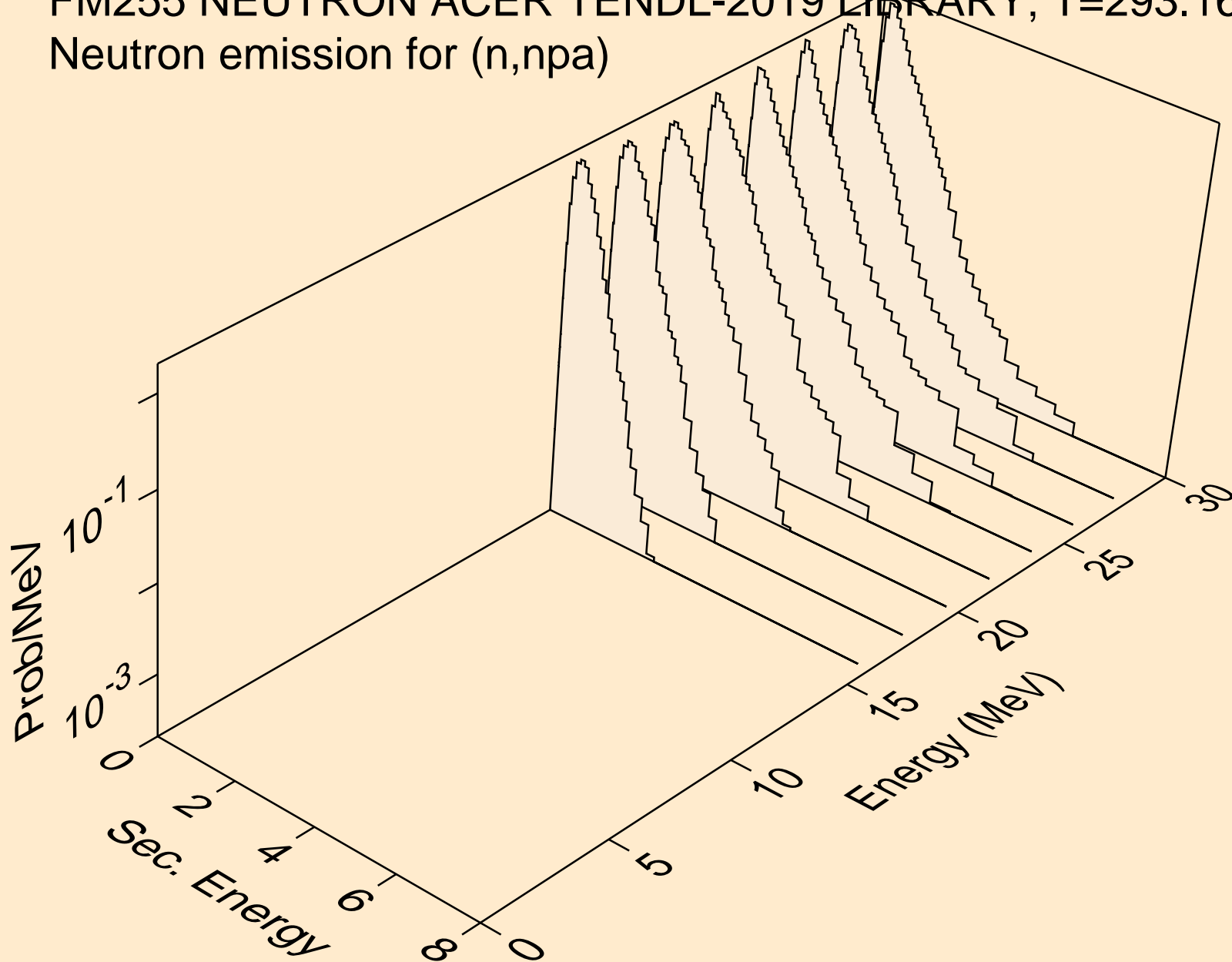

FM255 NEUTRON ACER TENDL-2019 LIBRARY; T=293.16K
Neutron emission for (n,n*c)

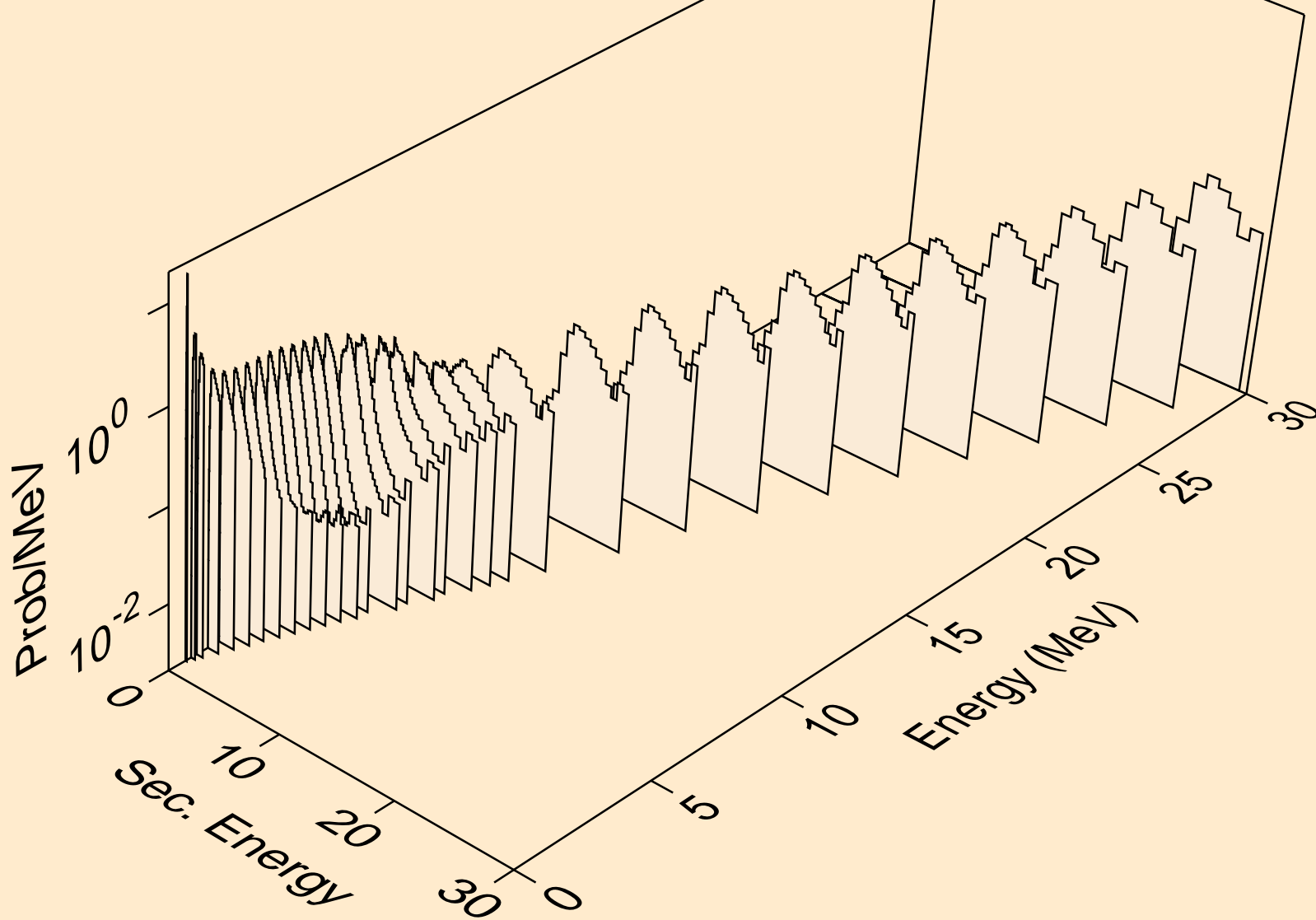

FM255 NEUTRON ACER TENDL-2019 LIBRARY; T=293.16K

Delayed nubar

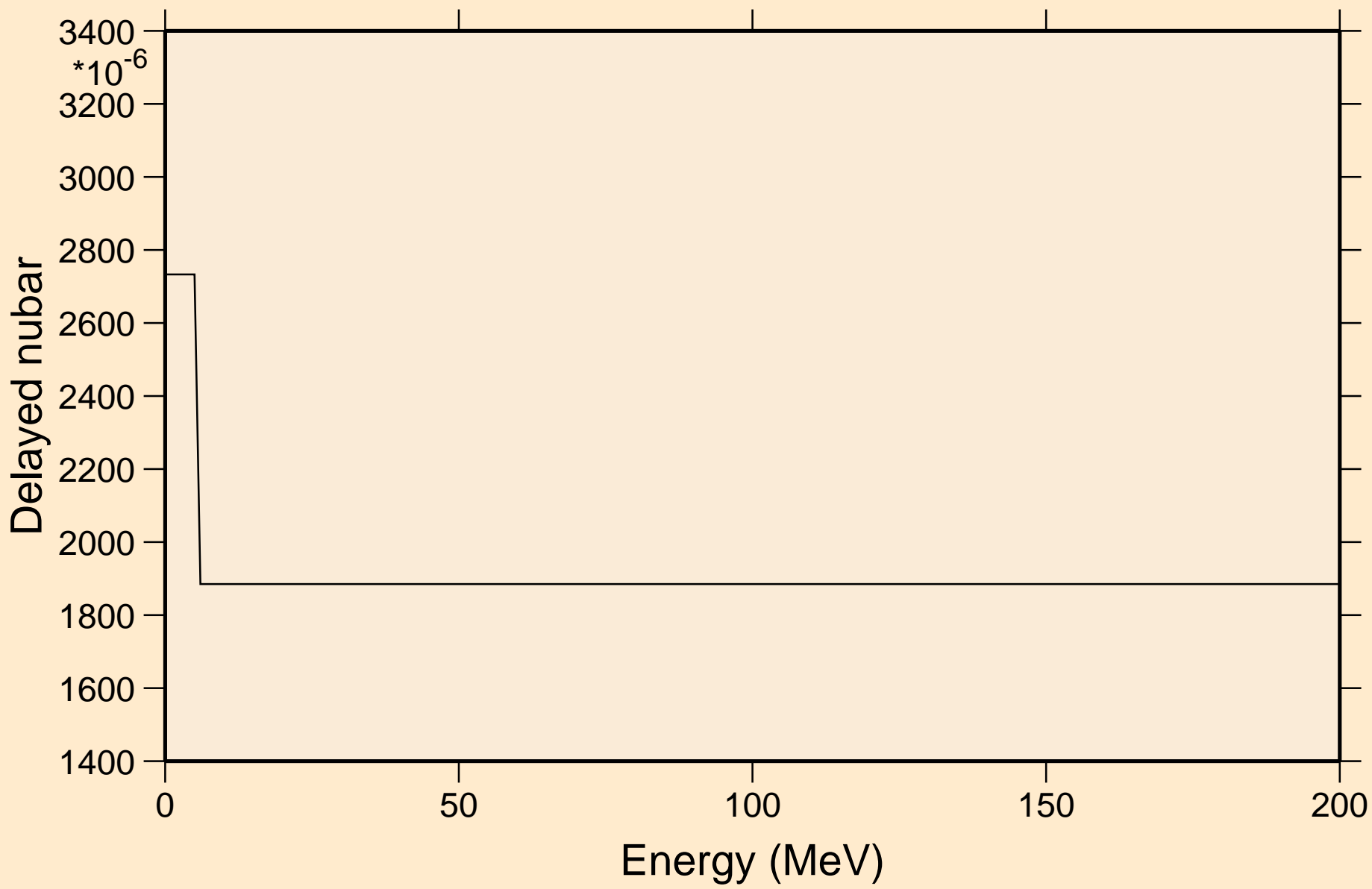

FM255 NEUTRON ACER TENDL-2019 LIBRARY; T=293.16K

Delayed neutron spectra

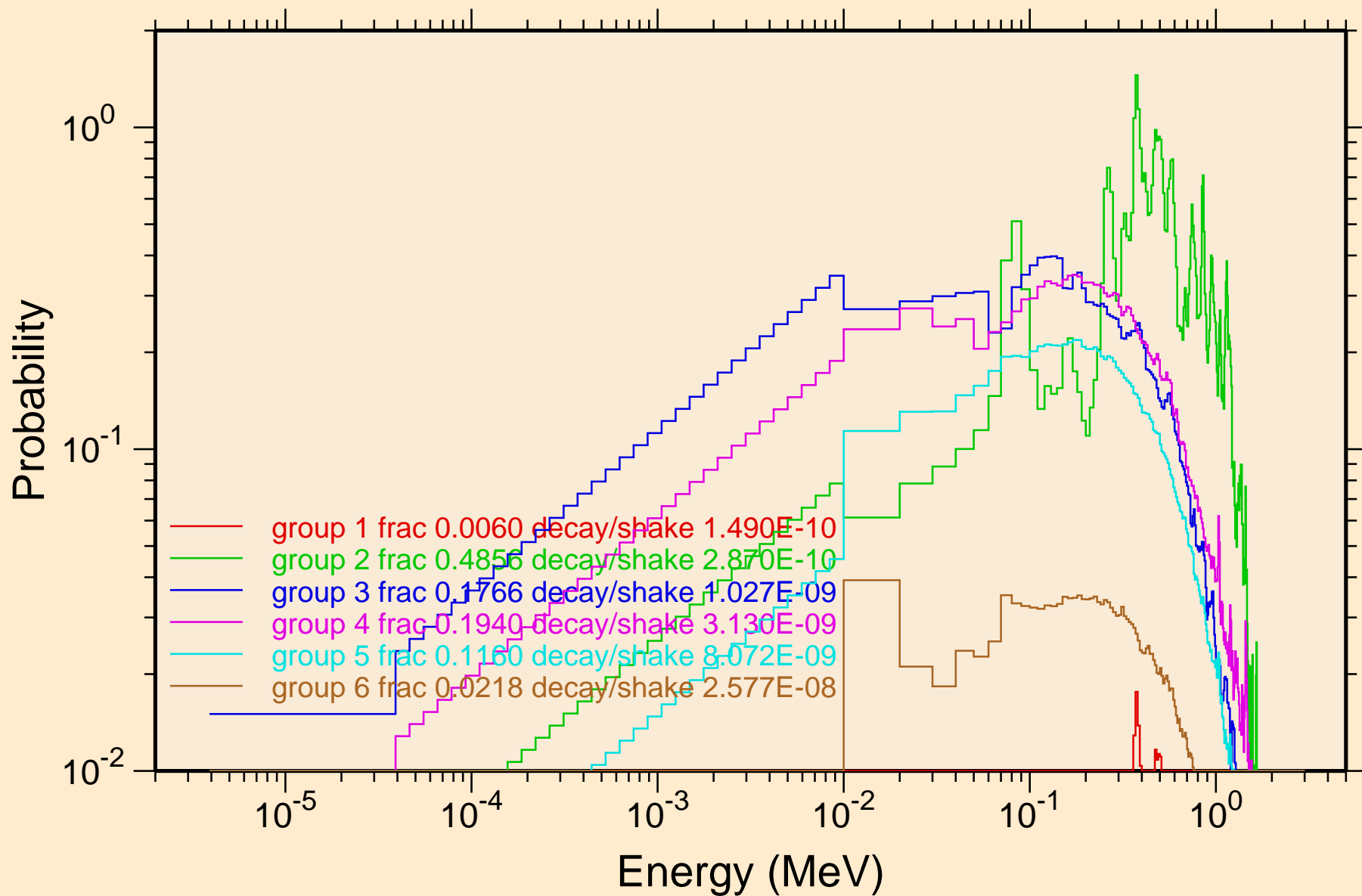

FM255 NEUTRON ACER TENDL-2019 LIBRARY; T=293.16K
Photon emission for (n,x)

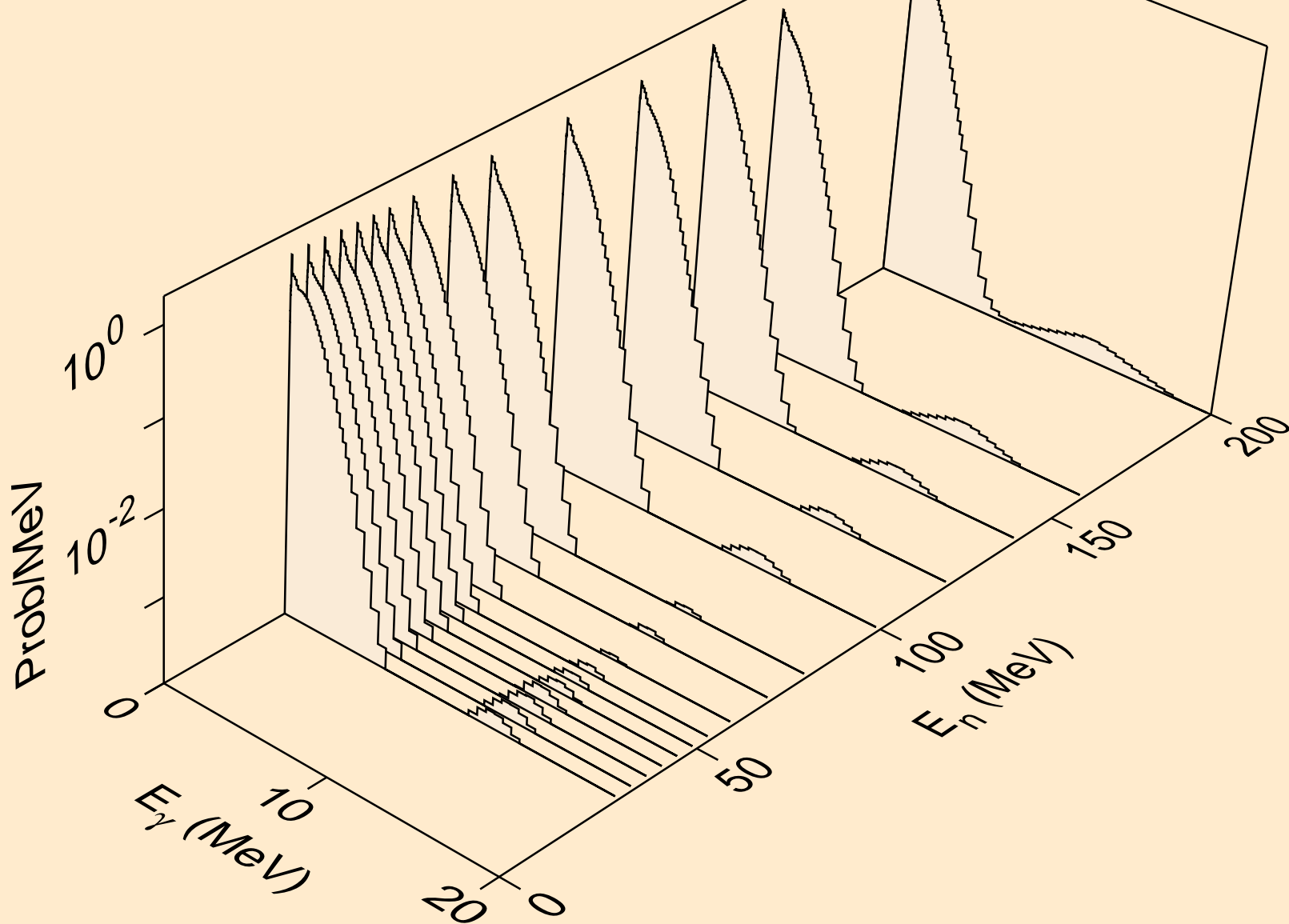

FM255 NEUTRON ACER TENDL-2019 LIBRARY; T=293.16K
Photon emission for (n,2nd)

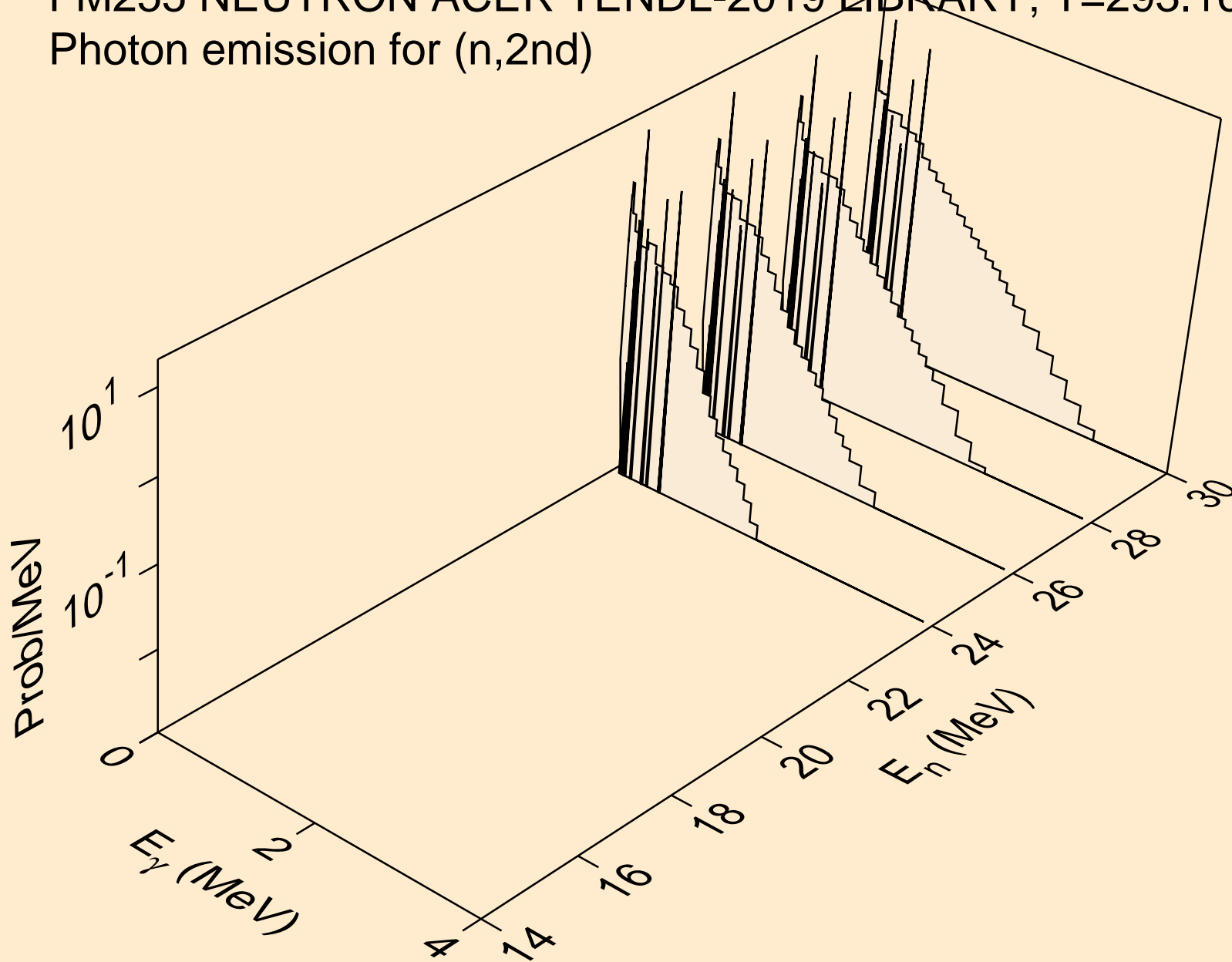

FM255 NEUTRON ACER TENDL-2019 LIBRARY; T=293.16K
Photon emission for (n,2n)

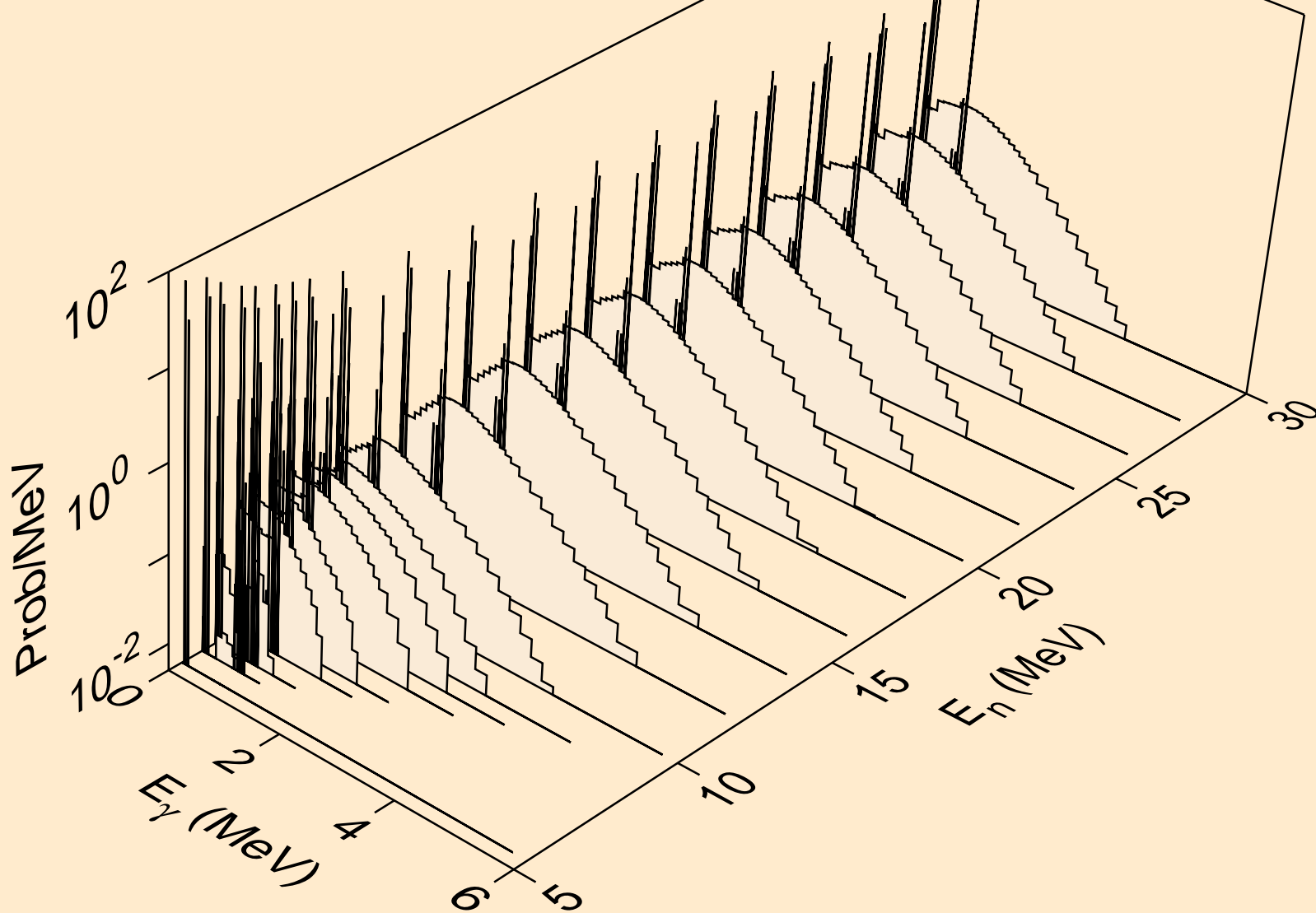

FM255 NEUTRON ACER TENDL-2019 LIBRARY; T=293.16K
Photon emission for (n,3n)

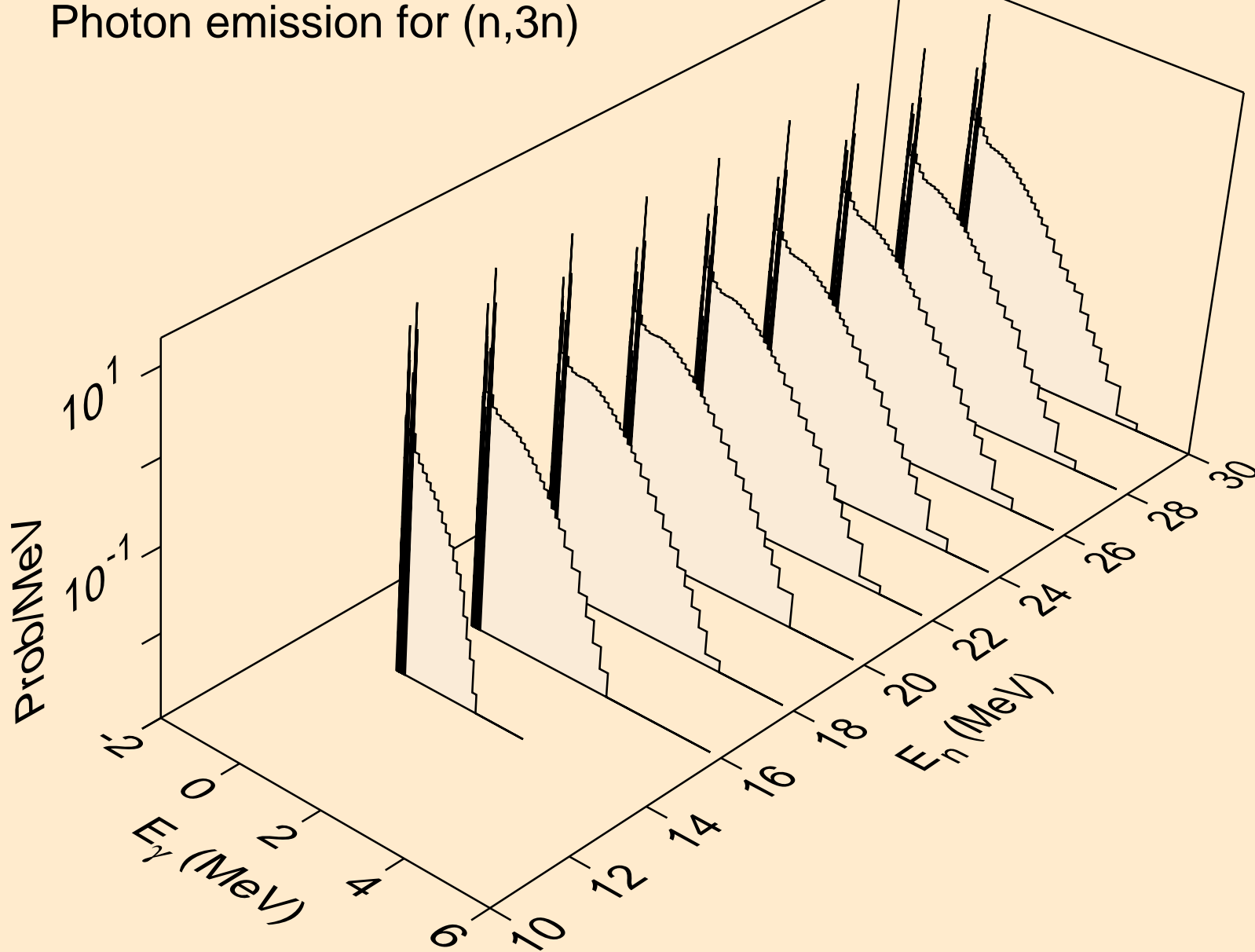

FM255 NEUTRON ACER TENDL-2019 LIBRARY; T=293.16K
Photon emission for (n,n*)a

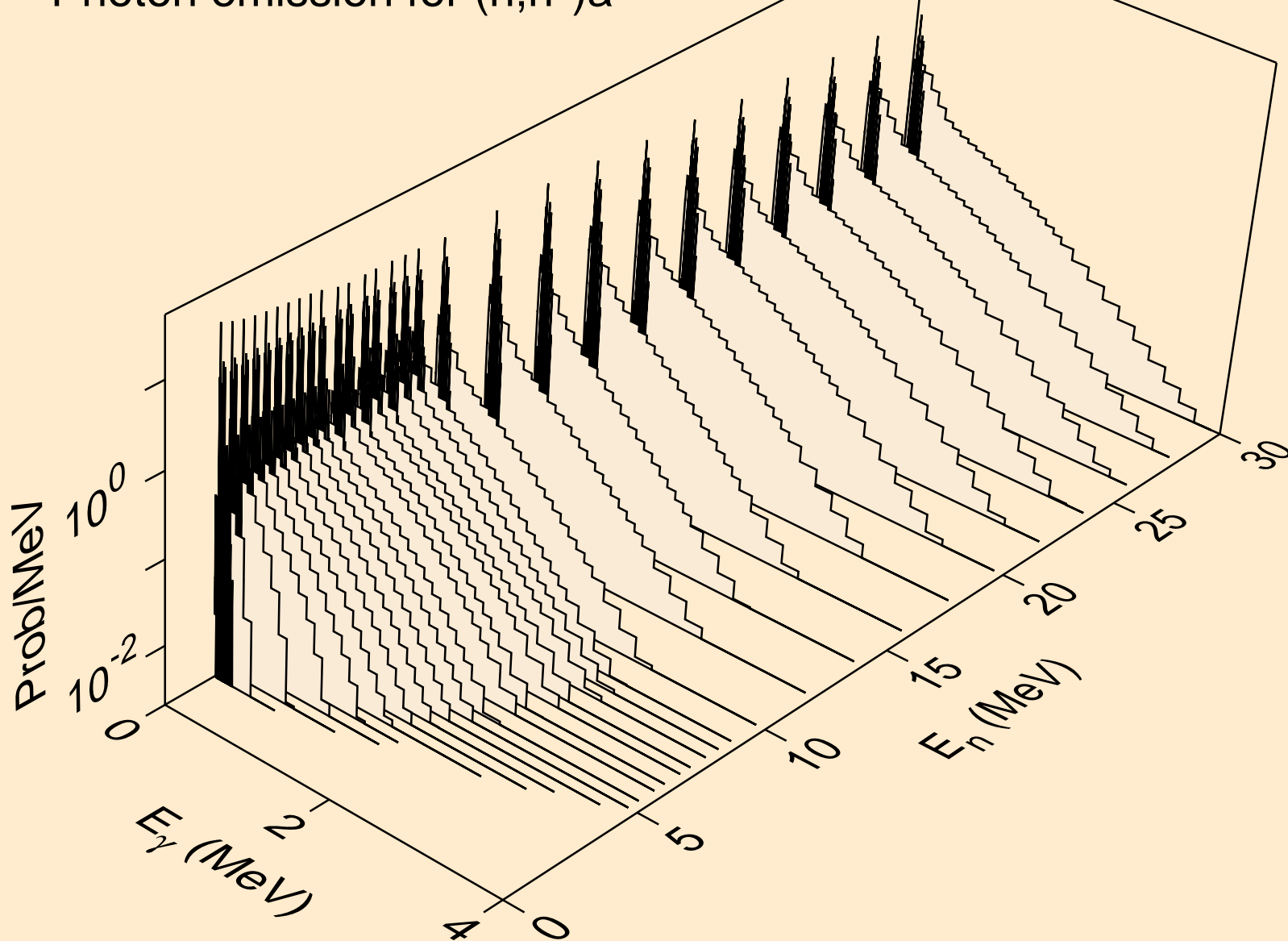

FM255 NEUTRON ACER TENDL-2019 LIBRARY; T=293.16K
Photon emission for (n,2n) α

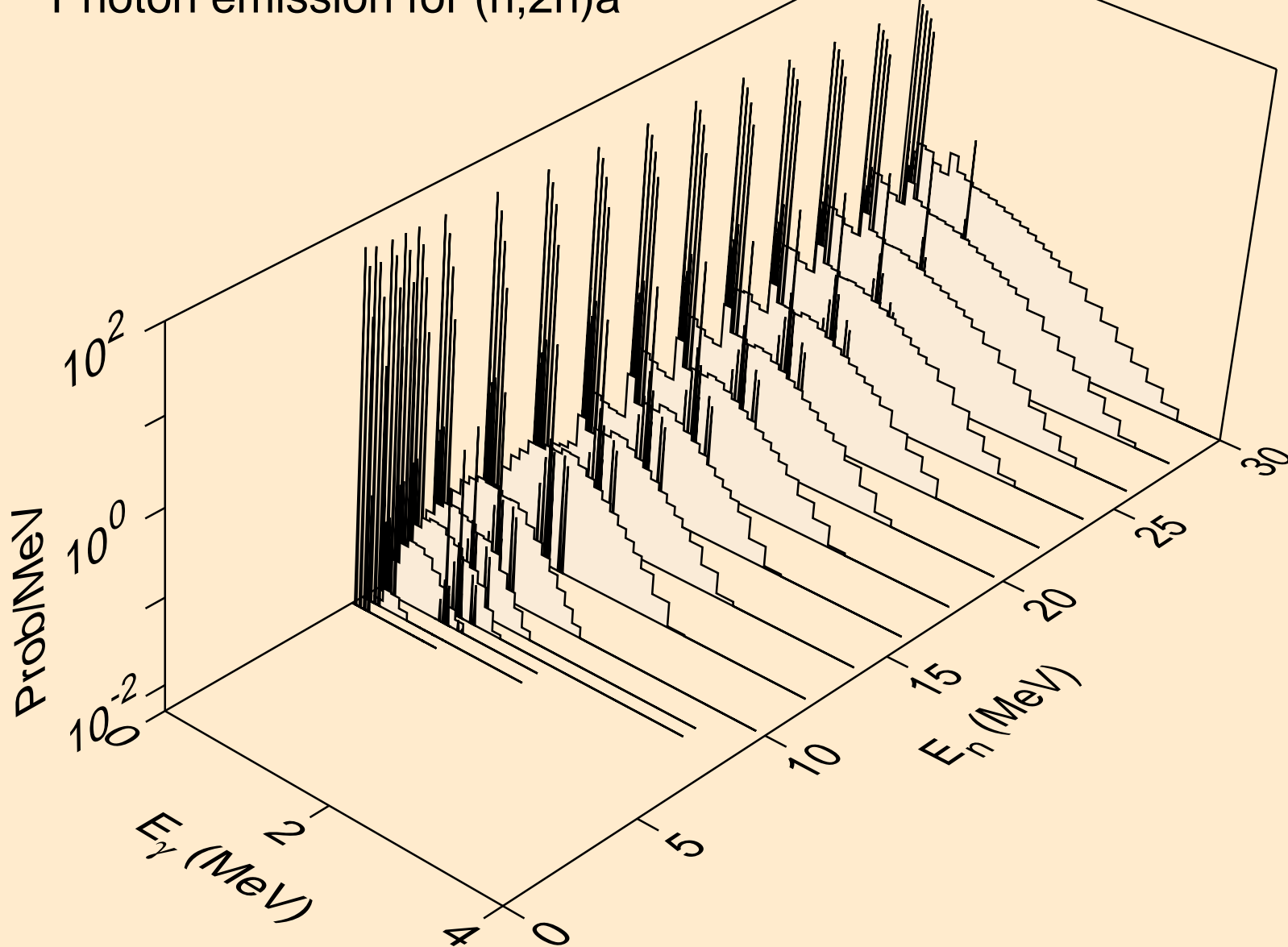

FM255 NEUTRON ACER TENDL-2019 LIBRARY; T=293.16K
Photon emission for (n,3n)a

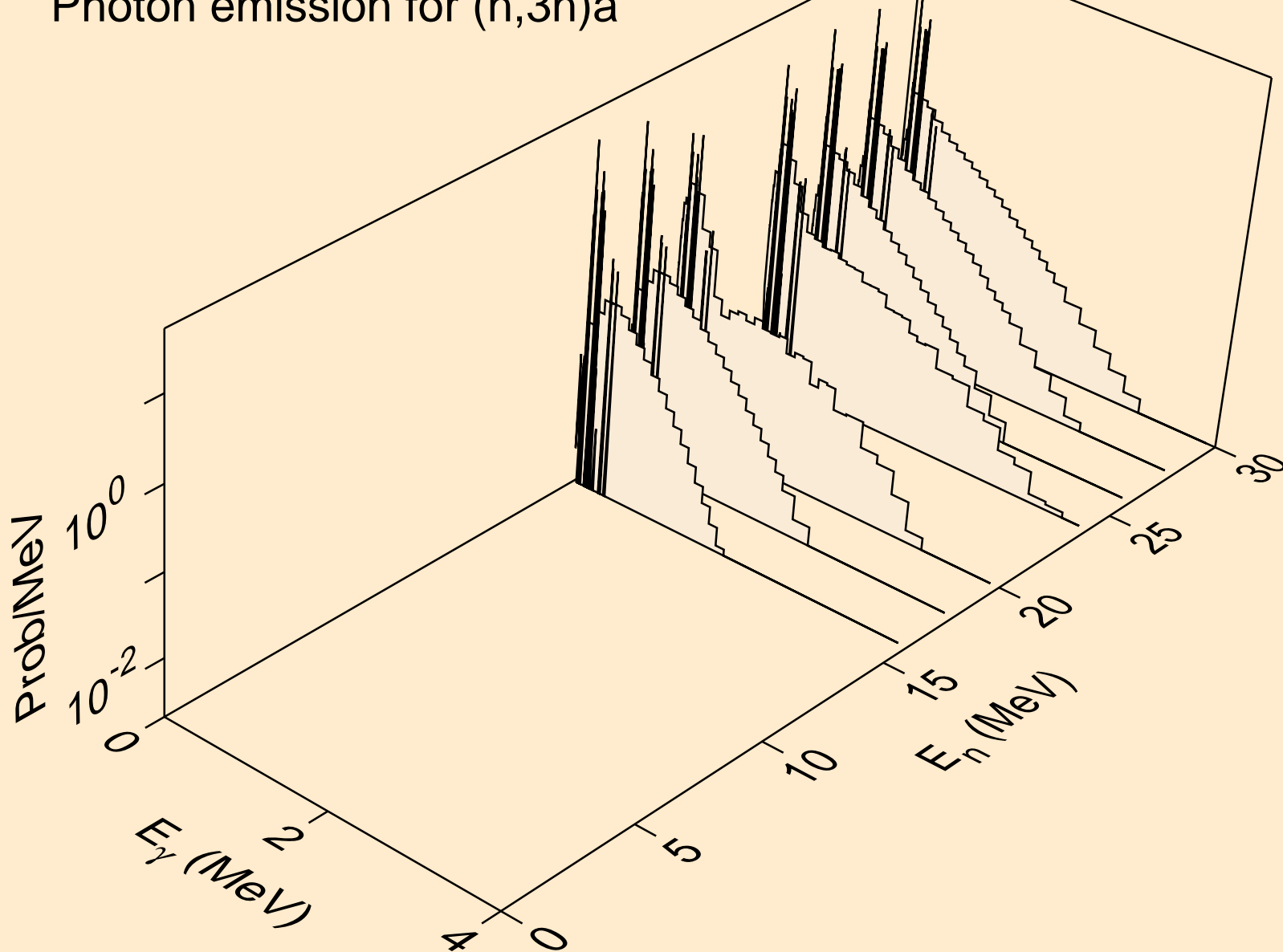

FM255 NEUTRON ACER TENDL-2019 LIBRARY; T=293.16K
Photon emission for (n,n*)p

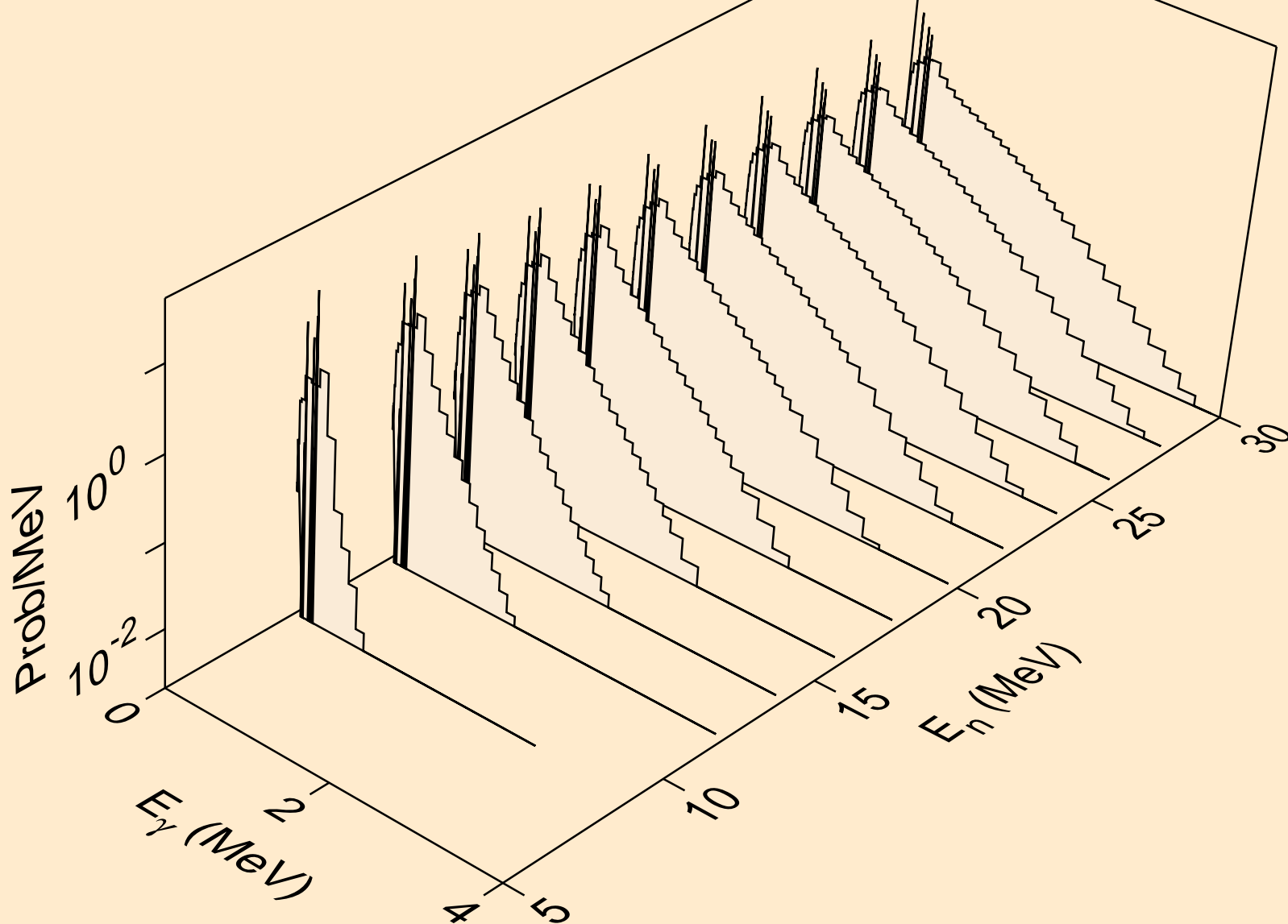

FM255 NEUTRON ACER TENDL-2019 LIBRARY; T=293.16K
Photon emission for (n,n*)d

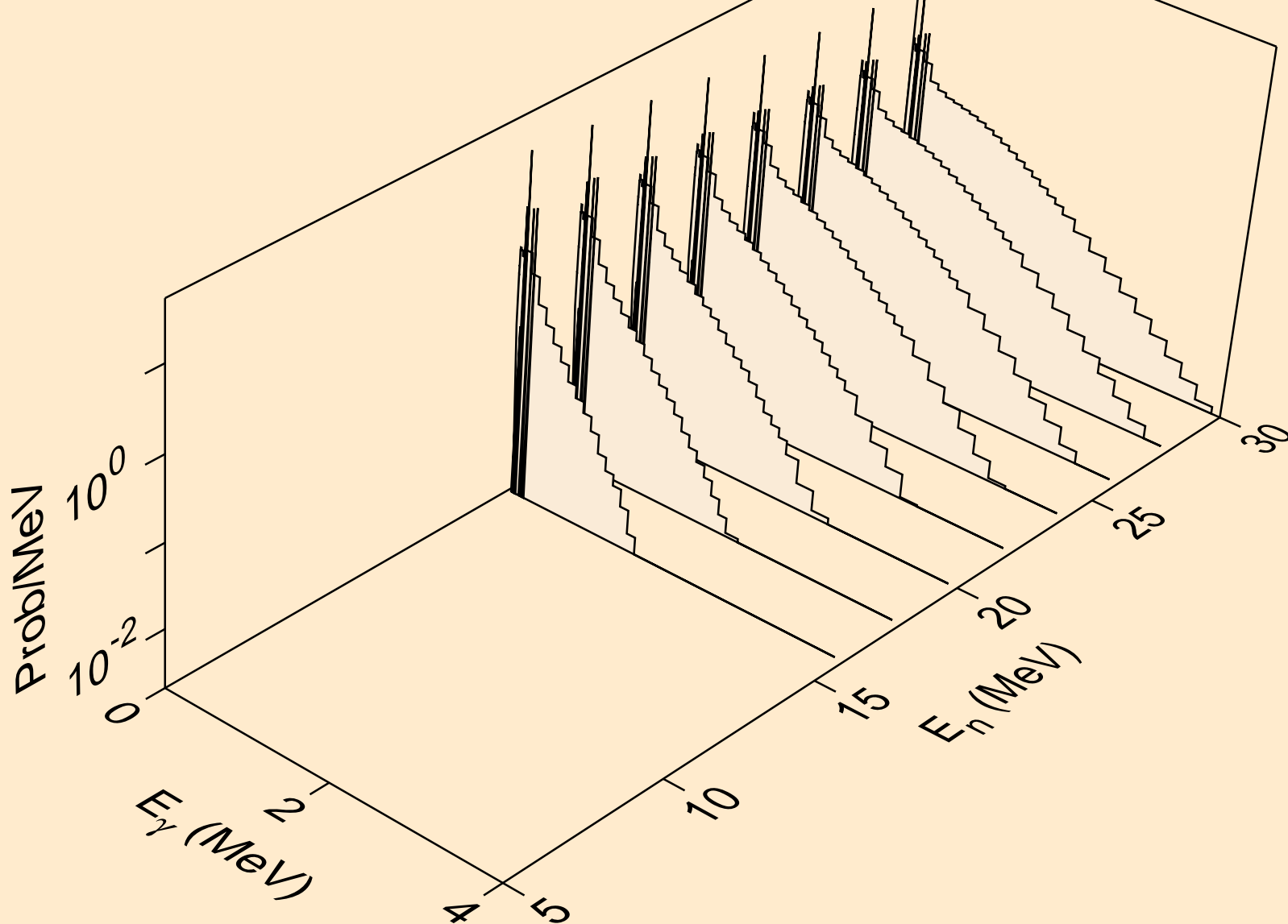

FM255 NEUTRON ACER TENDL-2019 LIBRARY; T=293.16K
Photon emission for (n,n*)t

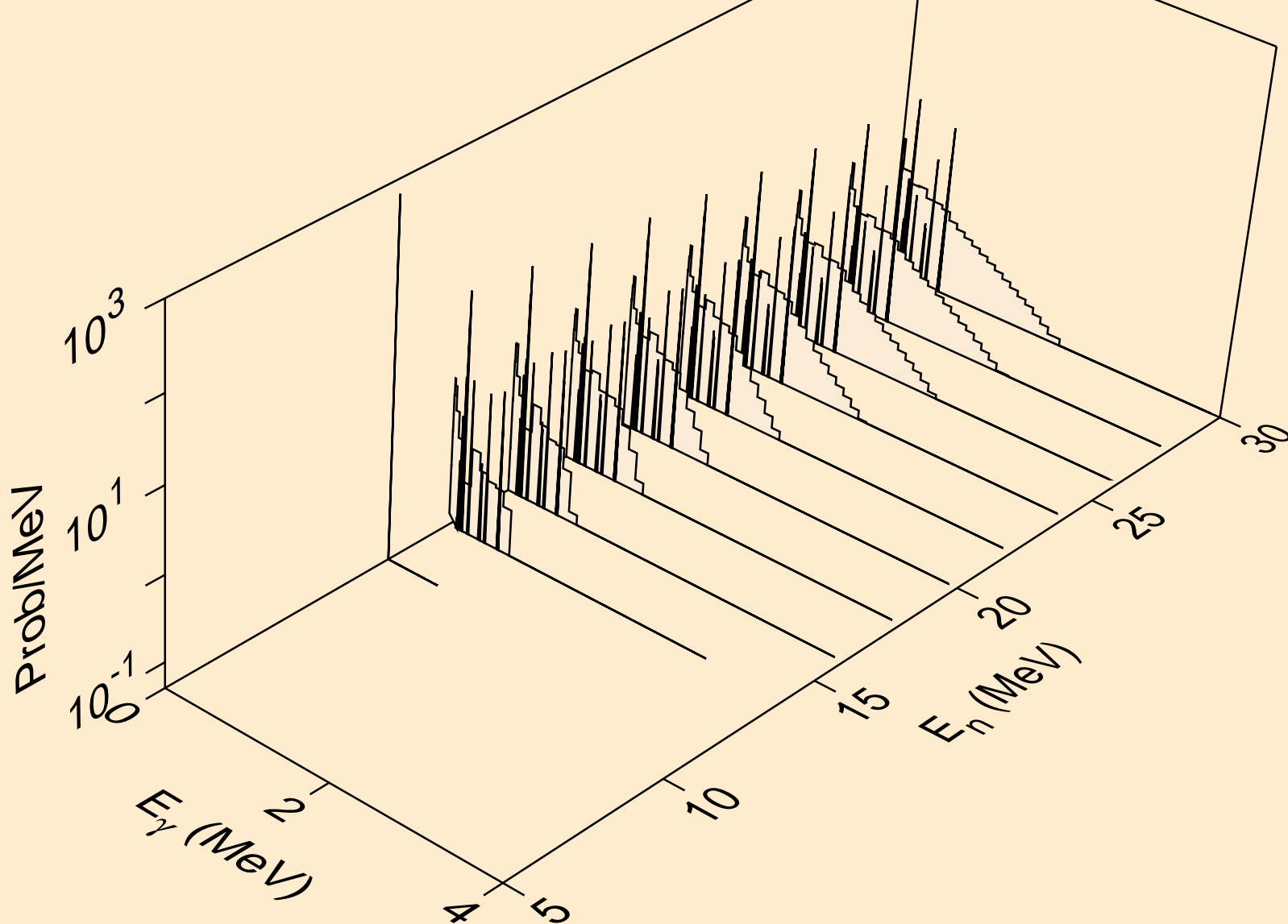

FM255 NEUTRON ACER TENDL-2019 LIBRARY; T=293.16K
Photon emission for (n,n*)he3

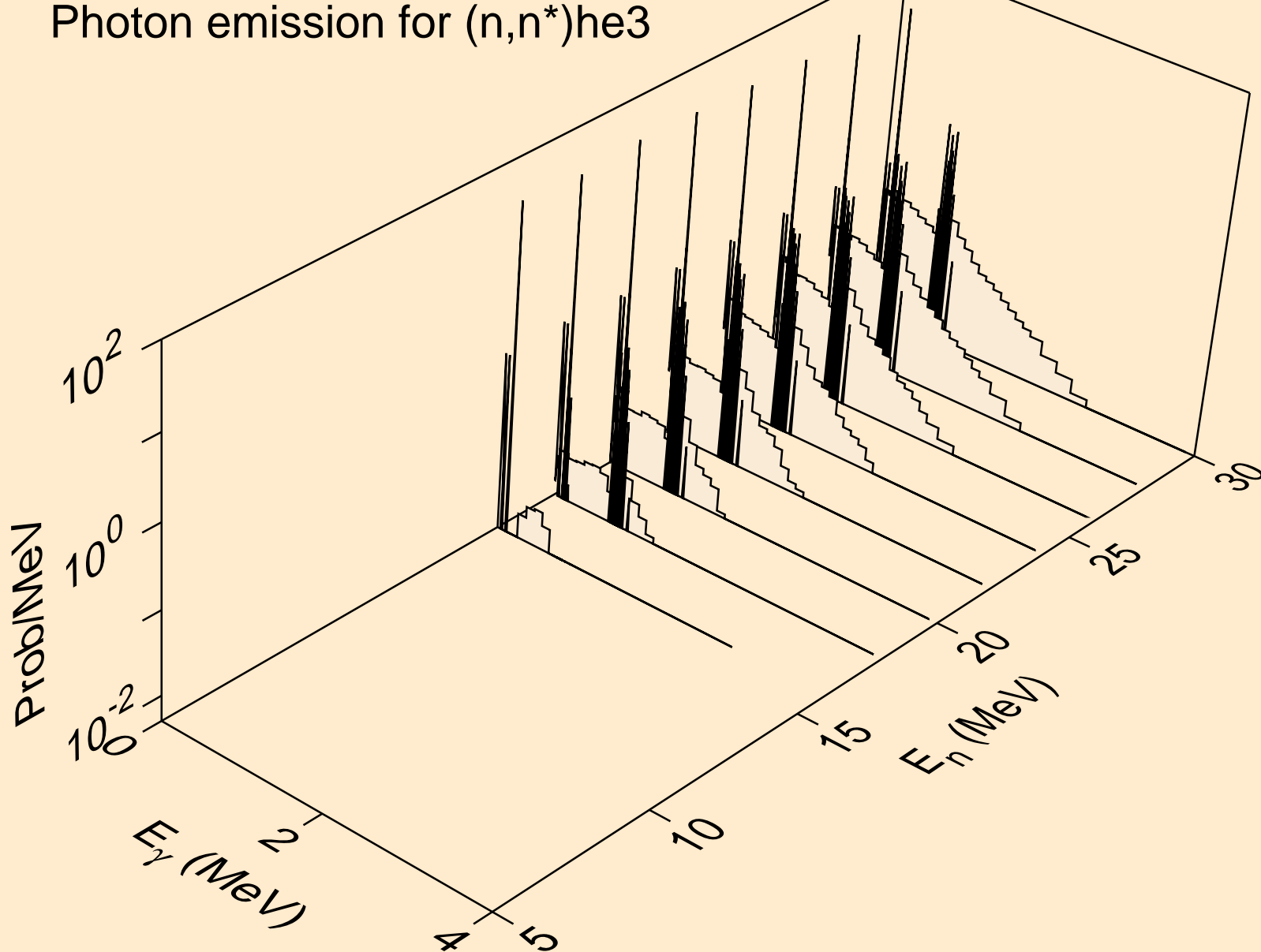

FM255 NEUTRON ACER TENDL-2019 LIBRARY; T=293.16K
Photon emission for (n,4n)

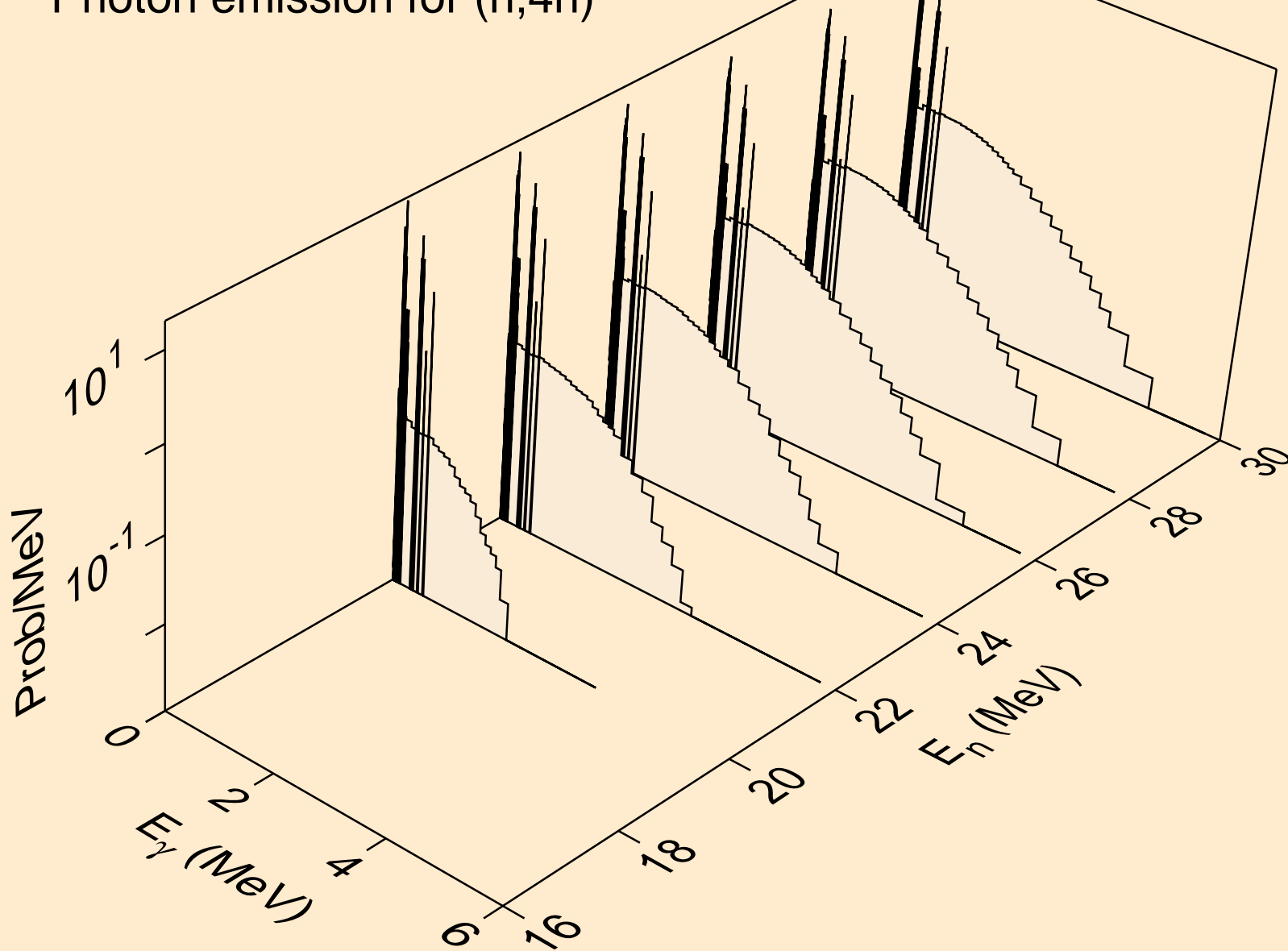

FM255 NEUTRON ACER TENDL-2019 LIBRARY; T=293.16K
Photon emission for (n,2np)

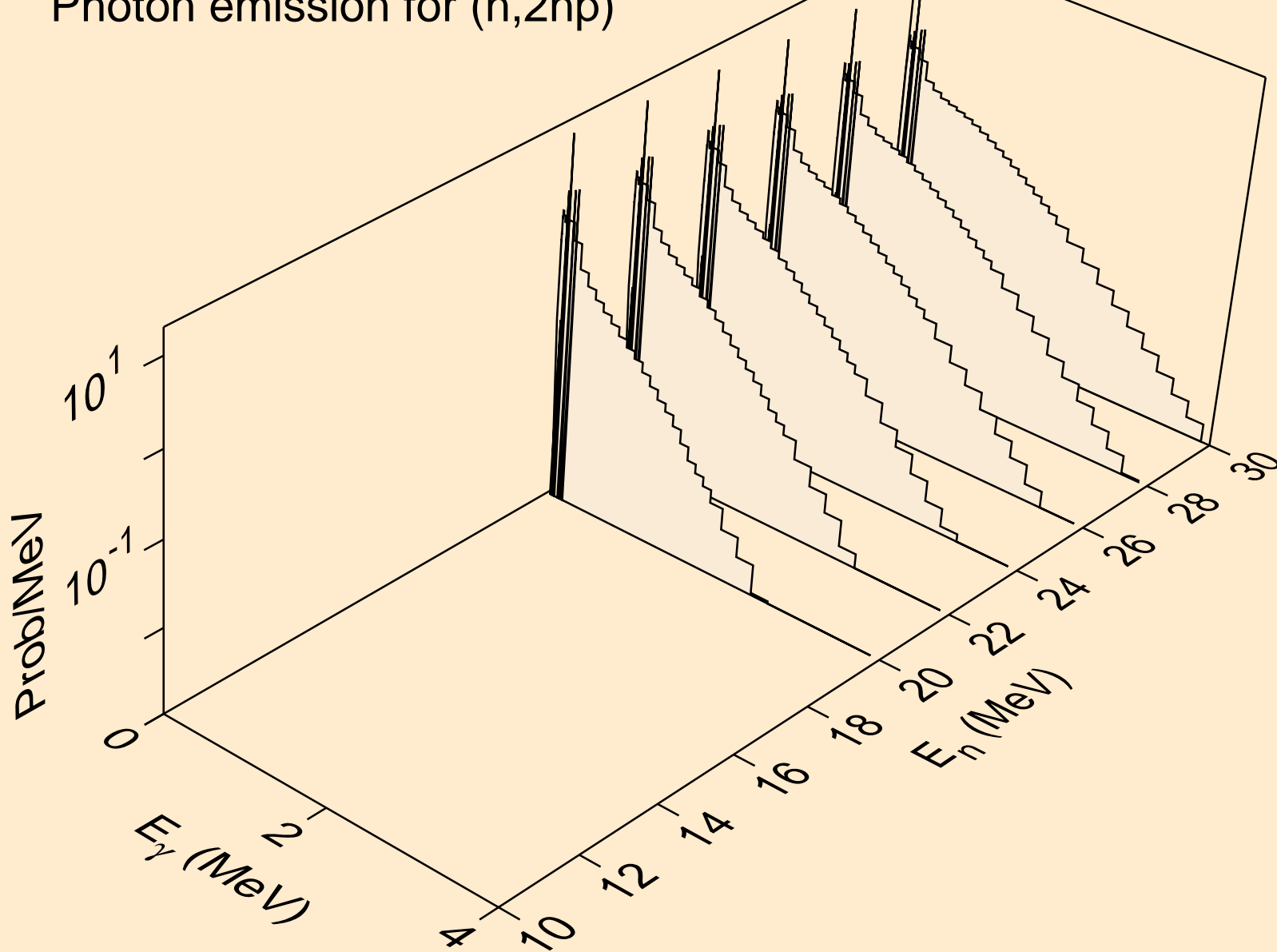

FM255 NEUTRON ACER TENDL-2019 LIBRARY; T=293.16K
Photon emission for (n,3np)

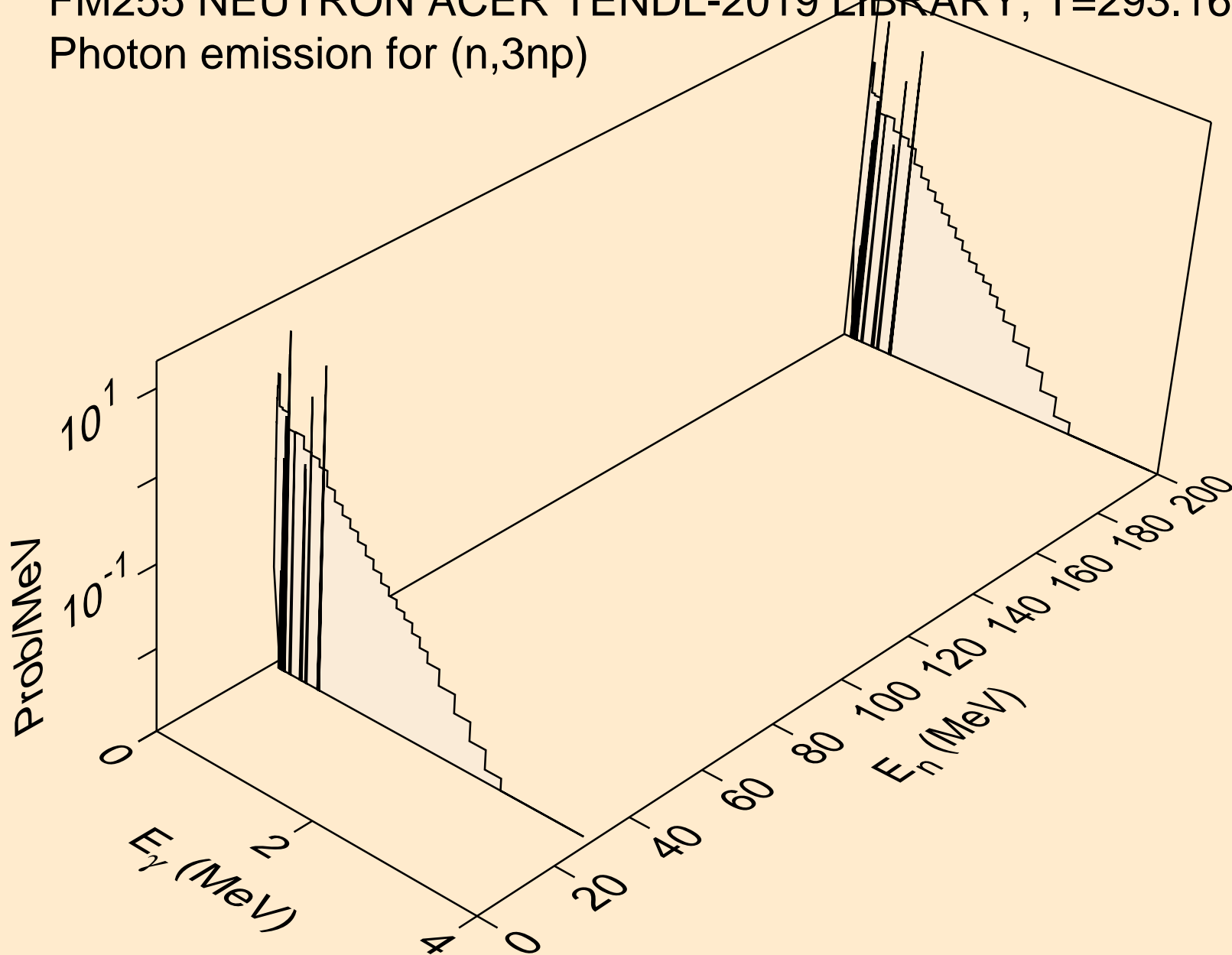

FM255 NEUTRON ACER TENDL-2019 LIBRARY; T=293.16K
Photon emission for (n,2np)

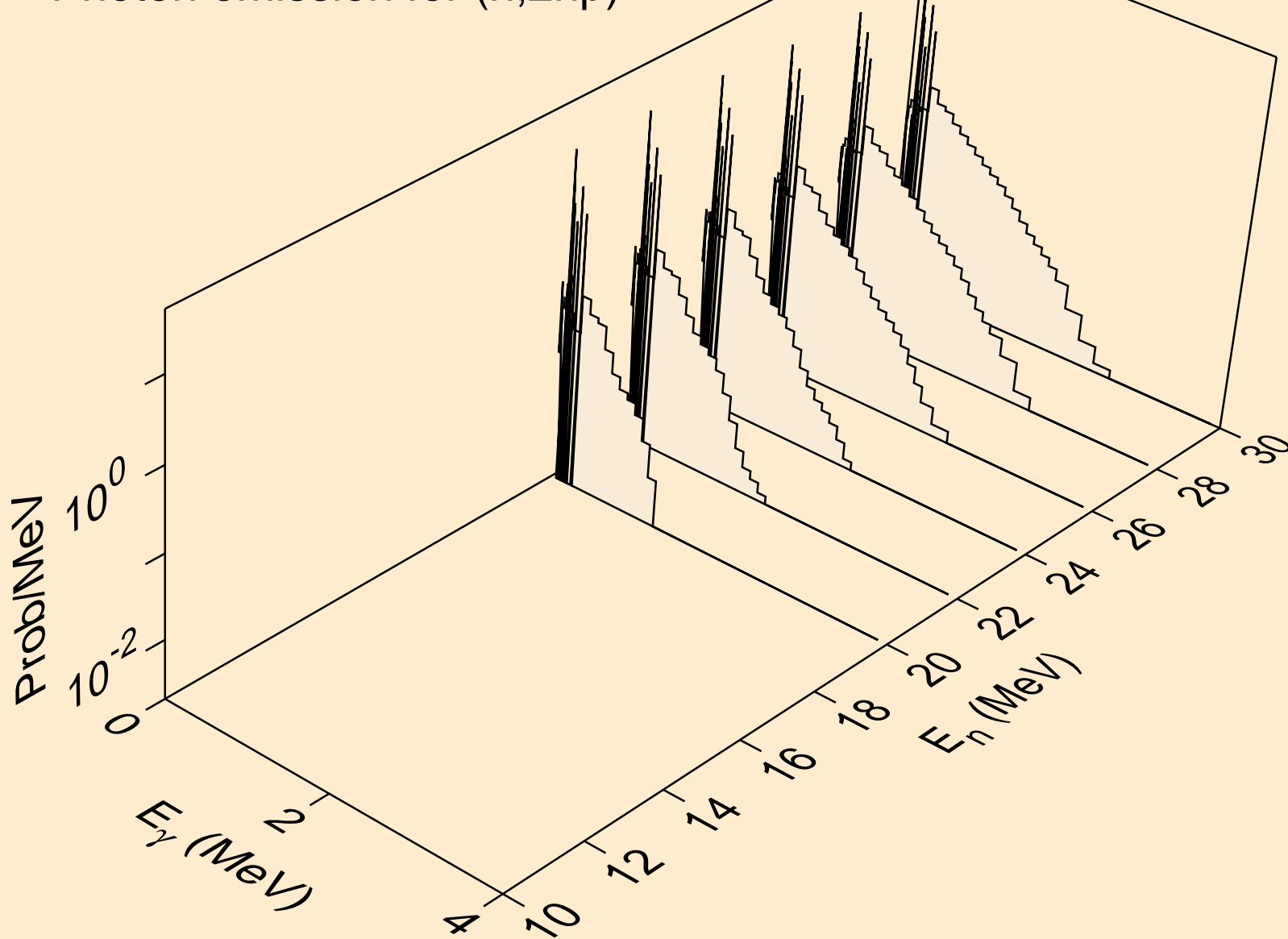

FM255 NEUTRON ACER TENDL-2019 LIBRARY; T=293.16K
Photon emission for (n,npa)

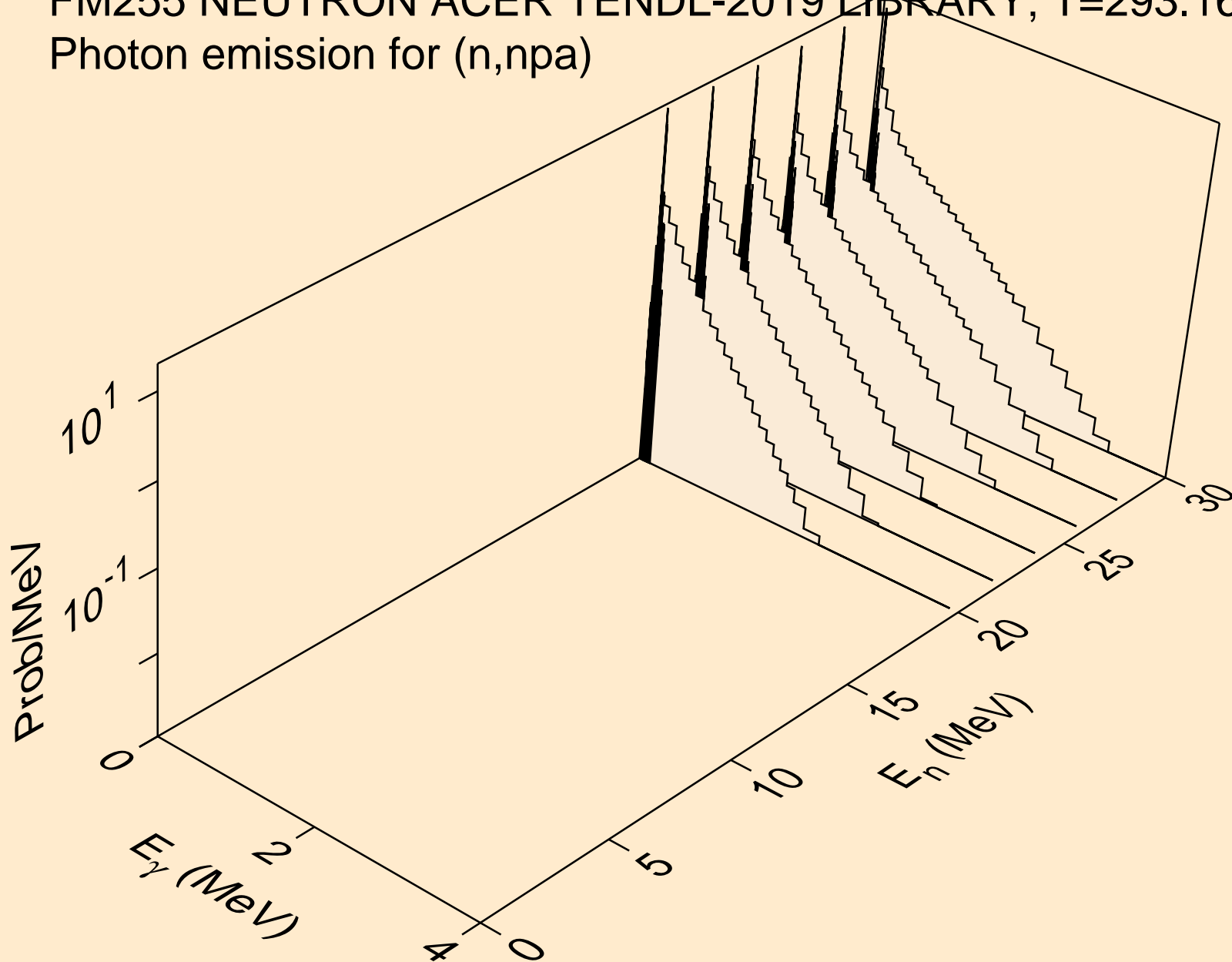

FM255 NEUTRON ACER TENDL-2019 LIBRARY; T=293.16K
Photon emission for (n,n*c)

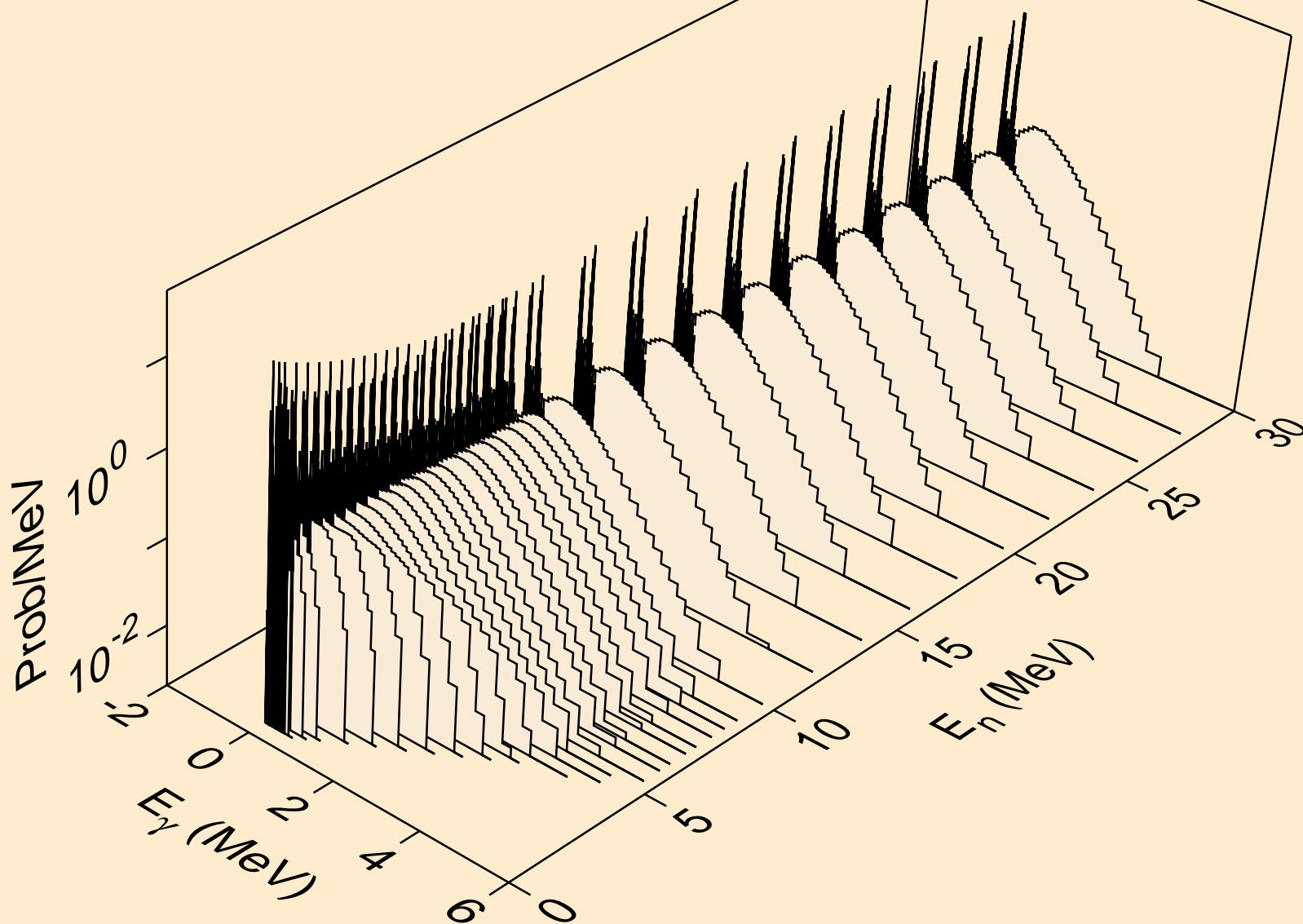

FM255 NEUTRON ACER TENDL-2019 LIBRARY; T=293.16K
Photon emission for (n,gma)

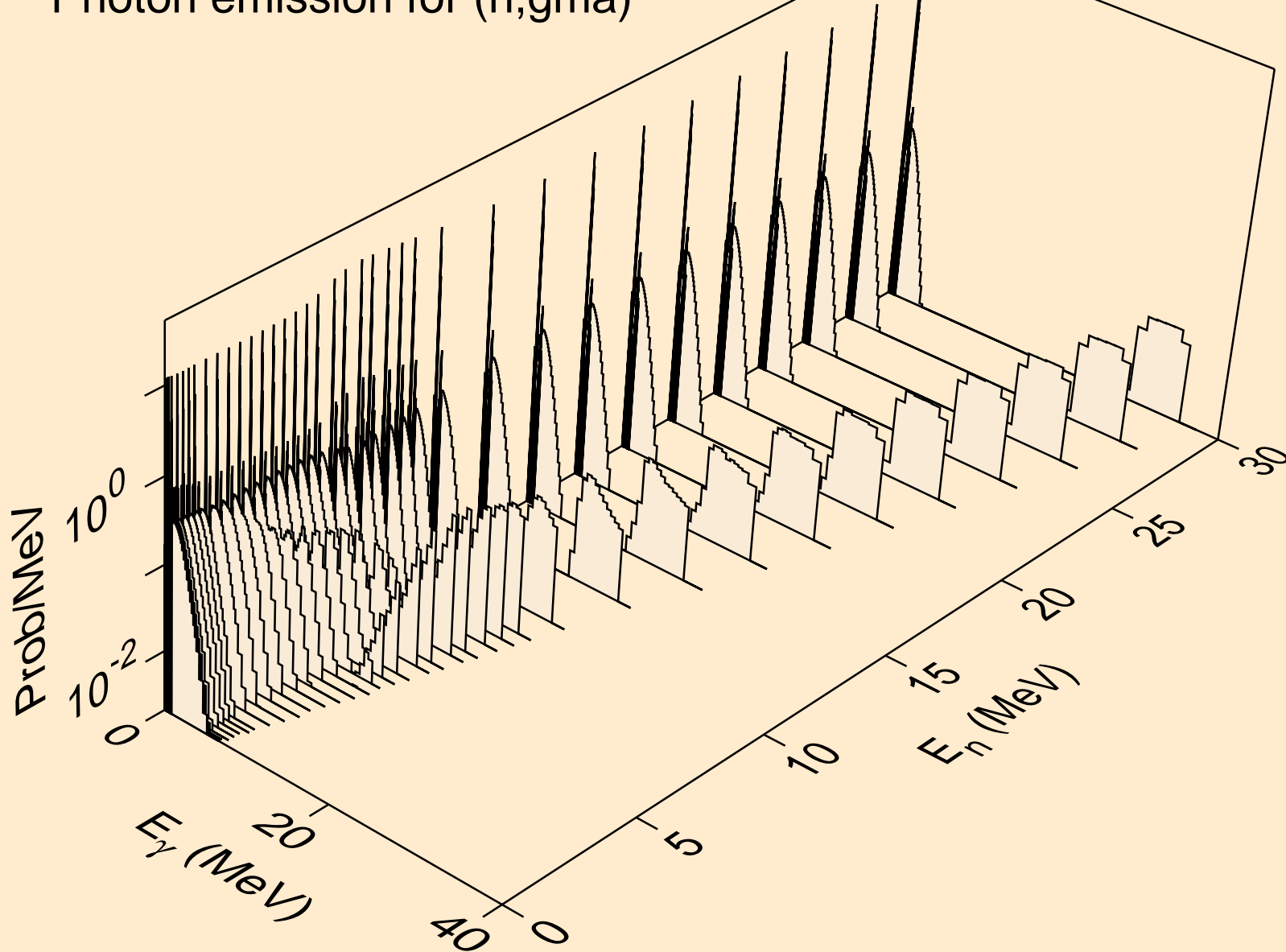

FM255 NEUTRON ACER TENDL-2019 LIBRARY; T=293.16K
Photon emission for (n,p)

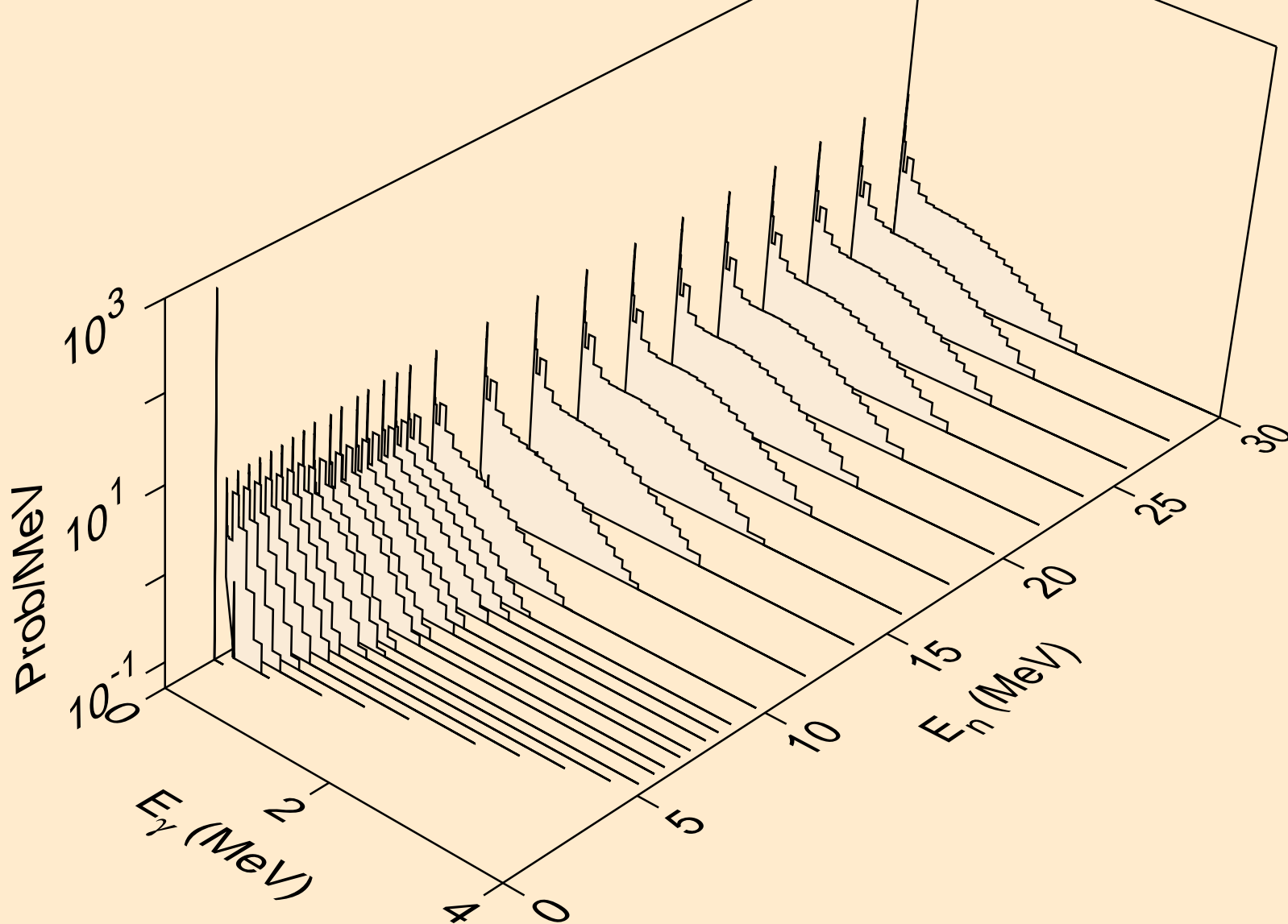

FM255 NEUTRON ACER TENDL-2019 LIBRARY; T=293.16K
Photon emission for (n,d)

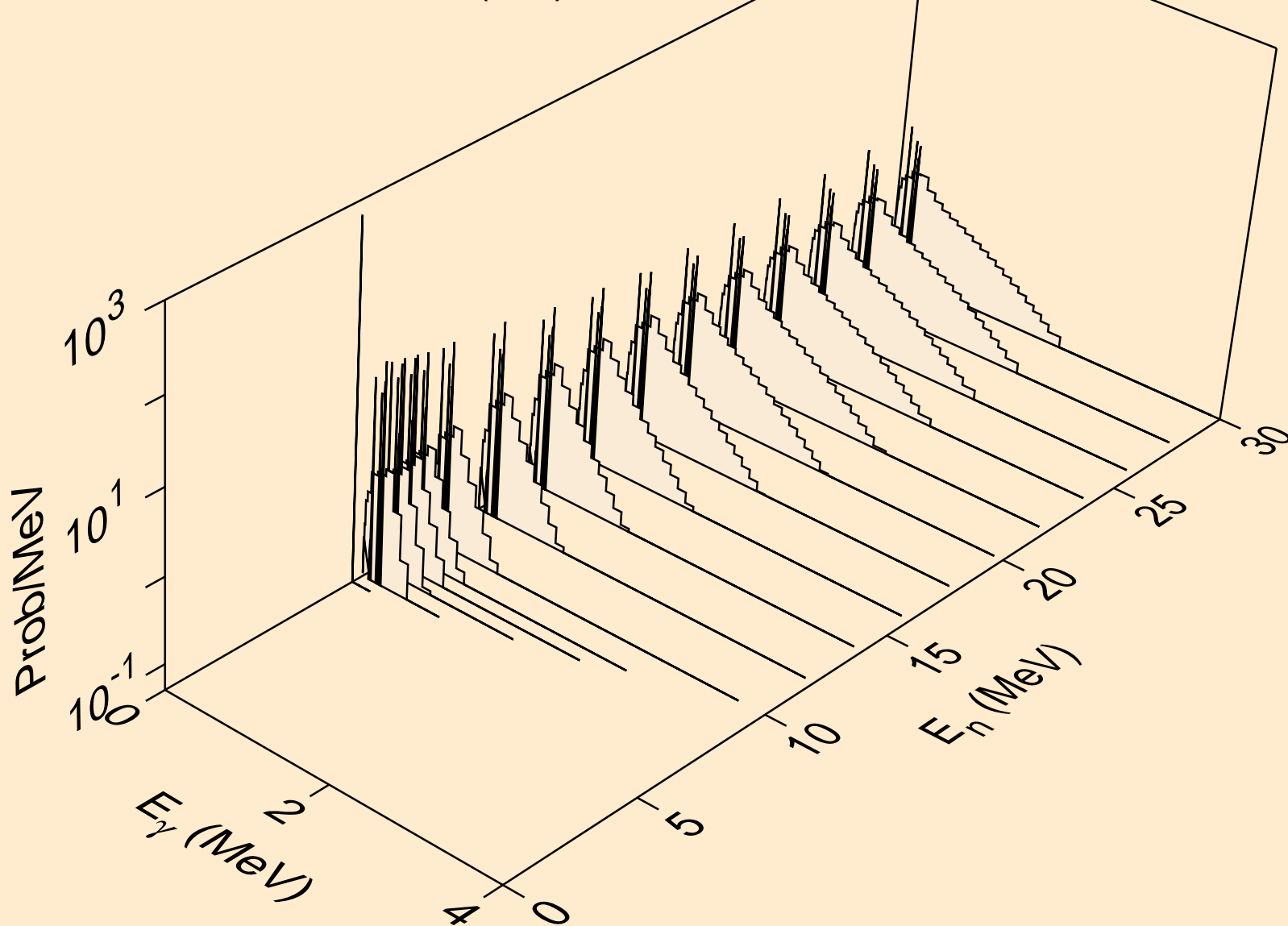

FM255 NEUTRON ACER TENDL-2019 LIBRARY; T=293.16K
Photon emission for (n,t)

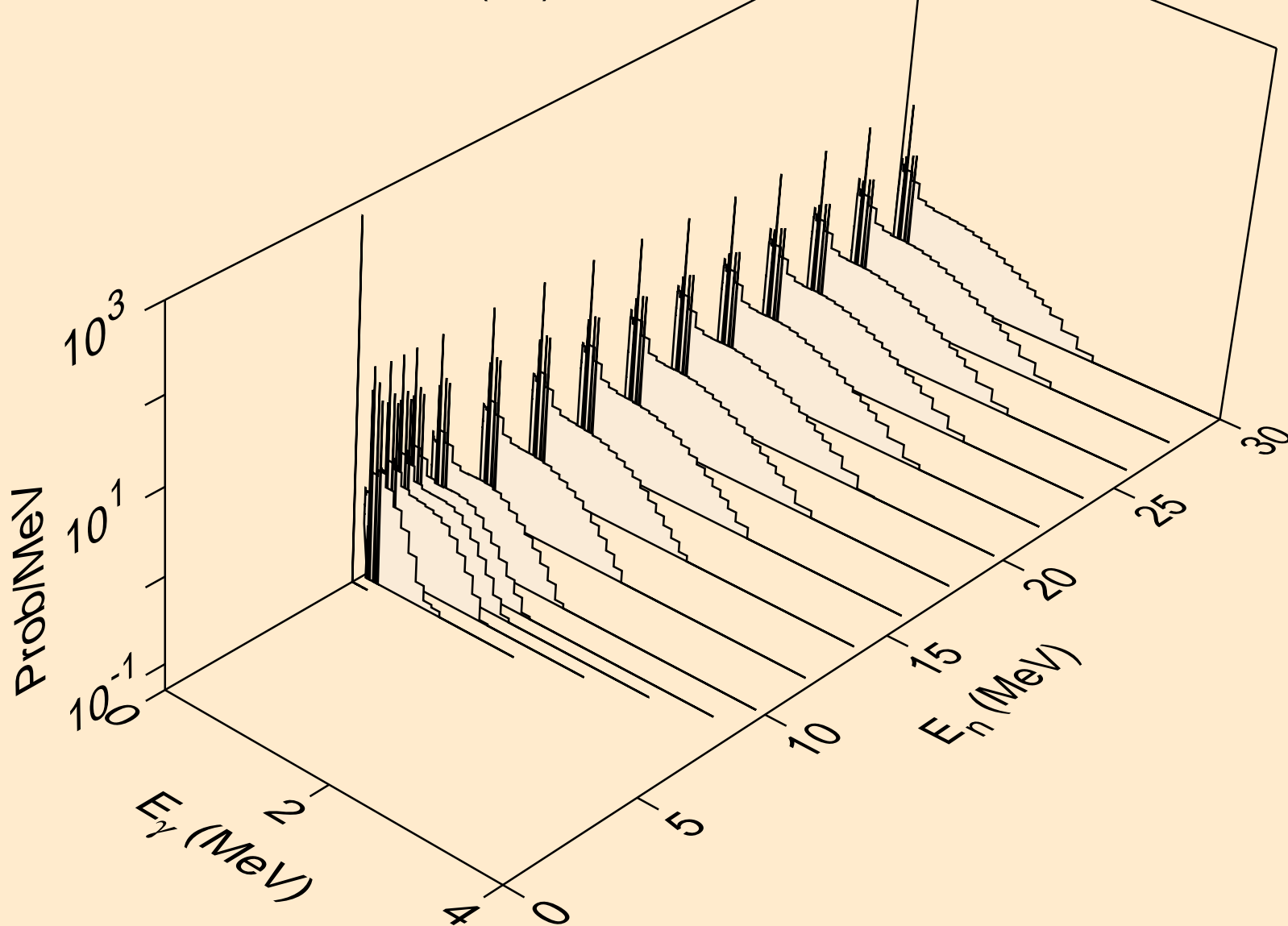

FM255 NEUTRON ACER TENDL-2019 LIBRARY; T=293.16K
Photon emission for (n,he3)

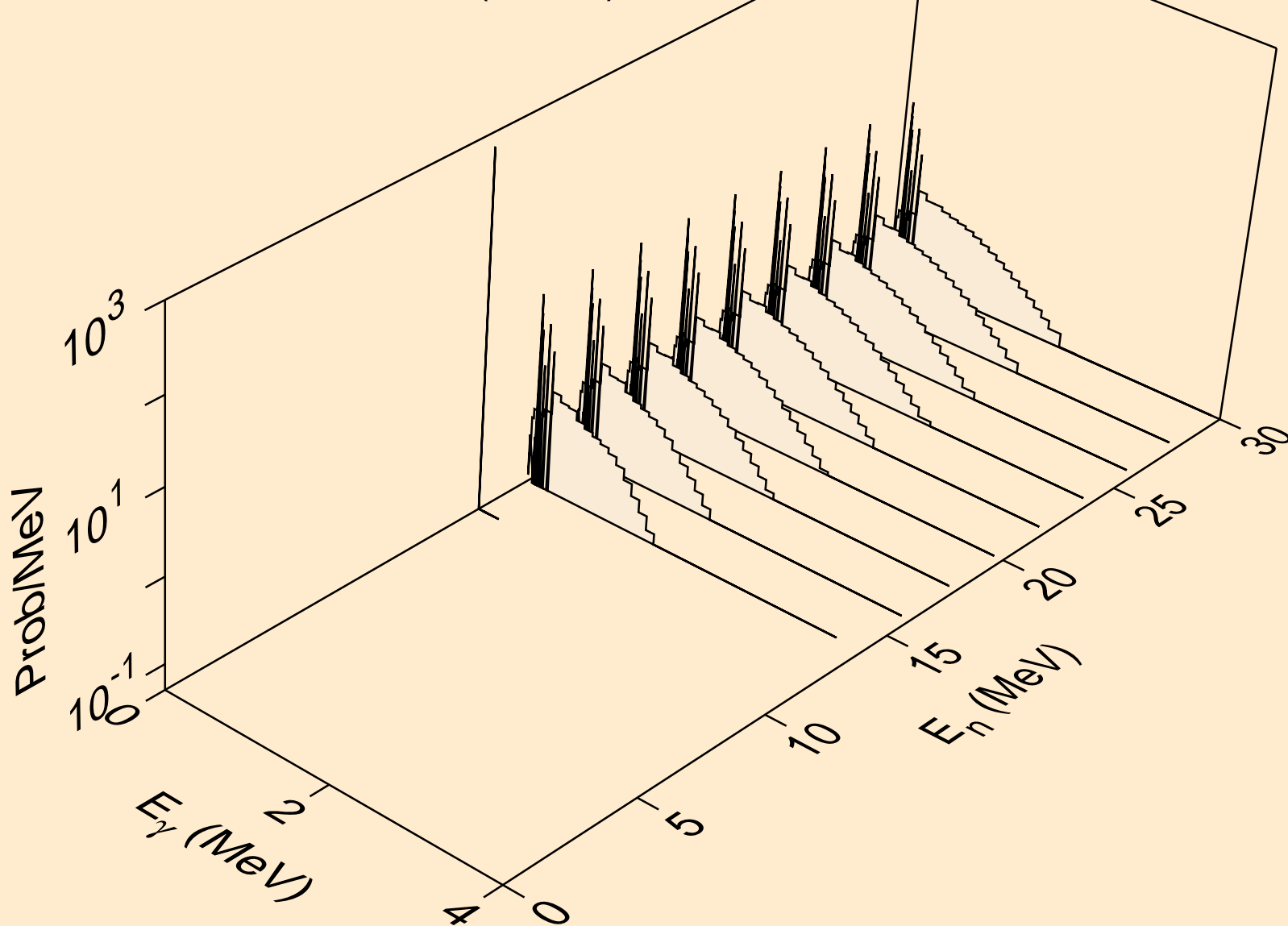

FM255 NEUTRON ACER TENDL-2019 LIBRARY; T=293.16K
Photon emission for (n,a)

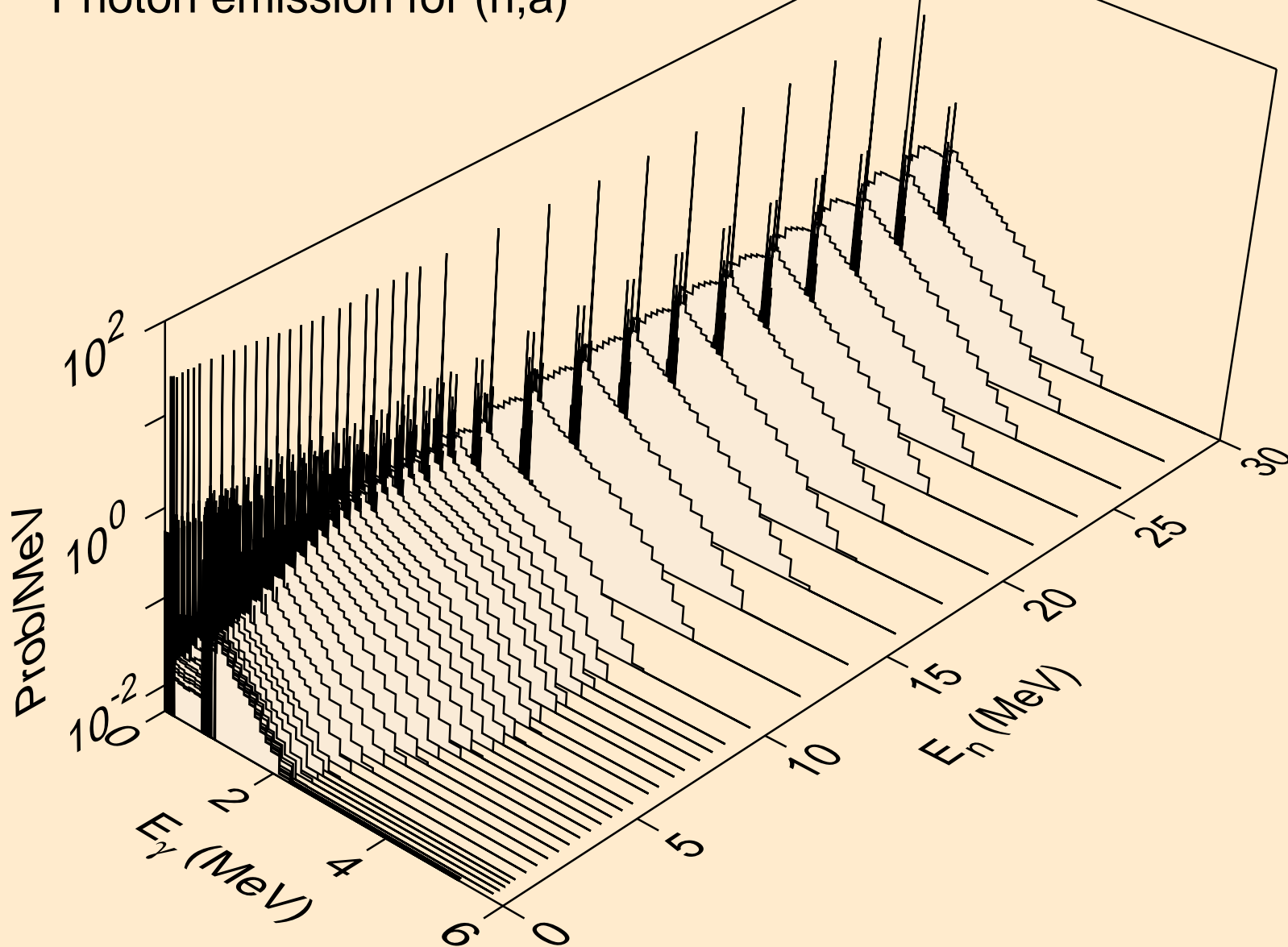

FM255 NEUTRON ACER TENDL-2019 LIBRARY; T=293.16K
Photon emission for (n,2p)

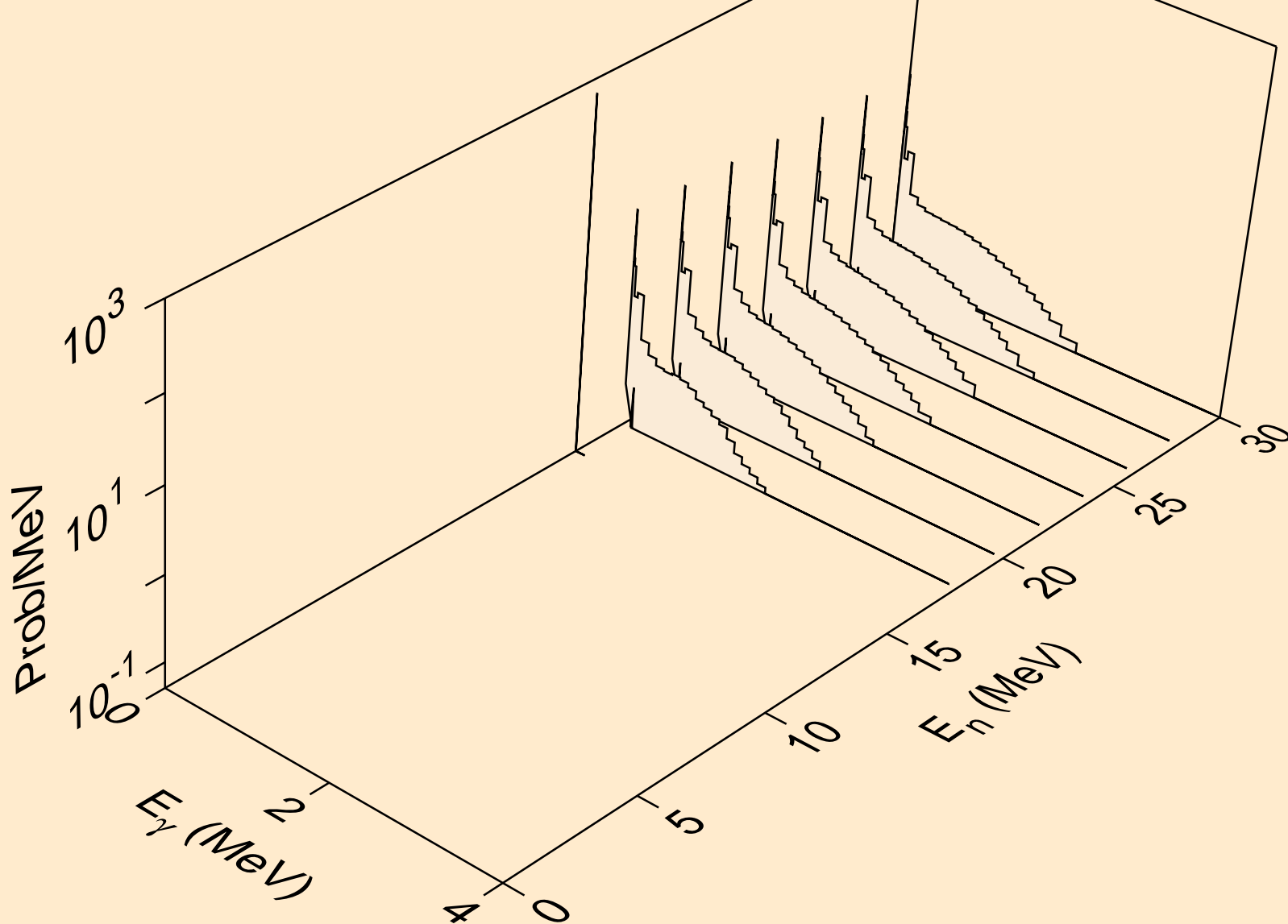

FM255 NEUTRON ACER TENDL-2019 LIBRARY; T=293.16K
thermal capture photon spectrum

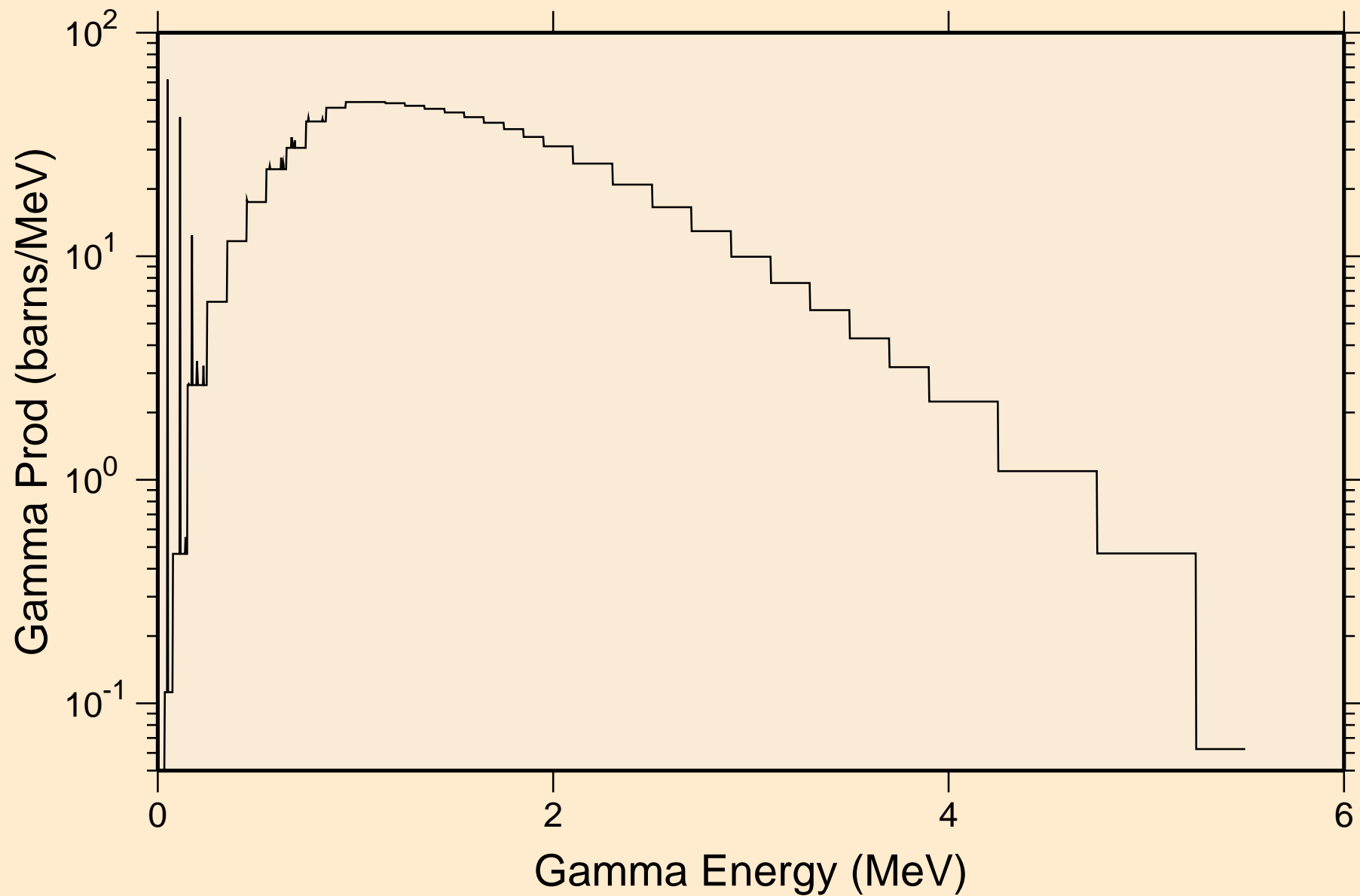

FM255 NEUTRON ACER TENDL-2019 LIBRARY; T=293.16K
14 MeV photon spectrum

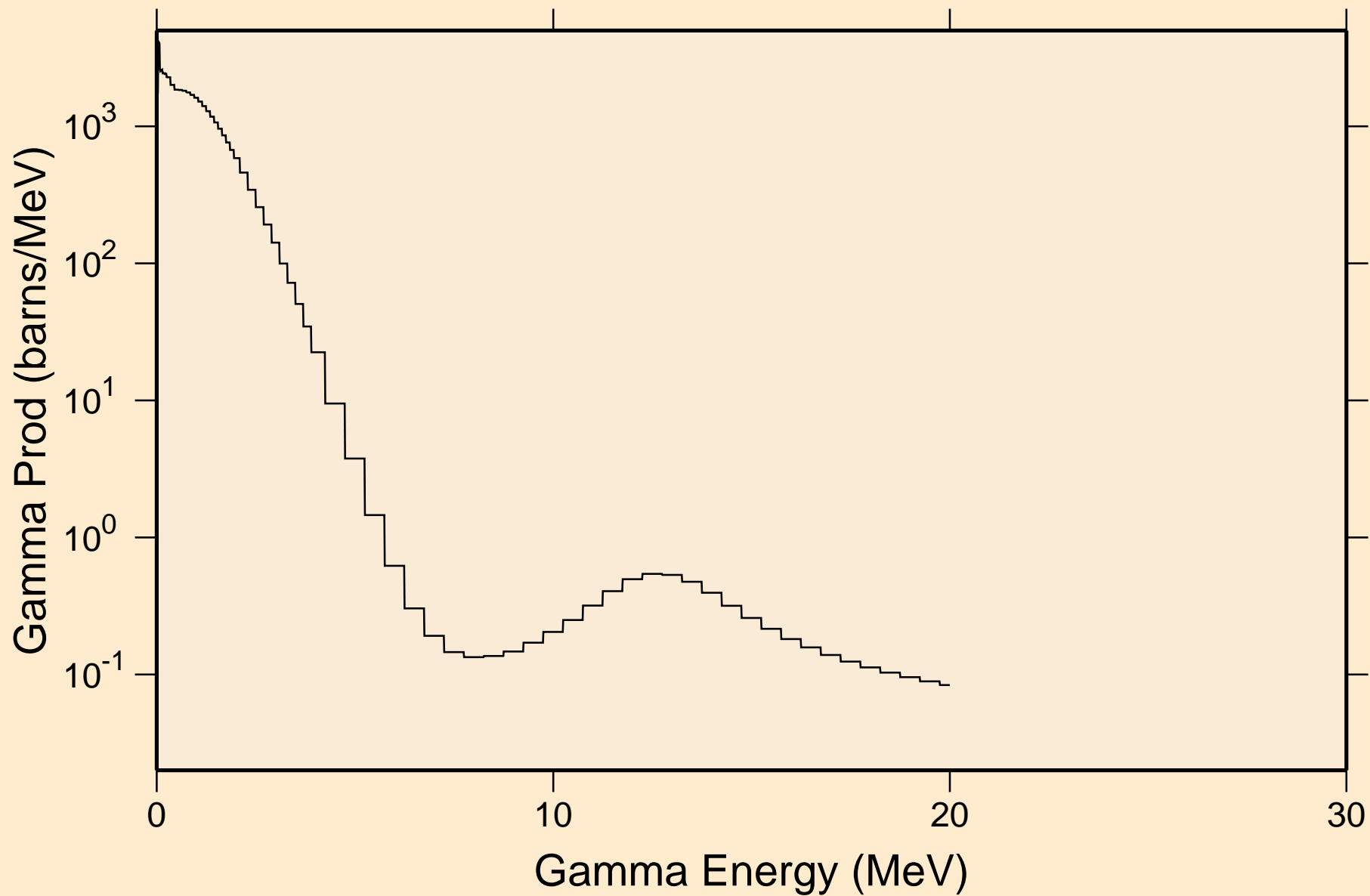

FM255 NEUTRON ACER TENDL-2019 LIBRARY; T=293.16K

Particle heating contributions

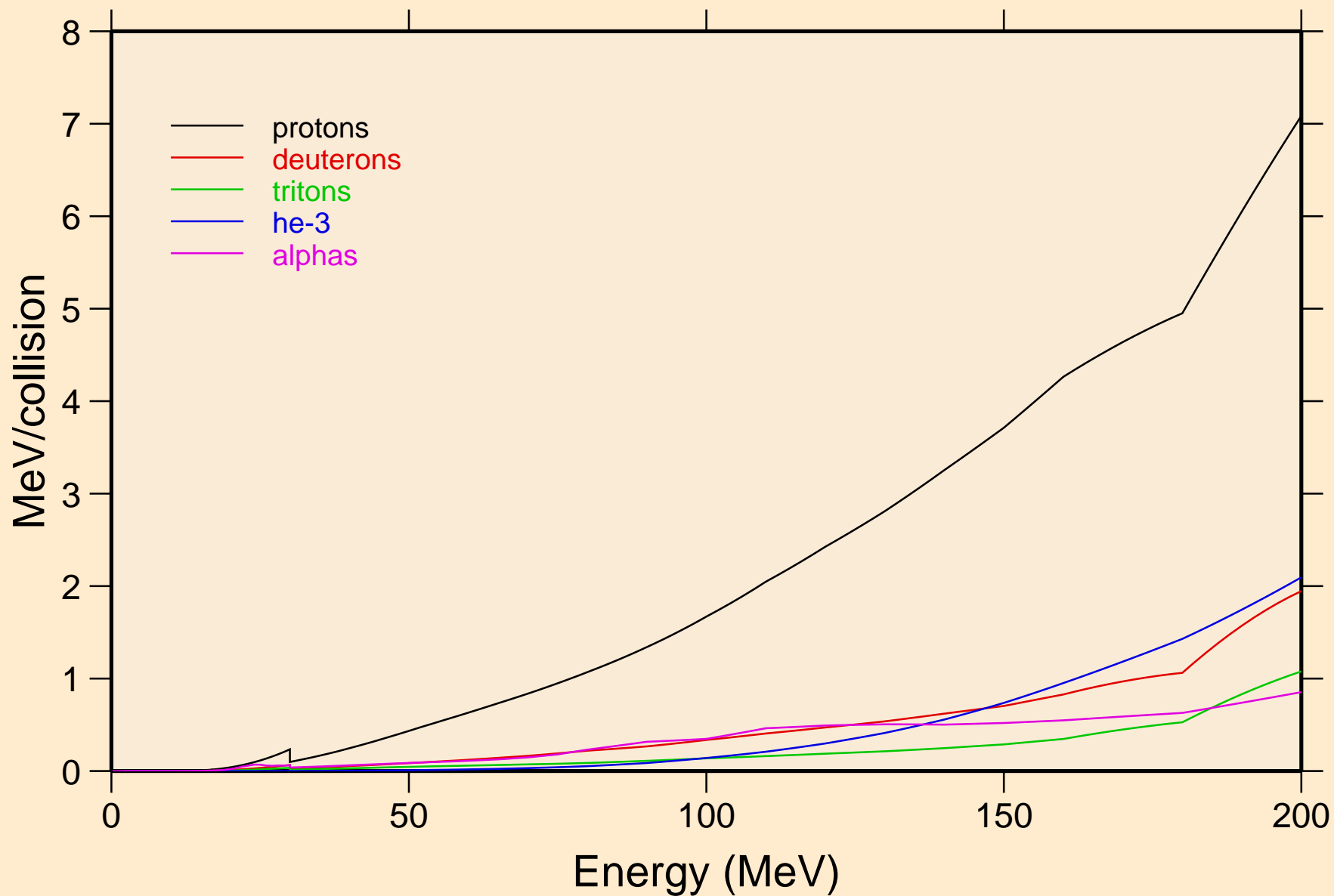

FM255 NEUTRON ACER TENDL-2019 LIBRARY; T=293.16K
Recoil Heating

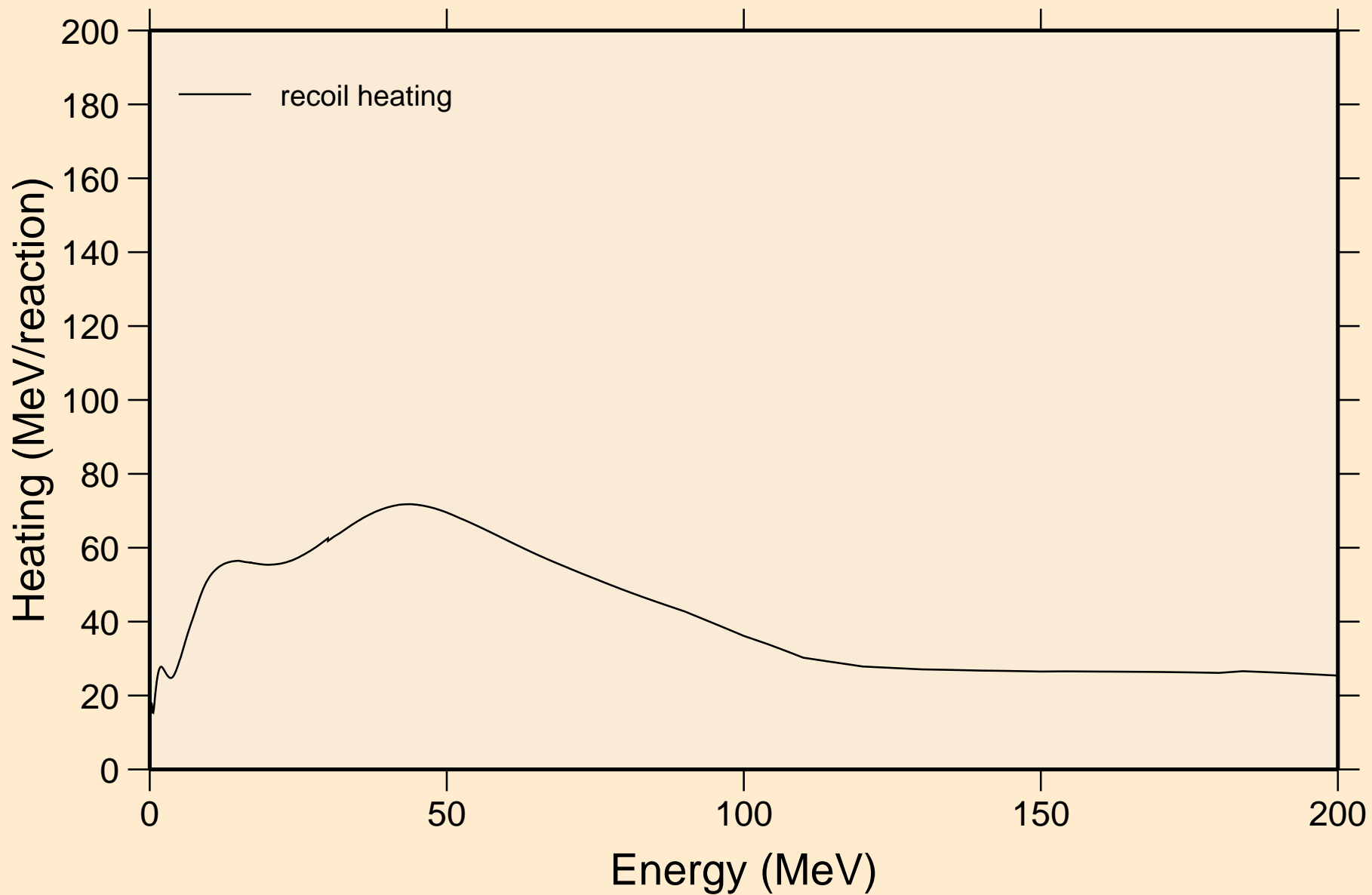

FM255 NEUTRON ACER TENDL-2019 LIBRARY; T=293.16K
Particle production cross sections

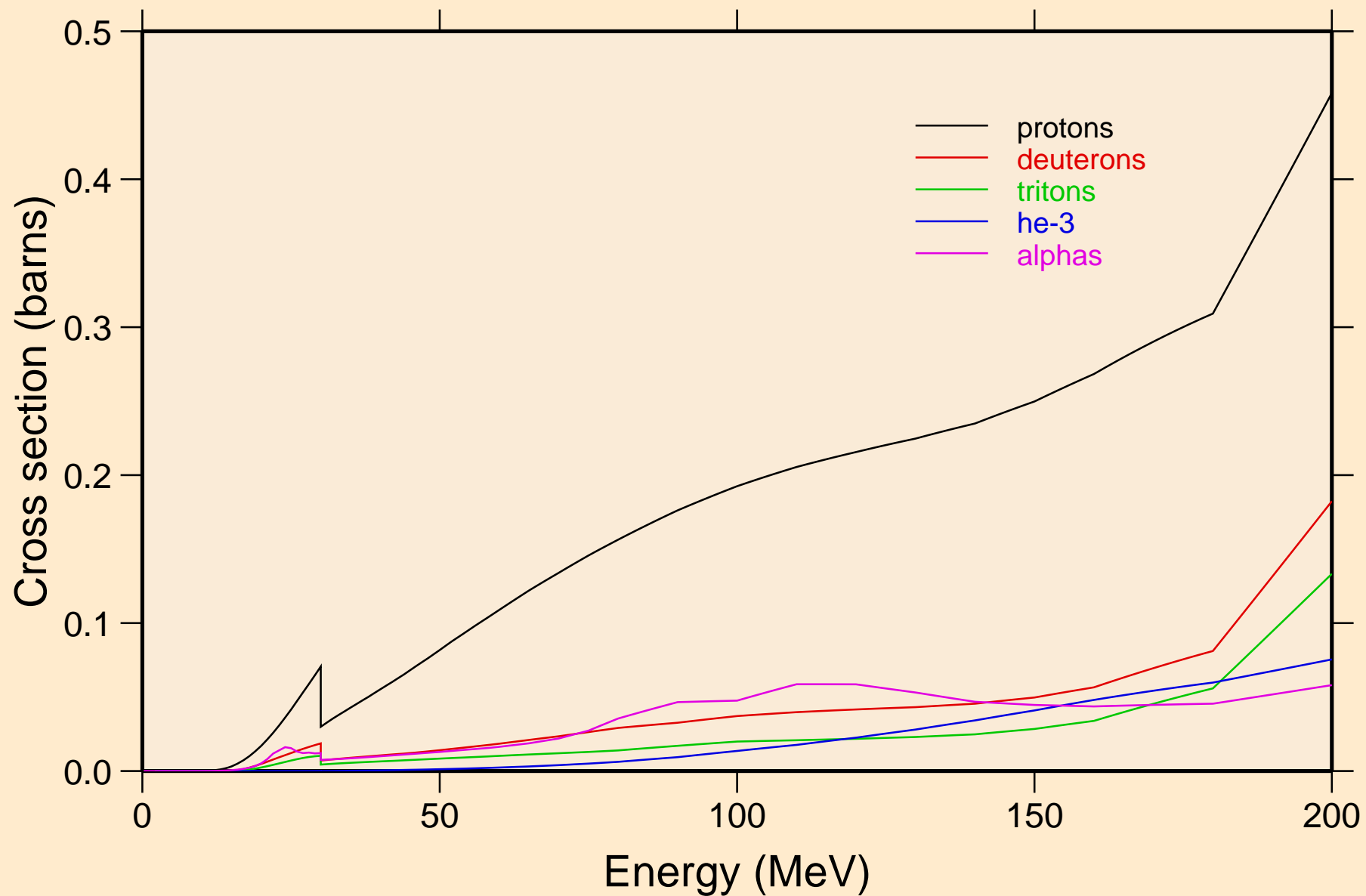

FM255 NEUTRON ACER TENDL-2019 LIBRARY; T=293.16K
protons from (n,x)

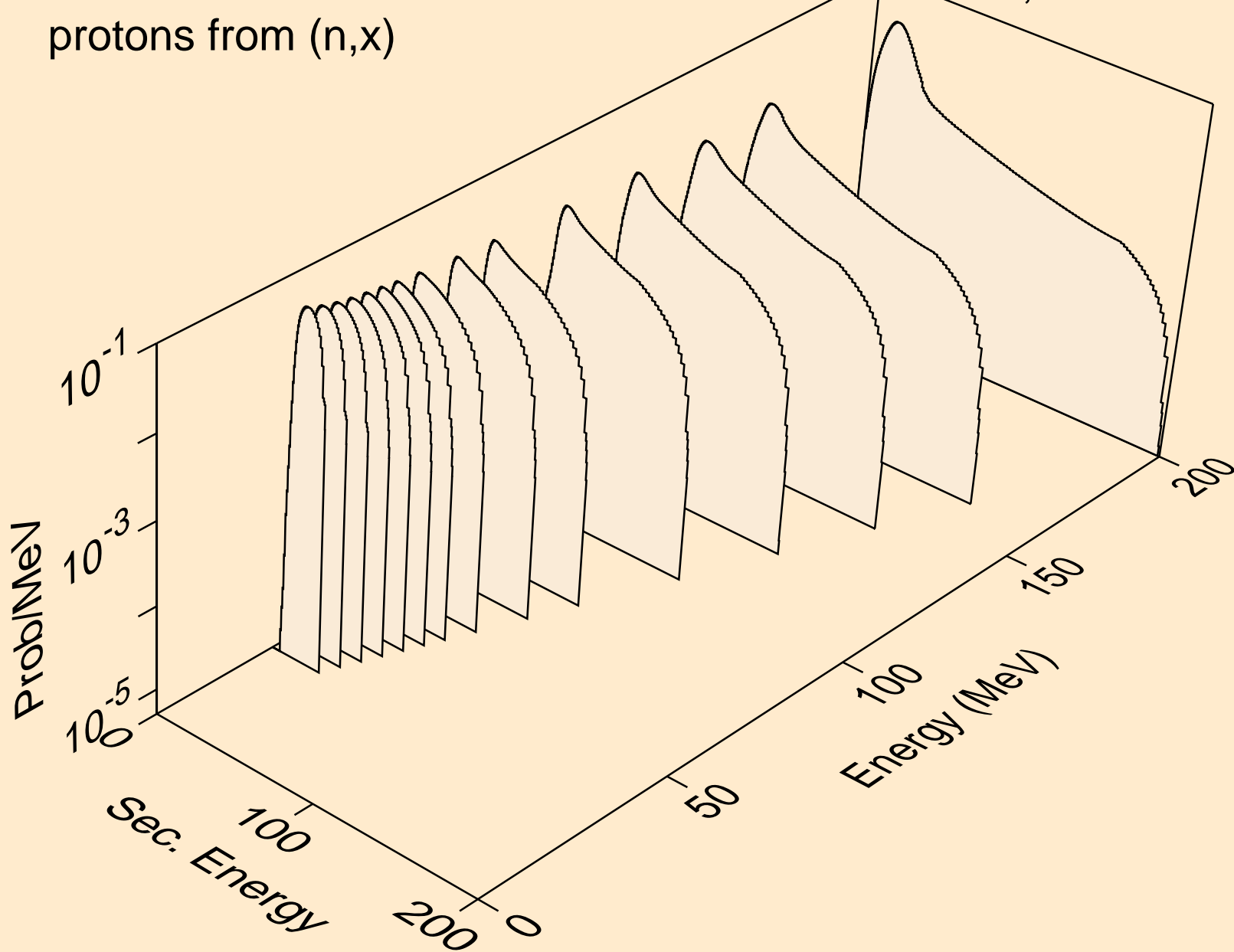

FM255 NEUTRON ACER TENDL-2019 LIBRARY; T=293.16K
protons from (n,n*)p

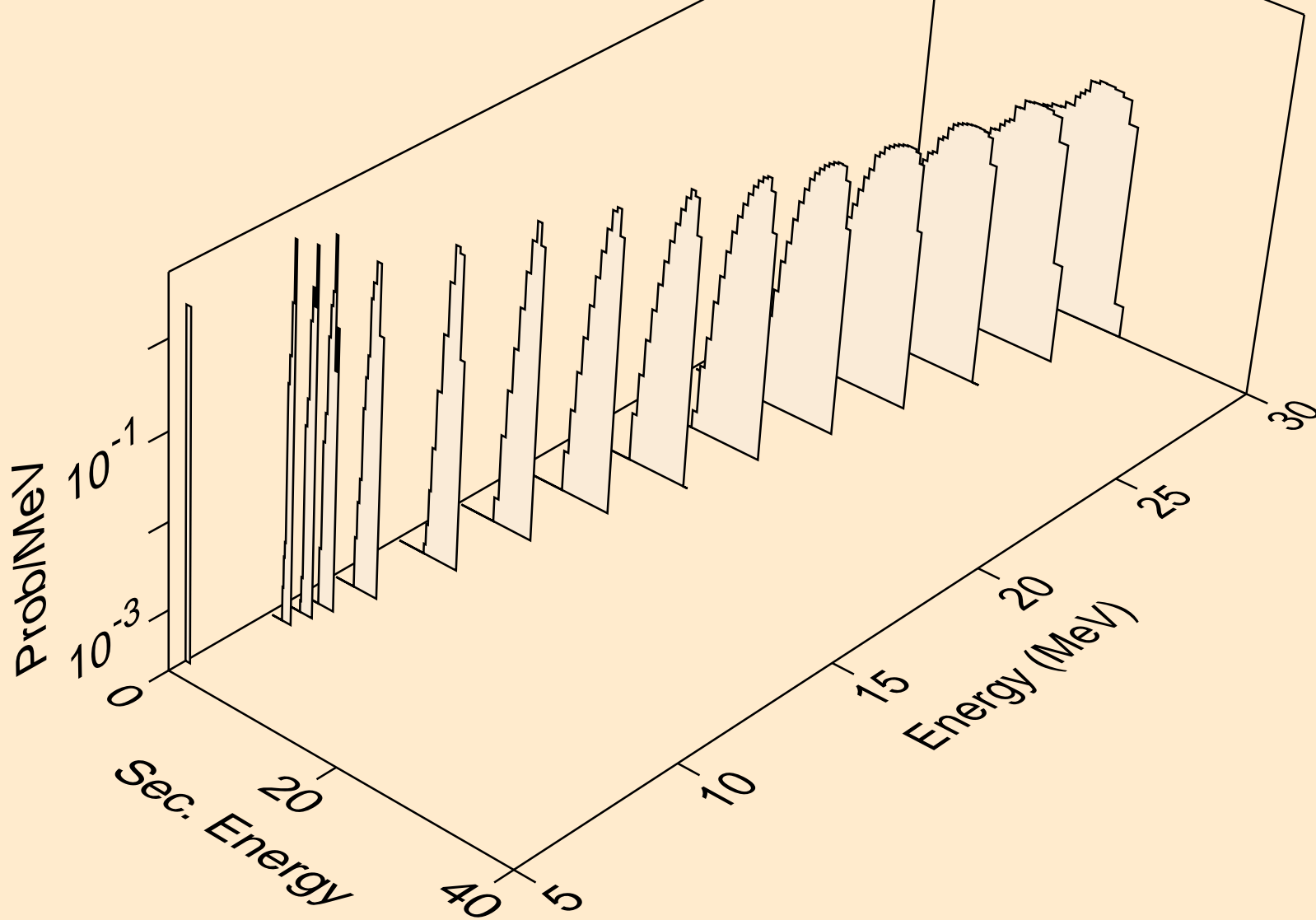

FM255 NEUTRON ACER TENDL-2019 LIBRARY; T=293.16K
protons from (n,2np)

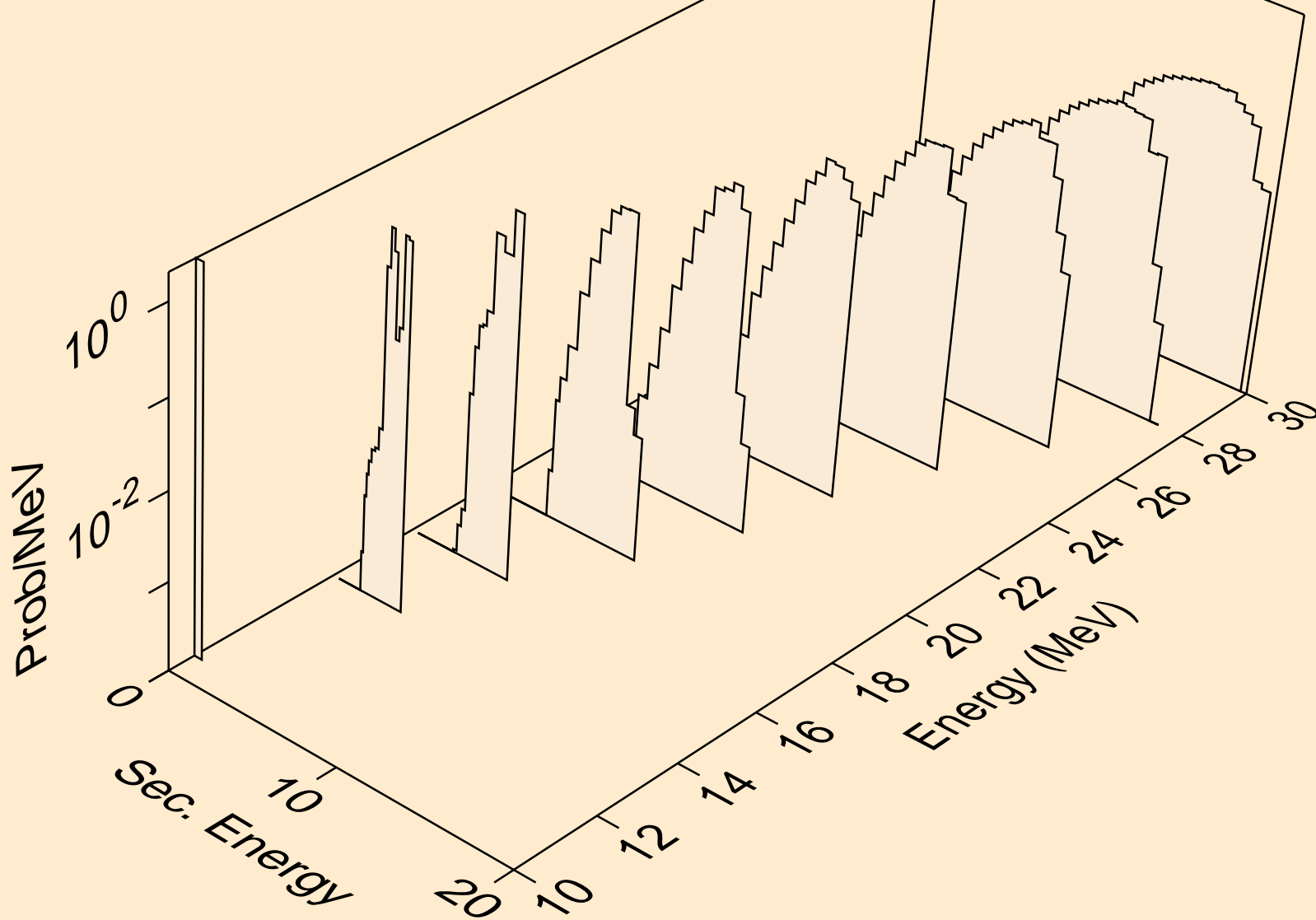

FM255 NEUTRON ACER TENDL-2019 LIBRARY; T=293.16K
protons from (n,3np)

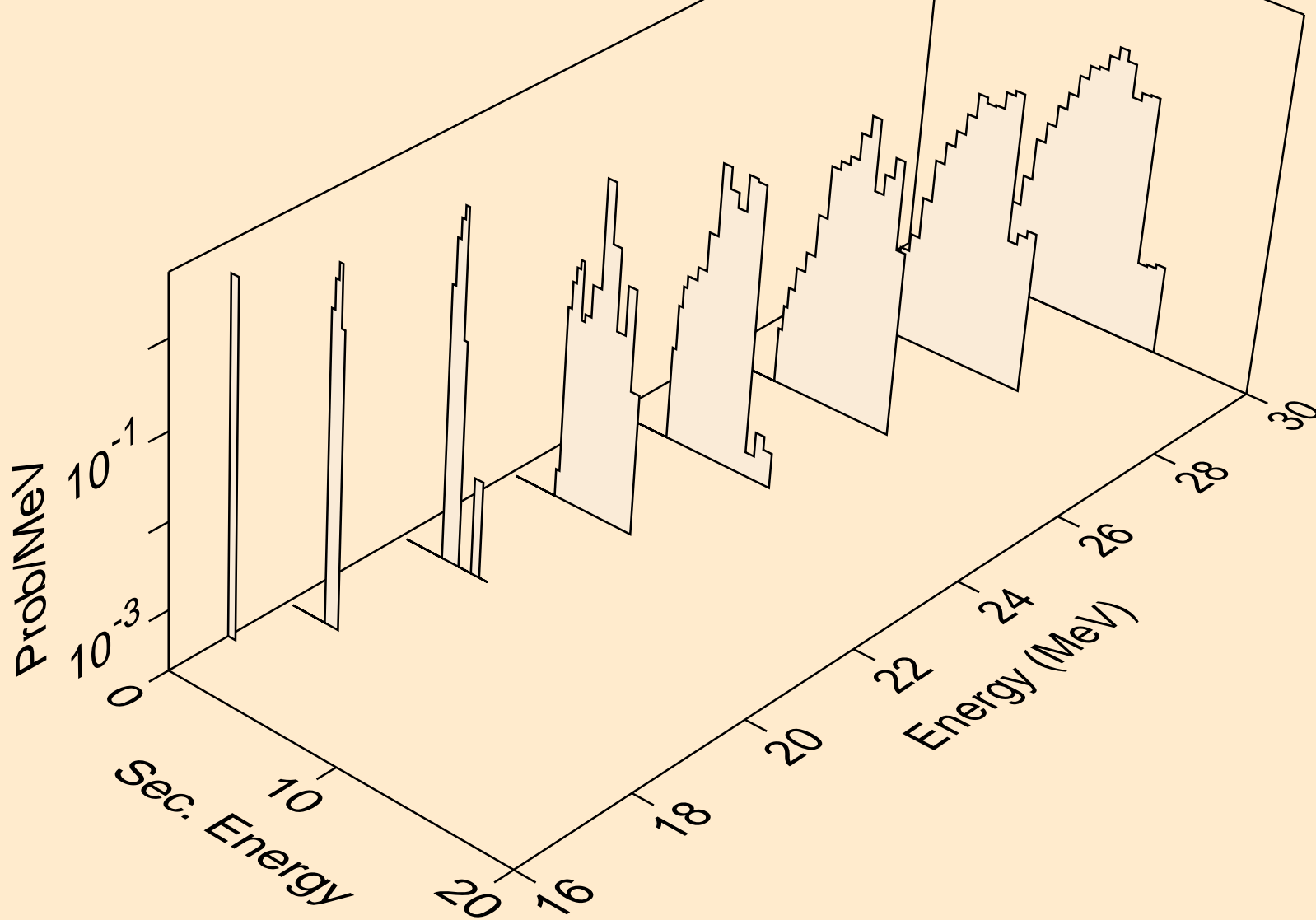

FM255 NEUTRON ACER TENDL-2019 LIBRARY; T=293.16K
protons from (n,2np)

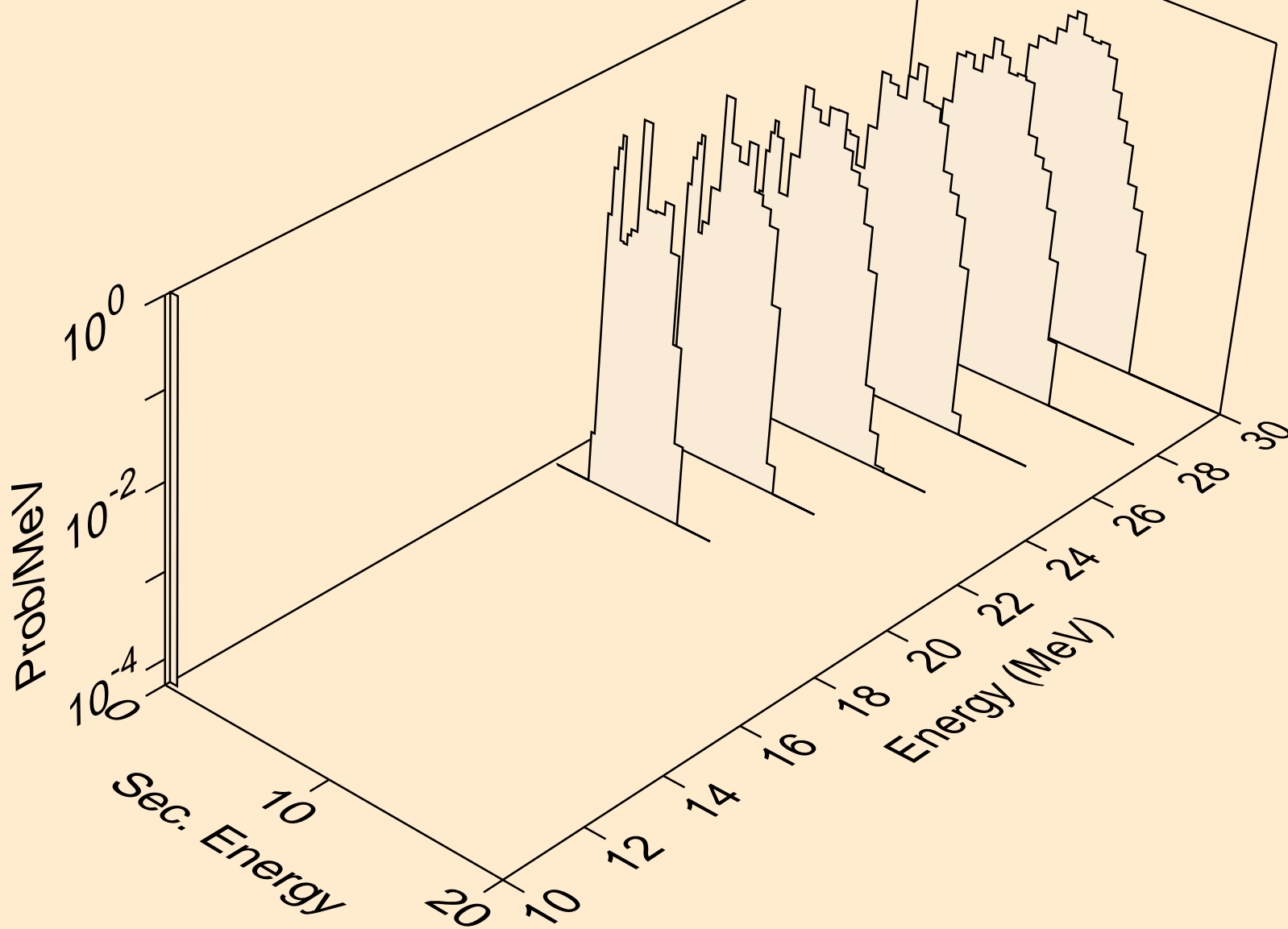

FM255 NEUTRON ACER TENDL-2019 LIBRARY; T=293.16K
protons from (n,npa)

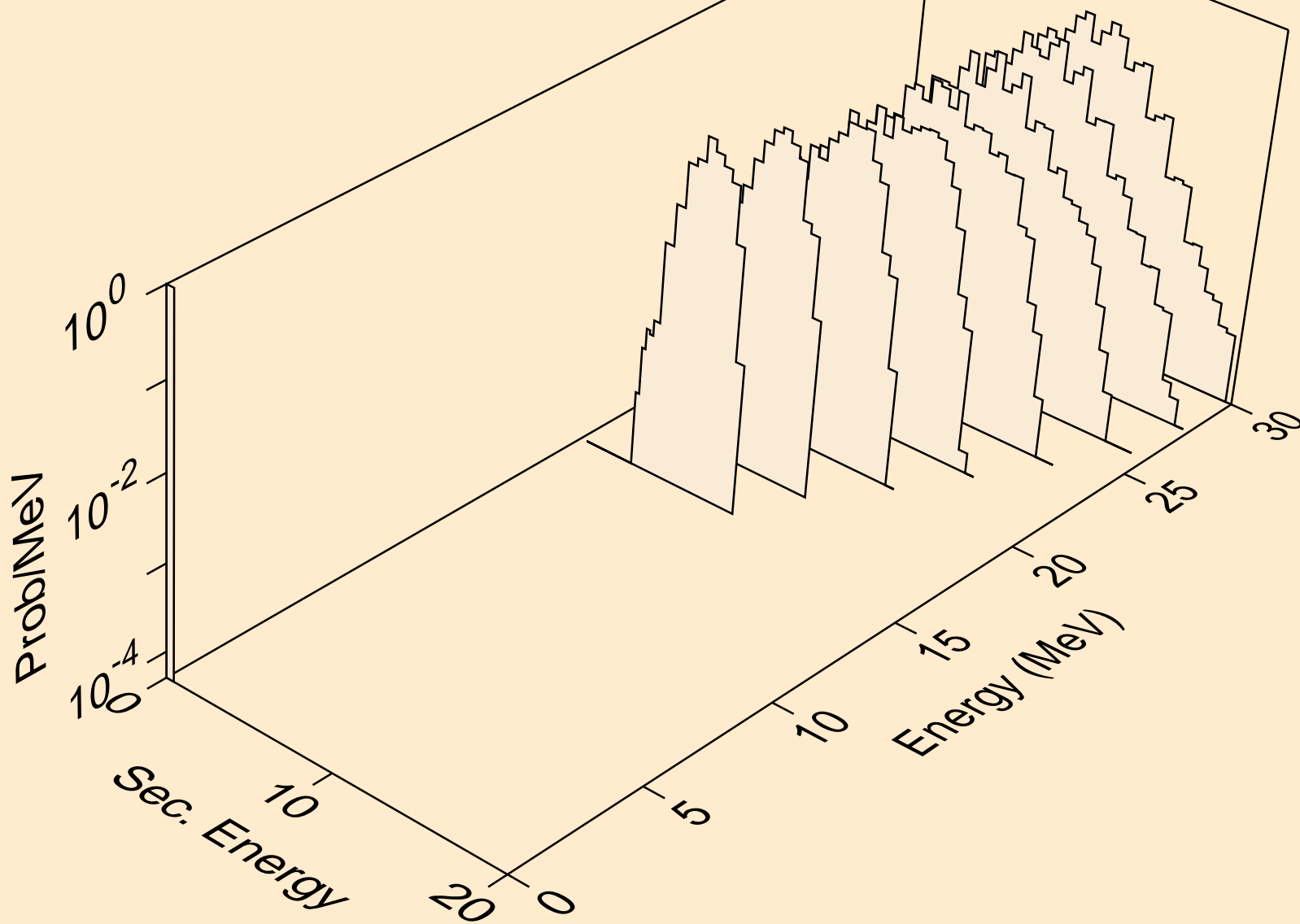

FM255 NEUTRON ACER TENDL-2019 LIBRARY; T=293.16K
protons from (n,p)

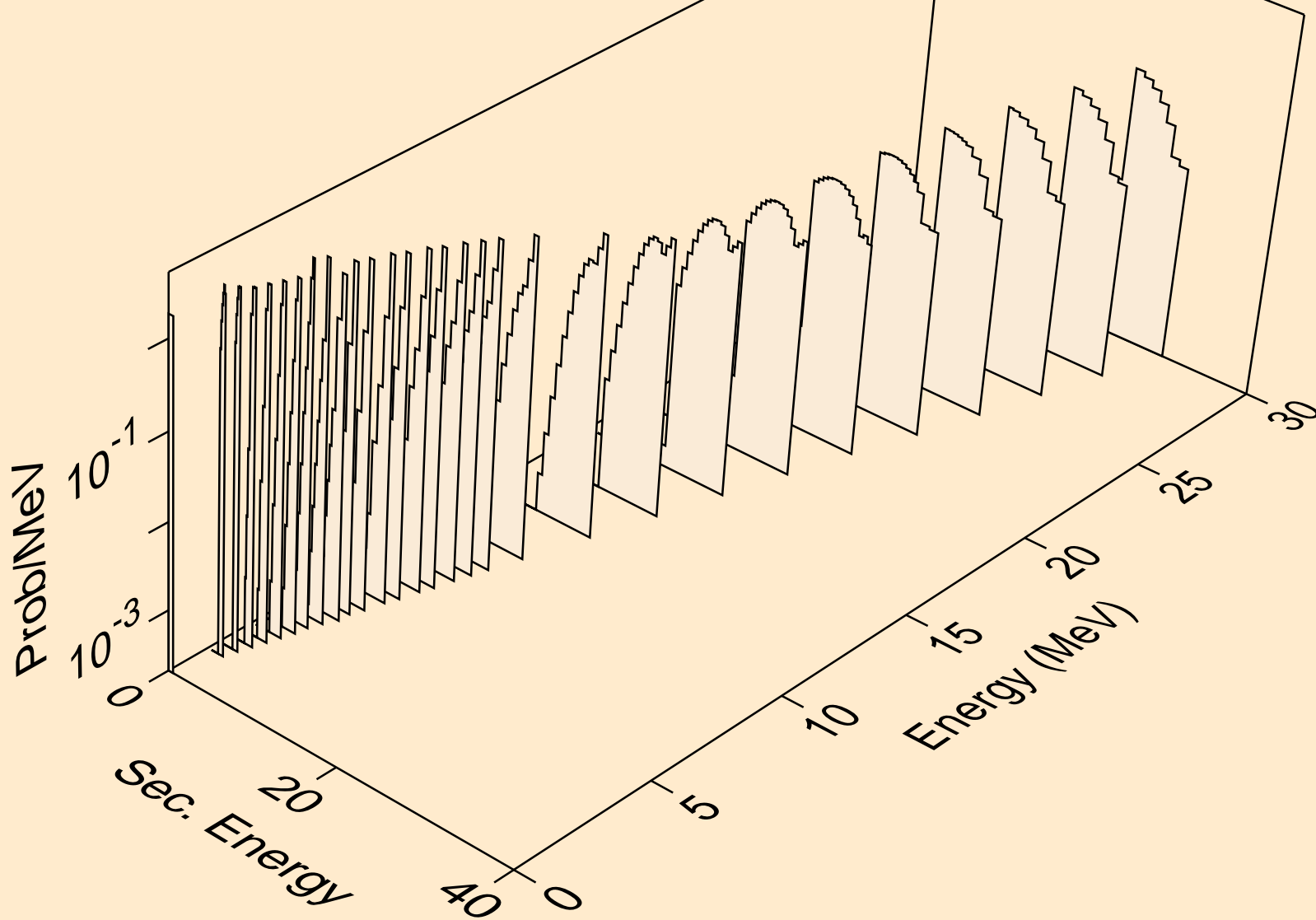

FM255 NEUTRON ACER TENDL-2019 LIBRARY; T=293.16K
protons from (n,2p)

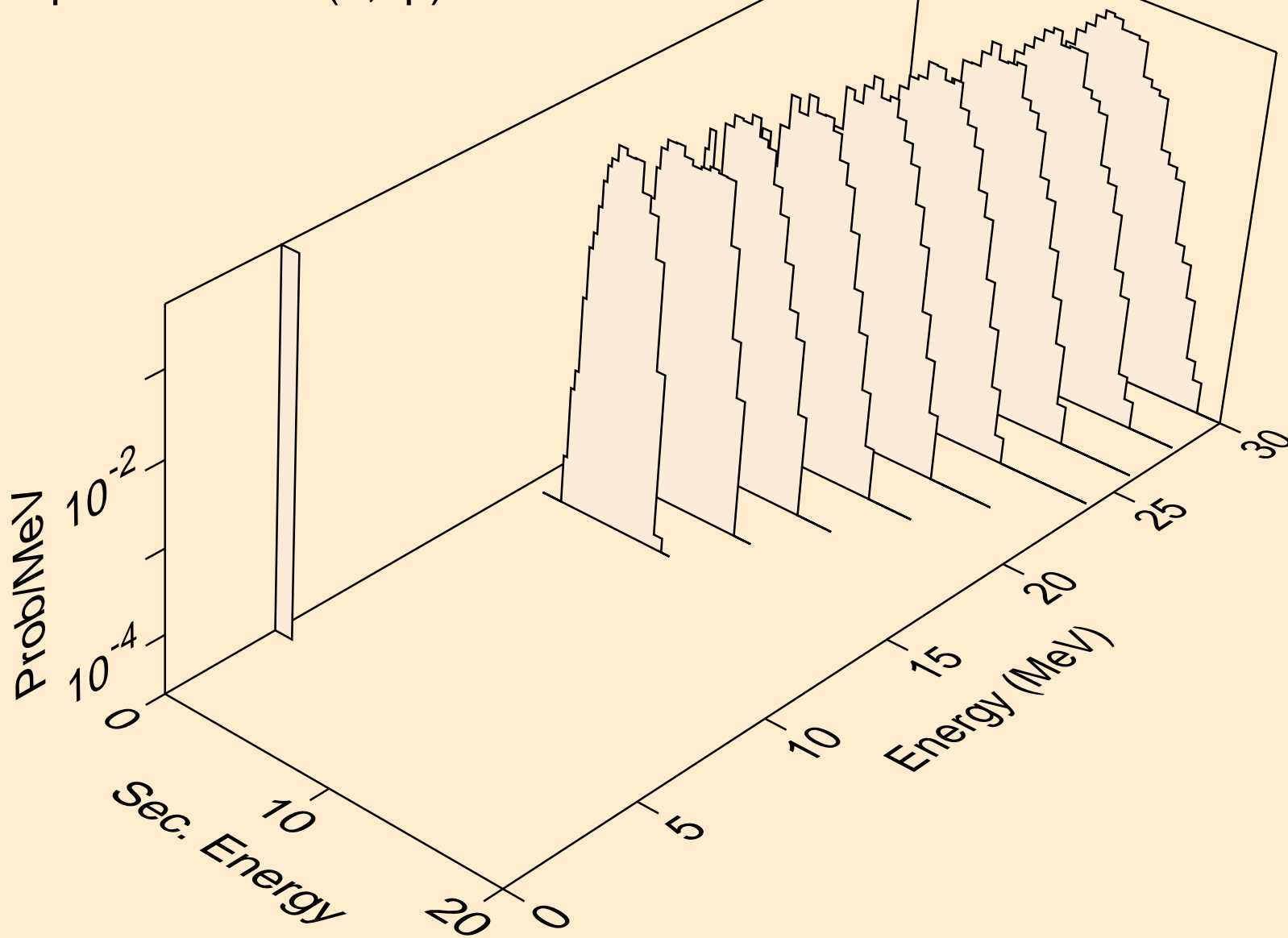

FM255 NEUTRON ACER TENDL-2019 LIBRARY; T=293.16K
deuterons from (n,x)

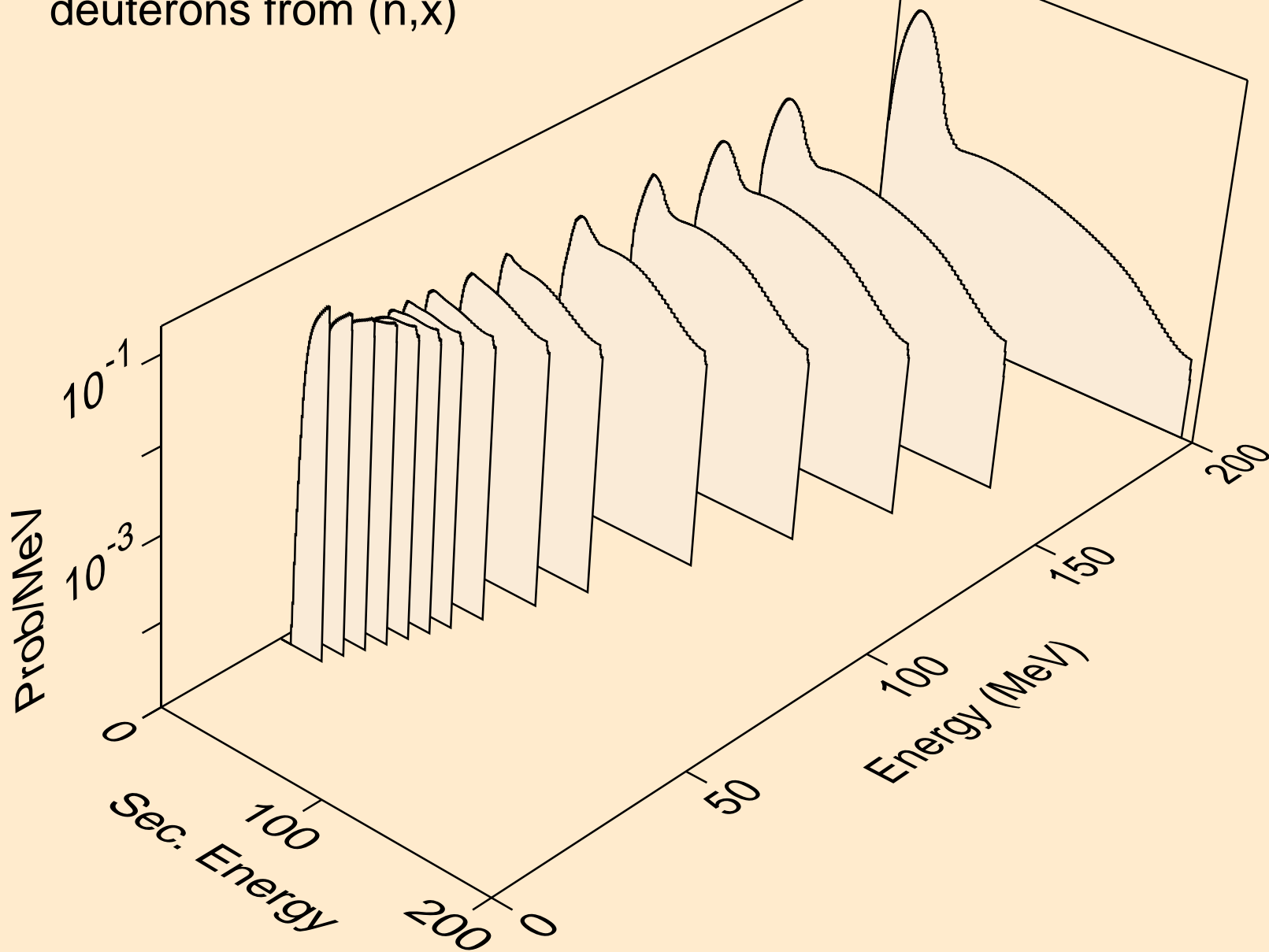

FM255 NEUTRON ACER TENDL-2019 LIBRARY; T=293.16K
deuterons from (n,2nd)

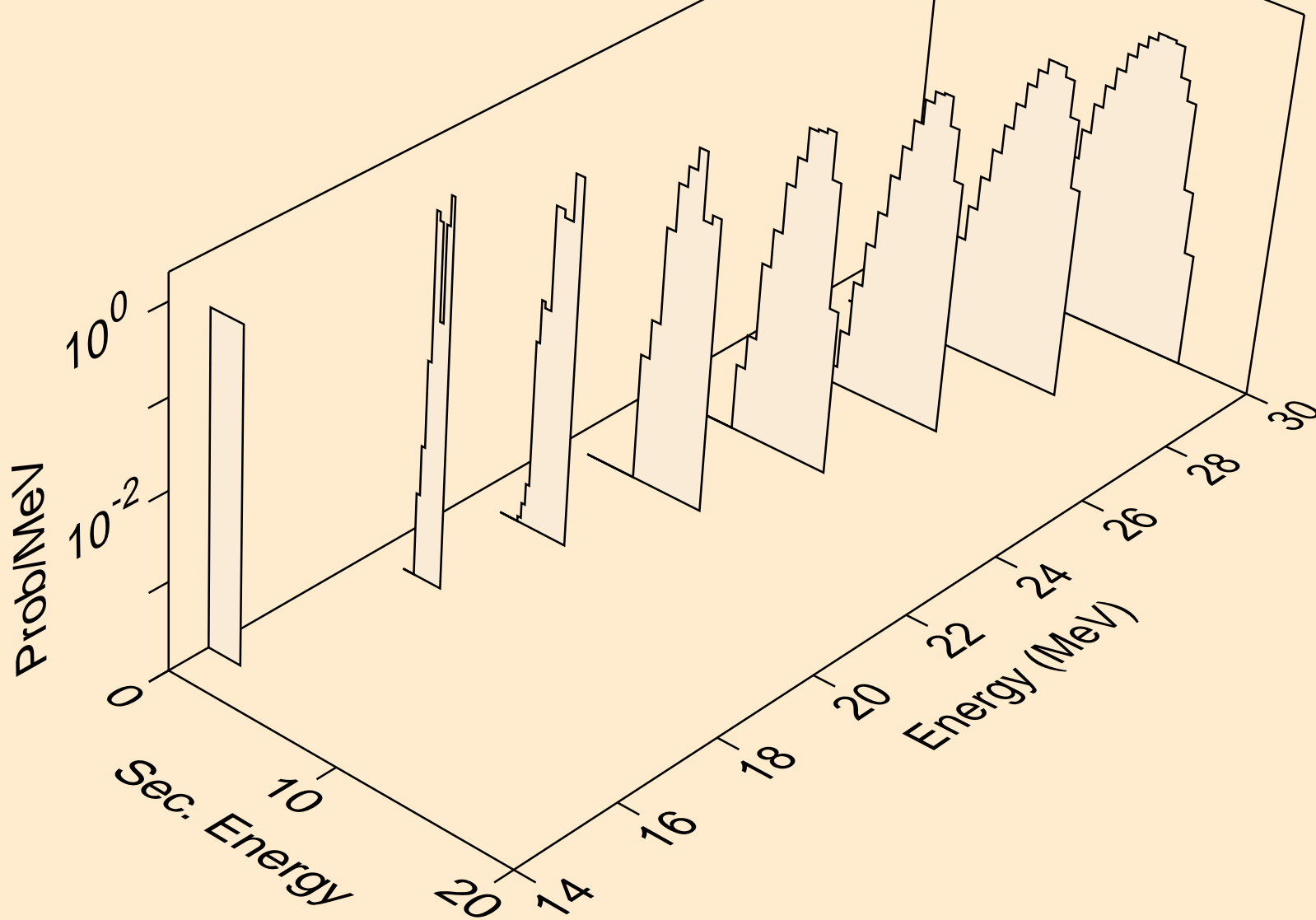

FM255 NEUTRON ACER TENDL-2019 LIBRARY; T=293.16K
deuterons from (n,n*)d

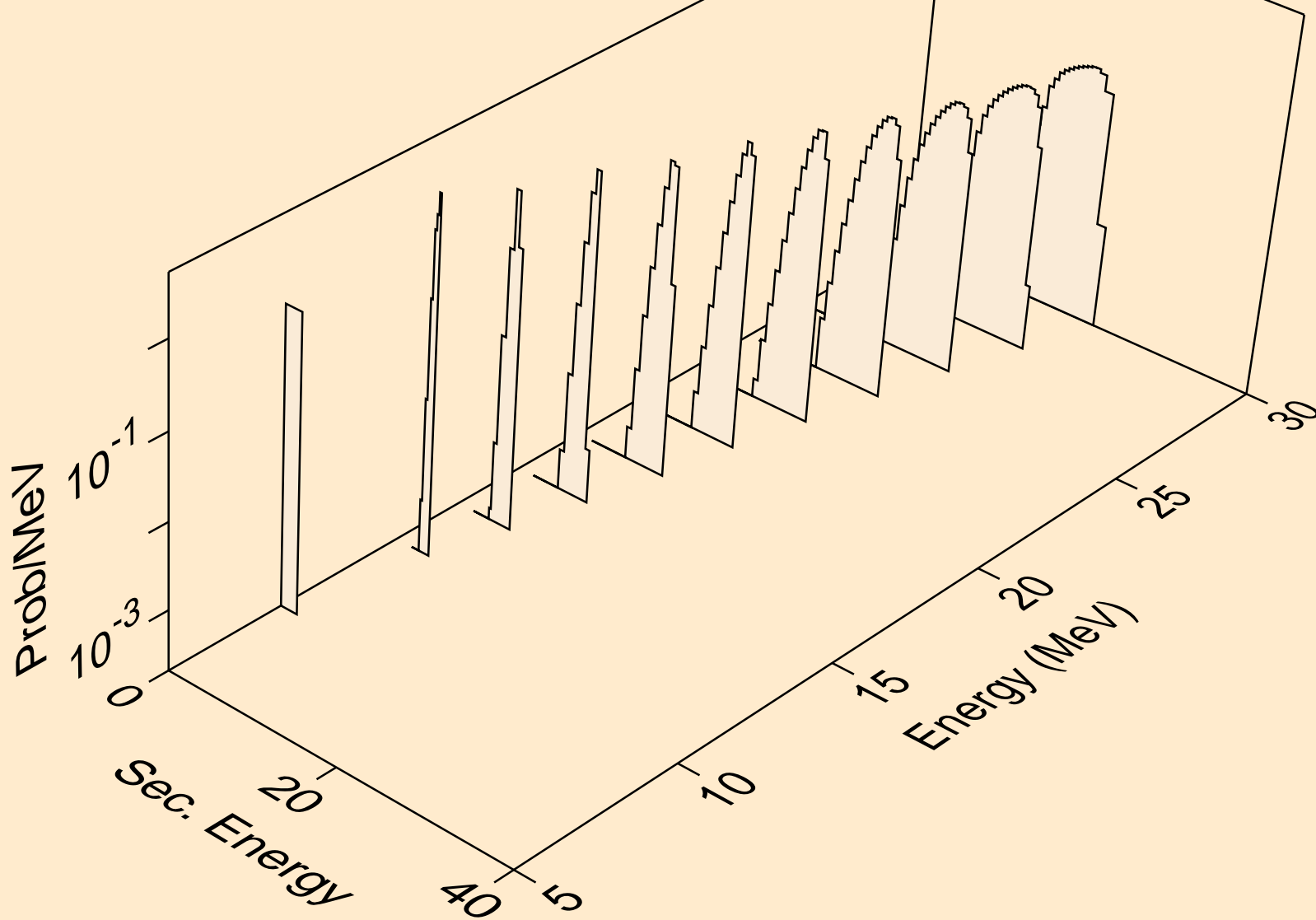

FM255 NEUTRON ACER TENDL-2019 LIBRARY; T=293.16K
deuterons from (n,d)

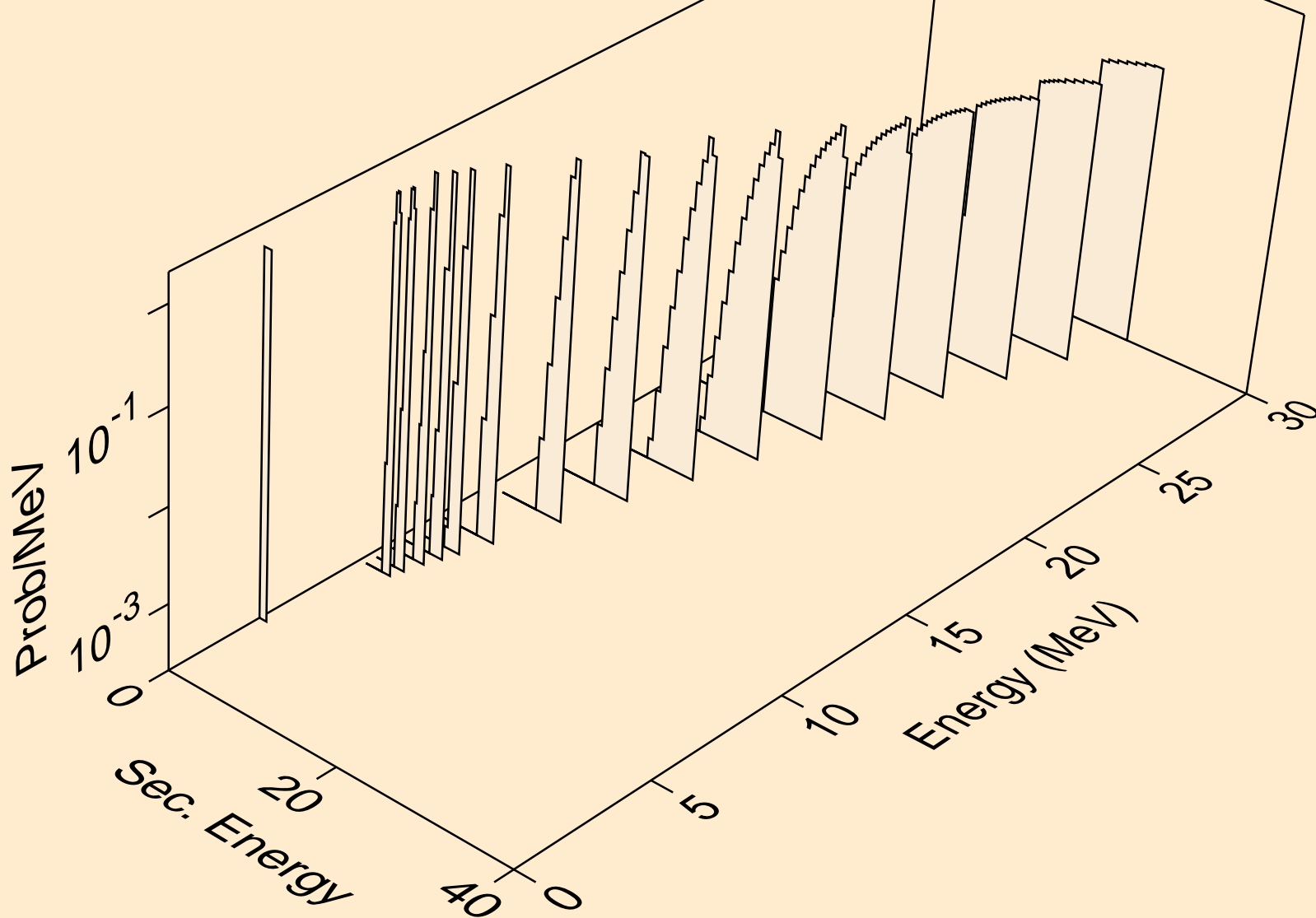

FM255 NEUTRON ACER TENDL-2019 LIBRARY; T=293.16K
tritons from (n,x)

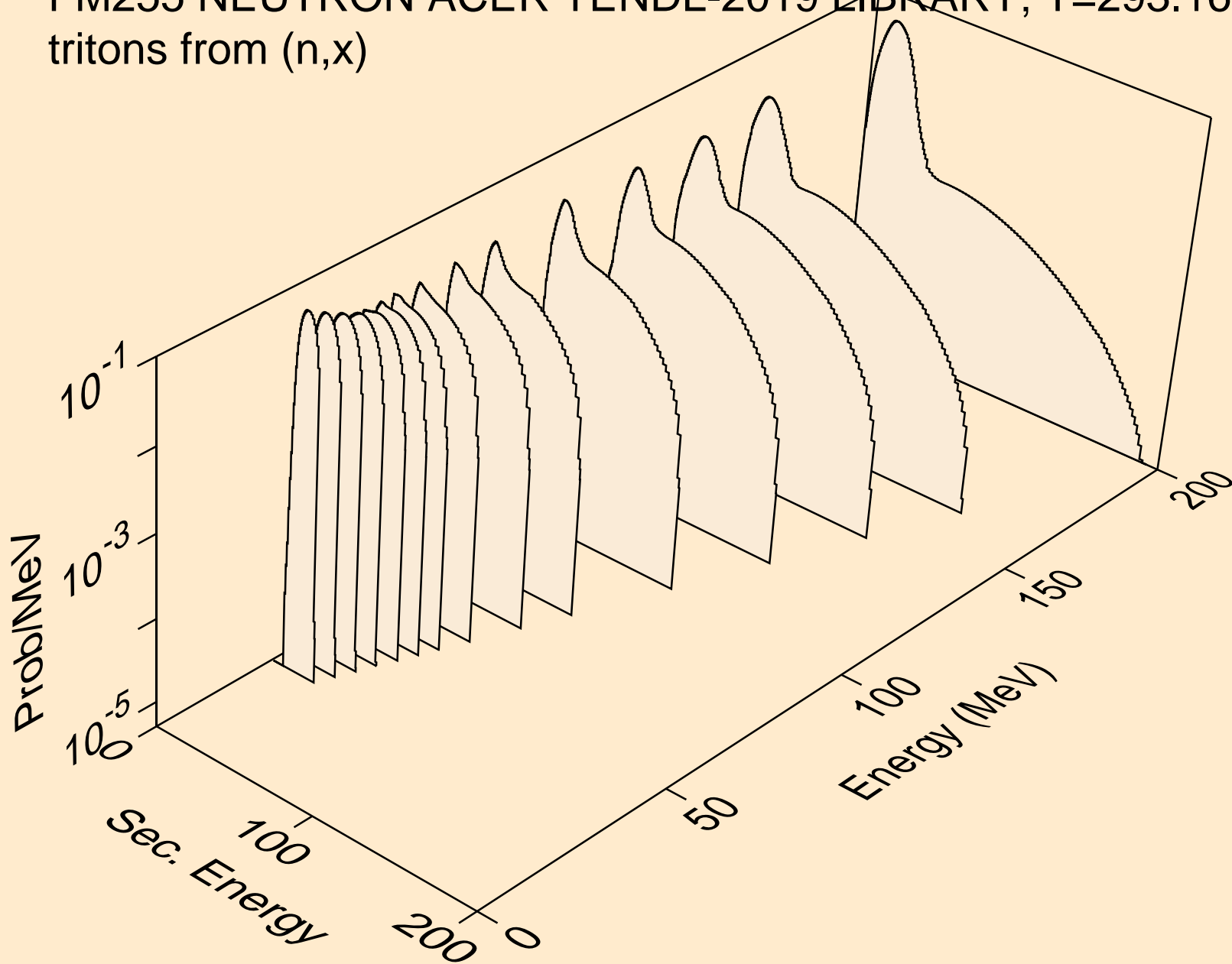

FM255 NEUTRON ACER TENDL-2019 LIBRARY; T=293.16K
tritons from (n,n*)t

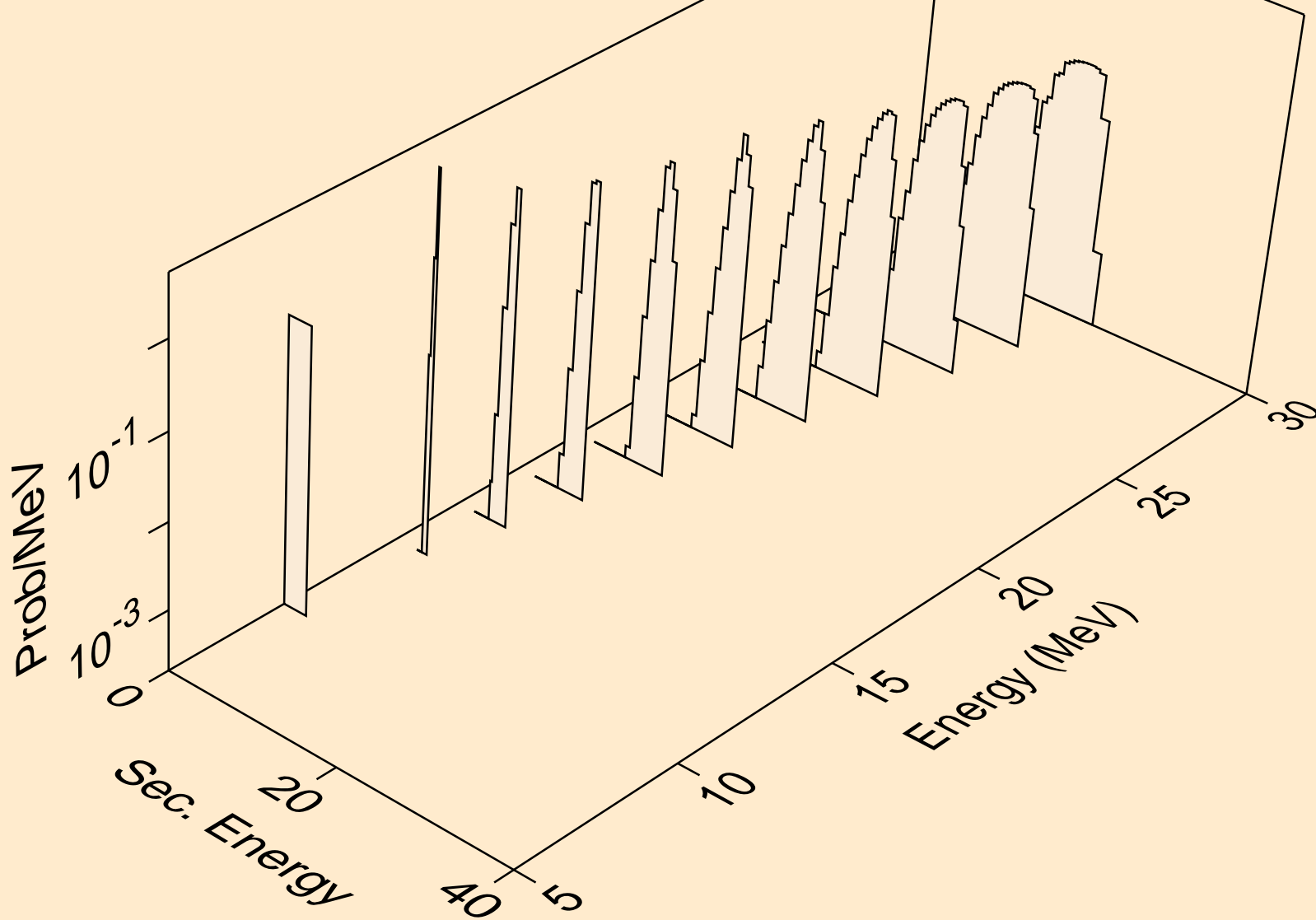

FM255 NEUTRON ACER TENDL-2019 LIBRARY; T=293.16K
tritons from (n,t)

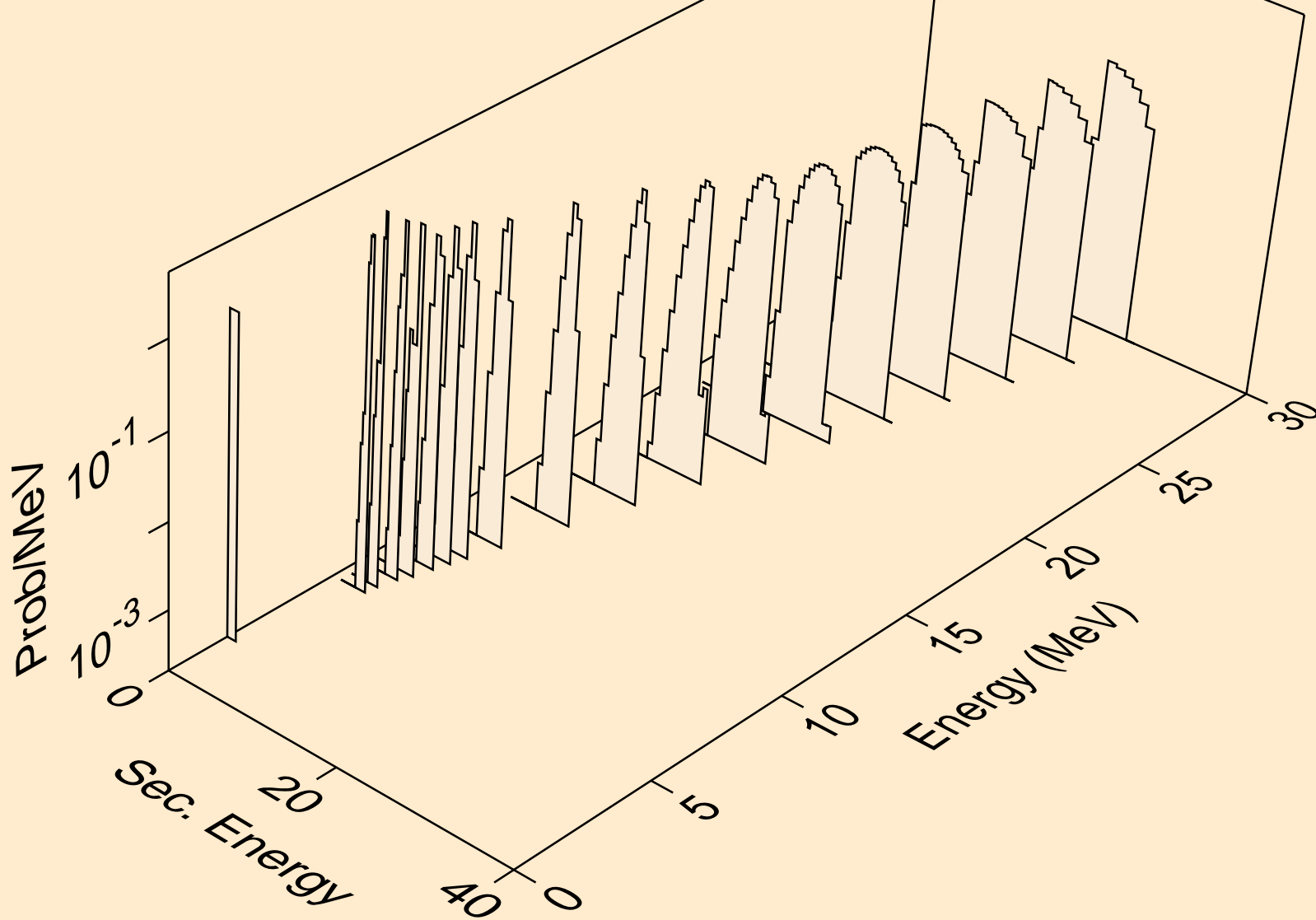

FM255 NEUTRON ACER TENDL-2019 LIBRARY; T=293.16K
he3s from (n,x)

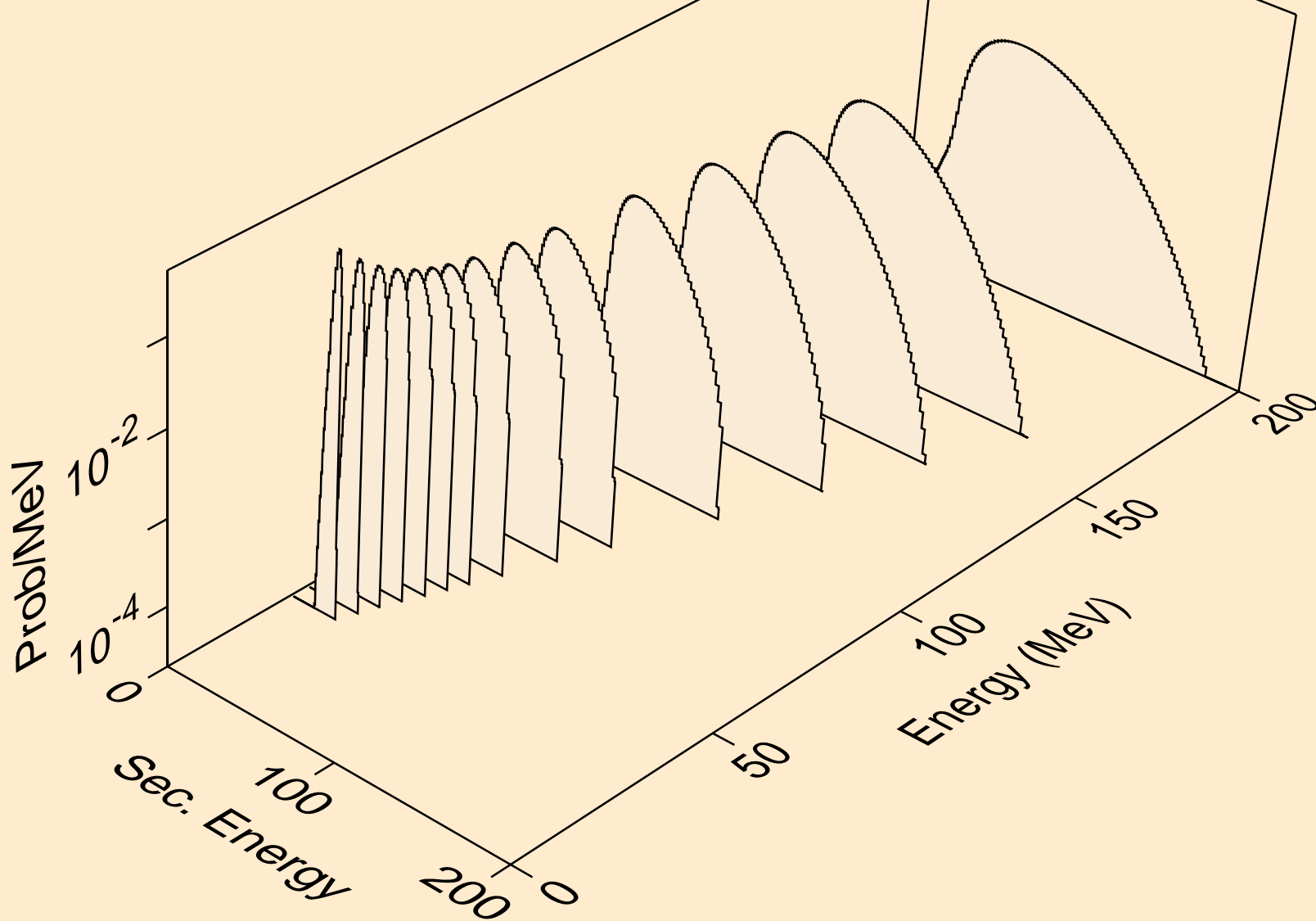

FM255 NEUTRON ACER TENDL-2019 LIBRARY; T=293.16K
he3s from (n,n*)he3

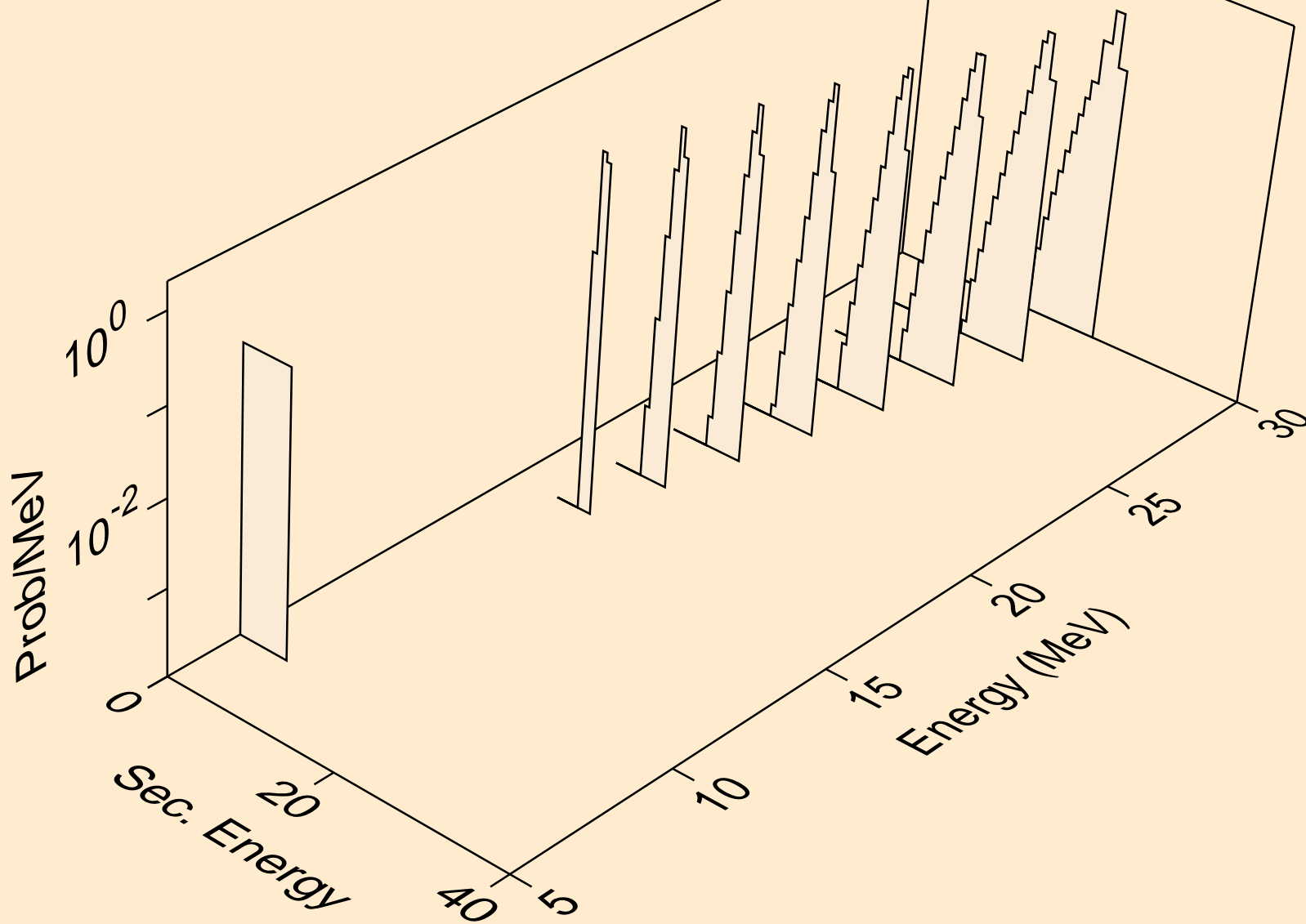

FM255 NEUTRON ACER TENDL-2019 LIBRARY; T=293.16K
he3s from (n,he3)

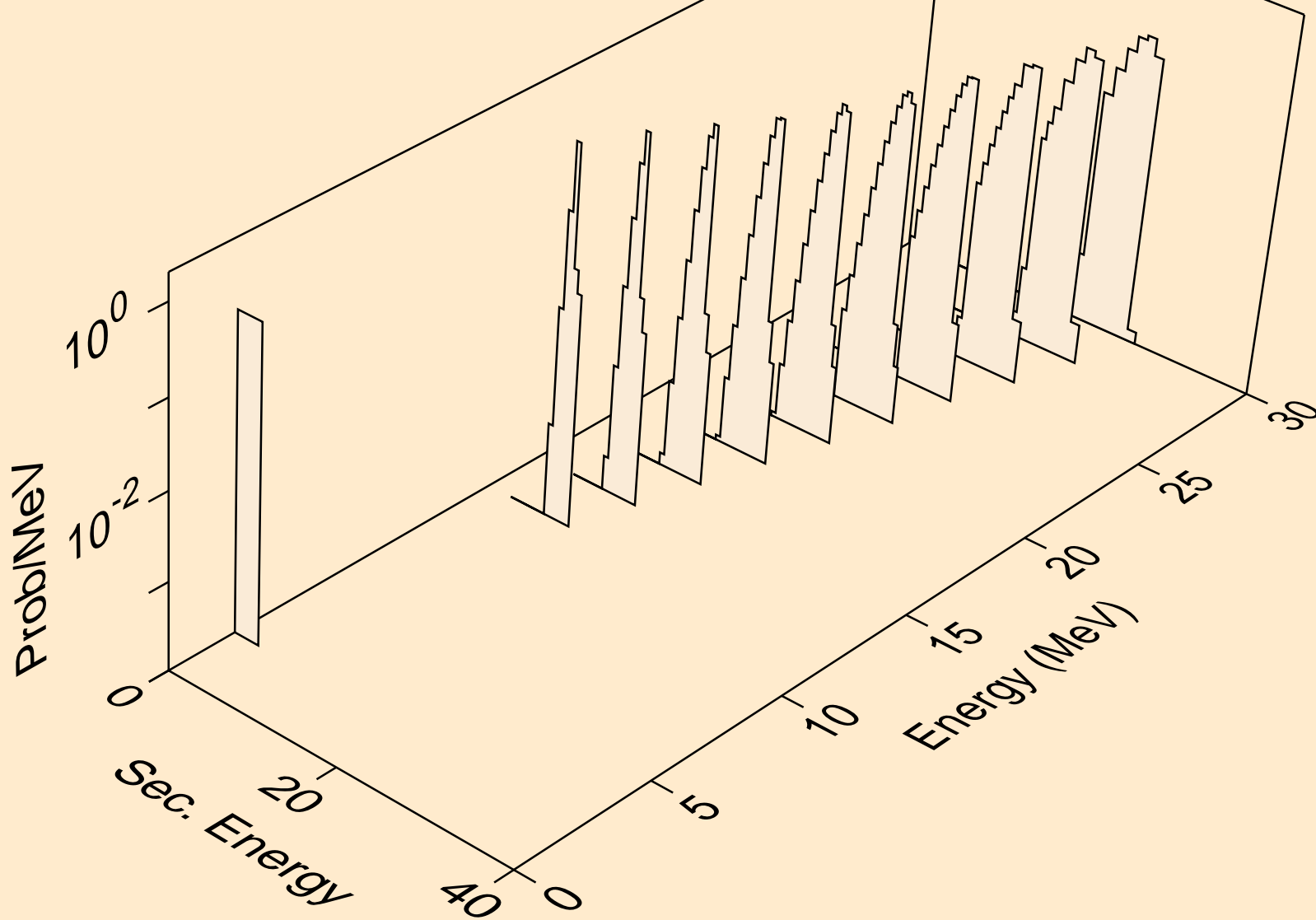

FM255 NEUTRON ACER TENDL-2019 LIBRARY; T=293.16K
alphas from (n,x)

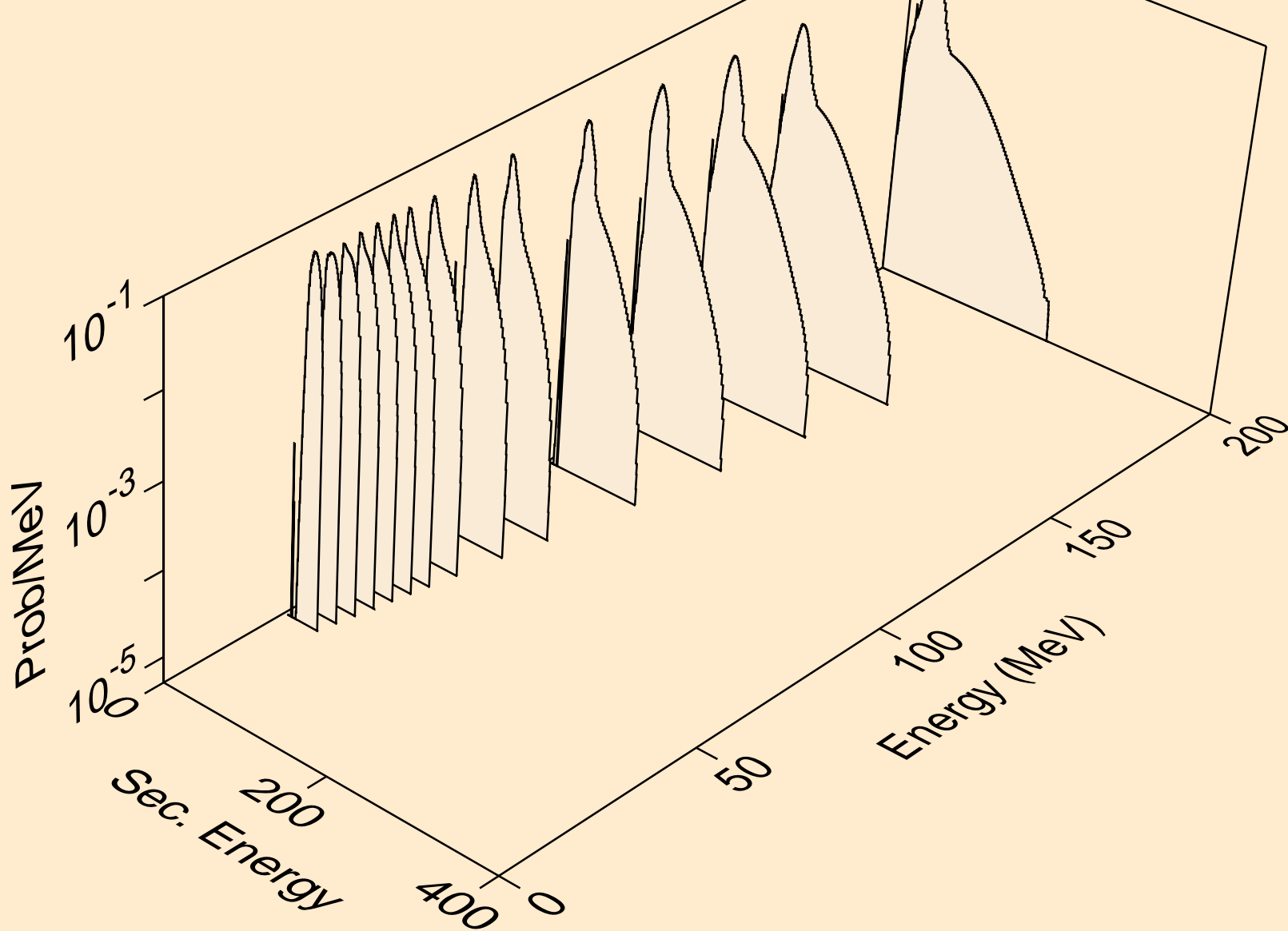

FM255 NEUTRON ACER TENDL-2019 LIBRARY; T=293.16K
alphas from (n,n*)a

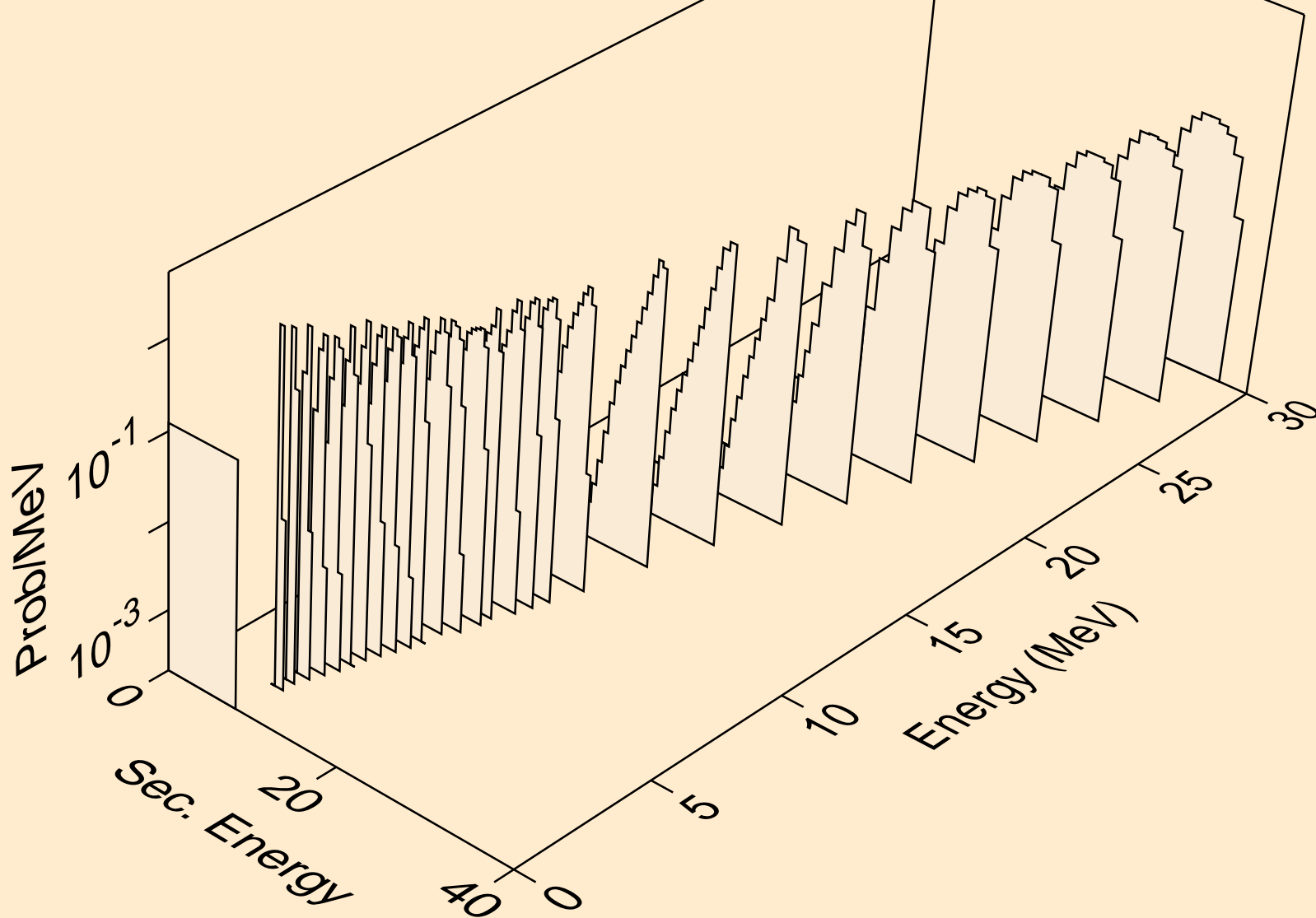

FM255 NEUTRON ACER TENDL-2019 LIBRARY; T=293.16K
alphas from (n,2n)a

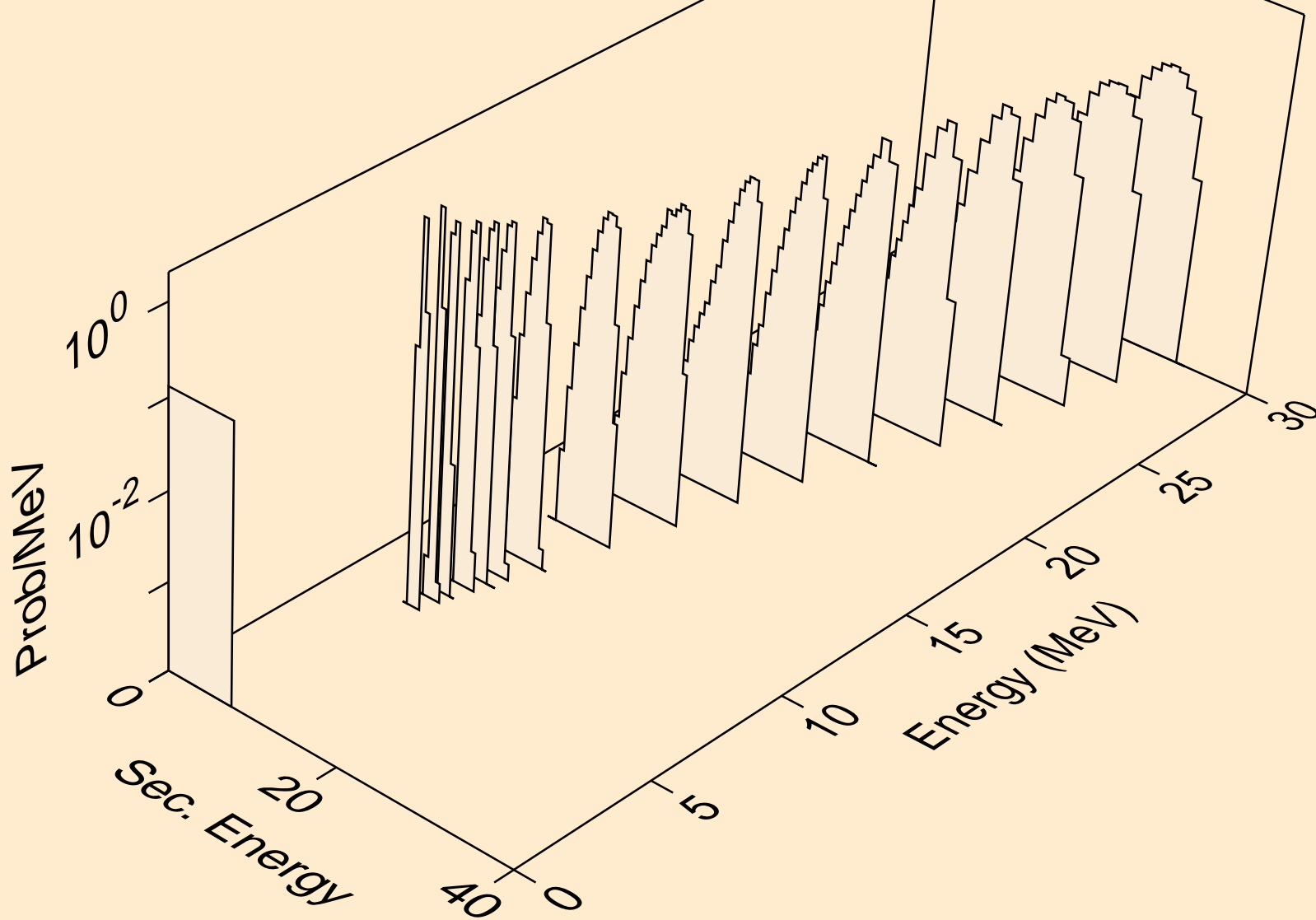

FM255 NEUTRON ACER TENDL-2019 LIBRARY; T=293.16K
alphas from (n,3n)a

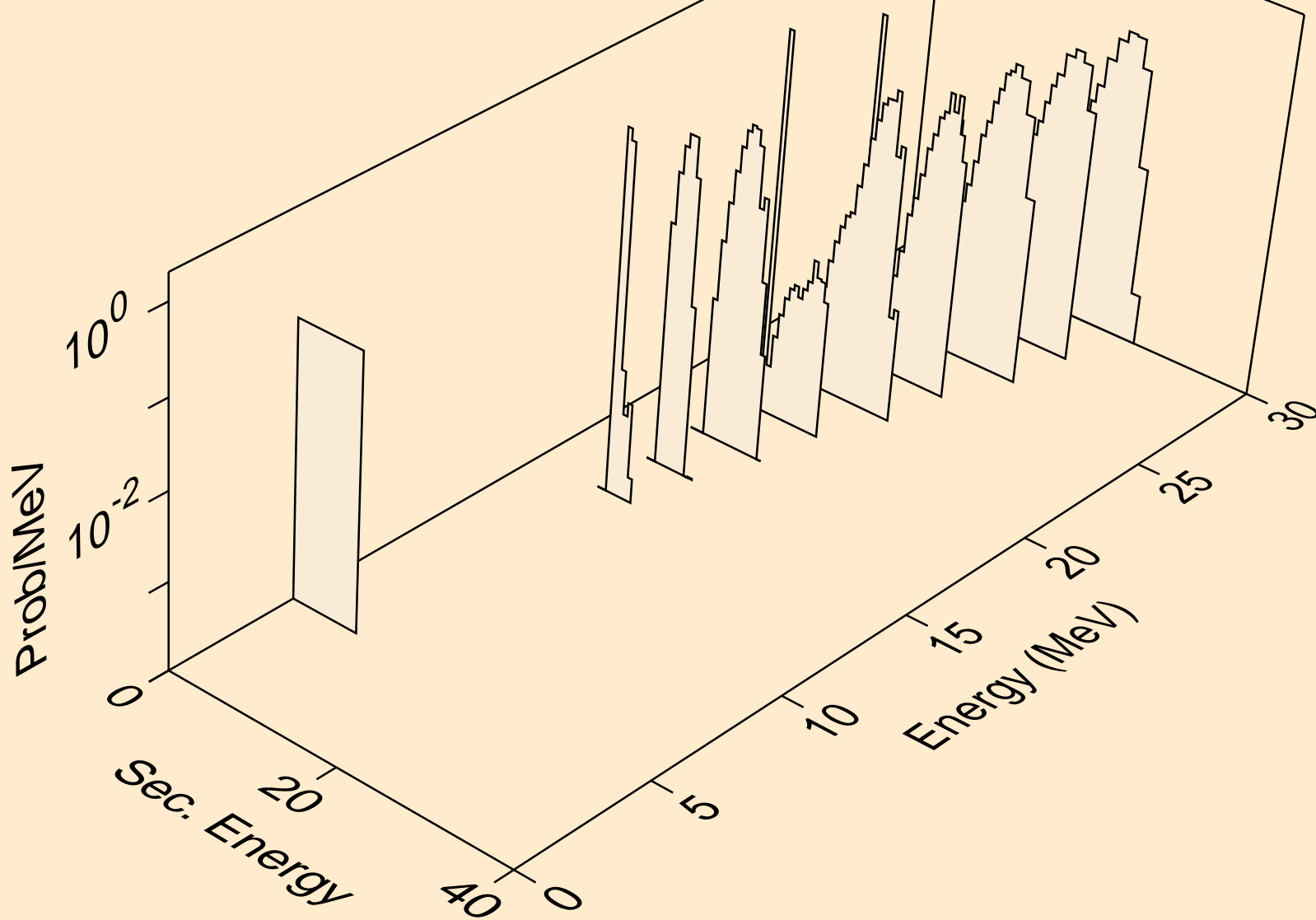

FM255 NEUTRON ACER TENDL-2019 LIBRARY; T=293.16K
alphas from (n,npa)

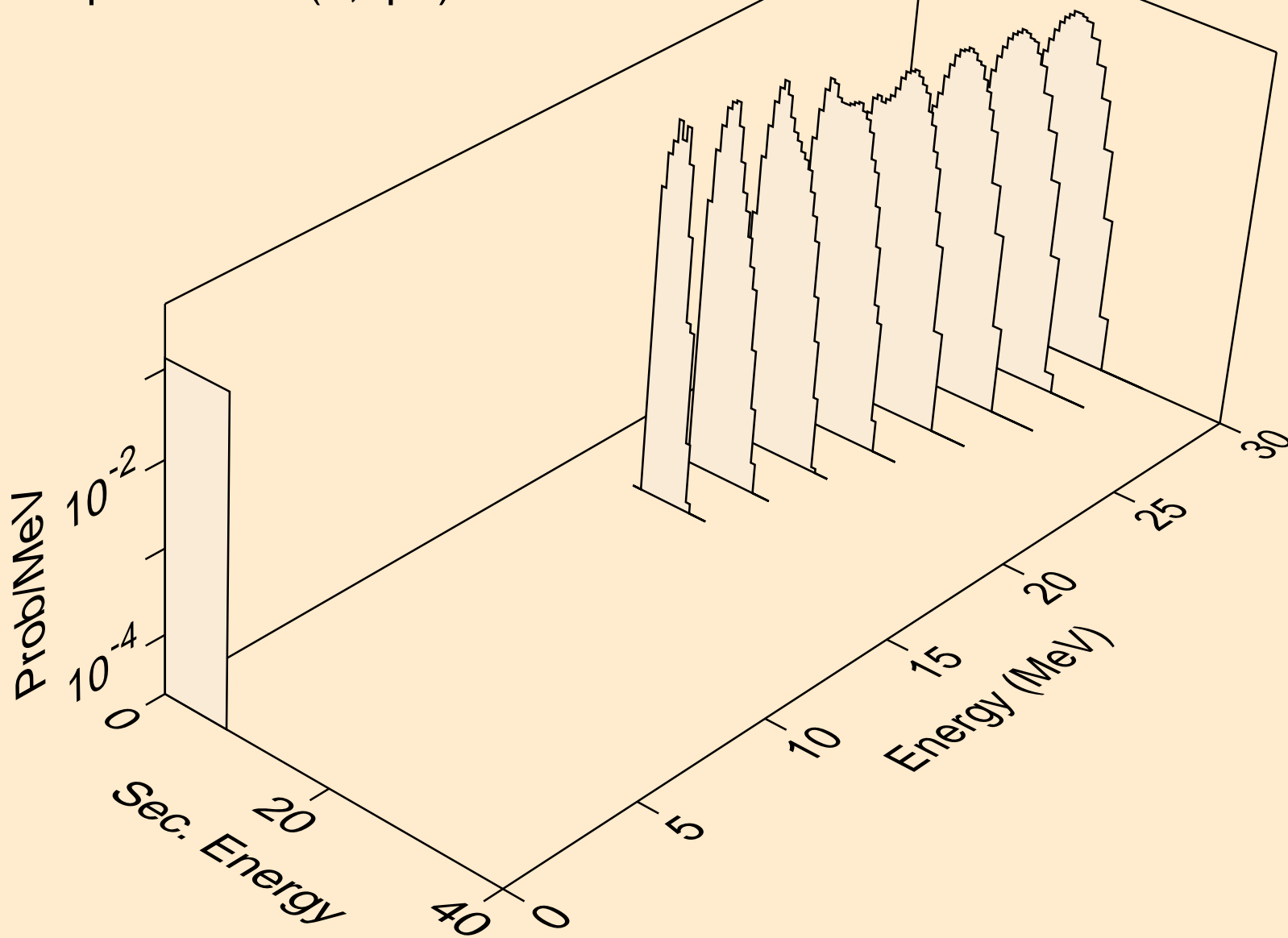

FM255 NEUTRON ACER TENDL-2019 LIBRARY; T=293.16K
alphas from (n,a)

