

FM257 NEUTRON ACER TENDL-2019 LIBRARY; T=293.16K
Principal cross sections

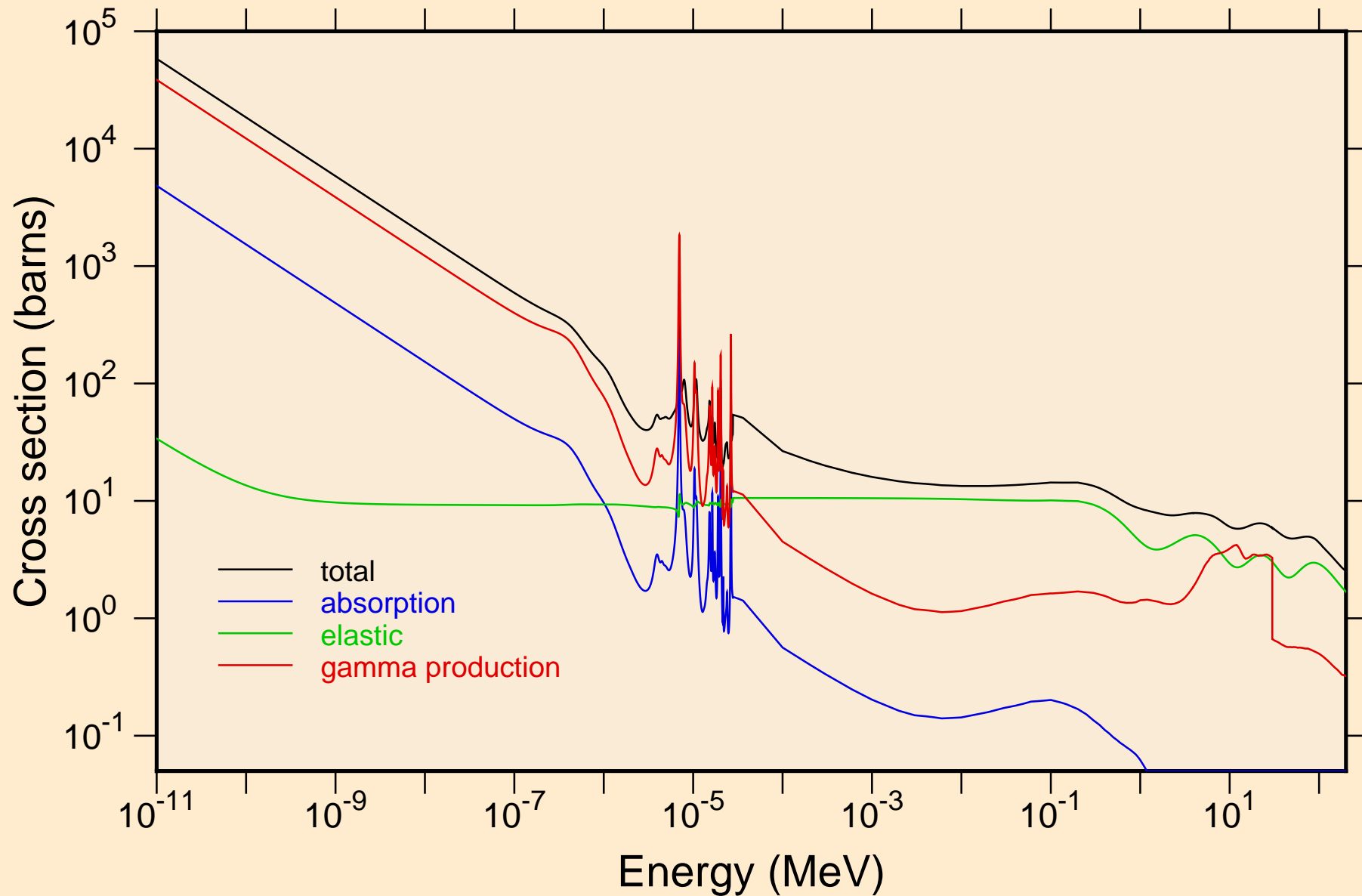

FM257 NEUTRON ACER TENDL-2019 LIBRARY; T=293.16K
resonance total cross section

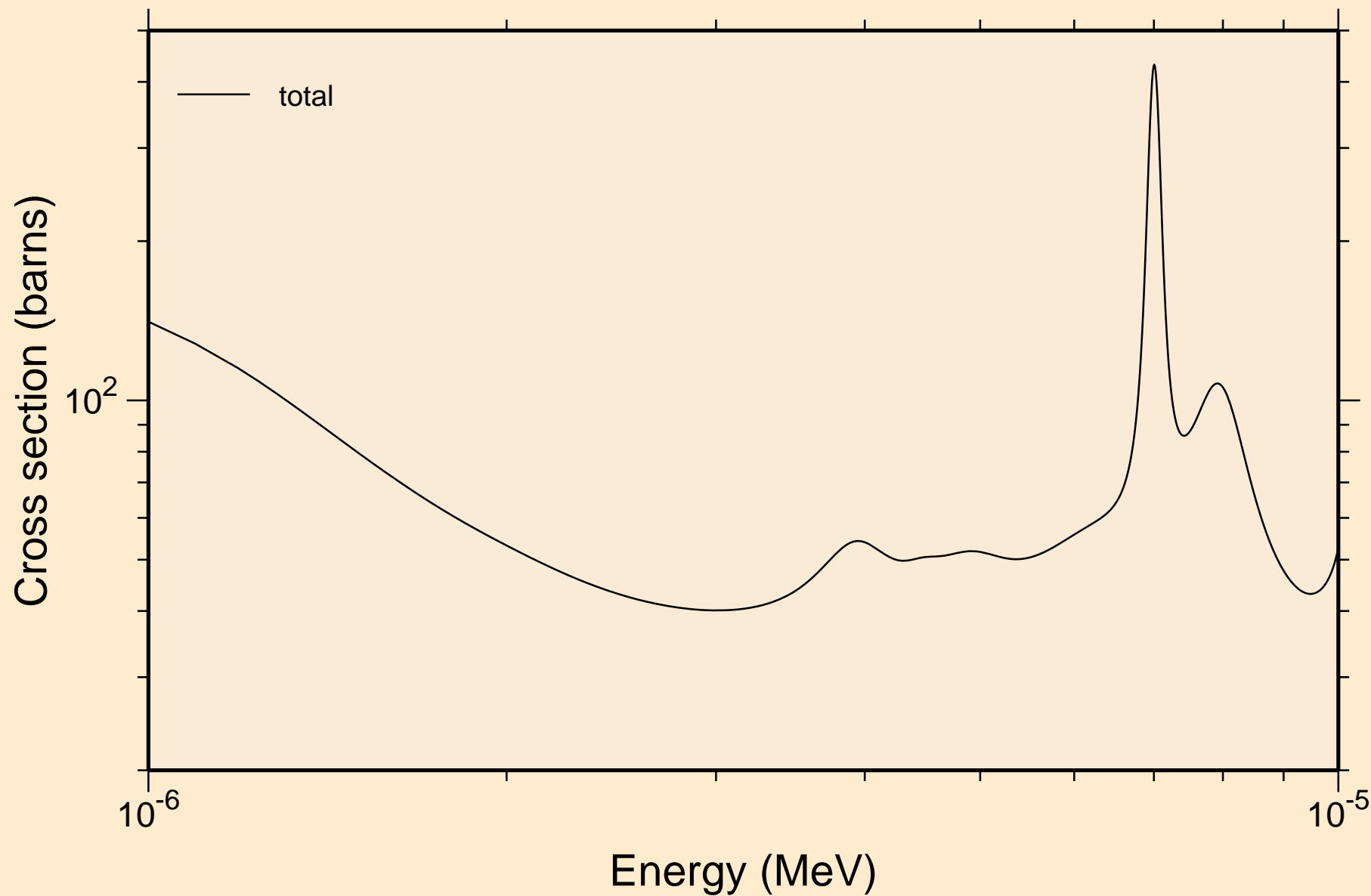

FM257 NEUTRON ACER TENDL-2019 LIBRARY; T=293.16K
resonance total cross section

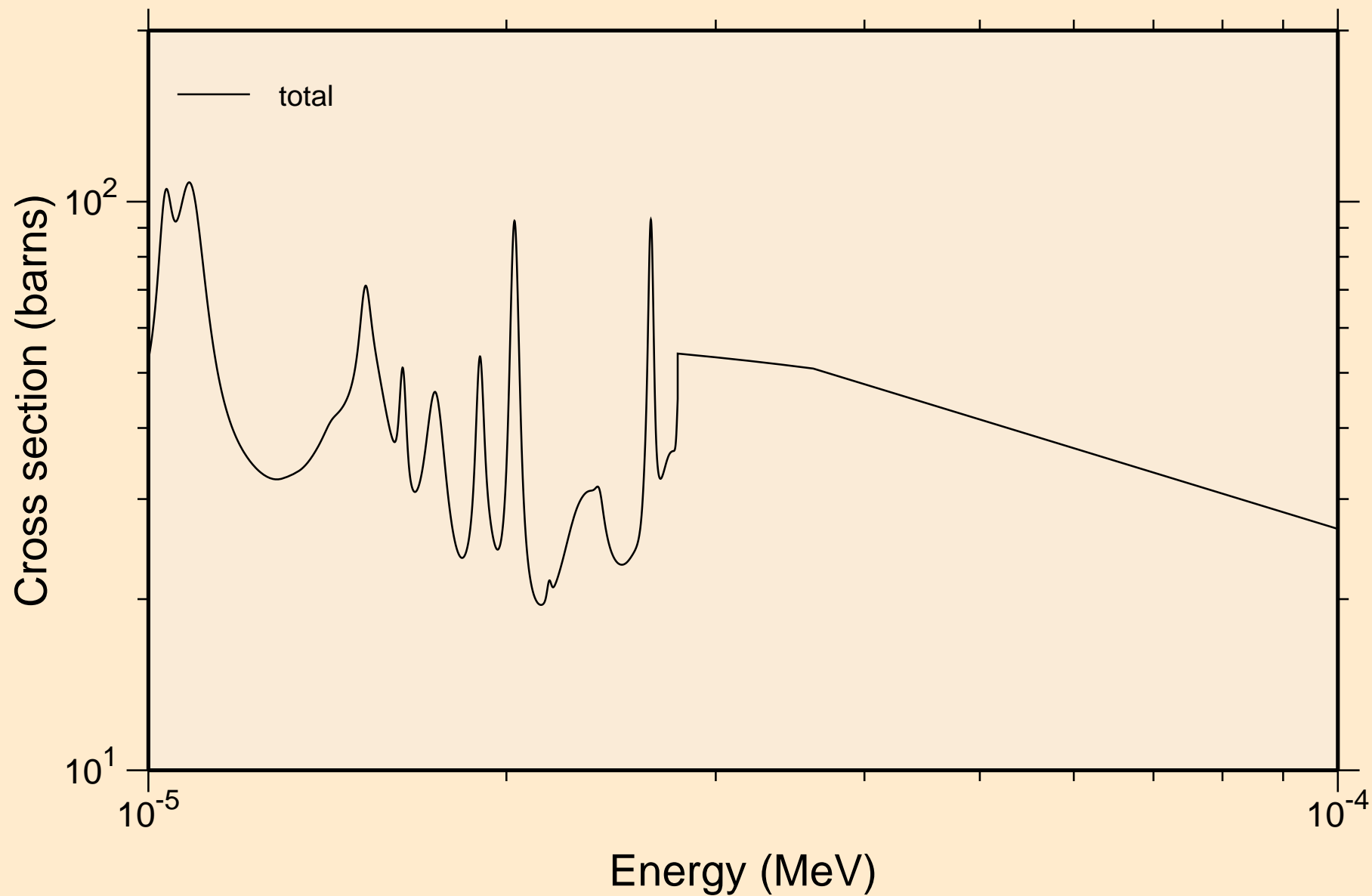

FM257 NEUTRON ACER TENDL-2019 LIBRARY; T=293.16K
resonance total cross section

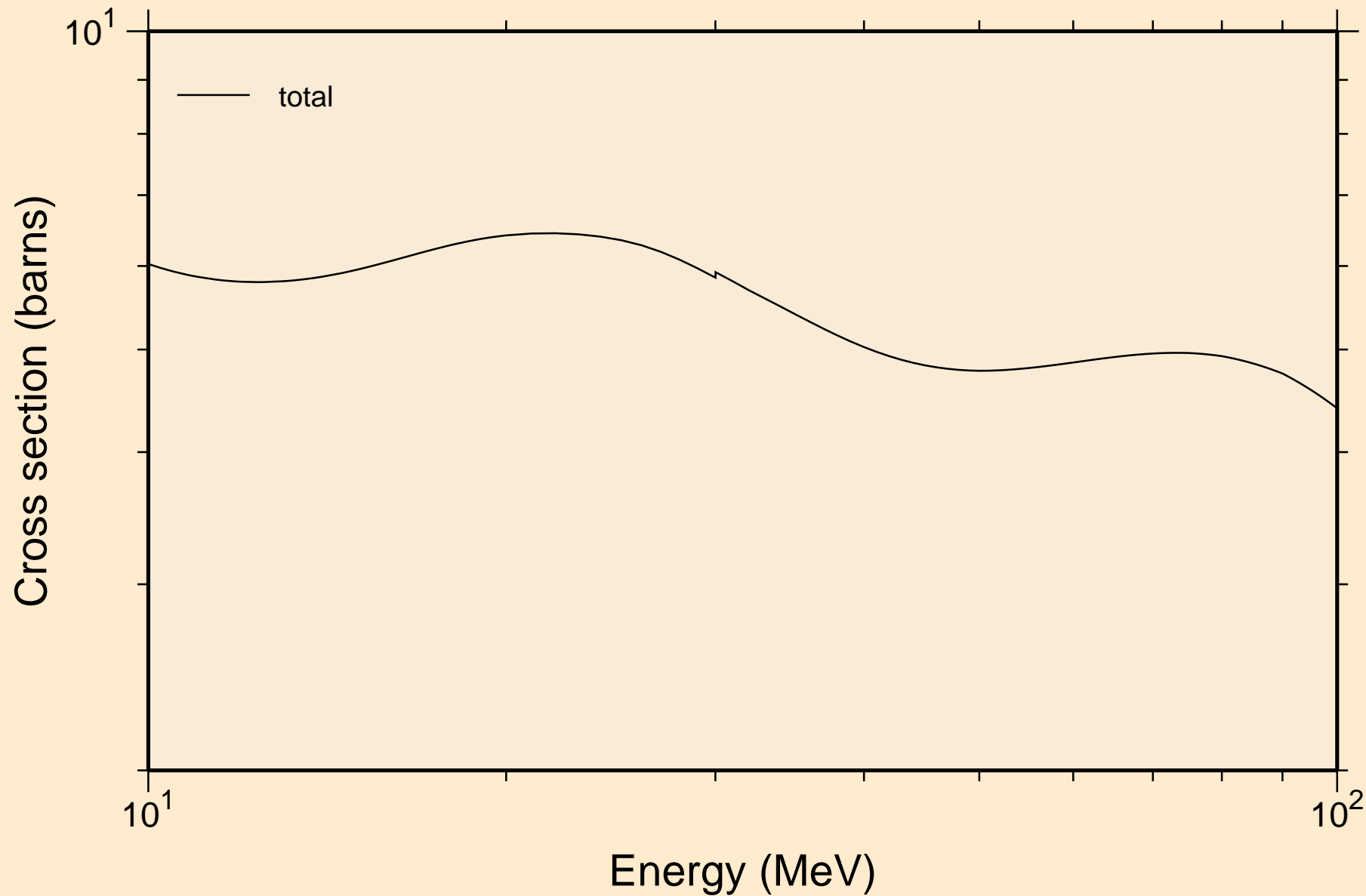

FM257 NEUTRON ACER TENDL-2019 LIBRARY; T=293.16K
resonance absorption cross sections

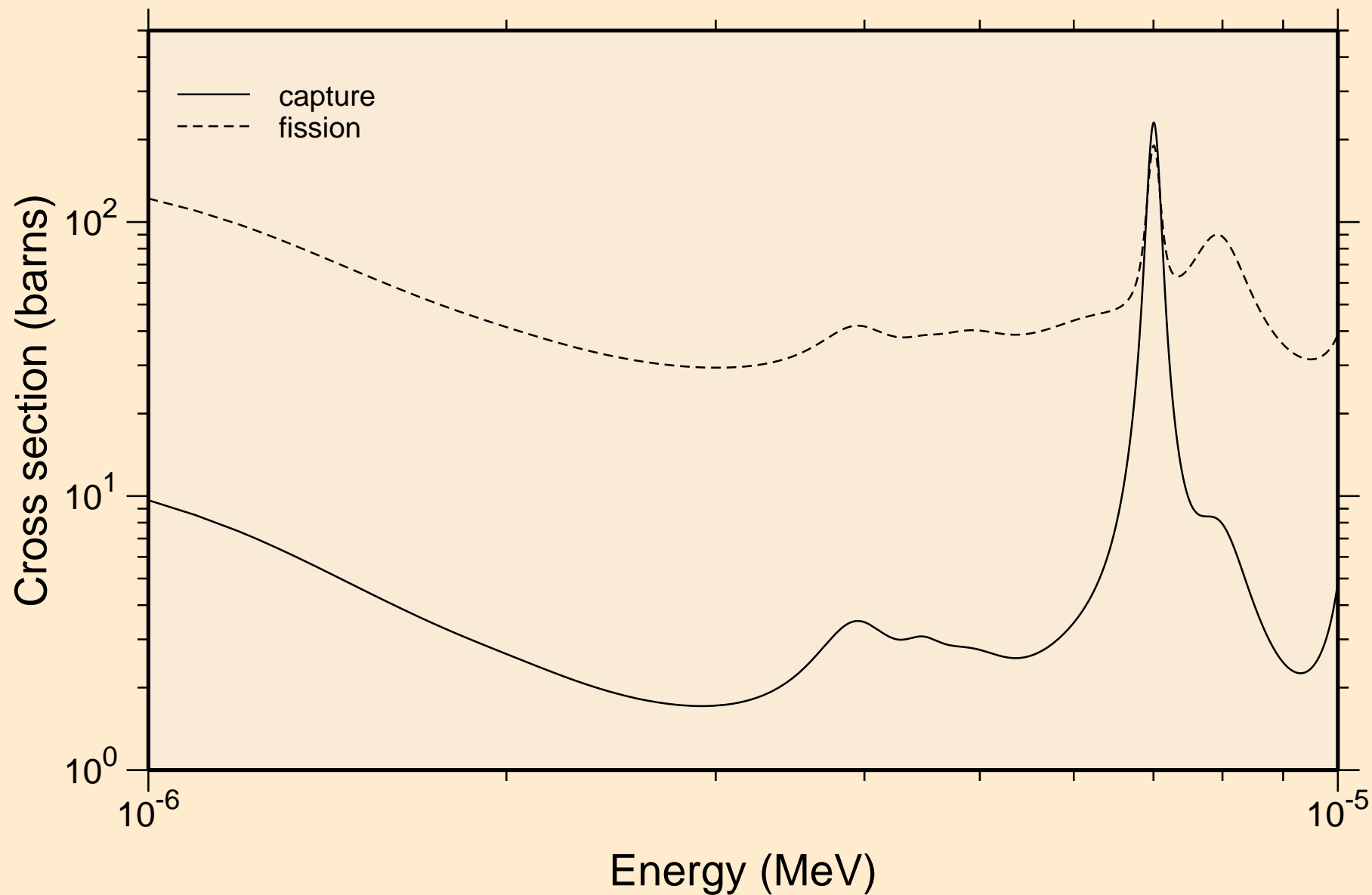

FM257 NEUTRON ACER TENDL-2019 LIBRARY; T=293.16K
resonance absorption cross sections

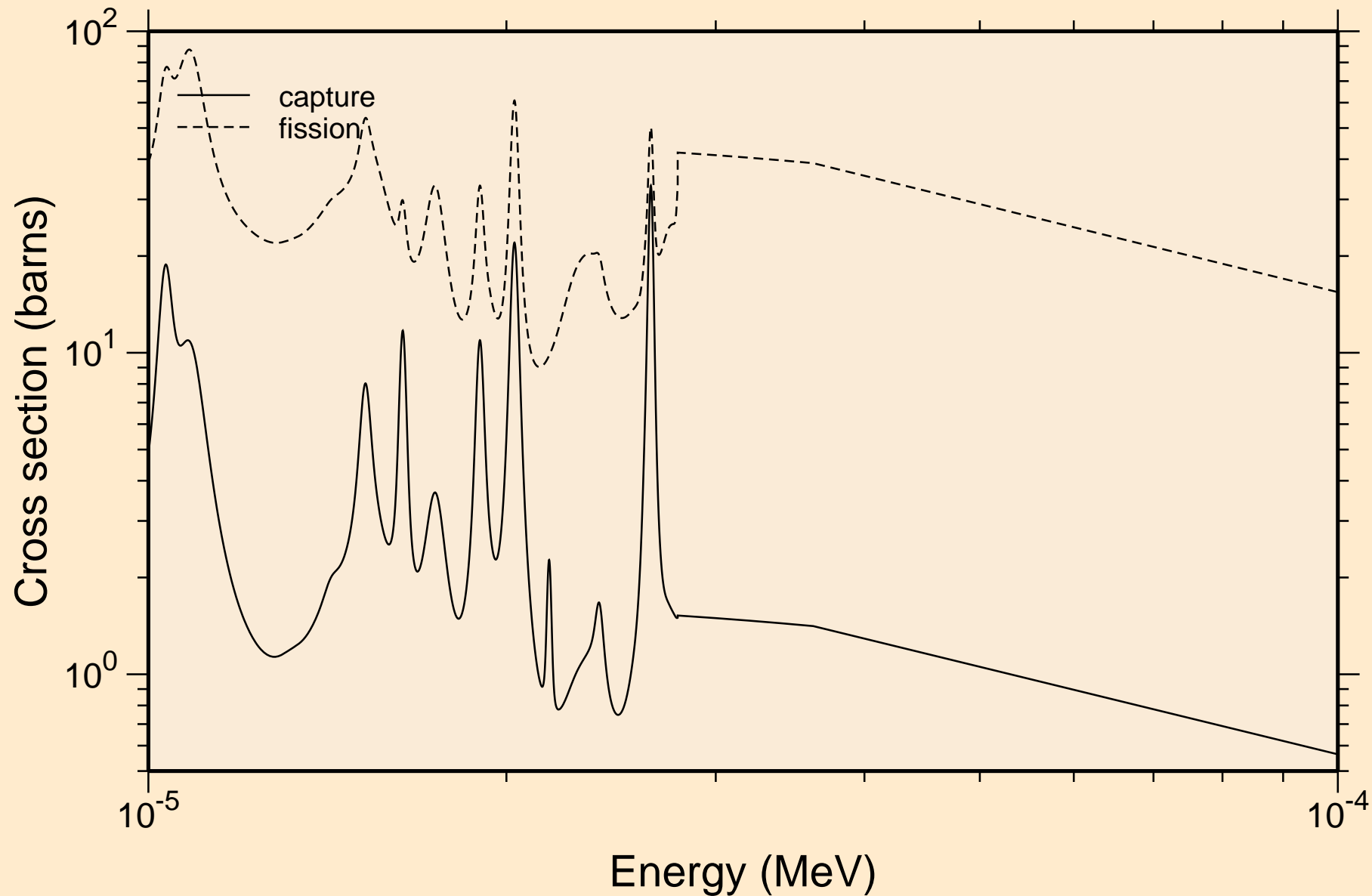

FM257 NEUTRON ACER TENDL-2019 LIBRARY; T=293.16K
resonance absorption cross sections

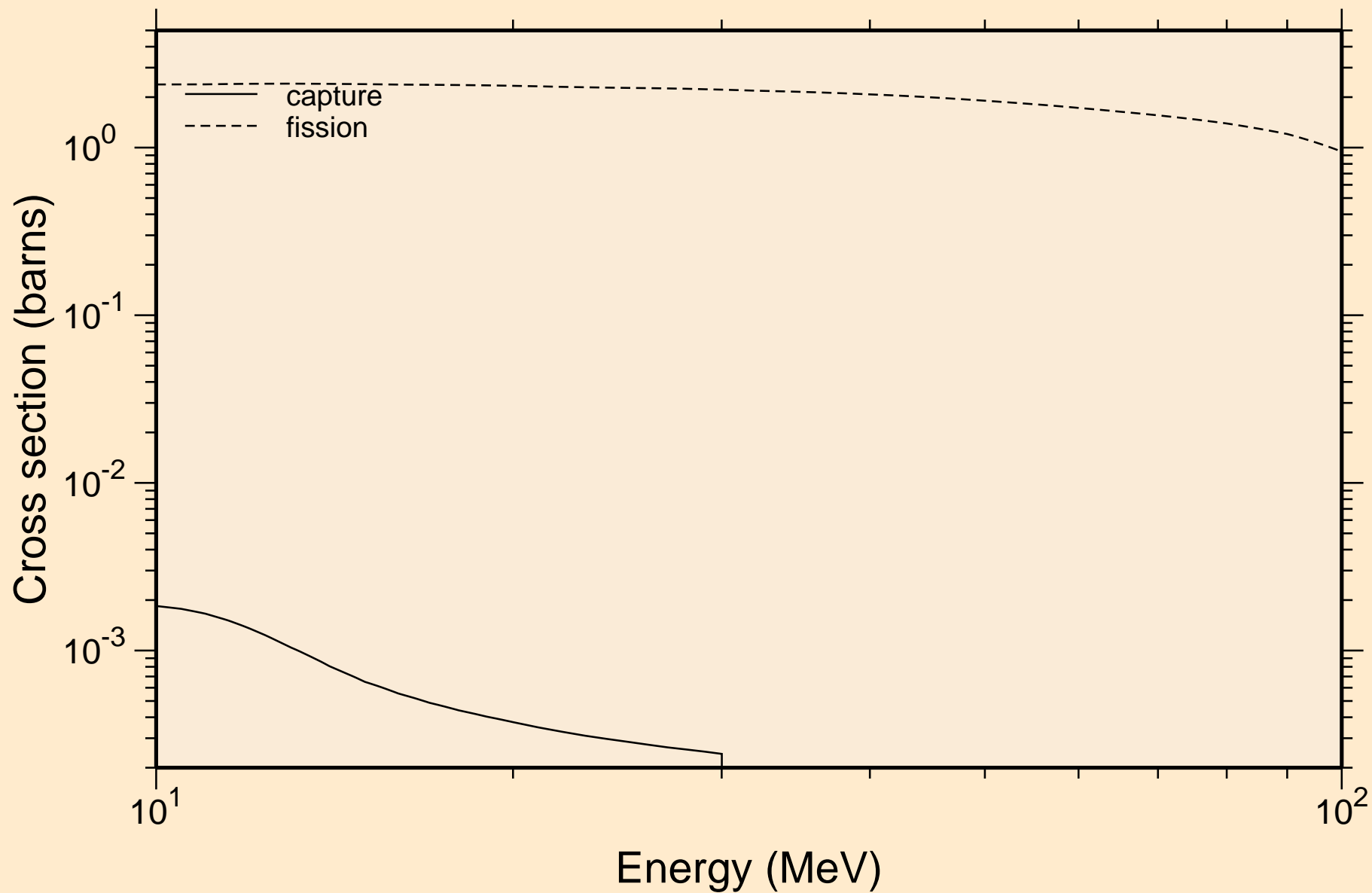

FM257 NEUTRON ACER TENDL-2019 LIBRARY; T=293.16K
Heating

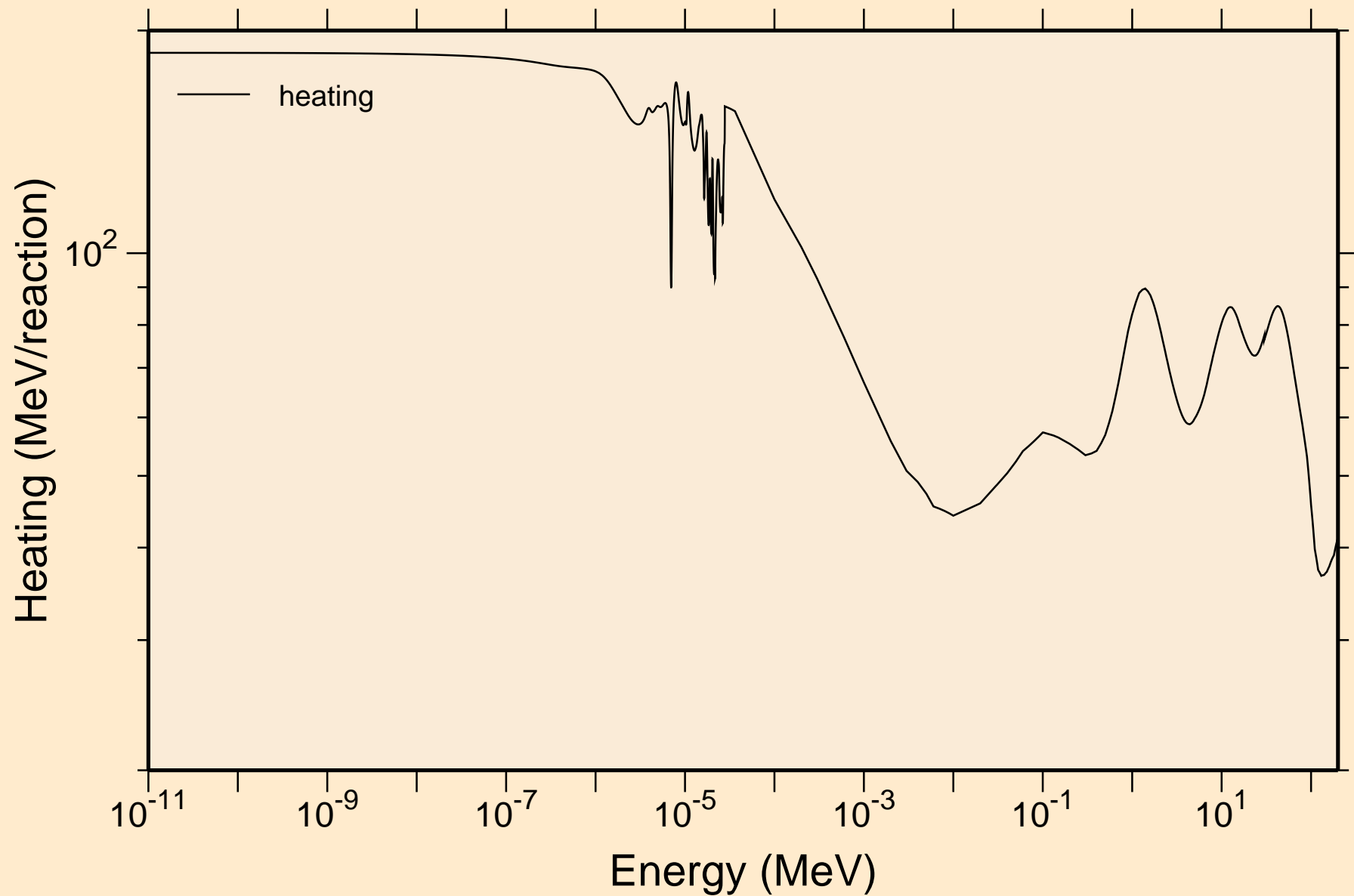

FM257 NEUTRON ACER TENDL-2019 LIBRARY; T=293.16K
Damage

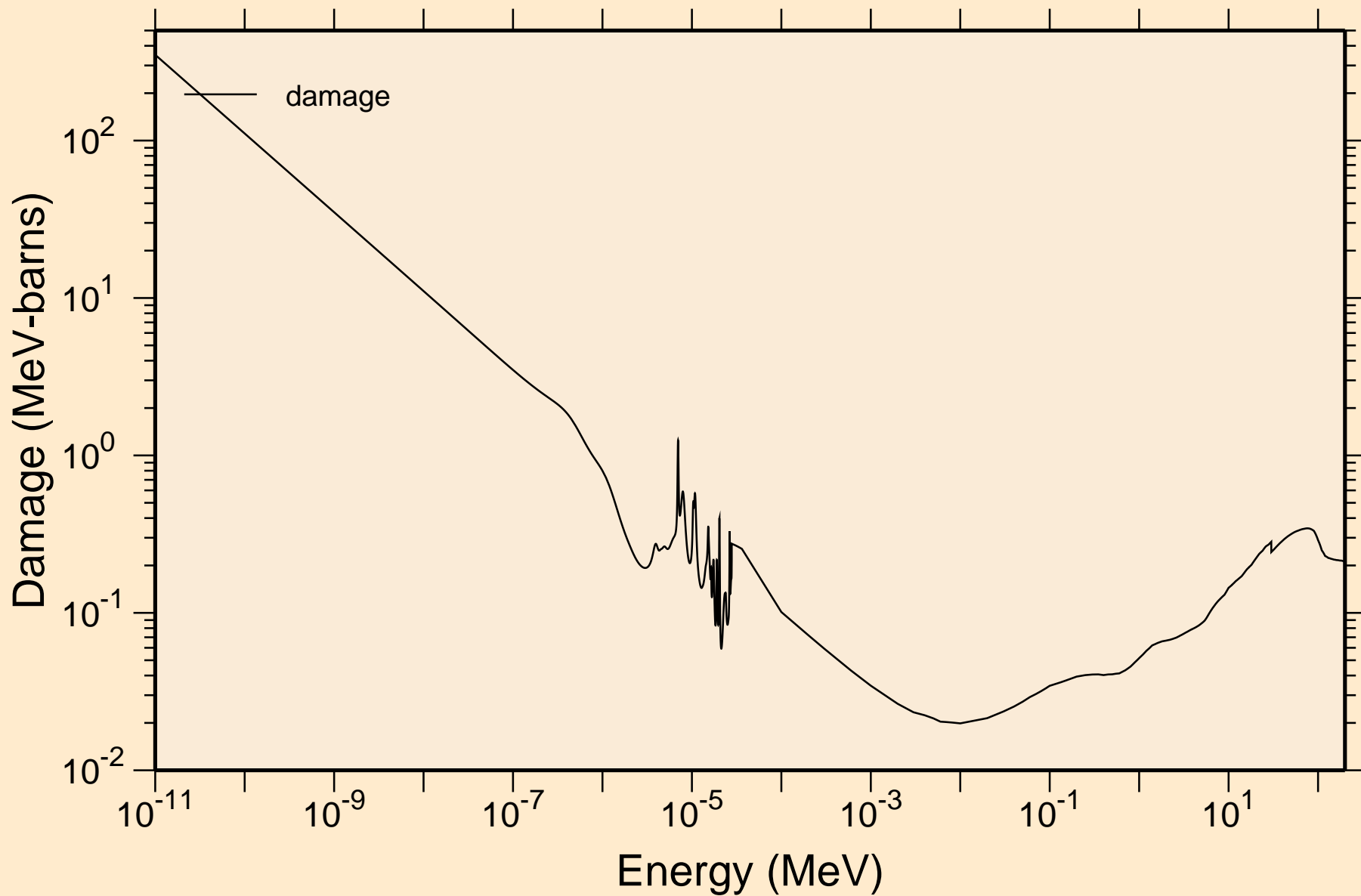

FM257 NEUTRON ACER TENDL-2019 LIBRARY; T=293.16K
Non-threshold reactions

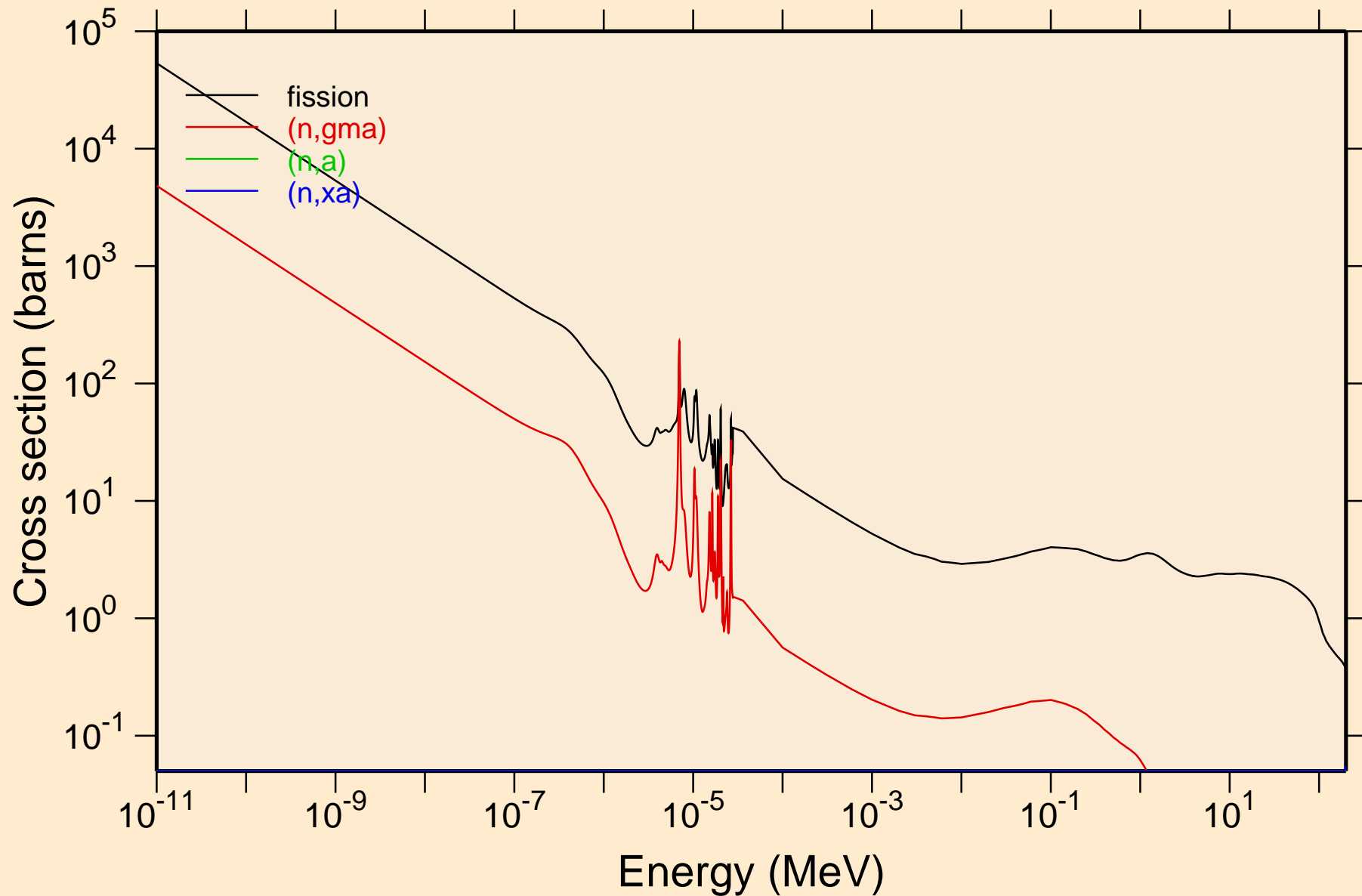

FM257 NEUTRON ACER TENDL-2019 LIBRARY; T=293.16K

Principal cross sections

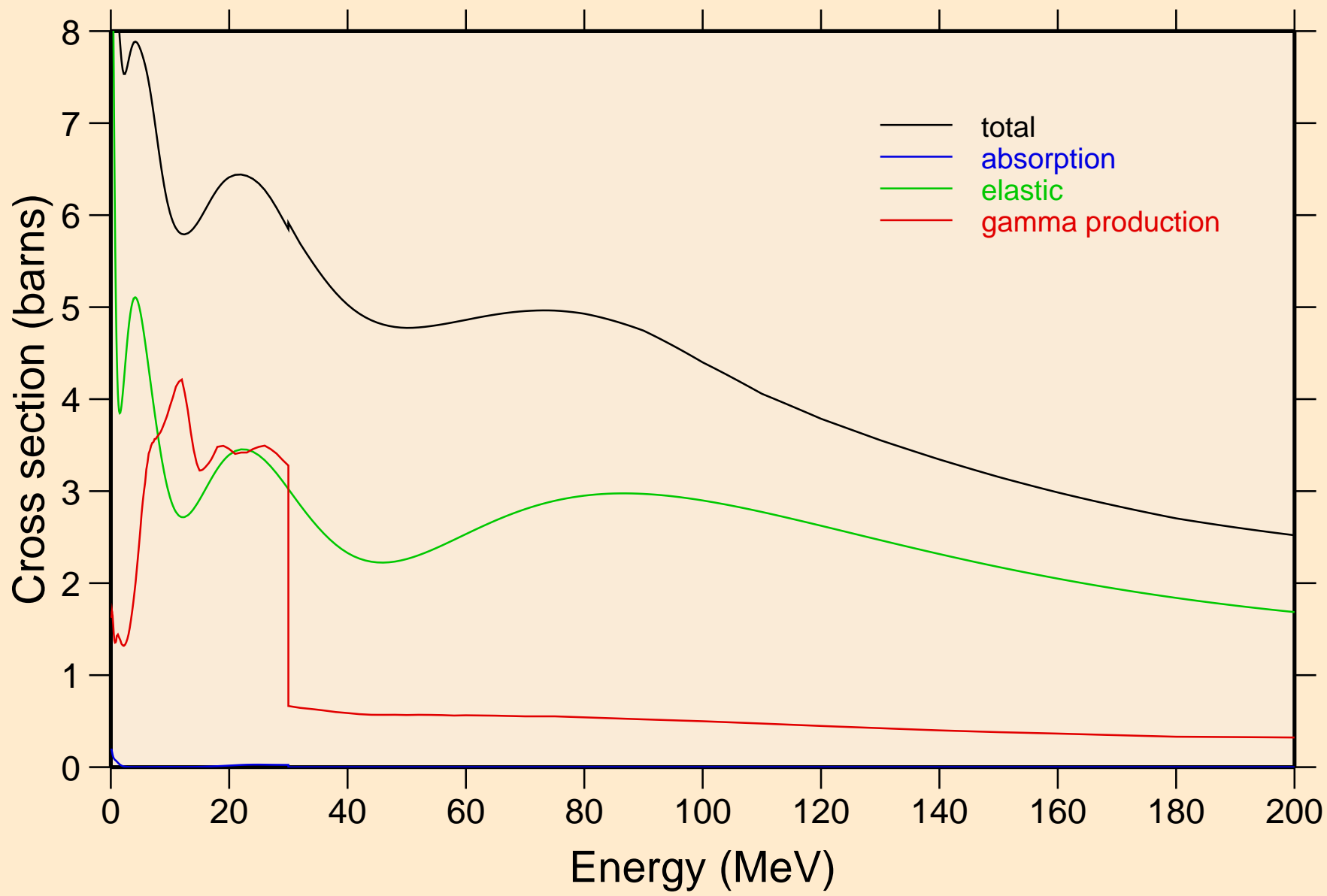

FM257 NEUTRON ACER TENDL-2019 LIBRARY; T=293.16K
Heating

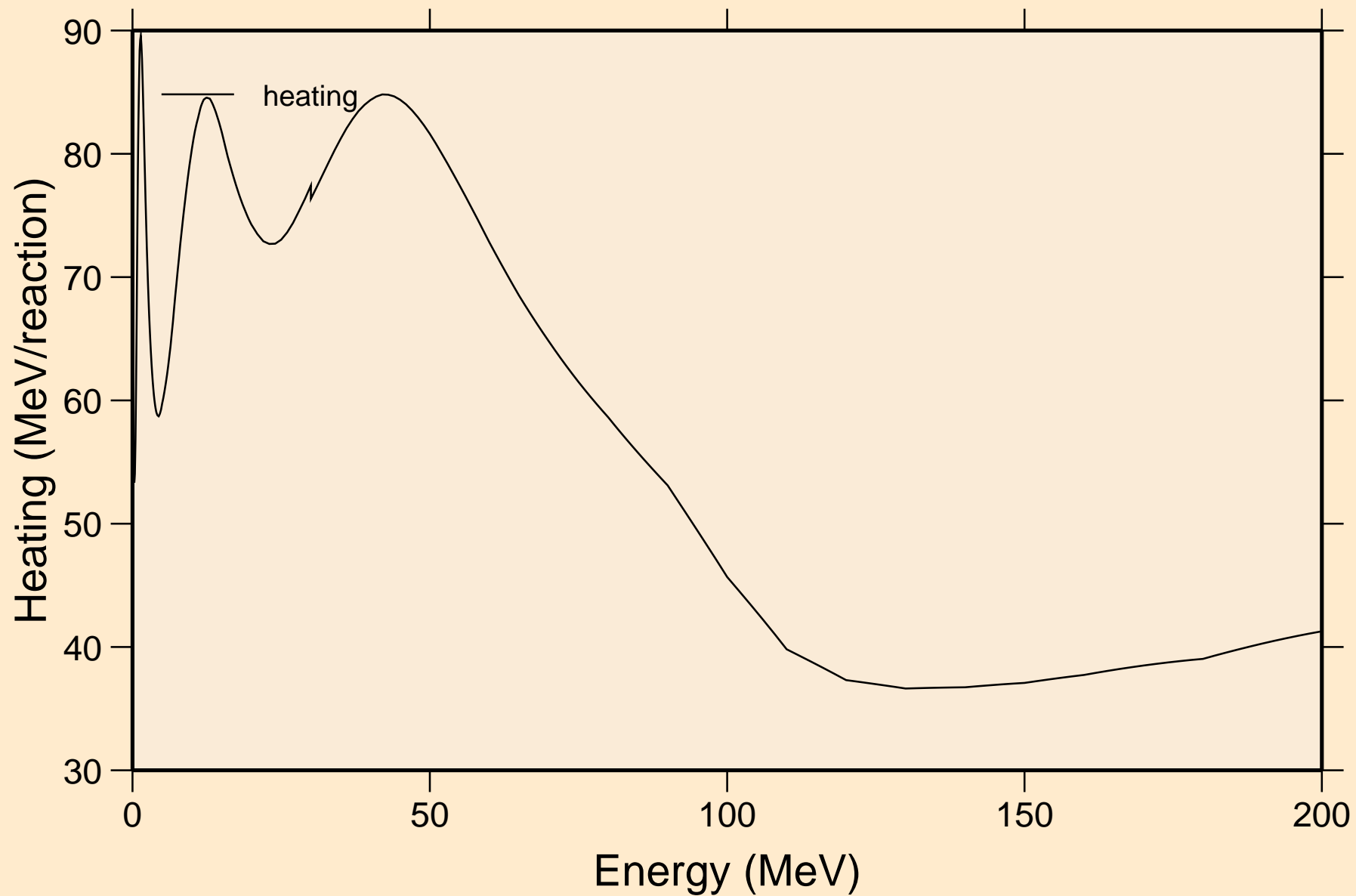

FM257 NEUTRON ACER TENDL-2019 LIBRARY; T=293.16K
Damage

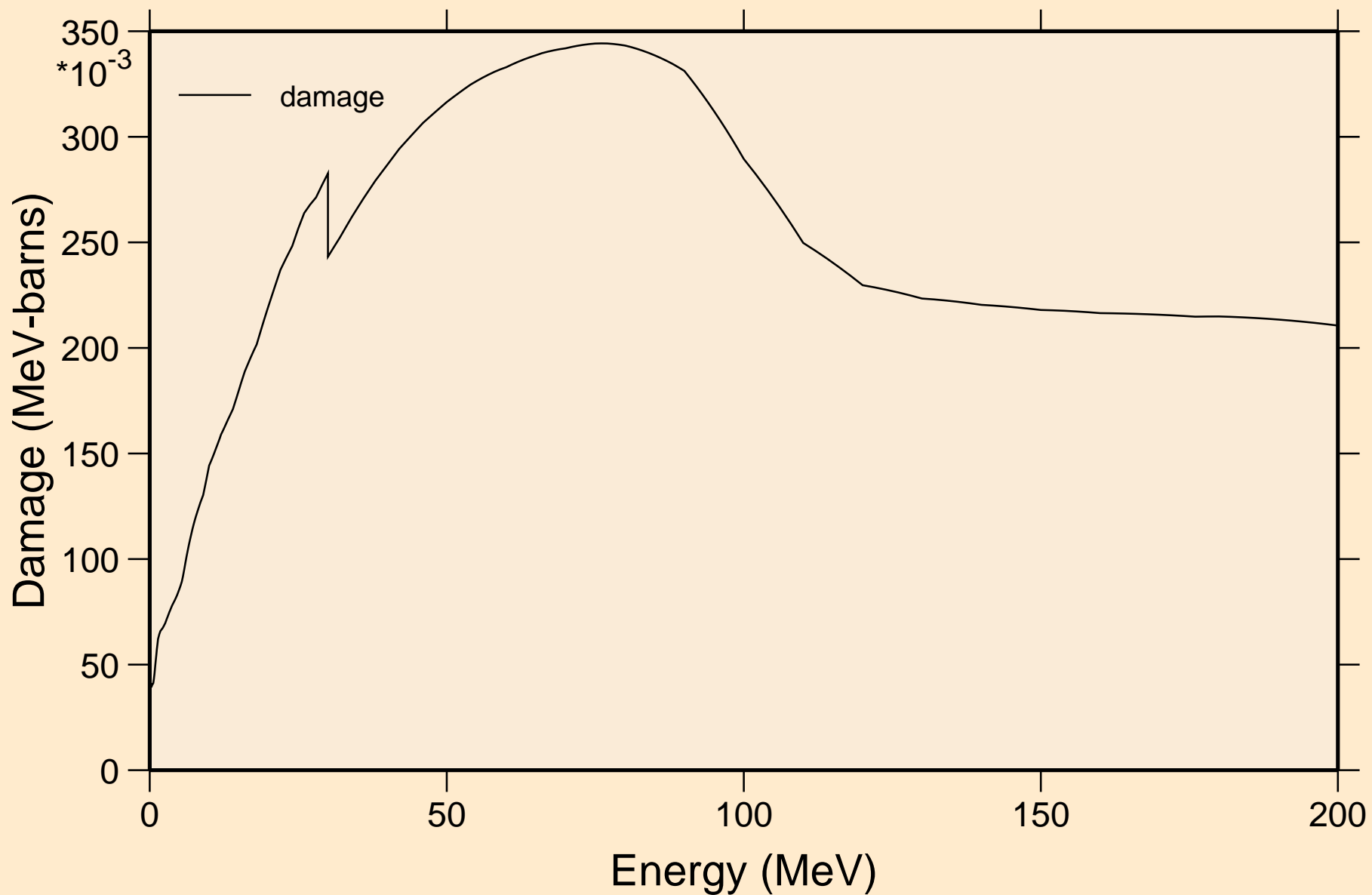

FM257 NEUTRON ACER TENDL-2019 LIBRARY; T=293.16K
Non-threshold reactions

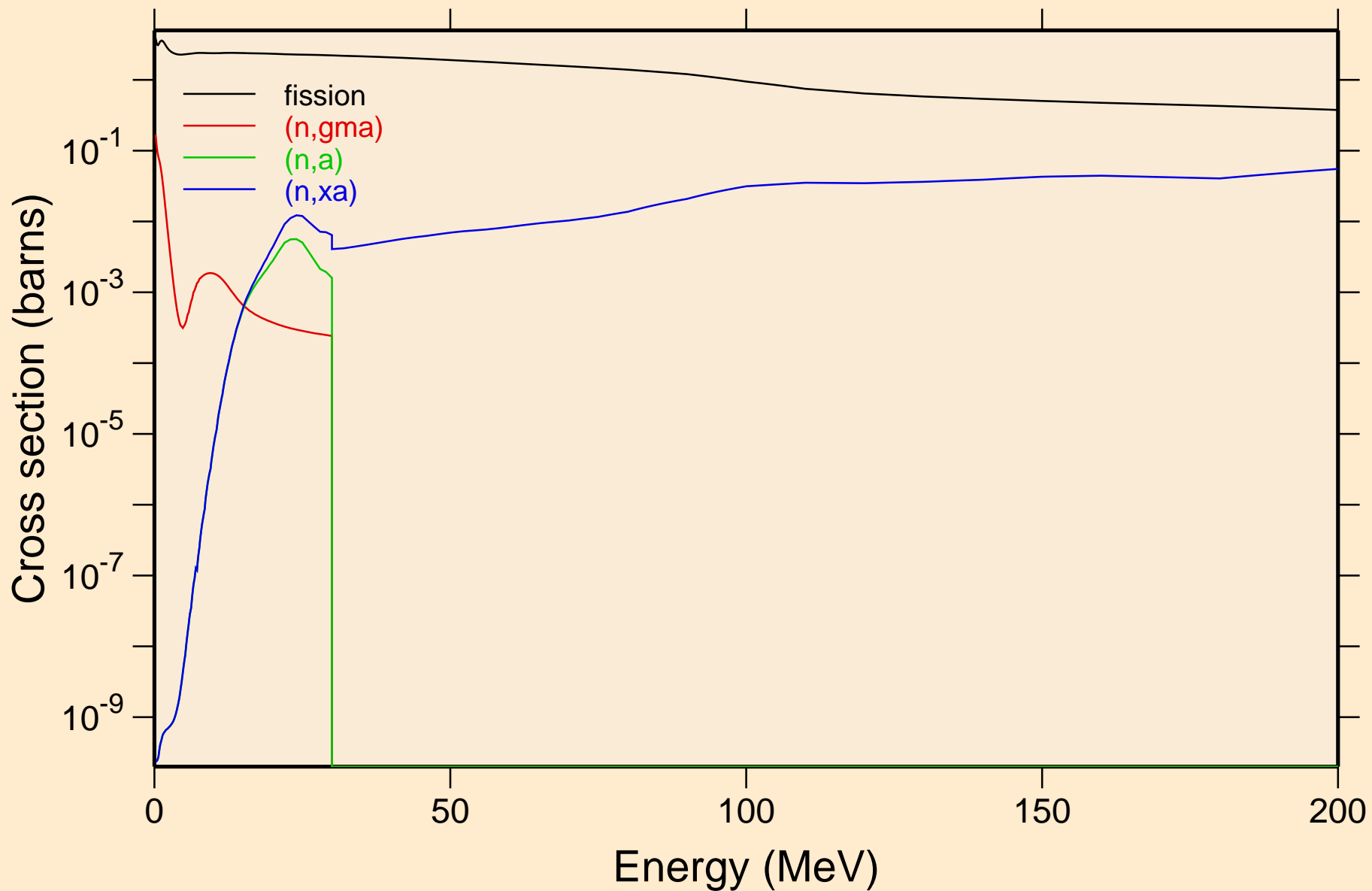

FM257 NEUTRON ACER TENDL-2019 LIBRARY; T=293.16K
Inelastic levels

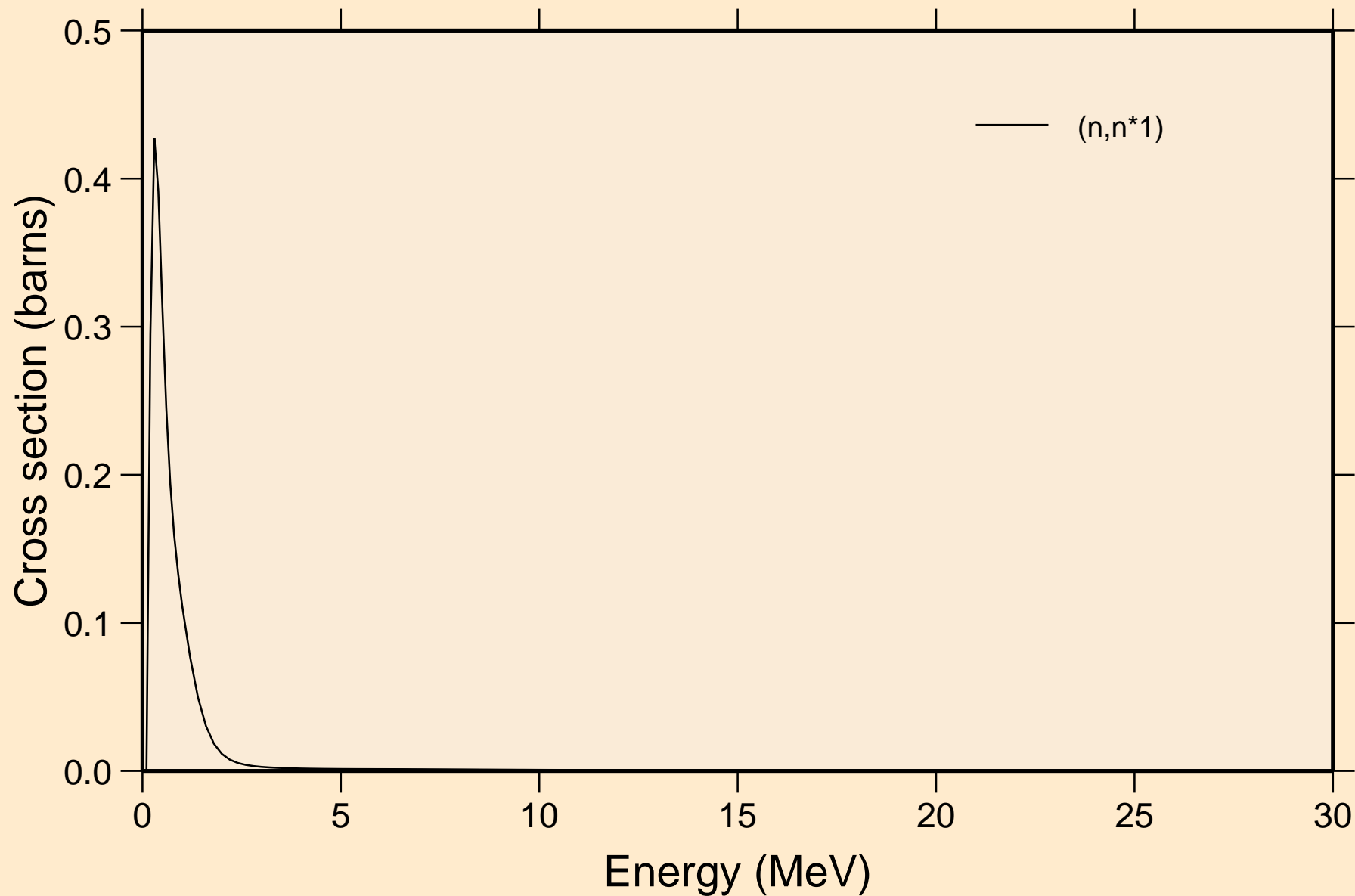

FM257 NEUTRON ACER TENDL-2019 LIBRARY; T=293.16K
Threshold reactions

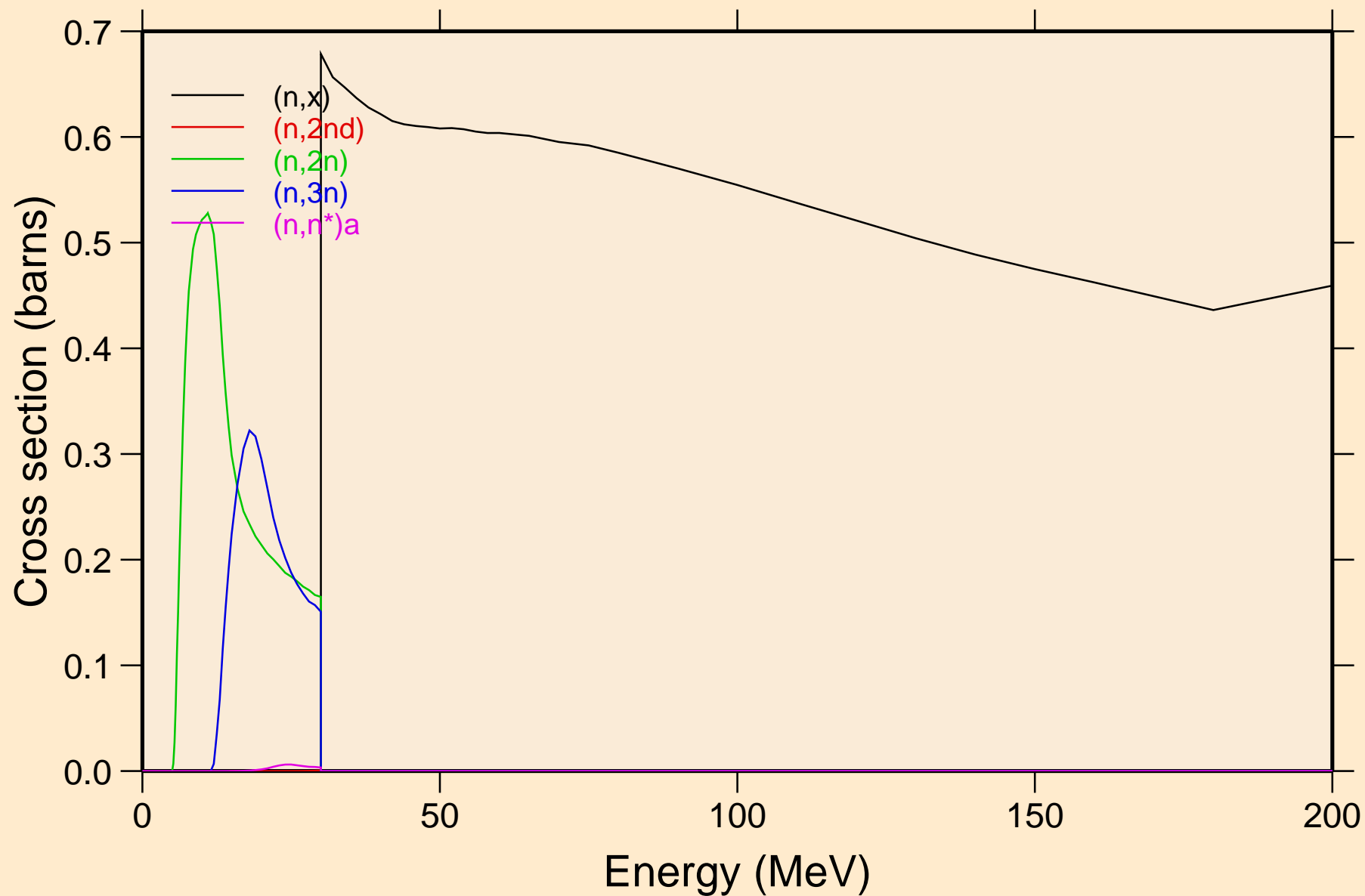

FM257 NEUTRON ACER TENDL-2019 LIBRARY; T=293.16K
Threshold reactions

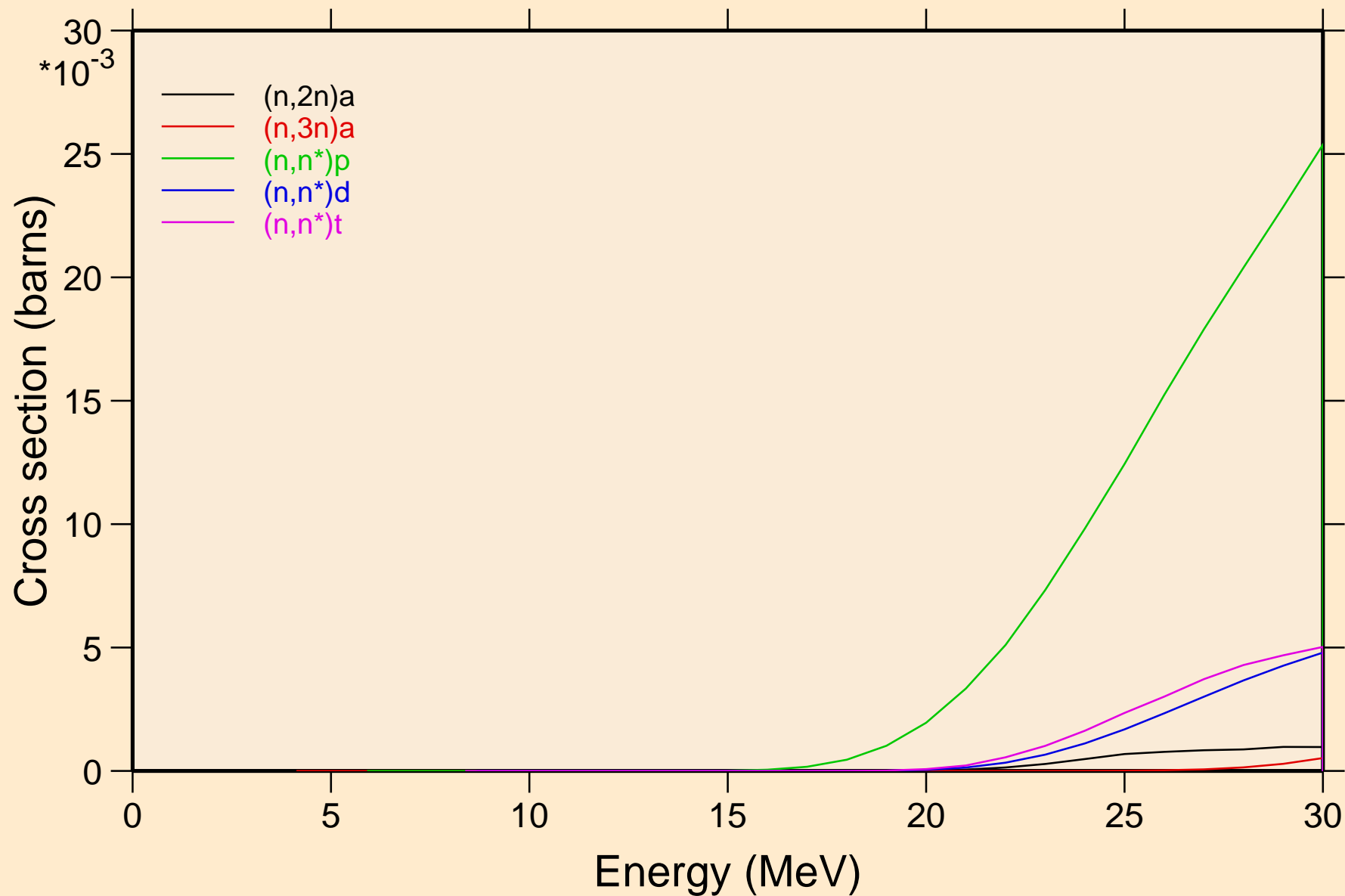

FM257 NEUTRON ACER TENDL-2019 LIBRARY; T=293.16K
Threshold reactions

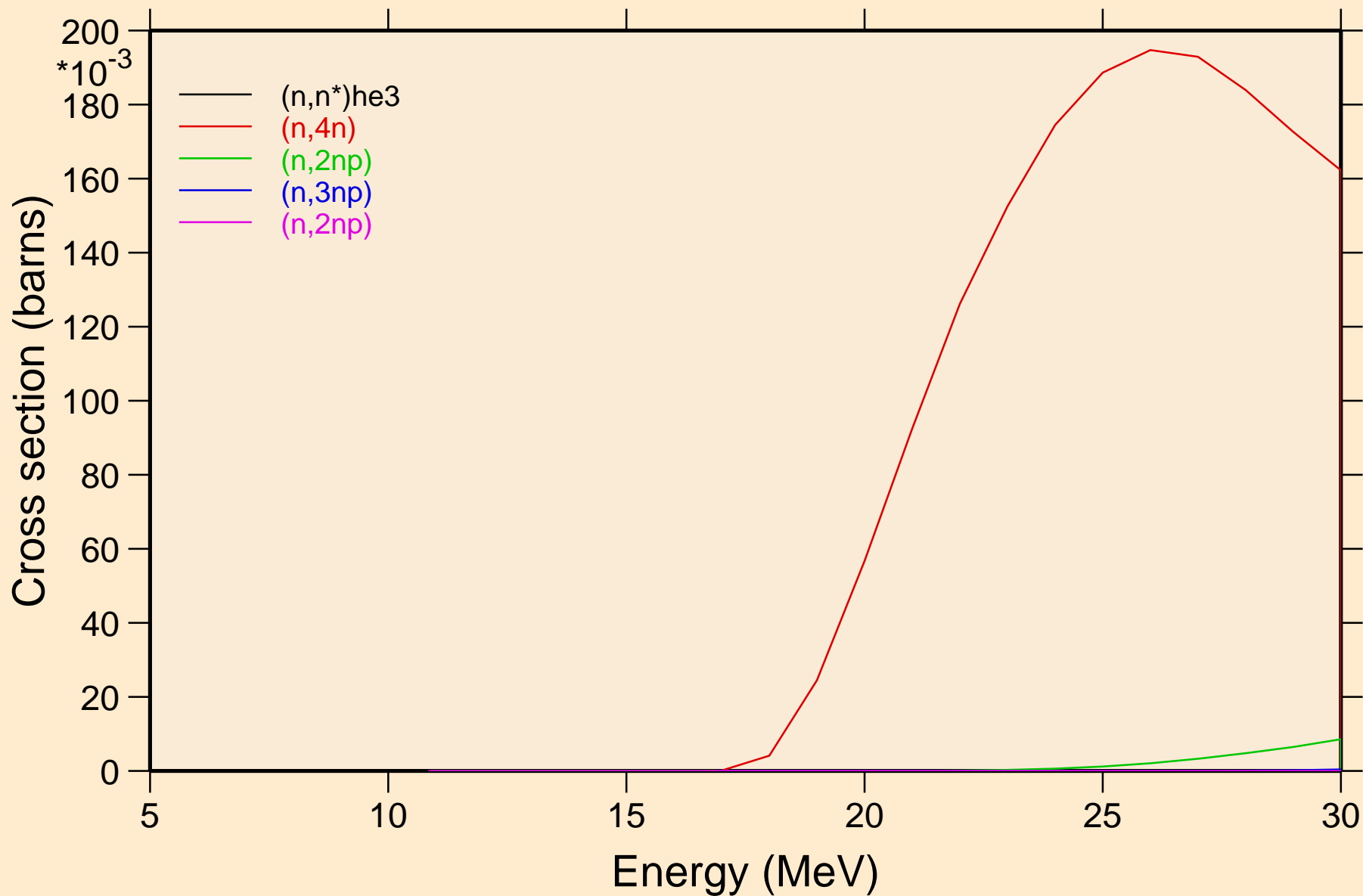

FM257 NEUTRON ACER TENDL-2019 LIBRARY; T=293.16K
Threshold reactions

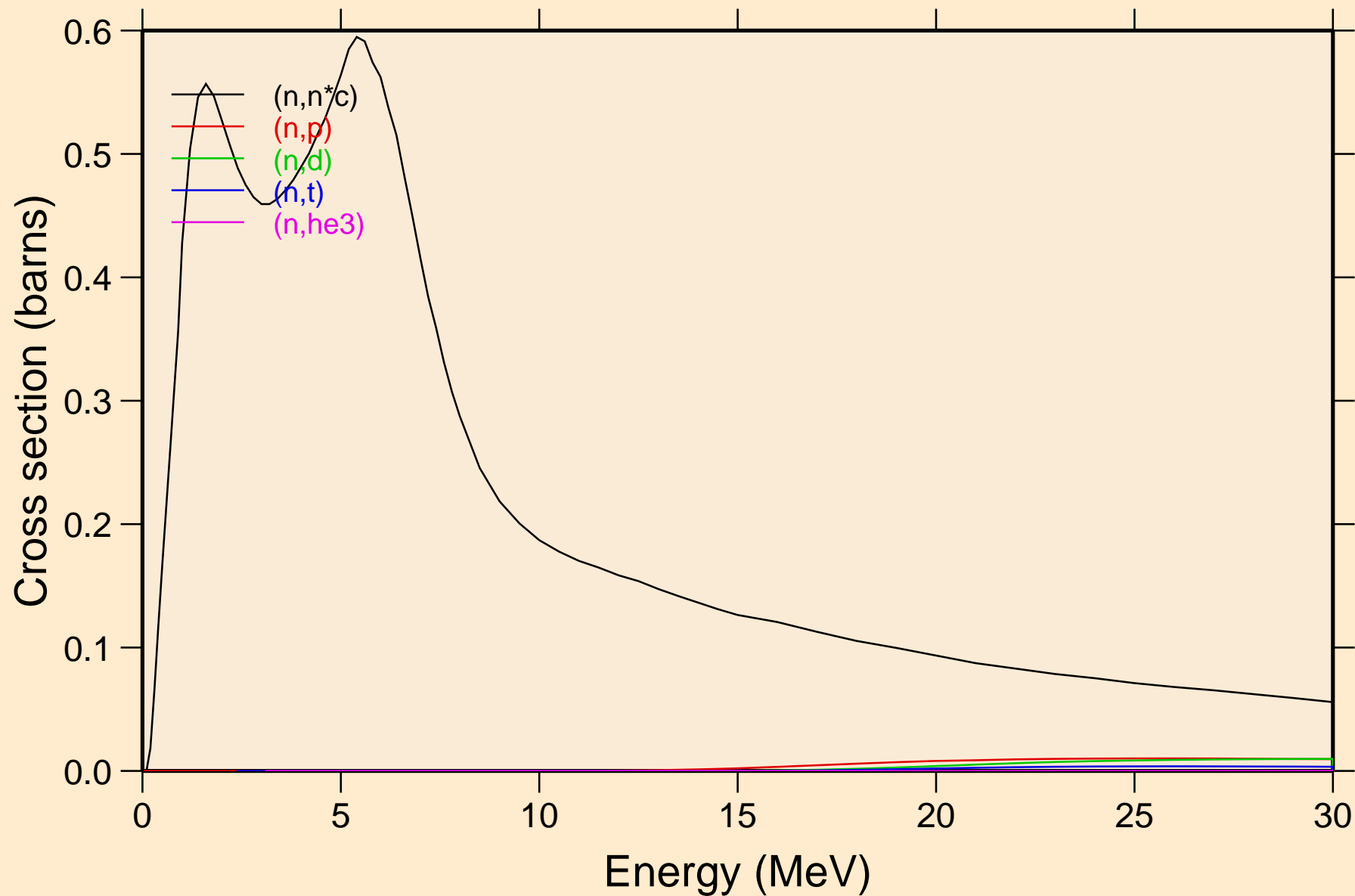

FM257 NEUTRON ACER TENDL-2019 LIBRARY; T=293.16K
Threshold reactions

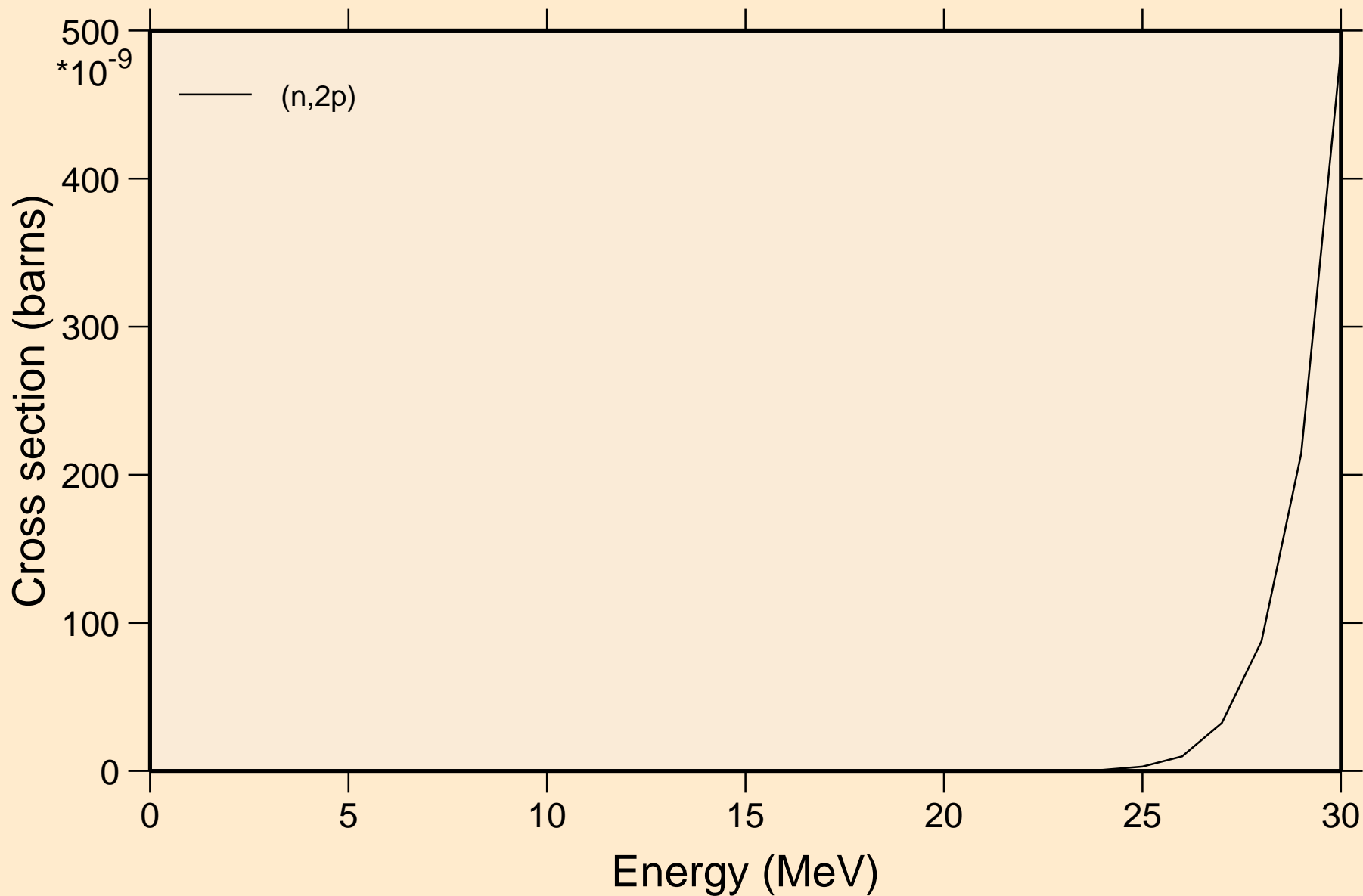

FM257 NEUTRON ACER TENDL-2019 LIBRARY; T=293.16K

Threshold reactions

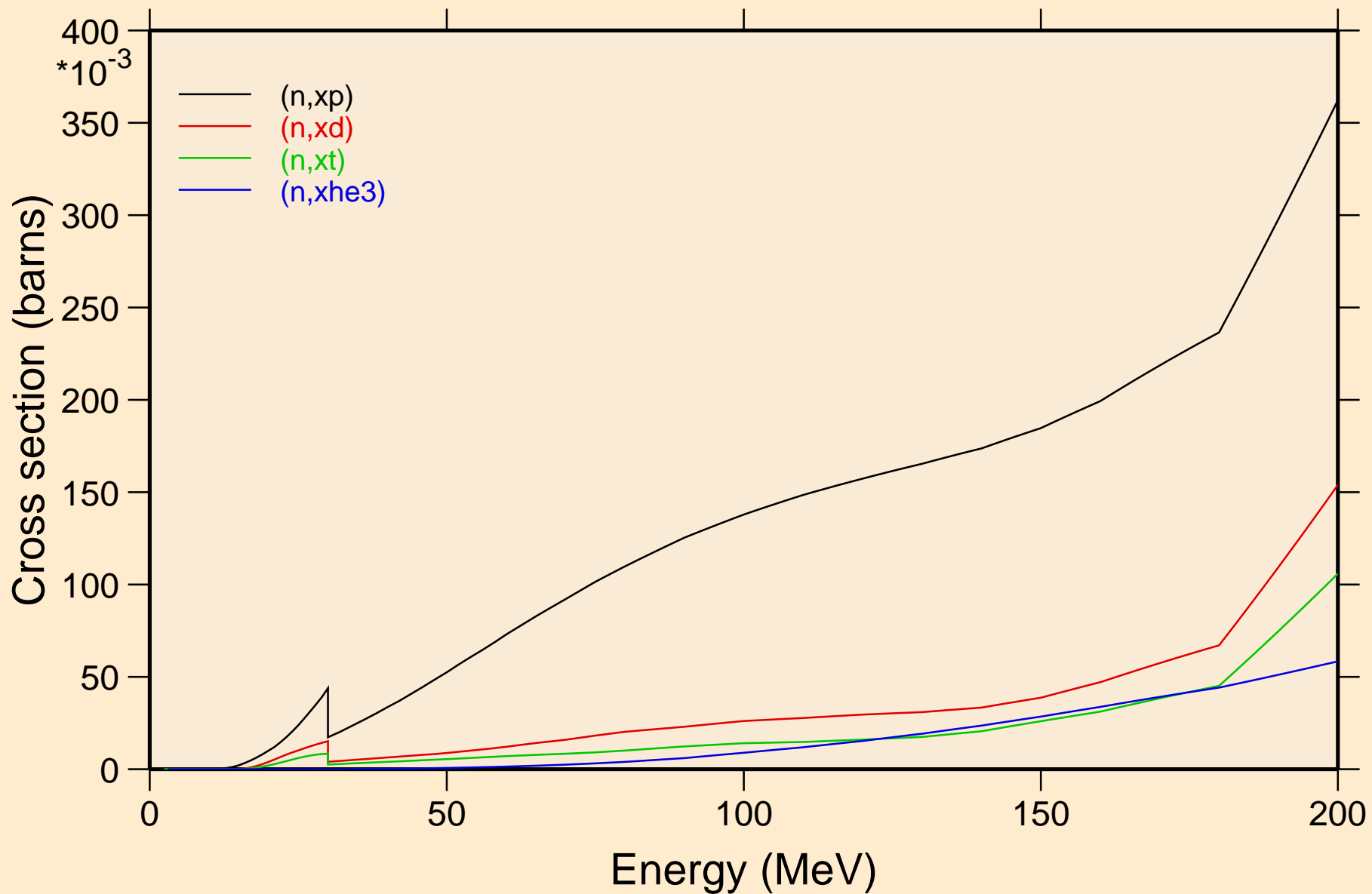

FM257 NEUTRON ACER TENDL-2019 LIBRARY; T=293.16K
angular distribution for elastic

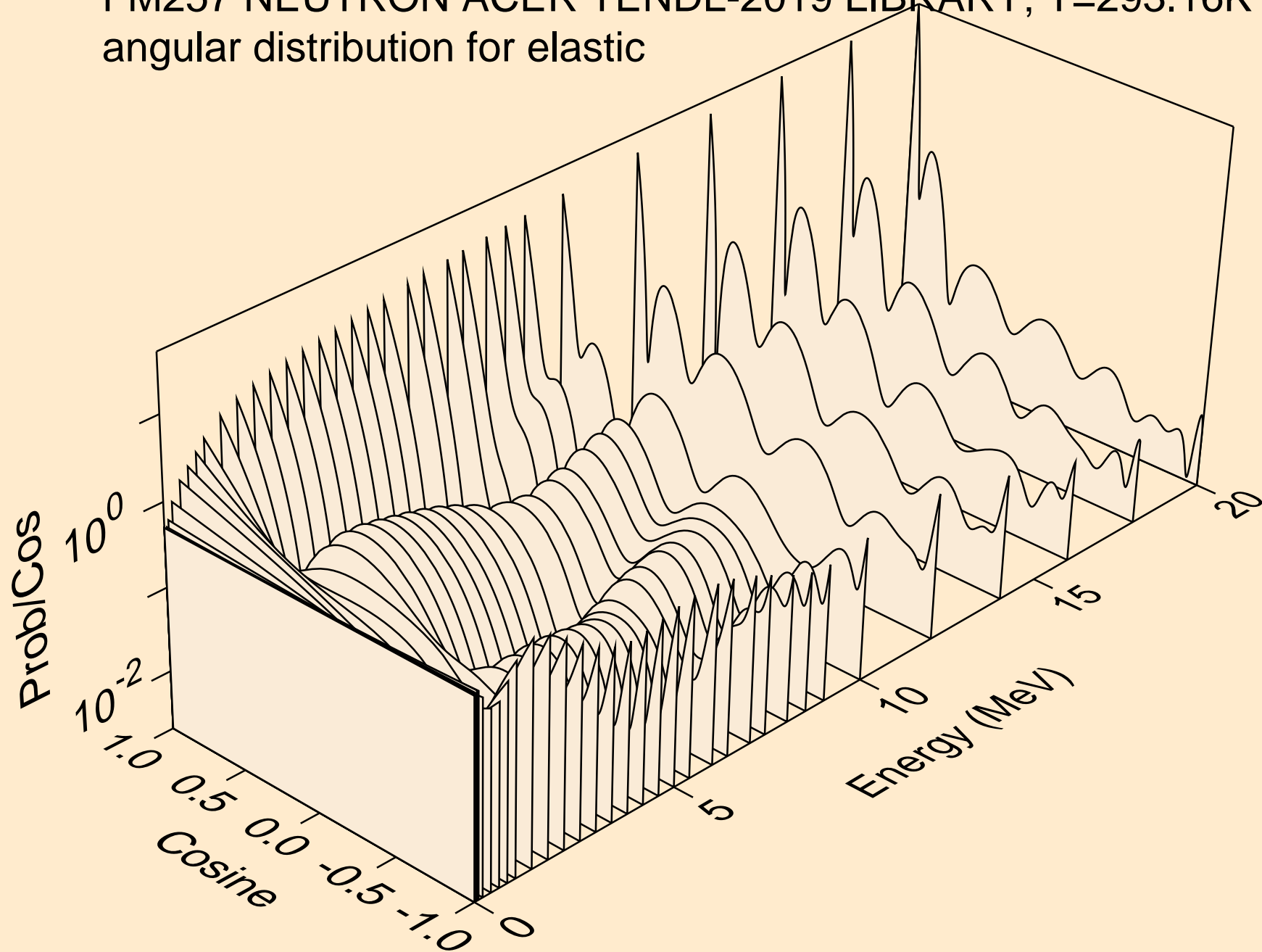

FM257 NEUTRON ACER TENDL-2019 LIBRARY; T=293.16K
angular distribution for elastic

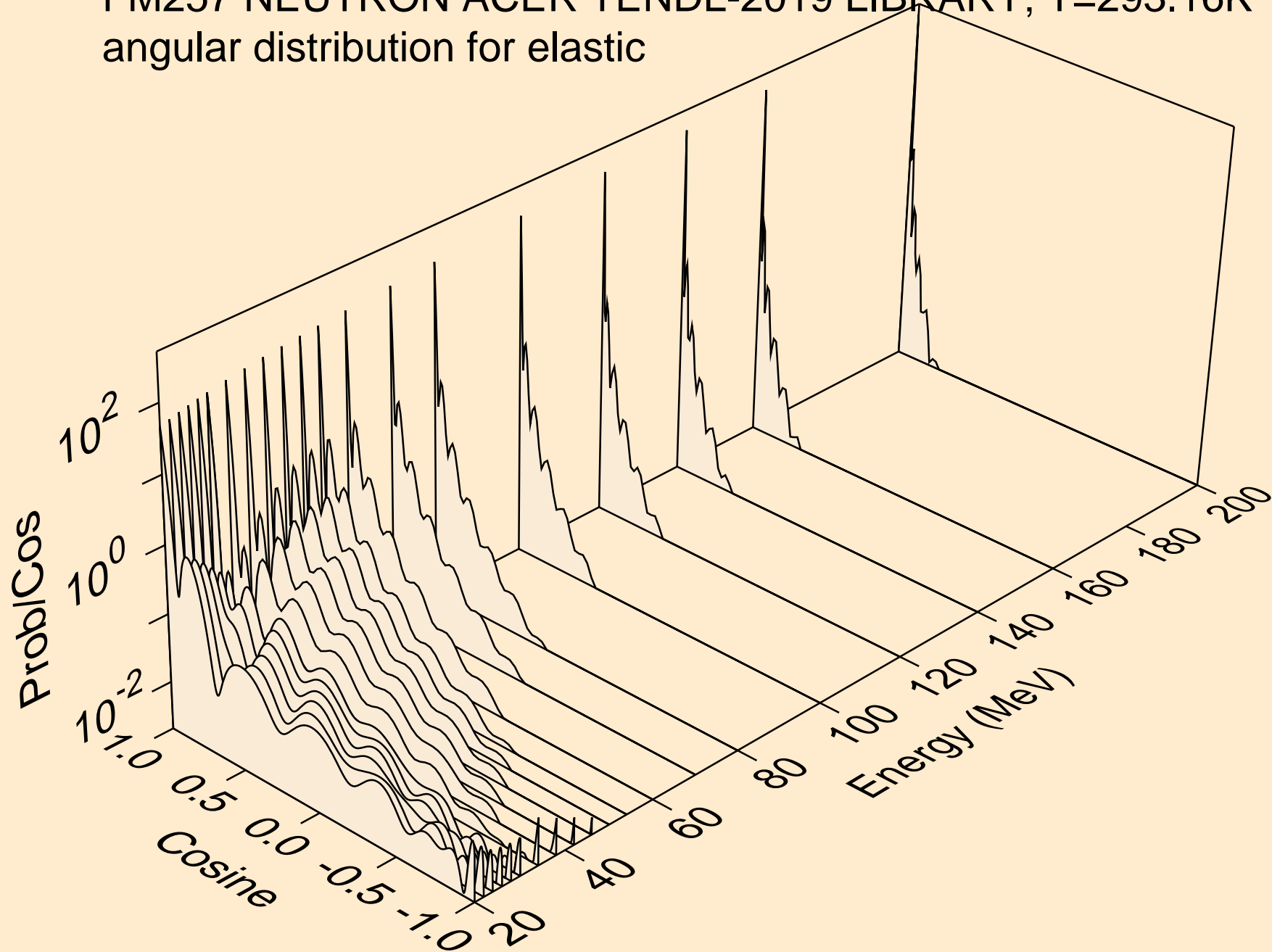

FM257 NEUTRON ACER TENDL-2019 LIBRARY; T=293.16K
angular distribution for (n,n*1)

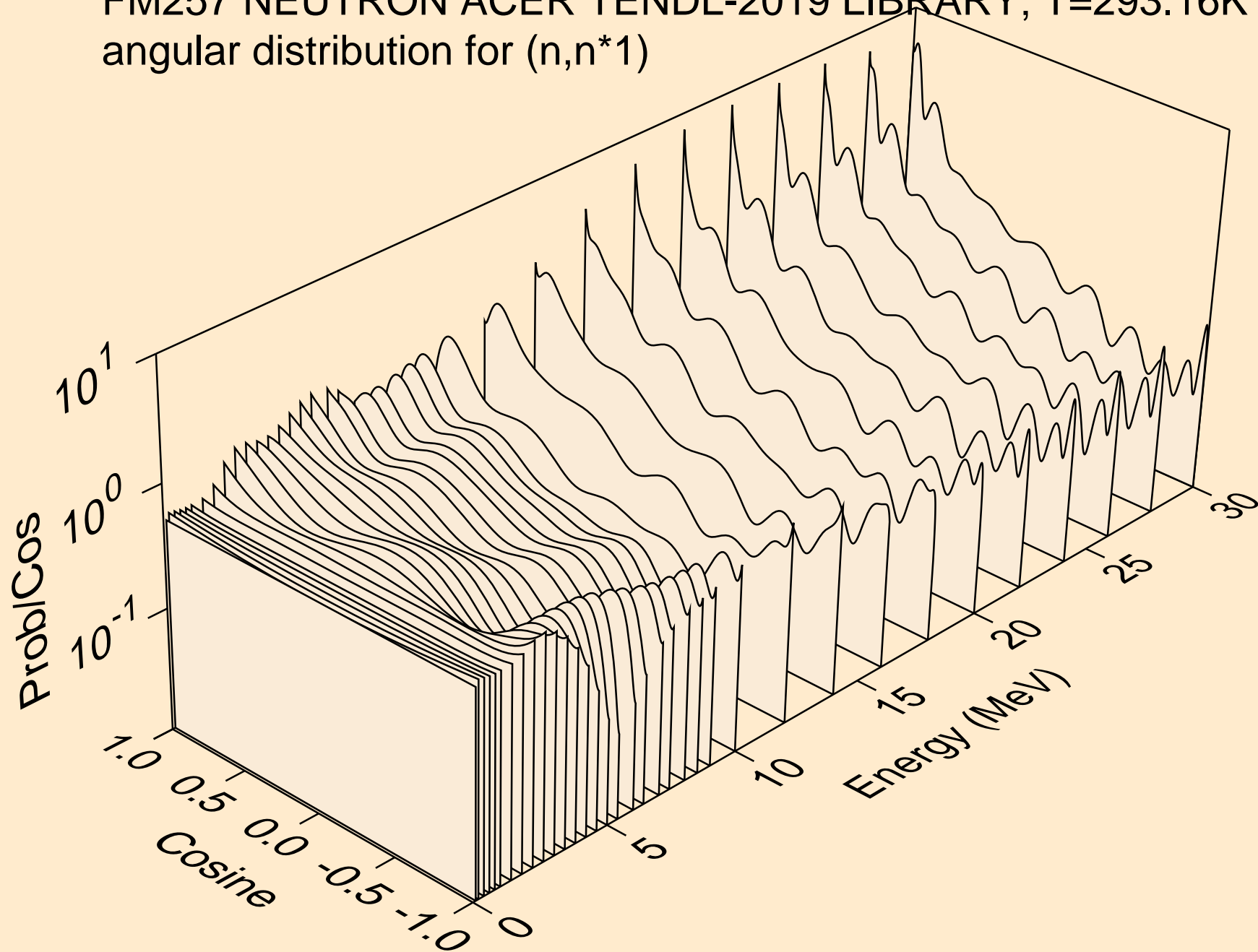

FM257 NEUTRON ACER TENDL-2019 LIBRARY; T=293.16K
Total fission nuubar

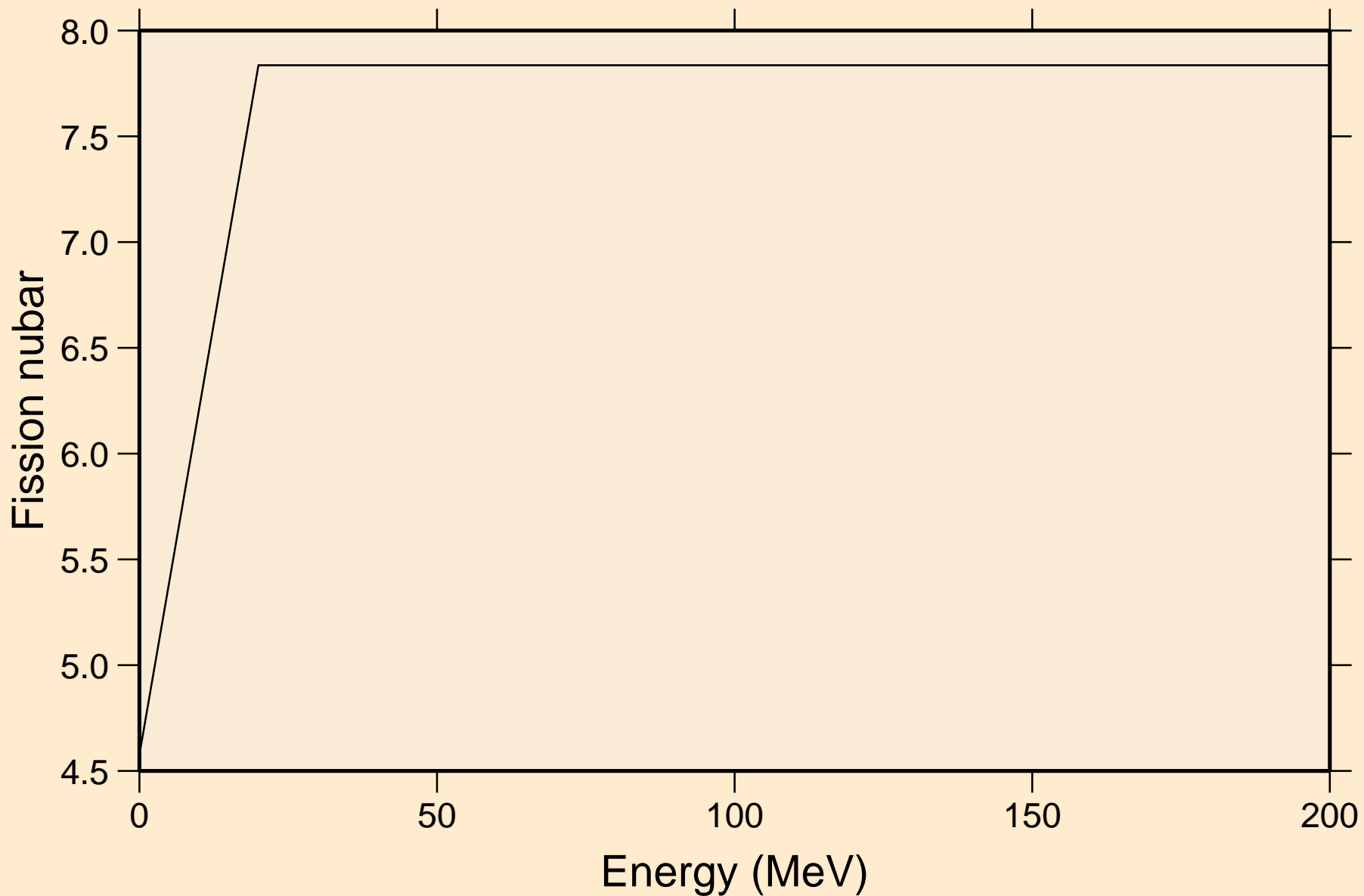

FM257 NEUTRON ACER TENDL-2019 LIBRARY; T=293.16K
Neutron emission for (n,x)

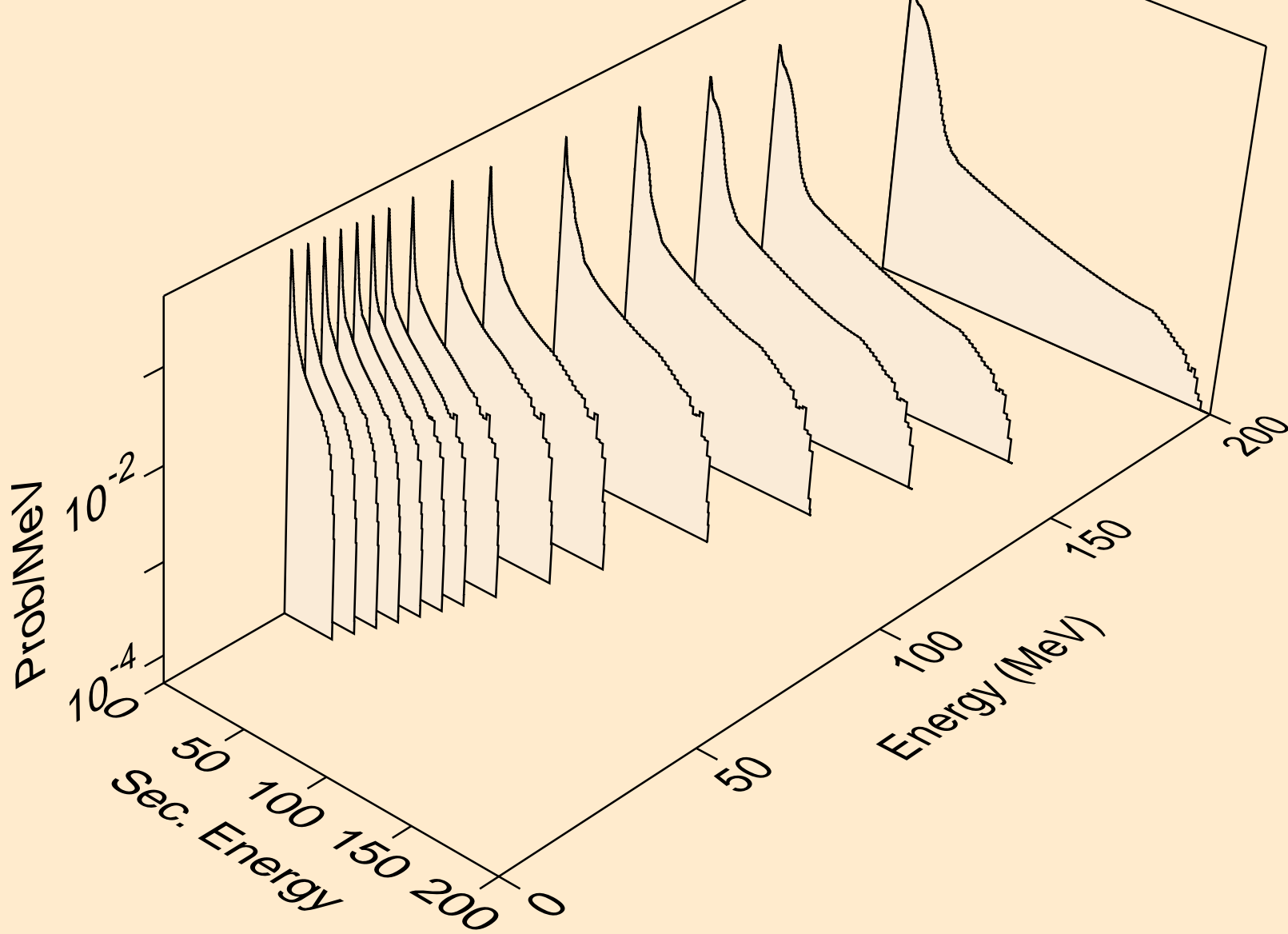

FM257 NEUTRON ACER TENDL-2019 LIBRARY; T=293.16K
Neutron emission for (n,2nd)

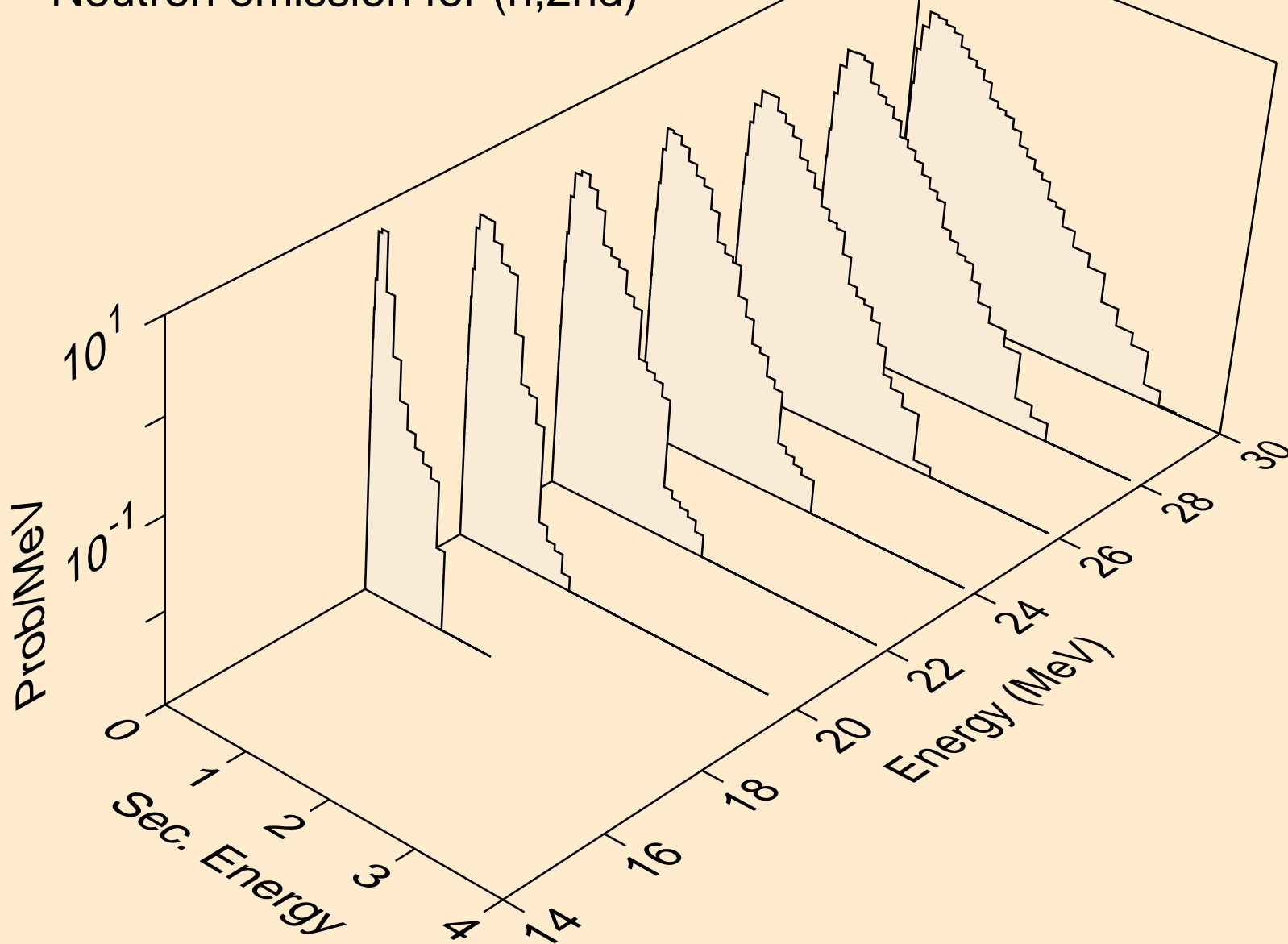

FM257 NEUTRON ACER TENDL-2019 LIBRARY; T=293.16K
Neutron emission for (n,2n)

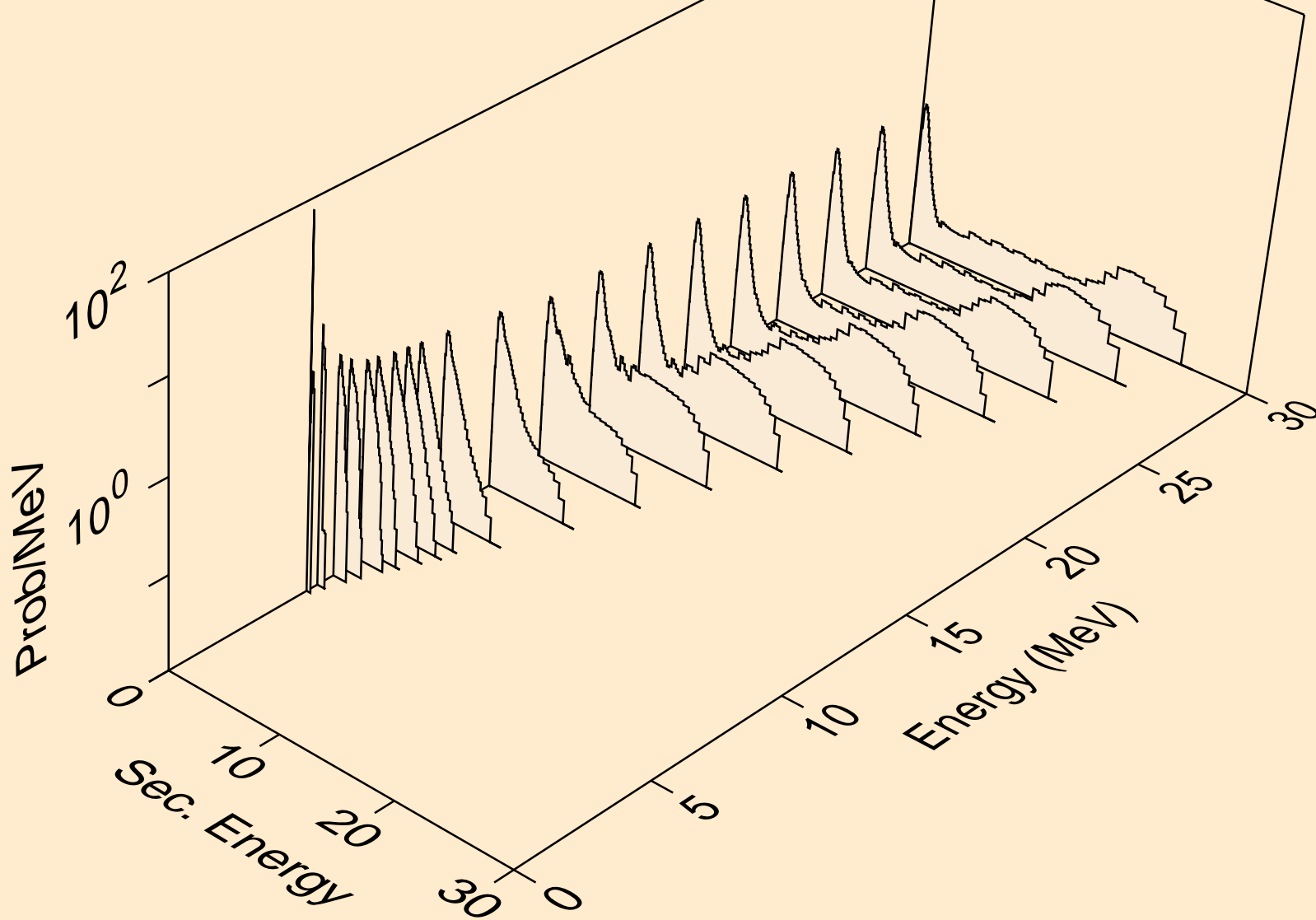

FM257 NEUTRON ACER TENDL-2019 LIBRARY; T=293.16K
Neutron emission for (n,3n)

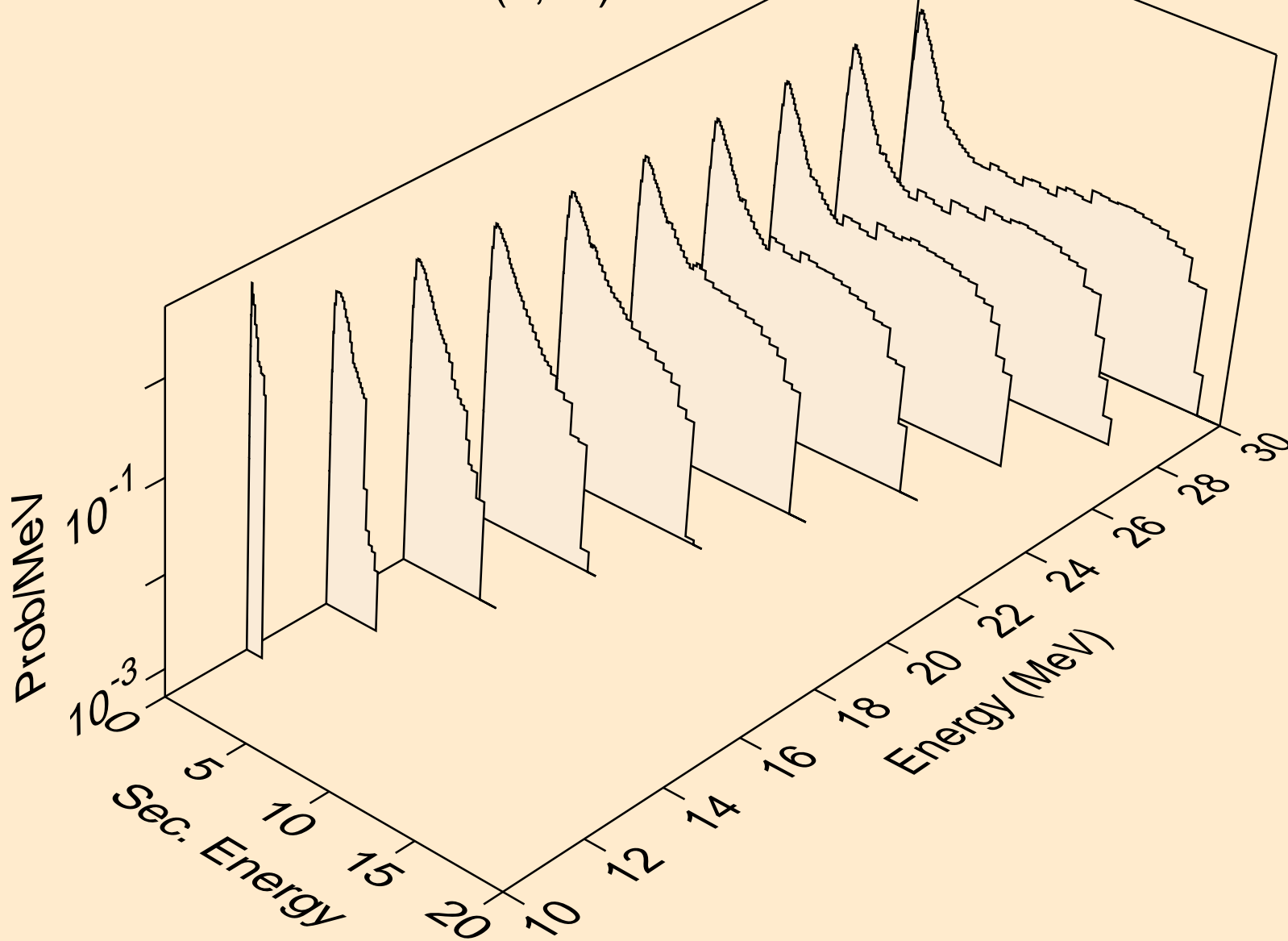

FM257 NEUTRON ACER TENDL-2019 LIBRARY; T=293.16K
Neutron emission for fission

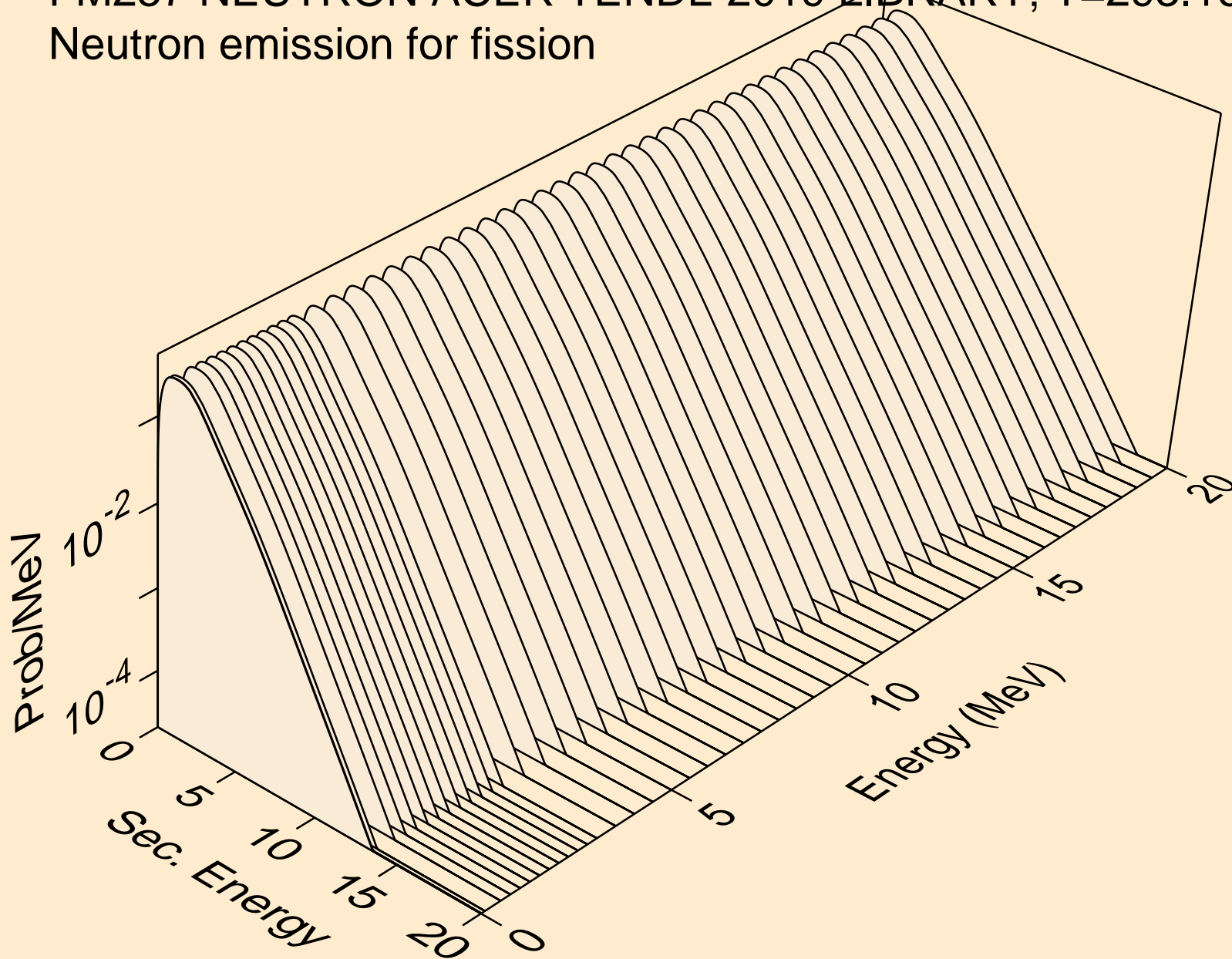

FM257 NEUTRON ACER TENDL-2019 LIBRARY; T=293.16K
Neutron emission for (n,n*)a

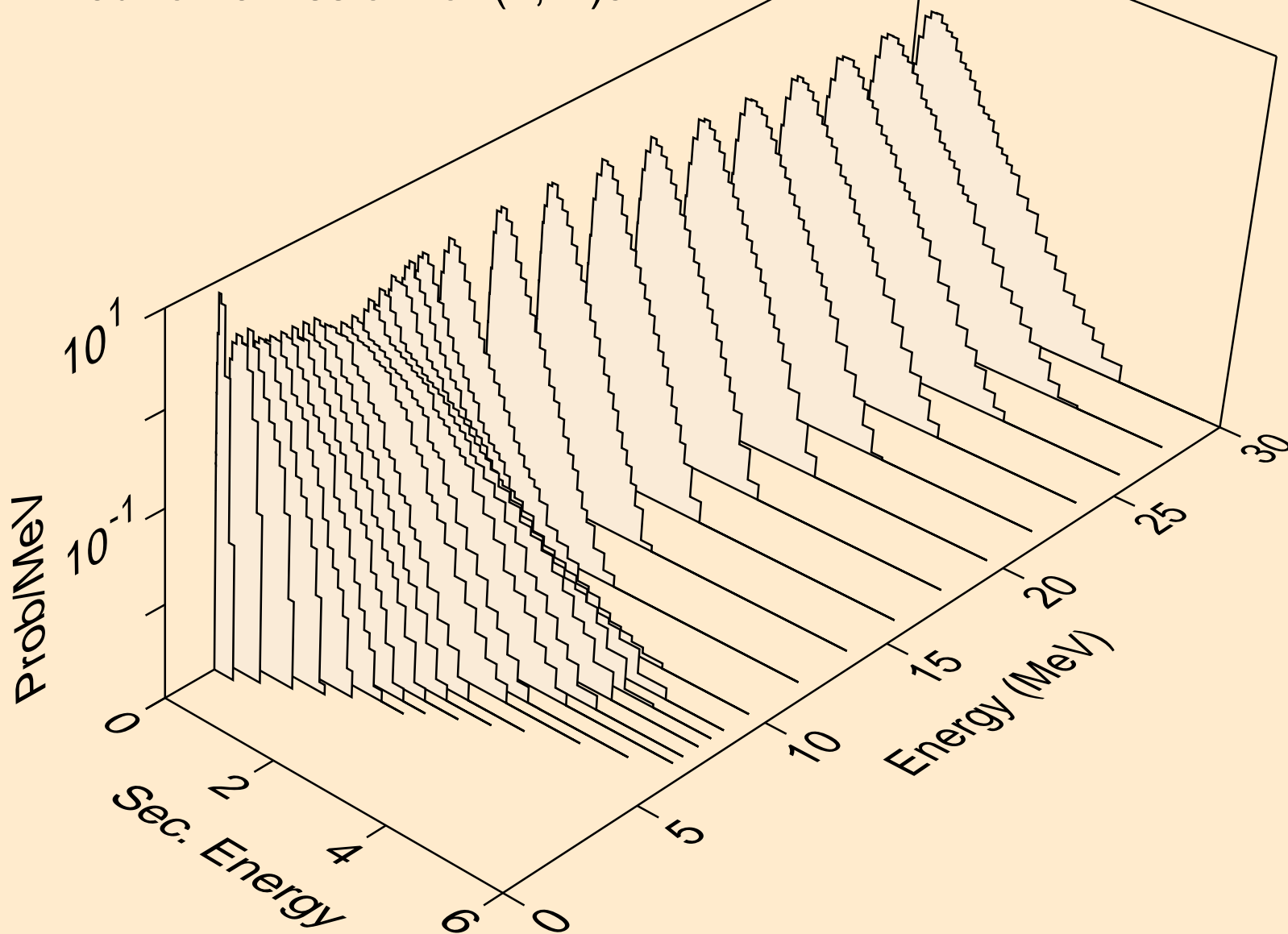

FM257 NEUTRON ACER TENDL-2019 LIBRARY; T=293.16K
Neutron emission for (n,2n)a

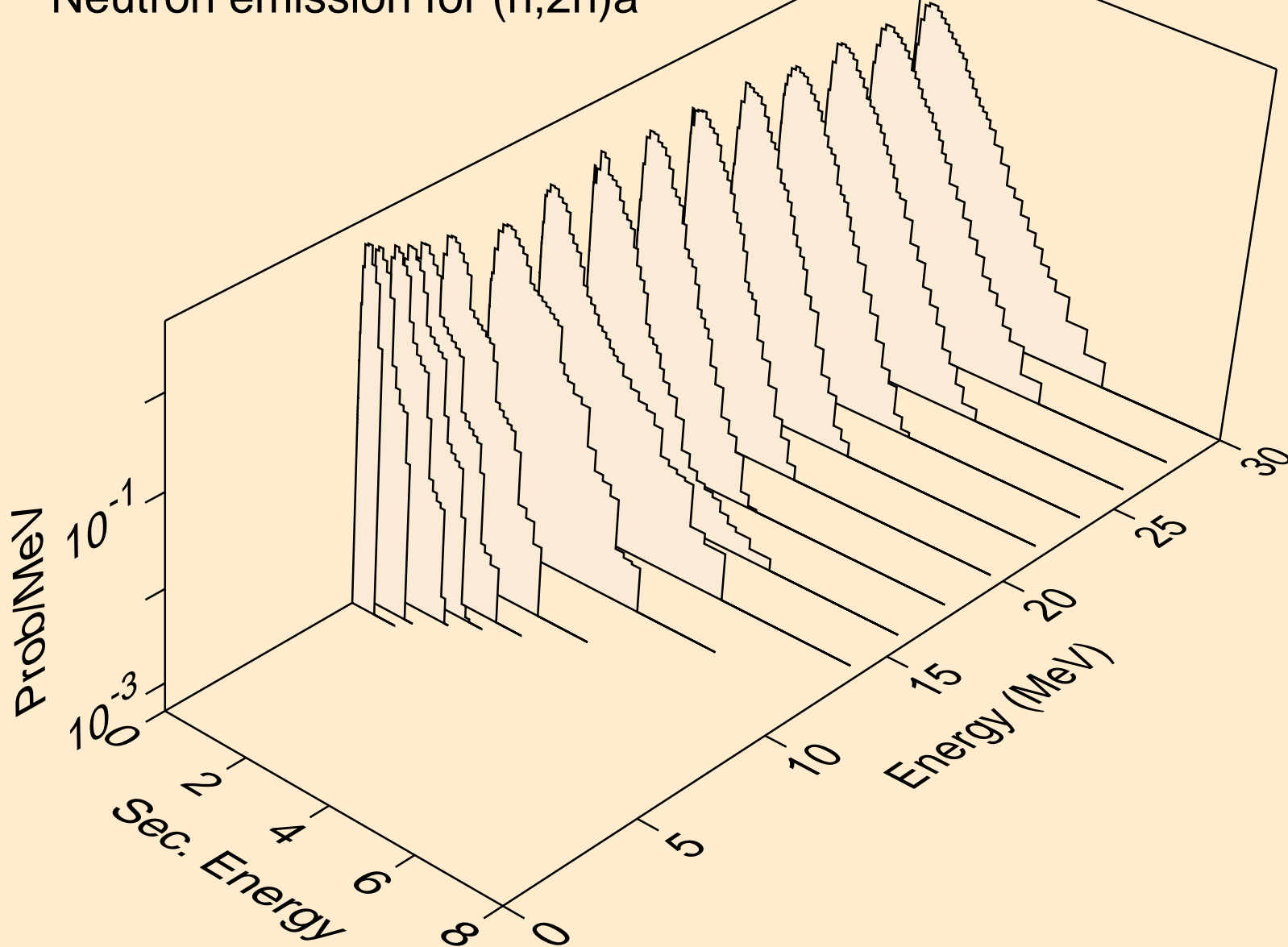

FM257 NEUTRON ACER TENDL-2019 LIBRARY; T=293.16K
Neutron emission for (n,3n)a

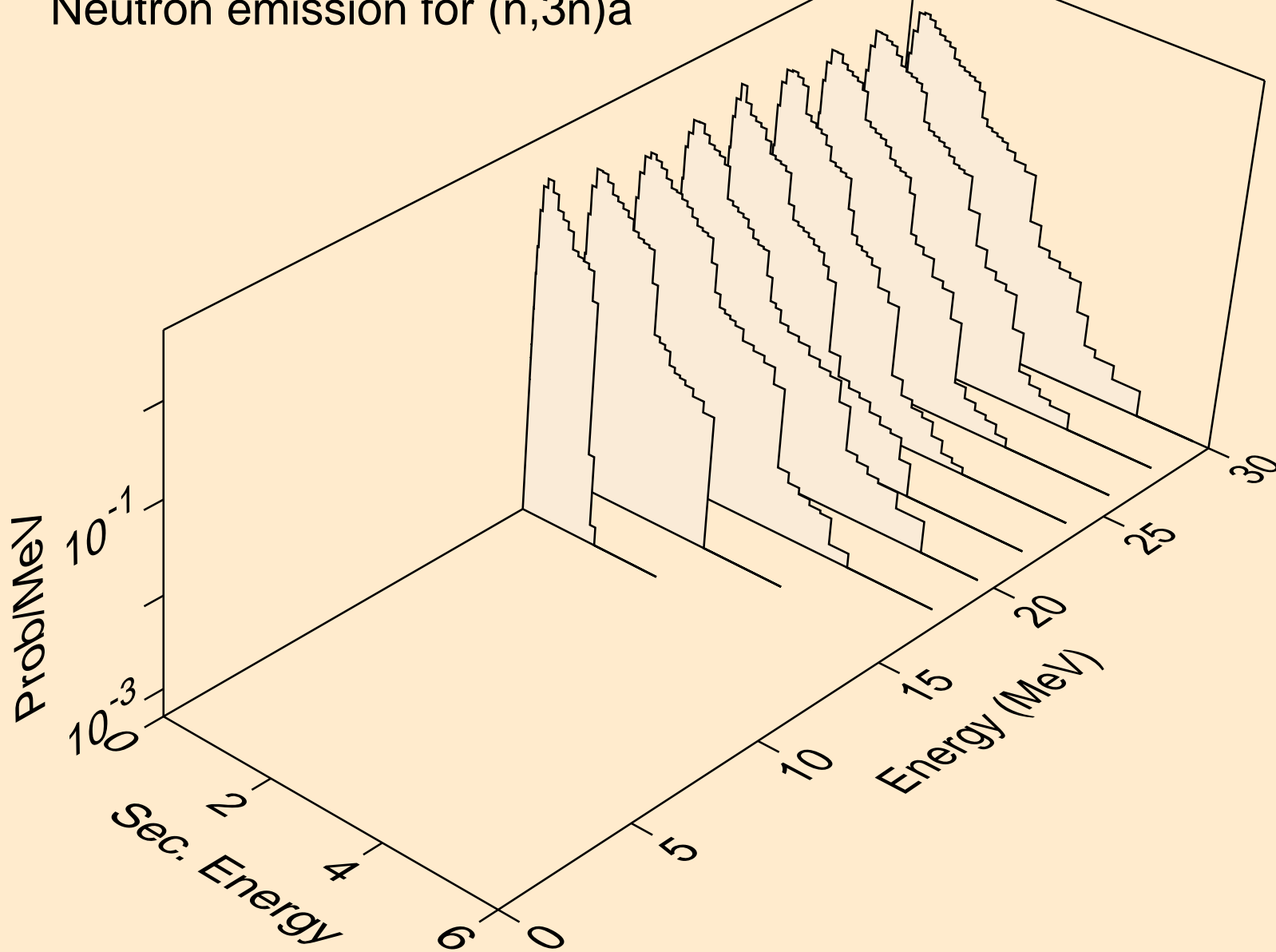

FM257 NEUTRON ACER TENDL-2019 LIBRARY; T=293.16K
Neutron emission for (n,n*)p

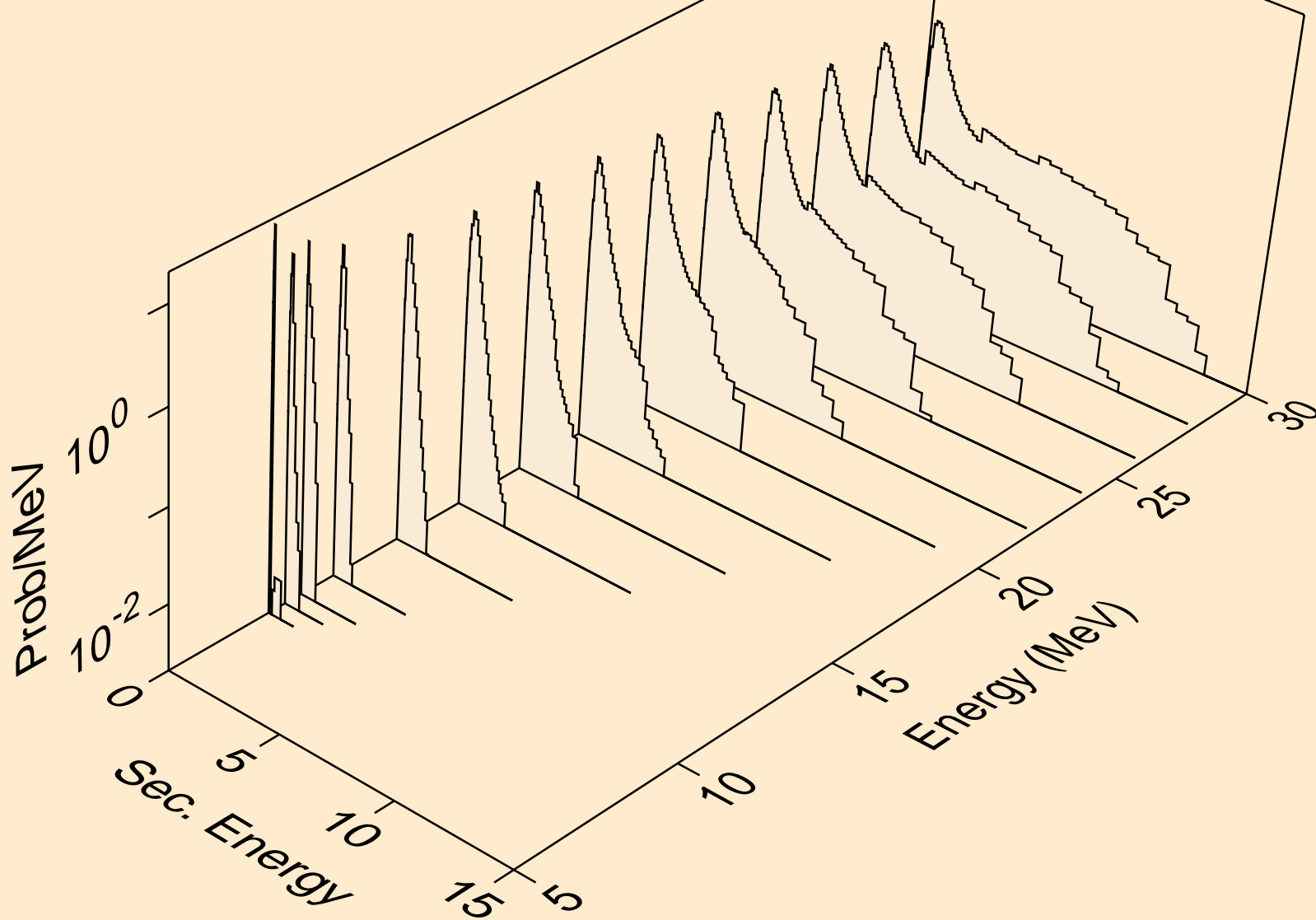

FM257 NEUTRON ACER TENDL-2019 LIBRARY; T=293.16K
Neutron emission for (n,n*)d

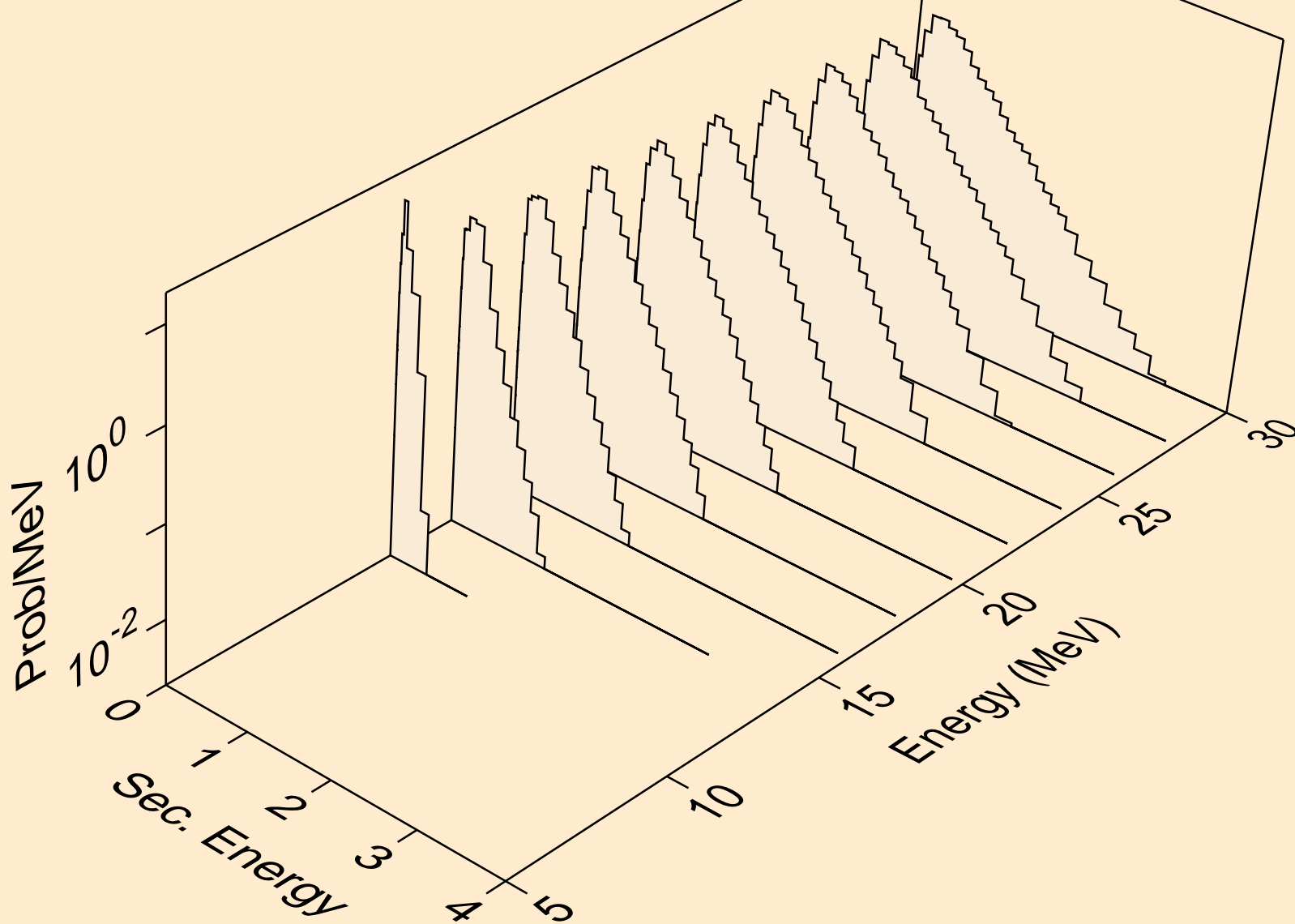

FM257 NEUTRON ACER TENDL-2019 LIBRARY; T=293.16K
Neutron emission for (n,n*)t

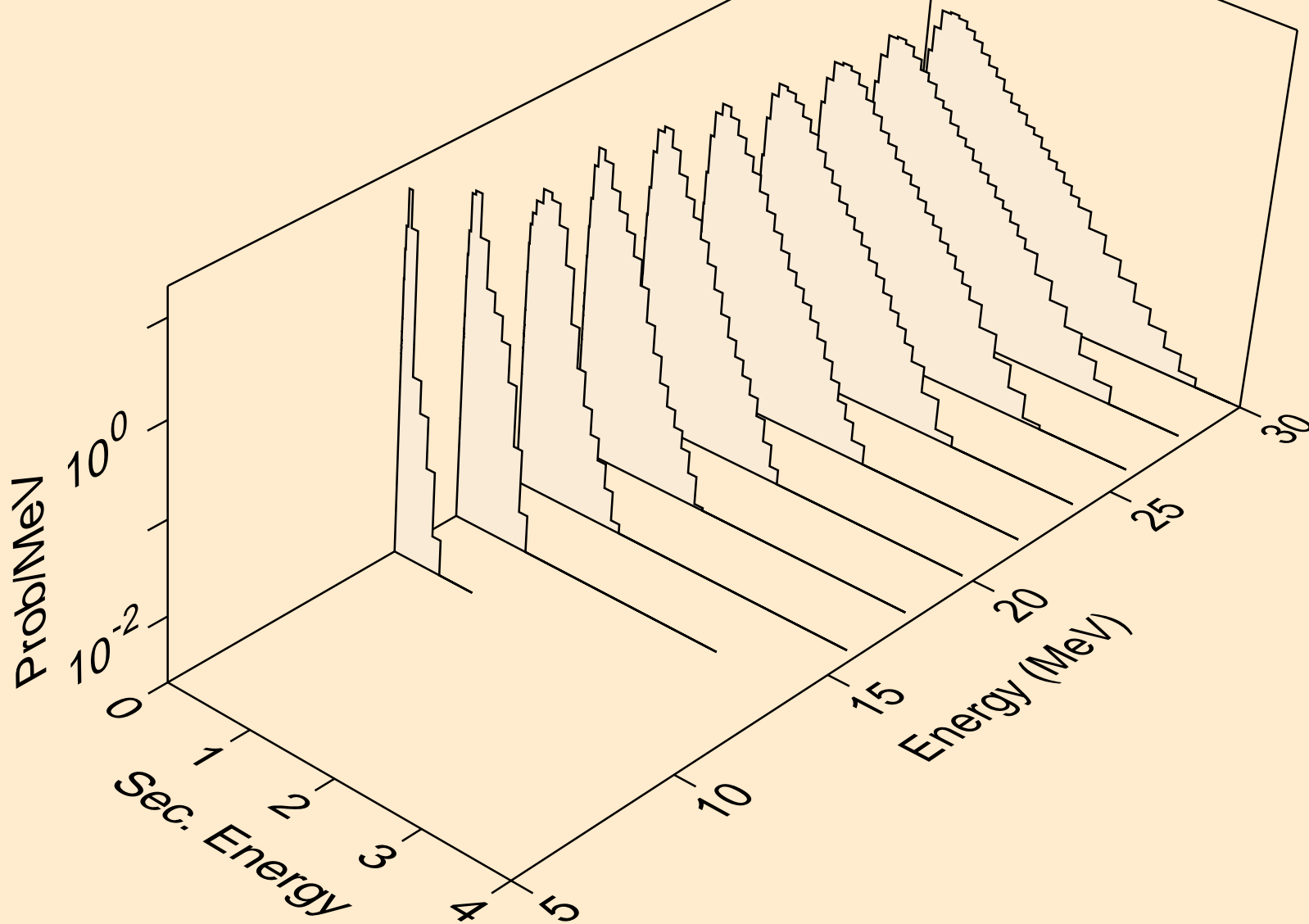

FM257 NEUTRON ACER TENDL-2019 LIBRARY; T=293.16K
Neutron emission for (n,n*)he3

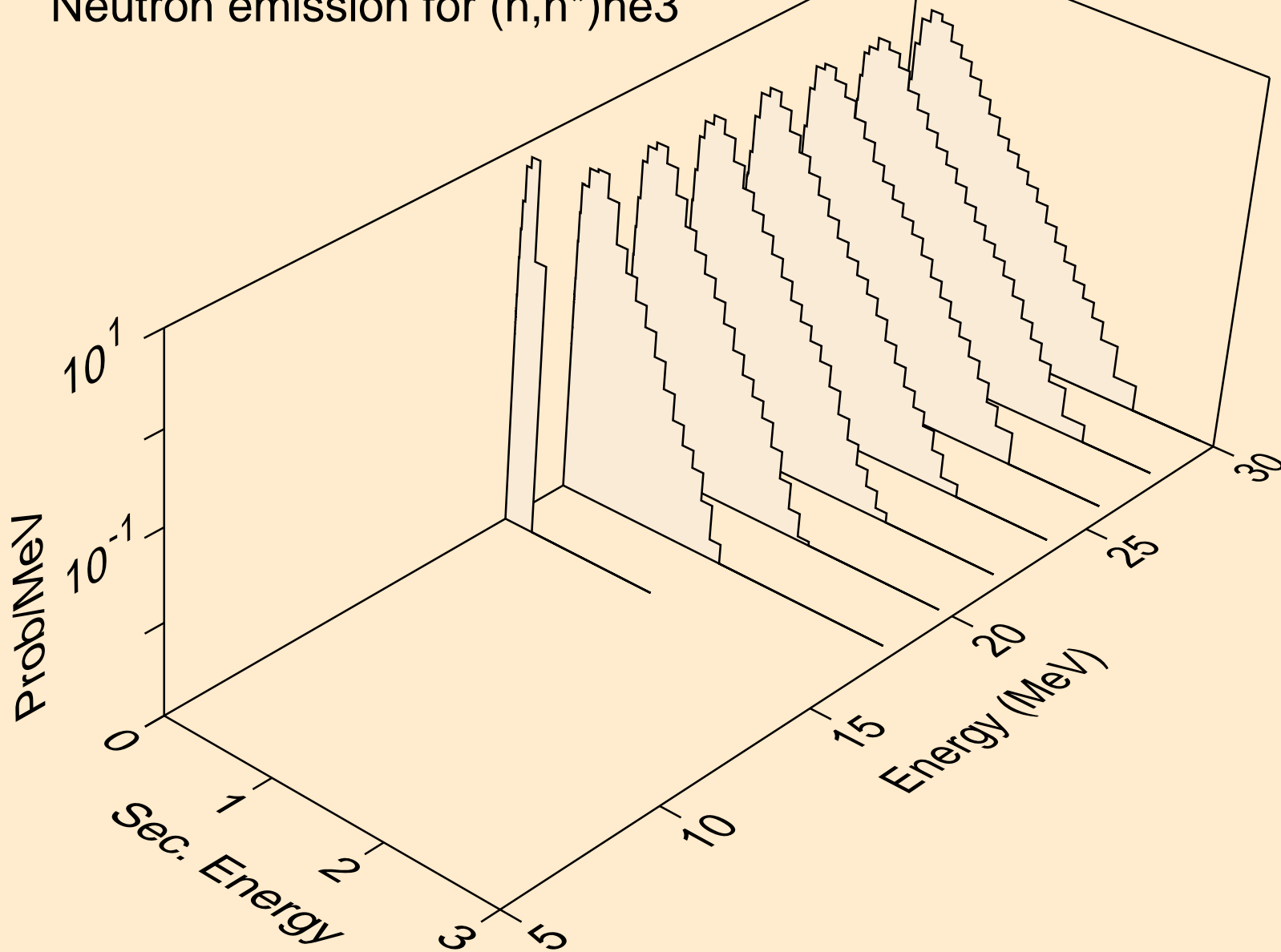

FM257 NEUTRON ACER TENDL-2019 LIBRARY; T=293.16K
Neutron emission for (n,4n)

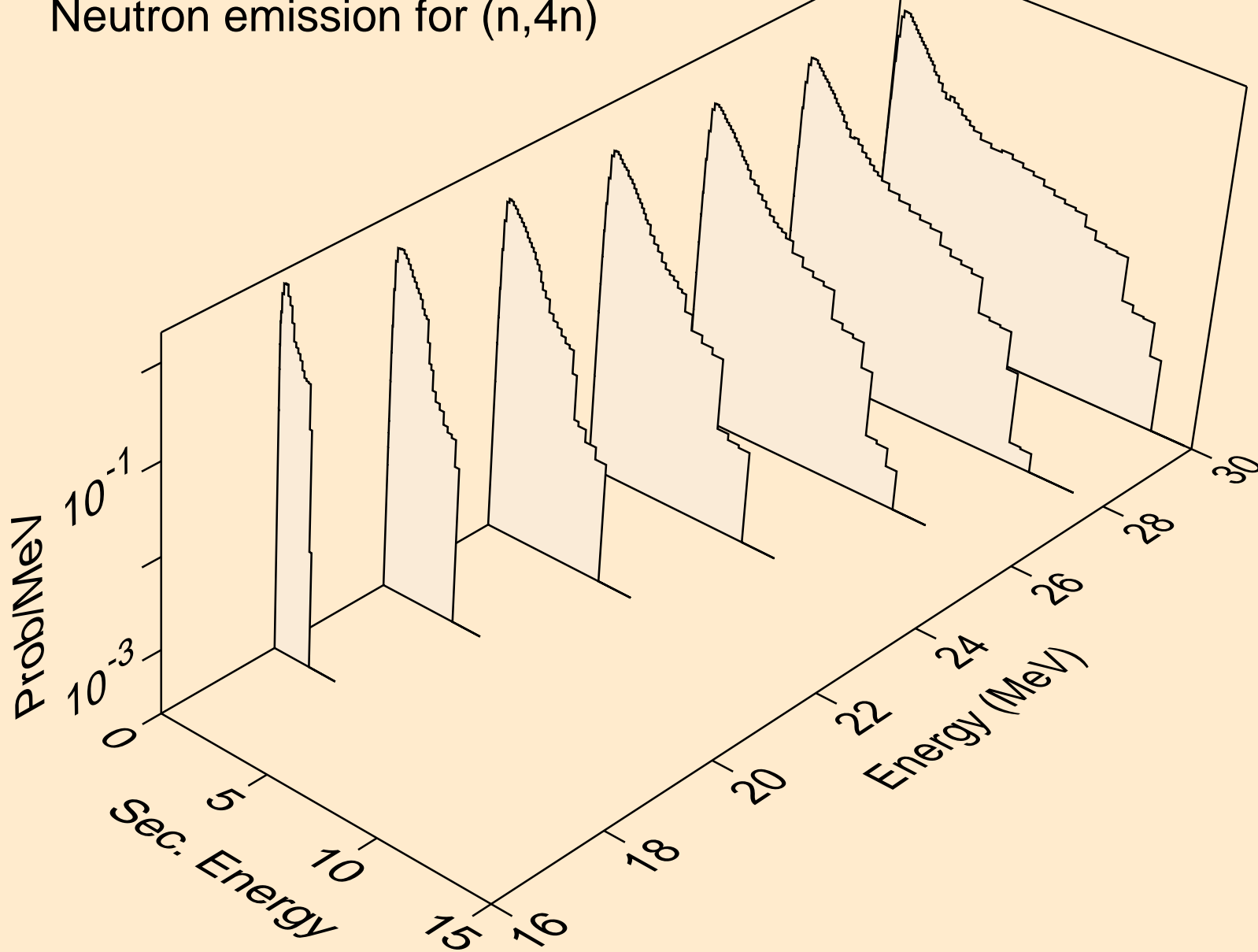

FM257 NEUTRON ACER TENDL-2019 LIBRARY; T=293.16K
Neutron emission for (n,2np)

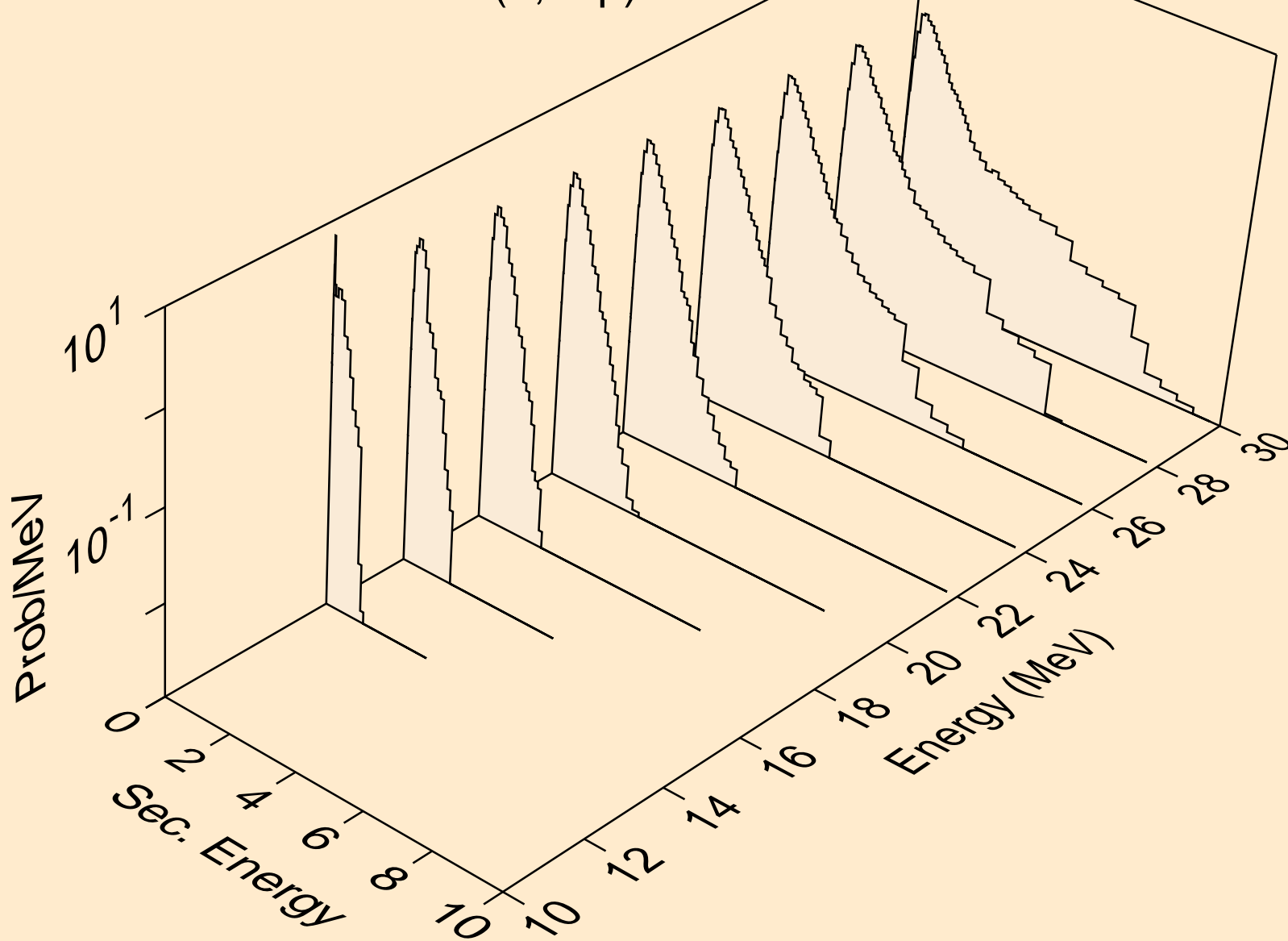

FM257 NEUTRON ACER TENDL-2019 LIBRARY; T=293.16K
Neutron emission for (n,3np)

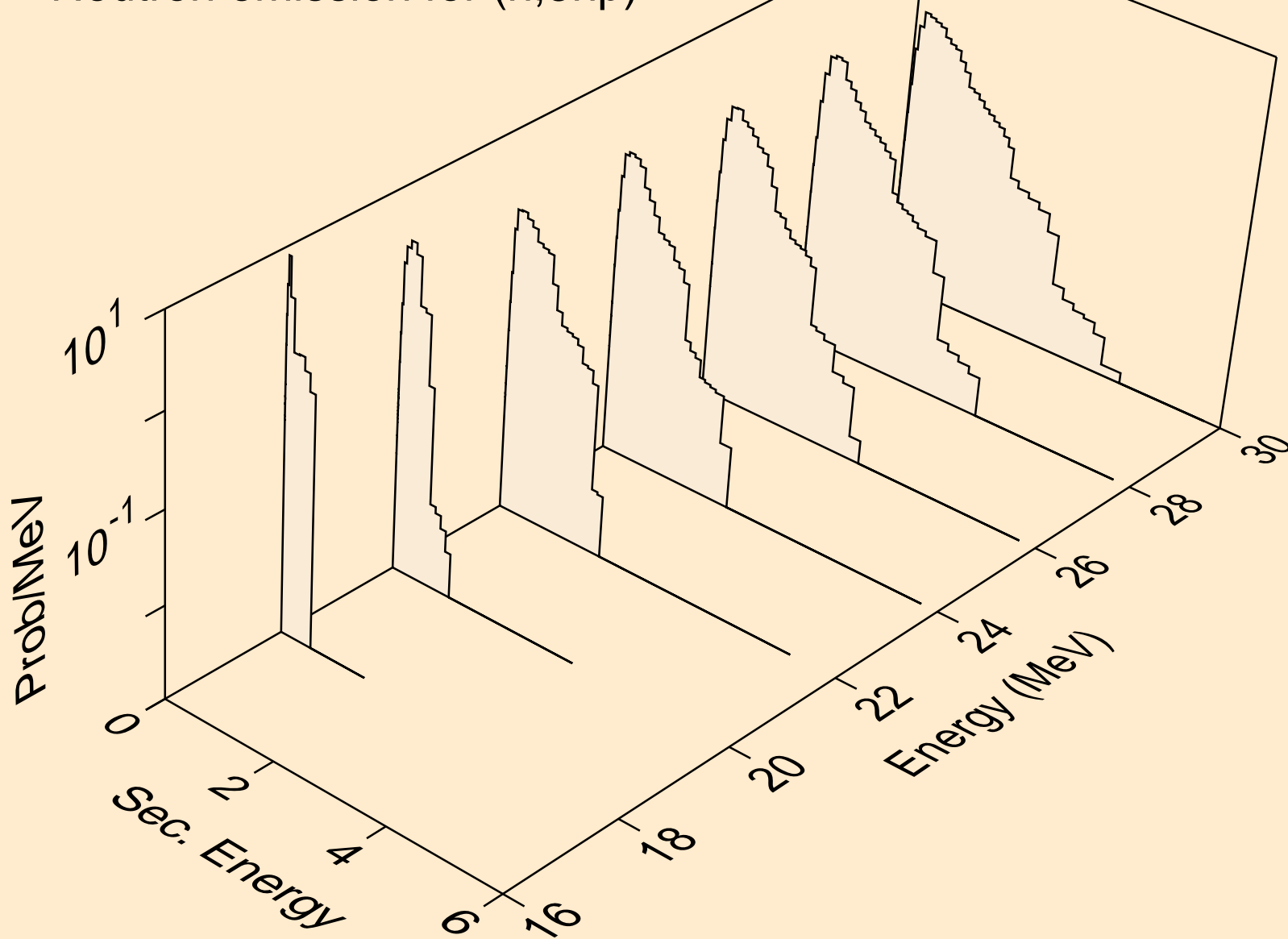

FM257 NEUTRON ACER TENDL-2019 LIBRARY; T=293.16K
Neutron emission for (n,2np)

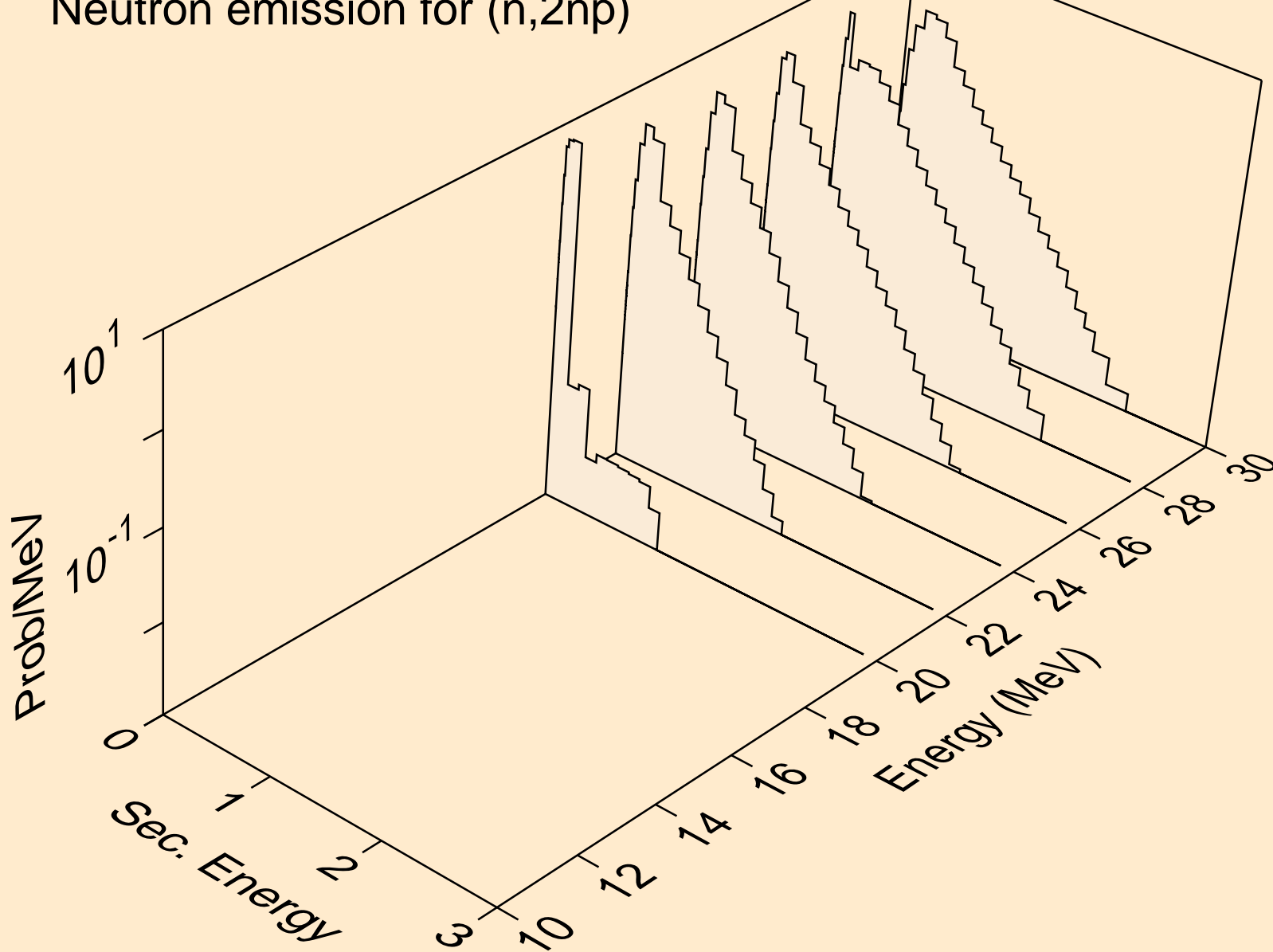

FM257 NEUTRON ACER TENDL-2019 LIBRARY; T=293.16K
Neutron emission for (n,n*c)

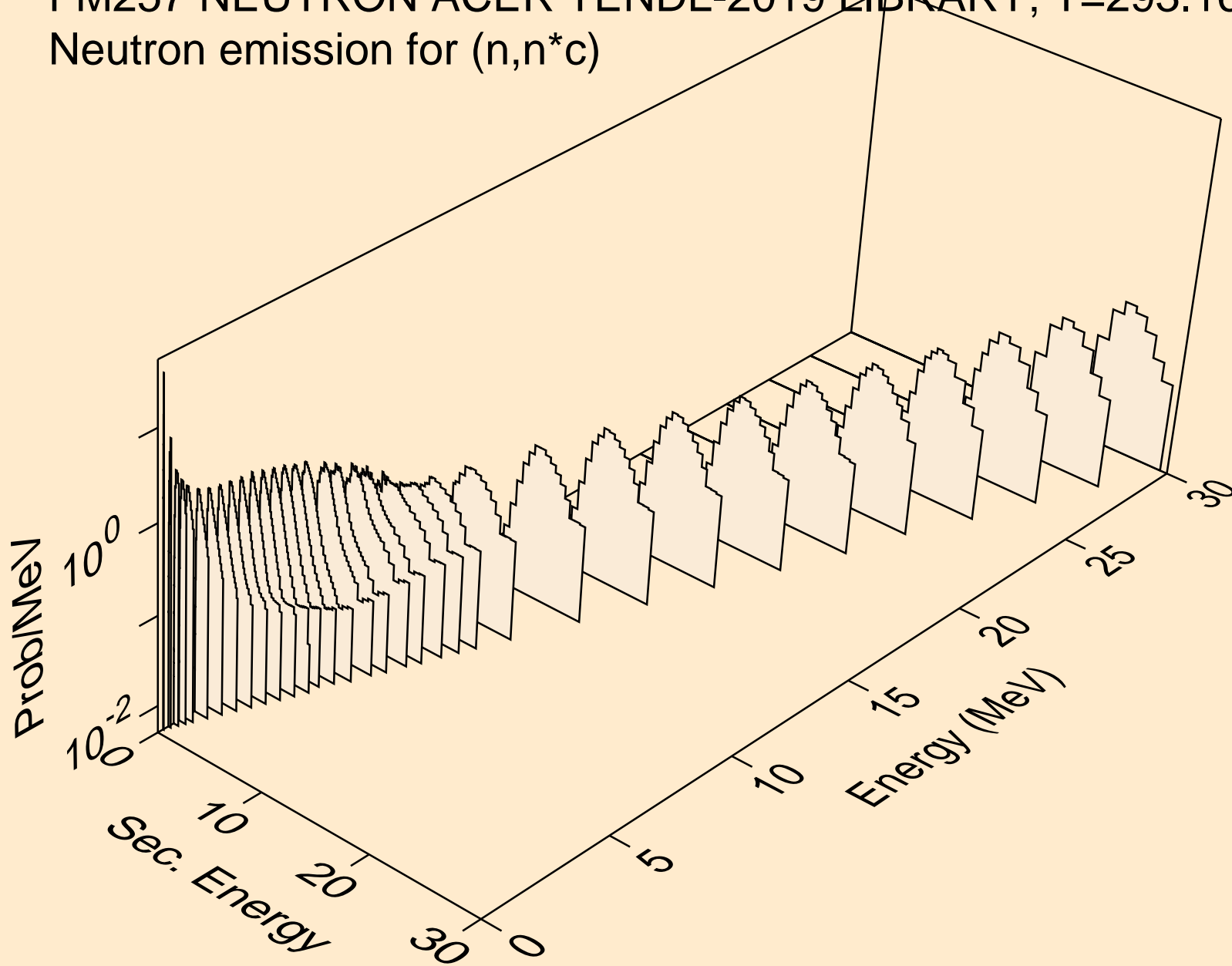

FM257 NEUTRON ACER TENDL-2019 LIBRARY; T=293.16K

Delayed nubar

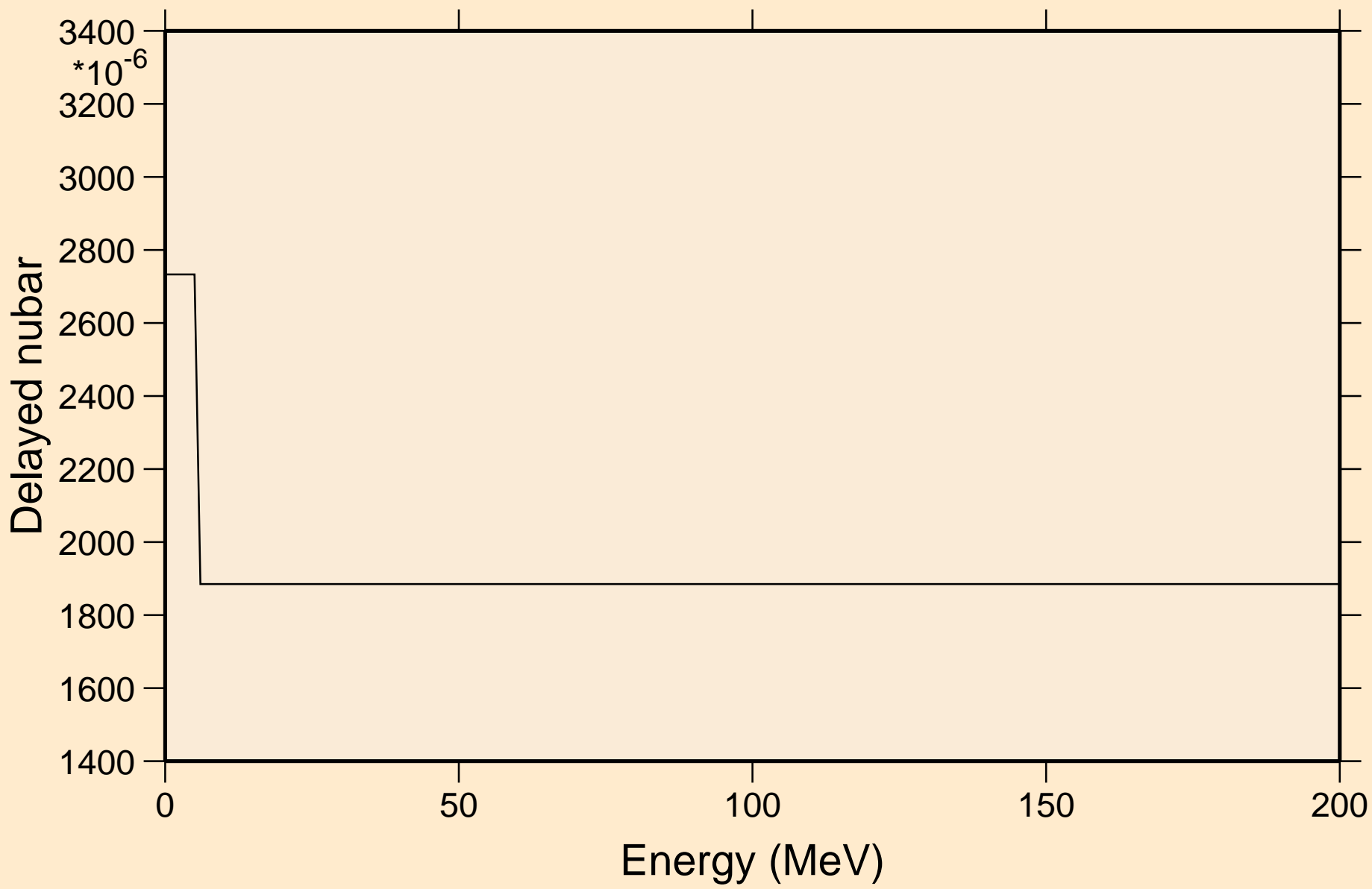

FM257 NEUTRON ACER TENDL-2019 LIBRARY; T=293.16K

Delayed neutron spectra

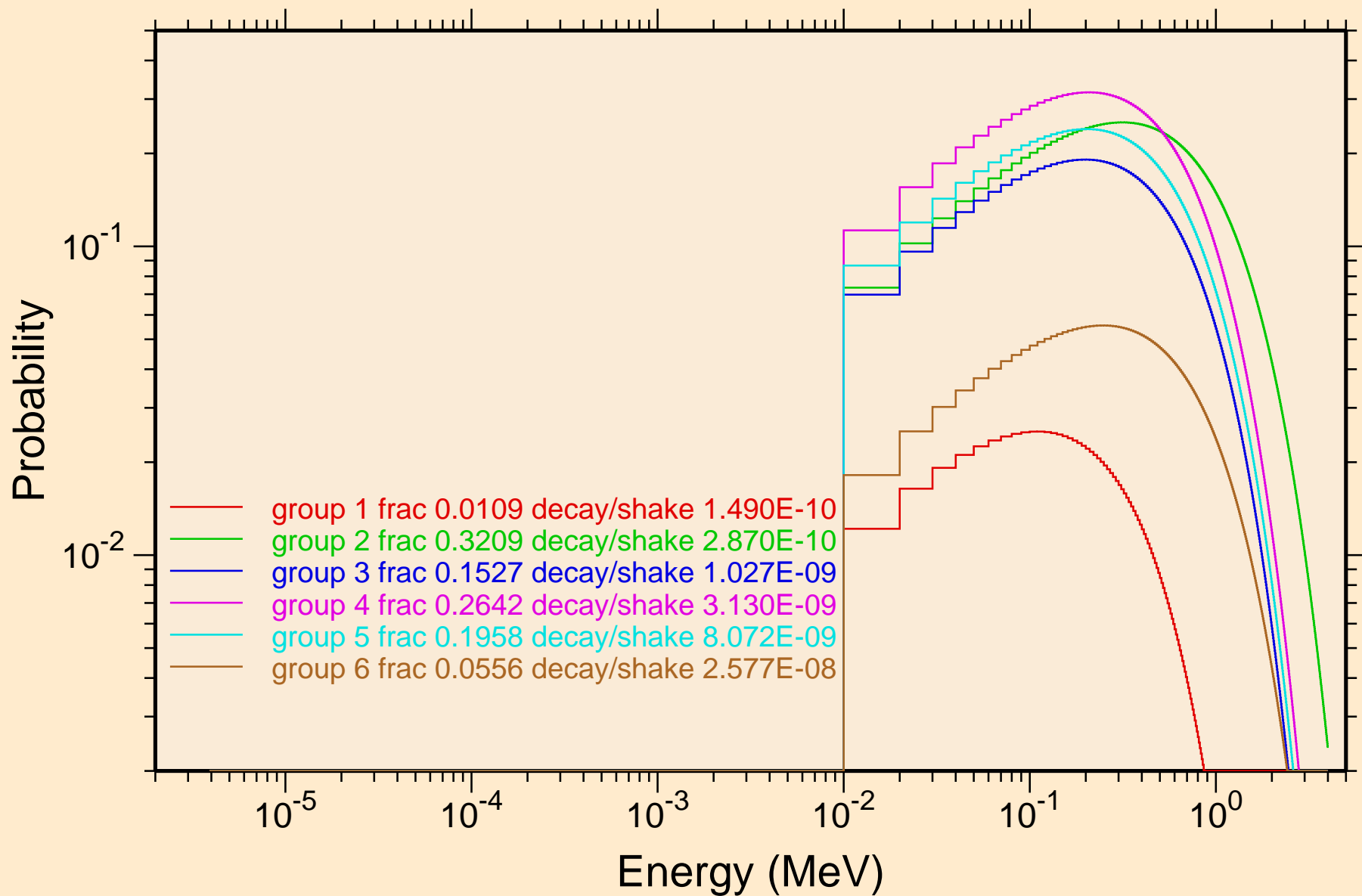

FM257 NEUTRON ACER TENDL-2019 LIBRARY; T=293.16K
Photon emission for (n,x)

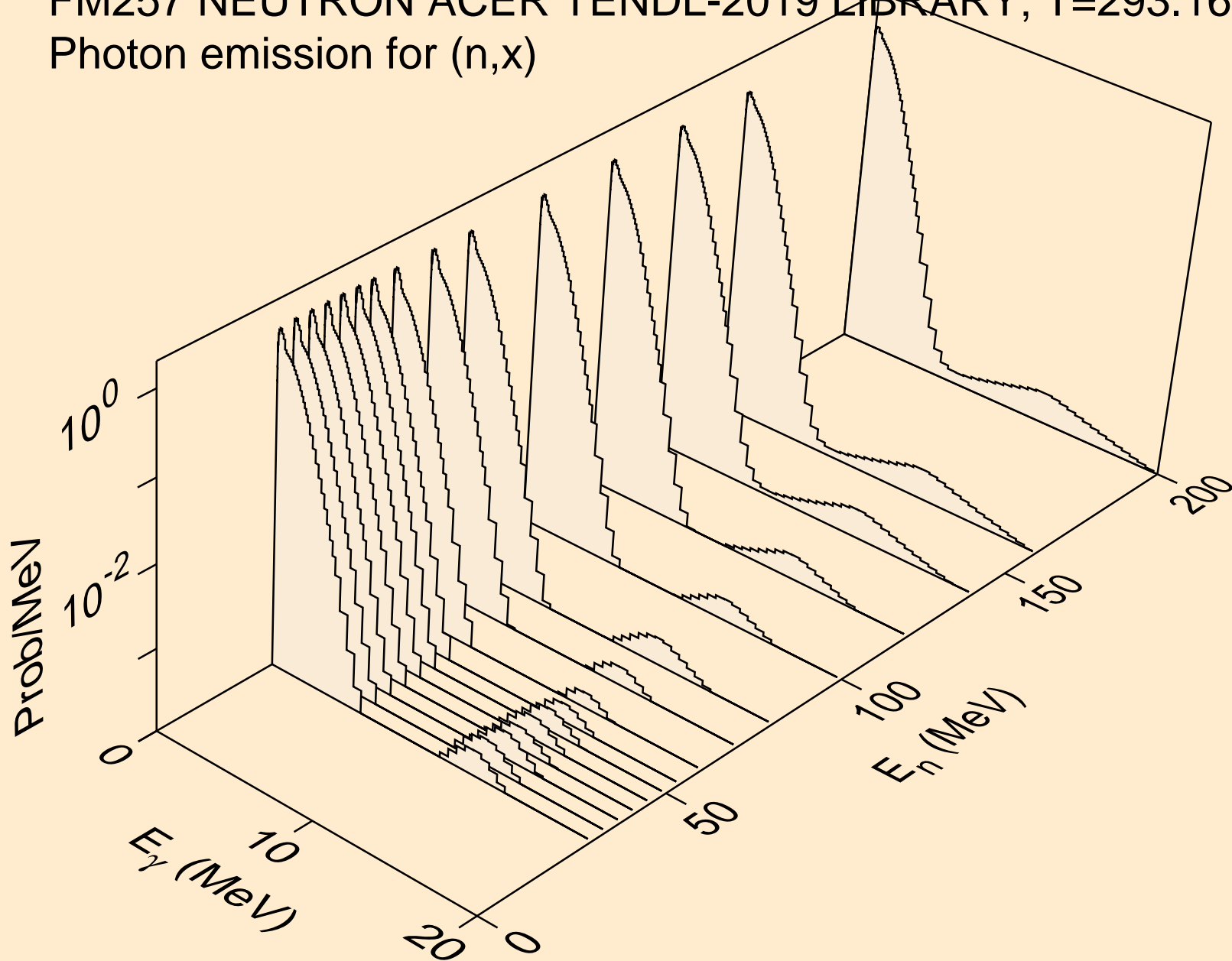

FM257 NEUTRON ACER TENDL-2019 LIBRARY; T=293.16K
Photon emission for (n,2nd)

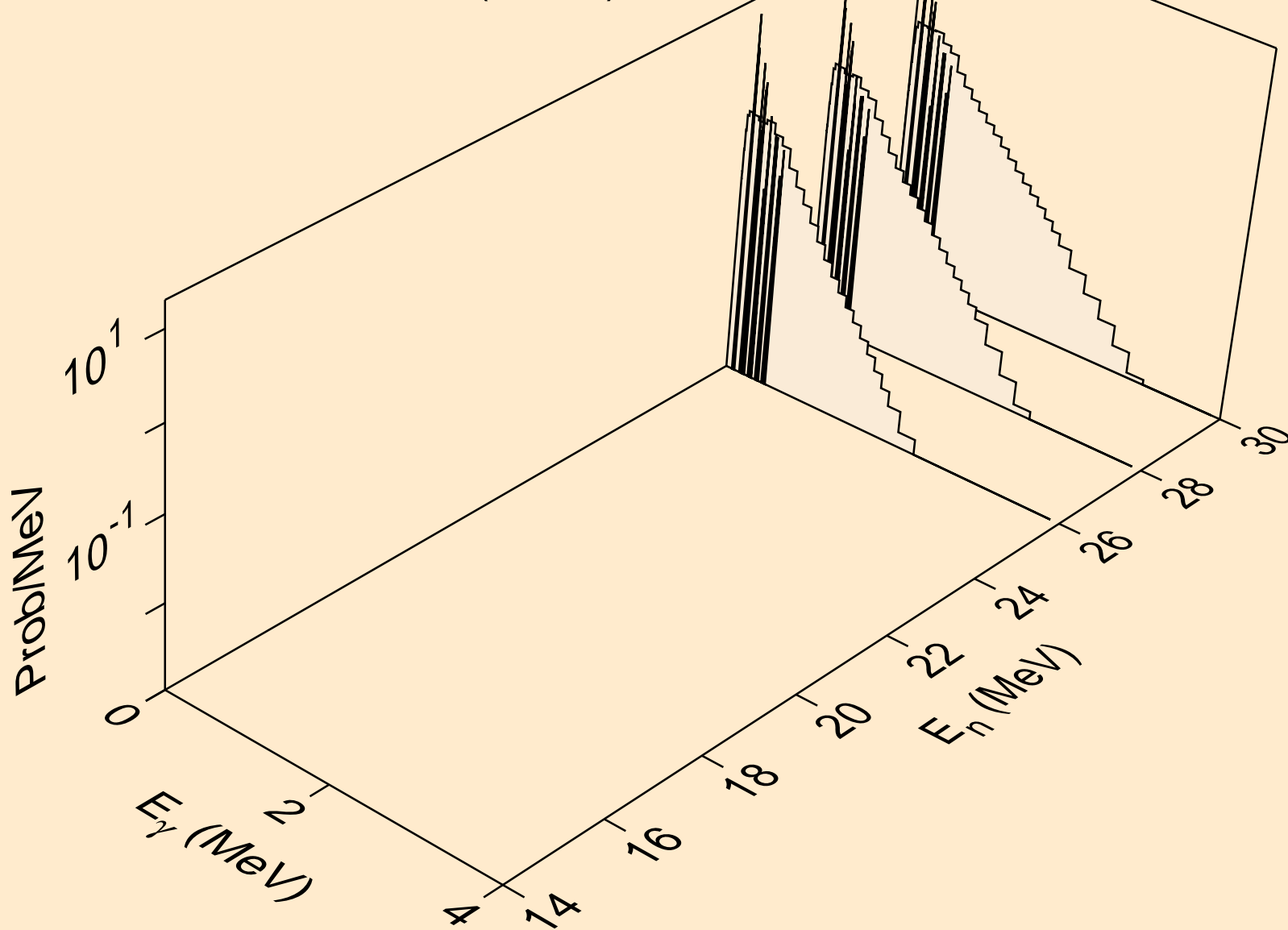

FM257 NEUTRON ACER TENDL-2019 LIBRARY; T=293.16K
Photon emission for (n,2n)

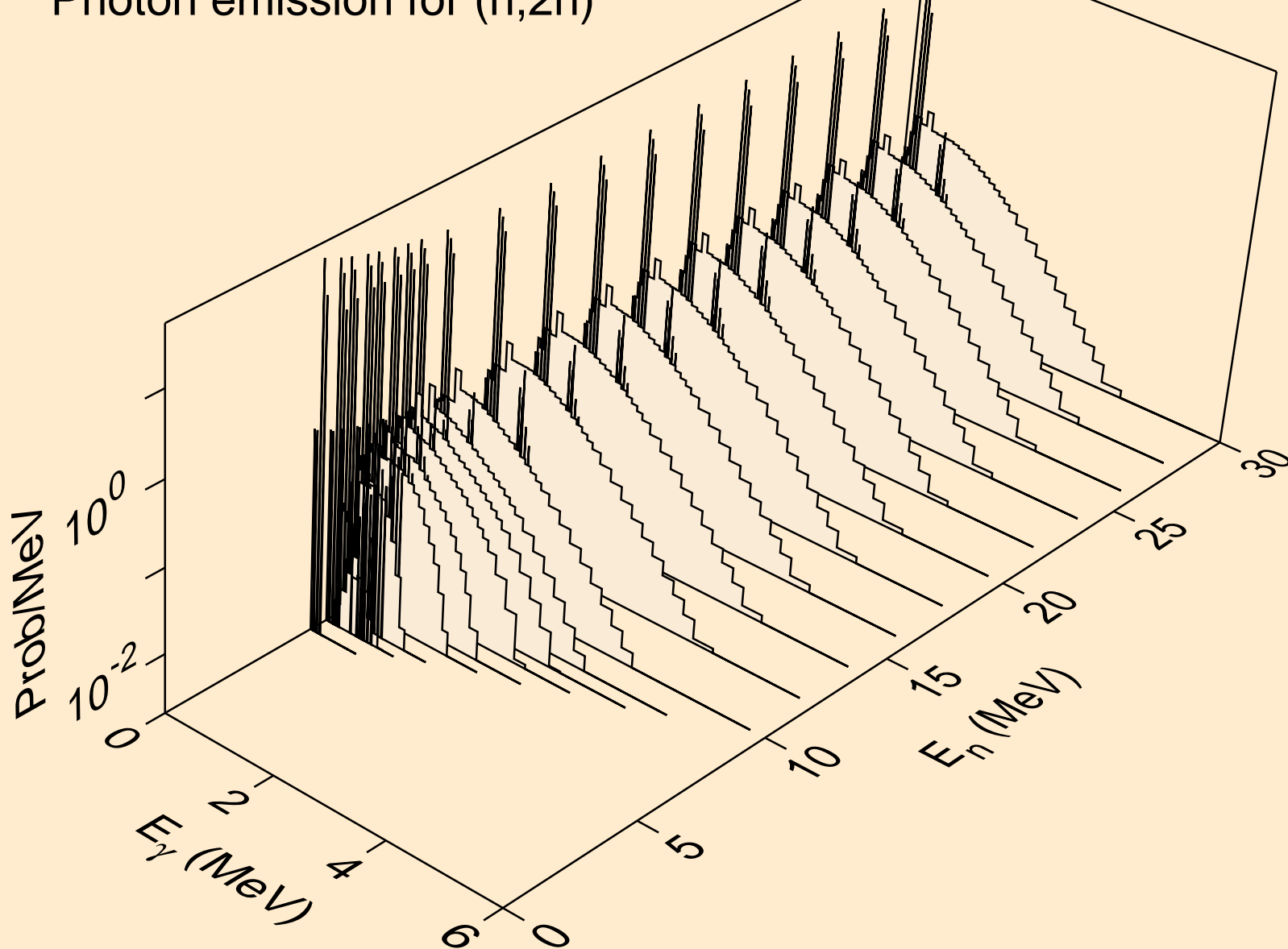

FM257 NEUTRON ACER TENDL-2019 LIBRARY; T=293.16K
Photon emission for (n,3n)

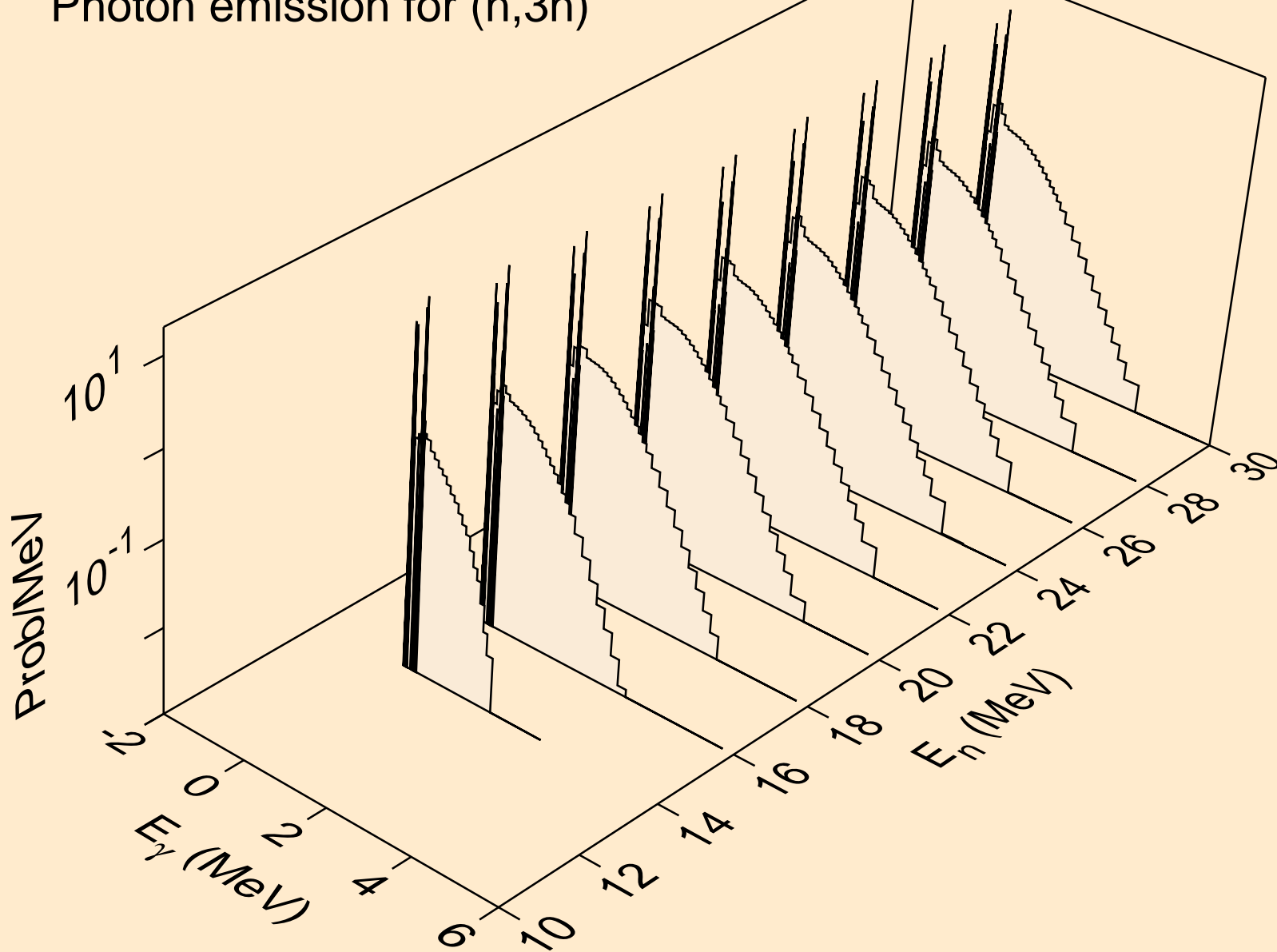

FM257 NEUTRON ACER TENDL-2019 LIBRARY; T=293.16K
Photon emission for (n,n*)a

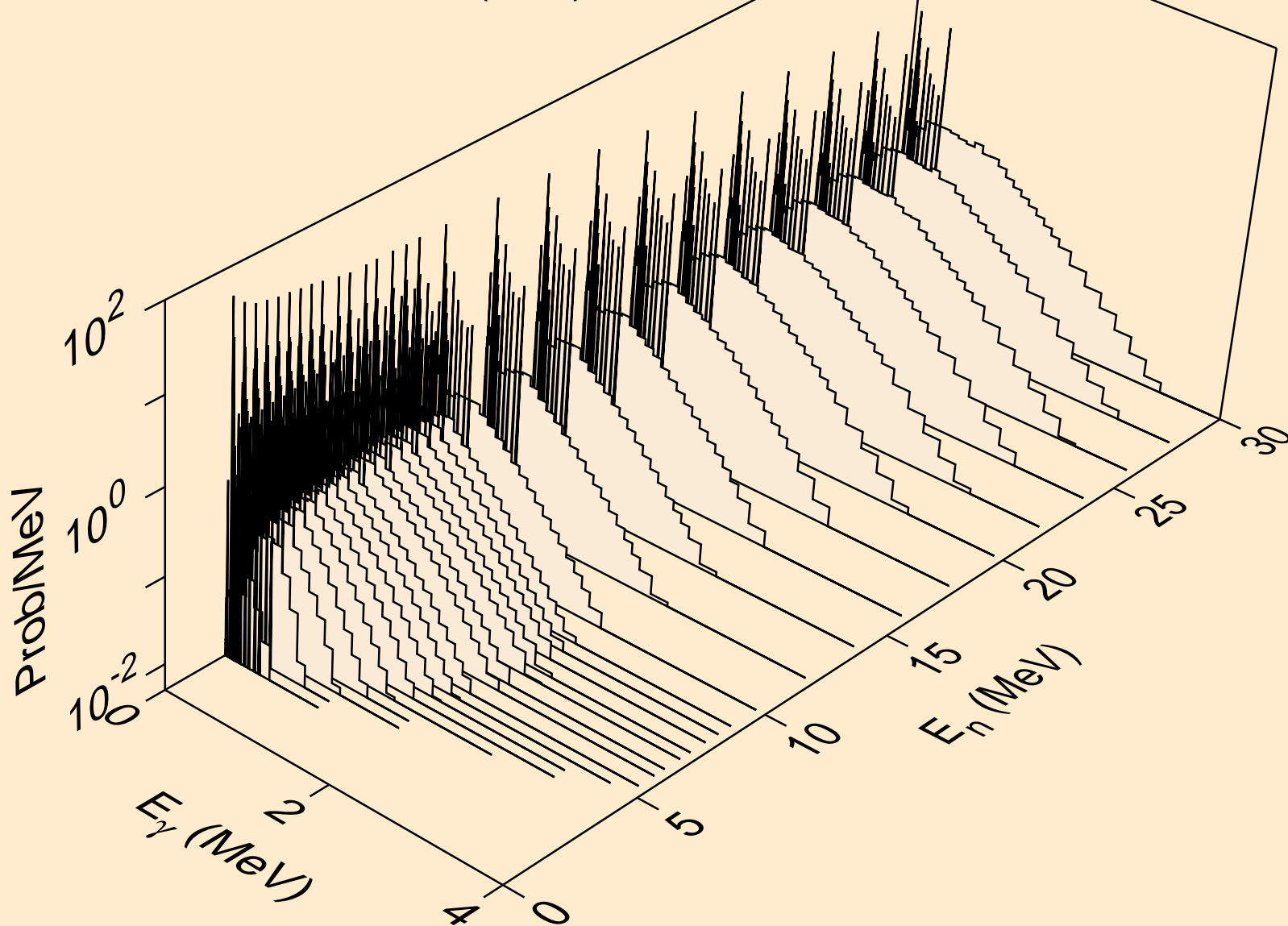

FM257 NEUTRON ACER TENDL-2019 LIBRARY; T=293.16K
Photon emission for (n,2n)a

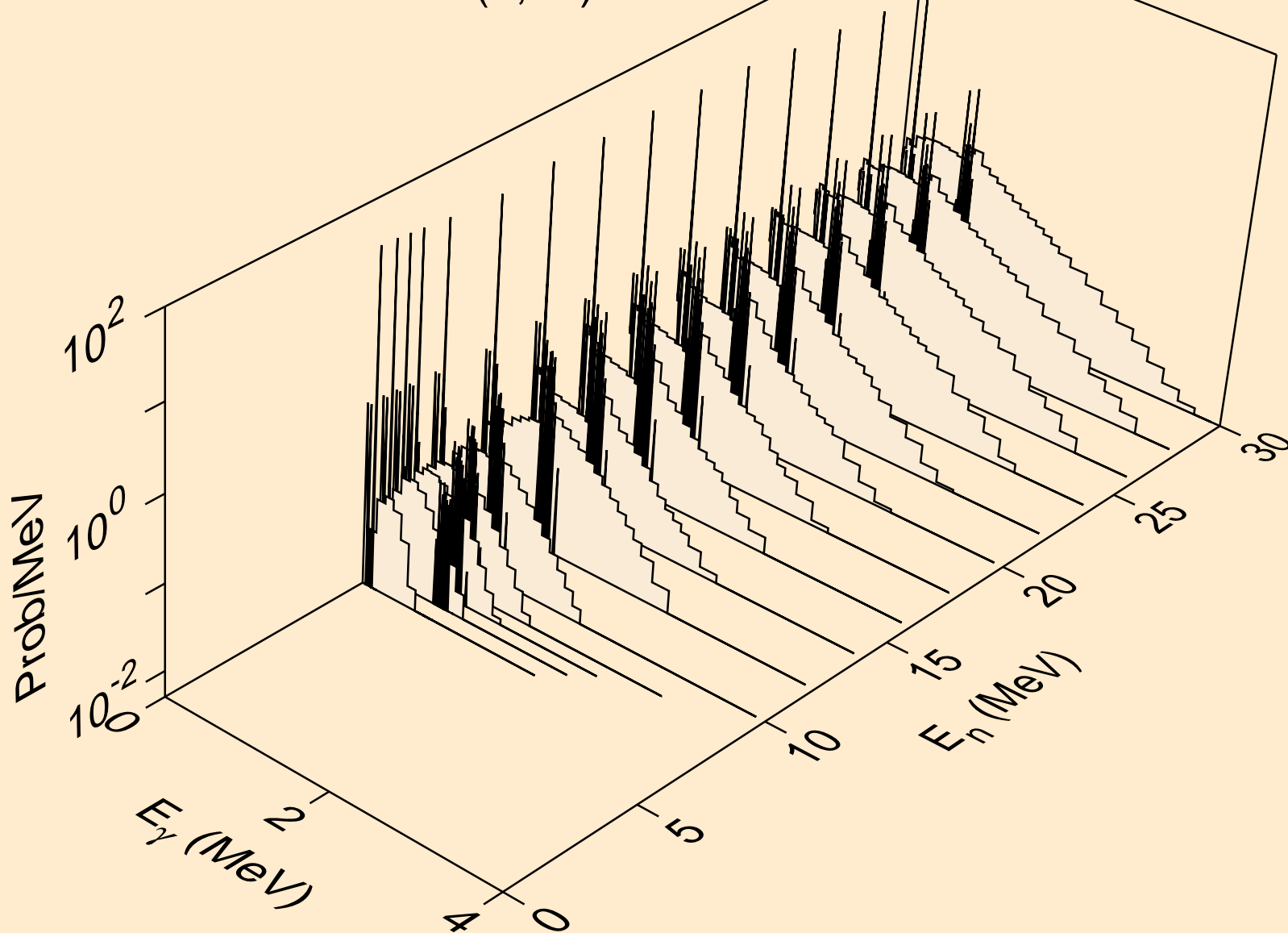

FM257 NEUTRON ACER TENDL-2019 LIBRARY; T=293.16K
Photon emission for (n,3n)a

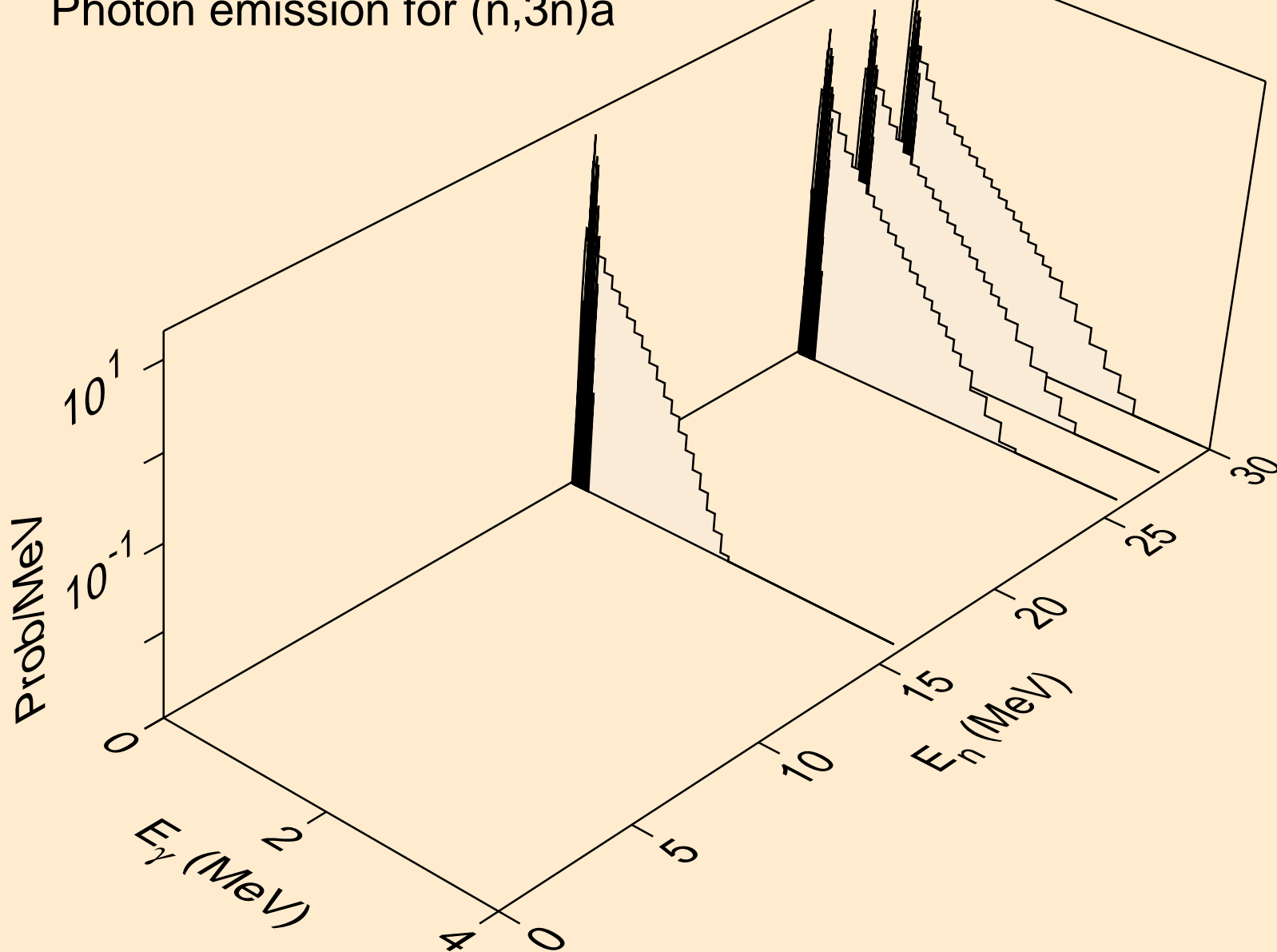

FM257 NEUTRON ACER TENDL-2019 LIBRARY; T=293.16K
Photon emission for (n,n*)p

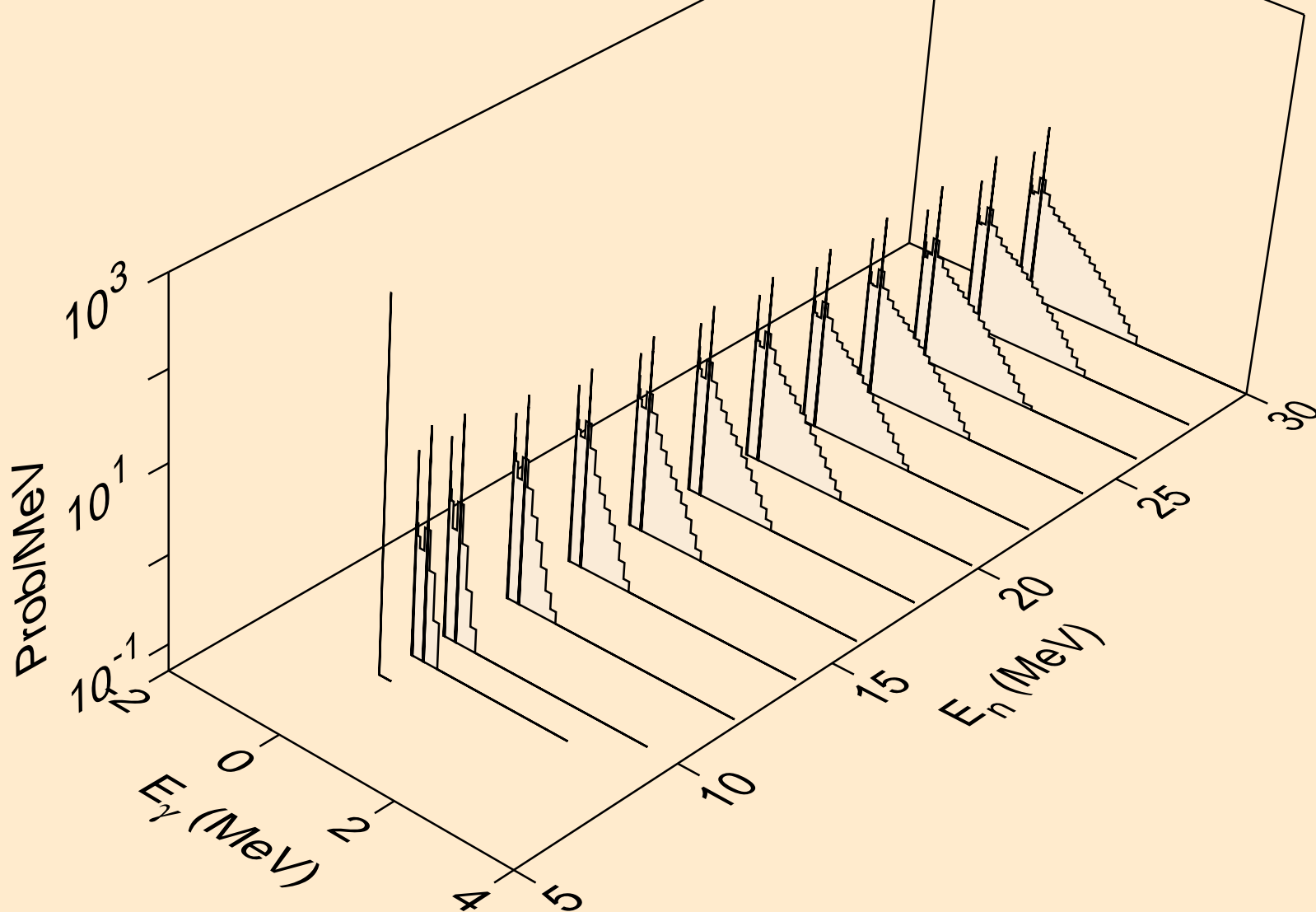

FM257 NEUTRON ACER TENDL-2019 LIBRARY; T=293.16K
Photon emission for (n,n*)d

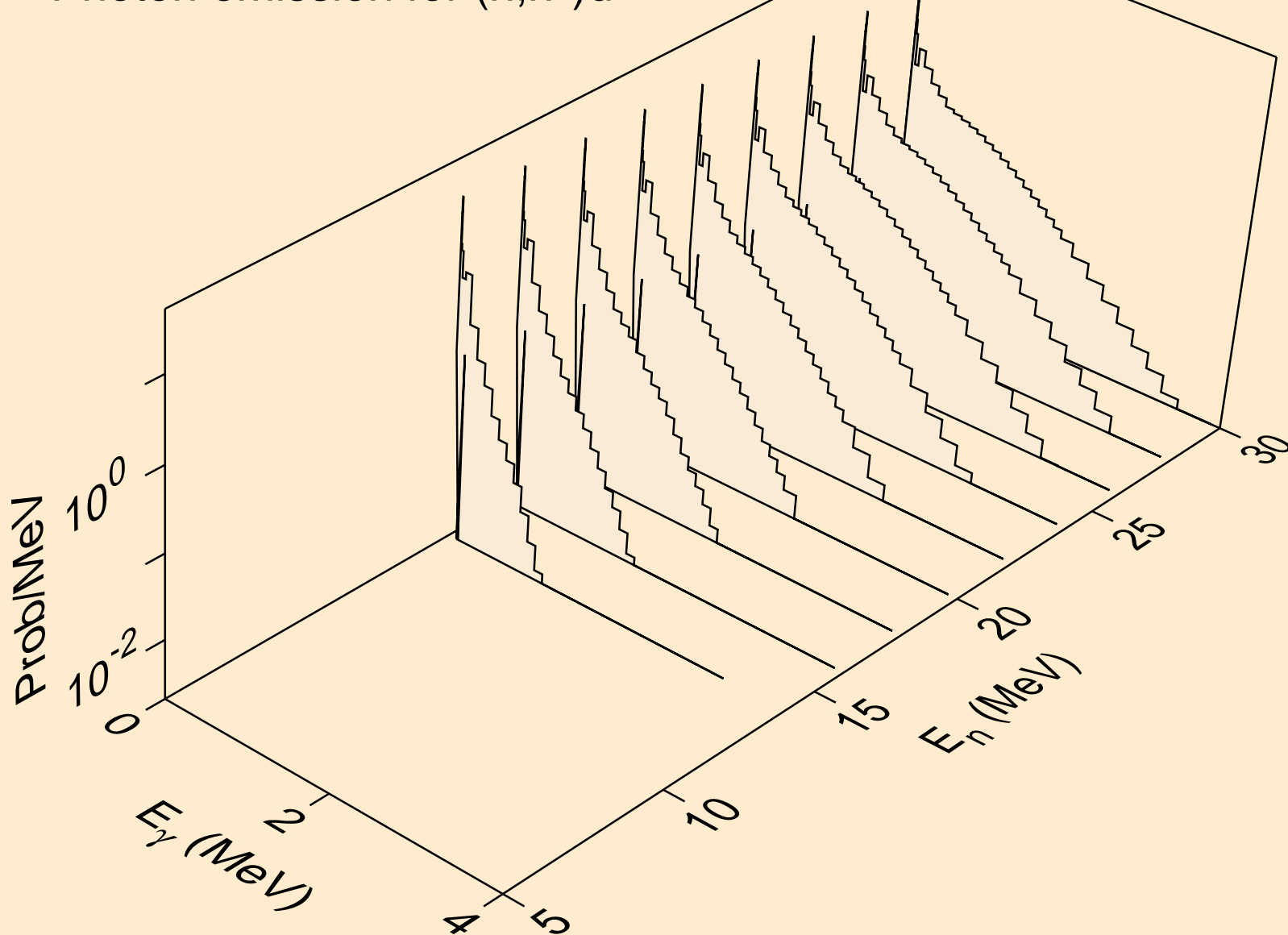

FM257 NEUTRON ACER TENDL-2019 LIBRARY; T=293.16K
Photon emission for (n,n*)t

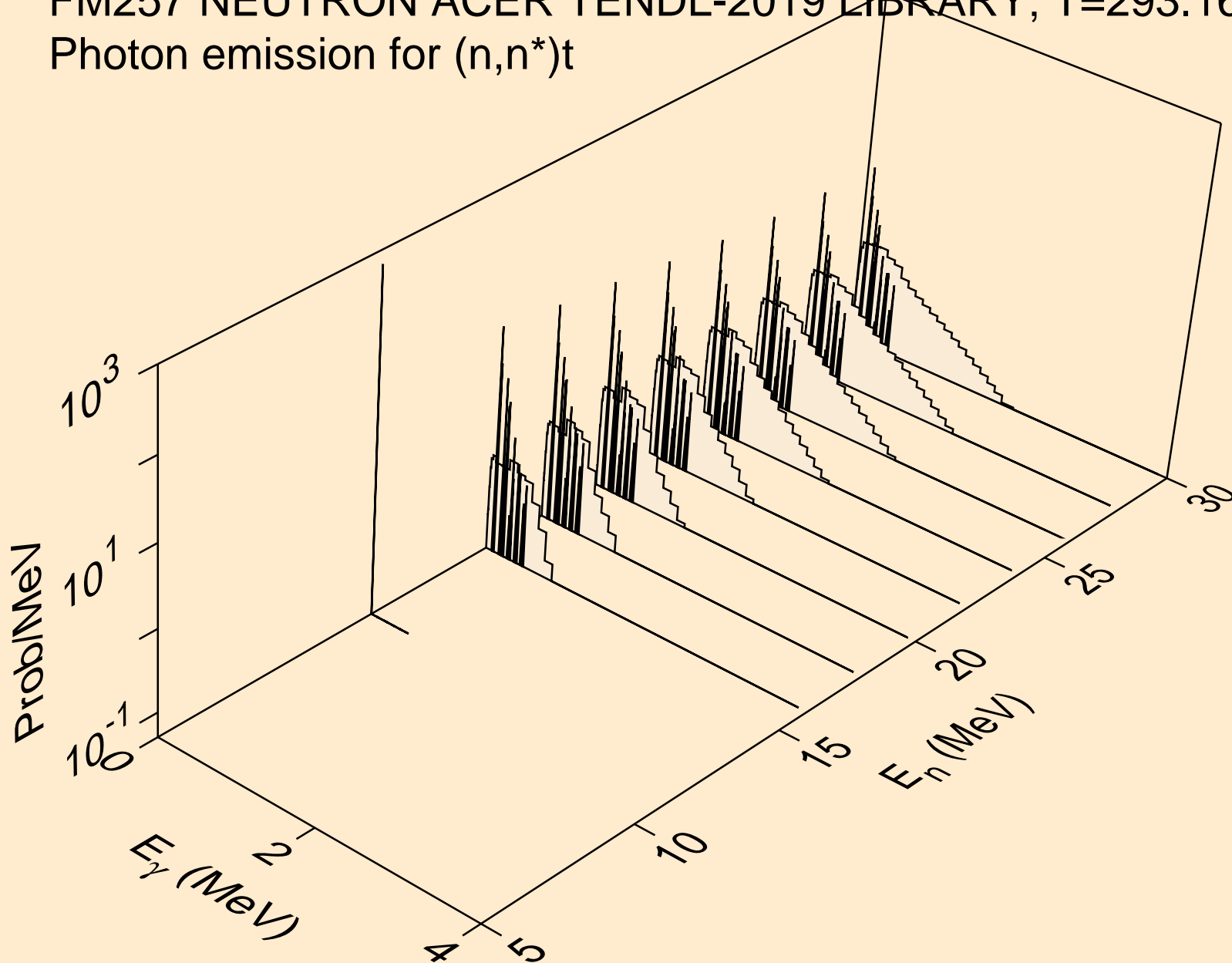

FM257 NEUTRON ACER TENDL-2019 LIBRARY; T=293.16K
Photon emission for (n,n*)he3

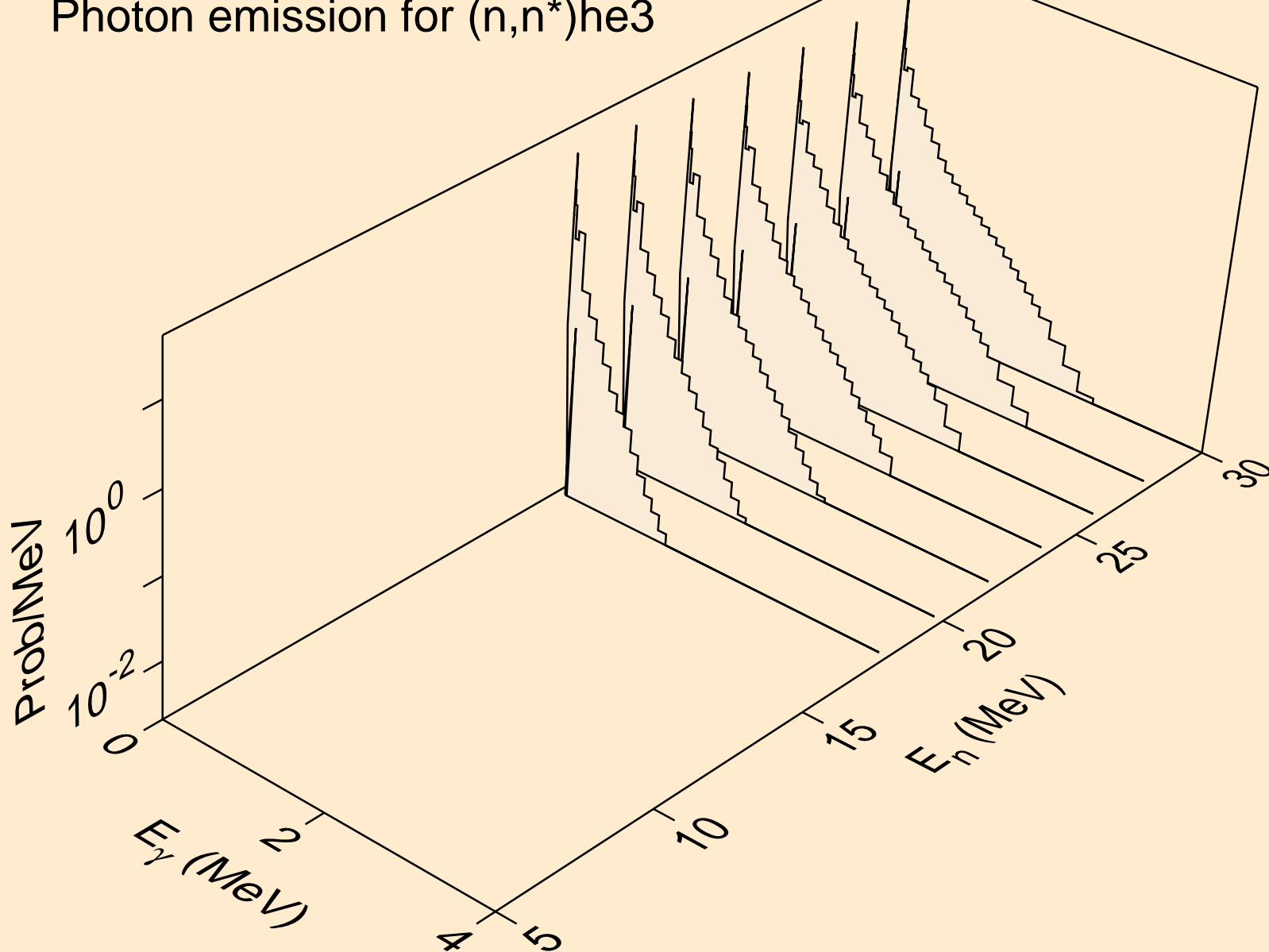

FM257 NEUTRON ACER TENDL-2019 LIBRARY; T=293.16K
Photon emission for (n,4n)

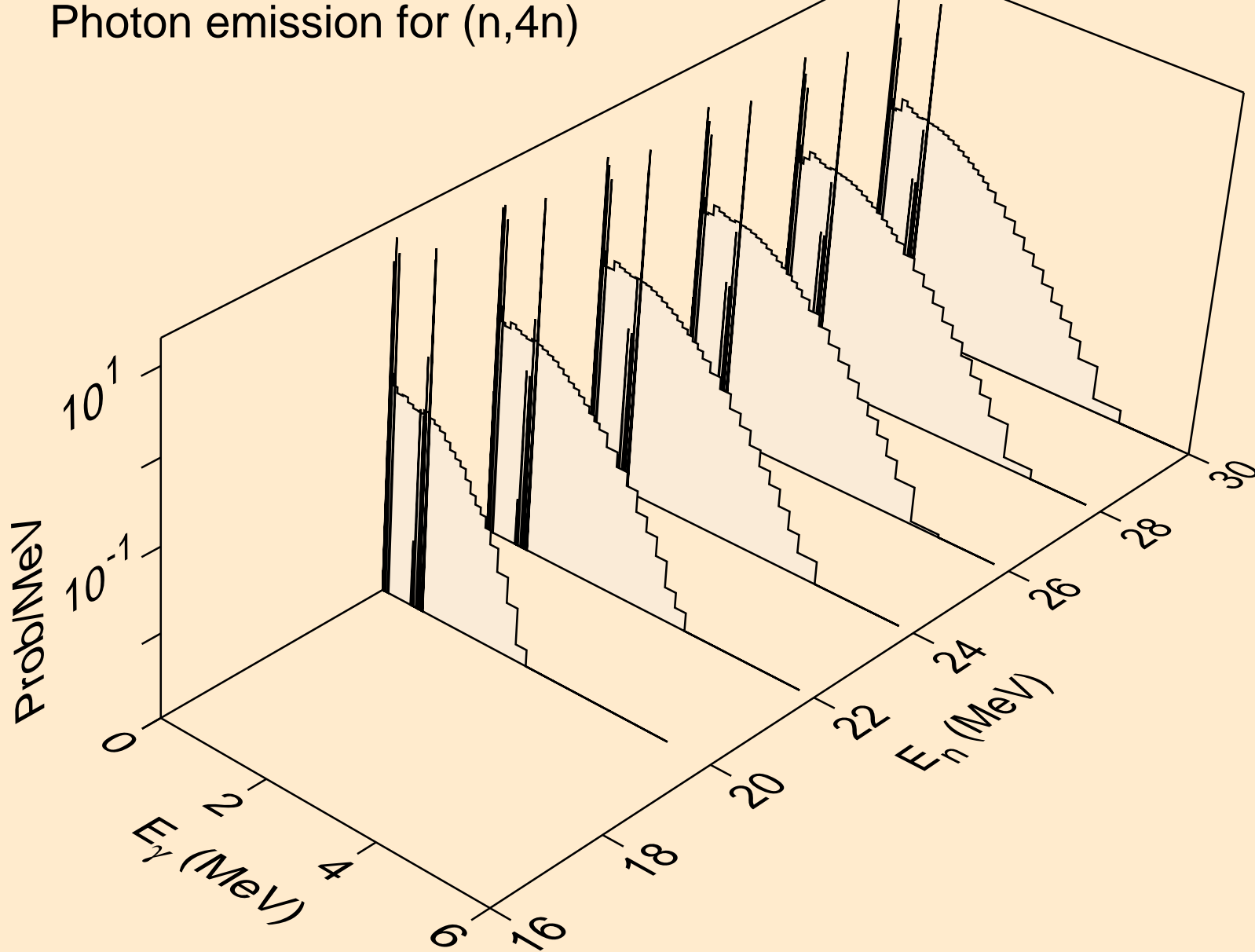

FM257 NEUTRON ACER TENDL-2019 LIBRARY; T=293.16K
Photon emission for (n,2np)

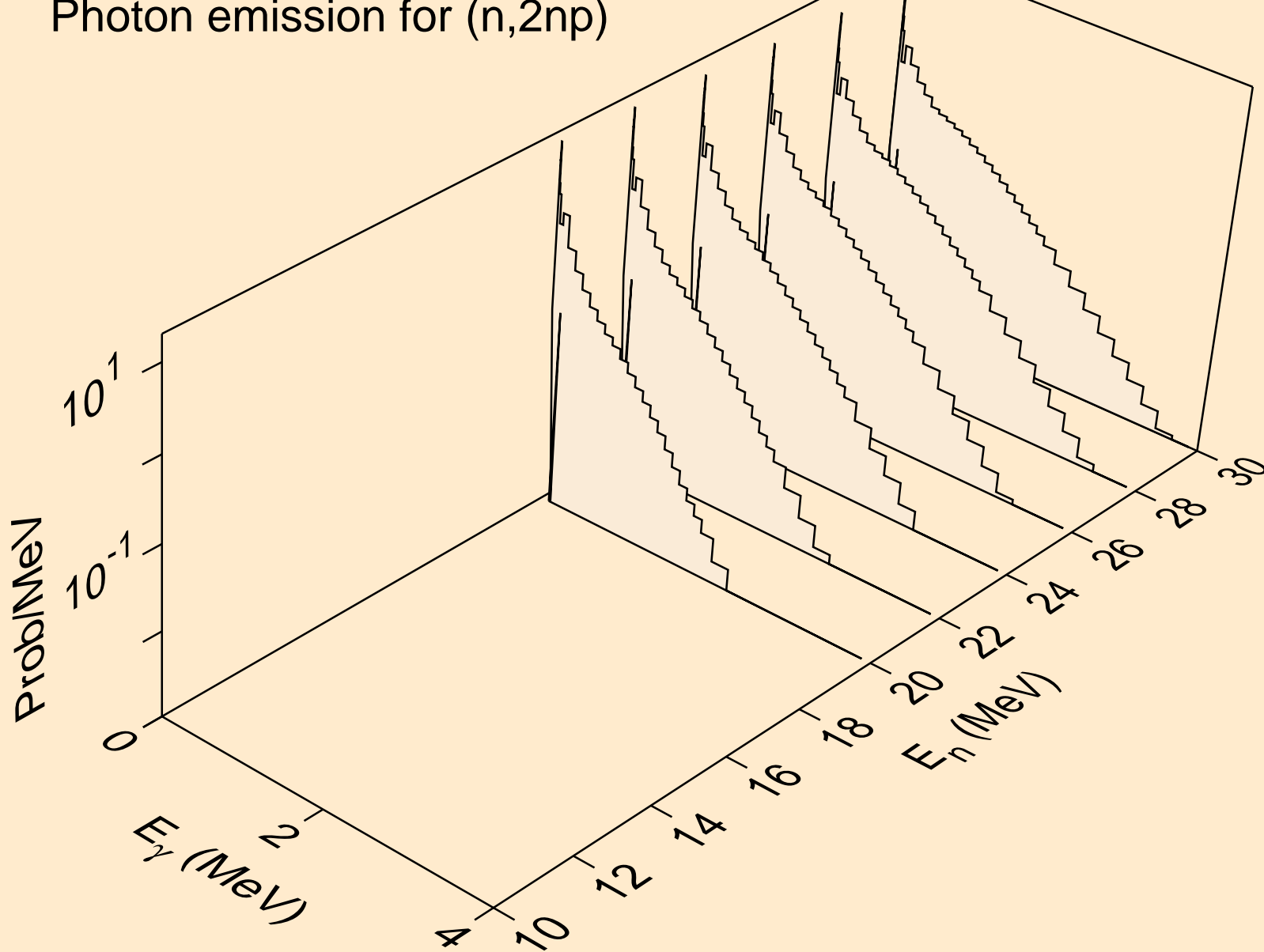

FM257 NEUTRON ACER TENDL-2019 LIBRARY; T=293.16K
Photon emission for (n,3np)

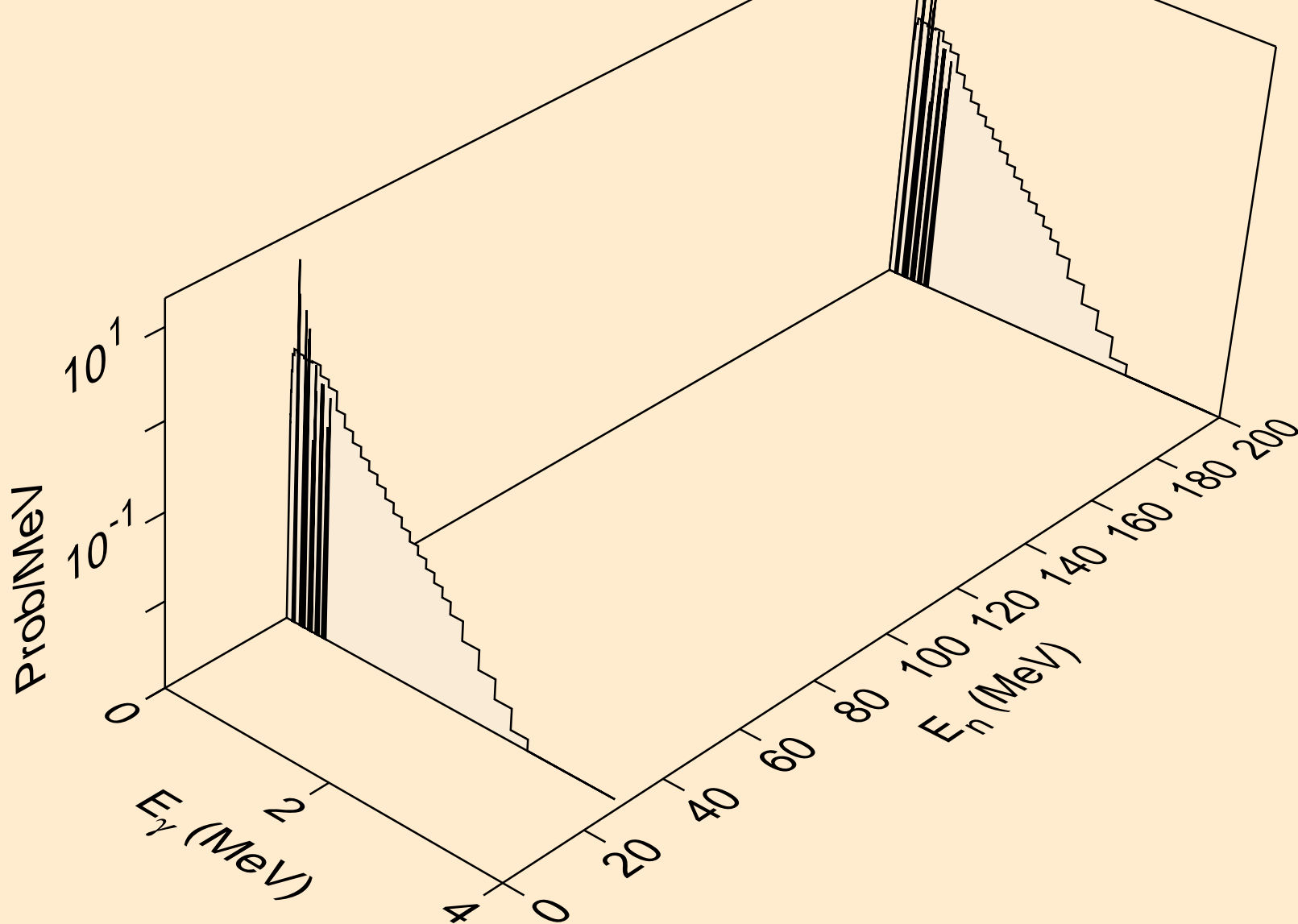

FM257 NEUTRON ACER TENDL-2019 LIBRARY; T=293.16K
Photon emission for (n,2np)

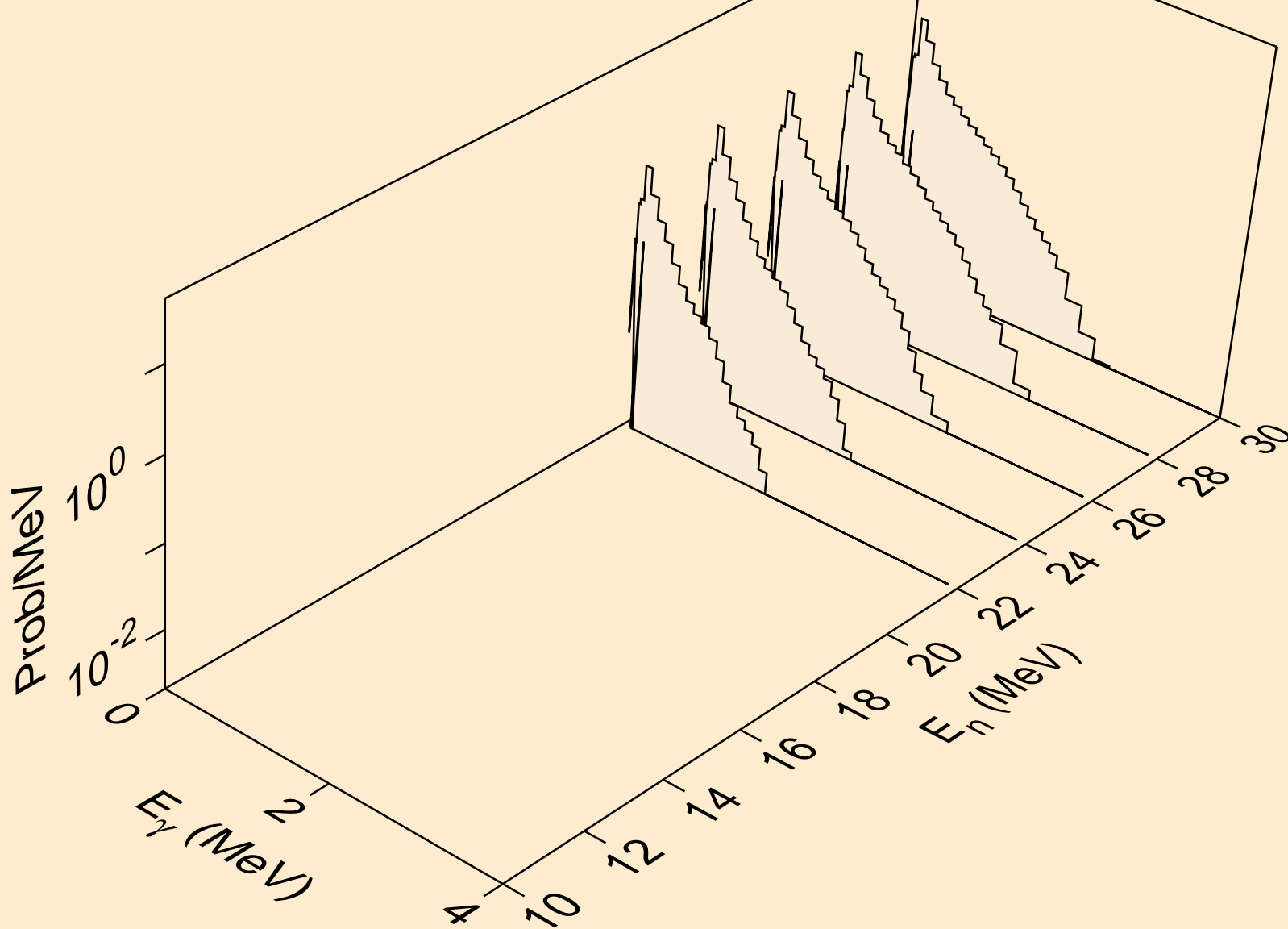

FM257 NEUTRON ACER TENDL-2019 LIBRARY; T=293.16K
Photon emission for (n,n*c)

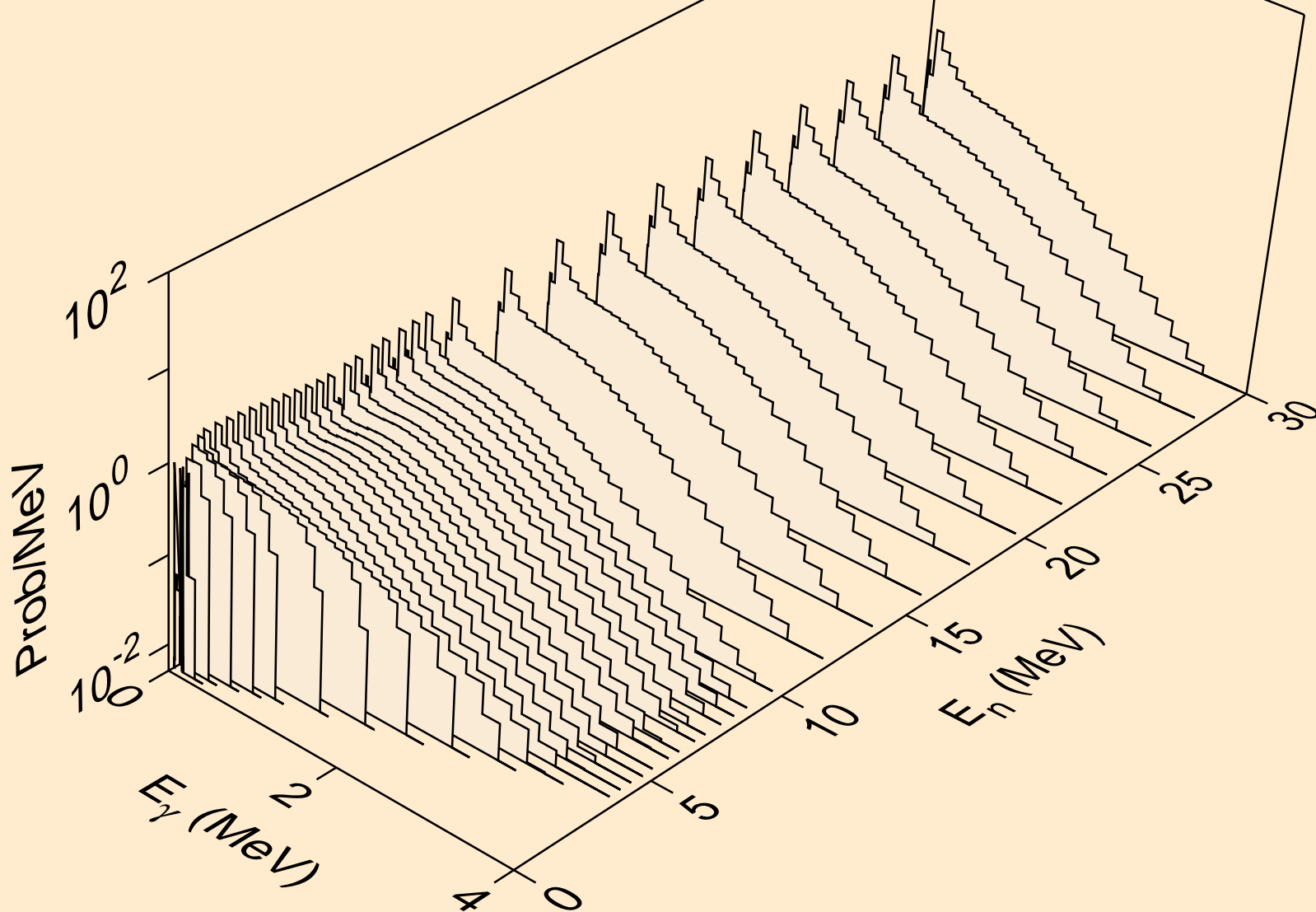

FM257 NEUTRON ACER TENDL-2019 LIBRARY; T=293.16K
Photon emission for (n,gma)

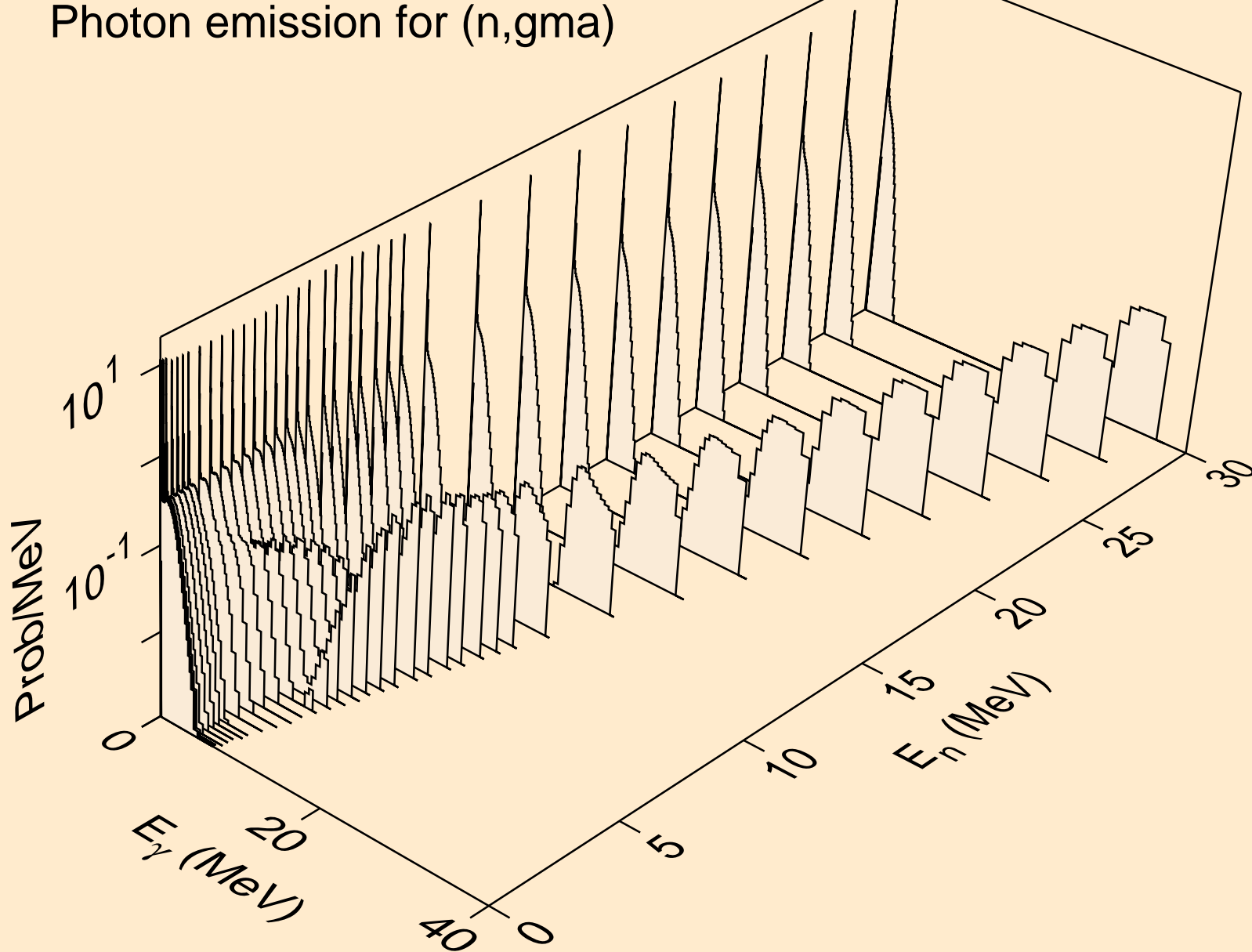

FM257 NEUTRON ACER TENDL-2019 LIBRARY; T=293.16K
Photon emission for (n,p)

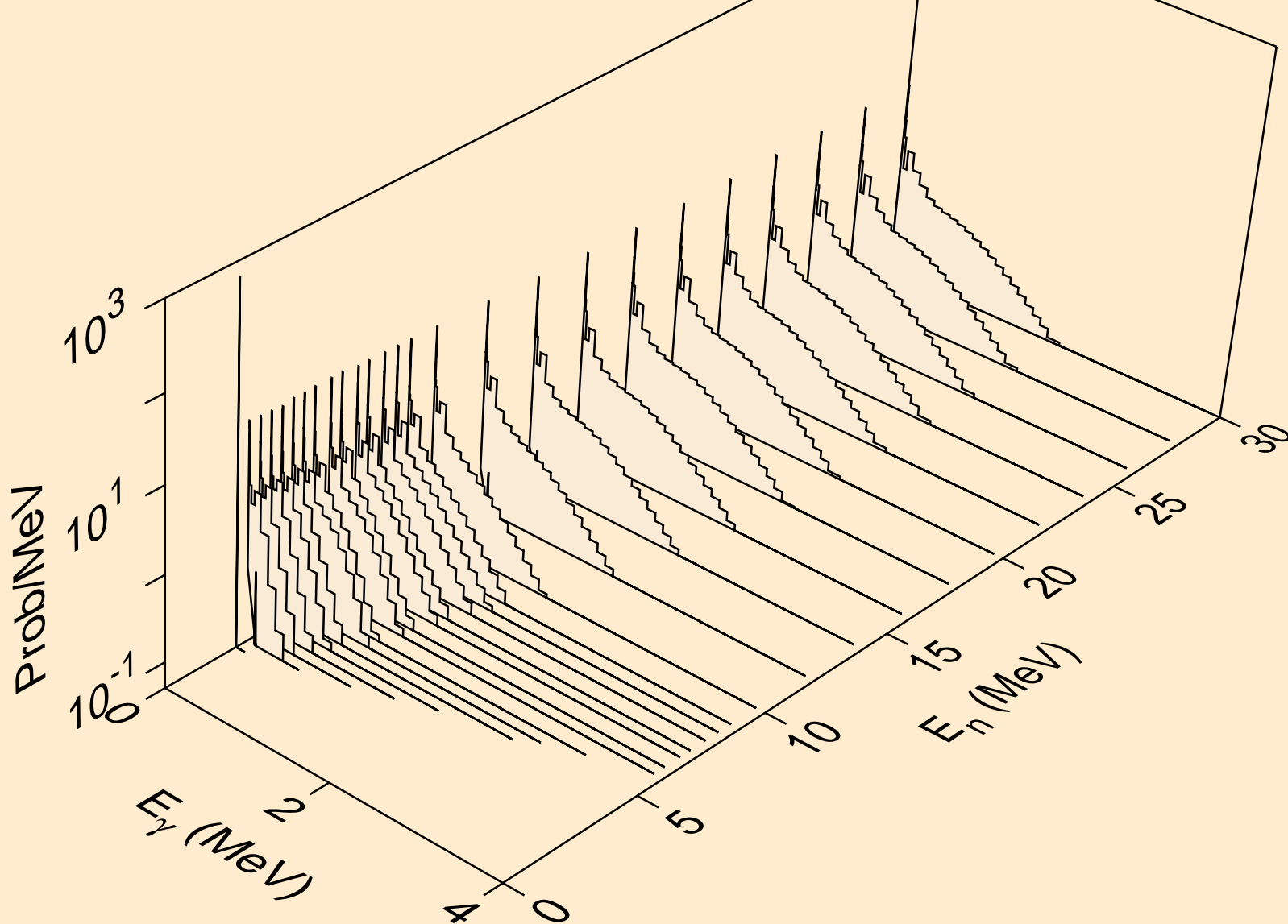

FM257 NEUTRON ACER TENDL-2019 LIBRARY; T=293.16K
Photon emission for (n,d)

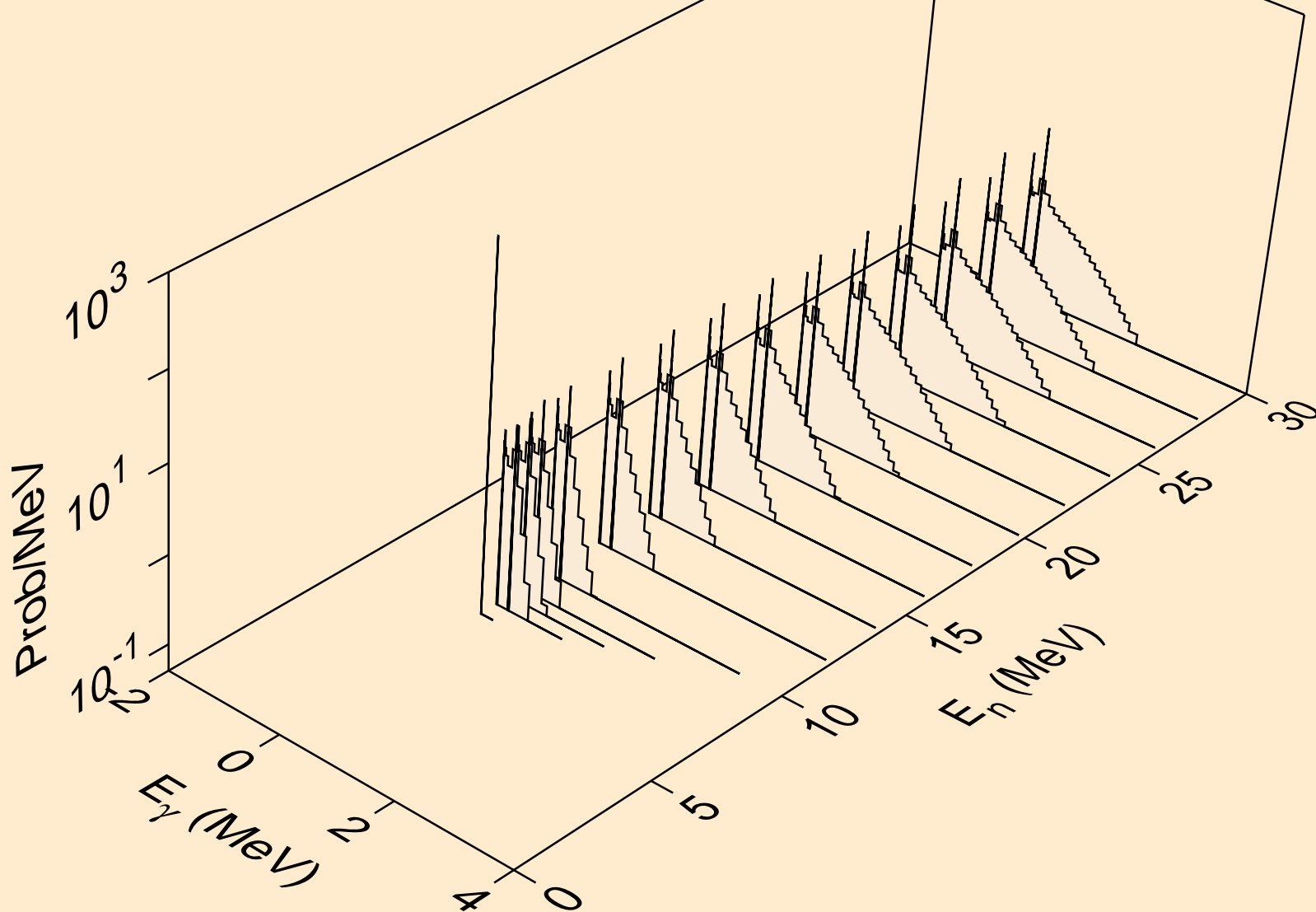

FM257 NEUTRON ACER TENDL-2019 LIBRARY; T=293.16K
Photon emission for (n,t)

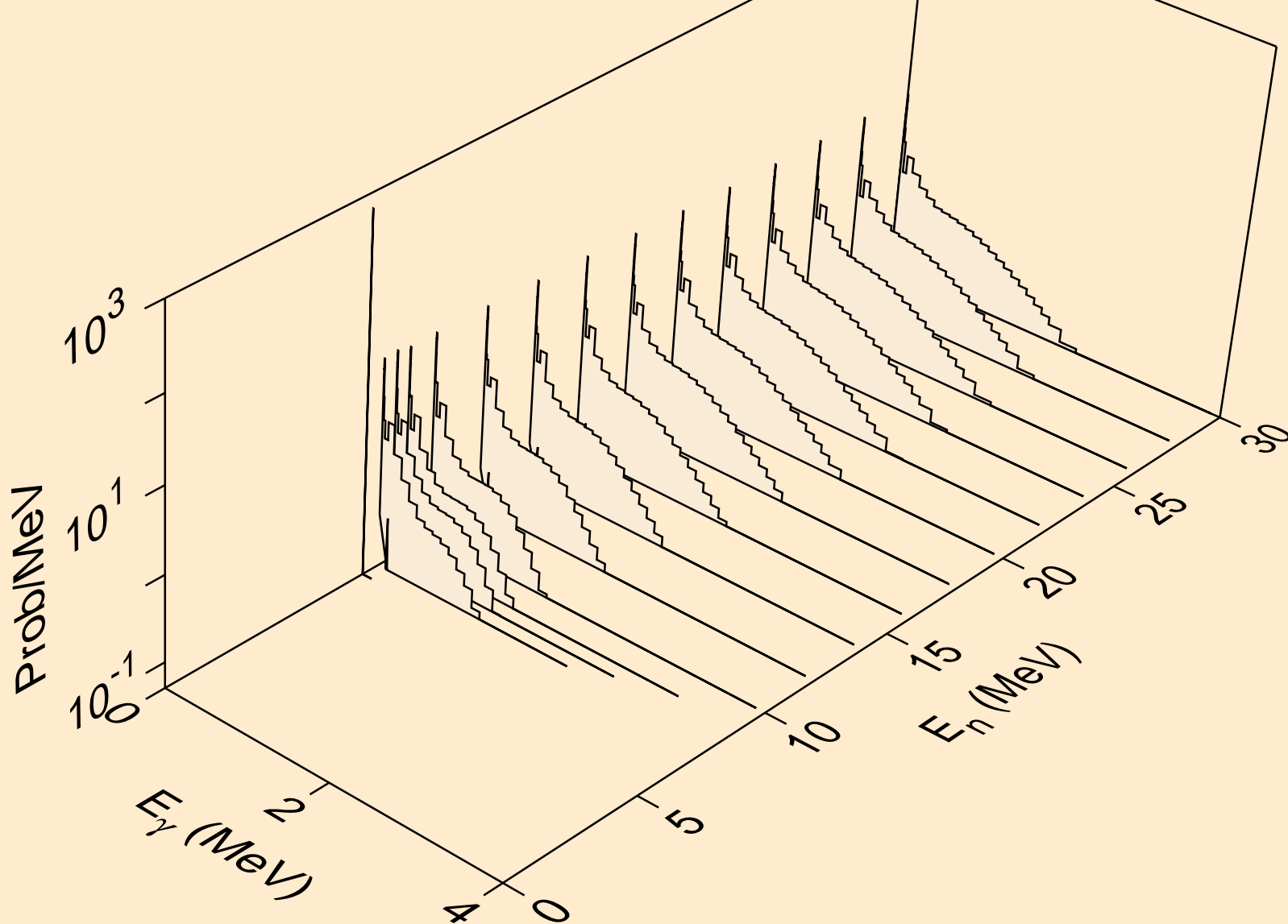

FM257 NEUTRON ACER TENDL-2019 LIBRARY; T=293.16K
Photon emission for (n,he3)

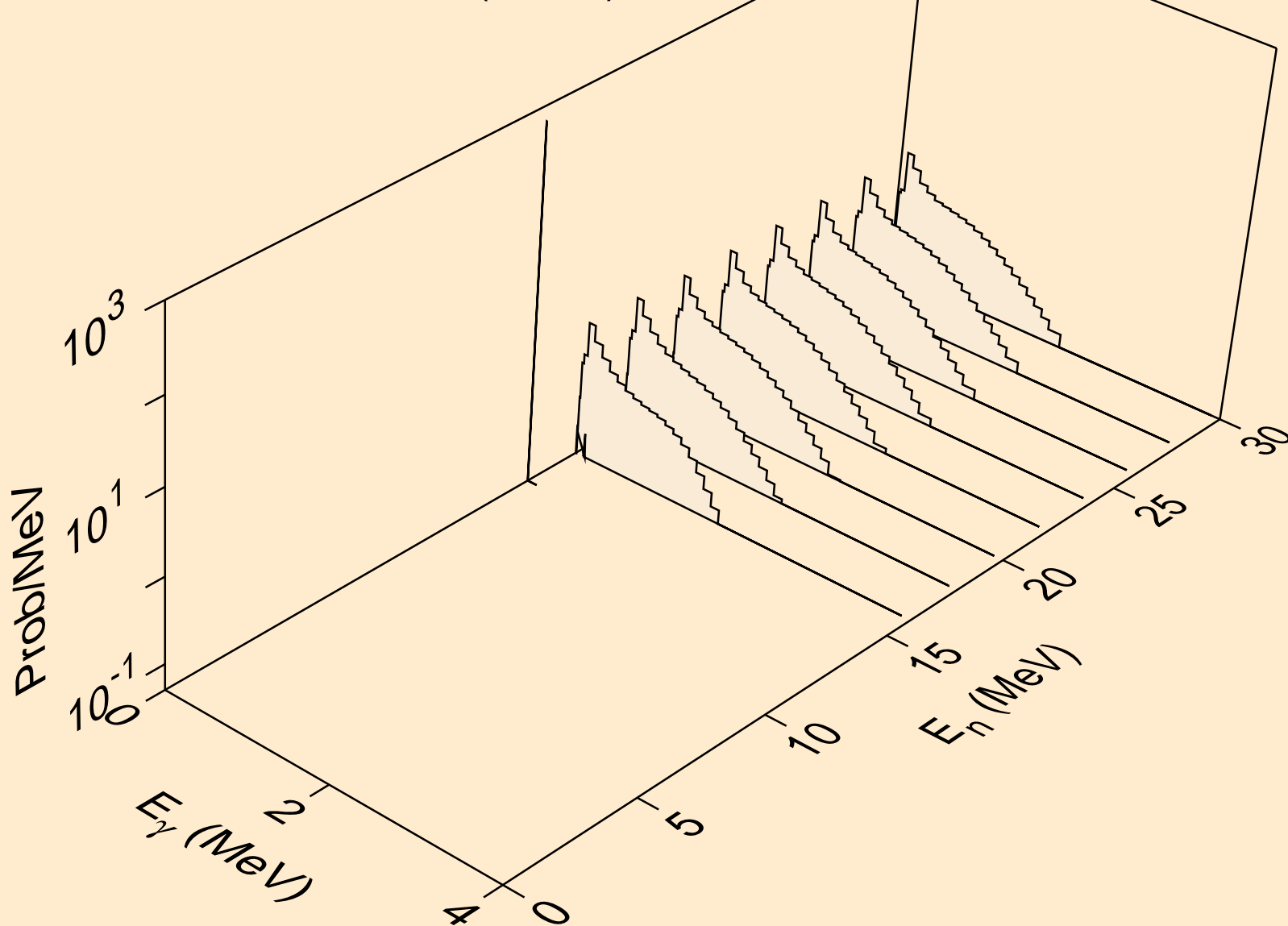

FM257 NEUTRON ACER TENDL-2019 LIBRARY; T=293.16K
Photon emission for (n,a)

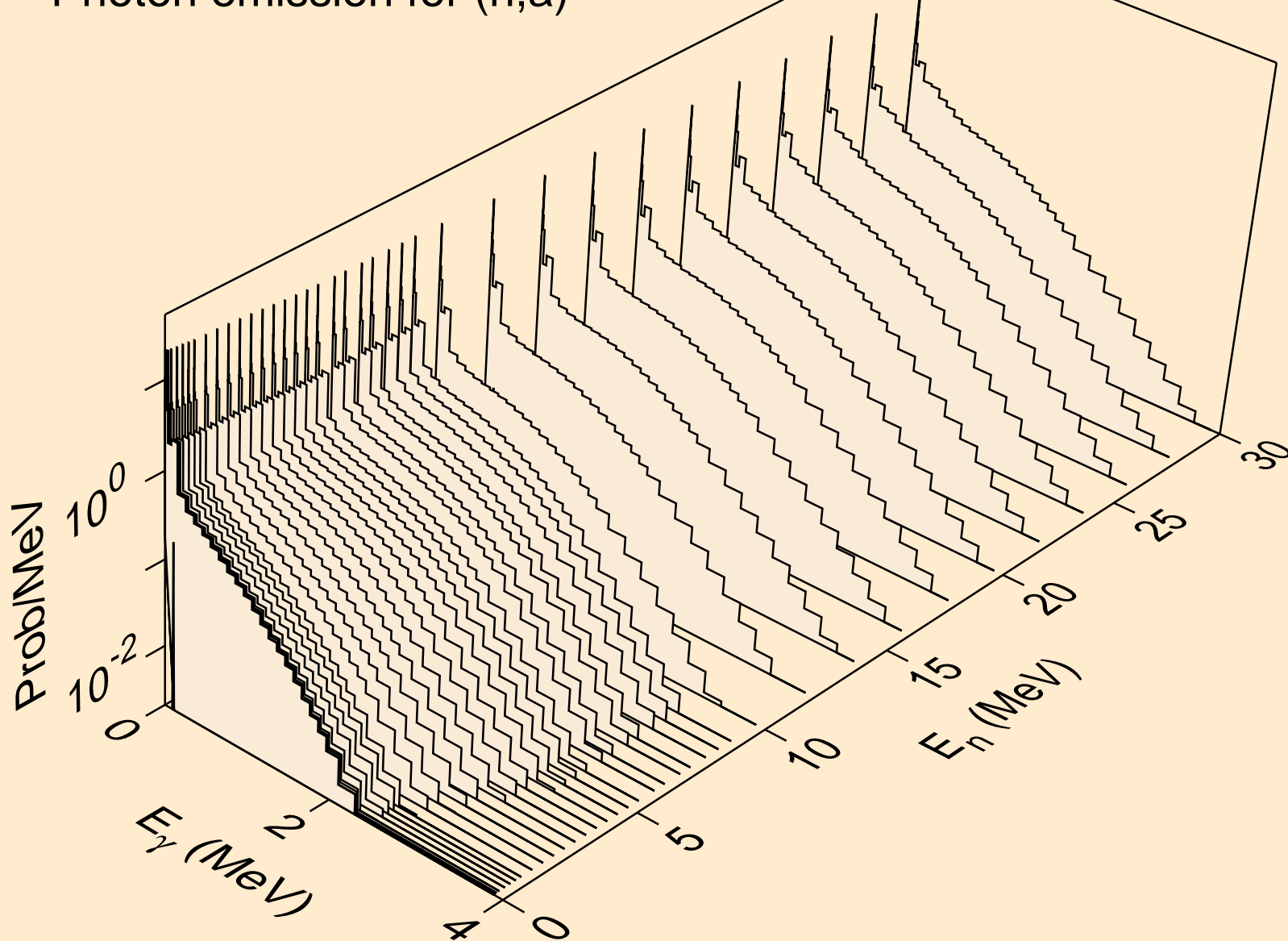

FM257 NEUTRON ACER TENDL-2019 LIBRARY; T=293.16K
Photon emission for (n,2p)

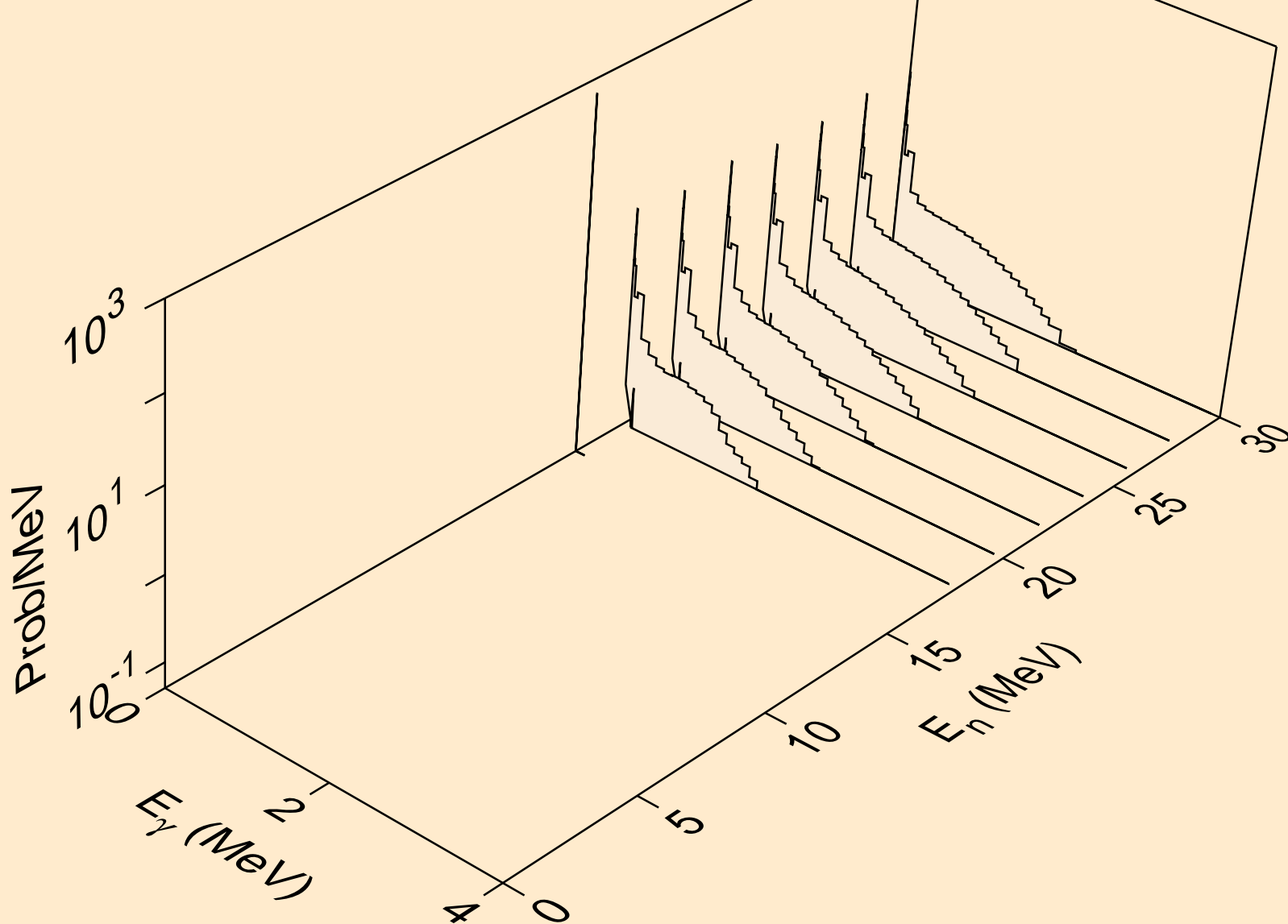

FM257 NEUTRON ACER TENDL-2019 LIBRARY; T=293.16K
thermal capture photon spectrum

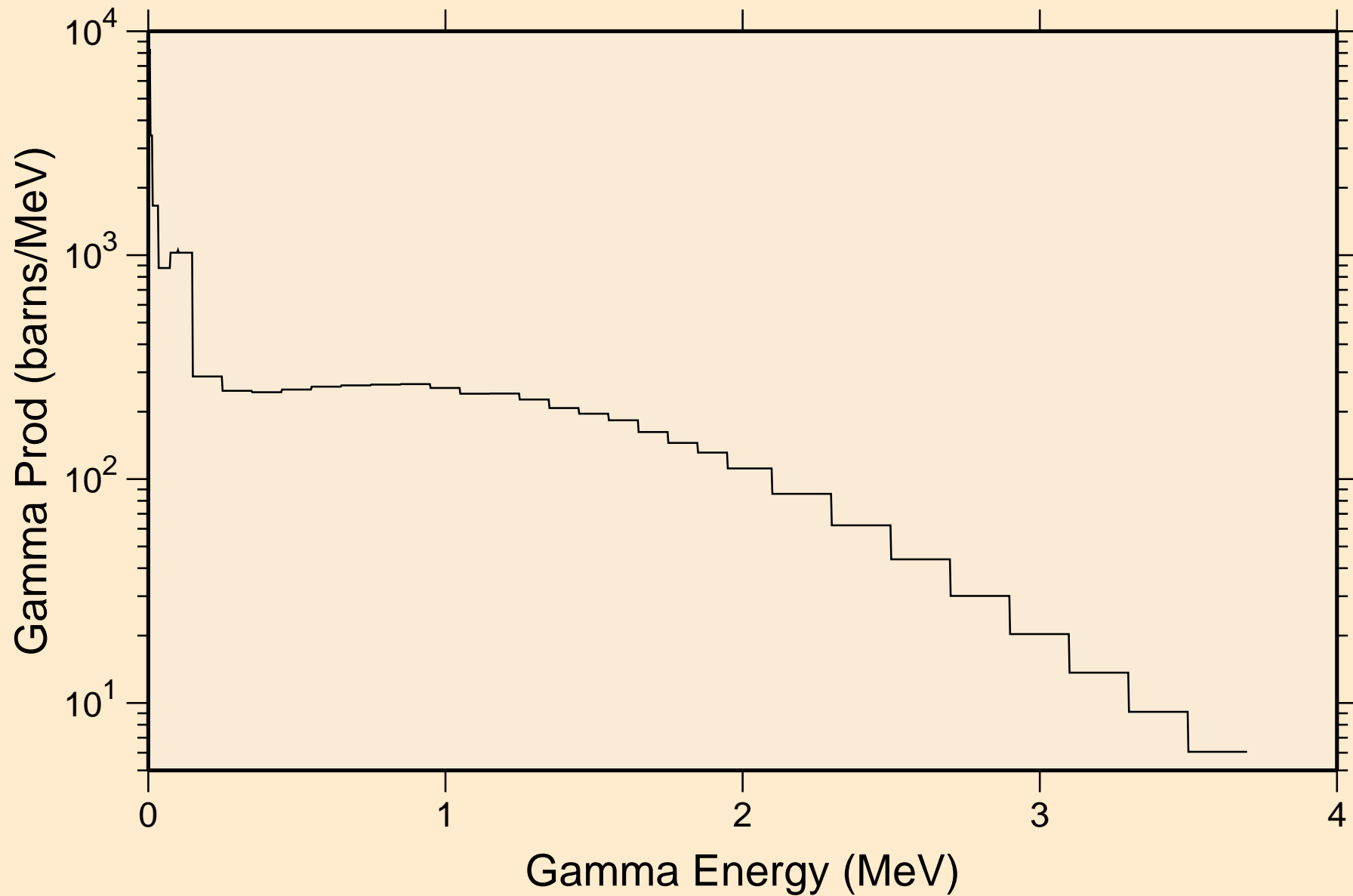

FM257 NEUTRON ACER TENDL-2019 LIBRARY; T=293.16K
14 MeV photon spectrum

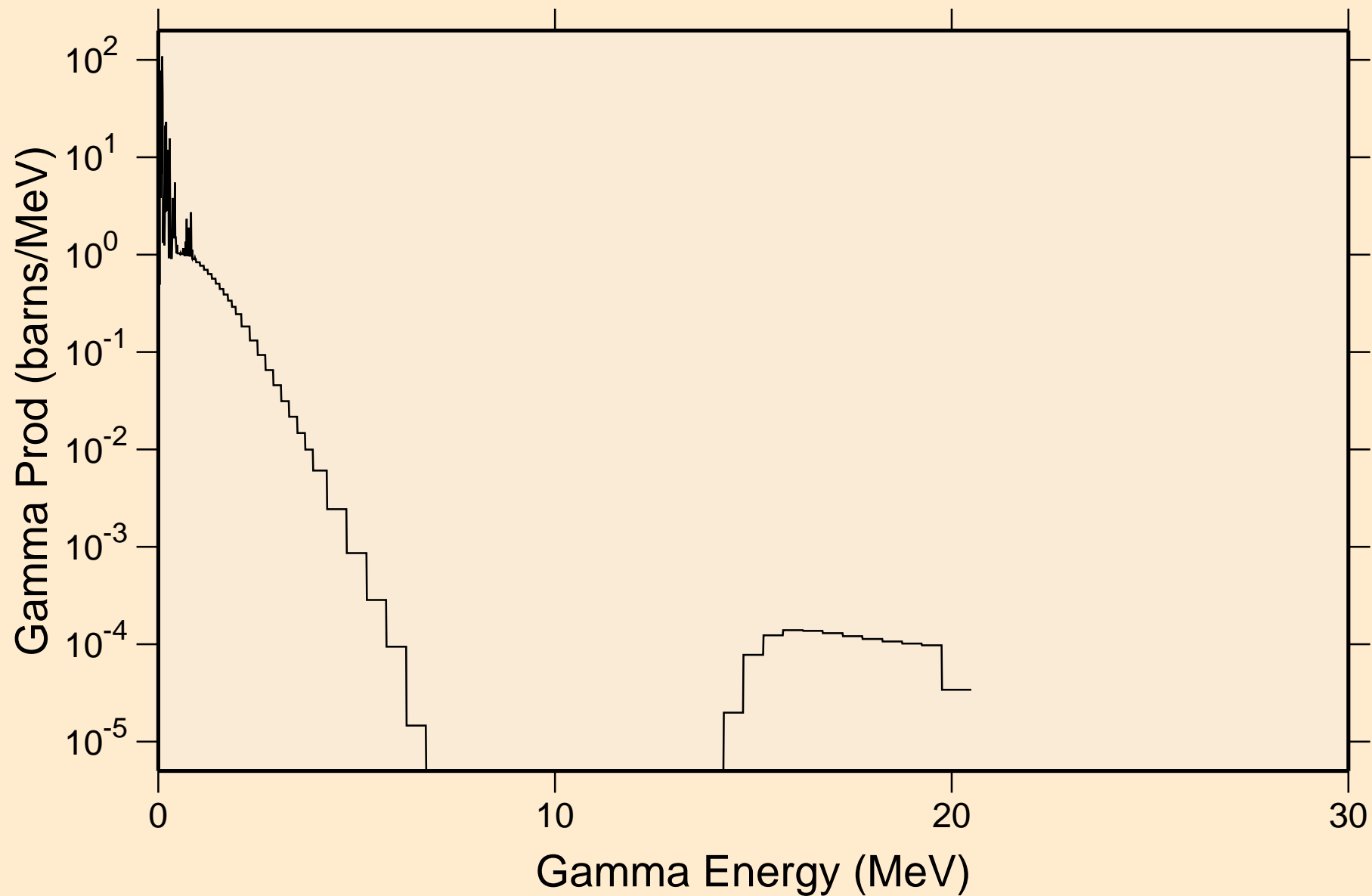

FM257 NEUTRON ACER TENDL-2019 LIBRARY; T=293.16K
Particle heating contributions

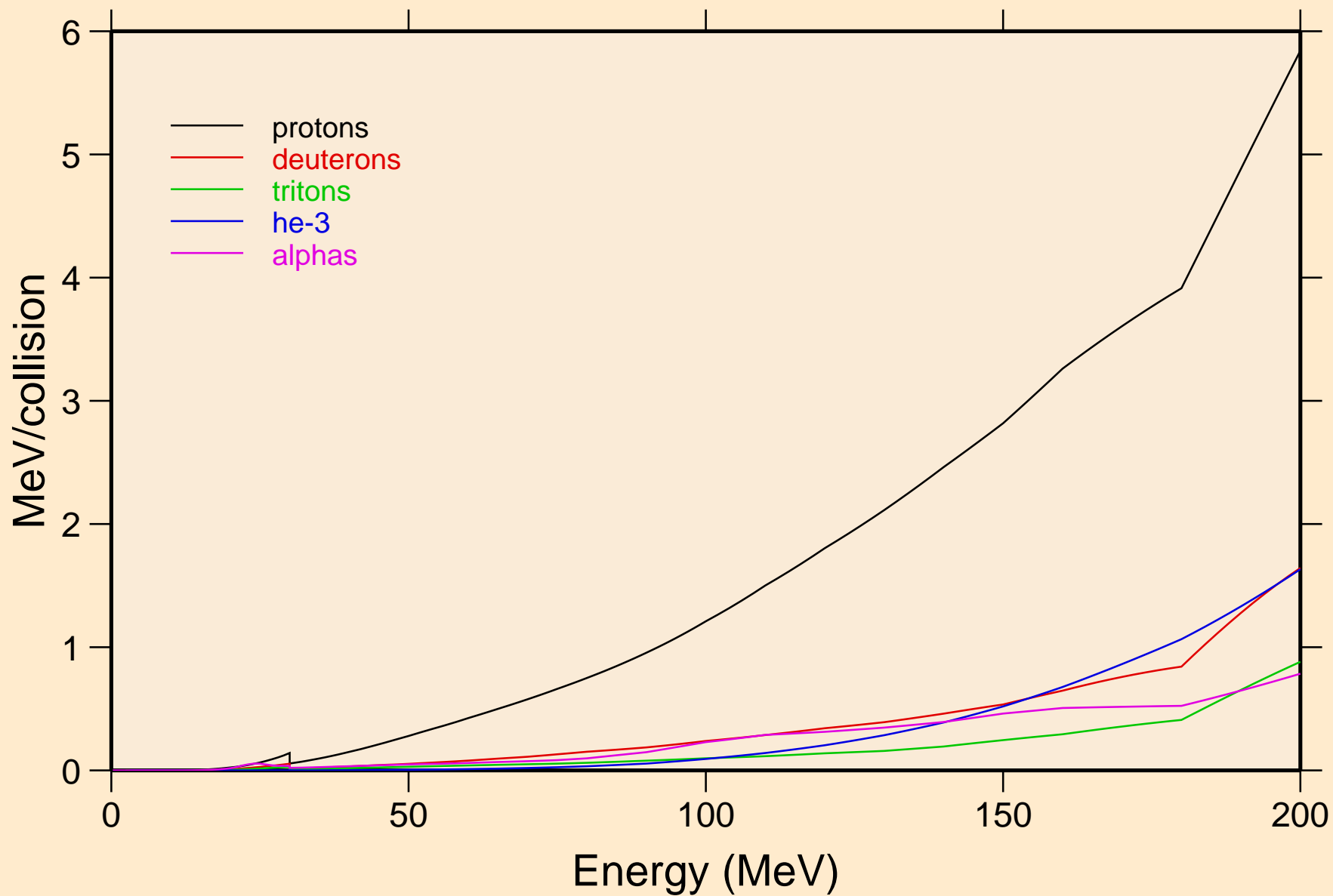

FM257 NEUTRON ACER TENDL-2019 LIBRARY; T=293.16K
Recoil Heating

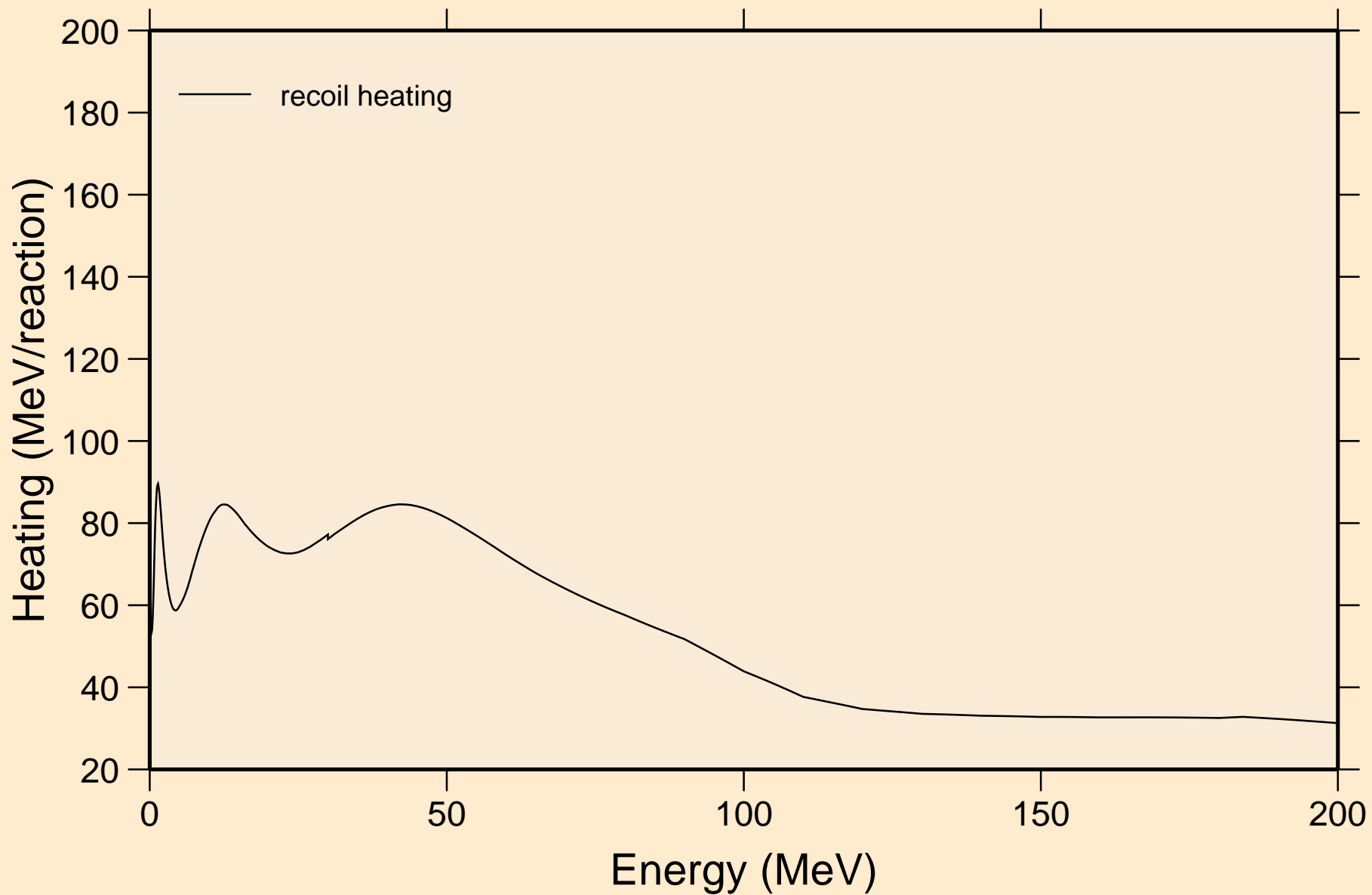

FM257 NEUTRON ACER TENDL-2019 LIBRARY; T=293.16K
Particle production cross sections

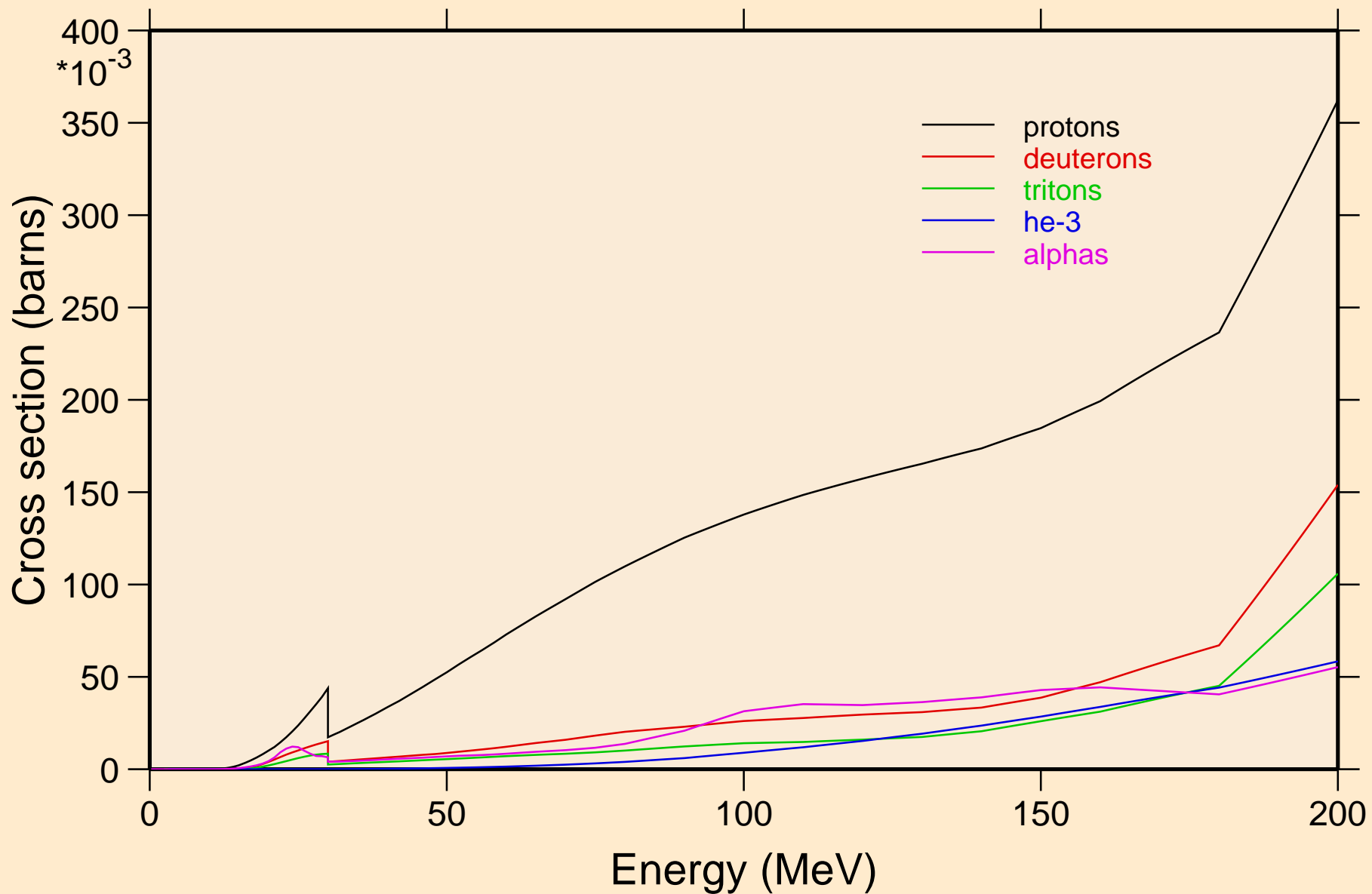

FM257 NEUTRON ACER TENDL-2019 LIBRARY; T=293.16K
protons from (n,x)

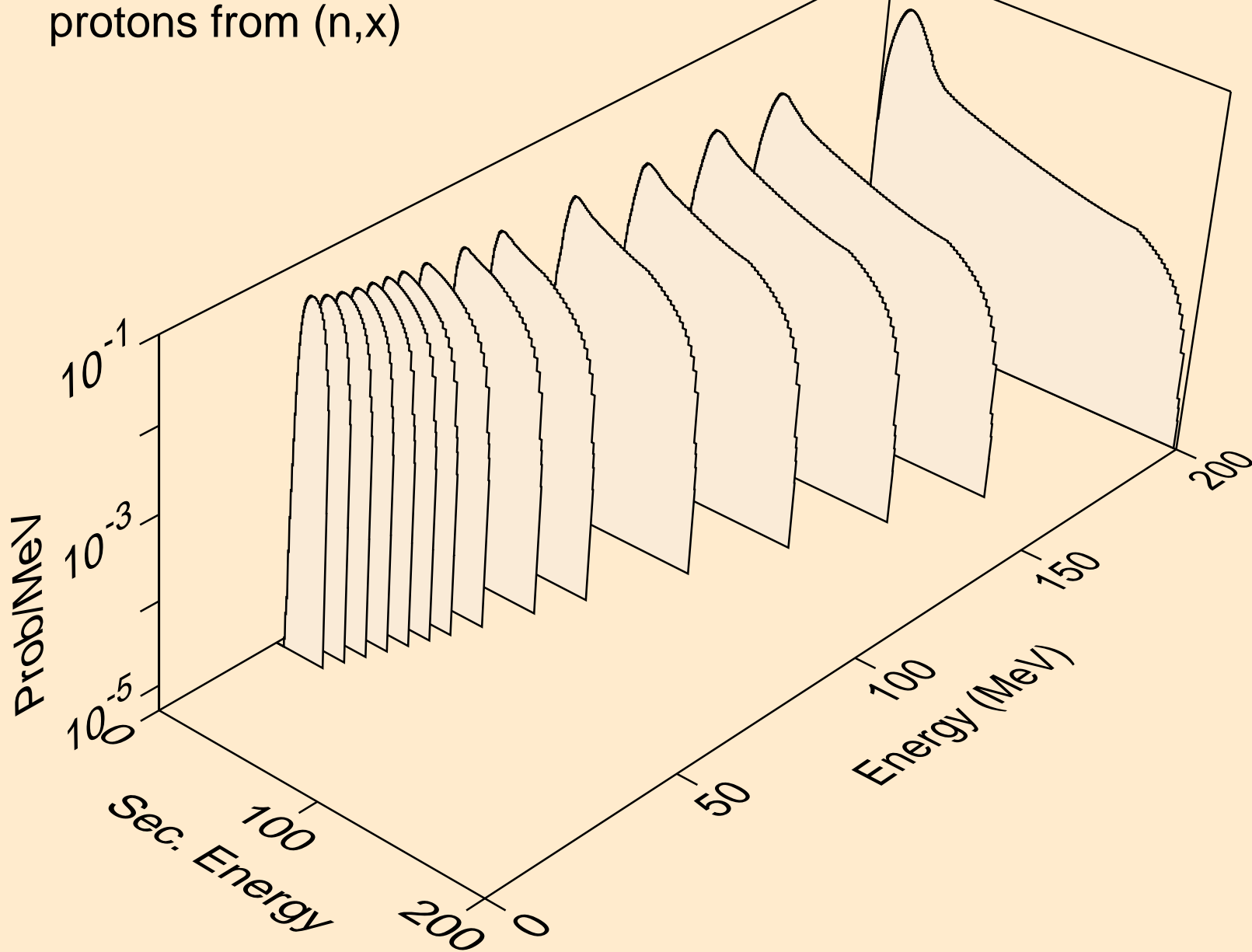

FM257 NEUTRON ACER TENDL-2019 LIBRARY; T=293.16K
protons from (n,n*)p

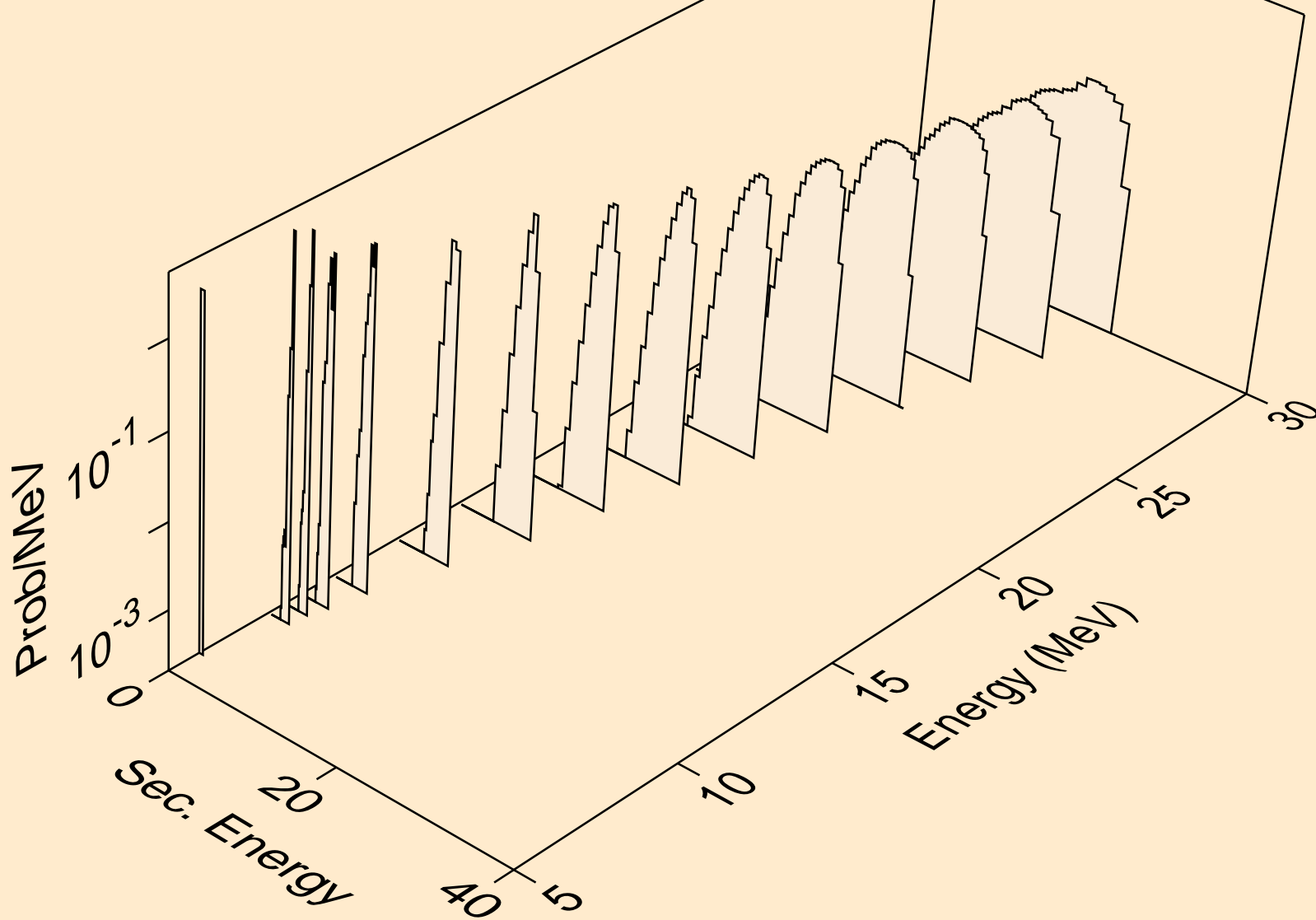

FM257 NEUTRON ACER TENDL-2019 LIBRARY; T=293.16K
protons from (n,2np)

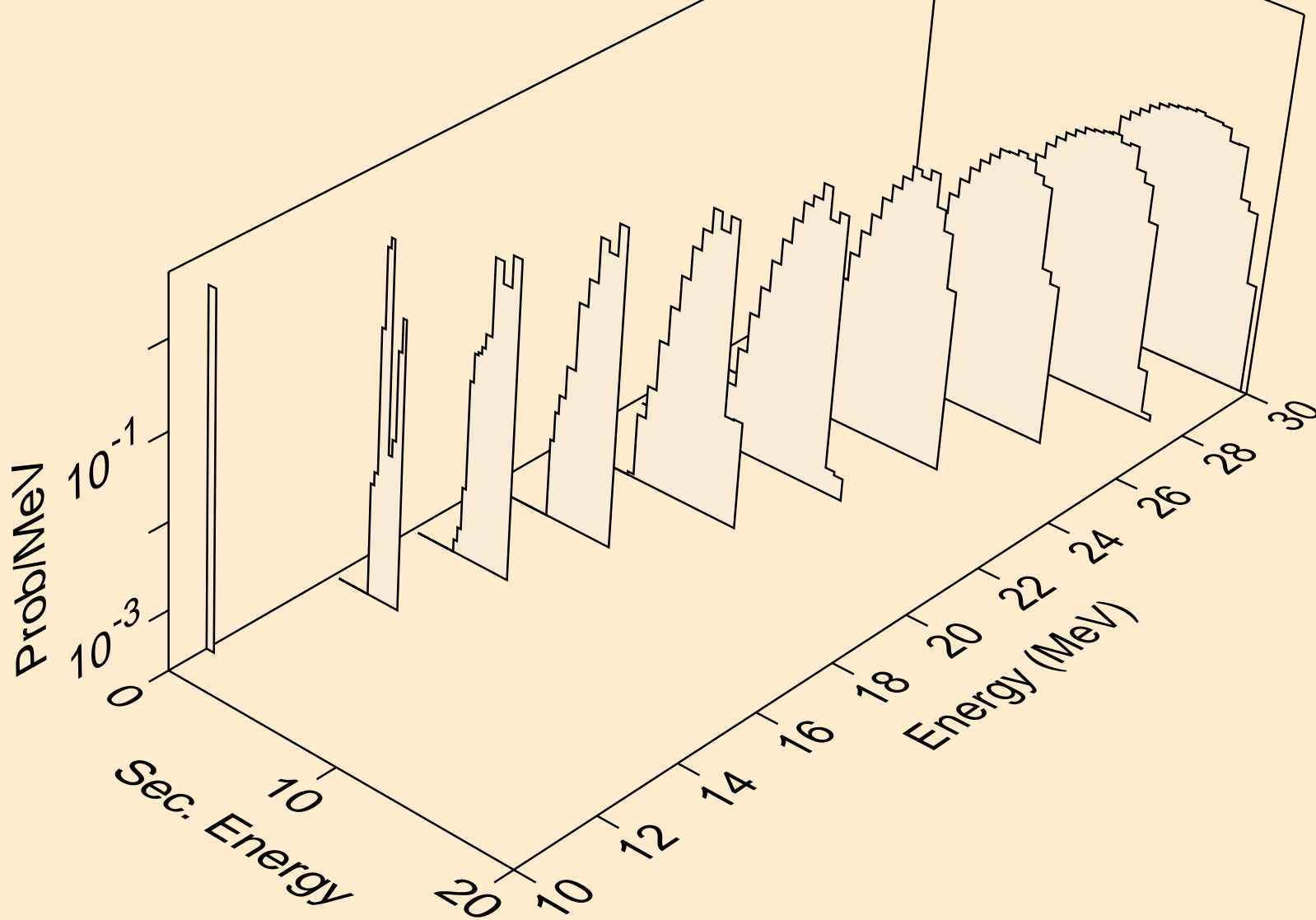

FM257 NEUTRON ACER TENDL-2019 LIBRARY; T=293.16K
protons from (n,3np)

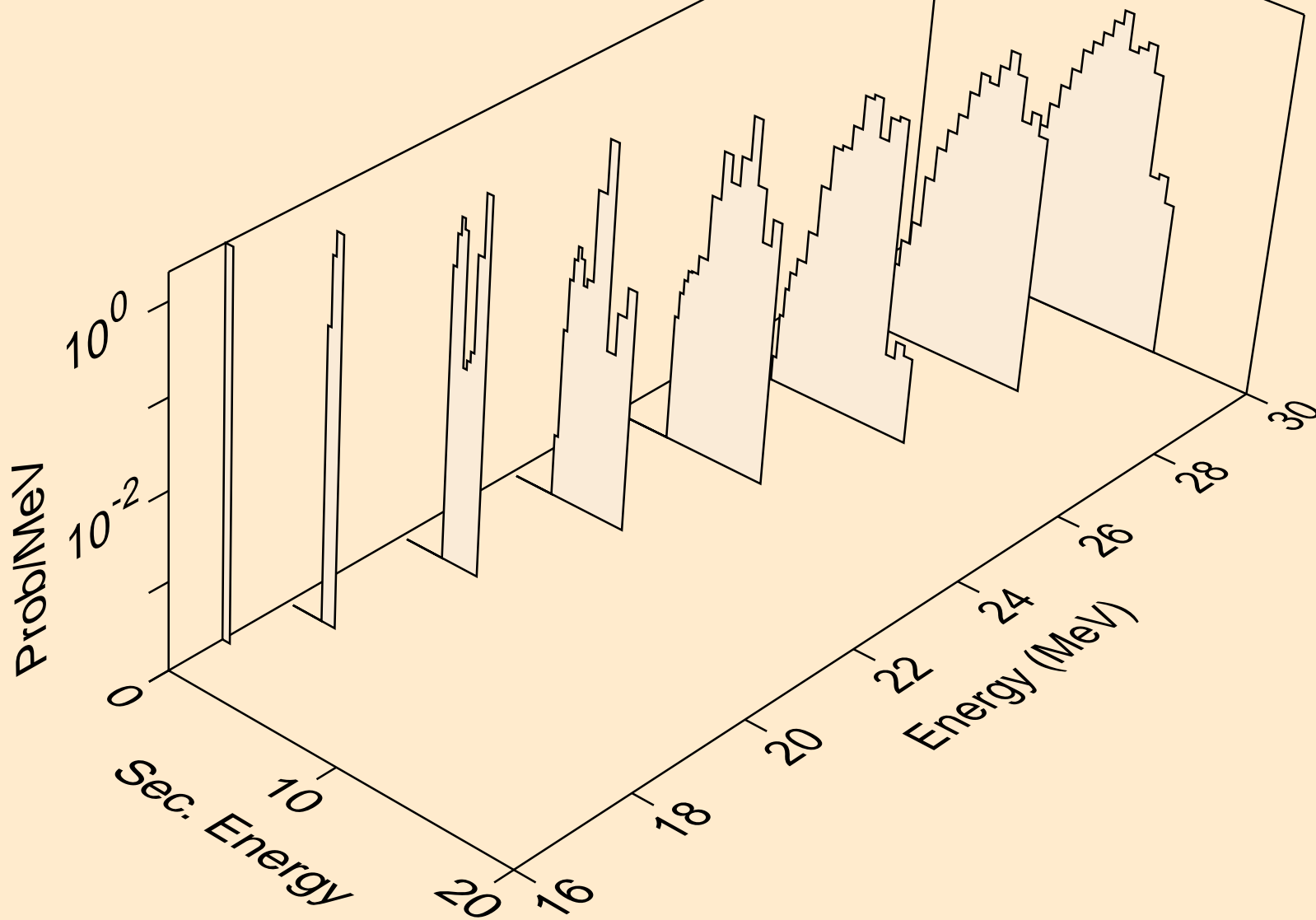

FM257 NEUTRON ACER TENDL-2019 LIBRARY; T=293.16K
protons from (n,2np)

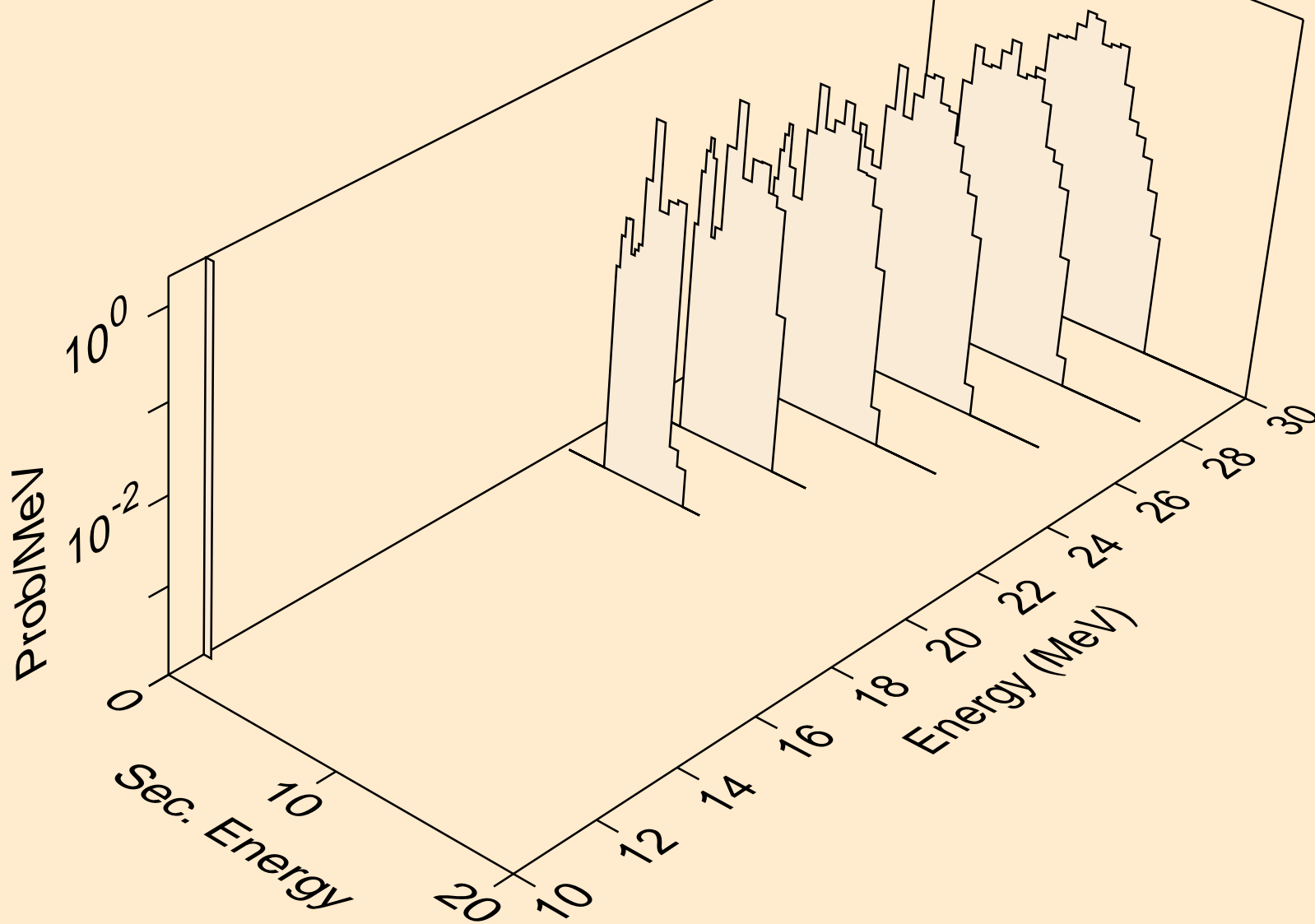

FM257 NEUTRON ACER TENDL-2019 LIBRARY; T=293.16K
protons from (n,p)

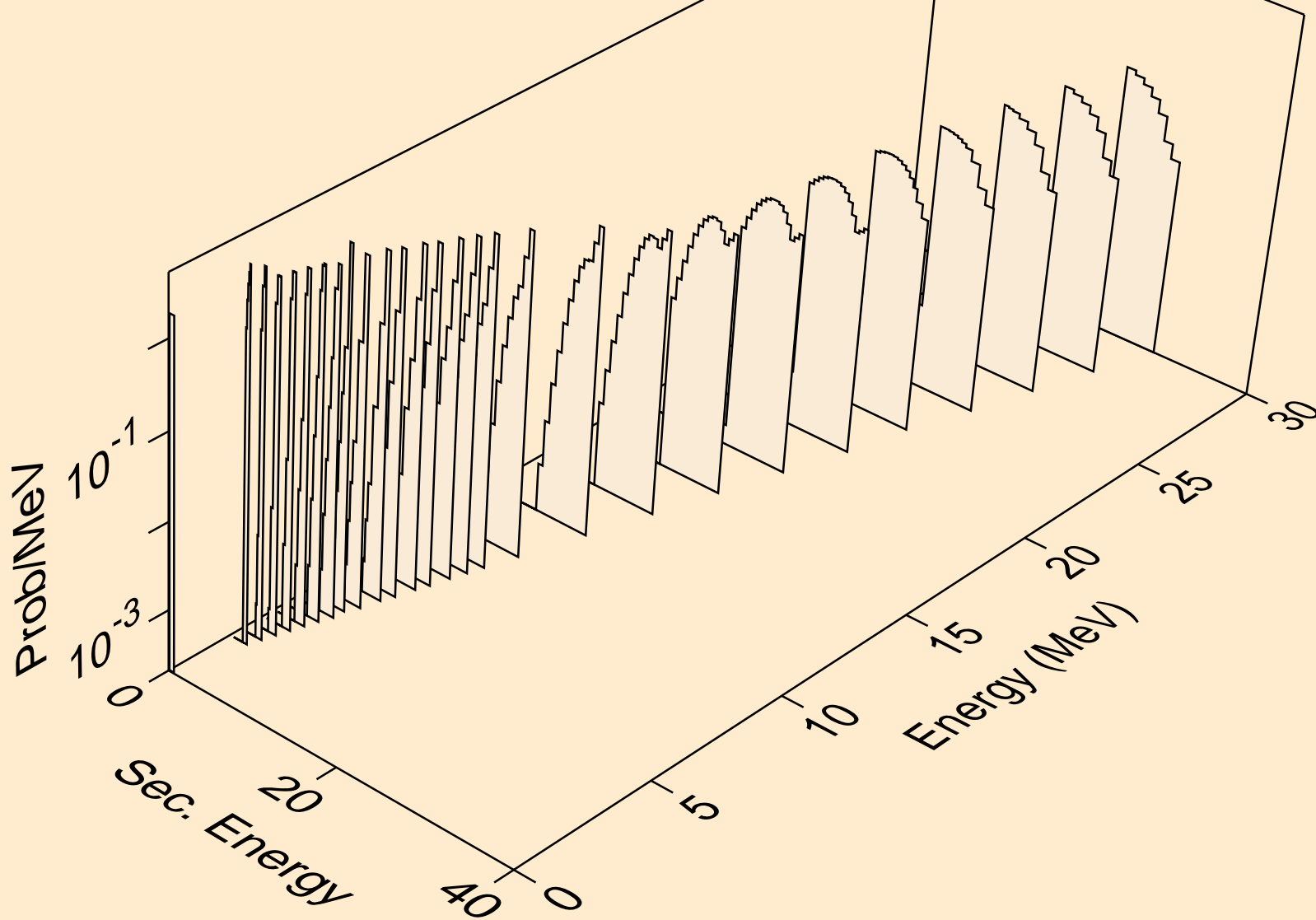

FM257 NEUTRON ACER TENDL-2019 LIBRARY; T=293.16K
protons from (n,2p)

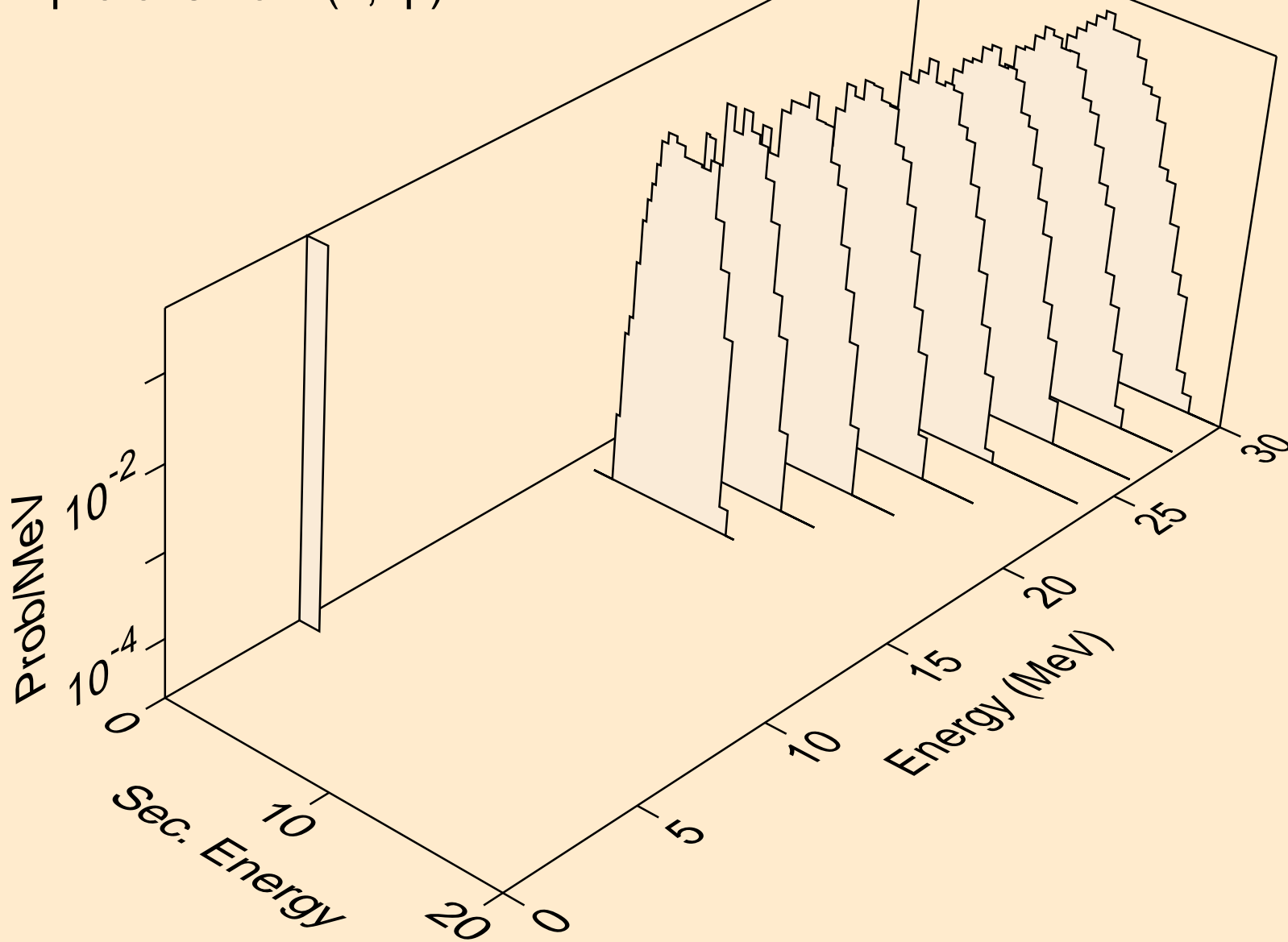

FM257 NEUTRON ACER TENDL-2019 LIBRARY; T=293.16K
deuterons from (n,x)

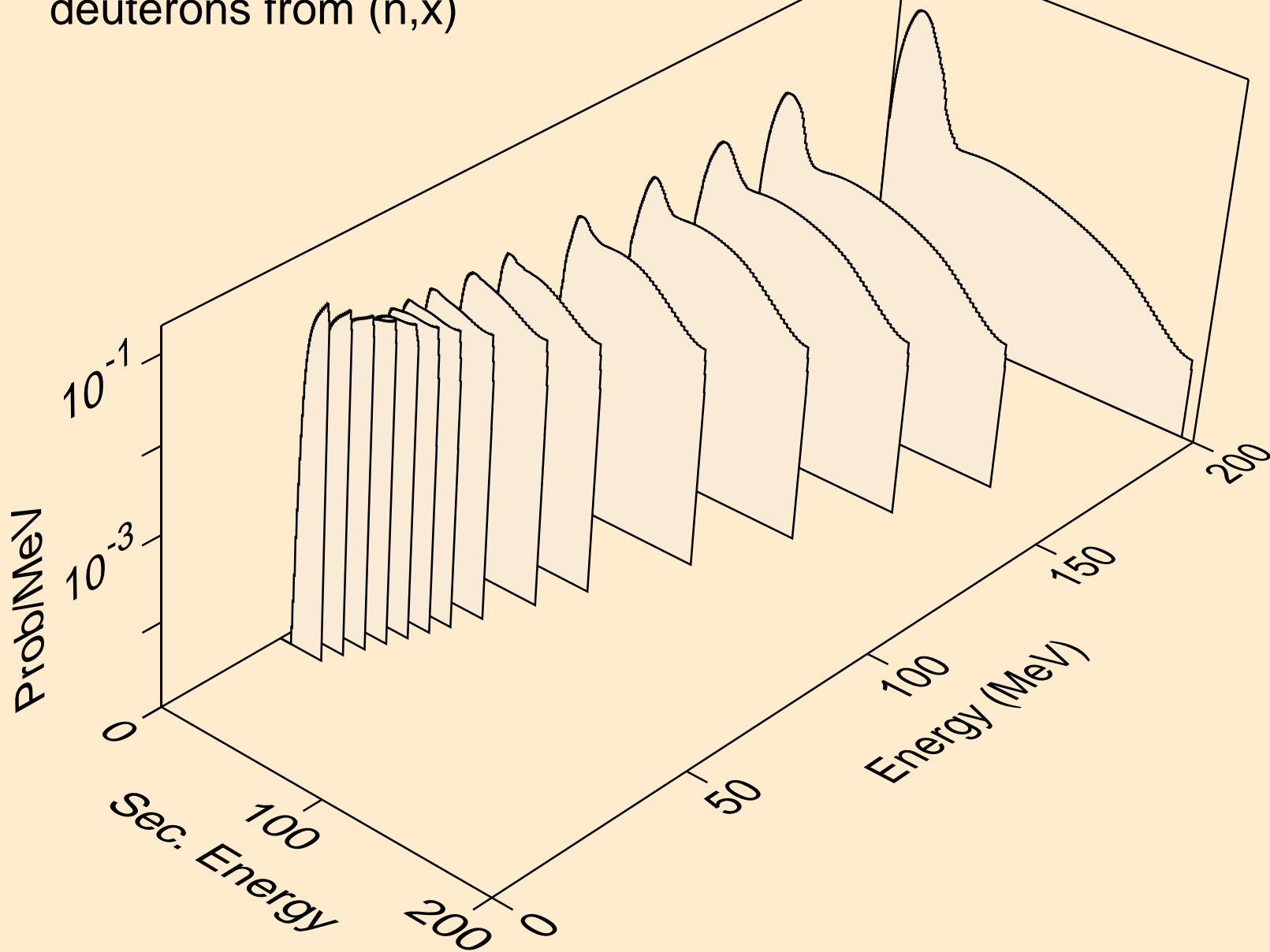

FM257 NEUTRON ACER TENDL-2019 LIBRARY; T=293.16K
deuterons from (n,2nd)

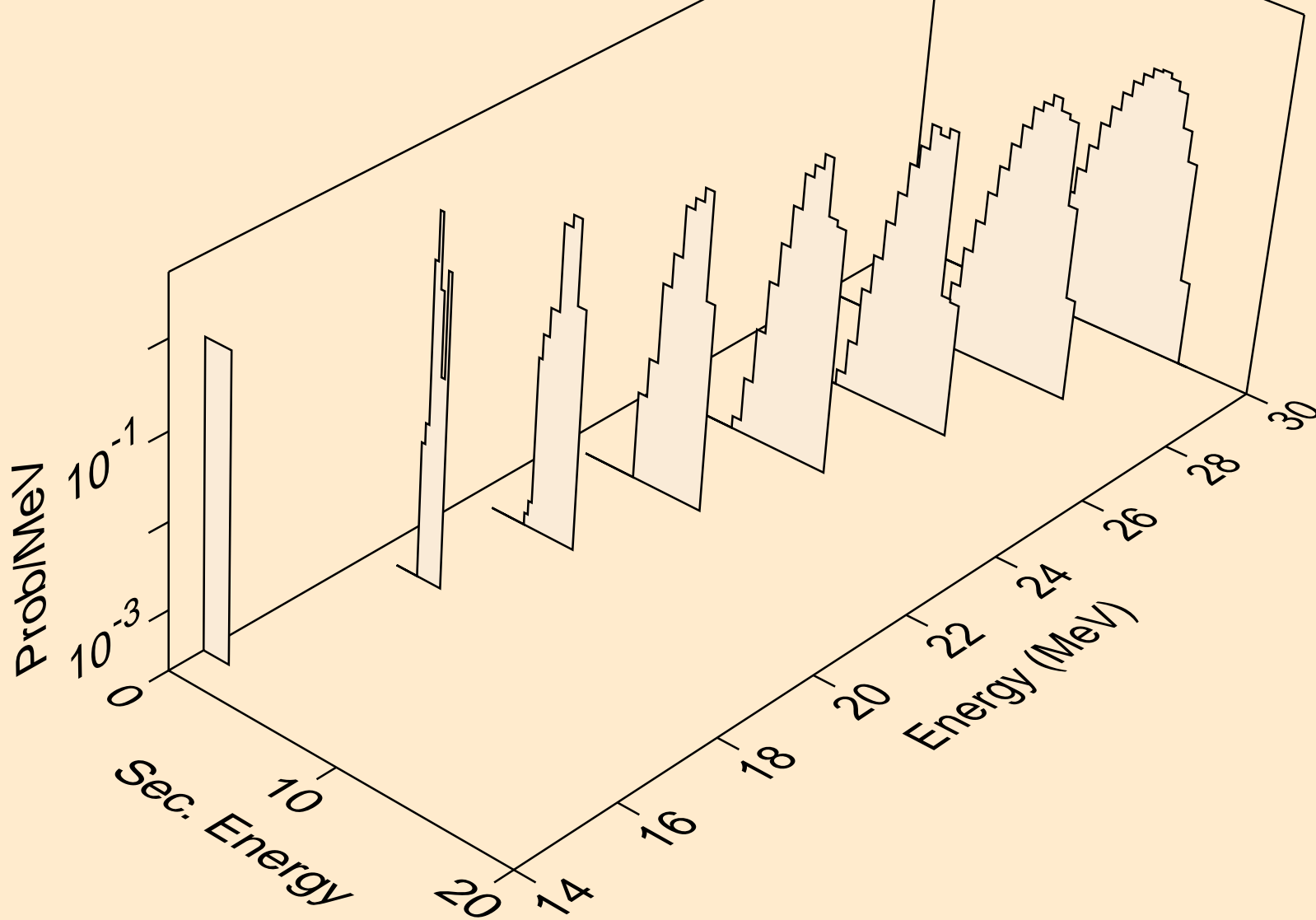

FM257 NEUTRON ACER TENDL-2019 LIBRARY; T=293.16K
deuterons from (n,n*)d

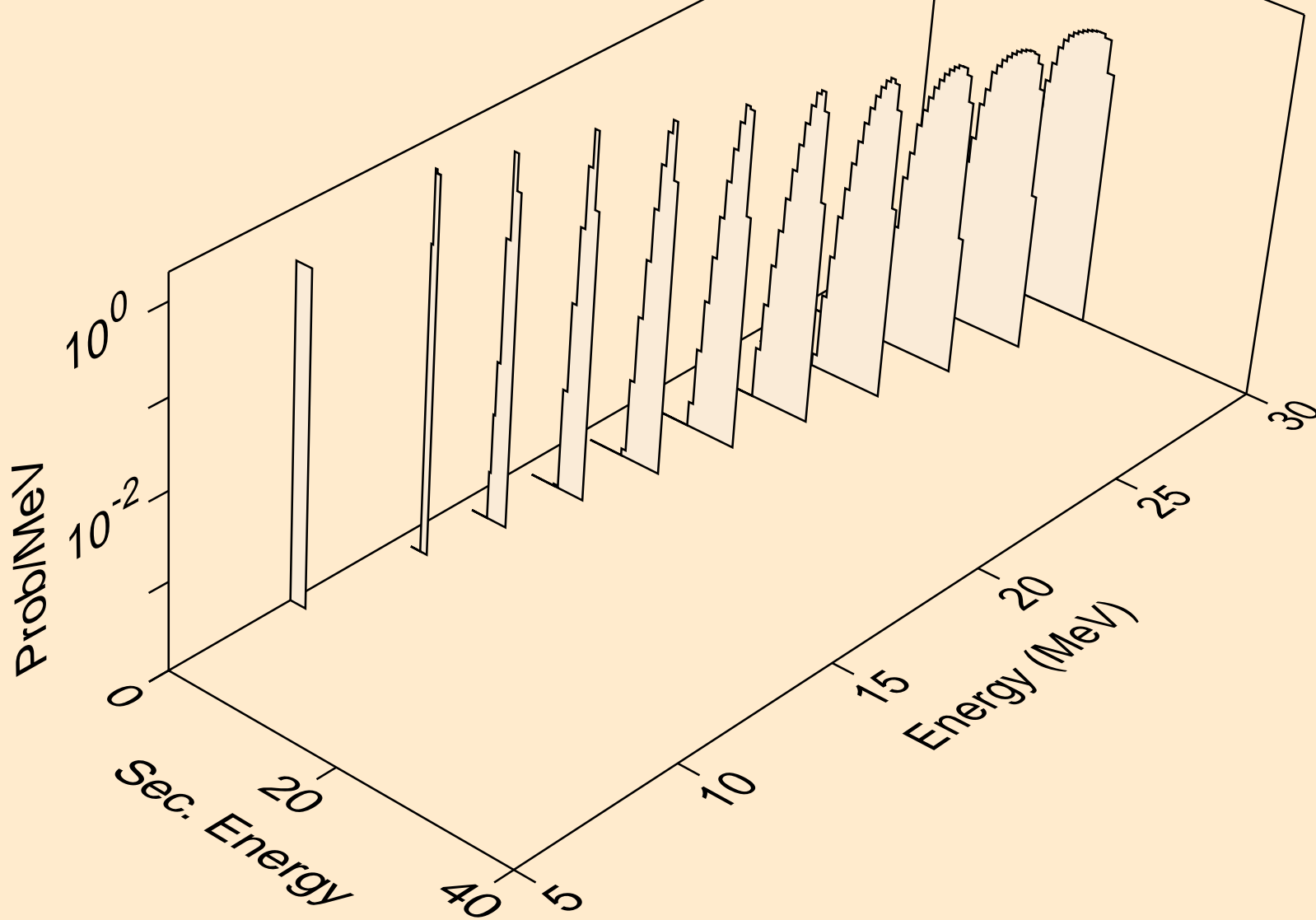

FM257 NEUTRON ACER TENDL-2019 LIBRARY; T=293.16K
deuterons from (n,d)

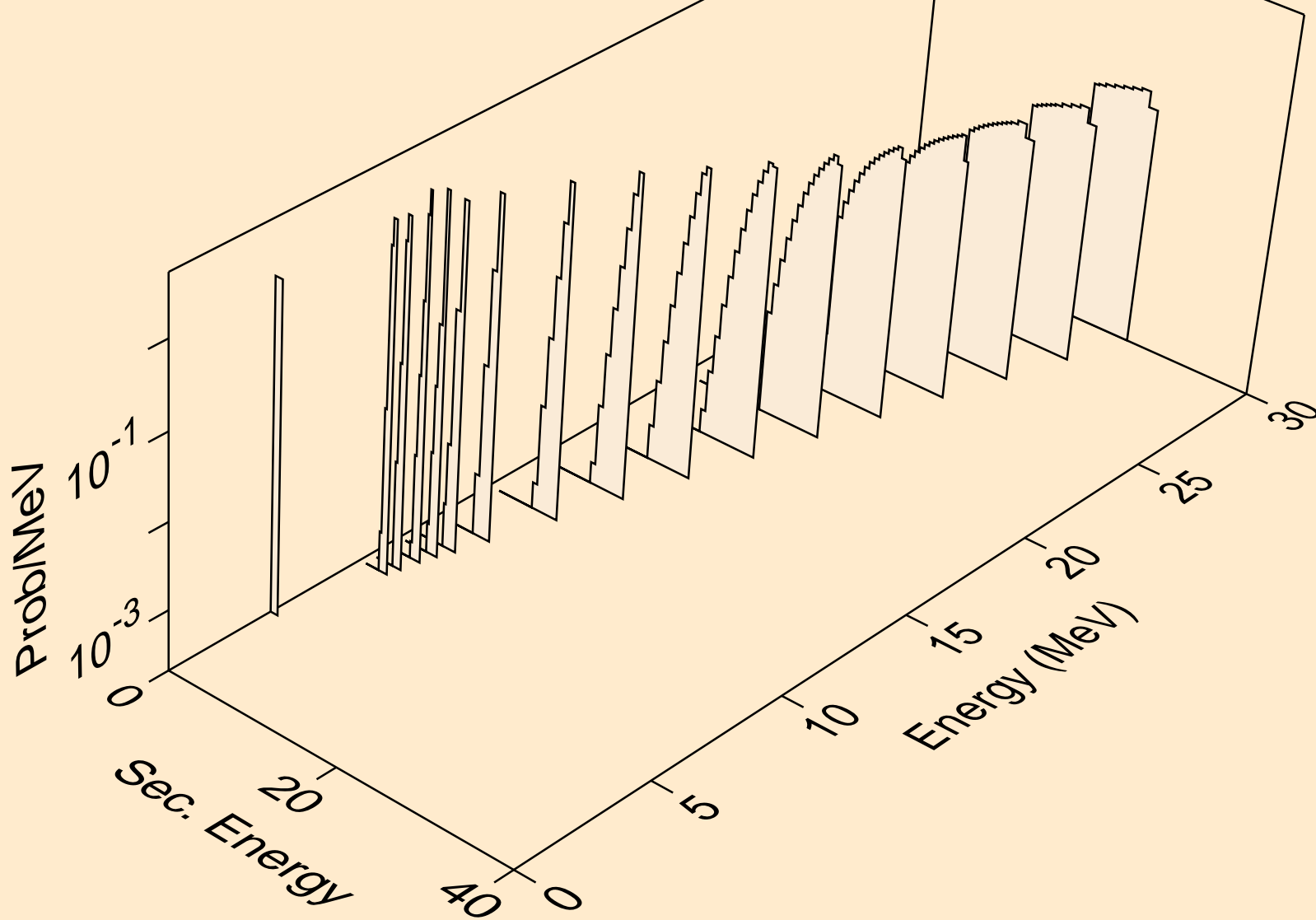

FM257 NEUTRON ACER TENDL-2019 LIBRARY; T=293.16K
tritons from (n,x)

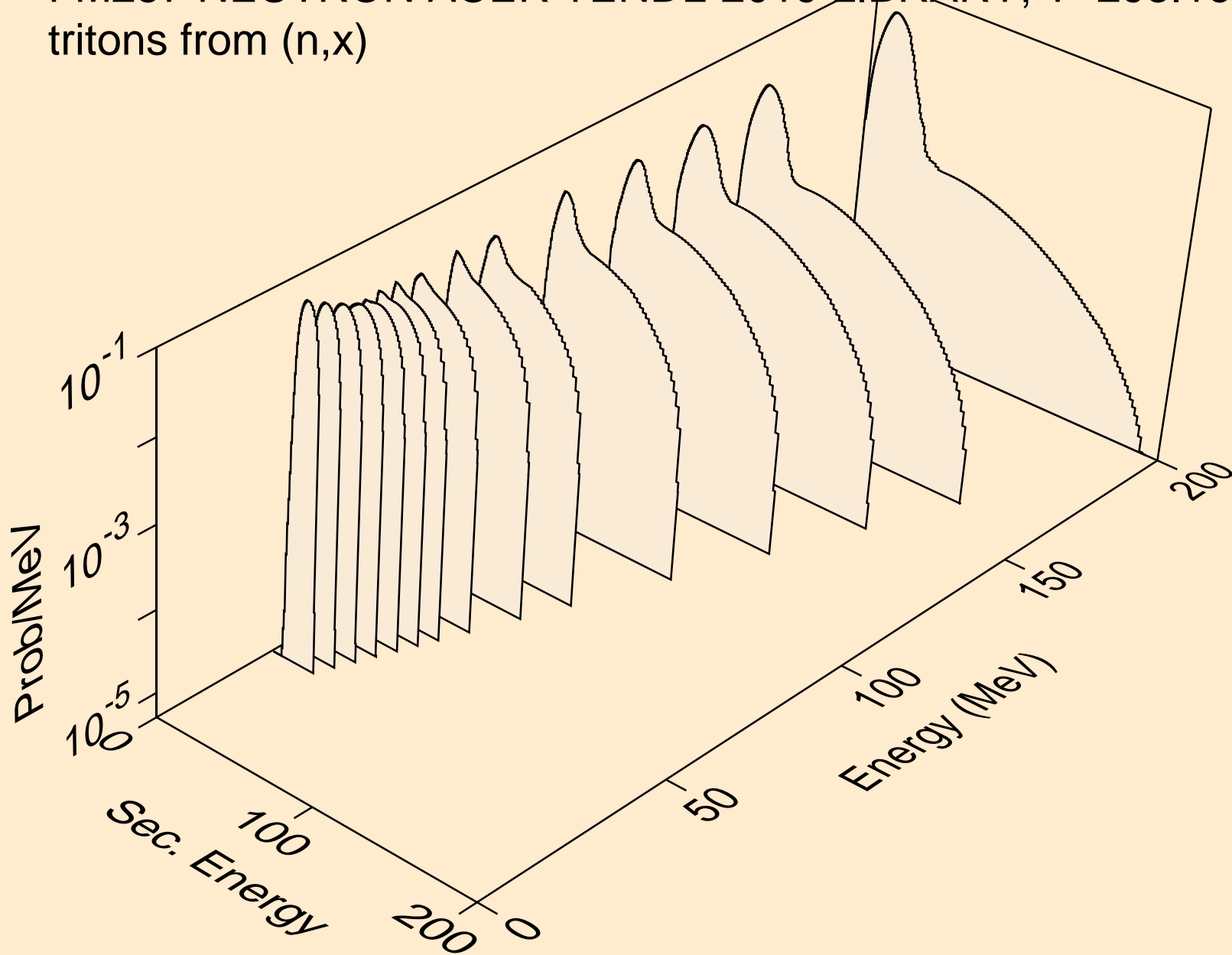

FM257 NEUTRON ACER TENDL-2019 LIBRARY; T=293.16K
tritons from (n,n*)t

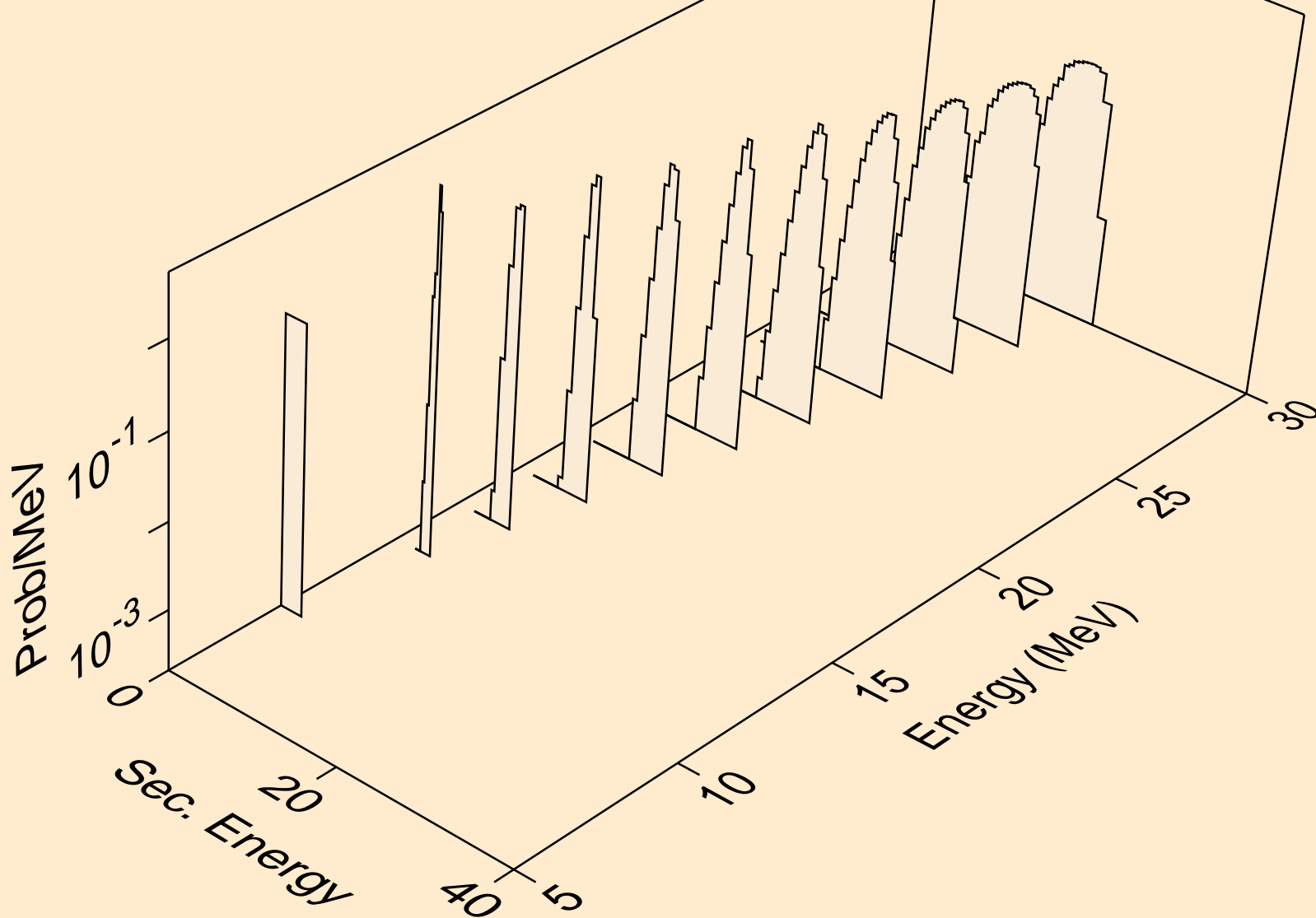

FM257 NEUTRON ACER TENDL-2019 LIBRARY; T=293.16K
tritons from (n,t)

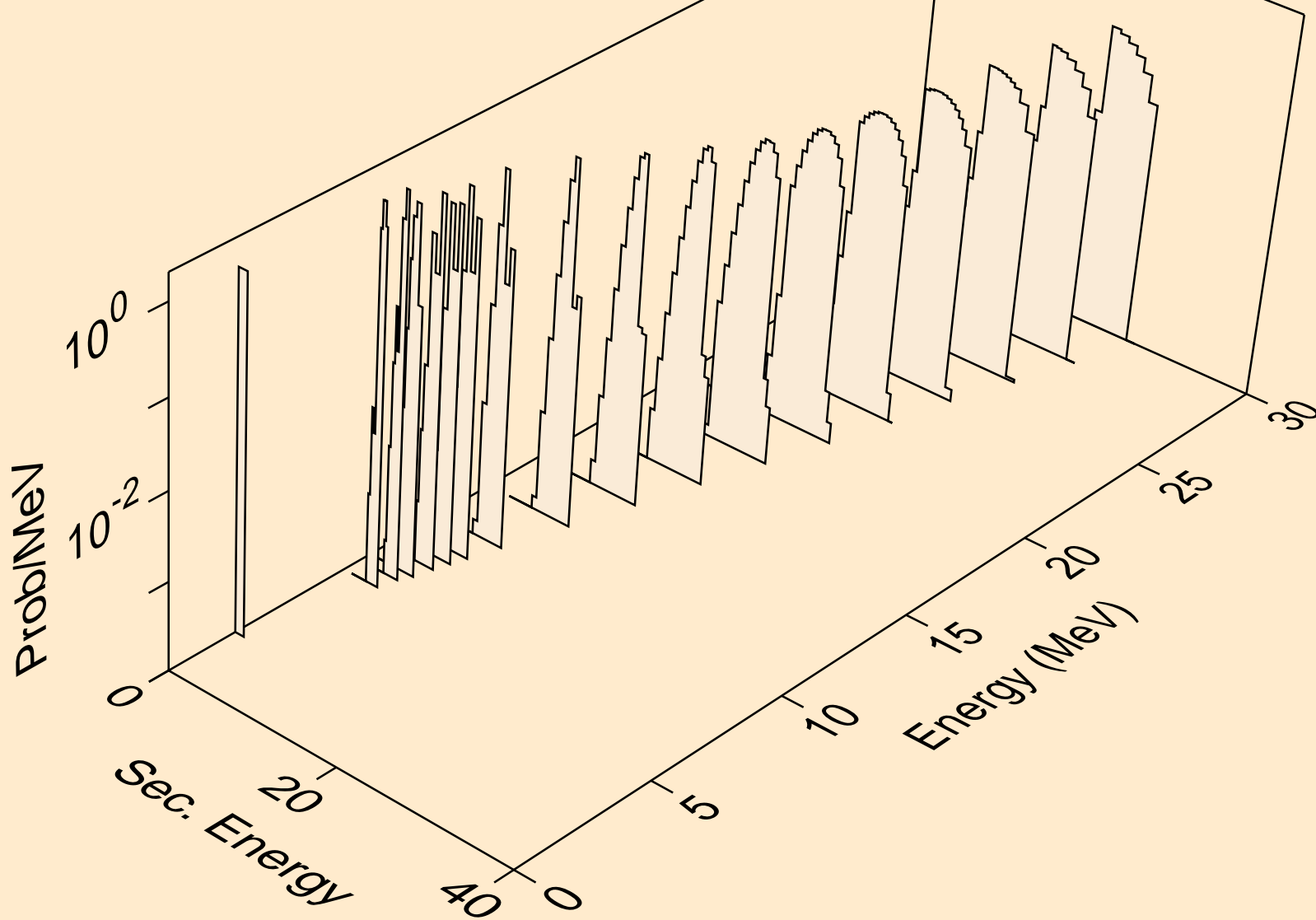

FM257 NEUTRON ACER TENDL-2019 LIBRARY; T=293.16K
he3s from (n,x)

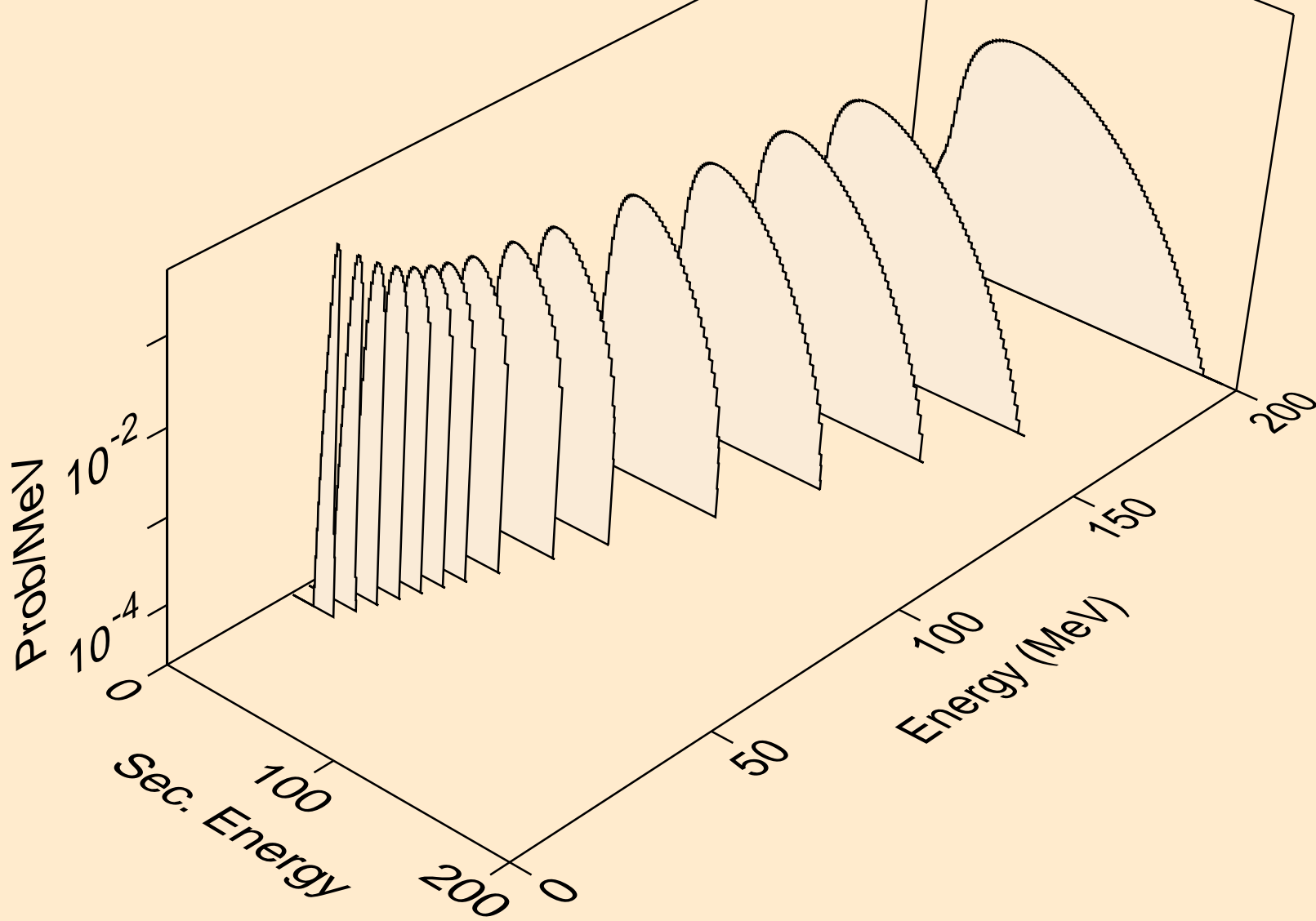

FM257 NEUTRON ACER TENDL-2019 LIBRARY; T=293.16K
he3s from (n,n*)he3

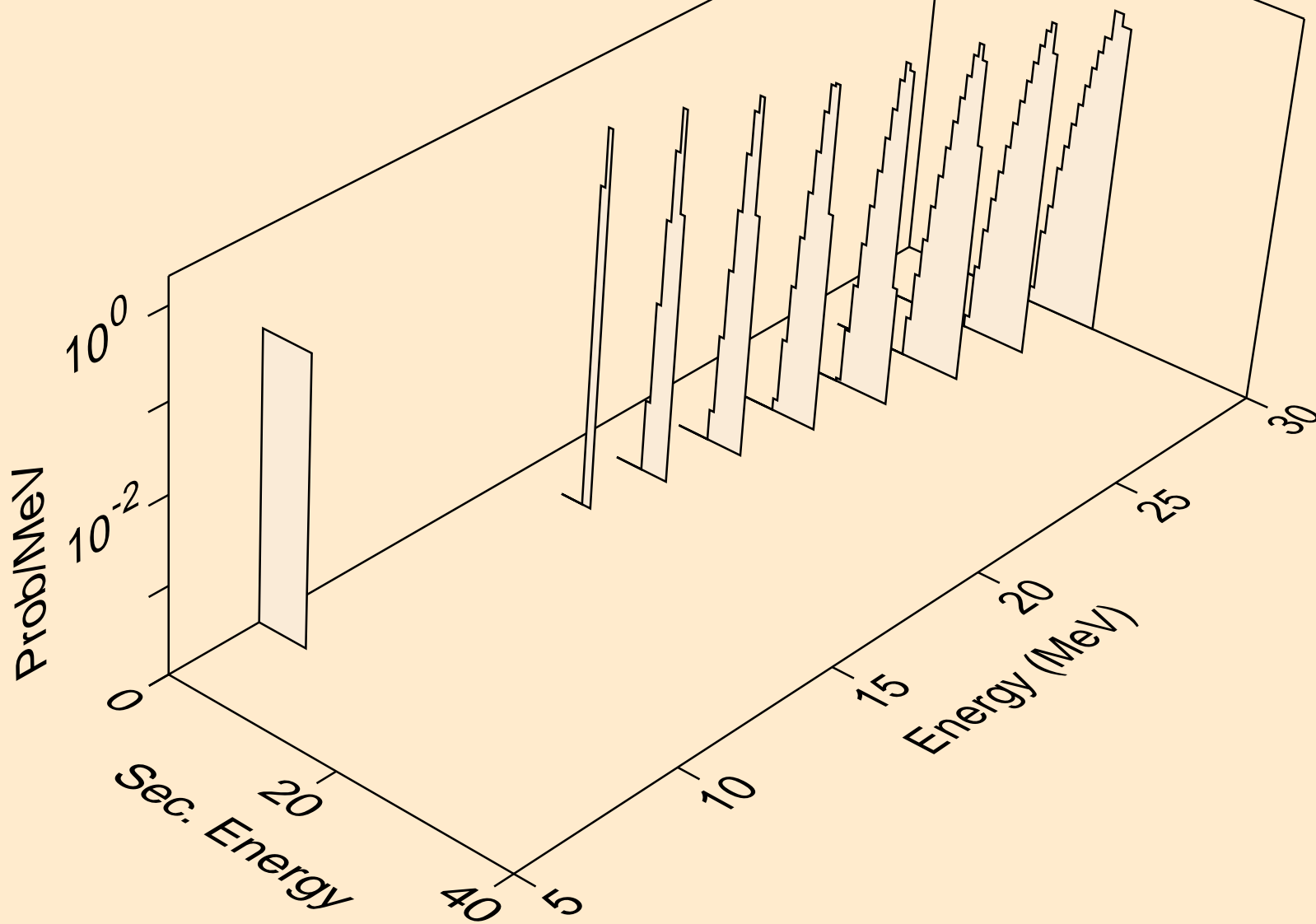

FM257 NEUTRON ACER TENDL-2019 LIBRARY; T=293.16K
he3s from (n,he3)

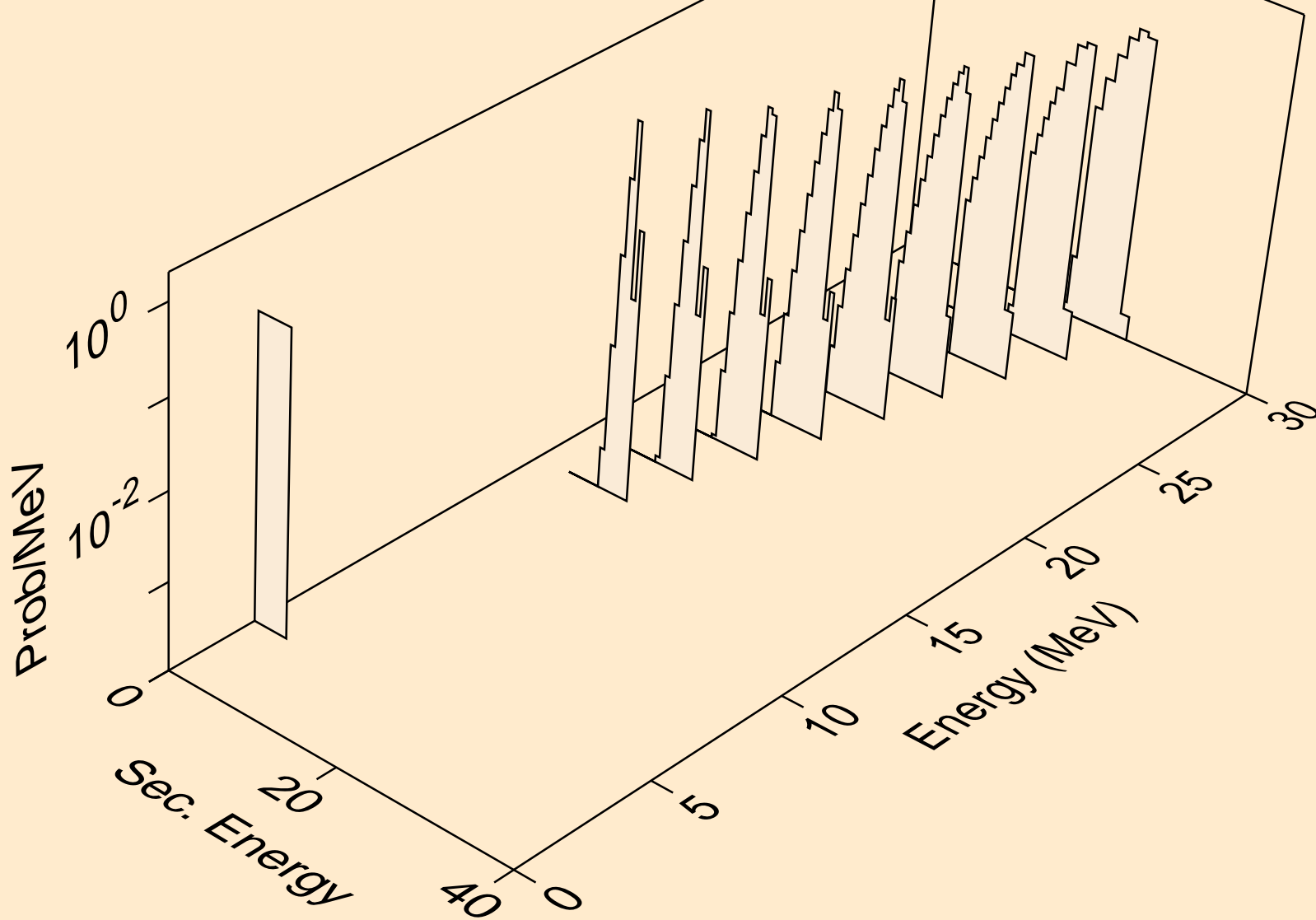

FM257 NEUTRON ACER TENDL-2019 LIBRARY; T=293.16K
alphas from (n,x)

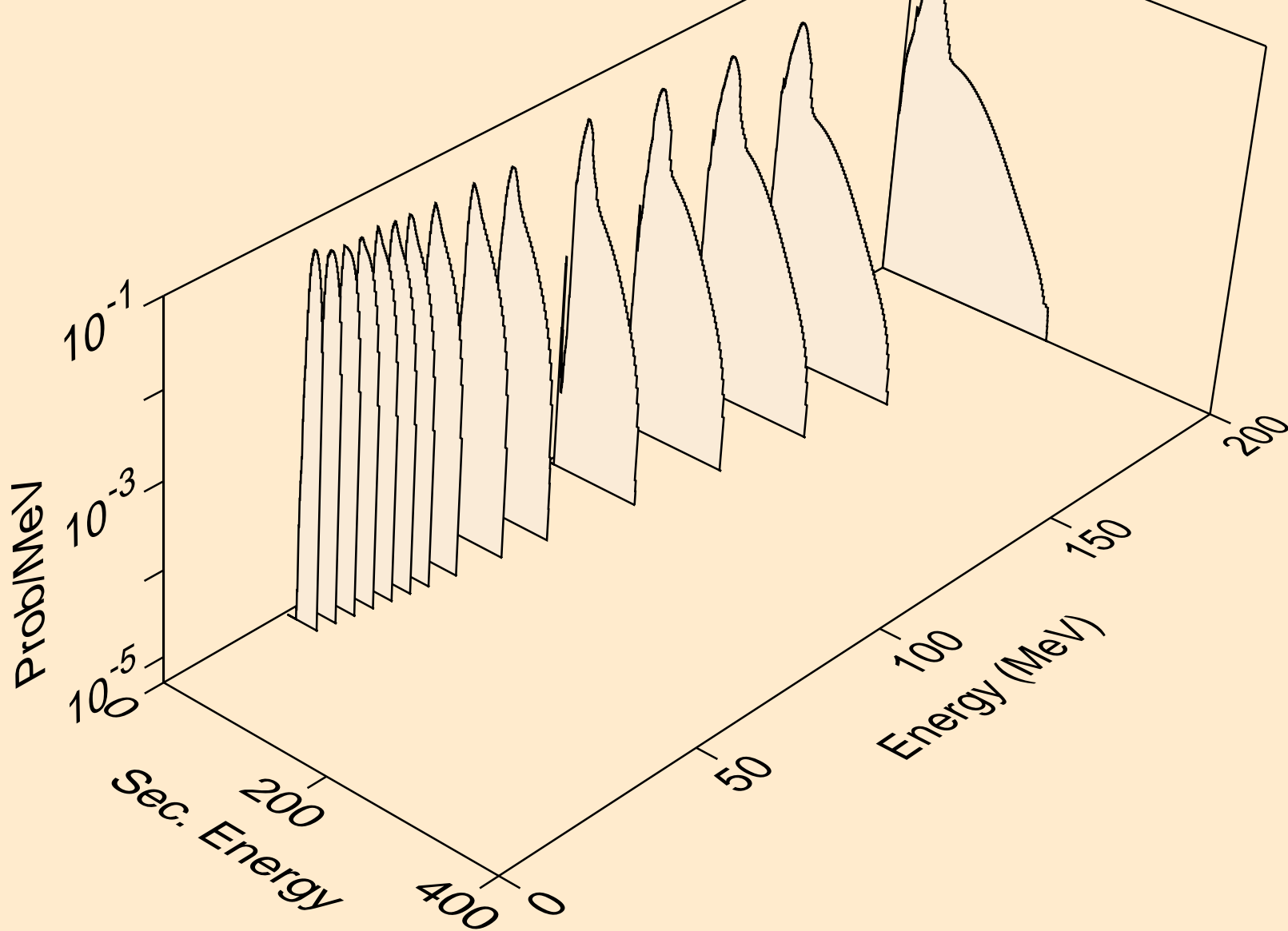

FM257 NEUTRON ACER TENDL-2019 LIBRARY; T=293.16K
alphas from (n,n*)a

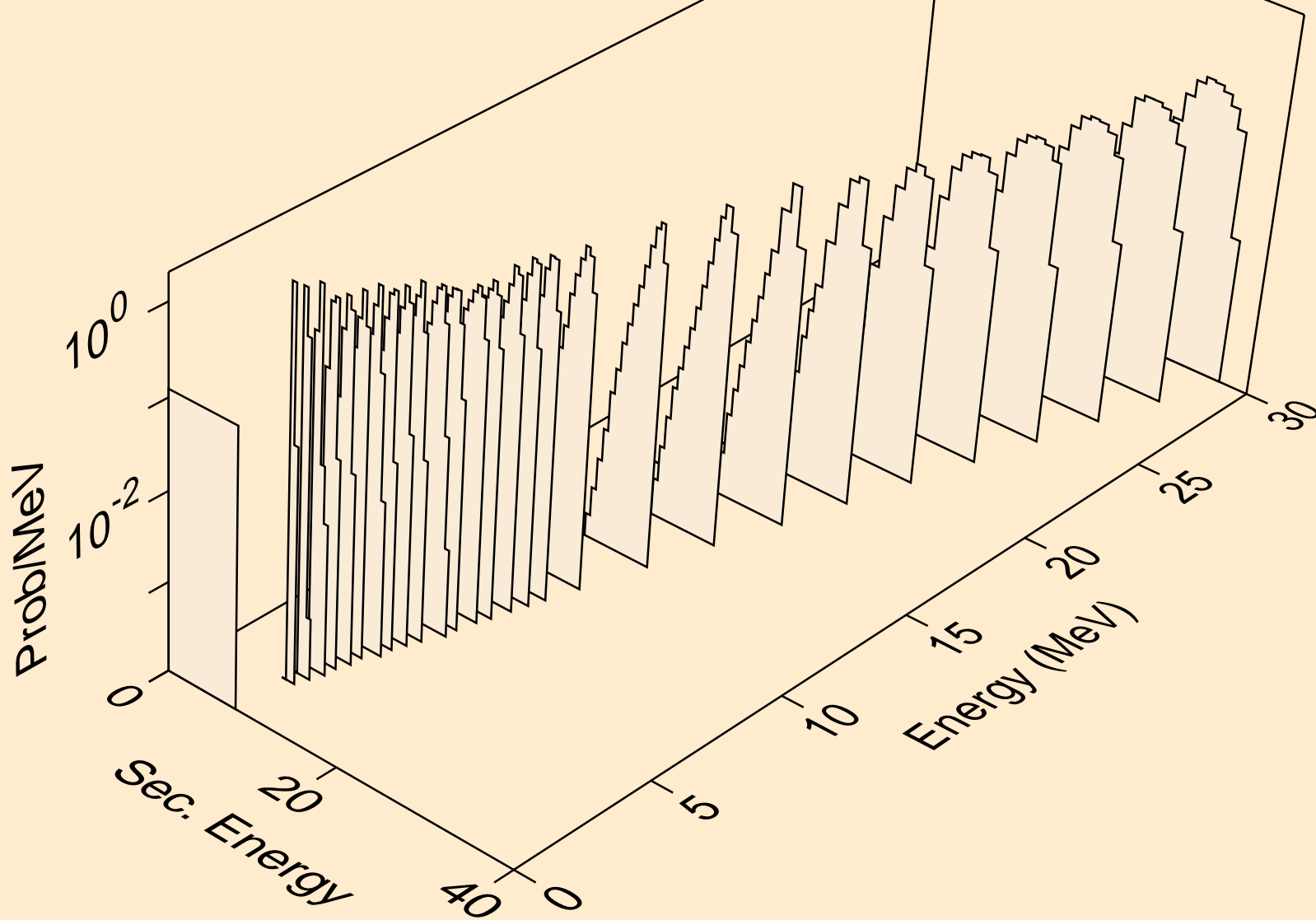

FM257 NEUTRON ACER TENDL-2019 LIBRARY; T=293.16K
alphas from (n,2n)a

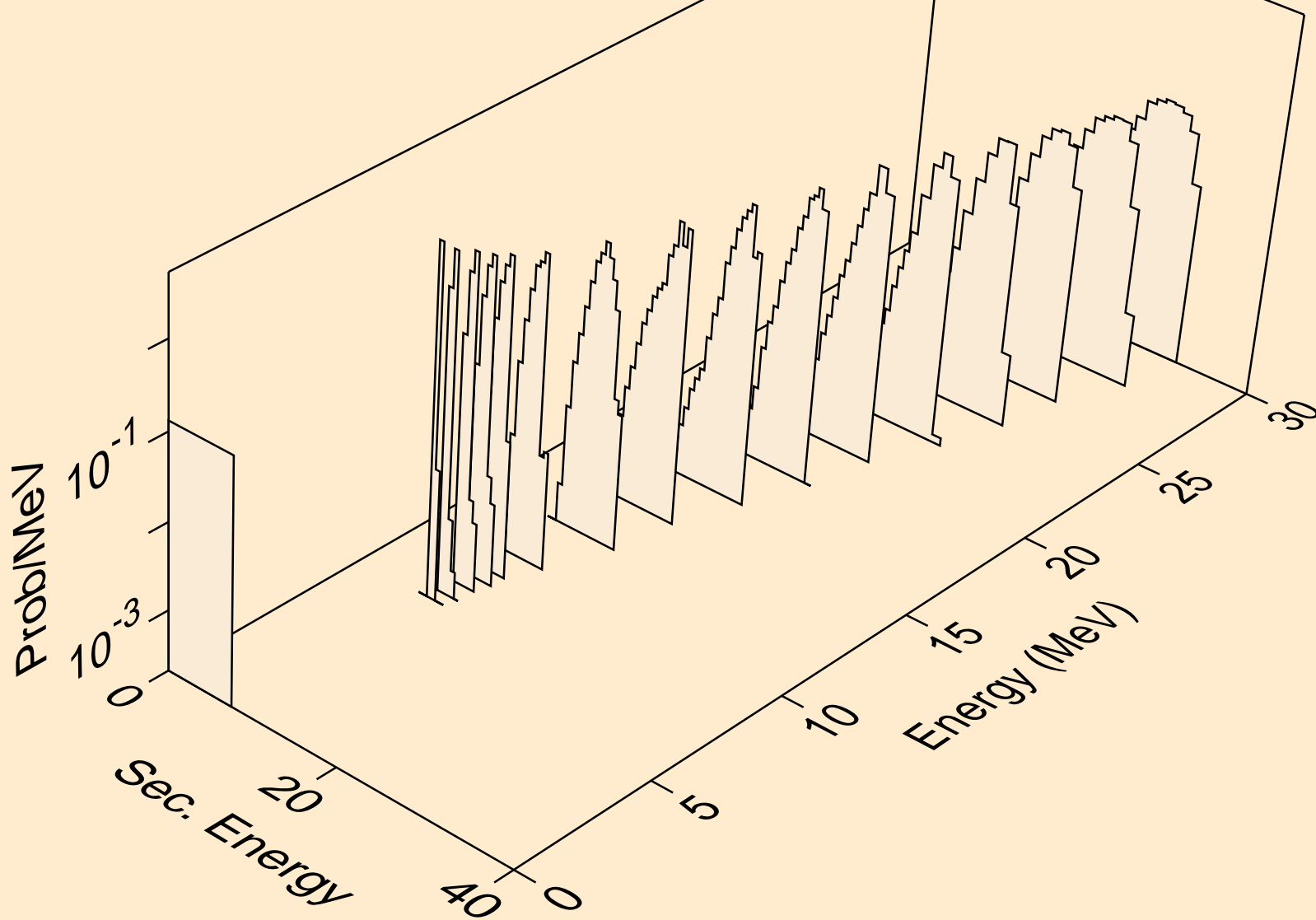

FM257 NEUTRON ACER TENDL-2019 LIBRARY; T=293.16K
alphas from (n,3n)a

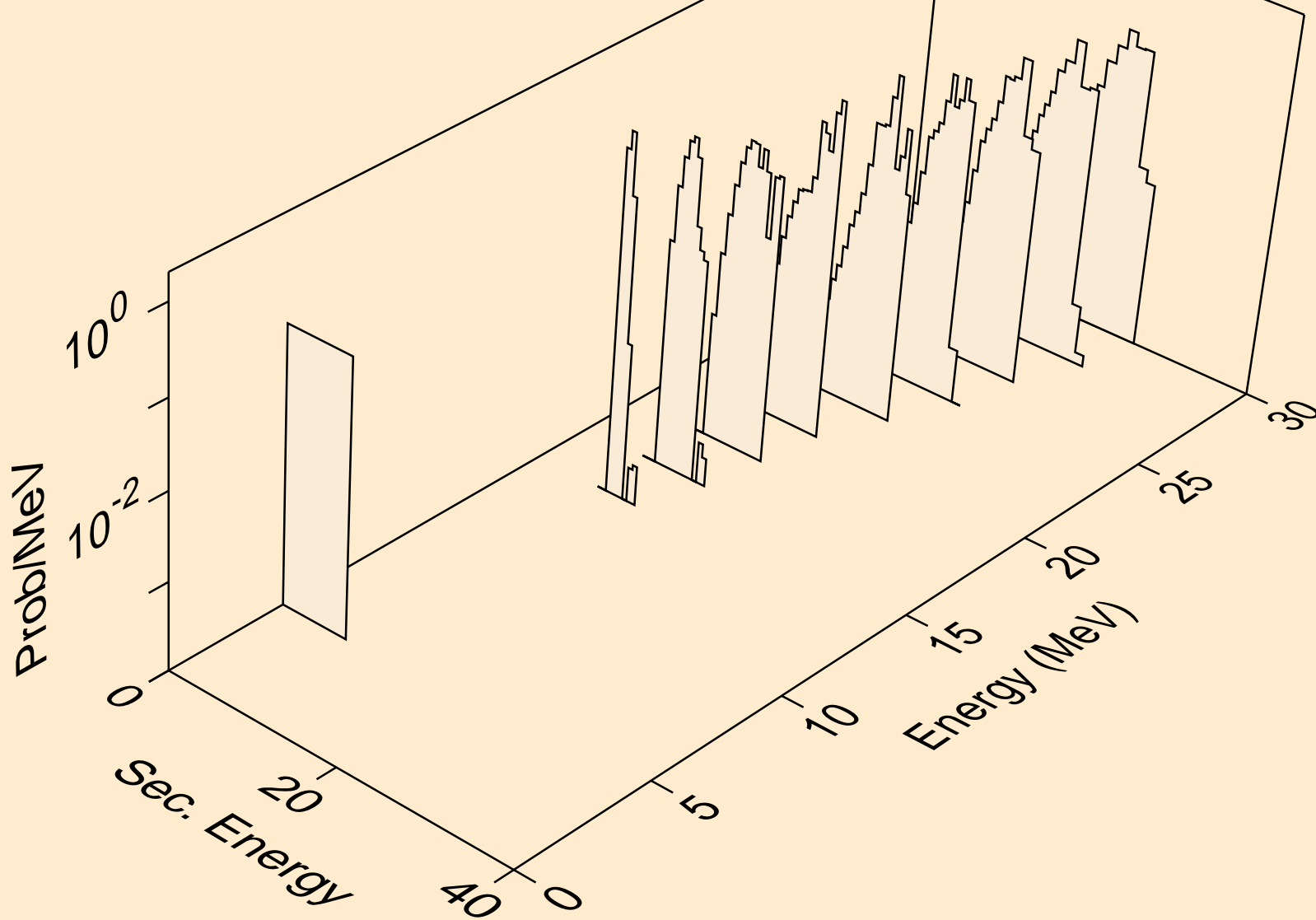

FM257 NEUTRON ACER TENDL-2019 LIBRARY; T=293.16K
alphas from (n,a)

