

GD156 NEUTRON ACER TENDL-2019 LIBRARY; T=293.16K  
Principal cross sections

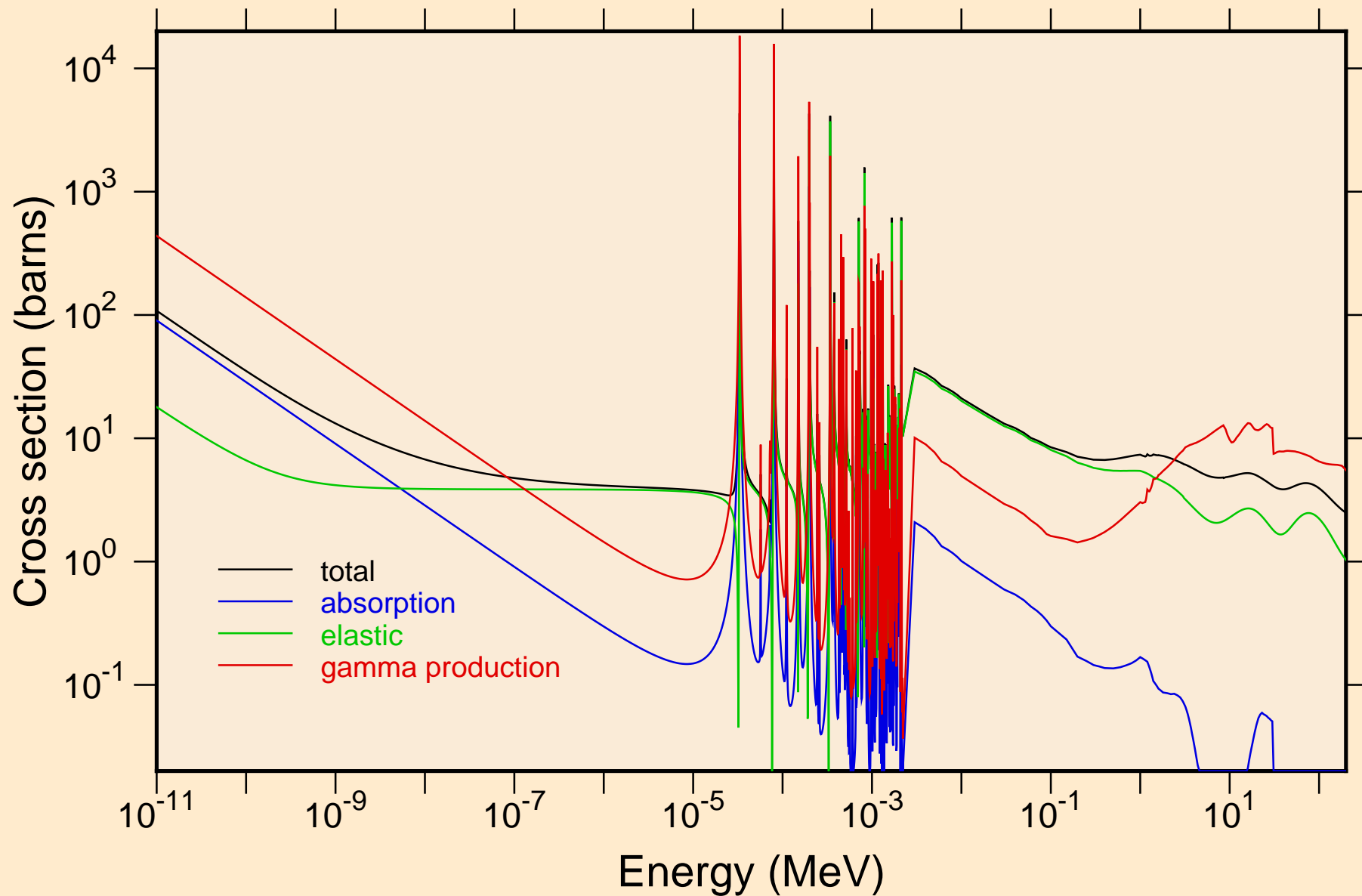

GD156 NEUTRON ACER TENDL-2019 LIBRARY; T=293.16K  
resonance total cross section

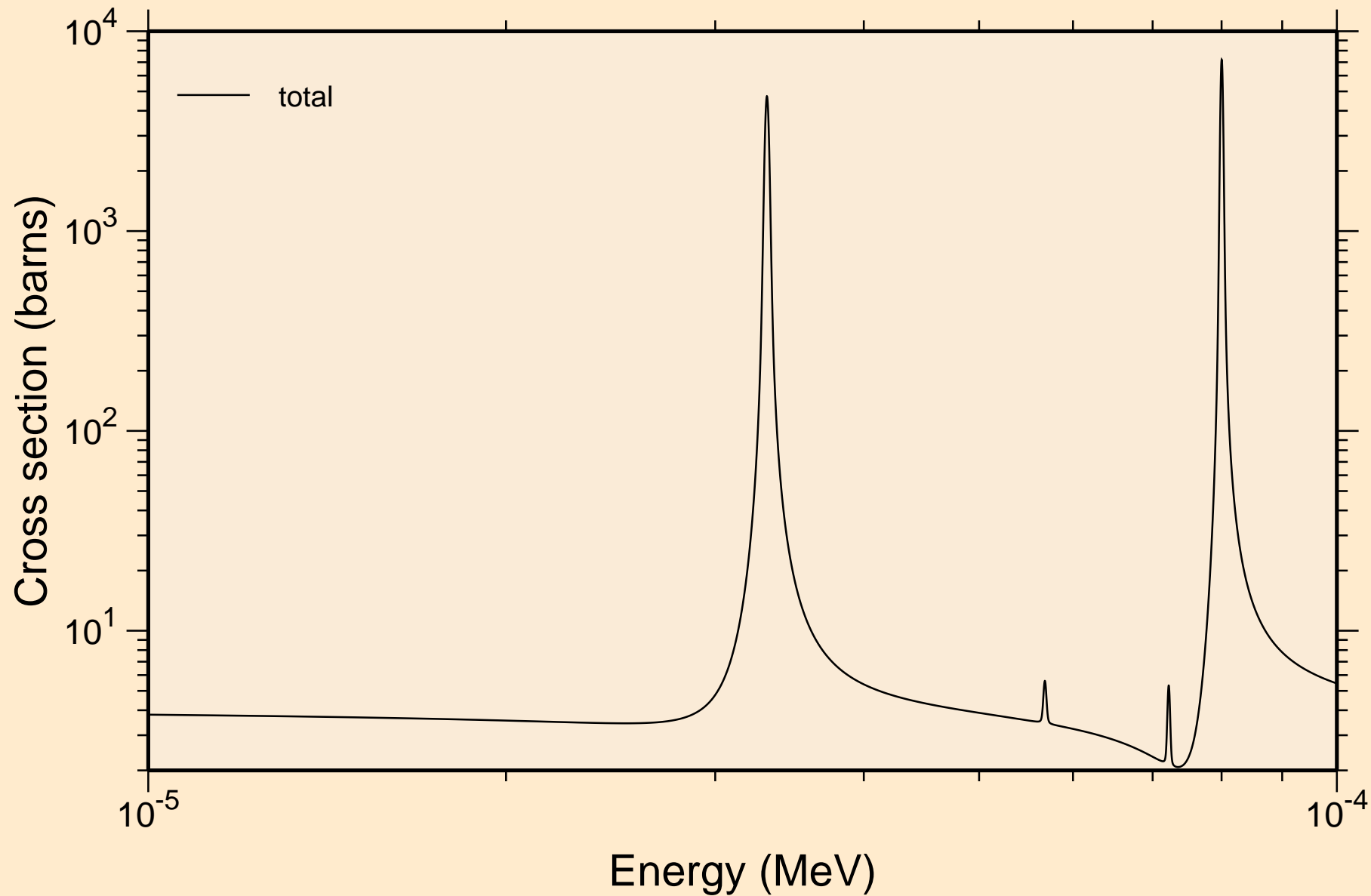

GD156 NEUTRON ACER TENDL-2019 LIBRARY; T=293.16K  
resonance total cross section

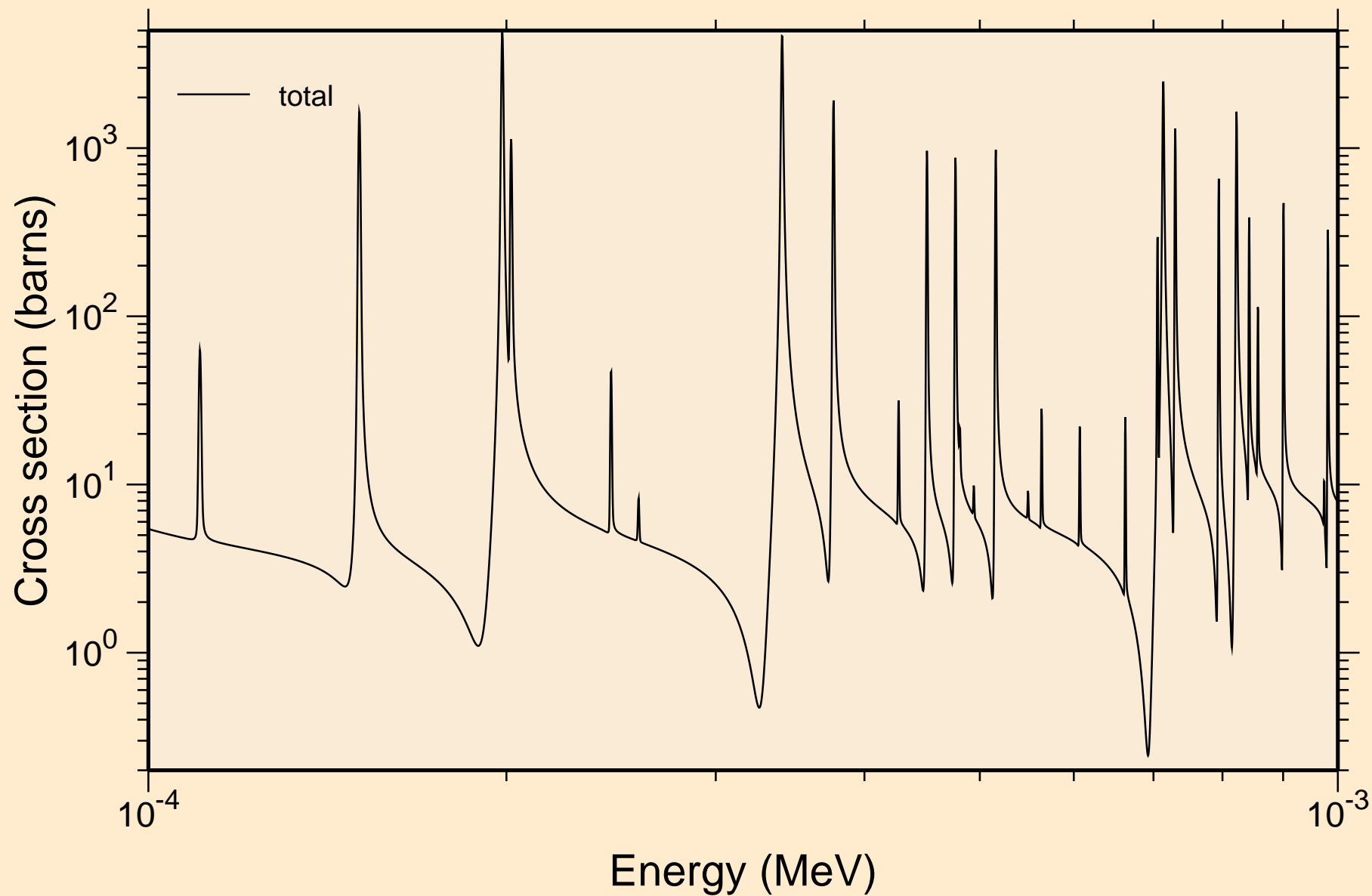

GD156 NEUTRON ACER TENDL-2019 LIBRARY; T=293.16K  
resonance total cross section

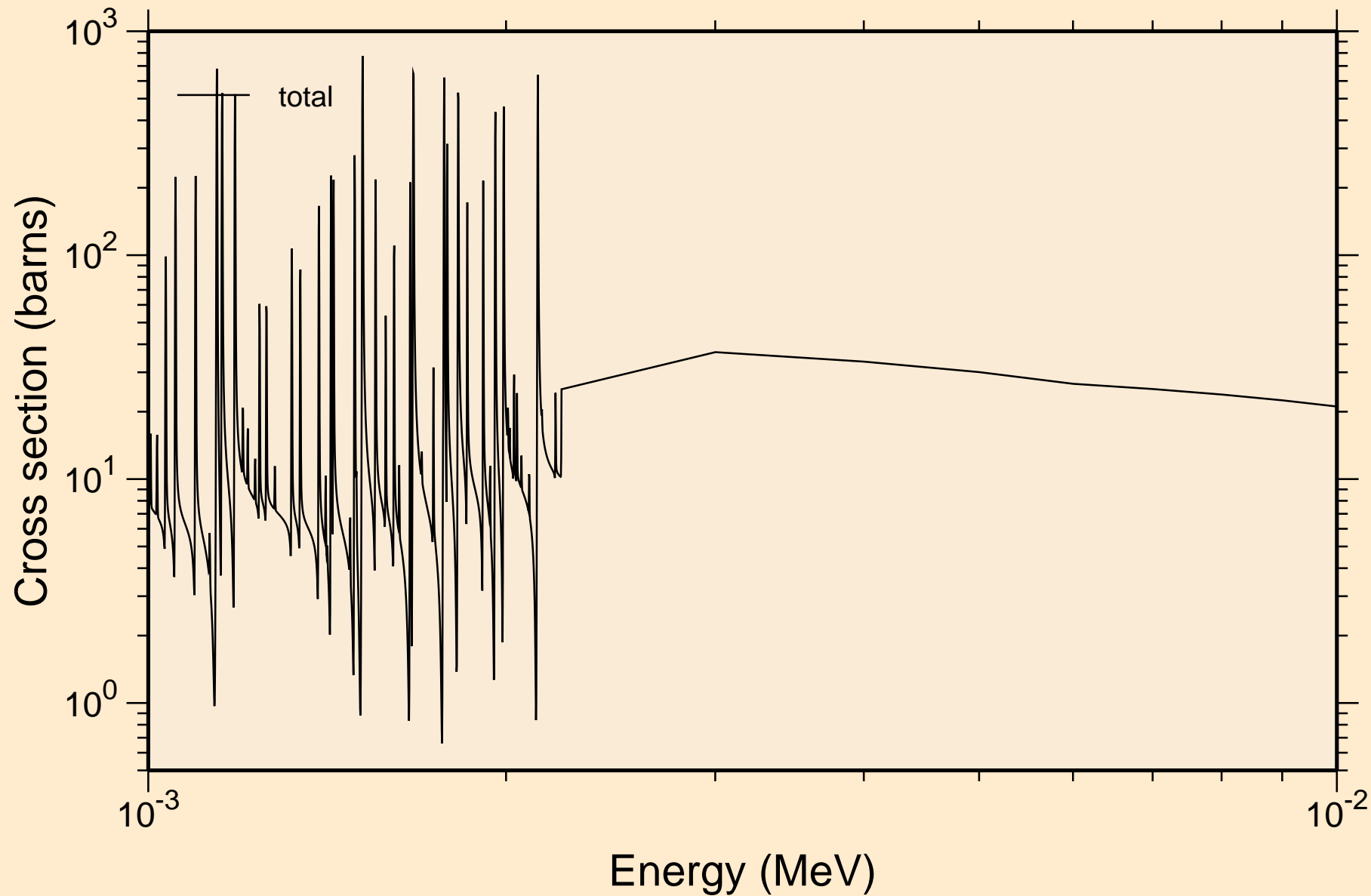

GD156 NEUTRON ACER TENDL-2019 LIBRARY; T=293.16K  
resonance total cross section

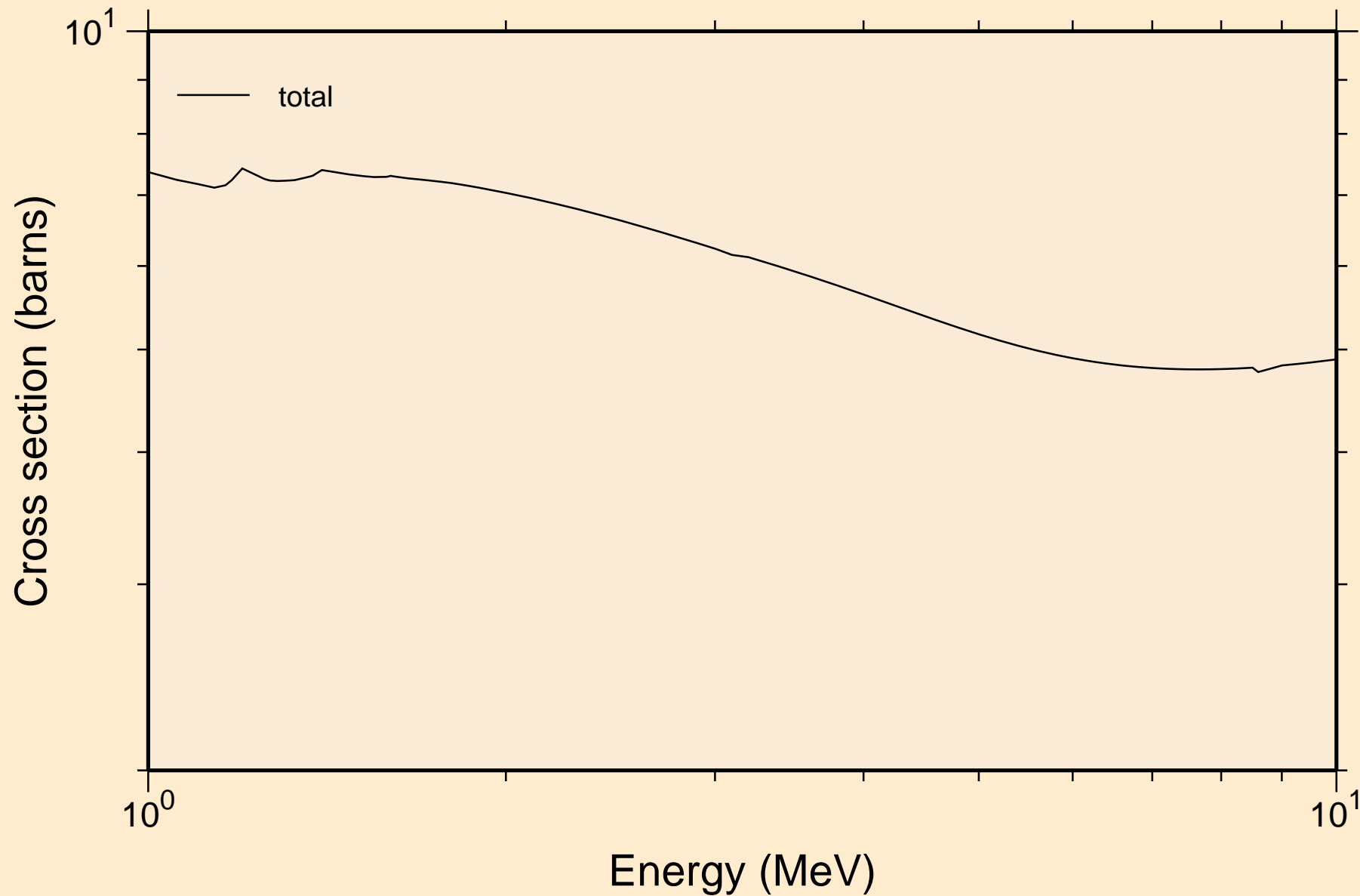

GD156 NEUTRON ACER TENDL-2019 LIBRARY; T=293.16K  
resonance absorption cross sections

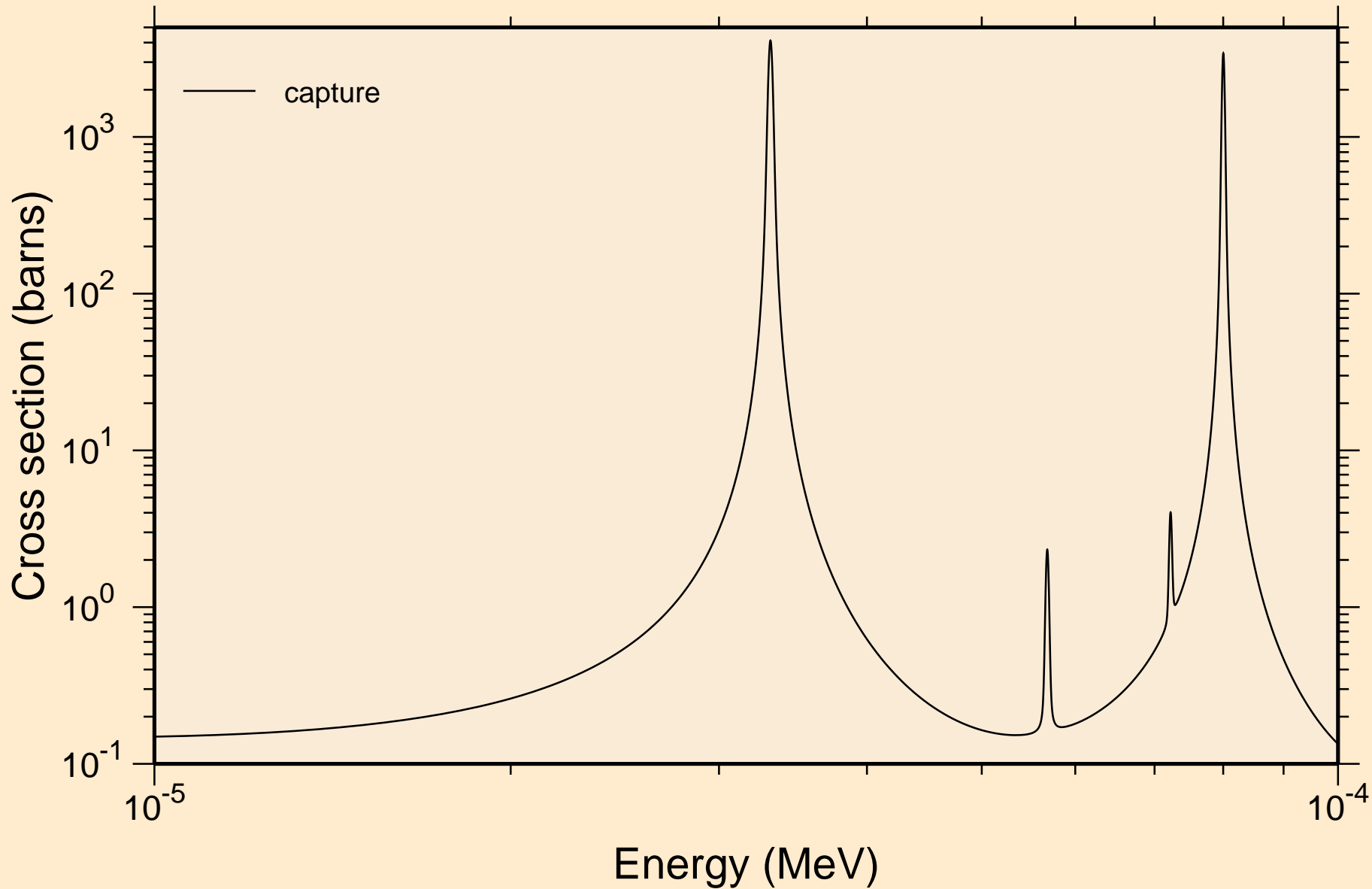

GD156 NEUTRON ACER TENDL-2019 LIBRARY; T=293.16K  
resonance absorption cross sections

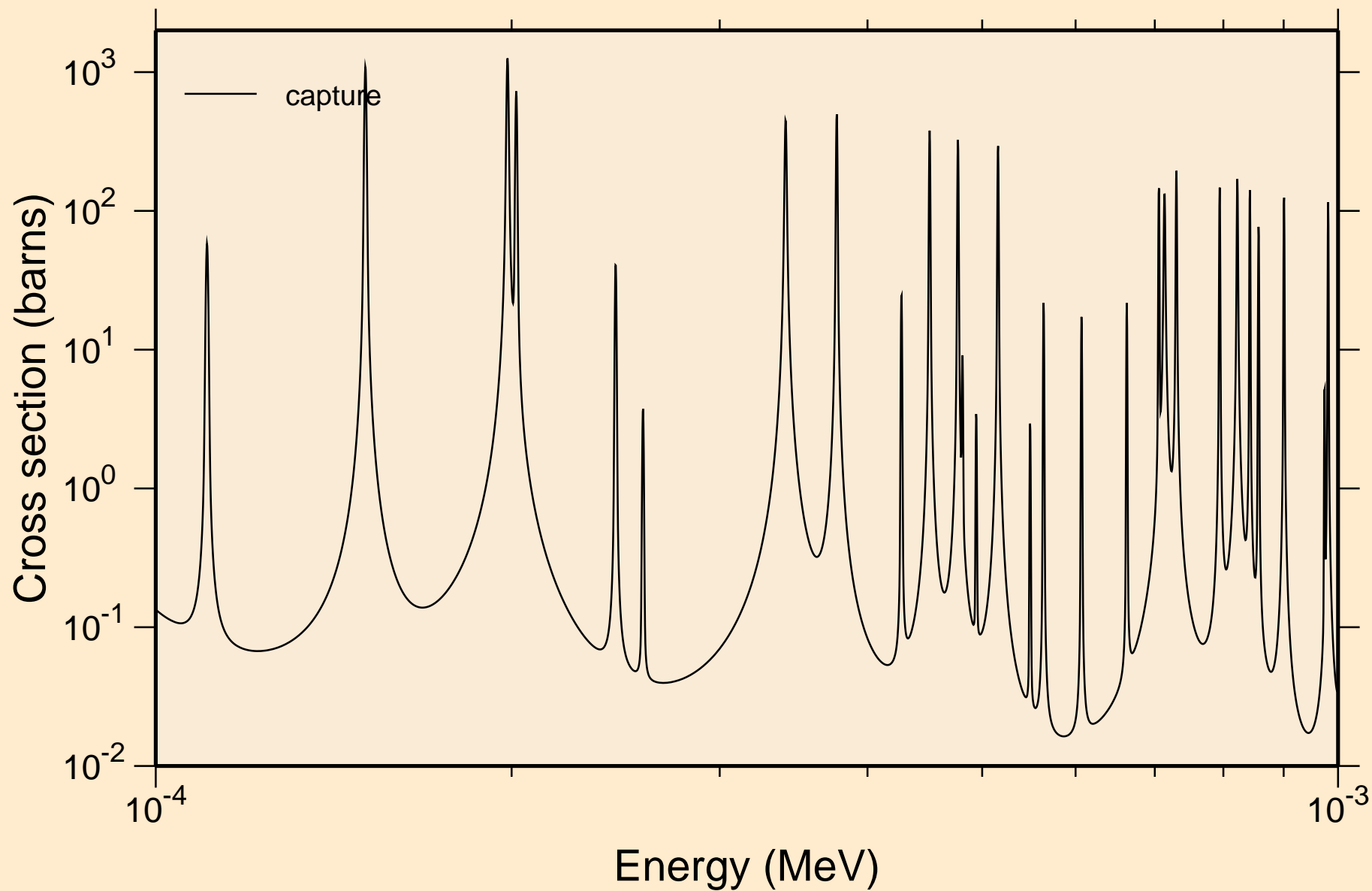

GD156 NEUTRON ACER TENDL-2019 LIBRARY; T=293.16K  
resonance absorption cross sections

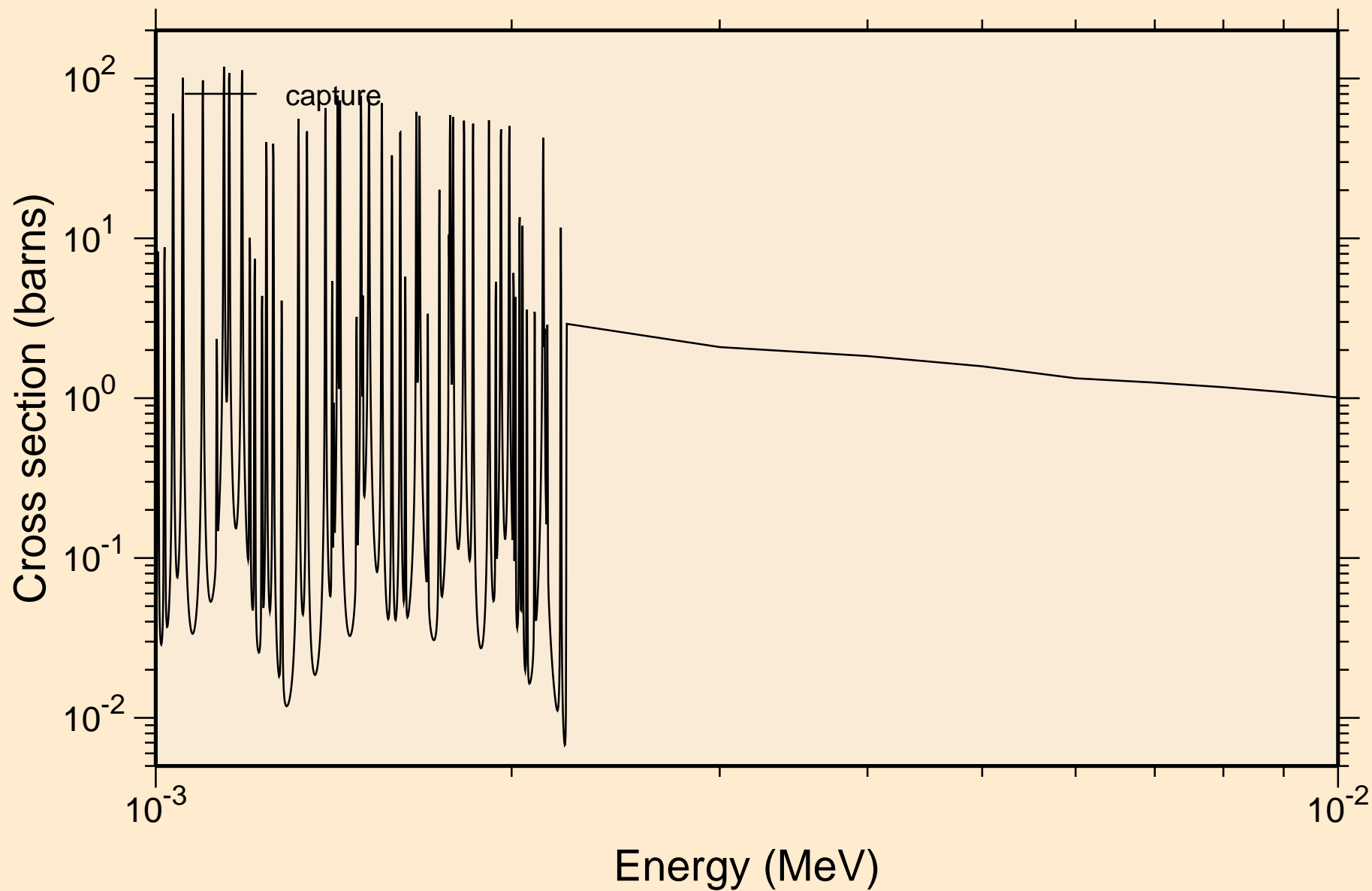



GD156 NEUTRON ACER TENDL-2019 LIBRARY; T=293.16K  
resonance absorption cross sections

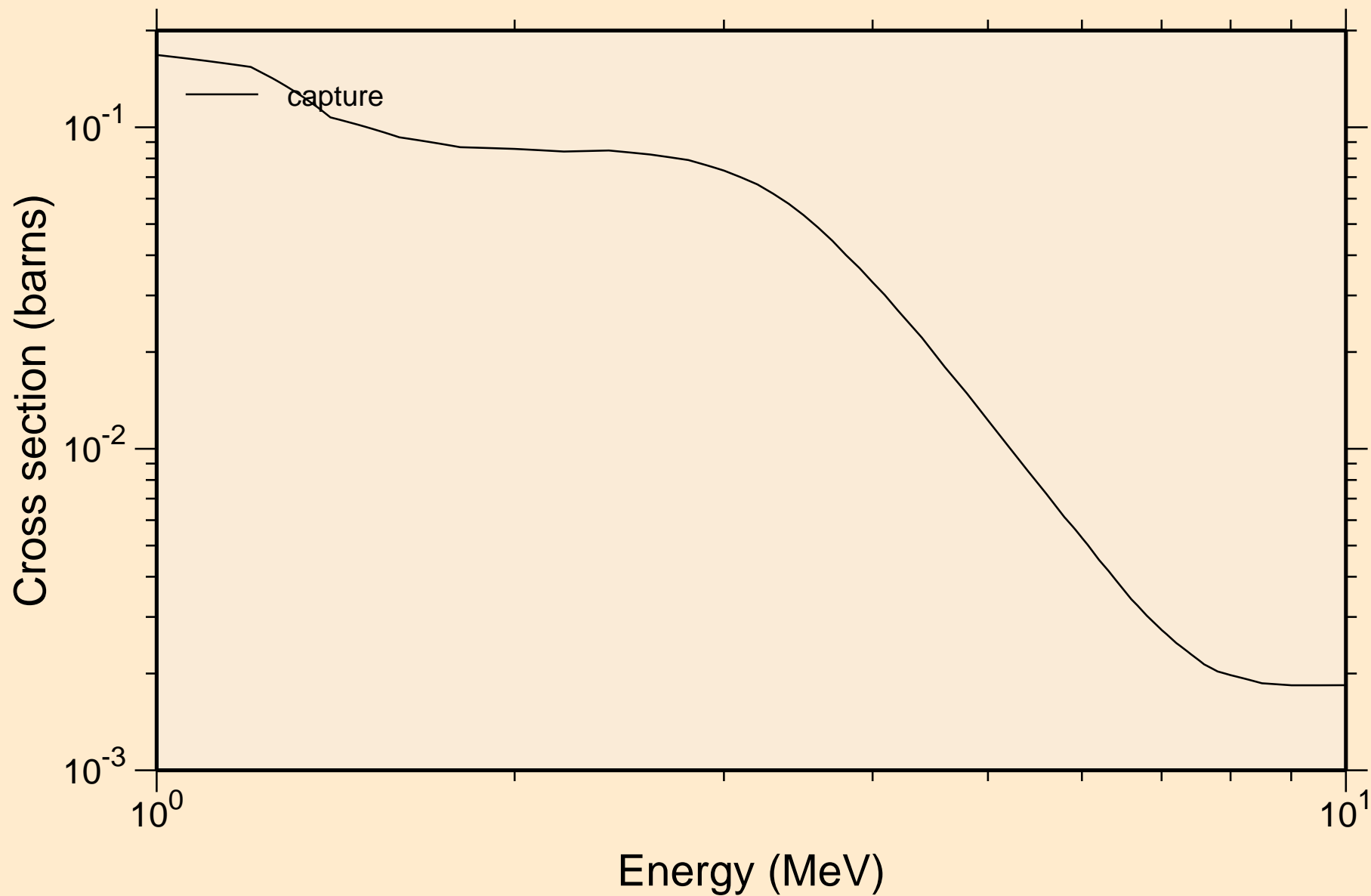

GD156 NEUTRON ACER TENDL-2019 LIBRARY; T=293.16K  
Heating

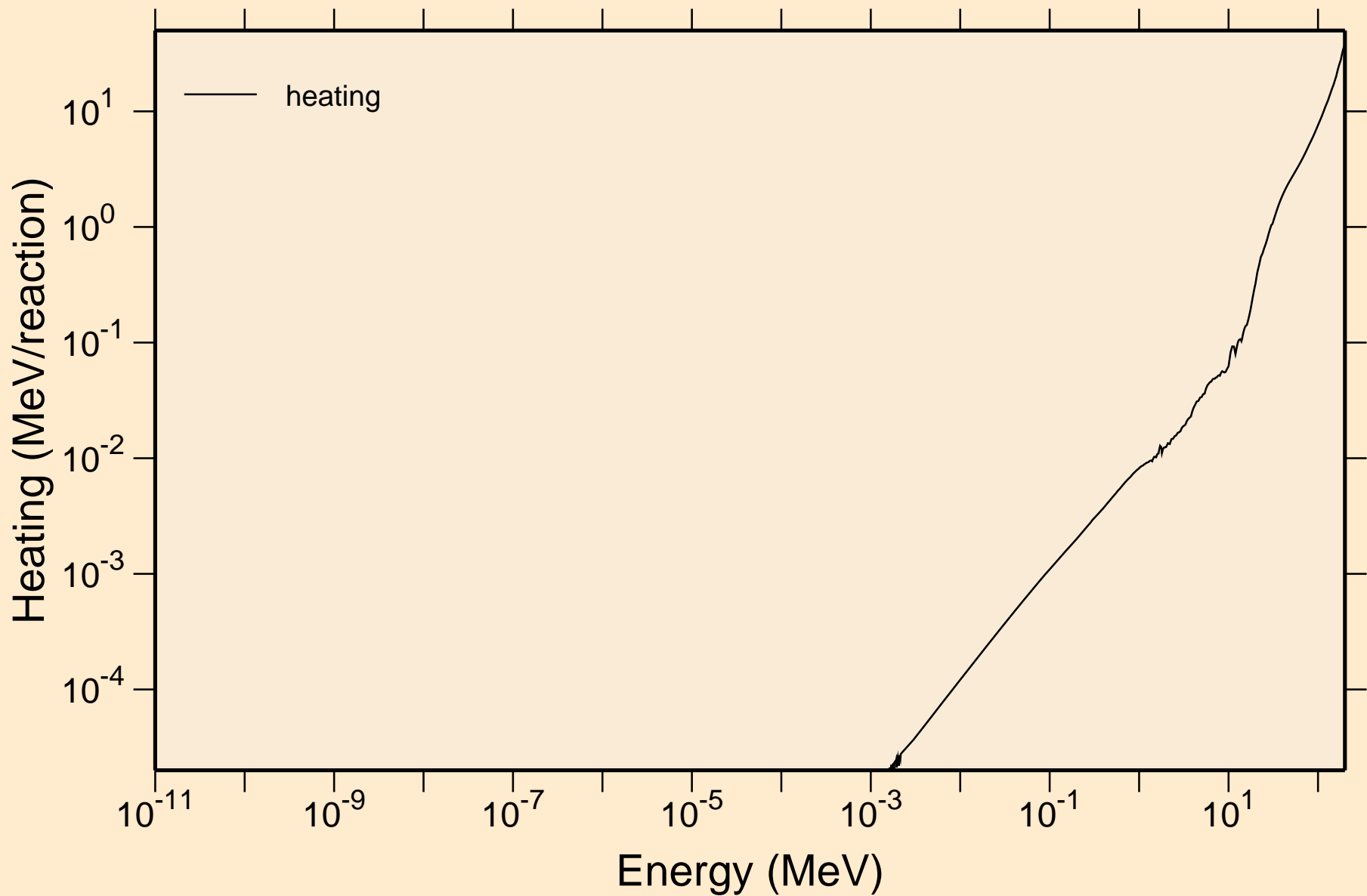

GD156 NEUTRON ACER TENDL-2019 LIBRARY; T=293.16K  
Damage

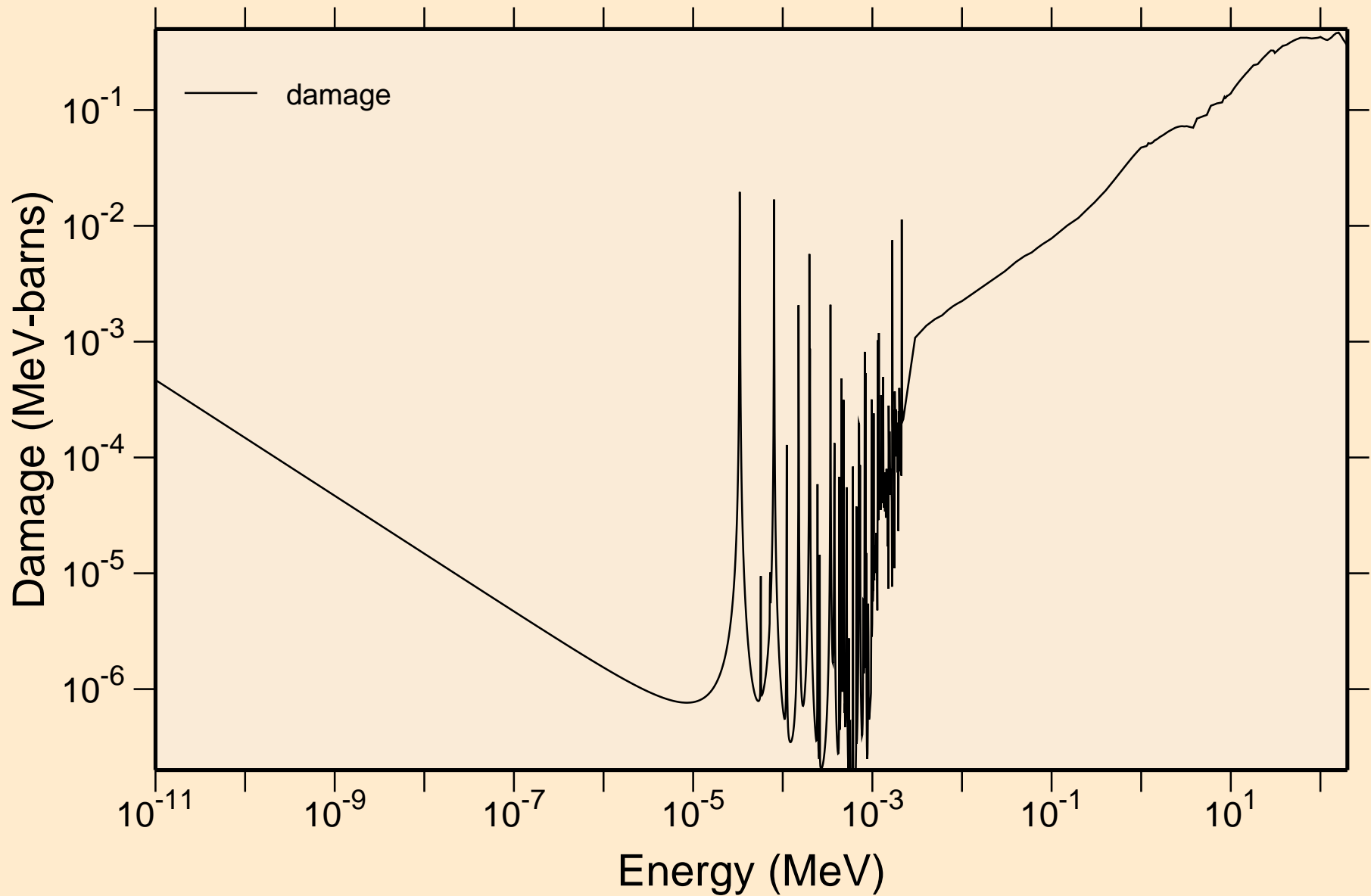

GD156 NEUTRON ACER TENDL-2019 LIBRARY; T=293.16K  
Non-threshold reactions

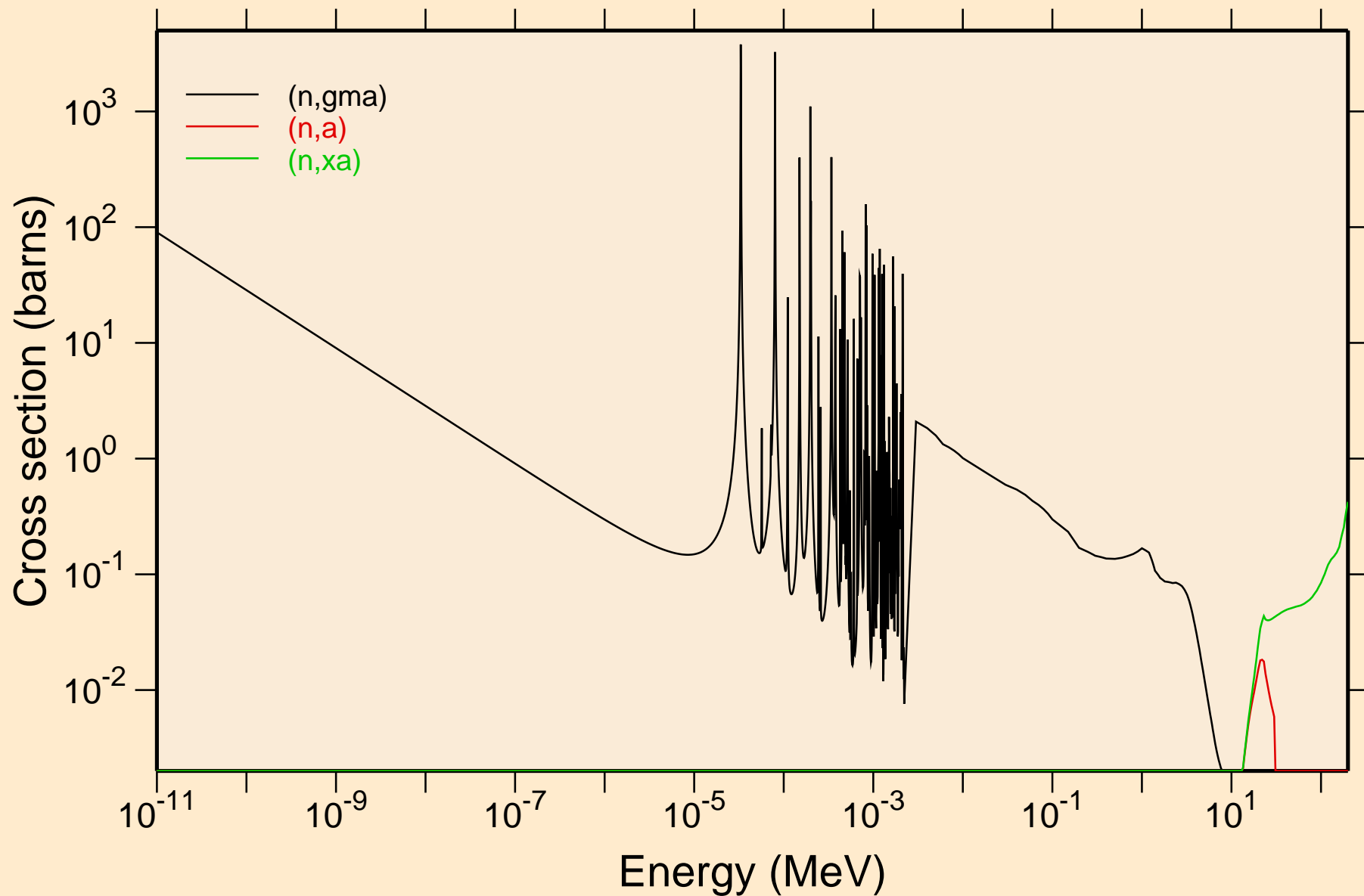

GD156 NEUTRON ACER TENDL-2019 LIBRARY; T=293.16K  
Principal cross sections

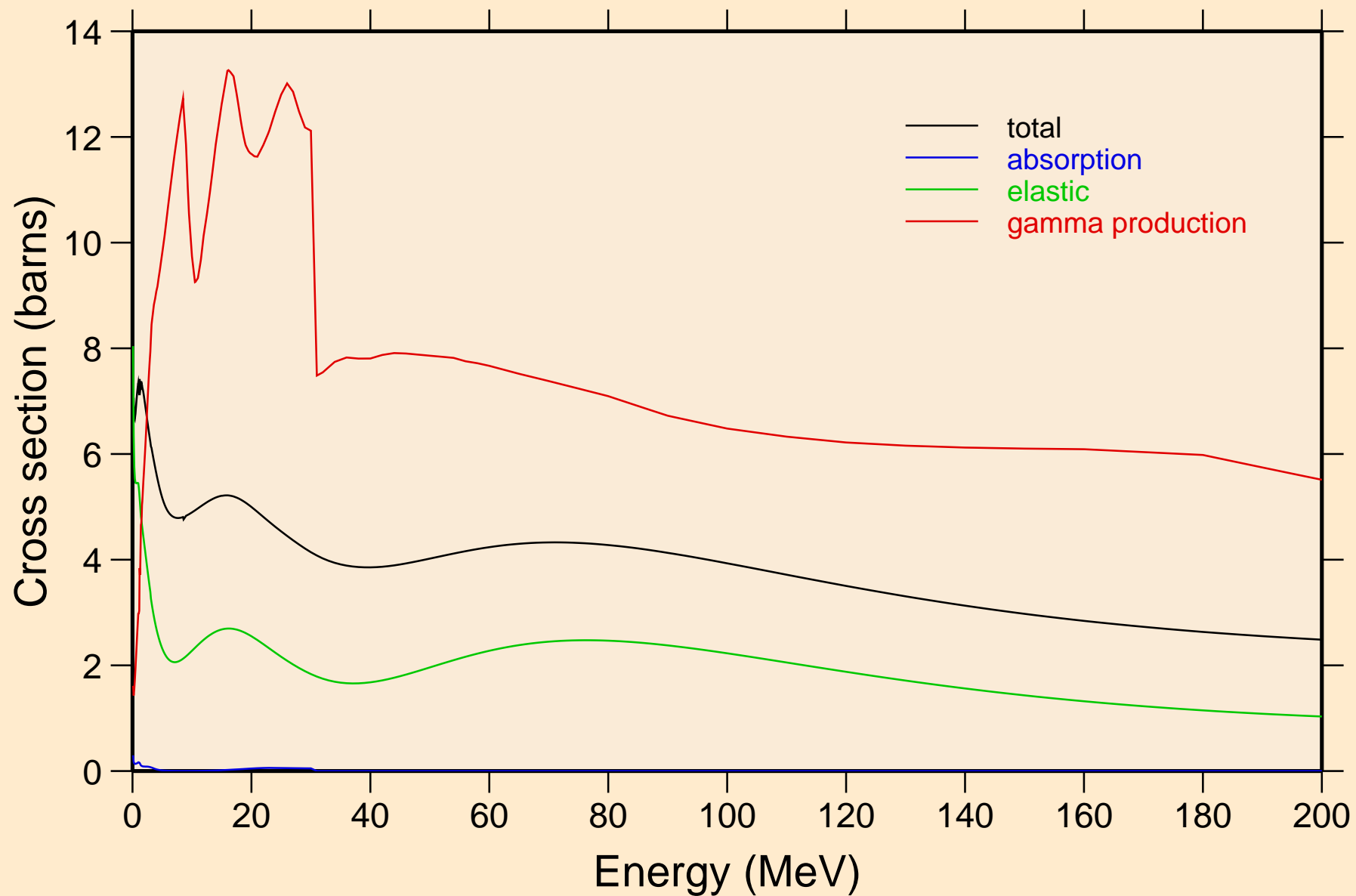

GD156 NEUTRON ACER TENDL-2019 LIBRARY; T=293.16K  
Heating

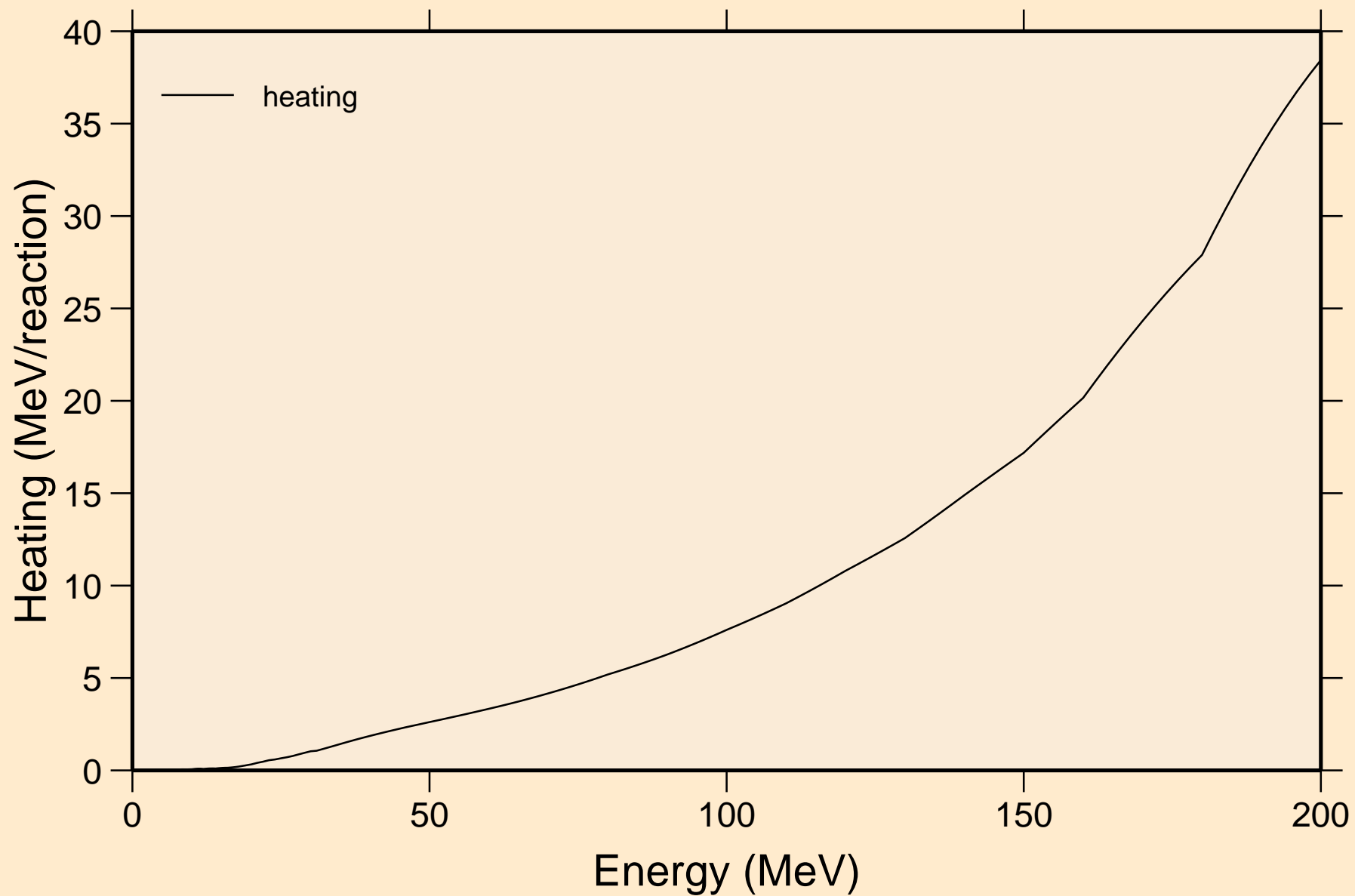

GD156 NEUTRON ACER TENDL-2019 LIBRARY; T=293.16K  
Damage

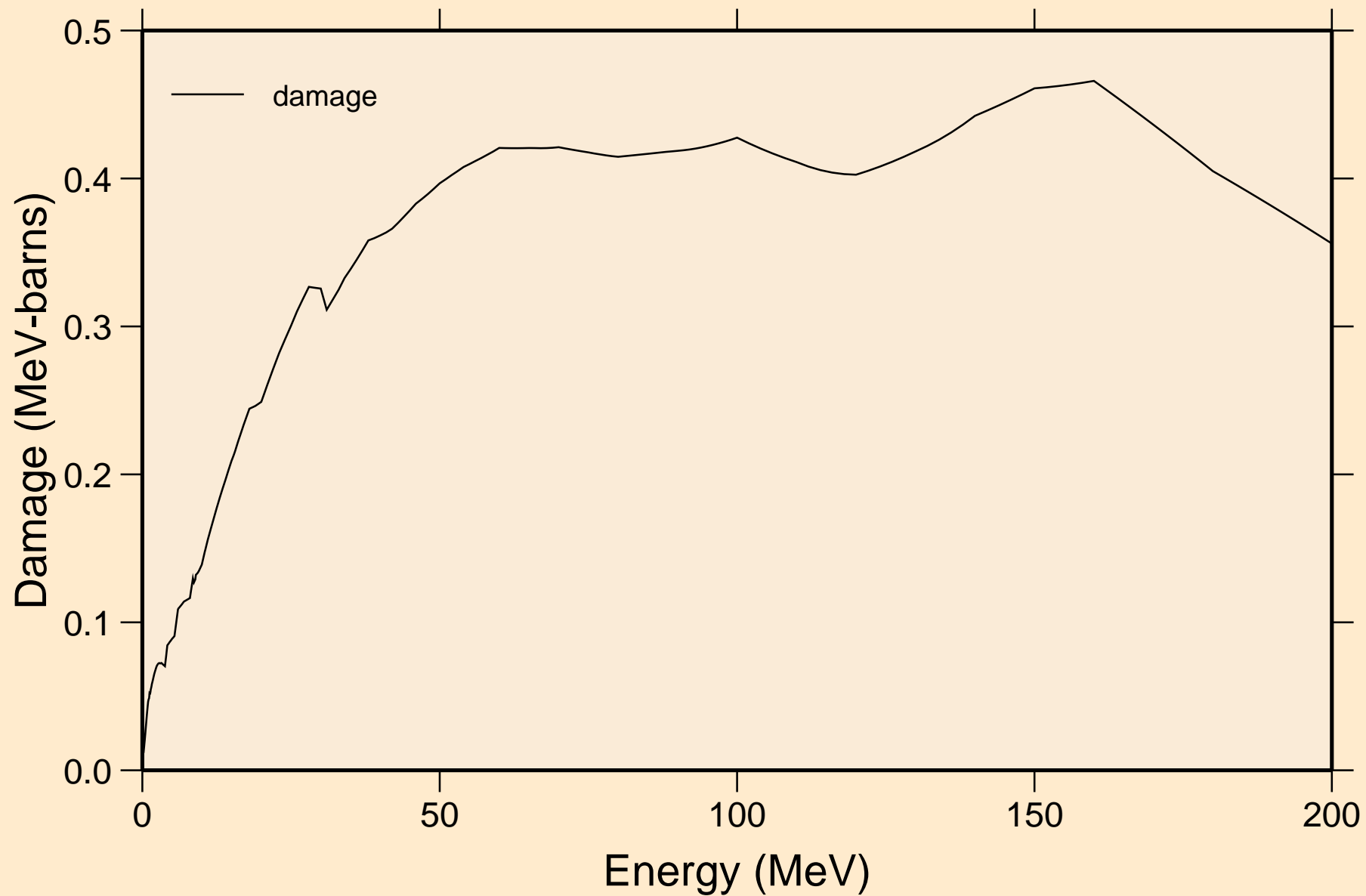

GD156 NEUTRON ACER TENDL-2019 LIBRARY; T=293.16K  
Non-threshold reactions

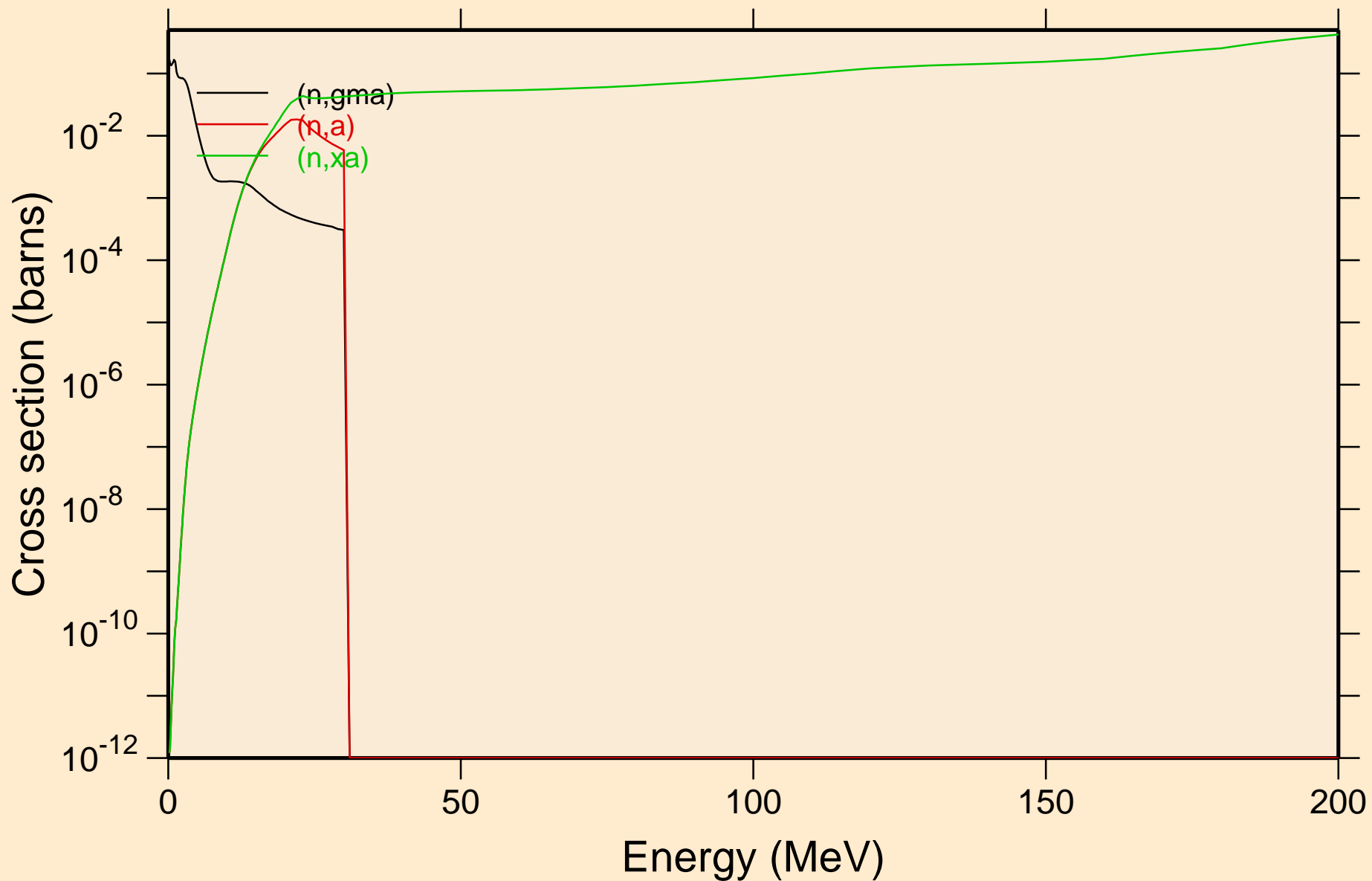



GD156 NEUTRON ACER TENDL-2019 LIBRARY; T=293.16K  
Inelastic levels

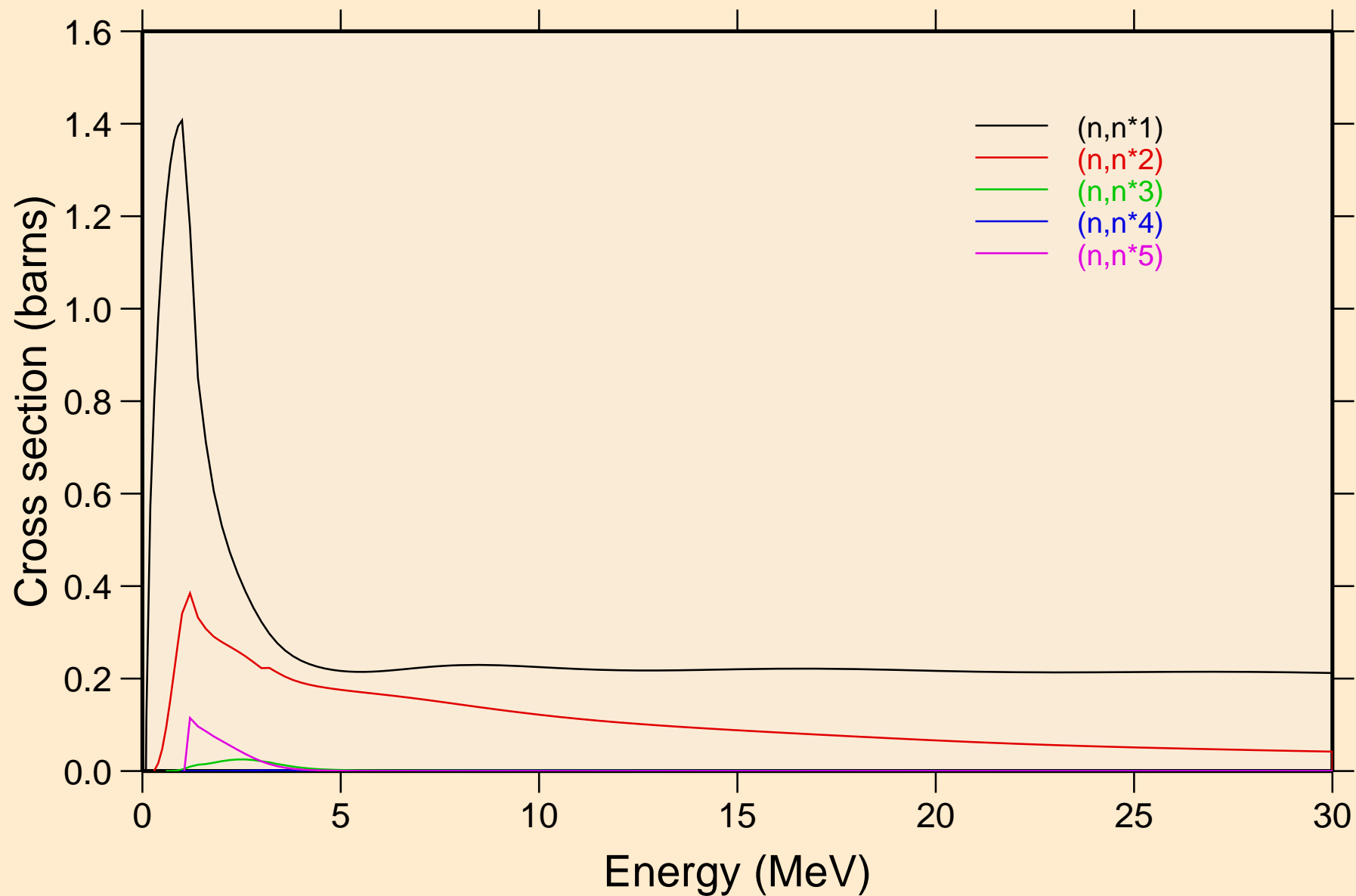

GD156 NEUTRON ACER TENDL-2019 LIBRARY; T=293.16K  
Inelastic levels

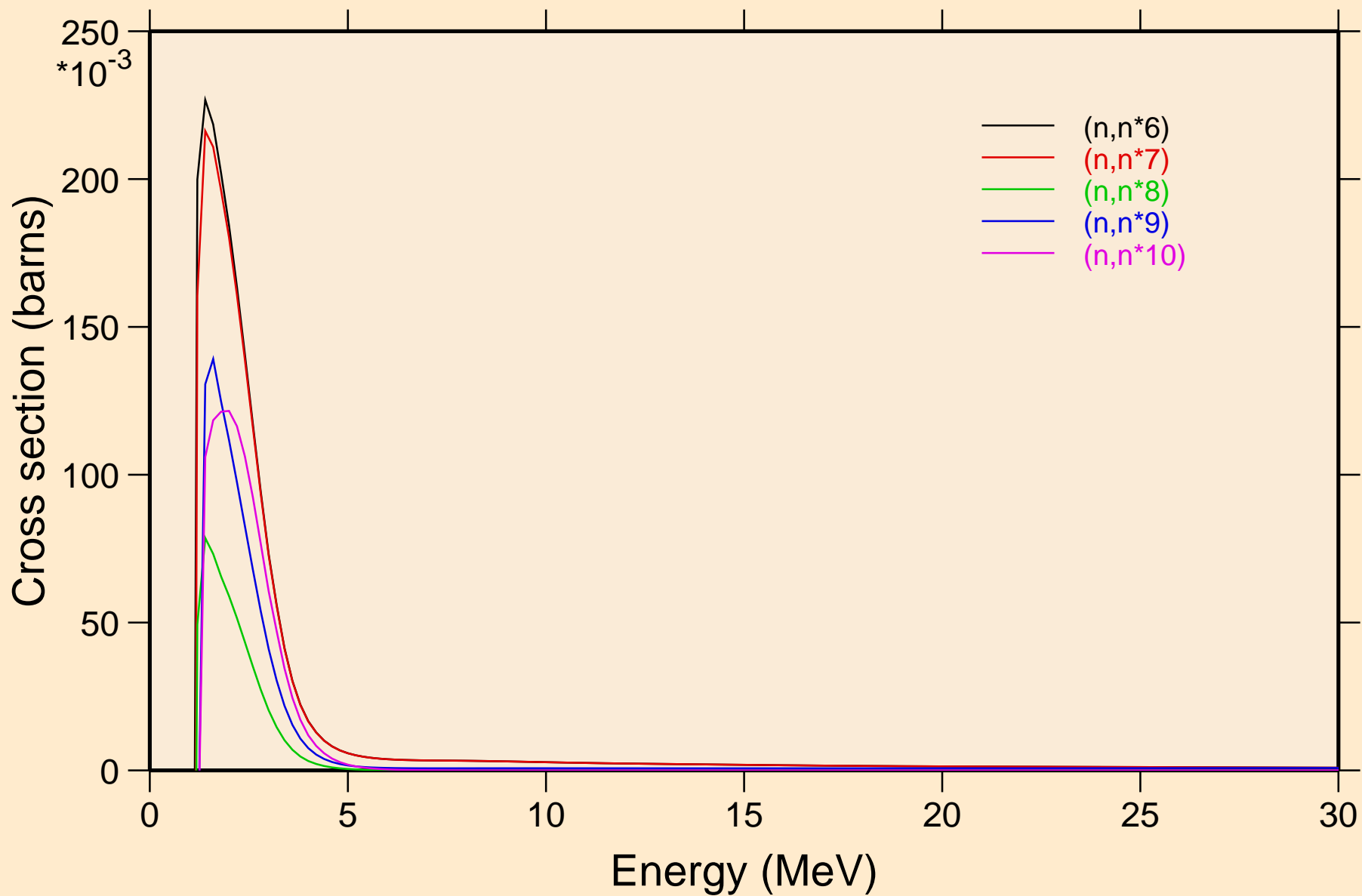

GD156 NEUTRON ACER TENDL-2019 LIBRARY; T=293.16K  
Inelastic levels

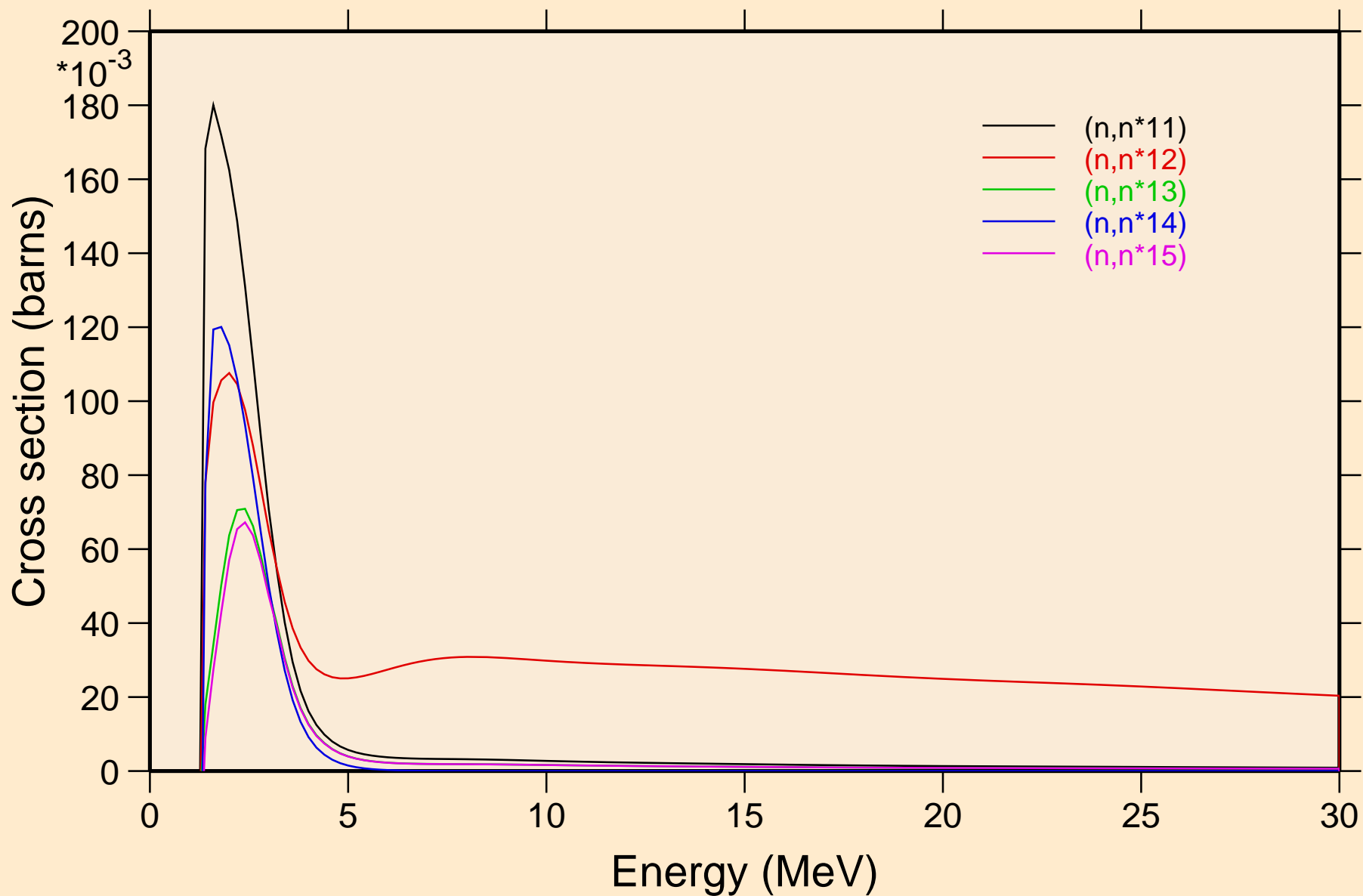

# GD156 NEUTRON ACER TENDL-2019 LIBRARY; T=293.16K

## Inelastic levels

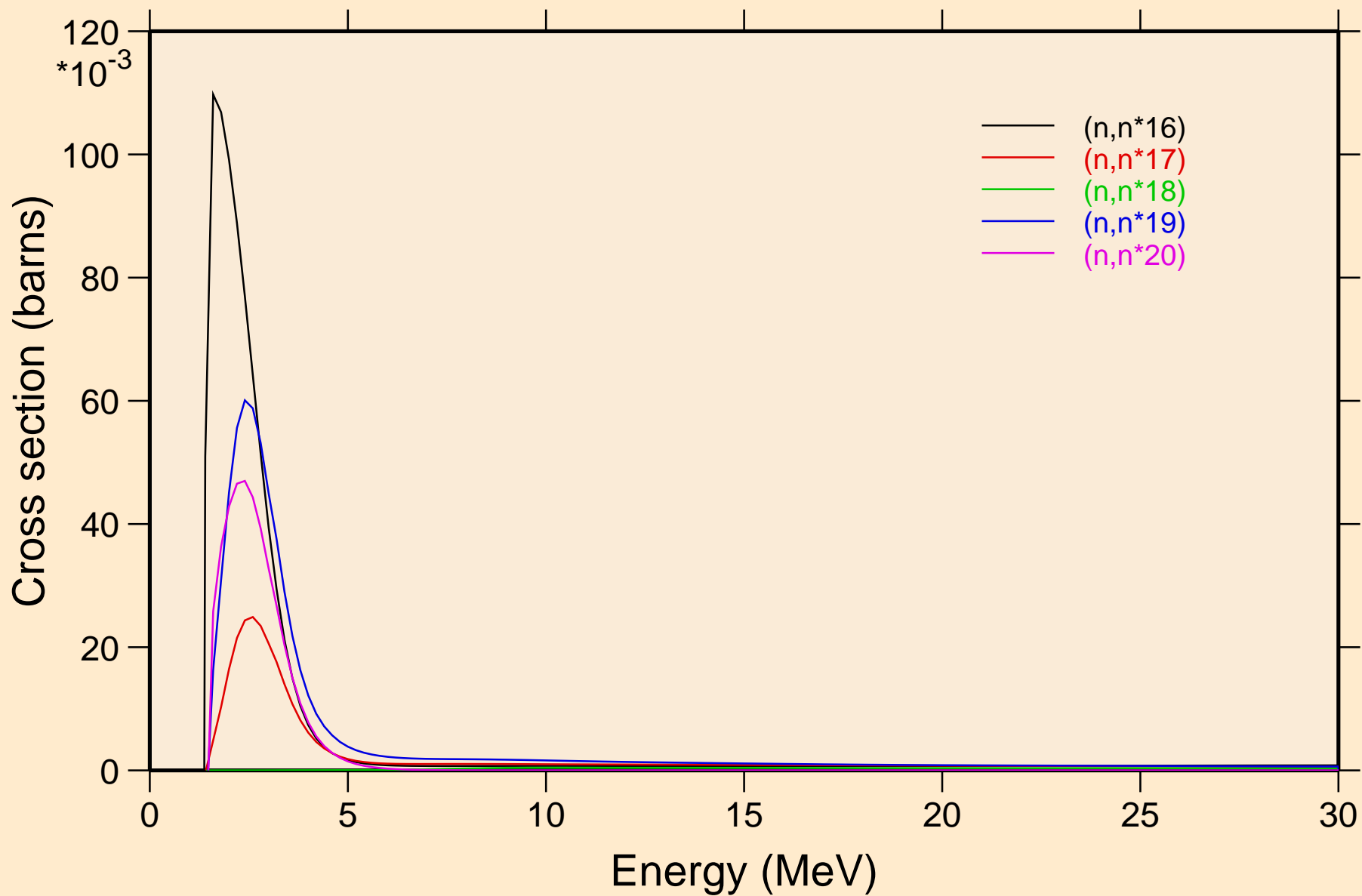

GD156 NEUTRON ACER TENDL-2019 LIBRARY; T=293.16K  
Inelastic levels

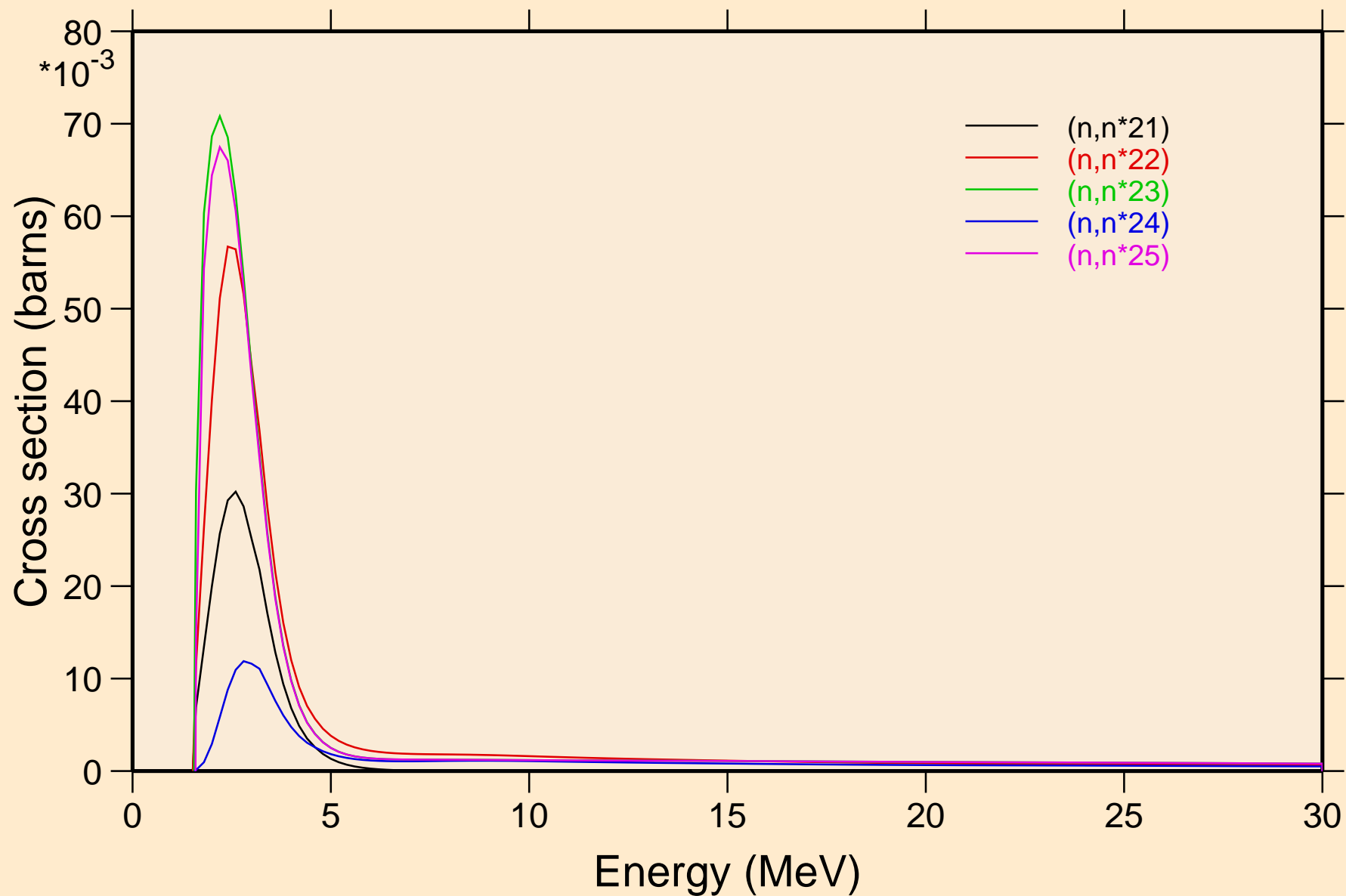

GD156 NEUTRON ACER TENDL-2019 LIBRARY; T=293.16K  
Inelastic levels

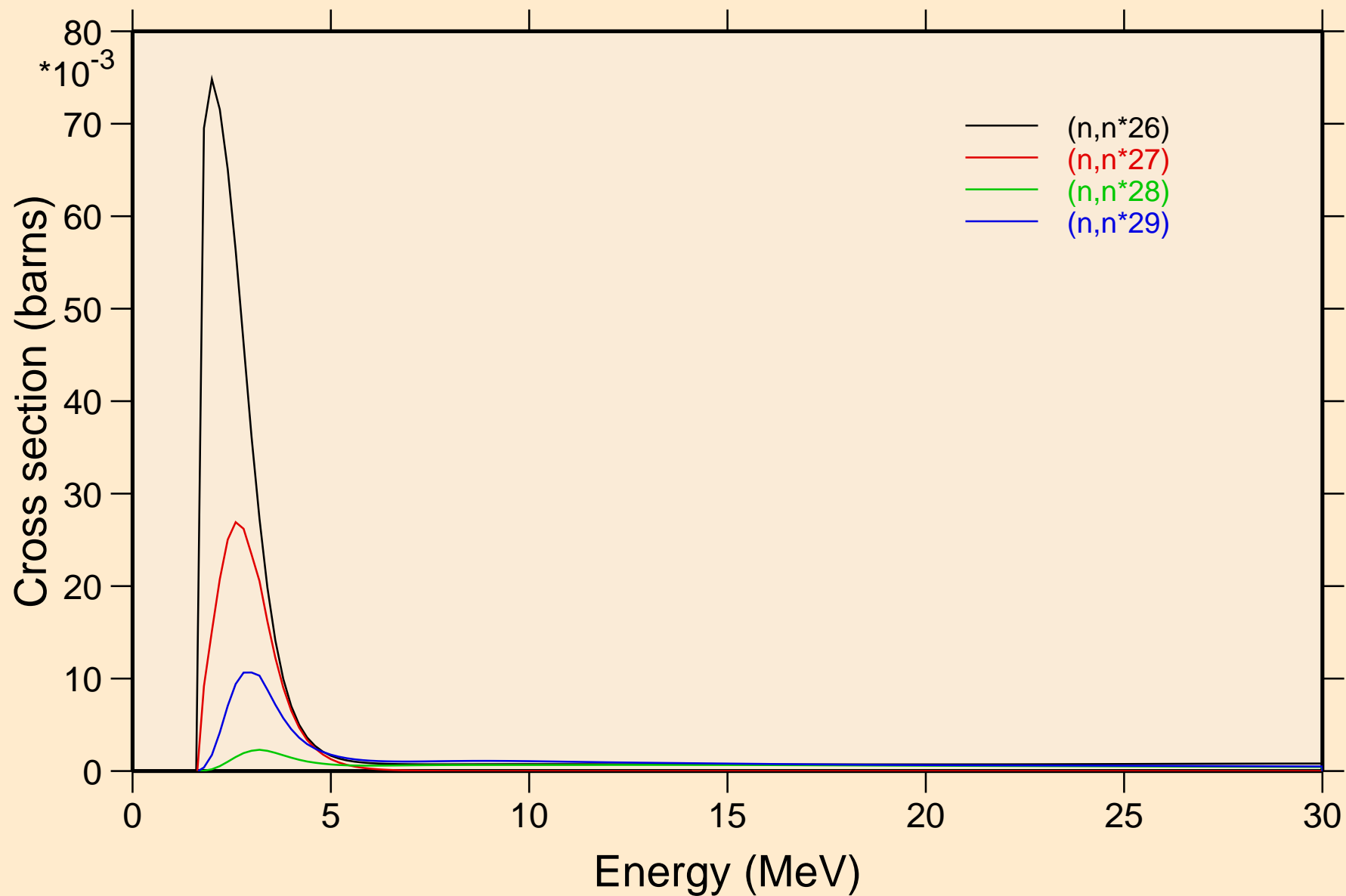

# GD156 NEUTRON ACER TENDL-2019 LIBRARY; T=293.16K

## Threshold reactions

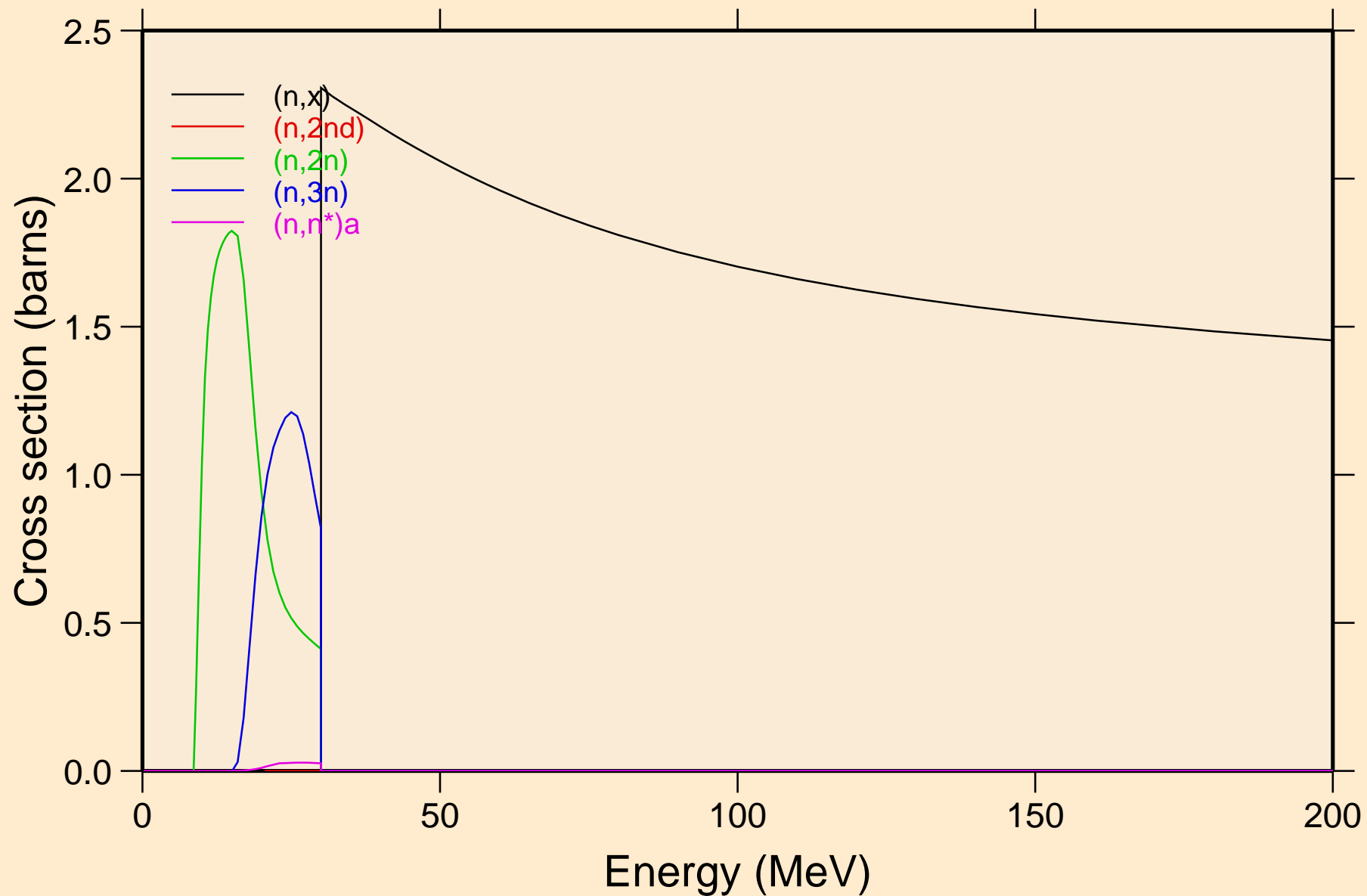

GD156 NEUTRON ACER TENDL-2019 LIBRARY; T=293.16K  
Threshold reactions

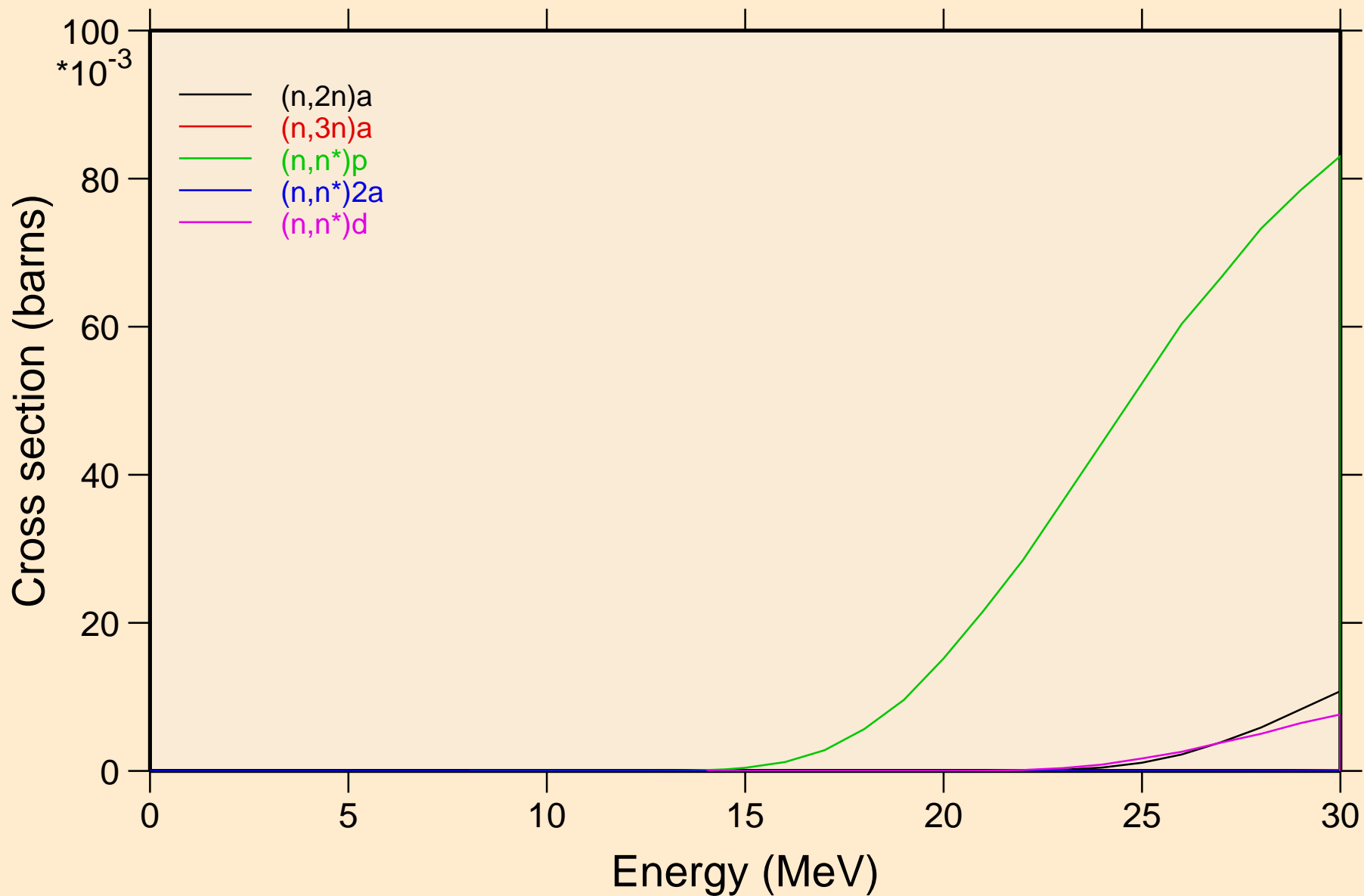



# GD156 NEUTRON ACER TENDL-2019 LIBRARY; T=293.16K

## Threshold reactions

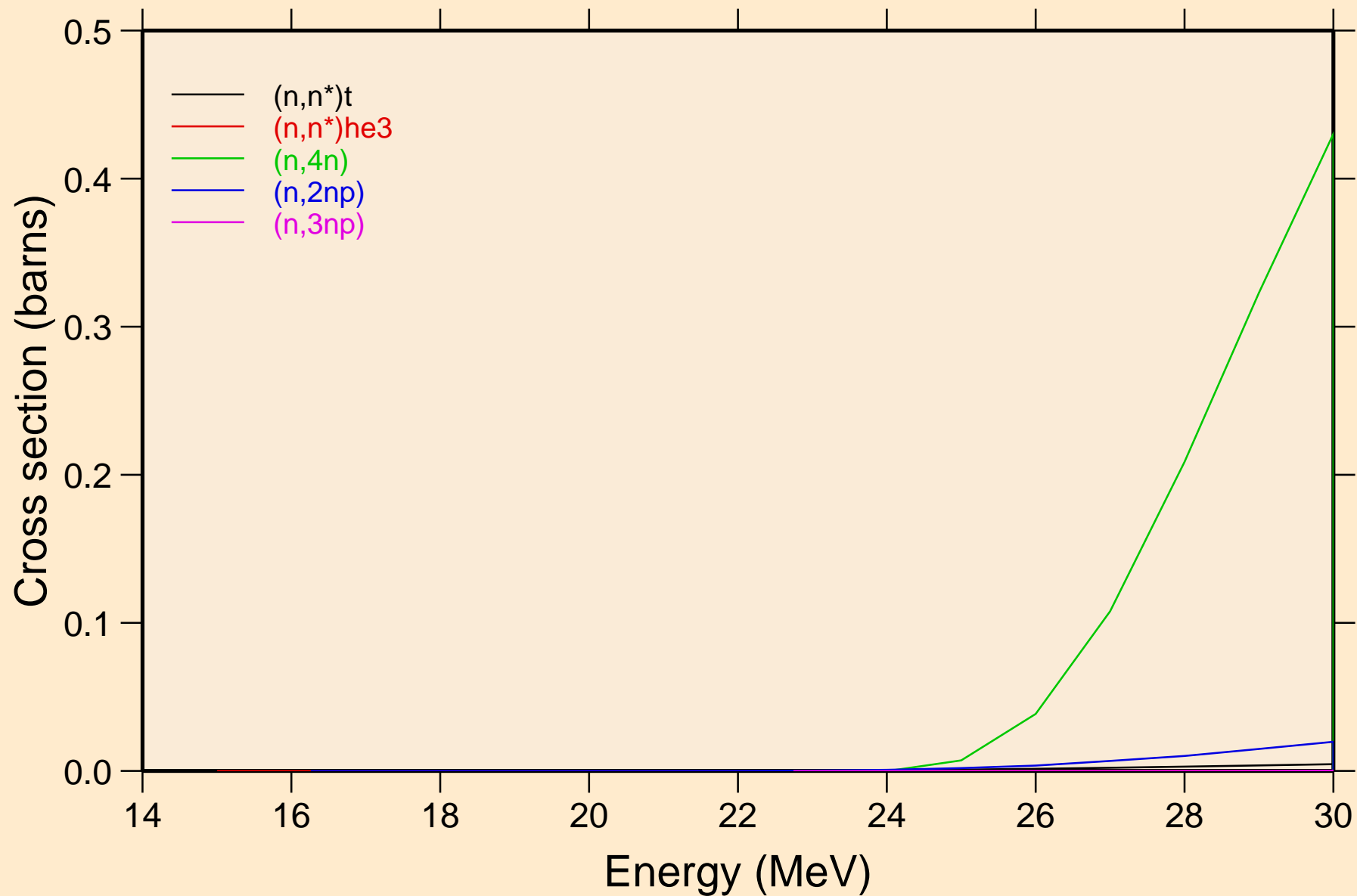

GD156 NEUTRON ACER TENDL-2019 LIBRARY; T=293.16K  
Threshold reactions

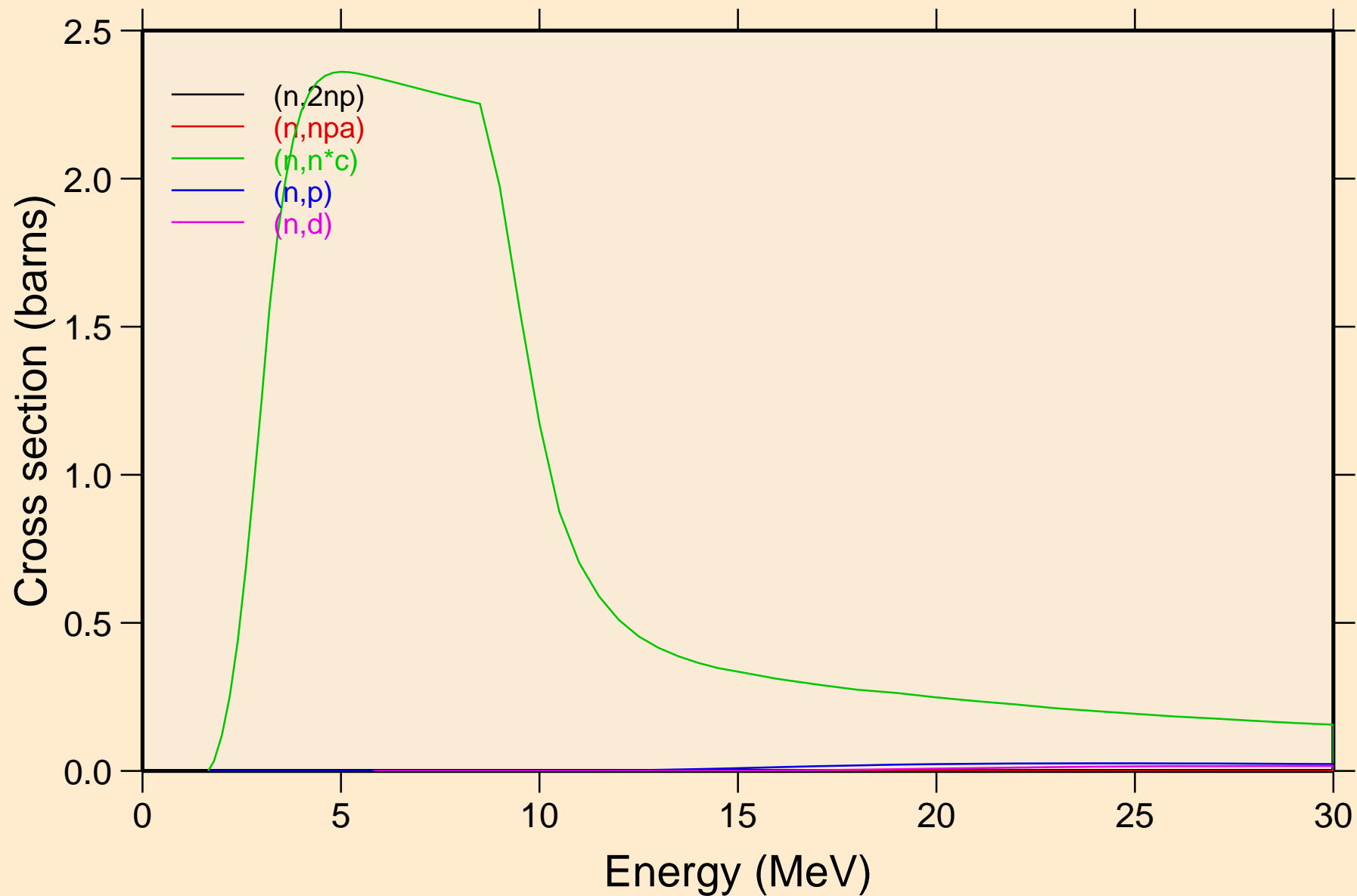

GD156 NEUTRON ACER TENDL-2019 LIBRARY; T=293.16K  
Threshold reactions

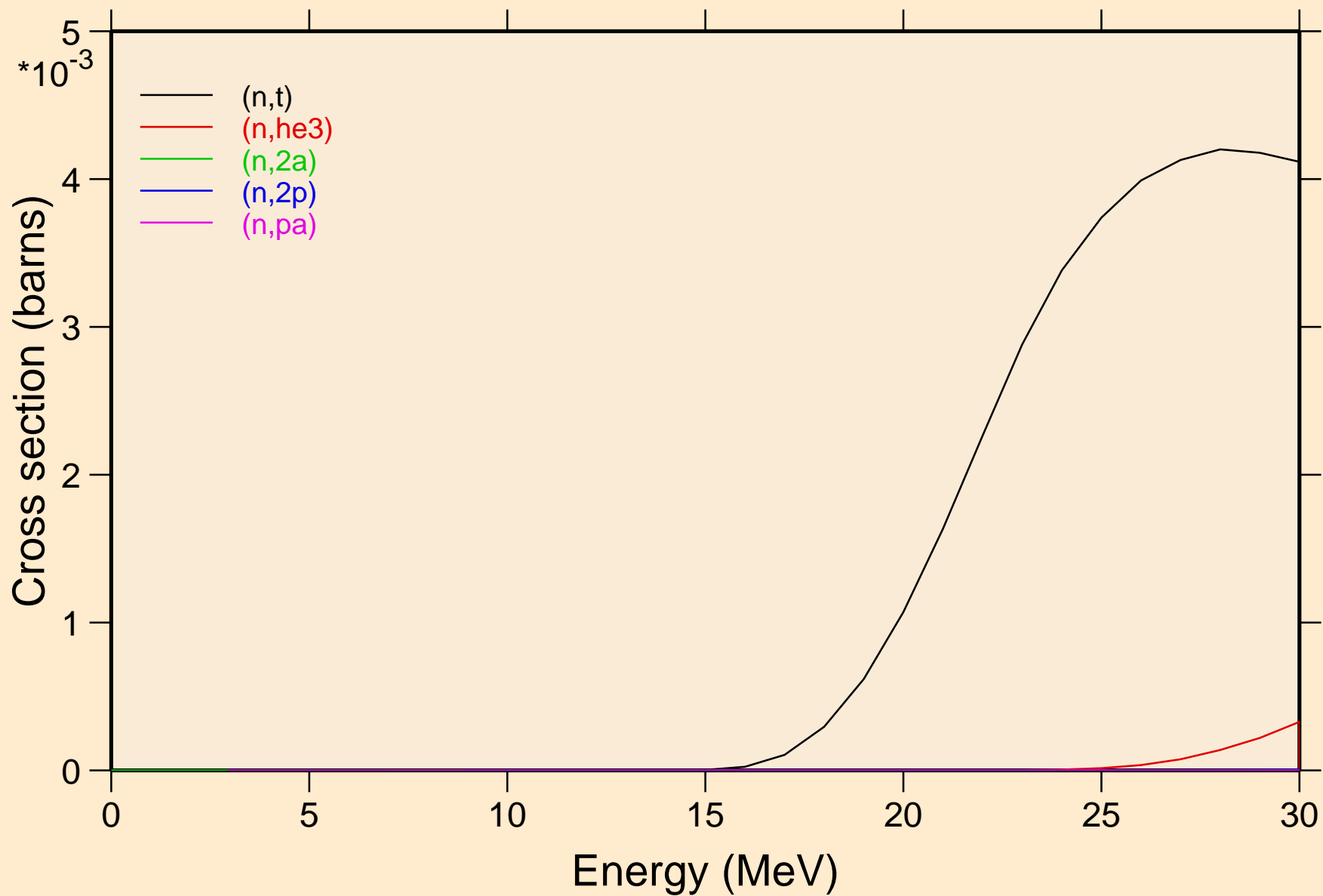

GD156 NEUTRON ACER TENDL-2019 LIBRARY; T=293.16K  
Threshold reactions

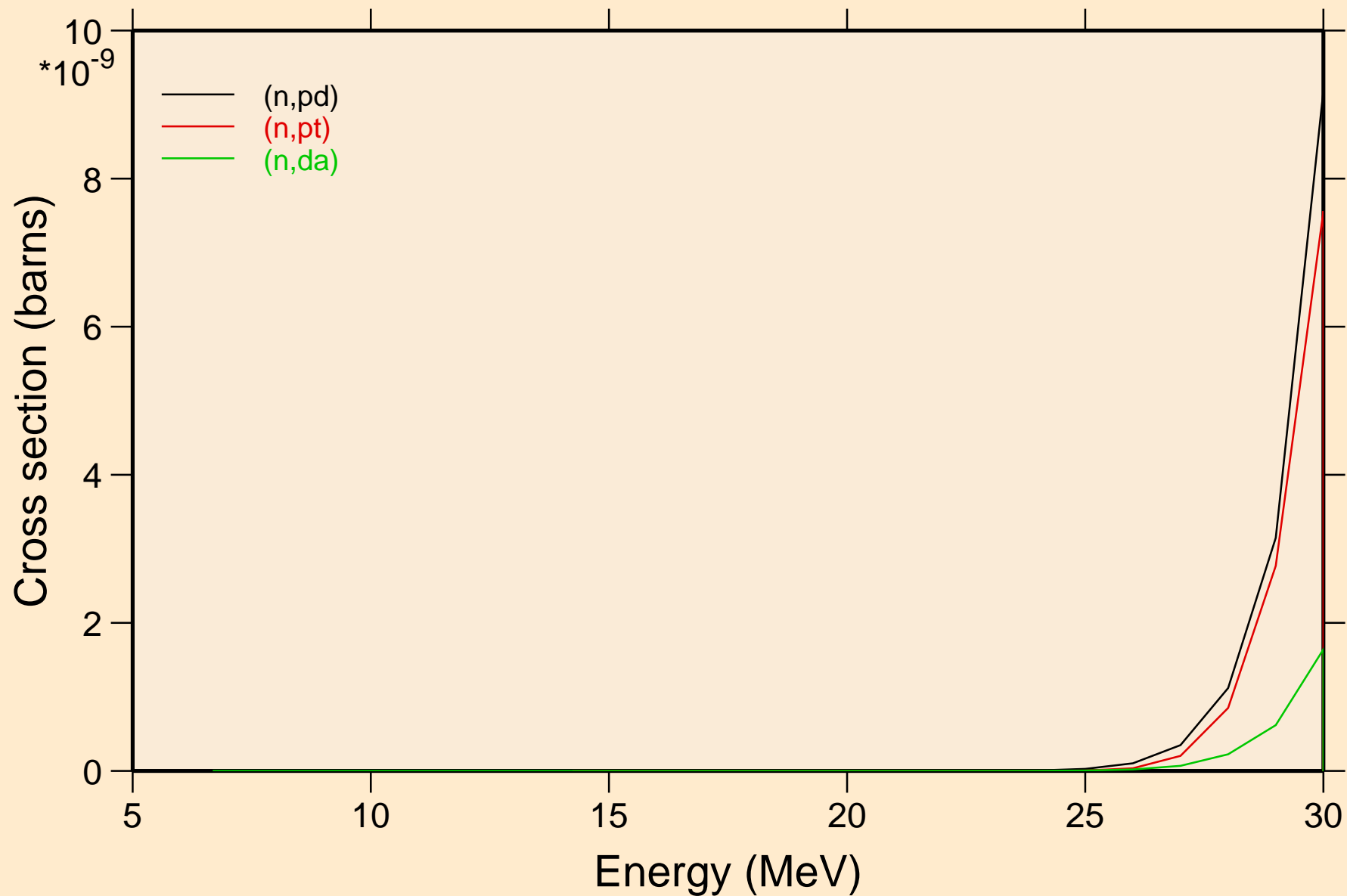

GD156 NEUTRON ACER TENDL-2019 LIBRARY; T=293.16K  
Threshold reactions

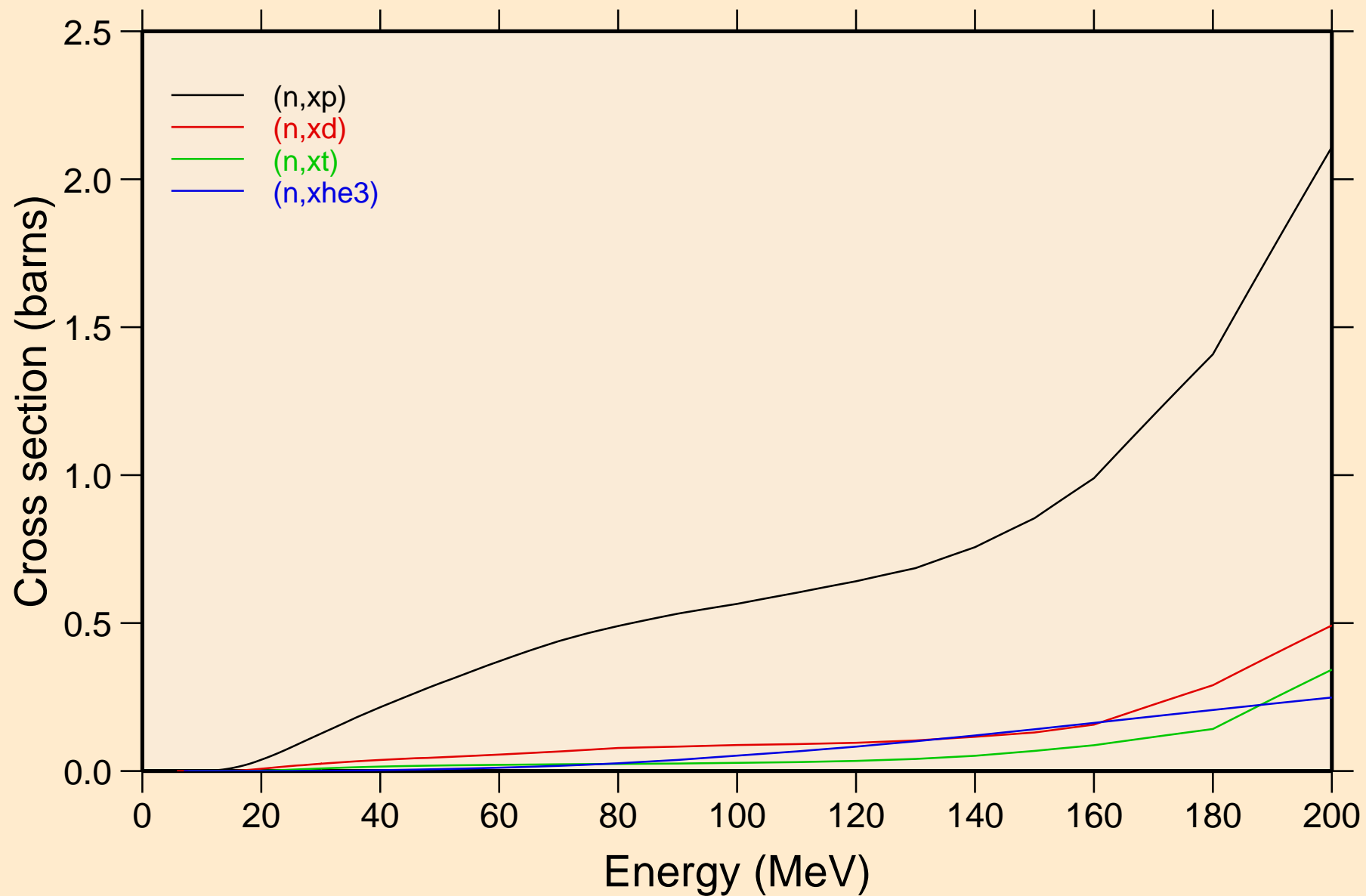

GD156 NEUTRON ACER TENDL-2019 LIBRARY; T=293.16K  
angular distribution for elastic

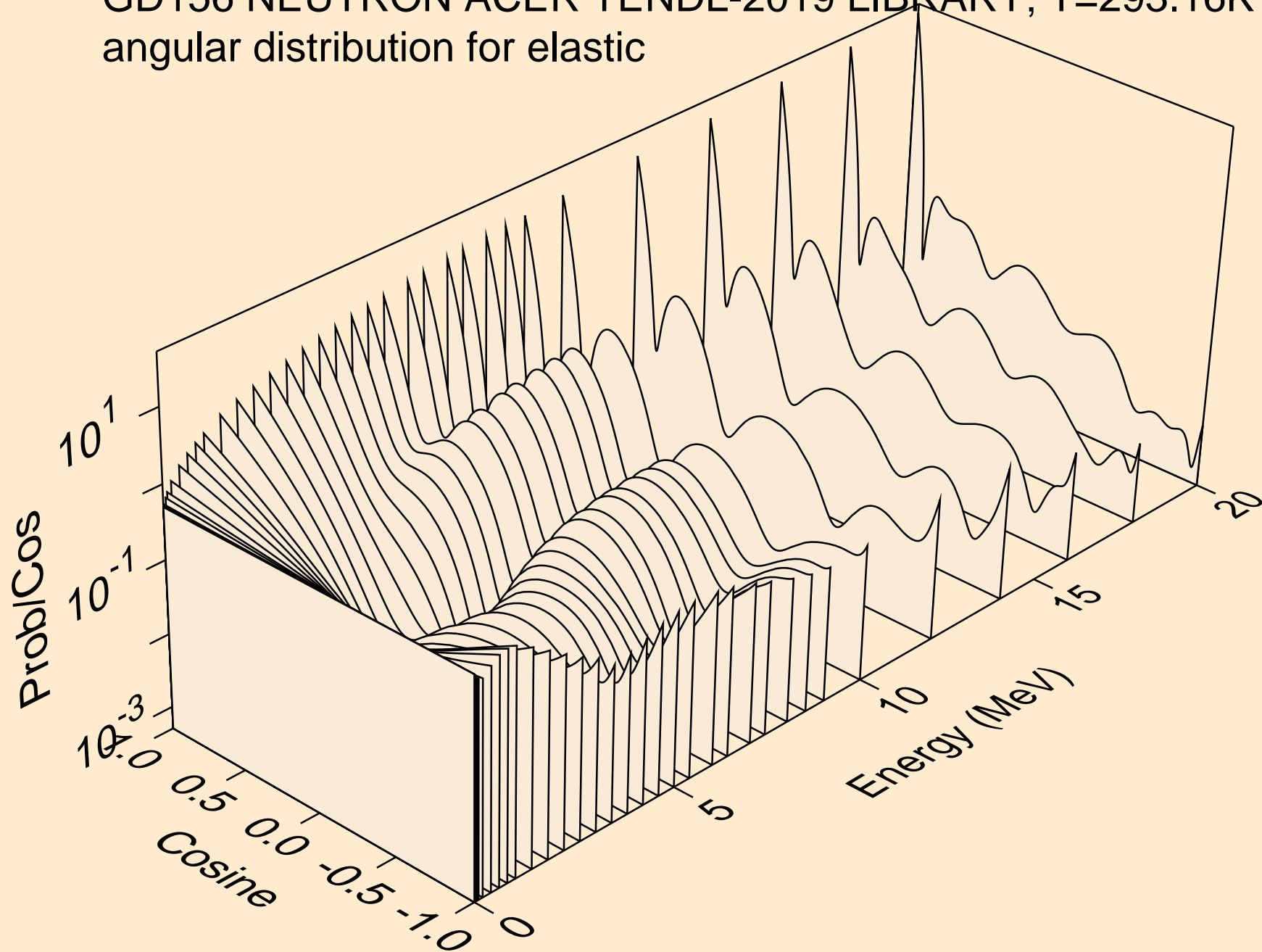

GD156 NEUTRON ACER TENDL-2019 LIBRARY; T=293.16K  
angular distribution for elastic

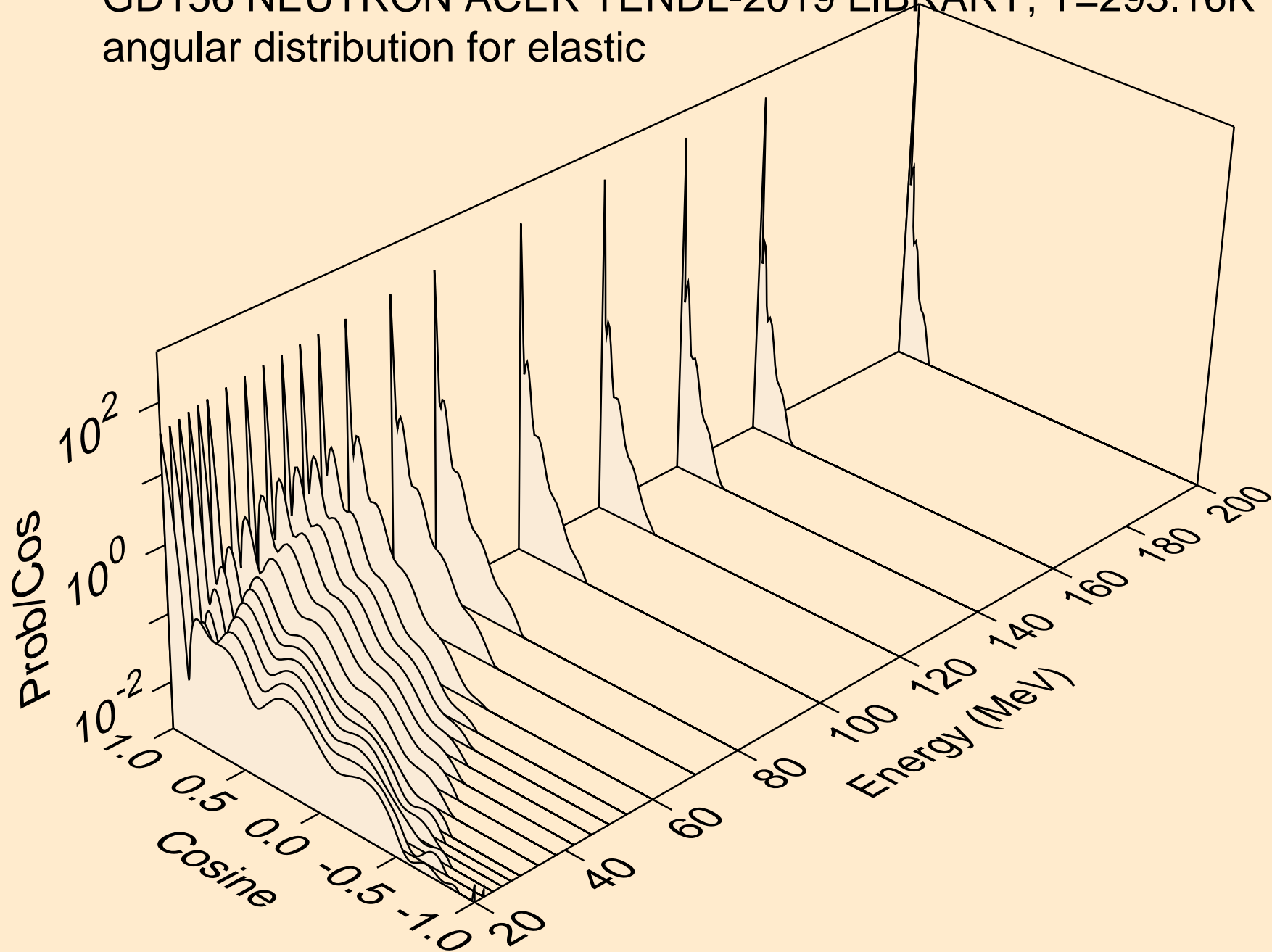

GD156 NEUTRON ACER TENDL-2019 LIBRARY; T=293.16K  
angular distribution for (n,n\*1)

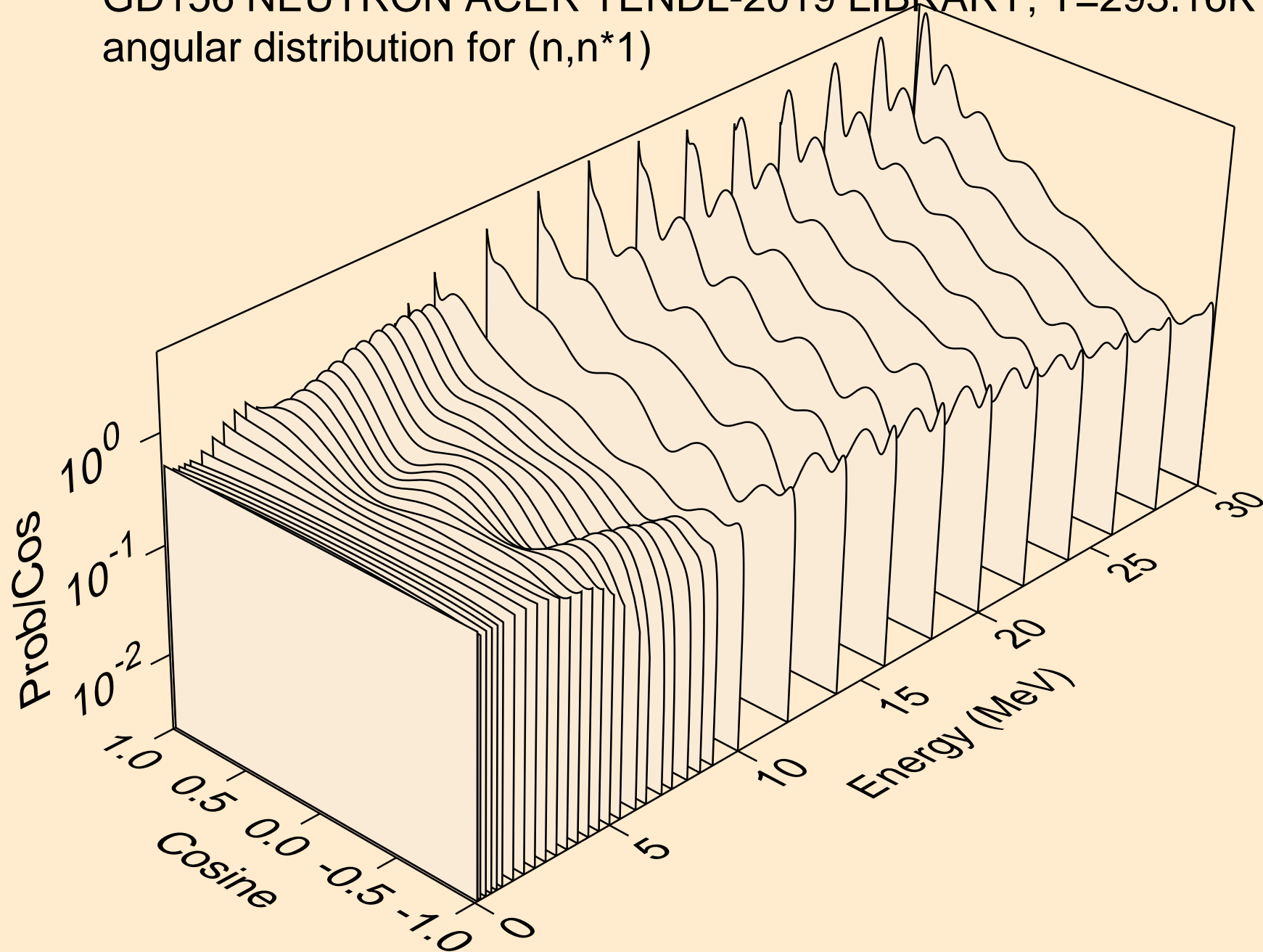



GD156 NEUTRON ACER TENDL-2019 LIBRARY; T=293.16K  
angular distribution for (n,n\*2)

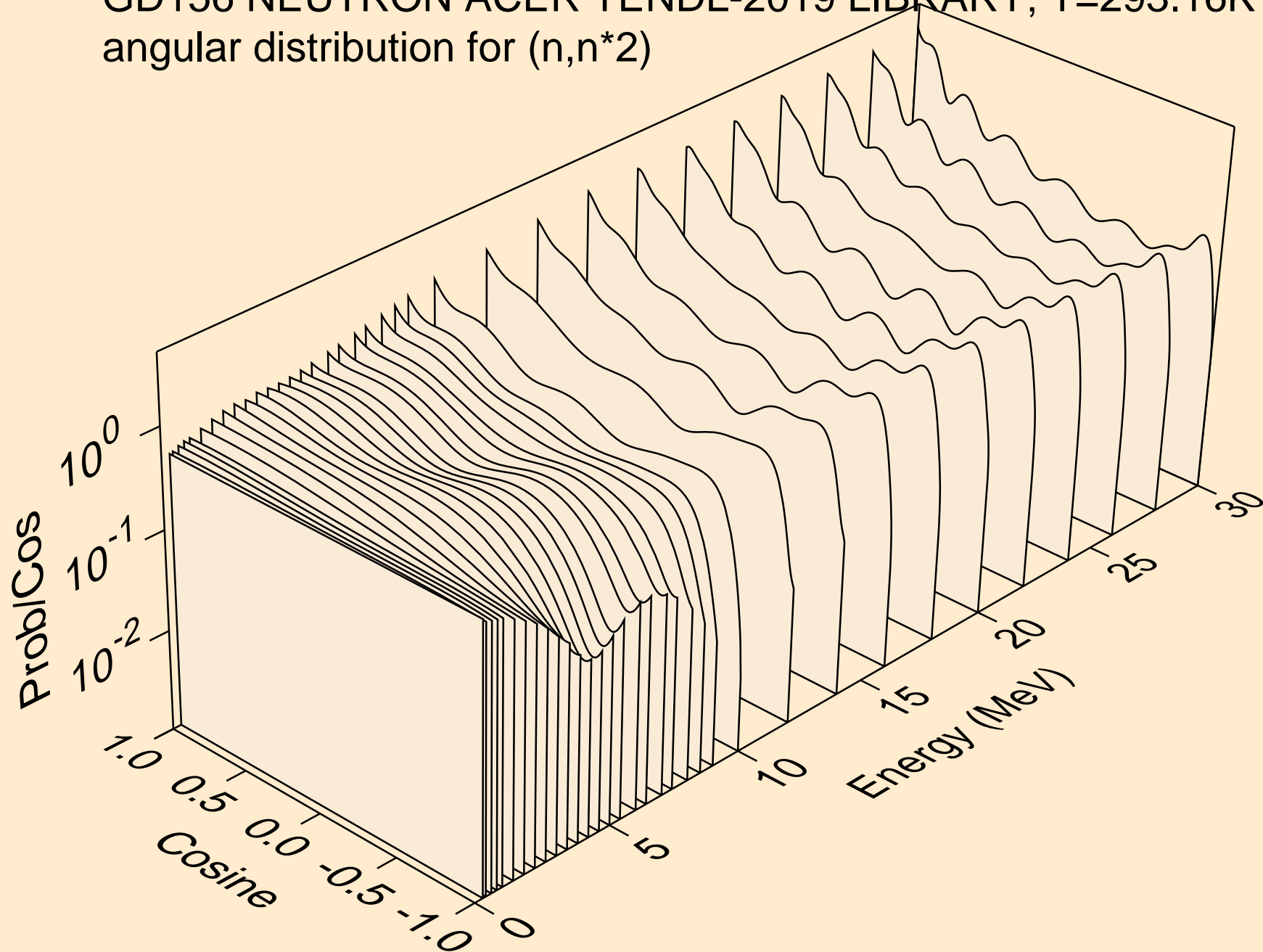

GD156 NEUTRON ACER TENDL-2019 LIBRARY; T=293.16K  
angular distribution for (n,n\*3)

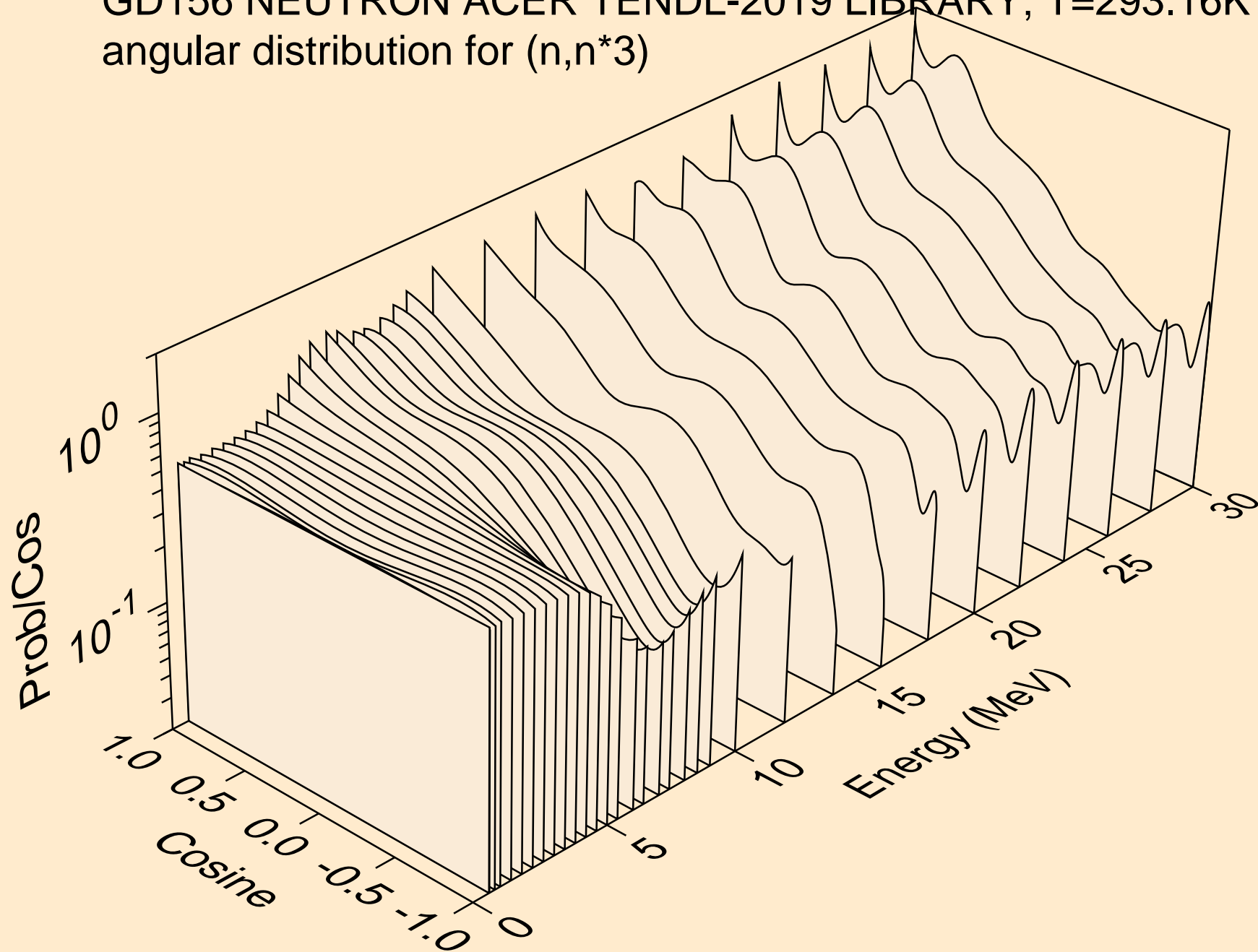

GD156 NEUTRON ACER TENDL-2019 LIBRARY; T=293.16K  
angular distribution for (n,n\*4)

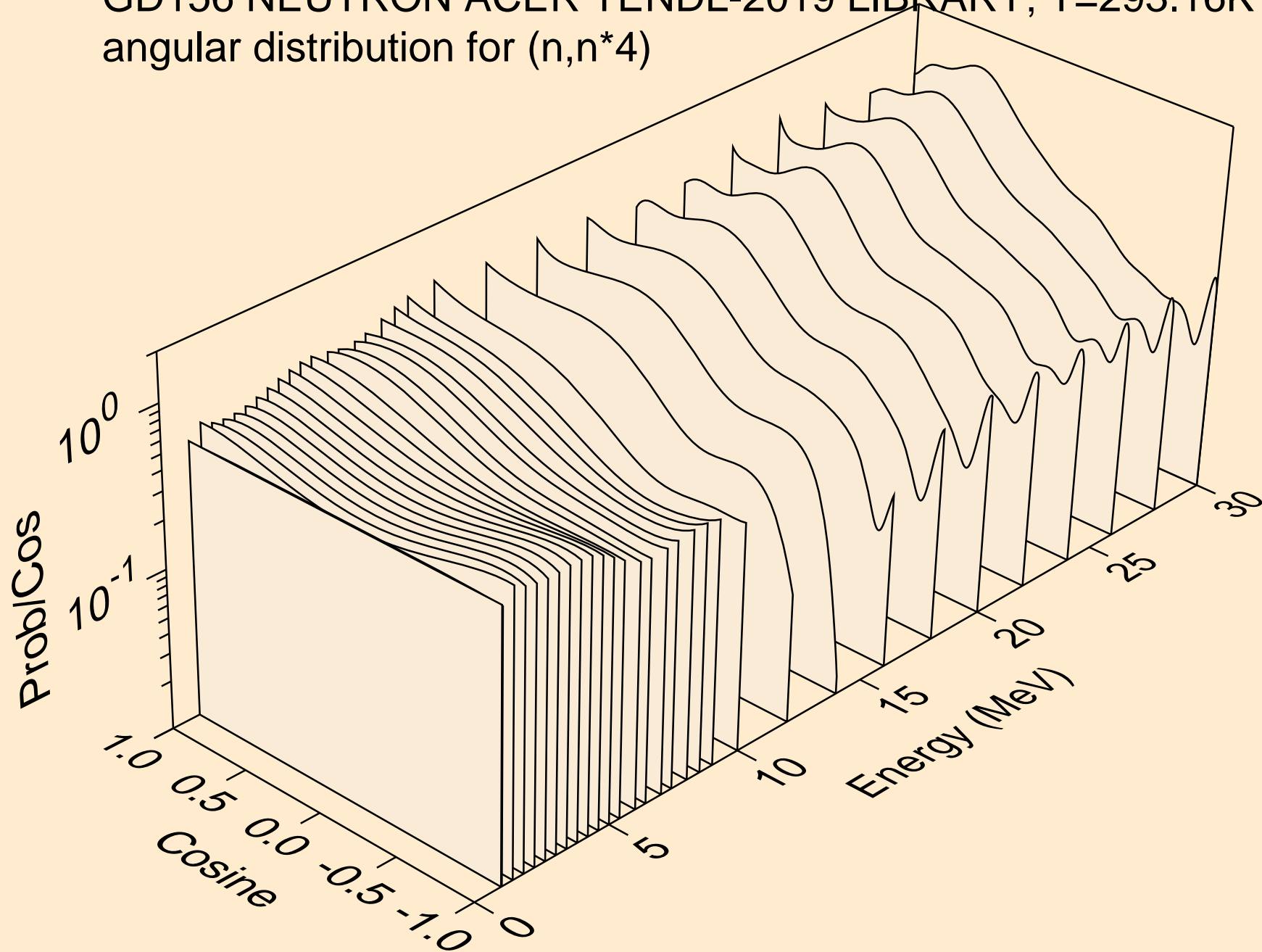

GD156 NEUTRON ACER TENDL-2019 LIBRARY; T=293.16K  
angular distribution for (n,n\*5)

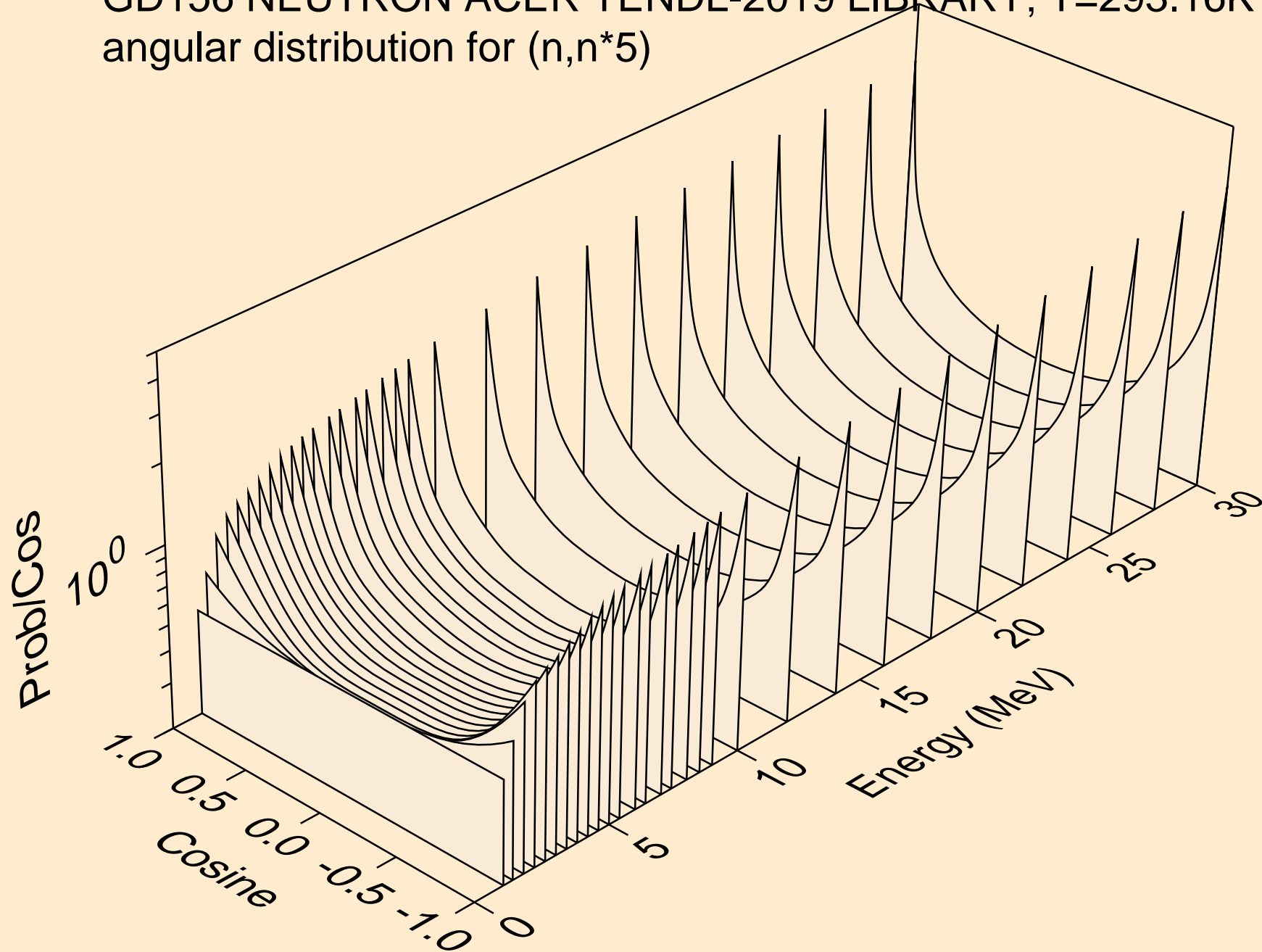

GD156 NEUTRON ACER TENDL-2019 LIBRARY; T=293.16K  
angular distribution for (n,n\*6)

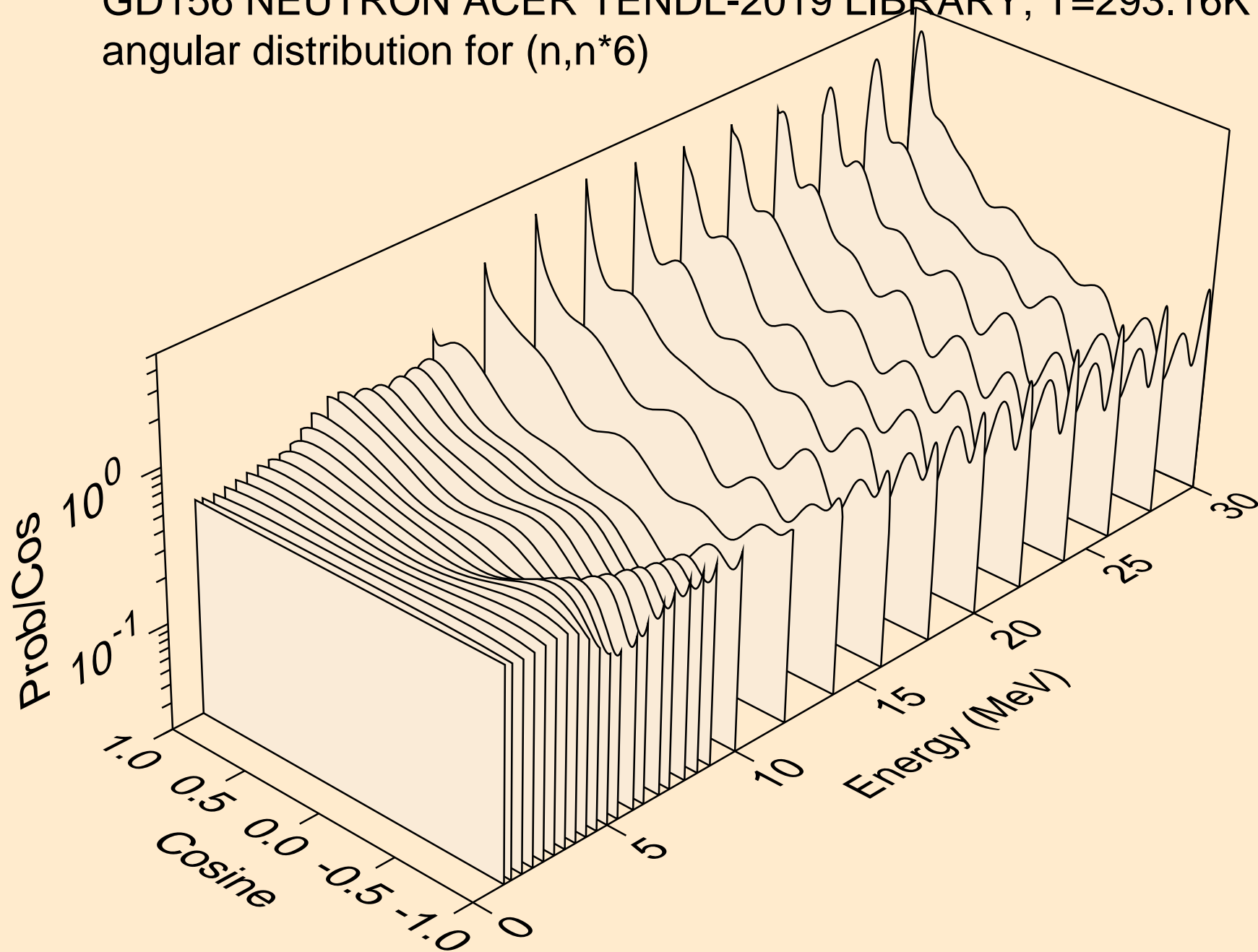

GD156 NEUTRON ACER TENDL-2019 LIBRARY; T=293.16K  
angular distribution for (n,n\*7)

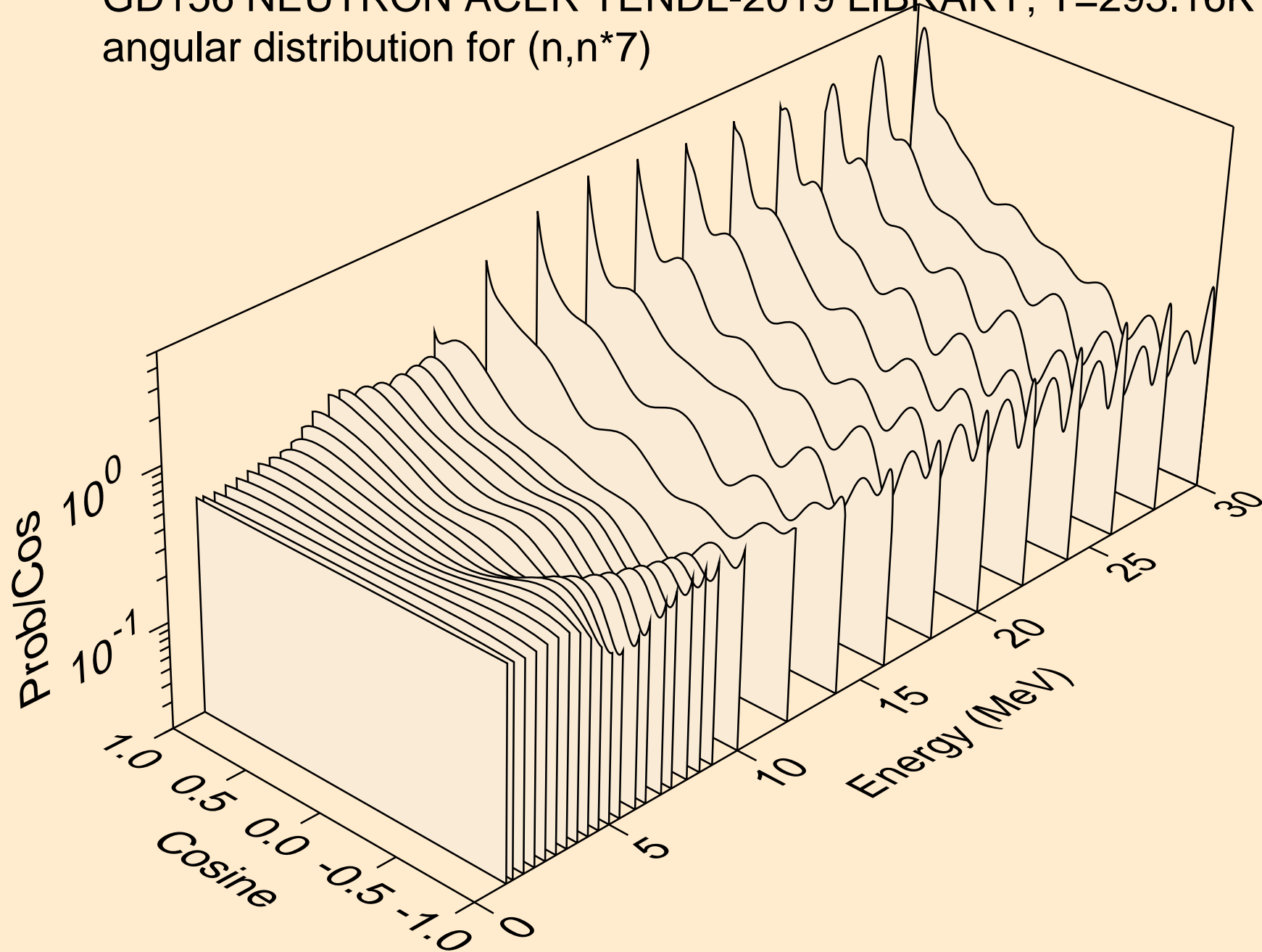

GD156 NEUTRON ACER TENDL-2019 LIBRARY; T=293.16K  
angular distribution for (n,n\*8)

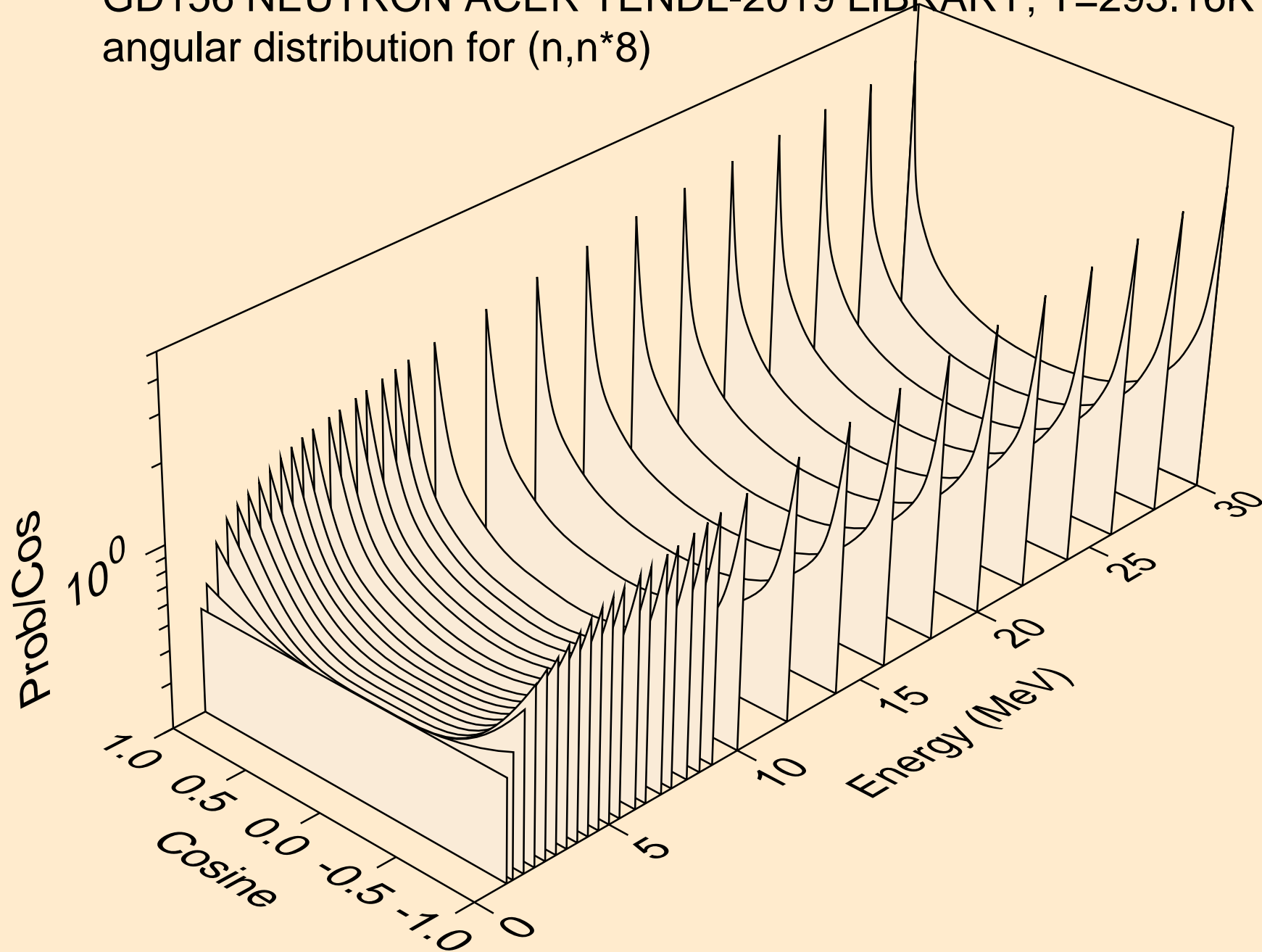

GD156 NEUTRON ACER TENDL-2019 LIBRARY; T=293.16K  
angular distribution for (n,n\*9)

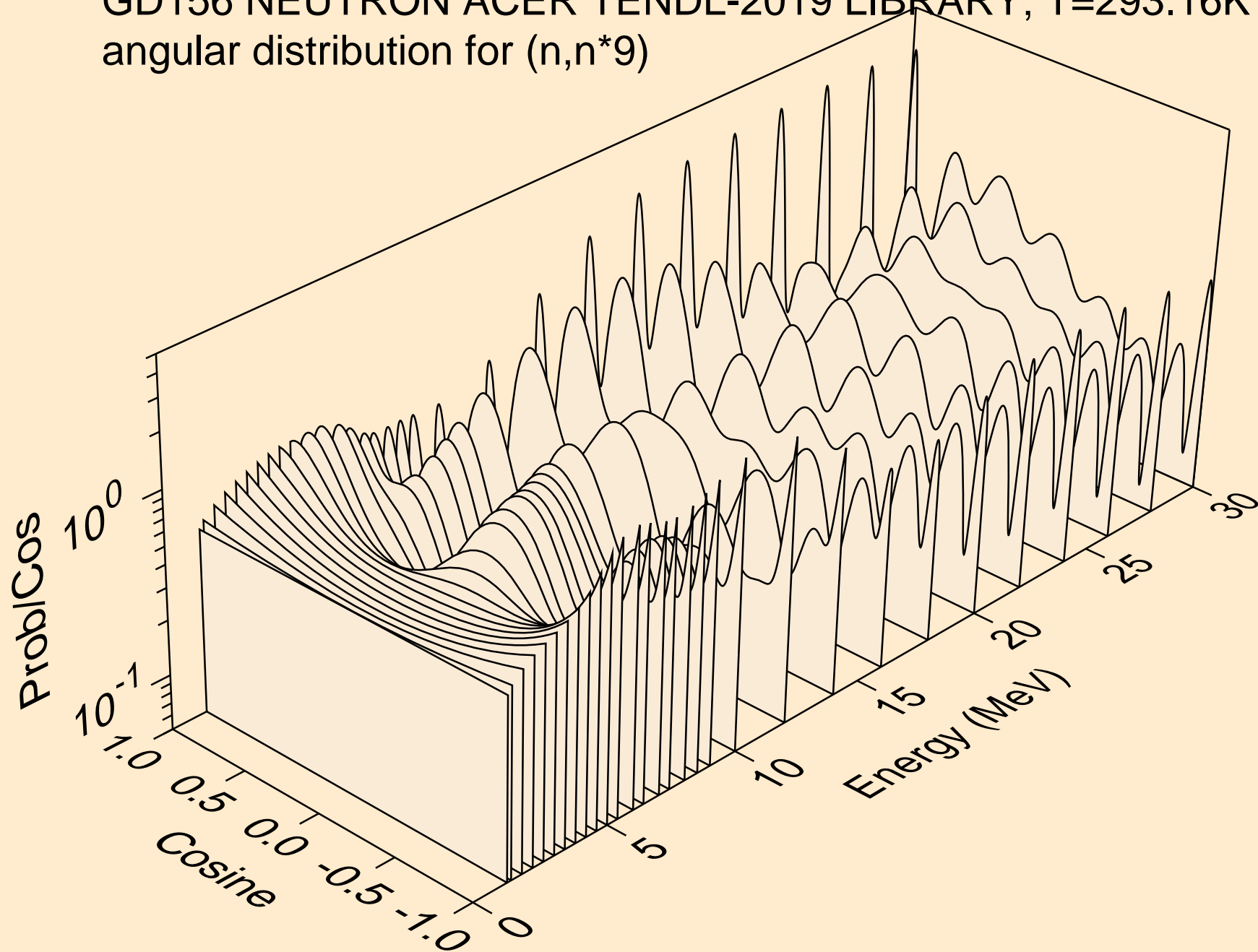



GD156 NEUTRON ACER TENDL-2019 LIBRARY; T=293.16K  
angular distribution for (n,n\*10)

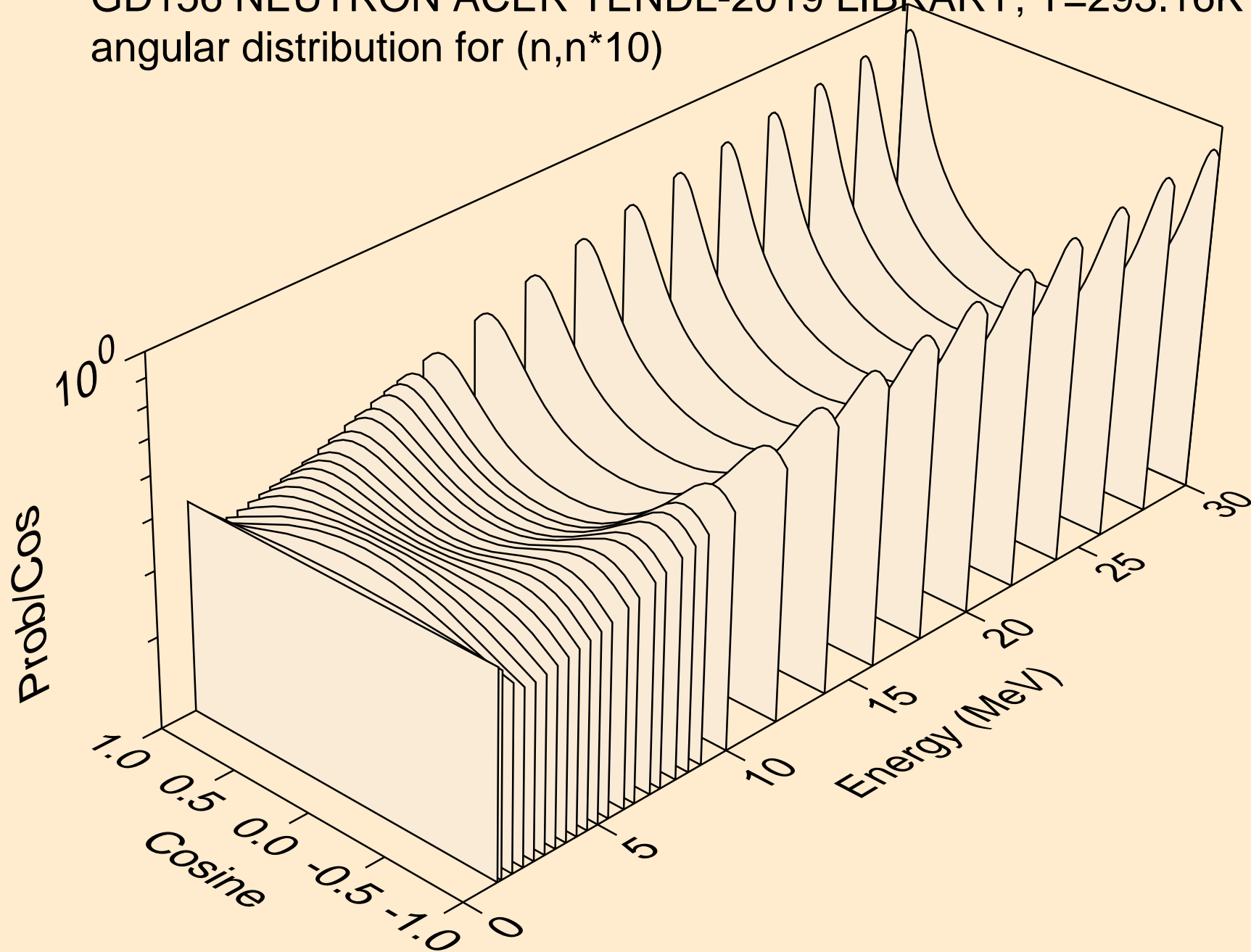

GD156 NEUTRON ACER TENDL-2019 LIBRARY; T=293.16K  
angular distribution for (n,n\*11)

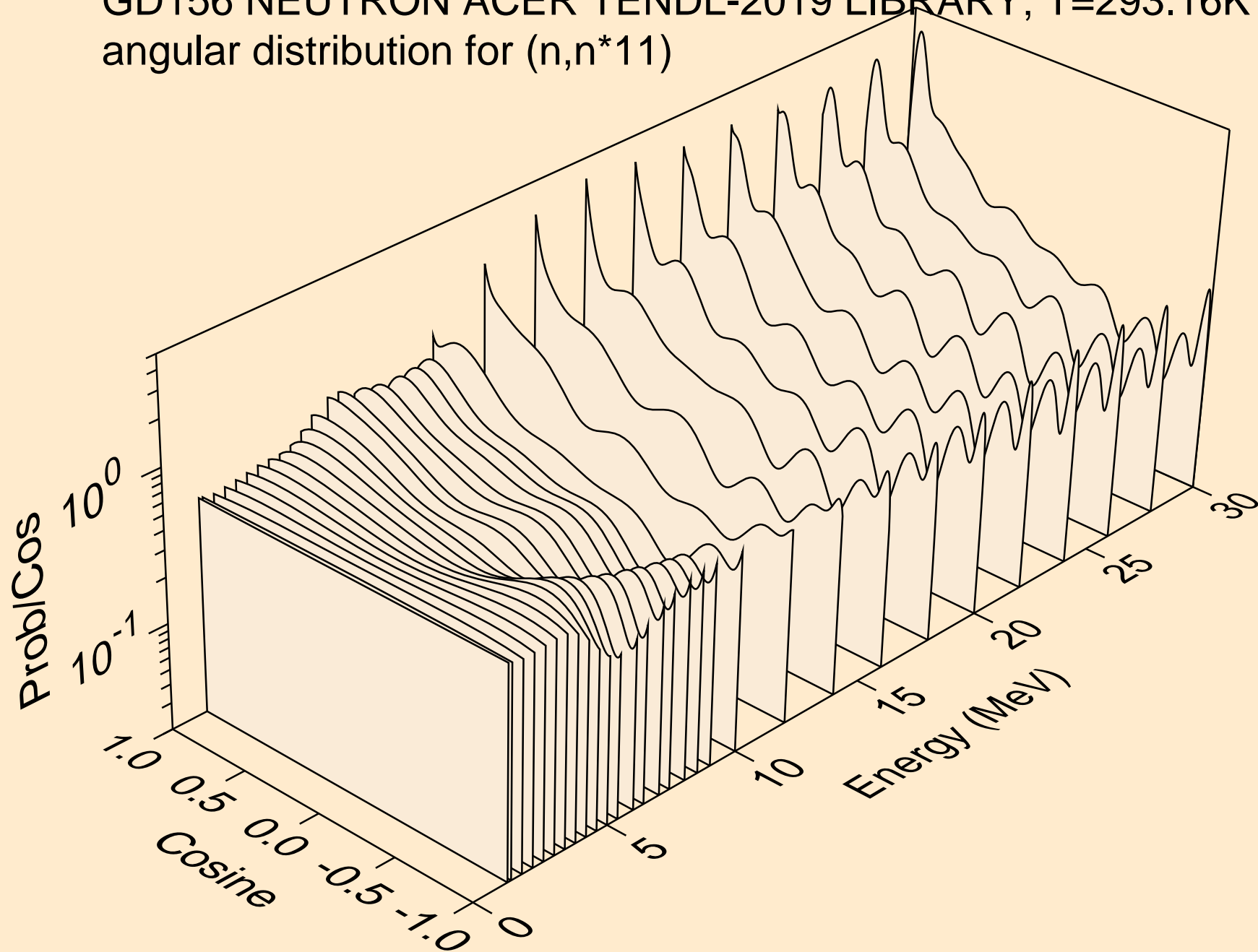

GD156 NEUTRON ACER TENDL-2019 LIBRARY; T=293.16K  
angular distribution for (n,n\*12)

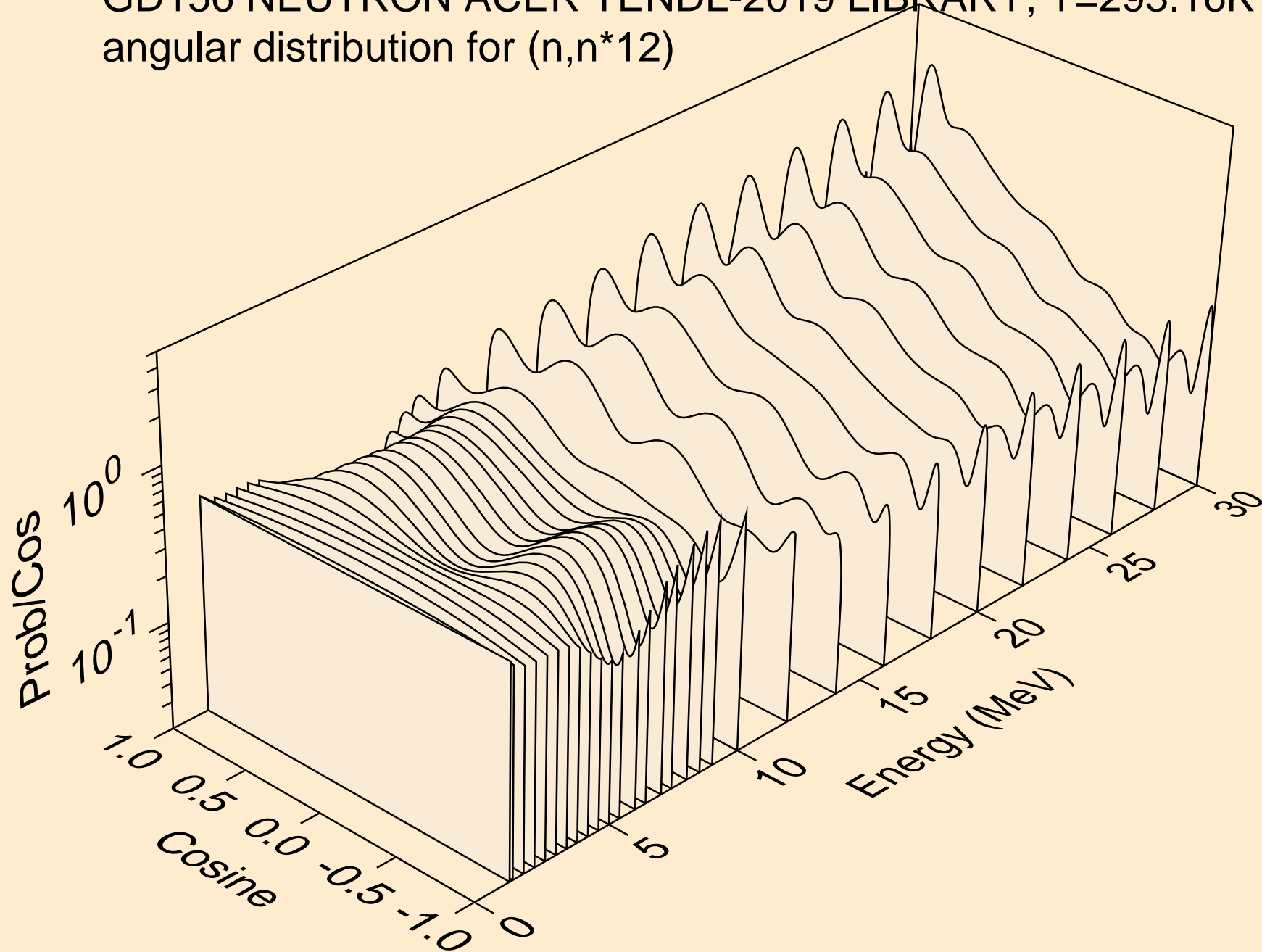

GD156 NEUTRON ACER TENDL-2019 LIBRARY; T=293.16K  
angular distribution for (n,n\*13)

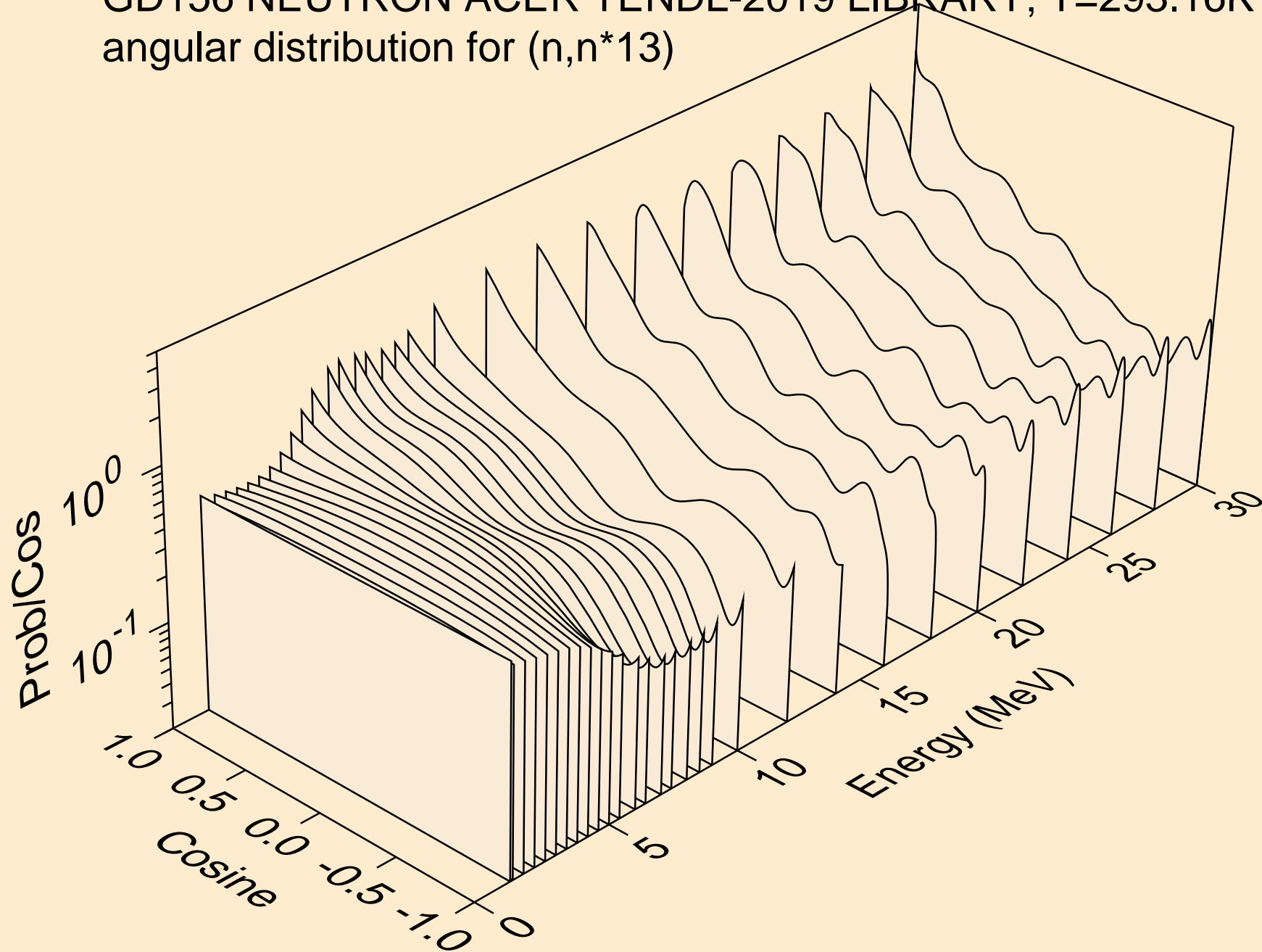

GD156 NEUTRON ACER TENDL-2019 LIBRARY; T=293.16K  
angular distribution for (n,n\*14)

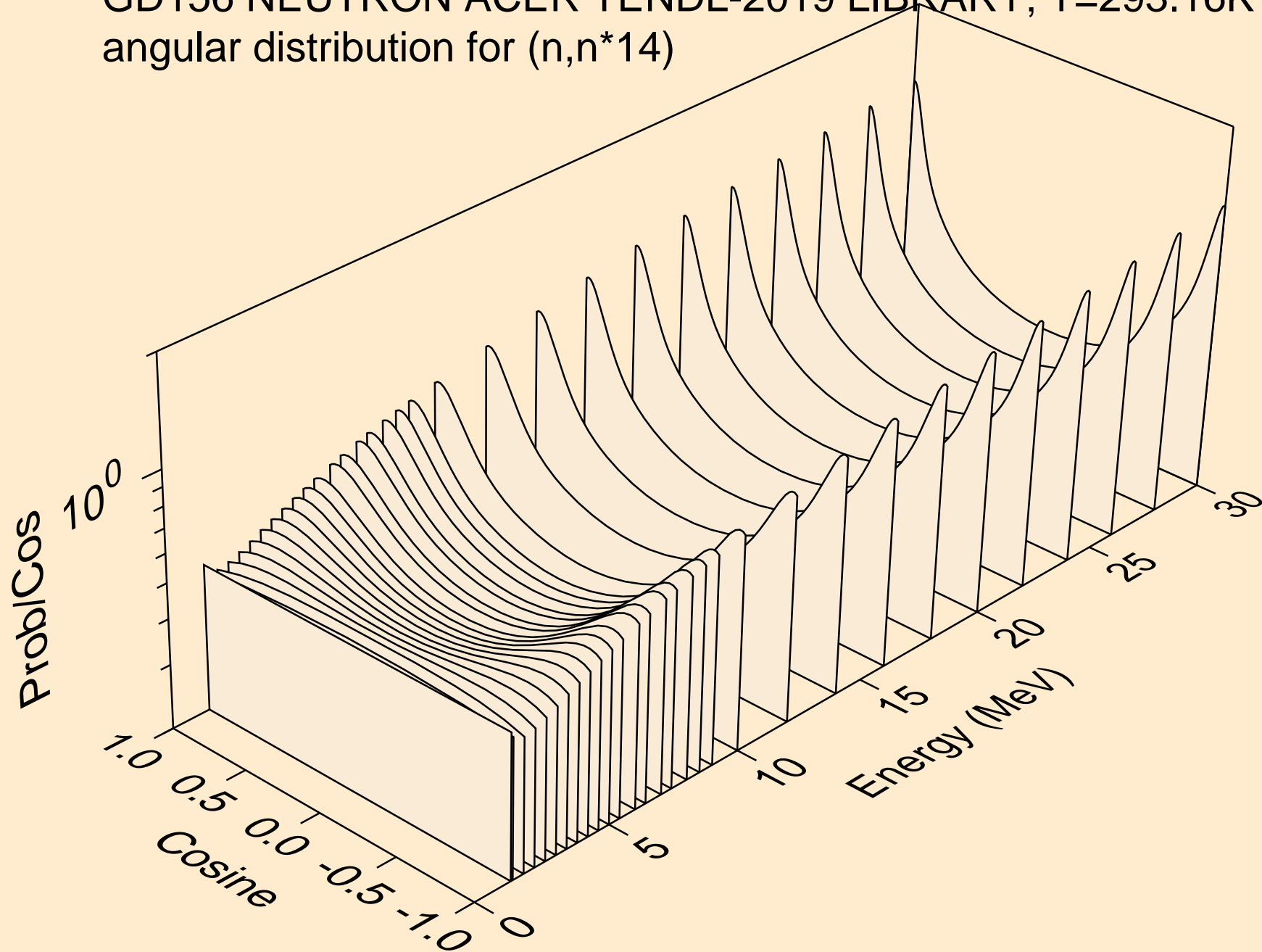

GD156 NEUTRON ACER TENDL-2019 LIBRARY; T=293.16K  
angular distribution for (n,n\*15)

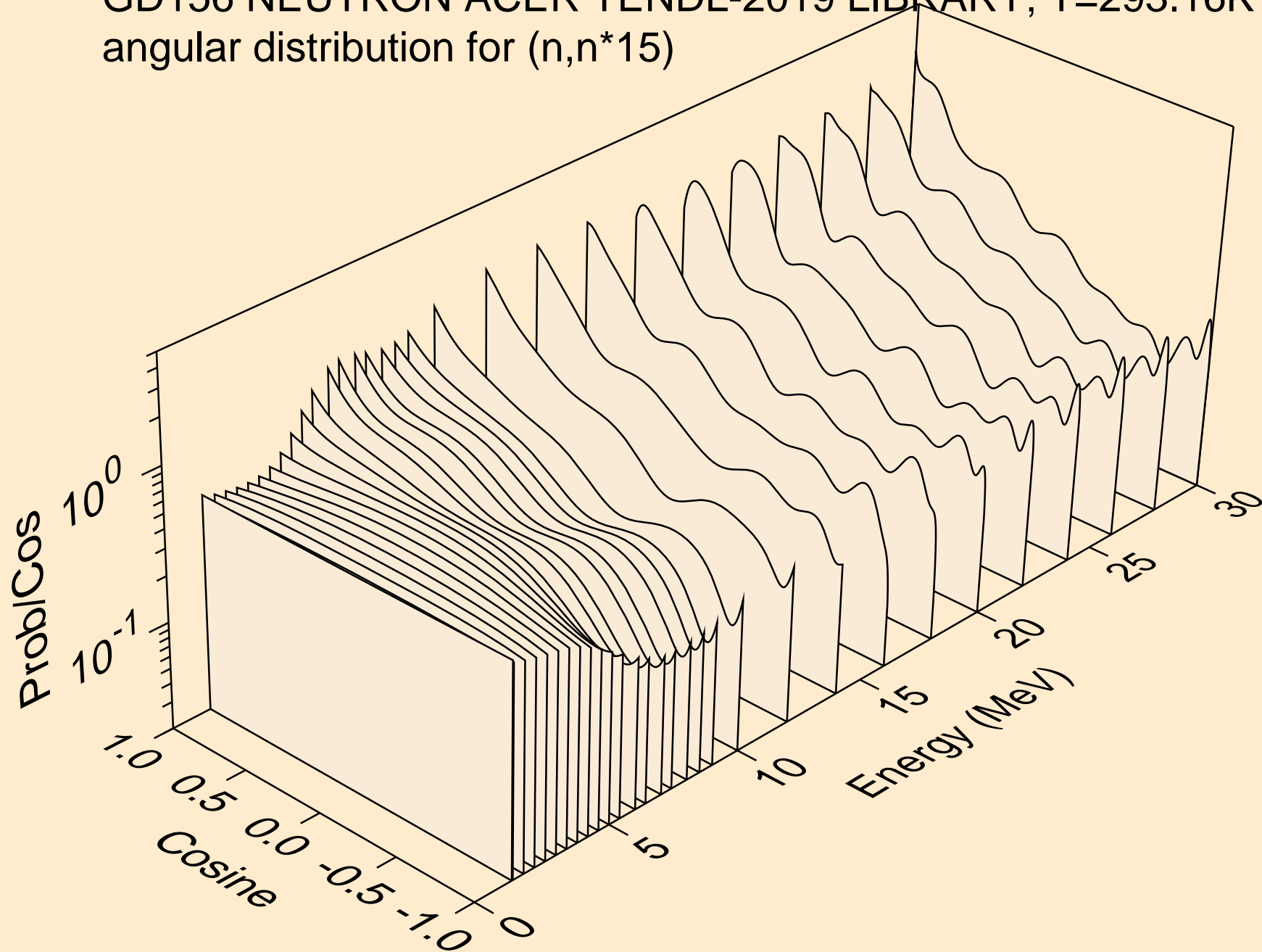

GD156 NEUTRON ACER TENDL-2019 LIBRARY; T=293.16K  
angular distribution for (n,n\*16)

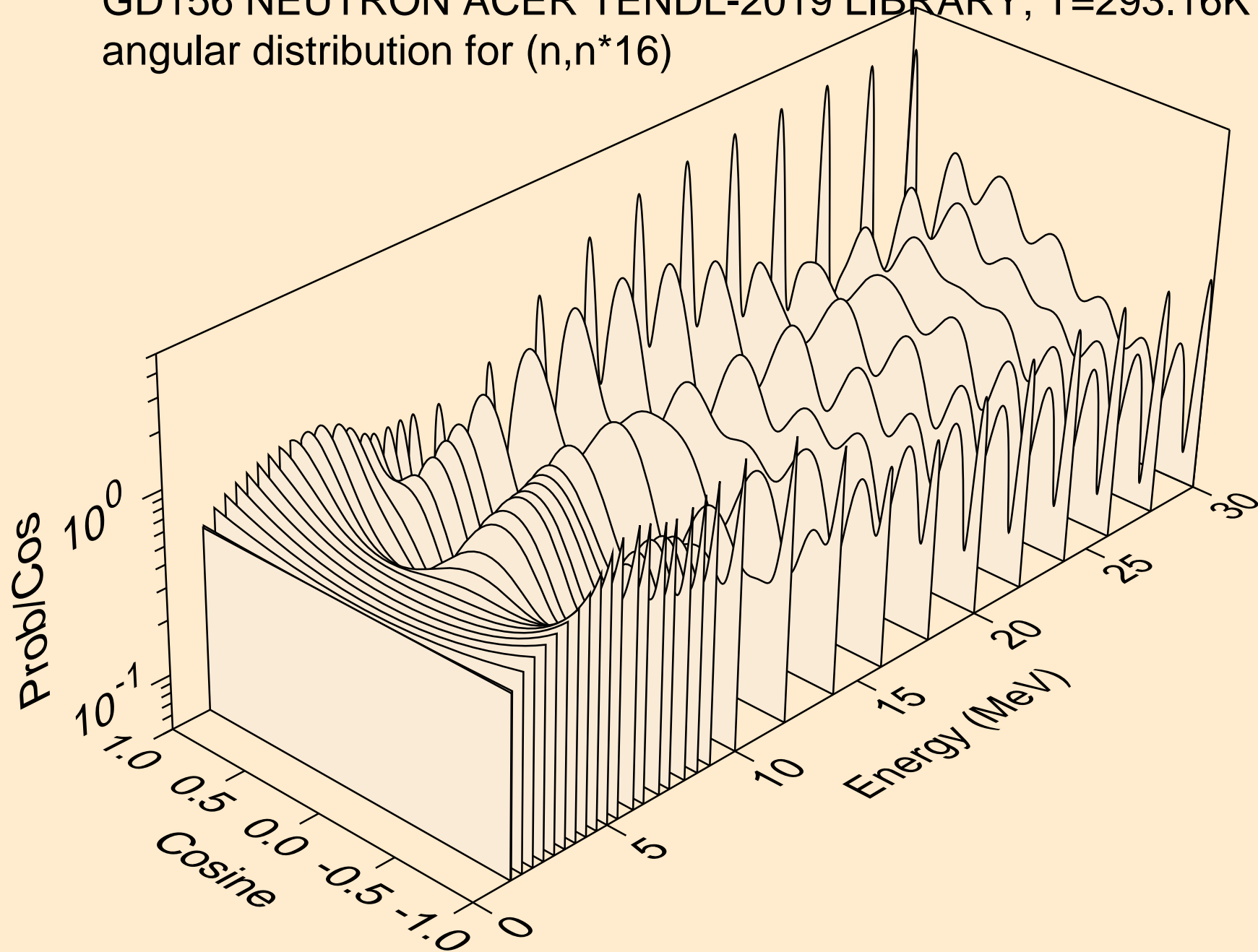

GD156 NEUTRON ACER TENDL-2019 LIBRARY; T=293.16K  
angular distribution for (n,n\*17)

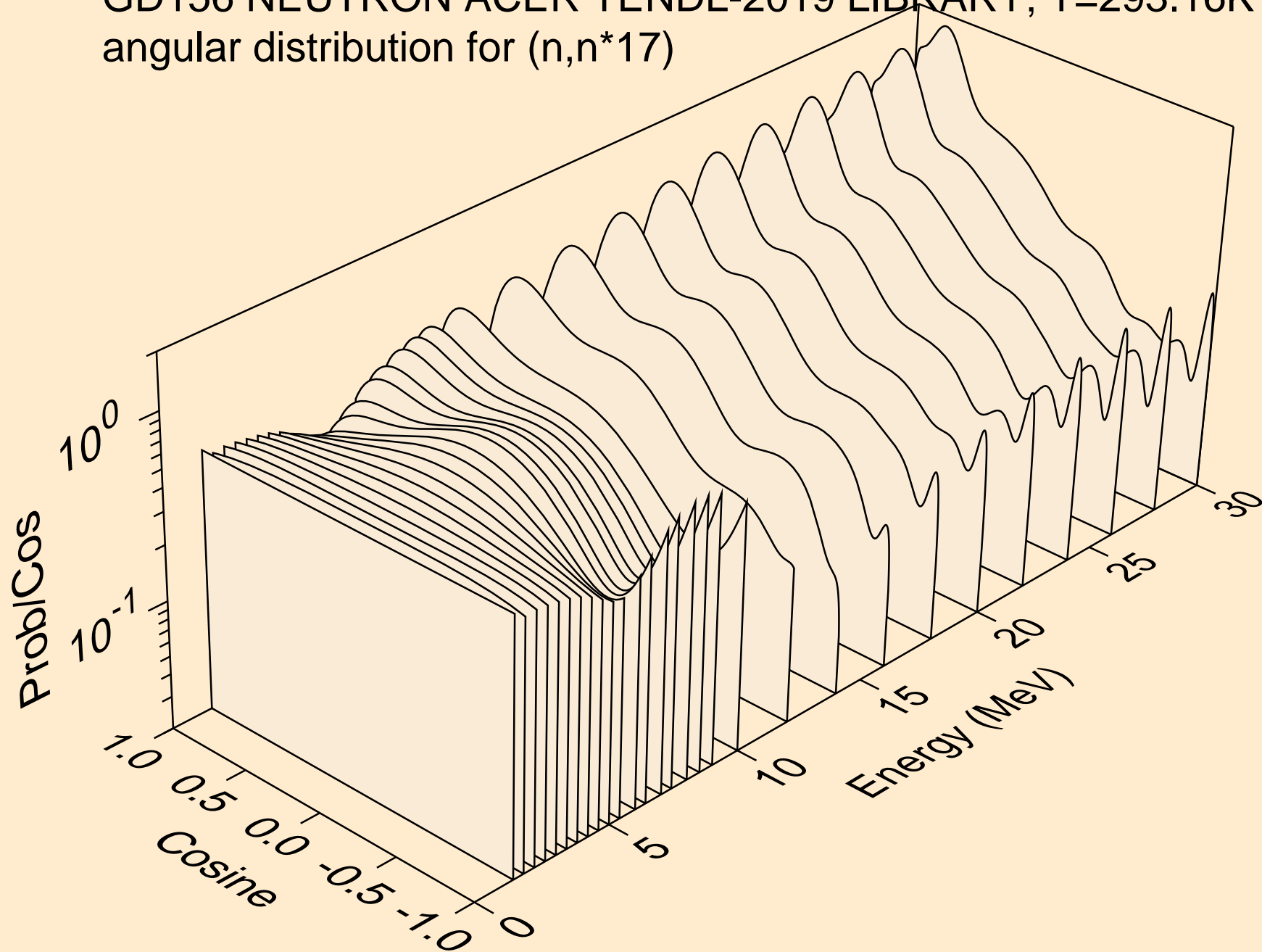



GD156 NEUTRON ACER TENDL-2019 LIBRARY; T=293.16K  
angular distribution for (n,n\*18)

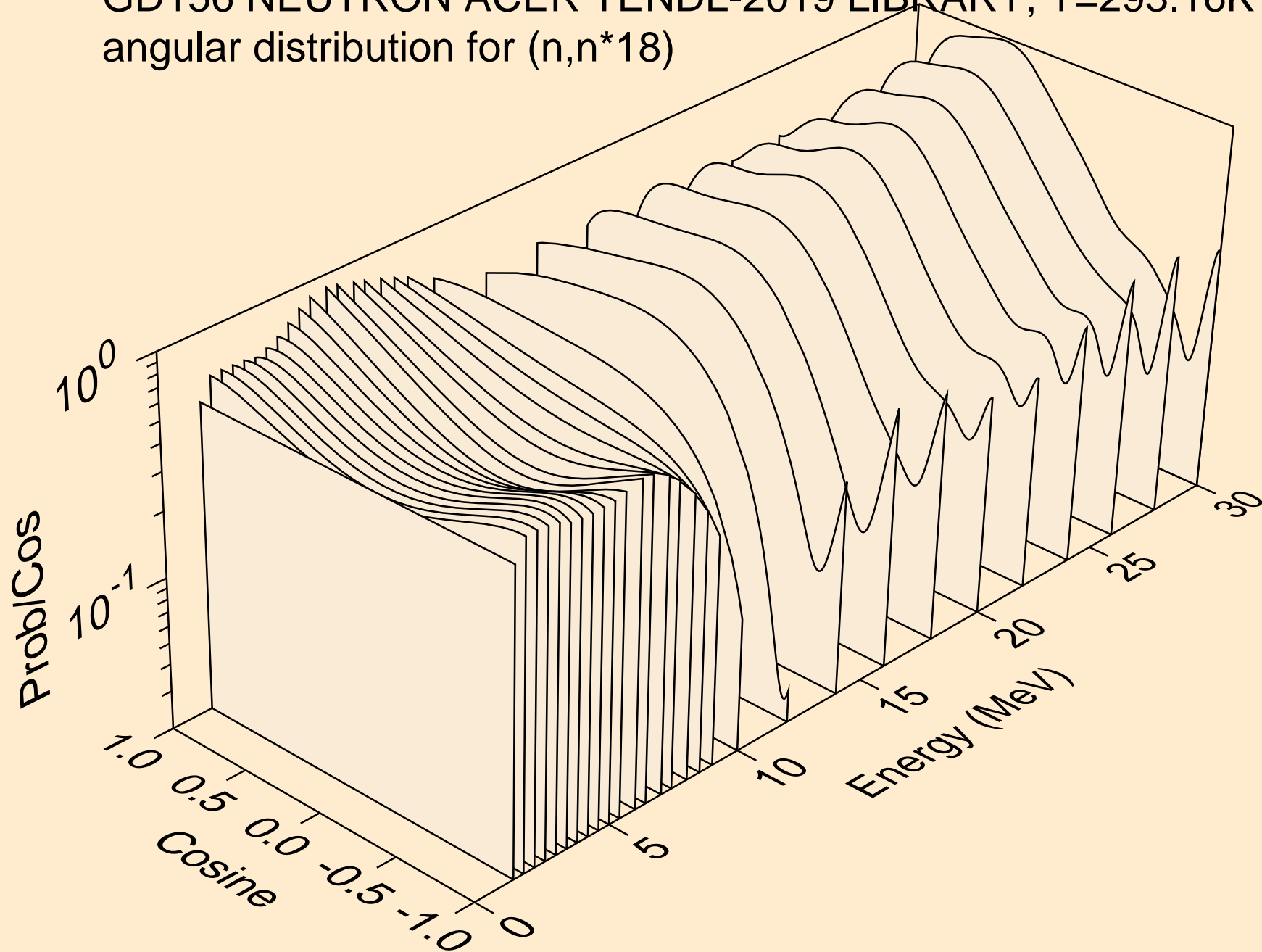

GD156 NEUTRON ACER TENDL-2019 LIBRARY; T=293.16K  
angular distribution for (n,n\*19)

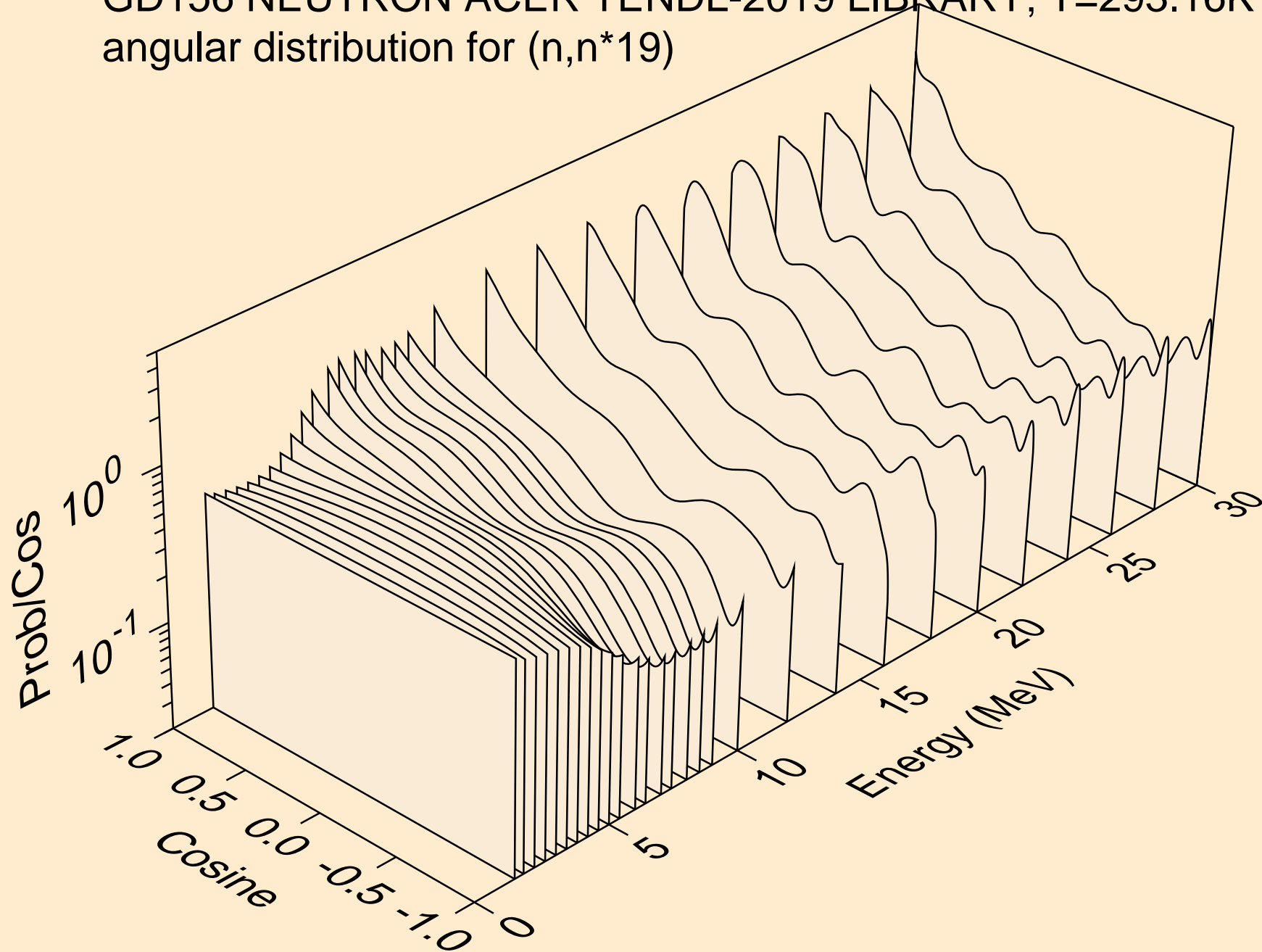

GD156 NEUTRON ACER TENDL-2019 LIBRARY; T=293.16K  
angular distribution for (n,n\*20)

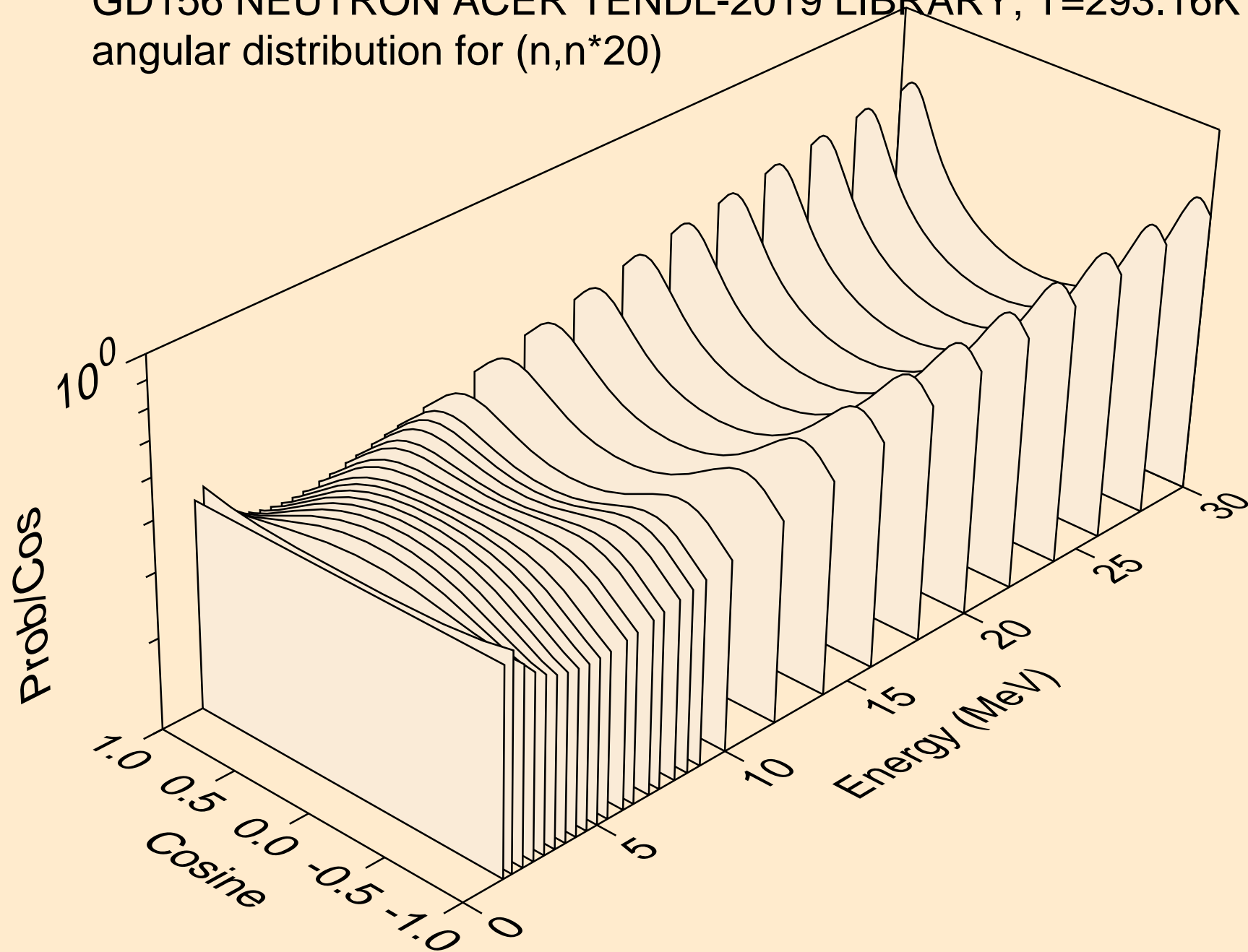

GD156 NEUTRON ACER TENDL-2019 LIBRARY; T=293.16K  
angular distribution for (n,n\*21)

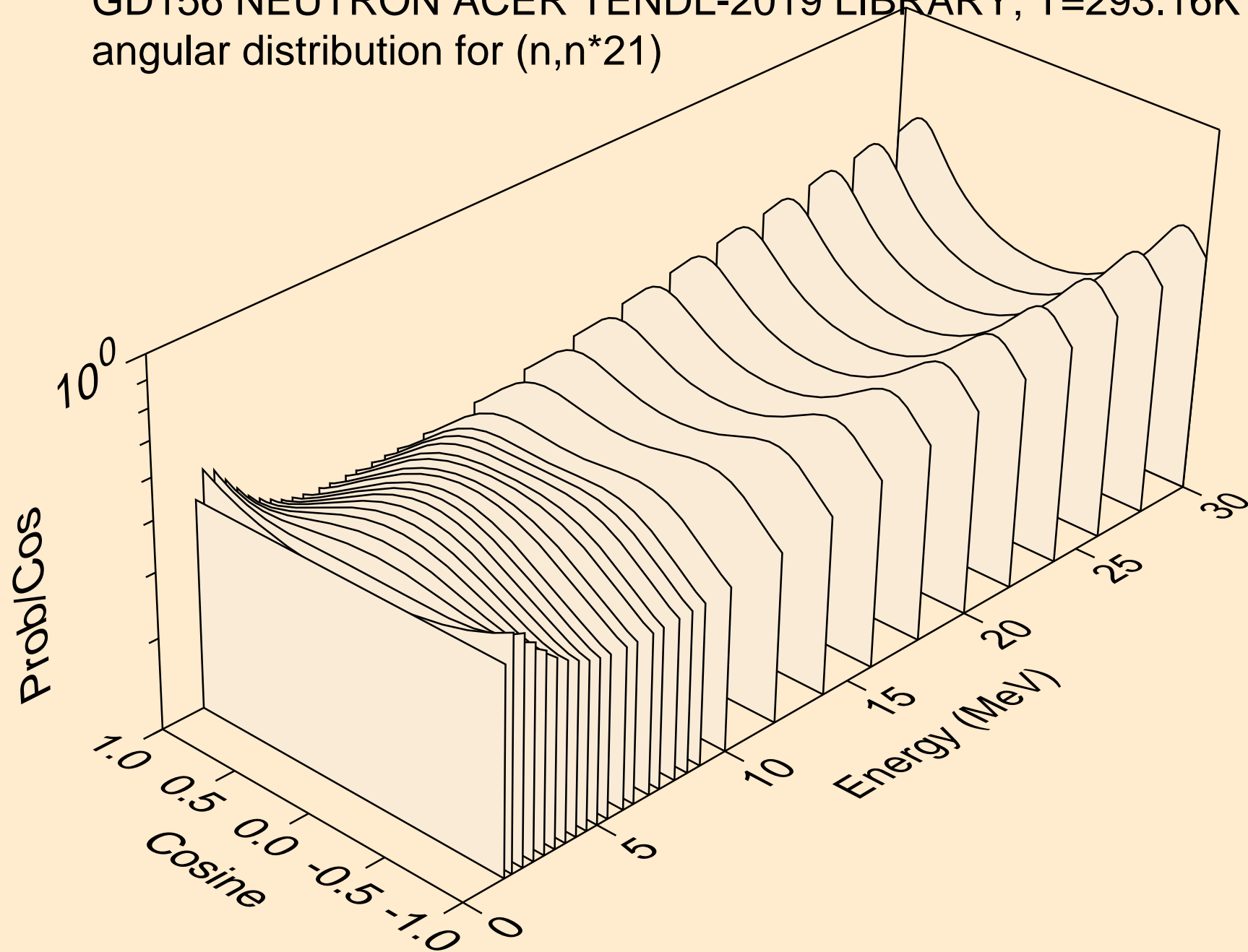

GD156 NEUTRON ACER TENDL-2019 LIBRARY; T=293.16K  
angular distribution for (n,n\*22)

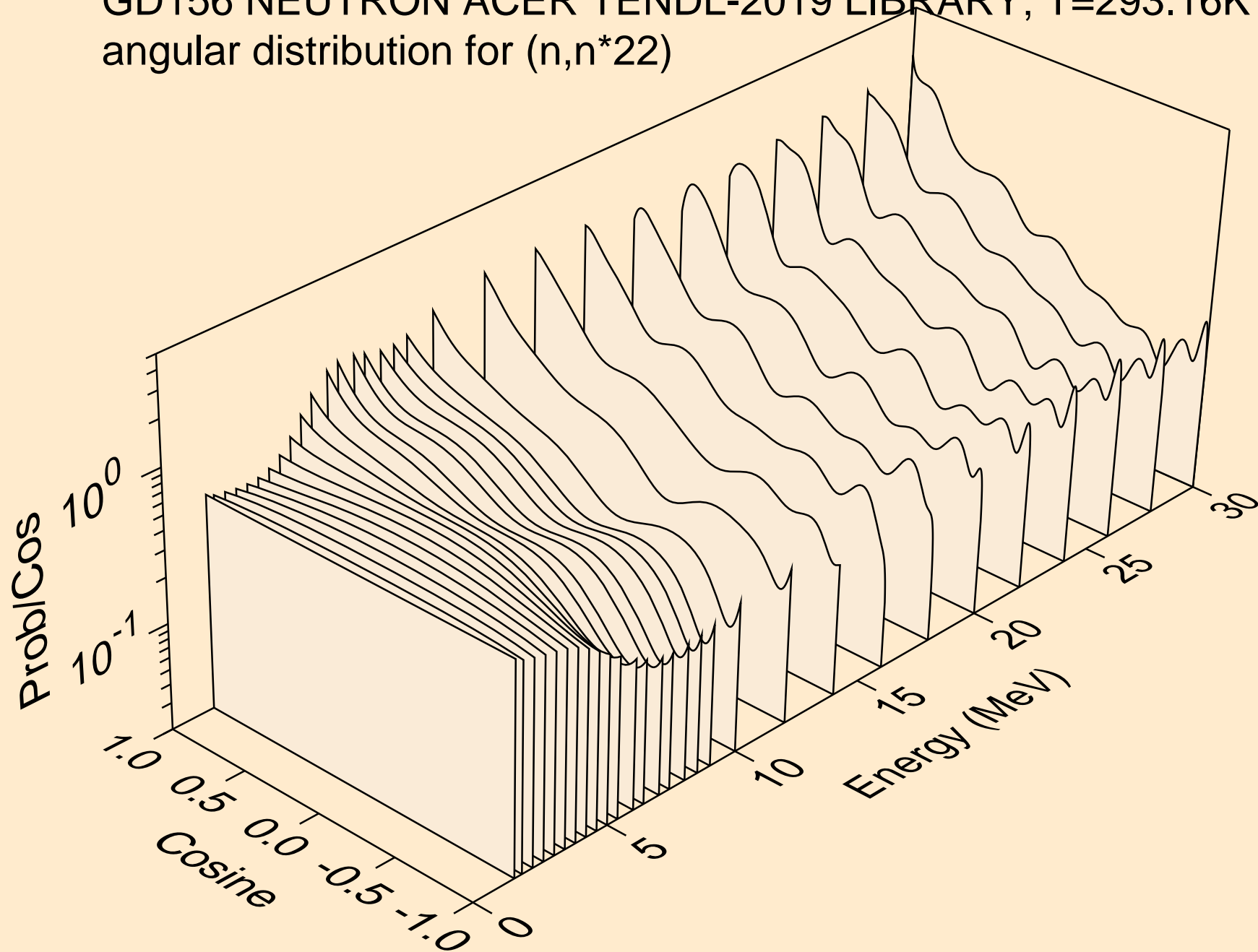

GD156 NEUTRON ACER TENDL-2019 LIBRARY; T=293.16K  
angular distribution for (n,n\*23)

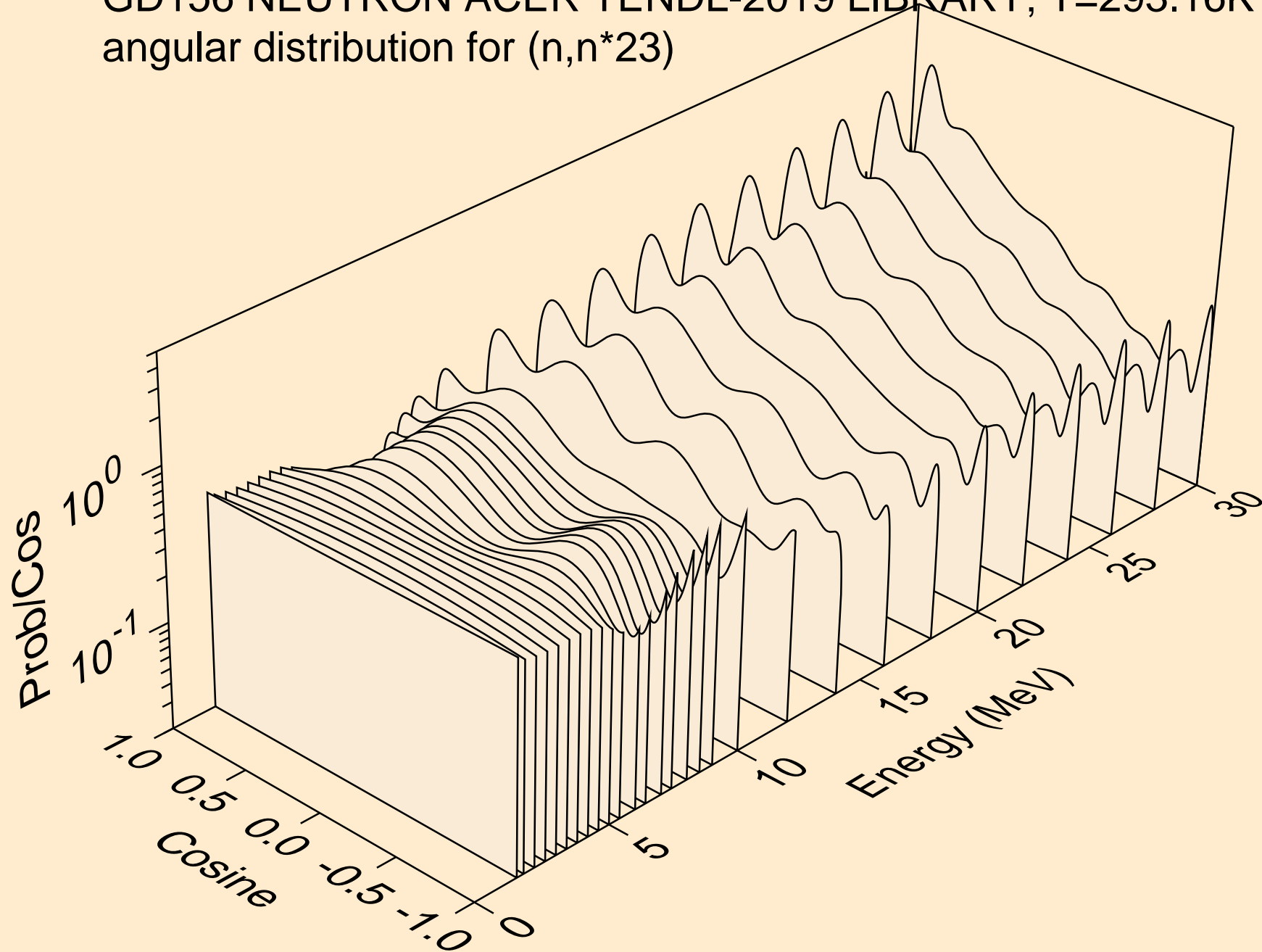

GD156 NEUTRON ACER TENDL-2019 LIBRARY; T=293.16K  
angular distribution for (n,n\*24)

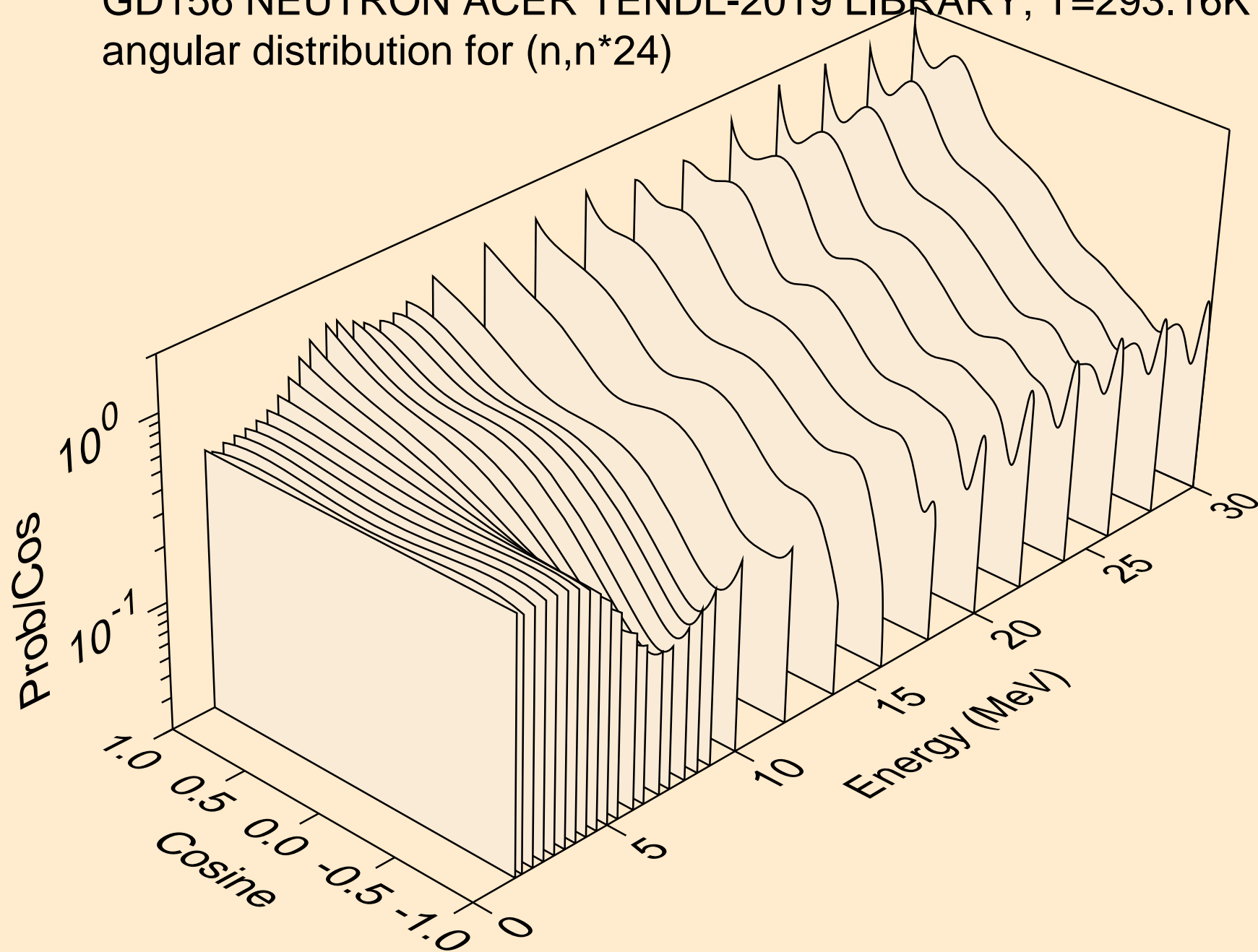

GD156 NEUTRON ACER TENDL-2019 LIBRARY; T=293.16K  
angular distribution for (n,n\*25)

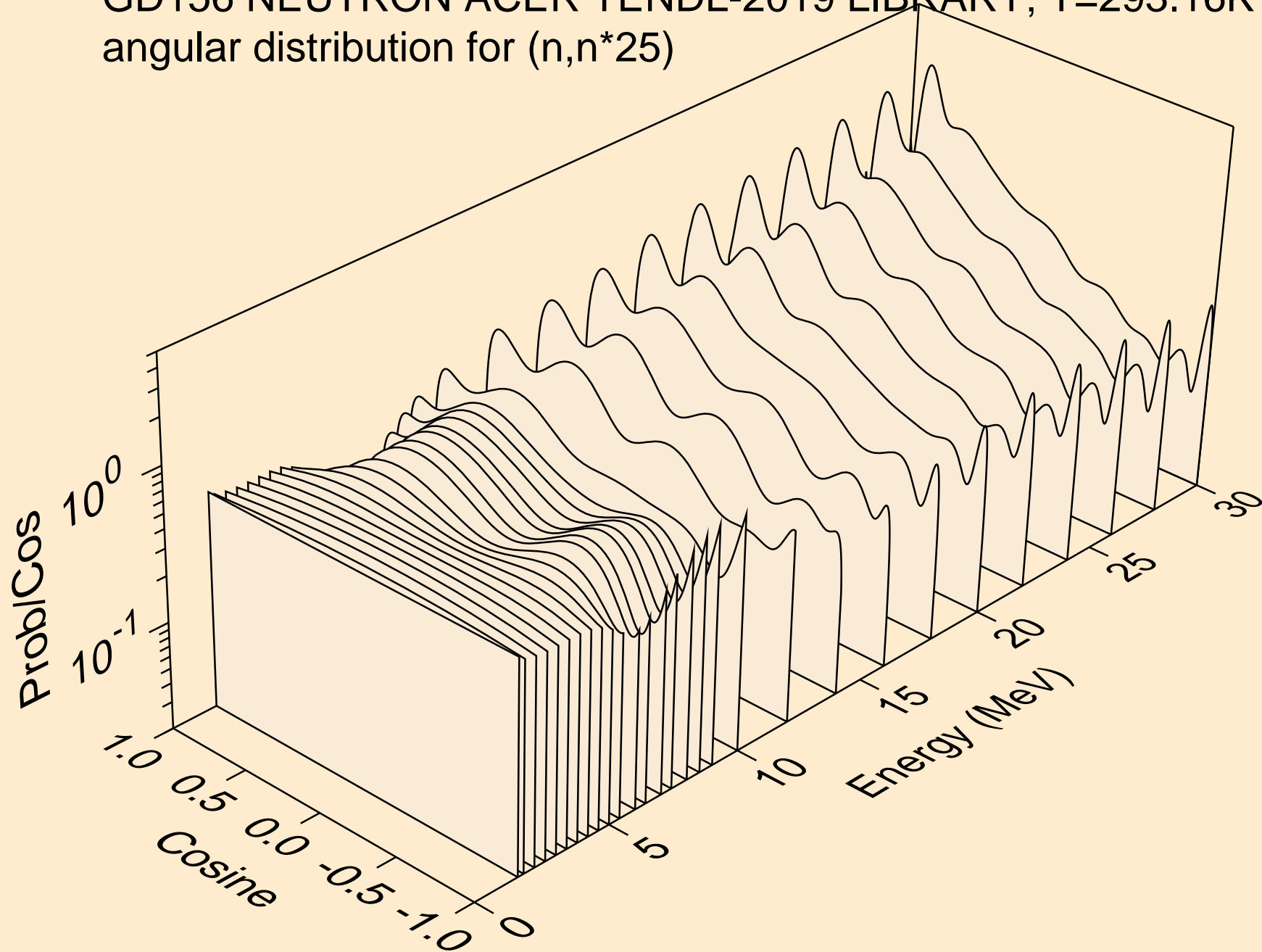



GD156 NEUTRON ACER TENDL-2019 LIBRARY; T=293.16K  
angular distribution for (n,n\*26)

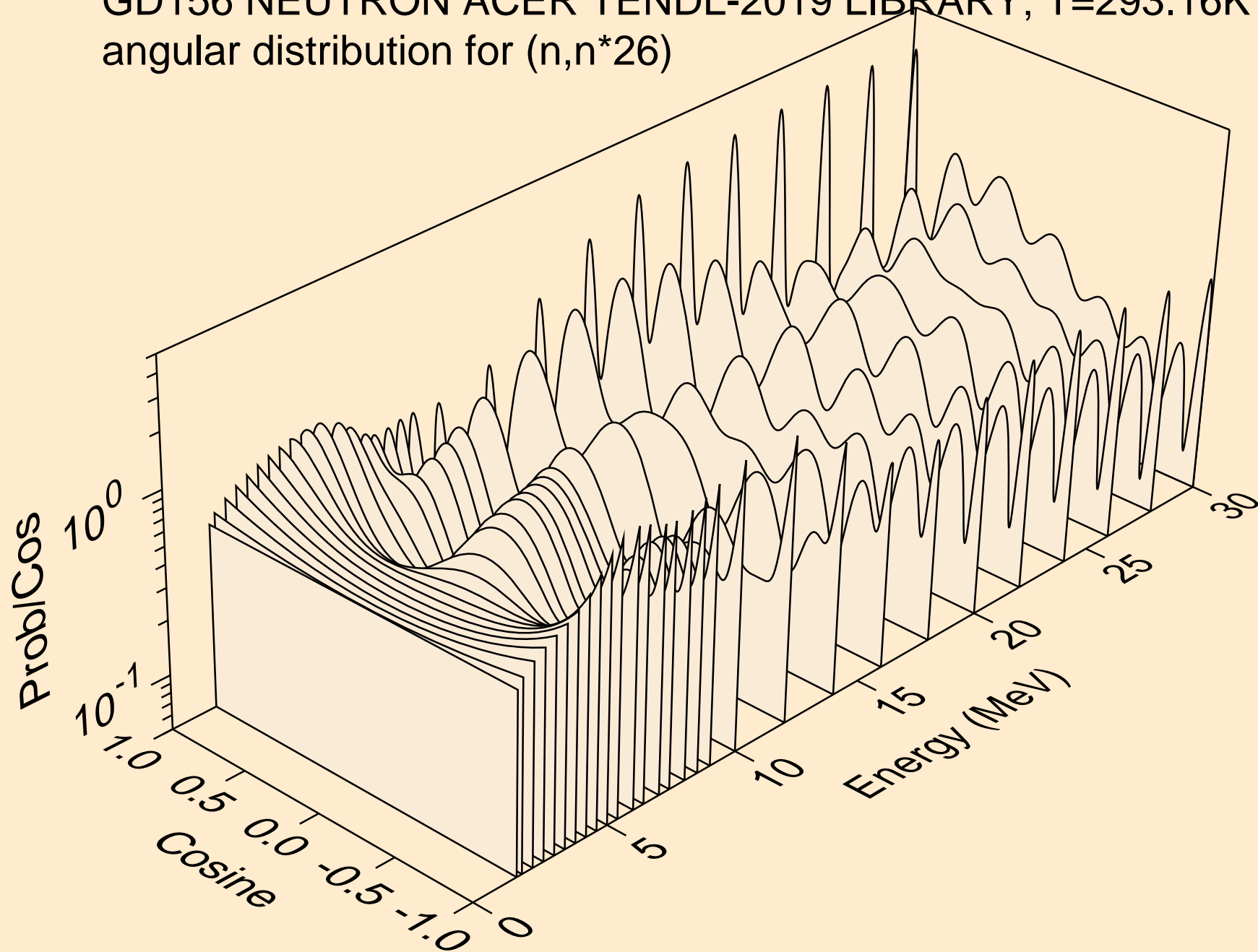

GD156 NEUTRON ACER TENDL-2019 LIBRARY; T=293.16K  
angular distribution for (n,n\*27)

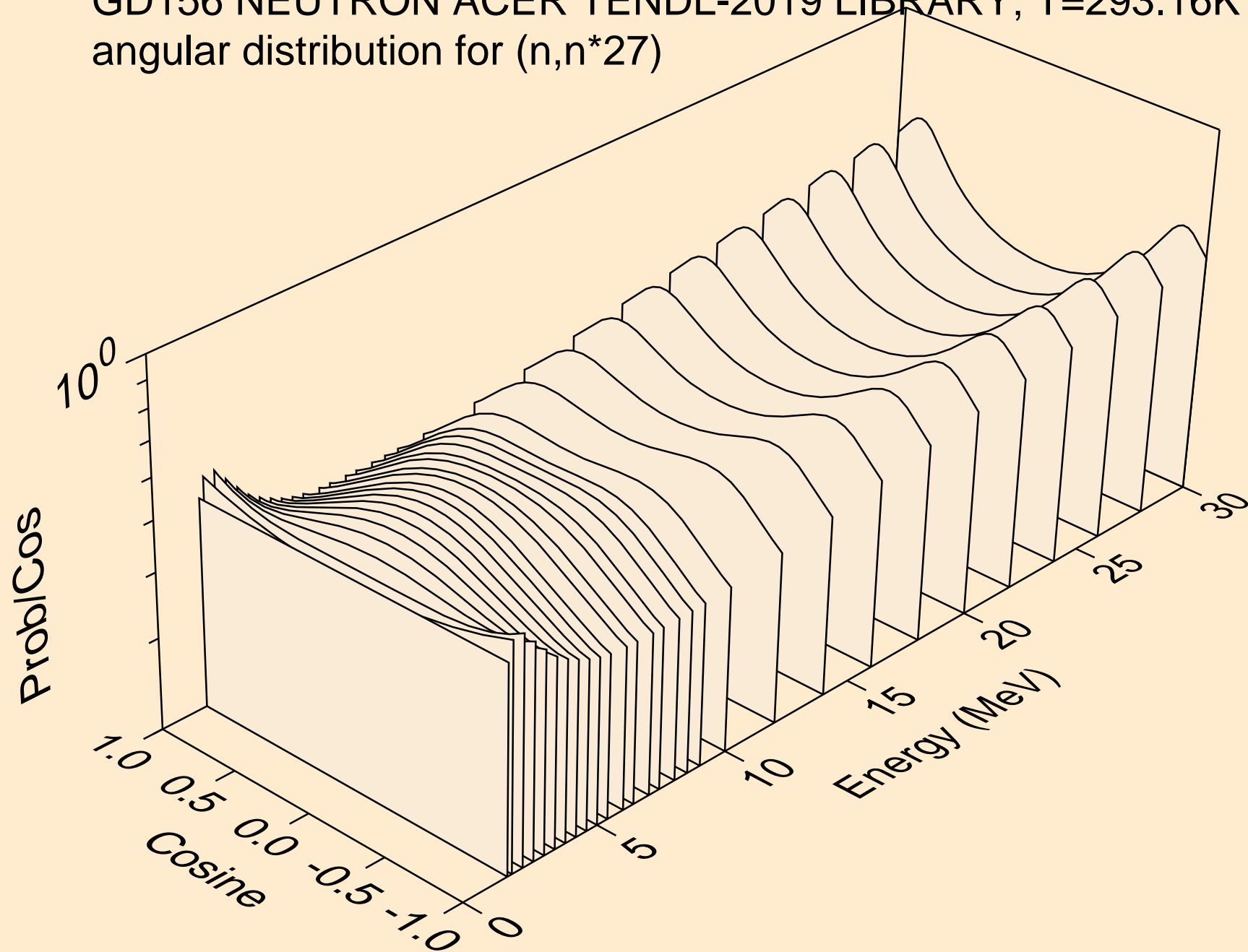

GD156 NEUTRON ACER TENDL-2019 LIBRARY; T=293.16K  
angular distribution for (n,n\*28)

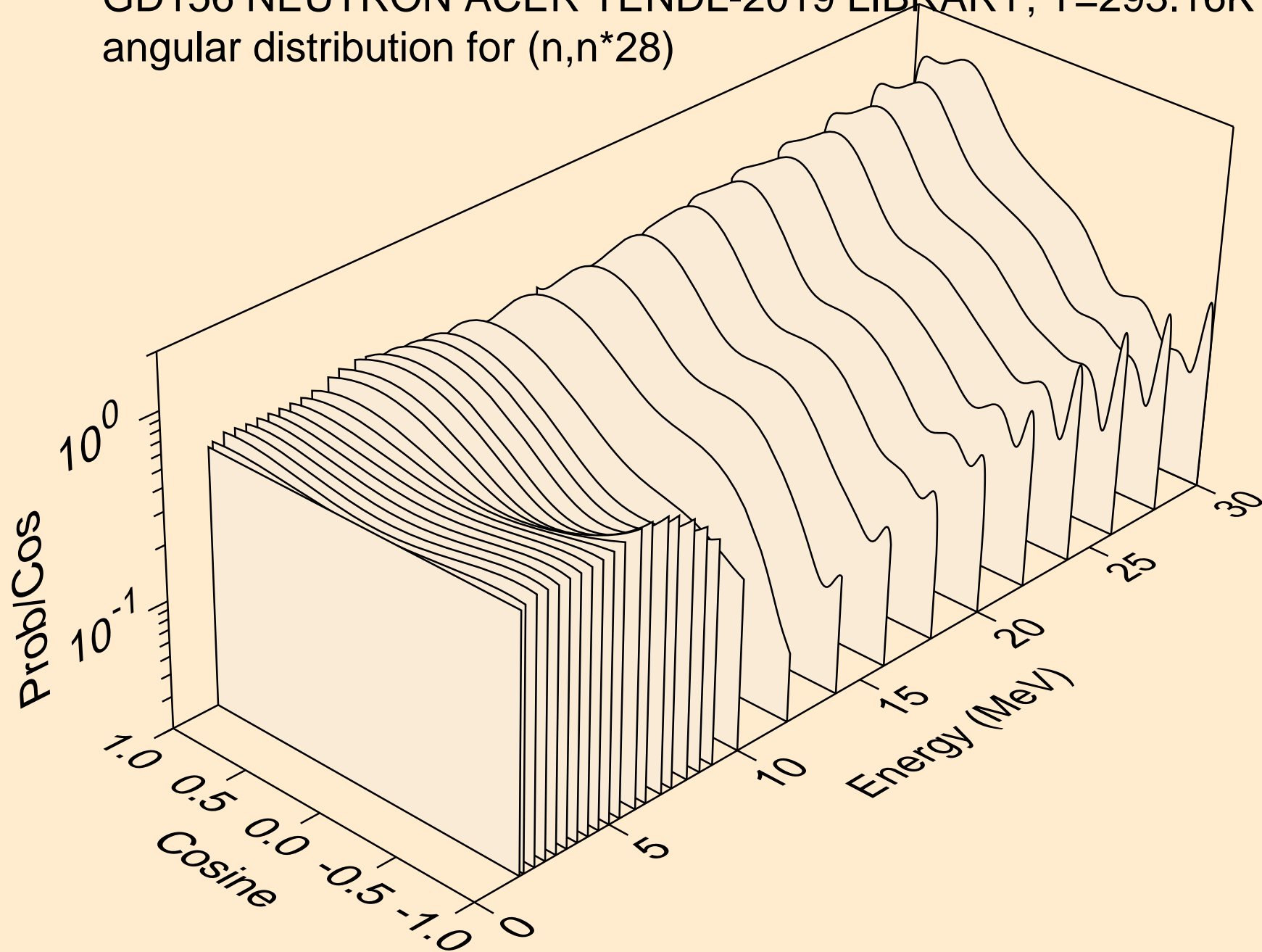

GD156 NEUTRON ACER TENDL-2019 LIBRARY; T=293.16K  
angular distribution for (n,n\*29)

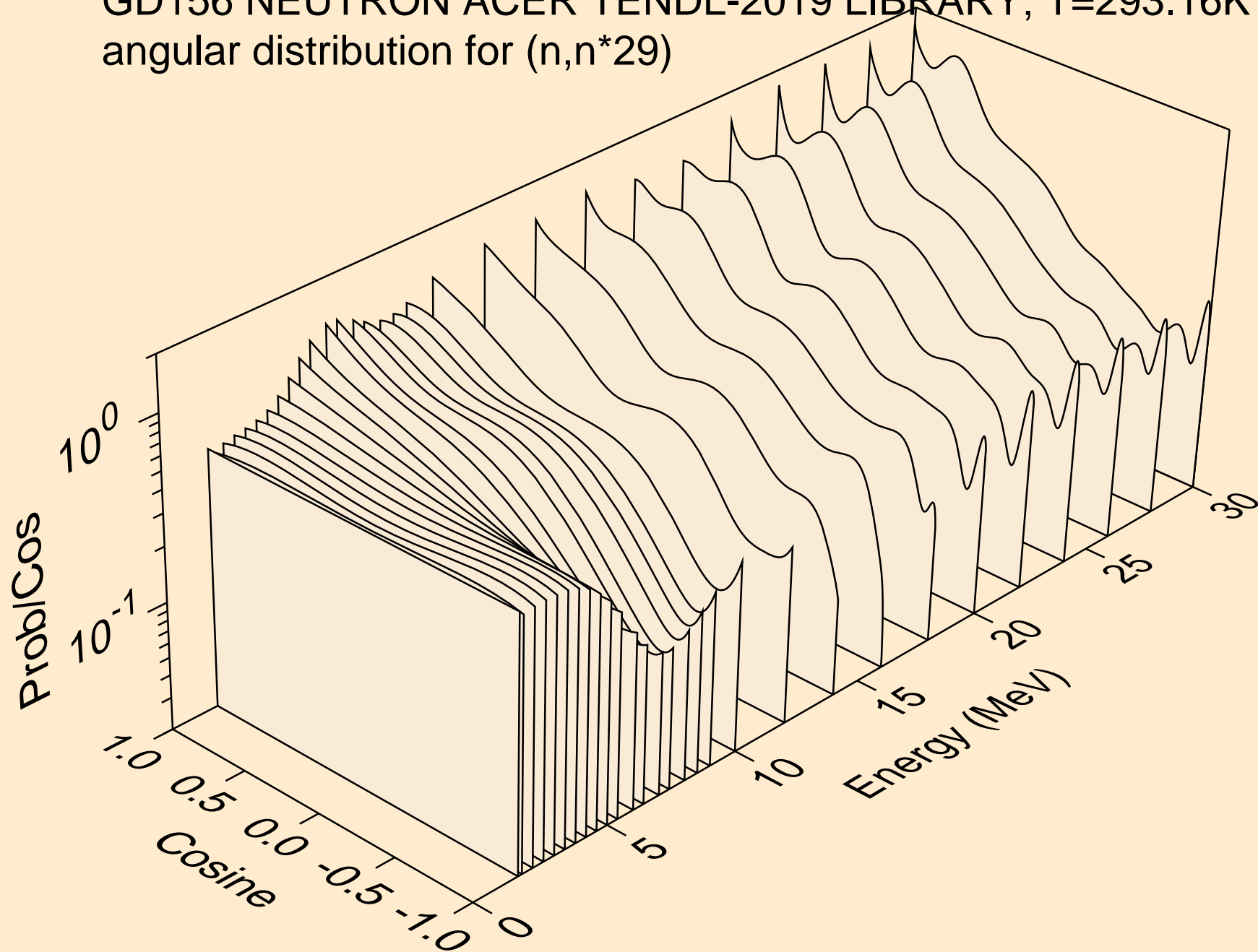

GD156 NEUTRON ACER TENDL-2019 LIBRARY; T=293.16K  
Neutron emission for (n,x)

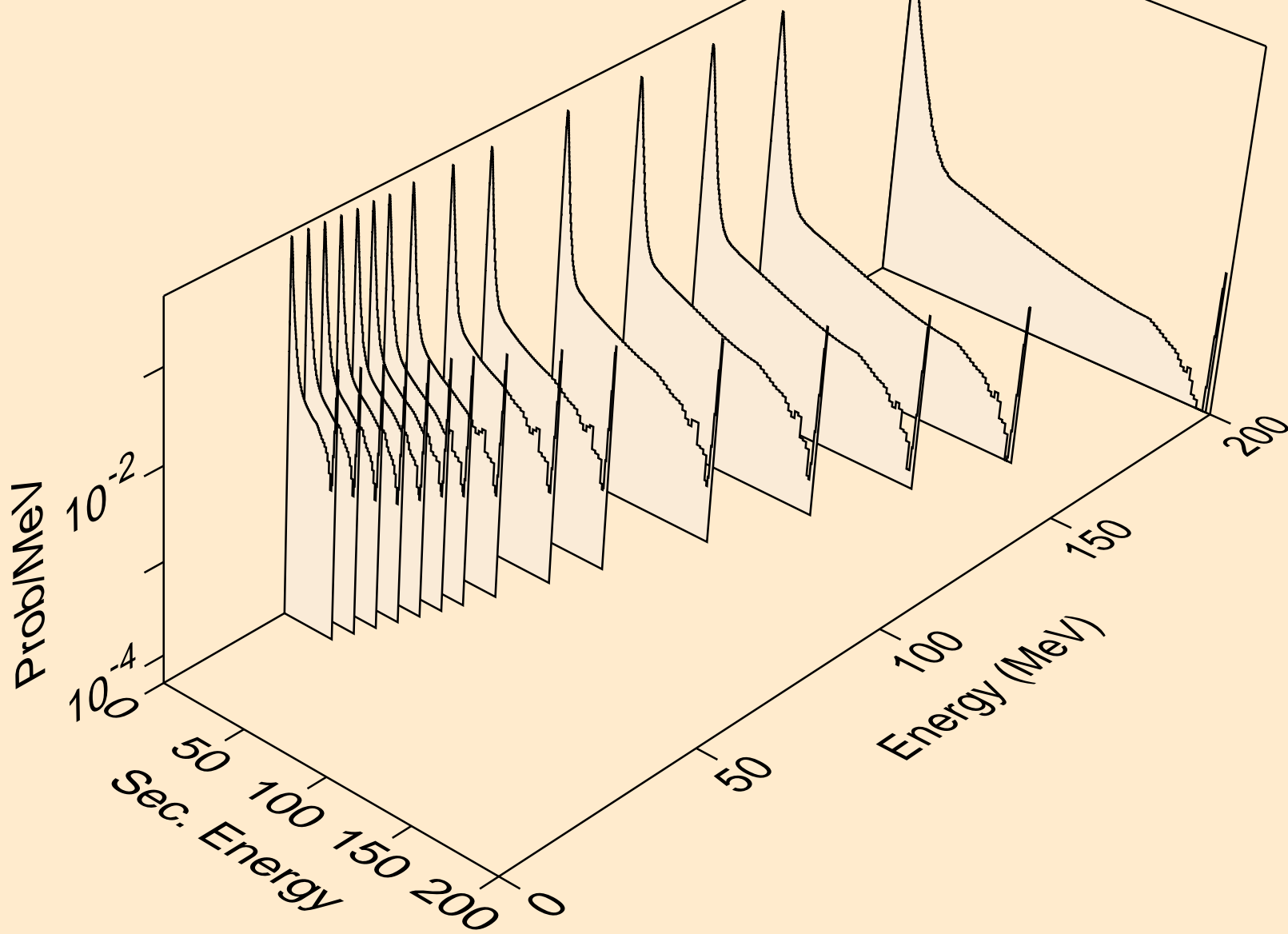

GD156 NEUTRON ACER TENDL-2019 LIBRARY; T=293.16K  
Neutron emission for (n,2nd)

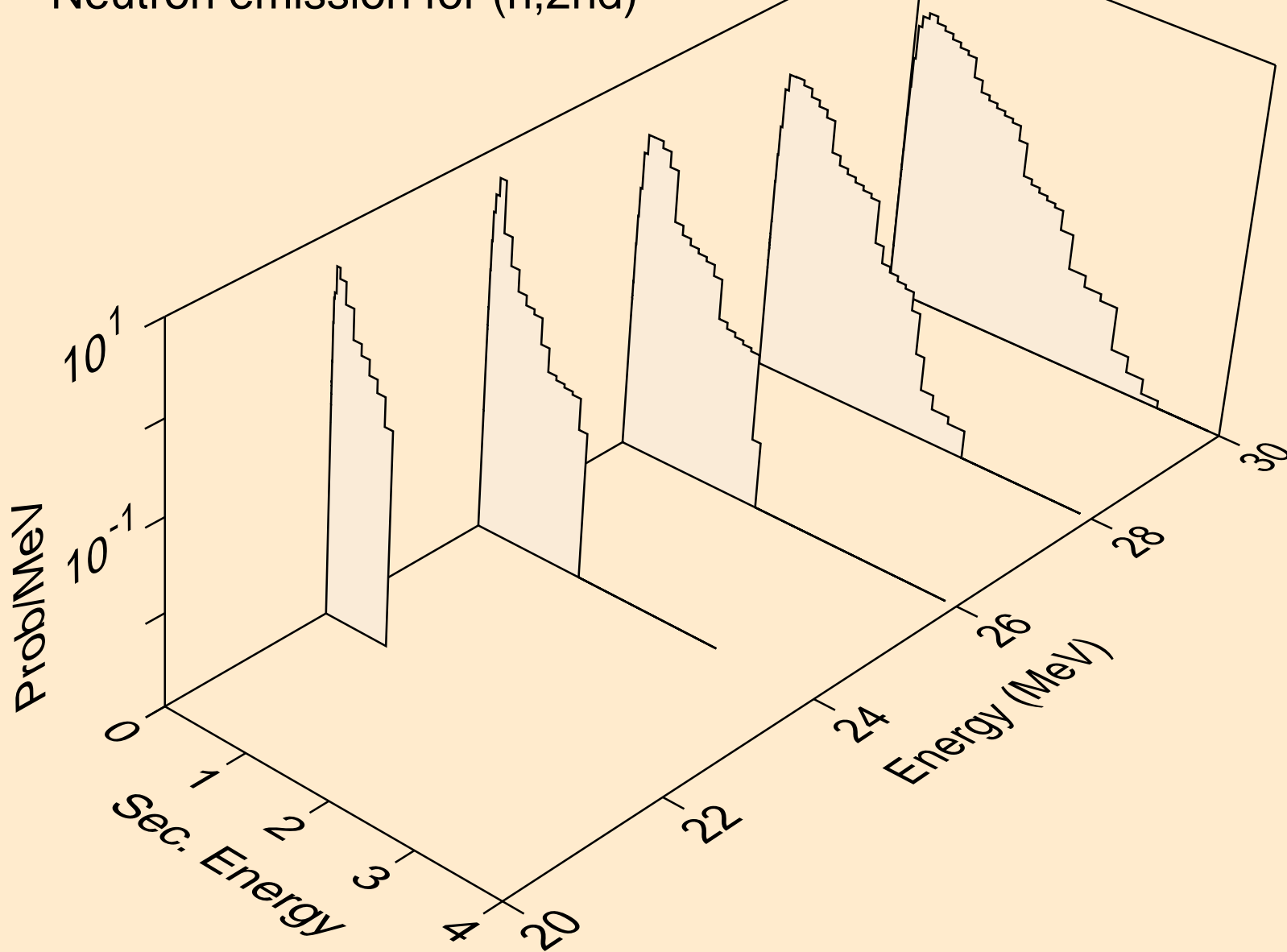

GD156 NEUTRON ACER TENDL-2019 LIBRARY; T=293.16K  
Neutron emission for (n,2n)

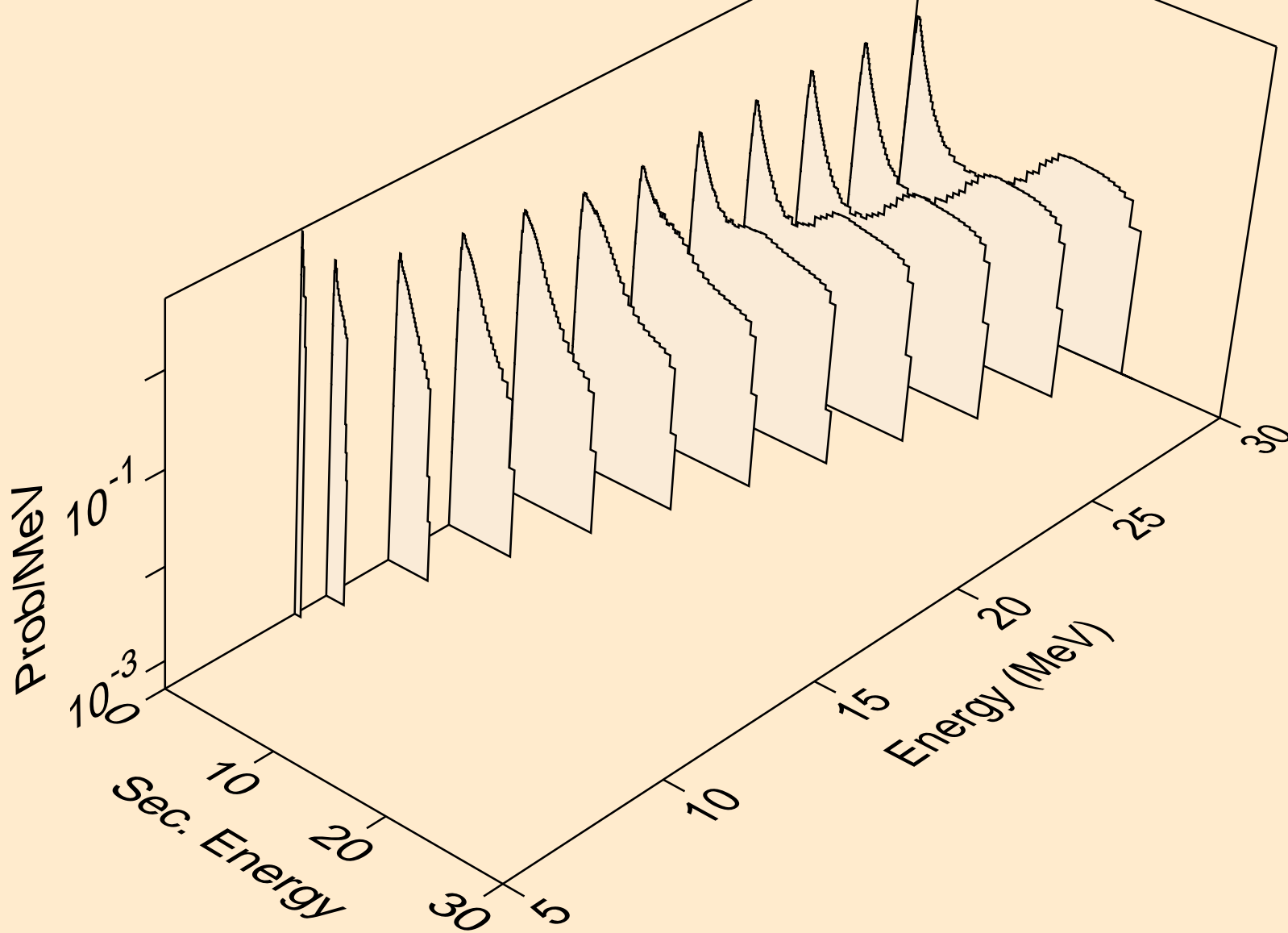

GD156 NEUTRON ACER TENDL-2019 LIBRARY; T=293.16K  
Neutron emission for (n,3n)

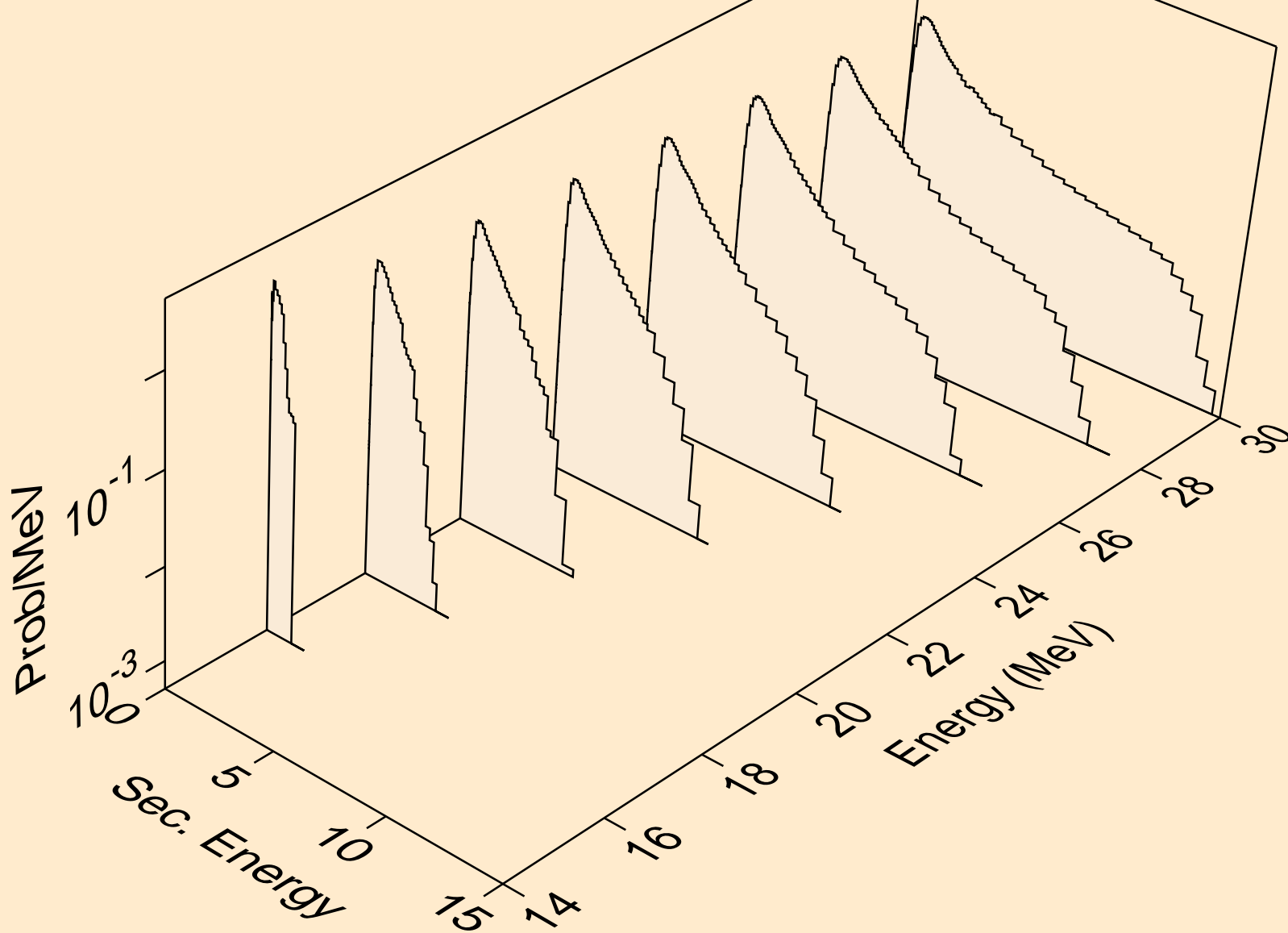



GD156 NEUTRON ACER TENDL-2019 LIBRARY; T=293.16K  
Neutron emission for (n,n\*)a

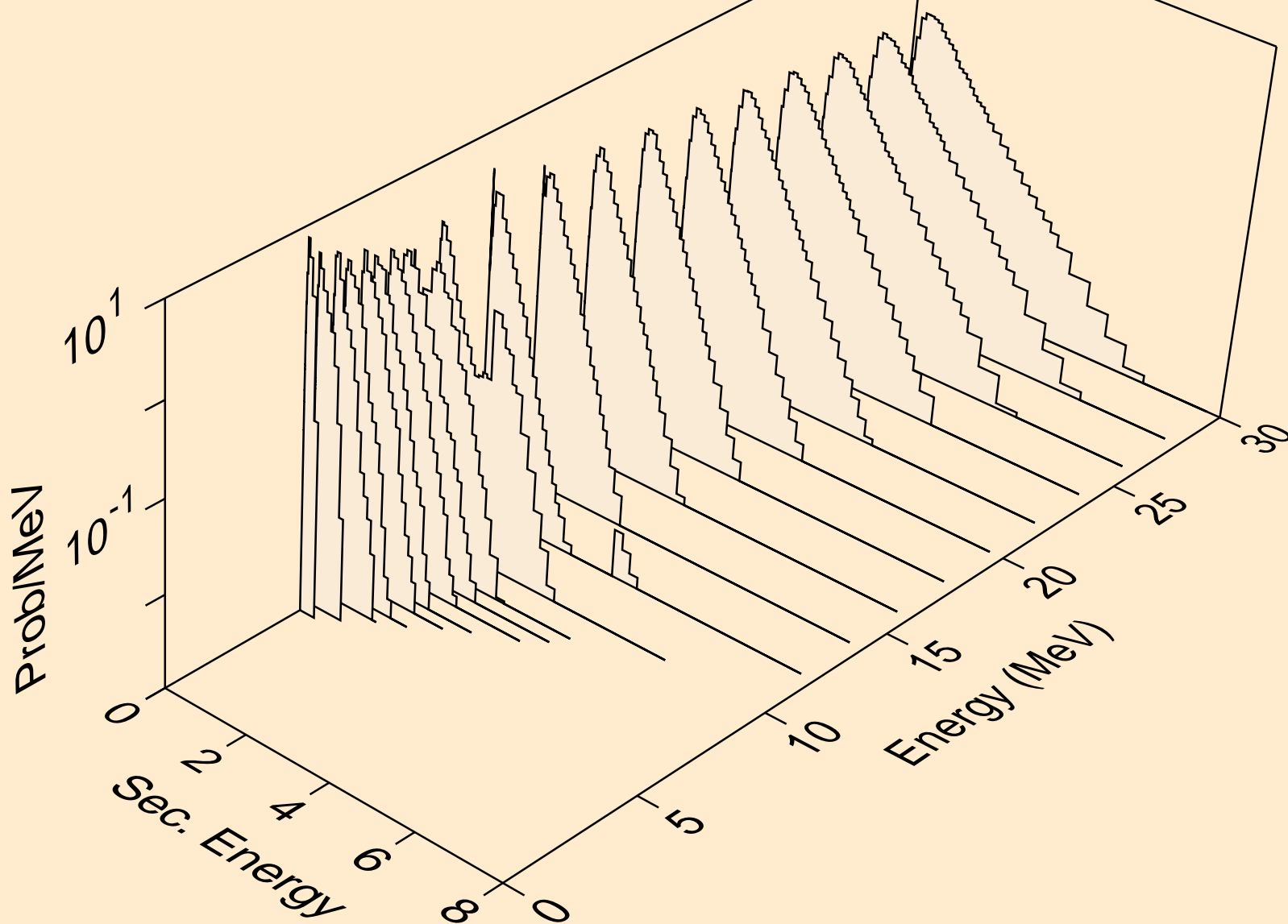

GD156 NEUTRON ACER TENDL-2019 LIBRARY; T=293.16K  
Neutron emission for (n,2n)a

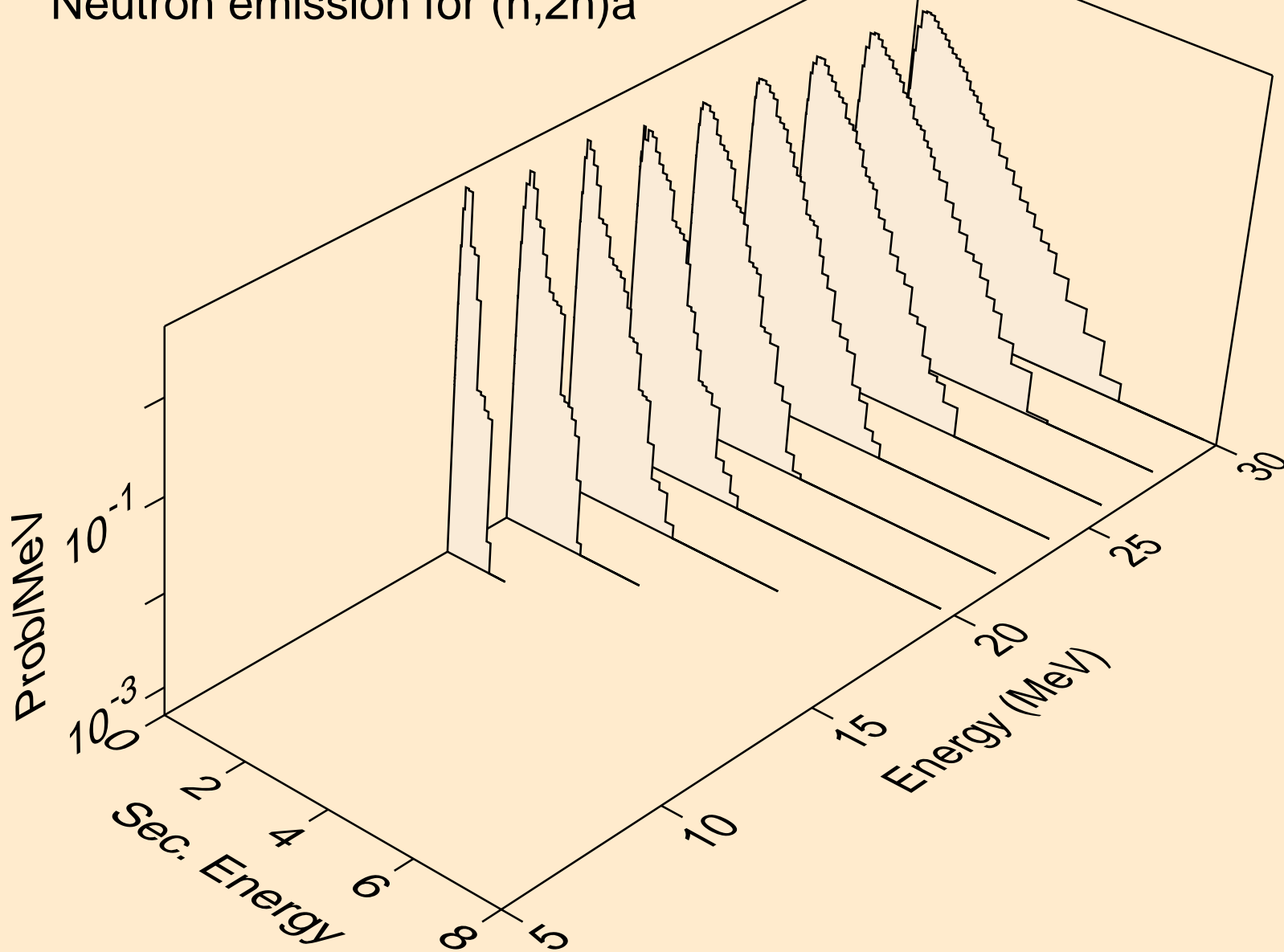

GD156 NEUTRON ACER TENDL-2019 LIBRARY; T=293.16K  
Neutron emission for (n,3n)a

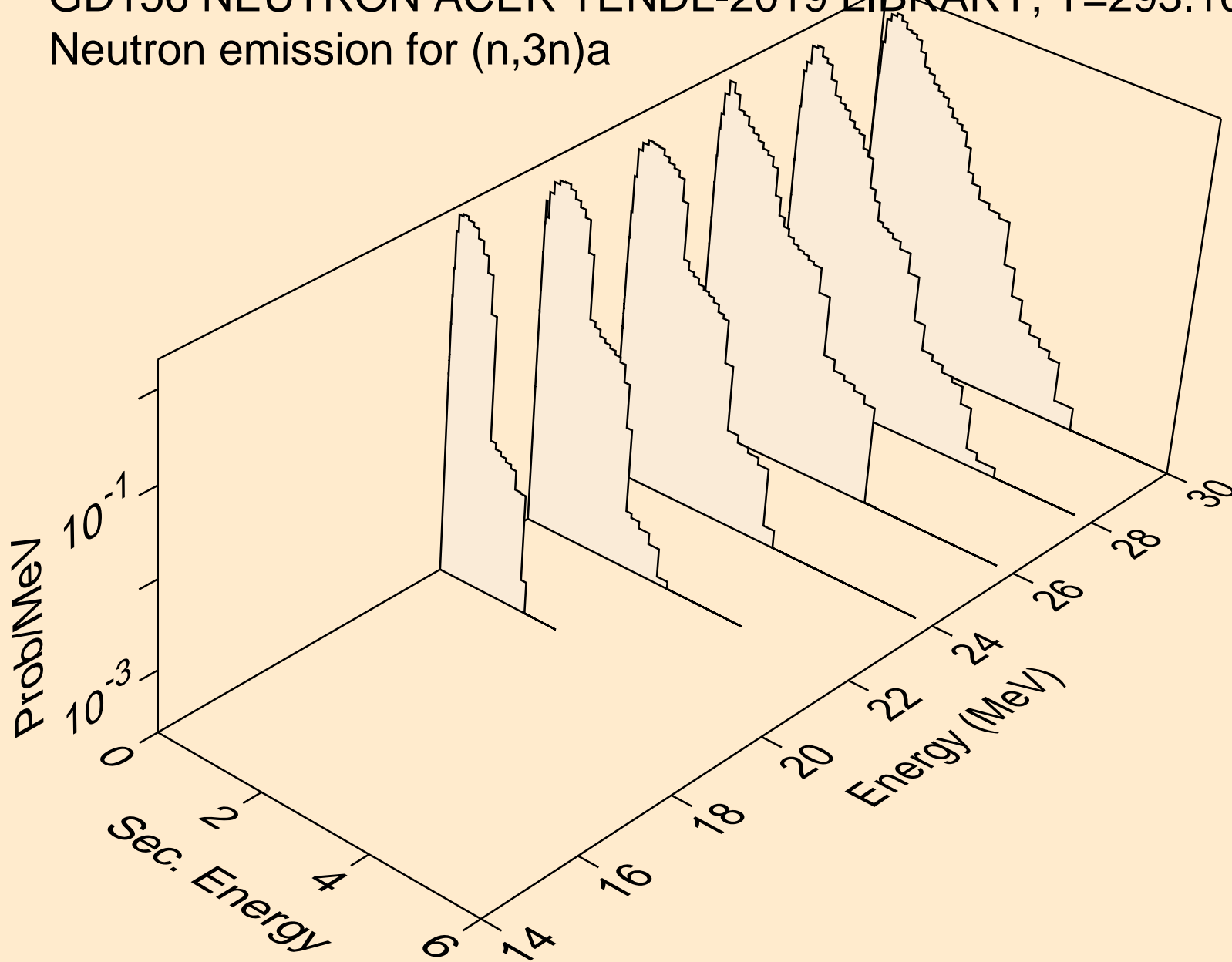

GD156 NEUTRON ACER TENDL-2019 LIBRARY; T=293.16K  
Neutron emission for (n,n\*)p

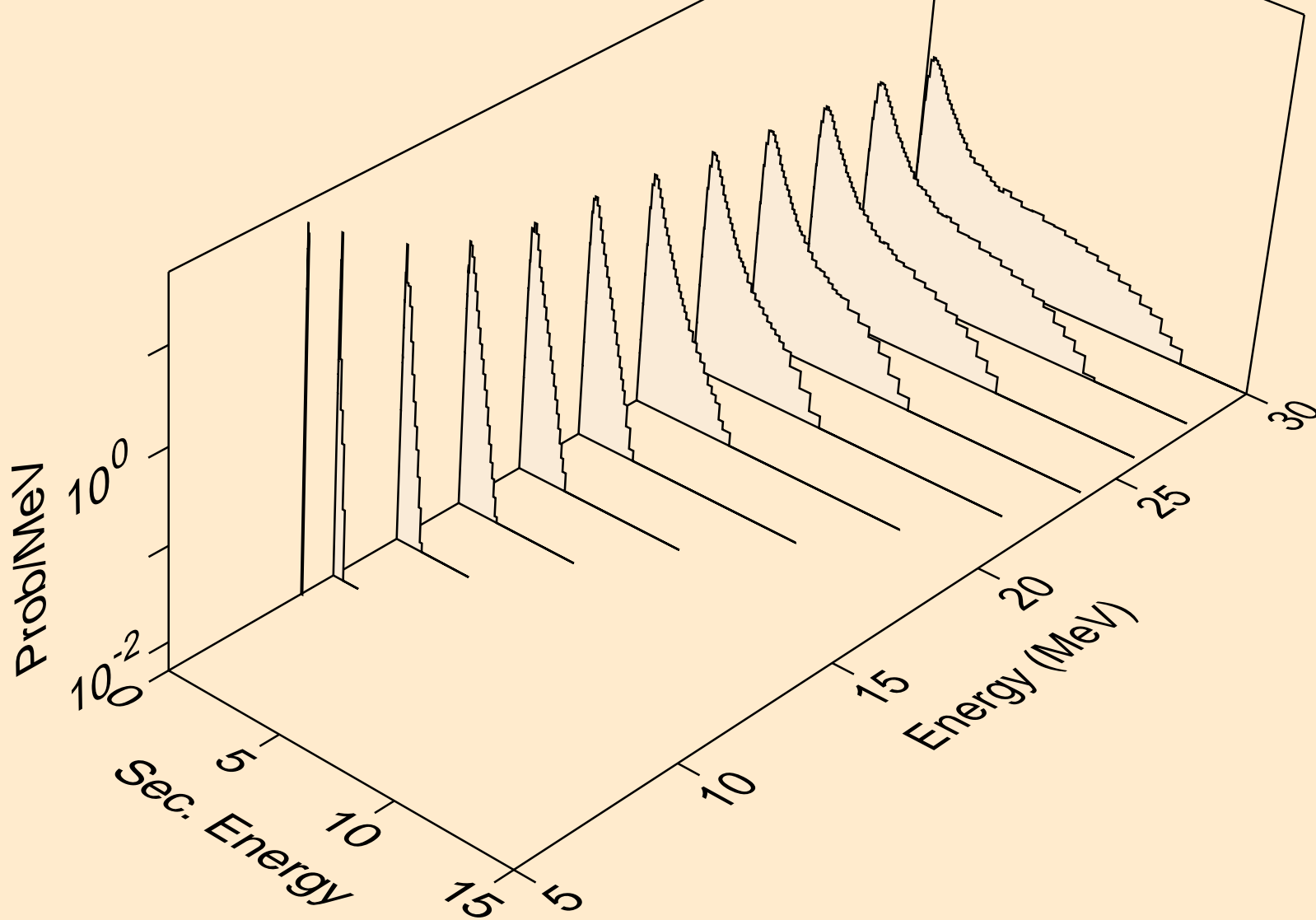

GD156 NEUTRON ACER TENDL-2019 LIBRARY; T=293.16K  
Neutron emission for (n,n\*)2a

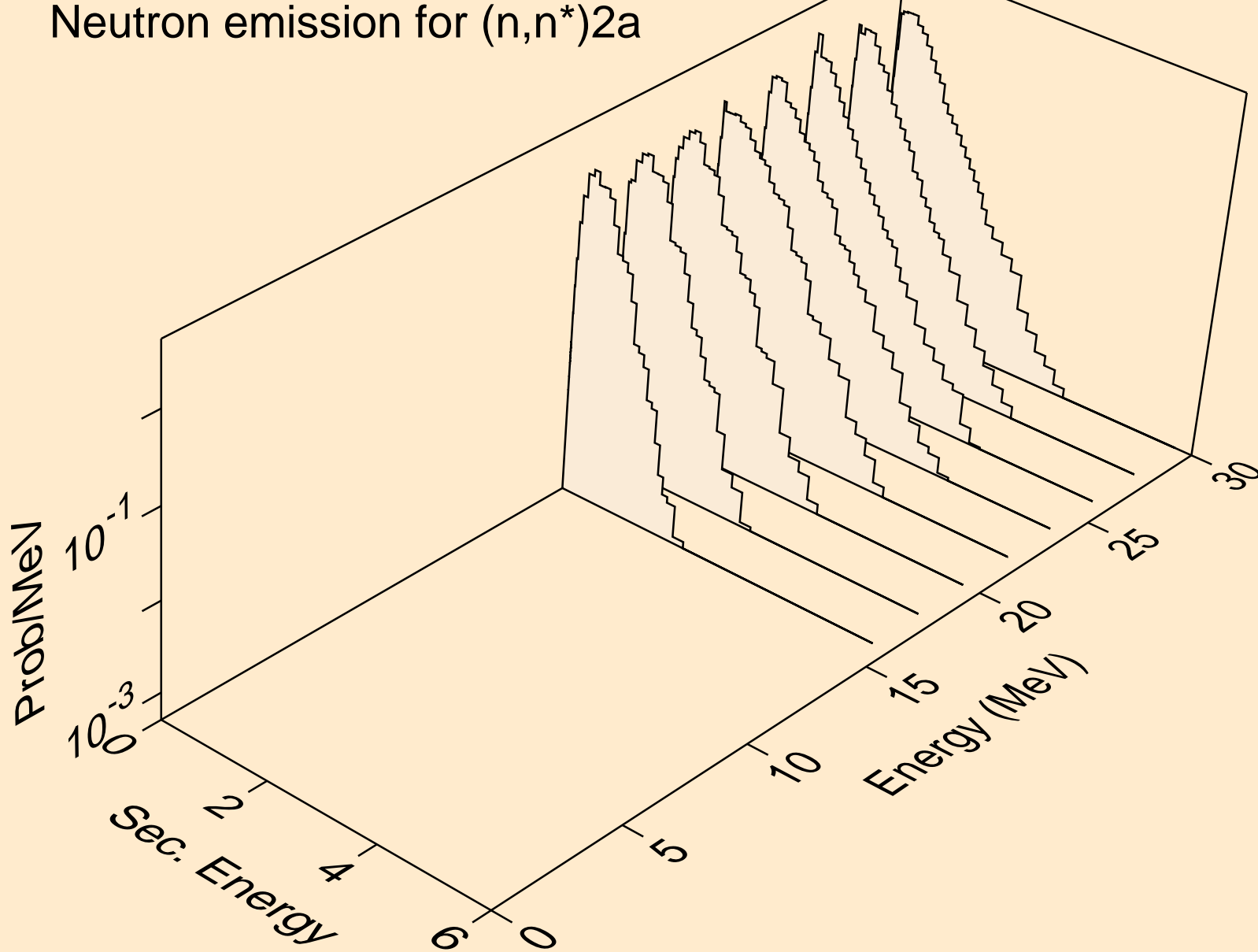

GD156 NEUTRON ACER TENDL-2019 LIBRARY; T=293.16K  
Neutron emission for (n,n\*)d

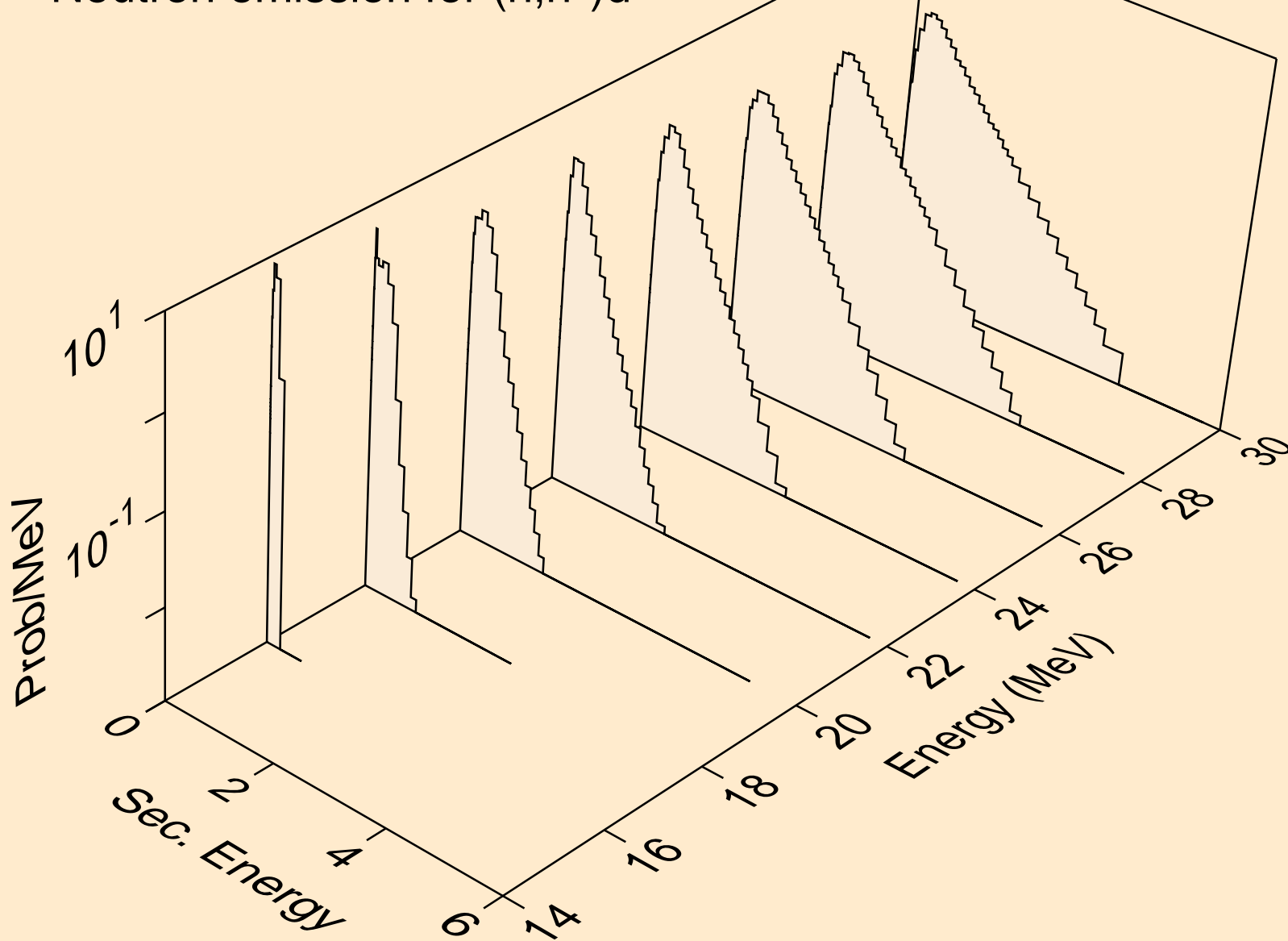

GD156 NEUTRON ACER TENDL-2019 LIBRARY; T=293.16K  
Neutron emission for (n,n\*)t

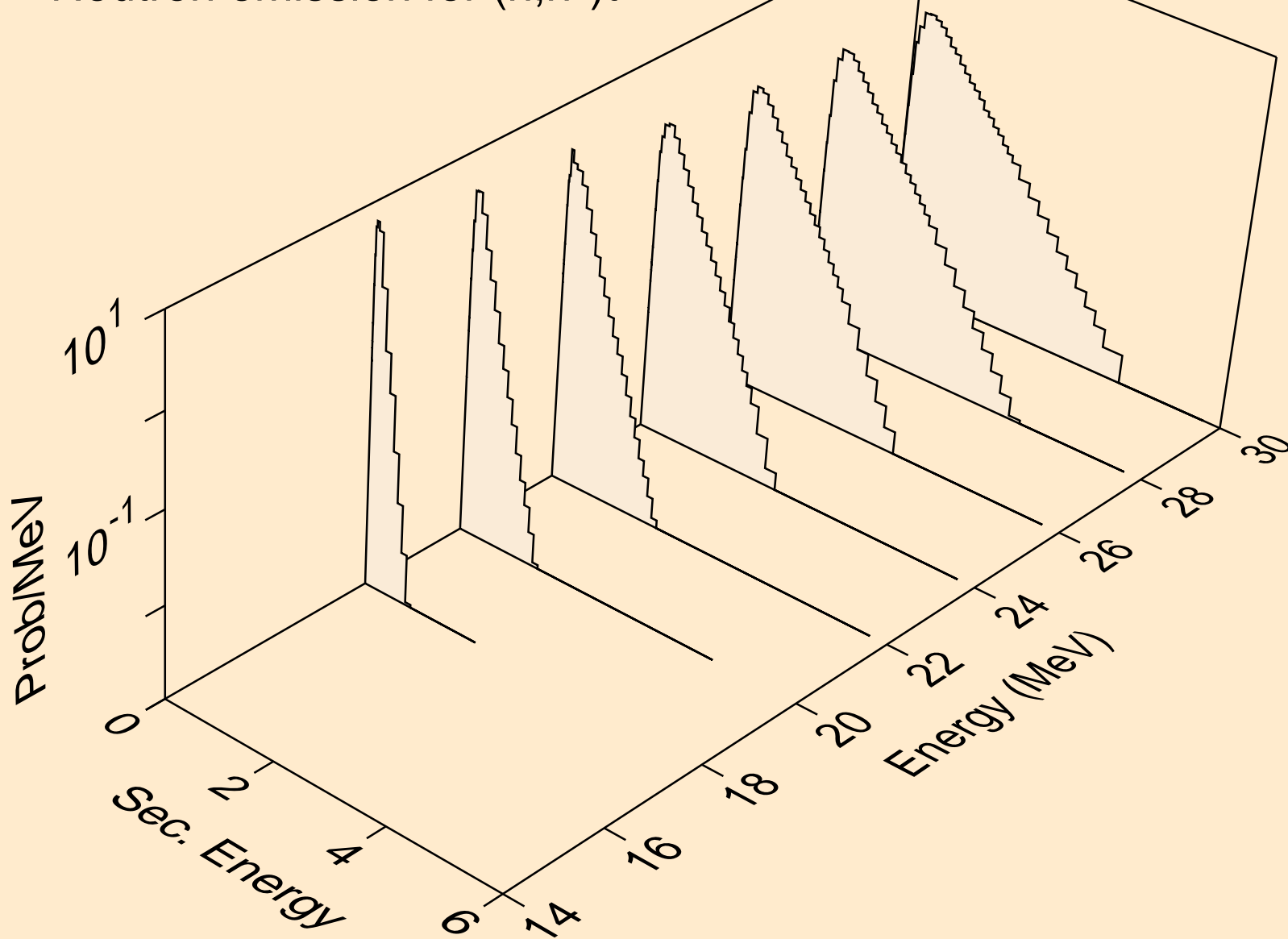

GD156 NEUTRON ACER TENDL-2019 LIBRARY; T=293.16K  
Neutron emission for (n,n\*)he3

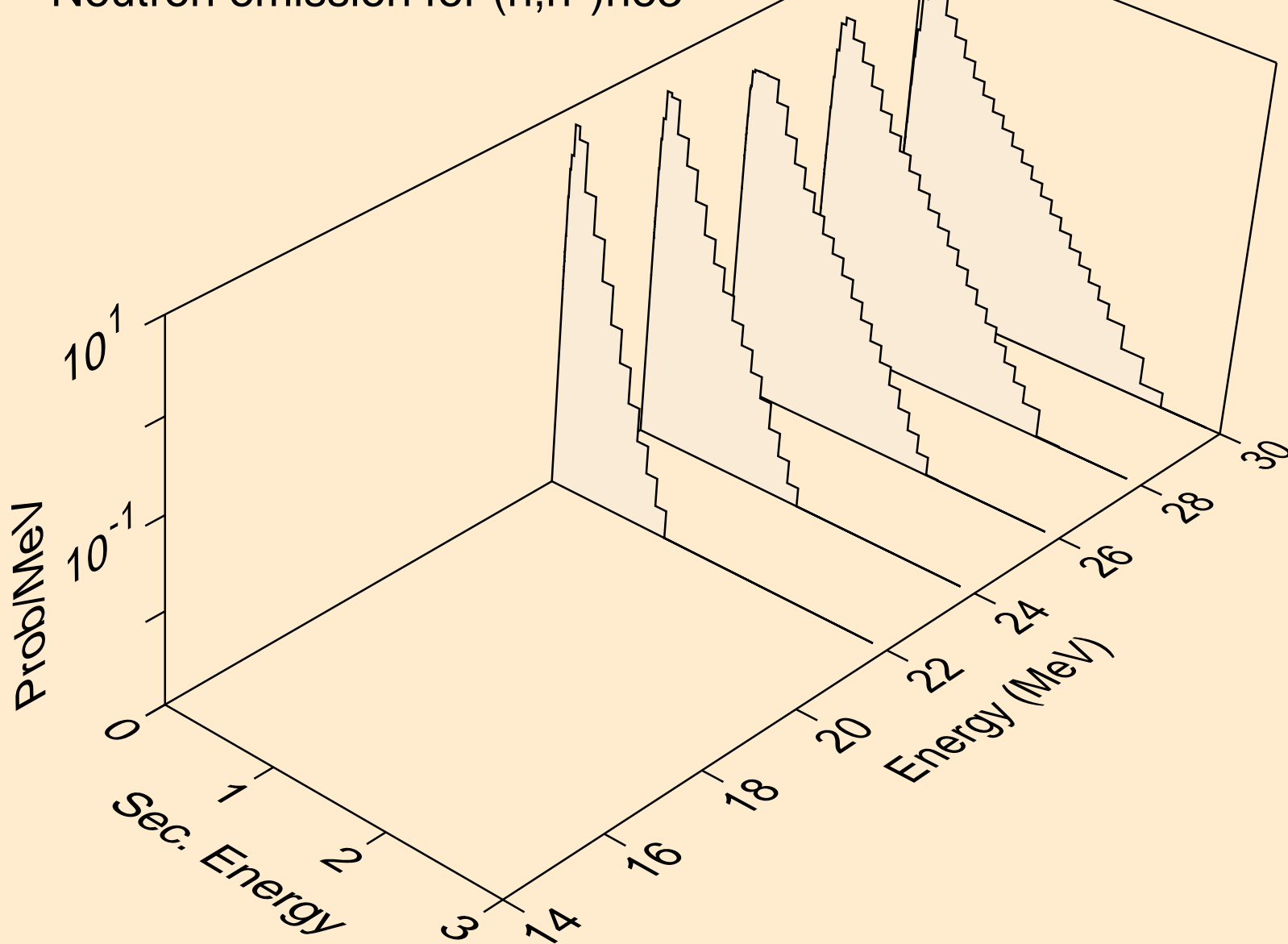



GD156 NEUTRON ACER TENDL-2019 LIBRARY; T=293.16K  
Neutron emission for (n,4n)

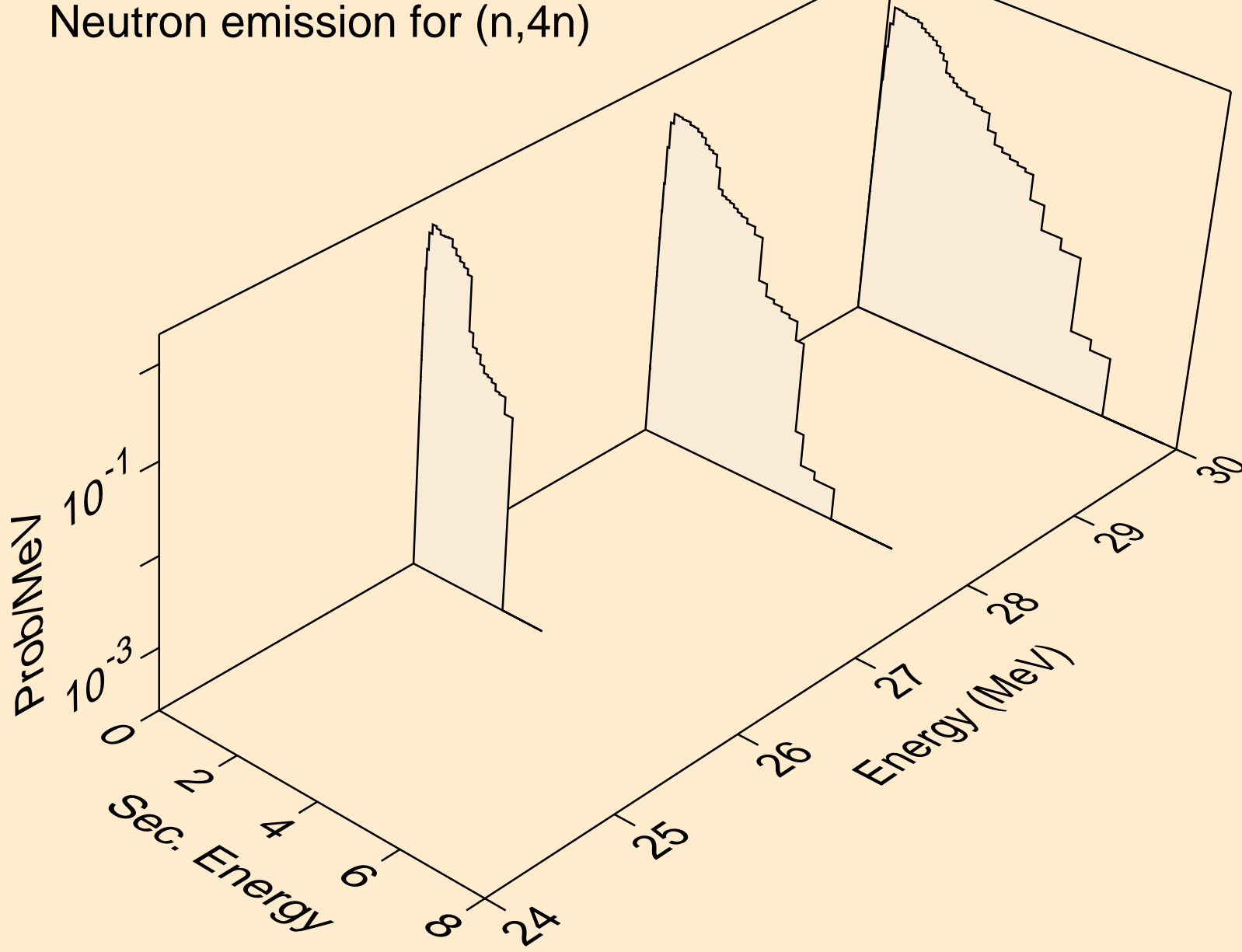

GD156 NEUTRON ACER TENDL-2019 LIBRARY; T=293.16K  
Neutron emission for (n,2np)

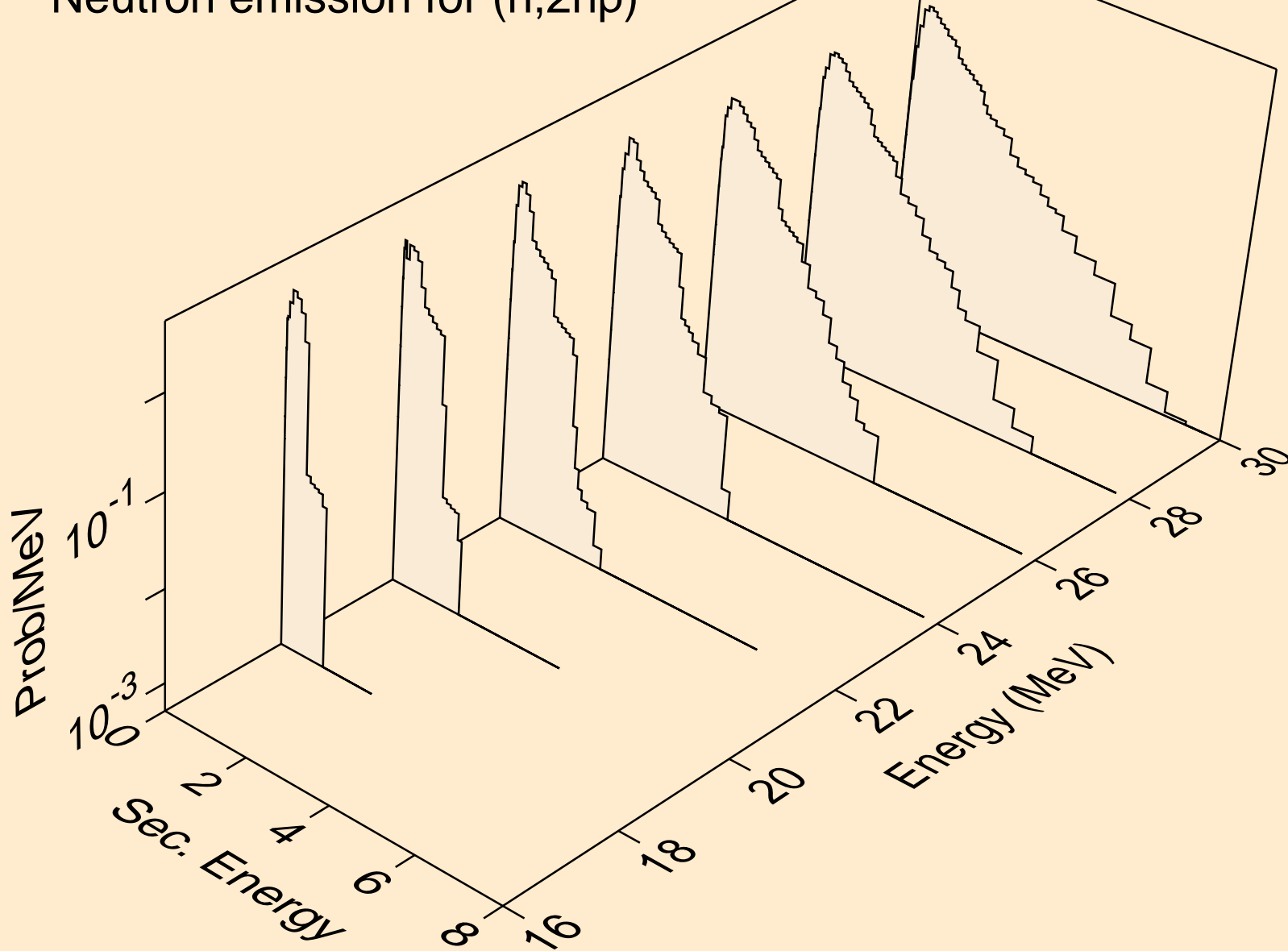

GD156 NEUTRON ACER TENDL-2019 LIBRARY; T=293.16K  
Neutron emission for (n,3np)

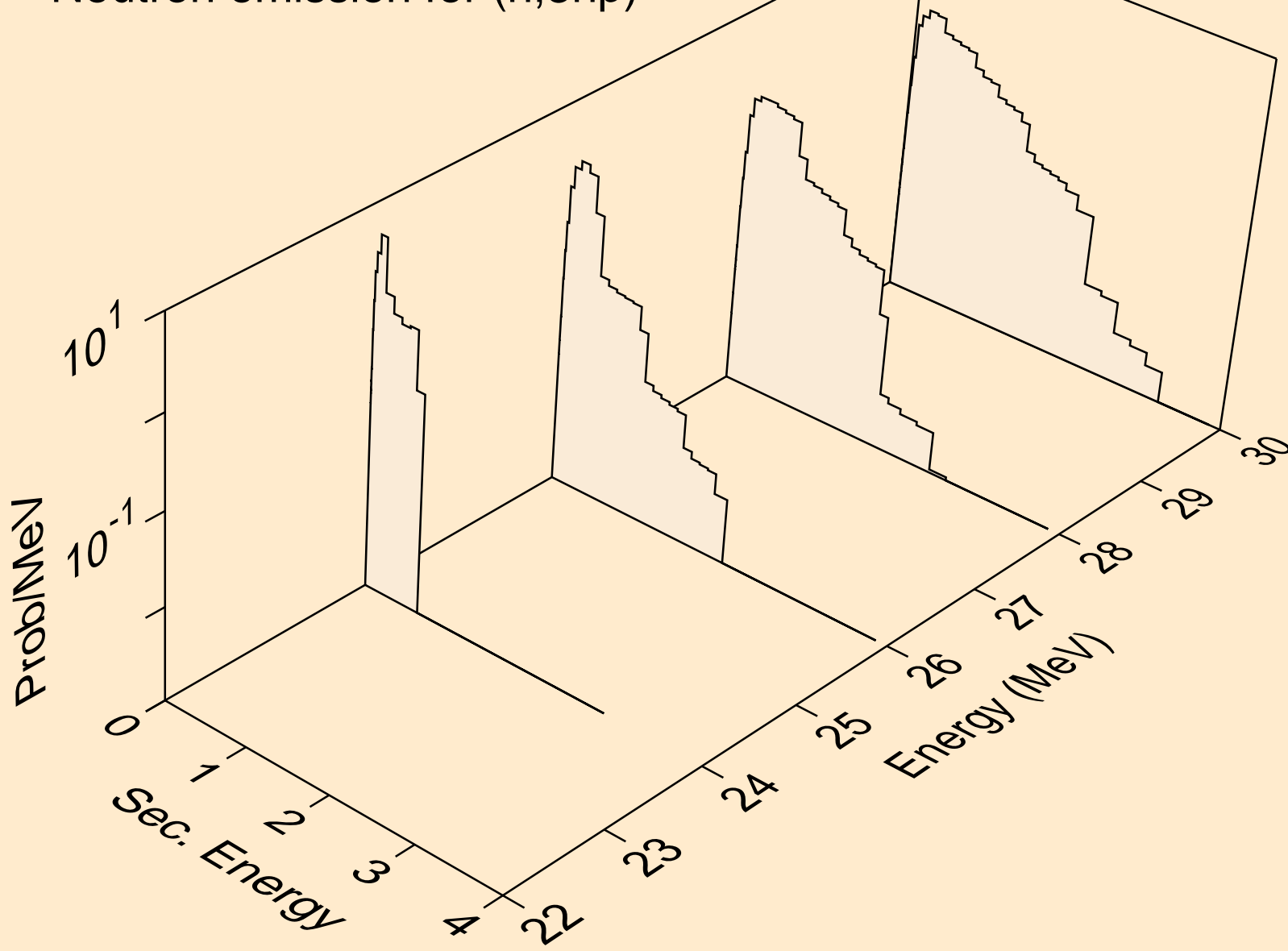

GD156 NEUTRON ACER TENDL-2019 LIBRARY; T=293.16K  
Neutron emission for (n,2np)

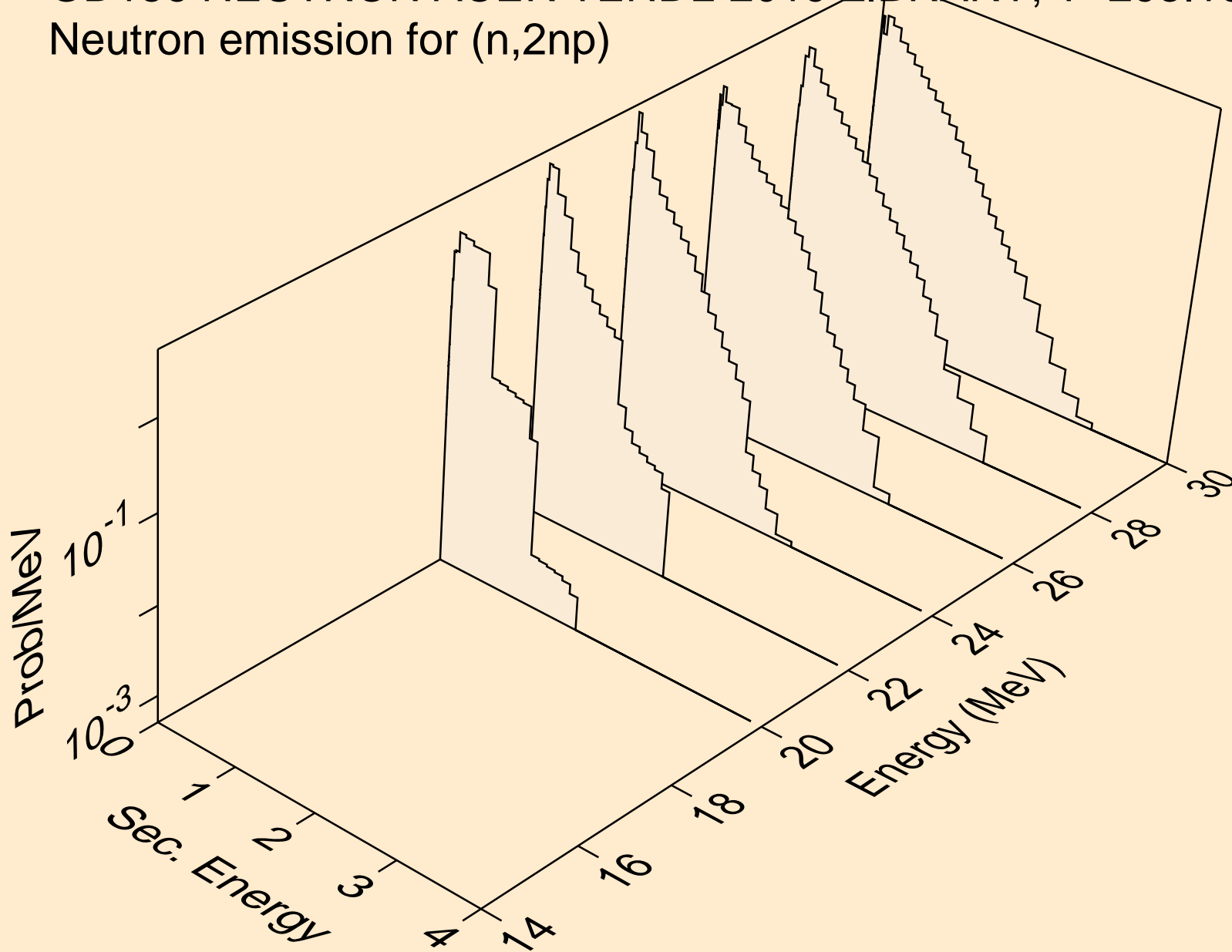

GD156 NEUTRON ACER TENDL-2019 LIBRARY; T=293.16K  
Neutron emission for (n,npa)

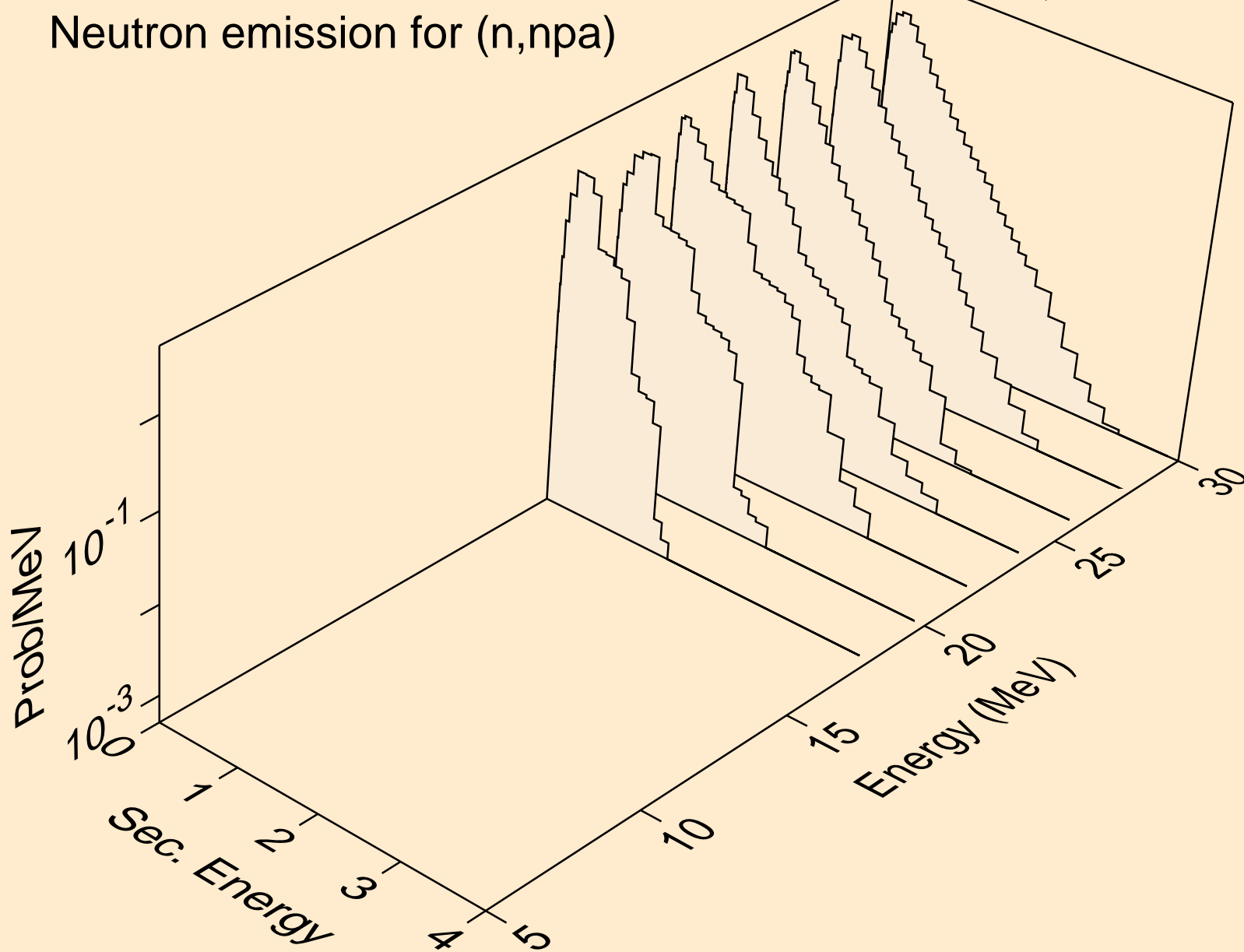

GD156 NEUTRON ACER TENDL-2019 LIBRARY; T=293.16K  
Neutron emission for (n,n\*c)

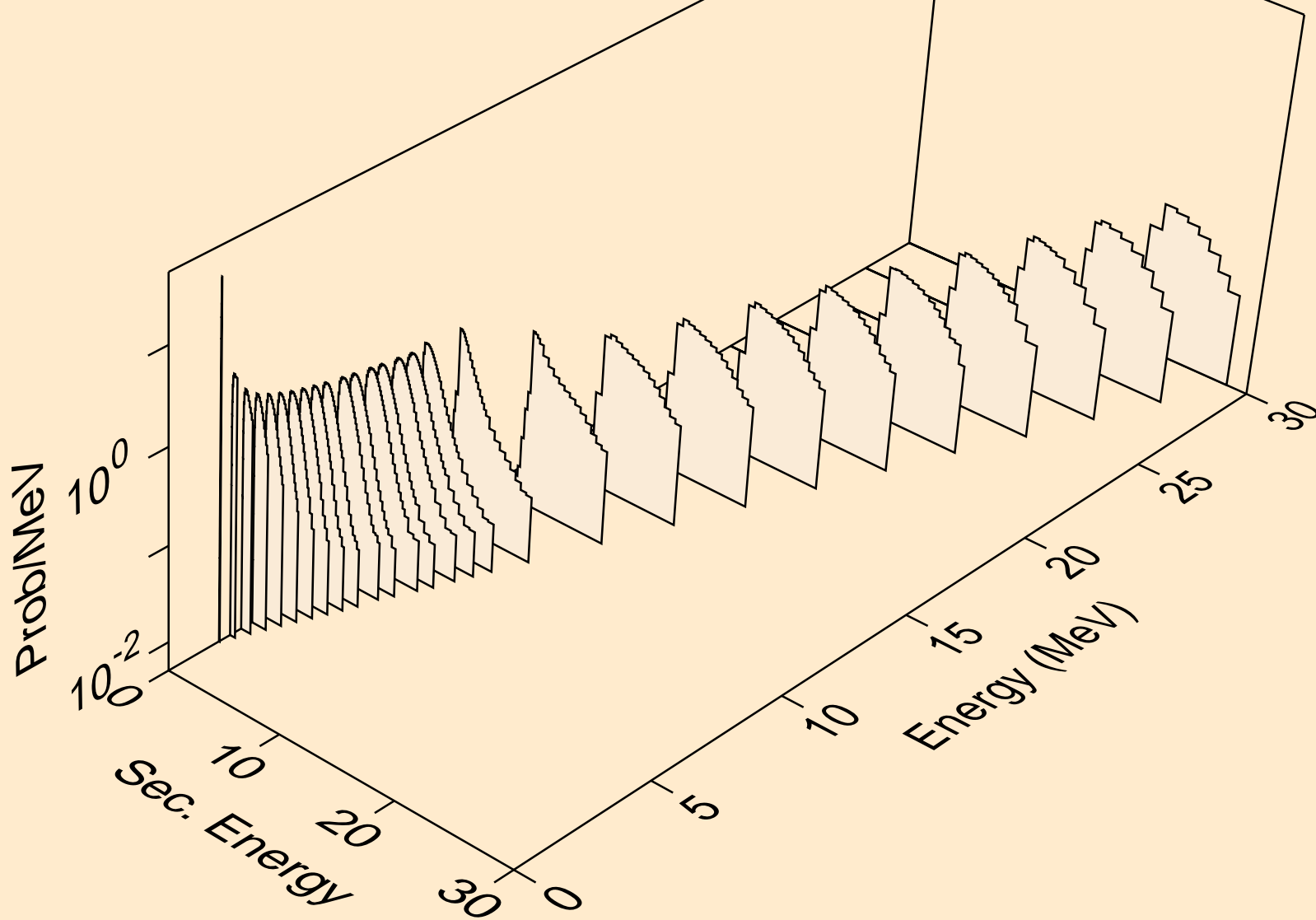

GD156 NEUTRON ACER TENDL-2019 LIBRARY; T=293.16K  
Photon emission for (n,x)

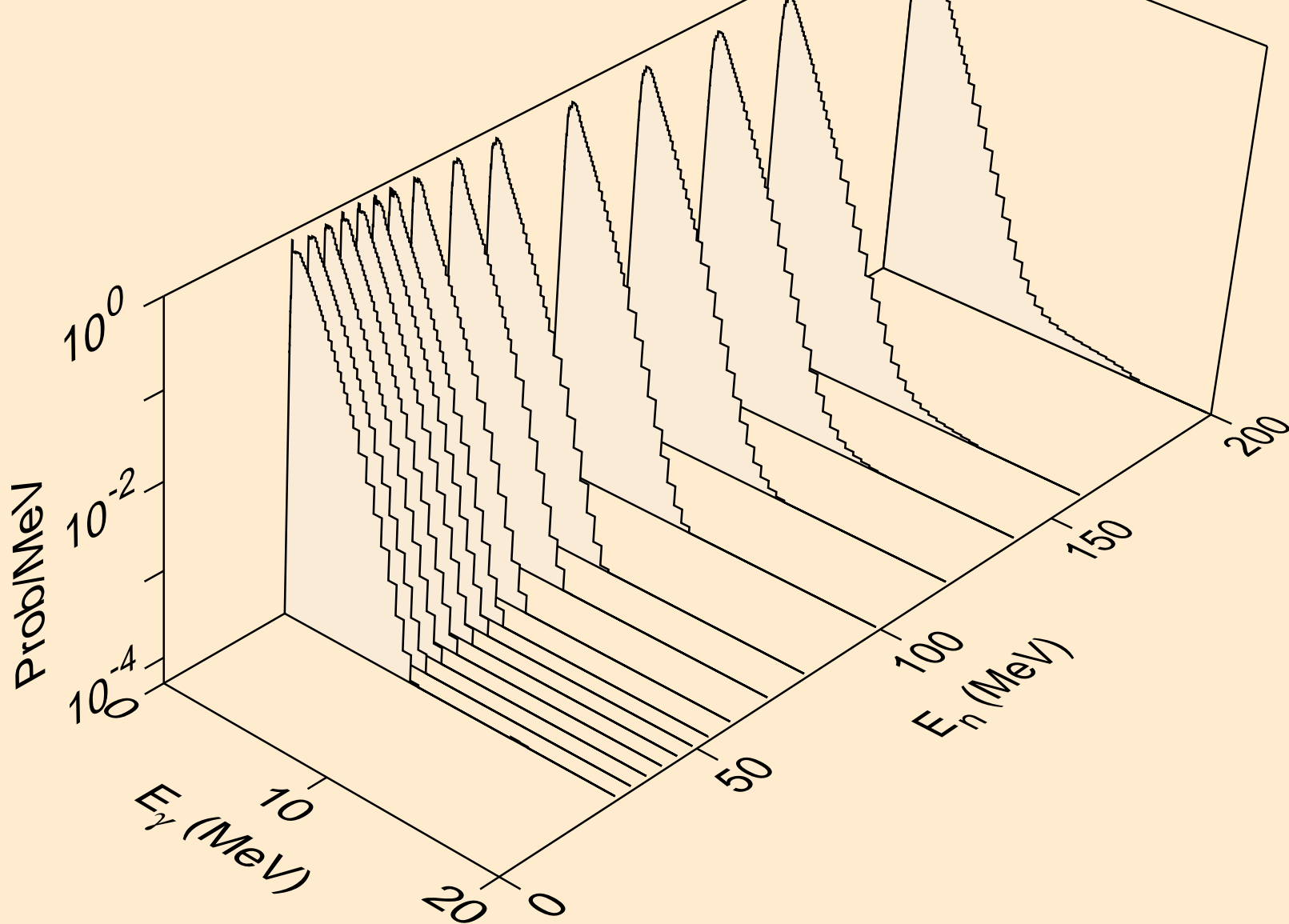

GD156 NEUTRON ACER TENDL-2019 LIBRARY; T=293.16K  
Photon emission for (n,2nd)

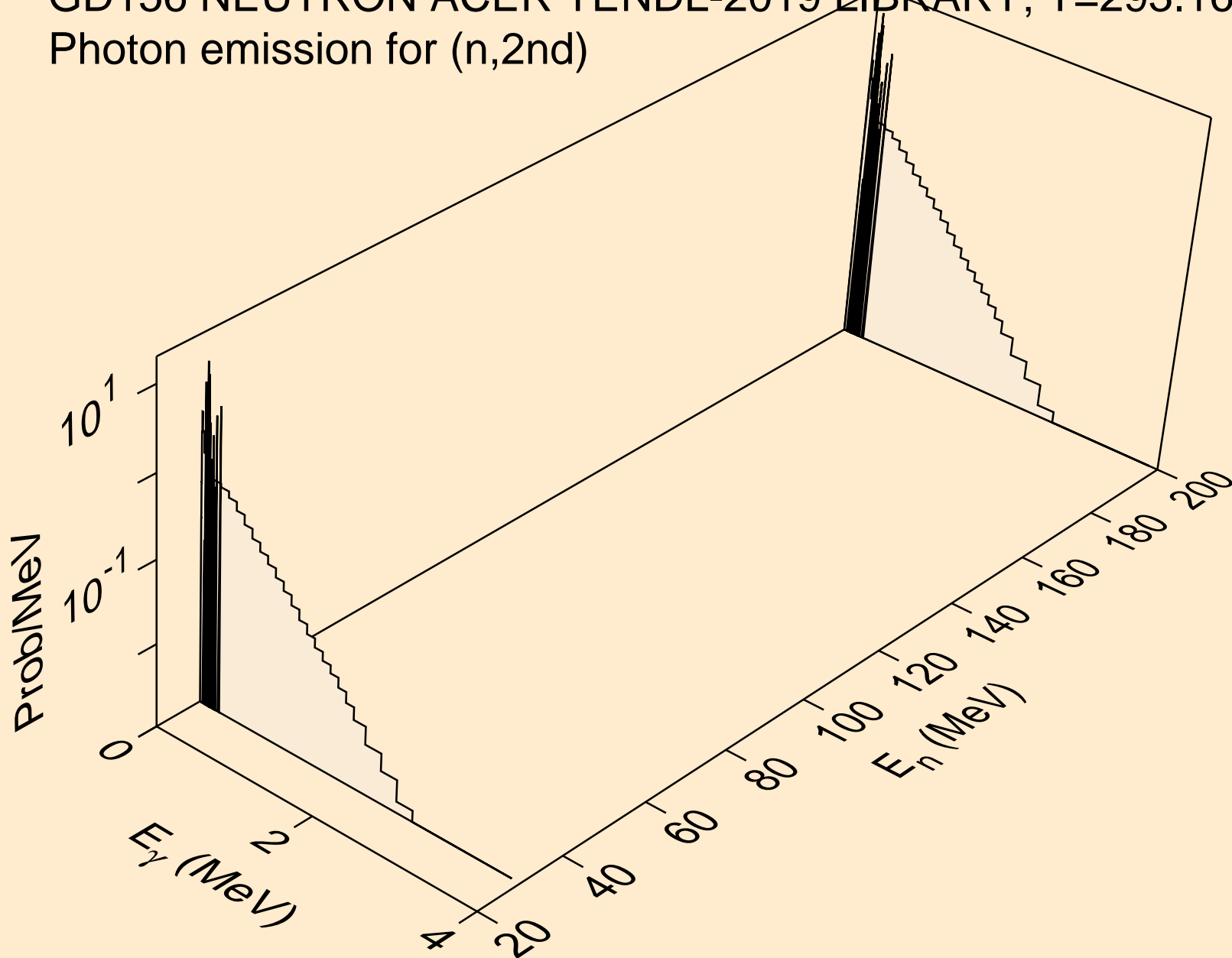



GD156 NEUTRON ACER TENDL-2019 LIBRARY; T=293.16K  
Photon emission for (n,2n)

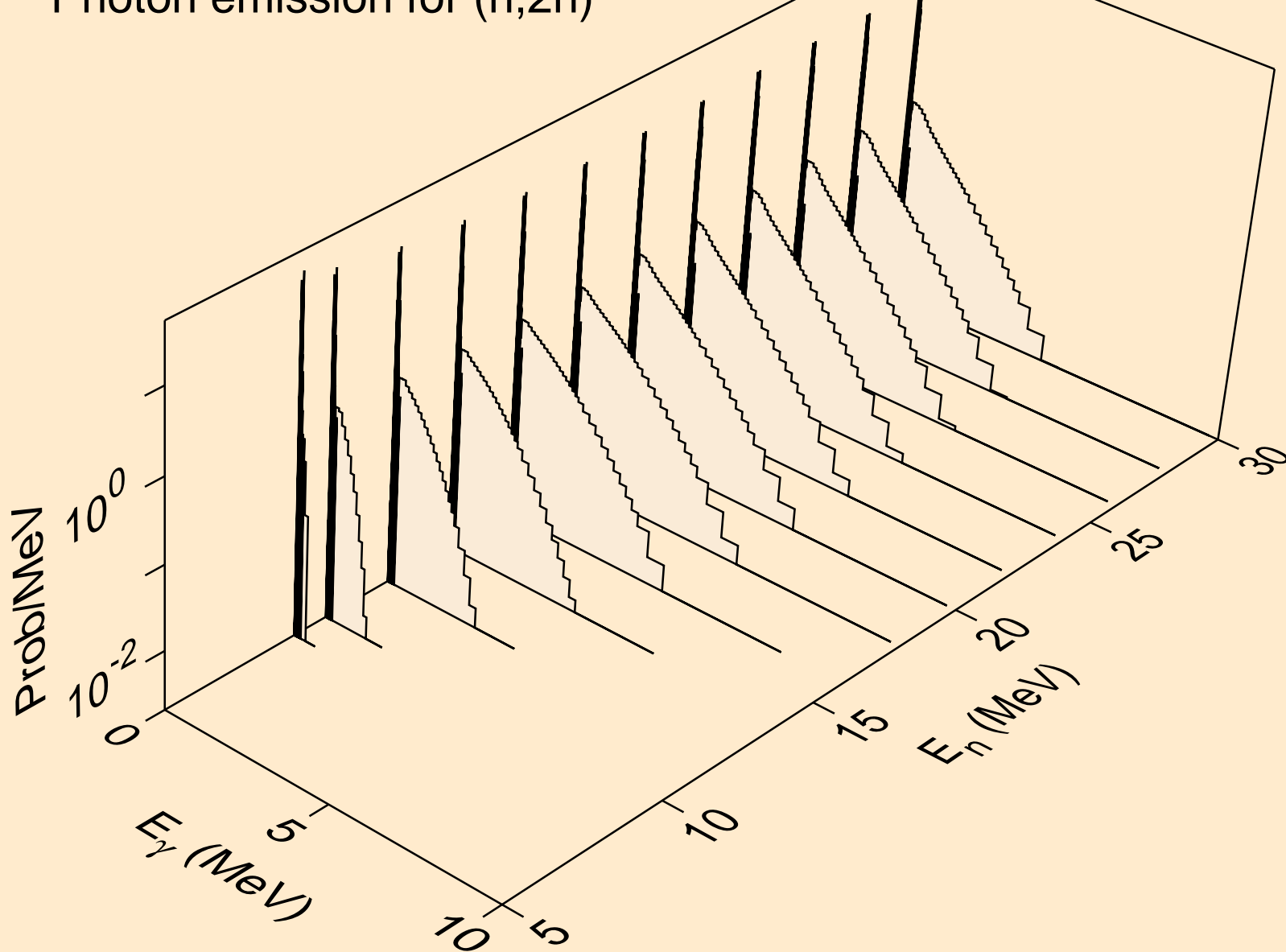

GD156 NEUTRON ACER TENDL-2019 LIBRARY; T=293.16K  
Photon emission for (n,3n)

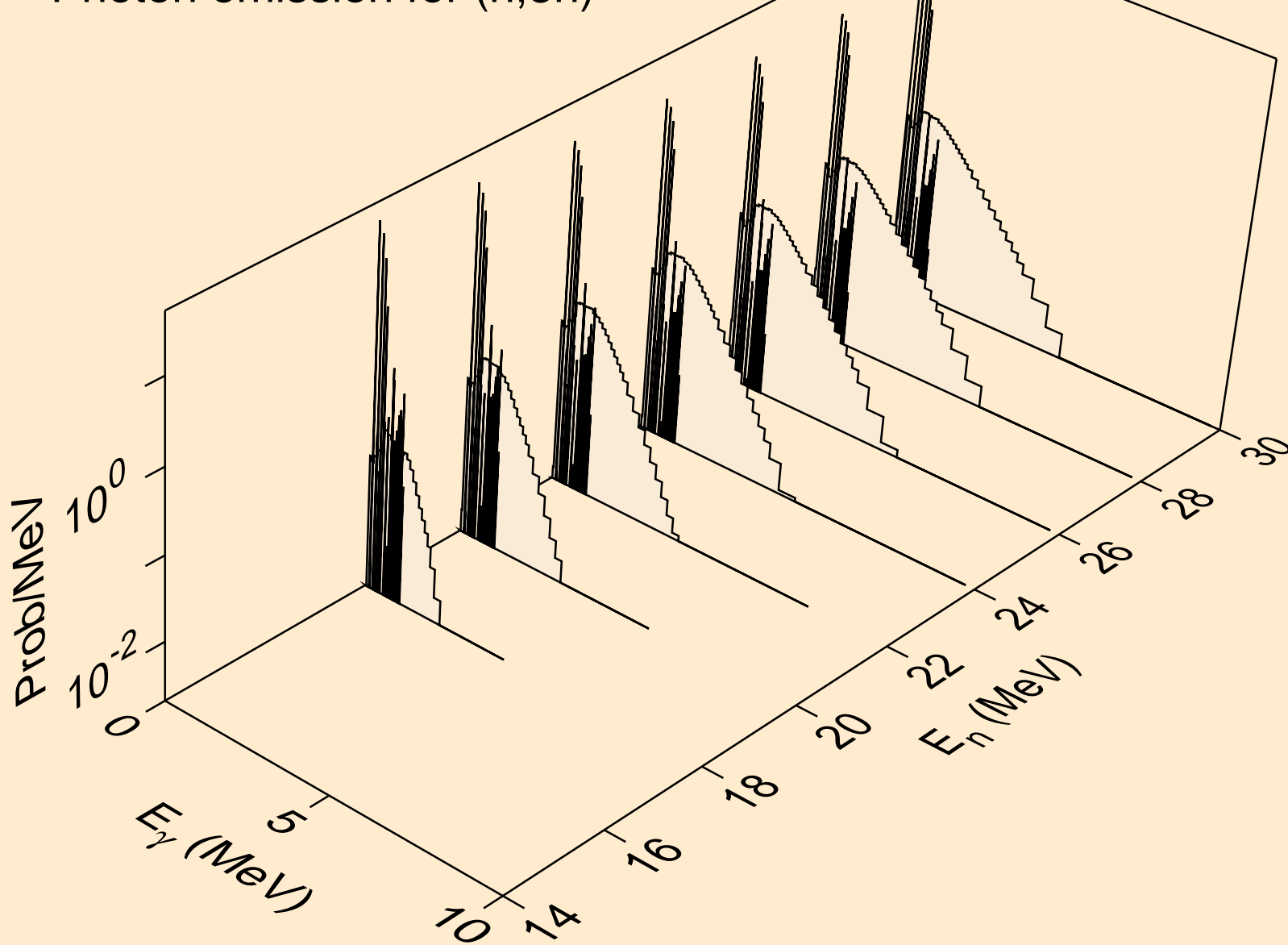

GD156 NEUTRON ACER TENDL-2019 LIBRARY; T=293.16K  
Photon emission for (n,n\*)a

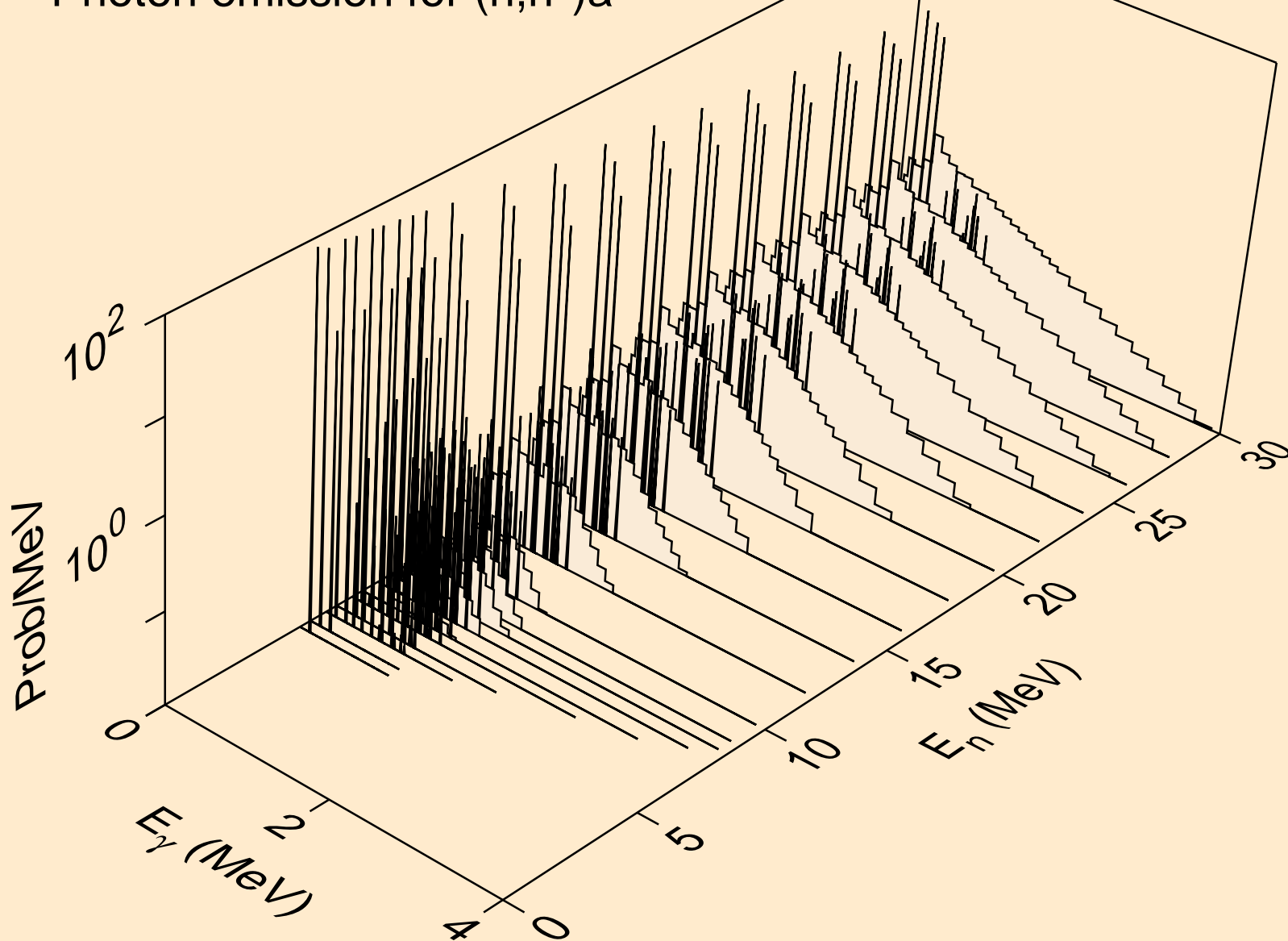

GD156 NEUTRON ACER TENDL-2019 LIBRARY; T=293.16K  
Photon emission for (n,2n)a

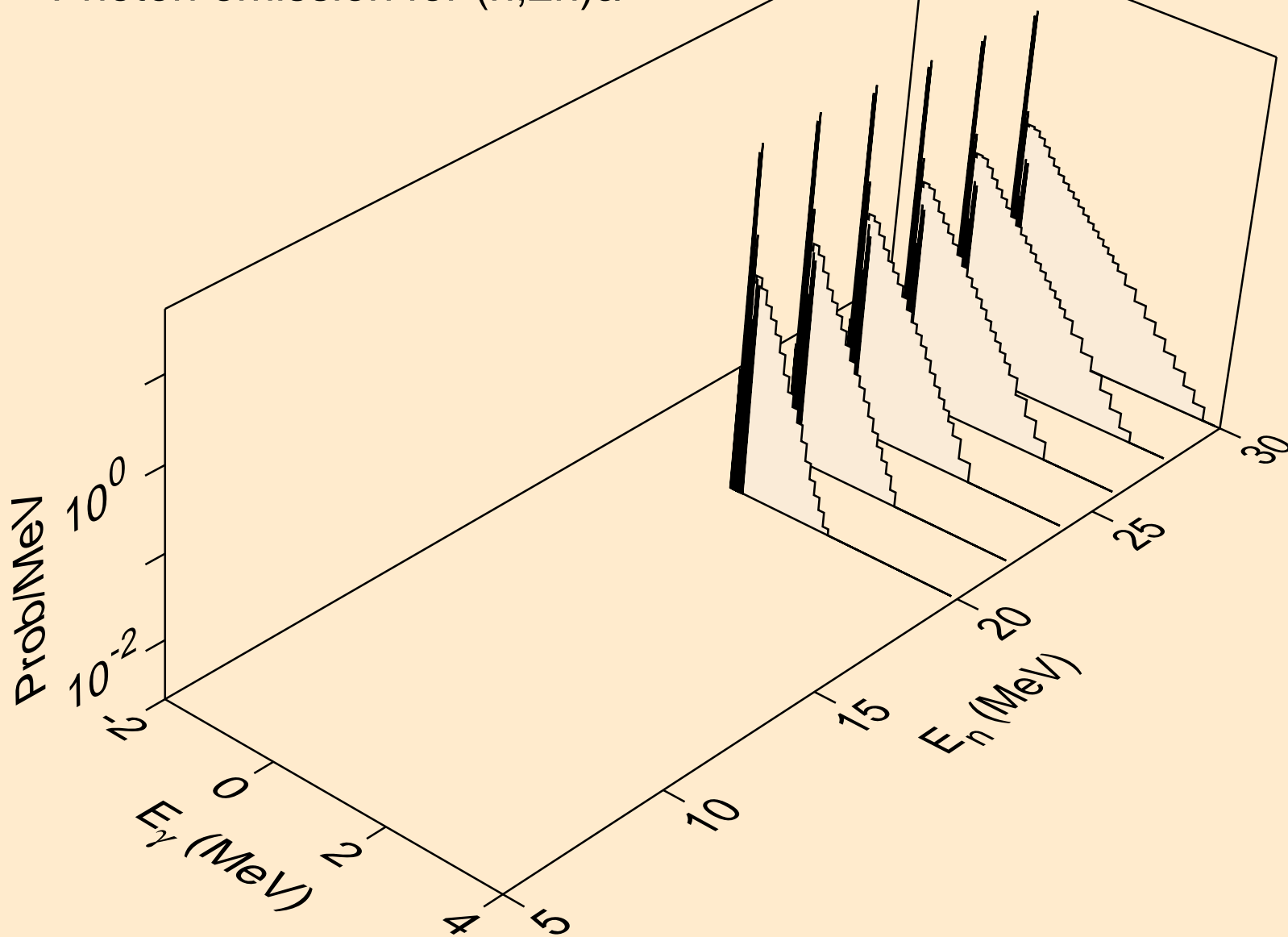

GD156 NEUTRON ACER TENDL-2019 LIBRARY; T=293.16K  
Photon emission for (n,3n)a

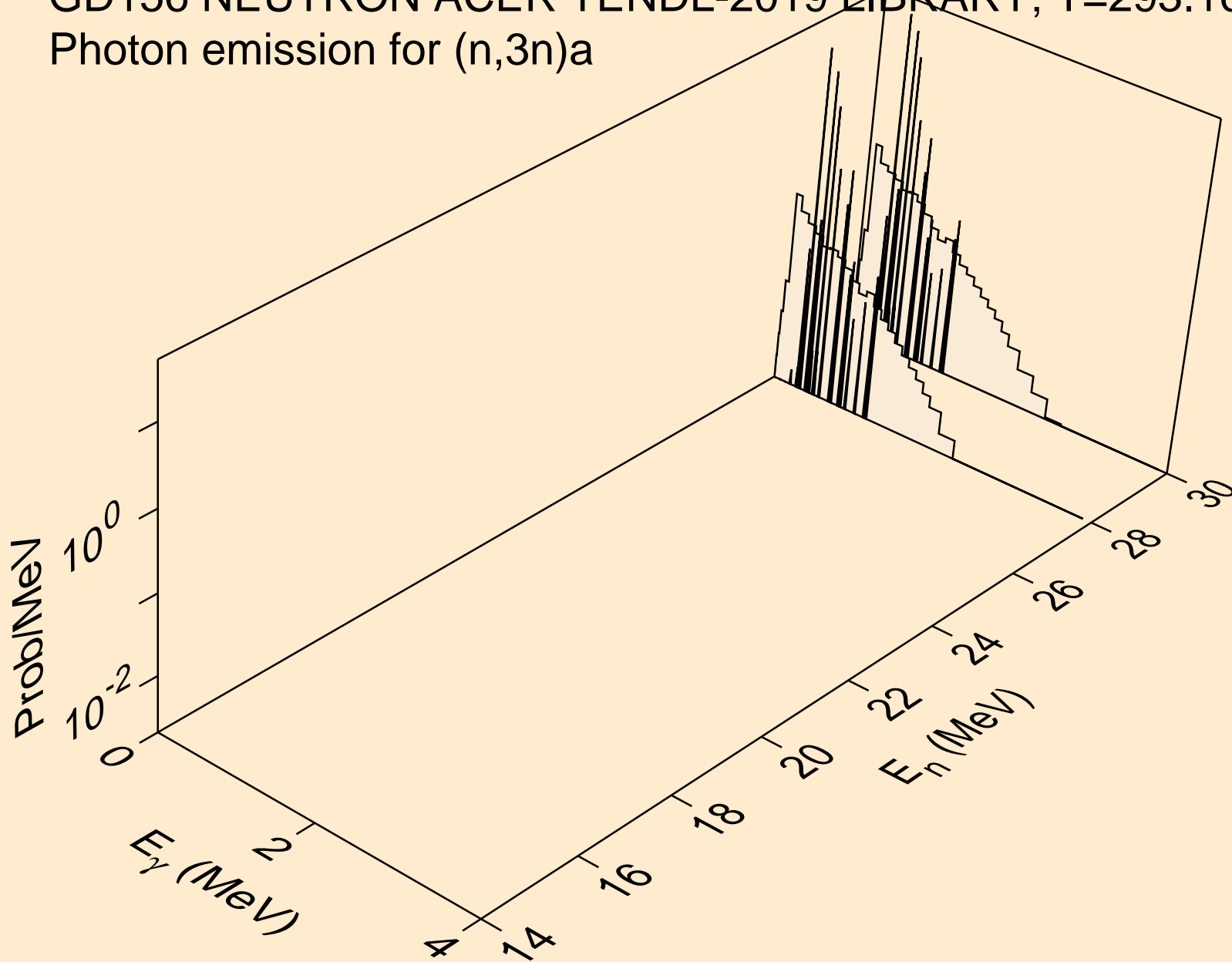

GD156 NEUTRON ACER TENDL-2019 LIBRARY; T=293.16K  
Photon emission for (n,n\*)p

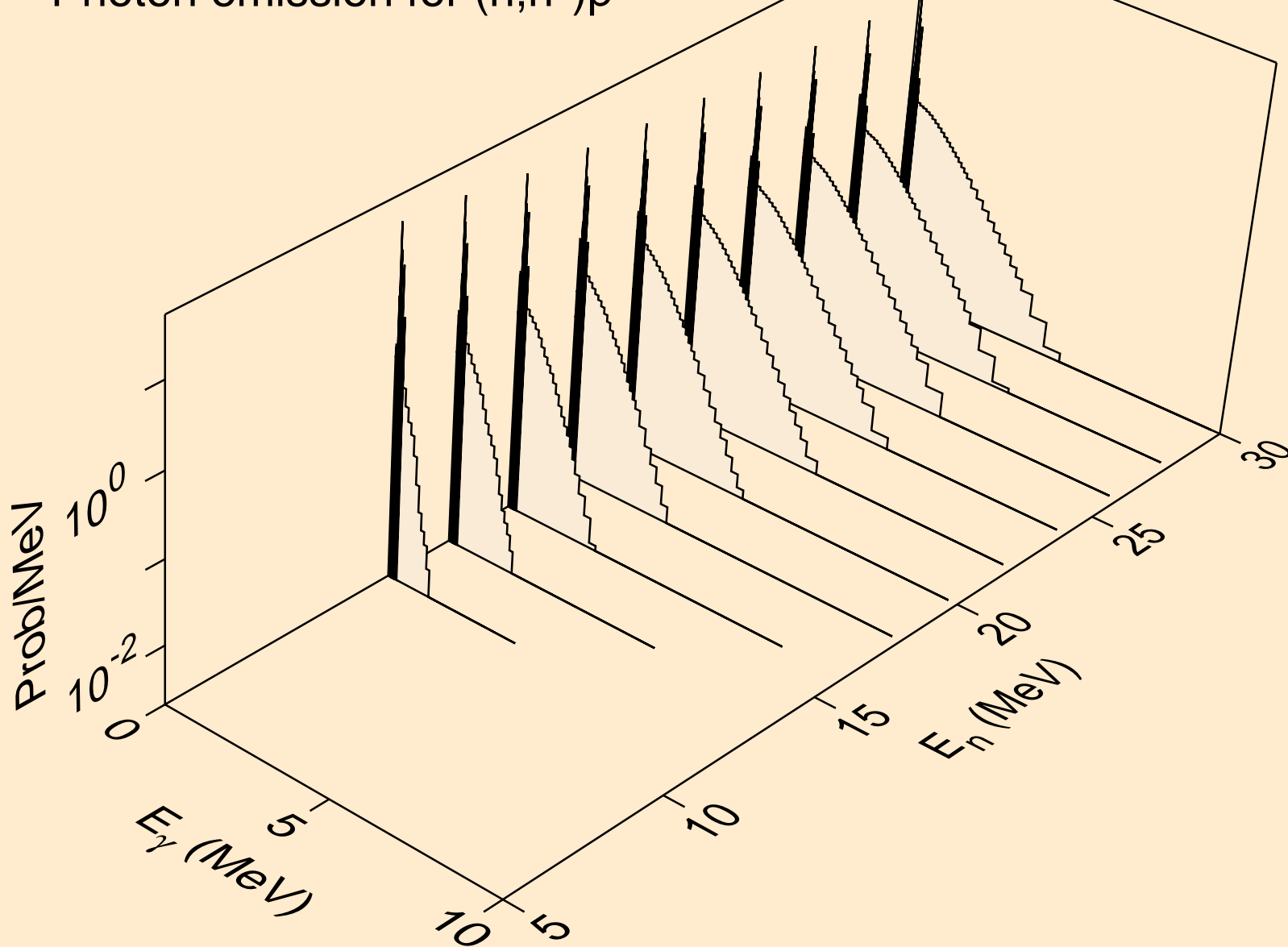

GD156 NEUTRON ACER TENDL-2019 LIBRARY; T=293.16K  
Photon emission for (n,n\*)2a

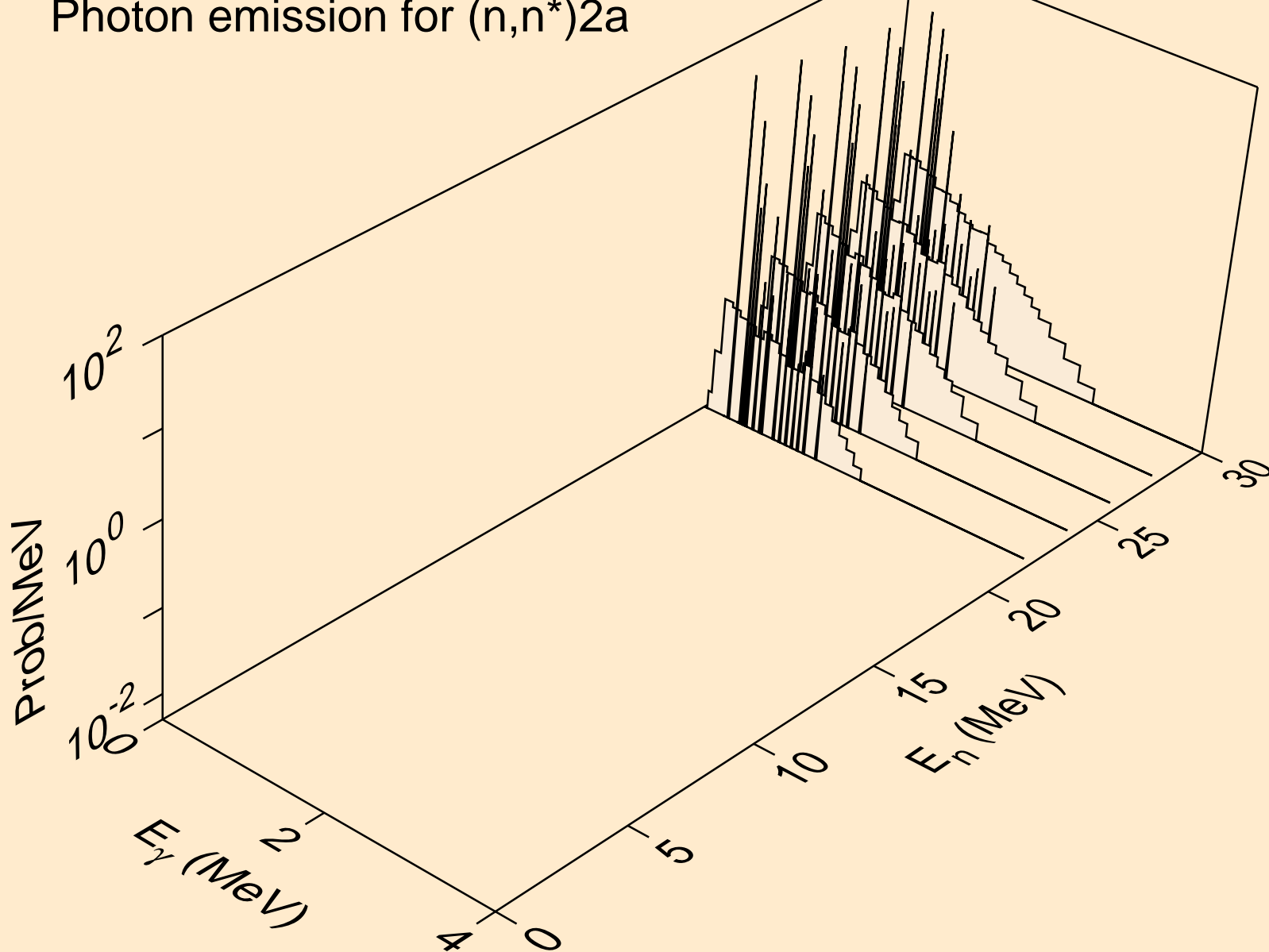

GD156 NEUTRON ACER TENDL-2019 LIBRARY; T=293.16K  
Photon emission for (n,n\*)d

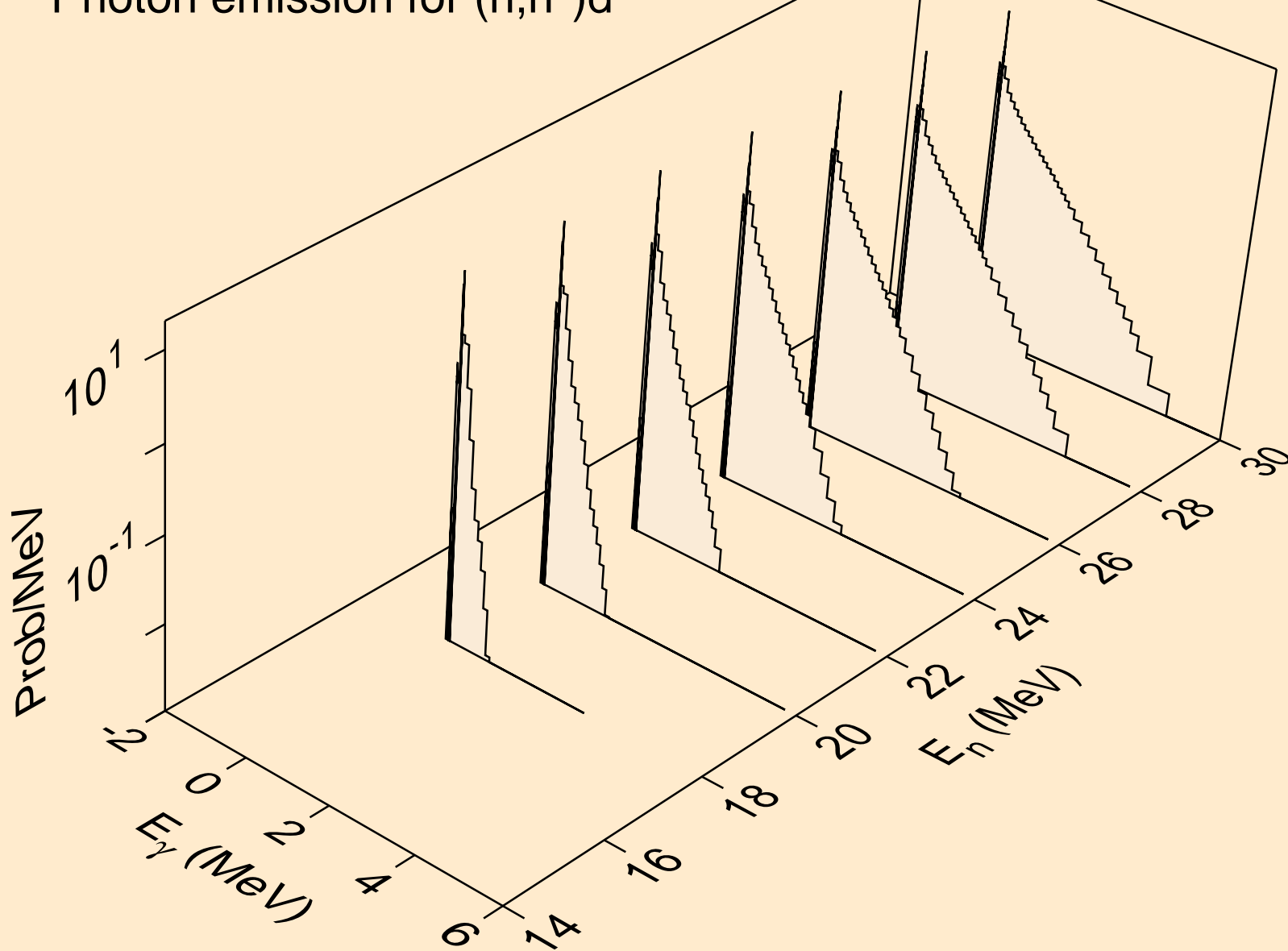



GD156 NEUTRON ACER TENDL-2019 LIBRARY; T=293.16K  
Photon emission for (n,n\*)t

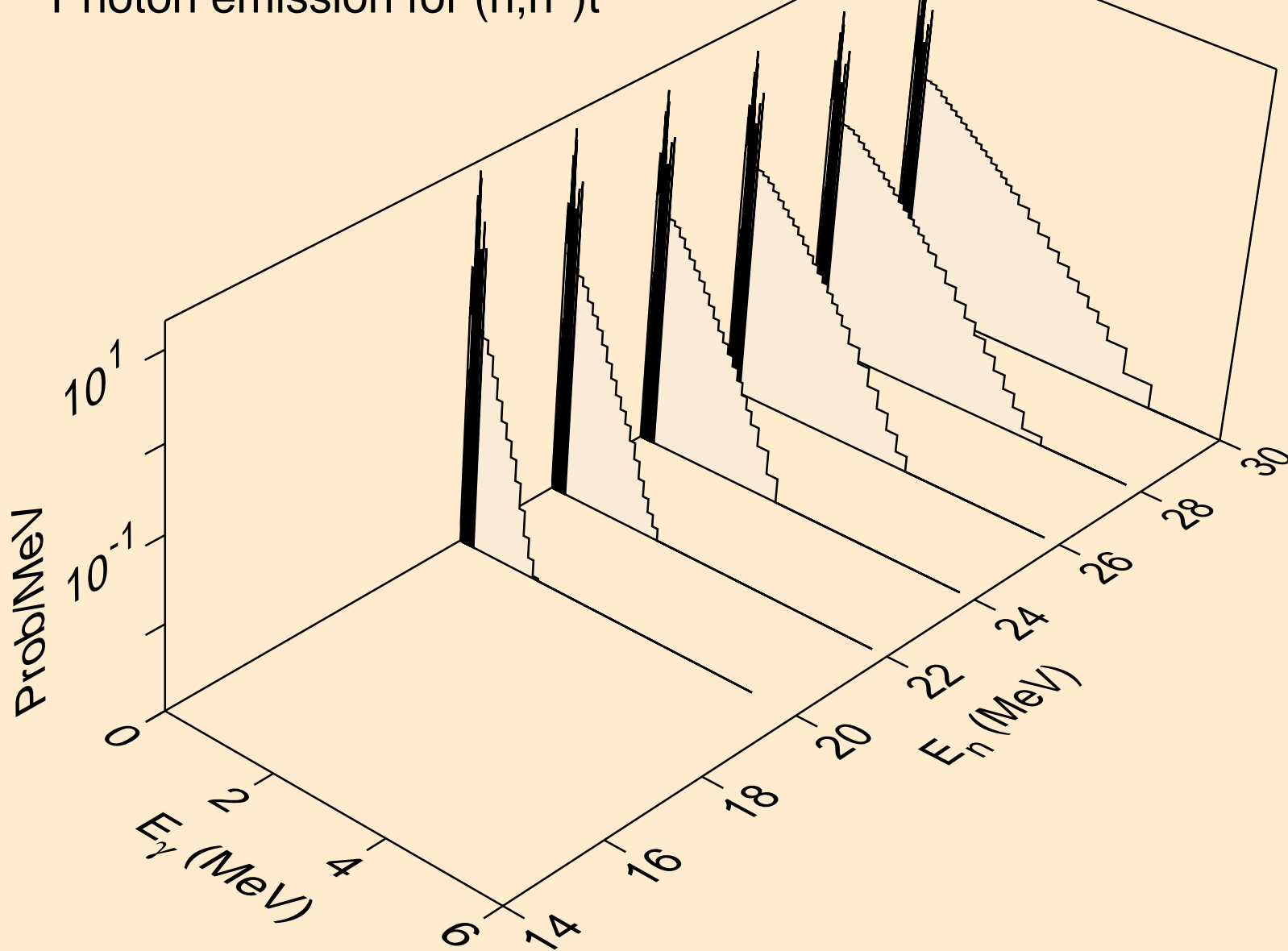

GD156 NEUTRON ACER TENDL-2019 LIBRARY; T=293.16K  
Photon emission for (n,n\*)he3

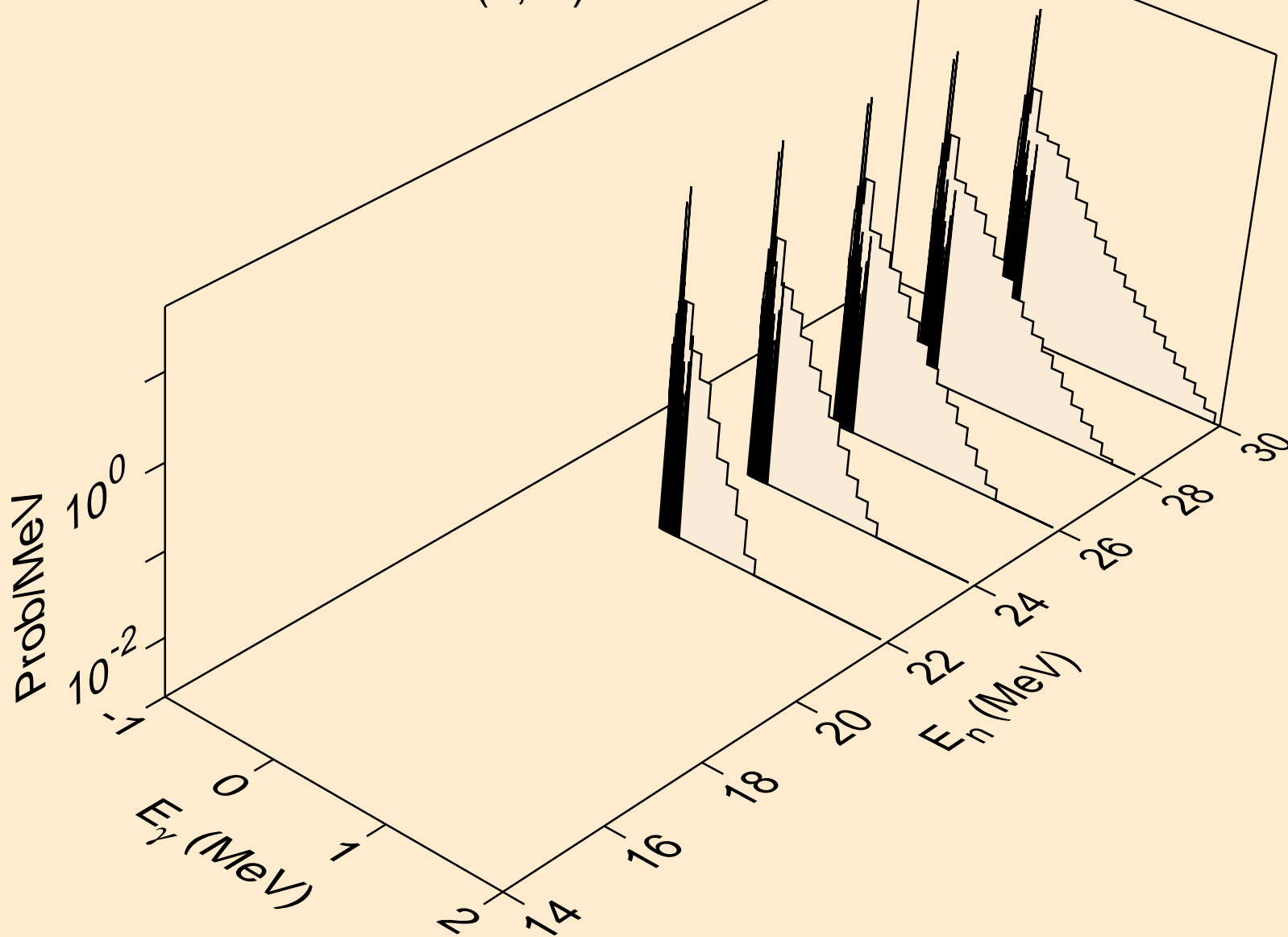

GD156 NEUTRON ACER TENDL-2019 LIBRARY; T=293.16K  
Photon emission for (n,4n)

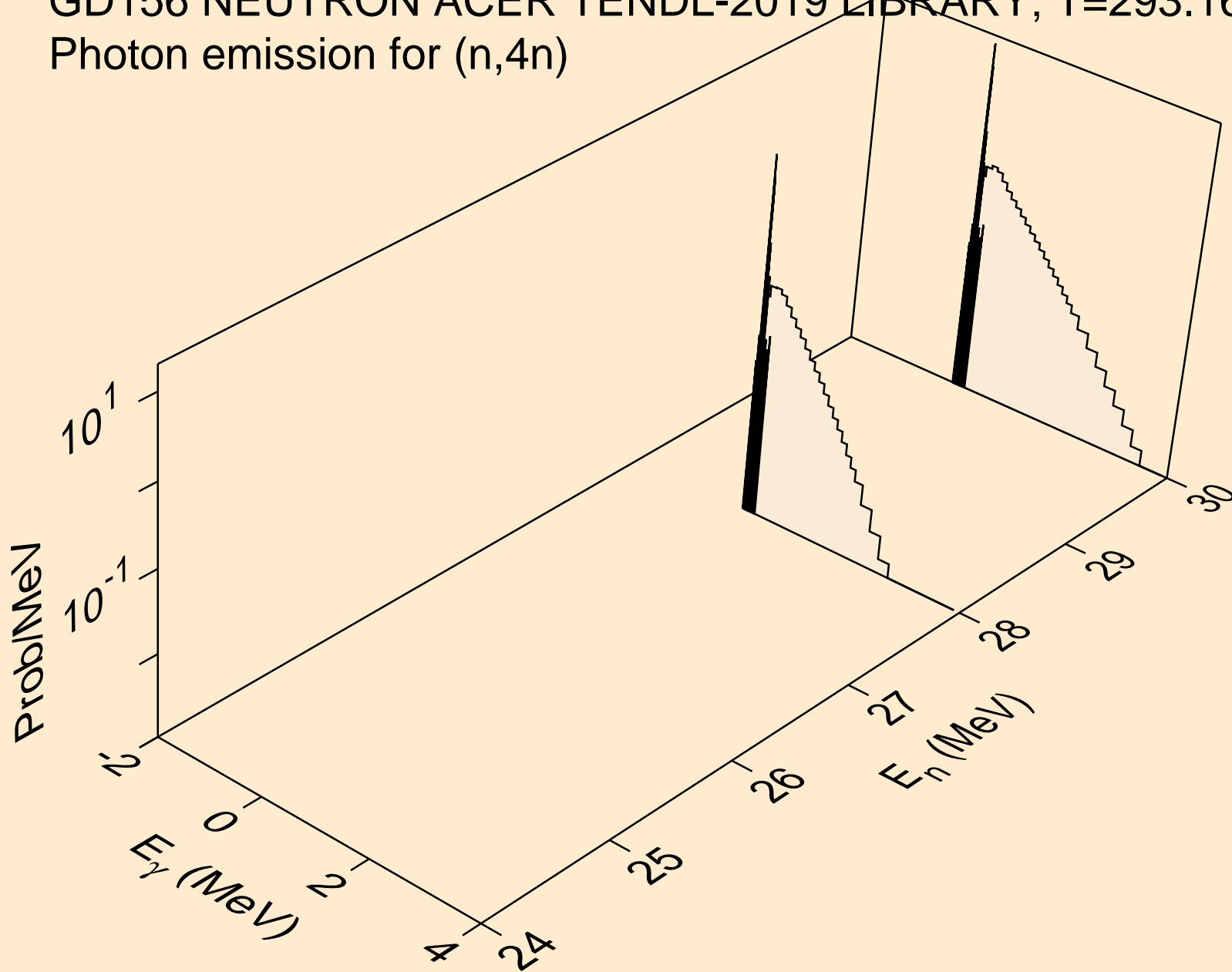

GD156 NEUTRON ACER TENDL-2019 LIBRARY; T=293.16K  
Photon emission for (n,2np)

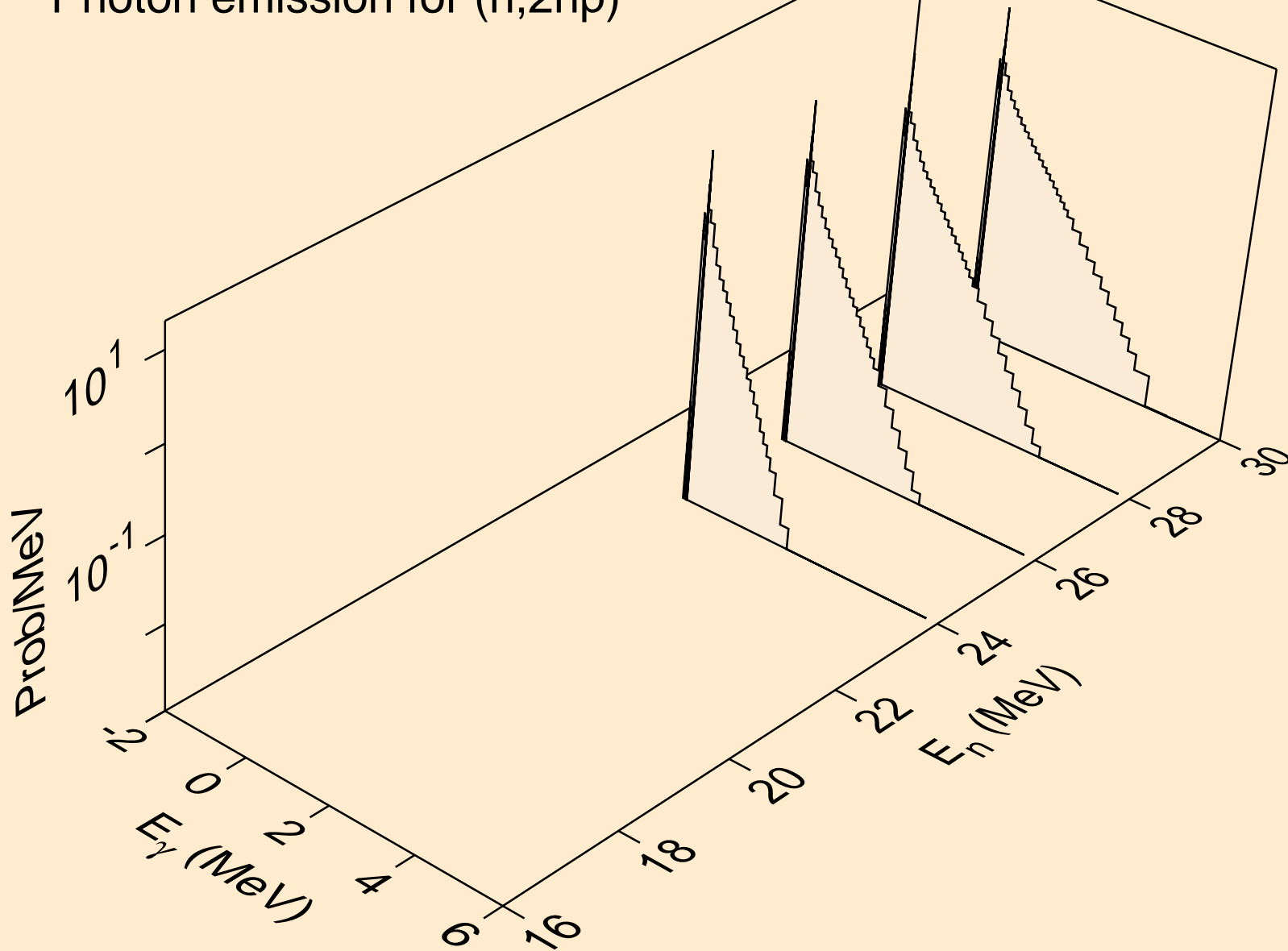

GD156 NEUTRON ACER TENDL-2019 LIBRARY; T=293.16K  
Photon emission for (n,3np)

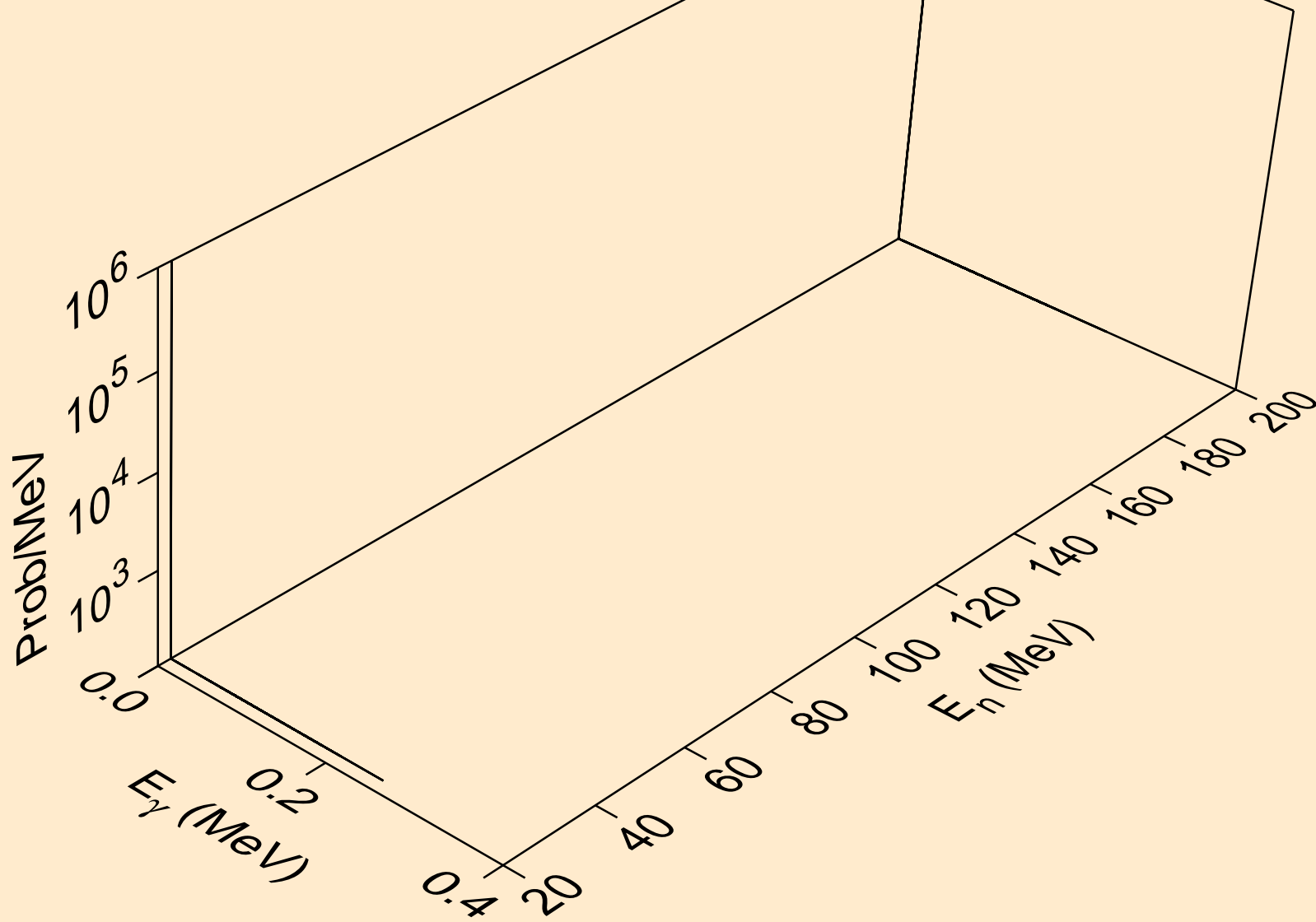

GD156 NEUTRON ACER TENDL-2019 LIBRARY; T=293.16K  
Photon emission for (n,2np)

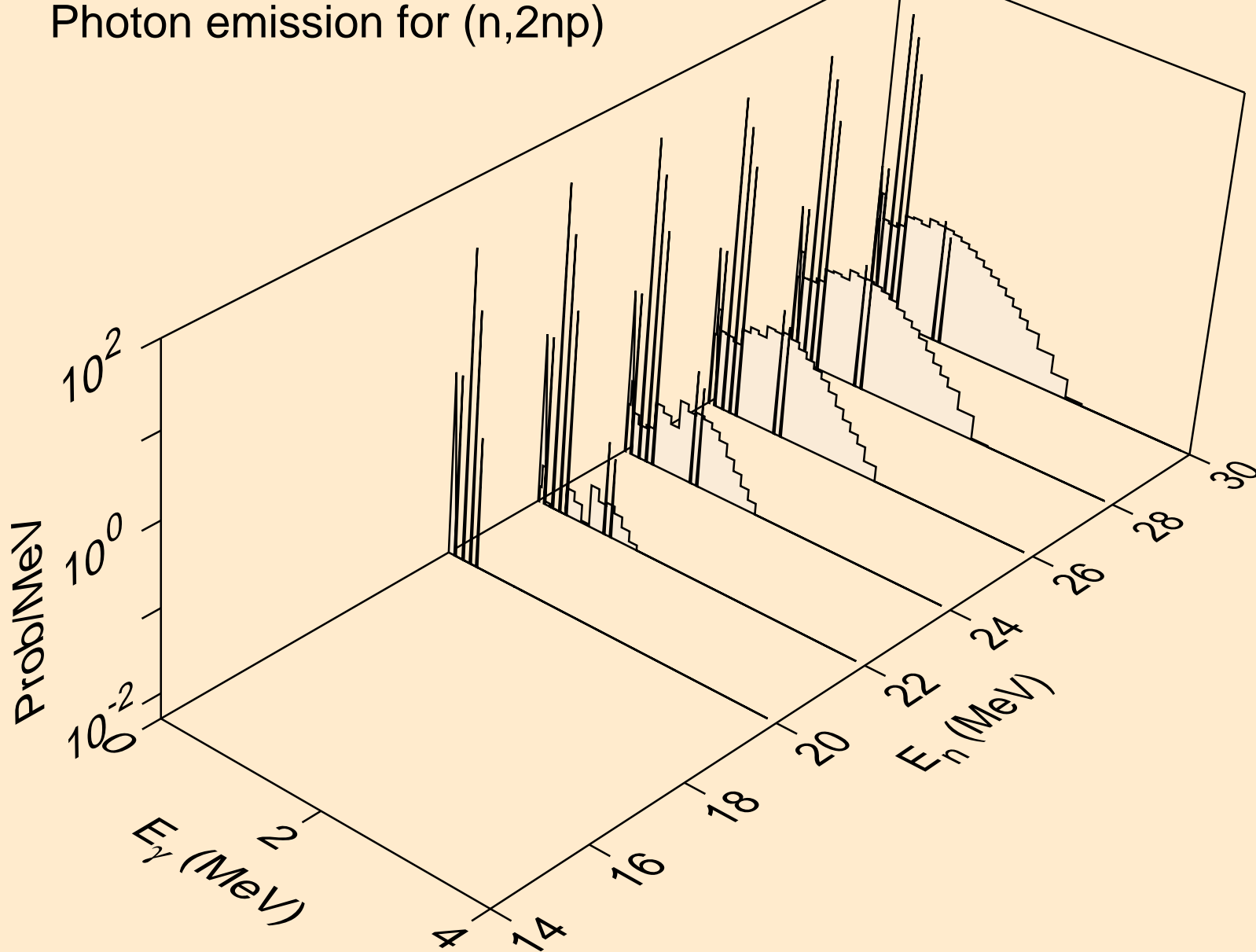

GD156 NEUTRON ACER TENDL-2019 LIBRARY; T=293.16K  
Photon emission for (n,npa)

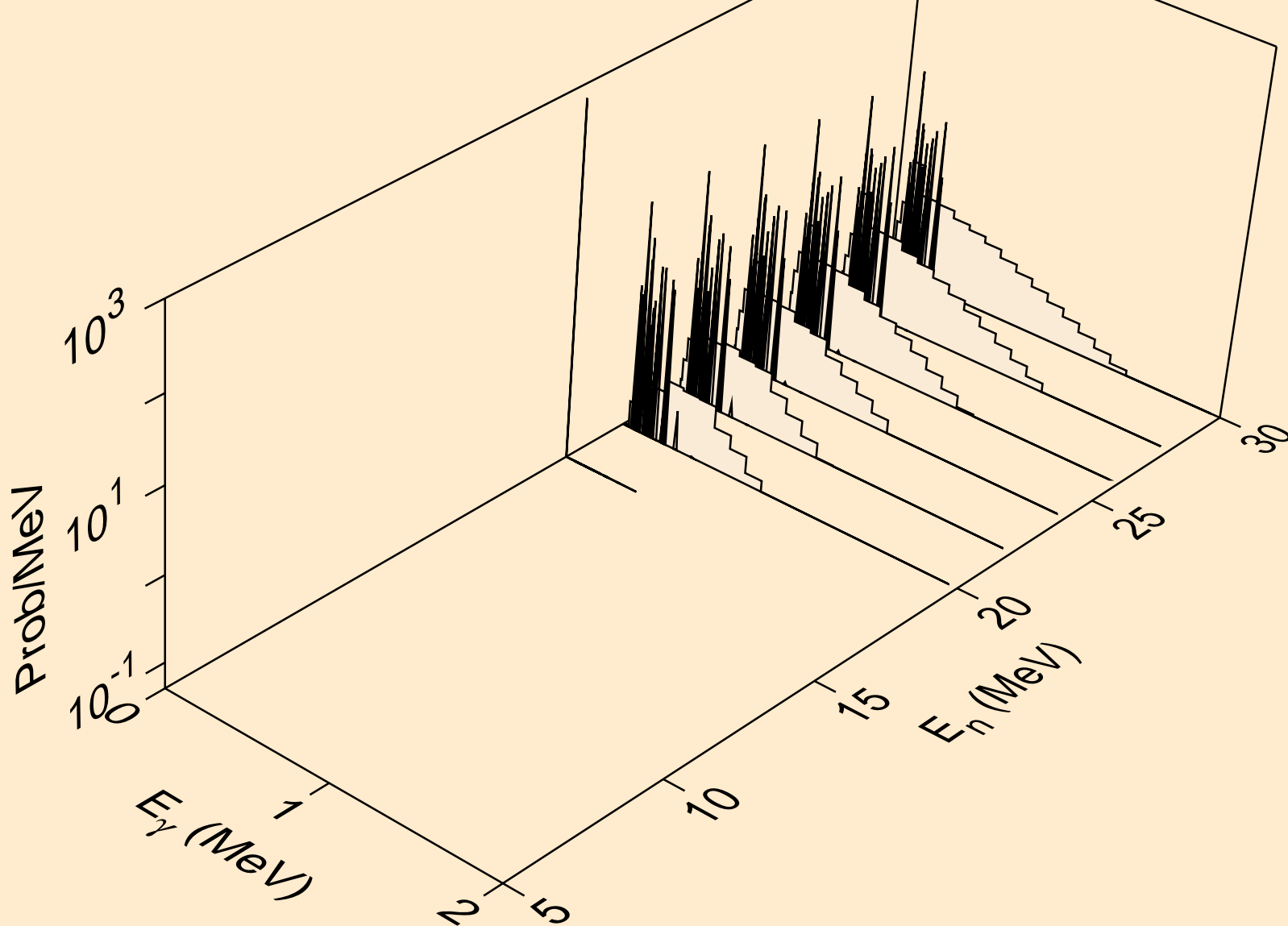

GD156 NEUTRON ACER TENDL-2019 LIBRARY; T=293.16K  
Photon emission for (n,n\*c)

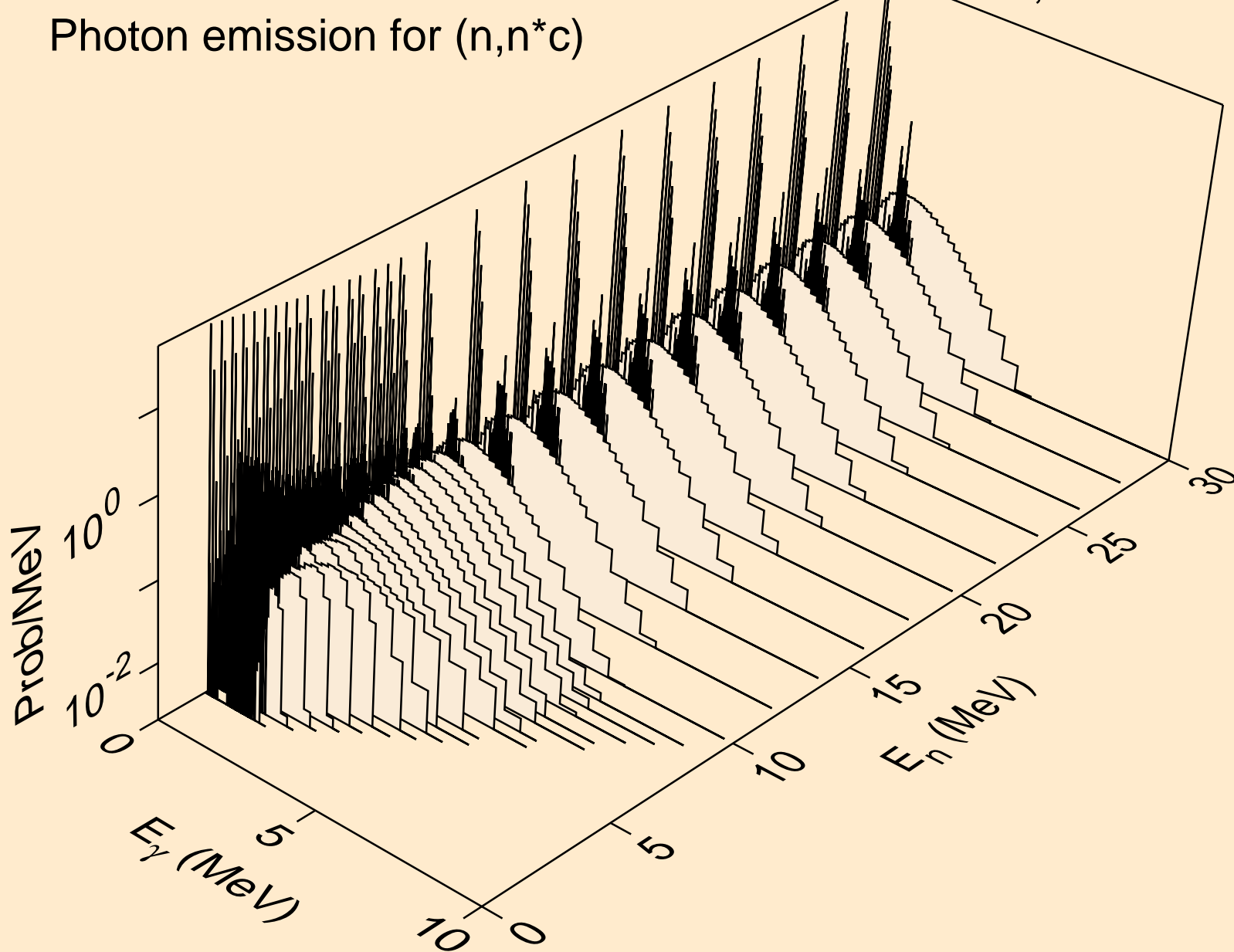



GD156 NEUTRON ACER TENDL-2019 LIBRARY; T=293.16K  
Photon emission for (n,gma)

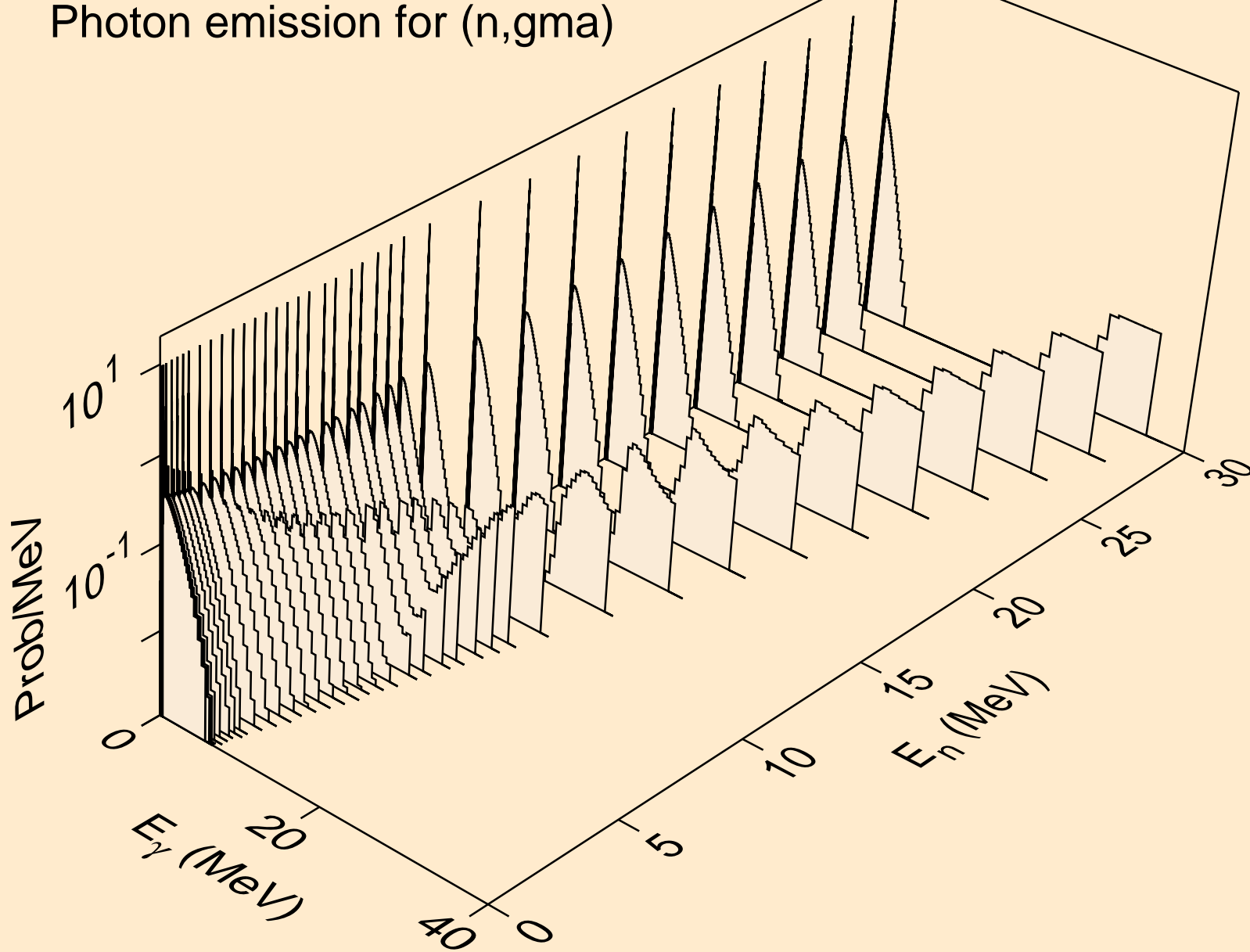

GD156 NEUTRON ACER TENDL-2019 LIBRARY; T=293.16K  
Photon emission for (n,p)

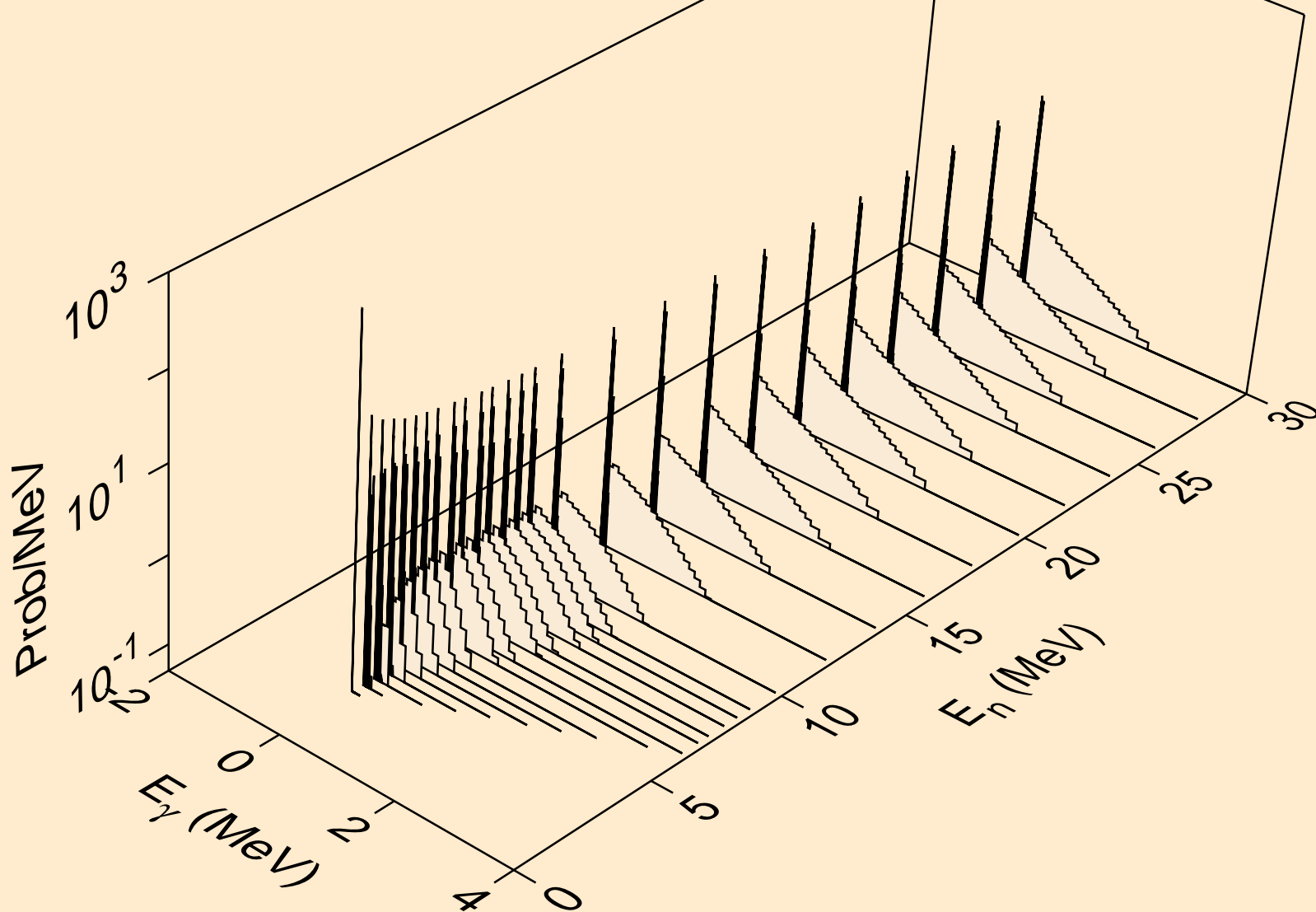

GD156 NEUTRON ACER TENDL-2019 LIBRARY; T=293.16K  
Photon emission for (n,d)

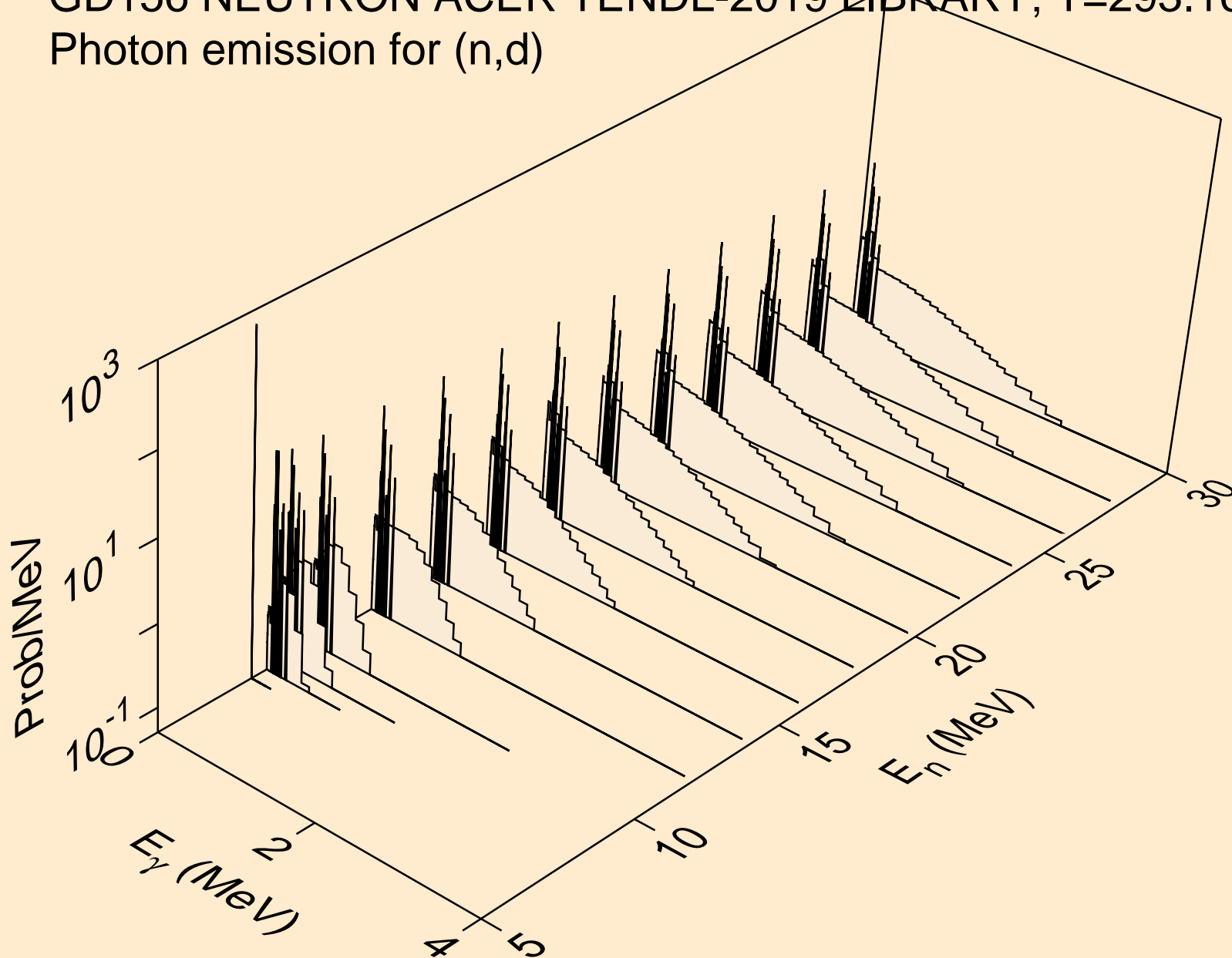

GD156 NEUTRON ACER TENDL-2019 LIBRARY; T=293.16K  
Photon emission for (n,t)

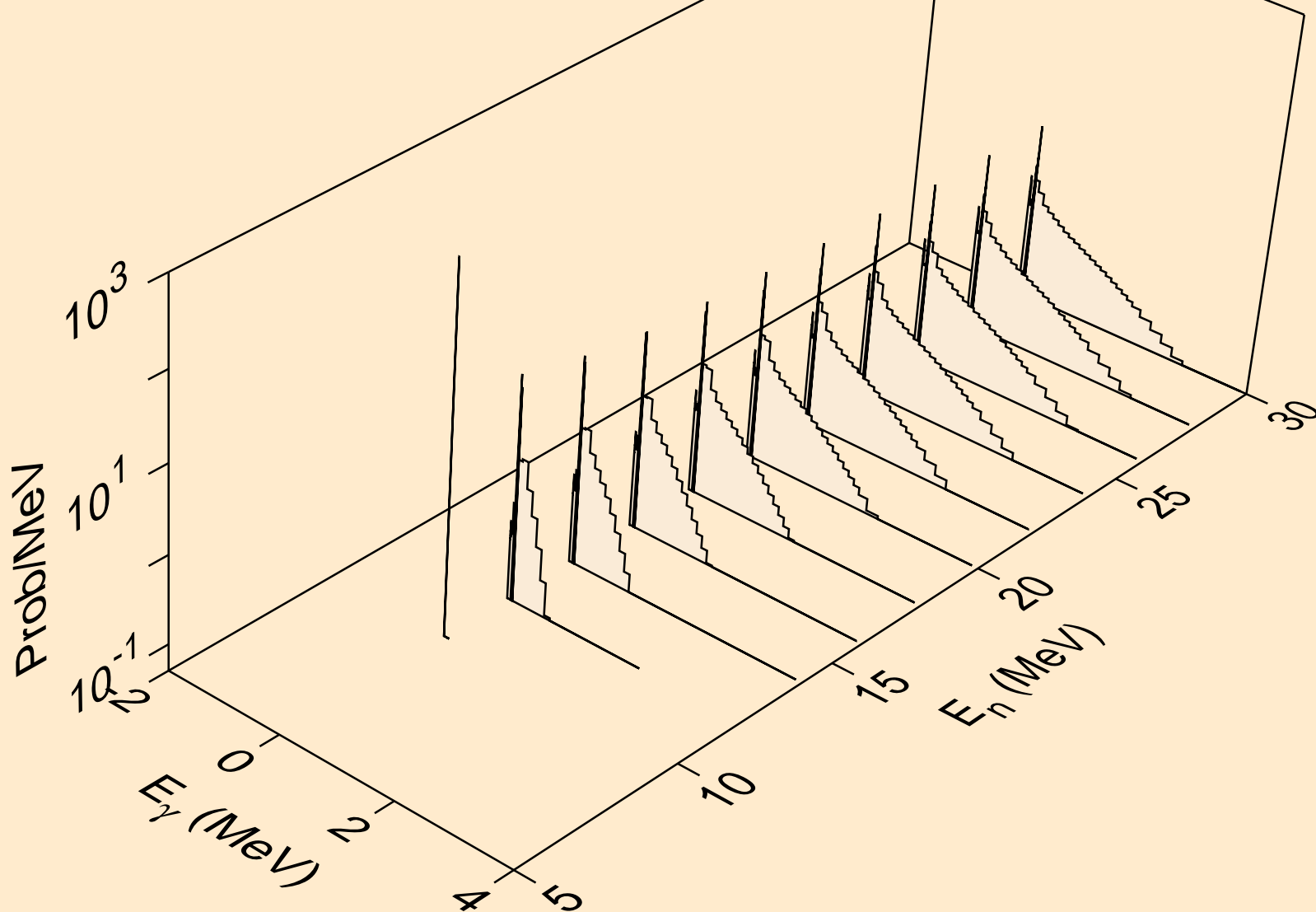

GD156 NEUTRON ACER TENDL-2019 LIBRARY; T=293.16K  
Photon emission for (n,he3)

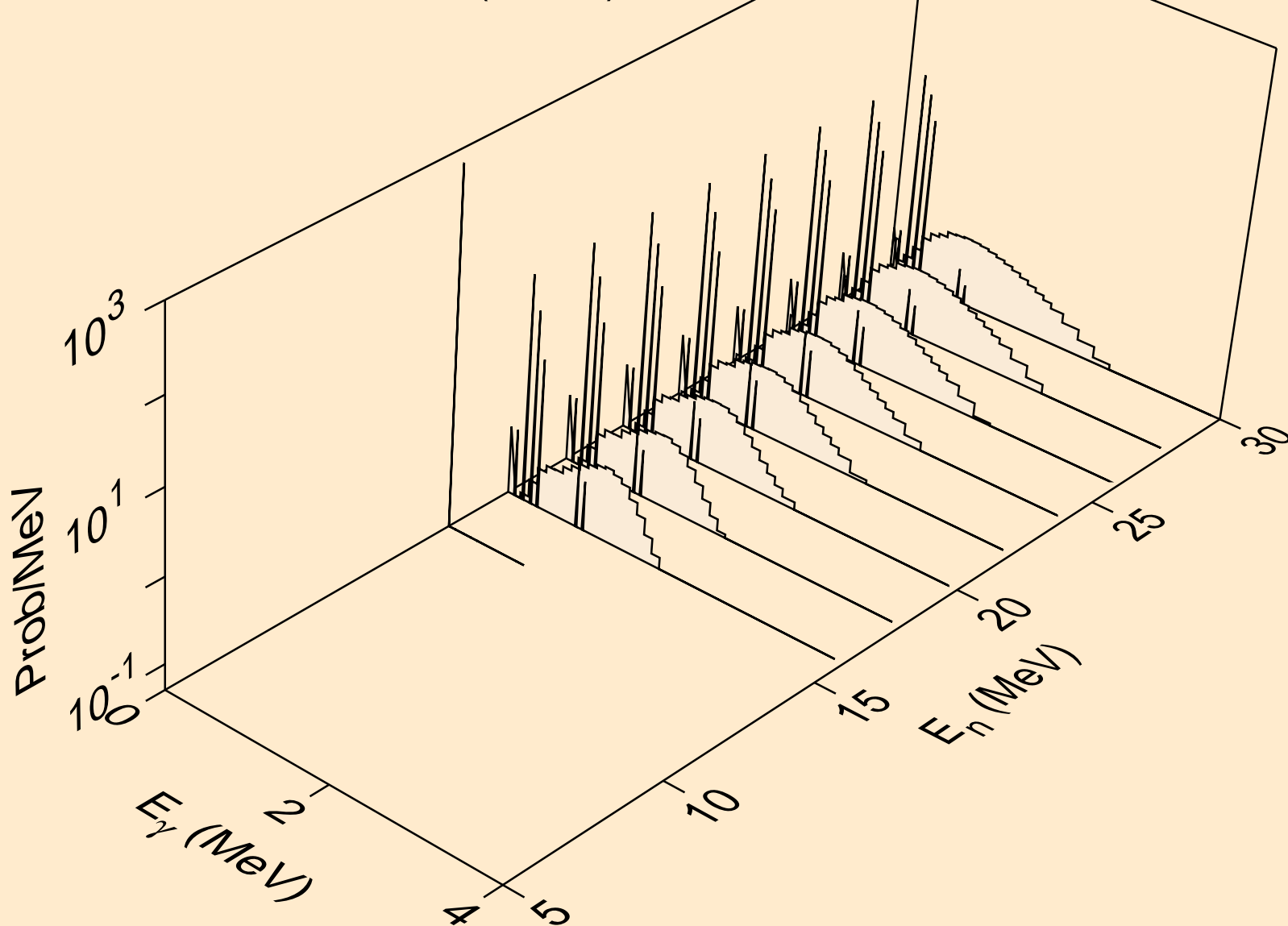

GD156 NEUTRON ACER TENDL-2019 LIBRARY; T=293.16K  
Photon emission for (n,a)

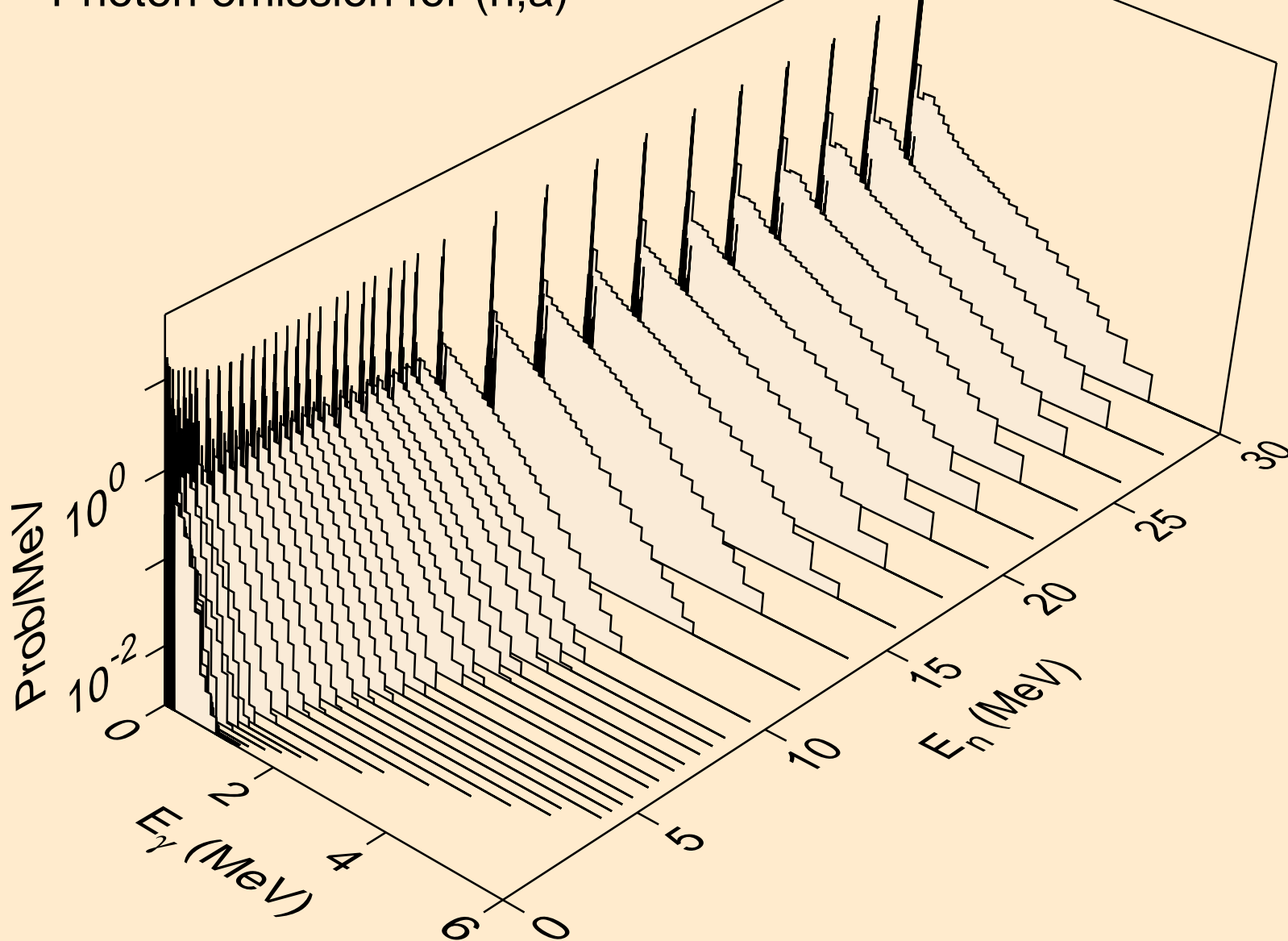

GD156 NEUTRON ACER TENDL-2019 LIBRARY; T=293.16K  
Photon emission for (n,2a)

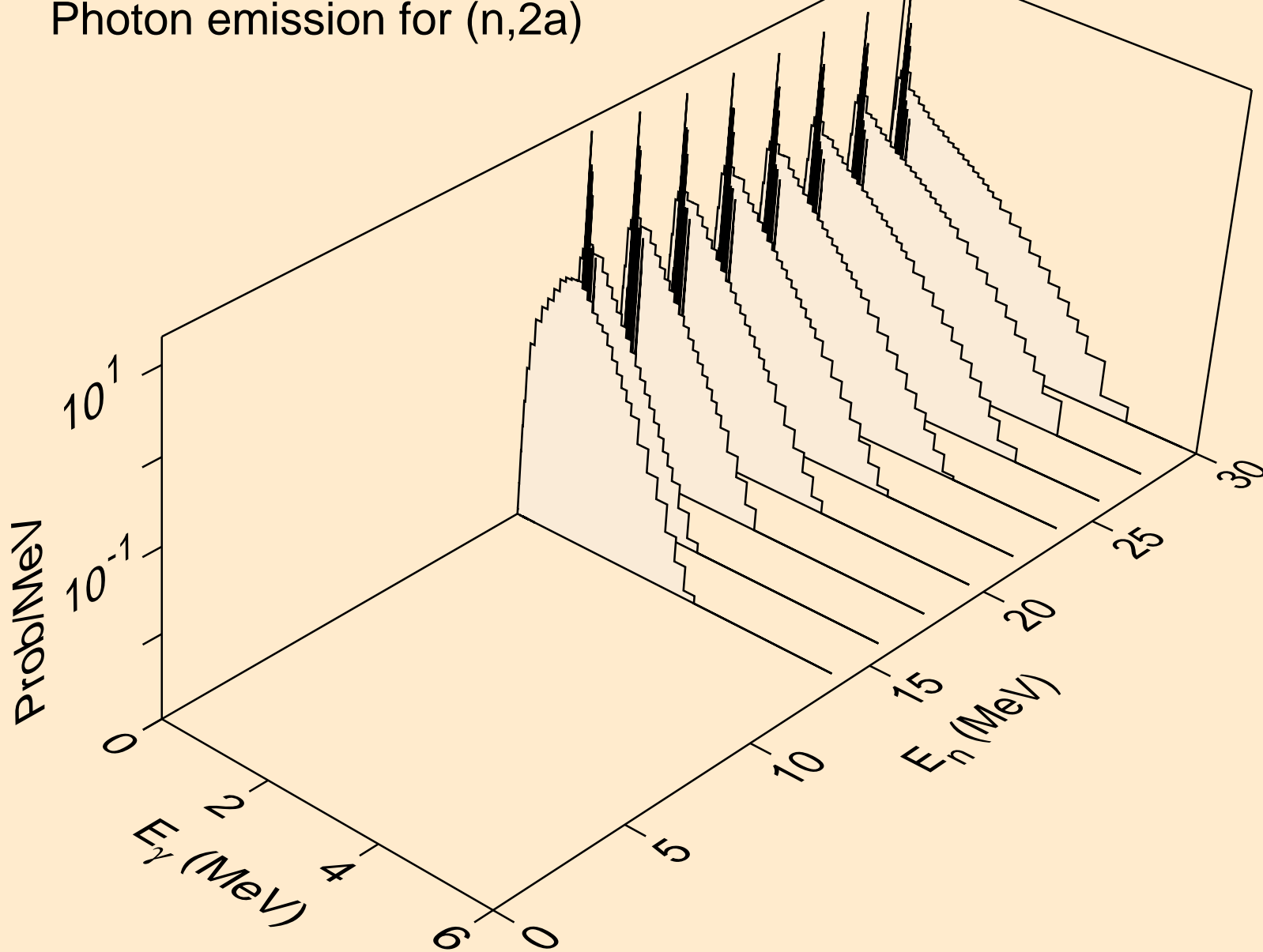

GD156 NEUTRON ACER TENDL-2019 LIBRARY; T=293.16K  
Photon emission for (n,2p)

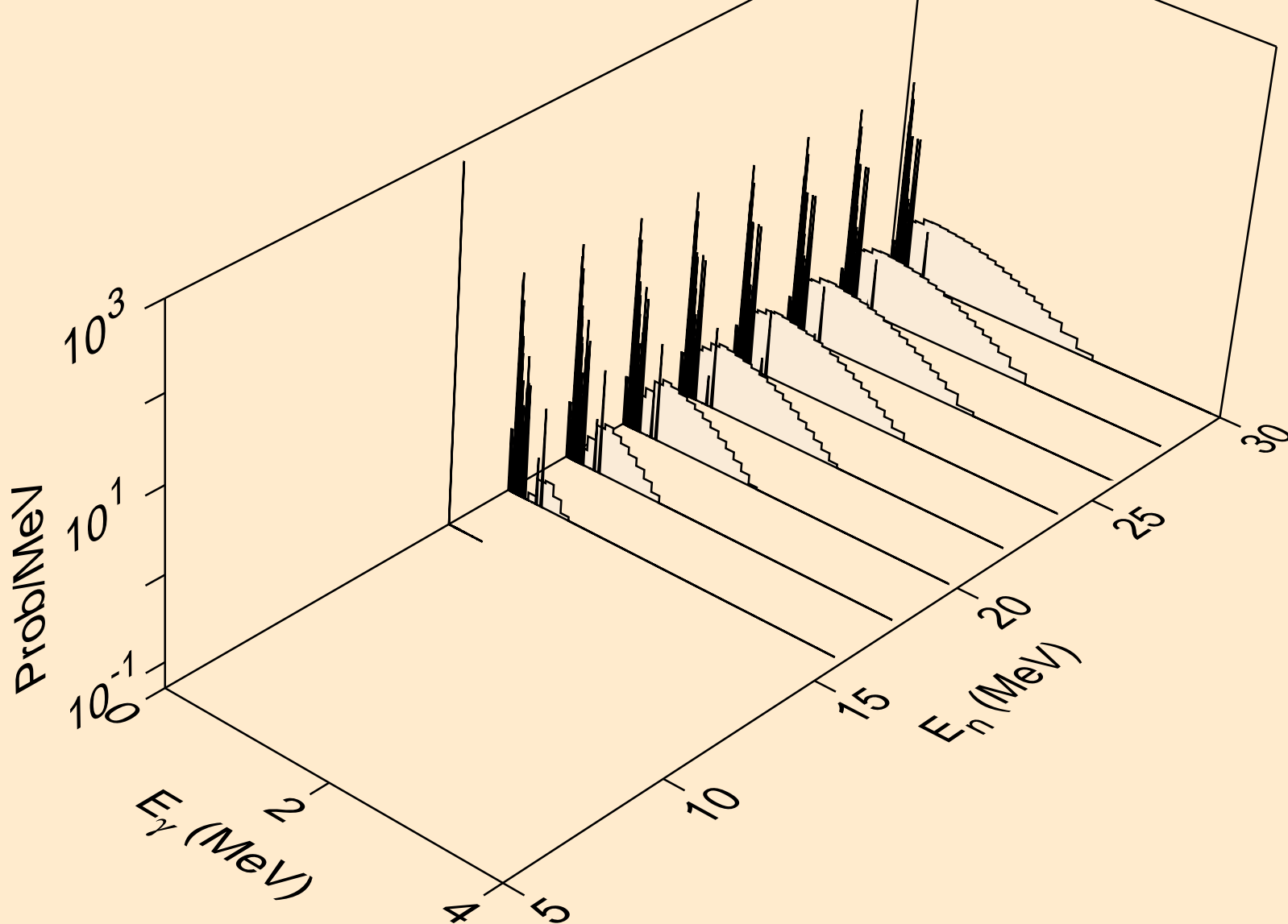



GD156 NEUTRON ACER TENDL-2019 LIBRARY; T=293.16K  
Photon emission for (n,p)

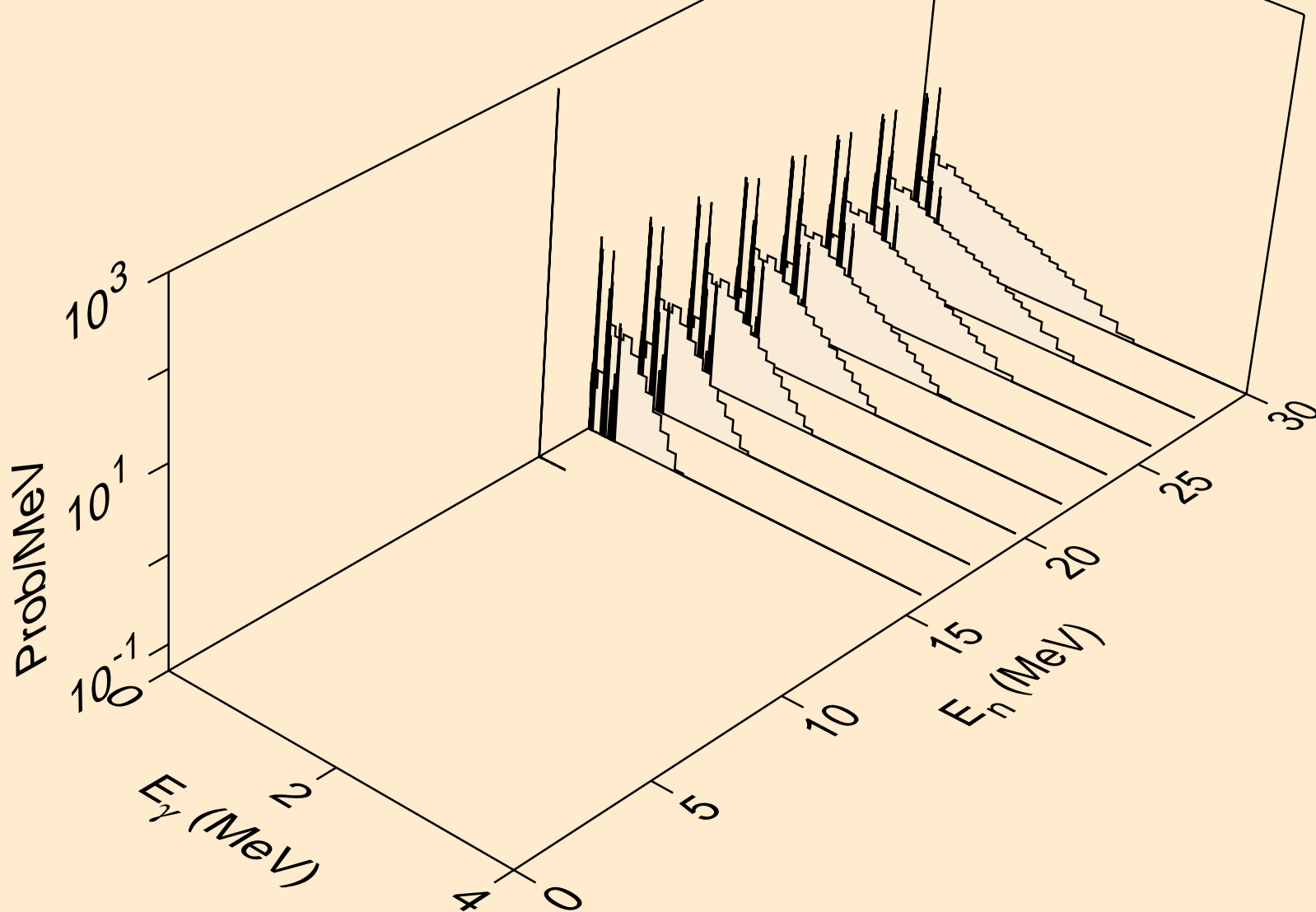

GD156 NEUTRON ACER TENDL-2019 LIBRARY; T=293.16K  
Photon emission for (n,pd)

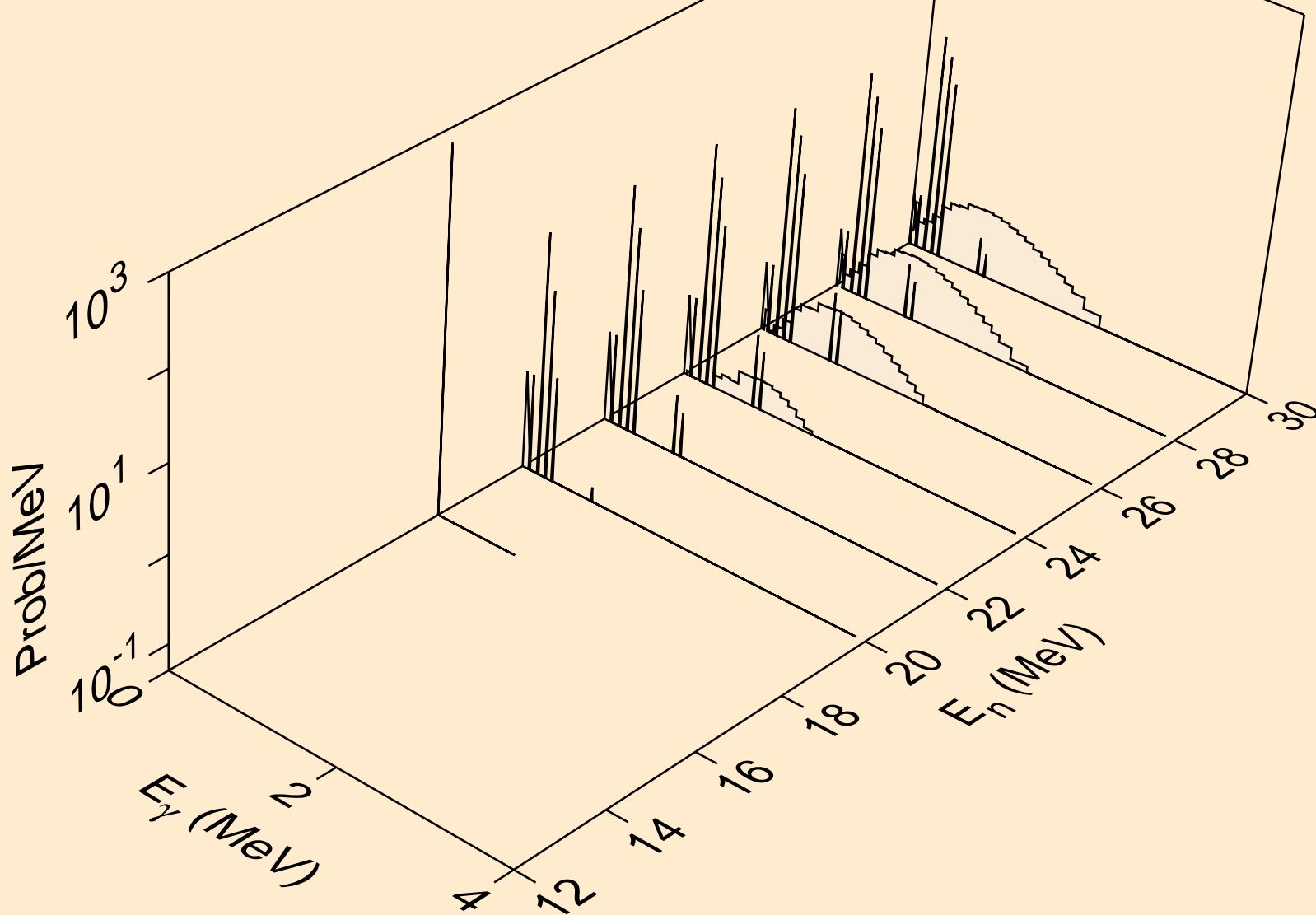

GD156 NEUTRON ACER TENDL-2019 LIBRARY; T=293.16K  
Photon emission for (n,pt)

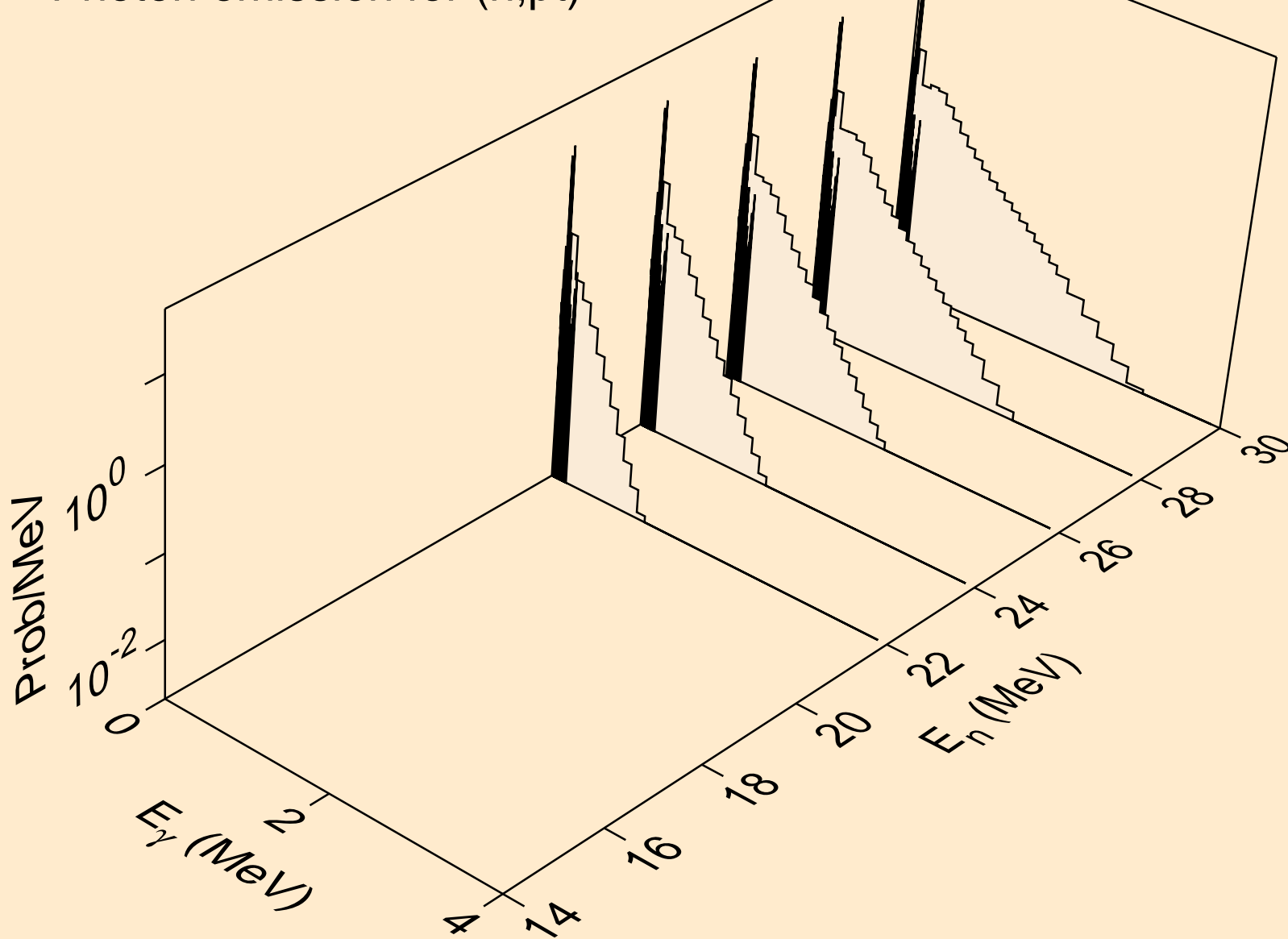

GD156 NEUTRON ACER TENDL-2019 LIBRARY; T=293.16K  
Photon emission for (n,da)

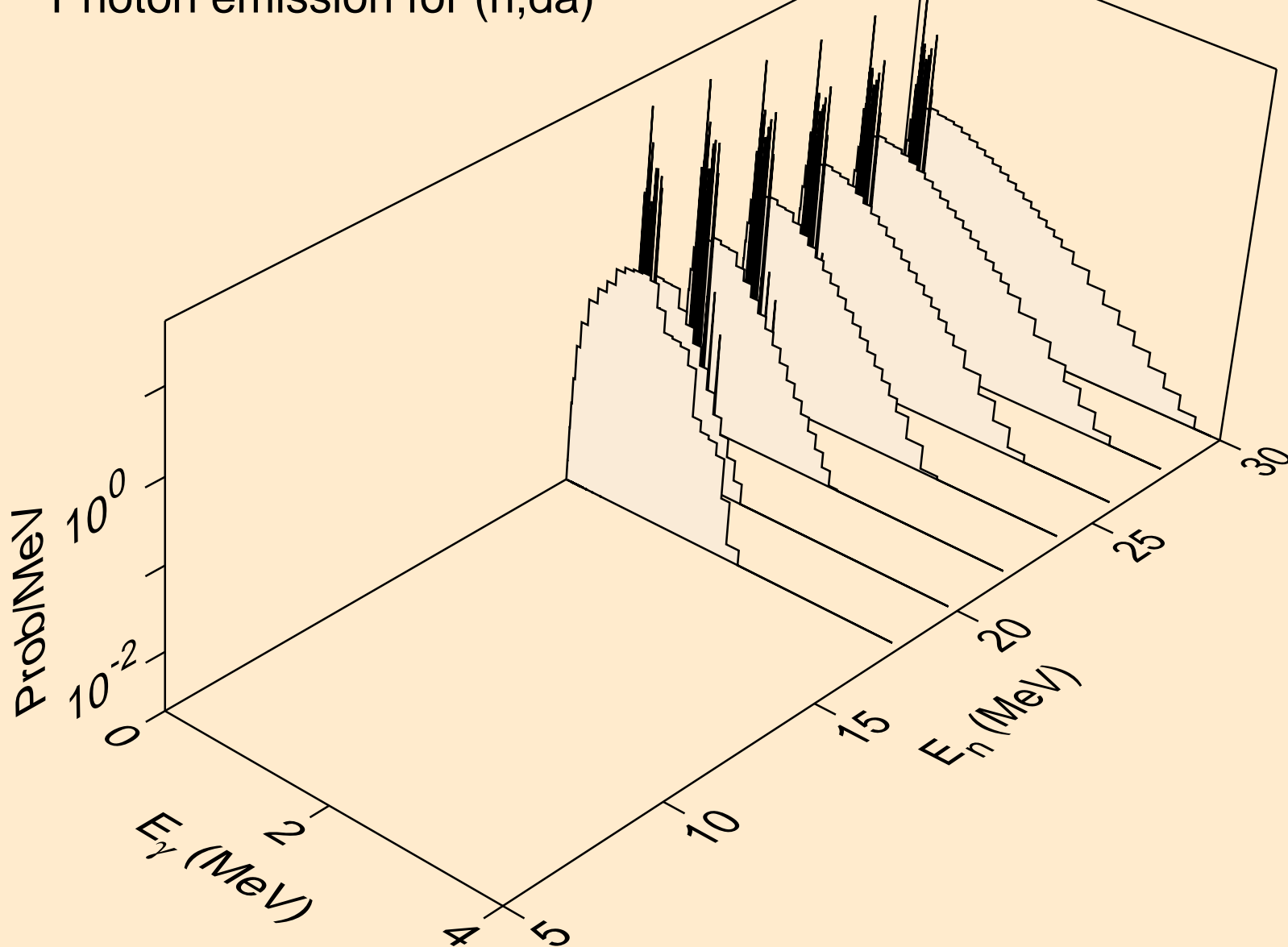

GD156 NEUTRON ACER TENDL-2019 LIBRARY; T=293.16K  
thermal capture photon spectrum

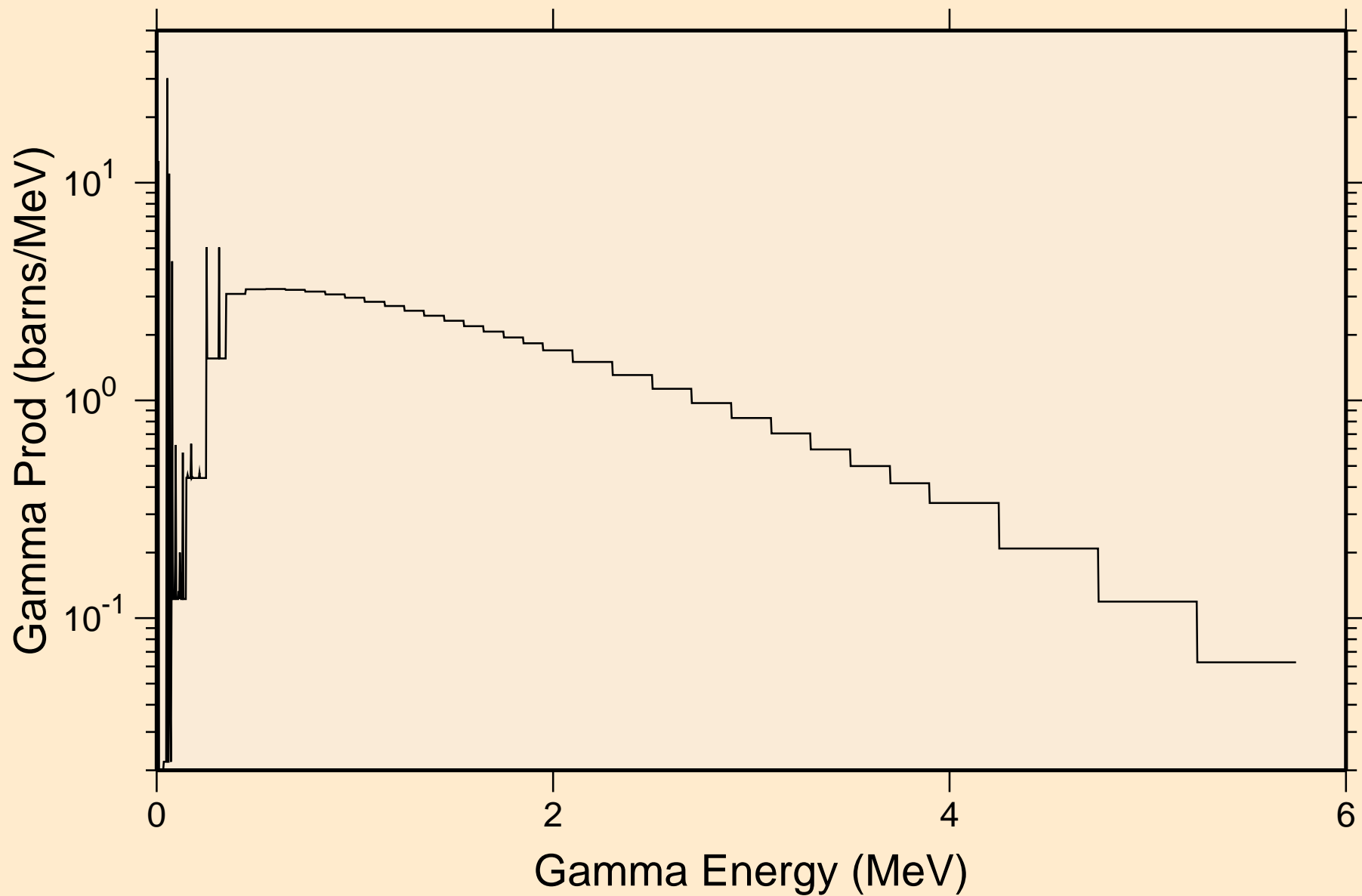

GD156 NEUTRON ACER TENDL-2019 LIBRARY; T=293.16K  
14 MeV photon spectrum

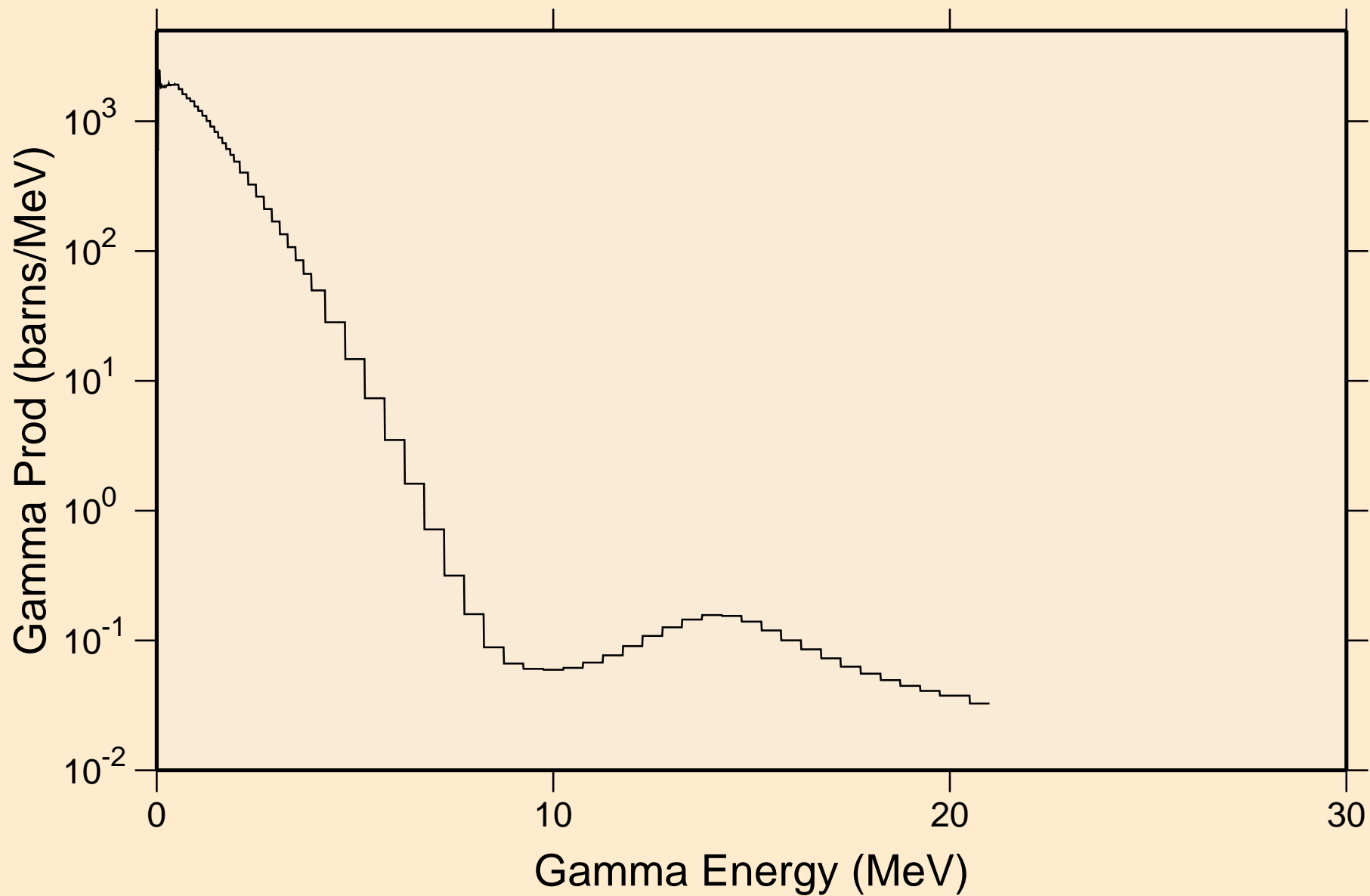

# GD156 NEUTRON ACER TENDL-2019 LIBRARY; T=293.16K

## Particle heating contributions

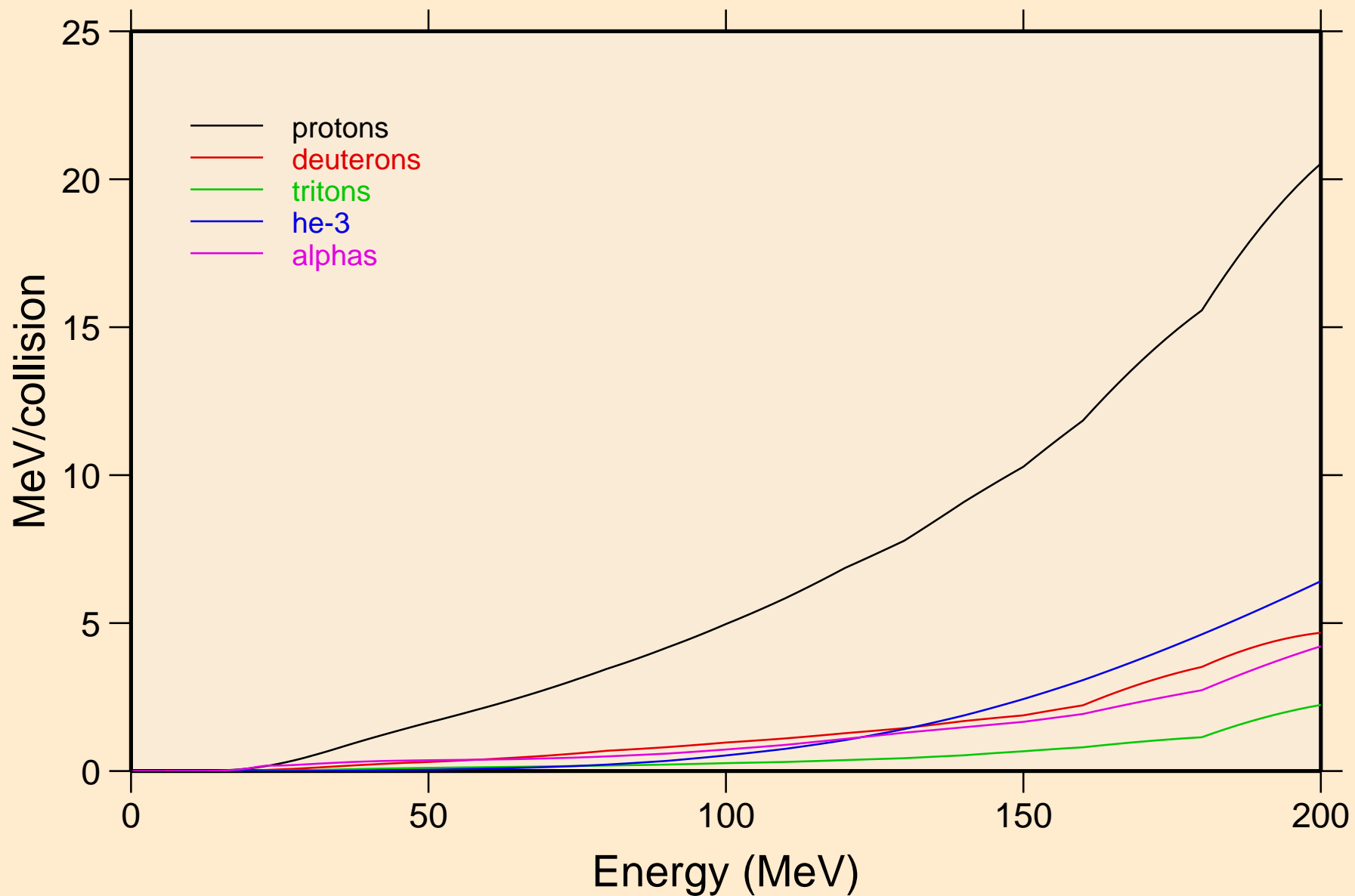

# GD156 NEUTRON ACER TENDL-2019 LIBRARY; T=293.16K

## Recoil Heating

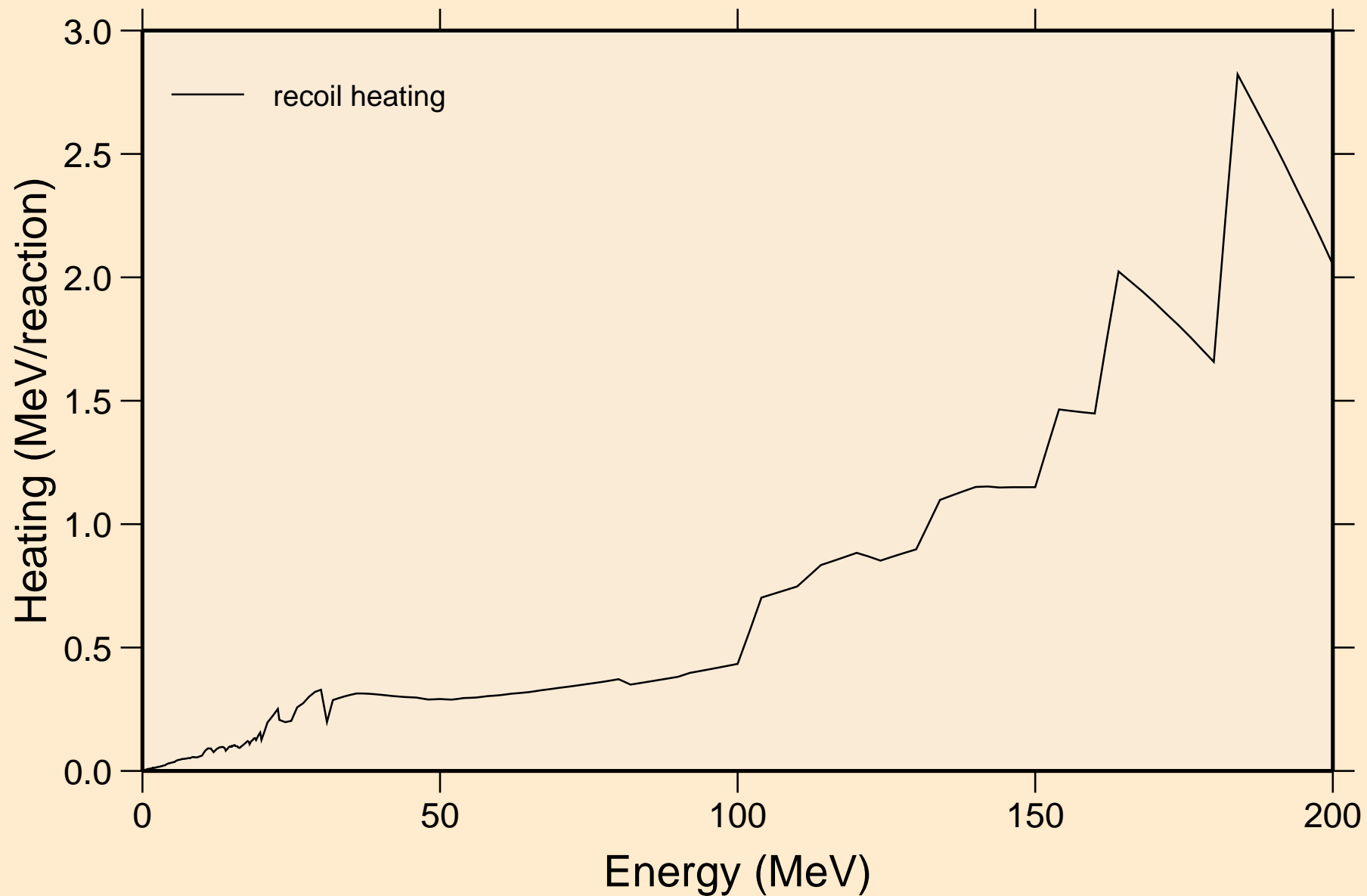



# GD156 NEUTRON ACER TENDL-2019 LIBRARY; T=293.16K

## Particle production cross sections

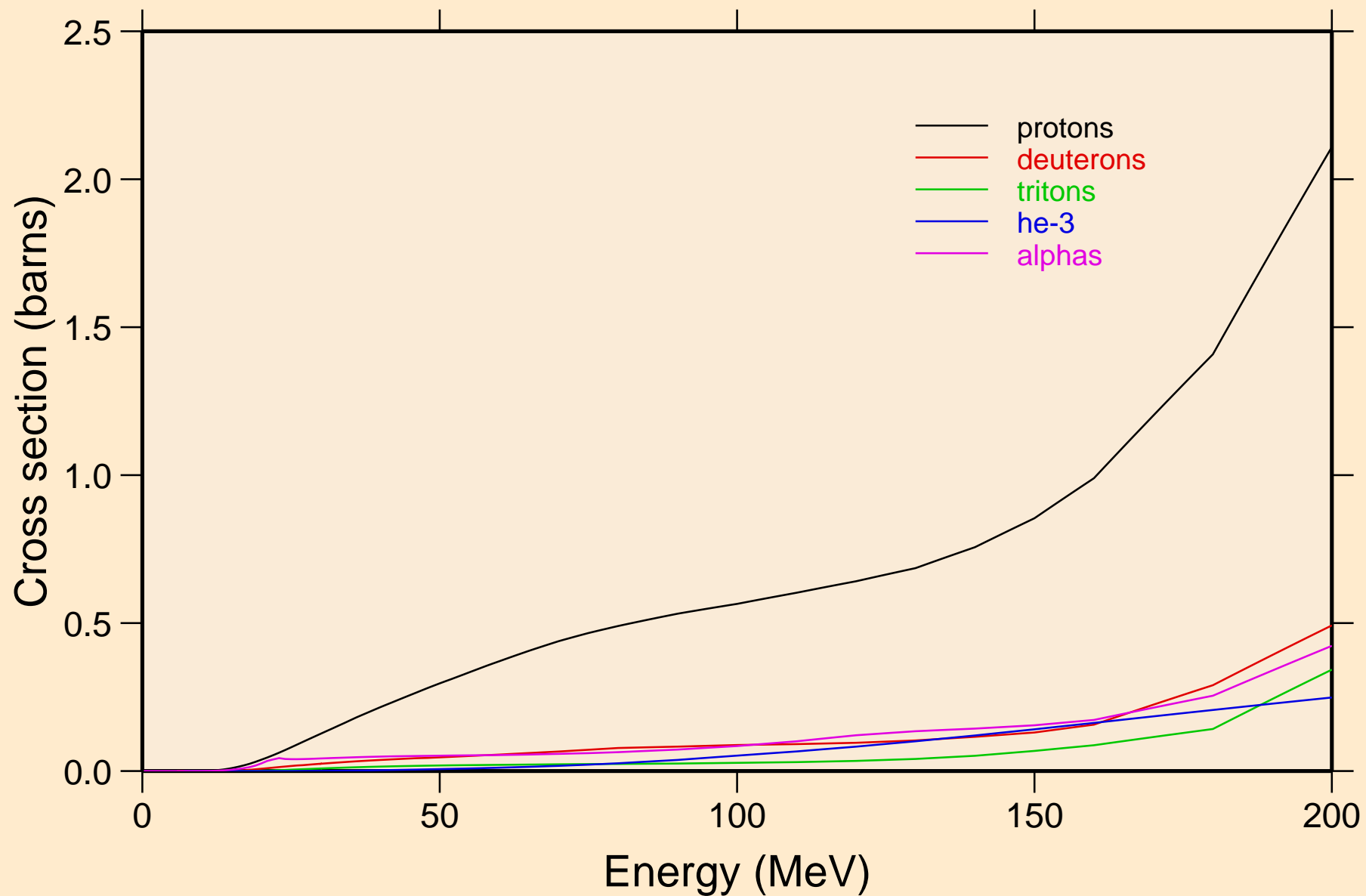

GD156 NEUTRON ACER TENDL-2019 LIBRARY; T=293.16K  
protons from (n,x)

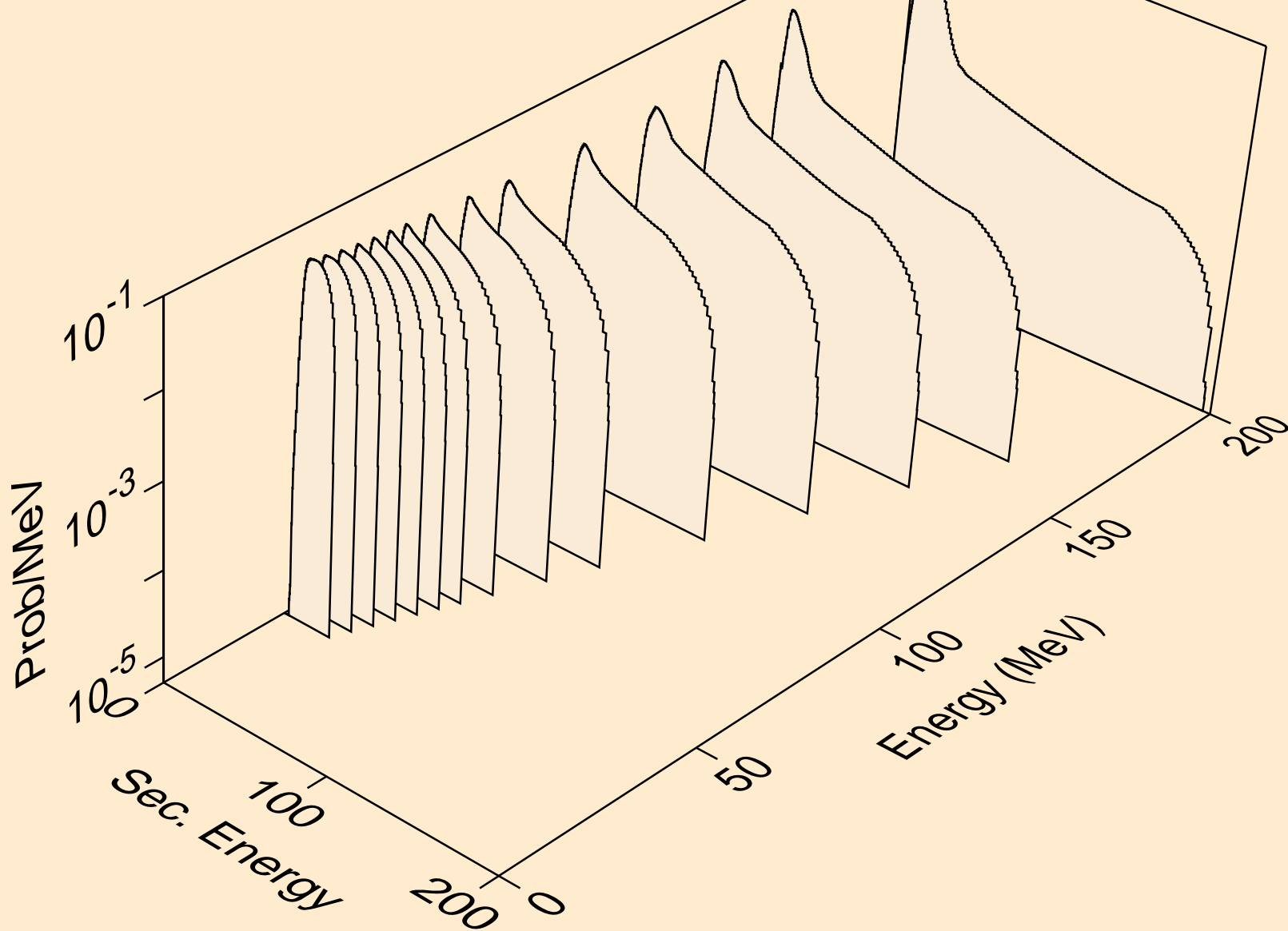

GD156 NEUTRON ACER TENDL-2019 LIBRARY; T=293.16K  
protons from (n,n\*)p

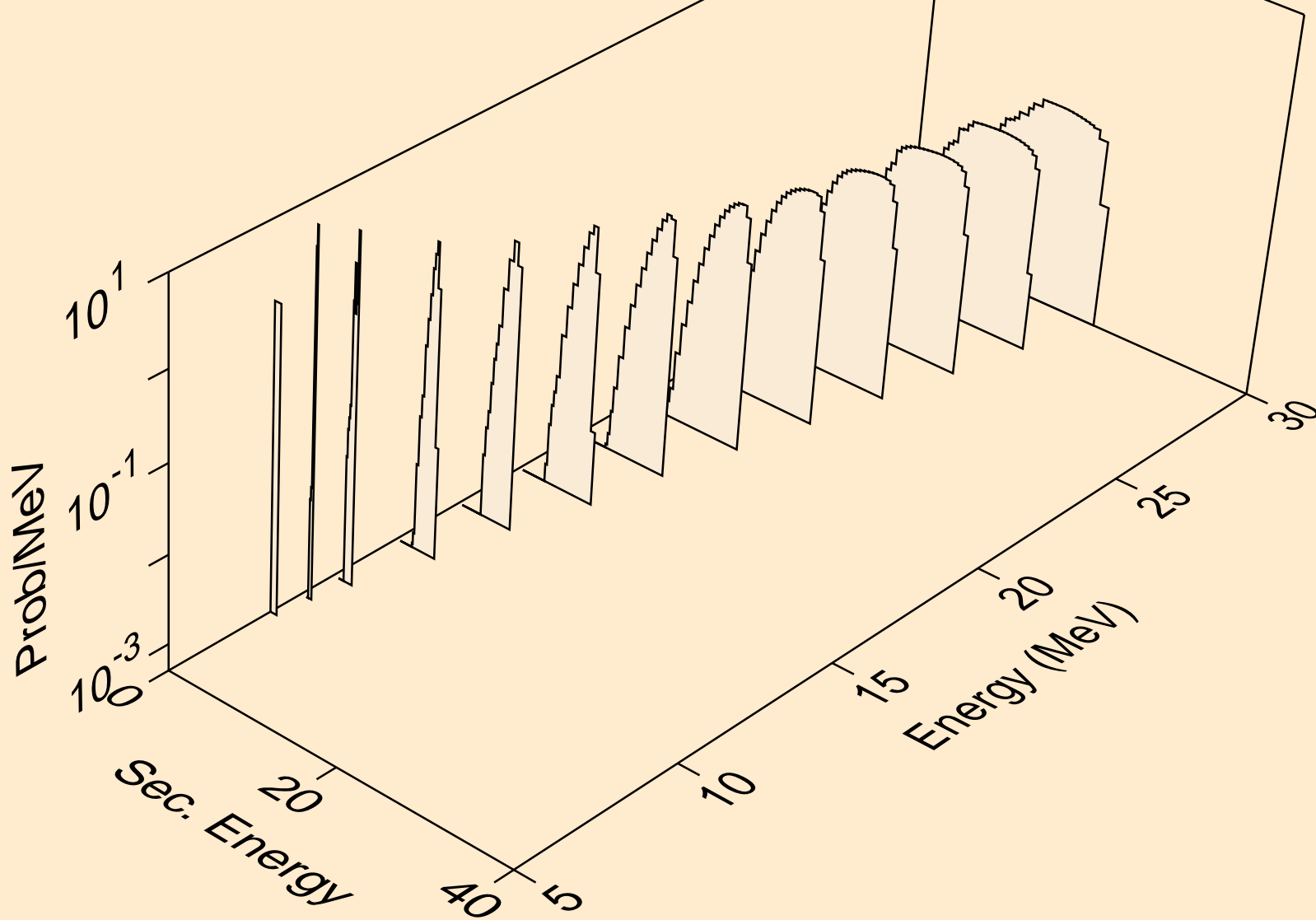

GD156 NEUTRON ACER TENDL-2019 LIBRARY; T=293.16K  
protons from (n,2np)

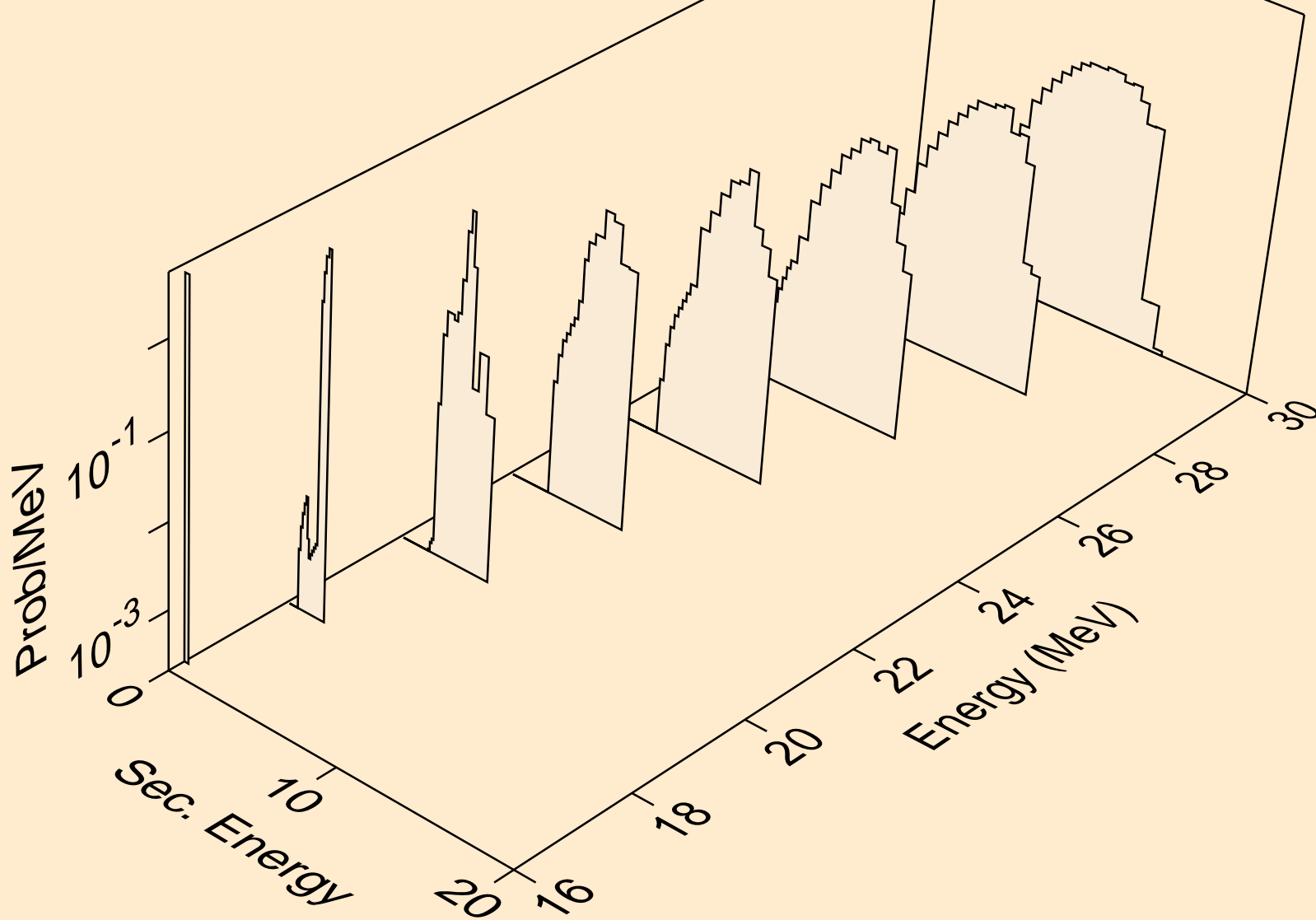

GD156 NEUTRON ACER TENDL-2019 LIBRARY; T=293.16K  
protons from (n,3np)

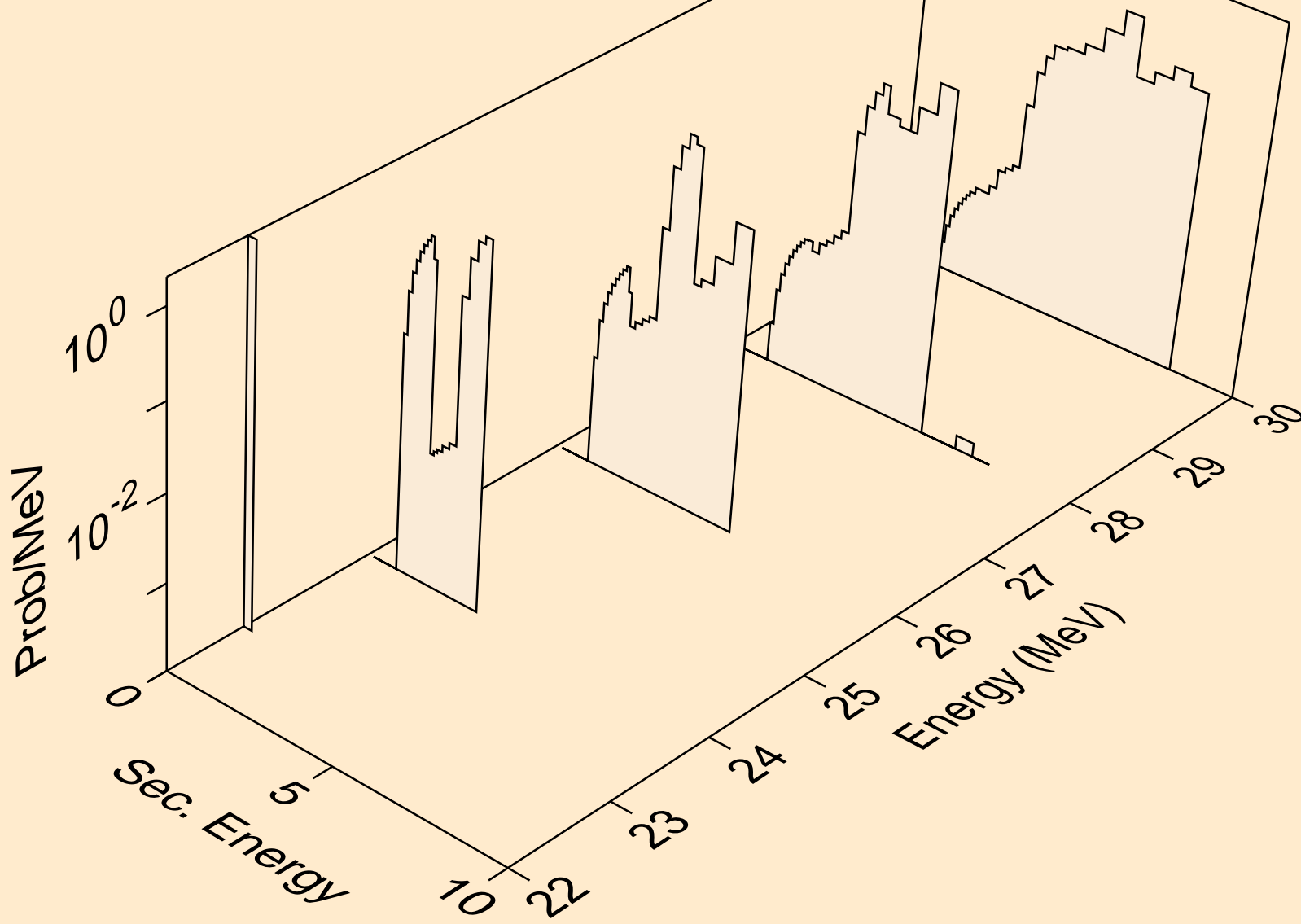

GD156 NEUTRON ACER TENDL-2019 LIBRARY; T=293.16K  
protons from (n,2np)

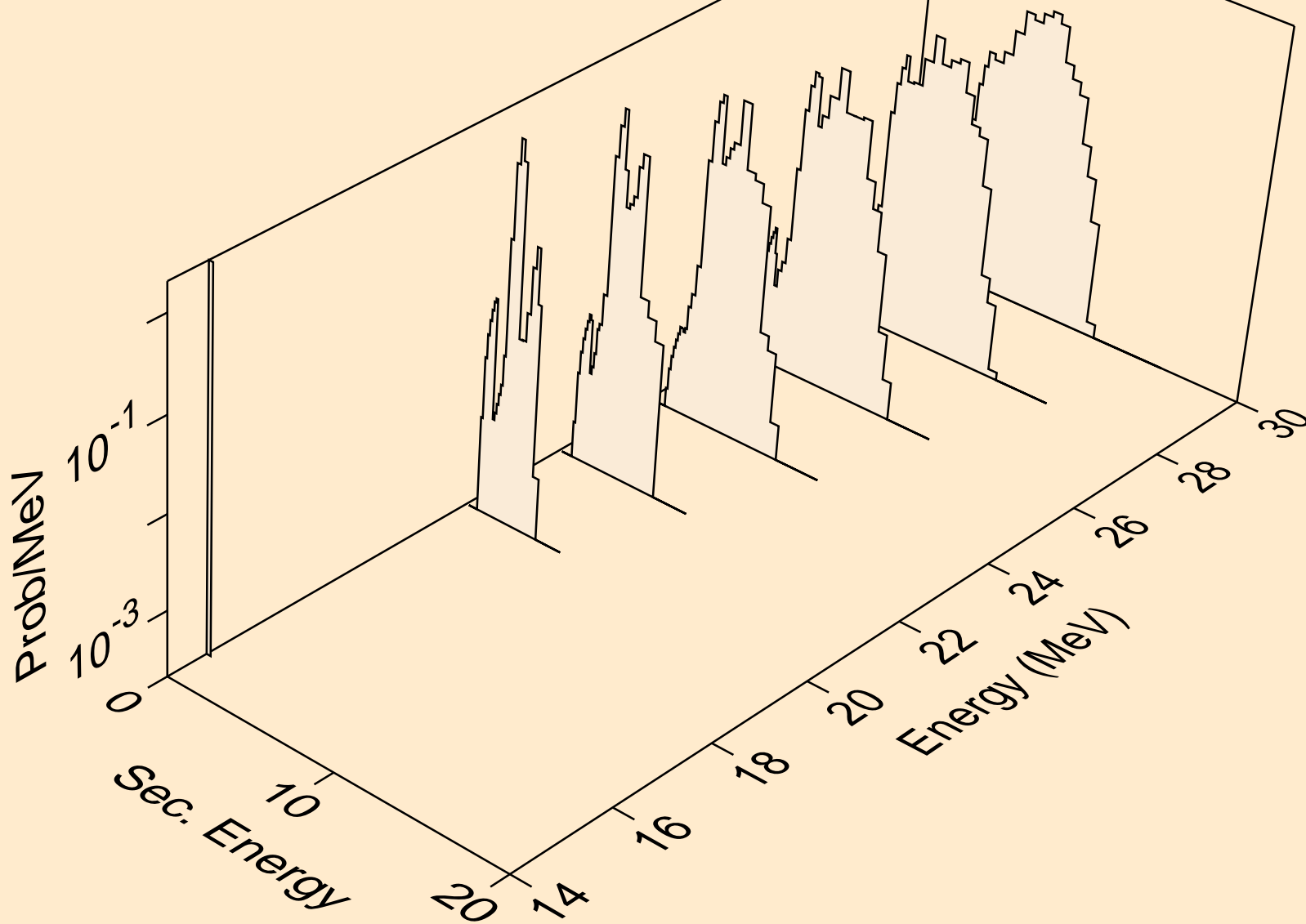

GD156 NEUTRON ACER TENDL-2019 LIBRARY; T=293.16K  
protons from (n,npa)

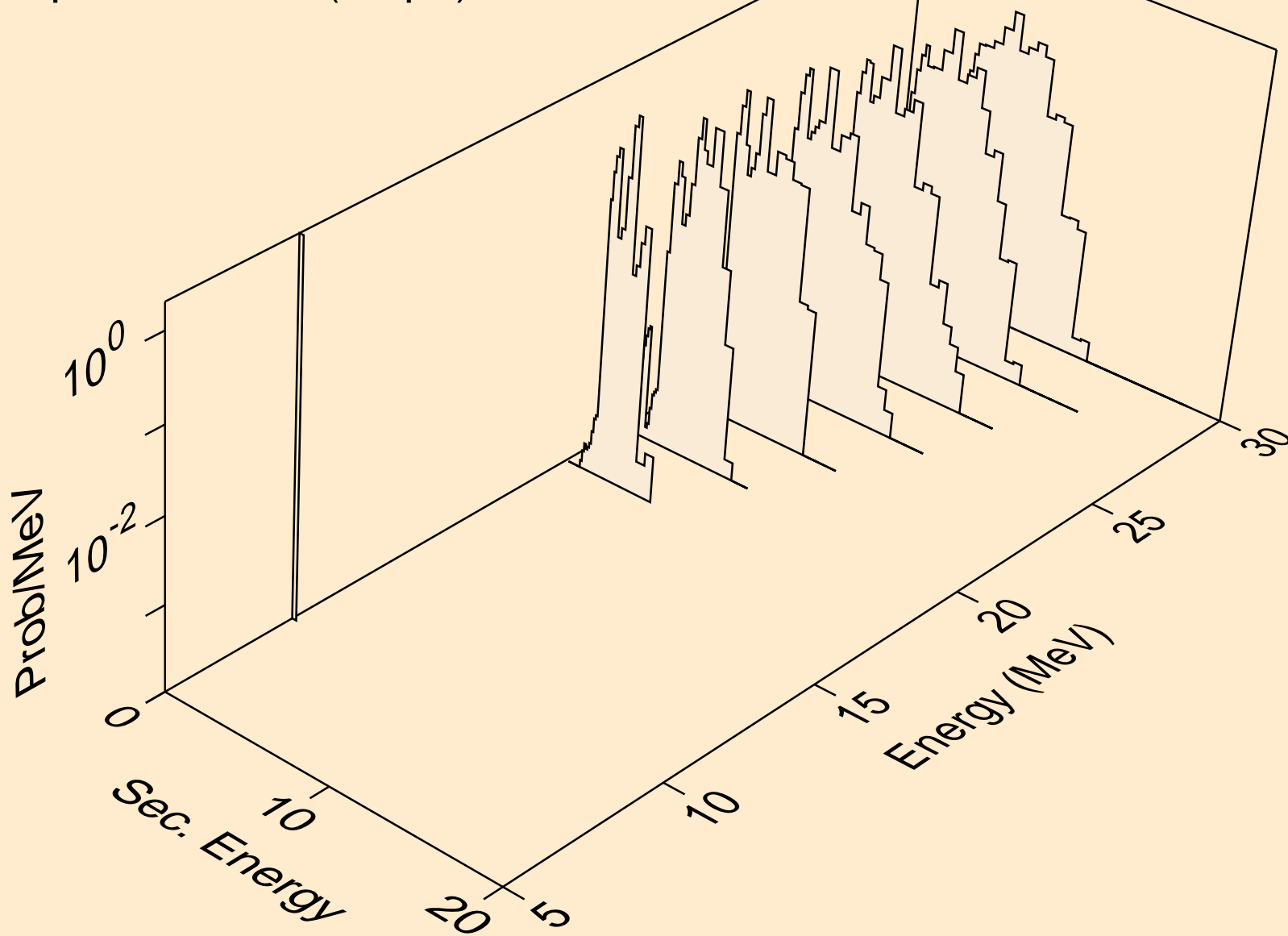

GD156 NEUTRON ACER TENDL-2019 LIBRARY; T=293.16K  
protons from (n,p)

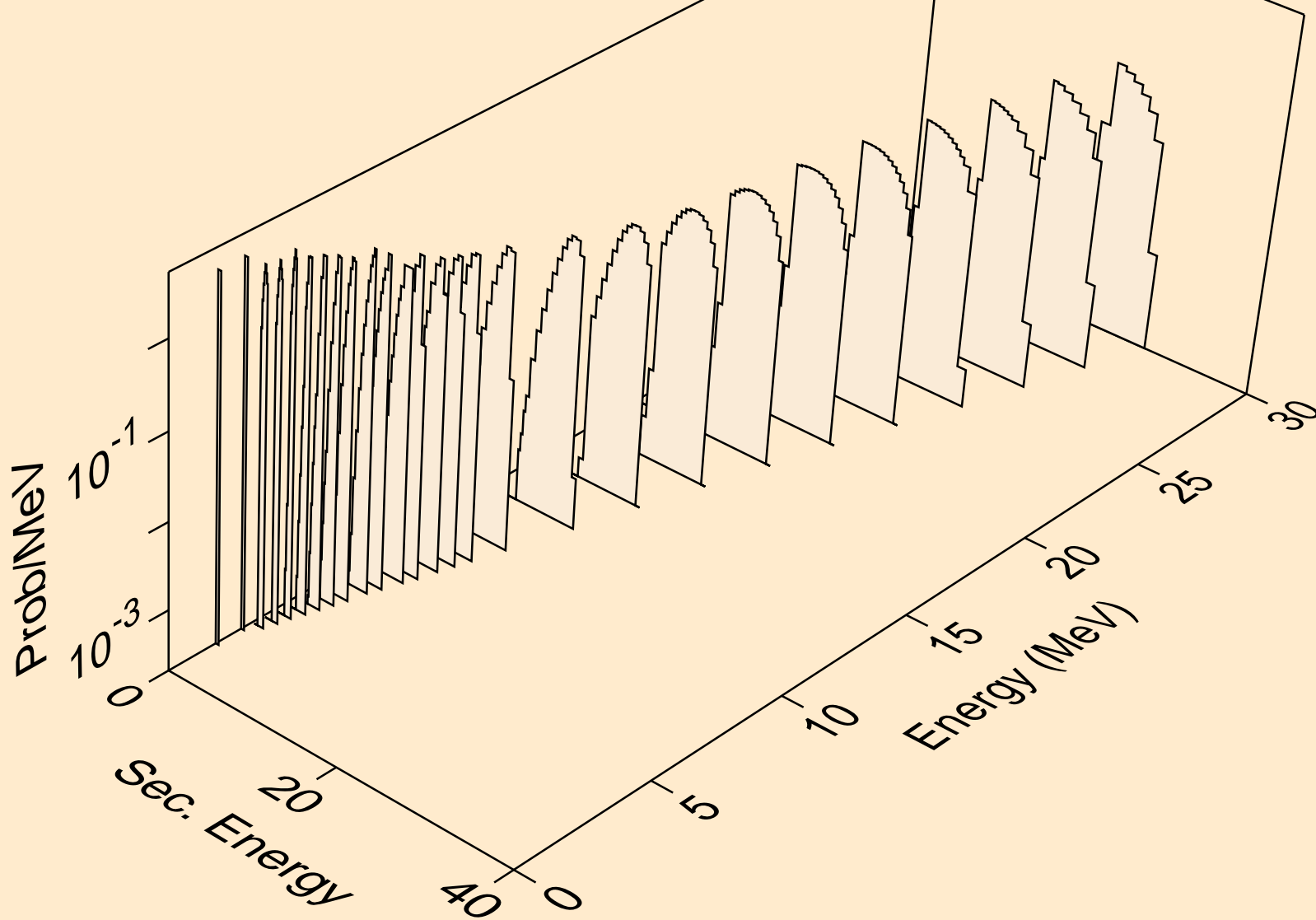



GD156 NEUTRON ACER TENDL-2019 LIBRARY; T=293.16K  
protons from (n,2p)

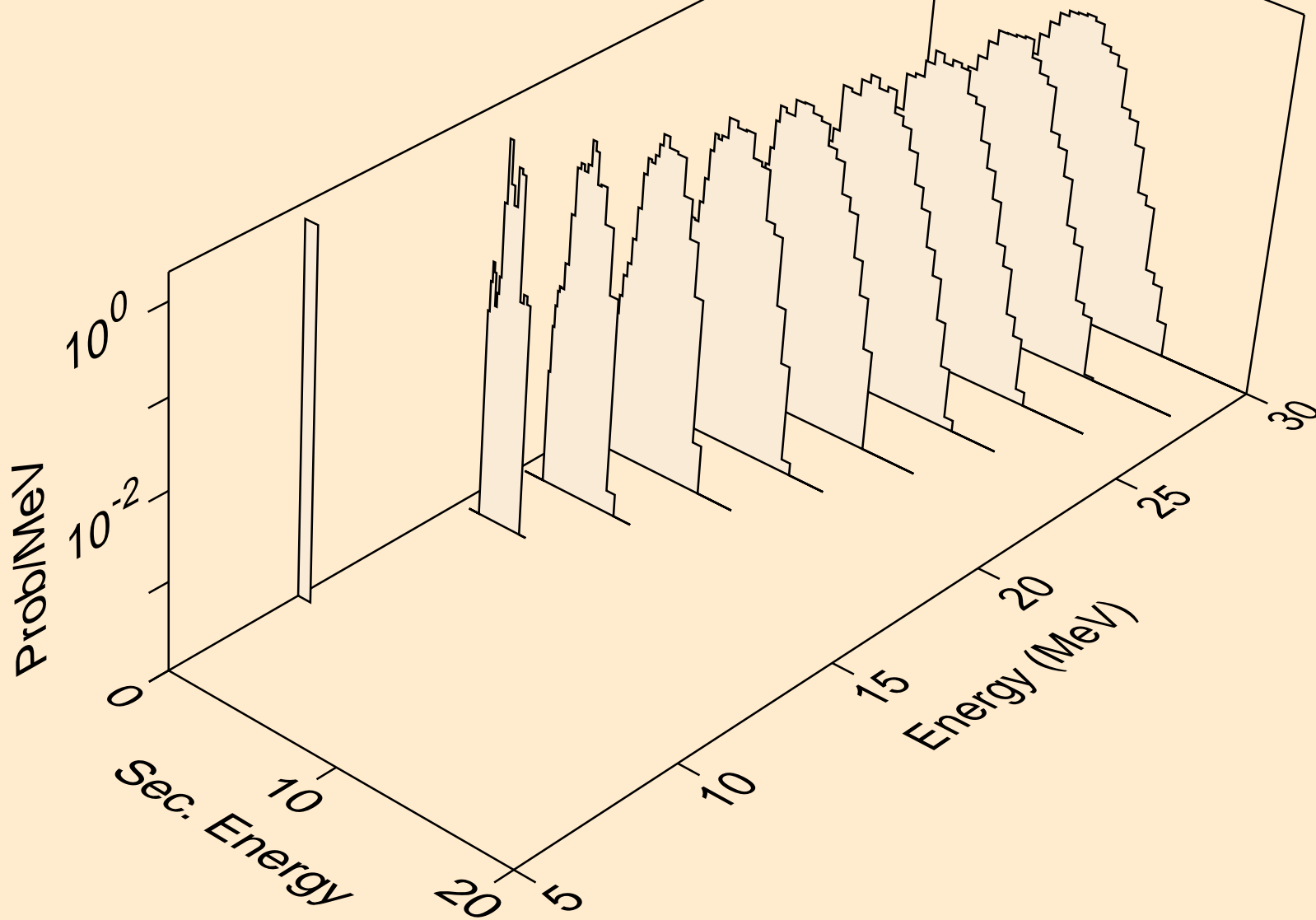

GD156 NEUTRON ACER TENDL-2019 LIBRARY; T=293.16K  
protons from (n,p)

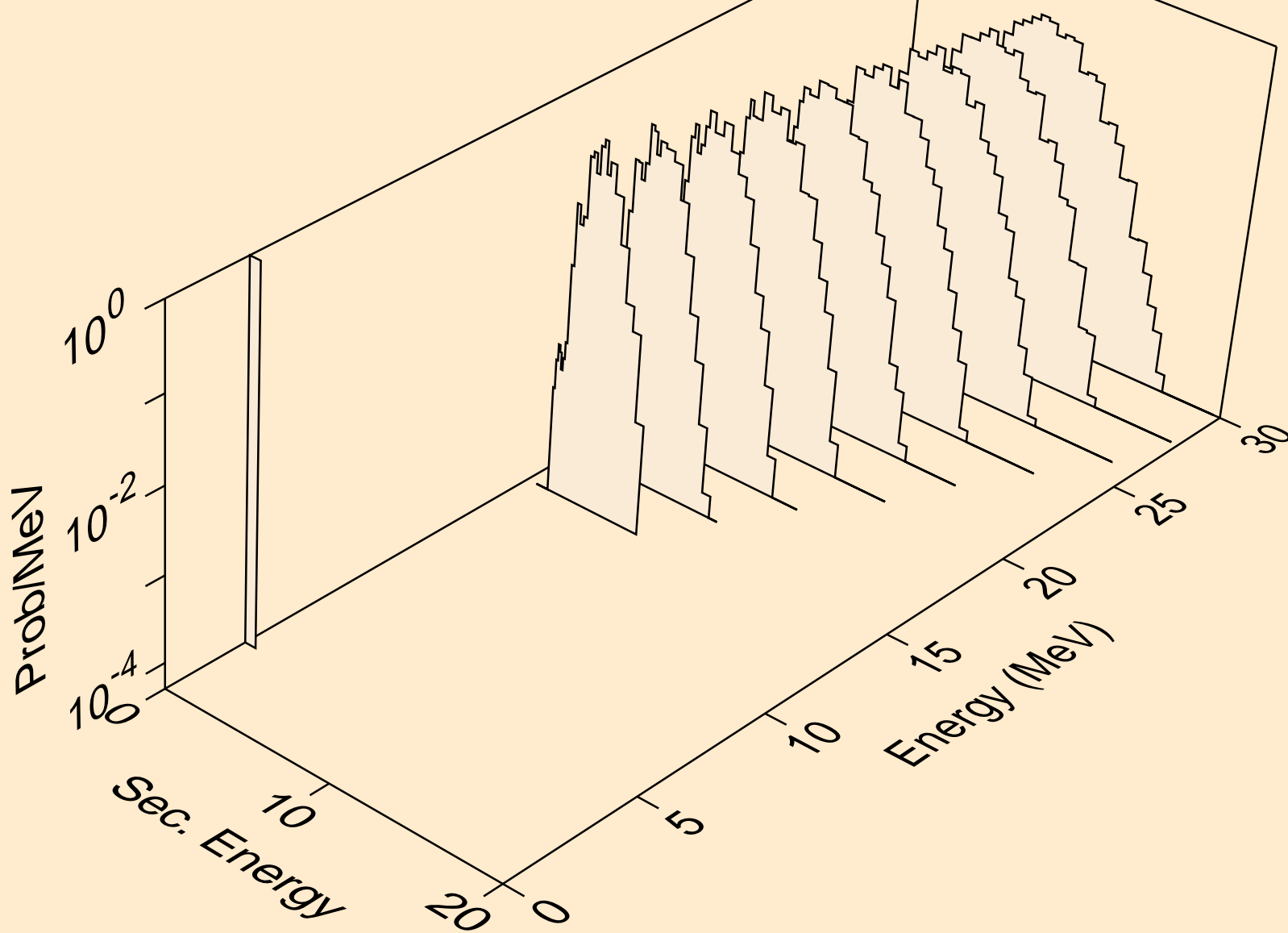

GD156 NEUTRON ACER TENDL-2019 LIBRARY; T=293.16K  
protons from (n,pd)

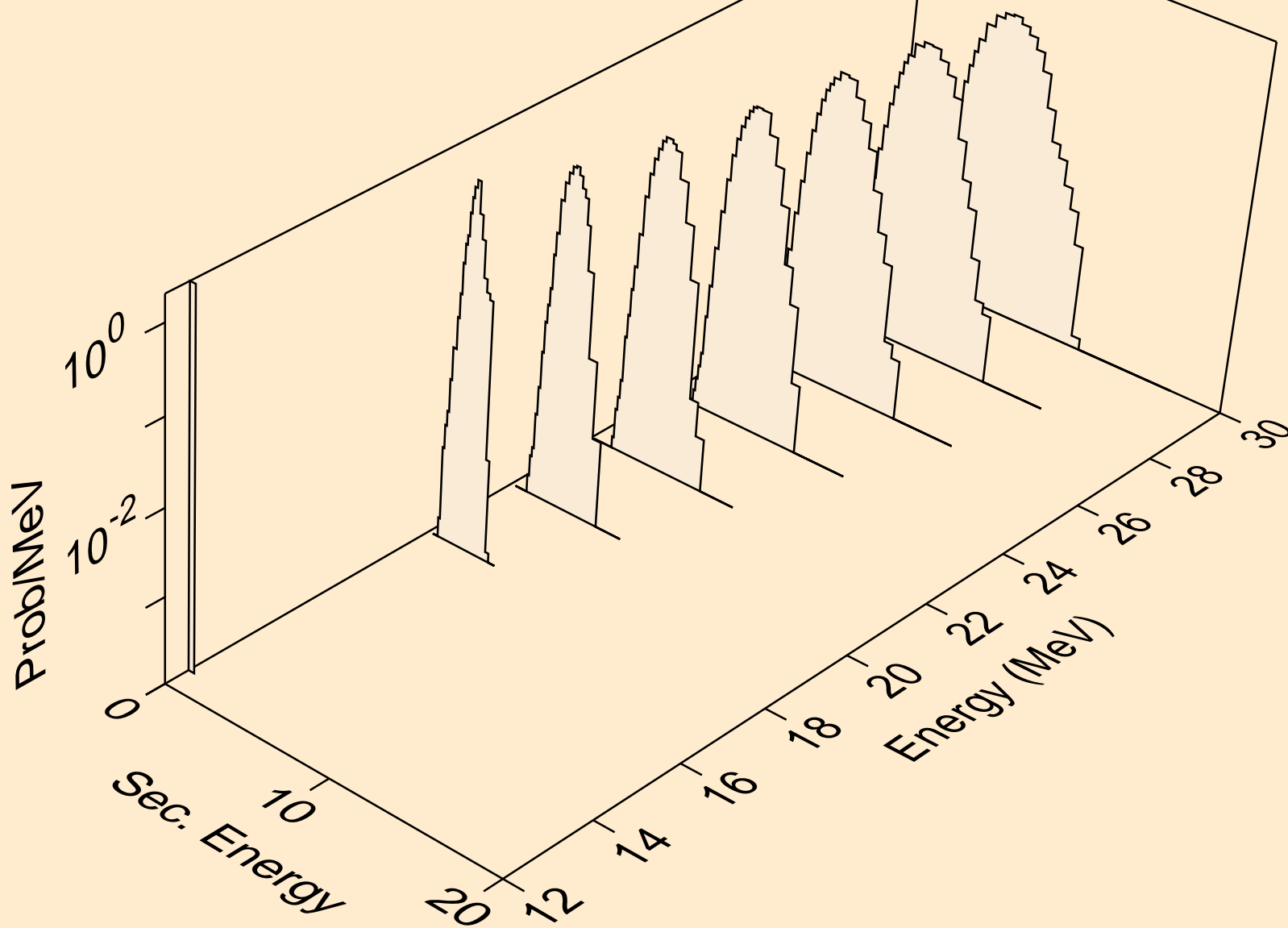

GD156 NEUTRON ACER TENDL-2019 LIBRARY; T=293.16K  
protons from (n,pt)

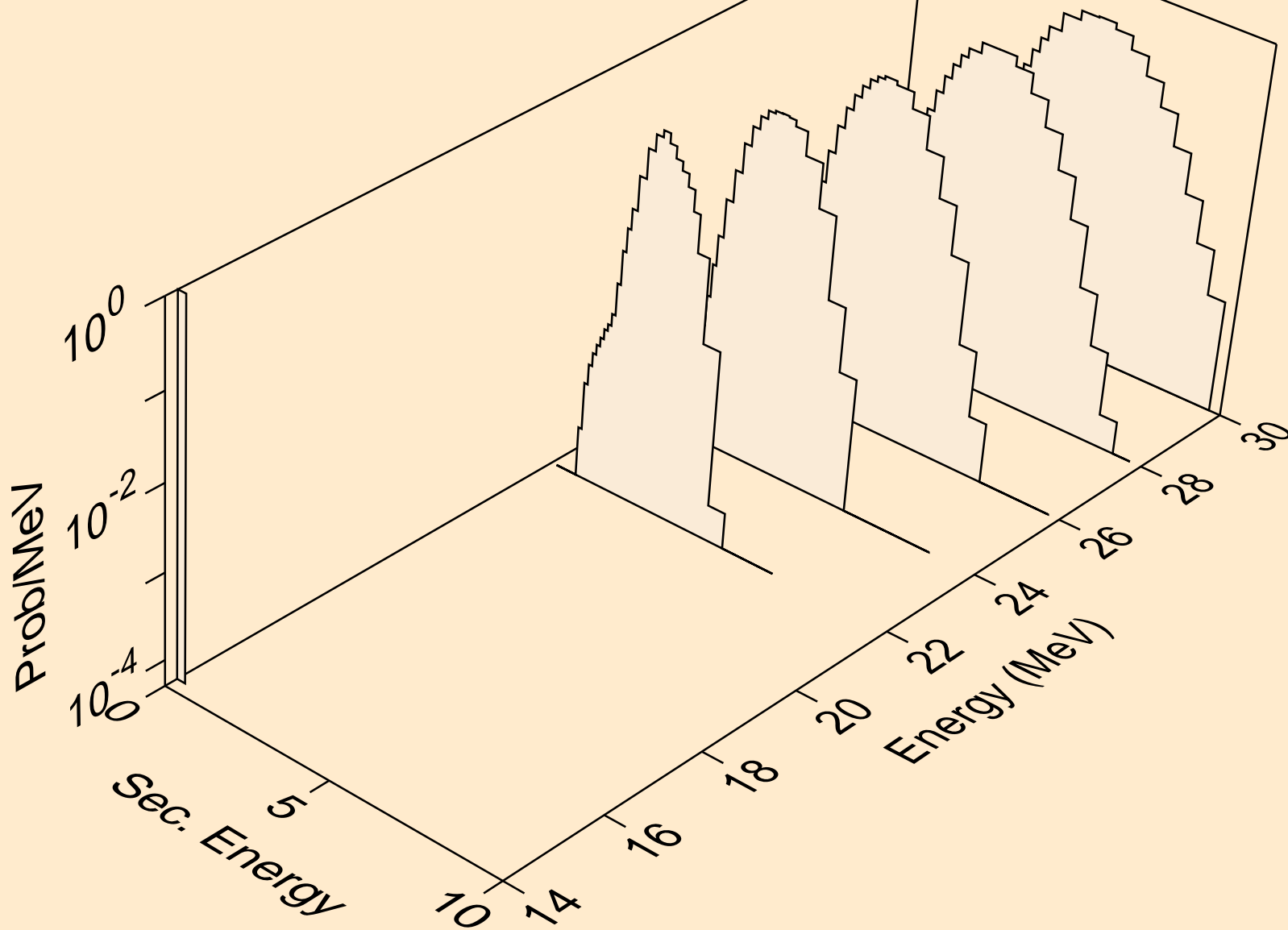

GD156 NEUTRON ACER TENDL-2019 LIBRARY; T=293.16K  
deuterons from (n,x)

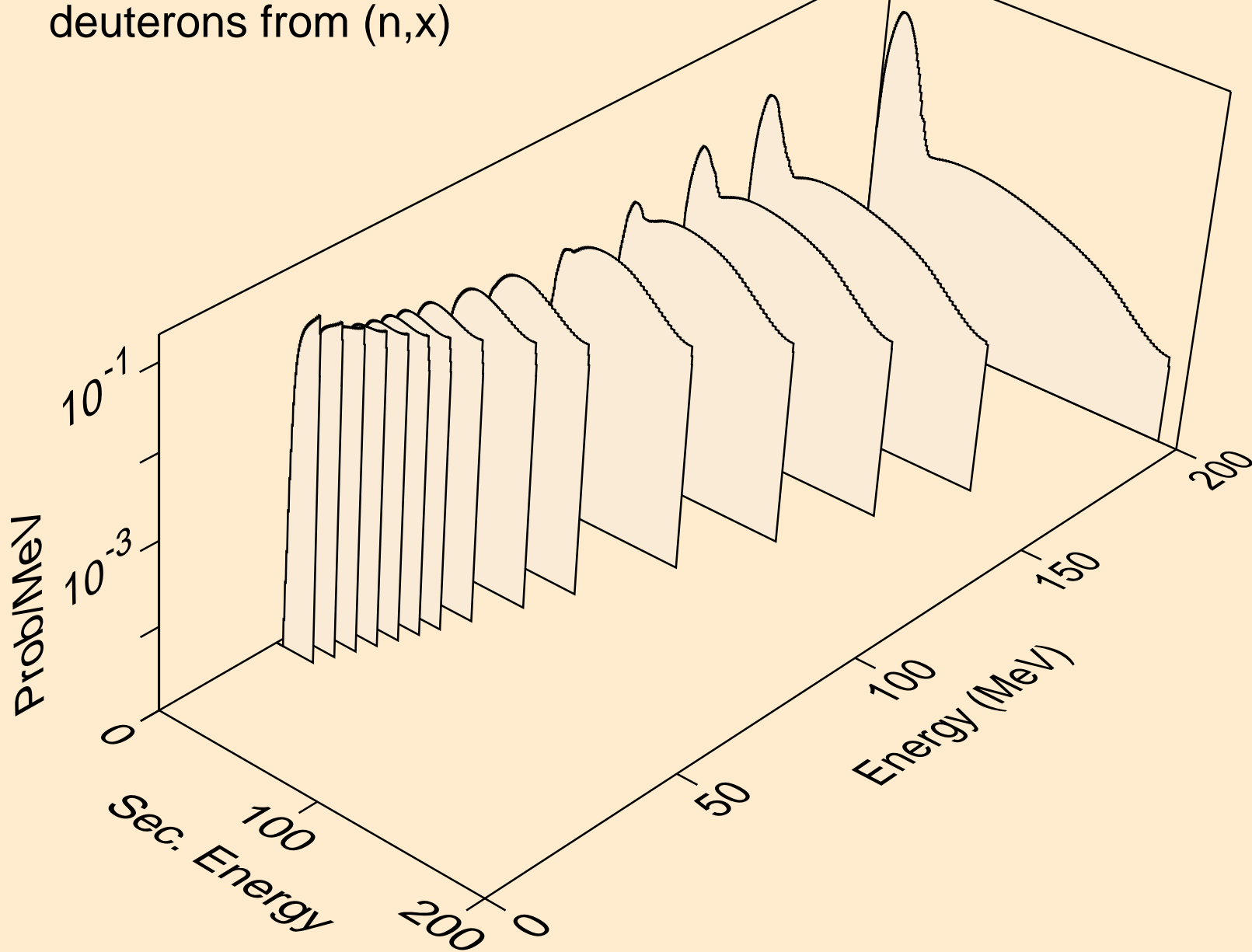

GD156 NEUTRON ACER TENDL-2019 LIBRARY; T=293.16K  
deuterons from (n,2nd)

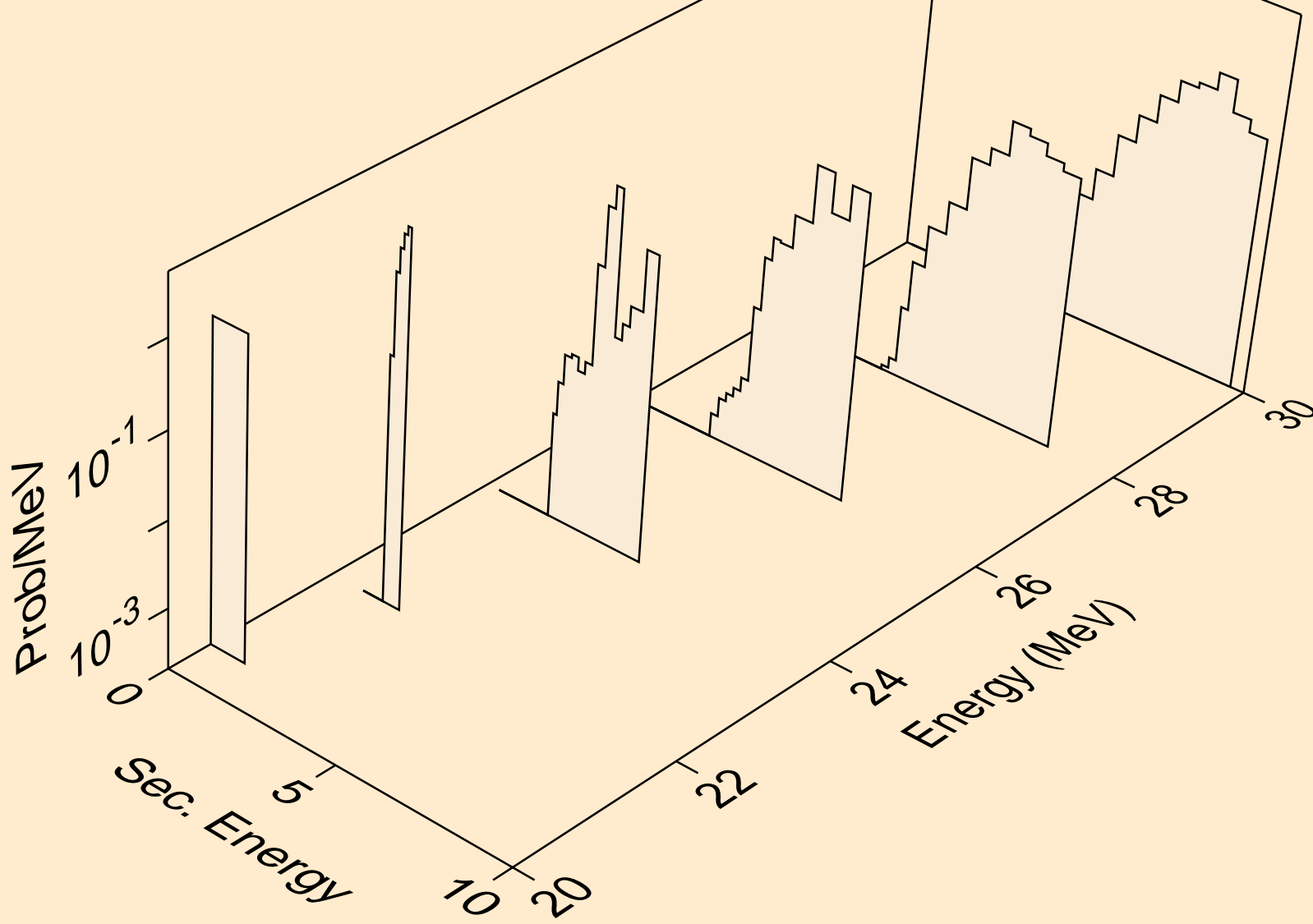

GD156 NEUTRON ACER TENDL-2019 LIBRARY; T=293.16K  
deuterons from (n,n\*)d

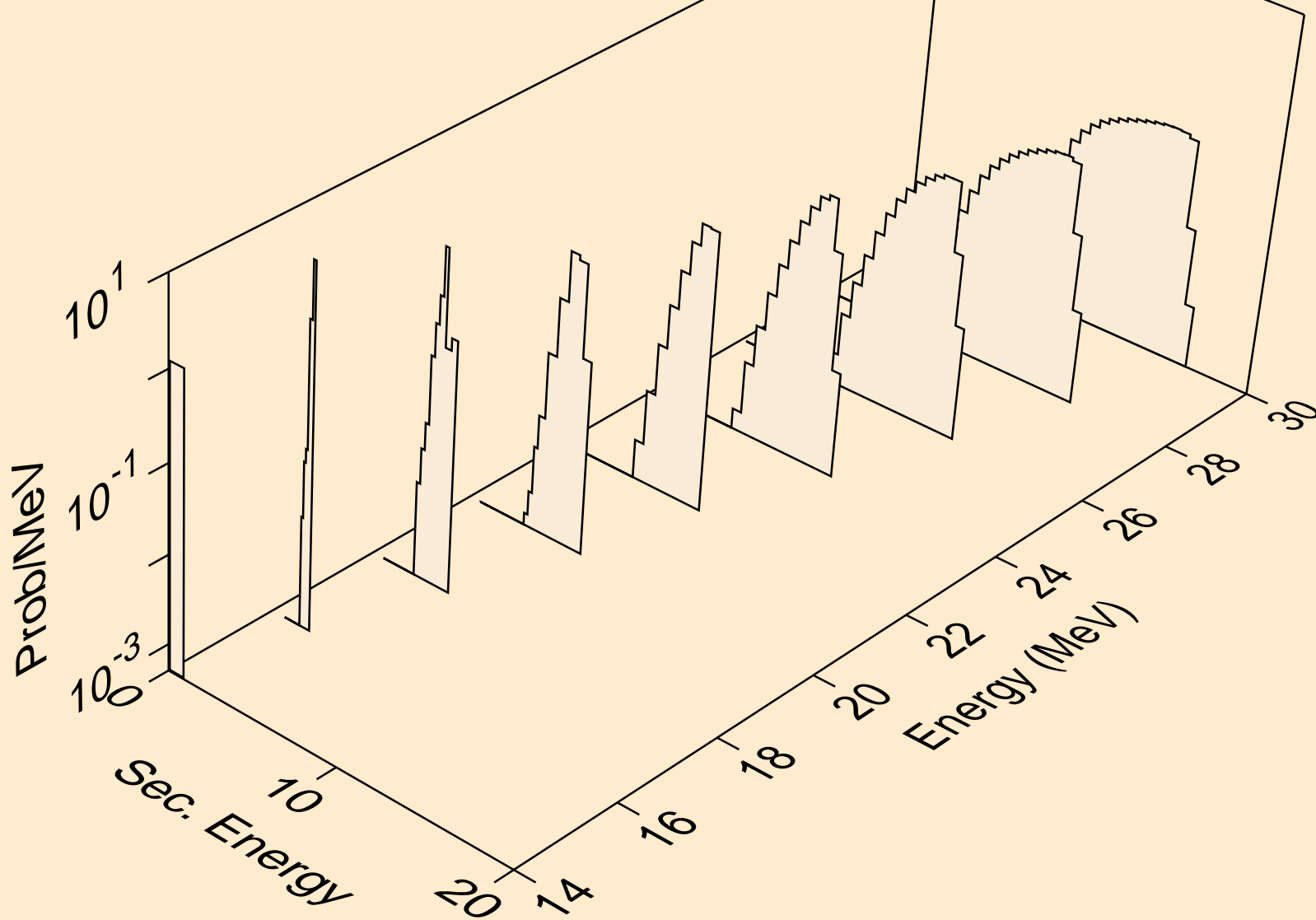

GD156 NEUTRON ACER TENDL-2019 LIBRARY; T=293.16K  
deuterons from (n,d)

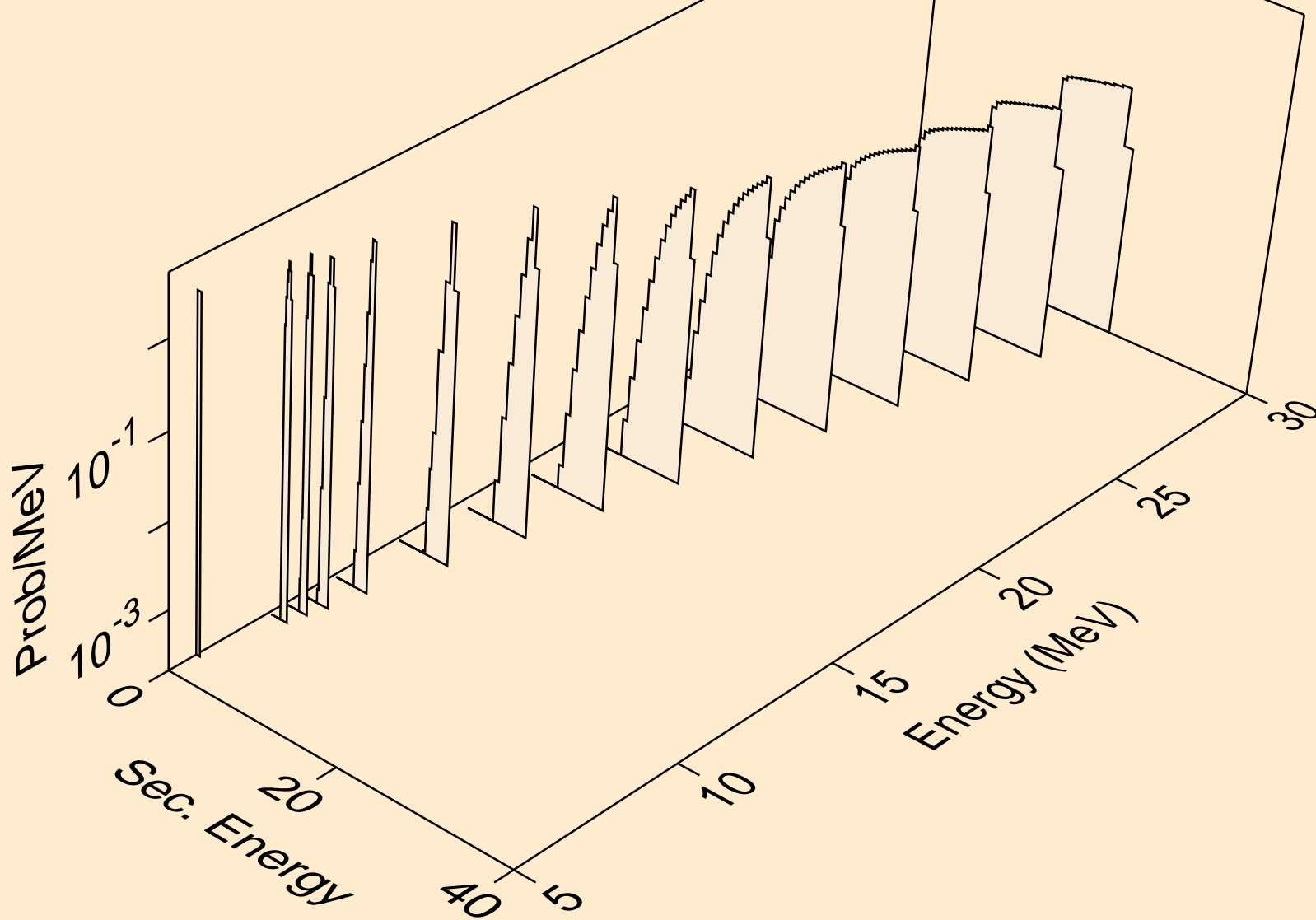



GD156 NEUTRON ACER TENDL-2019 LIBRARY; T=293.16K  
deuterons from (n,pd)

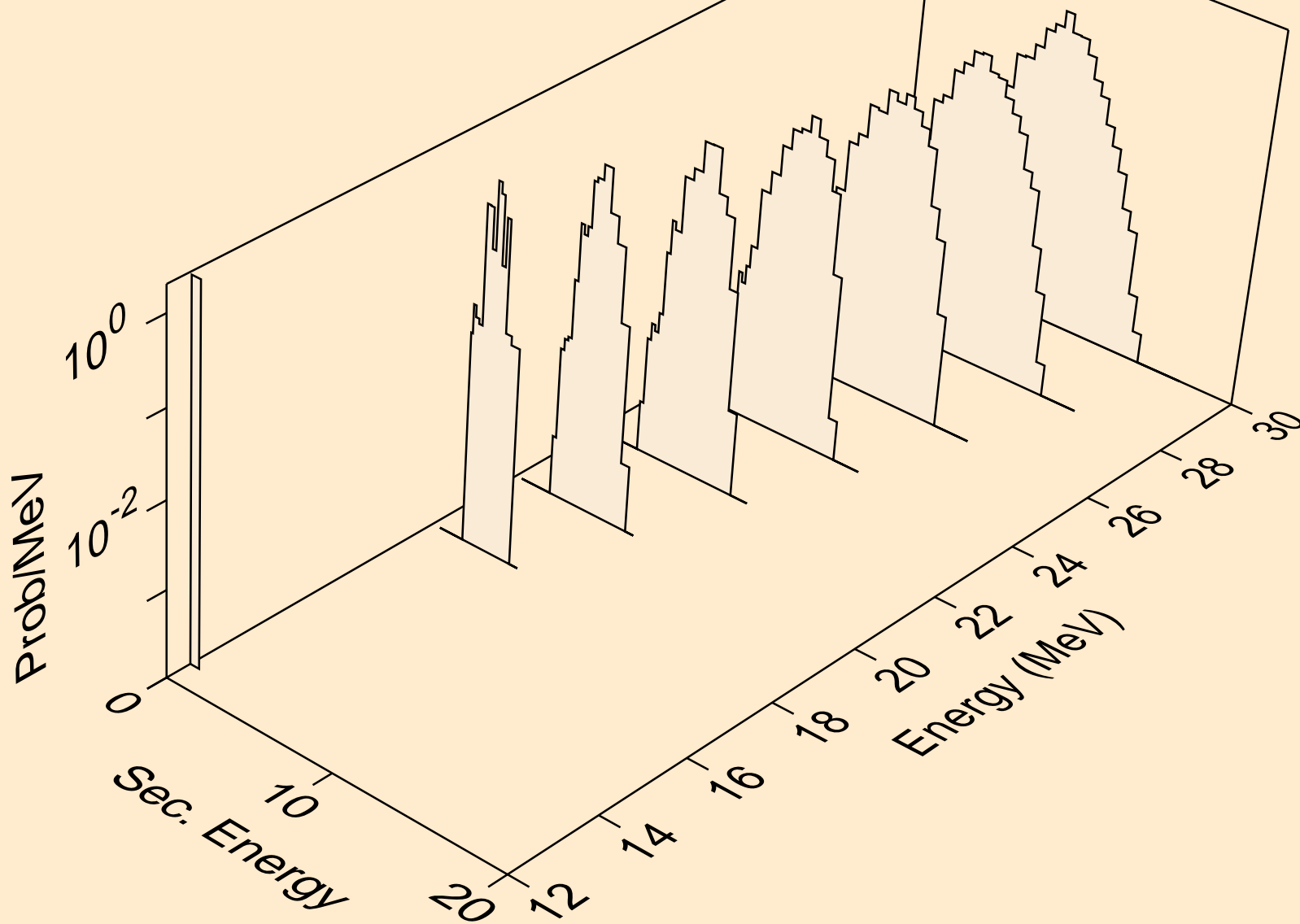

GD156 NEUTRON ACER TENDL-2019 LIBRARY; T=293.16K  
deuterons from (n,da)

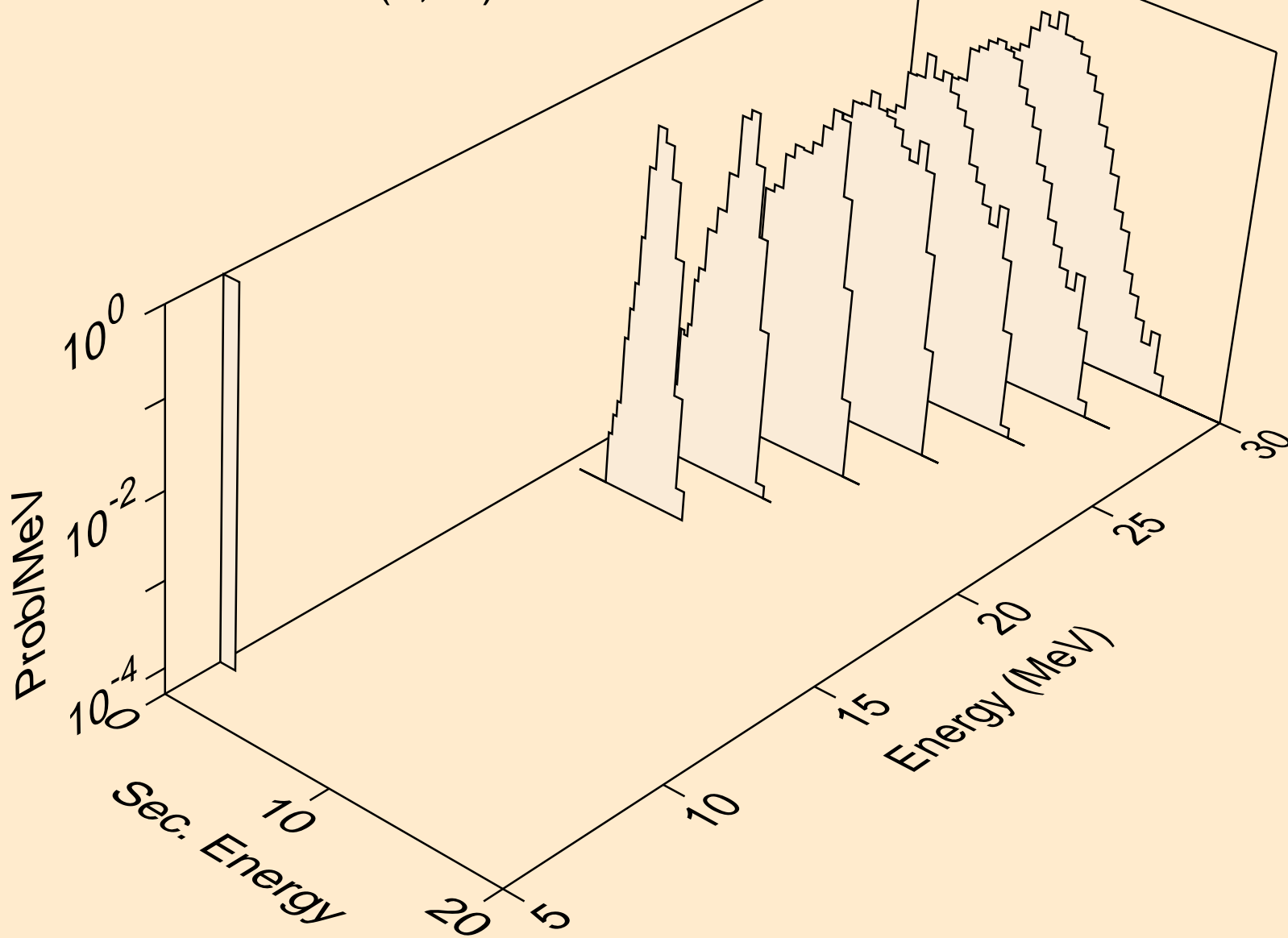

GD156 NEUTRON ACER TENDL-2019 LIBRARY; T=293.16K  
tritons from (n,x)

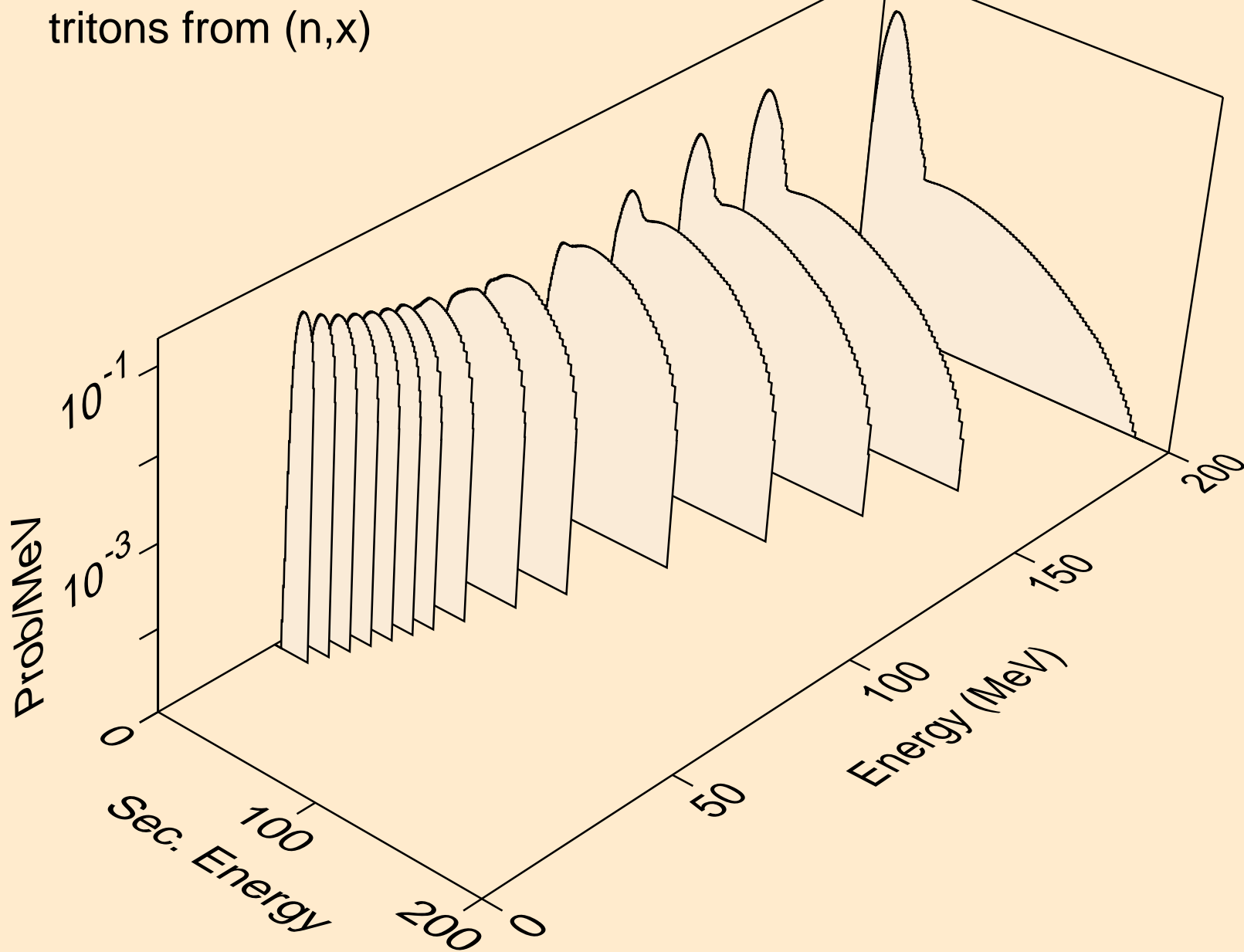

GD156 NEUTRON ACER TENDL-2019 LIBRARY; T=293.16K  
tritons from (n,n\*)t

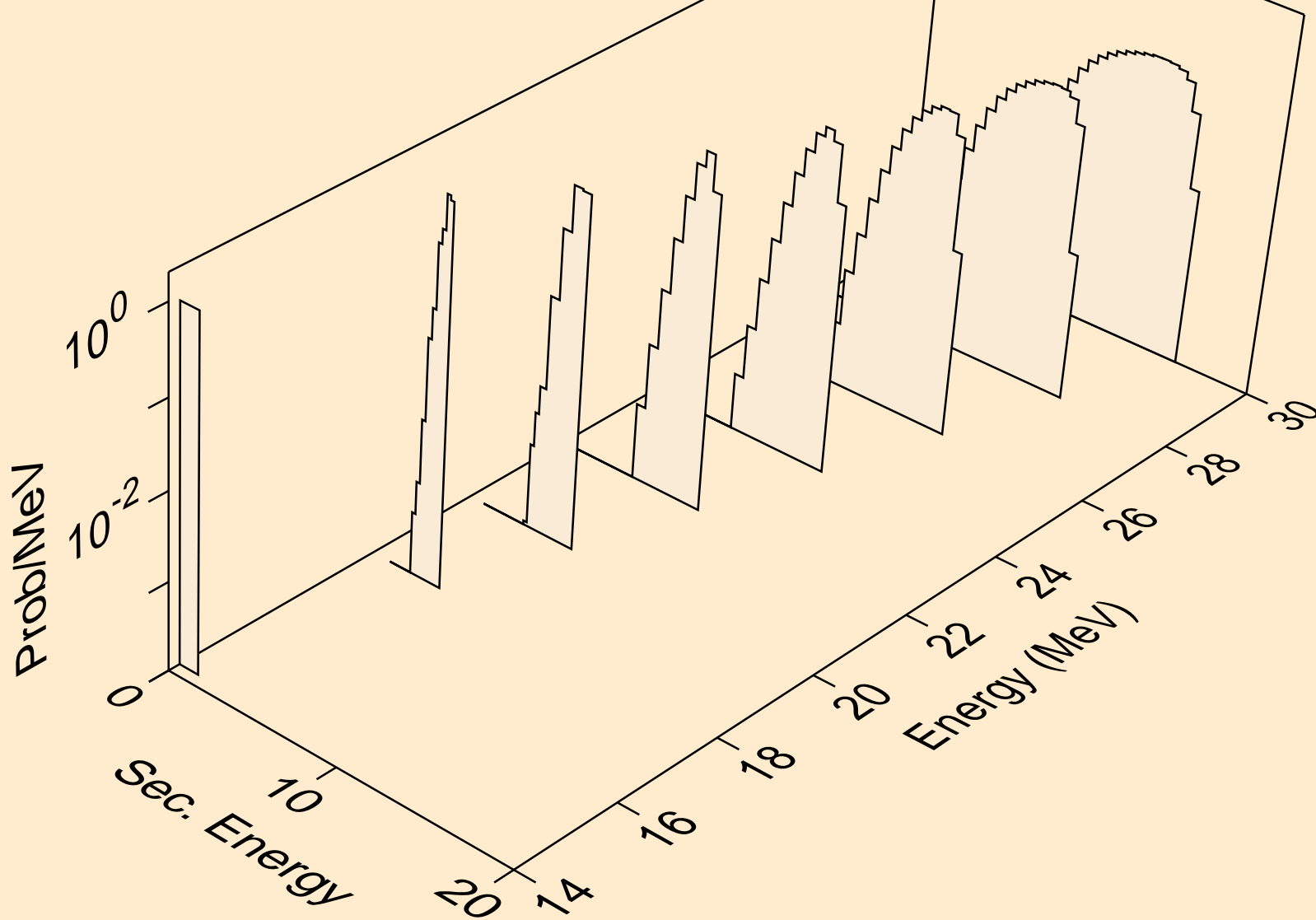

GD156 NEUTRON ACER TENDL-2019 LIBRARY; T=293.16K  
tritons from (n,t)

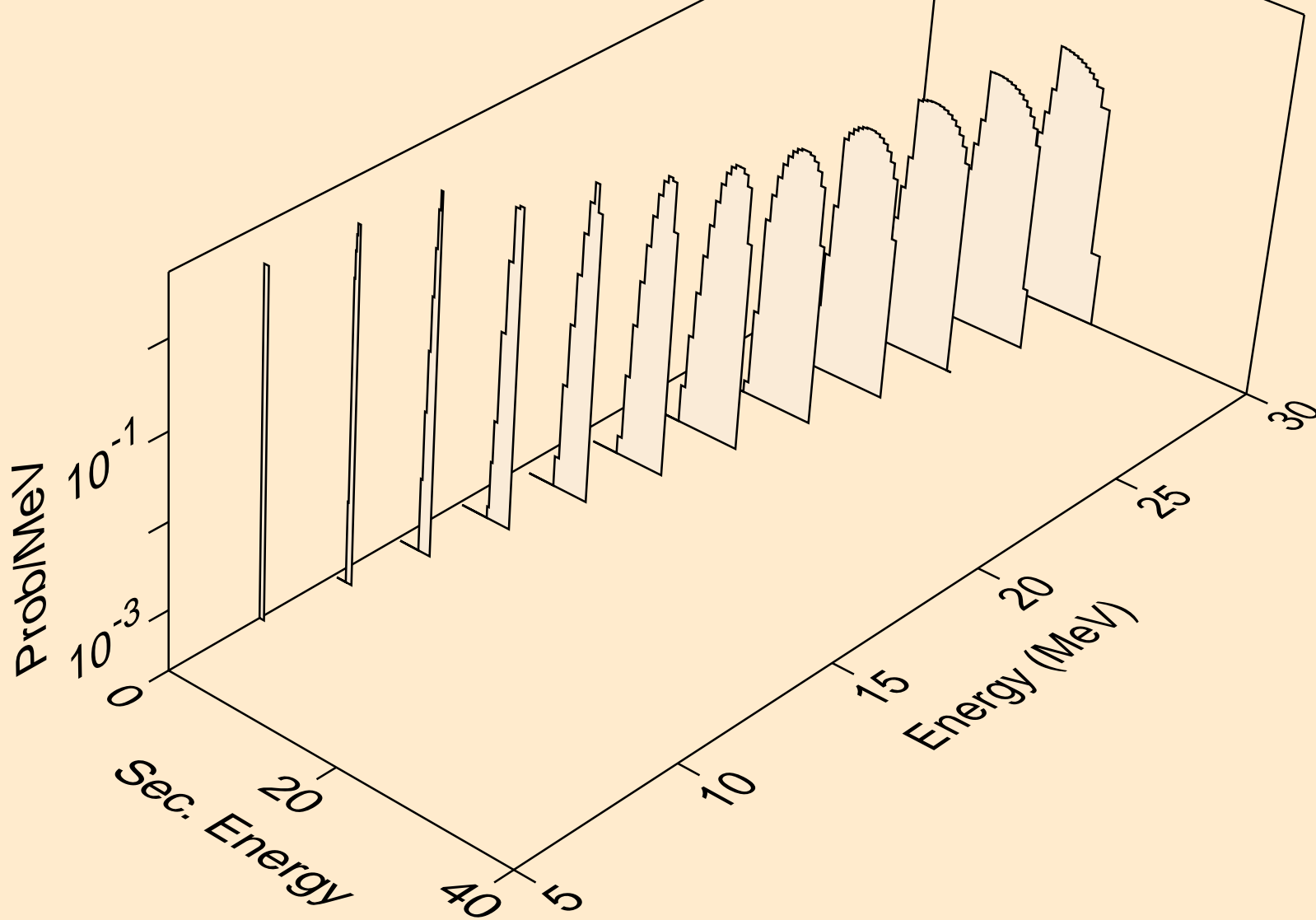

GD156 NEUTRON ACER TENDL-2019 LIBRARY; T=293.16K  
tritons from (n,pt)

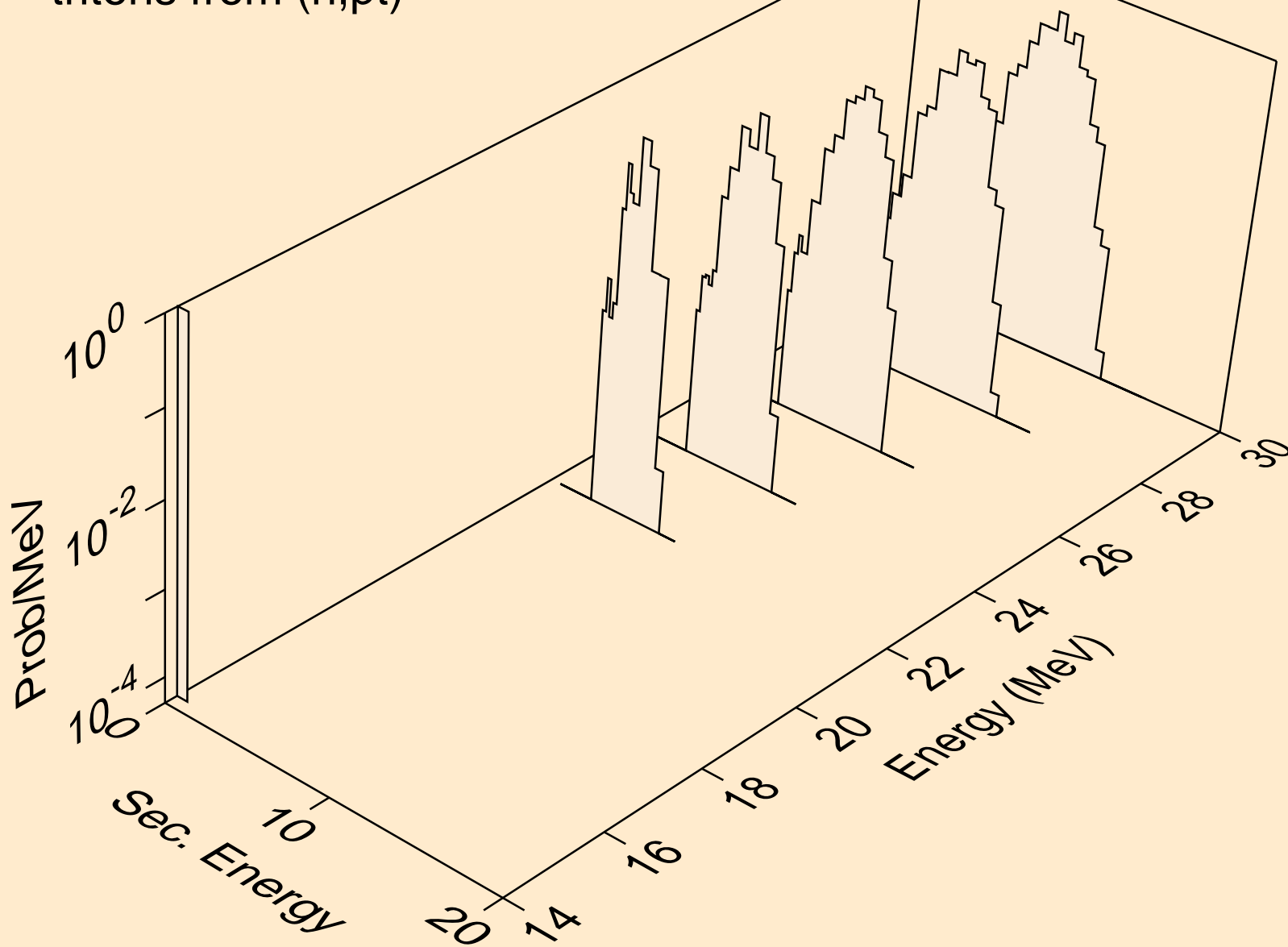

GD156 NEUTRON ACER TENDL-2019 LIBRARY; T=293.16K  
he3s from (n,x)

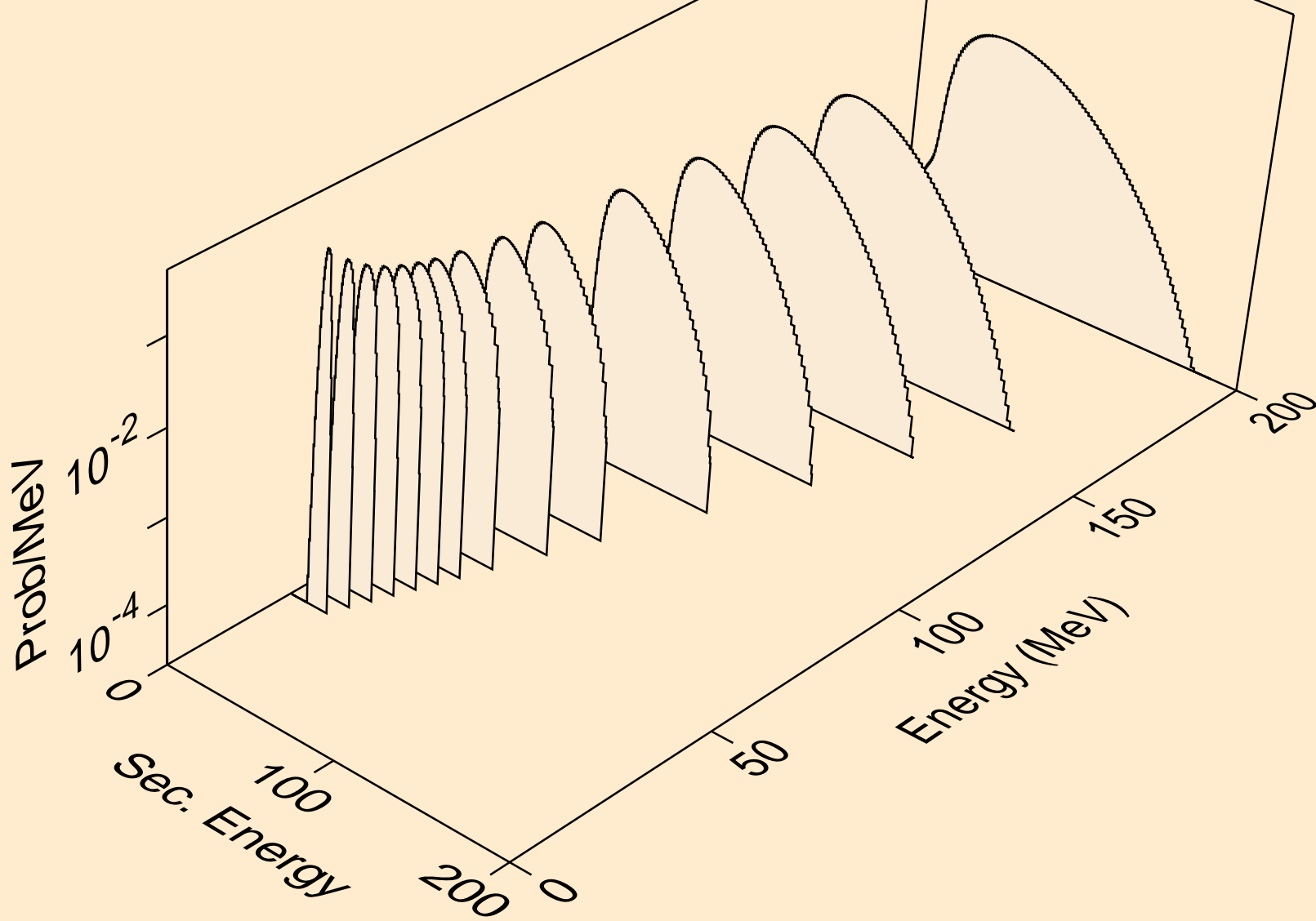

GD156 NEUTRON ACER TENDL-2019 LIBRARY; T=293.16K  
he3s from (n,n\*)he3

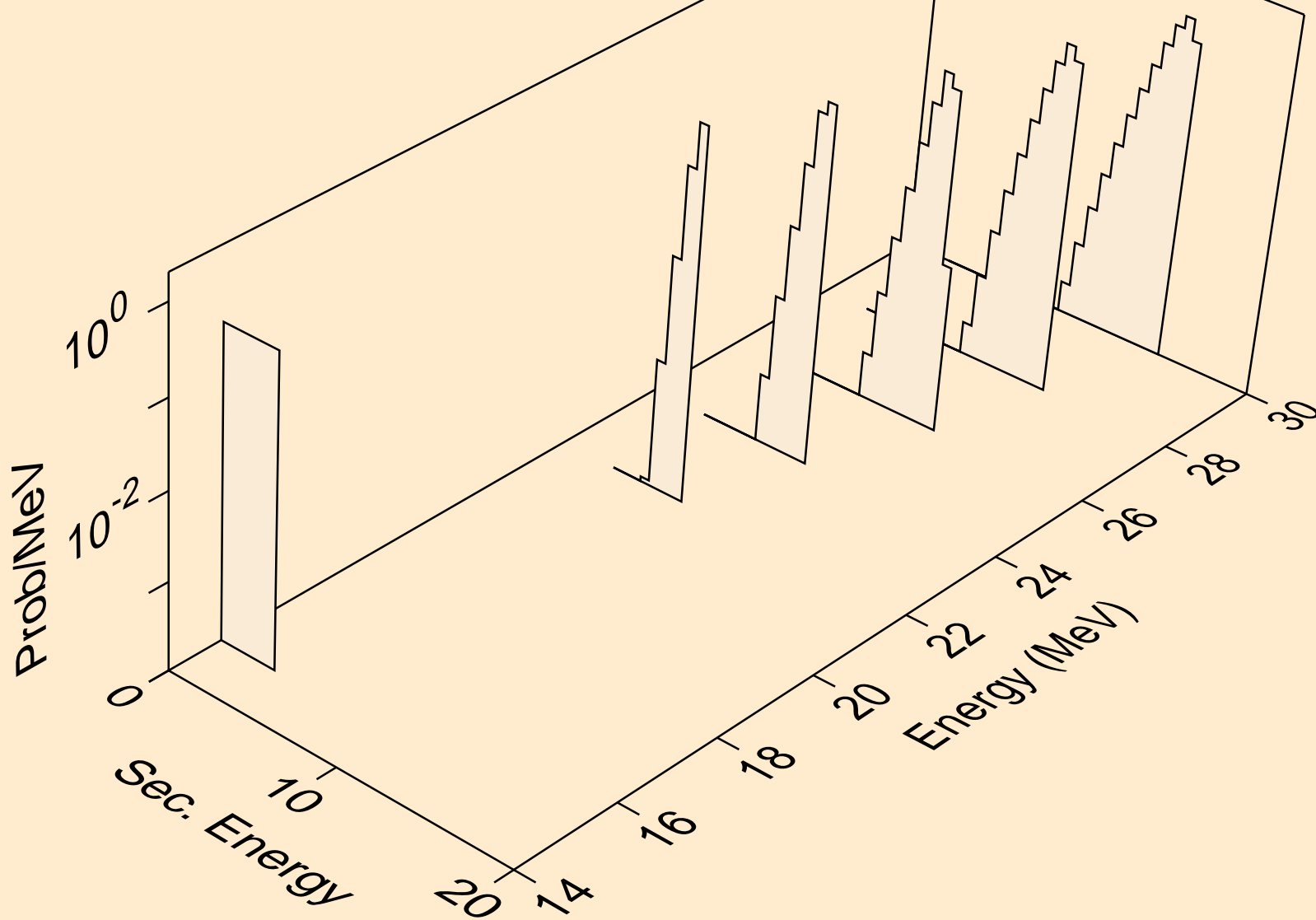



GD156 NEUTRON ACER TENDL-2019 LIBRARY; T=293.16K  
he3s from (n,he3)

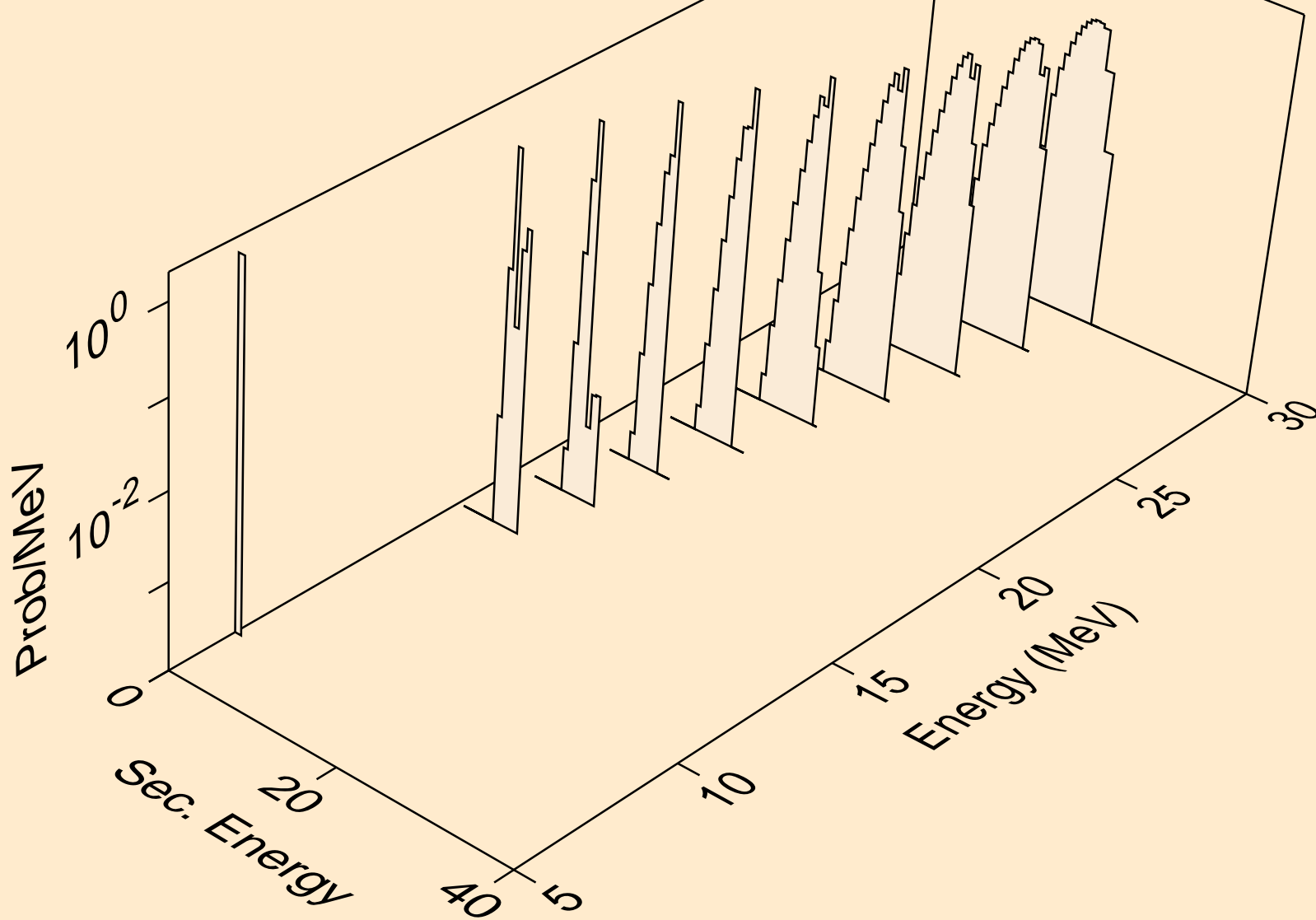

GD156 NEUTRON ACER TENDL-2019 LIBRARY; T=293.16K  
alphas from (n,x)

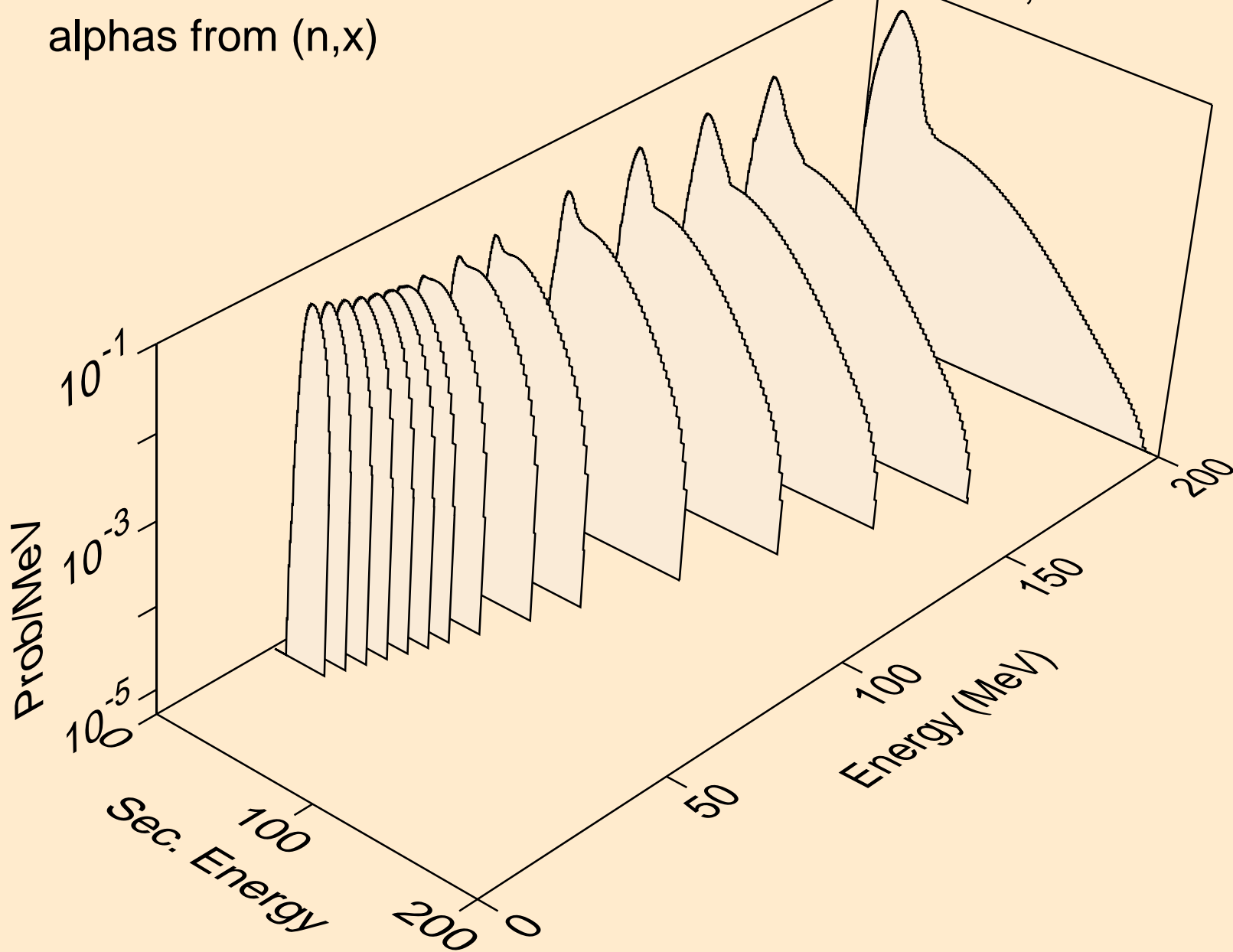

GD156 NEUTRON ACER TENDL-2019 LIBRARY; T=293.16K  
alphas from (n,n\*)a

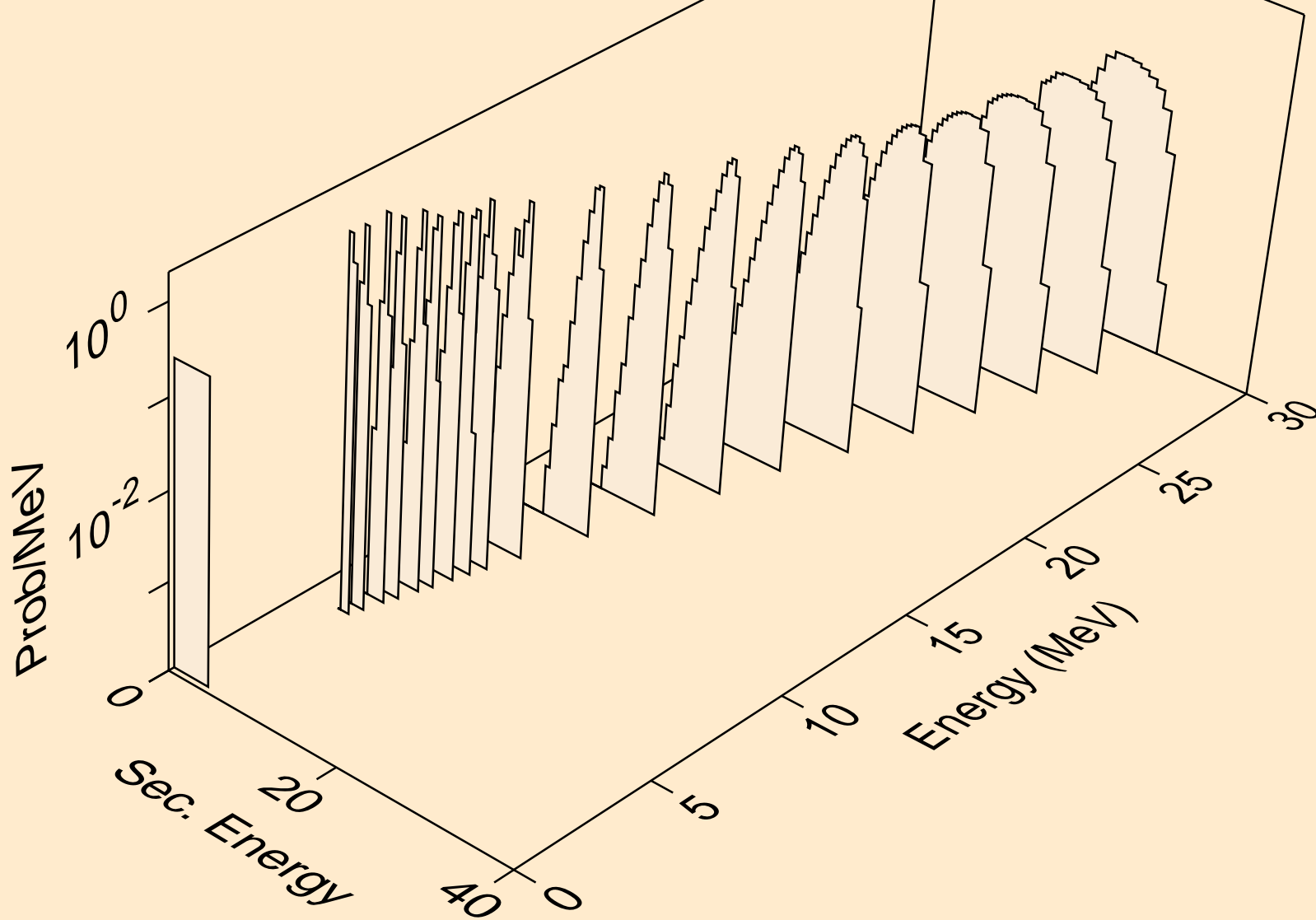

GD156 NEUTRON ACER TENDL-2019 LIBRARY; T=293.16K  
alphas from (n,2n)a

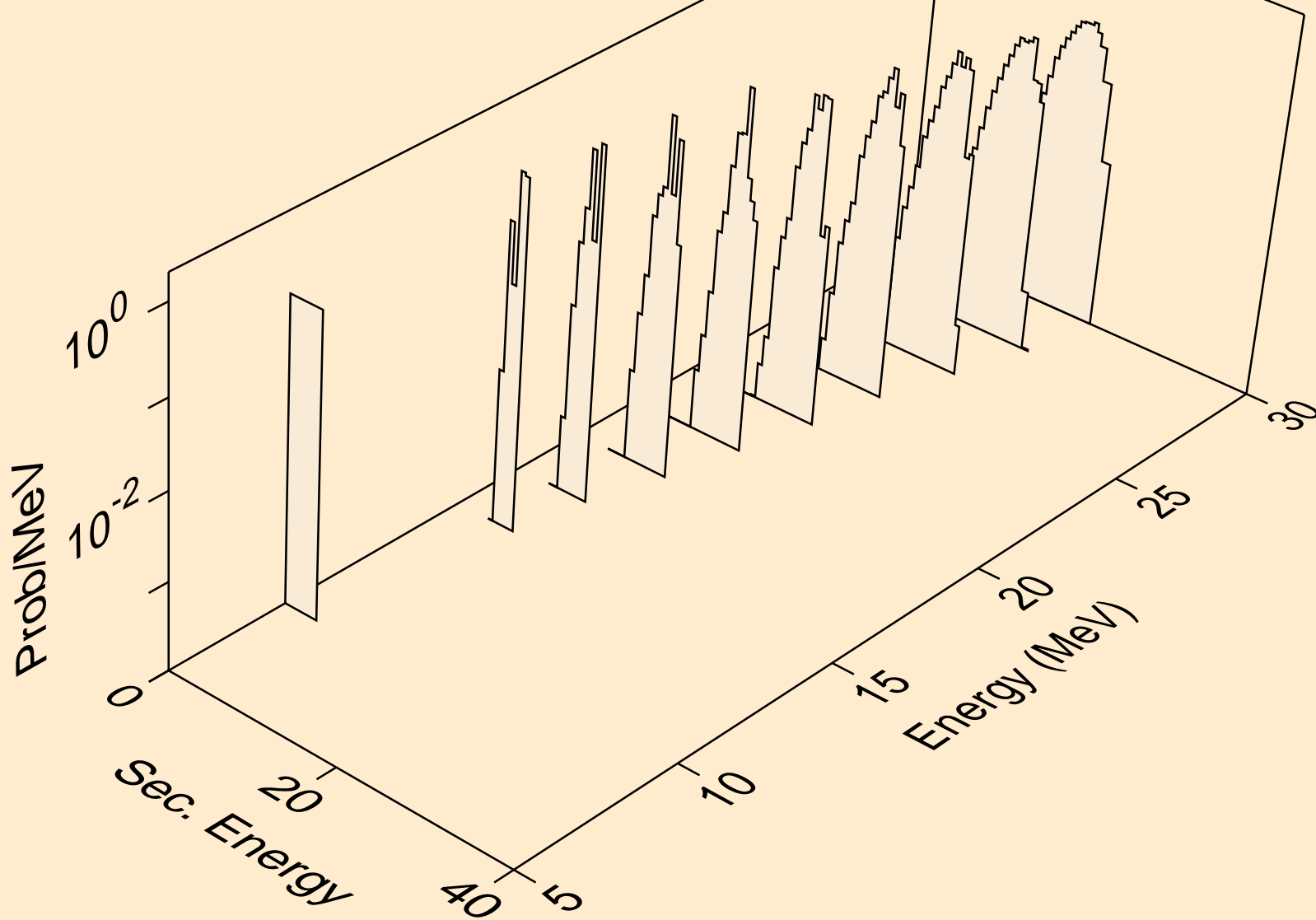

GD156 NEUTRON ACER TENDL-2019 LIBRARY; T=293.16K  
alphas from (n,3n)a

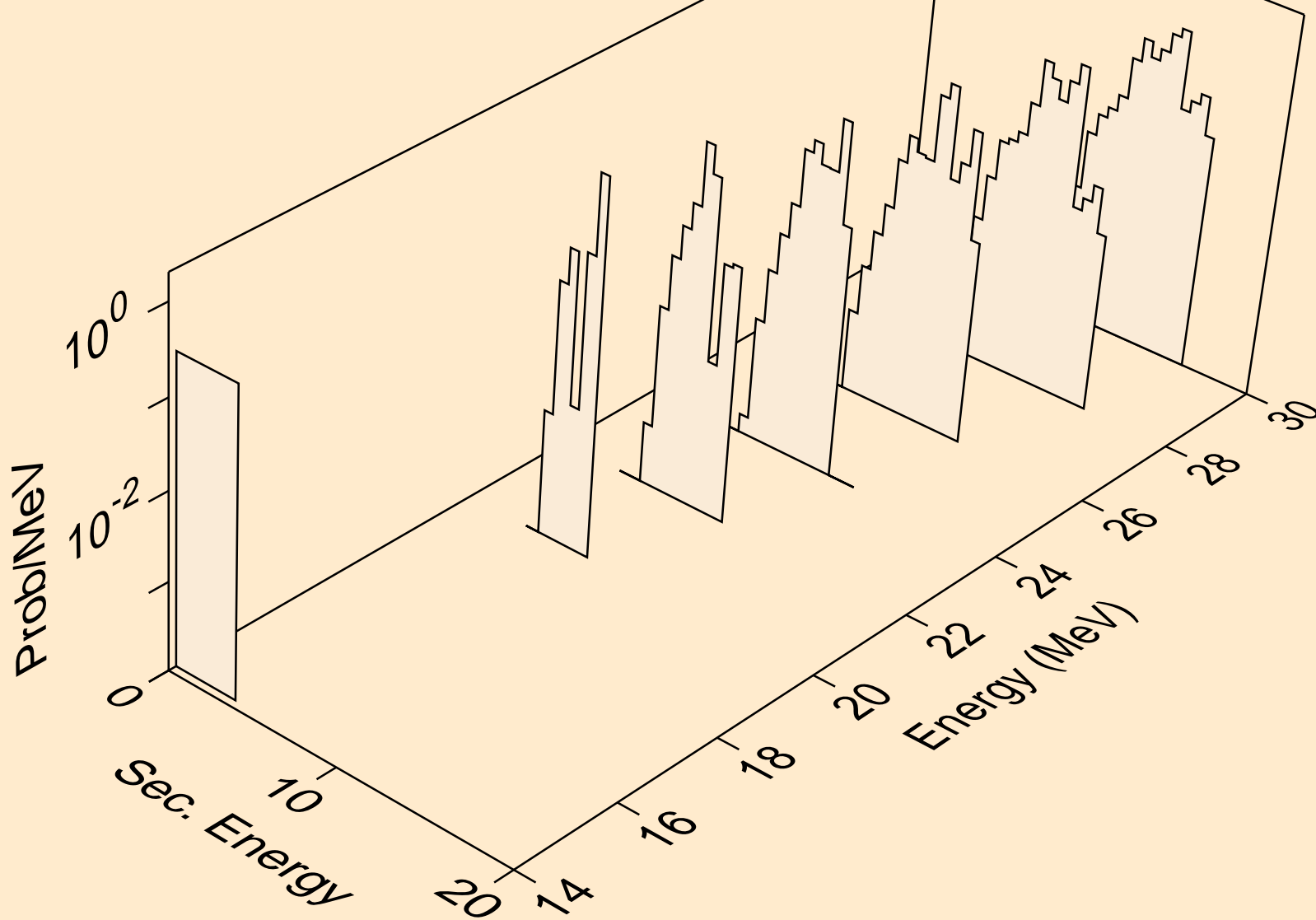

GD156 NEUTRON ACER TENDL-2019 LIBRARY; T=293.16K  
alphas from (n,n\*)2a

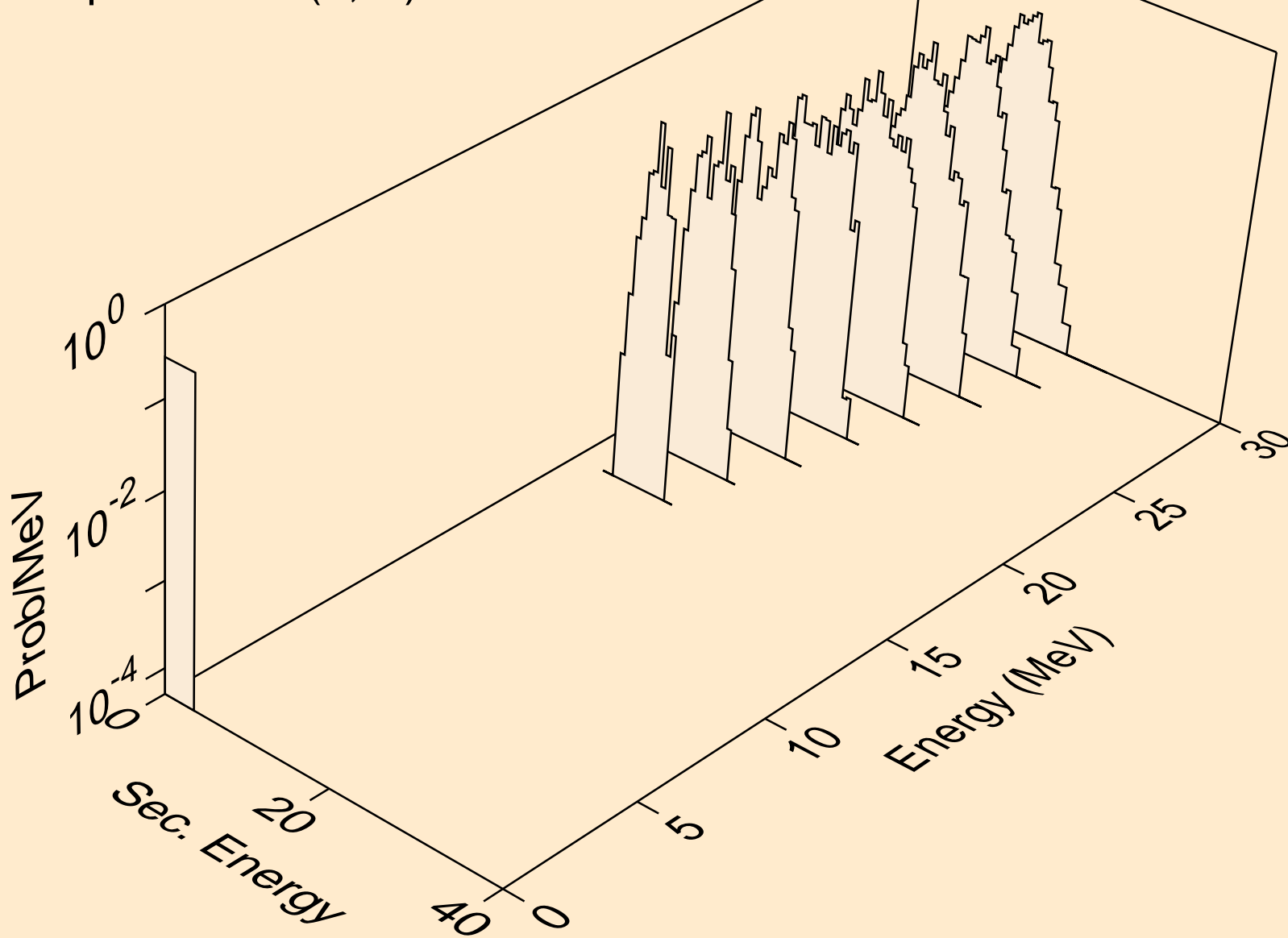

GD156 NEUTRON ACER TENDL-2019 LIBRARY; T=293.16K  
alphas from (n,npa)

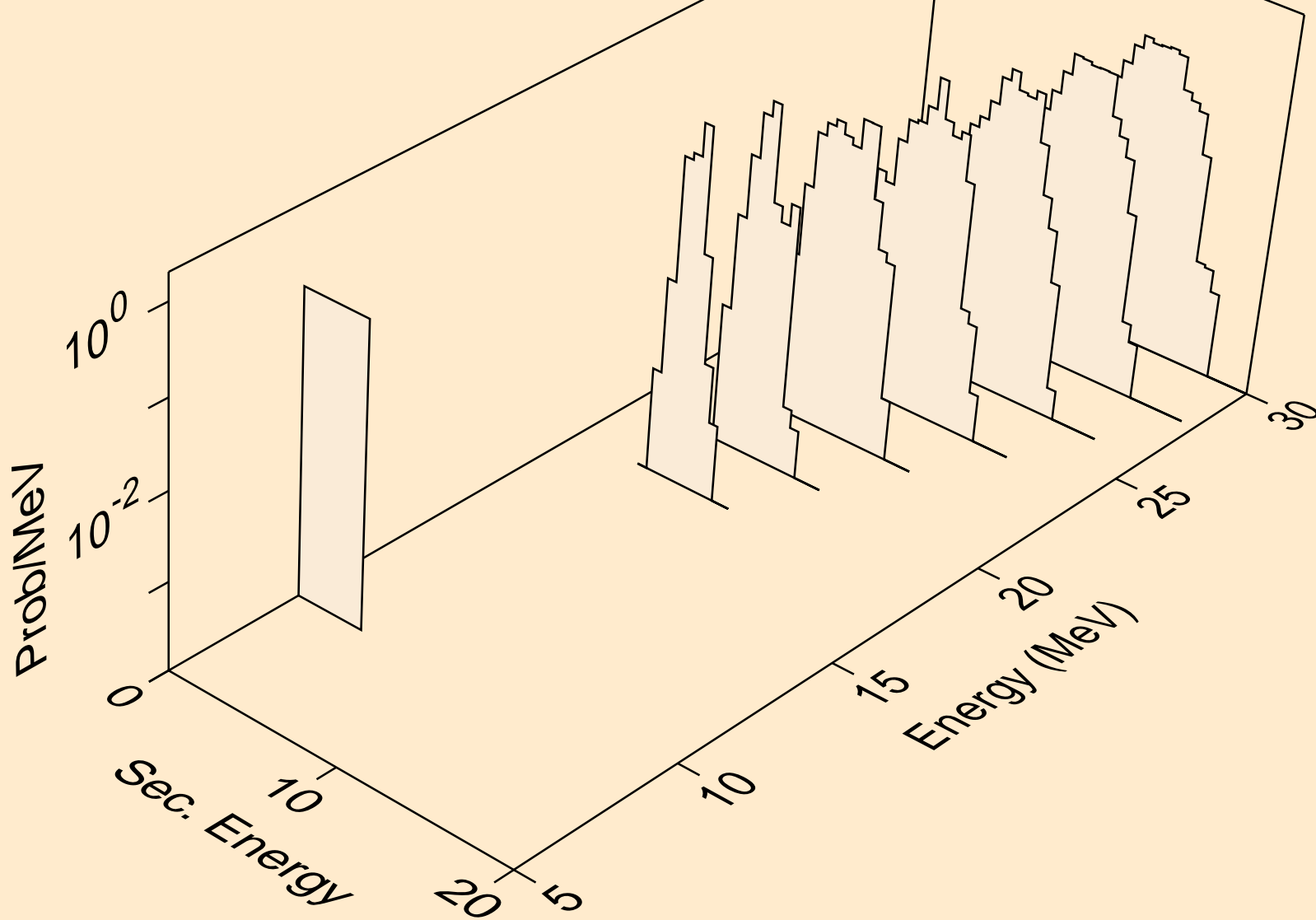

GD156 NEUTRON ACER TENDL-2019 LIBRARY; T=293.16K  
alphas from (n,a)

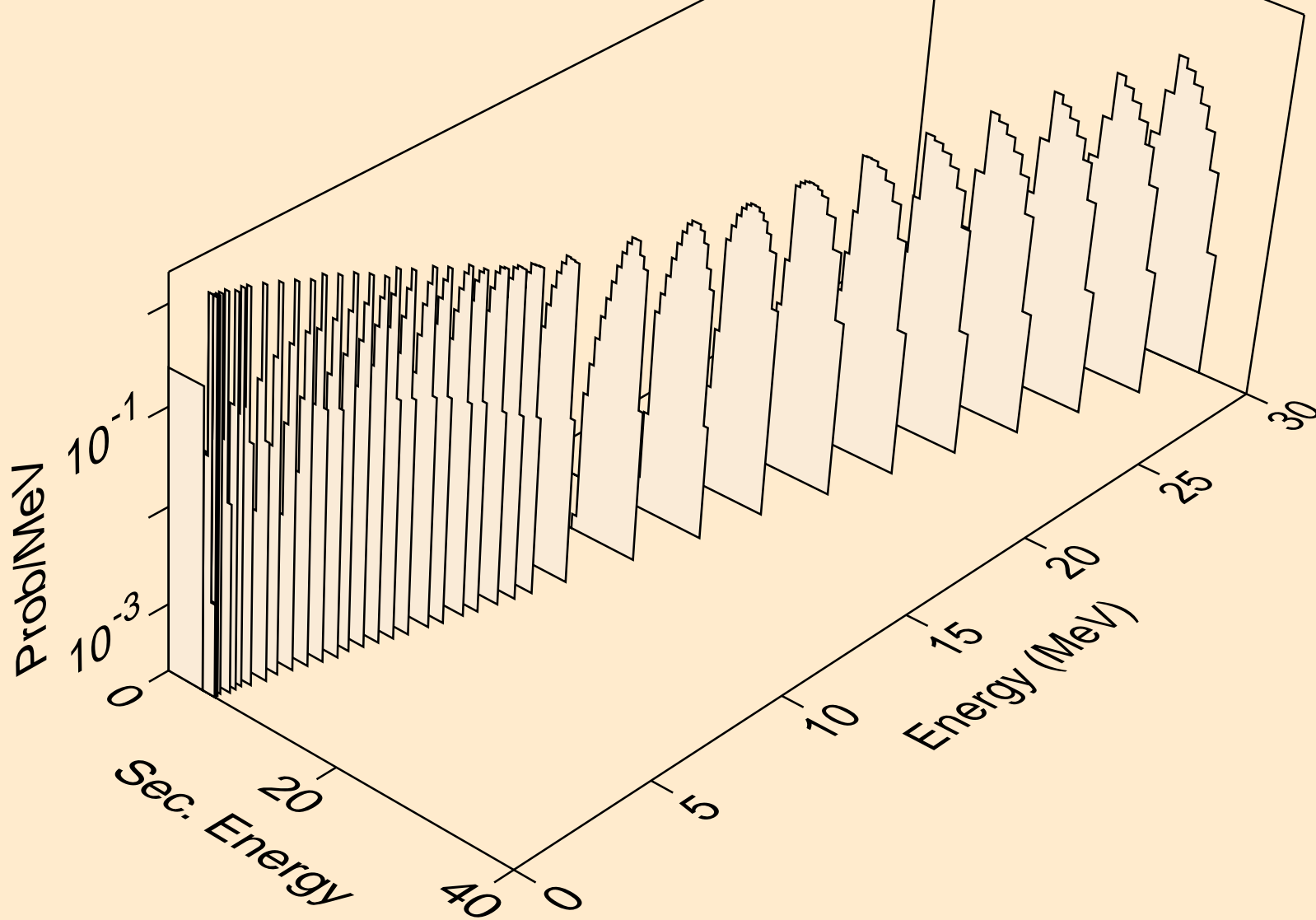



GD156 NEUTRON ACER TENDL-2019 LIBRARY; T=293.16K  
alphas from (n,2a)

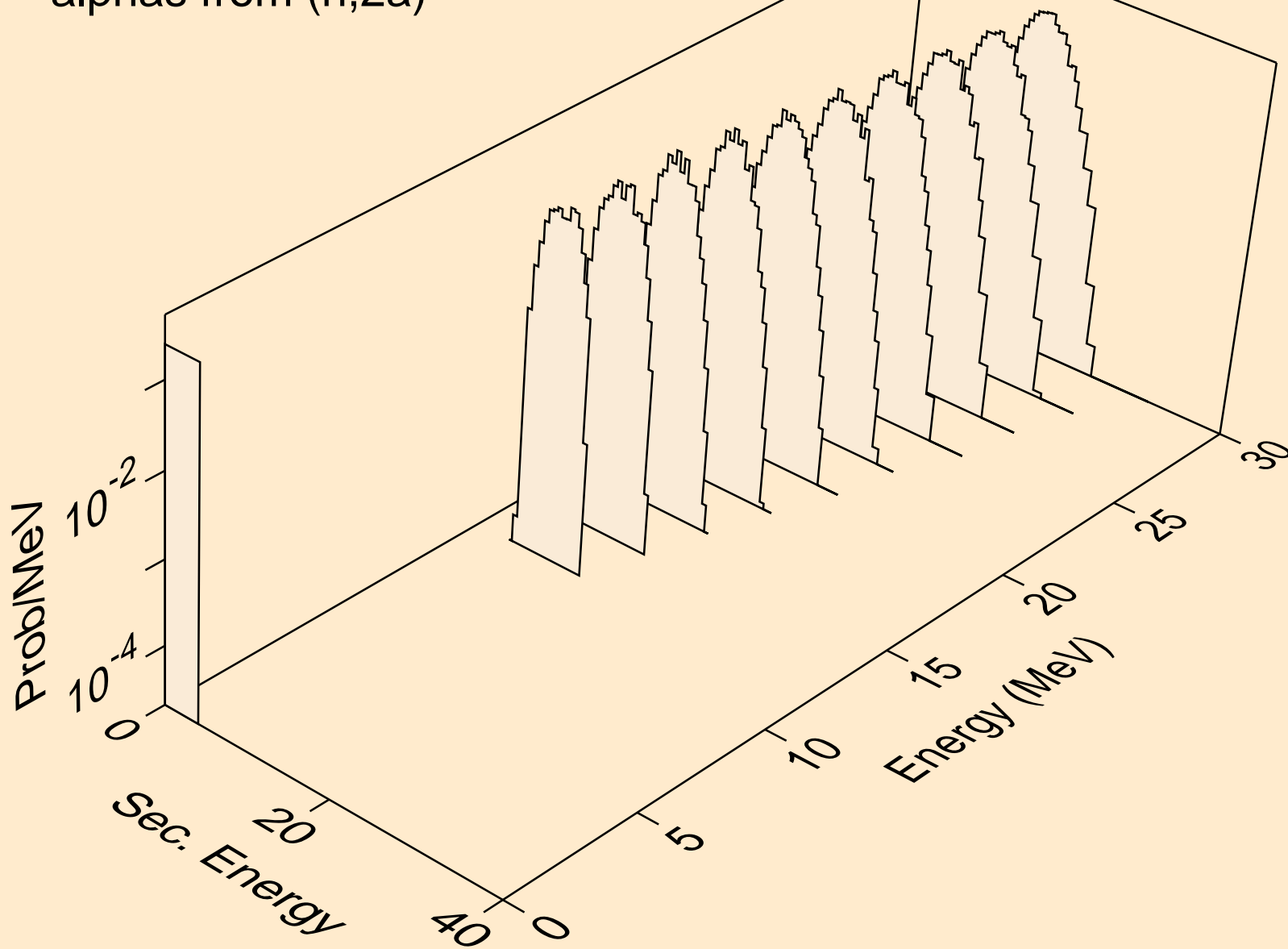

GD156 NEUTRON ACER TENDL-2019 LIBRARY; T=293.16K  
alphas from (n,pa)

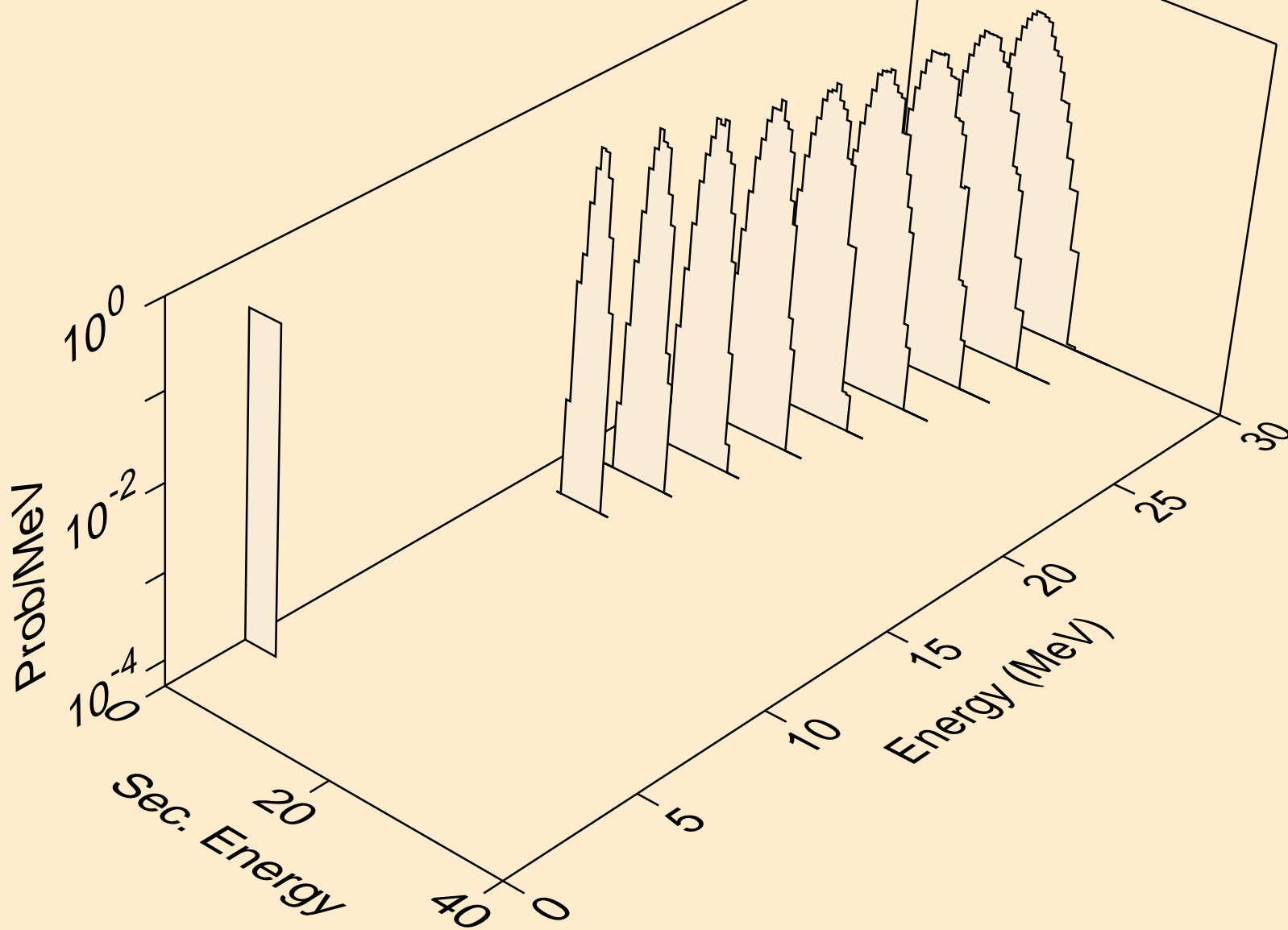

GD156 NEUTRON ACER TENDL-2019 LIBRARY; T=293.16K  
alphas from (n,da)

