

# GD158 NEUTRON ACER TENDL-2019 LIBRARY; T=293.16K

## Principal cross sections

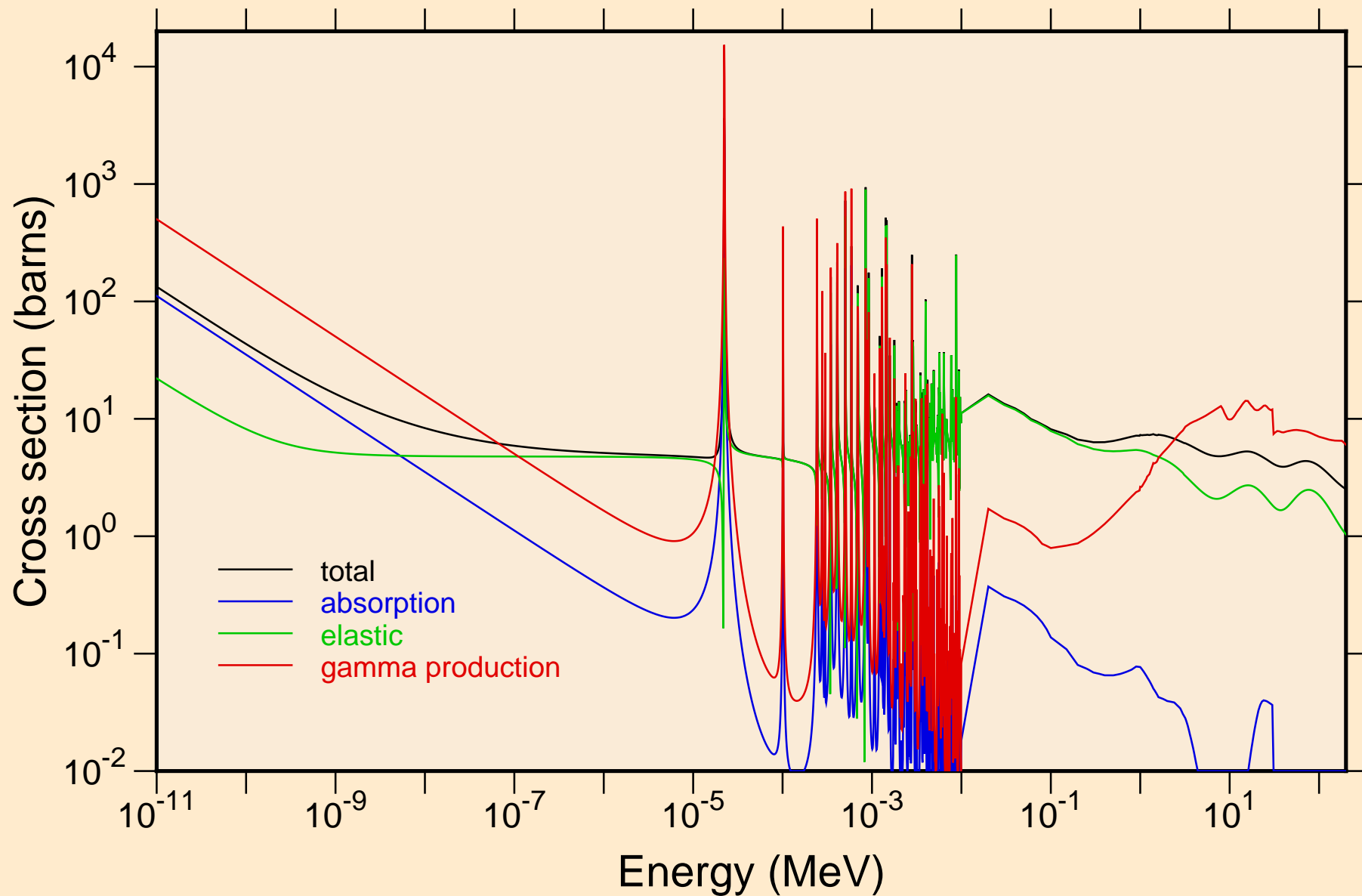

GD158 NEUTRON ACER TENDL-2019 LIBRARY; T=293.16K  
resonance total cross section

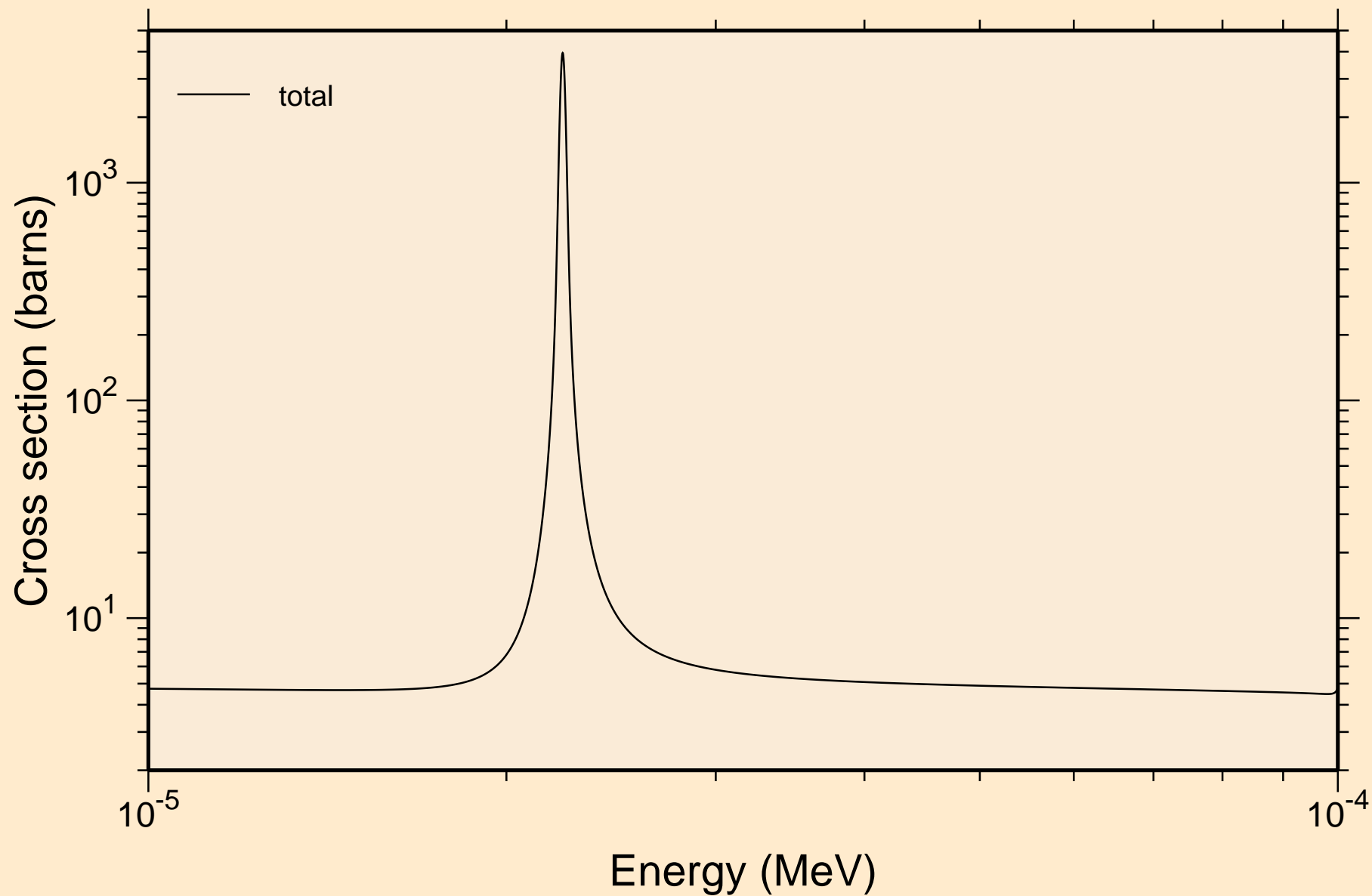

GD158 NEUTRON ACER TENDL-2019 LIBRARY; T=293.16K  
resonance total cross section

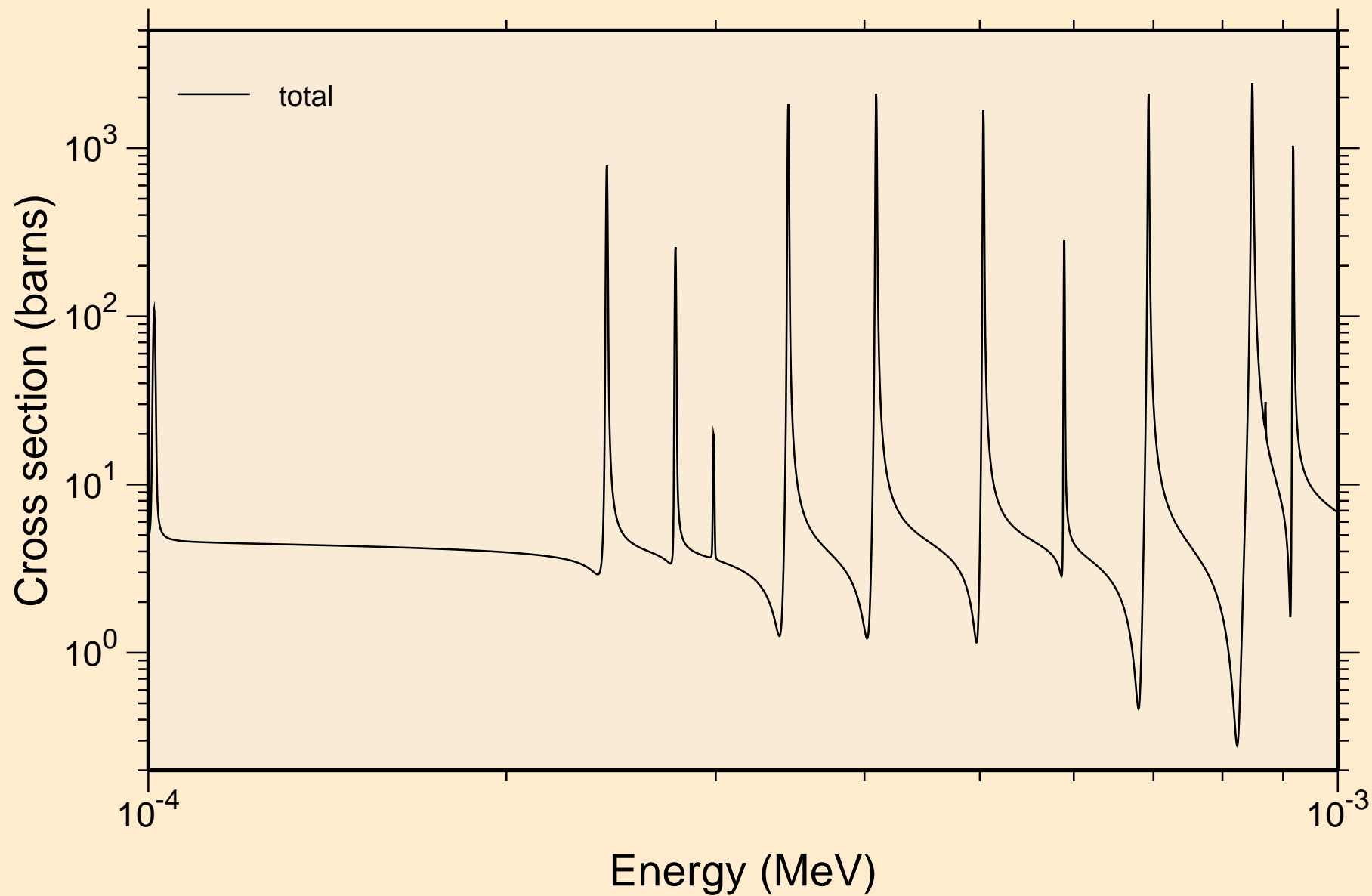

GD158 NEUTRON ACER TENDL-2019 LIBRARY; T=293.16K  
resonance total cross section

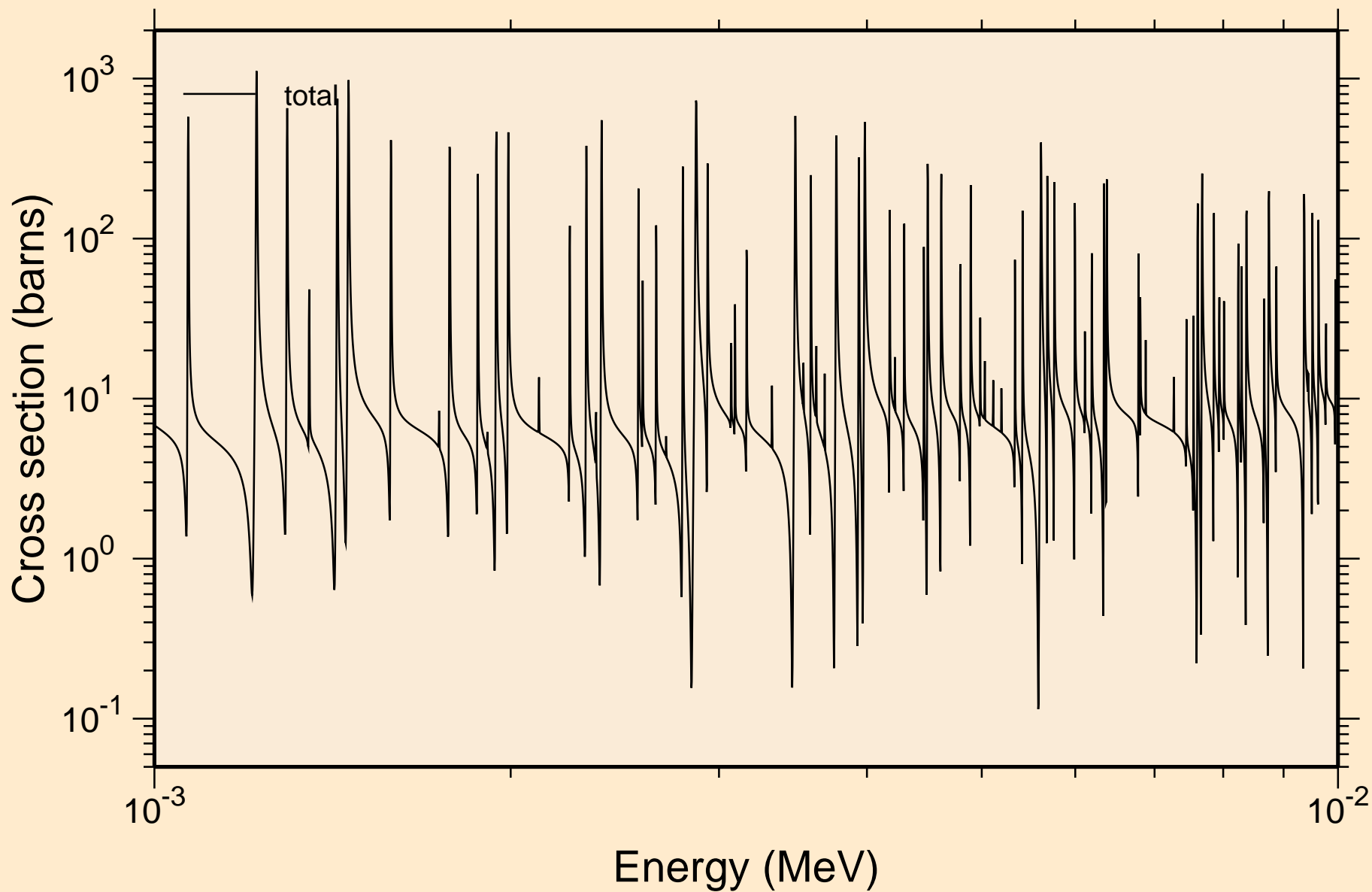

GD158 NEUTRON ACER TENDL-2019 LIBRARY; T=293.16K  
resonance total cross section

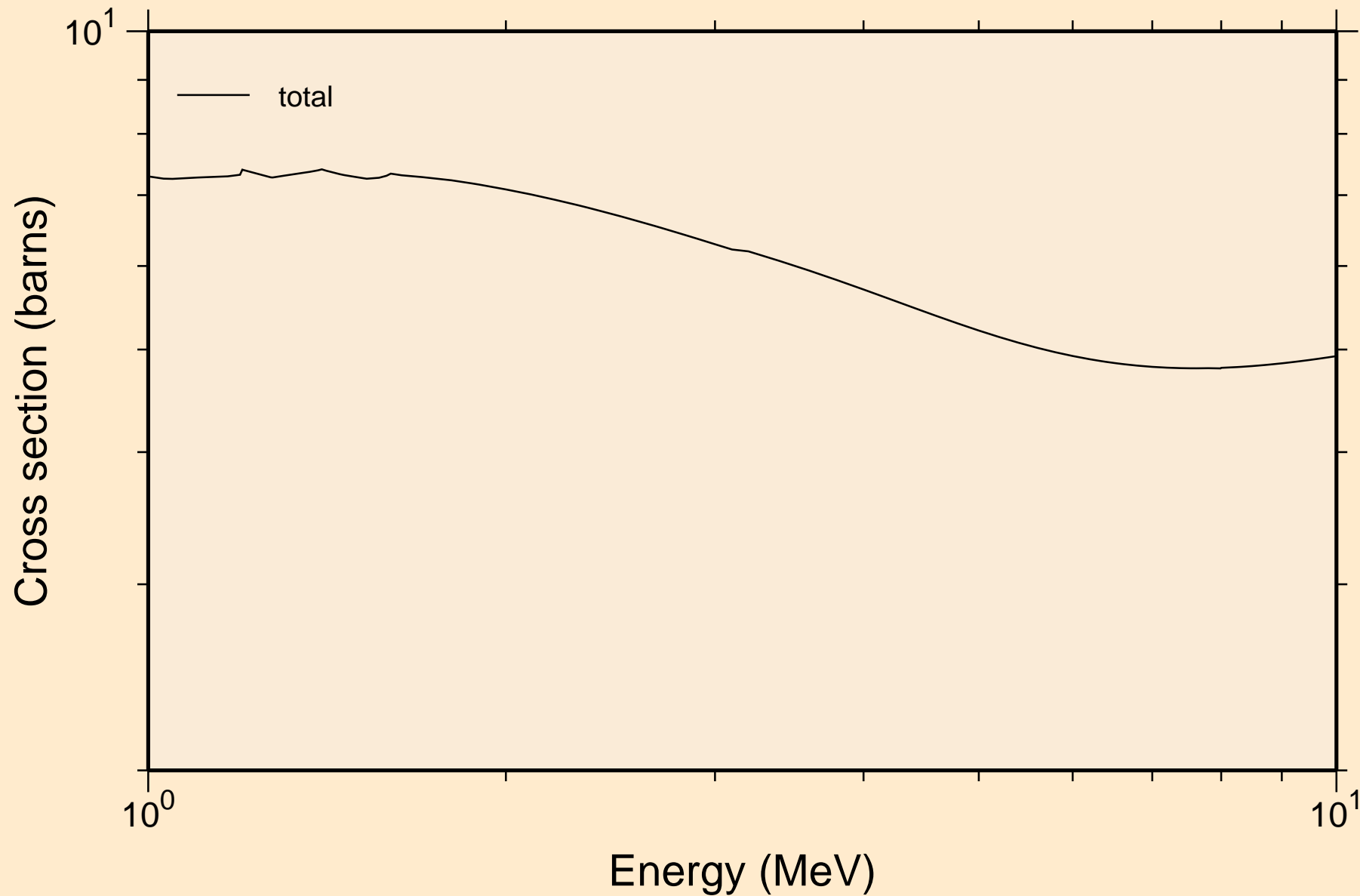

GD158 NEUTRON ACER TENDL-2019 LIBRARY; T=293.16K  
resonance absorption cross sections

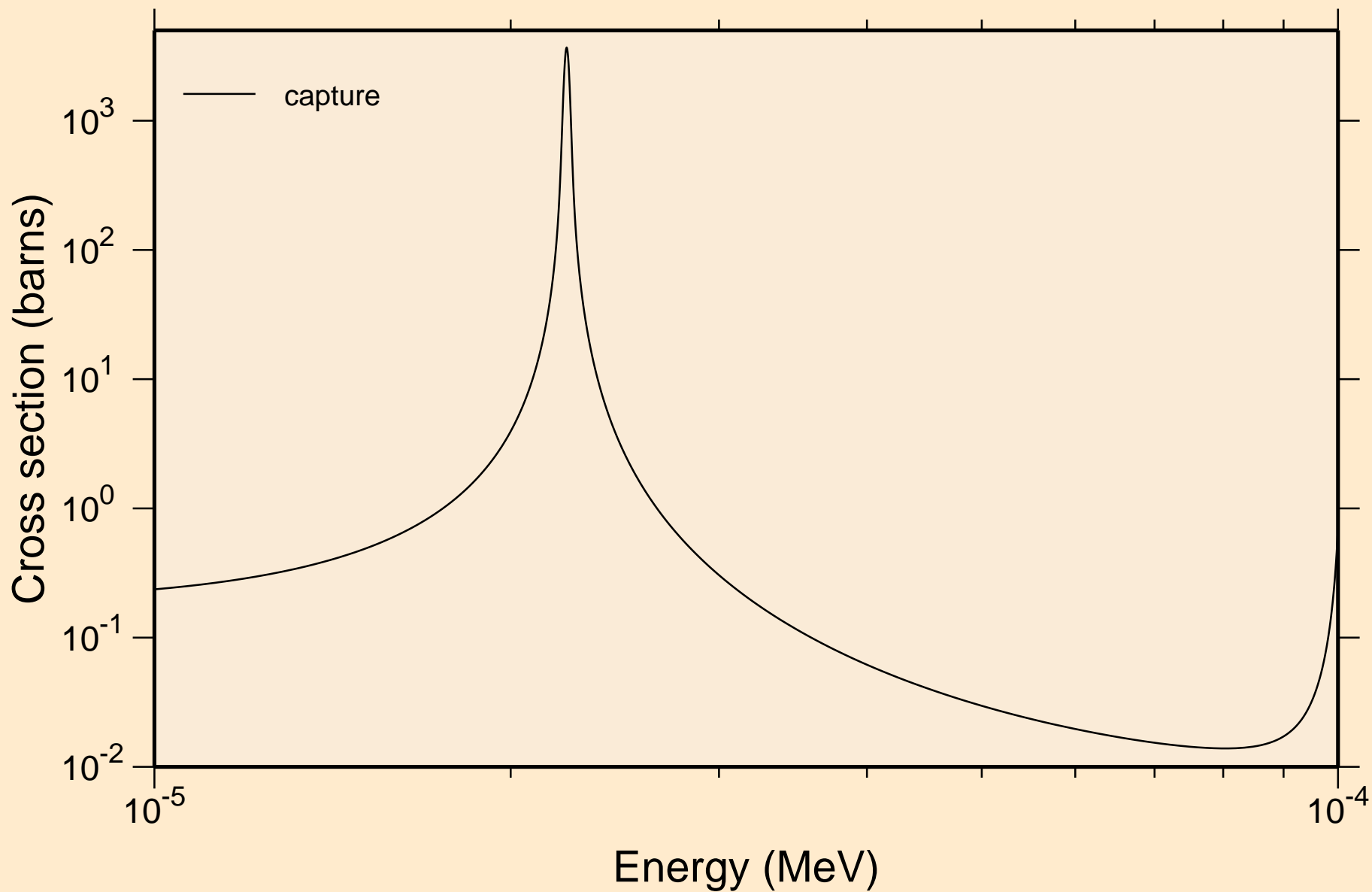

GD158 NEUTRON ACER TENDL-2019 LIBRARY; T=293.16K  
resonance absorption cross sections

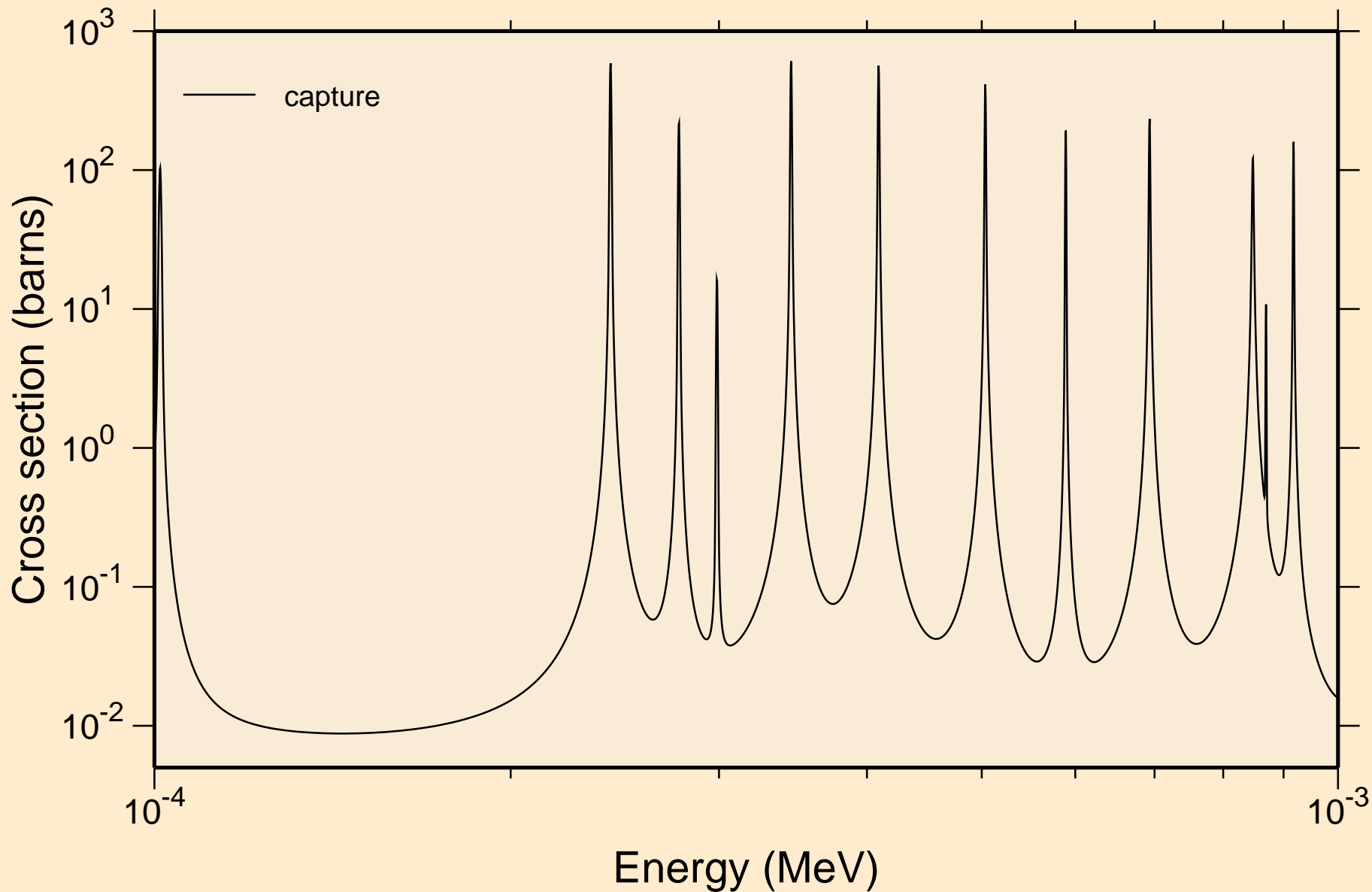

GD158 NEUTRON ACER TENDL-2019 LIBRARY; T=293.16K  
resonance absorption cross sections

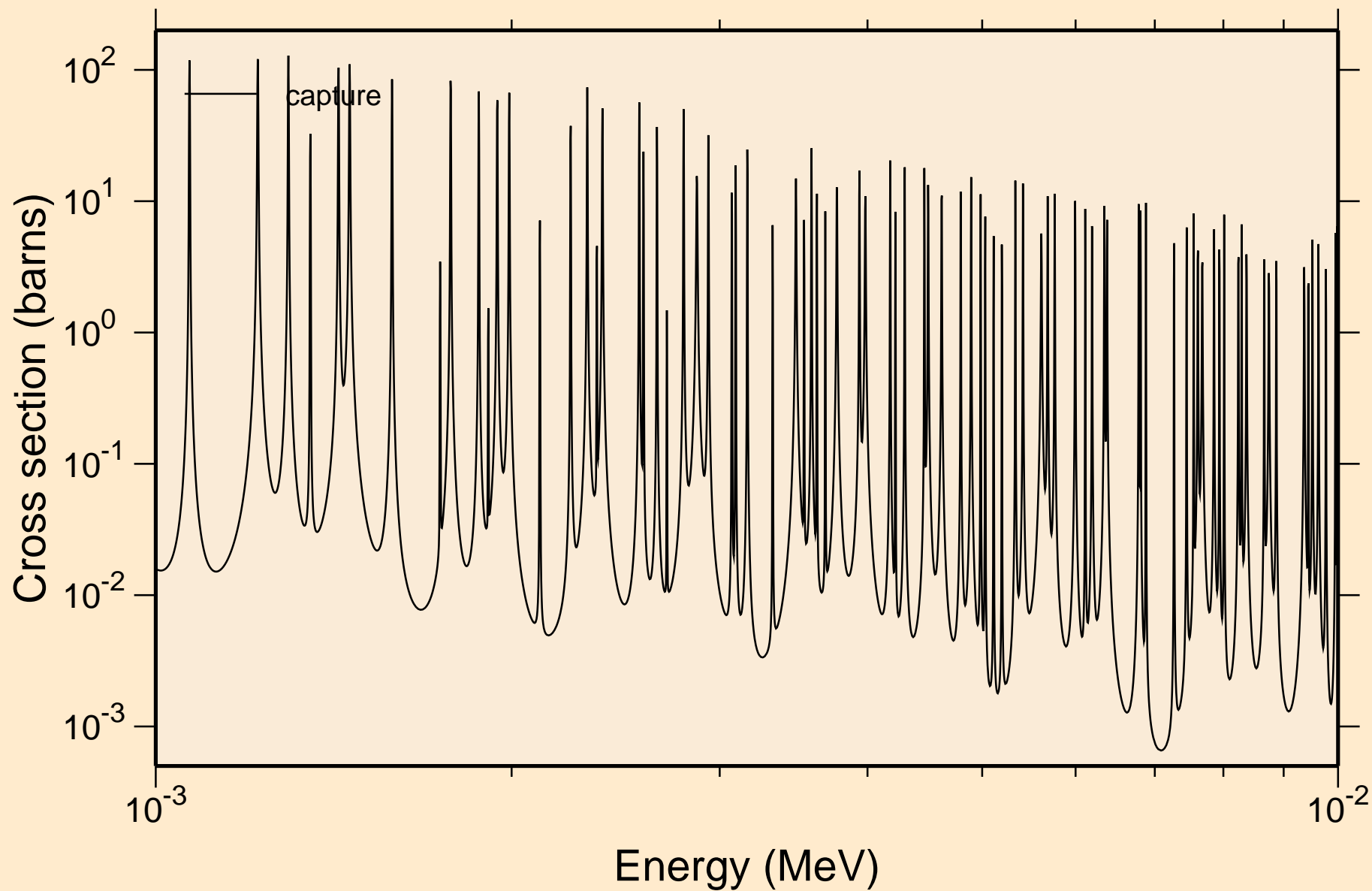



GD158 NEUTRON ACER TENDL-2019 LIBRARY; T=293.16K  
resonance absorption cross sections

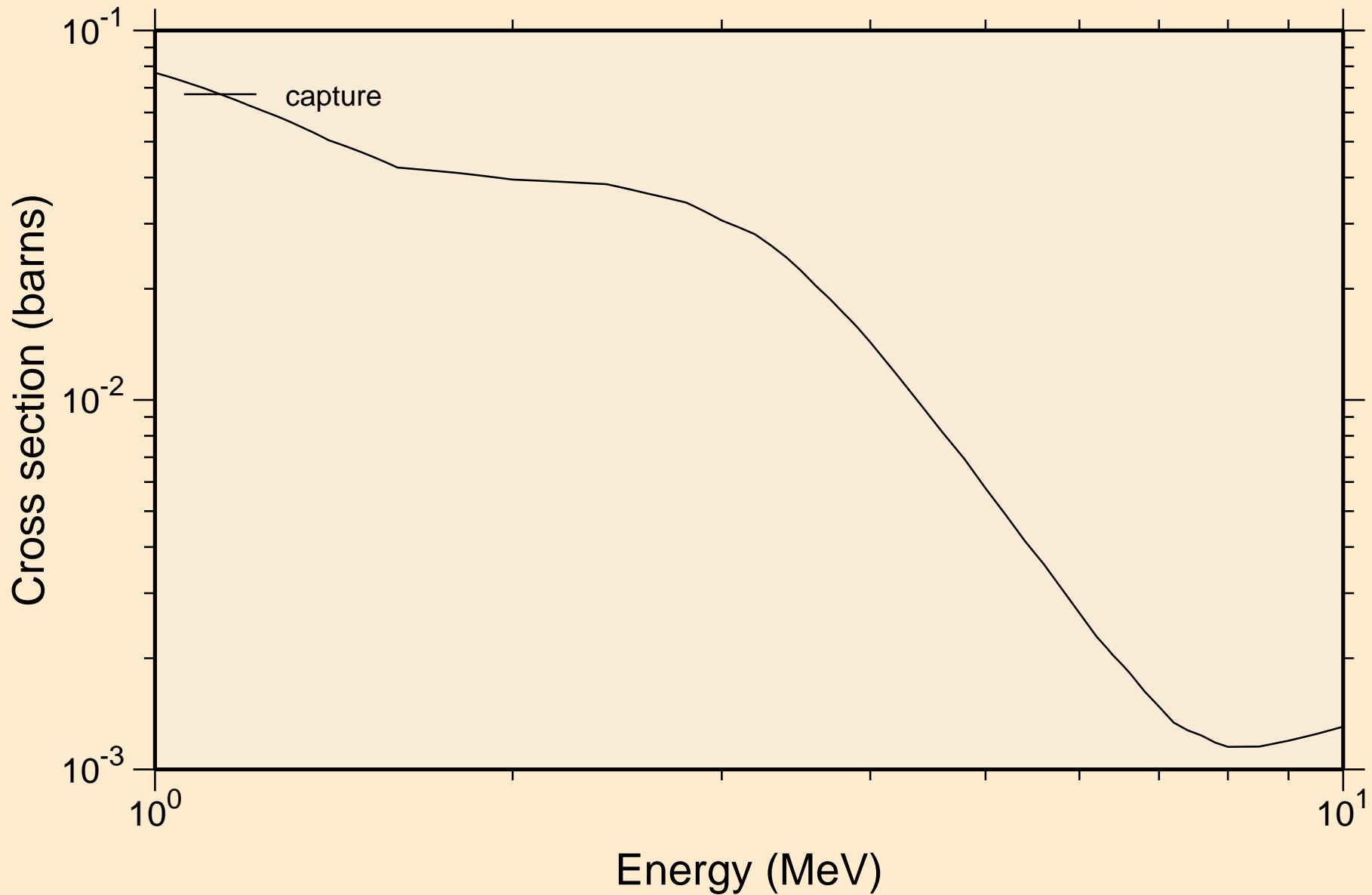

GD158 NEUTRON ACER TENDL-2019 LIBRARY; T=293.16K  
Heating

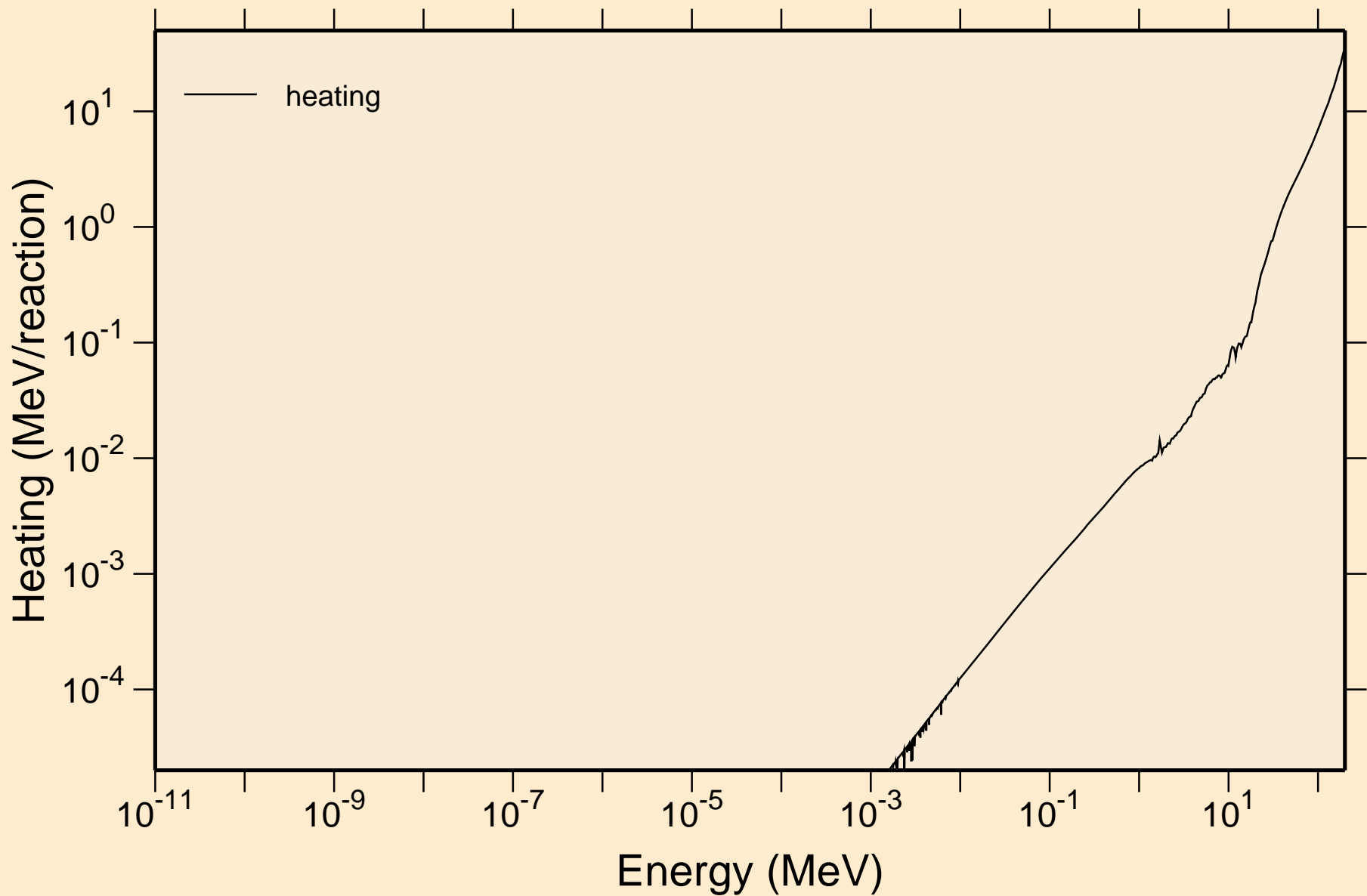

# GD158 NEUTRON ACER TENDL-2019 LIBRARY; T=293.16K Damage

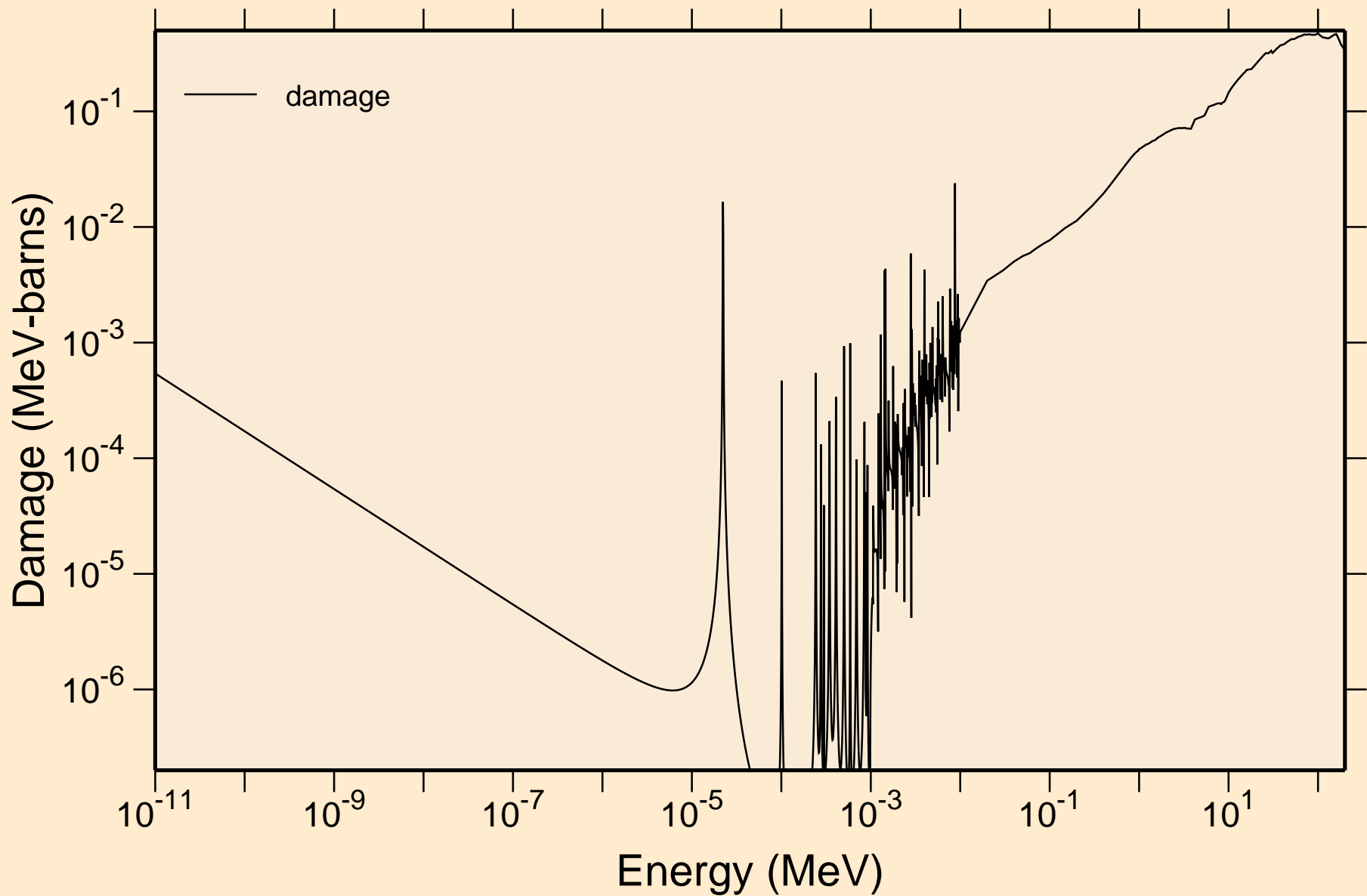

GD158 NEUTRON ACER TENDL-2019 LIBRARY; T=293.16K  
Non-threshold reactions

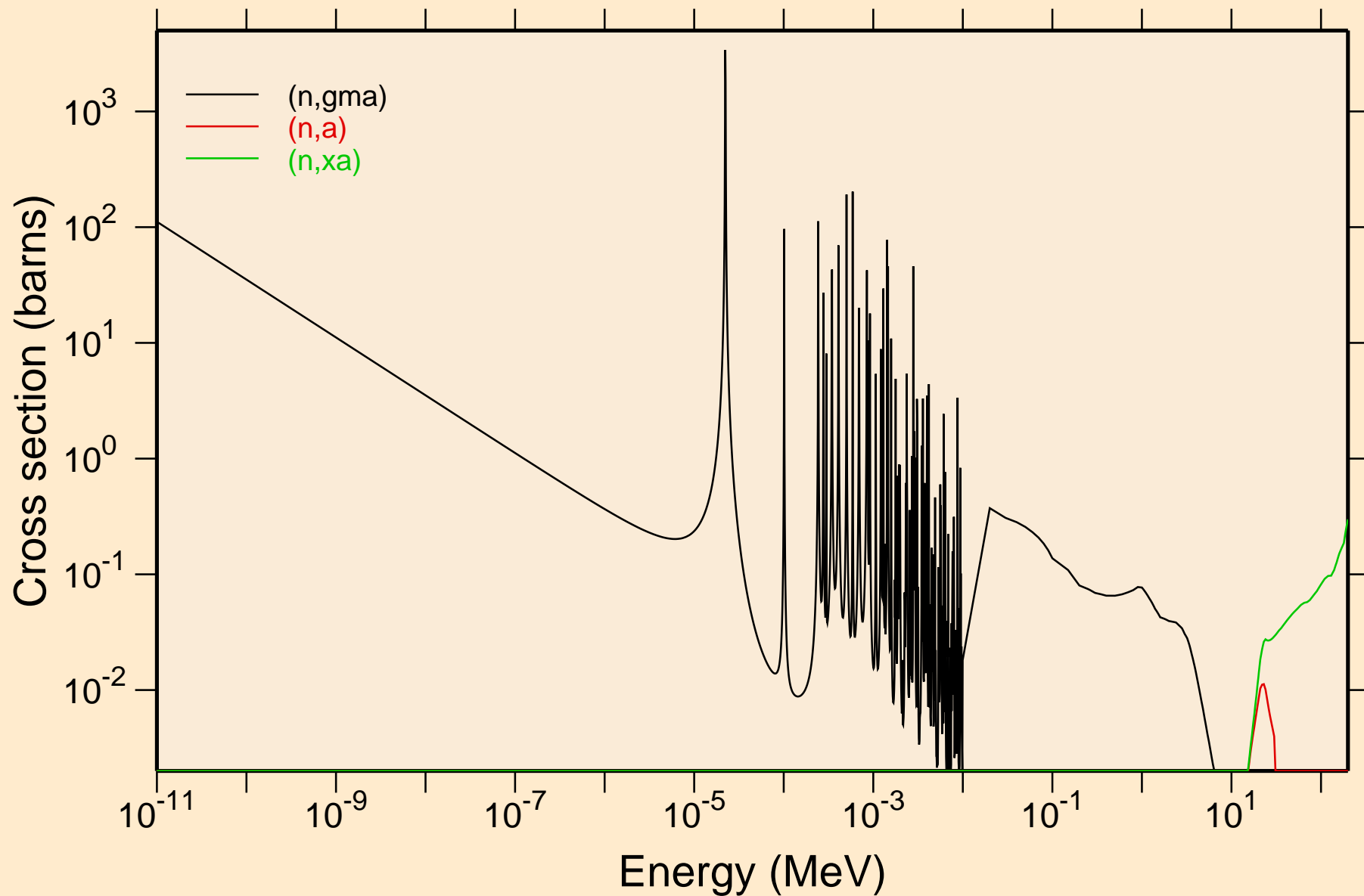

GD158 NEUTRON ACER TENDL-2019 LIBRARY; T=293.16K  
Principal cross sections

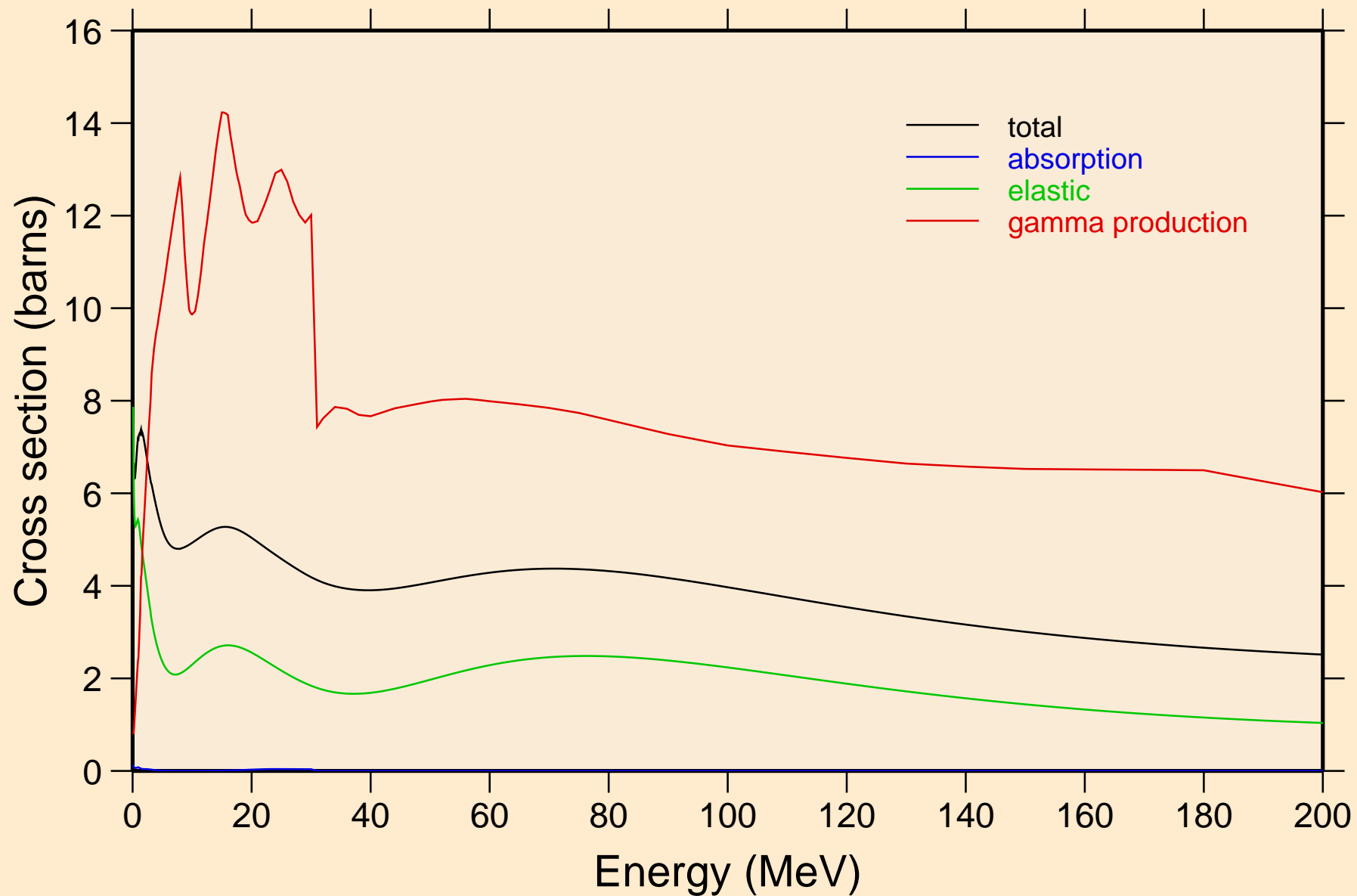

# GD158 NEUTRON ACER TENDL-2019 LIBRARY; T=293.16K

## Heating

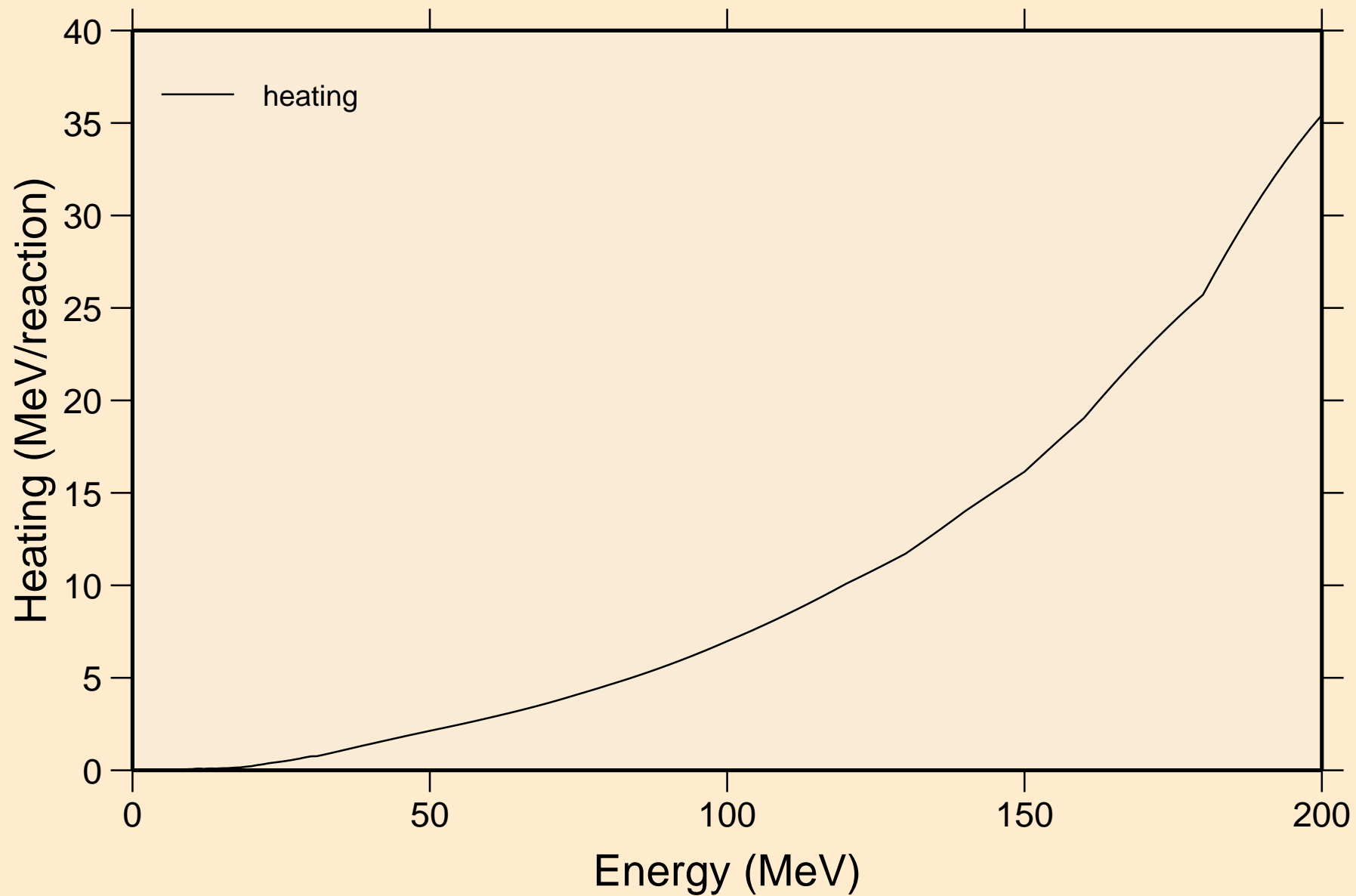

# GD158 NEUTRON ACER TENDL-2019 LIBRARY; T=293.16K Damage

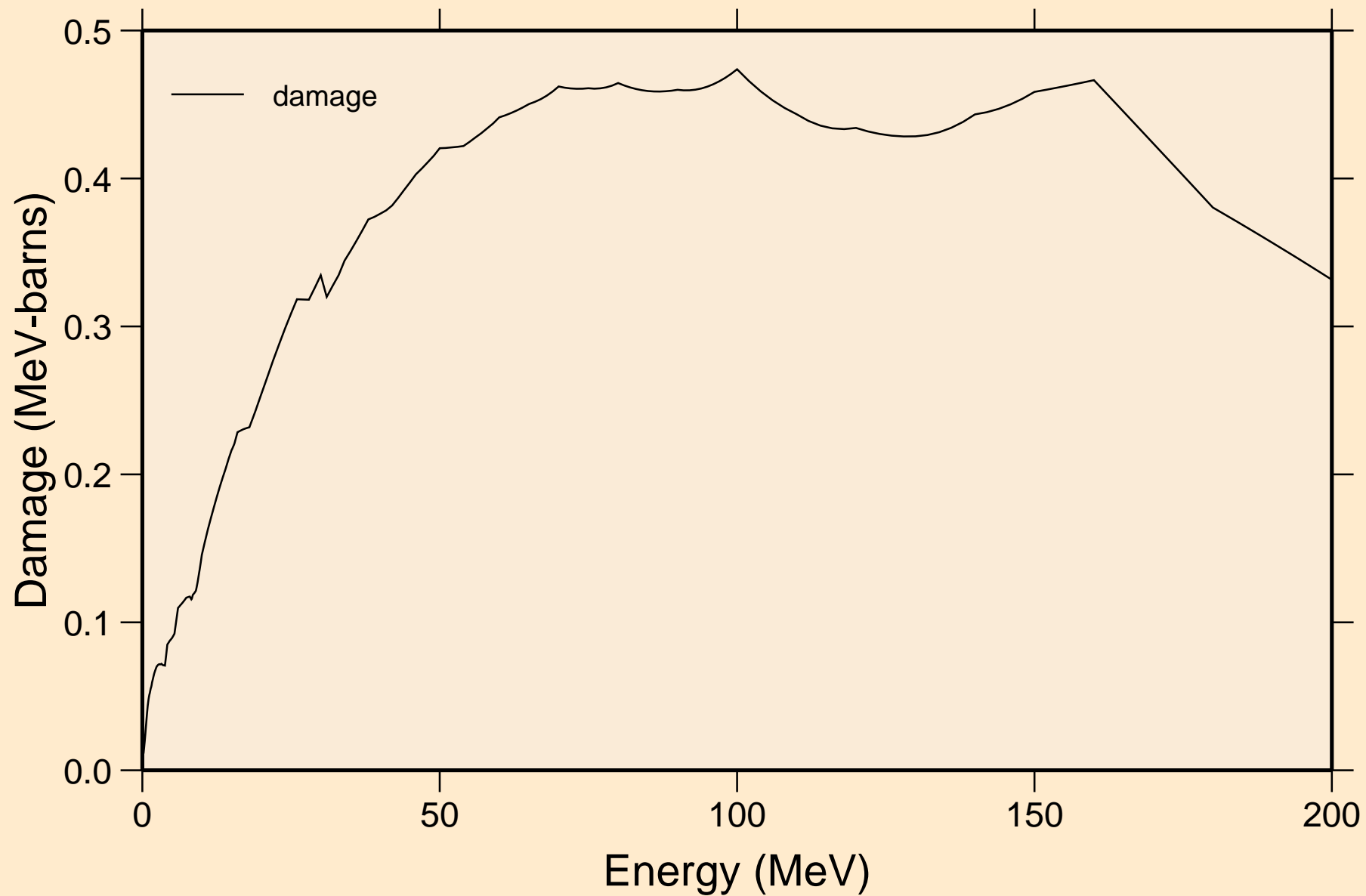

GD158 NEUTRON ACER TENDL-2019 LIBRARY; T=293.16K  
Non-threshold reactions

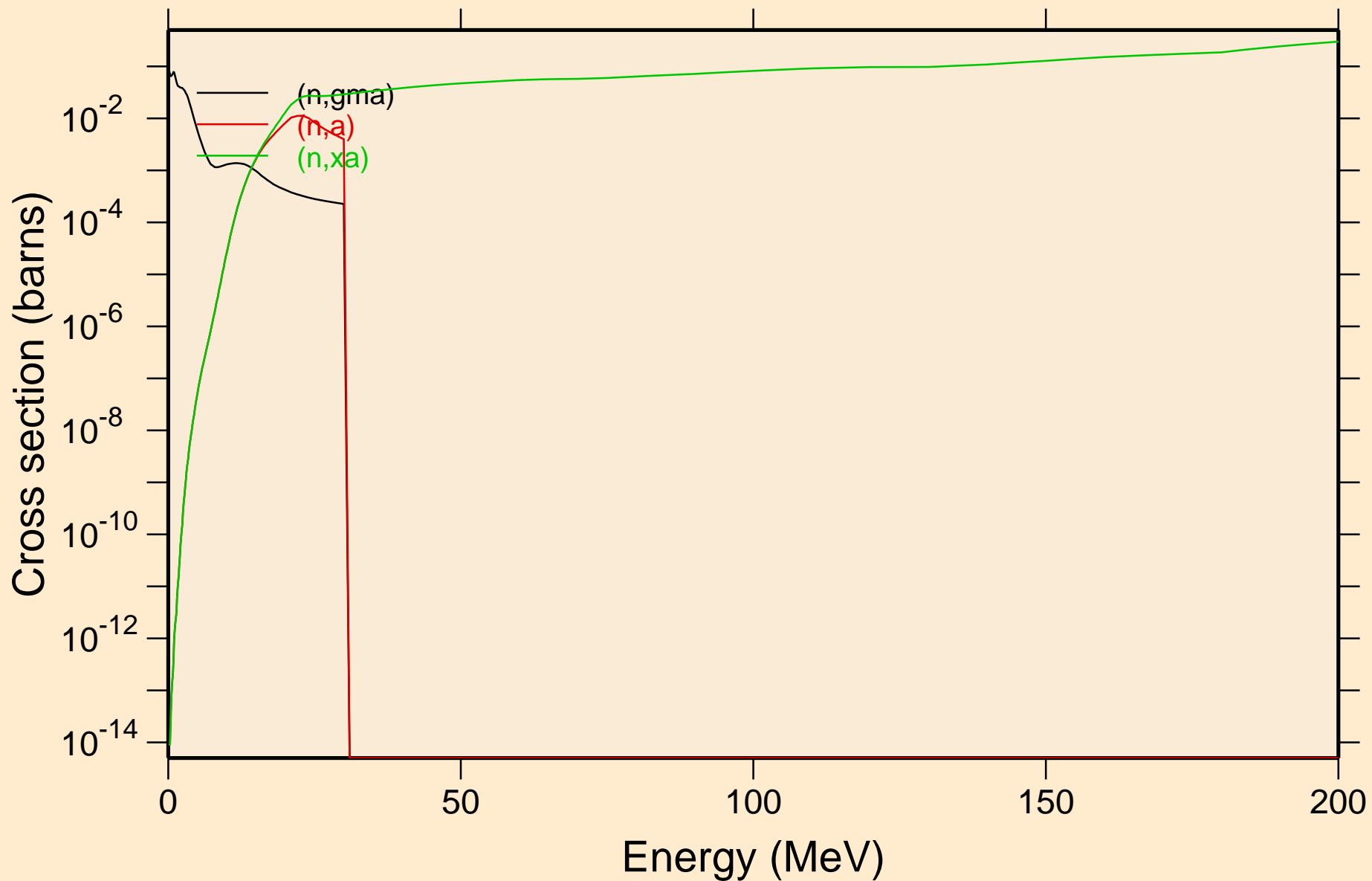



# GD158 NEUTRON ACER TENDL-2019 LIBRARY; T=293.16K

## Inelastic levels

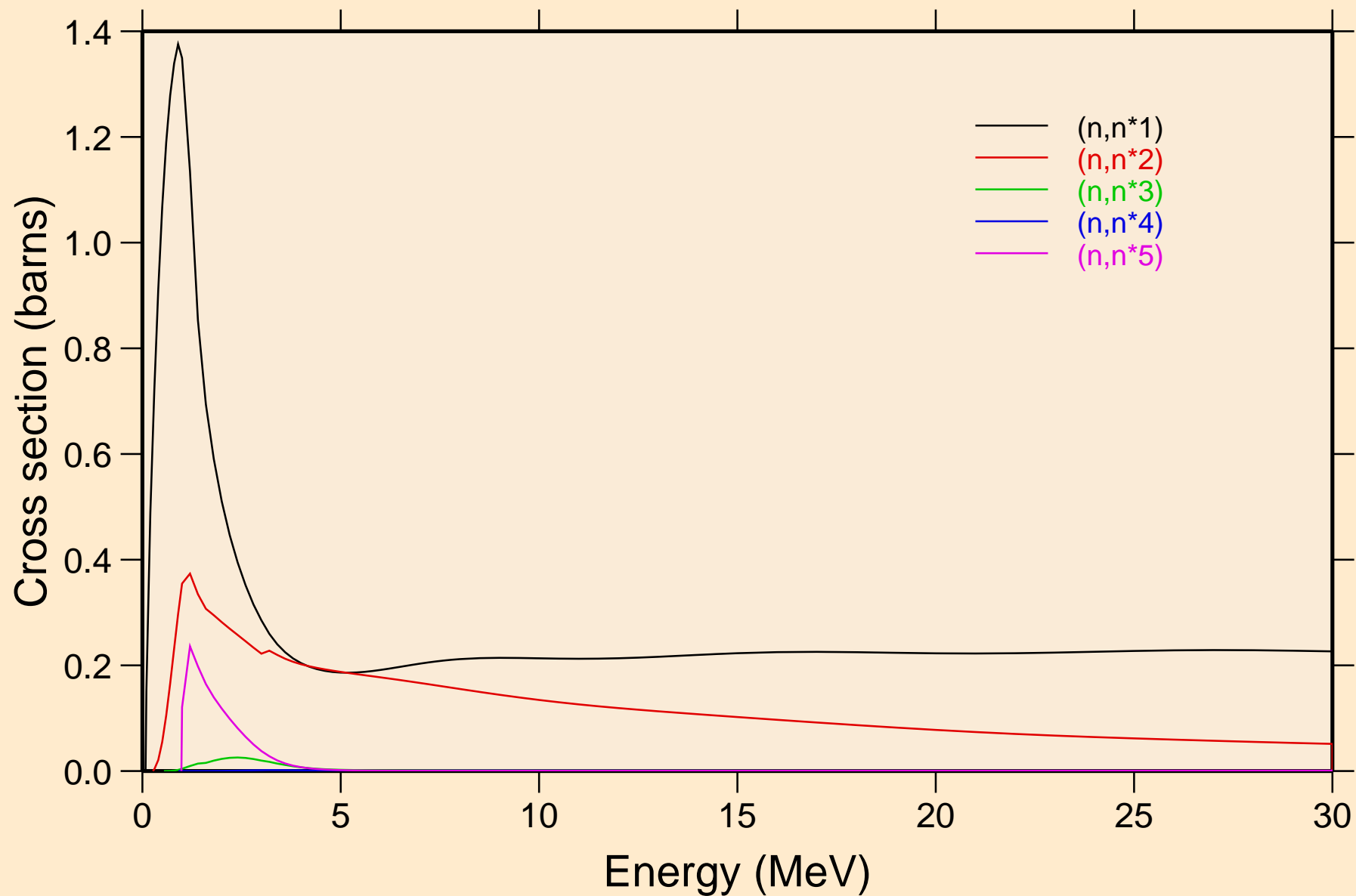

# GD158 NEUTRON ACER TENDL-2019 LIBRARY; T=293.16K

## Inelastic levels

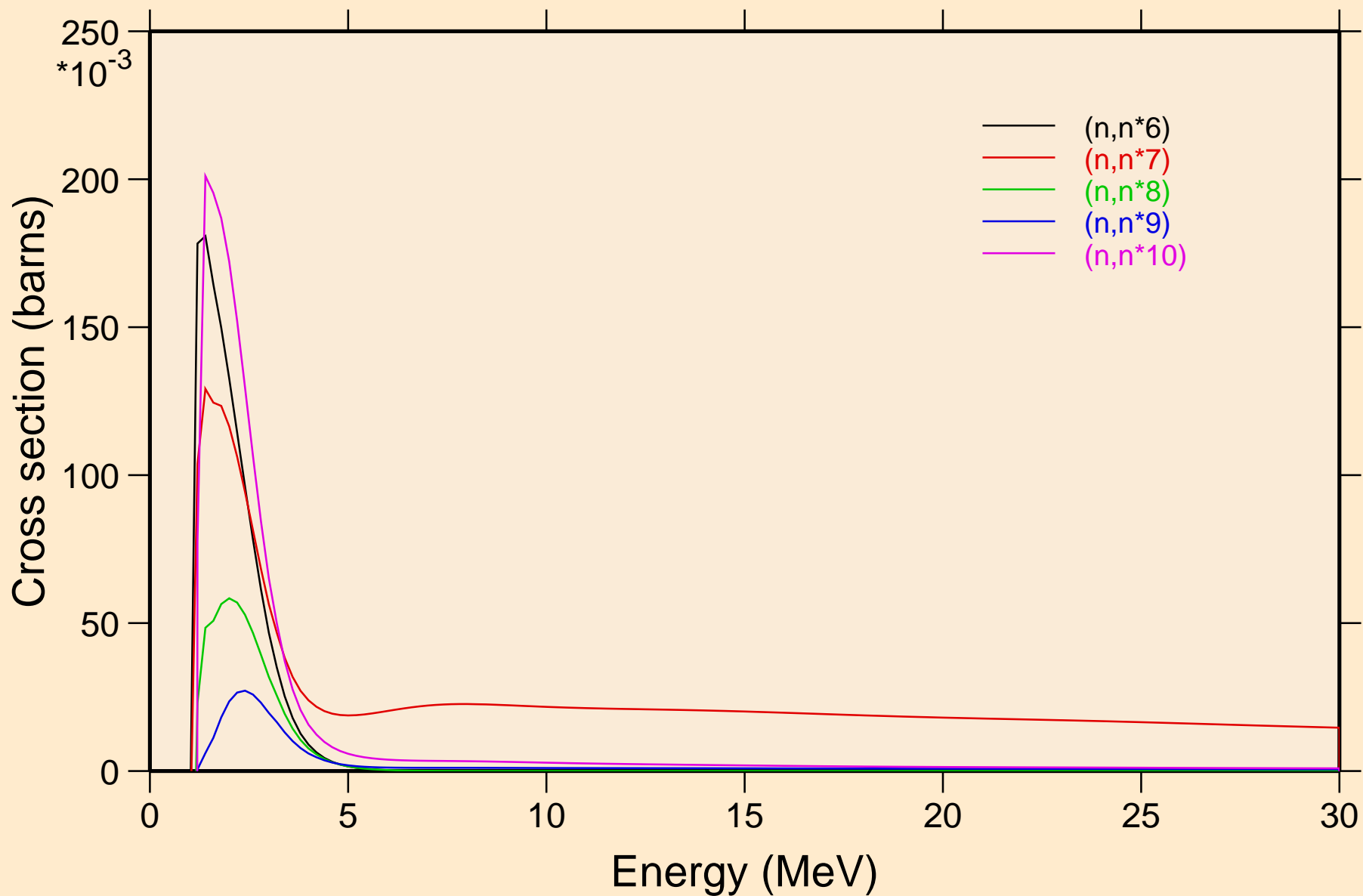

GD158 NEUTRON ACER TENDL-2019 LIBRARY; T=293.16K  
Inelastic levels

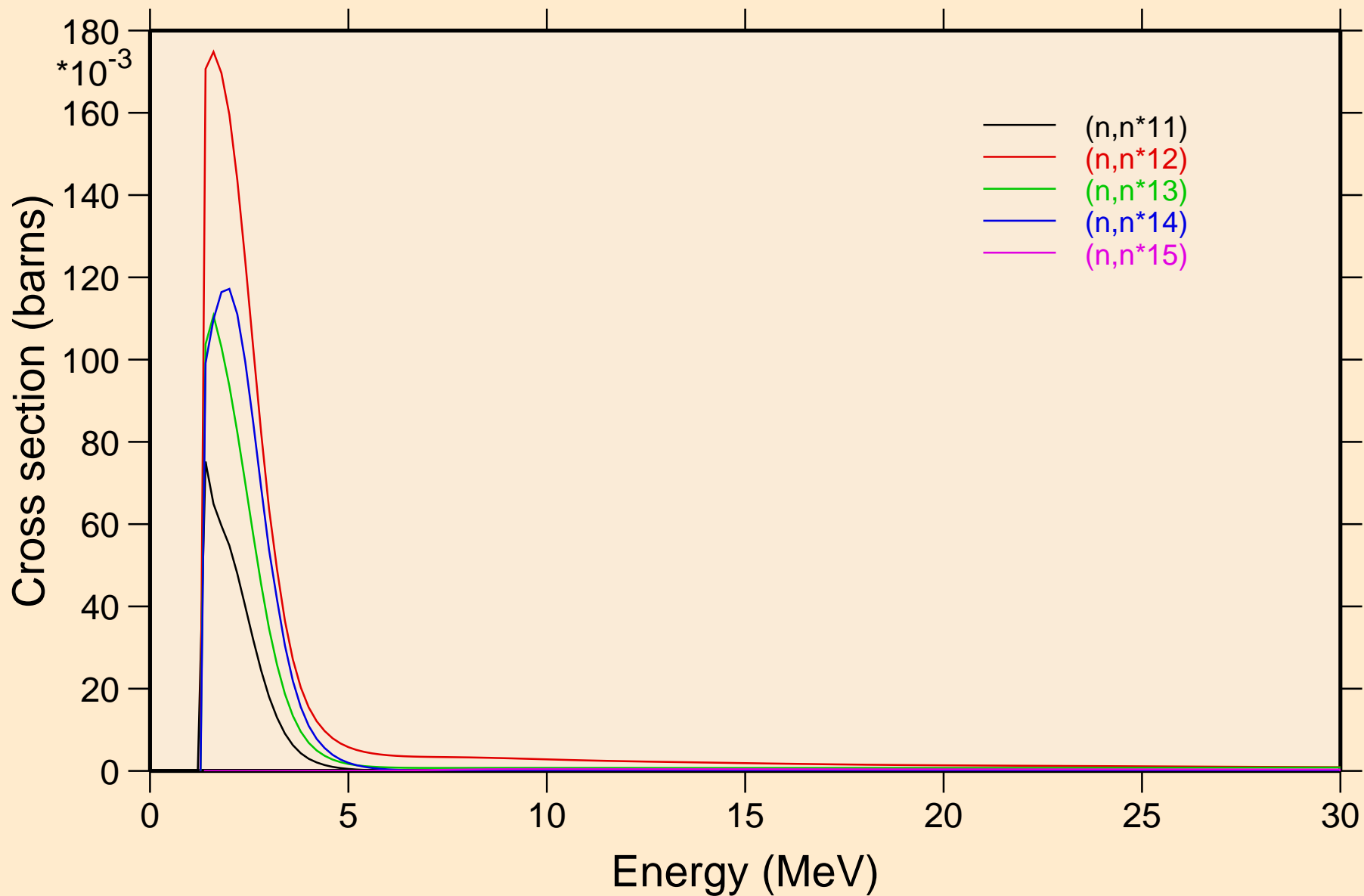

GD158 NEUTRON ACER TENDL-2019 LIBRARY; T=293.16K  
Inelastic levels

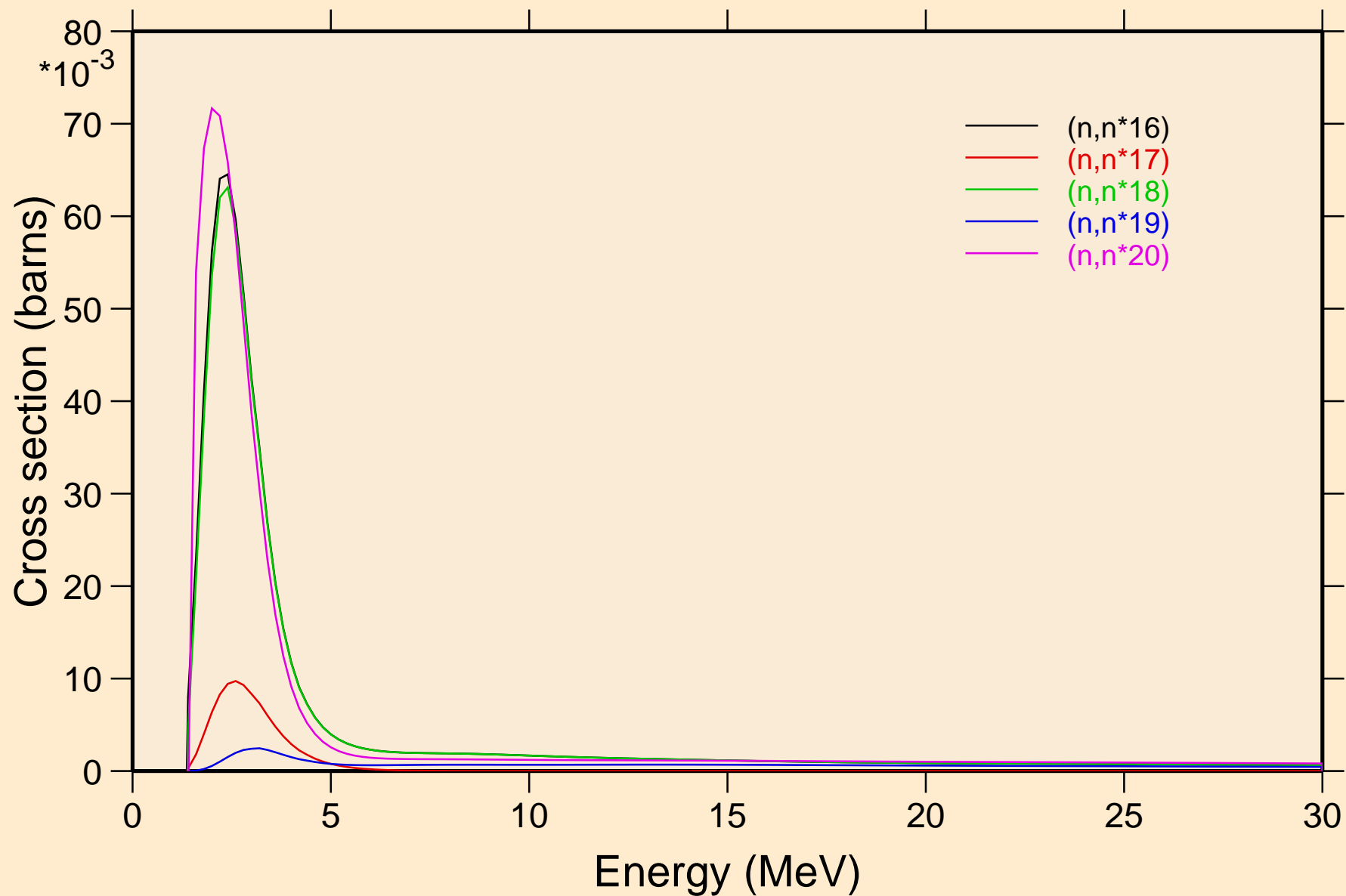

GD158 NEUTRON ACER TENDL-2019 LIBRARY; T=293.16K  
Inelastic levels

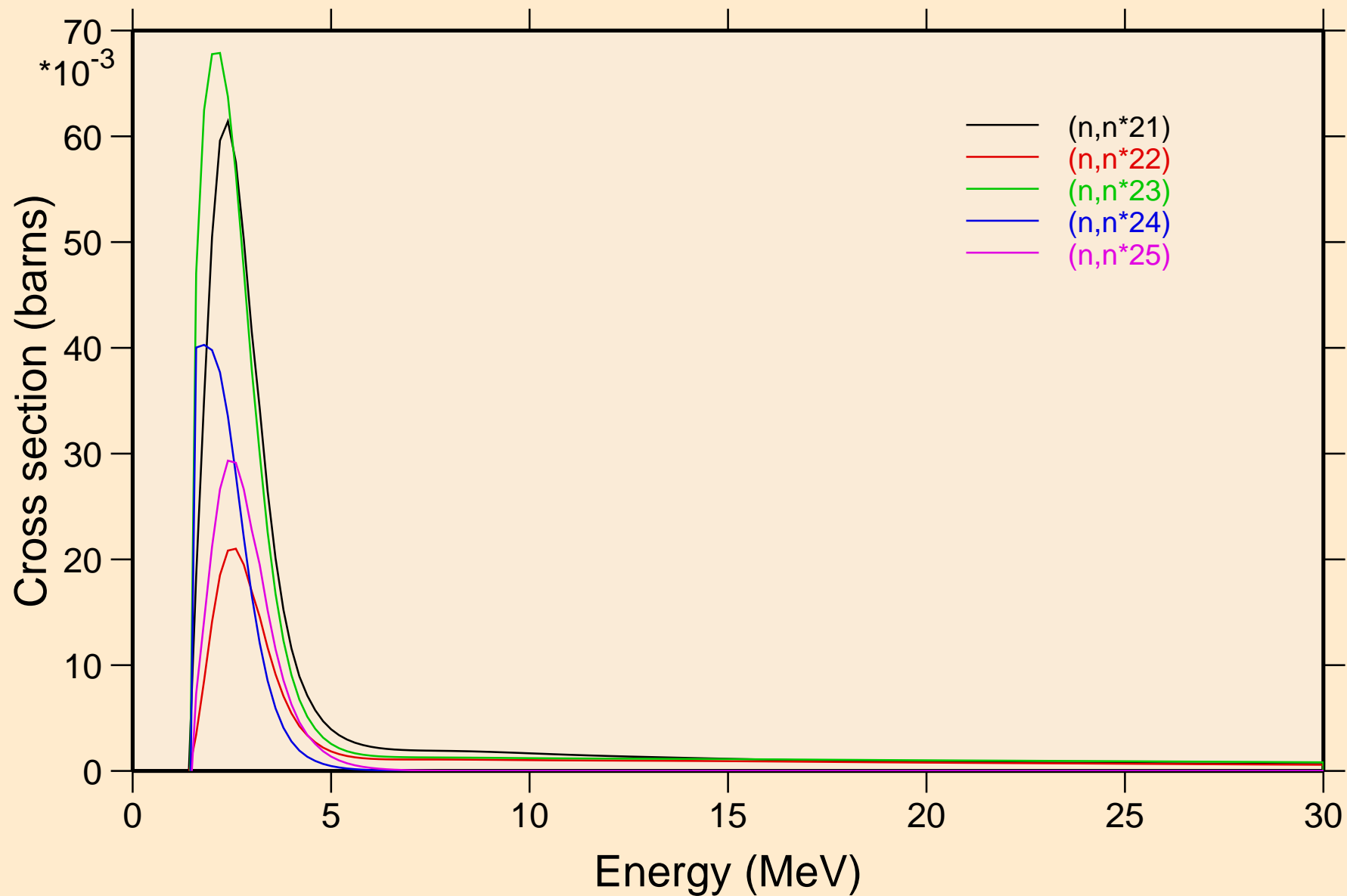

GD158 NEUTRON ACER TENDL-2019 LIBRARY; T=293.16K  
Inelastic levels

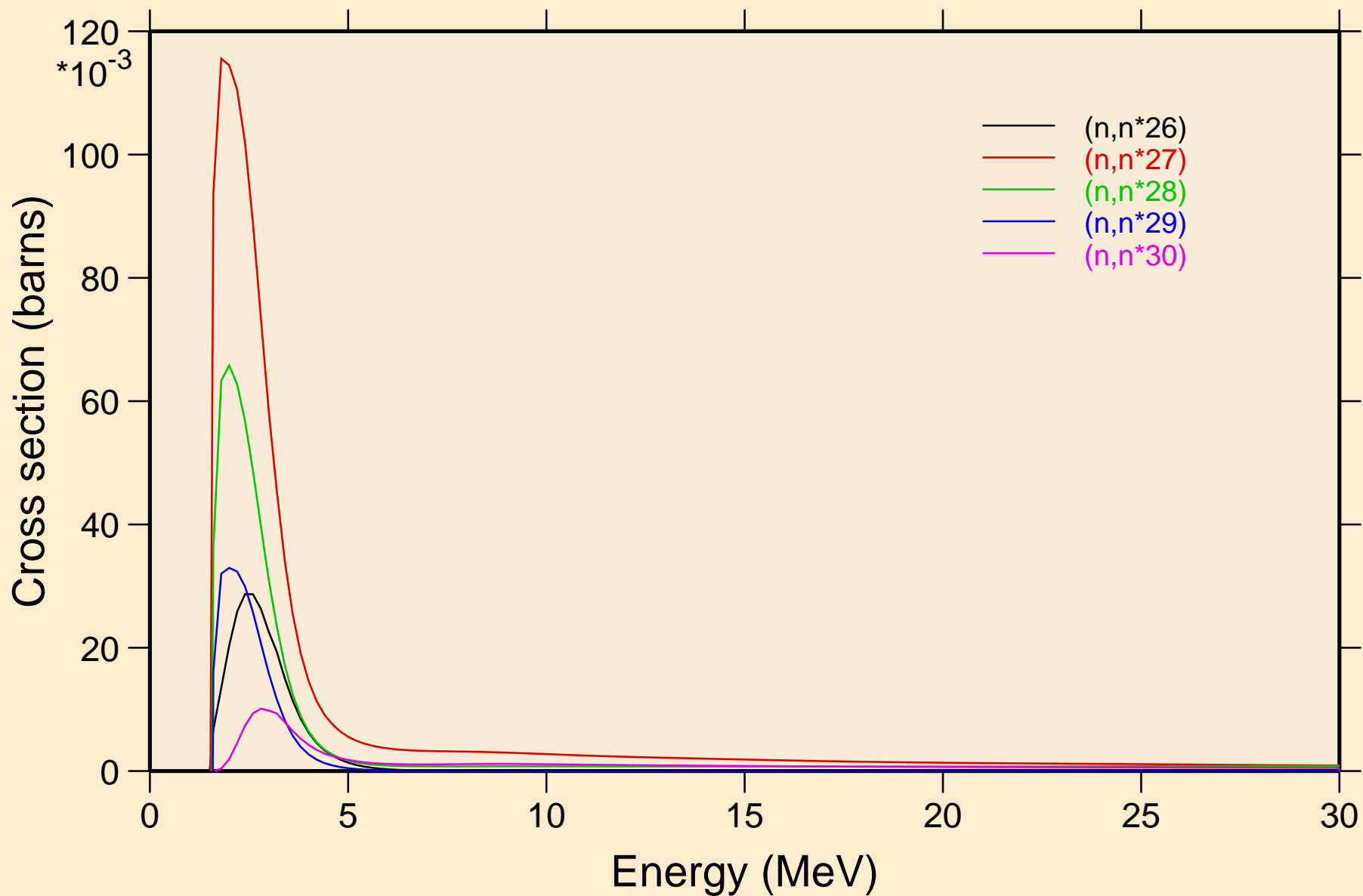

# GD158 NEUTRON ACER TENDL-2019 LIBRARY; T=293.16K

## Threshold reactions

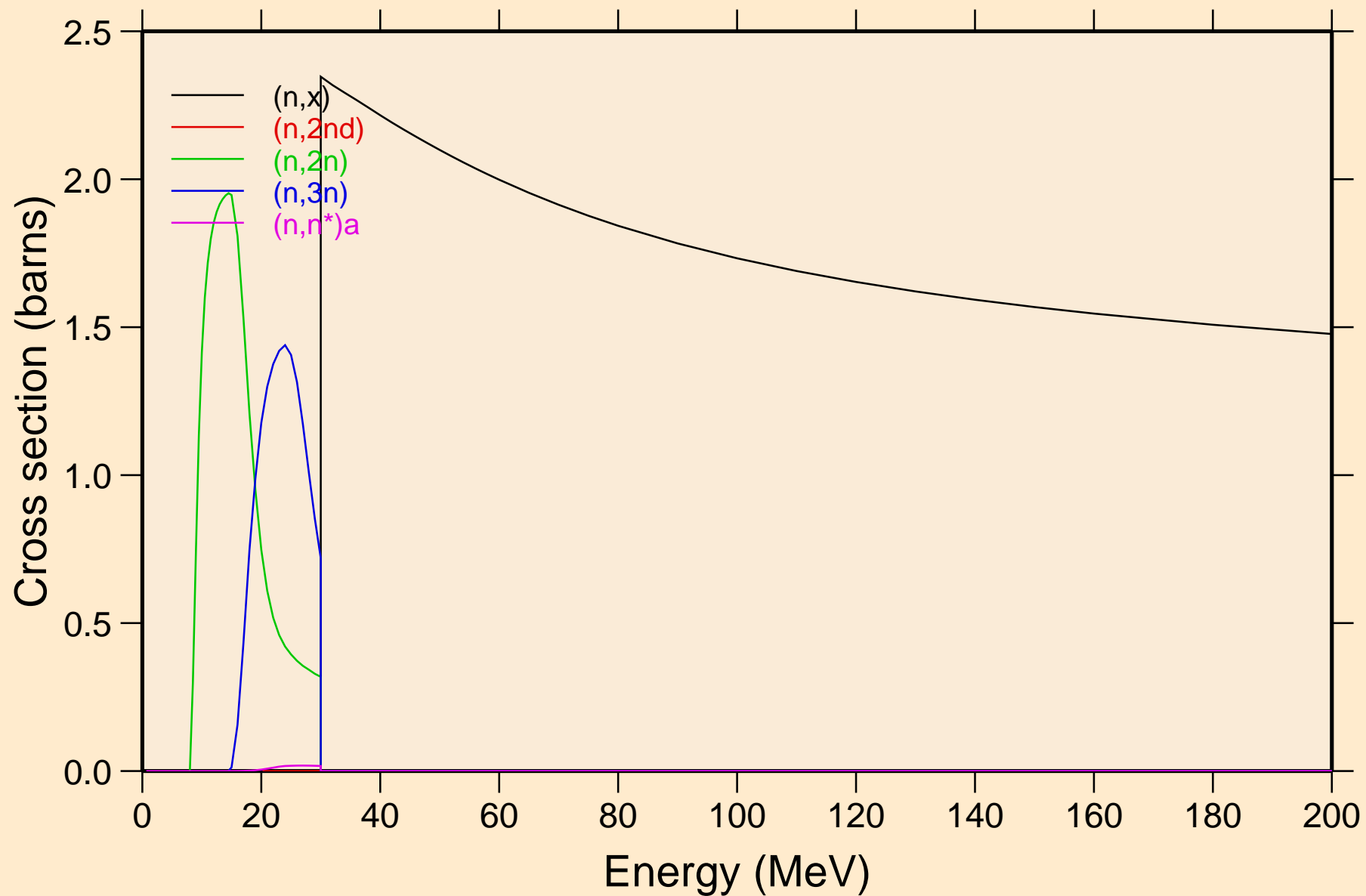

GD158 NEUTRON ACER TENDL-2019 LIBRARY; T=293.16K  
Threshold reactions

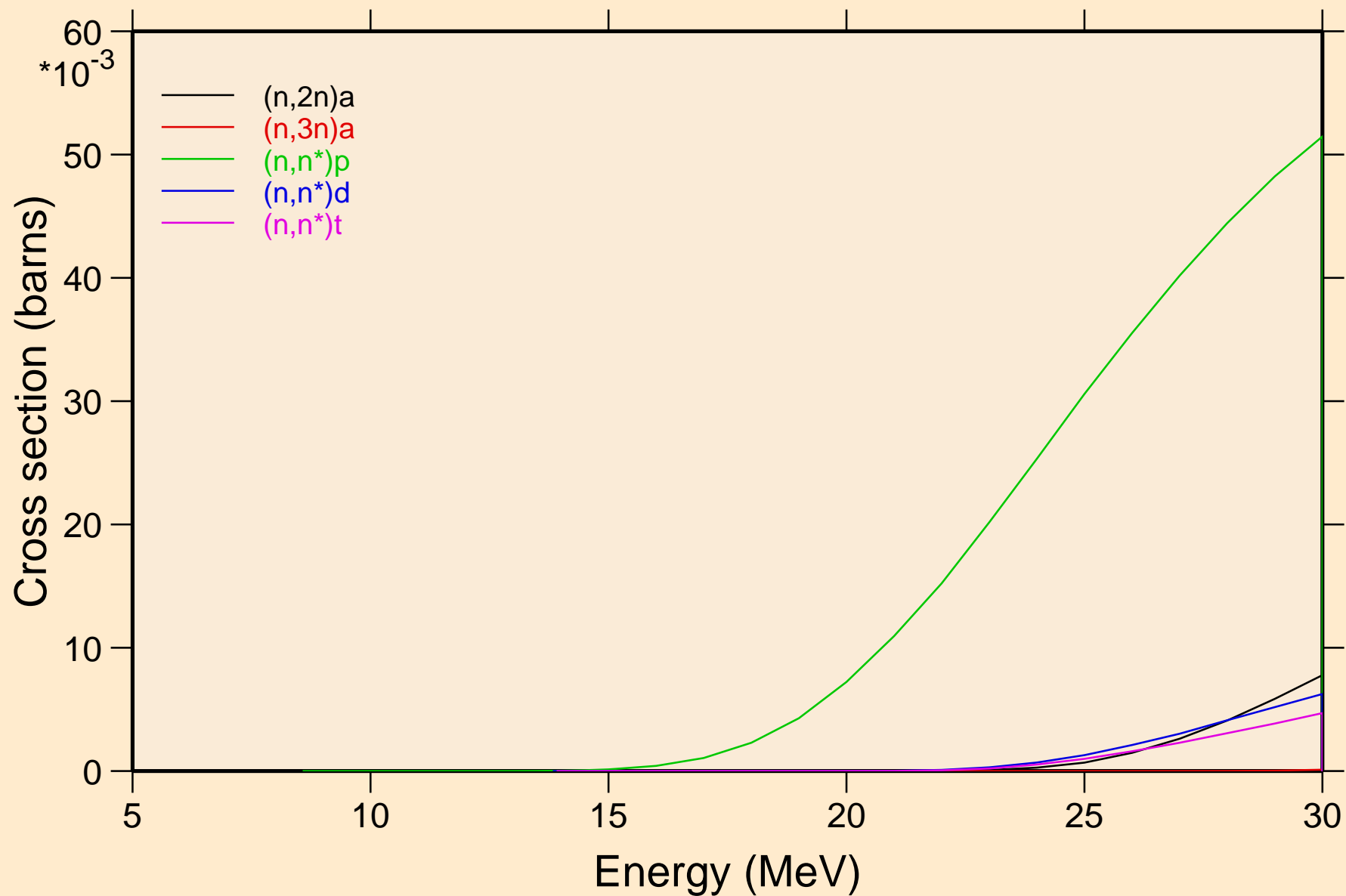



GD158 NEUTRON ACER TENDL-2019 LIBRARY; T=293.16K  
Threshold reactions

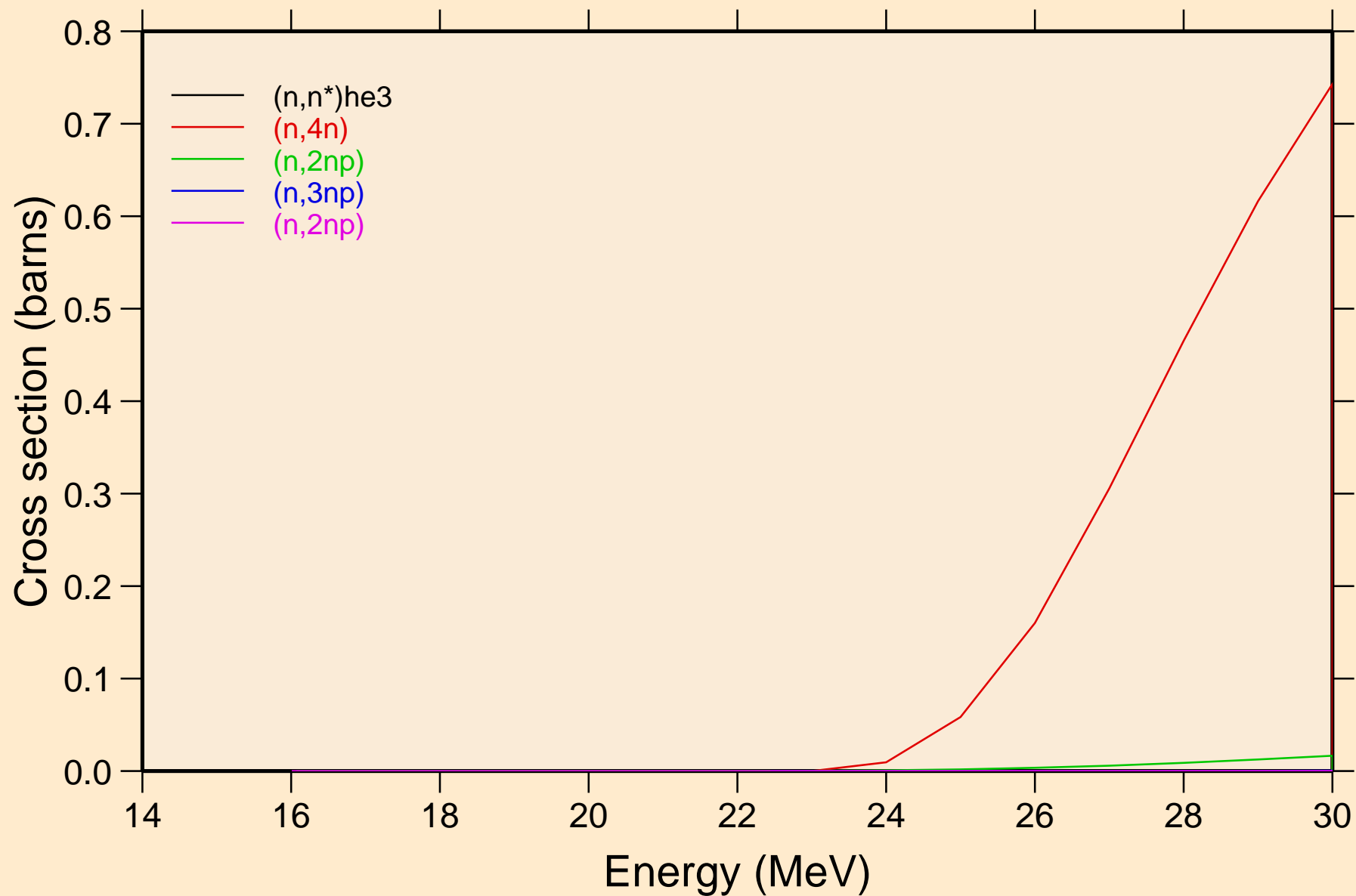

GD158 NEUTRON ACER TENDL-2019 LIBRARY; T=293.16K  
Threshold reactions

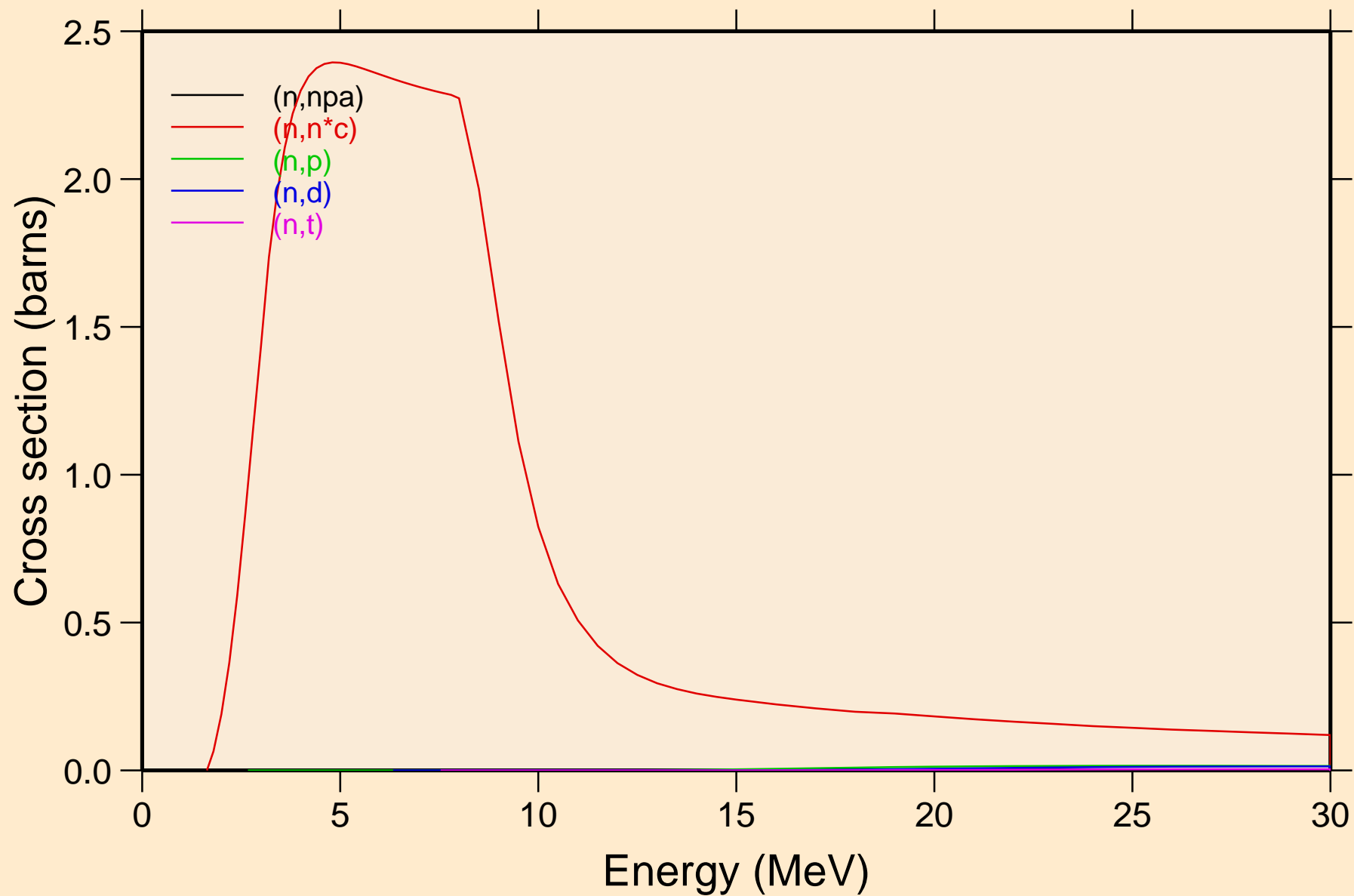

GD158 NEUTRON ACER TENDL-2019 LIBRARY; T=293.16K  
Threshold reactions

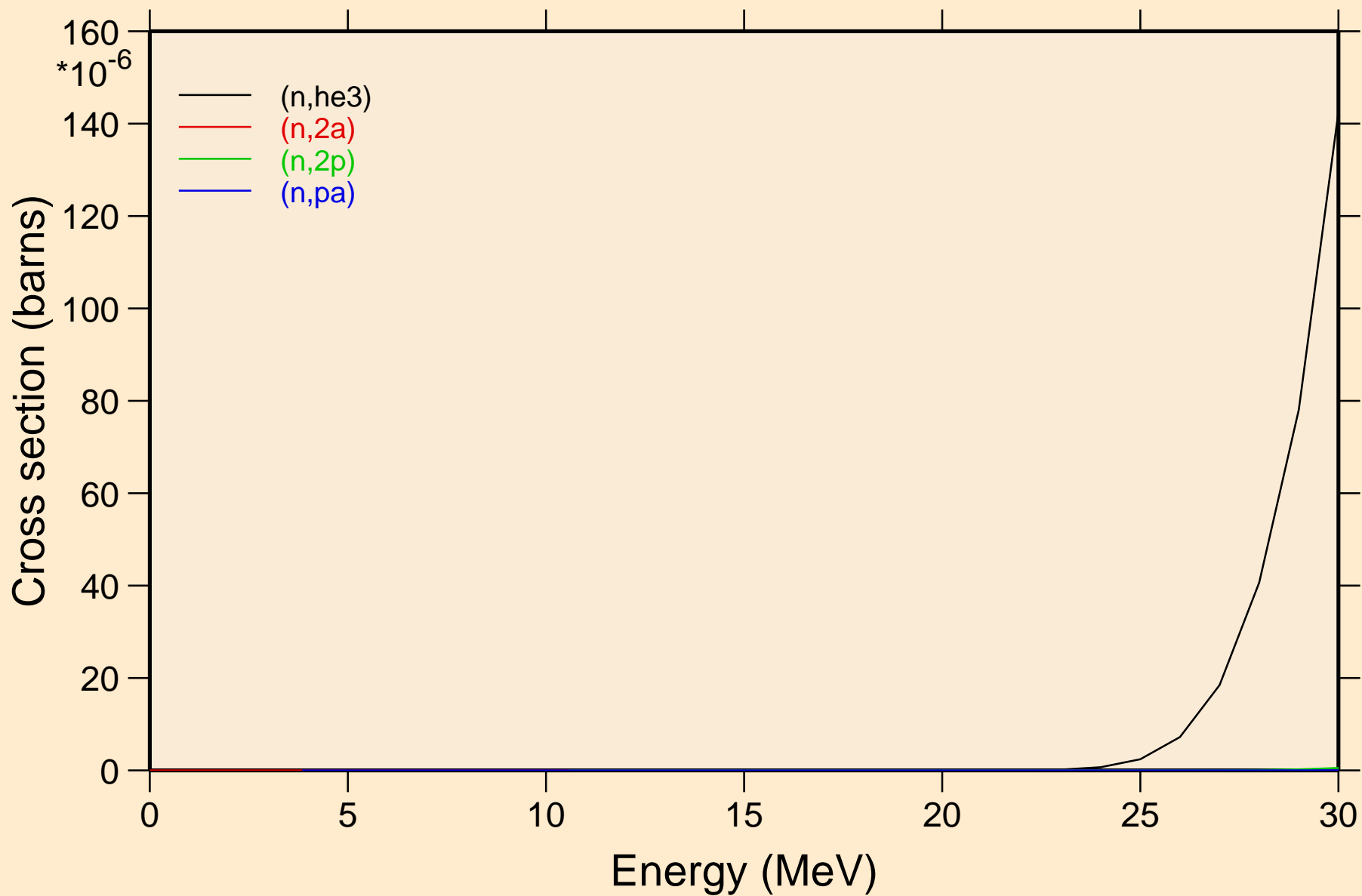

# GD158 NEUTRON ACER TENDL-2019 LIBRARY; T=293.16K

## Threshold reactions

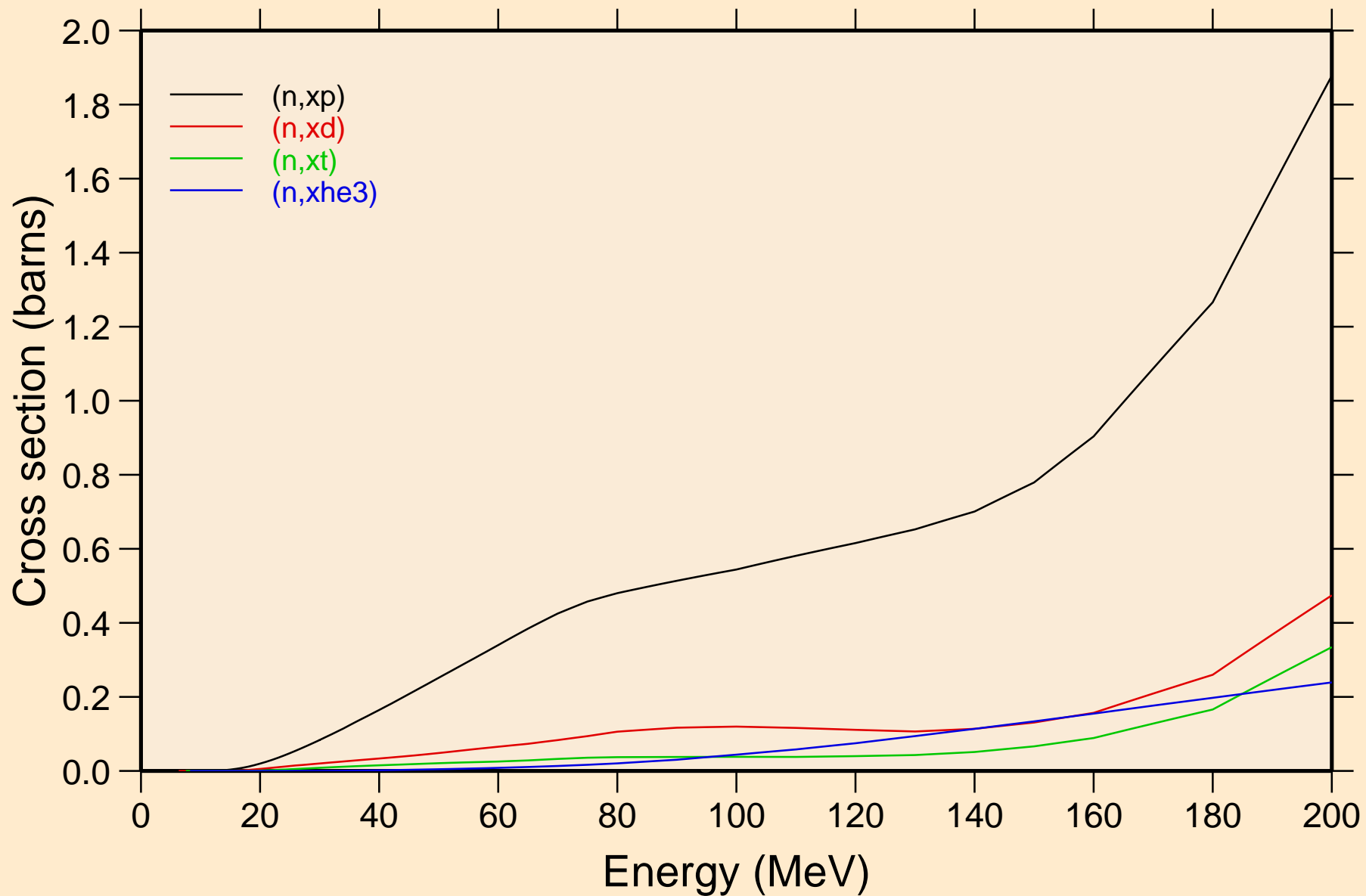

GD158 NEUTRON ACER TENDL-2019 LIBRARY; T=293.16K  
angular distribution for elastic

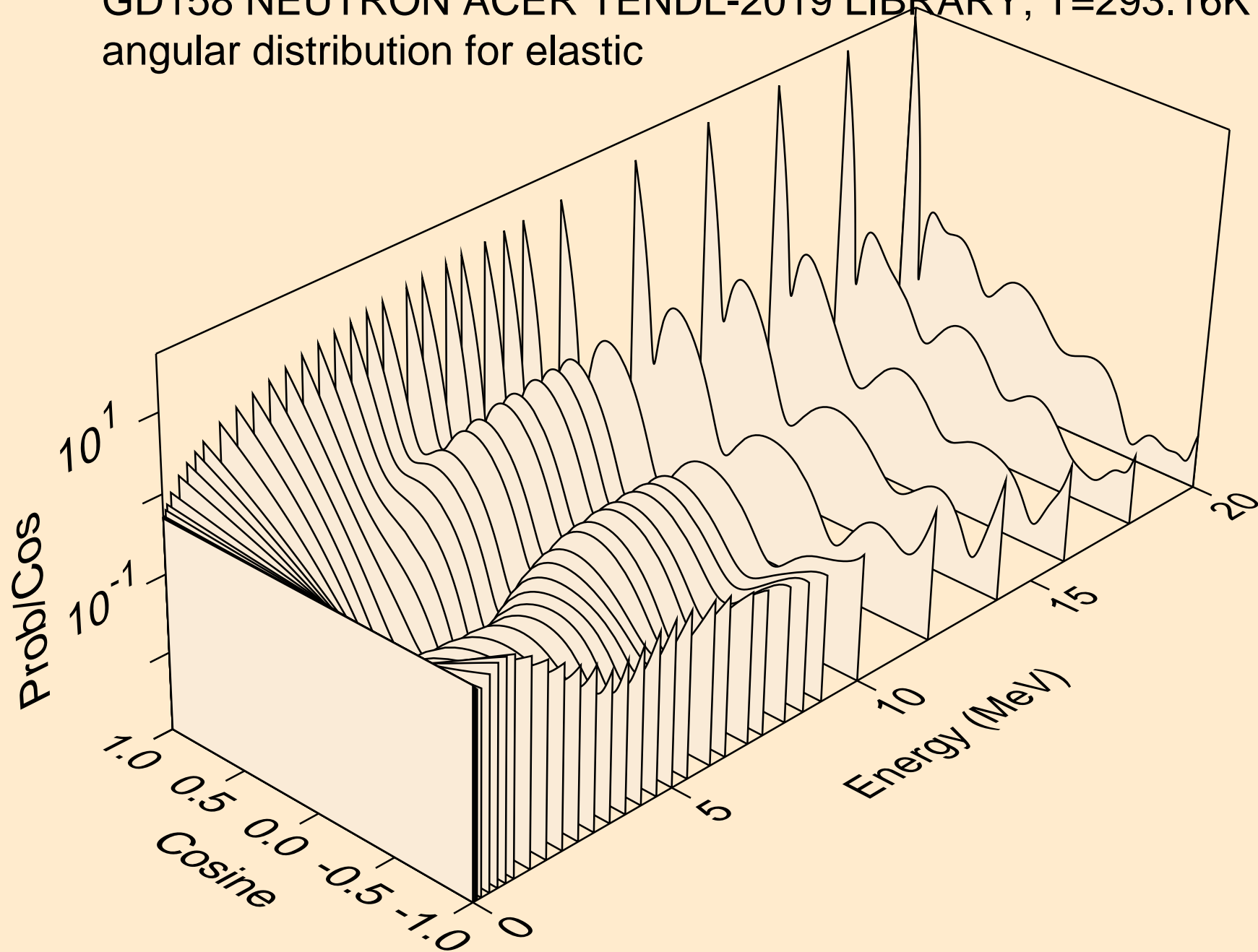

GD158 NEUTRON ACER TENDL-2019 LIBRARY; T=293.16K  
angular distribution for elastic

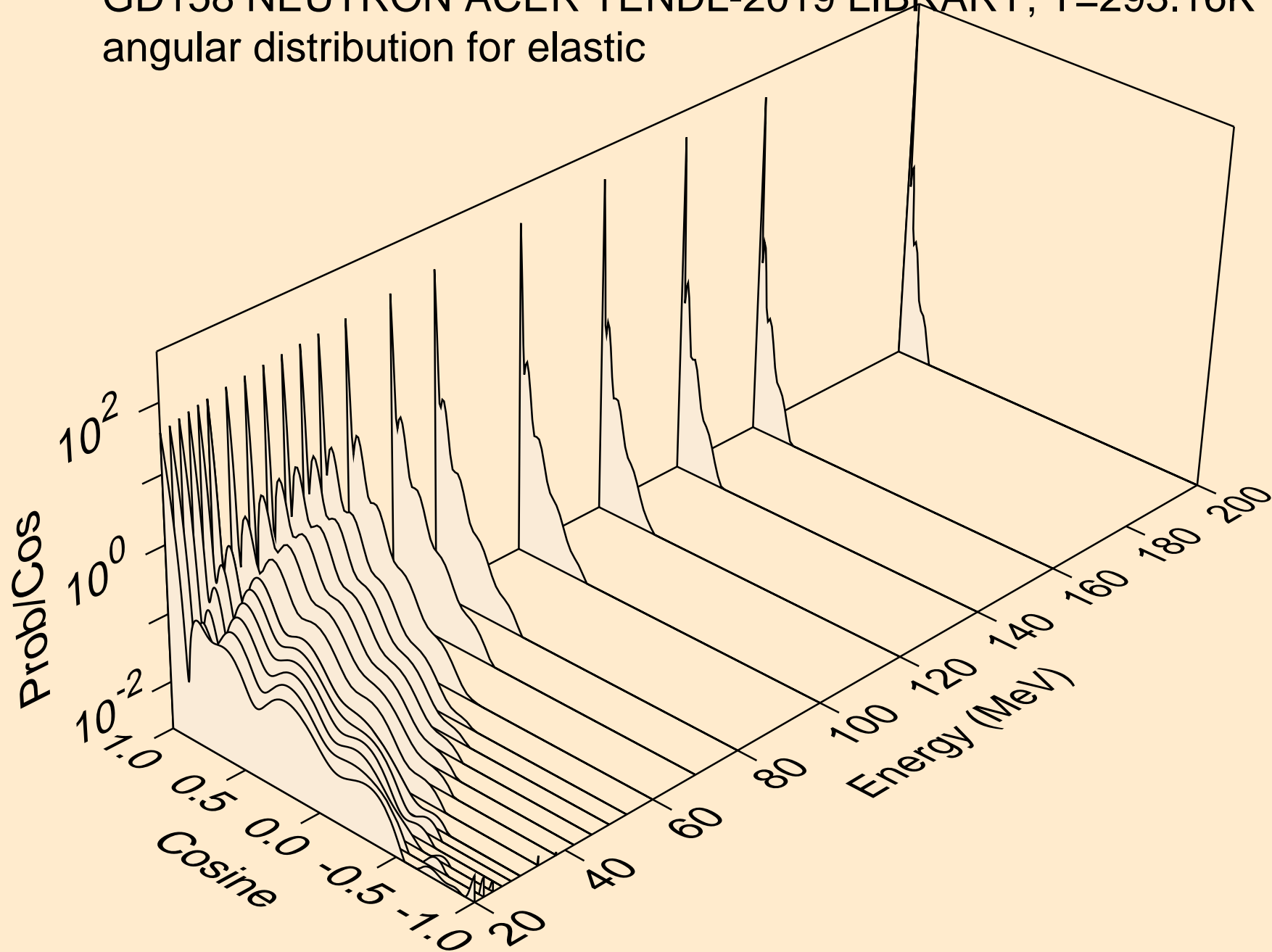

GD158 NEUTRON ACER TENDL-2019 LIBRARY; T=293.16K  
angular distribution for (n,n\*1)

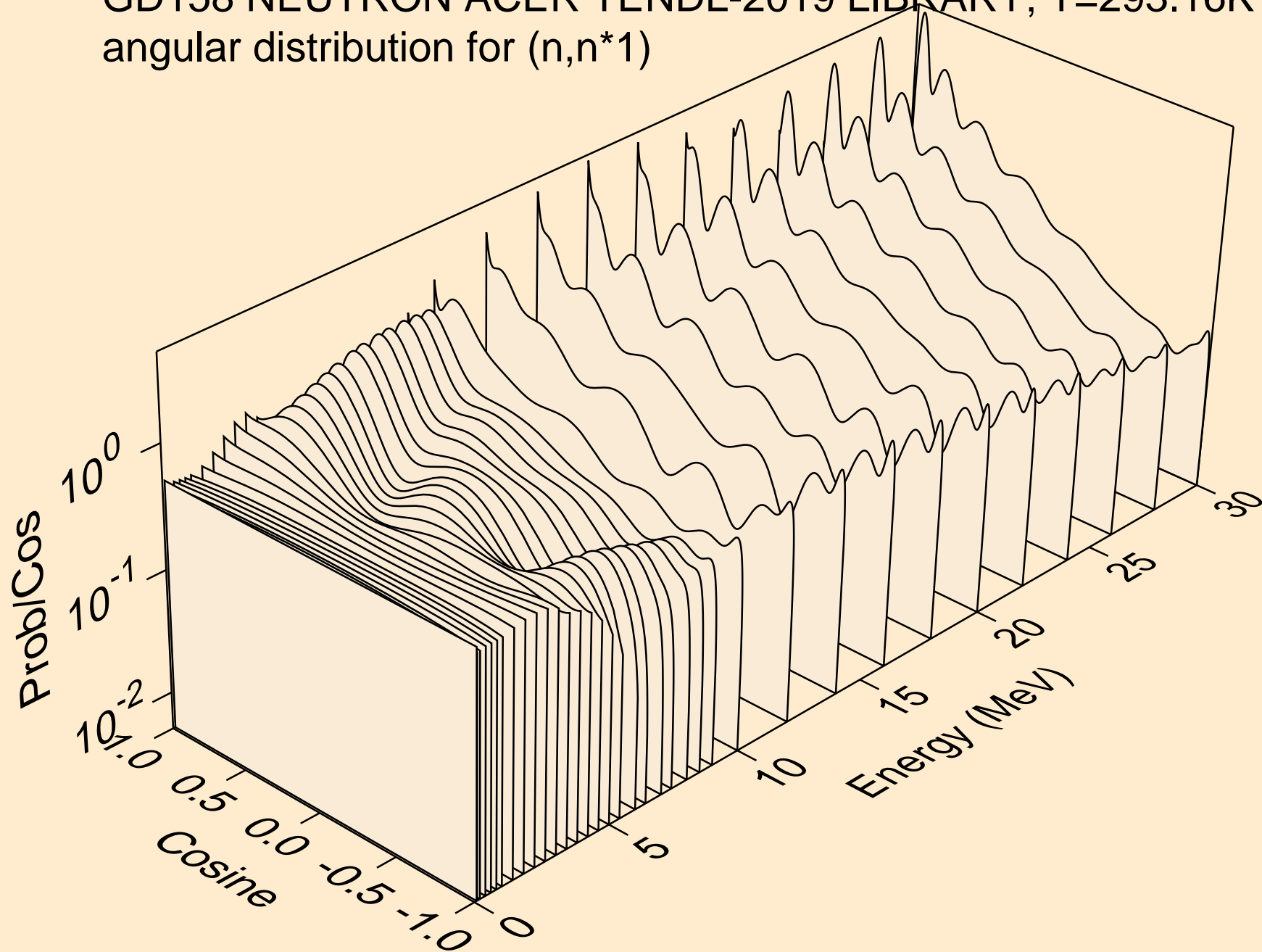

GD158 NEUTRON ACER TENDL-2019 LIBRARY; T=293.16K  
angular distribution for (n,n\*2)

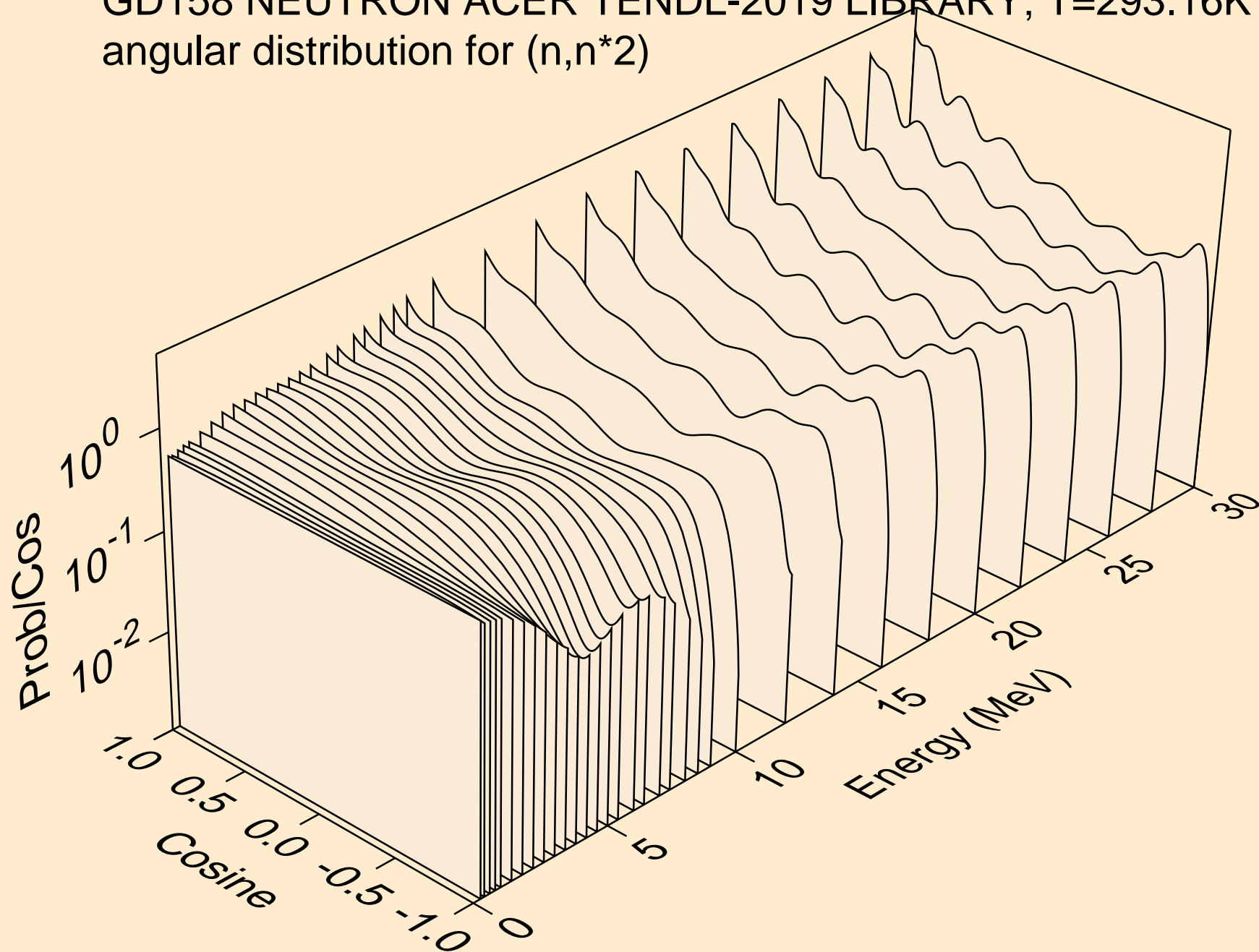



GD158 NEUTRON ACER TENDL-2019 LIBRARY; T=293.16K  
angular distribution for (n,n\*3)

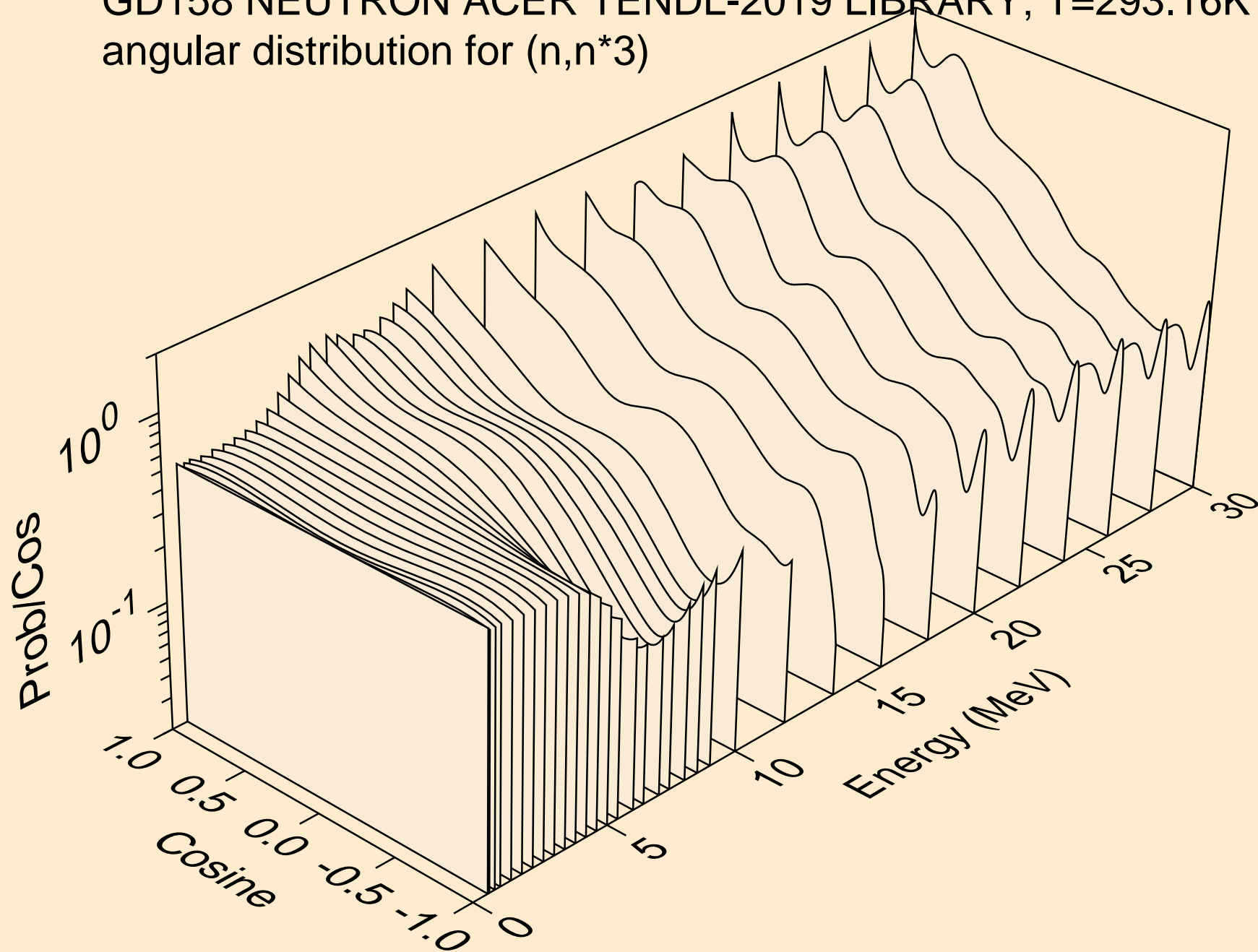

GD158 NEUTRON ACER TENDL-2019 LIBRARY; T=293.16K  
angular distribution for (n,n\*4)

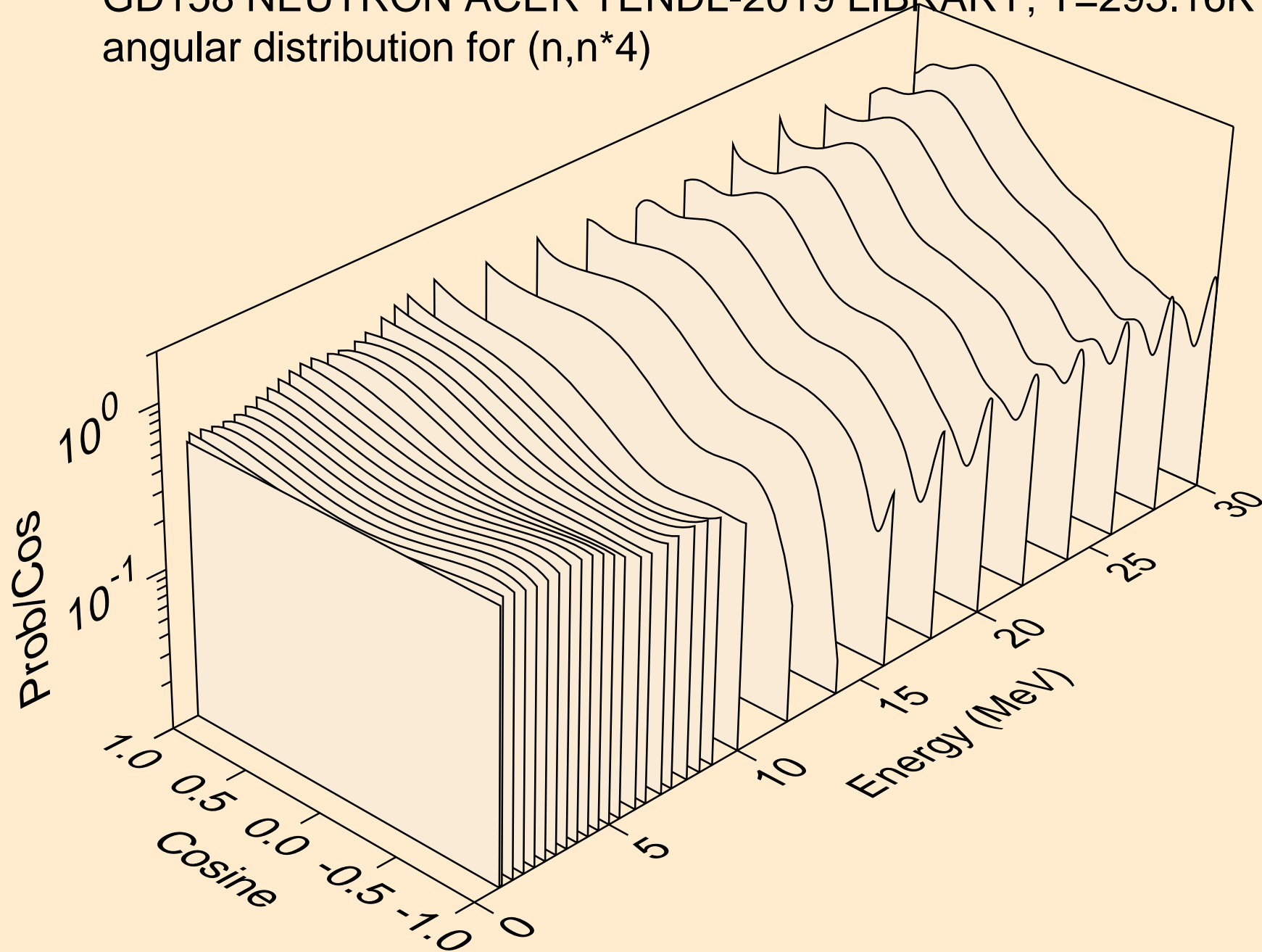

GD158 NEUTRON ACER TENDL-2019 LIBRARY; T=293.16K  
angular distribution for (n,n\*5)

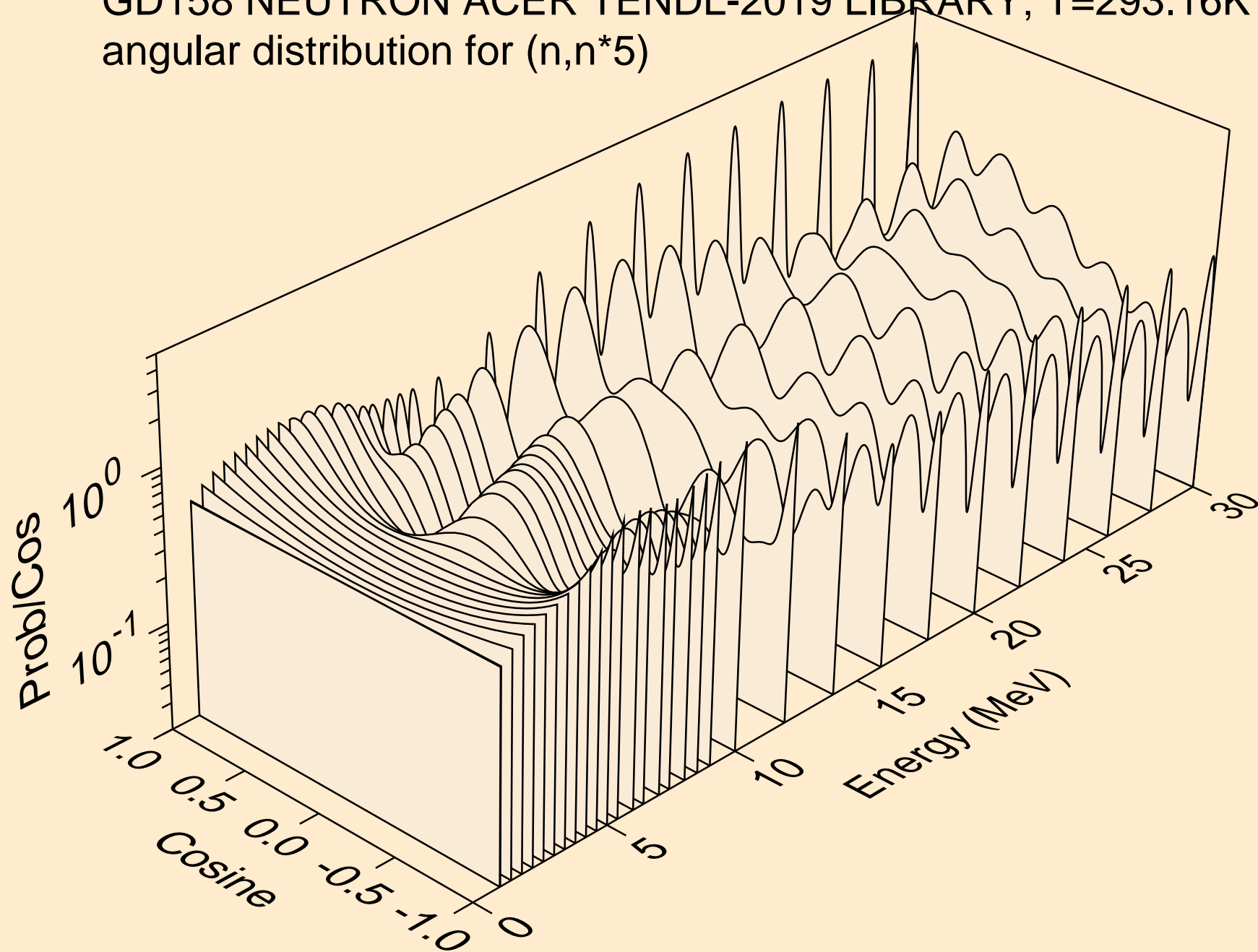

GD158 NEUTRON ACER TENDL-2019 LIBRARY; T=293.16K  
angular distribution for (n,n\*6)

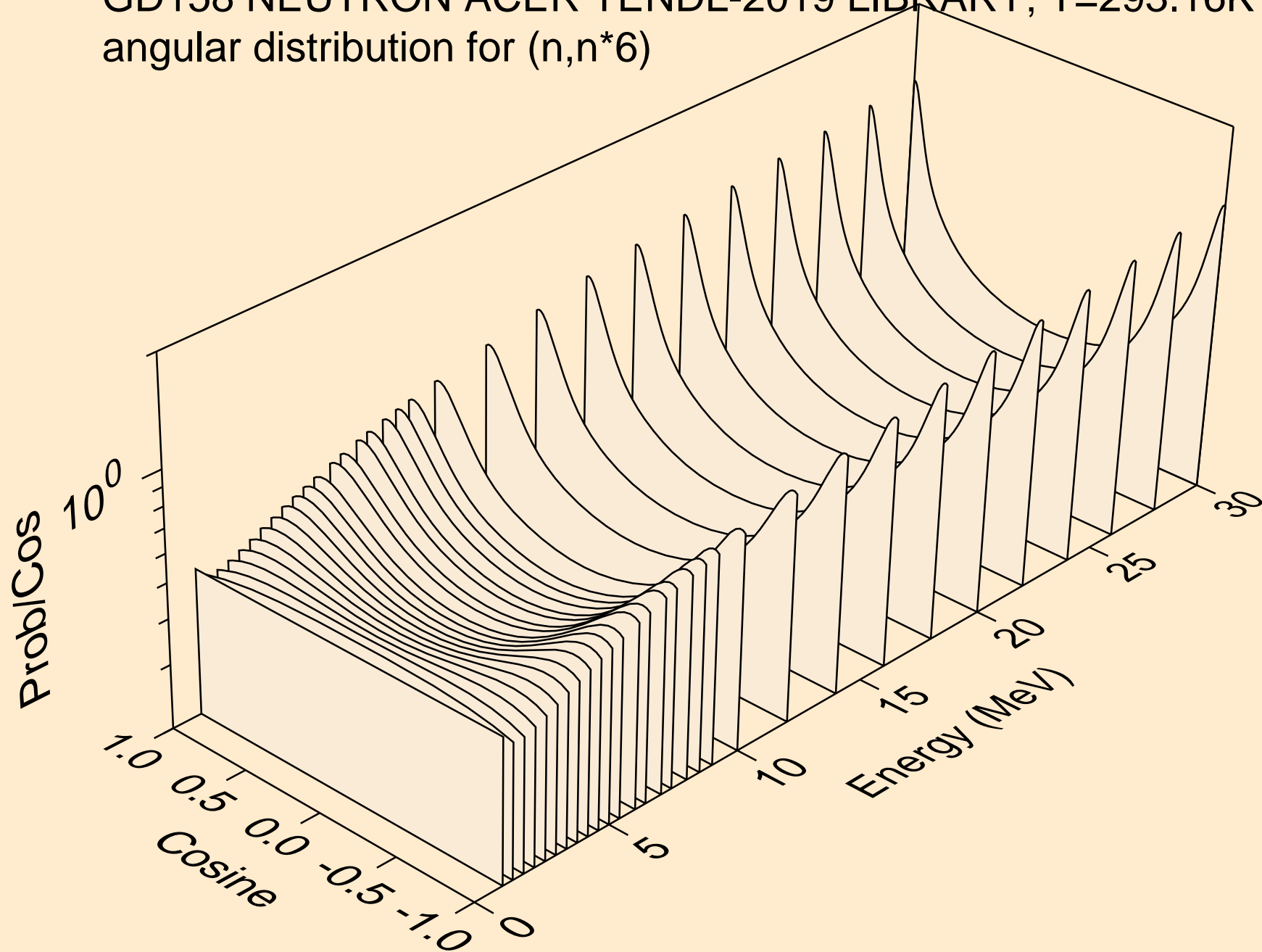

GD158 NEUTRON ACER TENDL-2019 LIBRARY; T=293.16K  
angular distribution for (n,n\*7)

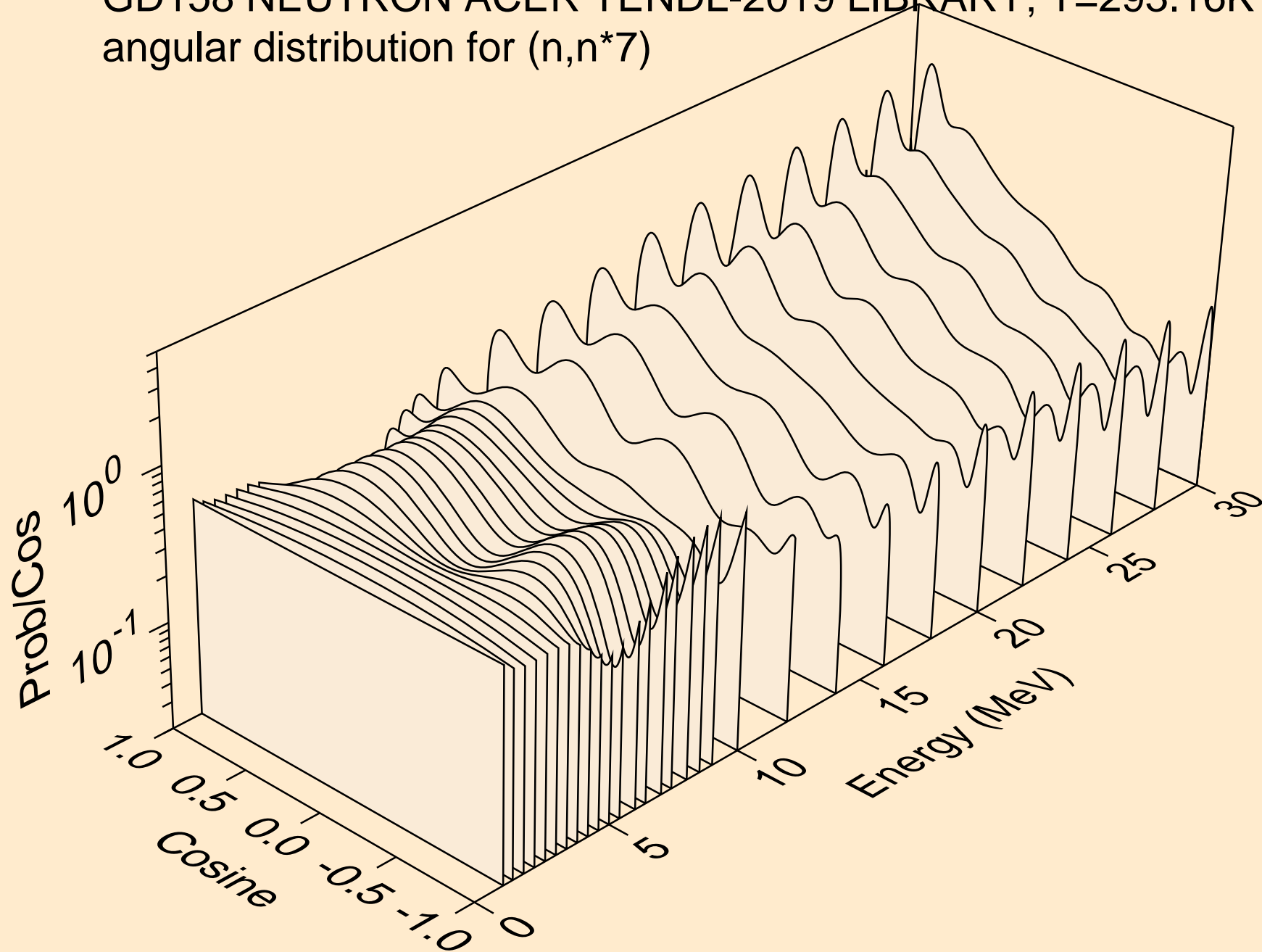

GD158 NEUTRON ACER TENDL-2019 LIBRARY; T=293.16K  
angular distribution for (n,n\*8)

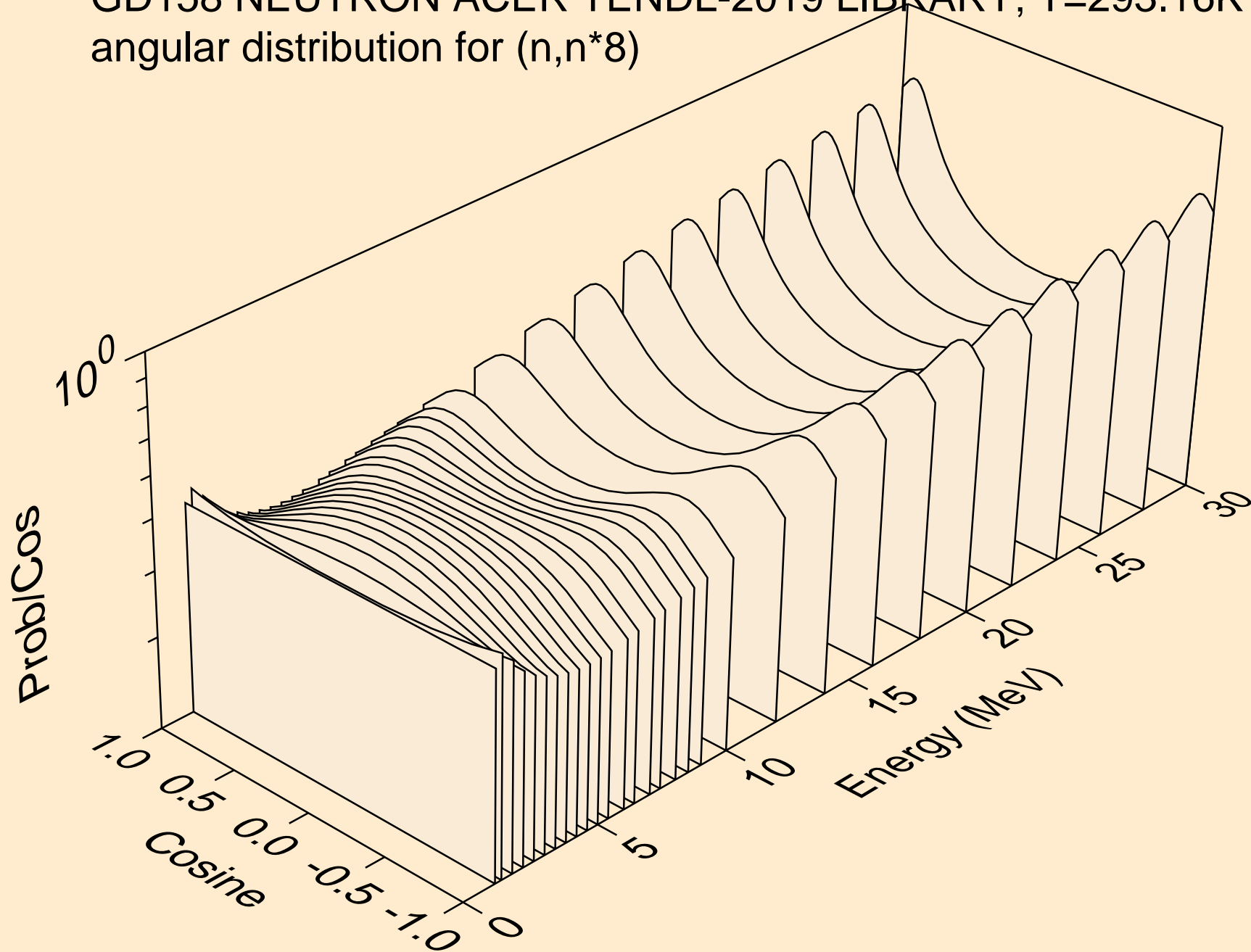

GD158 NEUTRON ACER TENDL-2019 LIBRARY; T=293.16K  
angular distribution for (n,n\*9)

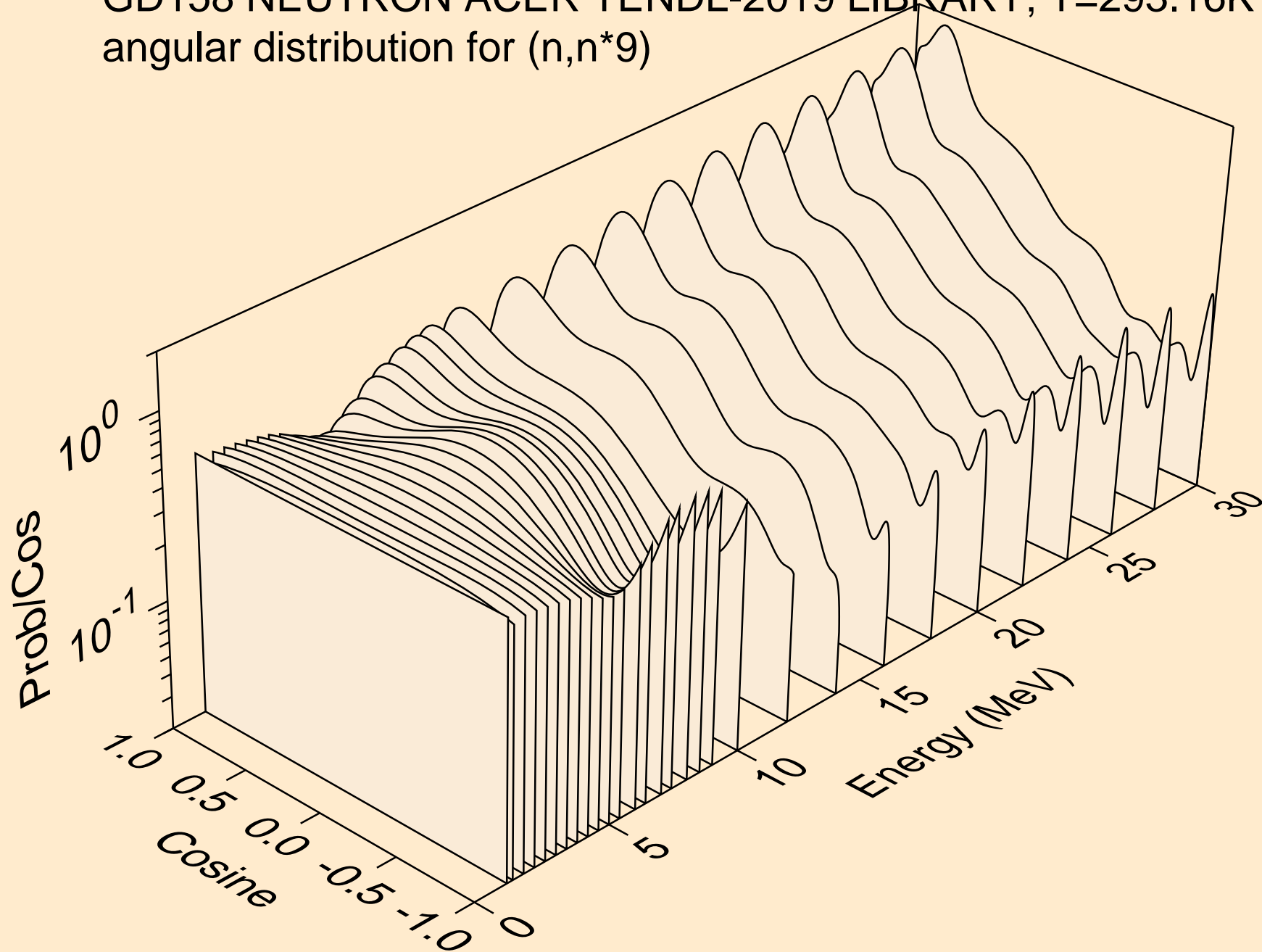

GD158 NEUTRON ACER TENDL-2019 LIBRARY; T=293.16K  
angular distribution for (n,n\*10)

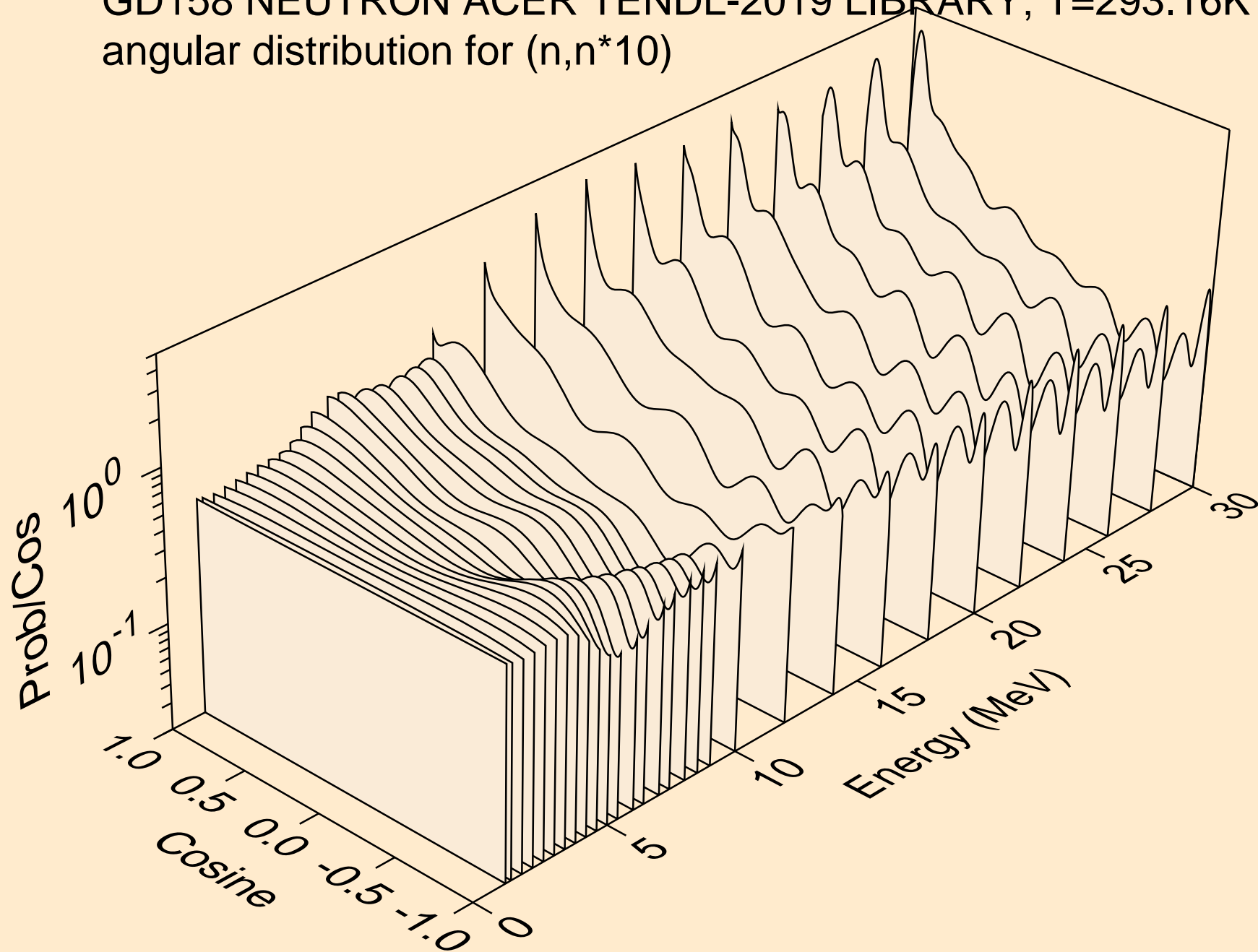



GD158 NEUTRON ACER TENDL-2019 LIBRARY; T=293.16K  
angular distribution for (n,n\*11)

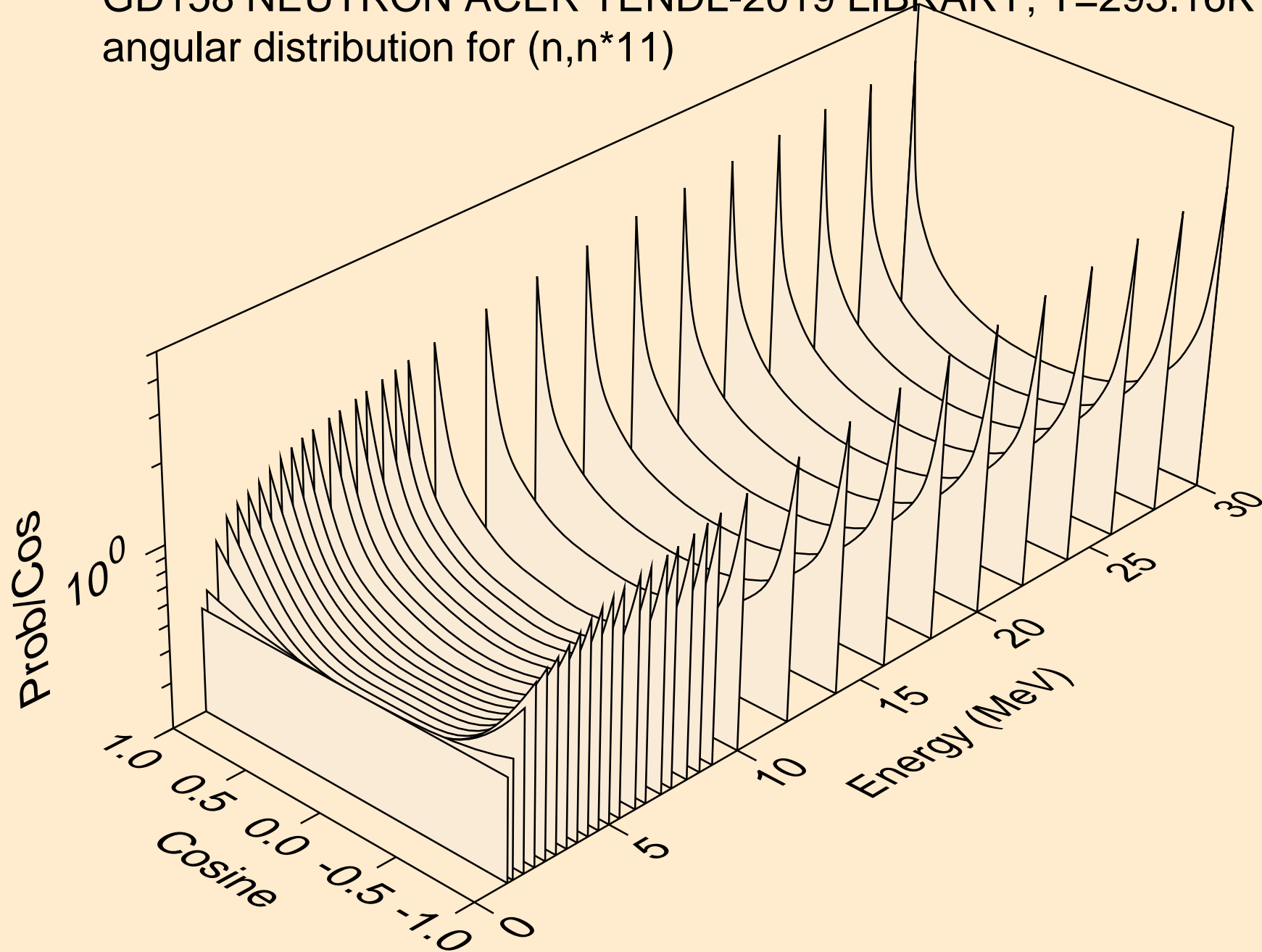

GD158 NEUTRON ACER TENDL-2019 LIBRARY; T=293.16K  
angular distribution for (n,n\*12)

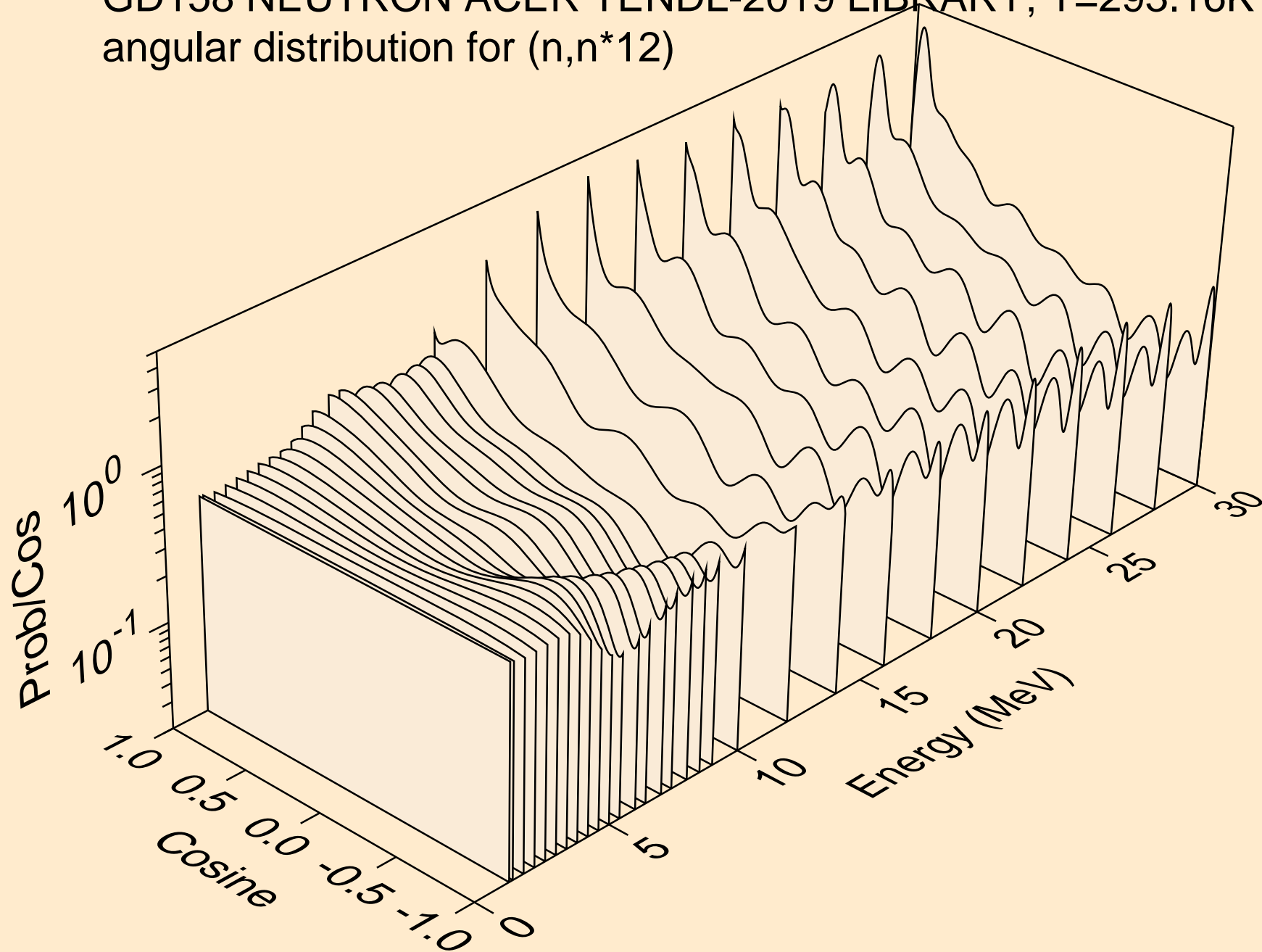

GD158 NEUTRON ACER TENDL-2019 LIBRARY; T=293.16K  
angular distribution for (n,n\*13)

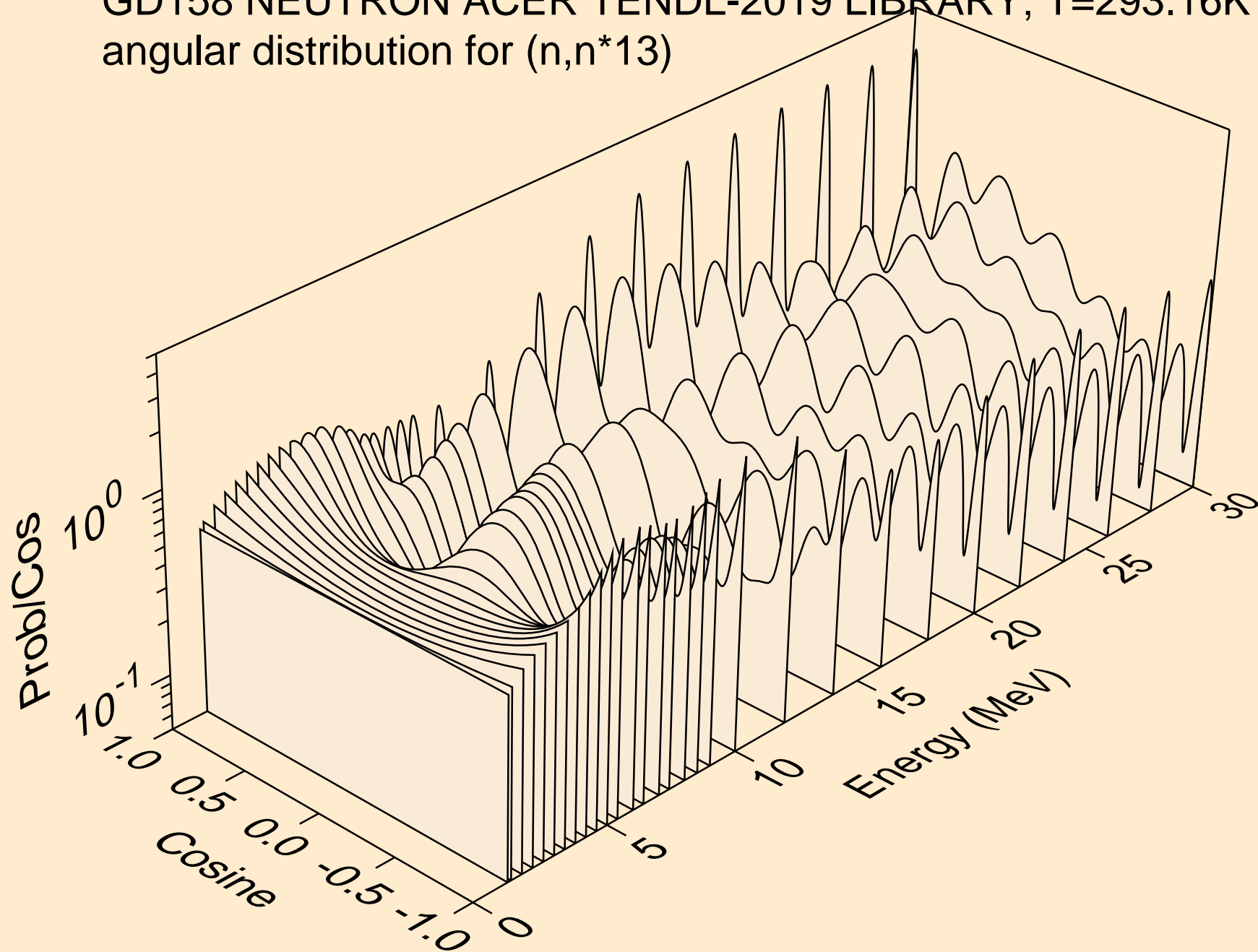

GD158 NEUTRON ACER TENDL-2019 LIBRARY; T=293.16K  
angular distribution for (n,n\*14)

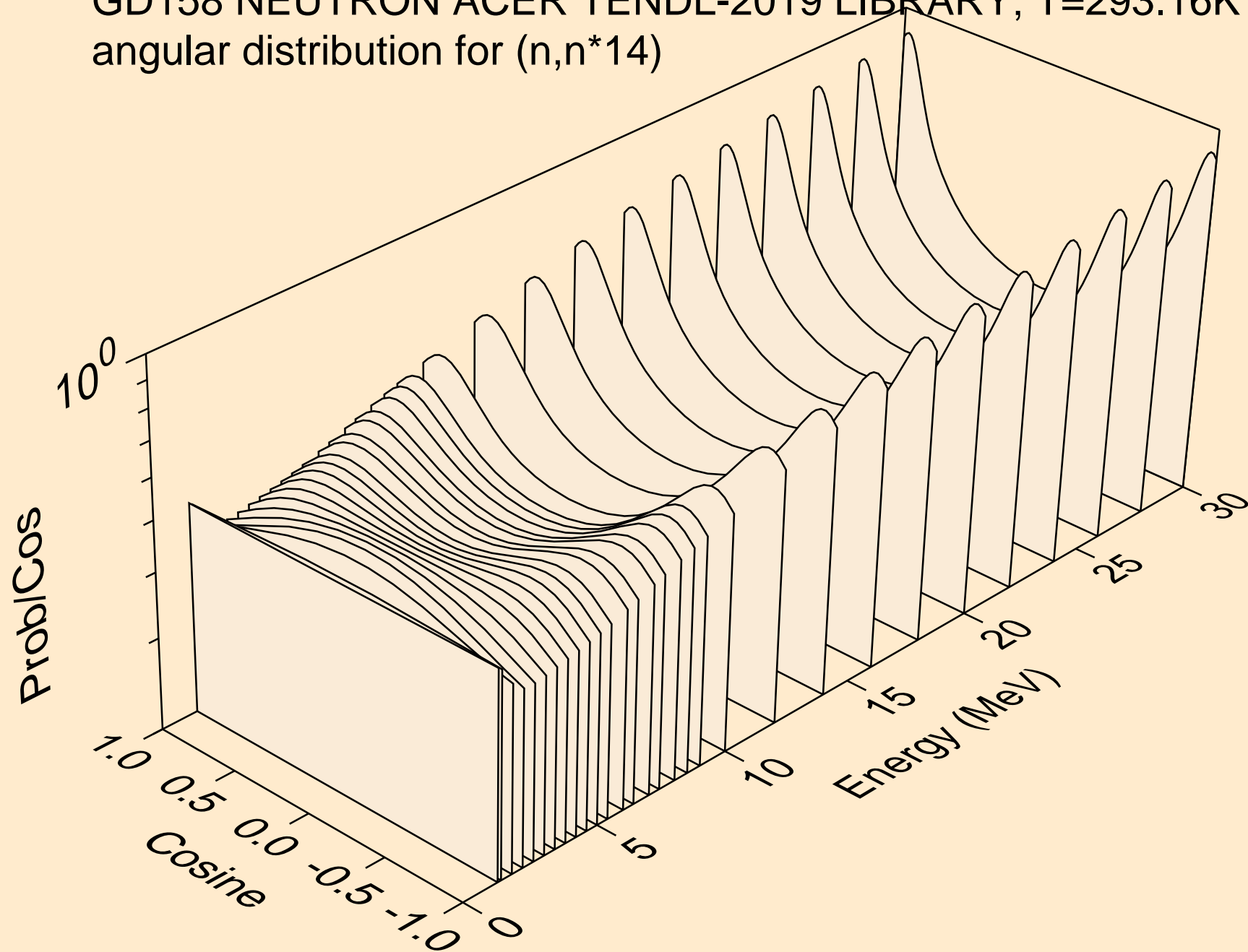

GD158 NEUTRON ACER TENDL-2019 LIBRARY; T=293.16K  
angular distribution for (n,n\*15)

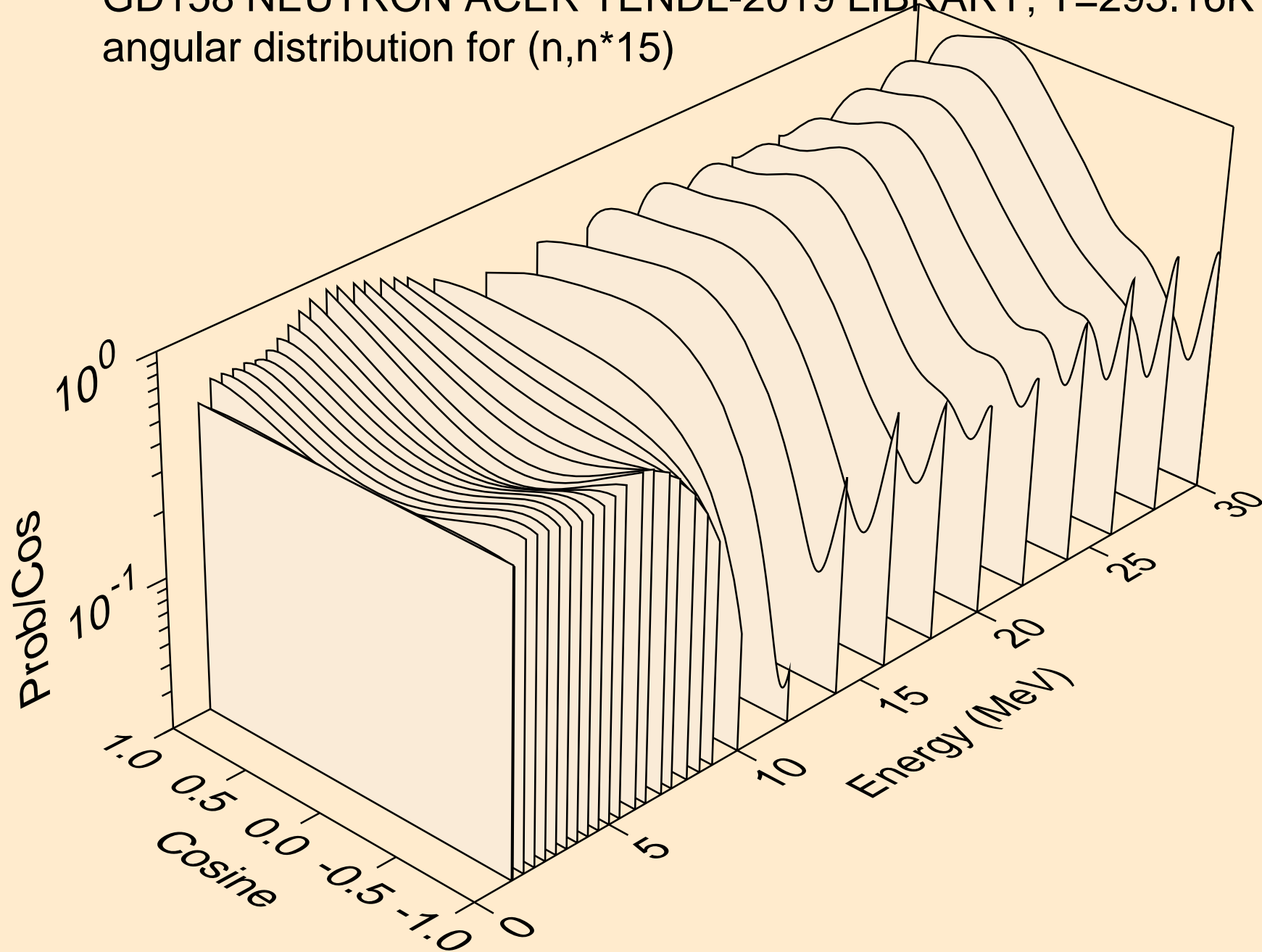

GD158 NEUTRON ACER TENDL-2019 LIBRARY; T=293.16K  
angular distribution for (n,n\*16)

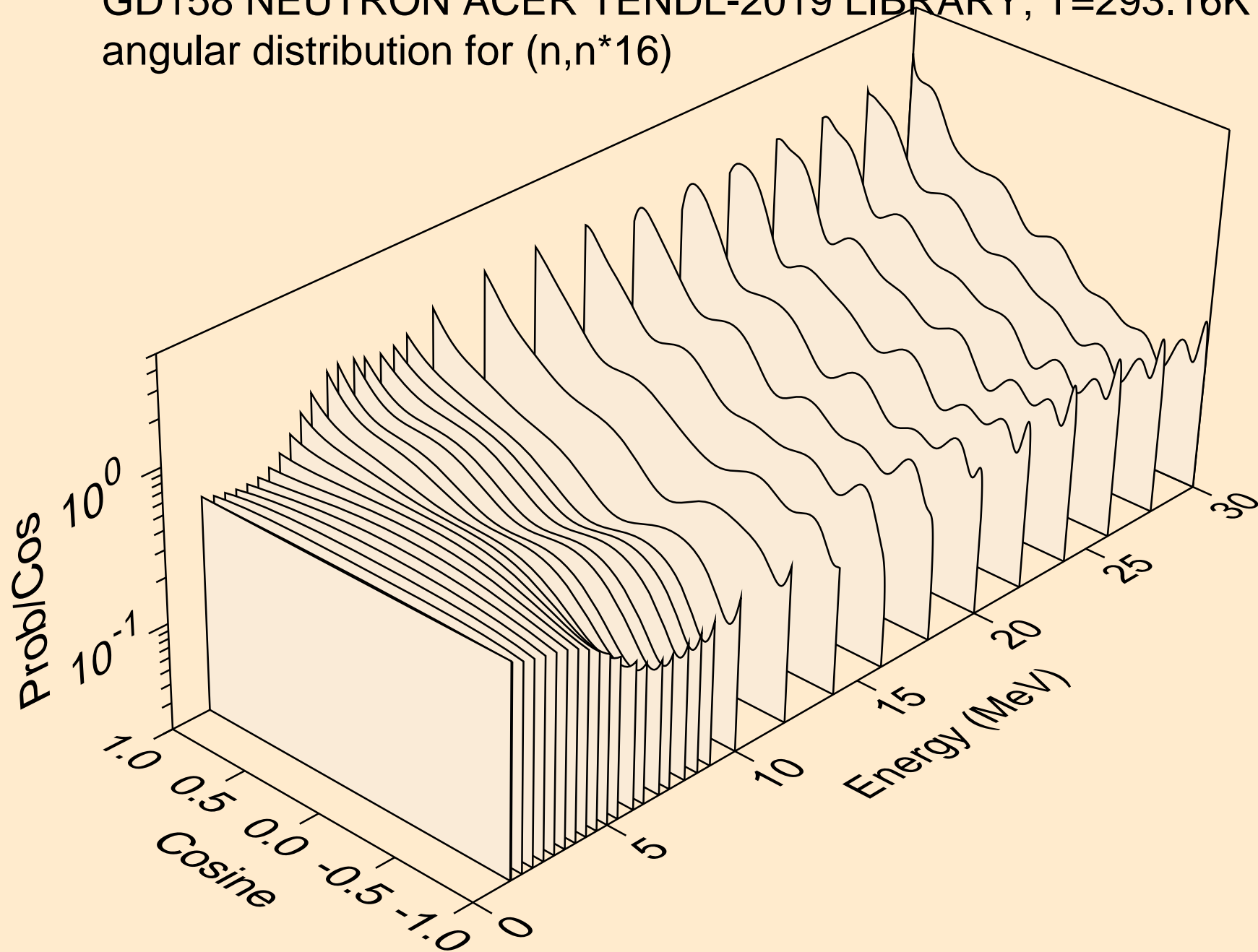

GD158 NEUTRON ACER TENDL-2019 LIBRARY; T=293.16K  
angular distribution for (n,n\*17)

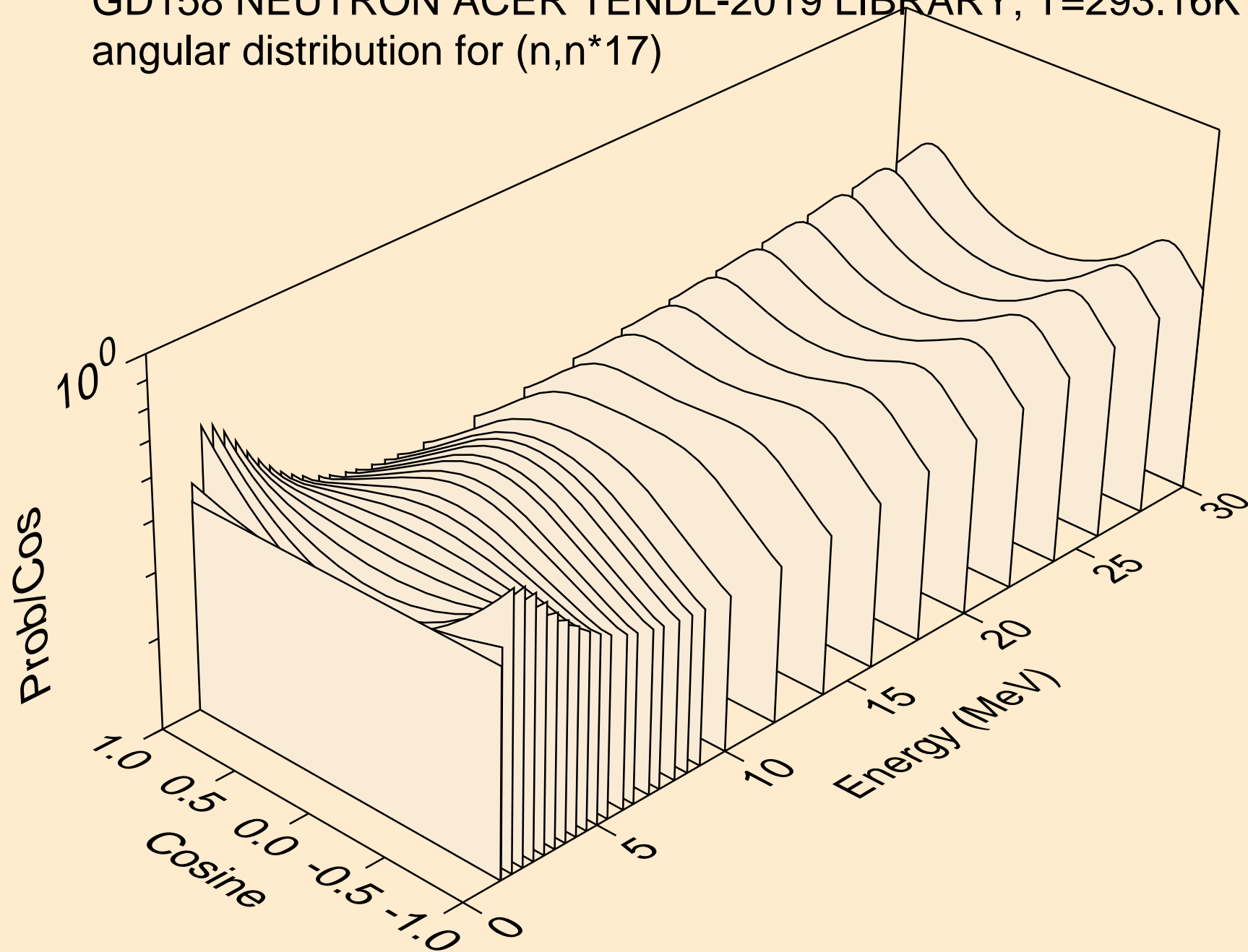

GD158 NEUTRON ACER TENDL-2019 LIBRARY; T=293.16K  
angular distribution for (n,n\*18)

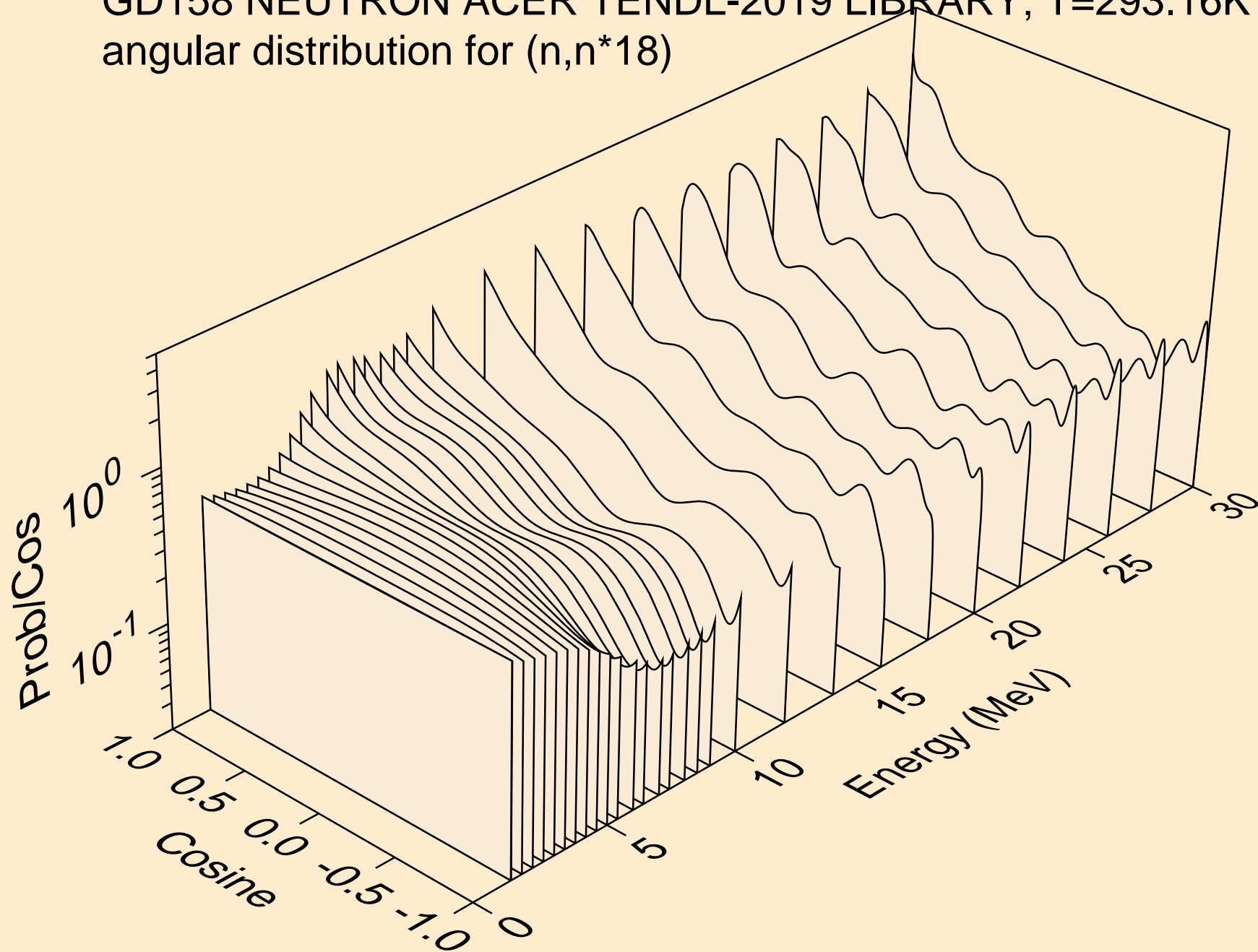



GD158 NEUTRON ACER TENDL-2019 LIBRARY; T=293.16K  
angular distribution for (n,n\*19)

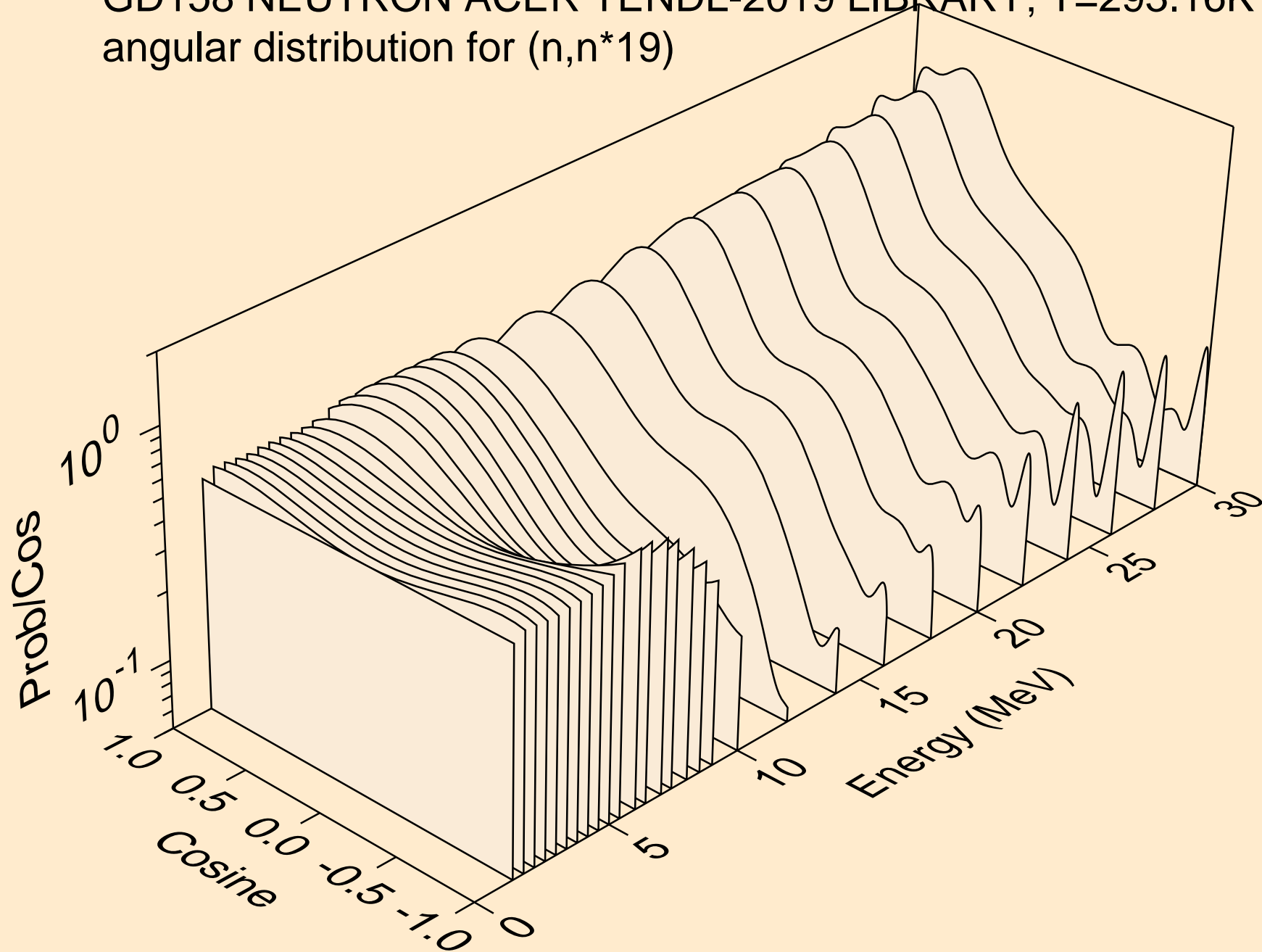

GD158 NEUTRON ACER TENDL-2019 LIBRARY; T=293.16K  
angular distribution for (n,n\*20)

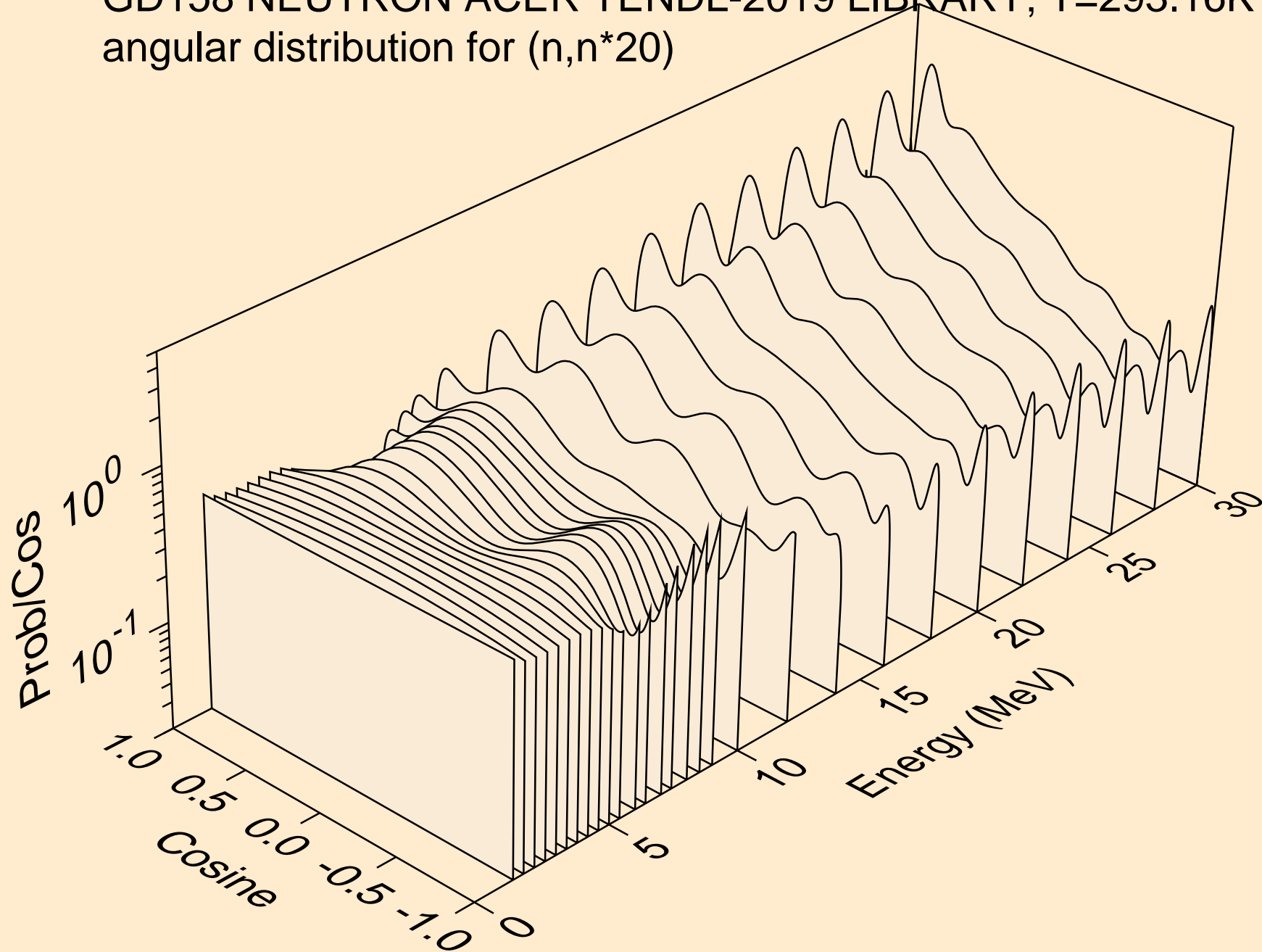

GD158 NEUTRON ACER TENDL-2019 LIBRARY; T=293.16K  
angular distribution for (n,n\*21)

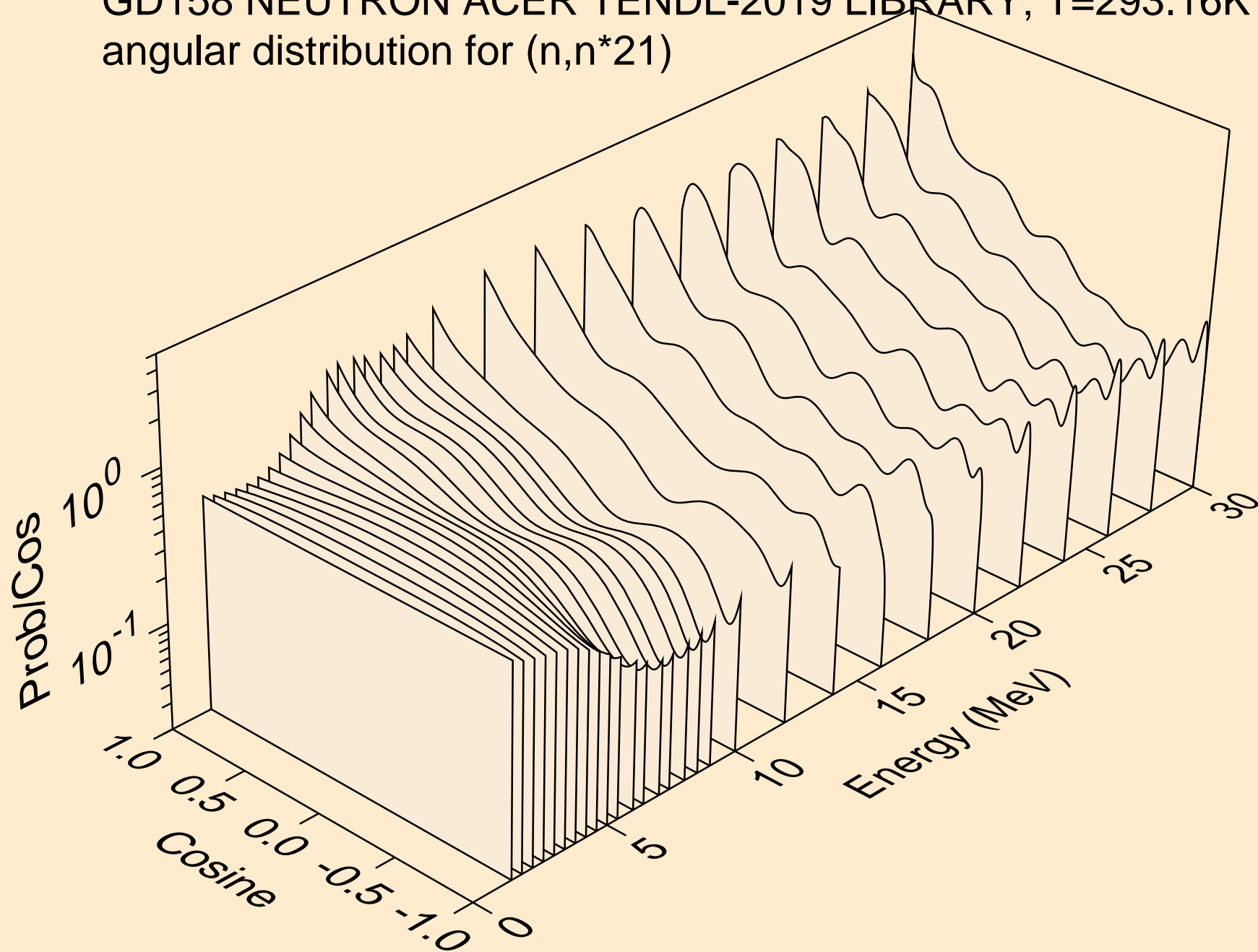

GD158 NEUTRON ACER TENDL-2019 LIBRARY; T=293.16K  
angular distribution for (n,n\*22)

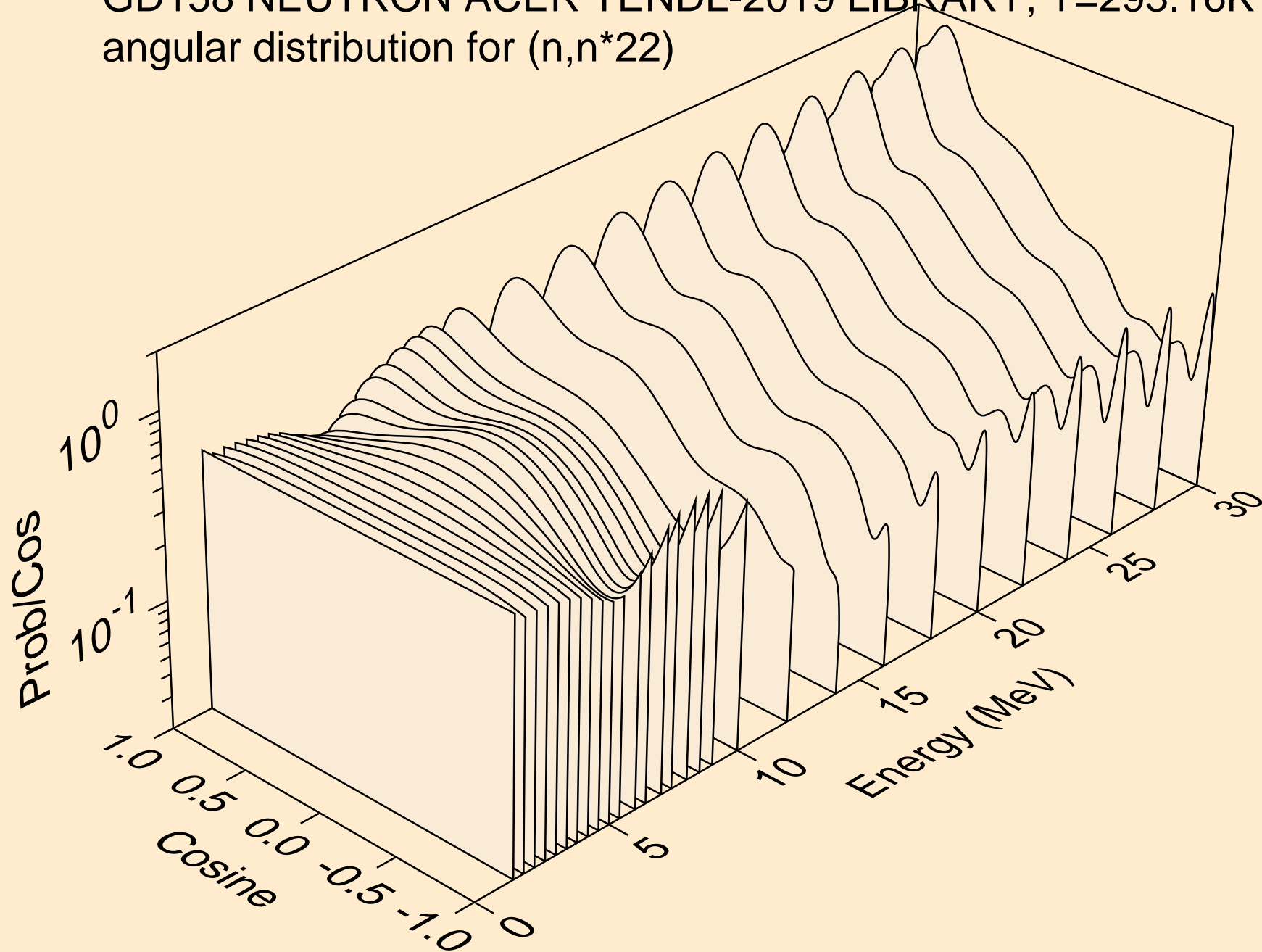

GD158 NEUTRON ACER TENDL-2019 LIBRARY; T=293.16K  
angular distribution for (n,n\*23)

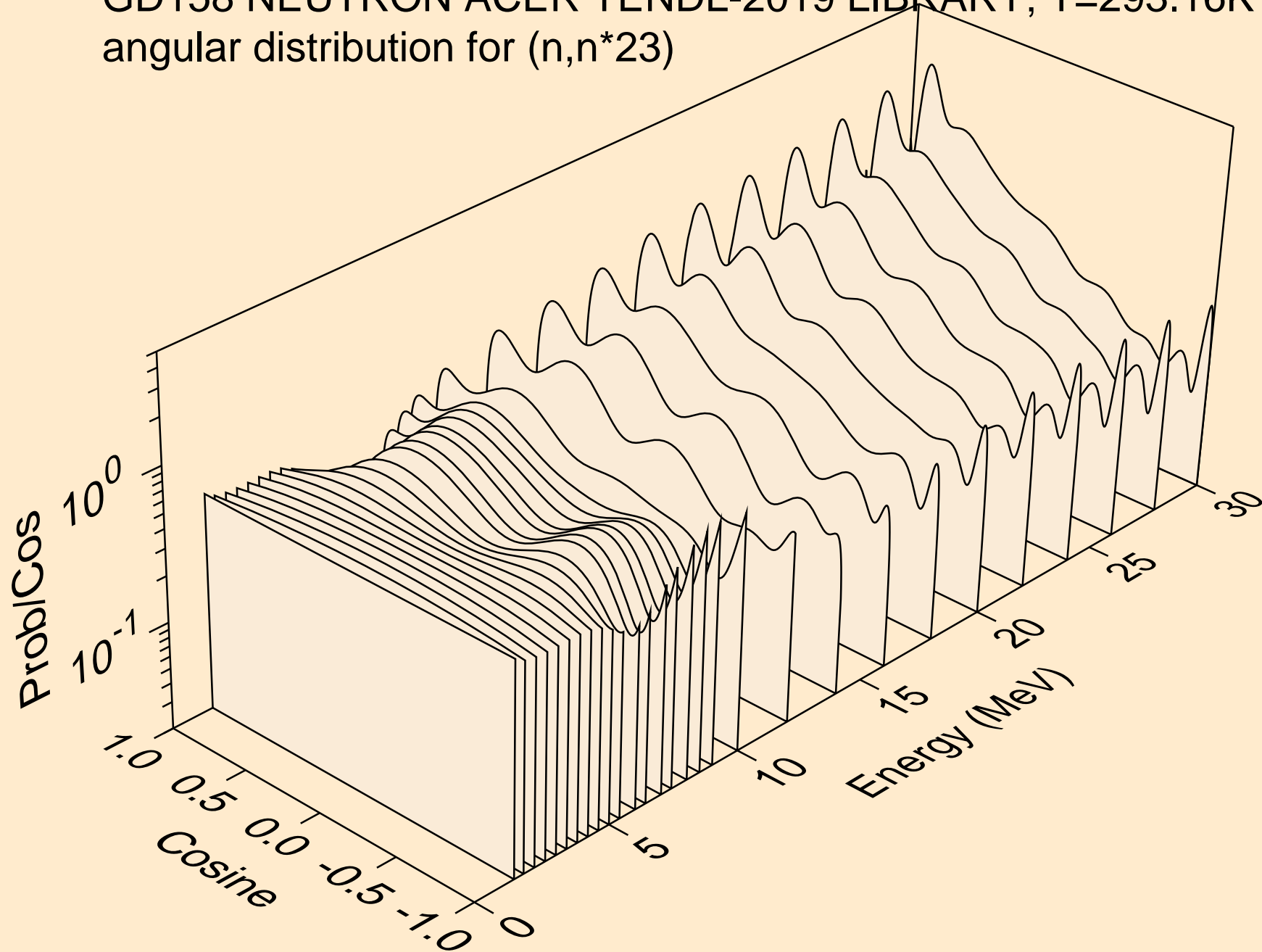

GD158 NEUTRON ACER TENDL-2019 LIBRARY; T=293.16K  
angular distribution for (n,n\*24)

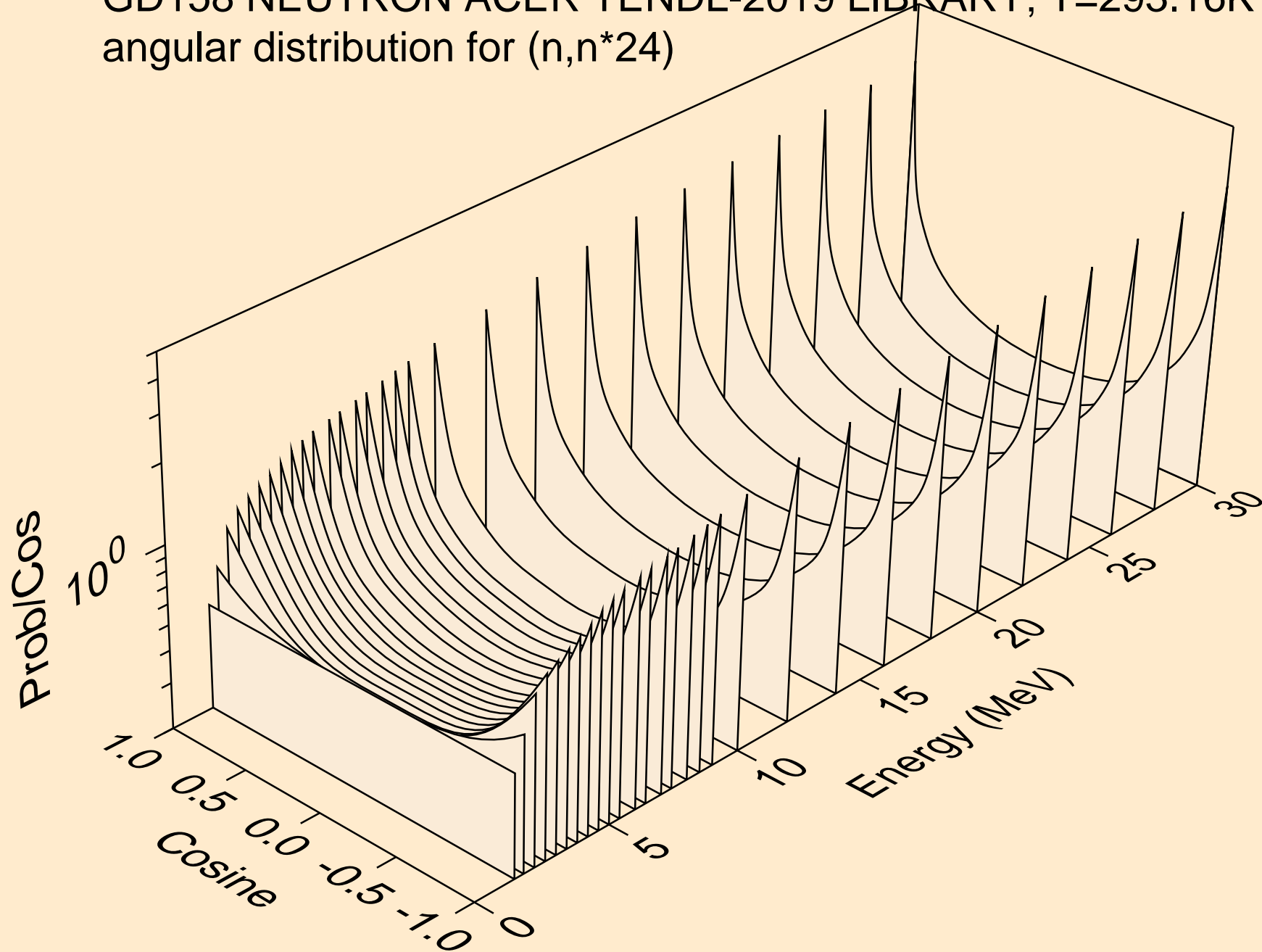

GD158 NEUTRON ACER TENDL-2019 LIBRARY; T=293.16K  
angular distribution for (n,n\*25)

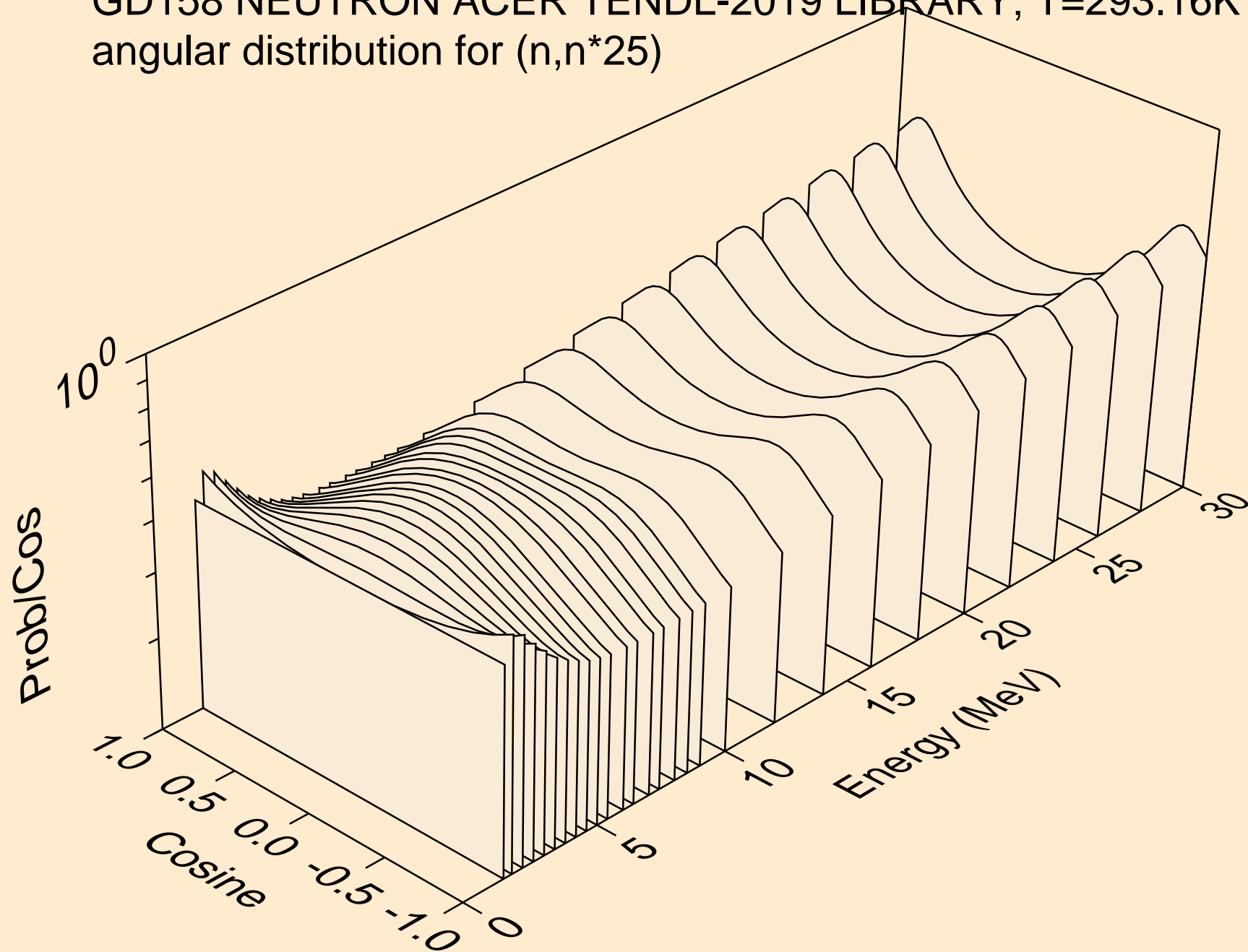

GD158 NEUTRON ACER TENDL-2019 LIBRARY; T=293.16K  
angular distribution for (n,n\*26)

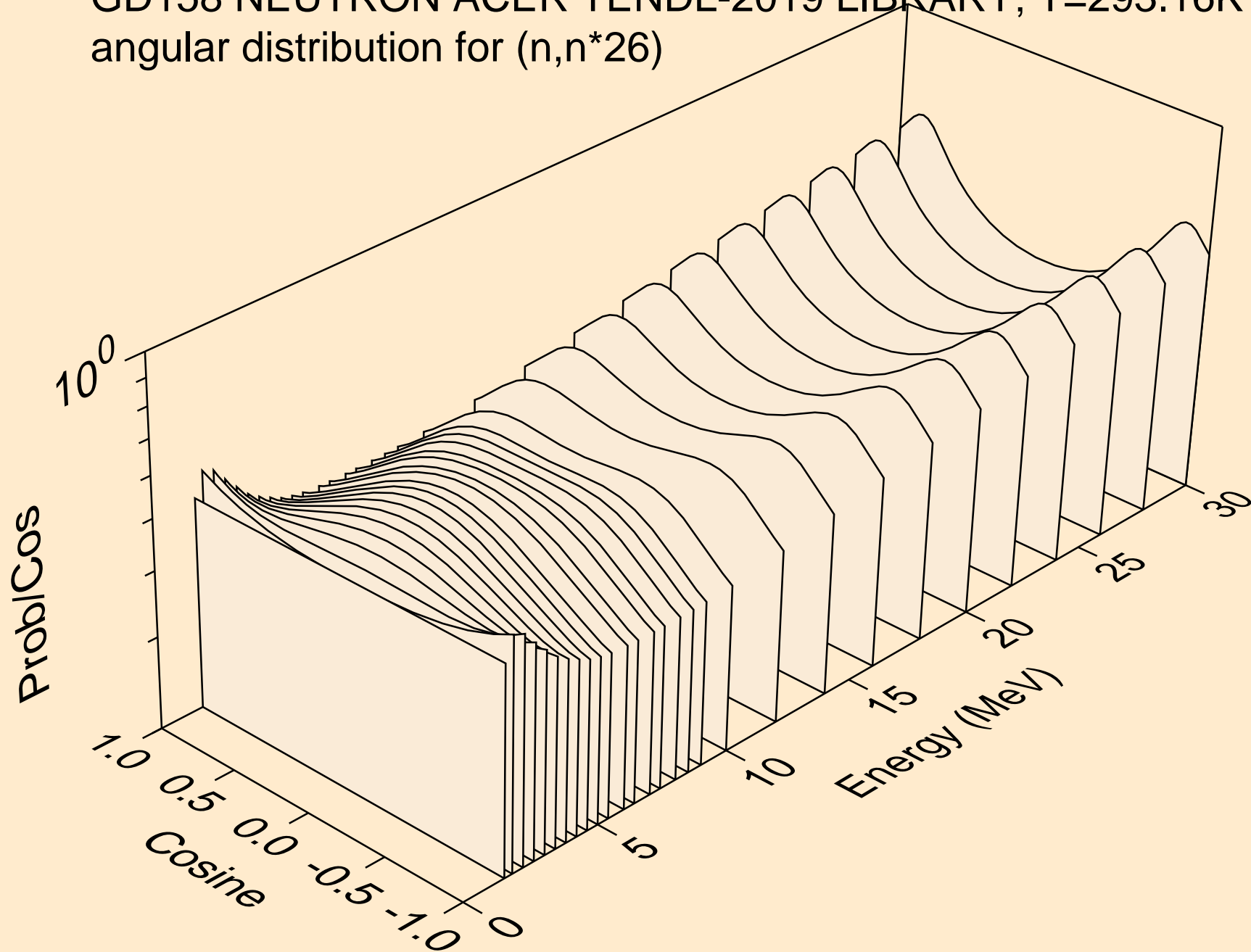



GD158 NEUTRON ACER TENDL-2019 LIBRARY; T=293.16K  
angular distribution for (n,n\*27)

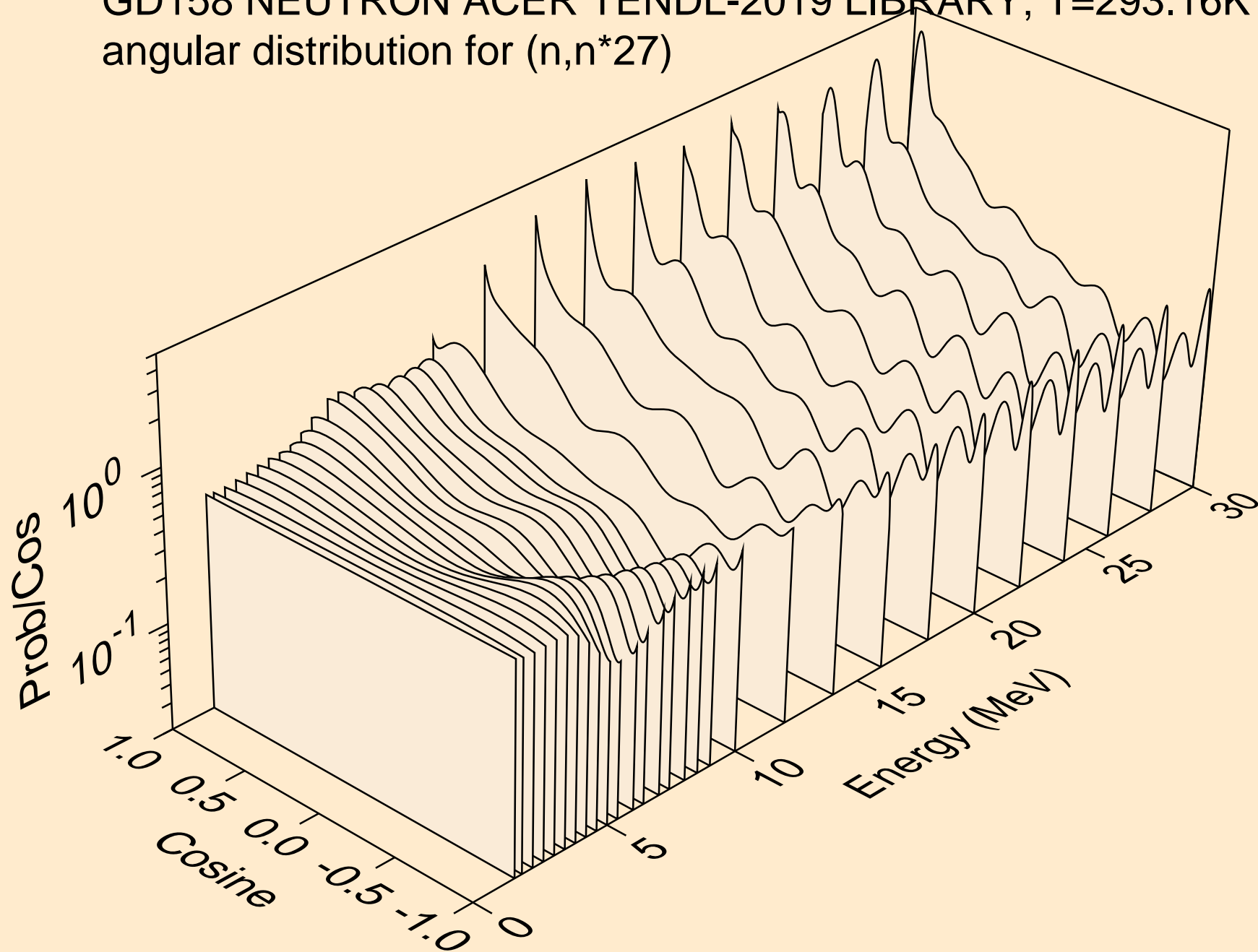

GD158 NEUTRON ACER TENDL-2019 LIBRARY; T=293.16K  
angular distribution for (n,n\*28)

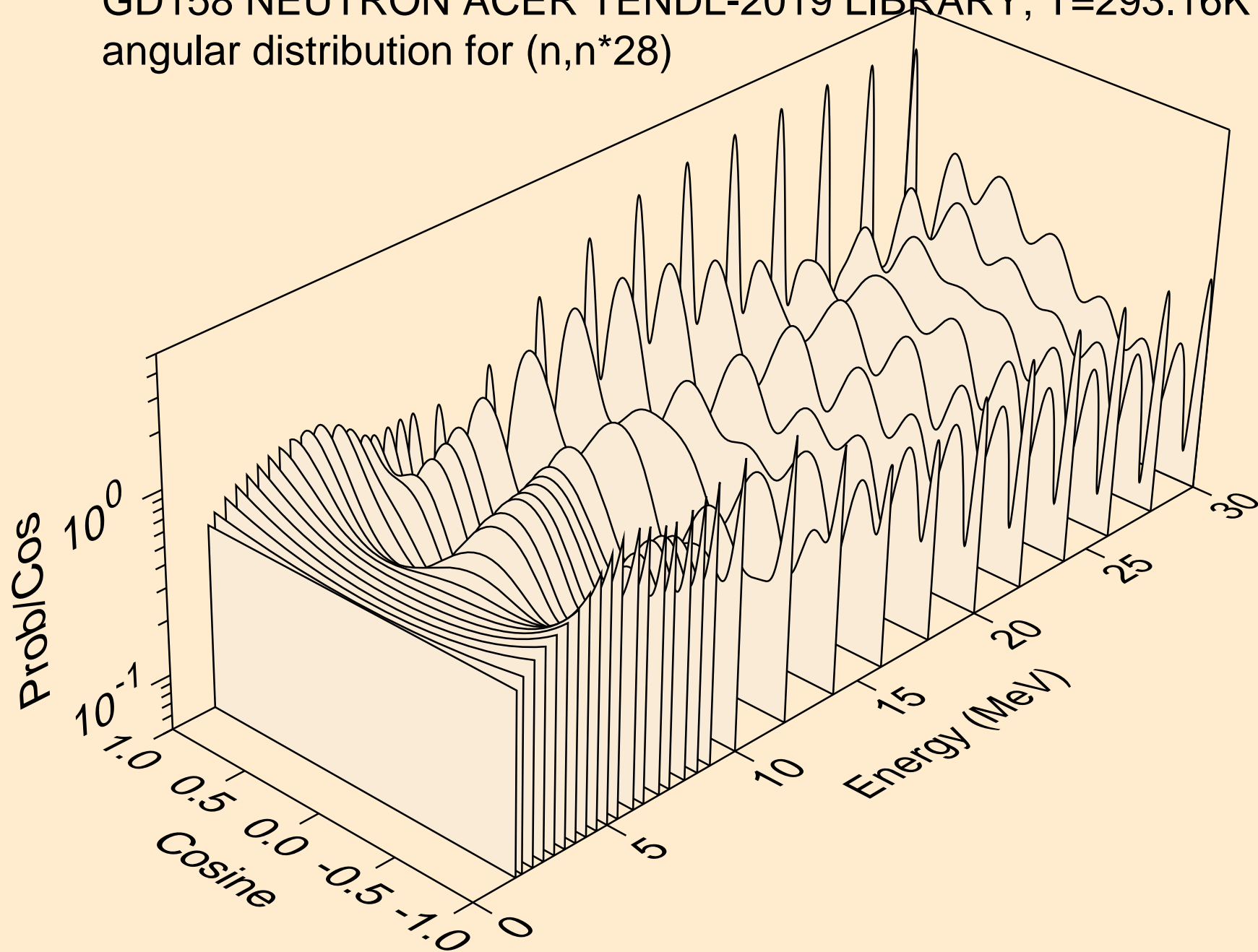

GD158 NEUTRON ACER TENDL-2019 LIBRARY; T=293.16K  
angular distribution for (n,n\*29)

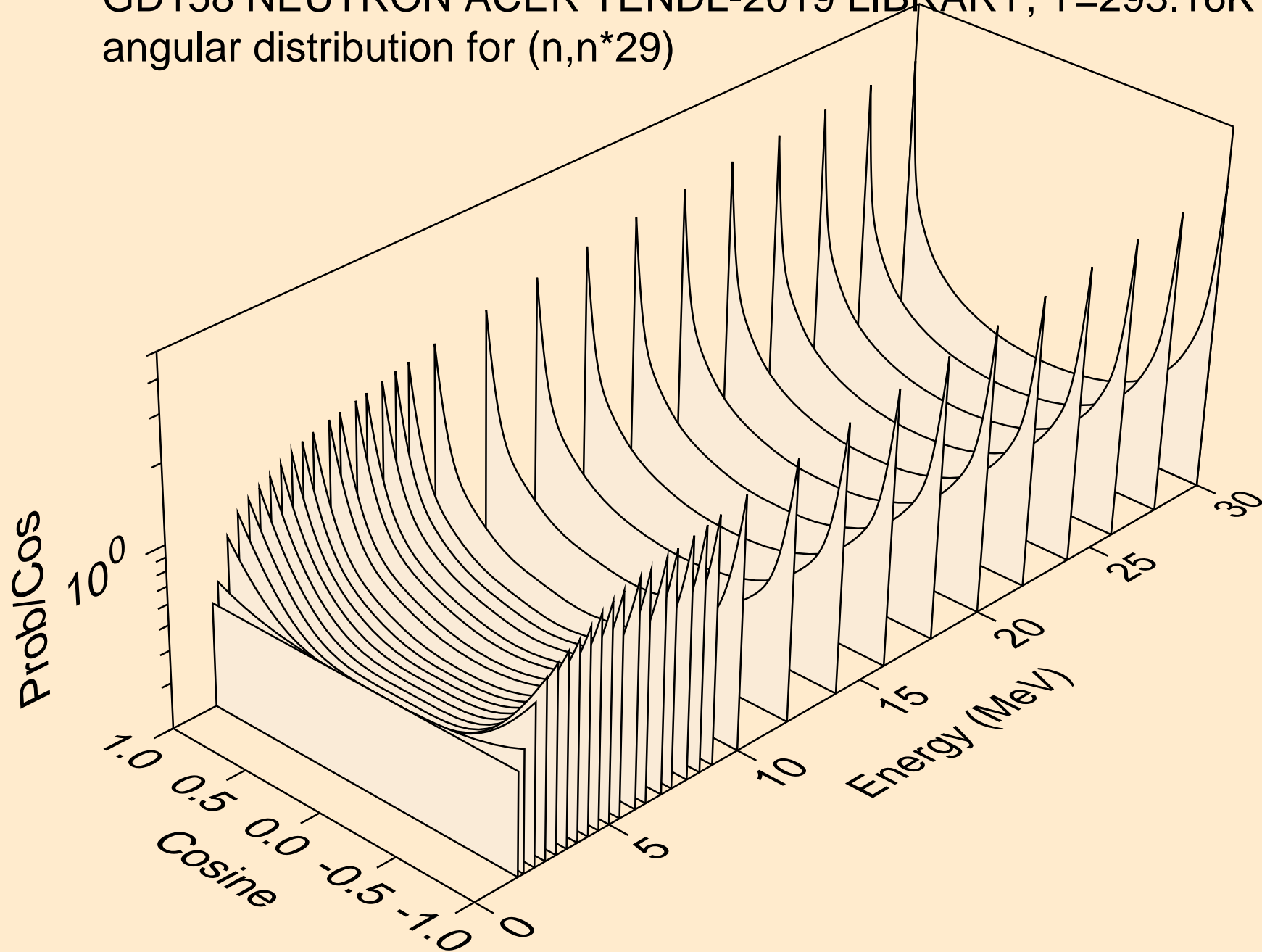

GD158 NEUTRON ACER TENDL-2019 LIBRARY; T=293.16K  
angular distribution for (n,n\*30)

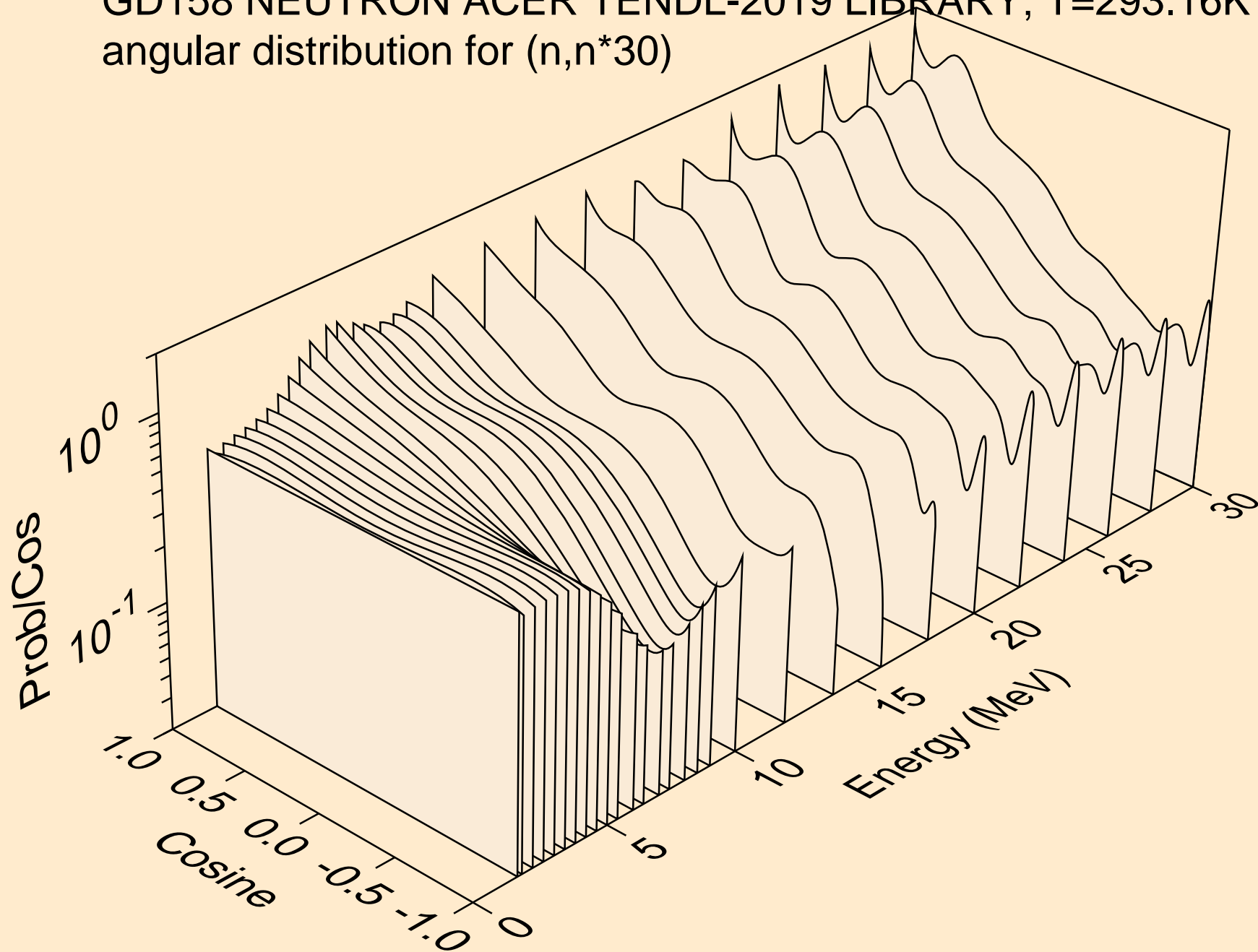

GD158 NEUTRON ACER TENDL-2019 LIBRARY; T=293.16K  
Neutron emission for (n,x)

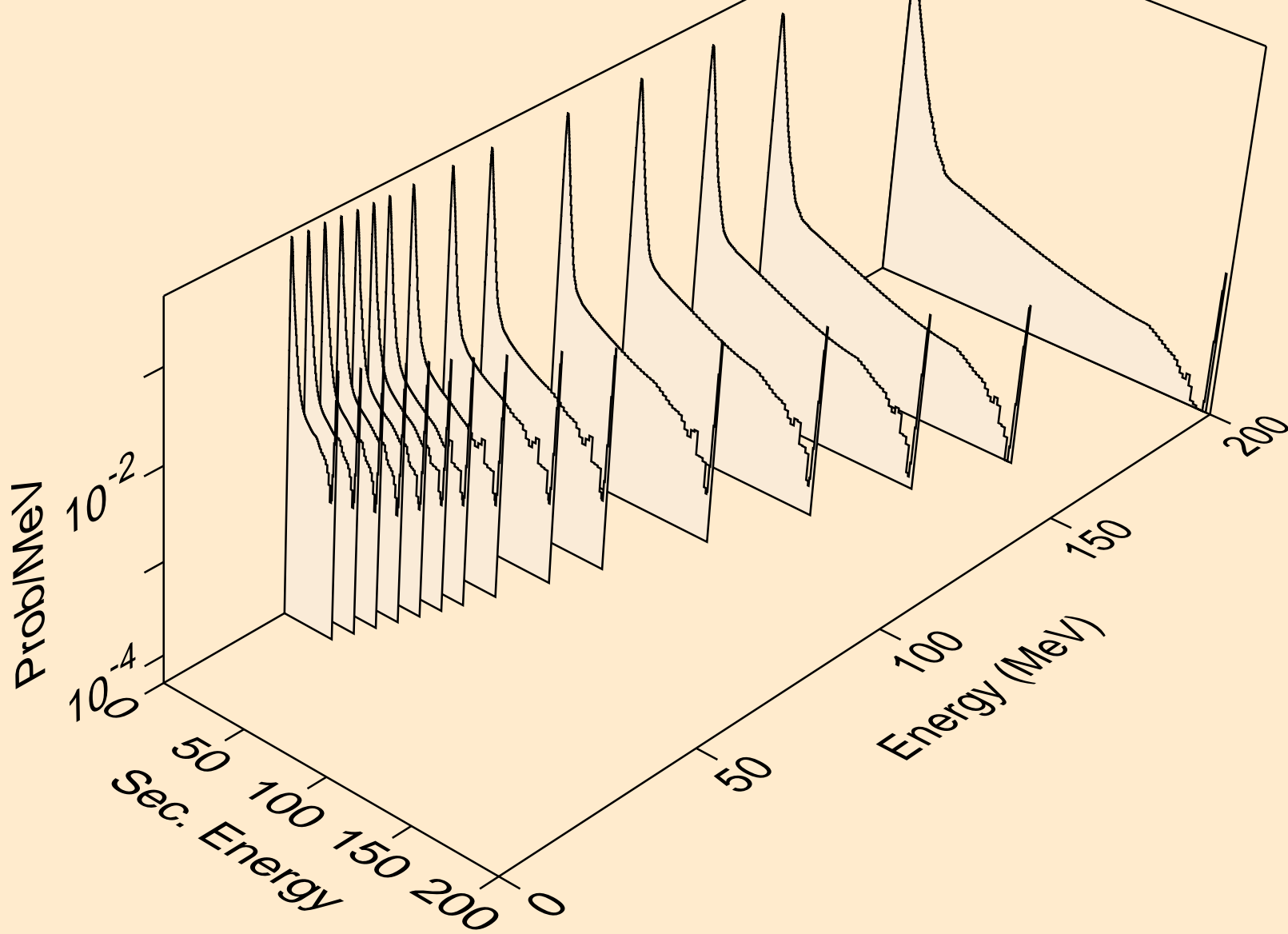

GD158 NEUTRON ACER TENDL-2019 LIBRARY; T=293.16K  
Neutron emission for (n,2nd)

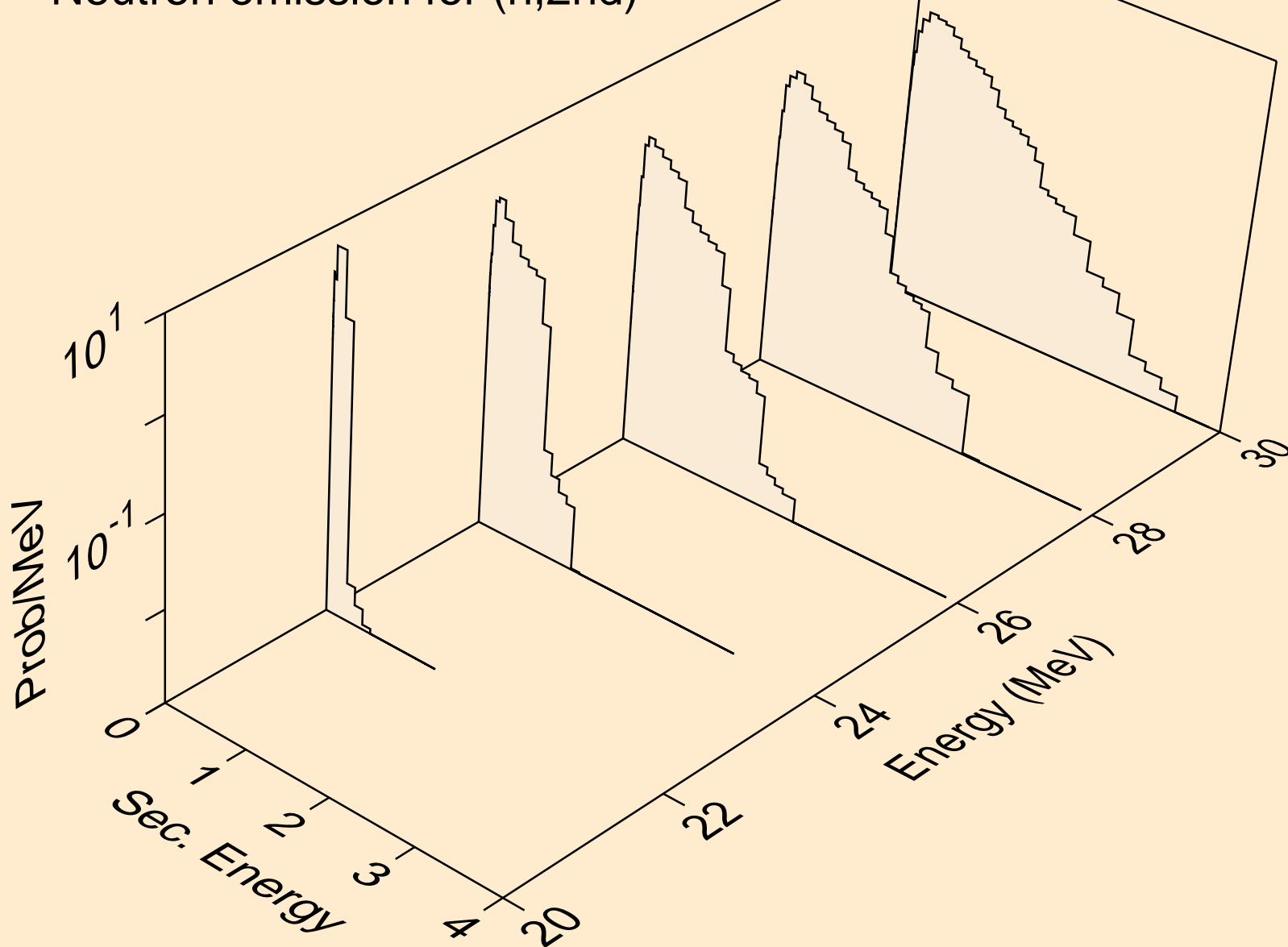

GD158 NEUTRON ACER TENDL-2019 LIBRARY; T=293.16K  
Neutron emission for (n,2n)

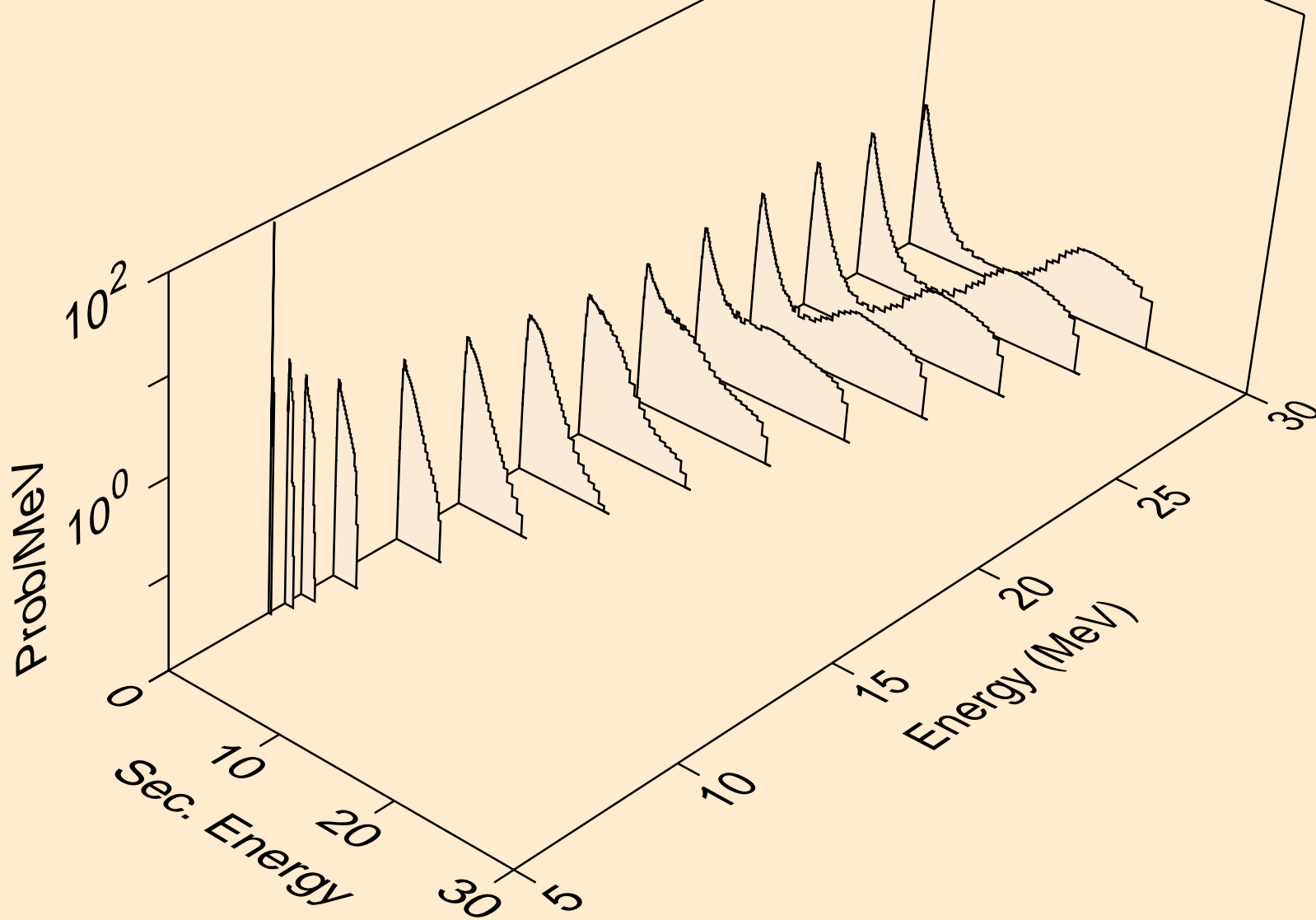

GD158 NEUTRON ACER TENDL-2019 LIBRARY; T=293.16K  
Neutron emission for (n,3n)

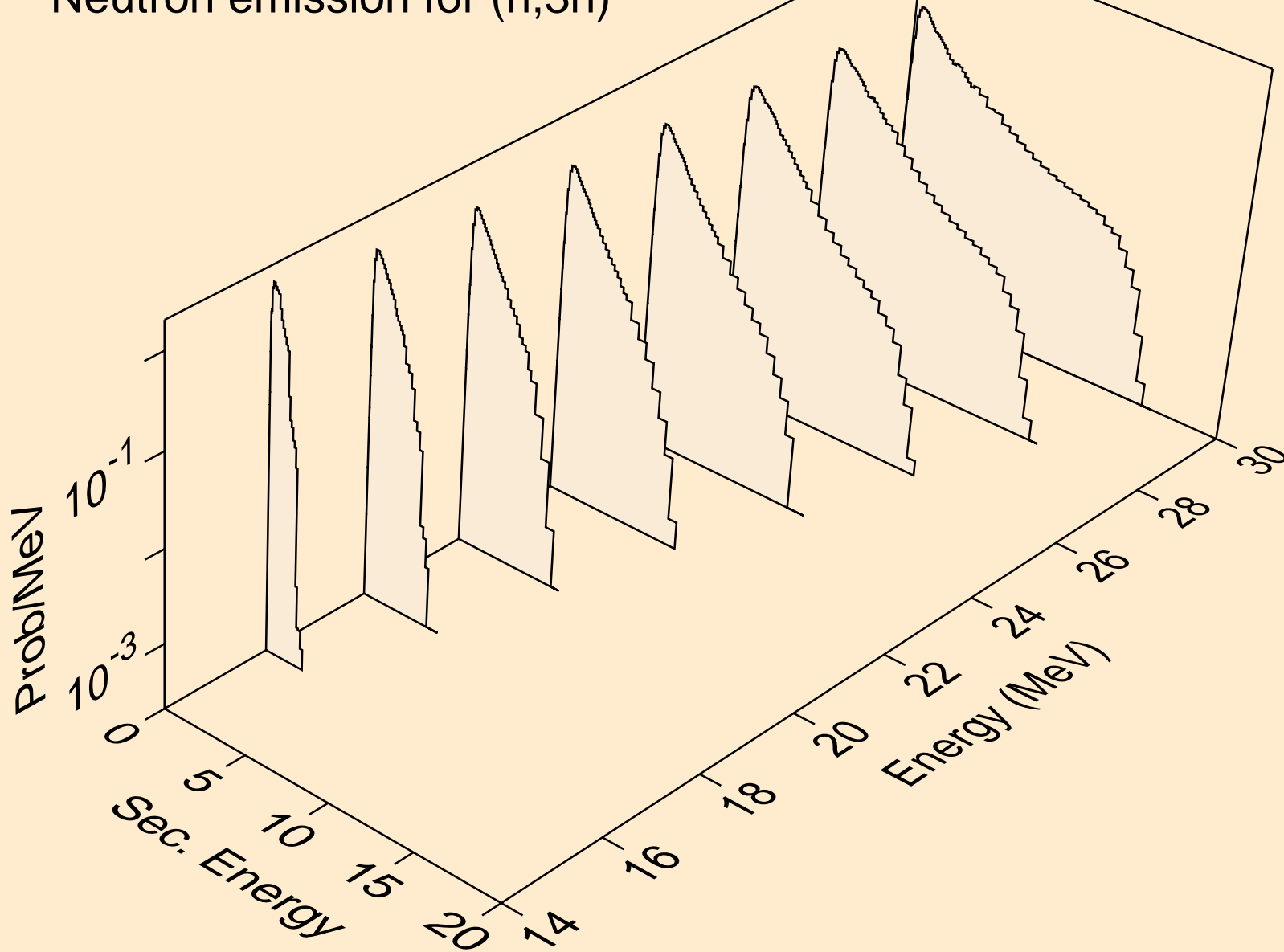



GD158 NEUTRON ACER TENDL-2019 LIBRARY; T=293.16K  
Neutron emission for (n,n\*)a

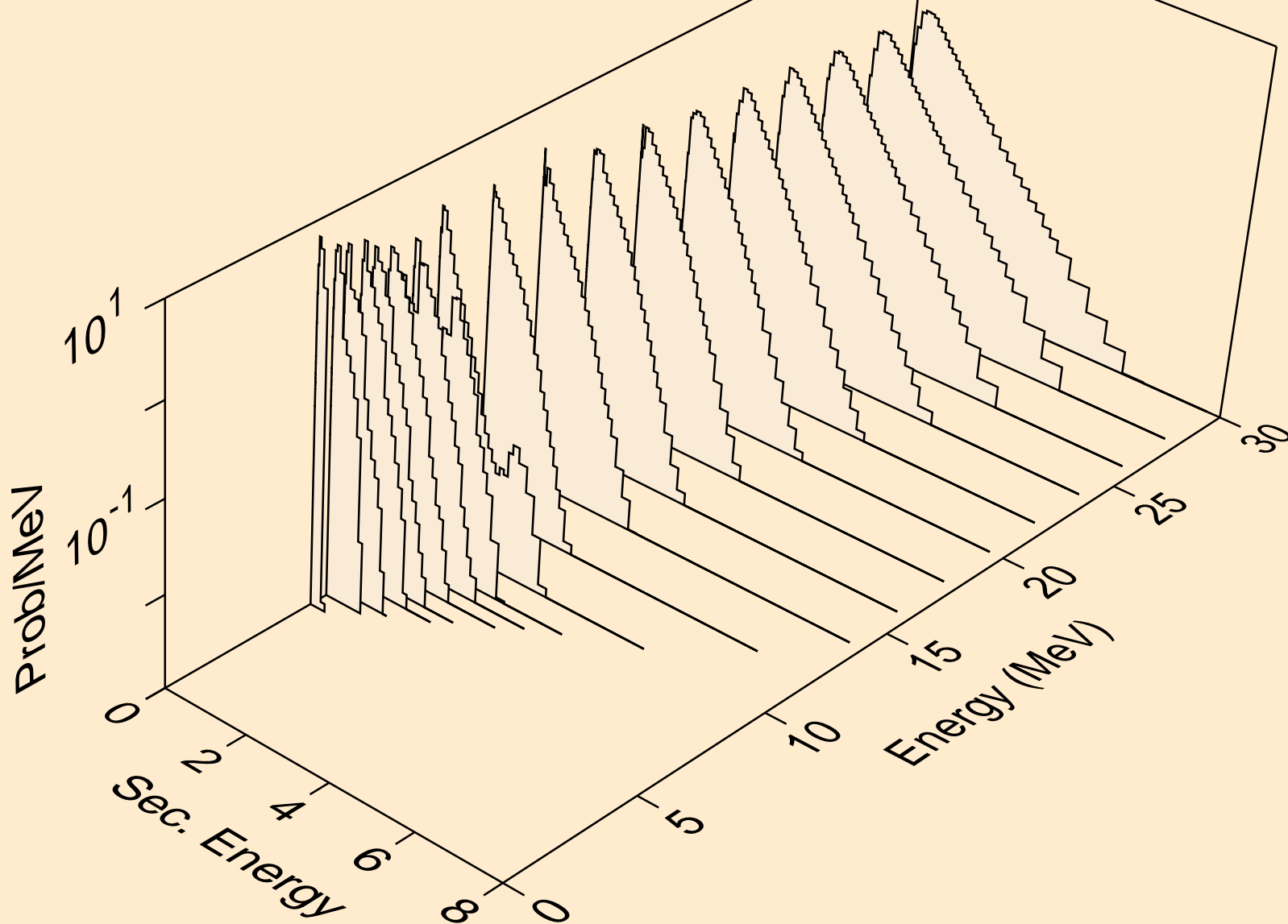

GD158 NEUTRON ACER TENDL-2019 LIBRARY; T=293.16K  
Neutron emission for (n,2n)a

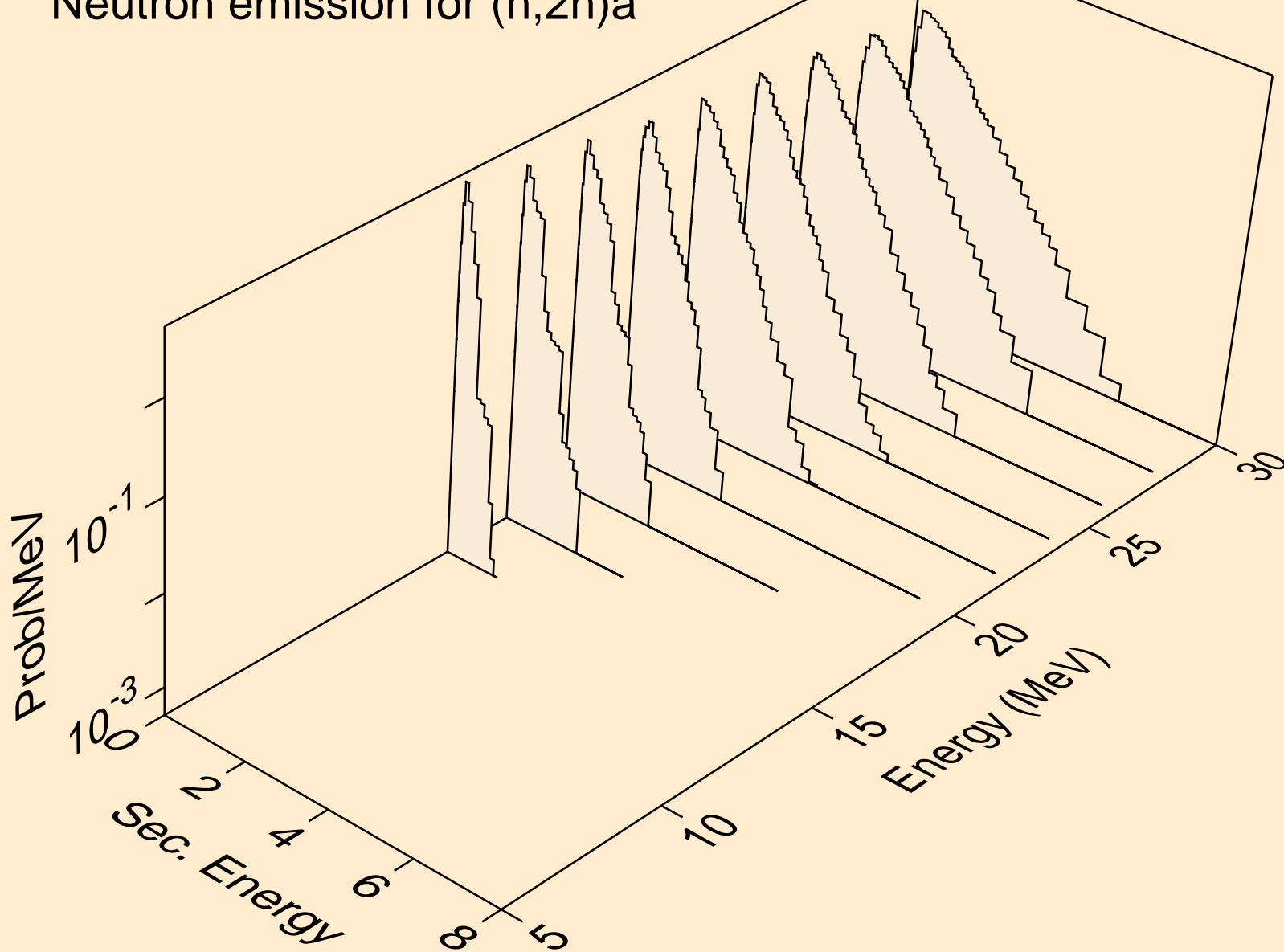

GD158 NEUTRON ACER TENDL-2019 LIBRARY; T=293.16K  
Neutron emission for (n,3n)a

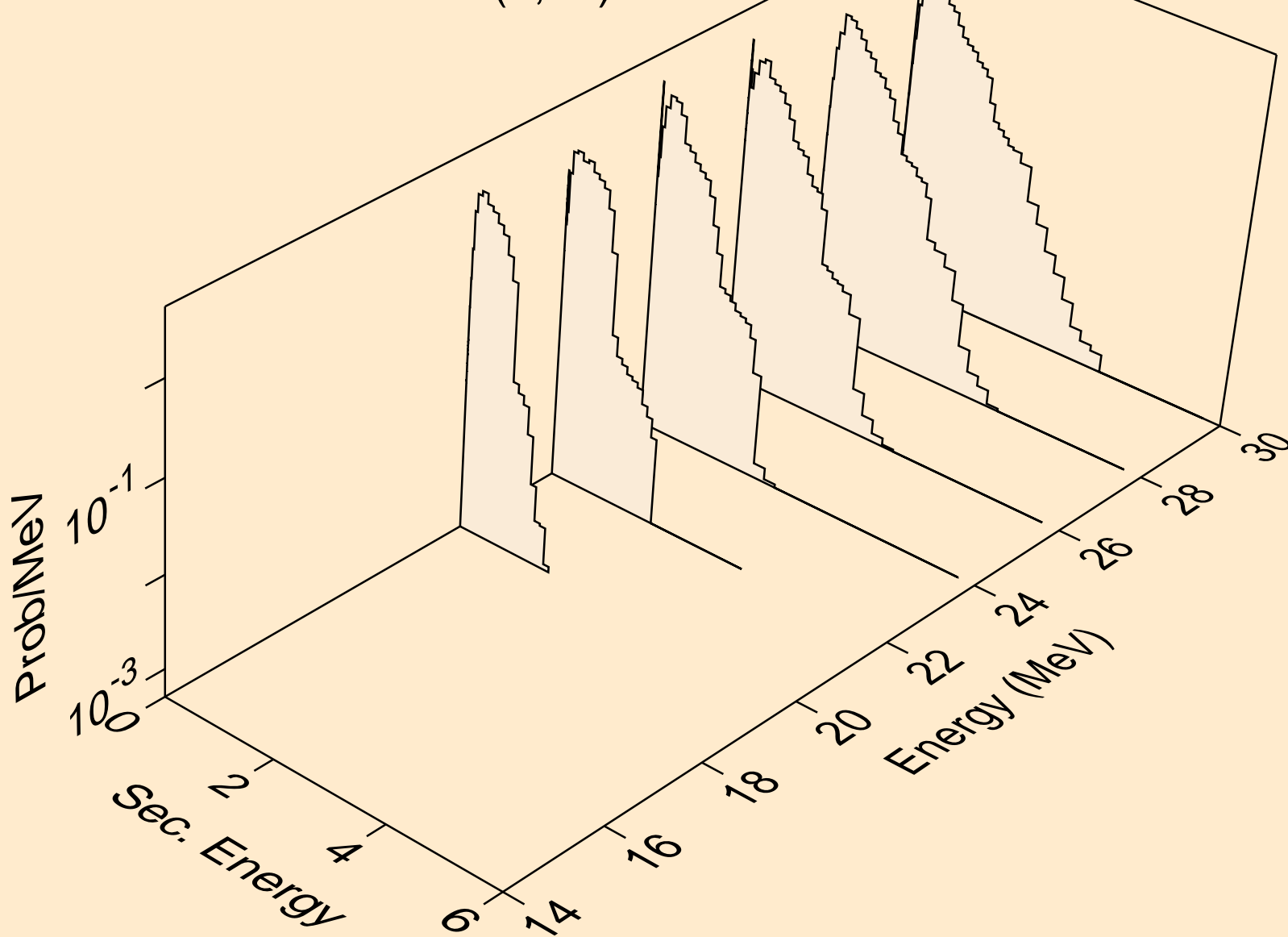

GD158 NEUTRON ACER TENDL-2019 LIBRARY; T=293.16K  
Neutron emission for (n,n\*)p

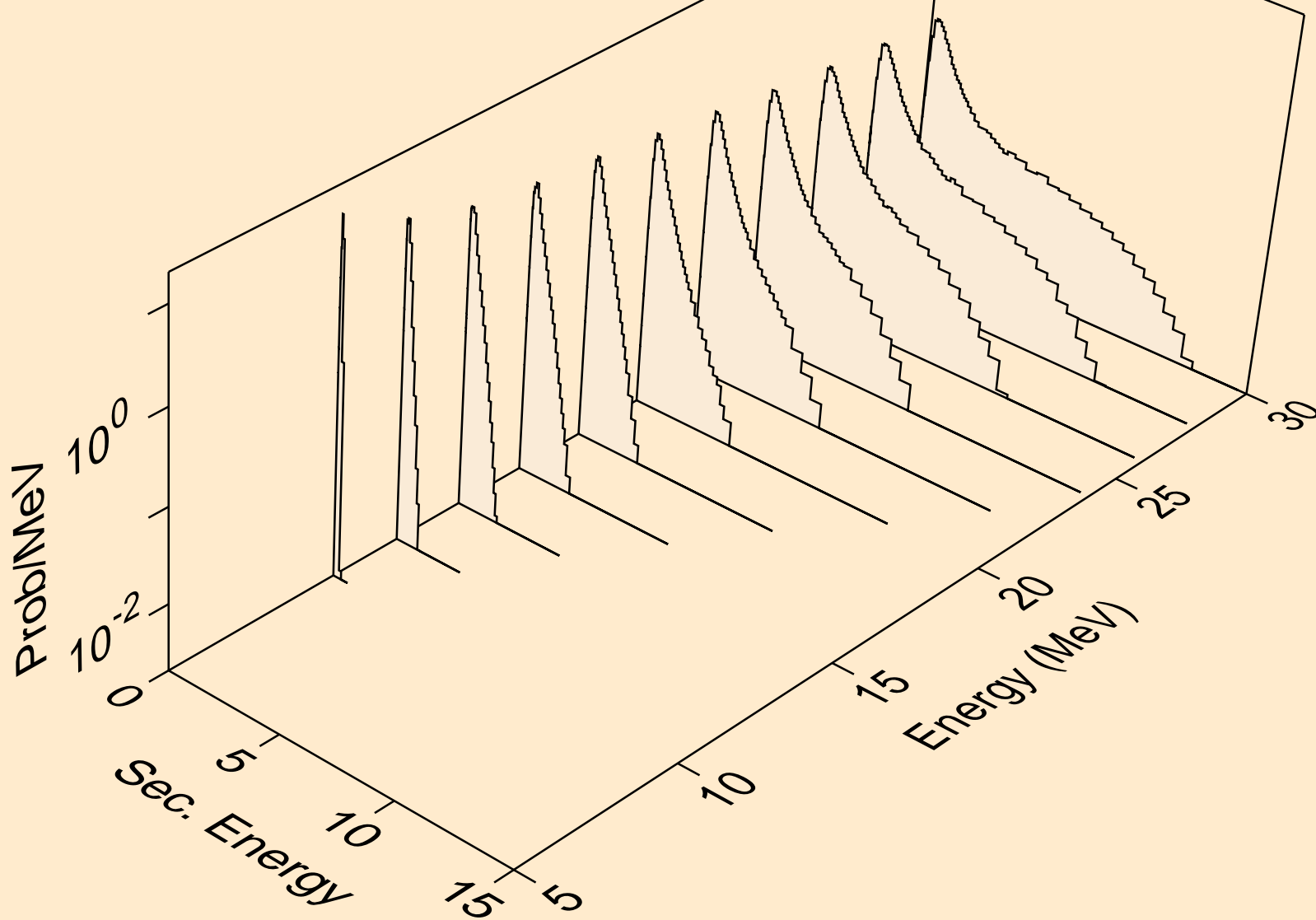

GD158 NEUTRON ACER TENDL-2019 LIBRARY; T=293.16K  
Neutron emission for (n,n\*)d

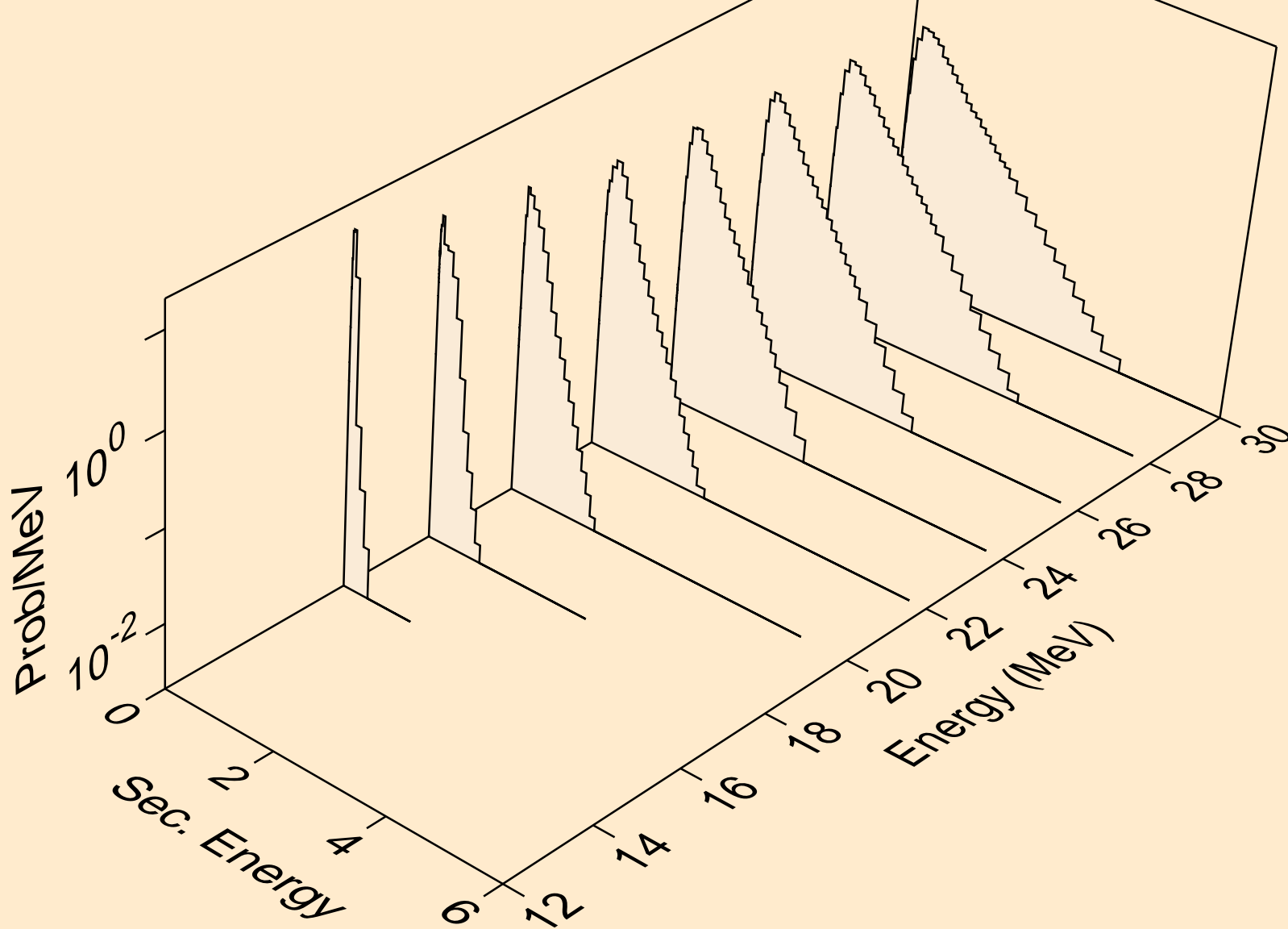

GD158 NEUTRON ACER TENDL-2019 LIBRARY; T=293.16K  
Neutron emission for (n,n\*)t

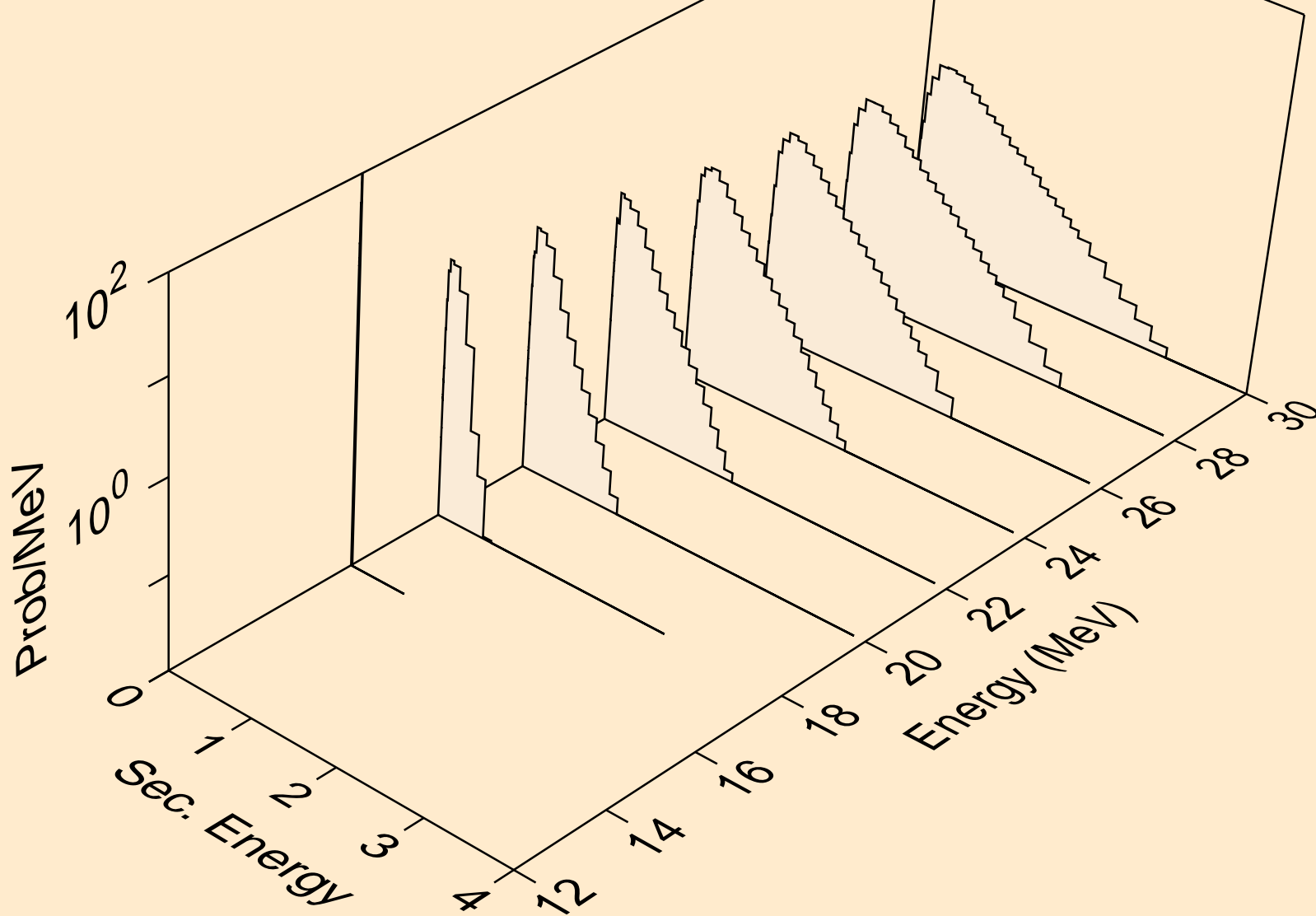

GD158 NEUTRON ACER TENDL-2019 LIBRARY; T=293.16K  
Neutron emission for (n,n\*)he3

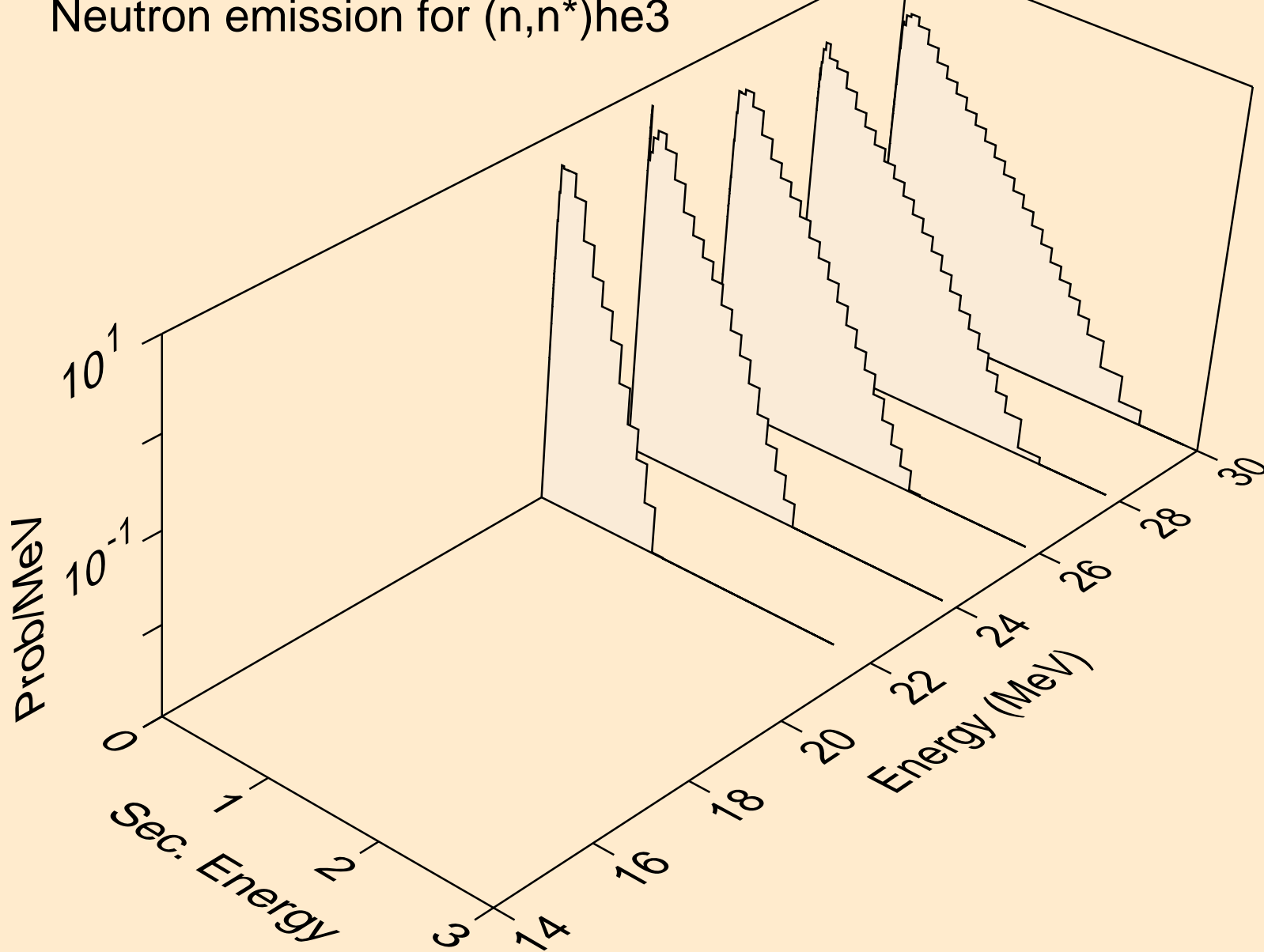

GD158 NEUTRON ACER TENDL-2019 LIBRARY; T=293.16K  
Neutron emission for (n,4n)

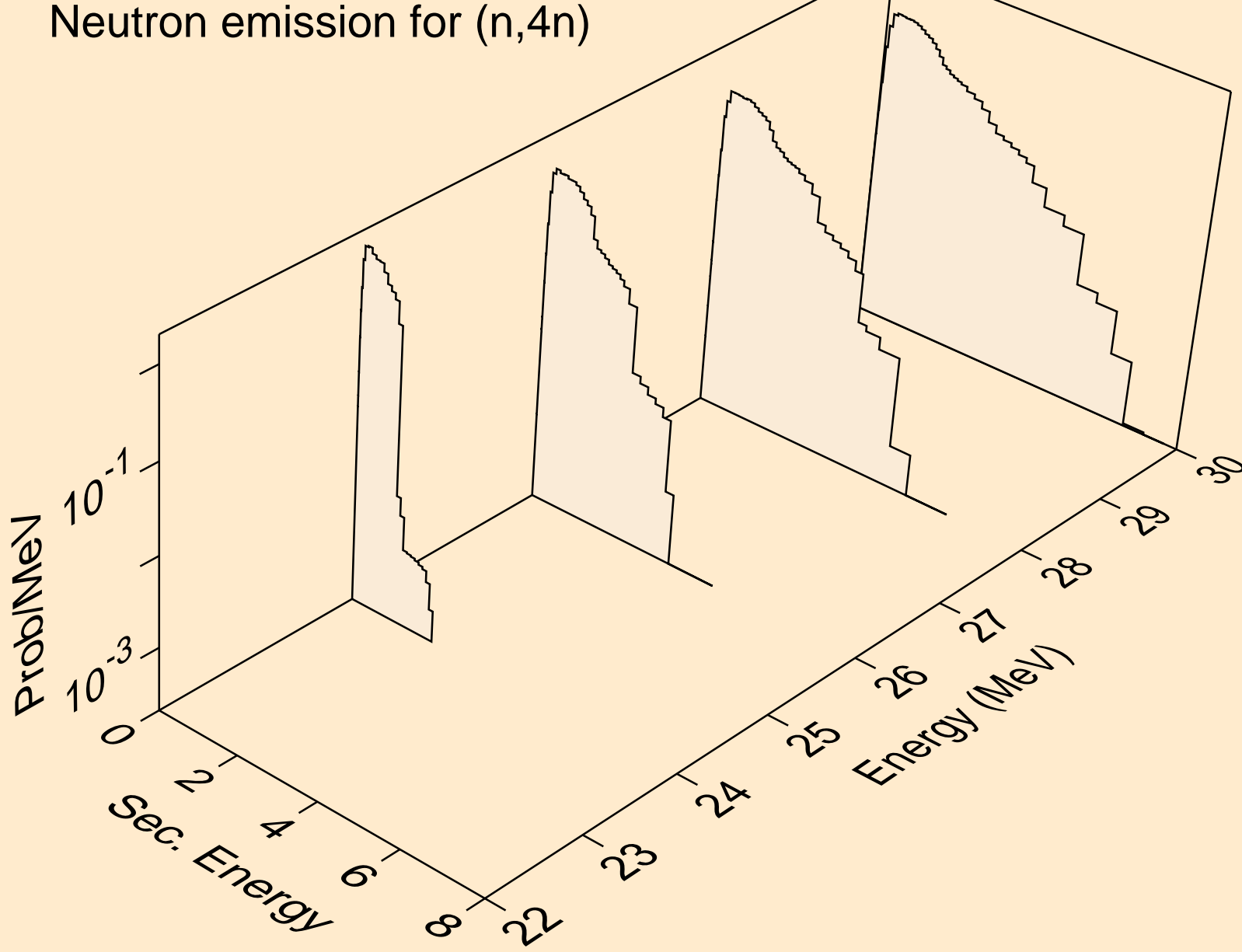



GD158 NEUTRON ACER TENDL-2019 LIBRARY; T=293.16K  
Neutron emission for (n,2np)

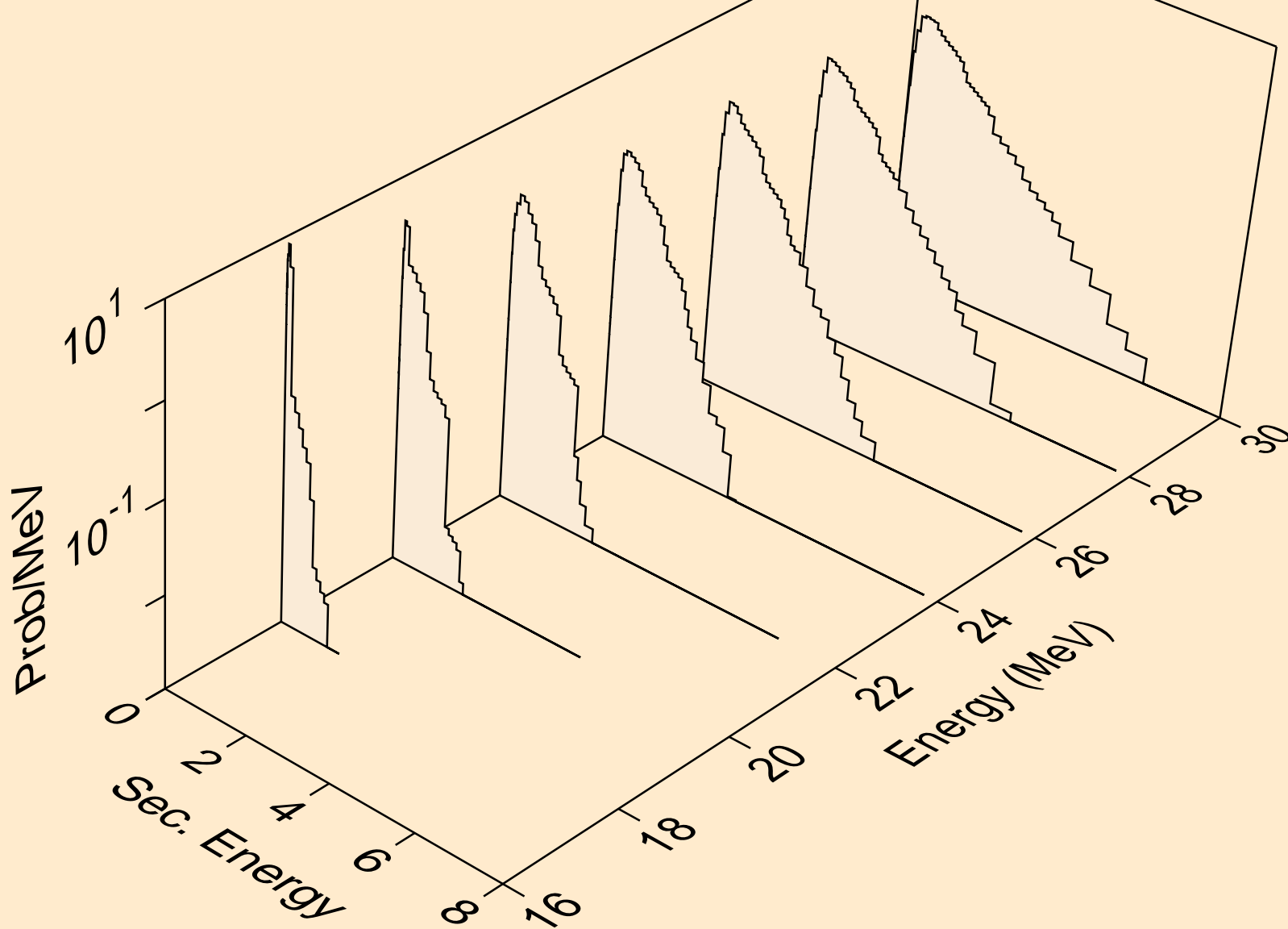

GD158 NEUTRON ACER TENDL-2019 LIBRARY; T=293.16K  
Neutron emission for (n,3np)

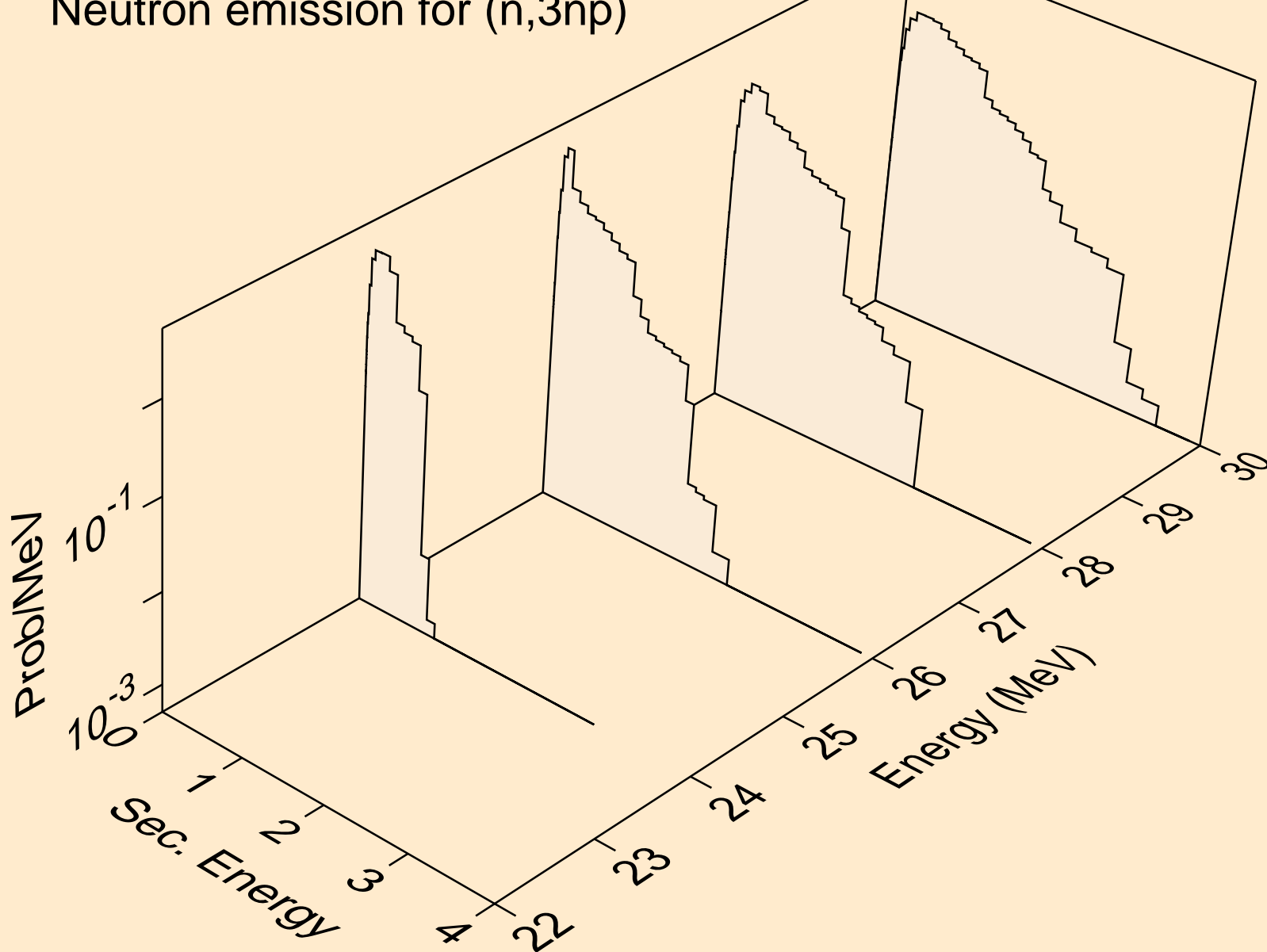

GD158 NEUTRON ACER TENDL-2019 LIBRARY; T=293.16K  
Neutron emission for (n,2np)

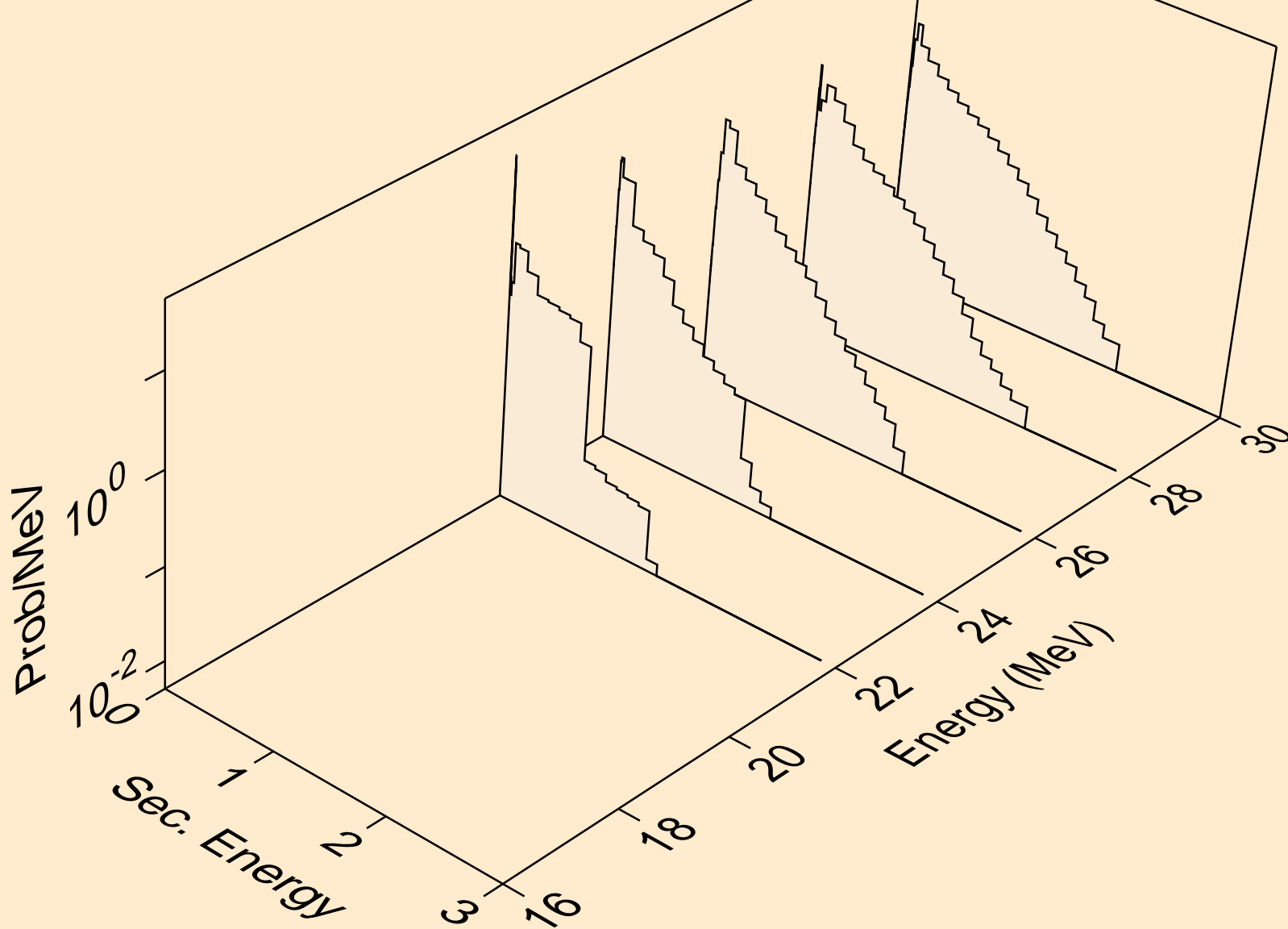

GD158 NEUTRON ACER TENDL-2019 LIBRARY; T=293.16K  
Neutron emission for (n,npa)

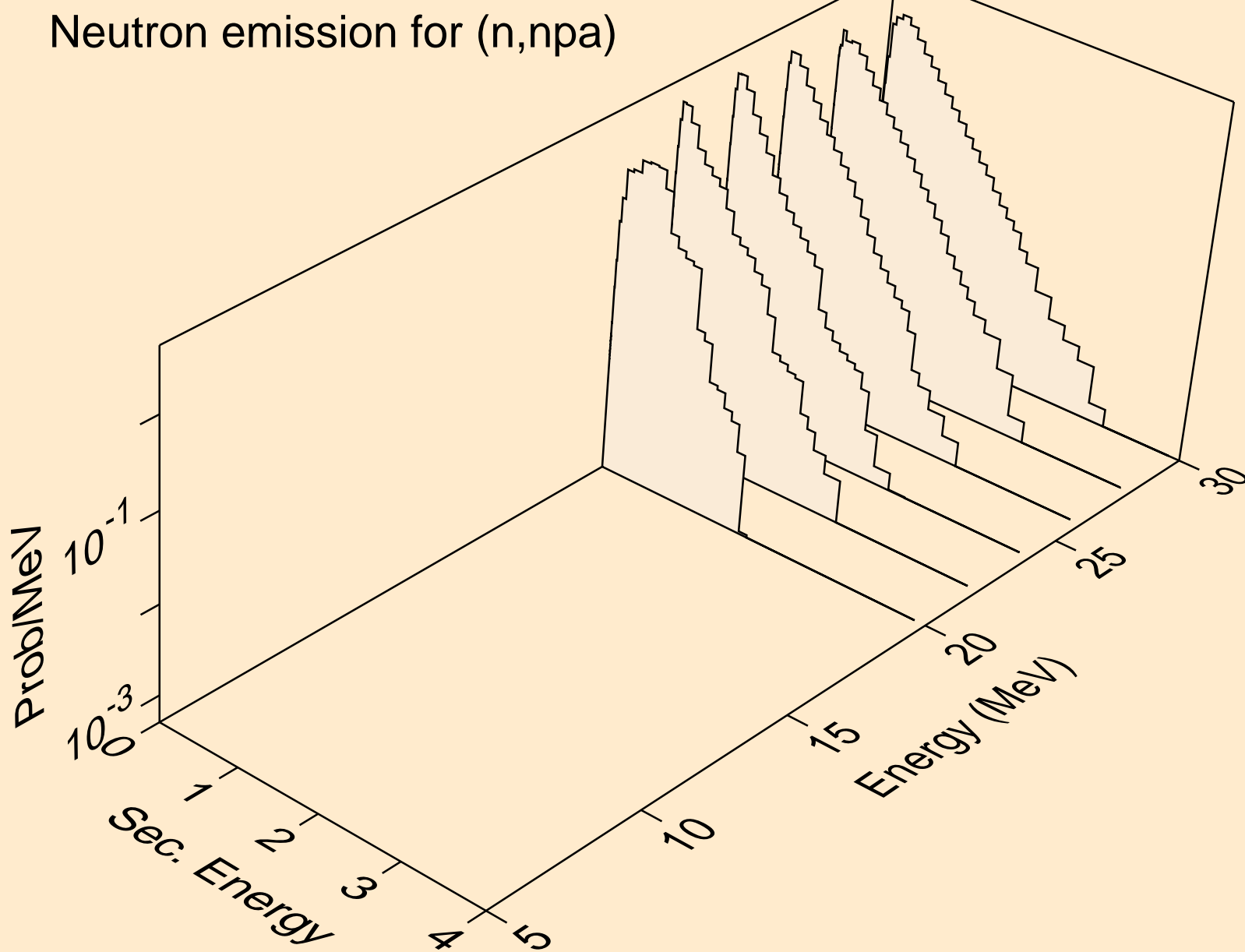

GD158 NEUTRON ACER TENDL-2019 LIBRARY; T=293.16K  
Neutron emission for (n,n\*c)

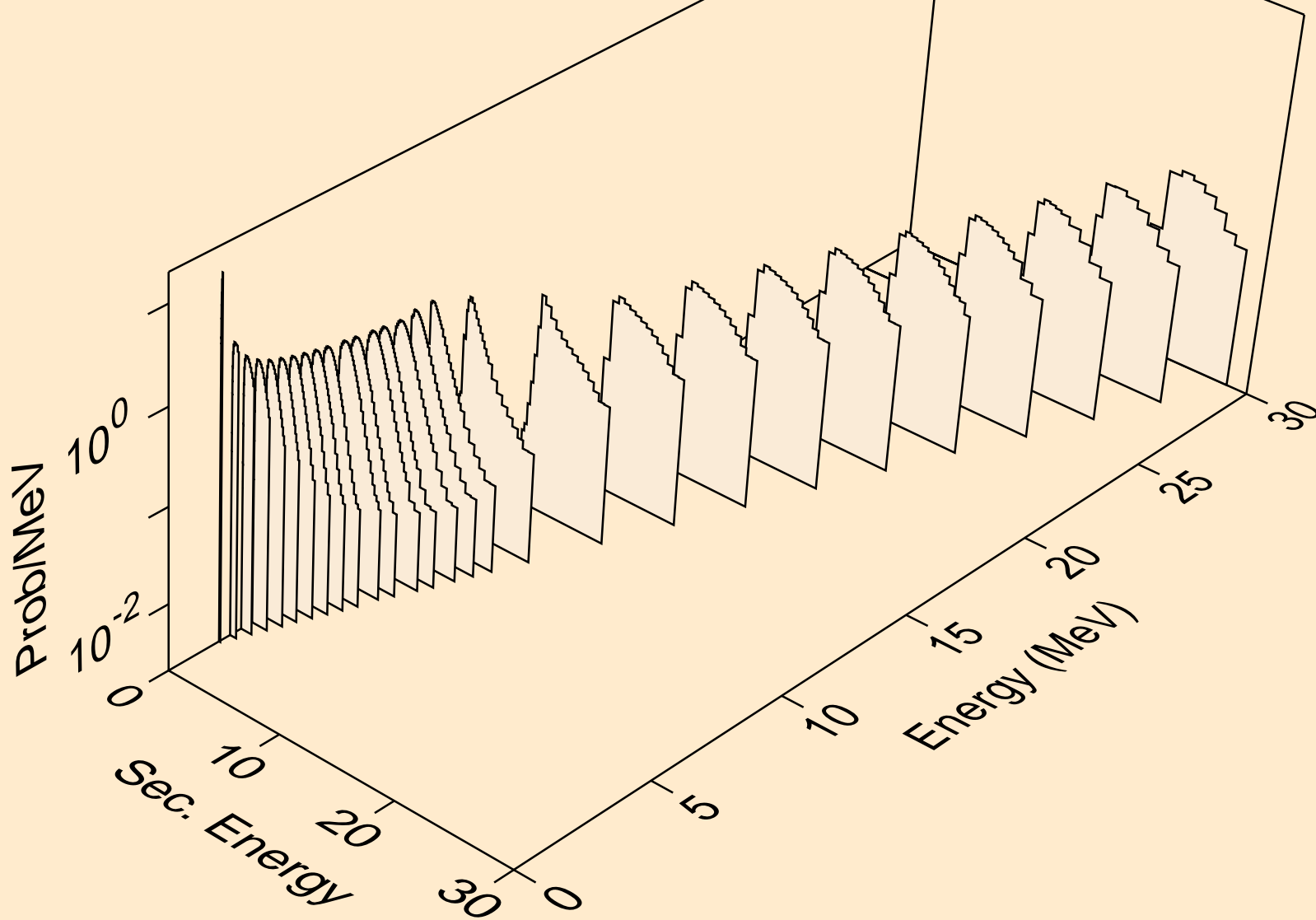

GD158 NEUTRON ACER TENDL-2019 LIBRARY; T=293.16K  
Photon emission for (n,x)

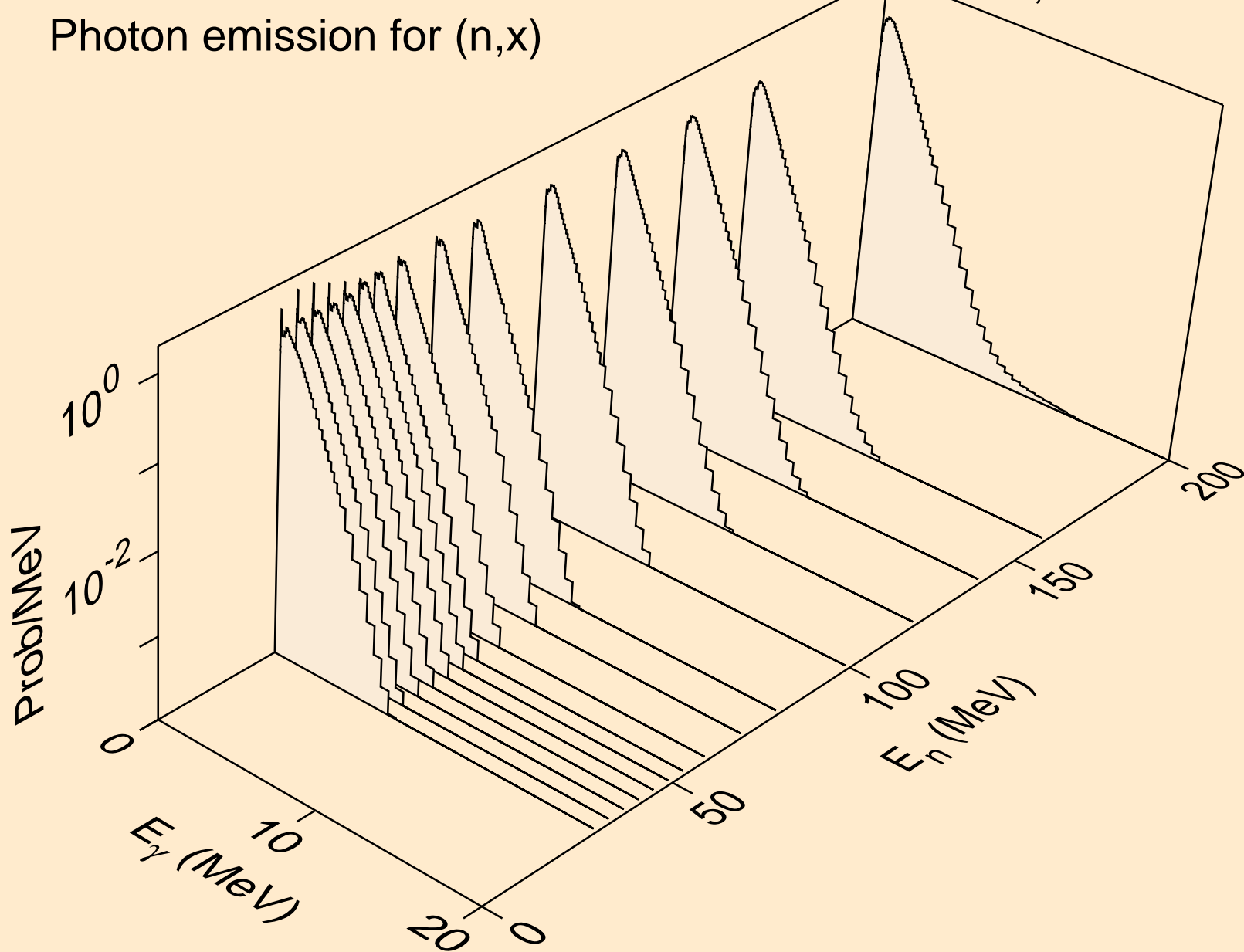

GD158 NEUTRON ACER TENDL-2019 LIBRARY; T=293.16K  
Photon emission for (n,2nd)

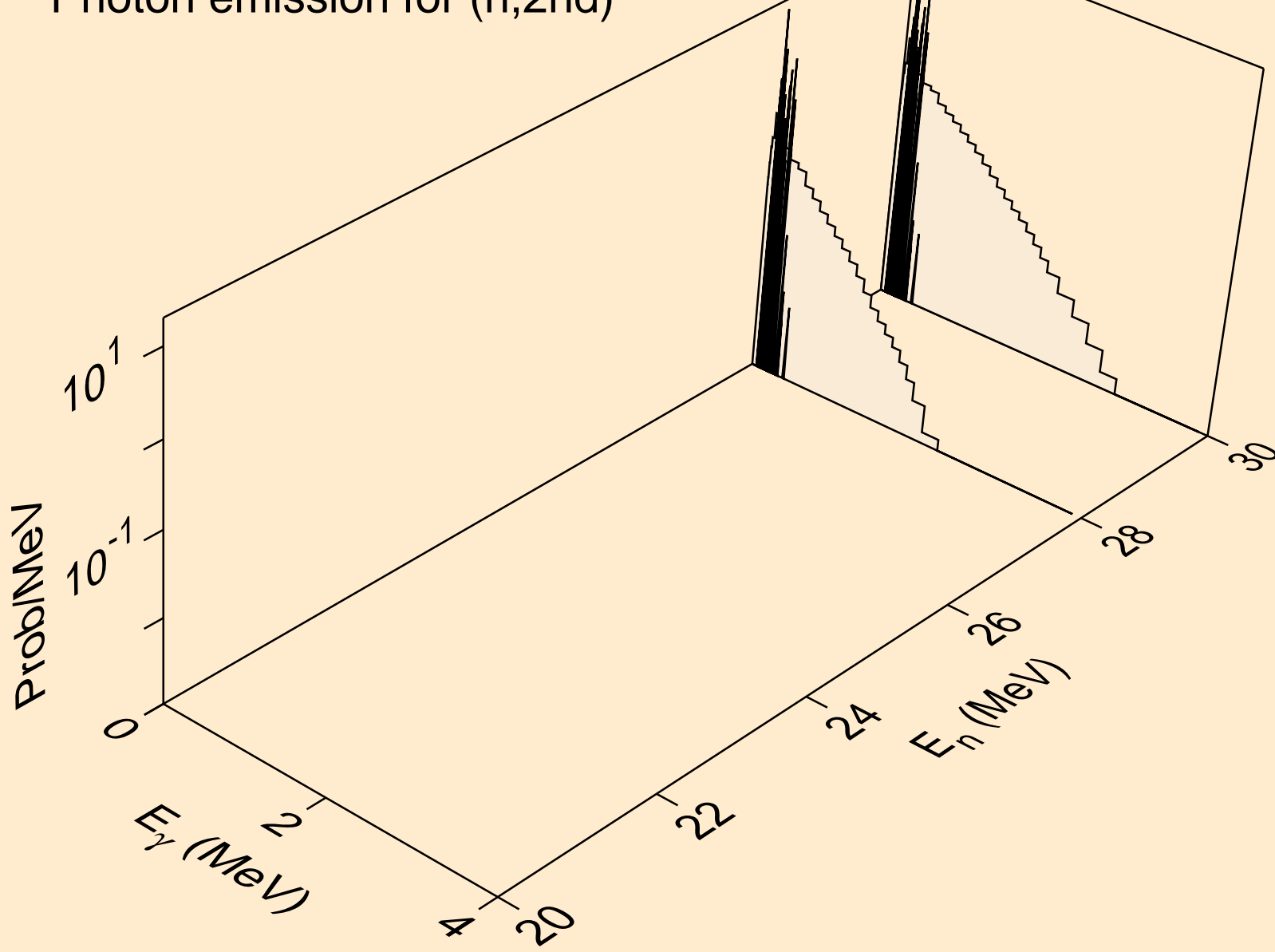

GD158 NEUTRON ACER TENDL-2019 LIBRARY; T=293.16K  
Photon emission for (n,2n)

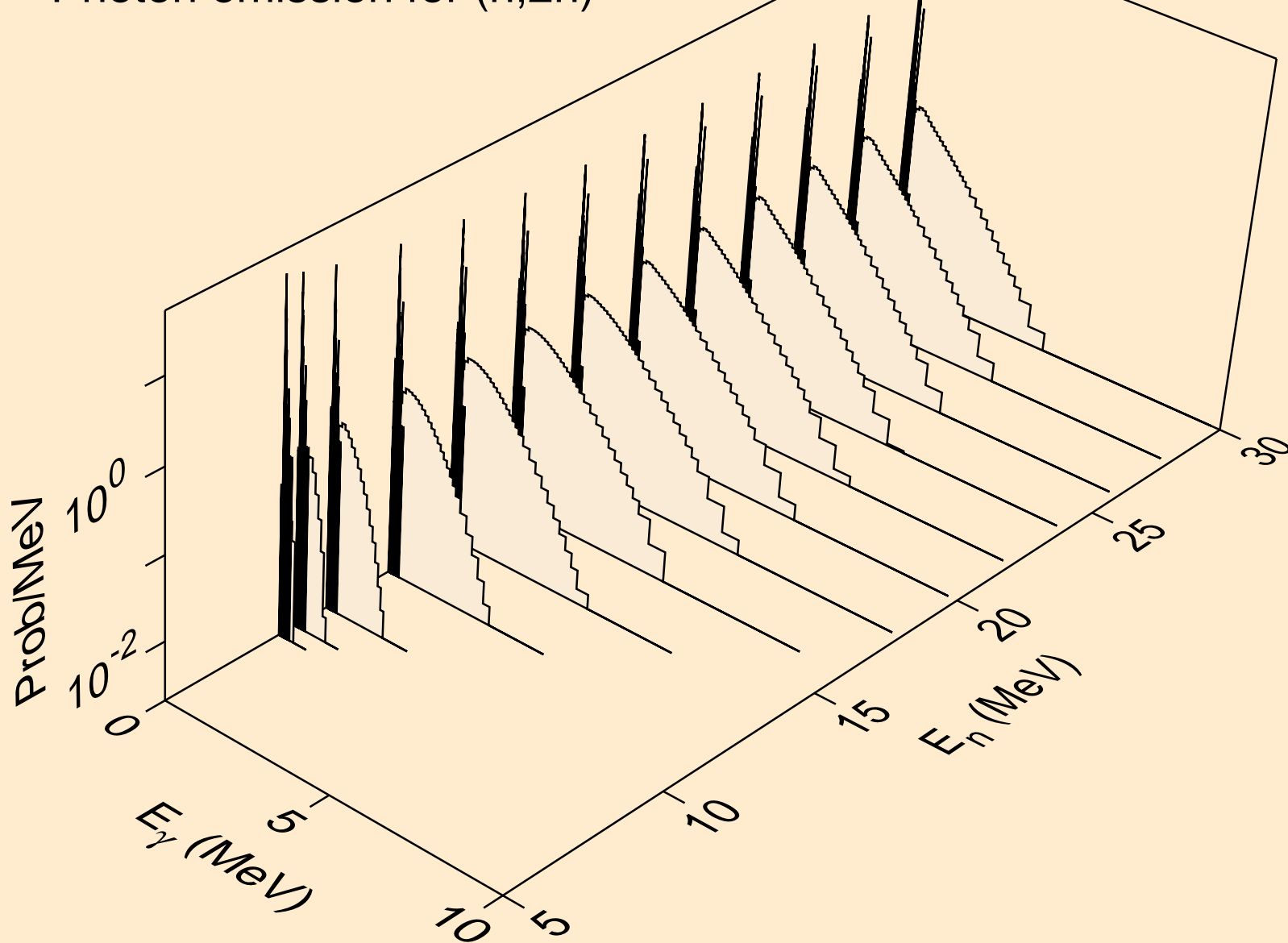



GD158 NEUTRON ACER TENDL-2019 LIBRARY; T=293.16K  
Photon emission for (n,3n)

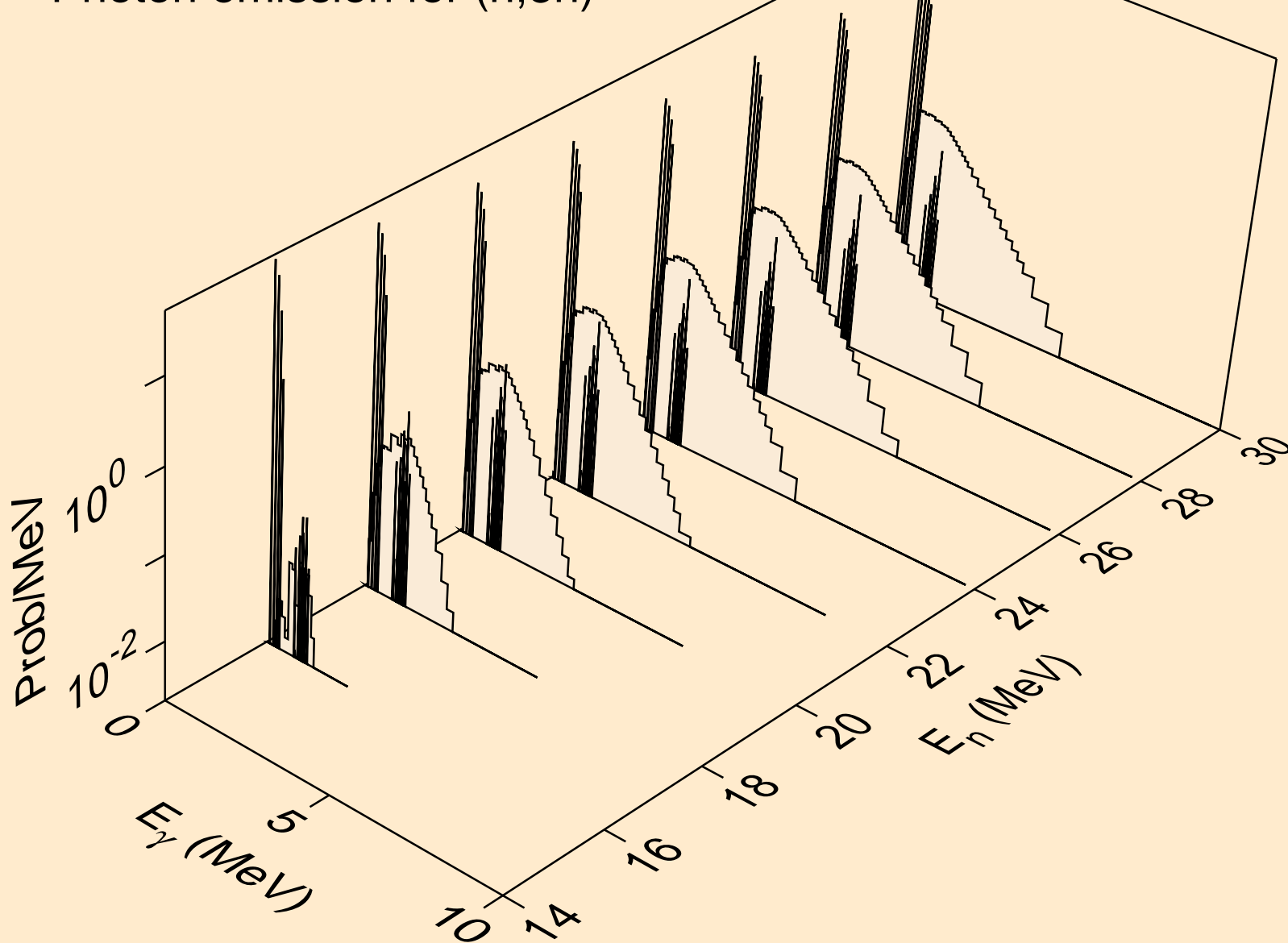

GD158 NEUTRON ACER TENDL-2019 LIBRARY; T=293.16K  
Photon emission for (n,n\*)a

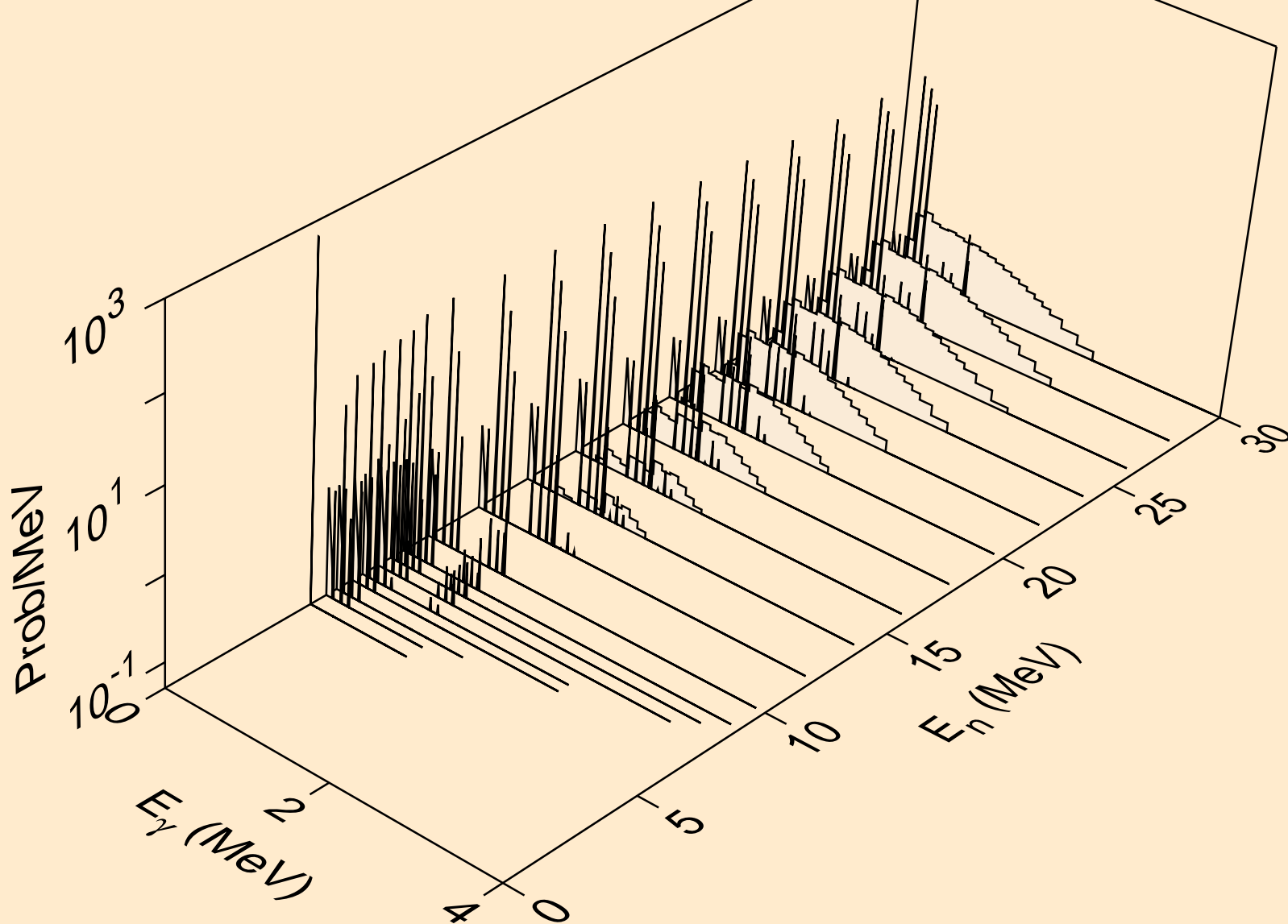

GD158 NEUTRON ACER TENDL-2019 LIBRARY; T=293.16K  
Photon emission for (n,2n)a

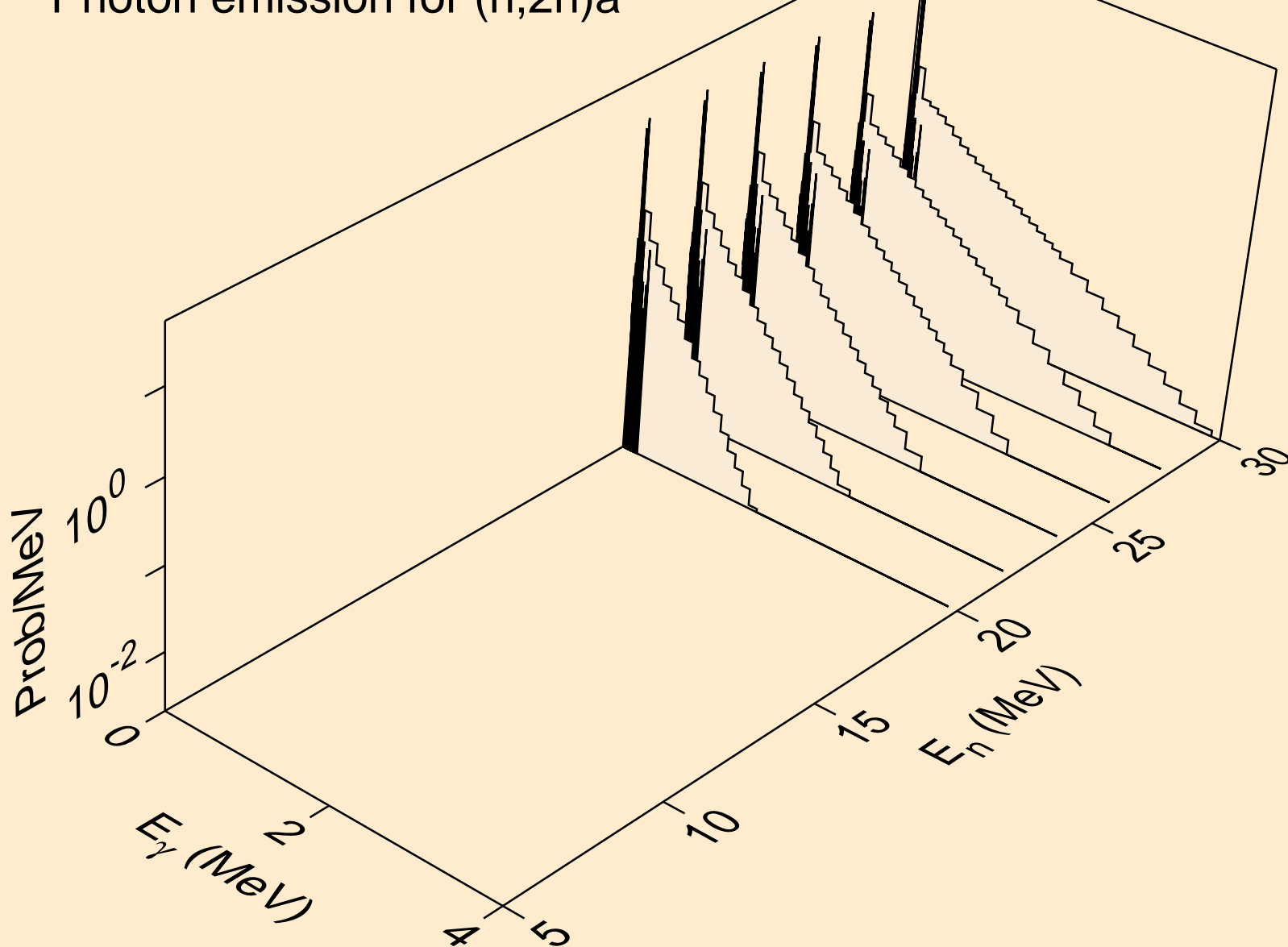

GD158 NEUTRON ACER TENDL-2019 LIBRARY; T=293.16K  
Photon emission for (n,3n)a

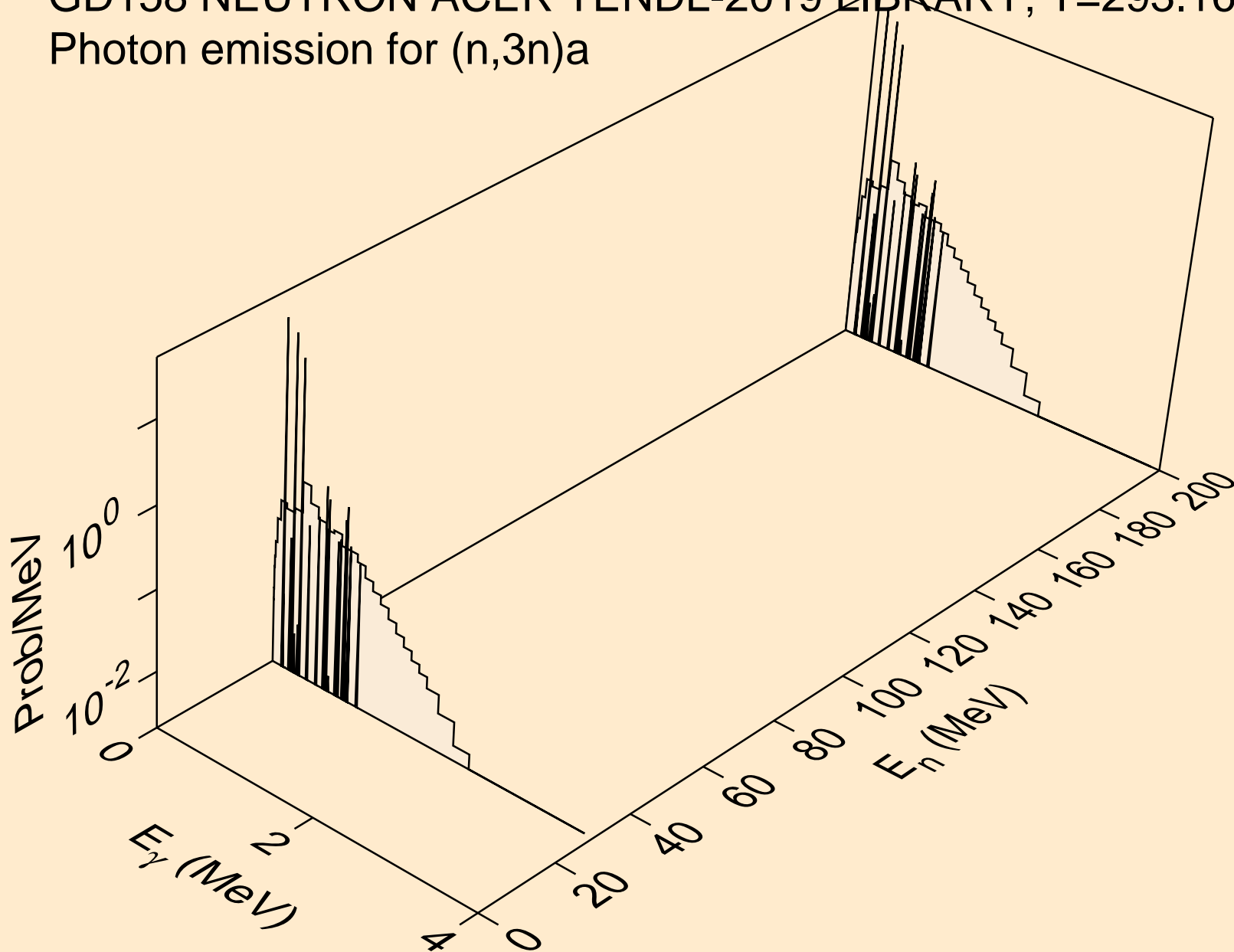

GD158 NEUTRON ACER TENDL-2019 LIBRARY; T=293.16K  
Photon emission for (n,n\*)p

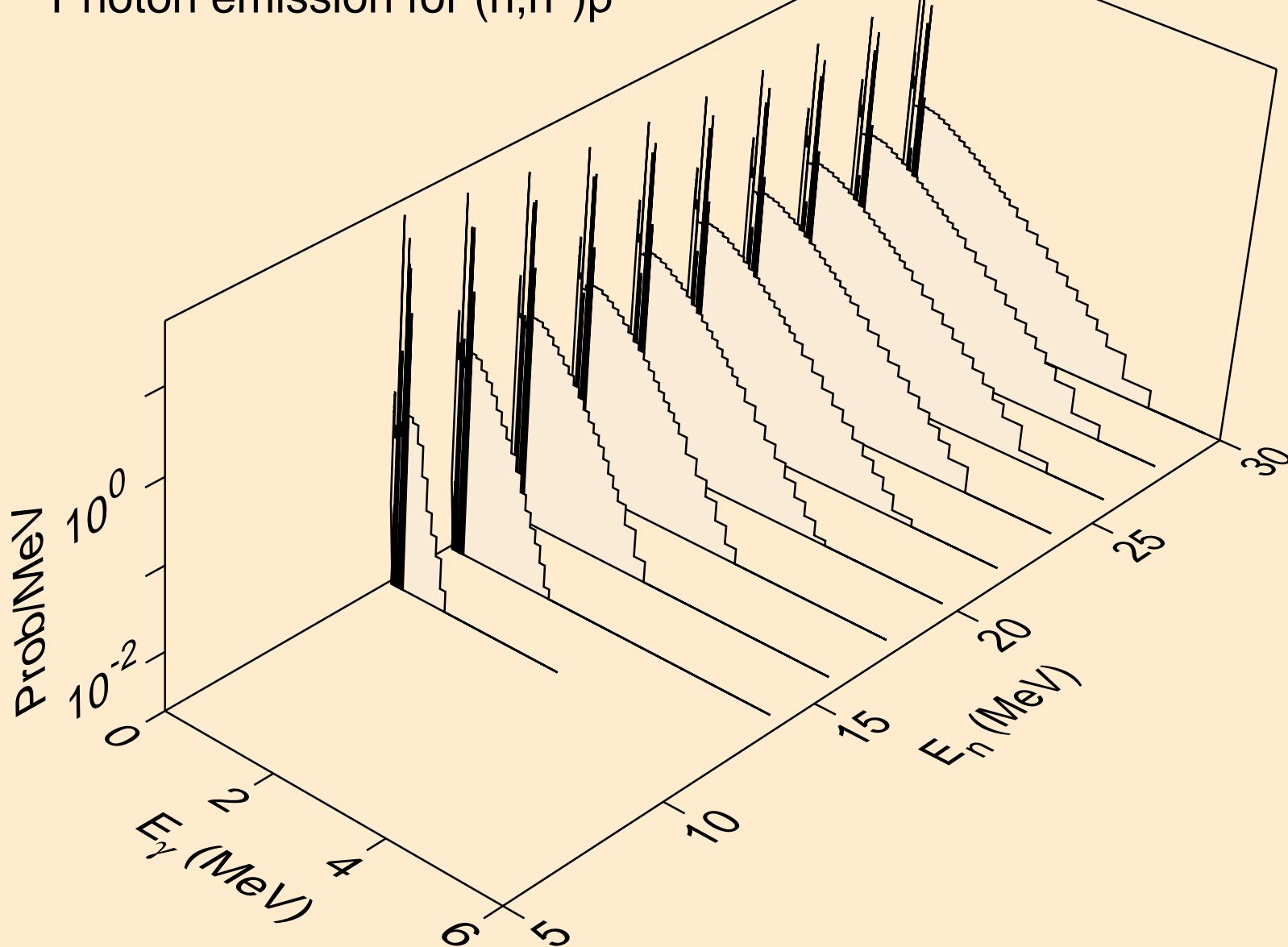

GD158 NEUTRON ACER TENDL-2019 LIBRARY; T=293.16K  
Photon emission for (n,n\*)d

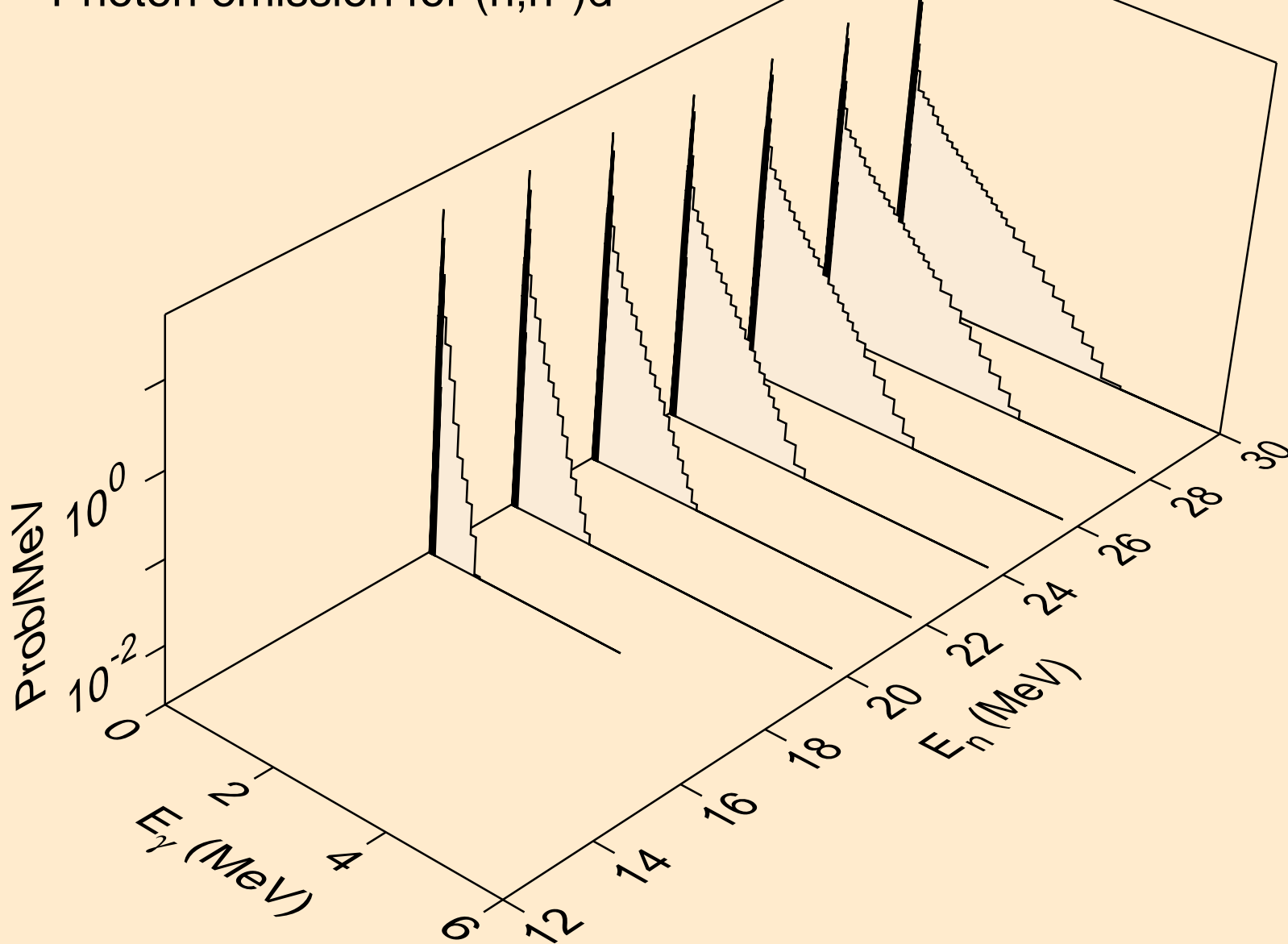

GD158 NEUTRON ACER TENDL-2019 LIBRARY; T=293.16K  
Photon emission for (n,n\*)t

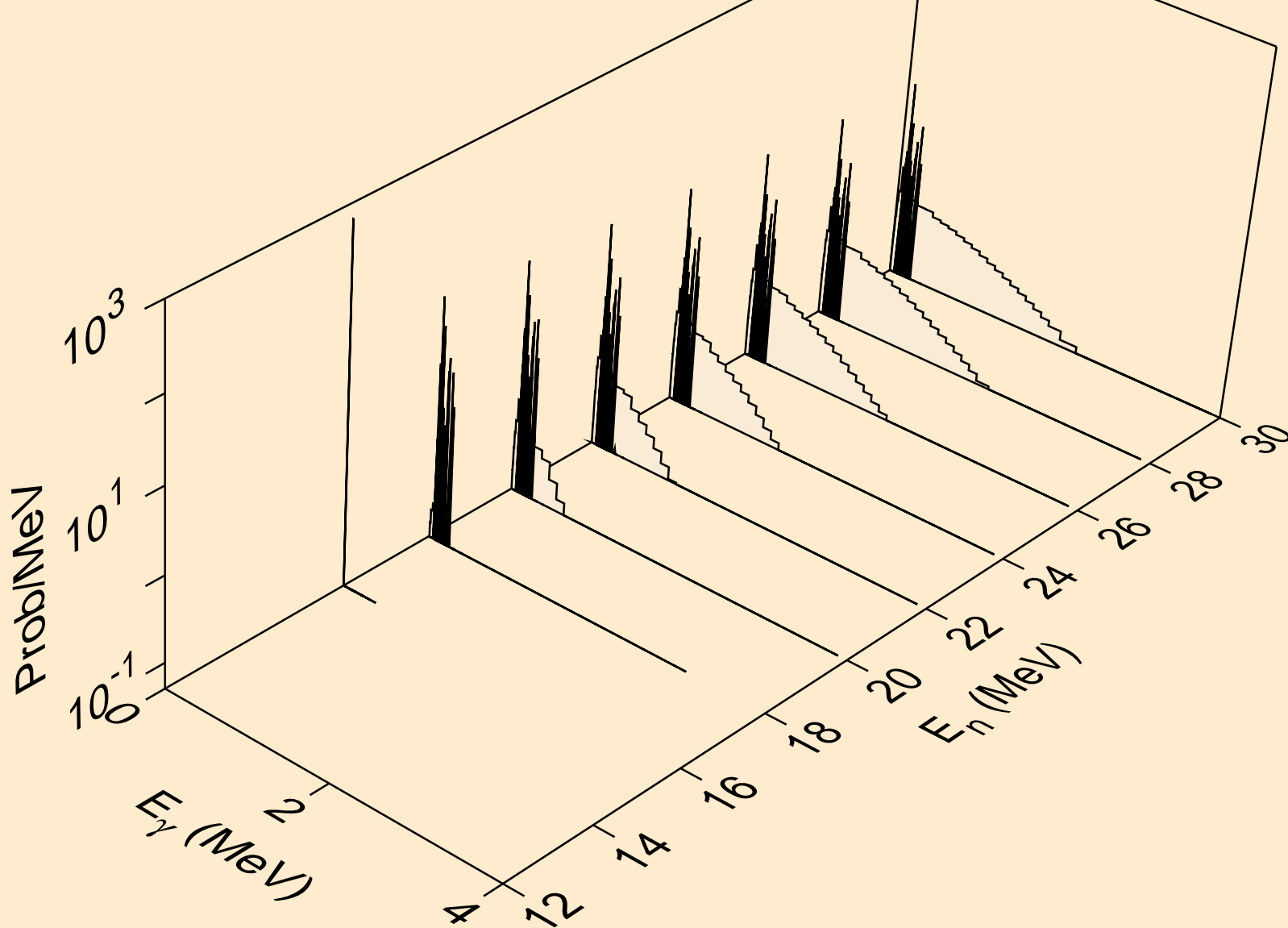

GD158 NEUTRON ACER TENDL-2019 LIBRARY; T=293.16K  
Photon emission for (n,n\*)he3

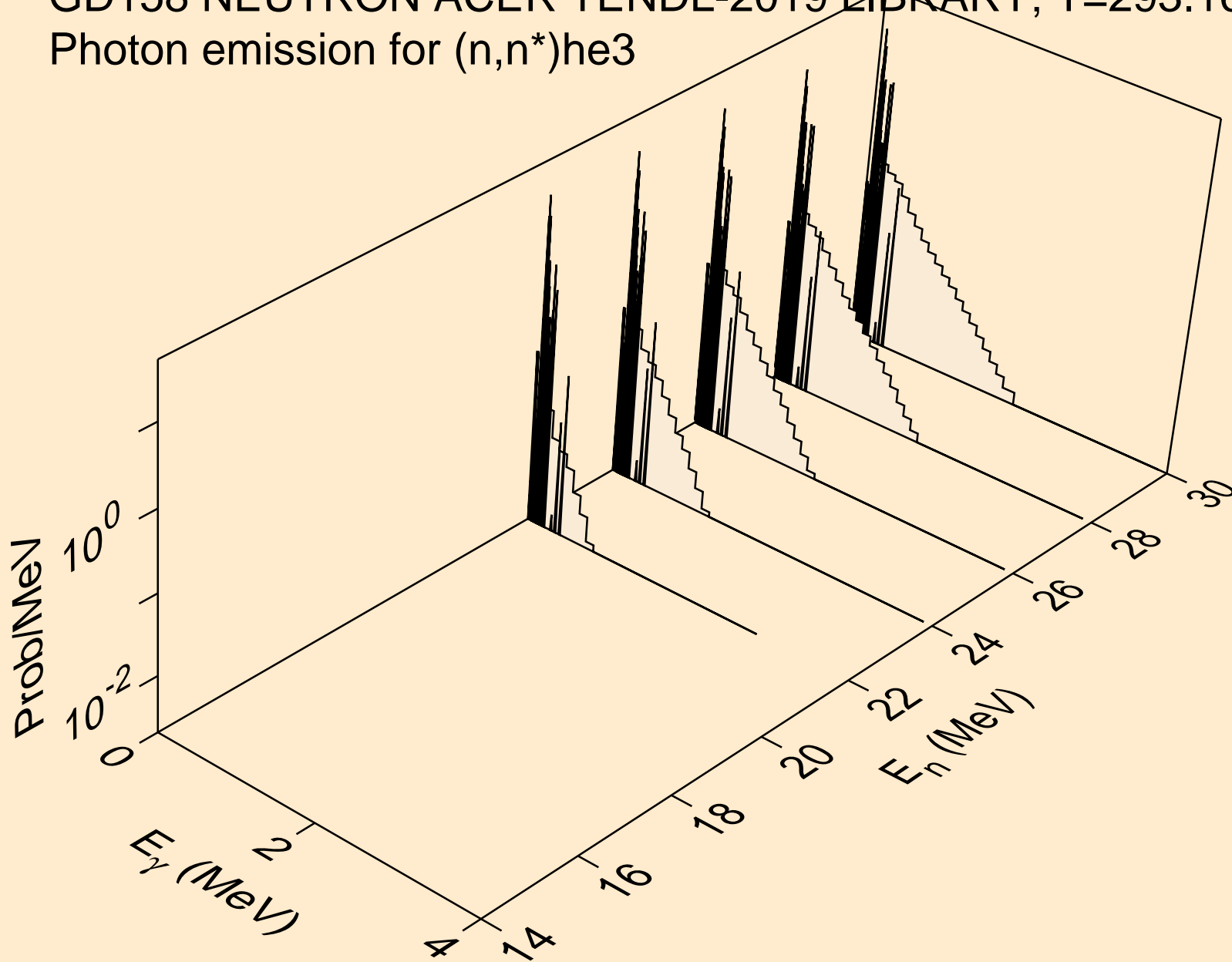



GD158 NEUTRON ACER TENDL-2019 LIBRARY; T=293.16K  
Photon emission for (n,4n)

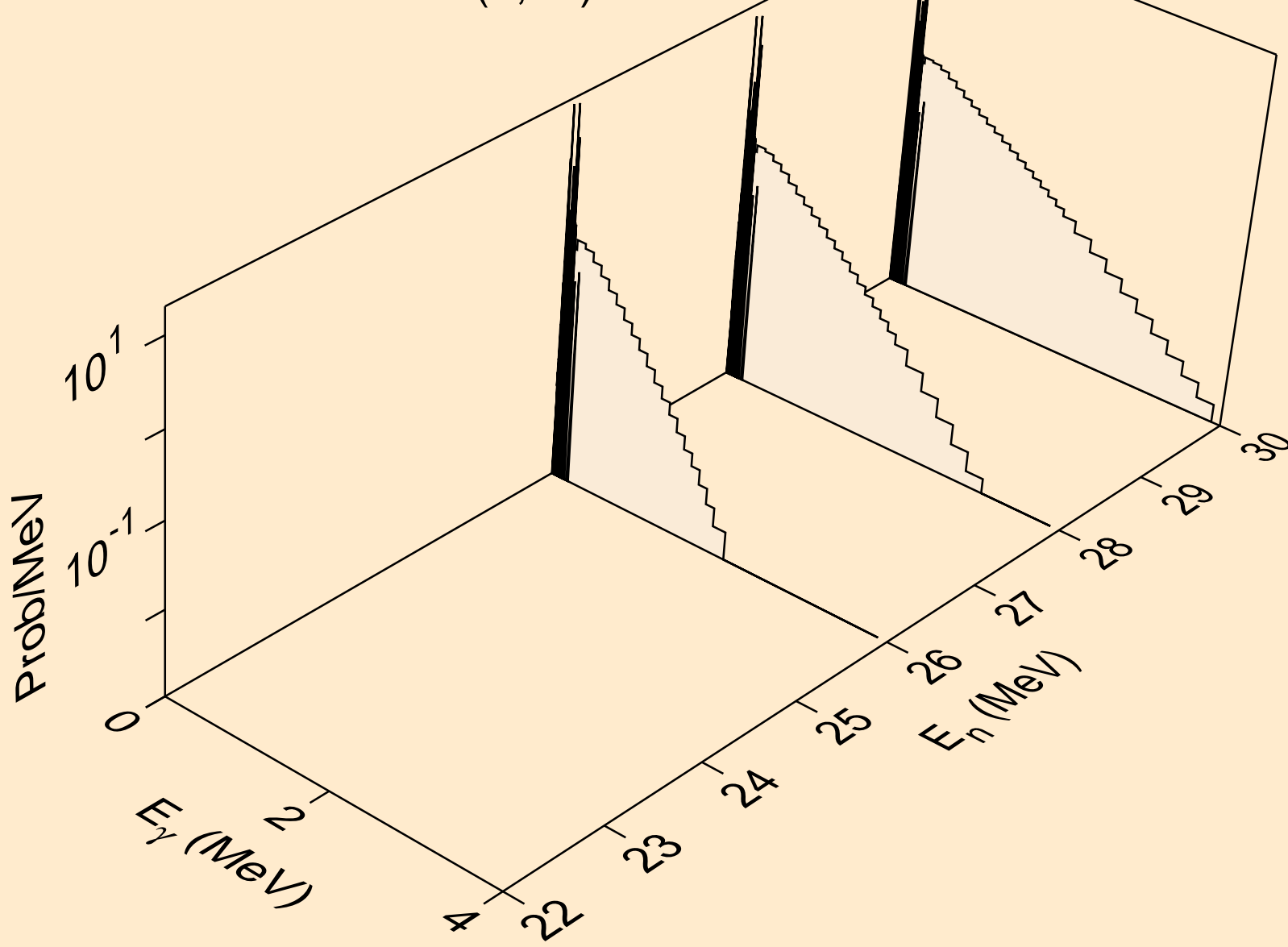

GD158 NEUTRON ACER TENDL-2019 LIBRARY; T=293.16K  
Photon emission for (n,2np)

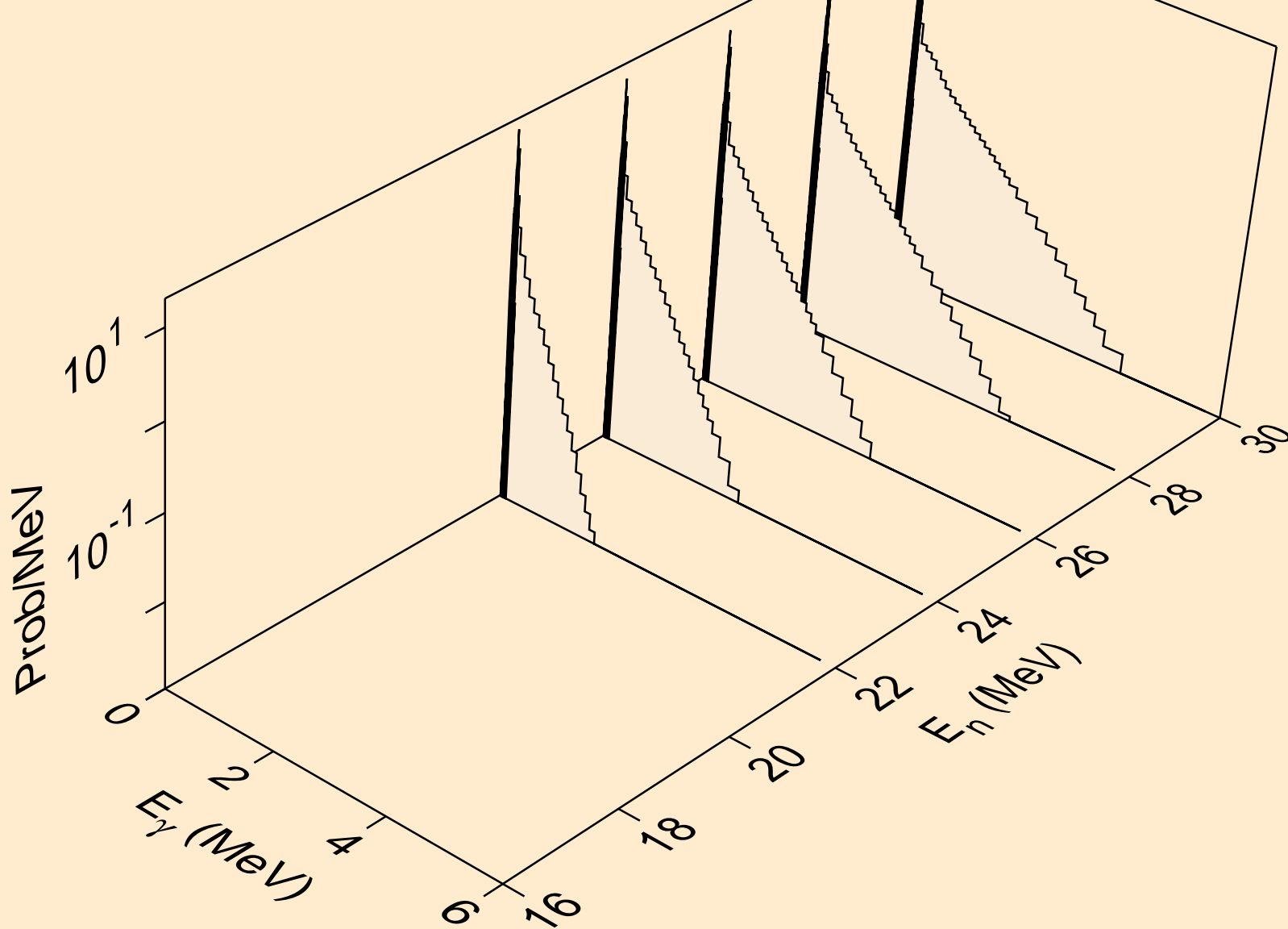

GD158 NEUTRON ACER TENDL-2019 LIBRARY; T=293.16K  
Photon emission for (n,3np)

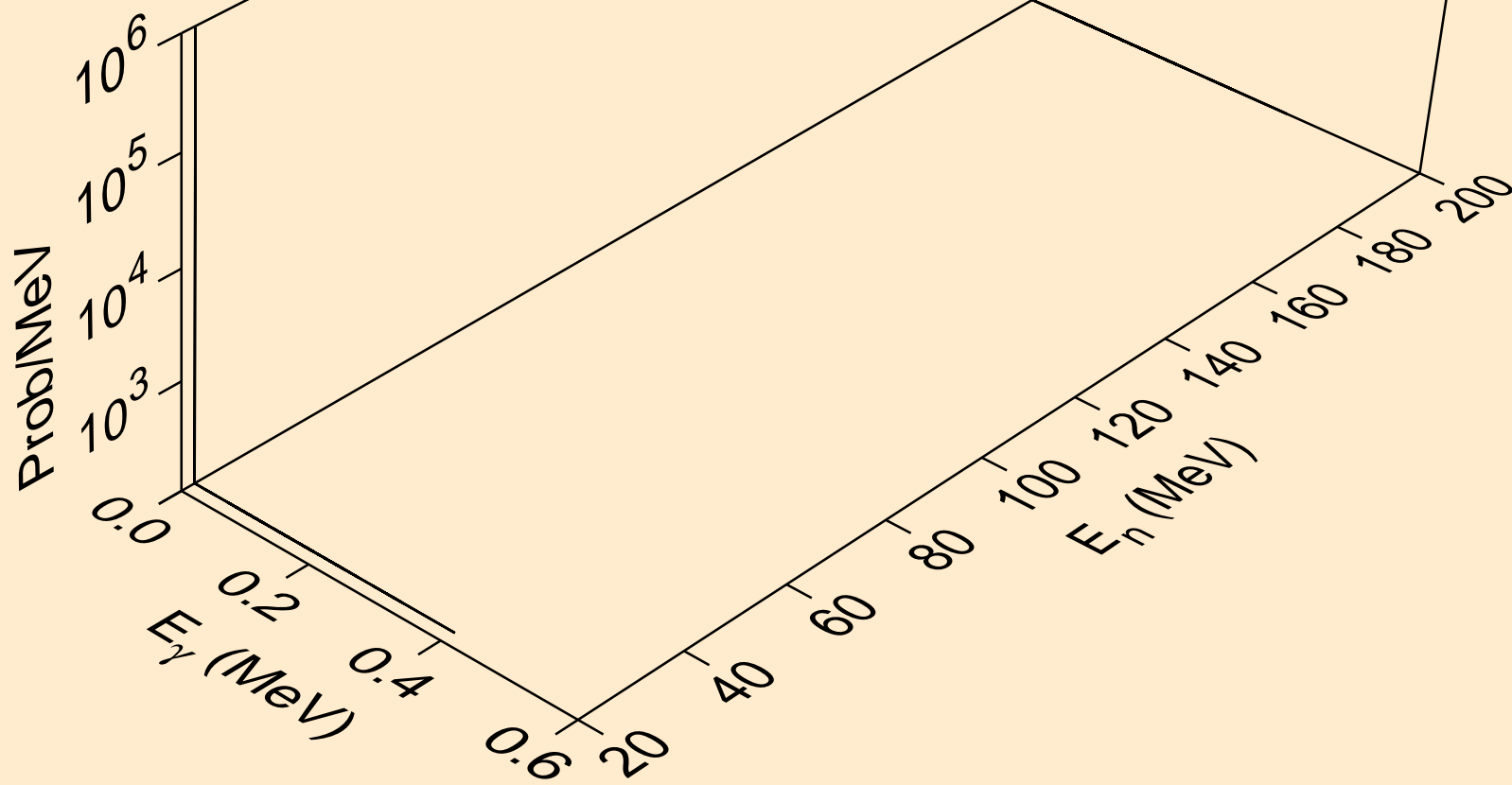

GD158 NEUTRON ACER TENDL-2019 LIBRARY; T=293.16K  
Photon emission for (n,2np)

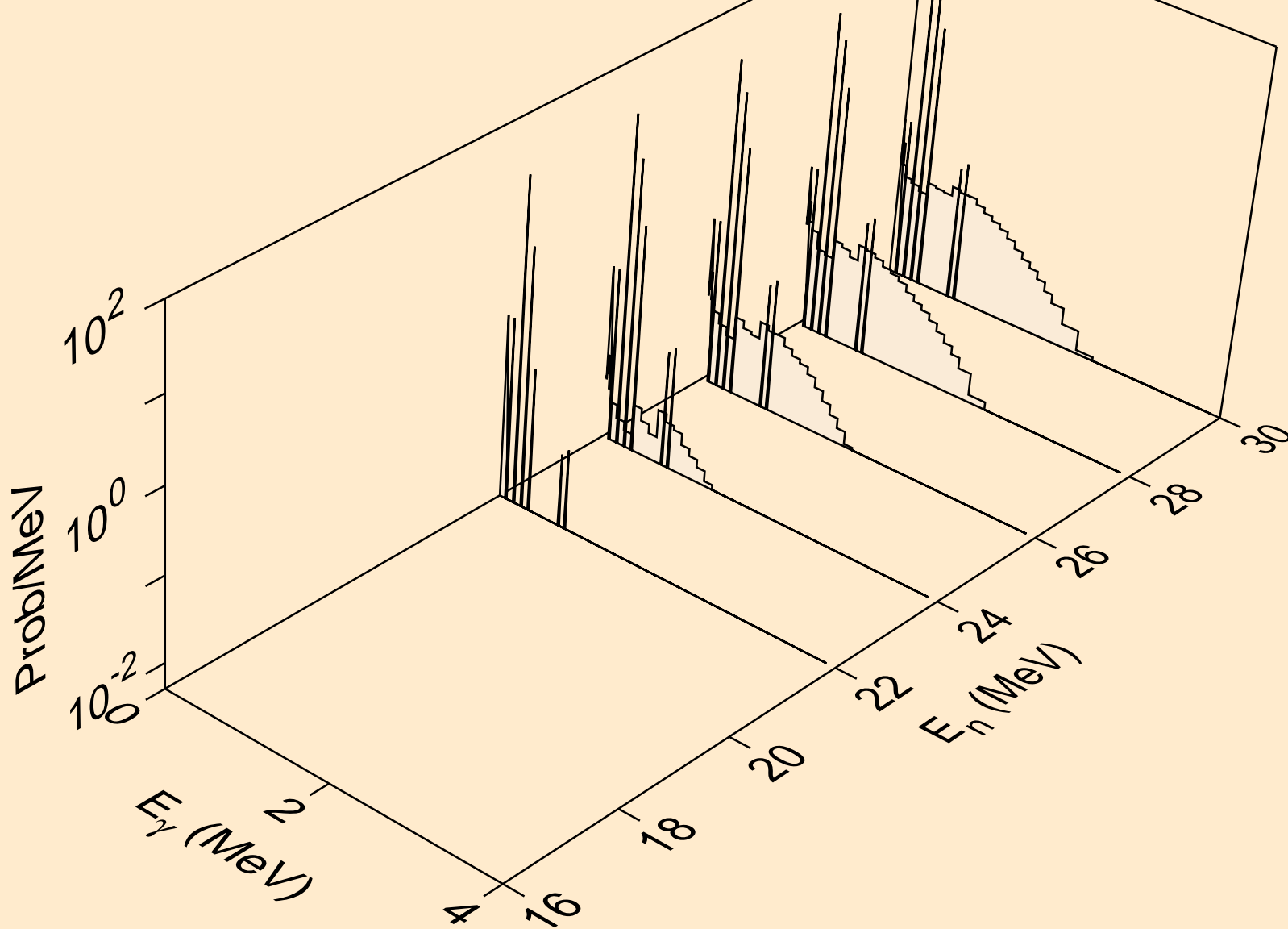

GD158 NEUTRON ACER TENDL-2019 LIBRARY; T=293.16K  
Photon emission for (n,npa)

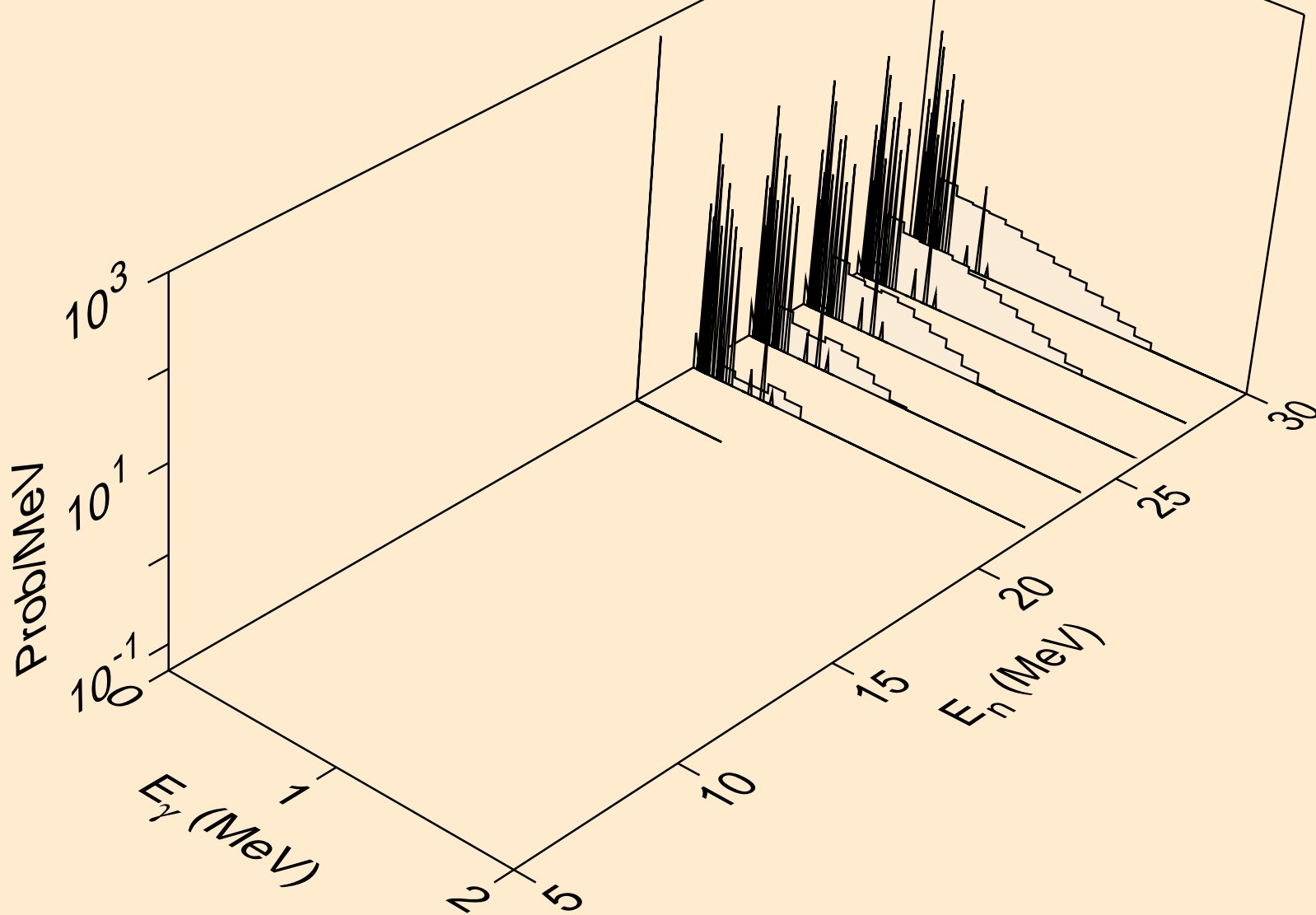

GD158 NEUTRON ACER TENDL-2019 LIBRARY; T=293.16K  
Photon emission for (n,n\*c)

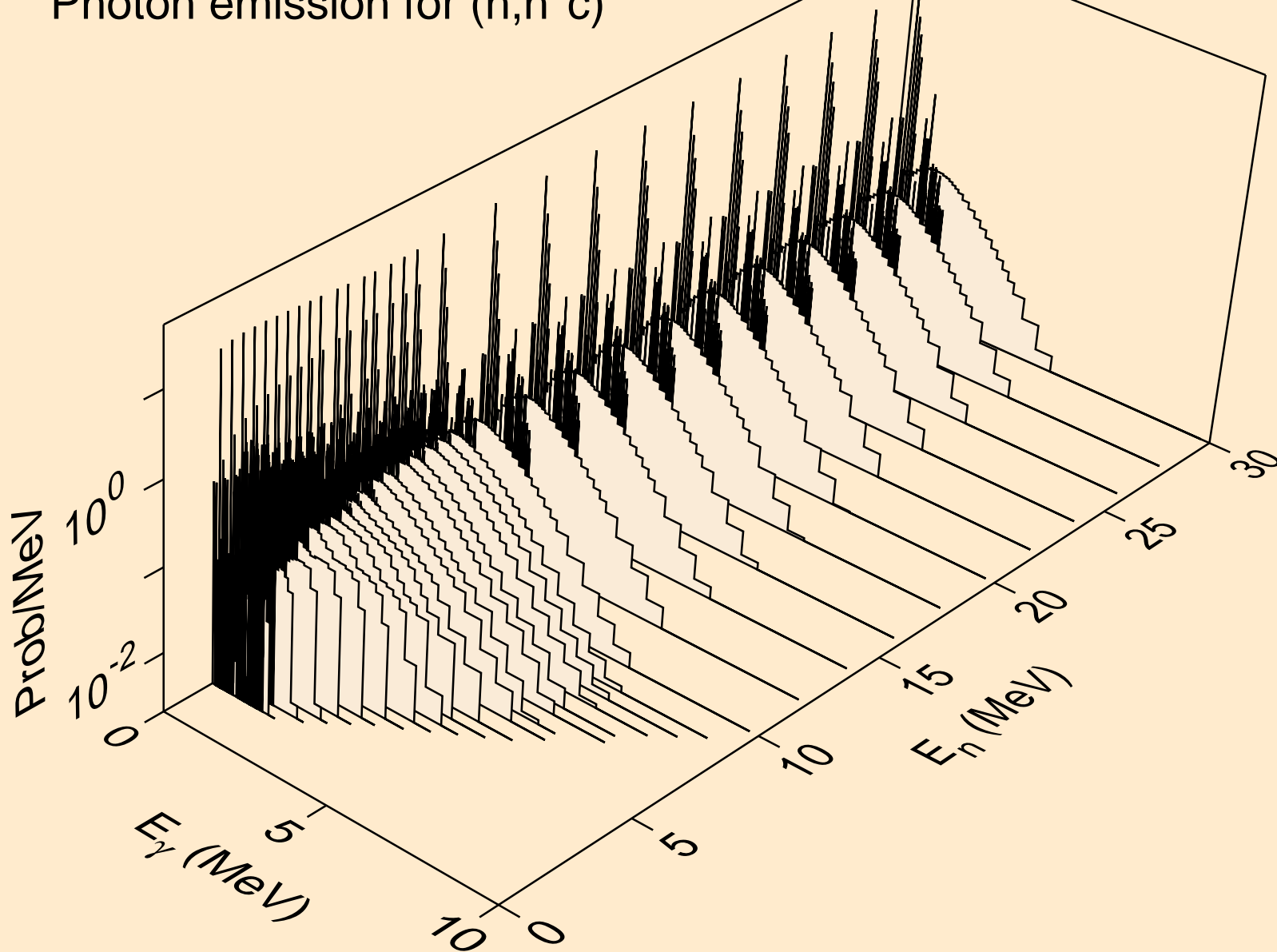

GD158 NEUTRON ACER TENDL-2019 LIBRARY; T=293.16K  
Photon emission for (n,gma)

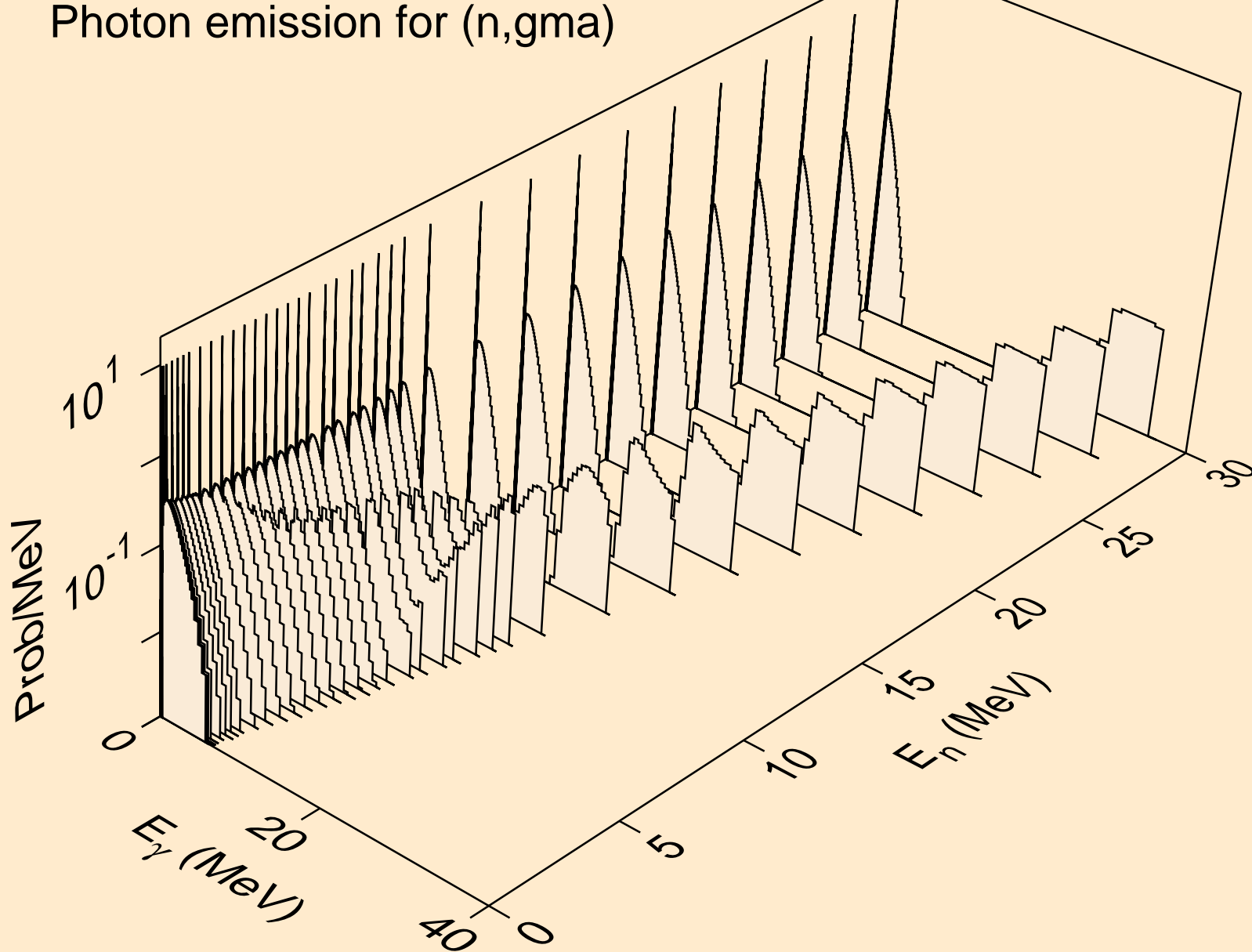

GD158 NEUTRON ACER TENDL-2019 LIBRARY; T=293.16K  
Photon emission for (n,p)

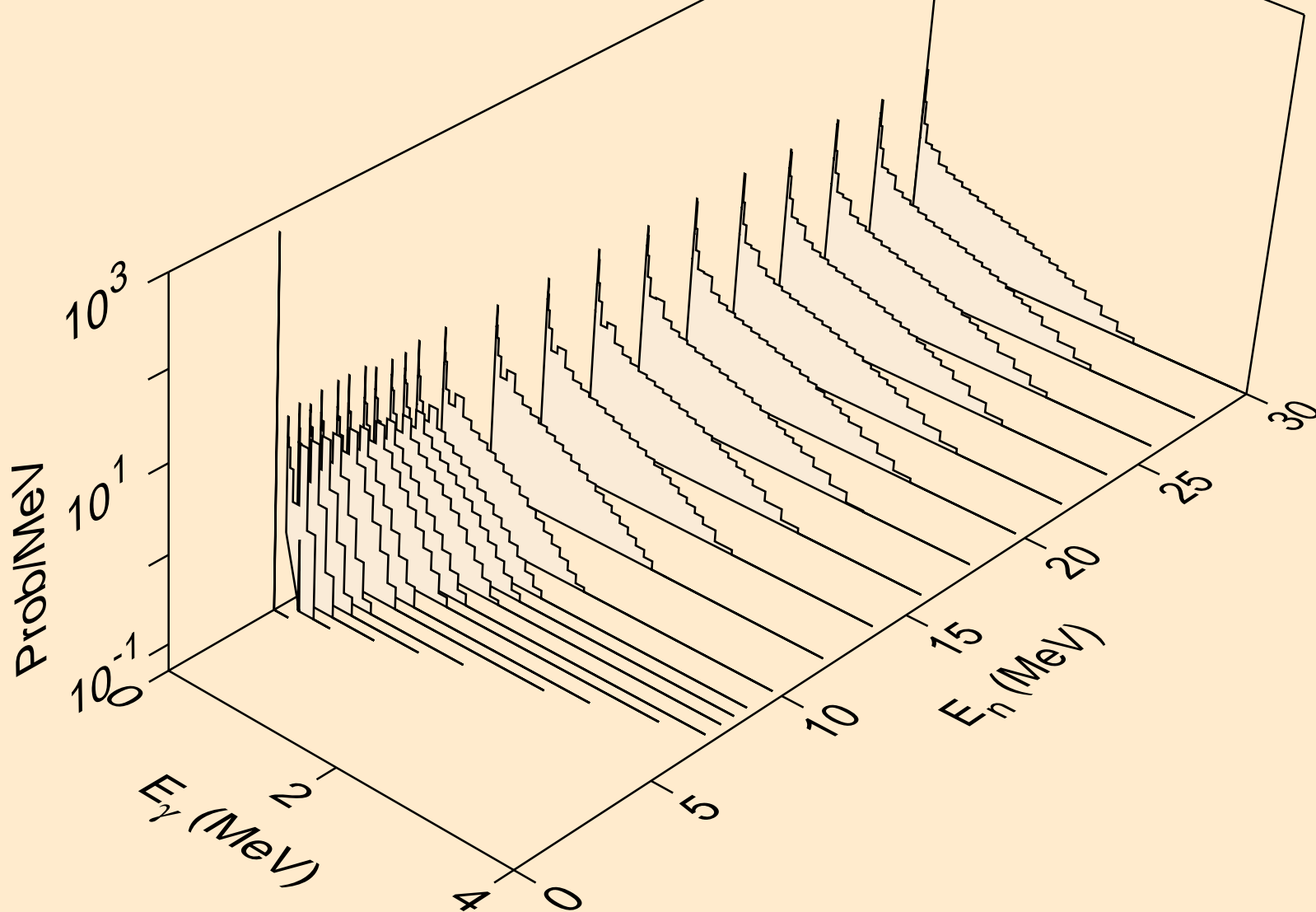



GD158 NEUTRON ACER TENDL-2019 LIBRARY; T=293.16K  
Photon emission for (n,d)

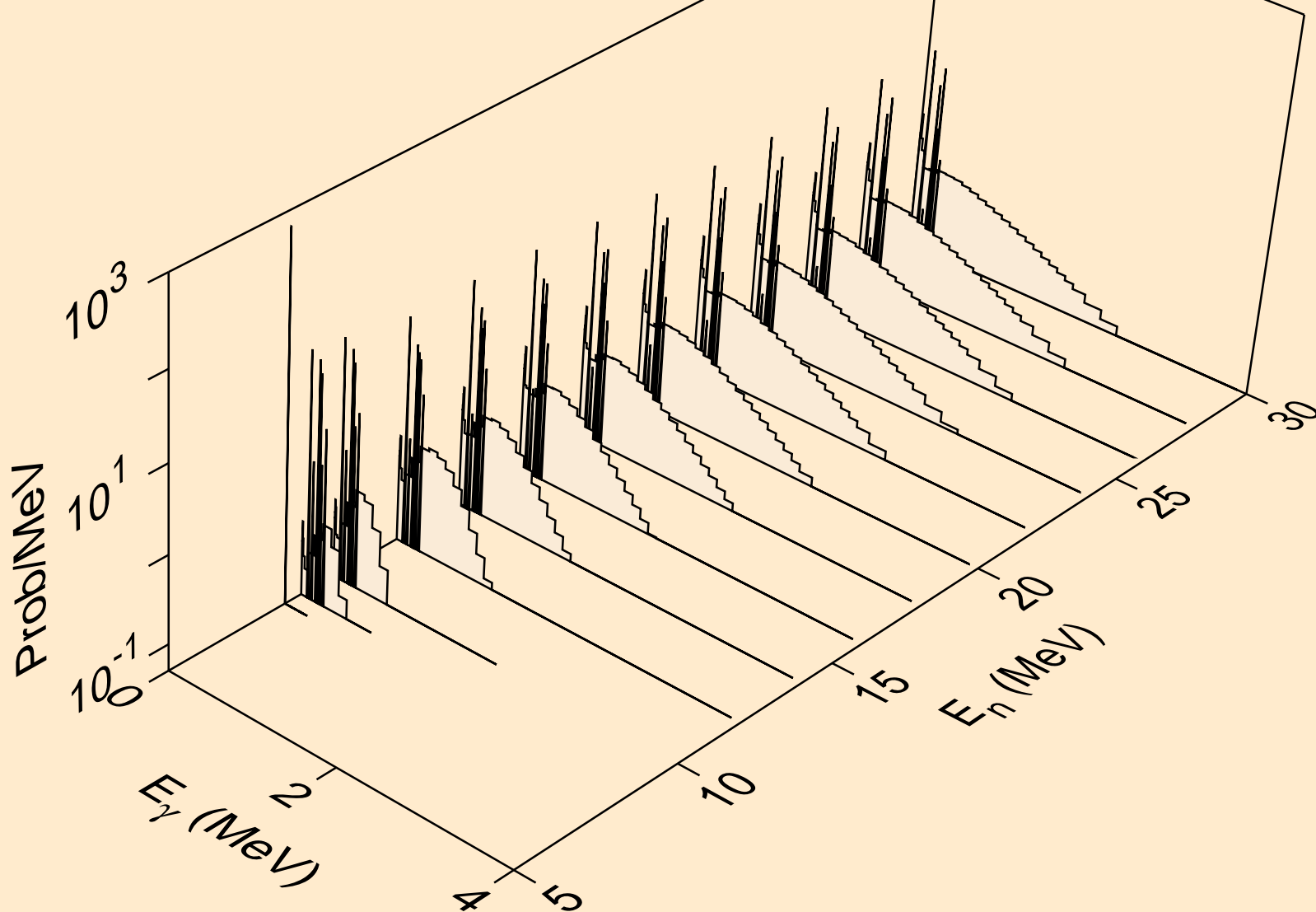

GD158 NEUTRON ACER TENDL-2019 LIBRARY; T=293.16K  
Photon emission for (n,t)

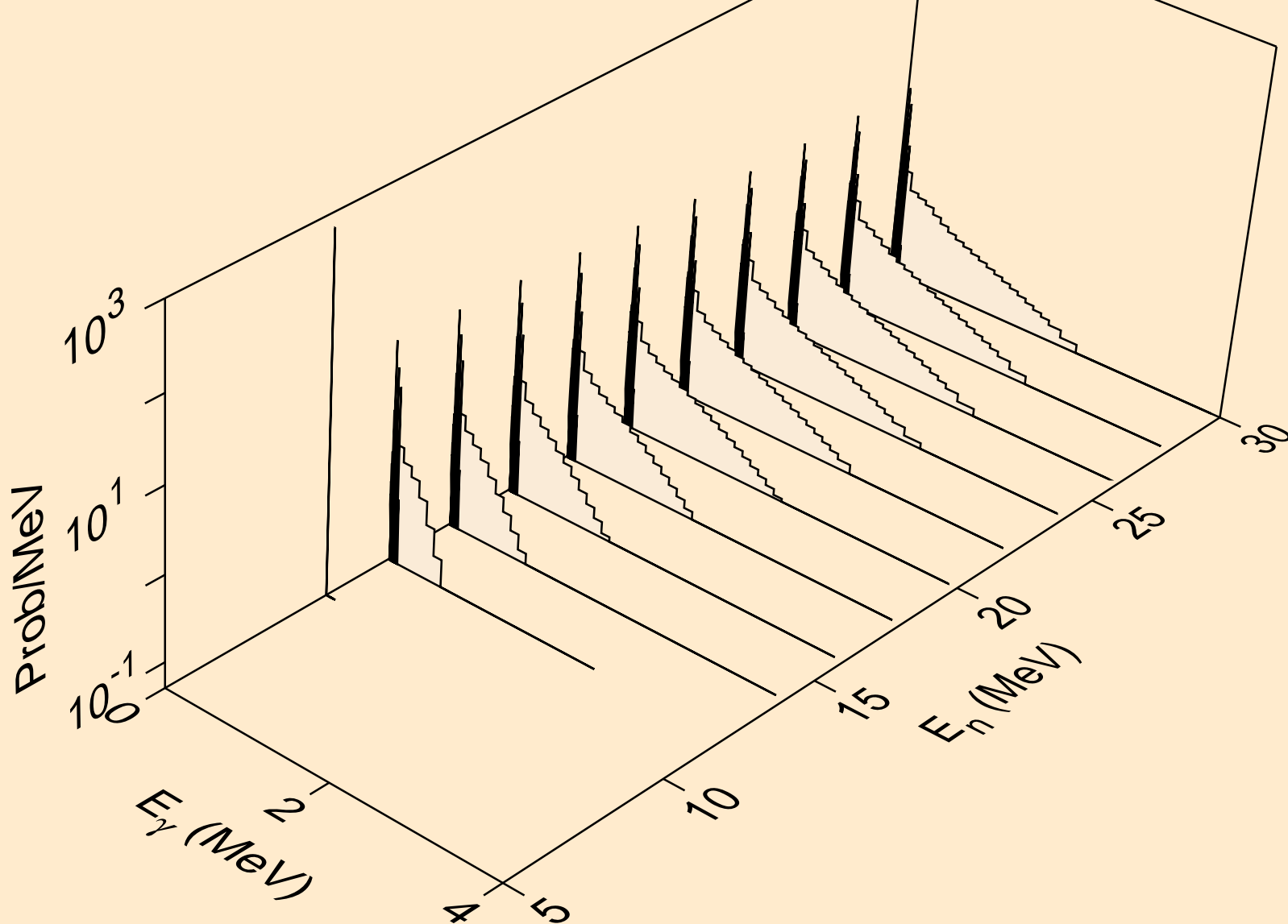

GD158 NEUTRON ACER TENDL-2019 LIBRARY; T=293.16K  
Photon emission for (n,he3)

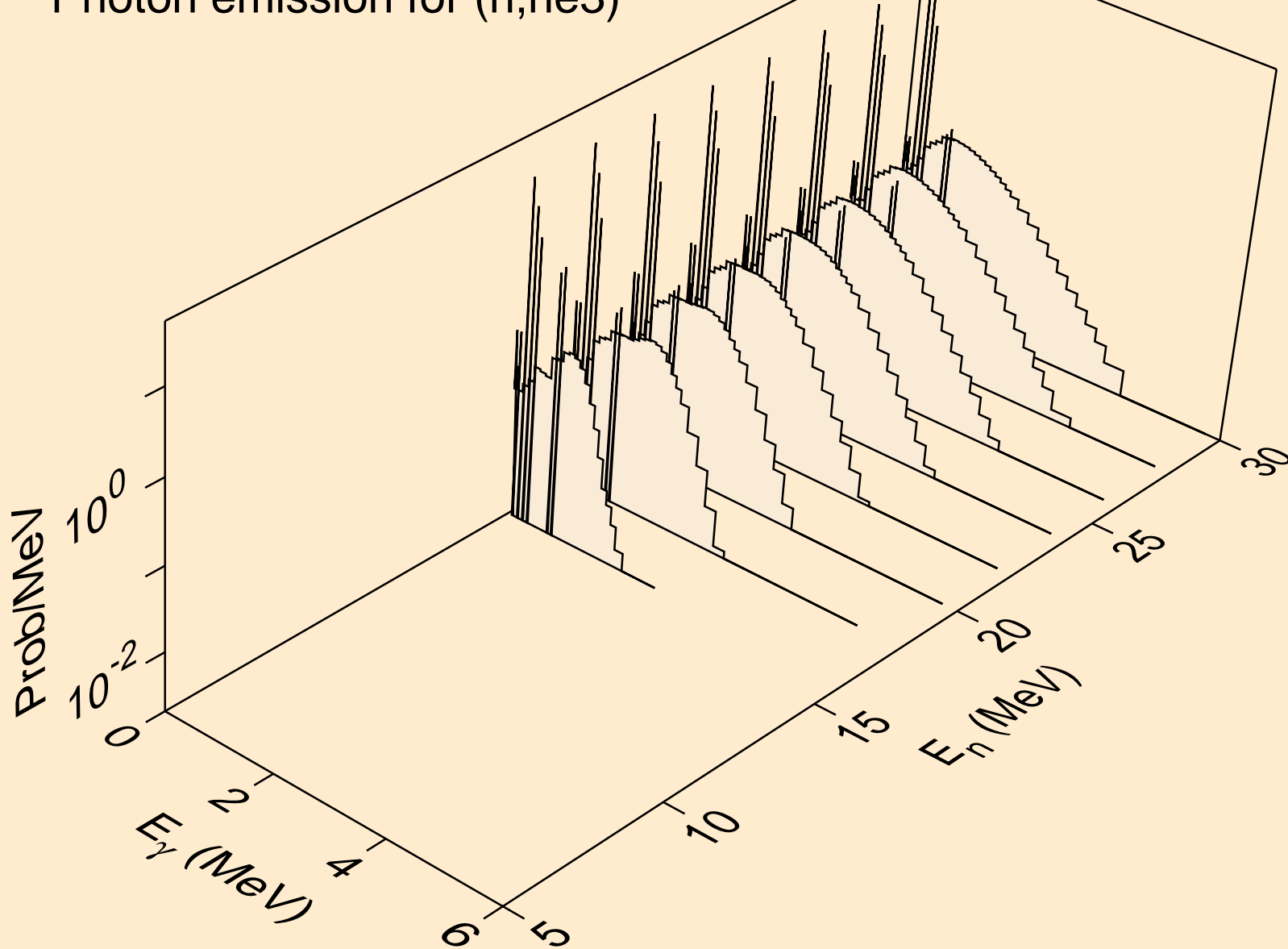

GD158 NEUTRON ACER TENDL-2019 LIBRARY; T=293.16K  
Photon emission for (n,a)

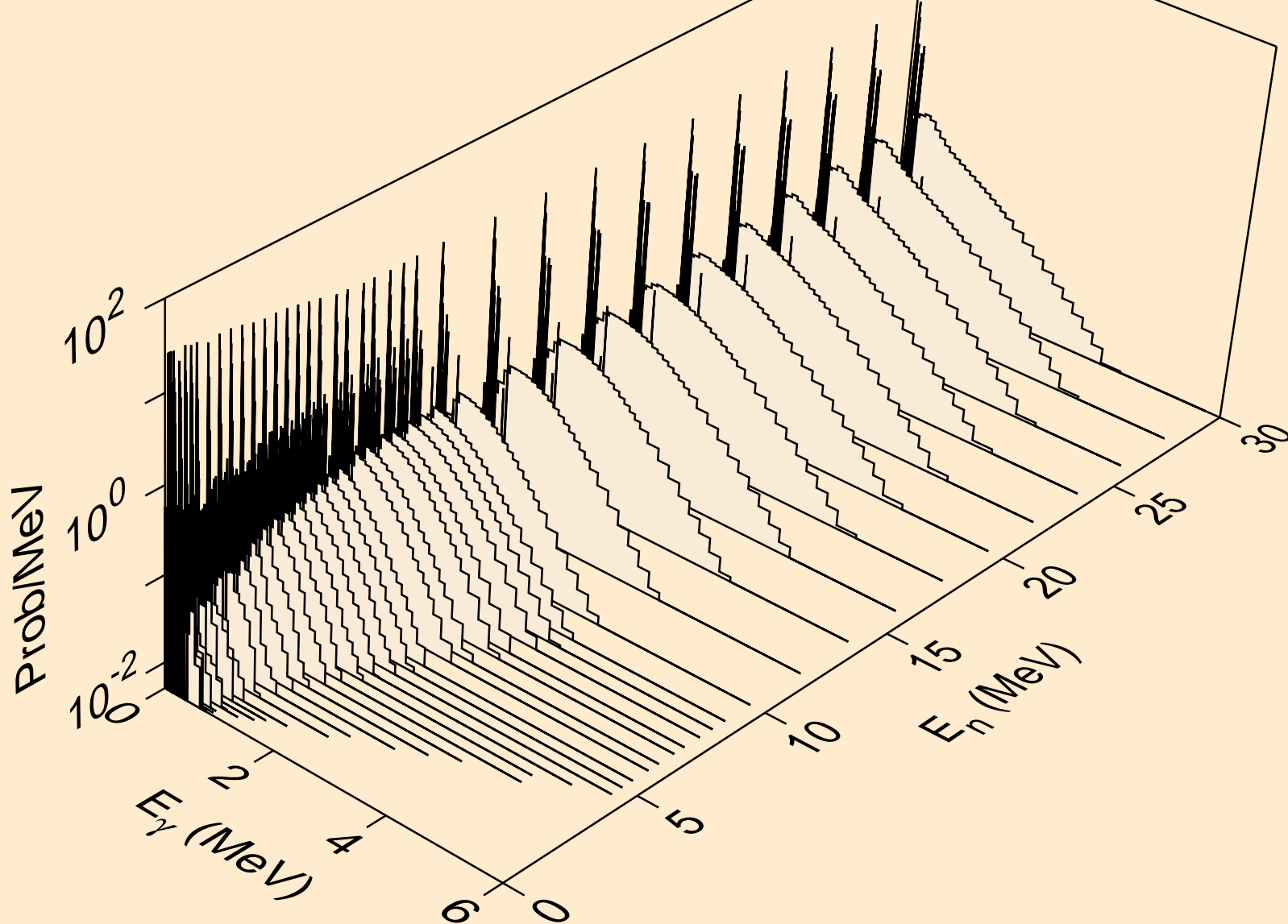

GD158 NEUTRON ACER TENDL-2019 LIBRARY; T=293.16K  
Photon emission for (n,2a)

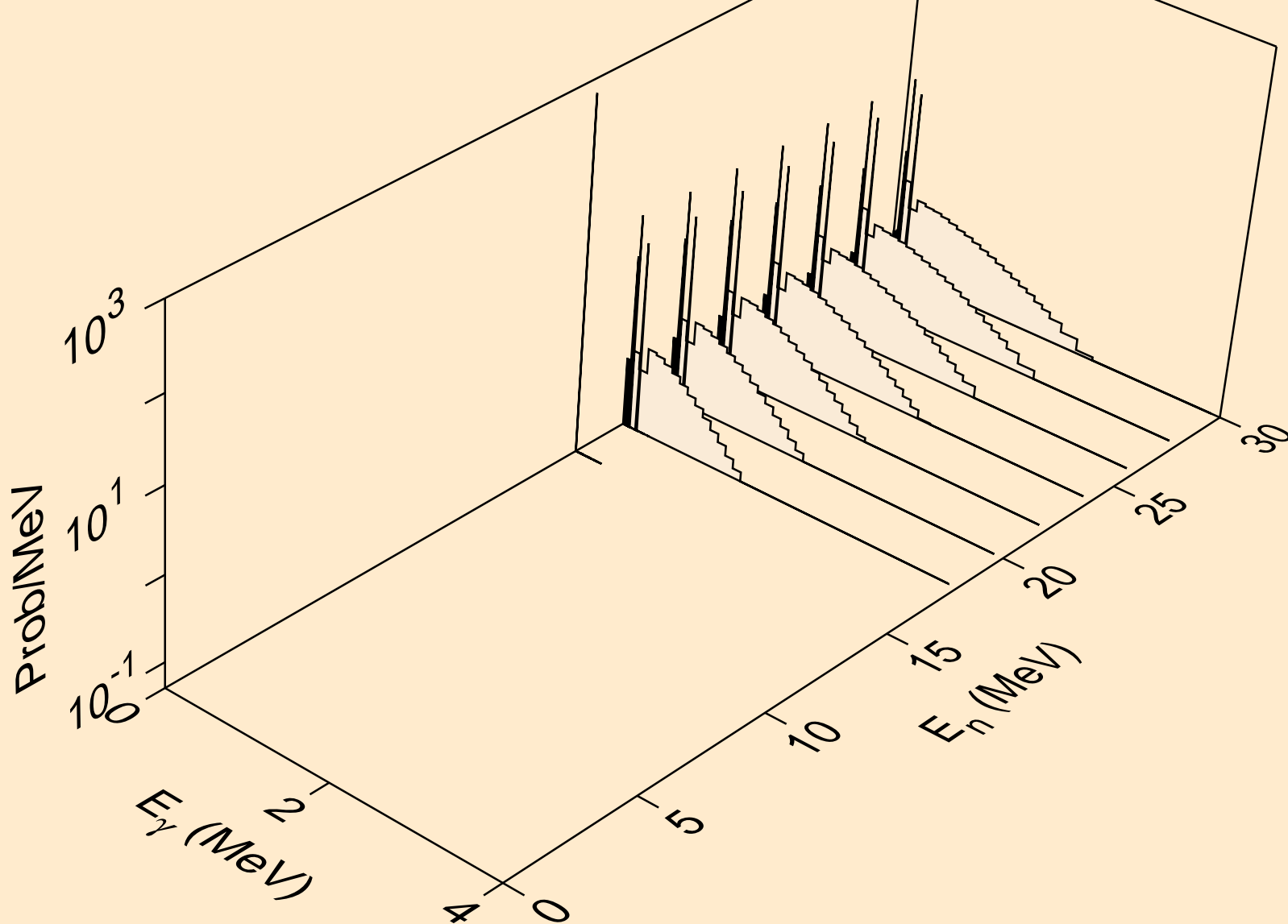

GD158 NEUTRON ACER TENDL-2019 LIBRARY; T=293.16K  
Photon emission for (n,2p)

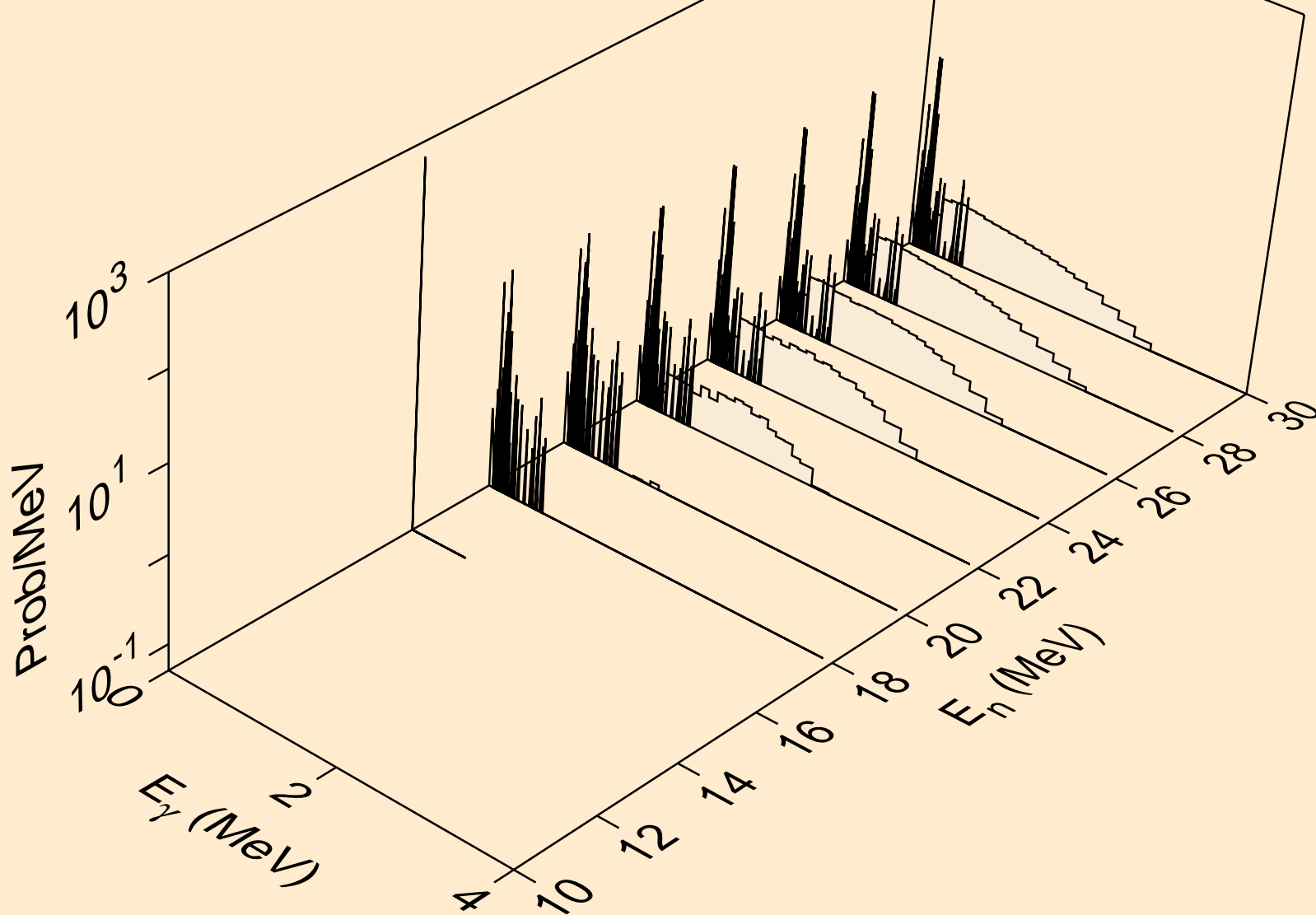

GD158 NEUTRON ACER TENDL-2019 LIBRARY; T=293.16K  
Photon emission for (n,p)

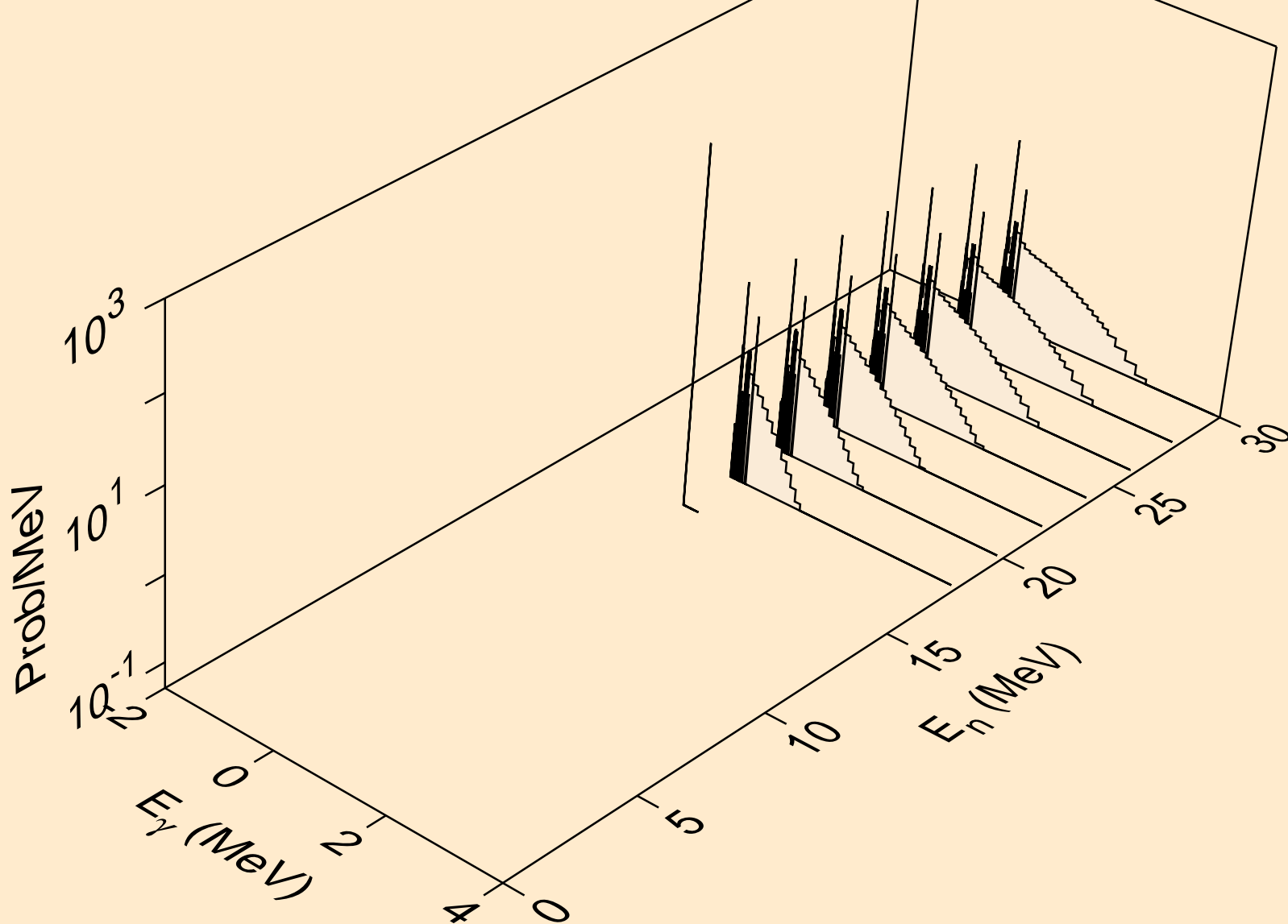

GD158 NEUTRON ACER TENDL-2019 LIBRARY; T=293.16K  
thermal capture photon spectrum

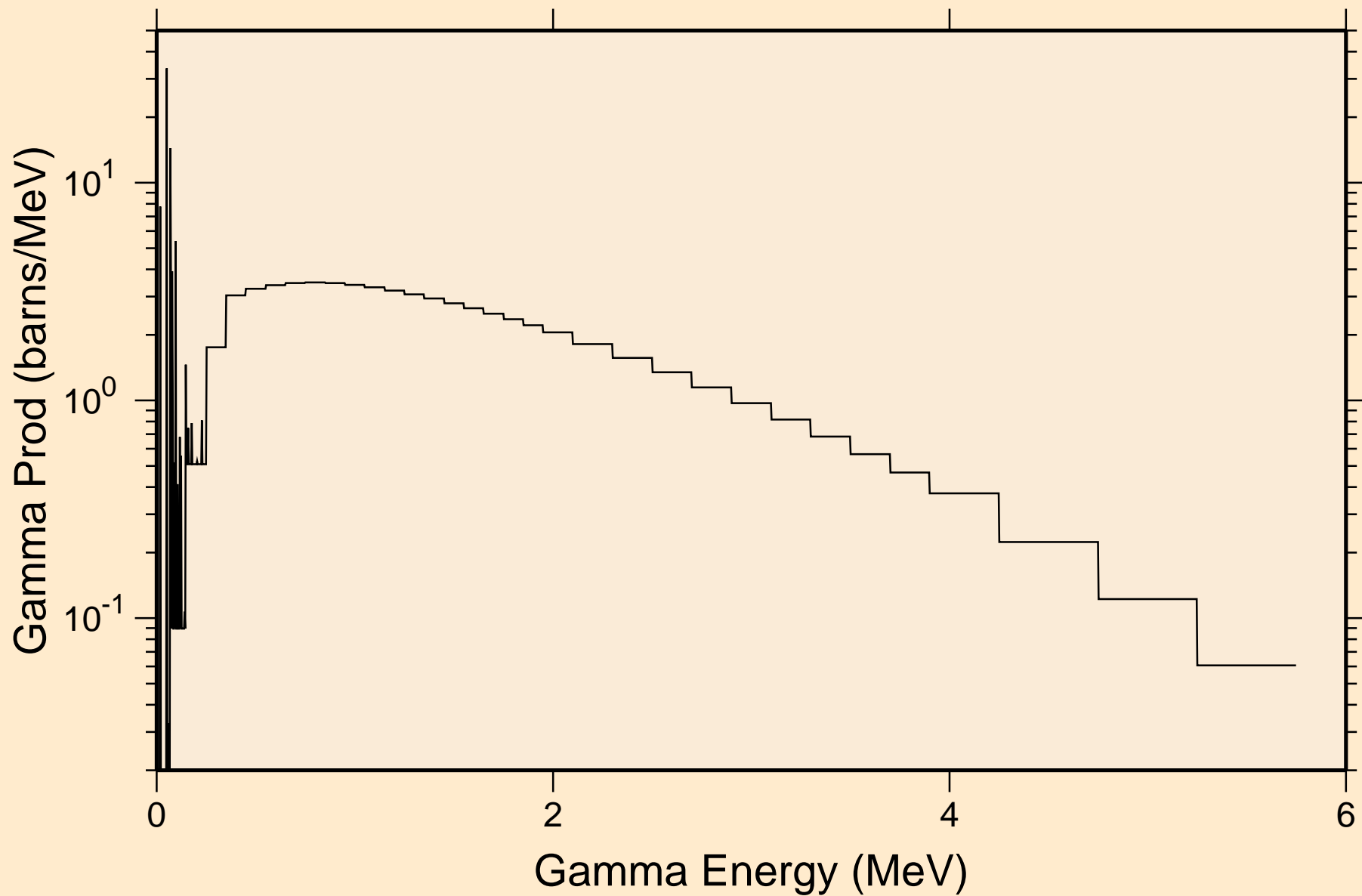



GD158 NEUTRON ACER TENDL-2019 LIBRARY; T=293.16K  
14 MeV photon spectrum

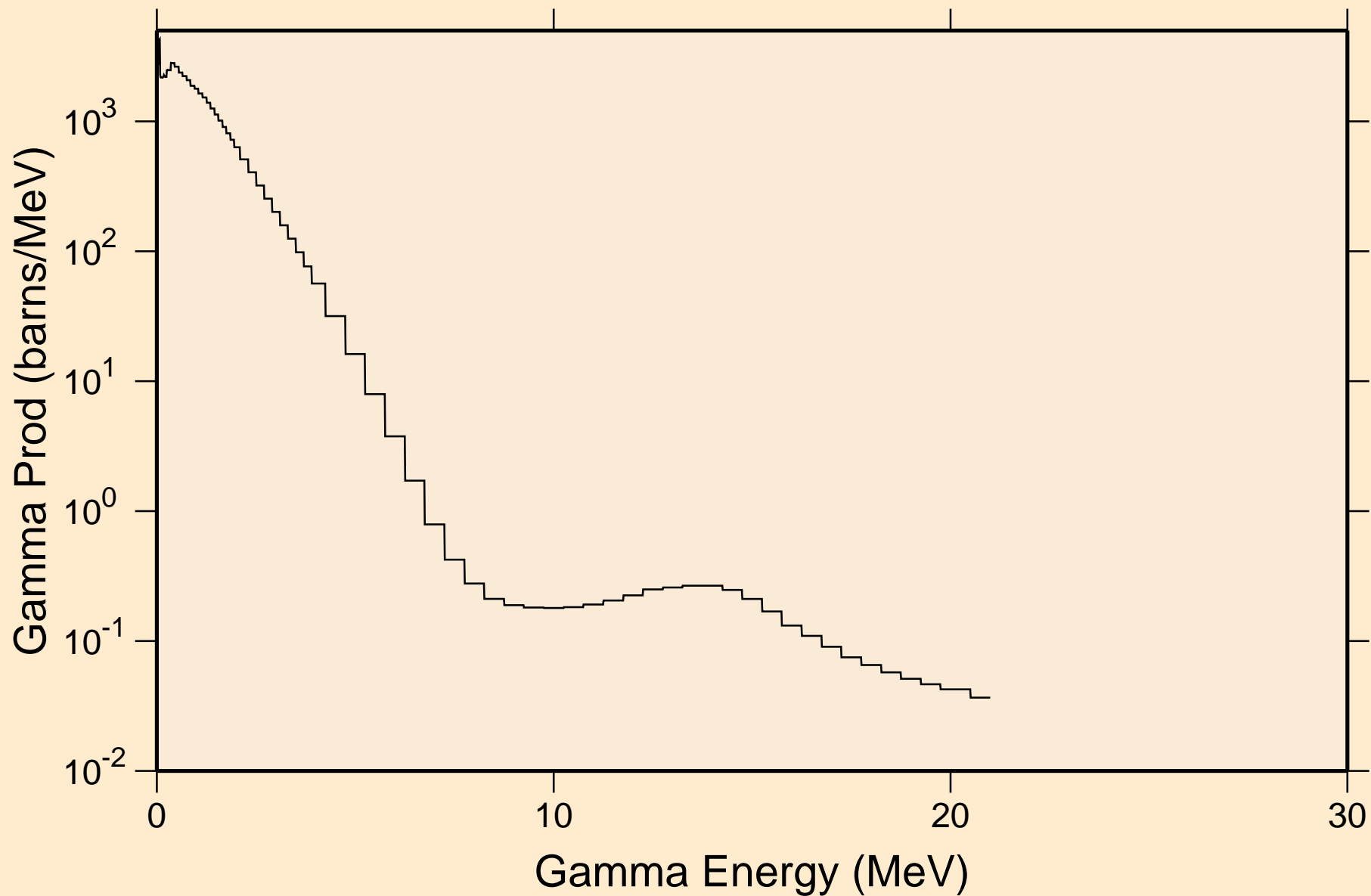

# GD158 NEUTRON ACER TENDL-2019 LIBRARY; T=293.16K

## Particle heating contributions

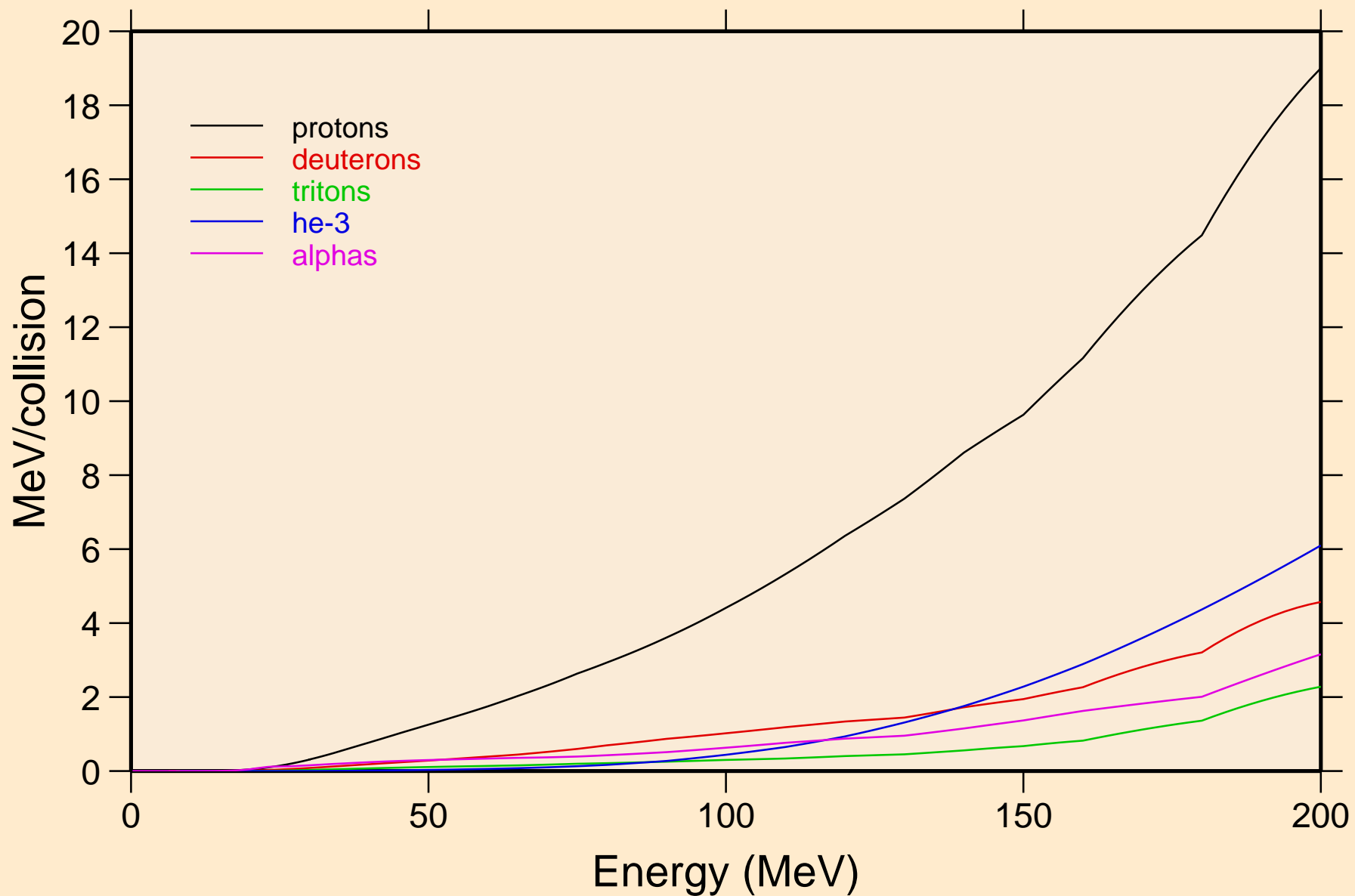

# GD158 NEUTRON ACER TENDL-2019 LIBRARY; T=293.16K

## Recoil Heating

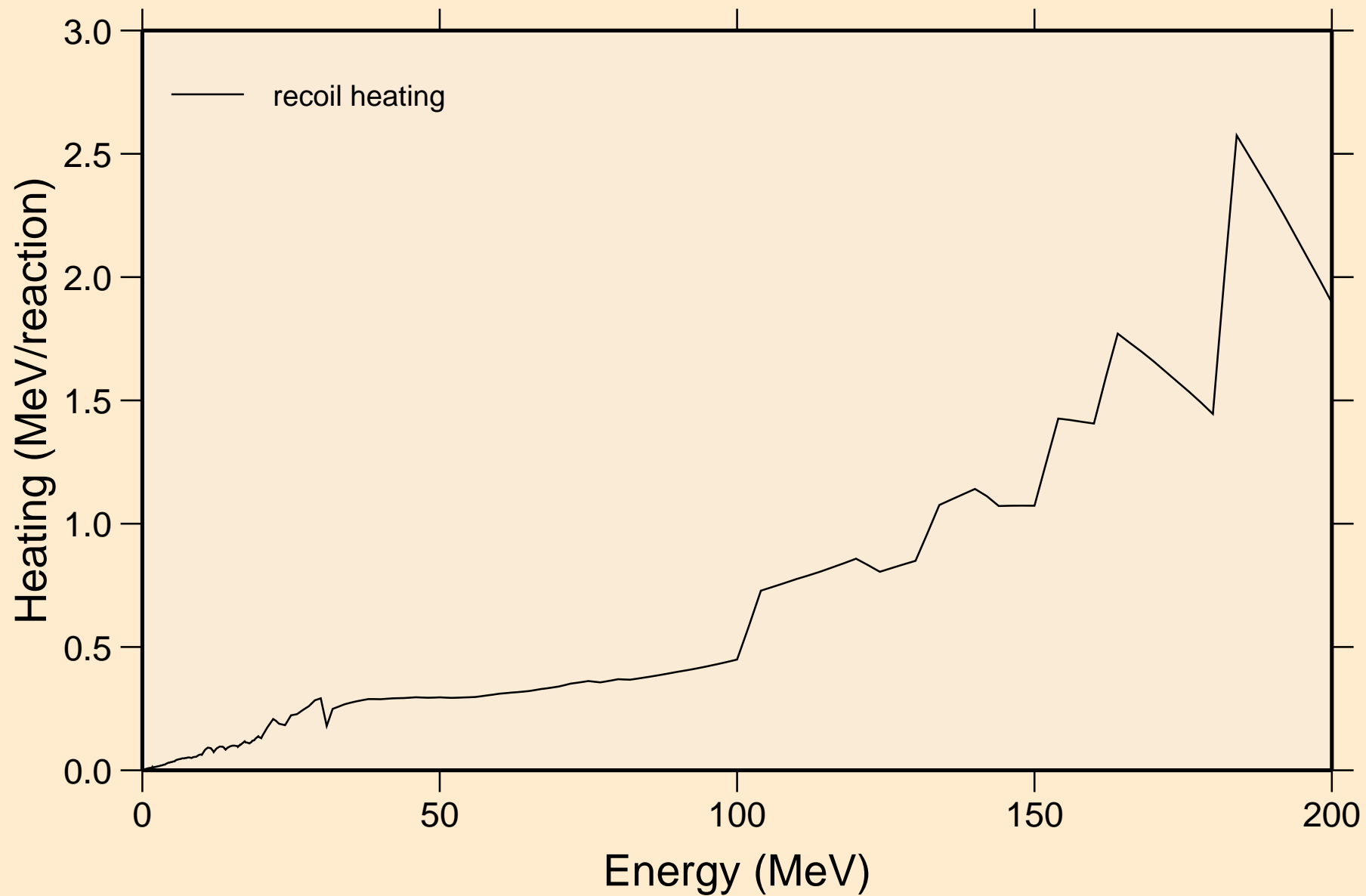

GD158 NEUTRON ACER TENDL-2019 LIBRARY; T=293.16K  
Particle production cross sections

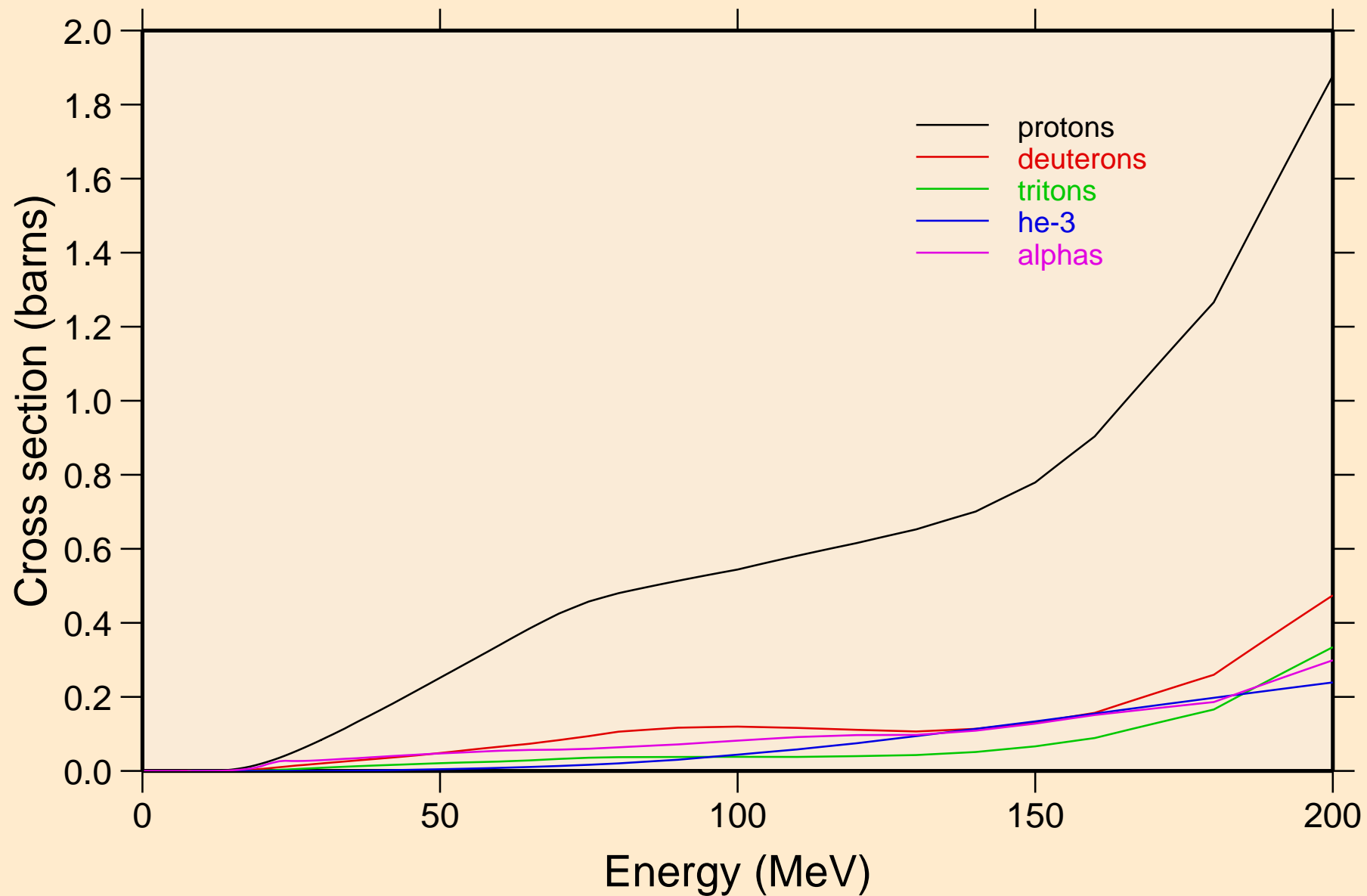

GD158 NEUTRON ACER TENDL-2019 LIBRARY; T=293.16K  
protons from (n,x)

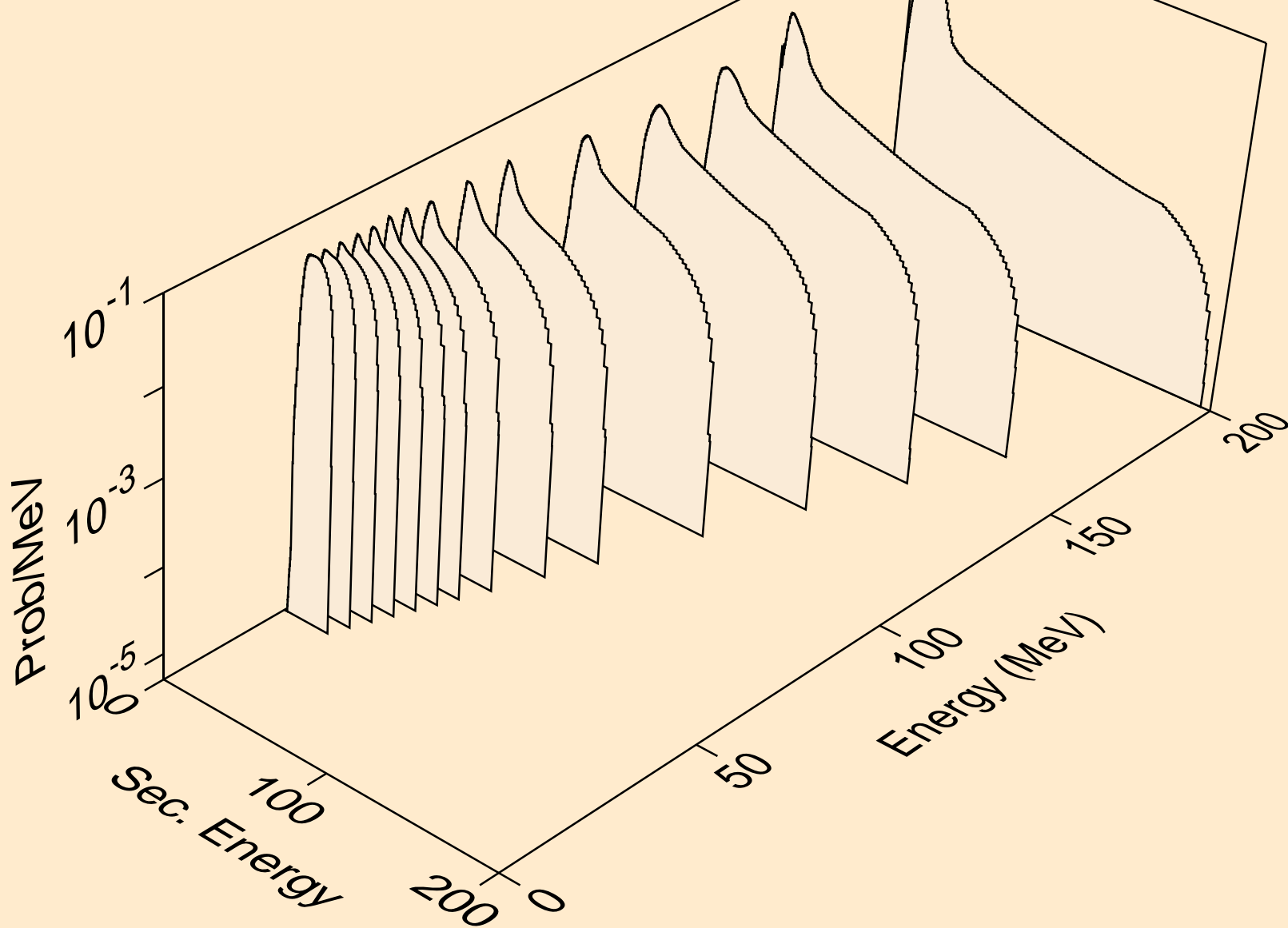

GD158 NEUTRON ACER TENDL-2019 LIBRARY; T=293.16K  
protons from (n,n\*)p

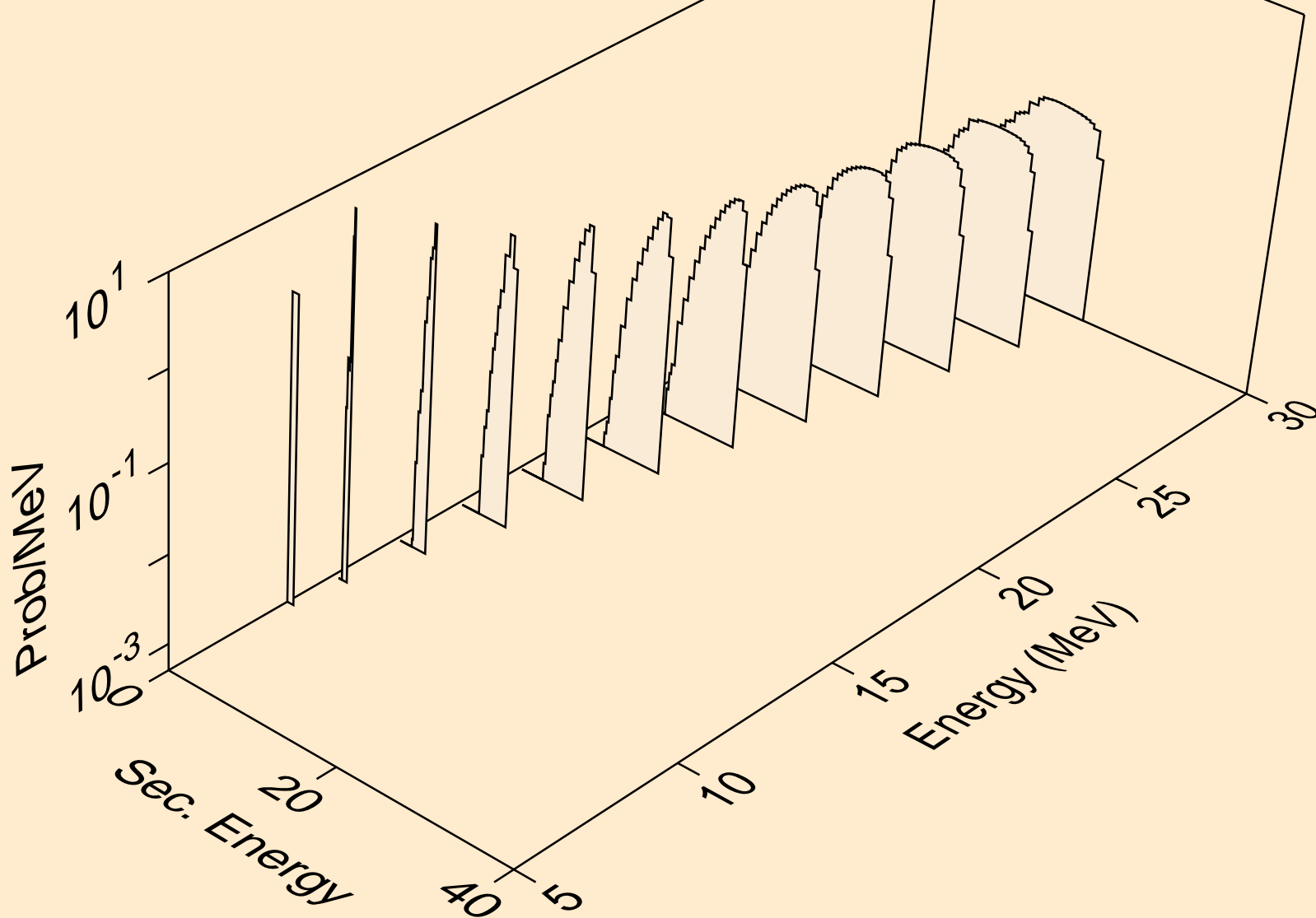

GD158 NEUTRON ACER TENDL-2019 LIBRARY; T=293.16K  
protons from (n,2np)

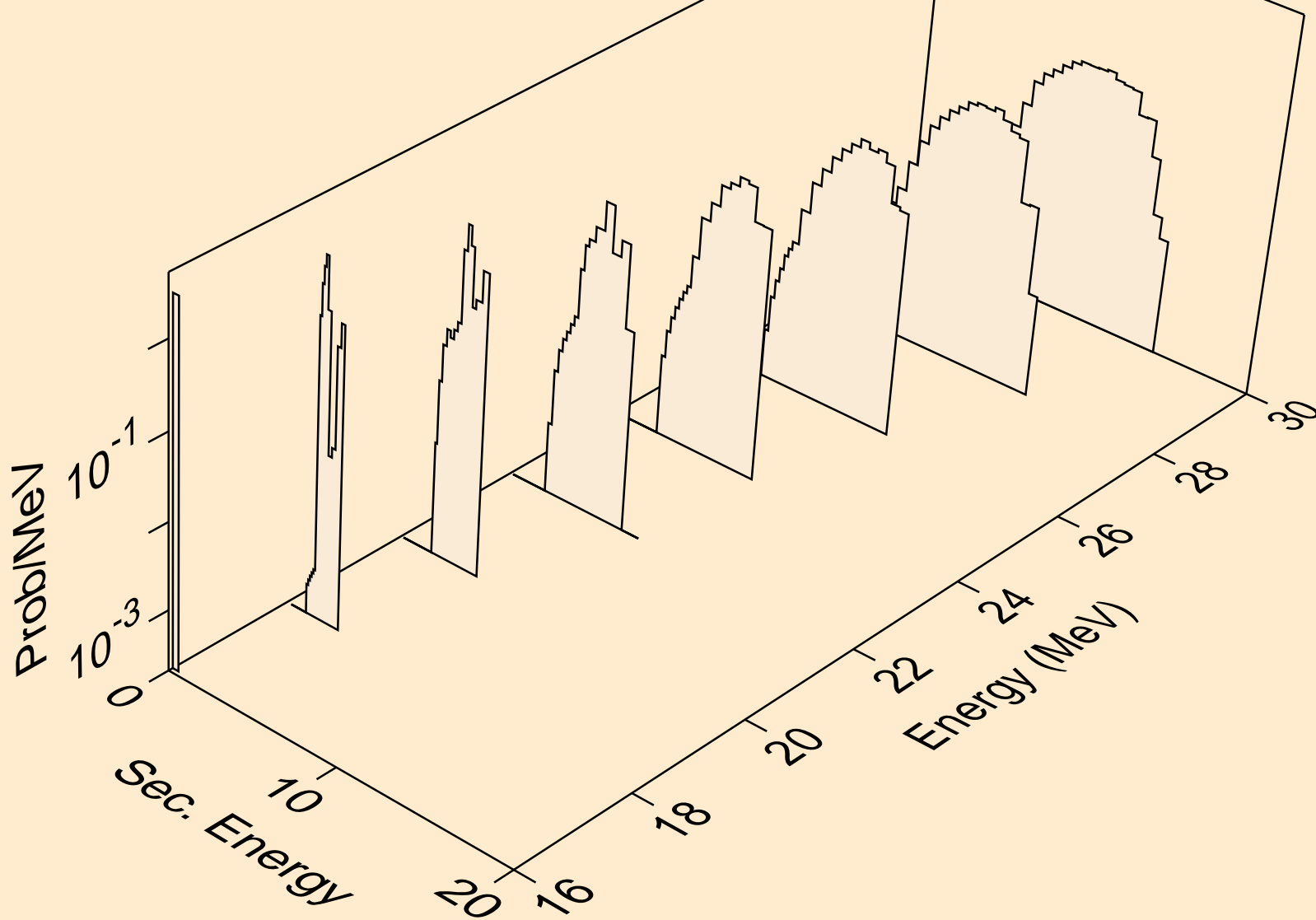

GD158 NEUTRON ACER TENDL-2019 LIBRARY; T=293.16K  
protons from (n,3np)

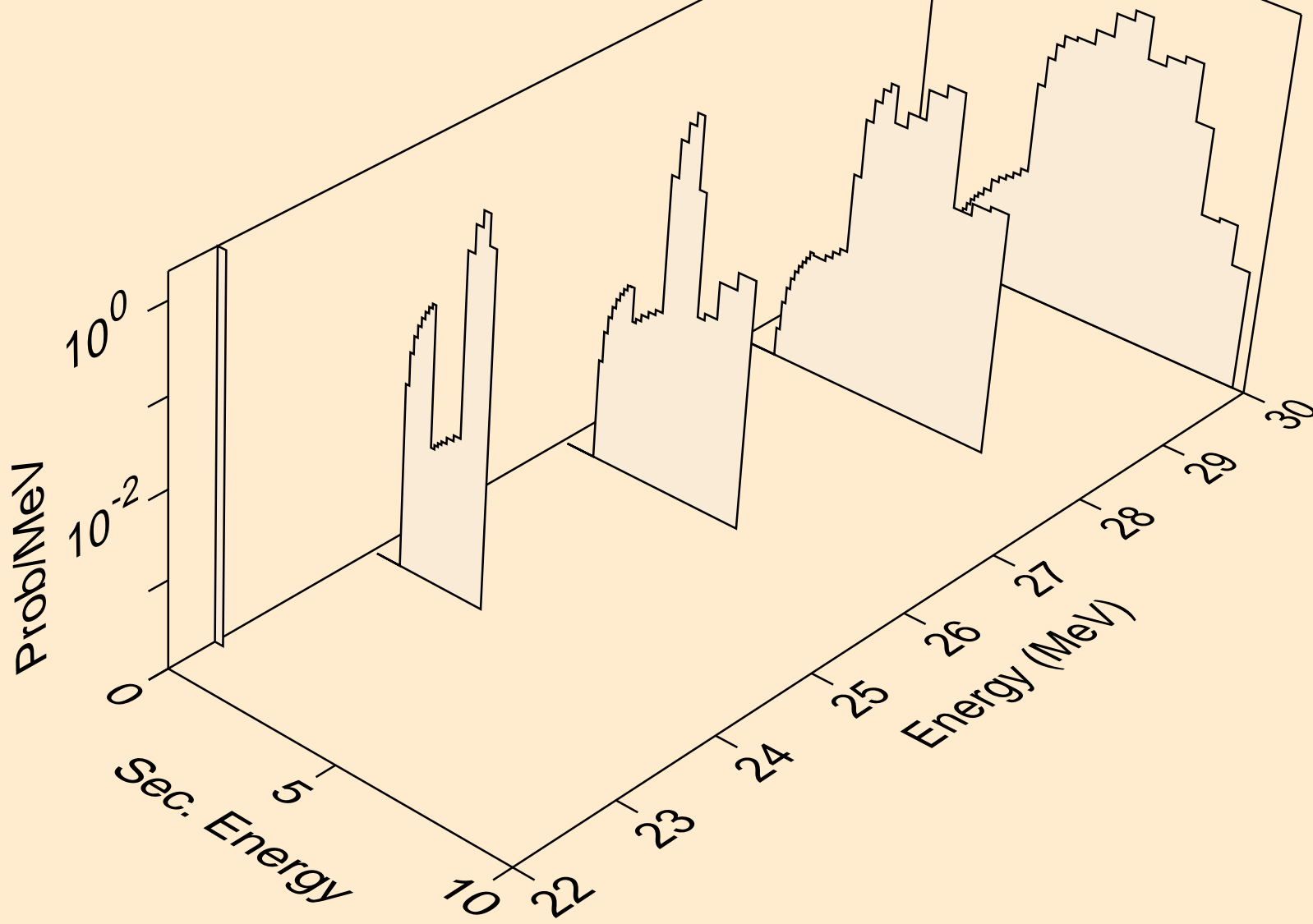



GD158 NEUTRON ACER TENDL-2019 LIBRARY; T=293.16K  
protons from (n,2np)

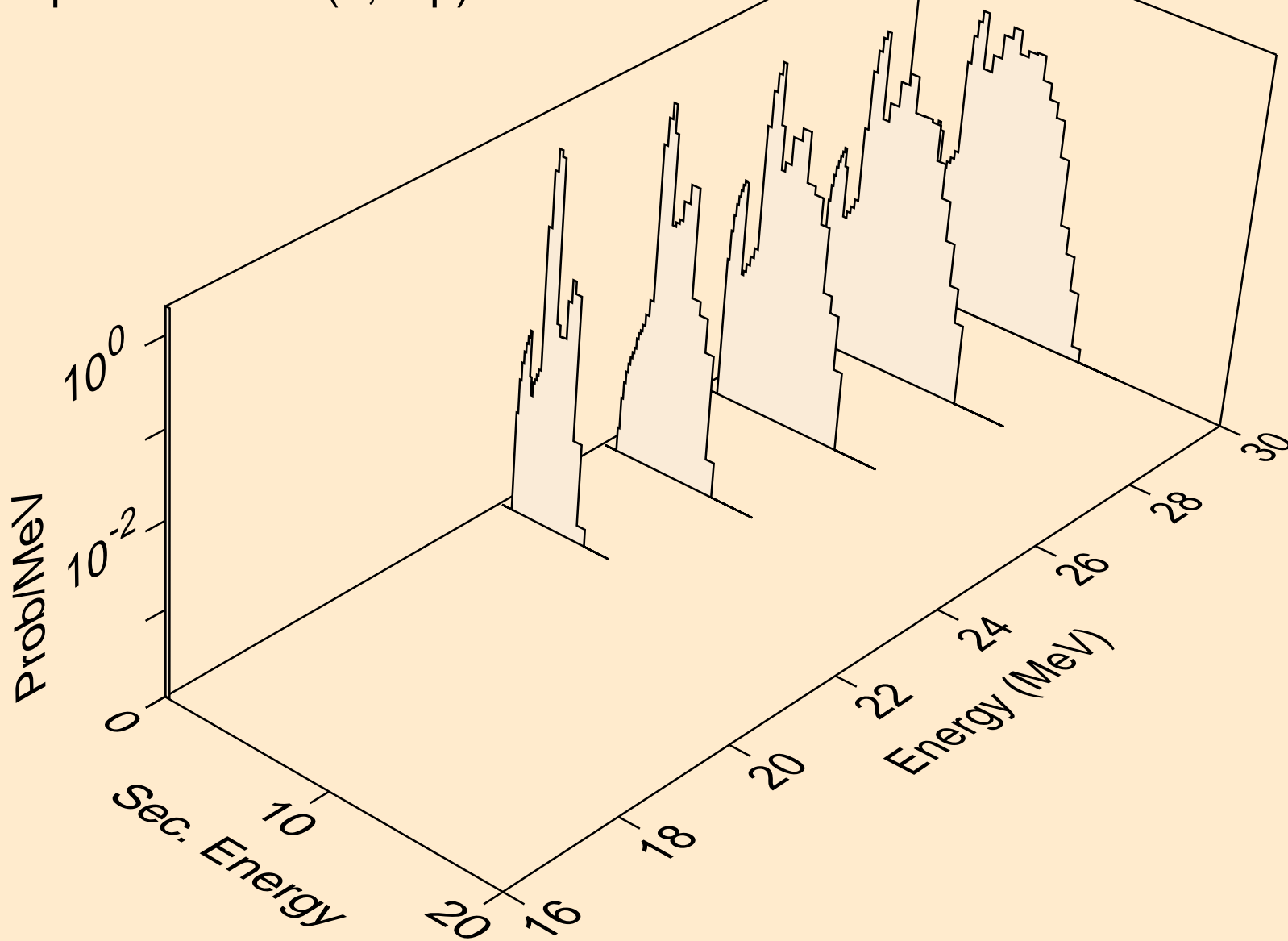

GD158 NEUTRON ACER TENDL-2019 LIBRARY; T=293.16K  
protons from (n,npa)

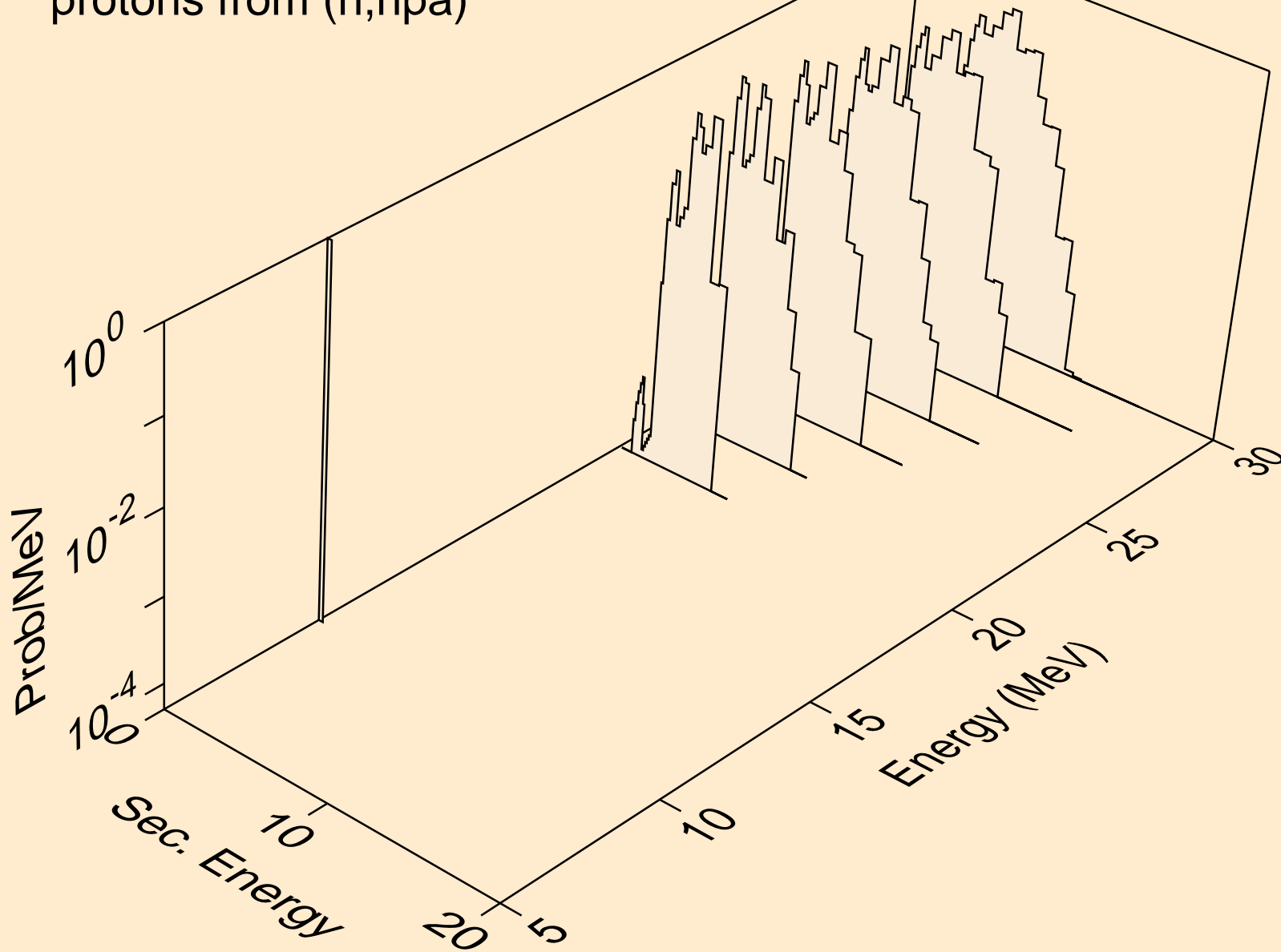

GD158 NEUTRON ACER TENDL-2019 LIBRARY; T=293.16K  
protons from (n,p)

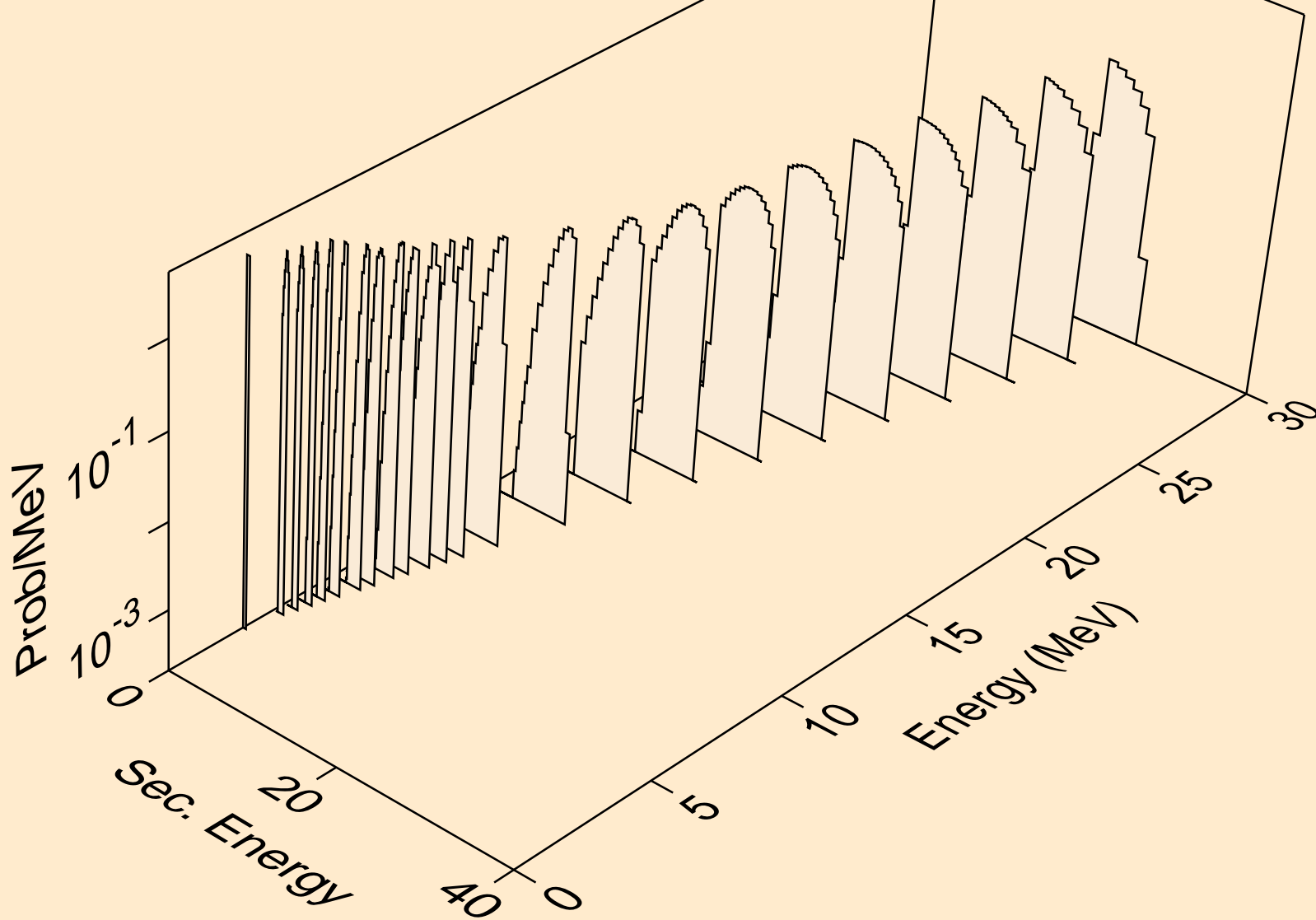

GD158 NEUTRON ACER TENDL-2019 LIBRARY; T=293.16K  
protons from (n,2p)

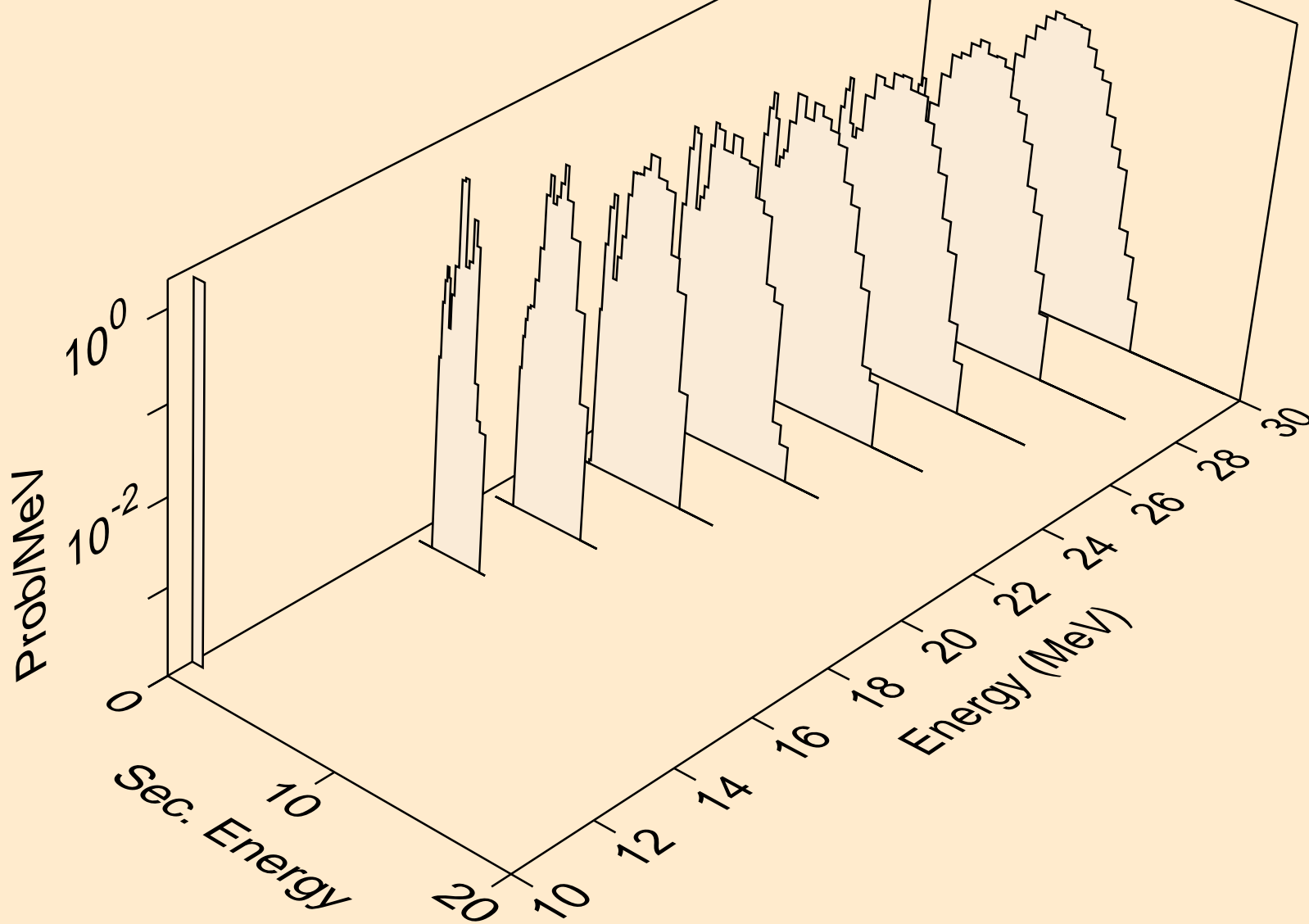

GD158 NEUTRON ACER TENDL-2019 LIBRARY; T=293.16K  
protons from (n,p)

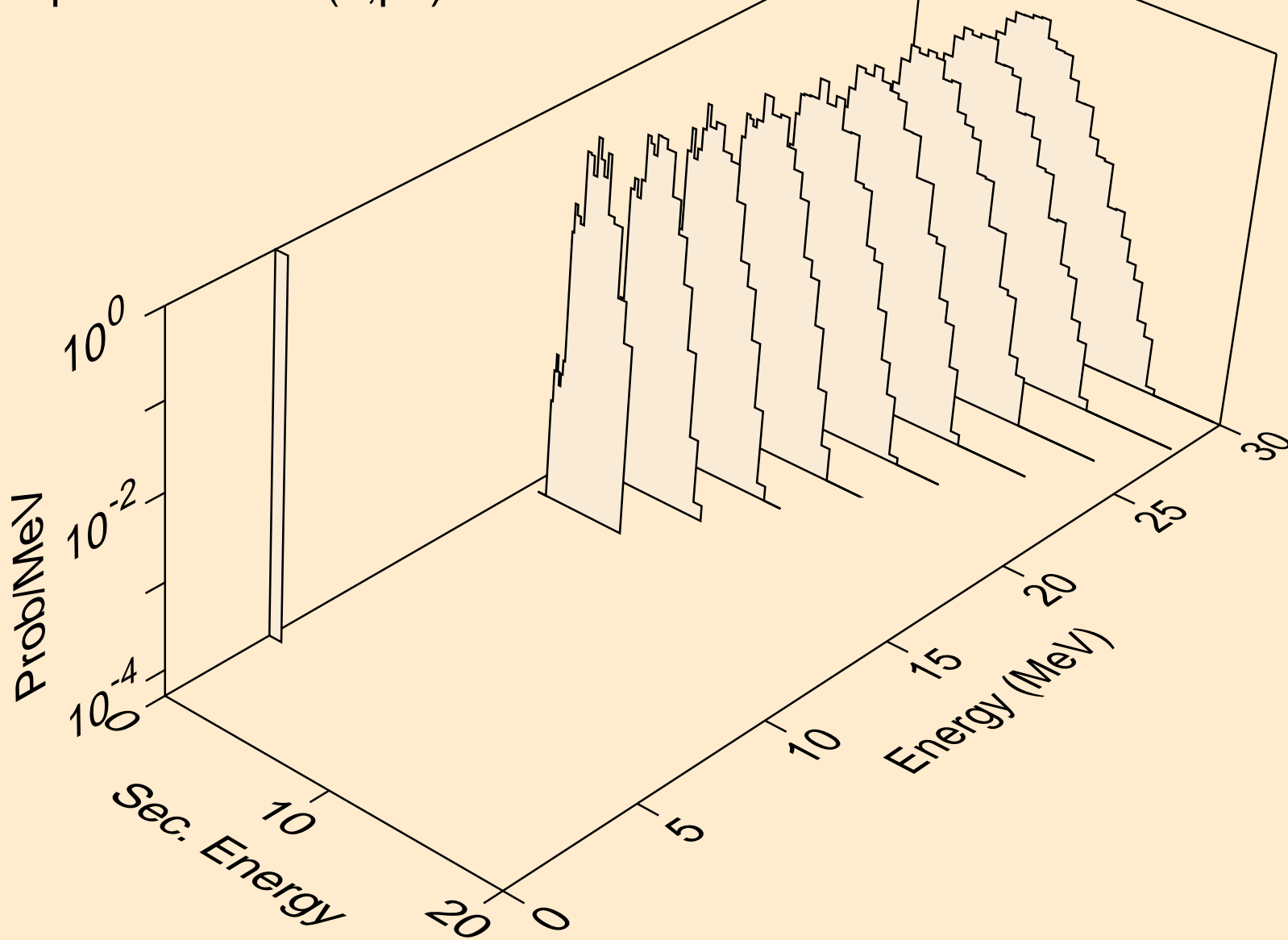

GD158 NEUTRON ACER TENDL-2019 LIBRARY; T=293.16K  
deuterons from (n,x)

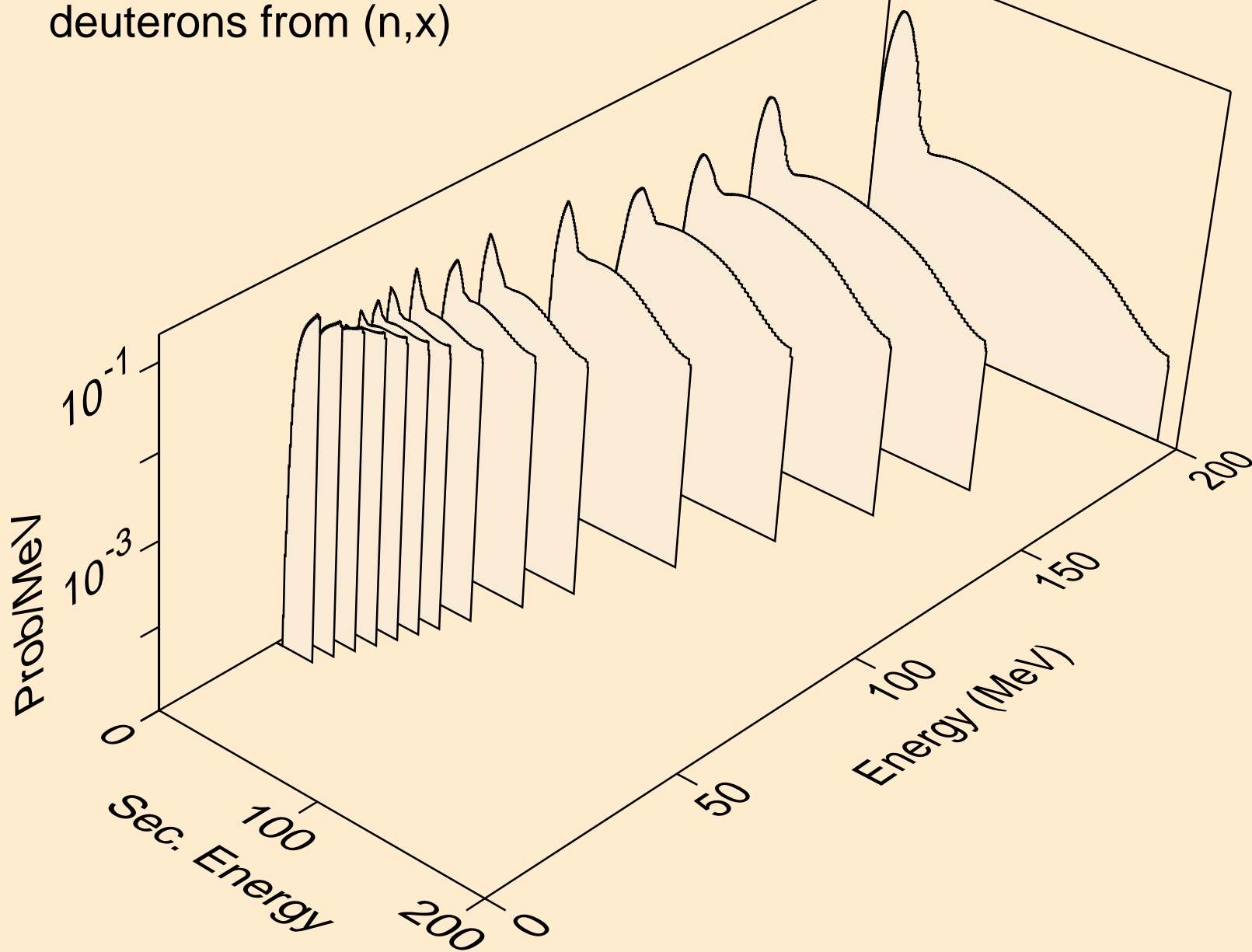

GD158 NEUTRON ACER TENDL-2019 LIBRARY; T=293.16K  
deuterons from (n,2nd)

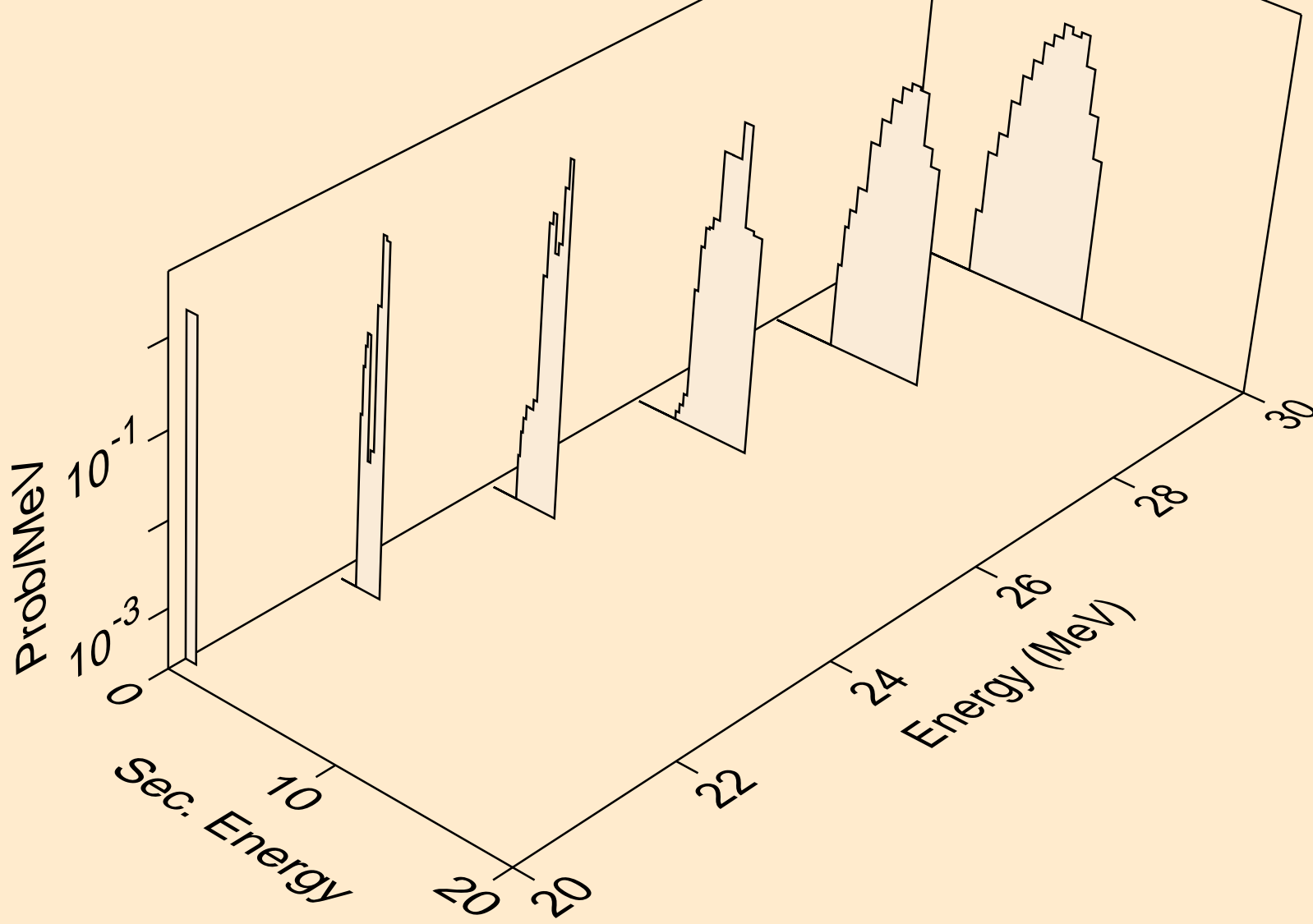

GD158 NEUTRON ACER TENDL-2019 LIBRARY; T=293.16K  
deuterons from (n,n\*)d

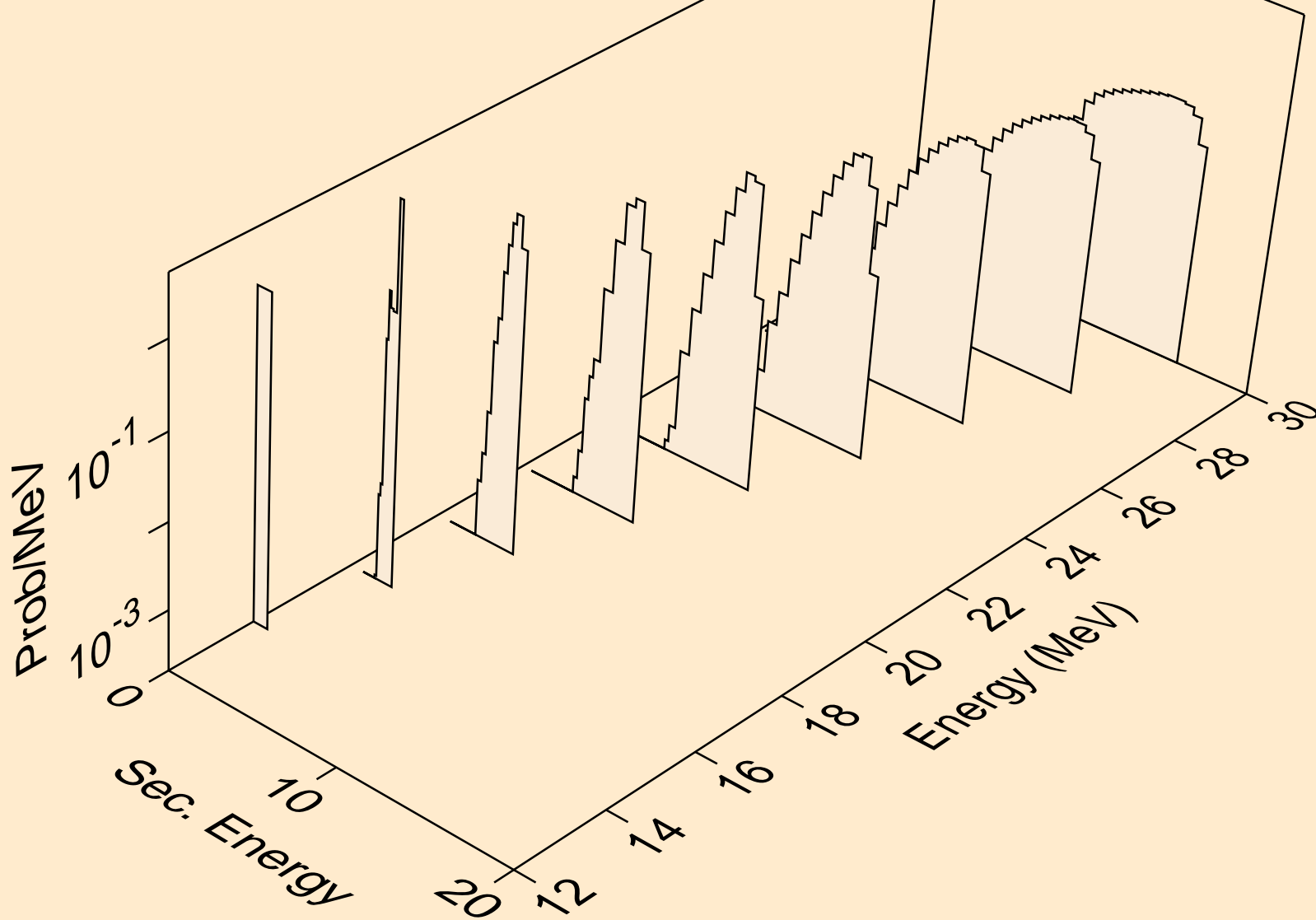



GD158 NEUTRON ACER TENDL-2019 LIBRARY; T=293.16K  
deuterons from (n,d)

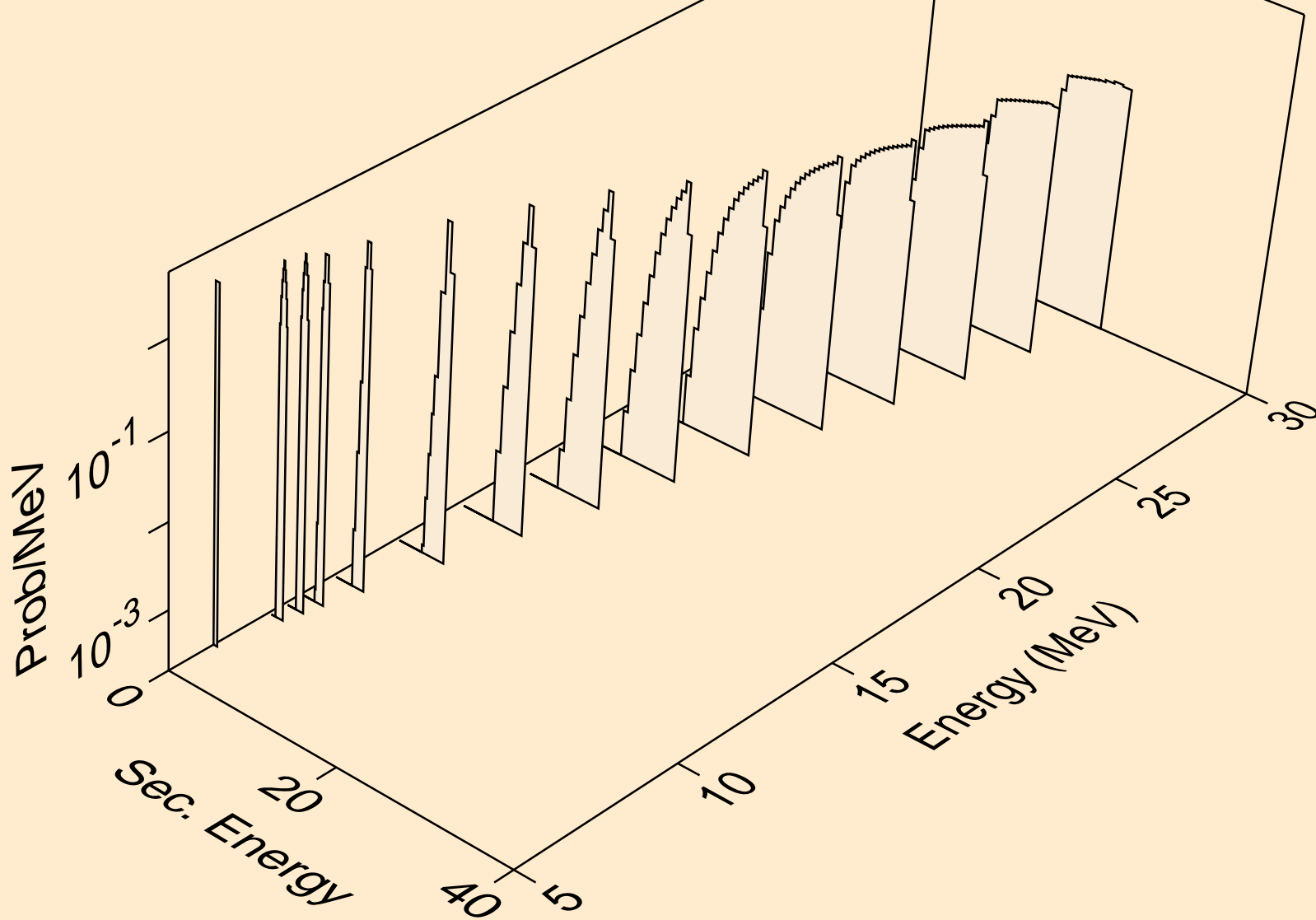

GD158 NEUTRON ACER TENDL-2019 LIBRARY; T=293.16K  
tritons from (n,x)

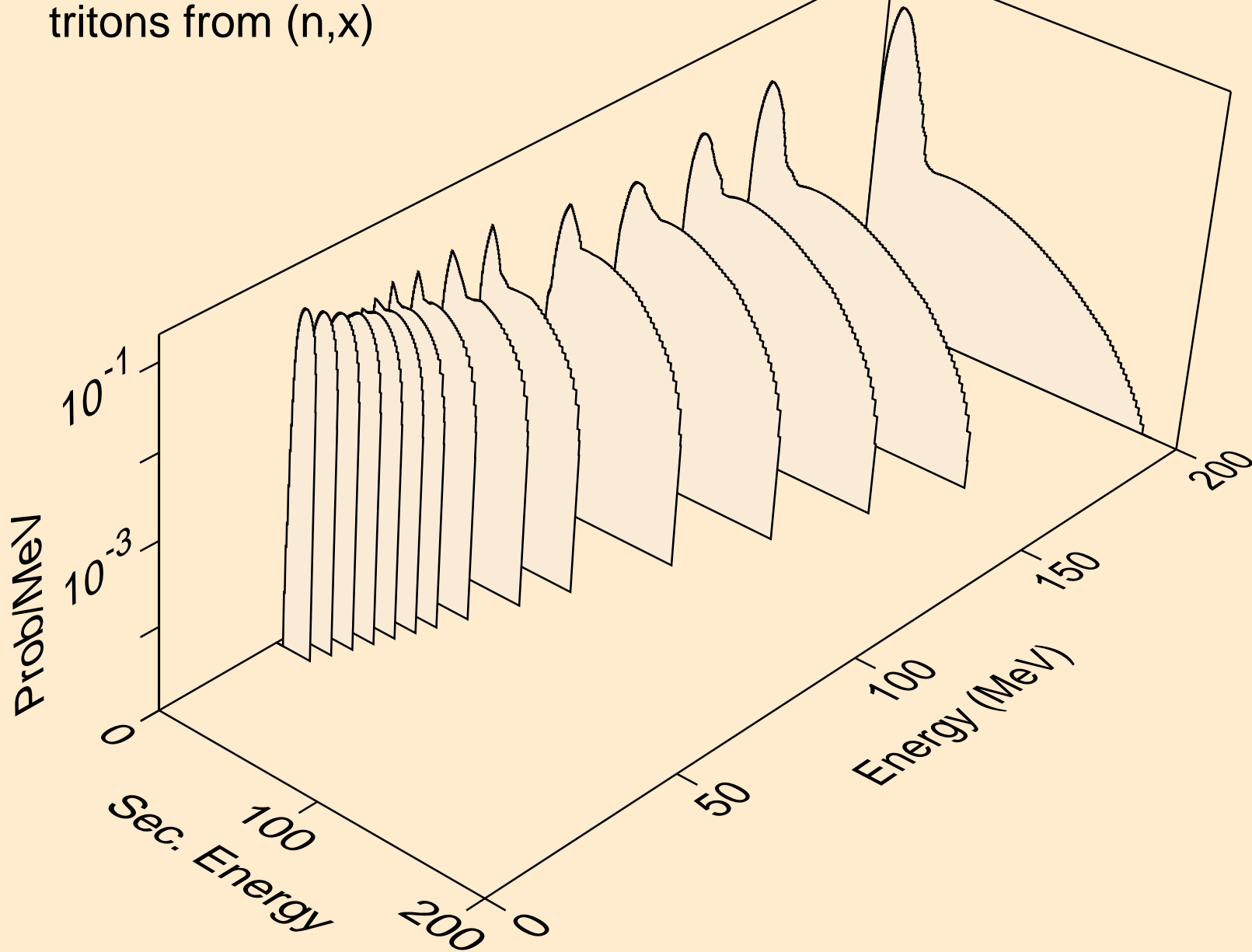

GD158 NEUTRON ACER TENDL-2019 LIBRARY; T=293.16K  
tritons from (n,n\*)t

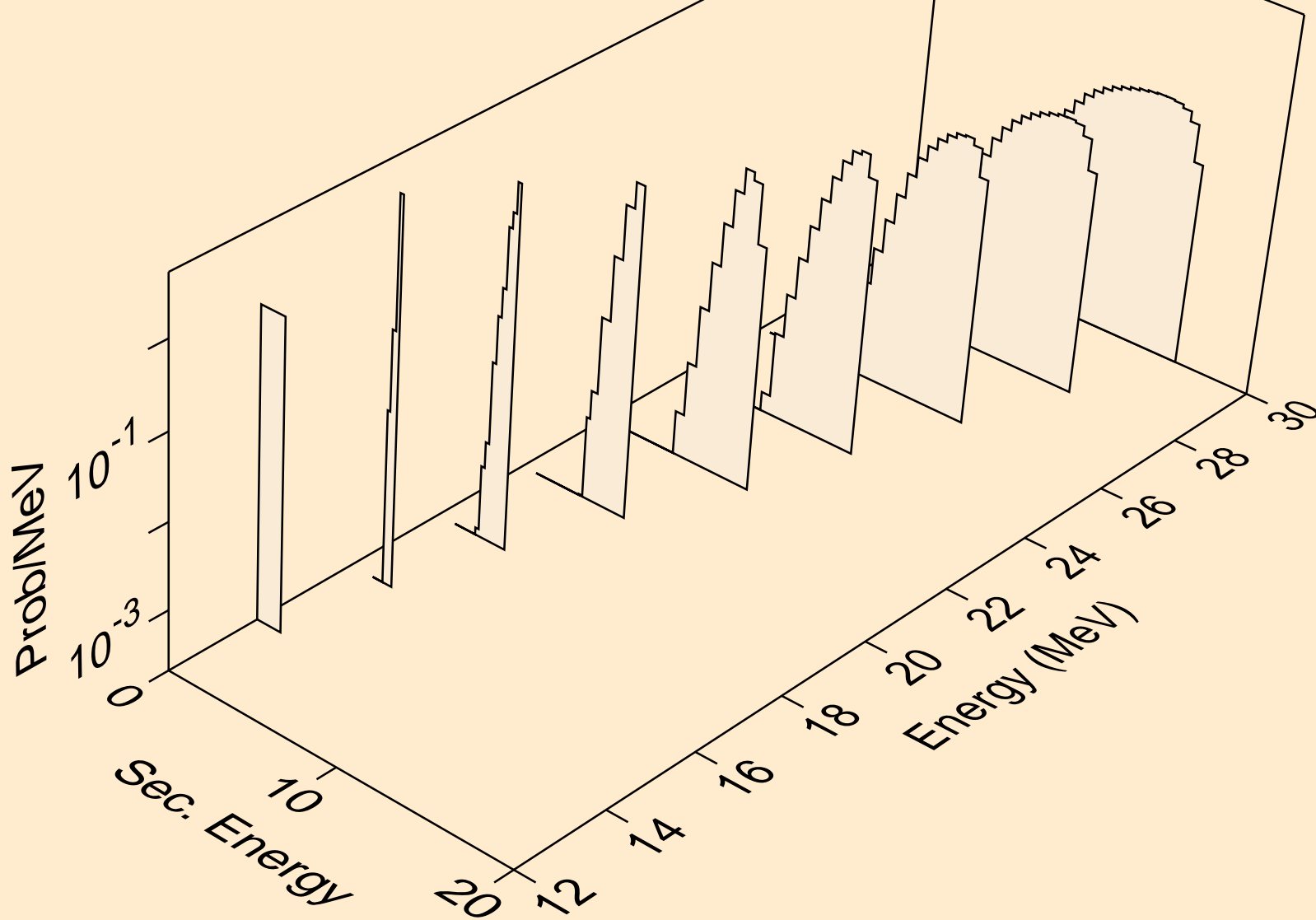

GD158 NEUTRON ACER TENDL-2019 LIBRARY; T=293.16K  
tritons from (n,t)

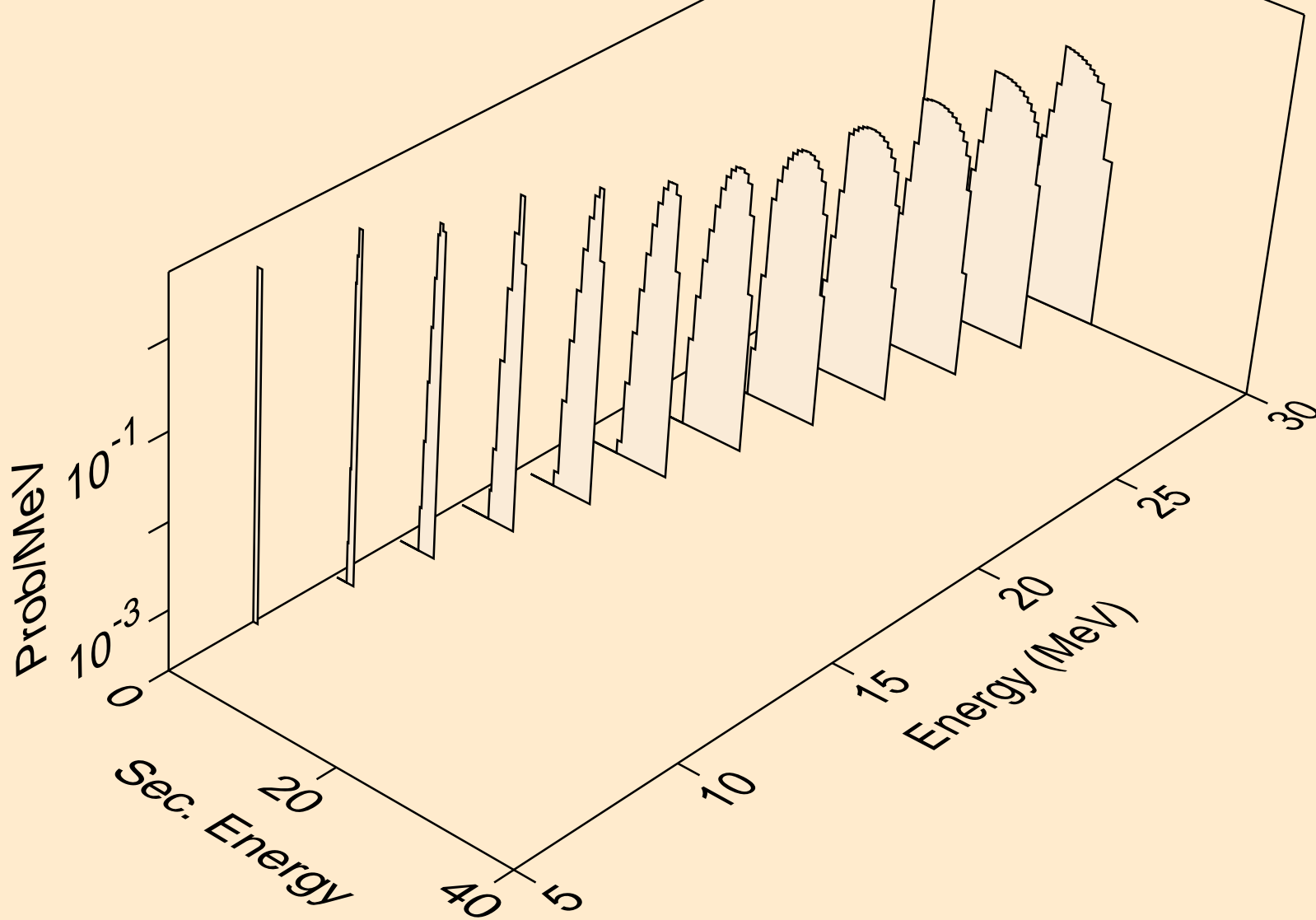

GD158 NEUTRON ACER TENDL-2019 LIBRARY; T=293.16K  
he3s from (n,x)

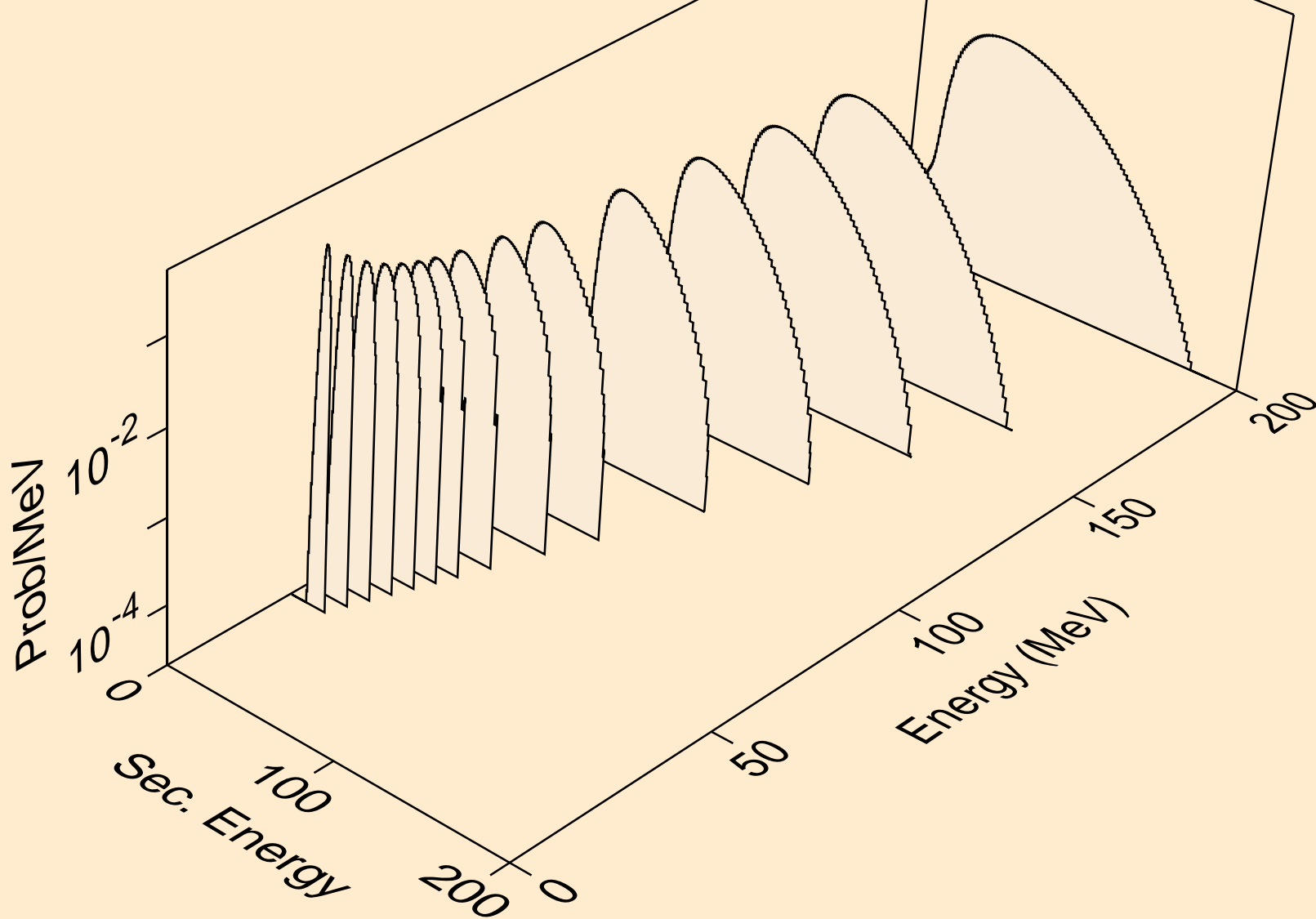

GD158 NEUTRON ACER TENDL-2019 LIBRARY; T=293.16K  
he3s from (n,n\*)he3

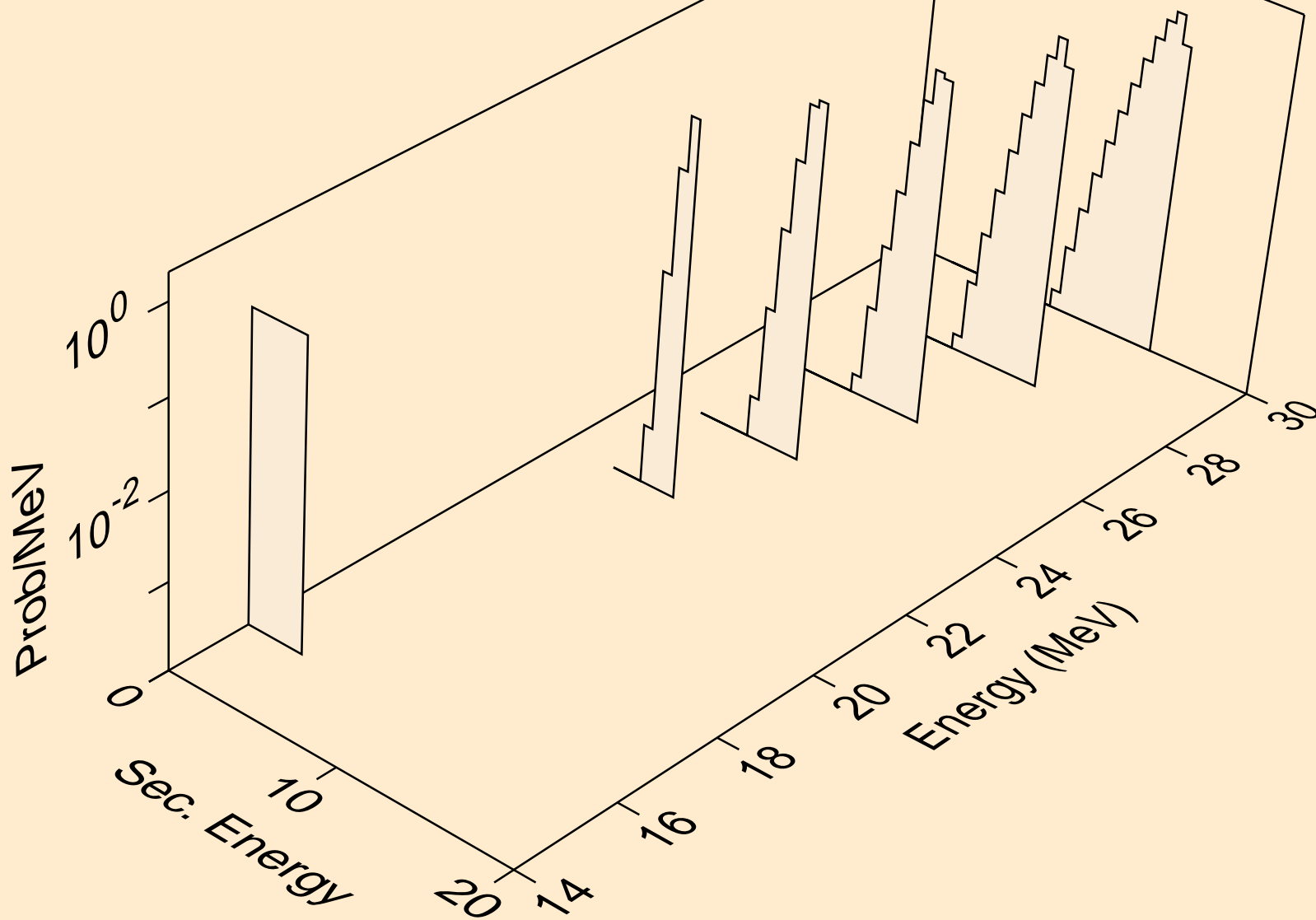

GD158 NEUTRON ACER TENDL-2019 LIBRARY; T=293.16K  
he3s from (n,he3)

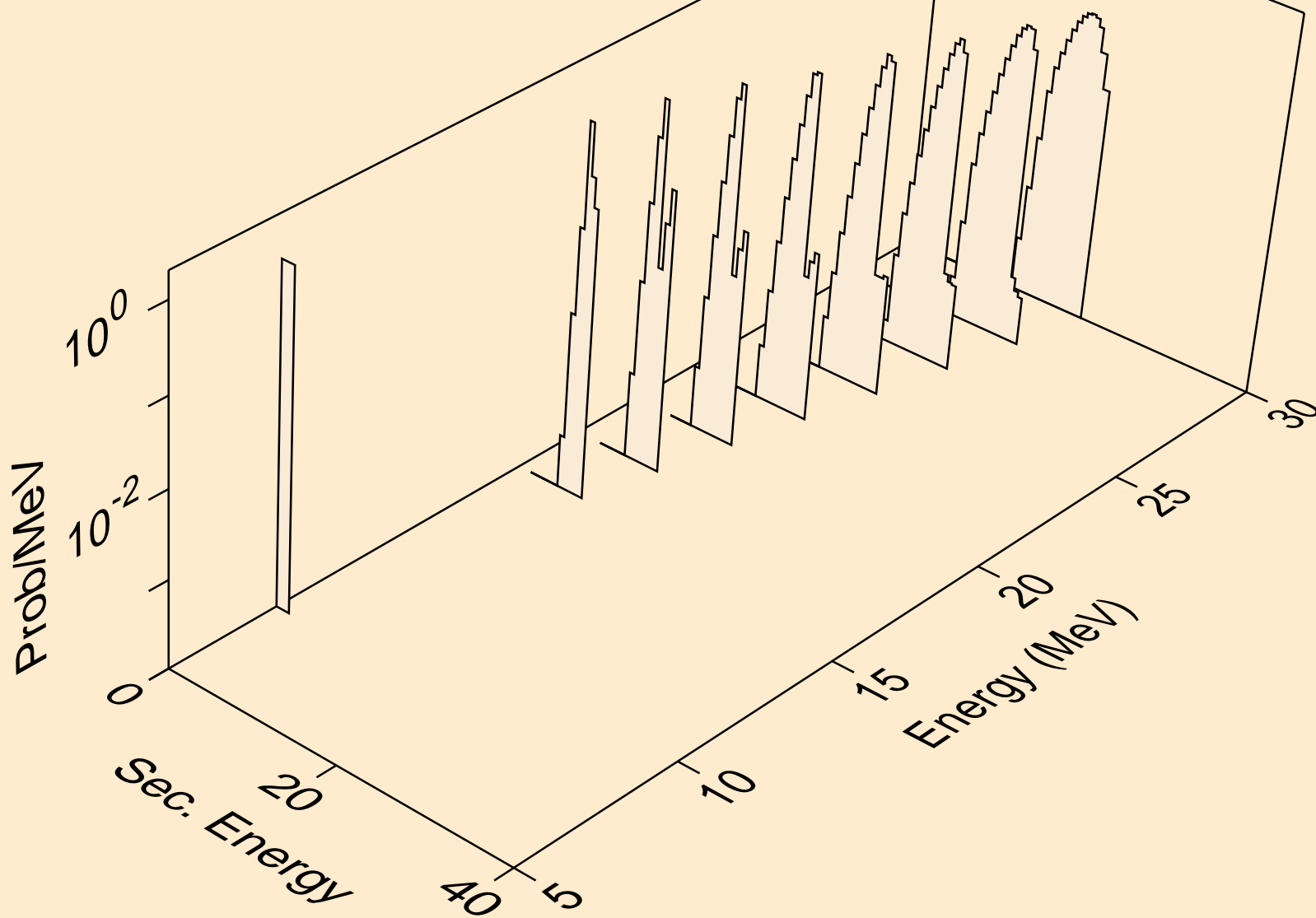

GD158 NEUTRON ACER TENDL-2019 LIBRARY; T=293.16K  
alphas from (n,x)

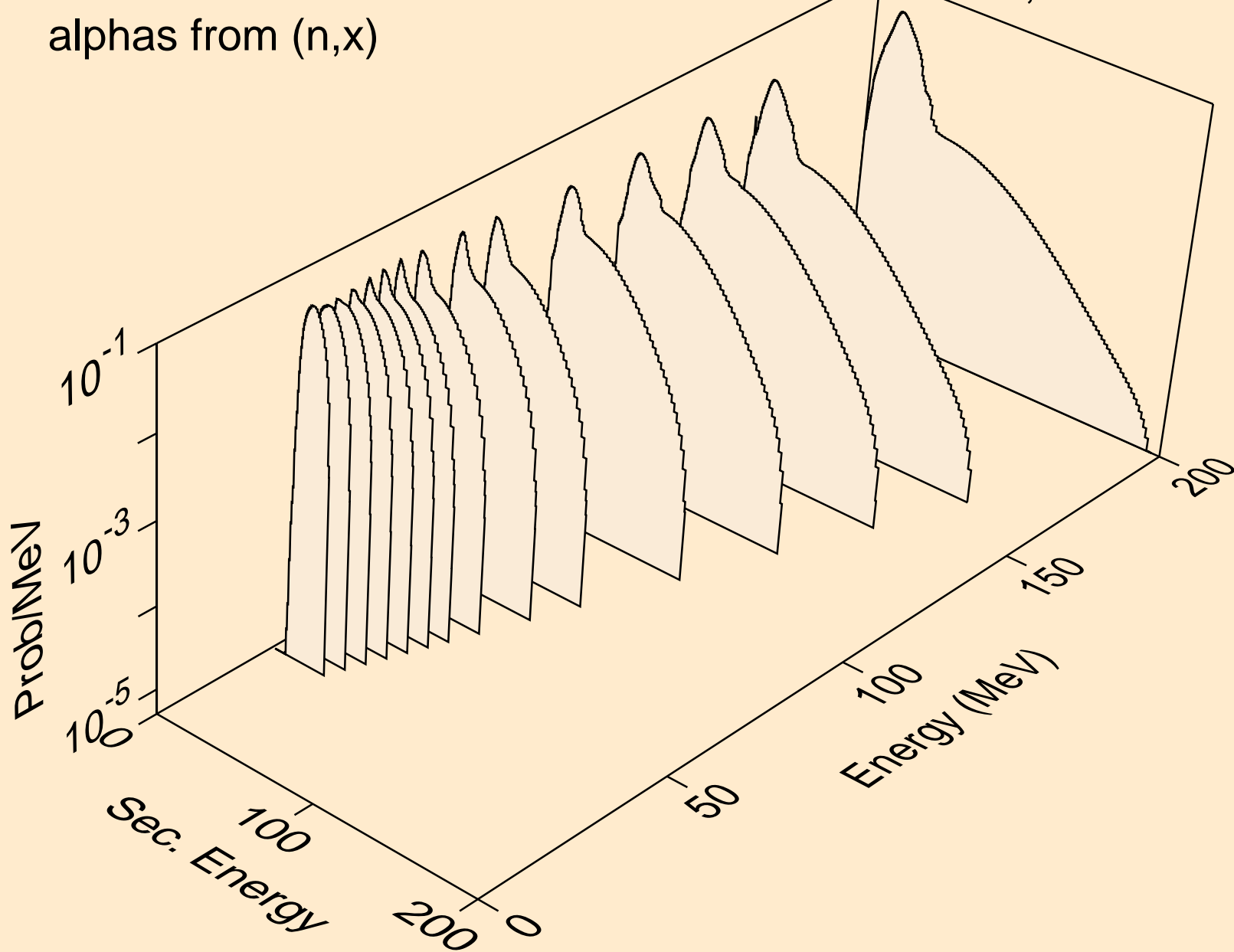



GD158 NEUTRON ACER TENDL-2019 LIBRARY; T=293.16K  
alphas from (n,n\*)a

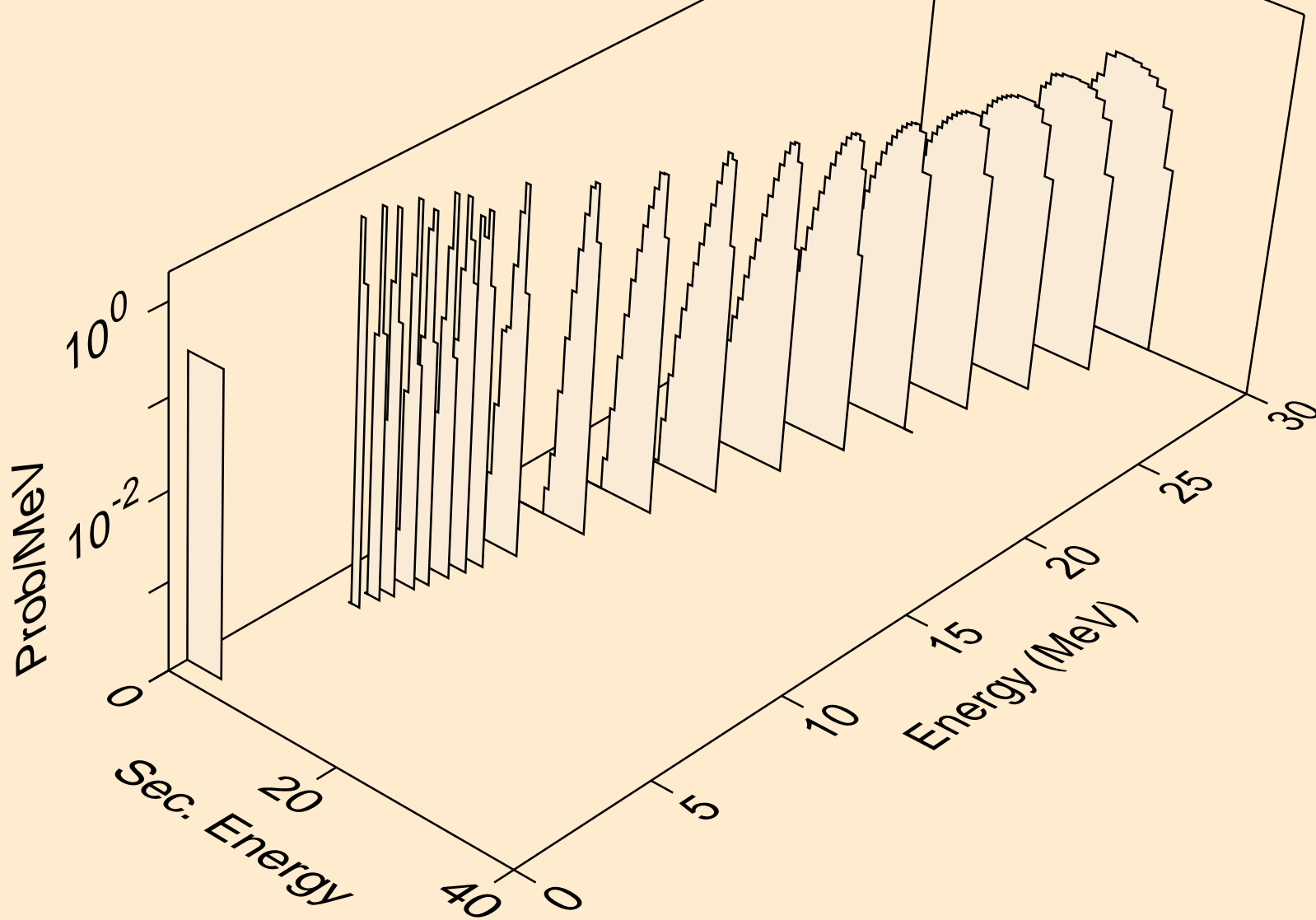

GD158 NEUTRON ACER TENDL-2019 LIBRARY; T=293.16K  
alphas from (n,2n)a

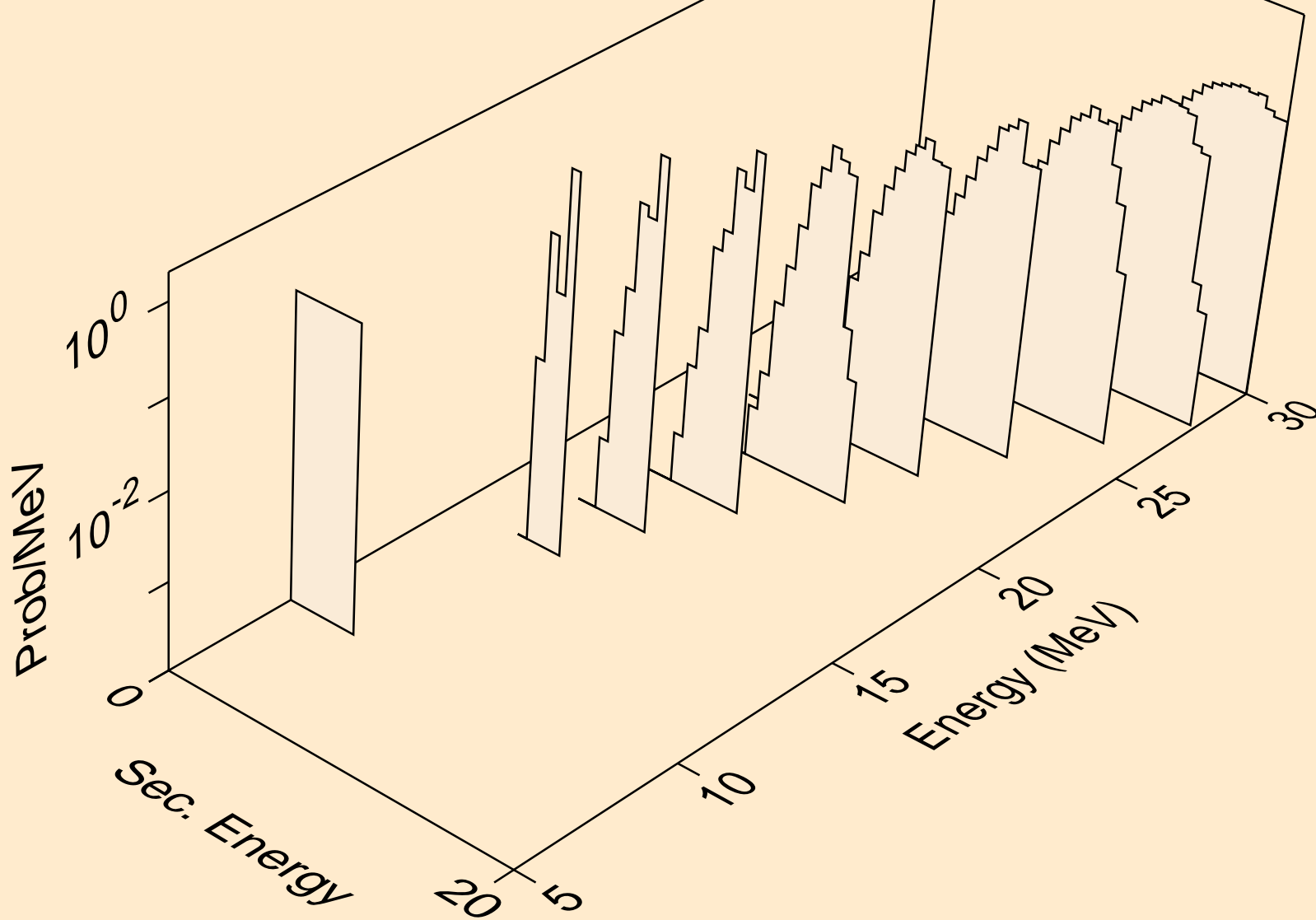

GD158 NEUTRON ACER TENDL-2019 LIBRARY; T=293.16K  
alphas from (n,3n)a

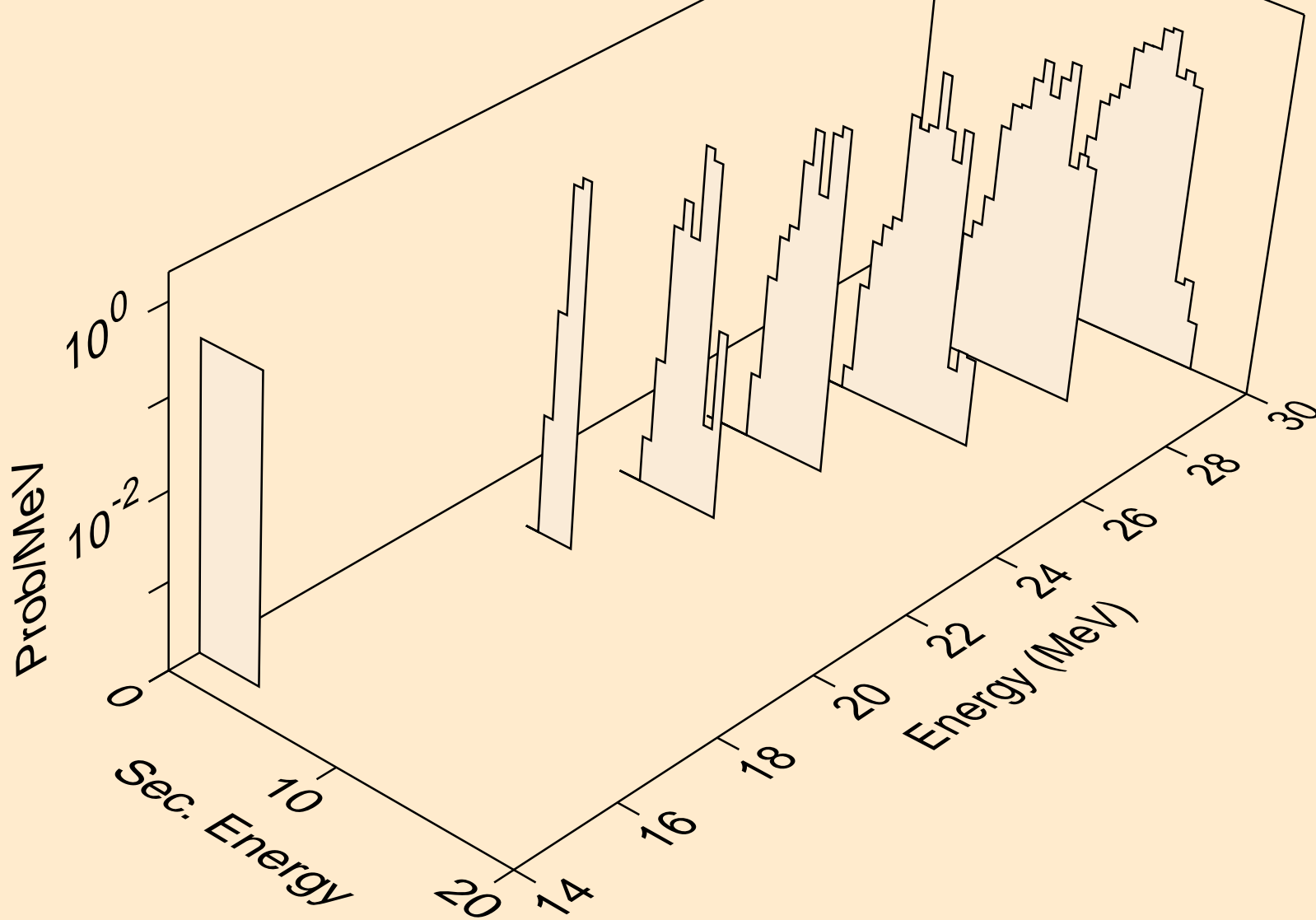

GD158 NEUTRON ACER TENDL-2019 LIBRARY; T=293.16K  
alphas from (n,npa)

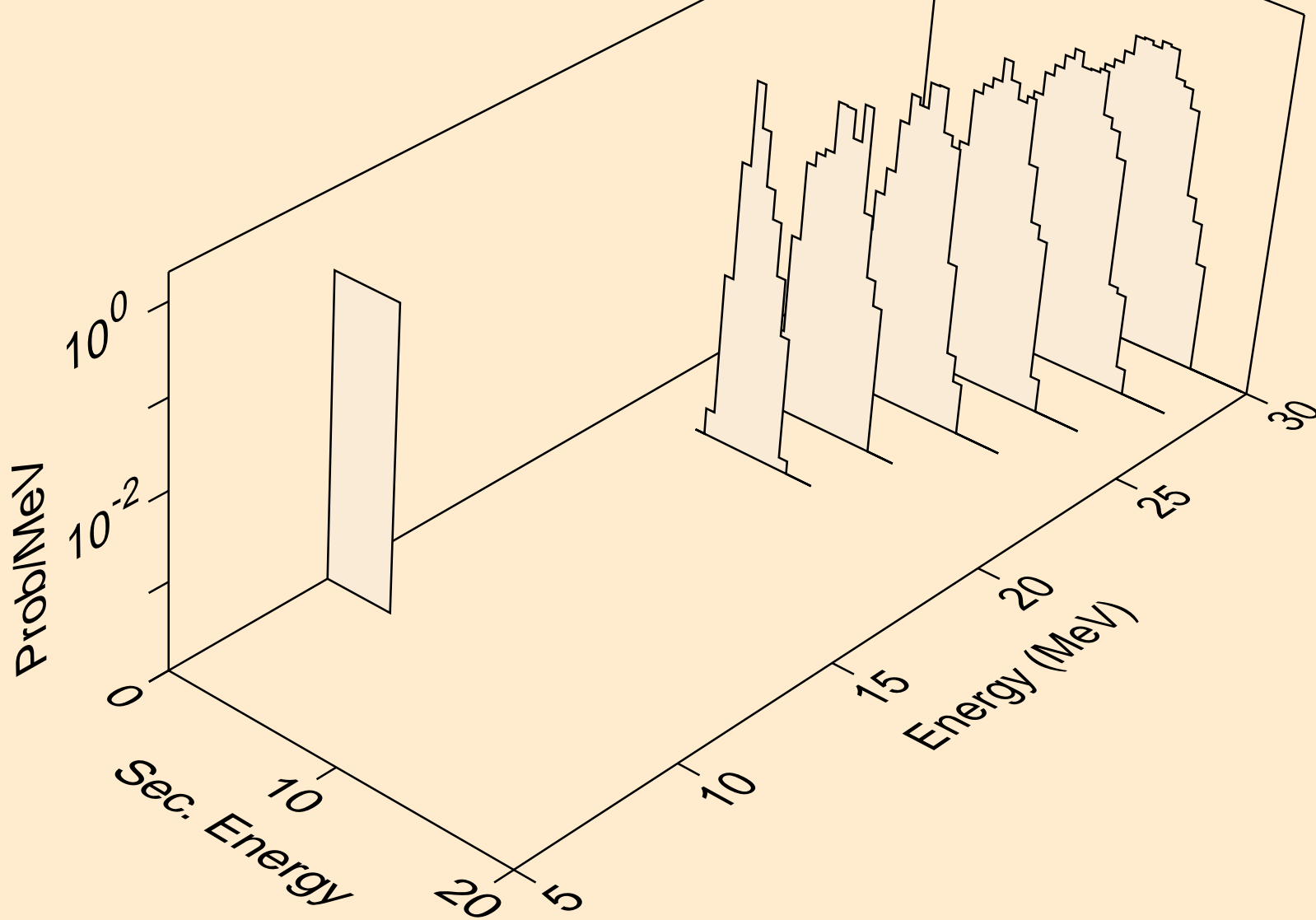

GD158 NEUTRON ACER TENDL-2019 LIBRARY; T=293.16K  
alphas from (n,a)

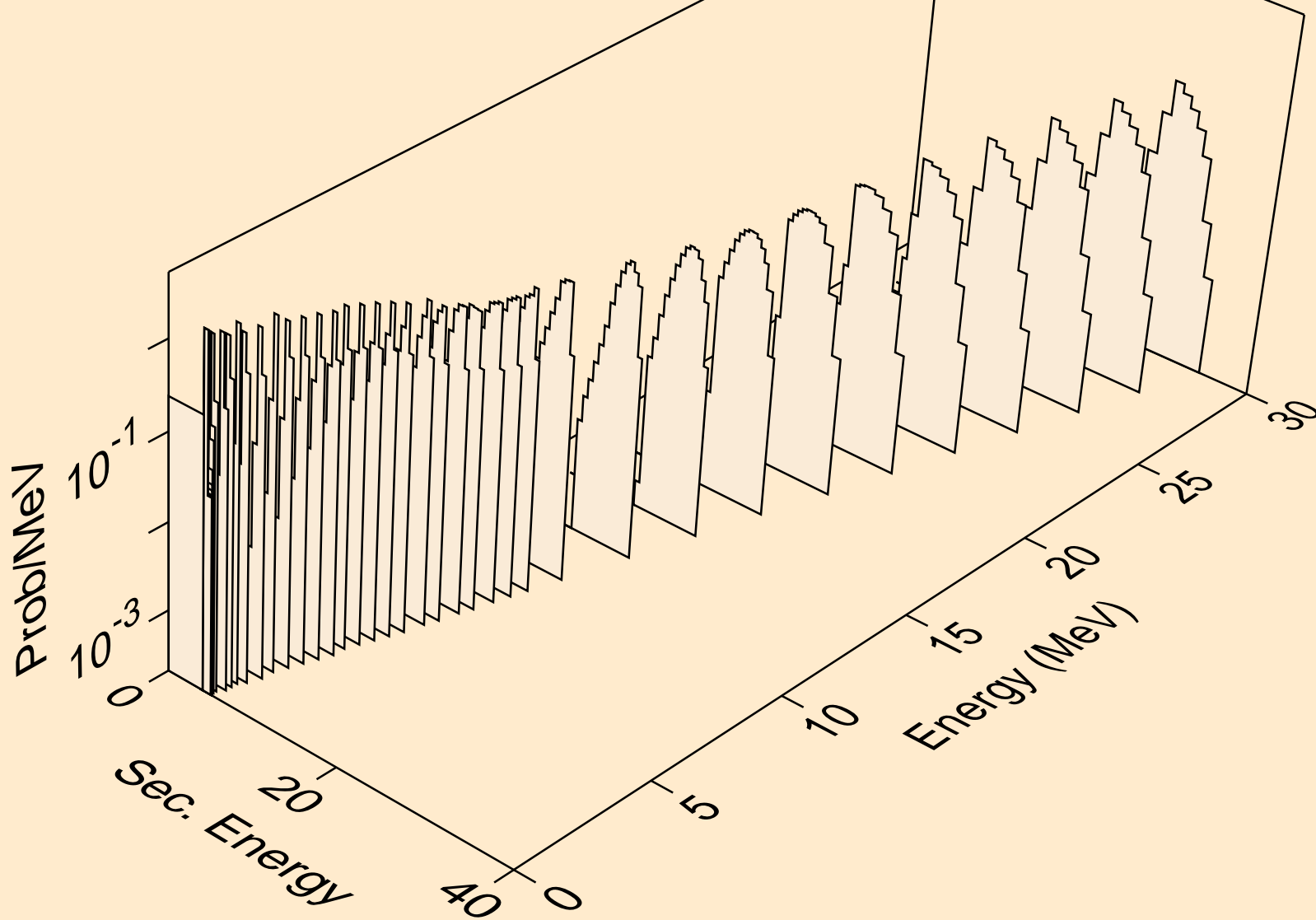

GD158 NEUTRON ACER TENDL-2019 LIBRARY; T=293.16K  
alphas from (n,2a)

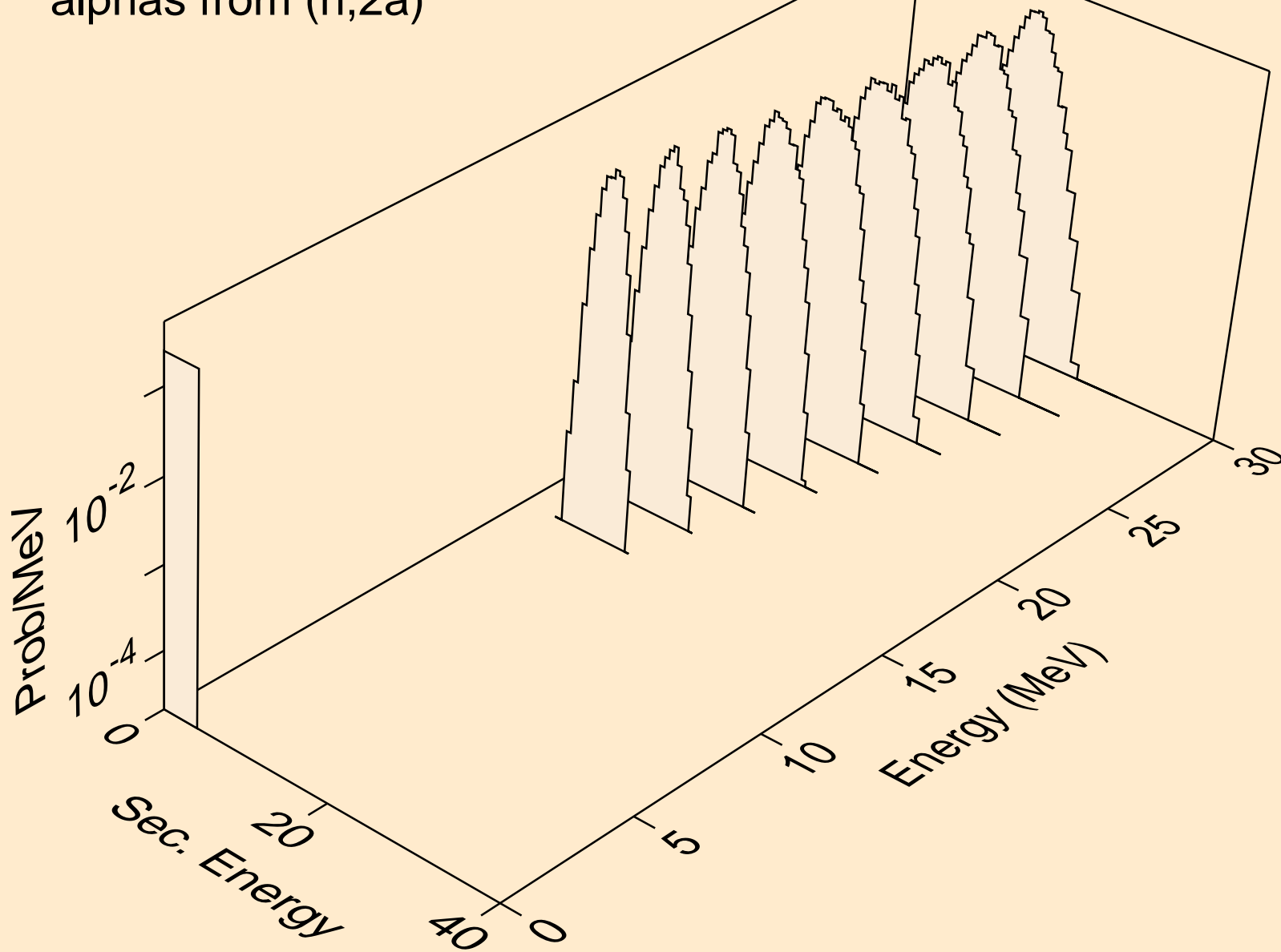

GD158 NEUTRON ACER TENDL-2019 LIBRARY; T=293.16K  
alphas from (n,pa)

